

## DESCRIPTION

Cruze LED is a specification lensed troffer series. This high quality luminaire is dedicated to the latest solid state lighting and driver technology for optimal performance and energy efficiency. The Cruze is compatible with all of today's popular ceiling systems and is available with a number of options and accessories for application versatility.

The Cruze series features efficiency, quality and performance. The series is an excellent choice for commercial office spaces, schools, hospitals or retail merchandising areas.

<b>Catalog #</b>		<b>Type</b>
<b>Project</b>		
<b>Comments</b>		<b>Date</b>
<b>Prepared by</b>		

## SPECIFICATION FEATURES

### Construction

Rigid housing is die formed of code gauge prime cold rolled steel and features full length die-formed stiffeners and unibody endplate for added strength. Side flanges are hemmed. Innovative design provides superior lens brightness uniformity and visual comfort. Unibody endplates are securely attached with interlocking tabs and screws. Four auxiliary fixture end suspension points provided. Endplates have integral Grid-lock feature for safety and convenience.

### Controls

The Cruze LED is Powered by Fifth Light, with a standard 0-10V continuous dimming driver that works with any 0-10V control/dimmer. Combine with energy saving products like occupancy sensors, daylighting controls and lighting relay panels to maximize energy savings. In addition, the Cruze can include a factory-installed integrated sensor system for occupancy and daylight dimming control and manual control from an optional handheld remote. Or, specify the Digital Addressable Lighting Interface (DALI) drivers, dimmable down to 10%, for use with Fifth Light controls. See ordering information for details on all three options.

### Electrical

Long-Life LED system coupled with electrical driver to deliver optimal performance. LED's available in 3000K, 3500K, 4000K or 5000K with a CRI  $\geq$  85. Projected life is 60,000 hours at 89% lumen output. cULus listed. Electronic drivers are available for 120-277V applications.

### Emergency Battery Pack Option

Optional 120v-277v integral emergency battery pack is available in 7-watts or 14-watts to meet critical life-safety lighting requirements. The 90-minute batteries provide constant power to the LED system, ensuring code-compliance. A test switch/indicator button can be tested safely from the ground using a laser pointer, while the patented EZ Key prevents accidental discharge of the battery during construction. See ordering information for details.

### Finish

Multistage, iron phosphate pretreatment ensures maximum bonding and rust inhibition. Housing finished with 90% reflective white enamel for superior performance.

### Hinging/Latching

Positive cam action steel latches with baked white enamel finish. Safety-lock T-hinges allow hinging and latching either side. Door assembly hinges down for easy access from below.

### Frame/Shielding

Die formed, heavy gauge, flat steel door with reinforced mitered corners and painted after fabrication, baked matte white enamel finish. Positive light seals. Acrylic frosted lens.

### Compliance

Modules are UL recognized components and indoor luminaires are cULus listed for 25°C ambient environments, RoHS compliant, and LED modules comply with IESNA LM-79 and LM-80 standards. DesignLights Consortium™ Qualified and classified for DLC Standard, refer to [www.designlights.org](http://www.designlights.org) for details.

### Warranty

Five year warranty.



**24CZ  
LED**

**2' X 4' TROFFER LED  
MODULE**

Specification Grade Troffer

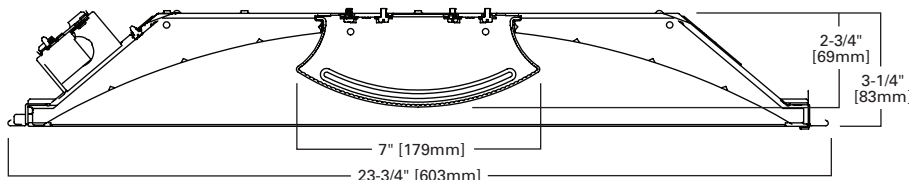

## MOUNTING DATA

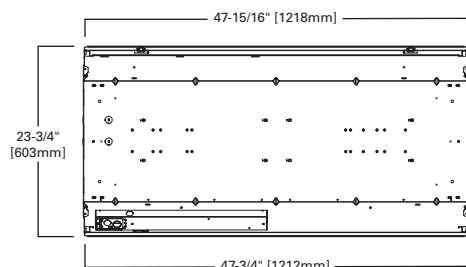

## LAMP CONFIGURATIONS

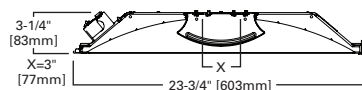

## CERTIFICATION DATA

cULus - 1598  
 Damp Location Listed  
 IC Rated  
 LM79/LM80 Compliant  
 ROHS Compliant  
 DesignLights Consortium™ Qualified  
 NOM Compliant

\*See Drywall Frame Kit Accessory in Ordering Information Section

**LINEAR DISCONNECT**

Safe and convenient means of disconnecting power

**CEILING COMPATIBILITY**

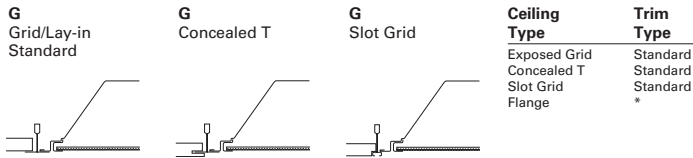

**PHOTOMETRICS**

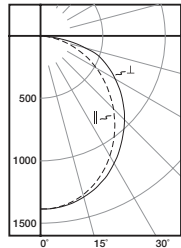

**24CZ-LD4-40-UNV-L835-CD1-U**

Electronic Driver  
 Linear LED 3500K  
 Spacing criterion:  
 (II) 1.2 x mounting  
 height, (⊥) 1.3 x  
 mounting height  
 Lumens: 3941  
 Input Watts: 33.4W  
 Efficacy: 118 lm/W  
 Test Report:  
 24CZ-LD4-40-UNV-  
 L835-CD1-U.IES

**Candlepower**

Angle	Along II	45°	Across ⊥
0	1381	1381	1381
5	1375	1371	1378
10	1351	1351	1361
15	1311	1315	1330
20	1255	1268	1290
25	1185	1208	1238
30	1103	1139	1171
35	1014	1060	1099
40	919	973	1022
45	820	883	945
50	715	790	861
55	614	698	777
60	512	604	686
65	413	510	598
70	307	417	508
75	212	329	369
80	120	207	222
85	46	80	72
90	0	0	0

**Coefficients of Utilization**

rc rw RCR	Effective floor cavity reflectance																							
	80%				70%				50%				30%				10%				0%			
	70	50	30	10	70	50	30	10	50	30	10	50	30	10	50	30	10	50	30	10	50	30	10	0
0	119	119	119	119	116	116	116	116	111	111	111	106	106	106	102	102	102	100						
1	108	103	99	95	106	101	97	93	97	93	90	93	90	88	89	87	85	83						
2	98	90	83	77	96	88	81	76	84	79	74	81	76	72	78	74	71	68						
3	89	79	70	64	87	77	69	63	74	67	62	71	65	61	69	64	60	57						
4	82	69	61	54	79	68	60	53	66	58	53	63	57	52	61	56	51	49						
5	75	62	53	46	73	61	52	46	59	51	45	57	50	45	55	49	44	42						
6	69	56	47	40	67	55	46	40	53	45	40	51	45	39	50	44	39	37						
7	64	51	42	36	63	50	41	35	48	41	35	47	40	35	45	39	35	33						
8	60	46	38	32	58	45	37	32	44	37	31	43	36	31	42	36	31	29						
9	56	42	34	29	55	42	34	28	41	33	28	40	33	28	39	32	28	26						
10	52	39	31	26	51	39	31	26	38	31	26	37	30	26	36	30	25	24						

**Zonal Lumen Summary**

Zone	Lumens	% Fixture
0-30	1060	26.9
0-40	1723	43.7
0-60	3027	76.8
0-90	3941	100.0
0-180	3941	100.0

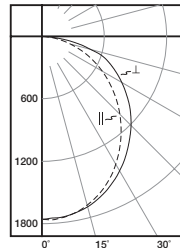

**24CZ-LD4-50-UNV-L835-CD1-U**

Electronic Driver  
 Linear LED 3500K  
 Spacing criterion:  
 (II) 1.2 x mounting  
 height, (⊥) 1.3 x  
 mounting height  
 Lumens: 4934  
 Input Watts: 44.5W  
 Efficacy: 110.9 lm/W  
 Test Report:  
 24CZ-LD4-50-UNV-  
 L835-CD1-U.IES

**Candlepower**

Angle	Along II	45°	Across ⊥
0	1736	1736	1736
5	1735	1731	1727
10	1704	1704	1705
15	1651	1659	1669
20	1581	1597	1613
25	1493	1519	1543
30	1388	1428	1463
35	1274	1327	1374
40	1154	1218	1278
45	1030	1102	1183
50	902	984	1081
55	772	868	970
60	644	750	861
65	514	632	751
70	389	519	641
75	262	411	462
80	150	266	283
85	57	107	100
90	0	0	0

**Coefficients of Utilization**

rc rw RCR	Effective floor cavity reflectance																							
	80%				70%				50%				30%				10%				0%			
	70	50	30	10	70	50	30	10	50	30	10	50	30	10	50	30	10	50	30	10	50	30	10	0
0	119	119	119	119	116	116	116	116	111	111	111	106	106	106	102	102	102	100						
1	108	103	99	95	106	101	97	93	97	93	90	93	90	88	89	87	85	83						
2	98	90	83	77	96	88	81	76	84	79	74	81	76	72	78	74	71	68						
3	89	79	70	63	87	77	69	63	74	67	62	71	65	61	69	64	60	57						
4	82	69	60	54	79	68	60	53	66	58	52	63	57	52	61	56	51	49						
5	75	62	53	46	73	61	52	46	59	51	45	57	50	45	55	49	44	42						
6	69	56	47	40	67	55	46	40	53	45	40	51	45	39	50	44	39	37						
7	64	51	42	36	63	50	41	35	48	41	35	47	40	35	45	39	35	33						
8	60	46	38	32	58	45	37	32	44	37	31	43	36	31	42	36	31	29						
9	56	42	34	29	55	42	34	28	41	33	28	40	33	28	39	32	28	26						
10	52	39	31	26	51	39	31	26	38	31	26	37	30	26	36	30	25	24						

**Zonal Lumen Summary**

Zone	Lumens	% Fixture
0-30	1330	26.9
0-40	2157	43.7
0-60	3786	76.7
0-90	4934	100.0
0-180	4934	100.0

## ENERGY AND PERFORMANCE DATA BY CATALOG NUMBER

Stock or MTO*	Catalog Logic (Ribbed Lens)	Delivered Lumens	Watts	Efficacy (lm/W)
MTO	24CZ-LD4-30-UNV-L830-CD1-U	2700	25.6	110
MTO	24CZ-LD4-30-UNV-L835-CD1-U	2940	24.6	120
MTO	24CZ-LD4-30-UNV-L840-CD1-U	3098	24.6	126
MTO	24CZ-LD4-30-UNV-L850-CD1-U	3233	24.6	132
MTO	24CZ-LD4-35-UNV-L830-CD1-U	3174	29.3	108
MTO	24CZ-LD4-35-UNV-L835-CD1-U	3456	29.3	118
MTO	24CZ-LD4-35-UNV-L840-CD1-U	3641	29.3	124
MTO	24CZ-LD4-35-UNV-L850-CD1-U	3801	29.3	130
MTO	24CZ-LD4-40-UNV-L830-CD1-U	3619	33.4	108
STOCK	24CZ-LD4-40-UNV-L835-CD1-U	3941	33.4	118
STOCK	24CZ-LD4-40-UNV-L840-CD1-U	4152	33.4	124
MTO	24CZ-LD4-40-UNV-L850-CD1-U	4334	33.4	130
MTO	24CZ-LD4-45-UNV-L830-CD1-U	4091	39.3	104
MTO	24CZ-LD4-45-UNV-L835-CD1-U	4455	39.3	113
MTO	24CZ-LD4-45-UNV-L840-CD1-U	4694	39.3	120
MTO	24CZ-LD4-45-UNV-L850-CD1-U	4899	39.3	125
MTO	24CZ-LD4-50-UNV-L830-CD1-U	4531	44.5	102
STOCK	24CZ-LD4-50-UNV-L835-CD1-U	4934	44.5	111
STOCK	24CZ-LD4-50-UNV-L840-CD1-U	5199	44.5	117
MTO	24CZ-LD4-50-UNV-L850-CD1-U	5426	44.5	122
MTO	24CZ-LD4-55-UNV-L830-CD1-U	4989	50.2	99
MTO	24CZ-LD4-55-UNV-L835-CD1-U	5433	50.2	108
MTO	24CZ-LD4-55-UNV-L840-CD1-U	5724	50.2	114
MTO	24CZ-LD4-55-UNV-L850-CD1-U	5975	50.2	119
MTO	24CZ-LD4-60-UNV-L830-CD1-U	5529	56.2	98
MTO	24CZ-LD4-60-UNV-L835-CD1-U	6021	56.2	107
MTO	24CZ-LD4-60-UNV-L840-CD1-U	6344	56.2	113
MTO	24CZ-LD4-60-UNV-L850-CD1-U	6621	56.2	118
MTO	24CZ-LD4-65-UNV-L830-CD1-U	6003	62.0	97
MTO	24CZ-LD4-65-UNV-L835-CD1-U	6537	62.0	105
MTO	24CZ-LD4-65-UNV-L840-CD1-U	6888	62.0	111
MTO	24CZ-LD4-65-UNV-L850-CD1-U	7189	62.0	116
MTO	24CZ-LD4-70-UNV-L830-CD1-U	6502	68.8	95
MTO	24CZ-LD4-70-UNV-L835-CD1-U	7080	68.8	103
MTO	24CZ-LD4-70-UNV-L840-CD1-U	7460	68.8	108
MTO	24CZ-LD4-70-UNV-L850-CD1-U	7786	68.8	113
MTO	24CZ-LD4-75-UNV-L830-CD1-U	6890	74.5	92
MTO	24CZ-LD4-75-UNV-L835-CD1-U	7503	74.5	101
MTO	24CZ-LD4-75-UNV-L840-CD1-U	7905	74.5	106
MTO	24CZ-LD4-75-UNV-L850-CD1-U	8251	74.5	111

\*Made to order (MTO) requires a typical four week lead time.

## Standard Efficacy Versions

Stock or MTO*	Catalog Logic (Ribbed Lens)	Delivered Lumens	Watts	Efficacy (lm/W)
STOCK	24CZ-LD4-40SE-UNV-L835-CD1-U	4022	40.2	100
STOCK	24CZ-LD4-40SE-UNV-L840-CD1-U	4238	40.2	105
STOCK	24CZ-LD4-50SE-UNV-L835-CD1-U	5008	56.4	89
STOCK	24CZ-LD4-50SE-UNV-L840-CD1-U	5361	56.4	95
MTO	24CZ-LD4-60SE-UNV-L835-CD1-U	6052	66.5	91
MTO	24CZ-LD4-60SE-UNV-L840-CD1-U	6374	66.5	96
MTO	24CZ-LD4-65SE-UNV-L835-CD1-U	6518	74.2	88
MTO	24CZ-LD4-65SE-UNV-L840-CD1-U	6868	74.2	93

\*Made to order (MTO) requires a typical four week lead time.

## LUMEN MAINTENANCE

Ambient Temperature	TM-21 Lumen Maintenance (60,000 hours)	Theoretical L70 (Hours)
25°C	> 89%	> 201,000

## ENERGY AND PERFORMANCE DATA BY CATALOG NUMBER

Stock or MTO*	Catalog Logic (Smooth Lens)	Delivered Lumens	Watts	Efficacy (lm/W)
MTO	24CZ-LD4-30-S-UNV-L830-CD1-U	2760	25.6	112
MTO	24CZ-LD4-30-S-UNV-L835-CD1-U	3005	24.6	122
MTO	24CZ-LD4-30-S-UNV-L840-CD1-U	3166	24.6	129
MTO	24CZ-LD4-30-S-UNV-L850-CD1-U	3305	24.6	135
MTO	24CZ-LD4-35-S-UNV-L830-CD1-U	3244	29.3	111
MTO	24CZ-LD4-35-S-UNV-L835-CD1-U	3532	29.3	121
MTO	24CZ-LD4-35-S-UNV-L840-CD1-U	3722	29.3	127
MTO	24CZ-LD4-35-S-UNV-L850-CD1-U	3885	29.3	133
MTO	24CZ-LD4-40-S-UNV-L830-CD1-U	3699	33.4	111
MTO	24CZ-LD4-40-S-UNV-L835-CD1-U	4028	33.4	121
MTO	24CZ-LD4-40-S-UNV-L840-CD1-U	4244	33.4	127
MTO	24CZ-LD4-40-S-UNV-L850-CD1-U	4430	33.4	133
MTO	24CZ-LD4-45-S-UNV-L830-CD1-U	4182	39.3	107
MTO	24CZ-LD4-45-S-UNV-L835-CD1-U	4553	39.3	116
MTO	24CZ-LD4-45-S-UNV-L840-CD1-U	4798	39.3	122
MTO	24CZ-LD4-45-S-UNV-L850-CD1-U	5007	39.3	128
MTO	24CZ-LD4-50-S-UNV-L830-CD1-U	4631	44.5	104
MTO	24CZ-LD4-50-S-UNV-L835-CD1-U	5043	44.5	113
MTO	24CZ-LD4-50-S-UNV-L840-CD1-U	5314	44.5	119
MTO	24CZ-LD4-50-S-UNV-L850-CD1-U	5546	44.5	125
MTO	24CZ-LD4-55-S-UNV-L830-CD1-U	5100	50.2	102
MTO	24CZ-LD4-55-S-UNV-L835-CD1-U	5553	50.2	111
MTO	24CZ-LD4-55-S-UNV-L840-CD1-U	5851	50.2	117
MTO	24CZ-LD4-55-S-UNV-L850-CD1-U	6107	50.2	122
MTO	24CZ-LD4-60-S-UNV-L830-CD1-U	5652	56.2	101
MTO	24CZ-LD4-60-S-UNV-L835-CD1-U	6154	56.2	110
MTO	24CZ-LD4-60-S-UNV-L840-CD1-U	6484	56.2	115
MTO	24CZ-LD4-60-S-UNV-L850-CD1-U	6768	56.2	121
MTO	24CZ-LD4-65-S-UNV-L830-CD1-U	6136	62.0	99
MTO	24CZ-LD4-65-S-UNV-L835-CD1-U	6682	62.0	108
MTO	24CZ-LD4-65-S-UNV-L840-CD1-U	7040	62.0	114
MTO	24CZ-LD4-65-S-UNV-L850-CD1-U	7348	62.0	118
MTO	24CZ-LD4-70-S-UNV-L830-CD1-U	6646	68.8	97
MTO	24CZ-LD4-70-S-UNV-L835-CD1-U	7237	68.8	105
MTO	24CZ-LD4-70-S-UNV-L840-CD1-U	7625	68.8	111
MTO	24CZ-LD4-70-S-UNV-L850-CD1-U	7958	68.8	116
MTO	24CZ-LD4-75-S-UNV-L830-CD1-U	7043	74.5	94
MTO	24CZ-LD4-75-S-UNV-L835-CD1-U	7669	74.5	103
MTO	24CZ-LD4-75-S-UNV-L840-CD1-U	8080	74.5	108
MTO	24CZ-LD4-75-S-UNV-L850-CD1-U	8433	74.5	113

\*Made to order (MTO) requires a typical four week lead time.

## Standard Efficacy Versions

Stock or MTO*	Catalog Logic (Smooth Lens)	Delivered Lumens	Watts	Efficacy (lm/W)
MTO	24CZ-LD4-40SE-S-UNV-L835-CD1-U	4091	40.2	102
MTO	24CZ-LD4-40SE-S-UNV-L840-CD1-U	4310	40.2	107
MTO	24CZ-LD4-50SE-S-UNV-L835-CD1-U	5175	56.4	92
MTO	24CZ-LD4-50SE-S-UNV-L840-CD1-U	5453	56.4	97
MTO	24CZ-LD4-60SE-S-UNV-L835-CD1-U	6153	66.5	93
MTO	24CZ-LD4-60SE-S-UNV-L840-CD1-U	6483	66.5	97
MTO	24CZ-LD4-65SE-S-UNV-L835-CD1-U	6630	74.2	89
MTO	24CZ-LD4-65SE-S-UNV-L840-CD1-U	6985	74.2	94

\*Made to order (MTO) requires a typical four week lead time.

ORDERING INFORMATION

SAMPLE NUMBER: 24CZ-LD4-45-UNV-L835-CD1-U

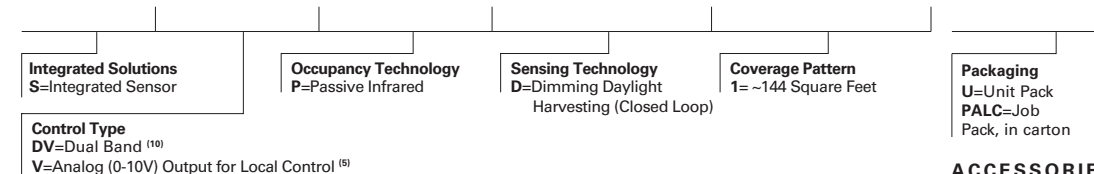
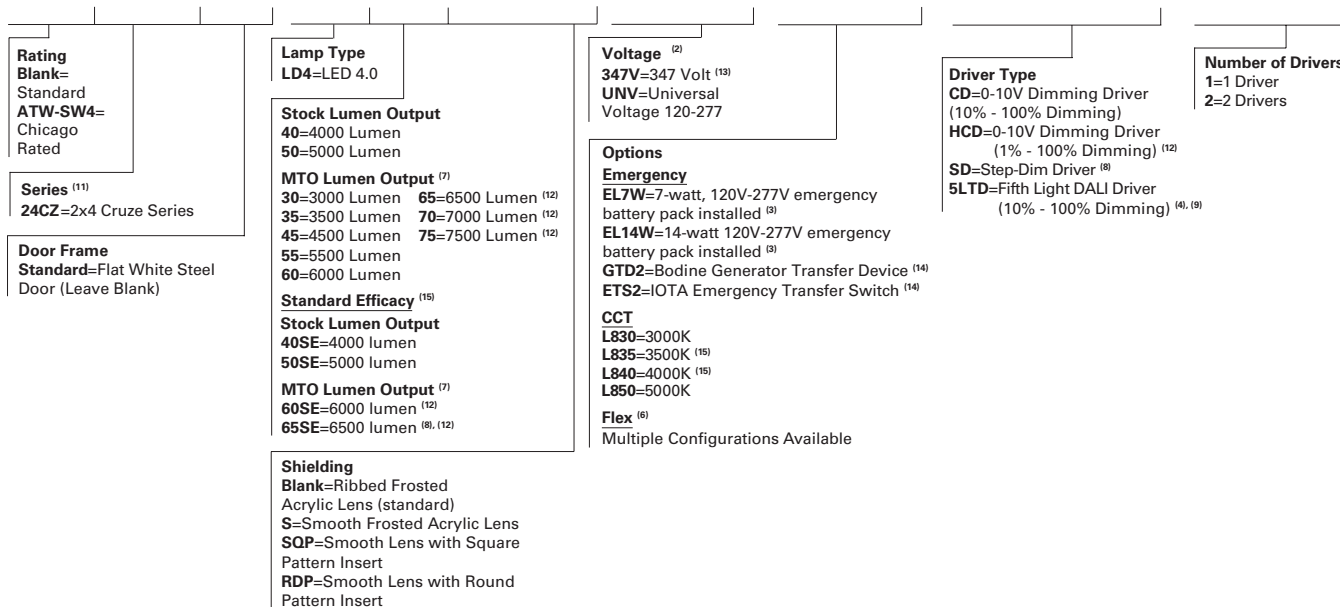

ACCESSORIES

- EQ-CLIP-U=T-BAR Safety Earthquake Clips <sup>(1)</sup>
- DF-24-W=2' x 4' Drywall Frame Kit
- SK-24-WS=2' x 4' Shallow Surface Mount Kit
- SK-24-WT=2' x 4' Tall Surface Mount Kit
- DF10P-C=Decorator Dimmer, 0-10V
- SF10P-=Decorator Slide Dimmer, 0-10V
- ISHH-01=Programming Remote for Integrated Sensor
- ISHH-02=Personal Control Remote for Integrated Sensor

**NOTES:** <sup>(1)</sup>An EQ Grid Clip is recommended for all 9/16" ceiling systems. Four required per fixture. <sup>(2)</sup>Products also available in non-US voltages and frequencies for international markets. <sup>(3)</sup>With integral test switch/indicator/laser test. For approximate delivered lumens multiply the lumens per watt of the desired fixture by the wattage of the emergency battery pack (100 lm/W x 7=700 lumens). IES-format photometry for luminaire under emergency operation available. <sup>(4)</sup>Must be used in conjunction with a DALI control system. For a complete listing of Fifth Light Technology products and other solutions from Cooper Controls, visit [www.eaton.com/lightingsystems](http://www.eaton.com/lightingsystems) <sup>(5)</sup>Integral sensor works only with "CD" driver and is factory prewired to the driver for stand-alone control. <sup>(6)</sup>Flex does not include dimming leads. Control leads provided by others. <sup>(7)</sup>Made-to-order (MTO) requires a typical four week leadtime. <sup>(8)</sup>Step dim driver option is not available with 3000 and 3500 lumen packages. Two step-dim drivers required for 7500 lumen packages. <sup>(9)</sup>Fifth Light (5LTD) driver option is not available with 3000 and 3500 lumen packages. <sup>(10)</sup>Provides blank band on opposite side from sensor band to provide symmetric appearance. <sup>(11)</sup>DesignLights Consortium™ Qualified and classified for DLC Standard (all lumen packages), refer to [www.designlights.org](http://www.designlights.org) for details. <sup>(12)</sup>HCD driver option requires two drivers with 6500, 7000 and 7500 lumen packages. <sup>(13)</sup>347V versions are not available with emergency options. <sup>(14)</sup>Used to transfer fixture to secondary power source for life-safety operation. When used with a dimming fixture, two devices are required to ensure control is disabled while operating under emergency power. <sup>(15)</sup>Standard efficacy versions are only available in 3500K and 4000K CCT.

Specifications & dimensions subject to change without notice. Consult your Eaton Representative for availability and ordering information.

SHIPPING DATA

Catalog No.	Wt.
24CZ-LD4-45	20.5 lbs.
24CZ-LD4-55	20.5 lbs.

**INTEGRATED SENSOR**

The Cruze with Integrated Sensor technology provides automatic energy savings without sacrificing performance. Traditionally, these types of energy savings required coordination between the luminaire and a lighting control system. The Cruze delivers superior lighting with integrated occupancy and daylighting controls.

Capture the benefits of traditional lighting controls, without complicated coverage planning or special wiring. Ideal for new construction or retrofit, the Cruze delivers automatic ON to an energy saving light level, while ensuring lighting is turned OFF when the space is unoccupied.

The integral daylight sensor reduces the need for special daylight zone planning. Each luminaire will automatically adjust the light level based on reflected light beneath the sensor in a closed loop method.

Occupied daylight light levels and unoccupied light levels can be adjusted using the integrated sensor programming remote (Catalog Number: ISHH-01). The integrated sensor personal remote (Catalog Number: ISHH-02) provides code compliant manual raise, lower, ON, OFF control.

The Cruze with Integrated Sensor is easy to install with no special wiring and ensures energy savings out-of-the-box with default control settings.

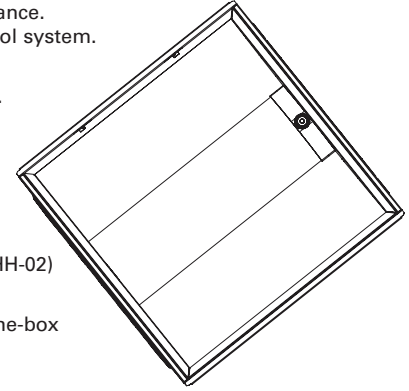

**How it works:**

- As the user enters the space controlled by the integral sensor, the lighting turns ON to the default daylight level.
- Lighting will remain at that the daylight level until the space is unoccupied. This will start the occupancy timeout period (default 20 minutes).
- If the space remains unoccupied for half of the timeout period, the lighting will automatically reduce to the Energy Saver light level. This adjustable light level is typically half of the occupied daylight level.
- At the end of the timeout period the lighting will go to the unoccupied light level. This adjustable light level uses the OFF default setting.

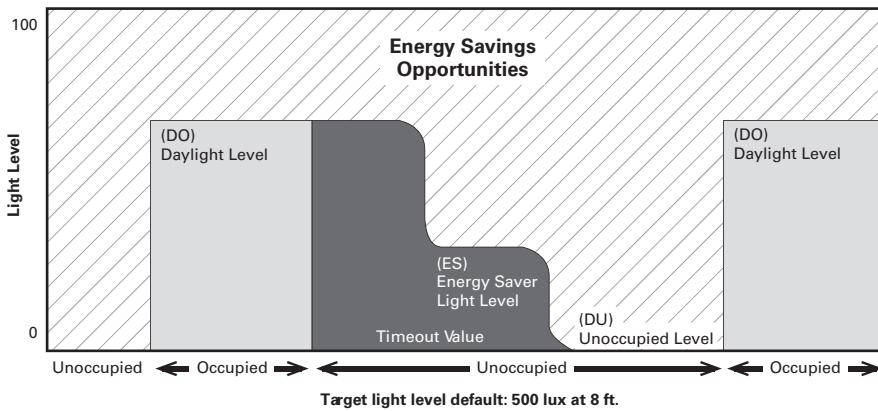

**Coverage**

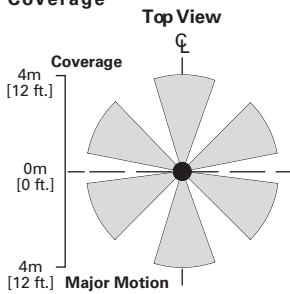

**Side View**

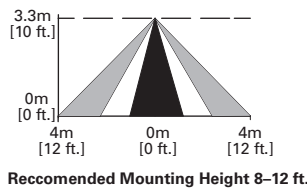

**Optional Remote Controls**



**ISHH-01 Programming Remote**



**ISHH-02 Personal Control Remote**