

# WVAC

# LIGHTING

Responsible Lighting®



## Connecting

Getting plugged in with WAC Lighting, you will come to know a company you can depend on to provide innovative luminaires based on cutting edge technology and listening to what is important to you.



## Factory Direct Relationship

For 30 years, our family has cherished this relationship with our customers who have invited us to serve them in their homes and businesses and in turn have supported the growth of our business.

## Engineering & Design

As the original designer and manufacturer of our products, we invest in research and development to generate technological advances that respond to market demands. Your feedback has turned our company into a unique design powerhouse structured with electrical engineering and industrial design capabilities.



## Responsible Manufacturing

Responsibility is central to our culture. We built our factories in New York, California, and China all from the ground up to handle the engineering, testing, fabrication and manufacturing of our products from a component level to grant us universal control over our quality, intellectual property, and environmental footprint.



## Changing Technology

In the ever changing world of LED, WAC Lighting will be your constant. We are committed to supplying differentiating lighting products to the marketplace that are designed to last, and illuminate beautifully. All backed by our 5 year warranty. Explore your creativity with our presentation of interesting niche products.

## Table of Contents

	LED Recessed .....	1 - 44
	LED Beauty Spots™ .....	45 - 48
	LED Exterior .....	49 - 56
	LED Step & Wall .....	57 - 62
	InvisiLED® .....	63 - 76
	LED Task & Cove .....	77 - 88
	LED Display Spotlights .....	89 - 98
	Track .....	99 - 162
	Rail .....	163 - 192
	Pendants & Sconces .....	193 - 286
	dwelLED™ .....	287 - 342

LED RECESSED













Designed to outperform conventional light sources from even smaller apertures, our LED recessed luminaires offer glare-free visual cutoff, precise color quality and full range dimming. A comprehensive program of LED recessed options perform a multitude of tasks in all apertures ranging from 1" to 6".

One-light to Four-light Multiple Recessed offered in three distinctive families feature individual aiming elements for broad applications. With lighting control, performance and aesthetics, WAC Lighting's comprehensive series of LED recessed lighting is designed and engineered for the most challenging spaces.

<b>Tesla LED 2" and 3.5"</b> Premium High Performance		<b>3-8</b>
<b>Plana LED 6"</b> High Brightness or High Color Rendering		<b>9</b>
<b>LEDme® 1", 3" and 4"</b> High Efficacy Performance		<b>11-18</b>
<b>LED Mini Multiples</b> Miniature Remodel and New Construction Adjustable 1, 2 and 3 Lights		<b>19-20</b>
<b>LED Precision Multiples</b> Retractable and Lockable Aiming 1, 2, 3, and 4 Lights		<b>21-22</b>
<b>Tesla LED Multiples</b> High Brightness Adjustable 1, 2, 3 and 4 Lights		<b>23-24</b>
<b>Low Voltage 2.5", 3" and 4"</b> 1 Watt Minimum Load for LED Retrofit		<b>25-30</b>
<b>Low Voltage Multiples</b> 1 Watt Minimum Load, 1, 2 and 3 Lights for LED Retrofit		<b>31-32</b>
<b>Line Voltage 4", 5", 6" and HID Multiples</b> Assorted Retrofit Lamp Options		<b>33-38</b>

Consult the factory to take advantage of our custom capabilities in large quantities

# Tesla 2" and 3.5" Recessed



Qualified for Both Residential and Commercial Applications



# Tesla 2" LED Energy Star®



**Power:** 10.5W (277V), 14.5W (120V)  
**Delivered Lumens:** Up to 730  
**Comparable:** 50W MR16  
**CRI:** Up to 90 (85 Typical)  
**Dimming:** 100%-1% (120V Only)  
**Rated Life:** 90,000 hours



## Premium High Performance Energy Star® LED

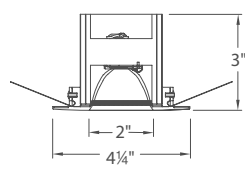

- Meets 2013 California Title 24 Efficiency
- Interchangeable reflectors for changing beam spreads
- 2" aperture
- UL listed for damp locations

## Trim (Order Housing Separately)

Trim (Order Housing Separately)	Model	Beam	Color Temp	Finish
 	<b>HR-2LD-ET109</b>	<b>S</b> 16.5° <b>N</b> 30° <b>F</b> 53°	<b>27</b> 2700K <b>9W</b> 3000K (90 CRI) <b>W</b> 3000K <b>35</b> 3500K <b>C</b> 4000K	<b>BN</b> Brushed Nickel <b>CB</b> Copper Bronze <b>WT</b> White

Example: **HR-2LD-ET109F-9W-BN**

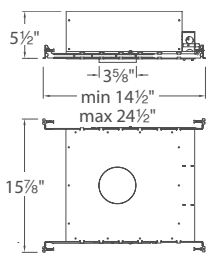
## Housings (Required)

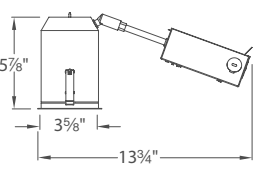
Housings (Required)	Model	Voltage	Installation	Rating
 	<b>HR-2LED-H09D-ICA</b>	120V	New Construction	IC-Rated – Airtight
	<b>HR-2LED-H09-HICA</b>	277V*		
 	<b>HR-2LED-R09D-A</b>	120V	Remodel	Non-IC – Airtight

\*Not Energy Star rated when using 277V housing

Non-IC housings require 3" of clearance from insulation on all sides.  
 Accommodates ceiling thickness of up to 1" for remodel & 3/4" for new construction.

## General Spacing Recommendation

Ceiling Height: 7-10 ft on the Floor

5 ft on Center Spacing for 25-30 fc of 2"

Compared to:

4 ft Spacing on 50W MR16 Downlights

80+ % Reduction in Energy and Fewer Lights Required

### Interchangeable Reflectors

Spot	<b>SL-REF-LUX10-S</b>
Narrow Flood	<b>SL-REF-LUX10-N</b>
Flood	<b>SL-REF-LUX10-F</b>

### Replacement LED Modules

2700K 85 CRI	<b>LXS8-PW27</b>
3000K 90 CRI	<b>LXS9-PW30</b>
3000K 85 CRI	<b>LXS8-PW30</b>
3500K 85 CRI	<b>LXS8-PW35</b>
4000K 85 CRI	<b>LXS8-PW40</b>

# Tesla 2" LED

**Power:** 10.5W (277V), 14.5W (120V)  
**Delivered Lumens:** Up to 590  
**Comparable:** 50W MR16  
**CRI:** Up to 90  
**Dimming:** 100% - 1% (120V Only)  
**Rated Life:** 90,000 hours

- Premium High Performance LED**
- Meets 2013 California Title 24 Efficiency
  - Smooth & continuous ELV dimming
  - 30° visual cutoff angle for glare control
  - Adjustable fixtures are ideal for sloped ceiling applications
  - Shower light is wet location listed

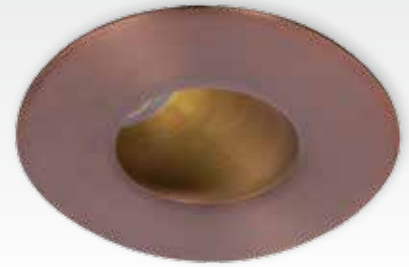

## Trims (Order Housing Separately)

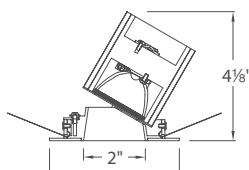
	Model	Beam	Color Temp	Finish
<p>Square Open Reflector</p>  	<b>HR-2LED-T709</b>		<b>27</b> 2700K <b>9W</b> 3000K (90 CRI) <b>W</b> 3000K <b>35</b> 3500K <b>C</b> 4000K	<b>BN</b> Brushed Nickel <b>CB</b> Copper Bronze <b>WT</b> White
<p>Square 0°- 30° Adjustable</p>  	<b>HR-2LED-T509</b>		<b>27</b> 2700K <b>9W</b> 3000K (90 CRI) <b>W</b> 3000K <b>35</b> 3500K <b>C</b> 4000K	<b>BN</b> Brushed Nickel <b>CB</b> Copper Bronze <b>WT</b> White
<p>Round Open Reflector</p>  	<b>HR-2LED-T109</b>	<b>S</b> 15° <b>N</b> 26° <b>F</b> 45°	<b>27</b> 2700K <b>9W</b> 3000K (90 CRI) <b>W</b> 3000K <b>35</b> 3500K <b>C</b> 4000K	<b>BN</b> Brushed Nickel <b>CB</b> Copper Bronze <b>WT</b> White
<p>Round 0°- 30° Adjustable</p>  	<b>HR-2LED-T309</b>		<b>27</b> 2700K <b>9W</b> 3000K (90 CRI) <b>W</b> 3000K <b>35</b> 3500K <b>C</b> 4000K	<b>BN</b> Brushed Nickel <b>CB</b> Copper Bronze <b>WT</b> White
<p>Round 30°- 45° Adjustable</p>  	<b>HR-2LED-T409</b>		<b>27</b> 2700K <b>9W</b> 3000K (90 CRI) <b>W</b> 3000K <b>35</b> 3500K <b>C</b> 4000K	<b>BN</b> Brushed Nickel <b>CB</b> Copper Bronze <b>WT</b> White
<p>Round Shower Light</p>   <p>Wet Location Listed</p>	<b>HR-2LED-T209</b>	<b>N</b> 26°	<b>27</b> 2700K <b>9W</b> 3000K (90 CRI) <b>W</b> 3000K <b>35</b> 3500K <b>C</b> 4000K	<b>BN</b> Brushed Nickel <b>CB</b> Copper Bronze <b>WT</b> White

Example: **HR-2LED-T109F-W-BN**

## Light Source Efficacy Comparison

50W MR16: 22 Lm/W	LED 76% More Efficient
	LED: 90 Lm/W

## Interchangeable Reflectors

Spot	<b>SL-REF-LUX10-S</b>
Narrow Flood	<b>SL-REF-LUX10-N</b>
Flood	<b>SL-REF-LUX10-F</b>

## Replacement LED Modules

2700K	85 CRI	<b>LXS8-PW27</b>
3000K	90 CRI	<b>LXS9-PW30</b>
3000K	85 CRI	<b>LXS8-PW30</b>
3500K	85 CRI	<b>LXS8-PW35</b>
4000K	85 CRI	<b>LXS8-PW40</b>

**Variable Beams**  
Interchangeable Reflectors Available

**0°- 30° Adjustable**  
For Wall Washing or Accenting

**Shower Light**  
Wet Location Listed

**30°- 45° Adjustable**  
For Sloped Ceilings



**2" Tesla Housings (Required)**

	Model	Voltage	Installation	Rating
<p><i>IC-Rated New Construction</i></p>	<b>HR-2LED-H09D-ICA</b>	120V	New Construction	IC-Rated – Airtight
	<b>HR-2LED-H09-HICA</b>	277V		
<p><i>Non-IC Remodel</i></p>	<b>HR-2LED-R09D-A*</b>	120V	Remodel	Non-IC – Airtight

\*Not compatible with HR-2LED-T309, HR-2LED-T409 or HR-2LED-T509

Non-IC housings require 3" of clearance from insulation on all sides.  
Accommodates ceiling thickness of up to 1" for remodel & 3/4" for new construction.

# Tesla 3.5" LED Energy Star®









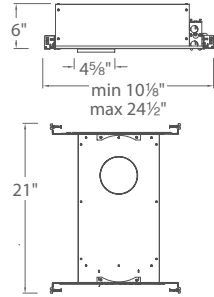

<b>Power:</b>	21.5W	<b>Premium High Performance Energy Star® LED</b> <ul style="list-style-type: none"> <li>• Meets 2013 California Title 24 Efficiency</li> <li>• 44° cutoff angle for glare control</li> <li>• 3.5" aperture</li> <li>• Smooth and continuous ELV dimming (120V only)</li> </ul>
<b>Delivered Lumens:</b>	Up to 1070	
<b>Comparable:</b>	75W MR16	
<b>CRI:</b>	Up to 90	
<b>100%-15% ELV Dimming:</b>	120V Only	
<b>0-10V Dimming:</b>	120V and 277V	
<b>Rated Life:</b>	50,000 hours	

## Energy Star® Trim (Order Housing Separately)

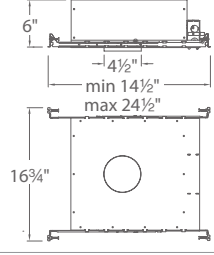
Energy Star® Trim (Order Housing Separately)	Model	Beam	Color Temp	Finish
 	<b>HR-3LD-ET118</b>	<b>F</b> 40°	<b>27</b> 2700K	<b>BN</b> Brushed Nickel <b>CB</b> Copper Bronze <b>WT</b> White
			<b>9W</b> 3000K (90 CRI)	
			<b>W</b> 3000K	
			<b>35</b> 3500K	
			<b>C</b> 4000K	

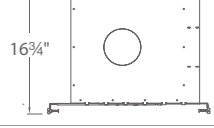
Example: **HR-3LD-ET118F-W-BN**

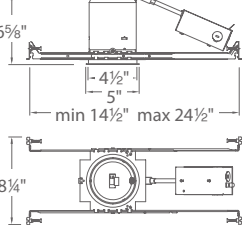
## Housings (Required)

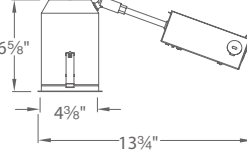
Housings (Required)	Model	Voltage	Installation	Rating
 	<b>HR-3LED-H18D1-ICA</b>		New Construction	IC-Rated – Airtight
 	<b>HR-3LED-H18D-ICA</b>	120V -277V	New Construction	
 	<b>HR-3LED-H18D-EMICA</b>		New Construction, Emergency Backup Battery	
 	<b>HR-3LED-H18D-A**</b>		New Construction	Non-IC – Airtight
 	<b>HR-3LED-R18D-A**</b>		Remodel	

\*\*Not compatible with HR-3LED-T318, HR-3LED-T418, HR-3LED-T518, HR-LED-T618 and HR-3LED-T918 (when adjusted)

Non-IC housings require 3" of clearance from insulation on all sides. Accommodates ceiling thickness of up to 1/2" - 1" for remodel & 1/2" - 3/4" for new construction.

## Light Source Efficacy Comparison











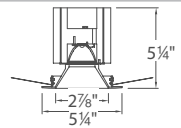

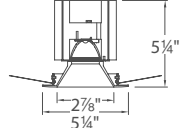

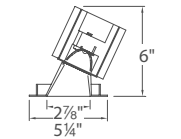
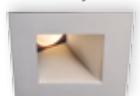
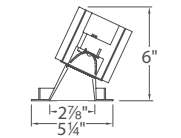
75W MR16: 16 Lm/W	LED 74% More Efficient
	LED: 61 Lm/W

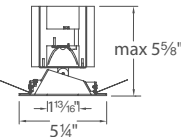
Interchangeable Reflectors		Replacement LED Modules		
Spot	<b>SL-REF-LUX10-S</b>	2700K	85 CRI	<b>LXS8-PW27</b>
Narrow Flood	<b>SL-REF-LUX10-N</b>	3000K	90 CRI	<b>LXS9-PW30</b>
Flood	<b>SL-REF-LUX10-F</b>	3000K	85 CRI	<b>LXS8-PW30</b>
		3500K	85 CRI	<b>LXS8-PW35</b>
		4000K	85 CRI	<b>LXS8-PW40</b>

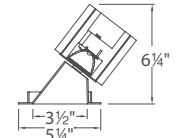
# Tesla 3.5" LED

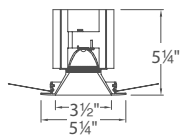
## Premium High Performance LED

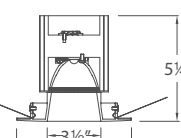
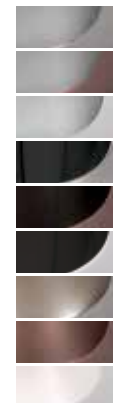
- Meets 2013 California Title 24 Efficiency
- Shower light is wet location listed
- Adjustable fixtures are ideal for sloped ceiling applications
- 35° visual cutoff angle for glare control
- 3.5" aperture
- Interchangeable reflectors for changing beam spreads

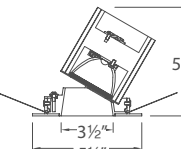
Trims (Order Housing Separately)	Model	Beam	Color Temp	Finish Reflector/Trim
<p>Square Downlight</p>   <p><b>HR-3LED-T718</b></p>		<p><b>S</b> 15° <b>N</b> 28° <b>F</b> 50°</p>		
<p>Square Shower Light (Wet Location Listed)</p>   <p><b>HR-3LED-T818</b></p>		<b>N</b> 28°		
<p>Square 0°- 30° Adjustable</p>   <p><b>HR-3LED-T518</b></p>		<p><b>S</b> 15° <b>N</b> 28° <b>F</b> 50°</p>		
<p>Square 30°- 45° Adjustable</p>   <p><b>HR-3LED-T918</b></p>		<p><b>S</b> 15° <b>N</b> 28° <b>F</b> 50°</p>	<p><b>27</b> 2700K <b>9W</b> 3000K (90 CRI) <b>W</b> 3000K <b>35</b> 3500K <b>C</b> 4000K</p>	<p><b>BN</b> Brushed Nickel/Brushed Nickel <b>CB</b> Copper Bronze/Copper Bronze <b>WT</b> White/White</p> 
<p>Round Pin Hole, 0°- 30° Adjustable</p>   <p><b>HR-3LED-T618</b></p>		<b>S</b> 15°		
<p>Round 30°- 45° Adjustable</p>   <p><b>HR-3LED-T418</b></p>		<p><b>S</b> 15° <b>N</b> 28° <b>F</b> 41°</p>		
<p>Round Shower Light (Wet Location Listed)</p>   <p><b>HR-3LED-T218</b></p>		<b>N</b> 28°		
<p>Round Downlight</p>   <p><b>HR-3LED-T118</b></p>		<p><b>S</b> 15° <b>N</b> 28° <b>F</b> 50°</p>	<p><b>27</b> 2700K <b>9W</b> 3000K (90 CRI) <b>W</b> 3000K <b>35</b> 3500K <b>C</b> 4000K</p>	<p><b>HZ/BN</b> Haze/Brushed Nickel <b>HZ/CB</b> Haze/Copper Bronze <b>HZ/WT</b> Haze/White <b>SB/BN</b> Specular Black/Brushed Nickel <b>SB/CB</b> Specular Black/Copper Bronze <b>SB/WT</b> Specular Black/White <b>BN</b> Brushed Nickel/Brushed Nickel <b>CB</b> Copper Bronze/Copper Bronze <b>WT</b> White/White</p> 
<p>Round 0°- 30° Adjustable</p>   <p><b>HR-3LED-T318</b></p>				

Example: **HR-3LED-T918F-W-CB**

# Plana 6" LED Energy Star®



## High Lumen Output or High Color Rendering

- Meets 2013 California Title 24 Efficiency
- 0-10V dimming for both 120V and 277V
- Energy Star®
- UL and CUL Listed for wet locations
- Ultra thin trim profile at less than 1/16"
- Deep regression of light source and a 45° cutoff angle produces very little glare
- Advanced LED technology for maximum light efficiency
- Accommodates ceiling thickness up to 1"
- WAC standard hanger bars provided
- Equipped with holder for C-channel (not supplied)



## Trim (Order Housing Separately)

Trim (Order Housing Separately)	Model	Finish	Reflector/Trim
 	<b>WR-6R1LD-T</b>	<b>HZ/WT</b> <b>SC/WT</b> <b>WT/WT</b>	<i>Haze/White</i> <i>Specular Clear/White</i> <i>White/White</i>

Example: **WR-6R1LD-T-WT/WT**

## Housings (Required)

### Bridgelux® - High Brightness

**Power:** 29W  
**Lumens:** Up to 1565  
**Comparable:** 39W HID  
**CRI:** Up to 90 (Typical 85)  
**Dimming:** 0-10V  
**Rated Life:** 70,000 Hours

### Xicato® - High CRI

**Power:** 22W  
**Lumens:** Up to 785  
**Comparable:** 50W PAR30  
**CRI:** 95  
**Dimming:** 0-10V  
**Rated Life:** 70,000 Hours

### When Brightness is of High Importance



### When Color Rendering is of High Importance

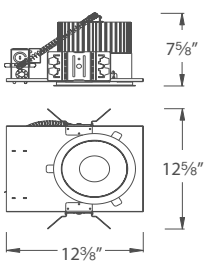

Model	Housing Type	Volt	Color Temp	Installation		
 	<b>30</b>	<i>Bridgelux</i>	120V	<b>927</b> 2700K (90 CRI) <b>27</b> 2700K	<b>T</b> <b>EM</b> <i>Non-IC New Construction</i> <i>Non-IC New Construction,</i> <i>Emergency Backup Battery</i>	
		<b>30H</b>	<i>Bridgelux</i>	277V		<b>9W</b> 3000K (90 CRI) <b>W</b> 3000K <b>35</b> 3500K <b>C</b> 4000K
		<b>30-X</b>	<i>Xicato</i>	120V		<b>27</b> 2700K <b>W</b> 3000K
	<b>30H-X</b>	<i>Xicato</i>	277V	<b>35</b> 3500K <b>C</b> 4000K		

Example: **WR-6RTL-30H9WEM**

Non-IC housings require 3" of clearance from insulation on all sides.  
 Accommodates ceiling thickness of up to 1/2" - 1".



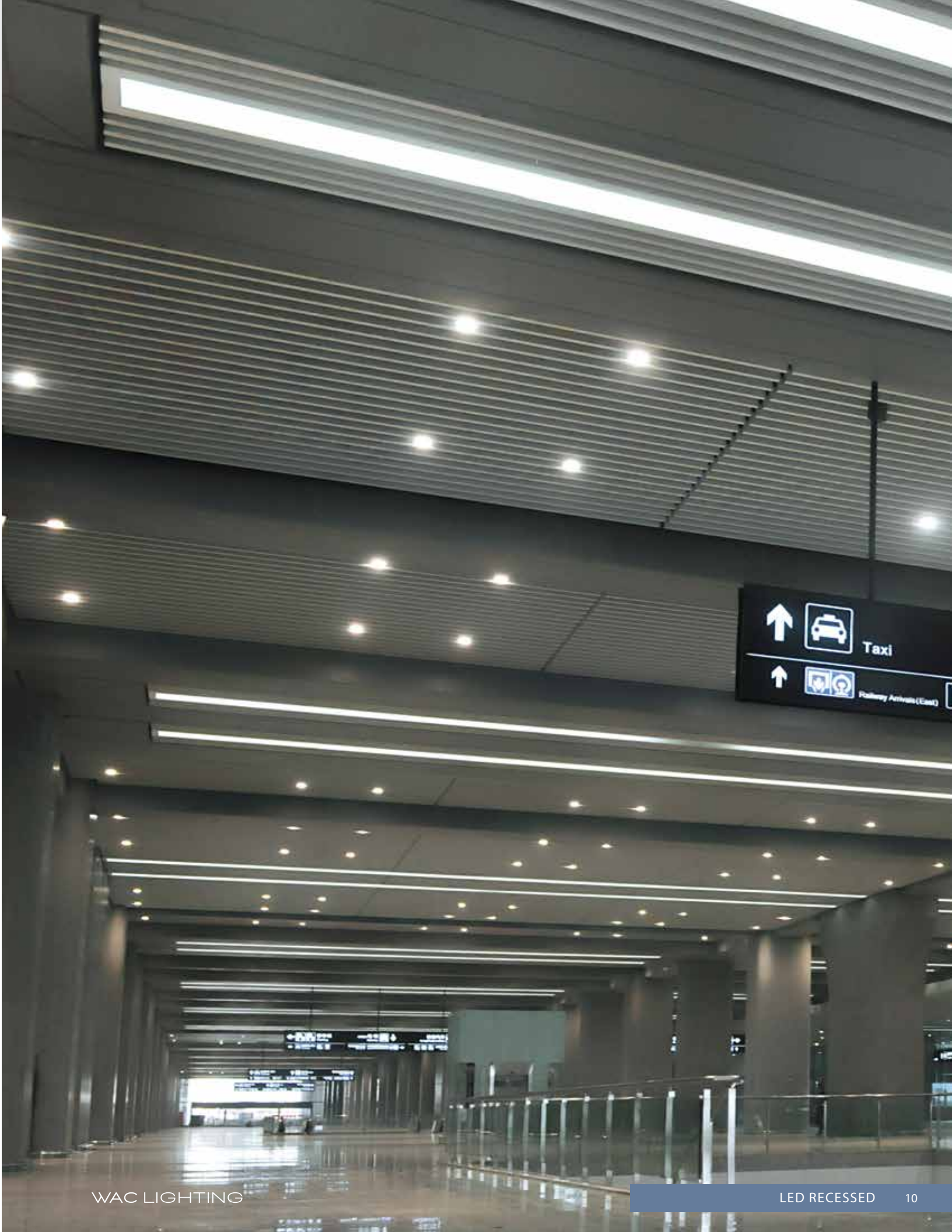

# LEDme® 1" LED Mini Recessed with Integral Driver







**Power:** 3.5W  
**Delivered Lumens:** Up to 200  
**Comparable:** 20W MR11  
**CRI:** Up to 85  
**Dimming:** 100% – 10%  
**Rated Life:** 100,000 hours

## Art & Accent Lighting

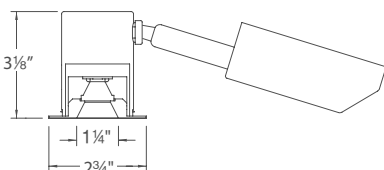
- All-in-one unit, ready to install right out of box
- Cutout: 2½", use standard hole saw
- Less than ¼" thick, super low profile die-cast aluminum trim
- Smooth & continuous ELV dimming

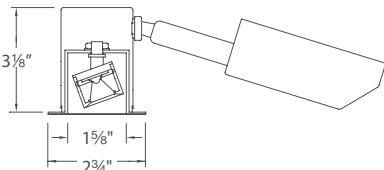
- Sold as new construction, may be re-configured in the field for remodel
- Narrow flood beam spread
- 350° horizontal rotation in adjustables
- IC rated in both integral & remote driver configurations

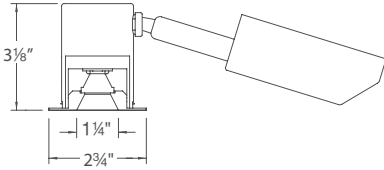
## Integral Driver/Housing & Trim

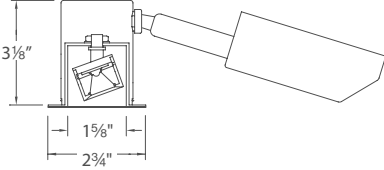
		Model	Color Temp	Finish
<p>Square Open Reflector</p>  		<b>HR-LED251E</b>		
<p>Square Adjustable 20° Adjustment from Vertical</p>  		<b>HR-LED252E</b>		
<p>Round Open Reflector</p>  		<b>HR-LED211E</b>		
<p>Round Adjustable 20° Adjustment from Vertical</p>  		<b>HR-LED212E</b>		
			<b>27</b> 2700K <b>W</b> 3000K <b>35</b> 3500K <b>C</b> 4500K	<b>BN</b> Brushed Nickel <b>GM</b> Gun Metal <b>WT</b> White

Example: **HR-LED212E-27-GM**

## New Construction Configuration

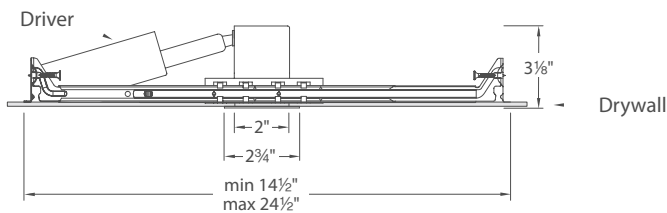

## Remodel Configuration

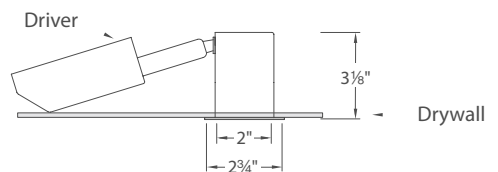

## Efficacy Comparison







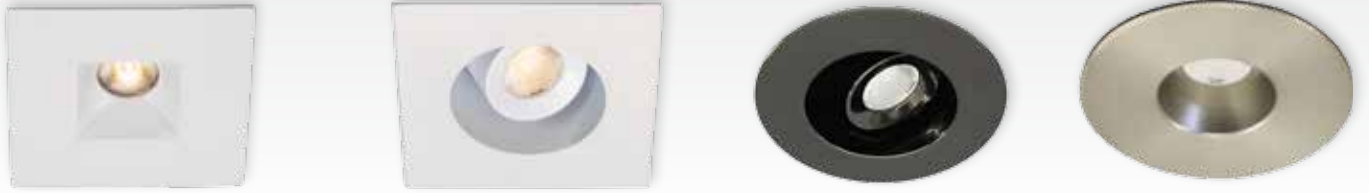

## Replacement LED Modules

- 2700K **RM1X3-27-DL**
- 3000K **RM1X3-30-DL**
- 3500K **RM1X3-35-DL**
- 4500K **RM1X3-45-DL**

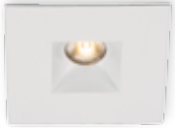
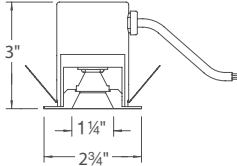
# LEDme® 1" LED Mini Recessed with Remote Driver

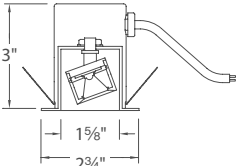

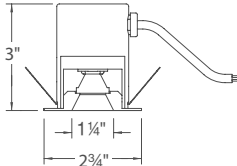
## Remote Driver Housing & Trim

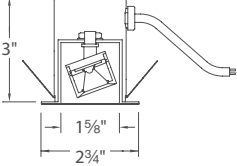
Remote Driver Housing & Trim		Model	Color Temp	Finish
<p><i>Square Open Reflector</i></p> 		<b>HR-LED271R</b>		
<p><i>Square Adjustable</i> 40° Adjustment from Vertical</p> 		<b>HR-LED272R</b>		
<p><i>Round Open Reflector</i></p> 		<b>HR-LED231R</b>		
<p><i>Round Adjustable</i> 40° Adjustment from Vertical</p> 		<b>HR-LED232R</b>		
			<b>27</b> 2700K <b>W</b> 3000K <b>35</b> 3500K <b>C</b> 4500K	<b>BN</b> Brushed Nickel <b>GM</b> Gun Metal <b>WT</b> White

Example: **HR-LED271R-27-WT**

## Remote Driver Configuration

Housing & Trim

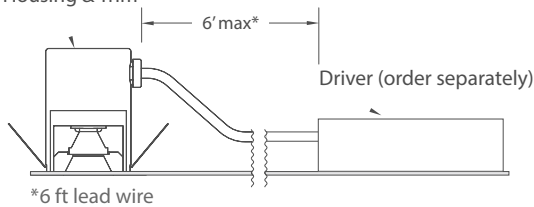

## LEDme® Class 2 Electronic Drivers

Hardwire	Dimming	Watt	Dimensions
<b>LD-700MA03-EDIM-IS</b>	Yes	3.5W	L: 5 5/8" W: 1 5/8" H: 1 1/8"
<b>LD-700MA09-EDIM-IS</b>	Yes	9W	L: 7 7/8" W: 3 3/8" H: 1 5/8"

ONLY for home-run wiring.

Plug-In	Dimming	Watt	Dimensions
<b>LED-700MA12-P</b>	No	12W	L: 5" W: 3 3/8" H: 1 5/8"

BOTH series wiring and home-run wiring acceptable.

## Multiple Terminal Block

Model	Dimensions
<b>MTB-01</b>	L: 3 1/4" W: 1 3/4" H: 7/8"

Accommodates up to 6 output connections.



## Replacement LED Modules

2700K	<b>RM1X3-27-DL</b>
3000K	<b>RM1X3-30-DL</b>
3500K	<b>RM1X3-35-DL</b>
4500K	<b>RM1X3-45-DL</b>

# LEDme<sup>®</sup> 3" LED Recessed





**Power:** 5.5W (IC-Rated), 8W (Non-IC)  
**Delivered Lumens:** Up to 375 (IC-Rated), 515 (Non-IC)  
**Comparable:** 35W-50W MR16  
**CRI:** Up to 85  
**Dimming:** 100% – 10%  
**Rated Life:** 100,000 hours

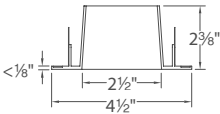

## Energy Saving Performance LED Downlights

- Super low profile trim at less than 1/8" thick
- Deep regression of LEDs produces a very low glare with 40° visual cutoff
- Shower light is wet location listed
- Smooth & continuous ELV dimming

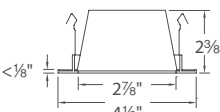
**68**  
Lm/W

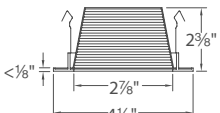
### Trims (Order Housing Separately)

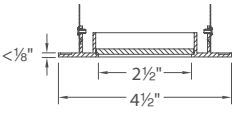
	Model	Finish	Reflector/Trim
<p>Square Open Reflector</p>  	<b>HR-LED351</b>	<b>BK/BN WT/WT</b>	<i>Black/Brushed Nickel White/White</i>
<p>Round Open Reflector</p>  	<b>HR-LED311</b>	<b>BK/BN WT/WT</b>	<i>Black/Brushed Nickel White/White</i>
<p>Round Step Baffle</p>  	<b>HR-LED321</b>	<b>BK/BN WT/WT</b>	<i>Black/Brushed Nickel White/White</i>

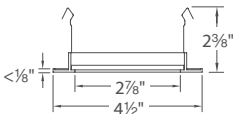
	Model	Finish	
<p>Square Shower Light</p>  	<b>HR-LED371</b>	<b>CH WT</b>	<i>Chrome White</i>
<p>Round Shower Light</p>  	<b>HR-LED331</b>		

Example: **HR-LED321-BK/BN**

### Replacement LED Modules

2700K **RM-3X3-27**  
 3000K **RM-3X3-30**  
 3500K **RM-3X3-35**  
 4500K **RM-3X3-45**

**LEDme® Downlight**  
TIR Lenses Array Provides Greatest Efficacy

**Shower Light**  
Wet Location Listed

**Step Baffle**  
More Advanced Glare Reduction  
than a Basic Baffle



**Lifetime Comparison: LED vs. 35W MR16**

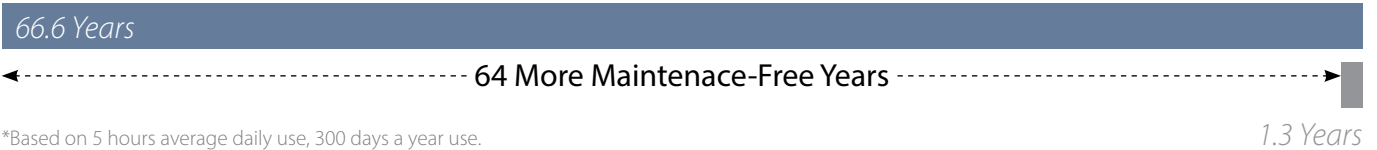
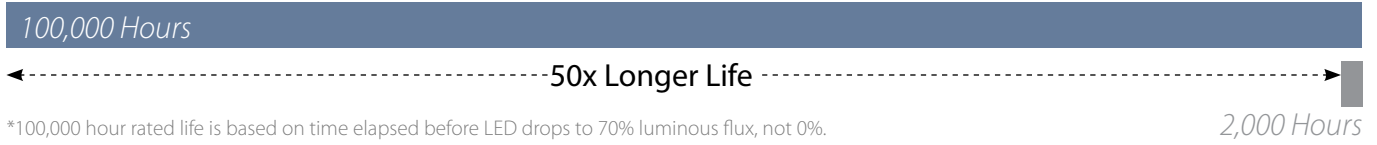

**3" LEDme® Housings (Required)**

	Model	Rating	Installation	Color Temp
<p><i>New Construction</i></p>	<b>HR-LED309</b>	<b>NIC</b>	IC-Rated Non-IC New Construction	<b>27</b> 2700K <b>W</b> 3000K <b>35</b> 3500K <b>C</b> 4500K
<p><i>Remodel</i></p>	<b>HR-LED309</b>	<b>RIC</b>	IC-Rated Non-IC Remodel	

Example: **HR-LED309-NIC-27**

Non-IC housings require 3" of clearance from insulation on all sides.  
Accommodates ceiling thickness of up to 3/4" for remodel & 1" for new construction.

# LEDme® 4" LED Energy Star®



**Power:** 10.2W (IC-Rated), 16W (Non-IC)  
**Delivered Lumens:** Up to 815 (IC-Rated), 1135 (Non-IC)  
**Comparable:** 50W/75W MR16  
**CRI:** Up to 85  
**Dimming:** 100% – 10%  
**Rated Life:** 100,000 hours

## Energy Saving Performance Energy Star® LED Downlights



- Super low profile trim at less than 1/8" thick
- Deep regression of LEDs produces a very low glare with 40° visual cutoff
- Shower light is wet location listed
- Smooth & continuous ELV dimming

**80**  
Lm/W

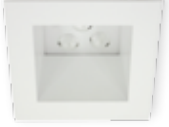
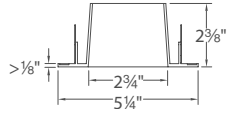
### Trims (Order Housing Separately)

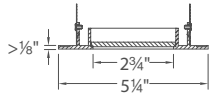
	Model	Finish	Reflector/Trim
<p><i>Square Open Reflector</i></p>  	<b>HR-LED451</b>	<b>BK/BN</b> <b>BK/WT</b> <b>WT/WT</b>	<i>Black/Brushed Nickel</i> <i>Black/White</i> <i>White/White</i>

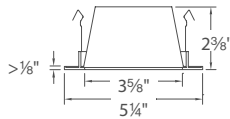
	Model	Finish	Reflector/Trim
<p><i>Square Shower Light</i></p>  	<b>HR-LED471</b>	<b>CH</b> <b>WT</b>	<i>Chrome</i> <i>White</i>

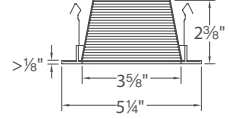
	Model	Finish	Reflector/Trim
<p><i>Round Open Reflector</i></p>  	<b>HR-LED411</b>	<b>BK/BN</b> <b>BK/WT</b> <b>WT/WT</b>	<i>Black/Brushed Nickel</i> <i>Black/White</i> <i>White/White</i>
<p><i>Round Step Baffle</i></p>  	<b>HR-LED421</b>	<b>WT/WT</b>	<i>White/White</i>

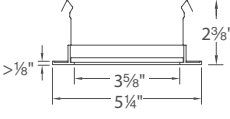
	Model	Finish	Reflector/Trim
<p><i>Round Shower Light</i></p>  	<b>HR-LED431</b>	<b>CH</b> <b>WT</b>	<i>Chrome</i> <i>White</i>

Example: **HR-LED421-WT/WT**

### Total Savings with LED vs. 75W PAR30

Years	1	2	3	4	5	6	7	8	9	10
Savings	-\$3,389	\$1,927	\$7,243	\$12,559	\$17,875	\$23,191	\$28,507	\$33,823	\$39,139	\$44,455

### Replacement LED Modules

2700K	<b>RM-6X3-27</b>
3000K	<b>RM-6X3-30</b>
3500K	<b>RM-6X3-35</b>
4500K	<b>RM-6X3-45</b>

\*Based on an electricity rate of \$0.22/kWh, 10 hours average daily use, 300 days a year use, 100 fixtures at \$150 per fixture.

**LEDme® Downlight**  
TIR Lenses Array Provides Greatest Efficacy

**Shower Light**  
Wet Location Listed

**Square Trims**  
Available for Both  
Open Reflector and Shower



**4" LEDme® Housings (Required)**

		Model	Rating	Color Temp	Installation
<p><i>New Construction</i></p>		<b>HR-LED418</b>	<b>NIC</b> <b>N</b>	<i>IC-Rated</i> <i>Non-IC</i>	<i>New Construction</i>
			<b>N</b>	<i>Non-IC</i>	<b>27</b> 2700K <b>W</b> 3000K <b>35</b> 3500K <b>C</b> 4500K
<p><i>Remodel</i></p>			<b>RIC</b> <b>R</b>	<i>IC-Rated</i> <i>Non-IC</i>	<i>Remodel</i>

Example: **HR-LED418-N-C-EM**

Non-IC housings require 3" of clearance from insulation on all sides.  
Accommodates ceiling thickness of up to 3/4" for remodel & 1" for new construction.

# LEDme® 4" LED Energy Star® Invisible Trim™



**Power:** 10.2W (IC-Rated), 16W (Non-IC)  
**Delivered Lumens:** Up to 815 (IC-Rated), 1135 (Non-IC)  
**Comparable:** 50W/75W PAR30  
**CRI:** Up to 85  
**Dimming:** 100% – 10%  
**Rated Life:** 100,000 hours





**80**  
Lm/W

## Finished Look Energy Star® Recessed Downlights

- Super low profile trim at less than 1/8" thick
- Deep regression of LEDs produces a very low glare with 40° visual cutoff
- Trim sits flush to ceiling for a sophisticated architectural look
- Smooth & continuous ELV dimming

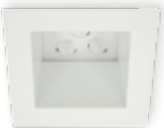
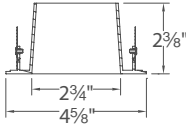

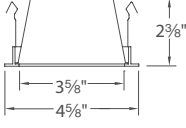
## Trims (Order Housing Separately)

	Model	Finish
<p>Invisible Trim™ Square Open Reflector</p>   <p><b>HR-LED451TL</b></p>	<b>WT/WT</b> White/White	
<p>Invisible Trim™ Round Open Reflector</p>   <p><b>HR-LED411TL</b></p>		

Example: **HR-LED451-WT/WT**

## Invisible Trim™ Housings Include a Spackle Frame to Permit a Stable Finished Installation

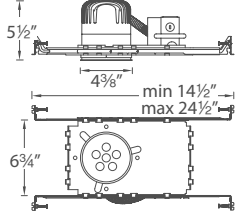
## Housings (Required)

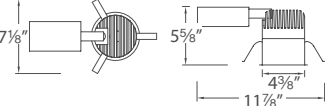
	Model	Rating	Shape	Color Temp	Installation
<p>New Construction</p>  	<b>HR-LED418</b>	<b>NIC</b> IC-Rated	<b>RO</b> Round	<b>27</b> 2700K	New Construction
		<b>N</b> Non-IC	<b>SQ</b> Square	<b>W</b> 3000K <b>C</b> 4500K	
<p>Remodel</p>  	<b>HR-LED418</b>	<b>RIC</b> IC-Rated	<b>RO</b> Round	<b>27</b> 2700K	Remodel
		<b>R</b> Non-IC	<b>SQ</b> Square	<b>W</b> 3000K <b>C</b> 4500K	

Example: **HR-LED418-NIC-SQ27**

Non-IC housings require 3" of clearance from insulation on all sides.  
 Accommodates ceiling thickness of up to 3/4" for remodel & 3/4" for new construction.

### Replacement LED Modules

2700K **RM-6X3-27**  
 3000K **RM-6X3-30**  
 3500K **RM-6X3-35**  
 4500K **RM-6X3-45**





### The Installation of Invisible Trim™

1.



Install the Housing

2.



Install the Spackle Frame

3.



Spackle to the Trim Edge

4.



After Drying, Install Regressed Trim

# LED Recessed Multiples

- Mini
- Precision
- Tesla



# Mini LED Multiple Spots

**Power:** 11W/light  
**Delivered Lumens:** Up to 755/light  
**Comparable:** 50W MR16  
**CRI:** Up to 90  
**Color Temp:** 3000K  
**Dimming:** 100 - 10%  
**Rated Life:** 50,000 hours  
**Input Voltage:** 120V



**69**  
Lm/W

## Miniature Recessed for Remodel & New Construction

- Meets 2013 California Title 24 Efficiency
- Individually adjustable luminaires
- Complete unit includes housing & trim
- All housings are Non-IC rated
- 30° visual cutoff for glare control

## Housing & Trim are Both Included

	Model	CRI	Installation	Trim/Reflector
<p>1-Light</p> <p>New Construction Housing (Airtight)</p> <p>Remodel Housing</p> <p>Trim</p>	<b>MT-3LD111NA-F30</b>	85	New Construction	<b>BK</b> White/Black <b>WT</b> White/White
	<b>MT-3LD111NA-F930</b>	90		
	<b>MT-3LD111R-F30</b>	85	Remodel	
	<b>MT-3LD111R-F930</b>	90		
<p>2-Lights</p> <p>New Construction Housing (Airtight)</p> <p>Remodel Housing</p> <p>Trim</p>	<b>MT-3LD211NA-F30</b>	85	New Construction	
	<b>MT-3LD211NA-F930</b>	90		
	<b>MT-3LD211R-F30</b>	85	Remodel	
	<b>MT-3LD211R-F930</b>	90		
<p>3-Lights</p> <p>New Construction Housing (Airtight)</p> <p>Remodel Housing</p> <p>Trim</p>	<b>MT-3LD311NA-F30</b>	85	New Construction	
	<b>MT-3LD311NA-F930</b>	90		
	<b>MT-3LD311R-F30</b>	85	Remodel	
	<b>MT-3LD311R-F930</b>	90		

Example: **MT-3LD211NA-F30-BK**

Non-IC housings require 3" of clearance from insulation on all sides.  
 Accommodates ceiling thickness of up to 1/2"-1" for remodel & 1/2"-1" for new construction.

# Precision Multiples 4" LED Energy Star®

**Power:** 16W / light  
**Delivered Lumens:** Up to 1100 / light  
**Comparable:** 75W MR16  
**CRI:** Up to 90  
**0-10V Dimming:** 120V and 277V  
**Rated Life:** 50,000 hours  
**Input Voltage:** 120V - 277V



## Retractable Energy Star® Spot Lights

- Meets 2013 California Title 24 Efficiency
- Perfect for lighting in commercial, architectural and retail applications
- Adjustable up to 90° from Vertical
- Accepts 1 replacement lens
- Non-IC housings

1100 Lumens  
 x 4 Lamps  
 4,400 Lumens

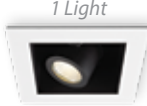
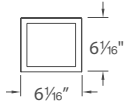
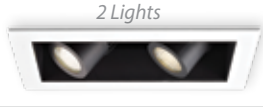
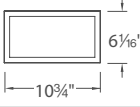
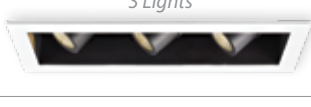
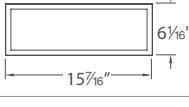
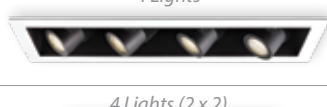
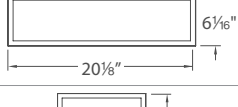

### Trims (Order Housing Separately)

	Model	Finish
 1 Light 	<b>MT-4LD116T</b>	Trim <b>WT</b> White
 2 Lights 	<b>MT-4LD216T</b>	
 3 Lights 	<b>MT-4LD316T</b>	
 4 Lights 	<b>MT-4LD416T</b>	
 4 Lights (2 x 2) 	<b>MT-4LD226T</b>	

### Invisible Trims (Order Housing Separately)

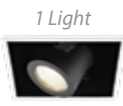
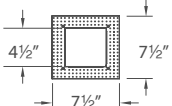
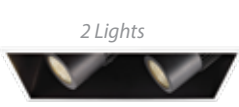
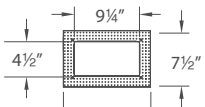
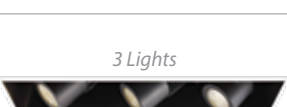
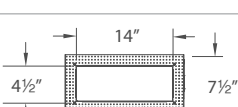
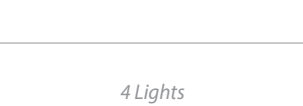
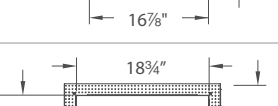
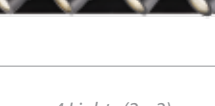
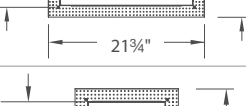
	Model	Finish
 1 Light 	<b>MT-4LD116TL</b>	Invisible Trim™ <b>WT</b> White
 2 Lights 	<b>MT-4LD216TL</b>	
 3 Lights 	<b>MT-4LD316TL</b>	
 4 Lights 	<b>MT-4LD416TL</b>	
 4 Lights (2 x 2) 	<b>MT-4LD226TL</b>	

Example: **MT-4LD226TL-WT**



Fully retractable from housing

Vertical Tilt  $\pm 90^\circ$



Rotatable 0-350°



Precision Module New Construction Housings (Required)

	Model	Beam	Color Temp	Rating	Module & Interior
	<b>MT-4LD116N</b> 1 Light				
	<b>MT-4LD216N</b> 2 Lights				
	<b>MT-4LD316N</b> 3 Lights	<b>S</b> 20° <b>F</b> 40°	<b>927</b> 2700 K (90 CRI) <b>27</b> 2700K <b>930</b> 3000K (90 CRI) <b>30</b> 3000K <b>35</b> 3500K <b>40</b> 4000K	Non-IC	<b>BK</b> Black
	<b>MT-4LD416N</b> 4 Lights				
	<b>MT-4LD226N</b> 4 Lights (2 x 2)				

Example: **MT-4LD316N-S30-BK**

Non-IC housings require 3" of clearance from insulation on all sides. Accommodates ceiling thickness of up to 1/2"-1" for new construction.

Do the Math

Lamps	1 Lamp	2 Lamps	3 Lamps	4 Lamps	Result
16W LED	16W	32W	48W	64W	79% More Efficient
75W MR16	75W	150W	225W	300W	Up to 236 More Watts

Lenses, Louvers & Lamps

Colored Lenses

Color	
<b>AMB</b>	Amber
<b>BLU</b>	Blue
<b>GRN</b>	Green
<b>RED</b>	Red
<b>YEL</b>	Yellow

Lenses & Louvers

<b>LENS-16-UVF</b>	UV Filter Lens
<b>LENS-16-FR</b>	Frosted Lens
<b>LENS-16-SPR</b>	Spread Lens
<b>LENS-16-BEL</b>	Beam Elongating Lens

# Tesla LED Multiple Spots Energy Star®













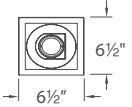

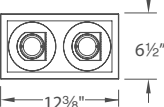

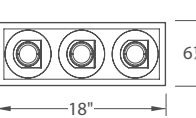

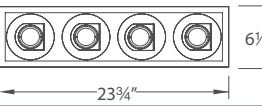
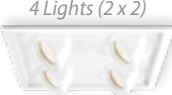
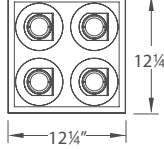
**Power:** 22.5W / light  
**Delivered Lumens:** Up to 1515 lm / light  
**Comparable:** 39W HID  
**CRI:** Up to 90  
**0-10V Dimming:** 120V and 277V  
**Rated Life:** 50,000 hours  
**Input Voltage:** 120V - 277V

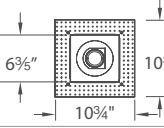
## High Brightness Energy Star® Adjustable Luminaires

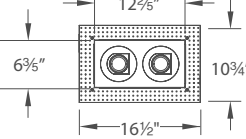
- Meets 2013 California Title 24 Efficiency
- ETL & cETL listed
- Individually retractable luminaires
- Accepts 1 lens and 1 accessory
- Non-IC airtight housings

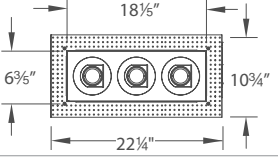
67  
Lm/W

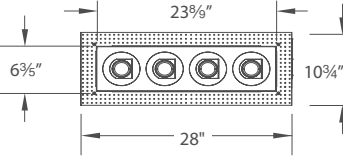
### Trims (Order Housing Separately)

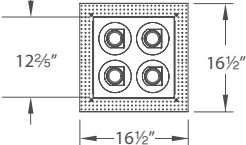
Trims (Order Housing Separately)	Model	Beam	Color Temp	Finish	Trim/Module
 	<b>MT-5LD125T</b>	Trim			
 	<b>MT-5LD225T</b>				
 	<b>MT-5LD325T</b>				
 	<b>MT-5LD425T</b>				
 	<b>MT-5LD445T</b>				
 	<b>MT-5LD125TL</b>				
 	<b>MT-5LD225TL</b>				
 	<b>MT-5LD325TL</b>				
 	<b>MT-5LD425TL</b>				
 	<b>MT-5LD445TL</b>				
		Invisible Trim™			

Example: **MT-5LD325T-S30-WT**

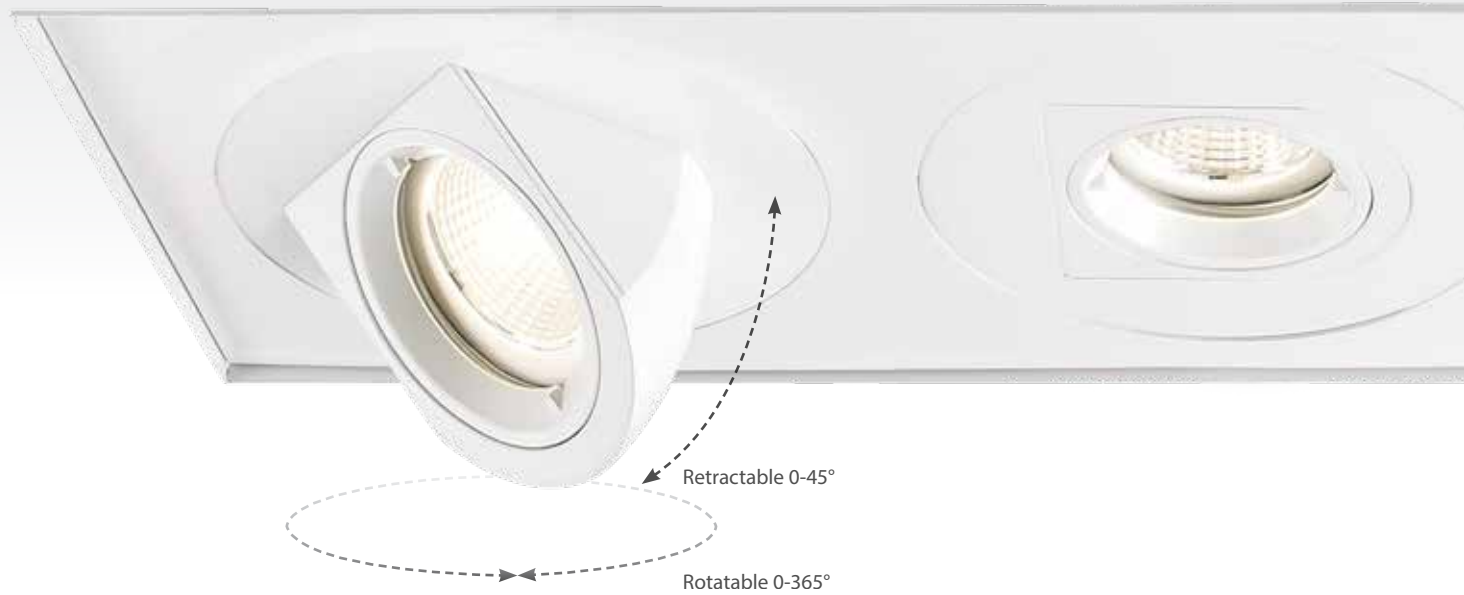

Tesla LED Multiple Spot Housings (Required)

	Model	Type	Installation	Rating
	<b>MT-5LD125H-NA</b>	1 Light	New Construction Non-IC – Airtight	
	<b>MT-5LD225H-NA</b>	2 Lights		
	<b>MT-5LD325H-NA</b>	3 Lights		
	<b>MT-5LD425H-NA</b>	4 Lights		
	<b>MT-5LD445H-NA</b>	4 Lights (2 x 2)		

Non-IC housings require 3" of clearance from insulation on all sides.  
Accommodates ceiling thickness of up to 1/2"-1" for new construction.

Colored Lenses		Color	Lenses & Louvers		
<b>LENS-16</b>	Colored Lens	<b>AMB</b>	Amber	<b>LENS-16-UVF</b>	UV Filter Lens
		<b>BLU</b>	Blue	<b>LENS-16-FR</b>	Frosted Lens
		<b>GRN</b>	Green	<b>LENS-16-CRL</b>	Cross Louver
		<b>RED</b>	Red	<b>LENS-16-SPR</b>	Spread Lens
		<b>YEL</b>	Yellow	<b>LENS-16-BEL</b>	Beam Elongating Lens
				<b>LENS-16-SNOOT</b>	Snoot
		<b>LENS-16-HCM</b>	Honeycomb Louver		

# Low Voltage 2.5" MR16





# 1Watt Minimum Load Transformers

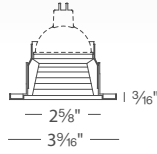

### Accommodates Most LED MR16 or Halogen MR16 Lamps

- Retention clips secure lens firmly to lamp
- Abrasion resistant powder coat paint or plated metal finish
- Clear lens included, see opposite page for replaceable lens options

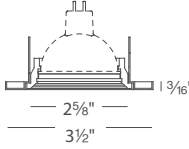

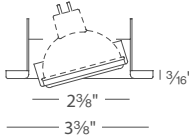



### Trims (Order Housing Separately)

	Model	Finish	Baffle/Trim
<p><i>Metal Trim Step Baffle</i></p>  	<b>HR-834</b>	<b>WT</b> <b>WT/WT</b>	<i>Black/White</i> <i>White/White</i>
<p><i>Metal Trim</i></p>  	<b>HR-836</b>	<b>BN</b> <b>CB</b> <b>WT</b>	<i>Brushed Nickel</i> <i>Copper Bronze</i> <i>White</i>
<p><i>Gimbal Ring, 25° Adjustment from Vertical</i></p>  	<b>HR-837</b>	<b>BK</b> <b>BN</b> <b>CB</b> <b>CH</b> <b>WT</b>	<i>Black</i> <i>Brushed Nickel</i> <i>Copper Bronze</i> <i>Chrome</i> <i>White</i>

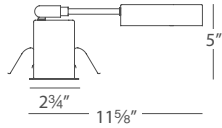
### Finish

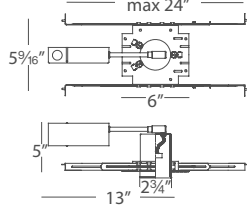
Example: **HR-836-CB**

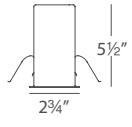
### Housings (Required)

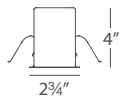
	Model	Installation	Output	Rating	Volt
<p><i>Electronic Non-IC Remodel</i></p>  	<b>HR-801</b>	<i>Remodel</i>			
<p><i>Electronic Non-IC New Construction</i></p>  	<b>HR-802</b>	<i>New Construction</i>	12V, 50W max		
<p><i>Non-IC Remodel</i></p>  	<b>HR-806**</b>	<i>Remote Transformer Remodel</i>			
<p><i>For Cabinet Use</i></p>  	<b>HR-800*</b>	<i>Remote Transformer</i>	12V/24V, 35W max		

\*Remote Electronic Class 2 Transformer Required (Sold Separately)

\*\*Remote Electronic or Magnetic Transformer Required (Sold Separately)

Non-IC housings require 3" of clearance from insulation on all sides.

Accommodates ceiling thickness of up to 3/4" for remodel & 5/8" for new construction.

### Lenses, Louvers & Lamps

#### Colored Lenses

#### Color

<b>LENS-16</b>	Colored Lens	<b>AMB</b> Amber <b>BLU</b> Blue <b>GRN</b> Green <b>RED</b> Red <b>YEL</b> Yellow
----------------	--------------	--

#### Lenses & Louvers

<b>LENS-16-UVF</b>	UV Filter Lens
<b>LENS-16-FR</b>	Frosted Lens
<b>LENS-16-HCL</b>	Honeycomb Louver
<b>LENS-16-SPR</b>	Spread Lens
<b>LENS-16-BEL</b>	Beam Elongating Lens

#### LED MR16 Lamp Finish

<b>MR16LED-BAB</b>	<b>BK</b> Black <b>WT</b> White
--------------------	------------------------------------



**Step Baffle**  
Absorbs Stray Light to Reduce Glare

**Metal Trim**  
Fabricated Steel Construction  
with Plated Metal Finish

**Gimbal Ring**  
Adjustable Angle While Keeping  
the Light at the Ceiling Plane



**1 Watt Minimum Class 2 Enclosed Electronic Transformers**

Model	Input	Output	L	W	H
<b>EN-1260-RB2</b>	120V	12V, 1 x 60W	6 <sup>5</sup> / <sub>8</sub> "	1 <sup>5</sup> / <sub>8</sub> "	1 <sup>1</sup> / <sub>8</sub> "
<b>EN-12120-RB2</b>	120V	12V, 2 x 60W	6"	3 <sup>1</sup> / <sub>4</sub> "	2 <sup>5</sup> / <sub>8</sub> "
<b>EN-12180-RB2</b>	120V	12V, 3 x 60W	6 <sup>3</sup> / <sub>4</sub> "	3 <sup>5</sup> / <sub>8</sub> "	2 <sup>5</sup> / <sub>8</sub> "
<b>EN-12300-RB2</b>	120V	12V, 5 x 60W	8 <sup>1</sup> / <sub>4</sub> "	4 <sup>5</sup> / <sub>8</sub> "	2 <sup>5</sup> / <sub>8</sub> "
<b>EN-2460-RB2</b>	120V	24V, 60W	2 <sup>1</sup> / <sub>8</sub> "	1 <sup>3</sup> / <sub>8</sub> "	1"
<b>EN-24100-RB2</b>	120V	24V, 96W	2 <sup>1</sup> / <sub>8</sub> "	1 <sup>3</sup> / <sub>8</sub> "	1"

For Use with HR-800 Housing

**1 Watt Minimum Enclosed Electronic Transformers**

Model	Input	Output	L	W	H
<b>EN-1260-RB-AR</b>	120V	12V, 60W	6 <sup>5</sup> / <sub>8</sub> "	1 <sup>5</sup> / <sub>8</sub> "	1 <sup>1</sup> / <sub>8</sub> "
<b>EN-1275-RB-AR</b>	120V	12V, 75W	6 <sup>5</sup> / <sub>8</sub> "	1 <sup>5</sup> / <sub>8</sub> "	1 <sup>1</sup> / <sub>8</sub> "
<b>EN-12100-RB-AR</b>	120V	12V, 100W	6 <sup>1</sup> / <sub>4</sub> "	3"	1 <sup>5</sup> / <sub>8</sub> "
<b>EN-12150-RB-AR</b>	120V	12V, 150W	6 <sup>1</sup> / <sub>4</sub> "	3"	1 <sup>5</sup> / <sub>8</sub> "
<b>EN-24150-RB-AR</b>	120V	24V, 150W	6 <sup>1</sup> / <sub>4</sub> "	3"	1 <sup>5</sup> / <sub>8</sub> "
<b>EN-B12PY-AR</b>	120V	12V, 250W	6 <sup>1</sup> / <sub>2</sub> "	3 <sup>3</sup> / <sub>8</sub> "	2 <sup>1</sup> / <sub>2</sub> "
<b>EN-B24PZ-AR</b>	120V	24V, 300W	6 <sup>1</sup> / <sub>2</sub> "	3 <sup>3</sup> / <sub>8</sub> "	2 <sup>1</sup> / <sub>2</sub> "

For Use with HR-806 Housing

# Low Voltage 3" Premium MR16

# 1Watt Minimum Load Transformers

### Accommodates Most LED MR16 or Halogen MR16 Lamps

- Die-cast aluminum construction
- Steel spring clips secure trim to housing
- Abrasion resistant powder coat paint or plated metal finish
- Smooth & continuous ELV or MLV dimming depending on transformer
- Various lamp options available including LED
- Clear lens included, replacement lens options available

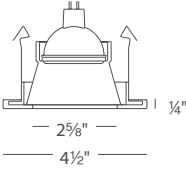

### Downlight Trims (Order Housing Separately)

	Model	Lamp	Finish	Reflector/Trim
<p><i>Open Reflector, 25° Adjustment from Vertical</i></p>  	<b>HR-D321</b>	MR16, 50W max	<b>SC/BN</b> <b>SC/WT</b>	Specular/Brushed Nickel Specular/White

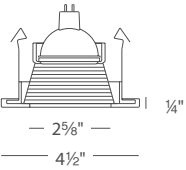
	Model	Lamp	Finish	Baffle/Trim
<p><i>Basic Baffle, 25° Adjustment from Vertical</i></p>  	<b>HR-D324</b>	MR16, 50W max	<b>WT/WT</b>	White/White

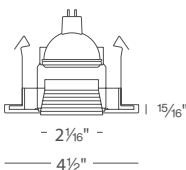
	Model	Lamp	Finish	Baffle/Trim
<p><i>Pin Hole</i></p>  	<b>HR-D325</b>	MR16, 35W max	<b>BK/WT</b> <b>WT/WT</b>	Black/White White/White

### Speciality Trims (Order Housing Separately)

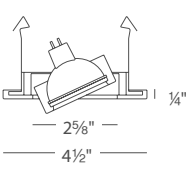
	Model	Lamp	Finish	Reflector/Trim
<p><i>Adjustable Gimbal Ring, 25° Adjustment from Vertical</i></p>  	<b>HR-D327</b>	MR16, 50W max	<b>BN</b> <b>WT</b>	Brushed Nickel White

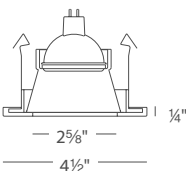
	Model	Lamp	Finish	Reflector/Trim
<p><i>Shower Light With Clear Flat Lens, 25° Adjustment from Vertical</i></p>  <p><i>Wet Location Listed</i></p> 	<b>HR-D329-S</b>	MR16, 35W max	<b>WT</b>	White

Example: **HR-D327-BN**

### Lenses, Louvers & Lamps

Colored Lenses		Color
<b>LENS-16</b>	Colored Lens	<b>AMB</b> Amber
		<b>BLU</b> Blue
		<b>GRN</b> Green
		<b>RED</b> Red
		<b>YEL</b> Yellow

Lenses & Louvers	
<b>LENS-16-UVF</b>	UV Filter Lens
<b>LENS-16-FR</b>	Frosted Lens
<b>LENS-16-HCL</b>	Honeycomb Louver
<b>LENS-16-SPR</b>	Spread Lens
<b>LENS-16-BEL</b>	Beam Elongating Lens

LED MR16 Lamp	Finish
<b>MR16LED-BAB</b>	<b>BK</b> Black
	<b>WT</b> White

**Open Reflector**  
 Produces Smooth Beams  
 & More Efficiency Without Glare

**Shower Light**  
 Wet Location Listed  
 with Clear Flat Lens

**Pin Hole**  
 Spot Distribution with  
 High Cutoff Eliminating Glare

**Gimbal Ring**  
 Adjustable Angle While Keeping  
 the Light at the Ceiling Line



**3" Low Voltage Housings (Required)**

	Model	Transformer	Installation	Output Rating	Volt
<p><i>Non-IC New Construction</i></p> <p><b>HR-302E</b> Electronic  <b>HR-302M</b> Magnetic</p>	<ul style="list-style-type: none"> <li>• Integral Electronic or Magnetic Transformer</li> <li>• J-Box and Transformer Accessible Through Ceiling</li> <li>• Rated for Branch and Chain Wiring</li> <li>• Suitable for Damp Locations</li> <li>• Suitable for use in "Shallow" Joist Installations</li> </ul>	<p>New Construction</p>	<p>12V, 50W max</p>	<p>Non-IC 120V</p>	
<p><i>Non-IC Remodel</i></p> <p><b>HR-301E</b> Electronic</p>					<p>Remodel</p>
<p><i>Non-IC Remodel</i></p> <p><b>HR-301M</b> Magnetic</p>					<p>Remodel</p>

Non-IC housings require 3" of clearance from insulation on all sides.  
 Accommodates ceiling thickness of up to 3/4" for remodel & 3/4" for new construction.

# Low Voltage 4" MR16







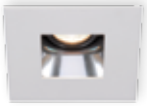
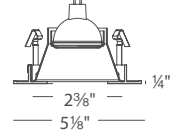

# 1Watt Minimum Load Transformers

### Accommodates Most LED MR16 or Halogen MR16 Lamps

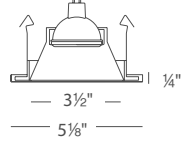

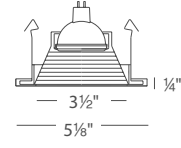
- Die-cast aluminum construction
- Steel spring clips secure trim to housing
- Abrasion resistant powder coat paint or plated metal finish

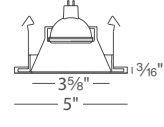
- Smooth & continuous ELV or MLV dimmer depending on transformer
- Transformer and junction box accessible from below the ceiling
- Various lamp options available including LED
- Clear lens supplied, can be replaced with various options (see below)

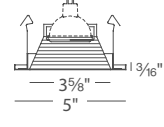
### Downlight Trims (Order Housing Separately)

	Model	Compatible Housing/Lamp	Finish	Reflector/Trim
<p>Square Open Reflector</p>  	<b>HR-D412-S</b>	MR16, 75W max		
<p>Round Open Reflector, 35° Adjustment from Vertical</p>  	<b>HR-D412</b>	MR16, 75W max	<b>SC/BN</b> <b>SC/WT</b>	Specular/Brushed Nickel Specular/White
<p>Step Baffle, 35° Adjustment from Vertical</p>  	<b>HR-D411</b>	MR16, 75W max	<b>WT/WT</b>	WhiteBaffle/White
<p>Open Reflector, 35° Adjustment from Vertical</p>  	<b>HR-8412</b>	MR16, 75W max	<b>BN</b> <b>CL</b>	Clear/Brushed Nickel Clear/White
<p>Step Baffle, 35° Adjustment from Vertical</p>  	<b>HR-8411</b>	MR16, 75W max	<b>BN</b> <b>CB</b> <b>WT</b> <b>WT/WT</b>	Black Baffle/Brushed Nickel Copper Bronze Baffle/Copper Bronze Black Baffle/White WhiteBaffle/White

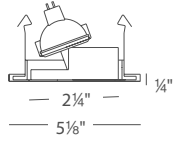
### Specialty Trims (Order Housing Separately)

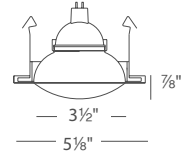
	Model	Compatible Housing/Lamp	Finish	
<p>Slot Trim, 35° Adjustment from Vertical</p>  	<b>HR-D413</b>	MR16, 75W max	<b>WT</b>	White
<p>Shower Light with Drop Dish Glass Dome</p>  <p>Wet Location Listed</p> 	<b>HR-D418</b>	MR16, 50W max	<b>CB</b> <b>WT</b>	Copper Bronze White

Example: **HR-D412-S-SC/WT**

### Lenses, Louvers & Lamps

#### Colored Lenses

#### Color

<b>LENS-16</b>	Colored Lens	<b>AMB</b> Amber <b>BLU</b> Blue <b>GRN</b> Green <b>RED</b> Red <b>YEL</b> Yellow
----------------	--------------	--

#### Lenses & Louvers

<b>LENS-16-UVF</b>	UV Filter Lens
<b>LENS-16-FR</b>	Frosted Lens
<b>LENS-16-HCL</b>	Honeycomb Louver
<b>LENS-16-SPR</b>	Spread Lens
<b>LENS-16-BEL</b>	Beam Elongating Lens

#### LED MR16 Lamp Finish

<b>MR16LED-BAB</b>	<b>BK</b> Black <b>WT</b> White
--------------------	------------------------------------

Specialty Trims (Order Housing Separately)

	Model	Compatible Housing/Lamp	Finish
<p>Directional Spot, 80° Adjustment from Vertical</p>	<b>HR-D425</b>	MR16, 75W max	<b>BK</b> Black <b>BN</b> Brushed Nickel <b>WT</b> White
<p>Directional Spot, 30° Adjustment from Vertical</p>	<b>HR-D416</b>	MR16, 75W max	<b>BN</b> Brushed Nickel <b>WT</b> White
<p>Shower Light Clear Flat Lens, 35° Adjustment from Vertical</p> <p>Wet Location Listed</p>	<b>HR-D418-S</b>	MR16, 50W max	<b>WT</b> White
<p>Gimbal Ring, 25° Adjustment from Vertical</p>	<b>HR-D417</b>	MR16, 75W max	<b>BN</b> Brushed Nickel <b>WT</b> White
<p>Gimbal Ring, 25° Adjustment from Vertical</p>	<b>HR-8417</b>	MR16, 75W max	<b>BK</b> Black <b>BN</b> Brushed Nickel <b>CB</b> Copper Bronze <b>WT</b> White

Example: **HR-D416-WT**

4" Low Voltage Housings (Required)

Model	Voltage	Transformer	Output	Installation	Rating
	120V	Electronic	12V, 50W max	New Construction	Non-IC
	120V	Magnetic	12V, 75W max	New Construction	Non-IC
	<b>H</b> 120V <b>HF</b> 277V	Magnetic	12V, 50W max	New Construction	IC Airtight
	<b>H</b> 120V <b>HF</b> 277V	Magnetic	12V, 50W max	New Construction	Non-IC
	120V	Electronic	12V, 50W max	Remodel	Non-IC
	<b>H</b> 120V <b>HF</b> 277V	Magnetic	12V, 50W max	Remodel	Non-IC

\*Not Compatible with HR-D418 or HR-D418-S

Non-IC housings require 3" of clearance from insulation on all sides.

Accommodates ceiling thickness of up to 3/4" for remodel & 3/4" for new construction.

# Low Voltage MR16 Multiple Spots

# 1Watt Minimum Load Transformers



### Accommodates Most LED MR16 or Halogen MR16 Lamps

- Soft start to prolong lamp life
- Invisible Trim™ design includes patented spackle trim to ensure a finished look to the ceiling
- Supplied clear glass lens can be replaced by a variety of lenses or accessories
- 25° vertical adjustment and 350° horizontal rotation
- Non-IC housings
- Various lamp options available including LED

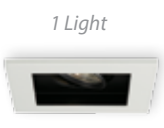
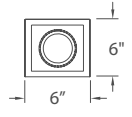
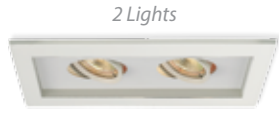
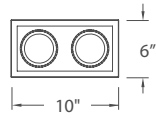
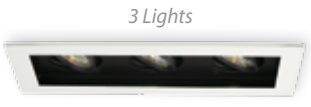
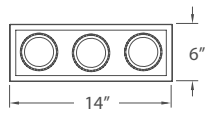
### Trims (Order Housing Separately)

	Model	Finish	Trim/Reflector
 1 Light 	<b>MT-116</b>		
 2 Lights 	<b>MT-216</b>	Trim	<b>WT/WT</b> White/White <b>WT/BK</b> White/Black
 3 Lights 	<b>MT-316</b>		

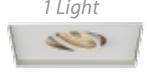
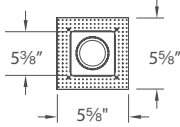
### Invisible Trims (Order Housing Separately)

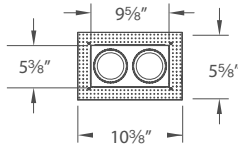
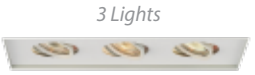
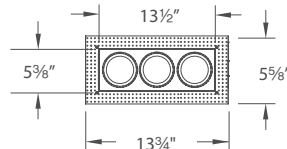
	Model	Finish	Trim/Reflector
 1 Light 	<b>MT-116TL</b>		
 2 Lights 	<b>MT-216TL</b>	Invisible Trim™	<b>WT</b> White
 3 Lights 	<b>MT-316TL</b>		

Example: **MT-316-WT/BK**

### Lenses, Louvers & Lamps

#### Colored Lenses

Color	
<b>AMB</b>	Amber
<b>BLU</b>	Blue
<b>GRN</b>	Green
<b>RED</b>	Red
<b>YEL</b>	Yellow

#### Lenses & Louvers

<b>LENS-16-UVF</b>	UV Filter Lens
<b>LENS-16-FR</b>	Frosted Lens
<b>LENS-16-HCL</b>	Honeycomb Louver
<b>LENS-16-SPR</b>	Spread Lens
<b>LENS-16-BEL</b>	Beam Elongating Lens

#### LED MR16 Lamp Finish

<b>MR16LED-BAB</b>	<b>BK</b> Black
	<b>WT</b> White

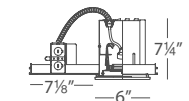
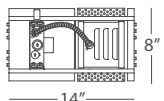
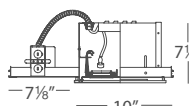
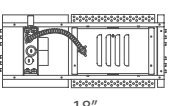
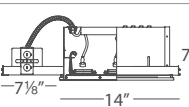
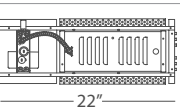

Low Voltage Multiple Spot housings (Required)

Low Voltage Multiple Spot housings (Required)		Model	Type	Rating	Lamp
		<b>MT-116HS</b>	1 Light	Non-IC	1 x MR16, 50W
		<b>MT-216HS</b>	2 Lights		2 x MR16, 50W
		<b>MT-316HS</b>	3 Lights		3 x MR16, 50W

Example: **MT-216HS**

Non-IC housings require 3" of clearance from insulation on all sides.  
Accommodates ceiling thickness of up to 1" for remodel & 3/4" for new construction.

# Line Voltage 4" PAR20

## Interchangeable Lamps

- Durable stamped metal construction
- Retention clips hold trim firmly to housing
- Abrasion resistant powder coat paint or plated metal finish
- Various lamp options available including LED



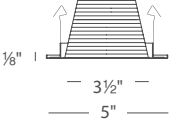

## Downlight Trims (Order Housing Separately)

	Model	Lamp	Finish	Reflector/Trim
 Open Reflector 	<b>R-421</b>	PAR20, 50W R20, 50W	<b>BN</b> <b>CL/WT</b>	Brushed Nickel Specular Clear/White



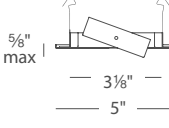

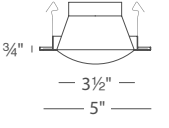
	Model	Lamp	Finish	Baffle/Trim
 Step Baffle 	<b>R-420</b>	PAR20, 50W R20, 50W	<b>BN</b> <b>CB</b> <b>WT/WT</b>	Brushed Nickel/Brushed Nickel Copper Bronze/Copper Bronze White/White

## Specialty Trims (Order Housing Separately)

	Model	Lamp	Finish	Trim
 Gimbal Ring 20° Adjustment from Vertical 	<b>R-432</b>	PAR20, 50W	<b>BN</b> <b>CB</b> <b>WT</b>	Brushed Nickel Copper Bronze White
 Shower Light with Glass Lens (Wet Location Listed) 	<b>R-422</b>	A19, 40W	<b>WT</b>	White

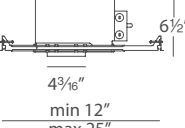
Example: **R-420-CB**

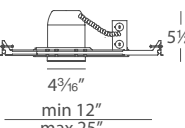
## Housings (Required)

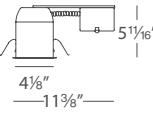
	Model	Installation	Rating	Voltage
 IC-Rated New Construction 	<b>R-402S-N-ICA</b>	New Construction	IC – Airtight Ready	120V
 Non-IC New Construction 	<b>R-400S-N-A</b>	New Construction	Non-IC – Airtight Ready	
 Non-IC Remodel 	<b>R-401S-R-A</b>	Remodel	Non-IC – Airtight Ready	

Non-IC housings require 3" of clearance from insulation on all sides.  
Accommodates ceiling thickness of up to 3/4" for remodel & 3/4" for new construction.

### LED PAR20 Lamp

Model	Finish
<b>PAR20LED-10N30</b>	<b>BK</b> Black <b>WT</b> White



# Line Voltage 5" PAR30/A19

## Interchangeable Lamps



- Durable stamped metal construction
- Steel spring clips secure lamp to housing
- Provided with foam rubber gasket around outer perimeter
- Abrasion resistant powder coat paint or plated metal finish
- Snap-in socket holders secure and position lamps
- Various lamp options available including LED

## Downlight Trims (Order Housing Separately)

	Model	Lamp	IC	Non-IC	Finish	Reflector/Trim
 Open Reflector 	<b>R-521</b>	A19 PAR30 R30	40W 50W 50W	60W 75W 75W	<b>CL/WT</b>	Specular Clear/White

	Model	Lamp	IC	Non-IC	Finish	Baffle/Trim
 Step Baffle 	<b>R-520</b>	A19 PAR30 R30	40W 50W 50W	60W 75W 75W	<b>BN CB WT/WT</b>	Brushed Nickel/Brushed Nickel Copper Bronze/Copper Bronze White/White

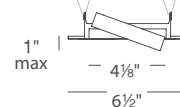

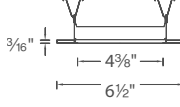
## Specialty Trims (Order Housing Separately)

	Model	Lamp	Non-IC	Finish	Trim
 Gimbal Ring 20° Adjustment from Vertical 	<b>R-532</b>	PAR30	75W	<b>BN WT</b>	Brushed Nickel White
 Shower Light with Glass Lens (Wet Location Listed) 	<b>R-522</b>	A19	40W	<b>WT</b>	White

Example: **R-522-WT**

Open Reflector	Step Baffle	Shower Light	Gimbal Ring
Produces Smooth Beams & More Efficiency Without Glare	Absorbs Stray Light to Reduce Glare	Wet Location Listed with Glass Lens	Adjustable Angle While Keeping the Light at the Ceiling Plane

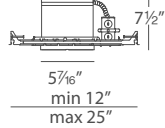
## Housings (Required)

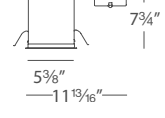
	Model	Installation	Rating	Voltage
 IC or Non-IC New Construction 	<b>R-500-N-UA</b>	New Construction	IC/Non-IC Rated – Airtight Ready  (Can be used in IC or Non-IC construction - depending on lamp type above)	120V
 IC or Non-IC Remodel 	<b>R-501-R-UA</b>	Remodel		

Non-IC housings require 3" of clearance from insulation on all sides.  
Accommodates ceiling thickness of up to 3/4" for remodel & 3/4" for new construction.

## LED PAR30 Lamp

Model	Finish
<b>PAR30LED-L14N30</b>	<b>BK</b> Black <b>WT</b> White







# Line Voltage 6" PAR30/A19

## Interchangeable Lamps

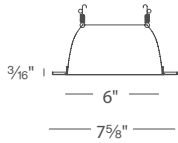
- Durable stamped metal construction
- Trims secured to housings with steel springs
- Provided with foam rubber gasket around outer perimeter
- Abrasion resistant powder coat paint or plated metal finish
- Various lamp options available including LED

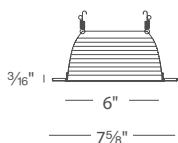

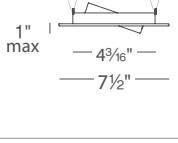

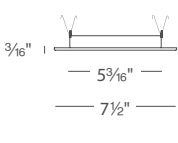
## Trims (Order Housing Separately)

	Model	Lamp	Finish	Reflector/Trim
 <p>Open Reflector</p> 	<b>R-656</b>	PAR30, 75W R30, 75W	<b>CL/WT</b>	Specular/White
 <p>Step Baffle</p> 	<b>R-620</b>	PAR30, 75W R30, 75W	<b>BN CB WT/WT</b>	Brushed Nickel/Brushed Nickel Copper Bronze/Copper Bronze White/White
 <p>Gimbal Ring 20° Adjustment from Vertical</p> 	<b>R-633</b>	PAR30, 75W	<b>BN WT</b>	Brushed Nickel White
 <p>Shower Light with Glass Lens</p> <p>(Wet Location Listed)</p> 	<b>R-651</b>	A19, 40W	<b>WT</b>	White

Example: **R-620-BN**

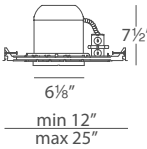
## Housings (Required)

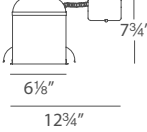
	Model	Installation	Rating	Voltage
 <p>IC-Rated New Construction</p> 	<b>R-602D-N-ICA</b>	New Construction	IC – Airtight Ready	120V
 <p>IC-Rated Remodel</p> 	<b>R-603D-R-ICA</b>	Remodel		

Non-IC housings require 3" of clearance from insulation on all sides.

Accommodates ceiling thickness of up to 3/4" for remodel & 3/4" for new construction.

## LED PAR30 Lamp

Model	Finish
<b>PAR30LED-L14N30</b> LED PAR30 Lamp	<b>BK</b> Black <b>WT</b> White

**Open Reflector**  
Produces Smooth Beams  
& More Efficiency Without Glare

**Step Baffle**  
Absorbs Stray Light to Reduce Glare

**Shower Light**  
Wet Location Listed  
with Glass Lens

**Gimbal Ring**  
Adjustable Angle While Keeping  
the Light at the Ceiling Plane







# Line Voltage PAR30 Multiple Spots

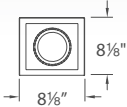

## Adjustable Recessed Lights

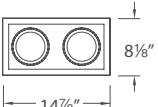
- May be installed in new construction or drop ceilings
- Invisible Trim™ design includes patented spackle trim to ensure smooth ceiling finish and a clean look
- 25° vertical adjustment, 350° horizontal rotation
- Order lamps separately

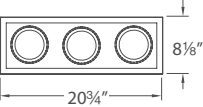
### Trims (Order Housing Separately)

	Model	Finish	Trim/Reflector
 1 Light  8 1/8"	<b>MT-130</b>	<b>WT/WT</b> <b>WT/BK</b>	White/White White/Black
 2 Lights  14 7/8" 8 1/8"	<b>MT-230</b>		
 3 Lights  20 3/4" 8 1/8"	<b>MT-330</b>		

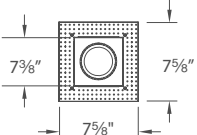
### Invisible Trims (Order Housing Separately)

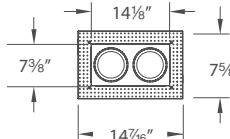
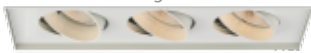
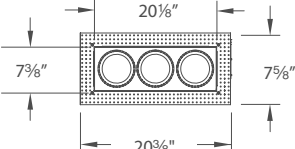
	Model	Finish	Trim/Reflector
 1 Light  7 5/8"	<b>MT-130TL</b>	<b>WT</b>	White
 2 Lights  14 1/8" 7 5/8"	<b>MT-230TL</b>		
 3 Lights  20 5/8" 7 5/8"	<b>MT-330TL</b>		

Example: **MT-330-WT/BK**

### Line Voltage PAR30 Multiple Spot housings (Required)

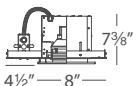
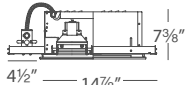
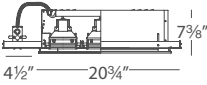
	Model	Type	Rating	Lamp
 4 1/2" — 8" — 7 3/8"	<b>MT-130HS</b>	1 Light	Non-IC	1 x PAR30, 75W
 4 1/2" — 14 7/8" — 7 3/8"	<b>MT-230HS</b>	2 Lights		2 x PAR30, 75W
 4 1/2" — 20 3/4" — 7 3/8"	<b>MT-330HS</b>	3 Lights		3 x PAR30, 75W

Example: **MT-130HS**

Non-IC housings require 3" of clearance from insulation on all sides.  
Accommodates ceiling thickness of up to 3/4" for remodel & 3/4" for new construction.

#### LED PAR30 Lamp







Model	Finish
<b>PAR30LED-L14N30</b>	<b>BK</b> Black <b>WT</b> White

# Metal Halide PAR30 Multiple Spots

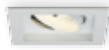
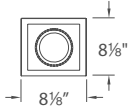
## Adjustable Recessed Lights

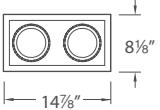
- All fixtures operate on all voltages from 120V through 277V
- Integral electronic ballasts
- May be installed in new construction or in grid ceilings
- Individually adjustable lighting elements offered with minimal extension below the ceiling plane
- 25° vertical adjustment, 350° horizontal rotation
- Order lamps separately (CDM PAR30 - 20W, 39W or 70W)

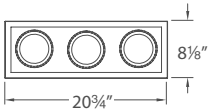
## Trims (Order Housing Separately)

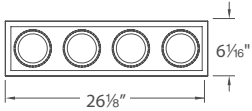
	Model	Finish	Trim/Reflector
 1 Light  8 1/8"	<b>MT-130MH</b>		
 2 Lights  14 7/8" 8 1/8"	<b>MT-230MH</b>	<b>WT/WT</b> White/White <b>WT/BK</b> White/Black	
 3 Lights  20 3/4" 8 1/8"	<b>MT-330MH</b>		
 4 Lights  26 1/8" 6 1/16"	<b>MT-430MH</b>		

Example: **MT-330MH-WT/BK**

## Metal Halide PAR30 Multiple Spot Housings (Required)

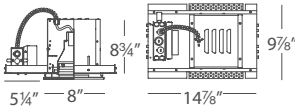
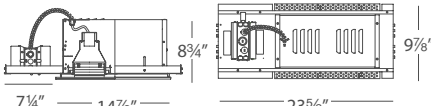
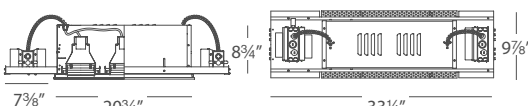
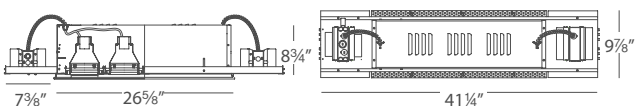
	Model	Type	Rating	Lamp
 5 1/4" 8" 8 3/4" 14 7/8" 9 7/8"	<b>MT-130MH</b>	1-Light	Non-IC	<b>20</b> 1 x 20W <b>39</b> 1 x 39W <b>70</b> 1 x 70W
 7 1/4" 14 7/8" 8 3/4" 23 5/8" 9 7/8"	<b>MT-230MH</b>	2-Lights		<b>20</b> 2 x 20W <b>39</b> 2 x 39W <b>70</b> 2 x 70W
 7 3/8" 20 3/4" 8 3/4" 33 1/4" 9 7/8"	<b>MT-330MH</b>	3-Lights		<b>20</b> 3 x 20W <b>39</b> 3 x 39W <b>70</b> 3 x 70W
 7 3/8" 26 5/8" 8 3/4" 41 1/4" 9 7/8"	<b>MT-430MH</b>	4-Lights		<b>20</b> 4 x 20W <b>39</b> 4 x 39W <b>70</b> 4 x 70W

Example: **MT-130MH-39**

Non-IC housings require 3" of clearance from insulation on all sides.  
Accommodates ceiling thickness of up to 3/4" for remodel & 3/4" for new construction.

# 1" Aperture Recessed Downlights

Select by Trim Type

	Product	Model	CCT	Max Lumens	Finish	Cutout	Compatible Housing	Input	Max Power	All Specs
Downlights		<b>HR-LED211E</b>	<b>27</b> 2700K <b>W</b> 3000K <b>35</b> 3500K <b>C</b> 4500K	200	<b>BN</b> <b>GM</b> <b>WT</b>	2½"	IC rated new construction and remodel in one configurable unit.	120 V	3.5W (LED)	p.11-12
		<b>HR-LED231R</b>	IC rated Remote Driver (Required, Order Separately)				p.11-12			
Adjustable		<b>HR-LED251E</b>	<b>27</b> 2700K <b>W</b> 3000K <b>35</b> 3500K <b>C</b> 4500K	200	<b>BN</b> <b>GM</b> <b>WT</b>	2½"	IC rated new construction and remodel in one configurable unit.	120 V	3.5W (LED)	p.11-12
		<b>HR-LED271R</b>	Remote Driver (Required, Order Separately)				p.11-12			
Adjustable		<b>HR-LED212E</b> (20° Adjustment from Vertical)	<b>27</b> 2700K <b>W</b> 3000K <b>35</b> 3500K <b>C</b> 4500K	200	<b>BN</b> <b>GM</b> <b>WT</b>	2½"	IC rated new construction and remodel in one configurable unit.	120 V	3.5W (LED)	p.11-12
		<b>HR-LED232R</b> (20° Adjustment from Vertical)	Remote Driver (Required, Order Separately)				p.11-12			
Adjustable		<b>HR-LED252E</b> (20° Adjustment from Vertical)	<b>27</b> 2700K <b>W</b> 3000K <b>35</b> 3500K <b>C</b> 4500K	200	<b>BN</b> <b>GM</b> <b>WT</b>	2½"	IC rated new construction and remodel in one configurable unit.	120 V	3.5W (LED)	p.11-12
		<b>HR-LED272R</b> (20° Adjustment from Vertical)	Remote Driver (Required, Order Separately)				p.11-12			

# 2" Aperture Recessed Downlights

Select by Trim Type

	Product	Model	Beam	CCT	Max Lumens	Finish	Cutout	Compatible Housing	All Specs	
Downlights		<b>HR-2LED-T109</b>	<b>S</b> 15° <b>N</b> 26° <b>F</b> 45°		595				p.5	
Adjustable		<b>HR-2LD-ET109</b> Energy Star®	<b>S</b> 16.5° <b>N</b> 30° <b>F</b> 53°		730	<b>BN</b> <b>CB</b> <b>WT</b>	2"	Model Housing Type* Voltage Max Power <b>HR-2LED-H09D-ICA</b> <b>a</b> 120V 14.5W (LED) L: 15 - 24½" W: 15½" H: 5½"	p. 4	
								<b>HR-2LED-H09-HICA</b> <b>a</b> 277V 10.5W (LED) L: 15 - 24½" W: 15½" H: 5½"		
								<b>HR-2LED-R09D-A</b> <b>d</b> 120V 14.5W (LED) L: 13¾" W: 3½" H: 5½"		
Adjustable		<b>HR-2LED-T709</b>	<b>S</b> 15° <b>N</b> 26° <b>F</b> 45°		615				p. 5	
Adjustable		<b>HR-2LED-T309</b> (0-30°)			590				p. 5	
Adjustable		<b>HR-2LED-T409</b> (30-45°)	<b>S</b> 15° <b>N</b> 26° <b>F</b> 45°		495	<b>BN</b> <b>CB</b> <b>WT</b>	2"	<b>HR-2LED-H09D-ICA</b> <b>a</b> 120V 14.5W (LED) L: 15 - 24½" W: 15½" H: 5½"	p. 5	
								<b>HR-2LED-H09-HICA</b> <b>a</b> 277V 10.5W (LED) L: 15 - 24½" W: 15½" H: 5½"		
Adjustable		<b>HR-2LED-T509</b> (0-30°)			540				p. 5	
Shower		<b>HR-2LED-T209</b>	<b>N</b> 26°		535	<b>BN</b> <b>CB</b> <b>WT</b>	2"	<b>HR-2LED-H09D-ICA</b> <b>a</b> 120V 14.5W (LED) L: 15 - 24½" W: 15½" H: 5½"	p. 5	
								<b>HR-2LED-H09-HICA</b> <b>a</b> 277V 10.5W (LED) L: 15 - 24½" W: 15½" H: 5½"		
								<b>HR-2LED-R09D-A</b> <b>d</b> 120V 14.5W (LED) L: 13¾" W: 3½" H: 5½"		

\*Compatible Housing Types

a: New Construction IC-Rated



b: New Construction Non-IC-Rated

c: Remodel IC-Rated

d: Remodel Non-IC-Rated













## 2.5" Aperture Recessed Downlights

Select by Trim Type

Product	Model	Max Lumens	Finish	Cutout	Compatible Housing	All Specs				
Low Voltage MR16		<b>HR-834</b>	800 (50W)	WT WT/WT	2 5/8"	Model	Housing Type*	Voltage	Max Power	p.25
		<b>HR-836</b>				<b>HR-802</b>	<b>b</b>	120V	50W MR16	p.25
		<b>HR-837</b>				<b>HR-801</b>	<b>d</b>	120V	50W MR16	
		540 (35W)	BK BN CB CH WT	<b>HR-800</b>	n/a	12V/24V	35W MR16	p.25		
				<b>HR-806</b>	<b>d</b>	12V/24V	35W MR16			

## 3" Aperture Recessed Downlights

Select by Trim Type

Product	Model	CCT	Max Lumens	Finish	Cutout	Compatible Housing	All Specs				
LED		2700K 3000K 3500K 4500K	515	BK/BN WT/WT	3 7/8"	Model	CCT	Hous Type*	Voltage	Max Power	p.13-14
						<b>HR-LED309-NIC</b>	27 W 2700K 35 W 3000K 35 C 3500K 4500K	<b>a</b>	120V	5.5W (LED)	p.13-14
						<b>HR-LED309-N</b>		<b>b</b>	120V	8W (LED)	
	<b>HR-LED309-RIC</b>	<b>c</b>	120V	5.5W (LED)							
	<b>HR-LED309-R</b>	<b>d</b>	120V	8W (LED)							
Low Voltage MR16		n/a	800	WT/WT	3 7/8"	<b>HR-302E</b>	<b>b</b>	120V	50W MR16	p.27-28	
						<b>HR-302M</b>	<b>b</b>	120V	50W MR16	p.27-28	
						<b>HR-301E</b>	<b>d</b>	120V	50W MR16		
LED		2700K 3000K 3500K 4500K	540	CH WT	3 7/8"	<b>HR-301M</b>	<b>d</b>	120V	50W MR16	p.27-28	
						<b>HR-LED309-NIC</b>	27 W 2700K 35 W 3000K 35 C 3500K 4500K	<b>a</b>	120V	5.8W (LED)	p.13-14
						<b>HR-LED309-N</b>		<b>b</b>	120V	8W (LED)	
	<b>HR-LED309-RIC</b>	<b>c</b>	120V	5.8W (LED)							
	<b>HR-LED309-R</b>	<b>d</b>	120V	8W (LED)							
Low Voltage MR16		n/a	800	WT	3 7/8"	<b>HR-302E</b>	<b>b</b>	120V	50W MR16	p.27-28	
						<b>HR-302M</b>	<b>b</b>	120V	50W MR16	p.27-28	
						<b>HR-301E</b>	<b>d</b>	120V	50W MR16		
				<b>BN WT</b>		<b>HR-301M</b>	<b>d</b>	120V	50W MR16	p.27-28	

\*Compatible Housing Types a: New Construction IC-Rated b: New Construction Non-IC-Rated c: Remodel IC-Rated d: Remodel Non-IC-Rated

# 3.5" Aperture Recessed Downlights

Select by Trim Type

	Product	Model	Beam	CCT	Max Lumens	Finish	Cutout	Compatible Housings	All Specs
Pin Hole		HR-3LED-T618	S 15°			BN CB WT			p.7-8
		HR-3LED-T318	S 15° N 28° F 50°		875	HZ/BN HZ/CB HZ/WT SB/BN SB/CB SB/WT BN CB WT			p.7-8
		HR-3LED-T118	S 15° N 28° F 50°			BN CB WT			p.7-8
Adjustable		HR-3LED-T418	S 15° N 28° F 41°						p.7-8
		HR-3LED-T518	S 15° N 28° F 50°	27 2700K W 3000K 35 3500K C 4500K 9W 3000K (90 CRI)	770	BN CB WT			p.7-8
		HR-3LED-T918	S 15° N 28° F 50°				4 5/8"		p.7-8
Shower		HR-3LED-T218	N 28°		875	BN CB WT			p.7-8
		HR-3LED-T818							p.7-8
		HR-3LED-T1818							p.7-8
Downlights		HR-3LED-ET118	F 40°		1070	BN CB WT			p.7-8
		HR-3LED-T718	S 15° N 28° F 50°		875	BN CB WT			p.7-8

Model	Housing Type*	Max Voltage	Max Power
HR-3LED-H18D-ICA L: 15 - 24 1/2" W: 16 3/4" H: 6"	a	120V - 277V	21.5W
HR-3LED-H18D-EMICA L: 15 - 24 1/2" W: 16 3/4" H: 6"	a	120V - 277V	21.5W
<i>Emergency Backup</i>			
HR-3LED-H18D1-ICA L: 10 1/8 - 24 1/2" W: 21" H: 6 1/2"	a	120V - 277V	21.5W
HR-3LED-H18D-A** L: 15 - 24 1/2" W: 8 1/4" H: 6 5/8"	b	120V - 277V	21.5W
HR-3LED-R18D-A** L: 13 3/4" W: 4 3/8" H: 6 5/8"	d	120V - 277V	21.5W









\*\*Not compatible with HR-3LED-T318, HR-3LED-T418, HR-3LED-T518, HR-LED-T618 and HR-3LED-T918 (when adjusted)

\*Compatible Housing Types a: New Construction IC-Rated b: New Construction Non-IC-Rated c: Remodel IC-Rated d: Remodel Non-IC-Rated



# 4" Aperture Recessed Downlights

Select by Trim Type

Product	Model	Beam	CCT	Max Lumens	Finish	Cutout	Compatible Housings	All Specs																																				
LED	 <b>HR-LED431</b>	n/a	2700K 3000K 3500K 4500K	1135	CH WT	4 3/8"	<table border="1"> <thead> <tr> <th>Model</th> <th>CCT</th> <th>Hous Type*</th> <th>Voltage</th> <th>Max Power</th> </tr> </thead> <tbody> <tr> <td><b>HR-LED418-NIC</b> L: 15 - 24 1/2" W: 6 3/4" H: 5 1/2"</td> <td rowspan="2">27 2700K 35 3000K 35 3500K C 4500K</td> <td>a</td> <td>120V</td> <td>10.2W</td> </tr> <tr> <td><b>HR-LED418-RIC</b> L: 11 7/8" W: 7 1/8" H: 5 5/8"</td> <td>c</td> <td>120V</td> <td>10.2W</td> </tr> <tr> <td><b>HR-LED418-N</b> L: 15 - 24 1/2" W: 6 3/4" H: 5 1/2"</td> <td rowspan="2">27 2700K 35 3000K 35 3500K C 4500K</td> <td>b</td> <td>120V</td> <td>16W</td> </tr> <tr> <td><b>HR-LED418-R</b> L: 11 7/8" W: 7 1/8" H: 5 5/8"</td> <td>d</td> <td>120V</td> <td>16W</td> </tr> <tr> <td><b>HR-LED418-N-EM</b> L: 15 - 24 1/2" W: 6 3/4" H: 5 1/2"</td> <td></td> <td>b</td> <td>120V</td> <td>16W Emergency Backup</td> </tr> </tbody> </table>	Model	CCT	Hous Type*	Voltage	Max Power	<b>HR-LED418-NIC</b> L: 15 - 24 1/2" W: 6 3/4" H: 5 1/2"	27 2700K 35 3000K 35 3500K C 4500K	a	120V	10.2W	<b>HR-LED418-RIC</b> L: 11 7/8" W: 7 1/8" H: 5 5/8"	c	120V	10.2W	<b>HR-LED418-N</b> L: 15 - 24 1/2" W: 6 3/4" H: 5 1/2"	27 2700K 35 3000K 35 3500K C 4500K	b	120V	16W	<b>HR-LED418-R</b> L: 11 7/8" W: 7 1/8" H: 5 5/8"	d	120V	16W	<b>HR-LED418-N-EM</b> L: 15 - 24 1/2" W: 6 3/4" H: 5 1/2"		b	120V	16W Emergency Backup	p.15-16								
	Model						CCT	Hous Type*	Voltage	Max Power																																		
<b>HR-LED418-NIC</b> L: 15 - 24 1/2" W: 6 3/4" H: 5 1/2"	27 2700K 35 3000K 35 3500K C 4500K	a	120V	10.2W																																								
<b>HR-LED418-RIC</b> L: 11 7/8" W: 7 1/8" H: 5 5/8"		c	120V	10.2W																																								
<b>HR-LED418-N</b> L: 15 - 24 1/2" W: 6 3/4" H: 5 1/2"	27 2700K 35 3000K 35 3500K C 4500K	b	120V	16W																																								
<b>HR-LED418-R</b> L: 11 7/8" W: 7 1/8" H: 5 5/8"		d	120V	16W																																								
<b>HR-LED418-N-EM</b> L: 15 - 24 1/2" W: 6 3/4" H: 5 1/2"		b	120V	16W Emergency Backup																																								
 <b>HR-LED471</b>								p.15-16																																				
Low Voltage MR16	 <b>HR-D418-S</b>	n/a	n/a	800 (50W) 1400 (75W)	WT	4 9/16"	<table border="1"> <tbody> <tr> <td><b>HR-8403H</b> L: 15 - 24 1/2" W: 10 3/4" H: 7 9/16"</td> <td>a</td> <td>120V</td> <td>50W MR16</td> </tr> <tr> <td><b>HR-8403HF</b> L: 15 - 24 1/2" W: 10 3/4" H: 7 9/16"</td> <td>a</td> <td>277V</td> <td>50W MR16</td> </tr> <tr> <td><b>HR-8402E</b> L: 15 - 24 1/2" W: 5 5/8" H: 4 1/4"</td> <td>b</td> <td>120V</td> <td>50W MR16</td> </tr> <tr> <td><b>HR-8402H</b> L: 15 - 24 1/2" W: 6 1/16" H: 5 1/2"</td> <td>b</td> <td>120V</td> <td>50W MR16</td> </tr> <tr> <td><b>HR-8402HF</b> L: 15 - 24 1/2" W: 6 1/16" H: 5 1/2"</td> <td>b</td> <td>277V</td> <td>50W MR16</td> </tr> <tr> <td><b>HR-8402HL*</b> L: 15 - 24 1/2" W: 6 1/16" H: 6 5/8"</td> <td>b</td> <td>120V</td> <td>75W MR16</td> </tr> <tr> <td><b>HR-8401E</b> L: 13 3/8" W: 4 5/8" H: 4 1/4"</td> <td>d</td> <td>120V</td> <td>50W MR16</td> </tr> <tr> <td><b>HR-8401H</b> L: 11 7/8" W: 4 1/8" H: 5 3/4"</td> <td>d</td> <td>120V</td> <td>50W MR16</td> </tr> <tr> <td><b>HR-8401HF</b> L: 11 7/8" W: 4 1/8" H: 5 3/4"</td> <td>d</td> <td>277V</td> <td>50W MR16</td> </tr> </tbody> </table> <p>*Not Compatible with HR-D418 or HR-D418-S</p>	<b>HR-8403H</b> L: 15 - 24 1/2" W: 10 3/4" H: 7 9/16"	a	120V	50W MR16	<b>HR-8403HF</b> L: 15 - 24 1/2" W: 10 3/4" H: 7 9/16"	a	277V	50W MR16	<b>HR-8402E</b> L: 15 - 24 1/2" W: 5 5/8" H: 4 1/4"	b	120V	50W MR16	<b>HR-8402H</b> L: 15 - 24 1/2" W: 6 1/16" H: 5 1/2"	b	120V	50W MR16	<b>HR-8402HF</b> L: 15 - 24 1/2" W: 6 1/16" H: 5 1/2"	b	277V	50W MR16	<b>HR-8402HL*</b> L: 15 - 24 1/2" W: 6 1/16" H: 6 5/8"	b	120V	75W MR16	<b>HR-8401E</b> L: 13 3/8" W: 4 5/8" H: 4 1/4"	d	120V	50W MR16	<b>HR-8401H</b> L: 11 7/8" W: 4 1/8" H: 5 3/4"	d	120V	50W MR16	<b>HR-8401HF</b> L: 11 7/8" W: 4 1/8" H: 5 3/4"	d	277V	50W MR16	p.29-30
	<b>HR-8403H</b> L: 15 - 24 1/2" W: 10 3/4" H: 7 9/16"						a	120V	50W MR16																																			
<b>HR-8403HF</b> L: 15 - 24 1/2" W: 10 3/4" H: 7 9/16"	a	277V	50W MR16																																									
<b>HR-8402E</b> L: 15 - 24 1/2" W: 5 5/8" H: 4 1/4"	b	120V	50W MR16																																									
<b>HR-8402H</b> L: 15 - 24 1/2" W: 6 1/16" H: 5 1/2"	b	120V	50W MR16																																									
<b>HR-8402HF</b> L: 15 - 24 1/2" W: 6 1/16" H: 5 1/2"	b	277V	50W MR16																																									
<b>HR-8402HL*</b> L: 15 - 24 1/2" W: 6 1/16" H: 6 5/8"	b	120V	75W MR16																																									
<b>HR-8401E</b> L: 13 3/8" W: 4 5/8" H: 4 1/4"	d	120V	50W MR16																																									
<b>HR-8401H</b> L: 11 7/8" W: 4 1/8" H: 5 3/4"	d	120V	50W MR16																																									
<b>HR-8401HF</b> L: 11 7/8" W: 4 1/8" H: 5 3/4"	d	277V	50W MR16																																									
 <b>HR-D418</b>					CB WT			p.29-30																																				
LED	 <b>MT-4LD116T</b>	20° 40°	2700K 3000K 3500K 4500K	1100	WT	4"	<table border="1"> <thead> <tr> <th>Model</th> <th>Beam</th> <th>CCT</th> <th>Hous Type*</th> <th>Voltage</th> <th>Max Power</th> </tr> </thead> <tbody> <tr> <td rowspan="4"><b>HR-4LD116N</b> L: 15 - 24 1/2" W: 6 3/4" H: 5 1/2"</td> <td>S 20°</td> <td>27 2700K</td> <td rowspan="4">b</td> <td rowspan="4">120V - 16W (LED) 277V</td> </tr> <tr> <td>F 40°</td> <td>30 3000K</td> </tr> <tr> <td></td> <td>35 3500K</td> </tr> <tr> <td></td> <td>40 4000K</td> </tr> <tr> <td></td> <td></td> <td>90 CRI</td> <td></td> <td></td> </tr> <tr> <td></td> <td></td> <td>927 2700K</td> <td></td> <td></td> </tr> <tr> <td></td> <td></td> <td>9W 3000K</td> <td></td> <td></td> </tr> </tbody> </table>	Model	Beam	CCT	Hous Type*	Voltage	Max Power	<b>HR-4LD116N</b> L: 15 - 24 1/2" W: 6 3/4" H: 5 1/2"	S 20°	27 2700K	b	120V - 16W (LED) 277V	F 40°	30 3000K		35 3500K		40 4000K			90 CRI					927 2700K					9W 3000K			p.21-22				
	Model						Beam	CCT	Hous Type*	Voltage	Max Power																																	
<b>HR-4LD116N</b> L: 15 - 24 1/2" W: 6 3/4" H: 5 1/2"	S 20°	27 2700K	b	120V - 16W (LED) 277V																																								
	F 40°	30 3000K																																										
		35 3500K																																										
		40 4000K																																										
		90 CRI																																										
		927 2700K																																										
		9W 3000K																																										
 <b>MT-4LD116TL</b>								p.21-23																																				
LED	 <b>MT-3LD1111A-F30</b> <i>(90 CRI Option)</i>	n/a	3000K	755	BK WT	4 3/4"	<table border="1"> <tbody> <tr> <td><b>New Construction Integral Housing</b></td> <td>Type*</td> <td>Voltage</td> <td>Max Power</td> </tr> <tr> <td>L: 15 - 24 1/2" W: 18 7/8" H: 5 5/8"</td> <td>b</td> <td>120V</td> <td>11W (LED)</td> </tr> <tr> <td><b>Remodel Integral Housing</b></td> <td>Type*</td> <td>Voltage</td> <td>Max Power</td> </tr> <tr> <td>L: 4 5/8" W: 4 1/8" H: 6"</td> <td>d</td> <td>120V</td> <td>11W (LED)</td> </tr> </tbody> </table>	<b>New Construction Integral Housing</b>	Type*	Voltage	Max Power	L: 15 - 24 1/2" W: 18 7/8" H: 5 5/8"	b	120V	11W (LED)	<b>Remodel Integral Housing</b>	Type*	Voltage	Max Power	L: 4 5/8" W: 4 1/8" H: 6"	d	120V	11W (LED)	p.20																				
	<b>New Construction Integral Housing</b>						Type*	Voltage	Max Power																																			
L: 15 - 24 1/2" W: 18 7/8" H: 5 5/8"	b	120V	11W (LED)																																									
<b>Remodel Integral Housing</b>	Type*	Voltage	Max Power																																									
L: 4 5/8" W: 4 1/8" H: 6"	d	120V	11W (LED)																																									
 <b>MT-3LD1111R-F30</b> <i>(90 CRI Option)</i>																																												

\*Compatible Housing Types

a: New Construction IC-Rated

b: New Construction Non-IC-Rated

c: Remodel IC-Rated

d: Remodel Non-IC-Rated

# 4" Aperture Recessed Downlights







Select by Trim Type

Product	Model	CCT	Max Lumens	Finish	Cutout	Compatible Housings	All Specs																																								
Downlights	HR-LED411TL <i>(Invisible Trim™)</i>	2700K 3000K 3500K 4500K	1135	WT/WT	4 3/8"	<table border="1"> <thead> <tr> <th>Model</th> <th>Shape</th> <th>CCT</th> <th>Hous Type*</th> <th>Max Volt</th> <th>Max Power</th> </tr> </thead> <tbody> <tr> <td>HR-LED418-NIC <i>L: 15 - 24 1/2" W: 6 3/4" H: 5 1/2"</i></td> <td rowspan="5">RO Round SQ Square</td> <td rowspan="5">27 2700K 35 3500K 35 3500K C 4500K</td> <td rowspan="2">a</td> <td rowspan="2">120V</td> <td rowspan="2">10.2W</td> </tr> <tr> <td>HR-LED418-RIC <i>L: 11 7/8" W: 7 1/8" H: 5 5/8"</i></td> </tr> <tr> <td>HR-LED418-N <i>L: 15 - 24 1/2" W: 6 3/4" H: 5 1/2"</i></td> <td rowspan="2">b</td> <td rowspan="2">120V</td> <td rowspan="2">15W</td> </tr> <tr> <td>HR-LED418-R <i>L: 11 7/8" W: 7 1/8" H: 5 5/8"</i></td> </tr> <tr> <td>HR-LED418-NIC <i>L: 15 - 24 1/2" W: 6 3/4" H: 5 1/2"</i></td> <td rowspan="3">a</td> <td rowspan="3">120V</td> <td rowspan="3">10.2W</td> </tr> <tr> <td>HR-LED418-RIC <i>L: 11 7/8" W: 7 1/8" H: 5 5/8"</i></td> </tr> <tr> <td>HR-LED418-N <i>L: 15 - 24 1/2" W: 6 3/4" H: 5 1/2"</i></td> </tr> <tr> <td>HR-LED418-R <i>L: 11 7/8" W: 7 1/8" H: 5 5/8"</i></td> <td rowspan="2">d</td> <td rowspan="2">120V</td> <td rowspan="2">16W</td> </tr> </tbody> </table>	Model	Shape	CCT	Hous Type*	Max Volt	Max Power	HR-LED418-NIC <i>L: 15 - 24 1/2" W: 6 3/4" H: 5 1/2"</i>	RO Round SQ Square	27 2700K 35 3500K 35 3500K C 4500K	a	120V	10.2W	HR-LED418-RIC <i>L: 11 7/8" W: 7 1/8" H: 5 5/8"</i>	HR-LED418-N <i>L: 15 - 24 1/2" W: 6 3/4" H: 5 1/2"</i>	b	120V	15W	HR-LED418-R <i>L: 11 7/8" W: 7 1/8" H: 5 5/8"</i>	HR-LED418-NIC <i>L: 15 - 24 1/2" W: 6 3/4" H: 5 1/2"</i>	a	120V	10.2W	HR-LED418-RIC <i>L: 11 7/8" W: 7 1/8" H: 5 5/8"</i>	HR-LED418-N <i>L: 15 - 24 1/2" W: 6 3/4" H: 5 1/2"</i>	HR-LED418-R <i>L: 11 7/8" W: 7 1/8" H: 5 5/8"</i>	d	120V	16W	p.17												
	Model			Shape			CCT	Hous Type*	Max Volt	Max Power																																					
	HR-LED418-NIC <i>L: 15 - 24 1/2" W: 6 3/4" H: 5 1/2"</i>			RO Round SQ Square			27 2700K 35 3500K 35 3500K C 4500K	a	120V	10.2W																																					
	HR-LED418-RIC <i>L: 11 7/8" W: 7 1/8" H: 5 5/8"</i>																																														
	HR-LED418-N <i>L: 15 - 24 1/2" W: 6 3/4" H: 5 1/2"</i>							b	120V	15W																																					
HR-LED418-R <i>L: 11 7/8" W: 7 1/8" H: 5 5/8"</i>																																															
HR-LED418-NIC <i>L: 15 - 24 1/2" W: 6 3/4" H: 5 1/2"</i>	a	120V	10.2W																																												
HR-LED418-RIC <i>L: 11 7/8" W: 7 1/8" H: 5 5/8"</i>																																															
HR-LED418-N <i>L: 15 - 24 1/2" W: 6 3/4" H: 5 1/2"</i>																																															
HR-LED418-R <i>L: 11 7/8" W: 7 1/8" H: 5 5/8"</i>	d	120V	16W																																												
HR-LED451TL <i>(Invisible Trim)</i>				WT/WT	p.17																																										
HR-LED411 <i>(Trim)</i>	BK/BN BK/WT WT/WT	p.15-16																																													
HR-LED421 <i>(Trim)</i>	WT/WT	p.15-16																																													
HR-LED451 <i>(Trim)</i>	BK/BN BK/WT WT/WT	p.15-16																																													
Adjustable	R-421	n/a	520	CL/WT	4 7/16"	<table border="1"> <tbody> <tr> <td>R-402S-N-ICA <i>L: 12 - 25" W: 4 1/8" H: 6"</i></td> <td>a</td> <td>120V</td> <td>50W PAR20</td> </tr> <tr> <td>R-400S-N-A <i>L: 12 - 25" W: 4 1/8" H: 5 1/2"</i></td> <td>b</td> <td>120V</td> <td>50W PAR20</td> </tr> <tr> <td>R-401S-R-A <i>L: 11 3/8" W: 4 1/8" H: 5 1/16"</i></td> <td>d</td> <td>120V</td> <td>50W PAR20</td> </tr> </tbody> </table>	R-402S-N-ICA <i>L: 12 - 25" W: 4 1/8" H: 6"</i>	a	120V	50W PAR20	R-400S-N-A <i>L: 12 - 25" W: 4 1/8" H: 5 1/2"</i>	b	120V	50W PAR20	R-401S-R-A <i>L: 11 3/8" W: 4 1/8" H: 5 1/16"</i>	d	120V	50W PAR20	p.33																												
	R-402S-N-ICA <i>L: 12 - 25" W: 4 1/8" H: 6"</i>			a			120V	50W PAR20																																							
	R-400S-N-A <i>L: 12 - 25" W: 4 1/8" H: 5 1/2"</i>			b			120V	50W PAR20																																							
R-401S-R-A <i>L: 11 3/8" W: 4 1/8" H: 5 1/16"</i>	d	120V	50W PAR20																																												
R-420	BN CB	p.33																																													
R-432	BN CB WT	p.33																																													
Slot	HR-D416	n/a	800 (50W)  1400 (75W)	BK BN WT	4 9/16"	<table border="1"> <tbody> <tr> <td>HR-8403H <i>L: 15 - 24 1/2" W: 10 3/4" H: 7 9/16"</i></td> <td>a</td> <td>120V</td> <td>50W MR16</td> </tr> <tr> <td>HR-8403HF <i>L: 15 - 24 1/2" W: 10 3/4" H: 7 9/16"</i></td> <td>a</td> <td>277V</td> <td>50W MR16</td> </tr> <tr> <td>HR-8402E <i>L: 15 - 24 1/2" W: 5 9/16" H: 4 1/4"</i></td> <td>b</td> <td>120V</td> <td>50W MR16</td> </tr> <tr> <td>HR-8402H <i>L: 15 - 24 1/2" W: 6 1/16" H: 5 1/2"</i></td> <td>b</td> <td>120V</td> <td>50W MR16</td> </tr> <tr> <td>HR-8402HF <i>L: 15 - 24 1/2" W: 6 1/16" H: 5 1/2"</i></td> <td>b</td> <td>277V</td> <td>50W MR16</td> </tr> <tr> <td>HR-8402HL* <i>L: 15 - 24 1/2" W: 6 1/16" H: 6 5/16"</i></td> <td>b</td> <td>120V</td> <td>75W MR16</td> </tr> <tr> <td>HR-8401E <i>L: 13 3/16" W: 4 5/16" H: 4 1/4"</i></td> <td>d</td> <td>120V</td> <td>50W MR16</td> </tr> <tr> <td>HR-8401H <i>L: 11 1/16" W: 4 1/8" H: 5 3/4"</i></td> <td>d</td> <td>120V</td> <td>50W MR16</td> </tr> <tr> <td>HR-8401HF <i>L: 11 1/16" W: 4 1/8" H: 5 3/4"</i></td> <td>d</td> <td>277V</td> <td>50W MR16</td> </tr> <tr> <td colspan="4">*Not Compatible with HR-D418 or HR-D418-S</td> </tr> </tbody> </table>	HR-8403H <i>L: 15 - 24 1/2" W: 10 3/4" H: 7 9/16"</i>	a	120V	50W MR16	HR-8403HF <i>L: 15 - 24 1/2" W: 10 3/4" H: 7 9/16"</i>	a	277V	50W MR16	HR-8402E <i>L: 15 - 24 1/2" W: 5 9/16" H: 4 1/4"</i>	b	120V	50W MR16	HR-8402H <i>L: 15 - 24 1/2" W: 6 1/16" H: 5 1/2"</i>	b	120V	50W MR16	HR-8402HF <i>L: 15 - 24 1/2" W: 6 1/16" H: 5 1/2"</i>	b	277V	50W MR16	HR-8402HL* <i>L: 15 - 24 1/2" W: 6 1/16" H: 6 5/16"</i>	b	120V	75W MR16	HR-8401E <i>L: 13 3/16" W: 4 5/16" H: 4 1/4"</i>	d	120V	50W MR16	HR-8401H <i>L: 11 1/16" W: 4 1/8" H: 5 3/4"</i>	d	120V	50W MR16	HR-8401HF <i>L: 11 1/16" W: 4 1/8" H: 5 3/4"</i>	d	277V	50W MR16	*Not Compatible with HR-D418 or HR-D418-S				p.29-30
	HR-8403H <i>L: 15 - 24 1/2" W: 10 3/4" H: 7 9/16"</i>			a			120V	50W MR16																																							
	HR-8403HF <i>L: 15 - 24 1/2" W: 10 3/4" H: 7 9/16"</i>			a			277V	50W MR16																																							
	HR-8402E <i>L: 15 - 24 1/2" W: 5 9/16" H: 4 1/4"</i>			b			120V	50W MR16																																							
	HR-8402H <i>L: 15 - 24 1/2" W: 6 1/16" H: 5 1/2"</i>			b			120V	50W MR16																																							
	HR-8402HF <i>L: 15 - 24 1/2" W: 6 1/16" H: 5 1/2"</i>			b			277V	50W MR16																																							
	HR-8402HL* <i>L: 15 - 24 1/2" W: 6 1/16" H: 6 5/16"</i>			b			120V	75W MR16																																							
	HR-8401E <i>L: 13 3/16" W: 4 5/16" H: 4 1/4"</i>			d			120V	50W MR16																																							
	HR-8401H <i>L: 11 1/16" W: 4 1/8" H: 5 3/4"</i>			d			120V	50W MR16																																							
	HR-8401HF <i>L: 11 1/16" W: 4 1/8" H: 5 3/4"</i>			d			277V	50W MR16																																							
	*Not Compatible with HR-D418 or HR-D418-S																																														
HR-D425	BK BN CB WT	p.29-30																																													
HR-8417 <i>(Steel)</i>	BK BN CB WT	p.29-30																																													
HR-D417 <i>(Die Cast Aluminum)</i>	BN WT	p.29-30																																													
HR-D412	SC/BN SC/WT	p.29-30																																													
HR-D412-S	SC/BN SC/WT	p.29-30																																													
HR-D411	WT/WT	p.29-30																																													
HR-8412	BN CL	p.29-30																																													
HR-8411	BN CB WT WT/WT	p.29-30																																													
HR-D413	WT	p.29-30																																													

\*Compatible Housing Types a: New Construction IC-Rated b: New Construction Non-IC-Rated c: Remodel IC-Rated d: Remodel Non-IC-Rated





# 5" Aperture Recessed Downlights

Select by Trim Type

Product	Model	Max Lumens	Finish	Cutout	Compatible Housing	All Specs																				
PAR30	 <b>R-521</b>	1000	CL/WT	5 1/16"	<table border="1"> <thead> <tr> <th>Model</th> <th>Housing Type*</th> <th>Voltage</th> <th>Max Power</th> </tr> </thead> <tbody> <tr> <td><b>R-500-N-UA</b> L: 12 - 25" W: 5 7/16" H: 7"</td> <td>a or b (depending on lamp type)</td> <td>120V</td> <td>75W PAR30</td> </tr> <tr> <td><b>R-501-R-UA</b> L: 11 9/16" W: 5 3/8" H: 7 3/4"</td> <td>c or d (depending on lamp type)</td> <td>120V</td> <td>75W PAR30</td> </tr> <tr> <td><b>R-500-N-UA</b> L: 12 - 25" W: 5 7/16" H: 7"</td> <td>a or b (depending on lamp type)</td> <td>120V</td> <td>40W A19</td> </tr> <tr> <td><b>R-501-R-UA</b> L: 11 9/16" W: 5 3/8" H: 7 3/4"</td> <td>c or d (depending on lamp type)</td> <td>120V</td> <td>40W A19</td> </tr> </tbody> </table>	Model	Housing Type*	Voltage	Max Power	<b>R-500-N-UA</b> L: 12 - 25" W: 5 7/16" H: 7"	a or b (depending on lamp type)	120V	75W PAR30	<b>R-501-R-UA</b> L: 11 9/16" W: 5 3/8" H: 7 3/4"	c or d (depending on lamp type)	120V	75W PAR30	<b>R-500-N-UA</b> L: 12 - 25" W: 5 7/16" H: 7"	a or b (depending on lamp type)	120V	40W A19	<b>R-501-R-UA</b> L: 11 9/16" W: 5 3/8" H: 7 3/4"	c or d (depending on lamp type)	120V	40W A19	p.34
	Model	Housing Type*	Voltage			Max Power																				
	<b>R-500-N-UA</b> L: 12 - 25" W: 5 7/16" H: 7"	a or b (depending on lamp type)	120V			75W PAR30																				
	<b>R-501-R-UA</b> L: 11 9/16" W: 5 3/8" H: 7 3/4"	c or d (depending on lamp type)	120V			75W PAR30																				
	<b>R-500-N-UA</b> L: 12 - 25" W: 5 7/16" H: 7"	a or b (depending on lamp type)	120V	40W A19																						
	<b>R-501-R-UA</b> L: 11 9/16" W: 5 3/8" H: 7 3/4"	c or d (depending on lamp type)	120V	40W A19																						
 <b>R-520</b>	1000	BN CB WT/WT	p.34																							
 <b>R-532</b>	1000	BN WT	p.34																							
 <b>R-522</b>	400	WT	p.34																							
Low Voltage MR16	 <b>MT116</b>	n/a	WT/WT WT/BK	5 5/8"	<table border="1"> <thead> <tr> <th>Model</th> <th>Housing Type*</th> <th>Voltage</th> <th>Max Power</th> </tr> </thead> <tbody> <tr> <td><b>MT-116HS</b> L: 14" W: 6" H: 7 1/4"</td> <td>b</td> <td>120V</td> <td>50W MR16</td> </tr> </tbody> </table>	Model	Housing Type*	Voltage	Max Power	<b>MT-116HS</b> L: 14" W: 6" H: 7 1/4"	b	120V	50W MR16	p.31-32												
	Model		Housing Type*			Voltage	Max Power																			
<b>MT-116HS</b> L: 14" W: 6" H: 7 1/4"	b	120V	50W MR16																							
 <b>MT116-TL</b>	WT	p.31-32																								





# 6" Aperture Recessed Downlights

Select by Trim Type

Product	Model	Max Lumens	Finish	Cutout	Compatible Housing	All Specs																					
LED	 <b>WR-6R1LD-T</b>	1565	HZ/WT SC/WT WT/WT	6 7/8"	<table border="1"> <thead> <tr> <th>Model</th> <th>Hous Type*</th> <th>Voltage</th> <th>90 CRI</th> <th>Color Temp</th> <th>Installation</th> <th>Max Power</th> </tr> </thead> <tbody> <tr> <td><b>WR-6RTLD (Bridgelux)</b> L: 12 5/8" W: 12 5/8" H: 7 5/8"</td> <td>b</td> <td>30 30H</td> <td>120V 277V</td> <td>9** 27 W 35 C</td> <td>2700K 3000K 3500K 4000K</td> <td>29W 22W</td> </tr> <tr> <td><b>WR-6RTLD (Xicato)</b> L: 12 5/8" W: 12 5/8" H: 7 5/8"</td> <td>b</td> <td>30-X 30H-X</td> <td>120V 277V</td> <td>n/a</td> <td></td> <td></td> </tr> </tbody> </table>	Model	Hous Type*	Voltage	90 CRI	Color Temp	Installation	Max Power	<b>WR-6RTLD (Bridgelux)</b> L: 12 5/8" W: 12 5/8" H: 7 5/8"	b	30 30H	120V 277V	9** 27 W 35 C	2700K 3000K 3500K 4000K	29W 22W	<b>WR-6RTLD (Xicato)</b> L: 12 5/8" W: 12 5/8" H: 7 5/8"	b	30-X 30H-X	120V 277V	n/a			p.9
					Model	Hous Type*	Voltage	90 CRI	Color Temp	Installation	Max Power																
<b>WR-6RTLD (Bridgelux)</b> L: 12 5/8" W: 12 5/8" H: 7 5/8"	b	30 30H	120V 277V	9** 27 W 35 C	2700K 3000K 3500K 4000K	29W 22W																					
<b>WR-6RTLD (Xicato)</b> L: 12 5/8" W: 12 5/8" H: 7 5/8"	b	30-X 30H-X	120V 277V	n/a																							
PAR30	 <b>R-620</b>	1050	BN CB WT/WT	6 7/8"	<table border="1"> <thead> <tr> <th>Model</th> <th>Type*</th> <th>Voltage</th> <th>Max Power</th> </tr> </thead> <tbody> <tr> <td><b>R-602D-N-ICA</b> L: 12 - 25" W: 6 1/8" H: 7"</td> <td>a</td> <td>120V</td> <td>75W</td> </tr> <tr> <td><b>R-603D-R-ICA</b> L: 12 3/4" W: 6 1/8" H: 7 3/4"</td> <td>c</td> <td>120V</td> <td>75W</td> </tr> </tbody> </table>	Model	Type*	Voltage	Max Power	<b>R-602D-N-ICA</b> L: 12 - 25" W: 6 1/8" H: 7"	a	120V	75W	<b>R-603D-R-ICA</b> L: 12 3/4" W: 6 1/8" H: 7 3/4"	c	120V	75W	p.35									
	Model		Type*			Voltage	Max Power																				
	<b>R-602D-N-ICA</b> L: 12 - 25" W: 6 1/8" H: 7"		a			120V	75W																				
	<b>R-603D-R-ICA</b> L: 12 3/4" W: 6 1/8" H: 7 3/4"		c			120V	75W																				
 <b>R-656</b> (100W max)	CL/WT	p.35																									
 <b>R-633</b>	BN WT	p.35																									
 <b>R-651</b> (60W max)	WT	p.35																									

# 7" Aperture Recessed Downlights

Select by Trim Type

Product	Model	CCT	Max Lumens	Finish	Cutout	Compatible Housing	All Specs												
LED	 <b>MT-5LD125T</b>	927 2700K (90 CRI) 27 2700K	1515	WT	6 5/8"	<table border="1"> <thead> <tr> <th>Model</th> <th>Hous Type*</th> <th>Voltage</th> <th>Max Power</th> </tr> </thead> <tbody> <tr> <td><b>MT-5LD125H-NA</b> L: 14 1/2 - 25" W: 16 1/8" H: 5"</td> <td>b</td> <td>120V</td> <td>22.5W (LED)</td> </tr> </tbody> </table>	Model	Hous Type*	Voltage	Max Power	<b>MT-5LD125H-NA</b> L: 14 1/2 - 25" W: 16 1/8" H: 5"	b	120V	22.5W (LED)	p.23-24				
	Model	Hous Type*					Voltage	Max Power											
<b>MT-5LD125H-NA</b> L: 14 1/2 - 25" W: 16 1/8" H: 5"	b	120V	22.5W (LED)																
 <b>MT-5LD125TL</b>	930 3000K (90 CRI) 30 3000K 35 3500K 40 4000K	p.23-24																	
PAR30	 <b>MT130</b>	n/a	n/a	WT/WT WT/BK	7 5/8"	<table border="1"> <thead> <tr> <th>Model</th> <th>Type*</th> <th>Voltage</th> <th>Max Power</th> </tr> </thead> <tbody> <tr> <td><b>MT-130HS</b> L: 14" W: 8" H: 7 5/8"</td> <td>b</td> <td>120V</td> <td>75W, PAR30</td> </tr> </tbody> </table>	Model	Type*	Voltage	Max Power	<b>MT-130HS</b> L: 14" W: 8" H: 7 5/8"	b	120V	75W, PAR30	p.37				
	Model			Type*			Voltage	Max Power											
<b>MT-130HS</b> L: 14" W: 8" H: 7 5/8"	b	120V	75W, PAR30																
 <b>MT130TL</b>	WT	p.37																	
Metal Halide	 <b>MT-130MH</b>			WT/WT WT/BK	7"	<table border="1"> <thead> <tr> <th>Model</th> <th>Lamp</th> <th>Type*</th> <th>Voltage</th> <th>Max Power</th> </tr> </thead> <tbody> <tr> <td rowspan="3"><b>MT-130MH</b> L: 14 7/8" W: 8" H: 8 3/4"</td> <td>20 20W</td> <td rowspan="3">b</td> <td rowspan="3">120V</td> <td rowspan="3">70W, CDM</td> </tr> <tr> <td>39 39W</td> </tr> <tr> <td>70 70W</td> </tr> </tbody> </table>	Model	Lamp	Type*	Voltage	Max Power	<b>MT-130MH</b> L: 14 7/8" W: 8" H: 8 3/4"	20 20W	b	120V	70W, CDM	39 39W	70 70W	p.38
Model	Lamp	Type*	Voltage	Max Power															
<b>MT-130MH</b> L: 14 7/8" W: 8" H: 8 3/4"	20 20W	b	120V	70W, CDM															
	39 39W																		
	70 70W																		

\*Compatible Housing Types a: New Construction IC-Rated b: New Construction Non-IC-Rated c: Remodel IC-Rated d: Remodel Non-IC-Rated

LED BEAUTY SPOTS™



Featured Product: DR-LED302-30-CH with DR-G362-CL

# LED Beauty Spots™

Polished and cut by hand from optic crystals to create sparkling patterns of light.  
An impressive custom crystal display arranged in a pattern or in a random array on walls or ceilings.  
Smooth and continuous ELV dimming. Also available in Xenon.

## 1. Choose a crystal (See next page for detailed images)

		<b>DR-G352-CL</b>	Clear
		<b>DR-G352-AM</b>	Amber
		<b>DR-G352-RD</b>	Red
		<b>DR-G352-BL</b>	Blue
		<b>DR-G362-CL</b>	Princess
		<b>DR-G361-CL</b>	Duchess
		<b>DR-G363-CL</b>	Empress
		<b>DR-G355-CL</b>	Cubix
		<b>DR-G356-CL</b>	Irix

## 2. Order a canopy for each crystal

			Color Temp	Lumens	Voltage	Wattage	Rated Life	Finish	Cutout
Integral LED		<b>DR-LED302-30-CH</b>	3000K	150	24V	4.5 W	50,000 hours	Chrome	2 3/8"
Bi-pin (12V Xenon included)		<b>DR-301-CH</b>	3000K	200	12V, 24V	20 W	10,000 hours	Chrome	2 3/8"

## 3. Select a corresponding transformer

		Input	Output	Min Load	Dimension (L x W x H)	Max Fixture Run	Max Run Length
Integral LED Canopy (Order with DR-LED302-30-CH)	<b>EN-2460-RB2</b>	120V	24V, 60W (class 2)	1W	6 1/2" x 1 5/8" x 1 1/4"	12	30'
	<b>EN-24100-RB2</b>	120V	24V, 96W (class 2)	1W	6 1/2" x 1 5/8" x 1 1/4"	21	40'
Xenon Bi-pin Canopy (Order with DR-301-CH)	<b>EN-1260-RB2</b>	120V	12V, 60W (class 2)	1W	6 5/8" x 1 5/8" x 1 1/8"	3	25'
	<b>EN-1275-RB-AR</b>	120V	12V, 75W	1W	6 5/8" x 1 5/8" x 1 1/8"	3	30'
	<b>EN-12100-RB-AR</b>	120V	12V, 100W	1W	6 1/4" x 3" x 1 5/8"	5	30'
	<b>EN-12150-RB-AR</b>	120V	12V, 150W	1W	6 1/4" x 3" x 1 5/8"	7	35'

# LED Beauty Spots™ Crystals

LED Beauty Spots™ system consists of a crystal, a canopy, and a transformer all sold separately  
Crystals are shown with LED canopy **DR-LED302-30-CH**  
See previous page for ordering information.

## Clear

DR-G352-CL



## Amber

DR-G352-AM



## Red

DR-G352-RD



## Blue

DR-G352-BL



## Princess

DR-G362-CL



## Duchess

DR-G361-CL



## Empress

DR-G363-CL

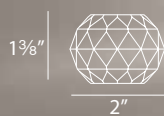

## Cubix

DR-G355-CL

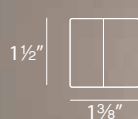

## Irix

DR-G356-CL

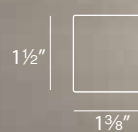

# LED EXTERIOR



Consult the factory to take advantage of our custom capabilities in large quantities.







**WS-W2504**

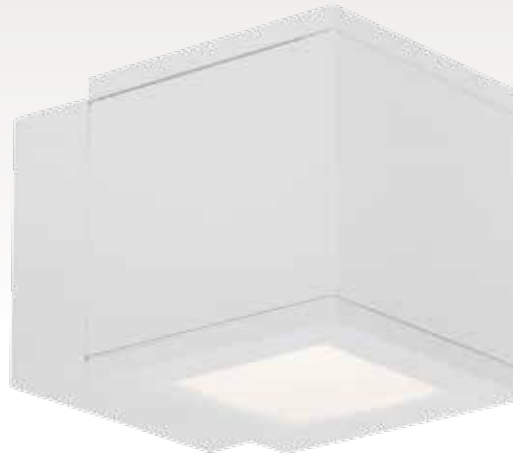



**WS-W2505**

**Comparable:** 75W MR16  
**Color Temp:** 3000K  
**CRI:** 85  
**Dimming:** 100% – 10%  
**Rated Life:** 70,000 hours

**High power exterior rated wall mount for safety and architectural illumination**

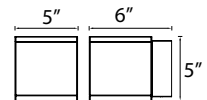
- Meets 2013 California Title 24 Efficiency
- IP65, ETL & cETL wet location listed
- Die-cast aluminum construction
- Powder coat finishes
- Smooth and continuous ELV dimming
- Universal driver (120V-220V-277V)



	Distribution		Beam	Voltage	Watt	Delivered Lumens	Finish
	<i>Down</i> <i>(Dark sky friendly)</i>	<b>WS-W2504</b>	88°	120V - 277V	17W	980	<b>AL</b> Brushed Aluminum <b>BK</b> Black <b>BZ</b> Bronze <b>GH</b> Graphite <b>WT</b> White
	<i>Up &amp; Down</i>	<b>WS-W2505</b>	70°	120V - 277V	33.5W	980 x2	

Example: **WS-W2505-GH**

# Rubix LED Ceiling Mount

**58**  
Lm/W

**73**  
Lm/W



**FM-W2505**



**FM-W2510**

	<b>FM-W2505</b>	<b>FM-W2510</b>
<b>Comparable:</b>	75W MR16	70W HID
<b>Color Temp:</b>	3000K	3000K
<b>CRI:</b>	85	85
<b>Dimming:</b>	100% – 10%	100 - 10%
<b>Rated Life:</b>	70,000 hours	70,000 hours

**High Power Exterior rated square ceiling mount for safety and architectural illumination**

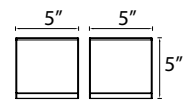

- Meets 2013 California Title 24 Efficiency
- IP65, ETL & cETL wet location listed
- Die-cast aluminum construction
- Powder coat finishes
- Smooth and continuous ELV dimming
- Universal driver (120V-220V-277V)



**FM-W2505**



**FM-W2510**

	Distribution	Beam	Voltage	Watt	Delivered Lumens	Finish
	Down	<b>FM-W2505</b>	88°	120V - 277V 17W	980	<b>AL</b> Brushed Aluminum <b>BK</b> Black <b>BZ</b> Bronze <b>GH</b> Graphite <b>WT</b> White
	Down	<b>FM-W2510</b>	97°	120V - 277V 32.5W	2365	

Example: **FM-W2510-GH**

# Tube LED Wall Mount

63  
Lm/W



**WS-W2605**







**WS-W2604**

**Comparable:** 75W MR16  
**Color Temp:** 3000K  
**CRI:** 85  
**Dimming:** 100% – 10%  
**Rated Life:** 70,000 hours

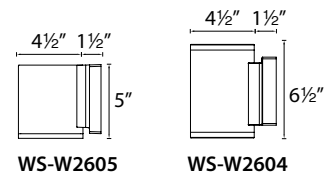
**High power exterior rated cylinder wall mount**

- Meets 2013 California Title 24 Efficiency
- IP65 rated, ETL & cETL wet location listed
- Solid aluminum construction
- Powder coat finishes
- Smooth and continuous ELV dimming

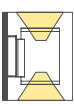

Distribution		Beam	Voltage	Watt	Delivered Lumens	Finish
		<b>WS-W2605</b> 35°	120V	18W	1145	<b>AL</b> Brushed Aluminum <b>BK</b> Black <b>BZ</b> Bronze <b>GH</b> Graphite <b>WT</b> White
		<b>WS-W2604</b> 20°	120V	32W	1098 x2	

Example: **WS-W2605-BK**

# Tube LED Ceiling Mount and Pendant Downlight

**59**  
Lm/W



**FM-W2605**



**PD-W2605**

**Comparable:** 75W MR16  
**Color Temp:** 3000K  
**CRI:** 85  
**Dimming:** 100% – 10%  
**Rated Life:** 70,000 hours

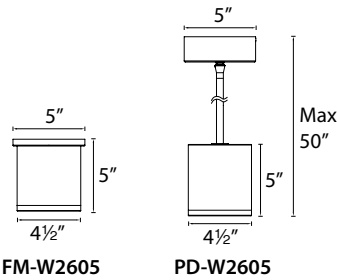

**High power exterior rated cylinder ceiling mount**

- Meets 2013 California Title 24 Efficiency
- IP65 rated, ETL & cETL wet location listed
- Solid aluminum construction
- Powder coat finishes
- Smooth and continuous ELV dimming



**FM-W2605**

**PD-W2605**

		Distribution		Beam	Voltage	Watt	Delivered Lumens	Finish
	Ceiling Mount	Down	<b>FM-W2605</b>	35°	120V	18W	1060	<b>AL</b> Brushed Aluminum <b>BK</b> Black <b>BZ</b> Bronze <b>GH</b> Graphite <b>WT</b> White
	Pendant	Down	<b>PD-W2605</b>	35°	120V	18W	1060	

Example: **PD-W2605-BK**

# Tube Architectural LED Wall Mount

**68**  
Lm/W



**Power:** 120V - 277V  
**CRI:** Up to 90  
**0-10V Dimming:** 100% - 10%  
**Rated Life:** 80,000 hours

## High performance facade LED wall mount light

- IP65 rated, ETL & cETL wet location listed
- Meets 2013 California Title 24 Efficiency
- Energy Star® rated
- Solid aluminum construction
- ANSI compliant warm/neutral LED bins, for the finest color consistency possible
- Universal driver (120V-220V-277V)

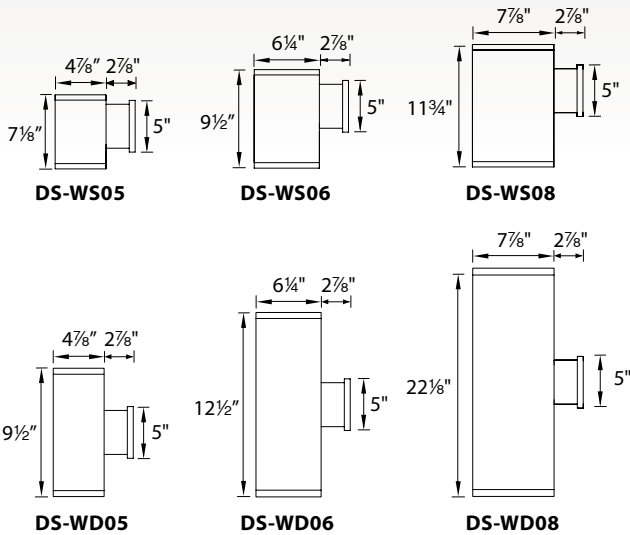

Distribution	Diameter	Watt	Max Delivered Lumens	Color Temp	Light Direction	Finish
Single <b>DS-WS</b>	<b>05</b>	5" 24W	1560	<b>F927</b> 2700K (90 CRI) <b>F27</b> 2700K	<b>S</b> Straight up or down <b>A</b> Away from the wall <b>B</b> Towards the wall	<b>BK</b> Black <b>WT</b> White <b>BZ</b> Bronze <b>GH</b> Graphite
	<b>06</b>	6" 42W	2445	<b>F930</b> 3000K (90CRI) <b>F30</b> 3000K		
	<b>08</b>	8" 54W	3685	<b>F35</b> 3500K		
Double <b>DS-WD</b>	<b>05</b>	5" 24W x2	1560 x2	<b>F927</b> 2700K (90CRI) <b>F27</b> 2700K <b>F930</b> 3000K (90CRI) <b>F30</b> 3000K <b>F35</b> 3500K	<b>S</b> Straight up and down	<b>BK</b> Black <b>WT</b> White <b>BZ</b> Bronze <b>GH</b> Graphite
	<b>06</b>	6" 42W x2	2445 x2		<b>A</b> Away from the wall	
	<b>08</b>	8" 54W x2	3685 x2		<b>B</b> Towards the wall	
	<b>C</b> One side each					

Example: **DS-WS06-F30B-BK**

# Tube Architectural LED Ceiling Mount and Pendant Downlight

**74**  
Lm/W



**Power:** 120V - 277V  
**CRI:** Up to 90  
**0-10V Dimming:** 100% - 10%  
**Rated Life:** 80,000 hours

## High performance exterior rated LED downlights

- IP65 rated, ETL & cETL wet location listed
- Meets 2013 California Title 24 Efficiency
- Energy Star® rated
- Solid aluminum construction
- ANSI compliant warm/neutral LED bins, for the finest color consistency possible
- Universal driver (120V-220V-277V)

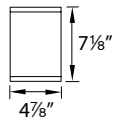

**DS-CD05**

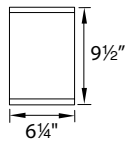

**DS-CD06**

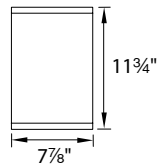

**DS-CD08**



**DS-CD05**



**DS-PD05**

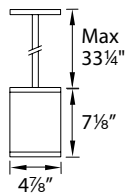

**DS-PD05**

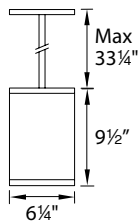

**DS-PD06**

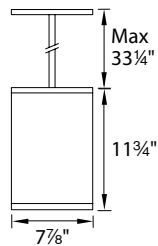

**DS-PD08**

	Diameter	Watt	Beam	Max Delivered Lumens	Max CBCP	Color Temp	Finish
Ceiling Mount <b>DS-CD</b>	<b>05</b> 5"	24W	<b>S</b> 20	1610	7065	<b>927</b> 2700K (90CRI) <b>27</b> 2700K <b>930</b> 3000K (90CRI) <b>30</b> 3000K <b>35</b> 3500K	<b>BK</b> Black <b>WT</b> White <b>BZ</b> Bronze <b>GH</b> Graphite
			<b>N</b> 27	1575	4485		
			<b>F</b> 36	1450	3045		
	<b>06</b> 6"	42W	<b>S</b> 17	2130	11725		
			<b>N</b> 30	2115	5495		
			<b>F</b> 42	2110	3500		
Pendant Mount <b>DS-PD</b>	<b>08</b> 8"	54W	<b>S</b> 14	4015	28660		
			<b>N</b> 28	4005	9390		
			<b>F</b> 40	4005	6490		

Example: **DS-CD08-S27-BZ**

# LED STEP & WALL

**SS:** 316 Marine Grade Stainless Steel Finish with Lifetime Warranty



Featured Product: **WL-LED100-C-SS**



# Rectangular Step and Wall Lights LEDme®



LED100  
Stainless Steel Finish

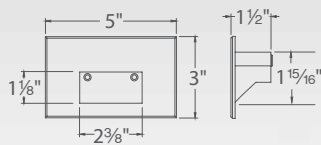

LED200  
Black Finish

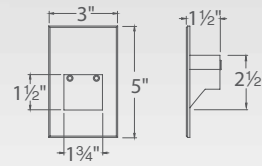

- |                                 |   |  |
|---------------------------------|---|--|
| <b>Power:</b> 3.9W              | • Die-cast aluminum or 316 marine grade stainless steel ( <b>SS</b> finish) | • 120V or 277V direct wiring, no driver needed |
| <b>Lumens:</b> Up to 68         | • Fits into 2" X 4" J-Box with minimum inside dimensions of 3"x2"x2"        | • No heat radiation                            |
| <b>CRI:</b> 85                  | • IP66, wet location rated for indoor and outdoor installations*            | • Smooth and continuous ELV dimming            |
| <b>Rated Life:</b> 40,000 hours | • 5 year WAC warranty (lifetime warranty for <b>SS</b> finish)              | • Replaceable LED module                       |

\*Finishes are not recommended for contact with chemicals or sustained contact with water. Use Stainless Steel Step and Wall Lights for harsh environments.

System	Color	Finish
<b>WL-LED100</b> <i>Horizontal Scoop, 120V</i>	<b>C</b> White 3000K (CCT)	<b>SS</b> Stainless Steel
<b>WL-LED100F</b> <i>Horizontal Scoop, 277V</i>	<b>AM</b> Amber 610nm (Peak)	<b>BK</b> Black
<b>WL-LED200</b> <i>Vertical Scoop, 120V</i>	<b>RD</b> Red 640nm (Peak)	<b>WT</b> White
<b>WL-LED200F</b> <i>Vertical Scoop, 277V</i>	<b>BL</b> Blue 450nm (Peak)	<b>BN</b> Brushed Nickel
		<b>BZ</b> Bronze

Example: **WL-LED100F-C-SS**

## Turtle Friendly

In coastal areas, bright step lights often attract marine life such as baby sea turtles, leading them away from the ocean by making them think it is the moon. Save the sea turtles by using amber or red step lights.



## Spacing Recommendations for Optimal Light Distribution

### Corridors / Hallways

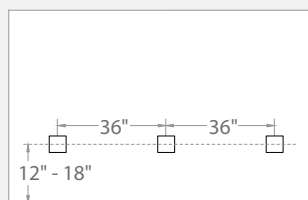

### Stairs - Wall Mount

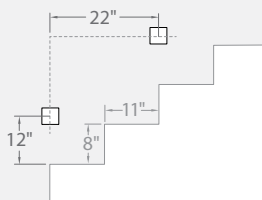

### Stairs - Step Mount

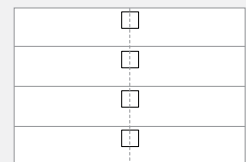

Mount in center of stair as close to the upper tread as possible. For best results use one light per step for steps narrower than 5 feet

# Rectangular Trimless Step and Wall Lights LEDme®

LED100TR

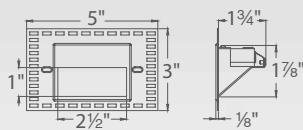

LED200TR

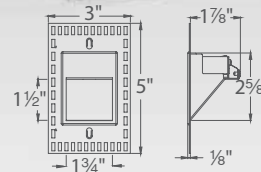

- |                                 |  |                                     |
|---------------------------------|--|-------------------------------------|
| <b>Power:</b> 3.3 W             | • Damp location listed   | • No heat radiation                 |
| <b>Lumens:</b> Up to 72         | • May be painted to match the color of wall or treads                | • Smooth and continuous ELV dimming |
| <b>CRI:</b> 85                  | • 120V direct wiring, no driver needed                               | • Replaceable LED module            |
| <b>Rated Life:</b> 40,000 hours | • Fits into 2" X 4" J-Box with minimum inside dimensions of 3"x2"x2" | • 5 year WAC warranty               |

System	Color	Finish
<b>WL-LED100TR</b> <i>Trimless Horizontal Scoop</i>	<b>C</b> White 3000K (CCT) <b>AM</b> Amber 610nm (Peak) <b>RD</b> Red 640nm (Peak) <b>BL</b> Blue 450nm (Peak)	<b>WT</b> White
<b>WL-LED200TR</b> <i>Trimless Vertical Scoop</i>		

Example: **WL-LED100TR-AM-WT**

## Healthier living for aging eyes

Aging eyes take longer to adjust to changes in light environment and momentary loss of vision is the number one cause of disabling falls. Step lights increase visibility in trouble spots such as entrances, stairwells, and hallways. Bright environments at night are also known to disrupt sleep patterns, but amber or red wall lights can replace the need for overhead lighting.



## Spacing Recommendations for Optimal Light Distribution

Corridors / Hallways

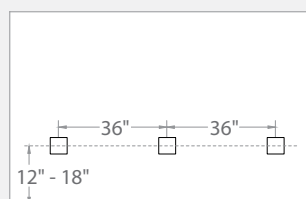

Stairs - Wall Mount

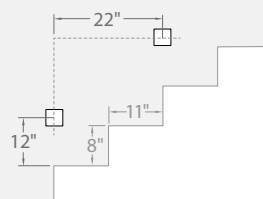

Stairs - Step Mount

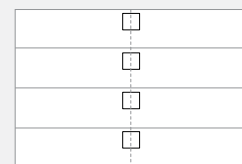

Mount in center of stair as close to the upper tread as possible. For best results use one light per step for steps narrower than 5 feet



Featured Product: **WL-LED100TR-AM-WT**

# Round Step and Wall Lights LEDme®



LED300  
Brushed Nickel Finish

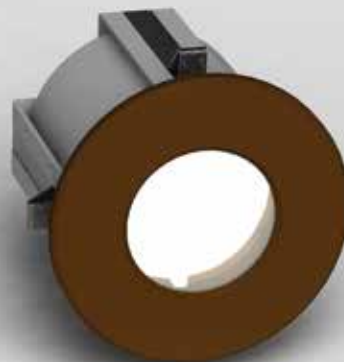
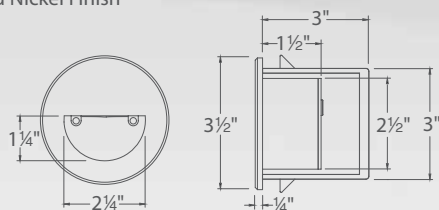

LED310  
Bronze Finish

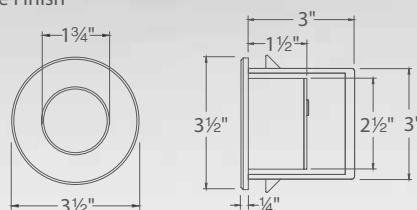

**Power:** 3.9 W  
**Lumens:** Up to 115  
**CRI:** 85  
**Rated Life:** 40,000 hours

- Die-cast aluminum construction
- IP66, wet location rated for interior and exterior installations\*
- Supplied with a junction box for custom recessed installation
- 120V direct wiring, no driver needed

- No heat radiation
- Smooth and continuous ELV dimming
- Replaceable LED module
- 5 year WAC warranty

\*Not recommended for contact with chemicals or sustained contact with water.

System	Color	Finish
WL-LED300 Scoop	<b>C</b> White 3000K (CCT)	<b>WT</b> White
	<b>AM</b> Amber 610nm (Peak)	
WL-LED310 Open	<b>RD</b> Red 640nm (Peak)	<b>BN</b> Brushed Nickel
	<b>BL</b> Blue 450nm (Peak)	<b>BZ</b> Bronze

Example: **WL-LED300-C-BN**

## Wayfinding

LEDme® Step and Wall lights can color-code pathways to indicate circulation directions or the designation of a space.



## Spacing Recommendations for Optimal Light Distribution

### Corridors / Hallways

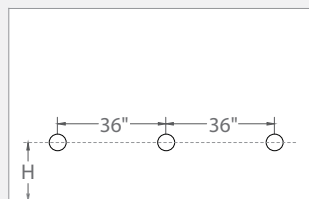

LED300 H: 12" - 18"  
LED310 H: 6"

### Stairs - Wall Mount

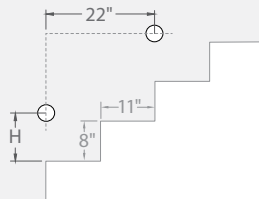

LED300 H: 12"  
LED310 H: 6"

### Stairs - Step Mount

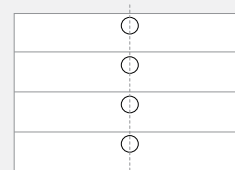

Mount in center of stair as close to the upper tread as possible. For best results use one light per step for steps narrower than 5 feet



Featured Product: WL-LED310-C-BN

InvisiLED®



Year  
warranty

**InvisiLED® Pro / Pro2**  
High Performance

**InvisiLED® Classic 24V**  
White + four colors

**InvisiLED® Palette / Daylight to Sunset**  
Color changing

**InvisiLED® Outdoor**  
IP68, Wet location





Consult the factory to take advantage of our custom capabilities in large quantities.

UV stabilized silicon prevents discoloration

UL listed for damp location (indoor products)

WAC LIGHTING

IP68 rated to be dust tight and submersible up to 5 feet.  
UL listed for wet location (outdoor products)

INVISILED® 64

# Pro2 InvisiLED®



Actual Size

**Power:** 4W / ft  
**Lumens:** Up to 330 lm / ft  
**CRI:** 90  
**Rated Life:** 80,000 hours

- Brightest InvisiLED® system available
- Designed for cove or task lighting
- UL listed for damp location
- 5 year warranty

- Maximum run length of 25 feet
- May be field cut every 6 inches at the end of a run
- Smooth and continuous ELV dimming

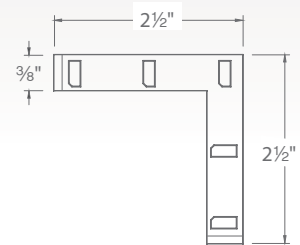
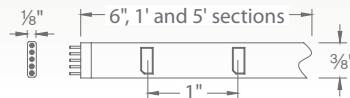

## Tape Selections

System	Color Temp	Length	Qty	Finish
<b>LED-TX24</b>	<b>27</b> 2700K	<b>6IN</b> 6 inches	1	<b>WT</b> White
	<b>30</b> 3000K	<b>1</b> 1 foot	1	
	<b>35</b> 3500K	<b>5</b> 5 feet	1	
	<b>45</b> 4500K	<b>1-40</b> 1 foot	40	

Example: **LED-TX2435-6IN-WT**

## "L" Connector

System	Color Temp	Finish
<b>LED-TX24</b>	<b>27</b> 2700K	<b>5L-WT</b> White
	<b>30</b> 3000K	
	<b>35</b> 3500K	
	<b>45</b> 4500K	

Example: **LED-TX2435-5L-WT**

Each "L" connector consumes 2 watt

## Class 2 Power Supply for Pro 2 (Required)

Type	Model	Power	Dim	Input	Output
Remote	<b>EN-2460-RB2-T</b>	60W	Yes	120V AC	24V AC
	<b>EN-24100-RB2-T</b>	96W			24V AC
Plug-in	<b>EN-2460-P-AR-T</b>	60W	Yes	120V AC	24V AC
	<b>EN-24100-P-AR-T</b>	96W			24V AC
Remote 277V	<b>EN-24100-277-R</b>	96W	No	277V AC	24V DC

## Accessories

Rigid Aluminum Channel	<b>LED-T-CH</b>	5 ft	Includes mounting hardware and diffuser lens Field cuttable
Lead Wire	<b>LED-TC-P-2</b> <b>LED-TC-P-12</b>	2 ft 12 ft	Alternative lengths for plug-in power supplies
Extension Cable	<b>LED-TC-EXT-144</b>	12 ft	Extends distance between a hard wired power supply or wiring box to a tape section
Low Voltage Wiring Box With Feed	<b>LED-TC-B-2</b>	L: 1 1/2 in W: 3/4 in H: 7/8 in	Neatly houses up to two wires with 2" female feed
Low Voltage Wiring Box	<b>LED-T-B</b>	L: 1 1/2 in W: 3/4 in H: 7/8 in	Neatly houses up to two wires
Wiring Box With Switch	<b>TB-S</b>	L: 6 1/4 in W: 1 5/8 in H: 1 1/4 in	Use when spanning a large gap in a system layout without leaving exposed wiring
Joiner Cable	<b>LED-TC-IC2</b> <b>LED-TC-IC6</b> <b>LED-TC-IC12</b> <b>LED-TC-IC36</b> <b>LED-TC-IC72</b>	2 in 6 in 12 in 36 in 72 in	Use between tape sections
"L" Connector	<b>LED-TC-L</b>		
3-Way "Y" Connector	<b>LED-TC-Y</b>		
4-Way "X" Connector	<b>LED-TC-X</b>		
End cap	<b>LED-TC-EC</b>	1 cut end cap 1 male end cap	
Mounting Clips	<b>LED-T-CL</b>	10 Qty	
Retrofit Channel	<b>LED-T-RC</b>	36 in	





## The Pro2 Advantage: Superior Brightness

InvisiLED® Pro2 features up to 330 lumens per foot of illumination. Two strips of Pro2 produce the same amount of light as a T5 fluorescent lamp but may be concealed within smaller spaces and offer greater application efficiency with 120° directional illumination. This enables the light to be visible even amidst brightly lit spaces such as the shopping mall depicted above.

Featured Product: **LED-TX2435-5-WT** in cove lighting

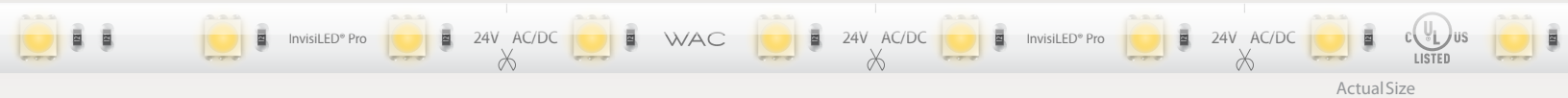

**Power:** 3W/ft  
**Lumens:** Up to 215 lm/ft  
**CRI:** 85  
**Rated Life:** 50,000 hours

- Designed for bright cove or task lighting
- UL listed for damp location
- 5 year warranty

- Maximum run length of 33 feet
- May be field cut every 2 inches at the end of a run
- Smooth and continuous ELV dimming

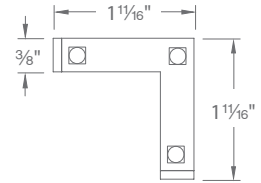
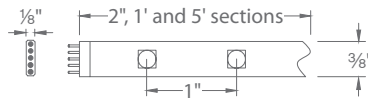

## Tape Selections

System	Color Temp	Length	Qty	Finish
<b>LED-T24</b>	<b>W</b> 2700K	<b>2IN</b> 2 inches	1	<b>WT</b> White
	<b>P</b> 3000K	<b>2IN-10</b> 2 inches	10	
	<b>35</b> 3500K	<b>1</b> 1 foot	1	
	<b>C</b> 4500K	<b>5</b> 5 feet	1	
		<b>1-40</b> 1 foot	40	

Example: **LED-T24W-1-40-WT**

## "L" Connector

System	Color Temp	Finish
<b>LED-T24</b>	<b>W</b> 2700K	<b>3L-WT</b> White
	<b>P</b> 3000K	
	<b>35</b> 3500K	
	<b>C</b> 4500K	

Example: **LED-T24W-3L-WT**







Each "L" connector consumes 1.2 watt

## Class 2 Power Supply for Pro (Required)

Type	Model	Power	Dim	Input	Output
Remote	<b>EN-2460-RB2-T</b>	60W	Yes	120V AC	24V AC
	<b>EN-24100-RB2-T</b>	96W			24V AC
Plug-in	<b>EN-2460-P-AR-T</b>	60W	Yes	120V AC	24V AC
	<b>EN-24100-P-AR-T</b>	96W			24V AC
Remote 277V	<b>EN-24100-277-R</b>	96W	No	277V AC	24V DC

## Accessories

Rigid Aluminum Channel	 <b>LED-T-CH</b>	5 ft	Includes mounting hardware and diffuser lens Field cuttable
Lead Wire	 <b>LED-TC-P-2</b> <b>LED-TC-P-12</b>	2 ft 12 ft	Alternative lengths for plug-in power supplies
Extension Cable	 <b>LED-TC-EXT-144</b>	12 ft	Extends distance between a hard wired power supply or wiring box to a tape section
Low Voltage Wiring Box With Feed	 <b>LED-TC-B-2</b>	L: 1 1/2 in W: 3/4 in H: 7/8 in	Neatly houses up to two wires with 2" female feed
Low Voltage Wiring Box	 <b>LED-T-B</b>	L: 1 1/2 in W: 3/4 in H: 7/8 in	Neatly houses up to two wires
Wiring Box With Switch	 <b>TB-S</b>	L: 6 1/4 in W: 1 3/8 in H: 1 1/4 in	Use when spanning a large gap in a system layout without leaving exposed wiring

Joiner Cable	 <b>LED-TC-IC2</b> 2 in <b>LED-TC-IC6</b> 6 in <b>LED-TC-IC12</b> 12 in <b>LED-TC-IC36</b> 36 in <b>LED-TC-IC72</b> 72 in	Use between tape sections
"L" Connector	 <b>LED-TC-L</b>	
3-Way "Y" Connector	 <b>LED-TC-Y</b>	
4-Way "X" Connector	 <b>LED-TC-X</b>	
End cap	 <b>LED-TC-EC</b>	1 cut end cap 1 male end cap
Mounting Clips	 <b>LED-T-CL</b>	10 Qty
Retrofit Channel	 <b>LED-T-RC</b>	36 in



## The Pro Experience: Customize Functionality

InvisiLED® Pro provides the most custom options from a bright task and cove lighting solution delivering over 200 lumens per foot. Four color temperatures accentuate the color scheme of the space, ranging from 2700K to bring out the warmth of wood stains to 4500k for clean and bright white spaces. Customize illuminated run lengths within 2 inches of accuracy to perfectly match custom cabinets with consistent 1 inch on-center spacing of diodes even through junctions of sections.

Featured Product: **LED-T24W-5-WT** as cove and undercabinet lighting

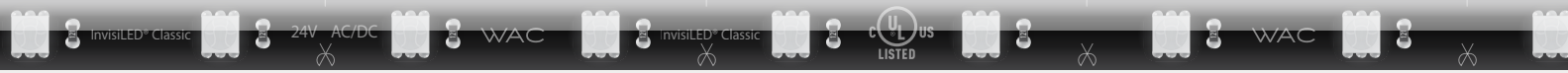

Actual Size

**Power:** 2W/ft  
**Lumens:** Up to 115 lm/ft  
**CRI:** 85  
**Rated Life:** 50,000 hours

- 5 colors: White, Amber, Blue, Green, Red
- Designed for accent lighting
- UL listed for damp location
- 5 year warranty

- Maximum run length 40 feet
- May be field cut every 2 inches at the end of a run
- Smooth and continuous ELV dimming

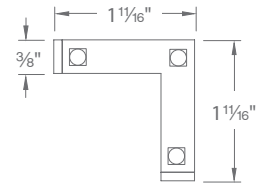
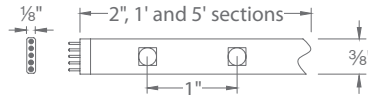

### Tape Selections

System	Length	Qty	Color	Peak Wavelength
<b>LED-T24</b>	<b>2IN</b> 2 inches	1	<b>AM</b> Amber	595nm
	<b>1</b> 1 foot	1	<b>BL</b> Blue	470nm
	<b>5</b> 5 feet	1	<b>GR</b> Green <b>RD</b> Red	530nm 625nm
<b>LED-T2430</b>	<b>2IN</b> 2 inches	1	<b>WT</b> White	3000K
	<b>2IN-10</b> 2 inches	10		
	<b>1</b> 1 foot	1		
	<b>1-40</b> 1 foot	40		
<b>5</b> 5 feet	1			

### "L" Connector

Color	Temp
<b>LED-T2430-3L-WT</b>	White 3000K

Each "L" connector consumes 0.6 watt

Example: **LED-T2430-1-40-WT**

### Class 2 Power Supply for Classic 24V (Required)

Type	Model	Power	Dim	Input	Output	
Remote	<b>EN-2460-RB2-T</b>	60W	Yes	120V AC	24V AC	Includes a 6 foot lead wire
	<b>EN-24100-RB2-T</b>	96W				
Plug-in	<b>EN-2460-P-AR-T</b>	60W	Yes	120V AC	24V AC	Includes a 6 foot lead wire
	<b>EN-24100-P-AR-T</b>	96W				
Remote 277V	<b>EN-24100-277-R</b>	96W	No	277V AC	24V DC	Order with LED-TC-B-2 or LED-T-EXT-144

### Accessories

Rigid Aluminum Channel		<b>LED-T-CH</b>	5 ft	Includes mounting hardware and diffuser lens Field cuttable
Lead Wire		<b>LED-TC-P-2</b> <b>LED-TC-P-12</b>	2 ft 12 ft	Alternative lengths for plug-in power supplies
Extension Cable		<b>LED-TC-EXT-144</b>	12 ft	Extends distance between a hard wired power supply or wiring box to a tape section
Low Voltage Wiring Box With Feed		<b>LED-TC-B-2</b>	L: 1 1/2 in W: 3/4 in H: 7/8 in	Neatly houses up to two wires with 2" female feed
Low Voltage Wiring Box		<b>LED-T-B</b>	L: 1 1/2 in W: 3/4 in H: 7/8 in	Neatly houses up to two wires
Wiring Box With Switch		<b>TB-S</b>	L: 6 1/4 in W: 1 1/8 in H: 1 1/4 in	Use when spanning a large gap in a system layout without leaving exposed wiring
Joiner Cable		<b>LED-TC-IC2</b> <b>LED-TC-IC6</b> <b>LED-TC-IC12</b> <b>LED-TC-IC36</b> <b>LED-TC-IC72</b>	2 in 6 in 12 in 36 in 72 in	Use between tape sections
"L" Connector		<b>LED-TC-L</b>		
3-Way "Y" Connector		<b>LED-TC-Y</b>		
4-Way "X" Connector		<b>LED-TC-X</b>		
End cap		<b>LED-TC-EC</b>	1 cut end cap 1 male end cap	
Mounting Clips		<b>LED-T-CL</b>	10 Qty	
Retrofit Channel		<b>LED-T-RC</b>	36 in	



## The Classic Approach: Style Accents

InvisiLED® Classic 24V series offers a 3000K white light in addition to four rich colors to accent any application. Highlight your space with unique accent and display lighting applications in cabinets, around moldings, or under counters and steps. In this unique diminutive size, InvisiLED® Classic allows you to light spaces never lit before to achieve the ultimate layered lighting effect.

Featured Product: **LED-T24-5-AM** with **LED-T-CH**

# Daylight to Sunset InvisiLED®

# Palette InvisiLED®

Actual Size



5100K

595nm

**Power:** 1.5W/ft  
**Rated Life:** 50,000 hours

- Color changing from cool white to amber
- DMX and wireless controller options for Daylight to Sunset system
- Maximum run length of 40 feet
- May be field cut every 6 inches at the end of a run
- UL listed for damp location
- Dim with wired / wireless controller
- 5 year warranty



### Tape Selections

System	Length	Qty	
<b>LED-TC</b>	<b>1</b>	1 foot	1
	<b>5</b>	5 feet	1
	<b>1-40</b>	1 foot	40
			<b>WA</b>

Example: **LED-TC-5-WA**



3500K

**Power:** 1.5W/ft  
**Rated Life:** 50,000 hours

- Variable colors with 3500K White
- DMX and wireless controller options for Palette system
- Maximum run length of 40 feet
- May be field cut every 6 inches at the end of a run
- UL listed for damp location
- Dim with wired / wireless controller
- 5 year warranty



### Tape Selections

System	Length	Qty	
<b>LED-TC</b>	<b>1</b>	1 foot	1
	<b>5</b>	5 feet	1
	<b>1-40</b>	1 foot	40
			<b>RGB</b>

Example: **LED-TC-1-40-RGB**

## Class 2 Power Supply for Daylight to Sunset and Palette (Required)





Type	Model	Power	Dim	Input	Output
Remote 	<b>EN-2460D-C</b>	60W	Yes	120V AC	24V DC 60W
Plug-in 	<b>EN-2460D-C-P</b>				

## Controller for Daylight to Sunset and Palette (Required)

Wired controller 	<b>LED-TC-CTR-MSD</b>	4 function wired controller with master and slave options	Allows brightness control, preset color selection, or playing a rotation of color transitions with variable speed control
--	-----------------------	---	---

## Accessories

Wireless Controller 	<b>LED-TO24-WS</b>	4 function wireless controller (Requires wired controller)
Signal Wire 	<b>LED-TC24-SW60</b> <b>LED-TC24-SW120</b>	60 in 120 in Links master and slave controllers
Rigid Aluminum Channel 	<b>LED-T-CH</b>	5 ft Includes mounting hardware and diffuser lens Field cuttable
Mounting Clips 	<b>LED-T-CL</b>	10 Qty
Retrofit Channel 	<b>LED-T-RC</b>	36 in

Joiner Cable 	<b>LED-TC-IC2</b> <b>LED-TC-IC6</b> <b>LED-TC-IC12</b> <b>LED-TC-IC36</b> <b>LED-TC-IC72</b>	2 in 6 in 12 in 36 in 72 in Use between tape sections
"L" Connector 	<b>LED-TC-L</b>	
3-Way "Y" Connector 	<b>LED-TC-Y</b>	
4-Way "X" Connector 	<b>LED-TC-X</b>	
End cap 	<b>LED-TC-EC</b>	1 cut end cap 1 male end cap

470nm

625nm

595nm

530nm



Featured Product: **LED-TC-5-RGB**

Wireless controller (accessory for wired controller)  
**LED-TO24-WS**

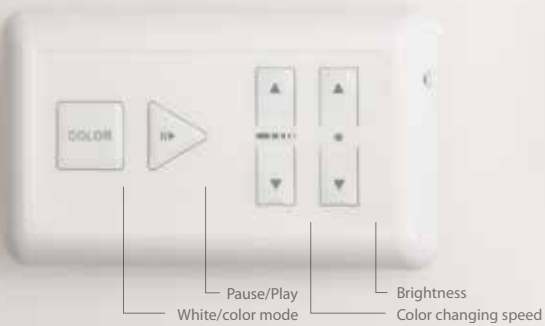

Wired controller  
**LED-TC-CTR-MSD**



# Pro Outdoor InvisiLED®

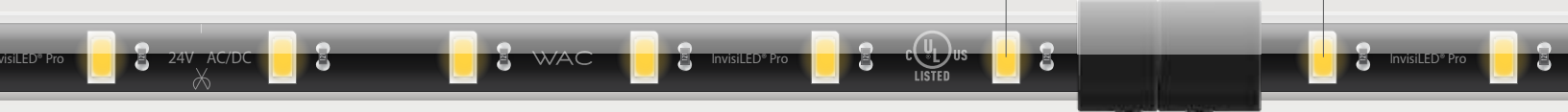

Minimal spacing of LEDs when joined together

Actual Size

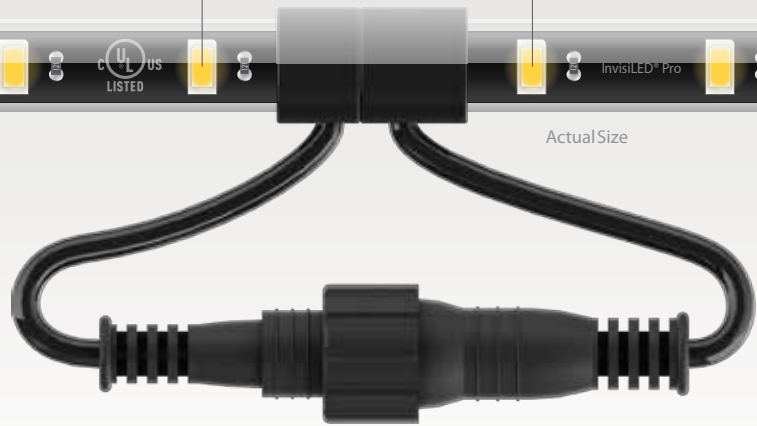

Double insulated silicon encasement and distinct electrical and mechanical junctions make for a superior watertight custom length system

- Power:** 3.5W/ft • IP-68 rated, UL listed for wet location  
**Lumens:** 220 lm/ft • Maximum run length of 28 ft  
**CRI:** 85 • May be field cut every 6 inches at the end of a run  
**Rated Life:** 80,000 hours • 5 year warranty

Featured Product: **LED-T2435-5-WT**

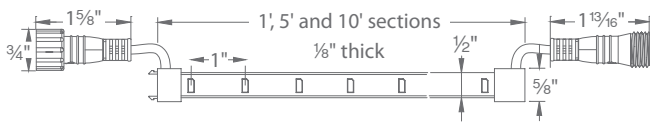

## Tape Selections



System	Length	Color	Power consumption
<b>LED-TO2435</b>	<b>1</b> 1 foot	<b>WT</b> White 3500K	3.5W/ft
	<b>5</b> 5 feet		
	<b>10</b> 10 feet		



Example: **LED-TO2435-10-WT**

## Class 2 Power Supply for Pro Outdoor (Required)

Type	Model	Power	Input	Output
Remote 	<b>EN-O24100-RB2-T</b>	96W	120V - 277V AC	24V DC <i>Includes a 6 foot lead wire</i>

## Accessories

Clear Channel 	<b>LED-TO24-CH5</b>	5 feet <i>Includes mounting hardware</i>
End cap 	<b>LED-TO24-EC</b>	
Mounting Clip 1 	<b>LED-TO24-C1</b>	<i>Secures on both edges (10 Qty)</i>
Mounting Clip 2 	<b>LED-TO24-C2</b>	<i>Secures on one edge (10 Qty)</i>
Mounting Clip 3 	<b>LED-TO24-C3</b>	<i>Spring clip secures beneath tape (10 Qty)</i>

Joiner Cable 	<b>LED-TO24-IC6</b> 6 in <b>LED-TO24-IC12</b> 12 in <b>LED-TO24-IC72</b> 72 in <b>LED-TO24-IC120</b> 120 in	<i>Use between tape sections</i>
4 Way "X" Connector 	<b>LED-TO24-X</b>	
3-Way "Y" Connector 	<b>LED-TO24-Y</b>	



The highest IP rating: IP68

Submersible up to 5 feet  
Dust tight



# Palette Outdoor InvisiLED®



- Power:** 1.5W / ft  
**Dimming:** Yes  
**Rated Life:** 80,000 hours
- IP-68 rated, UL listed for wet location
  - Variable colors with 3500K White
  - DMX and wireless controller options for Palette outdoor system
  - Maximum run length of 40 feet
  - May be field cut every 2 inches at the end of a run
  - Dim with wired / wireless controller only
  - 5 year warranty



Double insulated silicon encasement and distinct electrical and mechanical junctions make for a superior watertight custom length system

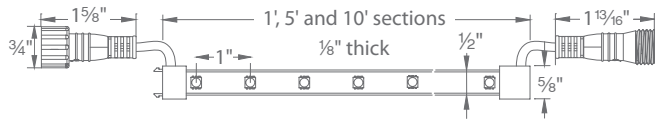



## Tape Selection

System	Length	Type
<b>LED-TCO</b>	<b>1</b>	1 foot
	<b>5</b>	5 feet
	<b>10</b>	10 feet
		<b>RGB</b>

Example: **LED-TCO-5-RGB**

## Controller for Palette Outdoor (Both Required)





Master Controller		<b>LED-TO24-CM</b>	4 function wired controller
Wireless Controller		<b>LED-TO24-WS</b>	4 function wireless controller

## Class 2 Power Supply for Palette Outdoor (Required)

Type	Model	Power	Input	Output
Remote	 <b>EN-O24100-RB2-T</b>	96W	120V - 277V AC	24V DC <i>Includes a 6 foot lead wire</i>

## Accessories

Slave Controller		<b>LED-TO24-CS</b>	Connects to Master Controller, adding 40 ft run
Signal Wire		<b>LED-TO24-SW60</b> <b>LED-TO24-SW120</b>	Master to Slave, 60 in Master to Slave, 120 in
DMX Signal Wire		<b>LED-TO24-MW60</b> <b>LED-TO24-MW120</b>	DMX to Master, 60 in DMX to Master, 120 in
End cap		<b>LED-TO24-EC</b>	
Clear Channel		<b>LED-TO24-CH5</b>	5 feet
Mounting Clip 1		<b>LED-TO24-C1</b>	Secures on both edges (10 Qty)
Mounting Clip 2		<b>LED-TO24-C2</b>	Secures on one edge (10 Qty)
Mounting Clip 3		<b>LED-TO24-C3</b>	Spring clip secures beneath tape (10 Qty)

Joiner Cable		<b>LED-TO24-IC6</b>	6 in	Extends distance between transformers and controllers
		<b>LED-TO24-IC12</b>	12 in	
		<b>LED-TO24-IC72</b>	72 in	
		<b>LED-TO24-IC120</b>	120 in	
RGB Joiner Cable		<b>LED-TO24-IC6-RGB</b>	6 in	Extends distance between tape(s) and controllers
		<b>LED-TO24-IC12-RGB</b>	12 in	
		<b>LED-TO24-IC72-RGB</b>	72 in	
		<b>LED-TO24-IC120-RGB</b>	120 in	
4 Way "X" Connector		<b>LED-TO24-X-RGB</b>		
3-Way "Y" Connector		<b>LED-TO24-Y-RGB</b>		



## The Chameleon Effect

InvisiLED® Palette Outdoor offers all the benefits of our Palette and Outdoor Pro series combined into one system designed to allow you to change the ambiance and color scheme of your exterior space at the touch of a button. Versatile enough to suit residential needs for home accent illumination with holiday flair as well as large commercial venues for various event functions that require a DMX link to professional control systems.

Featured Product: **LED-TCO-5-RGB** with **LED-TO24-CH5**

# TASK and COVE



Consult the factory to take advantage of our custom capabilities in large quantities.

# LINE™ LED Edge Lit Task Luminaires

First of its kind, LINE™ edge-lit LED task luminaire adapts advanced technology for glare-free illumination in 2700K and 3000K color temperatures. Patent Pending.

1/4"

30°

Professional, asymmetrical forward throw illumination for full coverage of the task plane.

## Up to 50 footcandles

Shown 2700K color temperature

LINE™ delivers optimal glare-free quality of light, free from multiple shadows or hot spots reflected back from countertops, all from a half-inch deep luminaire.

# LINE™ LED Edge Lit Task Luminaire

Perfect for highly reflective surfaces such as stainless steel and polished stone, LINE™ produces an evenly diffuse light with asymmetrical distribution at 30° to cover a task plane.



Magnetized design for easy installation and maintenance  
 Fingertip High/Low settings for localized brightness control

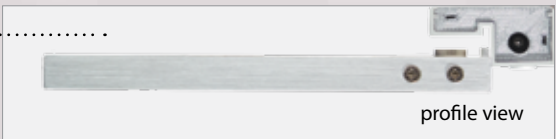

**Color Temp:** 2700K, 3000K  
**CRI:** 90  
**Dimming:** 100% – 10% smooth and continuous ELV dimming for 120V only  
 100% / 50% high/low settings on board  
**Rated Life:** 80,000 hours  
 Patent Pending



## Line Luminaires (Power supplies sold separately)

Model	Length	Color Temp	Finish	Watt	Max Lumens	Max Fixture Run	
						60 W	96 W
LN-LED	06 6"	27 2700K 30 3000K	AL Brushed Aluminum	7W	180	8	13
	12 12"			12.5W	415	4	7
	18 18"			19W	595	3	5
	24 24"			23W	850	2	4
	30 30"			26W	950	2	3

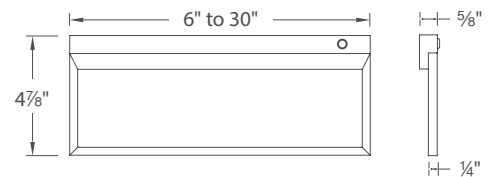

Example: **LN-LED18-27-AL**  
 "I" connector included with each luminaire

## Class 2 Power Supply for LINE™ (Required)





Type	Model	Output	Input	Dim	Dimensions
Remote	<b>EN-2460-RB2-S</b>	60W (24V)	120V	Yes	6½" × 1⅝" × 1¼"
	<b>EN-24100-RB2-S</b>	96W (24V)			
Remote 277V*	<b>EN-24100-277-R</b>	96W (24V)	277V	No	7⅞" × 2¾" × 1⅝"
Plug-In	<b>EN-2460-P-AR-S</b>	60W (24V)	120V	Yes	2¾" × 1⅝" × 1¾" 4⅝" × 2" × 1⅝"
	<b>EN-24100-P-AR-S</b>	96W (24V)			

\* Requires a SL-EXT-144 extension cable (order separately)







## LINE™ Accessories

### Connection Accessories

"I" Connector		<b>SL-I</b>	Ø¼" × 7⁄8"	For end-to-end connection of LINE™ sections.
Joiner Cables		<b>SL-IC-06</b> <b>SL-IC-12</b> <b>SL-IC-24</b> <b>SL-IC-36</b>	6" 12" 24" 36"	Connects two sections of LINE™.
Custom Cable Extenders		<b>SL-IF</b>	Ø¾" × 3⁄8"	Two female ends. Connects two joiner cables to create custom lengths.
4-way "X" Connector		<b>SL-X</b>	Wires: 4" each Connectors: 1½" each	"X" connector has four male connectors and can be used to easily customize your design layout.
3-way "Y" Connector		<b>SL-Y</b>	Wires: 4" each Connectors: 1½" each	"Y" connector has three male connectors and can be used to easily customize your design layout.

### Power Supply Accessories

Wiring Box with On/Off Switch option		<b>TB-S</b>	6¼" × 1⅝" × 1¼"	Use when spanning a large gap in a system layout without leaving exposed wiring (i.e. lighting kitchen cabinets on either side of a sink or window).
Multiple Terminal Block		<b>MTB-08</b>	8 outputs 4⅞" × 1⅝" × ¾"	Easily wire multiple output connections for a neat installation without the use of open splices. One power supply input and 8 outputs. 5A capacity. Three mounting screws included.
12' Extension Cable		<b>SL-EXT-144</b>	Wire: 144" Connector: 1½"	Use to extend the distance between power supply or wiring box (TB-S) to a LINE™ section.
Wire Clip (10 Pack)		<b>SL-WC-1</b>	½" × ¾"	Use to tack power cords or joiner cables neatly to a surface.



## Straight Edge<sup>®</sup> LED Strip Light for Task and Cove

**Color Temp:** 2700K, 4500K  
**CRI:** 85  
**Dimming:** 100% – 1% smooth and continuous ELV dimming for 120V only  
**Rated Life:** 70,000 hours

Adjustable angle mounting clip allows fixture to be easily aimed while securely mounted for optimal lighting performance and flexibility. **SL-C3-WT** (order separately)



- Each section includes two flat mounting clips, two 45° angle mounting clips and one "I" connector
- Extruded aluminum with spread diffuser lens

Model	Length	Color Temp	Finish	Watt	Max Lumens	Max Fixture Run		
						60 W	96 W	
<b>LS-LED</b>	<b>08</b>	7¼"	<b>W C</b> 2700K 4500K	<b>WT</b> White	2.6W	130	23	38
	<b>14</b>	13¾"			4.8W	245	12	20
	<b>20</b>	19¼"			7.2W	352	8	13
	<b>26</b>	25¼"			9.6W	484	6	10
	<b>32</b>	31¼"			11.9W	617	5	8

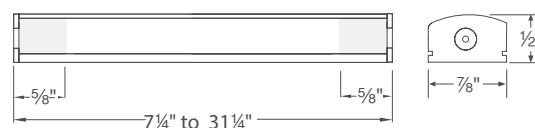

Example: **LS-LED08-C-WT**

### Class 2 Power Supply for Straight Edge<sup>®</sup> (Required)

Type	Model	Output	Input	Dim	Dimensions
Remote	<b>EN-2460-RB2-S</b> <b>EN-24100-RB2-S</b>	60W (24V) 96W (24V)	120V	Yes	6½" × 1⅝" × 1¼"
Remote 277V*	<b>EN-24100-277-R</b>	96W (24V)	277V	No	7⅞" × 2¾" × 1⅜"
Plug-In	<b>EN-2460-P-AR-S</b> <b>EN-24100-P-AR-S</b>	60W (24V) 96W (24V)	120V	Yes	2¾" × 1⅝" × 1¾" 4⅝" × 2" × 1⅝"

\* Requires a SL-EXT-144 extension cable (order separately)







# Straight Edge® Accessories





## Connection Accessories

"I" Connector		<b>SL-I</b>	Ø¼" × 7⁄8"	For end-to-end connection of Straight Edge® sections.
Joiner Cables		<b>SL-IC-06</b> <b>SL-IC-12</b> <b>SL-IC-24</b> <b>SL-IC-36</b>	6" 12" 24" 36"	Connects two sections of Straight Edge®.
Custom Cable Extenders		<b>SL-IF</b>	Ø³⁄₈" × 3⁵⁄₈"	Two female ends. Connects two joiner cables to create custom lengths.
4-way "X" Connector		<b>SL-X</b>	Wires: 4" each Connectors: 1½" each	"X" connector has four male connectors and can be used to easily customize your design layout.
3-way "Y" Connector		<b>SL-Y</b>	Wires: 4" each Connectors: 1½" each	"Y" connector has three male connectors and can be used to easily customize your design layout.

## Mounting Accessories

Flat Mounting Clip (2 pack)		<b>SL-C1-WT</b>	1" × 1⁄₈" × 1¼"	Metal clip used to mount Straight Edge® sections flat to a surface.
45° Angle Mounting Clip (2 pack)		<b>SL-C2-WT</b>	1" × 1" × 1½"	Metal clip used to mount Straight Edge® sections in corners. Set at 45°.
Adjustable Angle Mounting Clip (2 pack)		<b>SL-C3-WT</b>	5⁄₈" × 5⁄₈" × 1¾"	Metal clip used to mount Straight Edge® sections at variable angles.
Magnetic Tape		<b>MAG-TAPE-36</b>	36" × 3⁄₄"	One magnetic side and one peel and stick side for mounting Straight Edge® sections to a metal surface. Easily cut in field.

## Power Supply Accessories

Wiring Box with On/Off Switch option		<b>TB-S</b>	6¼" × 1⁵⁄₈" × 1¼"	Use when spanning a large gap in a system layout without leaving exposed wiring (i.e. lighting kitchen cabinets on both sides of a sink or window).
Multiple Terminal Block		<b>MTB-08</b>	8 outputs 4⁷⁄₈" × 1⁵⁄₈" × 3⁄₄"	Easily wire multiple output connections for a neat installation without the use of open splices. One power supply input and either 6 or 8 outputs. 5A capacity. Three mounting screws included.
12' Extension Cable		<b>SL-EXT-144</b>	Wire: 144" Connector: 1½"	Use to extend the distance between power supply or wiring box (TB-S) to a Straight Edge® section.
Wire Clip (10 Pack)		<b>SL-WC-1</b>	½" × 3⁄₈"	Use to tack power cords or joiner cables neatly to a surface.



## Light Bars LEDme®

**Color Temp:** 2700K, 3000K  
**CRI:** 85  
**Dimming:** 100% – 10% smooth and continuous ELV dimming  
**Rated Life:** 70,000 hours

- Integral drivers
- 1 inch Profile
- Extruded aluminum construction for optimal thermal management
- Multiple knock outs per fixture for ease of wiring

Minimal space between diffusers for a virtually seamless line of illumination



On center spacing of LED's is maintained when joined together for visual continuity

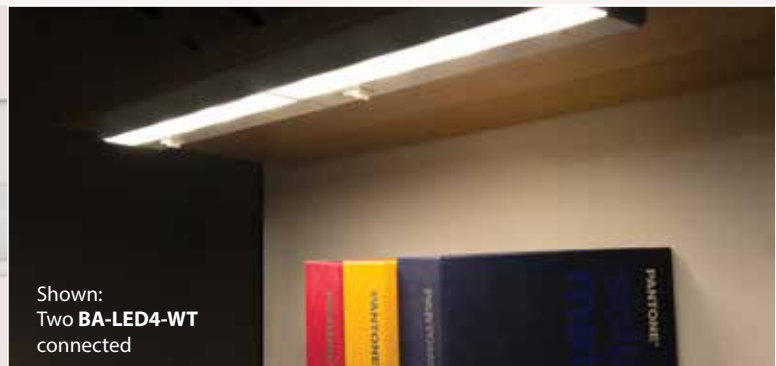

Shown:  
Two **BA-LED4-WT**  
connected

Color Temp	Model	Length	Finish	Watt	Lumens
2700K	<b>BA-LED</b>	<b>2-27</b> 8"		3.6W	150
		<b>4-27</b> 12"	<b>BB</b> Bronze	6.2W	285
		<b>6-27</b> 18"	<b>SN</b> Satin Nickel	9.7W	465
		<b>8-27</b> 24"	<b>WT</b> White	12.7W	584
		<b>10-27</b> 30"		15.5W	694
3000K	<b>BA-LED</b>	<b>2</b> 8"		3.6W	130
		<b>4</b> 12"	<b>BB</b> Bronze	6.2W	255
		<b>6</b> 18"	<b>SN</b> Satin Nickel	9.7W	400
		<b>8</b> 24"	<b>WT</b> White	12.7W	505
		<b>10</b> 30"		15.5W	655

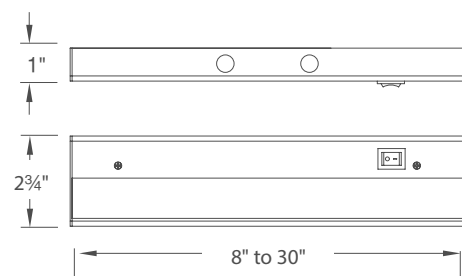

Example: **BA-LED4-27-WT**

- May be hard-wired with 120V power or used with a plug-in power cord
- Subsequent fixtures may be powered with an "I" Connector or Interconnect Cable carrying 120V
- May be individually switched and/or wired to a wall box switch/dimmer

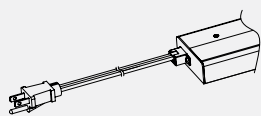

Power Cord

Model	WT	Length
<b>BA-PC6</b>	WT White	6'
	BK Black	

Supplies power in any application.

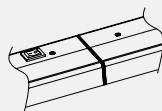

"I" Connector

Model
<b>BA-I-WT</b>

Interconnection for seamless end to end transitions. Each light bar includes one.

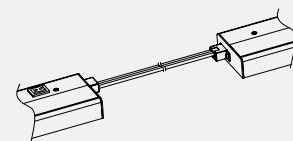

Interconnect Cable

Model	WT	Length
<b>BA-IC12</b>	WT White	12"
<b>BA-IC24</b>	BK Black	24"
<b>BA-IC36</b>	BK Black	36"

Links two light bars using a single power connection.

Built in high/low setting



## Premium Xenon Light Bars Line Voltage

**Power:** 20W per light  
**Dimming:** 100% – 5%  
**Rated Life:** 10,000 hours

- Steel construction
- Smooth and continuous dimming with standard incandescent dimmers
- Frosted borosilicate glass lenses for true white light transmission
- Multiple knock outs per fixture for ease of wiring

Individual reflectors for optical efficiency



Model	Length	# of Lights	Finish	Watt
<b>BA-LIX</b>	<b>1</b> 6"	1	<b>BB</b> Bronze <b>SN</b> Satin Nickel <b>WT</b> White	20W
	<b>2</b> 12"	2		40W
	<b>3</b> 18"	3		60W
	<b>4</b> 24"	4		80W
	<b>6</b> 36"	6		120W

Example: **BA-LIX-1-WT**

Lamp: 120V 20W, Xenon Bi-pin included

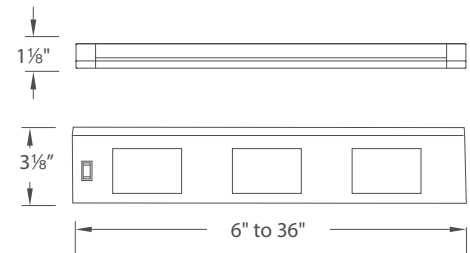

- May be hard-wired with 120V power or used with a plug-in power cord
- Subsequent fixtures may be powered with an "I" Connector or Interconnect Cable carrying 120V
- May be individually switched and/or wired to a wall box switch/dimmer

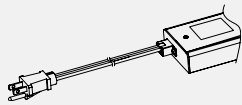

Power Cord

Model	WT	Length
<b>BA-PC6</b>	WT White BK Black	6'

Supplies power in any application.

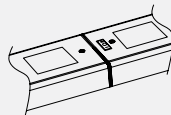

"I" Connector

Model
<b>BA-I-WT</b>

Interconnection for seamless end to end transitions. Each light bar includes one.

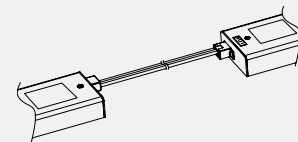

Interconnect Cable

Model	WT	Length
<b>BA-IC12</b>	WT White	12"
<b>BA-IC24</b>	BK Black	24"
<b>BA-IC36</b>	BK Black	36"

Links two light bars using a single power connection.



LED87



LED87S

## 24V LED Button Lights

### Recessed or Surface Mount with 24V transformer

<b>Power:</b>	24V, 4.8W	<b>CRI:</b>	85
<b>Lumens:</b>	180 (round), 155 (square)	<b>Dimming:</b>	100% – 10% smooth and continuous ELV dimming
<b>Compares To:</b>	20W Xenon Bi-pin	<b>Rated Life:</b>	70,000 hours
<b>Color Temp:</b>	2700K, 3000K	<b>Cutout:</b>	2 1/8" for round recessed applications

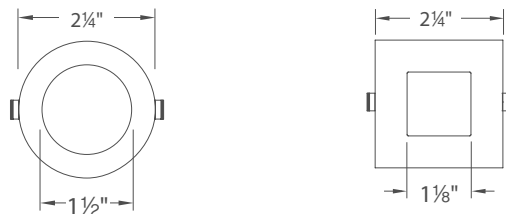

Model	Color temp	Finish
<b>HR-LED87-27</b>	Round	2700K
<b>HR-LED87S-27</b>	Square	2700K
<b>HR-LED87</b>	Round	3000K
<b>HR-LED87S</b>	Square	3000K

<b>BK</b>	Black
<b>BN</b>	Brushed Nickel
<b>CB</b>	Copper Bronze
<b>CH</b>	Chrome
<b>DB</b>	Dark Bronze
<b>WT</b>	White

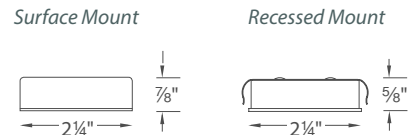

Same cutout for recessed applications, round or square

Example: **HR-LED87S-WT**  
Includes 6 foot lead wire

### Class 2 Electronic Transformers (Required)

Single transformer powers 20 button lights

- 1W minimum load



Type	Model	Input	Output	Power Up To	Dimensions
Remote	<b>EN-2460-RB2</b>	120V	24V AC/60W	12 × LED87	6 1/2" x 1 5/8" x 1 1/4"
	<b>EN-24100-RB2</b>	120V	24V AC/96W	20 × LED87	6 1/2" x 1 5/8" x 1 1/4"
Plug-In	<b>EN-2460-P-AR</b>	120V	24V AC/60W	12 × LED87	2 3/4" x 1 5/8" x 1 3/4"
Multiple terminal box	<b>MTB-01</b>				

Includes 6' cord and 5 SL-WC-1 clips.

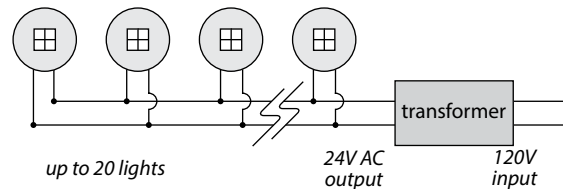

Minimizes wiring back to transformer

### Frosted Lens Accessory

Softens light and reduces glare for square or round

Model #

**LENS-13-FR**

### Retrofit Housing

Use to replace HR-88 and HR-86 using existing wiring and cutout, LEDme® Button light not included.

Model #

Finish

<b>HR-LED-COV</b>	<b>BK</b>	Black
	<b>BN</b>	Brushed Nickel
	<b>CB</b>	Copper Bronze
	<b>CH</b>	Chrome
	<b>DB</b>	Dark Bronze
	<b>WT</b>	White

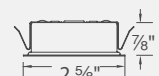

Example: **HR-LED-COV-BK**



Designed for recessed or surface mounted installations, versatile LEDme® Button Lights deliver strong light output with the latest energy efficient LED technology. These fixtures offer a long lasting 70,000 hour life, minimizing re-lamping needs and saving energy. Thermally efficient LEDme® Button Lights with minimal projected heat or UV radiation and are ideal for illuminating sensitive perishables, apparel, artwork and collectibles.

Shown: **HR-LED875-BK** recessed mounted



Xenon HR-86  
Shown as surface mounted  
Copper Bronze finish



Halogen HR-88  
Shown as recessed mounted  
White finish

## Button Lights Low Voltage

### Recessed or Surface Mount

Lamping: 12V 20W Xenon/Halogen Bi-Pin included  
Power: 12V/24V 20W max

Cutout: 2 3/8" for recessed applications



Lamp	Model	Finish
Xenon Bi-Pin	<b>HR-86</b>	<b>BK</b> Black
Halogen Bi-Pin	<b>HR-88</b>	<b>BN</b> Brushed Nickel
		<b>CB</b> Copper Bronze
		<b>CH</b> Chrome
		<b>DB</b> Dark Bronze
		<b>WT</b> White

Example: **HR-86-CB**  
Includes 6 foot lead wire

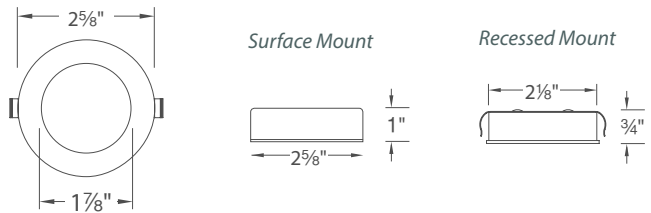

### Low Voltage Transformer (Required)

#### Class 2 Enclosed Electronic Transformers

- Enclosed Class 2 transformers have multiple outputs in 60W increments
- 1W minimum load



Model	Input	Output	Dimensions
<b>EN-1260-RB2</b>	12V	1 x 60W	6 1/2" x 1 5/8" x 1 1/4"
<b>EN-12120-RB2*</b>	12V	2 x 60W	6" x 3 1/4" x 2 5/8"
<b>EN-12180-RB2*</b>	120V	3 x 60W	6 3/4" x 3 5/8" x 2 5/8"
<b>EN-12300-RB2*</b>		5 x 60W	8 1/2" x 4 5/8" x 2 5/8"
<b>EN-2460-RB2</b>	24V AC	/60W	6 1/2" x 1 5/8" x 1 1/4"
<b>EN-24100-RB2</b>	24V AC	/96W	6 1/2" x 1 5/8" x 1 1/4"
Multiple terminal box	<b>MTB-01</b>		

\*Includes LED indicator lights and integral push in terminals

#### OR UL Listed Class 2 Plug-In Electronic Transformers

- Plug-in power supply with on/off toggle switch and 6' detachable cord
- 1W minimum load



Model	Finish	Input	Output	Dimensions
<b>EN-1260-P-AR</b>	<b>BK</b> Black	120V	12V, 60W	2 3/4" x 1 5/8" x 1 3/4"
	<b>WT</b> White			
<b>EN-2460-P-AR</b>		120V	24V AC/60W	2 3/4" x 1 5/8" x 1 3/4"
Multiple terminal box	<b>MTB-01</b>			

Frosted Lens Accessory  
Softens light and reduce glare

Model #  
**LENS-45-FR-N**

# Miniature Recessed Low Voltage



Eyeball  
HR-1135  
Copper Bronze finish



Spot  
HR-1136  
Brushed Nickel finish

Model	Finish
<b>HR-1135</b>	<b>BK</b> Black
	<b>CB</b> Copper Bronze
	<b>WT</b> White

Example: **HR-1135-CB**  
Lamp: 12V, 35W max, MR11, order separately  
Includes 36 inch lead wire

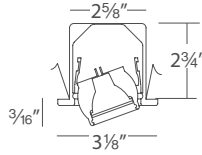

Model	Finish
<b>HR-1136</b>	<b>BK</b> Black
	<b>BN</b> Brushed Nickel
	<b>CB</b> Copper Bronze
	<b>CH</b> Chrome
	<b>WT</b> White

Example: **HR-1136-BN**  
Lamp: 12V, 20W max, MR11, order separately  
Includes 36 inch lead wire

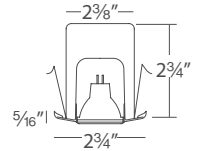

Gimbal Ring  
HR-1137  
Brushed Nickel finish



Glass Dome  
HR-1138  
White finish

Model	Finish
<b>HR-1137</b>	<b>BK</b> Black
	<b>BN</b> Brushed Nickel
	<b>CB</b> Copper Bronze
	<b>CH</b> Chrome
	<b>WT</b> White

Example: **HR-1137-BK**  
Lamp: 12V, 20W max, MR11, order separately  
Includes 36 inch lead wire

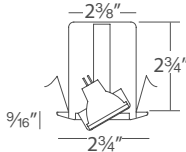

Model	Finish
<b>HR-1138</b>	<b>WT</b> White

Example: **HR-1138-WT**  
Lamp: 12V, 20W max, JC-20, included  
Includes 36 inch lead wire

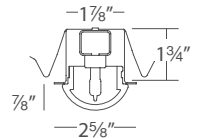

## Low Voltage Transformer (Required)

### Class 2 Enclosed Electronic Transformers

- Enclosed Class 2 transformers have multiple outputs in 60W increments
- 1W minimum load



Model	Input	Output	Dimensions
<b>EN-1260-RB2</b>	120V	12V, 1 x 60W	6 1/2" x 1 5/8" x 1 1/4"
<b>EN-12120-RB2*</b>		12V, 2 x 60W	6" x 3 1/4" x 2 5/8"
<b>EN-12180-RB2*</b>		12V, 3 x 60W	6 3/4" x 3 5/8" x 2 5/8"
<b>EN-12300-RB2*</b>		12V, 5 x 60W	8 1/2" x 4 5/8" x 2 5/8"
Multiple terminal box		<b>MTB-01</b>	

\*Includes LED indicator lights and integral push in terminals

OR

### UL Listed Class 2 Plug-In Electronic Transformers

- Plug-in power supply with on/off toggle switch and 6' detachable cord
- 1W minimum load



Model	Finish	Input	Output	Dimensions
<b>EN-1260-P-AR</b>	<b>BK</b> Black	120V	12V	2 3/4" x 1 5/8" x 1 3/4"
	<b>WT</b> White		60W	
Multiple terminal box		<b>MTB-01</b>		

# DISPLAY SPOTLIGHTS



Consult the factory to take advantage of our custom capabilities in large quantities.

Shown four **MO-LED17F-27-WT**





## Reflex LEDme® Monopoint

**Power:** 17W  
**Lumens:** Up to 1125  
**CBCP:** Up to 3780  
**Comparable:** 20W HID  
**CRI:** 85  
**Dimming:** 100% – 10%  
**Rated Life:** 100,000 hours

**Professional performance for best-selling LED luminaire design. Comparable to 20W HID**

- Energy Star® Rated
- Alternate beam angles may be ordered separately
- Smooth and continuous ELV dimming
- ANSI Compliant warm/neutral LED bins for a finer color consistency
- Accepts one lens/accessory
- Die-cast aluminum construction



Model	Beam	Color Temp	Finish
<b>MO-LED17</b>	<b>S</b> 20°	<b>27</b> 2700K	<b>BK</b> Black <b>WT</b> White
		<b>30</b> 3000K	
	<b>F</b> 45°	<b>35</b> 3500K	
		<b>40</b> 4000K	

Example: **MO-LED17S-27-WT**

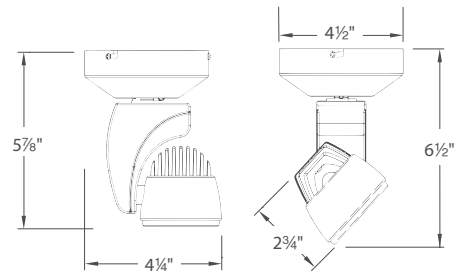

### Accessories

#### Replacement Modules

2700K	<b>RM-7X3-27</b>
3000K	<b>RM-7X3-30</b>
3500K	<b>RM-7X3-35</b>
4000K	<b>RM-7X3-40</b>

#### Lenses and Accessories

Color Lens	<b>LENS-20</b>	LED17	<b>AMB</b>	Amber
			<b>BLU</b>	Blue
			<b>GRN</b>	Green
			<b>RED</b>	Red
			<b>YEL</b>	Yellow
			<b>FR</b>	Frost
			<b>SPR</b>	Spread Lens
			<b>BEL</b>	Beam Elongating



Tool-free lens assembly for easy change of beam angle

## ARGOS LEDme<sup>®</sup> Monopoint

**Power:** 25W  
**Lumens:** Up to 1525  
**CBCP:** Up to 5868  
**Comparable:** 39W HID  
**CRI:** 85  
**Dimming:** 100% – 10%  
**Rated Life:** 100,000 hours

### LED luminaire with minimal size form factor Outperforms a 39W HID

- Energy Star<sup>®</sup> rated
- Smooth and continuous ELV dimming
- Free of projected heat and UV radiation
- Die-cast aluminum construction
- Tool-free lens assembly for easy in field change of beam angle
- ANSI Compliant Warm/Neutral LED Bins for a finer color consistency
- 360° horizontal and 90° vertical hot aiming
- Accepts one lens



**61**  
Lm/W

Model	Beam	Color Temp	Finish
<b>MO-LED25</b>	<b>S</b> 20°	<b>27</b> 2700K	<b>BK</b> Black <b>WT</b> White
	<b>F</b> 42°	<b>30</b> 3000K	
		<b>35</b> 3500K	
		<b>40</b> 4000K	

Example: **MO-LED25S-30-BK**

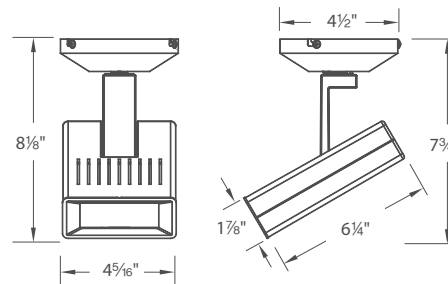

#### Interchangeable TIR assembly

20°	<b>OPH-10X3-20D</b>	<b>BK</b> Black
42°	<b>OPH-10X3-42D</b>	<b>PT</b> Platinum
		<b>WT</b> White

#### Replaceable LED Modules

2700K	<b>RM-10X3-27</b>
3000K	<b>RM-10X3-30</b>
3500K	<b>RM-10X3-35</b>
4000K	<b>RM-10X3-40</b>

#### Lens

<b>LENS-1X3-FR</b>	Frosted
<b>LENS-1X3-DIC-AMB</b>	Amber dichroic
<b>LENS-1X3-DIC-BLU</b>	Blue dichroic
<b>LENS-1X3-DIC-GRN</b>	Green dichroic
<b>LENS-1X3-DIC-RED</b>	Red dichroic
<b>LENS-1X3-DIC-YEL</b>	Yellow dichroic



Compatible with Framing Projector accessory. Sold separately

## Impulse LEDme® Monopoint

**Power:** 14W  
**Lumens:** Up to 951  
**CBCP:** Up to 4481  
**Comparable:** 75W MR16  
**CRI:** Up to 90  
**Dimming:** 100% – 10%  
**Rated Life:** 60,000 hours

### Clean profile design in 2 finishes.

#### Comparable to 75W MR16

- Meets 2013 California Title 24 Efficiency
- Smooth and continuous ELV dimming
- Free of projected heat and UV radiation
- ANSI Compliant Warm/Neutral LED Bins for a finer color consistency
- 360° horizontal rotation and 180° vertical aiming

**68**  
Lm/W

Model	Beam	Color Temp	Finish
<b>MO-LED810</b>	<b>S</b> 20°	<b>927</b> 2700K (90 CRI)	<b>BK</b> Black <b>WT</b> White
		<b>27</b> 2700K	
	<b>F</b> 40°	<b>9W</b> 3000K (90 CRI)	
		<b>WW</b> 3000K	
		<b>35</b> 3500K	
		<b>CW</b> 4000K	

Example: **MO-LED810S-WW-WT**

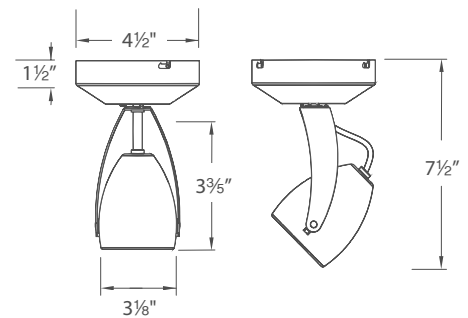

#### Interchangeable Beam Reflectors

20°	<b>RF-S</b>
40°	<b>RF-F</b>

#### Replaceable LED Modules

2700K (90 CRI)	<b>BXRC-27G1000</b>
2700K	<b>BXRC-27E1000</b>
3000K (90 CRI)	<b>BXRC-30G1000</b>
3000K	<b>BXRC-30E1000</b>
3500K	<b>BXRC-35E1000</b>
4000K	<b>BXRC-40E1000</b>

#### Framing Projector



Model	Finish
<b>008FP</b>	<b>BK</b> Black <b>WT</b> White

Example: **008FP-BK**



without Framing Projector



with Framing Projector

# Low Voltage LED MR16 Display Spot Lights

- Integral Electronic transformer
- Accepts 12V LED MR16, Halogen MR16 lamps up to 50W max
- LED MR16 included when ordered as LED
- 1 watt minimum load

- Can be wall or ceiling mounted
- Available extensions from 6 to 48 inches
- Clear lens included (see below for alternate lens options)



ME-007

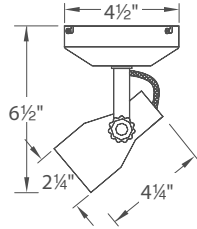

Model	Lamp	Extension (optional)	Finish
<b>ME-007LED</b>	LED	<b>X6</b> 6"	<b>BK</b> Black
		<b>X12</b> 12"	
<b>ME-007</b>	Halogen	<b>X18</b> 18"	<b>BN</b> Brushed Nickel
		<b>X24</b> 24"	
		<b>X36</b> 36"	<b>WT</b> White
		<b>X48</b> 48"	

Example: **ME-007LED-BK** or **ME-007LED-X6-BK** (with 6" extension)



## Framing Projector Accessory

Model	Finish
008FP	<b>BK</b> Black
	<b>WT</b> White



ME-808

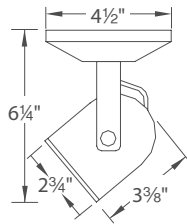

Model	Lamp	Extension (optional)	Finish
<b>ME-808LED</b>	LED	<b>X6</b> 6"	<b>BK</b> Black
		<b>X12</b> 12"	
<b>ME-808</b>	Halogen	<b>X18</b> 18"	<b>WT</b> White
		<b>X24</b> 24"	
		<b>X36</b> 36"	
		<b>X48</b> 48"	

Example: **ME-808LED-WT** or **ME-808LED-X12-WT** (with 12" extension)



ME-826

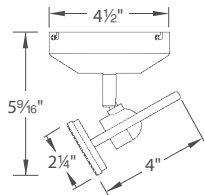

Model	Lamp	Extension (optional)	Finish
<b>ME-826LED</b>	LED	<b>X6</b> 6"	<b>BK</b> Black
		<b>X12</b> 12"	
<b>ME-826</b>	Halogen	<b>X18</b> 18"	<b>BN</b> Brushed Nickel
		<b>X24</b> 24"	
		<b>X36</b> 36"	<b>WT</b> White
		<b>X48</b> 48"	

Example: **ME-826LED-BN** or **ME-826LED-X36-BN** (with 36" extension)

## Lenses

Color Lens	LENS-16	AMB	Amber
		<b>BLU</b>	Blue
		<b>GRN</b>	Green
		<b>RED</b>	Red
		<b>YEL</b>	Yellow

UV Filter Lens	<b>LENS-16-UVF</b>
Frosted Lens	<b>LENS-16-FR</b>
Spread Lens	<b>LENS-16-SPR</b>
Beam Elongating	<b>LENS-16-BEL</b>
Honeycomb Louver	<b>LENS-16-HCL</b>

## LED

<b>Power:</b>	8W	<b>Color Temp:</b>	3000K
<b>Lumens:</b>	450	<b>CRI:</b>	85
<b>CBCP:</b>	833	<b>Dimming:</b>	Yes
<b>Comparable:</b>	35 W MR16	<b>Rated Life:</b>	25,000 hours

# Low Voltage LED MR16 Flexible Spot Lights

- Accepts 12V LED MR16, Halogen MR16 lamps up to 50W max
- LED MR16 included when ordered as LED
- 1 watt minimum load
- Can be wall or ceiling mounted

- Integral Electronic transformer (ME-204)
- Mesh solid bulb shield ordered separately

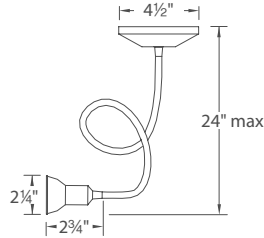

ME-204

Shown with optional bulb shield accessory

Model	Lamp	Transformer	Finish	
<b>ME-204LED</b>	LED	Integral Electronic Transformer	<b>BK</b>	Black
<b>ME-204</b>	Halogen		<b>BN</b>	Brushed Nickel
			<b>WT</b>	White

Example: **ME-204LED-WT**

Mounts to standard junction box

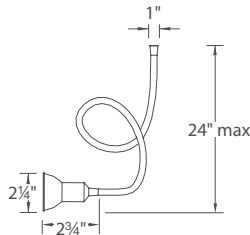

MM-204

Shown with optional bulb shield accessory

Model	Lamp	Transformer	Finish	
<b>MM-204LED</b>	LED	Remote Transformer (order separately)	<b>BK</b>	Black
<b>MM-204</b>	Halogen		<b>BN</b>	Brushed Nickel
			<b>WT</b>	White

Example: **MM-204LED-BK**

Install in walls, ceilings, or furniture wherever accessible from both sides up to thickness of 1 inch

## Remote Transformers (Required)

### Enclosed Electronic

Model	Output	Dimensions		
<b>EN-2460-RB2</b>	24V, 1-60W (class 2)	L: 6 1/2"	W: 1 5/8"	H: 1 1/4"
<b>EN-24100-RB2</b>	24V, 1-96W (class 2)	L: 6 1/2"	W: 1 5/8"	H: 1 1/4"
<b>EN-1260-RB2</b>	12V, 1-60W (class 2)	L: 6 5/8"	W: 1 5/8"	H: 1 1/8"
<b>EN-1275-RB-AR</b>	12V, 1-75W	L: 6 5/8"	W: 1 5/8"	H: 1 1/8"
<b>EN-12100-RB-AR</b>	12V, 1-100W	L: 6 1/4"	W: 3"	H: 1 5/8"
<b>EN-12150-RB-AR</b>	12V, 1-150W	L: 6 1/4"	W: 3"	H: 1 5/8"

OR

### Magnetic

Model	Output	Dimensions		
<b>SRT-300M-12V</b>	12V, 300W	L: 10 3/4"	W: 4 1/4"	H: 4 1/8"
<b>SRT-600M-12V</b>	12V, 600W	L: 11 1/2"	W: 5 1/4"	H: 5 1/8"

## Bulb Shield Accessory



Mesh



Solid

Model	Finish
<b>MBS-16</b> Mesh Shield	<b>BK</b> Black
<b>SBS-16</b> Solid Shield	<b>BN</b> Brushed Nickel
	<b>WT</b> White

Example: **MBS-16-BN**

## LED

<b>Power:</b>	8W	<b>Color Temp:</b>	3000K
<b>Lumens:</b>	450	<b>CRI:</b>	85
<b>CBCP:</b>	833	<b>Dimming:</b>	Yes
<b>Comparable:</b>	35W MR16	<b>Rated Life:</b>	25,000 hours

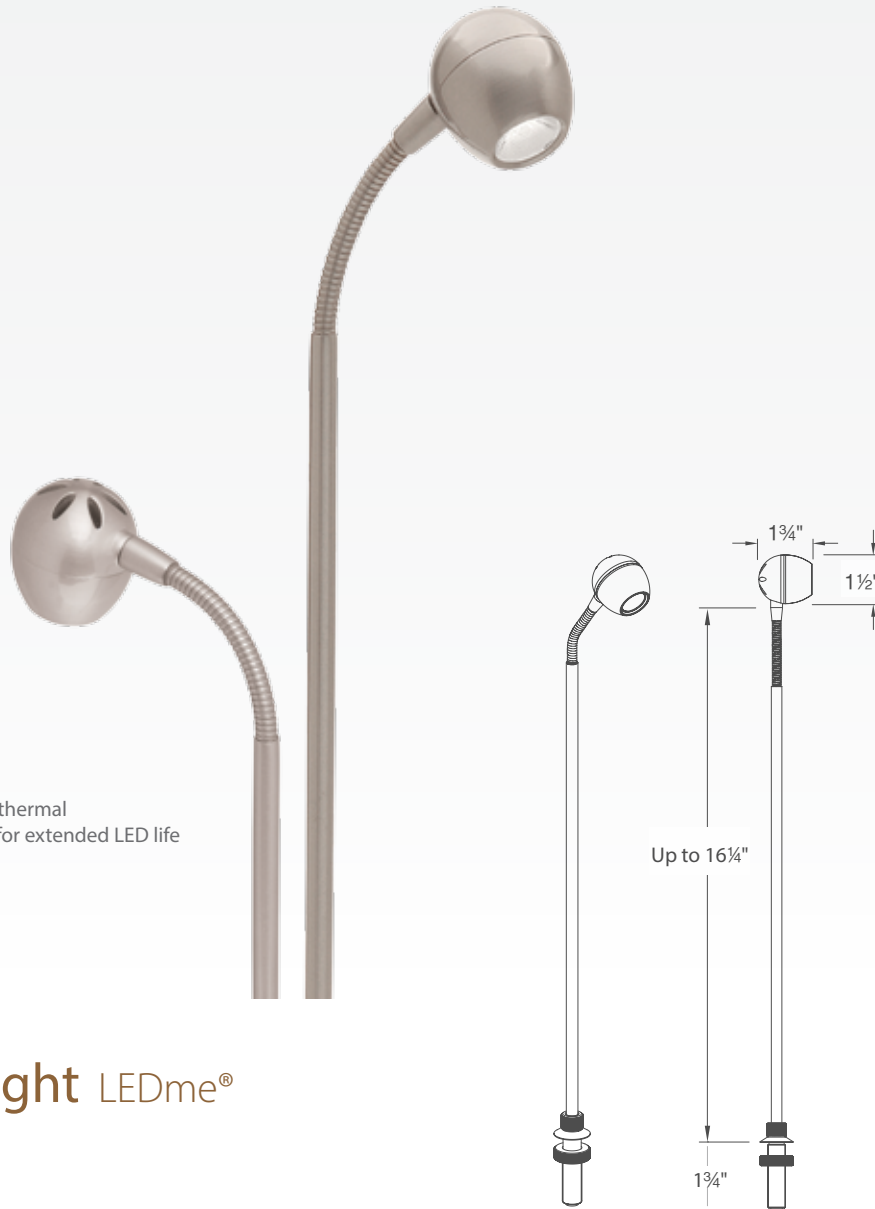

Flexible neck

Vents provide thermal management for extended LED life

## Display Spot Light LEDme®

**Power:** 3W  
**Lumens:** Up to 110  
**Color Temp:** 3000K, 4500K  
**CRI:** 85  
**Rated Life:** 100,000 hours

- Die-cast aluminum construction
- Threaded rod allows for mounting in varying applications
- Adjustable from 4 to 16 1/4 inches, may be cut in field for custom lengths
- Includes 6 ft of lead wire

### LEDme® Driver (Required)

- Reliable constant current LED power supply
- Surge protection
- Short circuit protection
- Powers up to 4 LEDme® Display Spot Lights



Model	Power	L	W	H
<b>LED-700MA12-P</b>	12W	5"	3"	1 5/8"

Model	Color Temp	Beam	Finish
<b>LED-SL-101</b>	<b>WW</b> 3000K	<b>F</b> 25°	<b>BK</b> Black
	<b>NW</b> 4500K	<b>W</b> 40°	<b>BN</b> Brushed Nickel
			<b>CH</b> Chrome

Example: **LED-SL-101-WW-F-CH**

### Accessory

#### Interchangeable Lens

Model	Beam
<b>SL-LEN</b>	<b>F</b> 25°
	<b>W</b> 40°



#### Replacement Modules

3000K	<b>RM1X3-30-SL</b>
4500K	<b>RM1X3-45-SL</b>



Shown two **LED-SL-101-WW-F-BN**



## Low Voltage Clamp Mount Spot Lights

**Lamping:** Accepts 12V LED MR16, Halogen MR16 lamps up to 50W max

- Includes 2" clamp and 10' cord with plug-in transformer
- 1W minimum load

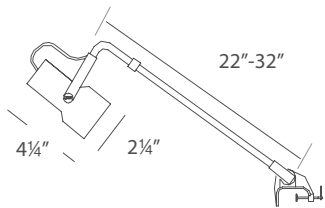

Model	Type	Finish
<b>DL-007</b>	<i>Telescoping neck</i>	<b>BK</b> <i>Black</i>

Example: **DL-007-BK**



Framing Projector (optional)

Model	Finish
<b>008FP-BK</b>	<i>Black</i>

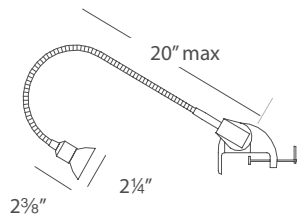

Model	Type	Finish
<b>DL-214</b>	<i>Gooseneck</i>	<b>BK</b> <i>Black</i> <b>WT</b> <i>White</i>

Example: **DL-214-WT**

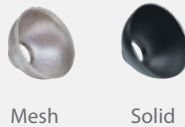

Bulb Shield Accessory

Model	Finish
<b>MBS-16</b> <i>Mesh Shield</i>	<b>BK</b> <i>Black</i>
<b>SBS-16</b> <i>Solid Shield</i>	<b>BN</b> <i>Brushed Nickel</i>
	<b>WT</b> <i>White</i>

Example: **MBS-16-BN**

### LED MR16

Model	Finish
<b>MR16LED-BAB</b>	<b>BK</b> <i>Black</i> <b>WT</b> <i>White</i>

### Accessory Alternative Clamps



Model	Finish	Description
<b>DLC-P</b> <i>Pipe Clamp</i>	<b>BK</b> <i>Black</i>	<i>For pipes 1/2" to 2 1/2"</i>
<b>DLC-4</b> <i>4" Clamp</i>	<b>WT</b> <i>White</i>	<i>For flat surfaces from 2" to 4" wide</i>

Example: **DLC-4-WT**





Shown with BR30 LED lamp  
Order separately

## Line Voltage Clamp Mount Spot Lights

- Telescoping adjustment from 22" to 32"
- Sliding adjustable socket to accommodate lamp positioning for DL-188
- Includes 2" clamp and 10' cord with plug

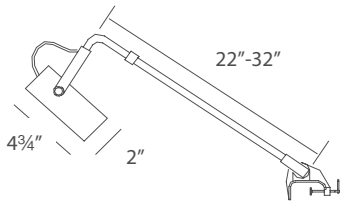

Model	Type	Lamp (order separately)	Finish
<b>DL-188</b>	<i>Telescoping neck</i>	LED PAR20/LED PAR30 LED BR20/LED BR30/LED BR40  120V, 150W max BR30/PAR20/PAR30/PAR38	<b>BK</b> Black <b>WT</b> White

Example: **DL-188-WT**

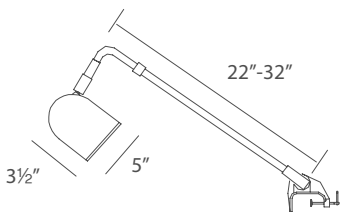

Model	Type	Lamp (order separately)	Finish
<b>DL-150</b>	<i>Telescoping Wash Light</i>	120V, 150W max, J-150-S	<b>BK</b> Black <b>WT</b> White

Example: **DL-150-BK**

### LED Lamps for DL-188

Model	Type	Finish
<b>PAR20LED-10N30</b>	PAR20	<b>BK</b> <b>WT</b>
<b>PAR30LED-L14N30</b>	PAR30	
<b>PAR38LED-17N30</b>	PAR38	
<b>BR20LED-7N27</b>	BR20	<b>WT</b>
<b>BR30LED-11N27</b>	BR30	
<b>BR40LED-15N27</b>	BR40	

### Accessory Alternative Clamps



Model	Finish	Description
<b>DLC-P</b> Pipe Clamp	<b>BK</b> Black	For pipes 1/2" to 2 1/2"
<b>DLC-4</b> 4" Clamp	<b>WT</b> White	For flat surfaces from 2" to 4" wide

Example: **DLC-4-WT**

# TRACK SYSTEMS





The cornerstone to our brand, WAC Lighting track systems have provided high performing technical lighting systems to the marketplace for decades. 5 standard track systems are offered in the product line, ranging from the museum-quality W track for upscale retail specifications to our standard commercial-grade H, L, and J track systems complete with a full assortment of LED luminaires assembled locally for custom CCT and light distribution options.

Track Luminaires are offered to perform in most interior applications ranging from spot lighting in high-ceiling retail and commercial spaces to diminutive residential accent lighting. Available in luminous flux options ranging from around 500 lumens comparable to 35W MR16 lamps, to over 3000 lumens comparable to a 70W HID or 200W Halogen.

Dozens of dedicated LED designs are offered in different distinctive looks to complement various interiors.

### W Track Systems

PALOMA		105-106
LOGOS		107-108
ARGOS		109-110
REFLEX PRO		111
EXTERMINATOR		112
WALL WASHER		113
VAMP		114

### H/L/J/J2 Track Systems

LOGOS		121
ARGOS		122
REFLEX		123-124
EXTERMINATOR		127
WALL WASHER		125
WASH LIGHT		126
IMPULSE		129
CARTIER		131
GALILEO		130
LOW VOLTAGE		133-139
LINE VOLTAGE		140-148

Consult the factory to take advantage of our custom capabilities in large quantities.

# W TRACK SYSTEM

Architectural 4-wire two-circuit track with recessed, trimless installations with recessed drivers for a minimal look, as well as surface-mount, or stem and cable suspension options. Available in 120V and 277V.



277V

120V

Surface Mount / Suspended  
Two Circuit Architectural Track

Heavy duty aluminum rigid track designed for suspension up to 8 feet or recessed installation



Flangeless

Flanged

120V / 277V  
Recessed  
Two Circuit Architectural Track

## Surface Two Circuit Architectural Track

**Description:** Heavy duty architectural grade track with two independently controllable circuits and stem or cable suspensions

**Power per Circuit:** 1920W max (120V), 4432W max (277V)

**Operating Current:** Each circuit is rated 20A (2 x 20A = 40A max)

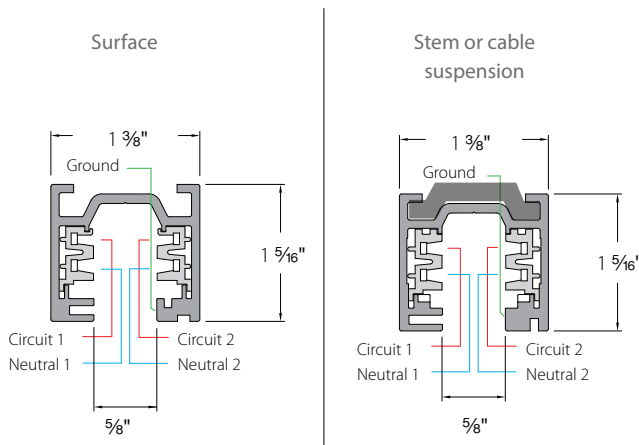

## Recessed Two Circuit Architectural Track

**Description:** Recessed architectural grade track with two independently controllable circuits with flangeless option

**Power per Circuit:** 1920W max (120V), 4432W max (277V)

**Operating Current:** Each circuit is rated 20A (2 x 20A = 40A max)

- Clean recessed architectural look in a flanged or flangeless installation

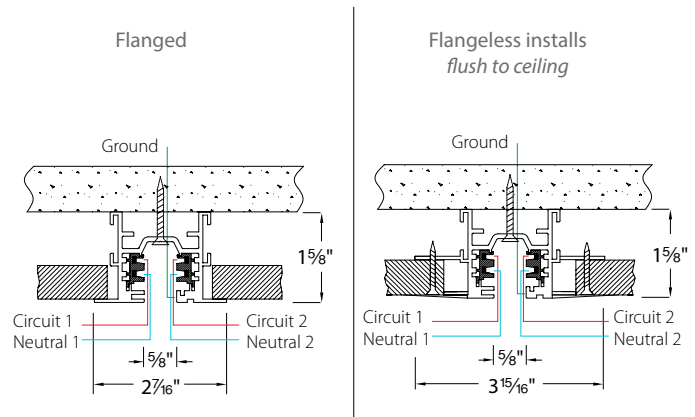

### Straight Configuration

- A WEDR** Live end connector (right)
- B WIC** I power connector
- C WPC** I connector
- D WEC** End cap

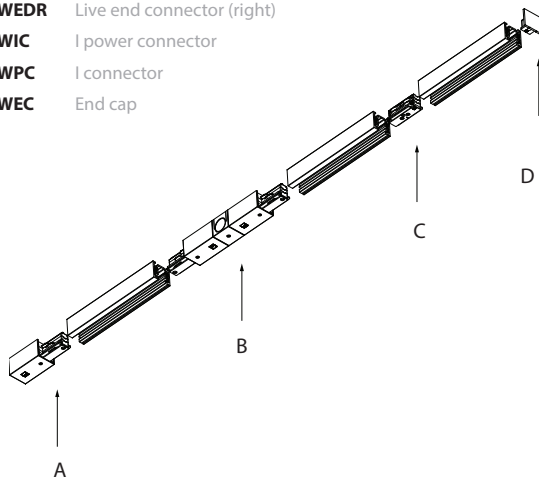

### Flexible Configurations

- A WEDR** Live end connector (right)
- B WEDL** Live end connector (left)
- C WFC** Flexible connector
- D WEC** End cap

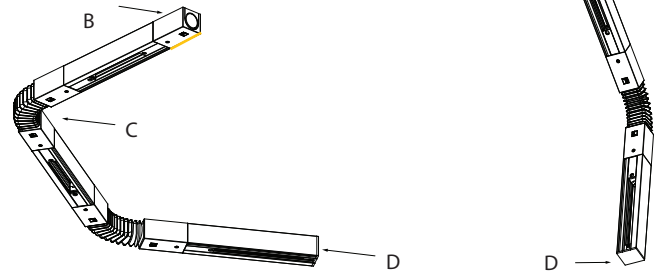

Horizontal Ceiling Mount

Vertical Wall-to-Ceiling Mount

### Grid Configuration

- A WLLC** L Connector Left
- B WLTC** T Connector Left
- C WRTC** T Connector Right
- D WXC** X Connector

= Indicates Electrical Continuity

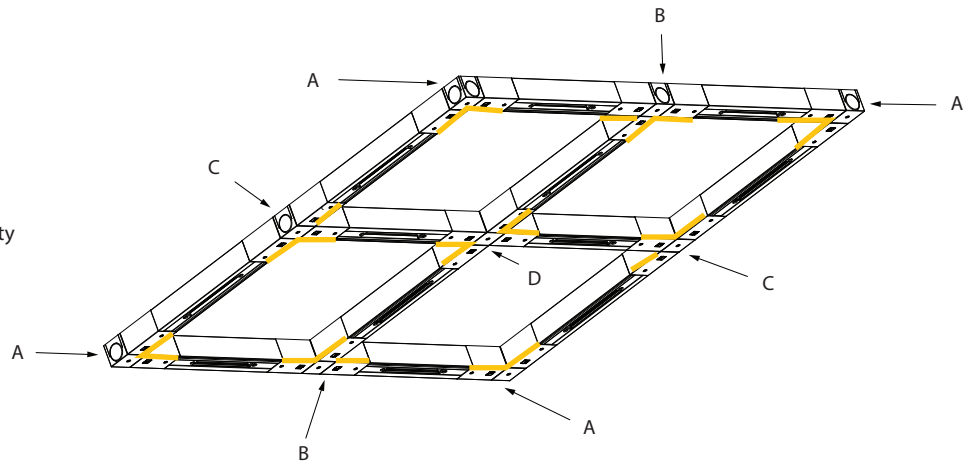

### Cable Suspension Mount

- A WMFP** Flexible Stem kit with power feed
- B WMED** Live end suspension mount
- C WEDL** Live end connector (left)
- D WMST-X** Cable suspension kit
- E WMT** Suspension hanger clip
- F WMST-TB** T bar cable suspension kit
- G WMST-XS** Sloped ceiling cable kit
- H WMLC** L connector suspension mount
- I WLLC** L connector left
- J WEC** End cap

Use one support for every 4 feet

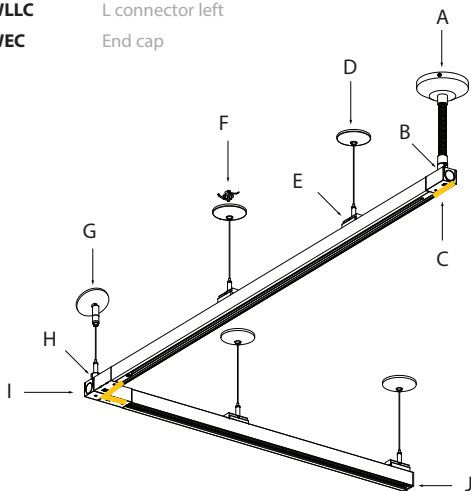

### Stem Suspension Mount

- A WMSP** Stem kit with power feed
- B WMED** Live end suspension mount
- C WEDR** Live end connector (right)
- D WMT-XS** Sloped ceiling stem kit
- E WMT** Suspension hanger clip
- F WMT-TB** T bar stem kit
- G WMT-X** Stem kit
- H WMLC** L connector suspension mount
- I WLLC** L connector left
- J WEC** End cap

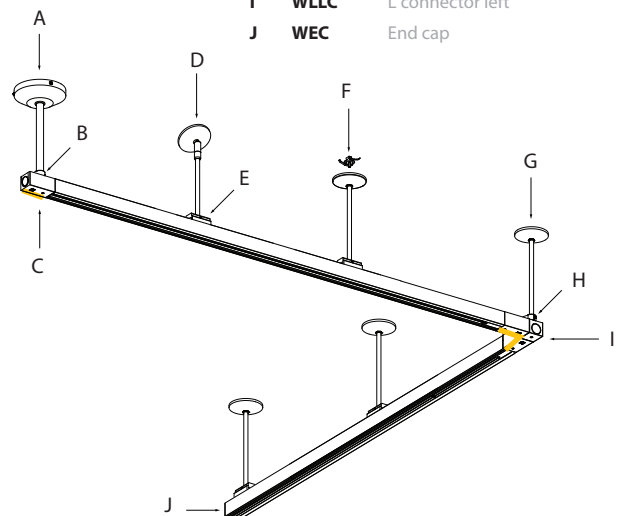

# W Track Surface Mount Two Circuit Architectural Track & Accessories

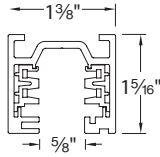

## 120V/277V Track Sections

Model	Length	Finish
<b>WT</b> 120V	<b>4</b> 4'	<b>BK</b> Black
<b>WHT</b> 277V	<b>8</b> 8'	<b>PT</b> Platinum
	<b>12</b> 12'	<b>WT</b> White

Example: **WHT4-PT**

Each section includes two matching end caps.

## Accessories

Model	Volt	Finish	Description
<b>WEDL</b> <b>WHEDL</b>	120V 277V	<b>BK</b> <b>PT</b> <b>WT</b>	Direct wiring through ceiling. Polarity on left side of track
<b>WEDR</b> <b>WHEDR</b>	120V 277V	<b>BK</b> <b>PT</b> <b>WT</b>	Direct wiring through ceiling. Polarity on right side of track
<b>WPC</b> <b>WHPC</b>	120V 277V	<b>BK</b> <b>PT</b> <b>WT</b>	Join two sections of track with electrical continuity.
<b>WIC</b> <b>WHIC</b>	120V 277V	<b>BK</b> <b>PT</b> <b>WT</b>	Power entry point at the connection of two tracks.
<b>WFC</b> <b>WHFC</b>	120V 277V	<b>BK</b> <b>PT</b> <b>WT</b>	Transition from wall-to-wall, wall-to-ceiling, or ceiling-to-ceiling. Power feedable.
<b>CP</b>	120V 277V	<b>BK</b> <b>PT</b> <b>WT</b>	Covers a standard 4" octagonal box.
<b>WEC</b>	120V 277V	<b>BK</b> <b>PT</b> <b>WT</b>	End Cap

= Indicates Electrical Continuity

"L" Connector - Left	<b>WLLC</b> <b>WHLLC</b>	120V 277V	<b>BK</b> <b>PT</b> <b>WT</b>	Join 2 track sections to make power feedable 90° left polarity turns.
"L" Connector - Right	<b>WRLC</b> <b>WHRLC</b>	120V 277V	<b>BK</b> <b>PT</b> <b>WT</b>	Join 2 track sections to make power feedable 90° right polarity turns.
"T" Connector - Left	<b>WLTC</b> <b>WHLTC</b>	120V 277V	<b>BK</b> <b>PT</b> <b>WT</b>	Join 3 track sections. Power feedable. Polarity on outside edge.
"T" Connector - Right	<b>WRTC</b> <b>WHRTC</b>	120V 277V	<b>BK</b> <b>PT</b> <b>WT</b>	Join 3 track sections. Power feedable. Polarity on inside edge.
"X" Connector	<b>WXC</b> <b>WHXC</b>	120V 277V	<b>BK</b> <b>PT</b> <b>WT</b>	Join 4 track sections. Power feedable.

## Track Current Limiter

Model	Volt	Rating	Finish	Description
<b>WEDL</b> <b>WHEDL</b>	120V 277V	<b>1A</b> 1 Amp <b>2A</b> 2.5Amp <b>5A</b> 5 Amp <b>7A</b> 7.5Amp <b>10A</b> 10Amp <b>12A</b> 12Amp	<b>BK</b> <b>PT</b> <b>WT</b>	Assures compliance to California Title 24 or ASHRAE 90.1 requirements
<b>WEDR</b> <b>WHEDR</b>	120V 277V			

## Suspension

Model	Length	Finish	Description
<b>WMSP</b>	<b>6</b> 6"	<b>BK</b> <b>PT</b> <b>WT</b>	Power feed to connect with a Live End or any Joiner/Feeder. Field cuttable.
	<b>12</b> 12"		
	<b>24</b> 24"		
	<b>36</b> 36"		
	<b>48</b> 48"		
<b>WMFP</b>	<b>48</b> 48"	<b>BK</b> <b>PT</b> <b>WT</b>	Flexible power feed to connect with a Live End or any Joiner/Feeder. Recommended for use with Cable Suspensions. Field cuttable.
	<b>96</b> 96"		
<b>WMT-X</b>	<b>6</b> 6"	<b>BK</b> <b>PT</b> <b>WT</b>	Suspend track from the ceiling. Field cuttable.
	<b>12</b> 12"		
	<b>24</b> 24"		
	<b>36</b> 36"		
	<b>48</b> 48"		
<b>WMT-TB</b>	<b>48</b> 48"	<b>BK</b> <b>PT</b> <b>WT</b>	Suspend from drop ceilings. Field cuttable.
	<b>96</b> 96"		
<b>WMT</b>	<b>XS6</b> 6"	<b>BK</b> <b>PT</b> <b>WT</b>	Suspend track from a sloped ceiling. Field cuttable.
	<b>XS12</b> 12"		
	<b>XS24</b> 24"		
	<b>XS36</b> 36"		
	<b>XS48</b> 48"		
<b>WMT</b>	<b>XS96</b> 96"	<b>BK</b> <b>PT</b> <b>WT</b>	Suspend track from a sloped ceiling. Field cuttable.
<b>WMST</b>	<b>XS48</b> 48"	<b>BK</b> <b>PT</b> <b>WT</b>	Suspend track from a sloped ceiling. Field cuttable.
	<b>XS96</b> 96"		
<b>WMST-X</b>	<b>48</b> 48"	<b>BK</b> <b>PT</b> <b>WT</b>	Suspend track from the ceiling. Field cuttable.
	<b>96</b> 96"		
<b>WMST-TB</b>	<b>96</b> 96"	<b>BK</b> <b>PT</b> <b>WT</b>	Suspend track from drop ceilings. Field cuttable.

## Suspension Accessories

Model	Finish
<b>WMPC</b>	<b>BK</b> <b>PT</b> <b>WT</b>
<b>WMIC</b>	<b>BK</b> <b>PT</b> <b>WT</b>
<b>WMED</b>	<b>BK</b> <b>PT</b> <b>WT</b>
<b>WMLC</b>	<b>BK</b> <b>PT</b> <b>WT</b>
<b>WMTC</b>	<b>BK</b> <b>PT</b> <b>WT</b>
<b>WMXC</b>	<b>BK</b> <b>PT</b> <b>WT</b>
<b>WMT</b>	<b>BK</b> <b>PT</b> <b>WT</b>

# W Track Recessed Two Circuit Architectural Track & Accessories

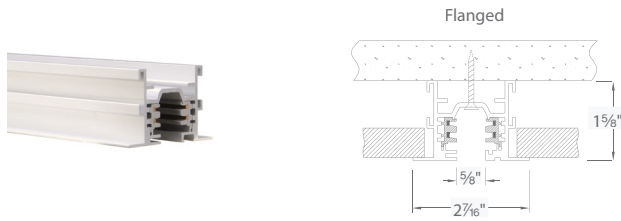

## Flanged Track Sections

Model	Length	Track Type	Finish
<b>WT</b> 120V	<b>4</b> 4'	<b>RT</b> Flanged	<b>BK</b> Black
<b>WHT</b> 277V	<b>8</b> 8'		<b>PT</b> Platinum
	<b>12</b> 12'		<b>WT</b> White

Example: **WHT8-RT-WT**

Each section includes two matching end caps.

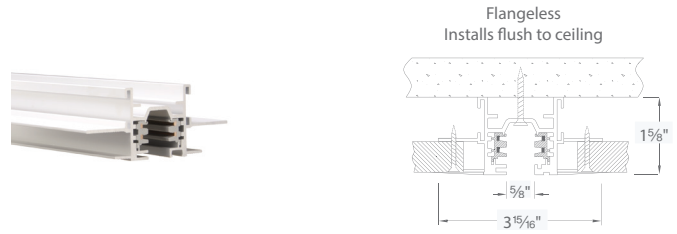

## Flangeless Track Sections

Model	Length	Track Type	Finish
<b>WT</b> 120V	<b>4</b> 4'	<b>RTL</b> Flangeless	<b>BK</b> Black
<b>WHT</b> 277V	<b>8</b> 8'		<b>PT</b> Platinum
	<b>12</b> 12'		<b>WT</b> White

Example: **WT8-RTL-WT**

Each section includes two matching end caps.

= Indicates Electrical Continuity

## Accessories

Accessories	Flanged	Flangeless	Model	Voltage	Flanged/Flangeless	Finish	Description
Live End Connector – Left			<b>WEDL</b> <b>WHEDL</b>	120V 277V	<b>RT</b> Flanged <b>RTL</b> Flangeless	<b>BK</b> <b>PT</b> <b>WT</b>	Use for direct wiring through ceiling.
Live End Connector – Right			<b>WEDR</b> <b>WHEDR</b>	120V 277V			
"I" Connector			<b>WPC</b> <b>WHPC</b>	120V 277V	<b>RT</b> Flanged / Flangeless	<b>BK</b> <b>PT</b> <b>WT</b>	Use to join two sections of track with electrical continuity.
"I" Power Connector			<b>WIC</b> <b>WHIC</b>	120V 277V	<b>RT</b> Flanged <b>RTL</b> Flangeless	<b>BK</b> <b>PT</b> <b>WT</b>	Power entry point at the connection of two tracks.
"L" Connector – Left			<b>WLLC</b> <b>WHLLC</b>	120V 277V	<b>RT</b> Flanged <b>RTL</b> Flangeless	<b>BK</b> <b>PT</b> <b>WT</b>	Use to join 2 track sections to make power feedable 90° left polarity turns.
"L" Connector – Right							
"T" Connector – Left			<b>WLTC</b> <b>WHLTC</b>	120V 277V	<b>RT</b> Flanged <b>RTL</b> Flangeless	<b>BK</b> <b>PT</b> <b>WT</b>	Use to join 3 track sections. Power feedable. Polarity on outside edge.
"T" Connector – Right							
"X" Connector			<b>WXC</b> <b>WHXC</b>	120V 277V	<b>RT</b> Flanged <b>RTL</b> Flangeless	<b>BK</b> <b>PT</b> <b>WT</b>	Use to join 4 track sections. Power feedable.
Suspension Hanger Clip			<b>WMT</b>	120V 277V	<b>RT</b> Flanged / Flangeless		To suspend the track. Without power feed.
End Cap			<b>WEC</b>	120V 277V	<b>RT</b> Flanged / Flangeless	<b>BK</b> <b>PT</b> <b>WT</b>	

## Track Current Limiter

Track Current Limiter	Model	Volt	Flanged/Flangeless	Rating	Finish	Description
Live end - Left	<b>WEDL</b> <b>WHEDL</b>	120V 277V	<b>RT</b> Flanged <b>RTL</b> Flangeless	<b>1A</b> 1 Amp <b>2A</b> 2.5Amp <b>5A</b> 5 Amp <b>7A</b> 7.5Amp <b>10A</b> 10Amp <b>12A</b> 12Amp	<b>BK</b> <b>PT</b> <b>WT</b>	Easy to install and aids in compliance to California Title 24 of ASHRAE 90.1 requirements
Live end - Right	<b>WEDR</b> <b>WHEDR</b>	120V 277V				

# Paloma Premium LED

## Museum-quality LED luminaires with high performance reflector optics and recessed drivers

- Meets 2013 California Title 24 Efficiency
- Die-cast aluminum construction
- 365° horizontal rotation and 180° vertical aiming
- Smooth and continuous ELV dimming for 120V
- 50,000 hours rated life

65  
Lm/W



Recessed Driver Hidden Within W Track

Accommodates 1 filter lens and 1 accessory  
*Color Lenses, Filter Lenses, and Beam Control*





## Paloma LED512

**Power:** 11.5W  
**Lumens:** Up to 780  
**CBCP:** Up to 3430  
**CRI:** Up to 90  
**Comparable:** 50W MR16

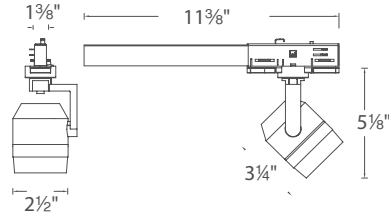

Track Type	System	Model	Beam	Color Temp	Finish
W Track	<b>WTK</b> 120V <b>WHK</b> 277V	<b>LED512</b>	<b>S</b> 19° <b>N</b> 24° <b>F</b> 36°	<b>927</b> 2700K (90CRI)	<b>BK</b> Black <b>PT</b> Platinum <b>WT</b> White
				<b>27</b> 2700K	
				<b>930</b> 3000K (90CRI)	
				<b>30</b> 3000K	
				<b>35</b> 3500K	
				<b>40</b> 4000K	

Example: **WTK-LED512S-27-WT**

### Lenses and Accessories (order separately)

Color Lens	<b>LENS-16</b>	<b>AMB</b> Amber <b>BLU</b> Blue <b>GRN</b> Green <b>RED</b> Red <b>YEL</b> Yellow	UV Filter Lens	<b>LENS-16-UVF</b>	Cross Louver Honeycomb Snoot	<b>LENS-16-CRL</b> <b>LENS-16-HCM</b> <b>LENS-16-SNOOT</b>
			Frosted Lens	<b>LENS-16-FR</b>		
			Spread Lens	<b>LENS-16-SPR</b>		
			Beam Elongating	<b>LENS-16-BEL</b>		



## Paloma LED522

**Power:** 23.5W  
**Lumens:** Up to 1310  
**CBCP:** Up to 5780  
**CRI:** Up to 90  
**Comparable:** 100W Halogen

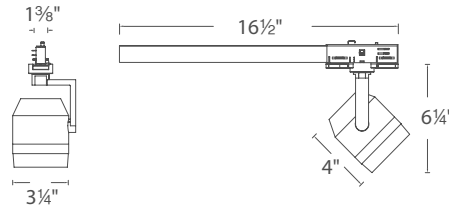

Track Type	System	Model	Beam	Color Temp	Finish
W Track	<b>WTK</b> 120V <b>WHK</b> 277V	<b>LED522</b>	<b>S</b> 19° <b>N</b> 24° <b>F</b> 36°	<b>927</b> 2700K (90CRI)	<b>BK</b> Black <b>PT</b> Platinum <b>WT</b> White
				<b>27</b> 2700K	
				<b>930</b> 3000K (90CRI)	
				<b>30</b> 3000K	
				<b>35</b> 3500K	
				<b>40</b> 4000K	

Example: **WTK-LED522F-35-BK**

### Lenses and Accessories (order separately)

Color Lens	<b>LENS-20</b>	<b>AMB</b> Amber <b>BLU</b> Blue <b>GRN</b> Green <b>RED</b> Red <b>YEL</b> Yellow	UV Filter Lens	<b>LENS-20-UVF</b>	Cross Louver Honeycomb Snoot	<b>LENS-20-CRL</b> <b>LENS-20-HCM</b> <b>LENS-20-SNOOT</b>
			Frosted Lens	<b>LENS-20-FR</b>		
			Spread Lens	<b>LENS-20-SPR</b>		
			Beam Elongating	<b>LENS-20-BEL</b>		

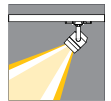

## Paloma LED532

**Power:** 28W  
**Lumens:** Up to 1755  
**CBCP:** Up to 9770  
**CRI:** Up to 90  
**Comparable:** 150W Halogen

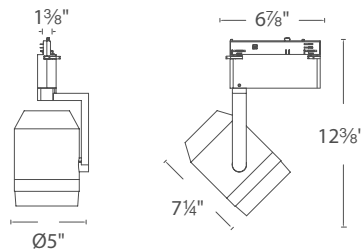

Track Type	System	Model	Beam	Color Temp	Finish
W Track	<b>WTK</b> 120V <b>WHK</b> 277V	<b>LED532</b>	<b>S</b> 16° <b>N</b> 25° <b>F</b> 36°	<b>927</b> 2700K (90CRI)	<b>BK</b> Black <b>PT</b> Platinum <b>WT</b> White
				<b>27</b> 2700K	
				<b>930</b> 3000K (90CRI)	
				<b>30</b> 3000K	
				<b>35</b> 3500K	
				<b>40</b> 4000K	

Example: **WTK-LED532N-40-WT**

### Lenses and Accessories (order separately)

Color Lens	<b>LENS-30</b>	<b>AMB</b> Amber <b>BLU</b> Blue <b>GRN</b> Green <b>RED</b> Red <b>YEL</b> Yellow	UV Filter Lens	<b>LENS-30-UVF</b>	Cross Louver Honeycomb Snoot	<b>LENS-30-CRL</b> <b>LENS-30-HCM</b> <b>LENS-30-SNOOT</b>
			Frosted Lens	<b>LENS-30-FR</b>		
			Spread Lens	<b>LENS-30-SPR</b>		
			Beam Elongating	<b>LENS-30-BEL</b>		

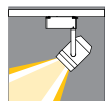



LED40



LED23

## LOGOS LEDme®

**Power:** 38W  
**Lumens:** Up to 3080  
**CBCP:** Up to 24,767  
**Comparable:** 70W HID  
**CRI:** 85  
**Dimming:** 100% – 10% (120V only)  
**Rated Life:** 100,000 hours

**Power:** 23W  
**Lumens:** Up to 1845  
**CBCP:** Up to 18,049  
**Comparable:** 39W HID  
**CRI:** 85  
**Dimming:** 100% – 10%  
**Rated Life:** 100,000 hours



Lockable aiming angle

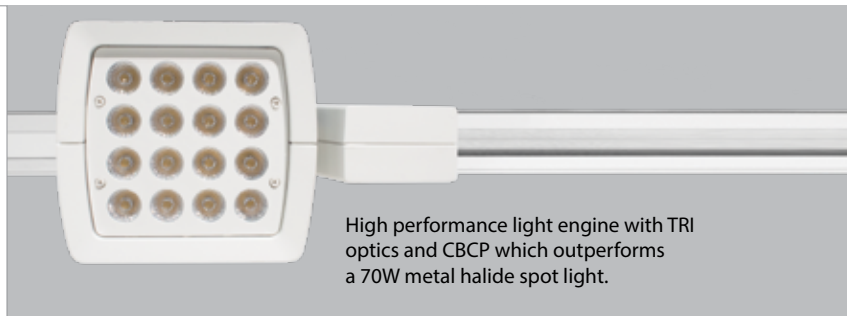

High performance light engine with TRI optics and CBCP which outperforms a 70W metal halide spot light.

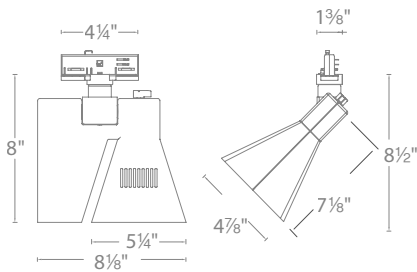

LED40

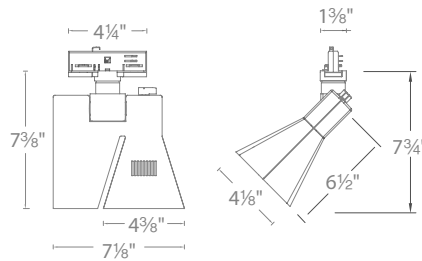

LED23

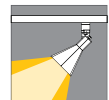

Track Type	System	Model	Beam	Color Temp	Finish
W Track	WTK 120V WHK 277V	LED23 23W LED40 40W	S* 12°	27 2700K 30 3000K 35 3500K 40 4000K	BK Black PT Platinum WT White
			N 24°		
			F 36°		
			E 19° x 32° elliptical spread		

Example: **WTK-LED23S-40-WT** \* not Energy Star Rated

### Interchangeable TIR lens assembly

	LED23	LED40	Finish
12°	OPH-9X3-12D	OPH-16X3-12D	BK Black
24°	OPH-9X3-25D	OPH-16X3-25D	PT Platinum
36°	OPH-9X3-40D	OPH-16X3-40D	WT White
19° x 32°	OPH-9X3-ELD	OPH-16X3-ELD	

### Replaceable LED Modules

	LED23	LED40	Finish
2700K	RM-9X3-27	RM-16X3-27	BK Black
3000K	RM-9X3-30	RM-16X3-30	PT Platinum
3500K	RM-9X3-35	RM-16X3-35	WT White
4000K	RM-9X3-40	RM-16X3-40	

Example: **OPH-9X3-25D-BK**



**Superior efficacy LED luminaires for retail requirements. Comparable to 39W and 70W HID**

- Energy Star® Rated
- Single tool-free lens assembly for easy in field change of beam angle
- 360° horizontal and 180° vertical aiming
- Die-cast aluminum construction
- Smooth and continuous ELV dimming
- High performance with fixture efficacy up to 80lm/W

# ARGOS LEDme®

**Power:** 25W  
**Lumens:** Up to 1525  
**CBCP:** Up to 5868  
**Comparable:** 39W HID  
**CRI:** 85  
**Dimming:** 100% – 10%  
**Rated Life:** 100,000 hours



## LED luminaire with minimal size form factor. Outperforms a 39W HID

- Energy Star® rated
- Smooth and continuous ELV dimming
- Free of projected heat and UV radiation
- Die-cast aluminum construction
- Tool-free lens assembly for easy in field change of beam angle
- ANSI Compliant Warm/Neutral LED Bins for a finer color consistency
- 360° horizontal and 90° vertical hot aiming
- Accepts one lens



Alternate beam angles may be ordered separately

Single tool-free lens assembly for easy in field change of beam angle



Track Type	System	Model	Beam	Color Temp	Finish
W Track	<b>WTK</b> 120V	<b>LED25</b>	<b>S</b> 20°	<b>27</b> 2700K	<b>BK</b> Black
	<b>WHK</b> 277V		<b>F</b> 42°	<b>30</b> 3000K	<b>PT</b> Platinum
				<b>35</b> 3500K	<b>WT</b> White
				<b>40</b> 4000K	

Example: **WTK-LED25S-27-BK**

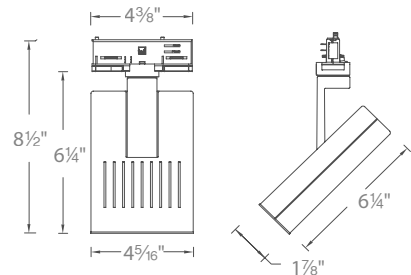
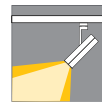

### Interchangeable TIR assembly

20°	<b>OPH-10X3-20D</b>	<b>BK</b> Black
42°	<b>OPH-10X3-42D</b>	<b>PT</b> Platinum
		<b>WT</b> White

### Replaceable LED Modules

2700K	<b>RM-10X3-27</b>
3000K	<b>RM-10X3-30</b>
3500K	<b>RM-10X3-35</b>
4000K	<b>RM-10X3-40</b>

### Lens

<b>LENS-1X3-FR</b>	Frosted
<b>LENS-1X3-DIC-AMB</b>	Amber dichroic
<b>LENS-1X3-DIC-BLU</b>	Blue dichroic
<b>LENS-1X3-DIC-GRN</b>	Green dichroic
<b>LENS-1X3-DIC-RED</b>	Red dichroic
<b>LENS-1X3-DIC-YEL</b>	Yellow dichroic





LED17



LED27

## Reflex PRO LEDme®

	LED17	LED27
<b>Power:</b>	17W	27W
<b>Lumens:</b>	Up to 1125	Up to 1890
<b>CBCP:</b>	Up to 3780	Up to 7455
<b>Comparable:</b>	20 W HID	39 W HID
<b>CRI:</b>	85	85
<b>Dimming:</b>	100% – 10% (for 120V only)	
<b>Rated Life:</b>	100,000 hours	100,000 hours

### Professional performance for best-selling LED luminaire.

#### Comparable to 20W and 39W HID

- Energy Star® Rated
- Alternate beam angles may be ordered separately
- Smooth and continuous ELV dimming
- ANSI Compliant warm/neutral LED bins for a finer color consistency
- Accepts one lens/accessory



360° horizontal and 180° vertical hot aiming



Die-cast aluminum construction

Track Type	System	Model	Watt	Beam	Color Temp	Finish
W Track	WTK 120V	LED17	17W	S 20° F 45°	27 2700K	BK Black PT Platinum WT White
	WTK 120V	LED27	27W		30 3000K	
	WHK 277V				35 3500K	
					40 4500K	

Example: **WHK-LED27F-35-WT**

#### Replaceable LED Modules

	LED17	LED27
2700K	RM-7X3-27	RM-11X3-27
3000K	RM-7X3-30	RM-11X3-30
3500K	RM-7X3-35	RM-11X3-35
4000K	RM-7X3-40	RM-11X3-40

#### Lenses and Accessories

Color Lens	LENS-20 LED17	LENS-25 LED27	AMB Amber	BLU Blue	GRN Green	RED Red	YEL Yellow	LENS-20 LED17	LENS-25 LED27	FR Frosted Lens	SPR Spread Lens	BEL Beam Elongating



LED17

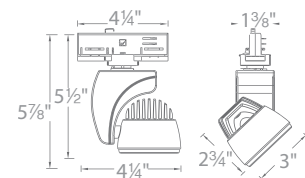

LED27

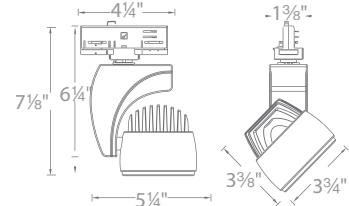



## Exterminator LEDme®

**Power:** 23W  
**Lumens:** Up to 1450  
**CBCP:** Up to 6772  
**Comparable:** 39 WHID  
**CRI:** Up to 90  
**Dimming:** 100% – 10% (120V only)  
**Rated Life:** 60,000 hours

**LED luminaire with high CRI and minimal size form factor for upscale retail. Comparable to a 39W HID**

- Energy Star® Rated
- Meets 2013 California Title 24 Efficiency
- Twist lock aiming mechanism
- Smooth and continuous ELV dimming
- 355° horizontal rotation and 180° vertical aiming
- ANSI Compliant Warm/Neutral LED Bins for a finer color consistency
- Accepts one lens/accessory



**63**  
Lm/W



Lockable vertical aiming for precise adjustments



Accommodates 1 lens  
Color Lenses, Filter Lenses, Beam Control Lenses

Track Type	System	Model	Beam	Color Temp	Finish
W Track	WTK 120V WHK 277V	LED20	S 20° F 40°	927 2700K (90CRI)	BK Black PT Platinum WT White
				27 2700K	
				930 3000K (90CRI)	
				30 3000K	
				35 3500K	
				40 4000K	

Example: WTK-LED20S-930-WT

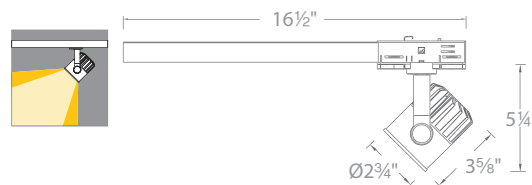

### Lenses and Accessories (order separately)

Color Lens	LENS-16	AMB Amber	BLU Blue	GRN Green	RED Red	YEL Yellow
------------	---------	-----------	----------	-----------	---------	------------

UV Filter Lens	LENS-16-UVF
Frosted Lens	LENS-16-FR
Spread Lens	LENS-16-SPR
Beam Elongating	LENS-16-BEL

### Interchangeable Reflectors

20°	RF-S
40°	RF-F

### Replaceable LED Modules

2700K (90 CRI)	BXRC-27G1000
2700K	BXRC-27E1000
3000K (90 CRI)	BXRC-30G1000
3000K	BXRC-30E1000
3500K	BXRC-35E1000
4000K	BXRC-40E1000



## Wall Washer LED

**Power:** 42W  
**Lumens:** Up to 2520  
**Comparable:** 55W CFL  
**CRI:** 85  
**Dimming:** 100% – 10% (120V only) ELV  
**Rated Life:** 100,000 hours

**Optimal uniformity from an asymmetrical wall wash luminaire designed to reduce necessary mounting distance from the wall compared to fluorescent wall washers**

- Energy Star® Rated
- Replaces halogen and fluorescent wall wash luminaires
- ANSI Compliant Warm/Neutral LED Bins for a finer color consistency
- Smooth and continuous ELV dimming
- Die-cast aluminum construction
- Thin profile
- 45° vertical tilt



Track Type	System	Model	Color Temp	Finish
W Track	WTK 120V WHK 277V	LED42W	27 2700K	BK Black
			30 3000K	PT Platinum
			35 3500K	WT White
			40 4000K	

Example: **WTK-LED42W-27-WT**

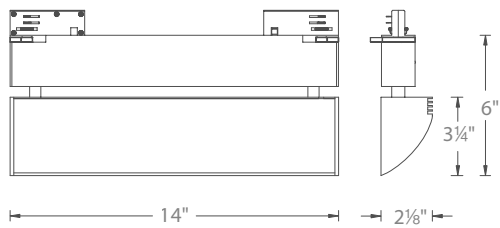

Average Footcandle Performance (3000K, aimed for peak illuminance)

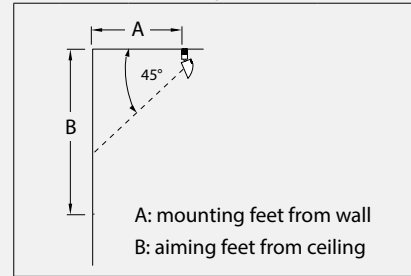

		A		
		2'	3'	4'
B	2'	128	79	51
	4'	51	41	32
	6'	26	23	20

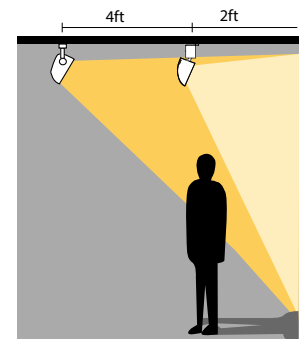

Due to the asymmetrical forward throw and tilting, WAC LED Wall Washer can be mounted closer to the wall than fluorescent



# Vamp HID Track Luminaires

## HID202A - Adjustable

**15° - 30° Adjustable beam angle on fixture**

**Lamping:** HID CDM T4, 20W/39W/70W

**Lens Options:** Up to 3 filter lenses and accessory

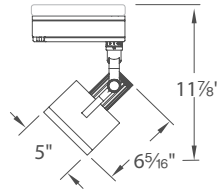

Track Type	System	Model	Power	Finish
W Track	<b>WTK</b> 120V	<b>HID202A</b>	<b>20E</b> 20W	<b>BK</b> Black
	<b>WHK</b> 277V		<b>39E</b> 39W	<b>PT</b> Platinum
			<b>70E</b> 70W	<b>WT</b> White

Example: **WTK-HID202A-20E-WT**

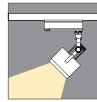

Patent Pending  
Beam Adjustment Control

### Lenses and Accessories

Color Lens	<b>LENS-111</b>	<b>AMB</b> Amber	<i>UV Filter Lens</i>	<b>LENS-111-UVF</b>	Cross Louver Honeycomb Snoot
		<b>BLU</b> Blue	<i>Frosted Lens</i>	<b>LENS-111-FR</b>	
		<b>GRN</b> Green	<i>Spread Lens</i>	<b>LENS-111-SPR</b>	
		<b>RED</b> Red	<i>Beam Elongating</i>	<b>LENS-111-BEL</b>	
		<b>YEL</b> Yellow			

## HID202

**Lamping:** HID CDM T4, 20W/39W/70W

**Lens Options:** Up to 3 filter lenses

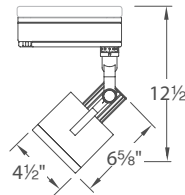

Track Type	System	Model	Beam	Power	Finish
W Track	<b>WTK</b> 120V	<b>HID202</b>	<b>S</b> 15°	<b>20E</b> 20W	<b>BK</b> Black
	<b>WHK</b> 277V		<b>N</b> 25°	<b>39E</b> 39W	<b>PT</b> Platinum
			<b>F</b> 40°	<b>70E</b> 70W	<b>WT</b> White

Example: **WTK-HID202N-70E-BK**

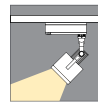

### Lenses and Accessories

Color Lens	<b>LENS-30</b>	<b>AMB</b> Amber	<i>UV Filter Lens</i>	<b>LENS-30-UVF</b>	Cross Louver Honeycomb Snoot
		<b>BLU</b> Blue	<i>Frosted Lens</i>	<b>LENS-30-FR</b>	
		<b>GRN</b> Green	<i>Spread Lens</i>	<b>LENS-30-SPR</b>	
		<b>RED</b> Red	<i>Beam Elongating</i>	<b>LENS-30-BEL</b>	
		<b>YEL</b> Yellow			

## HID220

**Lamping:** HID CDM PAR20, 20W/39W

**Lens Options:** Up to 3 filter lenses and accessory

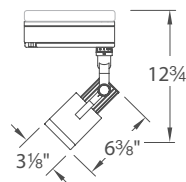

Track Type	System	Model	Power	Finish
W Track	<b>WTK</b> 120V	<b>HID220</b>	<b>20E</b> 20W	<b>BK</b> Black
	<b>WHK</b> 277V		<b>39E</b> 39W	<b>PT</b> Platinum
				<b>WT</b> White

Example: **WTK-HID220-39E-PT**

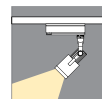

### Lenses and Accessories

Color Lens	<b>LENS-20</b>	<b>AMB</b> Amber	<i>UV Filter Lens</i>	<b>LENS-20-UVF</b>	Cross Louver Honeycomb Snoot
		<b>BLU</b> Blue	<i>Frosted Lens</i>	<b>LENS-20-FR</b>	
		<b>GRN</b> Green	<i>Spread Lens</i>	<b>LENS-20-SPR</b>	
		<b>RED</b> Red	<i>Beam Elongating</i>	<b>LENS-20-BEL</b>	
		<b>YEL</b> Yellow			

# H / L / J / J2 TRACK SYSTEM



A variety of 120V rigid track systems that can be used for new construction or retrofitted onto most existing track system installations. All track luminaires are offered in H, L, J, or J2 adapters to specify as needed. Available in 4 finishes.

H Track

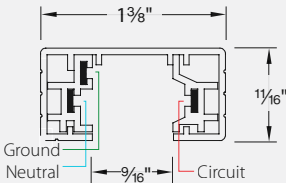

L Track

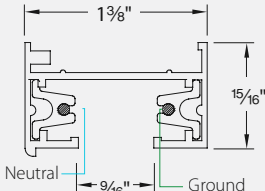

J Track

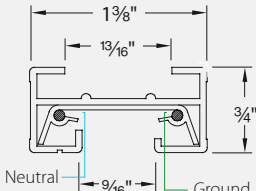

J2 Track

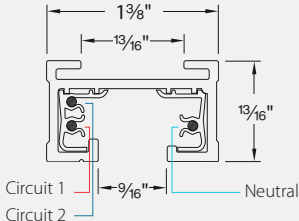

# H / L / J Track Systems Design Guidelines

Choose track system	WAC Lighting offers standard systems: L, H and J single circuit track systems and our J2 two circuit system.
Laying out the track design	Determine layout of track and choose appropriate connectors to achieve the look you desire. Mark along the ceiling to indicate the placement of the track.
Power	For direct ceiling mounting connect to J box using a live end connector in conjunction with a canopy plate. For suspension mounting, connect to J box using a suspension kit canopy. Your maximum load capacity per circuit is 1920W. Determine the total wattage of the fixtures before laying out the remainder of the system.
Mounting	For direct ceiling mounting, screw directly into ceiling. For drop ceilings, use two T-bar clips for 2 foot or 4 foot track and three for 6 foot or 8 foot track. In order to suspend the track, determine your ceiling type, flat or sloped, and choose appropriate standoffs. Use three supports minimum for an 8 foot section and two for a 4 foot section. Custom length suspensions are possible with the use of suspension rods.
Joining track sections	"I" connectors can be either conductive or non conductive. Non-conductive dead end "I" connectors may be used to electrically separate two runs without any visible separation to the design. Other available connectors include an "X" connector, "L" connector, "T" connector, and a flexible track connector.
Quick Connect™	Quick Connect™ Fixtures and Pendants allow for an extensive selection of glass and metal elements to complement the 120V track design. All Quick Connect™ elements require the appropriate Quick Connect™ track adapter. (e.g. EN-HQ50AR-BK)
Useful Tips	Track is supplied with two end caps.  Assistance is only a phone call away. If you need help or design ideas please call WAC Lighting to speak to a friendly technical support specialist at (800)526-2588.

## Sample Layout (example using L Track System)

A	<b>SK18</b>	18" Track suspension rod
B	<b>LLE</b>	Live end connector
C	<b>LT2</b>	2 foot Section of L Track
D	<b>LL-LEFT</b>	"L" Connector (Left)
E	<b>L-LED17S-27</b>	LEDme™ LED track head
F	<b>L-ENDCAP</b>	End Cap (included with track section)

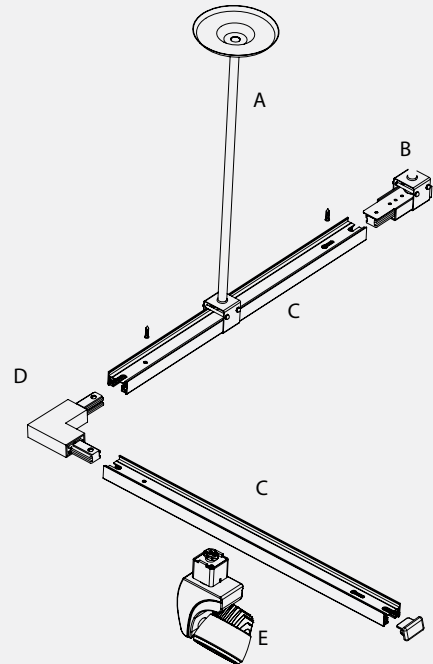

## Selecting Connectors (example using H Track)

- In order to select the appropriate connectors to maintain electrical continuity, start at your power source and walk the length of the track. If you turn left, use a left connector. If you turn right, use a right connector.

Polarity is just a matter of matching ends

The 2 wire side of an "H" Track has an indicator groove running its length

- Using a left connector, the track would run with the groove along the outside

- Using a right connector, the track would run with the groove along the inside

■ = Electrical Continuity

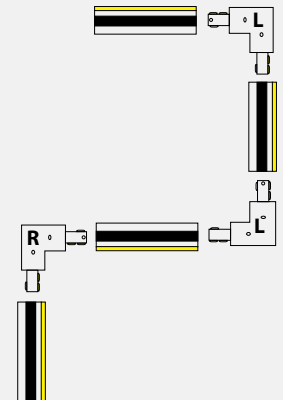
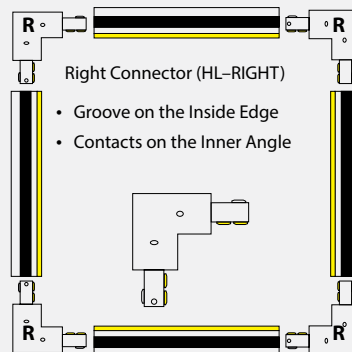
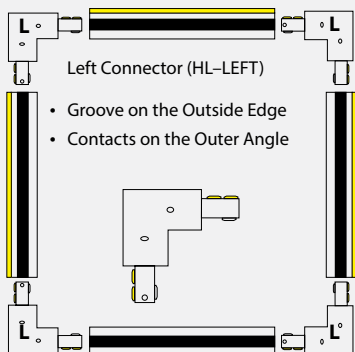

# H / L / J Track Systems

**Description:** Single circuit, H, L and J Track  
**Power per Circuit:** 120V, 1920W max  
**Operating Current:** Rated 20A max

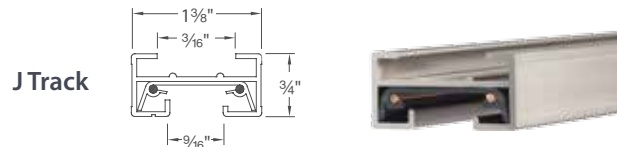
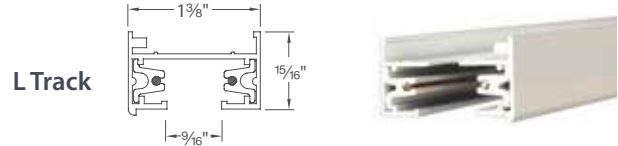
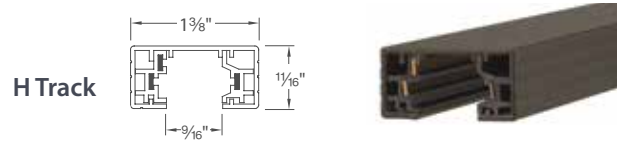

## Track Sections

Model	Length	Finish	Description
<b>HT</b> H Track	2 2'	<b>BK</b> Black	120V 3-wire track
	4 4'	<b>BN</b> Brushed Nickel	
	6 6'	<b>WT</b> White	
	8 8'	<b>DB*</b> Dark Bronze	
<b>LT</b> L Track <b>JT</b> J Track	2 2'	<b>BK</b> Black	120V 2-wire track
	4 4'	<b>BN</b> Brushed Nickel	
	6 6'	<b>WT</b> White	
	8 8'	<b>WT</b> White	

Example: **HT6-BK**

Each section includes two matching end caps.

## Quick Connect Adapter

















Model	Finish	Description
<b>EN-HQ50AR</b> H Track <b>EN-LQ50AR</b> L Track <b>EN-JQ50AR</b> J/J2 Track	<b>BK</b> Black <b>BN</b> Brushed Nickel <b>WT</b> White <b>DB*</b> Dark Bronze	Use to easily connect any Quick Connect pendant or fixture. Min.Load: 1W Max Load: 50W

## Track Suspension

Model	Length	Finish	Description
<b>SK</b>	18 18" 36 36"	<b>BK</b> Black <b>BN</b> Brushed Nickel <b>WT</b> White <b>DB*</b> Dark Bronze	Extends track from ceiling. Includes track bracket, rod and ceiling canopy.
	24 24" 48 48"		
<b>R</b>	18 18" 48 48"	<b>BK</b> Black <b>BN</b> Brushed Nickel <b>WT</b> White <b>DB*</b> Dark Bronze	Use with Rod Coupler (RI) to further extend track from ceiling.
	24 24" 72 72"		
	36 36"		
<b>SK14</b>		<b>BK</b> Black <b>BN</b> Brushed Nickel <b>WT</b> White <b>DB*</b> Dark Bronze	Use with suspension kits to accommodate sloped ceilings. Max capacity: 7A, 800W, 120V
<b>RI</b>		<b>BK</b> Black <b>BN</b> Brushed Nickel <b>WT</b> White <b>DB*</b> Dark Bronze	Join two rods for suspensions longer than 48".
<b>SK05</b>	Includes two collars	<b>BK</b> Black <b>BN</b> Brushed Nickel <b>WT</b> White <b>DB*</b> Dark Bronze	Used when suspension rod is field cut to custom lengths. One kit of two required for each rod.
<b>X</b>	6 6" 24 24"	<b>BK</b> Black <b>BN</b> Brushed Nickel <b>WT</b> White <b>DB*</b> Dark Bronze	Extends low voltage track heads from track. Specify extension, fixture and finish. Only available as complete unit. Example: X18-HHT-809-WT
	12 12" 36 36"		
	18 18" 48 48"		
<b>H</b>	18 18" 36 36"	<b>BK</b> Black <b>BN</b> Brushed Nickel <b>WT</b> White <b>DB*</b> Dark Bronze	Extends H System line voltage track heads.
	24 24" 48 48"		
<b>TBKT</b>	18"	<b>BK</b> Black <b>BN</b> Brushed Nickel <b>WT</b> White <b>DB*</b> Dark Bronze	Extends track 24" from wall. Use two per 4' length, three per 8' length.

Example: **SK24-BK**

\*DB finish only available for H Track

Accessories	Model	Finish	Description
Live End Connector 	<b>HLE</b> <b>LLE</b> <b>JLE</b>	<b>BK</b> Black <b>BN</b> Brushed Nickel <b>WT</b> White <b>DB*</b> Dark Bronze	4¼" × 1⅜" × ¾" 4¼" × 1⅜" × ¾" 4¾" × 1¼" × ¾" 4¾" × 1¼" × ¾" Use for direct wiring through ceiling. A canopy plate is required when using with a standard junction box.
Live End BX Connector 	<b>HBXLE</b> <b>LBXLE</b> <b>JBXLE</b>	<b>BK</b> Black <b>BN</b> Brushed Nickel <b>WT</b> White <b>DB*</b> Dark Bronze	6" × 1⅜" × 1¼" 5¾" × 1⅜" × 1¼" 6¼" × 1⅜" × 1¼" Use with surface mounted BX or non-metallic sheathed cable. Also provides through the ceiling connection.
"I" Power Connector 	<b>HI-PWR</b> <b>LI-PWR</b> <b>JI-PWR</b>	<b>BK</b> Black <b>BN</b> Brushed Nickel <b>WT</b> White <b>DB*</b> Dark Bronze	6¾" × 1⅜" × ¾" 7" × 1⅜" × ¾" 7½" × 1⅜" × ¾" Power entry point at the connection of 2 tracks.
"L" Connector Left 	<b>HL-LEFT</b> <b>LL-LEFT</b> <b>JL-LEFT</b>	<b>BK</b> Black <b>BN</b> Brushed Nickel <b>WT</b> White <b>DB*</b> Dark Bronze	2¾" × 2¾" × ¾" 4¼" × 4¼" × ¾" 4¼" × 4¼" × ¾" Use to join 2 track sections to make power feedable 90° left polarity turns.
"L" Connector Right 	<b>HL-RIGHT</b> <b>LL-RIGHT</b> <b>JL-RIGHT</b>		2¾" × 2¾" × ¾" 4¼" × 4¼" × ¾" 4¼" × 4¼" × ¾" Use to join 2 track sections to make power feedable 90° right polarity turns.
"T" Connector 	<b>HT</b> <b>LT</b> <b>JT</b>	<b>BK</b> Black <b>BN</b> Brushed Nickel <b>WT</b> White <b>DB*</b> Dark Bronze	4" × 2¾" × ¾" 7¼" × 4¼" × ¾" 7½" × 4¼" × ¾" Use to join 3 track sections. Power feedable on H and J only. "T" Connector with opposite polarity can be custom ordered.
"X" Connector 	<b>HX</b> <b>LX</b> <b>JX</b>	<b>BK</b> Black <b>BN</b> Brushed Nickel <b>WT</b> White <b>DB*</b> Dark Bronze	4½" × 4½" × ¾" 7½" × 7½" × ¾" 7½" × 7½" × ¾" Use to join 4 track sections. Power feedable on H and J only.
"I" Connector 	<b>HI</b> <b>LI</b> <b>JI</b>	<b>BK</b> Black <b>BN</b> Brushed Nickel <b>WT</b> White <b>DB*</b> Dark Bronze	3" × 1⅜" × ¾" 3½" × 1⅜" × ¾" 3" × 1⅜" × ¾" Use to join two sections of track with electrical continuity.
"I" Dead End Connector 	<b>HI-DEC</b> <b>LI-DEC</b> <b>JI-DEC</b>	<b>BK</b> Black <b>BN</b> Brushed Nickel <b>WT</b> White <b>DB*</b> Dark Bronze	3" × 1⅜" × ¾" 3½" × 1⅜" × ¾" 3" × 1⅜" × ¾" Joins two sections of track without electrical continuity.
Flexible Track Connector 	<b>HFLX</b> <b>LFLX</b> <b>JFLX</b>	<b>BK</b> Black <b>BN</b> Brushed Nickel <b>WT</b> White <b>DB*</b> Dark Bronze	11" × 1⅜" × ¾" 9¾" × 1⅜" × ¾" 8½" × 1⅜" × ¾" Connects two track sections at variable angles. Use as a transition from wall-to-wall, wall-to-ceiling, or ceiling-to-ceiling. Power feedable.
Suspension Loop 	<b>H-LOOP</b> <b>L-LOOP</b> <b>J-LOOP</b>	<b>BK</b> Black <b>BN</b> Brushed Nickel <b>WT</b> White <b>DB*</b> Dark Bronze	1⅜" × 1⅜" × 3" 1⅜" × 1⅜" × 3" 1⅜" × 1⅜" × 3" 3 inch electrical loop accepts chain hung fixtures up to 35lbs. Contains compartment for electrical connections.
15' Cord, Male Plug 	<b>HCORD</b> use with H and J	<b>BK</b> Black <b>WT</b> White	15' Maximum capacity: 7A, 800W, 120V.
15' Cord, Male Plug w/Switch 	<b>LCORDSET</b> use with L		
T-Bar Drop Ceiling Attachment 	<b>T-BARCLIP</b>	Chrome	1½" × 1¼" Attaches track to T-bar drop ceilings. Use two for 2 foot or 4 foot tracks, three for 6 foot or 8 foot tracks.
Monopoint Canopy Adapter  L/JMP HMP	<b>HMP</b> <b>LMP</b> <b>JMP</b>	<b>BK</b> Black <b>BN</b> Brushed Nickel <b>WT</b> White <b>DB*</b> Dark Bronze	Ø 4¾" Ø 4⅜" 5⅜" × 5⅜" Mount a single H, L or J system track fixture to a junction box. When used with a low voltage track head the transformer box will protrude off of the face of the monopoint.
Canopy Plate 	<b>CP</b>	<b>BK</b> Black <b>BN</b> Brushed Nickel <b>WT</b> White <b>DB*</b> Dark Bronze	4½" × 4½" Covers a standard 4 inch junction box. Use with any powerable connectors.
Floating Canopy Connector 	<b>HFC</b> <b>LFC</b> <b>JFC</b>	<b>BK</b> Black <b>BN</b> Brushed Nickel <b>WT</b> White <b>DB*</b> Dark Bronze	4½" × 4½" × 1½" 4¼" × 4¼" × 1⅜" 4⅝" × 4⅝" × 1⅜" Connects to octagon box. Allows track to be powered anywhere along the length of the track

\*DB finish only available for H Track

# H Track Current Limiter ASHRAE 90.1 and California Title 24 Compliant

## Low Cost Energy Code Compliance Made Easy

- Easy to install and assures compliance to California Title 24 or ASHRAE 90.1 requirements
- Energy code track installations are subject to wattage limitations based upon the size and usage of the space
- To order appropriate current limiter, select the model number which corresponds to the H system to the maximum allowable wattage
- May be mounted as a standard canopy, used in place of an "I" connector or as a live-end

## How It Works

- If the track is overloaded the current limiter circuit breaker will trip and shut down power to the track
- May be reset when the overall sum of fixture wattages are reduced below the circuit breaker rating
- It's that easy to ensure energy efficient usage of track installations

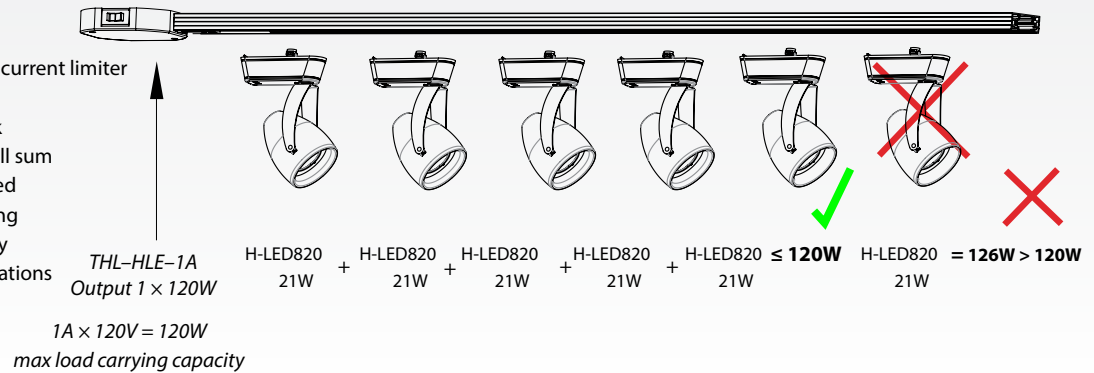

Model	H Track	Circuit Breaker	Max Wattage	Finishes	Dimensions
Single Live End	<b>THL-HLE-1A</b>	1 × 1A	1 × 120W	<b>BK</b> Black <b>BN</b> Brushed Nickel <b>DB</b> Dark Bronze <b>WT</b> White	7½" × 5" × 1¼"
	<b>THL-HLE-2A</b>	1 × 2.5A	1 × 300W		
	<b>THL-HLE-5A</b>	1 × 5A	1 × 600W		
	<b>THL-HLE-7A</b>	1 × 7.5A	1 × 900W		
	<b>THL-HLE-10A</b>	1 × 10A	1 × 1200W		
Double Live End	<b>THL-HI-1-1A</b>	1 × 1A	1 × 120W		
	<b>THL-HI-2-1A</b>	2 × 1A	2 × 120W		
	<b>THL-HI-1-2A</b>	1 × 2.5A	1 × 300W		
	<b>THL-HI-2-2A</b>	2 × 2.5A	2 × 300W		
	<b>THL-HI-1-5A</b>	1 × 5A	1 × 600W		
	<b>THL-HI-2-5A</b>	2 × 5A	2 × 600W		
	<b>THL-HI-1-7A</b>	1 × 7.5A	1 × 900W		
	<b>THL-HI-2-7A</b>	2 × 7.5A	2 × 900W		
	<b>THL-HI-1-10A</b>	1 × 10A	1 × 1200W		
	<b>THL-HI-2-10A</b>	2 × 10A	2 × 1200W		
Double Live End (Left)	<b>THL-LEFT-1-1A</b>	1 × 1A	1 × 120W		
	<b>THL-LEFT-2-1A</b>	2 × 1A	2 × 120W		
	<b>THL-LEFT-1-2A</b>	1 × 2.5A	1 × 300W		
	<b>THL-LEFT-2-2A</b>	2 × 2.5A	2 × 300W		
	<b>THL-LEFT-1-5A</b>	1 × 5A	1 × 600W		
	<b>THL-LEFT-2-5A</b>	2 × 5A	2 × 600W		
	<b>THL-LEFT-1-7A</b>	1 × 7.5A	1 × 900W		
	<b>THL-LEFT-2-7A</b>	2 × 7.5A	2 × 900W		
	<b>THL-LEFT-1-10A</b>	1 × 10A	1 × 1200W		
	<b>THL-LEFT-2-10A</b>	2 × 10A	2 × 1200W		
Double Live End (Right)	<b>THL-RIGHT-1-1A</b>	1 × 1A	1 × 120W		
	<b>THL-RIGHT-2-1A</b>	2 × 1A	2 × 120W		
	<b>THL-RIGHT-1-2A</b>	1 × 2.5A	1 × 300W		
	<b>THL-RIGHT-2-2A</b>	2 × 2.5A	2 × 300W		
	<b>THL-RIGHT-1-5A</b>	1 × 5A	1 × 600W		
	<b>THL-RIGHT-2-5A</b>	2 × 5A	2 × 600W		
	<b>THL-RIGHT-1-7A</b>	1 × 7.5A	1 × 900W		
	<b>THL-RIGHT-2-7A</b>	2 × 7.5A	2 × 900W		
	<b>THL-RIGHT-1-10A</b>	1 × 10A	1 × 1200W		
	<b>THL-RIGHT-2-10A</b>	2 × 10A	2 × 1200W		

# J2 Track

**Description:** Two circuit track with independently controllable circuits  
**Power per Circuit:** 1920 W max  
**Operating Current:** Each circuit is rated 20A (2 x 20A = 40A max)



- Saves on installation costs by eliminating the need for long separate feed runs

## Track Sections

Model	Length	Finish	Description
<b>J2</b> J2 Track	<b>T4</b> 4'	<b>BK</b> Black <b>WT</b> White	120V 3-wire, wide style track
	<b>T8</b> 8'		
	<b>T12</b> 12'		

Example: **J2-T4-WT**

Each section includes two matching end caps.

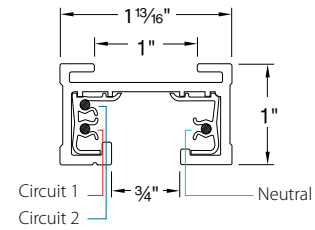

## J Clip

Model	Description
<b>JCLIP</b>	Each 4' section includes 3 Each 8' section includes 6 Each 12' section includes 9

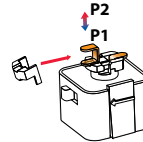

Locks connectors on luminaire into 2-circuit mode

## Quick Connect Adapter

Model	Finish
<b>EN-JQ50AR</b>	<b>BK</b> Black <b>WT</b> White



## Track Suspension

Model	Length	Finish
<b>SK</b>	<b>18</b> 18"	<b>BK</b> Black <b>WT</b> White
	<b>24</b> 24"	
<b>R</b>	<b>18</b> 18"	<b>BK</b> Black <b>WT</b> White
	<b>24</b> 24"	
	<b>36</b> 36"	
<b>SK14</b>		<b>BK</b> Black <b>WT</b> White
<b>RI</b>		<b>BK</b> Black <b>WT</b> White
<b>SK05</b>	Includes two collars	<b>BK</b> Black <b>WT</b> White
<b>X</b>	<b>6</b> 6"	<b>BK</b> Black <b>WT</b> White
	<b>12</b> 12"	
	<b>18</b> 18"	
<b>TBKT</b>	18"	<b>BK</b> Black <b>WT</b> White
<b>J2-WCOV</b>		<b>BK</b> Black <b>WT</b> White

## Accessories

Model	Finish	Dimensions
<b>J2-LE</b>	<b>BK</b> Black <b>WT</b> White	4 3/4"
<b>J2-BXLE</b>	<b>BK</b> Black <b>WT</b> White	5 7/8"
<b>J2-IPWR</b>	<b>BK</b> Black <b>WT</b> White	7"
<b>J2-LLEFT</b>	<b>BK</b> Black <b>WT</b> White	4 1/4" x 4 1/4"
<b>J2-LRIGHT</b>		
<b>J2-T</b>	<b>BK</b> Black <b>WT</b> White	7" x 4 1/4"
<b>J2-X</b>	<b>BK</b> Black <b>WT</b> White	7" x 7"
<b>J2-I</b>	<b>BK</b> Black <b>WT</b> White	4 1/2"
<b>J2-IDEC</b>	<b>BK</b> Black <b>WT</b> White	3 1/2"
<b>J2-FLX</b>	<b>BK</b> Black <b>WT</b> White	11 1/2"
<b>T-BARCLIP</b>		1 1/2" x 1 1/4"
<b>J2-UCP</b>	<b>BK</b> Black <b>WT</b> White	4 1/8" x 4 1/8"
<b>J2-TBLE</b>	<b>BK</b> Black <b>WT</b> White	4 1/8" x 4 1/8"

Example: **J2-FLX-BK**



LED40

LED23

## LOGOS LEDme®

**LED40**  
**Power:** 38W  
**Lumens:** Up to 3080  
**CBCP:** Up to 24,767  
**Comparable:** 70 W HID  
**CRI:** 85  
**Dimming:** 100% – 10%  
**Rated Life:** 100,000 hours

**LED23**  
**Power:** 23W  
**Lumens:** Up to 1845  
**CBCP:** Up to 18,049  
**Comparable:** 39 W HID  
**CRI:** 85  
**Dimming:** 100% – 10%  
**Rated Life:** 100,000 hours



### Superior efficacy LED luminaires for retail requirements. Comparable to 39W and 70W HID

- Energy Star® Rated
- Single tool-free lens assembly for easy in field change of beam angle
- ANSI Compliant Warm/Neutral LED Bins for a finer color consistency
- 360° horizontal and 180° vertical aiming
- Die-cast aluminum construction
- Smooth and continuous ELV dimming
- High performance with fixture efficacy up to 80Lm/W

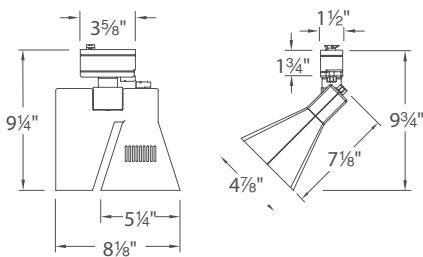

LED40

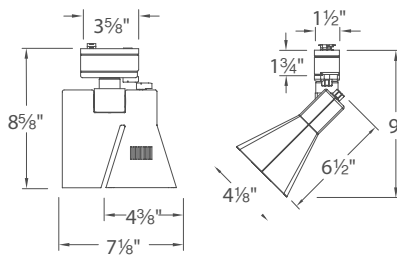

LED23

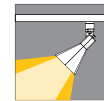

Track Type	Model	Beam	Color Temp	Finish
<b>H</b> H Track	<b>LED23</b> 23W <b>LED40</b> 40W	<b>S*</b> 12°	<b>27</b> 2700K	<b>BK</b> Black <b>WT</b> White
<b>L</b> L Track		<b>N</b> 24°	<b>30</b> 3000K	
<b>J</b> J/J2 Track		<b>F</b> 36°	<b>35</b> 3500K	
		<b>E</b> 19° x 32° elliptical spread	<b>40</b> 4000K	

Example: **L-LED23S-40-WT**

\* not Energy Star Rated

#### Interchangeable TIR lens assembly

	LED23	LED40	Finish
12°	<b>OPH-9X3-12D</b>	<b>OPH-16X3-12D</b>	<b>BK</b> Black
24°	<b>OPH-9X3-25D</b>	<b>OPH-16X3-25D</b>	<b>PT</b> Platinum
36°	<b>OPH-9X3-40D</b>	<b>OPH-16X3-40D</b>	<b>WT</b> White
19° x 32°	<b>OPH-9X3-ELD</b>	<b>OPH-16X3-ELD</b>	

#### Replaceable LED Modules

2700K	<b>RM-9X3-27</b>	<b>RM-16X3-27</b>	<b>BK</b> Black
3000K	<b>RM-9X3-30</b>	<b>RM-16X3-30</b>	<b>PT</b> Platinum
3500K	<b>RM-9X3-35</b>	<b>RM-16X3-35</b>	<b>WT</b> White
4000K	<b>RM-9X3-40</b>	<b>RM-16X3-40</b>	

Example: **OPH-9X3-25D-BK**





## ARGOS LEDme®

**Power:** 25W  
**Lumens:** Up to 1525  
**CBCP:** Up to 5868  
**Comparable:** 39 W HID  
**CRI:** 85  
**Dimming:** 100% – 10%  
**Rated Life:** 100,000 hours



**61**  
Lm/W

**LED luminaire with minimal size form factor  
Outperforms a 39W HID**

- Energy Star® rated
- Smooth and continuous ELV dimming
- Free of projected heat and UV radiation
- Die-cast aluminum construction
- Tool-free lens assembly for easy in field change of beam angle
- ANSI Compliant Warm/Neutral LED Bins for a finer color consistency
- 360° horizontal and 90° vertical hot aiming
- Accepts one lens

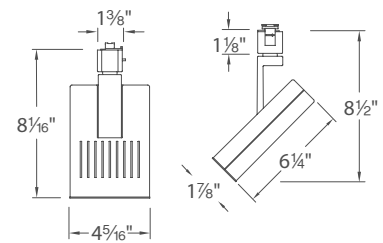
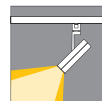

Track Type	Model	Beam	Color Temp	Finish
<b>H</b> H Track	<b>LED25</b>	<b>S</b> 20°	<b>27</b> 2700K	<b>BK</b> Black
<b>L</b> L Track		<b>F</b> 42°	<b>30</b> 3000K	<b>WT</b> White
<b>J</b> J/J2 Track		<b>35</b> 3500K		
		<b>40</b> 4000K		

Example: **L-LED25S-27-BK**

Available in  
monopoint MO-LED25.  
See p.91 for detail.



### Interchangeable TIR assembly

20°	<b>OPH-10X3-20D</b>	<b>BK</b> Black
42°	<b>OPH-10X3-42D</b>	<b>PT</b> Platinum <b>WT</b> White

### Replaceable LED Modules

2700K	<b>RM-10X3-27</b>
3000K	<b>RM-10X3-30</b>
3500K	<b>RM-10X3-35</b>
4000K	<b>RM-10X3-40</b>

### Lens

<b>LENS-1X3-FR</b>	Frosted
<b>LENS-1X3-DIC-AMB</b>	Amber dichroic
<b>LENS-1X3-DIC-BLU</b>	Blue dichroic
<b>LENS-1X3-DIC-GRN</b>	Green dichroic
<b>LENS-1X3-DIC-RED</b>	Red dichroic
<b>LENS-1X3-DIC-YEL</b>	Yellow dichroic



Reflex PRO  
LED27



LED18



LED9

## Reflex and Reflex PRO LEDme®

	LED27	LED18	LED9
<b>Power:</b>	27W	18W	9W
<b>Lumens:</b>	Up to 1890	Up to 1065	Up to 555
<b>CBCP:</b>	Up to 7455	Up to 8800	Up to 4585
<b>Comparable:</b>	39W HID	20W HID	50W MR16
<b>CRI:</b>	85	85	85
<b>Dimming:</b>		100% – 10%	100% – 10%
<b>Rated Life:</b>	100,000 hours	100,000 hours	100,000 hours

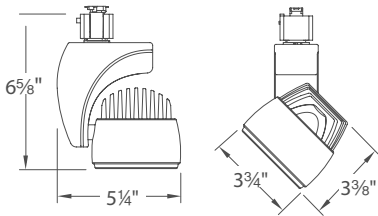

PRO LED27 and LED18

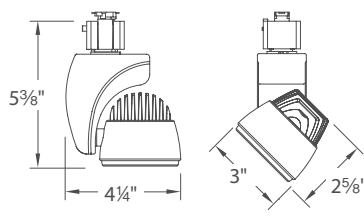

LED9

Track Type	Model	Beam	Color Temp	Finish
<b>H</b> H Track	<b>LED9</b> 9W	<b>S</b> 10°	<b>27</b> 2700K	<b>BK</b> Black
<b>L</b> L Track			<b>WW</b> 3000K	
<b>J</b> J/J2 Track			<b>35</b> 3500K	
	<b>LED18</b> 18W	<b>F</b> 25°	<b>35</b> 3500K	<b>BN</b> Brushed Nickel
			<b>CW</b> 4500K	
			<b>WT</b> White	
	<b>LED27</b> 27W	<b>S</b> 20°	<b>27</b> 2700K	<b>BK</b> Black
			<b>30</b> 3000K	
			<b>35</b> 3500K	
			<b>40</b> 4000K	
		<b>F</b> 45°		<b>BN</b> Brushed Nickel
				<b>WT</b> White



\*Lumen output may vary depending on color temperature and beam angles.

Example: **H-LED27F-27-BN**

### Replacement LED Modules

	LED9	LED18	LED27
2700K	<b>RM-3X3-27</b>	<b>RM-6X3-27</b>	<b>RM-11X3-27</b>
3000K	<b>RM-3X3-30</b>	<b>RM-6X3-30</b>	<b>RM-11X3-30</b>
3500K	<b>RM-3X3-35</b>	<b>RM-6X3-35</b>	<b>RM-11X3-35</b>
4000K			<b>RM-11X3-40</b>
4500K	<b>RM-3X3-45</b>	<b>RM-6X3-45</b>	

### Lenses and Accessories

Color Lens	<b>LENS-20</b> LED9	<b>LENS-25</b> LED18/LED27
<b>AMB</b>	Amber	
<b>BLU</b>	Blue	
<b>GRN</b>	Green	
<b>RED</b>	Red	
<b>YEL</b>	Yellow	
<b>FR</b>	Frost	
<b>SPR</b>	Spread Lens	
<b>BEL</b>	Beam Elongating	



Featured Product: LEDme® Reflex – H-LED18F-WW-WT

**Best selling LED track luminaire in two sizes. Comparable to 39W, 20W HID and 50W MR16**

- Energy Star® Rated
- Smooth and continuous ELV dimming for 120V
- Free of projected heat and UV radiation
- Die-cast aluminum construction
- ANSI Compliant warm/neutral LED bins for a finer color consistency
- Accepts one lens
- 360° horizontal rotation and 180° vertical aiming



## Wall Washer LED

**Power:** 42W  
**Lumens:** Up to 2520  
**Comparable:** 55W CFL  
**CRI:** 85  
**Dimming:** 100% – 10% ELV  
**Rated Life:** 100,000 hours

**Optimal uniformity from an asymmetrical wall wash luminaire designed to reduce necessary mounting distance from the wall compared to fluorescent wall washers**

- Energy Star® Rated
- Replaces halogen and fluorescent wall wash luminaires
- Smooth and continuous ELV dimming
- ANSI Compliant Warm/Neutral LED Bins for a finer color consistency
- Aluminum construction
- Thin profile
- 45° vertical tilt



**60**  
Lm/W

System	Model	Color Temp	Finish
H H Track	LED42W	27 2700K	BK Black
L L Track		30 3000K	
J J/J2 Track		35 3500K	WT White
		40 4000K	

Example: H-LED42W-30-WT

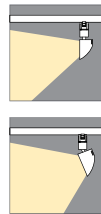
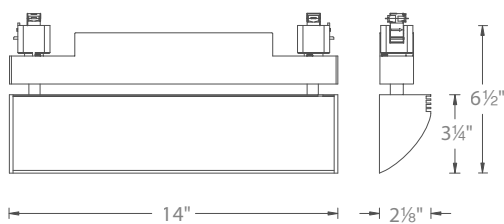

Average Footcandle Performance  
(3000K, aimed for peak illuminance)

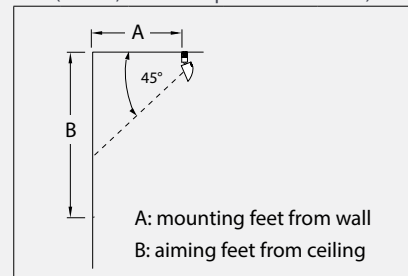

		A		
		2'	3'	4'
B	2'	128	79	51
	4'	51	41	32
	6'	26	23	20

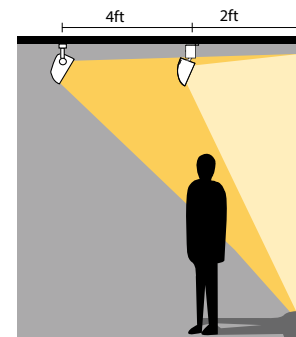

Due to the asymmetrical forward throw and tilting, WAC LED Wall Washer can be mounted closer to the wall than fluorescent



# Wash Light LEDme®

	LED110W	LED210W
<b>Power:</b>	14W	27W
<b>Lumens:</b>	Up to 935	Up to 1990
<b>Comparable:</b>	75W MR16	39W HID
<b>CRI:</b>	85	85
<b>Dimming:</b>	100% - 10%	100% - 10%
<b>Rated Life:</b>	70,000 hours	70,000 hours

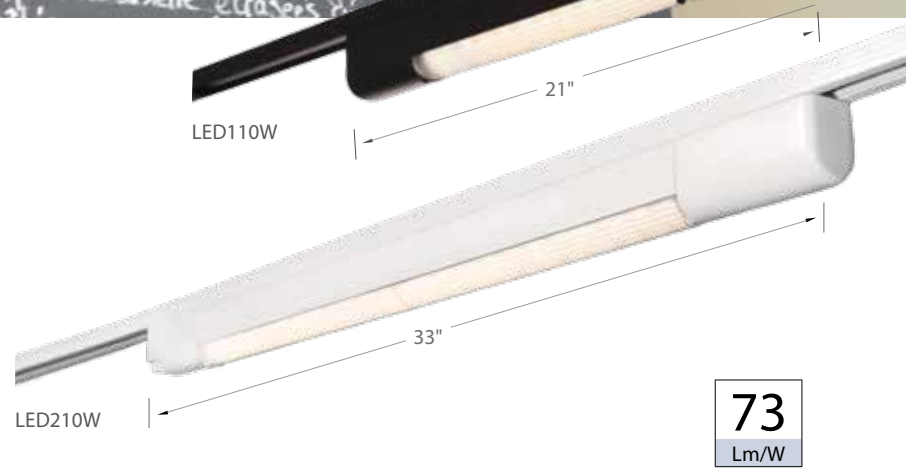

## Low Profile design to illuminate bookcases, shelving, wall art, and retail signage.

- Meets 2013 California Title 24 Efficiency
- Smooth and continuous ELV dimming
- ANSI Compliant Warm/Neutral LED Bins for a finer color consistency
- Perfect solution for lighting stacks, shelves or signage
- Low profile, extends only 2" from track
- Adjustable aiming of beam and various mounting orientations

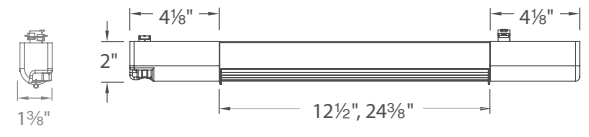

System	Model	Length	Color Temp	Finish
<b>H</b> H Track	<b>LED110W</b>	20 3/4"	<b>WW</b> 3000K	<b>BK</b> Black
<b>L</b> L Track		<b>LED210W</b>		
<b>J</b> J/J2 Track	32 5/8"			

Example: L-LED110W-WW-BK

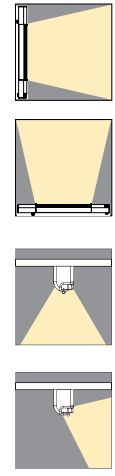

**Average Footcandle Performance (3000K, aimed for peak illuminance)**

		LED110W			LED210W		
		A			A		
		1'	2'	3'	1'	2'	3'
B	2'	49	31	19	110	69	42
	4'	15	12	10	32	28	22
	6'	7	6	5	15	14	12

Replaceable LED Modules

	LED110W	LED210W
3000K	<b>RM36X02-30RE1-24-1</b>	<b>RM36X02-30RE1-24-1</b> <b>RM36X02-30RE1-24-2</b>
4000K	<b>RM36X02-40RE1-24-1</b>	<b>RM36X02-40RE1-24-1</b> <b>RM36X02-40RE1-24-2</b>

For LED210 order both modules listed.



**63**  
Lm/W

## Exterminator LEDme®

**Power:** 23W  
**Lumens:** Up to 1453  
**CBCP:** Up to 6772  
**Comparable:** 39W HID  
**CRI:** Up to 90  
**Dimming:** 100% – 10%  
**Rated Life:** 60,000 hours

### LED luminaire with high CRI and minimal size

#### Comparable to a 39W HID

- Energy Star® Rated
- Meets 2013 California Title 24 Efficiency
- Smooth and continuous ELV dimming
- ANSI Compliant warm/neutral LED bins for a finer color consistency
- Accepts 1 lens/accessory  
*Color Lenses, Filter Lenses, Beam Control Lenses*
- 355° horizontal rotation and 180° vertical aiming
- Lockable vertical aiming for precise adjustments

Twist lock aiming mechanism



Removable lens cap for easy change of lenses



Track Type	Model	Beam	Color Temp	Finish
<b>H</b> H Track	<b>LED20</b>	<b>S</b> 20° <b>F</b> 40°	<b>927</b> 2700K (90 CRI)	<b>BK</b> Black <b>WT</b> White
<b>L</b> L Track			<b>27</b> 2700K	
<b>J</b> J/J2 Track			<b>930</b> 3000K (90 CRI)	
			<b>30</b> 3000K	
			<b>35</b> 3500K	
			<b>40</b> 4000K	

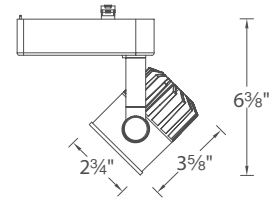
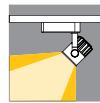

Example: **L-LED20S-930-WT**

### Lenses and Accessories (order separately)

Color Lens	LENS-16	AMB	BLU	GRN	RED	YEL
		Amber	Blue	Green	Red	Yellow

UV Filter Lens	<b>LENS-16-UVF</b>
Frosted Lens	<b>LENS-16-FR</b>
Spread Lens	<b>LENS-16-SPR</b>
Beam Elongating Lens	<b>LENS-16-BEL</b>

### Replaceable LED Modules

2700K (90 CRI)	<b>BXRC-27G1000</b>
2700K	<b>BXRC-27E1000</b>
3000K (90 CRI)	<b>BXRC-30G1000</b>
3000K	<b>BXRC-30E1000</b>
3500K	<b>BXRC-35E1000</b>
4000K	<b>BXRC-40E1000</b>

### Interchangeable Reflectors

20°	<b>RF-S</b>
40°	<b>RF-F</b>



## Framing Projector LEDme®

Power: 22W  
 CRI: Up to 90  
 Life: 60,000 hours

### Can be used to project images, signs, and corporate logos

- Meets 2013 California Title 24 Efficiency
- Uses two lenses to allow precise focus adjustment
- Accepts "D" size Glass and Metal Gobos; consult WAC Lighting for info on purchasing gobos
- 355° horizontal rotation and 90° vertical aiming
- ANSI Compliant Warm/Neutral LED Bins for a finer color consistency
- Accepts 1 lens



System	Model	Watt	Color Temp	Finish
<b>H</b> H Track	<b>LED009</b>	22W	<b>927</b> 2700K (90 CRI)	<b>BK</b> Black <b>WT</b> White
<b>L</b> L Track			<b>27</b> 2700K	
<b>J</b> J/J2 Track			<b>9W</b> 3000K (90 CRI)	
			<b>WW</b> 3000K	
			<b>35</b> 3500K	
			<b>CW</b> 4000K	

Example: **H-LED009-CW-BK**

### Lenses and Accessories

Color Lens	LENS-16	AMB	Amber
		<b>BLU</b>	Blue
		<b>GRN</b>	Green
		<b>RED</b>	Red
		<b>YEL</b>	Yellow

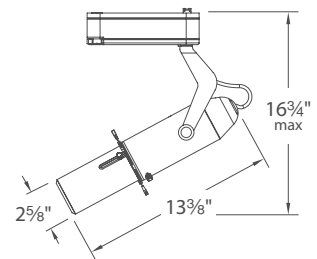
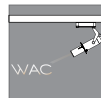



LED810



LED820

# Impulse LEDme®

	LED810	LED820
<b>Power:</b>	14W	23W
<b>Lumens:</b>	Up to 951	Up to 1366
<b>CBCP:</b>	Up to 4481	Up to 6048
<b>Comparable:</b>	75W MR16	100W Halogen
<b>CRI:</b>	Up to 90	Up to 90
<b>Dimming:</b>	100% – 10%	100% – 10%
<b>Rated Life:</b>	60,000 hours	60,000 hours



**68**  
Lm/W

**Clean profile design in 3 finishes.**

**Comparable to 75W MR16 and 100W Halogen**

- Meets 2013 California Title 24 Efficiency
- Smooth and continuous ELV dimming
- Free of projected heat and UV radiation
- ANSI Compliant Warm/Neutral LED Bins for a finer color consistency
- 360° horizontal rotation and 180° vertical aiming

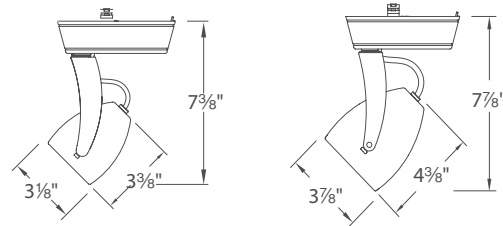

System	Model	Beam	Color Temp	Finish
<b>H</b> H Track <b>L</b> L Track <b>J</b> J/J2 Track	<b>LED810</b>	<b>S</b> 20°	<b>927</b> 2700K (90 CRI)	<b>BK</b> Black <b>DB</b> Dark Bronze <b>WT</b> White
			<b>27</b> 2700K	
		<b>F</b> 40°	<b>9W</b> 3000K (90 CRI)	
			<b>WW</b> 3000K	
		<b>35</b> 3500K		
		<b>CW</b> 4000K		



**Interchangeable Beam Reflectors**

20°	<b>RF-S</b>
40°	<b>RF-F</b>

*Replaceable LED Modules*

2700K (90 CRI)	<b>BXRC-27G1000</b>
2700K	<b>BXRC-27E1000</b>
3000K (90 CRI)	<b>BXRC-30G1000</b>
3000K	<b>BXRC-30E1000</b>
3500K	<b>BXRC-35E1000</b>
4000K	<b>BXRC-40E1000</b>

System	Model	Beam	Color Temp	Finish
<b>H</b> H Track <b>L</b> L Track <b>J</b> J/J2 Track	<b>LED820</b>	<b>S</b> 20°	<b>927</b> 2700K (90 CRI)	<b>BK</b> Black <b>DB</b> Dark Bronze <b>WT</b> White
			<b>27</b> 2700K	
		<b>F</b> 40°	<b>9W</b> 3000K (90 CRI)	
			<b>WW</b> 3000K	
		<b>35</b> 3500K		
		<b>CW</b> 4000K		

Example: **L-LED820S-27-DB**

Lenses and Accessories (order separately)

Color Lens	<b>LENS-16</b>	<b>AMB</b> Amber <b>BLU</b> Blue <b>GRN</b> Green <b>RED</b> Red <b>YEL</b> Yellow
------------	----------------	--

UV Filter Lens	<b>LENS-16-UVF</b>
Frosted Lens	<b>LENS-16-FR</b>
Spread Lens	<b>LENS-16-SPR</b>
Beam Elongating	<b>LENS-16-BEL</b>



Model	Finish
<b>008FP</b> Framing Projector	<b>BK</b> Black
<b>801BD</b> Barn Door	<b>DB</b> Dark Bronze
	<b>WT</b> White

Accommodates both LED810 and LED820





# Galileo LEDme®

**72**  
Lm/W

**Power:** 14W  
**Lumens:** Up to 1014  
**CBCP:** Up to 4843  
**Comparable:** 75W MR16  
**CRI:** Up to 90  
**Dimming:** 100% – 8%  
**Life:** 60,000 hours

**Modern element with consistent profile regardless of aiming direction. Comparable to 75W MR16**

- Meets 2013 California Title 24 Efficiency
- Smooth and continuous ELV dimming
- ANSI Compliant Warm/Neutral LED Bins for a finer color consistency
- Replaceable LED module

System	Model	Beam	Color Temp	Finish
<b>H</b> H Track	<b>LED610</b>	<b>S</b> 20°	<b>927</b> 2700K (90 CRI)	<b>BK</b> Black <b>BN</b> Brushed Nickel <b>WT</b> White
<b>L</b> L Track			<b>27</b> 2700K	
<b>J</b> J/J2 Track		<b>F</b> 32°	<b>9W</b> 3000K (90 CRI)	
			<b>WW</b> 3000K	
		<b>35</b> 3500K		
		<b>CW</b> 4000K		



Example: **L-LED610S-CW-BK**

### Interchangeable Beam Reflectors

20°	<b>RF-S</b>
40°	<b>RF-F</b>

### Replaceable LED Modules

2700K (90 CRI)	<b>BXRC-27G1000</b>
2700K	<b>BXRC-27E1000</b>
3000K (90 CRI)	<b>BXRC-30G1000</b>
3000K	<b>BXRC-30E1000</b>
3500K	<b>BXRC-35E1000</b>
4000K	<b>BXRC-40E1000</b>

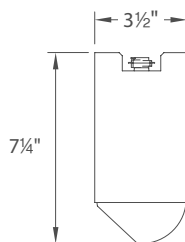



**76**  
Lm/W

## Cartier LEDme®

**Power:** 14W  
**Lumens:** Up to 1070  
**CBCP:** Up to 5166  
**Comparable:** 75W MR16  
**Typical CRI:** Up to 90  
**Dimming:** 100% – 8%  
**Life:** 60,000 hours

Retro design with unique dual yoke construction

Elegant hand cut onyx crystal hot aiming handle



### Classic instrument design in beautiful plated metal finishes. Comparable to 75W MR16

- Meets 2013 California Title 24 Efficiency
- Smooth and continuous ELV dimming
- ANSI Compliant Warm/Neutral LED Bins for a finer color consistency
- Replaceable LED module and reflectors

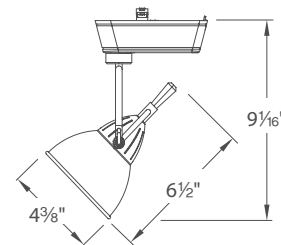

System	Model	Beam	Color Temp	Finish
<b>H</b> H Track	<b>LED710</b>	<b>S</b> 20° <b>F</b> 32°	<b>927</b> 2700K (90 CRI)	<b>AB</b> Antique Bronze <b>AN</b> Antique Nickel
<b>L</b> L Track			<b>27</b> 2700K	
<b>J</b> J/J2 Track			<b>9WW</b> 3000K (90 CRI)	
			<b>WW</b> 3000K	
			<b>35</b> 3500K	
	<b>CW</b> 4000K			

Example: **L-LED710S-CW-AN**

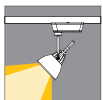

#### Interchangeable Beam Reflectors

20°	<b>RF-S</b>
40°	<b>RF-F</b>

#### Replaceable LED Modules

2700K (90 CRI)	<b>BXRC-27G1000</b>
2700K	<b>BXRC-27E1000</b>
3000K (90 CRI)	<b>BXRC-30G1000</b>
3000K	<b>BXRC-30E1000</b>
3500K	<b>BXRC-35E1000</b>
4000K	<b>BXRC-40E1000</b>

# LEDme® Quick Connect™ Luminaires

**Power:** 7.5 W  
**Lumens:** Up to 280  
**CBCP:** Up to 2,451  
**Comparable:** 35W MR16  
**Color Temp:** 3000K  
**CRI:** 85  
**Rated Life:** 30,000 hours

- Smooth and continuous ELV dimming down to 15% or better depending on system power supply minimum loads
- Replacement LED module may be ordered separately (model: **RM3X3-30-QF**)
- 360° horizontal rotation and 90° vertical adjustment
- Die-cast aluminum construction



	Model #	Extension	Finish
Orb	<b>QF-LED171</b>	<b>X3</b> 3in	<b>BN</b> <i>Brushed Nickel</i> <b>DB</b> <i>Dark Bronze</i>
		<b>X6</b> 6in	
		<b>X12</b> 12in	
Forza	<b>QF-LED173</b>		

Example: **QF-LED173X3-BN**

### Track Adapter (required)

System	Model	Finish
L Track	<b>EN-LQ50AR</b>	<b>BK, BN, WT</b>
H Track	<b>EN-HQ50AR</b>	<b>BK, BN, DB, WT</b>
J Track	<b>EN-JQ50AR</b>	<b>BK, BN, WT</b>



**Power:** 4W (Portal), 3W (Charge/Ovum)  
**Lumens:** Up to 109  
**CBCP:** Up to 1,536  
**Color Temp:** 3000K  
**CRI:** 85  
**Rated Life:** 50,000 hours

- Smooth and continuous ELV dimming down to 15% or better depending on system power supply minimum loads
- Strong projected light output with no projected heat
- 360° horizontal rotation and 90° vertical adjustment
- Die-cast aluminum construction

	Model #	Finish
Portal	<b>QF-LED103-W</b>	<b>BN</b> <i>Brushed Nickel</i>
		<b>DB</b> <i>Dark Bronze</i>
		<b>WT</b> <i>White</i>

	Model #	Finish	Beam Angle	Finish
Ovum	<b>QF-LED101-W</b>	<b>F</b>	25°	<b>BN</b> <i>Brushed Nickel</i>
			40°	<b>DB</b> <i>Dark Bronze</i>
Charge	<b>QF-LED102-W</b>	<b>WT</b>		<i>White</i>

Example: **QF-LED101-W-F-BN**

### Track Adapter (required)

System	Model	Finish
L Track	<b>EN-LQ50AR</b>	<b>BK, BN, WT</b>
H Track	<b>EN-HQ50AR</b>	<b>BK, BN, DB, WT</b>
J Track	<b>EN-JQ50AR</b>	<b>BK, BN, WT</b>

## Caribe LED, Halogen MR16

**Lamping:** 12V LED MR16, Halogen MR16 lamps up to 75W max

**Lens Options:** Up to 2 lenses using optional lens ring

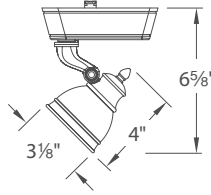

System	Model	Watt	Lens Ring	Finish
<b>HHT</b>	<i>H Track</i>	<b>874LED</b>	8W	<b>AB</b> <i>Antique Bronze</i>
<b>LHT</b>	<i>L Track</i>	<b>874</b>	50W	
<b>JHT</b>	<i>J/J2 Track</i>	<b>874L</b>	75W	

Example: **LHT-874-AB** or **LHT-874LENS-AB**

Lenses and Accessories (order Lens Ring version that holds up two lenses/accessories)

Color Lens	LENS-16	AMB	Amber	UV Filter Lens	LENS-16-UVF
		BLU	Blue	Frosted Lens	LENS-16-FR
		GRN	Green	Spread Lens	LENS-16-SPR
		RED	Red	Beam Elongating	LENS-16-BEL
		YEL	Yellow	Honeycomb Louver	LENS-16-HCL

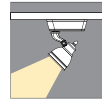

## Rialto LED, Halogen MR16

**Lamping:** 12V LED MR16, Halogen MR16 lamps up to 75W max

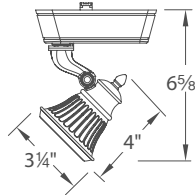

System	Model	Watt	Finish
<b>HHT</b>	<i>H Track</i>	<b>886LED</b>	8W
<b>LHT</b>	<i>L Track</i>	<b>886</b>	50W
<b>JHT</b>	<i>J/J2 Track</i>	<b>886L</b>	75W

Example: **LHT-886LED-AB**

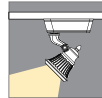

## Radiant LED, Halogen MR16

**Lamping:** 12V LED MR16, Halogen MR16 lamps up to 75W max

**Lens Options:** 1 lens with the use of a lens clip

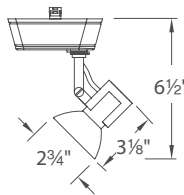

System	Model	Watt	Finish
<b>HHT</b>	<i>H Track</i>	<b>856LED</b>	8W
<b>LHT</b>	<i>L Track</i>	<b>856</b>	50W
<b>JHT</b>	<i>J/J2 Track</i>	<b>856L</b>	75W

Example: **JHT-856L-BN**

Lenses and Accessories (use with lens clip)

lens clip	LENS-16-CLIP	AMB	Amber	UV Filter Lens	LENS-16-UVF
		BLU	Blue	Frosted Lens	LENS-16-FR
		GRN	Green	Spread Lens	LENS-16-SPR
		RED	Red	Beam Elongating	LENS-16-BEL
		YEL	Yellow	Honeycomb Louver	LENS-16-HCL

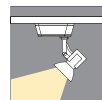

**LED** Power: 8W  
Lumens: 450  
CBCP: 833

**Comparable:** 35W MR16  
**Beam:** 35°  
**Color Temp:** 3000K

**Dimming:** 100% – 10%  
**Rated Life:** 25,000 hr

- MR16 LED included with purchase of LED version
- 1 watt to 60 watt load transformer for LED

## Range LED, Halogen MR16

**Lamping:** 12V LED MR16, Halogen MR16 lamps up to 75W max

**Lens Options:** Clear lens included

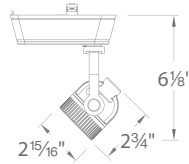

System	Model	Watt	Finish
<b>HHT</b> H Track	<b>164LED</b>	8W	<b>BK</b> Black
<b>LHT</b> L Track	<b>164L</b>	75W	<b>WT</b> White
<b>JHT</b> J/J2 Track			

Example: **LHT-164L-BK**

### Lenses and Accessories

Color Lens	LENS-16	AMB Amber	BLU Blue	GRN Green	RED Red	YEL Yellow	UV Filter Lens	Frosted Lens	Spread Lens	Beam Elongating	Honeycomb Louver	LENS-16-UVF	LENS-16-FR	LENS-16-SPR	LENS-16-BEL	LENS-16-HCL

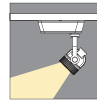

- Clear lens included, see p.419-420 for lens options

## Double Droid LED, Halogen MR16

**Lamping:** Use two 12V LED MR16, Halogen MR16 lamps up to 35W max

**Lens Options:** Clear lens included

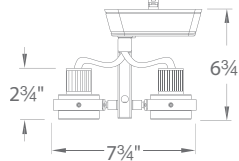

System	Model	Watt	Finish
<b>HHT</b> H Track	<b>817LED</b>	8W	<b>BK</b> Black
<b>LHT</b> L Track	<b>817</b>	35W	<b>PT/BK</b> Platinum/Black
<b>JHT</b> J/J2 Track			<b>PT/WT</b> Platinum/White
			<b>WT</b> White

Example: **LHT-817-PT/BK**

### Lenses and Accessories

Color Lens	LENS-16	AMB Amber	BLU Blue	GRN Green	RED Red	YEL Yellow	UV Filter Lens	Frosted Lens	Spread Lens	Beam Elongating	Honeycomb Louver	LENS-16-UVF	LENS-16-FR	LENS-16-SPR	LENS-16-BEL	LENS-16-HCL



## Dune LED, Halogen MR16

**Lamping:** 12V LED MR16, Halogen MR16 lamps up to 75W max

**Lens Options:** Clear lens included

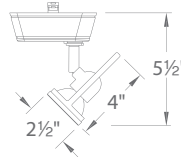

System	Model	Watt	Finish
<b>HHT</b> H Track	<b>826LED</b>	8W	<b>BK</b> Black
<b>LHT</b> L Track	<b>826</b>	50W	<b>BN</b> Brushed Nickel
<b>JHT</b> J/J2 Track	<b>826L</b>	75W	<b>WT</b> White

Example: **LHT-826-BN**

### Lenses and Accessories

Color Lens	LENS-16	AMB Amber	BLU Blue	GRN Green	RED Red	YEL Yellow	UV Filter Lens	Frosted Lens	Spread Lens	Beam Elongating	Honeycomb Louver	LENS-16-UVF	LENS-16-FR	LENS-16-SPR	LENS-16-BEL	LENS-16-HCL



Available in monopoint **ME-826**  
See p.93 for detail.



<b>LED</b>	<b>Power:</b> 8W	<b>Comparable:</b> 35W MR16	<b>Dimming:</b> 100% – 10%	• MR16 LED included with purchase of LED version
	<b>Lumens:</b> 450	<b>Beam:</b> 35°	<b>Rated Life:</b> 25,000 hr	• 1 watt to 60 watt load transformer for LED
	<b>CBCP:</b> 833	<b>Color Temp:</b> 3000K		

## 816 LED, Halogen MR16

**Lamping:** 12V LED MR16, Halogen MR16 lamps up to 75W max

**Lens Options:** 1 lens with the use of a lens clip

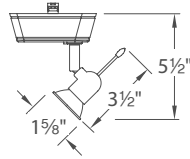

System	Model	Watt	Finish
HHT	H Track	<b>816LED</b>	8W <b>BK</b> Black
LHT	L Track	<b>816</b>	50W <b>BN</b> Brushed Nickel
JHT	J/J2 Track	<b>816L</b>	75W <b>WT</b> White

Example: **LHT-816-BN**

Lenses and Accessories (use with lens clip)

lens clip	LENS-16-CLIP	
Color Lens	<b>LENS-16</b>	
	<b>AMB</b>	Amber
	<b>BLU</b>	Blue
	<b>GRN</b>	Green
	<b>RED</b>	Red
<b>YEL</b>	Yellow	

UV Filter Lens	<b>LENS-16-UVF</b>
Frosted Lens	<b>LENS-16-FR</b>
Spread Lens	<b>LENS-16-SPR</b>
Beam Elongating	<b>LENS-16-BEL</b>
Honeycomb Louver	<b>LENS-16-HCL</b>

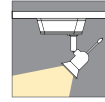

## 204 LED, Halogen MR16

**Lamping:** 12V LED MR16, Halogen MR16 lamps up to 75W max

**Lens Options:** 1 lens with the use of a lens clip

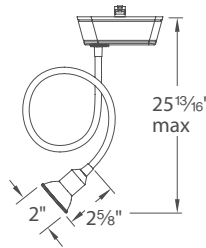

System	Model	Watt	Finish
HHT	H Track	<b>204LED</b>	8W <b>BK</b> Black
LHT	L Track	<b>204</b>	50W <b>BN</b> Brushed Nickel
JHT	J/J2 Track	<b>204L</b>	75W <b>WT</b> White

Example: **LHT-204-BK**

Lenses and Accessories (use with lens clip)

lens clip	LENS-16-CLIP	
Color Lens	<b>LENS-16</b>	
	<b>AMB</b>	Amber
	<b>BLU</b>	Blue
	<b>GRN</b>	Green
	<b>RED</b>	Red
<b>YEL</b>	Yellow	

UV Filter Lens	<b>LENS-16-UVF</b>
Frosted Lens	<b>LENS-16-FR</b>
Spread Lens	<b>LENS-16-SPR</b>
Beam Elongating	<b>LENS-16-BEL</b>
Honeycomb Louver	<b>LENS-16-HCL</b>

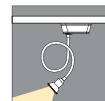

Bulb Shield Accessory (order separately)

	<b>MBS-16</b> Mesh Shield	<b>BK</b>
	<b>SBS-16</b> Solid Shield	<b>BN</b>
		<b>WT</b>

## 846 LED, Halogen MR16

**Lamping:** 12V LED MR16, Halogen MR16 lamps up to 75W max

**Lens Options:** Clear lens included

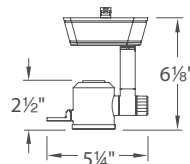

System	Model	Watt	Finish
HHT	H Track	<b>846LED</b>	8W <b>BK</b> Black
LHT	L Track	<b>846</b>	50W <b>WT</b> White
JHT	J/J2 Track	<b>846L</b>	75W

Example: **LHT-846-BK**

Lenses and Accessories

Color Lens	<b>LENS-16</b>	
<b>AMB</b>	Amber	
<b>BLU</b>	Blue	
<b>GRN</b>	Green	
<b>RED</b>	Red	
<b>YEL</b>	Yellow	

UV Filter Lens	<b>LENS-16-UVF</b>
Frosted Lens	<b>LENS-16-FR</b>
Spread Lens	<b>LENS-16-SPR</b>
Beam Elongating	<b>LENS-16-BEL</b>
Honeycomb Louver	<b>LENS-16-HCL</b>

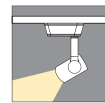

**LED** Power: 8W  
Lumens: 450  
CBCP: 833

**Comparable:** 35W MR16  
**Beam:** 35°  
**Color Temp:** 3000K

**Dimming:** 100% – 10%  
**Rated Life:** 25,000 hr

- MR16 LED included with purchase of LED version
- 1 watt to 60 watt load transformer for LED

## 808 LED, Halogen MR16

**Lamping:** 12V LED MR16, Halogen MR16 lamps up to 75W max

**Lens Options:** Clear lens included

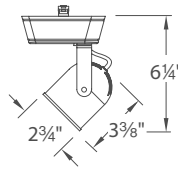

System	Model	Watt	Finish
<b>HHT</b> H Track	<b>808LED</b>	8W	<b>BK</b> Black
<b>LHT</b> L Track	<b>808</b>	50W	<b>DB</b> Dark Bronze
<b>JHT</b> J/J2 Track	<b>808L</b>	75W	<b>WT</b> White

Example: **LHT-808-DB**

### Lenses and Accessories

Color Lens	<b>LENS-16</b>	<b>AMB</b> Amber <b>BLU</b> Blue <b>GRN</b> Green <b>RED</b> Red <b>YEL</b> Yellow	UV Filter Lens Frosted Lens Spread Lens Beam Elongating Honeycomb Louver	<b>LENS-16-UVF</b> <b>LENS-16-FR</b> <b>LENS-16-SPR</b> <b>LENS-16-BEL</b> <b>LENS-16-HCL</b>
------------	----------------	--	--	---

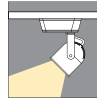

Available in  
monopoint **ME-808**  
See p.93 for detail.



## 809 LED, Halogen MR16

**Lamping:** 12V LED MR16, Halogen MR16 lamps up to 75W max

**Lens Options:** Clear lens included

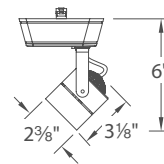

System	Model	Watt	Finish
<b>HHT</b> H Track	<b>809LED</b>	8W	<b>BK</b> Black
<b>LHT</b> L Track	<b>809</b>	50W	<b>BN</b> Brushed Nickel
<b>JHT</b> J/J2 Track	<b>809L</b>	75W	<b>WT</b> White

Example: **LHT-809-BK**

### Lenses and Accessories

Color Lens	<b>LENS-16</b>	<b>AMB</b> Amber <b>BLU</b> Blue <b>GRN</b> Green <b>RED</b> Red <b>YEL</b> Yellow	UV Filter Lens Frosted Lens Spread Lens Beam Elongating Honeycomb Louver	<b>LENS-16-UVF</b> <b>LENS-16-FR</b> <b>LENS-16-SPR</b> <b>LENS-16-BEL</b> <b>LENS-16-HCL</b>
------------	----------------	--	--	---

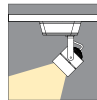

## 866 Halogen MR16

**Lamping:** 12V Halogen MR16 lamps up to 75W max

**Lens Options:** 1 lens with the use of a lens clip

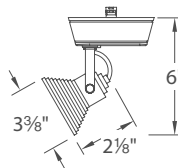

System	Model	Watt	Finish
<b>HHT</b> H Track	<b>866</b>	50W	<b>WT</b> White
<b>LHT</b> L Track	<b>866L</b>	75W	
<b>JHT</b> J/J2 Track	<b>866L</b>	75W	

Example: **LHT-866-WT**

### Lenses and Accessories (use with lens clip)

lens clip	<b>LENS-16-CLIP</b>			
Color Lens	<b>LENS-16</b>	<b>AMB</b> Amber <b>BLU</b> Blue <b>GRN</b> Green <b>RED</b> Red <b>YEL</b> Yellow	UV Filter Lens Frosted Lens Spread Lens Beam Elongating Honeycomb Louver	<b>LENS-16-UVF</b> <b>LENS-16-FR</b> <b>LENS-16-SPR</b> <b>LENS-16-BEL</b> <b>LENS-16-HCL</b>



**LED** Power: 8W  
Lumens: 450  
CBCP: 833

**Comparable:** 35W MR16  
**Beam:** 35°  
**Color Temp:** 3000K

**Dimming:** 100% – 10%  
**Rated Life:** 25,000 hr

- MR16 LED included with purchase of LED version
- 1 watt to 60 watt load transformer for LED

## 160 LED, Halogen MR16

**Lamping:** 12V LED MR16, Halogen MR16 lamps up to 75W max

**Lens Options:** Clear lens included

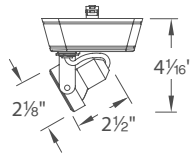

System	Model	Watt	Finish
<b>HHT</b> H Track	<b>160LED</b>	8W	<b>BK</b> Black
<b>LHT</b> L Track	<b>160</b>	50W	<b>WT</b> White
<b>JHT</b> J/J2 Track	<b>160L</b>	75W	

Example: **LHT-160-WT**

### Lenses and Accessories

Color Lens	LENS-16	AMB Amber	BLU Blue	GRN Green	RED Red	YEL Yellow	UV Filter Lens	Frosted Lens	Spread Lens	Beam Elongating	Honeycomb Louver	LENS-16-UVF	LENS-16-FR	LENS-16-SPR	LENS-16-BEL	LENS-16-HCL
------------	---------	-----------	----------	-----------	---------	------------	----------------	--------------	-------------	-----------------	------------------	-------------	------------	-------------	-------------	-------------

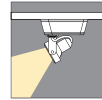

## 802 LED, Halogen MR16

**Lamping:** 12V LED MR16, Halogen MR16 lamps up to 75W max

**Lens Options:** Clear lens included

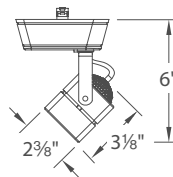

System	Model	Watt	Finish
<b>HHT</b> H Track	<b>802LED</b>	8W	<b>BK</b> Black
<b>LHT</b> L Track	<b>802</b>	50W	<b>BN</b> Brushed Nickel
<b>JHT</b> J/J2 Track	<b>802L</b>	75W	<b>WT</b> White

Example: **LHT-802-BN**

### Lenses and Accessories

Color Lens	LENS-16	AMB Amber	BLU Blue	GRN Green	RED Red	YEL Yellow	UV Filter Lens	Frosted Lens	Spread Lens	Beam Elongating	Honeycomb Louver	LENS-16-UVF	LENS-16-FR	LENS-16-SPR	LENS-16-BEL	LENS-16-HCL
------------	---------	-----------	----------	-----------	---------	------------	----------------	--------------	-------------	-----------------	------------------	-------------	------------	-------------	-------------	-------------

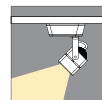

## 801 LED, Halogen MR16

**Lamping:** 12V LED MR16, Halogen MR16 lamps up to 75W max

**Lens Options:** Clear lens included

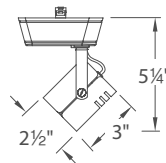

System	Model	Watt	Finish
<b>HHT</b> H Track	<b>801LED</b>	8W	<b>BK</b> Black
<b>LHT</b> L Track	<b>801</b>	50W	<b>WT</b> White
<b>JHT</b> J/J2 Track	<b>801L</b>	75W	

Example: **LHT-801-WT**

### Lenses and Accessories

Color Lens	LENS-16	AMB Amber	BLU Blue	GRN Green	RED Red	YEL Yellow	UV Filter Lens	Frosted Lens	Spread Lens	Beam Elongating	Honeycomb Louver	LENS-16-UVF	LENS-16-FR	LENS-16-SPR	LENS-16-BEL	LENS-16-HCL
------------	---------	-----------	----------	-----------	---------	------------	----------------	--------------	-------------	-----------------	------------------	-------------	------------	-------------	-------------	-------------

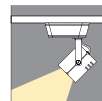

### Barn Door Accessory

Model	Finish
<b>801BD</b>	<b>BK</b> Black <b>WT</b> White

order separately

**LED** Power: 8W  
Lumens: 450  
CBCP: 833

**Comparable:** 35W MR16  
**Beam:** 35°  
**Color Temp:** 3000K

**Dimming:** 100% – 10%  
**Rated Life:** 25,000 hr

- MR16 LED included with purchase of LED version
- 1 watt to 60 watt load transformer for LED



## 007 LED, Halogen MR16

**Lamping:** 12V LED MR16, Halogen MR16 lamps up to 75W max

**Lens Options:** Clear lens included

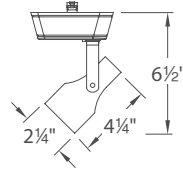

System	Model	Watt	Finish
<b>HHT</b> H Track	<b>007LED</b>	8W	<b>BK</b> Black
<b>LHT</b> L Track	<b>007</b>	50W	<b>BN</b> Brushed Nickel
<b>JHT</b> J/J2 Track	<b>007L</b>	75W	<b>WT</b> White

Example: **LHT-007-WT**

### Lenses and Accessories

Color Lens	LENS-16	AMB	Amber	BLU	Blue	GRN	Green	RED	Red	YEL	Yellow	UV Filter Lens	LENS-16-UVF
												Frosted Lens	LENS-16-FR
												Spread Lens	LENS-16-SPR
												Beam Elongating	LENS-16-BEL
												Honeycomb Louver	LENS-16-HCL



### Framing Projector

Model	Finish
<b>008FP</b>	<b>BK</b> Black
	<b>WT</b> White

order separately



## 180 LED, Halogen MR16

**Lamping:** 12V LED MR16, Halogen MR16 lamps up to 75W max

**Lens Options:** Clear lens included

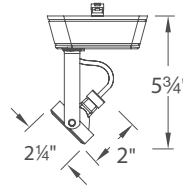

System	Model	Watt	Finish
<b>HHT</b> H Track	<b>180LED</b>	8W	<b>BK</b> Black
<b>LHT</b> L Track	<b>180</b>	50W	<b>BN</b> Brushed Nickel
<b>JHT</b> J/J2 Track	<b>180L</b>	75W	<b>WT</b> White

Example: **LHT-180-BN**

### Lenses and Accessories

Color Lens	LENS-16	AMB	Amber	BLU	Blue	GRN	Green	RED	Red	YEL	Yellow	UV Filter Lens	LENS-16-UVF
												Frosted Lens	LENS-16-FR
												Spread Lens	LENS-16-SPR
												Beam Elongating	LENS-16-BEL
												Honeycomb Louver	LENS-16-HCL

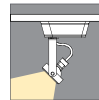

## Framing Projector 009L Halogen MR16

**Lamping:** 12V Halogen MR16 lamps up to 75W max

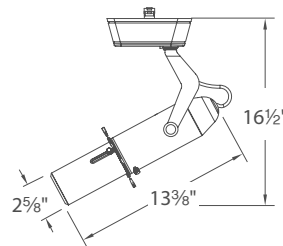

System	Model	Watt	Finish
<b>HHT</b> H Track	<b>009L</b>	75W	<b>BK</b> Black
<b>LHT</b> L Track			<b>WT</b> White
<b>JHT</b> J/J2 Track			

Example: **LHT-009L-BK**

\*Order lamp separately

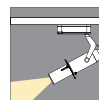

**LED** Power: 8W  
Lumens: 450  
CBCP: 833

**Comparable:** 35W MR16  
**Beam:** 35°  
**Color Temp:** 3000K

**Dimming:** 100% - 10%  
**Rated Life:** 25,000 hr

- MR16 LED included with purchase of LED version
- 1 watt to 60 watt load transformer for LED

## 814 Halogen MR16

**Lamping:** 12V Halogen MR16 lamps up to 75W max  
**Lamp Shield** 1 glass or metal shield, order separately

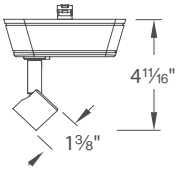

System	Model	Watt	Finish
<b>HHT</b> H Track	<b>814</b>	50W max	<b>BK</b> Black
<b>LHT</b> L Track	<b>814L</b>	75W max	<b>WT</b> White
<b>JHT</b> J/J2 Track			

Example: **LHT-814-WT** \*Order lamp separately

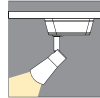

Glass and Shield (required, order separately)

G111	G112	G113	G114
2 1/4"W x 1 3/4"H	2 1/2"W x 1 3/4"H	3 3/8"W x 1 7/8"H	2 5/8"W x 2 1/2"H
<b>AM BL WT</b>	<b>AM WT</b>	<b>AM WT</b>	<b>AM BL RD WT</b>

G115	G116
2 1/4"W x 1 3/4"H	2 1/4"W x 1 3/4"H
<b>BN DB</b>	<b>BN DB</b>

Example: **G111-BL**

**AM**-Amber, **BL**-Blue, **BN**-Brushed Nickel, **DB**-Dark Bronze, **RD**-Red, **WT**-White

## 936 AR111/PAR36

**Lamping:** 12V AR111 lamp up to 75W max or PAR36 50W

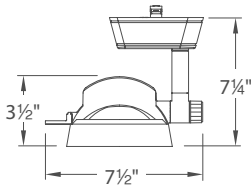

System	Model	Watt	Finish
<b>HHT</b> H Track	<b>936</b>	50W	<b>BK</b> Black
<b>LHT</b> L Track	<b>936L</b>	75W	<b>WT</b> White
<b>JHT</b> J/J2 Track			

Example: **LHT-936L-WT** \*Order lamp separately

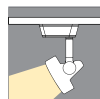

Shown in White finish with G114-WT glass



Shown in Black finish with G112-AM glass



## 763, 764, 765 LED, Halogen PAR/R

Back loading accommodates most LED retrofit lamp on market

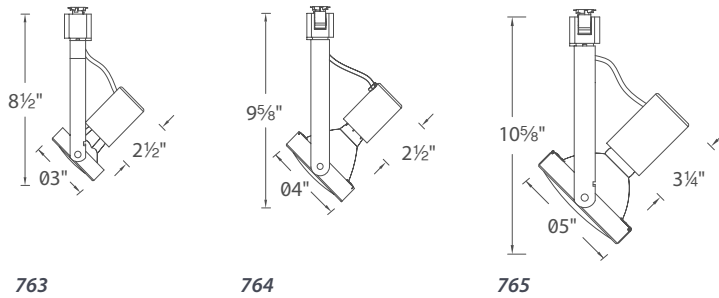

System	Model	Lamp	Finish
<b>HTK</b> H Track	<b>763</b>	LED BR20 7.5W, LED PAR20 10.3W	<b>BK</b> Black
<b>LTK</b> L Track	<b>764</b>	LED BR30 14W, LED PAR30 14.6W	<b>BN</b> Brushed Nickel
<b>JTK</b> J/J2 Track	<b>765</b>	LED BR40 17W, LED PAR38 17.8W	<b>WT</b> White

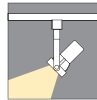

Example: **HTK-763-WT**

\*Order lamp separately

## 725 Halogen PAR20/R20

Lamping: 120V Halogen PAR20, R20 up to 60W max

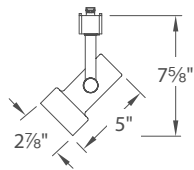

System	Model	Finish
<b>HTK</b> H Track	<b>725</b>	<b>BK</b> Black
<b>LTK</b> L Track		<b>WT</b> White
<b>JTK</b> J/J2 Track		

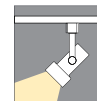

Example: **LTK-725-WT**

\*Order lamp separately

## 703 LED, Halogen PAR30/BR30

Lamping: LED BR30 14W, LED PAR30 14.6W, see p.344 for order details or Halogen 120V PAR30, BR30 100W max

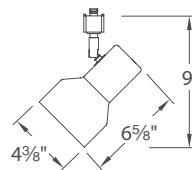

System	Model	Finish
<b>HTK</b> H Track	<b>703</b>	<b>BK</b> Black
<b>LTK</b> L Track		<b>WT</b> White
<b>JTK</b> J/J2 Track		

Example: **HTK-703-BK**

\*Order lamp separately

### LED Lamps

Model	Type	Finish
<b>PAR20LED-10N30</b>	PAR20	<b>BK</b>
<b>PAR30LED-L14N30</b>	PAR30	<b>WT</b>
<b>BR20LED-7N27</b>	BR20	<b>WT</b>
<b>BR30LED-11N27</b>	BR30	<b>WT</b>

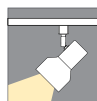

Shown **HTK-764-WT** with **BR30LED-11N27-WT** LED lamp



## 720, 730, 738 Halogen PAR20/R20/PAR30/PAR38/BR40

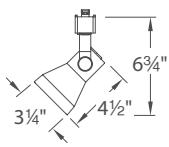

720

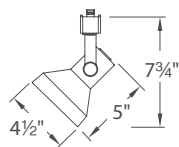

730

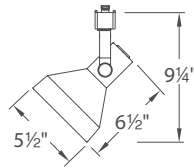

738

System	Model	Lamp	Finish
<b>HTK</b> H Track	<b>720</b>	PAR20 50W	<b>BK</b> Black
<b>LTK</b> L Track	<b>730</b>	PAR30 75W	<b>WT</b> White
<b>JTK</b> J/J2 Track	<b>738</b>	PAR38 150W	



Example: **LTK-738-BK** \*Order lamp separately

## 178 Universal Medium Base

**Lamping:** LED BR20/30/40, LED PAR20/30/38, see p.344 for order details or Halogen 120V A, BR, G, PAR20/30/38 50W max

**Lens Options:** 1 lens with the use of a lens clip, PAR lamps only

System	Model	Finish
<b>HTK</b> H Track		<b>BK</b> Black
<b>LTK</b> L Track	<b>178</b>	<b>BN</b> Brushed Nickel
<b>JTK</b> J/J2 Track		<b>WT</b> White

Example: **LTK-178-BN** \*Order lamp separately

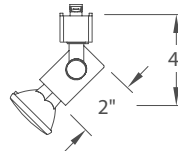

### LED Lamps

Model	Type	Finish
<b>PAR20LED-10N30</b>	PAR20	<b>BK</b>
<b>PAR30LED-L14N30</b>	PAR30	<b>WT</b>
<b>PAR38LED-17N30</b>	PAR38	
<b>BR20LED-7N27</b>	BR20	<b>WT</b>
<b>BR30LED-11N27</b>	BR30	

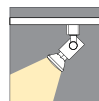

Barn Door (order separately)

Model	Finish
<b>PAR20BD</b>	<b>BK</b> Black
<b>PAR30BD</b>	<b>BN</b> Brushed Nickel
<b>PAR38BD</b>	<b>WT</b> White

## 188 Universal Medium Base

**Lamping:** LED BR20/30/40, LED PAR20/30/38, see p.344 for order details or Halogen 120V A, BR, G, PAR20/30/38 50W max

**Lens Options:** 1 lens with the use of a lens clip, PAR lamps only

System	Model	Finish
<b>HTK</b> H Track		<b>BK</b> Black
<b>LTK</b> L Track	<b>188</b>	<b>BN</b> Brushed Nickel
<b>JTK</b> J/J2 Track		<b>WT</b> White

Example: **LTK-188-WT** \*Order lamp separately

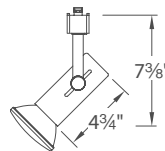

Shown with **BR30LED-11N27-WT** LED lamp

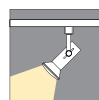

Barn Door (order separately)

Model	Finish
<b>PAR20BD</b>	<b>BK</b> Black
<b>PAR30BD</b>	<b>BN</b> Brushed Nickel
<b>PAR38BD</b>	<b>WT</b> White

## Radiant Halogen PAR20/PAR30/PAR38

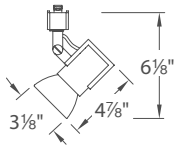

773

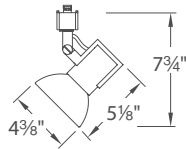

774

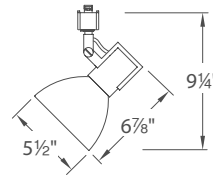

775

System	Model	Lamp	Finish
<b>HTK</b>	<i>H Track</i>	<b>773</b>	PAR20 50W max
<b>LTK</b>	<i>L Track</i>	<b>774</b>	PAR30 75W max
<b>JTK</b>	<i>J/J2 Track</i>	<b>775</b>	PAR38 150W max
			<b>AB</b> <i>Antique Bronze</i>
			<b>BK</b> <i>Black</i>
			<b>BN</b> <i>Brushed Nickel</i>
			<b>WT</b> <i>White</i>

Example: **HTK-774-BN**

*\*Order lamp separately*

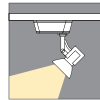

Shown **HTK-774-BN** with **PAR30 75W Halogen lamp**

## Studio Halogen PAR20/PAR30/PAR38

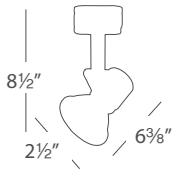

713

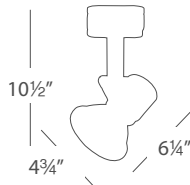

733

System	Model	Lamp	Finish
<b>HTK</b>	<i>H Track</i>	<b>713</b>	PAR20 50W max
<b>LTK</b>	<i>L Track</i>		PAR30 75W max
<b>JTK</b>	<i>J/J2 Track</i>	<b>733</b>	PAR38 150W max
			<b>BK</b> <i>Black</i>
			<b>WT</b> <i>White</i>

Example: **HTK-713-BK**

*\*Order lamp separately*

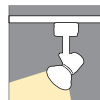

Shown **HTK-713-BK** with **PAR20 50W Halogen lamp**

## 150 Quartz J-150-S

Lamping: 120V J-150-S 150W max

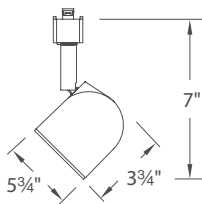

System	Model	Finish
<b>HTK</b>	<i>H Track</i>	<b>150</b>
<b>LTK</b>	<i>L Track</i>	
<b>JTK</b>	<i>J/J2 Track</i>	
		<b>BK</b> <i>Black</i>
		<b>WT</b> <i>White</i>

Example: **LTK-150-BK**

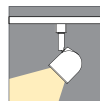

## Rialto Halogen PAR20/PAR30

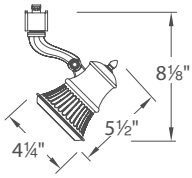

793

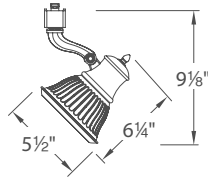

794

System	Model	Lamp	Finish
<b>HTK</b> H Track	<b>793</b>	PAR20 50W max	<b>AB</b> Antique Bronze
<b>LTK</b> L Track			
<b>JTK</b> J/J2 Track			

Example: **LTK-794-AB**

\*Order lamp separately

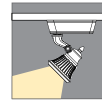

Shown **HTK-794-AB** with **PAR30 75W Halogen lamp**

- 360° horizontal rotation and 90° vertical aiming
- Fully enclosed back to prevent light leaks

## Caribe Halogen PAR20

**Lamping:** Halogen 120V PAR20 50W max

**Lens Options:** Up to 2 lenses using optional lens ring

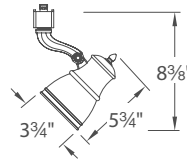

System	Model	Lens Ring	Finish
<b>HTK</b> H Track	<b>797</b>	<b>LENS</b> optional	<b>AB</b> Antique Bronze
<b>LTK</b> L Track			
<b>JTK</b> J/J2 Track			

Example: **LTK-797-AB** or **LTK-797LENS-AB**

\*Order lamp separately

Lenses and Accessories (order Lens Ring version that holds up two lenses/accessories)

Color Lens	<b>LENS-20</b>	<b>AMB</b> Amber	Frosted Lens Spread Lens Beam Elongating	<b>LENS-20-FR</b>
		<b>BLU</b> Blue		<b>LENS-20-SPR</b>
		<b>GRN</b> Green		<b>LENS-20-BEL</b>
		<b>RED</b> Red		
		<b>YEL</b> Yellow		

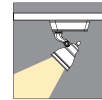

Shown **HTK-798-AB** with **PAR30 75W Halogen lamp**

## Caribe Halogen PAR30

**Lamping:** Halogen 120V PAR30 75W max

**Lens Options:** Up to 2 lenses using optional lens ring

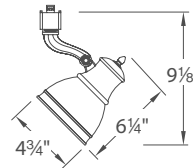

System	Model	Lens Ring	Finish
<b>HTK</b> H Track	<b>798</b>	<b>LENS</b> optional	<b>AB</b> Antique Bronze
<b>LTK</b> L Track			
<b>JTK</b> J/J2 Track			

Example: **LTK-798-AB** or **LTK-798LENS-AB**

\*Order lamp separately

Lenses and Accessories

Color Lens	<b>LENS-30</b>	<b>AMB</b> Amber	Cross Louver Frosted Lens Spread Lens	<b>LENS-30-CRL</b>
		<b>BLU</b> Blue		<b>LENS-30-FR</b>
		<b>GRN</b> Green		<b>LENS-30-SPR</b>
		<b>RED</b> Red		
		<b>YEL</b> Yellow		

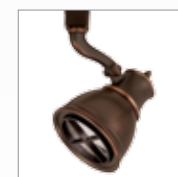
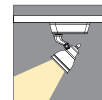

Shown with optional lens ring and cross louver accessory

- Spun and cast aluminum construction
- 360° horizontal rotation and 90° vertical aiming
- Fully enclosed back to prevent light leaks





### 103 LED, Halogen GU10

**Lamping:** LED 8W  
or 120V GU10 50W, included

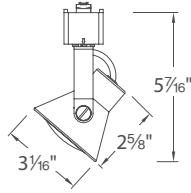

System	Model	Watt	Finish
<b>HTK</b> H Track	<b>103LED</b> <b>103</b>	8W 50W	<b>BK</b> Black
<b>LTK</b> L Track			<b>DB</b> Dark Bronze
<b>JTK</b> J/J2 Track			<b>WT</b> White

Example: **HTK-103LED-DB**



### 104 LED, Halogen GU10

**Lamping:** LED 8W  
or 120V GU10 50W, included

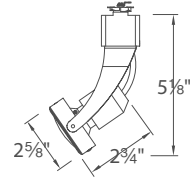

System	Model	Watt	Finish
<b>HTK</b> H Track	<b>104LED</b> <b>104</b>	8W 50W	<b>BK</b> Black
<b>LTK</b> L Track			<b>DB</b> Dark Bronze
<b>JTK</b> J/J2 Track			<b>WT</b> White

Example: **LTK-104LED-WT**



### 101 Halogen GU10

**Lamping:** 120V GU10 50W, included

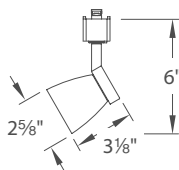

System	Model	Watt	Finish
<b>HTK</b> H Track	<b>101</b>	50W	<b>AM/BK</b> Amber/Black
<b>LTK</b> L Track			<b>AM/WT</b> Amber/White
<b>JTK</b> J/J2 Track			<b>WT/BK</b> White/Black
			<b>WT/WT</b> White/White

Example: **LTK-101-AM/BK**



### 102 Halogen GU10

**Lamping:** 120V GU10 50W, included

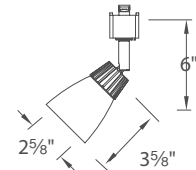

System	Model	Watt	Finish
<b>HTK</b> H Track	<b>102</b>	50W	<b>WT/WT</b> White/White
<b>LTK</b> L Track			
<b>JTK</b> J/J2 Track			

Example: **LTK-102-WT/WT**

**LED** Power: 8W  
Lumens: 470  
CBCP: 877

**Comparable:** 35W MR16  
**Beam:** 35°  
**Color Temp:** 3000K

**Dimming:** 100% – 10%  
**Rated Life:** 25,000 hours

• GU10 LED included with purchase of LED version



## 701 PAR20

Lamping: 120V A/PAR20/R20 order separately

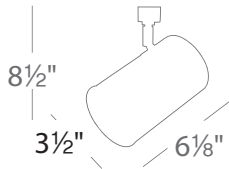

System	Model	Finish
<b>HTK</b> H Track	<b>701</b>	<b>BK</b> Black
<b>LTK</b> L Track		<b>WT</b> White
<b>JTK</b> J/J2 Track		

Example: **HTK-701-WT**



## 764-39/70E HID

Lamping: 120V CDM PAR30L 39W, 70W, order separately

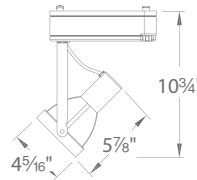

System	Model	Watt	Finish
<b>HTK</b> H Track	<b>764</b>	<b>39E</b> 39W	<b>BK</b> Black
<b>LTK</b> L Track		<b>70E</b> 70W	<b>WT</b> White
<b>JTK</b> J/J2 Track			

Example: **LTK-764-39E-WT** \*Order lamp separately

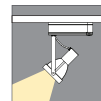

## 765-70E HID

Lamping: 120V CDM PAR38 70W, order separately

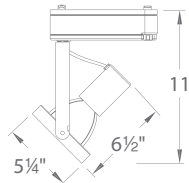

System	Model	Watt	Finish
<b>HTK</b> H Track	<b>765-70E</b>	70W	<b>BK</b> Black
<b>LTK</b> L Track			<b>WT</b> White
<b>JTK</b> J/J2 Track			

Example: **LTK-765-70E-BK** \*Order lamp separately

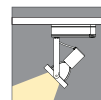

- Ideal for retail spot lighting applications
- Integral electronic ballast
- Front loading for convenient re-lamping

# Vamp HID Track Luminaires

## HID202A - Adjustable

**15° - 30° Adjustable beam angle on fixture**

**Lamping:** HID CDM T4, 20W/39W/70W

**Lens Options:** Up to 3 filter lenses and 1 accessory

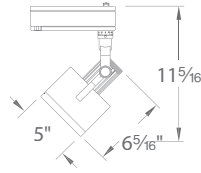

Track Type	Model	Power	Finish
<b>HTK</b> H Track	<b>HID202A</b>	<b>20E</b> 20W	<b>BK</b> Black
<b>LTK</b> L Track		<b>39E</b> 39W	<b>WT</b> White
<b>JTK</b> J/J2 Track		<b>70E</b> 70W	

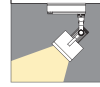

Example: **LTK-HID202A-20E-WT** \*Order lamp separately

### Lenses and Accessories

Color Lens	<b>LENS-111</b>	<b>AMB</b> Amber <b>BLU</b> Blue <b>GRN</b> Green <b>RED</b> Red <b>YEL</b> Yellow	<b>UV Filter Lens</b> <b>Frosted Lens</b> <b>Spread Lens</b> <b>Beam Elongating</b>	<b>LENS-111-UVF</b> <b>LENS-111-FR</b> <b>LENS-111-SPR</b> <b>LENS-111-BEL</b>	<b>Cross Louver</b> <b>Honeycomb</b> <b>Snoot</b>	<b>LENS-111-CRL</b> <b>LENS-111-HCL</b> <b>LENS-111-SNOOT</b>
------------	-----------------	--	--	---	---	---



Patent Pending  
Beam Adjustment Control

## Vamp HID202

**Lamping:** HID CDM T4

**Lens Options:** Up to 3 filter lenses and 1 accessory

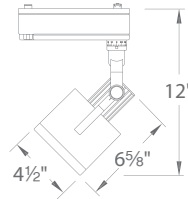

Track Type	Model	Beam	Power	Finish
<b>HTK</b> H Track	<b>HID202</b>	<b>S</b> 15°	<b>20E</b> 20W	<b>BK</b> Black
<b>LTK</b> L Track		<b>N</b> 25°	<b>39E</b> 39W	<b>WT</b> White
<b>JTK</b> J/J2 Track		<b>F</b> 40°	<b>70E</b> 70W	

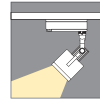

Example: **JTK-HID202N-70E-BK** \*Order lamp separately

### Lenses and Accessories

Color Lens	<b>LENS-30</b>	<b>AMB</b> Amber <b>BLU</b> Blue <b>GRN</b> Green <b>RED</b> Red <b>YEL</b> Yellow	<b>UV Filter Lens</b> <b>Frosted Lens</b> <b>Spread Lens</b> <b>Beam Elongating</b>	<b>LENS-30-UVF</b> <b>LENS-30-FR</b> <b>LENS-30-SPR</b> <b>LENS-30-BEL</b>	<b>Cross Louver</b> <b>Honeycomb</b> <b>Snoot</b>	<b>LENS-30-CRL</b> <b>LENS-30-HCL</b> <b>LENS-30-SNOOT</b>
------------	----------------	--	--	---	---	--

## Vamp HID220

**Lamping:** HID CDM PAR20

**Lens Options:** Up to 3 filter lenses and 1 accessory

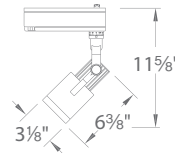

Track Type	Model	Power	Finish
<b>HTK</b> H Track	<b>HID220</b>	<b>20E</b> 20W	<b>BK</b> Black
<b>LTK</b> L Track		<b>39E</b> 39W	<b>WT</b> White
<b>JTK</b> J/J2 Track			

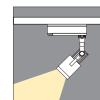

Example: **HTK-HID220-20E-WT** \*Order lamp separately

### Lenses and Accessories

Color Lens	<b>LENS-20</b>	<b>AMB</b> Amber <b>BLU</b> Blue <b>GRN</b> Green <b>RED</b> Red <b>YEL</b> Yellow	<b>UV Filter Lens</b> <b>Frosted Lens</b> <b>Spread Lens</b> <b>Beam Elongating</b>	<b>LENS-20-UVF</b> <b>LENS-20-FR</b> <b>LENS-20-SPR</b> <b>LENS-20-BEL</b>	<b>Cross Louver</b> <b>Honeycomb</b> <b>Snoot</b>	<b>LENS-20-CRL</b> <b>LENS-20-HCL</b> <b>LENS-20-SNOOT</b>
------------	----------------	--	--	---	---	--





Spring-lock horizontal adjustment



Push button vertical aiming



Clean architectural design with concealed wiring



Locking adapter for secure connection to track









- Ideal for retail applications
- Accommodates up to 3 filter lenses and 1 accessory  
*Color Lenses, Filter Lenses, Beam Control Accessories*
- 350° horizontal rotation and 90° vertical aiming
- Lockable aiming with indexing scale in 10° increments

- Threaded lens cap is easily removed for simple front load re-lamping
- Die-cast aluminum construction
- Engineered for use with our W Track or H, L, J/J2 Track systems

# Select by Lamp Type Low Voltage Fixtures







## LED

Power	Max Lumens	Max CBCP		System	Model	Beam	Color Temp	Finish	Features	Full Specs
11.5W 23.5W 28W	780 1310 1755	3430 5780 9770		WTK 120V WHK 277V	LED512 LED522 LED532	S 19° N 24° F 36°	927 2700K 27 2700K 930 3000K 30 3000K 35 3500K 40 4000K	BK PT WT	<ul style="list-style-type: none"> <li>ANSI Compliant LED Bins</li> <li>Color lenses, Filter lenses</li> <li>CRI: Up to 90</li> </ul>	p.106
23W 38W	1845 3080	18,049 24,767		WTK 120V WHK 277V HLJ 120V	LED23 LED40	S 12° N 24° F 36° E 19° x 32°	27 2700K 30 3000K 35 3500K 40 4000K	BK PT WT BK WT	<ul style="list-style-type: none"> <li>Energy Star® rated</li> <li>CRI: 85</li> </ul>	p.107 p.121
25W	1525	5868		WTK 120V WHK 277V HLJ 120V	LED25	S 20° F 42°	27 2700K 30 3000K 35 3500K 40 4000K	BK PT WT BK WT	<ul style="list-style-type: none"> <li>Energy Star® rated</li> <li>CRI: 85</li> </ul>	p.109 p.122
9W 18W	555 1065	4585 8800		HLJ 120V	LED9 LED18	S 10° F 25°	27 2700K WW 3000K 35 3500K CW 4500K	BK BN WT	<ul style="list-style-type: none"> <li>Energy Star® rated</li> <li>ANSI Compliant LED Bins</li> <li>Color lenses, Filter lenses</li> <li>CRI: 85</li> </ul>	p.123
17W	1125	3780		WTK 120V WHK 277V	LED17	S 20° F 45°	27 2700K 30 3000K 35 3500K 40 4000K	BK PT WT	<ul style="list-style-type: none"> <li>Energy Star® rated</li> <li>ANSI Compliant LED Bins</li> <li>Color lenses</li> <li>Filter lenses</li> <li>CRI: 85</li> </ul>	p.111
27W	1890	7455		WTK 120V WHK 277V HLJ 120V	LED27	S 10° F 45°	27 2700K 30 3000K 35 3500K 40 4000K	BK PT WT BK BN WT	<ul style="list-style-type: none"> <li>Energy Star® rated</li> <li>ANSI Compliant LED Bins</li> <li>Color lenses</li> <li>Filter lenses</li> <li>CRI: 85</li> </ul>	p.111 p.123
23W	1450	6772		WTK 120V WHK 277V HLJ 120V	LED20	S 20° F 40°	27 2700K 30 3000K 35 3500K 40 4000K	BK PT WT BK WT	<ul style="list-style-type: none"> <li>Energy Star® rated</li> <li>Color Lenses, Filter Lenses, Beam Control Accessories (p.343)</li> <li>CRI: 85</li> </ul>	p.112 p.127

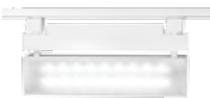
BK-Black, BN-Brushed Nickel, WT-White

# Select by Lamp Type Low Voltage Fixtures









## LED

Power	Max Lumens	Max CBCP		System	Model	Beam	Color Temp	Finish	Features	Full Specs
14W 27W	935 1990			<b>H L J</b> 120V	<b>LED110W LED210W</b>		<b>WW</b> 3000K <b>CW</b> 4000K	<b>BK WT</b>	<ul style="list-style-type: none"> <li>• Low profile, extends only 2" from track</li> <li>• Adjustable beam angle</li> <li>• CRI: 85</li> </ul>	p.126
42W	2540			<b>WTK</b> 120V <b>WHK</b> 277V  <b>H L J</b> 120V	<b>LED42W</b>		<b>27</b> 2700K <b>30</b> 3000K <b>35</b> 3500K <b>40</b> 4000K	<b>BK PT WT</b>	<ul style="list-style-type: none"> <li>• Energy Star® rated</li> <li>• Wall Wash asymmetrical distribution</li> <li>• CRI: 85</li> </ul>	p.113 p.125
14W	951	4481		<b>H L J</b> 120V	<b>LED810</b>	<b>S</b> 20° <b>F</b> 40°	<b>927</b> 2700K <b>27</b> 2700K <b>9W</b> 3000K <b>WW</b> 3000K <b>35</b> 3500K <b>CW</b> 4000K	<b>BK DB WT</b>	<ul style="list-style-type: none"> <li>• Replaceable Cree multi-chip module</li> <li>• Barn door, Framing projector</li> <li>• CRI: Up to 90</li> </ul>	p.129
23W	1366	6048		<b>H L J</b> 120V	<b>LED820</b>	<b>S</b> 20° <b>F</b> 40°	<b>927</b> 2700K <b>27</b> 2700K <b>9W</b> 3000K <b>WW</b> 3000K <b>35</b> 3500K <b>CW</b> 4000K	<b>BK DB WT</b>	<ul style="list-style-type: none"> <li>• Replaceable Cree multi-chip module</li> <li>• Barn door, Framing projector</li> <li>• CRI: Up to 90</li> </ul>	p.129
14W	1070	5766		<b>H L J</b> 120V	<b>LED710</b>	<b>S</b> 20° <b>F</b> 40°	<b>927</b> 2700K <b>27</b> 2700K <b>9W</b> 3000K <b>WW</b> 3000K <b>35</b> 3500K <b>CW</b> 4000K	<b>AB AN</b>	<ul style="list-style-type: none"> <li>• Replaceable Cree multi-chip module</li> <li>• CRI: Up to 90</li> </ul>	p.131
14W	1014	4843		<b>H L J</b> 120V	<b>LED610</b>	<b>S</b> 20° <b>F</b> 40°	<b>927</b> 2700K <b>27</b> 2700K <b>9W</b> 3000K <b>WW</b> 3000K <b>35</b> 3500K <b>CW</b> 4000K	<b>BK BN WT</b>	<ul style="list-style-type: none"> <li>• Replaceable Cree multi-chip module</li> <li>• CRI: Up to 90</li> </ul>	p.130
22W	143			<b>H L J</b> 120V	<b>LED009</b>		<b>927</b> 2700K <b>27</b> 2700K <b>9W</b> 3000K <b>WW</b> 3000K <b>35</b> 3500K <b>CW</b> 4000K	<b>BK WT</b>	<ul style="list-style-type: none"> <li>• Can be used to project images, signs, and corporate logos</li> <li>• CRI: Up to 90</li> </ul>	p.128

**AB**-Antique Bronze, **AN**-Antique Nickel, **BK**-Black, **BN**-Brushed Nickel, **DB**-Dark Bronze, **WT**-White

# Select by Lamp Type Low Voltage Fixtures

## LED Low Voltage

Power	Lumens	CBCP		System	Model	Color Temp	Finish	Features	Full Specs
8W	450	850		HHT LHT JHT	120V <b>164LED</b>	3000K	BK WT	<ul style="list-style-type: none"> <li>• 1 watt to 50 watt load transformer</li> <li>• Fixtures specifically designed to ensure proper lamp fit</li> <li>• CRI: 85</li> <li>• LED lamp included</li> </ul>	p.134
8W	450	850		HHT LHT JHT	120V <b>886LED</b>	3000K	AB	<ul style="list-style-type: none"> <li>• 1 watt to 50 watt load transformer</li> <li>• Fixtures specifically designed to ensure proper lamp fit</li> <li>• CRI: 85</li> <li>• LED lamp included</li> </ul>	p.133
8W	450	850		HHT LHT JHT	120V <b>874LED</b>	3000K	AB	<ul style="list-style-type: none"> <li>• 1 watt to 50 watt load transformer</li> <li>• Fixtures specifically designed to ensure proper lamp fit</li> <li>• CRI: 85</li> <li>• LED lamp included</li> </ul>	p.133
8W	450	850		HHT LHT JHT	120V <b>856LED</b>	3000K	AB BK BN WT	<ul style="list-style-type: none"> <li>• 1 watt to 50 watt load transformer</li> <li>• Fixtures specifically designed to ensure proper lamp fit</li> <li>• CRI: 85</li> <li>• LED lamp included</li> </ul>	p.133
8W	2 x 360	850		HHT LHT JHT	120V <b>817LED</b>	3000K	BK PT/BK PT/WT WT	<ul style="list-style-type: none"> <li>• 1 watt to 50 watt load transformer</li> <li>• Fixtures specifically designed to ensure proper lamp fit</li> <li>• CRI: 85</li> <li>• LED lamp included</li> </ul>	p.134
8W	450	850		HHT LHT JHT	120V <b>826LED</b>	3000K	BK BN WT	<ul style="list-style-type: none"> <li>• 1 watt to 50 watt load transformer</li> <li>• Fixtures specifically designed to ensure proper lamp fit</li> <li>• CRI: 85</li> <li>• LED lamp included</li> </ul>	p.134
8W	450	850		HHT LHT JHT	120V <b>816LED</b>	3000K	BK BN WT	<ul style="list-style-type: none"> <li>• 1 watt to 50 watt load transformer</li> <li>• Fixtures specifically designed to ensure proper lamp fit</li> <li>• CRI: 85</li> <li>• LED lamp included</li> </ul>	p.134
8W	450	850		HHT LHT JHT	120V <b>808LED</b>	3000K	BK DB WT	<ul style="list-style-type: none"> <li>• 1 watt to 50 watt load transformer</li> <li>• Fixtures specifically designed to ensure proper lamp fit</li> <li>• CRI: 85</li> <li>• LED lamp included</li> </ul>	p.134

AB-Antique Bronze, BK-Black, BN-Brushed Nickel, DB-Dark Bronze, PT/BK- Platinum/Black, PT/WT- Platinum/White, WT-White



# Select by Lamp Type Low and Line Voltage Fixtures

Power	Lumens	CBCP		System	Model	Color Temp	Finish	Features	Full Specs
8W	450	850		<b>HHT LHT JHT</b>	120V <b>160LED</b>	3000K	<b>BK BN WT</b>	<ul style="list-style-type: none"> <li>• 1 watt to 50 watt load transformer</li> <li>• Fixtures specifically designed to ensure proper lamp fit</li> <li>• CRI: 85</li> <li>• LED lamp included</li> </ul>	p.137
8W	450	850		<b>HHT LHT JHT</b>	120V <b>180LED</b>	3000K	<b>BK BN WT</b>	<ul style="list-style-type: none"> <li>• 1 watt to 50 watt load transformer</li> <li>• Fixtures specifically designed to ensure proper lamp fit</li> <li>• CRI: 85</li> <li>• LED lamp included</li> </ul>	p.138
8W	450	850		<b>HHT LHT JHT</b>	120V <b>809LED</b>	3000K	<b>BK BN WT</b>	<ul style="list-style-type: none"> <li>• 1 watt to 50 watt load transformer</li> <li>• Fixtures specifically designed to ensure proper lamp fit</li> <li>• CRI: 85</li> <li>• LED lamp included</li> </ul>	p.136
8W	450	850		<b>HHT LHT JHT</b>	120V <b>802LED</b>	3000K	<b>BK BN WT</b>	<ul style="list-style-type: none"> <li>• 1 watt to 50 watt load transformer</li> <li>• Fixtures specifically designed to ensure proper lamp fit</li> <li>• CRI: 85</li> <li>• LED lamp included</li> </ul>	p.137
8W	450	850		<b>HHT LHT JHT</b>	120V <b>204LED</b>	3000K	<b>BK BN WT</b>	<ul style="list-style-type: none"> <li>• 1 watt to 50 watt load transformer</li> <li>• Fixtures specifically designed to ensure proper lamp fit</li> <li>• CRI: 85</li> <li>• LED lamp included</li> </ul>	p.135
8W	450	850		<b>HHT LHT JHT</b>	120V <b>801LED</b>	3000K	<b>BK WT</b>	<ul style="list-style-type: none"> <li>• 1 watt to 50 watt load transformer</li> <li>• Fixtures specifically designed to ensure proper lamp fit</li> <li>• CRI: 85</li> <li>• LED lamp included</li> </ul>	p.137
8W	450	850		<b>HHT LHT JHT</b>	120V <b>007LED</b>	3000K	<b>BK BN WT</b>	<ul style="list-style-type: none"> <li>• 1 watt to 50 watt load transformer</li> <li>• Fixtures specifically designed to ensure proper lamp fit</li> <li>• CRI: 85</li> <li>• LED lamp included</li> </ul>	p.137

**BK**-Black, **BN**-Brushed Nickel, **DB**-Dark Bronze, **WT**-White

# Select by Lamp Type LED and HID Fixtures

## LED Line Voltage

8W	470	900		<b>HTK</b> <b>LTK</b> <b>JTK</b>	120V	<b>103LED</b>	3000K	<b>BK</b> <b>DB</b> <b>WT</b>	<ul style="list-style-type: none"> <li>• GU10LED included</li> <li>• Lamp comes pre-installed in fixture</li> <li>• Fixtures specifically designed to ensure proper lamp fit</li> <li>• CRI: 85</li> <li>• LED lamp included</li> </ul>	p.145
8W	470	900		<b>HTK</b> <b>LTK</b> <b>JTK</b>	120V	<b>104LED</b>	3000K	<b>BK</b> <b>DB</b> <b>WT</b>	<ul style="list-style-type: none"> <li>• GU10LED included</li> <li>• Lamp comes pre-installed in fixture</li> <li>• Fixtures specifically designed to ensure proper lamp fit</li> <li>• CRI: 85</li> <li>• LED lamp included</li> </ul>	p.145

## HID PAR20

Power	lumen	CBCP		System	Model #	Finish	Features	Full Specs
20W 39W	980 2000	12000 16000		<b>WTK</b> 120V <b>WHK</b> 277V <b>LTK</b> 120V <b>HTK</b> 120V <b>JTK</b> 120V	<b>HID220-20E</b> <b>HID220-39E</b>	<b>BK</b> <b>PT</b> <b>WT</b>	<ul style="list-style-type: none"> <li>• Die-cast aluminum construction</li> <li>• Accommodates 3 filter lenses and 1 accessory. Color lenses, filter lenses, beam control (p.343)</li> <li>• Order lamp separately</li> </ul>	p.114 p.147



## HID PAR30

39W 70W	2200 5000	32000 66000		<b>LTK</b> 120V <b>HTK</b> 120V <b>JTK</b> 120V	<b>764-39E</b> <b>764-70E</b>	<b>BK</b> <b>PT/BK</b> <b>PT/WT</b> <b>WT</b>	<ul style="list-style-type: none"> <li>• Metal construction</li> <li>• Beam spreads from 10° to 60°</li> <li>• Order lamp separately</li> </ul>	p.146
------------	--------------	----------------	--	---	----------------------------------	--	---	-------

## HID PAR38

70W	4100	42000		<b>LTK</b> 120V <b>HTK</b> 277V <b>JTK</b> 277V	<b>765-70E</b>	<b>BK</b> <b>PT/BK</b> <b>PT/WT</b> <b>WT</b>	<ul style="list-style-type: none"> <li>• Metal construction</li> <li>• Beam spreads from 10° to 60°</li> <li>• Order lamp separately</li> </ul>	p.146
-----	------	-------	---	---	----------------	--	---	-------

## HID T4









Power	lumen	CBCP		System	Model #	Beam	Power	Finish	Features	Full Specs
20W 39W 70W	1800 3300 6400	65000		<b>WTK</b> 120V <b>WHK</b> 277V <b>LTK</b> 120V <b>HTK</b> 120V <b>JTK</b> 120V	<b>HID202A</b>		<b>20E</b> <b>39E</b> <b>70E</b>	<b>BK</b> <b>PT</b> <b>WT</b>	<ul style="list-style-type: none"> <li>• Die-cast aluminum construction</li> <li>• Accommodates 3 filter lenses and 1 accessory. Color lenses, filter lenses, beam control (p.343)</li> <li>• Order lamp separately</li> </ul>	p.114 p.147
20W 39W 70W	1800 3300 6400	32000		<b>WTK</b> 120V <b>WHK</b> 277V <b>LTK</b> 120V <b>HTK</b> 120V <b>JTK</b> 120V	<b>HID202</b>	<b>S</b> 15° <b>N</b> 25° <b>F</b> 40°	<b>20E</b> <b>39E</b> <b>70E</b>	<b>BK</b> <b>PT</b> <b>WT</b>	<ul style="list-style-type: none"> <li>• Die-cast aluminum construction</li> <li>• Accommodates 3 filter lenses and 1 accessory. Color lenses, filter lenses, beam control (p.343)</li> <li>• Order lamp separately</li> </ul>	p.114 p.147

**BK**-Black, **PT**-Platinum, **PT/BK**-Platinum/Black, **PT/WT**-Platinum/White, **WT**-White



# Select by Lamp Type Low Voltage Fixtures

## MR16

Power	Max lumen	Max CBCP		System	Model #	Finish	Features	Full Specs
50W max 75W max	970 1410	4400 84000		LHT HHT JHT	<b>874-LENS</b> <b>874L-LENS</b>	<b>AB</b>	<ul style="list-style-type: none"> <li>Machined brass and spun aluminum</li> <li>Traditional decorative design</li> <li>Electroplated 3 step antique finish</li> <li>Color lenses, Filter lenses, Louvers (p.343)</li> <li>Order lamp separately</li> </ul>	p.133
50W max 75W max	970 1410	4000 14000		LHT HHT JHT	<b>886</b> <b>886L</b>	<b>AB</b>	<ul style="list-style-type: none"> <li>Machined brass detail</li> <li>Traditional decorative design</li> <li>Electroplated 3 step antique finish</li> <li>Order lamp separately</li> </ul>	p.133
75W max	1410	9000		LHT HHT JHT	<b>164L</b>	<b>BK</b> <b>WT</b>	<ul style="list-style-type: none"> <li>Die-cast aluminum construction</li> <li>Lock and release push button aiming</li> <li>10° interval marks for precise aiming</li> <li>Color lenses, Beam control lenses, Filter lenses, Louvers, Hood (p.343)</li> <li>Order lamp separately</li> </ul>	p.134
2 x 35W max	2 x 710	3000		LHT HHT JHT	<b>817</b>	<b>BK</b> <b>PT/BK</b> <b>PT/WT</b> <b>WT</b>	<ul style="list-style-type: none"> <li>Die-cast aluminum construction</li> <li>Silicon hot aiming sleeve</li> <li>Color lenses, Filter lenses, Honeycomb Louver (p.343)</li> <li>Order lamp separately</li> </ul>	p.134
50W max 75W max	970 1400	4400 14000		LHT HHT JHT	<b>866</b> <b>866L</b>	<b>WT</b>	<ul style="list-style-type: none"> <li>Die-cast aluminum construction</li> <li>Features an etched glass shade</li> <li>use with lens clip</li> <li>Color lenses, Filter lenses, Honeycomb Louver (p.343)</li> <li>Order lamp separately</li> </ul>	p.136
50W max 75W max	970 1400	4500 13000		LHT HHT JHT	<b>846</b> <b>846L</b>	<b>BK</b> <b>WT</b>	<ul style="list-style-type: none"> <li>Die-cast aluminum construction</li> <li>Built in hot aiming adjustment knob</li> <li>Color lenses, Filter lenses, Honeycomb Louver (p.343)</li> <li>Order lamp separately</li> </ul>	p.135
50W max 75W max	970 1400	4600 12000		LHT HHT JHT	<b>816</b> <b>816L</b>	<b>BK</b> <b>BN</b> <b>WT</b>	<ul style="list-style-type: none"> <li>Die-cast aluminum construction</li> <li>Ball and joint style adjustment</li> <li>Hot aiming wand</li> <li>use with lens clip</li> <li>Color lenses, Filter lenses, Honeycomb Louver (p.343)</li> <li>Order lamp separately</li> </ul>	p.135
50W max 75W max	970 1400	4500 11000		LHT HHT JHT	<b>809</b> <b>809L</b>	<b>BK</b> <b>BN</b> <b>WT</b>	<ul style="list-style-type: none"> <li>Die-cast aluminum construction</li> <li>Screw and swivel yoke for precise aiming</li> <li>Round fixture with mesh back vent</li> <li>Color lenses, Filter lenses, Louvers (p.343)</li> <li>Order lamp separately</li> </ul>	p.136

For additional MR16 spot light options, using a 120V Track adapter, see Quick Connect™ selection

**AB**-Antique Bronze, **BK**-Black, **BN**-Brushed Nickel, **DB**-Dark Bronze, **PT/BK**-Platinum/Black, **PT/WT**-Platinum/White, **WT**-White

# Select by Lamp Type Low Voltage Fixtures

## MR16





Power	Lumen	CBCP	System	Model #	Finish	Features	Full Specs
50W max 75W max	970 1410	4400 14000	 LHT HHT JHT	<b>802</b> <b>802L</b>	<b>BK</b> <b>BN</b> <b>WT</b>	<ul style="list-style-type: none"> <li>Die-cast aluminum construction</li> <li>Screw and swivel yoke for precise aiming</li> <li>Square fixture with mesh back vent</li> <li>Color lenses, Filter lenses, Louvers (p.343)</li> <li>Order lamp separately</li> </ul>	p.137
50W max 75W max	970 1410	4400 14000	 LHT HHT JHT	<b>007</b> <b>007L</b>	<b>BK</b> <b>BN</b> <b>WT</b>	<ul style="list-style-type: none"> <li>Die-cast aluminum construction</li> <li>Screw and swivel yoke for precise aiming</li> <li>Available framing projector accessory (008FP)</li> <li>Color lenses, Filter lenses, Honeycomb louver (p.343)</li> <li>Order lamp separately</li> </ul>	p.138
75W max	1410	14,000	 LHT HHT JHT	<b>009L</b>	<b>BK</b> <b>WT</b>	<ul style="list-style-type: none"> <li>Framing projector fixture</li> <li>Die-cast aluminum construction</li> <li>Adjustable metal shims for framing control</li> <li>Accepts two gobos</li> <li>Custom Gobos</li> <li>Order lamp separately</li> </ul>	p.138
50W max 75W max	970 1410	4400 14000	 LHT HHT JHT	<b>826</b> <b>826L</b>	<b>BK</b> <b>BN</b> <b>WT</b>	<ul style="list-style-type: none"> <li>Die cast aluminum construction</li> <li>Screw on lens cap</li> <li>Loop back provides for easy aiming</li> <li>Color lenses, Filter lenses, Honeycomb Louver (p.343)</li> <li>Order lamp separately</li> </ul>	p.134
50W max 75W max	970 1410	4400 14000	 LHT HHT JHT	<b>856</b> <b>856L</b>	<b>AB</b> <b>BK</b> <b>BN</b> <b>WT</b>	<ul style="list-style-type: none"> <li>Die-cast aluminum construction</li> <li>Screw and swivel yoke for precise aiming</li> <li>Fully enclosed back prevents light leaks</li> <li>use with lens clip</li> <li>Color lenses, Filter lenses, Honeycomb Louver (p.343)</li> <li>Order lamp separately</li> </ul>	p.133
50W max 75W max	970 1410	4400 14000	 LHT HHT JHT	<b>814</b> <b>814L</b>	<b>BK</b> <b>WT</b>	<ul style="list-style-type: none"> <li>Die-cast aluminum construction</li> <li>Multiple glass and shield options</li> <li>Order lamp separately</li> </ul>	p.139
50W max 75W max	970 1410	4400 14000	 LHT HHT JHT	<b>808</b> <b>808L</b>	<b>BK</b> <b>DB</b> <b>WT</b>	<ul style="list-style-type: none"> <li>Metal construction</li> <li>Screw and swivel yoke for precise aiming</li> <li>Recessed lamp for minimal glare</li> <li>Color lenses, Filter lenses, Honeycomb Louver (p.343)</li> <li>Order lamp separately</li> </ul>	p.136
50W max 75W max	970 1410	4400 14000	 LHT HHT JHT	<b>180</b> <b>180L</b>	<b>BK</b> <b>BN</b> <b>WT</b>	<ul style="list-style-type: none"> <li>Metal construction</li> <li>350° horiz. rotation and 180° vert. aiming</li> <li>Gimbal ring fixture creates an open look</li> <li>Color lenses, Filter lenses, Honeycomb Louver (p.343)</li> <li>Order lamp separately</li> </ul>	p.135

For additional MR16 spot light options, using a 120V Track adapter, see Quick Connect™ section (p.165-170)

**AB**-Antique Bronze, **BK**-Black, **BN**-Brushed Nickel, **DB**-Dark Bronze, **WT**-White

# Select by Lamp Type Low Voltage Fixtures

## MR16

Power	lumen	CBCP		System	Model #	Finish	Features	Full Specs
50W max 75W max	970 1410	4400 14000		LHT HHT JHT	204 204L	BK BN WT	<ul style="list-style-type: none"> <li>• Metal construction</li> <li>• Flexible cable arm for easy aiming</li> <li>• Solid and mesh bulb shield accessories</li> <li>• use with lens clip</li> <li>• Color lenses, Filter lenses, Honeycomb Louver (p.343)</li> <li>• Order lamp separately</li> </ul>	p.135
50W max 75W max	970 1410	4400 14000		LHT HHT JHT	160 160L	BK WT	<ul style="list-style-type: none"> <li>• Metal construction</li> <li>• Close to ceiling, low profile look</li> <li>• Vertical aiming lock</li> <li>• Color lenses, Filter lenses, Honeycomb Louver (p.343)</li> <li>• Order lamp separately</li> </ul>	p.137
50W max 75W max	970 1410	4400 14000		LHT HHT JHT	801 801L	BK WT	<ul style="list-style-type: none"> <li>• Metal construction</li> <li>• Available barn door accessory</li> <li>• Powder coat paint finish</li> <li>• Barn Door (801BD) option available</li> <li>• Order lamp separately</li> </ul>	p.137
50W max 75W max	970 1410	4400 14000		LHT HHT JHT	816 816L	BK BN WT	<ul style="list-style-type: none"> <li>• Die-cast aluminum construction</li> <li>• Ball and joint style adjustment</li> <li>• Hot aiming wand use with lens clip</li> <li>• Color lenses, Filter lenses, Honeycomb Louver (p.343)</li> <li>• Order lamp separately</li> </ul>	p.135

For additional MR16 spot light options, using a 120V Track adapter, see Quick Connect™ section (p.165-170)









## AR111/PAR36 Low Voltage

Power	lumen	CBCP		System	Model #	Finish	Features	Full Specs
50W max 75W max	650	17800 23500		LHT HHT JHT	936 936L	BK WT	<ul style="list-style-type: none"> <li>• Metal construction</li> <li>• Locking tension knob for vertical aiming</li> <li>• Order lamp separately</li> </ul>	p.139

BK-Black, BN-Brushed Nickel, WT-White

# Select by Lamp Type Line Voltage Fixtures









## PAR20

Power	lumen	CBCP		System	Model #	Finish	Features	Full Specs
50W max	550	1200		LTK HTK JTK	713	BK WT	<ul style="list-style-type: none"> <li>Die-cast aluminum construction</li> <li>Lockable precision aiming</li> <li>Powder coat paint finish</li> <li>Order lamp separately</li> </ul>	p.142
50W max	500	1000		LTK HTK JTK	797-LENS	AB	<ul style="list-style-type: none"> <li>Machined brass and spun aluminum</li> <li>Traditional decorative design</li> <li>Electroplated 3 step antique finish</li> <li>Color lenses, Filter lenses, Honeycomb Louver (p.343)</li> <li>Order lamp separately</li> </ul>	p.143
50W max	500	1000		LTK HTK JTK	793	AB	<ul style="list-style-type: none"> <li>Machined brass detail</li> <li>Traditional decorative design</li> <li>Electroplated 3 step antique finish</li> <li>Order lamp separately</li> </ul>	p.143
50W max	500	1000		LTK HTK JTK	773	AB BK BN WT	<ul style="list-style-type: none"> <li>Die-cast aluminum construction</li> <li>Lockable aiming screws for precise control</li> <li>Order lamp separately</li> </ul>	p.142
50W max	500	1200		LTK HTK JTK	720	BK WT	<ul style="list-style-type: none"> <li>Die-cast aluminum construction</li> <li>Locking tension knob for vertical aiming</li> <li>LED lamp available (p.344)</li> <li>Order lamp separately</li> </ul>	p.141
50W max	500	1000		LTK HTK JTK	725	BK WT	<ul style="list-style-type: none"> <li>Metal construction</li> <li>Fully enclosed back prevents light leaks</li> <li>Order lamp separately</li> </ul>	p.140
50W max	500	900		LTK HTK JTK	763	BK BN WT	<ul style="list-style-type: none"> <li>Metal construction</li> <li>Front loading gimbal ring</li> <li>Lockable aiming screws for precise control</li> <li>LED lamp available (p.344)</li> <li>Order lamp separately</li> </ul>	p.140
50W max	500	1000		LTK HTK JTK	178	BK BN WT	<ul style="list-style-type: none"> <li>Metal construction</li> <li>Lockable vertical aiming</li> <li>Adjustable socket depth</li> <li>Barn door (p.343)</li> <li>Order lamp separately</li> </ul>	p.141
50W max	500	1000		LTK HTK JTK	188	BK BN WT	<ul style="list-style-type: none"> <li>Metal construction</li> <li>Lockable vertical aiming</li> <li>Adjustable socket depth accommodates various lamp types</li> <li>Barn door (p.343)</li> <li>LED lamp available (p.344)</li> <li>Order lamp separately</li> </ul>	p.141

AB-Antique Bronze, AN-Antique Nickel, BK-Black, BN-Brushed Nickel, DB-Dark Bronze, WT-White

# Select by Lamp Type Line Voltage Fixtures

## PAR30

Power	lumen	CBCP		System	Model #	Finish	Features	Full Specs
75W max	600	6000		LTK HTK JTK	713	BK WT	<ul style="list-style-type: none"> <li>Die-cast aluminum construction</li> <li>Lockable precision aiming</li> <li>Powder coat paint finish</li> <li>Order lamp separately</li> </ul>	p.142
75W max	1000	9000		LTK HTK JTK	798-LENS	AB	<ul style="list-style-type: none"> <li>Machined solid brass construction</li> <li>Traditional decorative design</li> <li>Electroplated Antique finishes</li> <li>Color lenses, Filter lenses, Honeycomb Louver (p.343)</li> <li>Order lamp separately</li> </ul>	p.143
75W max	1000	9000		LTK HTK JTK	794	AB	<ul style="list-style-type: none"> <li>Machined solid brass construction</li> <li>Traditional decorative design</li> <li>Electroplated Antique finishes</li> <li>Order lamp separately</li> </ul>	p.143
75W max	1000	9000		LTK HTK JTK	774	AB BK BN WT	<ul style="list-style-type: none"> <li>Die-cast aluminum construction</li> <li>Lockable aiming screws for precise control</li> <li>Order lamp separately</li> </ul>	p.142
75W max	1000	9600		LTK HTK JTK	730	BK WT	<ul style="list-style-type: none"> <li>Die-cast aluminum construction</li> <li>Locking tension knob for vertical aiming</li> <li>LED lamp available (p.344)</li> <li>Order lamp separately</li> </ul>	p.141
100W max	6000	20000		LTK HTK JTK	703	BK WT	<ul style="list-style-type: none"> <li>Metal construction</li> <li>Fully enclosed backing prevents light leaks</li> <li>Phenolic baffle to reduce glare</li> <li>LED lamp available (p.344)</li> <li>Order lamp separately</li> </ul>	p.140
75W max	1000	9000		LTK HTK JTK	764	BK BN WT	<ul style="list-style-type: none"> <li>Metal construction</li> <li>Front loading gimbal ring</li> <li>LED lamp available (p.344)</li> <li>Order lamp separately</li> </ul>	p.140
150W max	1400	4000		LTK HTK JTK	178	BK BN WT	<ul style="list-style-type: none"> <li>Metal construction</li> <li>Lockable vertical aiming</li> <li>Adjustable socket depth accommodates various lamp types</li> <li>Barn door (p.343)</li> <li>LED lamp available (p.344)</li> <li>Order lamp separately</li> </ul>	p.141

AB-Antique Bronze, AN-Antique Nickel, BK-Black, BN-Brushed Nickel, DB-Dark Bronze, WT-White

# Select by Lamp Type Line Voltage Fixtures





## PAR38

Power	lumen	CBCP		System	Model #	Finish	Features	Full Specs
150W max	1300	4500		LTK HTK JTK	733	BK WT	<ul style="list-style-type: none"> <li>Die-cast aluminum construction</li> <li>Lockable precision aiming</li> <li>Powder coat paint finish</li> <li>Order lamp separately</li> </ul>	p.142
150W max	1300	4500		LTK HTK JTK	775	AB BK BN WT	<ul style="list-style-type: none"> <li>Die-cast aluminum construction</li> <li>Lockable aiming screws for precise control</li> <li>Order lamp separately</li> </ul>	p.142
150W max	1300	4500		LTK HTK JTK	738	BK WT	<ul style="list-style-type: none"> <li>Die-cast aluminum construction</li> <li>Locking tension knob for vertical aiming</li> <li>Order lamp separately</li> </ul>	p.141
150W max	1300	4500		LTK HTK JTK	765	BK BN WT	<ul style="list-style-type: none"> <li>Metal construction</li> <li>Lockable aiming screws for precise control</li> <li>LED lamp available (p.344)</li> <li>Order lamp separately</li> </ul>	p.140
150W max	1300	4500		LTK HTK JTK	178	BK BN WT	<ul style="list-style-type: none"> <li>Metal construction</li> <li>Lockable vertical aiming</li> <li>Fixed position socket</li> <li>Barn door (p.343)</li> <li>Order lamp separately</li> </ul>	p.141
150W max	1300	4500		LTK HTK JTK	188	BK BN DB WT	<ul style="list-style-type: none"> <li>Metal construction</li> <li>Lockable vertical aiming</li> <li>Barn door (p.343)</li> <li>LED lamp available (p.344)</li> <li>Order lamp separately</li> </ul>	p.141

## Quartz

Power	lumen	CBCP		System	Model #	Finish	Features	Full Specs
150W	2500			LTK HTK JTK	150	BK WT	<ul style="list-style-type: none"> <li>Die-cast aluminum construction</li> <li>Ball and hub style aiming</li> <li>Lamp included</li> </ul>	p.142

## GU10

Power	lumen	CBCP		System	Model #	Finish	Features	Full Specs
50W max	400	700		LTK HTK JTK	101	AM/BK AM/WT WT/BK WT/WT	<ul style="list-style-type: none"> <li>Metal construction with glass shade</li> <li>Size of an MR16 fixture, with no transformer</li> <li>Order lamp separately</li> </ul>	p.145
50W max	400	700		LTK HTK JTK	102	AM/BK AM/WT WT/BK WT/WT	<ul style="list-style-type: none"> <li>Metal construction with glass shade</li> <li>Size of an MR16 fixture, with no transformer</li> <li>Order lamp separately</li> </ul>	p.145
50W max	400	700		LTK HTK JTK	103	BK DB WT	<ul style="list-style-type: none"> <li>Metal construction</li> <li>Lockable aiming screw for precise control</li> <li>Size of an MR16 fixture, with no transformer</li> <li>Order lamp separately</li> </ul>	p.145
50W max	400	700		LTK HTK JTK	104	BK DB WT	<ul style="list-style-type: none"> <li>Metal construction</li> <li>Size of an MR16 fixture, with no transformer</li> <li>Yoke mounted, gimbal ring adjustment</li> <li>Order lamp separately</li> </ul>	p.145

AB-Antique Bronze, AM/BK-Amber/Black, AM/WT-Amber/White, BK-Black, BN-Brushed Nickel, WT-White, WT/BK-White/Black, WT/WT-White

# Quick Connect™ Pendants and Fixtures

Refer to page numbers for specifications and ordering information. Order one Quick Connect™ track adapter per pendant or fixture used.



							
Haven (p. 195)	Mini Haven (p. 197)	Gia (p. 199)	Giselle (p. 201)	Kalysta (p. 203)	Sorriso (p. 205)	Lucia (p. 207)	Candy (p. 209)
							
Ice (p. 211)	Fügü (p. 212)	Cascade (p. 213)	Brittany (p. 219)	Mini Brittany (p. 219)	Zanzibar (p. 220)	Rococo (p. 221)	Rhu (p. 222)
							
Truffle (p. 223)	Tigra (p. 223)	Ginkgo (p. 224)	Willow (p. 224)	Alpa (p. 225)	Fiori (p. 231)	Passion (p. 232)	Eden (p. 233)
							
Ambrosia (p. 233)	Rhea (p. 234)	Ingo (p. 235)	Clarity (p. 241)	Bullet (p. 243)	Stadt (p. 244)	Roxy (p. 245)	Über (p. 247)
							
Quest (p. 248)	Pome (p. 249)	Tikal (p. 250)	Tulum (p. 250)	Polaris (p. 251)	Prisma (p. 251)	Gem (p. 252)	Genesis (p. 253)
							
Micha (p. 261)	Sarah (p. 262)	Lauren (p. 263)	Ella (p. 264)	Jill (p. 265)	Fabergé (p. 266)	Mason (p. 273)	Madison (p. 274)
							
Cambridge (p. 274)	Wyandotte (p. 275)	Freeport (p. 276)	Milford (p. 277)	Plymouth (p. 277)	Sheffield (p. 278)	Mirabel (p. 278)	Huntington (p. 279)
							
Artemis (p. 280)	Quick Connect™ Fixtures (p. 165-170)						

# Lamps LED

## MR16

Model	Finish
<b>MR16LED-BAB</b>	<b>BK WT</b>



<b>Power:</b>	8W	<b>CRI:</b>	85
<b>Base:</b>	GU5.3	<b>Dimming:</b>	100% - 10%
<b>Voltage:</b>	12V	<b>Life:</b>	25,000 hours
<b>Lumens:</b>	450	<b>Dimensions:</b>	Ø2" x 1 <sup>15</sup> / <sub>16</sub> "
<b>Color Temp:</b>	3000K		

## GU10

Model	Finish
<b>GU10LED-BAB</b>	<b>BK WT</b>



<b>Power:</b>	8W	<b>CRI:</b>	85
<b>Base:</b>	GU10	<b>Dimming:</b>	100% - 10%
<b>Voltage:</b>	120V	<b>Life:</b>	25,000 hours
<b>Lumens:</b>	470	<b>Dimensions:</b>	Ø2" x 2 <sup>1</sup> / <sub>16</sub> "
<b>Color Temp:</b>	3000K		

## PAR20

Model	Finish
<b>PAR20LED-10N30</b>	<b>BK WT</b>



<b>Power:</b>	10.3W	<b>CRI:</b>	85
<b>Base:</b>	med	<b>Dimming:</b>	100% - 20%
<b>Voltage:</b>	120V	<b>Life:</b>	25,000 hours
<b>Lumens:</b>	450	<b>Dimensions:</b>	Ø2 <sup>1</sup> / <sub>2</sub> " x 3 <sup>7</sup> / <sub>16</sub> "
<b>Color Temp:</b>	3000K		

## PAR30

Model	Finish
<b>PAR30LED-L14N30</b>	<b>BK WT</b>



<b>Power:</b>	14.6W	<b>CRI:</b>	85
<b>Base:</b>	med	<b>Dimming:</b>	100% - 20%
<b>Voltage:</b>	120V	<b>Life:</b>	25,000 hours
<b>Lumens:</b>	600	<b>Dimensions:</b>	Ø3 <sup>3</sup> / <sub>4</sub> " x 4 <sup>3</sup> / <sub>4</sub> "
<b>Color Temp:</b>	3000K		

## PAR38

Model	Finish
<b>PAR38LED-17N30</b>	<b>BK WT</b>



<b>Power:</b>	17.8W	<b>CRI:</b>	85
<b>Base:</b>	med	<b>Dimming:</b>	100% - 20%
<b>Voltage:</b>	120V	<b>Life:</b>	25,000 hours
<b>Lumens:</b>	825	<b>Dimensions:</b>	Ø4 <sup>13</sup> / <sub>16</sub> " x 5 <sup>3</sup> / <sub>16</sub> "
<b>Color Temp:</b>	3000K		

## BR20

Model
<b>BR20LED-7N27-WT</b>



<b>Power:</b>	7.5W	<b>CRI:</b>	85
<b>Base:</b>	med	<b>Dimming:</b>	100% - 10%
<b>Voltage:</b>	120V	<b>Life:</b>	40,000 hours
<b>Lumens:</b>	490	<b>Dimensions:</b>	Ø2 <sup>1</sup> / <sub>2</sub> " x 3 <sup>7</sup> / <sub>8</sub> "
<b>Color Temp:</b>	2700K		

## BR30

Model
<b>BR30LED-11N27-WT</b>



<b>Power:</b>	14W	<b>CRI:</b>	85
<b>Base:</b>	med	<b>Dimming:</b>	100% - 10%
<b>Voltage:</b>	120V	<b>Life:</b>	40,000 hours
<b>Lumens:</b>	830	<b>Dimensions:</b>	Ø3 <sup>3</sup> / <sub>4</sub> " x 5 <sup>5</sup> / <sub>16</sub> "
<b>Color Temp:</b>	2700K		

## BR40

Model
<b>BR40LED-15N27-WT</b>



<b>Power:</b>	17W	<b>CRI:</b>	85
<b>Base:</b>	med	<b>Dimming:</b>	100% - 10%
<b>Voltage:</b>	120V	<b>Life:</b>	40,000 hours
<b>Lumens:</b>	1180	<b>Dimensions:</b>	Ø4 <sup>7</sup> / <sub>8</sub> " x 5 <sup>13</sup> / <sub>16</sub> "
<b>Color Temp:</b>	2700K		



# LENSES

## Colored Lens

- Changes color of the light



Model	Color
<b>LENS-16</b>	<b>AMB</b> Amber
<b>LENS-20</b>	<b>BLU</b> Blue
<b>LENS-25</b>	<b>GRN</b> Green
<b>LENS-30</b>	<b>RED</b> Red
<b>LENS-111</b>	<b>YEL</b> Yellow

Example: LENS-20-BLU



## Beam Elongating Lens

- Creates a horizontal or vertical strip of elongated light

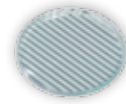

Model
<b>LENS-16-BEL</b>
<b>LENS-20-BEL</b>
<b>LENS-25-BEL</b>
<b>LENS-30-BEL</b>
<b>LENS-111-BEL</b>

Example: LENS-16-BEL



## Frosted Lens

- Softens light and reduces glare



Model

<b>LENS-16-FR</b>
<b>LENS-20-FR</b>
<b>LENS-25-FR</b>
<b>LENS-30-FR</b>
<b>LENS-111-FR</b>

Example: LENS-16-FR

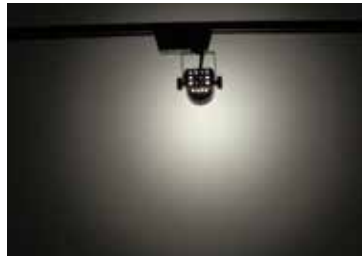

## Honeycomb Louver

- Reduces glare at a 30° angle

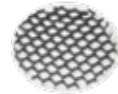

Model

<b>LENS-16-HCL</b>
<b>LENS-20-HCL</b>
<b>LENS-25-HCL</b>
<b>LENS-30-HCL</b>
<b>LENS-111-HCL</b>

Example: LENS-16-HCL



## Spread Lens

- Spreads light in an even pattern



Model

<b>LENS-16-SPR</b>
<b>LENS-20-SPR</b>
<b>LENS-25-SPR</b>
<b>LENS-30-SPR</b>
<b>LENS-111-SPR</b>

Example: LENS-16-SPR



## Cross Louver

- Controls spill light and glare
- 45° cutoff



Model

<b>LENS-16-CRL</b>
<b>LENS-20-CRL</b>
<b>LENS-25-CRL</b>
<b>LENS-30-CRL</b>
<b>LENS-111-CRL</b>

Example: LENS-20-CRL



# RAIL SYSTEMS

- Quick Connect™
- Duorail™
- Solorail™
- Flexrail1



# Quick Connect™ Pendants and Fixtures

Order one **LM2-QADP** (Duorail™), **LM-QADP** (Solorail™) or **HM1-EN50** (Flexrail1™) per pendant or fixture used.





Charge 102

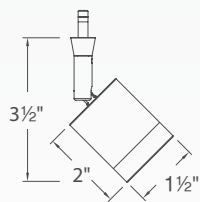

Portal 103

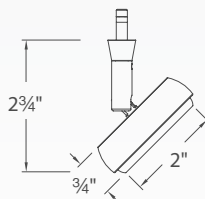

Ovum 101

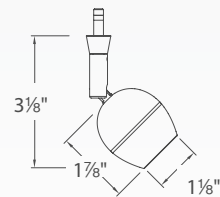

## Quick Connect™ Fixtures LEDme®

**Power:** 4W (Portal), 3W (Charge/Ovum)  
**Lumens:** Up to 110  
**CBCP:** Up to 1,536

**Color Temp:** 3000K  
**CRI:** 85  
**Rated Life:** 80,000 hours



	Model #	Finish
Portal	<b>QF-LED103-W</b>	<b>BN</b> <i>Brushed Nickel</i>
		<b>DB</b> <i>Dark Bronze</i>
		<b>WT</b> <i>White</i>
Ovum	<b>QF-LED101-W</b>	<b>F</b> 25° <b>BN</b> <i>Brushed Nickel</i>
		<b>W</b> 40° <b>DB</b> <i>Dark Bronze</i>
Charge	<b>QF-LED102-W</b>	<b>WT</b> <i>White</i>

- Smooth and continuous ELV dimming down to 15% or better depending on system power supply minimum loads
- Strong projected light output with no projected heat
- 360° horizontal rotation and 90° vertical adjustment
- Die-cast aluminum construction

Example: **QF-LED101-W-F-BN**

Power consumption may vary depending on the efficiency of the power supply being used, LED may be retrofit to existing 12V systems  
 Systems using older electronic transformers may need to upgrade to 1 watt minimum load transformers

**Adapters** (order separately)  
 Canopy See p.285 for canopy options

System	Model	Finish
Solorail™	<b>LM-QADP</b>	<b>BN, DB</b>
Duorail™	<b>LM2-QADP</b>	<b>BN, DB</b>
Flexrail1™	<b>HM1-EN50</b>	<b>DB, PT</b>

System	Model	Finish
L Track	<b>EN-LQ50AR</b>	<b>BK, BN, WT</b>
H Track	<b>EN-HQ50AR</b>	<b>BK, BN, DB, WT</b>
J Track	<b>EN-JQ50AR</b>	<b>BK, BN, WT</b>



Super Ego 183

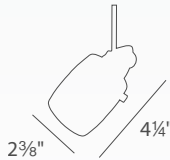

Merlin 185

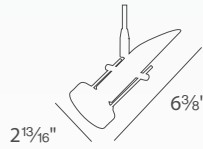

Focus 199

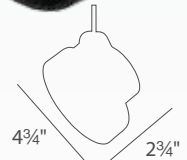

## Quick Connect™ Fixtures Low Voltage

**Lamping:** Accepts 12V LED MR16, Halogen MR16 lamps up to 50W max (order lamp separately)  
Focus - 12V/24V AR111 (order lamp separately)

	Model #	Extension	Finish
Super Ego	<b>QF-183</b>	X3 3"	<b>BN</b> Brushed Nickel
			<b>DB</b> Dark Bronze
Merlin	<b>QF-185</b>		<b>BN</b> Brushed Nickel
Focus	<b>QF-199</b>	X3 3"	<b>BN</b> Brushed Nickel
			<b>DB</b> Dark Bronze

Example: **QF-199X3-BN**

- 360° horizontal rotation and 90° vertical adjustment
- Machined brass construction
- Additional extensions are available up to 48"



### Fixture Extensions

<b>Q-X18</b> 18"	<b>BN</b> <b>DB</b>	Designed for use with QF track heads to extend the stem, cannot be shortened in the field
<b>Q-X24</b> 24"		
<b>Q-X36</b> 36"		
<b>Q-X48</b> 48"		

### LED MR16

Model	Finish
<b>MR16LED-BAB</b>	<b>BK</b> <b>WT</b>

### Lenses and Accessories

Color Lens	<b>LENS-16</b>	<b>AMB</b> Amber
		<b>BLU</b> Blue
		<b>GRN</b> Green
		<b>RED</b> Red
		<b>YEL</b> Yellow

UV Filter Lens	<b>LENS-16-UVF</b>
Frosted Lens	<b>LENS-16-FR</b>
Spread Lens	<b>LENS-16-SPR</b>
Beam Elongating	<b>LENS-16-BEL</b>
Honeycomb Louver	<b>LENS-16-HCL</b>

### Adapters (order separately)

Canopy See p.285 for canopy options

System	Model	Finish
Solorail™	<b>LM-QADP</b>	<b>BN, DB</b>
Duorail™	<b>LM2-QADP</b>	<b>BN, DB</b>
Flexrail1™	<b>HM1-EN50</b>	<b>DB, PT</b>

System	Model	Finish
L Track	<b>EN-LQ50AR</b>	<b>BK, BN, WT</b>
H Track	<b>EN-HQ50AR</b>	<b>BK, BN, DB, WT</b>
J Track	<b>EN-JQ50AR</b>	<b>BK, BN, WT</b>



Telas 182

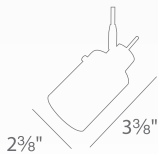

Orb 171

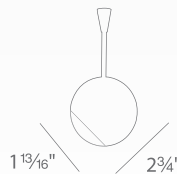

Forza 173

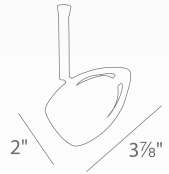

## Quick Connect™ Fixtures LEDme®

**Lamping:** **Telas** - Accepts 12V LED MR16, Halogen MR16 lamps up to 50W max (order lamp separately)  
**Orb / Forza** - Integral LED



The uniquely designed Orb retains the same profile regardless of the aiming direction

	Model #	Extension	Finish
Telas	<b>QF-182</b>		<b>BN</b> <i>Brushed Nickel</i>
Orb	<b>QF-LED171</b>	<b>X3</b> 3in	<b>BN</b> <i>Brushed Nickel</i> <b>DB</b> <i>Dark Bronze</i>
		<b>X6</b> 6in	
		<b>X12</b> 12in	
Forza	<b>QF-LED173</b>		<b>BN</b> <i>Brushed Nickel</i>

Example: **QF-LED173X3-BN**

Power consumption may vary depending on the efficiency of the power supply being used, LED may be retrofit to existing 12V systems. Systems using older electronic transformers may need to upgrade to 1 watt minimum load transformers

- Smooth and continuous ELV dimming down to 15% or better depending on system power supply minimum loads
- Replacement LED module may be ordered separately (model: **RM3X3-30-QF**)
- 360° horizontal rotation and 90° vertical adjustment
- Die-cast aluminum construction

### Orb / Forza

<b>Power:</b>	5W	<b>Color Temp:</b>	3000K
<b>Lumens:</b>	Up to 290	<b>CRI:</b>	85
<b>CBCP:</b>	Up to 2,451	<b>Rated Life:</b>	100,000 hours
<b>Comparable:</b>	35W MR16		

### Adapters (order separately)

Canopy See p.285 for canopy options

System	Model	Finish
Solorail™	<b>LM-QADP</b>	<b>BN, DB</b>
Duorail™	<b>LM2-QADP</b>	<b>BN, DB</b>
Flexrail1™	<b>HM1-EN50</b>	<b>DB, PT</b>

System	Model	Finish
L Track	<b>EN-LQ50AR</b>	<b>BK, BN, WT</b>
H Track	<b>EN-HQ50AR</b>	<b>BK, BN, DB, WT</b>
J Track	<b>EN-JQ50AR</b>	<b>BK, BN, WT</b>



### Rolls 190

Shown with G114-BL



### Kogel 184

Shown with G111-AM



### Ego 194

Shown with G115-BN

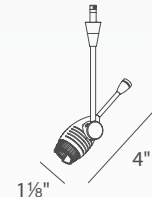

## Quick Connect™ Fixtures Low Voltage

**Lamping:** Accepts 12V LED MR16, Halogen MR16 lamps up to 50W max (order lamp separately)

	Model #	Extension	Finish
Rolls	<b>QF-190</b>	<b>X3</b> 3" <b>X6</b> 6" <b>X12</b> 12"	<b>BN</b> Brushed Nickel <b>DB</b> Dark Bronze
Kogel	<b>QF-184</b>		
Ego	<b>QF-194</b>		

Example: **QF-194X3-DB**

- Glass and shield options in various finishes available (see table below)
- 360° horizontal rotation and 90° vertical adjustment
- Machined brass construction
- Additional extensions are available up to 48"



#### Fixture Extensions

<b>Q-X18</b>	18"	<b>BN</b> Designed for use with QF track heads to extend the stem, cannot be shortened in the field <b>DB</b>
<b>Q-X24</b>	24"	
<b>Q-X36</b>	36"	
<b>Q-X48</b>	48"	

Glass and Shield Options (order separately)

G111	G112	G113	G114 cased glass	G115 mesh	G116 solid
2 1/4"W × 1 3/4"H	2 1/2"W × 1 3/4"H	3 3/8"W × 1 7/8"H	2 5/8"W × 2 1/2"H	2 1/4"W × 1 3/4"H	2 1/4"W × 1 3/4"H
<b>AM BL WT</b>	<b>AM WT</b>	<b>AM WT</b>	<b>AM BL RD WT</b>	<b>BN DB</b>	<b>BN DB</b>

Example: **G111-BL**

**AM**-Amber, **BL**-Blue, **BN**-Brushed Nickel, **DB**-Dark Bronze, **RD**-Red, **WT**-White

LED MR16 (order separately)

Model	Finish
<b>MR16LED-BAB</b>	<b>BK WT</b>

#### Adapters (order separately)

Canopy See p.285 for canopy options

System	Model	Finish
Solorail™	<b>LM-QADP</b>	<b>BN, DB</b>
Duorail™	<b>LM2-QADP</b>	<b>BN, DB</b>
Flexrail1™	<b>HM1-EN50</b>	<b>DB, PT</b>

System	Model	Finish
L Track	<b>EN-LQ50AR</b>	<b>BK, BN, WT</b>
H Track	<b>EN-HQ50AR</b>	<b>BK, BN, DB, WT</b>
J Track	<b>EN-JQ50AR</b>	<b>BK, BN, WT</b>



**Windsor 186**

Shown with G116-DB

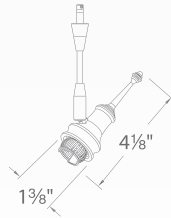

**Wales 187**

Shown with G111-WT

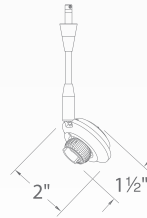

**Middleton 188**

Shown with G116-BN

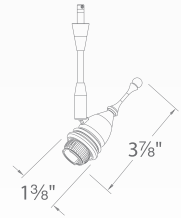

## Quick Connect™ Fixtures Low Voltage

**Lamping:** Accepts 12V LED MR16, Halogen MR16 lamps up to 50W max (order lamp separately)

	Model #	Extension	Finish
Windsor	<b>QF-186</b>	<b>X3</b> 3"	<b>DB</b> Dark Bronze
Wales	<b>QF-187</b>		<b>BN</b> Brushed Nickel <b>DB</b> Dark Bronze
Middleton	<b>QF-188</b>		<b>BN</b> Brushed Nickel

Example: **QF-186X3-DB**

- Glass and shield options in various finishes available (see table below)
- 360° horizontal rotation and 90° vertical adjustment
- Machined brass construction
- Additional extensions are available up to 48"



### Fixture Extensions

<b>Q-X18</b> 18"	<b>BN</b> <b>DB</b>	Designed for use with QF track heads to extend the stem, cannot be shortened in the field
<b>Q-X24</b> 24"		
<b>Q-X36</b> 36"		
<b>Q-X48</b> 48"		

### Glass and Shield Options (order separately)

G111	G112	G113	G114 cased glass	G115 mesh	G116 solid
2 1/4"W x 1 3/4"H	2 1/2"W x 1 3/4"H	3 3/8"W x 1 7/8"H	2 5/8"W x 2 1/2"H	2 1/4"W x 1 3/4"H	2 1/4"W x 1 3/4"H
<b>AM</b> <b>BL</b> <b>WT</b>	<b>AM</b> <b>WT</b>	<b>AM</b> <b>WT</b>	<b>AM</b> <b>BL</b> <b>RD</b> <b>WT</b>	<b>BN</b> <b>DB</b>	<b>BN</b> <b>DB</b>

Example: **G111-BL**

**AM**-Amber, **BL**-Blue, **BN**-Brushed Nickel, **DB**-Dark Bronze, **RD**-Red, **WT**-White

LED MR16 (order separately)

Model	Finish
<b>MR16LED-BAB</b>	<b>BK</b> <b>WT</b>

### Adapters (order separately)

Canopy See p.285 for canopy options

System	Model	Finish
Solorail™	<b>LM-QADP</b>	<b>BN, DB</b>
Duorail™	<b>LM2-QADP</b>	<b>BN, DB</b>
Flexrail™	<b>HM1-EN50</b>	<b>DB, PT</b>

System	Model	Finish
L Track	<b>EN-LQ50AR</b>	<b>BK, BN, WT</b>
H Track	<b>EN-HQ50AR</b>	<b>BK, BN, DB, WT</b>
J Track	<b>EN-JQ50AR</b>	<b>BK, BN, WT</b>





**Adeo 195**

Shown with G113-WT

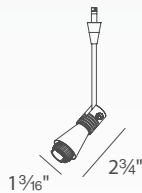

**Mint 181**

Shown with G112-AM



**Twist 197**

Shown with G116-BN

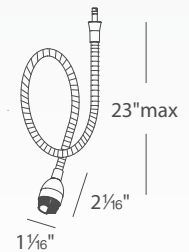

## Quick Connect™ Fixtures Low Voltage

**Lamping:** Accepts 12V LED MR16, Halogen MR16 lamps up to 50W max (order lamp separately)

	Model #	Extension	Finish
Adeo	<b>QF-195</b>	<b>X3</b> 3"	<b>BN</b> <i>Brushed Nickel</i>
Mint	<b>QF-181</b>		<b>BN</b> <i>Brushed Nickel</i> <b>DB</b> <i>Dark Bronze</i>

Twist	<b>QF-197</b>	<b>BN</b> <i>Brushed Nickel</i>
-------	---------------	---------------------------------

Example: **QF-195X3-BN**



- Glass and shield options in various finishes available (see table below)
- 360° horizontal rotation and 90° vertical adjustment
- Machined brass construction
- Additional extensions are available up to 48"



### Fixture Extensions

<b>Q-X18</b>	18"	<b>BN</b> <i>Brushed Nickel</i> <b>DB</b> <i>Dark Bronze</i>	Designed for use with QF track heads to extend the stem, cannot be shortened in the field
<b>Q-X24</b>	24"		
<b>Q-X36</b>	36"		
<b>Q-X48</b>	48"		

Glass and Shield Options (order separately)

G111	G112	G113	G114 cased glass	G115 mesh	G116 solid
2 1/4"W × 1 3/4"H	2 1/2"W × 1 3/4"H	3 3/8"W × 1 7/8"H	2 5/8"W × 2 1/2"H	2 1/4"W × 1 3/4"H	2 1/4"W × 1 3/4"H
  	 	 	   	 	 
<b>AM</b> <b>BL</b> <b>WT</b>	<b>AM</b> <b>WT</b>	<b>AM</b> <b>WT</b>	<b>AM</b> <b>BL</b> <b>RD</b> <b>WT</b>	<b>BN</b> <b>DB</b>	<b>BN</b> <b>DB</b>

Example: **G111-BL**

**AM**-Amber, **BL**-Blue, **BN**-Brushed Nickel, **DB**-Dark Bronze, **RD**-Red, **WT**-White

LED MR16 (order separately)

Model	Finish
<b>MR16LED-BAB</b>	<b>BK</b> <b>WT</b>

### Adapters (order separately)

Canopy See p.285 for canopy options

System	Model	Finish
Solorail™	<b>LM-QADP</b>	<b>BN, DB</b>
Duorail™	<b>LM2-QADP</b>	<b>BN, DB</b>
Flexrail™	<b>HM1-EN50</b>	<b>DB, PT</b>

System	Model	Finish
L Track	<b>EN-LQ50AR</b>	<b>BK, BN, WT</b>
H Track	<b>EN-HQ50AR</b>	<b>BK, BN, DB, WT</b>
J Track	<b>EN-JQ50AR</b>	<b>BK, BN, WT</b>



## DUORAIL™

Premium Monorail System

Offering the sleek look of a monorail, but engineered for more capacity and control, Duorail™ features two circuits that can be independently switched or dimmed. Duorail™ is the thinnest two-circuit low voltage system in the industry at just  $\frac{1}{16}$ " tall and a  $\frac{1}{4}$ " wide and maintains a maximum capacity of 50 amperes for demanding rail applications.

Each circuit uses up to 300 watts at 12 volts or 600 watts at 24 volts. For large applications both circuits can be switched together for up to 1,200 watts at 24 volts. Precision fabricated brass components and electroplated solid copper conductors ensure durability and reliability.

# How to order Duorail™ System

## Design Guidelines

Wattage	300W is the maximum load allowable for 12V systems, per circuit. 600W is the maximum load allowable for 24V systems, per circuit.				
Transformers	<b>Surface mount magnetic</b> - high wattage capacity. <b>Remote mount magnetic</b> - larger capacities, minimize voltage drop if located within 10 feet of power feed.				
Mounting	Determine the ceiling type. Select standoffs that match the height of the power feed component or surface mount transformer. Minimum three supports for 8 foot section, two for 4 foot section. Custom length suspensions are possible by using cables or suspension rods with rod couplers.				
Joining Sections	A variety of designs can be achieved by using various connectors. Some are electrically conductive, others join rails mechanically but not electrically. Dead End Connectors allow you to connect runs together mechanically that exceed the max wattage per circuit.				
Shaping	Shaping rail before mounting on the ceiling allows you to determine the best location for standoffs. Use a bending machine for professional installations.				
	 <table border="0"> <tr> <td>Model #</td> <td>For perfect small radius bends.</td> </tr> <tr> <td><b>HM1-BM</b></td> <td>Clamps onto work benches or flat surfaces up to 2".</td> </tr> </table>	Model #	For perfect small radius bends.	<b>HM1-BM</b>	Clamps onto work benches or flat surfaces up to 2".
Model #	For perfect small radius bends.				
<b>HM1-BM</b>	Clamps onto work benches or flat surfaces up to 2".				
Cutting	May be field cut. See supplied instructions for further details.				
Quick Connect™	Quick Connect™ transformer attaches to rail and accepts all Quick Connect™ fixtures and pendants with low voltage LM2-QADP.				
Useful Tips	System may be dimmed with a dimmer appropriate for the transformer type, ie: electronic or magnetic. Assistance is only a phone call away. Please call WAC Lighting to speak to a friendly lighting specialist at <b>800.526.2588</b> .				

## Sample Layout

A	<b>SRT-300M-12V</b>	Single circuit magnetic transformer
B	<b>LM2-T8</b>	Rail section
C	<b>LM2-X3</b>	Standoff (matches powerfeed)
D	<b>LM2-I</b>	"I" connector
E	<b>LM2-EC</b>	End cap (2 supplied with every track)
F	<b>LM2-QADP</b>	Quick Connect™ adapter
G	<b>QP518</b>	Quick Connect™ pendant
H	<b>QF-182</b>	Quick Connect™ fixture
I	<b>LM2-CPC</b>	Two circuit power feed

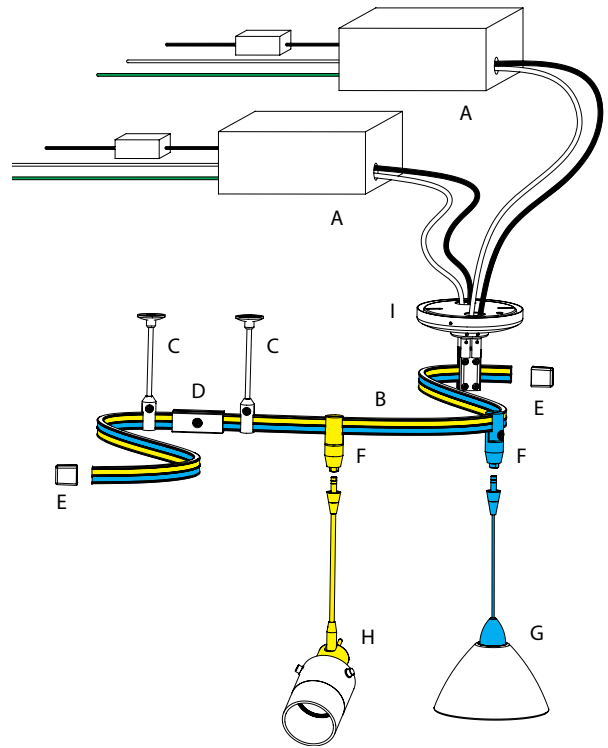

**1** Measure the amount of rail needed and choose a finish. Our Duorail™ and Solorail™ systems are available in Brushed Nickel (BN) or Dark Bronze (DB) finishes.

Layout: Use rope, chalk or string on floor level, or a scale drawing with string to estimate rail needs. Broad curves work best (12" minimum radius). When working with curves, we recommend ordering up to 25% more rail than estimated to compensate for in-field design adjustments during installation. Rail should pass under or near a junction box.

## Rail Sections

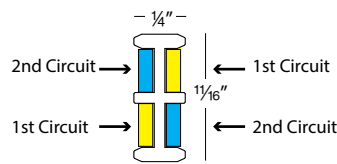

Model #	Finish
<b>LM2 T4</b> 4'	<b>BN</b> Brushed Nickel
<b>LM2 T8</b> 8'	<b>DB</b> Dark Bronze

Example: **LM2-T4-BN**  
Includes two matching end caps.

**2** Choose the Quick Connect™ pendants or fixtures (see p.165-p.170 and p.193-280) for the rail system. Make sure to order one Quick Connect™ adapter per pendant or fixture ordered (LM2-QADP) for the finish chosen. For example, BN finish would be item LM2-QADP-BN. Add up the total wattage needed in the system.

## Quick Connect™ Adapter for Duorail™

The threaded male adapter makes compatibility a snap. Simply insert the metal fitting into the system adapter, hand tighten the collar and you're done!

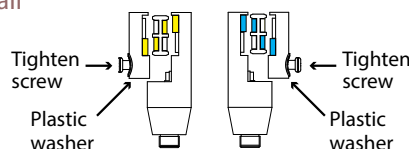

Model #	Finish
<b>LM2-QADP</b>	<b>BN</b> Brushed Nickel
	<b>DB</b> Dark Bronze

Example: **LM2-QADP-BN**  
Order one per Quick Connect™ fixture or pendant used.

# How to order Duorail™ System

**3** Choose the appropriate sized magnetic or electronic transformer with sufficient electrical load to accommodate the total wattage used for the system. Please consult voltage drop guidelines and take into consideration voltage drop for combined rail sections.

## Surface Mount with Integrated Transformer

Magnetic transformers are an excellent choice when displaying with LED lamps and fixtures where minimum load may be concern

### Magnetic Transformer



<b>LM2-EN12-300M</b>	<b>BN</b>	Brushed Nickel
	<b>DB</b>	Dark Bronze

12V, 2 x 150W    Ø 9"

Use with standard (LM2-X8) standoff. Separate input leads for separate switching, or wire together for maximizing load capacity.

**Voltage Drop Guidelines:** Run length: 40'

### Magnetic Transformer



<b>LM2-EN12-500M</b>	<b>BN</b>	Brushed Nickel
	<b>DB</b>	Dark Bronze

12V, 2 x 250W    Ø 10½"

Use with standard (LM2-X8) standoff. Separate input leads for separate switching, or wire together for maximizing load capacity.

**Voltage Drop Guidelines:** Run length: 2 x 40'

### Sloped Ceiling Feed



<b>LM2-SCP48</b>	<b>BN</b>	Brushed Nickel	48"
	<b>DB</b>	Dark Bronze	96"

Feed two 25A max circuits. Use with surface mounted transformer. Use at any angle, easily shortened. Includes two LM-RI couplers.

### Debuzzing Coil



All magnetic transformers emit a small amount of buzzing. Our magnetic surface-mounted transformers have a built-in debuzzing coil, which substantially reduces the buzzing. If the buzzing noise is still noticeable, a separate debuzzing coil may be wired in series on the 120 volt input line. Select the correct debuzzing coil based on the wattage of the transformer.

<b>LM-DBC12-150</b>	12V, 150W	Ø 2¾"
<b>LM-DBC12/24-300</b>	12V/24V, 300W	Ø 2¾"
<b>LM-DBC12/24-600</b>	12V/24V, 600W	Ø 4¾"

## Power Feeds (For use with remote transformers)

### Two Circuit Power Feed



<b>LM2-CPC</b>	<b>BN</b>	Brushed Nickel	Ø 4½"
	<b>DB</b>	Dark Bronze	

Feeds two 25A max circuits. Use with 3" standoff (LM2-X3).

### Four Circuit Power Feed



<b>LM2-DCPC</b>	<b>BN</b>	Brushed Nickel	Ø 5½"
	<b>DB</b>	Dark Bronze	

Feeds Four 25A max power feeds. Order with a dead end "I" connector (LM2-IDEC). Use with 3" standoff (LM2-X3).

### Cable Power Feed



<b>LM2-PCS48</b>	<b>BN</b>	Brushed Nickel	Ø 4½" x 48"
	<b>DB</b>	Dark Bronze	

Feeds two 25A max circuits. Use on sloped ceilings with remote transformers.

## Remote Transformers



Watt	12 Volts	Breakers	24 Volts	Breakers	L	W	H
300W	<b>SRT-300M-12V</b>	1	<b>SRT-300M-24V</b>	1	10¾"	4¼"	4½"
600W	<b>SRT-600M-12V</b>	2	<b>SRT-600M-24V</b>	1	11½"	6½"	5¾"
					12½"	6½"	5¾"

### Voltage Drop Guidelines (based on 10 gauge wire)

Model #	Run length	Distance to power feed
SRT-300M-12V	40' max	10ft max
SRT-600M-12V	2 x 40' max	10ft max
SRT-300M-24V	40' max	10ft max
SRT-600M-24V	40' max	10ft max

On a full load voltage drop can cause a system to exceed the 25A rating. Guidelines assist with layouts only. When installing a 12V system, ensure that a min. of 12V is supplied at power feeds. 10AWG wire should be used with remote transformers. Multi-tap output terminals (remote magnetic transformers) help make up for voltage drop before the power feed. Use a tester to verify no less than 11V is found at the end of the run and no more 25A is being drawn from the power feed.

# How to order Duorail™ System

4







Measure the height of the ceiling and determine the distance from the floor to the rail to calculate length of the standoffs needed to suspend the rail from the ceiling. Determine number of standoffs and connectors for the rail. Use a minimum of 3 standoffs per 8 foot section and 2 standoffs per 4 foot section

Rail Suspension	Model #	Finish	Dimensions	Description
Standard Ceiling Standoff	 <b>LM2-X3</b> <b>LM2-X5</b> <b>LM2-X8</b>	<b>BN</b> <i>Brushed Nickel</i> <b>DB</b> <i>Dark Bronze</i>	3" 5¾" 8"	Supports rail for flat ceilings and surfaces.
T-Bar Ceiling Standoff	 <b>LM2-TB3</b> <b>LM2-TB5</b> <b>LM2-TB8</b>	<b>BN</b> <i>Brushed Nickel</i> <b>DB</b> <i>Dark Bronze</i>	3" 5¾" 8"	Conceals a T-Bar clip under the canopy for standard 1" T-Bar ceilings.
Sloped Ceiling Standoff	 <b>LM2-XS5</b>	<b>BN</b> <i>Brushed Nickel</i> <b>DB</b> <i>Dark Bronze</i>	5¾"	Supports rail for sloped ceiling. Accommodates angles up to 45°.
Aircraft Suspension Cable	 <b>LM2-CS48</b> <b>LM2-CS96</b>	<b>BN</b> <i>Brushed Nickel</i> <b>DB</b> <i>Dark Bronze</i>	48" 96"	Supports monorail for flat or sloped ceilings.
Extension Rod	 <b>LM-R12</b> <b>LM-R24</b> <b>LM-R36</b> <b>LM-R48</b>	<b>BN</b> <i>Brushed Nickel</i> <b>DB</b> <i>Dark Bronze</i>	12" 24" 36" 48"	Use with standoffs and power feeds. Use two per circuit with rod couplers to extend power feeds. Field cut to size and join with rod couplers.
Rod Coupler	 <b>LM-RI</b>	<b>BN</b> <i>Brushed Nickel</i> <b>DB</b> <i>Dark Bronze</i>	Ø 3/8" × 7/8" H	Use two per power feed, four per dual power feed, one additional coupler per rod needed when joining two rods in excess of 48".

Example: **LM2-CS48-BN**

5

Determine the hardware accessories to join the rail sections together in the configuration chosen.

Rail Connectors	Model #	Finish	Dimensions	Description
"I" Dead-End Connector	 <b>LM2-IDEC</b>	<b>BN</b> <i>Brushed Nickel</i> <b>DB</b> <i>Dark Bronze</i>	5/8" × 2"	Connects two sections of rail with no electrical continuity.
"I" Connector	 <b>LM2-I</b>	<b>BN</b> <i>Brushed Nickel</i> <b>DB</b> <i>Dark Bronze</i>	5/8" × 2"	Connects two sections of rail with electrical continuity.
"X" Dead-End Connector	 <b>LM2-XDEC</b>	<b>BN</b> <i>Brushed Nickel</i> <b>DB</b> <i>Dark Bronze</i>	5/8" × 2" × 2"	Joins four monorails in an "X" without electrical continuity.
"L" Connector	 <b>LM2-L</b>	<b>BN</b> <i>Brushed Nickel</i> <b>DB</b> <i>Dark Bronze</i>	5/8" × 1½" × 1½"	90° monorail connection with electrical continuity
Variable Angle Connector	 <b>LM2-VA</b>	<b>BN</b> <i>Brushed Nickel</i> <b>DB</b> <i>Dark Bronze</i>	Ø 1" × 1¼" × 3½"	The Variable Angle Connector allows an angle adjustment up to 110° with electrical continuity at the connection.
"T" Connector	 <b>LM2-T</b>	<b>BN</b> <i>Brushed Nickel</i> <b>DB</b> <i>Dark Bronze</i>	5/8" × 1½" × 1½"	Connects two sections of a monorail in a "T" with electrical continuity

Example: **LM2-XDEC-BN**





## SOLORAIL™

Single Circuit Monorail System

WAC Lighting low voltage monorail system can be shaped and cut in the field to navigate curves for custom designs. The versatile Solorail™ accommodates hundreds of Quick Connect™ pendants and fixtures.

Designed with the thinnest profile in the industry,  $\frac{1}{16}$ " tall and  $\frac{3}{8}$ " wide, Solorail™ is engineered for rigorous usage in commercial, hospitality and retail applications. Featuring electroplated solid copper bus bars and CNC precision fabricated components, with a maximum capacity of 25 amperes; or 300 watts at 12 volts and 600 watts at 24 volts.

# How to order Solorail™ System

## Design Guidelines

Wattage	300W is the maximum load allowable for 12V systems. 600W is the maximum load allowable for 24V systems.
Transformers	<b>Surface mount electronic</b> - well suited for small runs. <b>Surface mount magnetic</b> - high wattage capacity. <b>Remote mount magnetic</b> - larger capacities, minimize voltage drop if located within 10 feet of power feed.
Mounting	Determine the ceiling type. Select standoffs that match the height of the power feed component or surface mount transformer. Minimum three supports for 8 foot section, two for 4 foot section. Custom length suspensions are possible by using cables or suspension rods with rod couplers.
Joining Sections	A variety of designs can be achieved by using various connectors. Some are electrically conductive, others join rails mechanically but not electrically. Dead End Connectors allow you to connect runs together mechanically that exceed the max wattage per circuit.
Shaping	Shaping rail before mounting on the ceiling allows you to determine the best location for standoffs. Use a bending machine for professional installations.

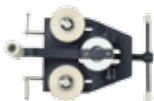

Model #  
**HM1-BM** For perfect small radius bends. Clamps onto work benches or flat surfaces up to 2".

Cutting	May be field cut. See supplied instructions for further details.
Quick Connect™	Quick Connect™ transformer attaches to rail and accepts all Quick Connect™ fixtures and pendants with LM-QADP.
Useful Tips	System may be dimmed with a dimmer appropriate for the transformer type, ie: electronic or magnetic. Assistance is only a phone call away. Please call WAC Lighting to speak to a friendly lighting specialist at <b>800.526.2588</b> .

## Sample Layout

A	<b>LM-EN12-150E</b>	Electronic transformer
B	<b>LM-T8</b>	Rail section
C	<b>LM-X4</b>	Standoff (matches Surface Mounted transformer height)
D	<b>LM-I</b>	"I" connector
E	<b>LM-EC</b>	End cap (2 supplied with every track)
F	<b>LM-QADP</b>	Quick Connect™ adapter
G	<b>QP518</b>	Quick Connect™ pendant
H	<b>QF-182</b>	Quick Connect™ fixture

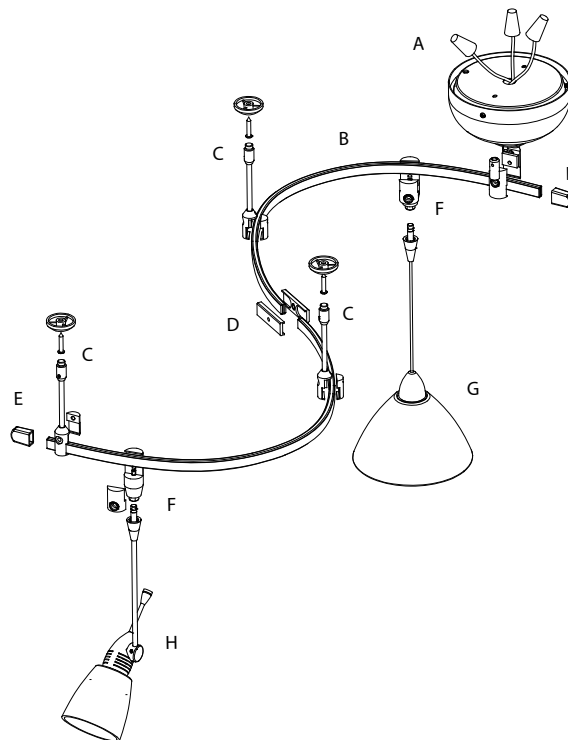

**1** Measure the amount of rail needed and choose a finish. Our Solorail™ and Duorail™ systems are available in Brushed Nickel (BN) or Dark Bronze (DB) finishes.

Layout: Use rope, chalk or string on floor level, or a scale drawing with string to estimate rail needs. Broad curves work best ( 12" minimum radius ). When working with curves, we recommend ordering up to 25% more rail than estimated to compensate for in-field design adjustments during installation. Rail should pass under or near a junction box.

## Rail Sections

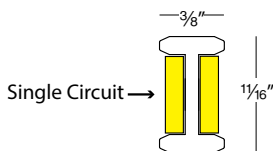
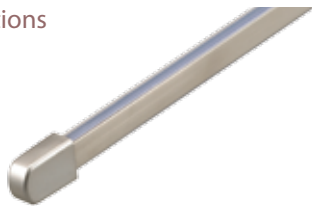

Model #	Finish
<b>LM T4</b> 4'	<b>BN</b> Brushed Nickel
<b>T8</b> 8'	<b>DB</b> Dark Bronze

Example: **LM-T4-BN**  
Includes two matching end caps.

**2** Choose the Quick Connect™ pendants or fixtures (p.165-170 and 193-280) for the rail system. Make sure to order one Quick Connect™ adapter per pendant or fixture ordered (LM-QADP) for the finish chosen. For example, BN finish would be item LM-QADP-BN. Add up the total wattage needed in the system.

## Quick Connect™ Adapter for Solorail™

The threaded male adapter makes compatibility a snap. Simply insert the metal fitting into the system adapter, hand tighten the collar and you're done!

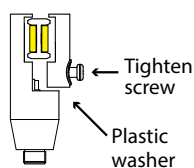

Model #	Finish
<b>LM-QADP</b>	<b>BN</b> Brushed Nickel
	<b>DB</b> Dark Bronze

Example: **LM-QADP-BN**  
Order one per Quick Connect™ fixture or pendant used.



# How to order Solorail™ System

**3** Choose the appropriate sized magnetic transformer with sufficient electrical load to accommodate the total wattage used for the system. Don't forget to take into consideration voltage drop for combined rail sections. Please consult voltage drop guidelines.

## Power Feeds (with integrated transformers)

### 75W LED Surface Mount Transformer



WAC Solorail™ LED transformer is the slimmest 75 watt surface mount canopy in the industry. At only 4 1/16" height and 4 1/2" in diameter, it has the capacity to power up nine 9W LED fixtures in one run while using 4 times less energy than common electronic transformers. Constructed of die-cast aluminum, this transformer mounts to a standard 4" ceiling junction box. Can be used with 3" standoffs and power extender.



Shown **LM-EN12-75E-BN** and **LM-X3-BN** standoff

<b>LM-EN12-75E</b>	<b>BN</b>	Brushed Nickel	Ø 4 1/2"
	<b>DB</b>	Dark Bronze	

12V, 75W. Use with 3" standoff (LM-X3).

### Electronic Transformer



<b>LM-EN12-150E</b>	<b>BN</b>	Brushed Nickel	Ø 5"
	<b>DB</b>	Dark Bronze	

12V, 150W. Use with 4 1/2" (LM-X4) standoff.

### Electronic Transformer



<b>LM-EN12-250E</b>	<b>BN</b>	Brushed Nickel	Ø 6"
	<b>DB</b>	Dark Bronze	

12V, 250W. Use with 4 1/2" (LM-X4) standoff.

### Magnetic Transformer



<b>LM-EN12-150M</b>	<b>BN</b>	Brushed Nickel	Ø 7 5/8"
	<b>DB</b>	Dark Bronze	

12V 150W. Use with 5 3/4" (LM-X5) standoff.

### Magnetic Transformer



<b>LM-EN12-300M</b>	12V	<b>BN</b>	Brushed Nickel	Ø 9"
		<b>DB</b>	Dark Bronze	

12V/24V 300W. Use with 5 3/4" (LM-X5) standoff.

### Dual Tap Magnetic Transformer



<b>LM-EN12-600M</b>	<b>BN</b>	Brushed Nickel	Ø 10 1/2"
	<b>DB</b>	Dark Bronze	

12V, 2 x 300W. Use with 5 3/4" (LM-X5) standoff.

### Sloped Ceiling Feed



<b>LM-SCP48</b> <b>LM-SCP96</b>	<b>BN</b>	Brushed Nickel	48"
	<b>DB</b>	Dark Bronze	96"

5A max. Use with surface mounted transformer. Use at any angle, easily shortened. Includes two LM-RI couplers.

### Debuzzing Coil

All magnetic transformers emit a small amount of buzzing. Our magnetic surface-mounted transformers have a built-in debuzzing coil, which substantially reduces the buzzing. If the buzzing noise is still noticeable, a separate debuzzing coil may be wired in series on the 120 volt input line. Select the correct debuzzing coil based on the wattage of the transformer.



<b>LM-DBC12-150</b>	12V, 150W	Ø 2 3/8"
<b>LM-DBC12/24-300</b>	12V/24V, 300W	Ø 2 3/8"
<b>LM-DBC12/24-600</b>	12V/24V, 600W	Ø 4 3/8"

### Voltage Drop Guidelines

	Run length
LM-EN12-150M	40'
LM-EN12-150E	20'
LM-EN12-250E	16'
LM-EN12-300M	40'
LM-EN12-600M	2 x 40'
LM-EN24-300M	50'
LM-EN24-600M	50'

# How to order Solorail™ System

Power Feeds (For use with remote transformers)

## Single Power Feed



<b>LM-CPC</b>	<b>BN</b>	Brushed Nickel	Ø 4½"
	<b>DB</b>	Dark Bronze	

25A max. Use with 3" standoff (LM-X3).

## Wall Power Feed



<b>LM-WPC</b>	<b>BN</b>	Brushed Nickel	Ø 4½"
	<b>DB</b>	Dark Bronze	

25A max. Feeds power to end of the rail.

## Dual Power Feed



<b>LM-DCPC</b>	<b>BN</b>	Brushed Nickel	Ø 5⅝"
	<b>DB</b>	Dark Bronze	

Two 25A max power feeds. Order with dead end "I" connector (LM-IDEC). Use with 3" standoff (LM-X3).

## Cable Power Feed



<b>LM-PCS48</b>	<b>BN</b>	Brushed Nickel	Ø 4½ × 48"
	<b>DB</b>	Dark Bronze	
<b>LM-PCS96</b>	<b>BN</b>	Brushed Nickel	Ø 4½ × 96"
	<b>DB</b>	Dark Bronze	

25A max. Use on sloped ceilings with remote transformers. Use at any angle, easily shortened.

## Wall Mount Power Feed Bracket



<b>LM-OWP</b>	<b>BN</b>	Brushed Nickel
	<b>DB</b>	Dark Bronze

Can be mounted up to 24" from wall. Supported by aircraft cables. Use with remote transformers. Use two LM-OW (p.180) per 4 ft., three per 8 ft.

## Remote Transformers

### Magnetic



Watt	12 Volts	Breakers	24 Volts	Breakers	L	W	H
300W	<b>SRT-300M-12V</b>	1	<b>SRT-300M-24V</b>	1	10¾"	4¼"	4⅝"
600W	<b>SRT-600M-12V</b>	2	<b>SRT-600M-24V</b>	1	11½"	6⅝"	5⅞"
					12½"	6⅝"	5⅞"

### OR Electronic



Watt	12 Volts
75W	<b>EN-1275-RB-AR</b>
100W	<b>EN-12100-RB-AR</b>







## Voltage Drop Guidelines (based on 10 gauge wire)

Model #	Run length	Distance to power feed
SRT-300M-12V	40' max	10ft max
SRT-600M-12V	2 × 40' max	10ft max
SRT-300M-24V	40' max	10ft max
SRT-600M-24V	40' max	10ft max

On a full load voltage drop can cause a system to exceed the 25A rating. Guidelines assist with layouts only. When installing a 12V system, ensure that a min. of 12V is supplied at power feeds. 10AWG wire should be used with remote transformers. Multi-tap output terminals (remote magnetic transformers) help make up for voltage drop before the power feed. Use a multimeter to verify no less than 11V is found at the end of the run and no more 25A is being drawn from the power feed.









# How to order Solorail™ System

**4** Measure the height of the ceiling and determine the distance from the floor to the rail to calculate length of the standoffs needed to suspend the rail from the ceiling. Determine number of standoffs and connectors for the rail.  
Use a minimum of 3 standoffs per 8 foot section and 2 standoffs per 4 foot section

Rail Suspension	Model #	Finish	Dimensions	Description
Standard Ceiling Standoff 	<b>LM-X3</b> <b>LM-X4</b> <b>LM-X5</b>	<b>BN</b> <i>Brushed Nickel</i> <b>DB</b> <i>Dark Bronze</i>	3" 4½" 5¾"	<i>Supports rail for flat ceilings and surfaces.</i>
T-Bar Ceiling Standoff 	<b>LM-TB3</b> <b>LM-TB4</b> <b>LM-TB5</b>	<b>BN</b> <i>Brushed Nickel</i> <b>DB</b> <i>Dark Bronze</i>	3" 4½" 5¾"	<i>Conceals a T-Bar clip under the canopy for standard 1" T-Bar ceilings.</i>
Sloped Ceiling Standoff 	<b>LM-XS5</b>	<b>BN</b> <i>Brushed Nickel</i> <b>DB</b> <i>Dark Bronze</i>	5¾"	<i>Supports rail for sloped ceiling. Accommodates angles up to 45°.</i>
Aircraft Suspension Cable 	<b>LM-CS48</b> <b>LM-CS96</b>	<b>BN</b> <i>Brushed Nickel</i> <b>DB</b> <i>Dark Bronze</i>	48" 96"	<i>Supports monorail for flat or sloped ceilings.</i>
Extension Rod 	<b>LM-R12</b> <b>LM-R24</b> <b>LM-R36</b> <b>LM-R48</b>	<b>BN</b> <i>Brushed Nickel</i> <b>DB</b> <i>Dark Bronze</i>	12" 24" 36" 48"	<i>Use with standoffs and power feeds. Use two per circuit with rod couplers to extend power feeds. Field cut to size and join with rod couplers.</i>
Rod Coupler 	<b>LM-RI</b>	<b>BN</b> <i>Brushed Nickel</i> <b>DB</b> <i>Dark Bronze</i>	Ø 3/8" x d 7/8"	<i>Use two per power feed, four per dual power feed, one additional coupler per rod needed when joining two rods in excess of 48".</i>
Wall Mount Support Bracket 	<b>LM-OW</b>	<b>BN</b> <i>Brushed Nickel</i> <b>DB</b> <i>Dark Bronze</i>		<i>Wall extenders allow rail to be mounted up to 24" from wall.</i>

Example: **LM-R12-BN**

**5** Determine the hardware accessories to join the rail sections together in the configuration chosen.

Rail Connectors	Model #	Finish	Dimensions	Description
Jumper Set 	<b>LM-JS</b>	<b>BN</b> <i>Brushed Nickel</i> <b>DB</b> <i>Dark Bronze</i>	6"	<i>Used to join two rails together.</i>
"I" Dead-End Connector 	<b>LM-IDEC</b>	<b>BN</b> <i>Brushed Nickel</i> <b>DB</b> <i>Dark Bronze</i>	5/8" x 2"	<i>Connects two sections of rail with no electrical continuity.</i>
"I" Connector 	<b>LM-I</b>	<b>BN</b> <i>Brushed Nickel</i> <b>DB</b> <i>Dark Bronze</i>	5/8" x 2"	<i>Connects two sections of rail with electrical continuity.</i>
"X" Dead-End Connector 	<b>LM-XDEC</b>	<b>BN</b> <i>Brushed Nickel</i> <b>DB</b> <i>Dark Bronze</i>	5/8" x 2" x 2"	<i>Joins four monorails in an "X" without electrical continuity.</i>
"L" Connector 	<b>LM-L</b>	<b>BN</b> <i>Brushed Nickel</i> <b>DB</b> <i>Dark Bronze</i>	5/8" x 1½" x 1½"	<i>90° monorail connection with electrical continuity</i>
Ceiling To Wall Connector 	<b>LM-CW</b>	<b>BN</b> <i>Brushed Nickel</i> <b>DB</b> <i>Dark Bronze</i>	5/8" x 1¾" x 1¾"	<i>90° monorail connection in a vertical plane with electrical continuity</i>
Variable Angle Connector 	<b>LM-VA</b>	<b>BN</b> <i>Brushed Nickel</i> <b>DB</b> <i>Dark Bronze</i>	Ø 1" x 1¼" x 3½"	<i>Allows an angle adjustment up to 110° with electrical continuity at the connection.</i>
"T" Connector 	<b>LM-T</b>	<b>BN</b> <i>Brushed Nickel</i> <b>DB</b> <i>Dark Bronze</i>	5/8" x 1½" x 1½"	<i>Connects two sections of a monorail in a "T" with electrical continuity</i>

Example: **LM-XDEC-BN**

# Starter and Pendant Kits Solorail™

**150W, 8ft Kit** Use with any combination of pendants or fixtures totaling 150W  
1Watt minimum load for compatibility with LED lamps and fixtures.



Model #	Finish
<b>LM-SK-150E</b>	<b>BN</b> <i>Brushed Nickel</i>
	<b>DB</b> <i>Dark Bronze</i>

Example: **LM-SK-150E-DB**

Solorail™ Quick Connect™ Adapters, Pendants and Fixtures ordered separately.  
See p.164 for all Quick Connect™ options.

- Kit Includes**
- 2 4 foot rail sections
  - 1 "I" connector
  - 2 End caps
  - 1 150W surface mount electronic transformer
  - 3 4½" standoff supports

**250W, 12ft Kit** Use with any combination of pendants or fixtures totaling 250W  
1Watt minimum load for compatibility with LED lamps and fixtures.



Model #	Finish
<b>LM-SK-250E</b>	<b>BN</b> <i>Brushed Nickel</i>
	<b>DB</b> <i>Dark Bronze</i>

Example: **LM-SK-250E-BN**

Solorail™ Quick Connect™ Adapters, Pendants and Fixtures ordered separately.  
See p.164 for all Quick Connect™ options.

- Kit Includes**
- 3 4 foot rail sections
  - 2 "I" connectors
  - 2 End caps
  - 1 250W surface mount electronic transformer
  - 5 4½" standoff supports

## Solorail™ 4 Light Pendant Kits (250W)



QP-G592-AB/DB

Model #	Finish – Glass/Rail	Additional Pendants
<b>LM-K592-AB/DB</b>	<i>Amber/Dark Bronze</i>	<b>QP-G592-AB/DB</b>

Add one additional 50W pendant or remove one pendant and add two additional 50W fixtures to maximize use of the 250W system.

- Kit Includes**
- 3 3½ foot rail sections
  - 2 "I" connectors
  - 2 End caps
  - 1 250W surface mount electronic transformer
  - 4 4½" standoff supports
  - 4 Pendant adapters
  - 4 Pendant sets, includes 50W halogen bi-pin lamps

# 5 Light Fixture Kits (250W) Solorail™

Choose from five different rail and fixture combinations.



Shown: **LM-K8111-AS/DB**



Spot Light  
Options



LM-K8111-AS/DB



LM-K8611-WT/DB



LM-K8711-WT/BN



LM-K8811-WT/BN



LM-K9415-BN/BN

Model #	Finish – Shade/Fixture	Additional Fixtures
<b>LM-K8111-AS/DB</b>	<i>Amber/Dark Bronze</i>	<b>QF-8111-AS/DB</b>
<b>LM-K8611-WT/DB</b>	<i>White/Dark Bronze</i>	<b>QF-8611-WT/DB</b>
<b>LM-K8711-WT/BN</b>	<i>White/Brushed Nickel</i>	<b>QF-8711-WT/BN</b>
<b>LM-K8811-WT/BN</b>	<i>White/Brushed Nickel</i>	<b>QF-8811-WT/BN</b>
<b>LM-K9415-BN/BN</b>	<i>Brushed Nickel/Brushed Nickel</i>	<b>QF-9415-BN/BN</b>

#### Kit Includes

- 3** 3½ foot rail sections
- 2** "I" connectors
- 2** End caps
- 1** 250W surface mount electronic transformer
- 4** 4½" standoff supports
- 5** Fixtures, includes 50W MR16 lamps, other MR16 lamps available order separately (p.344-345)

Add additional fixtures or pendants by using lower wattage lamps, 20W and 35W lamps available. Do not exceed 250W.





## FLEXRAIL1™

120V bendable monorail with 1920W capacity

Offering a slender profile that is easy to assemble and customize, Flexrail1™ offers a technological and flexible system. The professional upgrade to traditional track creates bold, eye-catching, three dimensional configurations while challenging ceilings are transformed with low and line voltage Quick Connect™ pendants and fixtures.

This sturdy, yet distinctive system is engineered for the most demanding retail and commercial applications where versatility, high performance and robust aesthetics are required. A wide assortment of new LED spot lights and wall wash lights are available for an energy conscious lighting plan.

# How to order Flexrail1™ system

## Design Guidelines

Layout	Use rope, chalk or string on floor level, or a scale drawing with string to estimate monorail needs. Broad curves work best (24" minimum radius). When working with curves, we recommend ordering up to 25% more rail than estimated to compensate for in-field design adjustments during installation. Rail should pass under or near a junction box.
Wattage	2400W down rated to 1920W in accordance with line voltage general guidelines.
Power	The rail should pass under or near a junction box supplying 120V. Stem and cable power feeds provide power and support for the rail. Flexible ceiling power feeds are used for custom length suspensions or sloped ceilings.
Mounting	Determine the ceiling type. Select standoffs that match the height of the power feed component. Minimum three supports for 8 foot section, two for 4 foot section. Custom length suspensions are possible by using cables or suspension rods with rod couplers.
Joining Sections	A variety of designs can be achieved by using various connectors. Some are electrically conductive, others join rails mechanically but not electrically. All rail connections must be made within a rail support. Dead End Connectors allow you to connect runs together mechanically that exceed the max wattage per circuit.
Shaping	Shaping rail before mounting on the ceiling allows you to determine the best location for standoffs. Use a bending machine for professional installations.



Model #  
**HM1-BM** Make perfect small radius bends. Clamps onto work benches or flat surfaces up to 2".

Cutting	May be field cut. See supplied instructions for further details.
Luminaires	Line voltage and low voltage luminaires may be mixed on the same rail. Low voltage luminaires have integral transformers. System may be dimmed with a dimmer appropriate for the transformer type, ie: electronic or magnetic.
Quick Connect™	Quick Connect™ transformer attaches to rail and accepts all Quick Connect™ fixtures and pendants with low voltage HM1-EN50.
Useful Tip	Assistance is only a phone call away. Please call WAC Lighting to speak to a friendly lighting specialist at <b>800.526.2588</b> .

## Sample Layout

A	<b>HM1-PCT6</b>	Stem power connector
B	<b>HM1-EC</b>	End cap
C	<b>HM1-T8</b>	Rail section
D	<b>HM1-X6</b>	Standoff
E	<b>HM1-EN50</b>	Quick Connect™ adapter
F	<b>QP-515</b>	Quick Connect™ pendant
G	<b>HM1-846</b>	Low voltage fixture
H	<b>HM1-LED17</b>	LED fixture
I	<b>HM1-I6</b>	"I" connector

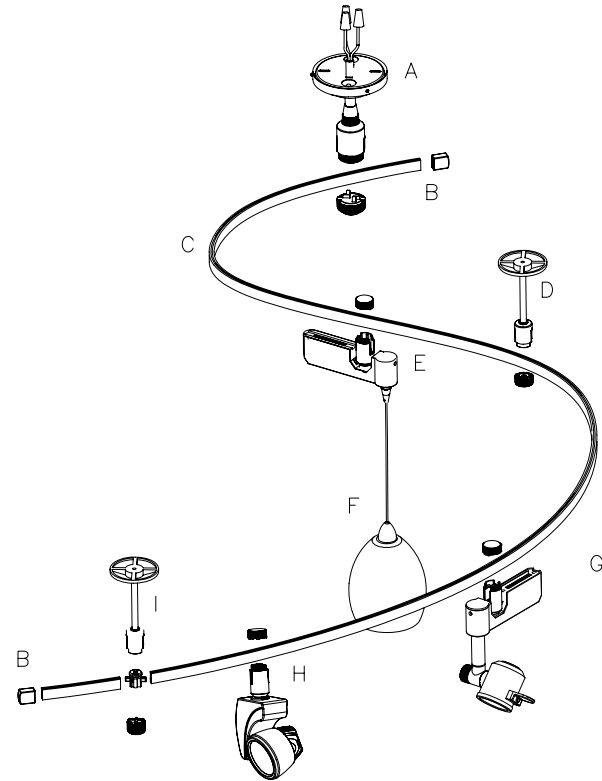

## 1 Measure the amount of rail needed and choose finish. Flexrail1™ is available in Platinum (PT) and Dark Bronze (DB)

Layout: Use rope, chalk or string on floor level, or a scale drawing with string to estimate rail needs. Broad curves work best (24" minimum radius). When working with curves, we recommend ordering up to 25% more rail than estimated to compensate for in-field design adjustments during installation. Rail should pass under or near a junction box.

### Rail Sections

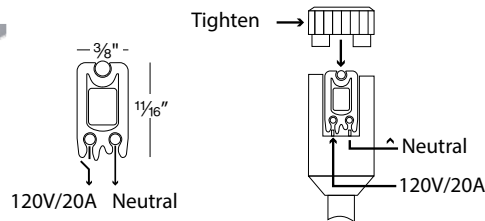

Model #                      Finish

<b>HM1</b>	<b>T4</b>	4'	<b>PT</b>	Platinum
	<b>T8</b>	8'	<b>DB</b>	Dark Bronze

Example: **HM1-T4-PT**  
Includes two matching end caps.

## 2 Select the Flexrail1™ Fixtures and/or Quick Connect™ Pendants or Fixtures for your rail system. When ordering the Quick Connect™ pendants or fixtures, make sure to order one Quick Connect™ adapter (HM1-EN50) for each in the finish chosen. For example, DB finish would be item HM1-EN50-DB.

### Quick Connect™ Adapter for Flexrail1™

The threaded male adapter makes compatibility a snap. Simply insert the metal fitting into the system adapter, hand tighten the collar and you're done!



Model #                      Finish

<b>HM1-EN50</b>	<b>PT</b>	Platinum
	<b>DB</b>	Dark Bronze

Example: **HM1-EN50-PT**  
Order one per Quick Connect™ fixture or pendant used.





# How to order Flexrail1™ system





**3** Measure the height of the ceiling and determine the distance from the floor to the rail to calculate the length of the power feed needed to suspend and power the rail from the ceiling. Select appropriate power feed based on height and ceiling type.

Power Feeds	Model #	Finish	Length	Description
 Stem Power Feed	<b>HM1-PCT6</b>	<b>PT</b> <i>Platinum</i> <b>DB</b> <i>Dark Bronze</i>	6"	May be placed anywhere along the length of the rail over a junction box supplying 120 volts. Also serves as a support. Cannot be extended or field cut.
	<b>HM1-PCT12</b>		12"	
	<b>HM1-PCT24</b>		24"	
	<b>HM1-PCT36</b>		36"	
	<b>HM1-PCT48</b>		48"	
 Flexible Ceiling Power Feed	<b>HM1-PCC12</b>	<b>PT</b> <i>Platinum</i> <b>DB</b> <i>Dark Bronze</i>	12"	Used for power on sloped ceilings, custom suspension lengths. Can be field cut.
	<b>HM1-PCC24</b>		24"	
	<b>HM1-PCC36</b>		36"	
	<b>HM1-PCC48</b>		48"	
	<b>HM1-PCC96</b>		96"	

**4** Determine the ceiling type. Select the standoffs that match the height of the power feed component. Minimum of three supports of 8 foot section and two for a 4 foot section. Custom lengths are possible by using suspension rods with rod couplers.

Rail Suspensions	Model	Finish	Dimensions	Description
 Standard Ceiling Standoff	<b>HM1-X6</b>	<b>PT</b> <i>Platinum</i> <b>DB</b> <i>Dark Bronze</i>	6"	Supports rail for flat ceilings and surfaces.
	<b>HM1-X12</b>		12"	
	<b>HM1-X24</b>		24"	
	<b>HM1-X36</b>		36"	
	<b>HM1-X48</b>		48"	
 T-Bar Ceiling Standoff	<b>HM1-TB6</b>	<b>PT</b> <i>Platinum</i> <b>DB</b> <i>Dark Bronze</i>	6"	Conceals a T-Bar clip under the canopy for standard 1" T-Bar ceilings.
	<b>HM1-TB12</b>		12"	
	<b>HM1-TB24</b>		24"	
	<b>HM1-TB36</b>		36"	
	<b>HM1-TB48</b>		48"	
 Sloped Ceiling Standoff	<b>HM1-XS6</b>	<b>PT</b> <i>Platinum</i> <b>DB</b> <i>Dark Bronze</i>	6"	Supports rail for sloped ceiling. Accommodates angles up to 45°.
	<b>HM1-XS12</b>		12"	
	<b>HM1-XS24</b>		24"	
	<b>HM1-XS36</b>		36"	
	<b>HM1-XS48</b>		48"	

**5** Based on your layout, determine the rail connectors that you may need to join the rail together. All rail connections must be made within a rail support. These connectors will count as the minimums needed to support your rail. Select the rail connectors that match the desired height of your rail.

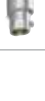
Rail Connectors	Model	Finish	Dimensions	Description
 "1" Connector	<b>HM1-I6</b>	<b>PT</b> <i>Platinum</i> <b>DB</b> <i>Dark Bronze</i>	6"	Connects two sections of rail with electrical continuity.
	<b>HM1-I12</b>		12"	
	<b>HM1-I24</b>		24"	
	<b>HM1-I36</b>		36"	
	<b>HM1-I48</b>		48"	
 "1" Dead-End Connector	<b>HM1-IDEC6</b>	<b>PT</b> <i>Platinum</i> <b>DB</b> <i>Dark Bronze</i>	6"	Connects two sections of rail with no electrical continuity.
	<b>HM1-IDEC12</b>		12"	
	<b>HM1-IDEC24</b>		24"	
	<b>HM1-IDEC36</b>		36"	
	<b>HM1-IDEC48</b>		48"	
 Variable Angle Connector	<b>HM1-VA6</b>	<b>PT</b> <i>Platinum</i> <b>DB</b> <i>Dark Bronze</i>	6"	Connects two sections of rail with electrical continuity. Connects at any angle up to 270°.
	<b>HM1-VA12</b>		12"	
	<b>HM1-VA24</b>		24"	
	<b>HM1-VA36</b>		36"	
	<b>HM1-VA48</b>		48"	
 Field Shortening Adapter	<b>HM-XADJ</b>	<b>PT</b> <i>Platinum</i>	9/16" × 13/16"	Use for custom length standoffs or "1" connector rods to replace threaded ends.
		<b>DB</b> <i>Dark Bronze</i>		
 Rod Coupler	<b>XI</b>	<b>PT</b> <i>Platinum</i>	1/2" × 13/16"	Connects two standoffs or "1" connector rods together to form a longer drop.
		<b>DB</b> <i>Dark Bronze</i>		
 Sloped Ceiling Adapter	<b>SK14S</b>	<b>PT</b> <i>Platinum</i>	1 1/16" × 2 5/16"	Use with standoffs and "1" connectors for mounting on a sloped ceiling.
		<b>DB</b> <i>Dark Bronze</i>		

Example: **HM1-VA6-PT**



LED17

LED27

## Reflex PRO LEDme® Flexrail1™

	<b>LED17</b>	<b>LED27</b>
<b>Power:</b>	17 W	27 W
<b>Lumens:</b>	Up to 1125	Up to 1890
<b>CBCP:</b>	Up to 3780	Up to 7455
<b>Comparable:</b>	20 W HID	39 W HID
<b>CRI:</b>	85	85
<b>Dimming:</b>	100% – 10%	
<b>Rated Life:</b>	100,000 hours	100,000 hours

**Professional performance for best-selling LED luminaire design to suit retail demands. Comparable to 20W and 39W HID**

- Energy Star® Rated
- Alternate beam angles may be ordered separately
- Smooth and continuous ELV dimming
- ANSI Compliant warm/neutral LED bins for a finer color consistency
- Accepts one lens/accessory
- Die-cast aluminum construction

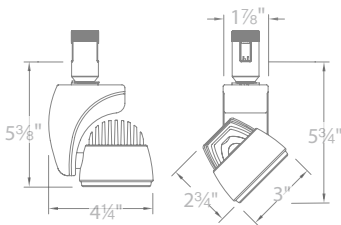

LED17

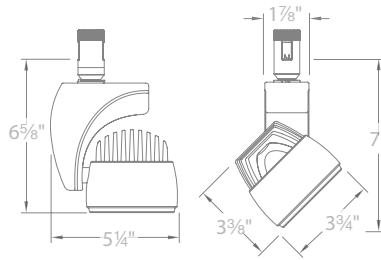

LED27

<b>HM1</b>	<b>LED17</b>	17W	<b>S</b> 20°	<b>27</b> 2700K	<b>PT</b> Platinum <b>DB</b> Dark Bronze
	<b>LED27</b>	27W	<b>F</b> 45°	<b>30</b> 3000K	
				<b>35</b> 3500K	
				<b>40</b> 4000K	

Example: **HM1-LED27S-30-DB**

### Accessories

#### Lenses

Color	<b>LENS-20</b>	LED17	<b>AMB</b> Amber
Lens	<b>LENS-25</b>	LED27	<b>BLU</b> Blue
			<b>GRN</b> Green
			<b>RED</b> Red
			<b>YEL</b> Yellow
	<b>LENS-20</b>	LED17	<b>FR</b> Frosted Lens
	<b>LENS-25</b>	LED27	<b>SPR</b> Spread Lens
			<b>BEL</b> Beam Elongating

#### Replaceable LED Modules

2700K	<b>RM-7X3-27</b>	<b>RM-11X3-27</b>
3000K	<b>RM-7X3-30</b>	<b>RM-11X3-30</b>
3500K	<b>RM-7X3-35</b>	<b>RM-11X3-35</b>
4000K	<b>RM-7X3-40</b>	<b>RM-11X3-40</b>





## ARGOS Flexrail1™

**Power:** 25W  
**Lumens:** Up to 1525  
**CBCP:** Up to 5868  
**Comparable:** 39W HID  
**CRI:** 85  
**Dimming:** 100% – 10%  
**Rated Life:** 100,000 hours

**LED luminaire with minimal size form factor for retail requirements.**

**Outperforms a 39W HID**

- Energy Star® rated
- Smooth and continuous ELV dimming
- Free of projected heat and UV radiation
- Die-cast aluminum construction
- Tool-free lens assembly for easy in field change of beam angle
- ANSI Compliant Warm/Neutral LED Bins for a finer color consistency
- 360° horizontal and 90° vertical hot aiming
- Accepts one lens



**61**  
Lm/W



Alternate beam angles may be ordered separately

Single tool-free lens assembly for easy in field change out of beam angle



System	Model	Beam	Color Temp	Finish
<b>HM1</b>	<b>LED25</b>	<b>S</b> 20°	<b>27</b> 2700K	<b>PT</b> <i>Platinum</i> <b>DB</b> <i>Dark Bronze</i>
			<b>30</b> 3000K	
		<b>F</b> 42°	<b>35</b> 3500K	
			<b>40</b> 4000K	

Example: **HM1-LED25S-27-PT**

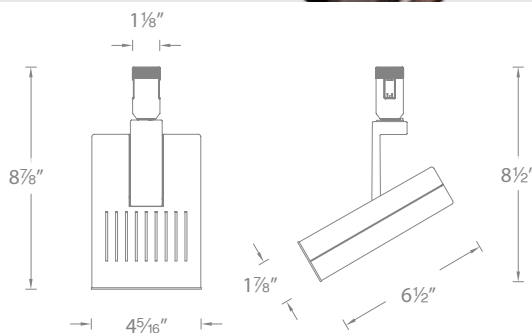

### Interchangeable TIR Assembly

20°	<b>OPH-10X3-20D</b>	<b>PT</b> <i>Platinum</i>
42°	<b>OPH-10X3-42D</b>	<b>DB</b> <i>Dark Bronze</i>

### Replaceable LED Modules

2700K	<b>RM-10X3-27</b>
3000K	<b>RM-10X3-30</b>
3500K	<b>RM-10X3-35</b>
4000K	<b>RM-10X3-40</b>

### Lens

<b>LENS-1X3-FR</b>	<i>Frosted</i>
<b>LENS-1X3-DIC-AMB</b>	<i>Amber dichroic</i>
<b>LENS-1X3-DIC-BLU</b>	<i>Blue dichroic</i>
<b>LENS-1X3-DIC-GRN</b>	<i>Green dichroic</i>
<b>LENS-1X3-DIC-RED</b>	<i>Red dichroic</i>
<b>LENS-1X3-DIC-YEL</b>	<i>Yellow dichroic</i>



## LED Wall Washer Flexrail1™

**Power:** 42W  
**Lumens:** Up to 2520  
**Comparable:** 70W HID  
**CRI:** 85  
**Rated Life:** 100,000 hours

**Optimal uniformity from an asymmetrical wall wash luminaire designed to reduce necessary mounting distance from the wall compared to fluorescent wall washers**

- Energy Star® rated
- Replaces halogen and fluorescent wall wash luminaires
- Smooth and continuous ELV dimming
- ANSI Compliant Warm/Neutral LED Bins for a finer color consistency
- Die-cast aluminum construction
- Thin profile
- 45° vertical tilt



**60**  
Lm/W

System	Model	Color Temp	Finish
HM1	LED42W	27 2700K	PT Platinum
		30 3000K	DB Dark Bronze
		35 3500K	
		40 4000K	

Example: HM1-LED42W-27-PT

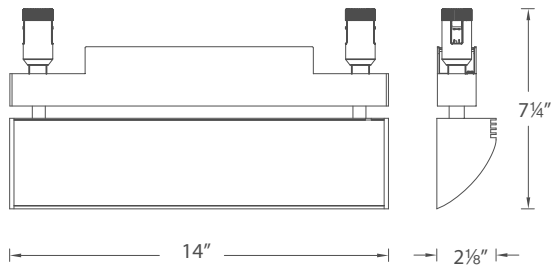

Average Footcandle Performance  
(3000K, aimed for peak illuminance)

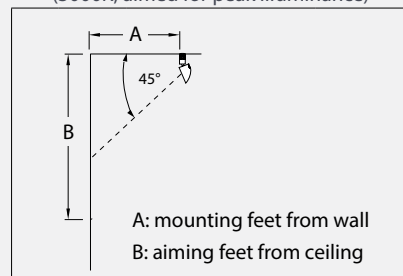

		A		
		2'	3'	4'
B	2'	128	79	51
	4'	51	41	32
	6'	26	23	20

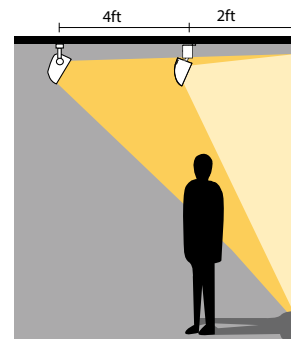

Due to the asymmetrical forward throw and tilting, WAC LED Wall Washer can be mounted closer to the wall than fluorescent

# 101 Halogen GU10

Lamping: 120V GU10 50W, included

- Die-cast aluminum construction
- Choice of decorative cased glass or metal shades

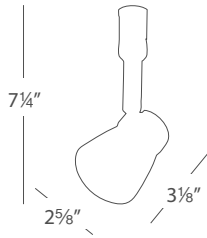

Model #	Finish
<b>HM1-101</b>	<b>AM/DB</b> Amber/Dark Bronze
	<b>AM/PT</b> Amber/Platinum
	<b>DB/DB</b> Dark Bronze
	<b>PT/PT</b> Platinum
	<b>WT/PT</b> White/Platinum
	<b>WT/DB</b> White/Dark Bronze

Example: **HM1-101-AM/DB**  
Lamp Included

LED GU10 (order separately)

Model	Finish
<b>GU10LED-BAB</b>	<b>BK</b> <b>WT</b>

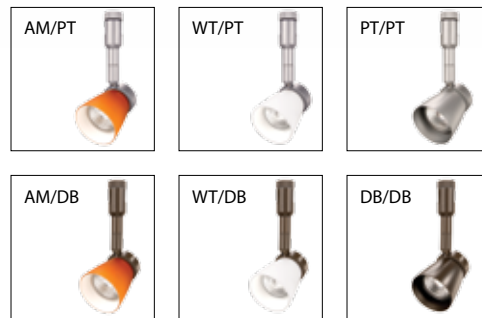

# 720, 730, 738 Halogen PAR20/PAR30/PAR38

- Die-cast aluminum construction
- Patented tool free locking mechanism for precise aiming

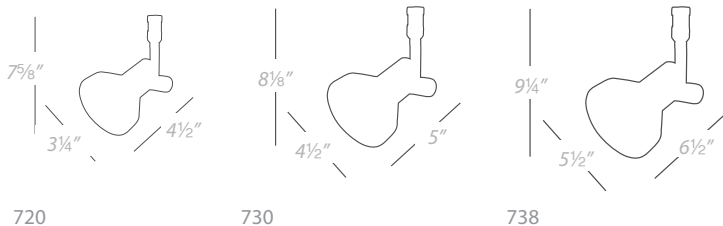

720

730

738

Model #	Lamp	Finish
<b>HM1-720</b>	120V, 50W max, PAR20	<b>PT</b> Platinum <b>DB</b> Dark Bronze
<b>HM1-730</b>	120V, 75W max, PAR30	
<b>HM1-738</b>	120V, 150W max, PAR38	

Example: **HM1-730-PT** \*Order lamp separately



## 846 LED, Halogen MR16

**Lamping:** accepts 12V LED MR16, Halogen MR16 lamps up to 50W max

**Lens Options:** accepts 1 lens, see below for alternate lens options

- 1W minimum load transformer
- Patented tool free locking mechanism for precise aiming
- Integral electronic transformer
- Die-cast aluminum construction
- Clear lens included

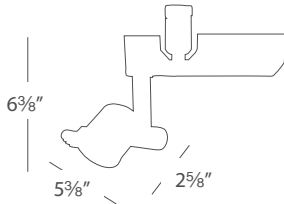

Shown with LED MR16

Model #	Watt	Finish
<b>HM1-846</b>	50W max	<b>PT</b> Platinum
<b>HM1-846L</b>	75W max	<b>DB</b> Dark Bronze

Example: **HM1-846-DB** \*Order lamp separately

LED MR16 (order separately)		Lenses and Accessories	
Model	Finish		
<b>MR16LED-BAB</b>	<b>BK</b> <b>WT</b>	Color Lens	<b>LENS-16</b>
		<b>AMB</b> Amber	UV Filter Lens
		<b>BLU</b> Blue	Frosted Lens
		<b>GRN</b> Green	Spread Lens
		<b>RED</b> Red	Beam Elongating
		<b>YEL</b> Yellow	Honeycomb Louver
			<b>LENS-16-UVF</b>
			<b>LENS-16-FR</b>
			<b>LENS-16-SPR</b>
			<b>LENS-16-BEL</b>
			<b>LENS-16-HCL</b>

## 849 LED, Halogen MR16

**Lamping:** accepts 12V LED MR16, Halogen MR16 lamps up to 50W max

**Lens Options:** accepts 1 lens, see below for alternate lens options

- 1W minimum load transformer
- Die-cast aluminum construction
- Integral electronic transformer
- Clear lens included

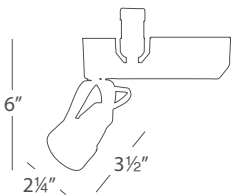

Shown with LED MR16 and Honeycomb Louver

Model #	Watt	Finish
<b>HM1-849</b>	50W max	<b>PT</b> Platinum
<b>HM1-849L</b>	75W max	<b>DB</b> Dark Bronze

Example: **HM1-849-PT** \*Order lamp separately

LED MR16 (order separately)		Lenses and Accessories	
Model	Finish		
<b>MR16LED-BAB</b>	<b>BK</b> <b>WT</b>	Color Lens	<b>LENS-16</b>
		<b>AMB</b> Amber	UV Filter Lens
		<b>BLU</b> Blue	Frosted Lens
		<b>GRN</b> Green	Spread Lens
		<b>RED</b> Red	Beam Elongating
		<b>YEL</b> Yellow	Honeycomb Louver
			<b>LENS-16-UVF</b>
			<b>LENS-16-FR</b>
			<b>LENS-16-SPR</b>
			<b>LENS-16-BEL</b>
			<b>LENS-16-HCL</b>

# PENDANTS & SCONCES

Eternity Jewelry Collection







It is said that 'Diamonds are Forever' and such is the inspiration for the Eternity Collection featuring opulent materials and jewelry designs all illuminated artfully with state-of-the-art LED technology. Extravagance drips from every page. Hand-cut 15mm crystals are secured to clear mitered or mouth-blown shades with no visible hardware for a uniquely beautiful and dishwasher-safe grouping of pendants. Italian-made 13th century Piastra craftsmanship is transformed into decadent ribbon candy pendants in silver and gold. 24K gold accents are also embedded within or fused to trim Venetian glassware to complete this celebration of beautiful jewelry design.



Shown: QP-LED939-BI/CH



Shown: QP-LED939-WD/CH



Shown: QP-LED939-CD/CH

## Haven Eternity Jewelry Collection

Lamping: LEDme® 12V Xenon BP-50  
 Power: 6.4W 50W max  
 Lumens: 450  
 Color Temp: 3000K  
 CRI: 85

Sophisticated LED technology meets unmatched brilliance with hand cut, hand polished crystal cascades. Haven pendants glisten in Black Ice, Champagne Diamond and White Diamond adornment.

System	Model	Lamping	Shade Color	Socket Finish
<b>MP</b>	Canopy	<b>LED939</b> <b>939</b>	<b>BI</b> Black Ice <b>CD</b> Champagne Diamond <b>WD</b> White Diamond (Clear)	<b>BN</b> Brushed Nickel <b>CH</b> Chrome <b>DB</b> Dark Bronze
<b>QP</b>	Quick Connect™			

Example: **QP-LED939-CD/DB**

Canopy models include Quick Adjust™ canopy  
 Quick Connect™ models require additional adapter (see p.284)

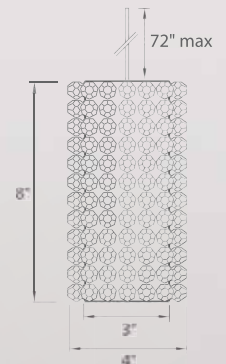





Shown: QP-LED539-BI/CH



Shown: QP-LED539-WD/CH



Shown: QP-LED539-CD/CH

## Mini Haven Eternity Jewelry Collection

Lamping: LEDme® 12V Halogen JC-50  
 Power: 4W 50W max  
 Lumens: 330  
 Color Temp: 3000K  
 CRI: 85

Opulent clusters of crystal beads add a dramatic radiance to transitional spaces. Offered in sparkling neutral tones to complement current color trends in interiors.

System	Model	Lamping	Shade Color	Socket Finish
<b>MP</b> Canopy	<b>LED539</b>	Integral LED	<b>BI</b> Black Ice	<b>BN</b> Brushed Nickel
<b>QP</b> Quick Connect™			<b>539</b>	<b>CD</b> Champagne Diamond
		Halogen/Xenon	<b>WD</b> White Diamond (Clear)	<b>DB</b> Dark Bronze

Example: QP-LED539-CD/DB

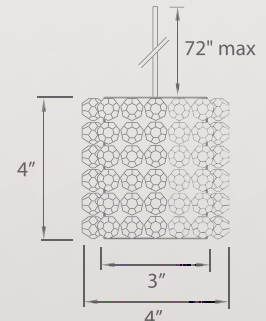

Canopy models include Quick Adjust™ canopy  
 Quick Connect™ models require additional adapter (see p.284)







Shown: **QP-LED542-CD/CH**

Shown: **QP-LED542-WD/CH**

Shown: **QP-LED542-BI/CH**

## Gia Eternity Jewelry Collection

Lamping: *LEDme® 12V Halogen JC-50*  
 Power: *4W 50W max*  
 Lumens: *330*  
 Color Temp: *3000K*  
 CRI: *85*

Breathtaking clusters of sparkle and brilliance. Integrating advanced LED technology these elegant pendants add more than just ambiance providing generous light sufficient for tasks. Place in multiples over bars and counters for incomparable drama.

System	Model	Lamping	Shade Color	Socket Finish
<b>MP</b>	<i>Canopy</i>	<b>LED542</b>	<b>BI</b> <i>Black Ice</i>	<b>BN</b> <i>Brushed Nickel</i>
<b>QP</b>	<i>Quick Connect™</i>	<b>542</b>	<b>CD</b> <i>Champagne Diamond</i>	<b>CH</b> <i>Chrome</i>
			<b>WD</b> <i>White Diamond (Clear)</i>	<b>DB</b> <i>Dark Bronze</i>

Example: **QP-LED542-CD/DB**

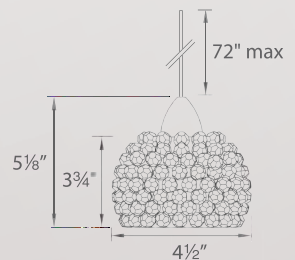

Canopy models include Quick Adjust™ canopy  
 Quick Connect™ models require additional adapter (see p.284)





Shown: QP-LED543-BI/CH



Shown: QP-LED543-WD/CH



Shown: QP-LED543-CD/CH

## Giselle Eternity Jewelry Collection

Lamping: LEDme® 12V Halogen JC-50  
 Power: 4W 50W max  
 Lumens: 330  
 Color Temp: 3000K  
 CRI: 85

Eye catching colorful opulence with innovation and class. A myriad of glistening crystals add an exquisite touch to the most sophisticated décor. Modern luminaires developed with proprietary LED technology and old world artisanship.

System	Model	Lamping	Shade Color	Socket Finish
<b>MP</b> Canopy	<b>LED543</b>	Integral LED	<b>BI</b> Black Ice	<b>BN</b> Brushed Nickel
<b>QP</b> Quick Connect™	<b>543</b>	Halogen/Xenon	<b>CD</b> Champagne Diamond	<b>CH</b> Chrome
			<b>WD</b> White Diamond (Clear)	<b>DB</b> Dark Bronze

Example: QP-LED543-CD/DB

Canopy models include Quick Adjust™ canopy  
 Quick Connect™ models require additional adapter (see p.284)

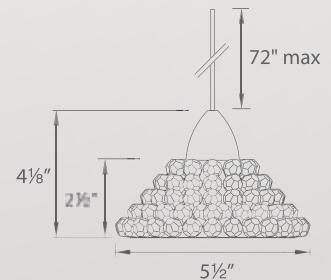







Shown: **QP-LED938-CD/CH**



Shown: **QP-LED938-BI/CH**



Shown: **QP-LED938-WD/CH**

## Kalysta Eternity Jewelry Collection

Lamping: *LEDme®* 12V Xenon BP-50  
 Power: 6.4W 50W max  
 Lumens: 450  
 Color Temp: 3000K  
 CRI: 85

Sophistication with a stylish profile. A scaled up transparent fluted glass vase adorned with hand applied 15mm multifaceted crystals in three exquisite colors. Design rich with appeal to complement any interior.

System	Model	Lamping	Shade Color	Socket Finish
<b>MP</b>	<i>Canopy</i>	<b>LED938</b> <b>938</b>	<b>BI</b> <i>Black Ice</i>	<b>BN</b> <i>Brushed Nickel</i>
<b>QP</b>	<i>Quick Connect™</i>		<b>CD</b> <i>Champagne Diamond</i>	<b>CH</b> <i>Chrome</i>
			<b>WD</b> <i>White Diamond (Clear)</i>	<b>DB</b> <i>Dark Bronze</i>

Example: **QP-LED938-CD/DB**

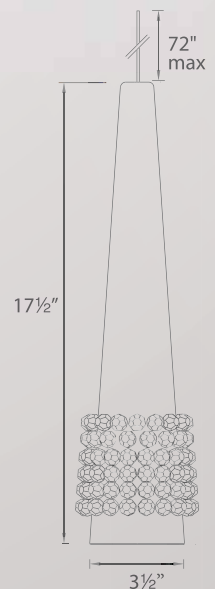

Canopy models include Quick Adjust™ canopy  
 Quick Connect™ models require additional adapter (see p.284)





Shown: **QP-LED336-GL/CH**

Shown: **QP-LED336-CL/CH**

Shown: **QP-LED336-SM/CH**

## Sorriso Eternity Jewelry Collection

**Lamping:** LEDme®  
**Power:** 3.7W  
**Lumens:** 165  
**Color Temp:** 3000K  
**CRI:** 85

An eye-catching conversation piece carved out of solid crystal. Dazzling rays of light thrown in different directions make a beautiful display when dropped in cascading clusters from a multi-light canopy.

System	Model	Lamping	Shade Color	Socket Finish
<b>MP</b> Canopy	<b>LED336</b>	Integral LED	<b>CL</b> Clear	<b>BN</b> Brushed Nickel
<b>QP</b> Quick Connect™			<b>GL</b> Gold	<b>CH</b> Chrome
			<b>SM</b> Smoke	<b>DB</b> Dark Bronze

Example: **QP-LED336-SM/BN**

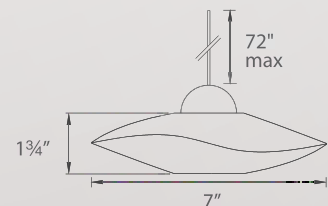

Canopy models include Quick Adjust™ canopy  
 Quick Connect™ models require additional adapter (see p.284)







Shown: **QP943-BZ/DB**



Shown: **QP943-GL/DB**

## Lucia Eternity Jewelry Collection

Lamping: *12V Xenon BP-50*  
 Power: *50W max*

Elegant lighting inspires awe and refinement. Grace your interiors with dramatically fluted Murano mouth blown iridescent glass in a pendant of exaggerated proportion. Hand trimmed in 24K gold for a small touch of opulence. Luxury is in the details.



System	Model	Lamping	Shade Color	Socket Finish
<b>MP</b> <i>Canopy</i>	<b>943</b>	<i>Xenon</i>	<b>BZ</b> <i>Bronze Iridescent</i>	<b>BN</b> <i>Brushed Nickel</i>
<b>QP</b> <i>Quick Connect™</i>			<b>GL</b> <i>Gold Iridescent</i>	<b>CH</b> <i>Chrome</i>

Example: **QP943-BZ/DB**



Canopy models include Quick Adjust™ canopy  
 Quick Connect™ models require additional adapter (see p.284)





Shown: QP-LED544-GL/DB

Shown: QP-LED544-SL/CH

Shown: QP-LED544-CL/BN

## Candy Eternity Jewelry Collection

**Lamping:** LEDme® 12V Halogen JC-50  
**Power:** 4W 50W max  
**Lumens:** 330  
**Color Temp:** 3000K  
**CRI:** 85

Exquisite lighting for gracious living. Artistic hand-formed arrangements of wide ribbons of Piastra art glass become a gorgeous play of sparkle and shadow in this deeply textured pendant concealing the latest LED technology. Also offered as an LED wall sconce for a truly stunning look.

System	Model	Lamping	Shade Color	Socket Finish
<b>MP</b>	Canopy	<b>LED544</b>	<b>CL</b> Clear	<b>BN</b> Brushed Nickel
<b>QP</b>	Quick Connect™	<b>544</b> Integral LED Halogen/Xenon	<b>GL</b> Gold	<b>CH</b> Chrome
			<b>SL</b> Silver	<b>DB</b> Dark Bronze

Example: **MP-LED544-GL/DB**

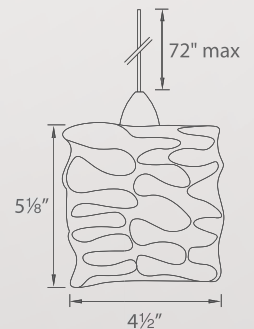

Canopy models include Quick Adjust™ canopy  
 Quick Connect™ models require additional adapter (see p.284)









Shown: **QP920-CL/CH**



Shown: **QP960-CL/CH**

## Ice Eternity Jewelry Collection

Lamping: **LEDme®** 12V Xenon BP-50  
 Power: 6.4W 50W max  
 Lumens: 450  
 Color Temp: 3000K  
 CRI: 85

Sparkling like rays of sunlight on an ice sculpture, the Ice pendant is handcrafted in Italy of clear mouth blown glass with detailed artistry and fluid movement of melting icicles.

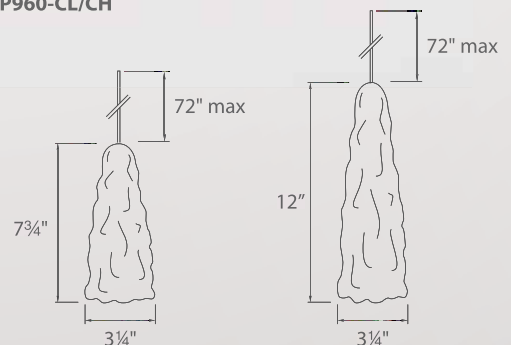

System	Model	Lamping	Shade Color	Socket Finish
<b>MP</b> Canopy <b>QP</b> Quick Connect™	<b>LED920</b> <b>920</b>	Integral LED Xenon Short Glass	<b>CL</b> Clear	<b>BN</b> Brushed Nickel
	<b>LED960</b> <b>960</b>	Integral LED Xenon Long Glass		<b>CH</b> Chrome <b>DB</b> Dark Bronze

Example: **MP-920-CL/BN**

Canopy models include Quick Adjust™ canopy  
 Quick Connect™ models require additional adapter (see p.284)





Shown: **QP924-GL/CH**

## Fügü Eternity Jewelry Collection

Lamping: *LED*      *12V Xenon BP-50*  
 Power: *2W*      *50W max*  
 Lumens: *110*  
 Color Temp: *3000K*  
 CRI: *85*

Fügü is the Japanese word for pufferfish. As a delicacy, lethally poisonous if not skillfully prepared and extravagant to indulge in. This mouth-blown Italian glass representation with embedded 24K gold flecks and hand-pulled spikes of sparkling clear glass credits the toxic beauty of these wonders of the sea.

System	Model	Lamping	Shade Color	Socket Finish
<b>MP</b> <i>Canopy</i>	<b>924LED</b>	<i>JC LED Bi-Pin</i>	<b>GL</b> <i>Gold</i>	<b>BN</b> <i>Brushed Nickel</i>
<b>QP</b> <i>Quick Connect™</i>	<b>924</b>	<i>Xenon</i>		<b>CH</b> <i>Chrome</i>
				<b>DB</b> <i>Dark Bronze</i>

Example: **MP-924-GL/DB**

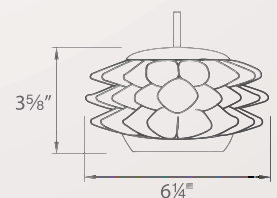

Canopy models include Quick Adjust™ canopy  
 Quick Connect™ models require additional adapter (see p.284)





Shown: **QP-LED332-CL/CH**

# Cascade Eternity Jewelry Collection

Lamping: *LEDme® 12V Xenon BP-50*  
 Power: *3.7W 50W max*  
 Lumens: *165*  
 Color Temp: *3000K*  
 CRI: *85*

A modern twist on Crystal, our original pendant design is exquisitely crafted and dressed with strands of hundreds of miniature faceted Crystals. Juxtaposed with jewelry-finished cast accessories, these upscale pendants utilize various light sources and low voltage technology to inspire curiosity and appreciation.

System	Model	Lamping	Shade Color	Socket Finish
<b>MP</b> <i>Canopy</i> <b>QP</b> <i>Quick Connect™</i>	<b>LED332</b> <b>332</b>	<i>Integral LED</i> <i>Xenon</i>	<b>CL</b> <i>Clear</i>	<b>CH</b> <i>Chrome</i>

Example: **QP-LED332-CL/CH**

Canopy models include Quick Adjust™ canopy  
 Quick Connect™ models require additional adapter (see p.284)

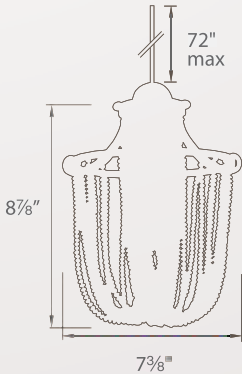



# Wall Sconce Systems

See p.282 for More Information

## HAVEN & MINI HAVEN

Sconce Model	Lamping	Shade Model	Shade Color	Sconce Finish
<b>WS72LED</b> <b>WS72</b> <b>WS57LED</b> <b>WS58LED</b> <b>WS58</b>	12V LED Socket Set 12V Halogen Socket Set Integral LED Integral LED 12V Halogen Bi-Pin	<b>G539</b> <i>Mini Haven</i>	<b>BI</b> Black Ice <b>CD</b> Champagne Diamond <b>WD</b> White Diamond	<b>BN</b> Brushed Nickel <b>CH</b> Chrome <b>RB</b> Rubbed Bronze
<b>WS72LED</b> <b>WS72</b>	LED 12V Halogen Bi-Pin	<b>G939</b> <i>Haven</i>		



Example: **WS72LED-G939WD/CH**



Example: **WS58LED-G539CD/RB**



Example: **WS57LED-G539BI/CH**

## GIA & GISELLE

Sconce Model	Lamping	Shade Model	Shade Color	Sconce Finish
<b>WS72LED</b> <b>WS72</b> <b>WS57LED</b> <b>WS58LED</b> <b>WS58</b>	12V LED Socket Set 12V Halogen Socket Set Integral LED Integral LED 12V Halogen Bi-Pin	<b>G542</b> <i>Gia</i> <b>G543</b> <i>Giselle</i>	<b>BI</b> Black Ice <b>CD</b> Champagne Diamond <b>WD</b> White Diamond	<b>BN</b> Brushed Nickel <b>CH</b> Chrome <b>RB</b> Rubbed Bronze



Example: **WS72LED-G542WD/CH**



Example: **WS58LED-G542BI/CH**



Example: **WS57LED-G542CD/RB**



Example: **WS72LED-G543CD/RB**



Example: **WS58LED-G543WD/CH**



Example: **WS57LED-G543BI/CH**

## CANDY

Sconce Model	Lamping	Shade Model	Shade Color	Sconce Finish
<b>WS72LED</b> <b>WS72</b> <b>WS57LED</b> <b>WS58LED</b> <b>WS58</b>	12V LED Socket Set 12V Halogen Socket Set Integral LED Integral LED 12V Halogen Bi-Pin	<b>G544</b> <i>Candy</i>	<b>CL</b> Clear <b>GL</b> Gold <b>SL</b> Silver	<b>BN</b> Brushed Nickel <b>CH</b> Chrome <b>RB</b> Rubbed Bronze



Example: **WS72LED-G544CL/CH**



Example: **WS58LED-G544SL/CH**



Example: **WS57LED-G544GL/RB**

## ICE

Sconce Model	Lamping	Shade Model	Shade Color	Sconce Finish
<b>WS72LED</b> <b>WS72</b>	12V LED Socket Set 12V Halogen Socket Set	<b>G920</b> <i>Ice</i>	<b>CL</b> Clear	<b>BN</b> Brushed Nickel <b>CH</b> Chrome <b>RB</b> Rubbed Bronze



Example: **WS72LED-G920CL/CH**

Artisan Collection







Showcasing beautiful artistry from small producers, our creative montage of pendants and wall sconces featuring art glass and hand-sculpted stone made in the Arts and Crafts tradition of developing unique techniques through years of practice and invention by master artisans. It is the vision of the craft artisan that helps create these visual wonders, noted for their creativity and time-honored craftsmanship. LED options are offered across the collection to meet current demands in energy-efficiency and quality lighting design.



Shown: **MP-LED333-OP/BN**



Shown: **MP-LED533-OP/BN**

## Brittany Artisan Collection

**Lamping:** LEDme® 12V Halogen JC-50  
**Power:** 3.7W 50W max  
**Lumens:** 165  
**Color Temp:** 3000K  
**CRI:** 85

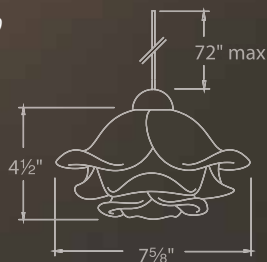

## Mini Brittany Artisan Collection

**Lamping:** LEDme® 12V Halogen JC-50  
**Power:** 4W 50W max  
**Lumens:** 330  
**Color Temp:** 3000K  
**CRI:** 85

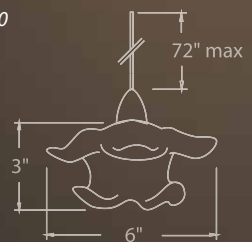

Hand crafted in Italy in a stunning glass art form, Brittany transforms layers of soft milky opaline glass that blossom into a dramatic opalescent flower. Gorgeous hues of amber, gold and milky blue come alive when illuminated.

System	Name	Model	Lamping	Shade Color	Socket Finish
<b>MP</b> Canopy <b>QP</b> Quick Connect™	Brittany	<b>LED333</b> <b>333</b>	Integral LED Halogen/Xenon	<b>OP</b> Opaline	<b>BN</b> Brushed Nickel
	Mini Brittany	<b>LED533</b> <b>533</b>	Integral LED Halogen/Xenon		<b>CH</b> Chrome <b>DB</b> Dark Bronze

Example: **QP-LED533-OP/BN**

Canopy models include Quick Adjust™ canopy  
 Quick Connect™ models require additional adapter (see p.284)





Shown: QP630-SF/CH



Shown: QP630-PK/DB

## Zanzibar Artisan Collection

**Lamping:** LED 12V Halogen JC-50  
**Power:** 2W 50W max  
**Lumens:** 110  
**Color Temp:** 3000K  
**CRI:** 85

Exotic woods and colorful birds reminiscent of paradise inspire this collection of art glass pendants. Each four layer glass shade is hand crafted featuring multi-colored lines pulled into unique striated bands.

System	Name	Lamping	Shade Color	Socket Finish
<b>MP</b> Canopy	<b>630LED</b>	JC LED Bi-Pin	<b>PK</b> Peacock	<b>BN</b> Brushed Nickel
<b>QP</b> Quick Connect™	<b>630</b>	Halogen	<b>SF</b> Saffron	<b>CH</b> Chrome
				<b>DB</b> Dark Bronze

Example: **QP630-PK/DB**

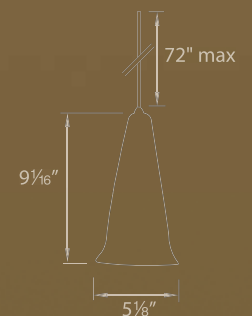

Canopy models include Quick Adjust™ canopy  
 Quick Connect™ models require additional adapter (see p.284)





## Rococo Artisan Collection

Shown: QP935LED-GL/DB

Lamping: LED 12V Xenon BP-50  
 Power: 2W 50W max  
 Lumens: 110  
 Color Temp: 3000K  
 CRI: 85

Beautiful mouth blown art glass hand crafted by fine Italian artisans, the Rococo pendant features amber and opal frit, richly layered in speckles of gold to add a distinctive touch of glamour and elegance to any space.

System	Model	Lamping	Shade Color	Socket Finish
<b>MP</b> Canopy	<b>935LED</b>	JC LED Bi-Pin	<b>GL</b> Gold	<b>BN</b> Brushed Nickel
<b>QP</b> Quick Connect™	<b>935</b>	Xenon		<b>CH</b> Chrome
				<b>DB</b> Dark Bronze

Example: **MP-935-GL/DB**

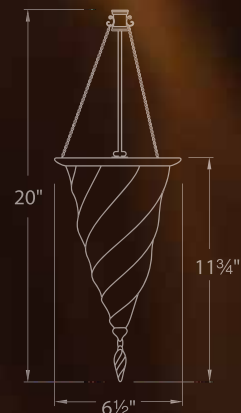

Canopy models include Quick Adjust™ canopy  
 Quick Connect™ models require additional adapter (see p.284)





## Rhu Artisan Collection

Shown: **QP-LED534-SM/DB**

**Lamping:** LEDme® 12V Halogen JC-50  
**Power:** 4W 50W max  
**Lumens:** 330  
**Color Temp:** 3000K  
**CRI:** 85

Imperfection at its perfection, the Rhu pendant turns crackled glass into an art form. Foggy hues bear a resemblance to the local weather of the Scottish sailing town that is also its namesake.

System	Model	Lamping	Shade Color	Socket Finish
<b>MP</b> Canopy	<b>LED534</b> <b>534</b>	Integral LED Halogen/Xenon	<b>SM</b> Smoke	<b>BN</b> Brushed Nickel
<b>QP</b> Quick Connect™				<b>CH</b> Chrome
				<b>DB</b> Dark Bronze

Example: **QP-LED534-SM/DB**

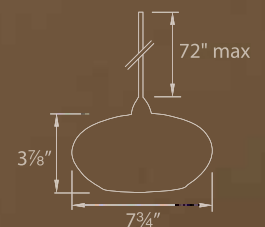

Canopy models include Quick Adjust™ canopy  
 Quick Connect™ models require additional adapter (see p.284)





Shown: QP933-AM/BN



Shown: QP918-AM/DB

## Truffle Artisan Collection

**Lamping:** LEDme® 12V Xenon BP-50  
**Power:** 6.4W 50W max  
**Lumens:** 450  
**Color Temp:** 3000K  
**CRI:** 85

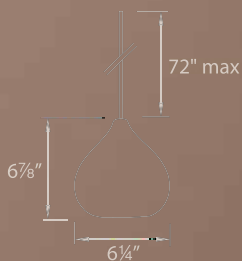

Like a chocolate treat, the rounded Truffle is a velvety smooth, cased blown glass decorated with a tasty textured design.

## Tigra Artisan Collection

**Lamping:** LEDme® 12V Xenon BP-50  
**Power:** 6.4W 50W max  
**Lumens:** 450  
**Color Temp:** 3000K  
**CRI:** 85

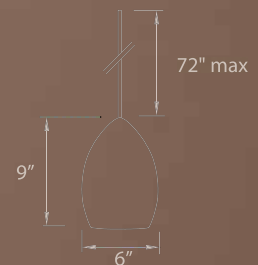

Striking, like black stripes on the golden coat of a wild Bengal tiger, Tigra roars with excitement and drama.

System	Name	Model	Lamping	Shade Color	Socket Finish
<b>MP</b> Canopy <b>QP</b> Quick Connect™	Tigra	<b>LED918 918</b>	Integral LED Xenon	<b>AM</b> Amber	<b>BN</b> Brushed Nickel
	Truffle	<b>LED933 933</b>	Integral LED Xenon		<b>CH</b> Chrome <b>DB</b> Dark Bronze

Example: QP918-AM/DB

Canopy models include Quick Adjust™ canopy  
 Quick Connect™ models require additional adapter (see p.284)





Shown: QP538-IR/DB



Shown: QP954-IR/DB

## Ginkgo Artisan Collection

**Lamping:** LEDme® 12V Halogen JC-50  
**Power:** 4W 50W max  
**Lumens:** 330  
**Color Temp:** 3000K  
**CRI:** 85

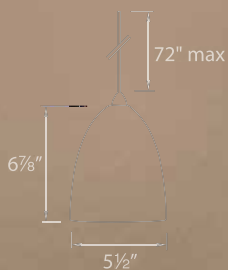

Hand painted background of blue, green, rose and gold shades shimmer on this unique glass pendant. When illuminated, the iridescent backdrop seems to disappear and the patterns float tone on tone.

## Willow Artisan Collection

**Lamping:** LEDme® 12V Xenon BP-50  
**Power:** 6.4W 50W max  
**Lumens:** 450  
**Color Temp:** 3000K  
**CRI:** 85

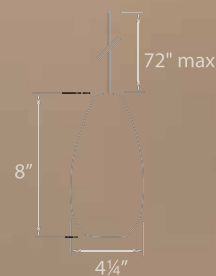

Beautifully hand painted brush strokes of blue run down the length of this gorgeous pendant like the branches of a delicate willow tree. Its pearlescent hues act as the canvas for this one of a kind pendant, eliciting a feeling of enchantment.

System	Name	Model	Lamping	Shade Color	Socket Finish
MP QP	Ginkgo	<b>LED538</b> <b>538</b>	Integral LED Halogen/Xenon	IR Iridescent	BN Brushed Nickel
	Willow	<b>LED954</b> <b>954</b>	Integral LED Xenon		CH Chrome DB Dark Bronze

Example: QP538-IR/DB

Canopy models include Quick Adjust™ canopy  
 Quick Connect™ models require additional adapter (see p.284)



Shown: **QP946-GT/BN**



Shown: **QP946-AL/DB**

## Alpa Artisan Collection

**Lamping:** LED 12V Xenon BP-50  
**Power:** 2W 50W max  
**Lumens:** 110  
**Color Temp:** 3000K  
**CRI:** 85

Complement the beautiful, natural look of today's counter tops with handsome, hand polished and turned natural stone. Organic patterns and hues vary with each block of stone revealing terra history.

System	Model	Lamping	Shade Color	Socket Finish
<b>MP</b> Canopy	<b>946LED</b>	JC LED Bi-Pin	<b>AL</b> Alabaster	<b>BN</b> Brushed Nickel
<b>QP</b> Quick Connect™	<b>946</b>	Xenon	<b>GT</b> Granite	<b>CH</b> Chrome
				<b>DB</b> Dark Bronze

Example: **QP946-AL/DB**

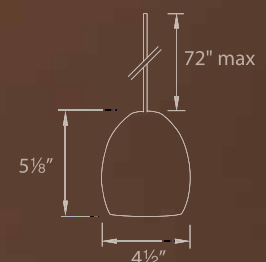

Canopy models include Quick Adjust™ canopy  
 Quick Connect™ models require additional adapter (see p.284)







# Wall Sconce Systems

See p.282 for More Information

## ZANZIBAR

Sconce Model	Lamping	Shade Model	Shade Color	Sconce Finish
<b>WS72</b>	12V Halogen Socket Set	<b>G630</b> Zanzibar	<b>PK</b> Peacock <b>SF</b> Saffron	<b>BN</b> Brushed Nickel <b>CH</b> Chrome <b>RB</b> Rubbed Bronze



Example: **WS72-G630SF/RB**

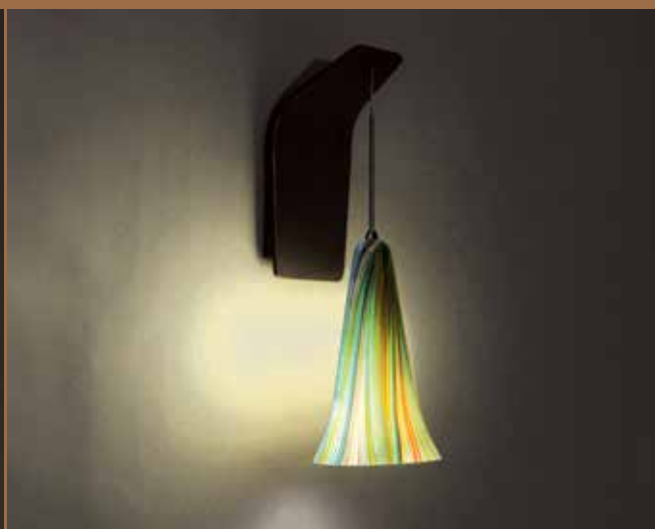

Example: **WS72-G630PK/RB**

\*For LED option, Order LED JC-Bi-pin (JCLEL-2-30-WT). Can be used in 12V Halogen Socket Set.

## GINKGO & WILLOW

Sconce Model	Lamping	Shade Model	Shade Color	Sconce Finish
<b>WS72LED</b> <b>WS72</b> <b>WS57LED</b> <b>WS58LED</b> <b>WS58</b>	12V LED Socket Set 12V Halogen Socket Set Integral LED Integral LED 12V Halogen Bi-Pin	<b>G538</b> Ginkgo	<b>IR</b> Iridescent	<b>BN</b> Brushed Nickel <b>CH</b> Chrome <b>RB</b> Rubbed Bronze
<b>WS72LED</b> <b>WS72</b>	12V LED Socket Set 12V Halogen Socket Set	<b>G954</b> Willow		



Example: **WS72LED-G538IR/RB**



Example: **WS58LED-G538IR/BN**



Example: **WS72LED-G954IR/RB**

# ALPA

Scence Model	Lamping	Shade Model	Shade Color	Scence Finish
<b>WS72LED</b>	12V LED Socket Set	<b>G946</b> Alpa	<b>AL</b> Alabaster	<b>BN</b> Brushed Nickel
<b>WS72</b>	12V Halogen Socket Set		<b>GT</b> Granite	<b>CH</b> Chrome
				<b>RB</b> Rubbed Bronze



Example: **WS72LED-G946AL/RB**

European Collection

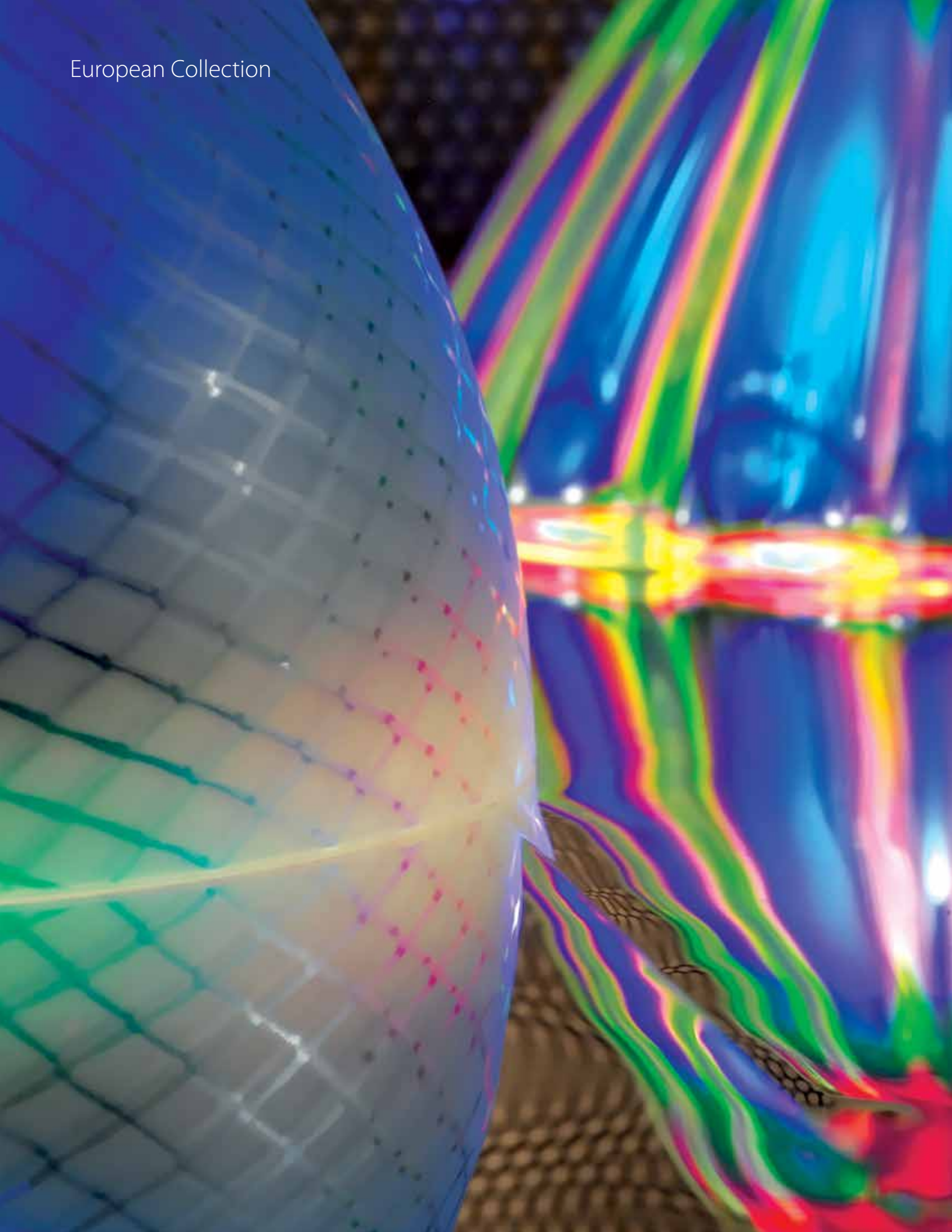



European glass tradition has a long heritage of artistic development and national identity. The European Collection of pendants and sconces from WAC Lighting brings to you our best-sellers ranging from German engineered optical designs to colorful Italian Murano glasswork.



Shown: QP-LED515-MF/DB

## Fiori European Collection

**Lamping:** LEDme® 12V Halogen JC-50  
**Power:** 4W 50W max  
**Lumens:** 330  
**Color Temp:** 3000K  
**CRI:** 85

Millefiori glass is made by Italian artisans fusing and stretching hand made Murrine glass rods into individual floral patterned slices of glass applied onto molten glass and mouth blown to form. The result is an intricate montage of colors and patterns.

System	Model	Lamping	Shade Color	Socket Finish
<b>MP</b> Canopy	<b>LED515</b> <b>515</b>	Integral LED Halogen/Xenon	<b>MF</b> Millefiori	<b>BN</b> Brushed Nickel
<b>QP</b> Quick Connect™				<b>CH</b> Chrome
				<b>DB</b> Dark Bronze

Example: **QP-LED515-MF/DB**

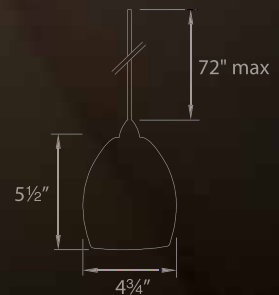

Canopy models include Quick Adjust™ canopy  
 Quick Connect™ models require additional adapter (see p.284)



Shown: **QP614-BG/BN**



Shown: **QP614-MF/CH**



Shown: **QP614-YR/DB**

## Passion European Collection

**Lamping:** LED 12V Halogen JC-50  
**Power:** 2W 50W max  
**Lumens:** 110  
**Color Temp:** 3000K  
**CRI:** 85

Inspired by Italian craft-making, these dramatic Murrine art glass pieces are striking in warm and cool color combinations.

System	Model	Lamping	Shade Color	Socket Finish
MP Canopy QP Quick Connect™	<b>614LED</b>	JC LED Bi-Pin	<b>BG</b> Blue/Green <b>MF</b> Millefiori	<b>BN</b> Brushed Nickel <b>CH</b> Chrome
	<b>614</b>	Halogen/Xenon	<b>YR</b> Yellow/Red <b>DB</b> Dark Bronze	<b>DB</b> Dark Bronze

Example: **QP614-BG/BN**

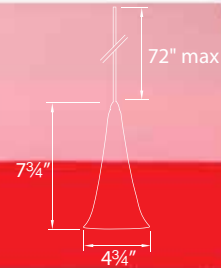

Canopy models include Quick Adjust™ canopy  
 Quick Connect™ models require additional adapter (see p.284)





Shown: **QP-LED518-DIC/CH**



Shown: **QP546-DIC/BN**

## Eden European Collection

Lamping: **LEDme®** 12V Halogen JC-50  
 Power: 4W 50W max  
 Lumens: 330  
 Color Temp: 3000K  
 CRI: 85

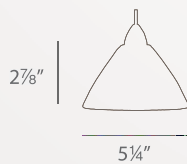

## Ambrosia European Collection

Lamping: **LEDme®** 12V Halogen JC-50  
 Power: 4W 50W max  
 Lumens: 330  
 Color Temp: 3000K  
 CRI: 85

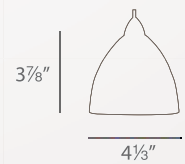

Spectacular dichroic glass pendants are diamonds in the rough. With German craftsmanship, our shades feature a unique iridescent technique resulting in a soap bubble effect on glass.

System	Name	Model	Lamping	Shade Color	Socket Finish
<b>MP</b> Canopy <b>QP</b> Quick Connect™	Eden	<b>LED518</b> <b>518</b>	Integral LED Halogen/Xenon	<b>DIC</b> Dichroic	<b>BN</b> Brushed Nickel <b>CH</b> Chrome <b>DB</b> Dark Bronze
	Ambrosia	<b>LED546</b> <b>546</b>	Integral LED Halogen/Xenon		

Example: **QP-LED546-DIC/CH**

Canopy models include Quick Adjust™ canopy  
 Quick Connect™ models require additional adapter (see p.284)







Shown: **QP599-WT/BN**



Shown: **QP-LED599-BL/CH**

## Rhea European Collection

**Lamping:** LEDme® 12V Halogen JC-50  
**Power:** 4W 50W max  
**Lumens:** 330  
**Color Temp:** 3000K  
**CRI:** 85

The white Rhea is mouth blown cased glass with a soda dip resulting in a unique air bubble effect, giving the glass a textured look with a smooth, glossy surface. The blue Rhea is mouth blown cased glass, textured and mottled with various size and color frits, incorporating lightly saturated hues and subtle textures that vary in shade and intensity with changes in light.

System	Model	Lamping	Shade Color	Socket Finish
<b>MP</b> Canopy	<b>LED599</b> <b>599</b>	Integral LED Halogen/Xenon	<b>BL</b> Blue <b>WT</b> White	<b>BN</b> Brushed Nickel
<b>QP</b> Quick Connect™				<b>CH</b> Chrome <b>DB</b> Dark Bronze

Example: **QP-LED599-BL/BN**

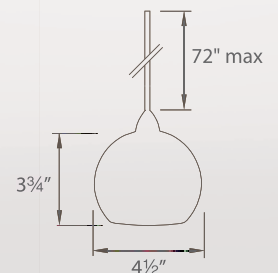

Canopy models include Quick Adjust™ canopy  
 Quick Connect™ models require additional adapter (see p.284)





Shown: **QP913-OE/BN**



Shown: **QP913-CF/CH**



Shown: **QP913-RD/BN**

## Ingo European Collection

**Lamping:** LED 12V Xenon BP-50  
**Power:** 2W 50W max  
**Lumens:** 110  
**Color Temp:** 3000K  
**CRI:** 85

Mouth blown pendants, inspired by the idyllic natural elements of Alpine winters. German craftsmanship in sophisticated slender shades.

System	Model	Lamping	Shade Color	Socket Finish
<b>MP</b> Canopy <b>QP</b> Quick Connect™	<b>913LED</b>	JC LED Bi-Pin	<b>OE</b> Opal Etched <b>RD</b> Red	<b>BN</b> Brushed Nickel <b>CH</b> Chrome <b>DB</b> Dark Bronze
	<b>913</b>	Xenon	<b>CF</b> Clear Frosted <b>OE</b> Opal Etched <b>RD</b> Red	

Example: **QP913-RD/BN**

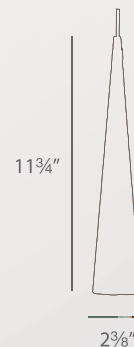

Canopy models include Quick Adjust™ canopy  
 Quick Connect™ models require additional adapter (see p.284)





# Wall Sconce Systems

See p.282 for More Information

## EDEN

Sconce Model	Lamping	Shade Model	Shade Color	Sconce Finish
<b>WS72LED</b> <b>WS72</b> <b>WS57LED</b> <b>WS58LED</b> <b>WS58</b>	12V LED Socket Set 12V Halogen Socket Set Integral LED Integral LED 12V Halogen Bi-Pin	<b>G518</b> <i>Eden</i>	<b>DIC</b> <i>Dichroic</i>	<b>BN</b> <i>Brushed Nickel</i> <b>CH</b> <i>Chrome</i> <b>RB</b> <i>Rubbed Bronze</i>



Example: **WS72LED-G518DIC/BN**



Example: **WS58LED-G518DIC/CH**



Example: **WS57LED-G518/BN**

## FIORI

Sconce Model	Lamping	Shade Model	Shade Color	Sconce Finish
<b>WS72LED</b> <b>WS72</b> <b>WS57LED</b> <b>WS58LED</b> <b>WS58</b>	12V LED Socket Set 12V Halogen Socket Set Integral LED Integral LED 12V Halogen Bi-Pin	<b>G515</b> <i>Fiori</i>	<b>MF</b> <i>Millefiori</i>	<b>BN</b> <i>Brushed Nickel</i> <b>CH</b> <i>Chrome</i> <b>RB</b> <i>Rubbed Bronze</i>



Example: **WS72LED-G515MF/BN**



Example: **WS58LED-G515MF/CH**



Example: **WS57LED-G515MF/BN**

# AMBROSIA

Sconce Model	Lamping	Shade Model	Shade Color	Sconce Finish
<b>WS72LED</b>	12V LED Socket Set	<b>G546</b>	<i>Ambrosia</i>	<b>DIC</b> <i>Dichroic</i>
<b>WS72</b>	12V Halogen Socket Set			
<b>WS57LED</b>	Integral LED			
<b>WS58LED</b>	Integral LED			
<b>WS58</b>	12V Halogen Bi-Pin			
				<b>BN</b> <i>Brushed Nickel</i> <b>CH</b> <i>Chrome</i> <b>RB</b> <i>Rubbed Bronze</i>



Example: **WS72LED-G546DIC/CH**



Example: **WS58LED-G46DIC/BN**



Example: **WS57LED-G546DIC/BN**

# RHEA

Sconce Model	Lamping	Shade Model	Shade Color	Sconce Finish
<b>WS72LED</b>	12V LED Socket Set	<b>G599</b>	<i>Rhea</i>	<b>BL</b> <i>Blue</i> <b>WT</b> <i>White</i>
<b>WS72</b>	12V Halogen Socket Set			
<b>WS57LED</b>	Integral LED			
<b>WS58LED</b>	Integral LED			
<b>WS58</b>	12V Halogen Bi-Pin			
				<b>BN</b> <i>Brushed Nickel</i> <b>CH</b> <i>Chrome</i> <b>RB</b> <i>Rubbed Bronze</i>



Example: **WS72LED-G599WT/BN**



Example: **WS58LED-G599BL/CH**



Example: **WS57LED-G599WT/CH**

Cosmopolitan Collection





Urban chic designs that celebrate the entertainment and hospitality industries make up the Cosmopolitan Collection, ranging from hip and modern concoctions of metal, shine, and sparkle to throwbacks to the underground glam of jazz and soul music. Unique proprietary designs of LED pendants punctuate the collection featuring looks that were not possible previously before the LED lighting revolution.



Shown: QP916-CL/CH

## Clarity Cosmopolitan Collection

**Lamping:** LEDme® 12V Xenon BP-50  
**Power:** 4W 50W max  
**Lumens:** 330  
**Color Temp:** 3000K  
**CRI:** 85

Created by German glass blowers, the Clarity art glass pendant demonstrates dazzling spectral properties.

System	Model	Lamping	Shade Color	Socket Finish
<b>MP</b> Canopy	<b>LED916</b> <b>916</b>	Integral LED Xenon	<b>CL</b> Clear	<b>BN</b> Brushed Nickel
<b>QP</b> Quick Connect™				<b>CH</b> Chrome

Example: **MP-916-CL/CH**

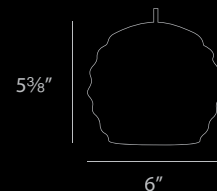

Canopy models include Quick Adjust™ canopy  
 Quick Connect™ models require additional adapter (see p.284)







Shown: **QP-LED966-CH/CH**



Shown: **QP-LED966-BN/BN**

## Bullet Cosmopolitan Collection

**Lamping:** LEDme® 12V Xenon BP-50  
**Power:** 6.4W 50W max  
**Lumens:** 450  
**Color Temp:** 3000K  
**CRI:** 85

Modern minimalist form derived from function. Bullet pendants are available in three hardware matching metal finishes. The white interior of the shade reflects light onto the surface below.

System	Model	Lamping	Shade Finish	Socket Finish
<b>MP</b> Canopy	<b>LED966</b>	Integral LED	<b>BN</b> Brushed Nickel	<b>BN</b> Brushed Nickel
<b>QP</b> Quick Connect™	<b>966</b>	Xenon	<b>CH</b> Chrome	<b>CH</b> Chrome

Example: **QP966-CH/CH**

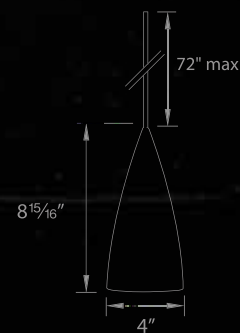

Canopy models include Quick Adjust™ canopy  
 Quick Connect™ models require additional adapter (see p.284)



Shown: QP-LED953-CH/CH



Shown: QP-LED953-BN/BN

## Stadt Cosmopolitan Collection

**Lamping:** LEDme® 12V Xenon BP-50  
**Power:** 4W 50W max  
**Lumens:** 330  
**Color Temp:** 3000K  
**CRI:** 85

Stadt, a spun metal spherical shade, is a modernist pendant rooted in the minimalist look of many of today's contemporary appliances and fixtures.

System	Model	Lamping	Shade Finish	Socket Finish
<b>MP</b> Canopy	<b>LED953</b>	Integral LED	<b>BN</b> Brushed Nickel	<b>BN</b> Brushed Nickel
<b>QP</b> Quick Connect™	<b>953</b>	Halogen/Xenon	<b>CH</b> Chrome	<b>CH</b> Chrome
			<b>DB</b> Dark Bronze	<b>DB</b> Dark Bronze

Example: **MP-LED953-BN/BN**

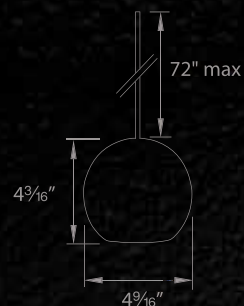

Canopy models include Quick Adjust™ canopy  
 Quick Connect™ models require additional adapter (see p.284)



Shown: QP-LED335-CL/CH

## Roxy Cosmopolitan Collection

**Lamping:** LEDme® 12V Xenon BP-50  
**Power:** 3.7W 50W max  
**Lumens:** 165  
**Color Temp:** 3000K  
**CRI:** 85

Originally conceived to showcase a beautiful design made possible by advances in lighting technology, the LED version of Roxy creates millions of sparkles with none of the glare found in conventional sources. Reminiscent of wild nights, our sophisticated update on the faceted ball of the disco era is fun and eye catching.

System	Name	Lamping	Shade Color	Socket Finish
<b>MP</b> Canopy	<b>LED335</b> <b>335</b>	Integral LED Xenon	<b>CL</b> Clear	<b>BN</b> Brushed Nickel
<b>QP</b> Quick Connect™				<b>CH</b> Chrome

Example: QP-LED335-CL/CH

Canopy models include Quick Adjust™ canopy  
 Quick Connect™ models require additional adapter (see p.284)

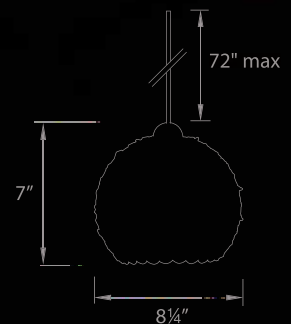





Shown: QP-LED315-PT/CH



Shown: MP-LED315-BK/BN

## Über Cosmopolitan Collection

**Lamping:** LEDme®  
**Power:** 4.5W  
**Lumens:** 210  
**Color Temp:** 3000K  
**CRI:** 85

Discover soft sparkling secrets by peering between the blades. Über's glimmering translucent diffuser gently reveals light through distinctive die-cast metal lines for a brilliantly accented LED pendant.

System	Model	Lamping	Shade Finish	Socket Finish
<b>MP</b> Canopy	<b>LED315</b>	Integral LED	<b>BK</b> Black	<b>BN</b> Brushed Nickel
<b>QP</b> Quick Connect™			<b>PT</b> Platinum	<b>CH</b> Chrome

Example: **MP-LED315-PT/CH**

Canopy models include Quick Adjust™ canopy  
 Quick Connect™ models require additional adapter (see p.284)

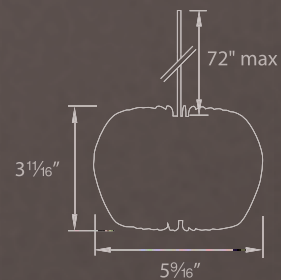

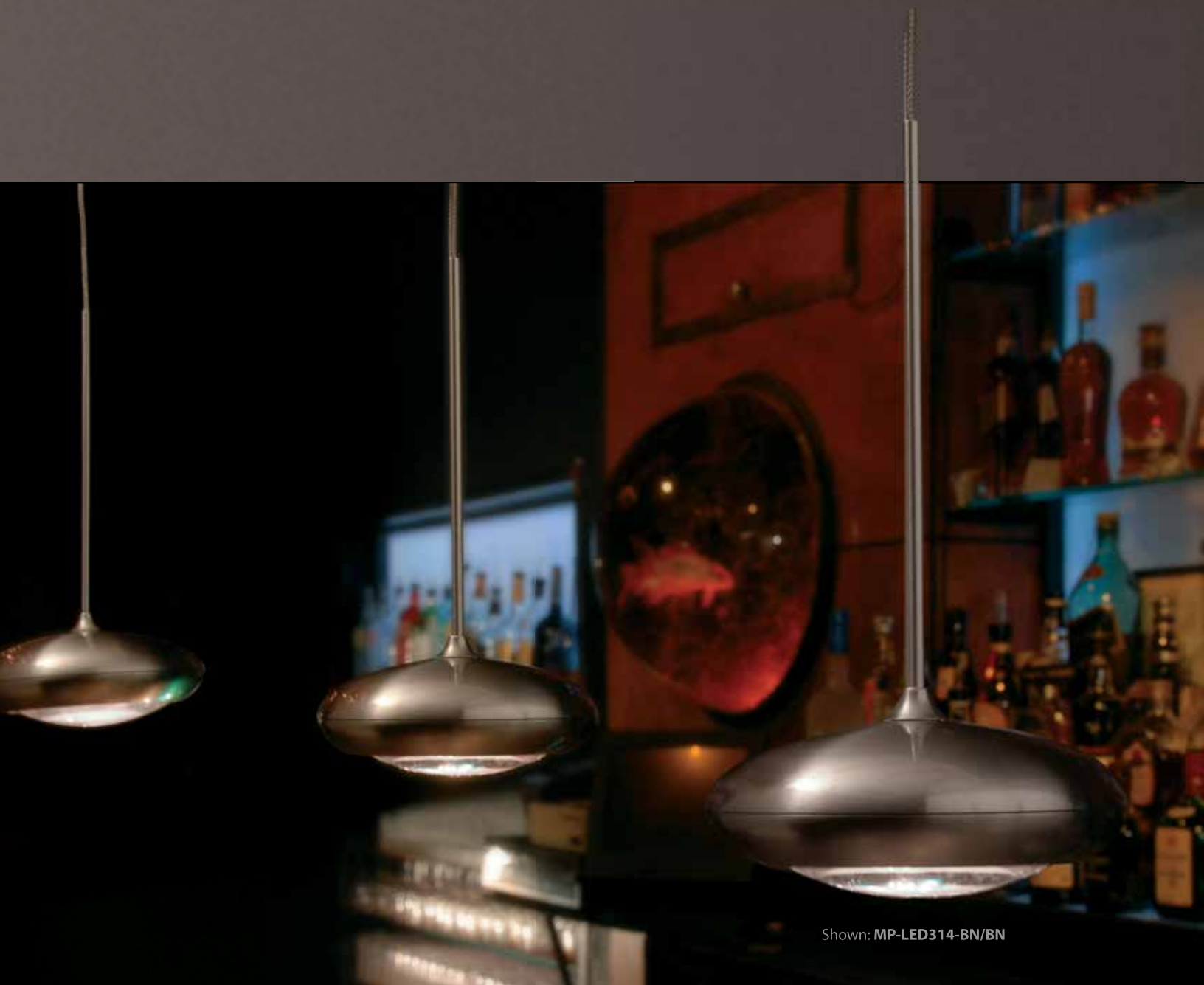

Shown: **MP-LED314-BN/BN**

## Quest Cosmopolitan Collection

**Lamping:** LEDme®  
**Power:** 4.5W  
**Lumens:** 210  
**Color Temp:** 3000K  
**CRI:** 85

The aerodynamic contours of Quest make for a striking art piece while maintaining its powerful LED lumen performance.

System	Model	Lamping	Finish	Shade/Canopy
<b>MP</b> Canopy <b>QP</b> Quick Connect™	<b>LED314</b>	Integral LED	<b>BN/BN</b>	Brushed Nickel/Brushed Nickel

Example: **QP-LED314-BN/BN**

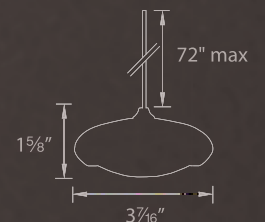

Canopy models include Quick Adjust™ canopy  
 Quick Connect™ models require additional adapter (see p.284)



Shown: **QP919-BU/DB**

## Pome Cosmopolitan Collection

**Lamping:** LED 12V Xenon BP-50  
**Power:** 2W 50W max  
**Lumens:** 110  
**Color Temp:** 3000K  
**CRI:** 85

Colored like a deep red apple, Pome is finely crafted in Germany with an exquisite trumpet design. Perfect to add an exquisite burgundy hue to a fine home, nightclub or restaurant.



System	Model	Lamping	Shade Color	Socket Finish
<b>MP</b> Canopy	<b>919LED</b>	JC LED Bi-Pin	<b>BU</b> Burgundy	<b>BN</b> Brushed Nickel
<b>QP</b> Quick Connect™	<b>919</b>	Xenon		<b>CH</b> Chrome
				<b>DB</b> Dark Bronze

Example: **QP919-BU/DB**

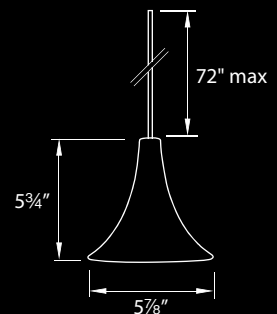

Canopy models include Quick Adjust™ canopy  
 Quick Connect™ models require additional adapter (see p.284)





Shown: **QP914-FR/CH**



Shown: **QP915-CF/CH**

## Tulum Cosmopolitan Collection

**Lamping:** LED 12V Xenon BP-50  
**Power:** 2W 50W max  
**Lumens:** 110  
**Color Temp:** 3000K  
**CRI:** 85

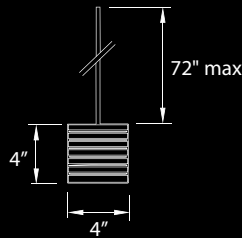

## Tikal Cosmopolitan Collection

**Lamping:** 12V Xenon BP-50  
**Power:** 50W max

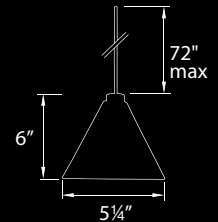

Enhance a modern or transitional setting with lovely frosted glass pendants designed with Mayan lines in Germany.



System	Name	Model	Lamping	Shade Color	Socket Finish
<b>MP</b> Canopy <b>QP</b> Quick Connect™	Tulum	<b>914LED</b>	JC LED Bi-Pin	<b>FR</b> Frosted	<b>BN</b> Brushed Nickel <b>CH</b> Chrome <b>DB</b> Dark Bronze
		<b>914</b>	Xenon		
	Tikal	<b>915</b>	Xenon	<b>CF</b> Clear Frosted	

Example: **QP915-CF/CH**

Canopy models include Quick Adjust™ canopy  
 Quick Connect™ models require additional adapter (see p.284)





Shown: **QP930-CL/CH**



Shown: **QP940-CL/CH**

## Polaris Cosmopolitan Collection

**Lamping:** 12V Xenon BP-50  
**Power:** 50W max

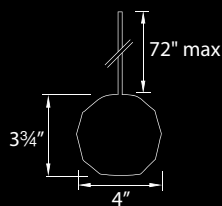

## Prisma Cosmopolitan Collection

**Lamping:** 12V Xenon BP-50  
**Power:** 50W max

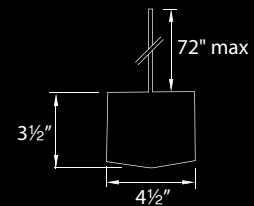

Optical crystals transformed into faceted shapes deploy a broad range of exciting lighting effects.

System	Name	Model	Lamping	Shade Color	Socket Finish
<b>MP</b> Canopy	<i>Polaris</i>	<b>930</b>	<i>Xenon</i>	<b>CL</b> <i>Clear</i>	<b>BN</b> <i>Brushed Nickel</i>
<b>QP</b> <i>Quick Connect™</i>	<i>Prisma</i>	<b>940</b>			<b>CH</b> <i>Chrome</i>
					<b>DB</b> <i>Dark Bronze</i>

Example: **QP930-CL/CH**

Canopy models include Quick Adjust™ canopy  
 Quick Connect™ models require additional adapter (see p.284)





Shown: QP-LED334-CL/CH

## Gem Cosmopolitan Collection

**Lamping:** LEDme®  
**Power:** 3.7W  
**Lumens:** 165  
**Color Temp:** 3000K  
**CRI:** 85

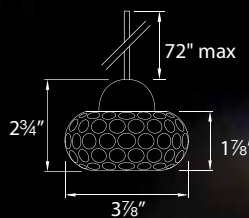

Crafted with tiny dimples that throw colorful sparkles, this lustrous diamond-like pendant is meticulously crafted with hand carved, optical crystal creating unparalleled elegance.

System	Model	Lamping	Shade Color	Socket Finish
<b>MP</b> Canopy <b>QP</b> Quick Connect™	<b>LED334</b>	Integral LED	<b>CL</b> Clear	<b>BN</b> Brushed Nickel <b>CH</b> Chrome <b>DB</b> Dark Bronze

Example: **QP-LED334-CL/CH**

Canopy models include Quick Adjust™ canopy  
 Quick Connect™ models require additional adapter (see p.284)





## Genesis Cosmopolitan Collection

**Lamping:** LEDme®  
**Power:** 5W  
**Lumens:** Up to 240  
**Color Temp:** 3000K  
**CRI:** 85

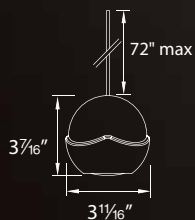

Patent Pending

With dual up-light and down light LED engines, Genesis combines functional performance with ambient lighting for a truly unique pendant. An evolutionary design in a diminutive size, resulting in a stunning decorative accent.

System	Model	Lamping	Finish	Shade/Socket
<b>MP</b> Canopy <b>QP</b> Quick Connect™	<b>LED311</b>	Integral LED	<b>BN/BN</b>	Brushed Nickel/Brushed Nickel

Shown: **QP-LED311-BN/BN**  
with **QMP-1SQ-TR-BN**

Example: **MP-LED311-BN/BN**

Canopy models include Quick Adjust™ canopy  
 Quick Connect™ models require additional adapter (see p.284)



Remote Transformer Required  
 (order separately)



# Genesis LED Cascading Pendants

## Cosmopolitan Collection

Lamping: LEDme®  
 Power: 5W per Light  
 Lumens: Up to 240 per Light  
 Color Temp: 3000K  
 CRI: 85

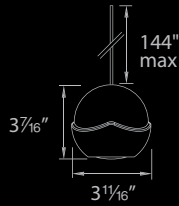

Model	Number of Lights	Canopy Finish
<b>QMP-LED311-MR</b>	1-Light	
<b>QMP-LED311/3-MR</b>	3-Light	Mirror
<b>QMP-LED311/6-MR</b>	6-Light	
<b>QMP-LED311/12-MR</b>	12-Light	

Example: **QMP-LED311/6-MR**

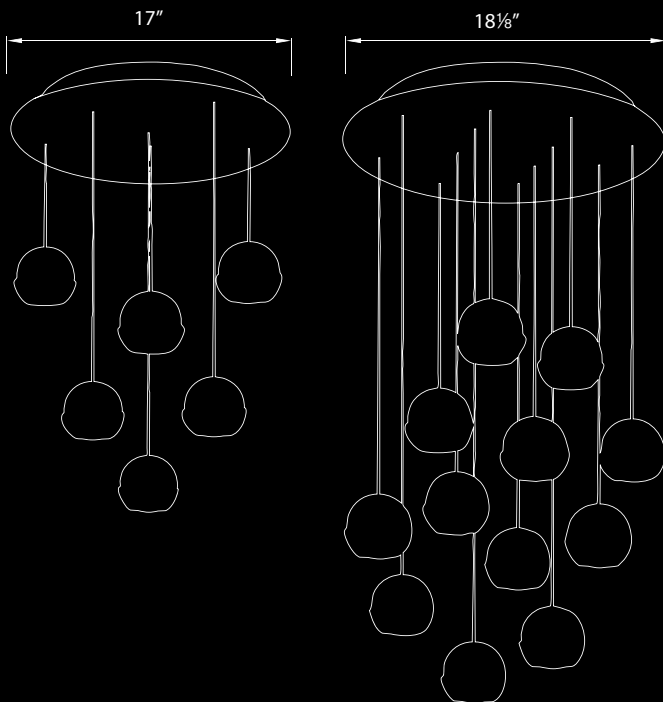
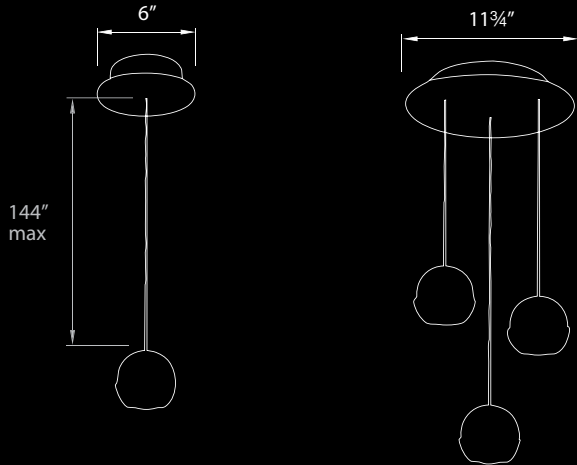

Shown: **QMP-LED311/12-MR**



Shown: **PLD-F4-404BN/BK**



Shown: **PLD-F4-404CO/BK**

## Felis Cosmopolitan Collection

Lamping: LED A19/G30  
 Power: 12W 100W max  
 Lumens: 810  
 Color Temp: 3000K  
 CRI: 85

A charming beehive design, Felis marries energy efficient technology with modern aesthetics.

System	Model	Lamping	Shade Finish	Finish
PLD-F4 Canopy	404LED 404	LED med. base 100W max A19/G30	BN CO	BK Black
				BN Brushed Nickel
HM1-F4 Flexrail1	404LED 404	LED med. base 100W max A19/G30	BN CO	WT White
HTK-F4 H Track				DB Dark Bronze
LTK-F4 L Track	404LED 404	LED med. base 100W max A19/G30	BN CO	PT Platinum
JTK-F4 J Track				BK Black
				BN Brushed Nickel
				WT White

Example: **PLD-F4-404CO/BK**

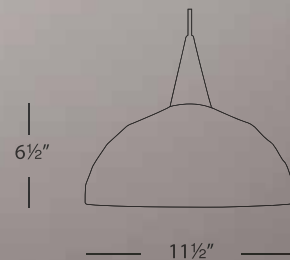

PLD-F4-404 includes canopy



# Wall Sconce Systems

See p.282 for More Information

## TIKAL & TULUM

Sconce Model	Lamping	Shade Model	Shade Color	Sconce Finish
<b>WS72LED</b> <b>WS72</b>	12V LED Socket Set 12V Halogen Socket Set	<b>G915</b> <i>Tikal</i>	<b>CF</b> <i>Clear Frosted</i>	<b>BN</b> <i>Brushed Nickel</i>
		<b>G914</b> <i>Tulum</i>	<b>FR</b> <i>Frosted</i>	<b>CH</b> <i>Chrome</i> <b>RB</b> <i>Rubbed Bronze</i>



Example: **WS72LED-G915CF/CH**



Example: **WS72LED-G914FR/BN**

## PRISMA

Sconce Model	Lamping	Shade Model	Shade Color	Sconce Finish
<b>WS72</b>	12V Halogen Socket Set	<b>G940</b> <i>Prisma</i>	<b>CL</b> <i>Clear</i>	<b>BN</b> <i>Brushed Nickel</i> <b>CH</b> <i>Chrome</i> <b>RB</b> <i>Rubbed Bronze</i>



Example: **WS72LED-G940CL/CH**



## GENESIS & QUEST

Sconce Model	Lamping	Shade Model	Shade Color	Sconce Finish
<b>WS72LED</b>	<i>12V LED Socket Set</i>	<b>G311</b> <i>Genesis</i>	<b>BN</b> <i>Brushed Nickel</i>	<b>BN</b> <i>Brushed Nickel</i>
		<b>G314</b> <i>Quest</i>		



Example: **WS72LED-G311BN/BN**



Example: **WS72LED-G314BN/BN**

## GEM

Sconce Model	Lamping	Shade Model	Shade Color	Sconce Finish
<b>WS72LED</b>	<i>12V LED Socket Set</i>	<b>G334</b> <i>Gem</i>	<b>CL</b> <i>Clear</i>	<b>BN</b> <i>Brushed Nickel</i>
				<b>CH</b> <i>Chrome</i>
				<b>RB</b> <i>Rubbed Bronze</i>



Example: **WS72LED-G334CL/CH**

Contemporary Collection

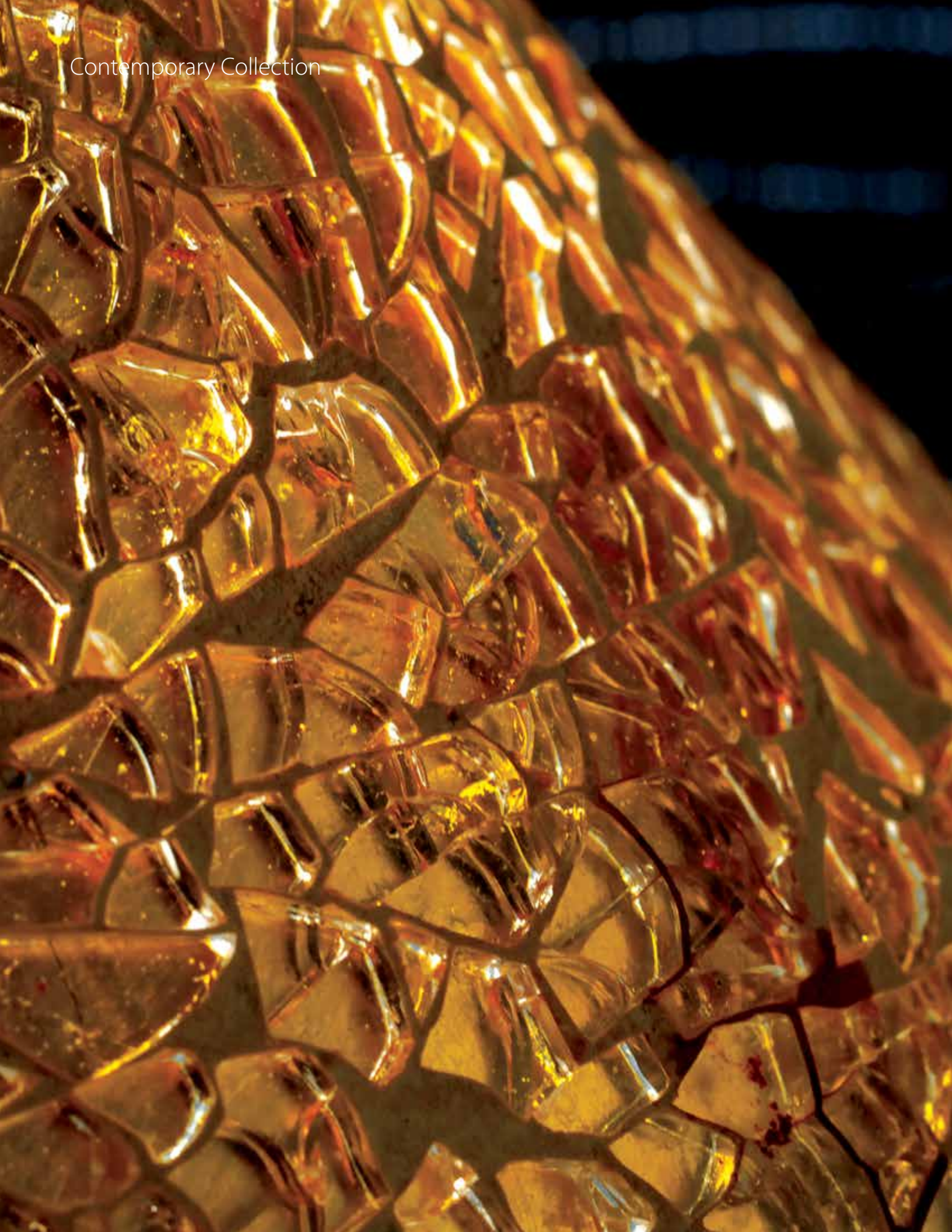



Pairing forward-thinking energy efficient technology with mouth-blown glass craft, the Contemporary Pendant and Sconce Collection represents the essential pendants used most in hotel and restaurant projects displayed in multiples. Now updated with the most cutting-edge in LED lighting options, these pendants and sconces are maintenance-free without sacrificing style or illumination.



Shown: QP559-MR/CH



Shown: QP-LED559-GL/CH

## Micha Contemporary Collection

**Lamping:** LEDme® 12V Halogen JC-50  
**Power:** 4W 50W max  
**Lumens:** 330  
**Color Temp:** 3000K  
**CRI:** 85

Hand crafted from crushed gold and mirrored glass and set in grout to enhance the unique textures. The Micha family of shades brings comforting warmth into your home.

System	Model	Lamping	Shade Color	Socket Finish
<b>MP</b> Canopy	<b>LED559</b>	Integral LED	<b>GL</b> Gold	<b>BN</b> Brushed Nickel
<b>QP</b> Quick Connect™	<b>559</b>	Halogen/Xenon	<b>MR</b> Mirror	<b>CH</b> Chrome
				<b>DB</b> Dark Bronze

Example: QP-LED559-GL/DB

Canopy models include Quick Adjust™ canopy  
 Quick Connect™ models require additional adapter (see p.284)

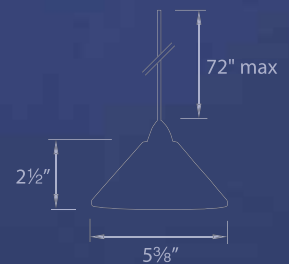



Shown: **QP-LED524-LB/BN**



Shown: **QP-LED524-AM/DB**



Shown: **QP-LED524-WT/CH**

## Sarah Contemporary Collection

**Lamping:** LEDme® 12V Halogen JC-50  
**Power:** 4W 50W max  
**Lumens:** 330  
**Color Temp:** 3000K  
**CRI:** 85

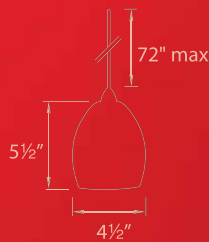

Warm soft colors and an elegant simple design make this the perfect choice for many different applications.

System	Model	Lamping	Shade Color	Socket Finish
<b>MP</b> Canopy <b>QP</b> Quick Connect™	<b>LED524</b>	Integral LED	<b>AM</b> Amber <b>LB</b> Light Blue	<b>BN</b> Brushed Nickel <b>CH</b> Chrome
	<b>524</b>	Halogen/Xenon	<b>WT</b> White	<b>DB</b> Dark Bronze

Example: **QP524-LB/CH**

Canopy models include Quick Adjust™ canopy  
 Quick Connect™ models require additional adapter (see p.284)





Shown: **QP613-WT/CH**



Shown: **QP613-AM/DB**



Shown: **QP613-BL/BN**



Shown: **QP613-RD/BN**

## Lauren Contemporary Collection

12V Halogen JC-50  
50W max

Set a high level of style with boldly colored, hand crafted glass pendants.

System	Model	Lamping	Shade Color	Socket Finish
<b>MP</b> Canopy	<b>613</b>	Halogen	<b>AM</b> Amber	<b>BN</b> Brushed Nickel
<b>QP</b> Quick Connect™			<b>BL</b> Blue	<b>CH</b> Chrome
			<b>RD</b> Red	<b>DB</b> Dark Bronze
			<b>WT</b> White	

Example: **QP613-AM/DB**

Canopy models include Quick Adjust™ canopy  
Quick Connect™ models require additional adapter (see p.284)

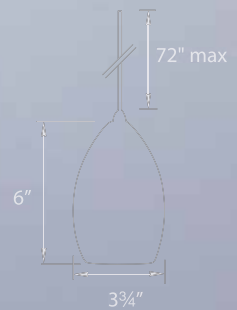



Shown: **QP513-AM/DB**



Shown: **QP-LED513-WT/CH**

## Ella Contemporary Collection

**Lamping:** LEDme® 12V Halogen JC-50  
**Power:** 4W 50W max  
**Lumens:** 330  
**Color Temp:** 3000K  
**CRI:** 85

A refined profile and appealing colors in cased glass.

System	Model	Lamping	Shade Color	Socket Finish
<b>MP</b> Canopy <b>QP</b> Quick Connect™	<b>LED513</b>	Integral LED	<b>AM</b> Amber <b>WT</b> White	<b>BN</b> Brushed Nickel <b>CH</b> Chrome <b>DB</b> Dark Bronze
	<b>513</b>	Halogen/Xenon		

Example: **QP-LED513-WT/CH**

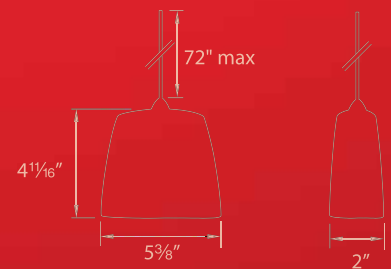

Canopy models include Quick Adjust™ canopy  
 Quick Connect™ models require additional adapter (see p.284)



# Jil Contemporary Collection

**Lamping:** LEDme® 12V Halogen JC-50  
**Power:** 4W 50W max  
**Lumens:** 330  
**Color Temp:** 3000K  
**CRI:** 85

The colorful designer look of mouth blown, cased glass pendants etched in an assortment of candy colors.

System	Model	Lamping	Shade Color	Socket Finish
<b>MP</b> Canopy	<b>LED512</b>	Integral LED	<b>AM</b> Amber	<b>BN</b> Brushed Nickel
<b>QP</b> Quick Connect™		Halogen/Xenon	<b>BL</b> Blue <b>RD</b> Red <b>WT</b> White	<b>CH</b> Chrome <b>DB</b> Dark Bronze

Example: **QP-LED512-RD/BN**

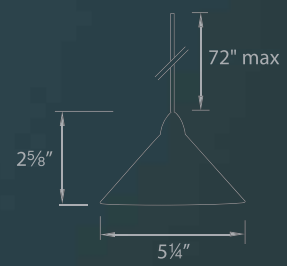

Canopy models include Quick Adjust™ canopy  
 Quick Connect™ models require additional adapter (see p.284)





Shown: **MP-LED541-WT/CH**



Shown: **MP-LED541-AM/DB**

## Fabergè Contemporary Collection

**Lamping:** LEDme® 12V Halogen JC-50  
**Power:** 4W 50W max  
**Lumens:** 330  
**Color Temp:** 3000K  
**CRI:** 85



An enticing palette of layered whites and ambers combined with a classic profile.

System	Model	Lamping	Shade Color	Socket Finish
<b>MP</b> Canopy	<b>LED541</b>	Integral LED	<b>AM</b> Amber	<b>BN</b> Brushed Nickel
<b>QP</b> Quick Connect™	<b>541</b>	Halogen/Xenon	<b>WT</b> White	<b>CH</b> Chrome
				<b>DB</b> Dark Bronze

Example: **QP-LED541-WT/CH**

Canopy models include Quick Adjust™ canopy  
 Quick Connect™ models require additional adapter (see p.284)

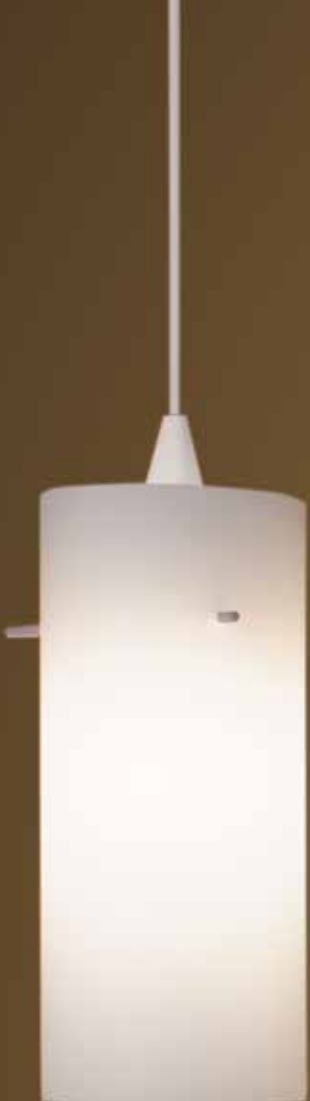

Shown: LTK-F4-454WT/WT



Shown: LTK-F4-454AM/BK

## Dax Cosmopolitan Collection

**Lamping:** LED A19/G30  
**Power:** 12W 100W max  
**Lumens:** 810  
**Color Temp:** 3000K  
**CRI:** 85

Simple and understated, cased white glass cylinders are finished in white or amber acid etched colors.

System	Model	Lamping	Shade Finish	Finish
<b>PLD-F4</b> Canopy				<b>BK</b> Black <b>BN</b> Brushed Nickel <b>WT</b> White
<b>HM1-F4</b> Flexrail1	<b>454LED</b> <b>454</b>	LED med. base 100W max A19/G30	<b>AM</b> Amber	<b>DB</b> Dark Bronze
<b>HTK-F4</b> H Track			<b>WT</b> White	<b>PT</b> Platinum
<b>LTK-F4</b> L Track				<b>BK</b> Black
<b>JTK-F4</b> J Track				<b>BN</b> Brushed Nickel <b>WT</b> White

Example: **PLD-F4-454LEDAM/BK**



PLD-F4-454 includes canopy

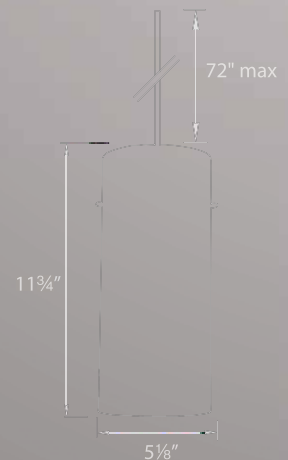



Shown: LTK-F4-451WT/WT

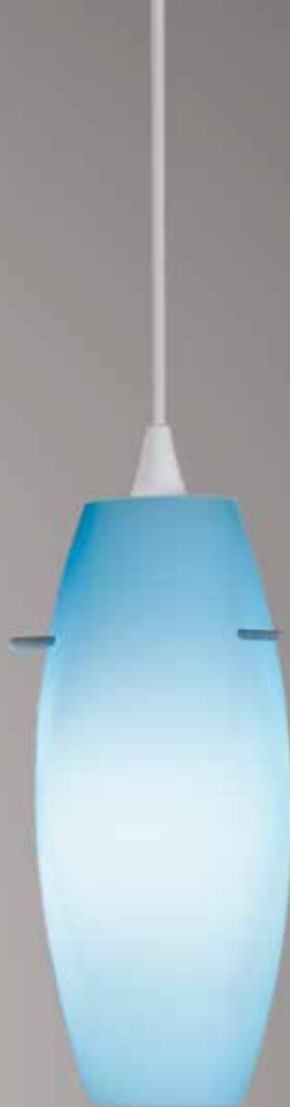

Shown: LTK-F4-451BL/WT



Shown: LTK-F4-451AM/BK

## Bongo Cosmopolitan Collection

**Lamping:** LED A19/G30  
**Power:** 12W 100W max  
**Lumens:** 810  
**Color Temp:** 3000K  
**CRI:** 85

With its exaggerated dimensions, the mouth blown, etched and cased glass Bongo pendants are perfect for medium to large spaces.

System	Model	Lamping	Shade Finish	Finish
<b>PLD-F4</b> Canopy	<b>451LED</b> <b>451</b>	LED med. base 100W max A19/G30	<b>AM</b> Amber <b>BL</b> Blue <b>WT</b> White	<b>BK</b> Black
<b>HM1-F4</b> Flexrail1				<b>BN</b> Brushed Nickel
<b>HTK-F4</b> H Track				<b>DB</b> Dark Bronze
<b>LTK-F4</b> L Track				<b>PT</b> Platinum
<b>JTK-F4</b> J Track				<b>BK</b> Black
				<b>BN</b> Brushed Nickel
				<b>WT</b> White

Example: **PLD-F4-451LEDBL/WT**



PLD-F4-451 includes canopy

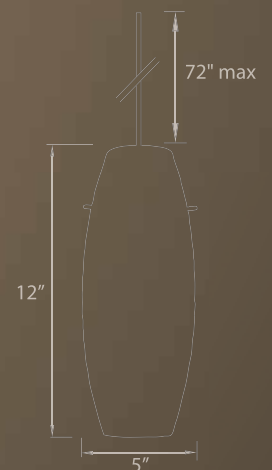

# Wall Sconce Systems

See p.282 for More Information

## JILL & MICHA

Sconce Model	Lamping	Shade Model	Shade Color	Sconce Finish
<b>WS72LED</b> <b>WS72</b> <b>WS57LED</b> <b>WS58LED</b> <b>WS58</b>	12V LED Socket Set 12V Halogen Socket Set Integral LED Integral LED 12V Halogen Bi-Pin	<b>G512</b> <i>Jill</i>	<b>AM</b> Amber <b>BL</b> Blue <b>RD</b> Red <b>WT</b> White	<b>BN</b> Brushed Nickel <b>CH</b> Chrome <b>RB</b> Rubbed Bronze
		<b>G559</b> <i>Micha</i>	<b>GL</b> Gold <b>MR</b> Mirror	



Example: **WS72LED-G512RD/CH**



Example: **WS58LED-G512BL/BN**



Example: **WS57LED-G512AM/RB**



Example: **WS72LED-G559MR/CH**



Example: **WS58LED-G559GL/RB**



Example: **WS57LED-G559MR/CH**

# ELLA & LAUREN

Sconce Model	Lamping	Shade Model	Shade Color	Sconce Finish
<b>WS72LED</b> <b>WS72</b>	12V LED Socket Set 12V Halogen Socket Set	<b>G513</b> <i>Ella</i>	<b>AM</b> Amber <b>WT</b> White	<b>BN</b> Brushed Nickel <b>CH</b> Chrome <b>RB</b> Rubbed Bronze
<b>WS72</b>	12V Halogen Socket Set	<b>G613</b> <i>Lauren</i>	<b>AM</b> Amber <b>BL</b> Blue <b>RD</b> Red <b>WT</b> White	



Example: **WS72LED-G513WT/CH**



Example: **WS72LED-G513AM/RB**



Example: **WS72-G613AM/RB**

\*For LED option, Order LED JC-Bi-pin (JCLEL-2-30-WT). Can be used in 12V Halogen Socket Set.

# FABERGÈ

Sconce Model	Lamping	Shade Model	Shade Color	Sconce Finish
<b>WS72LED</b> <b>WS72</b> <b>WS57LED</b> <b>WS58LED</b> <b>WS58</b>	12V LED Socket Set 12V Halogen Socket Set Integral LED Integral LED 12V Halogen Bi-Pin	<b>G541</b> <i>Fabergè</i>	<b>AM</b> Amber <b>WT</b> White	<b>BN</b> Brushed Nickel <b>CH</b> Chrome <b>RB</b> Rubbed Bronze



Example: **WS72LED-G541WT/BN**



Example: **WS58LED-G541AM/RB**



Example: **WS57LED-G541WT/CH**

Early Electric Collection





A modern rejuvenation of the details characteristic to this historic period. These stunning LED pendants make energy efficient lighting possible in beautiful luminaires designed to suit classic upscale interiors. Each is an alluring work of art, ideal for boutiques and luxury residences. Using minimal wattage, these nostalgic pendants provide warm illumination but are cool to the touch.



Shown: QP-LED497-CL/CH

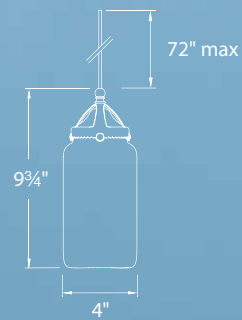

## Mason Early Electric Collection

Lamping: LED  
 Power: 5.6W  
 Lumens: 350  
 Color Temp: 3000K  
 CRI: 85

An iconic symbol of functionality, the mason jar has a long heritage of cozy gatherings and made-from-scratch days. This whimsical piece is the cornerstone to the collection. A must have.

System	Model	Lamping	Shade Color	Socket Finish
<b>MP</b> Canopy	<b>LED497</b>	Integral LED	<b>CL</b> Clear	<b>BN</b> Brushed Nickel
<b>QP</b> Quick Connect™				<b>CH</b> Chrome
				<b>DB</b> Dark Bronze

Example: **MP-LED497-CL/CH**

Canopy models include Quick Adjust™ canopy  
 Quick Connect™ models require additional adapter (see p.284)







Shown: **QP-LED499-CR/CH**



Shown: **QP-LED491-CL/CH**

## Cambridge Early Electric Collection

Lamping: *LED*  
 Power: *5.6W*  
 Lumens: *376*  
 Color Temp: *3000K*  
 CRI: *85*

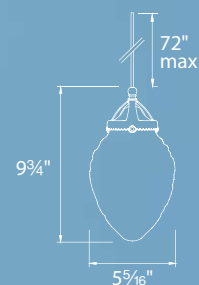

Prismatic sparkles softly illuminate from the exquisite Cambridge pendant, intricately sculpted of faceted crystal with meticulous attention to detail and integrated with sophisticated LED technology.

## Madison Early Electric Collection

Lamping: *LED*  
 Power: *5.6W*  
 Lumens: *360*  
 Color Temp: *3000K*  
 CRI: *85*

Like a frosty winter windowpane, this distinctive crackled glass cylinder sparkles in the light. Transforming rooms with inviting illumination in a design that speaks gently of refinement and elegance.

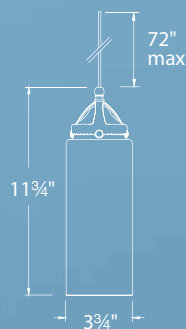

System	Name	Model	Lamping	Shade Color	Socket Finish
<b>MP</b> Canopy <b>QP</b> Quick Connect™	Cambridge	<b>LED491</b>	Integral LED	<b>CL</b> Clear	<b>BN</b> Brushed Nickel
	Madison	<b>LED499</b>		<b>CR</b> Clear Cracked	<b>CH</b> Chrome <b>DB</b> Dark Bronze

Example: **MP-LED491-CL/CH**

Canopy models include Quick Adjust™ canopy  
 Quick Connect™ models require additional adapter (see p.284)



Classic utilitarian styling with a nostalgic feeling. The timeless Wyandotte pendant is a staple amongst early electric reproduction luminaires. A handsome, industrial design with authentic hardware details.



Shown: **QP-LED483-AB/DB**



Shown: **QP-LED483-BN/BN**

# Wyandotte

## Early Electric Collection

Lamping: *LED*  
 Power: *5.6W*  
 Lumens: *385*  
 Color Temp: *3000K*  
 CRI: *85*



System	Model	Lamping	Shade Finish	Socket Finish
<b>MP</b> <i>Canopy</i>	<b>LED483</b>	<i>Integral LED</i>	<b>AB</b> <i>Antique Bronze</i>	<b>BN</b> <i>Brushed Nickel</i>
<b>QP</b> <i>Quick Connect™</i>				

Example: **MP-LED483-AB/DB**

Canopy models include Quick Adjust™ canopy  
 Quick Connect™ models require additional adapter (see p.284)

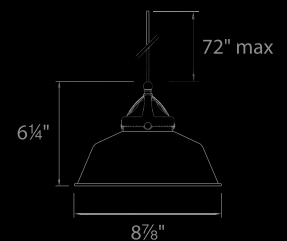



Shown: **QP-LED481-CH/CH**



Shown: **QP-LED481-AB/DB**



Shown: **QP-LED481-BN/BN**

## Freeport Early Electric Collection

Lamping: *LED*  
 Power: *5.6W*  
 Lumens: *362*  
 Color Temp: *3000K*  
 CRI: *85*

Originally designed as a functional fixture for stairwells, sheds and machine shops, Freeport captures the industrial look of yesteryear in a well-proportioned design. Vintage style in a miniaturized LED version with thick-walled glass and beautiful finishes.



System	Model	Lamping	Shade Finish	Socket Finish
<b>MP</b> <i>Canopy</i>	<b>LED481</b>	<i>Integral LED</i>	<b>AB</b> <i>Antique Bronze</i>	<b>BN</b> <i>Brushed Nickel</i>
<b>QP</b> <i>Quick Connect™</i>			<b>CH</b> <i>Chrome</i>	<b>DB</b> <i>Dark Bronze</i>

Example: **MP-LED481-CH/CH**

Canopy models include Quick Adjust™ canopy  
 Quick Connect™ models require additional adapter (see p.284)

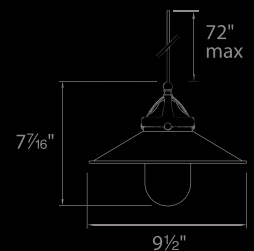



Shown: **QP-LED492-WT/BN**



Shown: **QP-LED494-SL/BN**

## Milford Early Electric Collection

Lamping: *LED*  
 Power: *5.6W*  
 Lumens: *370*  
 Color Temp: *3000K*  
 CRI: *85*

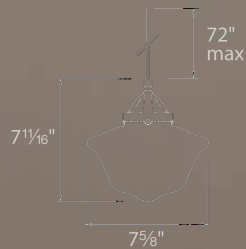

## Plymouth Early Electric Collection

Lamping: *LED*  
 Power: *5.6W*  
 Lumens: *370*  
 Color Temp: *3000K*  
 CRI: *85*

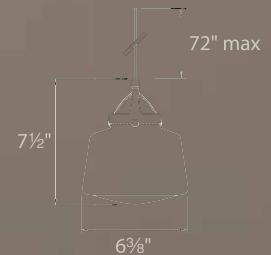

A timeless classic with period perfect authenticity, good lighting design is always a welcomed constant. The soft schoolhouse milky white glass shade creates a warm glow, radiating charm and nostalgia for discriminating designers.

The authentic period reproduction piece is handcrafted of mouth-blown milk white opal glass with hand-painted silver bands. The timeless form picks up a nostalgic feel in a modern day energy efficient luminaire.

System	Name	Model	Lamping	Shade Color	Finish
<b>MP</b> <i>Canopy</i>	<i>Milford</i>	<b>LED492</b>	<i>Integral LED</i>	<b>WT</b> <i>White</i>	<b>BN</b> <i>Brushed Nickel</i>
	<i>Quick Connect™</i>	<b>LED494</b>	<i>Integral LED</i>	<b>SL</b> <i>Silver</i>	<b>CH</b> <i>Chrome</i>
<b>QP</b>	<i>Plymouth</i>			<b>DB</b> <i>Dark Bronze</i>	

Example: **MP-LED492-WT/BN**



Canopy models include Quick Adjust™ canopy  
 Quick Connect™ models require additional adapter (see p.284)



Shown: QP-LED493-WT/CH



Shown: QP-LED495-WT/CH

## Sheffield Early Electric Collection

Lamping: *LED*  
 Power: *5.6W*  
 Lumens: *378*  
 Color Temp: *3000K*  
 CRI: *85*

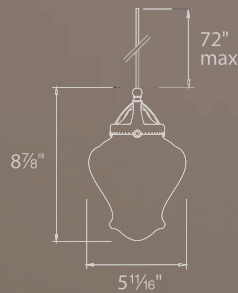

Handcrafted to reflect the understated beauty, and timelessness of authentic period styling. A classic ginger jar style with milky white cased glass. The soft curves and fresh profile of this pendant is right at home in both restored historic and transitional interiors.

## Mirabel Early Electric Collection

Lamping: *LED*  
 Power: *5.6W*  
 Lumens: *375*  
 Color Temp: *3000K*  
 CRI: *85*

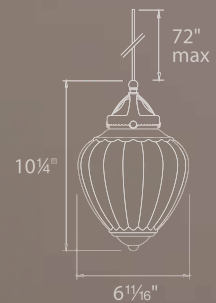

Honoring the Victorian penchant for faceted embellishment, the subtle yet stylish opal cased glass of Mirabel spins a new twist on a classic design. A charming, molded design with gentle illumination.

System	Name	Model	Lamping	Shade Color	Finish
<b>MP</b> Canopy	Sheffield	<b>LED493</b>	<i>Integral LED</i>	<b>WT</b> <i>White</i>	<b>BN</b> <i>Brushed Nickel</i>
<b>QP</b> Quick Connect	Mirabel	<b>LED495</b>			<b>CH</b> <i>Chrome</i>
					<b>DB</b> <i>Dark Bronze</i>

Example: **MP-LED495-WT/CH**

Canopy models include Quick Adjust™ canopy  
 Quick Connect™ models require additional adapter (see p.284)





Shown: **QP-LED498-WT/BN**



Shown: **QP-LED498-AM/DB**

## Huntington Early Electric Collection

Lamping: *LED*  
 Power: *5.6W*  
 Lumens: *360*  
 Color Temp: *3000K*  
 CRI: *85*

The bungalow styling of this pendant brings a quaint charm to your home. With softened acid etched opal and amber glass shades, it is a perfect addition to Arts and Crafts interiors.

System	Model	Lamping	Shade Color	Finish
<b>MP</b> <i>Canopy</i>	<b>LED498</b>	<i>Integral LED</i>	<b>WT</b> <i>White</i>	<b>BN</b> <i>Brushed Nickel</i>
<b>QP</b> <i>Quick Connect™</i>			<b>AM</b> <i>Amber</i>	<b>CH</b> <i>Chrome</i>
			<b>DB</b> <i>Dark Bronze</i>	

Example: **MP-LED498-WT/BN**

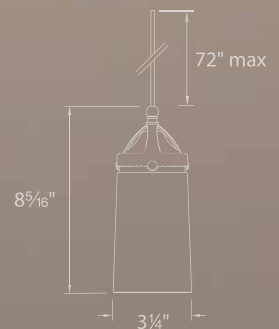

Canopy models include Quick Adjust™ canopy  
 Quick Connect™ models require additional adapter (see p.284)



Shown: **QP-LED496-IR/DB**

## Artemis Early Electric Collection

Lamping: *LED*  
 Power: *5.6W*  
 Lumens: *155*  
 Color Temp: *3000K*  
 CRI: *85*

A nostalgic design transformed beautifully into an energy efficient LED pendant.  
 Handcrafted with an iridescent sheen and blown into a gracefully lustrous form.

System	Model	Lamping	Shade Color	Finish
<b>MP</b> <i>Canopy</i>	<b>LED496</b>	<i>Integral LED</i>	<b>IR</b> <i>Iridescent</i>	<b>BN</b> <i>Brushed Nickel</i>
<b>QP</b> <i>Quick Connect</i>				<b>CH</b> <i>Chrome</i>
				<b>DB</b> <i>Dark Bronze</i>

Example: **MP-LED496-IR/DB**

Canopy models include Quick Adjust™ canopy  
 Quick Connect™ models require additional adapter (see p.284)

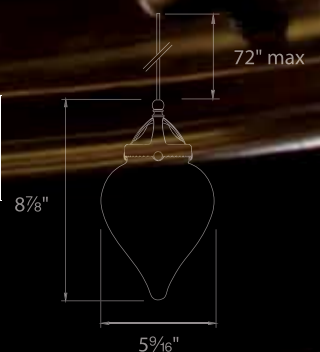





# Wall Sconce Systems

A Custom Sconce in Two Easy Steps:

1. Select Shade
2. Select Sconce Bracket

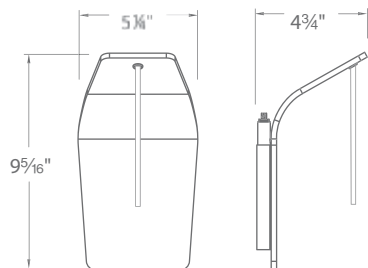

<b>Model:</b>	<i>WS72LED</i>	<i>WS72</i>
<b>Lamping:</b>	<i>12V LED Socket Sets</i>	<i>12V Halogen/ Xenon Socket Sets</i>
<b>Power:</b>	<i>3.7W - 5.6W</i>	<i>Up to 60W max</i>
<b>Lumens:</b>	<i>Up to 427</i>	
<b>Color Temp:</b>	<i>3000K</i>	
<b>CRI:</b>	<i>85</i>	
<b>Dim:</b>	<i>100% - 10%</i>	

Compatible with all Quick Connect™ Pendants under 6" in diameter



Allows for Easy Cable Adjustments up to 72"

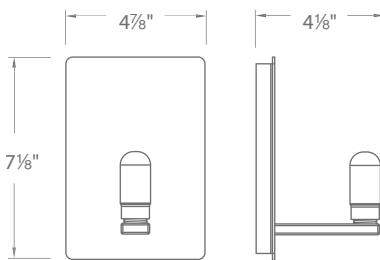

<b>Model:</b>	<i>WS58LED</i>	<i>WS58</i>
<b>Lamping:</b>	<i>Integral LED</i>	<i>12V Halogen/ Xenon Bi-Pin</i>
<b>Power:</b>	<i>6W</i>	<i>50W max</i>
<b>Lumens:</b>	<i>305</i>	
<b>CCT:</b>	<i>3000K</i>	
<b>CRI:</b>	<i>85</i>	
<b>Dim:</b>	<i>100% - 10%</i>	

Accommodates any 500 series glass under 6" in diameter

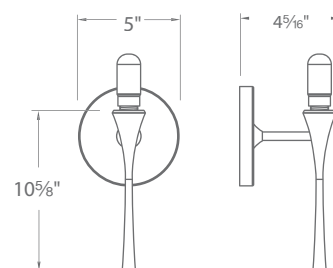

<b>Model:</b>	<i>WS57LED</i>
<b>Lamping:</b>	<i>Integral LED</i>
<b>Power:</b>	<i>6W</i>
<b>Lumens:</b>	<i>305</i>
<b>CCT:</b>	<i>3000K</i>
<b>CRI:</b>	<i>85</i>
<b>Dim:</b>	<i>100% - 10%</i>







Accommodates any 500 series glass under 6" in diameter

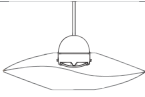

All Bi-Pin socket sets can accept an LED Bi-Pin (**JCLEL-2-30-WT** - order separately).  
All sconces come with an electronic transformer and are available with LED lamping.

# Quick Connect™ Socket Sets

Low Voltage Quick Connect™ socket sets include a 6 foot braided cable that may be cut in the field to the desired height. A 12 foot socket set may be ordered separately.

Series	Specifications	Model	Length	Finish
 <p>300 Series LEDme® Socket Set</p>	<ul style="list-style-type: none"> <li>• Shade mounts easily to socket by removing threaded collar, sliding socket into shade cutout and re-attaching collar</li> <li>• Smooth and continuous ELV dimming</li> <li>• 50,000 hour rated life</li> <li>• Energy efficient</li> <li>• No projected UV or IR radiation</li> <li>• 3.7W; 165 Lumens</li> </ul>	<p><b>QP-LED303</b> <b>QP-LED303X12</b></p>	<p>6 ft 12 ft</p>	
 <p>400 Series Early Electric LEDme® Socket Set</p>	<ul style="list-style-type: none"> <li>• Three threaded screws are used to secure shade to socket</li> <li>• Smooth and continuous ELV dimming</li> <li>• 50,000 hour rated life</li> <li>• Energy efficient</li> <li>• No projected UV or IR radiation</li> <li>• 5.6W; 427 Lumens</li> </ul>	<p><b>QP-LED403</b> <b>QP-LED403X12</b></p>	<p>6 ft 12 ft</p>	
 <p>500 Series LEDme® Socket Set</p>	<ul style="list-style-type: none"> <li>• Threaded ring secures shade to socket</li> <li>• Smooth and continuous ELV dimming</li> <li>• 50,000 hour rated life</li> <li>• Energy efficient</li> <li>• No projected UV or IR radiation</li> <li>• 4W; 330 Lumens</li> </ul>	<p><b>QP-LED503</b> <b>QP-LED503X12</b></p>	<p>6 ft 12 ft</p>	
 <p>500 Series Low Voltage Socket Set</p>	<ul style="list-style-type: none"> <li>• Bulb shield secures shade to socket</li> <li>• Includes 12V, 50W halogen bi-pin</li> <li>• Smooth and continuous dimming</li> <li>• 20W and 35W lamps available to reduce glare (see p.345)</li> <li>• Accepts 12V or 24V Halogen or LED G6.35 bi-pin lamps</li> </ul>	<p><b>QP-501</b> <b>QP-501X12</b></p>	<p>6 ft 12 ft</p>	<p><b>BN</b> <i>Brushed Nickel</i> <b>CH</b> <i>Chrome</i> <b>DB</b> <i>Dark Bronze</i></p>
 <p>600 Series Low Voltage Socket Set</p>	<ul style="list-style-type: none"> <li>• Height adjuster used to position lamp inside the shade</li> <li>• Bulb shield included</li> <li>• Includes 12V, 50W halogen lamp</li> <li>• Smooth and continuous dimming</li> <li>• 20W and 35W lamps available to reduce glare (see p.345)</li> <li>• Accepts 12V or 24V Halogen or LED G6.35 bi-pin lamps</li> </ul>	<p><b>QP-601</b> <b>QP-601X12</b></p>	<p>6 ft 12 ft</p>	
 <p>900 Series LEDme® Socket Set</p>	<ul style="list-style-type: none"> <li>• Includes collar with threaded set screw to allow for varying lamp positions inside the shade</li> <li>• Smooth and continuous ELV dimming</li> <li>• Do not rest glass on socket base</li> <li>• 50,000 hour rated life</li> <li>• Energy efficient</li> <li>• No projected UV or IR radiation</li> <li>• 6.4W; 450 Lumens</li> </ul>	<p><b>QP-LED903</b> <b>QP-LED903X12</b></p>	<p>6 ft 12 ft</p>	
 <p>900 Series Low Voltage Socket Set</p>	<ul style="list-style-type: none"> <li>• Includes collar with threaded set screw to allow for varying lamp positions inside the shade</li> <li>• Do not rest glass on socket base</li> <li>• Includes 12V, 50W xenon lamp</li> <li>• Smooth and continuous dimming</li> <li>• MR16G can be used depending on shade selection</li> <li>• Accepts 12V or 24V Xenon G6.35 bi-pin lamps</li> </ul>	<p><b>QP-902</b> <b>QP-902X12</b></p>	<p>6 ft 12 ft</p>	

Example: **QP-LED503X12-CH**

# Quick Connect™ Adapters

The Quick Connect™ collection includes a wide array of pendants and fixtures with different mounting options. The threaded male adapter makes inter-system compatibility a snap. Simply insert the metal fitting into the system adapter and hand tighten the collar. **Order one per Quick Connect™ fixture or pendant used.**









System Adapter	Specifications	Model	Finish
<p>120V Track H, L, J</p> <p>p.117</p> 	<ul style="list-style-type: none"> <li>• Allows all Quick Connect™ elements to be used with the H, L, J, J2 track systems</li> <li>• 1W minimum load transformer</li> <li>• Smooth and continuous ELV dimming</li> <li>• *Dark Bronze only available for H-Track</li> </ul>	<p><b>EN-HQ50AR</b> <i>H Track</i></p> <p><b>EN-LQ50AR</b> <i>L Track</i></p> <p><b>EN-JQ50AR</b> <i>J Track</i></p>	<p><b>BK</b> <i>Black</i></p> <p><b>BN</b> <i>Brushed Nickel</i></p> <p><b>WT</b> <i>White</i></p> <p><b>DB*</b> <i>Dark Bronze</i></p>
<p>Solorail™</p> <p>p.177</p> 	<ul style="list-style-type: none"> <li>• Allows all Quick Connect™ elements to be used with the Solorail™ system</li> </ul>	<p><b>LM-QADP</b></p>	<p><b>BN</b> <i>Brushed Nickel</i></p> <p><b>DB</b> <i>Dark Bronze</i></p>
<p>Duorail™</p> <p>p.172</p> 	<ul style="list-style-type: none"> <li>• Allows all Quick Connect™ elements to be used with the Duorail™ system</li> </ul>	<p><b>LM2-QADP</b></p>	<p><b>BN</b> <i>Brushed Nickel</i></p> <p><b>DB</b> <i>Dark Bronze</i></p>
<p>Flexrail1™</p> <p>p.185</p> 	<ul style="list-style-type: none"> <li>• Allows all Quick Connect™ elements to be used with the Flexrail1™ system</li> <li>• Smooth and continuous ELV dimming</li> <li>• 1 watt minimum load</li> </ul>	<p><b>HM1-EN50</b></p>	<p><b>DB</b> <i>Dark Bronze</i></p> <p><b>PT</b> <i>Platinum</i></p>

Example: **LM2-QADP-BN**

# Quick Connect™ Canopies



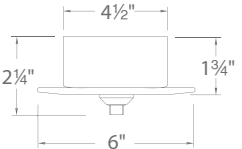

## Mirror Glass Multipoint Canopies (Integral Transformers)

- For use with any of our hundreds of Quick Connect™ pendants
- 1W minimum load
- 60W Integral electronic transformer for each drop
- Smooth and continuous ELV dimming

			Model	Finish
12-Point Mirrored Canopy Round			<b>QMP-G12RN</b>	<b>MR</b> <i>Mirror</i>
6-Point Mirrored Canopy Round			<b>QMP-G6RN</b>	
3-Point Mirrored Canopy Round			<b>QMP-G3RN</b>	
3-Point Mirrored Canopy Rectangular			<b>QMP-G3RE</b>	
1-Point Mirrored Canopy Round			<b>QMP-G1RN</b>	

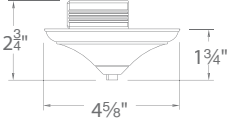
## Monopoint Canopies (Integral Transformers)

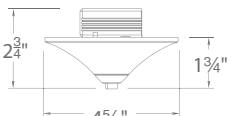
- 1W minimum load required
- 60W Integral electronic transformer
- Smooth and continuous ELV dimming
- For use with a 4" junction box; includes optional collar for shallow junction box

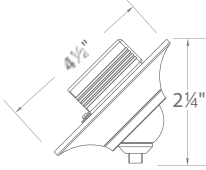

			Model	Finish
Early Electric Canopy			<b>QMP-60ERN-1</b>	<b>AB</b> <i>Antique Bronze</i> <b>BN</b> <i>Brushed Nickel</i> <b>CH</b> <i>Chrome</i>
Adapter Canopy			<b>QMP-60ERN</b>	<b>BN</b> <i>Brushed Nickel</i> <b>CH</b> <i>Chrome</i> <b>DB</b> <i>Dark Bronze</i>
Sloped Ceiling Canopy			<b>QMP-S60ERN</b>	<b>BN</b> <i>Brushed Nickel</i> <b>CH</b> <i>Chrome</i> <b>DB</b> <i>Dark Bronze</i>
<ul style="list-style-type: none"> <li>• Swivels up to 45° in either direction and will accept all WAC Lighting Quick Connect™ pendants and fixtures</li> <li>• For use with a 4" junction box; includes collar for shallow junction box</li> </ul>				

Example: **QMP-60ERN-BN**

# Quick Connect™ Canopies



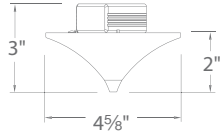

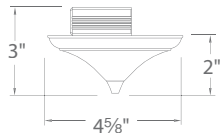
## Quick Adjust™ Monopoint Canopies (Integral Transformers)

- 1W minimum load required
- 60W Integral electronic transformer
- Smooth and continuous ELV dimming

		Model	Finish
<p>Quick Adjust™ Pendant Canopy</p>  <p>• UL &amp; CUL Listed • Adjustable pendants can be raised/lowered after installation • For use with a 4" junction box; includes collar for shallow junction box</p>		<b>MP-60E</b>	<b>BN</b> <i>Brushed Nickel</i> <b>CH</b> <i>Chrome</i> <b>DB</b> <i>Dark Bronze</i>
<p>Early Electric Quick Adjust™ Pendant Canopy</p>  <p>• UL &amp; CUL Listed • Adjustable pendants can be raised/lowered after installation • For use with a 4" junction box; includes collar for shallow junction box</p>		<b>MP-60E-1</b>	<b>AB</b> <i>Antique Bronze</i> <b>BN</b> <i>Brushed Nickel</i> <b>CH</b> <i>Chrome</i>

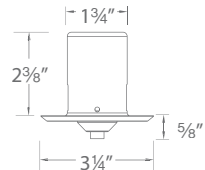
## Monopoint Canopies (Remote Transformers Required)

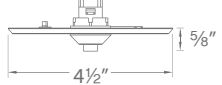
- Order remote transformer separately
- No visible hardware

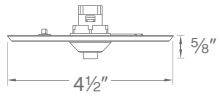
		Model	Finish
<p>Miniature Round Canopy with Wiring Compartment</p>  <p>• The recessed "housing" is a wiring compartment with one knock-out that accepts trade size connectors • The housing is installed in the cutout hole and then the faceplate is attached</p>		<b>QMP-MI-TR</b>	<b>BN</b> <i>Brushed Nickel</i> <b>CH</b> <i>Chrome</i> <b>DB</b> <i>Dark Bronze</i>
<p>Round Canopy for Junction Box</p>  <p>• Mounts over a standard 4" junction box • Base plate covers junction box opening, the canopy attaches to base plate with a metal nut</p>		<b>QMP-1RN-TR</b>	<b>BN</b> <i>Brushed Nickel</i> <b>CH</b> <i>Chrome</i> <b>DB</b> <i>Dark Bronze</i> <b>WT</b> <i>White</i>
<p>Square Canopy For Junction Box</p>  <p>• Mounts over a standard 4" junction box • Base plate covers junction box opening, the canopy attaches to base plate with metal nut</p>		<b>QMP-1SQ-TR</b>	<b>BN</b> <i>Brushed Nickel</i> <b>CH</b> <i>Chrome</i> <b>DB</b> <i>Dark Bronze</i>

Example: **MP-60E-1-CH**

# dwelLED™

by WAC Lighting

[dwell-E-D]

LED technology becomes accessible for decorative luminaires, with transitional styling and 2700K warm white light for even the most demanding applications.

dwelLED™ decorative LED luminaires are designed to integrate within a variety of spaces ranging from multi-family residential to commercial and healthcare. Options include ADA compliance, ELV dimming, 277 volt power, wet location, and a variety of sizes and finishes.

The dwelLED collection incorporates indoor and outdoor sconces, vanities, swing-arm reading lights, ceiling-mount lights, picture lights, and chandeliers, all engineered optimally for energy efficient LEDs.

Consult the factory to take advantage of our custom capabilities in large quantities.



Vanities & Sconces .....	289 - 296
Wall Sconces .....	297 - 304
Ceiling Mounts .....	305 - 312
Pendants .....	313 - 322
Chandeliers .....	323 - 324
Picture Lights .....	325 - 328
Swing Arms .....	329 - 336
Outdoor .....	337 - 342





## Svelte LED Vanities & Sconces

### Gracefully slender at 3 inches in width

- 5mm thick mitered glass with ceramic glaze
- Vertical or horizontal mount
- ADA compliant
- Meets 2013 California Title 24 Efficiency
- No driver or transformer needed
- Conversion plate for 4 inch J box included
- Smooth and continuous ELV dimming
- ETL & cETL damp location listed
- 277V available (special order)

Color Temp: 2700K  
 CRI: 90  
 Dimming: 100% – 10%  
 Rated Life: 80,000 hours

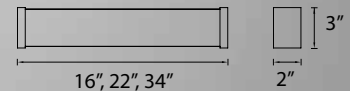

Water clear glass with mitered edge lines speak to the sophistication of this ultra minimalist, rectilinear luminaire, artfully framed with die-cast metal end caps. Robust illumination as a vanity in hospitality bath applications or as a sconce in hallways. Proprietary LED technology.

		Length		Watt	LED Lumens	Delivered Lumens	Finish
	<i>Small</i>	16"	<b>WS-7316</b>	24.5W	1845	875	<b>BN</b> <i>Brushed Nickel</i> <b>CH</b> <i>Chrome</i> 
	<i>Medium</i>	22"	<b>WS-7322</b>	34.5W	2580	1350	
	<i>Large</i>	34"	<b>WS-7334</b>	48W	4043	2100	

Example: **WS-7316-CH**  
 For 277V, add an "F" before the finish: **WS-7316F-CH**

Patent pending





## Elemental LED Vanities & Sconces



### A streamlined luminaire sealed to meet healthcare facility requirements

- IP65 rated, ETL & cETL wet location listed for indoor application
- Mouth blown etched triplex glass
- Vertical or horizontal mount
- ADA Compliant
- Meets 2013 California Title 24 Efficiency
- No driver or transformer needed
- Smooth and continuous ELV dimming
- 277V available (special order)

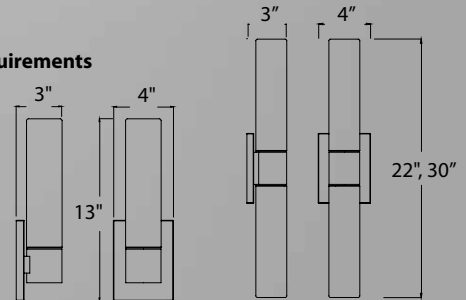
**Color Temp:** 2700K  
**CRI:** 90  
**Dimming:** 100% – 10%  
**Rated Life:** 80,000 hours

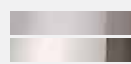

The uniform cylinder transitions from cased etched opal glass to perfectly plated metal seamlessly.  
 Wall mounted vertically . on either side of a mirror or place one horizontally above for flattering diffuse illumination.

		Length		Watt	LED Lumens	Delivered Lumens	Finish
	<i>Small</i>	13"	<b>WS-7213</b>	15.5W	1118	730	<b>BN</b> Brushed Nickel <b>CH</b> Chrome 
	<i>Medium</i>	22"	<b>WS-7222</b>	30.5W	2236	1505	
	<i>Large</i>	30"	<b>WS-7230</b>	39.5W	2925	1955	

Example: **WS-7222-BN**  
 For 277V, add an "F" before the finish: **WS-7222F-BN**

Patent pending



## Astoria LED Vanities & Sconces



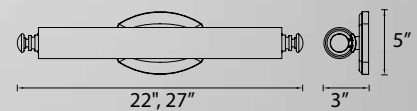
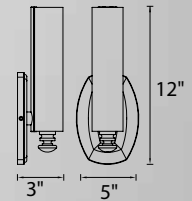

**Understated elegance that transitions old world charm to modern day styling**

- Mouth blown etched triplex glass
- Vertical or horizontal mount
- ADA Compliant
- Meets 2013 California Title 24 Efficiency
- No driver or transformer needed
- Smooth and continuous ELV dimming
- ETL & cETL damp location listed
- 277V available (special order)

**Color Temp:** 2700K  
**CRI:** 90  
**Dimming:** 100% – 10%  
**Rated Life:** 80,000 hours



Mouth blown and acid etched 3-layer glass combined with casted and plated hardware and proprietary LED technology designed for powerful lumen output and excellent color rendering. A fit and finish to complement today's bath hardware and traditional lighting finishes.

		Length		Watt	LED Lumens	Delivered Lumens	Finish
	<i>Small</i>	12"	<b>WS-7012</b>	15W	1118	655	<b>AN</b> <i>Antique Nickel</i> <b>BB</b> <i>Burnished Brass</i> <b>BO</b> <i>Brushed Bronze</i> <b>PN</b> <i>Polished Nickel</i> 
	<i>Medium</i>	22"	<b>WS-7022</b>	31.5W	2236	1610	
	<i>Large</i>	27"	<b>WS-7027</b>	38W	2925	1950	

Example: **WS-7022-BO**  
 For 277V, add an "F" before the finish: **WS-7022F-BO**

Patent pending



p.308 Bristol ceiling mount





# Bristol LED Vanities & Sconces

- Modern technology, masculine traditional**
- Mouth blown etched triplex glass
  - Four finishes to complement most bath hardware
  - Vertical or horizontal mount
  - ADA compliant
  - Meets 2013 California Title 24 Efficiency
  - No driver or transformer needed
  - Smooth and continuous ELV dimming
  - ETL & cETL damp location listed
  - 277V available (special order)

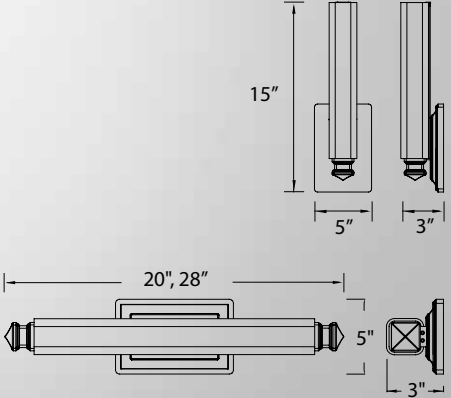
**Color Temp:** 2700K  
**CRI:** 90  
**Dimming:** 100% – 10%  
**Rated Life:** 80,000 hours

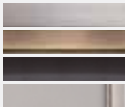

Handsome traditional styling upgraded with modern LED technology make for a beautiful luminaire, with energy savings and zero-maintenance. Etched blown glass with soft square edges illuminates with unparalleled uniformity and efficacy. Cast metal decorative transitional end caps and matching rectangular back plate complete the masculine design. Four designer finishes available to complement popular bath hardware and art frames.

		Length		Watt	LED Lumens	Delivered Lumens	Finish
	<i>Small</i>	15"	<b>WS-7115</b>	19W	1462	990	<b>AN</b> <i>Antique Nickel</i> <b>BB</b> <i>Burnished Brass</i> <b>BO</b> <i>Brushed Bronze</i> <b>PN</b> <i>Polished Nickel</i> 
	<i>Medium</i>	20"	<b>WS-7120</b>	25.5W	1845	1345	
	<i>Large</i>	28"	<b>WS-7128</b>	37.5W	2925	1935	

Example: **WS-7120-AN**  
 For 277V, add an "F" before the finish: **WS-7120F-AN**

Patent pending



## Sonoma LED Vanities & Sconces



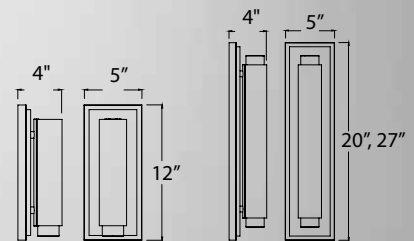

### Hand applied natural shell tiles over plated mirror chrome

- Mouth blown etched triplex glass
- ADA compliant
- Meets 2013 California Title 24 Efficiency
- No driver or transformer needed
- Vertical or horizontal mount
- Smooth and continuous ELV dimming
- ETL & cETL damp location listed
- 277V available (special order)

**Color Temp:** 2700K  
**CRI:** 90  
**Dimming:** 100% – 10%  
**Rated Life:** 80,000 hours



An upscale transitional design to complement many bath renovations. Mouth blown etched opal glass shines at the forefront of a stunning natural seashell mosaic artfully tiled by hand for visual depth and attention to detail. Mount vertically or horizontal for various locations and applications.

		Length		Watt	LED Lumens	Delivered Lumens	Finish
	<i>Small</i>	12"	<b>WS-6312</b>	7.5W	592	340	<b>CH</b> Chrome 
	<i>Medium</i>	20"	<b>WS-6320</b>	13.5W	980	695	
	<i>Large</i>	27"	<b>WS-6327</b>	17.5W	1346	865	

Example: **WS-6312-CH**  
 For 277V, add an "F" before the finish: **WS-6312F-CH**

Patent pending



p.307 Vie ceiling mount







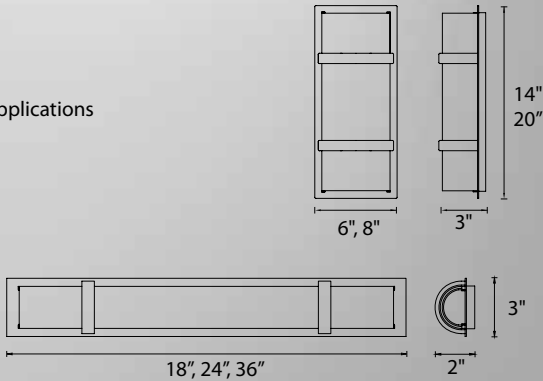

# Vie LED Vanities & Sconces

- Sleek elegance for narrow applications**
- Bath lights have 3 inch wide format for narrow applications
  - Screened white glass
  - Vertical or horizontal mount
  - Bath lights are ADA compliant
  - Meets 2013 California Title 24 Efficiency
  - Conversion plate for 4 inch J box included
  - Smooth and continuous ELV dimming
  - ETL & cETL damp location listed
  - No driver or transformer needed
  - 277V available (special order)

**Color Temp:** 2700K  
**CRI:** 90  
**Dimming:** 100% – 10%  
**Rated Life:** 80,000 hours

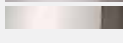

Sleek understated elegance in a unique format perfect for narrow bath applications and niches. Utilizing proprietary LED technology, the bath luminaire operates without a driver or transformer and dims beautifully with an ELV dimmer. Cool contemporary Brushed Nickel and Chrome finishes.

		Length	Watt	LED Lumens	Delivered Lumens	Finish
	Wall Sconce	14" <b>WS-6614</b>	18.5W	1462	755	<b>BN</b> Brushed Nickel  <b>CH</b> Chrome 
	Wall Sconce	20" <b>WS-6620</b>	24.5W	1845	1040	
	Bath Light	18" <b>WS-6618</b>	25.5W	1845	1085	
	Bath Light	24" <b>WS-6624</b>	35W	2580	1585	
	Bath Light	36" <b>WS-6636</b>	55W	4043	2360	

Example: **WS-6614-BN**  
 For 277V, add an "F" before the finish: **WS-6614F-BN**

Patent pending



Line takes edge-lit LED technology inside a thin rotary panel to softly provide uniform illumination for flattering facial rendering. The rotating panel can be tilted for direct light in the daytime or indirect light at night. Offered in 2700K and 3000K with variety of related products to complement room interiors.



p.324 Line chandelier



p.78 - 80 Line undercabinet

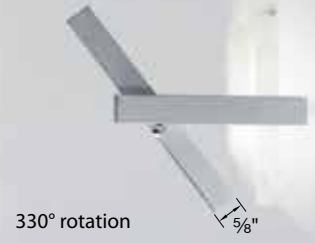





## Line LED Vanities & Sconces

**Color Temp:** 2700K, 3000K  
**CRI:** 90  
**Dimming:** 100% – 10%  
**Rated Life:** 80,000 hours

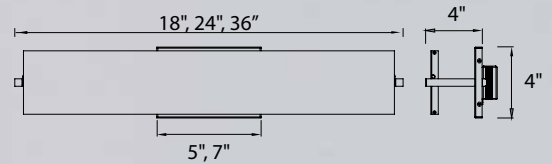
### Super thin, 5/8" edge-lit LED panel

- Vertical or horizontal mount with 330° adjustment
- Meets 2013 California Title 24 Efficiency
- Smooth and continuous ELV dimming
- ETL & cETL damp location listed
- Transformer located in J box
- 277V available (special order)



	Length		Watt	Color Temp	LED Lumens	Delivered Lumens	Finish
	18"	<b>WS-6718-27</b> <b>WS-6718-30</b>	16.5W	2700K 3000K	1004 1109	770 850	<b>AL</b> Brushed Aluminum 
	24"	<b>WS-6724-27</b> <b>WS-6724-30</b>	20W	2700K 3000K	1339 1478	1035 1140	
	36"	<b>WS-6736-27</b> <b>WS-6736-30</b>	29W	2700K 3000K	2009 2218	1380 1520	

Example: **WS-6724-30-AL**

For 277V, add an "F" before the color temperature: **WS-6724F-30-AL**

Patent pending





## Emblem LED Wall Sconce

**Color Temp:** 2700K  
**CRI:** 90  
**Dimming:** 100% – 10%  
**Rated Life:** 80,000 hours

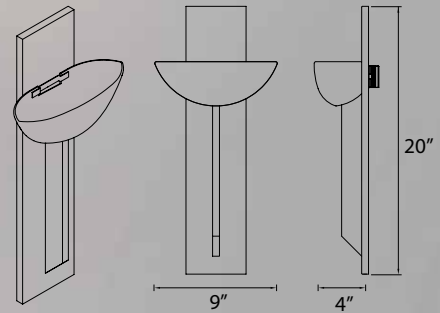
- Mouth blown triplex oval glass
- ADA compliant
- Meets 2013 California Title 24 Efficiency
- Smooth and continuous ELV dimming
- ETL & cETL damp location listed
- Transformer located in J box
- 277V available (special order)



A tall proportioned hospitality sconce for higher ceiling spaces that meets ADA requirements. Emblem is a sleek transitional piece with a soft white etched glass shade and a beautiful warm brushed nickel finish.

		Watt	LED Lumens	Delivered Lumens	Finish
	<b>WS-13020</b>	10.5W	567	375	<b>BN</b> <i>Brushed Nickel</i> 

Example: **WS-13020-BN**  
 For 277V, add an "F" before the finish: **WS-13020F-BN**

Patent pending





## Mythical LED Wall Sconces



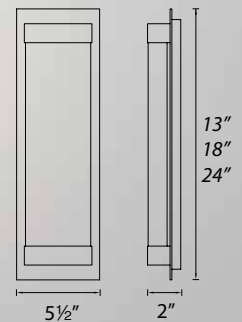

**Color Temp:** 3000K  
**CRI:** 90  
**Dimming:** 100% – 10%  
**Rated Life:** 80,000 hours

### One-inch thick solid crystal with bubbles

- ADA compliant
- Meets 2013 California Title 24 Efficiency
- Smooth and continuous ELV dimming
- No driver or transformer needed
- ETL & cETL damp location listed
- 277V available (special order)



A simple modern design that features a solid crystal block illuminated from within the frame that creates magnificent sparkles as the bubbles within catch the light. Polished Nickel fittings and concealed hardware complete this curiosity inspiring sconce.

		Height		Watt	LED Lumens	Delivered Lumens	Finish
	Small	13"	<b>WS-12713</b>	5.5W	415	70	<b>PN</b> Polished Nickel 
	Medium	18"	<b>WS-12718</b>	10.5W	830	140	
	Large	24"	<b>WS-12724</b>	10.5W	830	160	

Example: **WS-12718-PN**  
 For 277V, add an "F" before the finish: **WS-12718F-PN**

Patent pending



A luminary building block. This interior pocket sconce provides warm ambient illumination with a diminutive form. Mounts in any direction, upward or downward, or arrange luminaires together in clusters for a geometric display of light and shadow for theaters, fine restaurants and boutique hotels.



## Bric LED Wall Sconce

**Color Temp:** 3000K  
**CRI:** 90  
**Dimming:** 100% – 10%  
**Rated Life:** 80,000 hours

- Powder coat white or plated brushed nickel finishes
- Concealed hardwares for a finished look at any viewing angle
- Can be mounted up or down
- ADA compliant
- Meets 2013 California Title 24 Efficiency
- Covers a 4" x 2" horizontal switch box
- 7"W x 5"H conversion plate for J box ensures sides to be flush with the fixture
- Smooth and continuous ELV dimming
- ETL & cETL damp location listed
- 277V available (special order)

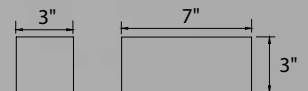

		Watt	LED Lumens	Delivered Lumens	Finish
	<b>WS-11807</b>	9.5W	803	660	<b>BN</b> <i>Brushed Nickel</i> 
					<b>WT</b> <i>White</i> 

Example: **WS-11807-WT**  
 For 277V, add an "F" before the finish: **WS-11807F-WT**

Patent pending



## Mosaic LED Wall Sconce

**Color Temp:** 2700K  
**CRI:** 90  
**Dimming:** 100% – 10%  
**Rated Life:** 80,000 hours

### Backlit natural shell tiles

- Etched glass diffuser top and bottom
- ADA compliant
- Meets 2013 California Title 24 Efficiency
- ETL & cETL damp location listed
- Smooth and continuous ELV dimming
- No driver or transformer needed
- 277V available (special order)

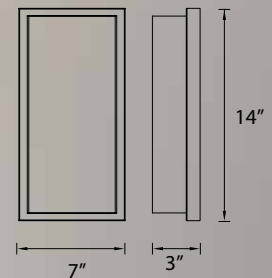

Add a touch of class to any décor with this natural shell inlay wall sconce. Exquisite mosaic tiles illuminate beautifully from high powered, robust LED technology to suit hallways and corridors in residential, hospitality, and commercial locations. Innovative proprietary technology and smart engineering operate the luminaire effectively without a driver or transformer.

		Watt	LED Lumens	Delivered Lumens	Finish
	<b>WS-12214</b>	38.5W	2925	1210	<b>CH</b> <i>Chrome</i> 

Example: **WS-12214-CH**

For 277V, add an "F" before the finish: **WS-12214F-CH**

Patent pending



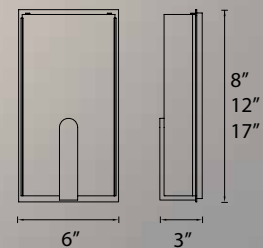

# Stella LED Wall Sconces

Color Temp: 2700K  
 CRI: 90  
 Dimming: 100% – 10%  
 Rated Life: 80,000 hours

- Screen white glass
- Etched glass diffuser top and bottom
- ADA compliant
- Meets 2013 California Title 24 Efficiency
- ETL & cETL damp location listed
- Smooth and continuous ELV dimming
- No driver or transformer needed
- 277V available (special order)



Well defined structural lines and sturdy aluminum construction define this modern wall luminaire. A fitting ambient lighting solution for residential and commercial interiors.

		Height		Watt	LED Lumens	Delivered Lumens	Finish
	Small	8"	<b>WS-13208</b>	9.5W	727	335	<b>BN</b> <i>Brushed Nickel</i> 
	Medium	12"	<b>WS-13212</b>	15.5W	1118	495	
	Large	17"	<b>WS-13217</b>	25.5W	1845	895	

Example: **WS-13217-BN**  
 For 277V, add an "F" before the finish: **WS-13217F-BN**

Patent pending



## Manhattan LED Wall Sconces



**Urban elegance and LED illumination softened with a fabric shade.**

- Trimless fabric shade
- Etched glass diffuser
- ADA compliant
- Meets 2013 California Title 24 Efficiency
- Smooth and continuous ELV dimming
- ETL & cETL damp location listed
- Transformer located in J box
- 277V available (special order)

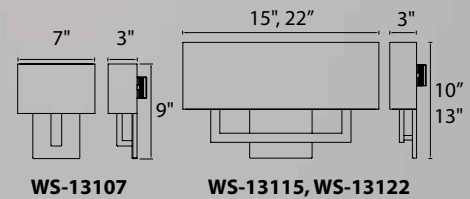
**Color Temp:** 2700K  
**CRI:** 90  
**Dimming:** 100% – 10%  
**Rated Life:** 80,000 hours

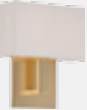
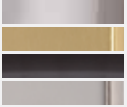

An unequivocal transitional choice for both formal and casual spaces.  
 Beautiful ambient lighting in a luxury residence or boutique hotel. Three ADA compliant sizes are available.

	Length	Watt	LED Lumens	Delivered Lumens	Finish
	<i>Small</i> 7"	<b>WS-13107</b> 6W	284	110	<b>BN</b> <i>Brushed Nickel</i> <b>BR</b> <i>Brushed Brass</i> <b>BO</b> <i>Brushed Bronze</i> <b>PN</b> <i>Polished Nickel</i> 
	<i>Medium</i> 15"	<b>WS-13115</b> 10.5W	566	250	
	<i>Large</i> 22"	<b>WS-13122</b> 15.5W	851	365	

Example: **WS-13107-BO**  
 For 277V, add an "F" before the finish: **WS-13107F-BO**

Patent pending



## Chicago LED Wall Sconces

### Clean soft-contemporary simplicity

- Trimless fabric shade
- Etched glass diffuser
- ADA compliant
- Meets 2013 California Title 24 Efficiency
- Smooth and continuous ELV dimming
- ETL & cETL damp location listed
- Transformer located in J box
- 277V available (special order)

**Color Temp:** 2700K  
**CRI:** 90  
**Dimming:** 100% – 10%  
**Rated Life:** 80,000 hours

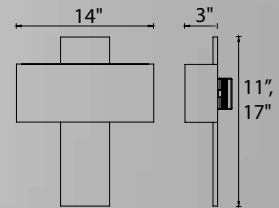

Warm 2700K LED lighting illuminates beautifully from within a quality trimless fabric shade treated to repel dust and stains. Four brushed and polished metal finishes complete the design on a substantively scaled ADA compliant sconce for fine hospitality venues.

		Height		Watt	LED Lumens	Delivered Lumens	Finish
	Small	11"	<b>WS-12511</b>	20.5W	1132	515	<b>BN</b> Brushed Nickel <b>BR</b> Brushed Brass <b>BO</b> Brushed Bronze <b>PN</b> Polished Nickel
	Large	17"	<b>WS-12517</b>	20.5W	1132	515	

Example: **WS-12517-BO**  
 For 277V, add an "F" before the finish: **WS-12517F-BO**

Patent pending



Multiple mid-powered LED source illuminate the glass diffuser uniformly and without socket shadows common in conventional flush mounts.



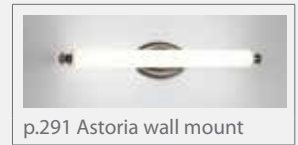

p.291 Astoria wall mount

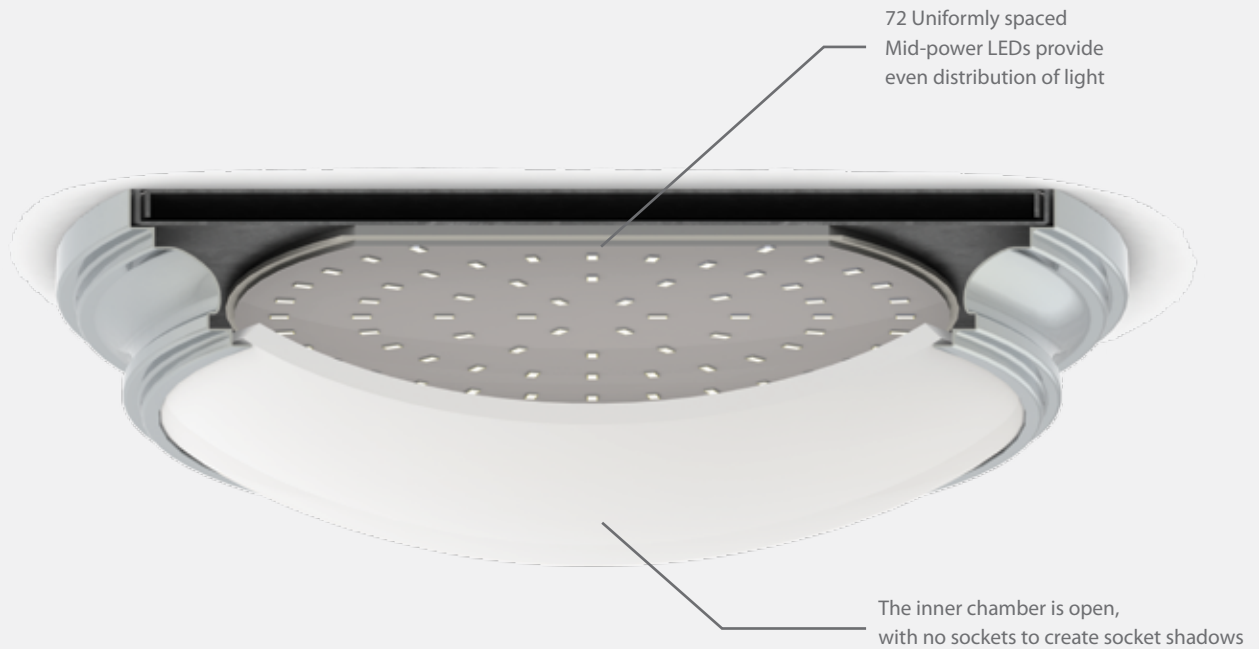



## Astoria LED Ceiling Mounts

**Color Temp:** 2700K  
**CRI:** 90  
**Dimming:** 100% – 10%  
**Rated Life:** 80,000 hours

### The latest LED light engines inside a retro-style housing.

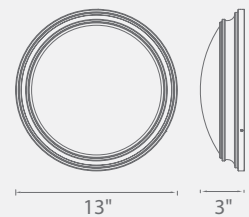
- Etched white glass diffuser
- Multiple LED array for uniform illumination
- Four finishes to complement most bath hardware
- Meets 2013 California Title 24 Efficiency
- No driver or transformer needed
- Smooth and continuous ELV dimming
- ETL & cETL damp location listed
- 277V available (special order)



		Voltage	Watt	LED Lumens	Delivered Lumens	Finish
	<b>FM-7013</b>	120V	30.5W	2620	1110	<b>AN</b> <i>Antique Nickel</i>
						<b>BB</b> <i>Burnished Brass</i>
						<b>BO</b> <i>Brushed Bronze</i>
						<b>PN</b> <i>Polished Nickel</i>

Patent pending

Example: **FM-7013-AN**  
 For 277V, add an "F" before the finish: **FM-7013F-AN**



p.294 Vie vanities



## Vie LED Ceiling Mount

**Color Temp:** 2700K  
**CRI:** 90  
**Dimming:** 100% – 10%  
**Rated Life:** 80,000 hours

- Mouth blown etched triplex glass
- Multiple LED array eliminates socket shadows
- Meets 2013 California Title 24 Efficiency
- No driver or transformer needed
- Smooth and continuous ELV dimming
- ETL & cETL damp location listed
- 277V available (special order)

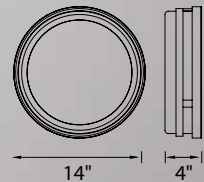

Setting the standard for exceptional beauty and reliable innovative design. Vie adds a luxurious look to modern spaces with unblemished plated finishes and etched opal glass over a multiple LED array.

		Voltage	Watt	LED Lumens	Delivered Lumens	Finish
	<b>FM-4313</b>	120V	30W	2620	1545	<b>BN</b> Brushed Nickel <b>CH</b> Chrome

Example: **FM-4313-BN**  
 For 277V, add an "F" before the finish: **FM-4313F-BN**

Patent pending

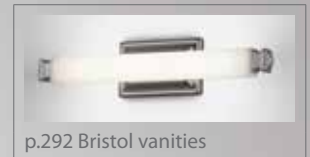

## Bristol LED Ceiling Mount

**Color Temp:** 2700K  
**CRI:** 90  
**Dimming:** 100% – 10%  
**Rated Life:** 80,000 hours

- Mouth blown triplex glass
- Multiple LED array eliminates socket shadows
- Four finishes to complement most bath hardware
- Meets 2013 California Title 24 Efficiency
- Smooth and continuous ELV dimming
- No driver or transformer needed
- ETL & cETL damp location listed
- 277V available (special order)

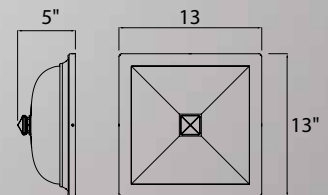

An exquisite traditional design combined with a multiple LED array intelligently engineered for beautiful consistent lighting without glare. A range of lustrous finishes available for design continuity within traditional spaces with traditional incandescent luminaires.

		Watt	LED Lumens	Delivered Lumens	Finish
	<b>FM-7113</b>	30W	2620	990	<b>AN</b> <i>Antique Nickel</i>
					<b>BB</b> <i>Burnished Brass</i>
					<b>BO</b> <i>Brushed Bronze</i>
					<b>PN</b> <i>Polished Nickel</i>

Example: **FM-7113-BO**  
 For 277V, add an "F" before the finish: **FM-7113F-BO**

Patent pending



## Slice LED Ceiling Mount



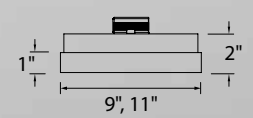

**Color Temp:** 2700K, 3000K  
**CRI:** 90  
**Dimming:** 100% – 10%  
**Rated Life:** 50,000 hours

**Broad based ambient lighting from a distinctive highly versatile flush mount luminaire.**

- Etched 3/4" thick pressed glass diffuser with interior ceramic glaze
- Mount as a ceiling fixture or wall sconce
- ADA compliant when mounted on wall
- Meets 2013 California Title 24 Efficiency
- ETL & cETL damp location listed for wall and ceiling application
- Smooth and continuous ELV dimming
- Transformer located in J box
- 277V available (special order)



Perfect as the sole light source in a room mounted to a ceiling or intriguing as a wall sconce.

	Diameter	Color Temp	Watt	LED Lumens	Delivered Lumens	Finish
	Small 9"	<b>FM-4109-27</b> 2700K	24.5W	1202	560	<b>BN</b> Brushed Nickel  <b>BZ</b> Bronze  <b>CH</b> Chrome 
		<b>FM-4109-30</b> 3000K	24.5W	1328	620	
	Large 11"	<b>FM-4111-27</b> 2700K	29W	1441	860	
		<b>FM-4111-30</b> 3000K	29W	1591	950	

Example: **FM-4109-27-BN**  
 For 277V, add an "F" before the finish: **FM-4109-27F-BN**

Patent pending



## Dice LED Ceiling Mount



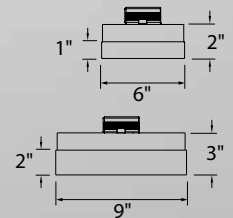

**Color Temp:** 2700K, 3000K  
**CRI:** 90  
**Dimming:** 100% – 10%  
**Rated Life:** 50,000 hours

### Etched 3/4" thick pressed glass diffuser with interior ceramic glaze

- Mount as a ceiling fixture or wall sconce
- ADA compliant when mounted on wall
- Meets 2013 California Title 24 Efficiency
- ETL & cETL damp location listed for wall and ceiling application
- Smooth and continuous ELV dimming
- Transformer located in J box
- 277V available (special order)



Thick-walled glass is uniformly illuminated in a design made for LED technology in a square format. Full range dimming control.

	Length	Color Temp	Watt	LED Lumens	Delivered Lumens	Finish
	Small 6"	<b>FM-4006-27</b> 2700K	15.5W	721	410	<b>BN</b> Brushed Nickel  <b>BZ</b> Bronze  <b>CH</b> Chrome 
		<b>FM-4006-30</b> 3000K	15.5W	797	455	
	Large 9"	<b>FM-4009-27</b> 2700K	24W	1158	635	
		<b>FM-4009-30</b> 3000K	24W	1278	700	

Example: **FM-4009-27-BN**

For 277V, add an "F" before the finish: **FM-4009-27F-BN**

Patent pending



Cutting-edge technology in the display industry transformed into a super-thin, less than an inch profile flush mount.

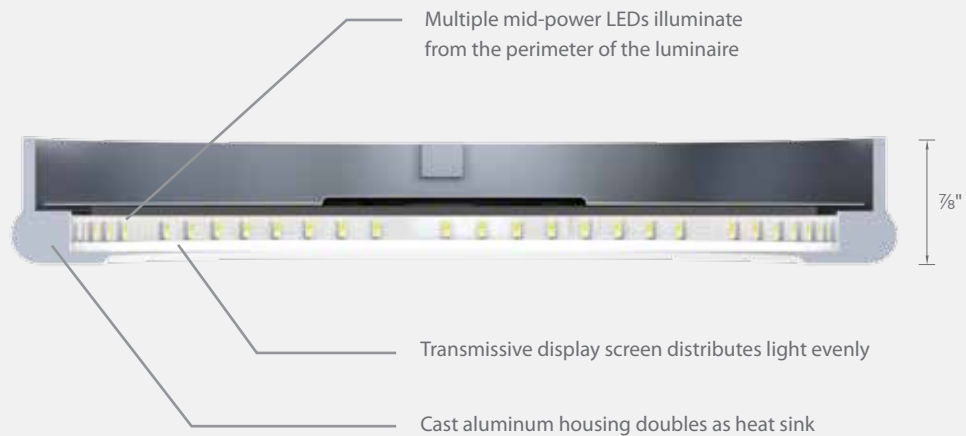



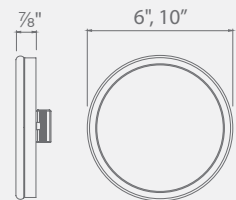

## Geos LED Ceiling Mount

**Color Temp:** 2700K, 3000K  
**CRI:** 90  
**Dimming:** 100% – 10%  
**Rated Life:** 70,000 hours

- Super thin, edge-lit LED panel
- Die-cast aluminum construction
- Wall or ceiling mount with twist-lock mechanism
- ADA compliant
- Meets 2013 California Title 24 Efficiency
- ETL & cETL damp location listed
- Smooth and continuous ELV dimming
- Transformer located in J box
- 277V available (special order)

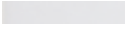

	Diameter	Watt		Color Temp	LED Lumens	Delivered Lumens	Finish
	6"	8W	<b>FM-4606-27</b>	2700K	551	270	<b>TT</b> Titanium  <b>WT</b> White 
			<b>FM-4606-30</b>	3000K	608	300	
	10"	12.5W	<b>FM-4610-27</b>	2700K	964	545	
			<b>FM-4610-30</b>	3000K	1064	600	

Example: **FM-4610-27-WT**  
 For 277V, add an "F" before the color temperature: **FM-4610F-27-BN**

Patent pending



Kiss incorporates delicate curvatures into its contoured lines, from the metallic rods to the spun metal socket and the white etched glass with a concave, enclosed bottom. The mouth blown triplex glass is specifically engineered to ensure that there is even distribution of light without shadows or hot spots.







## Kiss LED Pendant

Color Temp: 2700K  
 CRI: 90  
 Dimming: 100% – 10%  
 Rated Life: 70,000 hours

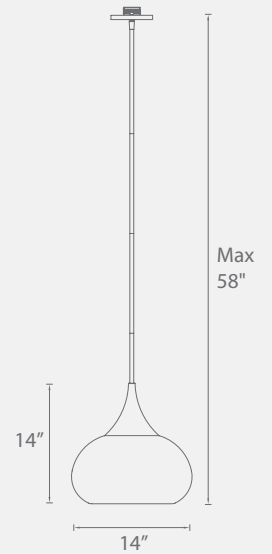
- Mouth blown triplex glass with concave bottom
- Integral swivel for sloped ceilings
- Three 12 inch and one 6 inch rods included (additional extension rods available)
- Supplied with 10 feet of wire
- Meets 2013 California Title 24 Efficiency
- Smooth and continuous ELV dimming
- ETL & cETL damp location listed
- Driver located in J box
- 277V available (special order)



	Watt	LED Lumens	Delivered Lumens	Finish
 <p><b>PD-51814</b></p>	14W	906	845	<b>BR</b> <i>Brushed Brass</i> <b>BN</b> <i>Brushed Nickel</i> <b>CH</b> <i>Chrome</i>

Example: **PD-51814-BN**  
 For 277V, add an "F" before the finish: **PD-51814F-BN**

Patent pending



## Elliptic LED Pendant



**Color Temp:** 2700K  
**CRI:** 90  
**Dimming:** 100% – 10%  
**Rated Life:** 70,000 hours

### Visually enticing with embossed layers of circumnavigating bands

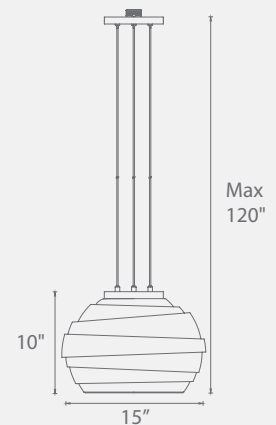
- Mouth blown etched glass with banded detail
- Cable suspension carrying low voltage may be field shortened
- Meets 2013 California Title 24 Efficiency
- Smooth and continuous ELV dimming
- ETL & cETL damp location listed
- Driver located in J box
- 277V available (special order)



A celestial spherical form with the visual orbiting movement of heavenly bodies. Mouth blown and etched triplex glass efficiently diffuses hot spots for beautiful ambient lighting. Ideal as a conversation piece overhead.

	Watt	LED Lumens	Delivered Lumens	Finish
	14W	906	735	<b>BN</b> <i>Brushed Nickel</i> 

Example: **PD-51915-BN**  
 For 277V, add an "F" before the finish: **PD-51915F-BN**

Patent pending





## Niveous LED Pendant

- Mouth blown etched triplex glass
- Integral swivel for sloped ceilings
- Three 12 inch and one 6 inch rods included (additional extension rods available)
- Supplied with 10 feet of wire
- Meets 2013 California Title 24 Efficiency
- Smooth and continuous ELV dimming
- ETL & cETL damp location listed
- Driver located in J box
- 277V available (special order)

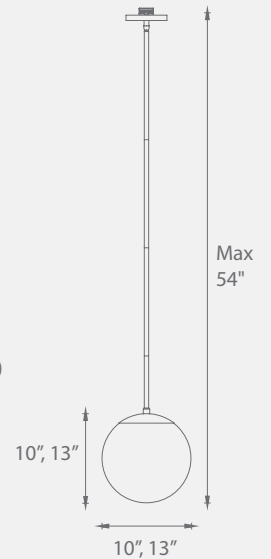
**Color Temp:** 2700K  
**CRI:** 90  
**Dimming:** 100% – 10%  
**Rated Life:** 70,000 hours



Optimized light distribution deploying multiple mid-powered LEDs to achieve an evenly lit globe, providing beautiful ambient illumination.

				Watt	LED Lumens	Delivered Lumens	Finish
	<i>Small</i>	10"	<b>PD-52310</b>	14W	906	685	<b>BN</b> Brushed Nickel <b>WT</b> White
	<i>Large</i>	13"	<b>PD-52313</b>	14W	906	715	

Example: **PD-52313-WT**  
 For 277V, add an "F" before the finish: **PD-52313F-WT**

Patent pending



An elegant distinctive look for LED technology. Mouth blown oval bronze glass with hammered optics tailored fit over a crescent die-cast LED housing that evokes beautiful patterns of ambient light like rays of sunshine on a fountain. Ideally placed in multiples at restaurants, hotel counters and kitchen islands.



## Lolli LED Pendant

**Color Temp:** 2700K  
**CRI:** 90  
**Dimming:** 100% – 10%  
**Rated Life:** 80,000 hours

### Unique oval bronze glass pendant with hammered optic

- Smooth and continuous ELV dimming
- Cable suspension carrying low voltage may be field shortened
- Meets 2013 California Title 24 Efficiency
- ETL & cETL damp location listed
- Transformer located in J box
- 277V available (special order)

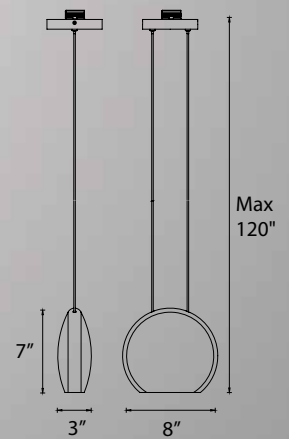

	Watt	LED Lumens	Delivered Lumens	Finish
 <b>PD-52008</b>	6.5W	284	165	<b>CH</b> Chrome 

For 277V, add an "F" before the finish: **PD-52008F-CH**

Patent pending



A high performance LED downlight in a retro style metal pendant available in three lustrous plated metal finishes.

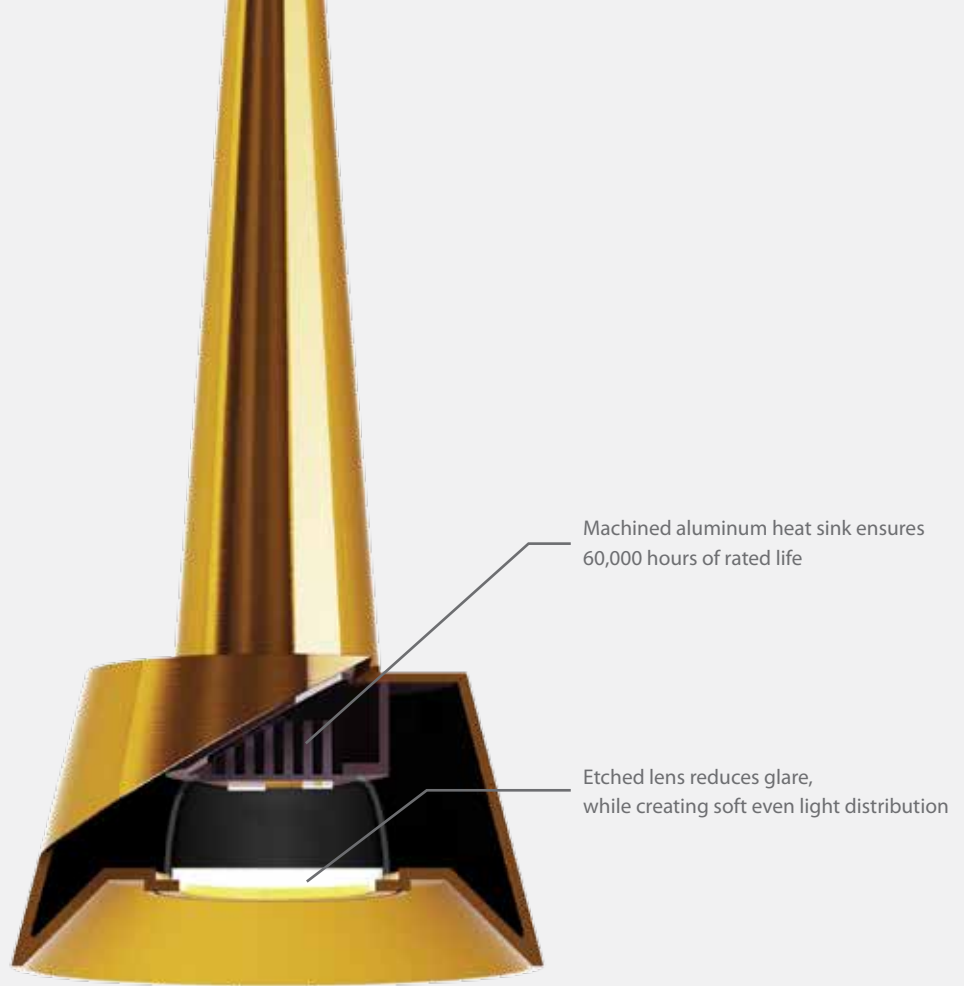



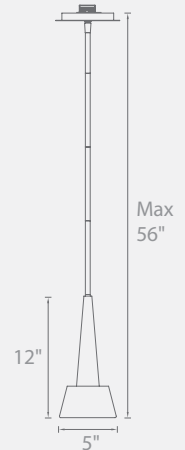

## Rocket LED Pendant

Color Temp: 2700K  
 CRI: 90  
 Dimming: 100% – 10%  
 Rated Life: 60,000 hours

- Retro style spun metal housing
- Upscale quality plated metal finishes
- Integral swivel for sloped ceilings
- Three 12 inch and one 6 inch rods included (additional extension rods available)
- Supplied with 10 feet of wire
- Meets 2013 California Title 24 Efficiency
- Smooth and continuous ELV dimming
- ETL & cETL damp location listed
- Driver located in the J box
- 277V available (special order)



		Watt	LED Lumens	Delivered Lumens	Finish
	<b>PD-51712</b>	12W	882	420	<b>BN</b> <i>Brushed Nickel</i> 
					<b>CH</b> <i>Chrome</i> 
					<b>LB</b> <i>Light Bronze</i> 

Example: **PD-51712-BN**  
 For 277V, add an "F" before the finish: **PD-51712F-BN**

Patent pending



Silky smooth curves round out an impeccable design with lustrous plated finishes. The Flair pendant has a white interior for true-white inter-reflected light and the powerful LEDs are shielded with a mouth blown etched opal diffuser for a finished look from any viewing angle. Use in multiples to reveal a wide wash of light over a conference table, dining area or kitchen island.







## Flair LED Pendant

**Color Temp:** 2700K  
**CRI:** 90  
**Dimming:** 100% – 10%  
**Rated Life:** 60,000 hours

### Spun metal housing with mouth blown etched triplex glass diffuser

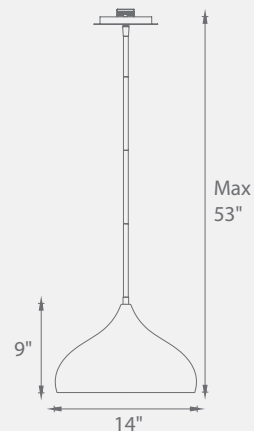
- Integral swivel for sloped ceilings
- Three 12 inch and one 6 inch rods included (additional extension rods available)
- Supplied with 10 feet of wire
- Meets 2013 California Title 24 Efficiency
- Smooth and continuous ELV dimming
- ETL & cETL damp location listed
- Driver located in J box
- 277V available (special order)



	Watt	LED Lumens	Delivered Lumens	Finish
	14W	906	435	<b>BO</b> Brushed Bronze <b>BN</b> Brushed Nickel <b>LB</b> Light Bronze

Example: **PD-52214-BN**  
 For 277V, add an "F" before the finish: **PD-52214F-BN**

Patent pending



Like other Line family products, the Line chandelier features a super thin, edge-lit LED panel that provides ambient light. This dramatically proportioned luminaire offers a direct-indirect light distribution which delivers ample light to work surfaces free of shadows while also illuminating the ceiling and upper portion of walls to give the space the sense of of immensity. A perfect addition to commercial offices or modern kitchen islands.



p.296 Line vanities



p.78 - 80 Line undercabinet





## Line LED Chandelier

**Color Temp:** 2700K, 3000K  
**CRI:** 90  
**Dimming:** 100% – 10%  
**Rated Life:** 80,000 hours

### Super thin, edge-lit LED panel illuminates up and down

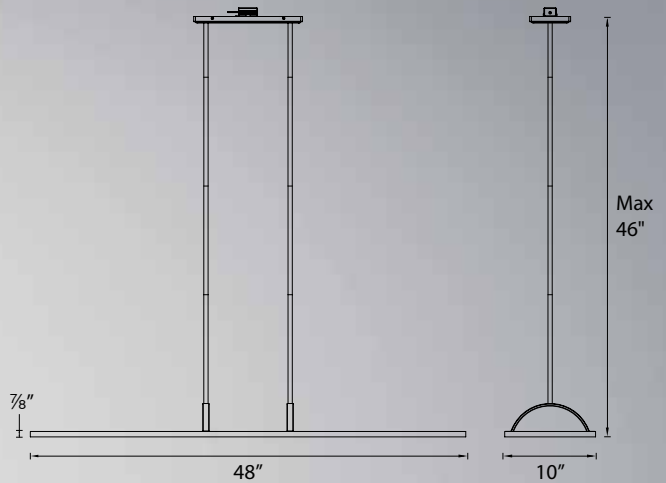
- Integral swivel for sloped ceilings
- Six 12 inch and two 6 inch rods included (additional extension rods available)
- Meets 2013 California Title 24 Efficiency
- Smooth and continuous ELV dimming
- ETL & cETL damp location listed
- Transformer located in J box
- 277V available (special order)



	Color Temp	Watt	LED Lumens	Delivered Lumens	Finish
	<b>PD-51148-27</b>	2700K	48W	4017	2770
	<b>PD-51148-30</b>	3000K	48W	4435	3055
					<b>AL</b> Brushed Aluminum 

Example: **PD-51148-27-AL**

For 277V, add an "F" before the color temperature: **PD-51148F-27-AL**

Patent pending



Recognized by the Lighting for Tomorrow LED luminaire design competition, Hemmingway illuminates fine artwork utilizing the optimal spectrum of colors. Unlike conventional luminaires, these LED picture lights provide full spectrum illumination without damaging infrared and ultraviolet rays. Available in four designer finishes and two sizes to complement upscale art framing.

# Chronophoton™ Technology

Conventional incandescent sources emit over 90% of the energy as heat that expands and contracts pigments of the painting along with ultraviolet that degrades vibrancy of colors.

Our LED picture lights with Chronophoton® technology ensure minimal light outside the range of visible light to preserve the quality of artwork over a prolonged period of exposure.

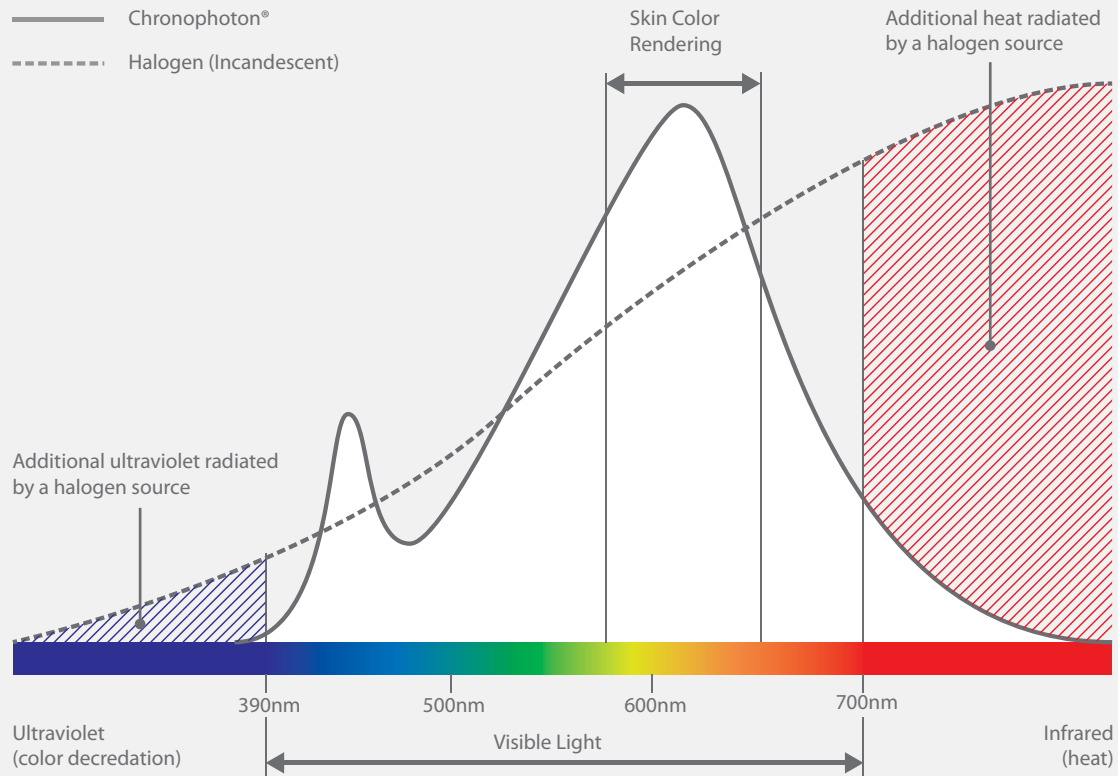



## Hemingway LED Picture Lights

**Color Temp:** 2700K  
**CRI:** 90  
**Dimming:** 100% – 10%  
**Rated Life:** 70,000 hours

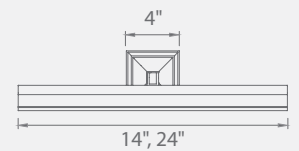
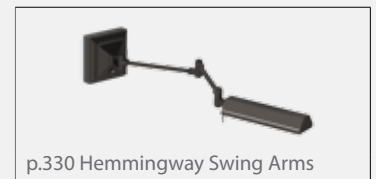
- Chronophoton™ Technology preserves artwork while providing vibrant color rendering
- Head rotates 90° up or down and extends out 14¾" from mounting surface
- Meets 2013 California Title 24 Efficiency
- Replaceable LED module
- For portable models, 8 foot cord & plug with 18 inch wire cover in matching finish included

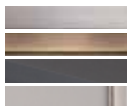

	Length	Watt	LED Lumens	Delivered Lumens		Finish
	14"	9.4W	595	302	<b>PL-LED14-27</b> <b>PL-LED14P-27</b>	Hard Wired Portable
	24"	16.9W	1186	605	<b>PL-LED24-27</b> <b>PL-LED24P-27</b>	Hard Wired Portable
						<b>AN</b> Antique Nickel <b>BB</b> Burnished Brass <b>RB</b> Rubbed Bronze <b>PN</b> Polished Nickel 

Example: **PL-LED24-27-CH**

Patent pending

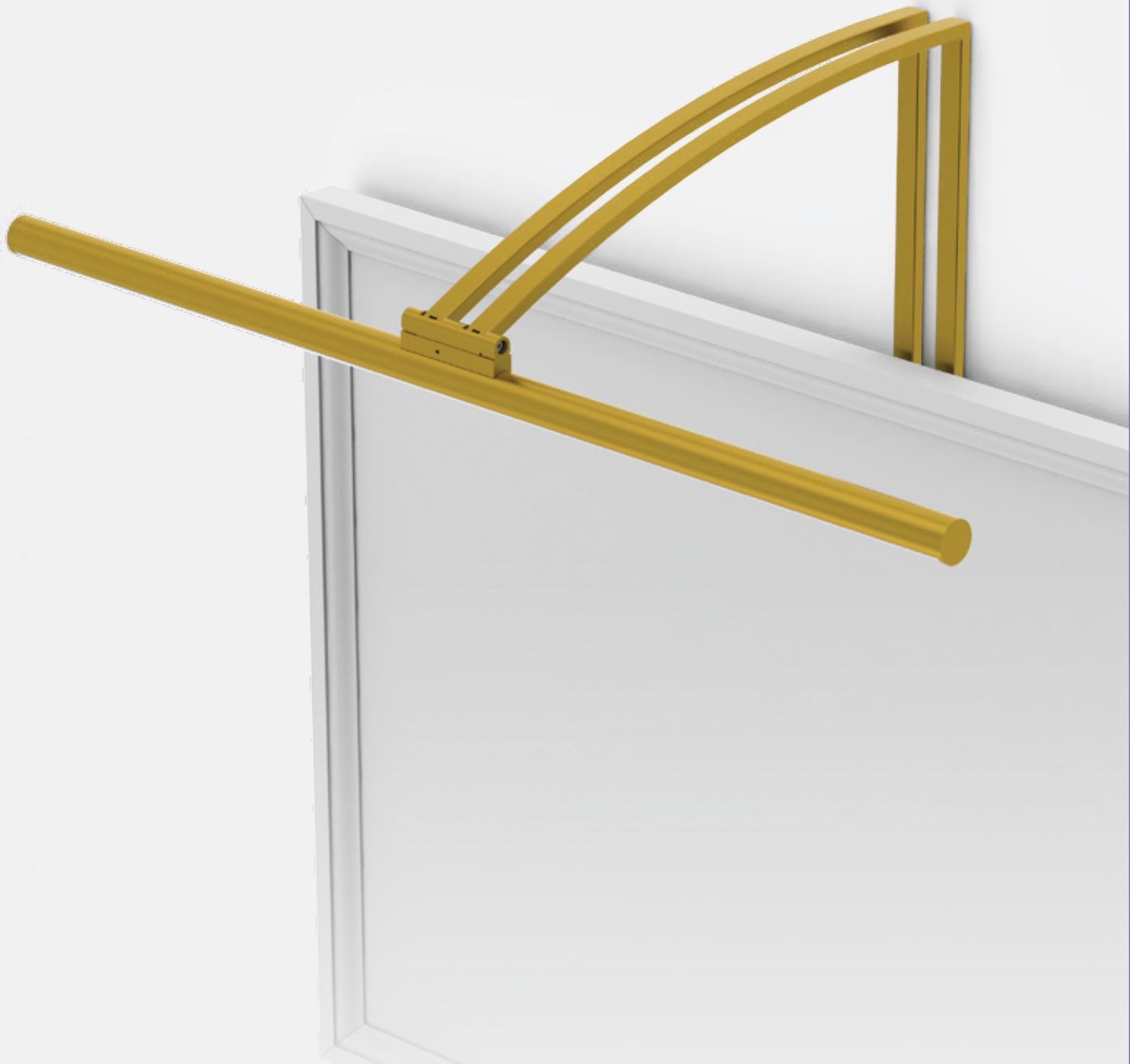

Designed to disappear, the low profile Vibe picture light features a canopy that both hides behind the artwork and serves as the mount. At less than an inch in diameter, the Vibe picture light shrouds the smallest light source available to provide substantial, full spectrum, and high quality lighting. Three lengths with 35 degree rotation accommodates artwork of varying sizes.

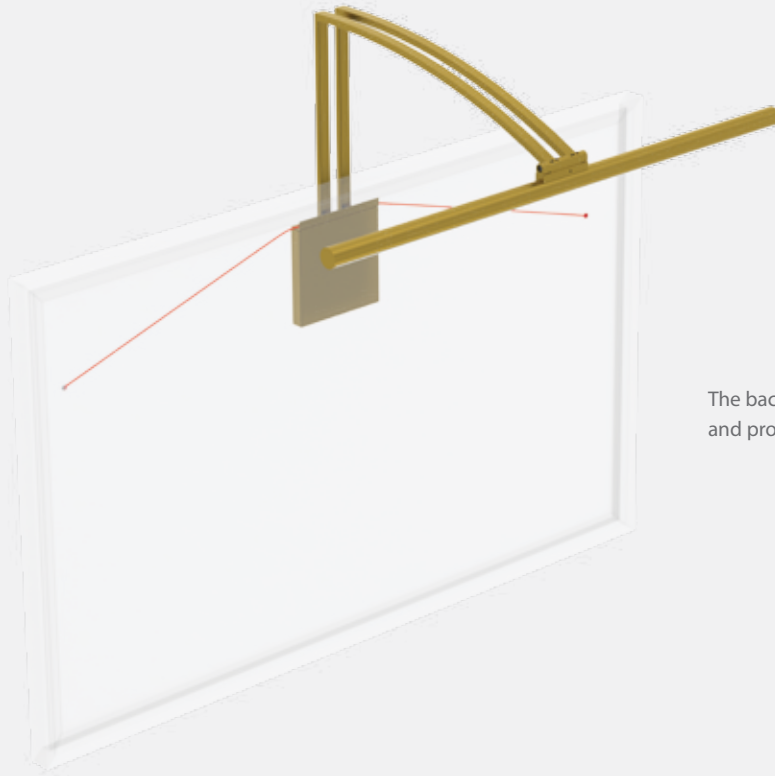

The back plate mounts on the wall, and provides a channel for the art frame to hang on





## Vibe LED Picture Lights

**Color Temp:** 2700K  
**CRI:** 90  
**Dimming:** 100% – 10%  
**Rated Life:** 70,000 hours

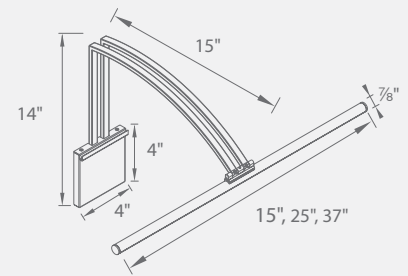
### Chronophoton™ Technology conserves artwork while providing vibrant color rendering

- Head rotates 35° up or down
- 110° beam angle
- Meets 2013 California Title 24 Efficiency
- Replaceable LED module
- For portable models, 8 foot cord & plug with 18 inch wire cover in matching finish included



	Length	Watt	LED Lumens	Delivered Lumens		Finish
	15"	8.5W	595	240	<b>PL-LED15-27</b> <b>PL-LED15P-27</b>	Hard Wired Portable
	25"	16W	1186	535	<b>PL-LED25-27</b> <b>PL-LED25P-27</b>	Hard Wired Portable
	37"	23W	1785	850	<b>PL-LED37-27</b> <b>PL-LED37P-27</b>	Hard Wired Portable
						<b>BK</b> Black <b>BN</b> Brushed Nickel <b>CH</b> Chrome <b>SB</b> Satin Brass 

Example: **PL-LED25-27-CH**

Patent pending



Contrary to its classical design, Hemmingway conceals the most current generation of high color rendering LED arrays which ensure even light distribution and comfortable task illumination. Every joint swings to deliver light wherever needed. Offered in four classic metal finishes matching the Hemmingway LED picture light.





## Hemmingway LED Swing Arm

**Color Temp:** 3000K  
**CRI:** 90  
**Dimming:** 100% – 10% (Integral dimmer)  
**Rated Life:** 50,000 hours

- Smooth swing arm operation
- One 18 inch cord cover included
- Fingertip touch dimming on canopy
- Meets 2013 California Title 24 Efficiency
- ETL & cETL damp location listed
- Fits 2"x4" vertical switch box
- Integral driver
- For hard-wired and portable (8 foot cord) installation

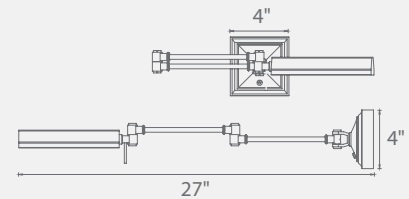

		Watt	LED Lumens	Delivered Lumens	Finish
	<b>BL-1527</b>	6.5 W	445	325	<b>AN</b> <i>Antique Nickel</i> <b>BB</b> <i>Burnished Brass</i> <b>RB</b> <i>Rubbed Bronze</i> <b>PN</b> <i>Polished Nickel</i>

Example: **BL-1527-BB**

Patent pending



Clean architectural lines with tightly engineered adjustability. Precision directional lighting with fingertip dimming for comfortable task illumination in the home or office. Available in three handsome plated finishes.

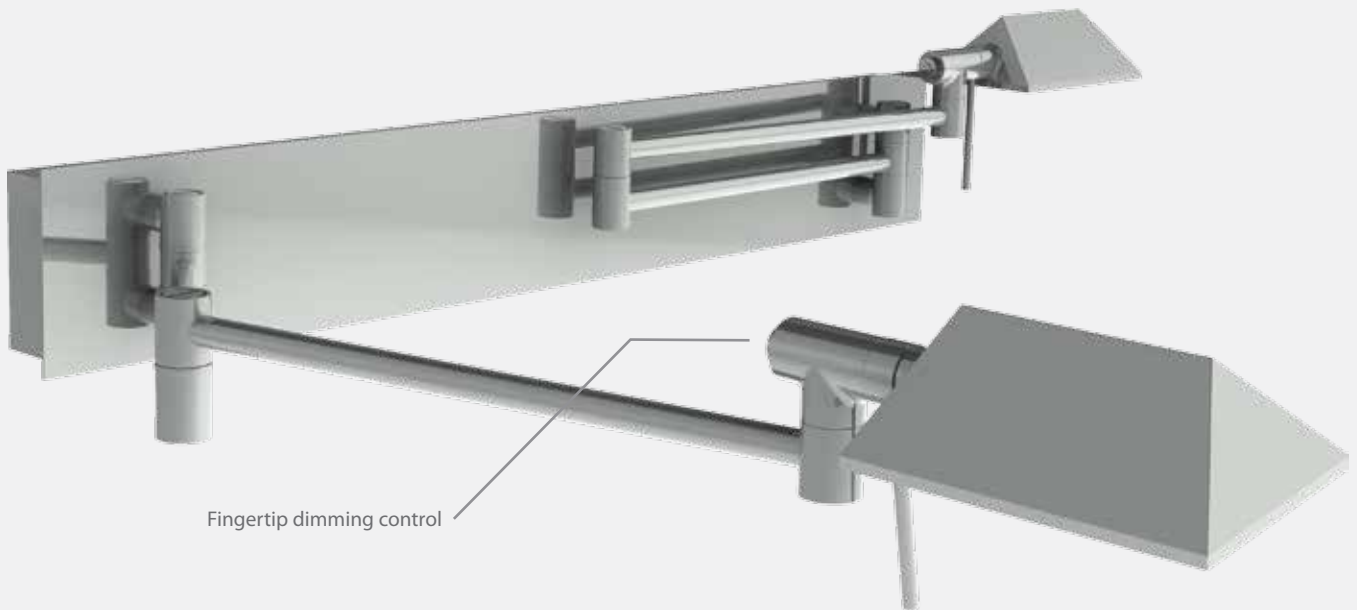



## Cue LED Swing Arms

**Color Temp:** 3000K  
**CRI:** 85  
**Dimming:** 100% - 10% (Integral dimmer)  
**Rated Life:** 30,000 hours

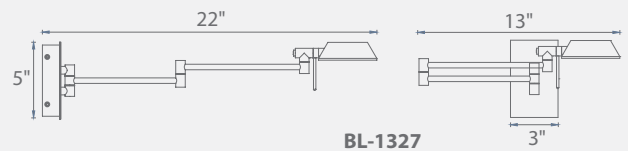
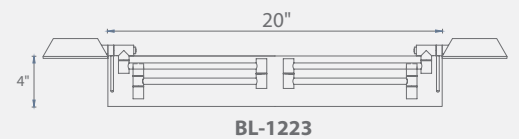
- Smooth swing arm operation
- Two 12 inch cord covers included
- Fingertip touch dimming on head
- Fits 2" x 4" switch box
- ETL & cETL damp location listed
- Integral driver
- Conversion plate for 4" J box included
- For hard-wired and portable (8 foot cord) installation



			Watt	LED Lumens	Delivered Lumens	Finish
	Single	<b>BL-1223</b>	8.5 W	489	315	<b>BR</b> Brushed Brass <b>BN</b> Brushed Nickel <b>CH</b> Chrome 
	Double	<b>BL-1327</b>	16.5 W	978	480	

Example: **BL-1327-CH**

Patent pending



Press on/off  
Hold to dim

A contemporary utilitarian design. Stretch incorporates a rubberized flexible and fixable arm as part of this unique modern design. The die-cast aluminum head also serves as the heat sink for the powerful 7.5 watt LED.

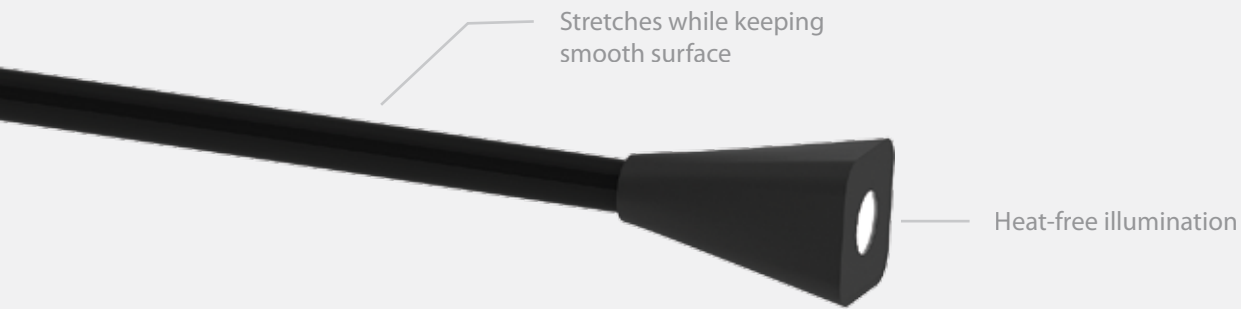

## Stretch LED Swing Arm

**Color Temp:** 3000K  
**CRI:** 85  
**Dimming:** 100% – 10% (integral dimmer)  
**Rated Life:** 30,000 hours

### A contemporary utilitarian design

- Flexible, yet fixable rubber tube for directing light
- Two 12 inch cord covers included
- Fits 2"x4" vertical switch box
- ETL & cETL damp location listed
- Fingertip touch dimming on back plate
- Integral driver
- Conversion plate for 4" J box included
- For hard-wired and portable (8 foot cord) installation

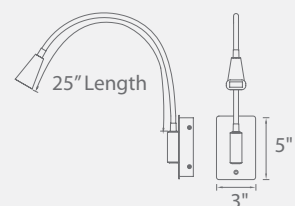

		Watt	LED Lumens	Delivered Lumens	Finish
	<b>BL-1630</b>	7.5W	489	260	<b>BK</b> Black
					<b>WT</b> White

Example: **BL-1630-WT**

Patent pending

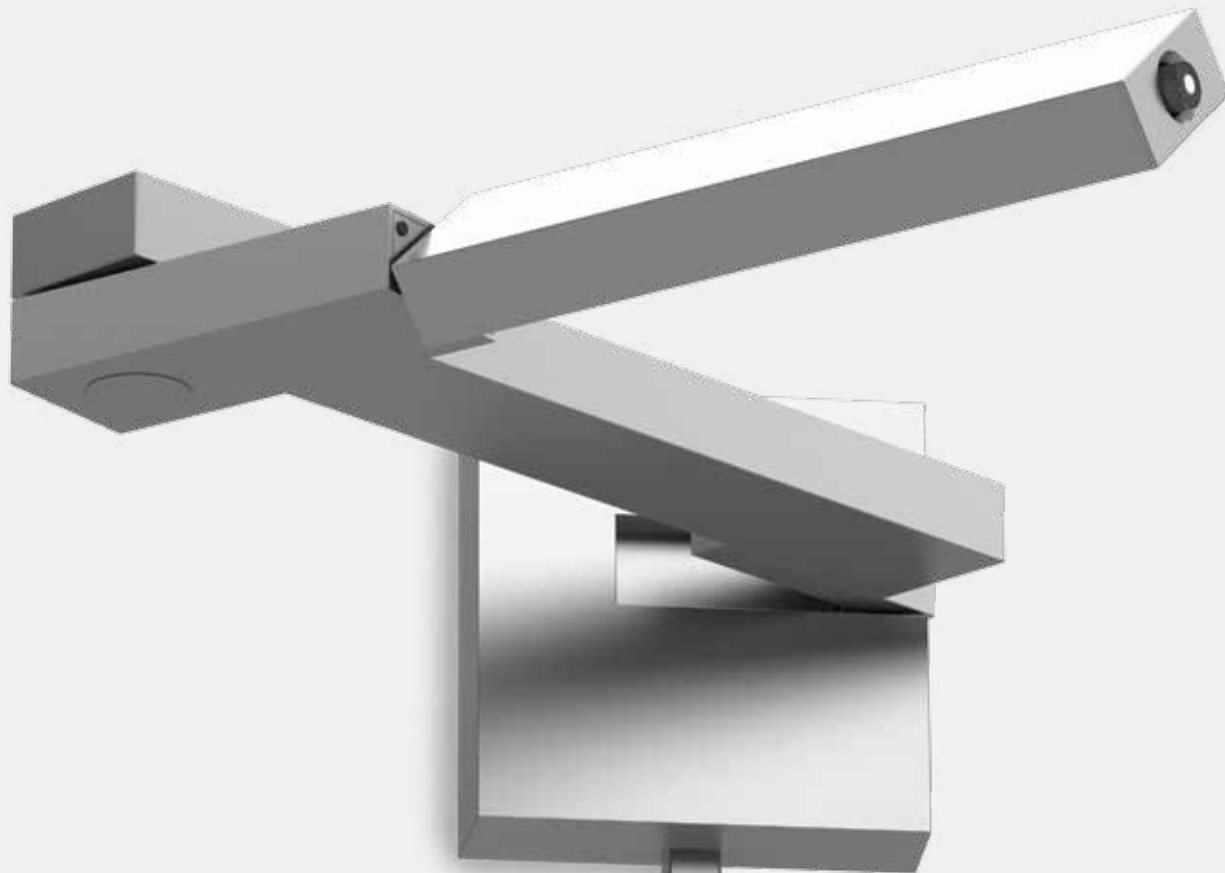

A clever LED swing arm reading light that folds-in completely to neatly and orderly fit within modern design elements. Integral memory touch dimmer conveniently located for fingertip control.



Bronze

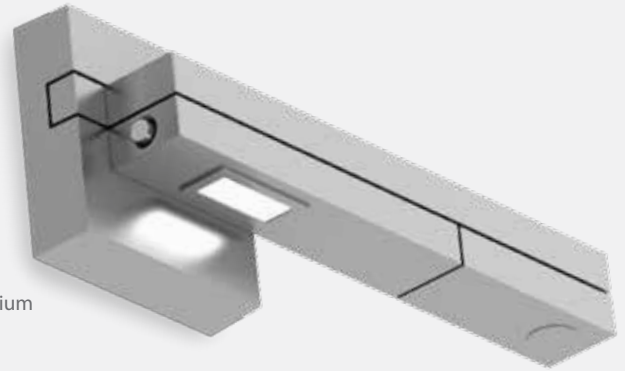

Titanium



## Flip LED Swing Arms

Color Temp: 3000K  
 CRI: 85  
 Dimming: 100% – 10% (integral dimmer)  
 Rated Life: 30,000 hours

### Bauhaus-style geometry in a left and right paired design.

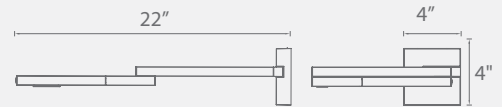
- Aluminum construction
- Two 12 inch cord covers included
- Fingertip touch dimming on head
- ETL & cETL damp location listed
- Integral driver
- For hard-wired and portable (8 foot cord) installation



			Watt	LED Lumens	Delivered Lumens	Finish
	Left	<b>BL-1021L</b>	8.5W	489	315	<b>BZ</b> Bronze <b>TT</b> Titanium 
	Right	<b>BL-1021R</b>	8.5W	489	315	

Example: **BL-1021R-BZ**

Patent pending



This original silhouetted luminaire is minimalistic and cleverly contemporary. Constructed of aluminum with indirect glare-free LED lighting and available in three bold finishes and sizes. Vertical or horizontal mounting options make this scone ideal for many interior and exterior locations.



# Janus

## LED Indoor / Outdoor

**Color Temp:** 3000K  
**CRI:** 90  
**Dimming:** 100% – 10%  
**Rated Life:** 80,000 hours

### Open frame silhouetted indirect LED sconce

- IP65, ETL & cETL wet location listed
- Backlit design for less glare
- May be mounted vertical or horizontal
- Aluminum construction
- Powder coat finishes
- Meets 2013 California Title 24 Efficiency
- No driver or transformer needed
- Smooth and continuous ELV dimming
- 277V available (special order)

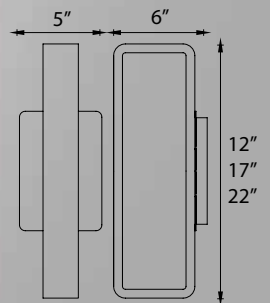

		Length		Watt	LED Lumens	Delivered Lumens	Finish
	Small	12"	<b>WS-W5812</b>	15W	1234	340	<b>BZ</b> Bronze <b>GH</b> Graphite <b>WT</b> White
	Medium	17"	<b>WS-W5817</b>	19W	1615	605	
	Large	22"	<b>WS-W5822</b>	30W	2468	960	

Example: **WS-W5812-GH**  
 For 277V, add an "F" before the finish: **WS-W5812F-GH**

Patent pending

# Uno

## LED Indoor / Outdoor

Color Temp: 3000K  
 CRI: 90  
 Dimming: 100% – 10%  
 Rated Life: 80,000 hours

### In a class of its own

- IP65, ETL & cETL wet location listed
- May be mounted up or down
- Aluminum construction
- Powder coat finishes
- ADA compliant (interior / exterior)
- Meets 2013 California Title 24 Efficiency
- No driver or transformer needed
- Smooth and continuous ELV dimming
- 277V available (special order)

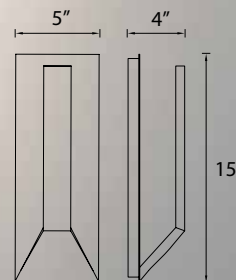

This LED luminaire was created for exterior and interior ambient lighting design continuity. The unique illuminating element on the face indirectly reflects light back towards the viewer in an intriguing dimensional character. The minimalist ADA design mounts in any vertical direction, upward or downward.

	Watt	LED Lumens	Delivered Lumens	Finish
	15W	1234	875	<b>BZ</b> Bronze <b>GH</b> Graphite <b>WT</b> White

Example: **WS-W5915-GH**  
 For 277V, add an "F" before the finish: **WS-W5915F-GH**

Patent pending

# Tao



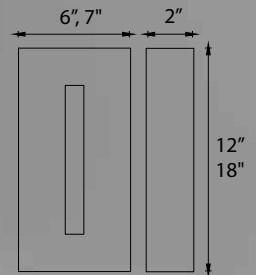

## LED Indoor / Outdoor

**Color Temp:** 3000K  
**CRI:** 90  
**Dimming:** 100% – 10%  
**Rated Life:** 80,000 hours

- IP65, ETL & cETL wet location listed
- Gravity cast aluminum housing
- Powder coat finishes
- Downlight adds functional path lighting
- Patterned crystal glass insert adds visual interest
- ADA compliant (interior / exterior)
- Meets 2013 California Title 24 Efficiency
- No driver or transformer needed
- Smooth and continuous ELV dimming
- 277V available (special order)



Architecturally harmonious form gravity cast from aluminum for structural durability. The architectural design features a sliver window of glass with an optical pattern for visual interest. Effective down lighting integrated for illuminating pathways. Wet location listed and ADA compliant for interior or exterior installations.

		Length		Watt	LED Lumens	Delivered Lumens	Finish
	Small	12"	<b>WS-W5312</b>	11W	830	220	<b>BZ</b> Bronze  <b>GH</b> Graphite 
	Large	18"	<b>WS-W5318</b>	15W	1218	250	

Example: **WS-W5318-GH**

For 277V, add an "F" before the finish: **WS-W5318F-GH**

Patent pending



Infiniti grazes the wall with energy-efficient LEDs, for architectural interest and illuminating walkways. The regressed luminous panel emulates light through a window for superior facial rendering from vertical plane illumination.

Edge-lit Ambient Light

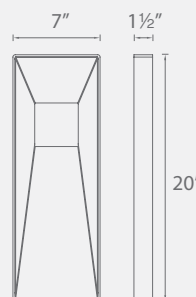
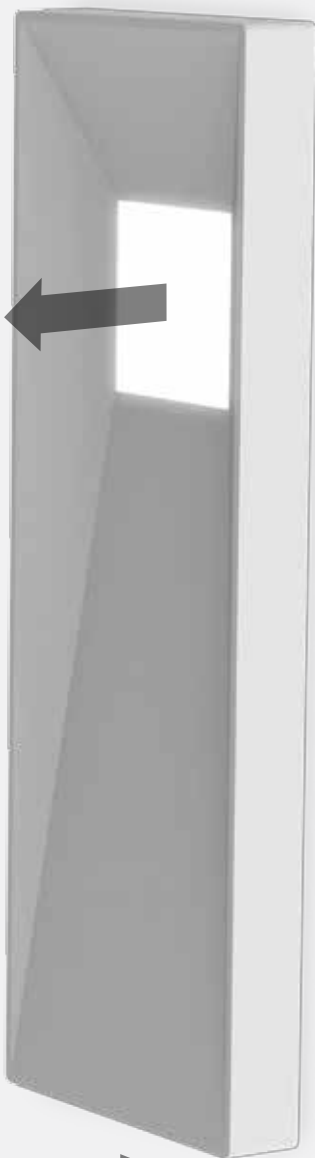

# Infiniti

## LED Indoor / Outdoor

**Color Temp:** 3000K  
**CRI:** 90  
**Dimming:** 100% – 10%  
**Rated Life:** 70,000 hours

- Outdoor rated side lit luminaire with downlight
- IP65, ETL & cETL wet location listed
- Die cast aluminum construction
- Powder coat finishes
- Integral transformer
- Meets 2013 California Title 24 Efficiency
- ADA compliant (interior / exterior)
- Smooth and continuous ELV dimming
- 277V available (special order)

		Watt	LED Lumens	Delivered Lumens	Finish
	<b>WS-W5720</b>	20.5W	1034	745	<b>BZ</b> Bronze <b>GH</b> Graphite <b>WT</b> White

Example: **WS-W5720-WT**  
 For 277V, add an "F" before the finish: **WS-W5720F-WT**

Patent pending

# Lenses & Accessories



Model	Size	
<b>Color Lens</b> - Changes the color of the light.		
<b>AMB</b>	Amber	
<b>BLU</b>	Blue	
<b>GRN</b>	Green	
<b>RED</b>	Red	
<b>YEL</b>	Yellow	
<b>Clear Lens</b> - Permits the safe use of MR16 lamps without glass.		
<b>CL</b>	Clear	
<b>UV Filter</b> - Protect artwork and delicate fabrics from fading.		
<b>UVF</b>	UV Filter	
<b>Frosted Lens</b>		
<b>FR</b>	Frosted	
<b>LENS-16</b>	MR16	<b>Beam Elongator</b> - Replaces standard MR16 and MR11 track fixture lens. Directs the lamp beam to create a horizontal or vertical strip of elongated light.
<b>LENS-20</b>	PAR20	
<b>LENS-25</b>	18W LED	
<b>LENS-30</b>	PAR30	
<b>LENS-38</b>	PAR38	
<b>LENS-111</b>	AR111	
<b>BEL</b>	Beam Elongator	
<b>Spread Lens</b> - Replaces standard MR16 and MR11 track fixture lens. Directs the lamp beam to create a diffused light. Spreads light in an even pattern.		
<b>SPR</b>	Spread Lens	
<b>Honey Comb Louver</b> - Shields lamp and reduces glare at a 30° angle		
<b>HCL</b>	Honey Comb Louver	

Example: **LENS-16-YEL**

**Cross Louver** - Black louver shields lamp and controls spill light and glare; 45° cutoff.

Model	Size	
<b>LENS-16</b>	MR16	<b>CRL</b> Cross Louver
<b>LENS-20</b>	PAR20	
<b>LENS-30</b>	PAR30	
<b>LENS-38</b>	PAR38	
<b>LENS-111</b>	AR111	

Example: **LENS-16-CRL**

**Snoot** - Shields lamp and reduces glare.

Model	Size	
<b>LENS-16</b>	MR16	<b>SNOOT</b> Snoot
<b>LENS-20</b>	PAR20	
<b>LENS-30</b>	PAR30	
<b>LENS-38</b>	PAR38	
<b>LENS-111</b>	AR111	

Example: **LENS-20-SNOOT**

**Mesh Bulb Shield** - Diffuses backlight from lamp.

Model	Size	Finish		
<b>MBS-16</b>	MR16	<b>BK</b>	Black	
		<b>BN</b>	Brushed Nickel	
		<b>WT</b>	White	

Example: **MBS-16-BN**

**Solid Bulb Shield** - Eliminates backlight from lamp.

Model	Size	Finish		
<b>SBS-16</b>	MR16	<b>BK</b>	Black	
		<b>BN</b>	Brushed Nickel	
		<b>WT</b>	White	

Example: **SBS-16-BK**

**Barn Door** - Four adjustable fins help to control glare.

Model	Size	Finish		
<b>801BD</b>	MR16	<b>BK</b>	Black	
		<b>DB</b>	Dark Bronze	
		<b>WT</b>	White	
<b>PAR20BD</b>	PAR20	<b>BK</b>	Black	
<b>PAR30BD</b>	PAR30	<b>BN</b>	Brushed Nickel	
		<b>DB</b>	Dark Bronze	
<b>PAR38BD</b>	PAR38	<b>WT</b>	White	

Example: **PAR20BD-BN**

**Lens Clip** - Snaps over lamp and holds any lens or the honeycomb louver firmly in place. Use only with exposed lamp fixtures.

Model	Finish	Size	
<b>LENS-16-CLIP</b>	Chrome	MR16	
<b>PAR20HLD-BK</b>	Black	PAR20	
<b>PAR30HLD-BK</b>	Black	PAR30	
<b>PAR38HLD-BK</b>	Black	PAR38	

Example: **PAR30HLD-BK**

# LED Lamps

Model	Finish	Beam	Lamp Type	Power	CCT	Volt	Lumens	Average Life	Base	CRI	Ø	L	
<b>JCLEL-2-30-WT</b>	White		JC Bi-pin	2W	3000K	12V	110	30,000 Hours	G5.3	85	3/4"	2 3/16"	
<b>MR16LED-BAB</b>	<b>BK</b> Black <b>WT</b> White	35°	MR16	8W	3000K	12V	450	25,000 Hours	GU5.3	85	2"	1 15/16"	
<b>GU10LED-BAB</b>	<b>BK</b> Black <b>WT</b> White	35°	GU10	8W	3000K	120V	470	25,000 Hours	GU10	85	2"	5 1/16"	
<b>PAR20LED-10N30</b>	<b>BK</b> Black <b>WT</b> White	30°	PAR20	10.3W	3000K	120V	450	25,000 Hours	med	85	2 1/2"	3 7/16"	
<b>PAR30LED-L14N30</b>	<b>BK</b> Black <b>WT</b> White	30°	PAR30	14.6W	3000K	120V	600	25,000 Hours	med	85	3 3/4"	4 3/4"	
<b>PAR38LED-17N30</b>	<b>BK</b> Black <b>WT</b> White	30°	PAR38	17.8W	3000K	120V	825	25,000 Hours	med	85	4 3/4"	5 3/4"	
<b>BR20LED-7N27-WT</b>	White		BR20	7.5W	2700K	120V	490	40,000 Hours	med	85	2 1/2"	3 7/8"	
<b>BR30LED-11N27-WT</b>	White		BR30	14W	2700K	120V	830	40,000 Hours	med	85	3 3/4"	5 5/16"	
<b>BR40LED-15N27-WT</b>	White		BR40	17W	2700K	120V	1020	40,000 Hours	med	85	4 3/4"	5 13/16"	
<b>A19LED-12-30-WT</b>	White		A19	12W	3000K	120V	810	25,000 Hours	med	85	2 3/8"	4 1/3"	

# MR16 Halogen Lamps

**MR16 Low Voltage Dichroic Reflector** – 120V Track, Flexrail1™, Recessed Downlights, Surface Mount Spots, Display Lights and Quick Connect™ Pendants and Fixtures

Model	Power	Color Temp	Volt	CBCP	Average Life	Base	Beam
<b>MR16-EXN</b>	50W	3000K	12V	1500	3,000 Hours	GU5.3	40°
<b>MR16-EXN-G</b>	50W	3000K	12V	1500	3,000 Hours	GU5.3	40°



**MR16 120V GU10 Base** – W, H/L/J/J2,, Flexrail1™ and Display Lights

<b>GU10-EXN</b>	50W	3000K	120V	650	2,000 Hours	GU10	40°
-----------------	-----	-------	------	-----	-------------	------	-----



# Halogen Lamps

**Low Voltage JC Bi-pin** – Quick Connect™ Pendants, Sconces

Model	Power	Color Temp	Volt	Lumens	Average Life	Base	Length
<b>JC-50-G635</b>	50W	2900K	12V	950	2,000 Hours	GY6.35	1 <sup>3</sup> / <sub>16</sub> "



**Low Voltage JC Bi-pin** – Button Lights and Miniature Recessed Fixtures

<b>JC-10</b>	10W	2900K	12V	140	2,000 Hours	G4	1 <sup>3</sup> / <sub>16</sub> "
<b>JC-20</b>	20W	2900K	12V	350	2,000 Hours	G4	1 <sup>3</sup> / <sub>16</sub> "



**Line Voltage J Type Double Ended**

<b>J-150-S</b>	150W	2900K	110-130V	2600	2,000 Hours	R7S	3 <sup>1</sup> / <sub>8</sub> "
----------------	------	-------	----------	------	-------------	-----	---------------------------------



# Xenon Lamps

**Low Voltage Bi-pin** – Quick Connect™ Pendants, Sconces

Model	Power	Color Temp	Volt	Lumens	Average Life	Base	Length
<b>BP-50-12V</b>	50W	3000K	12V	600	10,000 Hours	GY6.35	1 <sup>15</sup> / <sub>16</sub> "



**Low Voltage Bi-pin** – Button Lights

<b>BP-10-12V</b>	10W	3000K	12V	100	10,000 Hours	G4	1 <sup>1</sup> / <sub>4</sub> "
<b>BP-20-12V</b>	20W	3000K	12V	200	10,000 Hours	G4	1 <sup>1</sup> / <sub>4</sub> "



**Line Voltage Bi-pin** – Xenon Light Bars

<b>JCD-20X-CL</b>	20W	3000K	120V	300	7,000 Hours	G8-0	1 <sup>1</sup> / <sub>2</sub> "
-------------------	-----	-------	------	-----	-------------	------	---------------------------------







# Remote Transformers

1W Minimum Load



## Class 2 Enclosed Electronic Transformers

- Secondary wiring for Class 2 transformers does not require conduit sheathed cable or clamp wiring techniques
- Intrinsically safe, Class 2 transformers permit no greater than a 5 amp current be drawn
- Non-metallic sheathed cable may be used for secondary wiring in walls and ceilings
- Drop down to a smaller gauge wire if space in fixture does not permit secure connection directly with the non-metallic sheathed cable
- Powers most cabinet fixtures
- All transformers are UL Listed

	Model	Input	Output	Min Load	L	W	H	
	<b>EN-1260-RB2</b> <b>EN-2460-RB2</b> <b>EN-24100-RB2</b>	120V 120V 120V	12V, 60W 24V, 60W 24V, 96W	1W 1W 1W	6½" 6½" 6½"	1⅝" 1⅝" 1⅝"	1¼" 1¼" 1¼"	Fits through small openings
	<b>EN-12120-RB2</b> <b>EN-12180-RB2</b> <b>EN-12300-RB2</b>	120V 120V 120V	12V, 2 × 60W 12V, 3 × 60W 12V, 5 × 60W	1W 1W 1W	6" 6¾" 8½"	3¼" 3⅝" 4⅝"	2⅝" 2⅝" 2⅝"	Includes LED indicator lights and integral push in terminals
	<b>EN-1260-P-AR-BK</b> <b>EN-1260-P-AR-WT</b> <b>EN-2460-P-AR</b>	120V 120V 120V	12V, 60W 12V, 60W 24V, 60W	1W 1W 1W	2¾" 2¾" 2¾"	1⅝" 1⅝" 1⅝"	1¼" 1¼" 1¼"	Plug-in power supply with on/off switch and 6' detachable cord



## Enclosed Electronic Transformers

- Use for all initial installations to ensure safe and primary side connections in a wiring compartment
- Dim with Electronic Low Voltage (ELV) dimmers



	Model	Input	Output	Min Load	L	W	H	
	<b>EN-1260-RB-AR</b> <b>EN-1275-RB-AR</b>	120V 120V	12V, 60W 12V, 75W	1W 1W	6½" 6½"	1⅝" 1⅝"	1¼" 1¼"	Enclosure has separate compartments for transformer, line and low voltage wiring
	<b>EN-12100-RB-AR</b> <b>EN-12150-RB-AR</b> <b>EN-24150-RB-AR</b> <b>EN-B12PY-AR</b> <b>EN-B24PZ-AR</b>	120V 120V 120V 120V 120V	12V, 100W 12V, 150W 24V, 150W 12V, 250W 24V, 300W	1W 1W 1W 1W 1W	6¼" 6¼" 6¼" 6¼" 6¼"	3" 3" 3" 3⅜" 3⅜"	1⅝" 1⅝" 1⅝" 2⅝" 2⅝"	Includes LED indicator lights and integral push in terminals

## Non-Enclosed Electronic Transformers

- UR (UL ready) components
- All connections must be made in an enclosure for proper installations

	Model	Input	Output	Min Load	L	W	H	
	<b>EN-1260-R2*</b> <b>EN-1260-R-AR</b> <b>EN-1275-R-AR</b>	120V 50/60Hz 120V 50/60Hz 120V 50/60Hz	12V, 60W 12V, 60W 12V, 75W	1W 1W 1W	2⅝" 2⅝" 2⅝"	1⅝" 1⅝" 1⅝"	1" 1" 1"	Designed to be used as a replacement part for factory installed transformers or installed in a properly listed enclosure
	<b>EN-12100-R-AR</b> <b>EN-12150-R-AR</b> <b>EN-24150-R-AR</b>	120V 50/60Hz 120V 50/60Hz 120V 50/60Hz	12V, 100W 12V, 150W 24V, 150W	1W 1W 1W	3½" 3½" 3½"	1½" 1½" 1½"	1⅝" 1⅝" 1⅝"	

\*U.L. Listed Class 2 Component

Enclosures	Model	L	W	H		Multiple Terminal Block	L	W	H
	<b>ETB</b>	6¼"	3"	1⅝"	Holds one EN-12100-R-AR, EN-12150-R-AR or EN-24150-R-AR		3¼"	1¼"	⅞"
	<b>METB</b>	6⅝"	1⅝"	1⅝"	Holds one EN-1260-R-AR, EN-1275-R-AR or EN-1260-R2	12.5A max accommodates up to 6 output connections for 14 AWG wires. Terminal block is used to easily wire together multiple output connections for a neat under cabinet installation without the use of open splices. Perfect for wiring up to 3 button lights at 20W or 6 button lights at 10W.			

# Numerical Index

## SYMBOLS

008FP .....92, 97  
801BD .....343

## A

A19LED-12-30-WT .....344

## B

BA-IC12 .....83, 84  
BA-IC24 .....83, 84  
BA-IC36 .....83, 84  
BA-I-WT .....83, 84  
BA-LED2 .....83  
BA-LED4 .....83  
BA-LED6 .....83  
BA-LED8 .....83  
BA-LED10 .....83  
BA-LIX1 .....84  
BA-LIX2 .....84  
BA-LIX3 .....84  
BA-LIX4 .....84  
BA-LIX6 .....84  
BA-PC6 .....83, 84  
BA-PC6-WT .....83, 84  
BL-1021R .....336  
BL-1223 .....332  
BL-1327 .....332  
BL-1527 .....330  
BL-1630 .....334  
BP-50-12V .....345  
BP-10-12V .....345  
BP-20-12V .....345  
BR20LED-7N27 .....161, 344  
BR30LED-11N27 .....161, 344  
BR30LED-11N27 .....161, 344  
BR40LED-15N27 .....161, 344  
BXRC-27E1000 .....92, 131  
BXRC-27G1000 .....92, 131  
BXRC-30E1000 .....92, 131  
BXRC-30G1000 .....92, 131  
BXRC-35E1000 .....92, 131  
BXRC-40E1000 .....92, 131

## C

CP .....118, 103

## D

DL-007 .....97  
DL-150 .....98  
DL-188 .....98  
DLC-4 .....97, 98  
DLC-P .....97, 98  
DR-G352 .....46, 47  
DR-G355 .....46, 48  
DR-G356 .....46, 48  
DR-G361 .....46, 48  
DR-G362 .....46, 48  
DR-G363 .....46, 48  
DS-CD .....56  
DS-PD .....56  
DS-WD .....55  
DS-W5 .....55

## E

EN-1260-P-AR .....87, 88, 346  
EN-1260-R-AR .....346  
EN-1260-RB2 .....26, 46, 87, 88, 346

EN-1260-RB-AR .....26, 346  
EN-1275-R-AR .....346  
EN-1275-RB-AR .....26, 94, 179, 346  
EN-2460D-C .....71  
EN-2460D-C-P .....71  
EN-2460-P-AR .....85, 346  
EN-2460-P-AR-S .....79, 81  
EN-2460-P-AR-T .....65, 67  
EN-2460-RB2 .....26, 46, 85, 87, 94  
EN-2460-RB2-S .....79, 81  
EN-2460-RB2-T .....65, 67, 69, 71, 73, 75  
EN-12100-R-AR .....346  
EN-12100-RB-AR .....26, 46, 94, 179, 346  
EN-12120-RB2 .....26, 87, 88, 346  
EN-12150-R-AR .....346  
EN-12150-RB-AR .....26, 46, 94, 346  
EN-12180-RB2 .....26, 87, 88, 346  
EN-12300-RB2 .....26, 87, 88, 346  
EN-24100-277-R .....79, 81  
EN-24100-277-R .....65, 67  
EN-24100-P-AR-S .....79, 81  
EN-24100-P-AR-T .....65, 67  
EN-24100-RB2 .....26, 46, 85, 87, 94  
EN-24100-RB2-S .....79, 81  
EN-24100-RB2-T .....65, 67, 69  
EN-24150-R-AR .....346  
EN-24150-RB-AR .....26, 346  
EN-B12PY-AR .....26  
EN-B24PZ-AR .....26, 346  
EN-HQ50AR .....117, 284  
EN-JQ50AR .....117, 120, 117  
EN-LQ50AR .....117  
EN-O24100-RB2-T .....73, 75  
ETB .....346

## F

FM-4006 .....310  
FM-4009 .....310  
FM-4109 .....309  
FM-4111 .....309  
FM-4313 .....307  
FM-4606 .....312  
FM-4610 .....312  
FM-7013 .....306  
FM-7113 .....308  
FM-W2505 .....52  
FM-W2510 .....52  
FM-W2605 .....54

## G

GU10-EXN .....345  
GU10LED-BAB .....161, 344

## H

H-LED009 .....128  
H-LED110W .....126  
H-LED18 .....123  
H-LED20 .....127  
H-LED210W .....126  
H-LED23 .....121  
H-LED27 .....123  
H-LED40 .....121  
H-LED42W .....125  
H-LED610 .....130  
H-LED710 .....131  
H-LED810 .....129  
H-LED820 .....129  
H-LED9 .....123

H6 .....117  
H12 .....117  
H18 .....117  
H24 .....117  
H36 .....117  
H48 .....117  
HBXLE .....118  
HCORD .....118  
HFC .....118  
HFLX .....118  
HHT-007 .....138  
HHT-007LED .....138  
HHT-009L .....138  
HHT-160 .....137  
HHT-160LED .....137  
HHT-164L .....134  
HHT-164LED .....134  
HHT-180 .....138  
HHT-180LED .....138  
HHT-204 .....135  
HHT-204LED .....135  
HHT-801 .....137  
HHT-801L .....137  
HHT-801LED .....137  
HHT-802 .....137  
HHT-802L .....137  
HHT-802LED .....137  
HHT-808 .....136  
HHT-808L .....136  
HHT-808LED .....136  
HHT-809 .....136  
HHT-809L .....136  
HHT-809LED .....136  
HHT-814 .....139  
HHT-814L .....139  
HHT-816 .....135  
HHT-816L .....135  
HHT-816LED .....135  
HHT-817 .....134  
HHT-817LED .....134  
HHT-826 .....134  
HHT-826L .....134  
HHT-826LED .....134  
HHT-846 .....135  
HHT-846L .....135  
HHT-846LED .....135  
HHT-856 .....133  
HHT-856L .....133  
HHT-856LED .....133  
HHT-866 .....136  
HHT-866L .....136  
HHT-874 .....133  
HHT-874LED .....133  
HHT-886 .....133  
HHT-886LED .....133  
HHT-936 .....139  
HI .....118  
HI-DEC .....118  
HI-PWR .....118  
HLE .....118  
HL-LEFT .....118  
H-LOOP .....118  
HL-RIGHT .....118  
HM1-101 .....191  
HM1-720 .....191  
HM1-730 .....191  
HM1-738 .....191  
HM1-846 .....192  
HM1-846L .....192  
HM1-849 .....192

# Numerical Index

HM1-849L.....	192	HR-3LED-H18D-EMICA.....	7	HR-LED411TL.....	17
HM1-BM.....	172	HR-3LED-H18D-ICA.....	7	HR-LED418.....	16, 17
HM1-EN50.....	284	HR-3LED-R18D-A.....	7	HR-LED421.....	15
HM1-F4-404.....	255	HR-3LED-T118.....	8	HR-LED431.....	15
HM1-F4-404LED.....	255	HR-3LED-T218.....	8	HR-LED451.....	15
HM1-F4-451.....	268	HR-3LED-T318.....	8	HR-LED451TL.....	17
HM1-F4-451LED.....	268	HR-3LED-T418.....	8	HR-LED471.....	15
HM1-F4-454.....	267	HR-3LED-T518.....	8	HR-LED-COV.....	85, 87
HM1-F4-454LED.....	267	HR-3LED-T618.....	8	HT.....	118
HM1-I6.....	186	HR-3LED-T718.....	8	HT2.....	117
HM1-I12.....	186	HR-3LED-T818.....	8	HT4.....	117
HM1-I24.....	186	HR-3LED-T918.....	8	HT6.....	117
HM1-I36.....	186	HR-86.....	87	HT8.....	117
HM1-I48.....	186	HR-88.....	87	HTK-101.....	145
HM1-IDEC6.....	186	HR-301E.....	28	HTK-102.....	145
HM1-IDEC12.....	186	HR-301M.....	28	HTK-103.....	145
HM1-IDEC24.....	186	HR-302E.....	28	HTK-103LED.....	145
HM1-IDEC36.....	186	HR-302M.....	28	HTK-104.....	145
HM1-IDEC48.....	186	HR-800.....	25	HTK-150.....	142
HM1-LED17.....	187	HR-801.....	25	HTK-178.....	141
HM1-LED25.....	122	HR-802.....	25	HTK-188.....	141
HM1-LED27.....	187	HR-806.....	25	HTK-703.....	140
HM1-LED42W.....	190	HR-834.....	25	HTK-713.....	142
HM1-PCC12.....	186	HR-836.....	25	HTK-720.....	141
HM1-PCC24.....	186	HR-837.....	25	HTK-725.....	140
HM1-PCC36.....	186	HR-1135.....	88	HTK-730.....	141
HM1-PCC48.....	186	HR-1136.....	88	HTK-733.....	142
HM1-PCC96.....	186	HR-1137.....	88	HTK-738.....	141
HM1-PCT6.....	186	HR-1138.....	88	HTK-763.....	140
HM1-PCT12.....	186	HR-8401.....	30	HTK-764.....	140
HM1-PCT24.....	186	HR-8402.....	30	HTK-764-39E.....	146
HM1-PCT36.....	186	HR-8402E.....	30	HTK-765.....	140
HM1-PCT48.....	186	HR-8402HL.....	30	HTK-765-70E.....	146
HM1-T4.....	185	HR-8403.....	30	HTK-793.....	143
HM1-T8.....	185	HR-8411.....	29	HTK-794.....	143
HM1-TB6.....	186	HR-8412.....	29	HTK-797.....	143
HM1-TB12.....	186	HR-8417.....	30	HTK-798.....	143
HM1-TB24.....	186	HR-D321.....	27	HTK-F4-404.....	255
HM1-TB36.....	186	HR-D324.....	27	HTK-F4-404LED.....	255
HM1-TB48.....	186	HR-D325.....	27	HTK-F4-451.....	268
HM1-VA6.....	186	HR-D327.....	27	HTK-F4-451LED.....	268
HM1-VA12.....	186	HR-D329-S.....	27	HTK-F4-454.....	267
HM1-VA24.....	186	HR-D411.....	29	HTK-F4-454LED.....	267
HM1-VA36.....	186	HR-D412.....	29	HTK-HID202.....	147
HM1-VA48.....	186	HR-D412-S.....	29	HTK-HID202A.....	147
HM1-X6.....	186	HR-D413.....	29	HTK-HID220.....	147
HM1-X12.....	186	HR-D416.....	30	HTK-LED25.....	122
HM1-X24.....	186	HR-D417.....	30	HX.....	118
HM1-X36.....	186	HR-D418.....	29		
HM1-X48.....	186	HR-D418-S.....	30		
HM1-XS6.....	186	HR-D425.....	30		
HM1-XS12.....	186	HR-LED87.....	85		
HM1-XS24.....	186	HR-LED87-27.....	85		
HM1-XS36.....	186	HR-LED87S.....	85		
HM1-XS48.....	186	HR-LED87S-27.....	85		
HMP.....	118	HR-LED211E.....	11		
HM-XADJ.....	186	HR-LED212E.....	11		
HR-2LD-ET109.....	4	HR-LED231R.....	12		
HR-2LED-H09D-ICA.....	4, 6	HR-LED232R.....	12		
HR-2LED-H09-HICA.....	4, 6	HR-LED251E.....	11		
HR-2LED-R09D-A.....	4, 6	HR-LED252E.....	11		
HR-2LED-T109.....	5	HR-LED271R.....	12		
HR-2LED-T209.....	5	HR-LED272R.....	12		
HR-2LED-T309.....	5	HR-LED309.....	14		
HR-2LED-T409.....	5	HR-LED311.....	13		
HR-2LED-T509.....	5	HR-LED321.....	13		
HR-2LED-T709.....	5	HR-LED331.....	13		
HR-3LD-ET118.....	7	HR-LED351.....	13		
HR-3LED-H18D1-ICA.....	7	HR-LED371.....	13		
HR-3LED-H18D-A.....	7	HR-LED411.....	15		

# Numerical Index

## J

J-LED009	128
J-LED110W	126
J-LED18	123
J-LED20	127
J-LED210W	126
J-LED23	121
J-LED27	123
J-LED40	121
J-LED42W	125
J-LED610	130
J-LED710	131
J-LED810	129
J-LED820	129
J-LED9	123
J2-BXLE	120
J2-FLX	120
J2-I	120
J2-IDEC	120
J2-IPWR	120
J2-LE	120
J2-LLEFT	120
J2-LRIGHT	120
J2-T	120
J2-T4	120
J2-T8	120
J2-TBLE	120
J2-UCP	120
J2-WCOV	120
J2-X	120
JBXLE	118
JC-10	345
JC-150-S	345
JC-20	345
JC-50-G635	345
JCD-20X-CL	345
JCLEd-2-30-WT	344
JCLIP	120
JFC	118
JFLX	118
JHT-007	138
JHT-007LED	138
JHT-009L	138
JHT-160	137
JHT-160LED	137
JHT-164L	134
JHT-164LED	134
JHT-180	138
JHT-180LED	138
JHT-204	135
JHT-204LED	135
JHT-801	137
JHT-801L	137
JHT-801LED	137
JHT-802	137
JHT-802L	137
JHT-802LED	137
JHT-808	136
JHT-808L	136
JHT-808LED	136
JHT-809	136
JHT-809L	136
JHT-809LED	136
JHT-814	139
JHT-814L	139
JHT-816	135
JHT-816L	135
JHT-816LED	135
JHT-817	134

JHT-817LED	134
JHT-826	134
JHT-826L	134
JHT-826LED	134
JHT-846	135
JHT-846L	135
JHT-846LED	135
JHT-856	133
JHT-856L	133
JHT-856LED	133
JHT-866	136
JHT-866L	136
JHT-874	133
JHT-874LED	133
JHT-886	133
JHT-886LED	133
JHT-936	139
JJ	118
JJ-DEC	118
JJ-PWR	118
JLE	118
JL-LEFT	118
J-LOOP	118
JL-RIGHT	118
JMP	118
JT	118
JT2	117
JT4	117
JT6	117
JT8	117
JTK-101	145
JTK-102	145
JTK-103	145
JTK-103LED	145
JTK-104	145
JTK-104LED	145
JTK-150	142
JTK-178	141
JTK-188	141
JTK-703	140
JTK-713	142
JTK-720	141
JTK-725	140
JTK-730	141
JTK-733	142
JTK-738	141
JTK-763	140
JTK-764	140
JTK-764-39E	146
JTK-765	140
JTK-765-70E	146
JTK-793	143
JTK-794	143
JTK-797	143
JTK-798	143
JTK-F4-404	255
JTK-F4-404LED	255
JTK-F4-451	268
JTK-F4-451LED	268
JTK-F4-454	267
JTK-F4-454LED	267
JTK-HID202	147
JTK-HID202A	147
JTK-HID220	147
JTK-LED25	122
JX	118

## L

L-LED009	128
L-LED9	123
L-LED18	123
L-LED20	127
L-LED23	121
L-LED27	123
L-LED40	121
L-LED42W	125
L-LED110W	126
L-LED210W	126
L-LED610	130
L-LED710	131
L-LED810	129
L-LED820	129
LBXLE	118
LCORDSET	118
LD-700MA03-EDIM-IS	12
LD-700MA09-EDIM-IS	12
LED-700MA12-P	12, 95
LED-SL-101	95
LED-T24	69, 70
LED-T2430	69
LED-T-B	65, 67, 69
LED-TC	71, 72
LED-TC24-SW60	71
LED-TC24-SW120	71
LED-TC-B-2	65, 67, 69
LED-TC-CTR-MSD	71, 72
LED-TC-EC	65, 67, 69, 71, 73
LED-TC-EXT-144	65, 67, 69
LED-T-CH	65, 67, 69, 70, 71
LED-TC-IC2	65, 67, 69, 73, 75
LED-TC-IC6	65, 67, 69, 71
LED-TC-IC12	65, 67, 69, 71
LED-TC-IC36	65, 67, 69, 71
LED-TC-IC72	65, 67, 69, 71
LED-TC-L	65, 67, 69, 71
LED-T-CL	65, 67, 69, 73, 75
LED-TCO	75
LED-TC-P-2	65, 67, 69
LED-TC-P-12	65, 67, 69
LED-TC-X	65, 67, 69, 71
LED-TC-Y	65, 67, 69, 71
LED-TO24-C1	73, 75
LED-TO24-C2	73, 75
LED-TO24-C3	73, 75
LED-TO24-CH5	73, 75, 76
LED-TO24-CM	75
LED-TO24-CS	75
LED-TO24-EC	73, 75
LED-TO24-IC6	73, 75
LED-TO24-IC6-RGB	75
LED-TO24-IC12	73, 75
LED-TO24-IC12-RGB	75
LED-TO24-IC72	73, 75
LED-TO24-IC72-RGB	75
LED-TO24-IC120	73, 75
LED-TO24-IC120-RGB	75
LED-TO24-MW60	75
LED-TO24-MW120	75
LED-TO24-SW60	75
LED-TO24-SW120	75
LED-TO24-WS	71, 75
LED-TO24-WS	72
LED-TO24-X	73
LED-TO24-X-RGB	75
LED-TO24-Y	73
LED-TO24-Y-RGB	75

# Numerical Index

LED-TO2435 .....	73	LM2-EN12-300M .....	173	LM-X4 .....	180
LED-T-RC .....	65, 67, 69, 71, 73, 75	LM2-EN12-500M .....	173	LM-X5 .....	180
LED-TX24 .....	65	LM2-I .....	174	LM-XDEC .....	180
LENS-1X3-DIC.....	91, 109	LM2-IDEC .....	174	LM-XS5 .....	180
LENS-13-FR.....	85	LM2-L .....	174	LN-LED06 .....	79
LENS-16 .....	162, 343	LM2-PCS48 .....	173, 178	LN-LED12 .....	79
LENS-20 .....	162, 343	LM2-PCS96 .....	173	LN-LED18 .....	79
LENS-25 .....	162, 343	LM2-QADP .....	172, 284	LN-LED24 .....	79
LENS-30 .....	162, 343	LM2-SCP48 .....	173, 178	LN-LED30 .....	79
LENS-45-FR-N.....	87	LM2-SCP96 .....	173	LS-LED08 .....	81
LENS-111 .....	162, 343	LM2-T .....	174	LS-LED14 .....	81
LFC .....	118	LM2-T4 .....	172	LS-LED20 .....	81
LFLX .....	118	LM2-T8 .....	172	LS-LED26 .....	81
LHT-007 .....	138	LM2-TB3 .....	174	LS-LED32 .....	81
LHT-007LED .....	138	LM2-TB5 .....	174	LT .....	118
LHT-009L .....	138	LM2-TB8 .....	174	LT2 .....	117
LHT-160LED .....	137	LM2-VA .....	174	LT4 .....	117
LHT-160 .....	137	LM2-X3 .....	174	LT6 .....	117
LHT-164L .....	134	LM2-X5 .....	174	LT8 .....	117
LHT-164LED .....	134	LM2-X8 .....	172, 174	LTK-101 .....	145
LHT-180 .....	138	LM2-XDEC.....	174	LTK-102 .....	145
LHT-180LED .....	138	LM2-XS5 .....	174	LTK-103 .....	145
LHT-204 .....	135	LM-CPC .....	179	LTK-103LED .....	145
LHT-204LED .....	135	LM-CS48 .....	180	LTK-104 .....	145
LHT-801 .....	137	LM-CS96 .....	180	LTK-104LED .....	145
LHT-801L .....	137	LM-CW .....	180	LTK-150 .....	142
LHT-801LED .....	137	LM-DBC12/24-300 .....	173, 178	LTK-178 .....	141
LHT-802 .....	137	LM-DBC12/24-600 .....	173, 178	LTK-188 .....	141
LHT-802L .....	137	LM-DBC12-150.....	173, 178	LTK-703 .....	140
LHT-802LED .....	137	LM-DCPC .....	179	LTK-713 .....	142
LHT-808 .....	136	LM-EN12-75E.....	178	LTK-720 .....	141
LHT-808L .....	136	LM-EN12-150E .....	178	LTK-725 .....	140
LHT-808LED .....	136	LM-EN12-150M.....	178	LTK-730 .....	141
LHT-809 .....	136	LM-EN12-250E .....	178	LTK-733 .....	142
LHT-809L .....	136	LM-EN12-300M.....	178	LTK-738 .....	141
LHT-809LED .....	136	LM-EN12-600M.....	178	LTK-763 .....	140
LHT-814 .....	139	LM-I .....	180	LTK-764 .....	140
LHT-814L .....	139	LM-IDEC .....	180	LTK-764-39E .....	146
LHT-816 .....	135	LM-JS .....	180	LTK-765 .....	140
LHT-816L .....	135	LM-K592-AB/DB .....	181	LTK-765-70E .....	146
LHT-816LED .....	135	LM-K8111-AS/DB.....	182	LTK-793 .....	143
LHT-817LED .....	134	LM-K8611-WT/DB.....	182	LTK-794 .....	143
LHT-817 .....	134	LM-K8711-WT/BN.....	182	LTK-797 .....	143
LHT-826 .....	134	LM-K8811-WT/BN.....	182	LTK-798 .....	143
LHT-826L .....	134	LM-K9415-BN/BN.....	182	LTK-F4-404 .....	255
LHT-826LED .....	134	LM-L .....	180	LTK-F4-404LED .....	255
LHT-846 .....	135	LM-OW .....	180	LTK-F4-451 .....	268
LHT-846L .....	135	LM-OWP .....	179	LTK-F4-451LED .....	268
LHT-846LED .....	135	LMP .....	118	LTK-F4-454 .....	267
LHT-856 .....	133	LM-PCS48.....	179	LTK-F4-454LED .....	267
LHT-856L .....	133	LM-PCS96.....	79	LTK-HID202.....	147
LHT-856LED .....	133	LM-QADP .....	172, 177, 185, 284	LTK-HID202A.....	147
LHT-866L .....	136	LM-R12 .....	174, 180	LTK-HID220.....	147
LHT-866 .....	136	LM-R24 .....	174, 180	LTK-LED25.....	122
LHT-874 .....	133	LM-R36 .....	174, 180	LX .....	118
LHT-874LED .....	133	LM-R48 .....	174, 180	LXS8-PW27 .....	4, 5, 7
LHT-886 .....	133	LM-RI .....	174, 180	LXS8-PW30 .....	4, 5, 7
LHT-886LED .....	133	LM-SCP48.....	178	LXS8-PW35 .....	4, 5, 7
LHT-936 .....	139	LM-SCP96.....	178	LXS8-PW40 .....	4, 5, 7
LI .....	118	LM-SK-150E.....	181	LXS9-PW30 .....	4, 5, 7
LI-DEC .....	118	LM-SK-250E.....	181		
LI-PWR .....	118	LM-T .....	180		
LLE .....	118	LM-T4 .....	172, 177, 185		
LL-LEFT .....	118	LM-T8 .....	177		
L-LOOP .....	118	LM-TB3 .....	180		
LL-RIGHT .....	118	LM-TB4 .....	180		
LM2-CPC.....	173, 178	LM-TB5 .....	180		
LM2-CS48.....	174	LM-TB8 .....	180		
LM2-CS96.....	174	LM-VA .....	180		
LM2-DCPC .....	173	LM-WPC .....	179		
		LM-X3 .....	180		

# Numerical Index

<b>M</b>		
MAG-TAPE-36.....	82	
MBS-16 .....	94, 97, 343	
ME-007 .....	93	
ME-007LED.....	93	
ME-204 .....	94	
ME-204LED.....	94	
ME-808 .....	93	
ME-808LED.....	93	
ME-826 .....	93	
ME-826LED.....	93	
METB .....	346	
MM-204.....	94	
MM-204LED.....	94	
MO-LED17.....	90	
MO-LED25.....	91	
MO-LED810.....	92	
MP-332 .....	213	
MP-333 .....	219	
MP-335 .....	245	
MP-512 .....	265	
MP-513 .....	264	
MP-515 .....	231	
MP-518 .....	233	
MP-524 .....	262	
MP-533 .....	219	
MP-534 .....	222	
MP-538 .....	224	
MP-539 .....	197	
MP-541 .....	266	
MP-542 .....	199	
MP-543 .....	201	
MP-544 .....	209	
MP-546 .....	233	
MP-559 .....	261	
MP-599 .....	234	
MP-60E.....	286	
MP-613 .....	263	
MP-614 .....	232	
MP-614LED.....	232	
MP-630 .....	220	
MP-630LED.....	220	
MP-913 .....	235	
MP-913LED.....	235	
MP-914 .....	250	
MP-914LED.....	250	
MP-915 .....	250	
MP-916 .....	241	
MP-918 .....	223	
MP-919 .....	249	
MP-919LED.....	249	
MP-920 .....	211	
MP-930 .....	251	
MP-933 .....	223	
MP-935 .....	221	
MP-935LED.....	221	
MP-938 .....	203	
MP-939 .....	195	
MP-940 .....	251	
MP-943 .....	207	
MP-946 .....	225	
MP-946LED.....	225	
MP-953 .....	244	
MP-954 .....	224	
MP-960 .....	211	
MP-966 .....	243	
MP-LED311.....	253	
MP-LED314.....	248	
MP-LED315.....	247	
MP-LED332.....	213	
MP-LED333.....	219	
MP-LED334.....	252	
MP-LED335.....	245	
MP-LED336.....	205	
MP-LED481.....	276	
MP-LED483.....	275	
MP-LED491.....	274	
MP-LED492.....	277	
MP-LED493.....	278	
MP-LED494.....	277	
MP-LED495.....	278	
MP-LED497.....	273	
MP-LED498.....	279	
MP-LED499.....	274	
MP-LED512.....	265	
MP-LED513.....	264	
MP-LED515.....	231	
MP-LED524.....	262	
MP-LED534.....	222	
MP-LED538.....	224	
MP-LED539.....	197	
MP-LED541.....	266	
MP-LED542.....	199	
MP-LED543.....	201	
MP-LED544.....	209	
MP-LED546.....	233	
MP-LED559.....	261	
MP-LED599.....	234	
MP-LED518.....	233	
MP-LED916.....	241	
MP-LED918.....	223	
MP-LED920.....	211	
MP-LED933.....	223	
MP-LED938.....	203	
MP-LED939.....	195	
MP-LED953.....	244	
MP-LED954.....	224	
MP-LED960.....	211	
MP-LED966.....	243	
MR16LED-BAB.....	25, 27, 29, 31, 97, 161, 166, 344	
MR16-EXN.....	345	
MT-3LD111NA-F30.....	20	
MT-3LD111NA-F930.....	20	
MT-3LD111R-F30.....	20	
MT-3LD111R-F930.....	20	
MT-3LD211NA-F30.....	20	
MT-3LD211NA-F930.....	20	
MT-3LD211R-F30.....	20	
MT-3LD211R-F930.....	20	
MT-3LD311NA-F30.....	20	
MT-3LD311NA-F930.....	20	
MT-3LD311R-F30.....	20	
MT-3LD311R-F930.....	20	
MT-4LD116N.....	22	
MT-4LD116T.....	21	
MT-4LD116TL.....	21	
MT-4LD216N.....	22	
MT-4LD216T.....	21	
MT-4LD216TL.....	21	
MT-4LD226N.....	22	
MT-4LD226T.....	21	
MT-4LD226TL.....	21	
MT-4LD316N.....	22	
MT-4LD316T.....	21	
MT-4LD316TL.....	21	
MT-4LD416N.....	22	
MT-4LD416T.....	21	
MT-4LD416TL.....	21	
MT-5LD125H-NA.....	24	
MT-5LD125T.....	23	
MT-5LD125TL.....	23	
MT-5LD225H-NA.....	24	
MT-5LD225T.....	23	
MT-5LD225TL.....	23	
MT-5LD325H-NA.....	24	
MT-5LD325T.....	23	
MT-5LD325TL.....	23	
MT-5LD425H-NA.....	24	
MT-5LD425T.....	23	
MT-5LD425TL.....	23	
MT-5LD445H-NA.....	24	
MT-5LD445T.....	23	
MT-5LD445TL.....	23	
MT-116.....	31	
MT-116HS.....	32	
MT-116TL.....	31	
MT-130.....	37	
MT-130HS.....	37	
MT-130MH.....	38	
MT-130TL.....	37	
MT-216.....	31	
MT-216HS.....	32	
MT-216TL.....	31	
MT-230.....	37	
MT-230HS.....	37	
MT-230MH.....	38	
MT-230TL.....	37	
MT-316.....	31	
MT-316HS.....	32	
MT-316TL.....	31	
MT-330.....	37	
MT-330HS.....	37	
MT-330MH.....	38	
MT-330TL.....	37	
MT-430MH.....	38	
MTB-01.....	85	
MTB-08.....	80, 82	
<b>O</b>		
OPH-9X3-12D.....	107	
OPH-9X3-25D.....	107	
OPH-9X3-40D.....	107	
OPH-9X3-ELD.....	107	
OPH-10X3-20D.....	91, 109	
OPH-10X3-42D.....	91, 109	
OPH-16X3-12D.....	107	
OPH-16X3-25D.....	107	
OPH-16X3-40D.....	107	
OPH-16X3-ELD.....	107	
<b>P</b>		
PAR20BD.....	343	
PAR20HLD.....	343	
PAR20LED-10N30.....	98, 161, 344	
PAR30BD.....	343	
PAR30HLD.....	343	
PAR30LED-L14N30.....	35, 37, 98, 161, 344	
PAR38BD.....	343	
PAR38HLD.....	343	
PAR38LED-17N30.....	98, 161, 344	
PD-51148.....	324	
PD-51712.....	320	
PD-51814.....	314	
PD-51915.....	315	
PD-52008.....	318	
PD-52214.....	322	
PD-52310.....	316	

# Numerical Index

PD-52313.....	316
PD-W2605.....	54
PL-LED14.....	326
PL-LED15.....	328
PL-LED24.....	326
PL-LED25.....	328
PL-LED37.....	328
PLD-F4-404.....	255
PLD-F4-404LED.....	255
PLD-F4-451.....	268
PLD-F4-451LED.....	268
PLD-F4-454.....	267
PLD-F4-454LED.....	267

## Q

QF-181.....	170
QF-182.....	167
QF-183.....	166
QF-184.....	168
QF-185.....	166
QF-186.....	169
QF-187.....	169
QF-188.....	169
QF-190.....	167, 168, 169
QF-194.....	166, 168, 169
QF-195.....	170
QF-197.....	166, 170
QF-199.....	166
QF-8111-AS/DB.....	182
QF-8611-WT/DB.....	182
QF-8711-WT/BN.....	182
QF-8811-WT/BN.....	182
QF-9415-BN/BN.....	182
QF-LED101-W.....	132, 165, 132
QF-LED102-W.....	132
QF-LED103-W.....	165, 132
QF-LED171.....	167, 132
QF-LED173.....	132, 167, 132
QMP-1RN-TR.....	286
QMP-1SQ-TR.....	286
QMP-60ERN.....	285
QMP-G1RN.....	285
QMP-G3RE.....	285
QMP-G3RN.....	285
QMP-G6RN.....	285
QMP-G12RN.....	285
QMP-LED311/3-MR.....	254
QMP-LED311/6-MR.....	254
QMP-LED311/12-MR.....	254
QMP-LED311-MR.....	254
QMP-MI-TR.....	286
QMP-S60ERN.....	285
QP-332.....	213
QP-333.....	219
QP-335.....	245
QP-501.....	283
QP-501X12.....	283
QP-512.....	265
QP-513.....	264
QP-515.....	231
QP-518.....	233
QP-524.....	262
QP-533.....	219
QP-534.....	222
QP-538.....	224
QP-539.....	197
QP-541.....	266
QP-542.....	199

QP-543.....	201
QP-544.....	209
QP-546.....	233
QP-559.....	261
QP-599.....	234
QP-601.....	283
QP-601X12.....	283
QP-613.....	263
QP-614.....	232
QP-614LED.....	232
QP-630.....	220
QP-630LED.....	220
QP-902.....	283
QP-902X12.....	283
QP-913.....	235
QP-913LED.....	235
QP-914.....	250
QP-914LED.....	250
QP-915.....	250
QP-916.....	241
QP-918.....	223
QP-919.....	249
QP-919LED.....	249
QP-920.....	211
QP-930.....	251
QP-933.....	223
QP-935.....	221
QP-935LED.....	221
QP-938.....	203
QP-939.....	195
QP-940.....	251
QP-943.....	207
QP-946.....	225
QP-946LED.....	225
QP-953.....	244
QP-954.....	224
QP-960.....	211
QP-966.....	243
QP-G592-AB/DB.....	181
QP-LED303.....	283
QP-LED303X12.....	283
QP-LED403.....	283
QP-LED403X12.....	283
QP-LED503.....	283
QP-LED503X12.....	283
QP-LED903.....	283
QP-LED903X12.....	283
QP-LED311.....	253
QP-LED314.....	248
QP-LED315.....	247
QP-LED332.....	213
QP-LED333.....	219
QP-LED334.....	252
QP-LED335.....	245
QP-LED336.....	205
QP-LED481.....	276
QP-LED483.....	275
QP-LED491.....	274
QP-LED492.....	277
QP-LED493.....	278
QP-LED494.....	277
QP-LED495.....	278
QP-LED497.....	273
QP-LED498.....	279
QP-LED499.....	274
QP-LED512.....	265
QP-LED513.....	264
QP-LED515.....	231
QP-LED518.....	233
QP-LED524.....	262

QP-LED534.....	222
QP-LED538.....	224
QP-LED539.....	197
QP-LED541.....	266
QP-LED542.....	199
QP-LED543.....	201
QP-LED544.....	209
QP-LED546.....	233
QP-LED559.....	261
QP-LED599.....	234
QP-LED916.....	241
QP-LED918.....	223
QP-LED920.....	211
QP-LED933.....	223
QP-LED938.....	203
QP-LED939.....	195
QP-LED953.....	244
QP-LED954.....	224
QP-LED960.....	211
QP-LED966.....	243
Q-X18.....	166
Q-X24.....	166
Q-X36.....	166
Q-X48.....	166

## R

R18.....	117, 120
R24.....	117, 120
R36.....	117, 120
R48.....	117, 120
R72.....	117, 120
R-4005-N-A.....	33
R-4015-R-A.....	33
R-4025-N-ICA.....	33
R-420.....	33
R-421.....	33
R-422.....	33
R-432.....	33
R-500-N-UA.....	34
R-501-R-UA.....	34
R-520.....	34
R-521.....	34
R-522.....	34
R-532.....	34
R-602D-N-ICA.....	35
R-603D-R-ICA.....	35
R-620.....	35
R-633.....	35
R-651.....	35
R-656.....	35
RF-F.....	92, 131
RF-S.....	92, 131
RI.....	117, 120
RM1X3-27-DL.....	11, 12
RM1X3-30-DL.....	11, 12
RM1X3-30-SL.....	95
RM1X3-35-DL.....	11, 12
RM1X3-45-DL.....	11, 12
RM1X3-45-SL.....	95
RM-3X3-27.....	13, 123
RM-3X3-30.....	13, 123
RM-3X3-35.....	13, 123
RM-3X3-45.....	13, 123
RM-6X3-27.....	15, 17, 123
RM-6X3-30.....	15, 17, 123
RM-6X3-35.....	15, 17, 123
RM-6X3-45.....	15, 17, 123
RM-7X3-27.....	90, 111
RM-7X3-30.....	90, 111

# Numerical Index

RM-7X3-35.....	90, 111
RM-7X3-40.....	90, 111
RM-9X3-27.....	107
RM-9X3-30.....	107
RM-9X3-35.....	107
RM-9X3-40.....	107
RM-10X3-27.....	91, 109
RM-10X3-30.....	91, 109
RM-10X3-35.....	91, 109
RM-10X3-40.....	91, 109
RM-11X3-27.....	111, 123
RM-11X3-30.....	111, 123
RM-11X3-35.....	111, 123
RM-11X3-40.....	111, 123
RM-16X3-27.....	107
RM-16X3-30.....	107
RM-16X3-35.....	107
RM-16X3-40.....	107
RM36X02-30RE1-24-1.....	126
RM36X02-30RE1-24-2.....	126
RM36X02-40RE1-24-1.....	126
RM36X02-40RE1-24-2.....	126

## S

SBS-16.....	94, 97, 343
SK.....	117, 120
SK05.....	117
SK14.....	117, 120
SK14S.....	186
SL-C1-WT.....	82
SL-C2-WT.....	82
SL-C3-WT.....	82
SL-EXT-144.....	80, 82
SL-I.....	80, 82
SL-IC-06.....	80, 82
SL-IC-12.....	80, 82
SL-IC-24.....	80, 82
SL-IC-36.....	80, 82
SL-IF.....	80, 82
SL-LEN.....	95
SL-REF-LUX.....	4
SL-REF-LUX10-F.....	4, 7
SL-REF-LUX10-N.....	4, 7
SL-REF-LUX10-S.....	4, 5, 7
SL-WC-1.....	80, 82
SL-X.....	80, 82
SL-Y.....	80, 82
SRT-300M-12V.....	94, 173, 179
SRT-300M-24V.....	173, 179
SRT-600M-12V.....	94, 173, 179
SRT-600M-24V.....	173, 179

## T

T-BARCLIP.....	118, 120
TBKT.....	117, 120
TB-S.....	65, 67, 69, 80, 82
THL-HI-1-1A.....	119
THL-HI-1-2A.....	119
THL-HI-1-5A.....	119
THL-HI-1-7A.....	119
THL-HI-1-10A.....	119
THL-HI-2-1A.....	119
THL-HI-2-2A.....	119
THL-HI-2-5A.....	119
THL-HI-2-7A.....	119
THL-HI-2-10A.....	119
THL-HLE-1A.....	119
THL-HLE-2A.....	119
THL-HLE-5A.....	119
THL-HLE-7A.....	119

THL-HLE-10A.....	119
THL-LEFT-1-1A.....	119
THL-LEFT-1-2A.....	119
THL-LEFT-1-5A.....	119
THL-LEFT-1-7A.....	119
THL-LEFT-1-10A.....	119
THL-LEFT-2-1A.....	119
THL-LEFT-2-2A.....	119
THL-LEFT-2-5A.....	119
THL-LEFT-2-7A.....	119
THL-LEFT-2-10A.....	119
THL-RIGHT-1-1A.....	119
THL-RIGHT-1-2A.....	119
THL-RIGHT-1-5A.....	119
THL-RIGHT-1-7A.....	119
THL-RIGHT-1-10A.....	119
THL-RIGHT-2-1A.....	119
THL-RIGHT-2-2A.....	119
THL-RIGHT-2-5A.....	119
THL-RIGHT-2-7A.....	119
THL-RIGHT-2-10A.....	119

## W

WEC.....	103, 104
WEDL.....	103, 104
WEDR.....	103, 104
WFC.....	103
WHEDL.....	103, 104
WHEDR.....	103, 104
WHFC.....	103
WHIC.....	103, 104
WHLLC.....	103, 104
WHLTC.....	103, 104
WHPC.....	103, 104
WHK-HID202.....	114
WHK-HID202A.....	114
WHK-HID220.....	114
WHK-LED17.....	111
WHK-LED20.....	112
WHK-LED23.....	107
WHK-LED25.....	109
WHK-LED27.....	111
WHK-LED512.....	106
WHK-LED522.....	106
WHK-LED532.....	106
WHK-LED533.....	219
WHRLC.....	103, 104
WHRTC.....	103, 104
WHT4.....	103
WHT8.....	103
WHT12.....	103
WHXC.....	103, 104
WIC.....	103, 104
WLLC.....	103, 104
WL-LED100.....	58
WL-LED100TR.....	59
WL-LED200.....	58
WL-LED200TR.....	59
WL-LED300.....	61
WL-LED310.....	61
WLTC.....	103, 104
WMED.....	103
WMFP.....	103
WMIC.....	103
WMLC.....	103
WMPC.....	103
WMSP.....	103
WMST.....	103
WMST-TB.....	103
WMST-X.....	103
WMT.....	103, 104

WMTC.....	103
WMT-TB.....	103
WMT-X.....	103
WMXC.....	103
WPC.....	103, 104
WR-6R1LD-T.....	9
WR-6RTLID.....	9
WRLC.....	103, 104
WRTC.....	103, 104
WS-6312.....	293
WS-6320.....	293
WS-6327.....	293
WS-6614.....	294
WS-6618.....	294
WS-6620.....	294
WS-6624.....	294
WS-6636.....	294
WS-6718.....	296
WS-6724.....	296
WS-6736.....	296
WS-7012.....	291
WS-7022.....	291
WS-7027.....	291
WS-7115.....	292
WS-7120.....	292
WS-7128.....	292
WS-7213.....	290
WS-7222.....	290
WS-7230.....	290
WS-7316.....	289
WS-7322.....	289
WS-7334.....	289
WS-11807.....	300
WS-12214.....	301
WS-12511.....	304
WS-12517.....	304
WS-12713.....	298
WS-12718.....	298
WS-12724.....	298
WS-13020.....	297
WS-13107.....	303
WS-13115.....	303
WS-13122.....	303
WS-13208.....	302
WS-13212.....	302
WS-13217.....	302
WS-W2504.....	51
WS-W2505.....	51
WS-W2604.....	53
WS-W2605.....	53
WS-W5312.....	340
WS-W5318.....	340
WS-W5720.....	342
WS-W5812.....	338
WS-W5817.....	338
WS-W5822.....	338
WS-W5915.....	339
WS58-G512.....	269
WS58-G513.....	270
WS58-G515.....	237
WS58-G518.....	237
WS58-G538.....	227
WS58-G539.....	215
WS58-G541.....	270
WS58-G542.....	215
WS58-G543.....	215
WS58-G544.....	216
WS58-G546.....	238
WS58-G559.....	269
WS58-G599.....	238
WS72-G512.....	269



# Numerical Index

WS72-G513.....	270
WS72-G515.....	237
WS72-G518.....	237
WS72-G538.....	227
WS72-G539.....	215
WS72-G541.....	270
WS72-G542.....	215
WS72-G543.....	215
WS72-G544.....	216
WS72-G546.....	238
WS72-G559.....	269
WS72-G599.....	238
WS72-G613.....	270
WS72-G630.....	227
WS72-G914.....	257
WS72-G915.....	257
WS72-G920.....	216
WS72-G939.....	215
WS72-G940.....	257
WS72-G946.....	228
WS72-G954.....	227
WS57LED-G311.....	258
WS57LED-G314.....	258
WS57LED-G334.....	258
WS57LED-G512.....	269
WS57LED-G513.....	270
WS57LED-G515.....	237
WS57LED-G518.....	237
WS57LED-G538.....	227
WS57LED-G539.....	215
WS57LED-G541.....	270
WS57LED-G542.....	215
WS57LED-G543.....	215
WS57LED-G544.....	216
WS57LED-G546.....	238
WS57LED-G559.....	269
WS57LED-G599.....	238
WS58LED-G311.....	258
WS58LED-G314.....	258
WS58LED-G334.....	258
WS58LED-G512.....	269
WS58LED-G513.....	270
WS58LED-G515.....	237
WS58LED-G518.....	237
WS58LED-G538.....	227
WS58LED-G539.....	215
WS58LED-G541.....	270
WS58LED-G542.....	215
WS58LED-G543.....	215
WS58LED-G544.....	216
WS58LED-G546.....	238
WS58LED-G559.....	269
WS58LED-G599.....	238
WS72LED-G311.....	258
WS72LED-G314.....	258
WS72LED-G334.....	258
WS72LED-G512.....	269
WS72LED-G513.....	270
WS72LED-G515.....	237
WS72LED-G518.....	237
WS72LED-G538.....	227
WS72LED-G539.....	215
WS72LED-G541.....	270
WS72LED-G542.....	215
WS72LED-G543.....	215
WS72LED-G544.....	216
WS72LED-G546.....	238
WS72LED-G559.....	269
WS72LED-G599.....	238
WS72LED-G914.....	257
WS72LED-G915.....	257
WS72LED-G920.....	216
WS72LED-G939.....	215
WS72LED-G940.....	257
WS72LED-G946.....	228
WS72LED-G954.....	227
WT4-RT.....	104
WT8-RT.....	104
WT12-RT.....	104
WT4-RTL.....	104
WT8-RTL.....	104
WT12-RTL.....	104
WTK-HID202.....	114
WTK-HID202A.....	114
WTK-HID220.....	114
WTK-LED17.....	111
WTK-LED20.....	112
WTK-LED23.....	107
WTK-LED25.....	109
WTK-LED27.....	111
WTK-LED40.....	107
WTK-LED40.....	107
WTK-LED42W.....	113
WTK-LED42W.....	113
WTK-LED512.....	106
WTK-LED522.....	106
WTK-LED532.....	106
WTK-LED533.....	219
WXC.....	103, 104
<b>X</b>	
XI.....	186

# Notes

## Headquarters

Tel: 877.810.6695

Fax: 866.810.6615

### East Coast Factory

44 Harbor Park Dr  
Port Washington, NY 11050

### West Coast Factory

1750 Archibald Ave  
Ontario, CA 91761

Consult the factory to take advantage of our custom capabilities in large quantities.  
For up to date product specifications and assistance please visit [www.waclighting.com](http://www.waclighting.com)

WAC Lighting retains the right to modify the design of our products at any time as part of the company's continuous improvement program.  
Copyright 2014

WAC LIGHTING  
Responsible Lighting®

wacighting.com  
1-800-526-2588

Material	Description	2011 DN	UPC Code
BA-LED10-WT	LED LGT BAR 30INCH 10X1W 3000K	110.95	790576142616
BA-LED2-BB	LED LGT BAR 6INCH 2X1W 3000K	54.95	790576142470
BA-LED2-SN	LED LGT BAR 6INCH 2X1W 3000K	54.95	790576142487
BA-LED2-WT	LED LGT BAR 6INCH 2X1W 3000K	54.95	790576142494
BA-LED4-BB	LED LGT BAR 12INCH 4X1W 3000K	69.95	790576142500
BA-LED4-SN	LED LGT BAR 12INCH 4X1W 3000K	69.95	790576142517
BA-LED4-WT	LED LGT BAR 12INCH 4X1W 3000K	69.95	790576142524
BA-LED6-BB	LED LGT BAR 18INCH 6X1W 3000K	79.95	790576142531
BA-LED6-SN	LED LGT BAR 18INCH 6X1W 3000K	79.95	790576142548
BA-LED6-WT	LED LGT BAR 18INCH 6X1W 3000K	79.95	790576142555
BA-LED8-BB	LED LGT BAR 24INCH 8X1W 3000K	89.95	790576142562
BA-LED8-SN	LED LGT BAR 24INCH 8X1W 3000K	89.95	790576142579
BA-LED8-WT	LED LGT BAR 24INCH 8X1W 3000K	89.95	790576142586
BA-LIX-1-BB	LINE VOLT XENON 1 LGT BAR 1X25W	21.95	790576114750
BA-LIX-1-SN	LINE VOLT XENON 1 LGT BAR 1X25W	21.95	790576114774
BA-LIX-1-WT	LINE VOLT XENON 1 LGT BAR 1X25W	21.95	790576114767
BA-LIX-2-BB	LINE VOLT XENON 2 LGT BAR 2X25W	32.50	790576114781
BA-LIX-2-SN	LINE VOLT XENON 2 LGT BAR 2X25W	32.50	790576114804
BA-LIX-2-WT	LINE VOLT XENON 2 LGT BAR 2X25W	32.50	790576114798
BA-LIX-3-BB	LINE VOLT XENON 3 LGT BAR 3X25W	40.95	790576114811
BA-LIX-3-SN	LINE VOLT XENON 3 LGT BAR 3X25W	40.95	790576114835
BA-LIX-3-WT	LINE VOLT XENON 3 LGT BAR 3X25W	40.95	790576114828
BA-LIX-4-BB	LINE VOLT XENON 4 LGT BAR 4X25W	47.50	790576114842
BA-LIX-4-SN	LINE VOLT XENON 4 LGT BAR 4X25W	47.50	790576114866
BA-LIX-4-WT	LINE VOLT XENON 4 LGT BAR 4X25W	47.50	790576114859
BA-LIX-6-BB	LINE VOLT XENON 6 LGT BAR 6X25W	65.95	790576114873
BA-LIX-6-SN	LINE VOLT XENON 6 LGT BAR 6X25W	65.95	790576114897
BA-LIX-6-WT	LINE VOLT XENON 6 LGT BAR 6X25W	65.95	790576114880
BA-PC6-WT	POWER CORD FOR LGT BARS-6 FOOT	4.95	790576086064
BA-X1-BB	LOW VOLT XENON 1 LGT BAR 1X18W	38.95	790576085319
BA-X1-SN	LOW VOLT XENON 1 LGT BAR 1X18W	38.95	790576085333
BA-X1-WT	LOW VOLT XENON 1 LGT BAR 1X18W	38.95	790576085326
BA-X2-BB	LOW VOLT XENON 2 LGT BAR 2X18W	47.50	790576085340
BA-X2-SN	LOW VOLT XENON 2 LGT BAR 2X18W	47.50	790576085364
BA-X2-WT	LOW VOLT XENON 2 LGT BAR 2X18W	47.50	790576085357
BA-X3-BB	LOW VOLT XENON 3 LGT BAR 3X18W	53.95	790576085371
BA-X3-SN	LOW VOLT XENON 3 LGT BAR 3X18W	53.95	790576085395
BA-X3-WT	LOW VOLT XENON 3 LGT BAR 3X18W	53.95	790576085388
BA-X4-BB	LOW VOLT XENON 4 LGT BAR 4X18W	67.95	790576085401
BA-X4-SN	LOW VOLT XENON 4 LGT BAR 4X18W	67.95	790576085425
BA-X4-WT	LOW VOLT XENON 4 LGT BAR 4X18W	67.95	790576085418
BA-X6-BB	LOW VOLT XENON 6 LGT BAR 6X18W	78.95	790576085432
BA-X6-SN	LOW VOLT XENON 6 LGT BAR 6X18W	78.95	790576085456
BA-X6-WT	LOW VOLT XENON 6 LGT BAR 6X18W	78.95	790576085449
BP-10-12V-CL	LAMP XENON BI-PIN 12V 10W CLEAR	3.95	790576087818
BP-10-12V-FR	LAMP XENON BI-PIN 12V 10W FROST	3.95	790576087825
BP-15-12V-CL	LAMP XENON BI-PIN 15W 12V CLEAR	3.95	790576018430
BP-15-12V-FR	LAMP XENON BI-PIN 15W 12V FROSTED	3.95	790576018447
BP-15-24V-CL	LAMP XENON BI-PIN 15W 24V CLEAR	3.95	790576018454
BP-15-24V-FR	LAMP XENON BI-PIN 15W 24V FROSTED	3.95	790576018461

Material	Description	2011 DN	UPC Code
BP-20-12V-CL	LAMP XENON BI-PIN 20W 12V CLEAR	3.95	790576018478
BP-20-12V-FR	LAMP XENON BI-PIN 20W 12V FROSTED	3.95	790576018485
BP-20-24V-CL	LAMP XENON BI-PIN 20W 24V CLEAR	3.95	790576018492
BP-20-24V-FR	LAMP XENON BI-PIN 20W 24V FROSTED	3.95	790576018508
BP-50-12V-CL	LAMP XENON BI-PIN 50W 12V CLEAR	6.95	790576061511
BP-50-24V-CL	LAMP XENON BI-PIN 50W 24V CLEAR	6.95	790576061528
CF09W-27-PAR20	CFL LAMP - MED BASE PAR20 9W 27	7.50	790576167596
CF11W-27-PAR30S	CFL LAMP - MED BASE PAR30S 11W	8.50	790576167602
CF15W-27-PAR30L	CFL LAMP - MED BASE PAR30L 15W	8.50	790576167619
CF23W-27-PAR38	CFL LAMP - MED BASE PAR38 23W 2	9.95	790576167626
CF-GU24-ADP	E26 MED BASE TO GU24 SOCKET ADA	1.65	790576167978
CFL13-GU24-WW	CFL GU24 LAMP 13W	9.95	790576160283
CFL23W-27-GU24	CFL GU24 LAMP 13W	9.95	790576160283
CP-BK	CANOPY PLATE	3.95	790576000862
CP-BN	CANOPY PLATE	4.95	790576160801
CP-DB	CANOPY PLATE	4.95	790576143996
CP-WT	CANOPY PLATE	3.95	790576000879
DL-007-BK	DISPLAY LIGHT LOW VOLT W/PLUG IN TRANS	60.95	790576015965
DL-007-WT	DISPLAY LIGHT LOW VOLT W/PLUG IN TRANS	60.95	790576015972
DL-024-BK	DISPLAY LIGHT LINE VOLTAGE	40.95	790576037769
DL-024-WT	DISPLAY LIGHT LINE VOLTAGE	40.95	790576037776
DL-150-BK	DISPLAY LIGHT LINE VOLTAGE	70.95	790576015125
DL-150-WT	DISPLAY LIGHT LINE VOLTAGE	70.95	790576015132
DL-167-BK	DISPLAY LIGHT LOW VOLT W/PLUG IN TRANS	53.95	790576104249
DL-188-BK	DISPLAY LIGHT LINE VOLTAGE	45.95	790576015088
DL-188-WT	DISPLAY LIGHT LINE VOLTAGE	45.95	790576015095
DL-214-BK	DISPLAY LIGHT LOW VOLT W/PLUG IN TRANS	53.95	790576037745
DL-214-WT	DISPLAY LIGHT LOW VOLT W/PLUG IN TRANS	53.95	790576037752
DL-701-BK	DISPLAY LIGHT LINE VOLTAGE	43.50	790576015101
DL-701-WT	DISPLAY LIGHT LINE VOLTAGE	43.50	790576015118
DLC-4A-BK	4" BRACKET	15.50	790576104232
DLC-4-BK	4 IN CLAMP FLAT SURFACES 1/2-4 IN WIDE	12.50	790576015163
DLC-4-WT	4 IN CLAMP FLAT SURFACES 1/2IN-4IN WIDE	12.50	790576015170
DLC-P-BK	PIPE CLAMP - UP TO 2 1/2IN IN DIAMETER	12.50	790576015149
DLC-P-WT	PIPE CLAMP - UP TO 2 1/2IN IN DIAMETER	12.50	790576015156
DM2-BK	TURN DIMMER 120V - 1/4IN SHAFT BK KNOB	9.95	790576001050
DM2-WT	TURN DIMMER 120V - 1/4IN SHAFT WT KNOB	9.95	790576001074
DM3-BK	TURN DIMMER 120V - 3/4IN SHAFT BK KNOB	9.95	790576001104
DM3-WT	TURN DIMMER 120V - 3/4IN SHAFT WT KNOB	9.95	790576001128
DR-301-CH	BEAUTY SPOT-FIXTURE W/BUILT IN HOUSING	20.95	790576083001
DR-301-WT	BEAUTY SPOT-FIXTURE W/BUILT IN HOUSING	18.95	790576084756
DR-G352-AM	BEAUTY SPOT-CRYSTAL SOLID COLOR-AMBER	19.95	790576083117
DR-G352-BL	BEAUTY SPOT-CRYSTAL SOLID COLOR-BLUE	19.95	790576083100
DR-G352-CL	BEAUTY SPOT-CRYSTAL SOLID COLOR-CLEAR	19.95	790576088990
DR-G352-GR	BEAUTY SPOT-CRYSTAL SOLID COLOR-GREEN	19.95	790576083131
DR-G352-RD	BEAUTY SPOT-CRYSTAL SOLID COLOR-RED	19.95	790576083124
DR-G355-CL	BEAUTY SPOT-CRYSTAL CUBE-CLEAR	16.95	790576083247
DR-G356-CL	BEAUTY SPOT-CRYSTAL CYLINDER-CLEAR	16.95	790576083254
DR-G357-FR	BEAUTY SPOT-CRYSTAL TUBE-FROSTED	14.95	790576083261
DR-G361-CL	BEAUTY SPOT-CRYSTAL PYRAMID-CLEAR	19.95	790576083018

Material	Description	2011 DN	UPC Code
DR-G362-CL	BEAUTY SPOT-CRYSTAL SKIRTED BALL-CLEAR	19.95	790576083025
DR-G363-CL	BEAUTY SPOT-CRYSTAL BALL-CLEAR	21.95	790576083032
EN-12100-R-AR	ELEC. TRANSF 120V-12V 100W	26.95	790576094632
EN-12100-RB-AR	ELEC. TRANSF 120V-12V 100W - EN	32.95	790576094663
EN-12120-RB2	E TRANS.120V-12V 120W-ENCLOSED	37.95	790576117010
EN-12150-R-AR	E TRANS.120V-12V 150W-ENCLOSED	32.95	790576094649
EN-12150-RB-AR	E TRANS.120V-12V 150W-ENCLOSED	40.95	790576094670
EN-12180-RB2	E TRANS.120V-12V 180W-ENCLOSED	61.95	790576117003
EN-12300-RB2	E TRANS.120V-12V 300W-ENCLOSED	84.95	790576117027
EN-1260N-R2	ELEC. TRANS. 120V - 12V 60W CLASS 2 ( 1W MIN )	21.95	790576194899
EN-1260-P-AR-BK	E TRANS.120V-12V 60W-PLUG IN CLASS II	23.95	790576094724
EN-1260-P-AR-T	LED TAPE LIGHT - PLUG IN DRIVER 12V 60W	24.95	790576128580
EN-1260-P-AR-WT	E TRANS.120V-12V 60W-PLUG IN CLASS II	23.95	790576094717
EN-1260-R2	E TRANS.120V-12V 60W-CLASS II	17.95	790576094694
EN-1260-R-AR	E TRANS.120V-12V 60W	15.95	790576094595
EN-1260-RB2	E TRANS.120V-12V 60W-ENCLOSED C	20.95	790576094700
EN-1260-RB2-N	1W MIN )	24.95	790576194905
EN-1260-RB2-T	LED TAPE LIGHT - REMOTE DRIVER 12V 60W	22.50	790576128597
EN-1260-RB-AR	E TRANS.120V-12V 60W-ENCLOSED	20.95	790576094601
EN-1275-R-AR	E TRANS.120V-12V 75W	19.95	790576094618
EN-1275-RB-AR	E TRANS.120V-12V 75W-ENCLOSED	23.95	790576094625
EN-24100-P-AR-T	PLUG IN POWER SUPPLY 24V 100W AC - CLASS 2	36.95	790576163949
EN-24100-RB2-T	REMOTE POWER SUPPLY 24V 100W AC - CLASS 2	29.95	790576163925
EN-24150-R-AR	E TRANS.120V-24V 150W	44.95	790576094656
EN-24150-RB-AR	E TRANS.120V-24V 150W-ENCLOSED	50.95	790576094687
EN-2460D-C	REMOTE POWER SUPPLY 24V 60W DC - CLASS 2	36.95	790576163512
EN-2460D-C-P	PLUG IN POWER SUPPLY 24V 60W DC - CLASS 2	41.95	790576163529
EN-2460-P-AR-T	PLUG IN POWER SUPPLY 24V 60W AC - CLASS 2	31.50	790576163956
EN-2460-RB2-T	REMOTE POWER SUPPLY 24V 60W AC - CLASS 2	29.95	790576163932
EN-B12PY-AR	E TRANS.120V-12V 250W-ENCLOSED	63.95	790576034034
EN-B24PZ-AR	E TRANS.120V-24V 300W-ENCLOSED	64.95	790576034027
EN-HQ50AR-BK	QC-H SERIES TRANSFORMER 50W	28.50	790576050690
EN-HQ50AR-BN	QC-H SERIES TRANSFORMER 50W	31.50	790576160627
EN-HQ50AR-DB	QC-H SERIES TRANSFORMER 50W	31.50	790576144009
EN-HQ50AR-WT	QC-H SERIES TRANSFORMER 50W	28.50	790576050706
EN-JQ50AR-BK	QC -J SERIES TRANSFORMER 50W	28.50	790576051451
EN-JQ50AR-BN	QC-J SERIES TRANSFORMER 50W	31.50	790576160634
EN-JQ50AR-DB	QC-J SERIES TRANSFORMER 50W	31.50	790576144016
EN-JQ50AR-WT	QC-J SERIES TRANSFORMER 50W	28.50	790576051468
EN-LQ50AR-BK	QC-L SERIES TRANSFORMER 50W	28.50	790576050676
EN-LQ50AR-BN	QC-L SERIES TRANSFORMER 50W	31.50	790576160641
EN-LQ50AR-DB	QC-L SERIES TRANSFORMER 50W	31.50	790576144023
EN-LQ50AR-WT	QC-L SERIES TRANSFORMER 50W	28.50	790576050683
EN-O24100-RB2-T	INVISILED 24V OUTDOOR REMOTE POWER SUPPLY	190.95	790576169002
ETB	JUNCTION BOX FOR EN-12P,PL,PE,PX E.TRANS	7.95	790576001784
F13W/T5/CW	LAMP FLUORESCENT MINI BI-PIN 13W 4200K	1.95	790576086163
F13W/T5/WW	LAMP FLUORESCENT MINI BI-PIN 13W 3000K	1.95	790576086156
F21W/T5/CW	T5 LAMP,21W,4100K	4.50	790576168296
F21W/T5/WW	FLUORESCENT T5 - MINI BIPIN 21W 2700K	4.50	790576168289
F28W/T5/CW	T5 LAMP,28W,4100K	4.95	790576168319

Material	Description	2011 DN	UPC Code
F28W/T5/WW	FLUORESCENT T5 - MINI BIPIN 28W 2700K	4.95	790576168302
F35W/T5/CW	FLUORESCENT T5 - MINI BIPIN 35W 4100K	4.95	790576168333
F35W/T5/WW	FLUORESCENT T5 - MINI BIPIN 35W 2700K	4.95	790576168326
F8W/T5/CW	LAMP FLUORESCENT MINI BI-PIN 8W 4050K	1.50	790576086149
F8W/T5/WW	LAMP FLUORESCENT MINI BI-PIN 8W 3000K	1.50	790576086132
FG-WIRE-BK	100FT 18 GAUGE FIBER GLASS WIRE	31.95	790576001814
FG-WIRE-WT	100FT 18 GAUGE FIBER GLASS WIRE	31.95	790576001821
G100-WT	G100 SERIES-WHITE CYLINDER GLASS SHADE	26.95	790576114491
G101-WT	G100 SERIES-WHITE CYLINDER GLASS SHADE	36.95	790576103013
G102-WT	G100 SERIES-WHITE CYLINDER GLASS SHADE	36.95	790576114699
G103-WT	G100 SERIES-WHITE CYLINDER GLASS SHADE	32.95	790576115061
G111-AM	G100 SERIES-AMBER BELL GLASS SHADE	9.95	790576053745
G111-BL	G100 SERIES-BLUE BELL GLASS SHADE	9.95	790576053738
G111-WT	G100 SERIES-WHITE BELL GLASS SHADE	9.95	790576053721
G112-AM	G100 SERIES-AMBER CYLINDER GLASS SHADE	11.95	790576053783
G112-WT	G100 SERIES-WHITE CYLINDER GLASS SHADE	11.95	790576053769
G113-AM	G100 SERIES-AMBER RING GLASS SHADE	11.95	790576053820
G113-WT	G100 SERIES-WHITE RING GLASS SHADE	11.95	790576053806
G114-AM	G100 SERIES-AMBER DEEP BELL GLASS SHADE	11.95	790576053868
G114-BL	G100 SERIES-BLUE DEEP BELL GLASS SHADE	11.95	790576053851
G114-GR	G100 SERIES-GREEN DEEP BELL GLASS SHADE	11.95	790576053899
G114-RD	G100 SERIES-RED DEEP BELL GLASS SHADE	11.95	790576053875
G114-WT	G100 SERIES-WHITE DEEP BELL GLASS SHADE	11.95	790576053844
G115-BN	G100 SERIES-CHROME MESH BULB SHIELD	10.95	790576136813
G115-CH	G100 SERIES-CHROME MESH BULB SHIELD	10.95	790576053912
G115-DB	G100 SERIES-BRONZE MESH BULB SHIELD	10.95	790576111070
G115-PT	G100 SERIES-PLATINUM MESH BULB SHIELD	10.95	790576053905
G116-BN	G100 SERIES-CHROME SOLID BULB SHIELD	9.95	790576136820
G116-CH	G100 SERIES-CHROME SOLID BULB SHIELD	9.95	790576053943
G116-DB	G100 SERIES-BRONZE SOLID BULB SHIELD	9.95	790576111087
G116-PT	G100 SERIES-PLATINUM SOLID BULB SHIELD	9.95	790576053936
G119-AM	G100 SERIES-AMBER CONE GLASS SHADE	10.95	790576082394
G119-BL	G100 SERIES-BLUE CONE GLASS SHADE	10.95	790576082387
G119-WT	G100 SERIES-WHITE CONE GLASS SHADE	10.95	790576082370
G332-CL	QP PENDANT GLASS	119.95	790576194882
G335-CL	QP PENDANT GLASS	59.95	790576194875
G512-AM	G500 SERIES-AMBER CONE GLASS SHADE	24.95	790576054216
G512-BL	G500 SERIES-BLUE CONE GLASS SHADE	24.95	790576054186
G512-GR	G500 SERIES-GREEN CONE GLASS SHADE	24.95	790576054193
G512-RD	G500 SERIES-RED CONE GLASS SHADE	24.95	790576054209
G512-WT	G500 SERIES-WHITE CONE GLASS SHADE	24.95	790576054179
G513-AM	G500 SERIES-AMBER CASED GLASS SHADE	33.95	790576054292
G513-WT	G500 SERIES-WHITE CASED GLASS SHADE	33.95	790576054308
G515-AM	QP-AMBER MILLEFIORE DOME GLASS	64.95	790576081564
G515-MF	G500 SERIES-MILLEFIORE DOME GLASS SHADE	64.95	790576054353
G517-WT	G500 SERIES-WHITE CONE GLASS SHADE	29.95	790576056463
G518-DIC	G500 SERIES-DICHROIC DOME GLASS SHADE	79.95	790576056661
G524-AM	G500 SERIES-AMBER DOME GLASS SHADE	28.95	790576062747
G524-LB	G500 SERIES GLASS SHADE	28.95	790576140728
G524-TQ	SARAH G500 SERIES GLASS SHADE	28.95	790576140711



Material	Description	2011 DN	UPC Code
G524-WT	G500 SERIES-WHITE DOME GLASS SHADE	28.95	790576062723
G530-GR	G500 SERIES-GREEN DOME GLASS SHADE	119.95	790576104386
G530-MC	5G500 SERIES-MIX COLOR DOME GLASS SHADE	119.95	790576104379
G534-SM	QP PENDANT GLASS	49.95	790576194516
G535-DIC	QP PENDANT GLASS	99.95	790576197388
G536-BL	QP PENDANT GLASS	64.95	790576194509
G541-AM	G500 SERIES-AMBER DOME GLASS SHADE	36.95	790576117515
G541-WT	G500 SERIES-WHITE DOME GLASS SHADE	36.95	790576117553
G546-DIC	G500 SERIES-DICHROIC DOME GLASS SHADE	99.95	790576116983
G548-FR	G548-FR GLASS	49.95	790576125220
G559-DIC	G559 DICHROIC GLASS WITH WHITE	39.95	790576167442
G559-GL	G559 GOLD GLASS WITH YELLOW GRO	39.95	790576167428
G559-MR	G559 MIRROR GLASS WITH BLACK GR	39.95	790576167435
G593-LI	QC - PENDANT GLASS SHADE #593	79.95	790576138855
G593-RD	QC - PENDANT GLASS SHADE #593	79.95	790576138770
G593-TQ	QC - PENDANT GLASS SHADE #593	79.95	790576138701
G598-WT	G500 SERIES GLASS SHADE	64.95	790576140766
G599-BL	G599 BLUE GLASS	49.95	790576167466
G599-UM	G599 UMBER GLASS	49.95	790576167862
G599-WT	G599 WHITE GLASS	49.95	790576167459
G611-AM	G600 SERIES-AMBER CONE GLASS SHADE	27.95	790576054452
G611-BL	G600 SERIES-BLUE CONE GLASS SHADE	27.95	790576054407
G611-RD	G600 SERIES-RED CONE GLASS SHADE	27.95	790576054445
G611-WT	G600 SERIES-WHITE CONE GLASS SHADE	27.95	790576054438
G613-AM	G600 SERIES-AMBER DOME GLASS SHADE	27.95	790576055190
G613-BL	G600 SERIES-BLUE DOME GLASS SHADE	27.95	790576054490
G613-RD	G600 SERIES-RED DOME GLASS SHADE	27.95	790576054513
G613-WT	G600 SERIES-WHITE DOME GLASS SHADE	27.95	790576054520
G614-BG	QP PENDANT GLASS	82.50	
G614-MF	QP PENDANT GLASS	82.50	
G614-YR	QP PENDANT GLASS	82.50	
G615-BG	G600 SERIES-BLUE/GRN DOME GLASS SHADE	69.95	790576051048
G619-RD	QC - PENDANT GLASS SHADE #619	84.95	790576137926
G619-TQ	QC - PENDANT GLASS SHADE #619	84.95	790576137919
G620-BL	QC - PENDANT GLASS SHADE #620	99.95	790576167848
G620-BR	QC - PENDANT GLASS SHADE #620	99.95	790576167831
G620-RD	QC - PENDANT GLASS SHADE #620	99.95	790576167824
G630-AM	QP PENDANT GLASS	49.95	790576194493
G630-GR	QP PENDANT GLASS	49.95	790576194486
G630-OR	QP PENDANT GLASS	49.95	790576194479
G711-WT	G700 SERIES-WHITE CYL/CONE GLASS SHADE	43.95	790576055237
G720-GR	QC - PENDANT SHADE CARNIVAL	189.95	790576125404
G720-RD	G720-RD	189.95	790576125428
G913-CF	G900 SERIES-CLR/FRST FLUTE GLASS SHADE	79.95	790576080109
G913-OE	G900 SERIES-OPAL ETCH FLUTE GLASS SHADE	89.95	790576080116
G913-RD	G900 SERIES-RED FLUTE GLASS SHADE	99.95	790576105376
G914-FR	G900 SERIES-FRST RIB SQUARE GLASS SHADE	69.95	790576080314
G915-CF	G900 SERIES-CLR/FRST PYRAMIDGLASS SHADE	63.50	790576080321
G916-CL	G900 SERIES-CLEAR RIB BALL GLASS SHADE	59.95	790576080338
G918-AM	G918-AM GLASS	69.95	790576125251

Material	Description	2011 DN	UPC Code
G918-BP	G900 SERIES-BLUE/PINK DOME GLASS SHADE	69.95	790576080468
G918-GO	G900 SERIES-GRN/ORNG DOME GLASS SHADE	69.95	790576080475
G918-YR	G900 SERIES-YEL/RED DOME GLASS SHADE	69.95	790576080482
G919-BU	G919-BU GLASS	49.95	790576125503
G930-CL	G900 SERIES-CLEAR ROUND CRYSTALSHADE	99.95	790576114200
G932-CL	G900 SERIES-CLEAR CYLINDER CRYSTALSHADE	99.95	790576114224
G933-AM	G933-AM GLASS	46.95	790576125145
G934-IR	G934-IR GLASS	69.95	790576125275
G936-AM	G936-AM GLASS	69.95	790576125091
G936-BW	G936-BW GLASS	69.95	790576125114
G940-CL	G940-CL GLASS	99.95	790576125152
G946-AL	G946-AL GLASS	62.95	790576125183
G946-GT	G946-GT GLASS	62.95	790576125190
G950-AM	QC - PENDANT GLASS SHADE #950	119.95	790576138688
G950-RD	QC - PENDANT GLASS SHADE #950	119.95	790576137971
G952-CL	G900 SERIES GLASS SHADE	99.95	790576140759
G953-BN	G953 SHADE IN BN	34.95	790576167879
G953-CH	G953 SHADE IN CH	34.95	790576167886
G962-BF	QC - PENDANT GLASS SHADE #962	129.95	790576167671
G962-RF	QC - PENDANT GLASS SHADE #962	129.95	790576167688
G963-GJ	QC - PENDANT GLASS SHADE #963	99.95	790576167695
G964-MR	QP PENDANT GLASS	59.95	790576194585
G966-BN	QP PENDANT GLASS	29.95	790576194561
G966-CH	QP PENDANT GLASS	29.95	790576194554
G966-DB	QP PENDANT GLASS	29.95	790576194547
G968-OR	QP PENDANT GLASS	119.95	790576197371
GU10-EXN	LAMP HALOGEN GU10 120V 50W 40DEGREE	3.25	790576103716
G-WS404-WT	WALL SCONCE GLASS SHADE CYLINDER	42.50	790576113098
G-WS410-IV	WALL SCONCE W/ GLASS SHADE - WILLIAMSBURG	76.50	790576186856
G-WS413-YR	WALL SCONCE W/ GLASS SHADE - AURORA	54.50	
G-WS414-AM	WALL SCONCE W/ GLASS SHADE - TIGRA	54.50	790576185750
G-WS415-AM	WALL SCONCE W/ GLASS SHADE - FLAVA	54.50	790576185767
G-WS415-BW	WALL SCONCE W/ GLASS SHADE - FLAVA	54.50	790576185781
H-009-CW-BK	PROJECTOR-4500K	249.95	790576194790
H-009-CW-WT	PROJECTOR-4500K	249.95	790576194806
H-009-WW-BK	PROJECTOR-3000K	249.95	790576194752
H-009-WW-WT	PROJECTOR-3000K	249.95	790576194769
H18-BK	H SERIES EXT FOR LINE VOLT TRACK HEAD	14.50	790576002026
H18-BN	H SERIES EXT FOR LINE VOLT TRACK HEAD	16.50	790576145426
H18-DB	H SERIES EXT FOR LINE VOLT TRACK HEAD	16.50	790576140124
H-18F-CW-BK	LED TRACK FIXTURE - 18W COOL WHITE FLOOD	194.95	790576145068
H-18F-CW-BN	LED TRACK FIXTURE - 18W COOL WHITE FLOOD	199.95	790576145105
H-18F-CW-WT	LED TRACK FIXTURE - 18W COOL WHITE FLOOD	194.95	790576145112
H-18F-WW-BK	LED TRACK FIXTURE - 18W WARM WHITE FLOOD	194.95	790576144962
H-18F-WW-BN	LED TRACK FIXTURE - 18W WARM WHITE FLOOD	199.95	790576144979
H-18F-WW-WT	LED TRACK FIXTURE - 18W WARM WHITE FLOOD	194.95	790576144986
H-18S-CW-BK	LED TRACK FIXTURE - 18W COOL WHITE SPOT	194.95	790576144870
H-18S-CW-BN	LED TRACK FIXTURE - 18W COOL WHITE SPOT	199.95	790576144887
H-18S-CW-WT	LED TRACK FIXTURE - 18W COOL WHITE SPOT	194.95	790576144894
H-18S-WW-BK	LED TRACK FIXTURE - 18W WARM WHITE SPOT	194.95	790576144764

Material	Description	2011 DN	UPC Code
H-18S-WW-BN	LED TRACK FIXTURE - 18W WARM WHITE SPOT	199.95	790576144771
H-18S-WW-WT	LED TRACK FIXTURE - 18W WARM WHITE SPOT	194.95	790576144788
H18-WT	H SERIES EXT FOR LINE VOLT TRACK HEAD	14.50	790576002033
H24-BK	H SERIES EXT FOR LINE VOLT TRACK HEAD	15.95	790576035710
H24-BN	H SERIES EXT FOR LINE VOLT TRACK HEAD	17.95	790576145433
H24-DB	H SERIES EXT FOR LINE VOLT TRACK HEAD	17.95	790576140131
H24-WT	H SERIES EXT FOR LINE VOLT TRACK HEAD	15.95	790576035727
H36-BK	H SERIES EXT FOR LINE VOLT TRACK HEAD	16.95	790576002040
H36-BN	H SERIES EXT FOR LINE VOLT TRACK HEAD	18.95	790576145440
H36-DB	H SERIES EXT FOR LINE VOLT TRACK HEAD	18.95	790576140148
H36-WT	H SERIES EXT FOR LINE VOLT TRACK HEAD	16.95	790576002057
H48-BK	H SERIES EXT FOR LINE VOLT TRACK HEAD	17.95	790576002064
H48-BN	H SERIES EXT FOR LINE VOLT TRACK HEAD	20.50	790576145457
H48-DB	H SERIES EXT FOR LINE VOLT TRACK HEAD	20.50	790576140155
H48-WT	H SERIES EXT FOR LINE VOLT TRACK HEAD	17.95	790576002071
H-9F-CW-BK	LED TRACK FIXTURE - 9W COOL WHITE FLOOD	144.95	790576144320
H-9F-CW-BN	TRACK FIXTURE - 9W COOL WHITE FLOOD	149.95	790576144337
H-9F-CW-WT	0.66TRACK FIXTURE - 9W COOL WHITE FLOOD	144.95	790576144696
H-9F-WW-BK	LED TRACK FIXTURE - 9W WARM WHITE FLOOD	144.95	790576144238
H-9F-WW-BN	LED TRACK FIXTURE - 9W WARM WHITE FLOOD	149.95	790576144245
H-9F-WW-WT	LED TRACK FIXTURE - 9W WARM WHITE FLOOD	144.95	790576144252
H-9S-CW-BK	LED TRACK FIXTURE - 9W COOL WHITE SPOT	144.95	790576144146
H-9S-CW-BN	LED TRACK FIXTURE - 9W COOL WHITE SPOT	149.95	790576144153
H-9S-CW-WT	LED TRACK FIXTURE - 9W COOL WHITE SPOT	144.95	790576144160
H-9S-WW-BK	LED TRACK FIXTURE - 9W WARM WHITE SPOT	144.95	790576144054
H-9S-WW-BN	LED TRACK FIXTURE - 9W WARM WHITE SPOT	149.95	790576144061
H-9S-WW-WT	LED TRACK FIXTURE - 9W WARM WHITE SPOT	144.95	790576144078
HBXLE-BK	H SERIES LIVE END CONNECTOR	8.95	790576002088
HBXLE-BN	H SERIES LIVE END CONNECTOR	9.95	790576144795
HBXLE-DB	H SERIES LIVE END CONNECTOR	9.95	790576139999
HBXLE-WT	H SERIES LIVE END CONNECTOR	8.95	790576002095
HCORD-BK	H SERIES CORD	6.95	790576002101
HCORD-WT	H SERIES CORD	6.95	790576002118
H-ENDCAP-BK	H SERIES END CAP FOR TRACK	0.95	790576023311
H-ENDCAP-BN	H SERIES END CAP FOR TRACK	0.95	790576144863
H-ENDCAP-DB	H SERIES END CAP FOR TRACK	0.95	790576140001
H-ENDCAP-WT	H SERIES END CAP FOR TRACK	0.95	790576023328
HFC-BK	H SERIES FLOATING CANOPY CONNECTOR	8.50	790576002132
HFC-BN	H SERIES FLOATING CANOPY CONNECTOR	9.95	790576145013
HFC-DB	H SERIES FLOATING CANOPY CONNECTOR	9.95	790576140018
HFC-WT	H SERIES FLOATING CANOPY CONNECTOR	8.50	790576002149
HFLX-BK	H SERIES FLEXIBLE TRACK CONNECTOR	11.50	790576002156
HFLX-BN	H SERIES FLEXIBLE TRACK CONNECTOR	12.95	790576145075
HFLX-DB	H SERIES FLEXIBLE TRACK CONNECTOR	12.95	790576140025
HFLX-WT	H SERIES FLEXIBLE TRACK CONNECTOR	11.50	790576002163
HHT-007-BK	H SERIES LOW VOLT TRACK HEAD 50W	28.95	790576002170
HHT-007-BN	H SERIES LOW VOLT TRACK HEAD 50W	32.95	790576147161
HHT-007L-BK	H SERIES LOW VOLT TRACK HEAD 75W	31.95	790576002217
HHT-007L-BN	H SERIES LOW VOLT TRACK HEAD 75W	35.95	790576160016
HHT-007L-WT	H SERIES LOW VOLT TRACK HEAD 75W	31.95	790576002224

Material	Description	2011 DN	UPC Code
HHT-007-WT	H SERIES LOW VOLT TRACK HEAD 50W	28.95	790576002187
HHT-009L-BK	H SERIES LOW VOLT FRAMING PROJECTOR 75W	149.50	790576049144
HHT-009L-WT	H SERIES LOW VOLT FRAMING PROJECTOR 75W	149.50	790576049151
HHT-1102-BK	H SERIES LOW VOLT TRACK HEAD 35W	26.95	790576002231
HHT-1102-WT	H SERIES LOW VOLT TRACK HEAD 35W	26.95	790576002262
HHT-1109-BK	H SERIES LOW VOLT TRACK HEAD 35W	26.95	790576002286
HHT-1109-WT	H SERIES LOW VOLT TRACK HEAD 35W	26.95	790576002316
HHT-1126-BK	H SERIES LOW VOLT TRACK HEAD 35W	45.95	790576002330
HHT-1126-WT	H SERIES LOW VOLT TRACK HEAD 35W	45.95	790576002347
HHT-160-BK	H SERIES LOW VOLT TRACK HEAD 50W	27.95	790576016009
HHT-160L-BK	H SERIES LOW VOLT TRACK HEAD 75W	30.95	790576021829
HHT-160L-WT	H SERIES LOW VOLT TRACK HEAD 75W	30.95	790576016405
HHT-160-WT	H SERIES LOW VOLT TRACK HEAD 50W	27.95	790576016016
HHT-163L-BK	H SERIES LOW VOLTAGE TRACK HEAD 75W	52.95	790576095196
HHT-163L-WT	H SERIES LOW VOLTAGE TRACK HEAD 75W	52.95	790576095202
HHT-164L-BK	H SERIES LOW VOLTAGE TRACK HEAD 75W	46.50	790576105567
HHT-164L-WT	H SERIES LOW VOLTAGE TRACK HEAD 75W	46.50	790576105574
HHT-180-BK	H SERIES LOW VOLT TRACK HEAD 50W	20.95	790576002354
HHT-180-BN	H SERIES LOW VOLT TRACK HEAD 50W	24.95	790576147178
HHT-180L-BK	H SERIES LOW VOLT TRACK HEAD 75W	23.95	790576002392
HHT-180L-BN	H SERIES LOW VOLT TRACK HEAD 75W	27.95	790576160047
HHT-180L-WT	H SERIES LOW VOLT TRACK HEAD 75W	23.95	790576002408
HHT-180-WT	H SERIES LOW VOLT TRACK HEAD 50W	20.95	790576002361
HHT-204-BK	H SERIES LOW VOLT TRACK HEAD 50W	31.95	790576016061
HHT-204-BN	H SERIES LOW VOLT TRACK HEAD 50W	35.95	790576147185
HHT-204L-BK	H SERIES LOW VOLT TRACK HEAD 75W	34.95	790576021973
HHT-204L-BN	H SERIES LOW VOLT TRACK HEAD 75W	38.95	790576160078
HHT-204L-WT	H SERIES LOW VOLT TRACK HEAD 75W	34.95	790576021850
HHT-204-WT	H SERIES LOW VOLT TRACK HEAD 50W	31.95	790576016078
HHT-311L-BK	H SERIES LOW VOLTAGE TRACK HEAD 75W	79.95	
HHT-311L-WT	H SERIES LOW VOLTAGE TRACK HEAD 75W	79.95	
HHT-316L-BK	H SERIES LOW VOLTAGE TRACK HEAD 75W	69.95	
HHT-316L-WT	H SERIES LOW VOLTAGE TRACK HEAD 75W	69.95	
HHT-801-BK	H SERIES LOW VOLT TRACK HEAD 50W	29.95	790576002453
HHT-801L-BK	H SERIES LOW VOLT TRACK HEAD 75W	32.95	790576002484
HHT-801L-WT	H SERIES LOW VOLT TRACK HEAD 75W	32.95	790576002491
HHT-801-WT	H SERIES LOW VOLT TRACK HEAD 50W	29.95	790576002460
HHT-802-BK	H SERIES LOW VOLT TRACK HEAD 50W	22.95	790576002507
HHT-802-BN	H SERIES LOW VOLT TRACK HEAD 50W	26.95	790576147192
HHT-802L-BK	H SERIES LOW VOLT TRACK HEAD 75W	25.95	790576002576
HHT-802L-BN	H SERIES LOW VOLT TRACK HEAD 75W	29.95	790576160108
HHT-802L-WT	SERIES LOW VOLT TRACK HEAD 75W	25.95	790576002606
HHT-802-WT	H SERIES LOW VOLT TRACK HEAD 50W	22.95	790576002538
HHT-808-BK	H SERIES LOW VOLT TRACK HEAD 50W	29.95	790576002644
HHT-808-DB	LOW VOLTAGE TRACK HEAD 50W	32.95	790576163291
HHT-808L-BK	H SERIES LOW VOLT TRACK HEAD 75W	32.95	790576002682
HHT-808L-DB	H SERIES LOW VOLT TRACK HEAD 75W	35.95	790576163338
HHT-808L-WT	H SERIES LOW VOLT TRACK HEAD 75W	32.95	790576002699
HHT-808-WT	H SERIES LOW VOLT TRACK HEAD 50W	29.95	790576002651
HHT-809-BK	SERIES LOW VOLT TRACK HEAD 50W	22.95	790576002705

Material	Description	2011 DN	UPC Code
HHT-809-BN	H SERIES LOW VOLT TRACK HEAD 50W	26.95	790576147208
HHT-809L-BK	H SERIES LOW VOLT TRACK HEAD 75W	25.95	790576002774
HHT-809L-BN	H SERIES LOW VOLTAGE TRACK HEAD 75W	29.95	790576160139
HHT-809L-WT	H SERIES LOW VOLT TRACK HEAD 75W	25.95	790576002804
HHT-809-WT	H SERIES LOW VOLT TRACK HEAD 50W	22.95	790576002736
HHT-814-BK	H SERIES LOW VOLT TRACK HEAD 50W	29.95	790576087443
HHT-814L-BK	H SERIES LOW VOLT TRACK HEAD 75W	32.95	790576088778
HHT-814L-WT	H SERIES LOW VOLT TRACK HEAD 75W	32.95	790576088785
HHT-814-WT	H SERIES LOW VOLT TRACK HEAD 50W	29.95	790576087436
HHT-815-BK	H SERIES LOW VOLT TRACK HEAD 50W	41.95	790576086682
HHT-815-PT/BK	H SERIES LOW VOLT TRACK HEAD 50W	44.95	790576086675
HHT-815-PT/WT	H SERIES LOW VOLT TRACK HEAD 50W	44.95	790576086668
HHT-815-WT	H SERIES LOW VOLT TRACK HEAD 50W	41.95	790576086651
HHT-816-BK	H SERIES LOW VOLT TRACK HEAD 50W	29.95	790576002811
HHT-816-BN	H SERIES LOW VOLT TRACK HEAD 50W	33.95	790576147215
HHT-816L-BK	H SERIES LOW VOLT TRACK HEAD 75W	32.95	790576002859
HHT-816L-BN	H SERIES LOW VOLT TRACK HEAD 75W	36.95	790576160160
HHT-816L-WT	H SERIES LOW VOLT TRACK HEAD 75W	32.95	790576002880
HHT-816-WT	H SERIES LOW VOLT TRACK HEAD 50W	29.95	790576002842
HHT-817-BK	H SERIES LOW VOLT TRACK HEAD 50W	59.95	790576086644
HHT-817-PT/BK	H SERIES LOW VOLT TRACK HEAD 50W	62.95	790576086637
HHT-817-PT/WT	H SERIES LOW VOLT TRACK HEAD 50W	62.95	790576086620
HHT-817-WT	H SERIES LOW VOLT TRACK HEAD 50W	59.95	790576086613
HHT-819-BK	H SERIES LOW VOLT TRACK HEAD 50W	41.95	790576086606
HHT-819L-BK	H SERIES LOW VOLT TRACK HEAD 75W	44.95	790576088655
HHT-819L-PT/BK	H SERIES LOW VOLT TRACK HEAD 75W	47.95	790576088815
HHT-819L-PT/WT	H SERIES LOW VOLT TRACK HEAD 75W	47.95	790576088822
HHT-819L-WT	H SERIES LOW VOLT TRACK HEAD 75W	44.95	790576088662
HHT-819-PT/BK	H SERIES LOW VOLT TRACK HEAD 50W	44.95	790576086590
HHT-819-PT/WT	H SERIES LOW VOLT TRACK HEAD 50W	44.95	790576086583
HHT-819-WT	H SERIES LOW VOLT TRACK HEAD 50W	41.95	790576086576
HHT-826-BK	H SERIES LOW VOLT TRACK HEAD 50W	34.95	790576002897
HHT-826-BN	H SERIES LOW VOLT TRACK HEAD 50W	38.95	790576147222
HHT-826L-BK	H SERIES LOW VOLT TRACK HEAD 75W	37.95	790576002910
HHT-826L-BN	H SERIES LOW VOLT TRACK HEAD 75W	41.95	790576160191
HHT-826L-WT	H SERIES LOW VOLT TRACK HEAD 75W	37.95	790576002927
HHT-826-WT	H SERIES LOW VOLT TRACK HEAD 50W	34.95	790576002903
HHT-846-BK	H SERIES LOW VOLT TRACK HEAD 50W	38.95	790576002934
HHT-846L-BK	H SERIES LOW VOLT TRACK HEAD 75W	41.95	790576002958
HHT-846L-WT	H SERIES LOW VOLT TRACK HEAD 75W	41.95	790576002965
HHT-846-WT	H SERIES LOW VOLT TRACK HEAD 50W	38.95	790576002941
HHT-856-BK	H SERIES LOW VOLT TRACK HEAD 50W	39.95	790576036205
HHT-856-BN	H SERIES LOW VOLT TRACK HEAD 50W	43.95	790576147239
HHT-856L-BK	H SERIES LOW VOLT TRACK HEAD 75W	42.95	790576040660
HHT-856L-BN	H SERIES LOW VOLT TRACK HEAD 75W	46.95	790576160221
HHT-856L-WT	H SERIES LOW VOLT TRACK HEAD 75W	42.95	790576040615
HHT-856-WT	H SERIES LOW VOLT TRACK HEAD 50W	39.95	790576036212
HHT-866-BK	H SERIES LOW VOLT TRACK HEAD 50W	30.95	790576037615
HHT-866L-BK	H SERIES LOW VOLT TRACK HEAD 75W	33.95	790576040691
HHT-866L-WT	H SERIES LOW VOLT TRACK HEAD 75W	33.95	790576040646

Material	Description	2011 DN	UPC Code
HHT-866-WT	H SERIES LOW VOLT TRACK HEAD 50W	30.95	790576037622
HHT-874-AB	H SERIES LOW VOLT TRACK HEAD 50W	59.95	790576143033
HHT-874-AN	H SERIES LOW VOLTAGE TRACK HEAD 50W	59.95	790576193533
HHT-874L-AB	H SERIES LOW VOLT TRACK HEAD 75W	62.95	790576143255
HHT-874L-AN	H SERIES LOW VOLTAGE TRACK HEAD 75W	62.95	790576193595
HHT-874-LENS-AB	H SERIES LOW VOLT TRACK HEAD 50W W/LENS	64.95	790576143125
HHT-874-LENS-AN	LENS OPTION	64.95	790576193564
HHT-874L-LENS-AB	H SERIES LOW VOLT TRACK HEAD 75W W/LENS	67.95	790576143286
HHT-874L-LENS-AN	LENS OPTION	67.95	790576193625
HHT-886-AB	H SERIES LOW VOLT TRACK HEAD 50W	59.95	790576143569
HHT-886-AN	H SERIES LOW VOLTAGE TRACK HEAD 50W	59.95	790576193779
HHT-886L-AB	H SERIES LOW VOLT TRACK HEAD 75W	62.95	790576143590
HHT-886L-AN	H SERIES LOW VOLTAGE TRACK HEAD 75W	62.95	790576193809
HHT-896-BK	MR16 TRACK LUMINAIRE	44.95	790576196824
HHT-896L-BK	MR16 TRACK LUMINAIRE	44.95	790576196848
HHT-896L-WT	MR16 TRACK LUMINAIRE	44.95	790576196855
HHT-896-WT	MR16 TRACK LUMINAIRE	44.95	790576196831
HHT-901-BK	H SERIES LOW VOLT TRACK HEAD 50W	35.95	790576003085
HHT-901-WT	H SERIES LOW VOLT TRACK HEAD 50W	35.95	790576003092
HHT-935L-BK	H SERIES LOW VOLTAGE TRACK HEAD 75W	49.95	790576105628
HHT-935L-WT	H SERIES LOW VOLTAGE TRACK HEAD 75W	49.95	790576105635
HHT-936-BK	H SERIES LOW VOLT TRACK HEAD 50W	43.95	790576003146
HHT-936L-BK	H SERIES LOW VOLT TRACK HEAD 75W	46.95	790576003160
HHT-936L-WT	H SERIES LOW VOLT TRACK HEAD 75W	46.95	790576003177
HHT-936-WT	H SERIES LOW VOLT TRACK HEAD 50W	43.95	790576003153
HHT-939L-BK	H SERIES LOW VOLTAGE TRACK HEAD 75W	55.95	790576095318
HHT-939L-WT	H SERIES LOW VOLTAGE TRACK HEAD 75W	55.95	790576095325
HI-BK	H SERIES STRAIGHT LINE CONNECTOR	4.95	790576003184
HI-BN	H SERIES STRAIGHT LINE CONNECTOR	6.50	790576145082
HI-DB	H SERIES STRAIGHT LINE CONNECTOR	6.50	790576140032
HI-DEC-BK	H SERIES I DEAD END STRAIGHT CONNECTOR	4.50	790576003191
HI-DEC-BN	H SERIES I DEAD END STRAIGHT CONNECTOR	5.95	790576145099
HI-DEC-DB	H SERIES I DEAD END STRAIGHT CONNECTOR	5.95	790576140049
HI-DEC-WT	H SERIES I DEAD END STRAIGHT CONNECTOR	4.50	790576003207
HI-PWR-BK	H SERIES I STRAIGHT LINE POWER CONNECTOR	7.95	790576003214
HI-PWR-BN	H SERIES I STRAIGHT LINE POWER CONNECTOR	9.50	790576145204
HI-PWR-DB	H SERIES I STRAIGHT LINE POWER CONNECTOR	9.50	790576140056
HI-PWR-WT	H SERIES I STRAIGHT LINE POWER CONNECTOR	7.95	790576003221
HI-WT	H SERIES STRAIGHT LINE CONNECTOR	4.95	790576003238
HLE-BK	.H SERIES LIVE END CONNECTOR	4.95	790576003269
HLE-BN	.H SERIES LIVE END CONNECTOR	5.95	790576145358
H-LED610F-CW-BK	LEDME TRACK LUMINAIRE	169.95	790576196077
H-LED610F-CW-BN	LEDME TRACK LUMINAIRE	174.95	790576196091
H-LED610F-CW-WT	LEDME TRACK LUMINAIRE	169.95	790576196084
H-LED610F-WW-BK	LEDME TRACK LUMINAIRE	169.95	790576196046
H-LED610F-WW-BN	LEDME TRACK LUMINAIRE	174.95	790576196060
H-LED610F-WW-WT	LEDME TRACK LUMINAIRE	169.95	790576196053
H-LED610S-CW-BK	LEDME TRACK LUMINAIRE	169.95	790576196985
H-LED610S-CW-BN	LEDME TRACK LUMINAIRE	174.95	790576197005
H-LED610S-CW-WT	LEDME TRACK LUMINAIRE	169.95	790576196992

Material	Description	2011 DN	UPC Code
H-LED610S-WW-BK	LEDME TRACK LUMINAIRE	169.95	790576196039
H-LED610S-WW-BN	LEDME TRACK LUMINAIRE	174.95	790576196978
H-LED610S-WW-WT	LEDME TRACK LUMINAIRE	169.95	790576196961
H-LED710F-CW-AB	LEDME TRACK LUMINAIRE	179.95	790576196329
H-LED710F-CW-AN	LEDME TRACK LUMINAIRE	179.95	790576196336
H-LED710F-CW-SB/BK	LEDME TRACK LUMINAIRE	184.95	790576196343
H-LED710F-WW-AB	LEDME TRACK LUMINAIRE	179.95	790576196268
H-LED710F-WW-AN	LEDME TRACK LUMINAIRE	179.95	790576196275
H-LED710F-WW-SB/BK	LEDME TRACK LUMINAIRE	184.95	790576196282
H-LED710S-CW-AB	LEDME TRACK LUMINAIRE	179.95	790576196299
H-LED710S-CW-AN	LEDME TRACK LUMINAIRE	179.95	790576196305
H-LED710S-CW-SB/BK	LEDME TRACK LUMINAIRE	184.95	790576196312
H-LED710S-WW-AB	LEDME TRACK LUMINAIRE	179.95	790576196237
H-LED710S-WW-AN	LEDME TRACK LUMINAIRE	179.95	790576196244
H-LED710S-WW-SB/BK	LEDME TRACK LUMINAIRE	184.95	790576196251
H-LED810F-CW-BK	LEDME TRACK LUMINAIRE	119.95	790576196657
H-LED810F-CW-WT	LEDME TRACK LUMINAIRE	119.95	790576196664
H-LED810F-WW-BK	LEDME TRACK LUMINAIRE	119.95	790576196619
H-LED810F-WW-WT	LEDME TRACK LUMINAIRE	119.95	790576196626
H-LED810S-CW-BK	LEDME TRACK LUMINAIRE	119.95	790576196633
H-LED810S-CW-WT	LEDME TRACK LUMINAIRE	119.95	790576196640
H-LED810S-WW-BK	LEDME TRACK LUMINAIRE	119.95	790576196596
H-LED810S-WW-WT	LEDME TRACK LUMINAIRE	119.95	790576196602
HLE-DB	H SERIES LIVE END CONNECTOR	5.95	790576139944
HLE-WT	H SERIES LIVE END CONNECTOR	4.95	790576003276
HL-LEFT-BK	H SERIES LEFT L-CONNECTOR	7.95	790576003245
HL-LEFT-BN	H SERIES LEFT L-CONNECTOR	9.50	790576145365
HL-LEFT-DB	H SERIES LEFT L-CONNECTOR	9.50	790576140063
HL-LEFT-WT	H SERIES LEFT L-CONNECTOR	7.95	790576003252
H-LOOP-BK	H SERIES SUSPENSION LOOP	8.95	790576020310
H-LOOP-BN	H SERIES SUSPENSION LOOP	10.50	790576145372
H-LOOP-DB	H SERIES SUSPENSION LOOP	10.50	790576140070
H-LOOP-WT	H SERIES SUSPENSION LOOP	8.95	790576020327
HL-RIGHT-BK	H SERIES RIGHT L-CONNECTOR	7.95	790576059280
HL-RIGHT-BN	H SERIES RIGHT L-CONNECTOR	9.50	790576145389
HL-RIGHT-DB	H SERIES RIGHT L-CONNECTOR	9.50	790576140087
HL-RIGHT-WT	H SERIES RIGHT L-CONNECTOR	7.95	790576059297
HM1-101-AM/DB	HM1- FIXTURE	34.50	790576125688
HM1-101-AM/PT	HM1- FIXTURE	34.50	790576125718
HM1-101-DB/DB	HM1- FIXTURE	34.50	790576125671
HM1-101-PT/PT	HM1- FIXTURE	34.50	790576125701
HM1-101-WT/DB	HM1- FIXTURE	34.50	790576125695
HM1-101-WT/PT	HM1- FIXTURE	34.50	790576125725
HM1-150-DB	FLEXRAIL1 LINE VOLTAGE TRACKHEA	54.95	790576115252
HM1-150-PT	FLEXRAIL1 LINE VOLTAGE TRACKHEAD-150W	54.95	790576115269
HM1-18F-CW-DB	LEDME FLEXRAIL1 - 18W COOL WHITE FLOOD	213.95	790576166360
HM1-18F-CW-PT	LEDME FLEXRAIL1 - 18W COOL WHITE FLOOD	213.95	790576166353
HM1-18F-WW-DB	LEDME FLEXRAIL1 - 18W WARM WHITE FLOOD	213.95	790576166339
HM1-18F-WW-PT	LEDME FLEXRAIL1 - 18W WARM WHITE FLOOD	213.95	790576166346
HM1-18S-CW-DB	LEDME FLEXRAIL1 - 18W COOL WHITE SPOT	213.95	790576166322

Material	Description	2011 DN	UPC Code
HM1-18S-CW-PT	LEDME FLEXRAIL1 - 18W COOL WHITE SPOT	213.95	790576166315
HM1-18S-WW-DB	LEDME FLEXRAIL1 - 18W WARM WHITE SPOT	213.95	790576166292
HM1-18S-WW-PT	LEDME FLEXRAIL1 - 18W WARM WHITE SPOT	213.95	790576166308
HM-150-BZ	LINE VOLT FLEXRAIL FIXTURE	56.95	790576106960
HM-150-PT	LINE VOLT FLEXRAIL FIXTURE	56.95	790576075303
HM1-512AM/DB	JILL PENDANT FOR FLEXRAIL1 - 120V 50W BI	82.95	790576154503
HM1-512AM/PT	JILL PENDANT FOR FLEXRAIL1 - 120V 50W BI	82.95	790576154510
HM1-512BL/DB	JILL PENDANT FOR FLEXRAIL1 - 120V 50W BI	82.95	790576154527
HM1-512BL/PT	JILL PENDANT FOR FLEXRAIL1 - 120V 50W BI	82.95	790576154534
HM1-512GR/DB	JILL PENDANT FOR FLEXRAIL1 - 120V 50W BI	82.95	790576154541
HM1-512GR/PT	JILL PENDANT FOR FLEXRAIL1 - 120V 50W BI	82.95	790576154558
HM1-512RD/DB	JILL PENDANT FOR FLEXRAIL1 - 120V 50W BI	82.95	790576154565
HM1-512RD/PT	JILL PENDANT FOR FLEXRAIL1 - 120V 50W BI	82.95	790576154572
HM1-512WT/DB	JILL PENDANT FOR FLEXRAIL1 - 120V 50W BI	82.95	790576154589
HM1-512WT/PT	JILL PENDANT FOR FLEXRAIL1 - 120V 50W BI	82.95	790576154596
HM1-513AM/DB	ELLA PENDANT FOR FLEXRAIL 1 - 12	91.95	790576154602
HM1-513AM/PT	ELLA PENDANT FOR FLEXRAIL 1 - 12	91.95	790576154619
HM1-513WT/DB	ELLA PENDANT FOR FLEXRAIL 1 - 12	91.95	790576154626
HM1-513WT/PT	ELLA PENDANT FOR FLEXRAIL 1 - 12	91.95	790576154633
HM1-515AM/DB	FIORE PENDANT FOR FLEXRAIL1 - 120V 50W B	122.95	790576154664
HM1-515AM/PT	FIORE PENDANT FOR FLEXRAIL1 - 120V 50W B	122.95	790576154671
HM1-515MF/DB	FIORE PENDANT FOR FLEXRAIL1 - 120V 50W B	122.95	790576154701
HM1-515MF/PT	FIORE PENDANT FOR FLEXRAIL1 - 120V 50W B	122.95	790576154718
HM1-517WT/DB	OBO PENDANT FOR FLEXRAIL1 - 120V 50W BI	87.95	790576154725
HM1-517WT/PT	OBO PENDANT FOR FLEXRAIL1 - 120V 50W BI	87.95	790576154732
HM1-518DIC/DB	EDEN PENDANT FOR FLEXRAIL1 - 120V 50W BI	137.95	790576154749
HM1-518DIC/PT	EDEN PENDANT FOR FLEXRAIL1 - 120V 50W BI	137.95	790576154756
HM1-524AM/DB	SARAH PENDANT FOR FLEXRAIL1 - 120V 50W B	86.95	790576154824
HM1-524AM/PT	SARAH PENDANT FOR FLEXRAIL1 - 120V 50W B	86.95	790576154831
HM1-524LB/DB	SARAH PENDANT FOR FLEXRAIL1 - 120V 50W B	86.95	790576154848
HM1-524LB/PT	SARAH PENDANT FOR FLEXRAIL1 - 120V 50W B	86.95	790576154855
HM1-524TQ/DB	SARAH PENDANT FOR FLEXRAIL1 - 120V 50W B	86.95	790576154862
HM1-524TQ/PT	SARAH PENDANT FOR FLEXRAIL1 - 120V 50W B	86.95	790576154879
HM1-524WT/DB	SARAH PENDANT FOR FLEXRAIL1 - 120V 50W B	86.95	790576154886
HM1-524WT/PT	SARAH PENDANT FOR FLEXRAIL1 - 120V 50W B	86.95	790576154893
HM1-530GR/DB	COUTURE PENDANT FOR FLEXRAIL1 - 120V 50W	177.95	790576154909
HM1-530GR/PT	COUTURE PENDANT FOR FLEXRAIL1 - 120V 50W	177.95	790576154916
HM1-530MC/DB	COUTURE PENDANT FOR FLEXRAIL1 - 120V 50W	177.95	790576154923
HM1-530MC/PT	COUTURE PENDANT FOR FLEXRAIL1 - 120V 50W	177.95	790576154930
HM1-534SM/DB	PENDANT FOR FLEXRAIL1 - 120V 50W	107.95	790576195377
HM1-534SM/PT	PENDANT FOR FLEXRAIL1 - 120V 50W	107.95	790576195384
HM1-535DIC/DB	PENDANT FOR FLEXRAIL1 - 120V 50W	157.95	
HM1-535DIC/PT	PENDANT FOR FLEXRAIL1 - 120V 50W	157.95	
HM1-536BL/DB	PENDANT FOR FLEXRAIL1 - 120V 50W	122.95	790576195599
HM1-536BL/PT	PENDANT FOR FLEXRAIL1 - 120V 50W	122.95	790576195605
HM1-541AM/DB	FABERGE PENDANT FOR FLEXRAIL1 - 120V 50W	94.95	790576154961
HM1-541AM/PT	FABERGE PENDANT FOR FLEXRAIL1 - 120V 50W	94.95	790576154978
HM1-541WT/DB	FABERGE PENDANT FOR FLEXRAIL1 - 120V 50W	94.95	790576154985
HM1-541WT/PT	FABERGE PENDANT FOR FLEXRAIL1 - 120V 50W	94.95	790576154992
HM1-546DIC/DB	AMBROSIA PENDANT FOR FLEXRAIL1 - 120V 50	157.95	790576155029



Material	Description	2011 DN	UPC Code
HM1-546DIC/PT	AMBROSIA PENDANT FOR FLEXRAIL1 - 120V 50	157.95	790576155036
HM1-548FR/DB	PURA PENDANT FOR FLEXRAIL1 - 120V 50W BI	107.95	790576155067
HM1-548FR/PT	PURA PENDANT FOR FLEXRAIL1 - 120V 50W BI	107.95	790576155074
HM1-559DIC/DB	MICHA PENDANT FOR FLEXRAIL1 - 120V 50W B	97.95	790576178165
HM1-559DIC/PT	MICHA PENDANT FOR FLEXRAIL1 - 120V 50W B	97.95	790576178202
HM1-559GL/DB	MICHA PENDANT FOR FLEXRAIL1 - 120V 50W B	97.95	790576173382
HM1-559GL/PT	MICHA PENDANT FOR FLEXRAIL1 - 120V 50W B	97.95	790576173429
HM1-559MR/DB	MICHA PENDANT FOR FLEXRAIL1 - 120V 50W B	97.95	790576179186
HM1-559MR/PT	MICHA PENDANT FOR FLEXRAIL1 - 120V 50W B	97.95	790576179223
HM1-593LI/DB	KOMAL PENDANT FOR FLEXRAIL1 - 120V 50W B	137.95	790576155142
HM1-593LI/PT	KOMAL PENDANT FOR FLEXRAIL1 - 120V 50W B	137.95	790576155159
HM1-593RD/DB	KOMAL PENDANT FOR FLEXRAIL1 - 120V 50W B	137.95	790576155166
HM1-593RD/PT	KOMAL PENDANT FOR FLEXRAIL1 - 120V 50W B	137.95	790576155173
HM1-593TQ/DB	KOMAL PENDANT FOR FLEXRAIL1 - 120V 50W B	137.95	790576155180
HM1-593TQ/PT	KOMAL PENDANT FOR FLEXRAIL1 - 120V 50W B	137.95	790576155197
HM1-598WT/DB	DAPPER PENDANT FOR FLEXRAIL1 - 120V 50W	122.95	790576155203
HM1-598WT/PT	DAPPER PENDANT FOR FLEXRAIL1 - 120V 50W	122.95	790576155210
HM1-599BL/DB	RHEA PENDANT FOR FLEXRAIL1 - 120V 50W B	107.95	790576175591
HM1-599BL/PT	RHEA PENDANT FOR FLEXRAIL1 - 120V 50W B	107.95	790576175621
HM1-599UM/DB	RHEA PENDANT FOR FLEXRAIL1 - 120V 50W B	107.95	790576177663
HM1-599UM/PT	RHEA PENDANT FOR FLEXRAIL1 - 120V 50W B	107.95	790576177700
HM1-599WT/DB	RHEA PENDANT FOR FLEXRAIL1 - 120V 50W B	107.95	790576176635
HM1-599WT/PT	RHEA PENDANT FOR FLEXRAIL1 - 120V 50W B	107.95	790576176673
HM-163L-DB	LOW VOLT FLEXRAIL FIXTURE	60.95	790576105918
HM-163L-PT	LOW VOLT FLEXRAIL FIXTURE	60.95	790576105901
HM-164L-DB	LOW VOLT FLEXRAIL FIXTURE	54.50	790576106052
HM-164L-PT	LOW VOLT FLEXRAIL FIXTURE	54.50	790576106045
HM1-720-DB	FLEXRAIL1 LINE VOLTAGE TRACKHEA	34.95	790576116570
HM1-720-PT	FLEXRAIL1 LINE VOLTAGE TRACKHEAD-50W	34.95	790576116563
HM1-730-DB	FLEXRAIL1 LINE VOLTAGE TRACKHEA	37.95	790576116594
HM1-730-PT	FLEXRAIL1 LINE VOLTAGE TRACKHEAD-75W	37.95	790576116587
HM1-738-DB	FLEXRAIL1 LINE VOLTAGE TRACKHEA	40.95	790576116617
HM1-738-PT	FLEXRAIL1 LINE VOLTAGE TRACKHEAD-150W	40.95	790576116600
HM1-773-DB	FLEXRAIL1 LINE VOLTAGE TRACKHEA	34.50	790576116631
HM1-773-PT	FLEXRAIL1 LINE VOLTAGE TRACKHEAD-50W	34.50	790576116624
HM1-774-DB	FLEXRAIL1 LINE VOLTAGE TRACKHEA	36.50	790576116655
HM1-774-PT	FLEXRAIL1 LINE VOLTAGE TRACKHEAD-75W	36.50	790576116648
HM1-775-DB	FLEXRAIL1 LINE VOLTAGE TRACKHEA	38.50	790576116679
HM1-775-PT	FLEXRAIL1 LINE VOLTAGE TRACKHEAD-150W	38.50	790576116662
HM1-783-DB	FLEXRAIL1 LINE VOLTAGE TRACKHEA	42.95	790576116693
HM1-783-PT	FLEXRAIL1 LINE VOLTAGE TRACKHEAD-50W	42.95	790576116686
HM1-784-DB	FLEXRAIL1 LINE VOLTAGE TRACKHEA	44.95	790576116716
HM1-784-PT	FLEXRAIL1 LINE VOLTAGE TRACKHEAD-75W	44.95	790576116709
HM1-785-DB	FLEXRAIL1 LINE VOLTAGE TRACKHEA	47.50	790576116730
HM1-785-PT	FLEXRAIL1 LINE VOLTAGE TRACKHEAD-150W	47.50	790576116723
HM1-846-DB	FLEXRAIL1-LOW VOLTAGE TRACKHEAD	44.95	790576115351
HM1-846L-DB	FLEXRAIL1-LOW VOLTAGE TRACKHEAD	47.95	790576115368
HM1-846L-PT	FLEXRAIL1-LOW VOLTAGE TRACKHEAD-75W	47.95	790576115375
HM1-846-PT	FLEXRAIL1-LOW VOLTAGE TRACKHEAD-50W	44.95	790576115382
HM1-849-DB	FLEXRAIL1-LOW VOLTAGE TRACKHEAD	42.95	790576115436

Material	Description	2011 DN	UPC Code
HM1-849L-DB	FLEXRAIL1-LOW VOLTAGE TRACKHEAD	45.95	790576115443
HM1-849L-PT	FLEXRAIL1-LOW VOLTAGE TRACKHEAD-75W	45.95	790576115450
HM1-849-PT	FLEXRAIL1-LOW VOLTAGE TRACKHEAD-50W	42.95	790576115467
HM1-936-DB	FLEXRAIL1-LOW VOLTAGE TRACKHEAD	49.95	790576116532
HM1-936L-DB	FLEXRAIL1-LOW VOLTAGE TRACKHEAD	52.95	790576116556
HM1-936L-PT	FLEXRAIL1-LOW VOLTAGE TRACKHEAD-75W	52.95	790576116549
HM1-936-PT	FLEXRAIL1-LOW VOLTAGE TRACKHEAD-50W	49.95	790576116525
HM1-9F-CW-DB	LEDME FLEXRAIL1 - 9W COOL WHITE FLOOD	163.95	790576166285
HM1-9F-CW-PT	LEDME FLEXRAIL1 - 9W COOL WHITE FLOOD	163.95	790576166278
HM1-9F-WW-DB	LEDME FLEXRAIL1 - 9W WARM WHITE FLOOD	163.95	790576166254
HM1-9F-WW-PT	LEDME FLEXRAIL1 - 9W WARM WHITE FLOOD	163.95	790576166261
HM1-9S-CW-DB	LEDME FLEXRAIL1 - 9W COOL WHITE SPOT	163.95	790576166247
HM1-9S-CW-PT	LEDME FLEXRAIL1 - 9W COOL WHITE SPOT	163.95	790576166230
HM1-9S-WW-DB	LEDME FLEXRAIL1 - 9W WARM WHITE SPOT	163.95	790576166216
HM1-9S-WW-PT	LEDME FLEXRAIL1 - 9W WARM WHITE SPOT	163.95	790576166223
HM1-BM	FLEXRAIL1 - BENDING MACHINE	141.95	790576117034
HM1-EC-DB	END CAP	1.95	790576116792
HM1-EC-PT	END CAP	1.95	790576116785
HM1-EN50-DB	FLEXRAIL1 - QUICK CONNECT ADAPTER	47.95	790576115559
HM1-EN50-PT	FLEXRAIL1 - QUICK CONNECT ADAPTER	47.95	790576115566
HM1-F1-402AM/DB	LISA PENDANT FOR FLEXRAIL1 - CFL GU24	116.95	790576183183
HM1-F1-402BL/DB	LISA PENDANT FOR FLEXRAIL1 - CFL GU24	116.95	790576183701
HM1-F1-402WM/DB	LISA PENDANT FOR FLEXRAIL1 - CFL GU24	116.95	790576184180
HM1-F1-403AM/DB	NOVA PENDANT FOR FLEXRAIL1 - CFL GU24	134.95	790576180854
HM1-F1-403BL/DB	NOVA PENDANT FOR FLEXRAIL1 - CFL GU24	134.95	790576181455
HM1-F1-403RD/DB	NOVA PENDANT FOR FLEXRAIL1 - CFL GU24	134.95	790576182049
HM1-F1-404BN/DB	FELIS PENDANT FOR FLEXRAIL1 - CFL GU24	99.95	790576184449
HM1-F1-404CO/DB	FELIS PENDANT FOR FLEXRAIL1 - CFL GU24	99.95	790576180267
HM1-F1-406OC/DB	FELIS PENDANT FOR FLEXRAIL1 - CFL GU24	134.95	790576182629
HM1-F1-408AM/DB	CREAMERY PENDANT FOR FLEXRAIL1 - CFL GU24	134.95	790576184654
HM1-F1-408WT/DB	CREAMERY PENDANT FOR FLEXRAIL1 - CFL GU24	134.95	790576184876
HM1-F1-421GR/DB	MOSS PENDANT FOR FLEXRAIL1 - CFL GU24	189.95	790576159546
HM1-F1-423PR/DB	SOLSTICE PENDANT FOR FLEXRAIL1 - CFL GU2	199.95	790576159553
HM1-F1-424WT/DB	SERAPHIM PENDANT FOR FLEXRAIL1 - CFL GU2	219.95	790576159560
HM1-F1-451AM/DB	BONGO PENDANT FOR FLEXRAIL1 - CFL GU24	119.95	790576181622
HM1-F1-451BL/DB	BONGO PENDANT FOR FLEXRAIL1 - CFL GU24	119.95	790576182247
HM1-F1-451WT/DB	BONGO PENDANT FOR FLEXRAIL1 - CFL GU24	119.95	790576182872
HM1-F1-454AM/DB	DAX PENDANT FOR FLEXRAIL1 - CFL GU24	119.95	790576183473
HM1-F1-454WT/DB	DAX PENDANT FOR FLEXRAIL1 - CFL GU24	119.95	790576183978
HM1-F1-471WT/DB	MODE PENDANT FOR FLEXRAIL1 - CFL GU24	119.95	790576159584
HM1-F1-472WT/DB	CLINTON PENDANT FOR FLEXRAIL1 - CFL GU24	141.95	790576159591
HM1-F1-474WT/DB	CAROL GARDENS PENDANT FOR FLEXRAIL1 - CF	144.95	790576159607
HM1-F1-483IV/DB	WILLIAMSBURG PENDANT FOR FLEXRAIL1 - CFL	149.95	790576159614
HM1-F1-484BL/DB	PENDANT FOR FLEXRAIL1 - CFL	149.95	790576200613
HM1-F1-485BL/DB	PENDANT FOR FLEXRAIL1 - CFL	189.95	
HM1-F1-487AM/DB	COBBLE HILL PENDANT FOR FLEXRAIL1 - CFL	149.95	790576159638
HM1-F1-488WT/DB	PARK SLOPE PENDANT FOR FLEXRAIL1 - CFL G	193.95	790576159645
HM1-F2-402AM/PT	LINE VOLTAGE FLEXRAIL1 PENDANT KIT	116.95	790576183244
HM1-F2-402BL/PT	LINE VOLTAGE FLEXRAIL1 PENDANT KIT	116.95	790576183756
HM1-F2-402WM/PT	LINE VOLTAGE FLEXRAIL1 PENDANT KIT	116.95	790576184227

Material	Description	2011 DN	UPC Code
HM1-F2-403AM/PT	LINE VOLTAGE FLEXRAIL1 PENDANT KIT	134.95	790576180908
HM1-F2-403BL/PT	LINE VOLTAGE FLEXRAIL1 PENDANT KIT	134.95	790576181493
HM1-F2-403RD/PT	LINE VOLTAGE FLEXRAIL1 PENDANT KIT	134.95	790576182094
HM1-F2-404BN/PT	LINE VOLTAGE FLEXRAIL1 PENDANT KIT	99.95	790576184487
HM1-F2-404CO/PT	LINE VOLTAGE FLEXRAIL1 PENDANT KIT	99.95	790576180311
HM1-F2-406OC/PT	LINE VOLTAGE FLEXRAIL1 PENDANT KIT	134.95	790576182674
HM1-F2-408AM/PT	LINE VOLTAGE FLEXRAIL1 PENDANT KIT	134.95	790576184692
HM1-F2-408WT/PT	LINE VOLTAGE FLEXRAIL1 PENDANT KIT	134.95	790576184883
HM1-F2-421GR/PT	LINE VOLTAGE FLEXRAIL1 PENDANT KIT	189.95	790576143118
HM1-F2-423PR/PT	LINE VOLTAGE FLEXRAIL1 PENDANT KIT	199.95	790576143224
HM1-F2-424WT/PT	LINE VOLTAGE FLEXRAIL1 PENDANT KIT	219.95	790576145341
HM1-F2-451AM/PT	LINE VOLTAGE FLEXRAIL1 PENDANT KIT	119.95	790576181660
HM1-F2-451BL/PT	LINE VOLTAGE FLEXRAIL1 PENDANT KIT	119.95	790576182292
HM1-F2-451WT/PT	LINE VOLTAGE FLEXRAIL1 PENDANT KIT	119.95	790576182919
HM1-F2-454AM/PT	LINE VOLTAGE FLEXRAIL1 PENDANT KIT	119.95	790576183510
HM1-F2-454WT/PT	LINE VOLTAGE FLEXRAIL1 PENDANT KIT	119.95	790576184005
HM1-F2-471WT/PT	LINE VOLTAGE FLEXRAIL1 PENDANT KIT	119.95	790576143644
HM1-F2-472WT/PT	LINE VOLTAGE FLEXRAIL1 PENDANT KIT	141.95	790576143828
HM1-F2-474WT/PT	LINE VOLTAGE FLEXRAIL1 PENDANT KIT	144.95	790576144375
HM1-F2-483IV/PT	LINE VOLTAGE FLEXRAIL1 PENDANT KIT	149.95	790576145327
HM1-F2-484BL/PT	LINE VOLTAGE FLEXRAIL1 PENDANT KIT	152.95	790576200620
HM1-F2-485BL/PT	LINE VOLTAGE FLEXRAIL1 PENDANT KIT	189.95	
HM1-F2-487AM/PT	LINE VOLTAGE FLEXRAIL1 PENDANT KIT	149.95	790576145334
HM1-F2-488WT/PT	LINE VOLTAGE FLEXRAIL1 PENDANT KIT	193.95	790576145303
HM1-F4-402AM/DB	CREAMERY PENDANT FOR CANOPY MOUNT - A19	92.50	790576152691
HM1-F4-402AM/PT	CREAMERY PENDANT FOR CANOPY MOUNT - A19	92.50	790576152707
HM1-F4-402BL/DB	CREAMERY PENDANT FOR CANOPY MOUNT - A19	92.50	790576152714
HM1-F4-402BL/PT	CREAMERY PENDANT FOR CANOPY MOUNT - A19	92.50	790576152721
HM1-F4-402WM/DB	CREAMERY PENDANT FOR CANOPY MOUNT - A19	92.50	790576152738
HM1-F4-402WM/PT	CREAMERY PENDANT FOR CANOPY MOUNT - A19	92.50	790576152745
HM1-F4-403AM/DB	CREAMERY PENDANT FOR CANOPY MOUNT - A19	110.50	790576152752
HM1-F4-403AM/PT	BONGO PENDANT FOR CANOPY MOUNT - A19	110.50	790576152769
HM1-F4-403BL/DB	BONGO PENDANT FOR CANOPY MOUNT - A19	110.50	790576152776
HM1-F4-403BL/PT	BONGO PENDANT FOR CANOPY MOUNT - A19	110.50	790576152783
HM1-F4-403RD/DB	BONGO PENDANT FOR CANOPY MOUNT - A19	110.50	790576152790
HM1-F4-403RD/PT	BONGO PENDANT FOR CANOPY MOUNT - A19	110.50	790576152806
HM1-F4-404BN/DB	FELIS PENDANT FOR CANOPY MOUNT - A19	75.50	790576152813
HM1-F4-404BN/PT	FELIS PENDANT FOR CANOPY MOUNT - A19	75.50	790576152820
HM1-F4-404CO/DB	FELIS PENDANT FOR CANOPY MOUNT - A19	75.50	790576152837
HM1-F4-404CO/PT	FELIS PENDANT FOR CANOPY MOUNT - A19	75.50	790576152844
HM1-F4-406OC/DB	FROST PENDANT FOR CANOPY MOUNT - A19	110.50	790576152851
HM1-F4-406OC/PT	FROST PENDANT FOR CANOPY MOUNT - A19	110.50	790576152868
HM1-F4-408AM/DB	CREAMERY PENDANT FOR CANOPY MOUNT - A19	110.50	790576152875
HM1-F4-408AM/PT	CREAMERY PENDANT FOR CANOPY MOUNT - A19	110.50	790576152882
HM1-F4-408WT/DB	CREAMERY PENDANT FOR CANOPY MOUNT - A19	110.50	790576152899
HM1-F4-408WT/PT	CREAMERY PENDANT FOR CANOPY MOUNT - A19	110.50	790576152905
HM1-F4-421GR/DB	FLEXRAIL1 PENDANT - A19	165.50	790576183602
HM1-F4-421GR/PT	LINE VOLTAGE FLEXRAIL1 PENDANT	165.50	790576183640
HM1-F4-423PR/DB	FLEXRAIL1 PENDANT - A19	175.50	790576182520
HM1-F4-424WT/DB	FLEXRAIL1 PENDANT - A19	195.50	790576180434

Material	Description	2011 DN	UPC Code
HM1-F4-424WT/PT	FLEXRAIL1 PENDANT - A19	195.50	790576180489
HM1-F4-451AM/DB	FLEXRAIL1 PENDANT - A19	95.50	790576152912
HM1-F4-451AM/PT	FLEXRAIL1 PENDANT - A19	95.50	790576152929
HM1-F4-451BL/DB	FLEXRAIL1 PENDANT - A19	95.50	790576152936
HM1-F4-451BL/PT	FLEXRAIL1 PENDANT - A19	95.50	790576152943
HM1-F4-451WT/DB	FLEXRAIL1 PENDANT - A19	95.50	790576152950
HM1-F4-451WT/PT	FLEXRAIL1 PENDANT - A19	95.50	790576152967
HM1-F4-454AM/DB	FLEXRAIL1 PENDANT - A19	95.50	790576152974
HM1-F4-454AM/PT	FLEXRAIL1 PENDANT - A19	95.50	790576152981
HM1-F4-454WT/DB	FLEXRAIL1 PENDANT - A19	95.50	790576152998
HM1-F4-454WT/PT	FLEXRAIL1 PENDANT - A19	95.50	790576153001
HM1-F4-471WT/DB	FLEXRAIL1 PENDANT - A19	95.50	790576184432
HM1-F4-471WT/PT	FLEXRAIL1 PENDANT - A19	95.50	790576184470
HM1-F4-472WT/DB	FLEXRAIL1 PENDANT - A19	105.50	790576180625
HM1-F4-472WT/PT	FLEXRAIL1 PENDANT - A19	105.50	790576180687
HM1-F4-474WT/DB	FLEXRAIL1 PENDANT - A19	120.50	790576184531
HM1-F4-474WT/PT	FLEXRAIL1 PENDANT - A19	120.50	790576184586
HM1-F4-483IV/DB	FLEXRAIL1 PENDANT - A19	125.50	790576180892
HM1-F4-483IV/PT	FLEXRAIL1 PENDANT - A19	125.50	790576180946
HM1-F4-484BL/DB	FLEXRAIL1 PENDANT - A19	125.50	790576200637
HM1-F4-484BL/PT	FLEXRAIL1 PENDANT - A19	125.50	790576200644
HM1-F4-485BL/DB	FLEXRAIL1 PENDANT - A19	165.50	
HM1-F4-485BL/PT	FLEXRAIL1 PENDANT - A19	165.50	
HM1-F4-487AM/DB	FLEXRAIL1 PENDANT - A19	125.50	790576183695
HM1-F4-487AM/PT	FLEXRAIL1 PENDANT - A19	125.50	790576183732
HM1-F4-488WT/DB	FLEXRAIL1 PENDANT - A19	169.50	790576182698
HM1-F4-488WT/PT	FLEXRAIL1 PENDANT - A19	169.50	790576182742
HM1-FL1-AB	HM1 LINE VOLTAGE PENDANT SOCKET	59.95	790576139555
HM1-FL2-PT	HM1 LINE VOLTAGE PENDANT SOCKET	59.95	790576139630
HM1-I12-DB	FLEXRAIL1- I CONNECTOR-12 INCH	34.95	790576115573
HM1-I12-PT	FLEXRAIL1- I CONNECTOR-12 INCH	34.95	790576115580
HM1-I24-DB	FLEXRAIL1- I CONNECTOR-24 INCH	35.95	790576115597
HM1-I24-PT	FLEXRAIL1- I CONNECTOR-24 INCH	35.95	790576115603
HM1-I36-DB	FLEXRAIL1- I CONNECTOR-36 INCH	36.95	790576115610
HM1-I36-PT	FLEXRAIL1- I CONNECTOR-36 INCH	36.95	790576115627
HM1-I48-DB	FLEXRAIL1- I CONNECTOR-48 INCH	37.95	790576115634
HM1-I48-PT	FLEXRAIL1- I CONNECTOR-48 INCH	37.95	790576115641
HM1-I6-DB	FLEXRAIL1- I CONNECTOR-6 INCH	33.50	790576115658
HM1-I6-PT	FLEXRAIL1- I CONNECTOR-6 INCH	33.50	790576115665
HM1-IDEC12-DB	FLEXRAIL1- I DEAD END CONNECTOR-12 IN	33.50	790576115672
HM1-IDEC12-PT	FLEXRAIL1- I DEAD END CONNECTOR-12 IN	33.50	790576115689
HM1-IDEC24-DB	FLEXRAIL1- I DEAD END CONNECTOR-24 IN	34.95	790576115696
HM1-IDEC24-PT	FLEXRAIL1- I DEAD END CONNECTOR-24 IN	34.95	790576115702
HM1-IDEC36-DB	FLEXRAIL1- I DEAD END CONNECTOR-36 IN	35.95	790576115719
HM1-IDEC36-PT	FLEXRAIL1- I DEAD END CONNECTOR-36 IN	35.95	790576115726
HM1-IDEC48-DB	FLEXRAIL1- I DEAD END CONNECTOR-48 IN	36.95	790576115733
HM1-IDEC48-PT	FLEXRAIL1- I DEAD END CONNECTOR-48 IN	36.95	790576115740
HM1-IDEC6-DB	FLEXRAIL1- I DEAD END CONNECTOR-6 IN	32.50	790576115757
HM1-IDEC6-PT	FLEXRAIL1- I DEAD END CONNECTOR-6 IN	32.50	790576115764
HM1-PCC12-DB	FLEXRAIL1-FLEXIBLE POWER FEED-12IN	46.50	790576115771

Material	Description	2011 DN	UPC Code
HM1-PCC12-PT	FLEXRAIL1-FLEXIBLE POWER FEED-12IN	46.50	790576115788
HM1-PCC24-DB	FLEXRAIL1-FLEXIBLE POWER FEED-24IN	58.95	790576115795
HM1-PCC24-PT	FLEXRAIL1-FLEXIBLE POWER FEED-24IN	58.95	790576115801
HM1-PCC36-DB	FLEXRAIL1-FLEXIBLE POWER FEED-36IN	59.50	790576115818
HM1-PCC36-PT	FLEXRAIL1-FLEXIBLE POWER FEED-36IN	59.50	790576115825
HM1-PCC48-DB	FLEXRAIL1-FLEXIBLE POWER FEED-48IN	65.95	790576115832
HM1-PCC48-PT	FLEXRAIL1-FLEXIBLE POWER FEED-48IN	65.95	790576115849
HM1-PCC96-DB	FLEXRAIL1-FLEXIBLE POWER FEED-96IN	72.95	790576115856
HM1-PCC96-PT	FLEXRAIL1-FLEXIBLE POWER FEED-96IN	72.95	790576115863
HM1-PCT12-DB	FLEXRAIL1-STEM POWER CONNECTOR-12IN	57.50	790576115870
HM1-PCT12-PT	FLEXRAIL1-STEM POWER CONNECTOR-12IN	57.50	790576115887
HM1-PCT24-DB	FLEXRAIL1-STEM POWER CONNECTOR-24IN	58.50	790576115894
HM1-PCT24-PT	FLEXRAIL1-STEM POWER CONNECTOR-24IN	58.50	790576115900
HM1-PCT36-DB	FLEXRAIL1-STEM POWER CONNECTOR-36IN	59.50	790576115917
HM1-PCT36-PT	FLEXRAIL1-STEM POWER CONNECTOR-36IN	59.50	790576115924
HM1-PCT48-DB	FLEXRAIL1-STEM POWER CONNECTOR-48IN	60.50	790576115931
HM1-PCT48-PT	FLEXRAIL1-STEM POWER CONNECTOR-48IN	60.50	790576115948
HM1-PCT6-DB	FLEXRAIL1-STEM POWER CONNECTOR-6IN	56.50	790576115955
HM1-PCT6-PT	FLEXRAIL1-STEM POWER CONNECTOR-6IN	56.50	790576115962
HM1-SOC501-DB	HM1 - PENDANT S SET FO G500 SERIES GLASS	57.95	790576142135
HM1-SOC501-PT	HM1 - PENDANT S SET FO G500 SERIES GLASS	57.95	790576142142
HM1-SOC96-DB	FLEXRAIL1- SOCKET SET 96 INCH	35.50	790576115979
HM1-SOC96-PT	FLEXRAIL1- SOCKET SET 96 INCH	35.50	790576115986
HM1-T30D-DB	FLEXRAIL1 -30 DEGREE BENT RAIL	20.95	790576170138
HM1-T30D-PT	FLEXRAIL1 -30 DEGREE BENT RAIL	20.95	790576170190
HM1-T45D-DB	FLEXRAIL1 -45 DEGREE BENT RAIL	20.95	790576170206
HM1-T45D-PT	FLEXRAIL1 -45 DEGREE BENT RAIL	20.95	790576170244
HM1-T4-DB	FLEXRAIL1 - 4 FOOT RAIL	33.50	790576116754
HM1-T4-PT	FLEXRAIL1 - 4 FOOT RAIL	33.50	790576116747
HM1-T60D-DB	FLEXRAIL1 -60 DEGREE BENT RAIL	20.95	790576170251
HM1-T60D-PT	FLEXRAIL1 -60 DEGREE BENT RAIL	20.95	790576170268
HM1-T8-DB	FLEXRAIL1 - 8 FOOT RAIL	60.95	790576116778
HM1-T8-PT	FLEXRAIL1 - 8 FOOT RAIL	60.95	790576116761
HM1-T90D-DB	FLEXRAIL1 -90 DEGREE BENT RAIL	20.95	790576170275
HM1-T90D-PT	FLEXRAIL1 -90 DEGREE BENT RAIL	20.95	790576170282
HM1-TB12-DB	FLEXRAIL1-DROP CEILING SUSPENSION-12IN	25.50	790576115993
HM1-TB12-PT	FLEXRAIL1-DROP CEILING SUSPENSION-12IN	25.50	790576116006
HM1-TB24-DB	FLEXRAIL1-DROP CEILING SUSPENSION-24IN	26.50	790576116013
HM1-TB24-PT	FLEXRAIL1-DROP CEILING SUSPENSION-24IN	26.50	790576116020
HM1-TB36-DB	FLEXRAIL1-DROP CEILING SUSPENSION-36IN	27.50	790576116037
HM1-TB36-PT	FLEXRAIL1-DROP CEILING SUSPENSION-36IN	27.50	790576116044
HM1-TB48-DB	FLEXRAIL1-DROP CEILING SUSPENSION-48IN	28.50	790576116051
HM1-TB48-PT	FLEXRAIL1-DROP CEILING SUSPENSION-48IN	28.50	790576116068
HM1-TB6-DB	FLEXRAIL1-DROP CEILING SUSPENSION-6IN	23.95	790576116075
HM1-TB6-PT	FLEXRAIL1-DROP CEILING SUSPENSION-6IN	23.95	790576116082
HM1-VA12-DB	FLEXRAIL1- VARIABLE CONNECTOR-12 IN	36.95	790576116099
HM1-VA12-PT	FLEXRAIL1- VARIABLE CONNECTOR-12 IN	36.95	790576116105
HM1-VA24-DB	FLEXRAIL1- VARIABLE CONNECTOR-24 IN	37.95	790576116112
HM1-VA24-PT	FLEXRAIL1- VARIABLE CONNECTOR-24 IN	37.95	790576116129
HM1-VA36-DB	FLEXRAIL1- VARIABLE CONNECTOR-36 IN	38.95	790576116136

Material	Description	2011 DN	UPC Code
HM1-VA36-PT	FLEXRAIL1- VARIABLE CONNECTOR-36 IN	38.95	790576116143
HM1-VA48-DB	FLEXRAIL1- VARIABLE CONNECTOR-48 IN	39.95	790576116150
HM1-VA48-PT	FLEXRAIL1- VARIABLE CONNECTOR-48 IN	39.95	790576116167
HM1-VA6-DB	FLEXRAIL1- VARIABLE CONNECTOR-6 IN	35.95	790576116174
HM1-VA6-PT	FLEXRAIL1- VARIABLE CONNECTOR-6 IN	35.95	790576116181
HM1-X12-DB	FLEXRAIL1- STANDARD STANDOFF-12 IN	29.50	790576116198
HM1-X12-PT	FLEXRAIL1- STANDARD STANDOFF-12 IN	29.50	790576116204
HM1-X24-DB	FLEXRAIL1- STANDARD STANDOFF-24 IN	30.50	790576116211
HM1-X24-PT	FLEXRAIL1- STANDARD STANDOFF-24 IN	30.50	790576116228
HM1-X36-DB	FLEXRAIL1- STANDARD STANDOFF-36 IN	31.50	790576116235
HM1-X36-PT	FLEXRAIL1- STANDARD STANDOFF-36 IN	31.50	790576116242
HM1-X48-DB	FLEXRAIL1- STANDARD STANDOFF-48 IN	32.50	790576116259
HM1-X48-PT	FLEXRAIL1- STANDARD STANDOFF-48 IN	32.50	790576116266
HM1-X6-DB	FLEXRAIL1- STANDARD STANDOFF-6 IN	28.50	790576116273
HM1-X6-PT	FLEXRAIL1- STANDARD STANDOFF-6 IN	28.50	790576116280
HM1-XS12-DB	FLEXRAIL1-SLOPED CEILING STANDOFF-12IN	29.50	790576116297
HM1-XS12-PT	FLEXRAIL1-SLOPED CEILING STANDOFF-12IN	29.50	790576116303
HM1-XS24-DB	FLEXRAIL1-SLOPED CEILING STANDOFF-24IN	30.50	790576116310
HM1-XS24-PT	FLEXRAIL1-SLOPED CEILING STANDOFF-24IN	30.50	790576116327
HM1-XS36-DB	FLEXRAIL1-SLOPED CEILING STANDOFF-36IN	31.50	790576116334
HM1-XS36-PT	FLEXRAIL1-SLOPED CEILING STANDOFF-36IN	31.50	790576116341
HM1-XS48-DB	FLEXRAIL1-SLOPED CEILING STANDOFF-48IN	32.50	790576116358
HM1-XS48-PT	FLEXRAIL1-SLOPED CEILING STANDOFF-48IN	32.50	790576116365
HM1-XS6-DB	FLEXRAIL1-SLOPED CEILING STANDOFF-6IN	28.50	790576116372
HM1-XS6-PT	FLEXRAIL1-SLOPED CEILING STANDOFF-6IN	28.50	790576116389
HM-402AM/BZ	FLEXRAIL2 LINE VOLT PENDANT KIT	106.50	790576183299
HM-402AM/PT	FLEXRAIL2 INCANDESCENT PENDANT	106.50	790576183336
HM-402BL/BZ	FLEXRAIL2 INCANDESCENT PENDANT	106.50	790576183794
HM-402BL/PT	FLEXRAIL2 INCANDESCENT PENDANT	106.50	790576183831
HM-402WM/BZ	FLEXRAIL2 INCANDESCENT PENDANT	106.50	790576184265
HM-402WM/PT	FLEXRAIL2 INCANDESCENT PENDANT	106.50	790576184302
HM-403AM/BZ	FLEXRAIL2 INCANDESCENT PENDANT	124.50	790576180953
HM-403AM/PT	FLEXRAIL2 INCANDESCENT PENDANT	124.50	790576181004
HM-403BL/BZ	FLEXRAIL2 INCANDESCENT PENDANT	124.50	790576181547
HM-403BL/PT	FLEXRAIL2 INCANDESCENT PENDANT	124.50	790576181592
HM-403RD/BZ	FLEXRAIL2 INCANDESCENT PENDANT	124.50	790576182131
HM-403RD/PT	FLEXRAIL2 INCANDESCENT PENDANT	124.50	790576182186
HM-404BN/BZ	FLEXRAIL2 INCANDESCENT PENDANT	89.50	790576184524
HM-404BN/PT	FLEXRAIL2 INCANDESCENT PENDANT	89.50	790576184562
HM-404CO/BZ	FLEXRAIL2 INCANDESCENT PENDANT	89.50	790576180366
HM-404CO/PT	FLEXRAIL2 INCANDESCENT PENDANT	89.50	790576180403
HM-406OC/BZ	FLEXRAIL2 INCANDESCENT PENDANT	124.50	790576182711
HM-406OC/PT	FLEXRAIL2 INCANDESCENT PENDANT	124.50	790576182773
HM-408AM/BZ	FLEXRAIL2 INCANDESCENT PENDANT	124.50	790576184739
HM-408AM/PT	FLEXRAIL2 INCANDESCENT PENDANT	124.50	790576184760
HM-408WT/BZ	FLEXRAIL2 INCANDESCENT PENDANT	124.50	790576184890
HM-408WT/PT	FLEXRAIL2 INCANDESCENT PENDANT	124.50	790576184906
HM-421GR/BZ	FLEXRAIL2 CFL GU24 PENDANT	179.50	790576183671
HM-421GR/PT	FLEXRAIL2 CFL GU24 PENDANT	179.50	790576183718
HM-423PR/BZ	FLEXRAIL2 CFL GU24 PENDANT	189.50	790576182636

Material	Description	2011 DN	UPC Code
HM-423PR/PT	FLEXRAIL2 CFL GU24 PENDANT	189.50	790576182681
HM-424WT/BZ	FLEXRAIL2 CFL GU24 PENDANT	209.50	790576180533
HM-424WT/PT	FLEXRAIL2 CFL GU24 PENDANT	209.50	790576180588
HM-451AM/BZ	FLEXRAIL2 INCANDESCENT PENDANT	109.50	790576181721
HM-451AM/PT	FLEXRAIL2 INCANDESCENT PENDANT	109.50	790576181776
HM-451BL/BZ	FLEXRAIL2 INCANDESCENT PENDANT	109.50	790576182346
HM-451BL/PT	FLEXRAIL2 INCANDESCENT PENDANT	109.50	790576182391
HM-451WT/BZ	FLEXRAIL2 INCANDESCENT PENDANT	109.50	790576182971
HM-451WT/PT	FLEXRAIL2 INCANDESCENT PENDANT	109.50	790576183022
HM-454AM/BZ	FLEXRAIL2 INCANDESCENT PENDANT	109.50	790576183558
HM-454AM/PT	FLEXRAIL2 INCANDESCENT PENDANT	109.50	790576183589
HM-454WT/BZ	FLEXRAIL2 INCANDESCENT PENDANT	109.50	790576184050
HM-454WT/PT	FLEXRAIL2 INCANDESCENT PENDANT	109.50	790576184098
HM-471WT/BZ	FLEXRAIL2 CFL GU24 PENDANT	109.50	790576184517
HM-471WT/PT	FLEXRAIL2 CFL GU24 PENDANT	109.50	790576184555
HM-472WT/BZ	FLEXRAIL2 CFL GU24 PENDANT	119.50	790576180731
HM-472WT/PT	FLEXRAIL2 CFL GU24 PENDANT	119.50	790576180786
HM-474WT/BZ	FLEXRAIL2 CFL GU24 PENDANT	134.50	790576184623
HM-474WT/PT	FLEXRAIL2 CFL GU24 PENDANT	134.50	790576184661
HM-483IV/BZ	FLEXRAIL2 CFL GU24 PENDANT	139.50	790576180991
HM-483IV/PT	FLEXRAIL2 CFL GU24 PENDANT	139.50	790576181042
HM-484BL/BZ	FLEXRAIL2 CFL GU24 PENDANT	139.50	790576200651
HM-484BL/PT	FLEXRAIL2 CFL GU24 PENDANT	139.50	790576200668
HM-485BL/BZ	FLEXRAIL2 CFL GU24 PENDANT	179.50	
HM-485BL/PT	FLEXRAIL2 CFL GU24 PENDANT	179.50	
HM-487AM/BZ	FLEXRAIL2 CFL GU24 PENDANT	139.50	790576183770
HM-487AM/PT	FLEXRAIL2 CFL GU24 PENDANT	139.50	790576183817
HM-488WT/BZ	FLEXRAIL2 CFL GU24 PENDANT	183.50	790576182797
HM-488WT/PT	FLEXRAIL2 CFL GU24 PENDANT	183.50	790576182841
HM-512AM/BZ	FLEXRAIL2 LINE VOLT XENON PENDANT	85.95	790576172415
HM-512AM/PT	FLEXRAIL2 LINE VOLT XENON PENDANT	85.95	790576172422
HM-512BL/BZ	FLEXRAIL2 LINE VOLT XENON PENDANT	85.95	790576172675
HM-512BL/PT	FLEXRAIL2 LINE VOLT XENON PENDANT	85.95	790576172705
HM-512GR/BZ	FLEXRAIL2 LINE VOLT XENON PENDANT	85.95	790576173085
HM-512GR/PT	FLEXRAIL2 LINE VOLT XENON PENDANT	85.95	790576173122
HM-512RD/BZ	FLEXRAIL2 LINE VOLT XENON PENDANT	85.95	790576173504
HM-512RD/PT	FLEXRAIL2 LINE VOLT XENON PENDANT	85.95	790576173535
HM-512WT/BZ	FLEXRAIL2 LINE VOLT XENON PENDANT	85.95	790576173856
HM-512WT/PT	FLEXRAIL2 LINE VOLT XENON PENDANT	85.95	790576173887
HM-513AM/BZ	FLEXRAIL2 LINE VOLT XENON PENDANT	94.95	790576174211
HM-513AM/PT	FLEXRAIL2 LINE VOLT XENON PENDANT	94.95	790576174242
HM-513WT/BZ	FLEXRAIL2 LINE VOLT XENON PENDANT	94.95	790576174570
HM-513WT/PT	FLEXRAIL2 LINE VOLT XENON PENDANT	94.95	790576174600
HM-515AM/BZ	FLEXRAIL2 LINE VOLT XENON PENDANT	125.95	790576175225
HM-515AM/PT	FLEXRAIL2 LINE VOLT XENON PENDANT	125.95	790576175256
HM-515MF/BZ	FLEXRAIL2 LINE VOLT XENON PENDANT	125.95	790576176185
HM-515MF/PT	FLEXRAIL2 LINE VOLT XENON PENDANT	125.95	790576176222
HM-517WT/BZ	FLEXRAIL2 LINE VOLT XENON PENDANT	90.95	790576176611
HM-517WT/PT	FLEXRAIL2 LINE VOLT XENON PENDANT	90.95	790576176659
HM-518DIC/BZ	FLEXRAIL2 LINE VOLT XENON PENDANT	140.95	790576177076

Material	Description	2011 DN	UPC Code
HM-518DIC/PT	FLEXRAIL2 LINE VOLT XENON PENDANT	140.95	790576177113
HM-524AM/BZ	FLEXRAIL2 LINE VOLT XENON PENDANT	89.95	790576178639
HM-524AM/PT	FLEXRAIL2 LINE VOLT XENON PENDANT	89.95	790576178677
HM-524LB/BZ	FLEXRAIL2 LINE VOLT XENON PENDANT	89.95	790576179049
HM-524LB/PT	FLEXRAIL2 LINE VOLT XENON PENDANT	89.95	790576179087
HM-524TQ/BZ	FLEXRAIL2 LINE VOLT XENON PENDANT	89.95	790576172590
HM-524TQ/PT	FLEXRAIL2 LINE VOLT XENON PENDANT	89.95	790576172637
HM-524WT/BZ	FLEXRAIL2 LINE VOLT XENON PENDANT	89.95	790576173009
HM-524WT/PT	FLEXRAIL2 LINE VOLT XENON PENDANT	89.95	790576173047
HM-530GR/BZ	FLEXRAIL2 LINE VOLT XENON PENDANT	180.95	790576173412
HM-530GR/PT	FLEXRAIL2 LINE VOLT XENON PENDANT	180.95	790576173450
HM-530MC/BZ	FLEXRAIL2 LINE VOLT XENON PENDANT	180.95	790576173740
HM-530MC/PT	FLEXRAIL2 LINE VOLT XENON PENDANT	180.95	790576173788
HM-534SM/BZ	FLEXRAIL2 LINE VOLT XENON PENDANT	110.95	790576195391
HM-534SM/PT	FLEXRAIL2 LINE VOLT XENON PENDANT	110.95	790576195407
HM-536BL/BZ	FLEXRAIL2 LINE VOLT XENON PENDANT	125.95	790576195612
HM-536BL/PT	FLEXRAIL2 LINE VOLT XENON PENDANT	125.95	790576195629
HM-535DIC/BZ	FLEXRAIL2 LINE VOLT XENON PENDANT	160.95	
HM-535DIC/PT	FLEXRAIL2 LINE VOLT XENON PENDANT	160.95	
HM-541AM/BZ	FLEXRAIL2 LINE VOLT XENON PENDANT	97.95	790576174457
HM-541AM/PT	FLEXRAIL2 LINE VOLT XENON PENDANT	97.95	790576174488
HM-541WT/BZ	FLEXRAIL2 LINE VOLT XENON PENDANT	97.95	790576174808
HM-541WT/PT	FLEXRAIL2 LINE VOLT XENON PENDANT	97.95	790576174839
HM-546DIC/BZ	FLEXRAIL2 LINE VOLT XENON PENDANT	160.95	790576181448
HM-546DIC/PT	FLEXRAIL2 LINE VOLT XENON PENDANT	160.95	790576181509
HM-548FR/BZ	FLEXRAIL2 LINE VOLT XENON PENDANT	110.95	790576176253
HM-548FR/PT	FLEXRAIL2 LINE VOLT XENON PENDANT	110.95	790576176284
HM-559DIC/BZ	FLEXRAIL2 LINE VOLT XENON PENDANT	100.95	790576178240
HM-559DIC/PT	FLEXRAIL2 LINE VOLT XENON PENDANT	100.95	790576178288
HM-559GL/BZ	FLEXRAIL2 LINE VOLT XENON PENDANT	100.95	790576173467
HM-559GL/PT	FLEXRAIL2 LINE VOLT XENON PENDANT	100.95	790576173498
HM-559MR/BZ	FLEXRAIL2 LINE VOLT XENON PENDANT	100.95	790576179261
HM-559MR/PT	FLEXRAIL2 LINE VOLT XENON PENDANT	100.95	790576172484
HM-593LI/BZ	FLEXRAIL2 LINE VOLT XENON PENDANT	140.95	790576174334
HM-593LI/PT	FLEXRAIL2 LINE VOLT XENON PENDANT	140.95	790576174389
HM-593RD/BZ	FLEXRAIL2 LINE VOLT XENON PENDANT	140.95	790576173993
HM-593RD/PT	FLEXRAIL2 LINE VOLT XENON PENDANT	140.95	790576174037
HM-593TQ/BZ	FLEXRAIL2 LINE VOLT XENON PENDANT	140.95	790576174686
HM-593TQ/PT	FLEXRAIL2 LINE VOLT XENON PENDANT	140.95	790576174723
HM-598WT/BZ	FLEXRAIL2 LINE VOLT XENON PENDANT	125.95	790576175034
HM-598WT/PT	FLEXRAIL2 LINE VOLT XENON PENDANT	125.95	790576175072
HM-599BL/BZ	FLEXRAIL2 LINE VOLT XENON PENDANT	110.95	790576175645
HM-599BL/PT	FLEXRAIL2 LINE VOLT XENON PENDANT	110.95	790576175676
HM-599UM/BZ	FLEXRAIL2 LINE VOLT XENON PENDANT	110.95	790576177748
HM-599UM/PT	FLEXRAIL2 LINE VOLT XENON PENDANT	110.95	790576177786
HM-599WT/BZ	FLEXRAIL2 LINE VOLT XENON PENDANT	110.95	790576176710
HM-599WT/PT	FLEXRAIL2 LINE VOLT XENON PENDANT	110.95	790576176758
HM-713-BZ	LINE VOLT FLEXRAIL FIXTURE	54.50	790576105956
HM-713-PT	LINE VOLT FLEXRAIL FIXTURE	54.50	790576105949
HM-715-BZ	LINE VOLT FLEXRAIL FIXTURE	59.95	790576105970



Material	Description	2011 DN	UPC Code
HM-715-PT	LINE VOLT FLEXRAIL FIXTURE	59.95	790576105963
HM-720-BZ	LINE VOLT FLEXRAIL FIXTURE	36.95	790576106953
HM-720-PT	LINE VOLT FLEXRAIL FIXTURE	36.95	790576075310
HM-727-BZ	LINE VOLT FLEXRAIL FIXTURE	61.95	790576105994
HM-727-PT	LINE VOLT FLEXRAIL FIXTURE	61.95	790576105987
HM-730-BZ	LINE VOLT FLEXRAIL FIXTURE	39.95	790576106946
HM-730-PT	LINE VOLT FLEXRAIL FIXTURE	39.95	790576075327
HM-733-BZ	LINE VOLT FLEXRAIL FIXTURE	58.50	790576106014
HM-733-PT	LINE VOLT FLEXRAIL FIXTURE	58.50	790576106007
HM-737-BZ	LINE VOLT FLEXRAIL FIXTURE	63.95	790576106038
HM-737-PT	LINE VOLT FLEXRAIL FIXTURE	63.95	790576106021
HM-738-BZ	LINE VOLT FLEXRAIL FIXTURE	42.95	790576106939
HM-738-PT	LINE VOLT FLEXRAIL FIXTURE	42.95	790576075334
HM-747-BZ	LINE VOLT FLEXRAIL FIXTURE	57.95	790576106090
HM-747-PT	LINE VOLT FLEXRAIL FIXTURE	57.95	790576106083
HM-757-BZ	LINE VOLT FLEXRAIL FIXTURE	59.95	790576106113
HM-757-PT	LINE VOLT FLEXRAIL FIXTURE	59.95	790576106106
HM-773-BZ	LINE VOLT FLEXRAIL FIXTURE	36.50	790576106922
HM-773MH39E-BZ	LINE VOLT FLEXRAIL FIXTURE - HID	166.50	790576112862
HM-773MH39E-PT	LINE VOLT FLEXRAIL FIXTURE - HID	166.50	790576081458
HM-773-PT	LINE VOLT FLEXRAIL FIXTURE	36.50	790576075402
HM-774-BZ	LINE VOLT FLEXRAIL FIXTURE	38.50	790576106915
HM-774MH39E-BZ	LINE VOLT FLEXRAIL FIXTURE - HID	171.50	790576112879
HM-774MH39E-PT	LINE VOLT FLEXRAIL FIXTURE - HID	171.50	790576081465
HM-774MH70E-BZ	LINE VOLT FLEXRAIL FIXTURE - HID	176.50	790576112886
HM-774MH70E-PT	LINE VOLT FLEXRAIL FIXTURE - HID	176.50	790576081472
HM-774-PT	LINE VOLT FLEXRAIL FIXTURE	38.50	790576075419
HM-775-BZ	LINE VOLT FLEXRAIL FIXTURE	40.50	790576106908
HM-775MH100E-BZ	LINE VOLT FLEXRAIL FIXTURE - HID	186.50	790576112909
HM-775MH100E-PT	LINE VOLT FLEXRAIL FIXTURE - HID	186.50	790576081496
HM-775MH70E-BZ	LINE VOLT FLEXRAIL FIXTURE - HID	181.50	790576112893
HM-775MH70E-PT	LINE VOLT FLEXRAIL FIXTURE - HID	181.50	790576081489
HM-775-PT	LINE VOLT FLEXRAIL FIXTURE	40.50	790576075426
HM-783-BZ	LINE VOLT FLEXRAIL FIXTURE	45.95	790576106892
HM-783MH39E-BZ	LINE VOLT FLEXRAIL FIXTURE - HID	174.95	790576112916
HM-783MH39E-PT	LINE VOLT FLEXRAIL FIXTURE - HID	174.95	790576081403
HM-783-PT	LINE VOLT FLEXRAIL FIXTURE	45.95	790576075372
HM-784-BZ	LINE VOLT FLEXRAIL FIXTURE	48.95	790576106885
HM-784MH39E-BZ	LINE VOLT FLEXRAIL FIXTURE - HID	179.95	790576112923
HM-784MH39E-PT	LINE VOLT FLEXRAIL FIXTURE - HID	179.95	790576081410
HM-784MH70E-BZ	LINE VOLT FLEXRAIL FIXTURE - HID	184.95	790576112930
HM-784MH70E-PT	LINE VOLT FLEXRAIL FIXTURE - HID	184.95	790576081427
HM-784-PT	LINE VOLT FLEXRAIL FIXTURE	48.95	790576075389
HM-785-BZ	LINE VOLT FLEXRAIL FIXTURE	49.50	790576106878
HM-785MH100E-BZ	LINE VOLT FLEXRAIL FIXTURE - HID	194.95	790576112954
HM-785MH100E-PT	LINE VOLT FLEXRAIL FIXTURE - HID	194.95	790576081441
HM-785MH70E-BZ	LINE VOLT FLEXRAIL FIXTURE - HID	189.95	790576112947
HM-785MH70E-PT	LINE VOLT FLEXRAIL FIXTURE - HID	189.95	790576081434
HM-785-PT	LINE VOLT FLEXRAIL FIXTURE	49.50	790576075396
HM-816-BZ	LOW VOLT FLEXRAIL FIXTURE	37.95	790576106861

Material	Description	2011 DN	UPC Code
HM-816L-BZ	LOW VOLT FLEXRAIL FIXTURE	40.95	790576106854
HM-816L-PT	LOW VOLT FLEXRAIL FIXTURE	40.95	790576075167
HM-816-PT	LOW VOLT FLEXRAIL FIXTURE	37.95	790576075150
HM-826-BZ	LOW VOLT FLEXRAIL FIXTURE	42.95	790576106847
HM-826L-BZ	LOW VOLT FLEXRAIL FIXTURE	45.95	790576106830
HM-826L-PT	LOW VOLT FLEXRAIL FIXTURE	45.95	790576075143
HM-826-PT	LOW VOLT FLEXRAIL FIXTURE	42.95	790576075136
HM-846-BZ	LOW VOLT FLEXRAIL FIXTURE	46.95	790576106823
HM-846L-BZ	LOW VOLT FLEXRAIL FIXTURE	49.95	790576106816
HM-846L-PT	LOW VOLT FLEXRAIL FIXTURE	49.95	790576075129
HM-846-PT	LOW VOLT FLEXRAIL FIXTURE	46.95	790576075112
HM-847-BZ	LOW VOLT FLEXRAIL FIXTURE	46.50	790576106809
HM-847L-BZ	LOW VOLT FLEXRAIL FIXTURE	49.50	790576106793
HM-847L-PT	LOW VOLT FLEXRAIL FIXTURE	49.50	790576075181
HM-847-PT	LOW VOLT FLEXRAIL FIXTURE	46.50	790576075174
HM-849-BZ	LOW VOLT FLEXRAIL FIXTURE	44.95	790576106786
HM-849L-BZ	LOW VOLT FLEXRAIL FIXTURE	47.95	790576106779
HM-849L-PT	LOW VOLT FLEXRAIL FIXTURE	47.95	790576075204
HM-849-PT	LOW VOLT FLEXRAIL FIXTURE	44.95	790576075198
HM-856-BZ	LOW VOLT FLEXRAIL FIXTURE	47.95	790576106762
HM-856L-BZ	LOW VOLT FLEXRAIL FIXTURE	50.95	790576106755
HM-856L-PT	LOW VOLT FLEXRAIL FIXTURE	50.95	790576075105
HM-856-PT	LOW VOLT FLEXRAIL FIXTURE	47.95	790576075099
HM-935L-BZ	LOW VOLT FLEXRAIL FIXTURE	57.95	790576106076
HM-935L-PT	LOW VOLT FLEXRAIL FIXTURE	57.95	790576106069
HM-936-BZ	LOW VOLT FLEXRAIL FIXTURE	51.95	790576106724
HM-936L-BZ	LOW VOLT FLEXRAIL FIXTURE	54.95	790576106717
HM-936L-PT	LOW VOLT FLEXRAIL FIXTURE	54.95	790576075228
HM-936-PT	LOW VOLT FLEXRAIL FIXTURE	51.95	790576075211
HM-939L-BZ	LOW VOLT FLEXRAIL FIXTURE	63.95	790576105932
HM-939L-PT	LOW VOLT FLEXRAIL FIXTURE	63.95	790576105925
HM-BM	BENDING MACHINE	141.95	790576079943
HM-DCB-PT	LINE VOLT MONO-SUSPENDED CEILIN	10.95	790576074764
HM-EC-BZ	FLEXRAIL-END CAP	1.95	790576106700
HM-EC-PT	FLEXRAIL-END CAP	1.95	790576075433
HM-EN50-BZ	FLEXRAIL-50W QUICK CONN XFMR	51.95	790576106694
HM-EN50-PT	FLEXRAIL-50W QUICK CONN XFMR	51.95	790576075051
HM-I12-BZ	FLEXRAIL-12INCH STRAIGHT LINE CONN	36.95	790576106670
HM-I12-PT	FLEXRAIL-12INCH STRAIGHT LINE CONN	36.95	790576074788
HM-I24-BZ	FLEXRAIL-24INCH STRAIGHT LINE CONN	37.95	790576106663
HM-I24-PT	FLEXRAIL-24INCH STRAIGHT LINE CONN	37.95	790576074795
HM-I36-BZ	FLEXRAIL-36INCH STRAIGHT LINE CONN	38.95	790576106656
HM-I36-PT	FLEXRAIL-36INCH STRAIGHT LINE CONN	38.95	790576074801
HM-I48-BZ	FLEXRAIL-48INCH STRAIGHT LINE CONN	39.95	790576106649
HM-I48-PT	FLEXRAIL-48INCH STRAIGHT LINE CONN	39.95	790576074818
HM-I6-BZ	FLEXRAIL-6INCH STRAIGHT LINE CONN	35.50	790576106632
HM-I6-PT	FLEXRAIL-6INCH STRAIGHT LINE CONN	35.50	790576074771
HM-IDEC12-BZ	FLEXRAIL-12INCH DEAD END I CONN	36.50	790576106625
HM-IDEC12-PT	FLEXRAIL-12INCH DEAD END I CONN	36.50	790576074832
HM-IDEC24-BZ	FLEXRAIL-24INCH DEAD END I CONN	37.95	790576106618

Material	Description	2011 DN	UPC Code
HM-IDEC24-PT	FLEXRAIL-24INCH DEAD END I CONN	37.95	790576074849
HM-IDEC36-BZ	FLEXRAIL-36INCH DEAD END I CONN	38.95	790576106601
HM-IDEC36-PT	FLEXRAIL-36INCH DEAD END I CONN	38.95	790576074856
HM-IDEC48-BZ	FLEXRAIL-48INCH DEAD END I CONN	39.95	790576106595
HM-IDEC48-PT	FLEXRAIL-48INCH DEAD END I CONN	39.95	790576074863
HM-IDEC6-BZ	FLEXRAIL-6INCH DEAD END I CONN	35.50	790576106588
HM-IDEC6-PT	FLEXRAIL-6INCH DEAD END I CONN	35.50	790576074825
HM-JSC12-BZ	FLEXRAIL-CONDUIT JUMPER CONNECTOR 12INCH	48.95	790576106571
HM-JSC12-PT	FLEXRAIL-CONDUIT JUMPER CONNECTOR 12INCH	48.95	790576093314
HM-JSC24-BZ	FLEXRAIL-CONDUIT JUMPER CONNECTOR 24INCH	53.95	790576106564
HM-JSC24-PT	FLEXRAIL-CONDUIT JUMPER CONNECTOR 24INCH	53.95	790576093321
HM-JSC36-BZ	FLEXRAIL-CONDUIT JUMPER CONNECTOR 36INCH	55.50	790576106557
HM-JSC36-PT	FLEXRAIL-CONDUIT JUMPER CONNECTOR 36INCH	55.50	790576093338
HMP-BK	H SERIES MONOPOINT CANOPY	10.95	790576003283
HMP-BN	H SERIES MONOPOINT CANOPY	12.50	790576145396
HM-PCC12-BZ	FLEXRAIL-STEM POWER CONNECTOR 12 INCH	48.50	790576106540
HM-PCC12-PT	FLEXRAIL-STEM POWER CONNECTOR 12 INCH	48.50	790576104768
HM-PCC24-BZ	FLEXRAIL-STEM POWER CONNECTOR 24 INCH	60.95	790576106533
HM-PCC24-PT	FLEXRAIL-STEM POWER CONNECTOR 24 INCH	60.95	790576105017
HM-PCC36-BZ	FLEXRAIL-STEM POWER CONNECTOR 36 INCH	61.50	790576106526
HM-PCC36-PT	FLEXRAIL-STEM POWER CONNECTOR 36 INCH	61.50	790576103570
HM-PCC48-BZ	FLEXRAIL-STEM POWER CONNECTOR 48 INCH	67.95	790576106519
HM-PCC48-PT	FLEXRAIL-CONDUIT POWER CONNECTOR 36 INCH	67.95	790576093291
HM-PCC96-BZ	FLEXRAIL-STEM POWER CONNECTOR 96 INCH	74.95	790576106502
HM-PCC96-PT	FLEXRAIL-CONDUIT POWER CONNECTOR 48 INCH	74.95	790576093307
HM-PCT12-BZ	FLEXRAIL-STEM POWER CONNECTOR 12 INCH	59.50	790576106496
HM-PCT12-PT	FLEXRAIL-STEM POWER CONNECTOR 12 INCH	59.50	790576093260
HM-PCT24-BZ	FLEXRAIL-STEM POWER CONNECTOR 24 INCH	60.50	790576106489
HM-PCT24-PT	FLEXRAIL-STEM POWER CONNECTOR 24 INCH	60.50	790576093277
HM-PCT36-BZ	FLEXRAIL-STEM POWER CONNECTOR 36 INCH	61.50	790576106472
HM-PCT36-PT	FLEXRAIL-STEM POWER CONNECTOR 36 INCH	61.50	790576093284
HM-PCT48-BZ	FLEXRAIL-STEM POWER CONNECTOR 48 INCH	62.50	790576106465
HM-PCT48-PT	FLEXRAIL-STEM POWER CONNECTOR 48 INCH	62.50	790576093345
HM-PCT6-BZ	FLEXRAIL-STEM POWER CONNECTOR 6 INCH	58.50	790576106458
HM-PCT6-PT	FLEXRAIL-STEM POWER CONNECTOR 6 INCH	58.50	790576093253
HMP-DB	H SERIES MONOPOINT CANOPY	12.50	790576140094
HM-PLD-G415-BZ	FLEXRAIL-PENDANT	67.50	790576106984
HM-PLD-G415-PT	FLEXRAIL-PENDANT	67.50	790576079172
HMP-WT	SERIES MONOPOINT CANOPY	10.95	790576003290
HM-SOC501-BZ	FLEXRAIL-PENDANT SOCKET SET -G500 SERIES CLASS	60.95	790576142159
HM-SOC501-PT	FLEXRAIL-PENDANT SOCKET SET -G500 SERIES CLASS	60.95	790576142166
HM-SOC96-BZ	FLEXRAIL-PENDANT SOCKET SET 96 INCH	49.50	790576106977
HM-SOC96-PT	FLEXRAIL-PENDANT SOCKET SET 96 INCH	49.50	790576079257
HM-T30D-BZ	FLEXRAIL -30 DEGREE BENT RAIL	22.95	790576106441
HM-T30D-PT	FLEXRAIL -30 DEGREE BENT RAIL	22.95	790576075013
HM-T45D-BZ	FLEXRAIL -45 DEGREE BENT RAIL	22.95	790576106434
HM-T45D-PT	FLEXRAIL -45 DEGREE BENT RAIL	22.95	790576075020
HM-T4-BZ	FLEXRAIL -4 FOOT	39.50	790576106427
HM-T4-PT	FLEXRAIL -4 FOOT	39.50	790576074566
HM-T60D-BZ	FLEXRAIL -60 DEGREE BENT RAIL	22.95	790576106410

Material	Description	2011 DN	UPC Code
HM-T60D-PT	FLEXRAIL -60 DEGREE BENT RAIL	22.95	790576075037
HM-T8-BZ	FLEXRAIL -8 FOOT	67.95	790576106403
HM-T8-PT	FLEXRAIL -8 FOOT	67.95	790576074573
HM-T90D-BZ	FLEXRAIL -90 DEGREE BENT RAIL	22.95	790576106397
HM-T90D-PT	FLEXRAIL -90 DEGREE BENT RAIL	22.95	790576075044
HM-TB12-BZ	FLEXRAIL -DROP CEILING SUSPN 12"	27.50	790576106380
HM-TB12-PT	FLEXRAIL -DROP CEILING SUSPN 12 IN	27.50	790576074726
HM-TB24-BZ	FLEXRAIL -DROP CEILING SUSPN 24"	28.50	790576106373
HM-TB24-PT	FLEXRAIL -DROP CEILING SUSPN 24 IN	28.50	790576074733
HM-TB36-BZ	FLEXRAIL -DROP CEILING SUSPN 36"	29.50	790576106366
HM-TB36-PT	FLEXRAIL -DROP CEILING SUSPN 36 IN	29.50	790576074740
HM-TB48-BZ	FLEXRAIL -DROP CEILING SUSPN 48"	30.50	790576106359
HM-TB48-PT	FLEXRAIL -DROP CEILING SUSPN 48 IN	30.50	790576074757
HM-TB6-BZ	FLEXRAIL -DROP CEILING SUSPN 6 INCH	25.95	790576106342
HM-TB6-PT	FLEXRAIL -DROP CEILING SUSPN 6 INCH	25.95	790576074719
HM-VA12-BZ	FLEXRAIL -12 INCH VARIABLE ANGLE CONNECTOR	39.95	790576105864
HM-VA12-PT	FLEXRAIL -12 INCH VARIABLE ANGLE CONNECTOR	39.95	790576105819
HM-VA24-BZ	FLEXRAIL -24 INCH VARIABLE ANGLE CONNECTOR	40.95	790576105871
HM-VA24-PT	FLEXRAIL -24 INCH VARIABLE ANGLE CONNECTOR	40.95	790576105826
HM-VA36-BZ	FLEXRAIL -36 INCH VARIABLE ANGLE CONNECTOR	41.95	790576105888
HM-VA36-PT	FLEXRAIL -36 INCH VARIABLE ANGLE CONNECTOR	41.95	790576105833
HM-VA48-BZ	FLEXRAIL -48 INCH VARIABLE ANGLE CONNECTOR	42.95	790576105895
HM-VA48-PT	FLEXRAIL -48 INCH VARIABLE ANGLE CONNECTOR	42.95	790576105840
HM-VA6-BZ	FLEXRAIL -6 INCH VARIABLE ANGLE CONNECTOR	38.95	790576105857
HM-VA6-PT	FLEXRAIL -6 INCH VARIABLE ANGLE CONNECTOR	38.95	790576105802
HM-W218-BZ	FLEXRAIL -FIXTURE #W218	165.50	790576106335
HM-W218-PT	FLEXRAIL -FIXTURE #W218	165.50	790576075235
HM-W227-BZ	FLEXRAIL -FIXTURE #W227	185.50	790576106328
HM-W227-PT	FLEXRAIL -FIXTURE #W227	185.50	790576075242
HM-W239-BZ	FLEXRAIL -FIXTURE #W239	211.50	790576106311
HM-W239-PT	FLEXRAIL -FIXTURE #W239	211.50	790576075259
HM-W240-BZ	FLEXRAIL -FIXTURE #W240	235.50	790576106304
HM-W240-PT	FLEXRAIL -FIXTURE #W240	235.50	790576075266
HM-X12-BZ	FLEXRAIL -12 INCH SUSPENSION	31.50	790576106298
HM-X12-PT	FLEXRAIL -12 INCH SUSPENSION	31.50	790576074603
HM-X24-BZ	FLEXRAIL -24 INCH SUSPENSION	32.50	790576106281
HM-X24-PT	FLEXRAIL -24 INCH SUSPENSION	32.50	790576074610
HM-X36-BZ	FLEXRAIL -36 INCH SUSPENSION	33.50	790576106274
HM-X36-PT	FLEXRAIL -36 INCH SUSPENSION	33.50	790576074627
HM-X48-BZ	FLEXRAIL -48 INCH SUSPENSION	34.50	790576106267
HM-X48-PT	FLEXRAIL -48 INCH SUSPENSION	34.50	790576074634
HM-X6-BZ	FLEXRAIL -6 INCH SUSPENSION	30.50	790576106250
HM-X6-PT	FLEXRAIL -6 INCH SUSPENSION	30.50	790576074597
HM-XADJ-DB	FLEXRAIL- FIELD SHORTENING ADAPTER	2.95	790576160009
HM-XADJ-PT	FLEXRAIL- FIELD SHORTENING ADAPTER	2.95	790576089737
HM-XS12-BZ	FLEXRAIL -SLOPED CEILING SUSPN 12IN	31.50	790576106236
HM-XS12-PT	FLEXRAIL -SLOPED CEILING SUSPN 12IN	31.50	790576074672
HM-XS24-BZ	FLEXRAIL -SLOPED CEILING SUSPN 24IN	32.50	790576106229
HM-XS24-PT	FLEXRAIL -SLOPED CEILING SUSPN 24IN	32.50	790576074689
HM-XS36-BZ	FLEXRAIL -SLOPED CEILING SUSPN 36IN	33.50	790576106212

Material	Description	2011 DN	UPC Code
HM-XS36-PT	FLEXRAIL -SLOPED CEILING SUSPN 36IN	33.50	790576074696
HM-XS48-BZ	FLEXRAIL -SLOPED CEILING SUSPN 48IN	34.50	790576106205
HM-XS48-PT	FLEXRAIL -SLOPED CEILING SUSPN 48IN	34.50	790576074702
HM-XS6-BZ	FLEXRAIL -SLOPED CEILING SUSPN 6IN	30.50	790576106199
HM-XS6-PT	FLEXRAIL -SLOPED CEILING SUSPN 6IN	30.50	790576074641
HR-1135-BK	LOW VOLT MINI - EYEBALL	13.95	790576019055
HR-1135-CB	LOW VOLT MINI - EYEBALL	15.95	790576123929
HR-1135-WT	LOW VOLT MINI - EYEBALL	13.95	790576019079
HR-1136-BK	LOW VOLT MINI - DOWNLIGHT	12.95	790576003320
HR-1136-BN	LOW VOLT MINI - DOWNLIGHT	14.95	790576030609
HR-1136-CB	LOW VOLT MINI - DOWNLIGHT	14.95	790576123936
HR-1136-CH	LOW VOLT MINI - DOWNLIGHT	14.95	790576003337
HR-1136-WT	LOW VOLT MINI - DOWNLIGHT	12.95	790576003351
HR-1137-BK	LOW VOLT MINI - ROUND ADJUSTABLE	12.95	790576003368
HR-1137-BN	LOW VOLT MINI - ROUND ADJUSTABLE	14.95	790576030647
HR-1137-CB	LOW VOLT MINI - ROUND ADJUSTABLE	14.95	790576123943
HR-1137-CH	LOW VOLT MINI - ROUND ADJUSTABLE	14.95	790576003375
HR-1137-WT	LOW VOLT MINI - ROUND ADJUSTABLE	12.95	790576003399
HR-1138-BN	LOW VOLT MINI - FROSTED DOME	15.95	790576023540
HR-1138-WT	LOW VOLT MINI - FROSTED DOME	14.95	790576003412
HR-301E	REC. LOW VOLT REMODEL W/ELEC TRANS	28.50	790576092652
HR-301M	REC. LOW VOLT REMODEL W/MAG TRANS	30.50	790576092645
HR-302E	REC. LOW VOLT NEW CONST ELEC TRANS	31.50	790576092638
HR-302M	REC. LOW VOLT NEWCONST W/MAG TRANS	33.50	790576092621
HR-800	REC. LOW VOLT REMODEL NO TRANSF INCL	6.25	790576003528
HR-8000-SOCKET	SOCKET WITH HEAT SHIELD	2.50	790576003535
HR-8001	REPLACEMENT TRANSF FOR 8401H-50W	21.95	790576003542
HR-8002	REPLACEMENT TRANSF FOR 8402H-50W	21.95	790576031699
HR-8002L	REPLACEMENT TRANSF FOR 8402HL-75W	25.95	790576042213
HR-8003	REPLACEMENT TRANSF FOR 8403H-50W	21.95	790576003573
HR-801	REC. LOW VOLT REMODEL W/ELEC TRANS	29.95	790576014937
HR-802	REC. LOW VOLT NEWCONST W/ELEC TRANS	31.95	790576014951
HR-806	REC. LOW VOLT REMODEL NO TRANSF INCL	7.25	790576041513
HR-833-BN	REC. LOW VOLT TRIM BEVELED SPOT	14.95	790576035888
HR-833-WT	REC. LOW VOLT TRIM BEVELED SPOT	12.95	790576035871
HR-834-BN	REC. LOW VOLT TRIM STEP BAFFLE	10.95	790576030579
HR-834-CB	REC. LOW VOLT TRIM STEP BAFFLE	10.95	790576123950
HR-834-WT	REC. LOW VOLT TRIM STEP BAFFLE	8.95	790576019000
HR-834-WT/WT	REC. LOW VOLT TRIM STEP BAFFLE	8.95	790576029658
HR-836-BK	REC. LOW VOLT TRIM METAL TRIM RING	8.95	790576003580
HR-836-BN	REC. LOW VOLT TRIM METAL TRIM RING	9.95	790576030586
HR-836-CB	REC. LOW VOLT TRIM METAL TRIM RING	9.95	790576123967
HR-836-WT	REC. LOW VOLT TRIM METAL TRIM RING	8.95	790576003603
HR-837-BK	REC. LOW VOLT TRIM MINI RND ADJUST	8.95	790576003610
HR-837-BN	REC. LOW VOLT TRIM MINI RND ADJUST	9.95	790576030593
HR-837-CB	REC. LOW VOLT TRIM MINI RND ADJUST	9.95	790576123844
HR-837-CH	REC. LOW VOLT TRIM MINI RND ADJUST	9.95	790576003627
HR-837-WT	REC. LOW VOLT TRIM MINI RND ADJUST	8.95	790576003641
HR-8401E	REC. LOW VOLT REMODEL W/ELEC TRANS	27.95	790576092232
HR-8401H	REC. LOW VOLT REMODEL W/MAG TRANS	25.95	790576003658

Material	Description	2011 DN	UPC Code
HR-8401HF	REC. LOW VOLT REMODEL W/MAG TRANS	33.95	790576037844
HR-8402E	REC. LOW VOLT NEWCONST W/ELEC TRANS	28.95	790576092225
HR-8402H	REC. LOW VOLT NEWCONST W/MAG TRANS	26.95	790576003689
HR-8402HF	REC. LOW VOLT NEWCONST W/MAG TRANS	36.95	790576037851
HR-8402HFL	REC. LOW VOLT NEWCONST W/MAG TRANS	41.95	790576037868
HR-8402HL	REC. LOW VOLT NEWCONST W/MAG TRANS	32.95	790576003719
HR-8403H	REC. LOW VOLT NEWCONST W/MAG TRANS	44.95	790576003733
HR-8403HF	REC. LOW VOLT NEWCONST W/MAG TRANS	52.95	790576037875
HR-8411-BN	REC. LOW VOLT TRIM STEP BAFFLE	12.50	790576032979
HR-8411-CB	REC. LOW VOLT TRIM STEP BAFFLE	12.50	790576123981
HR-8411-WT	REC. LOW VOLT TRIM STEP BAFFLE	9.95	790576003757
HR-8411-WT/WT	REC. LOW VOLT TRIM STEP BAFFLE	9.95	790576003764
HR-8412-BN	REC. LOW VOLT TRIM OPEN SPECULAR	12.95	790576032986
HR-8412-CL	REC. LOW VOLT TRIM OPEN SPECULAR	10.50	790576003788
HR-8414-WT	REC. LOW VOLT TRIM ADJUST EYEBALL	10.95	790576003849
HR-8414-WT/WT	REC. LOW VOLT TRIM ADJUST EYEBALL	10.95	790576003856
HR-8417-BK	REC. LOW VOLT TRIM GIMBAL RING	12.50	790576003870
HR-8417-BN	REC. LOW VOLT TRIM GIMBAL RING	14.95	790576032962
HR-8417-CB	REC. LOW VOLT TRIM GIMBAL RING	14.95	790576124018
HR-8417-WT	REC. LOW VOLT TRIM GIMBAL RING	12.50	790576003894
HR-86-BK	LOW VOLT - ROUND XENON BUTTON 12V20W	10.50	790576075563
HR-86-BN	LOW VOLT - ROUND XENON BUTTON 12V20W	12.50	790576075587
HR-86-CB	LOW VOLT - ROUND XENON BUTTON 12V20W	12.50	790576123912
HR-86-CH	LOW VOLT - ROUND XENON BUTTON 12V20W	12.50	790576075594
HR-86-DB	LOW VOLT - ROUND XENON BUTTON 1	12.50	790576167640
HR-86-WT	LOW VOLT - ROUND XENON BUTTON 12V20W	10.50	790576075570
HR-88-BK	LOW VOLT - ROUND HALOGEN BUTTON 12V20W	8.95	790576003979
HR-88-BN	LOW VOLT - ROUND HALOGEN BUTTON 12V20W	10.95	790576032955
HR-88-CB	LOW VOLT - ROUND HALOGEN BUTTON 12V20W	10.95	790576123837
HR-88-CH	LOW VOLT - ROUND HALOGEN BUTTON 12V20W	10.95	790576003986
HR-88-DB	LOW VOLT - ROUND HALOGEN BUTTON	10.95	790576167633
HR-88-WT	LOW VOLT - ROUND HALOGEN BUTTON 12V20W	8.95	790576004006
HR-D321-SC/BN	REC. LOW VOLT TRIM OPEN SPECULAR	22.95	790576092003
HR-D321-SC/WT	REC. LOW VOLT TRIM OPEN SPECULAR	19.95	790576091976
HR-D324-BK/BN	REC. LOW VOLT TRIM STEP BAFFLE	22.95	790576092010
HR-D324-BK/WT	REC. LOW VOLT TRIM STEP BAFFLE	19.95	790576092027
HR-D324-WT/WT	REC. LOW VOLT TRIM STEP BAFFLE	19.95	790576092034
HR-D325-BK/WT	REC. LOW VOLT TRIM PINHOLE	18.95	790576092041
HR-D325-WT/WT	REC. LOW VOLT TRIM PINHOLE	18.95	790576092058
HR-D326-BK	REC. LOW VOLT TRIM SLOT	20.95	790576092065
HR-D326-BN	REC. LOW VOLT TRIM SLOT	23.95	790576092072
HR-D326-WT	REC. LOW VOLT TRIM SLOT	20.95	790576092089
HR-D327-BK	REC. LOW VOLT TRIM GIMBAL RING	19.95	790576092096
HR-D327-BN	REC. LOW VOLT TRIM GIMBAL RING	22.95	790576092102
HR-D327-WT	REC. LOW VOLT TRIM GIMBAL RING	19.95	790576092119
HR-D329-CB	3" TRIM DROP DISH GLASS DOME FOR SHOWERS	27.95	790576124926
HR-D329-S-WT	3" SHOWER LIGHT FLAT GLASS	23.95	790576166438
HR-D329-WT	REC. LOW VOLT TRIM DROP DISH SHOWER	27.95	790576092133
HR-D332-AM	REC. LOW VOLT TRIM FRST GLASS RING	24.50	790576092140
HR-D332-WT	REC. LOW VOLT TRIM FRST GLASS RING	24.50	790576092164

Material	Description	2011 DN	UPC Code
HR-D333-AM/WT	REC. LOW VOLT TRIM GLASS CYLINDER	25.95	790576092171
HR-D333-WT/WT	REC. LOW VOLT TRIM GLASS CYLINDER	25.95	790576092195
HR-D334-BN	REC. LOW VOLT TRIM WALL WASHER	28.95	790576092218
HR-D334-WT	REC. LOW VOLT TRIM WALL WASHER	25.95	790576092201
HR-D411-BK/BN	REC. LOW VOLT TRIM BASIC BAFFLE	20.95	790576092331
HR-D411-BK/WT	REC. LOW VOLT TRIM BASIC BAFFLE	16.95	790576092355
HR-D411-WT/WT	REC. LOW VOLT TRIM BASIC BAFFLE	16.95	790576092362
HR-D412-BK/WT	REC. LOW VOLT TRIM OPEN REFLECTOR	16.95	790576092317
HR-D412-SC/BN	REC. LOW VOLT TRIM OPEN REFLECTOR	19.95	790576092324
HR-D412-SC/WT	REC. LOW VOLT TRIM OPEN REFLECTOR	16.95	790576092294
HR-D413-WT	REC. LOW VOLT TRIM ADJUST SLOT	18.50	790576092577
HR-D414-WT/WT	REC. LOW VOLT TRIM ADJUST EYEBALL	16.50	790576092393
HR-D415-BK/WT	REC. LOW VOLT TRIM PINHOLE	16.50	790576092546
HR-D415-WT/WT	REC. LOW VOLT TRIM PINHOLE	16.50	790576092553
HR-D416-BK	REC. LOW VOLT TRIM ADJUST SPOT	28.95	790576092430
HR-D416-BN	REC. LOW VOLT TRIM ADJUST SPOT	32.95	790576092447
HR-D416-WT	REC. LOW VOLT TRIM ADJUST SPOT	28.95	790576092454
HR-D417-BK	REC. LOW VOLT TRIM GIMBAL RING	18.50	790576092584
HR-D417-BN	REC. LOW VOLT TRIM GIMBAL RING	22.50	790576092591
HR-D417-WT	REC. LOW VOLT TRIM GIMBAL RING	18.50	790576092614
HR-D418-CB	4" TRIM DROP DISH GLASS DOME FOR SHOWERS	28.95	790576124919
HR-D418-S-WT	4" SHOWER LIGHT FLAT GLASS	26.95	790576166445
HR-D418-WT	REC. LOW VOLT TRIM DROP DISH SHOWER	28.95	790576092461
HR-D419-WT/WT	REC. LOW VOLT TRIM WALL WASHER	19.95	790576092485
HR-D420-CH	REC. LOW VOLT TRIM ACRYLIC DISC	24.50	790576092522
HR-D423-AM	REC. LOW VOLT TRIM ETCH GLASS RING	24.50	790576092492
HR-D423-BL	REC. LOW VOLT TRIM ETCH GLASS RING	24.50	790576092508
HR-D423-WT	REC. LOW VOLT TRIM ETCH GLASS RING	24.50	790576092515
HR-D425-BK	REC. LOW VOLT TRIM ADJUST SPOT	29.95	790576092409
HR-D425-BN	REC. LOW VOLT TRIM ADJUST SPOT	33.95	790576092416
HR-D425-WT	REC. LOW VOLT TRIM ADJUST SPOT	29.95	790576092423
HR-LED211-C-WT	2" LED DOWNLIGHT - HOUSING & TRIM 4300K 3W ROUND	69.95	790576170497
HR-LED211E-C-WT	LED 2IN OPEN TRIM DOWNLIGHT	69.95	790576192949
HR-LED211E-W-WT	LED 2IN OPEN TRIM DOWNLIGHT	69.95	790576192932
HR-LED211-W-WT	2" LED DOWNLIGHT - HOUSING & TRIM 3000K 3W ROUND	69.95	790576170350
HR-LED212-C-WT	2" LED DOWNLIGHT - HOUSING & TRIM 4300K 3W ROUND	74.95	790576170718
HR-LED212E-C-WT	LED 2IN ADJUSTABLE DOWNLIGHT	74.95	790576192987
HR-LED212E-W-WT	LED 2IN ADJUSTABLE DOWNLIGHT	74.95	790576192970
HR-LED212-W-WT	2" LED DOWNLIGHT - HOUSING & TRIM 3000K 3W ROUND	74.95	790576170640
HR-LED231R-C-BN	REFLECTOR 2IN MINIATURE RECESSED, OPEN ROUND TRIM	44.50	790576187570
HR-LED231R-C-GM	REFLECTOR 2IN MINIATURE RECESSED, OPEN ROUND TRIM	44.50	790576187556
HR-LED231R-C-WT	REFLECTOR 2IN MINIATURE RECESSED, OPEN ROUND TRIM	41.50	790576187594
HR-LED231R-W-BN	REFLECTOR 2IN MINIATURE RECESSED, OPEN ROUND TRIM	44.50	790576187587
HR-LED231R-W-GM	REFLECTOR 2IN MINIATURE RECESSED, OPEN ROUND TRIM	44.50	790576187563
HR-LED231R-W-WT	REFLECTOR 2IN MINIATURE RECESSED, OPEN ROUND TRIM	41.50	790576187600
HR-LED232R-C-BN	REFLECTOR 2IN MINIATURE RECESSED, ADJUSTABLE ROUND TRIM	49.95	790576187693
HR-LED232R-C-GM	REFLECTOR 2IN MINIATURE RECESSED, ADJUSTABLE ROUND TRIM	49.95	790576187679
HR-LED232R-C-WT	REFLECTOR 2IN MINIATURE RECESSED, ADJUSTABLE ROUND TRIM	46.95	790576187716
HR-LED232R-W-BN	REFLECTOR 2IN MINIATURE RECESSED, ADJUSTABLE ROUND TRIM	49.95	790576187709
HR-LED232R-W-GM	REFLECTOR 2IN MINIATURE RECESSED, ADJUSTABLE ROUND TRIM	49.95	790576187686

Material	Description	2011 DN	UPC Code
HR-LED232R-W-WT	LED 2IN MINIATURE RECESSED, ADJUSTABLE - SQUARE TRIM	46.95	790576187723
HR-LED251-C-WT	2" LED DOWNLIGHT - HOUSING & TRIM 4500K 3W SQUARE	69.95	790576170633
HR-LED251E-C-WT	LED 2IN OPEN TRIM DOWNLIGHT - SQUARE	69.95	790576192963
HR-LED251E-W-WT	LED 2IN OPEN TRIM DOWNLIGHT - SQUARE	69.95	790576192956
HR-LED251-W-WT	2" LED DOWNLIGHT - HOUSING & TRIM 3000K 3W SQUARE	69.95	790576170619
HR-LED252-C-WT	2" LED DOWNLIGHT - HOUSING & TRIM 4500K 3W SQUARE	74.95	790576170824
HR-LED252E-C-WT	LED 2IN ADJUSTABLE DOWNLIGHT - SQUARE	74.95	790576193007
HR-LED252E-W-WT	LED 2IN ADJUSTABLE DOWNLIGHT - SQUARE	74.95	790576192994
HR-LED252-W-WT	2" LED DOWNLIGHT - HOUSING & TRIM 3000K 3W SQUARE	74.95	790576170817
HR-LED271R-C-BN	LED 2IN MINIATURE RECESSED, OPEN REFLECTOR, SQUARE TRIM	48.50	790576187518
HR-LED271R-C-GM	LED 2IN MINIATURE RECESSED, OPEN REFLECTOR, SQUARE TRIM	48.50	790576187495
HR-LED271R-C-WT	LED 2IN MINIATURE RECESSED, OPEN REFLECTOR, SQUARE TRIM	45.50	790576187532
HR-LED271R-W-BN	LED 2IN MINIATURE RECESSED, OPEN REFLECTOR, SQUARE TRIM	48.50	790576187525
HR-LED271R-W-GM	LED 2IN MINIATURE RECESSED, OPEN REFLECTOR, SQUARE TRIM	48.50	790576187501
HR-LED271R-W-WT	LED 2IN MINIATURE RECESSED, OPEN REFLECTOR, SQUARE TRIM	45.50	790576187549
HR-LED272R-C-BN	LED 2IN MINIATURE RECESSED, ADJUSTABLE - SQUARE TRIM	52.95	790576187631
HR-LED272R-C-GM	LED 2IN MINIATURE RECESSED, ADJUSTABLE - SQUARE TRIM	52.95	790576187617
HR-LED272R-C-WT	LED 2IN MINIATURE RECESSED, ADJUSTABLE - SQUARE TRIM	49.95	790576187655
HR-LED272R-W-BN	LED 2IN MINIATURE RECESSED, ADJUSTABLE - SQUARE TRIM	52.95	790576187648
HR-LED272R-W-GM	LED 2IN MINIATURE RECESSED, ADJUSTABLE - SQUARE TRIM	52.95	790576187624
HR-LED272R-W-WT	LED 2IN MINIATURE RECESSED, ADJUSTABLE - SQUARE TRIM	49.95	790576187662
HR-LED309-N-C	3" LED DOWNLIGHT NEW CONST HOUSING NON-IC 4500K 10W	119.50	790576170848
HR-LED309-NIC-C	3" LED DOWNLIGHT NEW CONST HOUSING IC 4500K 10W	123.95	790576170886
HR-LED309-NIC-W	3" LED DOWNLIGHT NEW CONST HOUSING IC 3000K 10W	123.95	790576170879
HR-LED309-N-W	3" LED DOWNLIGHT NEW CONST HOUSING NON-IC 3000K 10W	119.50	790576170831
HR-LED309-R-C	3" LED DOWNLIGHT REMODEL HOUSING NON-IC 4500K 10W	117.50	790576170862
HR-LED309-RIC-C	3" LED DOWNLIGHT REMODEL HOUSING IC 4500K 10W	121.50	790576170961
HR-LED309-RIC-W	3" LED DOWNLIGHT REMODEL HOUSING IC 3000K 10W	121.50	790576170923
HR-LED309-R-W	3" LED DOWNLIGHT REMODEL HOUSING NON-IC 3000K 10W	117.50	790576170855
HR-LED311-BK/BN	3" LED DOWNLIGHT TRIM - ROUND	23.95	790576171005
HR-LED311-BK/WT	3" LED DOWNLIGHT TRIM - ROUND	21.95	790576171012
HR-LED311-WT/WT	3" LED DOWNLIGHT TRIM - ROUND	21.95	790576171029
HR-LED321-BK/BN	3" LED DOWNLIGHT TRIM - ROUND	23.95	790576171036
HR-LED321-BK/WT	3" LED DOWNLIGHT TRIM - ROUND	21.95	790576171043
HR-LED321-WT/WT	3" LED DOWNLIGHT TRIM - ROUND	21.95	790576171050
HR-LED331-CH	3" LED DOWNLIGHT TRIM - ROUND	23.95	790576171081
HR-LED331-WT	3" LED DOWNLIGHT TRIM - ROUND	21.95	790576171067
HR-LED351-BK/BN	3" LED DOWNLIGHT TRIM - SQUARE	25.95	790576171098
HR-LED351-BK/WT	3" LED DOWNLIGHT TRIM - SQUARE	23.95	790576171104
HR-LED351-WT/WT	3" LED DOWNLIGHT TRIM - SQUARE	23.95	790576171111
HR-LED371-CH	3" LED DOWNLIGHT TRIM - SQUARE	24.95	790576171166
HR-LED371-WT	3" LED DOWNLIGHT TRIM - SQUARE	22.95	790576171159
HR-LED411-BK/BN	4" LED DOWNLIGHT TRIM - ROUND	20.95	790576171340
HR-LED411-BK/WT	4" LED DOWNLIGHT TRIM - ROUND	18.95	790576171227
HR-LED411TL-BK/BN	4" LED DOWNLIGHT TRIM - INVISIBLE TRIM - ROUND	21.95	790576171692
HR-LED411TL-BK/WT	4" LED DOWNLIGHT TRIM - INVISIBLE TRIM - ROUND	19.95	790576171531
HR-LED411TL-WT/WT	4" LED DOWNLIGHT TRIM - INVISIBLE TRIM - ROUND	19.95	790576171548
HR-LED411-WT/WT	4" LED DOWNLIGHT TRIM - ROUND	18.95	790576171234
HR-LED418-N-C	4" LED DOWNLIGHT NEW CONST HOUSING NON-IC 4500K 14W	124.95	790576171319
HR-LED418-NIC-C	4" LED DOWNLIGHT NEW CONST HOUSING IC 4500K 14W	129.95	790576171210



Material	Description	2011 DN	UPC Code
HR-LED418-NIC-ROC	4" LED DOWNLIGHT NEW CONST HOUSING IC	139.95	790576172217
HR-LED418-NIC-ROW	4" LED DOWNLIGHT NEW CONST HOUSING IC	139.95	790576172200
HR-LED418-NIC-SQC	4" LED DOWNLIGHT NEW CONST HOUSING IC	139.95	790576172279
HR-LED418-NIC-SQW	4" LED DOWNLIGHT NEW CONST HOUSING IC	139.95	790576172262
HR-LED418-NIC-W	4" LED DOWNLIGHT NEW CONST HOUSING IC	129.95	790576171197
HR-LED418-N-ROC	4" LED DOWNLIGHT NEW CONST HOUSING NON-IC	134.95	790576172255
HR-LED418-N-ROW	4" LED DOWNLIGHT NEW CONST HOUSING NON-IC	134.95	790576172231
HR-LED418-N-SQC	4" LED DOWNLIGHT NEW CONST HOUSING NON-IC	134.95	790576172293
HR-LED418-N-SQW	4" LED DOWNLIGHT NEW CONST HOUSING NON-IC	134.95	790576172286
HR-LED418-N-W	4" LED DOWNLIGHT NEW CONST HOUSING NON-IC	124.95	790576171302
HR-LED418-R-C	4" LED DOWNLIGHT REMODEL HOUSING NON-IC	121.95	790576171333
HR-LED418-RIC-C	4" LED DOWNLIGHT REMODEL HOUSING IC #500K	126.95	790576171296
HR-LED418-RIC-ROC	4" LED DOWNLIGHT REMODEL HOUSING IC #500K	136.95	790576171432
HR-LED418-RIC-ROW	4" LED DOWNLIGHT REMODEL HOUSING IC 5000K	136.95	790576171425
HR-LED418-RIC-SQC	4" LED DOWNLIGHT REMODEL HOUSING IC #500K	136.95	790576171494
HR-LED418-RIC-SQW	4" LED DOWNLIGHT REMODEL HOUSING IC 5000K	136.95	790576171487
HR-LED418-RIC-W	4" LED DOWNLIGHT REMODEL HOUSING IC 5000K	126.95	790576171272
HR-LED418-R-ROC	4" LED DOWNLIGHT REMODEL HOUSING NON-IC	131.95	790576171463
HR-LED418-R-ROW	4" LED DOWNLIGHT REMODEL HOUSING NON-IC	131.95	790576171449
HR-LED418-R-SQC	4" LED DOWNLIGHT REMODEL HOUSING NON-IC	131.95	790576171517
HR-LED418-R-SQW	4" LED DOWNLIGHT REMODEL HOUSING NON-IC	131.95	790576171500
HR-LED418-R-W	4" LED DOWNLIGHT REMODEL HOUSING NON-IC	121.95	790576171326
HR-LED421-BK/BN	4" LED DOWNLIGHT TRIM - ROUND	20.95	790576171357
HR-LED421-BK/WT	4" LED DOWNLIGHT TRIM - ROUND	18.95	790576171241
HR-LED421-TL-BK/BN	4" LED DOWNLIGHT TRIM - INVISIBLE TRIM - ROUND	21.95	790576171555
HR-LED421-TL-BK/WT	4" LED DOWNLIGHT TRIM - INVISIBLE TRIM - ROUND	19.95	790576171562
HR-LED421-TL-WT/WT	4" LED DOWNLIGHT TRIM - INVISIBLE TRIM - ROUND	19.95	790576171579
HR-LED421-WT/WT	4" LED DOWNLIGHT TRIM - ROUND	18.95	790576171265
HR-LED431-CH	4" LED DOWNLIGHT TRIM - ROUND	20.95	790576171364
HR-LED431-WT	4" LED DOWNLIGHT TRIM - ROUND	18.95	790576171258
HR-LED451-BK/BN	4" LED DOWNLIGHT TRIM - SQUARE	21.95	790576171371
HR-LED451-BK/WT	4" LED DOWNLIGHT TRIM - SQUARE	19.95	790576171388
HR-LED451-TL-BK/BN	4" LED DOWNLIGHT TRIM - INVISIBLE TRIM - SQUARE	22.95	790576171586
HR-LED451-TL-BK/WT	4" LED DOWNLIGHT TRIM - INVISIBLE TRIM - SQUARE	20.95	790576171593
HR-LED451-TL-WT/WT	4" LED DOWNLIGHT TRIM - INVISIBLE TRIM - SQUARE	20.95	790576171609
HR-LED451-WT/WT	4" LED DOWNLIGHT TRIM - SQUARE	19.95	790576171395
HR-LED471-CH	4" LED DOWNLIGHT TRIM - ROUND	21.95	790576171418
HR-LED471-WT	4" LED DOWNLIGHT TRIM - ROUND	19.95	790576171401
HR-LED85-BK	LED ROUND BUTTON LIGHTS 3X1W 3000K	29.95	790576142678
HR-LED85-BN	LED ROUND BUTTON LIGHTS 3X1W 3000K	31.95	790576142722
HR-LED85-CB	LED ROUND BUTTON LIGHTS 3X1W 3000K	31.95	790576142739
HR-LED85-CH	LED ROUND BUTTON LIGHTS 3X1W 3000K	31.95	790576142753
HR-LED85-DB	LED ROUND BUTTON LIGHTS 3X1W 3000K	31.95	790576166452
HR-LED85-WT	LED ROUND BUTTON LIGHTS 3X1W 3000K	29.95	790576142777
HR-LED-COV-BK	LED BUTTON RETROFIT HOUSING	3.95	790576166469
HR-LED-COV-BN	LED BUTTON RETROFIT HOUSING	4.95	790576166476
HR-LED-COV-CB	LED BUTTON RETROFIT HOUSING	4.95	790576166513
HR-LED-COV-CH	LED BUTTON RETROFIT HOUSING	4.95	790576166506
HR-LED-COV-DB	LED BUTTON RETROFIT HOUSING	4.95	790576166490
HR-LED-COV-WT	LED BUTTON RETROFIT HOUSING	3.95	790576166483

Material	Description	2011 DN	UPC Code
HT2-BK	H SERIES 2FT TRACK W/ 2 ENDCAPS	10.95	790576005157
HT2-BN	H SERIES 2FT TRACK IN BN	14.50	790576124469
HT2-DB	H SERIES 2FT TRACK W/ 2 ENDCAPS	14.50	790576139951
HT2-WT	H SERIES 2FT TRACK W/ 2 ENDCAPS	10.95	790576005164
HT4-BK	H SERIES 4FT TRACK W/ 2 ENDCAPS	14.50	790576005171
HT4-BN	H SERIES 4FT TRACK W/ 2 ENDCAPS	20.95	790576124476
HT4-DB	H SERIES 4FT TRACK W/ 2 ENDCAPS	20.95	790576139968
HT4-WT	H SERIES 4FT TRACK W/ 2 ENDCAPS	14.50	790576005188
HT6-BK	H SERIES 6FT TRACK W/ 2 ENDCAPS	20.95	790576005195
HT6-BN	H SERIES 6FT TRACK W/ 2 ENDCAPS	30.50	790576124483
HT6-DB	H SERIES 6FT TRACK W/ 2 ENDCAPS	30.50	790576139975
HT6-WT	H SERIES 6FT TRACK W/ 2 ENDCAPS	20.95	790576005201
HT8-BK	H SERIES 8FT TRACK W/ 2 ENDCAPS	23.95	790576005218
HT8-BN	H SERIES 8FT TRACK W/ 2 ENDCAPS	36.95	790576124513
HT8-DB	H SERIES 8FT TRACK W/ 2 ENDCAPS	36.95	790576139982
HT8-WT	H SERIES 8FT TRACK W/ 2 ENDCAPS	23.95	790576005225
HT-BK	H SERIES T CONNECTOR	9.95	790576005119
HT-BN	H SERIES T CONNECTOR	11.50	790576145402
HT-DB	H SERIES T CONNECTOR	11.50	790576140100
HTK-024-BK	H SERIES LINE VOLT TRACK HEAD	27.95	790576033839
HTK-024-WT	H SERIES LINE VOLT TRACK HEAD	27.95	790576033846
HTK-048-BK	H SERIES LINE VOLT TRACK HEAD	39.95	790576033921
HTK-048-WT	H SERIES LINE VOLT TRACK HEAD	39.95	790576033938
HTK-101-AM/BK	H SERIES LINE VOLTAGE TRACK HEAD	24.50	790576108810
HTK-101-AM/WT	H SERIES LINE VOLTAGE TRACK HEAD	24.50	790576108797
HTK-101-WT/BK	H SERIES LINE VOLTAGE TRACK HEAD	24.50	790576108827
HTK-101-WT/WT	H SERIES LINE VOLTAGE TRACK HEAD	24.50	790576108803
HTK-102-AM/BK	H SERIES LINE VOLTAGE TRACK HEAD	24.50	790576108933
HTK-102-AM/WT	H SERIES LINE VOLTAGE TRACK HEAD	24.50	790576108919
HTK-102-WT/BK	H SERIES LINE VOLTAGE TRACK HEAD	24.50	790576108940
HTK-102-WT/WT	H SERIES LINE VOLTAGE TRACK HEAD	24.50	790576108926
HTK-103-BK	H SERIES LINE VOLTAGE TRACK HEAD	19.95	790576109039
HTK-103-WT	H SERIES LINE VOLTAGE TRACK HEAD	19.95	790576109046
HTK-104-BK	H SERIES LINE VOLTAGE TRACK HEAD	18.95	790576109091
HTK-104-WT	H SERIES LINE VOLTAGE TRACK HEAD	18.95	790576109107
HTK-105-BK	H SERIES LINE VOLTAGE TRACK HEAD	19.95	790576109152
HTK-105-WT	H SERIES LINE VOLTAGE TRACK HEAD	19.95	790576109169
HTK-132E-AB	H SERIES CFL TRACK HEAD 32W	124.95	790576141855
HTK-132E-AN	H SERIES CFL TRACK HEAD 32W	124.95	790576193748
HTK-150-BK	H SERIES LINE VOLT TRACK HEAD - DIE CAST	44.95	790576005256
HTK-150-WT	H SERIES LINE VOLT TRACK HEAD - DIE CAST	44.95	790576005263
HTK-178-BK	H SERIES LINE VOLT TRACK HEAD	8.95	790576014128
HTK-178-BN	H SERIES LINE VOLT TRACK HEAD	12.95	790576147437
HTK-178-WT	H SERIES LINE VOLT TRACK HEAD	8.95	790576014135
HTK-188-BK	H SERIES LINE VOLT TRACK HEAD	9.95	790576005270
HTK-188-BN	H SERIES LINE VOLT TRACK HEAD	13.95	790576147444
HTK-188-DB	LINE VOLTAGE TRACK HEAD	13.95	790576163383
HTK-188-WT	H SERIES LINE VOLT TRACK HEAD	9.95	790576005287
HTK-331-BK	H SERIES LINE VOLTAGE TRACK HEAD	75.95	
HTK-331-WT	H SERIES LINE VOLTAGE TRACK HEAD	75.95	

Material	Description	2011 DN	UPC Code
HTK-512AM/BN	JILL PENDANT FOR H SERIES TRACK - 120V 5	74.95	790576155234
HTK-512AM/DB	JILL PENDANT FOR H SERIES TRACK	74.95	790576155227
HTK-512BL/BN	JILL PENDANT FOR H SERIES TRACK - 120V 5	74.95	790576155258
HTK-512BL/DB	JILL PENDANT FOR H SERIES TRACK - 120V 5	74.95	790576155241
HTK-512GR/BN	JILL PENDANT FOR H SERIES TRACK - 120V 5	74.95	790576155272
HTK-512GR/DB	JILL PENDANT FOR H SERIES TRACK - 120V 5	74.95	790576155265
HTK-512RD/BN	JILL PENDANT FOR H SERIES TRACK - 120V 5	74.95	790576155296
HTK-512RD/DB	JILL PENDANT FOR H SERIES TRACK - 120V 5	74.95	790576155289
HTK-512WT/BN	JILL PENDANT FOR H SERIES TRACK - 120V 5	74.95	790576155319
HTK-512WT/DB	JILL PENDANT FOR H SERIES TRACK - 120V 5	74.95	790576155302
HTK-513AM/BN	ELLA PENDANT FOR H SERIES TRACK - 120V 5	83.95	790576155333
HTK-513AM/DB	ELLA PENDANT FOR H SERIES TRACK - 120V 5	83.95	790576155326
HTK-513WT/BN	ELLA PENDANT FOR H SERIES TRACK - 120V 5	83.95	790576155357
HTK-513WT/DB	ELLA PENDANT FOR H SERIES TRACK - 120V 5	83.95	790576155340
HTK-515AM/BN	FIORE PENDANT FOR H SERIES TRACK - 120V	114.95	790576155432
HTK-515AM/DB	FIORE PENDANT FOR H SERIES TRACK - 120V	114.95	790576155425
HTK-515MF/BN	FIORE PENDANT FOR H SERIES TRACK - 120V	114.95	790576155432
HTK-515MF/DB	FIORE PENDANT FOR H SERIES TRACK - 120V	114.95	790576155425
HTK-517WT/BN	OBO PENDANT FOR H SERIES TRACK - 120V 50	79.95	790576155456
HTK-517WT/DB	OBO PENDANT FOR H SERIES TRACK - 120V 50	79.95	790576155449
HTK-518DIC/BN	EDEN PENDANT FOR H SERIES TRACK - 120V 5	129.95	790576155470
HTK-518DIC/DB	EDEN PENDANT FOR H SERIES TRACK - 120V 5	129.95	790576155463
HTK-524AM/BN	SARAH PENDANT FOR H SERIES TRACK - 120V	78.95	790576155555
HTK-524AM/DB	SARAH PENDANT FOR H SERIES TRACK - 120V	78.95	790576155548
HTK-524LB/BN	SARAH PENDANT FOR H SERIES TRACK - 120V	78.95	790576155579
HTK-524LB/DB	SARAH PENDANT FOR H SERIES TRACK - 120V	78.95	790576155562
HTK-524TQ/BN	SARAH PENDANT FOR H SERIES TRACK - 120V	78.95	790576155593
HTK-524TQ/DB	SARAH PENDANT FOR H SERIES TRACK - 120V	78.95	790576155586
HTK-524WT/BN	SARAH PENDANT FOR H SERIES TRACK - 120V	78.95	790576155616
HTK-524WT/DB	SARAH PENDANT FOR H SERIES TRACK - 120V	78.95	790576155609
HTK-530GR/BN	COUTURE PENDANT FOR H SERIES TRACK - 120	169.95	790576155630
HTK-530GR/DB	COUTURE PENDANT FOR H SERIES TRACK - 120	169.95	790576155623
HTK-530MC/BN	COUTURE PENDANT FOR H SERIES TRACK - 120	169.95	790576155654
HTK-530MC/DB	COUTURE PENDANT FOR H SERIES TRACK - 120	169.95	790576155647
HTK-534SM/BN	PENDANT FOR H SERIES TRACK - 120	99.95	790576195315
HTK-534SM/DB	PENDANT FOR H SERIES TRACK - 120	99.95	790576195322
HTK-535DIC/DB		149.95	
HTK-535DIC/DB		149.95	
HTK-536BL/BN	PENDANT FOR H SERIES TRACK - 120	114.95	790576195537
HTK-536BL/DB	PENDANT FOR H SERIES TRACK - 120	114.95	790576195544
HTK-541AM/BN	FABERGE PENDANT FOR H SERIES TRACK - 120	86.95	790576155692
HTK-541AM/DB	FABERGE PENDANT FOR H SERIES TRACK - 120	86.95	790576155685
HTK-541WT/BN	FABERGE PENDANT FOR H SERIES TRACK - 120	86.95	790576155715
HTK-541WT/DB	FABERGE PENDANT FOR H SERIES TRACK - 120	86.95	790576155708
HTK-546DIC/BN	AMBROSIA PENDANT FOR H SERIES TRACK - 12	149.95	790576155753
HTK-546DIC/DB	AMBROSIA PENDANT FOR H SERIES TRACK - 12	149.95	790576155746
HTK-548FR/BN	PURA PENDANT FOR H SERIES TRACK - 120V 5	99.95	790576155791
HTK-548FR/DB	PURA PENDANT FOR H SERIES TRACK - 120V 5	99.95	790576155784
HTK-559DIC/BN	MICHA PENDANT FOR H SERIES TRACK - 120V	89.95	790576177977
HTK-559DIC/DB	MICHA PENDANT FOR H SERIES TRACK - 120V	89.95	790576178004

Material	Description	2011 DN	UPC Code
HTK-559GL/BN	MICHA PENDANT FOR H SERIES TRACK - 120V	89.95	790576173146
HTK-559GL/DB	MICHA PENDANT FOR H SERIES TRACK - 120V	89.95	790576173184
HTK-559MR/BN	MICHA PENDANT FOR H SERIES TRACK - 120V	89.95	790576178974
HTK-559MR/DB	MICHA PENDANT FOR H SERIES TRACK - 120V	89.95	790576179018
HTK-593LI/BN	KOMAL PENDANT FOR H SERIES TRACK - 120V	129.95	790576155876
HTK-593LI/DB	KOMAL PENDANT FOR H SERIES TRACK - 120V	129.95	790576155869
HTK-593RD/BN	KOMAL PENDANT FOR H SERIES TRACK - 120V	129.95	790576155890
HTK-593RD/DB	KOMAL PENDANT FOR H SERIES TRACK - 120V	129.95	790576155883
HTK-593TQ/BN	KOMAL PENDANT FOR H SERIES TRACK - 120V	129.95	790576155913
HTK-593TQ/DB	KOMAL PENDANT FOR H SERIES TRACK - 120V	129.95	790576155906
HTK-598WT/BN	DAPPER PENDANT FOR H SERIES TRACK - 120V	114.95	790576155937
HTK-598WT/DB	DAPPER PENDANT FOR H SERIES TRACK - 120V	114.95	790576155920
HTK-599BL/BN	RHEA PENDANT FOR H SERIES TRACK - 120V	99.95	790576175416
HTK-599BL/DB	RHEA PENDANT FOR H SERIES TRACK - 120V	99.95	790576175454
HTK-599UM/BN	RHEA PENDANT FOR H SERIES TRACK - 120V	99.95	790576177465
HTK-599UM/DB	RHEA PENDANT FOR H SERIES TRACK - 120V	99.95	790576177502
HTK-599WT/BN	RHEA PENDANT FOR H SERIES TRACK - 120V	99.95	790576176413
HTK-599WT/DB	RHEA PENDANT FOR H SERIES TRACK - 120V	99.95	790576176451
HTK-701-BK	H SERIES LINE VOLT TRACK HEAD	10.95	790576005294
HTK-701-WT	H SERIES LINE VOLT TRACK HEAD	10.95	790576005300
HTK-703-BK	H SERIES LINE VOLT TRACK HEAD	10.95	790576005331
HTK-703-WT	H SERIES LINE VOLT TRACK HEAD	10.95	790576005348
HTK-704-BK	H SERIES LINE VOLT TRACK HEAD	12.50	790576005355
HTK-704-WT	H SERIES LINE VOLT TRACK HEAD	12.50	790576005362
HTK-705-BK	H SERIES LINE VOLT TRACK HEAD	17.95	790576005379
HTK-705-WT	H SERIES LINE VOLT TRACK HEAD	17.95	790576005386
HTK-706-BK	H SERIES LINE VOLT TRACK HEAD	17.95	790576005393
HTK-706-WT	H SERIES LINE VOLT TRACK HEAD	17.95	790576005409
HTK-713-BK	H SERIES LINE VOLTAGE TRACK HEAD	42.50	790576095400
HTK-713-WT	H SERIES LINE VOLTAGE TRACK HEAD	42.50	790576095417
HTK-715-BK	H SERIES LINE VOLTAGE TRACK HEAD	47.95	790576095493
HTK-715-WT	H SERIES LINE VOLTAGE TRACK HEAD	47.95	790576095509
HTK-717-BK	H SERIES LINE VOLT TRACK HEAD	11.95	790576035901
HTK-717-WT	H SERIES LINE VOLT TRACK HEAD	11.95	790576035918
HTK-718-BK	H SERIES LINE VOLT TRACK HEAD	12.50	790576005416
HTK-718-WT	H SERIES LINE VOLT TRACK HEAD	12.50	790576005423
HTK-720-BK	H SERIES LINE VOLT TRACK HEAD - DIE CAST	24.95	790576005430
HTK-720-WT	H SERIES LINE VOLT TRACK HEAD - DIE CAST	24.95	790576005447
HTK-725-BK	H SERIES LINE VOLT TRACK HEAD	10.95	790576005454
HTK-725-WT	H SERIES LINE VOLT TRACK HEAD	10.95	790576005461
HTK-727-BK	H SERIES LINE VOLTAGE TRACK HEAD	49.95	790576095585
HTK-727-WT	H SERIES LINE VOLTAGE TRACK HEAD	49.95	790576095592
HTK-730-BK	H SERIES LINE VOLT TRACK HEAD - DIE CAST	27.95	790576005478
HTK-730-WT	H SERIES LINE VOLT TRACK HEAD - DIE CAST	27.95	790576005485
HTK-733-BK	H SERIES LINE VOLTAGE TRACK HEAD	46.50	790576095677
HTK-733-WT	H SERIES LINE VOLTAGE TRACK HEAD	46.50	790576095684
HTK-737-BK	H SERIES LINE VOLTAGE TRACK HEAD	51.95	790576095769
HTK-737-WT	H SERIES LINE VOLTAGE TRACK HEAD	51.95	790576095776
HTK-738-BK	H SERIES LINE VOLT TRACK HEAD - DIE CAST	30.95	790576005492
HTK-738-WT	H SERIES LINE VOLT TRACK HEAD - DIE CAST	30.95	790576005508

Material	Description	2011 DN	UPC Code
HTK-747-BK	H SERIES LINE VOLTAGE TRACK HEAD	45.95	790576105680
HTK-747-WT	H SERIES LINE VOLTAGE TRACK HEAD	45.95	790576105697
HTK-753-BK	H SERIES LINE VOLT TRACK HEAD - DIE CAST	24.95	790576005577
HTK-753-WT	H SERIES LINE VOLT TRACK HEAD - DIE CAST	24.95	790576005584
HTK-754-BK	H SERIES LINE VOLT TRACK HEAD - DIE CAST	27.95	790576005591
HTK-754-WT	H SERIES LINE VOLT TRACK HEAD - DIE CAST	27.95	790576005607
HTK-755-BK	H SERIES LINE VOLT TRACK HEAD - DIE CAST	30.95	790576005614
HTK-755-WT	H SERIES LINE VOLT TRACK HEAD - DIE CAST	30.95	790576005621
HTK-757-BK	H SERIES LINE VOLTAGE TRACK HEAD	47.95	790576105741
HTK-757-WT	H SERIES LINE VOLTAGE TRACK HEAD	47.95	790576105758
HTK-763-39E-BK	H SERIES HID TRACK HEAD PAR20 39W	141.50	790576118888
HTK-763-39E-PT/BK	H SERIES HID TRACK HEAD PAR20 39W	145.50	790576118918
HTK-763-39E-PT/WT	H SERIES HID TRACK HEAD PAR20 39W	145.50	790576118925
HTK-763-39E-WT	H SERIES HID TRACK HEAD PAR20 39W	141.50	790576118901
HTK-763-BK	H SERIES LINE VOLT TRACK HEAD	11.50	790576038186
HTK-763-BN	H SERIES LINE VOLT TRACK HEAD	15.50	790576147451
HTK-763-WT	H SERIES LINE VOLT TRACK HEAD	11.50	790576038193
HTK-764-39E-BK	H SERIES HID TRACK HEAD PAR30L 39W	146.50	790576119007
HTK-764-39E-PT/BK	H SERIES HID TRACK HEAD PAR30L 39W	150.50	790576119038
HTK-764-39E-PT/WT	H SERIES HID TRACK HEAD PAR30L 39W	150.50	790576119045
HTK-764-39E-WT	H SERIES HID TRACK HEAD PAR30L 39W	146.50	790576119014
HTK-764-70E-BK	H SERIES HID TRACK HEAD PAR30L 70W	151.50	790576119137
HTK-764-70E-PT/BK	H SERIES HID TRACK HEAD PAR30L 70W	155.50	790576119151
HTK-764-70E-PT/WT	H SERIES HID TRACK HEAD PAR30L 70W	155.50	790576119168
HTK-764-70E-WT	H SERIES HID TRACK HEAD PAR30L 70W	151.50	790576119144
HTK-764-BK	H SERIES LINE VOLT TRACK HEAD	12.25	790576038216
HTK-764-BN	H SERIES LINE VOLT TRACK HEAD	16.25	790576147468
HTK-764-WT	H SERIES LINE VOLT TRACK HEAD	12.25	790576038223
HTK-765-70E-BK	H SERIES HID TRACK HEAD PAR38 70W	156.50	790576119250
HTK-765-70E-PT/BK	H SERIES HID TRACK HEAD PAR38 70W	160.50	790576119274
HTK-765-70E-PT/WT	H SERIES HID TRACK HEAD PAR38 70W	160.50	790576119281
HTK-765-70E-WT	H SERIES HID TRACK HEAD PAR38 70W	156.50	790576119267
HTK-765-BK	H SERIES LINE VOLT TRACK HEAD	13.00	790576038247
HTK-765-BN	H SERIES LINE VOLT TRACK HEAD	17.00	790576147475
HTK-765-WT	H SERIES LINE VOLT TRACK HEAD	13.00	790576038254
HTK-773-BK	H SERIES LINE VOLT TRACK HEAD	24.50	790576035963
HTK-773-BN	H SERIES LINE VOLT TRACK HEAD	28.50	790576147482
HTK-773-WT	H SERIES LINE VOLT TRACK HEAD	24.50	790576035970
HTK-774-BK	H SERIES LINE VOLT TRACK HEAD	26.50	790576035987
HTK-774-BN	H SERIES LINE VOLT TRACK HEAD	30.50	790576147499
HTK-774-WT	H SERIES LINE VOLT TRACK HEAD	26.50	790576035994
HTK-775-BK	H SERIES LINE VOLT TRACK HEAD	28.50	790576036007
HTK-775-BN	H SERIES LINE VOLT TRACK HEAD	32.50	790576147505
HTK-775-WT	H SERIES LINE VOLT TRACK HEAD	28.50	790576036014
HTK-793-AB	H SER. LINE VOLTAGE TRACK HEAD PAR20 50W	64.95	790576141862
HTK-793-AN	H SERIES LINE VOLTAGE TRACK HEAD PAR20 50W	64.95	790576193342
HTK-794-AB	H SER. LINE VOLTAGE TRACK HEAD PAR30 75W	66.95	790576141886
HTK-794-AN	H SERIES LINE VOLTAGE TRACK HEAD PAR30 75W	66.95	790576193373
HTK-795-AB	H SER.LINE VOLTAGE TRACK HEAD PAR38 150W	68.95	790576141893
HTK-795-AN	H SERIES LINE VOLTAGE TRACK HEAD PAR38 150W	68.95	790576193403

Material	Description	2011 DN	UPC Code
HTK-797-AB	H SER. LINE VOLTAGE TRACK HEAD PAR20 50W	64.95	790576141824
HTK-797-AN	H SERIES LINE VOLTAGE TRACK HEAD PAR20 50W	64.95	790576193250
HTK-797-LENS-AB	H SERIES LINE VOLT TRACK HEAD 50W W/LENS	69.95	790576143385
HTK-797-LENS-AN	W/ LENS OPTION	69.95	790576193656
HTK-798-AB	H SER. LINE VOLTAGE TRACK HEAD PAR30 75W	66.95	790576141831
HTK-798-AN	H SERIES LINE VOLTAGE TRACK HEAD PAR30 75W	66.95	790576193281
HTK-798-LENS-AB	H SERIES LINE VOLT TRACK HEAD 75W W/LENS	71.95	790576143477
HTK-798-LENS-AN	W/ LENS OPTION	71.95	790576193687
HTK-799-AB	H SER LINE VOLTAGE TRACK HEAD PAR38 150W	68.95	790576141848
HTK-799-AN	H SERIES LINE VOLTAGE TRACK HEAD PAR38 150W	68.95	790576193311
HTK-799-LENS-AB	H SERIES LINE VOLT TRACK HEAD 150W W/LEN	73.95	790576143538
HTK-799-LENS-AN	- W/ LENS OPTION	73.95	790576193717
HTK-F1-402AM/DB	H SERIES TRACK PENDANT - CFL GU24	116.95	790576183381
HTK-F1-402BL/DB	H SERIES TRACK PENDANT - CFL GU24	116.95	790576183862
HTK-F1-402WM/DB	H SERIES TRACK PENDANT - CFL GU24	116.95	790576184340
HTK-F1-403AM/DB	H SERIES TRACK PENDANT - CFL GU24	134.95	790576181059
HTK-F1-403BL/DB	H SERIES TRACK PENDANT - CFL GU24	134.95	790576181653
HTK-F1-403RD/DB	H SERIES TRACK PENDANT - CFL GU24	134.95	790576182230
HTK-F1-404BN/DB	H SERIES TRACK PENDANT - CFL GU24	99.95	790576184609
HTK-F1-404CO/DB	H SERIES TRACK PENDANT - CFL GU24	99.95	790576180458
HTK-F1-406OC/DB	H SERIES TRACK PENDANT - CFL GU24	134.95	790576182827
HTK-F1-408AM/DB	H SERIES TRACK PENDANT - CFL GU24	134.95	790576184784
HTK-F1-408WT/DB	H SERIES TRACK PENDANT - CFL GU24	134.95	790576184913
HTK-F1-421GR/DB	MOSS PENDANT FOR H SERIES TRACK - CFL GU	189.95	790576159652
HTK-F1-423PR/DB	SOLSTICE PENDANT FOR H SERIES TRACK - CF	199.95	790576159669
HTK-F1-424WT/DB	SERAPHIM PENDANT FOR H SERIES TRACK - CF	219.95	790576159676
HTK-F1-451AM/DB	H SERIES TRACK PENDANT - CFL GU24	119.95	790576181820
HTK-F1-451BL/DB	H SERIES TRACK PENDANT - CFL GU24	119.95	790576182445
HTK-F1-451WT/DB	H SERIES TRACK PENDANT - CFL GU24	119.95	790576183077
HTK-F1-454AM/DB	H SERIES TRACK PENDANT - CFL GU24	119.95	790576183626
HTK-F1-454WT/DB	H SERIES TRACK PENDANT - CFL GU24	119.95	790576184135
HTK-F1-471WT/DB	MODE PENDANT FOR H SERIES TRACK - CFL GU	119.95	790576159690
HTK-F1-472WT/DB	CLINTON PENDANT FOR H SERIES TRACK - CFL	129.95	790576159706
HTK-F1-474WT/DB	CAROL GARDENS PENDANT FOR H SERIES TRACK	144.95	790576159713
HTK-F1-483IV/DB	WILLIAMSBURG PENDANT FOR H SERIES TRACK	149.95	790576159720
HTK-F1-484BL/DB	PENDANT FOR H SERIES TRACK	149.95	790576200675
HTK-F1-485BL/DB	PENDANT FOR H SERIES TRACK	189.95	#N/A
HTK-F1-487AM/DB	COBBLE HILL PENDANT FOR H SERIES TRACK -	149.95	790576159744
HTK-F1-488WT/DB	PARK SLOPE PENDANT FOR H SERIES TRACK -	193.95	790576159751
HTK-F2-402AM/BN	H SERIES TRACK PENDANT - CFL GU24	116.95	790576183428
HTK-F2-402BL/BN	H SERIES TRACK PENDANT - CFL GU24	116.95	790576183916
HTK-F2-402WM/BN	H SERIES TRACK PENDANT - CFL GU24	116.95	790576184388
HTK-F2-403AM/BN	H SERIES TRACK PENDANT - CFL GU24	134.95	790576181103
HTK-F2-403BL/BN	H SERIES TRACK PENDANT - CFL GU24	134.95	790576181691
HTK-F2-403RD/BN	H SERIES TRACK PENDANT - CFL GU24	134.95	790576182285
HTK-F2-404BN/BN	H SERIES TRACK PENDANT - CFL GU24	99.95	790576184647
HTK-F2-404CO/BN	H SERIES TRACK PENDANT - CFL GU24	99.95	790576180519
HTK-F2-406OC/BN	H SERIES TRACK PENDANT - CFL GU24	134.95	790576182865
HTK-F2-408AM/BN	H SERIES TRACK PENDANT - CFL GU24	134.95	790576184791
HTK-F2-408WT/BN	H SERIES TRACK PENDANT - CFL GU24	134.95	790576184920

Material	Description	2011 DN	UPC Code
HTK-F2-421GR/BN	LINE VOLTAGE TRACK MOUNT PENDANT KIT	189.95	790576143170
HTK-F2-423PR/BN	LINE VOLTAGE TRACK MOUNT PENDANT KIT	199.95	790576143354
HTK-F2-424WT/BN	LINE VOLTAGE TRACK MOUNT PENDANT KIT	219.95	790576144542
HTK-F2-451AM/BN	H SERIES TRACK PENDANT - CFL GU24	119.95	790576181875
HTK-F2-451BL/BN	H SERIES TRACK PENDANT - CFL GU24	119.95	790576182490
HTK-F2-451WT/BN	H SERIES TRACK PENDANT - CFL GU24	119.95	790576183121
HTK-F2-454AM/BN	H SERIES TRACK PENDANT - CFL GU24	119.95	790576183688
HTK-F2-454WT/BN	H SERIES TRACK PENDANT - CFL GU24	119.95	790576184173
HTK-F2-471WT/BN	LINE VOLTAGE TRACK MOUNT PENDANT KIT	119.95	790576143705
HTK-F2-472WT/BN	LINE VOLTAGE TRACK MOUNT PENDANT KIT	129.95	790576143873
HTK-F2-474WT/BN	LINE VOLTAGE TRACK MOUNT PENDANT KIT	144.95	790576144429
HTK-F2-483IV/BN	LINE VOLTAGE TRACK MOUNT PENDANT KIT	149.95	790576144481
HTK-F2-484BL/BN	H SERIES TRACK PENDANT - CFL GU24	149.95	790576200682
HTK-F2-485BL/BN	H SERIES TRACK PENDANT - CFL GU24	189.95	#N/A
HTK-F2-487AM/BN	LINE VOLTAGE TRACK MOUNT PENDANT KIT	149.95	790576144511
HTK-F2-488WT/BN	LINE VOLTAGE TRACK MOUNT PENDANT KIT	193.95	790576144450
HTK-F4-402AM/BK	LIZA PENDANT FOR H SERIES TRACK MOUNT -	80.95	790576153018
HTK-F4-402AM/BN	LIZA PENDANT FOR H SERIES TRACK MOUNT -	81.95	790576153025
HTK-F4-402AM/WT	LIZA PENDANT FOR H SERIES TRACK MOUNT -	80.95	790576153032
HTK-F4-402BL/BK	LIZA PENDANT FOR H SERIES TRACK MOUNT -	80.95	790576153049
HTK-F4-402BL/BN	LIZA PENDANT FOR H SERIES TRACK MOUNT -	81.95	790576153056
HTK-F4-402BL/WT	LIZA PENDANT FOR H SERIES TRACK MOUNT -	80.95	790576153063
HTK-F4-402WM/BK	LIZA PENDANT FOR H SERIES TRACK MOUNT -	80.95	790576153070
HTK-F4-402WM/BN	LIZA PENDANT FOR H SERIES TRACK MOUNT -	81.95	790576153087
HTK-F4-402WM/WT	LIZA PENDANT FOR H SERIES TRACK MOUNT -	80.95	790576153094
HTK-F4-403AM/BK	NOVA PENDANT FOR H SERIES TRACK MOUNT -	98.95	790576153100
HTK-F4-403AM/BN	NOVA PENDANT FOR H SERIES TRACK MOUNT -	99.95	790576153117
HTK-F4-403AM/WT	NOVA PENDANT FOR H SERIES TRACK MOUNT -	98.95	790576153124
HTK-F4-403BL/BK	NOVA PENDANT FOR H SERIES TRACK MOUNT -	98.95	790576153131
HTK-F4-403BL/BN	NOVA PENDANT FOR H SERIES TRACK MOUNT -	99.95	790576153148
HTK-F4-403BL/WT	NOVA PENDANT FOR H SERIES TRACK MOUNT -	98.95	790576153155
HTK-F4-403RD/BK	NOVA PENDANT FOR H SERIES TRACK MOUNT -	98.95	790576153162
HTK-F4-403RD/BN	NOVA PENDANT FOR H SERIES TRACK MOUNT -	99.95	790576153179
HTK-F4-403RD/WT	NOVA PENDANT FOR H SERIES TRACK MOUNT -	98.95	790576153186
HTK-F4-404BN/BK	FELIS PENDANT FOR H SERIES TRACK MOUNT -	63.95	790576153193
HTK-F4-404BN/BN	FELIS PENDANT FOR H SERIES TRACK MOUNT -	64.95	790576153209
HTK-F4-404BN/WT	FELIS PENDANT FOR H SERIES TRACK MOUNT -	63.95	790576153216
HTK-F4-404CO/BK	FELIS PENDANT FOR H SERIES TRACK MOUNT -	63.95	790576153223
HTK-F4-404CO/BN	FELIS PENDANT FOR H SERIES TRACK MOUNT -	64.95	790576153230
HTK-F4-404CO/WT	FELIS PENDANT FOR H SERIES TRACK MOUNT -	63.95	790576153247
HTK-F4-406OC/BK	FROST PENDANT FOR H SERIES TRACK MOUNT -	98.95	790576153254
HTK-F4-406OC/BN	FROST PENDANT FOR H SERIES TRACK MOUNT -	99.95	790576153261
HTK-F4-406OC/WT	FROST PENDANT FOR H SERIES TRACK MOUNT -	98.95	790576153278
HTK-F4-408AM/BK	CREAMERY PENDANT FOR H SERIES TRACK MOUN	98.95	790576153285
HTK-F4-408AM/BN	CREAMERY PENDANT FOR H SERIES TRACK MOUN	99.95	790576153292
HTK-F4-408AM/WT	CREAMERY PENDANT FOR H SERIES TRACK MOUN	98.95	790576153308
HTK-F4-408WT/BK	CREAMERY PENDANT FOR H SERIES TRACK MOUN	98.95	790576153315
HTK-F4-408WT/BN	CREAMERY PENDANT FOR H SERIES TRACK MOUN	99.95	790576153322
HTK-F4-408WT/WT	CREAMERY PENDANT FOR H SERIES TRACK MOUN	98.95	790576153339
HTK-F4-421GR/BK	H SERIES TRACK PENDANT - A19	153.95	790576183749

Material	Description	2011 DN	UPC Code
HTK-F4-421GR/BN	H SERIES TRACK PENDANT - A19	154.95	790576183787
HTK-F4-421GR/WT	LINE VOLTAGE TRACK MOUNT PENDAN	153.95	790576183824
HTK-F4-423PR/BK	H SERIES TRACK PENDANT - A19	163.95	790576182735
HTK-F4-423PR/BN	H SERIES TRACK PENDANT - A19	164.95	790576182780
HTK-F4-424WT/BK	H SERIES TRACK PENDANT - A19	183.95	790576180649
HTK-F4-424WT/BN	H SERIES TRACK PENDANT - A19	184.95	790576180694
HTK-F4-424WT/WT	H SERIES TRACK PENDANT - A19	183.95	790576180748
HTK-F4-451AM/BK	BONGO PENDANT FOR H SERIES TRACK MOUNT -	83.95	790576153346
HTK-F4-451AM/BN	BONGO PENDANT FOR H SERIES TRACK MOUNT -	84.95	790576153353
HTK-F4-451AM/WT	BONGO PENDANT FOR H SERIES TRACK MOUNT -	83.95	790576153360
HTK-F4-451BL/BK	BONGO PENDANT FOR H SERIES TRACK MOUNT -	83.95	790576153377
HTK-F4-451BL/BN	BONGO PENDANT FOR H SERIES TRACK MOUNT -	84.95	790576153384
HTK-F4-451BL/WT	BONGO PENDANT FOR H SERIES TRACK MOUNT -	83.95	790576153391
HTK-F4-451WT/BK	BONGO PENDANT FOR H SERIES TRACK MOUNT -	83.95	790576153407
HTK-F4-451WT/BN	BONGO PENDANT FOR H SERIES TRACK MOUNT -	84.95	790576153414
HTK-F4-451WT/WT	BONGO PENDANT FOR H SERIES TRACK MOUNT -	83.95	790576153421
HTK-F4-454AM/BK	DAX PENDANT FOR H SERIES TRACK MOUNT - A	83.95	790576153438
HTK-F4-454AM/BN	DAX PENDANT FOR H SERIES TRACK MOUNT - A	84.95	790576153445
HTK-F4-454AM/WT	DAX PENDANT FOR H SERIES TRACK MOUNT - A	83.95	790576153452
HTK-F4-454WT/BK	DAX PENDANT FOR H SERIES TRACK MOUNT - A	83.95	790576153469
HTK-F4-454WT/BN	DAX PENDANT FOR H SERIES TRACK MOUNT - A	84.95	790576153476
HTK-F4-454WT/WT	DAX PENDANT FOR H SERIES TRACK MOUNT - A	83.95	790576153483
HTK-F4-471WT/BK	H SERIES TRACK PENDANT - A19	83.95	790576184593
HTK-F4-471WT/BN	H SERIES TRACK PENDANT - A19	84.95	790576184630
HTK-F4-471WT/WT	H SERIES TRACK PENDANT - A19	83.95	790576184678
HTK-F4-472WT/BK	H SERIES TRACK PENDANT - A19	93.95	790576180823
HTK-F4-472WT/BN	H SERIES TRACK PENDANT - A19	94.95	790576180885
HTK-F4-472WT/WT	H SERIES TRACK PENDANT - A19	93.95	790576180922
HTK-F4-474WT/BK	H SERIES TRACK PENDANT - A19	108.95	790576184708
HTK-F4-474WT/BN	H SERIES TRACK PENDANT - A19	109.95	790576180106
HTK-F4-474WT/WT	H SERIES TRACK PENDANT - A19	108.95	790576180151
HTK-F4-483IV/BK	H SERIES TRACK PENDANT - A19	113.95	790576181097
HTK-F4-483IV/BN	H SERIES TRACK PENDANT - A19	114.95	790576181134
HTK-F4-483IV/WT	H SERIES TRACK PENDANT - A19	113.95	790576181189
HTK-F4-484BL/BK	H SERIES TRACK PENDANT - A19	113.95	790576200699
HTK-F4-484BL/BN	H SERIES TRACK PENDANT - A19	114.95	790576200705
HTK-F4-484BL/WT	H SERIES TRACK PENDANT - A19	113.95	790576200712
HTK-F4-485BL/BK	H SERIES TRACK PENDANT - A19	153.95	#N/A
HTK-F4-485BL/BN	H SERIES TRACK PENDANT - A19	154.95	#N/A
HTK-F4-485BL/WT	H SERIES TRACK PENDANT - A19	153.95	#N/A
HTK-F4-487AM/BK	H SERIES TRACK PENDANT - A19	113.95	790576183855
HTK-F4-487AM/BN	H SERIES TRACK PENDANT - A19	114.95	790576183893
HTK-F4-487AM/WT	H SERIES TRACK PENDANT - A19	113.95	790576183930
HTK-F4-488WT/BK	H SERIES TRACK PENDANT - A19	157.95	790576182896
HTK-F4-488WT/BN	H SERIES TRACK PENDANT - A19	158.95	790576182957
HTK-F4-488WT/WT	H SERIES TRACK PENDANT - A19	157.95	790576183015
HTK-HID301-39E-BK	H SERIES LINE VOLTAGE TRACK HEAD - HID LARC	227.95	
HTK-HID301-39E-WT	H SERIES LINE VOLTAGE TRACK HEAD - HID LARC	227.95	
HTK-HID301-70E-BK	H SERIES LINE VOLTAGE TRACK HEAD - HID LARC	238.95	
HTK-HID301-70E-WT	H SERIES LINE VOLTAGE TRACK HEAD - HID LARC	238.95	



Material	Description	2011 DN	UPC Code
HTK-HID303F-20E-BK	H SERIES LINE VOLTAGE TRACK HEAD - HID LARC	214.95	
HTK-HID303F-20E-WT	H SERIES LINE VOLTAGE TRACK HEAD - HID LARC	214.95	
HTK-HID303F-39E-BK	H SERIES LINE VOLTAGE TRACK HEAD - HID LARC	219.95	
HTK-HID303F-39E-WT	H SERIES LINE VOLTAGE TRACK HEAD - HID LARC	219.95	
HTK-HID303F-70E-BK	H SERIES LINE VOLTAGE TRACK HEAD - HID LARC	224.95	
HTK-HID303F-70E-WT	H SERIES LINE VOLTAGE TRACK HEAD - HID LARC	224.95	
HTK-HID303N-20E-BK	H SERIES LINE VOLTAGE TRACK HEAD - HID LARC	214.95	
HTK-HID303N-20E-WT	H SERIES LINE VOLTAGE TRACK HEAD - HID LARC	214.95	
HTK-HID303N-39E-BK	H SERIES LINE VOLTAGE TRACK HEAD - HID LARC	219.95	
HTK-HID303N-39E-WT	H SERIES LINE VOLTAGE TRACK HEAD - HID LARC	219.95	
HTK-HID303S-20E-BK	H SERIES LINE VOLTAGE TRACK HEAD - HID LARC	214.95	
HTK-HID303S-20E-WT	H SERIES LINE VOLTAGE TRACK HEAD - HID LARC	214.95	
HTK-HID303S-39E-BK	H SERIES LINE VOLTAGE TRACK HEAD - HID LARC	219.95	
HTK-HID303S-39E-WT	H SERIES LINE VOLTAGE TRACK HEAD - HID LARC	219.95	
HTK-HID303S-70E-BK	H SERIES LINE VOLTAGE TRACK HEAD - HID LARC	224.95	
HTK-HID303S-70E-WT	H SERIES LINE VOLTAGE TRACK HEAD - HID LARC	224.95	
HTK-HID310-20E-BK	H SERIES LINE VOLTAGE TRACK HEAD - HID LARC	199.95	
HTK-HID310-20E-WT	H SERIES LINE VOLTAGE TRACK HEAD - HID LARC	199.95	
HTK-HID310-39E-BK	H SERIES LINE VOLTAGE TRACK HEAD - HID LARC	204.95	
HTK-HID310-39E-WT	H SERIES LINE VOLTAGE TRACK HEAD - HID LARC	204.95	
HTK-HID330-39E-BK	H SERIES LINE VOLTAGE TRACK HEAD - HID LARC	214.95	
HTK-HID330-39E-WT	H SERIES LINE VOLTAGE TRACK HEAD - HID LARC	214.95	
HTK-HID330-70E-BK	H SERIES LINE VOLTAGE TRACK HEAD - HID LARC	219.95	
HTK-HID330-70E-WT	H SERIES LINE VOLTAGE TRACK HEAD - HID LARC	219.95	
HTK-W126E-HS-BK	H SERIES CFL WALL WASHER 1X26W	89.50	790576049465
HTK-W126E-HS-WT	H SERIES CFL WALL WASHER 1X26W	89.50	790576049687
HTK-W218E-HS-BK	H SERIES CFL WALL WASHER 2X18W	149.50	790576049748
HTK-W218E-HS-WT	H SERIES CFL WALL WASHER 2X18W	149.50	790576049755
HTK-W227E-HS-BK	H SERIES CFL WALL WASHER 2X27W	155.50	790576049946
HTK-W227E-HS-WT	H SERIES CFL WALL WASHER 2X27W	155.50	790576049953
HTK-W239E-HS-BK	H SERIES CFL WALL WASHER 2X39W	165.50	790576050027
HTK-W239E-HS-WT	H SERIES CFL WALL WASHER 2X39W	165.50	790576050034
HTK-W240E-HS-BK	H SERIES CFL WALL WASHER 2X40W	171.50	790576049991
HTK-W240E-HS-WT	H SERIES CFL WALL WASHER 2X40W	171.50	790576050003
HT-SOCKET-BK	REPLACEMENT SOCKET	1.95	790576005126
HT-WT	H SERIES T CONNECTOR	9.95	790576005140
HX-BK	H SERIES X CONNECTOR	11.95	790576005638
HX-BN	H SERIES X CONNECTOR	13.50	790576145419
HX-DB	H SERIES X CONNECTOR	13.50	790576140117
HX-WT	H SERIES X CONNECTOR	11.95	790576005645
J-009-CW-BK	PROJECTOR-4500K	249.95	790576194851
J-009-CW-WT	PROJECTOR-4500K	249.95	790576194868
J-009-WW-BK	PROJECTOR-3000K	249.95	790576194837
J-009-WW-WT	PROJECTOR-3000K	249.95	790576194844
J-100	LAMP HALOGEN R7S 110V-130V 100W 118MM	2.95	790576005713
J-100-S	LAMP HALOGEN R7S 110V-130V 100W 78MM	2.95	790576005720
J-150	LAMP HALOGEN R7S 110V-130V 150W 118MM	2.95	790576005768
J-150-S	LAMP HALOGEN R7S 110V-130V 150W 78MM	2.95	790576005775
J-18F-CW-BK	LED TRACK FIXTURE - 18W COOL WHITE FLOOD	194.95	790576145242
J-18F-CW-BN	LED TRACK FIXTURE - 18W COOL WHITE FLOOD	199.95	790576145280

Material	Description	2011 DN	UPC Code
J-18F-CW-WT	LED TRACK FIXTURE - 18W COOL WHITE FLOOD	194.95	790576145310
J-18F-WW-BK	LED TRACK FIXTURE - 18W WARM WHITE FLOOD	194.95	790576145037
J-18F-WW-BN	J TRACK 18W LED TRACK FIXTURE	199.95	790576145044
J-18F-WW-WT	LED TRACK FIXTURE - 18W WARM WHITE FLOOD	194.95	790576145051
J-18S-CW-BK	LED TRACK FIXTURE - 18W COOL WHITE SPOT	194.95	790576144931
J-18S-CW-BN	LED TRACK FIXTURE - 18W COOL WHITE SPOT	199.95	790576144948
J-18S-CW-WT	LED TRACK FIXTURE - 18W COOL WHITE SPOT	194.95	790576144955
J-18S-WW-BK	LED TRACK FIXTURE - 18W WARM WHITE SPOT	194.95	790576144832
J-18S-WW-BN	J TRACK 18W LED TRACK FIXTURE	199.95	790576144849
J-18S-WW-WT	LED TRACK FIXTURE - 18W WARM WHITE SPOT	194.95	790576144856
J-250-S	LAMP HALOGEN R7S 110V-130V 250W 78MM	2.95	790576015552
J2-BXLE-BK	J SERIES 2 CIRCUIT BX LIVE END	14.50	790576036915
J2-BXLE-WT	J SERIES 2 CIRCUIT BX LIVE END	14.50	790576036922
J2-FLX-BK	J SERIES 2 CIRCUIT FLEXIBLE CONNECTOR	23.50	790576037196
J2-FLX-WT	J SERIES 2 CIRCUIT FLEXIBLE CONNECTOR	23.50	790576037202
J2-I-BK	J SERIES 2 CIRCUIT I JOINER	7.50	790576036939
J2-IDEC-BK	J SERIES 2 CIRCUIT I JOINER W/DEAD END	6.50	790576037035
J2-IDEC-WT	J SERIES 2 CIRCUIT I JOINER W/DEAD END	6.50	790576037042
J2-IPWR-BK	J SERIES 2 CIRCUIT W/POWER FEED	13.95	790576036953
J2-IPWR-WT	J SERIES 2 CIRCUIT W/POWER FEED	13.95	790576037028
J2-I-WT	J SERIES 2 CIRCUIT I JOINER	7.50	790576036946
J2-LE-BK	J SERIES 2 CIRCUIT LIVE END	10.50	790576037059
J2-LE-WT	J SERIES 2 CIRCUIT LIVE END	10.50	790576037066
J2-LLEFT-BK	J SERIES 2 CIRCUIT LEFT L JOINER	16.95	790576037073
J2-LLEFT-WT	J SERIES 2 CIRCUIT LEFT L JOINER	16.95	790576037080
J2-LRIGHT-BK	J SERIES 2 CIRCUIT RIGHT L JOINER	16.95	790576037134
J2-LRIGHT-WT	J SERIES 2 CIRCUIT RIGHT L JOINER	16.95	790576037141
J2-T12-BK	J SERIES 2 CIRCUIT 12FT TRACK	69.95	790576036892
J2-T12-WT	J SERIES 2 CIRCUIT 12FT TRACK	69.95	790576036908
J2-T4-BK	J SERIES 2 CIRCUIT 4FT TRACK	25.95	790576036854
J2-T4-WT	J SERIES 2 CIRCUIT 4FT TRACK	25.95	790576036861
J2-T8-BK	J SERIES 2 CIRCUIT 8FT TRACK	48.50	790576036878
J2-T8-WT	J SERIES 2 CIRCUIT 8FT TRACK	48.50	790576036885
J2-T-BK	J SERIES 2 CIRCUIT T JOINER	19.95	790576037158
J2-TBLE-BK	J SERIES 2 CIRCUIT T-BAR LIVE END	16.50	790576037233
J2-TBLE-WT	J SERIES 2 CIRCUIT T-BAR LIVE END	16.50	790576037240
J2-T-WT	J SERIES 2 CIRCUIT T JOINER	19.95	790576037165
J2-UCP-BK	J SERIES 2 CIRCUIT CANOPY COVER	5.95	790576037219
J2-UCP-WT	J SERIES 2 CIRCUIT CANOPY COVER	5.95	790576037226
J2-WCOV-BK	J SERIES 2 CIRCUIT TRACK SUSP WIRE COVER	6.50	790576037257
J2-WCOV-WT	J SERIES 2 CIRCUIT TRACK SUSP WIRE COVER	6.50	790576037264
J2-X-BK	J SERIES 2 CIRCUIT X JOINER	23.50	790576037172
J2-X-WT	J SERIES 2 CIRCUIT X JOINER	23.50	790576037189
J-9F-CW-BK	LED TRACK FIXTURE - 9W COOL WHITE FLOOD	144.95	790576144733
J-9F-CW-BN	LED TRACK FIXTURE - 9W COOL WHITE FLOOD	149.95	790576144740
J-9F-CW-WT	LED TRACK FIXTURE - 9W COOL WHITE FLOOD	144.95	790576144757
J-9F-WW-BK	LED TRACK FIXTURE - 9W WARM WHITE FLOOD	144.95	790576144290
J-9F-WW-BN	LED TRACK FIXTURE - 9W WARM WHITE FLOOD	149.95	790576144306
J-9F-WW-WT	LED TRACK FIXTURE - 9W WARM WHITE FLOOD	144.95	790576144313
J-9S-CW-BK	TRACK FIXTURE - 9W COOL WHITE SPOT	144.95	790576144207

Material	Description	2011 DN	UPC Code
J-9S-CW-BN	LED TRACK FIXTURE - 9W COOL WHITE SPOT	149.95	790576144214
J-9S-CW-WT	LED TRACK FIXTURE - 9W COOL WHITE SPOT	144.95	790576144221
J-9S-WW-BK	LED TRACK FIXTURE - 9W WARM WHITE SPOT	144.95	790576144115
J-9S-WW-BN	LED TRACK FIXTURE - 9W WARM WHITE SPOT	149.95	790576144122
J-9S-WW-WT	LED TRACK FIXTURE - 9W WARM WHITE SPOT	144.95	790576144139
JBXLE-BK	J SERIES LIVE END CONNECTOR FOR BX CABLE	8.50	790576005881
JBXLE-BN	J SERIES LIVE END CONNECTOR FOR BX CABLE	9.50	790576145464
JBXLE-DB	J SERIES LIVE END CONNECTOR FOR BX CABLE	9.50	790576140209
JBXLE-WT	J SERIES LIVE END CONNECTOR FOR BX CABLE	8.50	790576005898
JC-05	LAMP HALOGEN G4 BI-PIN 12V 5W	1.25	790576005904
JC-10	LAMP HALOGEN G4 BI-PIN 12V 10W	1.25	790576005911
JC-20	LAMP HALOGEN G4 BI-PIN 12V 20W	1.25	790576005928
JC-20-G635	HALOGEN LAMP GY635 BI-PIN 12V 2	1.25	790576168791
JC-50	LAMP HALOGEN G6.35 BI-PIN 12V 50W	1.25	790576005935
JCD-25-CL	LAMP HALOGEN G8.0 BI-PIN 110V-130V 25W	2.50	790576020433
JCD-25X-CL	LAMP XENON BI-PIN 25W 120V CLEAR	2.50	790576114903
JCD-50-CL	LAMP HALOGEN GY6.35 BI-PIN 110V-130V 50W	2.50	790576005966
JCD-50-FR	LAMP HALOGEN GY6.35 BI-PIN 110V-130V 50W	2.50	790576005973
JCLIP	J SERIES 2 CIRCUIT CONVERSION CLIP	0.15	790576005980
J-ENDCAP-BK	J SERIES END CAP FOR TRACK	0.95	790576023359
J-ENDCAP-BN	J SERIES END CAP FOR TRACK	0.95	790576145471
J-ENDCAP-DB	J SERIES END CAP FOR TRACK	0.95	790576140216
J-ENDCAP-WT	J SERIES END CAP FOR TRACK	0.95	790576023366
JFC-BK	J SERIES FLOATING CANOPY CONNECTOR	7.95	790576006192
JFC-BN	J SERIES FLOATING CANOPY CONNECTOR	9.50	790576145488
JFC-DB	J SERIES FLOATING CANOPY CONNECTOR	9.50	790576140223
JFC-WT	J SERIES FLOATING CANOPY CONNECTOR	7.95	790576006208
JFLX-BK	J SERIES FLEXIBLE TRACK CONNECTOR	10.95	790576006215
JFLX-BN	J SERIES FLEXIBLE TRACK CONNECTOR	12.50	790576145495
JFLX-DB	J SERIES FLEXIBLE TRACK CONNECTOR	12.50	790576140230
JFLX-WT	J SERIES FLEXIBLE TRACK CONNECTOR	10.95	790576006222
JHT-007-BK	J SERIES LOW VOLT TRACK HEAD 50W	28.95	790576006239
JHT-007-BN	J SERIES LOW VOLT TRACK HEAD 50W	32.95	790576147345
JHT-007L-BK	J SERIES LOW VOLT TRACK HEAD 75W	31.95	790576018874
JHT-007L-BN	J SERIES LOW VOLT TRACK HEAD 75W	35.95	790576160023
JHT-007L-WT	J SERIES LOW VOLT TRACK HEAD 75W	31.95	790576006253
JHT-007-WT	J SERIES LOW VOLT TRACK HEAD 50W	28.95	790576006246
JHT-009L-BK	J SERIES LOW VOLT FRAMING PROJECTOR 75W	149.50	790576049168
JHT-009L-WT	J SERIES LOW VOLT FRAMING PROJECTOR 75W	149.50	790576049175
JHT-1102-BK	J SERIES LOW VOLT TRACK HEAD 35W	26.95	790576006260
JHT-1102-WT	J SERIES LOW VOLT TRACK HEAD 35W	26.95	790576006291
JHT-1109-BK	J SERIES LOW VOLT TRACK HEAD 35W	26.95	790576006307
JHT-1109-WT	J SERIES LOW VOLT TRACK HEAD 35W	26.95	790576006338
JHT-1126-BK	J SERIES LOW VOLT TRACK HEAD 35W	45.95	790576006345
JHT-1126-WT	J SERIES LOW VOLT TRACK HEAD 35W	45.95	790576006352
JHT-160-BK	J SERIES LOW VOLT TRACK HEAD 50W	27.95	790576016023
JHT-160L-BK	J SERIES LOW VOLT TRACK HEAD 75W	30.95	790576021867
JHT-160L-WT	J SERIES LOW VOLT TRACK HEAD 75W	30.95	790576021874
JHT-160-WT	J SERIES LOW VOLTAGE TRACK HEAD 50W	27.95	790576016030
JHT-163L-BK	J SERIES LOW VOLTAGE TRACK HEAD 75W	52.95	790576095257

Material	Description	2011 DN	UPC Code
JHT-163L-WT	J SERIES LOW VOLTAGE TRACK HEAD 75W	52.95	790576095264
JHT-164L-BK	J SERIES LOW VOLTAGE TRACK HEAD 75W	46.50	790576105604
JHT-164L-WT	J SERIES LOW VOLTAGE TRACK HEAD 75W	46.50	790576105611
JHT-180-BK	J SERIES LOW VOLT TRACK HEAD 50W	20.95	790576006369
JHT-180-BN	J SERIES LOW VOLT TRACK HEAD 50W	24.95	790576147352
JHT-180L-BK	J SERIES LOW VOLT TRACK HEAD 75W	23.95	790576006383
JHT-180L-BN	J SERIES LOW VOLT TRACK HEAD 75W	27.95	790576160054
JHT-180L-WT	J SERIES LOW VOLT TRACK HEAD 75W	23.95	790576006390
JHT-180-WT	J SERIES LOW VOLT TRACK HEAD 50W	20.95	790576006376
JHT-204-BK	J SERIES LOW VOLT TRACK HEAD 50W	31.95	790576016085
JHT-204-BN	J SERIES LOW VOLT TRACK HEAD 50W	35.95	790576147369
JHT-204L-BK	J SERIES LOW VOLT TRACK HEAD 75W	34.95	790576021904
JHT-204L-BN	J SERIES LOW VOLT TRACK HEAD 75W	38.95	790576160085
JHT-204L-WT	J SERIES LOW VOLT TRACK HEAD 75W	34.95	790576021911
JHT-204-WT	J SERIES LOW VOLT TRACK HEAD 50W	31.95	790576016092
JHT-311L-BK	J SERIES LOW VOLTAGE TRACK HEAD 75W	79.95	790576122854
JHT-311L-WT	J SERIES LOW VOLTAGE TRACK HEAD 75W	79.95	790576122861
JHT-316L-BK	J SERIES LOW VOLTAGE TRACK HEAD 75W	69.95	790576122823
JHT-316L-WT	J SERIES LOW VOLTAGE TRACK HEAD 75W	69.95	790576122830
JHT-801-BK	J SERIES LOW VOLT TRACK HEAD 50W	29.95	790576006444
JHT-801L-BK	J SERIES LOW VOLT TRACK HEAD 75W	32.95	790576006468
JHT-801L-WT	J SERIES LOW VOLT TRACK HEAD 75W	32.95	790576006475
JHT-801-WT	J SERIES LOW VOLT TRACK HEAD 50W	29.95	790576006451
JHT-802-BK	J SERIES LOW VOLT TRACK HEAD 50W	22.95	790576006482
JHT-802-BN	J SERIES LOW VOLT TRACK HEAD 50W	26.95	790576147376
JHT-802L-BK	J SERIES LOW VOLT TRACK HEAD 75W	25.95	790576006529
JHT-802L-BN	J SERIES LOW VOLT TRACK HEAD 75W	29.95	790576160115
JHT-802L-WT	J SERIES LOW VOLT TRACK HEAD 75W	25.95	790576006550
JHT-802-WT	J SERIES LOW VOLT TRACK HEAD 50W	22.95	790576006512
JHT-808-BK	J SERIES LOW VOLT TRACK HEAD 50W	29.95	790576006581
JHT-808-DB	LOW VOLTAGE TRACK HEAD 50W	32.95	790576163321
JHT-808L-BK	J SERIES LOW VOLT TRACK HEAD 75W	32.95	790576006604
JHT-808L-DB	J SERIES LOW VOLT TRACK HEAD 75W	35.95	790576163345
JHT-808L-WT	J SERIES LOW VOLTAGE TRACK HEAD 75W	32.95	790576006611
JHT-808-WT	J SERIES LOW VOLT TRACK HEAD 50W	29.95	790576006598
JHT-809-BK	J SERIES LOW VOLT TRACK HEAD 50W	22.95	790576006628
JHT-809-BN	J SERIES LOW VOLT TRACK HEAD 50W	26.95	790576147383
JHT-809L-BK	J SERIES LOW VOLT TRACK HEAD 75W	25.95	790576006666
JHT-809L-BN	J SERIES LOW VOLTAGE TRACK HEAD 75W	29.95	790576160146
JHT-809L-WT	J SERIES LOW VOLT TRACK HEAD 75W	25.95	790576006697
JHT-809-WT	J SERIES LOW VOLT TRACK HEAD 50W	22.95	790576006659
JHT-814-BK	J SERIES LOW VOLT TRACK HEAD 50W	29.95	790576087429
JHT-814L-BK	J SERIES LOW VOLT TRACK HEAD 75W	32.95	790576088853
JHT-814L-WT	J SERIES LOW VOLT TRACK HEAD 75W	32.95	790576088860
JHT-814-WT	J SERIES LOW VOLT TRACK HEAD 50W	29.95	790576087405
JHT-815-BK	J SERIES LOW VOLT TRACK HEAD 50W	41.95	790576086484
JHT-815-PT/BK	J SERIES LOW VOLT TRACK HEAD 50W	44.95	790576086477
JHT-815-PT/WT	J SERIES LOW VOLT TRACK HEAD 50W	44.95	790576086460
JHT-815-WT	J SERIES LOW VOLT TRACK HEAD 50W	41.95	790576086453
JHT-816-BK	J SERIES LOW VOLT TRACK HEAD 50W	29.95	790576006703

Material	Description	2011 DN	UPC Code
JHT-816-BN	J SERIES LOW VOLT TRACK HEAD 50W	33.95	790576147390
JHT-816L-BK	J SERIES LOW VOLT TRACK HEAD 75W	32.95	790576006741
JHT-816L-BN	J SERIES LOW VOLT TRACK HEAD 75W	36.95	790576160177
JHT-816L-WT	J SERIES LOW VOLT TRACK HEAD 75W	32.95	790576006772
JHT-816-WT	SERIES LOW VOLT TRACK HEAD 50W	29.95	790576006734
JHT-817-BK	J SERIES LOW VOLT TRACK HEAD 50W	59.95	790576086446
JHT-817-PT/BK	J SERIES LOW VOLT TRACK HEAD 50W	62.95	790576086439
JHT-817-PT/WT	J SERIES LOW VOLT TRACK HEAD 50W	62.95	790576086422
JHT-817-WT	J SERIES LOW VOLT TRACK HEAD 50W	59.95	790576086415
JHT-819-BK	J SERIES LOW VOLT TRACK HEAD 50W	41.95	790576086408
JHT-819L-BK	J SERIES LOW VOLT TRACK HEAD 75W	44.95	790576088693
JHT-819L-PT/BK	J SERIES LOW VOLT TRACK HEAD 75W	47.95	790576088891
JHT-819L-PT/WT	J SERIES LOW VOLT TRACK HEAD 75W	47.95	790576088907
JHT-819L-WT	J SERIES LOW VOLT TRACK HEAD 75W	44.95	790576088709
JHT-819-PT/BK	J SERIES LOW VOLT TRACK HEAD 50W	44.95	790576086392
JHT-819-PT/WT	J SERIES LOW VOLT TRACK HEAD 50W	44.95	790576086385
JHT-819-WT	J SERIES LOW VOLT TRACK HEAD 50W	41.95	790576086378
JHT-826-BK	J SERIES LOW VOLT TRACK HEAD 50W	34.95	790576006789
JHT-826-BN	J SERIES LOW VOLT TRACK HEAD 50W	38.95	790576147406
JHT-826L-BK	J SERIES LOW VOLT TRACK HEAD 75W	37.95	790576006802
JHT-826L-BN	J SERIES LOW VOLT TRACK HEAD 75W	41.95	790576160207
JHT-826L-WT	J SERIES LOW VOLT TRACK HEAD 75W	37.95	790576006819
JHT-826-WT	J SERIES LOW VOLT TRACK HEAD 50W	34.95	790576006796
JHT-846-BK	J SERIES LOW VOLT TRACK HEAD 50W	38.95	790576006826
JHT-846L-BK	J SERIES LOW VOLT TRACK HEAD 75W	41.95	790576006840
JHT-846L-WT	J SERIES LOW VOLT TRACK HEAD 75W	41.95	790576006857
JHT-846-WT	J SERIES LOW VOLT TRACK HEAD 50W	38.95	790576006833
JHT-856-BK	J SERIES LOW VOLT TRACK HEAD 50W	39.95	790576036229
JHT-856-BN	SERIES LOW VOLT TRACK HEAD 50W	43.95	790576147413
JHT-856L-BK	J SERIES LOW VOLT TRACK HEAD 75W	42.95	790576040653
JHT-856L-BN	J SERIES LOW VOLT TRACK HEAD 75W	46.95	790576160238
JHT-856L-WT	J SERIES LOW VOLT TRACK HEAD 75W	42.95	790576040608
JHT-856-WT	J SERIES LOW VOLT TRACK HEAD 50W	39.95	790576036236
JHT-866-BK	J SERIES LOW VOLT TRACK HEAD 50W	30.95	790576037660
JHT-866L-BK	J SERIES LOW VOLT TRACK HEAD 75W	33.95	790576040684
JHT-866L-WT	J SERIES LOW VOLT TRACK HEAD 75W	33.95	790576040639
JHT-866-WT	J SERIES LOW VOLT TRACK HEAD 50W	30.95	790576037653
JHT-874-AB	J SERIES LOW VOLT TRACK HEAD 50W	59.95	790576143095
JHT-874-AN	J SERIES LOW VOLTAGE TRACK HEAD 50W	59.95	790576193557
JHT-874L-AB	J SERIES LOW VOLT TRACK HEAD 75W	62.95	790576143279
JHT-874L-AN	J SERIES LOW VOLTAGE TRACK HEAD 75W	62.95	790576193618
JHT-874-LENS-AB	J SERIES LOW VOLT TRACK HEAD 50W W/LENS	64.95	790576143248
JHT-874-LENS-AN	LENS OPTION	64.95	790576193588
JHT-874L-LENS-AB	J SERIES LOW VOLT TRACK HEAD 75W W/LENS	67.95	790576143309
JHT-874L-LENS-AN	LENS OPTION	67.95	790576193649
JHT-886-AB	J SERIES LOW VOLT TRACK HEAD 50W	59.95	790576143583
JHT-886-AN	J SERIES LOW VOLTAGE TRACK HEAD 50W	59.95	790576193793
JHT-886L-AB	J SERIES LOW VOLT TRACK HEAD 75W	62.95	790576143682
JHT-886L-AN	J SERIES LOW VOLTAGE TRACK HEAD 75W	62.95	790576193823
JHT-896-BK	MR16 TRACK LUMINAIRE	44.95	790576196909

Material	Description	2011 DN	UPC Code
JHT-896L-BK	MR16 TRACK LUMINAIRE	44.95	790576196923
JHT-896L-WT	MR16 TRACK LUMINAIRE	44.95	790576196930
JHT-896-WT	MR16 TRACK LUMINAIRE	44.95	790576196916
JHT-901-BK	J SERIES LOW VOLT TRACK HEAD 50W	35.95	790576006932
JHT-901-WT	J SERIES LOW VOLT TRACK HEAD 50W	35.95	790576006949
JHT-935L-BK	J SERIES LOW VOLTAGE TRACK HEAD 75W	49.95	790576105666
JHT-935L-WT	J SERIES LOW VOLTAGE TRACK HEAD 75W	49.95	790576105673
JHT-936-BK	J SERIES LOW VOLT TRACK HEAD 50W	43.95	790576006956
JHT-936L-BK	J SERIES LOW VOLT TRACK HEAD 75W	46.95	790576006970
JHT-936L-WT	J SERIES LOW VOLT TRACK HEAD 75W	46.95	790576006987
JHT-936-WT	J SERIES LOW VOLT TRACK HEAD 50W	43.95	790576006963
JHT-939L-BK	J SERIES LOW VOLTAGE TRACK HEAD 75W	55.95	790576095370
JHT-939L-WT	J SERIES LOW VOLTAGE TRACK HEAD 75W	55.95	790576095387
JI-BK	J SERIES STRAIGHT LINE CONNECTOR	4.50	790576006994
JI-BN	J SERIES STRAIGHT LINE CONNECTOR	5.95	790576145501
JI-DB	J SERIES STRAIGHT LINE CONNECTOR	5.95	790576140247
JI-DEC-BK	J SERIES I DEAD END STRAIGHT CONNECTOR	4.50	790576007007
JI-DEC-BN	J SERIES I DEAD END STRAIGHT CONNECTOR	5.95	790576145518
JI-DEC-DB	J SERIES I DEAD END STRAIGHT CONNECTOR	5.95	790576140261
JI-DEC-WT	J SERIES I DEAD END STRAIGHT CONNECTOR	4.50	790576007014
JI-PWR-BK	J SERIES I STRAIGHT LINE POWER CONNECTOR	7.50	790576007021
JI-PWR-BN	J SERIES I STRAIGHT LINE POWER CONNECTOR	8.95	790576145532
JI-PWR-DB	J SERIES I STRAIGHT LINE POWER CONNECTOR	8.95	790576140278
JI-PWR-WT	J SERIES I STRAIGHT LINE POWER CONNECTOR	7.50	790576007038
JI-WT	J SERIES STRAIGHT LINE CONNECTOR	4.50	790576007045
JLE-BK	J SERIES LIVE END CONNECTOR	4.50	790576007076
JLE-BN	J SERIES LIVE END CONNECTOR	5.95	790576145549
J-LED610F-CW-BK	LEDME TRACK LUMINAIRE	169.95	790576196190
J-LED610F-CW-BN	LEDME TRACK LUMINAIRE	174.95	790576196213
J-LED610F-CW-WT	LEDME TRACK LUMINAIRE	169.95	790576196206
J-LED610F-WW-BK	LEDME TRACK LUMINAIRE	169.95	790576196169
J-LED610F-WW-BN	LEDME TRACK LUMINAIRE	174.95	790576196183
J-LED610F-WW-WT	LEDME TRACK LUMINAIRE	169.95	790576196176
J-LED610S-CW-BK	LEDME TRACK LUMINAIRE	169.95	790576197104
J-LED610S-CW-BN	LEDME TRACK LUMINAIRE	174.95	790576197111
J-LED610S-CW-WT	LEDME TRACK LUMINAIRE	169.95	790576197128
J-LED610S-WW-BK	LEDME TRACK LUMINAIRE	169.95	790576197074
J-LED610S-WW-BN	LEDME TRACK LUMINAIRE	174.95	790576197081
J-LED610S-WW-WT	LEDME TRACK LUMINAIRE	169.95	790576197098
J-LED710F-CW-AB	LEDME TRACK LUMINAIRE	179.95	790576196565
J-LED710F-CW-AN	LEDME TRACK LUMINAIRE	179.95	790576196572
J-LED710F-CW-SB/BK	LEDME TRACK LUMINAIRE	184.95	790576196589
J-LED710F-WW-AB	LEDME TRACK LUMINAIRE	179.95	790576196503
J-LED710F-WW-AN	LEDME TRACK LUMINAIRE	179.95	790576196510
J-LED710F-WW-SB/BK	LEDME TRACK LUMINAIRE	184.95	790576196527
J-LED710S-CW-AB	LEDME TRACK LUMINAIRE	179.95	790576196534
J-LED710S-CW-AN	LEDME TRACK LUMINAIRE	179.95	790576196541
J-LED710S-CW-SB/BK	LEDME TRACK LUMINAIRE	184.95	790576196558
J-LED710S-WW-AB	LEDME TRACK LUMINAIRE	179.95	790576196473
J-LED710S-WW-AN	LEDME TRACK LUMINAIRE	179.95	790576196480

Material	Description	2011 DN	UPC Code
J-LED710S-WW-SB/BK	LEDME TRACK LUMINAIRE	184.95	790576196497
J-LED810F-CW-BK	LEDME TRACK LUMINAIRE	119.95	790576196800
J-LED810F-CW-WT	LEDME TRACK LUMINAIRE	119.95	790576196817
J-LED810F-WW-BK	LEDME TRACK LUMINAIRE	119.95	790576196770
J-LED810F-WW-WT	LEDME TRACK LUMINAIRE	119.95	790576196787
J-LED810S-CW-BK	LEDME TRACK LUMINAIRE	119.95	790576196794
J-LED810S-CW-WT	LEDME TRACK LUMINAIRE	119.95	790576197357
J-LED810S-WW-BK	LEDME TRACK LUMINAIRE	119.95	790576196756
J-LED810S-WW-WT	LEDME TRACK LUMINAIRE	119.95	790576196763
JLE-DB	J SERIES LIVE END CONNECTOR	5.95	790576140285
JLE-WT	J SERIES LIVE END CONNECTOR	4.50	790576007083
JL-LEFT-BK	J SERIES LEFT L-CONNECTOR	6.95	790576007052
JL-LEFT-BN	J SERIES LEFT L-CONNECTOR	8.95	790576145556
JL-LEFT-DB	J SERIES LEFT L-CONNECTOR	8.95	790576140292
JL-LEFT-WT	J SERIES LEFT L-CONNECTOR	6.95	790576007069
J-LOOP-BK	J SERIES SUSPENSION LOOP	8.95	790576019963
J-LOOP-BN	J SERIES SUSPENSION LOOP	10.50	790576145563
J-LOOP-DB	J SERIES SUSPENSION LOOP	10.50	790576140308
J-LOOP-WT	J SERIES SUSPENSION LOOP	8.95	790576019970
JL-RIGHT-BK	J SERIES RIGHT L-CONNECTOR	6.95	790576059303
JL-RIGHT-BN	J SERIES RIGHT L-CONNECTOR	8.95	790576145570
JL-RIGHT-DB	J SERIES RIGHT L-CONNECTOR	8.95	790576140315
JL-RIGHT-WT	J SERIES RIGHT L-CONNECTOR	6.95	790576059310
JMP-BK	J SERIES MONOPOINT CANOPY	9.95	790576007090
JMP-BN	J SERIES MONOPOINT CANOPY	11.50	790576145587
JMP-DB	J SERIES MONOPOINT CANOPY	11.50	790576140322
JMP-WT	J SERIES MONOPOINT CANOPY	9.95	790576007106
JT2-BK	J SERIES 2FT TRACK W/2 ENDCAPS	9.95	790576007151
JT2-BN	J SERIES 2FT TRACK W/2 ENDCAPS	12.95	790576124872
JT2-DB	J SERIES 2FT TRACK W/2 ENDCAPS	12.95	790576140162
JT2-WT	J SERIES 2FT TRACK W/2 ENDCAPS	9.95	790576007168
JT4-BK	J SERIES 4FT TRACK W/2 ENDCAPS	13.95	790576007175
JT4-BN	J SERIES 4FT TRACK W/2 ENDCAPS	20.50	790576124889
JT4-DB	J SERIES 4FT TRACK W/2 ENDCAPS	20.50	790576140179
JT4-WT	J SERIES 4FT TRACK W/2 ENDCAPS	13.95	790576007182
JT6-BK	J SERIES 6FT TRACK W/2 ENDCAPS	20.50	790576007199
JT6-BN	J SERIES 6FT TRACK W/2 ENDCAPS	29.95	790576124896
JT6-DB	J SERIES 6FT TRACK W/2 ENDCAPS	29.95	790576140186
JT6-WT	J SERIES 6FT TRACK W/2 ENDCAPS	20.50	790576007205
JT8-BK	J SERIES 8FT TRACK W/2 ENDCAPS	23.50	790576007212
JT8-BN	J SERIES 8FT TRACK W/2 ENDCAPS	36.50	790576124902
JT8-DB	J SERIES 8FT TRACK W/2 ENDCAPS	36.50	790576140193
JT8-WT	J SERIES 8FT TRACK W/2 ENDCAPS	23.50	790576007229
JT-BK	J SERIES T CONNECTOR	9.50	790576007137
JT-BN	J SERIES T CONNECTOR	10.95	790576145594
JT-DB	J SERIES T CONNECTOR	10.95	790576140339
JTK-024-BK	J SERIES LINE VOLT TRACK HEAD	27.95	790576033891
JTK-024-WT	J SERIES LINE VOLT TRACK HEAD	27.95	790576033907
JTK-048-BK	J SERIES LINE VOLT TRACK HEAD	39.95	790576033983
JTK-048-WT	J SERIES LINE VOLT TRACK HEAD	39.95	790576033990

Material	Description	2011 DN	UPC Code
JTK-101-AM/BK	J SERIES LINE VOJTAGE TRACK HEAD	24.50	790576108896
JTK-101-AM/WT	J SERIES LINE VOJTAGE TRACK HEAD	24.50	790576108872
JTK-101-WT/BK	J SERIES LINE VOJTAGE TRACK HEAD	24.50	790576108902
JTK-101-WT/WT	J SERIES LINE VOJTAGE TRACK HEAD	24.50	790576108889
JTK-102-AM/BK	J SERIES LINE VOJTAGE TRACK HEAD	24.50	790576109015
JTK-102-AM/WT	J SERIES LINE VOJTAGE TRACK HEAD	24.50	790576108995
JTK-102-WT/BK	J SERIES LINE VOJTAGE TRACK HEAD	24.50	790576109022
JTK-102-WT/WT	J SERIES LINE VOJTAGE TRACK HEAD	24.50	790576109008
JTK-103-BK	J SERIES LINE VOJTAGE TRACK HEAD	19.95	790576109077
JTK-103-WT	J SERIES LINE VOJTAGE TRACK HEAD	19.95	790576109084
JTK-104-BK	J SERIES LINE VOJTAGE TRACK HEAD	18.95	790576109138
JTK-104-WT	J SERIES LINE VOJTAGE TRACK HEAD	18.95	790576109145
JTK-105-BK	J SERIES LINE VOJTAGE TRACK HEAD	19.95	790576109190
JTK-105-WT	J SERIES LINE VOJTAGE TRACK HEAD	19.95	790576109206
JTK-132E-AB	J SERIES CFL TRACK HEAD 32W	125.95	790576141978
JTK-132E-AN	J SERIES CFL TRACK HEAD 32W	124.95	790576193762
JTK-150-BK	J SERIES LINE VOLT TRACK HEAD - DIE CAST	44.95	790576007250
JTK-150-WT	J SERIES LINE VOLT TRACK HEAD - DIE CAST	44.95	790576007267
JTK-178-BK	J SERIES LINE VOLT TRACK HEAD	8.95	790576014166
JTK-178-BN	J SERIES LINE VOLT TRACK HEAD	12.95	790576147598
JTK-178-WT	J SERIES LINE VOLT TRACK HEAD	8.95	790576014173
JTK-188-BK	J SERIES LINE VOLT TRACK HEAD	9.95	790576007274
JTK-188-BN	J SERIES LINE VOLT TRACK HEAD	13.95	790576147604
JTK-188-DB	J SERIES LINE VOLT TRACK HEAD	13.95	790576163376
JTK-188-WT	J SERIES LINE VOLT TRACK HEAD	9.95	790576007281
JTK-331-BK	L SERIES LINE VOLTAGE TRACK HEAD	75.95	790576122885
JTK-331-WT	L SERIES LINE VOLTAGE TRACK HEAD	75.95	790576122892
JTK-512AM/BN	JILL PENDANT FOR J SERIES TRACK - 120V 5	74.95	790576155951
JTK-512AM/DB	JILL PENDANT FOR J SERIES TRACK - 120V 5	74.95	790576155944
JTK-512BL/BN	JILL PENDANT FOR J SERIES TRACK - 120V 5	74.95	790576155975
JTK-512BL/DB	JILL PENDANT FOR J SERIES TRACK - 120V 5	74.95	790576155968
JTK-512GR/BN	JILL PENDANT FOR J SERIES TRACK - 120V 5	74.95	790576155999
JTK-512GR/DB	JILL PENDANT FOR J SERIES TRACK - 120V 5	74.95	790576155982
JTK-512RD/BN	JILL PENDANT FOR J SERIES TRACK - 120V 5	74.95	790576156019
JTK-512RD/DB	JILL PENDANT FOR J SERIES TRACK - 120V 5	74.95	790576156002
JTK-512WT/BN	JILL PENDANT FOR J SERIES TRACK - 120V 5	74.95	790576156033
JTK-512WT/DB	JILL PENDANT FOR J SERIES TRACK - 120V 5	74.95	790576156026
JTK-513AM/BN	ELLA PENDANT FOR J SERIES TRACK - 120V 5	83.95	790576156057
JTK-513AM/DB	ELLA PENDANT FOR J SERIES TRACK - 120V 5	83.95	790576156040
JTK-513WT/BN	ELLA PENDANT FOR J SERIES TRACK - 120V 5	83.95	790576156071
JTK-513WT/DB	ELLA PENDANT FOR J SERIES TRACK - 120V 5	83.95	790576156064
JTK-515AM/BN	FIORE PENDANT FOR J SERIES TRACK - 120V	114.95	790576156118
JTK-515AM/DB	FIORE PENDANT FOR J SERIES TRACK - 120V	114.95	790576156101
JTK-515MF/BN	FIORE PENDANT FOR J SERIES TRACK - 120V	114.95	790576156118
JTK-515MF/DB	FIORE PENDANT FOR J SERIES TRACK - 120V	114.95	790576156101
JTK-517WT/BN	OBO PENDANT FOR J SERIES TRACK - 120V 50	79.95	790576156170
JTK-517WT/DB	OBO PENDANT FOR J SERIES TRACK - 120V 50	79.95	790576156163
JTK-518DIC/BN	EDEN PENDANT FOR J SERIES TRACK - 120V 5	129.95	790576156194
JTK-518DIC/DB	EDEN PENDANT FOR J SERIES TRACK - 120V 5	129.95	790576156187
JTK-524AM/BN	SARAH PENDANT FOR J SERIES TRACK - 120V	78.95	790576156279



Material	Description	2011 DN	UPC Code
JTK-524AM/DB	SARAH PENDANT FOR J SERIES TRACK - 120V	78.95	790576156262
JTK-524LB/BN	SARAH PENDANT FOR J SERIES TRACK - 120V	78.95	790576156293
JTK-524LB/DB	SARAH PENDANT FOR J SERIES TRACK - 120V	78.95	790576156286
JTK-524TQ/BN	SARAH PENDANT FOR J SERIES TRACK - 120V	78.95	790576156316
JTK-524TQ/DB	SARAH PENDANT FOR J SERIES TRACK - 120V	78.95	790576156309
JTK-524WT/BN	SARAH PENDANT FOR J SERIES TRACK - 120V	78.95	790576156330
JTK-524WT/DB	SARAH PENDANT FOR J SERIES TRACK - 120V	78.95	790576156323
JTK-530GR/BN	COUTURE PENDANT FOR J SERIES TRACK - 120	169.95	790576156354
JTK-530GR/DB	COUTURE PENDANT FOR J SERIES TRACK - 120	169.95	790576156347
JTK-530MC/BN	COUTURE PENDANT FOR J SERIES TRACK - 120	169.95	790576156378
JTK-530MC/DB	COUTURE PENDANT FOR J SERIES TRACK - 120	169.95	790576156361
JTK-534SM/BN	PENDANT FOR J SERIES TRACK - 120	99.95	790576195353
JTK-534SM/DB	PENDANT FOR J SERIES TRACK - 120	99.95	790576195360
JTK-536BL/BN	PENDANT FOR J SERIES TRACK - 120	114.95	790576195575
JTK-536BL/DB	PENDANT FOR J SERIES TRACK - 120	114.95	790576195582
JTK-541AM/BN	FABERGE PENDANT FOR J SERIES TRACK - 120	86.95	790576156415
JTK-541AM/DB	FABERGE PENDANT FOR J SERIES TRACK - 120	86.95	790576156408
JTK-541WT/BN	FABERGE PENDANT FOR J SERIES TRACK - 120	86.95	790576156439
JTK-541WT/DB	FABERGE PENDANT FOR J SERIES TRACK - 120	86.95	790576156422
JTK-546DIC/BN	AMBROSIA PENDANT FOR J SERIES TRACK - 12	149.95	790576156477
JTK-546DIC/DB	AMBROSIA PENDANT FOR J SERIES TRACK - 12	149.95	790576156460
JTK-548FR/BN	PURA PENDANT FOR J SERIES TRACK - 120V 5	99.95	790576156514
JTK-548FR/DB	PURA PENDANT FOR J SERIES TRACK - 120V 5	99.95	790576156507
JTK-559DIC/BN	MICHA PENDANT FOR J SERIES TRACK - 120V	89.95	790576178097
JTK-559DIC/DB	MICHA PENDANT FOR J SERIES TRACK - 120V	89.95	790576178127
JTK-559GL/BN	MICHA PENDANT FOR J SERIES TRACK - 120V	89.95	790576173306
JTK-559GL/DB	MICHA PENDANT FOR J SERIES TRACK - 120V	89.95	790576173344
JTK-559MR/BN	MICHA PENDANT FOR J SERIES TRACK - 120V	89.95	790576179124
JTK-559MR/DB	MICHA PENDANT FOR J SERIES TRACK - 120V	89.95	790576179155
JTK-593LI/BN	KOMAL PENDANT FOR J SERIES TRACK - 120V	129.95	790576156590
JTK-593LI/DB	KOMAL PENDANT FOR J SERIES TRACK - 120V	129.95	790576156583
JTK-593RD/BN	KOMAL PENDANT FOR J SERIES TRACK - 120V	129.95	790576156613
JTK-593RD/DB	KOMAL PENDANT FOR J SERIES TRACK - 120V	129.95	790576156606
JTK-593TQ/BN	KOMAL PENDANT FOR J SERIES TRACK - 120V	129.95	790576156637
JTK-593TQ/DB	KOMAL PENDANT FOR J SERIES TRACK - 120V	129.95	790576156620
JTK-598WT/BN	DAPPER PENDANT FOR J SERIES TRACK - 120V	114.95	790576156651
JTK-598WT/DB	DAPPER PENDANT FOR J SERIES TRACK - 120V	114.95	790576156644
JTK-599BL/BN	RHEA PENDANT FOR J SERIES TRACK - 120V	99.95	790576175546
JTK-599BL/DB	RHEA PENDANT FOR J SERIES TRACK - 120V	99.95	790576175560
JTK-599UM/BN	RHEA PENDANT FOR J SERIES TRACK - 120V	99.95	790576177601
JTK-599UM/DB	RHEA PENDANT FOR J SERIES TRACK - 120V	99.95	790576177625
JTK-599WT/BN	RHEA PENDANT FOR J SERIES TRACK - 120V	99.95	790576176574
JTK-599WT/DB	RHEA PENDANT FOR J SERIES TRACK - 120V	99.95	790576176604
JTK-701-BK	J SERIES LINE VOLT TRACK HEAD	10.95	790576007298
JTK-701-WT	J SERIES LINE VOLT TRACK HEAD	10.95	790576007304
JTK-703-BK	J SERIES LINE VOLT TRACK HEAD	10.95	790576007342
JTK-703-WT	J SERIES LINE VOLT TRACK HEAD	10.95	790576007359
JTK-704-BK	J SERIES LINE VOLT TRACK HEAD	12.50	790576007366
JTK-704-WT	J SERIES LINE VOLT TRACK HEAD	12.50	790576007373
JTK-705-BK	J SERIES LINE VOLT TRACK HEAD	17.95	790576007380

Material	Description	2011 DN	UPC Code
JTK-705-WT	J SERIES LINE VOLT TRACK HEAD	17.95	790576007397
JTK-706-BK	J SERIES LINE VOLT TRACK HEAD	17.95	790576007403
JTK-706-WT	J SERIES LINE VOLT TRACK HEAD	17.95	790576007410
JTK-713-BK	J SERIES LINE VOLTAGE TRACK HEAD	42.50	790576095462
JTK-713-WT	J SERIES LINE VOLTAGE TRACK HEAD	42.50	790576095479
JTK-715-BK	J SERIES LINE VOLTAGE TRACK HEAD	47.95	790576095554
JTK-715-WT	J SERIES LINE VOLTAGE TRACK HEAD	47.95	790576095561
JTK-717-BK	J SERIES LINE VOLT TRACK HEAD	11.95	790576035949
JTK-717-WT	J SERIES LINE VOLT TRACK HEAD	11.95	790576035956
JTK-718-BK	J SERIES LINE VOLT TRACK HEAD	12.50	790576007427
JTK-718-WT	J SERIES LINE VOLT TRACK HEAD	12.50	790576007434
JTK-720-BK	J SERIES LINE VOLT TRACK HEAD - DIE CAST	24.95	790576007458
JTK-720-WT	J SERIES LINE VOLT TRACK HEAD - DIE CAST	24.95	790576007465
JTK-725-BK	J SERIES LINE VOLT TRACK HEAD	10.95	790576007472
JTK-725-WT	J SERIES LINE VOLT TRACK HEAD	10.95	790576007489
JTK-727-BK	J SERIES LINE VOLTAGE TRACK HEAD	49.95	790576095646
JTK-727-WT	J SERIES LINE VOLTAGE TRACK HEAD	49.95	790576095653
JTK-730-BK	J SERIES LINE VOLT TRACK HEAD - DIE CAST	27.95	790576007496
JTK-730-WT	J SERIES LINE VOLT TRACK HEAD - DIE CAST	27.95	790576007502
JTK-733-BK	J SERIES LINE VOLTAGE TRACK HEAD	46.50	790576095738
JTK-733-WT	J SERIES LINE VOLTAGE TRACK HEAD	46.50	790576095745
JTK-737-BK	J SERIES LINE VOLTAGE TRACK HEAD	51.95	790576095820
JTK-737-WT	J SERIES LINE VOLTAGE TRACK HEAD	51.95	790576095837
JTK-738-BK	J SERIES LINE VOLT TRACK HEAD - DIE CAST	30.95	790576007519
JTK-738-WT	SERIES LINE VOLT TRACK HEAD - DIE CAST	30.95	790576007526
JTK-747-BK	J SERIES LINE VOLTAGE TRACK HEAD	45.95	790576105727
JTK-747-WT	J SERIES LINE VOLTAGE TRACK HEAD	45.95	790576105734
JTK-753-BK	J SERIES LINE VOLT TRACK HEAD - DIE CAST	24.95	790576007595
JTK-753-WT	J SERIES LINE VOLT TRACK HEAD - DIE CAST	24.95	790576007601
JTK-754-BK	J SERIES LINE VOLT TRACK HEAD - DIE CAST	27.95	790576007618
JTK-754-WT	J SERIES LINE VOLT TRACK HEAD - DIE CAST	27.95	790576007625
JTK-755-BK	J SERIES LINE VOLT TRACK HEAD - DIE CAST	30.95	790576007632
JTK-755-WT	J SERIES LINE VOLT TRACK HEAD - DIE CAST	30.95	790576007649
JTK-757-BK	J SERIES LINE VOLTAGE TRACK HEAD	47.95	790576105789
JTK-757-WT	J SERIES LINE VOLTAGE TRACK HEAD	47.95	790576105796
JTK-763-39E-BK	J SERIES HID TRACK HEAD PAR20 39W	141.50	790576118963
JTK-763-39E-PT/BK	J SERIES HID TRACK HEAD PAR20 39W	145.50	790576118987
JTK-763-39E-PT/WT	J SERIES HID TRACK HEAD PAR20 39W	145.50	790576118994
JTK-763-39E-WT	J SERIES HID TRACK HEAD PAR20 39W	141.50	790576118970
JTK-763-BK	J SERIES LINE VOLT TRACK HEAD	11.50	790576038360
JTK-763-BN	J SERIES LINE VOLT TRACK HEAD	15.50	790576147611
JTK-763-WT	J SERIES LINE VOLT TRACK HEAD	11.50	790576038377
JTK-764-39E-BK	J SERIES HID TRACK HEAD PAR30L 39W	146.50	790576119090
JTK-764-39E-PT/BK	J SERIES HID TRACK HEAD PAR30L 39W	150.50	790576119113
JTK-764-39E-PT/WT	J SERIES HID TRACK HEAD PAR30L 39W	150.50	790576119120
JTK-764-39E-WT	J SERIES HID TRACK HEAD PAR30L 39W	146.50	790576119106
JTK-764-70E-BK	J SERIES HID TRACK HEAD PAR30L 70W	151.50	790576119212
JTK-764-70E-PT/BK	J SERIES HID TRACK HEAD PAR30L 70W	155.50	790576119236
JTK-764-70E-PT/WT	J SERIES HID TRACK HEAD PAR30L 70W	155.50	790576119243
JTK-764-70E-WT	J SERIES HID TRACK HEAD PAR30L 70W	151.50	790576119229

Material	Description	2011 DN	UPC Code
JTK-764-BK	J SERIES LINE VOLT TRACK HEAD	12.25	790576038391
JTK-764-BN	J SERIES LINE VOLT TRACK HEAD	16.25	790576147628
JTK-764-WT	J SERIES LINE VOLT TRACK HEAD	12.25	790576038407
JTK-765-70E-BK	J SERIES HID TRACK HEAD PAR38 70W	156.50	790576119335
JTK-765-70E-PT/BK	J SERIES HID TRACK HEAD PAR38 70W	160.50	790576119359
JTK-765-70E-PT/WT	J SERIES HID TRACK HEAD PAR38 70W	160.50	790576119366
JTK-765-70E-WT	J SERIES HID TRACK HEAD PAR38 70W	156.50	790576119342
JTK-765-BK	J SERIES LINE VOLT TRACK HEAD	13.00	790576038520
JTK-765-BN	J SERIES LINE VOLT TRACK HEAD	17.00	790576147635
JTK-765-WT	J SERIES LINE VOLT TRACK HEAD	13.00	790576038421
JTK-773-BK	J SERIES LINE VOLT TRACK HEAD	24.50	790576036083
JTK-773-BN	J SERIES LINE VOLT TRACK HEAD	28.50	790576147642
JTK-773-WT	J SERIES LINE VOLT TRACK HEAD	24.50	790576036090
JTK-774-BK	J SERIES LINE VOLT TRACK HEAD	26.50	790576036106
JTK-774-BN	J SERIES LINE VOLT TRACK HEAD	30.50	790576147659
JTK-774-WT	J SERIES LINE VOLT TRACK HEAD	26.50	790576036113
JTK-775-BK	J SERIES LINE VOLT TRACK HEAD	28.50	790576036120
JTK-775-BN	J SERIES LINE VOLT TRACK HEAD	32.50	790576147666
JTK-775-WT	J SERIES LINE VOLT TRACK HEAD	28.50	790576036137
JTK-793-AB	J SER. LINE VOLTAGE TRACK HEAD PAR20 50W	64.95	790576141992
JTK-793-AN	J SERIES LINE VOLTAGE TRACK HEAD PAR20 50W	64.95	790576193366
JTK-794-AB	J SER.LINE VOLTAGE TRACK HEAD PAR30 75W	66.95	790576142012
JTK-794-AN	J SERIES LINE VOLTAGE TRACK HEAD PAR30 75W	66.95	790576193397
JTK-795-AB	J SER LINE VOLTAGE TRACK HEAD PAR38 150W	68.95	790576142036
JTK-795-AN	J SERIES LINE VOLTAGE TRACK HEAD PAR38 150W	68.95	790576193410
JTK-797-AB	J SER. LINE VOLTAGE TRACK HEAD PAR20 50W	64.95	790576141916
JTK-797-AN	J SERIES LINE VOLTAGE TRACK HEAD PAR20 50W	64.95	790576193274
JTK-797-LENS-AB	J SERIES LINE VOLT TRACK HEAD 50W W/LENS	69.95	790576143439
JTK-797-LENS-AN	W/ LENS OPTION	69.95	790576193670
JTK-798-AB	J SER. LINE VOLTAGE TRACK HEAD PAR30 75W	66.95	790576141930
JTK-798-AN	J SERIES LINE VOLTAGE TRACK HEAD PAR30 75W	66.95	790576193304
JTK-798-LENS-AB	J SERIES LINE VOLT TRACK HEAD 75W W/LENS	71.95	790576143521
JTK-798-LENS-AN	W/ LENS OPTION	71.95	790576193700
JTK-799-AB	J SER.LINE VOLTAGE TRACK HEAD PAR38 150W	68.95	790576141954
JTK-799-AN	J SERIES LINE VOLTAGE TRACK HEAD PAR38 150W	68.95	790576193335
JTK-799-LENS-AB	J SERIES LINE VOLT TRACK HEAD 150W W/LEN	73.95	790576143552
JTK-799-LENS-AN	W/ LENS OPTION	73.95	790576193731
JTK-F1-402AM/DB	J SERIES TRACK PENDANT - CFL GU24	116.95	790576183466
JTK-F1-402BL/DB	J SERIES TRACK PENDANT - CFL GU24	116.95	790576183954
JTK-F1-402WM/DB	J SERIES TRACK PENDANT - CFL GU24	116.95	790576184425
JTK-F1-403AM/DB	J SERIES TRACK PENDANT - CFL GU24	134.95	790576181158
JTK-F1-403BL/DB	J SERIES TRACK PENDANT - CFL GU24	134.95	790576181752
JTK-F1-403RD/DB	J SERIES TRACK PENDANT - CFL GU24	134.95	790576182339
JTK-F1-404BN/DB	J SERIES TRACK PENDANT - CFL GU24	99.95	790576184685
JTK-F1-404CO/DB	J SERIES TRACK PENDANT - CFL GU24	99.95	790576180557
JTK-F1-406OC/DB	J SERIES TRACK PENDANT - CFL GU24	134.95	790576182926
JTK-F1-408AM/DB	J SERIES TRACK PENDANT - CFL GU24	134.95	790576184807
JTK-F1-408WT/DB	J SERIES TRACK PENDANT - CFL GU24	134.95	790576184937
JTK-F1-421GR/DB	MOSS PENDANT FOR J SERIES TRACK - CFL GU	189.95	790576159768
JTK-F1-423PR/DB	SOLSTICE PENDANT FOR J SERIES TRACK - CF	199.95	790576159775

Material	Description	2011 DN	UPC Code
JTK-F1-424WT/DB	SERAPHIM PENDANT FOR J SERIES TRACK - CF	219.95	790576159782
JTK-F1-451AM/DB	J SERIES TRACK PENDANT - CFL GU24	119.95	790576181929
JTK-F1-451BL/DB	J SERIES TRACK PENDANT - CFL GU24	119.95	790576182544
JTK-F1-451WT/DB	J SERIES TRACK PENDANT - CFL GU24	119.95	790576183176
JTK-F1-454AM/DB	J SERIES TRACK PENDANT - CFL GU24	119.95	790576183725
JTK-F1-454WT/DB	J SERIES TRACK PENDANT - CFL GU24	119.95	790576184210
JTK-F1-471WT/DB	MODE PENDANT FOR J SERIES TRACK - CFL GU	119.95	790576159805
JTK-F1-472WT/DB	CLINTON PENDANT FOR J SERIES TRACK - CFL	129.95	790576159812
JTK-F1-474WT/DB	CAROL GARDENS PENDANT FOR J SERIES TRACK	144.95	790576159829
JTK-F1-483IV/DB	WILLIAMSBURG PENDANT FOR J SERIES TRACK	149.95	790576159836
JTK-F1-484BL/DB	PENDANT FOR J SERIES TRACK	149.95	790576200729
JTK-F1-485BL/DB	PENDANT FOR J SERIES TRACK	189.95	
JTK-F1-487AM/DB	COBBLE HILL PENDANT FOR J SERIES TRACK -	149.95	790576159850
JTK-F1-488WT/DB	PARK SLOPE PENDANT FOR J SERIES TRACK -	193.95	790576159867
JTK-F2-402AM/BN	J SERIES TRACK PENDANT - CFL GU24	116.95	790576183503
JTK-F2-402BL/BN	J SERIES TRACK PENDANT - CFL GU24	116.95	790576183992
JTK-F2-402WM/BN	J SERIES TRACK PENDANT - CFL GU24	116.95	790576184463
JTK-F2-403AM/BN	J SERIES TRACK PENDANT - CFL GU24	134.95	790576181202
JTK-F2-403BL/BN	J SERIES TRACK PENDANT - CFL GU24	134.95	790576181790
JTK-F2-403RD/BN	J SERIES TRACK PENDANT - CFL GU24	134.95	790576182384
JTK-F2-404BN/BN	J SERIES TRACK PENDANT - CFL GU24	99.95	790576184722
JTK-F2-404CO/BN	J SERIES TRACK PENDANT - CFL GU24	99.95	790576180618
JTK-F2-406OC/BN	J SERIES TRACK PENDANT - CFL GU24	134.95	790576182964
JTK-F2-408AM/BN	J SERIES TRACK PENDANT - CFL GU24	134.95	790576184814
JTK-F2-408WT/BN	J SERIES TRACK PENDANT - CFL GU24	134.95	790576184944
JTK-F2-421GR/BN	LINE VOLTAGE TRACK MOUNT PENDANT KIT	189.95	790576143187
JTK-F2-423PR/BN	LINE VOLTAGE TRACK MOUNT PENDANT KIT	199.95	790576143361
JTK-F2-424WT/BN	LINE VOLTAGE TRACK MOUNT PENDANT KIT	219.95	790576144559
JTK-F2-451AM/BN	J SERIES TRACK PENDANT - CFL GU24	119.95	790576181974
JTK-F2-451BL/BN	J SERIES TRACK PENDANT - CFL GU24	119.95	790576182605
JTK-F2-451WT/BN	J SERIES TRACK PENDANT - CFL GU24	119.95	790576183220
JTK-F2-454AM/BN	J SERIES TRACK PENDANT - CFL GU24	119.95	790576183763
JTK-F2-454WT/BN	J SERIES TRACK PENDANT - CFL GU24	119.95	790576184258
JTK-F2-471WT/BN	LINE VOLTAGE TRACK MOUNT PENDANT KIT	119.95	790576143712
JTK-F2-472WT/BN	LINE VOLTAGE TRACK MOUNT PENDANT KIT	129.95	790576143880
JTK-F2-474WT/BN	LINE VOLTAGE TRACK MOUNT PENDANT KIT	144.95	790576144436
JTK-F2-483IV/BN	LINE VOLTAGE TRACK MOUNT PENDANT KIT	149.95	790576144498
JTK-F2-484BL/BN	J SERIES TRACK PENDANT - CFL GU24	149.95	790576200736
JTK-F2-485BL/BN	J SERIES TRACK PENDANT - CFL GU24	189.95	
JTK-F2-487AM/BN	LINE VOLTAGE TRACK MOUNT PENDANT KIT	149.95	790576144528
JTK-F2-488WT/BN	LINE VOLTAGE TRACK MOUNT PENDANT KIT	193.95	790576144443
JTK-F4-402AM/BK	LIZA PENDANT FOR J SERIES TRACK MOUNT -	80.95	790576153490
JTK-F4-402AM/BN	LIZA PENDANT FOR J SERIES TRACK MOUNT -	81.95	790576153506
JTK-F4-402AM/WT	LIZA PENDANT FOR J SERIES TRACK MOUNT -	80.95	790576153513
JTK-F4-402BL/BK	LIZA PENDANT FOR J SERIES TRACK MOUNT -	80.95	790576153520
JTK-F4-402BL/BN	LIZA PENDANT FOR J SERIES TRACK MOUNT -	81.95	790576153537
JTK-F4-402BL/WT	LIZA PENDANT FOR J SERIES TRACK MOUNT -	80.95	790576153544
JTK-F4-402WM/BK	LIZA PENDANT FOR J SERIES TRACK MOUNT -	80.95	790576153551
JTK-F4-402WM/BN	LIZA PENDANT FOR J SERIES TRACK MOUNT -	81.95	790576153568
JTK-F4-402WM/WT	LIZA PENDANT FOR J SERIES TRACK MOUNT -	80.95	790576153575

Material	Description	2011 DN	UPC Code
JTK-F4-403AM/BK	NOVA PENDANT FOR J SERIES TRACK MOUNT -	98.95	790576153582
JTK-F4-403AM/BN	NOVA PENDANT FOR J SERIES TRACK MOUNT -	99.95	790576153599
JTK-F4-403AM/WT	NOVA PENDANT FOR J SERIES TRACK MOUNT -	98.95	790576153605
JTK-F4-403BL/BK	NOVA PENDANT FOR J SERIES TRACK MOUNT -	98.95	790576153612
JTK-F4-403BL/BN	NOVA PENDANT FOR J SERIES TRACK MOUNT -	99.95	790576153629
JTK-F4-403BL/WT	NOVA PENDANT FOR J SERIES TRACK MOUNT -	98.95	790576153636
JTK-F4-403RD/BK	NOVA PENDANT FOR J SERIES TRACK MOUNT -	98.95	790576153643
JTK-F4-403RD/BN	NOVA PENDANT FOR J SERIES TRACK MOUNT -	99.95	790576153650
JTK-F4-403RD/WT	NOVA PENDANT FOR J SERIES TRACK MOUNT -	98.95	790576153667
JTK-F4-404BN/BK	FELIS PENDANT FOR J SERIES TRACK MOUNT -	63.95	790576153674
JTK-F4-404BN/BN	FELIS PENDANT FOR J SERIES TRACK MOUNT -	64.95	790576153681
JTK-F4-404BN/WT	FELIS PENDANT FOR J SERIES TRACK MOUNT -	63.95	790576153698
JTK-F4-404CO/BK	FELIS PENDANT FOR J SERIES TRACK MOUNT -	63.95	790576153704
JTK-F4-404CO/BN	FELIS PENDANT FOR J SERIES TRACK MOUNT -	64.95	790576153711
JTK-F4-404CO/WT	FELIS PENDANT FOR J SERIES TRACK MOUNT -	63.95	790576153728
JTK-F4-406OC/BK	FROST PENDANT FOR J SERIES TRACK MOUNT -	98.95	790576153735
JTK-F4-406OC/BN	FROST PENDANT FOR J SERIES TRACK MOUNT -	99.95	790576153742
JTK-F4-406OC/WT	FROST PENDANT FOR J SERIES TRACK MOUNT -	98.95	790576153759
JTK-F4-408AM/BK	CREAMERY PENDANT FOR J SERIES TRACK MOUN	98.95	790576153766
JTK-F4-408AM/BN	CREAMERY PENDANT FOR J SERIES TRACK MOUN	99.95	790576153773
JTK-F4-408AM/WT	CREAMERY PENDANT FOR J SERIES TRACK MOUN	98.95	790576153780
JTK-F4-408WT/BK	CREAMERY PENDANT FOR J SERIES TRACK MOUN	98.95	790576153797
JTK-F4-408WT/BN	CREAMERY PENDANT FOR J SERIES TRACK MOUN	99.95	790576153803
JTK-F4-408WT/WT	CREAMERY PENDANT FOR J SERIES TRACK MOUN	98.95	790576153810
JTK-F4-421GR/BK	J SERIES TRACK PENDANT - A19	153.95	790576183879
JTK-F4-421GR/BN	J SERIES TRACK PENDANT - A19	154.95	790576183909
JTK-F4-421GR/WT	LINE VOLTAGE TRACK MOUNT PENDAN	153.95	790576183947
JTK-F4-423PR/BK	J SERIES TRACK PENDANT - A19	163.95	790576182889
JTK-F4-423PR/BN	J SERIES TRACK PENDANT - A19	164.95	790576182933
JTK-F4-424WT/BK	J SERIES TRACK PENDANT - A19	183.95	790576180793
JTK-F4-424WT/BN	J SERIES TRACK PENDANT - A19	184.95	790576180861
JTK-F4-424WT/WT	J SERIES TRACK PENDANT - A19	183.95	790576180915
JTK-F4-451AM/BK	BONGO PENDANT FOR J SERIES TRACK MOUNT -	83.95	790576153827
JTK-F4-451AM/BN	BONGO PENDANT FOR J SERIES TRACK MOUNT -	84.95	790576153834
JTK-F4-451AM/WT	BONGO PENDANT FOR J SERIES TRACK MOUNT -	83.95	790576153841
JTK-F4-451BL/BK	BONGO PENDANT FOR J SERIES TRACK MOUNT -	83.95	790576153858
JTK-F4-451BL/BN	BONGO PENDANT FOR J SERIES TRACK MOUNT -	84.95	790576153865
JTK-F4-451BL/WT	BONGO PENDANT FOR J SERIES TRACK MOUNT -	83.95	790576153872
JTK-F4-451WT/BK	BONGO PENDANT FOR J SERIES TRACK MOUNT -	83.95	790576153889
JTK-F4-451WT/BN	BONGO PENDANT FOR J SERIES TRACK MOUNT -	84.95	790576153896
JTK-F4-451WT/WT	BONGO PENDANT FOR J SERIES TRACK MOUNT -	83.95	790576153902
JTK-F4-454AM/BK	DAX PENDANT FOR J SERIES TRACK MOUNT - A	83.95	790576153919
JTK-F4-454AM/BN	DAX PENDANT FOR J SERIES TRACK MOUNT - A	84.95	790576153926
JTK-F4-454AM/WT	DAX PENDANT FOR J SERIES TRACK MOUNT - A	83.95	790576153933
JTK-F4-454WT/BK	DAX PENDANT FOR J SERIES TRACK MOUNT - A	83.95	790576153940
JTK-F4-454WT/BN	DAX PENDANT FOR J SERIES TRACK MOUNT - A	84.95	790576153957
JTK-F4-454WT/WT	DAX PENDANT FOR J SERIES TRACK MOUNT - A	83.95	790576153964
JTK-F4-471WT/BK	J SERIES TRACK PENDANT - A19	83.95	790576184715
JTK-F4-471WT/BN	J SERIES TRACK PENDANT - A19	84.95	790576184746
JTK-F4-471WT/WT	J SERIES TRACK PENDANT - A19	83.95	790576184777

Material	Description	2011 DN	UPC Code
JTK-F4-472WT/BK	J SERIES TRACK PENDANT - A19	93.95	790576180977
JTK-F4-472WT/BN	J SERIES TRACK PENDANT - A19	94.95	790576181028
JTK-F4-472WT/WT	J SERIES TRACK PENDANT - A19	93.95	790576181073
JTK-F4-474WT/BK	J SERIES TRACK PENDANT - A19	108.95	790576180205
JTK-F4-474WT/BN	J SERIES TRACK PENDANT - A19	109.95	790576180250
JTK-F4-474WT/WT	J SERIES TRACK PENDANT - A19	108.95	790576180304
JTK-F4-483IV/BK	J SERIES TRACK PENDANT - A19	113.95	790576181226
JTK-F4-483IV/BN	J SERIES TRACK PENDANT - A19	114.95	790576181271
JTK-F4-483IV/WT	J SERIES TRACK PENDANT - A19	113.95	790576181325
JTK-F4-484BL/BK	J SERIES TRACK PENDANT - A19	113.95	790576200743
JTK-F4-484BL/BN	J SERIES TRACK PENDANT - A19	114.95	790576200750
JTK-F4-484BL/WT	J SERIES TRACK PENDANT - A19	113.95	790576200767
JTK-F4-485BL/BK	J SERIES TRACK PENDANT - A19	153.95	
JTK-F4-485BL/BN	J SERIES TRACK PENDANT - A19	154.95	
JTK-F4-485BL/WT	J SERIES TRACK PENDANT - A19	153.95	
JTK-F4-487AM/BK	J SERIES TRACK PENDANT - A19	113.95	790576183961
JTK-F4-487AM/BN	J SERIES TRACK PENDANT - A19	114.95	790576184012
JTK-F4-487AM/WT	J SERIES TRACK PENDANT - A19	113.95	790576184043
JTK-F4-488WT/BK	J SERIES TRACK PENDANT - A19	157.95	790576183060
JTK-F4-488WT/BN	J SERIES TRACK PENDANT - A19	158.95	790576183114
JTK-F4-488WT/WT	J SERIES TRACK PENDANT - A19	157.95	790576183152
JTK-HID301-39E-BK	J SERIES LINE VOLTAGE TRACK HEAD - HID LARC	227.95	790576123394
JTK-HID301-39E-WT	J SERIES LINE VOLTAGE TRACK HEAD - HID LARC	227.95	790576123400
JTK-HID301-70E-BK	J SERIES LINE VOLTAGE TRACK HEAD - HID LARC	238.95	790576123424
JTK-HID301-70E-WT	J SERIES LINE VOLTAGE TRACK HEAD - HID LARC	238.95	790576123431
JTK-HID303F-20E-BK	J SERIES LINE VOLTAGE TRACK HEAD - HID LARC	214.95	790576123172
JTK-HID303F-20E-WT	J SERIES LINE VOLTAGE TRACK HEAD - HID LARC	214.95	790576123189
JTK-HID303F-39E-BK	J SERIES LINE VOLTAGE TRACK HEAD - HID LARC	219.95	790576123264
JTK-HID303F-39E-WT	J SERIES LINE VOLTAGE TRACK HEAD - HID LARC	219.95	790576123271
JTK-HID303F-70E-BK	J SERIES LINE VOLTAGE TRACK HEAD - HID LARC	224.95	790576123356
JTK-HID303F-70E-WT	J SERIES LINE VOLTAGE TRACK HEAD - HID LARC	224.95	790576123486
JTK-HID303N-20E-BK	J SERIES LINE VOLTAGE TRACK HEAD - HID LARC	214.95	790576123141
JTK-HID303N-20E-WT	J SERIES LINE VOLTAGE TRACK HEAD - HID LARC	214.95	790576123158
JTK-HID303N-39E-BK	J SERIES LINE VOLTAGE TRACK HEAD - HID LARC	219.95	790576123233
JTK-HID303N-39E-WT	J SERIES LINE VOLTAGE TRACK HEAD - HID LARC	219.95	790576123240
JTK-HID303S-20E-BK	J SERIES LINE VOLTAGE TRACK HEAD - HID LARC	214.95	790576123110
JTK-HID303S-20E-WT	J SERIES LINE VOLTAGE TRACK HEAD - HID LARC	214.95	790576123127
JTK-HID303S-39E-BK	J SERIES LINE VOLTAGE TRACK HEAD - HID LARC	219.95	790576123202
JTK-HID303S-39E-WT	J SERIES LINE VOLTAGE TRACK HEAD - HID LARC	219.95	790576123219
JTK-HID303S-70E-BK	J SERIES LINE VOLTAGE TRACK HEAD - HID LARC	224.95	790576123295
JTK-HID303S-70E-WT	J SERIES LINE VOLTAGE TRACK HEAD - HID LARC	224.95	790576123301
JTK-HID310-20E-BK	J SERIES LINE VOLTAGE TRACK HEAD - HID LARC	199.95	790576127262
JTK-HID310-20E-WT	J SERIES LINE VOLTAGE TRACK HEAD - HID LARC	199.95	790576127286
JTK-HID310-39E-BK	J SERIES LINE VOLTAGE TRACK HEAD - HID LARC	204.95	790576127279
JTK-HID310-39E-WT	J SERIES LINE VOLTAGE TRACK HEAD - HID LARC	204.95	790576127309
JTK-HID330-39E-BK	J SERIES LINE VOLTAGE TRACK HEAD - HID LARC	214.95	790576123059
JTK-HID330-39E-WT	J SERIES LINE VOLTAGE TRACK HEAD - HID LARC	214.95	790576123066
JTK-HID330-70E-BK	J SERIES LINE VOLTAGE TRACK HEAD - HID LARC	219.95	790576123080
JTK-HID330-70E-WT	J SERIES LINE VOLTAGE TRACK HEAD - HID LARC	219.95	790576123097
JTK-W126E-HS-BK	J SERIES CFL WALL WASHER 1X26W	89.50	790576049694

Material	Description	2011 DN	UPC Code
JTK-W126E-HS-WT	J SERIES CFL WALL WASHER 1X26W	89.50	790576049700
JTK-W218E-HS-BK	J SERIES CFL WALL WASHER 2X18W	149.50	790576049762
JTK-W218E-HS-WT	J SERIES CFL WALL WASHER 2X18W	149.50	790576049779
JTK-W227E-HS-BK	J SERIES CFL WALL WASHER 2X27W	155.50	790576049960
JTK-W227E-HS-WT	J SERIES CFL WALL WASHER 2X27W	155.50	790576049977
JTK-W239E-HS-BK	J SERIES CFL WALL WASHER 2X39W	165.50	790576050041
JTK-W239E-HS-WT	J SERIES CFL WALL WASHER 2X39W	165.50	790576050058
JTK-W240E-HS-BK	J SERIES CFL WALL WASHER 2X40W	171.50	790576050089
JTK-W240E-HS-WT	J SERIES CFL WALL WASHER 2X40W	171.50	790576050096
JT-WT	J SERIES T CONNECTOR	9.50	790576007144
JX-BK	J SERIES X CONNECTOR	10.95	790576007656
JX-BN	J SERIES X CONNECTOR	12.95	790576145600
JX-DB	J SERIES X CONNECTOR	12.95	790576140346
JX-WT	J SERIES X CONNECTOR	10.95	790576007663
L-009-CW-BK	PROJECTOR-4500K	249.95	790576194813
L-009-CW-WT	PROJECTOR-4500K	249.95	790576194820
L-009-WW-BK	PROJECTOR-3000K	249.95	790576194776
L-009-WW-WT	PROJECTOR-3000K	249.95	790576194783
L126-BK	LOUVER FOR W126E-HS CFL WALL WASHER-BK	11.95	790576047935
L126-CL	LOUVER FOR W126E-HS CFL WALL WASHER-CL	11.95	790576047959
L126-WT	LOUVER FOR W126E-HS CFL WALL WASHER-WT	11.95	790576047942
L-18F-CW-BK	LED TRACK FIXTURE - 18W COOL WHITE FLOOD	194.95	790576145136
L-18F-CW-BN	TRACK FIXTURE - 18W COOL WHITE FLOOD	199.95	790576145181
L-18F-CW-WT	LED TRACK FIXTURE - 18W COOL WHITE FLOOD	194.95	790576145228
L-18F-WW-BK	LED TRACK FIXTURE - 18W WARM WHITE FLOOD	194.95	790576144993
L-18F-WW-BN	LED TRACK FIXTURE - 18W WARM WHITE FLOOD	199.95	790576145006
L-18F-WW-WT	LED TRACK FIXTURE - 18W WARM WHITE FLOOD	194.95	790576145020
L-18S-CW-BK	LED TRACK FIXTURE - 18W COOL WHITE SPOT	194.95	790576144900
L-18S-CW-BN	LED TRACK FIXTURE - 18W COOL WHITE SPOT	199.95	790576144917
L-18S-CW-WT	LED TRACK FIXTURE - 18W COOL WHITE SPOT	194.95	790576144924
L-18S-WW-BK	LED TRACK FIXTURE - 18W WARM WHITE SPOT	194.95	790576144801
L-18S-WW-BN	LED TRACK FIXTURE - 18W WARM WHITE SPOT	199.95	790576144818
L-18S-WW-WT	LED TRACK FIXTURE - 18W WARM WHITE SPOT	194.95	790576144825
L218-BK	LOUVER FOR W218E-HS CFL WALL WASHER-BK	13.95	790576048048
L218-CL	LOUVER FOR W218E-HS CFL WALL WASHER-CL	13.95	790576048062
L218-WT	LOUVER FOR W218E-HS CFL WALL WASHER-WT	13.95	790576048055
L227-BK	LOUVER FOR W227E-HS CFL WALL WASHER-BK	16.50	790576048154
L227-CL	LOUVER FOR W227E-HS CFL WALL WASHER-CL	16.50	790576048178
L227-WT	LOUVER FOR W227E-HS CFL WALL WASHER-WT	16.50	790576048161
L239-BK	LOUVER FOR W239E-HS CFL WALL WASHER-BK	19.95	790576048697
L239-CL	LOUVER FOR W239E-HS CFL WALL WASHER-CL	19.95	790576048710
L239-WT	LOUVER FOR W239E-HS CFL WALL WASHER-WT	19.95	790576048703
L240-BK	LOUVER FOR W240E-HS CFL WALL WASHER-BK	22.95	790576048420
L240-CL	LOUVER FOR W240E-HS CFL WALL WASHER-CL	22.95	790576048444
L240-WT	LOUVER FOR W240E-HS CFL WALL WASHER-WT	22.95	790576048437
L-9F-CW-BK	LED TRACK FIXTURE - 9W COOL WHITE FLOOD	144.95	790576144702
L-9F-CW-BN	LED TRACK FIXTURE - 9W COOL WHITE FLOOD	149.95	790576144719
L-9F-CW-WT	LED TRACK FIXTURE - 9W COOL WHITE FLOOD	144.95	790576144726
L-9F-WW-BK	LED TRACK FIXTURE - 9W WARM WHITE FLOOD	144.95	790576144269
L-9F-WW-BN	LED TRACK FIXTURE - 9W WARM WHITE FLOOD	149.95	790576144276

Material	Description	2011 DN	UPC Code
L-9F-WW-WT	LED TRACK FIXTURE - 9W WARM WHITE FLOOD	144.95	790576144283
L-9S-CW-BK	LED TRACK FIXTURE - 9W COOL WHITE SPOT	144.95	790576144177
L-9S-CW-BN	LED TRACK FIXTURE - 9W COOL WHITE SPOT	149.95	790576144184
L-9S-CW-WT	LED TRACK FIXTURE - 9W COOL WHITE SPOT	144.95	790576144191
L-9S-WW-BK	LED TRACK FIXTURE - 9W WARM WHITE SPOT	144.95	790576144085
L-9S-WW-BN	LED TRACK FIXTURE - 9W WARM WHITE SPOT	149.95	790576144092
L-9S-WW-WT	LED TRACK FIXTURE - 9W WARM WHITE SPOT	144.95	790576144108
LBXLE-BK	L SERIES LIVE END CONNECTOR FOR BX CABLE	8.50	790576000817
LBXLE-BN	L SERIES LIVE END CONNECTOR FOR BX CABLE	9.50	790576145617
LBXLE-DB	L SERIES LIVE END CONNECTOR FOR BX CABLE	9.50	790576140407
LBXLE-WT	L SERIES LIVE END CONNECTOR FOR BX CABLE	8.50	790576000824
LCORDSET-BK	L SERIES 15FT CORD MALE PLUG AND SWITCH	4.95	790576000848
LCORDSET-WT	L SERIES 15FT CORD MALE PLUG AND SWITCH	4.95	790576000855
LD-700MA03-EDIM-IS	LED DIMMABLE ELECTRONIC DRIVER - 700MA 3W - REMOTE	21.50	790576189048
LD-700MA09-EDIM-IS	LED DIMMABLE ELECTRONIC DRIVER - 700MA 9W - REMOTE	37.50	790576189055
LED-350MA03-RB	LED DRIVER - 350MA 3W - REMOTE	18.95	790576163697
LED-350MA09-DIM-RB	9W/350MA PUCK DIM LED DRIVER	44.95	790576167411
LED-350MA09-RB	LED DRIVER - 350MA 9W - REMOTE	34.95	790576163680
LED-350MA12-DIM-RB	12W/350MA PUCK DIM LED DRIVER	50.50	790576167404
LED-350MA12-RB	LED DRIVER - 350MA 12W - REMOTE	39.95	790576163673
LED-700MA12-P	LED DRIVER - 700MA 12W - PORTABLE	34.95	790576139111
LED-FS-60	LED FESTOON IAMP (0.60w)	5.95	790576125299
LED-FS-60-24V	LED FESTOON LAMP 24V	6.50	790576184852
LED-RL-150-AM	LED ROPE LIGHT KIT 120V 150FT	605.95	790576186368
LED-RL-150-BL	LED ROPE LIGHT KIT 120V 150FT	605.95	790576186207
LED-RL-150-GR	LED ROPE LIGHT KIT 120V 150FT	605.95	790576186252
LED-RL-150-RD	LED ROPE LIGHT KIT 120V 150FT	605.95	790576186290
LED-RL-150-WT	LED ROPE LIGHT KIT 120V 150FT	530.95	790576186153
LED-RL-15-AM	LED ROPE LIGHT KIT 120V 15FT A	73.50	790576186337
LED-RL-15-BL	LED ROPE LIGHT KIT 120V 15FT B	73.50	790576186184
LED-RL-15-GR	LED ROPE LIGHT KIT 120V 15FT G	73.50	790576186238
LED-RL-15-RD	LED ROPE LIGHT KIT 120V 15FT R	73.50	790576186276
LED-RL-15-WT	LED ROPE LIGHT KIT 120V 15FT W	65.95	790576186139
LED-RL-30-AM	LED ROPE LIGHT KIT 120V 30FT A	133.50	790576186344
LED-RL-30-BL	LED ROPE LIGHT KIT 120V 30FT B	133.50	790576186191
LED-RL-30-GR	LED ROPE LIGHT KIT 120V 30FT G	133.50	790576186245
LED-RL-30-RD	LED ROPE LIGHT KIT 120V 30FT R	133.50	790576186283
LED-RL-30-WT	LED ROPE LIGHT KIT 120V 30FT W	118.50	790576186146
LED-RL-3-BL	LED ROPE LIGHT KIT 120V 3FT BL	19.50	790576186177
LED-RL-3-GR	LED ROPE LIGHT KIT 120V 3FT GR	19.50	790576186221
LED-RL-3-WT	LED ROPE LIGHT KIT 120V 3FT WH	17.95	790576185958
LED-RL-3X-BL	LED ROPE LIGHT 120V 3FT SECTION	13.50	790576186399
LED-RL-3X-GR	LED ROPE LIGHT 120V 3FT SECTION	13.50	790576186412
LED-RL-3X-WT	LED ROPE LIGHT 120V 3FT SECTION	11.95	790576186405
LED-RL-5-AM	LED ROPE LIGHT KIT 120V 5FT AM	28.50	790576186320
LED-RL-5-RD	LED ROPE LIGHT KIT 120V 5FT RED	28.50	790576186313
LED-RL-5X-AM	LED ROPE LIGHT 120V 5FT SECTION	22.50	790576186436
LED-RL-5X-RD	LED ROPE LIGHT 120V 5FT SECTION	22.50	790576186429
LED-RL-CP	LED ROPE LIGHT - MOUNTING CLIPS	1.50	790576186382
LED-RL-PL	POWER CORD 6FT (1.6A W/ UL,CSA	5.95	790576186443



Material	Description	2011 DN	UPC Code
LED-SL-101-CW-F-BK	CASE WITH STEM - EGG - CW	55.95	790576139524
LED-SL-101-CW-F-BN	CASE WITH STEM - EGG - CW	59.95	790576139340
LED-SL-101-CW-F-CH	CASE WITH STEM - EGG - CW	59.95	790576139432
LED-SL-101-CW-S-BK	LED DISPLAY LIGHT	55.95	790576139517
LED-SL-101-CW-S-BN	LED DISPLAY LIGHT	59.95	790576139333
LED-SL-101-CW-S-CH	LED DISPLAY LIGHT	59.95	790576139425
LED-SL-101-CW-W-BK	LED DISPLAY LIGHT	55.95	790576139531
LED-SL-101-CW-W-BN	LED DISPLAY LIGHT	59.95	790576139357
LED-SL-101-CW-W-CH	LED DISPLAY LIGHT	59.95	790576139449
LED-SL-101-NW-F-BK	CASE WITH STEM - EGG - NW	55.95	790576139494
LED-SL-101-NW-F-BN	CASE WITH STEM - EGG - NW	59.95	790576139296
LED-SL-101-NW-F-CH	CASE WITH STEM - EGG - NW	59.95	790576139401
LED-SL-101-NW-S-BK	LED DISPLAY LIGHT	55.95	790576139487
LED-SL-101-NW-S-BN	LED DISPLAY LIGHT	59.95	790576139289
LED-SL-101-NW-S-CH	LED DISPLAY LIGHT	59.95	790576139395
LED-SL-101-NW-W-BK	LED DISPLAY LIGHT	55.95	790576139500
LED-SL-101-NW-W-BN	LED DISPLAY LIGHT	59.95	790576139326
LED-SL-101-NW-W-CH	LED DISPLAY LIGHT	59.95	790576139418
LED-SL-101-WW-F-BK	CASE WITH STEM-EGG-WW	55.95	790576139463
LED-SL-101-WW-F-BN	CASE WITH STEM-EGG-WW	59.95	790576139265
LED-SL-101-WW-F-CH	CASE WITH STEM-EGG-WW	59.95	790576139371
LED-SL-101-WW-S-BK	LED DISPLAY LIGHT	55.95	790576139456
LED-SL-101-WW-S-BN	LED DISPLAY LIGHT	59.95	790576139258
LED-SL-101-WW-S-CH	LED DISPLAY LIGHT	59.95	790576139364
LED-SL-101-WW-W-BK	LED DISPLAY LIGHT	55.95	790576139470
LED-SL-101-WW-W-BN	LED DISPLAY LIGHT	59.95	790576139272
LED-SL-101-WW-W-CH	LED DISPLAY LIGHT	59.95	790576139388
LED-T-1-25-WT	LED - 12 IN SECTION W/MALE AND FEMALE	399.95	790576128474
LED-T-1-AM	1FT LED TAPE LIGHT AMBER 12V AC/DC	21.50	790576129532
LED-T-1-BL	1FT LED TAPE LIGHT BLUE 12V AC/DC	21.50	790576128375
LED-T-1-GR	1FT LED TAPE LIGHT GREEN 12V AC/DC	21.50	790576128382
LED-T-1-RD	1FT LED TAPE LIGHT RED 12V AC/DC	21.50	790576128351
LED-T-1-WT	1FT LED TAPE LIGHT WHITE 12V AC/DC	18.95	790576128399
LED-T24-1-40-WT	40 X 1FT 24V INVISILED™ CLASSIC	699.95	790576164069
LED-T24-1-AM	1 FT 24V INVISILED™ CLASSIC	25.95	790576164120
LED-T24-1-BL	1 FT 24V INVISILED™ CLASSIC	25.95	790576164137
LED-T24-1-GR	1 FT 24V INVISILED™ CLASSIC	25.95	790576164144
LED-T24-1-RD	1 FT 24V INVISILED™ CLASSIC	25.95	790576164113
LED-T24-1-WT	1 FT 24V INVISILED™ CLASSIC	22.00	790576164151
LED-T24-2IN-10-AM	10 X 2IN 24V INVISILED™ CLASSIC	37.50	790576163994
LED-T24-2IN-10-BL	10 X 2IN 24V INVISILED™ CLASSIC	37.50	790576163987
LED-T24-2IN-10-GR	10 X 2IN 24V INVISILED™ CLASSIC	37.50	790576163970
LED-T24-2IN-10-RD	10 X 2IN 24V INVISILED™ CLASSIC	37.50	790576164007
LED-T24-2IN-10-WT	10 X 2IN 24V INVISILED™ CLASSIC	28.95	790576163963
LED-T24-2IN-AM	2 IN 24V INVISILED™ CLASSIC	4.50	790576164045
LED-T24-2IN-BL	2 IN 24V INVISILED™ CLASSIC	4.50	790576164038
LED-T24-2IN-GR	2 IN 24V INVISILED™ CLASSIC	4.50	790576164021
LED-T24-2IN-RD	2 IN 24V INVISILED™ CLASSIC	4.50	790576164052
LED-T24-2IN-WT	2 IN 24V INVISILED™ CLASSIC	3.50	790576164014
LED-T24-5-AM	5 FT 24V INVISILED™ CLASSIC	119.95	790576165424

Material	Description	2011 DN	UPC Code
LED-T24-5-BL	5 FT 24V INVISILED™ CLASSIC	119.95	790576165462
LED-T24-5-GR	5 FT 24V INVISILED™ CLASSIC	119.95	790576165448
LED-T24-5-RD	5 FT 24V INVISILED™ CLASSIC	119.95	790576165455
LED-T24-5-WT	5 FT 24V INVISILED™ CLASSIC	99.95	790576165431
LED-T24P-1-40-WT	PERFORMANCE	799.95	790576194271
LED-T24P-1-WT	PERFORMANCE	24.95	790576194219
LED-T24P-2IN-10-WT	PERFORMANCE	32.50	790576194257
LED-T24P-2IN-WT	PERFORMANCE	3.95	790576194240
LED-T24P-5-WT	PERFORMANCE	114.95	790576194233
LED-T24P-KIT	SOLUTION KIT	525.00	790576194264
LED-T-2IN-10-AM	LED - 2 IN SECTION W/MALE AND FEMALE	31.95	790576129563
LED-T-2IN-10-BL	LED - 2 IN SECTION W/MALE AND FEMALE	31.95	790576128559
LED-T-2IN-10-GR	LED - 2 IN SECTION W/MALE AND FEMALE	31.95	790576128566
LED-T-2IN-10-RD	LED - 2 IN SECTION W/MALE AND FEMALE	31.95	790576128535
LED-T-2IN-10-WT	LED - 2 IN SECTION W/MALE AND FEMALE	27.95	790576128573
LED-T-2IN-AM	LED - 2 IN SECTION W/MALE AND FEMALE	3.95	790576129556
LED-T-2IN-BL	LED - 2 IN SECTION W/MALE AND FEMALE	3.95	790576128504
LED-T-2IN-GR	LED - 2 IN SECTION W/MALE AND FEMALE	3.95	790576128511
LED-T-2IN-RD	LED - 2 IN SECTION W/MALE AND FEMALE	3.95	790576128481
LED-T-2IN-WT	LED - 2 IN SECTION W/MALE AND FEMALE	3.10	790576128528
LED-T-5-AM	5FT LED TAPE LIGHT AMBER 12V AC/DC	97.95	790576135236
LED-T-5-BL	5FT LED TAPE LIGHT BLUE 12V AC/DC	97.95	790576135243
LED-T-5-GR	5FT LED TAPE LIGHT GREEN 12V AC/DC	97.95	790576135250
LED-T-5-RD	5FT LED TAPE LIGHT RED 12V AC/DC	97.95	790576135229
LED-T-5-WT	5FT LED TAPE LIGHT WHITE 12V AC/DC	84.95	790576135267
LED-TC-1-40-RGB	40 X 1FT INVISILED™ PALETTE	999.95	790576163611
LED-TC-1-40-WA	40 X 1 FT INVISILED™ AURA	999.95	790576163901
LED-TC-1-RGB	1 FT INVISILED™ PALETTE	29.95	790576163628
LED-TC-1-WA	1 FT INVISILED™ AURA	29.95	790576163888
LED-TC24-SW120	CONTROLLER TO CONTROLLER	24.95	790576192871
LED-TC24-SW60	CONTROLLER TO CONTROLLER	14.95	790576192888
LED-TC-5-RGB	5 FT INVISILED™ PALLETE	139.95	790576163604
LED-TC-5-WA	5 FT INVISILED™ AURA	139.95	790576163895
LED-TC-CTR-MSD	PORTS	69.95	790576192833
LED-TC-EC	END CAP FOR 24V INVISILED™	0.95	790576163499
LED-TC-IC12	12" JOINER CABLE	2.95	790576163543
LED-TC-IC2	2" JOINER CABLE	2.50	790576163567
LED-TC-IC6	6" JOINER CABLE	2.95	790576163550
LED-TC-IC72	72" JOINER CABLE	3.95	790576163536
LED-T-CL	LED TAPE LIGHT - MOUNTING CLIPS	2.50	790576128696
LED-TC-L	L CONNECTOR FOR 24V INVISILED™	2.50	790576163598
LED-TCO-10-RGB	10 FT INVISILED PALETTE OUTDOOR	319.95	790576188393
LED-TCO-1-RGB	1 FT INVISILED PALETTE OUTDOOR	35.95	790576188379
LED-TCO-5-RGB	5 FT INVISILED PALETTE OUTDOOR	169.95	790576188386
LED-TC-X	X-CONNECTOR FOR 24V INVISILED™	4.50	790576163581
LED-TC-Y	Y-CONNECTOR FOR 24V INVISILED™	3.50	790576163574
LED-T-EC	LED TAPE LIGHT - CUT END CAP	0.50	790576128672
LED-T-IC12	LED TAPE LIGHT - 12" JOINER CABLE	2.95	790576128641
LED-T-IC2	LED TAPE LIGHT - 2" JOINER CABLE	2.50	790576128627
LED-T-IC6	LED TAPE LIGHT - 6" JOINER CABLE	2.95	790576128634

Material	Description	2011 DN	UPC Code
LED-T-IC72	LED TAPE LIGHT - 72" JOINER CABLE	3.95	790576128658
LED-T-KIT	LED TAPE LIGHT SOLUTION KIT	499.95	790576128313
LED-T-L	LED TAPE LIGHT - L CONNECTOR	2.95	790576128665
LED-TO24-10-AM	LED Outdoor Tape Light - 10 ft section, w/ male and female ends	268.95	790576168944
LED-TO24-10-BL	LED Outdoor Tape Light - 10 ft section, w/ male and female ends	268.95	790576168951
LED-TO24-10-GR	LED Outdoor Tape Light - 10 ft section, w/ male and female ends	268.95	790576168968
LED-TO24-10-RD	LED Outdoor Tape Light - 10 ft section, w/ male and female ends	268.95	790576168937
LED-TO24-10-WT	LED Outdoor Tape Light - 10 ft section, w/ male and female ends	238.95	790576168975
LED-TO24-1-AM	LED Outdoor Tape Light - 1 ft section, w/ male and female ends	31.95	790576168845
LED-TO24-1-BL	LED Outdoor Tape Light - 1 ft section, w/ male and female ends	31.95	790576168852
LED-TO24-1-GR	LED Outdoor Tape Light - 1 ft section, w/ male and female ends	31.95	790576168869
LED-TO24-1-RD	LED Outdoor Tape Light - 1 ft section, w/ male and female ends	31.95	790576168838
LED-TO24-1-WT	LED Outdoor Tape Light - 1 ft section, w/ male and female ends	28.95	790576168876
LED-TO24-5-AM	LED Outdoor Tape Light - 5 ft section, w/ male and female ends	142.95	790576168890
LED-TO24-5-BL	LED Outdoor Tape Light - 5 ft section, w/ male and female ends	142.95	790576168906
LED-TO24-5-GR	LED Outdoor Tape Light - 5 ft section, w/ male and female ends	142.95	790576168913
LED-TO24-5-RD	LED Outdoor Tape Light - 5 ft section, w/ male and female ends	142.95	790576168883
LED-TO24-5-WT	LED Outdoor Tape Light - 5 ft section, w/ male and female ends	127.95	790576168920
LED-TO24-C1	ALUMINUM CLIP - 10 PIECES	5.50	790576169040
LED-TO24-C2	ALUMINUM CLIP - 10 PIECES	5.50	790576169057
LED-TO24-C3	ALUMINUM CLIP - 10 PIECES	5.50	790576169064
LED-TO24-CH1	RETROFIT CHANNEL	4.95	790576169019
LED-TO24-CH5	RETROFIT CHANNEL	20.95	790576169026
LED-TO24-CM	INVISILED PALETTE OUTDOOR CONTROLLER - MASTER	101.95	790576188409
LED-TO24-CS	INVISILED PALETTE OUTDOOR CONTROLLER - SLAVE	101.95	790576188416
LED-TO24-EC	LED-TO-EC	0.95	790576168982
LED-TO24-IC12	OUTDOOR PALETTE JOINER CABLE	5.50	790576169200
LED-TO24-IC120	OUTDOOR PALETTE JOINER CABLE	26.50	790576169224
LED-TO24-IC120-RGB	120" JOINER CABLE FOR INVISILED™ PALETTE OUTDOOR, FROM CONTROLLER TO INVISILED™	26.50	790576188508
LED-TO24-IC12-RGB	12" JOINER CABLE FOR INVISILED™ PALETTE OUTDOOR, FROM CONTROLLER TO INVISILED™	5.50	790576188485
LED-TO24-IC6	OUTDOOR PALETTE JOINER CABLE	4.50	790576169194
LED-TO24-IC6-RGB	6" JOINER CABLE FOR INVISILED™ PALETTE OUTDOOR, FROM CONTROLLER TO INVISILED™	4.50	790576188478
LED-TO24-IC72	OUTDOOR PALETTE JOINER CABLE	15.95	790576169217
LED-TO24-IC72-RGB	72" JOINER CABLE FOR INVISILED™ PALETTE OUTDOOR, FROM CONTROLLER TO INVISILED™	15.95	790576188492
LED-TO24-SW120	120" INVISILED PALETTE OUTDOOR SIGNAL WIRE	26.50	790576188454
LED-TO24-SW60	60" INVISILED PALETTE OUTDOOR SIGNAL WIRE	15.95	790576188430
LED-TO24-WS	INVISILED PALETTE OUTDOOR CONTROLLER - WIRELESS	62.95	790576188423
LED-TO24-X	LED Outdoor Tape Light - X CONNECTOR	15.95	790576172125
LED-TO24-X-RGB	X-CONNECTOR FOR INVISILED™ PALETTE OUTDOOR	15.95	790576188515
LED-TO24-Y	LED Outdoor Tape Light - Y CONNECTOR	12.95	790576172132
LED-TO24-Y-RGB	Y-CONNECTOR FOR INVISILED™ PALETTE OUTDOOR	12.95	790576188522
LED-T-P-12	LED TAPE LIGHT - 12' ADDITIONAL LEAD WIRE	6.50	790576128610
LED-T-P-2	LED TAPE LIGHT - 2' ADDITIONAL LEAD WIRE	1.95	790576128603
LED-T-RC	LED TAPE LIGHT - RETROFIT CHANNEL	3.95	790576128702
LED-T-X	X-CONNECTOR FOR 12V TAPE LIGHT	4.50	790576167015
LED-T-Y	Y-CONNECTOR FOR 12V INVISILED™	2.95	790576167008
L-ENDCAP-BK	L SERIES END CAP FOR TRACK	0.95	790576023335
L-ENDCAP-BN	L SERIES END CAP FOR TRACK	0.95	790576145624
L-ENDCAP-DB	L SERIES END CAP FOR TRACK	0.95	790576140414
L-ENDCAP-WT	L SERIES END CAP FOR TRACK	0.95	790576023342

Material	Description	2011 DN	UPC Code
LENS-111-AMB	LENS FOR AR111 FIXTURES AMBER	10.95	790576096216
LENS-111-BEL	AR111 STRIPE GLASS	13.50	790576134789
LENS-111-BLU	LENS FOR AR111 FIXTURES BLUE	10.95	790576096223
LENS-111-CL	CLEAR LENS FOR AR111 FIXTURES	6.50	790576096209
LENS-111-CRL	CROSS LOUVER FOR AR111 FIXTURES	14.95	790576095899
LENS-111-DIC-AMB	LENS FOR AR111 FIXTURES AMBER D	16.95	790576096261
LENS-111-DIC-BLU	LENS FOR AR111 FIXTURES BLUE DI	16.95	790576096278
LENS-111-DIC-GRN	LENS FOR AR111 FIXTURES GREEN D	16.95	790576096308
LENS-111-DIC-RED	LENS FOR AR111 FIXTURES RED DIC	16.95	790576096285
LENS-111-DIC-YEL	LENS FOR AR111 FIXTURES YELLOW	16.95	790576096292
LENS-111-FR	LENS FOR AR111 FIXTURES FROSTED	6.50	790576127552
LENS-111-GRN	LENS FOR AR111 FIXTURES GREEN	10.95	790576096254
LENS-111-HCL	HONEY COMB LOUVER FOR AR111 FIXTURES	13.95	790576096346
LENS-111-RED	LENS FOR AR111 FIXTURES RED	10.95	790576096230
LENS-111-SPR	BEAM SPREADER FOR AR111 FIXTURES	13.50	790576134772
LENS-111-UVF	UV FILTER FOR AR111 FIXTURES	67.50	790576134826
LENS-111-YEL	LENS FOR AR111 FIXTURES YELLOW	10.95	790576096247
LENS-11-AMB	LENS FOR MR11 FIXTURES AMBER	5.50	790576007717
LENS-11-BEL	MR11 STRIPE GLASS	4.95	790576007724
LENS-11-BLU	LENS FOR MR11 FIXTURES BLUE	5.50	790576007731
LENS-11-CL	CLEAR LENS FOR MR11 FIXTURES	1.15	790576015200
LENS-11-DIC-AMB	LENS FOR MR11 FIXTURES AMBER DICHROIC	10.95	790576039848
LENS-11-DIC-BLU	LENS FOR MR11 FIXTURES BLUE DICHROIC	10.95	790576039862
LENS-11-DIC-GRN	LENS FOR MR11 FIXTURES GREEN DICHROIC	10.95	790576039886
LENS-11-DIC-RED	LENS FOR MR11 FIXTURES RED DICHROIC	10.95	790576039855
LENS-11-DIC-YEL	LENS FOR MR11 FIXTURES YELLOW DICHROIC	10.95	790576039879
LENS-11-FR	FROSTED LENS FOR MR11 FIXTURES	1.25	790576122755
LENS-11-GRN	LENS FOR MR11 FIXTURES GREEN	5.50	790576007748
LENS-11-HCL	HONEY COMB LOUVER FOR MR11 FIXTURES	5.50	790576007755
LENS-11-RED	LENS FOR MR11 FIXTURES RED	5.50	790576007762
LENS-11-SPR	BEAM SPREADER FOR MR11 FIXTURES	4.95	790576007779
LENS-11-UVF	MR11 UV GLASS	13.95	790576007786
LENS-11-YEL	LENS FOR MR11 FIXTURES YELLOW	5.50	790576007793
LENS-16-AMB	LENS FOR MR16 FIXTURES AMBER	5.50	790576007809
LENS-16-BEL	BEAM ELONGATOR FOR MR16 FIXTURES	4.95	790576007816
LENS-16-BLU	LENS FOR MR16 FIXTURES BLUE	5.50	790576007823
LENS-16-CL	GLASS OF PACKING	1.15	790576007915
LENS-16-CLIP	LENS CLIP FOR 204,214 MR16	2.25	790576018997
LENS-16-CRL	CROSS LOUVER FOR MR16 FIXTURES	9.95	790576095851
LENS-16-DIC-AMB	LENS FOR MR16 FIXTURES AMBER DICHROIC	11.95	790576036311
LENS-16-DIC-BLU	LENS FOR MR16 FIXTURES BLUE DICHROIC	11.95	790576036304
LENS-16-DIC-GRN	LENS FOR MR16 FIXTURES GREEN DICHROIC	11.95	790576036335
LENS-16-DIC-RED	LENS FOR MR16 FIXTURES RED DICHROIC	11.95	790576036298
LENS-16-DIC-YEL	LENS FOR MR16 FIXTURES YELLOW DICHROIC	11.95	790576036328
LENS-16-FR	LENS FOR MR16 FIXTURES FROSTED	1.50	790576007922
LENS-16-GRN	LENS FOR MR16 FIXTURES GREEN	5.50	790576007830
LENS-16-HCL	HONEY COMB LOUVER FOR MR16 FIXTURES	5.50	790576007847
LENS-16-RED	LENS FOR MR16 FIXTURES RED	5.50	790576007854
LENS-16-SPR	BEAM SPREADER FOR MR16 FIXTURES	4.95	790576007861
LENS-16-UVF	UV FILTER FOR MR16 FIXTURES	13.95	790576007878

Material	Description	2011 DN	UPC Code
LENS-16-YEL	LENS FOR MR16 FIXTURES YELLOW	5.50	790576007885
LENS-20-AMB	LENS FOR PAR20 FIXTURES AMBER	6.50	790576095905
LENS-20-BEL	PAR20 STRIPE GLASS	6.95	790576134154
LENS-20-BLU	LENS FOR PAR20 FIXTURES BLUE	6.50	790576095912
LENS-20-CL	CLEAR GLASS FOR 9W TRACKHEAD SPOT	2.25	790576142883
LENS-20-CRL	CROSS LOUVER FOR PAR20 FIXTURES	10.95	790576095868
LENS-20-DIC-AMB	LENS FOR PAR20 FIXTURES AMBER DICHROIC	12.95	790576095950
LENS-20-DIC-BLU	LENS FOR PAR20 FIXTURES BLUE DICHROIC	12.95	790576095967
LENS-20-DIC-GRN	LENS FOR PAR20 FIXTURES GREEN DICHROIC	12.95	790576095998
LENS-20-DIC-RED	LENS FOR PAR20 FIXTURES RED DICHROIC	12.95	790576095974
LENS-20-DIC-YEL	LENS FOR PAR20 FIXTURES YELLOW DICHROIC	12.95	790576095981
LENS-20-FR	LENS FOR PAR20 FIXTURES FROSTED	2.50	790576127521
LENS-20-GRN	LENS FOR PAR20 FIXTURES GREEN	6.50	790576095943
LENS-20-HCL	HONEY COMB LOUVER FOR PAR20 FIXTURES	8.50	790576096315
LENS-20-RED	LENS FOR PAR20 FIXTURES RED	6.50	790576095929
LENS-20-SPR	BEAM SPREADER FOR PAR20 FIXTURES	6.95	790576134147
LENS-20-UVF	UV FILTER FOR PAR20 FIXTURES	23.95	790576134796
LENS-20-YEL	LENS FOR PAR20 FIXTURES YELLOW	6.50	790576095936
LENS-25-AMB	LENS FOR 18W LED FIXTURE - AMBER	8.50	790576160290
LENS-25-BLU	LENS FOR 18W LED FIXTURE - BLUE	8.50	790576160306
LENS-25-CL	LENS FOR 18W LED FIXTURE - CLEAR	3.50	790576160313
LENS-25-DIC-AMB	LENS FOR 18W LED FIXTURE - DICHROIC AMBER	15.95	790576160320
LENS-25-DIC-BLU	LENS FOR 18W LED FIXTURE - DICHROIC BLUE	15.95	790576160337
LENS-25-DIC-GRN	LENS FOR 18W LED FIXTURE - DICHROIC GREEN	15.95	790576160344
LENS-25-DIC-RED	LENS FOR 18W LED FIXTURE - DICHROIC RED	15.95	790576160351
LENS-25-DIC-YEL	LENS FOR 18W LED FIXTURE - DICHROIC YELLOW	15.95	790576160368
LENS-25-FR	LENS FOR 18W LED FIXTURE - FROSTED	3.50	790576160375
LENS-25-GRN	LENS FOR 18W LED FIXTURE - GREEN	8.50	790576160382
LENS-25-HCL	LENS FOR 18W LED FIXTURE - HONEY COMB	9.95	790576160412
LENS-25-RED	LENS FOR 18W LED FIXTURE - RED	8.50	790576160399
LENS-25-YEL	LENS FOR 18W LED FIXTURE - YELLOW	8.50	790576160405
LENS-30-AMB	LENS FOR PAR30 FIXTURES AMBER	8.50	790576096001
LENS-30-BEL	PAR30 STRIPE GLASS	8.95	790576134741
LENS-30-BLU	LENS FOR PAR30 FIXTURES BLUE	8.50	790576096018
LENS-30-CL	CLEAR LENS FOR PAR30 FIXTURES - CLEAR	4.50	790576163710
LENS-30-CRL	CROSS LOUVER FOR PAR30 FIXTURES	12.95	790576095875
LENS-30-DIC-AMB	LENS FOR PAR30 FIXTURES AMBER DICHROIC	14.95	790576096056
LENS-30-DIC-BLU	LENS FOR PAR30 FIXTURES BLUE DICHROIC	14.95	790576096063
LENS-30-DIC-GRN	LENS FOR PAR30 FIXTURES GREEN DICHROIC	14.95	790576096094
LENS-30-DIC-RED	LENS FOR PAR30 FIXTURES RED DICHROIC	14.95	790576096070
LENS-30-DIC-YEL	LENS FOR PAR30 FIXTURES YELLOW DICHROIC	14.95	790576096087
LENS-30-FR	LENS FOR PAR30 FIXTURES FROSTED	4.50	790576127538
LENS-30-GRN	LENS FOR PAR30 FIXTURES GREEN	8.50	790576096049
LENS-30-HCL	HONEY COMB LOUVER FOR PAR30 FIXTURES	10.95	790576096322
LENS-30-RED	LENS FOR PAR30 FIXTURES RED	8.50	790576096025
LENS-30-SPR	BEAM SPREADER FOR PAR30 FIXTURES	8.95	790576134734
LENS-30-UVF	UV FILTER FOR PAR30 FIXTURES	45.95	790576134802
LENS-30-YEL	LENS FOR PAR30 FIXTURES YELLOW	8.50	790576096032
LENS-38-AMB	LENS FOR PAR38 FIXTURES AMBER	9.95	790576096100
LENS-38-BEL	PAR38 STRIPE GLASS	11.50	790576134765

Material	Description	2011 DN	UPC Code
LENS-38-BLU	LENS FOR PAR38 FIXTURES BLUE	9.95	790576096117
LENS-38-CL	CLEAR LENS FOR PAR38 FIXTURES	5.50	790576164632
LENS-38-CRL	CROSS LOUVER FOR PAR38 FIXTURES	13.95	790576095882
LENS-38-DIC-AMB	LENS FOR PAR38 FIXTURES AMBER DICHROIC	15.95	790576096155
LENS-38-DIC-BLU	LENS FOR PAR38 FIXTURES BLUE DICHROIC	15.95	790576096162
LENS-38-DIC-GRN	LENS FOR PAR38 FIXTURES GREEN DICHROIC	15.95	790576096193
LENS-38-DIC-RED	LENS FOR PAR38 FIXTURES RED DICHROIC	15.95	790576096179
LENS-38-DIC-YEL	LENS FOR PAR38 FIXTURES YELLOW DICHROIC	15.95	790576096186
LENS-38-FR	LENS FOR PAR38 FIXTURES FROSTED	5.50	790576127545
LENS-38-GRN	LENS FOR PAR38 FIXTURES GREEN	9.95	790576096148
LENS-38-HCL	HONEY COMB LOUVER FOR PAR38 FIXTURES	13.95	790576096339
LENS-38-RED	LENS FOR PAR38 FIXTURES RED	9.95	790576096124
LENS-38-SPR	BEAM SPREADER FOR PAR38 FIXTURES	11.50	790576134758
LENS-38-UVF	UV FILTER FOR PAR38 FIXTURES	56.95	790576134819
LENS-38-YEL	LENS FOR PAR38 FIXTURES YELLOW	9.95	790576096131
LENS-45-FR-N	47MM FROSTED LENS FOR HR-86,88	0.95	790576057453
LFC-BK	L SERIES FLOATING CANOPY CONNECTOR	7.95	790576001791
LFC-BN	L SERIES FLOATING CANOPY CONNECTOR	9.50	790576145631
LFC-DB	L SERIES FLOATING CANOPY CONNECTOR	9.50	790576140421
LFC-WT	L SERIES FLOATING CANOPY CONNECTOR	7.95	790576001807
LFLX-BK	L SERIES FLEXIBLE TRACK CONNECTOR	10.95	790576001845
LFLX-BN	L SERIES FLEXIBLE TRACK CONNECTOR	12.50	790576145648
LFLX-DB	L SERIES FLEXIBLE TRACK CONNECTOR	12.50	790576140438
LFLX-WT	L SERIES FLEXIBLE TRACK CONNECTOR	10.95	790576001852
LHT-007-BK	L SERIES LOW VOLT TRACK HEAD 50W	28.95	790576004150
LHT-007-BN	L SERIES LOW VOLT TRACK HEAD 50W	32.95	790576147253
LHT-007L-BK	L SERIES LOW VOLT TRACK HEAD 75W	31.95	790576004181
LHT-007L-BN	L SERIES LOW VOLT TRACK HEAD 75W	35.95	790576160030
LHT-007L-WT	L SERIES LOW VOLT TRACK HEAD 75W	31.95	790576004198
LHT-007-WT	L SERIES LOW VOLT TRACK HEAD 50W	28.95	790576004167
LHT-009L-BK	L SERIES LOW VOLT FRAMING PROJECTOR 75W	149.50	790576049182
LHT-009L-WT	L SERIES LOW VOLT FRAMING PROJECTOR 75W	149.50	790576049199
LHT-1102-BK	L SERIES LOW VOLT TRACK HEAD 35W	26.95	790576004204
LHT-1102-WT	L SERIES LOW VOLT TRACK HEAD 35W	26.95	790576004235
LHT-1109-BK	L SERIES LOW VOLT TRACK HEAD 35W	26.95	790576004242
LHT-1109-WT	L SERIES LOW VOLT TRACK HEAD 35W	26.95	790576004273
LHT-1126-BK	L SERIES LOW VOLT TRACK HEAD 35W	45.95	790576004280
LHT-1126-WT	L SERIES LOW VOLT TRACK HEAD 35W	45.95	790576004297
LHT-160-BK	L SERIES LOW VOLT TRACK HEAD 50W	27.95	790576016047
LHT-160L-BK	L SERIES LOW VOLT TRACK HEAD 75W	30.95	790576021928
LHT-160L-WT	L SERIES LOW VOLT TRACK HEAD 75W	30.95	790576021935
LHT-160-WT	L SERIES LOW VOLT TRACK HEAD 50W	27.95	790576016054
LHT-163L-BK	L SERIES LOW VOLTAGE TRACK HEAD 75W	52.95	790576095226
LHT-163L-WT	L SERIES LOW VOLTAGE TRACK HEAD 75W	52.95	790576095233
LHT-164L-BK	L SERIES LOW VOLTAGE TRACK HEAD 75W	46.50	790576105581
LHT-164L-WT	L SERIES LOW VOLTAGE TRACK HEAD 75W	46.50	790576105598
LHT-180-BK	L SERIES LOW VOLT TRACK HEAD 50W	20.95	790576004303
LHT-180-BN	L SERIES LOW VOLT TRACK HEAD 50W	24.95	790576147260
LHT-180L-BK	L SERIES LOW VOLT TRACK HEAD 75W	23.95	790576004341
LHT-180L-BN	L SERIES LOW VOLT TRACK HEAD 75W	27.95	790576160061

Material	Description	2011 DN	UPC Code
LHT-180L-WT	L SERIES LOW VOLT TRACK HEAD 75W	23.95	790576004358
LHT-180-WT	L SERIES LOW VOLT TRACK HEAD 50W	20.95	790576004310
LHT-204-BK	L SERIES LOW VOLT TRACK HEAD 50W	31.95	790576016108
LHT-204-BN	L SERIES LOW VOLT TRACK HEAD 50W	35.95	790576147277
LHT-204L-BK	L SERIES LOW VOLT TRACK HEAD 75W	34.95	790576021966
LHT-204L-BN	L SERIES LOW VOLT TRACK HEAD 75W	38.95	790576160092
LHT-204L-WT	L SERIES LOW VOLT TRACK HEAD 75W	34.95	790576018669
LHT-204-WT	L SERIES LOW VOLT TRACK HEAD 50W	31.95	790576016115
LHT-311L-BK	L SERIES LOW VOLTAGE TRACK HEAD 75W	79.95	
LHT-311L-WT	L SERIES LOW VOLTAGE TRACK HEAD 75W	79.95	
LHT-316L-BK	L SERIES LOW VOLTAGE TRACK HEAD 75W	69.95	
LHT-316L-WT	L SERIES LOW VOLTAGE TRACK HEAD 75W	69.95	790576185194
LHT-801-BK	L SERIES LOW VOLT TRACK HEAD 50W	29.95	790576004426
LHT-801L-BK	L SERIES LOW VOLT TRACK HEAD 75W	32.95	790576004457
LHT-801L-WT	L SERIES LOW VOLT TRACK HEAD 75W	32.95	790576004464
LHT-801-WT	L SERIES LOW VOLT TRACK HEAD 50W	29.95	790576004433
LHT-802-BK	L SERIES LOW VOLT TRACK HEAD 50W	22.95	790576004471
LHT-802-BN	L SERIES LOW VOLT TRACK HEAD 50W	26.95	790576147284
LHT-802L-BK	L SERIES LOW VOLT TRACK HEAD 75W	25.95	790576004532
LHT-802L-BN	L SERIES LOW VOLT TRACK HEAD 75W	29.95	790576160122
LHT-802L-WT	L SERIES LOW VOLT TRACK HEAD 75W	25.95	790576004563
LHT-802-WT	L SERIES LOW VOLT TRACK HEAD 50W	22.95	790576004501
LHT-808-BK	L SERIES LOW VOLT TRACK HEAD 50W	29.95	790576004594
LHT-808-DB	LOW VOLTAGE TRACK HEAD 50W	32.95	790576163307
LHT-808L-BK	L SERIES LOW VOLT TRACK HEAD 75W	32.95	790576004631
LHT-808L-DB	L SERIES LOW VOLT TRACK HEAD 75W	35.95	790576163352
LHT-808L-WT	L SERIES LOW VOLT TRACK HEAD 75W	32.95	790576004648
LHT-808-WT	L SERIES LOW VOLT TRACK HEAD 50W	29.95	790576004600
LHT-809-BK	L SERIES LOW VOLT TRACK HEAD 50W	22.95	790576004655
LHT-809-BN	L SERIES LOW VOLT TRACK HEAD 50W	26.95	790576147291
LHT-809L-BK	L SERIES LOW VOLT TRACK HEAD 75W	25.95	790576004716
LHT-809L-BN	L SERIES LOW VOLTAGE TRACK HEAD 75W	29.95	790576160153
LHT-809L-WT	L SERIES LOW VOLT TRACK HEAD 75W	25.95	790576004747
LHT-809-WT	L SERIES LOW VOLT TRACK HEAD 50W	22.95	790576004686
LHT-814-BK	L SERIES LOW VOLT TRACK HEAD 50W	29.95	790576087399
LHT-814L-BK	L SERIES LOW VOLT TRACK HEAD 75W	32.95	790576088938
LHT-814L-WT	L SERIES LOW VOLT TRACK HEAD 75W	32.95	790576088945
LHT-814-WT	L SERIES LOW VOLT TRACK HEAD 50W	29.95	790576087382
LHT-815-BK	L SERIES LOW VOLT TRACK HEAD 50W	41.95	790576086286
LHT-815-PT/BK	L SERIES LOW VOLT TRACK HEAD 50W	44.95	790576086279
LHT-815-PT/WT	L SERIES LOW VOLT TRACK HEAD 50W	44.95	790576086262
LHT-815-WT	L SERIES LOW VOLT TRACK HEAD 50W	41.95	790576086255
LHT-816-BK	L SERIES LOW VOLT TRACK HEAD 50W	29.95	790576004754
LHT-816-BN	L SERIES LOW VOLT TRACK HEAD 50W	33.95	790576147307
LHT-816L-BK	L SERIES LOW VOLT TRACK HEAD 75W	32.95	790576004792
LHT-816L-BN	L SERIES LOW VOLT TRACK HEAD 75W	36.95	790576160184
LHT-816L-WT	L SERIES LOW VOLT TRACK HEAD 75W	32.95	790576004822
LHT-816-WT	L SERIES LOW VOLT TRACK HEAD 50W	29.95	790576004785
LHT-817-BK	L SERIES LOW VOLT TRACK HEAD 50W	59.95	790576086248
LHT-817-PT/BK	L SERIES LOW VOLT TRACK HEAD 50W	62.95	790576086231

Material	Description	2011 DN	UPC Code
LHT-817-PT/WT	L SERIES LOW VOLT TRACK HEAD 50W	62.95	790576086224
LHT-817-WT	L SERIES LOW VOLT TRACK HEAD 50W	59.95	790576086217
LHT-819-BK	L SERIES LOW VOLT TRACK HEAD 50W	41.95	790576086200
LHT-819L-BK	L SERIES LOW VOLT TRACK HEAD 75W	44.95	790576088730
LHT-819L-PT/BK	L SERIES LOW VOLT TRACK HEAD 75W	47.95	790576088976
LHT-819L-PT/WT	L SERIES LOW VOLT TRACK HEAD 75W	47.95	790576088983
LHT-819L-WT	L SERIES LOW VOLT TRACK HEAD 75W	44.95	790576088747
LHT-819-PT/BK	L SERIES LOW VOLT TRACK HEAD 50W	44.95	790576086194
LHT-819-PT/WT	L SERIES LOW VOLT TRACK HEAD 50W	44.95	790576086187
LHT-819-WT	L SERIES LOW VOLT TRACK HEAD 50W	41.95	790576086170
LHT-826-BK	L SERIES LOW VOLT TRACK HEAD 50W	34.95	790576004839
LHT-826-BN	L SERIES LOW VOLT TRACK HEAD 50W	38.95	790576147314
LHT-826L-BK	L SERIES LOW VOLT TRACK HEAD 75W	37.95	790576004853
LHT-826L-BN	L SERIES LOW VOLT TRACK HEAD 75W	41.95	790576160214
LHT-826L-WT	L SERIES LOW VOLT TRACK HEAD 75W	37.95	790576004860
LHT-826-WT	L SERIES LOW VOLT TRACK HEAD 50W	34.95	790576004846
LHT-846-BK	L SERIES LOW VOLT TRACK HEAD 50W	38.95	790576004877
LHT-846L-BK	L SERIES LOW VOLT TRACK HEAD 75W	41.95	790576004891
LHT-846L-WT	L SERIES LOW VOLT TRACK HEAD 75W	41.95	790576004907
LHT-846-WT	+ SERIES LOW VOLT TRACK HEAD 50W	38.95	790576004884
LHT-856-BK	L SERIES LOW VOLT TRACK HEAD 50W	39.95	790576036243
LHT-856-BN	L SERIES LOW VOLT TRACK HEAD 50W	43.95	790576147321
LHT-856L-BK	L SERIES LOW VOLT TRACK HEAD 75W	42.95	790576040677
LHT-856L-BN	L SERIES LOW VOLT TRACK HEAD 75W	46.95	790576160245
LHT-856L-WT	L SERIES LOW VOLT TRACK HEAD 75W	42.95	790576040622
LHT-856-WT	L SERIES LOW VOLT TRACK HEAD 50W	39.95	790576036250
LHT-866-BK	L SERIES LOW VOLT TRACK HEAD 50W	30.95	790576037684
LHT-866L-BK	L SERIES LOW VOLT TRACK HEAD 75W	33.95	790576062754
LHT-866L-WT	L SERIES LOW VOLT TRACK HEAD 75W	33.95	790576045290
LHT-866-WT	SERIES LOW VOLT TRACK HEAD 50W	30.95	790576037691
LHT-874-AB	L SERIES LOW VOLT TRACK HEAD 50W	59.95	790576143064
LHT-874-AN	L SERIES LOW VOLTAGE TRACK HEAD 50W	59.95	790576193540
LHT-874L-AB	L SERIES LOW VOLT TRACK HEAD 75W	62.95	790576143262
LHT-874L-AN	L SERIES LOW VOLTAGE TRACK HEAD 75W	62.95	790576193601
LHT-874-LENS-AB	L SERIES LOW VOLT TRACK HEAD 50W W/LENS	64.95	790576143231
LHT-874-LENS-AN	LENS OPTION	64.95	790576193571
LHT-874L-LENS-AB	L SERIES LOW VOLT TRACK HEAD 75W W/LENS	67.95	790576143293
LHT-874L-LENS-AN	LENS OPTION	67.95	790576193632
LHT-886-AB	L SERIES LOW VOLT TRACK HEAD 50W	59.95	790576143576
LHT-886-AN	L SERIES LOW VOLTAGE TRACK HEAD 50W	59.95	790576193786
LHT-886L-AB	L SERIES LOW VOLT TRACK HEAD 75W	62.95	790576143606
LHT-886L-AN	L SERIES LOW VOLTAGE TRACK HEAD 75W	62.95	790576193816
LHT-896-BK	MR16 TRACK LUMINAIRE	44.95	790576196862
LHT-896L-BK	MR16 TRACK LUMINAIRE	44.95	790576196886
LHT-896L-WT	MR16 TRACK LUMINAIRE	44.95	790576196893
LHT-896-WT	MR16 TRACK LUMINAIRE	44.95	790576196879
LHT-901-BK	L SERIES LOW VOLT TRACK HEAD 50W	35.95	790576005034
LHT-901-WT	L SERIES LOW VOLT TRACK HEAD 50W	35.95	790576005041
LHT-935L-BK	L SERIES LOW VOLTAGE TRACK HEAD 75W	49.95	790576105642
LHT-935L-WT	L SERIES LOW VOLTAGE TRACK HEAD 75W	49.95	790576105659



Material	Description	2011 DN	UPC Code
LHT-936-BK	L SERIES LOW VOLT TRACK HEAD 50W	43.95	790576005072
LHT-936L-BK	L SERIES LOW VOLT TRACK HEAD 75W	46.95	790576005096
LHT-936L-WT	L SERIES LOW VOLT TRACK HEAD 75W	46.95	790576005102
LHT-936-WT	L SERIES LOW VOLT TRACK HEAD 50W	43.95	790576005089
LHT-939L-BK	L SERIES LOW VOLTAGE TRACK HEAD 75W	55.95	790576095349
LHT-939L-WT	L SERIES LOW VOLTAGE TRACK HEAD 75W	55.95	790576095356
LI-BK	L SERIES STRAIGHT LINE CONNECTOR	4.50	790576005652
LI-BN	L SERIES STRAIGHT LINE CONNECTOR	5.95	790576145655
LI-DB	L SERIES STRAIGHT LINE CONNECTOR	5.95	790576140445
LI-DEC-BK	L SERIES I DEAD END STRAIGHT CONNECTOR	4.50	790576039640
LI-DEC-BN	L SERIES I DEAD END STRAIGHT CONNECTOR	5.95	790576145679
LI-DEC-DB	L SERIES I DEAD END STRAIGHT CONNECTOR	5.95	790576140452
LI-DEC-WT	L SERIES I DEAD END STRAIGHT CONNECTOR	4.50	790576039657
LI-PWR-BK	L SERIES I STRAIGHT LINE POWER CONNECTOR	7.50	790576019789
LI-PWR-BN	L SERIES I STRAIGHT LINE POWER CONNECTOR	8.95	790576145686
LI-PWR-DB	L SERIES I STRAIGHT LINE POWER CONNECTOR	8.95	790576140469
LI-PWR-WT	L SERIES I STRAIGHT LINE POWER CONNECTOR	7.50	790576019796
LI-WT	L SERIES STRAIGHT LINE CONNECTOR	4.50	790576005669
LLE-BK	L SERIES LIVE END CONNECTOR	4.50	790576007694
LLE-BN	L SERIES LIVE END CONNECTOR	5.95	790576145693
L-LED610F-CW-BK	LEDME TRACK LUMINAIRE	169.95	790576196138
L-LED610F-CW-BN	LEDME TRACK LUMINAIRE	174.95	790576196152
L-LED610F-CW-WT	LEDME TRACK LUMINAIRE	169.95	790576196145
L-LED610F-WW-BK	LEDME TRACK LUMINAIRE	169.95	790576196107
L-LED610F-WW-BN	LEDME TRACK LUMINAIRE	174.95	790576196121
L-LED610F-WW-WT	LEDME TRACK LUMINAIRE	169.95	790576196114
L-LED610S-CW-BK	LEDME TRACK LUMINAIRE	169.95	790576197043
L-LED610S-CW-BN	LEDME TRACK LUMINAIRE	174.95	790576197050
L-LED610S-CW-WT	LEDME TRACK LUMINAIRE	169.95	790576197067
L-LED610S-WW-BK	LEDME TRACK LUMINAIRE	169.95	790576197012
L-LED610S-WW-BN	LEDME TRACK LUMINAIRE	174.95	790576197029
L-LED610S-WW-WT	LEDME TRACK LUMINAIRE	169.95	790576197036
L-LED710F-CW-AB	LEDME TRACK LUMINAIRE	179.95	790576196442
L-LED710F-CW-AN	LEDME TRACK LUMINAIRE	179.95	790576196459
L-LED710F-CW-SB/BK	LEDME TRACK LUMINAIRE	184.95	790576196466
L-LED710F-WW-AB	LEDME TRACK LUMINAIRE	179.95	790576196381
L-LED710F-WW-AN	LEDME TRACK LUMINAIRE	179.95	790576196398
L-LED710F-WW-SB/BK	LEDME TRACK LUMINAIRE	184.95	790576196404
L-LED710S-CW-AB	LEDME TRACK LUMINAIRE	179.95	790576196411
L-LED710S-CW-AN	LEDME TRACK LUMINAIRE	179.95	790576196428
L-LED710S-CW-SB/BK	LEDME TRACK LUMINAIRE	184.95	790576196435
L-LED710S-WW-AB	LEDME TRACK LUMINAIRE	179.95	790576196350
L-LED710S-WW-AN	LEDME TRACK LUMINAIRE	179.95	790576196367
L-LED710S-WW-SB/BK	LEDME TRACK LUMINAIRE	184.95	790576196374
L-LED810F-CW-BK	LEDME TRACK LUMINAIRE	119.95	790576196732
L-LED810F-CW-WT	LEDME TRACK LUMINAIRE	119.95	790576196749
L-LED810F-WW-BK	LEDME TRACK LUMINAIRE	119.95	790576196695
L-LED810F-WW-WT	LEDME TRACK LUMINAIRE	119.95	790576196701
L-LED810S-CW-BK	LEDME TRACK LUMINAIRE	119.95	790576196718
L-LED810S-CW-WT	LEDME TRACK LUMINAIRE	119.95	790576196725

Material	Description	2011 DN	UPC Code
L-LED810S-WW-BK	LEDME TRACK LUMINAIRE	119.95	790576196671
L-LED810S-WW-WT	LEDME TRACK LUMINAIRE	119.95	790576196688
LLE-DB	L SERIES LIVE END CONNECTOR	5.95	790576140476
LLE-WT	L SERIES LIVE END CONNECTOR	4.50	790576007700
LL-LEFT-BK	L SERIES LEFT L-CONNECTOR	6.95	790576007670
LL-LEFT-BN	L SERIES LEFT L-CONNECTOR	8.95	790576145709
LL-LEFT-DB	L SERIES LEFT L-CONNECTOR	8.95	790576140483
LL-LEFT-WT	L SERIES LEFT L-CONNECTOR	6.95	790576007687
L-LOOP-BK	L SERIES SUSPENSION LOOP	8.95	790576020334
L-LOOP-BN	L SERIES SUSPENSION LOOP	10.50	790576145716
L-LOOP-DB	L SERIES SUSPENSION LOOP	10.50	790576140490
L-LOOP-WT	L SERIES SUSPENSION LOOP	8.95	790576020341
LL-RIGHT-BK	L SERIES RIGHT L-CONNECTOR	6.95	790576059327
LL-RIGHT-BN	L SERIES RIGHT L-CONNECTOR	8.95	790576145723
LL-RIGHT-DB	L SERIES RIGHT L-CONNECTOR	8.95	790576140506
LL-RIGHT-WT	L SERIES RIGHT L-CONNECTOR	6.95	790576059334
LM2-CPC-BN	2-CIRCUIT LV MONORAIL SINGLE POWER FEED	35.50	790576136363
LM2-CPC-CH	2-CIRCUIT LV MONORAIL SINGLE POWER FEED	35.50	790576129280
LM2-CPC-DB	2-CIRCUIT LV MONORAIL SINGLE POWER FEED	35.50	790576129303
LM2-CS48-BN	LV MONORAIL2 48' AIRCRAFT CABLE SUSPENS.	22.50	790576136332
LM2-CS48-CH	LV MONORAIL2 48' AIRCRAFT CABLE SUSPENS.	22.50	790576129242
LM2-CS48-DB	LV MONORAIL2 48' AIRCRAFT CABLE SUSPENS.	22.50	790576129228
LM2-CS96-BN	LV MONORAIL2 96' AIRCRAFT CABLE SUSPENS.	25.95	790576136349
LM2-CS96-CH	LV MONORAIL2 96' AIRCRAFT CABLE SUSPENS.	25.95	790576129259
LM2-CS96-DB	LV MONORAIL2 96' AIRCRAFT CABLE SUSPENS.	25.95	790576129273
LM2-DCPC-BN	2-CIRCUIT LV MONORAIL DUAL POWER FEED	52.50	790576136370
LM2-DCPC-CH	2-CIRCUIT LV MONORAIL DUAL POWER FEED	52.50	790576129334
LM2-DCPC-DB	2-CIRCUIT LV MONORAIL DUAL POWER FEED	52.50	790576129310
LM2-EC-BN	2-CIRCUIT LV MONORAIL END CAP	1.50	790576136189
LM2-EC-CH	2-CIRCUIT LV MONORAIL END CAP	1.50	790576128795
LM2-EC-DB	2-CIRCUIT LV MONORAIL END CAP	1.50	790576128818
LM2-EN12-300M-BN	LV MONORAIL2 300W MAGNETIC TRANSFORMER	199.50	790576136424
LM2-EN12-300M-CH	LV MONORAIL2 300W MAGNETIC TRANSFORMER	199.50	790576129464
LM2-EN12-300M-DB	LV MONORAIL2 300W MAGNETIC TRANSFORMER	199.50	790576129488
LM2-EN12-500M-BN	LV MONORAIL2 500W MAGNETIC TRANSFORMER	293.95	790576136431
LM2-EN12-500M-CH	LV MONORAIL2 500W MAGNETIC TRANSFORMER	293.95	790576129518
LM2-EN12-500M-DB	LV MONORAIL2 500W MAGNETIC TRANSFORMER	293.95	790576129495
LM2-I-BN	2-CIRCUIT LV MONORAIL I CONNECTOR	13.95	790576136196
LM2-I-CH	2-CIRCUIT LV MONORAIL I CONNECTOR	13.95	790576128825
LM2-I-DB	2-CIRCUIT LV MONORAIL I CONNECTOR	13.95	790576128849
LM2-IDEC-BN	LV MONORAIL2 DEAD STRAIGHT CONNECTOR	9.95	790576136202
LM2-IDEC-CH	LV MONORAIL2 DEAD STRAIGHT CONNECTOR	9.95	790576128856
LM2-IDEC-DB	LV MONORAIL2 DEAD STRAIGHT CONNECTOR	9.95	790576128870
LM2-L-BN	2-CIRCUIT LV MONORAIL L CONNECTOR	16.95	790576136219
LM2-L-CH	2-CIRCUIT LV MONORAIL L CONNECTOR	16.95	790576128887
LM2-L-DB	2-CIRCUIT LV MONORAIL L CONNECTOR	16.95	790576128900
LM2-PCS48-BN	2-CIRCUIT LV MONORAIL CABLE POWER FEED	58.95	790576136387
LM2-PCS48-CH	2-CIRCUIT LV MONORAIL CABLE POWER FEED	58.95	790576129341
LM2-PCS48-DB	2-CIRCUIT LV MONORAIL CABLE POWER FEED	58.95	790576129365
LM2-PCS96-BN	2-CIRCUIT LV MONORAIL CABLE POWER FEED	69.50	790576136394

Material	Description	2011 DN	UPC Code
LM2-PCS96-CH	2-CIRCUIT LV MONORAIL CABLE POWER FEED	69.50	790576129396
LM2-PCS96-DB	2-CIRCUIT LV MONORAIL CABLE POWER FEED	69.50	790576129372
LM2-QADP-BN	2-CIRCUIT LV MONORAIL QC FEMALE ADAPTER	10.50	790576136257
LM2-QADP-CH	2-CIRCUIT LV MONORAIL QC FEMALE ADAPTER	10.50	790576128979
LM2-QADP-DB	2-CIRCUIT LV MONORAIL QC FEMALE ADAPTER	10.50	790576128993
LM2-SCP48-BN	LV MONORAIL2 SLOPED CEILING POWER FEED	57.50	790576136400
LM2-SCP48-CH	LV MONORAIL2 SLOPED CEILING POWER FEED	57.50	790576129402
LM2-SCP48-DB	LV MONORAIL2 SLOPED CEILING POWER FEED	57.50	790576129426
LM2-SCP96-BN	LV MONORAIL2 SLOPED CEILING POWER FEED	68.95	790576136417
LM2-SCP96-CH	LV MONORAIL2 SLOPED CEILING POWER FEED	68.95	790576129457
LM2-SCP96-DB	LV MONORAIL2 SLOPED CEILING POWER FEED	68.95	790576129433
LM2-T30D-BN	2-CIRCUIT LV MONORAIL 30 DEGREE BENT RAIL	31.50	790576170572
LM2-T30D-CH	2-CIRCUIT LV MONORAIL 30 DEGREE BENT RAIL	31.50	790576170480
LM2-T30D-DB	2-CIRCUIT LV MONORAIL 30 DEGREE BENT RAIL	31.50	790576170565
LM2-T45D-BN	2-CIRCUIT LV MONORAIL 45 DEGREE BENT RAIL	31.50	790576170589
LM2-T45D-CH	2-CIRCUIT LV MONORAIL 45 DEGREE BENT RAIL	31.50	790576170503
LM2-T45D-DB	2-CIRCUIT LV MONORAIL 45 DEGREE BENT RAIL	31.50	790576170558
LM2-T4-BN	2-CIRCUIT LV MONORAIL 4FT RAIL	55.95	790576136165
LM2-T4-CH	2-CIRCUIT LV MONORAIL 4FT RAIL	55.95	790576128740
LM2-T4-DB	2-CIRCUIT LV MONORAIL 4FT RAIL	55.95	790576145938
LM2-T60D-BN	2-CIRCUIT LV MONORAIL 60 DEGREE BENT RAIL	31.50	790576170596
LM2-T60D-CH	2-CIRCUIT LV MONORAIL 60 DEGREE BENT RAIL	31.50	790576170510
LM2-T60D-DB	2-CIRCUIT LV MONORAIL 60 DEGREE BENT RAIL	31.50	790576170541
LM2-T8-BN	2-CIRCUIT LV MONORAIL 8FT RAIL	104.95	790576136172
LM2-T8-CH	2-CIRCUIT LV MONORAIL 8FT RAIL	104.95	790576128788
LM2-T8-DB	2-CIRCUIT LV MONORAIL 8FT RAIL	104.95	790576128764
LM2-T90D-BN	2-CIRCUIT LV MONORAIL 90 DEGREE BENT RAIL	31.50	790576170602
LM2-T90D-CH	2-CIRCUIT LV MONORAIL 90 DEGREE BENT RAIL	31.50	790576170527
LM2-T90D-DB	2-CIRCUIT LV MONORAIL 90 DEGREE BENT RAIL	31.50	790576170534
LM2-TB3-BN	2-CIRCUIT LV MONORAIL 3 INCH STANDOFF	16.50	790576136301
LM2-TB3-CH	2-CIRCUIT LV MONORAIL 3 INCH STANDOFF	16.50	790576129129
LM2-TB3-DB	2-CIRCUIT LV MONORAIL 3 INCH STANDOFF	16.50	790576129143
LM2-TB5-BN	2-CIRCUIT LV MONORAIL 5 INCH STANDOFF	17.95	790576136318
LM2-TB5-CH	2-CIRCUIT LV MONORAIL 5 INCH STANDOFF	17.95	790576129174
LM2-TB5-DB	2-CIRCUIT LV MONORAIL 5 INCH STANDOFF	17.95	790576129150
LM2-TB8-BN	2-CIRCUIT LV MONORAIL 8 INCH STANDOFF	18.95	790576136325
LM2-TB8-CH	2-CIRCUIT LV MONORAIL 8 INCH STANDOFF	18.95	790576129181
LM2-TB8-DB	2-CIRCUIT LV MONORAIL 8 INCH STANDOFF	18.95	790576129204
LM2-T-BN	2-CIRCUIT LV MONORAIL T CONNECTOR	19.50	790576136226
LM2-T-CH	2-CIRCUIT LV MONORAIL T CONNECTOR	19.50	790576128917
LM2-T-DB	2-CIRCUIT LV MONORAIL T CONNECTOR	19.50	790576128931
LM2-VA-BN	LM2 VARIABLE ANGLE CONNECTOR	29.95	790576136240
LM2-VA-CH	LM2 VARIABLE ANGLE CONNECTOR	29.95	790576124735
LM2-VA-DB	LM2 VARIABLE ANGLE CONNECTOR	29.95	790576124728
LM2-X3-BN	LV MONORAIL2 3'STANDARD CEILING STANDOFF	16.95	790576136264
LM2-X3-CH	LV MONORAIL2 3'STANDARD CEILING STANDOFF	16.95	790576129006
LM2-X3-DB	LV MONORAIL2 3'STANDARD CEILING STANDOFF	16.95	790576129020
LM2-X5-BN	LV MONORAIL2 5'STANDARD CEILING STANDOFF	18.50	790576136271
LM2-X5-CH	LV MONORAIL2 5'STANDARD CEILING STANDOFF	18.50	790576129051
LM2-X5-DB	LV MONORAIL2 5'STANDARD CEILING STANDOFF	18.50	790576129037

Material	Description	2011 DN	UPC Code
LM2-X8-BN	LV MONORAIL2 8' STANDARD CEILING STANDOF	19.50	790576136288
LM2-X8-CH	LV MONORAIL2 8'STANDARD CEILING STANDOFF	19.50	790576129068
LM2-X8-DB	LV MONORAIL2 8'STANDARD CEILING STANDOFF	19.50	790576129082
LM2-XDEC-BN	2-CIRCUIT LV MONORAIL DEAD X CONNECTOR	10.95	790576136233
LM2-XDEC-CH	2-CIRCUIT LV MONORAIL DEAD X CONNECTOR	10.95	790576128948
LM2-XDEC-DB	2-CIRCUIT LV MONORAIL DEAD X CONNECTOR	10.95	790576128962
LM2-XS5-BN	LV MONORAIL2 5'SLOPED CEILING STANDOFF	18.95	790576136295
LM2-XS5-CH	LV MONORAIL2 5'SLOPED CEILING STANDOFF	18.95	790576129099
LM2-XS5-DB	LV MONORAIL2 5'SLOPED CEILING STANDOFF	18.95	790576129112
LM-CPC-BN	LV MONORAIL-CLOSE TO CEILING POWER FEED	30.95	790576137247
LM-CPC-CH	LV MONORAIL-CLOSE TO CEILING POWER FEED	30.95	790576056135
LM-CPC-DB	LV MONORAIL-CLOSE TO CEILING POWER FEED	30.95	790576109497
LM-CS48-BN	LV MONORAIL CABLE CEILING SUSPEN 48IN	20.95	790576137162
LM-CS48-CH	LV MONORAIL CABLE CEILING SUSPEN 48IN	20.95	790576056111
LM-CS48-DB	LV MONORAIL CABLE CEILING SUSPEN 48IN	20.95	790576109503
LM-CS96-BN	LV MONORAIL CABLE CEILING SUSPEN 96IN	23.95	790576137179
LM-CS96-CH	LV MONORAIL CABLE CEILING SUSPEN 96IN	23.95	790576056128
LM-CS96-DB	LV MONORAIL CABLE CEILING SUSPEN 96IN	23.95	790576109510
LM-CW-BN	LV MONORAIL-CEILING TO WALL CONNECTOR	12.95	790576137384
LM-CW-CH	LV MONORAIL-CEILING TO WALL CONNECTOR	12.95	790576055992
LM-CW-DB	LV MONORAIL-CEILING TO WALL CONNECTOR	12.95	790576109527
LM-DBC12/24-300	LV MONORAIL-12/24V 300W DEBUZZING COIL	21.95	790576058054
LM-DBC12/24-600	LV MONORAIL-12/24V 600W DEBUZZING COIL	34.95	790576058061
LM-DBC12-150	LV MONORAIL-12V 150W DEBUZZING COIL	18.95	790576058047
LM-DCPC-BN	LV MONORAIL-CLS TO CEILING PWR FEED-DUAL	43.95	790576137261
LM-DCPC-CH	LV MONORAIL-CLS TO CEILING PWR FEED-DUAL	43.95	790576056159
LM-DCPC-DB	LV MONORAIL-CLS TO CEILING PWR FEED-DUAL	43.95	790576109534
LM-EC-BN	LV MONORAIL-END CAP	1.50	790576137087
LM-EC-CH	LV MONORAIL-END CAP	1.50	790576055947
LM-EC-DB	LV MONORAIL-END CAP	1.50	790576109541
LM-EN12-150E-BN	LV MONORAIL-SURF. MOUNT ELECT 12V 150W	80.50	790576137445
LM-EN12-150E-CH	LV MONORAIL-SURF. MOUNT ELECT 12V 150W	80.50	790576056685
LM-EN12-150E-DB	LV MONORAIL-SURF. MOUNT ELECT 12V 150W	80.50	790576109558
LM-EN12-150M-BN	LV MONORAIL SURF MOUNT MAGNET 12V 150W	123.95	790576137452
LM-EN12-150M-CH	LV MONORAIL SURF MOUNT MAGNET 12V 150W	123.95	790576056197
LM-EN12-150M-DB	LV MONORAIL SURF MOUNT MAGNET 12V 150W	123.95	790576109565
LM-EN12-250E-BN	LV MONORAIL-SURF. MOUNT ELECT 12V 250W	104.95	790576137469
LM-EN12-250E-CH	LV MONORAIL-SURF. MOUNT ELECT 12V 250W	104.95	790576058085
LM-EN12-250E-DB	LV MONORAIL-SURF. MOUNT ELECT 12V 250W	104.95	790576109572
LM-EN12-300M-BN	LV MONORAIL SURF MOUNT MAGNET 12V 300W	189.95	790576137476
LM-EN12-300M-CH	LV MONORAIL SURF MOUNT MAGNET 12V 300W	189.95	790576056203
LM-EN12-300M-DB	LV MONORAIL SURF MOUNT MAGNET 12V 300W	189.95	790576109589
LM-EN12-600M-BN	LV MONORAIL SURF MOUNT MAGNET 12V 600W	296.95	790576137506
LM-EN12-600M-CH	LV MONORAIL SURF MOUNT MAGNET 12V 600W	296.95	790576056234
LM-EN12-600M-DB	LV MONORAIL SURF MOUNT MAGNET 12V 600W	296.95	790576109596
LM-EN24-300M-BN	LV MONORAIL SURF MOUNT MAGNET 24V 300W	189.95	790576137483
LM-EN24-300M-CH	LV MONORAIL SURF MOUNT MAGNET 24V 300W	189.95	790576056227
LM-EN24-300M-DB	LV MONORAIL SURF MOUNT MAGNET 24V 300W	189.95	790576109602
LM-EN24-600M-BN	LV MONORAIL SURF MOUNT MAGNET 24V 600W	296.95	790576137490
LM-EN24-600M-CH	LV MONORAIL SURF MOUNT MAGNET 24V 600W	296.95	790576056241

Material	Description	2011 DN	UPC Code
LM-EN24-600M-DB	LV MONORAIL SURF MOUNT MAGNET 24V 600W	296.95	790576109619
LM-I-BN	LV MONORAIL-I CONNECTOR	8.95	790576137360
LM-I-CH	LV MONORAIL-I CONNECTOR	8.95	790576055954
LM-I-DB	LV MONORAIL-I CONNECTOR	8.95	790576109640
LM-IDEC-BN	LV MONORAIL-DEAD END STRAIGHT CONNECTOR	5.95	790576137377
LM-IDEC-CH	LV MONORAIL-DEAD END STRAIGHT CONNECTOR	5.95	790576055961
LM-IDEC-DB	LV MONORAIL-DEAD END STRAIGHT CONNECTOR	5.95	790576109657
LM-JS-BN	LV MONORAIL-JUMPER SET	19.50	790576137438
LM-JS-CH	LV MONORAIL-JUMPER SET	19.50	790576056005
LM-JS-DB	LV MONORAIL-JUMPER SET	19.50	790576109664
LM-K590-WT/PT	LV MONORAIL ELEMENT KIT W/G590-WT 250W	236.50	790576117188
LM-K591-WT/PT	LV MONORAIL ELEMENT KIT W/G591-WT 250W	236.50	790576117195
LM-K592-AB/BZ	LOW VOLTAGE MONORAIL KITS	236.50	790576117218
LM-K8111-BZ/AS	LV MONORAIL TRACKHEAD KIT W/G111-AS	236.50	790576117249
LM-K8115-BZ/BZ	LV MONORAIL TRACKHEAD KIT W/G115-BZ	236.50	790576117256
LM-K9411-PT/WT	LV MONORAIL TRACKHEAD KIT W/G111-WT	236.50	790576117225
LM-K9415-PT/PT	LV MONORAIL TRACKHEAD KIT W/G115-PT	236.50	790576117232
LM-L-BN	LV MONORAIL-L CONNECTOR	11.95	790576137391
LM-L-CH	LV MONORAIL-L CONNECTOR	11.95	790576055978
LM-L-DB	LV MONORAIL-L CONNECTOR	11.95	790576109671
LM-OW-BN	LV MONORAIL WALL EXT BRACKET SUPPORT	40.50	790576137230
LM-OW-CH	LV MONORAIL WALL EXT BRACKET SUPPORT	40.50	790576079585
LM-OW-DB	LV MONORAIL WALL EXT BRACKET SUPPORT	40.50	790576109688
LM-OWP-BN	LV MONORAIL WALL EXT BRACKET PWR FEED	48.95	790576137223
LM-OWP-CH	LV MONORAIL WALL EXT BRACKET PWR FEED	48.95	790576079561
LM-OWP-DB	LV MONORAIL WALL EXT BRACKET PWR FEED	48.95	790576109695
LMP-BK	L SERIES MONOPOINT CANOPY	9.95	790576008950
LMP-BN	L SERIES MONOPOINT CANOPY	11.50	790576145730
LM-PCS48-BN	LV MONORAIL-CABLE SUSP PWR FEED 48IN	34.95	790576137278
LM-PCS48-CH	LV MONORAIL-CABLE SUSP POWER FEED 48IN	34.95	790576056173
LM-PCS48-DB	LV MONORAIL-CABLE SUSP POWER FEED 48IN	34.95	790576109701
LM-PCS96-BN	LV MONORAIL-CABLE SUSP PWR FEED 96IN	48.50	790576137285
LM-PCS96-CH	LV MONORAIL-CABLE SUSP POWER FEED 96IN	48.50	790576056180
LM-PCS96-DB	LV MONORAIL-CABLE SUSP POWER FEED 96IN	48.50	790576109718
LMP-DB	L SERIES MONOPOINT CANOPY	11.50	790576140513
LMP-WT	L SERIES MONOPOINT CANOPY	9.95	790576008967
LM-QADP-BN	QUICK CONNECT ADAPTER-MONORAIL	8.95	790576137513
LM-QADP-CH	QUICK CONNECT ADAPTER-MONORAIL	8.95	790576056319
LM-QADP-DB	QUICK CONNECT ADAPTER-MONORAIL	8.95	790576109725
LM-R12-BN	LV MONORAIL 12IN EXTENSION ROD	7.95	790576137292
LM-R12-CH	LV MONORAIL 12IN EXTENSION ROD	7.95	790576056067
LM-R12-DB	LV MONORAIL 12IN EXTENSION ROD	7.95	790576109732
LM-R24-BN	LV MONORAIL 24IN EXTENSION ROD	9.95	790576137308
LM-R24-CH	LV MONORAIL 24IN EXTENSION ROD	9.95	790576056074
LM-R24-DB	LV MONORAIL 24IN EXTENSION ROD	9.95	790576109749
LM-R36-BN	LV MONORAIL 36IN EXTENSION ROD	11.95	790576137315
LM-R36-CH	LV MONORAIL 36IN EXTENSION ROD	11.95	790576056081
LM-R36-DB	LV MONORAIL 36IN EXTENSION ROD	11.95	790576109756
LM-R48-BN	LV MONORAIL 48IN EXTENSION ROD	13.95	790576137322
LM-R48-CH	LV MONORAIL 48IN EXTENSION ROD	13.95	790576056098

Material	Description	2011 DN	UPC Code
LM-R48-DB	LV MONORAIL 48IN EXTENSION ROD	13.95	790576109763
LM-RI-BN	LV MONORAIL-ROD COUPLER	2.95	790576137353
LM-RI-CH	LV MONORAIL-ROD COUPLER	2.95	790576056104
LM-RI-DB	LV MONORAIL-ROD COUPLER	2.95	790576109770
LM-SCP48-BN	LV MONORAIL SLOPE CEILING PWR ADAP 48IN	30.95	790576137339
LM-SCP48-CH	LV MONORAIL SLOPE CEILING PWR ADAP 48IN	30.95	790576079547
LM-SCP48-DB	LV MONORAIL SLOPE CEILING PWR ADAP 48IN	30.95	790576109787
LM-SCP96-BN	LV MONORAIL SLOPE CEILING PWR ADAP 96IN	47.50	790576137346
LM-SCP96-CH	LV MONORAIL SLOPE CEILING PWR ADAP 96IN	47.50	790576079523
LM-SCP96-DB	LV MONORAIL SLOPE CEILING PWR ADAP 96IN	47.50	790576109794
LM-SK-150E-BN	LV MONORAIL POWER SUPPLY&RAIL KIT 150W	178.50	790576137520
LM-SK-150E-CH	LV MONORAIL POWER SUPPLY&RAIL KIT 150W	178.50	790576062525
LM-SK-150E-DB	LV MONORAIL POWER SUPPLY&RAIL KIT 150W	178.50	790576159980
LM-SK-250E-BN	LV MONORAIL POWER SUPPLY&RAIL KIT 250W	199.50	790576137537
LM-SK-250E-CH	LV MONORAIL POWER SUPPLY&RAIL KIT 250W	199.50	790576062532
LM-SK-250E-DB	LV MONORAIL POWER SUPPLY&RAIL KIT 250W	199.50	790576159997
LM-T30D-BN	LV MONORAIL 30 DEGREE BENT RAIL	17.50	790576170442
LM-T30D-CH	LV MONORAIL 30 DEGREE BENT RAIL	17.50	790576170367
LM-T30D-DB	LV MONORAIL 30 DEGREE BENT RAIL	17.50	790576170435
LM-T45D-BN	LV MONORAIL 45 DEGREE BENT RAIL	17.50	790576170459
LM-T45D-CH	LV MONORAIL 45 DEGREE BENT RAIL	17.50	790576170374
LM-T45D-DB	LV MONORAIL 45 DEGREE BENT RAIL	17.50	790576170428
LM-T4-BN	LV MONORAIL-4FT RAIL	30.95	790576137063
LM-T4-CH	LV MONORAIL-4FT RAIL	30.95	790576055923
LM-T4-DB	LV MONORAIL-4FT RAIL	30.95	790576109824
LM-T60D-BN	LV MONORAIL 60 DEGREE BENT RAIL	17.50	790576170466
LM-T60D-CH	LV MONORAIL 60 DEGREE BENT RAIL	17.50	790576170381
LM-T60D-DB	LV MONORAIL 60 DEGREE BENT RAIL	17.50	790576170411
LM-T8-BN	LV MONORAIL-8FT RAIL	57.95	790576137070
LM-T8-CH	LV MONORAIL-8FT RAIL	57.95	790576055930
LM-T8-DB	LV MONORAIL-8FT RAIL	57.95	790576109831
LM-T90D-BN	LV MONORAIL 90 DEGREE BENT RAIL	17.50	790576170473
LM-T90D-CH	LV MONORAIL 90 DEGREE BENT RAIL	17.50	790576170398
LM-T90D-DB	LV MONORAIL 90 DEGREE BENT RAIL	17.50	790576170404
LM-TB3-BN	LV MONORAIL-DROP CEILING SUSPENSION 3IN	12.95	790576137131
LM-TB3-CH	LV MONORAIL-DROP CEILING SUSPENSION 3IN	12.95	790576056043
LM-TB3-DB	LV MONORAIL-DROP CEILING SUSPENSION 3IN	12.95	790576109848
LM-TB4-BN	LV MONORAIL-DROP CEILING SUSPEN. 4 1/2IN	13.95	790576137148
LM-TB4-CH	LV MONORAIL-DROP CEILING SUSPEN. 4 1/2IN	13.95	790576057613
LM-TB4-DB	LV MONORAIL-DROP CEILING SUSPEN. 4 1/2IN	13.95	790576109855
LM-TB5-BN	V MONORAIL-DROP CEILING SUSPENSION 6IN	14.50	790576137155
LM-TB5-CH	LV MONORAIL-DROP CEILING SUSPENSION 6IN	14.50	790576056050
LM-TB5-DB	LV MONORAIL-DROP CEILING SUSPENSION 6IN	14.50	790576109862
LM-T-BN	LV MONORAIL-T CONNECTOR	18.50	790576137407
LM-T-CH	LV MONORAIL-T CONNECTOR	18.50	790576055985
LM-T-DB	LV MONORAIL-T CONNECTOR	18.50	790576109879
LM-VA-BN	VARIABLE ANGLE CONNECTOR.	29.95	790576137421
LM-VA-CH	VARIABLE ANGLE CONNECTOR.	29.95	790576115030
LM-VA-DB	VARIABLE ANGLE CONNECTOR.	29.95	790576115047
LM-WPC-BN	LV MONORAIL-WALL POWER FEED	31.50	790576137254

Material	Description	2011 DN	UPC Code
LM-WPC-CH	LV MONORAIL-WALL POWER FEED	31.50	790576056166
LM-WPC-DB	LV MONORAIL-WALL POWER FEED	31.50	790576109886
LM-X3-BN	LV MONORAIL-3IN SUSPENSION	13.95	790576137094
LM-X3-CH	LV MONORAIL-3IN SUSPENSION	13.95	790576056012
LM-X3-DB	LV MONORAIL-3IN SUSPENSION	13.95	790576109893
LM-X4-BN	LV MONORAIL-4 1/2IN SUSPENSION	14.50	790576137100
LM-X4-CH	LV MONORAIL-4 1/2IN SUSPENSION	14.50	790576057606
LM-X4-DB	LV MONORAIL-4 1/2IN SUSPENSION	14.50	790576109909
LM-X5-BN	LV MONORAIL 5 3/4IN SUSPENSION	14.95	790576137117
LM-X5-CH	LV MONORAIL 5 3/4IN SUSPENSION	14.95	790576056029
LM-X5-DB	LV MONORAIL 5 3/4IN SUSPENSION	14.95	790576109916
LM-XDEC-BN	LV MONORAIL-X CONNECTOR	7.95	790576137414
LM-XDEC-CH	LV MONORAIL-X CONNECTOR	7.95	790576057583
LM-XDEC-DB	LV MONORAIL-X CONNECTOR	7.95	790576109923
LM-XS5-BN	LV MONORAIL 5IN SLOPED CEILING STANDOFF	15.50	790576137124
LM-XS5-CH	LV MONORAIL 5IN SLOPED CEILING STANDOFF	15.50	790576056036
LM-XS5-DB	LV MONORAIL 5IN SLOPED CEILING STANDOFF	15.50	790576109930
LP-007-BK	LOW VOLT SURFACE MOUNT MAGNETIC 50W	42.95	790576021607
LP-007-BN	LOW VOLT SURFACE MOUNT MAGNETIC 50W	46.95	790576040141
LP-007-WT	LOW VOLT SURFACE MOUNT MAGNETIC 50W	42.95	790576021577
LP-808-BK	LOW VOLT SURFACE MOUNT MAGNETIC 50W	44.95	790576021584
LP-808-WT	LOW VOLT SURFACE MOUNT MAGNETIC 50W	44.95	790576021591
LT2-BK	L SERIES 2FT TRACK W/2 ENDCAPS	9.95	790576010182
LT2-BN	L SERIES 2FT TRACK W/2 ENDCAPS	12.95	790576124643
LT2-DB	L SERIES 2FT TRACK W/2 ENDCAPS	12.95	790576140353
LT2-WT	L SERIES 2FT TRACK W/2 ENDCAPS	9.95	790576010199
LT4-BK	L SERIES 4FT TRACK W/2 ENDCAPS	13.95	790576010205
LT4-BN	L SERIES 4FT TRACK W/2 ENDCAPS	20.50	790576124841
LT4-DB	L SERIES 4FT TRACK W/2 ENDCAPS	20.50	790576140360
LT4-WT	L SERIES 4FT TRACK W/2 ENDCAPS	13.95	790576010212
LT6-BK	L SERIES 6FT TRACK W/2 ENDCAPS	20.50	790576010229
LT6-BN	L SERIES 6FT TRACK W/2 ENDCAPS	29.95	790576124858
LT6-DB	L SERIES 6FT TRACK W/2 ENDCAPS	29.95	790576140377
LT6-WT	L SERIES 6FT TRACK W/2 ENDCAPS	20.50	790576010236
LT8-BK	L SERIES 8FT TRACK W/2 ENDCAPS	23.50	790576010243
LT8-BN	L SERIES 8FT TRACK IN BN	36.50	790576124865
LT8-DB	L SERIES 8FT TRACK W/2 ENDCAPS	36.50	790576140384
LT8-WT	L SERIES 8FT TRACK W/2 ENDCAPS	23.50	790576010250
LT-BK	L SERIES T CONNECTOR	9.50	790576010274
LT-BN	L SERIES T CONNECTOR	10.95	790576145747
LT-DB	L SERIES T CONNECTOR	10.95	790576140520
LTK-024-BK	L SERIES LINE VOLT TRACK HEAD	27.95	790576033860
LTK-024-WT	L SERIES LINE VOLT TRACK HEAD	27.95	790576033877
LTK-048-BK	L SERIES LINE VOLT TRACK HEAD	39.95	790576033952
LTK-048-WT	L SERIES LINE VOLT TRACK HEAD	39.95	790576033969
LTK-101-AM/BK	L SERIES LINE VOLTAGE TRACK HEAD	24.50	790576108858
LTK-101-AM/WT	L SERIES LINE VOLTAGE TRACK HEAD	24.50	790576108834
LTK-101-WT/BK	L SERIES LINE VOLTAGE TRACK HEAD	24.50	790576108865
LTK-101-WT/WT	L SERIES LINE VOLTAGE TRACK HEAD	24.50	790576108841
LTK-102-AM/BK	L SERIES LINE VOLTAGE TRACK HEAD	24.50	790576108971

Material	Description	2011 DN	UPC Code
LTK-102-AM/WT	L SERIES LINE VOLTAGE TRACK HEAD	24.50	790576108957
LTK-102-WT/BK	L SERIES LINE VOLTAGE TRACK HEAD	24.50	790576108988
LTK-102-WT/WT	L SERIES LINE VOLTAGE TRACK HEAD	24.50	790576108964
LTK-103-BK	L SERIES LINE VOLTAGE TRACK HEAD	19.95	790576109053
LTK-103-WT	L SERIES LINE VOLTAGE TRACK HEAD	19.95	790576109060
LTK-104-BK	L SERIES LINE VOLTAGE TRACK HEAD	18.95	790576109114
LTK-104-WT	L SERIES LINE VOLTAGE TRACK HEAD	18.95	790576109121
LTK-105-BK	L SERIES LINE VOLTAGE TRACK HEAD	19.95	790576109176
LTK-105-WT	L SERIES LINE VOLTAGE TRACK HEAD	19.95	790576109183
LTK-132E-AB	L SERIES CFL TRACK HEAD 32W	124.95	790576141961
LTK-132E-AN	L SERIES CFL TRACK HEAD 32W	124.95	790576193755
LTK-150-BK	L SERIES LINE VOLT TRACK HEAD - DIE CAST	44.95	790576010311
LTK-150-WT	L SERIES LINE VOLT TRACK HEAD - DIE CAST	44.95	790576010328
LTK-178-BK	L SERIES LINE VOLT TRACK HEAD	8.95	790576014142
LTK-178-BN	L SERIES LINE VOLT TRACK HEAD	12.95	790576147512
LTK-178-WT	L SERIES LINE VOLT TRACK HEAD	8.95	790576014159
LTK-188-BK	L SERIES LINE VOLT TRACK HEAD	9.95	790576010335
LTK-188-BN	L SERIES LINE VOLT TRACK HEAD	13.95	790576147529
LTK-188-DB	LINE VOLTAGE TRACK HEAD	13.95	790576163369
LTK-188-WT	L SERIES LINE VOLT TRACK HEAD	9.95	790576010342
LTK-331-BK	L SERIES LINE VOLTAGE TRACK HEAD	75.95	
LTK-331-WT	L SERIES LINE VOLTAGE TRACK HEAD	75.95	
LTK-512AM/BN	JILL PENDANT FOR L SERIES TRACK - 120V 5	74.95	790576156675
LTK-512AM/DB	JILL PENDANT FOR L SERIES TRACK - 120V 5	74.95	790576156668
LTK-512BL/BN	JILL PENDANT FOR L SERIES TRACK - 120V 5	74.95	790576156699
LTK-512BL/DB	JILL PENDANT FOR L SERIES TRACK - 120V 5	74.95	790576156682
LTK-512GR/BN	JILL PENDANT FOR L SERIES TRACK - 120V 5	74.95	790576156712
LTK-512GR/DB	JILL PENDANT FOR L SERIES TRACK - 120V 5	74.95	790576156705
LTK-512RD/BN	JILL PENDANT FOR L SERIES TRACK - 120V 5	74.95	790576156736
LTK-512RD/DB	JILL PENDANT FOR L SERIES TRACK - 120V 5	74.95	790576156729
LTK-512WT/BN	JILL PENDANT FOR L SERIES TRACK - 120V 5	74.95	790576156750
LTK-512WT/DB	JILL PENDANT FOR L SERIES TRACK - 120V 5	74.95	790576156743
LTK-513AM/BN	ELLA PENDANT FOR L SERIES TRACK - 120V 5	83.95	790576156774
LTK-513AM/DB	ELLA PENDANT FOR L SERIES TRACK - 120V 5	83.95	790576156767
LTK-513WT/BN	ELLA PENDANT FOR L SERIES TRACK - 120V 5	83.95	790576156798
LTK-513WT/DB	ELLA PENDANT FOR L SERIES TRACK - 120V 5	83.95	790576156781
LTK-515AM/BN	FIORE PENDANT FOR L SERIES TRACK - 120V	114.95	790576156859
LTK-515AM/DB	FIORE PENDANT FOR L SERIES TRACK - 120V	114.95	790576156842
LTK-515MF/BN	FIORE PENDANT FOR L SERIES TRACK - 120V	114.95	790576156859
LTK-515MF/DB	FIORE PENDANT FOR L SERIES TRACK - 120V	114.95	790576156842
LTK-517WT/BN	OBO PENDANT FOR L SERIES TRACK - 120V 50	79.95	790576156897
LTK-517WT/DB	OBO PENDANT FOR L SERIES TRACK - 120V 50	79.95	790576156880
LTK-518DIC/BN	EDEN PENDANT FOR L SERIES TRACK - 120V 5	129.95	790576156910
LTK-518DIC/DB	EDEN PENDANT FOR L SERIES TRACK - 120V 5	129.95	790576156903
LTK-524AM/BN	SARAH PENDANT FOR L SERIES TRACK - 120V	78.95	790576156996
LTK-524AM/DB	SARAH PENDANT FOR L SERIES TRACK - 120V	78.95	790576156989
LTK-524LB/BN	SARAH PENDANT FOR L SERIES TRACK - 120V	78.95	790576157016
LTK-524LB/DB	SARAH PENDANT FOR L SERIES TRACK - 120V	78.95	790576157009
LTK-524TQ/BN	SARAH PENDANT FOR L SERIES TRACK - 120V	78.95	790576157030
LTK-524TQ/DB	SARAH PENDANT FOR L SERIES TRACK - 120V	78.95	790576157023



Material	Description	2011 DN	UPC Code
LTK-524WT/BN	SARAH PENDANT FOR L SERIES TRACK - 120V	78.95	790576157054
LTK-524WT/DB	SARAH PENDANT FOR L SERIES TRACK - 120V	78.95	790576157047
LTK-530GR/BN	COUTURE PENDANT FOR L SERIES TRACK - 120	169.95	790576157078
LTK-530GR/DB	COUTURE PENDANT FOR L SERIES TRACK - 120	169.95	790576157061
LTK-530MC/BN	COUTURE PENDANT FOR L SERIES TRACK - 120	169.95	790576157092
LTK-530MC/DB	COUTURE PENDANT FOR L SERIES TRACK - 120	169.95	790576157085
LTK-534SM/BN	PENDANT FOR L SERIES TRACK - 120	99.95	790576195339
LTK-534SM/DB	PENDANT FOR L SERIES TRACK - 120	99.95	790576195346
LTK-535DIC/BN	PENDANT FOR L SERIES TRACK - 120	149.95	
LTK-535DIC/DB	PENDANT FOR L SERIES TRACK - 120	149.95	
LTK-536BL/BN	PENDANT FOR L SERIES TRACK - 120	114.95	790576195551
LTK-536BL/DB	PENDANT FOR L SERIES TRACK - 120	114.95	790576195568
LTK-541AM/BN	FABERGE PENDANT FOR L SERIES TRACK - 120	86.95	790576157139
LTK-541AM/DB	FABERGE PENDANT FOR L SERIES TRACK - 120	86.95	790576157122
LTK-541WT/BN	FABERGE PENDANT FOR L SERIES TRACK - 120	86.95	790576157153
LTK-541WT/DB	FABERGE PENDANT FOR L SERIES TRACK - 120	86.95	790576157146
LTK-546DIC/BN	AMBROSIA PENDANT FOR L SERIES TRACK - 12	149.95	790576157191
LTK-546DIC/DB	AMBROSIA PENDANT FOR L SERIES TRACK - 12	149.95	790576157184
LTK-548FR/BN	PURA PENDANT FOR L SERIES TRACK - 120V 5	99.95	790576157238
LTK-548FR/DB	PURA PENDANT FOR L SERIES TRACK - 120V 5	99.95	790576157221
LTK-559DIC/BN	MICHA PENDANT FOR L SERIES TRACK - 120V	89.95	790576178035
LTK-559DIC/DB	MICHA PENDANT FOR L SERIES TRACK - 120V	89.95	790576178066
LTK-559GL/BN	MICHA PENDANT FOR L SERIES TRACK - 120V	89.95	790576173221
LTK-559GL/DB	MICHA PENDANT FOR L SERIES TRACK - 120V	89.95	790576173269
LTK-559MR/BN	MICHA PENDANT FOR L SERIES TRACK - 120V	89.95	790576179056
LTK-559MR/DB	MICHA PENDANT FOR L SERIES TRACK - 120V	89.95	790576179094
LTK-593LI/BN	KOMAL PENDANT FOR L SERIES TRACK - 120V	129.95	790576157313
LTK-593LI/DB	KOMAL PENDANT FOR L SERIES TRACK - 120V	129.95	790576157306
LTK-593RD/BN	KOMAL PENDANT FOR L SERIES TRACK - 120V	129.95	790576157337
LTK-593RD/DB	KOMAL PENDANT FOR L SERIES TRACK - 120V	129.95	790576157320
LTK-593TQ/BN	KOMAL PENDANT FOR L SERIES TRACK - 120V	129.95	790576157351
LTK-593TQ/DB	KOMAL PENDANT FOR L SERIES TRACK - 120V	129.95	790576157344
LTK-598WT/BN	DAPPER PENDANT FOR L SERIES TRACK - 120V	114.95	790576157375
LTK-598WT/DB	DAPPER PENDANT FOR L SERIES TRACK - 120V	114.95	790576157368
LTK-599BL/BN	RHEA PENDANT FOR L SERIES TRACK - 120V	99.95	790576175485
LTK-599BL/DB	RHEA PENDANT FOR L SERIES TRACK - 120V	99.95	790576175515
LTK-599UM/BN	RHEA PENDANT FOR L SERIES TRACK - 120V	99.95	790576177533
LTK-599UM/DB	RHEA PENDANT FOR L SERIES TRACK - 120V	99.95	790576177571
LTK-599WT/BN	RHEA PENDANT FOR L SERIES TRACK - 120V	99.95	790576176499
LTK-599WT/DB	RHEA PENDANT FOR L SERIES TRACK - 120V	99.95	790576176536
LTK-701-BK	L SERIES LINE VOLT TRACK HEAD	10.95	790576010359
LTK-701-WT	L SERIES LINE VOLT TRACK HEAD	10.95	790576010366
LTK-703-BK	L SERIES LINE VOLT TRACK HEAD	10.95	790576010397
LTK-703-WT	L SERIES LINE VOLT TRACK HEAD	10.95	790576010403
LTK-704-BK	L SERIES LINE VOLT TRACK HEAD	12.50	790576010410
LTK-704-WT	L SERIES LINE VOLT TRACK HEAD	12.50	790576010427
LTK-705-BK	L SERIES LINE VOLT TRACK HEAD	17.95	790576010434
LTK-705-WT	L SERIES LINE VOLT TRACK HEAD	17.95	790576010441
LTK-706-BK	L SERIES LINE VOLT TRACK HEAD	17.95	790576010458
LTK-706-WT	L SERIES LINE VOLT TRACK HEAD	17.95	790576021508

Material	Description	2011 DN	UPC Code
LTK-713-BK	L SERIES LINE VOLTAGE TRACK HEAD	42.50	790576095431
LTK-713-WT	L SERIES LINE VOLTAGE TRACK HEAD	42.50	790576095448
LTK-715-BK	L SERIES LINE VOLTAGE TRACK HEAD	47.95	790576095523
LTK-715-WT	L SERIES LINE VOLTAGE TRACK HEAD	47.95	790576095530
LTK-717-BK	L SERIES LINE VOLT TRACK HEAD	11.95	790576035925
LTK-717-WT	L SERIES LINE VOLT TRACK HEAD	11.95	790576035932
LTK-718-BK	L SERIES LINE VOLT TRACK HEAD	12.50	790576010472
LTK-718-WT	L SERIES LINE VOLT TRACK HEAD	12.50	790576010489
LTK-720-BK	L SERIES LINE VOLT TRACK HEAD - DIE CAST	24.95	790576010496
LTK-720-WT	L SERIES LINE VOLT TRACK HEAD - DIE CAST	24.95	790576010502
LTK-725-BK	L SERIES LINE VOLT TRACK HEAD	10.95	790576010519
LTK-725-WT	L SERIES LINE VOLT TRACK HEAD	10.95	790576010526
LTK-727-BK	L SERIES LINE VOLTAGE TRACK HEAD	49.95	790576095615
LTK-727-WT	L SERIES LINE VOLTAGE TRACK HEAD	49.95	790576095622
LTK-730-BK	L SERIES LINE VOLT TRACK HEAD - DIE CAST	27.95	790576010540
LTK-730-WT	L SERIES LINE VOLT TRACK HEAD - DIE CAST	27.95	790576010557
LTK-733-BK	L SERIES LINE VOLTAGE TRACK HEAD	46.50	790576095707
LTK-733-WT	L SERIES LINE VOLTAGE TRACK HEAD	46.50	790576095714
LTK-737-BK	L SERIES LINE VOLTAGE TRACK HEAD	51.95	790576095790
LTK-737-WT	L SERIES LINE VOLTAGE TRACK HEAD	51.95	790576095806
LTK-738-BK	L SERIES LINE VOLT TRACK HEAD - DIE CAST	30.95	790576010564
LTK-738-WT	L SERIES LINE VOLT TRACK HEAD - DIE CAST	30.95	790576010571
LTK-747-BK	L SERIES LINE VOLTAGE TRACK HEAD	45.95	790576105703
LTK-747-WT	L SERIES LINE VOLTAGE TRACK HEAD	45.95	790576105710
LTK-753-BK	L SERIES LINE VOLT TRACK HEAD - DIE CAST	24.95	790576010649
LTK-753-WT	L SERIES LINE VOLT TRACK HEAD - DIE CAST	24.95	790576010656
LTK-754-BK	L SERIES LINE VOLT TRACK HEAD - DIE CAST	27.95	790576010663
LTK-754-WT	L SERIES LINE VOLT TRACK HEAD - DIE CAST	27.95	790576010670
LTK-755-BK	L SERIES LINE VOLT TRACK HEAD - DIE CAST	30.95	790576010687
LTK-755-WT	L SERIES LINE VOLT TRACK HEAD - DIE CAST	30.95	790576010694
LTK-757-BK	L SERIES LINE VOLTAGE TRACK HEAD	47.95	790576105765
LTK-757-WT	L SERIES LINE VOLTAGE TRACK HEAD	47.95	790576105772
LTK-763-39E-BK	L SERIES HID TRACK HEAD PAR20 39W	141.50	790576118932
LTK-763-39E-PT/BK	L SERIES HID TRACK HEAD PAR20 39W	145.50	790576118956
LTK-763-39E-PT/WT	L SERIES HID TRACK HEAD PAR20 39W	145.50	790576119021
LTK-763-39E-WT	L SERIES HID TRACK HEAD PAR20 39W	141.50	790576118949
LTK-763-BK	L SERIES LINE VOLT TRACK HEAD	11.50	790576038278
LTK-763-BN	L SERIES LINE VOLT TRACK HEAD	15.50	790576147536
LTK-763-WT	L SERIES LINE VOLT TRACK HEAD	11.50	790576038285
LTK-764-39E-BK	L SERIES HID TRACK HEAD PAR30L 39W	146.50	790576119052
LTK-764-39E-PT/BK	L SERIES HID TRACK HEAD PAR30L 39W	150.50	790576119076
LTK-764-39E-PT/WT	L SERIES HID TRACK HEAD PAR30L 39W	150.50	790576119083
LTK-764-39E-WT	L SERIES HID TRACK HEAD PAR30L 39W	146.50	790576119069
LTK-764-70E-BK	L SERIES HID TRACK HEAD PAR30L 70W	151.50	790576119175
LTK-764-70E-PT/BK	L SERIES HID TRACK HEAD PAR30L 70W	155.50	790576119199
LTK-764-70E-PT/WT	L SERIES HID TRACK HEAD PAR30L 70W	155.50	790576119205
LTK-764-70E-WT	L SERIES HID TRACK HEAD PAR30L 70W	151.50	790576119182
LTK-764-BK	L SERIES LINE VOLT TRACK HEAD	12.25	790576038308
LTK-764-BN	L SERIES LINE VOLT TRACK HEAD	16.25	790576147543
LTK-764-WT	L SERIES LINE VOLT TRACK HEAD	12.25	790576038315

Material	Description	2011 DN	UPC Code
LTK-765-70E-BK	L SERIES HID TRACK HEAD PAR38 70W	156.50	790576119298
LTK-765-70E-PT/BK	L SERIES HID TRACK HEAD PAR38 70W	160.50	790576119311
LTK-765-70E-PT/WT	L SERIES HID TRACK HEAD PAR38 70W	160.50	790576119328
LTK-765-70E-WT	L SERIES HID TRACK HEAD PAR38 70W	156.50	790576119304
LTK-765-BK	L SERIES LINE VOLT TRACK HEAD	13.00	790576038339
LTK-765-BN	L SERIES LINE VOLT TRACK HEAD	17.00	790576147550
LTK-765-WT	L SERIES LINE VOLT TRACK HEAD	13.00	790576038346
LTK-773-BK	L SERIES LINE VOLT TRACK HEAD	24.50	790576036021
LTK-773-BN	L SERIES LINE VOLT TRACK HEAD	28.50	790576147567
LTK-773-WT	L SERIES LINE VOLT TRACK HEAD	24.50	790576036038
LTK-774-BK	L SERIES LINE VOLT TRACK HEAD	26.50	790576036045
LTK-774-BN	L SERIES LINE VOLT TRACK HEAD	30.50	790576147574
LTK-774-WT	L SERIES LINE VOLT TRACK HEAD	26.50	790576036052
LTK-775-BK	L SERIES LINE VOLT TRACK HEAD	28.50	790576036069
LTK-775-BN	L SERIES LINE VOLT TRACK HEAD	32.50	790576147581
LTK-775-WT	L SERIES LINE VOLT TRACK HEAD	28.50	790576036076
LTK-793-AB	L SER. LINE VOLTAGE TRACK HEAD PAR20 50W	64.95	790576141985
LTK-793-AN	L SERIES LINE VOLTAGE TRACK HEAD PAR20 50W	64.95	790576193359
LTK-794-AB	L SER. LINE VOLTAGE TRACK HEAD PAR30 75W	66.95	790576142005
LTK-794-AN	L SERIES LINE VOLTAGE TRACK HEAD PAR30 75W	66.95	790576193380
LTK-795-AB	LINE VOLTAGE TRACK HEAD PAR38 150W	68.95	790576142029
LTK-795-AN	L SERIES LINE VOLTAGE TRACK HEAD PAR38 150W	68.95	790576193427
LTK-797-AB	L SER. LINE VOLTAGE TRACK HEAD PAR20 50W	64.95	790576141909
LTK-797-AN	L SERIES LINE VOLTAGE TRACK HEAD PAR20 50W	64.95	790576193267
LTK-797-LENS-AB	L SERIES LINE VOLT TRACK HEAD 50W W/LENS	69.95	790576143422
LTK-797-LENS-AN	W/ LENS OPTION	69.95	790576193663
LTK-798-AB	L SER. LINE VOLTAGE TRACK HEAD PAR30 75W	66.95	790576141923
LTK-798-AN	L SERIES LINE VOLTAGE TRACK HEAD PAR30 75W	66.95	790576193298
LTK-798-LENS-AB	L SERIES LINE VOLT TRACK HEAD 75W W/LENS	71.95	790576143514
LTK-798-LENS-AN	W/ LENS OPTION	71.95	790576193694
LTK-799-AB	L SER.LINE VOLTAGE TRACK HEAD PAR38 150W	68.95	790576141947
LTK-799-AN	L SERIES LINE VOLTAGE TRACK HEAD PAR38 150W	68.95	790576193328
LTK-799-LENS-AB	L SERIES LINE VOLT TRACK HEAD 150W W/LEN	73.95	790576143545
LTK-799-LENS-AN	- W/ LENS OPTION	73.95	790576193724
LTK-F1-402AM/DB	L SERIES TRACK PENDANT - CFL GU24	116.95	790576183541
LTK-F1-402BL/DB	L SERIES TRACK PENDANT - CFL GU24	116.95	790576184036
LTK-F1-402WM/DB	L SERIES TRACK PENDANT - CFL GU24	116.95	790576184500
LTK-F1-403AM/DB	L SERIES TRACK PENDANT - CFL GU24	134.95	790576181257
LTK-F1-403BL/DB	L SERIES TRACK PENDANT - CFL GU24	134.95	790576181844
LTK-F1-403RD/DB	L SERIES TRACK PENDANT - CFL GU24	134.95	790576182438
LTK-F1-404BN/DB	L SERIES TRACK PENDANT - CFL GU24	99.95	790576184753
LTK-F1-404CO/DB	L SERIES TRACK PENDANT - CFL GU24	99.95	790576180663
LTK-F1-406OC/DB	L SERIES TRACK PENDANT - CFL GU24	134.95	790576183008
LTK-F1-408AM/DB	L SERIES TRACK PENDANT - CFL GU24	134.95	790576184821
LTK-F1-408WT/DB	L SERIES TRACK PENDANT - CFL GU24	134.95	790576184951
LTK-F1-421GR/DB	MOSS PENDANT FOR L SERIES TRACK - CFL GU	189.95	790576159874
LTK-F1-423PR/DB	SOLSTICE PENDANT FOR L SERIES TRACK - CF	199.95	790576159881
LTK-F1-424WT/DB	SERAPHIM PENDANT FOR L SERIES TRACK - CF	219.95	790576159898
LTK-F1-451AM/DB	L SERIES TRACK PENDANT - CFL GU24	119.95	790576182032
LTK-F1-451BL/DB	L SERIES TRACK PENDANT - CFL GU24	119.95	790576182650

Material	Description	2011 DN	UPC Code
LTK-F1-451WT/DB	L SERIES TRACK PENDANT - CFL GU24	119.95	790576183275
LTK-F1-454AM/DB	L SERIES TRACK PENDANT - CFL GU24	119.95	790576183800
LTK-F1-454WT/DB	L SERIES TRACK PENDANT - CFL GU24	119.95	790576184296
LTK-F1-471WT/DB	MODE PENDANT FOR L SERIES TRACK - CFL GU	119.95	790576159911
LTK-F1-472WT/DB	CLINTON PENDANT FOR L SERIES TRACK - CFL	129.95	790576159928
LTK-F1-474WT/DB	CAROL GARDENS PENDANT FOR L SERIES TRACK	144.95	790576159935
LTK-F1-483IV/DB	WILLIAMSBURG PENDANT FOR L SERIES TRACK	149.95	790576159942
LTK-F1-484BL/DB	PENDANT FOR L SERIES TRACK	149.95	790576200774
LTK-F1-485BL/DB	PENDANT FOR L SERIES TRACK	189.95	
LTK-F1-487AM/DB	COBBLE HILL PENDANT FOR L SERIES TRACK -	149.95	790576159966
LTK-F1-488WT/DB	PARK SLOPE PENDANT FOR L SERIES TRACK -	193.95	790576159973
LTK-F2-402AM/BN	L SERIES TRACK PENDANT - CFL GU24	116.95	790576183596
LTK-F2-402BL/BN	L SERIES TRACK PENDANT - CFL GU24	116.95	790576184067
LTK-F2-402WM/BN	L SERIES TRACK PENDANT - CFL GU24	116.95	790576184548
LTK-F2-403AM/BN	L SERIES TRACK PENDANT - CFL GU24	134.95	790576181301
LTK-F2-403BL/BN	L SERIES TRACK PENDANT - CFL GU24	134.95	790576181899
LTK-F2-403RD/BN	L SERIES TRACK PENDANT - CFL GU24	134.95	790576182483
LTK-F2-404BN/BN	L SERIES TRACK PENDANT - CFL GU24	99.95	790576180120
LTK-F2-404CO/BN	L SERIES TRACK PENDANT - CFL GU24	99.95	790576180717
LTK-F2-406OC/BN	L SERIES TRACK PENDANT - CFL GU24	134.95	790576183053
LTK-F2-408AM/BN	L SERIES TRACK PENDANT - CFL GU24	134.95	790576184838
LTK-F2-408WT/BN	L SERIES TRACK PENDANT - CFL GU24	134.95	790576184968
LTK-F2-421GR/BN	LINE VOLTAGE TRACK MOUNT PENDANT KIT	189.95	790576143149
LTK-F2-423PR/BN	LINE VOLTAGE TRACK MOUNT PENDANT KIT	199.95	790576143323
LTK-F2-424WT/BN	LINE VOLTAGE TRACK MOUNT PENDANT KIT	219.95	790576144535
LTK-F2-451AM/BN	L SERIES TRACK PENDANT - CFL GU24	119.95	790576182087
LTK-F2-451BL/BN	L SERIES TRACK PENDANT - CFL GU24	119.95	790576182704
LTK-F2-451WT/BN	L SERIES TRACK PENDANT - CFL GU24	119.95	790576183329
LTK-F2-454AM/BN	L SERIES TRACK PENDANT - CFL GU24	119.95	790576183848
LTK-F2-454WT/BN	L SERIES TRACK PENDANT - CFL GU24	119.95	790576184326
LTK-F2-471WT/BN	LINE VOLTAGE TRACK MOUNT PENDANT KIT	119.95	790576143699
LTK-F2-472WT/BN	LINE VOLTAGE TRACK MOUNT PENDANT KIT	129.95	790576143866
LTK-F2-474WT/BN	LINE VOLTAGE TRACK MOUNT PENDANT KIT	144.95	790576144412
LTK-F2-483IV/BN	LINE VOLTAGE TRACK MOUNT PENDANT KIT	149.95	790576144474
LTK-F2-484BL/BN	LINE VOLTAGE TRACK MOUNT PENDANT KIT	149.95	790576200781
LTK-F2-485BL/BN	LINE VOLTAGE TRACK MOUNT PENDANT KIT	189.95	
LTK-F2-487AM/BN	LINE VOLTAGE TRACK MOUNT PENDANT KIT	149.95	790576144504
LTK-F2-488WT/BN	LINE VOLTAGE TRACK MOUNT PENDANT KIT	193.95	790576144467
LTK-F4-402AM/BK	LIZA PENDANT FOR L SERIES TRACK MOUNT -	80.95	790576153971
LTK-F4-402AM/BN	LIZA PENDANT FOR L SERIES TRACK MOUNT -	81.95	790576153988
LTK-F4-402AM/WT	LIZA PENDANT FOR L SERIES TRACK MOUNT -	80.95	790576153995
LTK-F4-402BL/BK	LIZA PENDANT FOR L SERIES TRACK MOUNT -	80.95	790576154008
LTK-F4-402BL/BN	LIZA PENDANT FOR L SERIES TRACK MOUNT -	81.95	790576154015
LTK-F4-402BL/WT	LIZA PENDANT FOR L SERIES TRACK MOUNT -	80.95	790576154022
LTK-F4-402WM/BK	LIZA PENDANT FOR L SERIES TRACK MOUNT -	80.95	790576154039
LTK-F4-402WM/BN	LIZA PENDANT FOR L SERIES TRACK MOUNT -	81.95	790576154046
LTK-F4-402WM/WT	LIZA PENDANT FOR L SERIES TRACK MOUNT -	80.95	790576154053
LTK-F4-403AM/BK	NOVA PENDANT FOR L SERIES TRACK MOUNT -	98.95	790576154060
LTK-F4-403AM/BN	NOVA PENDANT FOR L SERIES TRACK MOUNT -	99.95	790576154077
LTK-F4-403AM/WT	NOVA PENDANT FOR L SERIES TRACK MOUNT -	98.95	790576154084

Material	Description	2011 DN	UPC Code
LTK-F4-403BL/BK	NOVA PENDANT FOR L SERIES TRACK MOUNT -	98.95	790576154091
LTK-F4-403BL/BN	NOVA PENDANT FOR L SERIES TRACK MOUNT -	99.95	790576154107
LTK-F4-403BL/WT	NOVA PENDANT FOR L SERIES TRACK MOUNT -	98.95	790576154114
LTK-F4-403RD/BK	NOVA PENDANT FOR L SERIES TRACK MOUNT -	98.95	790576154121
LTK-F4-403RD/BN	NOVA PENDANT FOR L SERIES TRACK MOUNT -	99.95	790576154138
LTK-F4-403RD/WT	NOVA PENDANT FOR L SERIES TRACK MOUNT -	98.95	790576154145
LTK-F4-404BN/BK	FELIS PENDANT FOR L SERIES TRACK MOUNT -	63.95	790576154152
LTK-F4-404BN/BN	FELIS PENDANT FOR L SERIES TRACK MOUNT -	64.95	790576154169
LTK-F4-404BN/WT	FELIS PENDANT FOR L SERIES TRACK MOUNT -	63.95	790576154176
LTK-F4-404CO/BK	FELIS PENDANT FOR L SERIES TRACK MOUNT -	63.95	790576154183
LTK-F4-404CO/BN	FELIS PENDANT FOR L SERIES TRACK MOUNT -	64.95	790576154190
LTK-F4-404CO/WT	FELIS PENDANT FOR L SERIES TRACK MOUNT -	63.95	790576154206
LTK-F4-406OC/BK	FROST PENDANT FOR L SERIES TRACK MOUNT -	98.95	790576154213
LTK-F4-406OC/BN	FROST PENDANT FOR L SERIES TRACK MOUNT -	99.95	790576154220
LTK-F4-406OC/WT	FROST PENDANT FOR L SERIES TRACK MOUNT -	98.95	790576154237
LTK-F4-408AM/BK	CREAMERY PENDANT FOR L SERIES TRACK MOUN	98.95	790576154244
LTK-F4-408AM/BN	CREAMERY PENDANT FOR L SERIES TRACK MOUN	99.95	790576154251
LTK-F4-408AM/WT	CREAMERY PENDANT FOR L SERIES TRACK MOUN	98.95	790576154268
LTK-F4-408WT/BK	CREAMERY PENDANT FOR L SERIES TRACK MOUN	98.95	790576154275
LTK-F4-408WT/BN	CREAMERY PENDANT FOR L SERIES TRACK MOUN	99.95	790576154282
LTK-F4-408WT/WT	CREAMERY PENDANT FOR L SERIES TRACK MOUN	98.95	790576154299
LTK-F4-421GR/BK	L SERIES TRACK PENDANT - A19	153.95	790576183985
LTK-F4-421GR/BN	L SERIES TRACK PENDANT - A19	154.95	790576184029
LTK-F4-421GR/WT	LINE VOLTAGE TRACK MOUNT PENDAN	153.95	790576184074
LTK-F4-423PR/BK	L SERIES TRACK PENDANT - A19	163.95	790576183046
LTK-F4-423PR/BN	L SERIES TRACK PENDANT - A19	164.95	790576183107
LTK-F4-424WT/BK	L SERIES TRACK PENDANT - A19	183.95	790576180960
LTK-F4-424WT/BN	L SERIES TRACK PENDANT - A19	184.95	790576181011
LTK-F4-424WT/WT	L SERIES TRACK PENDANT - A19	183.95	790576181066
LTK-F4-451AM/BK	BONGO PENDANT FOR L SERIES TRACK MOUNT -	83.95	790576154305
LTK-F4-451AM/BN	BONGO PENDANT FOR L SERIES TRACK MOUNT -	84.95	790576154312
LTK-F4-451AM/WT	BONGO PENDANT FOR L SERIES TRACK MOUNT -	83.95	790576154329
LTK-F4-451BL/BK	BONGO PENDANT FOR L SERIES TRACK MOUNT -	83.95	790576154336
LTK-F4-451BL/BN	BONGO PENDANT FOR L SERIES TRACK MOUNT -	84.95	790576154343
LTK-F4-451BL/WT	BONGO PENDANT FOR L SERIES TRACK MOUNT -	83.95	790576154350
LTK-F4-451WT/BK	BONGO PENDANT FOR L SERIES TRACK MOUNT -	83.95	790576154367
LTK-F4-451WT/BN	BONGO PENDANT FOR L SERIES TRACK MOUNT -	84.95	790576154374
LTK-F4-451WT/WT	BONGO PENDANT FOR L SERIES TRACK MOUNT -	83.95	790576154381
LTK-F4-454AM/BK	DAX PENDANT FOR L SERIES TRACK MOUNT - A	83.95	790576154398
LTK-F4-454AM/BN	DAX PENDANT FOR L SERIES TRACK MOUNT - A	84.95	790576154404
LTK-F4-454AM/WT	DAX PENDANT FOR L SERIES TRACK MOUNT - A	83.95	790576154411
LTK-F4-454WT/BK	DAX PENDANT FOR L SERIES TRACK MOUNT - A	83.95	790576154428
LTK-F4-454WT/BN	DAX PENDANT FOR L SERIES TRACK MOUNT - A	84.95	790576154435
LTK-F4-454WT/WT	DAX PENDANT FOR L SERIES TRACK MOUNT - A	83.95	790576154442
LTK-F4-471WT/BK	L SERIES TRACK PENDANT - A19	83.95	790576180083
LTK-F4-471WT/BN	L SERIES TRACK PENDANT - A19	84.95	790576180137
LTK-F4-471WT/WT	L SERIES TRACK PENDANT - A19	83.95	790576180182
LTK-F4-472WT/BK	L SERIES TRACK PENDANT - A19	93.95	790576181127
LTK-F4-472WT/BN	L SERIES TRACK PENDANT - A19	94.95	790576181165
LTK-F4-472WT/WT	L SERIES TRACK PENDANT - A19	93.95	790576181233

Material	Description	2011 DN	UPC Code
LTK-F4-474WT/BK	L SERIES TRACK PENDANT - A19	108.95	790576180359
LTK-F4-474WT/BN	L SERIES TRACK PENDANT - A19	109.95	790576180410
LTK-F4-474WT/WT	L SERIES TRACK PENDANT - A19	108.95	790576180465
LTK-F4-483IV/BK	L SERIES TRACK PENDANT - A19	113.95	790576181363
LTK-F4-483IV/BN	L SERIES TRACK PENDANT - A19	114.95	790576181417
LTK-F4-483IV/WT	L SERIES TRACK PENDANT - A19	113.95	790576181462
LTK-F4-484BL/BK	L SERIES TRACK PENDANT - A19	113.95	790576200798
LTK-F4-484BL/BN	L SERIES TRACK PENDANT - A19	114.95	790576200804
LTK-F4-484BL/WT	L SERIES TRACK PENDANT - A19	113.95	790576200811
LTK-F4-485BL/BK	L SERIES TRACK PENDANT - A19	153.95	
LTK-F4-485BL/BN	L SERIES TRACK PENDANT - A19	154.95	
LTK-F4-485BL/WT	L SERIES TRACK PENDANT - A19	153.95	
LTK-F4-487AM/BK	L SERIES TRACK PENDANT - A19	113.95	790576184081
LTK-F4-487AM/BN	L SERIES TRACK PENDANT - A19	114.95	790576184128
LTK-F4-487AM/WT	L SERIES TRACK PENDANT - A19	113.95	790576184166
LTK-F4-488WT/BK	L SERIES TRACK PENDANT - A19	157.95	790576183206
LTK-F4-488WT/BN	L SERIES TRACK PENDANT - A19	158.95	790576183251
LTK-F4-488WT/WT	L SERIES TRACK PENDANT - A19	157.95	790576183305
LTK-HID301-39E-BK	L SERIES LINE VOLTAGE TRACK HEAD - HID LARC	227.95	
LTK-HID301-39E-WT	L SERIES LINE VOLTAGE TRACK HEAD - HID LARC	227.95	
LTK-HID301-70E-BK	L SERIES LINE VOLTAGE TRACK HEAD - HID LARC	238.95	
LTK-HID301-70E-WT	L SERIES LINE VOLTAGE TRACK HEAD - HID LARC	238.95	
LTK-HID303F-20E-BK	L SERIES LINE VOLTAGE TRACK HEAD - HID LARC	214.95	
LTK-HID303F-20E-WT	L SERIES LINE VOLTAGE TRACK HEAD - HID LARC	214.95	
LTK-HID303F-39E-BK	L SERIES LINE VOLTAGE TRACK HEAD - HID LARC	219.95	
LTK-HID303F-39E-WT	L SERIES LINE VOLTAGE TRACK HEAD - HID LARC	219.95	
LTK-HID303F-70E-BK	L SERIES LINE VOLTAGE TRACK HEAD - HID LARC	224.95	
LTK-HID303F-70E-WT	L SERIES LINE VOLTAGE TRACK HEAD - HID LARC	224.95	
LTK-HID303N-20E-BK	L SERIES LINE VOLTAGE TRACK HEAD - HID LARC	214.95	
LTK-HID303N-20E-WT	L SERIES LINE VOLTAGE TRACK HEAD - HID LARC	214.95	
LTK-HID303N-39E-BK	L SERIES LINE VOLTAGE TRACK HEAD - HID LARC	219.95	
LTK-HID303N-39E-WT	L SERIES LINE VOLTAGE TRACK HEAD - HID LARC	219.95	
LTK-HID303S-20E-BK	L SERIES LINE VOLTAGE TRACK HEAD - HID LARC	214.95	
LTK-HID303S-20E-WT	L SERIES LINE VOLTAGE TRACK HEAD - HID LARC	214.95	
LTK-HID303S-39E-BK	L SERIES LINE VOLTAGE TRACK HEAD - HID LARC	219.95	
LTK-HID303S-39E-WT	L SERIES LINE VOLTAGE TRACK HEAD - HID LARC	219.95	
LTK-HID303S-70E-BK	L SERIES LINE VOLTAGE TRACK HEAD - HID LARC	224.95	
LTK-HID303S-70E-WT	L SERIES LINE VOLTAGE TRACK HEAD - HID LARC	224.95	
LTK-HID310-20E-BK	L SERIES LINE VOLTAGE TRACK HEAD - HID LARC	199.95	
LTK-HID310-20E-WT	L SERIES LINE VOLTAGE TRACK HEAD - HID LARC	199.95	
LTK-HID310-39E-BK	L SERIES LINE VOLTAGE TRACK HEAD - HID LARC	204.95	
LTK-HID310-39E-WT	L SERIES LINE VOLTAGE TRACK HEAD - HID LARC	204.95	
LTK-HID330-39E-BK	L SERIES LINE VOLTAGE TRACK HEAD - HID LARC	214.95	
LTK-HID330-39E-WT	L SERIES LINE VOLTAGE TRACK HEAD - HID LARC	214.95	
LTK-HID330-70E-BK	L SERIES LINE VOLTAGE TRACK HEAD - HID LARC	219.95	
LTK-HID330-70E-WT	L SERIES LINE VOLTAGE TRACK HEAD - HID LARC	219.95	
LTK-W126E-HS-BK	L SERIES CFL WALL WASHER 1X26W	89.50	790576049717
LTK-W126E-HS-WT	L SERIES CFL WALL WASHER 1X26W	89.50	790576049724
LTK-W218E-HS-BK	L SERIES CFL WALL WASHER 2X18W	149.50	790576049786
LTK-W218E-HS-WT	L SERIES CFL WALL WASHER 2X18W	149.50	790576049793

Material	Description	2011 DN	UPC Code
LTK-W227E-HS-BK	L SERIES CFL WALL WASHER 2X27W	155.50	790576049984
LTK-W227E-HS-WT	L SERIES CFL WALL WASHER 2X27W	155.50	790576050010
LTK-W239E-HS-BK	L SERIES CFL WALL WASHER 2X39W	165.50	790576050065
LTK-W239E-HS-WT	L SERIES CFL WALL WASHER 2X39W	165.50	790576050072
LTK-W240E-HS-BK	L SERIES CFL WALL WASHER 2X40W	171.50	790576050102
LTK-W240E-HS-WT	L SERIES CFL WALL WASHER 2X40W	171.50	790576050119
LT-WT	L SERIES T CONNECTOR	9.50	790576010281
LX-BK	L SERIES X CONNECTOR	10.95	790576010724
LX-BN	L SERIES X CONNECTOR	12.95	790576145754
LX-DB	L SERIES X CONNECTOR	12.95	790576140537
LX-WT	L SERIES X CONNECTOR	10.95	790576010731
MBS-11-BK	MESH BULB SHIELD FOR 204, 214 MR11 SIZE	3.95	790576014395
MBS-11-BN	MESH BULB SHIELD FOR 204, 214 MR11 SIZE	4.50	790576030739
MBS-11-WT	MESH BULB SHIELD FOR 204, 214 MR11 SIZE	3.95	790576014401
MBS-16-BK	MESH BULB SHIELD FOR 204, 214 MR16 SIZE	4.50	790576014371
MBS-16-BN	MESH BULB SHIELD FOR 204, 214 MR16 SIZE	4.95	790576030708
MBS-16-WT	MESH BULB SHIELD FOR 204, 214 MR16 SIZE	4.50	790576014388
ME-007-BK	LOW VOLT SURFACE MOUNT ELECTRONIC 50W	40.95	790576016269
ME-007-BN	LOW VOLT SURFACE MOUNT ELECTRONIC 50W	43.95	790576040165
ME-007-WT	LOW VOLT SURFACE MOUNT ELECTRONIC 50W	40.95	790576016276
ME-204-BK	LOW VOLT SURFACE MOUNT 50W	43.95	790576016436
ME-204-BN	LOW VOLT SURFACE MOUNT 50W	46.95	790576032887
ME-204-WT	LOW VOLT SURFACE MOUNT 50W	43.95	790576016443
ME-808-BK	LOW VOLT SURFACE MOUNT ELECTRONIC 50W	41.95	790576016290
ME-808-WT	LOW VOLT SURFACE MOUNT ELECTRONIC 50W	41.95	790576016306
ME-826-BK	LOW VOLT SURFACE MOUNT ELECTRONIC 50W	44.95	790576017068
ME-826-BN	LOW VOLT SURFACE MOUNT ELECTRONIC 50W	48.95	790576035413
ME-826-WT	LOW VOLT SURFACE MOUNT ELECTRONIC 50W	44.95	790576017075
ME-866-WT/PT	LOW VOLT SURFACE MOUNT ELECTRONIC 50W	45.95	790576103907
ME-866-WT/WT	LOW VOLT SURFACE MOUNT ELECTRONIC 50W	42.95	790576103914
METB	MINI JNCTN BOX FOR EN-12P,PL E. TRANS	5.95	790576032924
MI-1126-BK	LOW VOLT SURFACE MOUNT NO TRANSF 35W	41.95	790576016245
MI-1126-BN	LOW VOLT SURFACE MOUNT NO TRANSF 35W	44.95	790576040578
MI-1126-WT	LOW VOLT SURFACE MOUNT NO TRANSF 35W	41.95	790576016252
MI-204-BK	LOW VOLT SURFACE MOUNT 50W	27.95	790576019246
MI-204-BN	LOW VOLT SURFACE MOUNT 50W	30.95	790576034386
MI-204-WT	LOW VOLT SURFACE MOUNT 50W	27.95	790576019253
MM-204-BK	LOW VOLT SURFACE MOUNT FLEXIBLE 50W	23.95	790576035024
MM-204-BN	LOW VOLT SURFACE MOUNT FLEXIBLE 50W	26.95	790576035048
MM-204-WT	LOW VOLT SURFACE MOUNT FLEXIBLE 50W	23.95	790576035031
MO-024-BK	LINE VOLT SURFACE MOUNT FLEXIBLE 150W	29.95	790576034270
MO-024-WT	LINE VOLT SURFACE MOUNT FLEXIBLE 150W	29.95	790576034287
MO-048-BK	LINE VOLT SURFACE MOUNT FLEXIBLE 150W	40.50	790576034300
MO-048-WT	LINE VOLT SURFACE MOUNT FLEXIBLE 150W	40.50	790576034317
MP-332-CL/BN	CANOPY MOUNT PENDANT	193.95	790576195025
MP-332-CL/CH	CANOPY MOUNT PENDANT	191.50	790576195032
MP-332-CL/DB	CANOPY MOUNT PENDANT	193.95	790576195049
MP-335-CL/BN	CANOPY MOUNT PENDANT	133.95	790576195148
MP-335-CL/CH	CANOPY MOUNT PENDANT	131.50	790576195155
MP-335-CL/DB	CANOPY MOUNT PENDANT	133.95	790576195162

Material	Description	2011 DN	UPC Code
MP-512-AM/BN	QUICK CONNECT SHADE W/ MONOPOINT CANOPY	94.50	790576172439
MP-512-AM/CH	QUICK CONNECT SHADE W/ MONOPOINT CANOPY	91.95	790576172446
MP-512-AM/DB	QUICK CONNECT SHADE W/ MONOPOINT CANOPY	94.50	790576172453
MP-512-BL/BN	QUICK CONNECT SHADE W/ MONOPOINT CANOPY	94.50	790576172736
MP-512-BL/CH	QUICK CONNECT SHADE W/ MONOPOINT CANOPY	91.95	790576172774
MP-512-BL/DB	QUICK CONNECT SHADE W/ MONOPOINT CANOPY	94.50	790576172811
MP-512-GR/BN	QUICK CONNECT SHADE W/ MONOPOINT CANOPY	94.50	790576173153
MP-512-GR/CH	QUICK CONNECT SHADE W/ MONOPOINT CANOPY	91.95	790576173191
MP-512-GR/DB	QUICK CONNECT SHADE W/ MONOPOINT CANOPY	94.50	790576173238
MP-512-RD/BN	QUICK CONNECT SHADE W/ MONOPOINT CANOPY	94.50	790576173542
MP-512-RD/CH	QUICK CONNECT SHADE W/ MONOPOINT CANOPY	91.95	790576173566
MP-512-RD/DB	QUICK CONNECT SHADE W/ MONOPOINT CANOPY	94.50	790576173597
MP-512-WT/BN	QUICK CONNECT SHADE W/ MONOPOINT CANOPY	94.50	790576173924
MP-512-WT/CH	QUICK CONNECT SHADE W/ MONOPOINT CANOPY	91.95	790576173955
MP-512-WT/DB	QUICK CONNECT SHADE W/ MONOPOINT CANOPY	94.50	790576173986
MP-513-AM/BN	QUICK CONNECT SHADE W/ MONOPOINT CANOPY	103.50	790576174273
MP-513-AM/CH	QUICK CONNECT SHADE W/ MONOPOINT CANOPY	100.95	790576174310
MP-513-AM/DB	QUICK CONNECT SHADE W/ MONOPOINT CANOPY	103.50	790576174341
MP-513-WT/BN	QUICK CONNECT SHADE W/ MONOPOINT CANOPY	103.50	790576174631
MP-513-WT/CH	QUICK CONNECT SHADE W/ MONOPOINT CANOPY	100.95	790576174662
MP-513-WT/DB	QUICK CONNECT SHADE W/ MONOPOINT CANOPY	103.50	790576174693
MP-515-AM/BN	QUICK CONNECT SHADE W/ MONOPOINT CANOPY	134.50	790576179667
MP-515-AM/CH	QUICK CONNECT SHADE W/ MONOPOINT CANOPY	131.95	790576179674
MP-515-AM/DB	QUICK CONNECT SHADE W/ MONOPOINT CANOPY	134.50	790576179681
MP-515-MF/BN	QUICK CONNECT SHADE W/ MONOPOINT CANOPY	134.50	790576179728
MP-515-MF/CH	QUICK CONNECT SHADE W/ MONOPOINT CANOPY	131.95	790576179735
MP-515-MF/DB	QUICK CONNECT SHADE W/ MONOPOINT CANOPY	134.50	790576179742
MP-517-WT/BN	QUICK CONNECT SHADE W/ MONOPOINT CANOPY	99.50	790576176697
MP-517-WT/CH	QUICK CONNECT SHADE W/ MONOPOINT CANOPY	96.95	790576176734
MP-517-WT/DB	QUICK CONNECT SHADE W/ MONOPOINT CANOPY	99.50	790576176772
MP-518-DIC/BN	QUICK CONNECT SHADE W/ MONOPOINT CANOPY	149.50	790576177151
MP-518-DIC/CH	QUICK CONNECT SHADE W/ MONOPOINT CANOPY	146.95	790576177182
MP-518-DIC/DB	QUICK CONNECT SHADE W/ MONOPOINT CANOPY	149.50	790576177212
MP-524-AM/BN	QUICK CONNECT SHADE W/ MONOPOINT CANOPY	98.50	790576179841
MP-524-AM/CH	QUICK CONNECT SHADE W/ MONOPOINT CANOPY	95.95	790576179858
MP-524-AM/DB	QUICK CONNECT SHADE W/ MONOPOINT CANOPY	98.50	790576179865
MP-524-LB/BN	QUICK CONNECT SHADE W/ MONOPOINT CANOPY	98.50	790576179872
MP-524-LB/CH	QUICK CONNECT SHADE W/ MONOPOINT CANOPY	95.95	790576179889
MP-524-LB/DB	QUICK CONNECT SHADE W/ MONOPOINT CANOPY	98.50	790576179896
MP-524-TQ/BN	QUICK CONNECT SHADE W/ MONOPOINT CANOPY	98.50	790576179902
MP-524-TQ/CH	QUICK CONNECT SHADE W/ MONOPOINT CANOPY	95.95	790576179919
MP-524-TQ/DB	QUICK CONNECT SHADE W/ MONOPOINT CANOPY	98.50	790576179926
MP-524-WT/BN	QUICK CONNECT SHADE W/ MONOPOINT CANOPY	98.50	790576179933
MP-524-WT/CH	QUICK CONNECT SHADE W/ MONOPOINT CANOPY	95.95	790576179940
MP-524-WT/DB	QUICK CONNECT SHADE W/ MONOPOINT CANOPY	98.50	790576179957
MP-530-GR/BN	QUICK CONNECT SHADE W/ MONOPOINT CANOPY	189.50	790576179964
MP-530-GR/CH	QUICK CONNECT SHADE W/ MONOPOINT CANOPY	186.95	790576179971
MP-530-GR/DB	QUICK CONNECT SHADE W/ MONOPOINT CANOPY	189.50	790576179988
MP-530-MC/BN	QUICK CONNECT SHADE W/ MONOPOINT CANOPY	189.50	790576180021
MP-530-MC/CH	QUICK CONNECT SHADE W/ MONOPOINT CANOPY	186.95	790576180038



Material	Description	2011 DN	UPC Code
MP-530-MC/DB	QUICK CONNECT SHADE W/ MONOPOINT CANOPY	189.50	790576180045
MP-534-SM/BN	QUICK CONNECT SHADE W/ MONOPOINT CANOPY	119.50	790576195414
MP-534-SM/CH	QUICK CONNECT SHADE W/ MONOPOINT CANOPY	116.95	790576195421
MP-534-SM/DB	QUICK CONNECT SHADE W/ MONOPOINT CANOPY	119.50	790576195438
MP-535-DIC/BN	QUICK CONNECT SHADE W/ MONOPOINT CANOPY	173.95	790576200880
MP-535-DIC/CH	QUICK CONNECT SHADE W/ MONOPOINT CANOPY	171.50	790576200897
MP-535-DIC/DB	QUICK CONNECT SHADE W/ MONOPOINT CANOPY	173.95	790576200903
MP-536-BL/BN	QUICK CONNECT SHADE W/ MONOPOINT CANOPY	134.50	790576195636
MP-536-BL/CH	QUICK CONNECT SHADE W/ MONOPOINT CANOPY	131.95	790576195643
MP-536-BL/DB	QUICK CONNECT SHADE W/ MONOPOINT CANOPY	134.50	790576195650
MP-541-AM/BN	QUICK CONNECT SHADE W/ MONOPOINT CANOPY	106.50	790576180441
MP-541-AM/CH	QUICK CONNECT SHADE W/ MONOPOINT CANOPY	103.95	790576180496
MP-541-AM/DB	QUICK CONNECT SHADE W/ MONOPOINT CANOPY	106.50	790576180540
MP-541-WT/BN	QUICK CONNECT SHADE W/ MONOPOINT CANOPY	106.50	790576180724
MP-541-WT/CH	QUICK CONNECT SHADE W/ MONOPOINT CANOPY	103.95	790576180779
MP-541-WT/DB	QUICK CONNECT SHADE W/ MONOPOINT CANOPY	106.50	790576180830
MP-546-DIC/BN	QUICK CONNECT SHADE W/ MONOPOINT CANOPY	169.50	790576181554
MP-546-DIC/CH	QUICK CONNECT SHADE W/ MONOPOINT CANOPY	166.95	790576181608
MP-546-DIC/DB	QUICK CONNECT SHADE W/ MONOPOINT CANOPY	169.50	790576181646
MP-548-FR/BN	QUICK CONNECT SHADE W/ MONOPOINT CANOPY	119.50	790576176314
MP-548-FR/CH	QUICK CONNECT SHADE W/ MONOPOINT CANOPY	116.95	790576176345
MP-548-FR/DB	QUICK CONNECT SHADE W/ MONOPOINT CANOPY	119.50	790576176383
MP-559-DIC/BN	QUICK CONNECT SHADE W/ MONOPOINT CANOPY	109.50	790576182308
MP-559-DIC/CH	QUICK CONNECT SHADE W/ MONOPOINT CANOPY	106.95	790576182360
MP-559-DIC/DB	QUICK CONNECT SHADE W/ MONOPOINT CANOPY	109.50	790576182414
MP-559-GL/BN	QUICK CONNECT SHADE W/ MONOPOINT CANOPY	109.50	790576182612
MP-559-GL/CH	QUICK CONNECT SHADE W/ MONOPOINT CANOPY	106.95	790576182667
MP-559-GL/DB	QUICK CONNECT SHADE W/ MONOPOINT CANOPY	109.50	790576182728
MP-559-MR/BN	QUICK CONNECT SHADE W/ MONOPOINT CANOPY	109.50	790576182452
MP-559-MR/CH	QUICK CONNECT SHADE W/ MONOPOINT CANOPY	106.95	790576182506
MP-559-MR/DB	QUICK CONNECT SHADE W/ MONOPOINT CANOPY	109.50	790576182568
MP-593-LI/BN	QUICK CONNECT SHADE W/ MONOPOINT CANOPY	149.50	790576182902
MP-593-LI/CH	QUICK CONNECT SHADE W/ MONOPOINT CANOPY	146.95	790576182940
MP-593-LI/DB	QUICK CONNECT SHADE W/ MONOPOINT CANOPY	149.50	790576182988
MP-593-RD/BN	QUICK CONNECT SHADE W/ MONOPOINT CANOPY	149.50	790576182766
MP-593-RD/CH	QUICK CONNECT SHADE W/ MONOPOINT CANOPY	146.95	790576182803
MP-593-RD/DB	QUICK CONNECT SHADE W/ MONOPOINT CANOPY	149.50	790576182858
MP-593-TQ/BN	QUICK CONNECT SHADE W/ MONOPOINT CANOPY	149.50	790576183039
MP-593-TQ/CH	QUICK CONNECT SHADE W/ MONOPOINT CANOPY	146.95	790576183084
MP-593-TQ/DB	QUICK CONNECT SHADE W/ MONOPOINT CANOPY	149.50	790576183138
MP-598-WT/BN	QUICK CONNECT SHADE W/ MONOPOINT CANOPY	134.50	790576183190
MP-598-WT/CH	QUICK CONNECT SHADE W/ MONOPOINT CANOPY	131.95	790576183237
MP-598-WT/DB	QUICK CONNECT SHADE W/ MONOPOINT CANOPY	134.50	790576183282
MP-599-BL/BN	QUICK CONNECT SHADE W/ MONOPOINT CANOPY	119.50	790576175706
MP-599-BL/CH	QUICK CONNECT SHADE W/ MONOPOINT CANOPY	116.95	790576175744
MP-599-BL/DB	QUICK CONNECT SHADE W/ MONOPOINT CANOPY	119.50	790576175799
MP-599-UM/BN	QUICK CONNECT SHADE W/ MONOPOINT CANOPY	119.50	790576177823
MP-599-UM/CH	QUICK CONNECT SHADE W/ MONOPOINT CANOPY	116.95	790576177861
MP-599-UM/DB	QUICK CONNECT SHADE W/ MONOPOINT CANOPY	119.50	790576177915
MP-599-WT/BN	QUICK CONNECT SHADE W/ MONOPOINT CANOPY	119.50	790576176796

Material	Description	2011 DN	UPC Code
MP-599-WT/CH	QUICK CONNECT SHADE W/ MONOPOINT CANOPY	116.95	790576176833
MP-599-WT/DB	QUICK CONNECT SHADE W/ MONOPOINT CANOPY	119.50	790576176888
MP-611-AM/BN	QUICK CONNECT SHADE W/ MONOPOINT CANOPY	97.50	790576178349
MP-611-AM/CH	QUICK CONNECT SHADE W/ MONOPOINT CANOPY	94.95	790576178363
MP-611-AM/DB	QUICK CONNECT SHADE W/ MONOPOINT CANOPY	97.50	790576178400
MP-611-BL/BN	QUICK CONNECT SHADE W/ MONOPOINT CANOPY	97.50	790576178448
MP-611-BL/CH	QUICK CONNECT SHADE W/ MONOPOINT CANOPY	94.95	790576178486
MP-611-BL/DB	QUICK CONNECT SHADE W/ MONOPOINT CANOPY	97.50	790576178523
MP-611-RD/BN	QUICK CONNECT SHADE W/ MONOPOINT CANOPY	97.50	790576178561
MP-611-RD/CH	QUICK CONNECT SHADE W/ MONOPOINT CANOPY	94.95	790576178608
MP-611-RD/DB	QUICK CONNECT SHADE W/ MONOPOINT CANOPY	97.50	790576178646
MP-611-WT/BN	QUICK CONNECT SHADE W/ MONOPOINT CANOPY	97.50	790576178684
MP-611-WT/CH	QUICK CONNECT SHADE W/ MONOPOINT CANOPY	94.95	790576178714
MP-611-WT/DB	QUICK CONNECT SHADE W/ MONOPOINT CANOPY	97.50	790576178745
MP-613-AM/BN	QUICK CONNECT SHADE W/ MONOPOINT CANOPY	97.50	790576178776
MP-613-AM/CH	QUICK CONNECT SHADE W/ MONOPOINT CANOPY	94.95	790576178813
MP-613-AM/DB	QUICK CONNECT SHADE W/ MONOPOINT CANOPY	97.50	790576178851
MP-613-BL/BN	QUICK CONNECT SHADE W/ MONOPOINT CANOPY	97.50	790576178875
MP-613-BL/CH	QUICK CONNECT SHADE W/ MONOPOINT CANOPY	94.95	790576178912
MP-613-BL/DB	QUICK CONNECT SHADE W/ MONOPOINT CANOPY	97.50	790576178950
MP-613-RD/BN	QUICK CONNECT SHADE W/ MONOPOINT CANOPY	97.50	790576178998
MP-613-RD/CH	QUICK CONNECT SHADE W/ MONOPOINT CANOPY	94.95	790576179032
MP-613-RD/DB	QUICK CONNECT SHADE W/ MONOPOINT CANOPY	97.50	790576179063
MP-613-WT/BN	QUICK CONNECT SHADE W/ MONOPOINT CANOPY	97.50	790576179100
MP-613-WT/CH	QUICK CONNECT SHADE W/ MONOPOINT CANOPY	94.95	790576179131
MP-613-WT/DB	QUICK CONNECT SHADE W/ MONOPOINT CANOPY	97.50	790576179179
MP-614-BG/BN	QUICK CONNECT SHADE W/ MONOPOINT CANOPY	151.95	
MP-614-BG/CH	QUICK CONNECT SHADE W/ MONOPOINT CANOPY	149.50	
MP-614-BG/DB	QUICK CONNECT SHADE W/ MONOPOINT CANOPY	151.95	
MP-614-MF/BN	QUICK CONNECT SHADE W/ MONOPOINT CANOPY	151.95	
MP-614-MF/CH	QUICK CONNECT SHADE W/ MONOPOINT CANOPY	149.50	
MP-614-MF/DB	QUICK CONNECT SHADE W/ MONOPOINT CANOPY	151.95	
MP-614-YR/BN	QUICK CONNECT SHADE W/ MONOPOINT CANOPY	151.95	
MP-614-YR/CH	QUICK CONNECT SHADE W/ MONOPOINT CANOPY	149.50	
MP-614-YR/DB	QUICK CONNECT SHADE W/ MONOPOINT CANOPY	151.95	
MP-615-BG/BN	QUICK CONNECT SHADE W/ MONOPOINT CANOPY	139.50	790576172668
MP-615-BG/CH	QUICK CONNECT SHADE W/ MONOPOINT CANOPY	136.95	790576172699
MP-615-BG/DB	QUICK CONNECT SHADE W/ MONOPOINT CANOPY	139.50	790576172729
MP-619-RD/BN	QUICK CONNECT SHADE W/ MONOPOINT CANOPY	154.50	790576173528
MP-619-RD/CH	QUICK CONNECT SHADE W/ MONOPOINT CANOPY	151.95	790576173559
MP-619-RD/DB	QUICK CONNECT SHADE W/ MONOPOINT CANOPY	154.50	790576173573
MP-619-TQ/BN	QUICK CONNECT SHADE W/ MONOPOINT CANOPY	154.50	790576173689
MP-619-TQ/CH	QUICK CONNECT SHADE W/ MONOPOINT CANOPY	151.95	790576173726
MP-619-TQ/DB	QUICK CONNECT SHADE W/ MONOPOINT CANOPY	154.50	790576173764
MP-620-BL/BN	QUICK CONNECT SHADE W/ MONOPOINT CANOPY	169.50	790576174464
MP-620-BL/CH	QUICK CONNECT SHADE W/ MONOPOINT CANOPY	166.95	790576174501
MP-620-BL/DB	QUICK CONNECT SHADE W/ MONOPOINT CANOPY	169.50	790576174532
MP-620-BR/BN	QUICK CONNECT SHADE W/ MONOPOINT CANOPY	169.50	790576174204
MP-620-BR/CH	QUICK CONNECT SHADE W/ MONOPOINT CANOPY	166.95	790576174235
MP-620-BR/DB	QUICK CONNECT SHADE W/ MONOPOINT CANOPY	169.50	790576174266

Material	Description	2011 DN	UPC Code
MP-620-RD/BN	QUICK CONNECT SHADE W/ MONOPOINT CANOPY	169.50	790576173948
MP-620-RD/CH	QUICK CONNECT SHADE W/ MONOPOINT CANOPY	166.95	790576173979
MP-620-RD/DB	QUICK CONNECT SHADE W/ MONOPOINT CANOPY	169.50	790576174013
MP-630-AM/BN	QUICK CONNECT SHADE W/ MONOPOINT CANOPY	119.50	790576195995
MP-630-AM/CH	QUICK CONNECT SHADE W/ MONOPOINT CANOPY	116.95	790576196008
MP-630-AM/DB	QUICK CONNECT SHADE W/ MONOPOINT CANOPY	119.50	790576196015
MP-630-GR/BN	QUICK CONNECT SHADE W/ MONOPOINT CANOPY	119.50	790576195933
MP-630-GR/CH	QUICK CONNECT SHADE W/ MONOPOINT CANOPY	116.95	790576195940
MP-630-GR/DB	QUICK CONNECT SHADE W/ MONOPOINT CANOPY	119.50	790576195957
MP-630-OR/BN	QUICK CONNECT SHADE W/ MONOPOINT CANOPY	119.50	790576195810
MP-630-OR/CH	QUICK CONNECT SHADE W/ MONOPOINT CANOPY	116.95	790576195827
MP-630-OR/DB	QUICK CONNECT SHADE W/ MONOPOINT CANOPY	119.50	790576195834
MP-711-WT/BN	QUICK CONNECT SHADE W/ MONOPOINT CANOPY	125.50	790576174815
MP-711-WT/CH	QUICK CONNECT SHADE W/ MONOPOINT CANOPY	122.95	790576174846
MP-711-WT/DB	QUICK CONNECT SHADE W/ MONOPOINT CANOPY	125.50	790576174877
MP-720-GR/BN	QUICK CONNECT SHADE W/ MONOPOINT CANOPY	271.50	790576174990
MP-720-GR/CH	QUICK CONNECT SHADE W/ MONOPOINT CANOPY	268.95	790576175027
MP-720-GR/DB	QUICK CONNECT SHADE W/ MONOPOINT CANOPY	271.50	790576175065
MP-720-RD/BN	QUICK CONNECT SHADE W/ MONOPOINT CANOPY	271.50	790576175102
MP-720-RD/CH	QUICK CONNECT SHADE W/ MONOPOINT CANOPY	268.95	790576175133
MP-720-RD/DB	QUICK CONNECT SHADE W/ MONOPOINT CANOPY	271.50	790576175157
MP-913-CF/BN	QUICK CONNECT SHADE W/ MONOPOINT CANOPY	153.95	790576175805
MP-913-CF/CH	QUICK CONNECT SHADE W/ MONOPOINT CANOPY	151.50	790576175843
MP-913-CF/DB	QUICK CONNECT SHADE W/ MONOPOINT CANOPY	153.95	790576175881
MP-913-OE/BN	QUICK CONNECT SHADE W/ MONOPOINT CANOPY	163.95	790576176048
MP-913-OE/CH	QUICK CONNECT SHADE W/ MONOPOINT CANOPY	161.50	790576176086
MP-913-OE/DB	QUICK CONNECT SHADE W/ MONOPOINT CANOPY	163.95	790576176116
MP-913-RD/BN	QUICK CONNECT SHADE W/ MONOPOINT CANOPY	173.95	790576176154
MP-913-RD/CH	QUICK CONNECT SHADE W/ MONOPOINT CANOPY	171.50	790576176192
MP-913-RD/DB	QUICK CONNECT SHADE W/ MONOPOINT CANOPY	173.95	790576176239
MP-914-FR/BN	QUICK CONNECT SHADE W/ MONOPOINT CANOPY	143.95	790576176260
MP-914-FR/CH	QUICK CONNECT SHADE W/ MONOPOINT CANOPY	141.50	790576176291
MP-914-FR/DB	QUICK CONNECT SHADE W/ MONOPOINT CANOPY	143.95	790576176321
MP-915-CF/BN	QUICK CONNECT SHADE W/ MONOPOINT CANOPY	137.50	790576176352
MP-915-CF/CH	QUICK CONNECT SHADE W/ MONOPOINT CANOPY	134.95	790576176390
MP-915-CF/DB	QUICK CONNECT SHADE W/ MONOPOINT CANOPY	137.50	790576176437
MP-916-CL/BN	QUICK CONNECT SHADE W/ MONOPOINT CANOPY	133.95	790576176475
MP-916-CL/CH	QUICK CONNECT SHADE W/ MONOPOINT CANOPY	131.50	790576176512
MP-916-CL/DB	QUICK CONNECT SHADE W/ MONOPOINT CANOPY	133.95	790576176550
MP-918-AM/BN	QUICK CONNECT SHADE W/ MONOPOINT CANOPY	143.95	790576176703
MP-918-AM/CH	QUICK CONNECT SHADE W/ MONOPOINT CANOPY	141.50	790576176741
MP-918-AM/DB	QUICK CONNECT SHADE W/ MONOPOINT CANOPY	143.95	790576176789
MP-918-BP/BN	QUICK CONNECT SHADE W/ MONOPOINT CANOPY	143.95	790576176826
MP-918-BP/CH	QUICK CONNECT SHADE W/ MONOPOINT CANOPY	141.50	790576176864
MP-918-BP/DB	QUICK CONNECT SHADE W/ MONOPOINT CANOPY	143.95	790576176901
MP-918-GO/BN	QUICK CONNECT SHADE W/ MONOPOINT CANOPY	143.95	790576176949
MP-918-GO/CH	QUICK CONNECT SHADE W/ MONOPOINT CANOPY	141.50	790576176987
MP-918-GO/DB	QUICK CONNECT SHADE W/ MONOPOINT CANOPY	143.95	790576177038
MP-918-YR/BN	QUICK CONNECT SHADE W/ MONOPOINT CANOPY	143.95	790576177069
MP-918-YR/CH	QUICK CONNECT SHADE W/ MONOPOINT CANOPY	141.50	790576177106

Material	Description	2011 DN	UPC Code
MP-918-YR/DB	QUICK CONNECT SHADE W/ MONOPOINT CANOPY	143.95	790576177137
MP-919-BU/BN	QUICK CONNECT SHADE W/ MONOPOINT CANOPY	123.95	790576177175
MP-919-BU/CH	QUICK CONNECT SHADE W/ MONOPOINT CANOPY	121.50	790576177205
MP-919-BU/DB	QUICK CONNECT SHADE W/ MONOPOINT CANOPY	123.95	790576177236
MP-930-CL/BN	QUICK CONNECT SHADE W/ MONOPOINT CANOPY	173.95	790576177588
MP-930-CL/CH	QUICK CONNECT SHADE W/ MONOPOINT CANOPY	171.50	790576177618
MP-930-CL/DB	QUICK CONNECT SHADE W/ MONOPOINT CANOPY	173.95	790576177656
MP-932-CL/BN	QUICK CONNECT SHADE W/ MONOPOINT CANOPY	173.95	790576177816
MP-932-CL/CH	QUICK CONNECT SHADE W/ MONOPOINT CANOPY	171.50	790576177854
MP-932-CL/DB	QUICK CONNECT SHADE W/ MONOPOINT CANOPY	173.95	790576177892
MP-933-AM/BN	QUICK CONNECT SHADE W/ MONOPOINT CANOPY	120.95	790576177939
MP-933-AM/CH	QUICK CONNECT SHADE W/ MONOPOINT CANOPY	118.50	790576177960
MP-933-AM/DB	QUICK CONNECT SHADE W/ MONOPOINT CANOPY	120.95	790576177991
MP-934-IR/BN	QUICK CONNECT SHADE W/ MONOPOINT CANOPY	143.95	790576178028
MP-934-IR/CH	QUICK CONNECT SHADE W/ MONOPOINT CANOPY	141.50	790576178059
MP-934-IR/DB	QUICK CONNECT SHADE W/ MONOPOINT CANOPY	143.95	790576178080
MP-936-AM/BN	QUICK CONNECT SHADE W/ MONOPOINT CANOPY	143.95	790576178110
MP-936-AM/CH	QUICK CONNECT SHADE W/ MONOPOINT CANOPY	141.50	790576178158
MP-936-AM/DB	QUICK CONNECT SHADE W/ MONOPOINT CANOPY	143.95	790576178196
MP-936-BW/BN	QUICK CONNECT SHADE W/ MONOPOINT CANOPY	143.95	790576178233
MP-936-BW/CH	QUICK CONNECT SHADE W/ MONOPOINT CANOPY	141.50	790576178271
MP-936-BW/DB	QUICK CONNECT SHADE W/ MONOPOINT CANOPY	143.95	790576178318
MP-940-CL/BN	QUICK CONNECT SHADE W/ MONOPOINT CANOPY	173.95	790576178653
MP-940-CL/CH	QUICK CONNECT SHADE W/ MONOPOINT CANOPY	171.50	790576178691
MP-940-CL/DB	QUICK CONNECT SHADE W/ MONOPOINT CANOPY	173.95	790576178721
MP-946-AL/BN	QUICK CONNECT SHADE W/ MONOPOINT CANOPY	136.95	790576178752
MP-946-AL/CH	QUICK CONNECT SHADE W/ MONOPOINT CANOPY	134.50	790576178783
MP-946-AL/DB	QUICK CONNECT SHADE W/ MONOPOINT CANOPY	136.95	790576178820
MP-946-GT/BN	QUICK CONNECT SHADE W/ MONOPOINT CANOPY	136.95	790576178868
MP-946-GT/CH	QUICK CONNECT SHADE W/ MONOPOINT CANOPY	134.50	790576178905
MP-946-GT/DB	QUICK CONNECT SHADE W/ MONOPOINT CANOPY	136.95	790576178943
MP-950-AM/BN	QUICK CONNECT SHADE W/ MONOPOINT CANOPY	193.95	790576179209
MP-950-AM/CH	QUICK CONNECT SHADE W/ MONOPOINT CANOPY	191.50	790576179247
MP-950-AM/DB	QUICK CONNECT SHADE W/ MONOPOINT CANOPY	193.95	790576179285
MP-950-RD/BN	QUICK CONNECT SHADE W/ MONOPOINT CANOPY	193.95	790576179308
MP-950-RD/CH	QUICK CONNECT SHADE W/ MONOPOINT CANOPY	191.50	790576179315
MP-950-RD/DB	QUICK CONNECT SHADE W/ MONOPOINT CANOPY	193.95	790576179322
MP-952-CL/BN	QUICK CONNECT SHADE W/ MONOPOINT CANOPY	173.95	790576179339
MP-952-CL/CH	QUICK CONNECT SHADE W/ MONOPOINT CANOPY	171.50	790576179346
MP-952-CL/DB	QUICK CONNECT SHADE W/ MONOPOINT CANOPY	173.95	790576179353
MP-953-BN/BN	QUICK CONNECT SHADE W/ MONOPOINT CANOPY	108.95	790576179452
MP-953-BN/CH	QUICK CONNECT SHADE W/ MONOPOINT CANOPY	106.50	790576179469
MP-953-BN/DB	QUICK CONNECT SHADE W/ MONOPOINT CANOPY	108.95	790576179476
MP-953-CH/BN	QUICK CONNECT SHADE W/ MONOPOINT CANOPY	108.95	790576179391
MP-953-CH/CH	QUICK CONNECT SHADE W/ MONOPOINT CANOPY	106.50	790576179407
MP-953-CH/DB	QUICK CONNECT SHADE W/ MONOPOINT CANOPY	108.95	790576179414
MP-962-BF/BN	QUICK CONNECT SHADE W/ MONOPOINT CANOPY	203.95	790576179513
MP-962-BF/CH	QUICK CONNECT SHADE W/ MONOPOINT CANOPY	201.50	790576179520
MP-962-BF/DB	QUICK CONNECT SHADE W/ MONOPOINT CANOPY	203.95	790576179537
MP-962-RF/BN	QUICK CONNECT SHADE W/ MONOPOINT CANOPY	203.95	790576179575

Material	Description	2011 DN	UPC Code
MP-962-RF/CH	QUICK CONNECT SHADE W/ MONOPOINT CANOPY	201.50	790576179582
MP-962-RF/DB	QUICK CONNECT SHADE W/ MONOPOINT CANOPY	203.95	790576179599
MP-963-GJ/BN	QUICK CONNECT SHADE W/ MONOPOINT CANOPY	173.95	790576179636
MP-963-GJ/CH	QUICK CONNECT SHADE W/ MONOPOINT CANOPY	171.50	790576179643
MP-963-GJ/DB	QUICK CONNECT SHADE W/ MONOPOINT CANOPY	173.95	790576179650
MP-964-MR/BN	QUICK CONNECT SHADE W/ MONOPOINT CANOPY	133.95	790576195209
MP-964-MR/CH	QUICK CONNECT SHADE W/ MONOPOINT CANOPY	131.50	790576195216
MP-964-MR/DB	QUICK CONNECT SHADE W/ MONOPOINT CANOPY	133.95	790576195223
MP-966-BN/BN	QUICK CONNECT SHADE W/ MONOPOINT CANOPY	103.95	790576195261
MP-966-CH/CH	QUICK CONNECT SHADE W/ MONOPOINT CANOPY	101.50	790576195247
MP-966-DB/DB	QUICK CONNECT SHADE W/ MONOPOINT CANOPY	103.95	790576196022
MP-968-OR/BN	QUICK CONNECT SHADE W/ MONOPOINT CANOPY	193.95	790576200859
MP-968-OR/CH	QUICK CONNECT SHADE W/ MONOPOINT CANOPY	191.50	790576200866
MP-968-OR/DB	QUICK CONNECT SHADE W/ MONOPOINT CANOPY	193.95	790576200873
MP-LED303-BN	QUICK CONNECT LED 300 SERIES SOCKET SET	114.95	790576194288
MP-LED303-CH	QUICK CONNECT LED 300 SERIES SOCKET SET	113.95	790576194295
MP-LED303-DB	QUICK CONNECT LED 300 SERIES SOCKET SET	114.95	790576194301
MP-LED311-BN/BN	LEDme QUICK CONNECT MONOPOINT PENDANT	158.50	790576169453
MP-LED314-BN/BN	LEDme QUICK CONNECT MONOPOINT PENDANT	136.50	790576169491
MP-LED315-BK/BN	LEDme QUICK CONNECT MONOPOINT PENDANT	148.50	790576169538
MP-LED315-PT/BN	LEDme QUICK CONNECT MONOPOINT PENDANT	148.50	
MP-LED332-CL/BN	LEDme QUICK CONNECT MONOPOINT PENDANT	234.95	790576194967
MP-LED332-CL/CH	LEDme QUICK CONNECT MONOPOINT PENDANT	233.95	790576194974
MP-LED332-CL/DB	LEDme QUICK CONNECT MONOPOINT PENDANT	234.95	790576194981
MP-LED335-CL/BN	LEDme QUICK CONNECT MONOPOINT PENDANT	174.95	790576195087
MP-LED335-CL/CH	LEDme QUICK CONNECT MONOPOINT PENDANT	173.95	790576195094
MP-LED335-CL/DB	LEDme QUICK CONNECT MONOPOINT PENDANT	174.95	790576195100
MP-LED503-BN	LEDme MONOPOINT WITH LEDME SOCKET SET	129.95	790576169835
MP-LED503-CH	LEDme MONOPOINT WITH LEDME SOCKET SET	127.95	790576169842
MP-LED503-DB	LEDme MONOPOINT WITH LEDME SOCKET SET	129.95	790576169859
MP-LED512-AM/BN	QUICK CONNECT SHADE W/ LED MONOPOINT CANOPY	155.95	790576172576
MP-LED512-AM/CH	QUICK CONNECT SHADE W/ LED MONOPOINT CANOPY	153.95	790576172606
MP-LED512-AM/DB	QUICK CONNECT SHADE W/ LED MONOPOINT CANOPY	155.95	790576172644
MP-LED512-BL/BN	QUICK CONNECT SHADE W/ LED MONOPOINT CANOPY	155.95	790576172972
MP-LED512-BL/CH	QUICK CONNECT SHADE W/ LED MONOPOINT CANOPY	153.95	790576173016
MP-LED512-BL/DB	QUICK CONNECT SHADE W/ LED MONOPOINT CANOPY	155.95	790576173054
MP-LED512-GR/BN	QUICK CONNECT SHADE W/ LED MONOPOINT CANOPY	155.95	790576173399
MP-LED512-GR/CH	QUICK CONNECT SHADE W/ LED MONOPOINT CANOPY	153.95	790576173436
MP-LED512-GR/DB	QUICK CONNECT SHADE W/ LED MONOPOINT CANOPY	155.95	790576173474
MP-LED512-RD/BN	QUICK CONNECT SHADE W/ LED MONOPOINT CANOPY	155.95	790576173757
MP-LED512-RD/CH	QUICK CONNECT SHADE W/ LED MONOPOINT CANOPY	153.95	790576173795
MP-LED512-RD/DB	QUICK CONNECT SHADE W/ LED MONOPOINT CANOPY	155.95	790576173832
MP-LED512-WT/BN	QUICK CONNECT SHADE W/ LED MONOPOINT CANOPY	155.95	790576174129
MP-LED512-WT/CH	QUICK CONNECT SHADE W/ LED MONOPOINT CANOPY	153.95	790576174150
MP-LED512-WT/DB	QUICK CONNECT SHADE W/ LED MONOPOINT CANOPY	155.95	790576174181
MP-LED513-AM/BN	QUICK CONNECT SHADE W/ LED MONOPOINT CANOPY	164.95	790576174471
MP-LED513-AM/CH	QUICK CONNECT SHADE W/ LED MONOPOINT CANOPY	162.95	790576174518
MP-LED513-AM/DB	QUICK CONNECT SHADE W/ LED MONOPOINT CANOPY	164.95	790576174549
MP-LED513-WT/BN	QUICK CONNECT SHADE W/ LED MONOPOINT CANOPY	164.95	790576174822
MP-LED513-WT/CH	QUICK CONNECT SHADE W/ LED MONOPOINT CANOPY	162.95	790576174860

Material	Description	2011 DN	UPC Code
MP-LED513-WT/DB	GANGRY CONNECT SHADE W/ LED MONOP OINT	164.95	790576174891
MP-LED515-AM/BN	GANGRY CONNECT SHADE W/ LED MONOP OINT	195.95	790576175478
MP-LED515-AM/CH	GANGRY CONNECT SHADE W/ LED MONOP OINT	193.95	790576175508
MP-LED515-AM/DB	GANGRY CONNECT SHADE W/ LED MONOP OINT	195.95	790576175539
MP-LED515-MF/BN	GANGRY CONNECT SHADE W/ LED MONOP OINT	195.95	790576176482
MP-LED515-MF/CH	GANGRY CONNECT SHADE W/ LED MONOP OINT	193.95	790576176529
MP-LED515-MF/DB	GANGRY CONNECT SHADE W/ LED MONOP OINT	195.95	790576176567
MP-LED517-WT/BN	GANGRY CONNECT SHADE W/ LED MONOP OINT	160.95	790576176932
MP-LED517-WT/CH	GANGRY CONNECT SHADE W/ LED MONOP OINT	158.95	790576176970
MP-LED517-WT/DB	GANGRY CONNECT SHADE W/ LED MONOP OINT	160.95	790576177021
MP-LED518-DIC/BN	GANGRY CONNECT SHADE W/ LED MONOP OINT	210.95	790576177335
MP-LED518-DIC/CH	GANGRY CONNECT SHADE W/ LED MONOP OINT	208.95	790576177373
MP-LED518-DIC/DB	GANGRY CONNECT SHADE W/ LED MONOP OINT	210.95	790576177410
MP-LED524-AM/BN	GANGRY CONNECT SHADE W/ LED MONOP OINT	159.95	790576178929
MP-LED524-AM/CH	GANGRY CONNECT SHADE W/ LED MONOP OINT	157.95	790576178967
MP-LED524-AM/DB	GANGRY CONNECT SHADE W/ LED MONOP OINT	159.95	790576179001
MP-LED524-LB/BN	GANGRY CONNECT SHADE W/ LED MONOP OINT	159.95	790576172514
MP-LED524-LB/CH	GANGRY CONNECT SHADE W/ LED MONOP OINT	157.95	790576172538
MP-LED524-LB/DB	GANGRY CONNECT SHADE W/ LED MONOP OINT	159.95	790576172569
MP-LED524-TQ/BN	GANGRY CONNECT SHADE W/ LED MONOP OINT	159.95	790576172880
MP-LED524-TQ/CH	GANGRY CONNECT SHADE W/ LED MONOP OINT	157.95	790576172927
MP-LED524-TQ/DB	GANGRY CONNECT SHADE W/ LED MONOP OINT	159.95	790576172965
MP-LED524-WT/BN	GANGRY CONNECT SHADE W/ LED MONOP OINT	159.95	790576173290
MP-LED524-WT/CH	GANGRY CONNECT SHADE W/ LED MONOP OINT	157.95	790576173337
MP-LED524-WT/DB	GANGRY CONNECT SHADE W/ LED MONOP OINT	159.95	790576173375
MP-LED530-GR/BN	GANGRY CONNECT SHADE W/ LED MONOP OINT	250.95	790576173627
MP-LED530-GR/CH	GANGRY CONNECT SHADE W/ LED MONOP OINT	248.95	790576173665
MP-LED530-GR/DB	GANGRY CONNECT SHADE W/ LED MONOP OINT	250.95	790576173702
MP-LED530-MC/BN	GANGRY CONNECT SHADE W/ LED MONOP OINT	250.95	790576174006
MP-LED530-MC/CH	GANGRY CONNECT SHADE W/ LED MONOP OINT	248.95	790576174044
MP-LED530-MC/DB	GANGRY CONNECT SHADE W/ LED MONOP OINT	250.95	790576174075
MP-LED534-SM/BN	GANGRY CONNECT SHADE W/ LED MONOP OINT	179.95	790576195476
MP-LED534-SM/CH	GANGRY CONNECT SHADE W/ LED MONOP OINT	177.95	790576195483
MP-LED534-SM/DB	GANGRY CONNECT SHADE W/ LED MONOP OINT	179.95	790576195490
MP-LED535-DIC/BN	GANGRY CONNECT SHADE W/ LED MONOP OINT	229.95	
MP-LED535-DIC/CH	GANGRY CONNECT SHADE W/ LED MONOP OINT	227.95	
MP-LED535-DIC/DB	GANGRY CONNECT SHADE W/ LED MONOP OINT	229.95	
MP-LED536-BL/BN	GANGRY CONNECT SHADE W/ LED MONOP OINT	194.95	790576195698
MP-LED536-BL/CH	GANGRY CONNECT SHADE W/ LED MONOP OINT	192.95	790576195704
MP-LED536-BL/DB	GANGRY CONNECT SHADE W/ LED MONOP OINT	194.95	790576195711
MP-LED541-AM/BN	GANGRY CONNECT SHADE W/ LED MONOP OINT	167.95	790576174709
MP-LED541-AM/CH	GANGRY CONNECT SHADE W/ LED MONOP OINT	165.95	790576174747
MP-LED541-AM/DB	GANGRY CONNECT SHADE W/ LED MONOP OINT	167.95	790576174778
MP-LED541-WT/BN	GANGRY CONNECT SHADE W/ LED MONOP OINT	167.95	790576175041
MP-LED541-WT/CH	GANGRY CONNECT SHADE W/ LED MONOP OINT	165.95	790576175089
MP-LED541-WT/DB	GANGRY CONNECT SHADE W/ LED MONOP OINT	167.95	790576175119
MP-LED546-DIC/BN	GANGRY CONNECT SHADE W/ LED MONOP OINT	230.95	790576175669
MP-LED546-DIC/CH	GANGRY CONNECT SHADE W/ LED MONOP OINT	228.95	790576175690
MP-LED546-DIC/DB	GANGRY CONNECT SHADE W/ LED MONOP OINT	230.95	790576175737
MP-LED548-FR/BN	GANGRY	180.95	790576176543

Material	Description	2011 DN	UPC Code
MP-LED548-FR/CH	QUICK CONNECT SHADE W/ LED MONOPOINT CANOPY	178.95	790576176581
MP-LED548-FR/DB	QUICK CONNECT SHADE W/ LED MONOPOINT CANOPY	180.95	790576176642
MP-LED559-DIC/BN	QUICK CONNECT SHADE W/ LED MONOPOINT CANOPY	170.95	790576178509
MP-LED559-DIC/CH	QUICK CONNECT SHADE W/ LED MONOPOINT CANOPY	168.95	790576178547
MP-LED559-DIC/DB	QUICK CONNECT SHADE W/ LED MONOPOINT CANOPY	170.95	790576178585
MP-LED559-GL/BN	QUICK CONNECT SHADE W/ LED MONOPOINT CANOPY	170.95	790576173696
MP-LED559-GL/CH	QUICK CONNECT SHADE W/ LED MONOPOINT CANOPY	168.95	790576173733
MP-LED559-GL/DB	QUICK CONNECT SHADE W/ LED MONOPOINT CANOPY	170.95	790576173771
MP-LED559-MR/BN	QUICK CONNECT SHADE W/ LED MONOPOINT CANOPY	170.95	790576172712
MP-LED559-MR/CH	QUICK CONNECT SHADE W/ LED MONOPOINT CANOPY	168.95	790576172743
MP-LED559-MR/DB	QUICK CONNECT SHADE W/ LED MONOPOINT CANOPY	170.95	790576172781
MP-LED593-LI/BN	QUICK CONNECT SHADE W/ LED MONOPOINT CANOPY	210.95	790576174594
MP-LED593-LI/CH	QUICK CONNECT SHADE W/ LED MONOPOINT CANOPY	208.95	790576174624
MP-LED593-LI/DB	QUICK CONNECT SHADE W/ LED MONOPOINT CANOPY	210.95	790576174655
MP-LED593-RD/BN	QUICK CONNECT SHADE W/ LED MONOPOINT CANOPY	210.95	790576174259
MP-LED593-RD/CH	QUICK CONNECT SHADE W/ LED MONOPOINT CANOPY	208.95	790576174280
MP-LED593-RD/DB	QUICK CONNECT SHADE W/ LED MONOPOINT CANOPY	210.95	790576174303
MP-LED593-TQ/BN	QUICK CONNECT SHADE W/ LED MONOPOINT CANOPY	210.95	790576174945
MP-LED593-TQ/CH	QUICK CONNECT SHADE W/ LED MONOPOINT CANOPY	208.95	790576174976
MP-LED593-TQ/DB	QUICK CONNECT SHADE W/ LED MONOPOINT CANOPY	210.95	790576175003
MP-LED598-WT/BN	QUICK CONNECT SHADE W/ LED MONOPOINT CANOPY	195.95	790576175232
MP-LED598-WT/CH	QUICK CONNECT SHADE W/ LED MONOPOINT CANOPY	193.95	790576175263
MP-LED598-WT/DB	QUICK CONNECT SHADE W/ LED MONOPOINT CANOPY	195.95	790576175287
MP-LED599-BL/BN	QUICK CONNECT SHADE W/ LED MONOPOINT CANOPY	180.95	790576175942
MP-LED599-BL/CH	QUICK CONNECT SHADE W/ LED MONOPOINT CANOPY	178.95	790576175997
MP-LED599-BL/DB	QUICK CONNECT SHADE W/ LED MONOPOINT CANOPY	180.95	790576176031
MP-LED599-UM/BN	QUICK CONNECT SHADE W/ LED MONOPOINT CANOPY	180.95	790576178042
MP-LED599-UM/CH	QUICK CONNECT SHADE W/ LED MONOPOINT CANOPY	178.95	790576178073
MP-LED599-UM/DB	QUICK CONNECT SHADE W/ LED MONOPOINT CANOPY	180.95	790576178103
MP-LED599-WT/BN	QUICK CONNECT SHADE W/ LED MONOPOINT CANOPY	180.95	790576177045
MP-LED599-WT/CH	QUICK CONNECT SHADE W/ LED MONOPOINT CANOPY	178.95	790576177083
MP-LED599-WT/DB	QUICK CONNECT SHADE W/ LED MONOPOINT CANOPY	180.95	790576177120
MR11-FTD	LAMP HALOGEN GU4 12V 20W 30DEG OPEN	2.75	790576008974
MR11-FTD-24V	LAMP HALOGEN GU4 24V 20W 30DEG OPEN	2.75	790576029405
MR11-FTD-G	LAMP HALOGEN GU4 12V 20W 30DEG W/LENS	2.95	790576008981
MR11-FTH	LAMP HALOGEN GU4 12V 35W 30DEG OPEN	2.75	790576008998
MR11-FTH-24V	LAMP HALOGEN GU4 24V 35W 30DEG OPEN	2.75	790576029412
MR11-FTH-24V-G	LAMP HALOGEN GU4 24V 35W 30DEG W/LENS	2.95	790576031118
MR11-FTH-G	LAMP HALOGEN GU4 12V 35W 30DEG W/LENS	2.95	790576009001
MR16-BAB	LAMP HALOGEN GU5.3 12V 20W 36DEG OPEN	2.75	790576009018
MR16-BAB-G	LAMP HALOGEN GU5.3 12V 20W 36DEG W/LENS	2.95	790576009025
MR16-ESX	LAMP HALOGEN GU5.3 12V 20W 12DEG OPEN	2.75	790576009032
MR16-EXN	LAMP HALOGEN GU5.3 12V 50W 40DEG OPEN	2.75	790576009049
MR16-EXN-24V	LAMP HALOGEN GU5.3 24V 50W 40DEG OPEN	2.75	790576029450
MR16-EXN-24V-G	LAMP HALOGEN GU5.3 24V 50W 40DEG W/LENS	2.95	790576029436
MR16-EXN-G	LAMP HALOGEN GU5.3 12V 50W 40DEG W/LENS	2.95	790576009063
MR16-EXN-IR	INFRARED MR16 50W 12V BEAM AN	12.95	790576185255
MR16-EXN-U/S	SUPERLINETM REFLEKTOTM MR-16 LAMPS_F	10.95	790576124544
MR16-EXN-U/UT	ULTRALINETM TITAN MR-16 LAMPS_FLOOD	12.95	790576124551
MR16-EXN-U/WS/4200	WHITESTARTM_FLOOD	10.95	790576124605

Material	Description	2011 DN	UPC Code
MR16-EXN-U/WS/5300	WHITESTARTM_FLOOD	10.95	790576124612
MR16-EXT	LAMP HALOGEN GU5.3 12V 50W 13DEG OPEN	2.75	790576009100
MR16-EXT-24V	LAMP HALOGEN GU5.3 24V 50W 13DEG OPEN	2.75	790576029429
MR16-EXT-IR	INFRARED MR16 50W 12V BEAM AN	12.95	790576185231
MR16-EXT-U/UT	ULTRALINETM TITAN MR-16 LAMPS_SPOT	12.95	790576124520
MR16-EXZ	LAMP HALOGEN GU5.3 12V 50W 24DEG OPEN	2.75	790576009117
MR16-EXZ-24V	LAMP HALOGEN GU5.3 24V 50W 24DEG OPEN	2.75	790576029443
MR16-EXZ-IR	INFRARED MR16 50W 12V BEAM AN	12.95	790576185248
MR16-EXZ-U/S	SUPERLINETM REFLEKTOTM MR-16 LAMPS_NF	10.95	790576124568
MR16-EXZ-U/UT	ULTRALINETM TITAN MR16_NARROW FLO	12.95	790576124537
MR16-EXZ-U/WS/4200	WHITESTARTM_NARROW FLOOD	10.95	790576124582
MR16-EXZ-U/WS/5300	WHITESTARTM_NARROW FLOOD	10.95	790576124599
MR16-FMT	12 DEGREE 12V 35W OPEN FRONT CLEAR	2.75	790576039893
MR16-FMT-24V	LAMP HALOGEN GU5.3 24V 35W 12DEG OPEN	2.75	790576039930
MR16-FMW	LAMP HALOGEN GU5.3 12V 35W 36DEG OPEN	2.75	790576009124
MR16-FMW-24V	LAMP HALOGEN G5.3 24V 35W 36DEG	2.75	790576039923
MR16-FMW-24V-G	LAMP HALOGEN GU5.3 24V 35W 36DEG W/LENS	2.95	790576087979
MR16-FMW-G	LAMP HALOGEN GU5.3 12V 35W 36DEG W/LENS	2.95	790576085906
MR16-FMW-IR	INFRARED MR16 35W 12V BEAM AN	12.95	790576185224
MR16-FPA	LAMP HALOGEN GU5.3 12V 65W 13DEG OPEN	2.75	790576034447
MR16-FPA-24V-G	LAMP HALOGEN GU5.3 24V 65W 13DEG W/LENS	2.95	790576062365
MR16-FPA-G	LAMP HALOGEN GU5.3 12V 65W 13DEG W/LENS	2.95	790576034454
MR16-FPB	LAMP HALOGEN GU5.3 12V 65W 40DEG OPEN	2.75	790576034423
MR16-FPB-24V-G	LAMP HALOGEN GU5.3 24V 65W 40DEG W/LENS	2.95	790576062372
MR16-FPB-G	LAMP HALOGEN GU5.3 12V 65W 40DEG W/LENS	2.95	790576034430
MR16-FRA-IR	INFRARED MR16 35W 12V BEAM AN	12.95	790576185217
MR16-FRB-IR	INFRARED MR16 35W 12V BEAM AN	12.95	790576185200
MR16-U/FROST	FROSTLINETM MR-16	9.50	790576124575
MT-116HS	1MULTI SPOT HOUSING FOR MT-116	86.95	790576047577
MT-116MH-20	MULTI SPOT HOUSING FOR MT-116	186.95	790576141039
MT-116MH-35	MULTI SPOT HOUSING FOR MT-116	191.95	790576141046
MT-116TL-WT	MULTI SPOT TRIMLESS MT-116	39.95	790576141138
MT-116-WT/BK	MULTI SPOT TRIM FOR MT-116H-MR16	29.95	790576047232
MT-116-WT/WT	MULTI SPOT TRIM FOR MT-116H-MR16	29.95	790576047249
MT-130HS	MULTI SPOT HOUSING FOR MT-130	69.95	790576141176
MT-130MH-20	MULTI SPOT HOUSING FOR MT-130MH	196.95	790576141336
MT-130MH-39	MULTI SPOT HOUSING FOR MT-130MH	201.95	790576141350
MT-130MH-70	MULTI SPOT HOUSING FOR MT-130MH	206.95	790576141367
MT-130MHTL-WT	MULTI SPOT TRIMLESS FOR MT-130MH	45.95	790576141558
MT-130MH-WT/BK	MULTI SPOT TRIM FOR MT-130MH	35.95	790576141473
MT-130MH-WT/WT	MULTI SPOT TRIM FOR MT-130MH	35.95	790576141480
MT-130TL-WT	MULTI SPOT TRIMLESS FOR MT-130HS	45.95	790576141299
MT-130-WT/BK	MULTI SPOT TRIM FOR MT-130HS	35.95	790576141213
MT-130-WT/WT	MULTI SPOT TRIM FOR MT-130HS	35.95	790576141220
MT-136HS	MULTI SPOT HOUSING FOR MT-136	96.95	790576047287
MT-136TL-WT	MULTI SPOT TRIMLESS FOR MT-136	42.95	790576141596
MT-136-WT/BK	MULTISPOT TRIM FOR MT-136H-AR111,PAR36	32.95	790576047263
MT-136-WT/WT	MULTISPOT TRIM FOR MT-136H-AR111,PAR36	32.95	790576047270
MT-138HS	MULTI SPOT HOUSING FOR MT-138	74.95	790576047317
MT-138TL-WT	MULTI SPOT TRIMLESS FOR MT-138	47.95	790576141626



Material	Description	2011 DN	UPC Code
MT-138-WT/BK	MULTI SPOT TRIM FOR MT-138H-PAR38	37.95	790576047294
MT-138-WT/WT	MULTI SPOT TRIM FOR MT-138H-PAR38	37.95	790576047300
MT-216HS	MULTI SPOT HOUSING FOR MT-216	116.95	790576047409
MT-216MH-20	MULTI SPOT HOUSING FOR MT-216	316.95	790576141053
MT-216MH-35	MULTI SPOT HOUSING FOR MT-216	326.95	790576141060
MT-216TL-WT	MULTI SPOT TRIMLESS FOR MT-216	51.95	790576141145
MT-216-WT/BK	MULTI SPOT TRIM FOR MT-216H-MR16	39.95	790576047324
MT-216-WT/WT	MULTI SPOT TRIM FOR MT-216H-MR16	39.95	790576047331
MT-230HS	MULTI SPOT HOUSING FOR MT-230	89.95	790576141183
MT-230MH-20	MULTI SPOT HOUSING FOR MT-230MH	316.95	790576141374
MT-230MH-39	MULTI SPOT HOUSING FOR MT-230MH	321.95	790576141381
MT-230MH-70	MULTI SPOT HOUSING FOR MT-230MH	326.95	790576141398
MT-230MHTL-WT	MULTI SPOT TRIMLESS FOR MT-230MH	67.95	790576141565
MT-230MH-WT/BK	MULTI SPOT TRIM FOR MT-230MH	55.95	790576141497
MT-230MH-WT/WT	MULTI SPOT TRIM FOR MT-230MH	55.95	790576141503
MT-230TL-WT	MULTI SPOT TRIMLESS FOR MT-230HS	67.95	790576141305
MT-230-WT/BK	MULTI SPOT TRIM FOR MT-230HS	55.95	790576141237
MT-230-WT/WT	MULTI SPOT TRIM FOR MT-230HS	55.95	790576141244
MT-236HS	MULTI SPOT HOUSING FOR MT-236	126.95	790576047485
MT-236TL-WT	MULTI SPOT TRIMLESS FOR MT-236	60.95	790576141602
MT-236-WT/BK	MULTI SPOT TRIM FOR MT-236H-AR111,PAR36	48.95	790576047423
MT-236-WT/WT	MULTI SPOT TRIM FOR MT-236H-AR111,PAR36	48.95	790576047478
MT-238HS	MULTI SPOT HOUSING FOR MT-238	94.95	790576046730
MT-238TL-WT	MULTI SPOT TRIMLESS FOR MT-238	69.95	790576141633
MT-238-WT/BK	MULTI SPOT TRIM FOR MT-238H-PAR38	57.95	790576047492
MT-238-WT/WT	MULTI SPOT TRIM FOR MT-238H-PAR38	57.95	790576047508
MT-316HS	MULTI SPOT HOUSING FOR MT-316	146.95	790576047539
MT-316MH-20	MULTI SPOT HOUSING FOR MT-316	446.95	790576141077
MT-316MH-35	MULTI SPOT HOUSING FOR MT-316	461.95	790576141084
MT-316TL-WT	MULTI SPOT TRIMLESS FOR MT-316	63.95	790576141152
MT-316-WT/BK	MULTI SPOT TRIM FOR MT-316H-MR16	49.95	790576047515
MT-316-WT/WT	MULTI SPOT TRIM FOR MT-316H-MR16	49.95	790576047522
MT-330HS	MULTI SPOT HOUSING FOR MT-330	109.95	790576141190
MT-330MH-20	MULTI SPOT HOUSING FOR MT-330MH	449.95	790576141404
MT-330MH-39	MULTI SPOT HOUSING FOR MT-330MH	454.95	790576141411
MT-330MH-70	MULTI SPOT HOUSING FOR MT-330MH	459.95	790576141435
MT-330MHTL-WT	MULTI SPOT TRIMLESS FOR MT-330MH	89.95	790576141572
MT-330MH-WT/BK	MULTI SPOT TRIM FOR MT-330MH	75.95	790576141510
MT-330MH-WT/WT	MULTI SPOT TRIM FOR MT-330MH	75.95	790576141527
MT-330TL-WT	MULTI SPOT TRIMLESS FOR MT-330HS	89.95	790576141312
MT-330-WT/BK	MULTI SPOT TRIM FOR MT-330HS	75.95	790576141251
MT-330-WT/WT	MULTI SPOT TRIM FOR MT-330HS	75.95	790576141268
MT-336HS	MULTI SPOT HOUSING FOR MT-336	156.95	790576047560
MT-336TL-WT	MULTI SPOT TRIMLESS FOR MT-336HS	79.95	790576141619
MT-336-WT/BK	MULTI SPOT TRIM FOR MT-336H-AR111,PAR36	65.95	790576047546
MT-336-WT/WT	MULTI SPOT TRIM FOR MT-336H-AR111,PAR36	65.95	790576047553
MT-416HS	MULTI SPOT HOUSING FOR MT-416	176.95	790576141022
MT-416MH-20	MULTI SPOT HOUSING FOR MT-416	576.95	790576141091
MT-416MH-35	MULTI SPOT HOUSING FOR MT-416	596.95	790576141107
MT-416TL-WT	MULTI SPOT TRIMLESS FOR MT-416	76.95	790576141169

Material	Description	2011 DN	UPC Code
MT-416-WT/BK	MULTI SPOT TRIM MT-416	60.95	790576141114
MT-416-WT/WT	MULTI SPOT TRIM MT-416	60.95	790576141121
MT-430HS	MULTI SPOT HOUSING FOR MT-430	132.95	790576141206
MT-430MH-20	MULTI SPOT HOUSING FOR MT-430MH	579.95	790576141442
MT-430MH-39	MULTI SPOT HOUSING FOR MT-430MH	584.95	790576141459
MT-430MH-70	MULTI SPOT HOUSING FOR MT-430MH	589.95	790576141466
MT-430MHTL-WT	MULTI SPOT TRIMLESS FOR MT-430MH	111.95	790576141589
MT-430MH-WT/BK	MULTI SPOT TRIM FOR MT-430MH	95.95	790576141534
MT-430MH-WT/WT	MULTI SPOT TRIM FOR MT-430MH	95.95	790576141541
MT-430TL-WT	MULTI SPOT TRIMLESS FOR MT-430HS	111.95	790576141329
MT-430-WT/BK	MULTI SPOT TRIM FOR MT-430HS	95.95	790576141275
MT-430-WT/WT	MULTI SPOT TRIM FOR MT-430HS	95.95	790576141282
MTB-01	MULTIPLE TERMINAL BLOCK-1 INPUT/6 OUTPUT	8.50	790576009131
MT-LED118F-CWHS-WT	LEDme™ MULTIPLE SPOT HOUSING FOR MT-LED118	229.95	790576188584
MT-LED118F-WWHS-WT	LEDme™ MULTIPLE SPOT HOUSING FOR MT-LED118	229.95	790576188560
MT-LED118S-CWHS-WT	LEDme™ MULTIPLE SPOT HOUSING FOR MT-LED118	229.95	790576188577
MT-LED118S-WWHS-WT	LEDme™ MULTIPLE SPOT HOUSING FOR MT-LED118	229.95	790576188553
MT-LED118TL-WT	LEDme™ MULTIPLE SPOT 4" INVISIBLE TRIM - 1 LIGHT	21.95	
MT-LED118-WT	LEDme™ MULTIPLE SPOT 4" TRIM - 1 LIGHT	17.95	790576188751
MT-LED218F-CWHS-WT	LEDme™ MULTIPLE SPOT HOUSING FOR MT-LED218	439.95	790576188621
MT-LED218F-WWHS-WT	LEDme™ MULTIPLE SPOT HOUSING FOR MT-LED218	439.95	790576188607
MT-LED218S-CWHS-WT	LEDme™ MULTIPLE SPOT HOUSING FOR MT-LED218	439.95	790576188614
MT-LED218S-WWHS-WT	LEDme™ MULTIPLE SPOT HOUSING FOR MT-LED218	439.95	790576188591
MT-LED218TL-WT	LEDme™ MULTIPLE SPOT 4" INVISIBLE TRIM - 1 LIGHT	30.95	
MT-LED218-WT	LEDme™ MULTIPLE SPOT 4" TRIM - 1 LIGHT	26.95	790576188768
MT-LED228F-CWHS-WT	LEDme™ MULTIPLE SPOT HOUSING FOR MT-LED228	799.95	790576188744
MT-LED228F-WWHS-WT	LEDme™ MULTIPLE SPOT HOUSING FOR MT-LED228	799.95	790576188720
MT-LED228S-CWHS-WT	LEDme™ MULTIPLE SPOT HOUSING FOR MT-LED228	799.95	790576188737
MT-LED228S-WWHS-WT	LEDme™ MULTIPLE SPOT HOUSING FOR MT-LED228	799.95	790576188713
MT-LED228TL-WT	LEDme™ MULTIPLE SPOT 4" INVISIBLE TRIM - 1 LIGHT	48.95	
MT-LED228-WT	LEDme™ MULTIPLE SPOT 4" TRIM - 1 LIGHT	44.95	790576188799
MT-LED318F-CWHS-WT	LEDme™ MULTIPLE SPOT HOUSING FOR MT-LED318	619.95	790576188669
MT-LED318F-WWHS-WT	LEDme™ MULTIPLE SPOT HOUSING FOR MT-LED318	619.95	790576188645
MT-LED318S-CWHS-WT	LEDme™ MULTIPLE SPOT HOUSING FOR MT-LED318	619.95	790576188652
MT-LED318S-WWHS-WT	LEDme™ MULTIPLE SPOT HOUSING FOR MT-LED318	619.95	790576188638
MT-LED318TL-WT	LEDme™ MULTIPLE SPOT 4" INVISIBLE TRIM - 1 LIGHT	39.95	
MT-LED318-WT	LEDme™ MULTIPLE SPOT 4" TRIM - 1 LIGHT	35.95	790576188775
MT-LED418F-CWHS-WT	LEDme™ MULTIPLE SPOT HOUSING FOR MT-LED418	799.95	790576188706
MT-LED418F-WWHS-WT	LEDme™ MULTIPLE SPOT HOUSING FOR MT-LED418	799.95	790576188683
MT-LED418S-CWHS-WT	LEDme™ MULTIPLE SPOT HOUSING FOR MT-LED418	799.95	790576188690
MT-LED418S-WWHS-WT	LEDme™ MULTIPLE SPOT HOUSING FOR MT-LED418	799.95	790576188676
MT-LED418TL-WT	LEDme™ MULTIPLE SPOT 4" INVISIBLE TRIM - 1 LIGHT	48.95	
MT-LED418-WT	LEDme™ MULTIPLE SPOT 4" TRIM - 1 LIGHT	44.95	790576188782
OF-A12WF-BN	OPAL,A12 WALL SCONCE AND CEILING	214.50	790576127934
OF-A12WF-CH	OPAL,A12 Wall Sconce and Ceiling	208.95	790576127941
OF-A14CF-BN	OPAL CEILING MOUNTS - SMALL WIDE CONE	247.50	790576127767
OF-A14CF-CH	OPAL CEILING MOUNTS - SMALL WIDE CONE	236.50	790576127774
OF-A14PF-BN	OPAL PENDANTS - SMALL WIDE CONE	273.95	790576127583
OF-A14PF-CH	OPAL PENDANTS - SMALL WIDE CONE	262.95	790576127590
OF-A17CF-BN	OPAL CEILING MOUNTS - MEDIUM WIDE CONE	394.95	790576127798

Material	Description	2011 DN	UPC Code
OF-A17CF-CH	OPAL CEILING MOUNTS - MEDIUM WIDE CONE	383.95	790576127781
OF-A17PF-BN	OPAL PENDANTS - MEDIUM WIDE CONE	434.50	790576127606
OF-A17PF-CH	OPAL PENDANTS - MEDIUM WIDE CONE	423.50	790576127613
OF-A20CF-BN	OPAL CEILING MOUNTS - LARGE WIDE CONE	504.95	790576127804
OF-A20CF-CH	OPAL CEILING MOUNTS - LARGE WIDE CONE	493.95	790576127811
OF-A20PF-BN	OPAL PENDANTS - LARGE WIDE CONE	544.50	790576127620
OF-A20PF-CH	OPAL PENDANTS - LARGE WIDE CONE	533.50	790576127637
OF-B12WF-BN	OPAL,B12 WALL SCONCE AND CEILING MOUNT	214.50	790576127965
OF-B12WF-CH	OPAL,B12 WALL SCONCE AND CEILING MOUNT	208.95	790576127958
OF-B14CF-BN	OPAL CEILING MOUNTS - SMALL ORB	247.50	790576127835
OF-B14CF-CH	OPAL CEILING MOUNTS - SMALL ORB	236.50	790576127828
OF-B14PF-BN	OPAL PENDANTS - SMALL ORB	273.95	790576127644
OF-B14PF-CH	OPAL PENDANTS - SMALL ORB	262.95	790576127651
OF-B17CF-BN	OPAL CEILING MOUNTS - MEDIUM ORB	394.95	790576127842
OF-B17CF-CH	OPAL CEILING MOUNTS - MEDIUM ORB	383.95	790576135410
OF-B17PF-BN	OPAL PENDANTS - MEDIUM ORB	434.50	790576127668
OF-B17PF-CH	OPAL PENDANTS - MEDIUM ORB	423.50	790576127675
OF-B20CF-BN	OPAL CEILING MOUNTS - LARGE ORB	504.95	790576127866
OF-B20CF-CH	OPAL CEILING MOUNTS - LARGE ORB	493.95	790576127859
OF-B20PF-BN	OPAL PENDANTS - LARGE ORB	544.50	790576127682
OF-B20PF-CH	OPAL PENDANTS - LARGE ORB	533.50	790576127699
PAN-826-PT	LOW VOLTAGE SURFACE MOUNT - 3 LIGHTS	73.95	790576104065
PAN-826-WT	LOW VOLT SURFACE MOUNT 3 LIGHT PAN	69.95	790576037288
PAN-866-WT/PT	LOW VOLTAGE SURFACE MOUNT - 3 LIGHTS	73.95	790576104119
PAN-866-WT/WT	LOW VOLTAGE SURFACE MOUNT - 3 LIGHTS	69.95	790576104126
PAR20BD-BK	BARN DOOR FOR 178/188/024/048 FIXTURE	11.95	790576031309
PAR20BD-BN	BARN DOOR FOR 178/188/024/048 FIXTURE	16.95	790576036380
PAR20BD-DB	BARN DOOR ATTACHMENT FOR	16.95	790576163413
PAR20BD-WT	BARN DOOR FOR 178/188/024/048 FIXTURE	11.95	790576031316
PAR30BD-BK	BARN DOOR FOR 178/188/024/048 FIXTURE	14.50	790576031330
PAR30BD-BN	BARN DOOR FOR 178/188/024/048 FIXTURE	21.50	790576036397
PAR30BD-DB	BARN DOOR ATTACHMENT FOR	21.50	790576163406
PAR30BD-WT	BARN DOOR FOR 178/188/024/048 FIXTURE	14.50	790576031347
PAR38BD-BK	BARN DOOR FOR 178/188/024/048 FIXTURE	16.50	790576031354
PAR38BD-BN	BARN DOOR FOR 178/188/024/048 FIXTURE	23.50	790576036403
PAR38BD-DB	BARN DOOR ATTACHMENT FOR	23.50	790576163390
PAR38BD-WT	BARN DOOR FOR 178/188/024/048 FIXTURE	16.50	790576031361
PLC13W-27-G24Q	CFL LAMP - G24Q BASE 13W 2700K	2.95	790576168241
PLC13W-41-G24Q	CFL LAMP - G24Q BASE 13W 4100K	2.95	790576168234
PLC18W-27-G24Q	CFL LAMP - G24Q BASE 18W 2700K	2.95	790576168227
PLC18W-41-G24Q	CFL LAMP - G24Q BASE 18W 4100K	2.95	790576168210
PLC26W-27-G24Q	CFL LAMP - G24Q BASE 26W 2700K	2.95	790576168203
PLC26W-41-G24Q	CFL LAMP - G24Q BASE 26W 4100K	2.95	790576168197
PLD-F1-402AM/AB	MONOPOINT PENDANT - CFL GU24	122.50	790576183091
PLD-F1-402BL/AB	MONOPOINT PENDANT - CFL GU24	122.50	790576183633
PLD-F1-402WM/AB	MONOPOINT PENDANT - CFL GU24	122.50	790576184104
PLD-F1-403AM/AB	MONOPOINT PENDANT - CFL GU24	140.50	790576180762
PLD-F1-403BL/AB	MONOPOINT PENDANT - CFL GU24	140.50	790576181356
PLD-F1-403RD/AB	MONOPOINT PENDANT - CFL GU24	140.50	790576181943
PLD-F1-404BN/AB	MONOPOINT PENDANT - CFL GU24	105.50	790576184364

Material	Description	2011 DN	UPC Code
PLD-F1-404CO/AB	MONOPOINT PENDANT - CFL GU24	105.50	790576180168
PLD-F1-406OC/AB	MONOPOINT PENDANT - CFL GU24	140.50	790576182537
PLD-F1-408AM/AB	MONOPOINT PENDANT - CFL GU24	140.50	790576184579
PLD-F1-408WT/AB	MONOPOINT PENDANT - CFL GU24	140.50	790576184845
PLD-F1-421GR/AB	LINE VOLTAGE CANOPY MOUNT PENDANT KIT	195.50	790576143026
PLD-F1-423PR/AB	LINE VOLTAGE CANOPY MOUNT PENDANT KIT	205.50	790576143194
PLD-F1-424WT/AB	LINE VOLTAGE CANOPY MOUNT PENDANT KIT	225.50	790576145167
PLD-F1-451AM/AB	MONOPOINT PENDANT - CFL GU24	125.50	790576181516
PLD-F1-451BL/AB	MONOPOINT PENDANT - CFL GU24	125.50	790576182148
PLD-F1-451WT/AB	MONOPOINT PENDANT - CFL GU24	125.50	790576182759
PLD-F1-454AM/AB	MONOPOINT PENDANT - CFL GU24	125.50	790576183374
PLD-F1-454WT/AB	MONOPOINT PENDANT - CFL GU24	125.50	790576183886
PLD-F1-471WT/AB	LINE VOLTAGE CANOPY MOUNT PENDANT KIT	125.50	790576143613
PLD-F1-472WT/AB	LINE VOLTAGE CANOPY MOUNT PENDANT KIT	135.50	790576143798
PLD-F1-474WT/AB	LINE VOLTAGE CANOPY MOUNT PENDANT KIT	150.50	790576144344
PLD-F1-483IV/AB	LINE VOLTAGE CANOPY MOUNT PENDANT KIT	155.50	790576145143
PLD-F1-484BL/AB	LINE VOLTAGE CANOPY MOUNT PENDANT KIT	155.50	790576200569
PLD-F1-485BL/AB	LINE VOLTAGE CANOPY MOUNT PENDANT KIT	195.50	
PLD-F1-487AM/AB	LINE VOLTAGE CANOPY MOUNT PENDANT KIT	155.50	790576145150
PLD-F1-488WT/AB	LINE VOLTAGE CANOPY MOUNT PENDANT KIT	199.50	790576145129
PLD-F2-402AM/BN	MONOPOINT PENDANT - CFL GU24	122.50	790576183145
PLD-F2-402BL/BN	MONOPOINT PENDANT - CFL GU24	122.50	790576183664
PLD-F2-402WM/BN	MONOPOINT PENDANT - CFL GU24	122.50	790576184142
PLD-F2-403AM/BN	MONOPOINT PENDANT - CFL GU24	140.50	790576180816
PLD-F2-403BL/BN	MONOPOINT PENDANT - CFL GU24	140.50	790576181400
PLD-F2-403RD/BN	MONOPOINT PENDANT - CFL GU24	140.50	790576181998
PLD-F2-404BN/BN	MONOPOINT PENDANT - CFL GU24	105.50	790576184401
PLD-F2-404CO/BN	MONOPOINT PENDANT - CFL GU24	105.50	790576180212
PLD-F2-406OC/BN	MONOPOINT PENDANT - CFL GU24	140.50	790576182575
PLD-F2-408AM/BN	MONOPOINT PENDANT - CFL GU24	140.50	790576184616
PLD-F2-408WT/BN	MONOPOINT PENDANT - CFL GU24	140.50	790576184869
PLD-F2-421GR/BN	LINE VOLTAGE CANOPY MOUNT PENDANT KIT	195.50	790576143057
PLD-F2-423PR/BN	LINE VOLTAGE CANOPY MOUNT PENDANT KIT	205.50	790576143200
PLD-F2-424WT/BN	LINE VOLTAGE CANOPY MOUNT PENDANT KIT	225.50	790576145235
PLD-F2-451AM/BN	MONOPOINT PENDANT - CFL GU24	125.50	790576181561
PLD-F2-451BL/BN	MONOPOINT PENDANT - CFL GU24	125.50	790576182193
PLD-F2-451WT/BN	MONOPOINT PENDANT - CFL GU24	125.50	790576182810
PLD-F2-454AM/BN	MONOPOINT PENDANT - CFL GU24	125.50	790576183411
PLD-F2-454WT/BN	MONOPOINT PENDANT - CFL GU24	125.50	790576183923
PLD-F2-471WT/BN	LINE VOLTAGE CANOPY MOUNT PENDANT KIT	125.50	790576143620
PLD-F2-472WT/BN	LINE VOLTAGE CANOPY MOUNT PENDANT KIT	135.50	790576143804
PLD-F2-474WT/BN	LINE VOLTAGE CANOPY MOUNT PENDANT KIT	150.50	790576144351
PLD-F2-483IV/BN	LINE VOLTAGE CANOPY MOUNT PENDANT KIT	155.50	790576145198
PLD-F2-484BL/BN	LINE VOLTAGE CANOPY MOUNT PENDANT KIT	155.50	790576200576
PLD-F2-485BL/BN	LINE VOLTAGE CANOPY MOUNT PENDANT KIT	195.50	
PLD-F2-487AM/BN	LINE VOLTAGE CANOPY MOUNT PENDANT KIT	155.50	790576145211
PLD-F2-488WT/BN	LINE VOLTAGE CANOPY MOUNT PENDANT KIT	199.50	790576145174
PLD-F4-402AM/BK	LIZA PENDANT FOR CANOPY MOUNT - A19	84.50	790576152219
PLD-F4-402AM/BN	LIZA PENDANT FOR CANOPY MOUNT - A19	87.50	790576152226
PLD-F4-402AM/WT	LIZA PENDANT FOR CANOPY MOUNT - A19	84.50	790576152233

Material	Description	2011 DN	UPC Code
PLD-F4-402BL/BK	LIZA PENDANT FOR CANOPY MOUNT - A19	84.50	790576152240
PLD-F4-402BL/BN	LIZA PENDANT FOR CANOPY MOUNT - A19	87.50	790576152257
PLD-F4-402BL/WT	LIZA PENDANT FOR CANOPY MOUNT - A19	84.50	790576152264
PLD-F4-402WM/BK	LIZA PENDANT FOR CANOPY MOUNT - A19	84.50	790576152271
PLD-F4-402WM/BN	LIZA PENDANT FOR CANOPY MOUNT - A19	87.50	790576152288
PLD-F4-402WM/WT	LIZA PENDANT FOR CANOPY MOUNT - A19	84.50	790576152295
PLD-F4-403AM/BK	LIZA PENDANT FOR CANOPY MOUNT - A19	102.50	790576152301
PLD-F4-403AM/BN	LIZA PENDANT FOR CANOPY MOUNT - A19	105.50	790576152318
PLD-F4-403AM/WT	LIZA PENDANT FOR CANOPY MOUNT - A19	102.50	790576152325
PLD-F4-403BL/BK	LIZA PENDANT FOR CANOPY MOUNT - A19	102.50	790576152332
PLD-F4-403BL/BN	LIZA PENDANT FOR CANOPY MOUNT - A19	105.50	790576152349
PLD-F4-403BL/WT	LIZA PENDANT FOR CANOPY MOUNT - A19	102.50	790576152356
PLD-F4-403RD/BK	NOVA PENDANT FOR CANOPY MOUNT - A19	102.50	790576152363
PLD-F4-403RD/BN	NOVA PENDANT FOR CANOPY MOUNT - A19	105.50	790576152370
PLD-F4-403RD/WT	NOVA PENDANT FOR CANOPY MOUNT - A19	102.50	790576152387
PLD-F4-404BN/BK	NOVA PENDANT FOR CANOPY MOUNT - A19	67.50	790576152394
PLD-F4-404BN/BN	NOVA PENDANT FOR CANOPY MOUNT - A19	70.50	790576152400
PLD-F4-404BN/WT	NOVA PENDANT FOR CANOPY MOUNT - A19	67.50	790576152417
PLD-F4-404CO/BK	NOVA PENDANT FOR CANOPY MOUNT - A19	67.50	790576152424
PLD-F4-404CO/BN	NOVA PENDANT FOR CANOPY MOUNT - A19	70.50	790576152431
PLD-F4-404CO/WT	NOVA PENDANT FOR CANOPY MOUNT - A19	67.50	790576152448
PLD-F4-406OC/BK	NOVA PENDANT FOR CANOPY MOUNT - A19	102.50	790576152455
PLD-F4-406OC/BN	NOVA PENDANT FOR CANOPY MOUNT - A19	105.50	790576152462
PLD-F4-406OC/WT	NOVA PENDANT FOR CANOPY MOUNT - A19	102.50	790576152479
PLD-F4-408AM/BK	NOVA PENDANT FOR CANOPY MOUNT - A19	102.50	790576152486
PLD-F4-408AM/BN	NOVA PENDANT FOR CANOPY MOUNT - A19	105.50	790576152493
PLD-F4-408AM/WT	NOVA PENDANT FOR CANOPY MOUNT - A19	102.50	790576152509
PLD-F4-408WT/BK	FELIS PENDANT FOR CANOPY MOUNT - A19	102.50	790576152516
PLD-F4-408WT/BN	FELIS PENDANT FOR CANOPY MOUNT - A19	105.50	790576152523
PLD-F4-408WT/WT	FELIS PENDANT FOR CANOPY MOUNT - A19	102.50	790576152530
PLD-F4-421GR/BK	MONOPOINT PENDANT - A19	157.50	790576183480
PLD-F4-421GR/BN	MONOPOINT PENDANT - A19	160.50	790576183527
PLD-F4-421GR/WT	LINE VOLTAGE CANOPY MOUNT PENDA	157.50	790576183565
PLD-F4-423PR/BK	SOLSTICE PENDANT FOR CANOPY MOUNT - A19	167.50	790576163741
PLD-F4-423PR/BN	MONOPOINT PENDANT - A19	170.50	790576182421
PLD-F4-424WT/BK	LINE VOLTAGE CANOPY MOUNT PENDANT KIT	187.50	790576165615
PLD-F4-424WT/BN	MONOPOINT PENDANT - A19	190.50	790576180328
PLD-F4-424WT/WT	MONOPOINT PENDANT - A19	187.50	790576180380
PLD-F4-451AM/BK	FELIS PENDANT FOR CANOPY MOUNT - A19	87.50	790576152547
PLD-F4-451AM/BN	FELIS PENDANT FOR CANOPY MOUNT - A19	90.50	790576152554
PLD-F4-451AM/WT	FELIS PENDANT FOR CANOPY MOUNT - A19	87.50	790576152561
PLD-F4-451BL/BK	FELIS PENDANT FOR CANOPY MOUNT - A19	87.50	790576152578
PLD-F4-451BL/BN	FELIS PENDANT FOR CANOPY MOUNT - A19	90.50	790576152585
PLD-F4-451BL/WT	FELIS PENDANT FOR CANOPY MOUNT - A19	87.50	790576152592
PLD-F4-451WT/BK	FELIS PENDANT FOR CANOPY MOUNT - A19	87.50	790576152608
PLD-F4-451WT/BN	FROST PENDANT FOR CANOPY MOUNT - A19	90.50	790576152615
PLD-F4-451WT/WT	FROST PENDANT FOR CANOPY MOUNT - A19	87.50	790576152622
PLD-F4-454AM/BK	FROST PENDANT FOR CANOPY MOUNT - A19	87.50	790576152639
PLD-F4-454AM/BN	FROST PENDANT FOR CANOPY MOUNT - A19	90.50	790576152646
PLD-F4-454AM/WT	FROST PENDANT FOR CANOPY MOUNT - A19	87.50	790576152653

Material	Description	2011 DN	UPC Code
PLD-F4-454WT/BK	CREAMERY PENDANT FOR CANOPY MOUNT - A19	87.50	790576152660
PLD-F4-454WT/BN	CREAMERY PENDANT FOR CANOPY MOUNT - A19	90.50	790576152677
PLD-F4-454WT/WT	CREAMERY PENDANT FOR CANOPY MOUNT - A19	87.50	790576152684
PLD-F4-471WT/BK	MONOPOINT PENDANT - A19	87.50	790576184319
PLD-F4-471WT/BN	MONOPOINT PENDANT - A19	90.50	790576184357
PLD-F4-471WT/WT	MONOPOINT PENDANT - A19	87.50	790576184395
PLD-F4-472WT/BK	MONOPOINT PENDANT - A19	97.50	790576180472
PLD-F4-472WT/BN	MONOPOINT PENDANT - A19	100.50	790576180526
PLD-F4-472WT/WT	MONOPOINT PENDANT - A19	97.50	790576180571
PLD-F4-474WT/BK	MONOPOINT PENDANT - A19	112.50	790576184418
PLD-F4-474WT/BN	MONOPOINT PENDANT - A19	115.50	790576184456
PLD-F4-474WT/WT	MONOPOINT PENDANT - A19	112.50	790576184494
PLD-F4-483IV/BK	MONOPOINT PENDANT - A19	117.50	790576180755
PLD-F4-483IV/BN	MONOPOINT PENDANT - A19	120.50	790576180809
PLD-F4-483IV/WT	MONOPOINT PENDANT - A19	117.50	790576180847
PLD-F4-484BL/BK	MONOPOINT PENDANT - A19	117.50	790576200583
PLD-F4-484BL/BN	MONOPOINT PENDANT - A19	120.50	790576200590
PLD-F4-484BL/WT	MONOPOINT PENDANT - A19	117.50	790576200606
PLD-F4-485BL/BK	MONOPOINT PENDANT - A19	157.50	
PLD-F4-485BL/BN	MONOPOINT PENDANT - A19	160.50	
PLD-F4-485BL/WT	MONOPOINT PENDANT - A19	157.50	
PLD-F4-487AM/BK	MONOPOINT PENDANT - A19	117.50	790576183572
PLD-F4-487AM/BN	MONOPOINT PENDANT - A19	120.50	790576183619
PLD-F4-487AM/WT	MONOPOINT PENDANT - A19	117.50	790576183657
PLD-F4-488WT/BK	MONOPOINT PENDANT - A19	161.50	790576182551
PLD-F4-488WT/BN	MONOPOINT PENDANT - A19	164.50	790576182599
PLD-F4-488WT/WT	MONOPOINT PENDANT - A19	161.50	790576182643
PLD-G402-AM	LINE VOLT PENDANT CONE GLASS SHADE	56.95	790576114972
PLD-G402-BL	LINE VOLT PENDANT CONE GLASS SHADE	56.95	790576034218
PLD-G402-WM	LINE VOLT PENDANT CONE GLASS SHADE	56.95	790576034195
PLD-G403-AM	LINE VOLT PENDANT GLOBE GLASS SHADE	74.95	790576034232
PLD-G403-BL	LINE VOLT PENDANT GLOBE GLASS SHADE	74.95	790576038711
PLD-G403-RD	LINE VOLT PENDANT GLOBE GLASS SHADE	74.95	790576034225
PLD-G404-BN	LINE VOLT PENDANT METAL SHADE	39.95	790576034256
PLD-G404-CO	LINE VOLT PENDANT METAL SHADE	39.95	790576034263
PLD-G406-OC	LINE VOLT PENDANT GLOBE GLASS SHADE	74.95	790576080284
PLD-G408-AM	LINE VOLT PENDANT DOME GLASS SHADE	74.95	790576080437
PLD-G408-WT	LINE VOLT PENDANT DOME GLASS SHADE	74.95	790576080420
PLD-G421-GR	QC-PENDANT SHADE MOSS	129.95	790576139821
PLD-G423-PR	QC-PENDANT SHADE SOLTICE	139.95	790576139838
PLD-G424-WT	QC-PENDANT SHADE MOSS	159.95	790576139845
PLD-G451-AM	LINE VOLT PENDANT CASED GLASS SHADE	59.95	790576080512
PLD-G451-BL	LINE VOLT PENDANT CASED GLASS SHADE	59.95	790576080499
PLD-G451-WT	LINE VOLT PENDANT CASED GLASS SHADE	59.95	790576080505
PLD-G454-AM	LINE VOLT PENDANT CYLINDER GLASS SHADE	59.95	790576114255
PLD-G454-WT	LINE VOLT PENDANT CYLINDER GLASS SHADE	59.95	790576112770
PLD-G471-WT	GU24 PENDENT GLASS SHADE	59.95	790576139739
PLD-G472-WT	GU24 PENDENT GLASS SHADE	69.95	790576139746
PLD-G474-WT	GU24 PENDENT GLASS SHADE	84.95	790576139753
PLD-G483-IV	GU24 PENDANT GLASS SHADE	89.95	790576139760

Material	Description	2011 DN	UPC Code
PLD-G484-BL	PENDANT	89.95	790576194462
PLD-G485-BL		129.95	790576197364
PLD-G487-AM	GU24 PENDENT GLASS SHADE	89.95	790576139791
PLD-G488-WT	GU24 PENDENT GLASS SHADE	133.95	790576139807
PLD-HTK501-BN	H TRACK - PENDANT FOR G500 SERIES GLASS	49.95	790576147734
PLD-HTK501-DB	H TRACK - PENDANT FOR G500 SERIES GLASS	49.95	790576141879
PLD-HTK96-BK	LINE VOLT PEND SOCKET SET FOR H SERIES	23.95	790576034041
PLD-HTK96-BN	LINE VOLT PEND SOCKET SET FOR H SERIES	24.95	790576147864
PLD-HTK96-WT	LINE VOLT PEND SOCKET SET FOR H SERIES	23.95	790576034058
PLD-HTK-FL1-AB	H-LINE VOLTAGE PENDANT SOCKET S	59.95	790576143019
PLD-HTK-FL2-BN	H-LINE VOLTAGE PENDANT SOCKET S	59.95	790576139654
PLD-JTK501-BN	J TRACK - PENDANT FOR G500 SERIES GLASS	49.95	790576147741
PLD-JTK501-DB	J TRACK - PENDANT FOR G500 SERIES GLASS	49.95	790576142104
PLD-JTK96-BK	LINE VOLT PEND SOCKET SET FOR J SERIES	23.95	790576034102
PLD-JTK96-BN	LINE VOLT PEND SOCKET SET FOR J SERIES	24.95	790576147888
PLD-JTK96-WT	LINE VOLT PEND SOCKET SET FOR J SERIES	23.95	790576034119
PLD-JTK-FL1-AB	J-LINE VOLTAGE PENDANT SOCKET S	59.95	790576142999
PLD-JTK-FL2-BN	J-LINE VOLTAGE PENDANT SOCKET S	59.95	790576139715
PLD-LTK501-BN	L TRACK - PENDANT FOR G500 SERIES GLASS	49.95	790576147758
PLD-LTK501-DB	L TRACK - PENDANT FOR G500 SERIES GLASS	49.95	790576142074
PLD-LTK96-BK	LINE VOLT PEND SOCKET SET FOR L SERIES	23.95	790576034072
PLD-LTK96-BN	LINE VOLT PEND SOCKET SET FOR L SERIES	24.95	790576147871
PLD-LTK96-WT	LINE VOLT PEND SOCKET SET FOR L SERIES	23.95	790576034089
PLD-LTK-FL1-AB	L-LINE VOLTAGE PENDANT SOCKET S	59.95	790576143002
PLD-LTK-FL2-BN	L-LINE VOLTAGE PENDANT SOCKET S	59.95	790576139678
PLD-MO96-BK	LINE VOLT PEND SOCKET SET W/MONOPOINT	27.50	790576034133
PLD-MO96-BN	LINE VOLT PEND SOCKET SET W/MONOPOINT	30.50	790576160665
PLD-MO96-WT	LINE VOLT PEND SOCKET SET W/MONOPOINT	27.50	790576034140
PLL18W-27-2G11	CFL LAMP - 2G11 BASE 18W 2700K	3.95	790576168180
PLL18W-41-2G11	CFL LAMP - 2G11 BASE 18W 4100K	3.95	790576168173
PLL24W-27-2G11	CFL LAMP - 2G11 BASE 24W 2700K	3.95	790576168166
PLL24W-41-2G11	CFL LAMP - 2G11 BASE 24W 4100K	3.95	790576168159
PLL36W-27-2G11	CFL LAMP - 2G11 BASE 36W 2700K	4.50	790576168142
PLL36W-41-2G11	CFL LAMP - 2G11 BASE 36W 4100K	4.50	790576168135
PLL40W-27-2G11	CFL LAMP - 2G11 BASE 40W 2700K	4.95	790576168128
PLL40W-41-2G11	CFL LAMP - 2G11 BASE 40W 4100K	4.95	790576168111
PLT18W-27-GX24Q	CFQ SERIES CFL LAMP	3.95	790576168340
PLT18W-41-GX24Q	CFQ SERIES CFL LAMP	3.95	790576168357
PLT26W-27-GX24Q	CFQ SERIES CFL LAMP	3.95	790576168364
PLT26W-41-GX24Q	CFQ SERIES CFL LAMP	3.95	790576168371
PLT32W-27-GX24Q	CFQ SERIES CFL LAMP	3.95	790576168388
PLT32W-41-GX24Q	CFQ SERIES CFL LAMP	3.95	790576168395
PLT42W-27-GX24Q	CFQ SERIES CFL LAMP	4.25	790576168401
PLT42W-41-GX24Q	CFQ SERIES CFL LAMP	4.25	790576168418
QF-181X12-BN	QC FIXTURE-G100 SERIES GLASS-12IN EXT	31.50	790576136578
QF-181X12-CH	QC FIXTURE-G100 SERIES GLASS-12IN EXT	31.50	790576082332
QF-181X12-DB	QC FIXTURE-G100 SERIES GLASS-12IN EXT	31.50	790576109947
QF-181X3-BN	QC FIXTURE-G100 SERIES GLASS-3IN EXT	27.95	790576136554
QF-181X3-CH	QC FIXTURE-G100 SERIES GLASS-3IN EXT	27.95	790576082301
QF-181X3-DB	QC FIXTURE-G100 SERIES GLASS-3IN EXT	27.95	790576109954

Material	Description	2011 DN	UPC Code
QF-181X6-BN	QC FIXTURE-G100 SERIES GLASS-6IN EXT	29.50	790576136561
QF-181X6-CH	QC FIXTURE-G100 SERIES GLASS-6IN EXT	29.50	790576082271
QF-181X6-DB	QC FIXTURE-G100 SERIES GLASS-6IN EXT	29.50	790576109961
QF-182X12-BN	QC FIXTURE-CL/FR GLASS INCL-12IN EXT	37.95	790576136707
QF-182X12-CH	QC FIXTURE-CL/FR GLASS INCL-12IN EXT	37.95	790576082219
QF-182X12-DB	QC FIXTURE-CL/FR GLASS INCL-12IN EXT	37.95	790576109985
QF-182X3-BN	QC FIXTURE-CL/FR GLASS INCL-3IN EXT	34.95	790576136684
QF-182X3-CH	QC FIXTURE-CL/FR GLASS INCL-3IN EXT	34.95	790576082189
QF-182X3-DB	QC FIXTURE-CL/FR GLASS INCL-3IN EXT	34.95	790576109992
QF-182X6-BN	QC FIXTURE-CL/FR GLASS INCL-6IN EXT	35.95	790576136691
QF-182X6-CH	QC FIXTURE-CL/FR GLASS INCL-6IN EXT	35.95	790576082158
QF-182X6-DB	QC FIXTURE-CL/FR GLASS INCL-6IN EXT	35.95	790576110004
QF-183X12-BN	QC FIXTURE-METAL SHIELD INCL-12IN EXT	37.95	790576136806
QF-183X12-CH	QC FIXTURE-METAL SHIELD INCL-12IN EXT	37.95	790576082097
QF-183X12-DB	QC FIXTURE-METAL SHIELD INCL-12IN EXT	37.95	790576110028
QF-183X3-BN	QC FIXTURE-METAL SHIELD INCL-3IN EXT	34.95	790576136783
QF-183X3-CH	QC FIXTURE-METAL SHIELD INCL-3IN EXT	34.95	790576082066
QF-183X3-DB	QC FIXTURE-METAL SHIELD INCL-3IN EXT	34.95	790576110035
QF-183X6-BN	QC FIXTURE-METAL SHIELD INCL-6IN EXT	35.95	790576136790
QF-183X6-CH	QC FIXTURE-METAL SHIELD INCL-6IN EXT	35.95	790576082035
QF-183X6-DB	QC FIXTURE-METAL SHIELD INCL-6IN EXT	35.95	790576110042
QF-184X12-BN	QC FIXTURE-G100 SERIES GLASS-12IN EXT	31.50	790576136639
QF-184X12-CH	QC FIXTURE-G100 SERIES GLASS-12IN EXT	31.50	790576081977
QF-184X12-DB	QC FIXTURE-G100 SERIES GLASS-12IN EXT	31.50	790576110066
QF-184X3-BN	QC FIXTURE-G100 SERIES GLASS-3IN EXT	27.95	790576136615
QF-184X3-CH	QC FIXTURE-G100 SERIES GLASS-3IN EXT	27.95	790576081946
QF-184X3-DB	QC FIXTURE-G100 SERIES GLASS-3IN EXT	27.95	790576110073
QF-184X6-BN	QC FIXTURE-G100 SERIES GLASS-6IN EXT	29.50	790576136622
QF-184X6-CH	QC FIXTURE-G100 SERIES GLASS-6IN EXT	29.50	790576081915
QF-184X6-DB	QC FIXTURE-G100 SERIES GLASS-6IN EXT	29.50	790576110080
QF-185X12-BN	QC FIXTURE-NO SHADE/GLASS-12IN EXT	48.95	790576136776
QF-185X12-CH	QC FIXTURE-NO SHADE/GLASS-12IN EXT	48.95	790576081854
QF-185X12-DB	QC FIXTURE-NO SHADE/GLASS-12IN EXT	48.95	790576110103
QF-185X3-BN	QC FIXTURE-NO SHADE/GLASS-3IN EXT	45.50	790576136752
QF-185X3-CH	QC FIXTURE-NO SHADE/GLASS-3IN EXT	45.50	790576081823
QF-185X3-DB	QC FIXTURE-NO SHADE/GLASS-3IN EXT	45.50	790576110110
QF-185X6-BN	QC FIXTURE-NO SHADE/GLASS-6IN EXT	46.95	790576136769
QF-185X6-CH	QC FIXTURE-NO SHADE/GLASS-6IN EXT	46.95	790576081793
QF-185X6-DB	QC FIXTURE-NO SHADE/GLASS-6IN EXT	46.95	790576110127
QF-190X12-BN	QC FIXTURE-G100 SERIES GLASS-12IN EXT	34.95	790576136516
QF-190X12-CH	QC FIXTURE-G100 SERIES GLASS-12IN EXT	34.95	790576053233
QF-190X12-DB	QC FIXTURE-G100 SERIES GLASS-12IN EXT	34.95	790576110141
QF-190X3-BN	QC FIXTURE-G100 SERIES GLASS-3IN EXT	31.50	790576136493
QF-190X3-CH	QC FIXTURE-G100 SERIES GLASS-3IN EXT	31.50	790576053202
QF-190X3-DB	QC FIXTURE-G100 SERIES GLASS-3IN EXT	31.50	790576110158
QF-190X6-BN	QC FIXTURE-G100 SERIES GLASS-6IN EXT	32.50	790576136509
QF-190X6-CH	QC FIXTURE-G100 SERIES GLASS-6IN EXT	32.50	790576053219
QF-190X6-DB	QC FIXTURE-G100 SERIES GLASS-6IN EXT	32.50	790576110165
QF-191X12-BN	QC FIXTURE-NO SHADE/GLASS-12IN EXT	45.50	790576136660
QF-191X12-CH	QC FIXTURE-NO SHADE/GLASS-12IN EXT	45.50	790576056395



Material	Description	2011 DN	UPC Code
QF-191X12-DB	QC FIXTURE-NO SHADE/GLASS-12IN EXT	45.50	790576110189
QF-191X3-BN	QC FIXTURE-NO SHADE/GLASS-3IN EXT	42.50	790576136646
QF-191X3-CH	QC FIXTURE-NO SHADE/GLASS-3IN EXT	42.50	790576056364
QF-191X3-DB	QC FIXTURE-NO SHADE/GLASS-3IN EXT	42.50	790576110196
QF-191X6-BN	QC FIXTURE-NO SHADE/GLASS-6IN EXT	43.50	790576136653
QF-191X6-CH	QC FIXTURE-NO SHADE/GLASS-6IN EXT	43.50	790576056371
QF-191X6-DB	QC FIXTURE-NO SHADE/GLASS-6IN EXT	43.50	790576110202
QF-194X12-BN	QC FIXTURE-G100 SERIES GLASS-12IN EXT	35.95	790576136608
QF-194X12-CH	QC FIXTURE-G100 SERIES GLASS-12IN EXT	35.95	790576053349
QF-194X12-DB	QC FIXTURE-G100 SERIES GLASS-12IN EXT	35.95	790576110226
QF-194X3-BK	QC FIXTURE-G100 SERIES GLASS-3IN EXT	32.50	790576069319
QF-194X3-BN	QC FIXTURE-G100 SERIES GLASS-3IN EXT	32.50	790576136585
QF-194X3-CH	QC FIXTURE-G100 SERIES GLASS-3IN EXT	32.50	790576053318
QF-194X3-DB	QC FIXTURE-G100 SERIES GLASS-3IN EXT	32.50	790576110233
QF-194X3-PT	QC FIXTURE-G100 SERIES GLASS-3IN EXT	32.50	790576053288
QF-194X3-WT	QC FIXTURE-G100 SERIES GLASS-3IN EXT	32.50	790576069326
QF-194X6-BN	QC FIXTURE-G100 SERIES GLASS-6IN EXT	33.50	790576136592
QF-194X6-CH	QC FIXTURE-G100 SERIES GLASS-6IN EXT	33.50	790576053325
QF-194X6-DB	QC FIXTURE-G100 SERIES GLASS-6IN EXT	33.50	790576110240
QF-195X12-BN	QC FIXTURE-G100 SERIES GLASS-12IN EXT	33.50	790576136547
QF-195X12-CH	QC FIXTURE-G100 SERIES GLASS-12IN EXT	33.50	790576053479
QF-195X12-DB	QC FIXTURE-G100 SERIES GLASS-12IN EXT	33.50	790576110264
QF-195X3-BN	QC FIXTURE-G100 SERIES GLASS-3IN EXT	30.50	790576136523
QF-195X3-CH	QC FIXTURE-G100 SERIES GLASS-3IN EXT	30.50	790576053431
QF-195X3-DB	QC FIXTURE-G100 SERIES GLASS-3IN EXT	30.50	790576110271
QF-195X6-BN	QC FIXTURE-G100 SERIES GLASS-6IN EXT	31.50	790576136530
QF-195X6-CH	QC FIXTURE-G100 SERIES GLASS-6IN EXT	31.50	790576053455
QF-195X6-DB	QC FIXTURE-G100 SERIES GLASS-6IN EXT	31.50	790576110288
QF-196-BK	QC FIXTURE-NO SHADE/GLASS-3IN EXT	27.95	790576069333
QF-196-BN	QC FIXTURE-NO SHADE/GLASS-3IN EXT	27.95	790576136745
QF-196-CH	QC FIXTURE-NO SHADE/GLASS-3IN EXT	27.95	790576056449
QF-196-DB	QC FIXTURE-NO SHADE/GLASS-3IN EXT	27.95	790576110301
QF-196-PT	QC FIXTURE-NO SHADE/GLASS-3IN EXT	27.95	790576056494
QF-196-WT	QC FIXTURE-NO SHADE/GLASS-3IN EXT	27.95	790576069340
QF-197-BN	QC FIXTURE-G100 SERIES-FLEXIBLE STEM	30.50	790576136677
QF-197-CH	QC FIXTURE-G100 SERIES-FLEXIBLE STEM	30.50	790576056500
QF-197-DB	QC FIXTURE-G100 SERIES-FLEXIBLE STEM	30.50	790576110318
QF-199X12-BN	QC FIXTURE-NO SHADE/GLASS-12IN EXT	47.95	790576136738
QF-199X12-CH	QC FIXTURE-NO SHADE/GLASS-12IN EXT	47.95	790576081694
QF-199X12-DB	QC FIXTURE-NO SHADE/GLASS-12IN EXT	47.95	790576110325
QF-199X3-BN	QC FIXTURE-NO SHADE/GLASS-3IN EXT	44.50	790576136714
QF-199X3-CH	QC FIXTURE-NO SHADE/GLASS-3IN EXT	44.50	790576081663
QF-199X3-DB	QC FIXTURE-NO SHADE/GLASS-3IN EXT	44.50	790576110332
QF-199X6-BN	QC FIXTURE-NO SHADE/GLASS-6IN EXT	45.50	790576136721
QF-199X6-CH	QC FIXTURE-NO SHADE/GLASS-6IN EXT	45.50	790576081670
QF-199X6-DB	QC FIXTURE-NO SHADE/GLASS-6IN EXT	45.50	790576110349
QF-8111-BZ/AS	LOW VOLTAGE MONORAIL QC-FIXTURE KIT	41.95	790576124315
QF-8115-BZ/BZ	LOW VOLTAGE MONORAIL QC-FIXTURE KIT	41.95	790576122618
QF-9411-PT/WT	LOW VOLTAGE MONORAIL QC-FIXTURE KIT	41.95	790576122595
QF-9415-PT/PT	LOW VOLTAGE MONORAIL QC-FIXTURE KIT	41.95	790576122601

Material	Description	2011 DN	UPC Code
QF-LED-101-WW-F-BN	LEDme™ LINEAR QUICKK CONNECT FIXTURE	49.95	790576187914
QF-LED-101-WW-F-CH	LEDme™ LINEAR QUICKK CONNECT FIXTURE	49.95	790576187891
QF-LED-101-WW-F-DB	LEDme™ LINEAR QUICKK CONNECT FIXTURE	49.95	790576187280
QF-LED-101-WW-S-BN	LEDme™ LINEAR QUICKK CONNECT FIXTURE	49.95	790576187921
QF-LED-101-WW-S-CH	LEDme™ LINEAR QUICKK CONNECT FIXTURE	49.95	790576188065
QF-LED-101-WW-S-DB	LEDme™ LINEAR QUICKK CONNECT FIXTURE	49.95	790576188089
QF-LED-101-WW-W-BN	LEDme™ LINEAR QUICKK CONNECT FIXTURE	49.95	790576187938
QF-LED-101-WW-W-CH	LEDme™ LINEAR QUICKK CONNECT FIXTURE	49.95	790576188072
QF-LED-101-WW-W-DB	LEDme™ LINEAR QUICKK CONNECT FIXTURE	49.95	790576188096
QF-LED-102-WW-F-BN	LEDme™ LINEAR QUICKK CONNECT FIXTURE	49.95	790576187839
QF-LED-102-WW-F-CH	LEDme™ LINEAR QUICKK CONNECT FIXTURE	49.95	790576187815
QF-LED-102-WW-F-DB	LEDme™ LINEAR QUICKK CONNECT FIXTURE	49.95	790576187792
QF-LED-102-WW-S-BN	LEDme™ LINEAR QUICKK CONNECT FIXTURE	49.95	790576188126
QF-LED-102-WW-S-CH	LEDme™ LINEAR QUICKK CONNECT FIXTURE	49.95	790576188140
QF-LED-102-WW-S-DB	LEDme™ LINEAR QUICKK CONNECT FIXTURE	49.95	790576188164
QF-LED-102-WW-W-BN	LEDme™ LINEAR QUICKK CONNECT FIXTURE	49.95	790576188133
QF-LED-102-WW-W-CH	LEDme™ LINEAR QUICKK CONNECT FIXTURE	49.95	790576188157
QF-LED-102-WW-W-DB	LEDme™ LINEAR QUICKK CONNECT FIXTURE	49.95	790576188171
QF-LED-103-WW-BN	LEDme™ LINEAR QUICKK CONNECT FIXTURE	54.95	790576187297
QF-LED-103-WW-CH	LEDme™ LINEAR QUICKK CONNECT FIXTURE	54.95	790576187761
QF-LED-103-WW-DB	LEDme™ LINEAR QUICKK CONNECT FIXTURE	54.95	790576187754
QF-LED171X12-BN	LEDme QUICK CONNECT FIXTURE 12IN	99.95	790576169309
QF-LED171X12-CH	LEDme QUICK CONNECT FIXTURE 12IN	99.95	790576169293
QF-LED171X12-DB	LEDme QUICK CONNECT FIXTURE 12IN	99.95	790576169316
QF-LED171X3-BN	LEDme QUICK CONNECT FIXTURE 3IN	96.95	790576169248
QF-LED171X3-CH	LEDme QUICK CONNECT FIXTURE 3IN	96.95	790576169231
QF-LED171X3-DB	LEDme QUICK CONNECT FIXTURE 3IN	96.95	790576169255
QF-LED171X6-BN	LEDme QUICK CONNECT FIXTURE 6IN	97.95	790576169279
QF-LED171X6-CH	LEDme QUICK CONNECT FIXTURE 6IN	97.95	790576169286
QF-LED171X6-DB	LEDme QUICK CONNECT FIXTURE 6IN	97.95	790576169262
QF-LED173X12-BN	LEDme QUICK CONNECT FIXTURE 12IN	99.95	790576169330
QF-LED173X12-CH	LEDme QUICK CONNECT FIXTURE 12IN	99.95	790576169347
QF-LED173X12-DB	LEDme QUICK CONNECT FIXTURE 12IN	99.95	790576169323
QF-LED173X3-BN	LEDme QUICK CONNECT FIXTURE 3IN	96.95	790576169392
QF-LED173X3-CH	LEDme QUICK CONNECT FIXTURE 3IN	96.95	790576169408
QF-LED173X3-DB	LEDme QUICK CONNECT FIXTURE 3IN	96.95	790576169385
QF-LED173X6-BN	LEDme QUICK CONNECT FIXTURE 6IN	97.95	790576169361
QF-LED173X6-CH	LEDme QUICK CONNECT FIXTURE 6IN	97.95	790576169354
QF-LED173X6-DB	LEDme QUICK CONNECT FIXTURE 6IN	97.95	790576169378
QMP-1RN-TR-BN	SURFACE MOUNT CANOPY METAL	13.95	790576189918
QMP-1RN-TR-CH	SURFACE MOUNT CANOPY METAL	12.95	790576189925
QMP-1RN-TR-DB	SURFACE MOUNT CANOPY METAL	13.95	790576189932
QMP-1RN-TR-WT	SURFACE MOUNT CANOPY METAL	11.95	790576193861
QMP-1SQ-TR-BN	SURFACE MOUNT CANOPY METAL	13.95	790576189888
QMP-1SQ-TR-CH	SURFACE MOUNT CANOPY METAL	12.95	790576189895
QMP-1SQ-TR-DB	SURFACE MOUNT CANOPY METAL	13.95	790576189901
MP-60E-BN	MONOPOINT PENDANT CANOPY - EASY ADJUST	69.50	
MP-60E-CH	MONOPOINT PENDANT CANOPY - EASY ADJUST	66.95	
MP-60E-DB	MONOPOINT PENDANT CANOPY - EASY ADJUST	69.50	
QMP-60-COL-BN	SURFACE MOUNT COLLAR FOR SHALLOW J-BOX	11.95	790576192635

Material	Description	2011 DN	UPC Code
QMP-60-COL-CH	SURFACE MOUNT COLLAR FOR SHALLOW J-BOX	10.95	790576192628
QMP-60-COL-DB	SURFACE MOUNT COLLAR FOR SHALLOW J-BOX	11.95	790576192611
QMP-60ERN-BN	SURFACE MOUNT CANOPY METAL	38.95	790576189963
QMP-60ERN-CH	SURFACE MOUNT CANOPY METAL	37.95	790576189970
QMP-60ERN-DB	SURFACE MOUNT CANOPY METAL	38.95	790576189987
QMP-G1RN-CH	QC 1 UNIT REC GLASS CANOPY 60W TRANS	37.95	
QMP-G1RN-BN	QC 1 UNIT REC GLASS CANOPY 60W TRANS	38.95	
QMP-G1RN-MR	QC 1 UNIT REC MIRRORED CANOPY 60W TRANS	39.95	
QMP-G3RE-BN	QC 3 UNIT REC GLASS CANOPY 3X60W TRANS	98.95	790576137551
QMP-G3RE-CH	QC 3 UNIT REC GLASS CANOPY 3X60W TRANS	95.50	790576060408
QMP-G3RE-MR	QC 3 UNIT REC MIRRORED CANOPY 3X60W TRANS	99.95	
QMP-G3RN-BN	QC 3 UNIT RND GLASS CANOPY 3X60W TRANS	98.95	790576137568
QMP-G3RN-CH	QC 3 UNIT RND GLASS CANOPY 3X60W TRANS	95.50	790576060378
QMP-G3RN-MR	QC 3 UNIT RND MIRRORED CANOPY 3X60W TRANS	99.95	
QMP-K590-PT/WT	MONOPOINT AND GLASS KIT W/G590-WT	64.95	790576118055
QMP-K591-PT/WT	MONOPOINT AND GLASS KIT W/G591-WT	64.95	790576118062
QMP-K592-BZ/AM	MONOPOINT AND GLASS KIT W/G592-AM	64.95	790576118086
QMP-MI-TR-BN	SURFACE MOUNT CANOPY METAL	13.95	790576137599
QMP-MI-TR-CH	SURFACE MOUNT CANOPY METAL	12.95	790576189949
QMP-MI-TR-DB	SURFACE MOUNT CANOPY METAL	13.95	790576189956
QP332-CL/BN	PENDANT WITH QP-902 SOCKET SETS	151.50	790576195018
QP332-CL/CH	PENDANT WITH QP-902 SOCKET SETS	151.50	790576195001
QP332-CL/DB	PENDANT WITH QP-902 SOCKET SETS	151.50	790576194998
QP335-CL/BN	PENDANT WITH QP-902 SOCKET SETS	91.50	790576195131
QP335-CL/CH	PENDANT WITH QP-902 SOCKET SETS	91.50	790576195124
QP335-CL/DB	PENDANT WITH QP-902 SOCKET SETS	91.50	790576195117
QP-501-BN	QC SOCKET SET-G500 SERIES JC-50	26.95	790576136448
QP-501-CH	QC SOCKET SET-G500 SERIES JC-50	26.95	790576056531
QP-501-DB	QC SOCKET SET-G500 SERIES JC-50	26.95	790576110387
QP-501X12-BN	QC-PENDANT SOCKET SET 12 FT CORD	48.95	790576148007
QP-501X12-CH	QC-PENDANT SOCKET SET 12 FT CORD	48.95	790576088198
QP-501X12-DB	QC-PENDANT SOCKET SET 12 FT CORD	48.95	790576123608
QP512-AM/BN	JILL PENDANT WITH QP-501 SOCKET SETS	51.95	790576148205
QP512-AM/CH	JILL PENDANT WITH QP-501 SOCKET SETS	51.95	790576148243
QP512-AM/DB	JILL PENDANT WITH QP-501 SOCKET SETS	51.95	790576148250
QP512-BL/BN	JILL PENDANT WITH QP-501 SOCKET SETS	51.95	790576148281
QP512-BL/CH	JILL PENDANT WITH QP-501 SOCKET SETS	51.95	790576148298
QP512-BL/DB	JILL PENDANT WITH QP-501 SOCKET SETS	51.95	790576148304
QP512-GR/BN	JILL PENDANT WITH QP-501 SOCKET SETS	51.95	790576148311
QP512-GR/CH	JILL PENDANT WITH QP-501 SOCKET SETS	51.95	790576148328
QP512-GR/DB	JILL PENDANT WITH QP-501 SOCKET SETS	51.95	790576148335
QP512-RD/BN	JILL PENDANT WITH QP-501 SOCKET SETS	51.95	790576148342
QP512-RD/CH	JILL PENDANT WITH QP-501 SOCKET SETS	51.95	790576148359
QP512-RD/DB	JILL PENDANT WITH QP-501 SOCKET SETS	51.95	790576148366
QP512-WT/BN	JILL PENDANT WITH QP-501 SOCKET SETS	51.95	790576148373
QP512-WT/CH	JILL PENDANT WITH QP-501 SOCKET SETS	51.95	790576148380
QP512-WT/DB	JILL PENDANT WITH QP-501 SOCKET SETS	51.95	790576148397
QP513-AM/BN	ELLA PENDANT WITH QP-501 SOCKET SETS	60.95	790576148403
QP513-AM/CH	ELLA PENDANT WITH QP-501 SOCKET SETS	60.95	790576148410
QP513-AM/DB	ELLA PENDANT WITH QP-501 SOCKET SETS	60.95	790576148427

Material	Description	2011 DN	UPC Code
QP513-WT/BN	ELLA PENDANT WITH QP-501 SOCKET SETS	60.95	790576148434
QP513-WT/CH	ELLA PENDANT WITH QP-501 SOCKET SETS	60.95	790576148441
QP513-WT/DB	ELLA PENDANT WITH QP-501 SOCKET SETS	60.95	790576148458
QP515-AM/BN	FIORE PENDANT WITH QP-501 SOCKET SETS	91.95	790576148496
QP515-AM/CH	FIORE PENDANT WITH QP-501 SOCKET SETS	91.95	790576148502
QP515-AM/DB	FIORE PENDANT WITH QP-501 SOCKET SETS	91.95	790576148519
QP515-MF/BN	FIORE PENDANT WITH QP-501 SOCKET SETS	91.95	790576148557
QP515-MF/CH	FIORE PENDANT WITH QP-501 SOCKET SETS	91.95	790576148564
QP515-MF/DB	FIORE PENDANT WITH QP-501 SOCKET SETS	91.95	790576148571
QP517-WT/BN	OBO PENDANT WITH QP-501 SOCKET SETS	56.95	790576148588
QP517-WT/CH	OBO PENDANT WITH QP-501 SOCKET SETS	56.95	790576148595
QP517-WT/DB	OBO PENDANT WITH QP-501 SOCKET SETS	56.95	790576148601
QP518-DIC/BN	EDEN PENDANT WITH QP-501 SOCKET SETS	106.95	790576148618
QP518-DIC/CH	EDEN PENDANT WITH QP-501 SOCKET SETS	106.95	790576148625
QP518-DIC/DB	EDEN PENDANT WITH QP-501 SOCKET SETS	106.95	790576148632
QP524-AM/BN	SARAH PENDANT WITH QP-501 SOCKET SETS	55.95	790576148731
QP524-AM/CH	SARAH PENDANT WITH QP-501 SOCKET SETS	55.95	790576148748
QP524-AM/DB	SARAH PENDANT WITH QP-501 SOCKET SETS	55.95	790576148755
QP524-LB/BN	SARAH PENDANT WITH QP-501 SOCKET SETS	55.95	790576148762
QP524-LB/CH	SARAH PENDANT WITH QP-501 SOCKET SETS	55.95	790576148779
QP524-LB/DB	SARAH PENDANT WITH QP-501 SOCKET SETS	55.95	790576148786
QP524-TQ/BN	SARAH PENDANT WITH QP-501 SOCKET SETS	55.95	790576151342
QP524-TQ/CH	SARAH PENDANT WITH QP-501 SOCKET SETS	55.95	790576151359
QP524-TQ/DB	SARAH PENDANT WITH QP-501 SOCKET SETS	55.95	790576151366
QP524-WT/BN	SARAH PENDANT WITH QP-501 SOCKET SETS	55.95	790576148793
QP524-WT/CH	SARAH PENDANT WITH QP-501 SOCKET SETS	55.95	790576148809
QP524-WT/DB	SARAH PENDANT WITH QP-501 SOCKET SETS	55.95	790576148816
QP530-GR/BN	COUTURE PENDANT WITH QP-501 SOCKET SETS	146.95	790576148823
QP530-GR/CH	COUTURE PENDANT WITH QP-501 SOCKET SETS	146.95	790576148830
QP530-GR/DB	COUTURE PENDANT WITH QP-501 SOCKET SETS	146.95	790576148847
QP530-MC/BN	COUTURE PENDANT WITH QP-501 SOCKET SETS	146.95	790576148854
QP530-MC/CH	COUTURE PENDANT WITH QP-501 SOCKET SETS	146.95	790576148861
QP530-MC/DB	COUTURE PENDANT WITH QP-501 SOCKET SETS	146.95	790576148878
QP534-SM/BN	PENDANT WITH QP-501 SOCKET SETS	76.95	790576195308
QP534-SM/CH	PENDANT WITH QP-501 SOCKET SETS	76.95	790576195292
QP534-SM/DB	PENDANT WITH QP-501 SOCKET SETS	76.95	790576195285
QP535-DIC/BN	PENDANT WITH QP-501 SOCKET SETS	126.95	790576200934
QP535-DIC/CH	PENDANT WITH QP-501 SOCKET SETS	126.95	790576200927
QP535-DIC/DB	PENDANT WITH QP-501 SOCKET SETS	126.95	790576200910
QP536-BL/BN	PENDANT WITH QP-501 SOCKET SETS	91.95	790576195520
QP536-BL/CH	PENDANT WITH QP-501 SOCKET SETS	91.95	790576195513
QP536-BL/DB	PENDANT WITH QP-501 SOCKET SETS	91.95	790576195506
QP541-AM/BN	FABERGE PENDANT WITH QP-501 SOCKET SETS	63.95	790576148915
QP541-AM/CH	FABERGE PENDANT WITH QP-501 SOCKET SETS	63.95	790576148922
QP541-AM/DB	FABERGE PENDANT WITH QP-501 SOCKET SETS	63.95	790576148939
QP541-WT/BN	FABERGE PENDANT WITH QP-501 SOCKET SETS	63.95	790576148946
QP541-WT/CH	FABERGE PENDANT WITH QP-501 SOCKET SETS	63.95	790576148953
QP541-WT/DB	FABERGE PENDANT WITH QP-501 SOCKET SETS	63.95	790576148960
QP546-DIC/BN	AMBROSIA PENDANT WITH QP-501 SOCKET SETS	126.95	790576149004
QP546-DIC/CH	AMBROSIA PENDANT WITH QP-501 SOCKET SETS	126.95	790576149011

Material	Description	2011 DN	UPC Code
QP546-DIC/DB	AMBROSIA PENDANT WITH QP-501 SOCKET SETS	126.95	790576149028
QP548-FR/BN	PURA PENDANT WITH QP-501 SOCKET SETS	76.95	790576149066
QP548-FR/CH	PURA PENDANT WITH QP-501 SOCKET SETS	76.95	790576149073
QP548-FR/DB	PURA PENDANT WITH QP-501 SOCKET SETS	76.95	790576149080
QP559-DIC/BN	MICHA PENDANT WITH QP-501 SOCKET SETS	66.95	790576177946
QP559-DIC/CH	MICHA PENDANT WITH QP-501 SOCKET SETS	66.95	790576177908
QP559-DIC/DB	MICHA PENDANT WITH QP-501 SOCKET SETS	66.95	790576177878
QP559-GL/BN	MICHA PENDANT WITH QP-501 SOCKET SETS	66.95	790576173115
QP559-GL/CH	MICHA PENDANT WITH QP-501 SOCKET SETS	66.95	790576173092
QP559-GL/DB	MICHA PENDANT WITH QP-501 SOCKET SETS	66.95	790576173061
QP559-MR/BN	MICHA PENDANT WITH QP-501 SOCKET SETS	66.95	790576178936
QP559-MR/CH	MICHA PENDANT WITH QP-501 SOCKET SETS	66.95	790576178899
QP559-MR/DB	MICHA PENDANT WITH QP-501 SOCKET SETS	66.95	790576178837
QP593-LI/BN	KOMAL PENDANT WITH QP-501 SOCKET SETS	106.95	790576149158
QP593-LI/CH	KOMAL PENDANT WITH QP-501 SOCKET SETS	106.95	790576149165
QP593-LI/DB	KOMAL PENDANT WITH QP-501 SOCKET SETS	106.95	790576149172
QP593-RD/BN	KOMAL PENDANT WITH QP-501 SOCKET SETS	106.95	790576151311
QP593-RD/CH	KOMAL PENDANT WITH QP-501 SOCKET SETS	106.95	790576151328
QP593-RD/DB	KOMAL PENDANT WITH QP-501 SOCKET SETS	106.95	790576151335
QP593-TQ/BN	KOMAL PENDANT WITH QP-501 SOCKET SETS	106.95	790576149219
QP593-TQ/CH	KOMAL PENDANT WITH QP-501 SOCKET SETS	106.95	790576149226
QP593-TQ/DB	KOMAL PENDANT WITH QP-501 SOCKET SETS	106.95	790576149233
QP598-WT/BN	DAPPER PENDANT WITH QP-501 SOCKET SETS	91.95	790576149240
QP598-WT/CH	DAPPER PENDANT WITH QP-501 SOCKET SETS	91.95	790576149257
QP598-WT/DB	DAPPER PENDANT WITH QP-501 SOCKET SETS	91.95	790576149264
QP599-BL/BN	RHEA PENDANT WITH QP-501 SOCKET SETS	76.95	790576175379
QP599-BL/CH	RHEA PENDANT WITH QP-501 SOCKET SETS	76.95	790576175331
QP599-BL/DB	RHEA PENDANT WITH QP-501 SOCKET SETS	76.95	790576175300
QP599-UM/BN	RHEA PENDANT WITH QP-501 SOCKET SETS	76.95	790576177427
QP599-UM/CH	RHEA PENDANT WITH QP-501 SOCKET SETS	76.95	790576177380
QP599-UM/DB	RHEA PENDANT WITH QP-501 SOCKET SETS	76.95	790576177342
QP599-WT/BN	RHEA PENDANT WITH QP-501 SOCKET SETS	76.95	790576176376
QP599-WT/CH	RHEA PENDANT WITH QP-501 SOCKET SETS	76.95	790576176338
QP599-WT/DB	RHEA PENDANT WITH QP-501 SOCKET SETS	76.95	790576176307
QP-601-BN	QC SOCKET SET-G600 SERIES JC-50	26.95	790576136455
QP-601-CH	QC SOCKET SET-G600 SERIES JC-50	26.95	790576056579
QP-601-DB	QC SOCKET SET-G600 SERIES JC-50	26.95	790576110400
QP-601X12-BN	QC-PENDANT SOCKET SET 12 FT CORD	48.95	790576159485
QP-601X12-CH	QC-PENDANT SOCKET SET 12 FT CORD	48.95	790576088044
QP-601X12-DB	QC-PENDANT SOCKET SET 12 FT CORD	48.95	790576118048
QP611-AM/BN	APRIL PENDANT WITH QP-601 SOCKET SETS	54.95	790576149271
QP611-AM/CH	APRIL PENDANT WITH QP-601 SOCKET SETS	54.95	790576149288
QP611-AM/DB	APRIL PENDANT WITH QP-601 SOCKET SETS	54.95	790576149295
QP611-BL/BN	APRIL PENDANT WITH QP-601 SOCKET SETS	54.95	790576149301
QP611-BL/CH	APRIL PENDANT WITH QP-601 SOCKET SETS	54.95	790576149318
QP611-BL/DB	APRIL PENDANT WITH QP-601 SOCKET SETS	54.95	790576149325
QP611-RD/BN	APRIL PENDANT WITH QP-601 SOCKET SETS	54.95	790576149332
QP611-RD/CH	APRIL PENDANT WITH QP-601 SOCKET SETS	54.95	790576149349
QP611-RD/DB	APRIL PENDANT WITH QP-601 SOCKET SETS	54.95	790576149356
QP611-WT/BN	APRIL PENDANT WITH QP-601 SOCKET SETS	54.95	790576149363

Material	Description	2011 DN	UPC Code
QP611-WT/CH	APRIL PENDANT WITH QP-601 SOCKET SETS	54.95	790576149370
QP611-WT/DB	APRIL PENDANT WITH QP-601 SOCKET SETS	54.95	790576149387
QP613-AM/BN	LAUREN PENDANT WITH QP-601 SOCKET SETS	54.95	790576149394
QP613-AM/CH	LAUREN PENDANT WITH QP-601 SOCKET SETS	54.95	790576149400
QP613-AM/DB	LAUREN PENDANT WITH QP-601 SOCKET SETS	54.95	790576149417
QP613-BL/BN	LAUREN PENDANT WITH QP-601 SOCKET SETS	54.95	790576149424
QP613-BL/CH	LAUREN PENDANT WITH QP-601 SOCKET SETS	54.95	790576149431
QP613-BL/DB	LAUREN PENDANT WITH QP-601 SOCKET SETS	54.95	790576149448
QP613-RD/BN	LAUREN PENDANT WITH QP-601 SOCKET SETS	54.95	790576149455
QP613-RD/CH	LAUREN PENDANT WITH QP-601 SOCKET SETS	54.95	790576149462
QP613-RD/DB	LAUREN PENDANT WITH QP-601 SOCKET SETS	54.95	790576149479
QP613-WT/BN	LAUREN PENDANT WITH QP-601 SOCKET SETS	54.95	790576149486
QP613-WT/CH	LAUREN PENDANT WITH QP-601 SOCKET SETS	54.95	790576149493
QP613-WT/DB	LAUREN PENDANT WITH QP-601 SOCKET SETS	54.95	790576149509
QP614-BG/BN	PASSION PENDANT WITH QP-601 SOCKET SETS	109.50	
QP614-BG-CH	PASSION PENDANT WITH QP-601 SOCKET SETS	109.50	
QP614-BG-DB	PASSION PENDANT WITH QP-601 SOCKET SETS	109.50	
QP614-MF/BN	PASSION PENDANT WITH QP-601 SOCKET SETS	109.50	
QP614-MF-CH	PASSION PENDANT WITH QP-601 SOCKET SETS	109.50	
QP614-MF-DB	PASSION PENDANT WITH QP-601 SOCKET SETS	109.50	
QP614-YR/BN	PASSION PENDANT WITH QP-601 SOCKET SETS	109.50	
QP614-YR-CH	PASSION PENDANT WITH QP-601 SOCKET SETS	109.50	
QP614-YR-DB	PASSION PENDANT WITH QP-601 SOCKET SETS	109.50	
QP615-BG/BN	TRISTA PENDANT WITH QP-601 SOCKET SETS	96.95	790576149608
QP615-BG/CH	TRISTA PENDANT WITH QP-601 SOCKET SETS	96.95	790576149615
QP615-BG/DB	TRISTA PENDANT WITH QP-601 SOCKET SETS	96.95	790576149622
QP619-RD/BN	PYRI PENDANT WITH QP-601 SOCKET SETS	111.95	790576149844
QP619-RD/CH	PYRI PENDANT WITH QP-601 SOCKET SETS	111.95	790576149851
QP619-RD/DB	PYRI PENDANT WITH QP-601 SOCKET SETS	111.95	790576149868
QP619-TQ/BN	PYRI PENDANT WITH QP-601 SOCKET SETS	111.95	790576149875
QP619-TQ/CH	PYRI PENDANT WITH QP-601 SOCKET SETS	111.95	790576149882
QP619-TQ/DB	PYRI PENDANT WITH QP-601 SOCKET SETS	111.95	790576149899
QP620-BL/BN	LAVA PENDANT WITH QP-601 SOCKET SETS	126.95	790576174433
QP620-BL/CH	LAVA PENDANT WITH QP-601 SOCKET SETS	126.95	790576174402
QP620-BL/DB	LAVA PENDANT WITH QP-601 SOCKET SETS	126.95	790576174365
QP620-BR/BN	LAVA PENDANT WITH QP-601 SOCKET SETS	126.95	790576174174
QP620-BR/CH	LAVA PENDANT WITH QP-601 SOCKET SETS	126.95	790576174143
QP620-BR/DB	LAVA PENDANT WITH QP-601 SOCKET SETS	126.95	790576174112
QP620-RD/BN	LAVA PENDANT WITH QP-601 SOCKET SETS	126.95	790576173917
QP620-RD/CH	LAVA PENDANT WITH QP-601 SOCKET SETS	126.95	790576173894
QP620-RD/DB	LAVA PENDANT WITH QP-601 SOCKET SETS	126.95	790576173863
QP630-AM/BN	PENDANT WITH QP-601 SOCKET SETS	76.95	790576195988
QP630-AM/CH	PENDANT WITH QP-601 SOCKET SETS	76.95	790576195971
QP630-AM/DB	PENDANT WITH QP-601 SOCKET SETS	76.95	790576195964
QP630-GR/BN	PENDANT WITH QP-601 SOCKET SETS	76.95	790576195926
QP630-GR/CH	PENDANT WITH QP-601 SOCKET SETS	76.95	790576195919
QP630-GR/DB	PENDANT WITH QP-601 SOCKET SETS	76.95	790576195902
QP630-OR/BN	PENDANT WITH QP-601 SOCKET SETS	76.95	790576195803
QP630-OR/CH	PENDANT WITH QP-601 SOCKET SETS	76.95	790576195797
QP630-OR/DB	PENDANT WITH QP-601 SOCKET SETS	76.95	790576195780

Material	Description	2011 DN	UPC Code
QP-701-BN	QC SOCKET SET-G700 SERIES BP-50-12V	38.95	790576136462
QP-701-CH	QC SOCKET SET-G700 SERIES BP-50-12V	38.95	790576056593
QP-701-DB	QC SOCKET SET-G700 SERIES BP-50-12V	38.95	790576110417
QP711-WT/BN	KONIC PENDANT WITH QP-601 SOCKET SETS	82.95	790576149967
QP711-WT/CH	KONIC PENDANT WITH QP-601 SOCKET SETS	82.95	790576149974
QP711-WT/DB	KONIC PENDANT WITH QP-601 SOCKET SETS	82.95	790576149981
QP720-GR/BN	CARNIVAL PENDANT WITH QP-701 SOCKET SETS	228.95	790576150024
QP720-GR/CH	CARNIVAL PENDANT WITH QP-701 SOCKET SETS	228.95	790576150031
QP720-GR/DB	CARNIVAL PENDANT WITH QP-701 SOCKET SETS	228.95	790576150048
QP720-RD/BN	CARNIVAL PENDANT WITH QP-701 SOCKET SETS	228.95	790576150055
QP720-RD/CH	CARNIVAL PENDANT WITH QP-701 SOCKET SETS	228.95	790576150062
QP720-RD/DB	CARNIVAL PENDANT WITH QP-701 SOCKET SETS	228.95	790576150079
QP-902-BN	QC SOCKET SET-G900 SERIES BP-50-12V	31.50	790576137049
QP-902-CH	QC SOCKET SET-G900 SERIES BP-50-12V	31.50	790576079455
QP-902-DB	QC SOCKET SET-G900 SERIES BP-50-12V	31.50	790576110448
QP-902X12-BN	QC-PENDANT SOCKET SET 12 FT CORD	53.50	790576159515
QP-902X12-CH	QC-PENDANT SOCKET SET 12 FT CORD	53.50	790576088167
QP-902X12-DB	QC-PENDANT SOCKET SET 12 FT CORD	53.50	790576124391
QP913-CF/BN	INGO PENDANT WITH QP-902 SOCKET SETS	111.50	790576150291
QP913-CF/CH	INGO PENDANT WITH QP-902 SOCKET SETS	111.50	790576150307
QP913-CF/DB	INGO PENDANT WITH QP-902 SOCKET SETS	111.50	790576150314
QP913-OE/BN	INGO PENDANT WITH QP-902 SOCKET SETS	121.50	790576150352
QP913-OE/CH	INGO PENDANT WITH QP-902 SOCKET SETS	121.50	790576150369
QP913-OE/DB	INGO PENDANT WITH QP-902 SOCKET SETS	121.50	790576150376
QP913-RD/BN	INGO PENDANT WITH QP-902 SOCKET SETS	131.50	790576150383
QP913-RD/CH	INGO PENDANT WITH QP-902 SOCKET SETS	131.50	790576150390
QP913-RD/DB	INGO PENDANT WITH QP-902 SOCKET SETS	131.50	790576150406
QP914-FR/BN	TULUM PENDANT WITH QP-902 SOCKET SETS	101.50	790576150413
QP914-FR/CH	TULUM PENDANT WITH QP-902 SOCKET SETS	101.50	790576150420
QP914-FR/DB	TULUM PENDANT WITH QP-902 SOCKET SETS	101.50	790576150437
QP915-CF/BN	TIKAL PENDANT WITH QP-902 SOCKET SETS	94.95	790576150444
QP915-CF/CH	TIKAL PENDANT WITH QP-902 SOCKET SETS	94.95	790576150451
QP915-CF/DB	TIKAL PENDANT WITH QP-902 SOCKET SETS	94.95	790576150468
QP916-CL/BN	CLARITY PENDANT WITH QP-902 SOCKET SETS	91.50	790576150475
QP916-CL/CH	CLARITY PENDANT WITH QP-902 SOCKET SETS	91.50	790576150482
QP916-CL/DB	CLARITY PENDANT WITH QP-902 SOCKET SETS	91.50	790576150499
QP918-AM/BN	TIGRA PENDANT WITH QP-902 SOCKET SETS	101.50	790576150536
QP918-AM/CH	TIGRA PENDANT WITH QP-902 SOCKET SETS	101.50	790576150543
QP918-AM/DB	TIGRA PENDANT WITH QP-902 SOCKET SETS	101.50	790576150550
QP918-BP/BN	AURORA PENDANT WITH QP-902 SOCKET SETS	101.50	790576150567
QP918-BP/CH	AURORA PENDANT WITH QP-902 SOCKET SETS	101.50	790576150574
QP918-BP/DB	AURORA PENDANT WITH QP-902 SOCKET SETS	101.50	790576150581
QP918-GO/BN	AURORA PENDANT WITH QP-902 SOCKET SETS	101.50	790576150598
QP918-GO/CH	AURORA PENDANT WITH QP-902 SOCKET SETS	101.50	790576150604
QP918-GO/DB	AURORA PENDANT WITH QP-902 SOCKET SETS	101.50	790576150611
QP918-YR/BN	AURORA PENDANT WITH QP-902 SOCKET SETS	101.50	790576150628
QP918-YR/CH	AURORA PENDANT WITH QP-902 SOCKET SETS	101.50	790576150635
QP918-YR/DB	AURORA PENDANT WITH QP-902 SOCKET SETS	101.50	790576150642
QP919-BU/BN	POME PENDANT WITH QP-902 SOCKET SETS	81.50	790576150659
QP919-BU/CH	POME PENDANT WITH QP-902 SOCKET SETS	81.50	790576150666

Material	Description	2011 DN	UPC Code
QP919-BU/DB	POME PENDANT WITH QP-902 SOCKET SETS	81.50	790576150673
QP930-CL/BN	POLARIS PENDANT WITH QP-902 SOCKET SETS	131.50	790576150772
QP930-CL/CH	POLARIS PENDANT WITH QP-902 SOCKET SETS	131.50	790576150789
QP930-CL/DB	POLARIS PENDANT WITH QP-902 SOCKET SETS	131.50	790576150796
QP932-CL/BN	PYXIS PENDANT WITH QP-902 SOCKET SETS	131.50	790576150833
QP932-CL/CH	PYXIS PENDANT WITH QP-902 SOCKET SETS	131.50	790576150840
QP932-CL/DB	PYXIS PENDANT WITH QP-902 SOCKET SETS	131.50	790576150857
QP933-AM/BN	TRUFFLE PENDANT WITH QP-902 SOCKET SETS	78.50	790576150864
QP933-AM/CH	TRUFFLE PENDANT WITH QP-902 SOCKET SETS	78.50	790576150871
QP933-AM/DB	TRUFFLE PENDANT WITH QP-902 SOCKET SETS	78.50	790576150888
QP934-IR/BN	COQUETTE PENDANT WITH QP-902 SOCKET SETS	101.50	790576150895
QP934-IR/CH	COQUETTE PENDANT WITH QP-902 SOCKET SETS	101.50	790576150901
QP934-IR/DB	COQUETTE PENDANT WITH QP-902 SOCKET SETS	101.50	790576150918
QP936-AM/BN	FLAVA PENDANT WITH QP-902 SOCKET SETS	101.50	790576150925
QP936-AM/CH	FLAVA PENDANT WITH QP-902 SOCKET SETS	101.50	790576150932
QP936-AM/DB	FLAVA PENDANT WITH QP-902 SOCKET SETS	101.50	790576150949
QP936-BW/BN	FLAVA PENDANT WITH QP-902 SOCKET SETS	101.50	790576150956
QP936-BW/CH	FLAVA PENDANT WITH QP-902 SOCKET SETS	101.50	790576150963
QP936-BW/DB	FLAVA PENDANT WITH QP-902 SOCKET SETS	101.50	790576150970
QP940-CL/BN	PRISMA PENDANT WITH QP-902 SOCKET SETS	131.50	790576151076
QP940-CL/CH	PRISMA PENDANT WITH QP-902 SOCKET SETS	131.50	790576151083
QP940-CL/DB	PRISMA PENDANT WITH QP-902 SOCKET SETS	131.50	790576151090
QP946-AL/BN	ALPA PENDANT WITH QP-902 SOCKET SETS	94.50	790576151106
QP946-AL/CH	ALPA PENDANT WITH QP-902 SOCKET SETS	94.50	790576151113
QP946-AL/DB	ALPA PENDANT WITH QP-902 SOCKET SETS	94.50	790576151120
QP946-GT/BN	ALPA PENDANT WITH QP-902 SOCKET SETS	94.50	790576151137
QP946-GT/CH	ALPA PENDANT WITH QP-902 SOCKET SETS	94.50	790576151144
QP946-GT/DB	ALPA PENDANT WITH QP-902 SOCKET SETS	94.50	790576151151
QP950-AM/BN	SHANTI PENDANT WITH QP-902 SOCKET SETS	151.50	790576151229
QP950-AM/CH	SHANTI PENDANT WITH QP-902 SOCKET SETS	151.50	790576151236
QP950-AM/DB	SHANTI PENDANT WITH QP-902 SOCKET SETS	151.50	790576151243
QP950-RD/BN	SHANTI PENDANT WITH QP-902 SOCKET SETS	151.50	790576151250
QP950-RD/CH	SHANTI PENDANT WITH QP-902 SOCKET SETS	151.50	790576151267
QP950-RD/DB	SHANTI PENDANT WITH QP-902 SOCKET SETS	151.50	790576151274
QP952-CL/BN	ALLURE PENDANT WITH QP-902 SOCKET SETS	131.50	790576151281
QP952-CL/CH	ALLURE PENDANT WITH QP-902 SOCKET SETS	131.50	790576151298
QP952-CL/DB	ALLURE PENDANT WITH QP-902 SOCKET SETS	131.50	790576151304
QP953-BN/BN	STADT PENDANT WITH QP-601 SOCKET SETS	66.50	790576179445
QP953-BN/CH	STADT PENDANT WITH QP-601 SOCKET SETS	66.50	790576179438
QP953-BN/DB	STADT PENDANT WITH QP-601 SOCKET SETS	66.50	790576179421
QP953-CH/BN	STADT PENDANT WITH QP-601 SOCKET SETS	66.50	790576179384
QP953-CH/CH	STADT PENDANT WITH QP-601 SOCKET SETS	66.50	790576179377
QP953-CH/DB	STADT PENDANT WITH QP-601 SOCKET SETS	66.50	790576179360
QP962-BF/BN	MISTICA PENDANT WITH QP-601 SOCKET SETS	161.50	790576179506
QP962-BF/CH	MISTICA PENDANT WITH QP-601 SOCKET SETS	161.50	790576179490
QP962-BF/DB	MISTICA PENDANT WITH QP-601 SOCKET SETS	161.50	790576179483
QP962-RF/BN	MISTICA PENDANT WITH QP-601 SOCKET SETS	161.50	790576179568
QP962-RF/CH	MISTICA PENDANT WITH QP-601 SOCKET SETS	161.50	790576179551
QP962-RF/DB	MISTICA PENDANT WITH QP-601 SOCKET SETS	161.50	790576179544
QP963-GJ/BN	YU PENDANT WITH QP-601 SOCKET SETS	131.50	790576179629



Material	Description	2011 DN	UPC Code
QP963-GJ/CH	YU PENDANT WITH QP-601 SOCKET SETS	131.50	790576179612
QP963-GJ/DB	YU PENDANT WITH QP-601 SOCKET SETS	131.50	790576179605
QP964-MR/BN	PENDANT WITH QP-902 SOCKET SETS	91.50	790576195193
QP964-MR/CH	PENDANT WITH QP-902 SOCKET SETS	91.50	790576195186
QP964-MR/DB	PENDANT WITH QP-902 SOCKET SETS	91.50	790576195179
QP966-BN/BN	PENDANT WITH QP-902 SOCKET SETS	61.50	790576195254
QP966-CH/CH	PENDANT WITH QP-902 SOCKET SETS	61.50	790576195230
QP966-DB/DB	PENDANT WITH QP-902 SOCKET SETS	61.50	790576195278
QP968-OR/BN	PENDANT WITH QP-902 SOCKET SETS	151.50	790576200842
QP968-OR/CH	PENDANT WITH QP-902 SOCKET SETS	151.50	790576200835
QP968-OR/DB	PENDANT WITH QP-902 SOCKET SETS	151.50	790576200828
QP-G590-WT/PT	LOW VOLTAGE MONORAIL QC-PENDANT KIT	41.95	790576122557
QP-G591-WT/PT	LOW VOLTAGE MONORAIL QC-PENDANT KIT	41.95	790576122564
QP-G592-AB/BZ	LOW VOLTAGE MONORAIL QC-PENDANT KIT	41.95	790576122588
QP-LED303-BN	QUICK CONNECT LED 300 SERIES SOCKET SET	79.95	790576194318
QP-LED303-CH	QUICK CONNECT LED 300 SERIES SOCKET SET	79.95	790576194325
QP-LED303-DB	QUICK CONNECT LED 300 SERIES SOCKET SET	79.95	790576194332
QP-LED303X12-BN	QUICK CONNECT LED 300 SERIES SOCKET SET	99.95	790576194349
QP-LED303X12-CH	QUICK CONNECT LED 300 SERIES SOCKET SET	99.95	790576194356
QP-LED303X12-DB	QUICK CONNECT LED 300 SERIES SOCKET SET	99.95	790576194363
QPLED311-BN/BN	LEDme QUICK CONNECT PENDANT	119.95	790576169460
QPLED311-BN/CH	LEDme QUICK CONNECT PENDANT	119.95	790576169477
QPLED311-BN/DB	LEDme QUICK CONNECT PENDANT	119.95	790576169484
QPLED314-BN/BN	LEDme QUICK CONNECT PENDANT	97.95	790576169507
QPLED314-BN/CH	LEDme QUICK CONNECT PENDANT	97.95	790576169514
QPLED314-BN/DB	LEDme QUICK CONNECT PENDANT	97.95	790576169521
QPLED315-BK/BN	LEDme QUICK CONNECT PENDANT	109.95	790576169545
QPLED315-BK/CH	LEDme QUICK CONNECT PENDANT	109.95	790576169552
QPLED315-BK/DB	LEDme QUICK CONNECT PENDANT	109.95	790576169569
QPLED315-PT/CH	LEDme QUICK CONNECT PENDANT	109.95	
QPLED315-PT/DB	LEDme QUICK CONNECT PENDANT	109.95	
QP-LED332-CL/BN	LEDme QUICK CONNECT PENDANT	199.95	790576194950
QP-LED332-CL/CH	LEDme QUICK CONNECT PENDANT	199.95	790576194943
QP-LED332-CL/DB	LEDme QUICK CONNECT PENDANT	199.95	790576194936
QP-LED335-CL/BN	LEDme QUICK CONNECT PENDANT	139.95	790576195070
QP-LED335-CL/CH	LEDme QUICK CONNECT PENDANT	139.95	790576195063
QP-LED335-CL/DB	LEDme QUICK CONNECT PENDANT	139.95	790576195056
QP-LED503-BN	LED SOCKET SET FOR G500 SERIES QC GLASS	91.95	790576169866
QP-LED503-CH	LED SOCKET SET FOR G500 SERIES QC GLASS	91.95	790576169880
QP-LED503-DB	LED SOCKET SET FOR G500 SERIES QC GLASS	91.95	790576169897
QP-LED503X12-BN	LED SOCKET SET FOR G500 SERIES QC GLASS - Y12	111.95	790576169903
QP-LED503X12-CH	LED SOCKET SET FOR G500 SERIES QC GLASS - Y12	111.95	790576169910
QP-LED503X12-DB	LED SOCKET SET FOR G500 SERIES QC GLASS - Y12	111.95	790576169927
QP-LED512-AM/BN	LEDme QUICK CONNECT SOCKET SET W/ GLASS SHADE	116.50	790576172460
QP-LED512-AM/CH	LEDme QUICK CONNECT SOCKET SET W/ GLASS SHADE	116.50	790576172507
QP-LED512-AM/DB	LEDme QUICK CONNECT SOCKET SET W/ GLASS SHADE	116.50	790576172545
QP-LED512-BL/BN	LEDme QUICK CONNECT SOCKET SET W/ GLASS SHADE	116.50	790576172859
QP-LED512-BL/CH	LEDme QUICK CONNECT SOCKET SET W/ GLASS SHADE	116.50	790576172897
QP-LED512-BL/DB	LEDme QUICK CONNECT SOCKET SET W/ GLASS SHADE	116.50	790576172934
QP-LED512-GR/BN	LEDme QUICK CONNECT SOCKET SET W/ GLASS SHADE	116.50	790576173276

Material	Description	2011 DN	UPC Code
QP-LED512-GR/CH	LEDING QUICK CONNECT SOCKET SET W/ GLASS SHADE	116.50	790576173313
QP-LED512-GR/DB	LEDING QUICK CONNECT SOCKET SET W/ GLASS SHADE	116.50	790576173351
QP-LED512-RD/BN	LEDING QUICK CONNECT SOCKET SET W/ GLASS SHADE	116.50	790576173634
QP-LED512-RD/CH	LEDING QUICK CONNECT SOCKET SET W/ GLASS SHADE	116.50	790576173672
QP-LED512-RD/DB	LEDING QUICK CONNECT SOCKET SET W/ GLASS SHADE	116.50	790576173719
QP-LED512-WT/BN	LEDING QUICK CONNECT SOCKET SET W/ GLASS SHADE	116.50	790576174020
QP-LED512-WT/CH	LEDING QUICK CONNECT SOCKET SET W/ GLASS SHADE	116.50	790576174068
QP-LED512-WT/DB	LEDING QUICK CONNECT SOCKET SET W/ GLASS SHADE	116.50	790576174099
QP-LED513-AM/BN	LEDING QUICK CONNECT SOCKET SET W/ GLASS SHADE	125.50	790576174372
QP-LED513-AM/CH	LEDING QUICK CONNECT SOCKET SET W/ GLASS SHADE	125.50	790576174419
QP-LED513-AM/DB	LEDING QUICK CONNECT SOCKET SET W/ GLASS SHADE	125.50	790576174440
QP-LED513-WT/BN	LEDING QUICK CONNECT SOCKET SET W/ GLASS SHADE	125.50	790576174730
QP-LED513-WT/CH	LEDING QUICK CONNECT SOCKET SET W/ GLASS SHADE	125.50	790576174761
QP-LED513-WT/DB	LEDING QUICK CONNECT SOCKET SET W/ GLASS SHADE	125.50	790576174792
QP-LED515-AM/BN	LEDING QUICK CONNECT SOCKET SET W/ GLASS SHADE	156.50	790576175362
QP-LED515-AM/CH	LEDING QUICK CONNECT SOCKET SET W/ GLASS SHADE	156.50	790576175409
QP-LED515-AM/DB	LEDING QUICK CONNECT SOCKET SET W/ GLASS SHADE	156.50	790576175447
QP-LED515-MF/BN	LEDING QUICK CONNECT SOCKET SET W/ GLASS SHADE	156.50	790576176369
QP-LED515-MF/CH	LEDING QUICK CONNECT SOCKET SET W/ GLASS SHADE	156.50	790576176406
QP-LED515-MF/DB	LEDING QUICK CONNECT SOCKET SET W/ GLASS SHADE	156.50	790576176444
QP-LED517-WT/BN	LEDING QUICK CONNECT SOCKET SET W/ GLASS SHADE	121.50	790576176819
QP-LED517-WT/CH	LEDING QUICK CONNECT SOCKET SET W/ GLASS SHADE	121.50	790576176857
QP-LED517-WT/DB	LEDING QUICK CONNECT SOCKET SET W/ GLASS SHADE	121.50	790576176895
QP-LED518-DIC/BN	LEDING QUICK CONNECT SOCKET SET W/ GLASS SHADE	171.50	790576177243
QP-LED518-DIC/CH	LEDING QUICK CONNECT SOCKET SET W/ GLASS SHADE	171.50	790576177274
QP-LED518-DIC/DB	LEDING QUICK CONNECT SOCKET SET W/ GLASS SHADE	171.50	790576177304
QP-LED524-AM/BN	LEDING QUICK CONNECT SOCKET SET W/ GLASS SHADE	120.50	790576178806
QP-LED524-AM/CH	LEDING QUICK CONNECT SOCKET SET W/ GLASS SHADE	120.50	790576178844
QP-LED524-AM/DB	LEDING QUICK CONNECT SOCKET SET W/ GLASS SHADE	120.50	790576178882
QP-LED524-LB/BN	LEDING QUICK CONNECT SOCKET SET W/ GLASS SHADE	120.50	790576179216
QP-LED524-LB/CH	LEDING QUICK CONNECT SOCKET SET W/ GLASS SHADE	120.50	790576179254
QP-LED524-LB/DB	LEDING QUICK CONNECT SOCKET SET W/ GLASS SHADE	120.50	790576172477
QP-LED524-TQ/BN	LEDING QUICK CONNECT SOCKET SET W/ GLASS SHADE	120.50	790576172767
QP-LED524-TQ/CH	LEDING QUICK CONNECT SOCKET SET W/ GLASS SHADE	120.50	790576172804
QP-LED524-TQ/DB	LEDING QUICK CONNECT SOCKET SET W/ GLASS SHADE	120.50	790576172842
QP-LED524-WT/BN	LEDING QUICK CONNECT SOCKET SET W/ GLASS SHADE	120.50	790576173177
QP-LED524-WT/CH	LEDING QUICK CONNECT SOCKET SET W/ GLASS SHADE	120.50	790576173214
QP-LED524-WT/DB	LEDING QUICK CONNECT SOCKET SET W/ GLASS SHADE	120.50	790576173252
QP-LED530-GR/BN	LEDING QUICK CONNECT SOCKET SET W/ GLASS SHADE	211.50	790576179995
QP-LED530-GR/CH	LEDING QUICK CONNECT SOCKET SET W/ GLASS SHADE	211.50	790576180007
QP-LED530-GR/DB	LEDING QUICK CONNECT SOCKET SET W/ GLASS SHADE	211.50	790576180014
QP-LED530-MC/BN	LEDING QUICK CONNECT SOCKET SET W/ GLASS SHADE	211.50	790576180052
QP-LED530-MC/CH	LEDING QUICK CONNECT SOCKET SET W/ GLASS SHADE	211.50	790576180069
QP-LED530-MC/DB	LEDING QUICK CONNECT SOCKET SET W/ GLASS SHADE	211.50	790576180090
QP-LED534-SM/BN	SHADE	141.50	790576195445
QP-LED534-SM/CH	SHADE	141.50	790576195452
QP-LED534-SM/DB	SHADE	141.50	790576195469
QP-LED536-BL/BN	SHADE	156.50	790576195667
QP-LED536-BL/CH	SHADE	156.50	790576195674
QP-LED536-BL/DB	SHADE	156.50	790576195681

Material	Description	2011 DN	UPC Code
QP-LED541-AM/BN	LED/MS QUICK CONNECT SOCKET SET W/ GLASS SHADE	128.50	790576180595
QP-LED541-AM/CH	LED/MS QUICK CONNECT SOCKET SET W/ GLASS SHADE	128.50	790576180632
QP-LED541-AM/DB	LED/MS QUICK CONNECT SOCKET SET W/ GLASS SHADE	128.50	790576180670
QP-LED541-WT/BN	LED/MS QUICK CONNECT SOCKET SET W/ GLASS SHADE	128.50	790576180878
QP-LED541-WT/CH	LED/MS QUICK CONNECT SOCKET SET W/ GLASS SHADE	128.50	790576180939
QP-LED541-WT/DB	LED/MS QUICK CONNECT SOCKET SET W/ GLASS SHADE	128.50	790576180984
QP-LED546-DIC/BN	LED/MS QUICK CONNECT SOCKET SET W/ GLASS SHADE	191.50	790576181707
QP-LED546-DIC/CH	LED/MS QUICK CONNECT SOCKET SET W/ GLASS SHADE	191.50	790576181745
QP-LED546-DIC/DB	LED/MS QUICK CONNECT SOCKET SET W/ GLASS SHADE	191.50	790576181806
QP-LED548-FR/BN	LED/MS QUICK CONNECT SOCKET SET W/ GLASS SHADE	141.50	790576176420
QP-LED548-FR/CH	LED/MS QUICK CONNECT SOCKET SET W/ GLASS SHADE	141.50	790576176468
QP-LED548-FR/DB	LED/MS QUICK CONNECT SOCKET SET W/ GLASS SHADE	141.50	790576176505
QP-LED559-DIC/BN	LED/MS QUICK CONNECT SOCKET SET W/ GLASS SHADE	131.50	790576178387
QP-LED559-DIC/CH	LED/MS QUICK CONNECT SOCKET SET W/ GLASS SHADE	131.50	790576178424
QP-LED559-DIC/DB	LED/MS QUICK CONNECT SOCKET SET W/ GLASS SHADE	131.50	790576178462
QP-LED559-GL/BN	LED/MS QUICK CONNECT SOCKET SET W/ GLASS SHADE	131.50	790576173580
QP-LED559-GL/CH	LED/MS QUICK CONNECT SOCKET SET W/ GLASS SHADE	131.50	790576173610
QP-LED559-GL/DB	LED/MS QUICK CONNECT SOCKET SET W/ GLASS SHADE	131.50	790576173658
QP-LED559-MR/BN	LED/MS QUICK CONNECT SOCKET SET W/ GLASS SHADE	131.50	790576172613
QP-LED559-MR/CH	LED/MS QUICK CONNECT SOCKET SET W/ GLASS SHADE	131.50	790576172651
QP-LED559-MR/DB	LED/MS QUICK CONNECT SOCKET SET W/ GLASS SHADE	131.50	790576172682
QP-LED593-LI/BN	LED/MS QUICK CONNECT SOCKET SET W/ GLASS SHADE	171.50	790576174495
QP-LED593-LI/CH	LED/MS QUICK CONNECT SOCKET SET W/ GLASS SHADE	171.50	790576174525
QP-LED593-LI/DB	LED/MS QUICK CONNECT SOCKET SET W/ GLASS SHADE	171.50	790576174563
QP-LED593-RD/BN	LED/MS QUICK CONNECT SOCKET SET W/ GLASS SHADE	171.50	790576174167
QP-LED593-RD/CH	LED/MS QUICK CONNECT SOCKET SET W/ GLASS SHADE	171.50	790576174198
QP-LED593-RD/DB	LED/MS QUICK CONNECT SOCKET SET W/ GLASS SHADE	171.50	790576174228
QP-LED593-TQ/BN	LED/MS QUICK CONNECT SOCKET SET W/ GLASS SHADE	171.50	790576174853
QP-LED593-TQ/CH	LED/MS QUICK CONNECT SOCKET SET W/ GLASS SHADE	171.50	790576174884
QP-LED593-TQ/DB	LED/MS QUICK CONNECT SOCKET SET W/ GLASS SHADE	171.50	790576174914
QP-LED598-WT/BN	LED/MS QUICK CONNECT SOCKET SET W/ GLASS SHADE	156.50	790576183343
QP-LED598-WT/CH	LED/MS QUICK CONNECT SOCKET SET W/ GLASS SHADE	156.50	790576183398
QP-LED598-WT/DB	LED/MS QUICK CONNECT SOCKET SET W/ GLASS SHADE	156.50	790576183442
QP-LED599-BL/BN	LED/MS QUICK CONNECT SOCKET SET W/ GLASS SHADE	141.50	790576175836
QP-LED599-BL/CH	LED/MS QUICK CONNECT SOCKET SET W/ GLASS SHADE	141.50	790576175867
QP-LED599-BL/DB	LED/MS QUICK CONNECT SOCKET SET W/ GLASS SHADE	141.50	790576175904
QP-LED599-UM/BN	LED/MS QUICK CONNECT SOCKET SET W/ GLASS SHADE	141.50	790576177953
QP-LED599-UM/CH	LED/MS QUICK CONNECT SOCKET SET W/ GLASS SHADE	141.50	790576177984
QP-LED599-UM/DB	LED/MS QUICK CONNECT SOCKET SET W/ GLASS SHADE	141.50	790576178011
QP-LED599-WT/BN	LED/MS QUICK CONNECT SOCKET SET W/ GLASS SHADE	141.50	790576176925
QP-LED599-WT/CH	LED/MS QUICK CONNECT SOCKET SET W/ GLASS SHADE	141.50	790576176956
QP-LED599-WT/DB	LED/MS QUICK CONNECT SOCKET SET W/ GLASS SHADE	141.50	790576177007
Q-X18-BN	QC FIXTURE EXTSION - 18 INCH	14.95	790576137186
Q-X18-CH	QC FIXTURE EXTSION - 18 INCH	14.95	790576053615
Q-X18-DB	QC FIXTURE EXTSION - 18 INCH	14.95	790576114040
Q-X24-BN	QC FIXTURE EXTSION - 24 INCH	15.95	790576137193
Q-X24-CH	QC FIXTURE EXTSION - 24 INCH	15.95	790576053622
Q-X24-DB	QC FIXTURE EXTSION - 24 INCH	15.95	790576114057
Q-X36-BN	QC FIXTURE EXTSION - 36 INCH	18.50	790576137209
Q-X36-CH	QC FIXTURE EXTSION - 36 INCH	18.50	790576053639

Material	Description	2011 DN	UPC Code
Q-X36-DB	QC FIXTURE EXTSION - 36 INCH	18.50	790576114064
Q-X48-BN	QC FIXTURE EXTSION - 48 INCH	20.50	790576137216
Q-X48-CH	QC FIXTURE EXTSION - 48 INCH	20.50	790576053646
Q-X48-DB	QC FIXTURE EXTSION - 48 INCH	20.50	790576114071
R18-BK	EXTENSION ROD FOR SUSPENSION KIT 18 IN	5.95	790576009209
R18-BN	EXTENSION ROD FOR SUSPENSION KIT 18 IN	8.50	790576145778
R18-DB	EXTENSION ROD FOR SUSPENSION KIT 18 IN	8.50	790576140643
R18-WT	EXTENSION ROD FOR SUSPENSION KIT 18 IN	5.95	790576009216
R24-BK	EXTENSION ROD FOR SUSPENSION KIT 24 IN	6.95	790576009223
R24-BN	EXTENSION ROD FOR SUSPENSION KIT 24 IN	8.95	790576145785
R24-DB	EXTENSION ROD FOR SUSPENSION KIT 24 IN	8.95	790576140650
R24-WT	EXTENSION ROD FOR SUSPENSION KIT 24 IN	6.95	790576009230
R36-BK	EXTENSION ROD FOR SUSPENSION KIT 36 IN	7.95	790576009247
R36-BN	EXTENSION ROD FOR SUSPENSION KIT 36 IN	9.95	790576145792
R36-DB	EXTENSION ROD FOR SUSPENSION KIT 36 IN	9.95	790576140667
R36-WT	EXTENSION ROD FOR SUSPENSION KIT 36 IN	7.95	790576009254
R-400S-N-A	R400 SERIES HOUSING NEW CONST NON-IC	10.95	790576120195
R-401S-R-A	R400 SERIES HOUSING REMODEL NON-IC	9.95	790576120201
R-402S-N-ICA	R400 SERIES HOUSING NEW CONST IC	15.95	790576120218
R-420-BK/WT	R400 SERIES TRIM STEP BAFFLE	5.95	790576120249
R-420-BN	R400 SERIES TRIM STEP BAFFLE	8.95	790576120263
R-420-CB	R400 SERIES TRIM STEP BAFFLE	8.95	790576120256
R-420-WT/WT	R400 SERIES TRIM STEP BAFFLE	5.95	790576017907
R-421-BN	R400 SERIES TRIM OPEN REFLECTOR	9.95	790576120294
R-421-CB	R400 SERIES TRIM OPEN REFLECTOR	9.95	790576120287
R-421-CL/WT	R400 SERIES TRIM OPEN REFLECTOR	6.95	790576120270
R-422-WT	R400 SERIES TRIM SHOWER	8.95	790576120416
R-424-BN	4°RESIDENTIAL SERIES TRIM ADJUSTABLE S	10.95	790576120386
R-424-CB	4°RESIDENTIAL SERIES TRIM ADJUSTABLE S	10.95	790576120362
R-424-WT	4°RESIDENTIAL SERIES TRIM ADJUSTABLE S	6.95	790576126975
R-430-BN	R400 SERIES TRIM PINHOLE	8.95	790576120409
R-430-CB	R400 SERIES TRIM PINHOLE	8.95	790576120393
R-430-WT	R400 SERIES TRIM PINHOLE	6.95	790576017983
R-432-BN	R400 SERIES TRIM ADJUSTABLE GIMBAL RING	10.95	790576120317
R-432-CB	R400 SERIES TRIM ADJUSTABLE GIMBAL RING	10.95	790576120300
R-432-WT	R400 SERIES TRIM ADJUSTABLE GIMBAL RING	6.95	790576029597
R-435-BN	R400 SERIES TRIM ADJUSTABLE EYEBALL	11.95	790576120331
R-435-CB	R400 SERIES TRIM ADJUSTABLE EYEBALL	11.95	790576120324
R-435-WT	R400 SERIES TRIM ADJUSTABLE EYEBALL	7.95	790576018003
R-440-WT/WT	R400 SERIES TRIM WALLWASH W/STEP BAFFLE	8.95	790576120348
R48-BK	EXTENSION ROD FOR SUSPENSION KIT 48 IN	8.95	790576009261
R48-BN	EXTENSION ROD FOR SUSPENSION KIT 48 IN	10.95	790576145808
R48-DB	EXTENSION ROD FOR SUSPENSION KIT 48 IN	10.95	790576140681
R48-PT	EXTENSION ROD FOR SUSPENSION KIT 48 IN	10.95	790576160610
R48-WT	EXTENSION ROD FOR SUSPENSION KIT 48 IN	8.95	790576009278
R4VI	REC. LINE VOLT NON IC NEW CONST	15.95	790576071602
R4VI-B-ICA	REC. LINE VOLT IC NEW CONST	20.50	790576071596
R4VI-R	REC. LINE VOLT NON IC REMODEL	13.95	790576071619
R4VT-21-SBK	REC. LINE VOLT TRIM OPEN REFLECTOR	17.50	790576071404
R4VT-21-SC	REC. LINE VOLT TRIM OPEN REFLECTOR	17.50	790576071398

Material	Description	2011 DN	UPC Code
R4VT-21-WT	REC. LINE VOLT TRIM OPEN REFLECTOR	17.50	790576071411
R4VT-22-BK	REC. LINE VOLT TRIM STEP BAFFLE	15.95	790576071435
R4VT-22-BN	REC. LINE VOLT TRIM STEP BAFFLE	22.95	790576071428
R4VT-22-WT	REC. LINE VOLT TRIM STEP BAFFLE	15.95	790576071442
R4VT-23-WT	REC. LINE VOLT TRIM PINHOLE	18.95	790576071459
R4VT-24-WT	REC. LINEVOLT TRIM EYEBALL	17.95	790576071466
R4VT-25-SBK	REC. LINEVOLT TRIM APERTURE CONE	20.95	790576071497
R4VT-25-SC	REC. LINEVOLT TRIM APERTURE CONE	20.95	790576071473
R4VT-26-BK	REC. LINEVOLT TRIM STEP BAFFLE	19.50	790576071503
R4VT-26-WT	REC. LINEVOLT TRIM STEP BAFFLE	19.50	790576071510
R-500-N-UA	R500 SERIES HOUSING NEW CONST IC/NON-IC	12.95	790576119991
R-501-R-UA	R500 SERIES HOUSING REMODEL IC/NON-IC	10.95	790576121932
R-520-BK/WT	R500 SERIES TRIM STEP BAFFLE	7.95	790576120058
R-520-BN	R500 SERIES TRIM STEP BAFFLE	10.95	790576120072
R-520-CB	R500 SERIES TRIM STEP BAFFLE	10.95	790576120065
R-520-WT/WT	5jâSTEP BAFFLE TRIM	7.95	790576120034
R-521-BN	R500 SERIES TRIM OPEN REFLECTOR	10.95	790576120102
R-521-CB	R500 SERIES TRIM OPEN REFLECTOR	10.95	790576120096
R-521-CL/WT	5jâOPEN SPECULAR TRIM	7.95	790576120089
R-522-WT	5jâSHOWER TRIM	8.95	790576120188
R-532-BN	R500 SERIES TRIM ADJUSTABLE GIMBAL RING	10.95	790576120133
R-532-CB	5jâGIMBAL RING TRIM	10.95	790576120126
R-532-WT	R500 SERIES TRIM ADJUSTABLE GIMBAL RING	7.95	790576120119
R-535-BN	5jâEYEBALL TIRM	13.95	790576120164
R-535-CB	R500 SERIES TRIM ADJUSTABLE EYEBALL	13.95	790576120157
R-535-WT	R500 SERIES TRIM ADJUSTABLE EYEBALL	9.95	790576120140
R-540-WT/WT	WALL WASH TRIM	9.95	790576120171
R5VF-113Q	REC. CFL NON IC NEW CONSTR 1X13W	52.50	790576068107
R5VF-126/32T	REC. CFL NON IC NEW CONSTR 1X26W	52.50	790576068091
R5VI	REC. LINE VOLT NON IC NEW CONST	15.95	790576068084
R5VI-ICA	REC. LINE VOLT IC NEW CONST	14.50	790576068077
R5VI-R-ICA	REC. LINE VOLT IC REMODEL	14.50	790576068060
R5VI-S-ICA	REC. LINE VOLT IC SHALLOWOW NEW CONST	14.50	790576068053
R5VI-S-R-ICA	REC. LINE VOLT IC SHALLOWOW REMODEL	14.50	790576068046
R5VT-21-SC	REC. LINE VOLT TRIM OPEN REFLECTOR	20.50	790576068015
R5VT-22-WT	REC. LINE VOLT TRIM OPEN REFLECTOR	20.50	790576067995
R5VT-23-SBK	REC. LINE VOLT TRIM APERTURE CONE	23.95	790576067582
R5VT-23-SC	REC. LINE VOLT TRIM APERTURE CONE	23.95	790576067971
R5VT-23-WT	REC. LINE VOLT TRIM APERTURE CONE	23.95	790576067957
R5VT-24-BK	REC. LINE VOLT TRIM STEP BAFFLE	20.50	790576067940
R5VT-24-WT	REC. LINE VOLT TRIM STEP BAFFLE	20.50	790576067933
R5VT-25-BK	REC. LINE VOLT TRIM STEP BAFFLE	13.95	790576067926
R5VT-25-WT	REC. LINE VOLT TRIM STEP BAFFLE	13.95	790576067919
R5VT-28-WT	REC. LINE VOLT TRIM FRESNEL(SHOWER)	19.95	790576067629
R5VT-29-SBK	REC. LINE VOLT TRIM APERTURE CONE	31.95	790576067636
R5VT-29-SC	REC. LINE VOLT TRIM APERTURE CONE	31.95	790576067902
R5VT-31-BK	REC. LINE VOLT TRIM STEP BAFFLE	29.50	790576067889
R5VT-31-WT	REC. LINE VOLT TRIM STEP BAFFLE	29.50	790576067872
R5VT-32-WT	REC. LINE VOLT TRIM GIMBAL RING	25.50	790576067865
R5VT-37-BK	REC. LINE VOLT TRIM EYEBALL	20.95	790576067797

Material	Description	2011 DN	UPC Code
R5VT-37-WT	REC. LINE VOLT TRIM EYEBALL	20.95	790576067780
R5VT-39-BK	REC. LINE VOLT TRIM SCOOP WALL WASH	25.50	790576067766
R5VT-39-WT	REC. LINE VOLT TRIM SCOOP WALL WASH	25.50	790576067759
R5VT-41-WT	REC. LINE VOLT TRIM SCOOP WALL WASH	20.50	790576067742
R5VT-42-SC	REC. LINE VOLT TRIM OPEN REFLECTOR	25.50	790576067735
R-600D-N-A	R600 SERIES HOUSING NEW CONST NON IC	9.95	790576119595
R-601D-R-A	R600 SERIES HOUSING REMODEL NON IC	9.95	790576119601
R-602D-N-ICA	R600 SERIES HOUSING NEW CONST IC	10.95	790576119618
R-603D-R-ICA	R600 SERIES HOUSING REMODEL IC	10.95	790576119625
R-620-BK/WT	R600 SERIES TRIM STEP BAFFLE	5.95	790576119700
R-620-BN	R600 SERIES TRIM STEP BAFFLE	7.95	790576119724
R-620-CB	R600 SERIES TRIM STEP BAFFLE	7.95	790576119717
R-620-WT/WT	R600 SERIES TRIM STEP BAFFLE	5.95	790576018072
R-621-BK/WT	R600 SERIES TRIM STEP BAFFLE	4.95	790576119731
R-621-BN	R600 SERIES TRIM STEP BAFFLE	7.95	790576119755
R-621-CB	R600 SERIES TRIM STEP BAFFLE	7.95	790576119748
R-621-WT/WT	R600 SERIES TRIM STEP BAFFLE	4.95	790576018096
R-622-BK/WT	R600 SERIES TRIM STEP BAFFLE	8.95	790576119786
R-622-BN	R600 SERIES TRIM STEP BAFFLE	11.95	790576119809
R-622-CB	R600 SERIES TRIM STEP BAFFLE	11.95	790576119793
R-622-WT/WT	R600 SERIES TRIM STEP BAFFLE	8.95	790576119779
R-633-BN	R600 SERIES TRIM ADJUSTABLE GIMBAL RING	11.95	790576119915
R-633-CB	R600 SERIES TRIM ADJUSTABLE GIMBAL RING	11.95	790576119908
R-633-WT	R600 SERIES TRIM ADJUSTABLE GIMBAL RING	8.95	790576029610
R-635-BN	R600 SERIES TRIM ADJUSTABLE EYEBALL	12.95	790576119953
R-635-CB	R600 SERIES TRIM ADJUSTABLE EYEBALL	12.95	790576119946
R-635-WT	R600 SERIES TRIM ADJUSTABLE EYEBALL	8.95	790576018164
R-636-BN	R600 SERIES TRIM ADJUSTABLE GIMBAL RING	11.95	790576119939
R-636-CB	R600 SERIES TRIM ADJUSTABLE GIMBAL RING	11.95	790576119922
R-636-WT	R600 SERIES TRIM ADJUSTABLE GIMBAL RING	8.95	790576018195
R-640-WT/WT	R600 SERIES TRIM WALLWASH W/STEP BAFFLE	8.95	790576119960
R-651-WT	R600 SERIES TRIM SHOWER	7.95	790576018232
R-656-BN	R600 SERIES TRIM OPEN REFLECTOR	9.95	790576119830
R-656-CB	R600 SERIES TRIM OPEN REFLECTOR	9.95	790576119823
R-656-CL/WT		7.95	790576119816
R-657-BN	R600 SERIES TRIM OPEN REFLECTOR	9.95	790576119861
R-657-CB	R600 SERIES TRIM OPEN REFLECTOR	9.95	790576119854
R-657-CL/WT	R600 SERIES TRIM OPEN REFLECTOR	7.95	790576119847
R-658-BN	R600 SERIES TRIM OPEN REFLECTOR	10.95	790576119892
R-658-CB	R600 SERIES TRIM OPEN REFLECTOR	10.95	790576119885
R-658-CL/WT	R600 SERIES TRIM OPEN REFLECTOR	8.95	790576119878
R-660S-N-A	R600 SERIES HOUS SHALLO NEWCONST NON-IC	11.95	790576119632
R-661S-R-A	R600 SERIES HOUS SHALLO REMODEL NON-IC	11.95	790576119649
R6HF-213Q	REC. CFL NEW CONST NON IC 2X13W	66.50	790576071152
R6HF-213Q-EM	REC. CFL NEWCONST 2X13W EMERG	226.50	790576071145
R6HF-218Q	REC. CFL NEW CONST NON IC 2X18W	66.50	790576071138
R6HF-218Q-EM	REC. CFL NEWCONST 2X18W EMERG	226.50	790576071121
R6HF-226Q	REC. CFL NEW CONST NON IC 2X26W	75.95	790576071114
R6HF-226Q-EM	REC. CFL NEWCONST 2X26W EMERG	235.95	790576071107
R6HT-21-SBK	REC. LINE VOLT TRIM OPEN REFLECTOR	51.50	790576067711

Material	Description	2011 DN	UPC Code
R6HT-21-SC	REC. LINE VOLT TRIM OPEN REFLECTOR	47.50	790576071077
R6HT-22-BK	REC. LINE VOLT TRIM STEP BAFFLE	39.50	790576071046
R6HT-22-WT	REC. LINE VOLT TRIM STEP BAFFLE	39.50	790576071039
R6HT-23-WT	REC. LINE VOLT TRIM CROSS LOUVER	52.95	790576071022
R6HT-24-WT	REC. LINE VOLT TRIM FRESNEL(SHOWER)	52.95	790576071015
R6VF-113Q	REC. CFL NON IC NEW CONSTR 1X13W	52.50	790576070995
R6VF-113Q-EM	REC. CFL NON IC NEW CONSTR EMERG	212.50	790576070988
R6VF-126/32T	REC. CFL NON IC NEW CONSTR 1X26W	52.50	790576070957
R6VF-126/32T-EM	REC. CFL NON IC NEW CONSTR EMERG	212.50	790576070940
R6VI	REC. LINE VOLT NON IC NEW CONST	16.50	790576070919
R6VI-B-ICA	REC. LINE VOLT IC BOX NEW CONST	22.95	790576070902
R6VI-ICA	REC. LINE VOLT IC NEW CONST	13.95	790576070896
R6VI-R-ICA	REC. LINE VOLT IC REMODEL	13.50	790576070889
R6VI-S-ICA	REC. LINE VOLT IC SHALLOWOW NEW CONST	14.50	790576070872
R6VI-S-R-ICA	REC. LINE VOLT IC SHALLOWOW REMODEL	11.95	790576070865
R6VM-P38E17-E100	REC. HID NEWCONST ELEC 100W 120V	199.95	790576070858
R6VM-P38E17-E70	REC. HID NEWCONST ELEC 70W 120V	194.95	790576070834
R6VM-P38E17-M100	REC. HID NEWCONST MAGN 100W 120V	199.95	790576070810
R6VM-P38E17-M100F	REC. HID NEWCONST MAGN 100W 277V	199.95	790576070803
R6VM-P38E17-M70	REC. HID NEWCONST MAGN 70W 120V	194.95	790576070797
R6VM-P38E17-M70F	REC. HID NEWCONST MAGN 70W 277V	199.95	790576070780
R6VT-21MH-SC	REC. LINE VOLT TRIM HID OPENREFLECT	23.95	790576070735
R6VT-21-SC	REC. LINE VOLT TRIM OPEN REFLECTOR	23.95	790576070759
R6VT-22-SC	REC. LINE VOLT TRIM OPEN REFLECTOR	26.95	790576070728
R6VT-23-SC	REC. LINE VOLT TRIM DEEP OPEN REFL	37.95	790576070704
R6VT-24-SC	REC. LINE VOLT TRIM OPEN REFLECTOR	26.95	790576070681
R6VT-26-WT	REC. LINE VOLT TRIM SPLAY REFLECTOR	11.95	790576070667
R6VT-27-SC	REC. LINE VOLT TRIM APERTURE CONE	21.95	790576070629
R6VT-27-WT	REC. LINE VOLT TRIM APERTURE CONE	20.95	790576070599
R6VT-29-BK	REC. LINE VOLT TRIM STEP BAFFLE	17.95	790576070575
R6VT-29MH-WT	REC. LINE VOLT TRIM HID STEP BAFFLE	17.50	790576070520
R6VT-29-WT	REC. LINE VOLT TRIM STEP BAFFLE	17.95	790576070544
R6VT-32-BK	REC. LINEVOLT TRIM DEEPSTEP BAFFLE	11.95	790576070513
R6VT-32-WT	REC. LINEVOLT TRIM DEEPSTEP BAFFLE	11.95	790576070506
R6VT-33-SA	REC. LINE VOLT TRIM CROSS LOUVER	39.95	790576087603
R6VT-33-WT	REC. LINE VOLT TRIM CROSS LOUVER	35.95	790576070490
R6VT-34-WT	REC. LINE VOLT TRIM FRESNEL(SHOWER)	17.95	790576070476
R6VT-35-WT	REC. LINE VOLT TRIM OPAL(SHOWER)	17.95	790576070469
R6VT-41-BK	REC. LINE VOLT SLOPE W/STEP BAFFLE	27.95	790576070377
R6VT-41-WT	REC. LINE VOLT SLOPE W/STEP BAFFLE	27.95	790576070360
R6VT-42-SBK	REC. LINE VOLT SLOPE W/STEP BAFFLE	32.95	790576067674
R6VT-42-SC	REC. LINE VOLT SLOPE W/APERTURECONE	32.95	790576070339
R6VT-43-BK	REC. LINE VOLT SLOPE W/STEP BAFFLE	31.95	790576070292
R6VT-43-WT	REC. LINE VOLT SLOPE W/STEP BAFFLE	31.95	790576070285
R6VT-44-SBK	REC. LINE VOLT SLOPE W/APERTURECONE	32.95	790576067681
R6VT-44-SC	REC. LINE VOLT SLOPE W/APERTURECONE	32.95	790576070254
R6VT-49-SC	REC. LINE VOLT TRIM ADJUSTABLE CONE	35.50	790576070216
R6VT-51-SBK	REC. LINE VOLT TRIM APERTURE CONE	40.50	790576067698
R6VT-51-SC	REC. LINE VOLT TRIM APERTURE CONE	40.50	790576070179
R6VT-52-BK	REC. LINE VOLT TRIM ADJ STEP BAFFLE	25.50	790576070148

Material	Description	2011 DN	UPC Code
R6VT-52-WT	REC. LINE VOLT TRIM ADJ STEP BAFFLE	25.50	790576070131
R6VT-58-BK	REC. LINE VOLT TRIM SCOOP WALL WASH	35.50	790576062709
R6VT-58-WT	REC. LINE VOLT TRIM SCOOP WALL WASH	35.50	790576062693
R6VT-59-BK	REC. LINE VOLT TRIM SCOOP WALL WASH	21.95	790576081380
R6VT-59-WT	REC. LINE VOLT TRIM SCOOP WALL WASH	21.95	790576081373
R6VT-60-S-SC	REC. LINE VOLT TRIM SHALLOW OPEN REFL	24.95	790576069937
R6VT-61-S-WT	REC. LINE VOLT TRIM SHALLOW SPLAY REFL	10.95	790576069890
R6VT-62-S-BK	REC. LINE VOLT TRIM SHALLOW SPLAY REFL	17.50	790576069876
R6VT-62-S-WT	REC. LINE VOLT TRIM SHALLOW STEPBAFFLE	17.50	790576069869
R6VT-63G-S-WT	REC. LINE VOLT TRIM SHALLOW GLS SHOWER	13.95	790576069838
R6VT-66-S-WT	REC. LINE VOLT TRIM SHALLOW EYEBALL	22.50	790576069685
R8HF-D	DOUBLE LAMP HORIZONTAL HOUSING	62.95	790576140803
R8HF-D-EM	8" DOUBLE LAMP HORIZONTAL HOUSING W/EMER	183.95	790576148069
R8HF-S	SINGLE LAMP HORIZONTAL HOUSING	62.95	790576140810
R8HF-S-EM	8" SINGLE LAMP HORIZONTAL HOUSING W/EMER	182.50	790576148076
R8HT-01-SC/WT	OPEN REFLECTOR, DOULBE LAMPS	26.95	790576140858
R8HT-02-BK/WT	REFLECTOR WITH BAFFLE, DOUBLE LAMPS	26.95	790576140872
R8HT-02-WT/WT	REFLECTOR WITH BAFFLE, DOUBLE LAMPS	26.95	790576140865
R8HT-03-SC/WT	8" DOWNLIGHT TRIM	37.50	790576141732
R8HT-03-WT/WT	8" DOWNLIGHT TRIM	37.50	790576141787
R8HT-04-SC/WT	OPEN REFLECTOR, SINGLE LAMPS	26.95	790576140889
R8HT-05-BK/WT	REFLECTOR WITH BAFFLE, SINGLE LAMP	26.95	790576140902
R8HT-05-WT/WT	REFLECTOR WITH BAFFLE, SINGLE LAMP	26.95	790576140896
R8HT-06-SC/WT	8" DOWNLIGHT TRIM	37.50	790576141749
R8HT-06-WT/WT	8" DOWNLIGHT TRIM	37.50	790576142364
R8HT-07-SC/WT	DOUBLE LAMPS WALL WASHER WITH LENS	39.50	790576141756
R8VF-S	SINGLE LAMP VERTICAL HOUSING	60.95	790576140797
R8VF-S-EM	8" SINGLE LAMP VERTICAL HOUSING W/EMERGE	172.95	790576148052
R8VT-01-SC/WT	OPEN REFLECTOR, SINGLE LAMP	24.95	790576140827
R8VT-02-BK/WT	REFLECTOR WITH BAFFLE, SINGLE LAMP	24.95	790576140841
R8VT-02-WT/WT	REFLECTOR WITH BAFFLE, SINGLE LAMP	24.95	790576140834
R8VT-03-SC/WT	8" DOWNLIGHT TRIM	35.50	790576141725
R8VT-03-WT/WT	8" DOWNLIGHT TRIM	35.50	790576141770
R-F403S-N-ICA	R400 SERIES CFL HOUSING NEWCONST IC	44.95	790576122175
R-F404S-R-ICA	R400 SERIES CFL HOUSING REMODEL IC	44.95	790576122182
R-F405S-N-A	4" NEW CONST. HOUSING - NON IC AIR TIGHT	44.95	790576135311
R-F406S-R-A	4" NEW CONST. HOUSING - NON IC AIR TIGHT	44.95	790576135328
R-F502-N-ICA	R500 SERIES CFL HOUSING NEW CONST IC	44.95	790576120010
R-F503-R-ICA	R500 SERIES CFL HOUSING REMODEL IC	44.95	790576121963
R-F504-N-A	5" CFL NEW CONST. HOUSING - NON IC AIR T	44.95	790576135298
R-F505-R-A	5" CFL REMODEL HOUSING-NON IC, AIR TIG	44.95	790576135304
R-F605D-N-ICA	R600 SERIES CFL HOUSING NEW CONST IC	39.95	790576119656
R-F606D-R-ICA	R600 SERIES CFL HOUSING REMODEL IC	39.95	790576119663
R-F607D-N-A	6" CFL NEW CONSTRUCTION HOUSING NON IC	39.95	790576135274
R-F608D-R-A	6" CFL REMODELING HOUSING NON IC	39.95	790576135281
RGK	GASKET	1.95	790576084732
RI-BK	ROD COUPLERS FOR R-EXTENSIONS	1.95	790576009308
RI-BN	ROD COUPLERS FOR R-EXTENSIONS	2.50	790576145815
RI-DB	ROD COUPLERS FOR R-EXTENSIONS	2.50	790576140698
RI-PT	ROD COUPLER FOR R EXTENSIONS	2.50	790576163659



Material	Description	2011 DN	UPC Code
RI-WT	ROD COUPLERS FOR R-EXTENSIONS	1.95	790576009315
RM1X3-30-DL	1 X 3 LEDme 2" DOWNLIGHT LIGHT MODULE 3000K	19.95	790576171784
RM1X3-30-SL	1X3W LEDME SHOWCASE LIGHT MUDULE 3000K	21.95	790576163864
RM1X3-45-DL	1 X 3 LEDme 2" DOWNLIGHT LIGHT MODULE 4500K	19.95	790576172149
RM1X3-45-SL	1X3W MODULE FOR LEDME SHOWCASE LGT 4500K	21.95	790576163857
RM1X3-60-SL	1X3W MODULE FOR LEDME SHOWCASE LGT 6000K	21.95	790576163840
RM2X1-30-BA	1X2W MODULE FOR LEDME BAR LIGHT 3000K	19.95	790576185651
RM3X1-30-HR	3X1W MODULE FOR LEDME BUTTON LIGHT 3000K	21.95	790576163833
RM3X1-30-QP	1X3W MODULE FOR LEDME QC PENDANT 3000K	64.95	790576172309
RM3X3-30-DL	3 X 3 LEDme 3" DOWNLIGHT LIGHT MODULE 3000K	39.95	790576172156
RM3X3-30-QF	3X3W MODULE FOR LEDME QF FIXTURE 3000K	29.95	790576169446
RM3X3-30-TK	3 X 3W MODULE FOR LEDME TRACK 3000K	49.95	790576163826
RM3X3-45-DL	1 X 3 LEDme 2" DOWNLIGHT LIGHT MODULE 4500K	39.95	790576172170
RM3X3-45-TK	3 X 3W MODULE FOR LEDME TRACK 4500K	49.95	790576163819
RM4X1-30-BA	1X4W MODULE FOR LEDME BAR LIGHT 3000K	34.95	790576185644
RM6X3-30-DL	1 X 3 LEDme 4" DOWNLIGHT LIGHT MODULE 3000K	69.95	790576172187
RM6X3-30-TK	6X3W MODULE FOR LEDME TRACK 3000K	94.95	790576163802
RM6X3-45-DL	1 X 3 LEDme 4" DOWNLIGHT LIGHT MODULE 4500K	69.95	790576172194
RM6X3-45-TK	6X3W MODULE FOR LEDME TRACK 4500K	94.95	790576163796
SADP-BK	LINEAR SYSTEM QUICK CONNECT ADAPTER	3.95	790576069203
SADP-WT	LINEAR SYSTEM QUICK CONNECT ADAPTER	3.95	790576069180
SBH-101-BK	LINEAR-SINGLE LAMP-XENON WEDGE BASE	2.95	790576020860
SBH-101-WT	LINEAR-SINGLE LAMP-XENON WEDGE BASE	2.95	790576020877
SBH-102-BK	LINEAR-DOUBLE LAMP-XENON WEDGE BASE	4.95	790576021461
SBH-102-WT	LINEAR-DOUBLE LAMP-XENON WEDGE BASE	4.95	790576020884
SBH-105-BK	LINEAR-SWIVEL W/REFLECTOR-XENON BI-PIN	6.50	790576020891
SBH-105-WT	LINEAR-SWIVEL W/REFLECTOR-XENON BI-PIN	6.50	790576020907
SBH-110-BK	LINEAR-W/REFLECTOR-XENON RIGID LOOP	3.95	790576020938
SBH-110-WT	LINEAR-W/REFLECTOR-XENON RIGID LOOP	3.95	790576021478
SBH-210-BK	LED FESTOON LAMP HOLDER, BLACK	3.95	790576136905
SBH-210-WT	LED FESTOON LAMP HOLDER, WHITE	3.95	790576136899
SBH-314-24-C-BK	LED FIXTURE FOR LINEAR SYSTEM 4000K	19.95	790576194721
SBH-314-24-C-WT	LED FIXTURE FOR LINEAR SYSTEM 4000K	19.95	790576194745
SBH-314-24-W-BK	LED FIXTURE FOR LINEAR SYSTEM 3000K	19.95	790576194714
SBH-314-24-W-WT	LED FIXTURE FOR LINEAR SYSTEM 3000K	19.95	790576194738
SBH-314-C-BK	LED FIXTURE FOR LINEAR SYSTEM 4000K	19.95	790576194646
SBH-314-C-WT	LED FIXTURE FOR LINEAR SYSTEM 4000K	19.95	790576194660
SBH-314-W-BK	LED FIXTURE FOR LINEAR SYSTEM 3000K	19.95	790576194639
SBH-314-W-WT	LED FIXTURE FOR LINEAR SYSTEM 3000K	19.95	790576194653
SBH-316-24-C-BK	LED FIXTURE FOR LINEAR SYSTEM 4000K	24.95	790576194684
SBH-316-24-C-WT	LED FIXTURE FOR LINEAR SYSTEM 4000K	24.95	790576194707
SBH-316-24-W-BK	LED FIXTURE FOR LINEAR SYSTEM 3000K	24.95	790576194677
SBH-316-24-W-WT	LED FIXTURE FOR LINEAR SYSTEM 3000K	24.95	790576194691
SBH-316-C-BK	LED FIXTURE FOR LINEAR SYSTEM 4000K	24.95	790576194608
SBH-316-C-WT	LED FIXTURE FOR LINEAR SYSTEM 4000K	24.95	790576194622
SBH-316-W-BK	LED FIXTURE FOR LINEAR SYSTEM 3000K	24.95	790576194592
SBH-316-W-WT	LED FIXTURE FOR LINEAR SYSTEM 3000K	24.95	790576194615
SBS-11-BK	SOLID BULB SHIELD FOR 204, 214 MR16 SIZE	3.50	790576014357
SBS-11-BN	SOLID BULB SHIELD FOR 204, 214 MR11 SIZE	3.95	790576030715
SBS-11-WT	SOLID BULB SHIELD FOR 204, 214 MR16 SIZE	3.50	790576014364

Material	Description	2011 DN	UPC Code
SBS-16-BK	SOLID BULB SHIELD FOR 204, 214 MR16 SIZE	3.95	790576014333
SBS-16-BN	SOLID BULB SHIELD FOR 204, 214 MR16 SIZE	4.50	790576030692
SBS-16-WT	SOLID BULB SHIELD FOR 204, 214 MR16 SIZE	3.95	790576014340
SBXLE-BK	LINEAR BX LIVE END CONNECTOR	5.95	790576033037
SBXLE-WT	LINEAR BX LIVE END CONNECTOR	5.95	790576033044
SEC-BK	LINEAR END CAP	1.50	790576021218
SEC-WT	LINEAR END CAP	1.50	790576021201
SF-202-BK	LINEAR-CUBE DIECAST DIRECTIONAL-MR11	15.50	790576038957
SF-202-WT	LINEAR-CUBE DIECAST DIRECTIONAL-MR11	15.50	790576038940
SF-209-BK	LINEAR-ROUND DIECAST DIRECTIONAL-MR11	15.50	790576020761
SF-209-WT	LINEAR-ROUND DIECAST DIRECTIONAL-MR11	15.50	790576020778
SF-211-BK	LINEAR-MINI GIMBAL RING-MR11	12.50	790576020808
SF-211-WT	LINEAR-MINI GIMBAL RING-MR11	12.50	790576020815
SF-212-BK	LINEAR-CUBE DIECAST DIRECTIONAL-MR16	15.50	790576038896
SF-212-WT	LINEAR-CUBE DIECAST DIRECTIONAL-MR16	15.50	790576038889
SF-216-BK	LINEAR-MINI GIMBAL RING-MR16	14.50	790576020846
SF-216-WT	LINEAR-MINI GIMBAL RING-MR16	14.50	790576020853
SF-219-BK	LINEAR-ROUND DIECAST DIRECTIONAL-MR16	15.50	790576038834
SF-219-WT	LINEAR-ROUND DIECAST DIRECTIONAL-MR16	15.50	790576038827
SFC-150E-BK	LINEAR-FLOATING CANOPY W/150W E.TRANSF	46.95	790576021409
SFC-150E-WT	LINEAR-FLOATING CANOPY W/150W E.TRANSF	46.95	790576021416
SFC-BK	LINEAR-FLOATING CANOPY W/O TRANSF	4.95	790576021386
SFC-WT	LINEAR-FLOATING CANOPY W/O TRANSF	4.95	790576021393
SI-BK	LINEAR STRAIGHT LINE CONNECTOR	3.95	790576021164
SI-WT	LINEAR STRAIGHT LINE CONNECTOR	3.95	790576021171
SJS4-BK	LINEAR JUMPER SET - 4INCH	8.95	790576165806
SJS4-WT	LINEAR JUMPER SET - 4INCH	8.95	790576165813
SJS-BK	LINEAR JUMPER SET	8.95	790576021249
SJS-WT	LINEAR JUMPER SET	8.95	790576021256
SK05-BK	ADAPTER KIT TO FIELD CUT SK EXTENSION	2.50	790576015194
SK05-BN	ADAPTER KIT TO FIELD CUT SK EXTENSION	4.95	790576145761
SK05-DB	ADAPTER KIT TO FIELD CUT SK EXTENSION	4.95	790576140636
SK05-WT	ADAPTER KIT TO FIELD CUT SK EXTENSION	2.50	790576015187
SK14-BK	SLOPED CEILING HANG STRAIGHT ADAPTER	5.95	790576009865
SK14-BN	SLOPED CEILING HANG STRAIGHT ADAPTER	7.50	790576145839
SK14-DB	SLOPED CEILING HANG STRAIGHT ADAPTER	7.50	790576140926
SK14S-BZ	FLEXRAIL 1 SLOPED CEILING ADAPTER	4.50	790576106120
SK14S-DB	FLEXRAIL 1 SLOPED CEILING ADAPTER	4.95	790576106120
SK14S-PT	FLEXRAIL 1 SLOPED CEILING ADAPTER	4.95	790576087740
SK14-WT	SLOPED CEILING HANG STRAIGHT ADAPTER	5.95	790576009872
SK18-BK	TRACK SUSPENSION KIT 18 IN	12.50	790576009902
SK18-BN	TRACK SUSPENSION KIT 18 IN	14.50	790576147857
SK18-DB	TRACK SUSPENSION KIT 18 IN	14.50	790576140933
SK18-WT	TRACK SUSPENSION KIT 18 IN	12.50	790576009919
SK24-BK	TRACK SUSPENSION KIT 24 IN	13.50	790576009926
SK24-BN	TRACK SUSPENSION KIT 24 IN	15.50	790576160528
SK24-DB	TRACK SUSPENSION KIT 24 IN	15.50	790576140940
SK24-WT	TRACK SUSPENSION KIT 24 IN	13.50	790576009933
SK36-BK	TRACK SUSPENSION KIT 36 IN	15.50	790576009940
SK36-BN	TRACK SUSPENSION KIT 36 IN	17.95	790576160542

Material	Description	2011 DN	UPC Code
SK36-DB	TRACK SUSPENSION KIT 36 IN	17.95	790576140957
SK36-WT	TRACK SUSPENSION KIT 36 IN	15.50	790576009957
SK48-BK	TRACK SUSPENSION KIT 48 IN	17.95	790576009964
SK48-BN	TRACK SUSPENSION KIT 48 IN	19.95	790576160566
SK48-DB	TRACK SUSPENSION KIT 48 IN	19.95	790576140964
SK48-WT	TRACK SUSPENSION KIT 48 IN	17.95	790576009971
SLB4-PT	LINEAR 4 FOOT LIGHT BAFFLE	19.50	790576069142
SLB4-WT	LINEAR 4 FOOT LIGHT BAFFLE	17.50	790576021294
SLB8-PT	LINEAR 8 FOOT LIGHT BAFFLE	30.95	790576069135
SLB8-WT	LINEAR 8 FOOT LIGHT BAFFLE	27.50	790576022178
SL-BK	LINEAR L CONNECTOR	5.50	790576021188
SLE-BK	LINEAR LIVE END CONNECTOR	3.95	790576021225
SLE-WT	LINEAR LIVE END CONNECTOR	3.95	790576021232
SL-LEN-F	LED LENS - NARROW FLOOD 25 DEG	2.50	790576139180
SL-LEN-S	LED LENS - SPOT 10 DEG	2.50	790576139173
SL-LEN-W	LED LENS - NARROW FLOOD 40 DEG	2.50	790576139197
SL-WT	LINEAR L CONNECTOR	5.50	790576021195
SRT-1000M-12V	REMOTE MAG. TRANSF. 12V	241.95	790576113265
SRT-1000M-24V	REMOTE MAG. TRANSF. 24V	249.95	790576113241
SRT-300M-12V	REMOTE MAG. TRANSF. 12V	129.95	790576059433
SRT-300M-24V	REMOTE MAG. TRANSF. 12V	139.95	790576059440
SRT-500M-12V	REMOTE MAG. TRANSF.12V	149.95	790576113302
SRT-500M-24V	REMOTE MAG. TRANSF. 24V	159.95	790576113296
SRT-600M-12V	REMOTE MAG. TRANSF.12V	159.95	790576113289
SRT-600M2-12V	REMOTE MAG. TRANSF. 2X300W 12V	314.95	790576160658
SRT-600M-24V	REMOTE MAG. TRANSF.24V	169.95	790576113272
SST-150E-BK	LINEAR ELECTR TRANSF SURFACE MOUNT 150W	48.95	790576021362
SST-150E-WT	LINEAR ELECTR TRANSF SURFACE MOUNT 150W	48.95	790576021379
SST-60E-BK	LINEAR ELECTR TRANSF SURFACE MOUNT 60W	32.95	790576021348
SST-60E-WT	LINEAR ELECTR TRANSF SURFACE MOUNT 60W	32.95	790576021355
ST4-BK	LINEAR 4 FOOT TRACK	13.95	790576020945
ST4-WT	LINEAR 4 FOOT TRACK	13.95	790576020952
ST8-BK	LINEAR 8 FOOT TRACK	25.95	790576020969
ST8-WT	LINEAR 8 FOOT TRACK	25.95	790576020976
SW-3-BR	IN-LINE SWITCH FOR DISPLAY LIGHT	3.95	790576021454
T3-3-12V-CL	LAMP XENON WEDGE 3W 12V CLEAR	1.95	790576018355
T3-3-12V-FR	LAMP XENON WEDGE 3W 12V FROSTED	1.95	790576018362
T3-5-12V-CL	LAMP XENON WEDGE 5W 12V CLEAR	1.95	790576018379
T3-5-12V-FR	LAMP XENON WEDGE 5W 12V FROSTED	1.95	790576018386
T3-5-24V-CL	LAMP XENON WEDGE 5W 24V CLEAR	1.95	790576018393
T3-5-24V-FR	LAMP XENON WEDGE 5W 24V FROSTED	1.95	790576018409
T3-7.5-24V-CL	LAMP XENON WEDGE 7.5W 24V CLEAR	1.95	790576018416
T3-7.5-24V-FR	LAMP XENON WEDGE 7.5W 24V FROSTED	1.95	790576018423
T5-18-12V-CL	XENON WEDGE-12V 18W-CLEAR	2.50	790576085562
T-BARCLIP	T-BAR DROP CEILING ATTACHMENT	0.95	790576010267
TBKT-BK	TRACK BRACKET-EXTENDS 24IN FROM WALL	11.95	790576014722
TBKT-WT	TRACK BRACKET-EXTENDS 24IN FROM WALL	11.95	790576014739
THL-HI-1-10A-BK	H TRACK CURRENT LIMITER - DOUBLE LIVE EN	106.95	790576130330
THL-HI-1-10A-BN	H TRACK CURRENT LIMITER - DOUBLE LIVE EN	108.95	790576130354
THL-HI-1-10A-DB	H TRACK CURRENT LIMITER - DOUBLE LIVE EN	108.95	790576146089

Material	Description	2011 DN	UPC Code
THL-HI-1-10A-WT	H TRACK CURRENT LIMITER - DOUBLE LIVE EN	106.95	790576130347
THL-HI-1-1A-BK	H TRACK CURRENT LIMITER - DOUBLE LIVE EN	106.95	790576130170
THL-HI-1-1A-BN	H TRACK CURRENT LIMITER - DOUBLE LIVE EN	108.95	790576130194
THL-HI-1-1A-DB	H TRACK CURRENT LIMITER - DOUBLE LIVE EN	108.95	790576146096
THL-HI-1-1A-WT	H TRACK CURRENT LIMITER - DOUBLE LIVE EN	106.95	790576130187
THL-HI-1-2A-BK	H TRACK CURRENT LIMITER - DOUBLE LIVE EN	106.95	790576130248
THL-HI-1-2A-BN	H TRACK CURRENT LIMITER - DOUBLE LIVE EN	108.95	790576130224
THL-HI-1-2A-DB	H TRACK CURRENT LIMITER - DOUBLE LIVE EN	108.95	790576146102
THL-HI-1-2A-WT	H TRACK CURRENT LIMITER - DOUBLE LIVE EN	106.95	790576130231
THL-HI-1-5A-BK	H TRACK CURRENT LIMITER - DOUBLE LIVE EN	106.95	790576130255
THL-HI-1-5A-BN	H TRACK CURRENT LIMITER - DOUBLE LIVE EN	108.95	790576130279
THL-HI-1-5A-DB	H TRACK CURRENT LIMITER - DOUBLE LIVE EN	108.95	790576146119
THL-HI-1-5A-WT	H TRACK CURRENT LIMITER - DOUBLE LIVE EN	106.95	790576130262
THL-HI-1-7A-BK	H TRACK CURRENT LIMITER - DOUBLE LIVE EN	106.95	790576130323
THL-HI-1-7A-BN	H TRACK CURRENT LIMITER - DOUBLE LIVE EN	108.95	790576130309
THL-HI-1-7A-DB	H TRACK CURRENT LIMITER - DOUBLE LIVE EN	108.95	790576146126
THL-HI-1-7A-WT	H TRACK CURRENT LIMITER - DOUBLE LIVE EN	106.95	790576130316
THL-HI-2-10A-BK	H TRACK CURRENT LIMITER - DOUBLE LIVE EN	128.95	790576132433
THL-HI-2-10A-BN	H TRACK CURRENT LIMITER - DOUBLE LIVE EN	130.95	790576132457
THL-HI-2-10A-DB	H TRACK CURRENT LIMITER - DOUBLE LIVE EN	130.95	790576146133
THL-HI-2-10A-WT	H TRACK CURRENT LIMITER - DOUBLE LIVE EN	128.95	790576132440
THL-HI-2-1A-BK	H TRACK CURRENT LIMITER - DOUBLE LIVE EN	128.95	790576132273
THL-HI-2-1A-BN	H TRACK CURRENT LIMITER - DOUBLE LIVE EN	130.95	790576132297
THL-HI-2-1A-DB	H TRACK CURRENT LIMITER - DOUBLE LIVE EN	130.95	790576146140
THL-HI-2-1A-WT	H TRACK CURRENT LIMITER - DOUBLE LIVE EN	128.95	790576132280
THL-HI-2-2A-BK	H TRACK CURRENT LIMITER - DOUBLE LIVE EN	128.95	790576132341
THL-HI-2-2A-BN	H TRACK CURRENT LIMITER - DOUBLE LIVE EN	130.95	790576132327
THL-HI-2-2A-DB	H TRACK CURRENT LIMITER - DOUBLE LIVE EN	130.95	790576146157
THL-HI-2-2A-WT	H TRACK CURRENT LIMITER - DOUBLE LIVE EN	128.95	790576132334
THL-HI-2-5A-BK	H TRACK CURRENT LIMITER - DOUBLE LIVE EN	128.95	790576132358
THL-HI-2-5A-BN	H TRACK CURRENT LIMITER - DOUBLE LIVE EN	130.95	790576132372
THL-HI-2-5A-DB	H TRACK CURRENT LIMITER - DOUBLE LIVE EN	130.95	790576146164
THL-HI-2-5A-WT	H TRACK CURRENT LIMITER - DOUBLE LIVE EN	128.95	790576132365
THL-HI-2-7A-BK	H TRACK CURRENT LIMITER - DOUBLE LIVE EN	128.95	790576132426
THL-HI-2-7A-BN	H TRACK CURRENT LIMITER - DOUBLE LIVE EN	130.95	790576132402
THL-HI-2-7A-DB	H TRACK CURRENT LIMITER - DOUBLE LIVE EN	130.95	790576146171
THL-HI-2-7A-WT	H TRACK CURRENT LIMITER - DOUBLE LIVE EN	128.95	790576132419
THL-HLE-10A-BK	H TRACK CURRENT LIMITER - SINGLE LIVE EN	103.50	790576129730
THL-HLE-10A-BN	H TRACK CURRENT LIMITER - SINGLE LIVE EN	105.95	790576129754
THL-HLE-10A-DB	H TRACK CURRENT LIMITER - SINGLE LIVE EN	105.95	790576146188
THL-HLE-10A-WT	H TRACK CURRENT LIMITER - SINGLE LIVE EN	103.50	790576129747
THL-HLE-1A-BK	H TRACK CURRENT LIMITER - SINGLE LIVE EN	103.50	790576129570
THL-HLE-1A-BN	H TRACK CURRENT LIMITER - SINGLE LIVE EN	105.95	790576129594
THL-HLE-1A-DB	H TRACK CURRENT LIMITER - SINGLE LIVE EN	105.95	790576146195
THL-HLE-1A-WT	H TRACK CURRENT LIMITER - SINGLE LIVE EN	103.50	790576129587
THL-HLE-2A-BK	H TRACK CURRENT LIMITER - SINGLE LIVE EN	103.50	790576129648
THL-HLE-2A-BN	H TRACK CURRENT LIMITER - SINGLE LIVE EN	105.95	790576129624
THL-HLE-2A-DB	H TRACK CURRENT LIMITER - SINGLE LIVE EN	105.95	790576146201
THL-HLE-2A-WT	H TRACK CURRENT LIMITER - SINGLE LIVE EN	103.50	790576129631
THL-HLE-5A-BK	H TRACK CURRENT LIMITER - SINGLE LIVE EN	103.50	790576129655

Material	Description	2011 DN	UPC Code
THL-HLE-5A-BN	H TRACK CURRENT LIMITER - SINGLE LIVE EN	105.95	790576129679
THL-HLE-5A-DB	H TRACK CURRENT LIMITER - SINGLE LIVE EN	105.95	790576146218
THL-HLE-5A-WT	H TRACK CURRENT LIMITER - SINGLE LIVE EN	103.50	790576129662
THL-HLE-7A-BK	H TRACK CURRENT LIMITER - SINGLE LIVE EN	103.50	790576129723
THL-HLE-7A-BN	H TRACK CURRENT LIMITER - SINGLE LIVE EN	105.95	790576129709
THL-HLE-7A-DB	H TRACK CURRENT LIMITER - SINGLE LIVE EN	105.95	790576146225
THL-HLE-7A-WT	H TRACK CURRENT LIMITER - SINGLE LIVE EN	103.50	790576129716
THL-LEFT-1-10A-BK	H TRACK CURRENT LIMITER - DOUBLE LIVE EN	108.95	790576130934
THL-LEFT-1-10A-BN	H TRACK CURRENT LIMITER - DOUBLE LIVE EN	111.50	790576130958
THL-LEFT-1-10A-DB	H TRACK CURRENT LIMITER - DOUBLE LIVE EN	111.50	790576146232
THL-LEFT-1-10A-WT	H TRACK CURRENT LIMITER - DOUBLE LIVE EN	108.95	790576130941
THL-LEFT-1-1A-BK	H TRACK CURRENT LIMITER - DOUBLE LIVE EN	108.95	790576130774
THL-LEFT-1-1A-BN	H TRACK CURRENT LIMITER - DOUBLE LIVE EN	111.50	790576130798
THL-LEFT-1-1A-DB	H TRACK CURRENT LIMITER - DOUBLE LIVE EN	111.50	790576146249
THL-LEFT-1-1A-WT	H TRACK CURRENT LIMITER - DOUBLE LIVE EN	108.95	790576130781
THL-LEFT-1-2A-BK	H TRACK CURRENT LIMITER - DOUBLE LIVE EN	108.95	790576130842
THL-LEFT-1-2A-BN	H TRACK CURRENT LIMITER - DOUBLE LIVE EN	111.50	790576130828
THL-LEFT-1-2A-DB	H TRACK CURRENT LIMITER - DOUBLE LIVE EN	111.50	790576146256
THL-LEFT-1-2A-WT	H TRACK CURRENT LIMITER - DOUBLE LIVE EN	108.95	790576130835
THL-LEFT-1-5A-BK	H TRACK CURRENT LIMITER - DOUBLE LIVE EN	108.95	790576130859
THL-LEFT-1-5A-BN	H TRACK CURRENT LIMITER - DOUBLE LIVE EN	111.50	790576130873
THL-LEFT-1-5A-DB	H TRACK CURRENT LIMITER - DOUBLE LIVE EN	111.50	790576146263
THL-LEFT-1-5A-WT	H TRACK CURRENT LIMITER - DOUBLE LIVE EN	108.95	790576130866
THL-LEFT-1-7A-BK	H TRACK CURRENT LIMITER - DOUBLE LIVE EN	108.95	790576130927
THL-LEFT-1-7A-BN	H TRACK CURRENT LIMITER - DOUBLE LIVE EN	111.50	790576130903
THL-LEFT-1-7A-DB	H TRACK CURRENT LIMITER - DOUBLE LIVE EN	111.50	790576146270
THL-LEFT-1-7A-WT	H TRACK CURRENT LIMITER - DOUBLE LIVE EN	108.95	790576130910
THL-LEFT-2-10A-BK	H TRACK CURRENT LIMITER - DOUBLE LIVE EN	130.95	790576133034
THL-LEFT-2-10A-BN	H TRACK CURRENT LIMITER - DOUBLE LIVE EN	132.95	790576133058
THL-LEFT-2-10A-DB	H TRACK CURRENT LIMITER - DOUBLE LIVE EN	132.95	790576146287
THL-LEFT-2-10A-WT	H TRACK CURRENT LIMITER - DOUBLE LIVE EN	130.95	790576133041
THL-LEFT-2-1A-BK	H TRACK CURRENT LIMITER - DOUBLE LIVE EN	130.95	790576132877
THL-LEFT-2-1A-BN	H TRACK CURRENT LIMITER - DOUBLE LIVE EN	132.95	790576132891
THL-LEFT-2-1A-DB	H TRACK CURRENT LIMITER - DOUBLE LIVE EN	132.95	790576146294
THL-LEFT-2-1A-WT	H TRACK CURRENT LIMITER - DOUBLE LIVE EN	130.95	790576132884
THL-LEFT-2-2A-BK	H TRACK CURRENT LIMITER - DOUBLE LIVE EN	130.95	790576132945
THL-LEFT-2-2A-BN	H TRACK CURRENT LIMITER - DOUBLE LIVE EN	132.95	790576132921
THL-LEFT-2-2A-DB	H TRACK CURRENT LIMITER - DOUBLE LIVE EN	132.95	790576146300
THL-LEFT-2-2A-WT	H TRACK CURRENT LIMITER - DOUBLE LIVE EN	130.95	790576132938
THL-LEFT-2-5A-BK	H TRACK CURRENT LIMITER - DOUBLE LIVE EN	130.95	790576132952
THL-LEFT-2-5A-BN	H TRACK CURRENT LIMITER - DOUBLE LIVE EN	132.95	790576132976
THL-LEFT-2-5A-DB	H TRACK CURRENT LIMITER - DOUBLE LIVE EN	132.95	790576146317
THL-LEFT-2-5A-WT	H TRACK CURRENT LIMITER - DOUBLE LIVE EN	130.95	790576132969
THL-LEFT-2-7A-BK	H TRACK CURRENT LIMITER - DOUBLE LIVE EN	130.95	790576133027
THL-LEFT-2-7A-BN	H TRACK CURRENT LIMITER - DOUBLE LIVE EN	132.95	790576133003
THL-LEFT-2-7A-DB	H TRACK CURRENT LIMITER - DOUBLE LIVE EN	132.95	790576146324
THL-LEFT-2-7A-WT	H TRACK CURRENT LIMITER - DOUBLE LIVE EN	130.95	790576133010
THL-RIGHT-1-10A-BK	H TRACK CURRENT LIMITER - DOUBLE LIVE EN	108.95	790576131139
THL-RIGHT-1-10A-BN	H TRACK CURRENT LIMITER - DOUBLE LIVE EN	111.50	790576131153
THL-RIGHT-1-10A-DB	H TRACK CURRENT LIMITER - DOUBLE LIVE EN	111.50	790576146331

Material	Description	2011 DN	UPC Code
THL-RIGHT-1-10A-WT	H TRACK CURRENT LIMITER - DOUBLE LIVE EN	108.95	790576131146
THL-RIGHT-1-1A-BK	H TRACK CURRENT LIMITER - DOUBLE LIVE EN	108.95	790576130972
THL-RIGHT-1-1A-BN	H TRACK CURRENT LIMITER - DOUBLE LIVE EN	111.50	790576130996
THL-RIGHT-1-1A-DB	H TRACK CURRENT LIMITER - DOUBLE LIVE EN	111.50	790576146348
THL-RIGHT-1-1A-WT	H TRACK CURRENT LIMITER - DOUBLE LIVE EN	108.95	790576130989
THL-RIGHT-1-2A-BK	H TRACK CURRENT LIMITER - DOUBLE LIVE EN	108.95	790576131047
THL-RIGHT-1-2A-BN	H TRACK CURRENT LIMITER - DOUBLE LIVE EN	111.50	790576131023
THL-RIGHT-1-2A-DB	H TRACK CURRENT LIMITER - DOUBLE LIVE EN	111.50	790576146355
THL-RIGHT-1-2A-WT	H TRACK CURRENT LIMITER - DOUBLE LIVE EN	108.95	790576131030
THL-RIGHT-1-5A-BK	H TRACK CURRENT LIMITER - DOUBLE LIVE EN	108.95	790576131054
THL-RIGHT-1-5A-BN	H TRACK CURRENT LIMITER - DOUBLE LIVE EN	111.50	790576131078
THL-RIGHT-1-5A-DB	H TRACK CURRENT LIMITER - DOUBLE LIVE EN	111.50	790576146362
THL-RIGHT-1-5A-WT	H TRACK CURRENT LIMITER - DOUBLE LIVE EN	108.95	790576131061
THL-RIGHT-1-7A-BK	H TRACK CURRENT LIMITER - DOUBLE LIVE EN	108.95	790576131122
THL-RIGHT-1-7A-BN	H TRACK CURRENT LIMITER - DOUBLE LIVE EN	111.50	790576131108
THL-RIGHT-1-7A-DB	H TRACK CURRENT LIMITER - DOUBLE LIVE EN	111.50	790576146379
THL-RIGHT-1-7A-WT	H TRACK CURRENT LIMITER - DOUBLE LIVE EN	108.95	790576131115
THL-RIGHT-2-10A-BK	H TRACK CURRENT LIMITER - DOUBLE LIVE EN	130.95	790576133232
THL-RIGHT-2-10A-BN	H TRACK CURRENT LIMITER - DOUBLE LIVE EN	132.95	790576133256
THL-RIGHT-2-10A-DB	H TRACK CURRENT LIMITER - DOUBLE LIVE EN	132.95	790576146386
THL-RIGHT-2-10A-WT	H TRACK CURRENT LIMITER - DOUBLE LIVE EN	130.95	790576133249
THL-RIGHT-2-1A-BK	H TRACK CURRENT LIMITER - DOUBLE LIVE EN	130.95	790576133072
THL-RIGHT-2-1A-BN	H TRACK CURRENT LIMITER - DOUBLE LIVE EN	132.95	790576133096
THL-RIGHT-2-1A-DB	H TRACK CURRENT LIMITER - DOUBLE LIVE EN	132.95	790576146393
THL-RIGHT-2-1A-WT	H TRACK CURRENT LIMITER - DOUBLE LIVE EN	130.95	790576133089
THL-RIGHT-2-2A-BK	H TRACK CURRENT LIMITER - DOUBLE LIVE EN	130.95	790576133140
THL-RIGHT-2-2A-BN	H TRACK CURRENT LIMITER - DOUBLE LIVE EN	132.95	790576133126
THL-RIGHT-2-2A-DB	H TRACK CURRENT LIMITER - DOUBLE LIVE EN	132.95	790576146409
THL-RIGHT-2-2A-WT	H TRACK CURRENT LIMITER - DOUBLE LIVE EN	130.95	790576133133
THL-RIGHT-2-5A-BK	H TRACK CURRENT LIMITER - DOUBLE LIVE EN	130.95	790576133157
THL-RIGHT-2-5A-BN	H TRACK CURRENT LIMITER - DOUBLE LIVE EN	132.95	790576133171
THL-RIGHT-2-5A-DB	H TRACK CURRENT LIMITER - DOUBLE LIVE EN	132.95	790576146416
THL-RIGHT-2-5A-WT	H TRACK CURRENT LIMITER - DOUBLE LIVE EN	130.95	790576133164
THL-RIGHT-2-7A-BK	H TRACK CURRENT LIMITER - DOUBLE LIVE EN	130.95	790576133225
THL-RIGHT-2-7A-BN	H TRACK CURRENT LIMITER - DOUBLE LIVE EN	132.95	790576133201
THL-RIGHT-2-7A-DB	H TRACK CURRENT LIMITER - DOUBLE LIVE EN	132.95	790576146423
THL-RIGHT-2-7A-WT	H TRACK CURRENT LIMITER - DOUBLE LIVE EN	130.95	790576133218
TJL-J2I-2-10A-BK	J2 TRACK CURRENT LIMITER - DOUBLE LIVE E	139.50	790576132242
TJL-J2I-2-10A-WT	J2 TRACK CURRENT LIMITER - DOUBLE LIVE E	139.50	790576132259
TJL-J2I-2-1A-BK	J2 TRACK CURRENT LIMITER - DOUBLE LIVE E	139.50	790576132129
TJL-J2I-2-1A-WT	J2 TRACK CURRENT LIMITER - DOUBLE LIVE E	139.50	790576132136
TJL-J2I-2-2A-BK	J2 TRACK CURRENT LIMITER - DOUBLE LIVE E	139.50	790576132174
TJL-J2I-2-2A-WT	J2 TRACK CURRENT LIMITER - DOUBLE LIVE E	139.50	790576132167
TJL-J2I-2-5A-BK	J2 TRACK CURRENT LIMITER - DOUBLE LIVE E	139.50	790576132181
TJL-J2I-2-5A-WT	J2 TRACK CURRENT LIMITER - DOUBLE LIVE E	139.50	790576132198
TJL-J2I-2-7A-BK	J2 TRACK CURRENT LIMITER - DOUBLE LIVE E	139.50	790576132235
TJL-J2I-2-7A-WT	J2 TRACK CURRENT LIMITER - DOUBLE LIVE E	139.50	790576132228
TJL-J2LE-2-10A-BK	J2 TRACK CURRENT LIMITER - SINGLE LIVE E	136.50	790576132099
TJL-J2LE-2-10A-WT	J2 TRACK CURRENT LIMITER - SINGLE LIVE E	136.50	790576132105
TJL-J2LE-2-1A-BK	J2 TRACK CURRENT LIMITER - SINGLE LIVE E	136.50	790576131979

Material	Description	2011 DN	UPC Code
TJL-J2LE-2-1A-WT	J2 TRACK CURRENT LIMITER - SINGLE LIVE E	136.50	790576131986
TJL-J2LE-2-2A-BK	J2 TRACK CURRENT LIMITER - SINGLE LIVE E	136.50	790576132020
TJL-J2LE-2-2A-WT	J2 TRACK CURRENT LIMITER - SINGLE LIVE E	136.50	790576132013
TJL-J2LE-2-5A-BK	J2 TRACK CURRENT LIMITER - SINGLE LIVE E	136.50	790576132037
TJL-J2LE-2-5A-WT	J2 TRACK CURRENT LIMITER - SINGLE LIVE E	136.50	790576132044
TJL-J2LE-2-7A-BK	J2 TRACK CURRENT LIMITER - SINGLE LIVE E	136.50	790576132082
TJL-J2LE-2-7A-WT	J2 TRACK CURRENT LIMITER - SINGLE LIVE E	136.50	790576132075
TJL-J2-LEFT-2-10ABK	J2 TRACK CURRENT LIMITER - L CONNECTOR	141.95	
TJL-J2-LEFT-2-10AWT	J2 TRACK CURRENT LIMITER - L CONNECTOR	141.95	
TJL-J2-LEFT-2-1ABK	J2 TRACK CURRENT LIMITER - L CONNECTOR	141.95	790576135823
TJL-J2-LEFT-2-1AWT	J2 TRACK CURRENT LIMITER - L CONNECTOR	141.95	790576135830
TJL-J2-LEFT-2-2ABK	J2 TRACK CURRENT LIMITER - L CONNECTOR	141.95	790576135878
TJL-J2-LEFT-2-2AWT	J2 TRACK CURRENT LIMITER - L CONNECTOR	141.95	790576135861
TJL-J2-LEFT-2-5ABK	J2 TRACK CURRENT LIMITER - L CONNECTOR	141.95	790576135885
TJL-J2-LEFT-2-5AWT	J2 TRACK CURRENT LIMITER - L CONNECTOR	141.95	790576135892
TJL-J2-LEFT-2-7ABK	J2 TRACK CURRENT LIMITER - L CONNECTOR	141.95	790576135939
TJL-J2-LEFT-2-7AWT	J2 TRACK CURRENT LIMITER - L CONNECTOR	141.95	790576135922
TJL-J2-RIGHT-2-10ABK	J2 TRACK CURRENT LIMITER - L CONNECTOR	141.95	
TJL-J2-RIGHT-2-10AWT	J2 TRACK CURRENT LIMITER - L CONNECTOR	141.95	
TJL-J2-RIGHT-2-1ABK	J2 TRACK CURRENT LIMITER - L CONNECTOR	141.95	
TJL-J2-RIGHT-2-1AWT	J2 TRACK CURRENT LIMITER - L CONNECTOR	141.95	
TJL-J2-RIGHT-2-2ABK	J2 TRACK CURRENT LIMITER - L CONNECTOR	141.95	
TJL-J2-RIGHT-2-2AWT	J2 TRACK CURRENT LIMITER - L CONNECTOR	141.95	
TJL-J2-RIGHT-2-5ABK	J2 TRACK CURRENT LIMITER - L CONNECTOR	141.95	
TJL-J2-RIGHT-2-5AWT	J2 TRACK CURRENT LIMITER - L CONNECTOR	141.95	
TJL-J2-RIGHT-2-7ABK	J2 TRACK CURRENT LIMITER - L CONNECTOR	141.95	
TJL-J2-RIGHT-2-7AWT	J2 TRACK CURRENT LIMITER - L CONNECTOR	141.95	
TJL-JI-1-10A-BK	J TRACK CURRENT LIMITER - DOUBLE LIVE EN	106.95	790576130736
TJL-JI-1-10A-BN	J TRACK CURRENT LIMITER - DOUBLE LIVE EN	108.95	790576130750
TJL-JI-1-10A-DB	J TRACK CURRENT LIMITER - DOUBLE LIVE EN	108.95	790576146430
TJL-JI-1-10A-WT	J TRACK CURRENT LIMITER - DOUBLE LIVE EN	106.95	790576130743
TJL-JI-1-1A-BK	J TRACK CURRENT LIMITER - DOUBLE LIVE EN	106.95	790576130576
TJL-JI-1-1A-BN	J TRACK CURRENT LIMITER - DOUBLE LIVE EN	108.95	790576130590
TJL-JI-1-1A-DB	J TRACK CURRENT LIMITER - DOUBLE LIVE EN	108.95	790576146447
TJL-JI-1-1A-WT	J TRACK CURRENT LIMITER - DOUBLE LIVE EN	106.95	790576130583
TJL-JI-1-2A-BK	J TRACK CURRENT LIMITER - DOUBLE LIVE EN	106.95	790576130644
TJL-JI-1-2A-BN	J TRACK CURRENT LIMITER - DOUBLE LIVE EN	108.95	790576130620
TJL-JI-1-2A-DB	J TRACK CURRENT LIMITER - DOUBLE LIVE EN	108.95	790576146454
TJL-JI-1-2A-WT	J TRACK CURRENT LIMITER - DOUBLE LIVE EN	106.95	790576130637
TJL-JI-1-5A-BK	J TRACK CURRENT LIMITER - DOUBLE LIVE EN	106.95	790576130651
TJL-JI-1-5A-BN	J TRACK CURRENT LIMITER - DOUBLE LIVE EN	108.95	790576130675
TJL-JI-1-5A-DB	J TRACK CURRENT LIMITER - DOUBLE LIVE EN	108.95	790576146461
TJL-JI-1-5A-WT	J TRACK CURRENT LIMITER - DOUBLE LIVE EN	106.95	790576130668
TJL-JI-1-7A-BK	J TRACK CURRENT LIMITER - DOUBLE LIVE EN	106.95	790576130729
TJL-JI-1-7A-BN	J TRACK CURRENT LIMITER - DOUBLE LIVE EN	108.95	790576130705
TJL-JI-1-7A-DB	J TRACK CURRENT LIMITER - DOUBLE LIVE EN	108.95	790576146478
TJL-JI-1-7A-WT	J TRACK CURRENT LIMITER - DOUBLE LIVE EN	106.95	790576130712
TJL-JI-2-10A-BK	J TRACK CURRENT LIMITER - DOUBLE LIVE EN	128.95	790576132839
TJL-JI-2-10A-BN	J TRACK CURRENT LIMITER - DOUBLE LIVE EN	130.95	790576132853
TJL-JI-2-10A-DB	J TRACK CURRENT LIMITER - DOUBLE LIVE EN	130.95	790576146485

Material	Description	2011 DN	UPC Code
TJL-JI-2-10A-WT	J TRACK CURRENT LIMITER - DOUBLE LIVE EN	128.95	790576132846
TJL-JI-2-1A-BK	J TRACK CURRENT LIMITER - DOUBLE LIVE EN	128.95	790576132679
TJL-JI-2-1A-BN	J TRACK CURRENT LIMITER - DOUBLE LIVE EN	130.95	790576132693
TJL-JI-2-1A-DB	J TRACK CURRENT LIMITER - DOUBLE LIVE EN	130.95	790576146492
TJL-JI-2-1A-WT	J TRACK CURRENT LIMITER - DOUBLE LIVE EN	128.95	790576132686
TJL-JI-2-2A-BK	J TRACK CURRENT LIMITER - DOUBLE LIVE EN	128.95	790576132747
TJL-JI-2-2A-BN	J TRACK CURRENT LIMITER - DOUBLE LIVE EN	130.95	790576132723
TJL-JI-2-2A-DB	J TRACK CURRENT LIMITER - DOUBLE LIVE EN	130.95	790576146508
TJL-JI-2-2A-WT	J TRACK CURRENT LIMITER - DOUBLE LIVE EN	128.95	790576132730
TJL-JI-2-5A-BK	J TRACK CURRENT LIMITER - DOUBLE LIVE EN	128.95	790576132754
TJL-JI-2-5A-BN	J TRACK CURRENT LIMITER - DOUBLE LIVE EN	130.95	790576132778
TJL-JI-2-5A-DB	J TRACK CURRENT LIMITER - DOUBLE LIVE EN	130.95	790576146515
TJL-JI-2-5A-WT	J TRACK CURRENT LIMITER - DOUBLE LIVE EN	128.95	790576132761
TJL-JI-2-7A-BK	J TRACK CURRENT LIMITER - DOUBLE LIVE EN	128.95	790576132822
TJL-JI-2-7A-BN	J TRACK CURRENT LIMITER - DOUBLE LIVE EN	130.95	790576132808
TJL-JI-2-7A-DB	J TRACK CURRENT LIMITER - DOUBLE LIVE EN	130.95	790576146522
TJL-JI-2-7A-WT	J TRACK CURRENT LIMITER - DOUBLE LIVE EN	128.95	790576132815
TJL-JLE-10A-BK	J TRACK CURRENT LIMITER - SINGLE LIVE EN	103.50	790576130132
TJL-JLE-10A-BN	J TRACK CURRENT LIMITER - SINGLE LIVE EN	105.95	790576130156
TJL-JLE-10A-DB	J TRACK CURRENT LIMITER - SINGLE LIVE EN	105.95	790576146539
TJL-JLE-10A-WT	J TRACK CURRENT LIMITER - SINGLE LIVE EN	103.50	790576130149
TJL-JLE-1A-BK	J TRACK CURRENT LIMITER - SINGLE LIVE EN	103.50	790576129976
TJL-JLE-1A-BN	J TRACK CURRENT LIMITER - SINGLE LIVE EN	105.95	790576129990
TJL-JLE-1A-DB	J TRACK CURRENT LIMITER - SINGLE LIVE EN	105.95	790576146546
TJL-JLE-1A-WT	J TRACK CURRENT LIMITER - SINGLE LIVE EN	103.50	790576129983
TJL-JLE-2A-BK	J TRACK CURRENT LIMITER - SINGLE LIVE EN	103.50	790576130040
TJL-JLE-2A-BN	J TRACK CURRENT LIMITER - SINGLE LIVE EN	105.95	790576130026
TJL-JLE-2A-DB	J TRACK CURRENT LIMITER - SINGLE LIVE EN	105.95	790576146553
TJL-JLE-2A-WT	J TRACK CURRENT LIMITER - SINGLE LIVE EN	103.50	790576130033
TJL-JLE-5A-BK	J TRACK CURRENT LIMITER - SINGLE LIVE EN	103.50	790576130057
TJL-JLE-5A-BN	J TRACK CURRENT LIMITER - SINGLE LIVE EN	105.95	790576130071
TJL-JLE-5A-DB	J TRACK CURRENT LIMITER - SINGLE LIVE EN	105.95	790576146560
TJL-JLE-5A-WT	J TRACK CURRENT LIMITER - SINGLE LIVE EN	103.50	790576130064
TJL-JLE-7A-BK	J TRACK CURRENT LIMITER - SINGLE LIVE EN	103.50	790576130125
TJL-JLE-7A-BN	J TRACK CURRENT LIMITER - SINGLE LIVE EN	105.95	790576130101
TJL-JLE-7A-DB	J TRACK CURRENT LIMITER - SINGLE LIVE EN	105.95	790576146577
TJL-JLE-7A-WT	J TRACK CURRENT LIMITER - SINGLE LIVE EN	103.50	790576130118
TJL-LEFT-1-10A-BK	J TRACK CURRENT LIMITER - DOUBLE LIVE EN	108.95	790576131733
TJL-LEFT-1-10A-BN	J TRACK CURRENT LIMITER - DOUBLE LIVE EN	111.50	790576131757
TJL-LEFT-1-10A-DB	J TRACK CURRENT LIMITER - DOUBLE LIVE EN	111.50	790576146584
TJL-LEFT-1-10A-WT	J TRACK CURRENT LIMITER - DOUBLE LIVE EN	108.95	790576131740
TJL-LEFT-1-1A-BK	J TRACK CURRENT LIMITER - DOUBLE LIVE EN	108.95	790576131573
TJL-LEFT-1-1A-BN	J TRACK CURRENT LIMITER - DOUBLE LIVE EN	111.50	790576131597
TJL-LEFT-1-1A-DB	J TRACK CURRENT LIMITER - DOUBLE LIVE EN	111.50	790576146591
TJL-LEFT-1-1A-WT	J TRACK CURRENT LIMITER - DOUBLE LIVE EN	108.95	790576131580
TJL-LEFT-1-2A-BK	J TRACK CURRENT LIMITER - DOUBLE LIVE EN	108.95	790576131641
TJL-LEFT-1-2A-BN	J TRACK CURRENT LIMITER - DOUBLE LIVE EN	111.50	790576131627
TJL-LEFT-1-2A-DB	J TRACK CURRENT LIMITER - DOUBLE LIVE EN	111.50	790576146607
TJL-LEFT-1-2A-WT	J TRACK CURRENT LIMITER - DOUBLE LIVE EN	108.95	790576131634
TJL-LEFT-1-5A-BK	J TRACK CURRENT LIMITER - DOUBLE LIVE EN	108.95	790576131658



Material	Description	2011 DN	UPC Code
TJL-LEFT-1-5A-BN	J TRACK CURRENT LIMITER - DOUBLE LIVE EN	111.50	790576131672
TJL-LEFT-1-5A-DB	J TRACK CURRENT LIMITER - DOUBLE LIVE EN	111.50	790576146614
TJL-LEFT-1-5A-WT	J TRACK CURRENT LIMITER - DOUBLE LIVE EN	108.95	790576131665
TJL-LEFT-1-7A-BK	J TRACK CURRENT LIMITER - DOUBLE LIVE EN	108.95	790576131726
TJL-LEFT-1-7A-BN	J TRACK CURRENT LIMITER - DOUBLE LIVE EN	111.50	790576131702
TJL-LEFT-1-7A-DB	J TRACK CURRENT LIMITER - DOUBLE LIVE EN	111.50	790576146621
TJL-LEFT-1-7A-WT	J TRACK CURRENT LIMITER - DOUBLE LIVE EN	108.95	790576131719
TJL-LEFT-2-10A-BK	J TRACK CURRENT LIMITER - DOUBLE LIVE EN	130.95	790576133843
TJL-LEFT-2-10A-BN	J TRACK CURRENT LIMITER - DOUBLE LIVE EN	132.95	790576133867
TJL-LEFT-2-10A-DB	J TRACK CURRENT LIMITER - DOUBLE LIVE EN	132.95	790576146638
TJL-LEFT-2-10A-WT	J TRACK CURRENT LIMITER - DOUBLE LIVE EN	130.95	790576133850
TJL-LEFT-2-1A-BK	J TRACK CURRENT LIMITER - DOUBLE LIVE EN	130.95	790576133683
TJL-LEFT-2-1A-BN	J TRACK CURRENT LIMITER - DOUBLE LIVE EN	132.95	790576133706
TJL-LEFT-2-1A-DB	J TRACK CURRENT LIMITER - DOUBLE LIVE EN	132.95	790576146645
TJL-LEFT-2-1A-WT	J TRACK CURRENT LIMITER - DOUBLE LIVE EN	130.95	790576133690
TJL-LEFT-2-2A-BK	J TRACK CURRENT LIMITER - DOUBLE LIVE EN	130.95	790576133751
TJL-LEFT-2-2A-BN	J TRACK CURRENT LIMITER - DOUBLE LIVE EN	132.95	790576133737
TJL-LEFT-2-2A-DB	J TRACK CURRENT LIMITER - DOUBLE LIVE EN	132.95	790576146652
TJL-LEFT-2-2A-WT	J TRACK CURRENT LIMITER - DOUBLE LIVE EN	130.95	790576133744
TJL-LEFT-2-5A-BK	J TRACK CURRENT LIMITER - DOUBLE LIVE EN	130.95	790576133768
TJL-LEFT-2-5A-BN	J TRACK CURRENT LIMITER - DOUBLE LIVE EN	132.95	790576133782
TJL-LEFT-2-5A-DB	J TRACK CURRENT LIMITER - DOUBLE LIVE EN	132.95	790576146669
TJL-LEFT-2-5A-WT	J TRACK CURRENT LIMITER - DOUBLE LIVE EN	130.95	790576133775
TJL-LEFT-2-7A-BK	J TRACK CURRENT LIMITER - DOUBLE LIVE EN	130.95	790576133836
TJL-LEFT-2-7A-BN	J TRACK CURRENT LIMITER - DOUBLE LIVE EN	132.95	790576133812
TJL-LEFT-2-7A-DB	J TRACK CURRENT LIMITER - DOUBLE LIVE EN	132.95	790576146676
TJL-LEFT-2-7A-WT	J TRACK CURRENT LIMITER - DOUBLE LIVE EN	130.95	790576133829
TJL-RIGHT-1-10A-BK	J TRACK CURRENT LIMITER - DOUBLE LIVE EN	108.95	790576131931
TJL-RIGHT-1-10A-BN	J TRACK CURRENT LIMITER - DOUBLE LIVE EN	111.50	790576131955
TJL-RIGHT-1-10A-DB	J TRACK CURRENT LIMITER - DOUBLE LIVE EN	111.50	790576146683
TJL-RIGHT-1-10A-WT	J TRACK CURRENT LIMITER - DOUBLE LIVE EN	108.95	790576131948
TJL-RIGHT-1-1A-BK	J TRACK CURRENT LIMITER - DOUBLE LIVE EN	108.95	790576131771
TJL-RIGHT-1-1A-BN	J TRACK CURRENT LIMITER - DOUBLE LIVE EN	111.50	790576131795
TJL-RIGHT-1-1A-DB	J TRACK CURRENT LIMITER - DOUBLE LIVE EN	111.50	790576146690
TJL-RIGHT-1-1A-WT	J TRACK CURRENT LIMITER - DOUBLE LIVE EN	108.95	790576131788
TJL-RIGHT-1-2A-BK	J TRACK CURRENT LIMITER - DOUBLE LIVE EN	108.95	790576131849
TJL-RIGHT-1-2A-BN	J TRACK CURRENT LIMITER - DOUBLE LIVE EN	111.50	790576131825
TJL-RIGHT-1-2A-DB	J TRACK CURRENT LIMITER - DOUBLE LIVE EN	111.50	790576146706
TJL-RIGHT-1-2A-WT	J TRACK CURRENT LIMITER - DOUBLE LIVE EN	108.95	790576131832
TJL-RIGHT-1-5A-BK	J TRACK CURRENT LIMITER - DOUBLE LIVE EN	108.95	790576131856
TJL-RIGHT-1-5A-BN	J TRACK CURRENT LIMITER - DOUBLE LIVE EN	111.50	790576131870
TJL-RIGHT-1-5A-DB	J TRACK CURRENT LIMITER - DOUBLE LIVE EN	111.50	790576146713
TJL-RIGHT-1-5A-WT	J TRACK CURRENT LIMITER - DOUBLE LIVE EN	108.95	790576131863
TJL-RIGHT-1-7A-BK	J TRACK CURRENT LIMITER - DOUBLE LIVE EN	108.95	790576131894
TJL-RIGHT-1-7A-BN	J TRACK CURRENT LIMITER - DOUBLE LIVE EN	111.50	790576131917
TJL-RIGHT-1-7A-DB	J TRACK CURRENT LIMITER - DOUBLE LIVE EN	111.50	790576146720
TJL-RIGHT-1-7A-WT	J TRACK CURRENT LIMITER - DOUBLE LIVE EN	108.95	790576131900
TJL-RIGHT-2-10A-BK	J TRACK CURRENT LIMITER - DOUBLE LIVE EN	130.95	790576134048
TJL-RIGHT-2-10A-BN	J TRACK CURRENT LIMITER - DOUBLE LIVE EN	132.95	790576134024
TJL-RIGHT-2-10A-DB	J TRACK CURRENT LIMITER - DOUBLE LIVE EN	132.95	790576146737

Material	Description	2011 DN	UPC Code
TJL-RIGHT-2-10A-WT	J TRACK CURRENT LIMITER - DOUBLE LIVE EN	130.95	790576134031
TJL-RIGHT-2-1A-BK	J TRACK CURRENT LIMITER - DOUBLE LIVE EN	130.95	790576133881
TJL-RIGHT-2-1A-BN	J TRACK CURRENT LIMITER - DOUBLE LIVE EN	132.95	790576133904
TJL-RIGHT-2-1A-DB	J TRACK CURRENT LIMITER - DOUBLE LIVE EN	132.95	790576146744
TJL-RIGHT-2-1A-WT	J TRACK CURRENT LIMITER - DOUBLE LIVE EN	130.95	790576133898
TJL-RIGHT-2-2A-BK	J TRACK CURRENT LIMITER - DOUBLE LIVE EN	130.95	790576133959
TJL-RIGHT-2-2A-BN	J TRACK CURRENT LIMITER - DOUBLE LIVE EN	132.95	790576133935
TJL-RIGHT-2-2A-DB	J TRACK CURRENT LIMITER - DOUBLE LIVE EN	132.95	790576146751
TJL-RIGHT-2-2A-WT	J TRACK CURRENT LIMITER - DOUBLE LIVE EN	130.95	790576133942
TJL-RIGHT-2-5A-BK	J TRACK CURRENT LIMITER - DOUBLE LIVE EN	130.95	790576133966
TJL-RIGHT-2-5A-BN	J TRACK CURRENT LIMITER - DOUBLE LIVE EN	132.95	790576133980
TJL-RIGHT-2-5A-DB	J TRACK CURRENT LIMITER - DOUBLE LIVE EN	132.95	790576146768
TJL-RIGHT-2-5A-WT	J TRACK CURRENT LIMITER - DOUBLE LIVE EN	130.95	790576133973
TJL-RIGHT-2-7A-BK	J TRACK CURRENT LIMITER - DOUBLE LIVE EN	130.95	790576134055
TJL-RIGHT-2-7A-BN	J TRACK CURRENT LIMITER - DOUBLE LIVE EN	132.95	790576134079
TJL-RIGHT-2-7A-DB	J TRACK CURRENT LIMITER - DOUBLE LIVE EN	132.95	790576147123
TJL-RIGHT-2-7A-WT	J TRACK CURRENT LIMITER - DOUBLE LIVE EN	130.95	790576134062
TLL-LEFT-1-10A-BK	L TRACK CURRENT LIMITER - DOUBLE LIVE EN	108.95	790576131337
TLL-LEFT-1-10A-BN	L TRACK CURRENT LIMITER - DOUBLE LIVE EN	111.50	790576131351
TLL-LEFT-1-10A-DB	L TRACK CURRENT LIMITER - DOUBLE LIVE EN	111.50	790576146775
TLL-LEFT-1-10A-WT	L TRACK CURRENT LIMITER - DOUBLE LIVE EN	108.95	790576131344
TLL-LEFT-1-1A-BK	L TRACK CURRENT LIMITER - DOUBLE LIVE EN	108.95	790576131177
TLL-LEFT-1-1A-BN	L TRACK CURRENT LIMITER - DOUBLE LIVE EN	111.50	790576131191
TLL-LEFT-1-1A-DB	L TRACK CURRENT LIMITER - DOUBLE LIVE EN	111.50	790576146782
TLL-LEFT-1-1A-WT	L TRACK CURRENT LIMITER - DOUBLE LIVE EN	108.95	790576131184
TLL-LEFT-1-2A-BK	L TRACK CURRENT LIMITER - DOUBLE LIVE EN	108.95	790576131245
TLL-LEFT-1-2A-BN	L TRACK CURRENT LIMITER - DOUBLE LIVE EN	111.50	790576131221
TLL-LEFT-1-2A-DB	L TRACK CURRENT LIMITER - DOUBLE LIVE EN	111.50	790576146799
TLL-LEFT-1-2A-WT	L TRACK CURRENT LIMITER - DOUBLE LIVE EN	108.95	790576131238
TLL-LEFT-1-5A-BK	L TRACK CURRENT LIMITER - DOUBLE LIVE EN	108.95	790576131252
TLL-LEFT-1-5A-BN	L TRACK CURRENT LIMITER - DOUBLE LIVE EN	111.50	790576131276
TLL-LEFT-1-5A-DB	L TRACK CURRENT LIMITER - DOUBLE LIVE EN	111.50	790576146805
TLL-LEFT-1-5A-WT	L TRACK CURRENT LIMITER - DOUBLE LIVE EN	108.95	790576131269
TLL-LEFT-1-7A-BK	L TRACK CURRENT LIMITER - DOUBLE LIVE EN	108.95	790576131320
TLL-LEFT-1-7A-BN	L TRACK CURRENT LIMITER - DOUBLE LIVE EN	111.50	790576131306
TLL-LEFT-1-7A-DB	L TRACK CURRENT LIMITER - DOUBLE LIVE EN	111.50	790576146812
TLL-LEFT-1-7A-WT	L TRACK CURRENT LIMITER - DOUBLE LIVE EN	108.95	790576131313
TLL-LEFT-2-10A-BK	L TRACK CURRENT LIMITER - DOUBLE LIVE EN	130.95	790576133478
TLL-LEFT-2-10A-BN	L TRACK CURRENT LIMITER - DOUBLE LIVE EN	132.95	790576133454
TLL-LEFT-2-10A-DB	L TRACK CURRENT LIMITER - DOUBLE LIVE EN	132.95	790576146829
TLL-LEFT-2-10A-WT	L TRACK CURRENT LIMITER - DOUBLE LIVE EN	130.95	790576133461
TLL-LEFT-2-1A-BK	L TRACK CURRENT LIMITER - DOUBLE LIVE EN	130.95	790576133287
TLL-LEFT-2-1A-BN	L TRACK CURRENT LIMITER - DOUBLE LIVE EN	132.95	790576133300
TLL-LEFT-2-1A-DB	L TRACK CURRENT LIMITER - DOUBLE LIVE EN	132.95	790576146836
TLL-LEFT-2-1A-WT	L TRACK CURRENT LIMITER - DOUBLE LIVE EN	130.95	790576133294
TLL-LEFT-2-2A-BK	L TRACK CURRENT LIMITER - DOUBLE LIVE EN	130.95	790576133324
TLL-LEFT-2-2A-BN	L TRACK CURRENT LIMITER - DOUBLE LIVE EN	132.95	790576133348
TLL-LEFT-2-2A-DB	L TRACK CURRENT LIMITER - DOUBLE LIVE EN	132.95	790576146843
TLL-LEFT-2-2A-WT	L TRACK CURRENT LIMITER - DOUBLE LIVE EN	130.95	790576133331
TLL-LEFT-2-5A-BK	L TRACK CURRENT LIMITER - DOUBLE LIVE EN	130.95	790576133393

Material	Description	2011 DN	UPC Code
TLL-LEFT-2-5A-BN	L TRACK CURRENT LIMITER - DOUBLE LIVE EN	132.95	790576133379
TLL-LEFT-2-5A-DB	L TRACK CURRENT LIMITER - DOUBLE LIVE EN	132.95	790576146850
TLL-LEFT-2-5A-WT	L TRACK CURRENT LIMITER - DOUBLE LIVE EN	130.95	790576133386
TLL-LEFT-2-7A-BK	L TRACK CURRENT LIMITER - DOUBLE LIVE EN	130.95	790576133409
TLL-LEFT-2-7A-BN	L TRACK CURRENT LIMITER - DOUBLE LIVE EN	132.95	790576133423
TLL-LEFT-2-7A-DB	L TRACK CURRENT LIMITER - DOUBLE LIVE EN	132.95	790576146867
TLL-LEFT-2-7A-WT	L TRACK CURRENT LIMITER - DOUBLE LIVE EN	130.95	790576133416
TLL-LI-1-10A-BK	L TRACK CURRENT LIMITER - DOUBLE LIVE EN	106.95	790576130538
TLL-LI-1-10A-BN	L TRACK CURRENT LIMITER - DOUBLE LIVE EN	108.95	790576130552
TLL-LI-1-10A-DB	L TRACK CURRENT LIMITER - DOUBLE LIVE EN	108.95	790576146874
TLL-LI-1-10A-WT	L TRACK CURRENT LIMITER - DOUBLE LIVE EN	106.95	790576130545
TLL-LI-1-1A-BK	L TRACK CURRENT LIMITER - DOUBLE LIVE EN	106.95	790576130378
TLL-LI-1-1A-BN	L TRACK CURRENT LIMITER - DOUBLE LIVE EN	108.95	790576130392
TLL-LI-1-1A-DB	L TRACK CURRENT LIMITER - DOUBLE LIVE EN	108.95	790576146881
TLL-LI-1-1A-WT	L TRACK CURRENT LIMITER - DOUBLE LIVE EN	106.95	790576130385
TLL-LI-1-2A-BK	L TRACK CURRENT LIMITER - DOUBLE LIVE EN	106.95	790576130446
TLL-LI-1-2A-BN	L TRACK CURRENT LIMITER - DOUBLE LIVE EN	108.95	790576130422
TLL-LI-1-2A-DB	L TRACK CURRENT LIMITER - DOUBLE LIVE EN	108.95	790576146898
TLL-LI-1-2A-WT	L TRACK CURRENT LIMITER - DOUBLE LIVE EN	106.95	790576130439
TLL-LI-1-5A-BK	L TRACK CURRENT LIMITER - DOUBLE LIVE EN	106.95	790576130453
TLL-LI-1-5A-BN	L TRACK CURRENT LIMITER - DOUBLE LIVE EN	108.95	790576130477
TLL-LI-1-5A-DB	L TRACK CURRENT LIMITER - DOUBLE LIVE EN	108.95	790576146904
TLL-LI-1-5A-WT	L TRACK CURRENT LIMITER - DOUBLE LIVE EN	106.95	790576130460
TLL-LI-1-7A-BK	L TRACK CURRENT LIMITER - DOUBLE LIVE EN	106.95	790576130521
TLL-LI-1-7A-BN	L TRACK CURRENT LIMITER - DOUBLE LIVE EN	108.95	790576130507
TLL-LI-1-7A-DB	L TRACK CURRENT LIMITER - DOUBLE LIVE EN	108.95	790576146911
TLL-LI-1-7A-WT	L TRACK CURRENT LIMITER - DOUBLE LIVE EN	106.95	790576130514
TLL-LI-2-10A-BK	L TRACK CURRENT LIMITER - DOUBLE LIVE EN	128.95	790576132631
TLL-LI-2-10A-BN	L TRACK CURRENT LIMITER - DOUBLE LIVE EN	130.95	790576132655
TLL-LI-2-10A-DB	L TRACK CURRENT LIMITER - DOUBLE LIVE EN	130.95	790576146928
TLL-LI-2-10A-WT	L TRACK CURRENT LIMITER - DOUBLE LIVE EN	128.95	790576132648
TLL-LI-2-1A-BK	L TRACK CURRENT LIMITER - DOUBLE LIVE EN	128.95	790576132471
TLL-LI-2-1A-BN	L TRACK CURRENT LIMITER - DOUBLE LIVE EN	130.95	790576132495
TLL-LI-2-1A-DB	L TRACK CURRENT LIMITER - DOUBLE LIVE EN	130.95	790576146935
TLL-LI-2-1A-WT	L TRACK CURRENT LIMITER - DOUBLE LIVE EN	128.95	790576132488
TLL-LI-2-2A-BK	L TRACK CURRENT LIMITER - DOUBLE LIVE EN	128.95	790576132549
TLL-LI-2-2A-BN	L TRACK CURRENT LIMITER - DOUBLE LIVE EN	130.95	790576132525
TLL-LI-2-2A-DB	L TRACK CURRENT LIMITER - DOUBLE LIVE EN	130.95	790576146942
TLL-LI-2-2A-WT	L TRACK CURRENT LIMITER - DOUBLE LIVE EN	128.95	790576132532
TLL-LI-2-5A-BK	L TRACK CURRENT LIMITER - DOUBLE LIVE EN	128.95	790576132556
TLL-LI-2-5A-BN	L TRACK CURRENT LIMITER - DOUBLE LIVE EN	130.95	790576132570
TLL-LI-2-5A-DB	L TRACK CURRENT LIMITER - DOUBLE LIVE EN	130.95	790576146959
TLL-LI-2-5A-WT	L TRACK CURRENT LIMITER - DOUBLE LIVE EN	128.95	790576132563
TLL-LI-2-7A-BK	L TRACK CURRENT LIMITER - DOUBLE LIVE EN	128.95	790576132624
TLL-LI-2-7A-BN	L TRACK CURRENT LIMITER - DOUBLE LIVE EN	130.95	790576132600
TLL-LI-2-7A-DB	L TRACK CURRENT LIMITER - DOUBLE LIVE EN	130.95	790576146966
TLL-LI-2-7A-WT	L TRACK CURRENT LIMITER - DOUBLE LIVE EN	128.95	790576132617
TLL-LLE-10A-BK	L TRACK CURRENT LIMITER - SINGLE LIVE EN	103.50	790576129938
TLL-LLE-10A-BN	L TRACK CURRENT LIMITER - SINGLE LIVE EN	105.95	790576129952
TLL-LLE-10A-DB	L TRACK CURRENT LIMITER - SINGLE LIVE EN	105.95	790576146973

Material	Description	2011 DN	UPC Code
TLL-LLE-10A-WT	L TRACK CURRENT LIMITER - SINGLE LIVE EN	103.50	790576129945
TLL-LLE-1A-BK	L TRACK CURRENT LIMITER - SINGLE LIVE EN	103.50	790576129778
TLL-LLE-1A-BN	L TRACK CURRENT LIMITER - SINGLE LIVE EN	105.95	790576129792
TLL-LLE-1A-DB	L TRACK CURRENT LIMITER - SINGLE LIVE EN	105.95	790576146980
TLL-LLE-1A-WT	L TRACK CURRENT LIMITER - SINGLE LIVE EN	103.50	790576129785
TLL-LLE-2A-BK	L TRACK CURRENT LIMITER - SINGLE LIVE EN	103.50	790576129846
TLL-LLE-2A-BN	L TRACK CURRENT LIMITER - SINGLE LIVE EN	105.95	790576129822
TLL-LLE-2A-DB	L TRACK CURRENT LIMITER - SINGLE LIVE EN	105.95	790576146997
TLL-LLE-2A-WT	L TRACK CURRENT LIMITER - SINGLE LIVE EN	103.50	790576129839
TLL-LLE-5A-BK	L TRACK CURRENT LIMITER - SINGLE LIVE EN	103.50	790576129853
TLL-LLE-5A-BN	L TRACK CURRENT LIMITER - SINGLE LIVE EN	105.95	790576129877
TLL-LLE-5A-DB	L TRACK CURRENT LIMITER - SINGLE LIVE EN	105.95	790576147000
TLL-LLE-5A-WT	L TRACK CURRENT LIMITER - SINGLE LIVE EN	103.50	790576129860
TLL-LLE-7A-BK	L TRACK CURRENT LIMITER - SINGLE LIVE EN	103.50	790576129921
TLL-LLE-7A-BN	L TRACK CURRENT LIMITER - SINGLE LIVE EN	105.95	790576129907
TLL-LLE-7A-DB	L TRACK CURRENT LIMITER - SINGLE LIVE EN	105.95	790576147017
TLL-LLE-7A-WT	L TRACK CURRENT LIMITER - SINGLE LIVE EN	103.50	790576129914
TLL-RIGHT-1-10A-BK	L TRACK CURRENT LIMITER - DOUBLE LIVE EN	108.95	790576131535
TLL-RIGHT-1-10A-BN	L TRACK CURRENT LIMITER - DOUBLE LIVE EN	111.50	790576131559
TLL-RIGHT-1-10A-DB	L TRACK CURRENT LIMITER - DOUBLE LIVE EN	111.50	790576147024
TLL-RIGHT-1-10A-WT	L TRACK CURRENT LIMITER - DOUBLE LIVE EN	108.95	790576131542
TLL-RIGHT-1-1A-BK	L TRACK CURRENT LIMITER - DOUBLE LIVE EN	108.95	790576131375
TLL-RIGHT-1-1A-BN	L TRACK CURRENT LIMITER - DOUBLE LIVE EN	111.50	790576131399
TLL-RIGHT-1-1A-DB	L TRACK CURRENT LIMITER - DOUBLE LIVE EN	111.50	790576147031
TLL-RIGHT-1-1A-WT	L TRACK CURRENT LIMITER - DOUBLE LIVE EN	108.95	790576131382
TLL-RIGHT-1-2A-BK	L TRACK CURRENT LIMITER - DOUBLE LIVE EN	108.95	790576131443
TLL-RIGHT-1-2A-BN	L TRACK CURRENT LIMITER - DOUBLE LIVE EN	111.50	790576131429
TLL-RIGHT-1-2A-DB	L TRACK CURRENT LIMITER - DOUBLE LIVE EN	111.50	790576147048
TLL-RIGHT-1-2A-WT	L TRACK CURRENT LIMITER - DOUBLE LIVE EN	108.95	790576131436
TLL-RIGHT-1-5A-BK	L TRACK CURRENT LIMITER - DOUBLE LIVE EN	108.95	790576131450
TLL-RIGHT-1-5A-BN	L TRACK CURRENT LIMITER - DOUBLE LIVE EN	111.50	790576131474
TLL-RIGHT-1-5A-DB	L TRACK CURRENT LIMITER - DOUBLE LIVE EN	111.50	790576147055
TLL-RIGHT-1-5A-WT	L TRACK CURRENT LIMITER - DOUBLE LIVE EN	108.95	790576131467
TLL-RIGHT-1-7A-BK	L TRACK CURRENT LIMITER - DOUBLE LIVE EN	108.95	790576131528
TLL-RIGHT-1-7A-BN	L TRACK CURRENT LIMITER - DOUBLE LIVE EN	111.50	790576131504
TLL-RIGHT-1-7A-DB	L TRACK CURRENT LIMITER - DOUBLE LIVE EN	111.50	790576147062
TLL-RIGHT-1-7A-WT	L TRACK CURRENT LIMITER - DOUBLE LIVE EN	108.95	790576131511
TLL-RIGHT-2-10A-BK	L TRACK CURRENT LIMITER - DOUBLE LIVE EN	130.95	790576133676
TLL-RIGHT-2-10A-BN	L TRACK CURRENT LIMITER - DOUBLE LIVE EN	132.95	790576133652
TLL-RIGHT-2-10A-DB	L TRACK CURRENT LIMITER - DOUBLE LIVE EN	132.95	790576147079
TLL-RIGHT-2-10A-WT	L TRACK CURRENT LIMITER - DOUBLE LIVE EN	130.95	790576133669
TLL-RIGHT-2-1A-BK	L TRACK CURRENT LIMITER - DOUBLE LIVE EN	130.95	790576133485
TLL-RIGHT-2-1A-BN	L TRACK CURRENT LIMITER - DOUBLE LIVE EN	132.95	790576133508
TLL-RIGHT-2-1A-DB	L TRACK CURRENT LIMITER - DOUBLE LIVE EN	132.95	790576147086
TLL-RIGHT-2-1A-WT	L TRACK CURRENT LIMITER - DOUBLE LIVE EN	130.95	790576133492
TLL-RIGHT-2-2A-BK	L TRACK CURRENT LIMITER - DOUBLE LIVE EN	130.95	790576133553
TLL-RIGHT-2-2A-BN	L TRACK CURRENT LIMITER - DOUBLE LIVE EN	132.95	790576133539
TLL-RIGHT-2-2A-DB	L TRACK CURRENT LIMITER - DOUBLE LIVE EN	132.95	790576147093
TLL-RIGHT-2-2A-WT	L TRACK CURRENT LIMITER - DOUBLE LIVE EN	130.95	790576133546
TLL-RIGHT-2-5A-BK	L TRACK CURRENT LIMITER - DOUBLE LIVE EN	130.95	790576133560

Material	Description	2011 DN	UPC Code
TLL-RIGHT-2-5A-BN	L TRACK CURRENT LIMITER - DOUBLE LIVE EN	132.95	790576133584
TLL-RIGHT-2-5A-DB	L TRACK CURRENT LIMITER - DOUBLE LIVE EN	132.95	790576147109
TLL-RIGHT-2-5A-WT	L TRACK CURRENT LIMITER - DOUBLE LIVE EN	130.95	790576133577
TLL-RIGHT-2-7A-BK	L TRACK CURRENT LIMITER - DOUBLE LIVE EN	130.95	790576133607
TLL-RIGHT-2-7A-BN	L TRACK CURRENT LIMITER - DOUBLE LIVE EN	132.95	790576133621
TLL-RIGHT-2-7A-DB	L TRACK CURRENT LIMITER - DOUBLE LIVE EN	132.95	790576147116
TLL-RIGHT-2-7A-WT	L TRACK CURRENT LIMITER - DOUBLE LIVE EN	130.95	790576133614
WS-110-BN	WALL SCONCE 120V 60W ROUND BACK PLATE	54.50	790576114408
WS-110-CH	WALL SCONCE 120V 60W ROUND BACK PLATE	54.50	790576114415
WS110-G100WT/BN	BLANC SINGLE SHADE WALL SCONCE - 120V 60	81.50	790576157382
WS110-G100WT/CH	BLANC SINGLE SHADE WALL SCONCE - 120V 60	81.50	790576157399
WS110-G101WT/BN	LINEN SINGLE SHADE WALL SCONCE - 120V 60	91.50	790576157405
WS110-G101WT/CH	LINEN SINGLE SHADE WALL SCONCE - 120V 60	91.50	790576157412
WS110-G102WT/BN	WAVES SINGLE SHADE WALL SCONCE - 120V 60	91.50	790576157429
WS110-G102WT/CH	WAVES SINGLE SHADE WALL SCONCE - 120V 60	91.50	790576157436
WS110-G103WT/BN	RIPPLE SINGLE SHADE WALL SCONCE - 120V 6	87.50	790576157443
WS110-G103WT/CH	RIPPLE SINGLE SHADE WALL SCONCE - 120V 6	87.50	790576157450
WS-120-BN	WALL SCONCE 120V 60W ROUND BACK PLATE	54.50	790576114422
WS-120-CH	WALL SCONCE 120V 60W ROUND BACK PLATE	54.50	790576114439
WS120-G100WT/BN	BLANC SINGLE SHADE WALL SCONCE - 120V 60	81.50	790576157467
WS120-G100WT/CH	BLANC SINGLE SHADE WALL SCONCE - 120V 60	81.50	790576157474
WS120-G101WT/BN	LINEN SINGLE SHADE WALL SCONCE - 120V 60	91.50	790576157481
WS120-G101WT/CH	LINEN SINGLE SHADE WALL SCONCE - 120V 60	91.50	790576157498
WS120-G102WT/BN	WAVES SINGLE SHADE WALL SCONCE - 120V 60	91.50	790576157504
WS120-G102WT/CH	WAVES SINGLE SHADE WALL SCONCE - 120V 60	91.50	790576157511
WS120-G103WT/BN	RIPPLE SINGLE SHADE WALL SCONCE - 120V 6	87.50	790576157528
WS120-G103WT/CH	RIPPLE SINGLE SHADE WALL SCONCE - 120V 6	87.50	790576157535
WS-130-BN	WALL SCONCE 120V 60W ROUND BACK PLATE	54.50	790576114446
WS-130-CH	WALL SCONCE 120V 60W ROUND BACK PLATE	54.50	790576114453
WS130-G100WT/BN	BLANC SINGLE SHADE WALL SCONCE - 120V 60	81.50	790576157542
WS130-G100WT/CH	BLANC SINGLE SHADE WALL SCONCE - 120V 60	81.50	790576157559
WS130-G101WT/BN	LINEN SINGLE SHADE WALL SCONCE - 120V 60	91.50	790576157566
WS130-G101WT/CH	LINEN SINGLE SHADE WALL SCONCE - 120V 60	91.50	790576157573
WS130-G102WT/BN	WAVES SINGLE SHADE WALL SCONCE - 120V 60	91.50	790576157580
WS130-G102WT/CH	WAVES SINGLE SHADE WALL SCONCE - 120V 60	91.50	790576157597
WS130-G103WT/BN	RIPPLE SINGLE SHADE WALL SCONCE - 120V 6	87.50	790576157603
WS130-G103WT/CH	RIPPLE SINGLE SHADE WALL SCONCE - 120V 6	87.50	790576157610
WS-230-BN	WALL SCONCE 120V 2X60W ROUND BACK PLATE	65.50	790576114460
WS-230-CH	WALL SCONCE 120V 2X60W ROUND BACK PLATE	65.50	790576115078
WS230-G100WT/BN	BLANC DOUBLE SHADE WALL SCONCE - 120V 60	119.50	790576157627
WS230-G100WT/CH	BLANC DOUBLE SHADE WALL SCONCE - 120V 60	119.50	790576157634
WS230-G101WT/BN	LINEN DOUBLE SHADE WALL SCONCE - 120V 60	139.50	790576157641
WS230-G101WT/CH	LINEN DOUBLE SHADE WALL SCONCE - 120V 60	139.50	790576157658
WS230-G102WT/BN	WAVES DOUBLE SHADE WALL SCONCE - 120V 60	139.50	790576157665
WS230-G102WT/CH	WAVES DOUBLE SHADE WALL SCONCE - 120V 60	139.50	790576157672
WS230-G103WT/BN	RIPPLE DOUBLE SHADE WALL SCONCE - 120V 6	131.50	790576157689
WS230-G103WT/CH	RIPPLE DOUBLE SHADE WALL SCONCE - 120V 6	131.50	790576157696
WS52-G512AM/BN	JILL WALL SCONCE - 12V 50W	98.95	790576157702
WS52-G512AM/CH	JILL WALL SCONCE - 12V 50W	98.95	790576157719
WS52-G512BL/BN	JILL WALL SCONCE - 12V 50W	98.95	790576157726

Material	Description	2011 DN	UPC Code
WS52-G512BL/CH	JILL WALL SCONCE - 12V 50W	98.95	790576157733
WS52-G512GR/BN	JILL WALL SCONCE - 12V 50W	98.95	790576157740
WS52-G512GR/CH	JILL WALL SCONCE - 12V 50W	98.95	790576157757
WS52-G512RD/BN	JILL WALL SCONCE - 12V 50W	98.95	790576157764
WS52-G512RD/CH	JILL WALL SCONCE - 12V 50W	98.95	790576157771
WS52-G512WT/BN	JILL WALL SCONCE - 12V 50W	98.95	790576157788
WS52-G512WT/CH	JILL WALL SCONCE - 12V 50W	98.95	790576157795
WS52-G515AM/BN	FIORE WALL SCONCE - 12V 50W	138.95	790576157801
WS52-G515AM/CH	FIORE WALL SCONCE - 12V 50W	138.95	790576157818
WS52-G515MF/BN	FIORE WALL SCONCE - 12V 50W	138.95	790576157849
WS52-G515MF/CH	FIORE WALL SCONCE - 12V 50W	138.95	790576157856
WS52-G518DIC/BN	EDEN WALL SCONCE - 12V 50W	153.95	790576157863
WS52-G518DIC/CH	EDEN WALL SCONCE - 12V 50W	153.95	790576157870
WS52-G524AM/BN	SARAH WALL SCONCE - 12V 50W	102.95	790576157924
WS52-G524AM/CH	SARAH WALL SCONCE - 12V 50W	102.95	790576157931
WS52-G524LB/BN	SARAH WALL SCONCE - 12V 50W	102.95	790576157948
WS52-G524LB/CH	SARAH WALL SCONCE - 12V 50W	102.95	790576157955
WS52-G524TQ/BN	SARAH WALL SCONCE - 12V 50W	102.95	790576157962
WS52-G524TQ/CH	SARAH WALL SCONCE - 12V 50W	102.95	790576157979
WS52-G524WT/BN	SARAH WALL SCONCE - 12V 50W	102.95	790576157986
WS52-G524WT/CH	SARAH WALL SCONCE - 12V 50W	102.95	790576157993
WS52-G530GR/BN	COUTURE WALL SCONCE - 12V 50W	193.95	790576158006
WS52-G530GR/CH	COUTURE WALL SCONCE - 12V 50W	193.95	790576158013
WS52-G530MC/BN	COUTURE WALL SCONCE - 12V 50W	193.95	790576158020
WS52-G530MC/CH	COUTURE WALL SCONCE - 12V 50W	193.95	790576158037
WS52-G536BL/BN	WALL SCONCE - 12V 50W	138.95	790576195728
WS52-G536BL/CH	WALL SCONCE - 12V 50W	138.95	790576195735
WS52-G546DIC/BN	AMBROSIA WALL SCONCE - 12V 50W	173.95	790576158082
WS52-G546DIC/CH	AMBROSIA WALL SCONCE - 12V 50W	173.95	790576158099
WS52-G559DIC/BN	MICHA WALL SCONCE- 12V 50W	113.95	790576178622
WS52-G559DIC/CH	MICHA WALL SCONCE- 12V 50W	113.95	790576178660
WS52-G559GL/BN	MICHA WALL SCONCE- 12V 50W	113.95	790576173818
WS52-G559GL/CH	MICHA WALL SCONCE- 12V 50W	113.95	790576173849
WS52-G559MR/BN	MICHA WALL SCONCE- 12V 50W	113.95	790576172828
WS52-G559MR/CH	MICHA WALL SCONCE- 12V 50W	113.95	790576172866
WS52-G599BL/BN	RHEA WALL SCONCE- 12V 50W	123.95	790576176079
WS52-G599BL/CH	RHEA WALL SCONCE- 12V 50W	123.95	790576176123
WS52-G599UM/BN	RHEA WALL SCONCE- 12V 50W	123.95	790576178134
WS52-G599UM/CH	RHEA WALL SCONCE- 12V 50W	123.95	790576178172
WS52-G599WT/BN	RHEA WALL SCONCE- 12V 50W	123.95	790576177168
WS52-G599WT/CH	RHEA WALL SCONCE- 12V 50W	123.95	790576177199
WS53-G513AM/BN	ELLA WALL SCONCE - 12V 50W	78.50	790576158129
WS53-G513AM/CH	ELLA WALL SCONCE - 12V 50W	78.50	790576158136
WS53-G513WT/BN	ELLA WALL SCONCE - 12V 50W	78.50	790576158143
WS53-G513WT/CH	ELLA WALL SCONCE - 12V 50W	78.50	790576158150
WS54-G513AM/BN	ELLA WALL SCONCE - 12V 50W	107.95	790576158167
WS54-G513AM/CH	ELLA WALL SCONCE - 12V 50W	107.95	790576158174
WS54-G513WT/BN	ELLA WALL SCONCE - 12V 50W	107.95	790576158181
WS54-G513WT/CH	ELLA WALL SCONCE - 12V 50W	107.95	790576158198
WS55-G512AM/BN	JILL WALL SCONCE - 120V 50W	69.50	790576158204

Material	Description	2011 DN	UPC Code
WS55-G512AM/CH	JILL WALL SCONCE - 120V 50W	69.50	790576158211
WS55-G512BL/BN	JILL WALL SCONCE - 120V 50W	69.50	790576158228
WS55-G512BL/CH	JILL WALL SCONCE - 120V 50W	69.50	790576158235
WS55-G512GR/BN	JILL WALL SCONCE - 120V 50W	69.50	790576158242
WS55-G512GR/CH	JILL WALL SCONCE - 120V 50W	69.50	790576158259
WS55-G512RD/BN	JILL WALL SCONCE - 120V 50W	69.50	790576158266
WS55-G512RD/CH	JILL WALL SCONCE - 120V 50W	69.50	790576158273
WS55-G512WT/BN	JILL WALL SCONCE - 120V 50W	69.50	790576158280
WS55-G512WT/CH	JILL WALL SCONCE - 120V 50W	69.50	790576158297
WS55-G515AM/BN	FIORE WALL SCONCE - 120V 50W	109.50	790576158303
WS55-G515AM/CH	FIORE WALL SCONCE - 120V 50W	109.50	790576158310
WS55-G515MF/BN	FIORE WALL SCONCE - 120V 50W	109.50	790576158341
WS55-G515MF/CH	FIORE WALL SCONCE - 120V 50W	109.50	790576158358
WS55-G518DIC/BN	EDEN WALL SCONCE - 120V 50W	124.50	790576158365
WS55-G518DIC/CH	EDEN WALL SCONCE - 120V 50W	124.50	790576158372
WS55-G524AM/BN	SARAH WALL SCONCE - 120V 50W	73.50	790576158426
WS55-G524AM/CH	SARAH WALL SCONCE - 120V 50W	73.50	790576158433
WS55-G524LB/BN	SARAH WALL SCONCE - 120V 50W	73.50	790576158440
WS55-G524LB/CH	SARAH WALL SCONCE - 120V 50W	73.50	790576158457
WS55-G524TQ/BN	SARAH WALL SCONCE - 120V 50W	73.50	790576158464
WS55-G524TQ/CH	SARAH WALL SCONCE - 120V 50W	73.50	790576158471
WS55-G524WT/BN	SARAH WALL SCONCE - 120V 50W	73.50	790576158488
WS55-G524WT/CH	SARAH WALL SCONCE - 120V 50W	73.50	790576158495
WS55-G530GR/BN	COUTURE WALL SCONCE - 120V 50W	164.50	790576158501
WS55-G530MC/CH	COUTURE WALL SCONCE - 120V 50W	164.50	790576158532
WS55-G536BL/BN	WALL SCONCE - 120V 50W	109.50	790576195766
WS55-G536BL/CH	WALL SCONCE - 120V 50W	109.50	790576195773
WS55-G546DIC/BN	AMBROSIA WALL SCONCE - 120V 50W	144.50	790576158587
WS55-G546DIC/CH	AMBROSIA WALL SCONCE - 120V 50W	144.50	790576158594
WS55-G559DIC/BN	MICHA WALL SCONCE - 120V 50W	84.50	790576178769
WS55-G559DIC/CH	MICHA WALL SCONCE - 120V 50W	84.50	790576178790
WS55-G559GL/BN	MICHA WALL SCONCE - 120V 50W	84.50	790576173931
WS55-G559GL/CH	MICHA WALL SCONCE - 120V 50W	84.50	790576173962
WS55-G559MR/BN	MICHA WALL SCONCE - 120V 50W	84.50	790576172989
WS55-G559MR/CH	MICHA WALL SCONCE - 120V 50W	84.50	790576173023
WS55-G599BL/BN	RHEA WALL SCONCE - 120V 50W	94.50	790576176246
WS55-G599BL/CH	RHEA WALL SCONCE - 120V 50W	94.50	790576176277
WS55-G599UM/BN	RHEA WALL SCONCE - 120V 50W	94.50	790576178295
WS55-G599UM/CH	RHEA WALL SCONCE - 120V 50W	94.50	790576178325
WS55-G599WT/BN	RHEA WALL SCONCE - 120V 50W	94.50	790576177281
WS55-G599WT/CH	RHEA WALL SCONCE - 120V 50W	94.50	790576177311
WS56-G512AM/BN	JILL WALL SCONCE - 120V 50W	69.50	790576158624
WS56-G512AM/CH	JILL WALL SCONCE - 120V 50W	69.50	790576158631
WS56-G512BL/BN	JILL WALL SCONCE - 120V 50W	69.50	790576158648
WS56-G512BL/CH	JILL WALL SCONCE - 120V 50W	69.50	790576158655
WS56-G512GR/BN	JILL WALL SCONCE - 120V 50W	69.50	790576158662
WS56-G512GR/CH	JILL WALL SCONCE - 120V 50W	69.50	790576158679
WS56-G512RD/BN	JILL WALL SCONCE - 120V 50W	69.50	790576158686
WS56-G512RD/CH	JILL WALL SCONCE - 120V 50W	69.50	790576158693
WS56-G512WT/BN	JILL WALL SCONCE - 120V 50W	69.50	790576158709

Material	Description	2011 DN	UPC Code
WS56-G512WT/CH	JILL WALL SCONCE - 120V 50W	69.50	790576158716
WS56-G515AM/BN	FIORE WALL SCONCE - 120V 50W	109.50	790576158723
WS56-G515AM/CH	FIORE WALL SCONCE - 120V 50W	109.50	790576158730
WS56-G515MF/BN	FIORE WALL SCONCE - 120V 50W	109.50	790576158761
WS56-G515MF/CH	FIORE WALL SCONCE - 120V 50W	109.50	790576158778
WS56-G518DIC/BN	EDEN WALL SCONCE - 120V 50W	124.50	790576158785
WS56-G518DIC/CH	EDEN WALL SCONCE - 120V 50W	124.50	790576158792
WS56-G524AM/BN	SARAH WALL SCONCE - 120V 50W	73.50	790576158846
WS56-G524AM/CH	SARAH WALL SCONCE - 120V 50W	73.50	790576158853
WS56-G524LB/BN	SARAH WALL SCONCE - 120V 50W	73.50	790576158860
WS56-G524LB/CH	SARAH WALL SCONCE - 120V 50W	73.50	790576158877
WS56-G524TQ/BN	SARAH WALL SCONCE - 120V 50W	73.50	790576158884
WS56-G524TQ/CH	SARAH WALL SCONCE - 120V 50W	73.50	790576158891
WS56-G524WT/BN	SARAH WALL SCONCE - 120V 50W	73.50	790576158907
WS56-G524WT/CH	SARAH WALL SCONCE - 120V 50W	73.50	790576158914
WS56-G530GR/BN	COUTURE WALL SCONCE - 120V 50W	164.50	790576158921
WS56-G530MC/CH	COUTURE WALL SCONCE - 120V 50W	164.50	790576158952
WS56-G536BL/BN	WALL SCONCE - 120V 50W	109.50	790576195742
WS56-G536BL/CH	WALL SCONCE - 120V 50W	109.50	790576195759
WS56-G546DIC/BN	AMBROSIA WALL SCONCE - 120V 50W	144.50	790576175775
WS56-G546DIC/CH	AMBROSIA WALL SCONCE - 120V 50W	144.50	790576159010
WS56-G559DIC/BN	MICHA WALL SCONCE - 120V 50W	84.50	790576178707
WS56-G559DIC/CH	MICHA WALL SCONCE - 120V 50W	84.50	790576178738
WS56-G559GL/BN	MICHA WALL SCONCE - 120V 50W	84.50	790576173870
WS56-G559GL/CH	MICHA WALL SCONCE - 120V 50W	84.50	790576173900
WS56-G559MR/BN	MICHA WALL SCONCE - 120V 50W	84.50	790576172903
WS56-G559MR/CH	MICHA WALL SCONCE - 120V 50W	84.50	790576172941
WS56-G599BL/BN	RHEA WALL SCONCE - 120V 50W	94.50	790576176161
WS56-G599BL/CH	RHEA WALL SCONCE - 120V 50W	94.50	790576176208
WS56-G599UM/BN	RHEA WALL SCONCE - 120V 50W	94.50	790576178219
WS56-G599UM/CH	RHEA WALL SCONCE - 120V 50W	94.50	790576178257
WS56-G599WT/BN	RHEA WALL SCONCE - 120V 50W	94.50	790576177229
WS56-G599WT/CH	RHEA WALL SCONCE - 120V 50W	94.50	790576177250
WS61-G611AM/BN	APRIL WALL SCONCE - 12V 50W	101.95	790576159041
WS61-G611AM/CH	APRIL WALL SCONCE - 12V 50W	101.95	790576159058
WS61-G611BL/BN	APRIL WALL SCONCE - 12V 50W	101.95	790576159065
WS61-G611BL/CH	APRIL WALL SCONCE - 12V 50W	101.95	790576159072
WS61-G611RD/BN	APRIL WALL SCONCE - 12V 50W	101.95	790576159089
WS61-G611RD/CH	APRIL WALL SCONCE - 12V 50W	101.95	790576159096
WS61-G611WT/BN	APRIL WALL SCONCE - 12V 50W	101.95	790576159102
WS61-G611WT/CH	APRIL WALL SCONCE - 12V 50W	101.95	790576159119
WS61-G613AM/BN	LAUREN WALL SCONCE - 12V 50W	101.95	790576159126
WS61-G613AM/CH	LAUREN WALL SCONCE - 12V 50W	101.95	790576159133
WS61-G613BL/BN	LAUREN WALL SCONCE - 12V 50W	101.95	790576159140
WS61-G613BL/CH	LAUREN WALL SCONCE - 12V 50W	101.95	790576159157
WS61-G613RD/BN	LAUREN WALL SCONCE - 12V 50W	101.95	790576159164
WS61-G613RD/CH	LAUREN WALL SCONCE - 12V 50W	101.95	790576159171
WS61-G613WT/BN	LAUREN WALL SCONCE - 12V 50W	101.95	790576159188
WS61-G613WT/CH	LAUREN WALL SCONCE - 12V 50W	101.95	790576159195
WS61-G614BG/BN	PASSION WALL SCONCE - 12V 50W	156.50	790576159201



Material	Description	2011 DN	UPC Code
WS61-G614BG/CH	PASSION WALL SCONCE - 12V 50W	156.50	790576159218
WS61-G614MF/BN	PASSION WALL SCONCE - 12V 50W	156.50	790576159225
WS61-G614MF/CH	PASSION WALL SCONCE - 12V 50W	156.50	790576159232
WS61-G614YR/BN	PASSION WALL SCONCE - 12V 50W	156.50	790576159249
WS61-G614YR/CH	PASSION WALL SCONCE - 12V 50W	156.50	790576159256
WS61-G615BG/BN	TRISTA WALL SCONCE - 12V 50W	143.95	790576159263
WS61-G615BG/CH	TRISTA WALL SCONCE - 12V 50W	143.95	790576159270
WS61-G620BL/BN	LAVA WALL SCONCE - 12V 50W	173.95	790576174556
WS61-G620BL/CH	LAVA WALL SCONCE - 12V 50W	173.95	790576174587
WS61-G620BR/BN	LAVA WALL SCONCE - 12V 50W	173.95	790576174297
WS61-G620BR/CH	LAVA WALL SCONCE - 12V 50W	173.95	790576174327
WS61-G630AM/BN	WALL SCONCE - 12V 50W	123.95	790576195889
WS61-G630AM/CH	WALL SCONCE - 12V 50W	123.95	790576195896
WS61-G630GR/BN	WALL SCONCE - 12V 50W	123.95	790576195865
WS61-G630GR/CH	WALL SCONCE - 12V 50W	123.95	790576195872
WS61-G630OR/BN	WALL SCONCE - 12V 50W	123.95	790576195841
WS61-G630OR/CH	WALL SCONCE - 12V 50W	123.95	790576195858
WS-CFL32-WT	WALL SCONCE BACKPLATE CFL 32W	54.50	790576112787
WS-INC60-WT	WALL SCONCE BACKPLATE INCANDESCENT 60W	35.50	790576112794
WS-K130-BN/WT	WALL SCONCE KIT WS-130-BN WITH G100-WT	62.95	790576118130
WS-K130-CH/WT	WALL SCONCE KIT WS-130-CH WITH G100-WT	62.95	790576118147
WS-K230-BN/WT	WALL SCONCE KIT WS-230-BN WITH G100-WT	94.50	790576118154
WS-K230-CH/WT	WALL SCONCE KIT WS-230-CH WITH G100-WT	94.50	790576118161
WS-MR52-BN	LOW VOLTAGE WALL SCONCE BRACKET	73.95	790576138299
WS-MR52-CH	LOW VOLTAGE WALL SCONCE BRACKET	73.95	790576064765
WS-MR53H-BN	LINE VOLTAGE WALL SCONCE BRACKET	44.50	790576138244
WS-MR53H-CH	LINE VOLTAGE WALL SCONCE BRACKET	44.50	790576069425
WS-MR54-BN	LOW VOLTAGE WALL SCONCE BRACKET	73.95	790576138312
WS-MR54-CH	LOW VOLTAGE WALL SCONCE BRACKET	73.95	790576065007
WS-MR55H-BN	LINE VOLTAGE WALL SCONCE BRACKET	44.50	790576138268
WS-MR55H-CH	LINE VOLTAGE WALL SCONCE BRACKET	44.50	790576069401
WS-MR56H-BN	LINE VOLTAGE WALL SCONCE BRACKET	44.50	790576138251
WS-MR56H-CH	LINE VOLTAGE WALL SCONCE BRACKET	44.50	790576069357
WS-MR61-BN	LOW VOLTAGE WALL SCONCE BRACKET	73.95	790576138305
WS-MR61-CH	LOW VOLTAGE WALL SCONCE BRACKET	73.95	790576064888
X12-BK	EXT. ROD FOR LOW VOLT TRACK HEADS 12IN	14.50	790576035765
X12-DB	EXT. ROD FOR LOW VOLT TRACK HEADS 12IN	16.50	790576140575
X12-PT	EXT. ROD FOR LOW VOLT TRACK HEADS 12IN	16.50	790576087689
X12-WT	EXT. ROD FOR LOW VOLT TRACK HEADS 12IN	14.50	790576035772
X18-BK	EXT. ROD FOR LOW VOLT TRACK HEADS 18IN	15.50	790576010748
X18-DB	EXT. ROD FOR LOW VOLT TRACK HEADS 18IN	17.50	790576140582
X18-PT	EXT. ROD FOR LOW VOLT TRACK HEADS 18IN	17.50	790576087696
X18-WT	EXT. ROD FOR LOW VOLT TRACK HEADS 18IN	15.50	790576011677
X24-BK	EXT. ROD FOR LOW VOLT TRACK HEADS 24IN	16.50	790576011769
X24-DB	EXT. ROD FOR LOW VOLT TRACK HEADS 24IN	18.50	790576140599
X24-PT	EXT. ROD FOR LOW VOLT TRACK HEADS 24IN	18.50	790576087702
X24-WT	EXT. ROD FOR LOW VOLT TRACK HEADS 24IN	16.50	790576012490
X36-BK	EXT. ROD FOR LOW VOLT TRACK HEADS 36IN	18.50	790576012551
X36-DB	EXT. ROD FOR LOW VOLT TRACK HEADS 36IN	20.50	790576140605
X36-PT	EXT. ROD FOR LOW VOLT TRACK HEADS 36IN	20.50	790576087719

Material	Description	2011 DN	UPC Code
X36-WT	EXT. ROD FOR LOW VOLT TRACK HEADS 36IN	18.50	790576013329
X48-BK	EXT. ROD FOR LOW VOLT TRACK HEADS 48IN	20.50	790576013367
X48-DB	EXT. ROD FOR LOW VOLT TRACK HEADS 48IN	22.50	790576140612
X48-PT	EXT. ROD FOR LOW VOLT TRACK HEADS 48IN	22.50	790576087726
X48-WT	EXT. ROD FOR LOW VOLT TRACK HEADS 48IN	20.50	790576013954
X6-BK	EXT. ROD FOR LOW VOLT TRACK HEADS 6IN	13.50	790576035734
X6-DB	EXT. ROD FOR LOW VOLT TRACK HEADS 6IN	15.50	790576140568
X6-PT	EXT. ROD FOR LOW VOLT TRACK HEADS 6IN	15.50	790576087672
X6-WT	EXT. ROD FOR LOW VOLT TRACK HEADS 6IN	13.50	790576035741
X72-BK	EXT. ROD FOR LOW VOLT TRACK HEADS 72IN	40.50	
X72-DB	EXT. ROD FOR LOW VOLT TRACK HEADS 72IN	44.95	
X72-PT	EXT. ROD FOR LOW VOLT TRACK HEADS 72IN	44.95	
X72-WT	EXT. ROD FOR LOW VOLT TRACK HEADS 72IN	40.50	
X96-BK	EXT. ROD FOR LOW VOLT TRACK HEADS 96IN	44.95	
X96-DB	EXT. ROD FOR LOW VOLT TRACK HEADS 96IN	48.95	
X96-PT	EXT. ROD FOR LOW VOLT TRACK HEADS 96IN	48.95	
X96-WT	EXT. ROD FOR LOW VOLT TRACK HEADS 96IN	44.95	
XF-10-12V-CL	XENON FESTOON LAMP 10W 12V CLEAR	2.50	790576160436
XF-10-12V-FR	XENON FESTOON LAMP 10W 12V FROSTED	2.50	790576160443
XF-10-24V-CL	XENON FESTOON LAMP 10W 24V CLEAR	2.50	790576160467
XF-10-24V-FR	XENON FESTOON LAMP 10W 24V FROSTED	2.50	790576160450
XF-5-12V-CL	XENON FESTOON LAMP 5W 12V CLEAR	2.50	790576160474
XF-5-12V-FR	XENON FESTOON LAMP 5W 12V FROSTED	2.50	790576160504
XF-5-24V-CL	XENON FESTOON LAMP 5W 24V CLEAR	2.50	790576160481
XF-5-24V-FR	XENON FESTOON LAMP 5W 24V FROSTED	2.50	790576160498
XI-BK	ROD COUPLERS FOR X-EXTENSIONS	1.95	790576014067
XI-DB	ROD COUPLERS FOR X-EXTENSIONS	1.95	790576140629
XI-PT	ROD COUPLERS FOR X-EXTENSIONS	1.95	790576087733
XI-WT	ROD COUPLERS FOR X-EXTENSIONS	1.95	790576014074
XL-10-12V-CL	LAMP XENON RIGID LOOP 10W 12V CLEAR	2.50	790576018553
XL-10-12V-FR	LAMP XENON RIGID LOOP 10W 12V FROSTED	2.50	790576018560
XL-10-24V-CL	LAMP XENON RIGID LOOP 10W 24V CLEAR	2.50	790576018577
XL-10-24V-FR	LAMP XENON RIGID LOOP 10W 24V FROSTED	2.50	790576018584
XL-5-12V-CL	LAMP XENON RIGID LOOP 5W 12V CL	2.50	790576018515
XL-5-12V-FR	LAMP XENON RIGID LOOP 5W 12V FR	2.50	790576018522
XL-5-24V-CL	LAMP XENON RIGID LOOP 5W 24V CL	2.50	790576018539
XL-5-24V-FR	LAMP XENON RIGID LOOP 5W 24V FR	2.50	790576018546
G515-BW	G500 SERIES-BLUE/WHITE DOME GLASS SHADE	56.95	790576054360
G520-OE	G500 SERIES-OPAL ETCH DOME GLASS SHADE	49.95	790576080086
G521-OE	G500 SERIES-OPAL ETCH CONE GLASS SHADE	59.95	790576080093
G545-DIC	G500 SERIES-DICHROIC DOME GLASS SHADE	89.95	790576117102
G547-FR	G547-FR GLASS	49.95	790576125213
G557-WT	G500 SERIES GLASS SHADE	59.95	790576140742
G617-BG	G600 SERIES-BLU/GRN TRUMPET GLASS SHADE	74.95	790576104492
G618-BL	G600 SERIES-BLUE BELL GLASS SHADE	79.95	790576104454
G618-GR	G600 SERIES-GREEN BELL GLASS SHADE	79.95	790576104461
G618-OR	G600 SERIES-ORANGE BELL GLASS SHADE	79.95	790576104485
G618-PR	G600 SERIES-PURPLE BELL GLASS SHADE	79.95	790576104447

Material	Description	2011 DN	UPC Code
G721-AU	QC - PENDANT GLASS SHADE #721	79.95	790576137933
G721-RD	QC - PENDANT GLASS SHADE #721	79.95	790576138664
G912-AY	G900 SERIES-AMETHYST OVAL GLASS SHADE	36.95	790576080062
G912-CL	G900 SERIES-CLEAR OVAL GLASS SHADE	36.95	790576080024
G912-GL	G900 SERIES-GOLD OVAL GLASS SHADE	36.95	790576080031
G912-TQ	G900 SERIES-TURQUOISE OVAL GLASS SHADE	36.95	790576080055
G913-RD	G900 SERIES-RED FLUTE GLASS SHADE	74.95	790576105376
G916-FR	QC - PENDANT SHADE	57.95	790576138756
G925-AB	G900 SERIES-AMB/BLU BOTTLE GLASS SHADE	72.95	790576114392
G925-AM	G900 SERIES-AMBER BOTTLE GLASS SHADE	72.95	790576104560
G931-CL	G900 SERIES-CLEAR CONE CRYSTALSHADE	94.95	790576114217
G936-RD	G936-RD GLASS	49.95	790576125107
G937-BL	G937-BL	109.95	790576125374
G937-YW	G937-YW	109.95	790576125381
HM1-515BW/DB	FIORE PENDANT FOR FLEXRAIL1 - 120V 50W B	111.90	790576154688
HM1-515BW/PT	FIORE PENDANT FOR FLEXRAIL1 - 120V 50W B	111.90	790576154695
HM1-520OE/DB	CAELUM PENDANT FOR FLEXRAIL1 - 120V 50W	104.90	790576154787
HM1-520OE/PT	CAELUM PENDANT FOR FLEXRAIL1 - 120V 50W	104.90	790576154794
HM1-521OE/DB	ETHER PENDANT FOR FLEXRAIL1 - 120V 50W B	114.90	790576154800
HM1-521OE/PT	ETHER PENDANT FOR FLEXRAIL1 - 120V 50W B	114.90	790576154817
HM1-545DIC/PT	ATLANTIS PENDANT FOR FLEXRAIL1 - 120V 50	144.90	790576155012
HM1-546DIC/DB	AMBROSIA PENDANT FOR FLEXRAIL1 - 120V 50	144.90	790576155029
HM1-547FR/DB	VIDA PENDANT FOR FLEXRAIL1 - 120V 50W BI	104.90	790576155043
HM1-547FR/PT	VIDA PENDANT FOR FLEXRAIL1 - 120V 50W BI	104.90	790576155050
HM1-557WT/DB	CHARM PENDANT FOR FLEXRAIL1 - 120V 50W B	114.90	790576155128
HM1-557WT/PT	CHARM PENDANT FOR FLEXRAIL1 - 120V 50W B	114.90	790576155135
HM-515BW/BZ	FLEXRAIL2 LINE VOLT XENON PENDANT	114.90	790576175577
HM-515BW/PT	FLEXRAIL2 LINE VOLT XENON PENDANT	114.90	790576175607
HM-520OE/BZ	FLEXRAIL2 LINE VOLT XENON PENDANT	107.90	790576177885
HM-520OE/PT	FLEXRAIL2 LINE VOLT XENON PENDANT	107.90	790576177922
HM-521OE/BZ	FLEXRAIL2 LINE VOLT XENON PENDANT	117.90	790576178264
HM-521OE/PT	FLEXRAIL2 LINE VOLT XENON PENDANT	117.90	790576178301
HM-545DIC/BZ	FLEXRAIL2 LINE VOLT XENON PENDANT	147.90	790576181035
HM-545DIC/PT	FLEXRAIL2 LINE VOLT XENON PENDANT	147.90	790576181080
HM-547FR/BZ	FLEXRAIL2 LINE VOLT XENON PENDANT	107.90	790576175812
HM-547FR/PT	FLEXRAIL2 LINE VOLT XENON PENDANT	107.90	790576175850
HM-557WT/BZ	FLEXRAIL2 LINE VOLT XENON PENDANT	117.90	790576177472
HM-557WT/PT	FLEXRAIL2 LINE VOLT XENON PENDANT	117.90	790576177519
HTK-515MF/BN	FIORE PENDANT FOR H SERIES TRACK - 120V	106.90	790576155432
HTK-515MF/DB	FIORE PENDANT FOR H SERIES TRACK - 120V	106.90	790576155425
HTK-520OE/BN	CAELUM PENDANT FOR H SERIES TRACK - 120V	99.90	790576155517
HTK-520OE/DB	CAELUM PENDANT FOR H SERIES TRACK - 120V	99.90	790576155500
HTK-521OE/BN	ETHER PENDANT FOR H SERIES TRACK - 120V	109.90	790576155531
HTK-521OE/DB	ETHER PENDANT FOR H SERIES TRACK - 120V	109.90	790576155524
HTK-545DIC/BN	ATLANTIS PENDANT FOR H SERIES TRACK - 12	139.90	790576155739
HTK-545DIC/DB	ATLANTIS PENDANT FOR H SERIES TRACK - 12	139.90	790576155722
HTK-547FR/BN	VIDA PENDANT FOR H SERIES TRACK - 120V 5	99.90	790576155777
HTK-547FR/DB	VIDA PENDANT FOR H SERIES TRACK - 120V 5	99.90	790576155760
HTK-557WT/BN	CHARM PENDANT FOR H SERIES TRACK - 120V	109.90	790576155852
HTK-557WT/DB	CHARM PENDANT FOR H SERIES TRACK - 120V	109.90	790576155845

Material	Description	2011 DN	UPC Code
JTK-515AM/BN	FIORE PENDANT FOR J SERIES TRACK - 120V	106.90	790576156118
JTK-515AM/DB	FIORE PENDANT FOR J SERIES TRACK - 120V	106.90	790576156101
JTK-520OE/BN	CAELUM PENDANT FOR J SERIES TRACK - 120V	99.90	790576156231
JTK-520OE/DB	CAELUM PENDANT FOR J SERIES TRACK - 120V	99.90	790576156224
JTK-521OE/BN	ETHER PENDANT FOR J SERIES TRACK - 120V	109.90	790576156255
JTK-521OE/DB	ETHER PENDANT FOR J SERIES TRACK - 120V	109.90	790576156248
JTK-545DIC/BN	ATLANTIS PENDANT FOR J SERIES TRACK - 12	139.90	790576156453
JTK-545DIC/DB	ATLANTIS PENDANT FOR J SERIES TRACK - 12	139.90	790576156446
JTK-547FR/BN	VIDA PENDANT FOR J SERIES TRACK - 120V 5	99.90	790576156491
JTK-547FR/DB	VIDA PENDANT FOR J SERIES TRACK - 120V 5	99.90	790576156484
JTK-557WT/BN	CHARM PENDANT FOR J SERIES TRACK - 120V	109.90	790576156576
JTK-557WT/DB	CHARM PENDANT FOR J SERIES TRACK - 120V	109.90	790576156569
LTK-515BW/BN	FIORE PENDANT FOR L SERIES TRACK - 120V	106.90	790576156859
LTK-515BW/DB	FIORE PENDANT FOR L SERIES TRACK - 120V	106.90	790576156842
LTK-520OE/BN	CAELUM PENDANT FOR L SERIES TRACK - 120V	99.90	790576156958
LTK-520OE/DB	CAELUM PENDANT FOR L SERIES TRACK - 120V	99.90	790576156941
LTK-521OE/BN	ETHER PENDANT FOR L SERIES TRACK - 120V	109.90	790576156972
LTK-521OE/DB	ETHER PENDANT FOR L SERIES TRACK - 120V	109.90	790576156965
LTK-545DIC/DB	ATLANTIS PENDANT FOR L SERIES TRACK - 12	139.90	790576157160
LTK-546DIC/BN	AMBROSIA PENDANT FOR L SERIES TRACK - 12	139.90	790576157191
LTK-547FR/BN	VIDA PENDANT FOR L SERIES TRACK - 120V 5	99.90	790576157214
LTK-547FR/DB	VIDA PENDANT FOR L SERIES TRACK - 120V 5	99.90	790576157207
LTK-557WT/BN	CHARM PENDANT FOR L SERIES TRACK - 120V	109.90	790576157290
LTK-557WT/DB	CHARM PENDANT FOR L SERIES TRACK - 120V	109.90	790576157283
MP-515-BW/BN	QUICK CONNECT SHADE W/ MONOPOINT CANOPY	120.45	790576179698
MP-515-BW/CH	QUICK CONNECT SHADE W/ MONOPOINT CANOPY	118.45	790576179704
MP-515-BW/DB	QUICK CONNECT SHADE W/ MONOPOINT CANOPY	120.45	790576179711
MP-520-OE/BN	QUICK CONNECT SHADE W/ MONOPOINT CANOPY	113.45	790576179759
MP-520-OE/CH	QUICK CONNECT SHADE W/ MONOPOINT CANOPY	111.45	790576179766
MP-520-OE/DB	QUICK CONNECT SHADE W/ MONOPOINT CANOPY	113.45	790576179773
MP-521-OE/BN	QUICK CONNECT SHADE W/ MONOPOINT CANOPY	123.45	790576179810
MP-521-OE/CH	QUICK CONNECT SHADE W/ MONOPOINT CANOPY	121.45	790576179827
MP-521-OE/DB	QUICK CONNECT SHADE W/ MONOPOINT CANOPY	123.45	790576179834
MP-545-DIC/BN	QUICK CONNECT SHADE W/ MONOPOINT CANOPY	153.45	790576181141
MP-545-DIC/CH	QUICK CONNECT SHADE W/ MONOPOINT CANOPY	151.45	790576181196
MP-545-DIC/DB	QUICK CONNECT SHADE W/ MONOPOINT CANOPY	153.45	790576181240
MP-547-FR/BN	QUICK CONNECT SHADE W/ MONOPOINT CANOPY	113.45	790576175898
MP-547-FR/CH	QUICK CONNECT SHADE W/ MONOPOINT CANOPY	111.45	790576175935
MP-547-FR/DB	QUICK CONNECT SHADE W/ MONOPOINT CANOPY	113.45	790576175973
MP-557-WT/BN	QUICK CONNECT SHADE W/ MONOPOINT CANOPY	98.70	790576182155
MP-557-WT/CH	QUICK CONNECT SHADE W/ MONOPOINT CANOPY	96.70	790576182209
MP-557-WT/DB	QUICK CONNECT SHADE W/ MONOPOINT CANOPY	98.70	790576182254
MP-617-BG/BN	QUICK CONNECT SHADE W/ MONOPOINT CANOPY	138.45	790576172750
MP-617-BG/CH	QUICK CONNECT SHADE W/ MONOPOINT CANOPY	136.45	790576172798
MP-617-BG/DB	QUICK CONNECT SHADE W/ MONOPOINT CANOPY	138.45	790576172835
MP-618-BL/BN	QUICK CONNECT SHADE W/ MONOPOINT CANOPY	143.45	790576173108
MP-618-BL/CH	QUICK CONNECT SHADE W/ MONOPOINT CANOPY	141.45	790576173139
MP-618-BL/DB	QUICK CONNECT SHADE W/ MONOPOINT CANOPY	143.45	790576173160
MP-618-GR/BN	QUICK CONNECT SHADE W/ MONOPOINT CANOPY	143.45	790576173207
MP-618-GR/CH	QUICK CONNECT SHADE W/ MONOPOINT CANOPY	141.45	790576173245

Material	Description	2011 DN	UPC Code
MP-618-GR/DB	QUICK CONNECT SHADE W/ MONOPOINT CANOPY	143.45	790576173283
MP-618-OR/BN	QUICK CONNECT SHADE W/ MONOPOINT CANOPY	143.45	790576173320
MP-618-OR/CH	QUICK CONNECT SHADE W/ MONOPOINT CANOPY	141.45	790576173368
MP-618-OR/DB	QUICK CONNECT SHADE W/ MONOPOINT CANOPY	143.45	790576173405
MP-618-PR/BN	QUICK CONNECT SHADE W/ MONOPOINT CANOPY	143.45	790576173443
MP-618-PR/CH	QUICK CONNECT SHADE W/ MONOPOINT CANOPY	141.45	790576173481
MP-618-PR/DB	QUICK CONNECT SHADE W/ MONOPOINT CANOPY	143.45	790576173511
MP-717-FR/BN	QUICK CONNECT SHADE W/ MONOPOINT CANOPY	98.70	790576174907
MP-717-FR/CH	QUICK CONNECT SHADE W/ MONOPOINT CANOPY	96.70	790576174938
MP-717-FR/DB	QUICK CONNECT SHADE W/ MONOPOINT CANOPY	98.70	790576174969
MP-721-AU/BN	QUICK CONNECT SHADE W/ MONOPOINT CANOPY	154.45	790576175171
MP-721-AU/CH	QUICK CONNECT SHADE W/ MONOPOINT CANOPY	152.45	790576175195
MP-721-AU/DB	QUICK CONNECT SHADE W/ MONOPOINT CANOPY	154.45	790576175218
MP-721-RD/BN	QUICK CONNECT SHADE W/ MONOPOINT CANOPY	154.45	790576175249
MP-721-RD/CH	QUICK CONNECT SHADE W/ MONOPOINT CANOPY	152.45	790576175270
MP-721-RD/DB	QUICK CONNECT SHADE W/ MONOPOINT CANOPY	154.45	790576175294
MP-912-AY/BN	QUICK CONNECT SHADE W/ MONOPOINT CANOPY	103.15	790576175317
MP-912-AY/CH	QUICK CONNECT SHADE W/ MONOPOINT CANOPY	101.15	790576175348
MP-912-AY/DB	QUICK CONNECT SHADE W/ MONOPOINT CANOPY	103.15	790576175386
MP-912-CL/BN	QUICK CONNECT SHADE W/ MONOPOINT CANOPY	103.15	790576175522
MP-912-CL/CH	QUICK CONNECT SHADE W/ MONOPOINT CANOPY	101.15	790576175553
MP-912-CL/DB	QUICK CONNECT SHADE W/ MONOPOINT CANOPY	103.15	790576175584
MP-912-GL/BN	QUICK CONNECT SHADE W/ MONOPOINT CANOPY	103.15	790576175614
MP-912-GL/CH	QUICK CONNECT SHADE W/ MONOPOINT CANOPY	101.15	790576175638
MP-912-GL/DB	QUICK CONNECT SHADE W/ MONOPOINT CANOPY	103.15	790576175652
MP-912-TQ/BN	QUICK CONNECT SHADE W/ MONOPOINT CANOPY	103.15	790576175683
MP-912-TQ/CH	QUICK CONNECT SHADE W/ MONOPOINT CANOPY	101.15	790576175720
MP-912-TQ/DB	QUICK CONNECT SHADE W/ MONOPOINT CANOPY	103.15	790576175768
MP-913-RD/BN	QUICK CONNECT SHADE W/ MONOPOINT CANOPY	142.45	790576176154
MP-913-RD/CH	QUICK CONNECT SHADE W/ MONOPOINT CANOPY	140.45	790576176192
MP-913-RD/DB	QUICK CONNECT SHADE W/ MONOPOINT CANOPY	142.45	790576176239
MP-916-FR/BN	QUICK CONNECT SHADE W/ MONOPOINT CANOPY	125.45	790576176598
MP-916-FR/CH	QUICK CONNECT SHADE W/ MONOPOINT CANOPY	123.45	790576176628
MP-916-FR/DB	QUICK CONNECT SHADE W/ MONOPOINT CANOPY	125.45	790576176666
MP-925-AB/BN	QUICK CONNECT SHADE W/ MONOPOINT CANOPY	140.45	790576177366
MP-925-AB/CH	QUICK CONNECT SHADE W/ MONOPOINT CANOPY	138.45	790576177403
MP-925-AB/DB	QUICK CONNECT SHADE W/ MONOPOINT CANOPY	140.45	790576177441
MP-925-AM/BN	QUICK CONNECT SHADE W/ MONOPOINT CANOPY	140.45	790576177489
MP-925-AM/CH	QUICK CONNECT SHADE W/ MONOPOINT CANOPY	138.45	790576177526
MP-925-AM/DB	QUICK CONNECT SHADE W/ MONOPOINT CANOPY	140.45	790576177557
MP-931-CL/BN	QUICK CONNECT SHADE W/ MONOPOINT CANOPY	162.45	790576177694
MP-931-CL/CH	QUICK CONNECT SHADE W/ MONOPOINT CANOPY	160.45	790576177731
MP-931-CL/DB	QUICK CONNECT SHADE W/ MONOPOINT CANOPY	162.45	790576177779
MP-936-RD/BN	QUICK CONNECT SHADE W/ MONOPOINT CANOPY	117.45	790576178332
MP-936-RD/CH	QUICK CONNECT SHADE W/ MONOPOINT CANOPY	115.45	790576178356
MP-936-RD/DB	QUICK CONNECT SHADE W/ MONOPOINT CANOPY	117.45	790576178370
MP-937-BL/BN	QUICK CONNECT SHADE W/ MONOPOINT CANOPY	177.45	790576178417
MP-937-BL/CH	QUICK CONNECT SHADE W/ MONOPOINT CANOPY	175.45	790576178455
MP-937-BL/DB	QUICK CONNECT SHADE W/ MONOPOINT CANOPY	177.45	790576178493
MP-937-YW/BN	QUICK CONNECT SHADE W/ MONOPOINT CANOPY	177.45	790576178530

Material	Description	2011 DN	UPC Code
MP-937-YW/CH	QUICK CONNECT SHADE W/ MONOPOINT CANOPY	175.45	790576178578
MP-937-YW/DB	QUICK CONNECT SHADE W/ MONOPOINT CANOPY	177.45	790576178615
MP-LED515-BW/BN	QUICK CONNECT SHADE W/ LED MONOPOINT CANOPY	186.9	790576175829
MP-LED515-BW/CH	QUICK CONNECT SHADE W/ LED MONOPOINT CANOPY	184.9	790576175874
MP-LED515-BW/DB	QUICK CONNECT SHADE W/ LED MONOPOINT CANOPY	186.9	790576175911
MP-LED520-OE/BN	QUICK CONNECT SHADE W/ LED MONOPOINT CANOPY	179.9	790576178141
MP-LED520-OE/CH	QUICK CONNECT SHADE W/ LED MONOPOINT CANOPY	177.9	790576178189
MP-LED520-OE/DB	QUICK CONNECT SHADE W/ LED MONOPOINT CANOPY	179.9	790576178226
MP-LED521-OE/BN	QUICK CONNECT SHADE W/ LED MONOPOINT CANOPY	189.9	790576178516
MP-LED521-OE/CH	QUICK CONNECT SHADE W/ LED MONOPOINT CANOPY	187.9	790576178554
MP-LED521-OE/DB	QUICK CONNECT SHADE W/ LED MONOPOINT CANOPY	189.9	790576178592
MP-LED545-DIC/BN	QUICK CONNECT SHADE W/ LED MONOPOINT CANOPY	219.9	790576175324
MP-LED545-DIC/CH	QUICK CONNECT SHADE W/ LED MONOPOINT CANOPY	217.9	790576175355
MP-LED545-DIC/DB	QUICK CONNECT SHADE W/ LED MONOPOINT CANOPY	219.9	790576175393
MP-LED547-FR/BN	QUICK CONNECT SHADE W/ LED MONOPOINT CANOPY	179.9	790576176130
MP-LED547-FR/CH	QUICK CONNECT SHADE W/ LED MONOPOINT CANOPY	177.9	790576176178
MP-LED547-FR/DB	QUICK CONNECT SHADE W/ LED MONOPOINT CANOPY	179.9	790576176215
MP-LED557-WT/BN	QUICK CONNECT SHADE W/ LED MONOPOINT CANOPY	189.9	790576177755
MP-LED557-WT/CH	QUICK CONNECT SHADE W/ LED MONOPOINT CANOPY	187.9	790576177793
MP-LED557-WT/DB	QUICK CONNECT SHADE W/ LED MONOPOINT CANOPY	189.9	790576177830
QP515-BW/BN	FIORE PENDANT WITH QP-501 SOCKET SETS	81.70	790576148526
QP515-BW/CH	FIORE PENDANT WITH QP-501 SOCKET SETS	81.70	790576148533
QP515-BW/DB	FIORE PENDANT WITH QP-501 SOCKET SETS	81.70	790576148540
QP520-OE/BN	CAELUM PENDANT WITH QP-501 SOCKET SETS	74.70	790576148670
QP520-OE/CH	CAELUM PENDANT WITH QP-501 SOCKET SETS	74.70	790576148687
QP520-OE/DB	CAELUM PENDANT WITH QP-501 SOCKET SETS	74.70	790576148694
QP521-OE/BN	ETHER PENDANT WITH QP-501 SOCKET SETS	84.70	790576148700
QP521-OE/CH	ETHER PENDANT WITH QP-501 SOCKET SETS	84.70	790576148717
QP521-OE/DB	ETHER PENDANT WITH QP-501 SOCKET SETS	84.70	790576148724
QP545-DIC/BN	ATLANTIS PENDANT WITH QP-501 SOCKET SETS	114.70	790576148977
QP545-DIC/CH	ATLANTIS PENDANT WITH QP-501 SOCKET SETS	114.70	790576148984
QP545-DIC/DB	ATLANTIS PENDANT WITH QP-501 SOCKET SETS	114.70	790576148991
QP547-FR/BN	VIDA PENDANT WITH QP-501 SOCKET SETS	74.70	790576149035
QP547-FR/CH	VIDA PENDANT WITH QP-501 SOCKET SETS	74.70	790576149042
QP547-FR/DB	VIDA PENDANT WITH QP-501 SOCKET SETS	74.70	790576149059
QP557-WT/BN	CHARM PENDANT WITH QP-501 SOCKET SETS	84.70	790576149127
QP557-WT/CH	CHARM PENDANT WITH QP-501 SOCKET SETS	84.70	790576149134
QP557-WT/DB	CHARM PENDANT WITH QP-501 SOCKET SETS	84.70	790576149141
QP617-BG/BN	NATURAL PENDANT WITH QP-601 SOCKET SETS	99.70	790576149639
QP617-BG/CH	NATURAL PENDANT WITH QP-601 SOCKET SETS	99.70	790576149646
QP617-BG/DB	NATURAL PENDANT WITH QP-601 SOCKET SETS	99.70	790576149653
QP618-BL/BN	FRUIT PENDANT WITH QP-601 SOCKET SETS	104.70	790576149721
QP618-BL/CH	FRUIT PENDANT WITH QP-601 SOCKET SETS	104.70	790576149738
QP618-BL/DB	FRUIT PENDANT WITH QP-601 SOCKET SETS	104.70	790576149745
QP618-GR/BN	FRUIT PENDANT WITH QP-601 SOCKET SETS	104.70	790576149752
QP618-GR/CH	FRUIT PENDANT WITH QP-601 SOCKET SETS	104.70	790576149769
QP618-GR/DB	FRUIT PENDANT WITH QP-601 SOCKET SETS	104.70	790576149776
QP618-OR/BN	FRUIT PENDANT WITH QP-601 SOCKET SETS	104.70	790576149783
QP618-OR/CH	FRUIT PENDANT WITH QP-601 SOCKET SETS	104.70	790576149790
QP618-OR/DB	FRUIT PENDANT WITH QP-601 SOCKET SETS	104.70	790576149806

Material	Description	2011 DN	UPC Code
QP618-PR/BN	FRUIT PENDANT WITH QP-601 SOCKET SETS	104.70	790576149813
QP618-PR/CH	FRUIT PENDANT WITH QP-601 SOCKET SETS	104.70	790576149820
QP618-PR/DB	FRUIT PENDANT WITH QP-601 SOCKET SETS	104.70	790576149837
QP-701-BN	QC SOCKET SET-G700 SERIES BP-50-12V	35.75	790576136462
QP-701-CH	QC SOCKET SET-G700 SERIES BP-50-12V	35.75	790576056593
QP-701-DB	QC SOCKET SET-G700 SERIES BP-50-12V	35.75	790576110417
QP-701X12-BN	QC-PENDANT SOCKET SET 12 FT CORD	55.75	790576159492
QP-701X12-CH	QC-PENDANT SOCKET SET 12 FT CORD	55.75	790576088075
QP-701X12-DB	QC-PENDANT SOCKET SET 12 FT CORD	55.75	790576122007
QP721-AU/BN	AYURVEDA PENDANT WITH QP-701 SOCKET SETS	115.70	790576150086
QP721-AU/CH	AYURVEDA PENDANT WITH QP-701 SOCKET SETS	115.70	790576150093
QP721-AU/DB	AYURVEDA PENDANT WITH QP-701 SOCKET SETS	115.70	790576150109
QP721-RD/BN	AYURVEDA PENDANT WITH QP-701 SOCKET SETS	115.70	790576150116
QP721-RD/CH	AYURVEDA PENDANT WITH QP-701 SOCKET SETS	115.70	790576150123
QP721-RD/DB	AYURVEDA PENDANT WITH QP-701 SOCKET SETS	115.70	790576150130
QP-901-BN	QC SOCKET SET-G900 SERIES MR16G	27.45	790576136479
QP-901-CH	QC SOCKET SET-G900 SERIES MR16G	27.45	790576079486
QP-901-DB	QC SOCKET SET-G900 SERIES MR16G	27.45	790576110431
QP-901X12-BN	QC-PENDANT SOCKET SET 12 FT CORD	46.45	790576159508
QP-901X12-CH	QC-PENDANT SOCKET SET 12 FT CORD	46.45	790576088136
QP-901X12-DB	QC-PENDANT SOCKET SET 12 FT CORD	46.45	790576123509
QP912-AY/BN	MINNI PENDANT WITH QP-901 SOCKET SETS	64.40	790576150147
QP912-AY/CH	MINNI PENDANT WITH QP-901 SOCKET SETS	64.40	790576150154
QP912-AY/DB	MINNI PENDANT WITH QP-901 SOCKET SETS	64.40	790576150161
QP912-CL/BN	MINNI PENDANT WITH QP-901 SOCKET SETS	64.40	790576150208
QP912-CL/CH	MINNI PENDANT WITH QP-901 SOCKET SETS	64.40	790576150215
QP912-CL/DB	MINNI PENDANT WITH QP-901 SOCKET SETS	64.40	790576150222
QP912-GL/BN	MINNI PENDANT WITH QP-901 SOCKET SETS	64.40	790576150239
QP912-GL/CH	MINNI PENDANT WITH QP-901 SOCKET SETS	64.40	790576150246
QP912-GL/DB	MINNI PENDANT WITH QP-901 SOCKET SETS	64.40	790576150253
QP912-TQ/BN	MINNI PENDANT WITH QP-901 SOCKET SETS	64.40	790576150260
QP912-TQ/CH	MINNI PENDANT WITH QP-901 SOCKET SETS	64.40	790576150277
QP912-TQ/DB	MINNI PENDANT WITH QP-901 SOCKET SETS	64.40	790576150284
QP913-RD/BN	INGO PENDANT WITH QP-902 SOCKET SETS	103.70	790576150383
QP913-RD/CH	INGO PENDANT WITH QP-902 SOCKET SETS	103.70	790576150390
QP913-RD/DB	INGO PENDANT WITH QP-902 SOCKET SETS	103.70	790576150406
QP916-FR/BN	CLARITY PENDANT WITH QP-902 SOCKET SETS	86.70	790576150505
QP916-FR/CH	CLARITY PENDANT WITH QP-902 SOCKET SETS	86.70	790576150512
QP916-FR/DB	CLARITY PENDANT WITH QP-902 SOCKET SETS	86.70	790576150529
QP925-AB/BN	INO PENDANT WITH QP-902 SOCKET SETS	101.70	790576150710
QP925-AB/CH	INO PENDANT WITH QP-902 SOCKET SETS	101.70	790576150727
QP925-AB/DB	INO PENDANT WITH QP-902 SOCKET SETS	101.70	790576150734
QP925-AM/BN	INO PENDANT WITH QP-902 SOCKET SETS	101.70	790576150741
QP925-AM/CH	INO PENDANT WITH QP-902 SOCKET SETS	101.70	790576150758
QP925-AM/DB	INO PENDANT WITH QP-902 SOCKET SETS	101.70	790576150765
QP931-CL/BN	CARINA PENDANT WITH QP-902 SOCKET SETS	123.70	790576150802
QP931-CL/CH	CARINA PENDANT WITH QP-902 SOCKET SETS	123.70	790576150819
QP931-CL/DB	CARINA PENDANT WITH QP-902 SOCKET SETS	123.70	790576150826
QP936-RD/BN	FLAVA PENDANT WITH QP-902 SOCKET SETS	78.70	790576150987
QP936-RD/CH	FLAVA PENDANT WITH QP-902 SOCKET SETS	78.70	790576150994

Material	Description	2011 DN	UPC Code
QP936-RD/DB	FLAVA PENDANT WITH QP-902 SOCKET SETS	78.70	790576151007
QP937-BL/BN	ETE PENDANT WITH QP-902 SOCKET SETS	138.70	790576151014
QP937-BL/CH	ETE PENDANT WITH QP-902 SOCKET SETS	138.70	790576151021
QP937-BL/DB	ETE PENDANT WITH QP-902 SOCKET SETS	138.70	790576151038
QP937-YW/BN	ETE PENDANT WITH QP-902 SOCKET SETS	138.70	790576151045
QP937-YW/CH	ETE PENDANT WITH QP-902 SOCKET SETS	138.70	790576151052
QP937-YW/DB	ETE PENDANT WITH QP-902 SOCKET SETS	138.70	790576151069
QP-LED515-BW/BN	LEDING QUICK CONNECT SOCKET SET W/ GLASS SHADE	148.9	790576175713
QP-LED515-BW/CH	LEDING QUICK CONNECT SOCKET SET W/ GLASS SHADE	148.9	790576175751
QP-LED515-BW/DB	LEDING QUICK CONNECT SOCKET SET W/ GLASS SHADE	148.9	790576175782
QP-LED520-OE/BN	LEDING QUICK CONNECT SOCKET SET W/ GLASS SHADE	141.9	790576179780
QP-LED520-OE/CH	LEDING QUICK CONNECT SOCKET SET W/ GLASS SHADE	141.9	790576179797
QP-LED520-OE/DB	LEDING QUICK CONNECT SOCKET SET W/ GLASS SHADE	141.9	790576179803
QP-LED521-OE/BN	LEDING QUICK CONNECT SOCKET SET W/ GLASS SHADE	151.9	790576178394
QP-LED521-OE/CH	LEDING QUICK CONNECT SOCKET SET W/ GLASS SHADE	151.9	790576178431
QP-LED521-OE/DB	LEDING QUICK CONNECT SOCKET SET W/ GLASS SHADE	151.9	790576178479
QP-LED545-DIC/BN	LEDING QUICK CONNECT SOCKET SET W/ GLASS SHADE	181.9	790576181295
QP-LED545-DIC/CH	LEDING QUICK CONNECT SOCKET SET W/ GLASS SHADE	181.9	790576181349
QP-LED545-DIC/DB	LEDING QUICK CONNECT SOCKET SET W/ GLASS SHADE	181.9	790576181394
QP-LED547-FR/BN	LEDING QUICK CONNECT SOCKET SET W/ GLASS SHADE	141.9	790576176017
QP-LED547-FR/CH	LEDING QUICK CONNECT SOCKET SET W/ GLASS SHADE	141.9	790576176055
QP-LED547-FR/DB	LEDING QUICK CONNECT SOCKET SET W/ GLASS SHADE	141.9	790576176093
QP-LED557-WT/BN	LEDING QUICK CONNECT SOCKET SET W/ GLASS SHADE	151.9	790576177649
QP-LED557-WT/CH	LEDING QUICK CONNECT SOCKET SET W/ GLASS SHADE	151.9	790576177687
QP-LED557-WT/DB	LEDING QUICK CONNECT SOCKET SET W/ GLASS SHADE	151.9	790576177717
WS52-G515BL/BN	FIORE WALL SCONCE - 12V 50W	124.95	790576157825
WS52-G515BL/CH	FIORE WALL SCONCE - 12V 50W	124.95	790576157832
WS52-G520OE/BN	CAELUM WALL SCONCE - 12V 50W	117.95	790576159355
WS52-G520OE/CH	CAELUM WALL SCONCE - 12V 50W	117.95	790576159362
WS52-G521OE/BN	ETHER WALL SCONCE - 12V 50W	127.95	790576159379
WS52-G521OE/CH	ETHER WALL SCONCE - 12V 50W	127.95	790576159386
WS52-G545DIC/BN	ATLANTIS WALL SCONCE - 12V 50W	157.95	790576158068
WS52-G545DIC/CH	ATLANTIS WALL SCONCE - 12V 50W	157.95	790576158075
WS52-G557WT/BN	CHARM WALL SCONCE - 12V 50W	127.95	790576158105
WS52-G557WT/CH	CHARM WALL SCONCE - 12V 50W	127.95	790576158112
WS55-G515BL/BN	FIORE WALL SCONCE - 120V 50W	97.75	790576158327
WS55-G515BL/CH	FIORE WALL SCONCE - 120V 50W	97.75	790576158334
WS55-G520OE/BN	CAELUM WALL SCONCE - 120V 50W	90.75	790576159478
WS55-G520OE/CH	CAELUM WALL SCONCE - 120V 50W	90.75	790576159409
WS55-G521OE/BN	ETHER WALL SCONCE - 120V 50W	100.75	790576159416
WS55-G521OE/CH	ETHER WALL SCONCE - 120V 50W	100.75	790576159423
WS55-G545DIC/BN	ATLANTIS WALL SCONCE - 120V 50W	130.75	790576158563
WS55-G545DIC/CH	ATLANTIS WALL SCONCE - 120V 50W	130.75	790576158570
WS55-G557WT/BN	CHARM WALL SCONCE - 120V 50W	100.75	790576158600
WS55-G557WT/CH	CHARM WALL SCONCE - 120V 50W	100.75	790576158617
WS56-G515BL/BN	FIORE WALL SCONCE - 120V 50W	97.75	790576158747
WS56-G515BL/CH	FIORE WALL SCONCE - 120V 50W	97.75	790576158754
WS56-G520OE/BN	CAELUM WALL SCONCE - 120V 50W	90.75	790576159430
WS56-G520OE/CH	CAELUM WALL SCONCE - 120V 50W	90.75	790576159447
WS56-G521OE/BN	ETHER WALL SCONCE - 120V 50W	100.75	790576159454



<b>Material</b>	<b>Description</b>	<b>2011 DN</b>	<b>UPC Code</b>
WS56-G521OE/CH	ETHER WALL SCONCE - 120V 50W	100.75	790576159461
WS56-G545DIC/BN	ATLANTIS WALL SCONCE - 120V 50W	130.75	790576175430
WS56-G545DIC/CH	ATLANTIS WALL SCONCE - 120V 50W	130.75	790576158990
WS56-G557WT/BN	CHARM WALL SCONCE - 120V 50W	100.75	790576159027
WS56-G557WT/CH	CHARM WALL SCONCE - 120V 50W	100.75	790576159034
WS61-G617BG/BN	NATURAL WALL SCONCE - 12V 50W	142.95	790576159287
WS61-G617BG/CH	NATURAL WALL SCONCE - 12V 50W	142.95	790576159294