



LUMARK

METALUX

SURE-LITES

ALL-PRO

HALO COMMERCIAL

CONSUMER PRODUCTS

Off The Shelf

Product Catalog

“Off The Shelf”

Cooper Lighting’s “Off The Shelf” stock program is designed to keep our most popular industrial, fluorescent, recessed, commercial and residential HID lighting products flowing both on and off your shelf! The “Off The Shelf” program teams high quality products with service benefits and merchandising support that is second to none. With “Off The Shelf,” growing your stock business has never been easier!



LUMARK

Metalux

SURE-LITES

ALL-PRO

HALO
Commercial

COOPER Lighting New Product Innovation P. 2



LUMARK – Commercial & Industrial Indoor/Outdoor

Wall Mounts P. 8
 Floodlights P. 20
 Quartz Floodlights P. 32
 Dusk-to-Dawn P. 33
 Area/Roadway P. 34
 Industrials P. 36
 Worklights P. 44



METALUX – Commercial & Industrial Fluorescent

Parabolics P. 47
 Recessed Static Troffers P. 48
 Surface Wraparounds P. 49
 Commercial Striplites P. 50
 Commercial Retrofit Kits P. 51
 High-Bay Industrials P. 52
 Industrial Vaportites P. 55



SURE-LITES – Exit & Emergency

Emergency Lighting P. 58
 Remotes P. 63
 Exit/Emergency Lighting P. 64
 Chicago Code P. 68



ALL-PRO – Recessed Lighting

5", 6" LED Recessed Retrofit P. 76
 3" Incandescent P. 78
 4" Incandescent P. 82
 4" Low Voltage P. 84
 5" Incandescent P. 86
 6" Incandescent P. 91
 6" Compact Fluorescent P. 117



Halo Commercial – Recessed Lighting

4", 6" PAR Directional P. 121
 6" Horizontal Compact Fluorescent P. 122
 6" Vertical Compact Fluorescent P. 124
 6" Vertical Incandescent and Integrated PAR Lamps P. 125
 6" Vertical Metal Halide P. 126
 8" Horizontal Compact Fluorescent P. 127
 8" Horizontal Compact Fluorescent P. 128
 8" Vertical Compact Fluorescent P. 129
 8" Vertical Incandescent and Integrated PAR Lamps P. 130



CONSUMER PRODUCTS – Security & Worklights

Worklights P. 132
 Motion Activated P. 139
 Quartz Floodlights P. 148
 Dusk-to-Dawn P. 149

Cooper Lighting New Product Innovation

Cooper Lighting's sustained level of success is attributed to a constant focus on meeting customer needs. With the shift towards methods of reducing energy use, Cooper Lighting continues to provide relevant, industry-leading solutions to challenging market needs. The Company's commitment to innovation, quality and value has resulted in an impressive line of award-winning patented product designs.



New Products

Lumark Crosstour LED Wall Pack Luminaire

Innovatively designed offering the industry's first universal all-in-one product platform, Crosstour LED Wall Pack provides solutions for wall, post, inverted and low-level installations. Available in scalable 30W, 20W or 10W models, the energy-efficient Crosstour features a unique low-profile design, tool-less installation, superior optical control and a rugged die-cast aluminum form. IP66 rated.

Metalux Commercial Retrofit Kit

The Metalux Commercial retrofit kit offers customers the ability to upgrade troffers or parabolics without the need to go above the plenum or remove the existing luminaire housing. Featuring Cooper Lighting's Advanced Retrofit Technology™, the kit has unique features, such as one-piece, tool-less reflectors and Ready-Set™, the industry's first patented captive and secure self-tapping screws, pre-wired ballast and assembly, no parts bag, and installation in under ten minutes. Save up to 60 percent energy over standard three- or four-lamp T12 or T8 luminaires.

Halo Commercial Downlights

Halo Commercial offers a broad line of recessed commercial downlights in 6" and 8" apertures, along with 4" and 6" PAR directional downlights. Halo Commercial offers high-quality, yet budget-conscious, downlighting with specification performance, and some of the highest efficiencies in commercial downlighting, which translates to savings in fewer fixtures and lower watts per square foot. The versatile housing frames work in both new and remodel construction, and feature the No-Fuss Bar Hanger system for ease of installation. Halo Commercial includes a versatile offering of open, lens and wall wash trims in a variety of standard finishes to complete any commercial lighting project.

Consumer Products LED Might-D-Light

The LED Might-D-Light and Might-D-Light Mini fold design allows convenient, easy storage. Integrated magnets which attach to most metals, and a hooking device allow for hands-free use. They are ideal for confined work areas or when portability is a must. Energy efficient solar powered LED motion activated security lighting requires no wiring and an easy-to-install lighting solution.

Cooper Lighting Commitment

Cooper Lighting is among the world's largest manufacturers of commercial, industrial, institutional, roadway and residential lighting fixtures. Metalux, Lumark, Sure-Lites, All-Pro and Halo Commercial are just a few of our contractor-preferred brands, trusted over the years for their quality and performance. More than any other lighting manufacturer, Cooper Lighting has aggressively invested in our state-of-the-art distribution and service network, LED technology and technically superior manufacturing facilities. Our vast, global system of dedicated resources ensures that the right products get to the right place at the right time.



Cooper Lighting LED Innovation Center

Cooper Lighting continues to make significant investments in key technology platforms. The Cooper Lighting LED Innovation Center located in Peachtree City, Georgia is a centralized resource for all global LED-based activities.



The SOURCE Training Facility

The Cooper Lighting SOURCE training facility sets the benchmark for lighting industry learning. The SOURCE provides the highest standards of professional lighting education and has been servicing lighting professionals for nearly twenty years.



Cooper Customer Center (C3)

www.cooper3.com

Experience a simple way to manage your Cooper operations and satisfy customers. Cooper Customer Center (C3) is the online solution designed to provide the information you need to make decisions. Access vital information for all Cooper divisions such as real-time product availability, net pricing, order status and tracking. C3 – simple, fast and accurate to save time and drive revenue.



Distribution Center Network

www.cooperlighting.com/documents/stockguide/stockguide.pdf

With thousands of lighting products located in our regional distribution centers, Cooper Lighting is your solutions provider for meeting demanding project deadlines. Our 24- to 48-hour shipping commitment on our most popular stock products ensures prompt product delivery to your branch location.

Electronic Data Interchange (EDI)

Reduce your transactional costs by leveraging Electronic Data Interchange (EDI). EDI capabilities include 810 Invoice, 820 EFT/Remittance Advice, 845 Into Stock Pricing, 850 Into Stock Purchase Order, 856 PO Acknowledge, 856 Advance Ship Notice and 997 Acknowledgement Notice.

Energy/Regulatory Compliancy

Cooper Lighting products are designed to meet stringent energy legislation and regulatory compliancy requirements, including Restriction of Hazardous Substances European Directive (ROHS) and the Energy Independence and Security Act.



ENERGY INDEPENDENCE
& SECURITY ACT (EISA)



LUMARK®

LUMARK combines craftsmanship and affordability in its full line of commercial high intensity discharge (HID) and energy-efficient LED products.

LUMARK has the experience and product line to properly illuminate complex applications, providing superior lighting for parking areas, site lighting, facade, landscape, pathways, security and other commercial applications.

From floodlighting to wall mount fixtures and area lighting, LUMARK answers difficult illumination problems with a wide range of quality products and superior technical support.



Area/Roadway



Wall Mount



Floodlighting



LED Technology and Reduced Energy Consumption



Crosstour LED



LED Wall-Pack (Glass Door)

Conservation of energy, expertise in design and rigorous reliability testing ensure superior luminaire performance. With advancements in LED technology, combined with Cooper Lighting's expertise in fixture and optical design, the Crosstour and Wal-Pak Series demonstrates that new technology saves energy without compromising performance.

Operating and maintenance cost of a lighting system are dramatically impacted by the specified lamp source and electrical system. Total system input watts and fixture operating life should be the driving considerations when addressing energy consumption and total cost of ownership. Energy savings increase when energy consumption is reduced and maintenance intervals are extended.

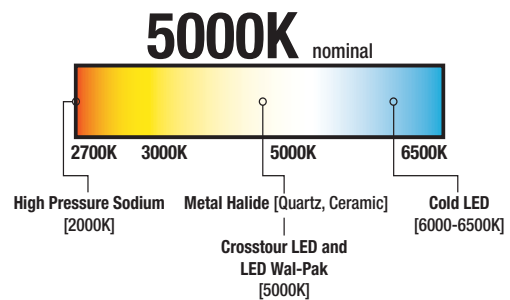

LED Technology

Light emitting diodes are solid state devices that offer uniform illumination, reliable long life, eco-friendly low maintenance and superior energy savings. Over 70% of the initial light output is maintained after 50,000 hours of operation. In application, an LED fixture can last up to six times longer than metal halide lamp sources.

Superior Illumination

Crosstour LED Wall Pack luminaires deliver up to 2240 lumens. Brilliant white 3500K or 5000K color temperature LEDs provide uniform white light similar to traditional metal halide light sources. Excellent color rendering, superior thermal management and optimized reflector technology make the Crosstour LED luminaire a superior performer.

LED and Metal Halide Light Distribution Comparison



Crosstour LED



Metal Halide Equivalent

NOTE: Typical mounting heights are 8'-12' (10W models) and 8'-25' (20W and 30W models). Simulation rendering using AGI32 Software.

Environmental Conservation



Tribute
(Full Cutoff)

Cooper Lighting builds on a long history of reliability to ensure superior luminaire performance. Leading industry developments in the advancement of LED technology, pulse start metal halide ballast efficiency and Dark Sky Compliant regulations comply with legislative requirements while meeting energy reduction needs.



Crosstour LED



LED Wall-Pack
(Full Cutoff Door)



Wally Cutoff
(Cutoff)



Impact Flood
w/visor (Cutoff)



ENERGY INDEPENDENCE
& SECURITY ACT (EISA)



Cooper Lighting is a lifetime member
of International Dark Sky Association.

Energy/Regulatory Compliancy

Cooper Lighting products are designed to meet stringent energy legislation and regulatory compliancy requirements including Restriction of Hazardous Substances European Directive (ROHS) and the Energy Independence and Security Act (EISA).

Dark Sky Compliant

In support of the continued effort of environmentally conscious lighting professionals and private organizations, like the International Dark Sky Association, Lumark outdoor lighting includes a number of lighting products and accessories specifically designed to control unwanted illumination. Check state and local legislation for Dark Sky compliance requirements and ordinances.

ALLOWABLE CANDELA	@ 90°	@ 80°
Full Cutoff	0	10%
Cutoff	2.5%	10%
Semi-Cutoff	5%	20%
Non-Cutoff	No Limit	No Limit

CROSSTOUR

LED Wall Pack

10W-30W LED

Applications

- Entrance • Pathway • Low Level
- Stairs • Recreational • Retail
- Security • Warehouse

Specifications

- Universal “all-in-one” product delivering energy-efficient optical control. Scalable low-profile form with tool-less features
- Ultimate versatility in application allows for wall/ surface, post/bollard, pathway/stairs, inverted or low-level installations
- Mounts to all standard 3-1/2" to 4" round and octagonal, 4" square, single gang and masonry junction boxes
- Up to 95% energy and maintenance savings. Years of maintenance-free use
- 8' - 25' mounting height
- 10, 20 or 30W models
- 5000K or 3500K (CCT) equal to metal halide bright warm color
- 10W models include a 120V LED driver with an operating temperature of -40°C to 40°C (-40°F to 104°F). 20W and 30W models universal 120-277V LED Driver with an operating temperature of -30°C to 40°C (-22°F to 104°F)
- Highly reflective anodized aluminum reflectors provide high-efficiency illumination
- Single-point, captive stainless steel hardware closure point
- Meets ADA requirements
- UL Listed and cUL certified for wet locations. IP66 Rated for ingress protection
- J-Box or conduit installation
- Approx. net weight 3.7 - 5.2 lbs. (1.7-2.36 kgs.)

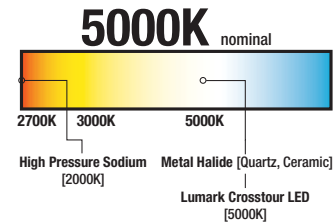
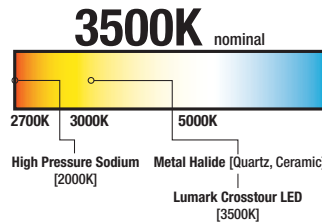
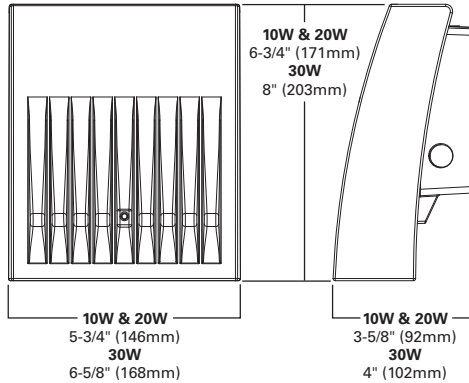

Delivered Lumens

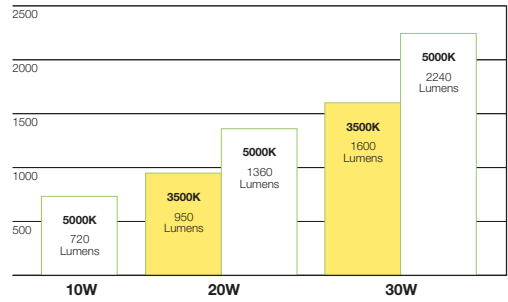

NOTE: Delivered lumens are estimated. See IES photometric files.



Wall or Surface Mount



Post or Bollard Mount



Pathway or Stairs



Inverted Mount

Accessories



Wire Guard (WG/XTOR)
Galvanized coated steel wire guard option prevents lens damage due to projected elements.



Scan this QR Code to learn more about Crosstour LED Wall Pack Luminaire



PATENTS PENDING



Ordering Information

Stock Number	UPC	Wattage	Source	Driver	LED Kelvin (CCT)	Housing Color	Photocontrol	HID Equivalent
10W Model								
XTOR1A	080083592456	10W	LED	120V	5000K	Carbon Bronze	--	70W
XTOR1A-PC1	080083592432	10W	LED	120V	5000K	Carbon Bronze	120V PC	70W
XTOR1A-WT	080083592449	10W	LED	120V	5000K	Summit White	--	70W
20W Model								
XTOR2A	080083592418	20W	LED	120-277V	5000K	Carbon Bronze	--	150W
XTOR2A-N	080083592357	20W	LED	120-277V	3500K	Carbon Bronze	--	150W
XTOR2A-PC1	080083592395	20W	LED	120-277V	5000K	Carbon Bronze	120V PC	150W
XTOR2A-WT	080083592401	20W	LED	120-277V	5000K	Summit White	--	150W
30W Model								
XTOR3A	080083592296	30W	LED	120-277V	5000K	Carbon Bronze	--	175W
XTOR3A-N	080083591831	30W	LED	120-277V	3500K	Carbon Bronze	--	175W
XTOR3A-PC1	080083592272	30W	LED	120-277V	5000K	Carbon Bronze	120V PC	175W
XTOR3A-WT	080083592289	30W	LED	120-277V	5000K	Summit White	--	175W

Energy Savings / Equivalency / Cross Reference Guide

Crosstour Series	Replacement Scale	HID Equivalency	Lamp System	HID Wattage	HID Rated Average Life (hrs)	Crosstour LED Wattage ²	Crosstour LED Life (hrs) ³	Energy Savings
XTOR1A	35W - 100W HID 32W CFL	Up to 70W MH	35W High Pressure Sodium	46	16,000	13W	50,000	72%
			50W Pulse Start Metal Halide	62	10,000			79%
			70W Pulse Start Metal Halide	95	12,000			86%
			32W Compact Fluorescent	36	16,000			64%
XTOR2A	100W - 175W HID 57W CFL	Up to 150W MH	100W Pulse Start Metal Halide	115	9,000	19W	50,000	83%
			150W Pulse Start Metal Halide	190	7,500			90%
			57W Compact Fluorescent	61	12,000			69%
XTOR3A	150W - 200W HID (2) 32W CFL	Up to 175W MH	175W Probe Start Metal Halide	210	7,500	30W	50,000	86%
			(2) 32W Compact Fluorescent	68	16,000			56%

NOTE: 1 Nominal lumens prior to optical and configuration losses based on 5000K CCT at 25°C ambient. 1A = 720 Lumens, 2A = 1360 Lumens, 3A = 2240 Lumens.
2 LED Wattage varies by Crosstour configuration and Kelvin CCT Color. **3** Hours of life based on 70% lumen maintenance.

WAL-PAK | Large Wall Pack

28-40W LED
100-400W High Pressure Sodium
150-400W Pulse Start Metal Halide

Applications

- Entrance • Parking Garage • Recreational • Retail • Security • Transportation • Warehouse

Specifications

- Single-point, captive stainless steel hardware closure point
- Highly reflective anodized aluminum reflectors provide high-efficiency illumination
- J-Box or conduit installation
- Surface mounts over junction box using fasteners (by others) or wired through tapped conduit openings
- UL Listed and cUL certified for wet locations. IP65 Rated for ingress protection
- Approx. net weight 32 - 42 lbs. (15-19 kgs.)
- Meets egress requirements

LED MODELS

- Up to 90% energy and maintenance savings
- Years of maintenance-free use
- 8' - 25' mounting height
- Equal to metal halide bright warm color
- 28W or 40W models
- Universal 120-277V LED Driver with an operating temperature of -30°C to 40°C (-22°F to 140°F)

- UL Listed to 40°C (104°F)

- ROHS Compliant

HID MODELS

- EISA Compliant
- Lamp included and available up to 400W HPS or MP
- Porcelain lamp socket
- Standard multi-tap (MT) ballast 120/208/240/277

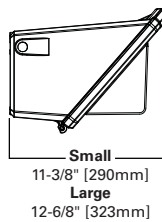
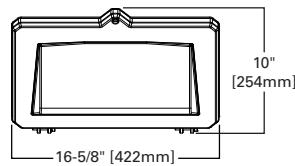

Borosilicate Glass Door

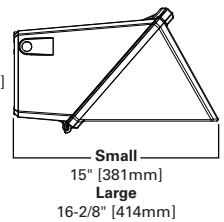
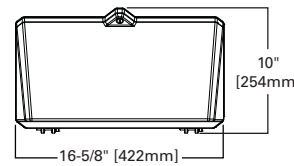

Full Cutoff Door

Photometry

Mounting Height	Footcandle Value for Isofootcandle lines				
	A	B	C	D	E
10'	11.25	4.50	2.25	1.13	.45
15'	5.00	2.00	1.00	.50	.20
20'	2.81	1.10	.56	.28	.11

Example of 150W (Glass) MP at 15 ft. mounting height, 12,500 lumen clear ED-17 lamp

Watts	Multiplier	
	HPS	MP
100	.26	-
150	.44	0.39
250	0.58	0.56
320	0.58	0.76
400	1.39	1.00

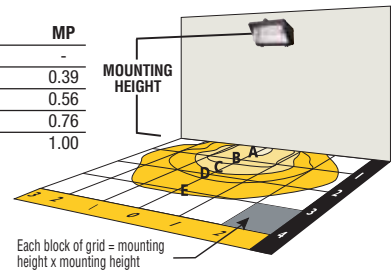

Accessories

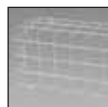

Wire Guard (WG/WPGL, WG/WPFC)

Galvanized coated steel wire guard option prevents lens damage due to projected elements. Use WPGL for borosilicate glass door. Use WPFC for full cutoff door.



VS/WPGL

Vandal shield for borosilicate glass lens door.







DARK SKY FCO
COMPLIANT Full Cutoff

In downlighting applications only.

Ordering Information

Stock Number	UPC	Wattage	Source	EISA Compliant	Lamp	Ballast/Driver	Lamp Included	Ballast Kit
Borosilicate Glass Door LED								
	WPL2A	080083557066	28W	LED	LED	120-277V Driver	LED	N/A
	WPL4A	080083557080	40W	LED	LED	120-277V Driver	LED	N/A
Borosilicate Glass Door Pulse Start Metal Halide								
	WPP15	080083541164	150W	MP	Medium-base, ED-17	CWA/MT/277V	MH150UMED	MPKT-150-CWA-MT
	WPP25	080083541171	250W	MP	(E) Mogul-base, ED-28	CWA/MT/277V	MS250/U/PS	MPKT-250-CWA-MT
	WPP32	080083547005	320W	MP	(E) Mogul-base, ED-28	CWA/MT/277V	MS320/U/PS	MPKT-320-CWA-MT
	WPP40	080083541195	400W	MP	(E) Mogul-base, ED-37	CWA/MT/277V	M400/PS/U	MPKT-400-CWA-MT
Borosilicate Glass Door High Pressure Sodium								
	WPS10	080083541201	100W	HPS	Mogul-base, B17	Hi.Rx/HPF/MT 277V	S626-100F6	HPKT-100-HIX-HPF-MT
	WPS15	080083541218	150W	HPS	Mogul-base, B17	Hi.Rx/HPF/MT 277V	S5456-150F6	HPKT-150-HIX-HPF-MT
	WPS25	080083541225	250W	HPS	Mogul-base, ED-18	CWA/MT/277V	S50VA-250FG	HPKT-250-CWA-MT
	WPS40	080083541232	400W	HPS	Medium-base, ED-18	CWA/MT/277V	S51WA-400FG	HPKT-400-CWA-MT
Full Cutoff Door LED								
	WPL2AC	080083557073	28W	LED	LED	120-277V Driver	LED	N/A
	WPL4AC	080083557097	40W	LED	LED	120-277V Driver	LED	N/A
Full Cutoff Door Pulse Start Metal Halide								
	WPP15C	080083541249	150W	MP	Medium-base, ED-17	CWA/MT/277V	MH150UMED	MPKT-150-CWA-MT
	WPP25C	080083541256	250W	MP	(E) Mogul-base, ED-28	CWA/MT/277V	MS250/U/PS	MPKT-250-CWA-MT
	WPP40C	080083541263	400W	MP	(E) Mogul-base, ED-37	CWA/MT/277V	M400/PS/U	MPKT-400-CWA-MT

HID / LED Replacement Cross Reference Chart*

HID SYSTEM	WAL-PAK LED REPLACEMENT MODEL
50W MH / HPS	WPL2A / WPL2AC
70W MH / HPS	WPL2A / WPL2AC
100W MH	WPL2A / WPL2AC
100 HPS	WPL4A / WPL4AC
150-175W MH / 150W HPS	WPL4A / WPL4AC

NOTES: * Cross reference chart is a guideline only. Contact your local Cooper Lighting representative for details.

iMPACT™ Architectural Wall Pack

100-150W Pulse Start Metal Halide

Applications

- Entrance • Facade •
- Parking Garage • Recreation •
- Retail • Security • Transportation

Specifications

- EISA Compliant
- Clear heat- and impact-resistant tempered glass lens
- Die-cast aluminum door assembly is hinged for easy relamping and maintenance
- Two-piece, die-cast aluminum housing designed to complement architectural site design
- Durable bronze polyester powder coat finish
- Fully gasketed lens assembly seals out external contaminants
- 4KV medium-base porcelain lamp socket
- Medium-base lamp included and available up to 150W MH
- Gasketed and zinc-plated rigid steel mounting attachment fits directly to 4" junction box or wall with "Hook-N-Lock" mechanism for quick installation
- U.L. Listed and CSA Certified for wet locations in down mount applications and damp locations in up mount applications
- Approx. net weight: 18 lbs. (8 kgs.)

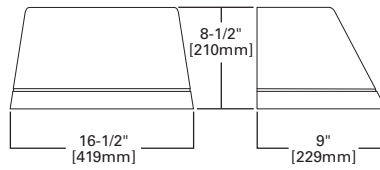

Trapezoid

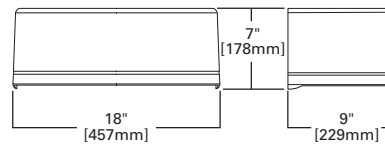

Cylinder

Photometry

Mounting Height	Footcandle Value for Isofootcandle lines					Multiplier	
	A	B	C	D	E	100	150
10'	4.50	2.25	1.13	.45	.23	.72	1.00
15'	2.00	1.00	.50	.20	.10		
20'	1.13	.56	.28	.11	.06		

Example of 150W MP at 15 ft. mounting height, 12,500 lumen clear lamp

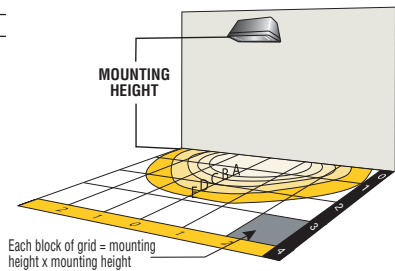



Trapezoid





In downlighting applications only.



Cylinder



Ordering Information

Stock Number	UPC	Wattage	Source	Lamp	Ballast	Lamp Included	Ballast Kit
IMPACT TRAPEZOID <i>Pulse Start Metal Halide</i>							
 MPIT10	623961932236	100W	MP	Medium-base, ED-17	Hi.Rx/HPF/MT/277V	MH100/U/MEDFG	MHKT-100-HIX-HPF-MT
MPIT15	623961904714	150W	MP	Medium-base, ED-17	CWA/MT/277V	MH150UMED	MPKT-150-CWA-MT
IMPACT CYLINDER <i>Pulse Start Metal Halide</i>							
 MPIC10	623961932298	100W	MP	Medium-base, ED-17	Hi.Rx/HPF/MT/277V	MH100/U/MEDFG	MHKT-100-HIX-HPF-MT
MPIC15	623961904936	150W	MP	Medium-base, ED-17	CWA/MT/277V	MH150UMED	MPKT-150-CWA-MT

Z-PAK Cutoff & Glass Wall Pack

**150W High Pressure Sodium
150W Pulse Start Metal Halide**

Applications

- Entrance • Parking Garage • Recreational • Retail • Security • Transportation • Warehouse

Specifications

- Patterned, flat-tempered (cutoff) or borosilicate glass lens minimize direct lamp imaging
- One-piece, die-cast door and lens assembly is hinged on the side for easy relamping and maintenance
- Die-cast aluminum housing with a durable polyester powder coat finish
- Z-Pak cutoff unit features unique angled housing for cutoff illumination and glare control
- Silicone gasketing seals out dirt and contaminants
- HID: 5KV mogul-base lamp socket
- Lamp included and available in 150W HPS/150W MP
- Mounts to junction box or surface mounted through tapped conduit openings
- Supplied with mounting knockouts for quick and easy installation
- U.L. wet location listed, CSA certified for outdoor use only
- Approx. net weight: HID: 18 lbs. (8.2 kgs.)

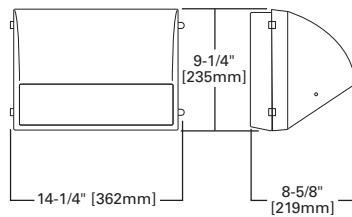

CUTOFF

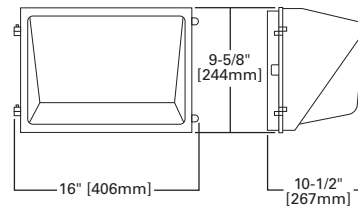

GLASS

Photometry

Mounting Height	Footcandle Value for Isofootcandle lines					Watts	Multiplier	
	A	B	C	D	E		HPS	MP
10'	11.25	4.50	2.25	1.13	.45	150	1.28	1.00
15'	5.00	2.00	1.00	.50	.20			
20'	2.81	1.10	.56	.28	.11			

Example of 150W MP at 15 ft. mounting height, 12,500 lumen clear ED-17 lamp

Accessories



Button Photocontrol (PB120V, PB277V BUTTON PC)
Field installed photoelectric control for automatic dusk-to-dawn operation; internally mounts to 1/2" threaded hub



External Photocontrol (PE/MT)
Field installed 120/208/240/277V photoelectric control for automatic dusk-to-dawn operation; externally mounts to 1/2" threaded hub and includes 1/2" - 3/4" reducing bushing



Full Cutoff Visor (FZ/FC/CO - Cutoff)
Easy to install accessory provides additional cutoff and glare control, bronze finish



Replacement Door (FZ/GS - Glass)
Heavy-duty die-cast aluminum doorframe with tempered glass hinges for easy installation, bronze finish

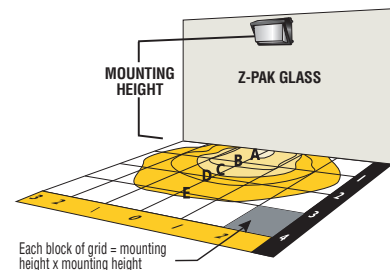
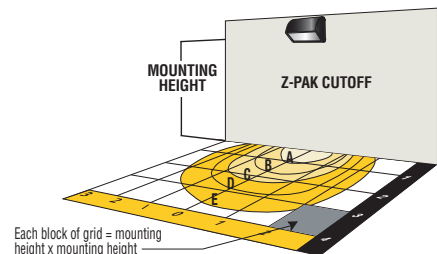



Z-Pak Glass





When used with FZ/FC/F0 accessory



Z-Pak Cutoff



Ordering Information

Stock Number	UPC	Wattage	Source	Lamp	Ballast	Lamp Included	Ballast Kit
 Z-PAK GLASS High Pressure Sodium							
HPFZ15	623961007279	150W	HPS	Medium-base, B17	Reactor/NPF/120V	S55RN-150F6	HPKT-150-REC-NPF-120V
Z-PAK GLASS Pulse Start Metal Halide							
MPFZ15	623961997167	150W	MP	Medium-base, ED-17	CWA/MT/277V	MH150UMED	MPKT-150-CWA-MT
 Z-PAK CUTOFF Pulse Start Metal Halide							
MPFZ15C	623961997525	150W	MP	Medium-base, ED-17	CWA/MT/277V	MH150UMED	MPKT-150-CWA-MT

WALLY Cutoff & Glass Wall Pack

70-150W High Pressure Sodium
70-100W Pulse Start Metal Halide

Applications

- Entrance • Parking Garage • Recreational • Retail • Security • Transportation • Warehouse

Specifications

- Patterned, flat-tempered (cutoff) or borosilicate glass lens minimize direct lamp imaging
- One-piece door design held in place with slot-head captive screws
- Wally Cutoff unit features unique angled housing with integral visor for cutoff illumination and glare control
- Die-cast aluminum housing in durable bronze (standard) or white polyester powder finish
- 4KV Medium-base porcelain lamp socket
- Lamp included and available up to 150W HPS/100W MP
- Flush mount to vertical surface or thru-way pipe mount through two NPS threaded knockouts
- Ships prewired and pre-assembled
- Supplied with mounting cover for quick and easy installation
- U.L. listed for wet location, CSA certified, for outdoor use only
- Approx. net weight: 11 lbs. (5 kgs.)

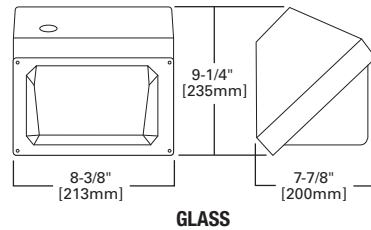
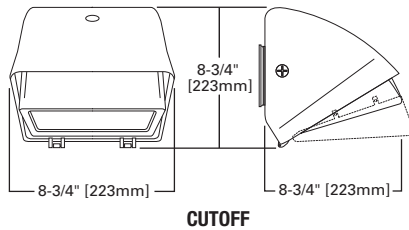

Photometry

Mounting Height	Footcandle Value for Isofootcandle lines					Watts	Multiplier	
	A	B	C	D	E		HPS	MP
8'	7.81	3.13	1.56	.78	.31	50	.44	.41
10'	5.00	2.00	1.00	.50	.20	70	.71	.64
12'	3.47	1.39	.69	.35	.14	100	1.05	1.00
						150	2.05	-

Example of 100W MP at 10 ft. mounting height, 9,000 lumen clear lamp

Accessories



Button Photocontrol (PB120V, PB277V BUTTON PC)
Field installed photoelectric control for automatic dusk-to-dawn operation; internally mounts to 1/2" threaded hub



External Photocontrol (PE/MT)
Field installed 120/208/240/277V photoelectric control for automatic dusk-to-dawn operation; externally mounts to 1/2" threaded hub and includes 1/2"-3/4" reducing bushing



Full Cutoff Visor (WY/FC/CO - Cutoff)
Easy to install accessory provides additional cutoff and glare control, bronze finish

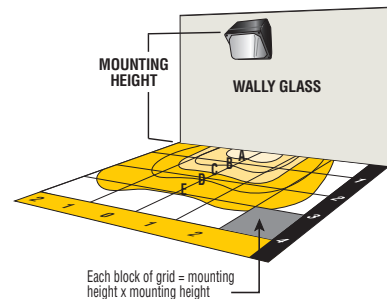
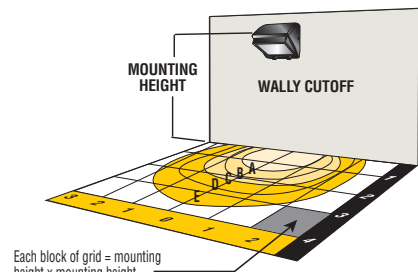



Wally Glass





Wally Cutoff

DARK SKY COMPLIANT **CO**
Cutoff



Ordering Information

Stock Number	UPC	Wattage	Source	Lamp	Ballast	Lamp Included	Ballast Kit
WALLY GLASS High Pressure Sodium							
 LS70G	622696399413	70W	HPS	Medium-base, ED-17	Reactor/NPF/120V	S62LG-70FG	HPKT-70-REC-NPF-120V
LS10G	622696399406	100W	HPS	Medium-base, ED-17	Reactor/NPF/120V	S54SG-100FG	HPKT-100-REC-NPF-120V
LS15G	662401051496	150W	HPS	Medium-base, ED-17	Reactor/NPF/120V	S55RN-150FG	HPKT-150-REC-NPF-120V
WALLY GLASS Pulse Start Metal Halide							
LP70G	623961978241	70W	MP	Medium-base, ED-17	Hi.Rx/NPF/120V/277V	MH70/U/MEDFG	MHKT-70-HIX-NPF-120/277V
LP10G	623961978258	100W	MP	Medium-base, ED-17	Hi.Rx/NPF/120V/277V	MH100/U/MEDFG	MHKT-100-HIX-NPF-120/277V
WALLY CUTOFF Pulse Start Metal Halide							
 LP70C	623961978265	70W	MP	Medium-base, ED-17	Hi.Rx/NPF/120V/277V	MH70/U/MEDFG	MHKT-70-HIX-NPF-120/277V
LP10C	623961978272	100W	MP	Medium-base, ED-17	Hi.Rx/NPF/120V/277V	MH100/U/MEDFG	MHKT-100-HIX-NPF-120/277V

WAL-LITE Polycarbonate Wall Pack

50-70W High Pressure Sodium

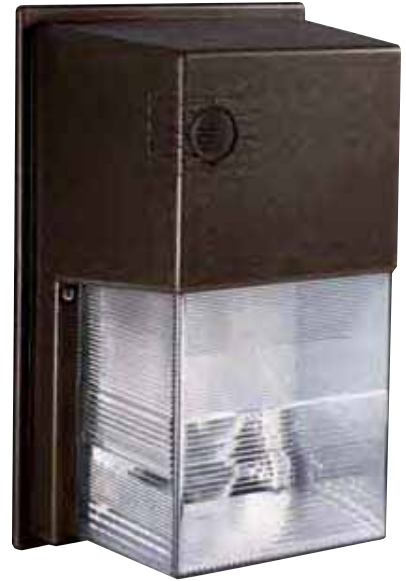

Applications

Entrance • Corridor • Parking
Garage • Pathway • Recreation •
Retail Security • Transportation •
Warehouse

Specifications

- Vandal-resistant, polycarbonate prismatic lens
- Optional photocontrol for automatic dusk-to-dawn operation
- Heavy-duty, injection-molded polycarbonate housing with bronze finish
- Die-cast aluminum back plate with mounting template
- Medium-base porcelain lamp socket
- Lamp included and available up to 70W HPS
- Aluminum reflector directs light down and out, reducing glare and wasted light
- Flush-mount to vertical surface or bottom NPS entry (1/2" NPS TAP)
- UL listed and CSA certified for wet locations
- Approx. net weight: 7 lbs. (3 kgs.)

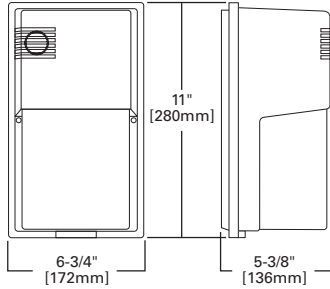

Ordering Information

Stock Number	UPC	Master Carton	Wattage	Source	Lamp	Ballast	Lamp Included
High Pressure Sodium							
HPWM70	662401326693	4	70W	HPS	Medium-base, ED-17	Reactor/NPF/120V	S62LG-70FG
High Pressure Sodium with Photocontrol							
HPWM50P	662401326655	4	50W	HPS	Medium-base, ED-17	Reactor/NPF/120V	S68LP-50FG
HPWM70P	662401326679	4	70W	HPS	Medium-base, ED-17	Reactor/NPF/120V	S62LG-70FG

Photometry

Mounting Height	Footcandle Value for Isofootcandle lines					Multiplier	
	A	B	C	D	E	Watts	HPS
8'	3.12	1.56	.78	.31	.16	35	.35
10'	2.00	1.00	.50	.20	.10	50	.63
12'	1.38	.69	.35	.14	.07	70	1.00

Example of 70W HPS at 10 ft. mounting height,
6,300 lumen clear lamp

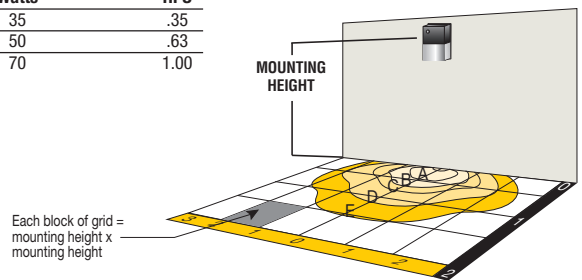



WAL-LITE | Glass Wall Pack

50-100W Pulse Start Metal Halide

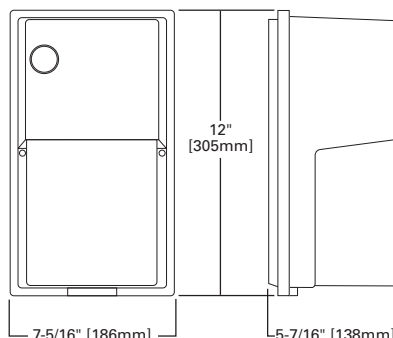

Ordering Information

Stock Number	UPC	Master Carton	Wattage	Source	Lamp	Ballast	Lamp Included	Ballast Kit
Metal Halide								
MPWM50G	623961986048	6	50W	MP	Medium-base, ED-17	Hi.Rx/HPF/120V/277V	MH50/U/M	MHKT-50-HIX-HPF-120/277V
MPWM70G	623961986055	6	70W	MP	ED-17	Hi.Rx/HPF/MT/277V	MH70/U/MEDFG	MHKT-70-HIX-HPF-MT
MPWM10G	623961986062	6	100W	MP	ED-17	Hi.Rx/HPF/MT/277V	MH100/U/MEDFG	MHKT-100-HIX-HPF-MT

Photometry

Mounting Height	Footcandle Value for Isofootcandle lines				Multiplier	
	A	B	C	D	Watts	MP
8'	3.12	1.56	.78	.31	50	.46
10'	2.00	1.00	.50	.20	70	.61
12'	1.38	.69	.35	.14	100	1.00

Example of 100W MP at 10ft. mounting height, 9,000 lumen clear lamp

Accessories



Button Photocontrol (PB120V, PB277V BUTTON PC)
Field installed 120V photoelectric control for automatic dusk-to-dawn operation; internally mounts to 1/2" threaded hub

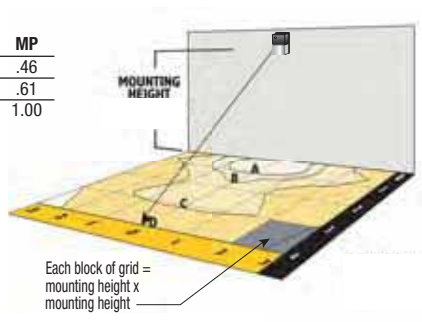

Applications

- Entrance • Corridor • Parking Garage • Pathway • Recreation • Retail • Security • Transportation • Warehouse

Specifications

- Clear, linear, prismatic, impact-resistant borosilicate glass lens
- Die-cast aluminum housing in bronze polyester powder-coat finish
- Housing is equipped with see-through window for field installed photocontrol (order separately)
- Housing mounts to back plate via two self-captive screws for easy lamp and wiring access
- Silicone gasket seals out dirt and contaminants
- Formed aluminum reflector maximizes light output
- 4KV pulse-rated medium-base porcelain lamp socket
- Lamp included and available up to 100W MP
- Flush-mount to vertical surface via die-cast aluminum back plate with mounting box template or bottom NPS entry
- U.L. listed and CSA certified for wet locations
- Approx. net weight: 12 lbs. (5.4 kgs.)

How to Floodlight

Aiming Floodlights

The illustrations below show common floodlighting applications and recommended best practices.

NEMA Beam Classifications

National Electrical Manufacturers Association (NEMA) classifications are used to describe the general shape and application of a distribution. NEMA classifications are used to classify both the horizontal and vertical components of a floodlight distribution.

NEMA	Field Angle	Description	Range Setback
1	.10-18°	.Narrowest Beam	...Long Setback
2	.18-29°	.Narrow Beam	...Long Setback
3	.29-46°	.Narrow Beam	...Long Setback
4	.46-70°	.Medium Beam	...Medium Setback
5	.70-100°	.Medium Beam	...Medium Setback
6	.100-130°	.Wide Beam	...Shorter Setback
7	.130°-Greater	.Widest Beam	...Short Setback

There will be wasted light when the floodlight is aimed at the far edge of the area to be illuminated.

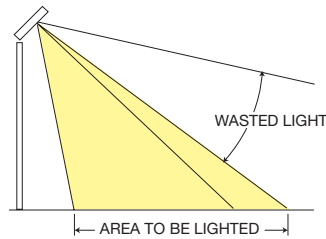

Aiming the floodlight too close to the near edge causes low level illumination at the far edge.

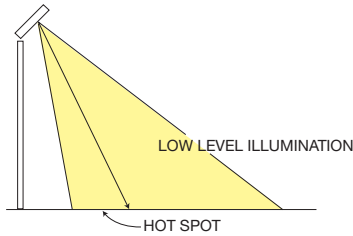

Good judgement in aiming floodlights is to aim them two-thirds of the distance to be lighted.

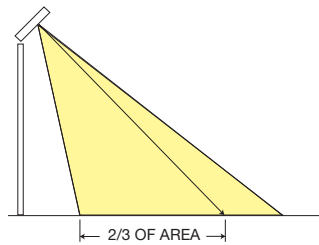

Aim floodlights at 30° below the horizontal to achieve better visual comfort. Mounting height may need to be increased to accomplish 30° below horizontal.

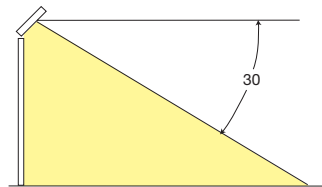

Where the edge of one beam intersects the aiming point of the next floodlight, there is more uniform light distribution.

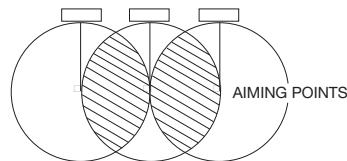

Common Pole Layouts

Ground Areas

The more lighting locations used, the better the quality of lighting with respect to uniformity, visibility and reduction of shadows. Pole spacings, a factor of the mounting height are recommended maximums. The minimum number of floodlights required at each location for adequate beam coverage is one for corner locations, two for side locations and four for center locations.

Vertical Areas

A standard layout for vertical areas using wide-angle floodlights is shown in Fig. A. The floodlight setback distance D should be at least one-quarter the height. Spacing between units should not exceed twice D .

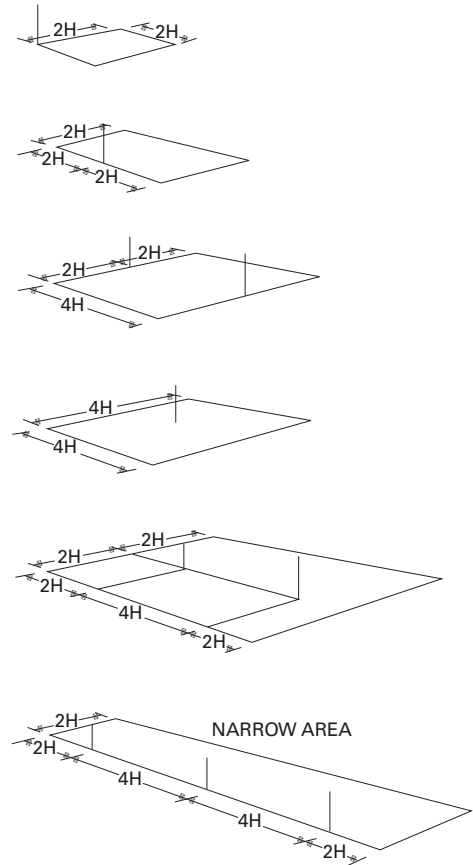

Surface Illumination Recommendations

Effective floodlighting design is a complex and subjective task. Results are heavily dependent upon surrounding light levels, surface finish of the intended target, spectral color distribution of the lamp source, mounting location allowances, and viewer's perceptions. The table on right lists IESNA (Illuminating Engineering Society of North America) recommended illuminance levels for the floodlighting of buildings and monuments.

Target Surface	Average Target Description	Finish Illuminance
Bright	Light Surfaces	.5 fc
Bright	Medium Light Surfaces	.7 fc
Bright	Dark Surfaces	1.0 fc
Dark	Light Surfaces	.2 fc
Dark	Medium Light Surfaces	.3 fc
Dark	Medium Dark Surfaces	.4 fc
Dark	Dark Surfaces	.5 fc

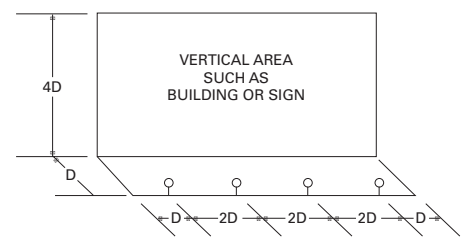

Fig. A

NIGHTHAWK III Area Floodlight

400-1000W High Pressure Sodium
400W Pulse Start Metal Halide
1000W Probe Start Metal Halide

Applications

- Accent • Facade • Recreation • Retail • Roadway • Security • Sign • Sports • Transportation

Specifications

- EISA Compliant
- Heat- and impact-resistant tempered glass mounts flush to die-cast aluminum door surface to reduce wind drag and prevent accumulation of dirt or moisture
- Die-cast aluminum door frame with integral cast hinges
- Heavy-duty corrosion-resistant die-cast aluminum housing with bronze polyester, powder coat finish
- Integral stamped steel ballast mounting bracket
- Formed aluminum flush draw-action latches offer easy tool-less access to lamp compartment
- Mogul-base porcelain lamp socket
- Lamp included. Available in 400W and 1000W HPS, MH or MP
- Heavy-duty steel yoke provides flexibility in mounting from a variety of surfaces (specify Y)
- Integral die-cast aluminum slipfitter fits 2-3/8" or 3" O.D. tenon. Cast-in degree marked in quadrant for easy and accurate aiming (specify S)
- U.L. listed for wet ground mount locations. CSA certified
- E.P.A. = 2.7
- Approx. net weight: 55 lbs. (25 kgs.)

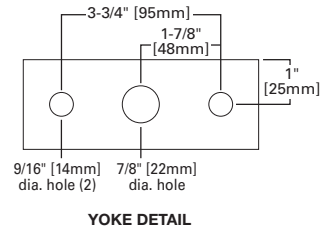
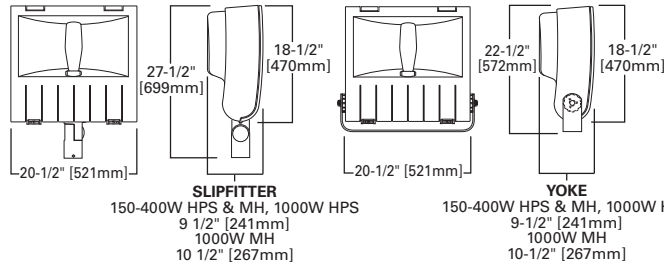

Photometry

Set back	Footcandle Value for Isofootcandle lines					Multiplier		
	A	B	C	D	E	Watts	HPS	MH/MP
20'	10.00	5.00	2.00	1.00	.50	400	1.39	1.00
25'	6.40	3.20	1.28	.64	.32	1000	3.89	3.06
30'	4.40	2.20	.88	.44	.55			
35'	3.27	1.64	.65	.33	.16			

Example of 400W MP at 20ft. set back with a 45° tilt, 40,000 lumen clear lamp

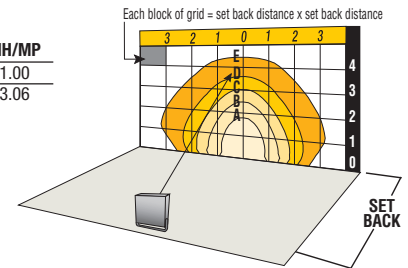

Accessories



Double Side Visor (SV/NK)
 Visor provides additional cutoff and glare control, bronze finish. Can be used with Top or Bottom Visor (TV/NK)



Photocontrol (0A/RA1016)
 Twistlock photoelectric control, 105-285V NEMA Type

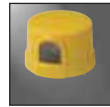

Photocontrol (0A/RA1027)
 Twistlock photoelectric control, 480V NEMA Type



Trunnion Yoke Slipfitter (TYS-BZ)
 Adaptable slipfitter for 2-3/8", 3", or 3-1/2" tenon with 3/4" NPS hole, bronze finish

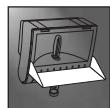

Top or Bottom Visor (TV/NK)
 Provides additional cutoff and glare control, bronze finish









Nighthawk
Slipfitter-Mount
(Specify S)

Nighthawk
Yoke-Mount
(Specify Y)



Ordering Information

Stock Number	UPC	Wattage	Source	EISA Compliant	Lamp	Ballast	Lamp Included	Ballast Kit
	NIGHTHAWK SLIPFITTER-MOUNT High Pressure Sodium							
HPNKS1K	623961565168	1000W	HPS		Mogul-base, E-25	CWA/MT/277V	S52XB-1000FG	HPKT-1000-CWA-MT
	NIGHTHAWK SLIPFITTER-MOUNT Pulse Start Metal Halide							
MPNKS40	623961755132	400W	MP	ⓔ	Mogul-base, BT-37	CWA/MT/277V	M400/PS/U	MPKT-400-CWA-MT
	NIGHTHAWK YOKE-MOUNT High Pressure Sodium							
HPNKY40	623961565199	400W	HPS		Mogul-base, ED-18	CWA/MT/277V	S51WA-400FG	HPKT-400-CWA-MT
HPNKY1K	623961565182	1000W	HPS		Mogul-base, E-25	CWA/MT/277V	S52XB-1000FG	HPKT-1000-CWA-MT
	NIGHTHAWK YOKE-MOUNT Pulse Start Metal Halide							
MPNKY40	623961755170	400W	MP	ⓔ	Mogul-base, BT-37	CWA/MT/277V	M400/PS/U	MPKT-400-CWA-MT
	NIGHTHAWK SLIPFITTER-MOUNT Probe Start Metal Halide							
MHNKS1K	623961565205	1000W	MH		Mogul-base, BT-56	CWA/MT/277V	M47PA-1000/UFG	MHKT-1000-CWA-MT
	NIGHTHAWK YOKE-MOUNT Probe Start Metal Halide							
MHNKY1K	623961565328	1000W	MH		Mogul-base, BT-56	CWA/MT/277V	M47PA-1000/UFG	MHKT-1000-CWA-MT

WARRIOR Large Floodlight

250-400W High Pressure Sodium
150-400W Pulse Start Metal Halide

Applications

- Accent • Facade • Parking Garage • Parking Lot • Recreation • Retail • Security • Sports • Transportation

Specifications

- EISA Compliant
- Clear tempered glass lens is heat- and impact-resistant
- Corrosion-resistant captive retaining screws
- Weather-resistant, die-cast aluminum housing with integral door hinges is finished in bronze polyester powder-coat
- Full-perimeter, high temperature foam-in-place silicone gasket
- Porcelain lamp socket
- Standard multi-tap (MT) 120/208/240/277 ballast
- Supplied with 3/16" galvanized steel trunnion (W prefix)
- Integral die-cast aluminum slipfitter fits 2-3/8" or 3" O.D. vertical tenon (X prefix)
- U.L. listed for wet ground mount locations. CSA certified.
- E.P.A. @ 45° = 1.3
- Approx. net weight: 35 lbs. (16 kgs.)

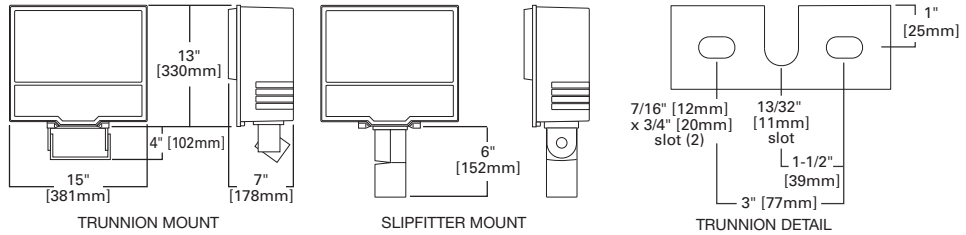

Photometry

Set back	Footcandle Value for Isofootcandle lines							Watts	Multiplier HPS	MP
	A	B	C	D	E	F	G			
20'	11.25	4.50	2.25	1.13	.45	.23	.11	150	-	.31
25'	7.20	2.88	1.44	.72	.29	.14	.07	250	.58	.56
30'	5.00	2.00	1.00	.50	.20	.10	.05	320	-	.75
								400	1.39	1.00

Example of 400W MP at 30ft. set back with a 45° tilt, 40,000 lumen clear lamp

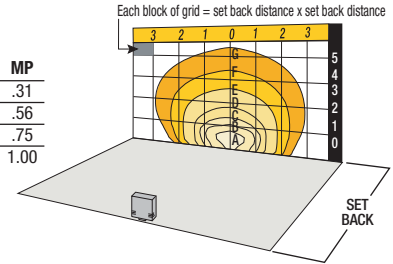

Accessories



Button Photocontrol (PB120V, PB277V BUTTON PC)
Field installed 120V photoelectric control for automatic dusk-to-dawn operation; internally mounts to 1/2" knockout in slipfitter cover

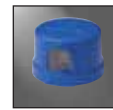

Photocontrol (0A/RA1016)
Twistlock photoelectric control, 105-285V NEMA Type



Photocontrol (0A/RA1027)
Twistlock photoelectric control, 480V NEMA Type



Right Angle Bracket (RABBZ)
Right angle 2-3/8" O.D. pipe bracket for slipfitter mount, bronze finish



Steel Angle Bracket (SAB-BZ)
Steel 45° angle bracket for trunnion mount, bronze finish

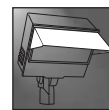

Top Visor (TV/WR)
Provides additional cutoff and glare control, bronze finish



Trunnion Yoke Slipfitter (TYS-BZ)
Adaptable for 2-3/8", 3", or 3-1/2" tenon with 3/4" NPS hole, bronze finish





Warrior
Slipfitter-Mount
(X Prefix)

Warrior
Trunnion-Mount
(W Prefix)



Ordering Information

Stock Number	UPC	Wattage	Source	EISA Compliant	Lamp	Ballast	Lamp Included	Ballast Kit
WARRIOR TRUNNION-MOUNT High Pressure Sodium								
 WS25	662400116592	250W	HPS		Mogul-base, ED-18	CWA/MT/277V	S50VA-250FG	HPKT-250-CWA-MT
WS40	662400117360	400W	HPS		Mogul-base, ED-18	CWA/MT/277V	S51WA-400FG	HPKT-400-CWA-MT
WARRIOR TRUNNION-MOUNT Pulse Start Metal Halide								
WP15	623961009280	150W	MP		Medium-base, ED-17	CWA/MT/277V	MH150UMED	MPKT-150-CWA-MT
WP25	623961754487	250W	MP	(E)	Mogul-base, ED-28	CWA/MT/277V	MS250/U/PS	MPKT-250-CWA-MT
WP32	623961009297	320W	MP	(E)	Mogul-base, ED-28	CWA/MT/277V	MS320/U/PS	MPKT-320-CWA-MT
WP40	623961754524	400W	MP	(E)	Mogul-base, ED-37	CWA/MT/277V	M400PSU	MPKT-400-CWA-MT
WARRIOR SLIPFITTER-MOUNT High Pressure Sodium								
 XS25	662400117469	250W	HPS		Mogul-base, ED-18	CWA/MT/277V	S50VA-250FG	HPKT-250-CWA-MT
XS40	662400117476	400W	HPS		Mogul-base, ED-18	CWA/MT/277V	S51WA-400FG	HPKT-400-CWA-MT
WARRIOR SLIPFITTER-MOUNT Pulse Start Metal Halide								
XP15	623961009266	150W	MP		Medium-base, ED-17	CWA/MT/277V	MH150UMED	MPKT-150-CWA-MT
XP25	623961751479	250W	MP	(E)	Mogul-base, ED-28	CWA/MT/277V	MS250/U/PS	MPKT-250-CWA-MT
XP40	623961754463	400W	MP	(E)	Mogul-base, ED-37	CWA/MT/277V	M400PSU	MPKT-400-CWA-MT

ARROWHEAD™ Large Floodlight

150-400W High Pressure Sodium
150-400W Pulse Start Metal Halide

Applications

- Accent • Entrance • Eave • Facade • Landscape Pathway • Recreation • Retail • Security • Sign

Specifications

- EISA compliant
- Tempered glass lens is impact- and thermal shock-resistant
- Die-cast aluminum housing in durable bronze polyester powder-coat finish
- Full-perimeter silicone gasket seals out external contaminants
- 5KV pulse-rated mogul-base porcelain lamp socket (lamp included)
- Formed-aluminum reflector optimizes beam efficiency and control
- Polyester powder-coated steel trunnion or slipfitter mount provides stability and adjustable aiming
- Integral die-cast aluminum slipfitter fits 2-3/8" vertical tenon (S prefix)
- U.L. listed for wet locations and ground mount applications. cUL certified
- E.P.A. = 1.59
- Approx. net weight: 30 lbs. (13.61 kgs.)

Trunnion

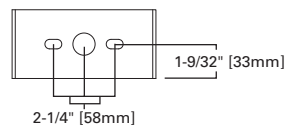
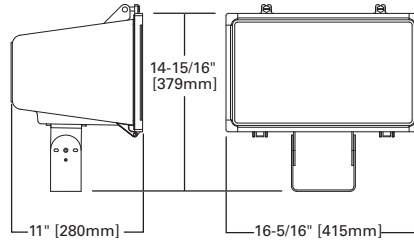

TRUNNION DETAIL

Slipfitter

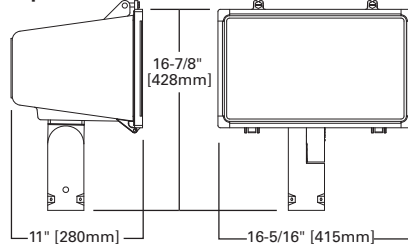

Photometry

Set back	Footcandle Value for Isofootcandle lines					Multiplier		
	A	B	C	D	E	Watts	HPS	MP
20'	11.25	4.5	2.25	1.13	.45	250	.70	.55
25'	7.2	2.88	1.44	.72	.29	400	1.28	1.00
30'	5.0	2.0	1.0	.50	.20			

Example of 400W MP at 30ft. set back with a 45° tilt, 40,000 lumen clear lamp

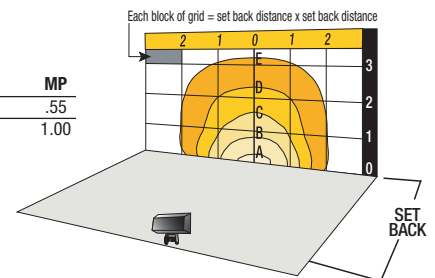

Accessories



Right Angle Bracket (RABBZ)
Right angle 2-3/8" O.D. pipe bracket for slipfitter mount, bronze finish.

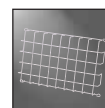

Wireguard (AH/WG)
Heavy duty welded construction provides protection for glass



Side & Top Visor (AH/V-BZ)
Provides additional cutoff and glare control, bronze finish



Steel Angle Bracket (SAB-BZ)
Steel 45° angle bracket for trunnion mount, bronze finish





Arrowhead
Trunion



Arrowhead
Slipfitter



Ordering Information

Stock Number	UPC	Wattage	Source	EISA Compliant	Lamp	Ballast	Lamp Included	Ballast Kit
Pulse Start Metal Halide Trunion								
 MPAH15T	080083532025	150W	MP		Medium-base, ED-17	CWA/MT/277V	MH150UMED	MPKT-150-CWA-MT
MPAH25T	080083532032	250W	MP	ⓔ	Mogul-base, ED-28	CWA/MT/277V	MS250/U/PS	MPKT-250-CWA-MT
MPAH40T	080083533152	400W	MP	ⓔ	Mogul-base, ED-37	CWA/MT/277V	M400/PS/U	MPKT-400-CWA-MT
Pulse Start Metal Halide Slipfitter								
 MPAH15S	080083533190	150W	MP		Medium-base, ED-17	CWA/MT/277V	MH150UMED	MPKT-150-CWA-MT
MPAH25S	080083533206	250W	MP	ⓔ	Medium-base, ED-28	CWA/MT/277V	MS250/U/PS	MPKT-250-CWA-MT
MPAH40S	080083533220	400W	MP	ⓔ	Medium-base, ED-37	CWA/MT/277V	M400/PS/U	MPKT-400-CWA-MT

IMPACT™ Architectural Floodlight

70-400W Pulse Start Metal Halide

Applications

- Accent • Facade • Landscape • Parking Lot • Pathway • Recreation • Retail • Security • Sign • Sports • Transportation

Specifications

- EISA Compliant
- Impact-resistant, clear, flat tempered glass lens
- Hinged die-cast aluminum door for easy internal access secured with recessed tamper-resistant stainless steel allen head fasteners
- Rugged, one-piece die-cast aluminum housing. Weather- and abrasion-resistant bronze polyester powder-coat finish
- One-piece extruded silicone gasket seals out external moisture and contaminants
- Medium-base, pulse-rated porcelain lamp socket on small floods; mogul-base on medium floods
- Lamp included and available up to 400W MP
- Premium aluminum reflector for high efficiency and maximum performance
- Heavy-duty, die-cast aluminum knuckle equipped with 3/4" NPT threaded stem (small) or slipfitter mounting to 2-3/8" O.D. pipe or tenon (medium)
- U.L. listed for wet ground mount location and CSA certified
- E.P.A. = 1.12 small, 2.1 medium
- Approx. net weight:
15 lbs. (6.8 kgs.) Small
40 lbs. (18 kgs.) Medium

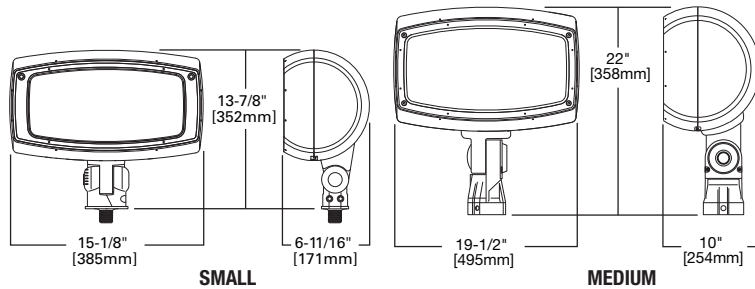

Photometry

Set back	Footcandle Value for Isofootcandle lines					Multiplier	
	A	B	C	D	E	Watts	MP
10'	20.00	8.00	4.00	2.00	.80	70	.42
15'	8.89	3.54	1.77	.89	.35	100	.56
20'	5.00	2.00	1.00	.50	.20	150	1.00

Impact Small

Example of 150W MP at 10ft. set back with a 45° tilt, 12,500 lumen clear lamp

Set Back	Footcandle Value for Isofootcandle lines							Multiplier	
	A	B	C	D	E	F	G	Watts	MP
20'	11.25	4.50	2.25	1.13	.45	.23	.11	250	.56
25'	7.20	2.88	1.44	.72	.29	.14	.07	400	1.00
30'	5.00	2.00	1.00	.50	.20	.10	.05		

Impact Medium

Example of 400W MP at 30ft. set back with a 45° tilt, 40,000 lumen clear lamp

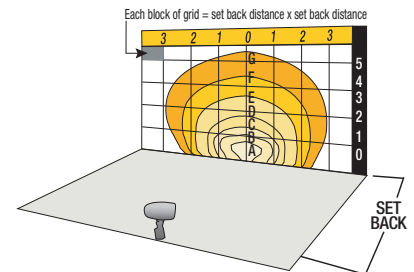
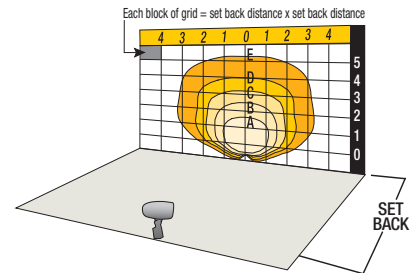

Accessories



Barn Doors
(MS/BD-BZ - Small, MM/BD-BZ - Medium)
Four extruded doors move independently for customized glare control, bronze finish



Four Sided Shield
(MS/4V-BZ - Small)
Formed aluminum four sided shield controls lamp glare, bronze finish



Right Angle Bracket (RABBZ)
Right angle 2-3/8" O.D. pipe bracket for slipfitter mount, bronze finish. For Impact small use with MS/SF-BZ.



Wire Guard
(MS/WG - Small)
Heavy-gauge welded construction provides protection for glass





IMPACT
Flood Small

IMPACT
Flood Medium



Ordering Information

Stock Number	UPC	Wattage	Source	EISA Compliant	Lamp	Ballast	Lamp Included	Ballast Kit
IMPACT SMALL Pulse Start Metal Halide								
 MPMS70	623961978227	70W	MP		Medium-base, ED-17	Hi.Rx/HPF/MT/277V	MH70/U/MEDFG	MHKT-70-HIX-HPF-MT
MPMS10	623961978234	100W	MP		Medium-base, ED-17	Hi.Rx/HPF/MT/277V	MH100/U/MEDFG	MHKT-100-HIX-HPF-MT
MPMS15	623961757501	150W	MP		Medium-base, ED-17	CWA/MT/277V	MP150-E-U-C-MD-E17	MHKT-150-CWA-MT
IMPACT MEDIUM Pulse Start Metal Halide								
 MPMM25	623961757433	250W	MP	ⓔ	Mogul-base, ED-28	CWA/MT/277V	MS250/U/PS	MHKT-250-CWA-MT
MPMM40	623961762901	400W	MP	ⓔ	Mogul-base, ED-28	CWA/MT/277V	M400/PS/U/BT28	MHKT-400-CWA-MT



Small Floodlight

70-150W High Pressure Sodium
70-150W Pulse Start Metal Halide

Applications

Accent • Entrance • Eave •
 Facade • Landscape • Pathway •
 Recreation • Retail • Security •
 Sign

Specifications

- Tempered glass lens is impact- and thermal shock-resistant
- Stainless steel latch allows easy access for relamping
- Optional tamper-resistant screw to minimize vandalism
- Die-cast aluminum housing with weather- and abrasion-resistant bronze polyester powder-coat finish
- Full-perimeter silicone gasket seals out external contaminants
- 4KV pulse-rated medium-base porcelain lamp socket
- Lamp included and available up to 150W HPS or 150W MP
- Formed-aluminum stippled reflector optimizes beam efficiency, control and light output
- Rugged 1G rated die-cast aluminum knuckle assembly fits 1/2" NPS outlet box (K suffix)
- Adjustable heavy-gauge steel trunnion-mount supplied prewired with one foot of wet location cord (T suffix)
- U.L. listed for wet location and ground mount applications. CSA certified
- E.P.A. = 0.72
- Approx. net weight: 8 -18 lbs. (4-8 kgs.)

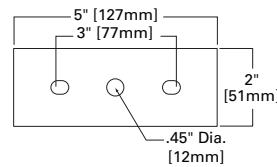
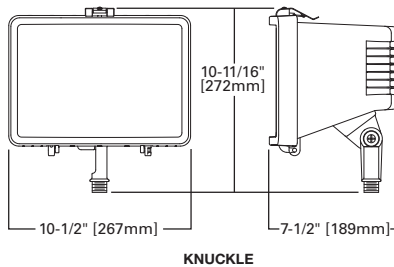

Photometry

Set Back	Footcandle Value for Isofootcandle lines					Multiplier		
	A	B	C	D	E	Watts	HPS	MP
10'	20.00	10.00	5.00	2.00	1.00	50	.29	.23
12'	13.89	6.94	3.45	1.38	.69	70	.45	.36
15'	8.89	4.44	2.22	1.11	.56	100	.68	.56
20'	5.00	2.50	1.25	.63	.31	150	1.14	1.00

Example of 150W MP at 10ft. set back with a 55° tilt, 12,500 lumen clear lamp

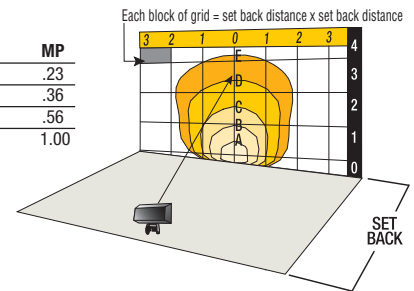

Accessories



Trunnion Yoke Slipfitter (TYS-BZ)
 Adaptable for 2-3/8", 3", or 3 1/2" tenon with 3/4" NPS hole, bronze finish



Steel Angle Bracket (SAB-BZ)
 Steel 45° angle bracket for trunnion mount, bronze finish

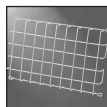

Wire Guard (SF/WG)
 Easy to install guard features heavy-gauge welded construction to protect glass from projected objects

Knuckle-Mount
Round box cover not included.



Trunnion-Mount
(T Suffix)



Ordering Information

Stock Number	UPC	Wattage	Source	Lamp	Ballast	Lamp Included	Ballast Kit
TRUNNION MOUNT <i>Pulse Start Metal Halide</i>							
MPSF10T-MT	623961042898	100W	MP	Medium-base, ED-17	Hi.Rx/HPF/MT/277V	MH100/U/MEDFG	MHKT-100-HIX-HPF-MT
MPSF15T-MT	623961757730	150W	MP	Medium-base, ED-17	CWA/MT/277V	MH150UMED	MHKT-150-CWA-MT
KNUCKLE MOUNT <i>High Pressure Sodium</i>							
HPSF70K	623960365400	70W	HPS	Medium-base, ED-17	Reactor/NPF/120V	S62LG-70FG	HPKT-70-REC-NPF-120
HPSF10K	623960365394	100W	HPS	Medium-base, ED-17	Reactor/NPF/120V	S54SG-100FG	HPKT-100-REC-NPF-120V
HPSF15K	623960365370	150W	HPS	Medium-base, ED-17	Reactor/NPF/120V	S55RN-150FG	HPKT-150-REC-NPF-120V
KNUCKLE MOUNT <i>Pulse Start Metal Halide</i>							
MPSF70K	623961978043	70W	MP	Medium-base, ED-17	Hi.Rx/NPF/120/277V	MH70/U/MEDFG	MHKT-70-HIX-NPF-120/277V
MPSF10K	623961978050	100W	MP	Medium-base, ED-17	Hi.Rx/NPF/120/277V	MH100/U/MEDFG	MHKT-100-HIX-NPF-120/277V
MPSF10K-MT	623961978111	100W	MP	Medium-base, ED-17	Hi.Rx/HPF/MT/277V	MH100/U/MEDFG	MHKT-100-HIX-HPF-MT
MPSF15K-MT	623961757723	150W	MP	Medium-base, ED-17	CWA/MT/277V	MH150UMED	MHKT-150-CWA-MT

WEDGE Quartz Floodlight

500W Quartz Halogen

Applications

Accent • Corridor • Entrance / Eave • Facade • Pathway • Retail • Security • Sign

Specifications

- Impact-resistant tempered glass lens with hinged die-cast door
- Stainless steel latch for tool-less entry
- Die-cast aluminum housing with extended heat dissipating fins in black finish
- Full-perimeter silicone gasket seals out external contaminants
- Double-ended quartz lamp included. Unit will also operate 300W
- Specular aluminum reflector
- Reinforced, adjustable, 1/2" NPS threaded mounting stem
- UL listed for wet location. CSA certified, for outdoor use only
- Wedge approx. net weight: 3 lbs. (1.36 kgs.)

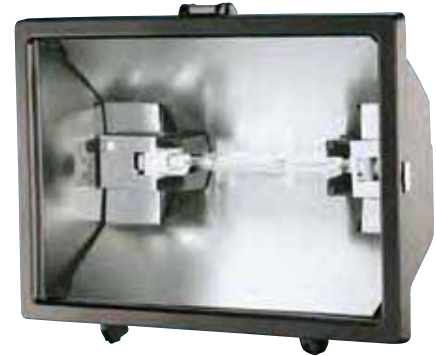
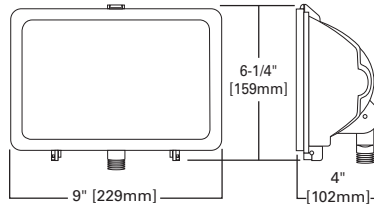

Ordering Information

Stock Number	UPC	Master Carton	Wattage	Source	Lamp	Voltage	Lamp Included
Quartz Halogen							
QZ5L	662400116813	4	500W	Quartz	Double-Ended T3	120V	BP-500Q

Photometry

Set Back	Footcandle Value for Isofootcandle lines			
	A	B	C	D
5'	20	8	4	2
10'	5	2	1	.5
12'	3.5	1.4	.69	.35

Example of 500W Quartz placed 5 ft. from surface, tilted back at 45° angle, 11,100 lumen clear lamp

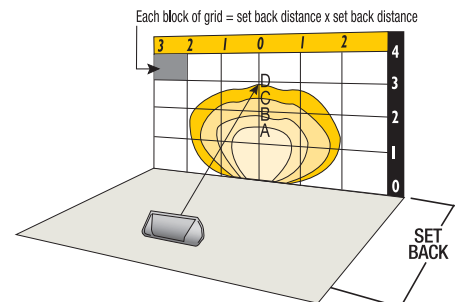

ETERNALUME | Area Dusk-to-Dawn Luminaire

70-150W High Pressure Sodium
100W Pulse Start Metal Halide

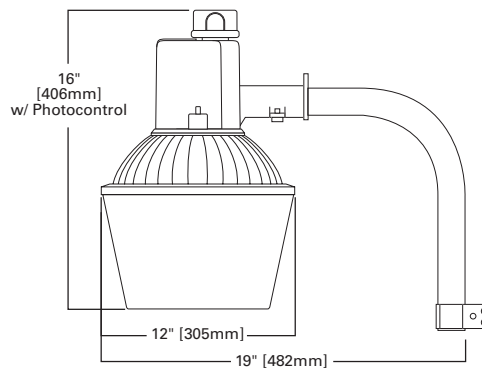

Applications

- Parking Lot • Pathway • Recreation • Retail • Roadway • Security • Transportation

Specifications

- High-impact, 12" wide, open-bottom acrylic refractor
- NEMA twistlock style photocontrol for automatic dusk-to-dawn operation
- Precision die-cut aluminum housing
- HPS: Mogul-base screw shell lamp socket with spring-loaded center contact
- MP: Medium-base screw shell protected lamp socket (open rated)
- Lamp included and available up to 150W HPS or 100W MP
- Fluted, formed specular aluminum reflector fastens to main housing for secure fit
- Sturdy curved 24" aluminum mounting arm (1-5/8" dia.) provides 18" projection from mounting surface, Hardware supplied. Natural finish.
- UL listed for wet locations. CSA certified
- Approx. net weight: 11 lbs. (5kgs)



Ordering Information

Stock Number	UPC	Wattage	Source	Lamp	Voltage	Lamp Included
High Pressure Sodium						
HPPEL70	662401746927	70W	HPS	Mogul,ED-23.5	Reactor/NPF/120V	S62ME-70FG
HPPEL10	662401746958	100W	HPS	Mogul,ED-23.5	Reactor/NPF/120V	S54SB-100FG
HPPEL15	662401746972	150W	HPS	Mogul,ED-23.5	Reactor/NPF/120V	S55SC-150FG
Pulse Start Metal Halide						
MPPEL10	623961986079	100W	MP	Medium, ED17P	HX/NPF/120V	MH100UMEDOR

Photometry

Mounting Height	Footcandle Value for Isofootcandle lines			Multiplier		
	A	B	C	Watts	HPS	MP
20'	2.0	1.0	.05	70	0.71	-
25'	1.3	.64	.32	100	1.05	1.00
30'	.88	.44	.22	150	1.77	-

Example of 100W HPS at 15 ft. mounting height, 9,500 lumen clear lamp

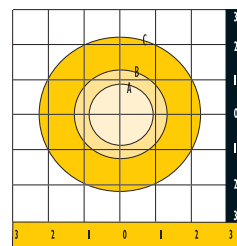

Each block of grid = mounting height x mounting height

TRIBUTE^{Area} Luminaire

150-400W High Pressure Sodium
150-400W Pulse Start Metal Halide

Applications

- Parking Areas • Access Roadways
- General Off Street Area • Site Lighting

Specifications

- EISA Compliant
- Clear, flat tempered glass lens
- One-piece, die-cast aluminum door frame features a single stainless steel latch for toolless opening and stainless steel hinges for tool-less removal
- Rugged, one-piece, die-cast aluminum housing with bronze polyester powder-coat finish
- One piece silicone protects the optical chamber from performance degrading contaminants
- Mogul-base porcelain lamp socket for HPS and 250-400W MP. Medium-base socket for 150W MP.
- Lamp included and available from 150W to 400W HPS or 150W to 400W MP
- Hydroformed anodized aluminum reflector adjustable Type II/III or Type IV distribution, Full Cutoff classification
- Ballast and related electrical componentry are hard-mounted to die-cast housing for optimal heat transfer and operating efficiency
- Includes 8" extruded square arm and round pole adapter with bronze polyester powder-coat finish
- U.L. listed for wet locations. CSA certified
- E.P.A. = 1.62 with arm, 1.19 without arm
- Approx. net weight: 39 lbs. (17.73 kgs.)

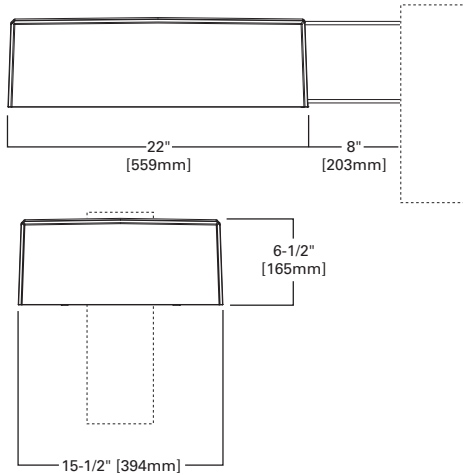

Photometry

Mounting Height	Footcandle Value for Isofootcandle lines					Multiplier		
	A	B	C	D	E	Watts	HPS	MP
20'	3.00	1.50	0.75	0.30	0.15	150	0.44	0.31
25'	2.00	1.00	0.50	0.20	0.10	250	0.76	0.57
30'	1.38	0.69	0.34	0.13	0.06	400	1.38	1.00

Example of 400W MP at 30 ft. mounting height, 40,000 lumen clear lamp.

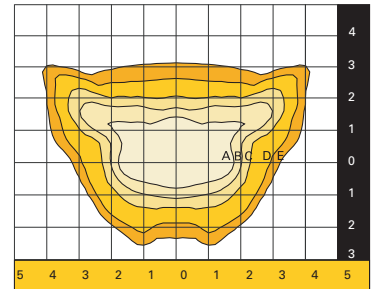

Accessories



Wall Mount (MA1219-BZ)
 Wall Mount bracket, hardware and steel adapter plate. Finished in bronze polyester powder coat



"All-in-One"
Includes fixture,
lamp, 8" square pole
arm and round pole adapter in a single carton.



DARK SKY COMPLIANT **FCO**
Full Cutoff

Available in Pole and Fixture Combo
Contact Local Cooper Lighting Agent for details.



(Shown with pole)

Ordering Information

Stock Number	UPC	Wattage	Source	EISA Compliant	Lamp	Distribution Type	Ballast	Lamp Included	Ballast Kit
High Pressure Sodium									
HPTR2315	623961643323	150W	HPS		Mogul-base, ED-23.5	II/III	CWA/MT/277V	S55SC-150FG	HPKT-150-HIX-HPF-MT
HPTR2325	623961508424	250W	HPS		Mogul-base, ED-18	II/III	CWA/MT/277V	S50VA-250FG	HPKT-250-CWA-MT
HPTR2340	623961643330	400W	HPS		Mogul-base, ED-18	II/III	CWA/MT/277V	S51WA-400FG	HPKT-400-CWA-MT
Pulse Start Metal Halide									
MPTR2315	623961009440	150W	MP		Medium-base, ED-17	II/III	CWA/MT/277V	MH150UMED	MPKT-150-CWA-MT
MPTR2325	623961750960	250W	MP	ⓔ	Mogul-base, ED-28	II/III	CWA/MT/277V	MS250/U/PS	MPKT-250-CWA-MT
MPTR2340	623961750984	400W	MP	ⓔ	Mogul-base, ED-28	II/III	CWA/MT/277V	M400/PS/U/BT28	MPKT-400-CWA-MT
MPTR4F40	623961751554	400W	MP	ⓔ	Mogul-base, ED-28	IV	CWA/MT/277V	M400/PS/U/BT28	MPKT-400-CWA-MT



Don't Sweat It!

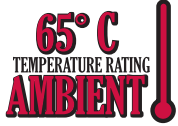

Cooper Lighting's Lumark Steeler series of open high-bays are rated for 65°C (149°F) ambient environments through 400W, while most competitors only meet U.L. requirements for 55°C (131°F).

Since optimal fixture life depends upon the ambient environment and rated temperature of the internal components, every degree has considerable performance implications. With the Steeler's superior housing construction, components run cooler than the competitive products. Cooler is better because the component life doubles for every 10°C cooler the system operates.



The benefit to having 65°C rating is two-fold:

1. 55°C rated fixtures cannot be used on a job where ambient temperature reaches 65°C without potential failures and down time.
2. When a 65°C rated fixture is used within a 55°C environment, the life expectancies of the electrical components double.

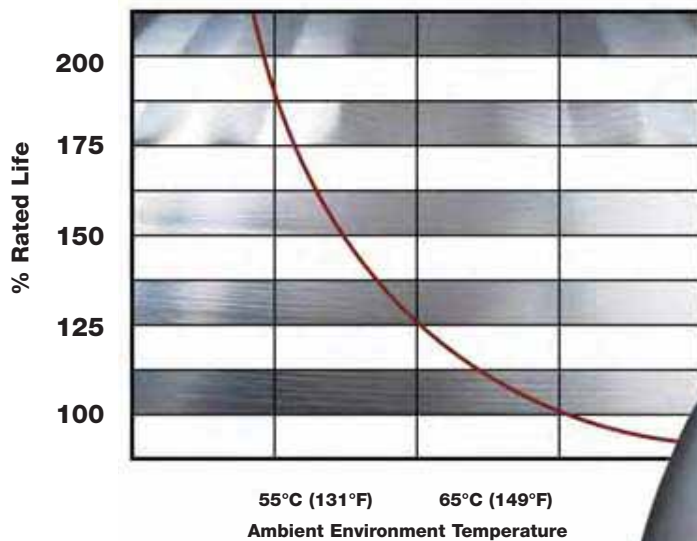

STEELER Aluminum High-Bay

320W & 400W Pulse Start Metal Halide Unit Pack



Components nested in one compact unit pack carton.

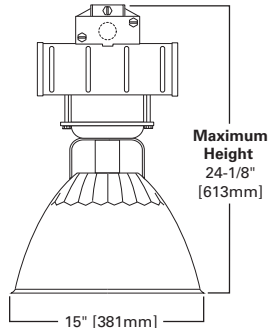

Applications

- Gymnasium • Recreation • Retail • Transportation • Warehouse

Specifications

- EISA Compliant
- High efficiency, computer-designed 15" spun aluminum reflector
- Formed steel open-air ballast housing with white finish
- Slide-on, die-cast aluminum mounting box with 3/4" tapped conduit opening
- Mogul-base porcelain lamp socket, open rated
- Lamp included and available in 400W MP
- Field-adjustable ladder brackets with eleven (11) distribution patterns
- Optional Quartz Restrike (Q) for hot strike after momentary power interruption. 250W (max) lamp included.
- Minimum starting temperature of -40°C (-40°F) for HPS and 30°C (-20°F) for MP
- cULus listed for damp location. CSA certified
- 65°C (149°F) ambient operation
- Approx. net weight: 30 lbs. (13 kgs.)



FASTEST
HIGH-BAY IN THE INDUSTRY
INSTALL

65°C
TEMPERATURE RATING
AMBIENT

Ordering Information

Stock Number	UPC	Wattage	Source	EISA Compliant	Lamp	Ballast	Lamp Included	Ballast Pod
<i>Pulse Start Metal Halide Unit Pack consists of: SA15 Spun Aluminum Reflector, Ballast Pod, and Mogul-Base Lamp.</i>								
MPSS40-OR	623961086366	400W	MP	ⓔ	ED37	CWA/MT/277V	MP400-O-BU-C-MR-E37-C	MPSS-400-MT-OR
MPSS32-OR	623961013232	320W	MP	ⓔ	ED37	CWA/MT/277V	MP350-O-BU-C-MR-E37-C	MPSS-320-MT-OR
<i>Pulse Start Metal Halide Unit Pack consists of: SA15 Spun Aluminum Reflector, Ballast Pod, Mogul-Base Lamp, Quartz Restrike Option.</i>								
MPSS40Q-OR	623961776915	400W	MP	ⓔ	ED37	CWA/MT/277V	MP400-O-BU-C-MR-E37-C	MPSS-400-MT-OR-Q

*OR suffix designates open rated fixture, 2005 NEC Compliant

Photometry

Mounting Height	Footcandle Value for Isofootcandle lines				
	A	B	C	D	E
25'	5.00	2.00	1.00	.50	.20
30'	3.47	1.39	.69	.35	.14
35'	1.63	.65	.33	.16	.07

Example of 400W MP at 25ft. mounting height, 40,000 lumen lamp

Watts	Multiplier	
	HPS	MP
400	1.29	1.00

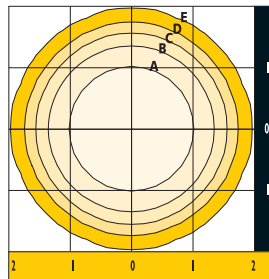

Accessories*



Hook (FH-1)
Die-cast aluminum hook with 3/4" threads



Wire Guard (WG15)
Heavy-gauge 15" wire guard provides additional lamp protection



Cord & Plug (PC6-120V)
6' Cord with NEMA 120V L5-15P Plug



Loop (FL-1)
Malleable iron plated fixture loop with 3/4" threads



Safety Hook (SHK)
Die-cast aluminum hook with safety screw and 3/4" threads



Cord & Plug (PC6-277V-WHT)
6' White Cord with NEMA 277V L5-15P Plug



Safety Glass (SGB15)
Safety glass bottom for 15" aluminum reflector, not compatible with WG15. 2005 NEC Compliant



Wire Guard w/Safety Glass (WG15/GLC)
Heavy-gauge 15" wire guard and safety glass lens provides additional lamp protection

*Not all accessories standard. Consult factory.

STEELER | Prismatic High-Bay

400W Pulse Start Metal Halide Unit Pack

Applications

Gymnasium • Recreation • Retail • Transportation • Warehouse

Specifications

- EISA Compliant
- High efficiency, clear prismatic 22" acrylic refractor
- Formed-steel, open-air ballast housing with white finish
- Slide-on, die-cast aluminum mounting box with 3/4" tapped conduit opening
- Mogul-base porcelain lamp socket, open rated
- Coated lamp included and available in 400W MP
- Field-adjustable universal ladder brackets with eleven distribution patterns
- Minimum starting temperature is -30°C (-20°F) for MP
- cULus listed for damp location. CSA certified
- 55°C (131°F) ambient operation open 40°C (104°F) ambient operation enclosed
- Approx. net weight: 30 lbs. (13 kgs.)

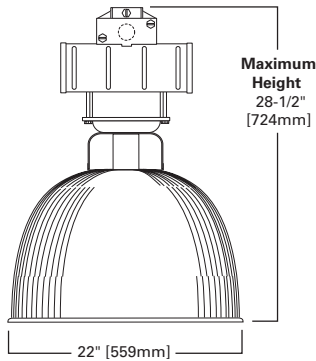

Photometry

Mounting Height	Footcandle Value for Isofootcandle lines					Watts	Multiplier HPS	MP
	A	B	C	D	E			
25'	5.00	2.00	1.00	.50	.20	400	1.29	1.00
30'	3.47	1.39	.69	.35	.14			
35'	1.63	.65	.33	.16	.07			

Example of 400W MP at 25ft. mounting height, 40,000 lumen coated lamp

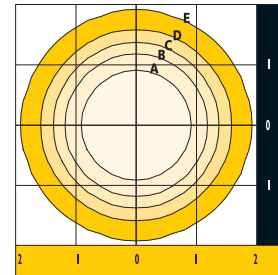

Accessories*

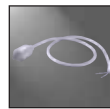

Cord & Plug (PC6-120V)
6' Cord with NEMA 120V L5-15P Plug



Hook (FH-1)
Die-cast aluminum hook with 3/4" threads



Safety Hook (SHK)
Die-cast aluminum hook with safety screw and 3/4" threads



Cord & Plug (PC6-277V-WHT)
6' White Cord with NEMA 277V L5-15P Plug



Loop (FL-1)
Malleable iron plated fixture loop with 3/4" threads



Wire Guard (WG22)
Heavy-gauge 22" wire guard provides additional lamp protection



Drop Lens (DB22)
Drop acrylic lens for 22" acrylic refractor 400W (max)



Safety Glass (SGB22)
Safety glass bottom for 22" acrylic refractor 400W (max), not compatible with wire guards

*Not all accessories standard. Consult factory.



Components nested in one compact unit pack carton.



FASTEST
HIGH-BAY IN THE INDUSTRY
INSTALL

55° C
TEMPERATURE RATING
AMBIENT

Ordering Information

Stock Number	UPC	Wattage	Source	EISA Compliant	Lamp	Ballast	Lamp Included	Ballast Pod
<i>Pulse Start Metal Halide Unit Pack consists of PD22 Acrylic Refractor, Ballast Pod and Coated Mogul-Base Lamp.</i>								
MPSS40-PD-OR	623961797446	400W	MP	ⓔ	ED37	CWA/MT/277V	MP400-O-BU-D-MR-E37-C	MPSS-400-MT-OR

*OR suffix designates open rated fixture, 2005 NEC Compliant



ENTERPRISE Industrial Low-Bay

250W, 320W & 400W Pulse Start Metal Halide Unit Pack

Applications

Gymnasium • Recreation • Retail • Transportation • Warehouse

Specifications

- EISA Compliant
- Enclosed and gasketed, high-efficiency, computer-designed 22" faceted aluminum reflector
- 100% virgin UV stabilized acrylic lens
- Formed-steel, open-air ballast housing with white finish
- Slide-on, die-cast aluminum mounting box with 3/4" tapped conduit opening
- Mogul-base porcelain lamp socket, open rated
- Lamp included and available from 250W to 400W MP
- Trunk latches secure reflector to housing for toolless entry while internal hangers hold optics for hands-free relamping
- Minimum starting temperature is -40°C (-40°F) for HPS and -30°C (-20°F) for MP
- cULus listed for damp location. CSA certified
- 40°C (104°F) ambient operation
- Approx. Net Weight: 30 lbs. (13 kgs.)

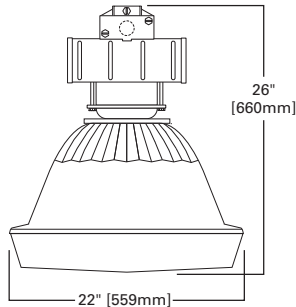

Photometry

Mounting Height	Footcandle Value for Isofootcandle lines					Watts	Multiplier HPS	MP
	A	B	C	D	E			
15'	8.89	2.55	1.77	.89	.35	250	.78	.58
20'	5.00	2.00	1.00	.50	.20	400	1.39	1.00
25'	3.20	1.28	.64	.32	.13			

Example of 400W MP at 20ft. mounting height, 40,000 lumen clear lamp.

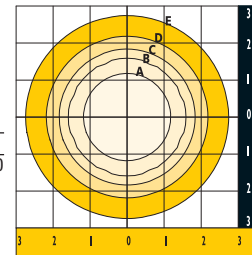

Accessories *

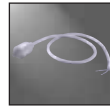

Cord & Plug (PC6-120V)
6' Cord with NEMA 120V L5-15P Plug

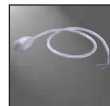

Cord & Plug (PC6-277V-WHT)
6' White Cord with NEMA 277V L5-15P Plug



Wire Guard (WG22/EP)
Heavy-gauge 22" wire guard for acrylic drop lens provides additional lamp and refractor protection



Hook (FH-1)
Die-cast aluminum hook with 3/4" threads



Loop (FL-1)
Malleable iron plated loop with 3/4" threads



Safety Hook (SHK)
Die-cast aluminum hook with safety screw and 3/4" threads

*Not all accessories standard. Consult factory.



Components nested in one compact unit pack carton.



40° C
TEMPERATURE RATING
AMBIENT

Ordering Information

Stock Number	UPC	Wattage	Source	EISA Compliant	Lamp	Ballast	Lamp Included	Ballast Pod
<i>Pulse Start Metal Halide Unit Pack consists of R22 Reflector EP22 Acrylic Lens, Ballast Pod and Mogul-Base Lamp.</i>								
FP25-OR	80083535859	250W	MP	ⓔ	ED28	CWA/MT/277V	MP250-0-BU-C-MR-E28-60-40-R-S	MPEP-22/28-250-MT-OR
FP32-OR	80083535866	320W	MP	ⓔ	ED37	CWA/MT/277V	MP320-0-BU-C-MR-E37-C	MPEP-22/28-320-MT-OR
FP40-OR	80083535880	400W	MP	ⓔ	ED37	CWA/MT/277V	MP400-0-BU-C-MR-E37-C	MPEP-22/28-400-MT-OR



VERTIMARK II Industrial Luminaire

175-250W Pulse Start Metal Halide

Applications

Parking Garage • Corridor • Transportation

Specifications

- EISA Compliant
- Type V acrylic prismatic refractor controls light for high vertical and horizontal footcandles
- Hinged refractor permits relamping without the use of tools
- Die-cast aluminum housing with white polyester powder-coat finish
- Removable ballast compartment cover provides easy internal access
- Quick mounting plate for 3/4" allows for hands free wiring
- Mogul-base porcelain lamp socket, open rated
- Lamp included and available from 175W to 250W MP
- cULus listed for damp location. CSA certified
- 40°C ambient operation
- Approx. net weight: 7 lbs. (8 kgs.)

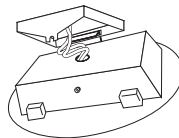
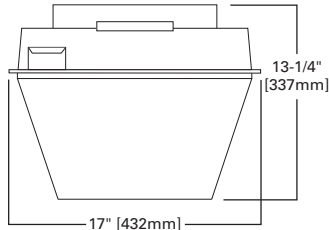

Quick mounting plate allows for hands free installation

Photometry

Mounting Height	Footcandle Value for Isofootcandle lines					Watts	Multiplier HPS	MP
	A	B	C	D	E			
10'	4.50	2.25	1.25	.45	.23	100	.68	-
15'	2.00	1.00	.50	.20	.10	175	-	1.00
20'	1.13	.56	.28	.11	.06	250	-	1.46

Example of 175W MP at 15ft. mounting height, 14,000 lumen clear lamp.

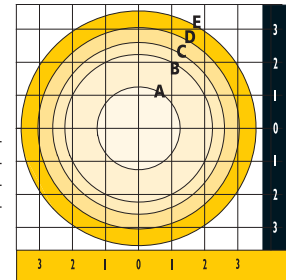

Accessories *

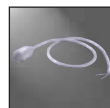

Cord & Plug (PC6-120V)
6' Cord with NEMA 120V L5-15P Plug

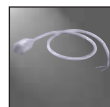

Cord & Plug (PC6-277V-WHT)
6' White Cord with NEMA 277V L5-15P Plug



Hook (FH-1)
Die-cast aluminum hook with 3/4" threads



Loop (FL-1)
Malleable iron plated loop with 3/4" threads



Safety Hook (SHK)
Die-cast aluminum hook with safety screw and 3/4" threads

Surface Mounting Bracket (IA1025)
Field installed bracket for 4" junction box

*Not all accessories standard. Consult factory.



Ordering Information

Stock Number	UPC	Wattage	Source	EISA Compliant	Lamp	Ballast	Lamp Included	Ballast Kit
Pulse Start Metal Halide								
MPBE-5A-175H-OR-MT-LL	800835355456	175W	MP	ⓔ	ED28	CWA/MT/277V	MP175W/BU/UUS/PS/740	MPKT-175-CWA-MT-OR
MPBE-5A-250H-OR-MT-LL	662401405572	250W	MP	ⓔ	ED28	CWA/MT/277V	MP250-O-BU-C-MR-E28-60-40-U-V	MPKT-250-CWA-MT-OR



ICVW1G

VAPORTIGHT Wall Mount

Up to 200W Incandescent

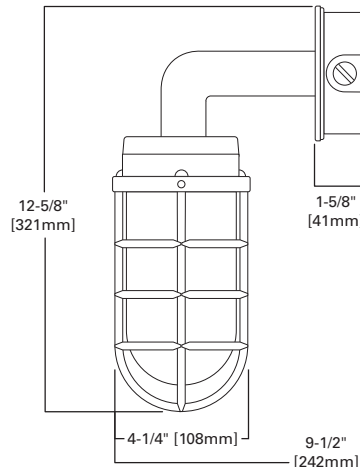

Ordering Information

Stock Number	UPC	Master Carton	Wattage	Source	Lamp
<i>Incandescent</i>					
ICVW1G	662401690299	4	Up to 200W	Incandescent	A21

Applications

- Accent • Entrance/Eave • Pathway • Recreation • Retail • Security • Transportation

Specifications

- Borosilicate glass globe protects against thermal shock breakage
- Threaded glass and guard for easy assembly
- Stainless steel locking screw for vandal protection
- Rigid, one-piece, die-cast aluminum guard for added protection from glass breakage
- Powder coated architectural grade grey finish
- High-temperature and chemical-resistant silicone gasket for durability
- 250V medium-base lamp socket. Porcelain exterior with 150°C wire
- Accommodates up to 200W A21 based incandescent or self-ballasted compact fluorescent lamps (not included)
- Supplied with round 4" box. Small housing equipped with 1/2" NPS conduit entry, large with 3/4" NPS, base up mounting only
- IP65, cULus listed for non-classified wet locations at 40°C ambient environments
- 90°C supply wiring
- Approx. net weight: 3.85 lbs. (1.74 kgs)

The First Choice

Choose the Steeler Worklight for your temporary lighting!

Lumark's Steeler Worklight is available with 2005 NEC-compliant, open-rated lamps with added UV protection to ensure a safe and reliable temporary lighting solution! Steeler Worklight's open-rated lamp has a protective barrier that contains particles in the event of a non-passive failure, while offering a reduction in UV exposure compared to standard metal halide lamps. In unpredictable construction sites, the open-rated Steeler Worklight helps promote a safe working environment.



STEELER Construction Worklight

400W Pulse Start Metal Halide Unit Pack

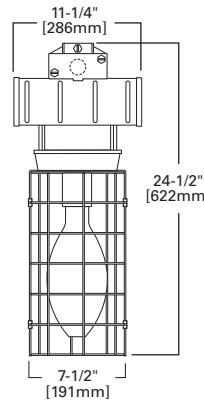

65°C
TEMPERATURE RATING
AMBIENT

Ordering Information

Stock Number	UPC	Wattage	Source	EISA Compliant	Lamp	Ballast	Lamp Included
<i>Pulse Start Metal Halide consists of: CWG Wire Guard, Ballast Pod, Safety Hook and Coated Mogul-Base Lamp</i>							
MPCW40-OR	623961013270	400W	MP	ⓔ	ED37	CWA/MT/277V	MP400-0-BU-D-MR-E37-C
<i>Pulse Start Metal Halide consists of: CWG Wire Guard, Ballast Pod, Safety Hook and Coated Mogul-based Lamp, 3' Cord with NEMA 120V L5-15P Plug</i>							
MPCW40-C3-OR	80083546251	400W	MP	ⓔ	ED37	CWA/MT/277V	MP400-0-BU-D-MR-E37-C

Accessories*



Hook (FH-1)
Die-cast aluminum hook with 3/4" threads



Loop (FL-1)
Malleable iron plated loop with 3/4" threads

*Not all accessories standard. Consult factory.

Applications

Temporary • Warehouse

Specifications

- EISA Compliant
- Durable formed and welded steel wire guard coated with a safety yellow polyester paint for easy visibility and safety
- Formed steel, open-air ballast housing with white polyester finish
- Slide-on die-cast aluminum mounting box with 3/4" tapped conduit opening
- Mogul-base porcelain lamp socket, open rated
- 3' cord with or without NEMA 120V L5-15P plug (C3 or PC3 suffix)
- Coated lamp supplied and available in 400W MP
- Unit pack of components nested in one compact carton
- Minimum starting temperature of -30°C (-20°F) for MP
- Die-cast aluminum hook with safety screw and 3/4" threads included
- cULus listed for damp locations. CSA listed
- 65°C (149°F) ambient operation
- Approx. net weight: 30 lbs. (13 kgs.)



METALUX[®]

Cooper Lighting is a leader in the design, development and production of high performance fluorescent lighting for commercial, industrial, institutional and retail markets. Heavy gauge steel construction, durable baked white finish and electrical assemblies ensure years of performance integrity. Cooper Lighting is your single fluorescent lighting source.



2EP3 Series Paralux III Parabolic



Dimensions

2EP3 Lamp Configurations

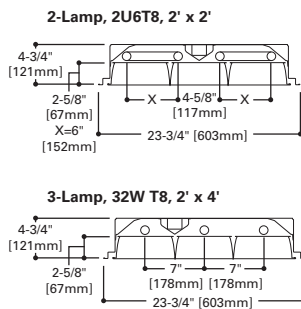

2EP3 Dimensions for Top View

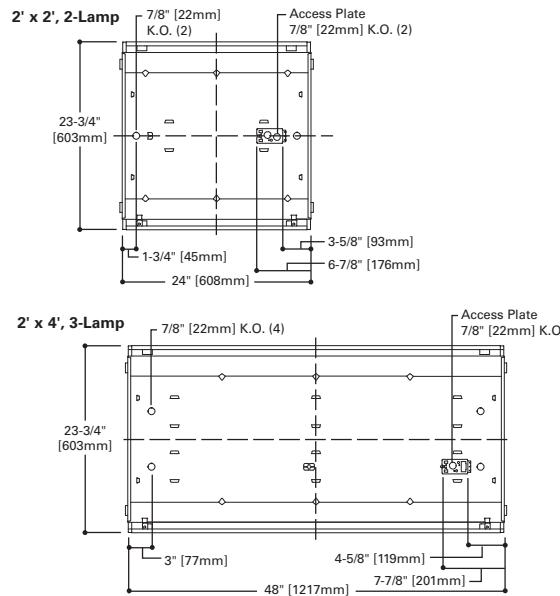

Applications



Commercial • Office • Schools • Hospitals • Retail Merchandising Areas

Specifications

- CEE listed ballast
- Self-locking, spring-loaded cam latches / T-hinges
- Four auxiliary fixture end suspension points provided
- Interlocking tabs and screws secure end plates
- Efficient air handling options
- Floating louver with black reveal
- UL/CUL Listed. Suitable for damp locations.

Ordering Information

Pallet quantities required on all Metalux orders.

Catalog Number	Description	UPC Code	Weight	Case Qty	Pallet ⁽¹⁾ Qty
 2EP3GX-2U6T8S331-UNV-EB81-U	2 U-Lamp, 2'x2' Static Parabolic, 9 Cell, Semi Specular/Low Iridescent Haze Nominal 3" Louver, CEE Listed Electronic Ballast, T8	080083520145	14.3	1	40
2EP3GAVX-2U6T8S331-UNV-EB81-U	2 U-Lamp, 2'x2' Air Supply Parabolic, w/Vanes, 9 Cell, Semi Specular/Low Iridescent Haze, Nominal 3" Louver, CEE Listed Electronic Ballast, T8	080083520220	14.3	1	40
AP32U	2 U-Lamp, 2'x2' Static Parabolic, 9 Cell, Semi Specular/Low Iridescent Haze, Nominal 3" Louver, CEE Listed Ballast, T8 w/Lamps & Flex	080083520176	16.1	1	32
 2EP3GAVX-332S361-UNV-EB81-U	3 Lamp, 2'x4' Air Supply Parabolic, w/Vanes, 18 Cell, Semi Specular/Low Iridescent Haze Nominal 3" Louver, CEE Listed Electronic Ballast, T8	662401000685	26.8	1	20
2EP3GX-332S361-UNV-EB81-U	3 Lamp, 2'x4' Static Parabolic, 18 Cell, Semi Specular/Low Iridescent Haze Nominal 3" Louver, CEE Listed Electronic Ballast, T8	662401012084	25.3	1	20
2EP3GX-332S361-UNV-L8735-EB81-U	3 Lamp, 2'x4' Static Parabolic, 18 Cell, Semi Specular/Low Iridescent Haze Nominal 3" Louver, CEE Listed Electronic Ballast, T8, w/Lamps	662400201908	27.36	1	20
2EP3GX-332S361-UNV-L8735-A3/8-2/18G-EB81-U	3 Lamp, 2'x4' Static Parabolic, 18 Cell, Semi Specular/Low Iridescent Haze Nominal 3" Louver, CEE Listed Electronic Ballast, T8, w/Lamps & Flex	662401339730	30.3	1	16
2EP3GX-332S361-UNV-L8741-EB81-U	3 Lamp, 2'x4' Static Parabolic, 18 Cell, Semi Specular/Low Iridescent Haze Nominal 3" Louver, CEE Listed Electronic Ballast, T8, w/Lamps	622697478087	27.36	1	20
2EP3GX-332S361-UNV-L8741-A3/8-2/18G-EB81-U	3 Lamp, 2'x4' Static Parabolic, 18 Cell, Semi Specular/Low Iridescent Haze Nominal 3" Louver, CEE Listed Electronic Ballast, T8, w/Lamps & Flex	662400213796	30.3	1	16
AP3	3 Lamp, 2'x4' Air Supply Parabolic w/Vanes, 18 Cell, Semi Specular/Low Iridescent Haze Nominal 3" Louver, CEE Listed Ballast, T8, w/Lamps & Flex	622696199785	30.3	1	16

NOTES: ⁽¹⁾ Metalux products must be ordered in pallet quantities to qualify for freight under the OffThe Shelf program.

GR8 Series Commercial Grade T8 Recessed Static Troffer

Dimensions

Dimensions for Top View

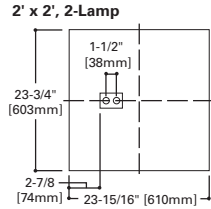

2' x 4', 3-Lamp

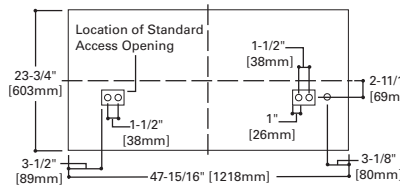

2' x 4', 4-Lamp

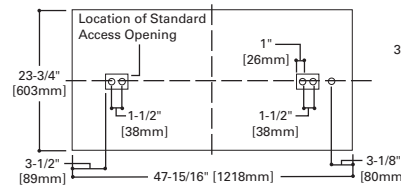

GR8 Lamp Configurations

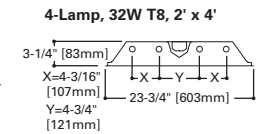
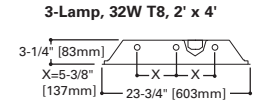
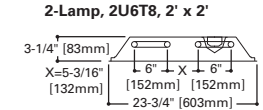

Applications

Commercial Offices • Schools • Hospitals • Retail Merchandising

Specifications

- Unibody construction
- Optimized for T8 lamps
- Equipped with energy saving ballasts/complies with federal energy efficiency standards
- Reinforced flat white steel door, mitered corners
- Positive light seal
- Spring loaded latch
- T-hinges
- Die embossed housing
- Four auxiliary fixture end suspension points provided
- End plate grid-lock feature
- UL/CUL Listed. Suitable for damp locations



Ordering Information

Pallet quantities required on all Metalux orders.

Catalog Number	Description	UPC Code	Weight	Case Qty	Pallet ⁽¹⁾ Qty
2GR8-2U6T8A-UNV-EB81-U	2 U-Lamp, 2'x2' Static Lensed Troffer, CEE Listed Electronic Ballast	623961643842	12.2	1	56
GR8-2U	2 U-Lamp, 2'x2' Static Lensed Troffer, CEE Listed Electronic Ballast, T8 w/Lamps & Flex	623961182563	15.29	1	56
2GR8-232A-UNV-EB81-U	2 Lamp, 2'x4' Static Lensed Troffer, CEE Listed Electronic Ballast, T8	623961759802	22.5	1	28
2GR8-332A-UNV-EB81-U	3 Lamp, 2'x4' Static Lensed Troffer, CEE Listed Electronic Ballast, T8	662401286805	20.5	1	28
2GR8-332A-UNV-EB82-U	3 Lamp, 2'x4' Static Lensed Troffer, CEE Listed Electronic Ballast (2), T8	662401341405	22.5	1	28
2GR8-332A-UNV-L8735-EB81-U	3 Lamp, 2'x4' Static Lensed Troffer, CEE Listed Electronic Ballast, T8 w/Lamps	662401012213	22.5	1	28
2GR8-332A-UNV-L8735-A3/8-2/18G-EB81-U	3 Lamp, 2'x4' Static Lensed Troffer, CEE Listed Electronic Ballast, T8 w/Lamps & Flex	662401335831	22.5	1	28
2GR8-332A-UNV-L8741-A3/8-2/18G-EB81-U	3 Lamp, 2'x4' Static Lensed Troffer, CEE Listed Electronic Ballast, T8 w/Lamps & Flex	623961689840	23.83	1	28
2GR8-432A-UNV-EB81-U	4 Lamp, 2'x4' Static Lensed Troffer, CEE Listed Electronic Ballast, T8	662400102229	20.5	1	28
2GR8-432A-UNV-EB82-U	4 Lamp, 2'x4' Static Lensed Troffer, CEE Listed Electronic Ballast (2), T8	662401286812	22.5	1	24
2GR8-432A-UNV-L8735-EB81-U	4 Lamp, 2'x4' Static Lensed Troffer, CEE Listed Electronic Ballast, T8 w/Lamps	662401335862	22.3	1	28
2GR8-432A-UNV-L8741-EB81-U	4 Lamp, 2'x4' Static Lensed Troffer, CEE Listed Electronic Ballast, T8 w/Lamps	623961689482	22.3	1	28
2GR8-432A-UNV-L8735-A3/8-2/18G-EB81-U	4 Lamp, 2'x4' Static Lensed Troffer, CEE Listed Electronic Ballast, T8 w/Lamps & Flex	662401335848	24.28	1	28
2GR8-432A-UNV-L8741-A3/8-2/18G-EB81-U	4 Lamp, 2'x4' Static Lensed Troffer, CEE Listed Electronic Ballast, T8 w/Lamps & Flex	662401321902	24.28	1	28
GR83	3 Lamp, 2'x4' Static Lensed Troffer, CEE Listed Electronic Ballast, T8 w/Lamps & Flex	623961285875	23.93	1	24
GR8	4 Lamp, 2'x4' Static Lensed Troffer, CEE Listed Electronic Ballast, T8 w/Lamps & Flex	622697079918	22.66	1	28

NOTES: ⁽¹⁾ Metalux products must be ordered in pallet quantities to qualify for freight under the Off The Shelf program.

WN Series WS Series WP Series

Commercial/Specification Grade T8 Surface Wraparound



Applications

- Commercial Spaces •
- Schools • Dormitories •
- Offices • Retail Areas

Specifications

- Energy saving ballasts comply with federal energy efficiency standards
- Low profile
- Low brightness/extruded acrylic refractor
- Heavy gauge end plates with embossed light seal
- Baked white enamel finish
- Lift and shift refractor for ease of re-lamping
- Surface or stem mounting ^{(1) (2)}
- Single or continuous row mounting ⁽³⁾
- Also available in tandem 8' lengths ⁽⁵⁾
- UL/CUL Listed. Suitable for damp locations.

Dimensions

WN Series Lamp Configurations

2-Lamp, 32W T8

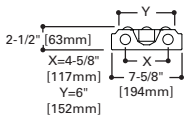

4-Lamp, 32W T8

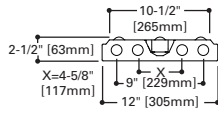

WS Series Lamp Configurations

2-Lamp, 32W T8

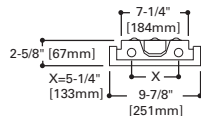

4-Lamp, 32W T8

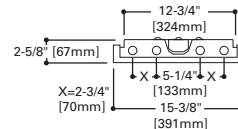

WN Series Dimensions for Top View

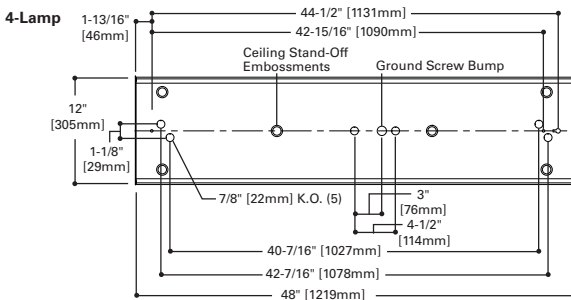
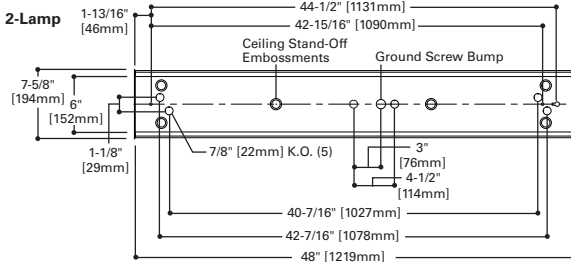

WS Series Dimensions for Top View

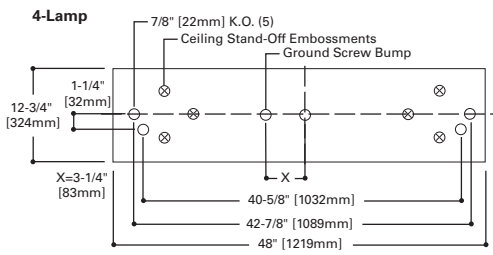
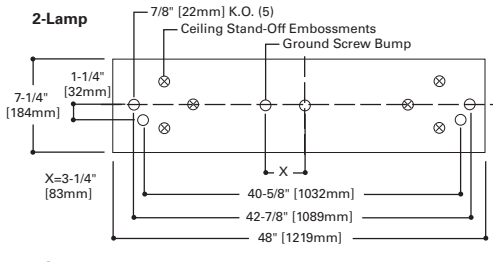

WP Series Lamp Configurations

2-Lamp, 32W T8

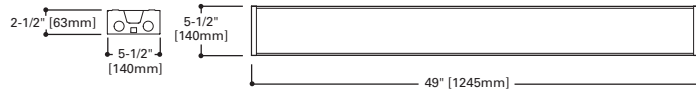

Ordering Information

Pallet quantities required on all Metalux orders.

Catalog Number	Description	UPC Code	Weight	Case Pallet ⁽⁴⁾	
				Qty	Qty
WN-232A-UNV-EB81-U	2 Lamp, 4' Standard Grade Wraparound, CEE Listed Electronic Ballast, T8	080083518845	9.6	1	90
WN-432A-UNV-EB81-U	4 Lamp, 4' Standard Grade Wraparound, CEE Listed Electronic Ballast, T8	080083518517	14	1	54
WS-232A-UNV-EB81-U	2 Lamp, 4' Specification Grade Wraparound, CEE Listed Electronic Ballast, T8	662401191352	11.2	1	48
WS-432A-UNV-EB81-U	4 Lamp, 4' Specification Grade Wraparound, CEE Listed Electronic Ballast, T8	662401191338	15.6	1	45
WP232R	2 Lamp, 4' Economy Grade Wraparound, Residential Electronic Ballast, T8, 120V, Energy Star	080083518654	6	1	96

NOTES: ⁽¹⁾ Stem mounting not available on 3-lamp fixtures. ⁽²⁾ 2 point suspension recommended for 2 and 4-lamp fixtures. ⁽³⁾ Steel endplates with 7/8" KO standard for continuous row mounting (only WN and WS series). ⁽⁴⁾ Metalux products must be ordered in pallet quantities to qualify for freight under the Off The Shelf program. ⁽⁵⁾ Only available in WN and WS series.

SNF Series | Commercial SSF Series | Striplite

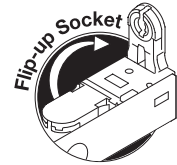

Applications

- Storage/Utility Areas • Coves • Display Cases • Shops • Task • General Area Lighting

Specifications

- Pre-installed flip-up sockets for easy installation
- Energy saving ballasts comply with federal energy efficiency standards
- Die formed channel
- Baked enamel finish
- End plate converts to channel aligner for continuous row mounting (SSF only)
- Easy wireway access
- Wireway cover removed without tools
- Numerous KOs for easy installation
- Also available in tandem 8' lengths
- UL/CUL Listed. Suitable for damp locations.

Dimensions

SSF Lamp Configurations

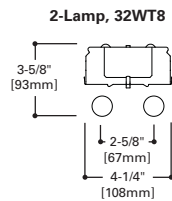

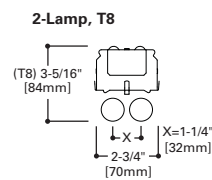
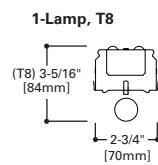

SNF Lamp Configurations



Available on fixtures with
EB81/Plus designation

Ordering Information

Pallet quantities required on all Metalux orders.

Catalog Number	Description	UPC Code	Weight	Case Qty	Pallet Qty ⁽¹⁾
 SSF-232-UNV-EB81-U	(2) 32W T8, 4' Strip, CEE Listed Electronic Ballast, w/Flip-Up Sockets	080083519590	5.4	1	90
SSF-232-UNV-EB81/PLUS-U	(2) 32W T8, 4' Strip, CEE Listed Electronic Plus Ballast, w/Flip-Up Sockets, -20°F Starting Temperature	080083571819	5.4	1	90
8TSSF-232-UNV-EB81-U	(4) 32W T8, 8' Tandem Strip, CEE Listed Electronic Ballast, w/Flip-Up Sockets	080083519682	11.4	1	72
8TSSF-232-UNV-EB81/PLUS-U	(4) 32W T8, 8' Tandem Strip, CEE Listed Electronic Plus Ballast, w/Flip-Up Sockets, -20°F Starting Temperature	080083542048	11.4	1	72
 SNF-232-UNV-EB81-U	(2) 32W T8, 4' Narrow Strip, CEE Listed Electronic Ballast, w/Flip-Up Sockets	080083519750	4.8	1	84
SNF-232-120V-REB1-U	(2) 32W T8, 4' Narrow Strip, 120V Residential, Energy Star Electronic Ballast, w/Flip-Up Sockets	080083526499	4.8	1	84
SNF-132-UNV-EB81-U	(1) 32W T8, 4' Narrow Strip, CEE Listed Electronic Ballast, w/Flip-Up Sockets	080083519859	4.8	1	84
SNF-117-UNV-EB81-U	(1) 17W T8, 2' Narrow Strip, Electronic Ballast, w/Flip-Up Sockets	080083519897	4.2	1	84
SNF-125-UNV-EB81-U	(1) 25W T8, 3' Narrow Strip, Electronic Ballast, w/Flip-Up Sockets	080083519873	4.2	1	84
SNF-217-UNV-EB81-U	(2) 17W T8, 2' Narrow Strip, Electronic Ballast, w/Flip-Up Sockets	080083519774	4.2	1	84
SNF-225-UNV-EB81-U	(2) 25W T8, 3' Narrow Strip, Electronic Ballast, w/Flip-Up Sockets	080083519767	4.2	1	84
8TSNF-232-UNV-EB81-U	(4) 32W T8, 8' Tandem Narrow Strip, CEE Listed Electronic Ballast, w/Flip-Up Sockets	080083519743	11.4	1	72
8TSNF-132-UNV-EB81-U	(2) 32W T8, 8' Tandem Narrow Strip, CEE Listed Electronic Ballast, w/Flip-Up Sockets	080083519927	11.4	1	72

NOTES: ⁽¹⁾ Metalux products must be ordered in pallet quantities to qualify for freight under the Off The Shelf program.

ART Series Parabolic/Troffer Retrofit Kits Commercial Kits

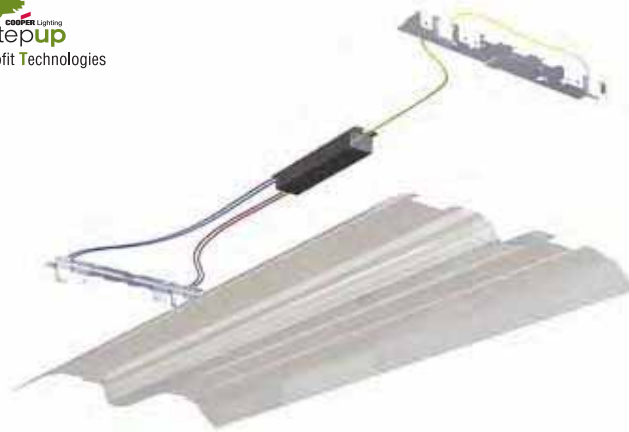

Dimensions

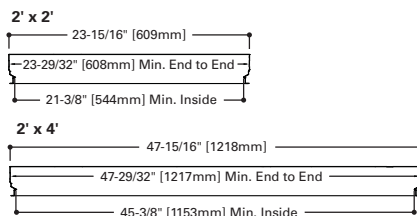
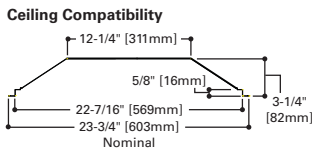
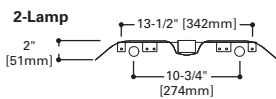

Applications

- Commercial • Back Office • Retail • Educational • Warehouse Store Room

Specifications

- Save money by re-using existing housing and shielding
- Perfect for T12 lamp/ballast replacement
- Fits parabolics or troffers as low as 3-1/4" deep
- Pre-wired and assembled with or without ballast
- Ready-Set™ captive screws for easy install
- CEE listed ballast
- One-piece tool-less white reflector
- UL/cUL listed for retrofits

Ordering Information

Bulk pack pallet quantity consists of reflector pack and electrical pack to make one retrofit kit set.



Catalog Number	Description	UPC Code	Weight	Case Qty	Pallet ⁽¹⁾ Qty
ART-2CRK-217-W-NB-EB8-10B	Retrofit Kit, Commercial, 2-lamp T8 for 2'x2' Parabolic/Troffer, White Reflector, Pre-wired Instant start sockets, NO Ballast, Bulk-pack	080083605699	13.75	10	120
ART-2CRK-232-W-NB-EB8-10B	Retrofit Kit, Commercial, 2-lamp T8 for 2'x4' Parabolic/Troffer, White Reflector, Pre-wired Instant start sockets, NO Ballast, Bulk-pack	080083611027	13.75	10	60
ART-2CRK-217-W-NB-ER8-10B	Retrofit Kit, Commercial, 2-lamp T8 for 2'x2' Parabolic/Troffer, White Reflector, Pre-wired Rapid start sockets, NO Ballast, Bulk-pack	080083611195	13.75	10	120
ART-2CRK-232-W-NB-ER8-10B	Retrofit Kit, Commercial, 2-lamp T8 for 2'x4' Parabolic/Troffer, White Reflector, Pre-wired Rapid start sockets, NO Ballast, Bulk-pack	080083611201	13.75	10	60
ART-2CRK-217-W-UNV-EB81-10B	Retrofit Kit, Commercial, 2-lamp T8 for 2'x2' Parabolic/Troffer, White Reflector, Pre-wired Instant start sockets w/CEE approved ballast, Bulk-pack	080083611010	17.5	10	120
ART-2CRK-232-W-UNV-EB81-10B	Retrofit Kit, Commercial, 2-lamp T8 for 2'x4' Parabolic/Troffer, White Reflector, Pre-wired Instant start sockets w/CEE approved ballast, Bulk-pack	080083611003	17.5	10	60
ART-2CRK-232-W-UNV-ER81-10B	Retrofit Kit, Commercial, 2-lamp T8 for 2'x4' Parabolic/Troffer, White Reflector, Pre-wired Rapid start sockets w/CEE approved ballast, Bulk-pack	080083611034	17.5	10	60
ART-2CRK-217-W-UNV-EB81-U	Retrofit Kit, Commercial, 2-lamp T8 for 2'x2' Parabolic/Troffer, White Reflector, Pre-wired Instant start sockets w/CEE approved ballast, Unit Pack	080083590728	8	1	20
ART-2CRK-232-W-UNV-EB81-U	Retrofit Kit, Commercial, 2-lamp T8 for 2'x4' Parabolic/Troffer, White Reflector, Pre-wired Instant start sockets w/CEE approved ballast, Unit Pack	080083590711	13	1	10

NOTES: ⁽¹⁾ Pallet quantities required on all Metalux orders.

I5 Series High-Bay Fluorescent Industrial Luminaire

Applications

Retail • Shopping Malls • Light Industrial • Recreational Environments

Specifications

- Specular enhanced aluminum standard for optical distribution. White painted optics optional.
- Great alternative to traditional HID high bay lighting
- Optional hanging devices available when retrofitting from HID
- Superior lumen maintenance exceeds that of HID. 90-95% of initial light output at end of life.
- Instant strike and re-strike ability
- Allows flexibility with use of dimming, motion sensors and emergency options
- Occupancy sensor available to instantly turn lights on and off
- UL/CUL Listed. Suitable for damp locations.



Dimensions

I5 Lamp Configurations

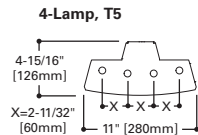

I5 Dimensions for Top View

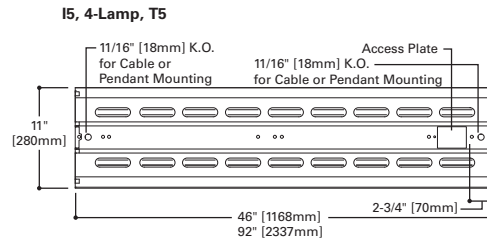

Ordering Information

Pallet quantities required on all Metalux orders.

Catalog Number	Description	UPC Code	Weight	Case Qty	Pallet ⁽¹⁾ Qty
I5454HT5-UPL	(4) 54W T5HO Program Start, 120-277V, Uplight, High Temp Ballast, V-hangers	623961831430	27.5	1	25
I5454HT5-UPL-L5	(4) 54W T5HO Program Start, 120-277V, Uplight, High Temp Ballast, w/5000K Lamps, V-hangers	623961832376	27.5	1	25
I5454HT5-UPL-L5-MS	(4) 54W T5HO Program Start, 120-277V, Uplight, High Temp Ballast, w/5000K Lamps, with Aisle (180°) Motion Sensor, V-hangers	623961832390	27.5	1	25
AYC-CHAIN/SET-U	(2) V-hangers, 36" Chain & (2) S-hooks (1/8 only)	662400106173	0.45	24	2400
Y-TOGGLE-10	10 ft. Long #2 Cable w/Y-Mounting Toggle	623961528552	0.46	80	3200

NOTES: ⁽¹⁾ Metalux products must be ordered in pallet quantities to qualify for freight under the Off The Shelf program.

HBL Series High-Bay Fluorescent Open Body Industrial Luminaire

F-BAY^{ULTRA}47



Dimensions

HBL Lamp Configurations

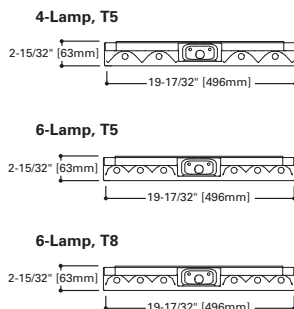

HBL Dimensions for Top View

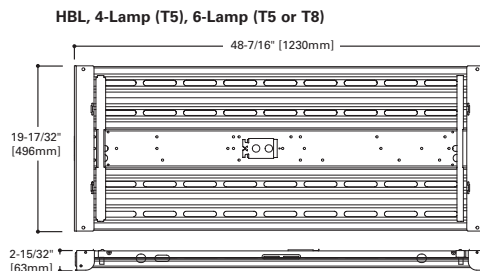

Applications

Retail • Shopping Malls • Light Industrial • Recreational Environments

Specifications

- Specular enhanced aluminum standard for optical distribution. White painted optics optional.
- Great alternative to traditional HID high bay lighting
- Optional hanging devices available when retrofitting from HID
- Superior lumen maintenance exceeds that of HID. 90-95% of initial light output at end of life.
- Instant strike and re-strike ability
- Allows flexibility with use of dimming, motion sensors and emergency options
- Occupancy sensor available to instantly turn lights on and off
- UL/CUL Listed. Suitable for damp locations.

Ordering Information

Pallet quantities required on all Metalux orders.



Catalog Number	Description	UPC Code	Weight	Case Qty	Pallet ⁽¹⁾ Qty
HBL632-UPL-L5	(6) 32W, T8 Instant Start HBF CEE Listed Ballast, 120-277V, Uplight, w/5000K Lamps, V-hangers	623961039812	17.5	1	27
HBL454T5-UPL-L5	(4) 54W, T5HO Program Start, 120-277V, Uplight, Std. Ballast, w/5000K Lamps, V-hangers	623961039829	17.5	1	27
HBL454T5-UPL-L5-MS	(4) 54W, T5HO Program Start, 120-277V, Uplight, Motion Sensor (180° & 360° Lens Included) w/5000K Lamp, V-hangers	623961039843	17.6	1	27
HBL654HT5-UPL-L5	(6) 54W, T5HO Program Start, 120-277V, Uplight, High Ambient Ballast, w/5000K Lamps, V-hangers	623961039850	17.5	1	27
HBL447T5-UPL-L5	(4) 47W, T5HO Program Start Ballast, 120-277V, Uplight, w/5000K Lamps, V-hangers	80083587407	17.5	1	27
HBL647HT5-UPL-L5	(6) 47W, T5HO Program Start, 120-277V, Uplight, High Ambient Ballast, w/5000K Lamps, V-hangers	80083587391	17.5	1	27
HBL-SPM	Single Monopoint Hanging Kit w/Hub (HBL only)	623961956201	0.69	4	180
HBAYC-CHAIN/SET-U	(2) Hook-Style V-hangers, 36" Chain & (2) S-Hooks (HB/2HB, and HBL only)	623961069734	2.56	4	180
AYC-CHAIN/SET-U	(2) V-hangers, 36" Chain & (2) S-hooks (15/18 only)	662400106173	0.45	24	2400
Y-TOGGLE-10	10 ft. Long #2 Cable w/Y-Mounting Toggle	623961528552	0.46	80	3200

NOTES: ⁽¹⁾ Metalux products must be ordered in pallet quantities to qualify for freight under the Off The Shelf program.

HBI Series High-Bay Fluorescent Full Body Industrial Luminaire

F-BAY^{ULTRA}47



Applications

Retail • Shopping Malls •
Light Industrial • Recreational
Environments.

Specifications

- Specular enhanced aluminum standard for optical distribution. White painted optics optional.
- Great alternative to traditional HID high bay lighting
- Optional hanging devices available when retrofitting from HID
- Superior lumen maintenance exceeds that of HID. 90-95% of initial light output at end of life.
- Instant strike and re-strike ability
- Allows flexibility with use of dimming, motion sensors and emergency options
- Occupancy sensor available to instantly turn lights on and off
- UL/CUL Listed. Suitable for damp locations.

Dimensions

HBI Lamp Configurations

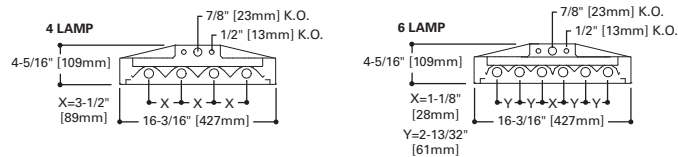

Ordering Information

Pallet quantities required on all Metalux orders.



Catalog Number	Description	UPC Code	Weight	Case Qty	Pallet ⁽¹⁾ Qty
HBI632	(6) 32W, T8 Instant Start HBF CEE Listed Ballast, 120-277V, V-hangers	080083535408	17.5	1	20
HBI632-UPL	(6) 32W, T8 Instant Start HBF CEE Listed Ballast, 120-277V, Uplight, V-hangers	080083535415	17.5	1	20
HBI632-UPL-L5	(6) 32W, T8 Instant Start HBF CEE Listed Ballast, 120-277V, Uplight w/5000K Lamps, 85CRI, 5000K, V-hangers	080083534838	17.5	1	20
HBI632PS-UPL-L5	(6) 32W, T8 Program Start HBF CEE Listed Ballast, 120-277V, Uplight w/5000K Lamps, 85CRI, V-hangers	080083535347	17.5	1	20
HBI654HT5-UPL	(6) 54W, T5HO Program Start HBF High Temp Ballast, 120-277V, Uplight, V-hangers	080083535354	17.5	1	20
HBI654HT5-UPL-L5	(6) 54W, T5HO Program Start HBF High Temp Ballast, 120-277V, Uplight, w/5000K Lamps, V-hangers	080083535361	17.5	1	20
HBI454HT5-UPL	(4) 54W, T5HO Program Start HBF High Temp Ballast, 120-277V, Uplight, V-hangers	080083535378	17.5	1	20
HBI454HT5-UPL-L5	(4) 54W, T5HO Program Start HBF High Temp Ballast 120-277V, Uplight, w/5000K Lamps, V-hangers	080083535385	17.5	1	20
HBI447HT5-UPL-L5	(4) 47W, T5HO Program Start, 120-277V, Uplight, High Temp Ballast, 5000K Lamps, V-hangers	080083587384	17.5	1	20
HBI647HT5-UPL-L5	(6) 47W, T5HO Program Start, 120-277V, Uplight, High Temp Ballast, 5000K Lamps, V-hangers	080083587377	21.5	1	20
HB-SPM	Single Monopoint Hanging Kit w/Hub (HBI only)	623961956218	0.69	4	180
Y-TOGGLE-10	10 ft. Long #2 Cable w/Y-Mounting Toggle	623961528552	0.46	80	3200

NOTES: ⁽¹⁾ Metalux products must be ordered in pallet quantities to qualify for freight under the Off The Shelf program.



VT3 Series Industrial Vaportite



Dimensions

VT3 Lamp Configurations

2-Lamp, T8 or T5

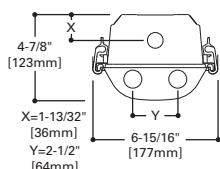

VT3 Dimensions for Top View

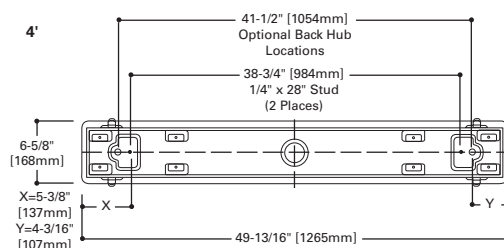

Available on fixtures with EB81/Plus designation

Applications

Commercial • Institutional • Industrial • Corrosive Environments

Specifications

- Energy saving ballasts comply with federal energy efficiency standards
- Reinforced fiberglass housing
- High-impact acrylic/DR diffuser material
- Continuous polyurethane gasketing provides a seamless seal
- Watertite hubs (standard at each end) accept 1/2" conduit
- Optional top-only hub entry or combination top and end-hub entry available for stem mounting applications
- Die-formed galvanized steel mounting brackets (Standard)
- Baked white enamel finish
- Internal geartray/high reflectance
- No holes required for surface/chain mounting
- Unitized internal/external brass mounting stud for structural integrity and continuity of ground
- U.L. Listed for wet locations (standard)
- UL/CUL Listed. Suitable for damp locations.

Ordering Information

Pallet quantities required on all Metalux orders.



Catalog Number	Description	UPC Code	Weight	Case Qty	Pallet Qty ⁽¹⁾
VT3-232DR-UNV-EB81-WL-GT4-U	(2) 32W T8 Instant Start, CEE Listed Electronic Ballast, 120/277V, Wet Location, Gear Tray provided with holes for M4 reflector accessory	623961996689	17.21	1	35
VT3-232DR-UNV-EB81/PLUS-WL-GT4-U	(2) 32W T8 Instant Start HPF CEE Listed Electronic Ballast, 120/277V, Wet Location, Gear Tray provided with holes for M4 reflector accessory, -20°F Starting Temp.	623961996627	17.21	1	35
VT3-254T5DR-UNV-EHT1-WL-GT4-U	(2) 54W T5H0 Program Start, 120/277V, High Ambient, Wet Location, Gear Tray provided with holes for M4 reflector accessory	623961996702	17.21	1	35
VT3-4FT-M4 PK	4 ft. Specular Interior Reflector Pack for VT3	623961629686	3.9	10	350
VT2-CHAIN/SET-U	Chain Hanging Set, Includes 6 ft. of Chain 4 Large S-Hooks and 4 Small S-Hooks	662400233213	0.9	4	336

NOTES: ⁽¹⁾ Metalux products must be ordered in pallet quantities to qualify for freight under the Off The Shelf program.

SURE-LITES®



The trusted name for exit signage and emergency lighting



Sure-Lites offers a comprehensive line of exit signs, emergency lights, lighting inverters and retrofit products. A full range of innovative solutions are available from routine commercial to upscale architectural to hazardous industrial locations.

Sure-Lites has been providing energy-efficient solutions through LED technology since 1995, moving beyond exit signs to develop LED emergency lighting products.

Thinking ahead, a dedicated engineering group focuses on advanced technology to continue developing more effective ways to provide exit and emergency lighting products.

ALL products are UL 924 LISTED, comply with the Life Safety code (NFPA 101) and are EPart compliant.



Emergency Lights





Exit Signs



SURE-LITES

All-Pro Emergency Light

APEL Series Thermoplastic Emergency Lighting

Applications

- General purpose applications

Specifications

- Dual-voltage input 120/277 VAC, 60Hz
- High-impact thermoplastic housing and mounting plate with textured finish
- Fully adjustable LED heads
- Long-life nickel cadmium battery
- Test switch/power and indicator light
- Suitable for wall or ceiling mount applications
- UL damp location listed
- Operational between 10°C to 40°C
- Meets or exceeds all UL924 requirements, Life Safety Code (NFPA 101), NEC/OSHA and most state and local codes

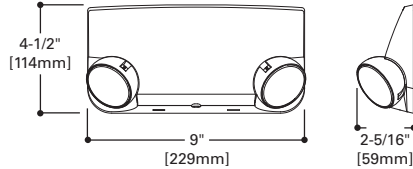

Sustainable LED Design



Ordering Information

SAMPLE NUMBER: APEL

APEL

Model Number
APEL

Housing Finish
Blank=White

Energy Data

Model No.	Input Power		Input Current		Power Factor	
	120V	277V	120V	277V	120V	277V
APEL	.33W	.47W	.06A	.07	.05	.03

Applications

- General purpose applications

Specifications

- Dual-voltage input 120/277VAC, 60Hz
- High-impact, white thermoplastic housing
- Square, two-head design
- Fully adjustable lamping
- Sealed lead calcium battery
- Test switch/power and indicator light
- Quick connect AC power connector facilitates installation
- Suitable for wall or ceiling mount applications
- UL damp location listed
- Meets or exceeds all UL924 requirements, Life Safety Code (NFPA 101), NEC/OSHA and most state and local codes, CSA certified

AP2SQ Series Thermoplastic Emergency Lighting

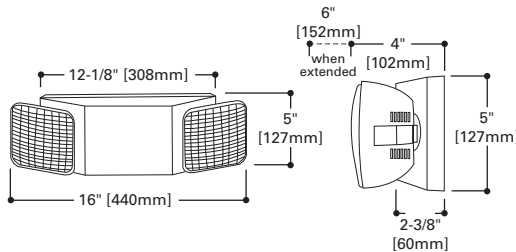

Ordering Information

SAMPLE NUMBER: AP2SQ

AP2SQ

Model Number
AP2SQ

Housing Finish
Blank=White

Electrical Ratings

Model	Rated Wattage to 87 1/2% of Rated D.C. Voltage		
	DC Voltage	1 1/2 Hours	2 Hours
AP2SQ	6	10.8	7.2

Lamp Information

Type	Wattage	Number
Incandescent	5.4	29-121

CU2 Series Polycarbonate Emergency Lighting

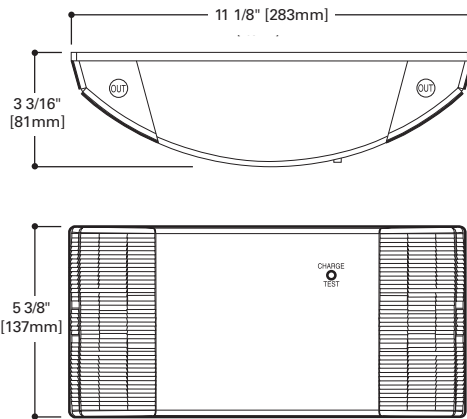

Ordering Information

Rated Wattage to 87 1/2% of Rated D.C. Voltage

Model	DC Voltage	1 1/2 Hours
CU2	6	10.8

Energy Data

Input Current (Max.):
120V=.12A
277V=.05A

Applications

- General purpose applications

Specifications

- Dual-voltage input 120/277 VAC, 60 Hz isolation transformer
- High-impact polycarbonate housing and mounting plate with designer-white textured finish
- Maintenance-sealed lead calcium battery
- Suitable for wall or ceiling mount applications (including floor proximity installations)
- Universal J-Box mounting pattern
- Line-latching, solid-state voltage limited charger, solid-state switching, low-voltage disconnect, brownout circuit, overload/short circuit protection, test switch/ power indicator light
- Damp Location Listed Standard
- UL 924, Life Safety (NFPA 101), NEC/OSHA, Most State and Local Codes
- ADA compliant

CC2 Series Polycarbonate Emergency Lighting



Applications

- General purpose applications

Specifications

- Dual-voltage input 120/277 VAC, 60Hz, isolation transformer
- Injection-molded, color-stable, high-impact UL-94-5V rated polycarbonate housing and mounting plate (housing is tethered to mounting plate.)
- Designer-white textured finish
- Two PAR36 type lamps in fully adjustable high-impact polycarbonate lampholders
- Maintenance-free sealed lead calcium battery
- Cutouts provided for surface conduit entry on top
- Universal J-box mounting pattern with keyhole slots
- Line-latching, solid-state voltage limited charger, solid-state switching, low-voltage disconnect, brownout circuit, overload/short circuit protection, test switch/power indicator light
- Meets or exceeds all current UL924 requirements, NOM Certified, Life Safety Code (NFPA 101), NEC/OSHA and most state and local codes

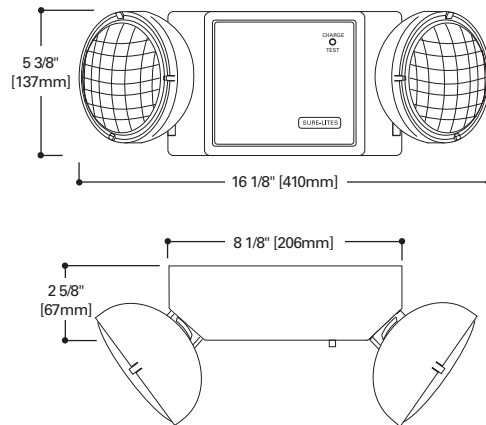

Ordering Information

Model	DC Voltage	Rated Wattage to 87 1/2% of rated D.C. Voltage		Lamp Information		
		1 1/2 hours		Type	Wattage	Number
CC2	6	12		Incandescent	5.4	029121

Energy Data

Model No.	Input Current (Max.):		
	120V	277V	347V
CC2	.12A	.05A	

CC4 Series Polycarbonate Emergency Lighting

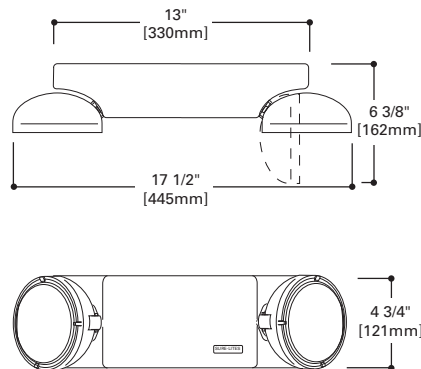

Applications

- General purpose applications

Specifications

- Dual-voltage input 120/277 VAC, 60Hz, isolation transformer
- Injection-molded, color-stable, high-impact UL-94-5V rated polycarbonate housing and mounting plate (Housing is tethered to mounting plate.)
- Designer-white textured finish
- Two PAR36 type lamps in fully adjustable high-impact polycarbonate lampholders
- Maintenance-free sealed lead calcium battery
- Cutouts provided for surface conduit entry on top
- Universal J-box mounting pattern with keyhole slots
- Line-latching, solid-state voltage limited charger, solid-state switching, low-voltage disconnect, brownout circuit, overload/short circuit protection, test switch/power indicator light
- Meets or exceeds all current UL924 requirements, Life Safety Code (NFPA 101), NEC/OSHA and most state and local codes

Ordering Information

Model	DC Voltage	Rated Wattage to 87 1/2% of rated D.C. Voltage				Lamp Information		
		1 1/2 hours	2 hours	3 hours	4 hours	Type	Wattage	Number
CC4 WH	6	18	15	10	8	Incandescent	9	29-84

Energy Data

Model No.	Input Current (Max.):		
	120V	277V	347V
CC4	.12A	.05A	.01A

XR Series Steel Emergency Lighting

Applications

- General purpose applications

Specifications

- Dual-voltage input 120/277 VAC, 60Hz
- 22 gauge die-formed steel housing
- High-impact, thermoplastic housing with white powder coat finish
- Two fully adjustable top-mounted thermoplastic heads (side mounting optional)
- Knockout, conduit or cord set
- Universal J-box mounting pattern with keyhole slots
- Remote capability
- Line-latching, solid-state voltage limited charger, solid-state switching, low-voltage disconnect, brownout circuit, overload/short-circuit protection, test switch/power indicator light
- Meets or exceeds all current UL924 requirements, Life Safety Code (NFPA 101), NEC/OSHA and most state and local codes

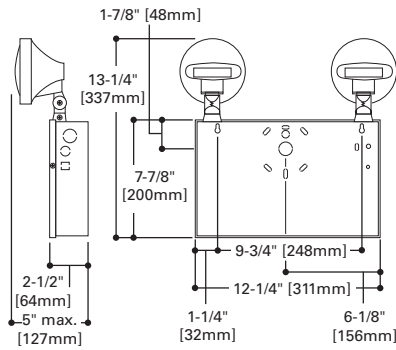

Ordering Information

Model Number	Battery	Rated Wattage to 87 1/2% of rated D.C. Voltage				Lamp Information			
		DC Voltage	1 1/2 hours	2 hours	3 hours	4 hours	Type	Wattage	
XR3	SLC	6	27	24	18	14	Incandescent	9	29-84
XR12208	SLC	12	54	48	36	28	Incandescent	9	29-86

SLC=Sealed Lead Calcium Battery

Energy Data

Model No.	Input Current (Max.):	
	120V	277V
XR3	.12A	.05A
XR12208	.30A	.13A

Remotes Emergency Lighting



Ordering Information

6 Volt Single Head Weatherproof Remotes (UL Wet Location Listed)

Catalog No.	Lamp Type	Volts	Watts	Lamp No.
6T6WWH	Halogen Sealed Beam	6	6	029-37
6X7WWH	Incandescent Sealed Beam	6	7.2	029-75

12 Volt Universal Heads

Catalog No.	Lamp Type	Volts	Watts	Lamp No.
12T8WHU	Halogen Sealed Beam	12	8	029-16
12X9WHU	Incandescent Wedge Base	12	9	029-86

Finish Code: WH-White

Applications

- General purpose applications

Description

- Flame and impact resistant injection molded thermoplastic PAR36 type lampholders.
- Available in White finish.
- Heads adjust 80° from vertical with 358° rotation.
- Supplied complete with thermoplastic lampholder housings, swivel, lamp and 5" diameter mounting plate.
- Universal mounting plate has three knockouts for mounting lampholders on either side or in center position.
- For double head remotes, specify two Universal Remote Head Assemblies.
- UL 924 Listed.



Ordering Information

Lamp Housing + Mounting Plate

Catalog No.	Finish	Lamp Type	Volts	Watts	Lamp No.
6 Volt Single Metal Head Remotes					
6T12MHWH	White	Halogen Sealed Beam	6	12	029-15

Applications

- General purpose applications

Description

- Lamp housing is made of corrosion resistant 22 gauge die formed spun aluminum with a powder coat finish.
- Die cast aluminum swivel assembly allows 80° adjustment from vertical with 358° rotation.
- Stainless steel mounting plate mounts flush on wall or ceiling and is designed for installation on standard electrical box.
- UL 924 Listed.
- Chicago Code

SURE-LITES

All-Pro Exit Sign
All-Pro Remote

APX Series Thermoplastic Exit Sign

Applications

- General purpose applications

Specifications

- Dual-voltage input 120/277 VAC, 60Hz
- High-impact thermoplastic housing
- Long-life LED lamps provide uniform diffused illumination
- Nickel cadmium battery
- Ceiling, wall or end mounting
- Field selectable chevrons
- Universal exits can be field configured as single face or double face
- Test switch with power indicator light
- UL damp location listed
- Operational between 10°C to 40°C
- Meets or exceeds all current UL924 requirements, Life Safety Code (NFPA 101), NEC/OSHA and most state and local codes
- EPA compliant

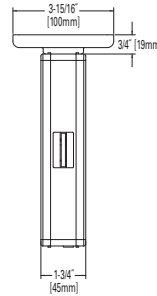
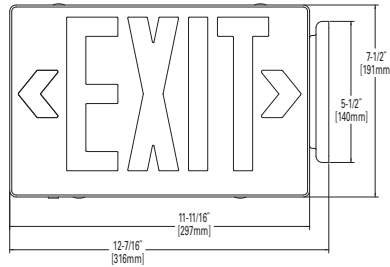

SustainableLEDDesign



Ordering Information

SAMPLE NUMBER: APX7R

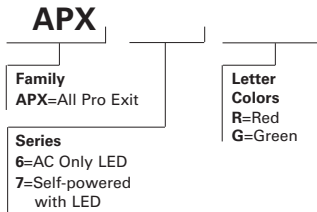

Energy Data

Model No.	Input Power		Input Current		Power Factor	
	120V	277V	120V	277V	120V	277V
APX6G	1.33W	1.76W	.07A	.07A	.17	.03
APX6R	1.31W	1.74W	.07A	.08A	.17	.08
APX7R	0.93W	1.05W	.07A	.08A	.11	.05
APX7R	0.99W	1.14W	.07A	.08A	.12	.06

APR Series Remote Emergency Lighting

Applications

- General purpose applications

Specifications

- Flame resistant and impact resistant, injection molded thermoplastic
- Lamp heads adjust 80° from vertical with 358° rotation
- Universal mounting plate
- 3.6V DC Input Voltage

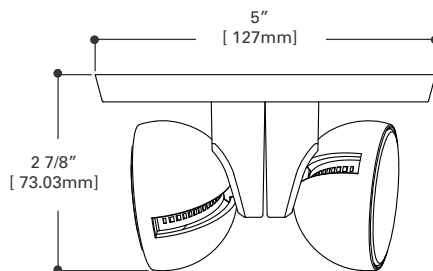

SustainableLEDDesign



Only for use with APCH.

Ordering Information

SAMPLE NUMBER: APX7R

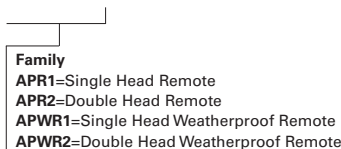

APC Series Thermoplastic Combo with Heads Emergency/Exit Lighting

Sustainable LED Design

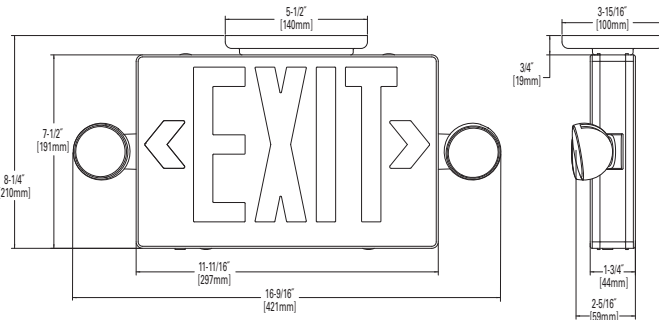

Ordering Information

SAMPLE NUMBER: APC7R, APCH7G

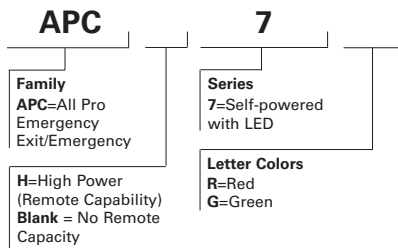

Energy Data

Model No.	Input Power		Input Current		Power Factor	
	120V	277V	120V	277V	120V	277V
APC7G	1.55W	1.45W	.09A	.09A	.14	.06
APC7R	1.31W	1.68W	.09A	.09A	.12	.07
APCH7G	2.80W	2.10W	.10A	.10A	.20	.07
APCH7R	2.34W	1.62W	.14A	.10A	.14	.06

Applications

- General purpose applications

Specifications

- Dual-voltage input 120/277 VAC, 60 Hz
- High-impact, thermoplastic housing
- Long-life LED lamps provide uniform diffused illumination
- Nickel cadmium battery
- Universal exits can be field configured as single-face or double-face
- Tri-mount system for ceiling, wall or end mounting
- Field selectable chevrons
- UL damp location listed
- Operates from 10°C to 40°C
- Meets or exceeds all current UL924 requirements, Life Safety Code (NFPA 101), NEC/OSHA and most state and local codes
- EPC compliant

AP Series Thermoplastic Combo with Heads Emergency/Exit Lighting

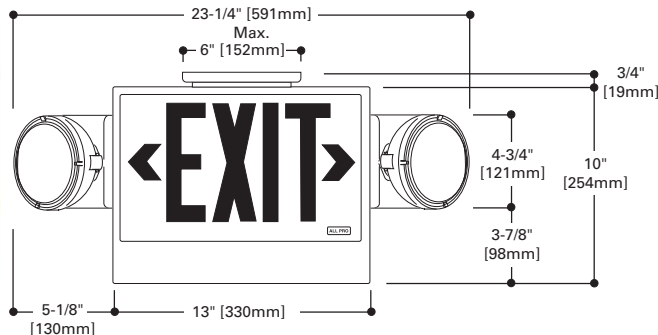

Ordering Information

SAMPLE NUMBER: AP70RWHDH

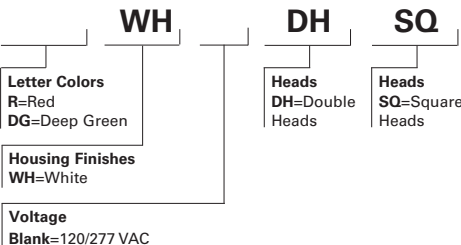
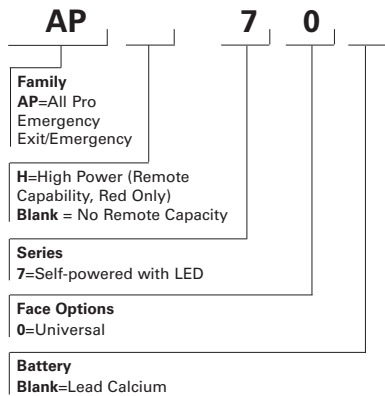

Specifications

- Dual-voltage input 120/277 VAC, 60 Hz
- High-impact, thermoplastic housing
- Heads DC: 6V, 5.4W incandescent wedge base lamps
- Lead calcium battery (11W remote capacity: APH only)
- Universal exits can be field configured as single-face or double-face
- Tri-mount system for ceiling, wall or end mounting
- Field selectable chevrons
- UL damp location listed
- Meets or exceeds all current UL924 requirements, Life Safety Code (NFPA 101), CSA Certified, NEC/OSHA and most state and local codes
- EPC compliant

Wattage Ratings

APH with Double heads (DH) has remote capacity of 11 watts for 1 1/2 hrs.

EEX Series | Edge-Lit/Surface Emergency Sign

Sustainable **LED** Design



Applications

- General purpose applications

Specifications

- Dual-voltage input 120/277 VAC, 60Hz
- Injection-molded polycarbonate housing
- Injection-molded, high-impact, clear acrylic panel
- LED lamping
- Nickel cadmium battery (EEX7 only)
- Full recharge time, 24 hours (max.)
- Snap-fit components facilitate installation in less than 5 minutes
- Tri-mount system for ceiling, wall or end mounting
- Universal, field installable chevrons
- Universal background with mirror and white inserts included
- Universal J-box mounting pattern
- Self-powered Exits feature line-latching, solid-state voltage limited charger, solid-state switching, brownout circuit, low-voltage disconnect, overload/short-circuit protection, test switch/power indicator light
- Damp location listed (AC only)
- Meets or exceeds all current UL924 requirements, UL Listed for floor proximity, UL Listed for Life Safety Code (NFPA 101), NEC/OSHA and most state and local codes
- EPA compliant

End Mount

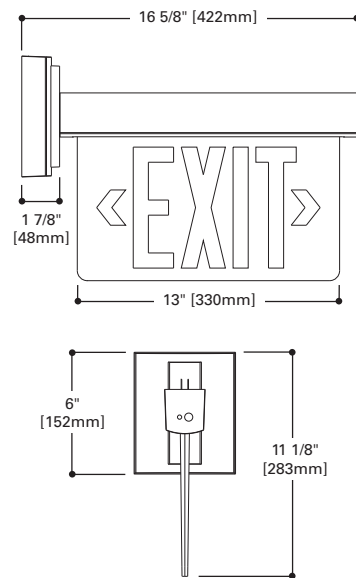

Wall Mount

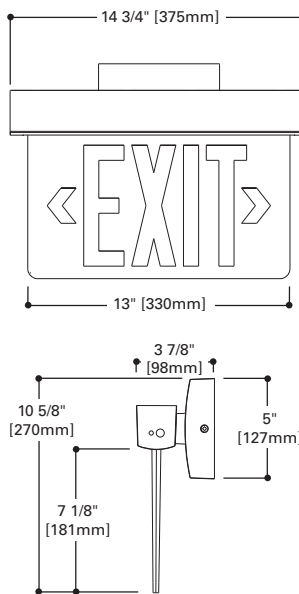

Ordering Information

SAMPLE NUMBER: EEX71R

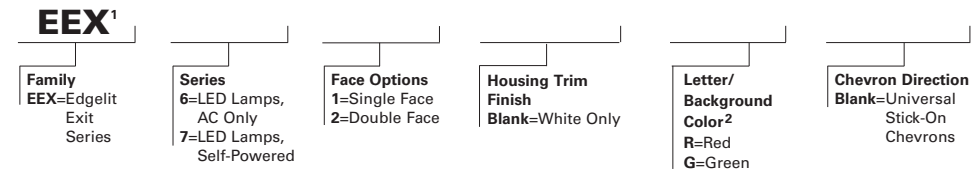

¹OSEEX61G is a Made To Order exit that will ship within 10 days (Quick Ship Program).

²Universal background clear, white insert and mirror insert included.

Energy Data – Self-Powered Exits

Charge Mode (Discharged Battery): Sealed Nickel Cadmium Battery

	Input Power:		Input Current (Max.):		Power Factor:		T.H.D.:	
	120V	277V	120V	277V	120V	277V	120V	277V
LED Exits								
LED Exits Red Lights	4.6W	4.2W	.066A	.026A	>.58	>.6	<41.5%	<42%
LED Exits Green Lights	4.0W	4.1W	.07A	.03A	>.47	>.47	<48%	<50%

Energy Data – AC Only Exits

	Input Power:		Input Current (Max.):		Power Factor:		T.H.D.:	
	120V	277V	120V	277V	120V	277V	120V	277V
LED Exits								
LED Exits -Red Letters	3.2W	3.1W	.056A	.023A	>.48	>.49	<46.3%	<47%
LED Exits -Green Letters	4.0W	4.1W	.07A	.03A	>.47	>.47	<48%	<50%

CX Series Die Cast Exit Sign

SustainableLED Design

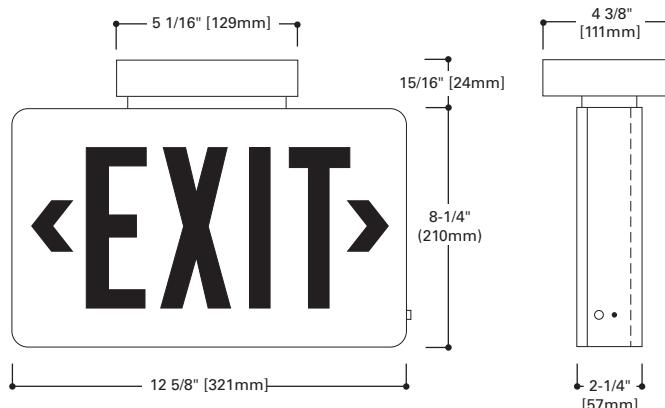

Ordering Information

SAMPLE NUMBER: CX7170RSD

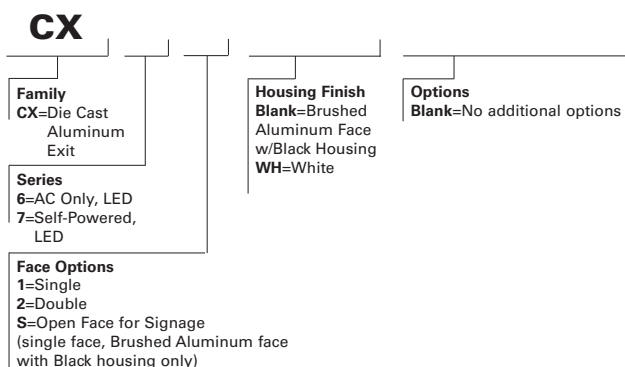

Energy Data – Self-Powered Exits

	Sealed Nickel Cadmium Battery					
	Input Power:		Input Current (Max.):		Power Factor:	
	120V	277V	120V	277V	120V	277V
LED Exits						
LED Exits -Red Letters	0.98W	1.04W	.07A	.07A	> .12	> .06
LED Exits -Green Letters	1.02W	1.12W	.07A	.07A	> .13	> .06

Energy Data – AC Only Exits

	Input Power:					
	120V		277V		Power Factor:	
	120V	277V	120V	277V	120V	277V
LED Exits						
LED Exits -Red Letters	0.98W	1.03W	.07A	.07A	> .12	> .06
LED Exits -Green Letters	1.00W	1.09W	.07A	.07A	> .13	> .05

Applications

- General purpose applications

Specifications

- Patented EZ Key external battery disconnect feature prevents unnecessary battery drainage and saves installation time
- Field selected red and green sign capability standard on all units
- Dual-voltage input 120/277 VAC, 60 Hz, isolation transformer
- Die-cast aluminum housing and canopy
- LED Lamping
- Exit can be universally mounted: ceiling, wall or end
- Universal pattern knock-outs on rear of single face housing for direct mounting to junction box
- NFPA 101-compliant knockout chevrons allow quick conversion to directional signs
- Self-powered exits feature line-latching, solid-state voltage limited charger, low-voltage disconnect, brownout circuit, over-load/short-circuit protection, test switch/power indicator light
- Damp Location Listed (AC Only)
- 0°C to 40°C
- Meets or exceeds all current UL924 requirements, Life Safety Code (NFPA 101), NEC/OSHA and most state and local codes, suitable for floor proximity installation.
- EPAct compliant

SURE-LITES

Chicago Code –
Emergency Light

ST1 Series | Steel/Chicago Code Emergency Lighting

Applications

- General purpose applications

Specifications

- Dual-voltage input 120/277 VAC, 60Hz
- 18-gauge, die-formed steel housing
- Two-side, fully mounted adjustable heads with glare-free lens
- Knockout, conduit or cord set
- Universal J-box mounting pattern with keyhole slots
- Line-latching, solid-state voltage limited charger, solid-state switching, low-voltage disconnect, brownout circuit, overload/short-circuit protection, test switch/ power indicator light
- Meets or exceeds all current UL924 requirements, Life Safety Code (NFPA 101), NEC/OSHA, most state and local codes.
- City of Chicago approval number 0590E

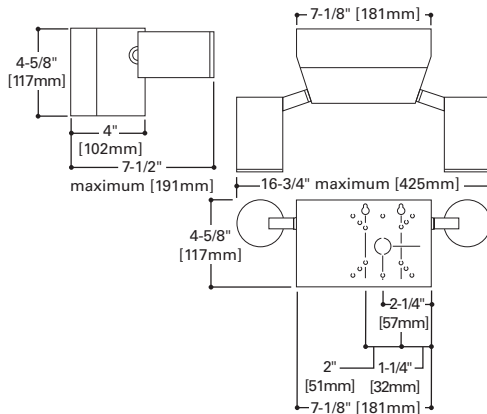

Ordering Information

Rated Wattage to 87 1/2% of Rated D.C. Voltage

Model	DC Voltage	1 1/2 Hours	2 Hours
ST1	6	27	24

Lamp Information

Type	Wattage	Number
Tungsten Halogen	12	29-66

Energy Data

Model No.	Input Current (Max.):	
	120V	277V
ST1	.12A	05A

XR Series Steel/Chicago Code Emergency Lighting

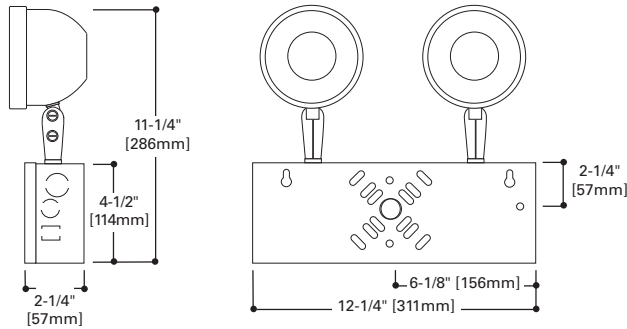

Figure 1

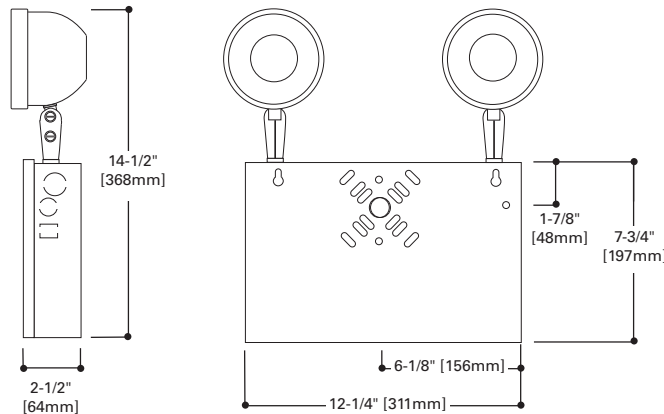

Figure 2

Applications

- General purpose applications

Specifications

- Dual-voltage input 120/277 VAC, 60Hz
- 22-gauge, die-formed steel
- Two fully-adjustable metal heads with die-cast swivel-top mounted
- Sealed lead calcium batteries
- Knockout, conduit or cord set
- Universal J-box mounting pattern with keyhole slots
- Remote capability
- Line-latching, solid-state voltage limited charger, solid-state switching, low-voltage disconnect, brownout circuit, overload/short-circuit protection, test switch/power indicator light
- Meets or exceeds all current UL924 requirements, Life Safety Code (NFPA 101), NEC/OSHA, most state and local codes.
- City of Chicago approval number 3238

Ordering Information

Rated Wattage to 87 1/2% of Rated D.C. Voltage

Model	Type	DC Voltage	1 1/2 Hours	Lamp Watts	Remote Watts	Figure	Type	Wattage	Number
XR6C	SLC	6	27	24	3	1	Halogen	12	29-66
XR9C*	SLC	6	54	24	30	2	Halogen	12	29-66

Lamp Information

*XR9C is UL Listed for 4 hours with 24 watt lamp load only – No remote load
SLC=Sealed Lead Calcium

SURE-LITES

Chicago Code –
Emergency Light

GC Series | Steel/Recessed/Chicago Code Emergency Lighting



Applications

- General purpose applications

Specifications

- Dual-voltage input 120/277 VAC, 60Hz
- 20-gauge, die-formed steel housing
- Knockout, conduit or cord set
- Flanged for mounting in grid-type suspended ceilings
- Single modular electrical connector
- Line-latching, solid-state voltage limited charger, solid-state switching, low-voltage disconnect, brownout circuit, overload/short-circuit protection, test switch/power indicator light
- Meets or exceeds all current UL924 requirements, Life Safety Code (NFPA 101), NEC/OSHA, most state and local codes.
- City of Chicago approval number 3238
- Chicago plenum mark (CCEA - City of Chicago Environmental Air)

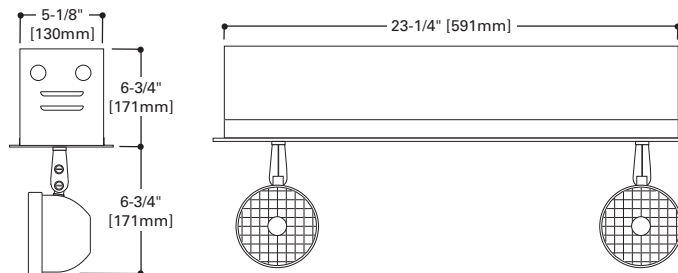

Ordering Information

Model	Rated Wattage to 87 1/2% of Rated D.C. Voltage			
	DC Voltage	2 Hours	3 Hours	4 Hours
GC15072	6	24	18	14

Lamp Information

Type	Wattage	Number
Halogen	12	29-15

Energy Data

Model No.	Input Current (Max.):	
	120V	277V
GC15072, GC15072CL	.12A	.05A

CHX Series | Steel/Chicago Code Exit Sign

Sustainable **LED** Design

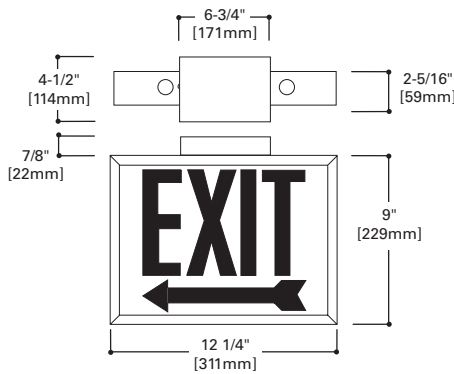

Ordering Information Steel Exits - AC Only

Type	Mounting	No Arrow	Arrow Right	Arrow Left	Double Arrow
CHX Series Exits AC Only LED					
Single Face w/Canopy	Wall/Ceiling/End	CHX61	CHX61AR	CHX61AL	CHX61DA
Self Powered LED					
Single Face w/Canopy	Wall/Ceiling/End	CHX71	CHX71AR	CHX71AL	CHX71DA

Energy Data

Model No.	Input Power	
	120V	277V
CHX - LED	3W	3W

Applications

- General purpose applications

Specifications

- Dual 120/277 VAC voltage, LED only
- 20-gauge steel housing
- Universal pattern knockouts on rear for direct mounting to junction box
- Steel canopy allows ceiling or end mounting
- Full length 3/4" stroke arrow on directional exits
- Red silkscreened lettering on translucent white, heat-tempered, impact-resistant glass lens
- Lens installs from side of fixture for more convenient, safe maintenance
- UL damp location listed
- UL 924 Listed, Life Safety Code (NFPA 101), NEC/OSHA, City of Chicago approved
- Operating temperature from -20°C to 40°C
- EPAAct compliant

SURE-LITES

Chicago Code –
Emergency/Exit Combo

CHX Series | Steel Combo wHeads/Chicago Code Emergency/Exit Sign

Applications

- General purpose applications

Specifications

- Dual-voltage input 120/277 VAC, 60Hz, LED only
- 20-gauge steel housing
- Universal pattern knockouts on rear for direct mounting to junction box
- Full-length, 3/4" stroke arrow on directional exits
- Red silkscreened lettering on white phosphorescent, heat-tempered, impact-resistant glass lens
- Lens installs from side of fixture
- Line-latching, solid-state voltage limited charger, solid-state switching, low-voltage disconnect, brownout circuit, overload/short-circuit protection, test switch/power indicator light
- Meets or exceeds all current UL924 requirements, Life Safety Code (NFPA 101), NEC/OSHA
- City of Chicago approved

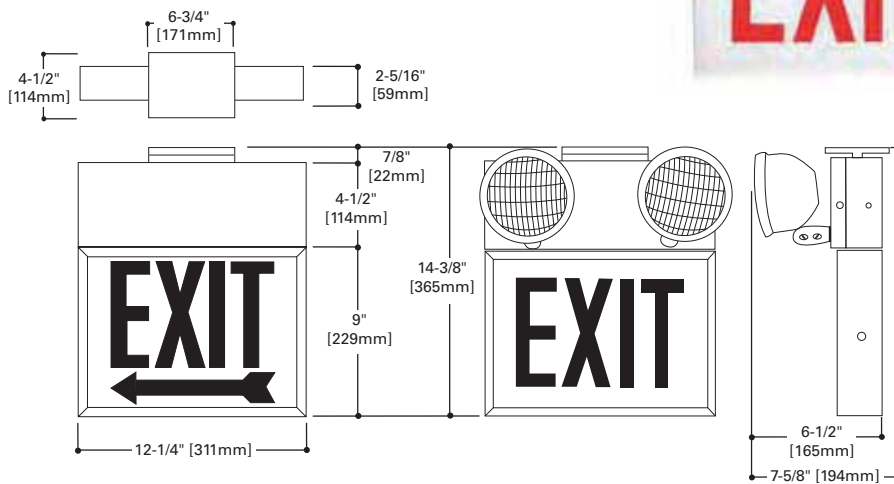

Steel Exits - Self-Powered

Type	Mounting	No Arrow
Self Powered Incandescent With Double Heads		
Single Face w/Canopy	Wall/Ceiling/End	CHX71DH

Energy Data

Model No.	Input Power:	
	120V	277V
CHX71DH	6W	6W

SURE-LITES
Emergency/Exit



ALL-PRO

All-Pro Recessed

THE ALL-PRO ADVANTAGE



Sustainable LED Design

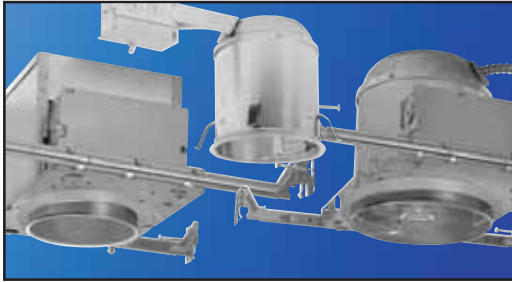

PART OF THE HALO FAMILY

- Compatible with Halo housings and trims - mix and match as needed
- UL and cUL listed.
- Meets or exceeds applicable listing and rating requirements.
- Can be used to meet OTS freight requirements.
- Full offering also on the Halo website at www.cooperlighting.com

Energy Efficient Solutions

- 5" / 6" RL7 LED all-purpose LED retrofit module-trim
- 6" Compact fluorescent housings and trims
- Can be used for California Title 24 and International Energy Conservation Code (IECC) High Efficacy Luminaire code Compliance



Full Line of Housings

- 3", 4", 5", 6" Aperture Sizes
- AIR-TITE™
- Remodel
- Non-IC
- Shallow Ceiling
- Compact Fluorescent
- New Construction
- Slope Ceiling
- Insulated Ceiling
- "No-Socket-Bracket"
- Low Voltage
- Line Voltage
- Universal

ALL-NAIL™ Bar Hanger

- Bar hangers have pre-installed nails.
- Bar hangers are pre-installed on housings.
- Integral T-Grid ceiling clip - No additional clips needed.
- Bar hangers can be re-oriented 90°.
- Bar hangers can be shortened without tools.
- Bar hangers have mini leveling foot.

Regressed Locking Screw and Multiple Crimp Points



- Patented regressed screw locks hanger bars in position - regressed design does not interfere with ceiling material.
- Screw can be tightened with slotted or phillips screwdriver or nut driver.
- Five bar hanger locking points on the frame allow the downlight to stay in place during drywalling.

Junction Box with Push-In Wire Connectors



- Push-in wire connectors speed installation - simply strip and insert supply wires into connectors. No additional wire nuts are required.
- Standard on most ALL-PRO housings.
- Integral wire traps for non-metallic sheathed cable - no additional connectors necessary.
- Pry-out (knockouts) for metallic cable and rigid conduit connectors.
- Rated for through branch circuit wiring.

AIR-TITE™

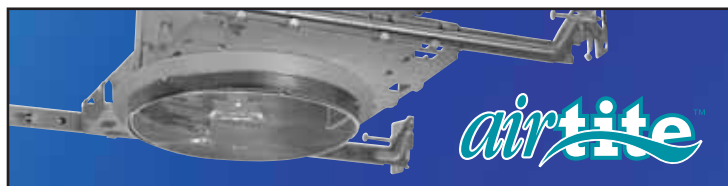

- Wide choice of AIR-TITE housings and trims to meet state codes as qualified per test standard ASTM-E283.
- Meets AIR-TITE Code standards such as: California Title 24, IECC, New York - ECC, Washington State EC
- AIR-TITE™ housings have pre-installed gasket

“No-Socket-Bracket” System



- “No-Socket-Bracket” housings and socket supporting trims speed installation of multiple units.
- Provides consistent lamp position in multiple units.

Trims



Wide Trim Selection

- Trim retention system choices include:
 - Torsion springs
 - Friction clips
 - Coil springs
- Many trims available in choice of torsion springs or friction clips.



Contractor Friendly Trim Rings

- All-Pro trims feature an extra wide trim ring.
- Helps hide any cutout irregularities.
- ERT707 and ERT709 trims in white and black baffle include both narrow style and wide style trim ring - use one, discard the other.



High Gloss Appliance White Finish

- Fingerprints don't show.
- Easy to clean.
- Matches appliances.
- Matches electrical devices - wall plates, switches etc.

ALL-PRO

6" LED Recessed Retrofit



RL706830WBS

6-Inch LED Recessed Retrofit Replacement Lamp Module-Trim with Dedicated LED High-Efficacy Connector

Specifications

- For use with Halo H750 series LED housings
- For use in insulated ceiling and non-insulated ceiling rated housings
- High efficacy LED with integral driver - dimmable



SustainableLEDesign

Energy Data (Typical)	
Min. Starting Temp -30°C (-22°F)	Sound Rating: Class A
EMI/RFI: FCC Title 47 CFR, Part 15, Class B (Consumer)	
Input Frequency: 50/60Hz	Power Factor: >0.90
THD: <20%	Input Voltage: 120V
Rated Wattage: 15W max.	Input Power: 14.5W
	Input Current: 121mA
Driver Compliance: UL60950, LPS rated	
Maximum IC (Insulated Ceiling) Ambient Continuous Operating Temperature: 25°C (77°F)	
Maximum Non-IC (NON-Insulated Ceiling) Ambient Continuous Operating Temperature: 40°C (104°F)	
LED Lighting Data	
Lumens: 636	Lumens per watt: 43.47
Correlated Color Temperature (CCT): 3000K	
Color Rendering Index (CRI, Ra): 81	

DIMENSIONS

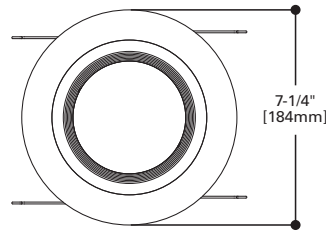
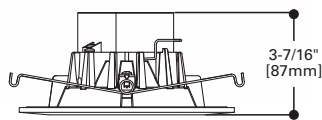

DESCRIPTION

The All-Pro RL706830WBS LED Module-Trim is for use with Halo H750 LED series 6" aperture recessed housings. The RL706830WBS includes a dedicated LED connector for California Title-24 compliance using a non-screw base socket, and for where a non-screw base high-efficacy luminaire is required. The RL7 with integral LED driver offers 120 volt dimming capability. The RL7 lens provides uniform illumination and wet location listing. The RL7 die-cast construction makes any housing AIR-TITE for added HVAC savings and code compliance.

MECHANICAL Module Trim

- Module construction includes LED, heat sink, reflector, lens, baffle and trim ring
- Durable die-cast aluminum construction
- Heat sink designed to conduct heat away from the LED keeping the junction temperatures below specified maximums, even when installed in insulated ceiling environments
- High Gloss Appliance White paint finish
- High Gloss Appliance White paint finish

Lens

- Impact-resistant polycarbonate
- Convex form for lamp-like appearance
- High lumen transmission
- Diffusing for even illumination

MOUNTING

Torsion Spring Brackets

- Precision formed steel torsion spring brackets secure torsion springs to fit compatible housings with torsion spring mounting tabs.
- Accessory (included): 5" & 6" Friction Blade Kit: Stainless steel friction blade provide alternative to torsion springs for retrofit in 5" and 6" housings without torsion spring mounting tabs.
- Friction blade design allows the RL7 to be installed in any position within the housing aperture (360 degrees).

Housing Compatibility

RL706830WBS LED Retrofit Module is listed with HALO H750 Series housings: H750ICAT, H750RICAT, H750T, H750TCP

LED

- 636 lumens
- Color Temperature: 3000°K
- CRI: 81
- Lumen Maintenance: L70/50 70% lumens / 50,000 hours
- Efficacy 43.47 Lumens per Watt
- LED is a chip on board design consisting of a multiple LED package to create one virtual light source for a productive "cone of light"

ELECTRICAL Power Connections

- LED connector is a non-screw base luminaire disconnect offering easy installation with the matching Halo H750 Series housings.
- Connector meets California Title-24 high-efficacy luminaire requirement for a non-screw base socket, and where required to qualify as a high-efficacy luminaire.
- HE26LED adapter available (order separately) if needed to accommodate a standard screw base ICAT housing

Ground Connection

- Separate grounding cable included on the RL7 module for attachment to the housing during installation.

LED Driver

- Dimmable driver is a 120 Volt, high efficiency, electronic power supply providing DC power to the LED.
- Driver meets FCC EMI/RFI Consumer Level limits for use in residential and commercial installations.
- Driver features power factor >.90, THD <20% and has integral thermal protection in the event of over temperature or internal failure.
- Driver is specifically designed for compatibility with RL7 series LED.
- Driver mounts externally to the module, allowing future replacement, if needed.

Dimming

- The RL7 LED is dimmable to 15% with standard 120V electronic low voltage dimmers (recommended), and many incandescent / magnetic low voltage dimmers; and dims to 5% using dimmers with low end trim adjustment.

- Note: Standard incandescent dimmers require a minimum load of typically >40 watts on the circuit for full range dimming performance (four LED modules).
- Note: For dimming with digital (smart) multi-location dimmers or when dimming fewer than four LED modules, electronic low voltage dimmers are required (ELV dimmers need a neutral connection in the wallbox).
- Refer to specification sheets online for dimming information, and refer to dimmer manufacturers for compatibility.

Warranty

Cooper Lighting provides a three year limited warranty on RL7 LED.

COMPLIANCE Labels

- UL/cUL Listed
- UL/cUL Listed for Damp Location
- UL/cUL Listed for Wet Location – Covered Ceiling
- May be installed in housings in direct contact with air-permeable insulation and combustible material

Qualification

- Can be used for State of California Title 24 high efficacy luminaire compliance
- Can be used for International Energy Conservation Code (IECC) high efficacy luminaire compliance

IC and AIR-TITE™

Certified under ASTM-E283 and listed UL/cUL 1598. With compatible housings, may be used to meet insulated ceiling and restricted air-flow code requirements.

Accessories (Order Separately)

HE26LED=Screw base adapter
HE26LED24PK=Screw base adapter, 24 pack



ALL-PRO

5" / 6" LED Recessed Retrofit

DIMENSIONS

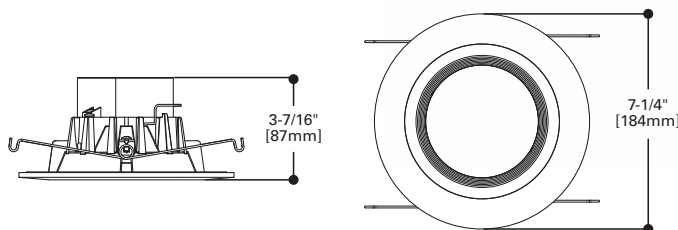

DESCRIPTION

The All-Pro RL706830E26WBS is a retrofit LED Module-Trim for 5" and 6" aperture recessed downlights. The RL706830E26WBS is designed for use with compatible 5" and 6" housings including the Halo H25, H5, H27, H7, H7U series and All-Pro ET/EI500, ET/EI2700, ET/EI700. The RL7 with integral LED driver offers 120 volt dimming capability. The RL7 lens provides uniform illumination and wet location listing. The RL7 die-cast construction makes any housing AIR-TITE for added HVAC savings and code compliance.

MECHANICAL Module Trim

- Module construction includes LED, heat sink, reflector, lens, baffle and trim ring
- Durable die-cast aluminum construction
- Heat sink designed to conduct heat away from the LED keeping the junction temperatures below specified maximums, even when installed in insulated ceiling environments
- High Gloss Appliance White paint finish

Lens

- Impact-resistant polycarbonate
- Convex form for lamp-like appearance
- High lumen transmission
- Diffusing for even illumination

MOUNTING

Torsion Spring Brackets

- Precision formed steel torsion spring brackets secure torsion springs to fit compatible housings with torsion spring mounting tabs.
- Accessory (included): 5" & 6" Friction Blade Kit: Stainless steel friction blade provide alternative to torsion springs for retrofit in 5" and 6" housings without torsion spring mounting tabs.
- Friction blade design allows the RL7 to be installed in any position within the housing aperture (360 degrees).

LED

- 636 lumens
- Color Temperature: 3000°K
- CRI: 81
- Lumen Maintenance: L70/50 70% lumens / 50,000 hours
- Efficacy 43.47 Lumens per Watt

- LED is a chip on board design consisting of a multiple LED package to create one virtual light source for a productive "cone of light"

ELECTRICAL

Power Connections

- E26 medium screw-base Edison connector provides easy retrofit of incandescent housings.

Ground Connection

- Separate grounding cable included on the RL7 module for attachment to the housing during installation.

LED Driver

- Dimmable driver is a 120 Volt, high efficiency, electronic power supply providing DC power to the LED.
- Driver meets FCC EMI/RFI Consumer Level limits for use in residential and commercial installations.
- Driver features power factor > .90, THD < 20% and has integral thermal protection in the event of over temperature or internal failure.
- Driver is specifically designed for compatibility with RL7 series LED.
- Driver mounts externally to the module, allowing future replacement, if needed.

Dimming

- The RL7 LED is dimmable to 15% with standard 120V electronic low voltage dimmers (recommended), and many incandescent / magnetic low voltage dimmers; and dims to 5% using dimmers with low end trim adjustment.
- Note: Standard incandescent dimmers require a minimum load of typically >40 watts on the circuit for full range dimming performance (four LED modules).
- Note: For dimming with digital (smart) multi-location dimmers or when dimming fewer than four LED modules, electronic low voltage dimmers are required (ELV dimmers need a neutral connection in the wallbox).
- Refer to specification sheets online for dimming information, and refer to dimmer manufacturers for compatibility.

Warranty

Cooper Lighting provides a three year limited warranty on RL7 LED.

COMPLIANCE

Labels

- UL/cUL Listed
- UL/cUL Listed for Damp Location
- UL/cUL Listed for Wet Location Covered Ceiling
- May be installed in housings in direct contact with airpermeable insulation and combustible material

Qualification

- Can be used for International Energy Conservation Code (IECC) high efficacy luminaire compliance

IC and AIR-TITE™

Certified under ASTM-E283 and listed UL/cUL 1598. With compatible housings, may be used to meet insulated ceiling and restricted air-flow code requirements.

Housing Compatibility

RL706830E26WBS UL/cUL Listed for installation in the following Halo and All-Pro E26 screw based 5" and 6" standard and shallow recessed housings:

HALO: H7ICAT, H7RICAT, H7ICT, H7RICT, H7ICATNB, H7ICTNB, H7T, H7RT, H7TNB, H7TCP, H7UIC, H7UICAT, H27ICAT, H27RICAT, H27ICT, H27RICT, H27T, H27RT, H5ICAT, H5RICAT, H5T, H5RT, H25ICAT

All-Pro: EI500AT, EI500RAT, ET500, ET500R, EI700AT, EI700RAT, EI700ATNB, EI700, EI700R, EI700ATNB, EI700NB, ET700, ET700R, EI700U, EI700UAT, EI2700AT, EI2700, EI2700R, ET2700, ET2700R

RL7LED has UL classified listing with other housings - see specifications online at www.cooperlighting.com.



RL706830E26WBS

5-Inch / 6-Inch LED Recessed Retrofit Replacement Lamp Module-Trim with E26 Medium Screw-base

Specifications

- For use in insulated ceiling and non-insulated ceiling rated housings
- High efficacy LED with integral driver - dimmable



Sustainable Design

Energy Data (Typical)	
Min. Starting Temp -30°C (-22°F)	Sound Rating: Class A
EMI/RFI: FCC Title 47 CFR, Part 15, Class B (Consumer)	
Input Frequency: 50/60Hz	Power Factor: >0.90
THD: <20%	Input Voltage: 120V
Rated Wattage: 15W max.	Input Power: 14.5W Input Current: 121mA
Driver Compliance: UL60950, LPS rated	
Maximum IC (Insulated Ceiling) Ambient Continuous Operating Temperature: 25°C (77°F)	
Maximum Non-IC (NON-Insulated Ceiling) Ambient Continuous Operating Temperature: 40°C (104°F)	
LED Lighting Data	
Lumens: 636	Lumens per watt: 43.47
Correlated Color Temperature (CCT): 3000K	
Color Rendering Index (CRI, Ra): 81	

ALL-PRO

3" Incandescent



ETR300 ETR300W

**3" Round Recessed
Housing and Trim Kit**
60W PAR16
Tungsten Halogen
Reflector Lamp

Specifications

- Thermally Protected Non-IC, AIR-TITE Housing
- May be used in insulated ceilings but insulation MUST be kept 3" from of sides of fixture



DIMENSIONS

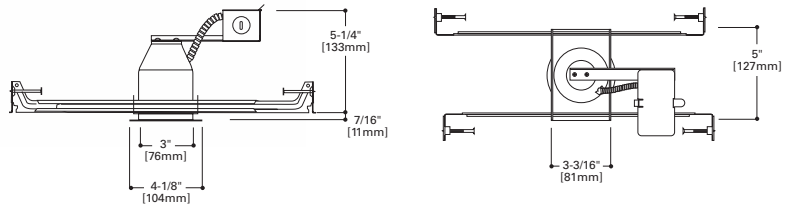

DESCRIPTION

ETR300 3" Round Aperture Non-IC AIR-TITE Housing for 60W PAR16 screw base reflector lamp. Black Baffle with Gloss White Trim Ring included.

ETR300W 3" Round Aperture Non-IC AIR-TITE Housing for 60W PAR16 screw base reflector lamp. White Baffle with Gloss White Trim Ring included.

For use in non-insulated ceilings. If ceiling insulation is present, it must be kept 3" from the fixtures on all sides.

HOUSING

Round die-formed CRS with gray powder coat finish.

PLASTER FRAME

- Galvanized steel construction.
- Boat-shaped plaster frame design with removable bar hangers for installation in new construction or in remodel construction from below the finished ceiling.
- ALL-PRO and ProSeries identity printed on plaster frame.

AIR-TITE GASKETS

Closed cell gaskets restrict airflow, meeting air tight code requirements without additional caulking.

TRIMS

Baffle trims in Gloss White or Black with Gloss White trim rings. Friction type springs hold baffle trims securely in the housing.

JUNCTION BOX

- Four 1/2" trade size conduit knockouts with true pry-out slots.
- Rated for feed through.
- Three Quick connect push type wire connectors included.

ALL-NAIL™ BAR HANGERS

- Bar Hanger features include:
- Pre-installed nail.
 - Mini leveling foot aligns the housing to the bottom of the joist.
 - Housing can be positioned at any point within 24" joist spans
 - Score lines allow tool-free shortening for narrow joist spacing.
 - Integral T-bar clip snaps onto T-bars – no additional clips are required

SOCKET

Ceramic E26 Medium Screw base.

THERMAL PROTECTOR

Self resetting thermal protector protects against improper lamping and direct contact with insulation.

LAMP

60W, 120V, E26 base PAR16 reflector lamp (by others).

LABELS

- UL/cUL Listed
- UL/cUL Listed for Damp Location
- UL/cUL Listed for Feed Through
- IP Rated (Improper Lamp)
- Certified under ASTM-E283 standard for air-tight construction.

**COMPLETE FIXTURE
INCLUDES HOUSING
AND TRIM**



ETR300W
White Trim, White Baffle

ETR300
White Trim, Black Baffle

60W, 120V, E26 PAR16
Lamp (by others)

DIMENSIONS

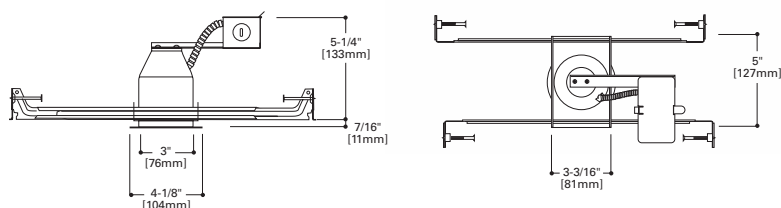

DESCRIPTION

ETR350 3" Round Aperture Non-IC AIR-TITE Housing for 50W MR16-120V GU10 lamp. Black Baffle with Gloss White Trim Ring included.

ETR350W 3" Round Aperture Non-IC AIR-TITE Housing for 50W MR16-120V GU10 lamp. White Baffle with Gloss White Trim Ring included.

For use in non-insulated ceilings. If ceiling insulation is present, it must be kept 3" from the fixtures on all sides.

HOUSING

Round die-formed CRS with gray powder coat finish.

PLASTER FRAME

- Galvanized steel construction.
- Boat-shaped plaster frame design with removable bar hangers for installation in new construction or in remodel construction from below the finished ceiling.
- ALL-PRO and ProSeries identity printed on plaster frame.

AIR-TITE GASKETS

Closed cell gaskets restrict air-flow, meeting air tight code requirements without additional caulking.

TRIMS

Baffle trims in Gloss White or Black with Gloss White trim rings. Friction type springs hold baffle trims securely in the housing.

JUNCTION BOX

- Four 1/2" trade size conduit knockouts with true pry-out slots.
- Rated for feed through.
- Three Quick connect push type wire connectors included.

ALL-NAIL™ BAR HANGERS

- Bar Hanger features include:
- Pre-installed nail.
 - Mini leveling foot aligns the housing to the bottom of the joist.
 - Housing can be positioned at any point within 24" joist spans
 - Score lines allow tool-free shortening for narrow joist spacing.
 - Integral T-bar clip snaps onto T-bars – no additional clips are required

SOCKET

GU10 base for bi-pin 120V line voltage halogen lamps.

THERMAL PROTECTOR

Self resetting thermal protector protects against improper lamping and direct contact with insulation.

LAMP

50W, 120V, GU10 base, MR16 reflector lamp (by others).

LABELS

- UL/cUL Listed
- UL/cUL Listed for Damp Location
- UL/cUL Listed for Feed Through
- IP Rated (Improper Lamp)
- Certified under ASTM-E283 standard for air-tight construction.

ACCESSORIES

(Order Separately)

Z28=50W, 120V, GU10 base, MR16 lamp



ETR350 ETR350W

3" Round Recessed Housing and Trim Kit

50W MR16 120V GU10 Tungsten Halogen Reflector Lamp

Specifications

- Thermally Protected Non-IC, AIR-TITE Housing
- May be used in insulated ceilings, but insulation must be kept 3" from all sides of fixture



COMPLETE FIXTURE INCLUDES HOUSING AND TRIM



ETR350W
White Trim, White Baffle

ETR350
White Trim, Black Baffle

Z28
50W, 120V,
GU10 base, MR16 lamp
(order separately)

ALL-PRO

3" Incandescent

DIMENSIONS

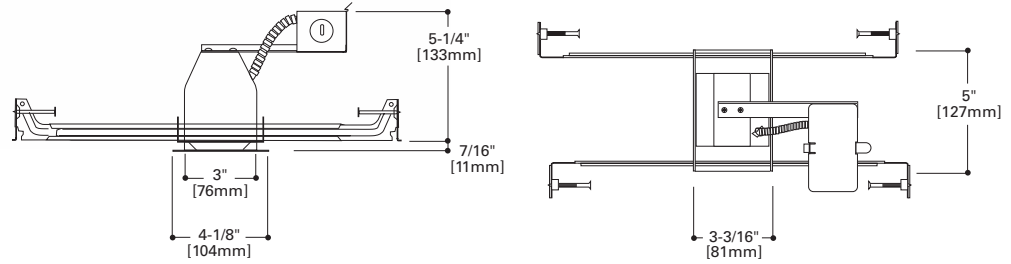

DESCRIPTION

ETS300 ETS300W

3" Square Recessed
Housing and Trim Kit

60W PAR16
Tungsten Halogen
Reflector Lamp

Specifications

- Thermally Protected Non-IC, AIR-TITE Housing
- May be used in insulated ceilings, but insulation must be kept 3" from all sides of fixture



ETS300 3" Square Aperture Non-IC AIR-TITE Housing for 60W PAR16 screw base reflector lamp. Black Baffle with Gloss White Trim Ring included.

ETS300W 3" Square Aperture Non-IC AIR-TITE Housing for 60W PAR16 screw base reflector lamp. White Baffle with Gloss White Trim Ring included.

For use in non-insulated ceilings. If ceiling insulation is present, it must be kept 3" from the fixtures on all sides.

HOUSING

Square die-formed CRS with gray powder coat finish.

PLASTER FRAME

- Galvanized steel construction.
- Boat-shaped plaster frame design with removable bar hangers for installation in new construction or in remodel construction from below the finished ceiling.
- ALL-PRO and ProSeries identity printed on plaster frame.

AIR-TITE GASKETS

Closed cell gaskets restrict air-flow, meeting air tight code requirements without additional caulking.

TRIMS

Baffle trims in Gloss White or Black with Gloss White trim rings. Friction type springs hold baffle trims securely in the housing.

JUNCTION BOX

- Four 1/2" trade size conduit knockouts with true pry-out slots.
- Rated for feed through.
- Three Quick connect push type wire connectors included.

ALL-NAIL™ BAR HANGERS

Bar Hanger features include:

- Pre-installed nail.
- Mini leveling foot aligns the housing to the bottom of the joist.
- Housing can be positioned at any point within 24" joist spans
- Score lines allow tool-free shortening for narrow joist spacing.
- Integral T-bar clip snaps onto T-bars – no additional clips are required

SOCKET

Ceramic E26 Medium Screw base.

THERMAL PROTECTOR

Self resetting thermal protector protects against improper lamping and direct contact with insulation.

LAMP

60W, 120V, E26 base PAR16 reflector lamp (by others).

LABELS

- UL/cUL Listed
- UL/cUL Listed for Damp Location
- UL/cUL Listed for Feed Through
- IP Rated (Improper Lamp)
- Certified under ASTM-E283 standard for air-tight construction.

COMPLETE FIXTURE
INCLUDES HOUSING
AND TRIM



ETS300W
White Trim, White Baffle

ETS300
White Trim, Black Baffle

60W, 120V, E26 PAR16
Lamp (by others)

DIMENSIONS

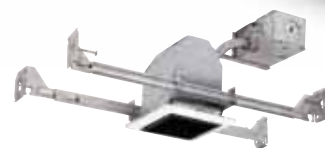
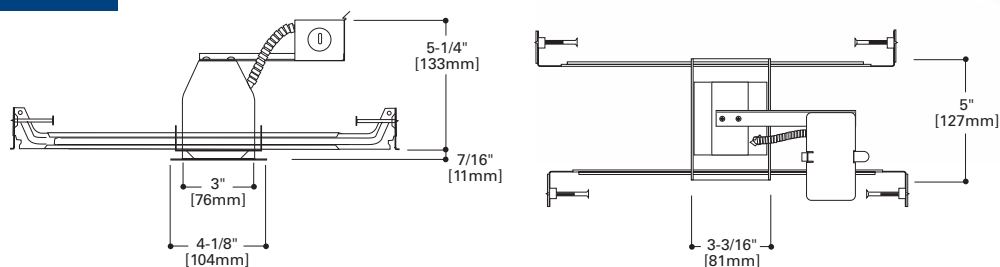

DESCRIPTION

ETS350 3" Square Aperture Non-IC AIR-TITE Housing for 50W MR16-120V GU10 lamp. Black Baffle with Gloss White Trim Ring included.

ETS350W 3" Square Aperture Non-IC AIR-TITE Housing for 50W MR16-120V GU10 lamp. White Baffle with Gloss White Trim Ring included.

For use in non-insulated ceilings. If ceiling insulation is present, it must be kept 3" from the fixtures on all sides.

HOUSING

Square die-formed CRS with gray powder coat finish.

PLASTER FRAME

- Galvanized steel construction.
- Boat-shaped plaster frame design with removable bar hangers for installation in new construction or in remodel construction from below the finished ceiling.
- ALL-PRO and ProSeries identity printed on plaster frame.

AIR-TITE GASKETS

Closed cell gaskets restrict air-flow, meeting air tight code requirements without additional caulking.

TRIMS

Baffle trims in Gloss White or Black with Gloss White trim rings. Friction type springs hold baffle trims securely in the housing.

JUNCTION BOX

- Four 1/2" trade size conduit knockouts with true pry-out slots.
- Rated for feed through.
- Three Quick connect push type wire connectors included.

ALL-NAIL™ BAR HANGERS

Bar Hanger features include:

- Pre-installed nail.
- Mini leveling foot aligns the housing to the bottom of the joist.
- Housing can be positioned at any point within 24" joist spans
- Score lines allow tool-free shortening for narrow joist spacing.
- Integral T-bar clip snaps onto T-bars – no additional clips are required

SOCKET

GU10 base for bi-pin 120V line voltage halogen lamps.

THERMAL PROTECTOR

Self resetting thermal protector protects against improper lamping and direct contact with insulation.

LAMP

50W, 120V, GU10 base, MR16 reflector lamp (by others).

LABELS

- UL/cUL Listed
- UL/cUL Listed for Damp Location
- UL/cUL Listed for Feed Through
- IP Rated (Improper Lamp)
- Certified under ASTM-E283 standard for air-tight construction.

ACCESSORIES

(Order Separately)
Z28=50W, 120V, GU10 base, MR16 lamp

ETS350 ETS350W

3" Square Recessed Housing and Trim Kit

50W MR16 - 120V GU10 Tungsten Halogen Lamp

Specifications

- Thermally Protected Non-IC, AIR-TITE Housing
- May be used in insulated ceilings, but insulation must be kept 3" from all sides of fixture



COMPLETE FIXTURE INCLUDES HOUSING AND TRIM



ETS350W
White Trim, White Baffle

ETS350
White Trim, Black Baffle

Z28
50W, 120V,
GU10 base, MR16 lamp
(order separately)

ALL-PRO

4" Incandescent

DIMENSIONS

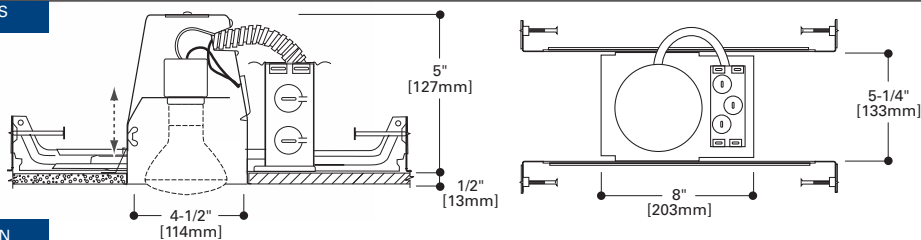

DESCRIPTION

The ET400SB is a Non-IC, AIR-TITE™ housing designed for use with small aperture trims. The shallow height allows it to be used in spaces where vertical height is limited. The ET400SB can be installed in new construction or where there is access above the ceiling. For use in non-insulated ceilings. If ceiling insulation is present, it must be kept 3" from the fixtures on all sides.

Housing

Die-formed CRS with gray powder coat finish.

Plaster Frame

- Housing is secured in plaster frame with spring barbs.
- The housing can be adjusted in the plaster frame.
- The housing can be removed from the plaster frame to provide access to the junction box.

Junction Box

- Positioned to accommodate straight conduit runs.
- Seven conduit knockouts are uniform 1/2" size with true pryout slots.
- Four pryouts with integral strain relief simplify "NM" non-metallic sheathed cable installation.
- Three quick connect wire connectors included.

ALL-NAIL™ Bar Hangers

- Bar Hanger features include:
- Pre-installed nail.
 - Mini leveling foot aligns the housing to the bottom of the joist.
 - Housing can be positioned at any point within 24" joist spans
 - Score lines allow tool-free shortening for narrow joist spacing.
 - Bar hangers may be repositioned 90° on plaster frame
 - Integral T-bar clip snaps onto T-bars – no additional clips are required

Socket

Adjustable position bracket with porcelain socket and nickel plated brass screw shell provides flexibility in lamp positioning.

Thermal Protector

Self resetting thermal protector deactivates fixture if overheating occurs due to improper lamping or misapplied insulation.

Labels

- UL/cUL Listed 1598 Luminaire
- UL/cUL Listed for Damp Location
- UL/cUL Listed for Feed Through
- UL/cUL Listed for Wet Location, covered ceiling
- Certified Under ASTM-E283 for air tight construction

ET400ATSB

4" Aperture, Non-IC, New Construction, AIR-TITE, 120V Line Voltage with Adjustable Socket Brackets

Specifications

- Thermally protected Non-IC housing
- May be used in insulated ceilings but insulation MUST be kept 3" from all sides of fixture



DIMENSIONS

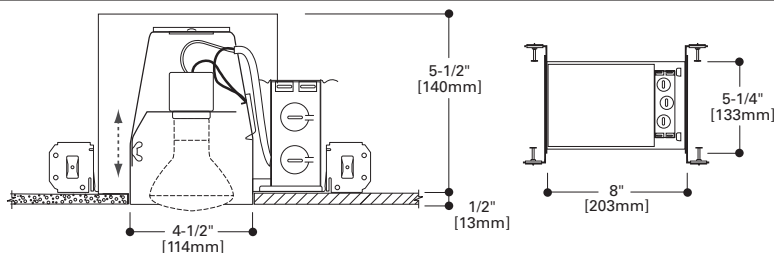

DESCRIPTION

The EI400ATSB is a small aperture housing for providing accent and task lighting. The EI400ATSB is designed for use in direct contact with insulation. AIR-TITE design meets restricted airflow requirements.

Outer Housing

Aluminum construction with IC - insulated ceiling and AT - AIR-TITE™ ratings.

Inner Housing

Double wall aluminum construction helps dissipate heat. The inner housing can be adjusted in the plaster frame to compensate for different ceiling materials.

Plaster Frame

- Galvanized steel construction.
- The inner housing can be removed from the plaster frame to provide access to the junction box.
- Plaster frame includes locking screws for hanger bars and cutouts for crimping hanger bars in position.
- AIR-TITE gasket is pre-installed.

Junction Box

- Positioned to accommodate straight conduit runs.

- Seven conduit knockouts are uniform 1/2" size with true pryout slots.
- Four pryouts with integral strain relief simplify "NM" non-metallic sheathed cable installation.
- Three quick connect wire connectors included.

ALL-NAIL™ Bar Hangers

- Bar Hanger features include:
- Pre-installed nail.
 - Mini leveling foot aligns the housing to the bottom of the joist.
 - Housing can be positioned at any point within 24" joist spans
 - Score lines allow tool-free shortening for narrow joist spacing.
 - Integral T-bar clip snaps onto T-bars – no additional clips are required

Socket

Adjustable position bracket with porcelain socket and nickel plated brass screw shell provides flexibility in lamp positioning.

Thermal Protector

Self resetting thermal protector deactivates fixture if overheating occurs due to improper lamping or misapplied insulation.

Labels

- UL/cUL Listed 1598 Luminaire
- UL/cUL Listed for Damp Location
- UL/cUL Listed for Wet Location, covered ceiling
- UL/cUL Listed for Feed Through
- UL/cUL Listed for Direct Contact with Insulation and combustible material

IC and AIR-TITE™

Certified under ASTM-E283 and listed UL/cUL 1598. May be used to meet insulated ceiling and restricted air-flow requirements such as:

- Washington State Energy Code
- International Energy Conservation Code (IECC)
- New York State Energy Conservation Construction Code (NY-ECCC)
- State of California Title 24 "Recessed Luminaires in Insulated Ceilings."

EI400ATSB

4" Aperture, ICAT, New Construction, AIR-TITE, 120V Line Voltage with Adjustable Socket Brackets

Specifications

- Thermally protected IC housing
- Housing may be covered with insulation
- AIR-TITE housing prevents airflow between attic and living areas
- For use with 120V incandescent lamps



DIMENSIONS

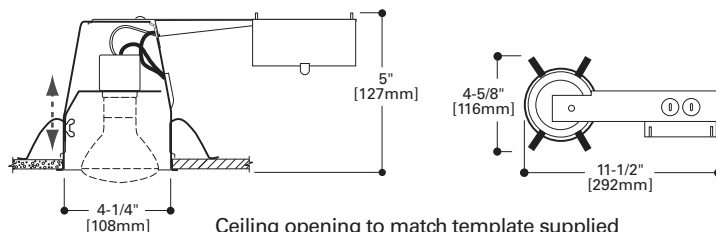

DESCRIPTION

The ET400RSB is a Non-IC, AIR-TITE™ remodel housing designed for use with small aperture trims. The shallow height allows it to be used in spaces where vertical height is limited. The ET400RSB is installed from below the ceiling. For use in non-insulated ceilings. If ceiling insulation is present, it must be kept 3" from the fixtures on all sides.

Housing

Die-formed CRS with gray powder coat finish.

Remodel Clips

Four remodel clips secure housing and accommodate 1/2" and 5/8" ceiling thickness.

Junction Box

- Seven conduit knockouts are uniform 1/2" size with true pryout slots.
- Four pryouts with integral strain relief simplify "NM" non-metallic sheathed cable installation.
- Three quick connect wire connectors included.

Socket

Adjustable position porcelain socket with nickel plated brass screw shell provides flexibility in lamp positioning.

Thermal Protector

Self resetting thermal protector deactivates fixture if overheating occurs due to improper lamping or misapplied insulation.

Labels

- UL/cUL Listed 1598 Luminaire
- UL/cUL Listed for Damp Location
- UL/cUL Listed for FeedThrough
- UL/cUL Listed for Wet Location, covered ceiling
- Certified Under ASTM-E283 for air tight construction

air-tite



ET400RATSB

4" Aperture, Non-IC, Remodel, AIR-TITE, 120V Line Voltage with Adjustable Socket Brackets

Specifications

- Thermally protected Non-IC housing
- May be used in insulated ceilings but insulation MUST be kept 3" from all sides of fixture
- For installation from below the ceiling

ERT403

Clear Specular Reflector

ET400ATSB 50W R20, 40W R16, 40W A19 (50W PAR20 ET400RATSB only)

EI400ATSB 35W PAR20, 30W R20, 40W R16, 40W A19, 50W PAR 20

Height: 2-1/2" [63mm]
OD: 5" [127mm]

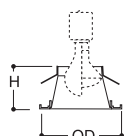

ERT403
High Gloss Appliance White Trim with Clear Specular Reflector

ERT401

Plastic Step Baffle

ET400ATSB 40W R16, 50W PAR20, 50W R20

EI400ATSB 35W PAR20, 30W R20

Height: 1-1/8" [28mm]
OD: 5" [127mm]

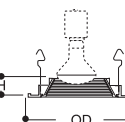

ERT401WHT
High Gloss Appliance White Trim Ring with White Baffle

ERT401
High Gloss Appliance White Trim Ring with Black Baffle

ERT402

Eyeball - 30° Tilt

ET400ATSB 40W R16, 60W PAR16

EI400ATSB 40W R16, 45W PAR16

Aperture: 2-1/8" [54mm]
OD: 5" [127mm]

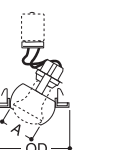

ERT402
High Gloss Appliance White Trim Ring with White Eyeball

ERT410

Metal Baffle

ET400ATSB 40W R16, 50W PAR20, 50W R20

EI400ATSB 30W R20, 35W PAR20, 50W PAR20

Height: 2-5/8" [67mm]
OD: 5-1/16" [129mm]

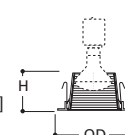

ERT410WHT
High Gloss Appliance White Metal Baffle, Gloss White Trim Ring

ERT410
Black Metal Baffle, Gloss White Trim Ring

ERT455

Prismatic Glass Lens Shower Light

ET400ATSB 40W A19, 50W PAR20, 50W R20

EI400ATSB 30W R20, 35W PAR20,

Height: 2-5/8" [67mm]
OD: 5-1/16" [129mm]

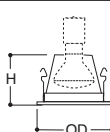

ERT455
Shower Light, High Gloss Appliance White Trim Ring

ALL-PRO

4" Low Voltage



ET400LVAT

4" Aperture, Non-IC, New Construction, AIR-TITE, 12V Low Voltage, MR16

Specifications

- Thermally protected Non-IC housing
- May be used insulated ceilings but insulation MUST be kept 3" from all sides of fixture
- Integral 120V magnetic transformer
- For use with 12V MR16 lamps



EI400LVAT

4" Aperture, IC, New Construction, AIR-TITE, 12V Low Voltage, MR16

Specifications

- IC housing
- Housing may be covered with insulation
- AIR-TITE housing prevents airflow between attic and living areas
- Integral 120V magnetic transformer
- For use with 12V MR16 lamps



84 **Note:** Some units may have different features.

DIMENSIONS

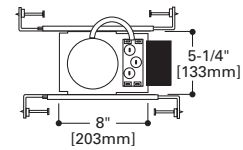
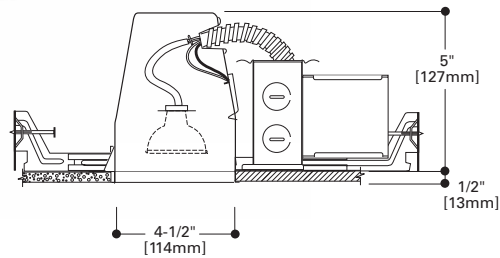

DESCRIPTION

The ET400LV is a small aperture low voltage housing for providing accent and task lighting. For use in non-insulated ceilings. If ceiling insulation is present, it must be kept 3" from the fixtures on all sides.

Housing

Die-formed CRS with gray powder coat finish.

Plaster Frame

- Housing is secured in plaster frame with spring barbs.
- The housing can be adjusted in the plaster frame.
- The housing can be removed from the plaster frame to provide access to the junction box.

Junction Box

- Positioned to accommodate straight conduit runs.
- Seven conduit knockouts are uniform 1/2" size with true pryout slots.

- Four pryouts with integral strain relief simplify "NM" non-metallic sheathed cable installation.
- Three quick connect wire connectors included.

ALL-NAIL™ Bar Hangers

Bar Hanger features include:

- Pre-installed nail.
- Mini leveling foot aligns the housing to the bottom of the joist.
- Housing can be positioned at any point within 24" joist spans
- Score lines allow tool-free shortening for narrow joist spacing.
- Bar hangers may be repositioned 90° on plaster frame
- Integral T-bar clip snaps onto T-bars – no additional clips are required

Socket

Ceramic socket with reflector for bi-pin 12V, MR16 lamps.

Transformer

120V Integral magnetic transformer steps line voltage down to lamp operating voltage.

Thermal Protector

Thermal protector integrated in the transformer deactivates fixture if overheating occurs due to improper operating condition or misapplied insulation.

Labels

- UL/cUL Listed 1598 Luminaire
- UL/cUL Listed for Damp Location
- UL/cUL Listed for Feed Through
- UL/cUL Listed for Wet Location, covered ceiling
- IP Rated (Improper Lamp)
- Certified Under ASTM-E283 for air tight construction

DIMENSIONS

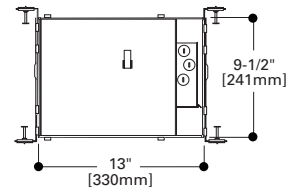
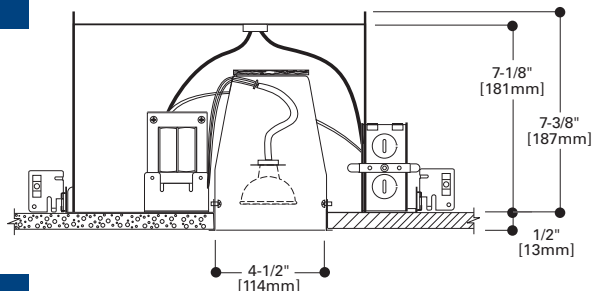

DESCRIPTION

The EI400LVAT housing has an integral low voltage transformer that supplies 12 volts to MR16 lamps. It can be used in ceilings where it will be in direct contact with insulation. AIR-TITE design meets restricted airflow requirements.

Housing

Double wall aluminum construction for greater heat dissipation. EI400LVAT housing is gasketed to prevent airflow from heated or air conditioned spaces.

Plaster Frame

- Galvanized steel construction.
- The inner housing can be removed from the plaster frame to provide access to the junction box.
- Plaster frame includes locking screws for hanger bars and cutouts for crimping hanger bars in position.
- AIR-TITE gasket is pre-installed.

Junction Box

- Positioned to accommodate straight conduit runs.
- Seven conduit knockouts are uniform 1/2" size with true pryout slots.

- Four pryouts with integral strain relief simplify "NM" non-metallic sheathed cable installation.
- Three quick connect wire connectors included.

ALL-NAIL™ Bar Hangers

Bar Hanger features include:

- Pre-installed nail.
- Mini leveling foot aligns the housing to the bottom of the joist.
- Housing can be positioned at any point within 24" joist spans
- Score lines allow tool-free shortening for narrow joist spacing.
- Bar hangers may be repositioned 90° on plaster frame
- Integral T-bar clip snaps onto T-bars – no additional clips are required

Socket

Ceramic socket with reflector for bi-pin 12V, MR16 lamps.

Transformer

120V Integral magnetic transformer steps line voltage down to lamp operating voltage.

Thermal Protector

Thermal protector integrated in the transformer deactivates fixture if overheating occurs due to improper operating condition.

Labels

- UL/cUL Listed 1598 Luminaire
- UL/cUL Listed for Damp Location
- UL/cUL Listed for Wet Location – Covered Ceiling
- UL/cUL Listed for Feed Through
- UL/cUL Listed for Direct Contact with Insulation and combustible material

IC and AIR-TITE™

Certified under ASTM-E283 and listed UL/cUL 1598. May be used to meet insulated ceiling and restricted air-flow requirements such as:

- Washington State Energy Code
- International Energy Conservation Code (IECC)
- New York State Energy Conservation Construction Code (NY-ECCC)
- State of California Title 24 "Recessed Luminaires in Insulated Ceilings."

Visit www.cooperlighting.com for more information on the complete ALL-PRO Stock and Specification offering. Product availability subject to change without notice.



DIMENSIONS

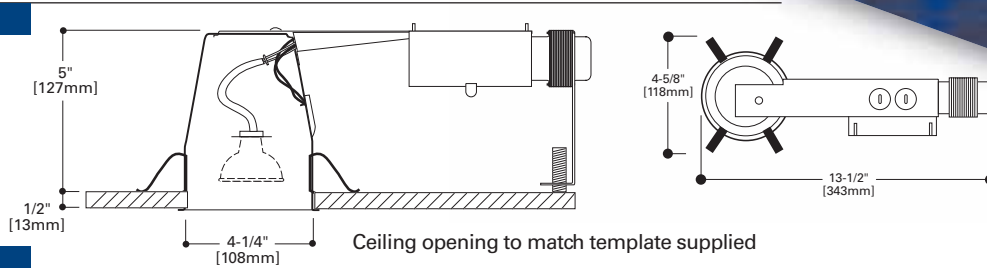

DESCRIPTION

The ET400LVR is a small aperture low voltage remodel housing for providing accent and task lighting. For use in non-insulated ceilings. If ceiling insulation is present, it must be kept 3" from the fixtures on all sides.

Housing

Die-stamped CRS with white powder coat finish.

Remodel Clips

Four remodel clips secure housing and accommodate 1/2" and 5/8" ceiling thickness.

Junction Box

- Six conduit knockouts are uniform 1/2" size with true pryout slots.
- Four pryouts with integral strain relief simplify "NM" non-metallic sheathed cable installation.
- Three quick connect wire connectors included.

Socket

Ceramic socket with reflector disc for bi-pin 12V, MR16 lamps.

Transformer

120V Integral magnetic transformer steps line voltage down to lamp operating voltage.

Support Bar

Support Bar helps support weight of junction box and transformer. Threaded stem can be adjusted for varying ceiling thicknesses.

Thermal Protector

Self resetting thermal protector deactivates fixture if overheating occurs due to improper lamping or misapplied insulation.

Labels

- UL/cUL Listed 1598 Luminaire
- UL/cUL Listed for Damp Location
- UL/cUL Listed for FeedThrough
- UL/cUL Listed for Wet Location, covered ceiling
- Certified Under ASTM-E283 for air tight construction



ET400LVRAT

4" Aperture, Non-IC, Remodel, AIR-TITE, 12V Low Voltage, MR16

Specifications

- Thermally protected Non-IC housing
- May be used in insulated ceilings but insulation MUST be kept 3" from all sides of fixture
- For installation from below the ceiling
- For 12V MR16 lamps



ERT403LV

Reflector

- "Cat's paw" retention spring

ET400LVAT
ET400LVRAT
EI400LVAT
12V 50W MR16

Height:
1-1/4" [31mm]
OD:
5" [127mm]

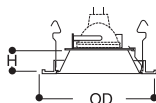

ERT403LV
High Gloss Appliance White Trim with Clear Specular Reflector

ERT401LV

Baffle

- "Cat's paw" retention spring

ET400LVAT
ET400LVRAT
EI400LVAT
12V 50W MR16

Height:
1-1/4" [31mm]
OD:
5" [127mm]

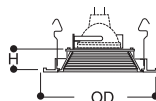

ERT401LVW
High Gloss Appliance White Trim with White Baffle

ERT401LV
High Gloss Appliance White Trim with Black baffle

ERT402LV

Eyeball - 30° Tilt

- "Cat's paw" retention spring

ET400LVAT
ET400LVRAT
EI400LVAT
12V 50W MR16

Aperture:
2" [51mm]
OD:
5" [127mm]

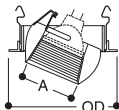

ERT402LV
High Gloss Appliance White Trim with White Eyeball

ERT404LV

Slot Aperture

- "Cat's paw" retention spring

ET400LVAT
ET400LVRAT
EI400LVAT
12V 50W MR16

Slot:
1-3/8" x 2-1/8"
[35mm x 54mm]
OD:
5" [127mm]

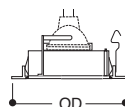

ERT404LV
High Gloss Appliance White Trim and Slot

ALL-PRO

5" Incandescent



ET500

5" Aperture, Non-IC, New Construction, 120V Line Voltage

Specifications

- Non-IC housing
- May be used in insulated ceilings but insulation MUST be kept 3" from all sides of fixture
- For use with 120V incandescent lamps



ET500R

5" Aperture, Non-IC, Remodel, 120V Line Voltage

Specifications

- Thermally protected Non-IC housing
- May be used in insulated ceilings but insulation MUST be kept 3" from all sides of fixture
- For use with 120V incandescent lamps
- Can be installed from below the ceiling



DIMENSIONS

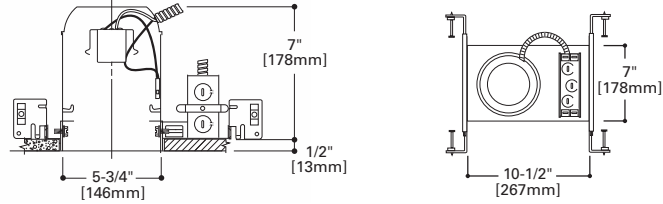

DESCRIPTION

The All-Pro 500 series utilizes a 5" aperture designed for smaller sized PAR20 and PAR30 halogen lamps. The 5" diameter trim size makes this series the right choice for applications where dramatic yet inconspicuous lighting is required. For use in non-insulated ceilings. If ceiling insulation is present, it must be kept 3" from the fixtures on all sides.

Housing

- Die-stamped CRS with white powder coat finish.
- Housing adjusts in plaster frame to accommodate ceiling up to 1-3/8" thick.

Plaster Frame

- Galvanized steel construction.
- The housing can be removed from plaster frame to provide access to the junction box.
- Regressed locking screw for securing hanger bars

- Cutouts for easily crimping hanger bars in position
- Junction Box**
- Positioned to accommodate straight conduit runs.
- Seven conduit knockouts are uniform 1/2" size with true pryout slots.
- Four pryouts with integral strain relief simplify "NM" non-metallic sheathed cable installation.
- Three quick connect wire connectors included.

ALL-NAIL™ Bar Hangers

- Bar Hanger features include:
- Pre-installed nail.
 - Mini leveling foot aligns the housing to the bottom of the joist.
 - Housing can be positioned at any point within 24" joist spans
 - Score lines allow tool-free shortening for narrow joist spacing.

- Bar hangers may be repositioned 90° on plaster frame
- Integral T-bar clip snaps onto T-bars – no additional clips are required

Socket

Porcelain E26 socket with nickel plated brass screw shell, snaps into trim for consistent lamp positioning.

Thermal Protector

Self resetting thermal protector deactivates fixture if overheating occurs due to improper lamping or misapplied insulation.

Labels

- UL/cUL Listed 1598 Luminaire
- UL/cUL Listed for Damp Location
- UL/cUL Listed for FeedThrough
- UL/cUL Listed for Wet Location, covered ceiling
- IP Rated (Improper Lamp)

DIMENSIONS

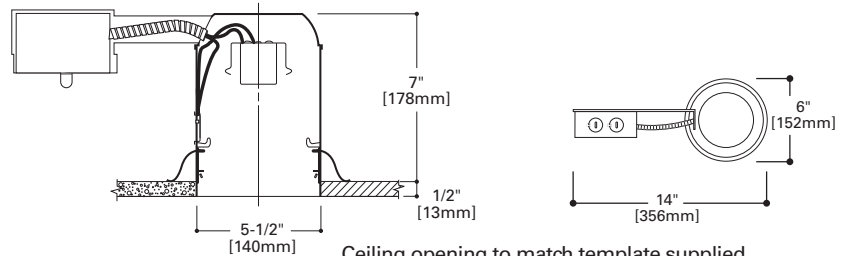

DESCRIPTION

The All-Pro 500 series utilizes a 5" aperture designed to accommodate smaller sized PAR20 and PAR30 halogen lamps. The 5" diameter trim size makes the ET500R the right choice for applications where dramatic yet inconspicuous lighting is required in an existing ceiling. For use in non-insulated ceilings. If ceiling insulation is present, it must be kept 3" from the fixtures on all sides.

Housing

- Die-stamped CRS with white powder coat finish.
- Integral flange secures fixture against ceiling.
- For installation from below the finished ceiling.

Remodel Clips

Four remodel clips secure housing and accommodate 1/2" and 5/8" ceiling thickness.

Junction Box

- Seven conduit knockouts are uniform 1/2" size with true pryout slots.
- Four pryouts with integral strain relief simplify "NM" non-metallic sheathed cable installation.

Socket

Porcelain E26 socket with nickel plated brass screw shell, snaps into trim for consistent lamp positioning.

Thermal Protector

Self resetting thermal protector deactivates fixture if overheating occurs due to improper lamping or misapplied insulation.

Labels

- UL/cUL Listed 1598 Luminaire
- UL/cUL Listed for Damp Location
- UL/cUL Listed for FeedThrough
- UL/cUL Listed for Wet Location, covered ceiling
- IP Rated (Improper Lamp)

ALL-PRO

5" Incandescent

DIMENSIONS

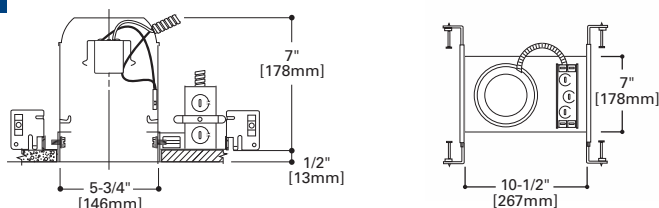

DESCRIPTION

The All-Pro 500 series has a 5" aperture designed for PAR20 and PAR30 halogen lamps. EI500AT is designed for use in insulated ceilings and may be completely covered in insulation. AIR-TITE™ design meets restricted air flow requirements.

Housing

- Die-stamped CRS with white powder coat finish.
- Housing adjusts in plaster frame to accommodate ceiling up to 1-3/8" thick.
- AIR-TITE gasket is pre-installed.

Plaster Frame

- Galvanized steel construction.
- The housing can be removed from plaster frame to provide access to the junction box.
- Regressed locking screw for securing hanger bars
- Cutouts for easily crimping hanger bars in position

Junction Box

- Positioned to accommodate straight conduit runs.

- Seven conduit knockouts are uniform 1/2" size with true pryout slots.
- Four pryouts with integral strain relief simplify "NM" non-metallic sheathed cable installation.
- Three quick connect wire connectors included

ALL-NAIL™ Bar Hangers

Bar Hanger features include:

- Pre-installed nail.
- Mini leveling foot aligns the housing to the bottom of the joist.
- Housing can be positioned at any point within 24" joist spans
- Score lines allow tool-free shortening for narrow joist spacing.
- Bar hangers may be repositioned 90° on plaster frame
- Integral T-bar clip snaps onto T-bars – no additional clips are required

Socket

Porcelain E26 socket with nickel plated brass screw shell, snaps into trim for consistent lamp positioning.

Thermal Protector

Self resetting thermal protector deactivates fixture if overheating occurs due to improper lamping or misapplied insulation.

Labels

- UL/cUL Listed 1598 Luminaire
- UL/cUL Listed for Damp Location
- UL/cUL Listed for FeedThrough
- UL/cUL Listed for Wet Location, covered ceiling
- UL/cUL Listed for Direct Contact with Insulation and combustible material

IC and AIR-TITE™

Certified under ASTM-E283 and listed UL/cUL 1598. May be used to meet insulated ceiling and restricted air-flow requirements such as:

- Washington State Energy Code
- International Energy Conservation Code (IECC)
- New York State Energy Conservation Construction Code (NY-ECCC)
- State of California Title 24 "Recessed Luminaires in Insulated Ceilings."



EI500AT

5" Aperture, IC, New Construction, AIR-TITE, 120V Line Voltage

Specifications

- Thermally protected IC housing
- AIR-TITE housing prevents airflow between attic and living areas
- Housing may be covered with insulation
- For use with 120V incandescent lamps



DIMENSIONS

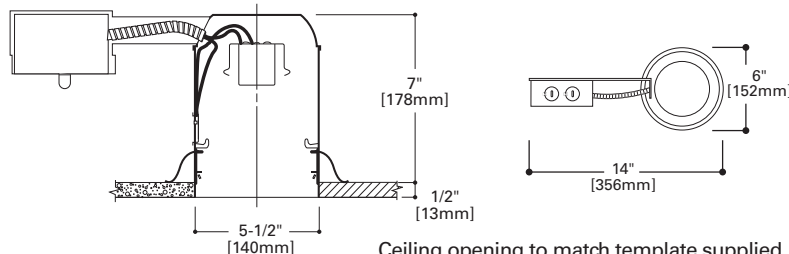

DESCRIPTION

The All-Pro 500 series has a 5" aperture designed for PAR20 and PAR30 halogen lamps. Designed for use in insulated existing ceilings and may be completely covered in insulation. AIR-TITE design meets restricted airflow requirements.

Housing

- Die-stamped CRS with white powder coat finish.
- Integral flange secures fixture against ceiling.
- AIR-TITE gasket is pre-installed.

Remodel Clips

Four remodel clips secure housing and accommodate 1/2" and 5/8" ceiling thickness.

- Seven conduit knockouts are uniform 1/2" size with true pryout slots.
- Four pryouts with integral strain relief simplify "NM" non-metallic sheathed cable installation.
- Three quick connect wire connectors included.

Socket

Porcelain E26 socket with nickel plated brass screw shell, snaps into trim for consistent lamp positioning.

Thermal Protector

Self resetting thermal protector deactivates fixture if overheating occurs due to improper lamping or misapplied insulation.

Labels

- UL/cUL Listed 1598 Luminaire
- UL/cUL Listed for Damp Location
- UL/cUL Listed for FeedThrough
- UL/cUL Listed for Wet Location, covered ceiling

IC and AIR-TITE™

Certified under ASTM-E283 and listed UL/cUL 1598. May be used to meet insulated ceiling and restricted air-flow requirements such as:

- Washington State Energy Code
- International Energy Conservation Code (IECC)
- New York State Energy Conservation Construction Code (NY-ECCC)
- State of California Title 24 "Recessed Luminaires in Insulated Ceilings."



EI500RAT

5" Aperture, IC, Remodel, AIR-TITE, 120V Line Voltage

Specifications

- Thermally protected IC AIR-TITE housing prevents airflow between attic and living areas
- Housing may be covered with insulation
- For use with 120V incandescent lamps
- For installation from below the ceiling



ALL-PRO

ET500, ET500R, EI500AT,
EI500RAT

ERT520

Reflector Cone

•Torsion Springs pull trim tight to ceiling

ET500	75W R30, 75W PAR30,
ET500R	75W PAR30L, 65W BR30

EI500AT	50W R30, 60W BR30, 75W PAR30
---------	---------------------------------

EI500RAT	50W PAR30L, 50W PAR30, 60W BR30
----------	------------------------------------

Height:
3-1/4" [82mm]
OD:
6-1/2"
[127mm]

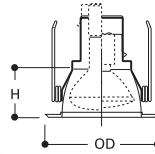

ERT520WHT
High Gloss Appliance White
Trim with White Reflector Cone



ERT520
High Gloss Appliance White
Trim with Clear Specular Re-
flector Cone

ERT521

Reflector

•Torsion Springs pull trim tight to ceiling

ET500	60W A19
ET500R	

EI500AT	40W A19
EI500RAT	

Height:
5" [127mm]
OD:
6-1/2"
[165mm]

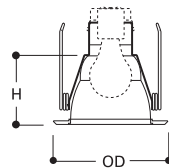

ERT521
High Gloss Appliance White
Trim with Clear Specular Re-
flector

ERT501

Metal Baffle Splay

•Torsion Springs pull trim tight to ceiling

ET500	50W R20, 50W PAR20, 75W R30, 75W PAR30
ET500R	

EI500AT	50W PAR20, 50W R20, 65W BR30, 75W PAR30
---------	--

EI500RAT	30W R20, 35W PAR20, 50W PAR30, 50W PAR30L, 60W BR30
----------	--

Height:
2-1/16"
[52mm]
OD:
6-1/2"
[165mm]

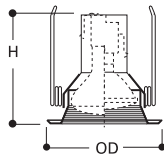

ERT501WHT
High Gloss Appliance White
Trim with White Baffle

ERT501
High Gloss Appliance White
Trim with Black Baffle

ERT512

Deep Coilex™ Baffle

•Torsion Springs pull trim tight to ceiling

ET500	75W R30, 75W PAR30
ET500R	

Height:
5" [127mm]
OD:
6-1/2" [165mm]

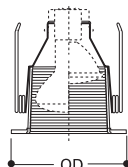

ERT512WHT
High Gloss Appliance White
Trim with White Baffle

ERT512
High Gloss Appliance White
Trim with Black Baffle

ALL-PRO

ET500, ET500R, EI500AT, EI500RAT

ERT513

Baffle

- Friction Clip retention
- Lamps-ERT513WHT:

ET500 75W A19, 65W BR30,
ET500R 75W R30, 75W PAR30L

EI500AT 65W BR30, 75W PAR30L
EI500RAT

- Lamps - ERT513:

ET500 60W A19, 65W BR30,
ET500R 75W R30, 75W PAR30L

EI500AT 50W PAR30L, 65W BR30
EI500RAT

Height:
5" [127mm]
OD:
6-3/4" [171mm]

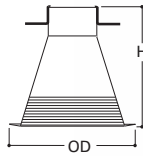

ERT513WHT
High Gloss Appliance White
Trim with White Baffle



ERT513
High Gloss Appliance White
Trim with Black Baffle

ERT513TS

Baffle

- Torsion springs pull trim tight to ceiling
- Lamps-ERT513WHTTS:

ET500 75W A19, 65W BR30,
ET500R 75W R30, 75W PAR30L

EI500AT 65W BR30, 75W PAR30L
EI500RAT

- Lamps - ERT513TS:

ET500 60W A19, 65W BR30,
ET500R 75W R30, 75W PAR30L

EI500AT 50W PAR30L, 65W BR30
EI500RAT

Height:
5" [127mm]
OD:
6-3/4"
[171mm]

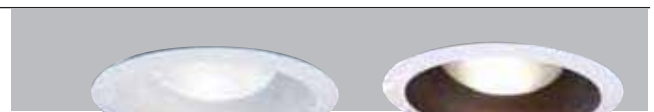
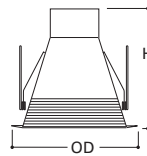

ERT513WHTTS
High Gloss Appliance White
Trim with White Baffle and
with torsion spring
construction

ERT513TS
High Gloss Appliance White
Trim with Black Baffle and with
torsion spring
construction

ERT570

Eyeball 30° Tilt

- Torsion Springs pull trim tight to ceiling

ET500 75W PAR30
ET500R

EI500AT 50W PAR30
EI500RAT

OD:
6-1/2"
[165mm]

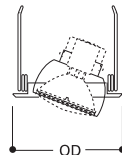

ERT570
High Gloss Appliance White
Trim with White Eyeball

ALL-PRO

ET500, ET500R, EI500AT, EI500RAT

ERT500

Splay Trim

- Torsion Springs pull trim tight to ceiling

ET500	65W BR30, 75W R30,
ET500R	75W PAR30

EI500AT	65W BR30, 75W PAR30,
	75W R30

EI500RAT	50W PAR30, 75W PAR30L,
	60W BR30

Height:
1-7/8" [48mm]
OD:
6-1/2" [165mm]

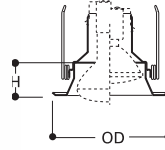

ERT500
High Gloss Appliance White
Splay Trim

ERT550

Frosted Drop Glass Shower Light

- Torsion Springs pull trim tight to ceiling

ET500	75W A19, 75W PAR30
ET500R	

EI500AT	40W A19, 50W PAR30
EI500RAT	

OD:
6-1/2" [165mm]

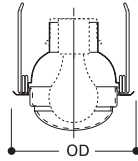

ERT550
High Gloss Appliance White
Trim with Frosted Drop Dif-
fuser - AIR-TITE Trim*

ERT551

Frosted Glass Lens Shower Light

- Torsion Springs pull trim tight to ceiling

ET500	60W A19, 50W PAR30,
ET500R	50W PAR30L, 65W BR30

EI500AT	35W PAR30L
EI500RAT	

Height:
5-1/2" [140mm]
OD:
6-1/2" [165mm]

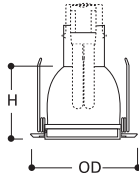

ERT551
High Gloss Appliance White
Trim with Frosted Lens

ERT552

Fresnel Glass Lens Shower Light

- Wet location listed for use in showers

ET500	60W A19, 50W PAR30,
ET500R	50W PAR30L, 65W BR30

EI500AT	35W PAR30L
EI500RAT	

Height:
3" [76mm]
OD:
6-1/2" [165mm]

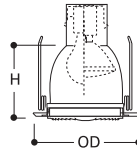

ERT552
High Gloss Appliance White
Trim with Fresnel Lens

ERT530

Wall Wash

- Torsion Springs pull trim tight to ceiling

ET500	50WTB19, 60W A19,
ET500R	60W BT15, 60W MB19

Height:
6-7/8" [174mm]
OD:
6-1/2" [165mm]

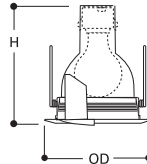

ERT530WHT
High Gloss Appliance White
Trim with White Scoop and
White Baffle

* When using an Air-Tite trim to meet California Title 24 air tight compliance, an additional gasket is required between the finished ceiling and the trim flange ring. For California Title 24 compliance use accessory trim gasket GA-ATRIM. Order separately in a 6 pack: GA-ATTRIM-6PK

DIMENSIONS

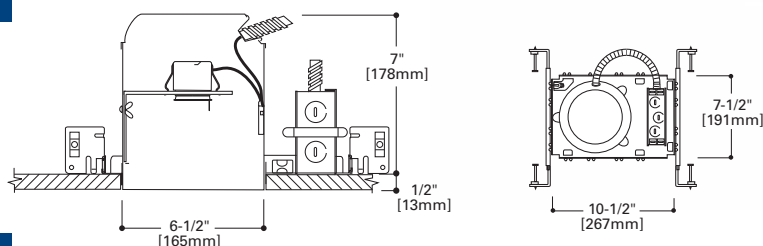

DESCRIPTION

The EI700 housing is designed for use in insulated ceilings where the housing will be in direct contact with insulation. EI700 may be converted into AIR-TITE installation when used with AIR-TITE trims. Look for the AIR-TITE trim logo in this section.

Housing

- Aluminum construction for greater heat dissipation.
- Rigid socket plate adjusts and locks without tools for various lamp sizes

Plaster Frame

- Housing adjusts in plaster frame to accommodate up to 1-3/4" thick ceilings.
- Regressed locking screw for securing hanger bars.
- Cutouts for easily crimping hanger bars in position.

Junction Box

- Positioned to accommodate straight conduit runs.
- Seven conduit knockouts are uniform 1/2" size with true pryout slots.
- Four pryouts with integral strain relief simplify "NM" non-metallic sheathed cable installation.
- Three quick connect wire connectors included.

ALL-NAIL™ Bar Hangers

- Bar Hanger features include:
- Pre-installed nail.
 - Mini leveling foot aligns the housing to the bottom of the joist.
 - Housing can be positioned at any point within 24" joist spans
 - Score lines allow tool-free shortening for narrow joist spacing.
 - Bar hangers may be repositioned 90° on plaster frame

- Integral T-bar clip snaps onto T-bars – no additional clips are required

Socket

Porcelain E26 socket with nickel plated brass screw shell, snaps into trim for consistent lamp positioning.

Thermal Protector

Self resetting thermal protector deactivates fixture if overheating occurs due to improper lamping or misapplied insulation.

Labels

- UL/cUL Listed 1598 Luminaire
- UL/cUL Listed for Damp Location
- UL/cUL Listed for FeedThrough
- UL/cUL Listed for Wet Location, covered ceiling
- UL/cUL Listed for Direct Contact with Insulation and combustible material
- IP Rated (Improper Lamp)



EI700

6" Aperture, IC, New Construction, 120V Line Voltage

Specifications

- Thermally protected IC housing
- Housing may be covered with insulation
- For use with 120V incandescent lamps

DIMENSIONS

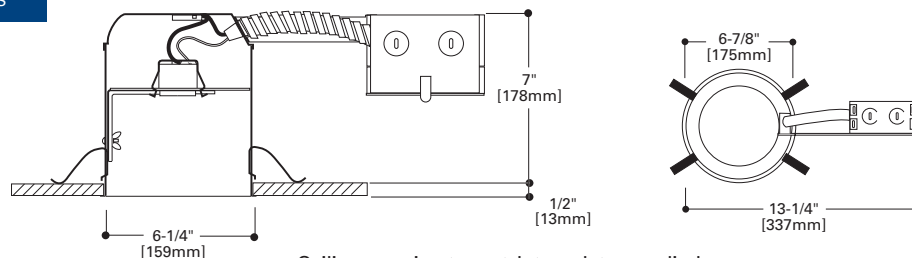

Ceiling opening to match template supplied

DESCRIPTION

The All-Pro EI700R remodel housing is designed for existing ceiling installations where the housing will be in direct contact with insulation. EI700R may be converted into AIR-TITE installation when used with AIR-TITE trims. Look for the AIR-TITE trim logo in this section.

Housing

- Aluminum construction for greater heat dissipation.
- Rigid socket plate adjusts and locks without tools for various lamp sizes.

Remodel Clips

Four remodel clips secure housing and accommodate 1/2" and 5/8" ceiling thickness.

Junction Box

- Seven conduit knockouts are uniform 1/2" size with true pryout slots.
- Four pryouts with integral strain relief simplify "NM" non-metallic sheathed cable installation.
- Three quick connect wire connectors included.

Socket

Porcelain E26 socket with nickel plated brass screw shell, snaps into trim for consistent lamp positioning.

Thermal Protector

Self resetting thermal protector deactivates fixture if overheating occurs due to improper lamping or misapplied insulation.

Labels

- UL/cUL Listed 1598 Luminaire
- UL/cUL Listed for Damp Location
- UL/cUL Listed for FeedThrough
- UL/cUL Listed for Wet Location, covered ceiling
- UL/cUL Listed for Direct Contact with Insulation and combustible material



EI700R

6" Aperture, IC, Remodel, 120V Line Voltage

Specifications

- Thermally protected IC housing
- Housing may be covered with insulation
- For use with 120V incandescent lamps
- For installation from below the ceiling

ALL-PRO

6" Incandescent



EI700AT

6" Aperture, IC,
New Construction, AIR-TITE,
120V Line Voltage

Specifications

- Thermally protected IC housing
- AIR-TITE housing prevents airflow between attic and living areas
- Housing may be covered with insulation
- For use with 120V incandescent lamps



DIMENSIONS

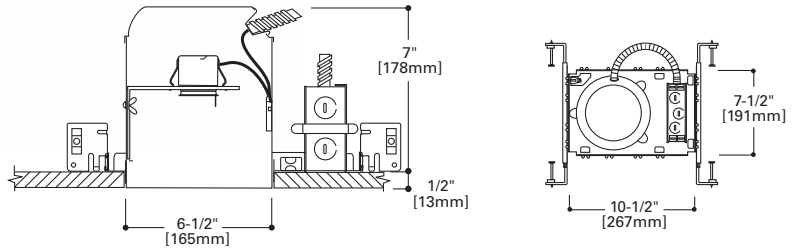

DESCRIPTION

The EI700AT housing is designed for use in insulated ceilings where the housing will be in direct contact with insulation material. AIR-TITE design meets restricted airflow requirements.

Housing

- Aluminum construction for greater heat dissipation.
- AIR-TITE gasket is pre-installed.

Socket Plate

- Rigid socket plate adjusts and locks without tools for various lamp sizes.

Plaster Frame

- Housing adjusts in plaster frame 1" to accommodate different ceiling thicknesses.
- Regressed locking screw for securing hanger bars.
- Cutouts for easily crimping hanger bars in position.

Junction Box

- Positioned to accommodate straight conduit runs.
- Seven conduit knockouts are uniform 1/2" size with true pryout slots.
- Four pryouts with integral strain relief simplify "NM" non-metallic sheathed cable installation.
- Three quick connect wire connectors included.

ALL-NAIL™ Bar Hangers

Bar Hanger features include:

- Pre-installed nail.
- Mini leveling foot aligns the housing to the bottom of the joist.
- Housing can be positioned at any point within 24" joist spans
- Score lines allow tool-free shortening for narrow joist spacing.
- Bar hangers may be repositioned 90° on plaster frame
- Integral T-bar clip snaps onto T-bars – no additional clips are required

Socket

Porcelain E26 socket with nickel plated brass screw shell.

Thermal Protector

Self resetting thermal protector deactivates fixture if overheating occurs due to improper lamping.

Labels

- UL/cUL Listed 1598 Luminaire
- UL/cUL Listed for Damp Location
- UL/cUL Listed for Feed Through
- UL/cUL Listed for Wet Location, covered ceiling
- UL/cUL Listed for Direct Contact with Insulation and combustible material

IC and AIR-TITE™

Certified under ASTM-E283 and listed UL/cUL 1598. May be used to meet insulated ceiling and restricted air-flow requirements such as:

- Washington State Energy Code
- International Energy Conservation Code (IECC)
- New York State Energy Conservation Construction Code (NY-ECCC)
- State of California Title 24 "Recessed Luminaires in Insulated Ceilings."

DIMENSIONS

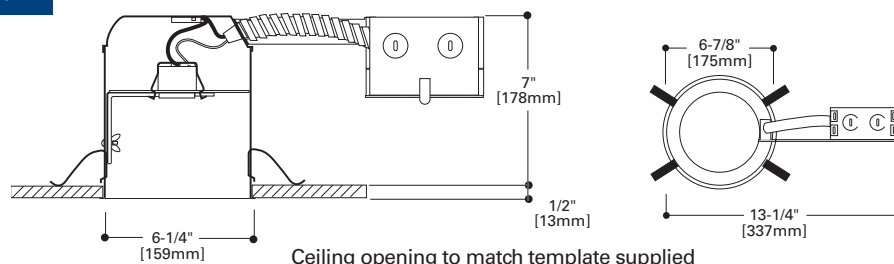

DESCRIPTION

The All-Pro EI700RAT remodel housing is designed for existing ceiling installations where the housing will be in direct contact with insulation. AIR-TITE design meets restricted airflow requirements.

Housing

- Aluminum construction for greater heat dissipation.
- AIR-TITE gasket is pre-installed.

Socket Plate

- Rigid socket plate adjusts and locks without tools for various lamp sizes.

Remodel Clips

Four remodel clips secure housing and accommodate 1/2" and 5/8" ceiling thickness.

Junction Box

- Positioned to accommodate straight conduit runs.
- Seven conduit knockouts are uniform 1/2" size with true pryout slots.

- Four pryouts with integral strain relief simplify "NM" non-metallic sheathed cable installation.
- Three quick connect wire connectors included.

Socket

Porcelain E26 socket with nickel plated brass screw shell.

Thermal Protector

Self resetting thermal protector deactivates fixture if overheating occurs due to improper lamping.

Labels

- UL/cUL Listed 1598 Luminaire
- UL/cUL Listed for Damp Location
- UL/cUL Listed for Feed Through
- UL/cUL Listed for Wet Location, covered ceiling
- UL/cUL Listed for Direct Contact with Insulation and combustible material

IC and AIR-TITE™

Certified under ASTM-E283 and listed UL/cUL 1598. May be used to meet insulated ceiling and restricted air-flow requirements such as:

- Washington State Energy Code
- International Energy Conservation Code (IECC)
- New York State Energy Conservation Construction Code (NY-ECCC)
- State of California Title 24 "Recessed Luminaires in Insulated Ceilings."



EI700RAT

6" Aperture, IC, Remodel, AIR-TITE, 120V Line Voltage

Specifications

- Thermally protected IC housing for use with 120V incandescent lamps
- AIR-TITE housing prevents airflow between attic and living areas
- Housing may be covered with insulation
- For installation from below the ceiling



ALL-PRO

6" Incandescent



EI700ATNB

6" Aperture, IC,
New Construction, AIR-TITE,
120V Line Voltage,
No Socket Bracket

Specifications

- Thermally protected IC housing
- AIR-TITE housing prevents airflow between attic and living areas
- Housing may be covered with insulation
- For use with 120V incandescent lamps
- "NB" no socket bracket housing saves installation time with fixed socket position on trims and quick wiring connectors in the junction box.



DIMENSIONS

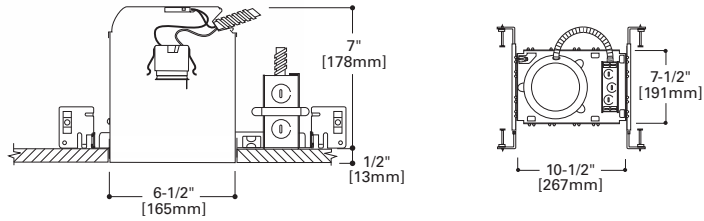

DESCRIPTION

The EI700ATNB is designed for installations where it will be in direct contact with insulation. These housings are designed to save installation time. They are designed without a socket plate for use with socket supporting trims only. There is no need to spend time adjusting or disconnecting the socket and removing the socket plate. AIR-TITE design meets restricted airflow requirements.

Housing

- Aluminum construction for greater heat dissipation.
- AIR-TITE gasket is pre-installed.

Plaster Frame

- Housing adjusts in plaster frame 1" to accommodate different ceiling thicknesses.
- Regressed locking screw for securing hanger bars.
- Cutouts for easily crimping hanger bars in position.

Junction Box

- Positioned to accommodate straight conduit runs.
- Seven conduit knockouts are uniform 1/2" size with true pryout slots.
- Four pryouts with integral strain relief simplify "NM" non-metallic sheathed cable installation.
- Three quick connect wire connectors included.

ALL-NAIL™ Bar Hangers

Bar Hanger features include:

- Pre-installed nail.
- Mini leveling foot aligns the housing to the bottom of the joist.
- Housing can be positioned at any point within 24" joist spans
- Score lines allow tool-free shortening for narrow joist spacing.
- Bar hangers may be repositioned 90° on plaster frame
- Integral T-bar clip snaps onto T-bars – no additional clips are required

Socket

Porcelain E26 socket with nickel plated brass screw shell.

Thermal Protector

Self resetting thermal protector deactivates fixture if overheating occurs due to improper lamping.

Labels

- UL/cUL Listed 1598 Luminaire
- UL/cUL Listed for Damp Location
- UL/cUL Listed for Feed Through
- UL/cUL Listed for Wet Location, covered ceiling
- UL/cUL Listed for Direct Contact with Insulation and combustible material

IC and AIR-TITE™

May be used to meet insulated ceiling and restricted air-flow requirements such as:

- Washington State Energy Code
- International Energy Conservation Code (IECC)
- New York State Energy Conservation Construction Code (NY-ECCC)
- State of California Title 24 "Recessed Luminaires in Insulated Ceilings."

DIMENSIONS

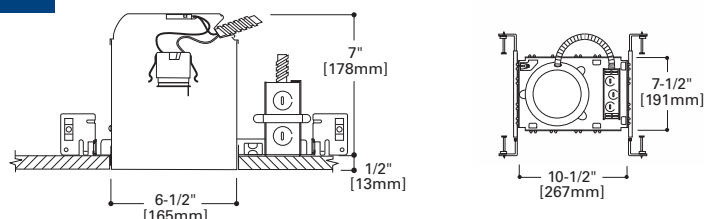

DESCRIPTION

The EI700NB is designed for installations where it will be in direct contact with insulation. These housings are designed to save installation time. They are designed without a socket plate for use with socket supporting trims only so there is no need to spend time adjusting or disconnecting the socket and removing the socket plate. EI700NB may be converted into AIR-TITE installation when used with AIR-TITE trims. Look for the AIR-TITE trim logo in this section.

Housing

- Aluminum construction for greater heat dissipation.

Plaster Frame

- Housing adjusts in plaster frame to accommodate up to 1-3/4" thick ceilings.
- Regressed locking screw for securing hanger bars.
- Cutouts for easily crimping hanger bars in position.

Junction Box

- Positioned to accommodate straight conduit runs.
- Seven conduit knockouts are uniform 1/2" size with true pryout slots.
- Four pryouts with integral strain relief simplify "NM" non-metallic sheathed cable installation.
- Three quick connect wire connectors included.

ALL-NAIL™ Bar Hangers

- Bar Hanger features include:
- Pre-installed nail.
 - Mini leveling foot aligns the housing to the bottom of the joist.
 - Housing can be positioned at any point within 24" joist spans
 - Score lines allow tool-free shortening for narrow joist spacing.
 - Bar hangers may be repositioned 90° on plaster frame
 - Integral T-bar clip snaps onto T-bars – no additional clips are required

Socket

Porcelain E26 socket with nickel plated brass screw shell.

Thermal Protector

Self resetting thermal protector deactivates fixture if overheating occurs due to improper lamping.

Labels

- UL/cUL Listed 1598 Luminaire
- UL/cUL Listed for Damp Location
- UL/cUL Listed for Feed Through
- UL/cUL Listed for Wet Location, covered ceiling
- UL/cUL Listed for Direct Contact with Insulation and combustible material



EI700NB

6" Aperture, IC,
New Construction,
120V Line Voltage,
No Socket Bracket

Specifications

- Thermally protected IC housing
- Housing may be covered with insulation
- For use with 120V incandescent lamps
- "NB" no socket bracket housing saves installation time with fixed socket position on trims and quick wiring connectors in the junction box.

ALL-PRO

E1700, E1700R, E1700AT,
E1700RAT, E1700ATNB,
E1700NB

ERT710

Specular Reflector
• Coil Spring retention

E1700	75W R30, 65W BR30,
E1700AT	50W PAR30, 75W PAR30L
E1700R	50W PAR30, 75W PAR30L,
E1700RAT	65W BR30, 75W R30

Height:
2-7/8" [73mm]
OD:
7-1/4" [184mm]

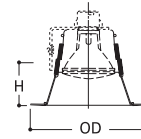

ERT710
High Gloss Appliance White
Trim with Clear Specular
Reflector

ERT712

White Reflector

- Socket supporting trim
- ERT712 - Friction clip retention
- ERT712TS - Torsion spring retention

E1700	40W A19, 65W BR30,
E1700AT	75W PAR30,
E1700R	75W PAR30L,
E1700RAT	75W R30, 90W BR40
E1700NB	
E1700ATNB	

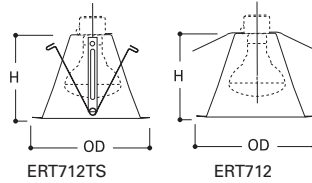

Height: 5-3/8" [136mm]
OD: 7-1/4" [184mm]



ERT712TS
High Gloss Appliance White Trim
with White reflector and Torsion
Spring Construction



ERT712
High Gloss Appliance White
Trim with White reflector

ERT707

Metal Baffle

- Coil spring retention
- Two trim rings (narrow and wide), supplied with trim

E1700	50W PAR30,
E1700AT	65W BR30,
E1700R	75W R30,
E1700RAT	75W PAR30L

Height:
2-7/8" [73mm]
Wide OD:
8" [203mm]
Narrow OD:
7-1/4" [184mm]

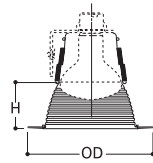

WIDE TRIM
RING

NARROW
TRIM RING



ERT707WHT
High Gloss Appliance White
Trim with White Baffle



ERT707
High Gloss Appliance White
Trim with Black Baffle

ERT713

Black Metal Baffle

- Socket supporting trim
- ERT713 - Friction clip retention
- ERT713TS - Torsion spring retention

E1700	40W A19, 65W BR30,
E1700AT	75W PAR30, 75W
E1700R	PAR30L, 90W BR40
E1700RAT	

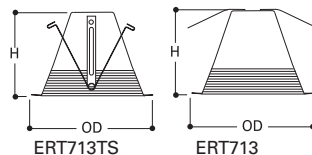

Height: 5" [127mm]
OD: 7-1/4" [184mm]



ERT713TS
High Gloss Appliance White Trim
with Black Baffle and Torsion
Spring Construction



ERT713
High Gloss Appliance White
Trim with Black Baffle

E1700NB	40W A19, 65W BR30,
E1700RATNB	75W R30, 75W PAR30, 75W PAR30L, 90W BR40

* When using an Air-Tite trim to meet California Title 24 air tight compliance, an additional gasket is required between the finished ceiling and the trim flange ring. For California Title 24 compliance use accessory trim gasket GA-ATRIM. Order separately in a 6 pack: GA-ATTRIM-6PK

ALL-PRO

E1700, E1700R, E1700AT,
E1700RAT, E1700ATNB,
E1700NB

ERT713WHT

White Metal Baffle

- Socket supporting trim
- ERT713WHT - Friction clip retention
- ERT713WHTTS - Torsion spring retention

E1700
E1700AT
E1700R
E1700RAT
E1700NB
E1700ATNB

40W A19, 65W BR30,
75W R30, 75W
PAR30, 75W PAR30L,
90W BR40

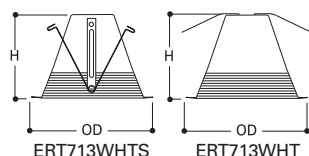

Height: 5-3/8" [136mm]
OD: 7-1/4" [184mm]



ERT713WHTTS

High Gloss Appliance White Trim with White Baffle and Torsion Spring Construction



ERT713WHT

High Gloss Appliance White Trim with White Baffle

ERT713L

Black Metal Baffle

- Provides deeper lamp regression for BR lamps
- ERT713LTS - Torsion spring retention
- ERT713L - Friction clip retention

E1700
E1700AT
E1700R
E1700RAT
E1700NB
E1700ATNB

75W BR40,
65W BR30,
75W PAR30L

Height: 5-3/8" [136mm]
OD: 7-1/4" [184mm]

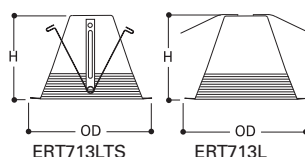

ERT713LTS

High Gloss Appliance White Trim with Black Baffle and Torsion Spring Construction

ERT714

Plastic Baffle

- Coil spring retention

E1700
E1700AT
E1700R
E1700RAT

50W PAR30, 65W
BR30, 75W PAR30L

Height: 2-1/4" [57mm]
OD: 8" [203mm]

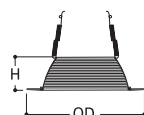

ERT714WHT

High Gloss Appliance White Trim with White Baffle

ERT714

High Gloss Appliance White Trim with Black Baffle

ERT704

Eyeball

- Torsion springs pull trim tight to ceiling

E1700
E1700AT
E1700R
E1700RAT
E1700NB
E1700ATNB

75W R30,
65W BR30,
75W PAR30L

Aperture: 3-15/16" [100mm]
OD: 8" [203mm]

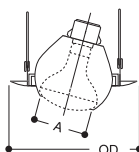

ERT704

High Gloss Appliance White Trim with White Eyeball

ERT711

Regressed Eyeball

E1700
E1700AT

50W PAR30

E1700NB
E1700ATNB

65W BR30, 75W R30

Height: 3" [76mm]
OD: 8" [203mm]

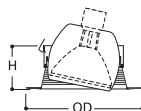

ERT711

High Gloss Appliance White Trim and Eyeball with Black Baffle

* When using an Air-Tite trim to meet California Title 24 air tight compliance, an additional gasket is required between the finished ceiling and the trim flange ring. For California Title 24 compliance use accessory trim gasket GA-ATRIM. Order separately in a 6 pack: GA-ATTRIM-6PK

ALL-PRO

EI700, EI700R, EI700AT,
EI700RAT, EI700ATNB,
EI700NB

ERT705

Open

- Coil Spring retention

EI700
EI700AT
EI700R
EI700RAT
EI700NB
EI700ATNB

65W BR30,
75W PAR30,
75W PAR30L

Aperture:
3-7/8"
[98mm]
OD:
8" [203mm]

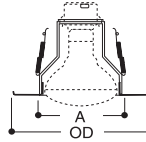

ERT705
High Gloss Appliance White
Trim

ERT721

Shower Light with Frosted Glass Lens and Reflector

- Torsion springs pull trim tight to ceiling
- Wet location listed for use in showers

Height:
4-1/4"
[108mm]
OD:
8" [203mm]

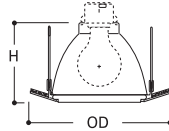

ERT721
High Gloss Appliance White Trim
with Frosted Glass Lens

EI700
EI700AT
EI700R
EI700RAT
EI700NB
EI700ATNB

40W A19

ERT725

Black Metal Baffle/Splay

- Combination baffle/splay trim
- Socket Supporting trim
- Wide Trim flange hides ceiling cut out irregularities
- ERT725TS - Torsion spring retention
- ERT725 - Friction clip retention

Height:
5-3/8" [136mm]
OD:
7-1/4" [184mm]

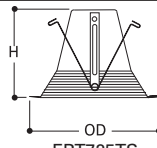

ERT725TS

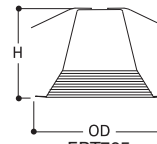

ERT725



ERT725TS
High Gloss Appliance White Trim
with Black Baffle and Torsion
Spring Construction

EI700
EI700AT
EI700R
EI700RAT
EI700NB
EI700ATNB

50W PAR30L,
65W BR30

ERT725WHT

White Metal Baffle/Splay

- Combination baffle/splay trim
- Socket Supporting trim
- Wide Trim flange hides ceiling cut out irregularities
- ERT725WHTTS - Torsion spring retention
- ET725WHT - Friction clip retention

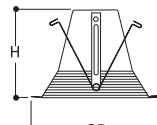

ERT725WHTTS

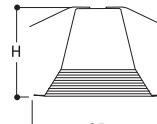

ERT725WHT



ERT725WHTTS
High Gloss Appliance White
Trim with White Baffle and
Torsion Spring Construction



ERT725WHT
High Gloss Appliance White
Trim with White Baffle

EI700
EI700R
EI700AT
EI700RAT
EI700NB
EI700ATNB

40W A19,
50W PAR30L,
65W BR30,
75W PAR30L

Height: 5-3/8" [136mm] OD: 7-1/4" [184mm]

ERT716

Shallow Metal Baffle

- Socket Supporting trim
- Friction clip retention

Height:
4-1/4" [108mm]
OD:
8" [203mm]

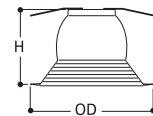

ERT716WHT
High Gloss Appliance White Trim
with White Baffle

EI700
EI700R
EI700AT
EI700RAT
EI700NB
EI700ATNB

40W A19,
65W BR30, 75W
PAR30, 75W PAR30L

ERT723

Shower Light with Glass Fresnel Lens and Reflector

- Torsion springs pull trim tight to ceiling
- Wet location listed for use in showers
- Socket supporting trim

Height:
4-1/4" [108mm]
OD:
8" [203mm]

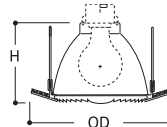

ERT723
High Gloss Appliance White
Trim with Glass Fresnel Lens

EI700
EI700R
EI700AT
EI700RAT
EI700NB
EI700ATNB

40W A19

DIMENSIONS

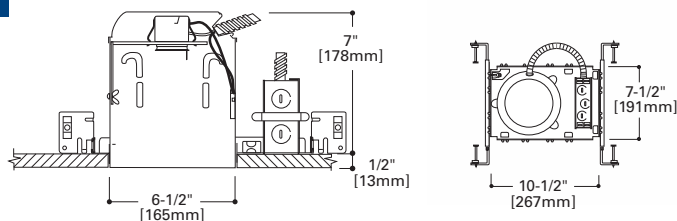

DESCRIPTION

The ET700 is for use in non-insulated ceilings. If ceiling insulation is present, it must be kept 3" from all sides of the fixture.

Housing

- Die-stamped CRS with white powder coat finish.

Socket Plate

- Rigid socket plate adjusts and locks without tools for various lamp sizes.

Plaster Frame

- Housing adjusts in plaster frame to accommodate up to 1-3/4" thick ceilings.
- Regressed locking screw for securing hanger bars.
- Cutouts for easily crimping hanger bars in position.

Junction Box

- Positioned to accommodate straight conduit runs.
- Seven conduit knockouts are uniform 1/2" size with true pryout slots.
- Four pryouts with integral strain relief simplify "NM" non-metallic sheathed cable installation.
- Three quick connect wire connectors included.

ALL-NAIL™ Bar Hangers

Bar Hanger features include:

- Pre-installed nail.
- Mini leveling foot aligns the housing to the bottom of the joist.
- Housing can be positioned at any point within 24" joist spans
- Score lines allow tool-free shortening for narrow joist spacing.

- Bar hangers may be repositioned 90° on plaster frame
- Integral T-bar clip snaps onto T-bars – no additional clips are required.

Socket

Porcelain E26 socket with nickel plated brass screw shell.

Thermal Protector

Self resetting thermal protector deactivates fixture if overheating occurs due to improper lamping or misapplied insulation.

Labels

- UL/cUL Listed 1598 Luminaire
- UL/cUL Listed for Damp Location
- UL/cUL Listed for FeedThrough
- UL/cUL Listed for Wet Location, covered ceiling
- IP Rated (Improper Lamp)



ET700

6" Aperture, Non-IC, New Construction, 120V Line Voltage

Specifications

- Thermally protected Non-IC housing
- May be used in insulated ceilings but insulation MUST be kept 3" from all sides of fixture
- For use with 120V incandescent lamps

DIMENSIONS

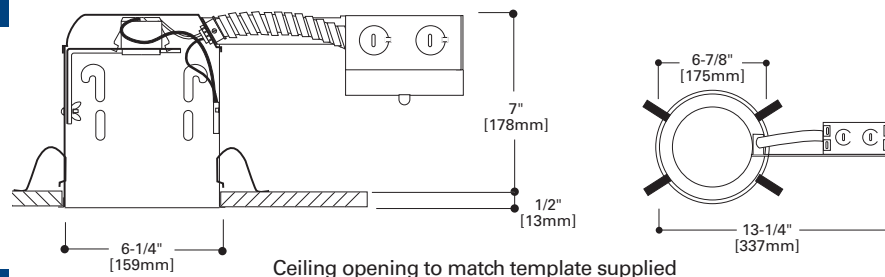

DESCRIPTION

The ET700R is for use in non-insulated existing ceilings. If ceiling insulation is present, it must be kept 3" from the fixtures on all sides. For installation from below the finished ceiling.

Housing

- Die-stamped CRS with white powder coat finish.

Socket Plate

- Rigid socket plate adjusts and locks without tools for various lamp sizes.

Remodel Clips

Four remodel clips secure housing and accommodate 1/2" and 5/8" ceiling thickness.

Junction Box

- Seven conduit knockouts are uniform 1/2" size with true pryout slots.
- Four pryouts with integral strain relief simplify "NM" non-metallic sheathed cable installation.
- Three quick connect wire connectors included.

Socket

Porcelain E26 socket with nickel plated brass screw shell.

Thermal Protector

Self resetting thermal protector deactivates fixture if overheating occurs due to improper lamping or misapplied insulation.

Labels

- UL/cUL Listed 1598 Luminaire
- UL/cUL Listed for Damp Location
- UL/cUL Listed for FeedThrough
- UL/cUL Listed for Wet Location, covered ceiling
- IP Rated (Improper Lamp)



ET700R

6" Aperture, IC, Remodel, 120V Line Voltage

Specifications

- Thermally protected Non-IC housing
- May be used in insulated ceilings but insulation MUST be kept 3" from all sides of fixture
- For use with 120V incandescent lamps
- For installation from below the ceiling

ALL-PRO

ET700, ET700R

ERT710

Specular Reflector

- Coil Spring retention

ET700 65W BR30, 75W R30, 75W PAR30, 150W R40, 150W PAR38

ET700R 65W BR30, 75W R30, 75W PAR30, 75W PAR30L, 150W R40

Height:
2-7/8" [73mm]
OD:
7-1/4" [184mm]

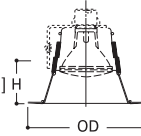

ERT710
High Gloss Appliance White Trim with Clear Specular Reflector

ERT712

White Reflector

- Socket supporting trim
- ERT712 - Friction clip retention
- ERT712TS - Torsion spring retention

ET700 85W BR30, 120W BR40, 100W R30, 75W PAR30L, 100W A19

ET700R 65W BR30, 75W PAR30L

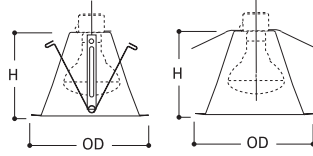

ERT712TS Height: 5-3/8" [136mm]
ERT712 OD: 7-1/4" [184mm]



ERT712TS
High Gloss Appliance White Trim with White reflector and Torsion Spring Construction

ERT712
High Gloss Appliance White Trim with White reflector

ERT707

Metal Baffle

- Coil spring retention
- Two trim rings (narrow and wide), supplied with trim

ET700 65W BR30, 75W R30, 75W PAR30

ET700R 65W BR30, 75W R30, 75W PAR30, 75W PAR30L

Height:
2-7/8" [73mm]
Wide OD:
8" [203mm]
Narrow OD:
7-1/4" [184mm]

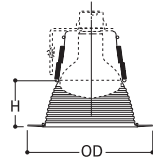

WIDE TRIM RING

NARROW TRIM RING



ERT707WHT
High Gloss Appliance White Trim with White Baffle

ERT707
High Gloss Appliance White Trim with Black Baffle

ERT709

Large Aperture Metal Baffle

- Coil spring retention
- Two trim rings (narrow and wide), supplied with trim

ET700 120W R40, 120W PAR38

Height:
2-5/8" [67mm]
Wide OD:
8" [203mm]
Narrow OD:
7-1/4" [184mm]

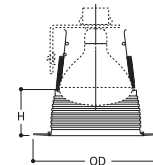

WIDE TRIM RING

NARROW TRIM RING



ERT709WHT
High Gloss Appliance White Trim with White Baffle

ERT709
High Gloss Appliance White Trim with Black Baffle

ERT713

Black Metal Baffle

- Socket supporting trim
- ERT713 - Friction clip retention
- ERT713TS - Torsion spring retention

ET700 75W PAR30L, 85W BR30, 100W R30, 100W A19, 120W BR40

ET700R 65W BR30, 75W PAR30L

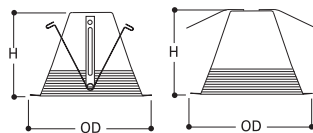

ERT713TS Height: 5" [127mm]
ERT713 OD: 7-1/4" [184mm]



ERT713TS
High Gloss Appliance White Trim with Black Baffle and Torsion Spring Construction

ERT713
High Gloss Appliance White Trim with Black Baffle

ERT713WHT

White Metal Baffle

- Socket supporting trim
- ERT713WHT - Friction clip retention
- ERT713WHTTS - Torsion spring retention

ET700 75W PAR30L, 85W BR30, 100W R30, 100W A19, 120W BR40

ET700R 65W BR30, 75W PAR30L

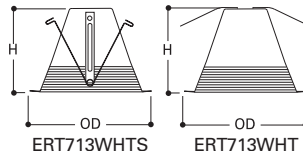

ERT713WHTTS Height: 5-3/8" [136mm]
ERT713WHT OD: 7-1/4" [184mm]



ERT713WHTTS
High Gloss Appliance White Trim with White Baffle and Torsion Spring Construction

ERT713WHT
High Gloss Appliance White Trim with White Baffle

* When using an Air-Tite trim to meet California Title 24 air tight compliance, an additional gasket is required between the finished ceiling and the trim flange ring. For California Title 24 compliance use accessory trim gasket GA-ATRIM. Order separately in a 6 pack: GA-ATTRIM-6PK

ERT713L

Black Metal Baffle

- Provides deeper lamp regression
- ERT713LTS - Torsion spring retention
- ET713L - Friction clip retention

ET700	75W A19, 75W PAR30L, 75W PAR30, 85W BR30, 100W R30, 120W BR40, 150W R40
ET700R	65W BR30, 75W PAR30L, 150W R40

Height:
5-3/8" [136mm]
OD:
7-1/4" [184mm]

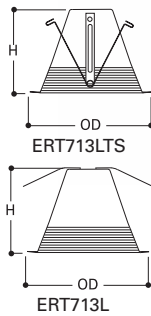

*air*¹⁹⁴
trim



ERT713LTS
High Gloss Appliance White Trim
with Black Baffle and Torsion
Spring Construction

ERT714

Plastic Baffle

- Coil spring retention

ET700	75W R30, 75W PAR30, 75W PAR30L, 85W BR30
ET700R	75W R30, 75W PAR30L, 85W BR30

Height:
2-1/4" [57mm]
OD:
8" [203mm]

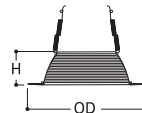

ERT714WHT
High Gloss Appliance White
Trim with White Baffle

ERT714
High Gloss Appliance White
Trim with Black Baffle

ERT717

Large Aperture Plastic Baffle

- Coil spring retention

ET700	150W PAR38, 120W BR40, 150W R40
ET700R	150W R40, 120W BR40

Height:
2-3/4" [70mm]
OD:
8" [203mm]

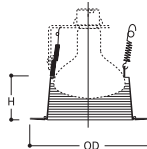

ERT717WHT
High Gloss Appliance White
Trim with White Baffle

ERT716

Shallow Metal Baffle

- Socket Supporting trim
- Friction clip retention

ET700	40W A19, 65W BR30, 75W PAR30, 75W PAR30L
ET700R	75W PAR30, 75W PAR30L

Height:
4-1/4" [108mm]
OD:
8" [203mm]

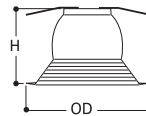

*air*¹⁹⁴
trim



ERT716WHT
High Gloss Appliance White
Trim with White Baffle

ERT704

Eyeball

- Torsion springs pull trim tight to ceiling

ET700	75W R30, 75W PAR30, 75W PAR30L
ET700R	75W PAR30L

Aperture:
3-15/16" [100mm]
OD:
8" [203mm]

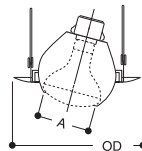

ERT704
High Gloss Appliance White
Trim with White Eyeball

ERT711

Regressed Eyeball

- Torsion springs pull trim tight to ceiling

ET700	65W BR30, 75W R30, 75W PAR30
-------	------------------------------

Height:
3" [76mm]
OD:
8" [203mm]

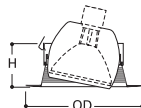

ERT711
High Gloss Appliance White Trim
and Eyeball with Black Baffle

ERT706

Open

- Coil spring retention

ET700	65W BR30, 75W R30, 75W PAR30
ET700R	65W R30, 75W R30, 75W PAR30, 75W PAR30L

Aperture:
3-7/8" [98mm]
OD:
8" [203mm]

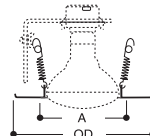

ERT706
High Gloss Appliance White Trim

ALL-PRO

ET700, ET700R

ERT708

Large Aperture Open

- Coil Spring Retention

ET700 120W BR40, 150W R40
ET700R

Aperture:
5-3/16" [131mm]

OD:
8" [203mm]

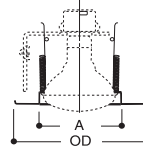

ERT708
High Gloss Appliance White
Trim

ERT701

Albalite Lens Shower Light

- Wet Location listed for use in showers
- Torsion spring retention

ET700 60W A19
ET700R

OD:
8" [203mm]

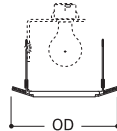

ERT701
High Gloss Appliance White Trim
with Albalite Lens

ERT702

Drop Opal Plastic Lens Shower Light

- Wet Location listed for use in showers
- Torsion spring retention

ET700 60W A19
ET700R

OD:
8" [203mm]

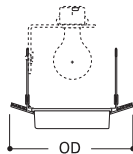

ERT702
High Gloss Appliance White
Trim with Drop Opal Lens

ERT703

Fresnel Lens Shower Light

- Wet Location listed for use in showers

ET700 60W A19
ET700R

OD:
8" [203mm]

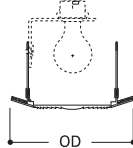

ERT703
High Gloss Appliance White Trim
with Fresnel lens

ERT705

Open

- Coil Spring retention
- Fixed socket position

ET700 65W BR30, 75W R30, 75W
PAR30, 75W PAR30L

OD:
8" [203mm]

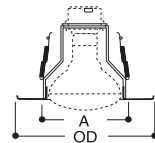

ERT705
White Trim

ERT721

Shower Light with Frosted Glass Lens and Reflector

- Torsion springs pull trim tight to ceiling
- Wet location listed for use in showers

Height:
4-1/4"
[108mm]
OD:
8" [203mm]

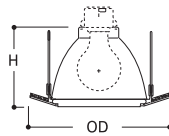

ERT721
High Gloss Appliance White Trim
with Frosted Glass Lens

ET700 60W A19
ET700R

ERT725

Black Metal Baffle/Splay

- Combination baffle/splay trim
- Socket Supporting trim
- Wide Trim flange hides ceiling cut out irregularities
- ERT725TS - Torsion spring retention
- ERT725 - Friction clip retention

Height:
5-3/8" [136mm]
OD:
7-1/4" [184mm]

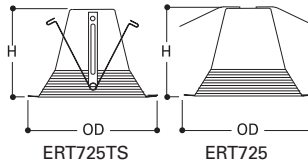

ERT725TS
High Gloss Appliance White
Trim with Black Baffle and
Torsion Spring Construction

ET700 50W PAR30L, 85W BR30,
ET700R 90W A19, 100W R30,

ERT725WHT

White Metal Baffle/Splay

- Combination baffle/splay trim
- Socket Supporting trim
- Wide Trim flange hides ceiling cut out irregularities
- ERT725WHTTS - Torsion spring retention
- ERT725WHT - Friction clip retention

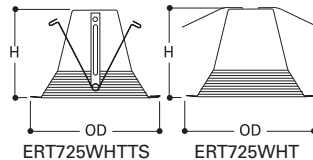

Height:
5-3/8" [136mm] OD:
7-1/4" [184mm]



ERT725WHTTS
High Gloss Appliance White
Trim with White Baffle and
Torsion Spring Construction

ERT725WHT
High Gloss Appliance White Trim
with White Baffle

ET700 50W PAR30L, 75W PAR30L,
ET700R 85W BR30, 90W A19, 100W R30

ERT723

Shower Light with Glass Fresnel Lens and Reflector

- Torsion springs pull trim tight to ceiling
- Wet location listed for use in showers
- Socket supporting trim

Height:
4-1/4" [108mm]
OD:
8" [203mm]

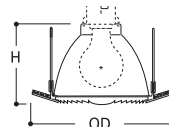

ERT723
High Gloss Appliance White
Trim with Glass Fresnel Lens

ET700 60W A19
ET700R

ALL-PRO

6" Incandescent



EI700U

6" Aperture, IC,
New Construction,
120V Line Voltage

Specifications

- Thermally protected IC housing
- Housing may be covered with insulation
- For use with 120V incandescent lamps



EI700UAT

6" Aperture, IC,
New Construction, AIR-TITE,
120V Line Voltage

Specifications

- Thermally protected IC housing
- AIR-TITE housing prevents airflow between attic and living areas
- Housing may be covered with insulation
- For use with 120V incandescent lamps



DIMENSIONS

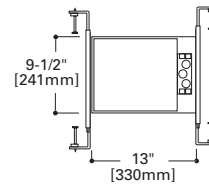
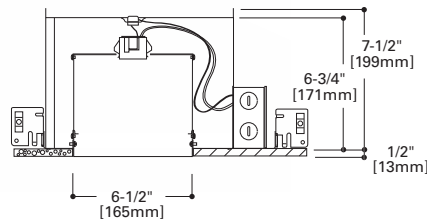

DESCRIPTION

The All-Pro EI700U housing is designed to be used in direct contact with insulation. The IC construction allows an unbroken insulation barrier to be maintained. EI700U may be converted into AIR-TITE installation when used with AIR-TITE trims. Look for the AIR-TITE trim logo in this section.

Housing

- Double wall aluminum construction for greater heat dissipation.
- Double wall housing allows higher wattages on select trims than single wall IC housing.

Socket Plate

- Fixed socket plate maintains consistent lamp position.

Plaster Frame

- Galvanized steel construction.
- Regressed locking screw for securing hanger bars
- Cutouts for easily crimping hanger bars in position.

Junction Box

- Positioned to accommodate straight conduit runs.
- Seven conduit knockouts are uniform 1/2" size with true pryout slots.
- Four pryouts with integral strain relief simplify "NM" non-metallic sheathed cable installation.
- Three quick connect wire connectors included.

ALL-NAIL™ Bar Hangers

Bar Hanger features include:

- Pre-installed nail.
- Mini leveling foot aligns the housing to the bottom of the joist.
- Housing can be positioned at any point within 24" joist spans
- Score lines allow tool-free shortening for narrow joist spacing.
- Bar hangers may be repositioned 90° on plaster frame
- Integral T-bar clip snaps onto T-bars – no additional clips are required

Socket

Porcelain E26 socket with nickel plated brass screw shell.

Thermal Protector

Self resetting thermal protector deactivates fixture if overheating occurs due to improper lamping or misapplied insulation.

Labels

- UL/cUL Listed 1598 Luminaire
- UL/cUL Listed for Damp Location
- UL/cUL Listed for Feed Through
- UL/cUL Listed for Direct Contact with Insulation and combustible material
- UL/cUL Listed for Wet Location – Covered Ceiling

DIMENSIONS

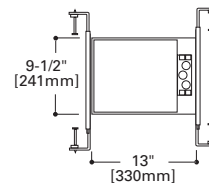
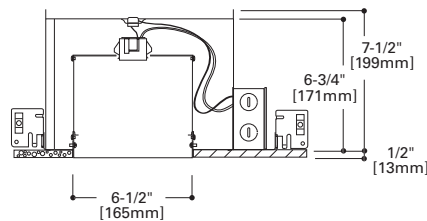

DESCRIPTION

The All-Pro EI700UAT housing is designed to be used in direct contact with insulation. The IC construction allows an unbroken insulation barrier to be maintained and the AIR-TITE design meets restricted airflow requirements.

Housing

- Double wall aluminum construction for greater heat dissipation.
- Double wall housing allows higher wattages on select trims than single wall IC housing.
- AIR-TITE gasket is pre-installed.

Socket Plate

- Fixed socket plate maintains consistent lamp position.

Plaster Frame

- Galvanized steel construction.
- Regressed locking screw for securing hanger bars
- Cutouts for easily crimping hanger bars in position

- Four pryouts with integral strain relief simplify "NM" non-metallic sheathed cable installation.
- Three quick connect wire connectors included.

ALL-NAIL™ Bar Hangers

Bar Hanger features include:

- Pre-installed nail.
- Mini leveling foot aligns the housing to the bottom of the joist.
- Housing can be positioned at any point within 24" joist spans
- Score lines allow tool-free shortening for narrow joist spacing.
- Bar hangers may be repositioned 90° on plaster frame
- Integral T-bar clip snaps onto T-bars – no additional clips are required

Labels

- UL/cUL Listed 1598 Luminaire
- UL/cUL Listed for Damp Location
- UL/cUL Listed for Feed Through
- UL/cUL Listed for Wet Location, covered ceiling
- UL/cUL Listed for Direct Contact with Insulation and combustible material

IC and AIR-TITE™

Certified under ASTM-E283 and listed UL/cUL 1598. May be used to meet insulated ceiling and restricted air-flow requirements such as:

- Washington State Energy Code
- International Energy Conservation Code (IECC)
- New York State Energy Conservation Construction Code (NY-ECCC)
- State of California Title 24 "Recessed Luminaires in Insulated Ceilings."

Socket

Porcelain E26 socket with nickel plated brass screw shell.

Thermal Protector

Self resetting thermal protector deactivates fixture if overheating occurs due to improper lamping or misapplied insulation.

Junction Box

- Positioned to accommodate straight conduit runs.
- Seven conduit knockouts are uniform 1/2" size with true pryout slots.

ERT710

Specular Reflector

- Coil Spring retention

E1700U
E1700UAT

75W PAR30, 75W PAR30L,
85W BR30, 90W BR40, 100W R30,
100W R40, 100W PAR38

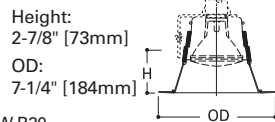

ERT710
High Gloss Appliance White Trim
with Clear Specular Reflector

ERT712

White Reflector

- Socket supporting trim
- ERT712 - Friction clip retention
- ERT712TS - Torsion spring retention

E1700U
E1700UAT

60W A19, 75W PAR30,
75W PAR30L, 85W BR30,
100W R30, 120W BR40

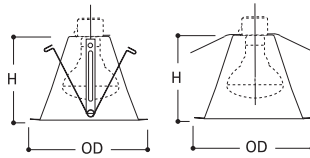

Height: OD:
5-3/8" [136mm] 7-1/4" [184mm]



ERT712TS
High Gloss Appliance White Trim
with White reflector and Torsion
Spring Construction



ERT712
High Gloss Appliance White
Trim with White reflector

ERT707

Metal Baffle

- Coil spring retention
- Two trim rings (narrow and wide),
supplied with trim

E1700U
E1700UAT

65W BR30, 75W R30, 75W
PAR30, 75W PAR30L, 90W
PAR38, 90W BR40, 100W R40

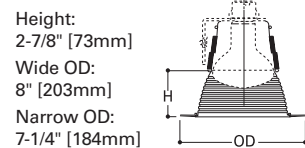

WIDE TRIM
RING



ERT707WHT
High Gloss Appliance White
Trim with White Baffle

NARROW
TRIM RING



ERT707
High Gloss Appliance White
Trim with Black Baffle

ERT709

Large Aperture Metal Baffle

- Coil spring retention
- Two trim rings (narrow and wide),
supplied with trim

E1700U
E1700UAT

90W BR40

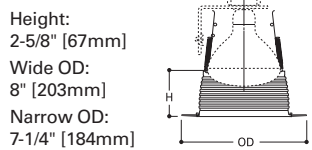

WIDE TRIM
RING



ERT709WHT
High Gloss Appliance White
Trim with White Baffle

NARROW
TRIM RING



ERT709
High Gloss Appliance White
Trim with Black Baffle

ERT713

Black Metal Baffle

- Socket supporting trim
- ERT713 - Friction clip retention
- ERT713TS - Torsion spring retention

E1700U
E1700UAT

60W A19, 75W PAR30, 75W
PAR30L, 85W BR30, 120W BR40

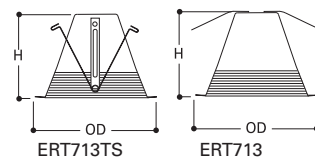

Height: OD:
5" [127mm] 7-1/4" [184mm]



ERT713TS
High Gloss Appliance White Trim
with Black Baffle and Torsion
Spring Construction



ERT713
High Gloss Appliance White
Trim with Black Baffle

ERT713WHT

White Metal Baffle

- Socket supporting trim
- ERT713WHT - Friction clip retention
- ERT713WHTTS - Torsion spring retention

E1700U
E1700UAT

60W A19, 75W PAR30, 75W
PAR30L, 85W BR30, 100W R30,
120W BR40

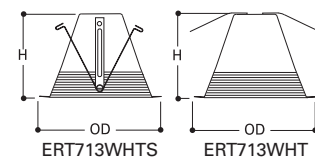

Height: OD:
5-3/8" [136mm] 7-1/4" [184mm]



ERT713WHTTS
High Gloss Appliance White
Trim with White Baffle and Tor-
sion Spring Construction



ERT713WHT
High Gloss Appliance White
Trim with White Baffle

* When using an Air-Tite trim to meet California Title 24 air tight compliance, an additional gasket is required between the finished ceiling and the trim flange ring. For California Title 24 compliance use accessory trim gasket GA-ATRIM. Order separately in a 6 pack: GA-ATTRIM-6PK

ALL-PRO

E1700U, E1700UAT

ERT713L

Black Metal Baffle

- Provides deeper lamp regression
- ERT713LTS - Torsion spring retention
- ERT713L - Friction clip retention

E1700U 40W A19, 75W PAR30, 75W
E1700UAT PAR30L, 85W BR30, 120W BR40

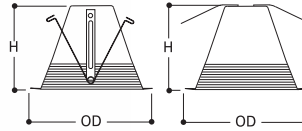

ERT713LTS Height: 5-3/8" [136mm]
ERT713L OD: 7-1/4" [184mm]

air191 trim



ERT713LTS
High Gloss Appliance White Trim with Black Baffle and Torsion Spring Construction

ERT714

Plastic Baffle

- Coil spring retention

E1700U 65W BR30, 75W PAR30,
E1700UAT 75W PAR30L

Height: 2-1/4" [57mm]
OD: 8" [203mm]

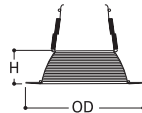

ERT714WHT
High Gloss Appliance White Trim with White Baffle

ERT714
High Gloss Appliance White Trim with Black Baffle

ERT725

Black Metal Baffle/Splay

- Combination baffle/splay trim
- Socket Supporting trim
- Wide Trim flange hides ceiling cut out irregularities
- ERT725TS - Torsion spring retention
- ERT725 - Friction clip retention

E1700U 40W A19, 75W PAR30L,
E1700UAT 85W BR30, 100W R30

Height: 5-3/8" [136mm]
OD: 7-1/4" [184mm]

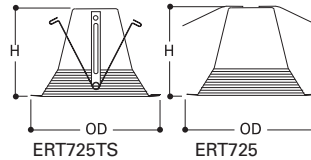

air191 trim



ERT725TS
High Gloss Appliance White Trim with Black Baffle and Torsion Spring Construction

ERT725WHT

White Metal Baffle/Splay

- Combination baffle/splay trim
- Socket Supporting trim
- Wide Trim flange hides ceiling cut out irregularities
- ERT725WHTTS - Torsion spring retention
- ERT725WHT - Friction clip retention

E1700U 60W A19, 75W PAR30L,
E1700UAT 85W BR30, 100W R30

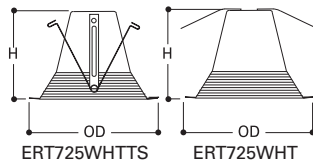

ERT725WHTTS Height: 5-3/8" [136mm]
ERT725WHT OD: 7-1/4" [184mm]

air191 trim



ERT725WHTTS
High Gloss Appliance White Trim with White Baffle and Torsion Spring Construction

air191 trim



ERT725WHT
High Gloss Appliance White Trim with White Baffle

ERT704

Eyeball

- Torsion springs pull trim tight to ceiling

E1700U 75W PAR30, 75W PAR30L,
E1700UAT 85W BR30, 100W R30

Aperture: 3-15/16" [100mm]
OD: 8" [203mm]

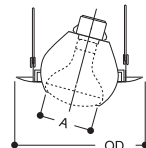

ERT704
High Gloss Appliance White Trim with White Eyeball

ERT705

Open

- Coil Spring retention
- Fixed Socket position

E1700U 75W PAR30, 75W PAR30L,
E1700UAT 85W BR30, 100W R30

Aperture:
3-7/8"
[98mm]
OD:
8" [203mm]

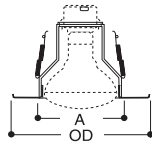

ERT705
High Gloss Appliance White
Trim

ERT708

Large Aperture Open

- Coil Spring Retention

E1700U 100W R40 (Requires H1999
E1700UAT Socket Extender)



H1999
Socket Extender

Aperture:
5-3/16" [131mm]
OD:
8" [203mm]

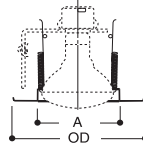

ERT708
High Gloss Appliance White
Trim

ERT701

Albalite Glass Lens Shower Light

- Wet Location listed for use in showers
- Torsion spring retention

E1700U 40W A19
E1700UAT

OD:
8" [203mm]

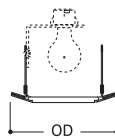

ERT701
High Gloss Appliance White Trim
with Albalite Glass Lens

ERT702

Drop Opal Plastic Lens Shower Light

- Wet Location listed for use in showers
- Torsion spring retention

E1700U 40W A19
E1700UAT

OD:
8" [203mm]

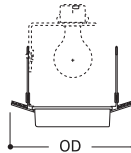

ERT702
High Gloss Appliance White Trim
with Drop Opal Plastic Lens

ERT703

Fresnel Glass Lens Shower Light

- Wet Location listed for use in showers

E1700U 40W A19
E1700UAT

OD:
8" [203mm]

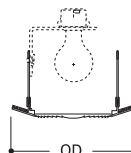

ERT703
High Gloss Appliance White Trim
with Fresnel Glass Lens

ERT721

Shower Light with Frosted Glass Lens and Reflector

- Torsion springs pull trim tight to ceiling
- Wet location listed for use in showers

E1700U 60W A19
E1700UAT

Height:
4-1/4"
[108mm]
OD:
8" [203mm]

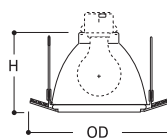

ERT721
High Gloss Appliance White Trim
with Frosted Glass Lens

ERT723

Shower Light with Glass Fresnel Lens and Reflector

- Torsion springs pull trim tight to ceiling
- Wet location listed for use in showers
- Socket supporting trim

E1700U 60W A19
E1700UAT

Height:
4-1/4"
[108mm]
OD:
8" [203mm]

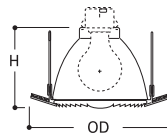

ERT723
High Gloss Appliance White
Trim with Glass Fresnel Lens

ALL-PRO

6" Incandescent

DIMENSIONS

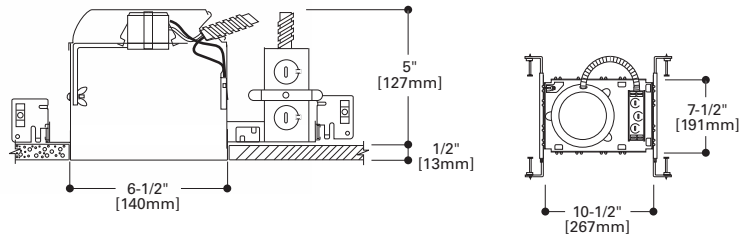

DESCRIPTION

The EI2700 housing is designed for use in shallow ceilings. The EI2700 is designed for shallow ceilings and direct contact with insulation.

Housing

- Aluminum construction for greater heat dissipation.

Socket Plate

- Rigid socket plate adjusts and locks without tools for various lamp sizes.

Plaster Frame

- Galvanized steel construction.
- Housing adjusts in plaster frame 1-3/8" to accommodate different ceiling thicknesses
- Regressed locking screw for securing hanger bars
- Cutouts for easily crimping hanger bars in position.

Junction Box

- Positioned to accommodate straight conduit runs.
- Seven conduit knockouts are uniform 1/2" size with true pryout slots.
- Four pryouts with integral strain relief simplify "NM" non-metallic sheathed cable installation.
- Three quick connect wire connectors included.

ALL-NAIL™ Bar Hangers

Bar Hanger features include:

- Pre-installed nail.
- Mini leveling foot aligns the housing to the bottom of the joist.
- Housing can be positioned at any point within 24" joist spans
- Score lines allow tool-free shortening for narrow joist spacing.

- Bar hangers may be repositioned 90° on plaster frame
- Integral T-bar clip snaps onto T-bars – no additional clips are required

Socket

Porcelain E26 socket with nickel plated brass screw shell.

Thermal Protector

Integral Thermal Protector deactivates fixture if an incorrect lamp is used or if ceiling insulation material is not applied correctly

Labels

- UL/cUL Listed 1598 Luminaire
- UL/cUL Listed for Damp Location
- UL/cUL Listed for FeedThrough
- UL/cUL Listed for Wet Location, covered ceiling
- UL/cUL Listed for Direct Contact with Insulation and combustible material

EI2700

6" Aperture, IC, Shallow Ceiling, New Construction, 120V Line Voltage

Specifications

- Thermally protected IC housing
- Housing may be covered with insulation
- For use with 120V incandescent lamps



EI2700R

6" Aperture, IC, Shallow Ceiling, Remodel, 120V Line Voltage

Specifications

- Thermally protected IC housing
- Housing may be covered with insulation
- For use with 120V incandescent lamps
- For installation from below the ceiling

DIMENSIONS

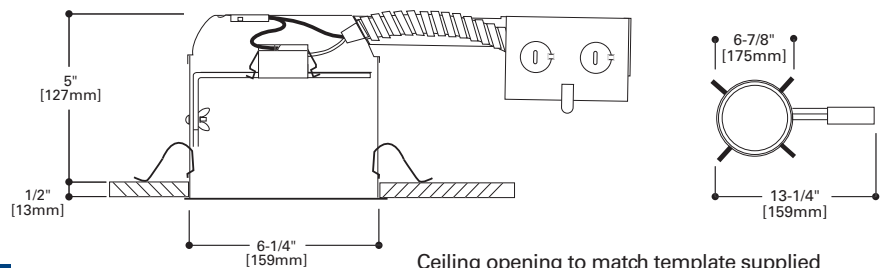

DESCRIPTION

The EI2700R housing is designed for remodeling use in existing shallow ceilings. The EI2700R housing is designed for shallow ceilings and direct contact with insulation. For installation from below the finished ceiling.

Housing

- Aluminum construction for greater heat dissipation.

Socket Plate

- Rigid socket plate adjusts and locks without tools for various lamp sizes.

Remodel Clips

Four remodel clips secure housing and accommodate 1/2" and 5/8" ceiling thickness.

Junction Box

- Seven conduit knockouts are uniform 1/2" size with true pryout slots.
- Four pryouts with integral strain relief simplify "NM" non-metallic sheathed cable installation.
- Three quick connect wire connectors included

Socket

Porcelain E26 socket with nickel plated brass screw shell.

Thermal Protector

Integral Thermal Protector deactivates fixture if an incorrect lamp is used or if ceiling insulation material is not applied correctly.

Labels

- UL/cUL Listed for Damp Location
- UL/cUL Listed for FeedThrough
- UL/cUL Listed for Wet Location, covered ceiling
- UL/cUL Listed for Direct Contact with Insulation and combustible material

DIMENSIONS

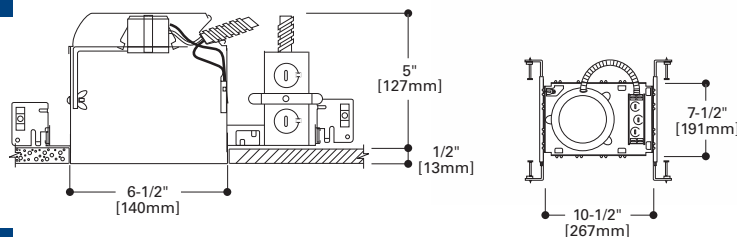

DESCRIPTION

The EI2700AT housing is designed for use in shallow ceilings where insulation is present. AIR-TITE design and meets restricted airflow requirements.

Housing

- Aluminum construction for greater heat dissipation.
- AIR-TITE gasket is pre-installed.

Socket Plate

- Rigid socket plate adjusts and locks without tools for various lamp sizes.

Plaster Frame

- Housing adjusts in plaster frame 1" to accommodate different ceiling thicknesses.
- Regressed locking screw for securing hanger bars.
- Cutouts for easily crimping hanger bars in position.

Junction Box

- Positioned to accommodate straight conduit runs.
- Seven conduit knockouts are uniform 1/2" size with true pryout slots.
- Four pryouts with integral strain relief simplify "NM" non-metallic sheathed cable

installation.

- Three quick connect wire connectors included

ALL-NAIL™ Bar Hangers

Bar Hanger features include:

- Pre-installed nail.
- Mini leveling foot aligns the housing to the bottom of the joist.
- Housing can be positioned at any point within 24" joist spans.
- Score lines allow tool-free shortening for narrow joist spacing.
- Bar hangers may be repositioned 90° on plaster frame.
- Integral T-bar clip snaps onto T-bars – no additional clips are required

Socket

Porcelain E26 socket with nickel plated brass screw shell.

Thermal Protector

Integral Thermal Protector deactivates fixture if an incorrect lamp is used or if ceiling insulation material is not applied correctly.

Labels

- UL/cUL Listed 1598 Luminaire
- UL/cUL Listed for Damp Location
- UL/cUL Listed for FeedThrough
- UL/cUL Listed for Wet Location, covered ceiling
- UL/cUL Listed for Direct Contact with Insulation and combustible material

IC and AIR-TITE™

Certified under ASTM-E283 and listed UL/cUL 1598. May be used to meet insulated ceiling and restricted air-flow requirements such as:

- Washington State Energy Code
- International Energy Conservation Code (IECC)
- New York State Energy Conservation Construction Code (NY-ECCC)
- State of California Title 24 "Recessed Luminaires in Insulated Ceilings."



EI2700AT

6" Aperture, IC, Shallow Ceiling, New Construction, AIR-TITE, 120V Line Voltage

Specifications

- Thermally protected IC housing
- AIR-TITE housing prevents airflow between attic and living areas
- Housing may be covered with insulation
- For use with 120V incandescent lamps



ALL-PRO

EI2700, EI2700AT,
EI2700R

ERT710

Specular Reflector
• Coil Spring retention

EI2700	50W PAR30, 65W BR30,
EI2700AT	75W R30, 75W PAR30L
EI2700R	

Height:
2-7/8" [73mm]
OD:
7-1/4" [184mm]

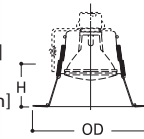

ERT710
High Gloss Appliance White
Trim with Clear Specular
Reflector

ERT707

Metal Baffle

- Coil spring retention
- Narrow and wide trim rings supplied with trim

EI2700	50W PAR30, 65W BR30,
EI2700AT	75W PAR30L

EI2700R	65W BR30, 75W PAR30L
---------	----------------------

Height:
2-7/8" [73mm]
Wide OD:
8" [203mm]
Narrow OD:
7-1/4" [184mm]

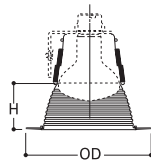

**WIDETRIM
RING**

**NARROW
TRIM RING**



ERT707WHT
High Gloss Appliance White
Trim with White Baffle

ERT707
High Gloss Appliance White
Trim with Black Baffle

ERT714

Plastic Baffle

- Coil spring retention

EI2700	65W BR30, 50W PAR30,
EI2700AT	75W PAR30L

EI2700R	50W PAR30, 60W BR30
---------	---------------------

Height:
2-1/4" [57mm]
Wide OD:
8" [203mm]

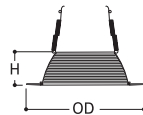

ERT714WHT
High Gloss Appliance White
Trim with White Baffle

ERT714
High Gloss Appliance White
Trim with Black Baffle

ERT716

Shallow Metal Baffle

- Socket Supporting trim
- Friction clip retention

EI2700	65W BR30, 75W PAR30,
EI2700AT	75W PAR30L
EI2700R	

Height:
4-1/4" [108mm]
OD:
8" [203mm]

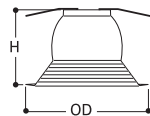

ERT716WHT
High Gloss Appliance White Trim
with White Baffle

ERT704

Eyeball

- Torsion springs pull trim tight to ceiling

EI2700	65W BR30, 75W R30,
EI2700AT	75W PAR30L

EI2700R	65W BR30, 75W R30, 75W PAR30L
---------	-------------------------------

Aperture:
3-15/16" [100mm]
OD:
8" [203mm]

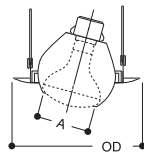

ERT704
High Gloss Appliance White
Trim with White Eyeball

ALL-PRO

E12700, E12700AT,
E12700R

ERT705

Open

- Coil Spring retention
- Fixed socket position

E12700 50W PAR30L, 60W BR30,
E12700AT 75W PAR30

E12700R 60W BR30

Aperture:
3-7/8"
[98mm]
OD:
8" [203mm]

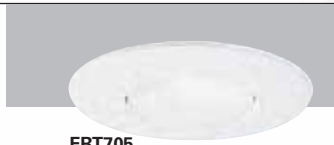
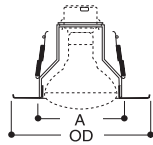

ERT705
High Gloss Appliance White
Trim

ERT721

Shower Light with Frosted Glass Lens and Reflector

- Torsion springs pull trim tight to ceiling
- Wet location listed for use in showers

E12700 35W PAR30L
E12700AT

E12700R 40W A19

Height:
4-1/4"
[108mm]
OD:
8" [203mm]

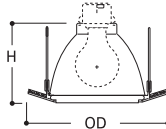

ERT721
High Gloss Appliance White Trim
with Frosted Glass Lens

ERT723

Shower Light with Glass Fresnel Lens and Reflector

- Torsion springs pull trim tight to ceiling
- Wet location listed for use in showers
- Socket supporting trim

E12700 35W PAR30L
E12700AT

E12700R 40W A19

Height:
4-1/4" [108mm]
OD:
8" [203mm]

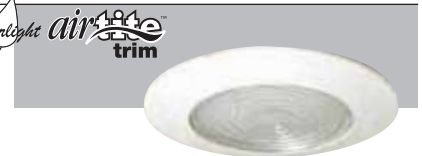
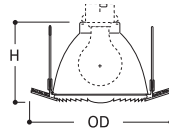

ERT723
High Gloss Appliance White
Trim with Glass Fresnel Lens

ALL-PRO

6" Incandescent



ET2700

6" Aperture, Non-IC,
Shallow Ceiling,
New Construction,
120V Line Voltage

Specifications

- Non-IC housing
- May be used in insulated ceilings but insulation MUST be kept 3" from all sides of fixture
- For use with 120V incandescent lamps

DIMENSIONS

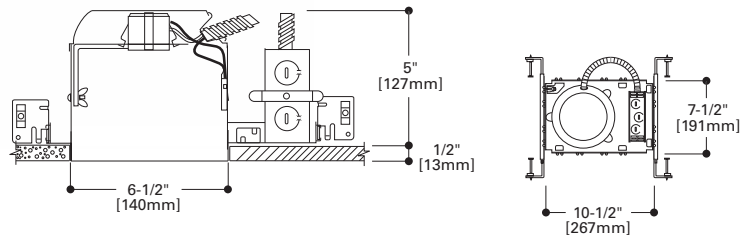

DESCRIPTION

The ET2700 housing is designed for use in shallow ceilings. For use in non-insulated ceilings. If ceiling insulation is present, it must be kept 3 inches from all sides of housing.

Housing

- Die-stamped CRS with white powder coat finish

Socket Plate

- Rigid socket plate adjusts and locks without tools for various lamp sizes

Plaster Frame

- Galvanized steel construction.
- Housing adjusts in plaster frame 1-3/8" to accommodate different ceiling thicknesses
- Regressed locking screw for securing hanger bars
- Cutouts for easily crimping hanger bars in position

Junction Box

- Positioned to accommodate straight conduit runs.
- Seven conduit knockouts are uniform 1/2" size with true pryout slots.
- Four pryouts with integral strain relief simplify "NM" non-metallic sheathed cable installation.
- Three quick connect wire connectors included.

ALL-NAIL™ Bar Hangers

Bar Hanger features include:

- Pre-installed nail.
- Mini leveling foot aligns the housing to the bottom of the joist.
- Housing can be positioned at any point within 24" joist spans
- Score lines allow tool-free shortening for narrow joist spacing.
- Bar hangers may be repositioned 90° on plaster frame

- Integral T-bar clip snaps onto T-bars – no additional clips are required

Socket

Porcelain E26 socket with nickel plated brass screw shell, snaps into trim for consistent lamp positioning.

Thermal Protector

Integral Thermal Protector deactivates fixture if an incorrect lamp is used or if ceiling insulation material is not applied correctly.

Labels

- UL/cUL Listed 1598 Luminaire
- UL/cUL Listed for Damp Location
- UL/cUL Listed for FeedThrough
- UL/cUL Listed for Wet Location, covered ceiling
- IP Rated (Improper Lamp)

ERT710

Specular Reflector

- Coil Spring retention

ET2700 75W PAR30, 75W PAR30L,
85W BR30, 100W R30

Height:
2-7/8" [73mm]
OD:
7-1/4" [184mm]

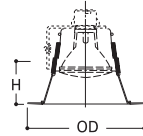

ERT710
High Gloss Appliance White
Trim with Clear Specular
Reflector

ERT707

Metal Baffle

- Coil spring retention

ET2700 65W BR30, 75W R30, 75W
PAR30, 75W PAR30L

Height:
2-7/8" [73mm]
Wide OD:
8" [203mm]
Narrow OD:
7-1/4" [184mm]

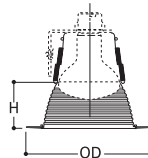

WIDETRIM
RING

NARROW
TRIM RING



ERT707WHT
High Gloss Appliance White
Trim with White Baffle

ERT707
High Gloss Appliance White
Trim with Black Baffle

ERT714

Plastic Baffle

- Coil spring retention

ET2700 75W R30, 75W PAR30,
85W BR30

Height:
2-1/4" [57mm]
OD:
8" [203mm]

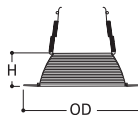

ERT714WHT
High Gloss Appliance White
Trim with White Baffle

ERT714
High Gloss Appliance White Trim
with Black Baffle

ERT716

Shallow Metal Baffle

- Socket Supporting trim
- Friction clip retention

ET2700 40W A19, 65W BR30,
75W PAR30, 75W PAR30L

Height:
4-1/4" [108mm]
OD:
8" [203mm]

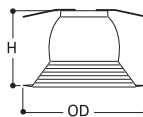

air¹⁰⁴
trim



ERT716WHT
High Gloss Appliance White
Trim with White Baffle

ERT704

Eyeball

- Torsion springs pull trim tight to ceiling

ET2700 65W BR30, 75W R30, 75W
PAR30, 75W PAR30L

Aperture:
3-15/16" [100mm]
OD:
8" [203mm]

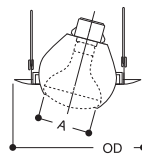

ERT704
High Gloss Appliance White
Trim with White Eyeball

ERT706

Open

- Coil spring retention

ET2700 65W BR30, 75W R30, 75W
PAR30, 75W PAR30L

Aperture:
3-7/8" [98mm]
OD:
8" [203mm]

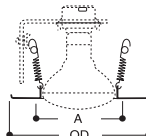

ERT706
High Gloss Appliance White
Trim

ALL-PRO

ET2700

ERT708

Large Aperture Open
• Coil spring retention

ET2700 120W BR40, 150W R40

Aperture:
3-7/8" [98mm]
OD:
8" [203mm]

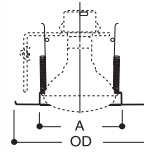

ERT708
High Gloss Appliance White
Trim

ERT701

Albalite Lens Shower Light

• Wet Location listed for use in showers

ET2700 60W A19

OD:
8" [203mm]

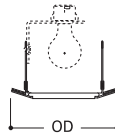

ERT701
High Gloss Appliance White
Trim with Albalite Lens

ERT702

Drop Opal Plastic Lens Shower Light

• Wet Location listed for use in showers

• Torsion spring retention

ET2700 60W A19

OD:
8" [203mm]

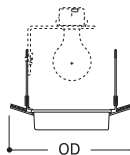

ERT702
High Gloss Appliance White
Trim with Drop Opal Lens

ERT703

Fresnel Lens Shower Light

• Wet Location listed for use in showers

• Torsion spring retention

ET2700 60W A19

OD:
8" [203mm]

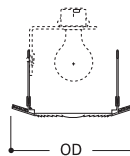

ERT703
High Gloss Appliance White
Trim with Glass Fresnel lens

DIMENSIONS

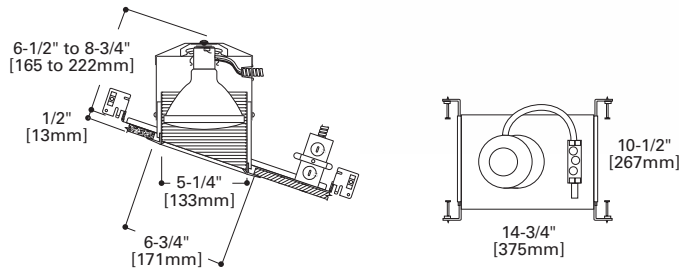

DESCRIPTION

Designed for sloped ceiling installations for ceilings from 2/12 to 6/12 pitch. The socket aiming mechanism allows the lamp to be aimed straight down regardless of ceiling pitch. For use in non-insulated ceilings. If ceiling insulation is present, it must be kept 3 inches from all sides of housing.

Housing Features

- Telescoping housing for ceiling construction down to 2" x 8". With deeper ceilings the housing provides sharper cutoff.
- Exclusive socket aiming mechanism swivels and rotates to properly align lamp. Slope indicator provides quick and consistent lamp settings (factory set for 3/12 slope).
- One piece seamless baffle presents a clean finished appearance

- Thermal protector guards against misuse of insulation materials

Junction Box

- Positioned to accommodate straight conduit runs.
- Seven conduit knockouts are uniform 1/2" size with true pryout slots.
- Four pryouts with integral strain relief simplify "NM" non-metallic sheathed cable installation.
- Three quick connect wire connectors included.

ALL-NAIL™ Bar Hangers

- Bar Hanger features include:
- Pre-installed nail.
 - Mini leveling foot aligns the housing to the bottom of the joist.
 - Housing can be positioned at any point within 24" joist spans.

- Score lines allow tool-free shortening for narrow joist spacing.
- Bar hangers may be repositioned 90° on plaster frame.
- Integral T-bar clip snaps onto T-bars – no additional clips are required

Socket

Porcelain E26 socket with nickel plated brass screw shell, snaps into trim for consistent lamp positioning.

Listings

- UL/cUL Listed 1598 Luminaire
- UL/cUL Listed for Damp Location
- UL/cUL Listed for Feed Through



ET4700

6" Aperture, Non-IC, New Construction, Slope Ceiling, 120V Line Voltage

Specifications

- Non-IC housing
- May be used in insulated ceilings but insulation MUST be kept 3" from all sides of fixture
- For use with 120V incandescent lamps
- Slope ceiling housing for 2/12 to 6/12 slope ceilings

ERT4980

Baffle

- One piece seamless baffle
- Baffle ridges are parallel to floor plane

Aperture:
5-1/4" [133mm]
OD:
8" [203mm]

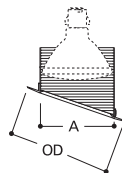

ERT4980WHT
High Gloss Appliance White
Trim with White Baffle

ET4700 90W PAR38

ALL-PRO

6" Incandescent



EI4700

6" Aperture, IC,
Slope Ceiling,
New Construction,
120V Line Voltage

EI4700AT

6" Aperture, IC,
Slope Ceiling,
New Construction,
AIR-TITE™,
120V Line Voltage

Specifications

- Thermally Protected IC Housing
- Housing may be covered with insulation
- EI4700AT AIR-TITE fixture prevents airflow between attic and living areas
- Slope ceiling housing for 2/12 to 6/12 slope ceilings

DIMENSIONS

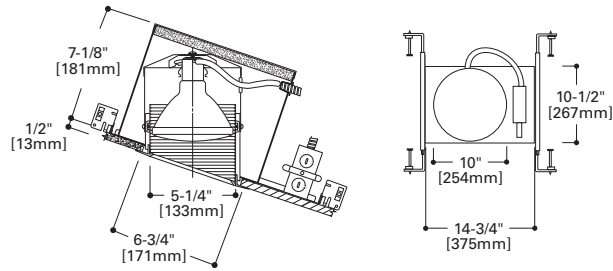

DESCRIPTION

Designed for sloped ceiling installations for ceilings from 2/12 to 6/12 pitch. The socket aiming mechanism allows the lamp to be aimed straight down regardless of ceiling pitch. For direct contact with insulation. In addition, EI4700AT design meets restricted airflow requirements.

Housing Features

- EI4700AT Housing is AIR-TITE with gasket pre-installed.
- Double wall housing construction. Door in outer housing allows junction box access from below ceiling.
- Exclusive socket aiming mechanism swivels and rotates to properly align lamp. Slope indicator provides quick and consistent lamp settings (factory set for 3/12 slope).
- Integral thermal protector guards against improper lamping.

Junction Box

- Positioned to accommodate straight conduit runs.
- Seven conduit knockouts are uniform 1/2" size with true pryout slots.
- Four pryouts with integral strain relief simplify "NM" non-metallic sheathed cable installation.
- Three quick connect wire connectors included.

ALL-NAIL™ Bar Hangers

- Bar Hanger features include:
- Pre-installed nail.
 - Mini leveling foot aligns the housing to the bottom of the joist.
 - Housing can be positioned at any point within 24" joist spans
 - Score lines allow tool-free shortening for narrow joist spacing.
 - Bar hangers may be repositioned 90° on plaster frame
 - Integral T-bar clip snaps onto T-bars – no additional clips are required

Labels

- UL/cUL Listed 1598 Luminaire
- UL/cUL Listed for Damp Location
- UL/cUL Listed for FeedThrough
- UL/cUL Listed for Wet Location, covered ceiling
- UL/cUL Listed for Direct Contact with Insulation and combustible material

IC and AIR-TITE™

Certified under ASTM-E283 and listed UL/cUL 1598. May be used to meet insulated ceiling and restricted air-flow requirements such as:

- Washington State Energy Code
- International Energy Conservation Code (IECC)
- New York State Energy Conservation Construction Code (NY-ECCC)
- State of California Title 24 "Recessed Luminaires in Insulated Ceilings."

ERT4980

Baffle

- One piece seamless baffle
- Baffle ridges are parallel to floor plane

Aperture:
5-1/2" [133mm]
OD:
8" [203mm]

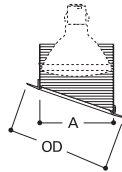

EI4700
EI4700AT 90W PAR38



ERT4980WHT
High Gloss Appliance White Trim
with White Baffle

DIMENSIONS

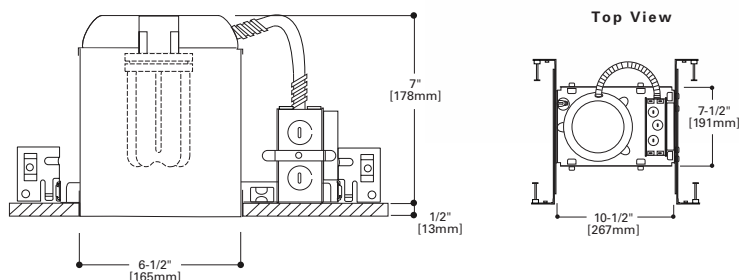

DESCRIPTION

The EI2072AT is designed for use in insulated ceilings and can be in direct contact with ceiling insulation. Includes 120V NPF electronic compact fluorescent ballast. AIR-TITE design meets restricted airflow requirements.

Housing

- Single wall aluminum housing.
- AIR-TITE gasket is pre-installed.

Plaster Frame

- Regressed locking screw for securing hanger bars.
- Cutouts for easily crimping hanger bars in position.

Junction Box

- Positioned to accommodate straight conduit runs.
- Seven conduit knockouts are uniform 1/2" size with true pryout slots.
- Four pryouts with integral strain relief simplify "NM" non-metallic sheathed cable installation.
- Three quick connect wire connectors included

ALL-NAIL™ Bar Hangers

- Bar Hanger features include:
- Pre-installed nail.
 - Mini leveling foot aligns the housing to the bottom of the joist.
 - Housing can be positioned at any point within 24" joist spans
 - Score lines allow tool-free shortening for narrow joist spacing.

- Bar hangers may be repositioned 90° on plaster frame
- Integral T-bar clip snaps onto T-bars – no additional clips are required

Socket

G24q-3/GX24q-3 socket for one 26W DTT - Double Twin Tube (Quad) or 26WTTT - Triple Twin Tube 4-pin lamp.

Lamp

- Compact Fluorescent lamp (by others) 26 watt lamp generic designations:
- DTT-Double Twin Tube (Quad) (CFQ):
 - CFQ26W/GX24q - 2700K, 3000K, 3500K, 4100K
 - TTT-Triple Twin Tube (CFTR):
 - CFTR26W/G24q - 2700K, 3000K, 3500K, 4100K
 - Up to 12,000 hr rated average life
 - 82CRI rated lamps provide excellent color and high visual comfort.
 - Color temperature (warm to cool) options offer 2700K warm, 3000K, 3500K medium warm and 4100K cool incandescent-like light

Electronic Ballast

120 volt, 60 Hz, NPF electronic ballast. Meets FCC Title 47 CFR Part 18 consumer level limits.

Labels

- UL/cUL Listed 1598 Luminaire
- UL/cUL Listed for Damp Location
- UL/cUL Listed for Feed Through
- UL/cUL Listed for Wet Location, covered ceiling
- UL/cUL Listed for Direct Contact with Insulation and combustible material

IC and AIR-TITE™

Certified under ASTM-E283 and listed UL/cUL 1598. May be used to meet insulated ceiling and restricted air-flow requirements such as:

- Washington State Energy Code
- International Energy Conservation Code (IECC)
- New York State Energy Conservation Construction Code (NY-ECCC)
- State of California Title 24 "Recessed Luminaires in Insulated Ceilings"



EI2072AT

6" Aperture, IC, New Construction, AIR-TITE Compact Fluorescent

26 Watt Compact Fluorescent

Specifications

- For Use In Insulated Ceilings
- For Direct Contact With Insulation
- Can be used to meet California Title 24 and IECC High Efficacy Requirements



ALL-PRO

6" Compact Fluorescent



EI2072RAT

6" Aperture, IC, Remodel, AIR-TITE, Compact Fluorescent

26 Watt Compact Fluorescent

Specifications

- For Use In Insulated Ceilings
- For Direct Contact With Insulation
- For installation from below the ceiling
- Can be used to meet California Title 24 and IECC High Efficacy Requirements



DIMENSIONS

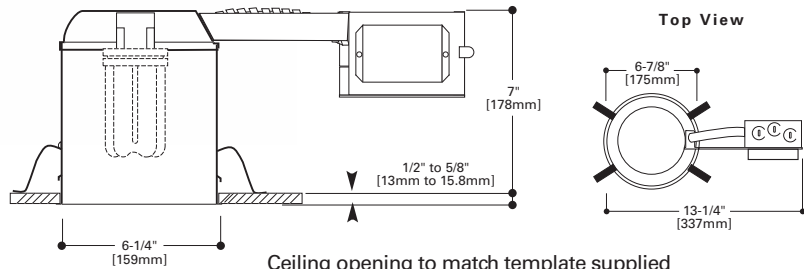

Ceiling opening to match template supplied

DESCRIPTION

The EI2072RAT is designed for remodel applications in insulated existing ceilings and can be in direct contact with ceiling insulation. Includes 120V, NPF electronic compact fluorescent ballast. AIR-TITE design meets restricted airflow requirements. For installation from below the finished ceiling.

Housing

- Single wall aluminum housing.
- AIR-TITE gasket is pre-installed.

Remodel Springs

Four remodel clips secure housing and accommodate 1/2" and 5/8" ceiling material.

Junction Box

- Positioned to accommodate straight conduit runs.
- Seven conduit knockouts are uniform 1/2" size with true pryout slots.
- Four pryouts with integral strain relief simplify "NM" non-metallic sheathed cable installation.
- Three quick connect wire connectors included.

Socket

G24q-3/GX24q-3 socket for one 26W DTT - Double Twin Tube (Quad) or 26W TTT - Triple Twin Tube 4-pin lamp.

Lamp

Compact Fluorescent lamp (by others) 26 watt lamp generic designations:

DTT-Double Twin Tube (Quad) (CFQ):

- CFQ26W/GX24q - 2700K, 3000K, 3500K, 4100K

TTT-Triple Twin Tube (CFTR):

- CFTR26W/G24q - 2700K, 3000K, 3500K, 4100K

- Up to 12,000 hr rated average life
- 82CRI rated lamps provide excellent color and high visual comfort.
- Color temperature (warm to cool) options offer 2700K warm, 3000K, 3500K medium warm and 4100K cool incandescent-like light.

Electronic Ballast

120 volt, 60Hz, NPF electronic ballast. Meets FCC Title 47 CFR Part 18 consumer level limits.

Labels

- UL/cUL Listed 1598 Luminaire
- UL/cUL Listed for Damp Location
- UL/cUL Listed for Feed Through
- UL/cUL Listed for Wet Location, covered ceiling
- UL/cUL Listed for Direct Contact with Insulation and combustible material

IC and AIR-TITE™

Certified under ASTM-E283 and listed UL/cUL 1598. May be used to meet insulated ceiling and restricted air-flow requirements such as:

- Washington State Energy Code
- International Energy Conservation Code (IECC)
- New York State Energy Conservation Construction Code (NY-ECCC)
- State of California Title 24 "Recessed Luminaires in Insulated Ceilings"

ERT770

Reflector

- Torsion springs pull trim tight to ceiling
- Self flanged trim ring
- Gloss White trim ring

Height:
5-3/8" [136mm]
OD:
7-1/4" [184mm]

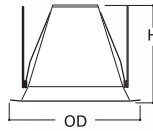

ERT770MTS
Gloss White Trim ring, Matte Haze Reflector



ERT770TS
Gloss White Trim Ring, Clear Specular Reflector

EI2072AT 26W DTT or 26W TTT 4-pin
EI2072RAT Compact Fluorescent lamp*

* DTT - Double Twin (Quad) Tube
TTT - Triple Twin Tube

ERT771

Reflector

- Torsion springs pull trim tight to ceiling
- Self flanged trim ring
- Gloss White trim ring

Height:
5-3/8" [136mm]
OD:
7-1/4" [184mm]

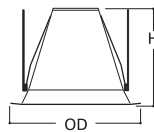

ERT771TS
Gloss White Trim Ring and Gloss White Reflector

EI2072AT 26W DTT or 26W TTT 4-pin
EI2072RAT Compact Fluorescent lamp*

* DTT - Double Twin (Quad) Tube
TTT - Triple Twin Tube

ERT772

Baffle with Reflector

- Self flanged trim with gloss white trim ring
- Trim consists of baffle, reflector and torsion springs

Height:
5-3/8" [136]
OD:
7-3/4" [197mm]

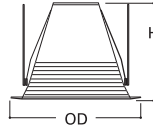

ERT772WHHTS
Gloss White Trim Ring, Gloss White Baffle with White Reflector and Torsion Springs

ERT772TS
Gloss White Trim Ring, Black Baffle with Torsion Springs

EI2072AT 26W DTT or 26W TTT 4-pin
EI2072RAT Compact Fluorescent lamp*

* DTT - Double Twin (Quad) Tube
TTT - Triple Twin Tube

ERT724

Drop Opal Lens Showerlight

- White trim with drop opal glass lens
- Wet location listed for use in showers
- Non-conductive, non-corrosive gasketed polymer trim ring
- Torsion spring retention

Height:
6-1/2" [165]
OD:
8" [203mm]

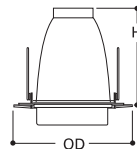

ERT724
Wet Location listed Gloss White Trim with Drop Opal Glass Lens

EI2072AT 26W DTT or 26W TTT 4-pin
EI2072RAT Compact Fluorescent lamp*

* DTT - Double Twin (Quad) Tube
TTT - Triple Twin Tube

Available
1st Quarter
2012

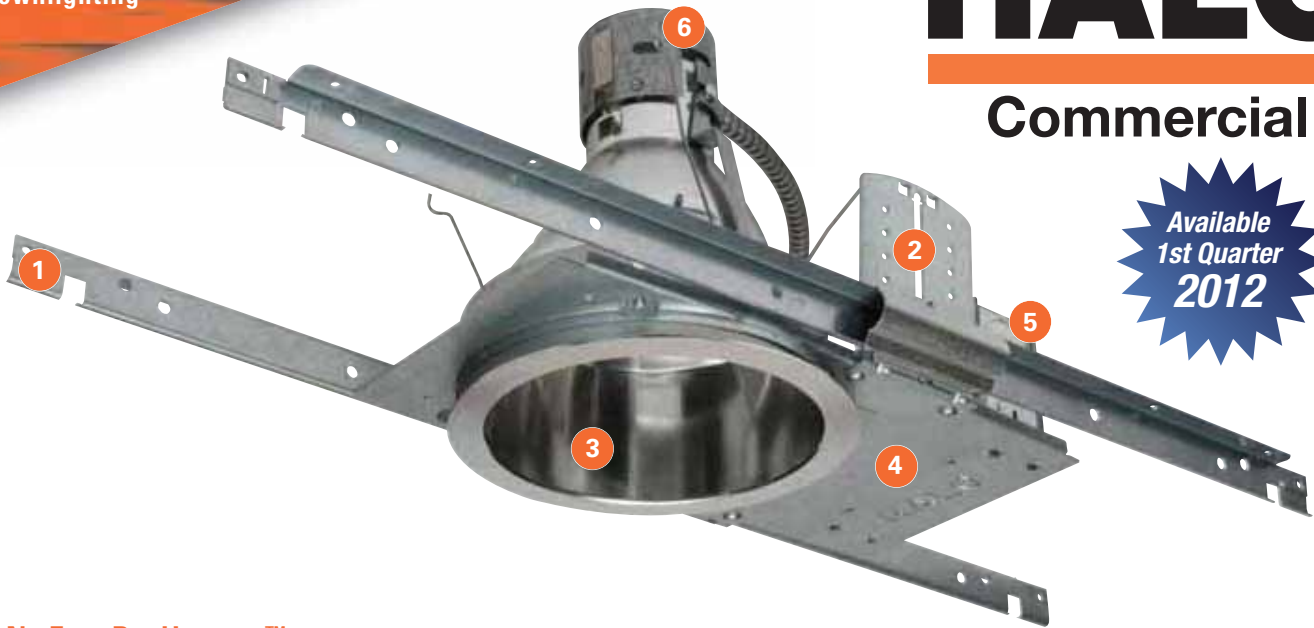

1. No Fuss Bar Hangers™

- Pre-installed and centered bar hangers
- Bars lock to tee grid with a screwdriver or pliers
- Centering marks on the bar hanger mechanism allow consistent positioning of fixtures

2. Adjustable Mounting Brackets

- Bar hanger brackets adjust 2" vertically from above the ceiling or through the aperture
- Brackets for use with the included No Fuss Bar Hangers™ or with 1/2" EMT
- Brackets are removable to facilitate remodel installation from below the ceiling

3. Reflector

- Highly efficient one piece aluminum reflector provides equal lamp and lamp image cutoff for a visually comfortable optic.
- Reflector styles include Open and Open Wall Wash in Specular Clear, Semi-Specular Clear, and Gold; with Baffles in White and Black.
- Lens styles are Prismatic, Diffuse, Clear, Fresnel, and Drop Opal Glass, with an optional polymer "dead front" ring.
- Reflector is held tightly to the finished ceiling surface with two torsion springs.
- Reflectors are self-flanged for clean appearance and no light leaks.
- Reflectors have polished flange with a white paint flange option. Baffles and White Reflectors offered in white paint flange.

4. Frame

- Boat-shaped galvanized steel frame.
- For new construction or remodeling installations.
- (2) remodel clips included to secure frame when installed from below the ceiling.
- Plaster lip collar is pre-set to 1/2" and adjusts from 1/2" to 2", for ceilings up to 2" thick.

5. Junction Box

- (4) 1/2" and (2) 3/4" trade size pry outs positioned to allow straight conduit runs
- Listed for feed through branch wiring.

6. Socket Housing

- Galvanized steel socket housing attaches securely to the reflector with captive thumbscrew on horizontal frame models, and twist-on socket cup on vertical frame models. Vents provide effective lamp thermal management

Ballast

- Compact fluorescent (CFL) and metal halide (MH) frames are supplied with energy efficient electronic ballasts.
- CFL offered in universal 120V - 277V input models, and MH offered in 120V / 277V dual input models.
- Other dimming and 347V input models available. Consult website: www.cooperlighting.com.

Emergency CFL Battery Pack Option

- Optional integral 120V/277V compact fluorescent battery pack models provide 90 minutes of emergency illumination.
- Long life maintenance free sealed nickel cadmium batteries recharge in 24 hours.
- Prewired on flexible metal conduit are remote test switch and indicator light.

Halo Commercial offers high-quality yet budget-conscious downlighting with specification allied performance, and some of the highest efficiencies in commercial downlighting. This means savings in fewer fixtures and lower watts per square foot, yet delivers a comfortable and well-lighted space.

Comprehensive commercial downlights in both 6" and 8" apertures support industry standard lamp sources including compact fluorescent, metal halide, and tungsten-halogen. In addition, adjustable PAR downlights in 4" and 6" apertures meet directional lighting requirements; supporting PAR halogen, integrated PAR LED and PAR CMH sources.

Versatile housing frames work in both new and remodel construction, and feature the No Fuss Bar Hanger™ system for ease of installation. Trim selection includes a full palette of open, lens, and wall wash trims in a variety of standard finishes to complete commercial lighting projects.

Ease of Ordering two components – frame and reflector trim. Frames come complete with ballast and socket assembly; and the No Fuss Bar Hangers™ are pre-installed and centered.

Open Reflector

Highly efficient one piece aluminum reflector provides for lamp and lamp image cutoff for a visually comfortable optic.

Lensed Reflector

One piece aluminum reflector secures lens in place with integrated spring clips for a visually comfortable optic and allows for tool-less lens exchange from below the ceiling. Available with clear, diffuse, prismatic, fresnel or drop opal glass lens.

Open Wall Wash Reflector

One piece aluminum reflector combined with spun aluminum kicker reflector provides for high efficient vertical illumination with a downlight component.

4" PAR Directional

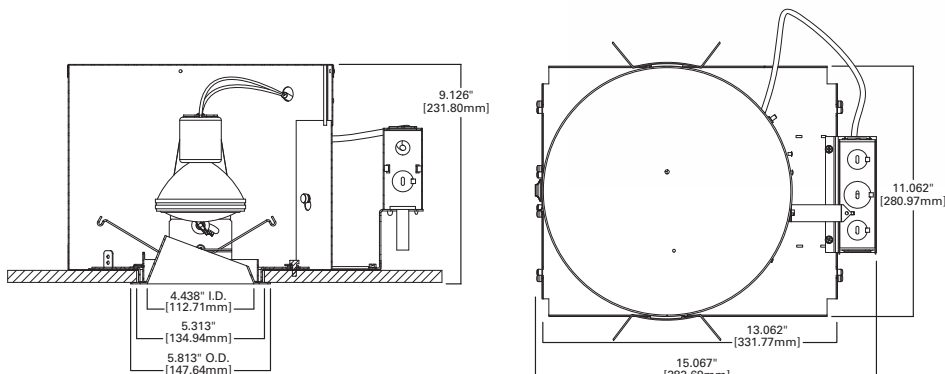

Accepts 75W Max. PAR16 / PAR20 / PAR30S

Tungsten-Halogen and Integrated PAR CMH and PAR LED* lamps*

SAMPLE NUMBER: PA4 4AC

Order housing, reflector and lamp separately for a complete luminaire.

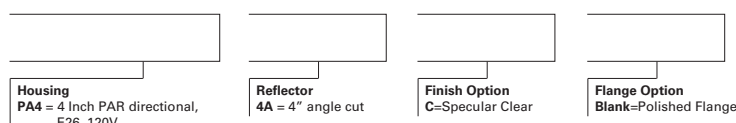

Housing
PA4 = 4 inch PAR directional,
E26, 120V

Reflector
4A = 4" angle cut

Finish Option
C=Specular Clear

Flange Option
Blank=Polished Flange

Other options and accessories available. Consult website: www.cooperlighting.com.
*Consult lamp manufacturer for compatibility.

Ordering Information

Catalog Number	Description	UPC Code	Weight	Case Qty	Pallet Qty
4" PAR Directional					
PA4	Housing, 4" PAR20/30S Directional, 120V	080083611669	x	x	x
4AC	Reflector, 4" Angle Cut Open Reflector, Specular Clear	080083611683	0.37	12	504

6" PAR Directional

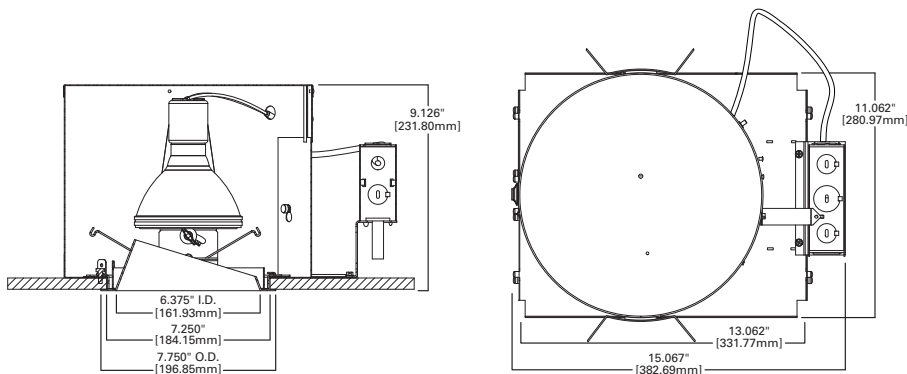

Accepts 150W Max PAR30L / PAR38

Tungsten-Halogen and Integrated PAR CMH and PAR LED* lamps*

SAMPLE NUMBER: PA6 6AC

Order housing, reflector and lamp separately for a complete luminaire.

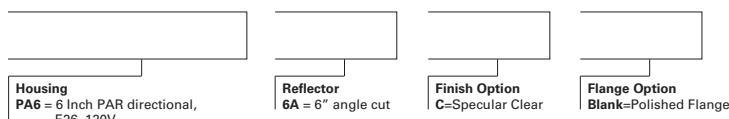

Housing
PA6 = 6 inch PAR directional,
E26, 120V

Reflector
6A = 6" angle cut

Finish Option
C=Specular Clear

Flange Option
Blank=Polished Flange

Other options and accessories available. Consult website: www.cooperlighting.com.
*Consult lamp manufacturer for compatibility.

Ordering Information

Catalog Number	Description	UPC Code	Weight	Case Qty	Pallet Qty
6" PAR Directional					
PA6	Housing, 6" PAR30L/38 Directional, 120V	080083611676	x	x	x
6AC	Reflector, 6" Angle Cut Open Reflector, Specular Clear	080083611720	0.47	12	360



PA4
4" PAR Directional

PA6
6" PAR Directional

- Die formed galvanized steel housing encloses lamp adjustment mechanism.
- Mounting brackets accept 1/2" EMT, C-Channel, and T-bar fasteners.
- Adjusts 1/2" vertically from above or below ceiling.
- Adjustment mechanism rotates 360° and tilts 40° and locks into any position.
- Angle cut aluminum parabolic reflectors minimize flashback for a visually comfortable optic.
- Reflectors are held securely together and are retained with two torsion springs holding the flange tightly to the finished ceiling surface.
- E26 medium base porcelain socket with nickel plated brass screw shell.
- Self heating insulation detector opens circuit if insulation is improperly installed.
- Listed for feed through branch wiring.

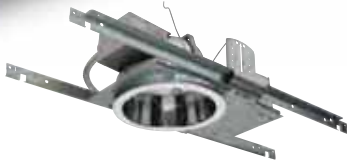

PD6H142
6" Horizontal Downlight

- Boat-shaped galvanized steel frame with a preset 1/2" plaster lip that adjusts to accommodate ceilings up to 2" thick.
- May be used for new construction or remodeling installations.
- Pre-installed and pre-centered No Fuss Bar Hangers™, or use with 1/2" EMT.
- Bar hanger receivers adjust 2" vertically from above the ceiling or through the aperture.
- Reflector assembly is retained with two torsion springs and held tightly to the finished ceiling surface.
- (4) 1/2" and (2) 3/4" trade size pry outs positioned to allow straight conduit runs. Listed for feed through branch wiring.
- 4-pin G24q base accepts (1) 26W DTT or 26/32/42W TTT lamp.
- Universal 120V - 277V UNV electronic ballast for 26/32/42W compact fluorescent lamp.
- Optional integral 120V/277V CFL battery pack provides 90 minutes of emergency illumination.

Horizontal 6" Compact Fluorescent

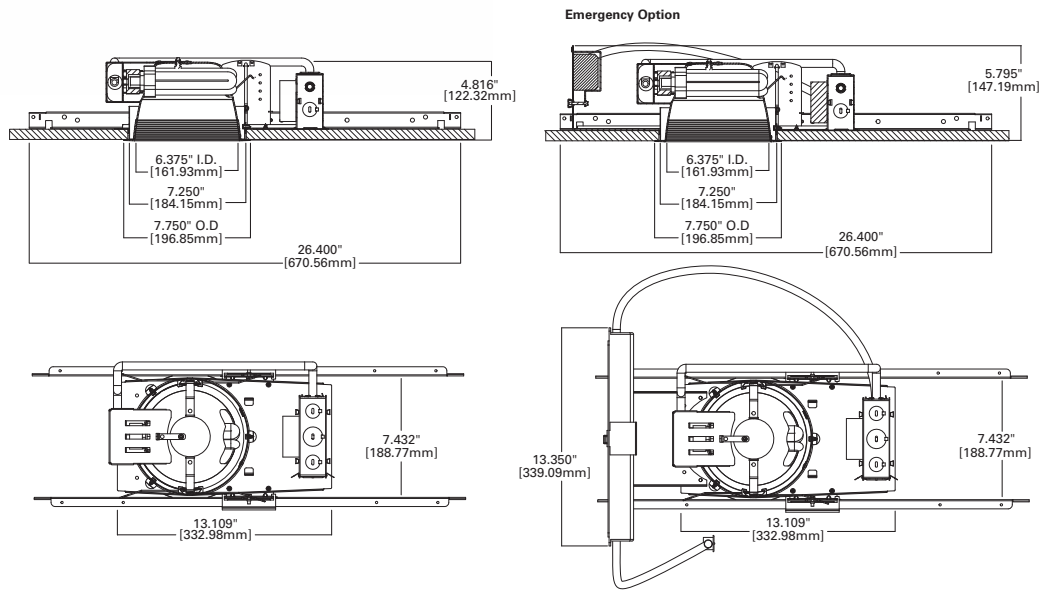

Accepts (1) 26 DTT or 26/32/42W TTT Lamp

SAMPLE NUMBER: PD6H142E 62HC
Order housing, reflector and lamp separately for a complete luminaire.

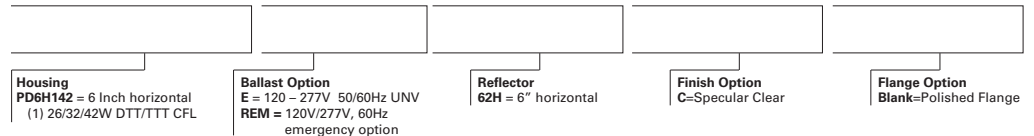

Other options and accessories available. Consult website: www.cooperlighting.com.

SAMPLE NUMBER: PD6H142E 62HWWC
Order housing, reflector and lamp separately for a complete luminaire.

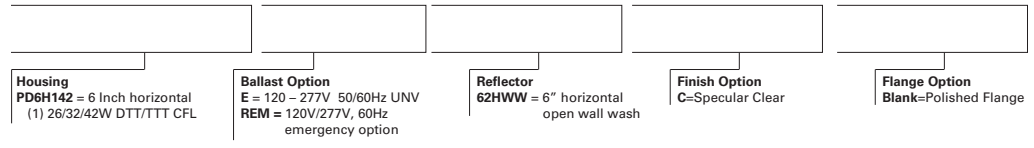

Other options and accessories available. Consult website: www.cooperlighting.com.

Ordering Information

Catalog Number	Description	UPC Code	Weight	Case Qty	Pallet Qty
Horizontal 6" Compact Fluorescent					
PD6H142E	Housing, 6" (1) 26W DTT, 26/32/42W TTT Horizontal, 120V-277V UNV	080083611744	4.2	6	60
PD6H142REM	Housing, 6" (1) 26W DTT, 26/32/42W TTT Horizontal, 120V/277V Emergency	080083611690	12.2	1	24
62HC	Reflector, 6" Horizontal, Open Reflector, Specular Clear	080083605262	0.965	1	225
62HWWC	Reflector, 6" Horizontal, Open Wall Wash, Specular Clear	080083605279	0.985	1	225

Accessories

RMB22	Optional bar hangers (pair) with integral nail for frame construction	662401000821	1	4	756
-------	---	--------------	---	---	-----

Horizontal 6" Compact Fluorescent

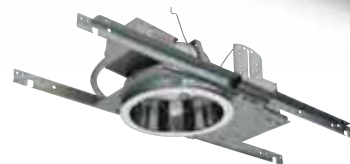
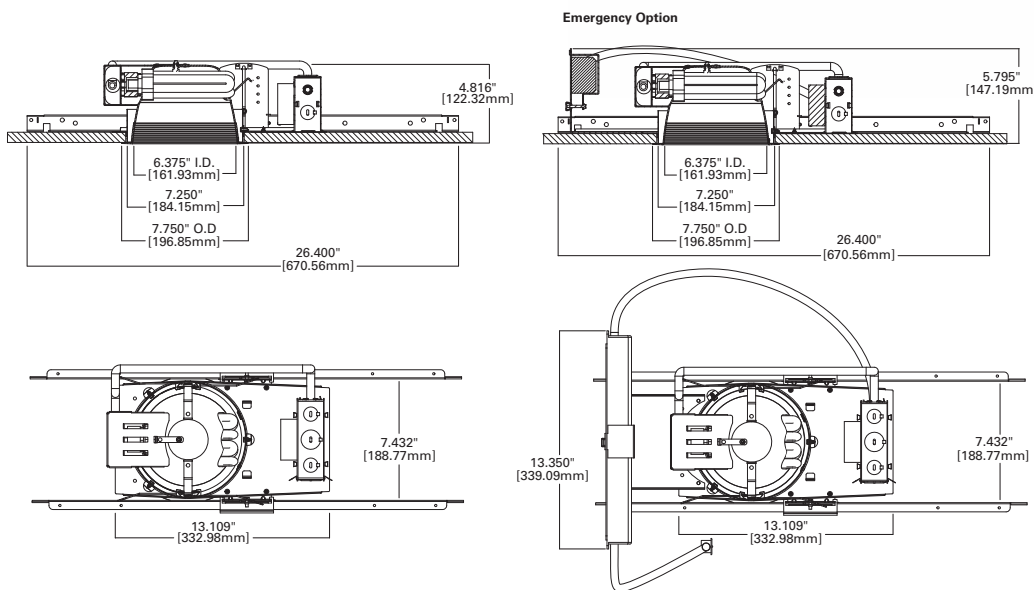

PD6H226
6" Horizontal Downlight

- Boat-shaped galvanized steel frame with a preset 1/2" plaster lip that adjusts to accommodate ceilings up to 2" thick.
- May be used for new construction or remodeling installations.
- Pre-installed and pre-centered No Fuss Bar Hangers™, or use with 1/2" EMT.
- Bar hanger receivers adjust 2" vertically from above the ceiling or through the aperture.
- Reflector assembly is retained with two torsion springs and held tightly to the finished ceiling surface.
- (4) 1/2" and (2) 3/4" trade size pry outs positioned to allow straight conduit runs. Listed for feed through branch wiring.
- 4-pin G24q base accepts (2) 26W DTT lamps.
- Universal 120V - 277V UNV electronic ballast for (2) 26W compact fluorescent lamp.
- Optional integral 120V/277V CFL battery pack provides 90 minutes of emergency illumination.

Accepts (2) 26W DTT Lamp

SAMPLE NUMBER: PD6H226E 62HC

Order housing, reflector and lamp separately for a complete luminaire.

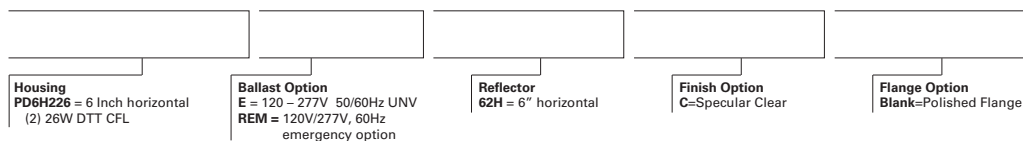

Other options and accessories available. Consult website: www.cooperlighting.com.

SAMPLE NUMBER: PD6H226E 62HWWC

Order housing, reflector and lamp separately for a complete luminaire.

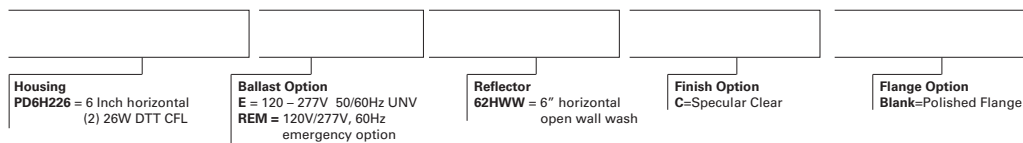

Other options and accessories available. Consult website: www.cooperlighting.com.

Ordering Information

Catalog Number	Description	UPC Code	Weight	Case Qty	Pallet Qty
Horizontal 6" Compact Fluorescent					
PD6H226E	Housing, 6" (2) 26W DTT Horizontal, 120V-277V UNV	080083611737	4.2	6	60
PD6H226REM	Housing, 6" (2) 26W DTT Horizontal, 120V/277V Emergency	080083611706	12.2	1	24
62HC	Reflector, 6" Horizontal, Open Reflector, Specular Clear	080083605262	0.965	1	225
62HWWC	Reflector, 6" Horizontal, Open Wall Wash, Specular Clear	080083605279	0.985	1	225

Accessories

RMB22	Optional bar hangers (pair) with integral nail for frame construction	662401000821	1	4	756
-------	---	--------------	---	---	-----



PD6V142
6" Vertical Downlight

- Boat-shaped galvanized steel frame with a preset 1/2" plaster lip that adjusts to accommodate ceilings up to 2" thick.
- May be used for new construction or remodeling installations.
- Pre-installed and pre-centered No Fuss Bar Hangers™, or use with 1/2" EMT.
- Bar hanger receivers adjust 2" vertically from above the ceiling or through the aperture.
- Reflector assembly is retained with two torsion springs and held tightly to the finished ceiling surface.
- (4) 1/2" and (2) 3/4" trade size pry outs positioned to allow straight conduit runs. Listed for feed through branch wiring.
- 4-pin G24q base accepts (1) 26W DTT or 26/32/42W TTT lamp.
- Universal 120V - 277V UNV electronic ballast for 26/32/42W compact fluorescent lamp.
- Optional integral 120V/277V CFL battery pack provides 90 minutes of emergency illumination.

Vertical 6" Compact Fluorescent

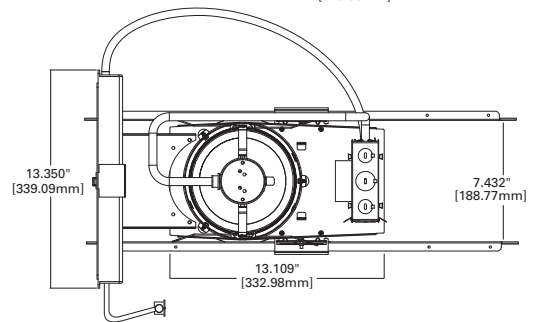
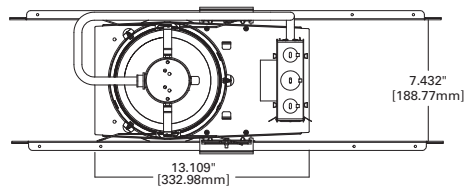
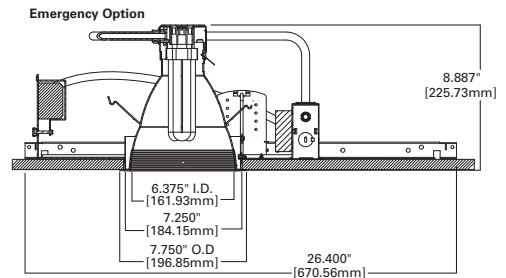
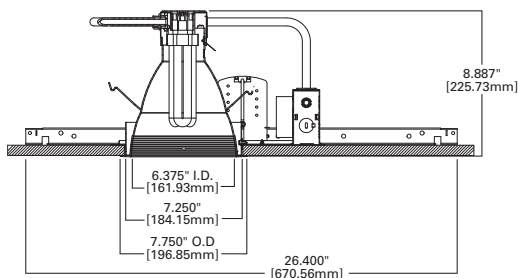

Accepts (1) 26 DTT or 26/32/42W TTT Lamp

SAMPLE NUMBER: PD6V142E 60VC

Order housing, reflector and lamp separately for a complete luminaire.

Housing PD6V142 = 6 Inch vertical 26/32/42W DTT/TTT CFL	Ballast Option E = 120 - 277V 50/60Hz UNV REM = 120V/277V, 60Hz emergency option	Reflector 60V = 6" vertical	Finish Option C=Specular Clear	Flange Option Blank=Polished Flange
---	--	---------------------------------------	--	---

Other options and accessories available. Consult website: www.cooperlighting.com.

SAMPLE NUMBER: PD6V142E 60VWWC

Order housing, reflector and lamp separately for a complete luminaire.

Housing PD6V142 = 6 Inch vertical 26/32/42W DTT/TTT CFL	Ballast Option E = 120 - 277V 50/60Hz UNV REM = 120V/277V, 60Hz emergency option	Reflector 60VWW = 6" vertical open wall wash	Finish Option C=Specular Clear	Flange Option Blank=Polished Flange
---	--	---	--	---

Other options and accessories available. Consult website: www.cooperlighting.com.

Ordering Information

Catalog Number	Description	UPC Code	Weight	Case Qty	Pallet Qty
Vertical 6" Compact Fluorescent					
PD6V142E	Housing, 6" (1) 26W DTT, 26/32/42W TTT Vertical, 120V-277V UNV	080083611812	4	6	60
PD6V142REM	Housing, 6" (1) 26W DTT, 26/32/42W TTT Vertical, 120V/277V Emergency	080083611713	12	1	24
60VC	Reflector, 6" Vertical, Open Reflector, Specular Clear	080083605286	1.085	1	125
60VWWC	Reflector, 6" Vertical, Open Wall Wash, Specular Clear	080083605293	1.168	1	125

Accessories

RMB22	Optional bar hangers (pair) with integral nail for frame construction	662401000821	1	4	756
-------	---	--------------	---	---	-----

Vertical 6" Incandescent and Integrated PAR Lamps

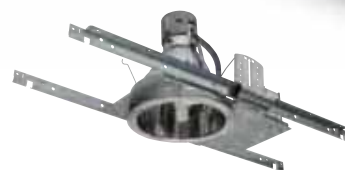
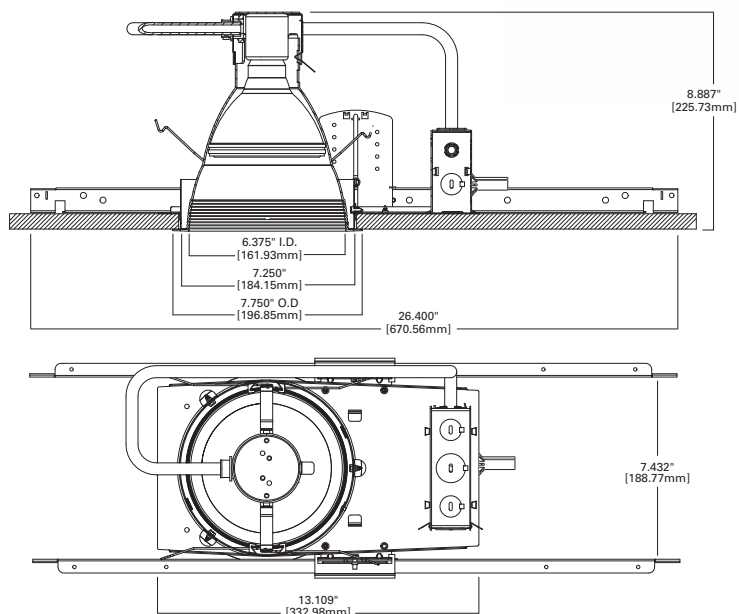

PD6V120 6" Vertical Downlight

- Boat-shaped galvanized steel frame with a preset 1/2" plaster lip that adjusts to accommodate ceilings up to 2" thick.
- May be used for new construction or remodeling installations.
- Pre-installed and pre-centered No Fuss Bar Hangers™, or use with 1/2" EMT.
- Bar hanger receivers adjust 2" vertically from above the ceiling or through the aperture.
- Reflector assembly is retained with two torsion springs and held tightly to the finished ceiling surface.
- (4) 1/2" and (2) 3/4" trade size pry outs positioned to allow straight conduit runs. Listed for feed through branch wiring.
- Self heating insulation detector opens circuit if insulation is improperly installed.

Accepts (1) 150W Max A21 / PAR38 / BR40 Tungsten Halogen and Integrated PAR CMH* and PAR LED* lamps

SAMPLE NUMBER: PD6V120 60VC

Order housing, reflector and lamp separately for a complete luminaire.

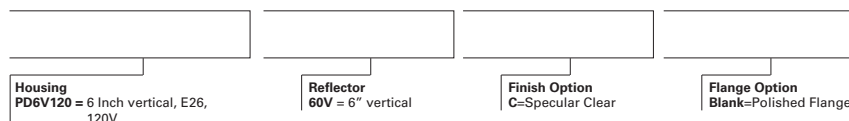

Other options and accessories available. Consult website: www.cooperlighting.com.
*Consult lamp manufacturer for downlighting compatibility.

SAMPLE NUMBER: PD6V120 60VWWC

Order housing, reflector and lamp separately for a complete luminaire.

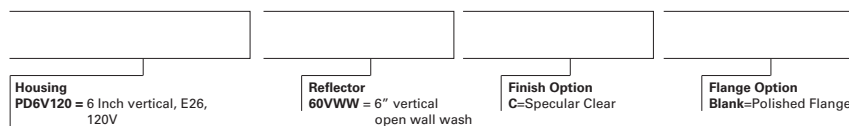

Other options and accessories available. Consult website: www.cooperlighting.com.
*Consult lamp manufacturer for downlighting compatibility.

Ordering Information

Catalog Number	Description	UPC Code	Weight	Case Qty	Pallet Qty
Vertical 6" Incandescent, and Integrated PAR CMH* and PAR LED*					
PD6V120	Housing, 6" Vertical E26, 120V	080083611805	3	6	60
60VC	Reflector, 6" Vertical, Open Reflector, Specular Clear	080083605286	1.085	1	125
60VWWC	Reflector, 6" Vertical, Open Wall Wash, Specular Clear	080083605293	1.168	1	125

Accessories

RMB22	Optional bar hangers (pair) with integral nail for frame construction	662401000821	1	4	756
-------	---	--------------	---	---	-----

*Consult lamp manufacturer for downlighting compatibility.

Vertical 6" Metal Halide



PD6V100E
6" Vertical Downlight

- Boat-shaped galvanized steel frame with a preset 1/2" plaster lip that adjusts to accommodate ceilings up to 2" thick.
- May be used for new construction or remodeling installations.
- Pre-installed and pre-centered No Fuss Bar Hangers™, or use with 1/2" EMT.
- Bar hanger receivers adjust 2" vertically from above the ceiling or through the aperture.
- Reflector assembly is retained with two torsion springs and held tightly to the finished ceiling surface.
- Pulse rated E26 medium base with porcelain socket and nickel plated brass screw shell for open fixture rated E17P (protected) lamp.
- (4) 1/2" and (2) 3/4" trade size pry outs positioned to allow straight conduit runs. Listed for feed through branch wiring.
- Dual input 120V/277V.

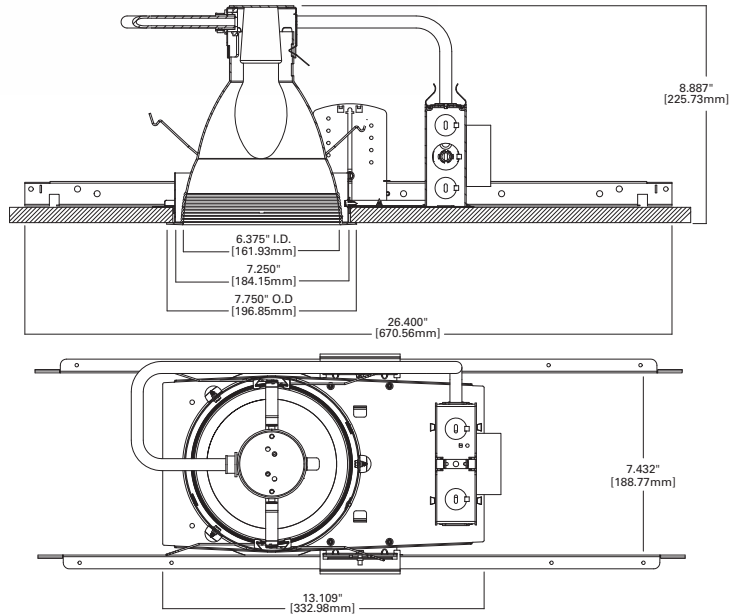

Accepts (1) 100W ED17P (protected) Metal Halide Lamp

SAMPLE NUMBER: PD6V100E 60VC

Order housing, reflector and lamp separately for a complete luminaire.

Housing PD6V = 6 Inch vertical E26 (protected) metal halide	Wattage / Ballast Option 100E = 100W MH, M90, M140, 120V/277V	Reflector 60V = 6" vertical	Finish Option C=Specular Clear	Flange Option Blank=Polished Flange
---	---	---------------------------------------	--	---

Other options and accessories available. Consult website: www.cooperlighting.com.

SAMPLE NUMBER: PD6V100E 6VWWC

Order housing, reflector and lamp separately for a complete luminaire.

Housing PD6V = 6 Inch vertical E26 (protected) metal halide	Wattage / Ballast Option 100E = 100W MH, M90, M140, 120V/277V	Reflector 60VWW = 6" vertical open wall wash	Finish Option C=Specular Clear	Flange Option Blank=Polished Flange
---	---	--	--	---

Other options and accessories available. Consult website: www.cooperlighting.com.

Ordering Information

Catalog Number	Description	UPC Code	Weight	Case Qty	Pallet Qty
Vertical 6" Metal Halide					
PD6V100E	Housing, 6" Vertical, E26 (protected) 100W Electronic MH, 120V/277V	080083611799	5.1	6	60
60VC	Reflector, 6" Vertical, Open Reflector, Specular Clear	080083605286	1.085	1	125
60VWWC	Reflector, 6" Vertical, Open Wall Wash, Specular Clear	080083605293	1.168	1	125

Accessories

RMB22	Optional bar hangers (pair) with integral nail for frame construction	662401000821	1	4	756
-------	---	--------------	---	---	-----

Horizontal 8" Compact Fluorescent

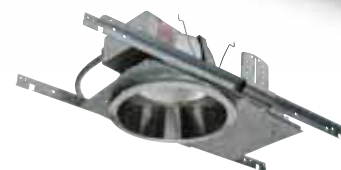
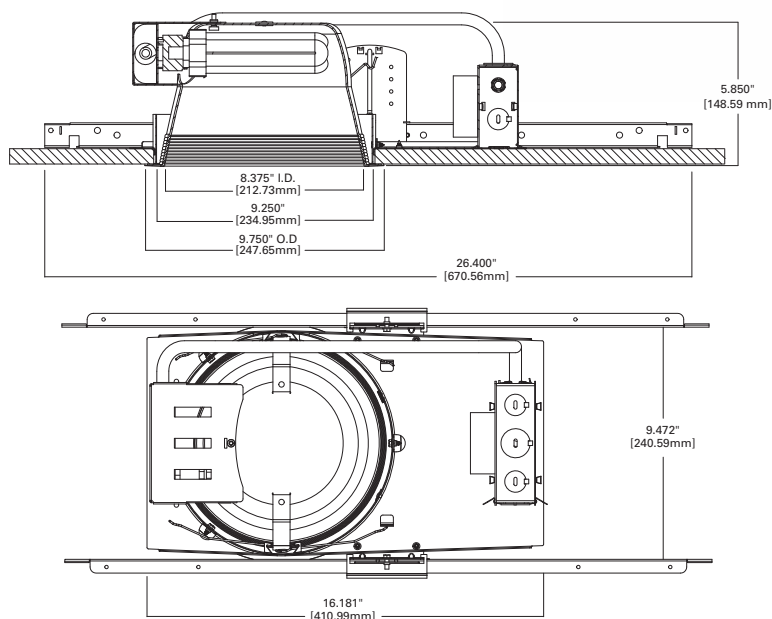

PD8H142
8" Downlight

- Boat-shaped galvanized steel frame with a preset 1/2" plaster lip that adjusts to accommodate ceilings up to 2" thick.
- May be used for new construction or remodeling installations.
- Pre-installed and pre-centered No Fuss Bar Hangers™, or use with 1/2" EMT.
- Bar hanger receivers adjust 2" vertically from above the ceiling or through the aperture.
- Reflector assembly is retained with two torsion springs and held tightly to the finished ceiling surface.
- (4) 1/2" and (2) 3/4" trade size pry outs positioned to allow straight conduit runs. Listed for feed through branch wiring.
- 4-pin G24q base accepts (1) 26W DTT or 26/32/42W TTT lamp.
- Universal 120V - 277V UNV electronic ballast for 26/32/42W compact fluorescent lamp.

Accepts (1) 26 DTT or 26/32/42W TTT Lamp

SAMPLE NUMBER: PD8H142E 82HC

Order housing, reflector and lamp separately for a complete luminaire.

Housing PD8H142 = 8 Inch horizontal (1) 26/32/42W DTT/TTT CFL	Ballast Option E = 120 - 277V 50/60Hz UNV	Reflector 82H = 8" horizontal	Finish Option C=Specular Clear	Flange Option Blank=Polished Flange
--	---	---	--	---

Other options and accessories available. Consult website: www.cooperlighting.com.

SAMPLE NUMBER: : PD8H142E 82HWWC

Order housing, reflector and lamp separately for a complete luminaire.

Housing PD8H142 = 8 Inch horizontal (1) 26/32/42W DTT/TTT CFL	Ballast Option E = 120 - 277V 50/60Hz UNV	Reflector 82HWW = 8" horizontal open wall wash	Finish Option C=Specular Clear	Flange Option Blank=Polished Flange
--	---	---	--	---

Other options and accessories available. Consult website: www.cooperlighting.com.

Ordering Information

Catalog Number	Description	UPC Code	Weight	Case Qty	Pallet Qty
Horizontal 8" Compact Fluorescent					
PD8H142E	Housing, 8" (1) 26W DTT, 26/32/42W TTT Horizontal, 120V-277V UNV	080083611782	4.8	6	36
82HC	Reflector, 8" Horizontal, Open Reflector, Specular Clear	080083605309	1.26	1	112
82HWWC	Reflector, 8" Horizontal, Open Wall Wash, Specular Clear	080083605316	1.4	1	112

Accessories

RMB22	Optional bar hangers (pair) with integral nail for frame construction	662401000821	1	4	756
-------	---	--------------	---	---	-----



PD8H242
8" Downlight

- Boat-shaped galvanized steel frame with a preset 1/2" plaster lip that adjusts to accommodate ceilings up to 2" thick.
- May be used for new construction or remodeling installations.
- Pre-installed and pre-centered No Fuss Bar Hangers™, or use with 1/2" EMT.
- Bar hanger receivers adjust 2" vertically from above the ceiling or through the aperture.
- Reflector assembly is retained with two torsion springs and held tightly to the finished ceiling surface.
- (4) 1/2" and (2) 3/4" trade size pry outs positioned to allow straight conduit runs. Listed for feed through branch wiring.
- 4-pin G24q base accepts (2) 26W DTT or 26/32/42W TTT lamps.
- Universal 120V - 277V UNV electronic ballast for (2) 26/32/42W compact fluorescent lamp.

Horizontal 8" Compact Fluorescent

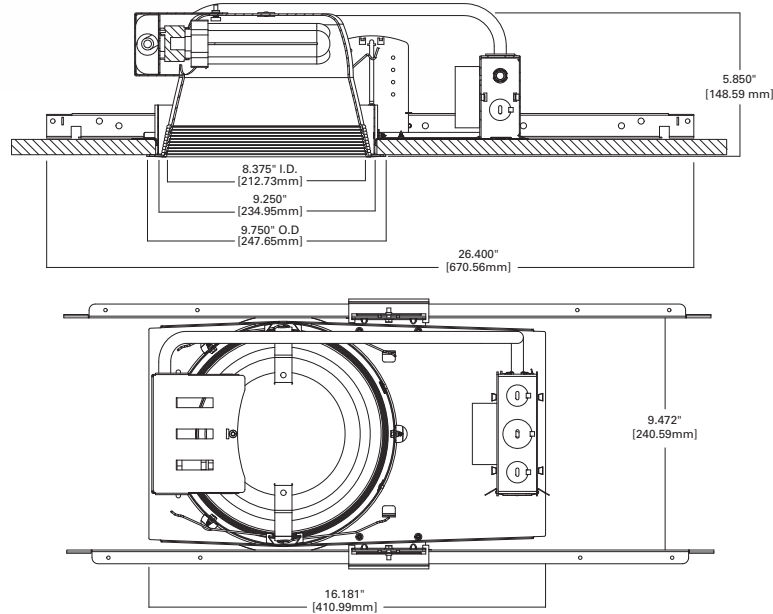

Accepts (2) 26 DTT or 26/32/42W TTT Lamps

SAMPLE NUMBER: PD8H242E 82HC
 Order housing, reflector and lamp separately for a complete luminaire.

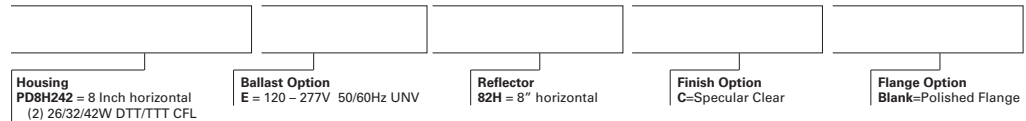

Other options and accessories available. Consult website: www.cooperlighting.com.

SAMPLE NUMBER: PD8H242E 82HWWC
 Order housing, reflector and lamp separately for a complete luminaire.

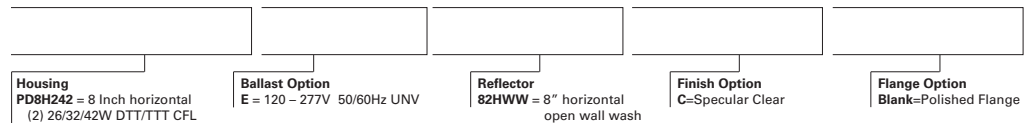

Other options and accessories available. Consult website: www.cooperlighting.com.

Ordering Information

Catalog Number	Description	UPC Code	Weight	Case Qty	Pallet Qty
Horizontal 8" Compact Fluorescent					
PD8H242E	Housing, 8" (2) 26W DTT, 26/32/42W TTT Horizontal, 120V-277V UNV	080083611775	4.8	6	36
82HC	Reflector, 8" Horizontal, Open Reflector, Specular Clear	080083605309	1.26	1	112
82HWWC	Reflector, 8" Horizontal, Open Wall Wash, Specular Clear	080083605316	1.4	1	112

Accessories

RMB22	Optional bar hangers (pair) with integral nail for frame construction	662401000821	1	4	756
-------	---	--------------	---	---	-----

Vertical 8" Compact Fluorescent

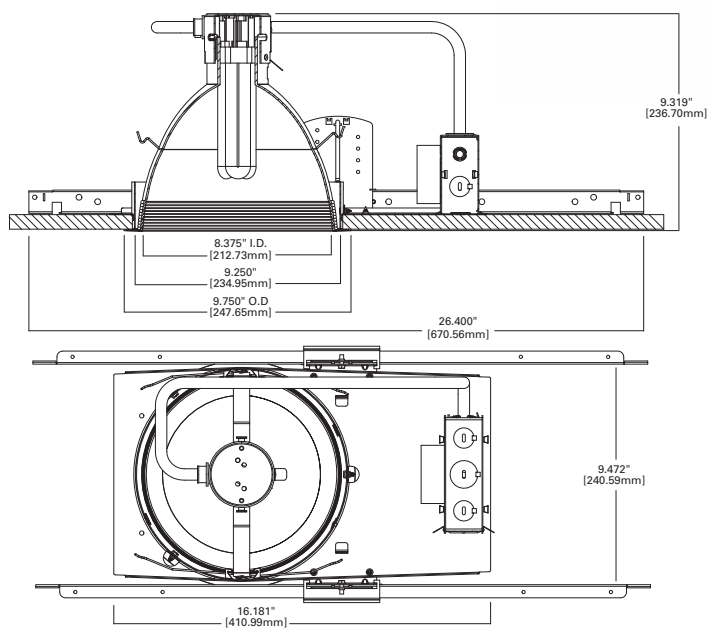

PD8V142 8" Downlight

- Boat-shaped galvanized steel frame with a preset 1/2" plaster lip that adjusts to accommodate ceilings up to 2" thick.
- May be used for new construction or remodeling installations.
- Pre-installed and pre-centered No Fuss Bar Hangers™, or use with 1/2" EMT.
- Bar hanger receivers adjust 2" vertically from above the ceiling or through the aperture.
- Reflector assembly is retained with two torsion springs and held tightly to the finished ceiling surface.
- (4) 1/2" and (2) 3/4" trade size pry outs positioned to allow straight conduit runs. Listed for feed through branch wiring.
- 4-pin G24q base accepts (1) 26W DTT or 26/32/42W TTT lamp.
- Universal 120V - 277V UNV electronic ballast for 26/32/42W compact fluorescent lamp.

Accepts (1) 26 DTT or 26/32/42W TTT Lamp

SAMPLE NUMBER: PD8V142E 80VC

Order housing, reflector and lamp separately for a complete luminaire.

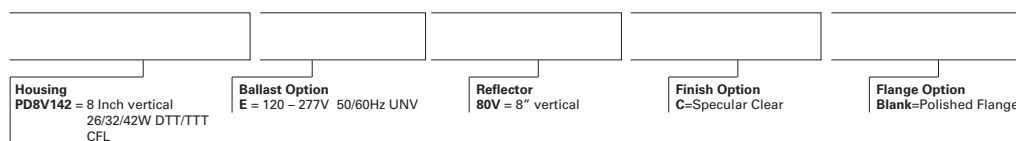

Other options and accessories available. Consult website: www.cooperlighting.com.

SAMPLE NUMBER: PD8V142E 80VWWC

Order housing, reflector and lamp separately for a complete luminaire.

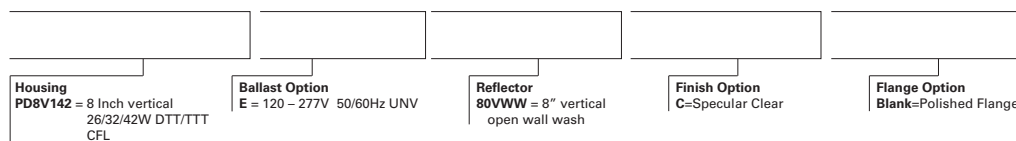

Other options and accessories available. Consult website: www.cooperlighting.com.

Ordering Information

Catalog Number	Description	UPC Code	Weight	Case Qty	Pallet Qty
Vertical 8" Compact Fluorescent					
PD8V142E	Housing, 8" (1) 26W DTT, 26/32/42W TTT Vertical, 120V-277V UNV	080083611768	4.4	6	36
80VC	Reflector, 8" Vertical, Open Reflector, Specular Clear	080083605323	1.5	1	80
80VWWC	Reflector, 8" Vertical, Open Wall Wash, Specular Clear	080083605330	1.6	1	80

Accessories

RMB22	Optional bar hangers (pair) with integral nail for frame construction	662401000821	1	4	756
-------	---	--------------	---	---	-----

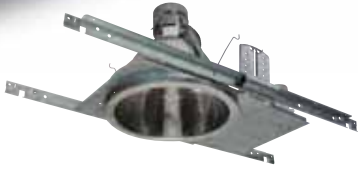

PD8V120 8" Downlight

- Boat-shaped galvanized steel frame with a preset 1/2" plaster lip that adjusts to accommodate ceilings up to 2" thick.
- May be used for new construction or remodeling installations.
- Pre-installed and pre-centered No Fuss Bar Hangers™, or use with 1/2" EMT.
- Bar hanger receivers adjust 2" vertically from above the ceiling or through the aperture.
- Reflector assembly is retained with two torsion springs and held tightly to the finished ceiling surface.
- (4) 1/2" and (2) 3/4" trade size pry outs positioned to allow straight conduit runs. Listed for feed through branch wiring.
- E26 medium base porcelain socket with nickel plated brass screw shell.
- Self heating insulation detector opens circuit if insulation is improperly installed.

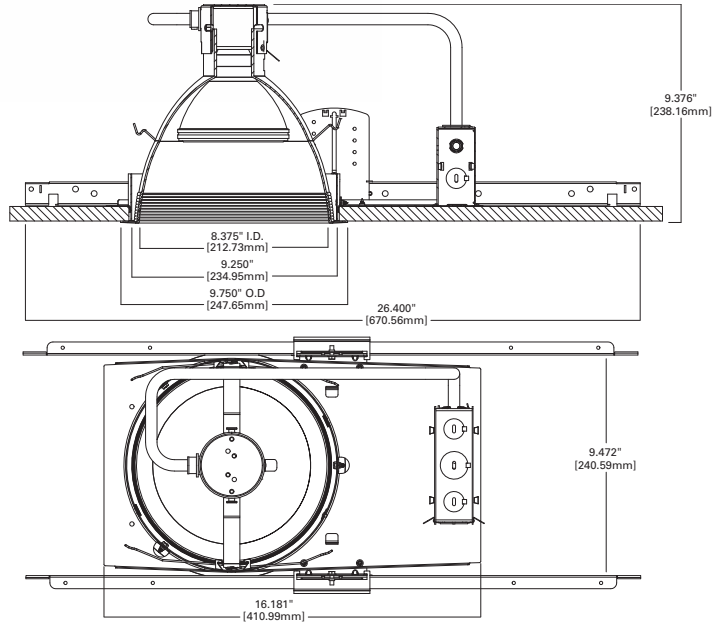

Accepts (1) 250W Max A21 / PAR38 / BR40 Tungsten Halogen and Integrated PAR CMH* and PAR LED* lamps

SAMPLE NUMBER: PD8V120 80VC

Order housing, reflector and lamp separately for a complete luminaire.

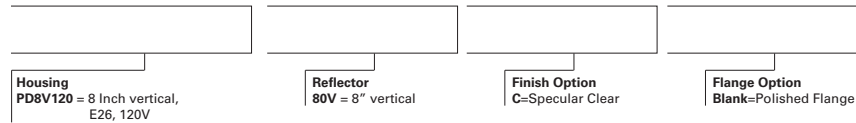

Other options and accessories available. Consult website: www.cooperlighting.com.
*Consult lamp manufacturer for downlighting compatibility.

SAMPLE NUMBER: PD8V120 80VWVC

Order housing, reflector and lamp separately for a complete luminaire.

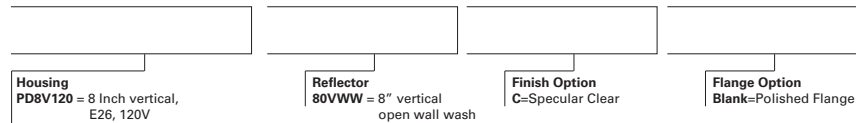

Other options and accessories available. Consult website: www.cooperlighting.com.
*Consult lamp manufacturer for downlighting compatibility.

Ordering Information

Catalog Number	Description	UPC Code	Weight	Case Qty	Pallet Qty
Vertical 8" Incandescent, and Integrated PAR CMH* and PAR LED*					
PD8V120	Housing, 8" Vertical E26, 120V	080083611751	3.4	6	36
80VC	Reflector, 8" Vertical, Open Reflector, Specular Clear	080083605323	1.5	1	80
80VWVC	Reflector, 8" Vertical, Open Wall Wash, Specular Clear	080083605330	1.6	1	80

Accessories

RMB22	Optional bar hangers (pair) with integral nail for frame construction	662401000821	1	4	756
-------	---	--------------	---	---	-----

*Consult lamp manufacturer for downlighting compatibility.

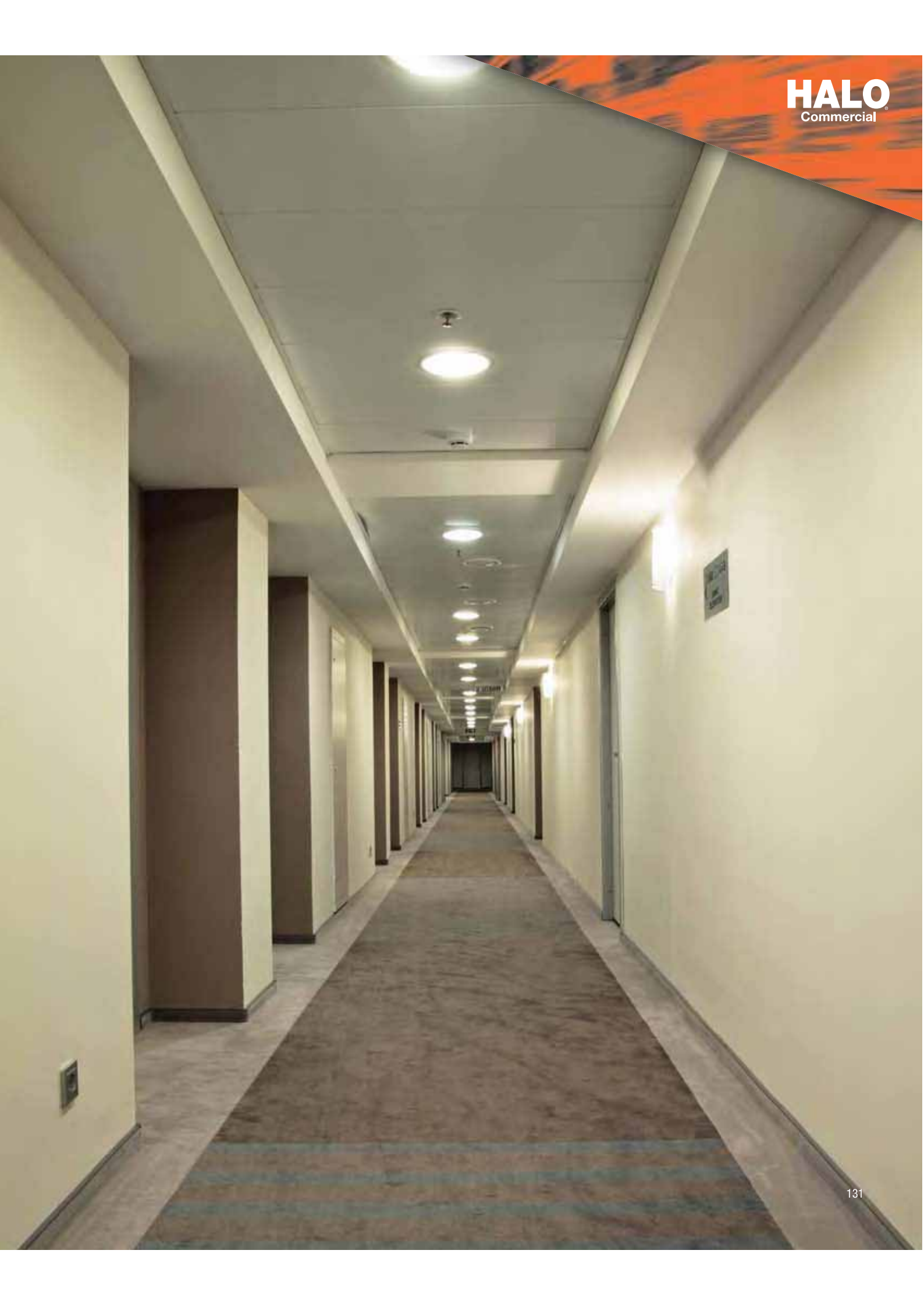

CONSUMER PRODUCTS

LED Worklights



LED Worklights

Cooper Lighting's LED Worklights are great tools to have around your house, garage, workshop or automobile. We offer several multi-functional worklights for handling almost any type of project or job.



The NEW Might-D-Light™ “MINI” LED Worklight's, sleek compact folding design and cool innovative bungee hooking mechanism puts the Mini in a class by itself!

The two high powered LEDs are 40 times brighter than typical LEDs and folds for convenient, easy storage. It's three integrated rare-earth magnets and unique bungee hooking mechanism allows for hands-free use.

Whether it's home maintenance, task lighting, auto repair or outdoor recreation, the Might-D-Light™ Mini is the perfect choice for illuminating those hard to reach places.

For more information visit: www.might-d-light.com



RECHARGEABLE LED Worklight



Rechargeable Folding LED Worklight



Applications

- Home • Garage
- Recreation • Automotive

Specifications

- Eighty long-life LED lights
- Cordless rechargeable unit with AC and DC charging adapters included
- Durable polycarbonate lens
- Nylon swivel hook
- Easy-grip cushioned handle
- Convenient ON/OFF switch
- Reflective strips for increased visibility during roadside applications
- Integrated neodymium magnets for securing to most metals
- 120 volt (standard household supply)
- Two-hour battery life



Model #	Description	Unit Carton info			Master Carton Info				Pallet Qty. (ea)
		UPC	Dimensions (in.)	Wt. (lbs)	I2of5	Dimensions (in.)	Qty.	Wt. (lbs)	
LED130	80 LED Rechargeable Folding Worklight	0 80083 51204 1	10.5H x 7.5W x 7.3D	2.75	1 00 80083 51204 8	10.9H x 15.0W x 7.8D	2	6.25	108
LED130C	80 LED Camo Rechargeable Folding Worklight	0 80083 57078 2	10.5H x 7.5W x 7.3D	2.75	1 00 80083 57078 9	10.9H x 15.0W x 7.8D	2	6.25	108

BATTERY POWERED LED Worklight



Compact Folding LED Worklight



Applications

- Home • Garage
- Recreation • Automotive

Specifications

- Compact folding LED worklight with bungee hooks
- 2 High powered LEDs 40x brighter than typical LEDs
- 3-Way integrated switch: Both panels ON/single panel ON/OFF
- Hinge adjusts up to 270°
- Durable polycarbonate lenses
- Versatile bungee hooking mechanism attaches to hard to hang places
- Extendable bungee hooks stow inside each panel for easy storage
- Up to 4.5 hour battery life
- Alkaline batteries included



Model #	Description	Unit Carton info			Master Carton Info				Pallet Qty. (ea)
		UPC	Dimensions (in.)	Wt. (lbs)	I2of5	Dimensions (in.)	Qty.	Wt. (lbs)	
LED125	Compact Folding LED Worklight	0 80083 58581 6	12H x 12W x 2D	.95	1 00 80083 58581 3	13.7H x 13.81W x 12.88D	6	7.72	162
LED125C	Compact Folding Camo LED Worklight	0 80083 61020 4	12H x 12W x 2D	.95	1 00 80083 61020 1	13.7H x 13.81W x 12.88D	6	7.72	162

Specifications and availability are subject to change without notice.

CONSUMER PRODUCTS

LED Worklights

Applications

- Home • Garage
- Recreation • Automotive

Specifications

- Thirty-five long-life LED lights
- Cordless rechargeable unit with AC and DC charging adapters included
- Nine LED lights on the end of light double as a spotlight or flashlight
- Durable plastic construction with polycarbonate lens
- 360° rotating swivel hook
- Cushioned grip with convenient instant-ON switch
- Magnetic clamp
- 120 volts (standard household supply)
- Up to twelve hours of battery life (when used only as a flashlight)

RECHARGEABLE LED Worklight

Rechargeable LED Worklight



AC & DC adapters included



SustainabLEDesign

The worklight doubles as a flashlight



Model #	Description	Unit Carton info			Master Carton Info				Pallet Qty. (ea)
		UPC	Dimensions (in.)	Wt. (lbs)	I2of5	Dimensions (in.)	Qty.	Wt. (lbs)	
LED120	35 LED Rechargeable Worklight	0 80083 50895 2	17.4H x 4.0W x 4.0D	1.90	1 00 80083 50895 9	18.1H x 8.8W x 8.8D	4	8.82	200

Applications

- Home • Garage
- Automotive

Specifications

- Sixty long-life LED lights
- Durable plastic construction with polycarbonate lens
- 360° rotating swivel hook
- Cushioned grip with instant-ON switch
- 120 volts (standard household supply)

PLUG-IN LED Worklight

Plug-in LED Worklight



SustainabLEDesign

Model #	Description	Unit Carton info			Master Carton Info				Pallet Qty. (ea)
		UPC	Dimensions (in.)	Wt. (lbs)	I2of5	Dimensions (in.)	Qty.	Wt. (lbs)	
LED110	60 LED Plug-in Worklight	0 80083 50894 5	18.1H x 4.0W x 5.0D	2.10	1 00 80083 50894 2	18.9H x 10.8W x 8.8D	4	9.30	160

Specifications and availability are subject to change without notice.

Visit www.cooperlighting.com for more information on the complete Cooper Lighting Stock and Specification offering. Product availability subject to change without notice.

Halogen Worklights

Strength and durability, safety and portability. That's what you get with the Cooper Lighting Halogen Worklight line. Our tough line of Worklights offer many innovative design features to meet any challenge while working in the field.

TRIPOD & SLED | Quartz Worklight

1200 Watt Halogen Standlight



Ratcheting Head



Quick Disconnect



Portable sled design with sled storage



Applications

- Temporary • Warehouse

Specifications

- Tri-pod stand with non-skid feet, adjusts up to 63"
- Quick disconnect feature for easy release from stand
- Ratcheting head for easy angle adjustments
- Thermal switch turns the light off if the unit becomes too hot
- Weatherproof HI/LO switch for adjustable light control
- Stand collapses within the sled for compact storage
- Heavy-duty wire grill guard and tempered glass for added safety
- Foam grip handles and pads on sled for comfort and surface protection
- 6 ft., 18-gauge, 3-prong grounded power cord with wrap

Model #	Description	Unit Carton info			Master Carton Info				Pallet Qty. (ea)
		UPC	Dimensions (in.)	Wt. (lbs)	I2of5	Dimensions (in.)	Qty.	Wt. (lbs)	
TQS1200QDR	1200W Halogen Stand Worklight	0 80083 53596 5	28.74H x 16.14W x 7.28D	21.51	1 00 80083 53596 2	16.73H x 15.35W x 29.52D	2	46.14	24

TRIPOD & SLED Quartz Worklight

Applications

- Temporary • Warehouse

Specifications

- Tri-pod stand with non-skid feet adjusts up to 72"
- Quick disconnect feature for easy release from stand
- Weatherproof ON/OFF switch
- Stand collapses within sled for compact storage
- Heavy-duty wire grill guard and tempered glass for added safety
- 6', 18-gauge, 3-prong grounded power cord with wrap
- Foam grip handles and pads on sled for comfort and surface protection
- Three 500 watt halogen bulbs (includes spare)

1000 Watt Halogen Standlight



Model #	Description	Unit Carton info			Master Carton Info				Pallet Qty. (ea)
		UPC	Dimensions (in.)	Wt. (lbs)	I2of5	Dimensions (in.)	Qty.	Wt. (lbs)	
TQS1000QD	1000W Halogen Stand Worklight	0 80083 53595 8	28.74H x 13.78W x 7.48D	17.35	1 00 80083 53595 5	15.74W x 14.37W x 29.52D	2	37.37	24

Applications

- Temporary • Warehouse

Specifications

- Tri-pod stand with non-skid feet adjusts up to 46"
- Quick disconnect feature for easy release from stand
- Weatherproof ON/OFF switch
- Heavy-duty wire grill guard and tempered glass for added safety
- Foam grip handles and pads on sled for comfort and surface protection
- 6', 18-gauge, 3-prong grounded power cord with wrap
- Two 500 watt halogen bulbs (includes spare)

500 Watt Halogen Standlight



Model #	Description	Unit Carton info			Master Carton Info				Pallet Qty. (ea)
		UPC	Dimensions (in.)	Wt. (lbs)	I2of5	Dimensions (in.)	Qty.	Wt. (lbs)	
SQS505QD	500W Halogen Stand Worklight	0 80083 53594 1	11.8H x 6.3W x 24.8D	8.95	1 00 80083 53594 8	13.38H x 12.59W x 25.59D	2	19.67	24

Specifications and availability are subject to change without notice.

Visit www.cooperlighting.com for more information on the complete Cooper Lighting Stock and Specification offering. Product availability subject to change without notice.

PORTABLE Quartz Worklight

600 Watt Halogen Worklight



Applications

- Temporary • Warehouse

Specifications

- Ratcheting head to easily adjust light angle
- Thermal switch turns unit off if fixture becomes too hot
- Weatherproof HI/LO switch for adjustable light control
- Light output (wattage) 300/600/OFF
- Heavy-duty wire grill guard and tempered glass for added safety
- Comfortable foam grip handle
- Die-cast aluminum housing
- 3', 18-gauge, 3-prong grounded power cord
- Three 300 watt halogen bulbs (includes spare)

Model #	Description	Unit Carton info			Master Carton Info				Pallet Qty. (ea)
		UPC	Dimensions (in.)	Wt. (lbs)	I2of5	Dimensions (in.)	Qty.	Wt. (lbs)	
PQS600R	600W Halogen Worklight	0 80083 52875 2	9.84H x 8.0W x 12.20D	6.94	1 00 80083 52875 9	20.47H x 16.93W x 13.0D	4	29.50	48

500 Watt Halogen Worklight



Applications

- Temporary • Warehouse

Specifications

- Weatherproof ON/OFF switch
- Heavy-duty wire grill guard and tempered glass for added safety
- Comfortable foam grip handle
- Die-cast aluminum housing
- 4', 18 gauge, 3-prong grounded power cord
- Two 500 watt halogen bulbs (includes spare)

Model #	Description	Unit Carton info			Master Carton Info				Pallet Qty. (ea)
		UPC	Dimensions (in.)	Wt. (lbs)	I2of5	Dimensions (in.)	Qty.	Wt. (lbs)	
PQS45	500W Halogen Portable Worklight	0 44427 00260 5	10.75H x 9.0W x 6.5D	4.25	3 00 44427 00260 6	19.0Wx11.5Hx14.0D	4	18.75	96

PORTABLE Quartz Worklight

250 Watt Halogen 4-In-1 Worklight

Applications

- Temporary • Warehouse

Specifications

- 4-in-1 includes hook, clamp spike and base
- Weatherproof ON/OFF switch
- Heavy-duty wire grill guard and tempered glass for added safety
- Die-cast aluminum housing
- 3', 18-gauge, 3-prong grounded power cord
- 250 watt halogen bulb



250W Halogen Bulb



Includes hook, clamp and spike

Model #	Description	Unit Carton info			Master Carton Info				Pallet Qty. (ea)
		UPC	Dimensions (in.)	Wt. (lbs)	I2of5	Dimensions (in.)	Qty.	Wt. (lbs)	
PQS2504IN1	250W Halogen 4-in-1 worklight	0 80083 52499 0	7.48H x 6.69W x 9.06	3.3	1 00 8008 352499 7	20.47H x 14.17W x 9.84D	6	21.3	180

Specifications and availability are subject to change without notice.

Visit www.cooperlighting.com for more information on the complete Cooper Lighting Stock and Specification offering. Product availability subject to change without notice.

Precision Plus Doppler Radar™

While motion sensor lighting has been used for two decades, Precision Plus Doppler Radar™ elevates these systems to a new dimension. It protects your home with improved reliability, area coverage and stable performance.

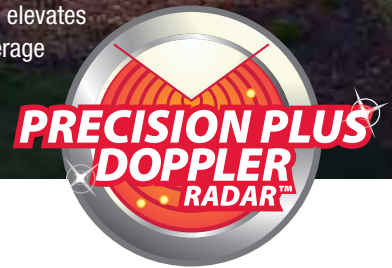

How It Works?

For the past two decades, motion sensor lighting has relied on PIR which detects heat from moving objects, such as people, animals and cars. Unfortunately, these sensors can be triggered by changes in the wind and temperature, as well as stray objects like branches or leaves. While PIR systems provide good side-to-side coverage, they often fail to detect objects moving straight toward them.

PIR - Passive Infrared Technology

Detects lateral movement from side to side.



Doppler Radar Technology

Detects movement towards and away from home. Straight-on coverage.



Precision Plus Doppler Radar™

Combines both passive infrared technology (PIR) and Doppler radar technology. Dual technologies detect movement from side to side and movement towards and away from the home.



For more information visit: www.PrecisionPlusDopplerRadar.com

CONSUMER PRODUCTS

Motion Activated

MOTION SENSOR



Applications

- Home • Garage • Wall / Eave
- Pathway • Security

Specifications

- Motion sensor detects 270° up to 90'
- Convenient, adjustable friction swivel heads
- Heavy-duty, die-cast metal rectangular twin-head design
- Adjustable "Sensitivity" setting
- Integral photo cell design prevents lights from turning ON with motion during daylight hours (auto mode)
- Two 100W (MAX) halogen bulbs (included)

270° Motion Sensor - 200 Watt Halogen Motion Security Floodlight



Model #	Description	Unit Carton info			Master Carton Info				Pallet Qty. (ea)
		UPC	Dimensions (in.)	Wt. (lbs)	I2of5	Dimensions (in.)	Qty.	Wt. (lbs)	
MS280D	270° 200W PAR Halogen - Bronze	0 80083 50426 8	6.8H x 12.1W x 6.9D	2.60	1 00 80083 50426 5	7.6H x 12.6W x 13.8D	2	6.10	108
MS280DW	270° 200W PARHalogen - White	0 80083 50427 5	6.8H x 12.1W x 6.9D	2.60	1 00 80083 50427 2	7.6H x 12.6W x 13.8D	2	6.10	108

Applications

- Home • Garage • Wall / Eave
- Pathway • Security

Specifications

- Motion sensor detects 270° up to 90'
- Die-cast metal housing
- Decorative metal lamp covers
- Easy adjustable heads
- Adjustable "sensitivity" setting
- Integral photo cell design prevents lights from turning ON with motion during daylight hours (auto mode)
- Requires two 100W (MAX) PAR bulbs (sold separately)



270° Motion Sensor - 200 Watt Halogen Motion Security Floodlight



Model #	Description	Unit Carton info			Master Carton Info				Pallet Qty. (ea)
		UPC	Dimensions (in.)	Wt. (lbs)	I2of5	Dimensions (in.)	Qty.	Wt. (lbs)	
MS276RD	270° 200W PAR with Reflectors - Bronze	0 80083 53914 7	11.4H x 6.7W x 5.4D	2.20	1 00 80083 53914 4	12.0H x 7.2W x 11.4D	2	5.20	160
MS276RDW	270° 200W PAR with Reflectors - White	0 80083 53915 4	11.4H x 6.7W x 5.4D	2.20	1 00 80083 53915 1	12.0H x 7.2W x 11.4D	2	5.20	160

Specifications and availability are subject to change without notice.

Visit www.cooperlighting.com for more information on the complete Cooper Lighting Stock and Specification offering. Product availability subject to change without notice.

COOPER Lighting

MOTION SENSOR



180° Motion Sensor - 200 Watt Halogen Motion Security Floodlight



100W PAR Bulb



Applications

- Home • Garage • Wall / Eave
- Pathway • Security

Specifications

- Motion sensor detects motion 180° up to 70'
- Die-cast metal housing
- Easy adjustable heads
- Adjustable "sensitivity" setting
- Integral photo cell design prevents lights from turning ON with motion during daylight hours (auto mode)
- Requires two 100W (MAX) PAR bulbs (sold separately)

Model #	Description	Unit Carton info			Master Carton Info				Pallet Qty. (ea)
		UPC	Dimensions (in.)	Wt. (lbs)	I2of5	Dimensions (in.)	Qty.	Wt. (lbs)	
MS185D	180° 200W PAR Halogen - Bronze	0 80083 60228 5	7.6H x 5.31W x 5.91D	1.57	1 00 80083 60228 2	8.27H x 6.5W x 11.42D	2	3.62	240
MS185DW	180° 200W PARHalogen - White	0 80083 60229 2	7.6H x 5.31W x 5.91D	1.57	1 00 80083 60229 9	8.27H x 6.5W x 11.42D	2	3.62	240

MOTION SENSOR



240° Motion Sensor - 200 Watt Halogen Motion Security Floodlight



100W GY8.6 Halogen Bulb



Applications

- Home • Garage • Wall / Eave
- Pathway • Security

Specifications

- Motion sensor detects motion 240 degrees up to 70 feet
- Heavy duty die-cast metal housing construction
- Motion sensor turns lights ON automatically when motion is detected
- OFF after a preselected time
- Integral photo cell design prevents lights from turning ON with motion during daylight hours (auto modes)
- Perfect for wall or eave mount applications
- (2) 100W (MAX) GY8.6 Halogen bulbs (included)

Model #	Description	Unit Carton info			Master Carton Info				Pallet Qty (ea)
		UPC	Dimensions (in.)	Wt. (lbs)	I2of5	Dimensions (in.)	Qty	Wt. (lbs)	
MS248	240° Halogen - Bronze	0 44427 00659 7	11.5H x 8.6W x 4.0D	2.50	1 00 44427 00659 4	12.0H x 8.8W x 8.5D	2	5.25	160
MS248W	240° Halogen - White	0 44427 00661 0	11.5H x 8.6W x 4.0D	2.50	1 00 44427 00661 7	12.0H x 8.8W x 8.5D	2	5.25	160

CONSUMER PRODUCTS

Motion Activated

MOTION SENSOR



Applications

- Home • Garage • Wall / Eave
- Pathway • Security

Specifications

- Motion sensor detects motion 180° up to 70'
- Heavy-duty, die-cast metal housing
- Metal lamp covers provide maximum bulb protection
- Motion sensor turns lights on automatically when motion is detected and OFF after a preselected time delay (4 or 12 minutes)
- Integral photo cell design prevents lights from turning on with motion during daylight hours (auto modes)
- Perfect for wall or eave mount applications
- Requires two 150W (MAX) PAR bulbs (sold separately)

240° Motion Sensor - 300 Watt Security Floodlight with Lamp Covers



150W PAR Bulb



Model #	Description	Unit Carton info			Master Carton Info				Pallet Qty. (ea)
		UPC	Dimensions (in.)	Wt. (lbs)	I2of5	Dimensions (in.)	Qty.	Wt. (lbs)	
MS245R	240° PAR - Bronze	0 44427 00655 9	11.1H x 6.6W x 4.9D	2.25	1 00 44427 00655 6	11.4H x 10.1W x 6.9D	2	5.00	144
MS245RW	240° PAR - White	0 44427 00657 3	11.1H x 6.6W x 4.9D	2.25	1 00 44427 00657 0	11.4H x 10.1W x 6.9D	2	5.00	144

Applications

- Home • Garage • Wall / Eave
- Pathway • Security

Specifications

- Motion sensor detects motion 240° up to 70'
- Heavy-duty, die-cast metal housing
- Metal lamp covers provide maximum bulb protection
- Motion sensor turns lights ON automatically when motion is detected and OFF after a preselected time delay (4 or 12 minutes)
- Integral photo cell design prevents lights from turning ON with motion during daylight hours (auto modes)
- Perfect for wall or eave mount applications
- Requires two 100W (MAX) PAR bulbs (sold separately)

MOTION SENSOR



180° Motion Sensor - 200 Watt Security Floodlight with Lamp Covers



150W PAR Bulb



Model #	Description	Unit Carton info			Master Carton Info				Pallet Qty. (ea)
		UPC	Dimensions (in.)	Wt. (lbs)	I2of5	Dimensions (in.)	Qty.	Wt. (lbs)	
MS185R	180° PAR - Bronze	0 44427 00639 9	9.1H x 5.7W x 4.9D	2.00	1 00 44427 00639 6	9.9H x 10.4W x 6.3D	2	4.50	256
MS185RW	180° PAR - White	0 44427 00641 2	9.1H x 5.7W x 4.9D	2.00	1 00 44427 00641 9	9.9H x 10.4W x 6.3D	2	4.50	256

Specifications and availability are subject to change without notice.

Visit www.cooperlighting.com for more information on the complete Cooper Lighting Stock and Specification offering. Product availability subject to change without notice.

COOPER Lighting

MOTION SENSOR



180° Motion Sensor - 300 Watt Security Halogen Floodlight



Applications

- Home • Garage • Wall / Eave
- Pathway • Security

Specifications

- Motion sensor detects motion 180° up to 70'
- Heavy-duty, die-cast metal housing
- Motion sensor turns light ON automatically when motion is detected and OFF after a preselected time delay (4 or 12 minutes)
- Integral photo cell design prevents lights from turning ON with motion during daylight hours (auto modes)
- Perfect for wall or eave mount applications
- 300W (MAX) halogen bulb (included)

Model #	Description	Unit Carton info			Master Carton Info				Pallet Qty. (ea)
		UPC	Dimensions (in.)	Wt. (lbs)	I2of5	Dimensions (in.)	Qty.	Wt. (lbs)	
MS188	180° Halogen - Bronze	0 44427 00643 6	7.0H x 8.3W x 7.5D	2.50	1 00 44427 00643 3	7.5H x 15.5W x 9.0D	2	5.25	150
MS188W	180° Halogen - White	0 44427 00645 0	7.0H x 8.3W x 7.5D	2.50	1 00 44427 00645 7	7.5H x 15.5W x 9.0D	2	5.25	150

Replacement MOTION SENSOR



180° Motion Sensor



Applications

- Home • Garage • Wall / Eave
- Pathway • Security

Specifications

- Motion sensor detects motion 180° up to 70'
- Motion sensor turns lights ON automatically when motion is detected and OFF after a preselected time delay (4 or 12 minutes)
- Integral photo cell prevents lights from turning ON with motion during daylight hours (auto modes)
- Power outage protection saves energy by automatically resetting at dawn if lights are triggered by power interruption

Model #	Description	Unit Carton info			Master Carton Info				Pallet Qty. (ea)
		UPC	Dimensions (in.)	Wt. (lbs)	I2of5	Dimensions (in.)	Qty.	Wt. (lbs)	
MS180	180° Sensor - Bronze	0 44427 00631 3	5.0H x 3.5W x 2.8D	0.50	1 00 44427 00631 0	5.3H x 7.3W x 6.3D	4	2.25	1344
MS180W	180° Sensor - White	0 44427 00633 7	5.0H x 3.5W x 2.8D	0.50	1 00 44427 00633 4	5.3H x 7.3W x 6.3D	4	2.25	1344

CONSUMER PRODUCTS

Motion Activated

MOTION SENSOR



Applications

- Home • Garage • Wall / Eave
- Pathway • Security

Specifications

- Motion sensor detects motion 110° up to 70'
- Heavy-duty, die-cast metal housing
- Motion sensor turns lights ON automatically when motion is detected and OFF after a preselected time delay (4 or 12 minutes)
- Power outage protection saves energy by automatically resetting at dawn if lights are triggered by power interruption
- Perfect for wall or eave mount applications
- 150W (MAX) halogen bulb (included)

110° Motion Sensor - 150 Watt Security Halogen Floodlight



150W Halogen Bulb



Model #	Description	Unit Carton info			Master Carton Info				Pallet Qty. (ea)
		UPC	Dimensions (in.)	Wt. (lbs)	I2of5	Dimensions (in.)	Qty.	Wt. (lbs)	
MS80	110° Halogen - Black	0 44427 00236 0	6.3H x 6.3W x 5.8D	1.75	2 00 44427 00236 4	6.8H x 12.0W x 6.8D	2	3.75	336
MS80W	110° Halogen - White	0 44427 00230 8	6.3H x 6.3W x 5.8D	1.75	2 00 44427 00230 2	6.8H x 12.0W x 6.8D	2	3.75	336

Applications

- Home • Garage • Wall / Eave
- Pathway • Security

Specifications

- Motion sensor detects motion 110° up to 60'
- Durable plastic construction
- Turns lights ON automatically when motion is detected and OFF after a preselected time delay
- Perfect for wall or eave mount applications
- Requires two 150W (MAX) PAR bulbs (sold separately)

MOTION SENSOR



110° Motion Sensor - 300 Watt Security Floodlight



150W PAR Bulb



Model #	Description	Unit Carton info			Master Carton Info				Pallet Qty. (ea)
		UPC	Dimensions (in.)	Wt. (lbs)	I2of5	Dimensions (in.)	Qty.	Wt. (lbs)	
MS34	110° PAR - Black	0 44427 35127 7	6.3H x 5.0W x 5.0D	1.00	2 00 44427 35127 1	6.8H x 15.5W x 10.3D	6	6.50	432
MS34W	110° PAR - White	0 44427 35128 4	6.3H x 5.0W x 5.0D	1.00	2 00 44427 35128 8	6.8H x 15.5W x 10.3D	6	6.50	432

Specifications and availability are subject to change without notice.

Visit www.cooperlighting.com for more information on the complete Cooper Lighting Stock and Specification offering. Product availability subject to change without notice.



MOTION SENSOR



110° Motion Sensor - 100 Watt Security Camera & Floodlight System

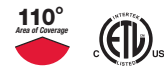

Applications

- Home • Garage • Business
- Entrance • Pathway • Security

Specifications

- Motion sensor detects motion 110° up to 40'
- 24-hour surveillance of home or business with color images and built-in microphone
- Delivers audio and video through TV
- Video signal can be recorded (recording device sold separately)
- Wireless technology – no cable required for camera to communicate with receiver
- Receiver and cords included
- Camera detects images 60° and up to 20'
- Floodlight turns ON at night with motion (camera on continuously day and night)
- 100W (MAX) halogen bulb (included)

Model #	Description	Unit Carton info			Master Carton Info				Pallet Qty. (ea)
		UPC	Dimensions (in.)	Wt. (lbs)	I2of5	Dimensions (in.)	Qty.	Wt. (lbs)	
MAC100	110° Halogen with Receiver - Black	0 44427 35133 8	9.0H x 8.5W x 5.5D	3.50	1 00 44427 35133 5	9.8H x 11.5W x 9.3D	2	7.25	160
MAC100W	110° Halogen with Receiver - White	0 80083 52981 0	9.0H x 8.5W x 5.5D	3.50	1 00 80083 52981 7	9.8H x 11.5W x 9.3D	2	7.25	160

110° Motion Sensor - 100 Watt Halogen Plug-In Security Floodlight



Applications

- Home • Garage • Sheds
- Entrance • Pathway • Security

Specifications

- Motion sensor detects motion 110° up to 40'
- Versatile plug-in design, 8 foot extra-reach electrical cord
- Adjustable time and light sensitivity settings
- Manual override - can be used as standard floodlight
- Motion sensor turns light ON automatically when motion is detected and OFF after a pre-selected time delay
- Receiver and cords included
- Integral photo cell design prevents light from turning ON during daylight hours
- Perfect for most indoor and outdoor wall mount applications; easy plug-in design
- 100W (MAX) Halogen bulb (included)

Model #	Description	Unit Carton info			Master Carton Info				Pallet Qty (ea)
		UPC	Dimensions (in.)	Wt. (lbs)	I2of5	Dimensions (in.)	Qty	Wt. (lbs)	
MS100PG	110° Halogen - Gray	0 44427 35123 9	13.3H x 6.5W x 5.5D	2.75	1 00 44427 35123 6	13.8H x 11.0W x 7.0D	2	6.25	154

Specifications and availability are subject to change without notice.

CONSUMER PRODUCTS

Motion Activated

Solar Powered LED MOTION SENSOR



Applications

- Carports • Posts • Sheds
- Pathway • Security

Specifications

- Motion sensor detects motion 100° up to 23'
- Durable weather resistant plastic construction
- Installs easily with no wiring necessary
- Built-in solar panel
- Includes (3) NI-MH rechargeable "AA" batteries
- Motion sensor turns light ON automatically at night when motion is detected
- Light sensor prevents light from turning ON during daylight hours
- Auto one-minute fixed-time setting
- Two long-life, bright-white LED bulbs (included)

100° Motion Sensor - Solar Powered LED Light



Sustainable Design

Model #	Description	Unit Carton info			Master Carton Info				Pallet Qty. (ea)
		UPC	Dimensions (in.)	Wt. (lbs)	I2of5	Dimensions (in.)	Qty.	Wt. (lbs)	
MSLED100	100° LED Solar - Black	0 80083 51784 8	6.5H x 7.9W x 4.7D	1.45	1 00 80083 51784 5	7.3H x 10.2W x 8.7D	2	3.42	176

Applications

- Home • Garage • Sheds
- Pathway • Security

Specifications

- Motion sensor detects motion 180° up to 70'
- Two bright, white LEDs
- LED indicator light flashes when unit needs to recharge
- Easy wall mounting
- Adjustable time settings
- Durable weather-resistant plastic construction
- 6" x 8" solar panel for maximum charging power with 16' cord
- Can be used as a twin head or single head depending on application
- Installs easily with no wiring necessary

Solar Powered LED MOTION SENSOR



180° Motion Sensor - Solar Powered LED Floodlight



Sustainable Design

Model #	Description	Unit Carton info			Master Carton Info				Pallet Qty. (ea)
		UPC	Dimensions (in.)	Wt. (lbs)	I2of5	Dimensions (in.)	Qty.	Wt. (lbs)	
MSLED180W	180° LED Solar - White	0 80083 56531 3	7.8H x 10.5W x 8.9D	3.53	1 00 80083 56531 0	8.5H x 11.1W x 18.5D	2	8.18	80

Specifications and availability are subject to change without notice.

Visit www.cooperlighting.com for more information on the complete Cooper Lighting Stock and Specification offering. Product availability subject to change without notice.

LAMP HOLDERS | Twin Floodlights

200 Watt Twin Head Halogen Floodlight

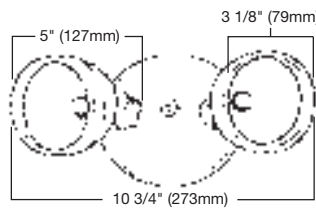

100W GY8.6 Halogen Bulb



Applications

- Home • Garage • Wall / Eave
- Pathway • Security

Specifications

- Heavy-duty, die-cast metal construction
- Decorative floodlight with twin head design
- Perfect for wall or eave mount applications
- Two 100W (MAX) GY8.6 halogen bulbs (included)

Model #	Description	Unit Carton info			Master Carton Info				Pallet Qty. (ea)
		UPC	Dimensions (in.)	Wt. (lbs)	I2of5	Dimensions (in.)	Qty.	Wt. (lbs)	
MX1	200W Halogen - Bronze	0 44427 00327 5	7.0H x 6.8W x 4.0D	1.50	2 00 44427 00327 9	7.5H x 8.5W x 7.5D	2	3.50	324
MX1W	200W Halogen - White	0 44427 00328 2	4.0H x 6.8W x 7.0D	1.50	2 00 44427 00328 6	7.5H x 8.3W x 7.5D	2	3.50	324

300 Watt Metal Twin Head PAR Floodlight

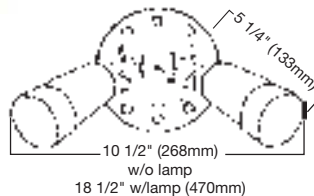

150W PAR Bulb



Applications

- Home • Garage • Wall / Eave
- Pathway • Security

Specifications

- Heavy-duty, die-cast metal construction
- Perfect for wall or eave mount applications
- Two 150W (MAX) PAR bulbs (sold separately)

Model #	Description	Unit Carton info			Master Carton Info				Pallet Qty. (ea)
		UPC	Dimensions (in.)	Wt. (lbs)	I2of5	Dimensions (in.)	Qty.	Wt. (lbs)	
MT250	300W PAR - Bronze	0 44427 30047 3	6.3H x 5.5W x 3.0D	1.00	1 00 44427 30047 0	6.8H x 18.5W x 6.0D	6	5.75	672
MT250W	300W PAR - White	0 44427 30048 0	6.3H x 5.5W x 3.0D	1.00	1 00 44427 30048 7	6.8H x 18.5W x 6.0D	6	5.75	672

MINI QUARTZ | Single & Twin Floodlights

Applications

- Home • Garage • Wall / Eave
- Pathway • Security

Specifications

- Heavy-duty die-cast metal construction
- Twin head design
- Perfect for wall or eave mount applications
- Two 150W (MAX) halogen bulbs (included)

300 Watt Compact Twin Head Halogen Floodlight



Model #	Description	Unit Carton info			Master Carton Info				Pallet Qty. (ea)
		UPC	Dimensions (in.)	Wt. (lbs)	I2of5	Dimensions (in.)	Qty.	Wt. (lbs)	
TMQ150	300W Halogen - Bronze	0 44427 00193 6	7.0H x 7.3W x 5.5D	2.50	2 00 44427 00193 0	7.8H x 11.5W x 7.8D	2	5.50	240
TMQ150W	300W Halogen - White	0 44427 00194 3	7.0H x 7.3W x 5.5D	2.50	2 00 44427 00194 7	7.8H x 11.5W x 7.8D	2	5.50	240

Applications

- Home • Garage • Wall / Eave
- Pathway • Security

Specifications

- Heavy-duty, die-cast metal construction
- Attractive compact design is less than half the size of conventional halogen floodlights
- Perfect for wall or eave mount applications
- 150W (MAX) halogen bulb (included)

150 Watt Compact Halogen Floodlight



Model #	Description	Unit Carton info			Master Carton Info				Pallet Qty. (ea)
		UPC	Dimensions (in.)	Wt. (lbs)	I2of5	Dimensions (in.)	Qty.	Wt. (lbs)	
MQF150	150W Halogen - Bronze	0 44427 00191 2	5.0H x 5.8W x 4.5D	1.25	1 00 44427 00191 9	5.5H x 27.3W x 6.3D	6	8.50	420
MQF150W	150W Halogen - White	0 44427 00192 9	5.0H x 5.8W x 4.5D	1.25	1 00 44427 00192 6	5.5H x 27.3W x 6.3D	6	8.50	420

Specifications and availability are subject to change without notice.

Visit www.cooperlighting.com for more information on the complete Lumark Stock and Specification offering. Product availability subject to change without notice.

CONSUMER PRODUCTS

Dusk-to-Dawn

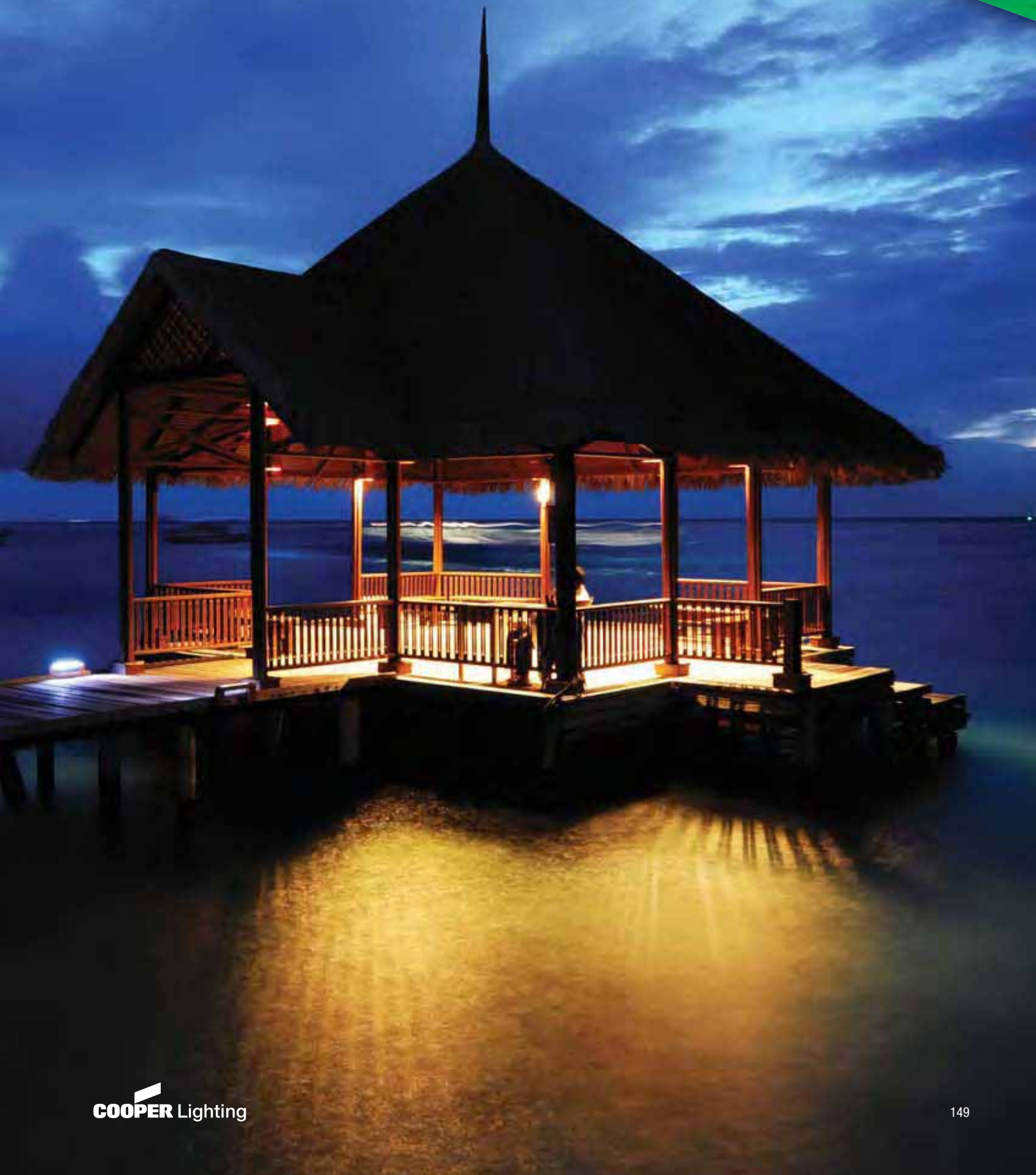

Dusk-to-Dawn | Entry and Patio Luminaire

Applications

- Patio • Entrance • Porch
- Pathway • Security

Specifications

- Heavy-duty, die-cast metal housing
- Nighttime ON/Daytime OFF
- Built-in light photo control
- Easily mounts to standard lampholder mounting plate
- Perfect for lighting porches, decks or work areas
- 42W (MAX) medium base fluorescent bulb (included)

42 Watt Fluorescent Entry and Patio Light



42W Fluorescent Bulb (B42FMED)



Model #	Description	Unit Carton info			Master Carton Info				Pallet Qty. (ea)
		UPC	Dimensions (in.)	Wt. (lbs)	I2of5	Dimensions (in.)	Qty.	Wt. (lbs)	
MD42FLW	42W Fluorescent - White	0 80083 50107 6	11.5H x 10.0W x 10.3D	4.5	1 00 80083 50107 3	12.5H x 21.3W x 11.0D	2	9.5	48

Dusk-to-Dawn | Entry and Patio Luminaire

Applications

- Patio • Entrance • Porch
- Pathway • Security

Specifications

- Corrosion resistant die-cast aluminum housing
- Nighttime ON/Daytime OFF
- Replaceable photo control
- Mounting pattern on top of box allows you to predrill holes for quick and easy installation
- Perfect for lighting dark, secluded areas or any place where a medium to large concentration of light is needed
- 65W (MAX) mogul base fluorescent bulb (included)

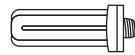

65W Fluorescent Bulb (B65FMOG)

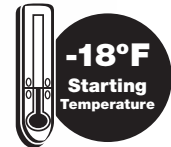

Model #	Description	Unit Carton info			Pallet Qty (ea)
		UPC	Dimensions (in.)	Wt. (lbs)	
AL6501FL	65W Fluorescent	0 8008 358496 3	16.6H x 11.5W x 11.5D	6.3	48

Specifications and availability are subject to change without notice.

Visit www.cooperlighting.com for more information on the complete Lumark Stock and Specification offering. Product availability subject to change without notice.

Dusk-to-Dawn Twin Head Halogen Floodlight

300 Watt Metal Twin Head Halogen Floodlight With Photo Control



150W PAR Bulb



Applications

- Home • Garage • Wall / Eave
- Pathway • Security

Specifications

- Heavy-duty, die-cast metal housing
- Nighttime ON/Daytime OFF
- Built-in photo control
- Perfect for wall or eave mount applications
- Two 150W (MAX) PAR bulbs (sold separately)

Model #	Description	Unit Carton info			Master Carton Info				Pallet Qty. (ea)
		UPC	Dimensions (in.)	Wt. (lbs)	I2of5	Dimensions (in.)	Qty.	Wt. (lbs)	
MT250PCW	300W PAR - White	0 44427 30050 3	6.5H x 5.8W x 3.5D	1.75	1 00 44427 30050 0	7.3H x 22.8W x 6.0D	6	8.00	240

Dusk-to-Dawn Entry and Patio Luminaire

13 Watt Fluorescent Entry Light



13W Fluorescent Bulb (PLC13W)



Applications

- Patio • Entrance • Porch
- Pathway • Security

Specifications

- High impact, weather resistant housing and lens
- Nighttime ON/Daytime OFF
- Built-in photo control
- Electronic ballast design provides reliable starting in cold weather applications
- Perfect for patio or entrance lighting
- 13W (MAX) Fluorescent bulb (included)

Model #	Description	Unit Carton info			Master Carton Info				Pallet Qty (ea)
		UPC	Dimensions (in.)	Wt. (lbs)	I2of5	Dimensions (in.)	Qty	Wt. (lbs)	
FE13PC	13W Fluorescent - Bronze	0 44427 45052 9	9.5H x 6.3W x 4.8D	1.50	2 00 44427 45052 3	10.0H x 10.0W x 6.8D	2	3.25	224
FE13PCW	13W Fluorescent - White	0 44427 45053 6	9.5H x 6.3W x 4.8D	1.50	1 00 44427 45053 0	10.0H x 10.0W x 6.8D	2	3.25	224

Dusk-to-Dawn | Entry and Patio Luminaire

Applications

- Home • Garage • Wall / Eave
- Pathway • Security

Specifications

- High impact, weather resistant housing and lens
- Nighttime ON/Daytime OFF
- Built-in photo control
- Electronic ballast design provides reliable starting in cold weather applications
- Perfect for wall or eave mount application
- Available in 26W (MAX) 4 Pin Fluorescent bulbs (included)

26 Watt Fluorescent Floodlight



18W/26W 4 Pin Fluorescent Bulb (FML18/FML26)



Model #	Description	Unit Carton info			Master Carton Info				Pallet Qty (ea)
		UPC	Dimensions (in.)	Wt. (lbs)	I2of5	Dimensions (in.)	Qty	Wt. (lbs)	
FNF26PC	26W Fluorescent - Bronze	0 44427 45056 7	8.8H x 5.8W x 4.8D	1.75	1 00 44427 45056 4	9.5H x 14.5W x 12.0D	6	12.50	288

Applications

- Home • Garage • Wall / Eave
- Pathway • Security

Specifications

- Frosted high-impact protective lens
- Perfect for wall mount / eave applications
- Self diagnostic LED (Title 24) indicator light
- Will accept 13W-27W GU24 bulbs
- Fluorescent bulb lasts 5 times longer than standard incandescent bulbs
- Photo control provides convenient nighttime ON/daytime OFF
- Heavy duty die-cast aluminum housing
- 120 Volts (standard household supply)

23 Watt GU24 Fluorescent Floodlight



23 Watt GU24 Fluorescent Bulb



Model #	Description	Unit Carton info			Master Carton Info				Pallet Qty (ea)
		UPC	Dimensions (in.)	Wt. (lbs)	I2of5	Dimensions (in.)	Qty	Wt. (lbs)	
FFL23PC-T24	23W Fluorescent GU24 D2D Floodlight - Black	0 8008 356528 3	6.8H x 7.1W x 6.9D	1.94	1 00 80083 56528 0	7.5H x 13.4W x 7.6D	2	5.07	192
FFL23PCW-T24	23W Fluorescent GU24 D2D Floodlight - White	0 8008 356529 0	6.8H x 7.1W x 6.9D	1.94	1 00 80083 56529 7	7.5H x 13.4W x 7.6D	2	5.07	192

Specifications and availability are subject to change without notice.

Visit www.cooperlighting.com for more information on the complete Lumark Stock and Specification offering. Product availability subject to change without notice.

Dusk-to-Dawn | Entry and Patio Luminaire

23 Watt GU24 Fluorescent Patio Light



23 Watt GU24 D2D Fluorescent Bulb



Applications

- Patio • Entrance • Porch
- Pathway • Security

Specifications

- Frosted high-impact protective lens
- Self diagnostic LED (Title 24) indicator light
- Will accept 13W-27W GU24 bulb
- Fluorescent bulb lasts 5 times longer than standard incandescent bulbs
- Photo control provides convenient nighttime ON/daytime OFF
- Heavy duty die-cast aluminum housing
- 120 Volts (standard household supply)

Model #	Description	Unit Carton info			Master Carton Info				Pallet Qty (ea)
		UPC	Dimensions (in.)	Wt. (lbs)	I2of5	Dimensions (in.)	Qty	Wt. (lbs)	
PFL23PC-T24	23W Fluorescent GU24 D2D Patio Light - Black	0 8008 356526 9	8.8H x 7.1W x 5.4D	2.2	1 00 80083 56526 6	9.4H x 11.7W x 7.5D	2	5.5	192
PFL23PCW-T24	23W Fluorescent GU24 D2D Patio Light - White	0 8008 356527 6	8.8H x 7.1W x 5.4D	2.2	1 00 80083 56527 3	9.4H x 11.7W x 7.5D	2	5.5	192

Product No.	Page No.	Product No.	Page No.	Product No.	Page No.
2EP3GAVX	47	ERT402	83	ERT771TS	119
12T8WHU	63	ERT402LV	85	ERT772TS	119
12X9WHU	63	ERT403	83	ERT772WHHTS	119
2EP3GX	47	ERT403LV	85	ET2700	112
2GR8	48	ERT404LV	85	ET400ATSB	82
4AC	121	ERT410	83	ET400LVAT	84
60VC	124, 125, 126	ERT410WHT	83	ET400LVRAT	85
60VWWC	124, 125, 126	ERT455	83	ET400RATSB	83
62HC	122, 123	ERT4980WHT	115, 116	ET4700	115
62HWWC	122, 123	ERT500	90	ET500	86
6AC	121	ERT501	88	ET500R	86
6T12MHWH	63	ERT501WHT	88	ET700	99
6T6WWH	63	ERT512	88	ET700R	99
6X7WWH	63	ERT512WHT	88	ETR300	78
80VC	129, 130	ERT513	89	ETR300W	78
80VWWC	129, 130	ERT513TS	89	ETR350	79
82HC	127, 128	ERT513WHT	89	ETR350W	79
82HWWC	127, 128	ERT513WHHTS	89	ETS300	80
8TSNF	50	ERT520	88	ETS300W	80
8TSSF	50	ERT520WHT	88	ETS350	81
AL6501FL	150	ERT521	88	ETS350W	81
AP	65	ERT530WHT	90	FE13PC	151
AP2SQ	58	ERT550	90	FE13PCW	151
AP3	47	ERT551	90	FFL23PC-T24	152
APC	65	ERT552	90	FFL23PCW-T24	152
APEL	58	ERT570	89	FNF26PC	152
APR	64	ERT701	102, 107, 114	FP25-OR	40
APX	64	ERT702	102, 107, 114	FP32-OR	40
ART	51	ERT703	102, 107, 114	FP40-OR	40
AYC-CHAIN/SET-U	52, 53	ERT704	97, 101, 106, 110, 113	GC	70
CC2	60	ERT705	98	GR8	48
CC4	61	ERT705	102, 107, 111	GR83	48
CHX	71, 72	ERT706	101, 113	HB-SPM	54
CU2	59	ERT707	96, 100, 105, 110, 113	HBAYC-CHAIN/SET-U	53
CX	67	ERT707WHT	96, 100, 105, 110, 113	HBI	54
EEX	66	ERT708	102, 107, 114	HBL	53
EI2072AT	117	ERT709	100, 105	HBL-SPM	53
EI2072RAT	118	ERT709WHT	100, 105	HPEL10	32
EI2700	108	ERT710	96, 100, 105, 110, 113	HPEL15	32
EI2700AT	109	ERT711	97, 101	HPEL70	32
EI2700R	108	ERT712	96, 100, 105	HPFZ15	14
EI400ATSB	82	ERT712TS	96, 100, 105	HPNKS1K	22
EI400LVAT	84	ERT713	96, 100, 105	HPNKY1K	22
EI4700	116	ERT713LTS	97, 101, 106	HPNKY40	22
EI4700AT	116	ERT713TS	96, 100, 105	HPSF10K	30
EI500AT	87	ERT713WHT	96, 100, 105	HPSF15K	30
EI500RT	87	ERT713WHHTS	96, 100, 105	HPSF70K	30
EI700	91	ERT714	97, 101, 106, 110, 113	HPTR2315	35
EI700AT	92	ERT714WHT	97, 101, 106, 110, 113	HPTR2325	35
EI700ATNB	94	ERT716WHT	98, 101, 110, 113	HPTR2340	35
EI700NB	95	ERT717WHT	101	HPWM50P	18
EI700R	91	ERT721	98, 103, 107, 111	HPWM70	18
EI700RAT	93	ERT723	98, 103, 107, 111	HPWM70P	18
EI700U	104	ERT724	119	I5	52
EI700UAT	104	ERT725TS	98, 103, 106	ICVW1G	43
ERT401	83	ERT725WHT	98, 103, 106	LED110	134
ERT401LV	85	ERT725WHHTS	98, 103, 106	LED120	134
ERT401LVW	85	ERT770MTS	119	LED125	133
ERT401WHT	83	ERT770TS	119	LED125C	133

Product No.	Page No.	Product No.	Page No.	Product No.	Page No.
LED130	133	MS180W	143	WP32.....	24
LED130C	133	MS185D	141	WP40.....	24
LP10C	16	MS185DW	141	WPL2A.....	10
LP10G	16	MS185R	142	WPL2AC	10
LP70C.....	16	MS185RW	142	WPL4A.....	10
LP70G	16	MS188.....	143	WPL4AC	10
LS10G	16	MS188W	143	WPP15.....	10
LS15G	16	MS245R	142	WPP15C	10
LS70G	16	MS245RW	142	WPP25.....	10
MAC100	145	MS248.....	141	WPP25C	10
MAC100W	145	MS248W	141	WPP32.....	10
MD42FLW.....	150	MS276RD	140	WPP40.....	10
MHNKS1K.....	22	MS276RDW	140	WPP40C	10
MHNKY1K.....	22	MS280D	140	WPS10	10
MPAH15S	26	MS280DW	140	WPS15	10
MPAH15T	26	MS34.....	144	WPS25	10
MPAH25S	26	MS34W	144	WPS40	10
MPAH25T	26	MS80.....	144	WS	49
MPAH40S	26	MS80W	144	WS25	24
MPAH40T	26	MSLED100	146	WS40	24
MPBE-5A-175H-OR-MT-LL.....	42	MSLED180W	146	XP15.....	24
MPBE-5A-250H-OR-MT-LL.....	42	MT250.....	147	XP25.....	24
MPCW40-C3-OR.....	45	MT250PC	151	XP40.....	24
MPCW40-OR	45	MT250PCW	151	XR12208	62
MPEL10.....	32	MT250W.....	147	XR3	62
MPFZ15	14	MX1.....	147	XR6C	69
MPFZ15C.....	14	MX1W.....	147	XR9C	69
MPIC10.....	12	PA4	121	XS25	24
MPIC15.....	12	PA6	121	XS40	24
MPIT10.....	12	PC6H226	123	XTOR1A.....	8
MPIT15.....	12	PD6H142.....	122	XTOR1A-PC1	8
MPMM25.....	28	PD6V	126	XTOR1A-WT	8
MPMM40.....	28	PD6V120	125	XTOR2A.....	8
MPMS10.....	28	PD6V142	124	XTOR2A-N	8
MPMS15.....	28	PD8H142.....	127	XTOR2A-PC1	8
MPMS70.....	28	PD8H242.....	128	XTOR2A-WT	8
MPNKS40.....	22	PD8V120	130	XTOR3A.....	8
MPNKY40.....	22	PD8V142	129	XTOR3A-N	8
MPSF10K.....	30	PFL23PC-T24	153	XTOR3A-PC1	8
MPSF10K-MT	30	PFL23PC-T24	153	XTOR3A-WT	8
MPSF10T-MT	30	PQS2504IN1	138	Y-TOGGLE-10	52, 53, 54
MPSF15K-MT	30	PQS45	137		
MPSF15T-MT	30	PQS600R.....	137		
MPSF70K.....	30	RL706830E26WBS	77		
MPSS32-OR	36	RL706830WBS	76		
MPSS40-OR	36	SNF	50		
MPSS40-PD-OR.....	38	SQS505QD	136		
MPSS40Q-OR	36	SSF.....	50		
MPTR2315	35	ST1.....	68		
MPTR2325	35	TMQ150	148		
MPTR2340	35	TMQ150W	148		
MPTR4F40.....	35	TQS1000QD.....	136		
MPWM10G	19	TQS1200QDR	135		
MPWM50G	19	VT2-CHAIN/SET-U	55		
MPWM70G	19	VT3.....	55		
MQF150	148	WN	49		
MQF150W	148	WP15.....	24		
MS100PG	145	WP232R	49		
MS180.....	143	WP25.....	24		

Cooper Lighting, LLC

Customer First Center
1121 Highway 74 South
Peachtree City, GA 30269

P: 770-486-4800

F: 770-486-4801

www.cooperlighting.com

International Sales, USA

Cooper Lighting, LLC
1121 Highway 74 South
Peachtree City, GA 30269

P: 770-486-4800

F: 770-486-4801

Canada

Cooper Lighting, LLC
5925 McLaughlin Road
Mississauga, Ontario L5R 1B8

P: 905-501-3000

F: 905-501-3172

The Cooper Lighting Family

Halo
Metalux
Lumark
Sure-Lites
Neo-Ray
Corelite
Portfolio
IRIS
Shaper
io
Lumière
Invue
McGraw-Edison
Streetworks
Fail-Safe
MWS
RSA
Ametrix

Domestic Facilities

Cranbury, New Jersey
Elk Grove Village, Illinois
Irving, Texas
Ontario, California
Peachtree City, Georgia

Canadian Facilities

Calgary, Alberta T2E 7V9
Mississauga, Ontario L5R 1B8



COOPER Lighting



COOPER Wiring Devices



COOPER Crouse-Hinds



COOPER Busmann



COOPER B-Line

Cooper Lighting, Lumark, Metalux, Sure-Lites, All-Pro and Halo Commercial are valuable trademarks of Cooper Industries in the United States and other countries. You are not permitted to use the Cooper Trademarks without the prior written consent of Cooper Industries.

Cooper Lighting, LLC

1121 Hwy 74 South
Peachtree City, Georgia 30269
P: 770-486-4800
www.cooperlighting.com