



General Purpose US Fuses

American Power Fuses AMP-TRAP 2000® AJT (Class J TD)



SMARTSPOT® with Maximum circuit protection

Amp-trap 2000® SmartSpot® AJT fuses now provide a visual open fuse indicator. With advanced material technology added to the existing product line the AJT fuse provides IEC Type "2" (No Damage) protection to main, feeder, and branch circuits, for all types of loads — yet, they require only half the mounting space needed for 600VAC Class RK fuses. AJTs time delay characteristics for handling typical in-rush currents, its current limiting ability.

Features/Benefits

- Solid State SmartSpot Indicator
- Time delay for motor starting and transformer inrush
- 300kA interrupting rating - self-certified, UL witnessed tests
- Extremely current limiting for low peak let-thru current
- Most current limiting UL class fuse
- Small footprint requires less mounting space and allows smaller, more economical fuse blocks
- Easy 2-to-1 selectivity for prevention of nuisance shutdowns
- Unique Class J dimensions prevent replacement errors
- High-visibility orange label gives instant recognition
- Metal-embossed date and catalog number for traceability and lasting identification
- Fiberglass body provides dimensional stability in harsh industrial settings
- High-grade silica filler ensures fast arc quenching
- Optional EI Indicator/Switch mount for AJT70 to 600 open fuse indication

Ratings

AC: 1 to 600A
 600VAC, 200kA I.R. (self certified for 600VAC, 300kA I.R., UL witnessed)

DC: 1 to 600A
 500VDC, 100kA I.R.

Highlights

- Smart Spot Indicator
- Time Delay
- Highly Current Limiting
- DC Ratings
- Optional Mechanical Indicator (70 to 600A fuses)

Applications

- Motor Circuits
- Mains
- Feeders
- Branch Circuits
- Lighting, Heating and General Loads
- Transformers
- Control Panels
- Circuit Breaker Back-up
- Bus Duct
- Load Centers

Approvals



- AJT (1-600):
- UL Listed to Standard 248-8
 - DC Listed to UL Standard 198L
 - CSA Certified to Standard C22.2 No. 248.8
 - IEC 269-2-1
- AJT (70-600) EI:
- UL Component Recognized
 - DC Tested to UL Standard 198L

General Purpose US Fuses



American Power Fuses AMP-TRAP 2000® AJT (Class J TD)



Standard Fuse Ampere Ratings, Catalog Numbers and Ref Numbers

Ampere Rating	Catalog Number	Reference Number	Ampere Rating	Catalog Number	Reference Number
1	AJT1	X214748	25	AJT25	X211160
1-1/4	AJT1-1/4	C215765	30	AJT30	W213229
1-1/2	AJT1-1/2	B215258	35	AJT35	M213727
1-6/10	AJT1-6/10	G216275	40	AJT40	C215259
1-8/10	AJT1-8/10	H216782	45	AJT45	D215766
2	AJT2	P219364	50	AJT50	Z217303
2-1/4	AJT2-1/4	A200882	60	AJT60	B218846
2-1/2	AJT2-1/2	T223094	70	AJT70*	L201421*
2-8/10	AJT2-8/10	M201422	80	AJT80*	W211159*
3	AJT3	Q211683	90	AJT90*	V212193*
3-2/10	AJT3-2/10	L212714	100	AJT100*	B215764*
3-1/2	AJT3-1/2	W212194	110	AJT110*	F216780*
4	AJT4	W214241	125	AJT125*	A217810*
4-1/2	AJT4-1/2	Y214749	150	AJT150*	Y218843*
5	AJT5	H216276	175	AJT175*	K219889*
5-6/10	AJT5-6/10	J216783	200	AJT200*	Y200880*
6	AJT6	D217813	225	AJT225*	V211158*
6-1/4	AJT6-1/4	P218329	250	AJT250*	K212713*
7	AJT7	Q219365	300	AJT300*	L213726*
8	AJT8	M219891	350	AJT350*	W214747*
9	AJT9	D222574	400	AJT400*	G216781*
10	AJT10	Y217302	450	AJT450*	M218327*
12	AJT12	C217812	500	AJT500*	N219363*
15	AJT15	N218328	600	AJT600*	C222573*
17-1/2	AJT17-1/2	A218845			
20	AJT20	Z201939			

*For optional indicator/switch mount add EI. For Example: AJT100EI. See table below

Note: Indicator not available for rating 1A to 7A.

Recommended Fuse Blocks With Box Connectors for Amp-trap® Class J Fuses

Fuse Ampere Rating	600V OR LESS			
	1 Pole		3 pole	
	Catalog Number	Reference Number	Catalog Number	Reference Number
0-30	US3J1I	M212922	US3J3I	K214967
31-60	US6J1I	F222047	US6J3I	M211381
61-100	61036J	Z201640	61038J	G212917
101-200	62001J	D214455	62003J	E214962
201-400	64031J	X218543	64033J	S219068
401-600	6631J	P201125	6633J	A201641

A variety of pole configurations and termination provisions is available.



General Purpose US Fuses

American Power Fuses AMP-TRAP 2000® AJT (Class J TD)

Dimensions

AMPERE RATING	A		B		C		D		E		F		G		H	
	In.	mm	In.	mm	In.	mm	In.	mm	In.	mm	In.	mm	In.	mm	In.	mm
1-30	2-1/4	57	13/16	21	-	-	-	-	-	-	-	-	-	-	-	-
31-60	2-3/8	60	1-1/16	27	-	-	-	-	-	-	-	-	-	-	-	
61-100	4-5/8	117	1-1/8	29	1/8	3.2	3/4	19	1	25	3-5/8	92	3/8	10	9/32	7
101-200	5-3/4	146	1-5/8	41	3/16	4.8	1-1/8	29	1-3/8	35	4-3/8	111	3/8	10	9/32	7
201-400	7-1/8	181	2-1/8	54	1/4	6.3	1-5/8	41	1-7/8	48	5-1/4	133	17/32	14	13/32	10
401-600	8	203	2-1/2	64	3/8	9.5	2	51	2-1/8	54	6	152	11/16	18	17/32	13

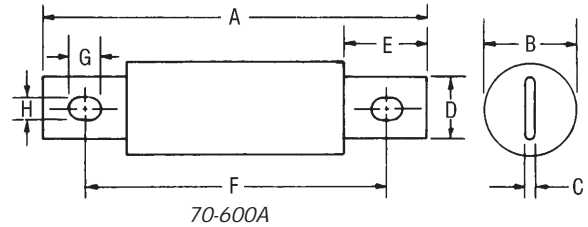
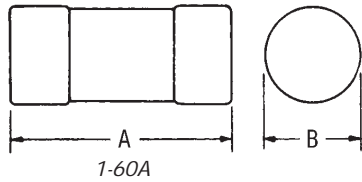

Optional Indicator/Microswitch Mount (EI) dimensions:

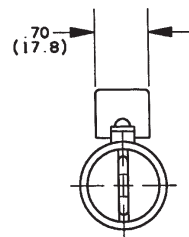
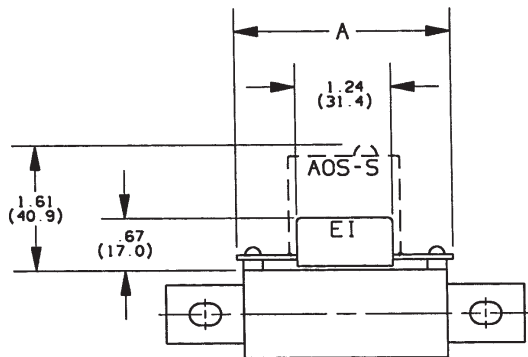

Note: Fuses with the EI option will receive the AOS-S or AOS-Q Add-On-Switch which is ordered separately.

Catalog Number	Reference Number	A
AJT70EI	Y201938	
AJT80EI	P211682	2.80
AJT90EI	V214240	(71.0)
AJT100EI	F216274	
AJT110EI	W217300	
AJT125EI	L218326	3.22
AJT150EI	M219362	(81.8)
AJT175EI	R223092	
AJT200EI	K201420	
AJT225EI	N211681	
AJT250EI	V213228	3.24
AJT300EI	T214239	(82.2)
AJT350EI	A215257	
AJT400EI	X217301	
AJT450EI	Z218844	
AJT500EI	L219890	3.61
AJT600EI	S223093	(91.8)

General Purpose US Fuses

American Power Fuses
AMP-TRAP 2000®
AJT (Class J TD)

AJT 1 to 600

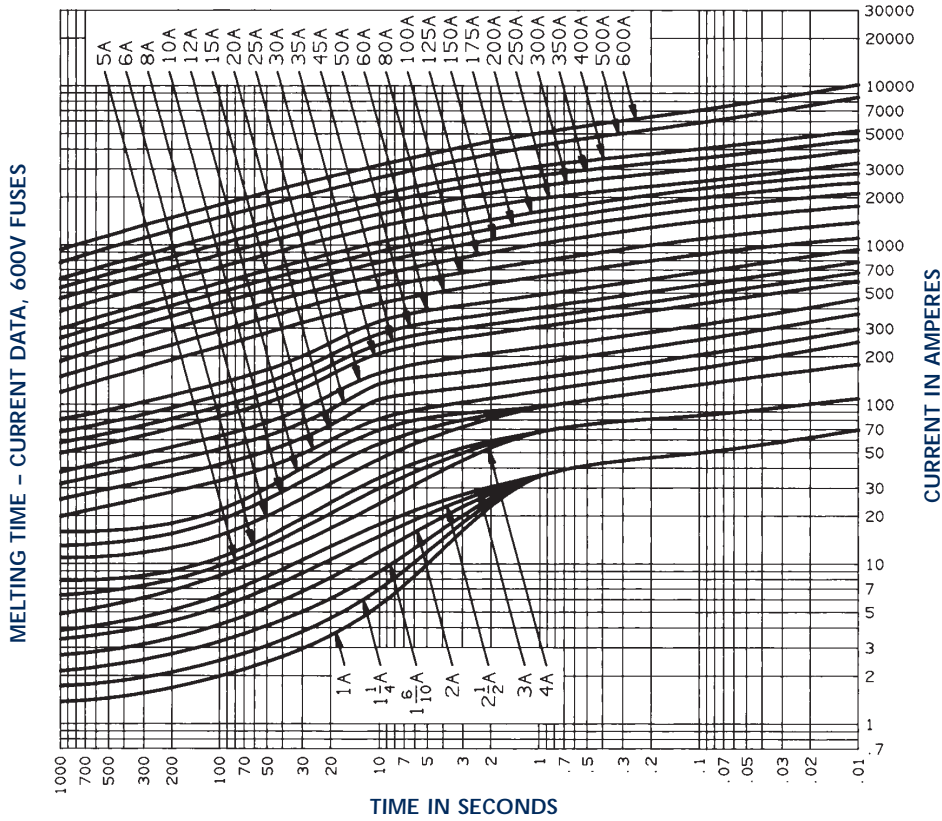

Peak Let-Through Current Data AJT 30 to 600, 600 Volts AC

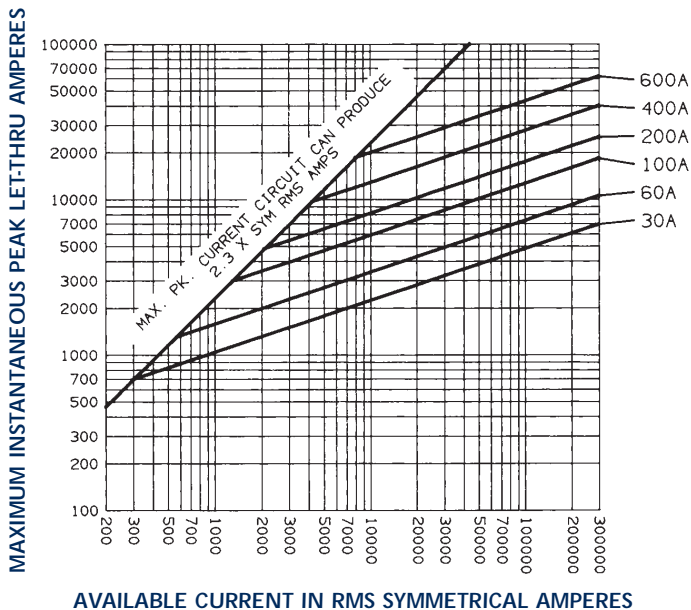

Three Phase Motor Fuse Selection

230 Volt Three Phase Class J AJT Fuses

Motor HP	Full Load Amperes at 230V	Recommended Fuse Ampere Rating Motor Acceleration Times		
		Minimum 2 sec.	Typical 5 sec.	Heavy Load Over 5 sec.
1/2	2.2	3	3-1/2	4
3/4	3.2	4	5	6
1	4.2	5	6-1/4	8
1-1/2	6	8	9	10
2	6.8	8	10	12
3	9.6	12	15	17-1/2
5	15.2	20	25	30
7-1/2	22	30	35	40
10	28	35	40	50
15	42	50	60	80
20	54	70	80	100
25	68	80	100	125
30	80	100	125	150
40	104	125	150	200
50	130	175	200	250
60	154	200	225	300
75	192	250	300	350
100	248	300	350	450
125	312	400	450	600
150	360	450	500	600
200	480	600	-	-



General Purpose US Fuses

American Power Fuses AMP-TRAP 2000® AJT (Class J TD)

Three Phase Motor Fuse Selection

380 Volt Three Phase Class J AJT Fuses

Motor HP	Full Load Amperes at 380V	Recommended Fuse Ampere Rating		
		Motor Acceleration Times		
		Minimum 2 sec.	Typical 5 sec.	Heavy Load Over 5 sec.
1/2	1.3	1-6/10	2	2-1/4
3/4	1.9	2-1/2	2-8/10	3-1/2
1	2.5	3-2/10	4	4-1/2
1-1/2	3.6	4-1/2	5-6/10	6
2	4.1	5	6	7
3	5.8	8	8	10
5	9.2	12	15	17-1/2
7-1/2	13.3	17-1/2	20	25
10	17	20	25	30
15	25	30	40	45
20	33	40	50	60
25	41	50	60	70
30	48	60	80	90
40	68	80	100	125
50	79	90	125	150
60	93	110	150	175
75	116	150	175	200
100	150	175	225	250
125	189	250	300	350
150	218	300	350	400
200	291	350	450	500

Three Phase Motor Fuse Selection

575 Volt Three Phase Class J AJT Fuses

Motor HP	Full Load Amperes at 575V	Recommended Fuse Ampere Rating		
		Motor Acceleration Times		
		Minimum 2 sec.	Typical 5 sec.	Heavy Load Over 5 sec.
1/2	.9	1-1/4	1-1/2	1-6/10
3/4	1.3	1-6/10	2	1-1/2
1	1.7	2-1/4	2-1/2	3
1-1/2	2.4	3	3-1/2	4-1/2
2	2.7	3-2/10	4	5
3	3.9	5	6	7
5	6.1	8	9	12
7-1/2	9	12	15	17-1/2
10	11	15	17-1/2	20
15	17	20	25	30
20	22	30	35	35
25	27	35	40	50
30	32	40	50	60
40	41	50	60	70
50	52	70	80	90
60	62	80	90	110
75	77	100	125	150
100	99	125	150	175
125	125	150	200	225
150	144	175	225	250
200	192	250	300	350
250	240	300	350	400
300	289	350	450	500

460 Volt Three Phase Class J AJT Fuses

Motor HP	Full Load Amperes at 460V	Recommended Fuse Ampere Rating		
		Motor Acceleration Times		
		Minimum 2 sec.	Typical 5 sec.	Heavy Load Over 5 sec.
1/2	1.1	1-1/2	1-6/10	2
3/4	1.6	2	2-1/4	3
1	2.1	2-1/2	3-2/10	4
1-1/2	3	3-1/2	4-1/2	5-6/10
2	3.4	4	5	6
3	4.8	6	8	9
5	7.6	10	12	15
7-1/2	11	15	15	20
10	14	17-1/2	20	25
15	21	25	30	40
20	27	35	40	50
25	34	40	50	60
30	40	50	60	70
40	52	70	80	90
50	65	80	100	125
60	77	100	125	150
75	96	125	150	175
100	124	175	200	250
125	156	200	225	300
150	180	225	250	350
200	240	300	350	450
250	302	400	450	600
300	361	450	600	-

Minimum - Minimum sizing may not be heavy enough for motors with code letter G or higher.

Typical - Suggested for most applications. Will coordinate with NEMA Class 20 overload relays. Suitable for motor acceleration times up to 5 seconds.

Heavy Load - In accordance with Table 430-152. If this fuse is not sufficient to start the load, it may be increased to a maximum of 225% of full-load amperes (430-52 Exc. 2b). Use this column for Design E Motors.



General Purpose US Fuses

American Power Fuses AMP-TRAP 2000® A4BQ (Class L TD)



Put the highest current-limitation...
at your service.

Amp-trap 2000® A4BQ fuses are 20% more current limiting than any other Class L fuse on the market. When correctly coordinated, they bring a superior level of protection to service entrance equipment. Downstream circuit components have maximum protection against short circuit let-thru current. A4BQs built-in, 4-second time delay characteristic (at 500% of rated current) accommodates harmless inrush currents with no nuisance opening.

Features/Benefits

- Fastest operation under short circuit conditions: Let-thru currents are typically 20% lower, with a corresponding let-thru energy (clearing I²t) up to 40% lower than the next fastest Class L fuse
- Time delay for high inrush loads such as motors and transformers, without nuisance opening
- 300kA interrupting rating - self-certified, UL witnessed tests
- Most current limiting for lowest peak let-thru current; even at fault currents up to 300kA
- Pure silver links ensure lowest let-thru current and longer fuse life
- Easy 2-to-1 selectivity for prevention of nuisance shutdowns and "blackouts"
- Rejection-style design prevents replacement errors
- High-visibility orange label gives instant recognition
- Reduced inventory because A4BQ can replace all older types of Class L fuses now in service
- Metal-embossed date and catalog number for traceability and lasting identification
- Fiberglass body provides dimensional stability in harsh industrial settings
- High-grade silica filler ensures fast arc quenching

Ratings

AC: 100 to 6000A 600VAC, 200k A I.R. (self certified for 600VAC, 300k A I.R., UL witnessed) 4-second delay at 500% rating

Note: 100-600A ratings are non-listed

DC: 601 to 3000A 600VDC, 100kA I.R.

Highlights

- Time Delay
- Industry's Most Current-Limiting Class L Fuse
- Pure Silver Elements
- AC & DC Rated

Applications

- Mains, Feeders
- Large Motors
- Lighting, Heating and General Loads
- Circuit Breaker Back-up
- DC Rated: UPS DC Links, Battery Disconnects, Other DC Applications

Approvals

- UL Listed to Standard 248-10 (601-6000A)
- DC Listed to UL Standard 198L (601-3000A)
- CSA Certified to Standard C22.2 No. 248.10 (601-6000A)

**Please contact factory for special trigger actuator*

General Purpose US Fuses

American Power Fuses AMP-TRAP 2000® A4BQ (Class L TD)

Standard Fuse Ampere Ratings

Ampere Rating	Catalog Number	Reference Number
100	A4BQ100	J215771
150	A4BQ150	X218336
200	A4BQ200	L222581
250	A4BQ250	H200889
300	A4BQ300	F201945
350	A4BQ350	Y211690
400	A4BQ400	E213237
450	A4BQ450	D214248
500	A4BQ500	F214756
600	A4BQ600	K215772
601	A4BQ601	H217311
650	A4BQ650	M217821
700	A4BQ700	Y218337
750	A4BQ750	K218854
800	A4BQ800	Z219373
900	A4BQ900	W219899
1000	A4BQ1000	P216282
1200	A4BQ1200	R216790
1350	A4BQ1350	G217310
1400	A4BQ1400	L217820
1500	A4BQ1500	J218853
1600	A4BQ1600	Y219372
1800	A4BQ1800	V219898
2000	A4BQ2000	B223101
2500	A4BQ2500	V201429
3000	A4BQ3000	F211168
3500	A4BQ3500	E212202
4000	A4BQ4000	W213735
5000	A4BQ5000	K215266
6000	A4BQ6000	Q216283

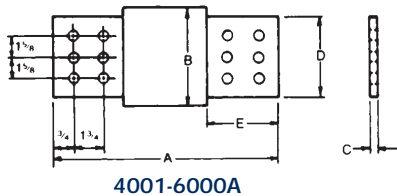
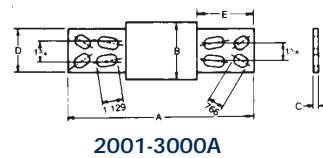
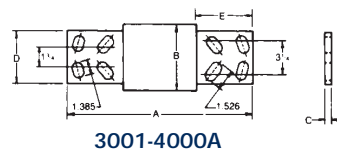
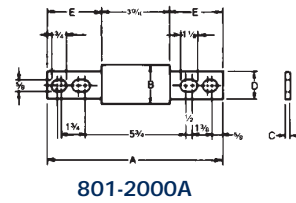
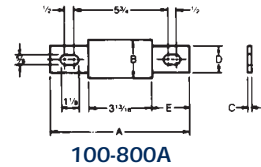

Safety Note: Class L fuses are dimensioned for one-way interchangeability. A Class L fuse of any lower ampere rating can be substituted for a given Class L fuse.

Dimensions

AMPERE RATING	A		B		C		D		E	
	In.	mm	In.	mm	In.	mm	In.	mm	In.	mm
100-600	8-5/8	219	2	51	5/16	8	1-5/8	41	2-13/32	61
601-800	8-5/8	219	2-1/2	63	3/8	9	2	51	2-13/32	61
801-1200	10-3/4	273	2-1/2	63	3/8	9	2	51	3-15/32	88
1201-1600	10-3/4	273	3	76	7/16	11	2-3/8	60	3-15/32	88
1601-2000	10-3/4	273	3-1/2	89	1/2	12	2-3/4	70	3-15/32	88
2001-2500	10-3/4	273	4-1/2	114	3/4	19	3-1/2	89	3-15/32	88
2501-3000	10-3/4	273	5	127	3/4	19	4	102	3-15/32	88
3001-4000	10-3/4	273	5-3/4	146	3/4	19	4-3/4	121	3-15/32	88
4001-5000	10-3/4	273	6-1/4	159	1	25	5-1/4	133	3-15/32	88
5001-6000	10-3/4	273	7-1/8	181	1	25	5-3/4	146	3-15/32	88



General Purpose US Fuses

American Power Fuses AMP-TRAP 2000® A4BQ (Class L TD)

A4BQ (601 to 6000) Let-Thru Current in kilo-Amperes

Available Fault RMS AMPS	601		800		1000		1200		1600		2000		2500		3000		4000		5000		6000	
	RMS	IP	RMS	IP	RMS	IP	RMS	IP	RMS	IP	RMS	IP	RMS	IP	RMS	IP	RMS	IP	RMS	IP	RMS	IP
10,000	7.4	17	8.7	20	10	23	10	23	10	23	10	23	10	23	10	23	10	23	10	23	10	23
15,000	8.3	19	10	23	12	27	13	30	15	35	15	35	15	35	15	35	15	35	15	35	15	35
20,000	9.1	21	11	25	13	29	14	33	17	39	20	46	20	46	20	46	20	46	20	46	20	46
25,000	9.8	23	12	27	13	31	15	35	18	42	22	50	25	58	25	58	25	58	25	58	25	58
30,000	10	24	13	29	14	33	16	37	20	45	23	53	29	66	30	69	30	69	30	69	30	69
35,000	11	25	13	30	15	35	17	39	20	47	24	56	30	69	35	81	35	81	35	81	35	81
40,000	12	27	14	32	16	37	18	41	21	49	25	58	31	72	36	83	40	92	40	92	40	92
50,000	13	29	15	34	17	40	19	44	23	53	27	63	34	78	39	89	48	111	50	115	50	115
60,000	13	30	16	36	18	42	20	47	25	57	29	67	36	83	41	94	51	118	60	138	60	138
80,000	14	33	17	40	20	46	23	52	27	62	32	73	40	91	45	104	57	130	67	153	77	176
100,000	16	36	19	43	22	50	24	56	29	67	34	79	43	98	49	112	61	140	72	165	83	190
150,000	18	41	21	49	25	57	28	64	33	77	39	90	49	112	56	128	70	160	82	189	94	217
200,000	20	45	24	54	27	63	31	71	37	84	43	100	53	123	61	141	77	176	90	208	104	239

The current limiting effect of A4BQ Class L fuses is presented in the table above. This table correlates actual fuse peak let-thru currents with equal value peak currents reached in the first half cycle (worst case) of short circuits in unfused circuits. The let-thru current is expressed as "Apparent RMS Symmetrical Amperes" in order to be more useful for practical applications. The currents are based on an assumed 15% power factor. Example: An A4BQ1200, when applied in a circuit with 40,000 RMS symmetrical amperes available, will limit that current during a short circuit, to an apparent 18,000 RMS symmetrical amperes. Under this condition, any equipment being protected would be subjected to only 18,000 RMS amperes.

A4BQ 601 to 6000

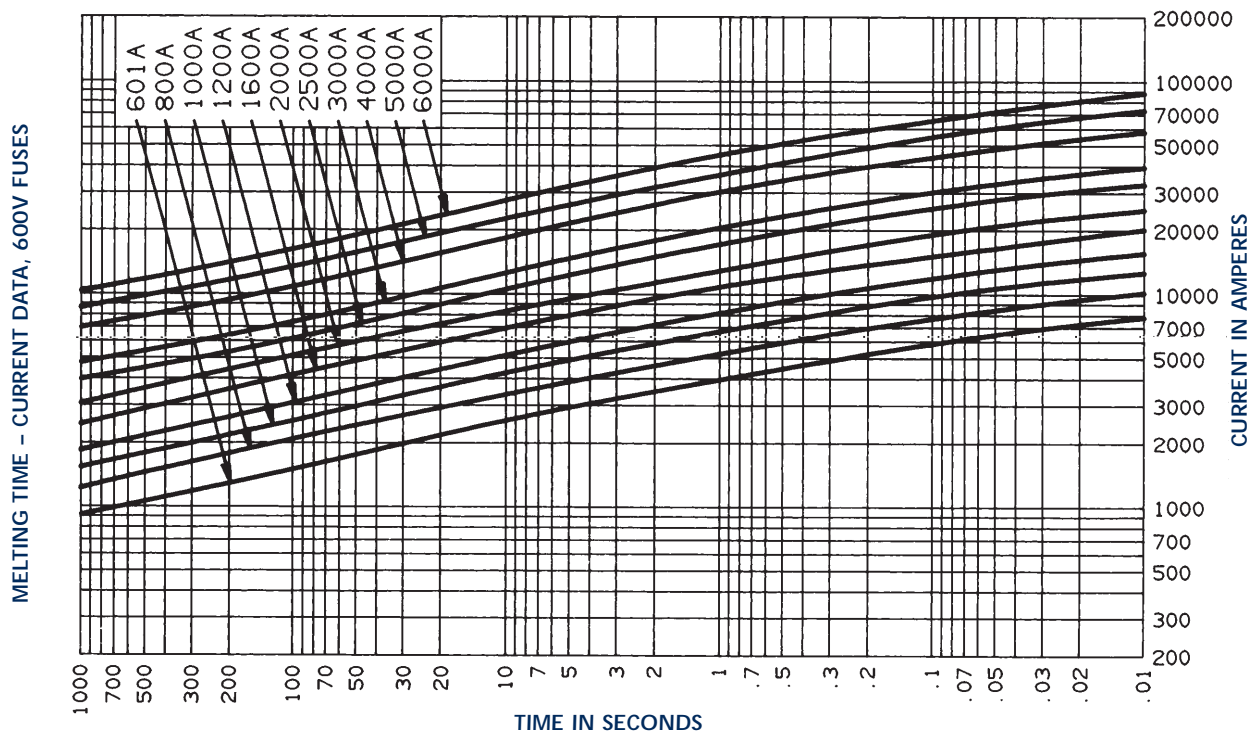

General Purpose US Fuses



American Power Fuses
AMP-TRAP 2000®
A4BQ (Class L TD)

Peak Let-Thru Current Data - A4BQ 601 to 6000, 600 Volts AC

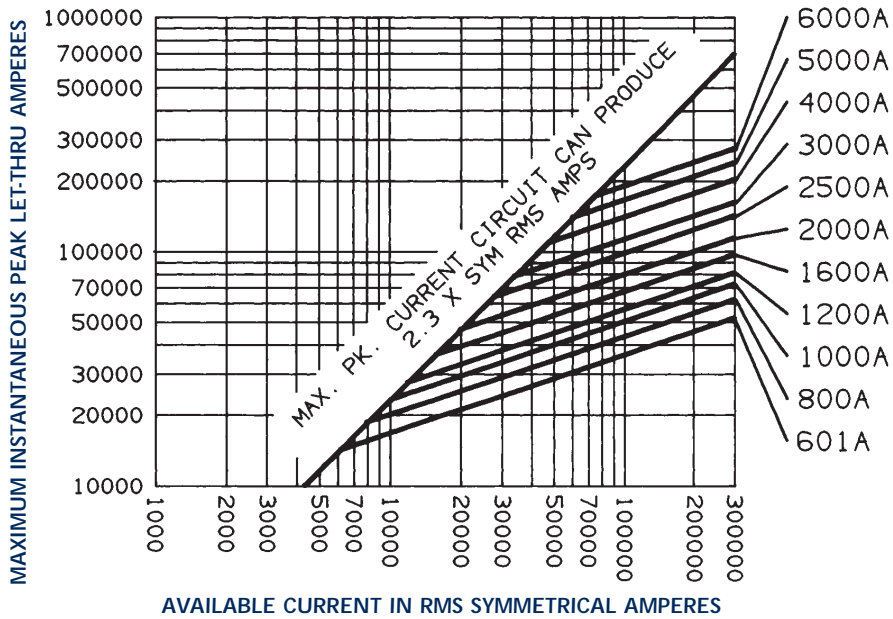



General Purpose US Fuses

American Power Fuses AMP-TRAP 2000® A2D and A6D (Class RK1 TD)



Upgrade yesterday's circuits to today's Type 2 protection

Amp-trap 2000® SmartSpot® A2D, A6D fuses now provide a visual open fuse indicator. With advanced material technology added to the existing product line the A2D, A6D fuses provide IEC Type "2" (No Damage) protection to main, feeder, and branch circuits, for all types of loads — A2D, A6D's time delay characteristics for handling harmless in-rush currents, its current limiting ability and wide range of ratings (from 1 to 600 Amperes) — give excellent protection for all your applications.

Features/Benefits

- Solid State SmartSpot Indicator
- Time delay for motor starting and transformer inrush currents without nuisance opening
- 300kA interrupting rating - self-certified, UL witnessed tests
- Extremely Current Limiting for low peak let-thru current
- Easy 2-to-1 selectivity for prevention of nuisance shut downs and "black outs"
- Rejection-style design prevents replacement errors (when used with recommended fuse blocks)
- High-visibility orange label gives instant recognition
- Reduced inventory by taking the place of RK5, K, and H fuses
- Metal-embossed date and catalog number for easier traceability and lasting identification
- Fiberglass body provides dimensional stability in harsh industrial settings
- Brass end-caps (blade-style) for cooler operation and superior performance

Ratings

- A2D AC: 1/10 to 600A 250VAC, 200kA I.R. (self certified for 250VAC, 300kA I.R., UL witnessed)
- A6D AC: 1/10 to 600A 600VAC, 200kA I.R. (self certified for 600VAC, 300kA I.R.)

Highlights

- SmartSpot Indicator
- Time Delay
- Current Limiting
- Plated Terminals

Applications

- Motors
- Safety Switches
- Transformers
- Branch Circuit Protection
- Disconnects
- Control Panels
- All General-purpose Circuits

Approvals



- UL Listed to Standard 248-12
- CSA Certified to Standard C22.2 No. 248.12

General Purpose US Fuses

American Power Fuses

AMP-TRAP 2000®

A2D and A6D (Class RK1 TD)

Standard Fuse Ampere Ratings

Ampere Rating	Cat. Number		Ref. Number		Amp. Rating	Cat. Number		Ref. Number	
	250V	600V	250V	600V		250V	600V	250V	600V
1/10	A2D1/10R	A6D1/10R	Q215248	R201932	10	A2D10R	A6D10R	Z216268	G211675
15/100	A2D15/100R	A6D15/100R	M217292	D212707	12	A2D12R	A6D12R	Z216774	M212186
2/10	A2D2/10R	A6D2/10R	J223085	C216271	15	A2D15R	A6D15R	R217802	N213222
3/10	A2D3/10R	A6D3/10R	K212184	G219357	17-1/2	A2D17-1/2R	A6D17-1/2R	C218318	E213720
4/10	A2D4/10R	A6D4/10R	N214740	E201415	20	A2D20R	A6D20R	P200872	C216777
1/2	A2D1/2R	A6D1/2R	T215757	P211153	25	A2D25R	A6D25R	B201412	Q217295
6/10	A2D6/10R	A6D6/10R	R218837	N214234	30	A2D30R	A6D30R	B212705	E219884
8/10	A2D8/10R	A6D8/10R	Q200873	D216778	35	A2D35R	A6D35R	L213220	W222567
1	A2D1R	A6D1R	Q218836	M214233	40	A2D40R	A6D40R	R215249	S201933
1-1/8	A2D1-1/8R	A6D1-1/8R	K213219	V222566	45	A2D45R	A6D45R	V215758	Q211154
1-1/4	A2D1-1/4R	A6D1-1/4R	A212704	D219883	50	A2D50R	A6D50R	N217293	E212708
1-4/10	A2D1-4/10R	A6D1-4/10R	B213717	L223087	60	A2D60R	A6D60R	E219355	R214743
1-6/10	A2D1-6/10R	A6D1-6/10R	J214230	R200874	70	A2D70R	A6D70R	N201929	E218320
1-8/10	A2D1-8/10R	A6D1-8/10R	M214739	D201414	75	A2D75R	-	L211150	-
2	A2D2R	A6D2R	P201930	V217805	80	A2D80R	A6D80R	D211672	S218838
2-1/4	A2D2-1/4R	A6D2-1/4R	C219882	T215251	90	A2D90R	A6D90R	J212183	F219356
2-1/2	A2D2-1/2R	A6D2-1/2R	D219354	Q214742	100	A2D100R	A6D100R	P215247	N211152
2-8/10	A2D2-8/10R	A6D2-8/10R	S222564	X215760	110	A2D110R	A6D110R	S215756	F211674
3	A2D3R	A6D3R	C213718	M223088	125	A2D125R	A6D125R	Y216267	L212185
3-2/10	A2D3-2/10R	A6D3-2/10R	E211673	T218839	150	A2D150R	A6D150R	Y216773	C212706
3-1/2	A2D3-1/2R	A6D3-1/2R	M211151	F218321	175	A2D175R	A6D175R	L217291	M213221
4	A2D4R	A6D4R	A216269	H211676	200	A2D200R	A6D200R	Q217801	D213719
4-1/2	A2D4-1/2R	A6D4-1/2R	K214231	S200875	225	A2D225R	A6D225R	B218317	L214232
5	A2D5R	A6D5R	S217803	P213223	250	A2D250R	A6D250R	P218835	P214741
5-6/10	A2D5-6/10R	A6D5-6/10R	A216775	N212187	300	A2D300R	A6D300R	C219353	S215250
6	A2D6R	A6D6R	T222565	V215252	350	A2D350R	A6D350R	B219881	W215759
6-1/4	A2D6-1/4R	A6D6-1/4R	D218319	F213721	400	A2D400R	A6D400R	R222563	B216270
7	A2D7R	A6D7R	K223086	Y215761	450	A2D450R	A6D450R	H223084	B216776
8	A2D8R	A6D8R	C201413	R217296	500	A2D500R	A6D500R	N200871	P217294
9	A2D9R	A6D9R	Q201931	W217806	600	A2D600R	A6D600R	A201411	T217804

Dimensions

Ampere Rating	A		B		C		D		E	
	In.	mm	In.	mm	In.	mm	In.	mm	In.	mm
250V-A2D										
0-30	2	51	9/16	14	-	-	-	-	-	-
31-60	3	76	13/16	21	-	-	-	-	-	-
61-100	5-8	149	1-1/16	27	1/8	3	3/4	19	1	25
101-200	7-1/8	181	1-9/16	40	3/16	5	1-1/8	28	1-3/8	35
201-400	8-5/8	219	2-1/16	53	1/4	6	1-5/8	41	1-7/8	48
401-600	10-3/8	264	2-9/16	66	1/4	6	2	51	2-1/4	57
600V-A6D										
0-30	5	127	13/16	21	-	-	-	-	-	-
31-60	5-1/2	139	1-1/16	27	-	-	-	-	-	-
61-100	7-7/8	200	1-5/16	34	1/8	3	3/4	19	1	25
101-200	9-5/8	244	1-13/16	46	3/16	5	1-1/8	28	1-3/8	35
201-400	11-5/8	295	2-9/16	66	1/4	6	1-5/8	41	1-7/8	48
401-600	13-3/8	340	3-1/8	80	1/4	6	2	51	2-1/4	57

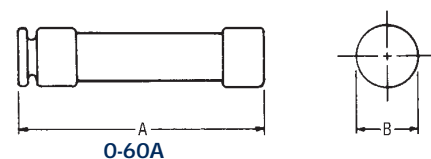
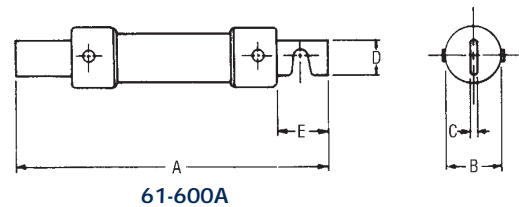



General Purpose US Fuses

American Power Fuses AMP-TRAP 2000® A2D and A6D (Class RK1 TD)

Recommended Fuse Blocks with Box Connectors for Amp-trap® Class RK1 Fuses

Fuse Ampere Rating	Catalog Number		Reference Number	
	250V		250V	
	1 Pole	3 pole	1 pole	3 pole
0-30	20306R	20308R	T213411	K215956
31-60	20606R	20608R	B212383	E214939
61-100	21036R	21038R	D201621	M212899
101-200	22001R	22003R	R213915	G214941
201-400	24001R	24003R	J219566	D222022
401-600	2631R	2633R	H214942	P215960

Fuse Ampere Rating	Catalog Number		Ref. Number	
	600V		600V	
	1 Pole	3 pole	1 pole	3 pole
0-30	60306R	60308R	H212389	K214438
31-60	60606R	60608R	K212391	M214440
61-100	61036R	61038R	W204788	Z211875
101-200	62001R	62003R	V212906	B213924
201-400	64001R	64003R	D219055	M222030
401-600	6631R	6633R	J216990	E218021

A variety of pole configurations and termination provisions is available.

A2D 15 to 600

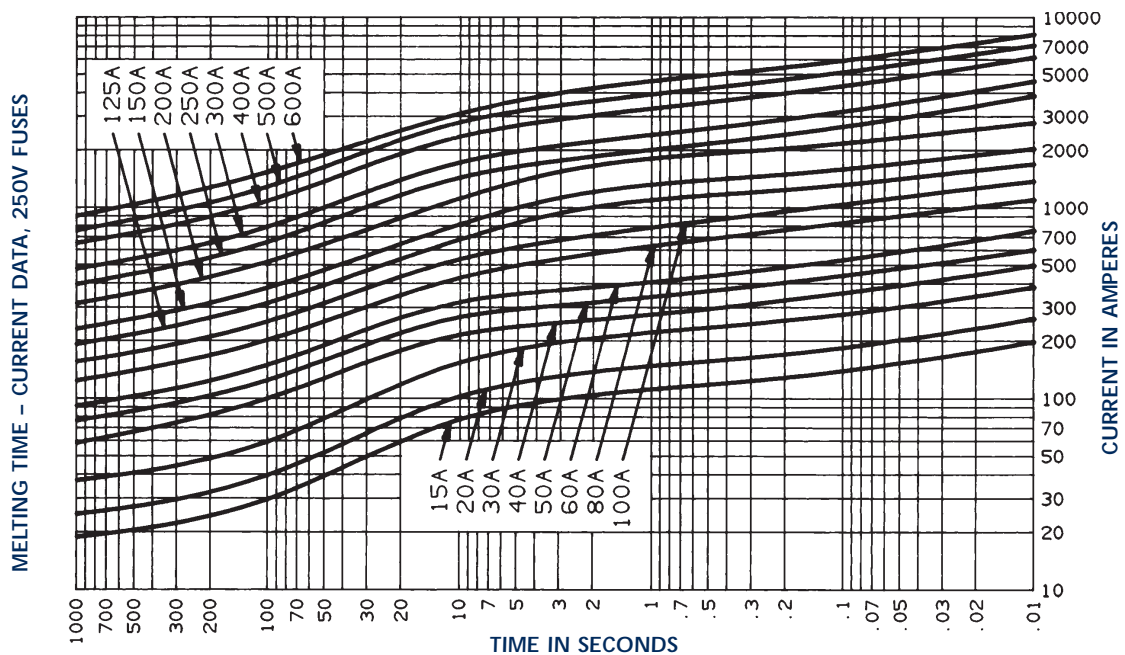

General Purpose US Fuses

American Power Fuses

AMP-TRAP 2000®

A2D and A6D (Class RK1 TD)

A2D 1/10 to 10

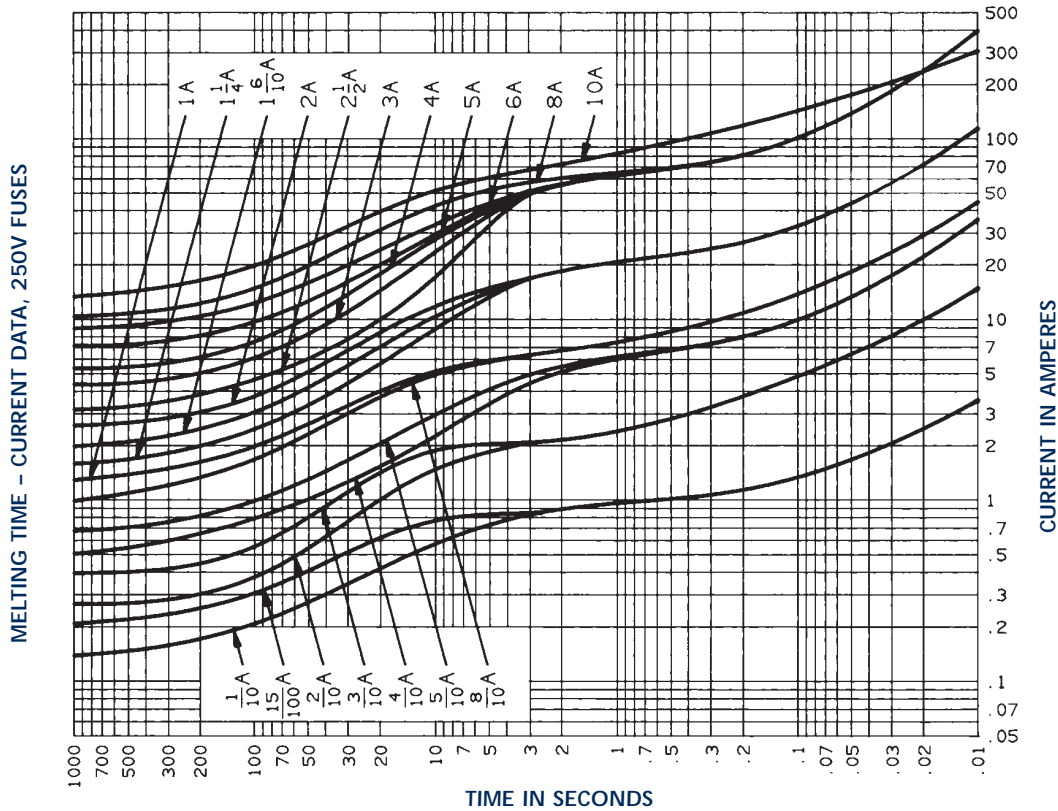

A6D 15 to 600

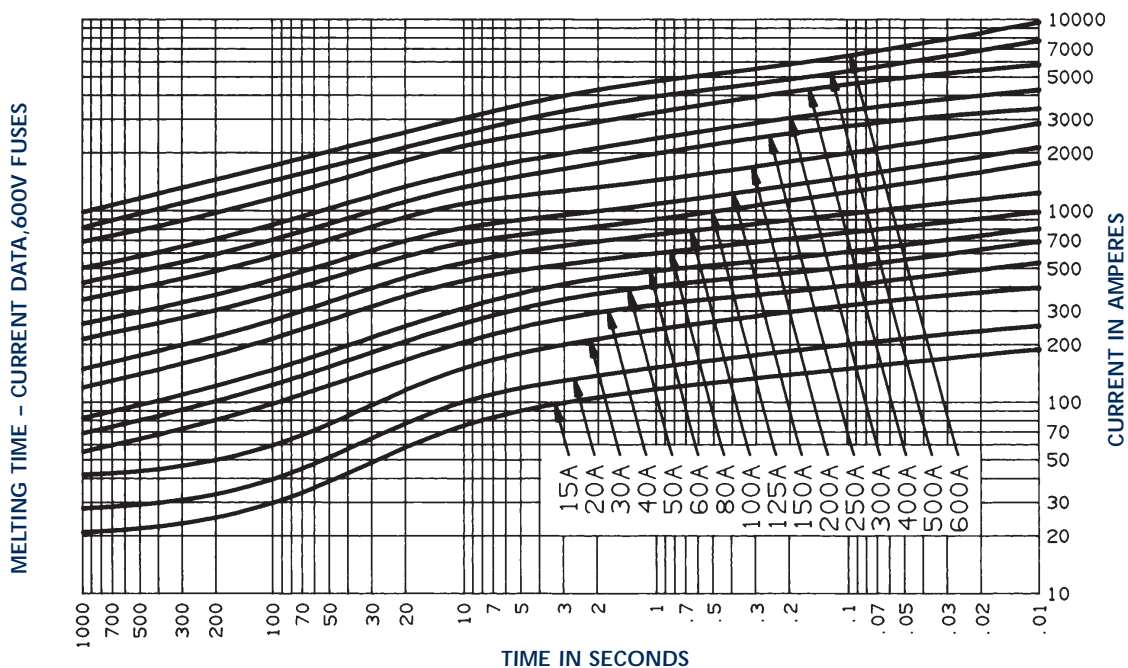



General Purpose US Fuses

American Power Fuses AMP-TRAP 2000® A2D and A6D (Class RK1 TD)

A6D 1/10 to 8

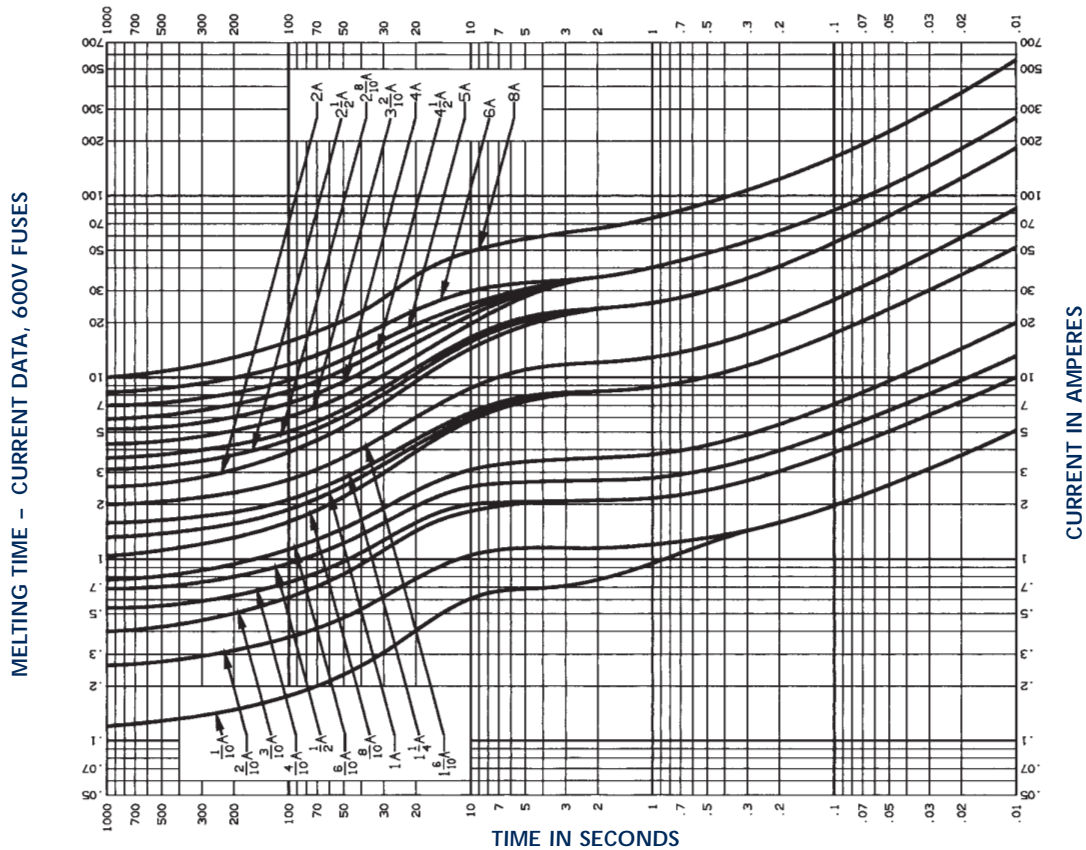

Peak Let-Thru Current Data A2D 30 to 600, 250 Volts AC

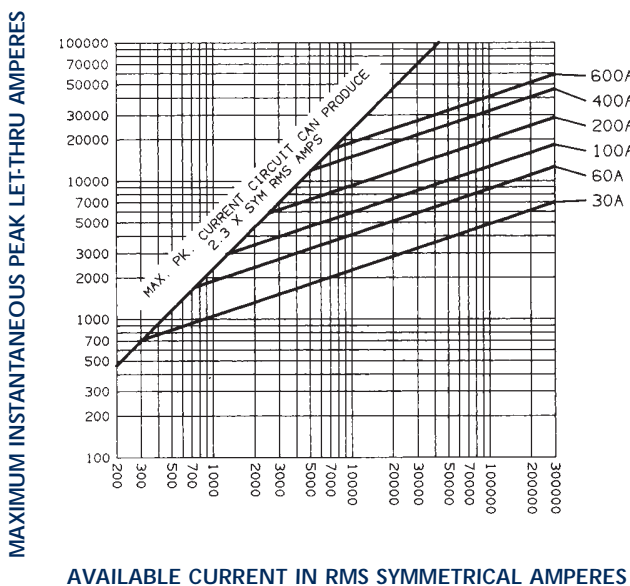

Peak Let-Thru Current Data A6D 30 to 600, 600 Volts AC

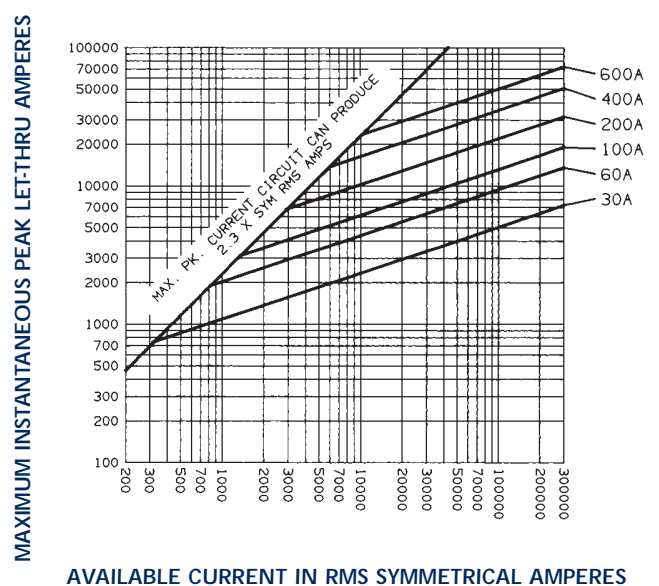

NOTE: SEE APPLICATION INFORMATION SECTION OF CATALOG (LOW VOLTAGE FUSES FOR MOTOR PROTECTION) FOR GUIDELINES ON THREE PHASE MOTOR FUSE SELECTION, CLASS RK1 A2D & RK1 A6D FUSES



General Purpose US Fuses

American Power Fuses AMP-TRAP 2000® ATDR (Class CC TD)



**The best protection for
today's small motors**

Amp-trap 2000® ATDR small-dimension fuses can provide IEC Type 2 "no damage" protection to your facility's increasingly sensitive branch circuit components and small motors – minimizing the risk of fault-related damage. ATDR Class CC fuses deliver the best time delay characteristics in their class with excellent cycling ability for small motor loads.

Features/Benefits

- Time delay for motor starting inrush currents without nuisance opening
- Highly current limiting for low peak let-thru current
- Improved cycling ability for frequent motor starts/stops without nuisance fuse opening
- Rejection-style design prevents replacement errors (when used with recommended fuse blocks)
- High-visibility orange label ensures instant recognition, simplifies replacement
- Metal-embossed date and catalog number for traceability and lasting identification
- Fiberglass body provides dimensional stability in harsh industrial settings
- High-grade silica filler ensures fast arc quenching and optimum current limitation

Ratings

AC: 1/4 to 30A 600VAC, 200kA I.R.

DC: 1/4 to 30A 300VDC, 100kA I.R.

Highlights

- Time Delay
- Best Choice for Small Motor Protection
- Highly Current-Limiting
- AC & DC Rated

Applications

- Small Motors
- Contactors
- Lighting, Heating and General Loads
- Branch Circuit Protector

Approvals



- UL Listed to Standard 248-4
- CSA Certified to Standard C22.2 No. 248.4
- DC Listed to UL Standard 198L

General Purpose US Fuses



American Power Fuses AMP-TRAP 2000® ATDR (Class CC TD)

Standard Fuse Ampere Ratings

Ampere Rating	Catalog Number	Reference Number	Ampere Rating	Catalog Number	Reference Number
1/4	ATDR1/4	W200855	4	ATDR4	V217276
1/2	ATDR1/2	Q223068	4-1/2	ATDR4-1/2	Z217786
8/10	ATDR8/10	K201397	5	ATDR5	K218302
1	ATDR1	T217275	5-6/10	ATDR5-6/10	Z218821
1-1/8	ATDR1-1/8	Y218820	6	ATDR6	L219338
1-1/4	ATDR1-1/4	J218301	6-1/4	ATDR6-1/4	L219867
1-4/10	ATDR1-4/10	K219337	7	ATDR7	A222548
1-1/2	ATDR1-1/2	Y217785	7-1/2	ATDR7-1/2	R223069
1-6/10	ATDR1-6/10	K219866	8	ATDR8	X200856
1-8/10	ATDR1-8/10	Z222547	9	ATDR9	Y201915
2	ATDR2	S212168	10	ATDR10	J201396
2-1/4	ATDR2-1/4	T213204	12	ATDR12	X201914
2-1/2	ATDR2-1/2	J212689	15	ATDR15	V211135
2-8/10	ATDR2-8/10	L213703	7-1/2	ATDR17-1/2	L211656
3	ATDR3	Y215232	20	ATDR20	R214214
3-2/10	ATDR3-2/10	J216254	25	ATDR25	V214723
3-1/2	ATDR3-1/2	C215742	30	ATDR30	G216758

Small Motor Fuse Protection, 600 Volts AC or Less

Motor Full load Amperes	ATDR Rating*	
	Minimum Duty	Normal Duty
.71 - .89	1-1/4	1-6/10
.90 - 1.19	1-6/10	2
1.20 - 1.34	2	2-1/2
1.35 - 1.79	2-1/2	3
1.80 - 2.25	3	4
2.26 - 2.69	4	5
2.70 - 2.90	4	6
2.91 - 3.20	5	6
3.21 - 3.75	5	7
3.76 - 4.50	6	8
4.51 - 5.34	8	10
5.35 - 5.69	10	12
5.70 - 6.70	12	12
6.71 - 7.79	12	15
7.80 - 8.88	15	17-1/2
8.89 - 11.1	17-1/2	20
11.2 - 13.3	20	25
13.4 - 15.2	25	30

Dimensions

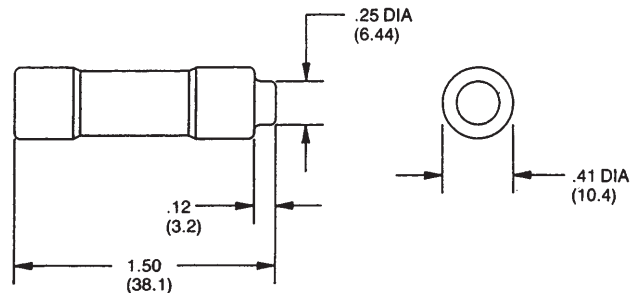

* The 1996 National Electrical Code allows time-delay Class CC fuses to be sized at up to 400% (maximum) of motor FLA, if needed.

Recommended Fuse Blocks for Class CC Fuses

Number of Poles	Catalog Number				Reference number			
	Ultrasafe Indicating Fuse Holder	Screw Connector w/ Double Quick Connects	Pressure Plate Connector w/ Double Quick Connects	Copper Box Connector	Ultrasafe Indicating Fuse Holder	Screw Connector w/ Double Quick Connects	Pressure Plate Connector w/ Double Quick Connects	Copper Box Connector
ADDER		30310R	30320R	30350R		W204857	Z217510	N213429
1	USCC1I	30311R	30321R	30351R	X213943	R212397	M218534	G213929
2	USCC2I	30312R	30322R	30352R	D217008	Z212910	Y219579	V214447
3	USCC3I	30313R	30323R	30353R	Y218038	M213428	B222779	X214955



General Purpose US Fuses

American Power Fuses
AMP-TRAP 2000®
ATDR (Class CC TD)

ATDR 1/4 to 30

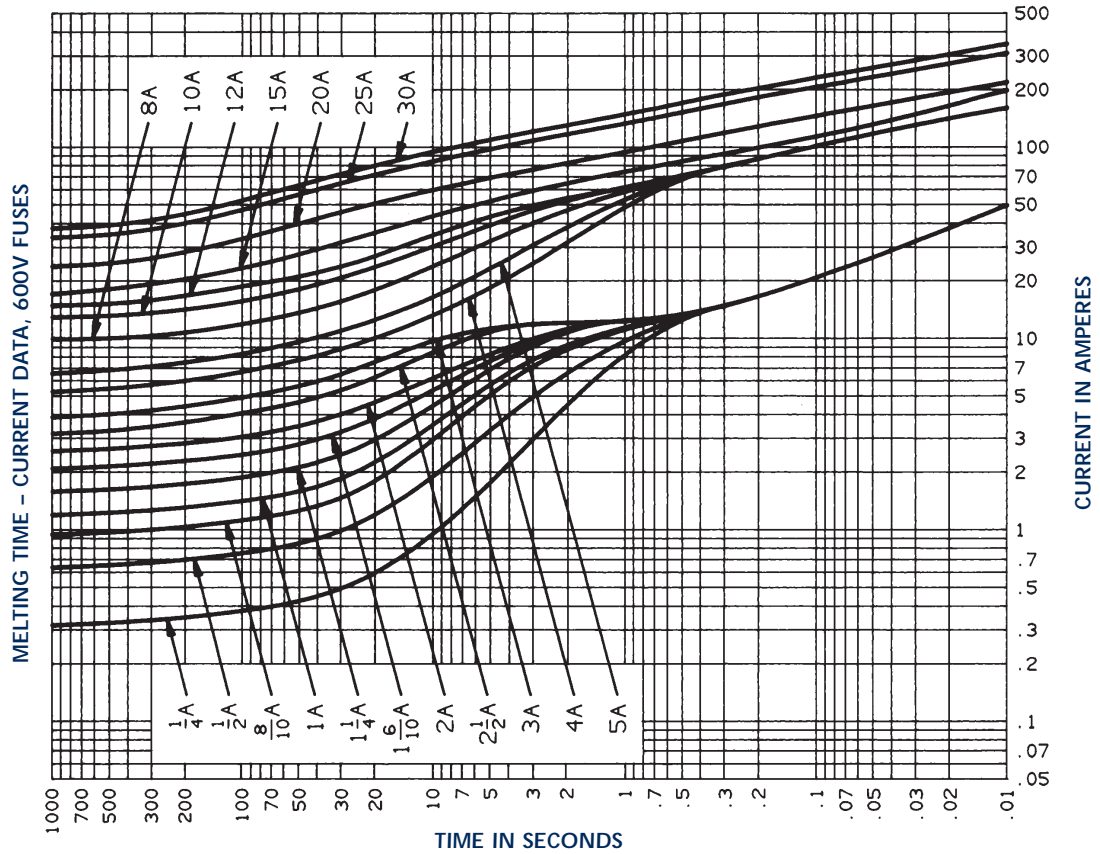

Peak Let-Through Current Data - ATDR 1/4 to 30, 600 Volts AC

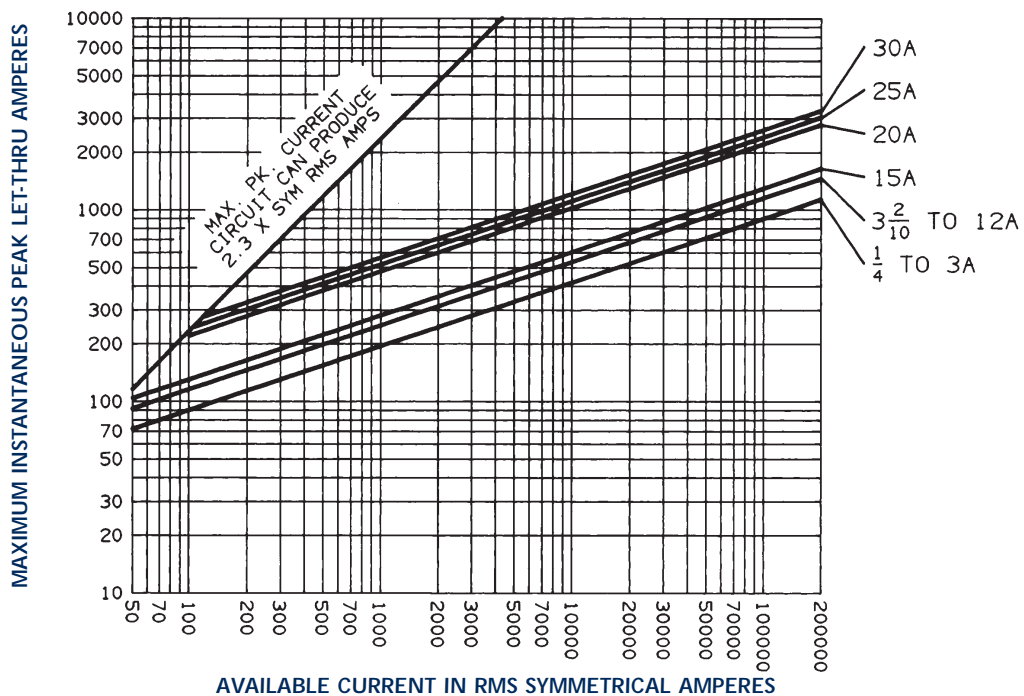



General Purpose US Fuses

American Power Fuses AMP-TRAP 2000® ATQR (Class CC TD)



Take control of fault currents headed for your control transformer

ATQR small-dimension fuses feature time delay characteristics ideally suited for the high inrush currents of control transformers, solenoids, and similar inductive loads. The newest member of our Amp-trap 2000® family of fuses - ATQR fuses provide superior protection for the branch circuits of electrical distribution systems.

Features/Benefits

- Time delay for control transformer inrush loads without nuisance opening
- Highly current limiting for low peak let-thru current
- Rejection-style design prevents replacement errors (when used with recommended fuse blocks)
- High-visibility orange label ensures instant recognition, and simplifies replacement
- Metal-embossed date and catalog number for traceability and lasting identification
- Fiberglass body provides dimensional stability in harsh industrial settings
- High-grade silica filler ensures fast arc quenching and high current limitation

Ratings

AC: 1/10 to 30A 600VAC, 200kA I.R.

Highlights

- Time Delay
- Best Choice for Small Transformer Protection
- Most Current-Limiting

Applications

- Control Transformers
- Solenoids
- Inductive Loads
- Lighting, Heating and General-purpose Loads

Approvals



- UL Listed to Standard 248-4
- CSA Certified to Standard C22.2 No. 248.4

General Purpose US Fuses



American Power Fuses AMP-TRAP 2000® ATQR (Class CC TD)



Standard Fuse Ampere Ratings, Reference Numbers

Ampere Rating	Catalog Number	Reference Number	Ampere Rating	Catalog Number	Reference Number
1/10	ATQR1/10	E201921	2-8/10	ATQR2-8/10	Q216260
1/8	ATQR1/8	A212175	3	ATQR3	T218310
15/100	ATQR15/100	S223507	3-2/10	ATQR3-2/10	V219346
3/16	ATQR3/16	J222556	3-1/2	ATQR3-1/2	G218828
2/10	ATQR2/10	Q216766	4	ATQR4	S201404
1/4	ATQR1/4	V211664	4-1/2	ATQR4-1/2	F201922
3/10	ATQR3/10	V219875	5	ATQR5	W211665
4/10	ATQR4/10	D211143	5-6/10	ATQR5-6/10	B212176
1/2	ATQR1/2	C211142	6	ATQR6	T212698
6/10	ATQR6/10	V213711	6-1/4	ATQR6-1/4	D213213
3/4	ATQR3/4	A223077	7	ATQR7	B214223
8/10	ATQR8/10	L215750	7-1/2	ATQR7-1/2	E214732
1	ATQR1	F218827	8	ATQR8	H215241
1-1/8	ATQR1-1/8	H222555	9	ATQR9	R216261
1-1/4	ATQR1-1/4	T219874	10	ATQR10	S212697
1-4/10	ATQR1-4/10	Z223076	12	ATQR12	C213212
1-1/2	ATQR1-1/2	T219345	15	ATQR15	T213710
1-6/10	ATQR1-6/10	E200863	17-1/2	ATQR17-1/2	A214222
1-8/10	ATQR1-8/10	R201403	20	ATQR20	D217284
2	ATQR2	D214731	25	ATQR25	H217794
2-1/4	ATQR2-1/4	K215749	30	ATQR30	F200864
2-1/2	ATQR2-1/2	G215240			

Recommended ATQR Class CC Primary Fuses For Single Phase Control Transformers

Trans VA	Primary		ATQR AMPS
	Volts	Fla	
25	600	0.04	1/10
	480	0.05	1/10
	240	0.10	2/10
	208	0.12	1/4
	120	0.21	4/10
50	600	0.08	1/4
	480	0.10	1/4
	240	0.21	4/10
	208	0.24	1/2
	120	0.42	6/10
75	600	0.13	1/4
	480	0.16	3/10
	240	0.31	1/2
	208	0.36	3/4
	120	0.63	1
100	600	0.17	3/10
	480	0.21	4/10
	240	0.42	6/10
	208	0.48	1
	120	0.83	1-1/2
150	600	0.25	1/2
	480	0.31	1/2
	240	0.63	1
	208	0.72	1-1/2
	120	1.25	2-1/2
200	600	0.33	1/2
	480	0.42	6/10
	240	0.83	1-1/2
	208	0.96	2
	120	1.67	3
250	600	0.42	6/10
	480	0.52	1-1/8
	240	1.04	2
	208	1.2	3
	120	2.08	4*

* Secondary protection is required for these ratings.
+ Fuse will withstand 30 x FLA for .01 second
++ Fuse will withstand 25 x FLA for .01 second

Trans VA	Primary		ATQR AMPS
	Volts	Fla	
300	600	0.50	1-1/8
	480	0.63	1-1/2
	240	1.25	2-1/2
	208	1.44	3
	120	2.5	5*
500	600	0.83	1-1/2
	480	1.04	2
	240	2.08	4*
	208	2.40	6*
	120	4.17	10*
750	600	1.25	2-1/2
	480	1.56	3
	240	3.13	7*
	208	3.61	8*
	120	6.25	15*
1000	600	1.67	3
	480	2.08	4*
	240	4.16	10*
	208	4.81	12*
	120	8.33	20*
1500	600	2.50	5*
	480	3.13	7*
	240	6.25	10
	208	7.21	20*
	120	12.5	25*
2000	600	3.33	8*
	480	4.17	10*
	240	8.33	20++*
	208	9.62	20++*
	600	5.00	12+*
3000	480	6.25	15+*
	240	12.5	30++*
	600	8.33	20++*
5000	480	10.4	25+*



General Purpose US Fuses

American Power Fuses AMP-TRAP 2000® ATQR (Class CC TD)

Recommended Fuse Blocks for Class CC Fuses

Catalog Number

Number of Poles	Ultrasafe Indicating Fuse Holder	Screw with Double Quick Connects	Pressure Plate with Double Quick Connects	Copper Box Connector
ADDER		30310R	30320R	30350R
1	USCC1I	30311R	30321R	30351R
2	USCC2I	30312R	30322R	30352R
3	USCC3I	30313R	30323R	30353R

Reference Number

Number of Poles	Ultrasafe Indicating Fuse Holder	Screw with Double Quick Connects	Pressure Plate with Double Quick Connects	Copper Box Connector
ADDER		W204857	Z217510	N213429
1	X213943	R212397	M218534	G213929
2	D217008	Z212910	Y219579	V214447
3	Y218038	M213428	B222779	X214955

Primary fuses - If primary FLA is less than 2 amps, fuse may be 300% max. (500% for motor control). If primary FLA exceeds 2 amps but is less than 9 amps, fuse may not exceed 167% of primary FLA unless secondary protection is used, when it may be increased to 250%. Fuse sizes shown are based on approx. 40 x FLA for .01 sec.

Dimensions

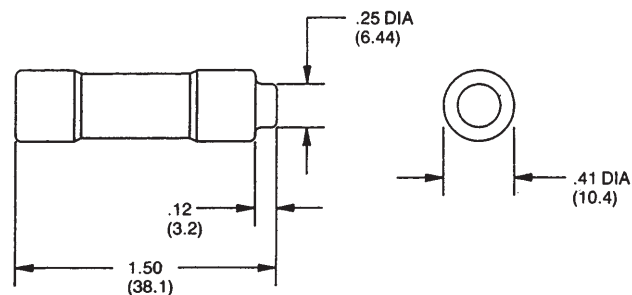

General Purpose US Fuses

American Power Fuses
 AMP-TRAP 2000®
 ATQR (Class CC TD)

ATQR 1/8 to 30

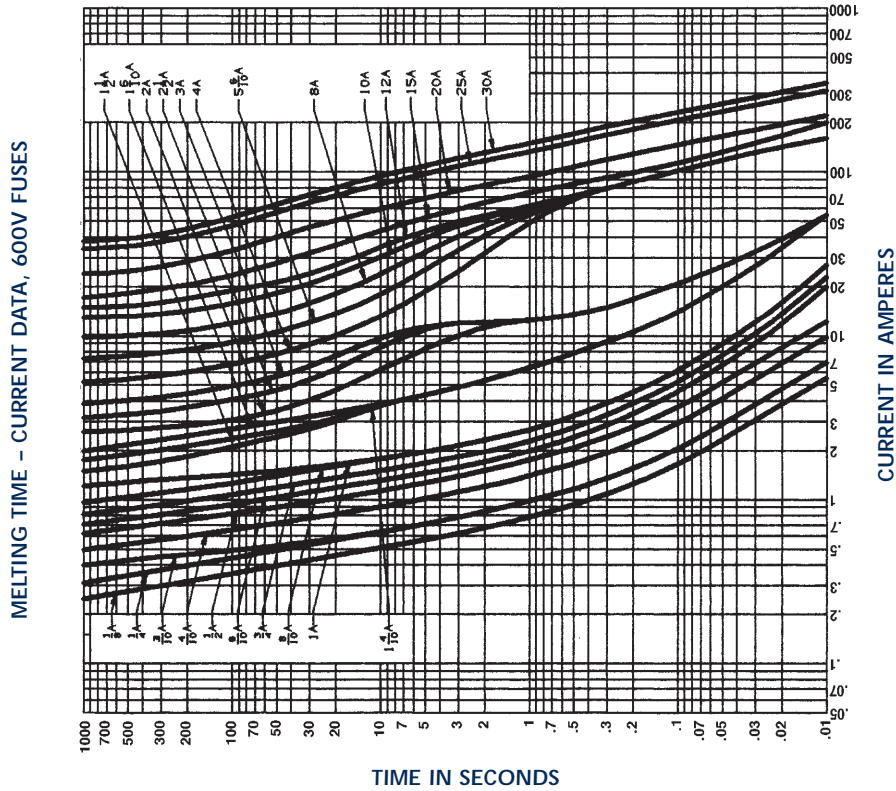

Peak Let-Through Current Data - ATQR 1/8 to 30, 600 Volts AC

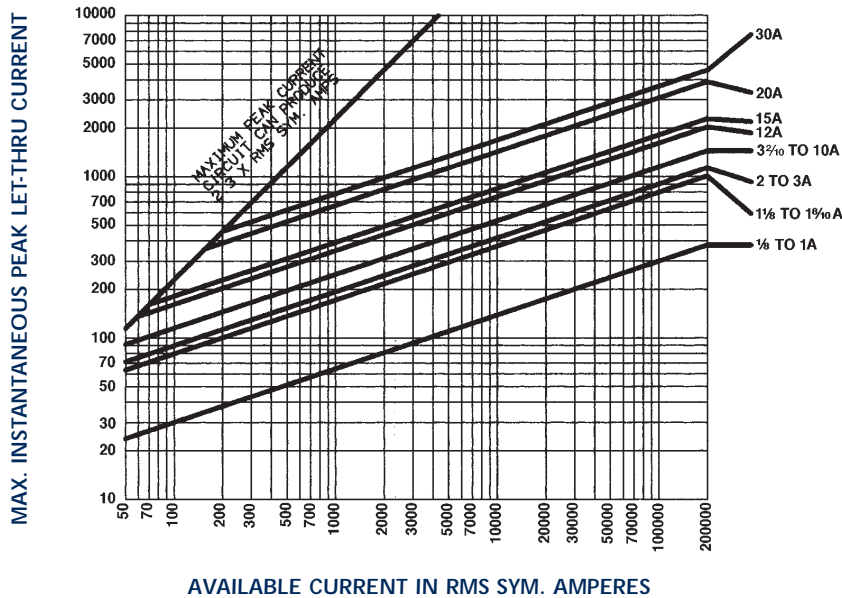



General Purpose US Fuses

American Power Fuses TRI-ONIC® TR and TRS (Class RK5 TD)



The industry's Most popular fuse for Motor circuit protection.

Tri-onic® SmartSpot® fuses now provide a visual open fuse indicator. With advanced material technology added to the existing product the TR and TRS current limiting time delay fuses are engineered for overcurrent protection of motors and transformers, service entrance equipment, feeder and branch circuits. Tri-onic proven time delay characteristic safely handles harmless starting currents and inrush currents associated with today's motors and transformers.

Features/Benefits

- Solid State SmartSpot Indicator
- Time delay for motor start-ups and transformer inrush currents without nuisance opening
- Current limiting for low peak let-thru current
- Rejection-style design prevents replacement errors (when used with recommended fuse blocks)
- Easy-to-read label for quick recognition and replacement
- Metal-embossed date and catalog number for traceability and lasting identification
- Fiberglass body provides dimensional stability in harsh industrial settings
- Brass end-caps (blade-style) for cooler operation and superior performance
- High-grade silica filler ensures fast arc quenching and high current limitation

Ratings

TR

AC: 1/10 to 600A 250VAC, 200kA I.R.

DC: 1/10 to 2 8/10A and 35 to 400A, 250VD, 20 A.I.R
3 to 30A & 450 to 600A,
160VDC, 20kA I.R.

TRS

AC: 1/10 to 600A, 600VAC, 200kA I.R.

DC: 1/10 to 12A, 600VDC, 20kA I.R.
70 to 600A, 600VDC, 100kA I.R.
15 to 60A, 300VDC, 20kA I.R.

Highlights

- Time Delay
- Current Limiting
- AC & DC Rated

Applications

- Motor Circuits
- Mains
- Feeders
- Branch Circuits
- Transformers
- Service Entrance Equipment
- General-purpose Protection

Approvals

- UL Listed to Standard 248-12
- CSA Certified to Standard C22.2 No. 248.12
- DC Listed to UL Standard 198L



General Purpose US Fuses

American Power Fuses

TRI-ONIC®

TR and TRS (Class RK5 TD)

Standard Fuse Ampere Ratings

Ampere Rating	Catalog Number		Reference Number		Ampere Rating	Catalog Number		Reference Number	
	250V	600V	250V	600V		250V	600V	250V	600V
1/10	TR1/10R	TRS1/10R	F222530	W216748	10	TR10R	TRS10R	D200839	N218811
15/100	TR15/100R	TRS15/100R	E201898	F223059	12	TR12R	TRS12R	S201381	B219858
2/10	TR2/10R	TRS2/10R	Z214198	X216749	15	TR15R	TRS15R	D211120	B201389
3/10	TR3/10R	TRS3/10R	C217260	J212160	17-1/2	TR17-1/2R	TRS17-1/2R	S211639	K211126
4/10	TR4/10R	TRS4/10R	Z223053	Y216750	20	TR20R	TRS20R	D214708	P217777
1/2	TR1/2R	TRS1/2R	Y223052	N217776	25	TR25R	TRS25R	G215217	B219329
6/10	TR6/10R	TRS6/10R	R216238	L213197	30	TR30R	TRS30R	F217769	K213196
8/10	TR8/10R	TRS8/10R	T219322	R217779	35	TR35R	TRS35R	F218804	J214207
1	TR1R	TRS1R	Z212151	H212159	40	TR40R	TRS40R	E200840	Q217778
1-1/8	TR1-1/8R	TRS1-1/8R	Q218284	G212158	45	TR45R	TRS45R	F201899	Q218813
1-1/4	TR1-1/4R	TRS1-1/4R	E217768	J211125	50	TR50R	TRS50R	B213188	D201391
1-4/10	TR1-4/10R	TRS1-4/10R	E218803	H213194	60	TR60R	TRS60R	P216742	M214716
1-6/10	TR1-6/10R	TRS1-6/10R	R219320	G214205	70	TR70R	TRS70R	Q219848	Y213691
1-8/10	TR1-8/10R	TRS1-8/10R	S219850	R215732	75	TR75R	TRS75R	E222529	P215730
2	TR2R	TRS2R	J215725	Q222539	80	TR80R	TRS80R	W223050	W216242
2-1/4	TR2-1/4R	TRS2-1/4R	A213187	H214206	90	TR90R	TRS90R	B200837	L217774
2-1/2	TR2-1/2R	TRS2-1/2R	Q212672	J213195	100	TR100R	TRS100R	K216738	D214202
2-8/10	TR2-8/10R	TRS2-8/10R	S213686	S215733	110	TR110R	TRS110R	B218800	K215220
3	TR3R	TRS3R	T219851	P215224	125	TR125R	TRS125R	N219317	N215729
3-2/10	TR3-2/10R	TRS3-2/10R	N216741	N201906	150	TR150R	TRS150R	P219847	S216745
3-1/2	TR3-1/2R	TRS3-1/2R	Q216237	M200847	175	TR175R	TRS175R	D222528	K217773
4	TR4R	TRS4R	A212152	D219860	200	TR200R	TRS200R	V223049	K218808
4-1/2	TR4-1/2R	TRS4-1/2R	G222531	A216246	225	TR225R	TRS225R	A200836	Y219855
5	TR5R	TRS5R	E214709	M211128	250	TR250R	TRS250R	P201378	L222535
5-6/10	TR5-6/10R	TRS5-6/10R	R212673	H223061	300	TR300R	TRS300R	B201895	J200844
6	TR6R	TRS6R	S218286	V215735	350	TR350R	TRS350R	A211117	J201902
6-1/4	TR6-1/4R	TRS6-1/4R	S218286	K212161	400	TR400R	TRS400R	P211636	G211123
7	TR7R	TRS7R	G218805	Z216751	450	TR450R	TRS450R	N218282	E212156
8	TR8R	TRS8R	V219852	R218814	500	TR500R	TRS500R	C218801	W212677
9	TR9R	TRS9R	H222532	S222541	600	TR600R	TRS600R	P219318	F213192

Note: Indicator not available (1/10-7) Amps

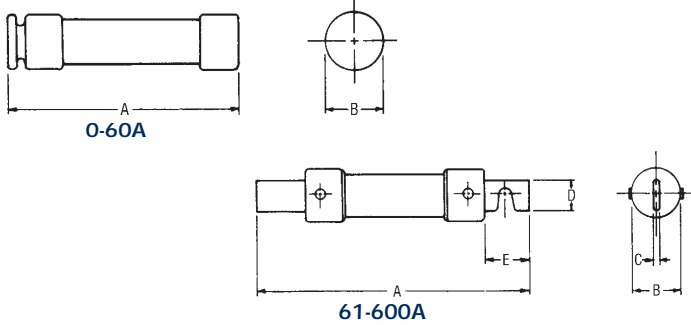

Recommended Fuse Blocks With Box Connectors For Tri-onic® Class RK5 Fuses

Fuse Ampere Rating	Catalog Number		Ref. Number	
	250V		250V	
	1 Pole	3 pole	1 pole	3 pole
0-30	20306R	20308R	T213411	K215956
31-60	20606R	20608R	B212383	E214939
61-100	21036R	21038R	D201621	M212899
101-200	22001R	22003R	R213915	G214941
201-400	24001R	24003R	J219566	D222022
401-600	2631R	2633R	H214942	P215960

Dimensions

Ampere Rating	A		B		C		D		E	
	In.	mm	In.	mm	In.	mm	In.	mm	In.	mm

250V-TR Fuses

0-30	2	51	9/16	14	-	-	-	-	-	-
31-60	3	76	13/16	21	-	-	-	-	-	-
61-100	5-7/8	149	1-1/16	27	1/8	3	3/4	19	1	25
101-200	7-1/8	181	1-9/16	40	3/16	5	1-1/8	28	1-3/8	35
201-400	8-5/8	219	2-1/16	53	1/4	6	1-5/8	41	1-7/8	48
401-600	10-3/8	264	2-9/16	66	1/4	6	2	51	2-1/4	57

600V-TRS Fuses

0-30	5	127	13/16	21	-	-	-	-	-	-
31-60	5-1/2	139	1-1/16	27	-	-	-	-	-	-
61-100	7-7/8	200	1-5/16	34	1/8	3	3/4	19	1	25
101-200	9-5/8	244	1-13/16	46	3/16	5	1-1/8	28	1-3/8	35
201-400	11-5/8	295	2-9/16	66	1/4	6	1-5/8	41	1-7/8	48
401-600	13-3/8	340	3-1/8	80	1/4	6	2	51	2-1/4	57

Fuse Ampere Rating	Catalog Number		Ref. Number	
	250V		250V	
	1 Pole	3 pole	1 pole	3 pole
0-30	60306R	60308R	H212389	K214438
31-60	60606R	60608R	K212391	M214440
61-100	61036R	61038R	W204788	Z211875
101-200	62001R	62003R	V212906	B213924
201-400	64001R	64003R	D219055	M222030
401-600	6631R	6633R	J216990	E218021

A variety of pole configurations and termination provisions is available.



General Purpose US Fuses

American Power Fuses
TRI-ONIC®
TR and TRS (Class RK5 TD)

TR 15 to 600

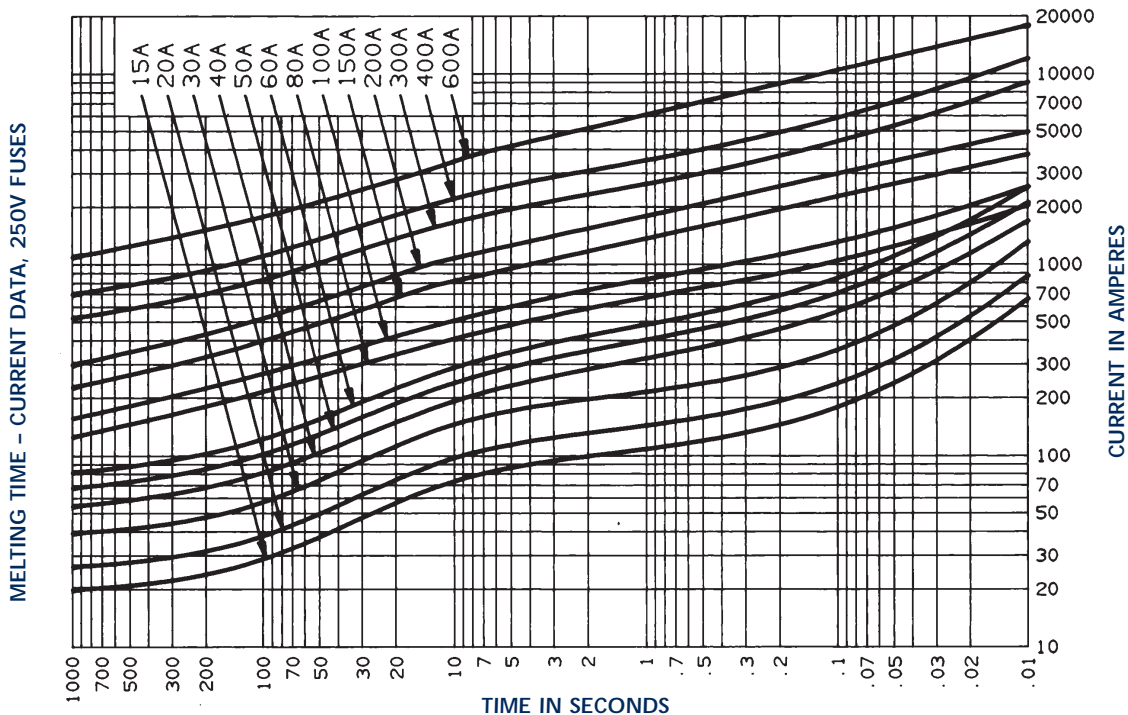

TR 1/10 to 12

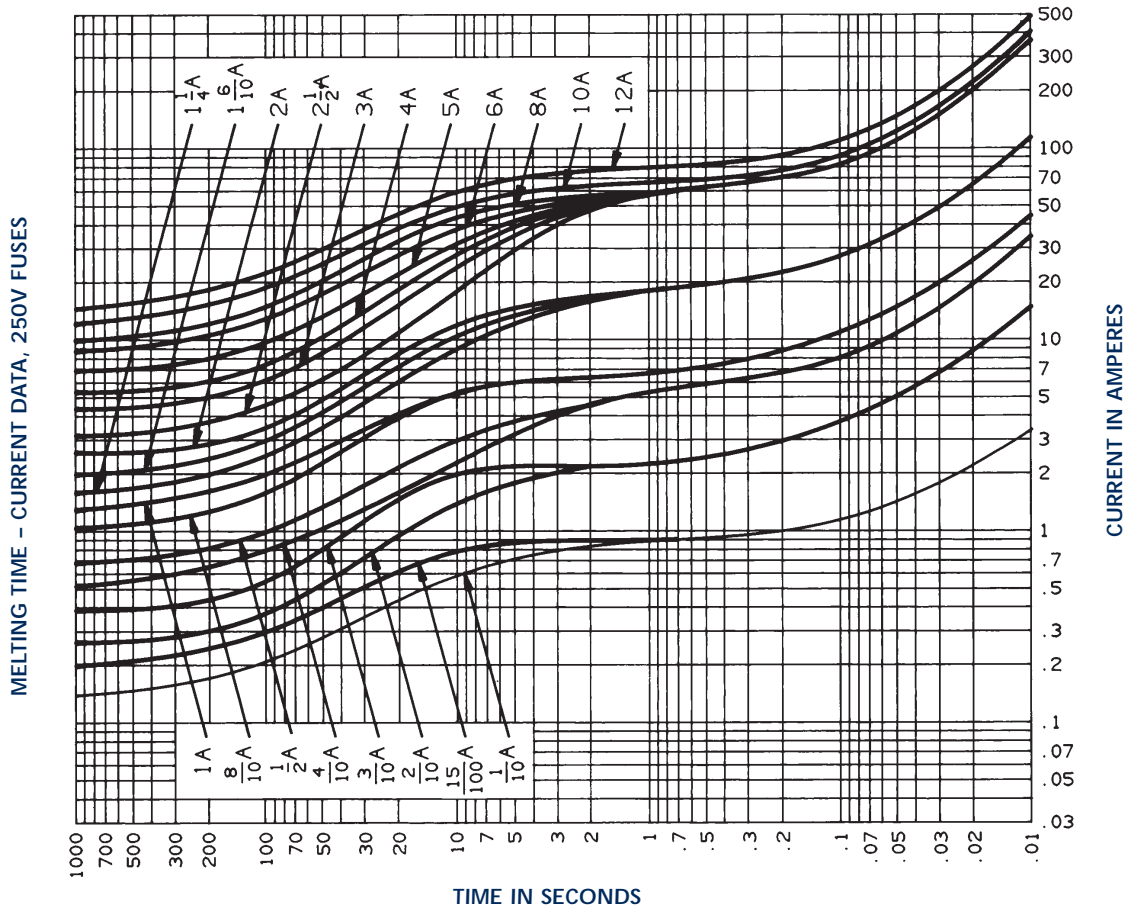

General Purpose US Fuses



American Power Fuses

TRI-ONIC®

TR and TRS (Class RK5 TD)

TRS 15 to 600

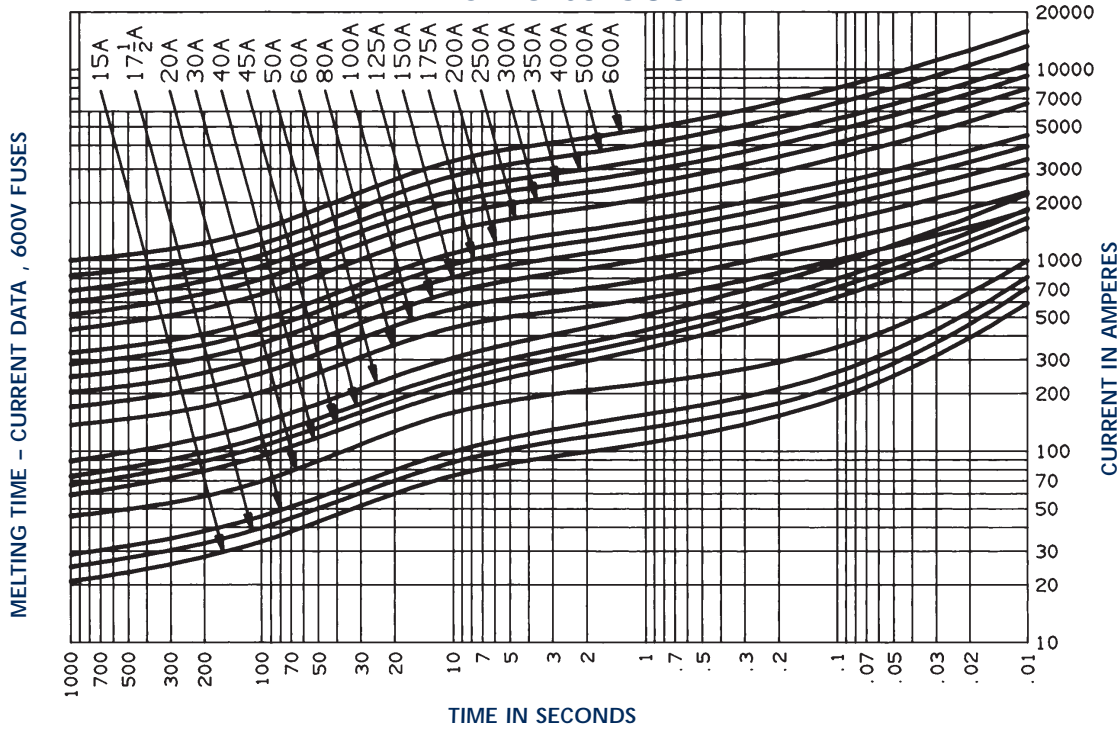

TRS 1/10 to 12

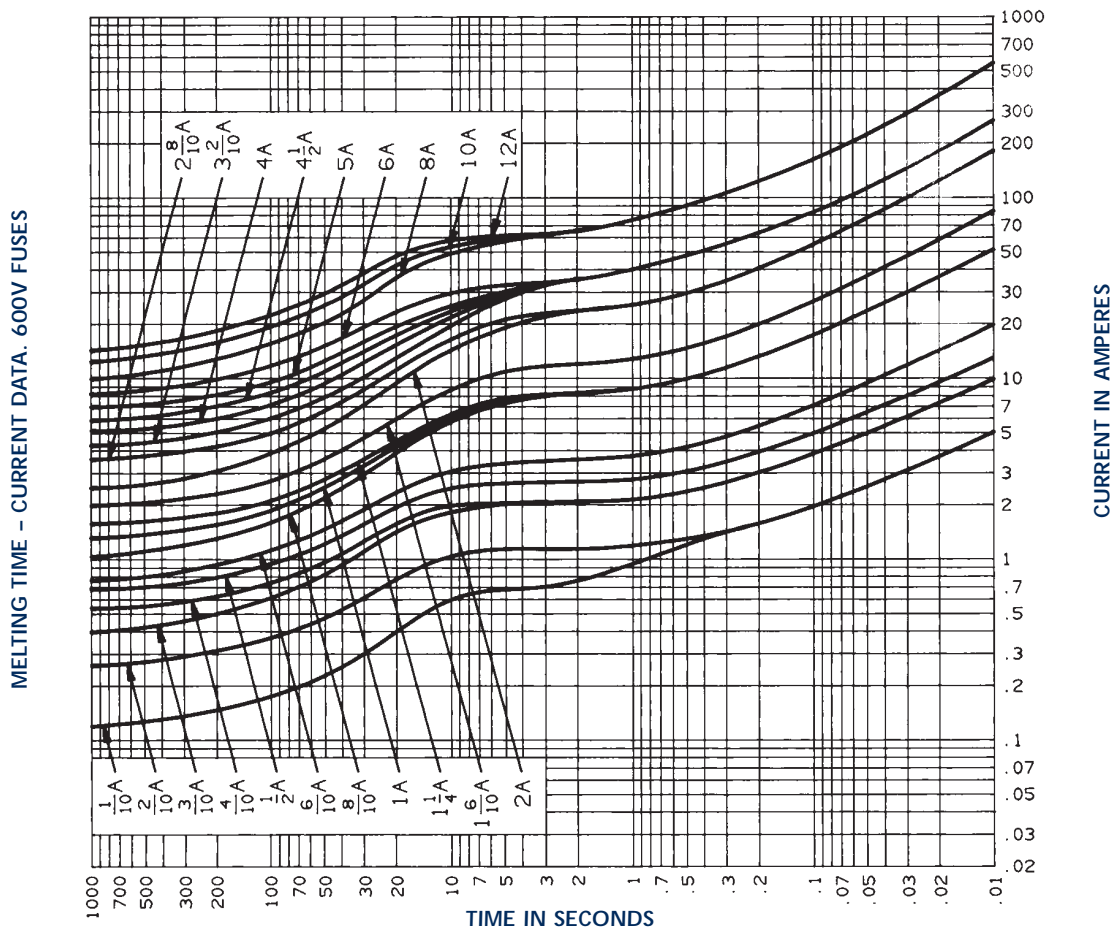



General Purpose US Fuses

American Power Fuses TRI-ONIC® TR and TRS (Class RK5 TD)

Peak Let-Thru Current Data - TR 30 to 600, 250 Volts AC

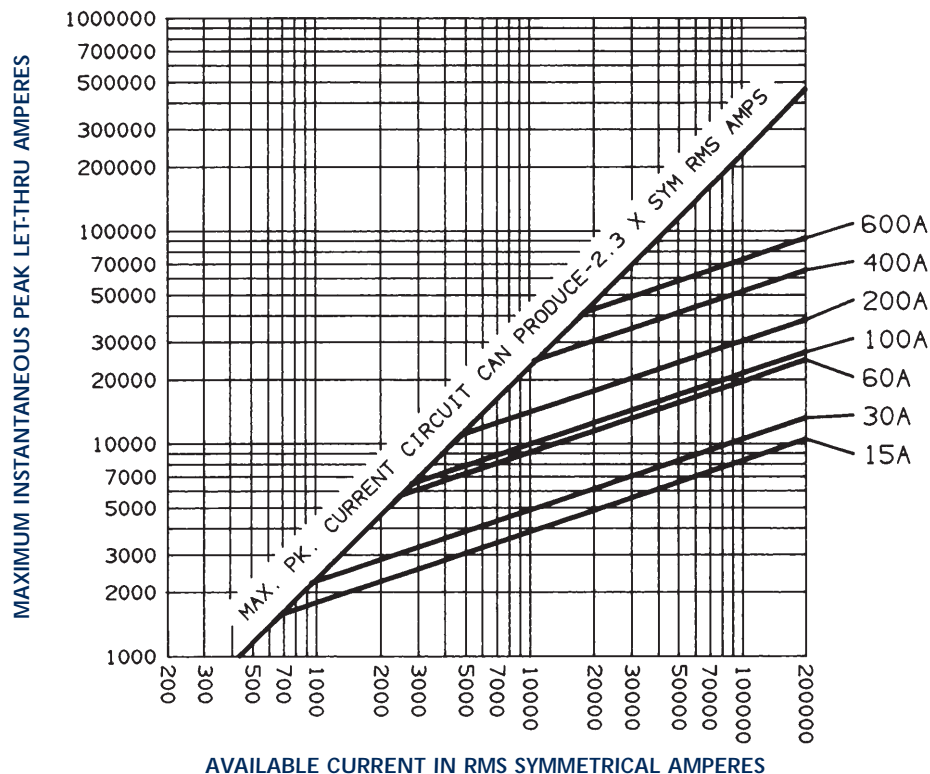

Peak Let-Thru Current Data - TRS 15 to 600, 600 Volts AC

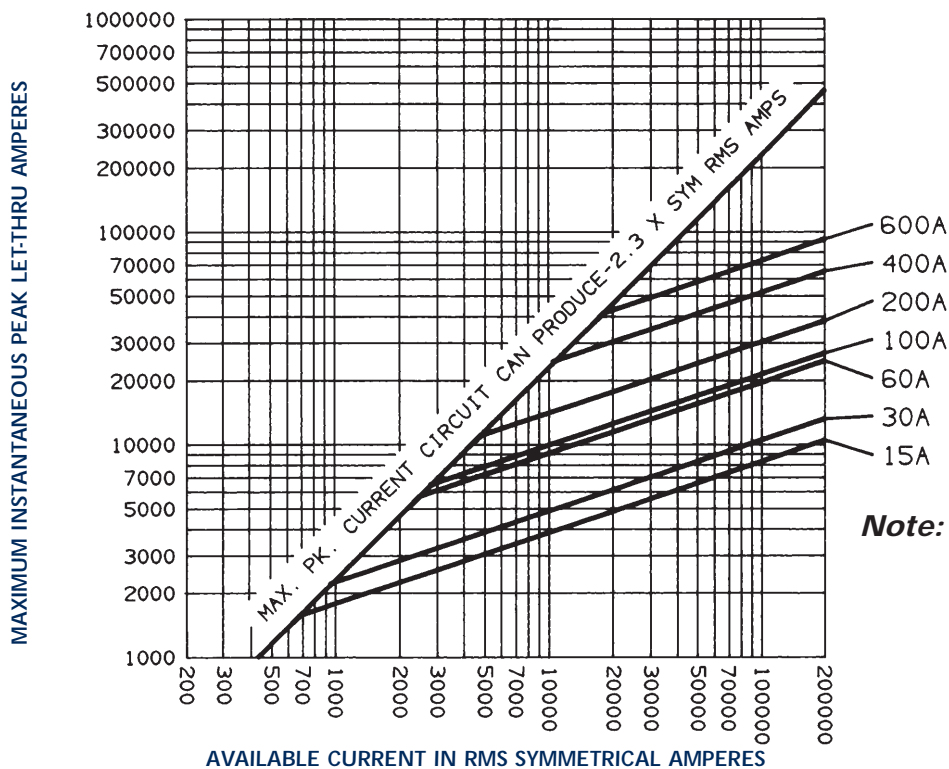

Note: See Application Information page L9 for All Motor and Transformer Tables.



American Power Fuses TRI-ONIC® TRS - RDC (DC Rated TD)



DC RATED FOR TOUGH DC APPLICATIONS

The Tri-onic DC fuse series is designed for DC circuit protection in surface and underground mines. The TRS-RDC is MSHA approved and meets the industry's most severe third party requirements for 600VDC rated fuses. The TRS-RDC is a time-delay fuse with essentially the same time-current characteristic as the standard Tri-onic.

Features/Benefits

- DC rated for mine duty and other long time-constant applications
- Time delay for motor start-ups and high inrush loads without nuisance opening
- Rugged glass melamine body for superior reliability in harsh environments

Ratings

DC: 1 to 30A 300VDC, 20kA.I.R.
(Consult Factory for Availability)

DC: 35 to 400A 600VDC, 20kA I.R.

Highlights

- Time Delay
- DC Rated

Applications

- Mine Circuits
- Trailing Cables
- Pump Motors
- Rail Heaters

Approvals

- MSHA Approval No. 28-26-0

General Purpose US Fuses



American Power Fuses

TRI-ONIC®

TRS - RDC (DC Rated TD)



Standard Fuse Ampere Ratings, Catalog Numbers

Ampere Rating	Catalog Number	Ampere Rating	Catalog Number	Ampere Rating	Catalog Number	Ampere Rating	Catalog Number	Ampere Rating	Catalog Number
1	TRS1RDC	10	TRS10RDC	40	TRS40RDC	90	TRS90RDC	200	TRS200RDC
2	TRS2RDC	12	TRS12RDC	45	TRS45RDC	100	TRS100RDC	250	TRS250RDC
3	TRS3RDC	15	TRS15RDC	50	TRS50RDC	125	TRS125RDC	300	TRS300RDC
5	TRS5RDC	20	TRS20RDC	60	TRS60RDC	150	TRS150RDC	400	TRS400RDC
6	TRS6RDC	30	TRS30RDC	70	TRS70RDC	175	TRS175RDC		
8	TRS8RDC	35	TRS35RDC	80	TRS80RDC				

Standard Fuse Ampere Ratings, Reference Numbers

Ampere Rating	Reference Number	Ampere Rating	Reference Number	Ampere Rating	Reference Number	Ampere Rating	Reference Number	Ampere Rating	Reference Number
1	Z212680	10	A219328	40	B218294	90	X218290	200	X219325
2	G223060	12	P222538	45	C219330	100	G214711	250	D223057
3	T215734	15	M201905	50	P201907	125	V216241	300	Y201386
5	D211649	20	P218812	60	Q215225	150	G217264	400	Y211644
6	B216247	30	C213695	70	E214203	175	W218289		
8	E219861	35	L214715	80	H217265				

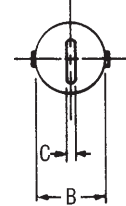
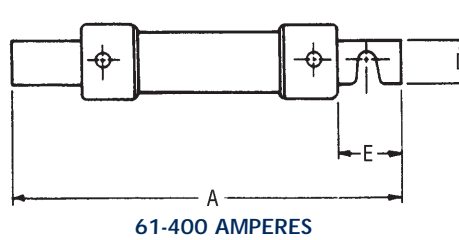
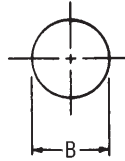
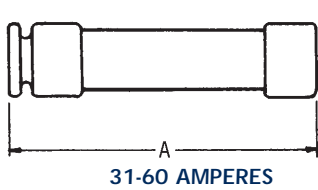

Dimensions

AMPERE RATING	A		B		C		D		E	
	In.	mm	In.	mm	In.	mm	In.	mm	In.	mm
1-30	5	127	13/16	21	-	-	-	-	-	-
31-60	5-1/2	139	1-1/16	27	-	-	-	-	-	-
61-100	7-7/8	200	1-5/16	34	1/8	3	3/4	19	1	25
101-200	9-5/8	244	1-13/16	46	3/16	5	1-1/8	28	1-3/8	35
201-400	11-5/8	295	2-9/16	66	1/4	6	1-5/8	41	1-7/8	48

TRS-RDC 60 to 400

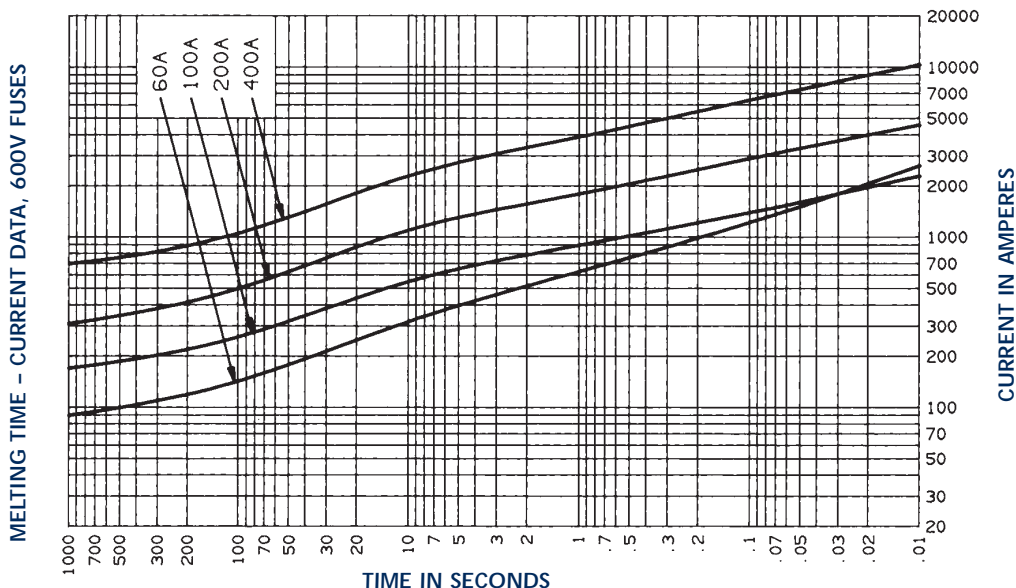



General Purpose US Fuses

American Power Fuses AMP-TRAP® A4J (Class J FA)



FOR EXCELLENT CURRENT LIMITING PROTECTION

A4J Class J fuses deliver excellent current-limiting protection to a wide variety of applications. Their unique dimensions prevent the substitution of other fuses with lower voltage ratings, interrupting ratings, or current-limiting capability.

Features/Benefits

- High current limitation for low peak let-thru current
- Unique dimensions prevent replacement by other fuseclasses
- Fiberglass body provides dimensional stability in harsh industrial environments

** Easy-to-read imprint label for quick recognition and replacement*

Ratings

AC: 1 to 600A
600VAC, 200kA I.R.

DC: 1 to 600A
300VDC, 20kA I.R.

Highlights

- Fast Acting
- Very Current-Limiting
- DC Ratings

Applications

- Capacitors
- Loadcenters
- Panelboards
- Switchboards
- Bus Duct
- Feeder Circuits
- Circuit Breakers
- Lighting, Heating, and General Loads

Approvals



- UL Listed to Standard 248-8.
- CSA Certified to Standard C22.2 No. 248.8
- DC Tested to UL198L limits
- EC 269-2-1

General Purpose US Fuses



American Power Fuses AMP-TRAP® A4J (Class J FA)



Standard Fuse Ampere Ratings, Reference Numbers

Ampere Rating	Catalog Number	Reference Number	Ampere Rating	Catalog Number	Reference Number	Ampere Rating	Catalog Number	Reference Number
1	A4J1	V217299	45	A4J45	J201419	175	A4J175	Q212189
3	A4J3	J219888	50	A4J50	X201937	200	A4J200	G212710
6	A4J6	T211157	60	A4J60	M211680	225	A4J225	X215254
10	A4J10	Z217809	70	A4J70	H212711	250	A4J250	T217298
15	A4J15	K218325	80	A4J80	J213724	300	A4J300	K219360
20	A4J20	X218842	90	A4J90	R214237	350	A4J350	H219887
25	A4J25	L219361	100	A4J100	N223089	400	A4J400	Z222570
30	A4J30	A222571	110	A4J110	V200877	450	A4J450	W200878
35	A4J35	Q223091	125	A4J125	V201935	500	A4J500	W201936
40	A4J40	X200879	150	A4J150	R211155	600	A4J600	S211156

Recommended Fuse Blocks With Box Connectors for Amp-trap Class J Fuses

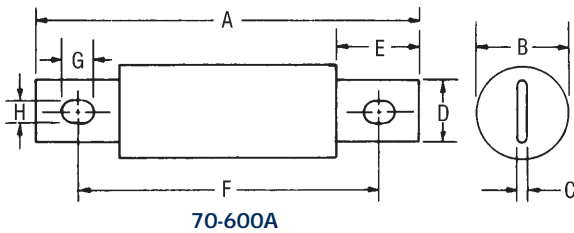
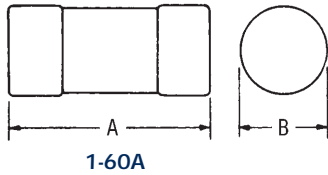

Fuse Ampere Rating	600V OR LESS			
	1 Pole		3 pole	
	Cat N°	Ref N°	Cat N°	Ref N°
0-30	US3J1I	M212922	US3J3I	K214967
31-60	US6J1I	F222047	US6J3I	M211381
61-100	61036J	Z201640	61038J	G212917
101-200	62001J	D214455	62003J	E214962
201-400	64031J	X218543	64033J	S219068
401-600	6631J	P201125	6633J	A201641

A variety of pole configurations and termination provisions is available. Refer to the fuse block section of this catalog for details.

Dimensions

Ampere Rating	A		B		C		D		E		F		G		H	
	In.	mm	In.	mm	In.	mm	In.	mm	In.	mm	In.	mm	In.	mm	In.	mm
1-30	2-1/4	57	13/16	21	-	-	-	-	-	-	-	-	-	-	-	-
31-60	2-3/8	60	1-1/16	27	-	-	-	-	-	-	-	-	-	-	-	-
61-100	4-5/8	117	1-1/8	29	1/8	3.2	3/4	19	1	25	3-5/8	92	3/8	10	9/32	7
101-200	5-3/4	146	1-5/8	41	3/16	4.8	1-1/8	29	1-3/8	35	4-3/8	111	3/8	10	9/32	7
201-400	7-1/8	181	2-1/8	54	1/4	6.3	1-5/8	41	1-7/8	48	5-1/4	133	17/32	13	13/32	10
401-600	8	203	2-1/2	64	3/8	9.5	2	51	2-1/8	54	6	152	11/16	18	17/32	13



General Purpose US Fuses

American Power Fuses
AMP-TRAP®
A4J (Class J FA)

A4J 30 to 600

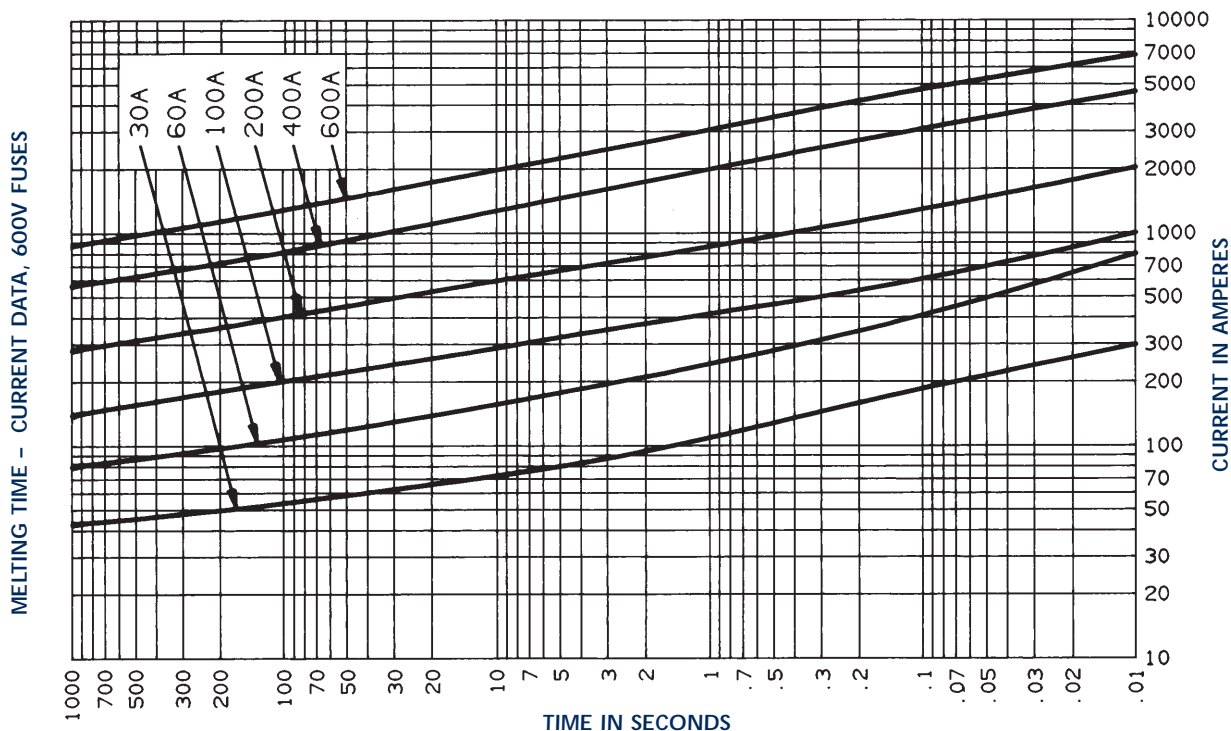

Peak Let-Through Current Data - 30 to 600, 600 Volts AC

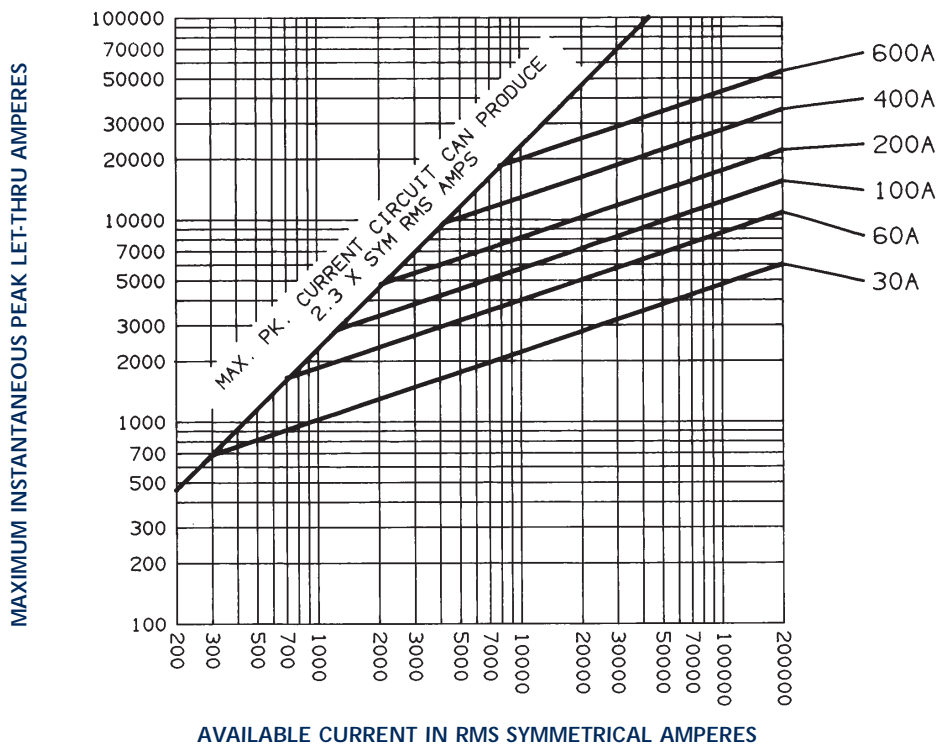



General Purpose US Fuses

American Power Fuses AMP-TRAP® A4BY (Class L)

Count on the high interrupting rating of our most widely-used class L fuse

When it comes to protecting service entrance equipment, feeder circuits, and circuit breakers, A4BY fuses have been the industry's favorite. The A4BY is a 100% rated device and may be applied at continuous currents up to its ampere rating. A 4-second minimum time delay at 500% rating allows the A4BY to pass normal current surges and to coordinate with ground fault relays.



Applications

- Mains, Feeders
- Circuit Breakers
- Loadcenters
- Panelboards
- Switchboards
- Metering Centers

Features/Benefits

- Unique dimensions prevent replacement by other fuse classes
- Blade stamped catalog numbers for permanent identification
- Glass melamine body and plated terminals provide superior reliability in harsh environments

Ratings

AC: 200 to 6,000A
600VAC, 200kA I.R.

DC: 200 to 2500A
300VDC, 100kA I.R.

Highlights

- Current-Limiting
- 4-Second Time Delay
- DC Ratings
- Uniform Characteristics in all Ampere Ratings

Approvals



- UL Listed to Standard 248-10 (601-6000A)
- CSA Certified to Standard C22.2 No. 248.10 (601-6000A)
- DC Tested to UL 198L limits (601-6000A)

Indicators:

Optional built-in fuse indicators (-TI) are available. Consult factory.

General Purpose US Fuses



American Power Fuses AMP-TRAP® A4BY (Class L)



Standard Fuse Ampere Ratings

Ampere Rating	Catalog Number	Ref. Number	Ampere Rating	Catalog Number	Ref. Number	Ampere Rating	Catalog Number	Ref. Number
200	A4BY200	P217823	801	A4BY801	K211172	2000	A4BY2000	A218339
250	A4BY250	P222584	900	A4BY900	C211694	2001	A4BY2001	M218856
300	A4BY300	J201948	1000	A4BY1000	X201431	2500	A4BY2500	L200892
350	A4BY350	Y212725	1100	A4BY1100	H211170	3000	A4BY3000	J211171
400	A4BY400	Z213738	1200	A4BY1200	A211692	3001	A4BY3001	H212205
500	A4BY500	T216286	1201	A4BY1201	X212724	3500	A4BY3500	H213240
600	A4BY600	Q217824	1350	A4BY1350	G213239	4000	A4BY4000	G214251
601	A4BY601	C219376	1400	A4BY1400	Y213737	4001	A4BY4001	J214759
650	A4BY650	Z219902	1500	A4BY1500	H214758	5000	A4BY5000	V216793
700	A4BY700	Q222585	1600	A4BY1600	L215267	6000	A4BY6000	N218857
750	A4BY750	M200893	1601	A4BY1601	T216792			
800	A4BY800	Z201433	1800	A4BY1800	K217313			

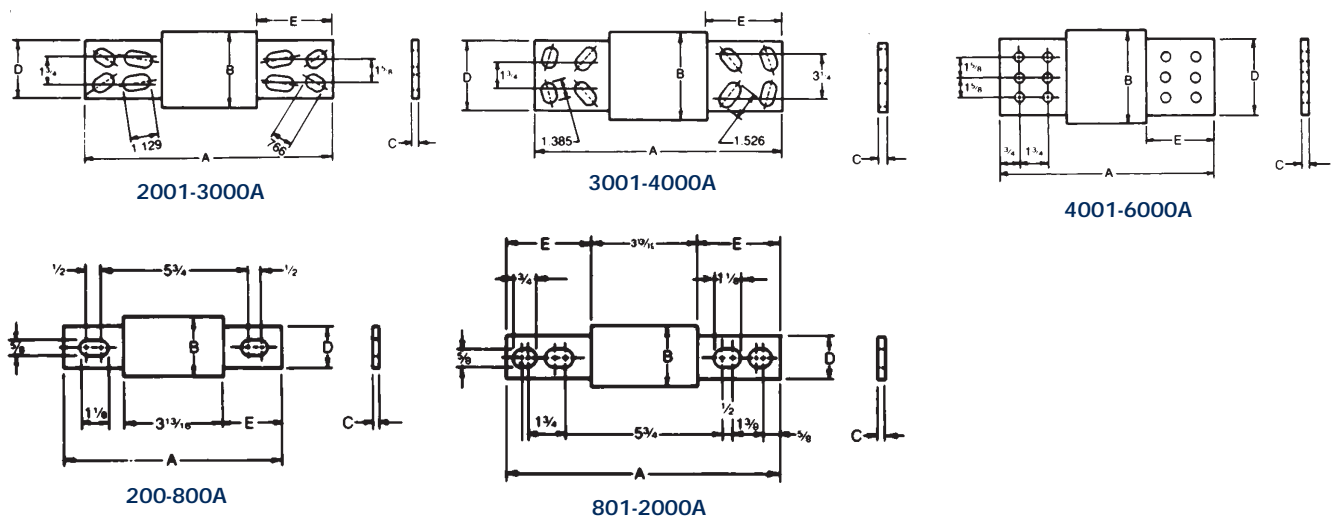

Dimensions

Ampere Rating	A		B		C		D		E	
	In.	mm	In.	mm	In.	mm	In.	mm	In.	mm
200-600*	8-5/8	219	2	51	5/16	8	1-5/8	41	2-13/32	61
601-800	8-5/8	219	2-1/2	63	3/8	9	2	51	2-13/32	61
801-1200	10-3/4	273	2-1/2	63	3/8	9	2	51	3-15/32	88
1201-1600	10-3/4	273	3	76	7/16	11	2-3/8	60	3-15/32	88
1601-2000	10-3/4	273	3-1/2	89	1/2	13	2-3/4	70	3-15/32	88
2001-2500	10-3/4	273	4-1/2	114	3/4	19	3-1/2	89	3-15/32	88
2501-3000	10-3/4	273	5	127	3/4	19	4	102	3-15/32	88
3001-4000	10-3/4	273	5-3/4	146	3/4	19	4-3/4	121	3-15/32	88
4001-5000	10-3/4	273	6-1/4	159	1	25	5-1/4	133	3-15/32	88
5001-6000	10-3/4	273	7-1/8	181	1	25	5-3/4	146	3-15/32	88

Safety Note: Class L fuses are dimensioned for one-way interchangeability.
A Class L fuse of any lower ampere rating can be substituted for a given Class L fuse.

General Purpose US Fuses

American Power Fuses AMP-TRAP® A4BY (Class L)

A4BY 200 to 6000

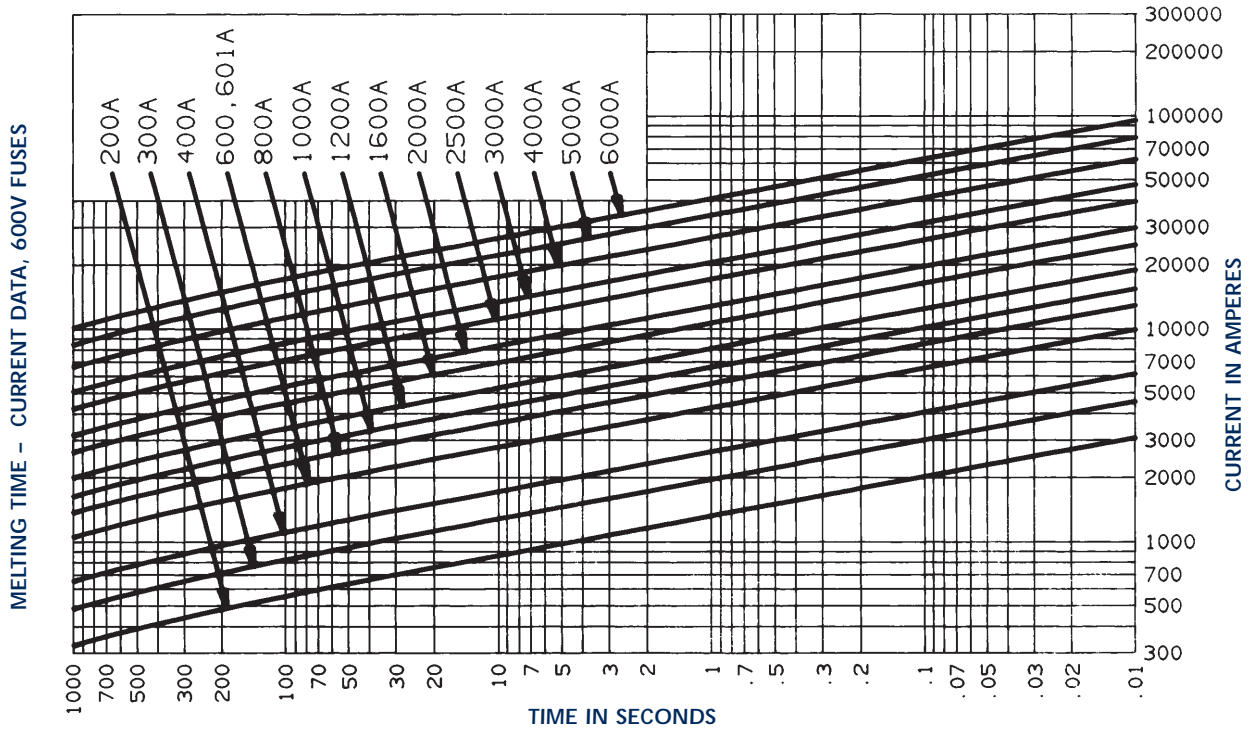

Peak Let-Thru Current Data - A4BY 300 to 6000, 600 Volts AC

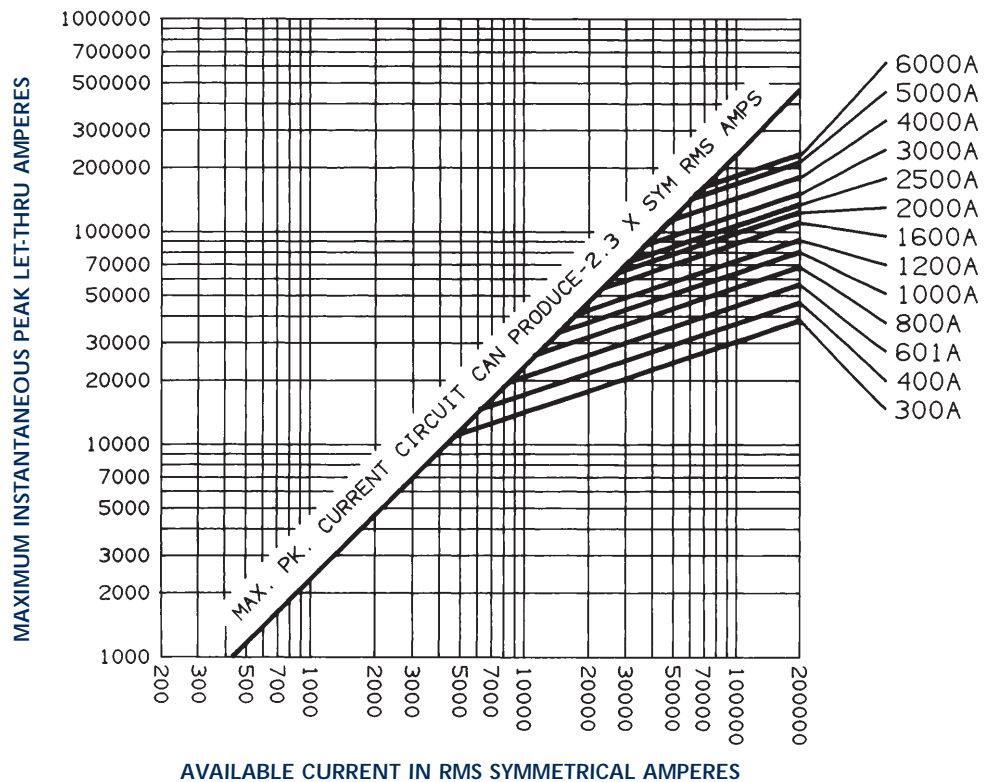

General Purpose US Fuses

American Power Fuses AMP-TRAP® A3T and A6T (Class T FA)



**These small dimension fuses
are the right fit... for a tight fit**

Fast acting A3T and A6T Class T fuses combine two highly desirable features -- high current limitation and a small physical size. Their unique dimensions prevent the substitution of other fuses with lower voltage ratings or current limiting capability. These fuses have glass melamine bodies for superior dimensional stability and catalog numbers stamped into the blades for permanent identification.

Features/Benefits

- Extremely current limiting for low peak let-thru current
- Unique dimensions prevent replacement by other fuse classes
- Blade-stamped catalog numbers for permanent identification
- Small physical size for greater design flexibility

Ratings

A3T

AC: 1 to 1200A 300VAC,
200kA I.R.

DC: 1 to 1200A 160VDC,
50kA I.R.

A6T

AC: 1 to 800A 600VAC,
200kA I.R.

DC: 1 to 800A 300VDC,
100kA I.R.

Highlights

- Fast Acting
- Extremely Current Limiting
- Small Physical Size
- DC Ratings

Applications

- Loadcenters
- Panelboards
- Switchboards
- Circuit Breakers
- Metering Centers

Approvals



- UL Listed to Standard 248-15
- CSA Certified to Standard C22.2
No. 248.15
- DC Tested to UL Standard 198L

General Purpose US Fuses



American Power Fuses

AMP-TRAP®

A3T and A6T (Class T FA)



Standard Fuse Ampere Ratings

Ampere Rating	Catalog Number		Reference Number		Ampere Rating	Catalog Number		Reference Number	
	300V	600V	300V	600V		300V	600V	300V	600V
1	A3T1	A6T1	Q212212	L219384	110	A3T110	A6T110	G218345	K219383
3	A3T3	A6T3	R214766	H201441	125	A3T125	A6T125	H219381	F219908
6	A3T6	A6T6	Y217831	S213249	150	A3T150	A6T150	D219906	Y222592
10	A3T10	A6T10	E212731	G219909	175	A3T175	A6T175	W222590	N223112
15	A3T15	A6T15	Q213247	Z222593	200	A3T200	A6T200	L223110	V200900
20	A3T20	A6T20	G213745	P223113	225	A3T225	A6T225	S200898	G201440
25	A3T25	A6T25	P214258	W200901	250	A3T250	A6T250	E201438	Q201954
30	A3T30	A6T30	V215275	R201955	300	A3T300	A6T300	N201952	S211179
35	A3T35	A6T35	W215782	T211180	350	A3T350	A6T350	Q211177	K211701
40	A3T40	A6T40	B216293	L211702	400	A3T400	A6T400	H211699	R212213
45	A3T45	A6T45	C216800	S212214	450	A3T450	A6T450	P212211	F212732
50	A3T50	A6T50	T217321	G212733	500	A3T500	A6T500	D212730	R213248
60	A3T60	A6T60	J218347	J213747	600	A3T600	A6T600	P213246	H213746
70	A3T70	A6T70	F213744	Q214259	700	A3T700	A6T700	N214257	S214767
80	A3T80	A6T80	Q214765	W215276	800	A3T800	A6T800	T215274	D216801
90	A3T90	A6T90	V215781	V217322	1000	A3T1000	-	W217829	-
100	A3T100	A6T100	R217319	W218864	1200	A3T1200	-	T218862	-

A3T

A6T

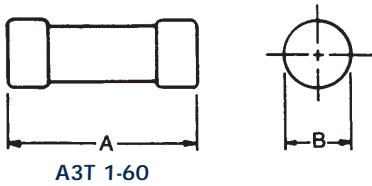

A3T 1-60

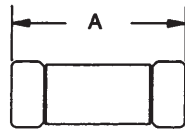

A6T 1-30

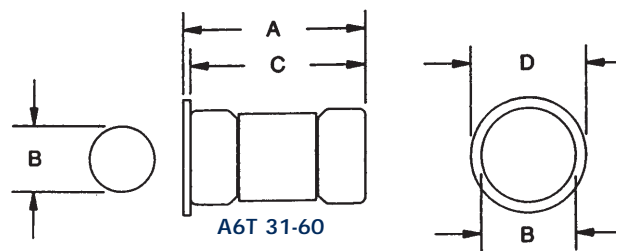

A6T 31-60

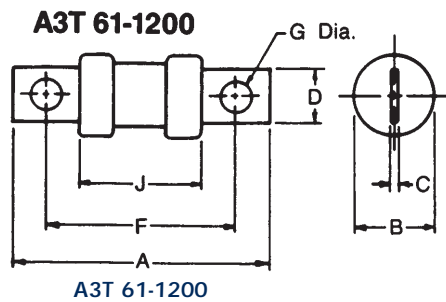

A3T 61-1200

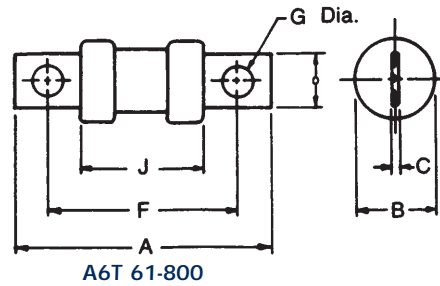

A6T 61-800

Dimensions

Ampere Rating	A		B		C		D		F		G		J	
	In.	mm	In.	mm	In.	mm	In.	mm	In.	mm	In.	mm	In.	mm
A3T														
1-30	.88	22.4	.41	10.3	-	-	-	-	-	-	-	-	-	-
31-60	.88	22.4	.56	14.1	-	-	-	-	-	-	-	-	-	-
61-100	2.16	54.9	.81	20.6	.12	3.2	.75	19.0	1.56	39.6	.28	7.1	.82	20.8
101-200	2.44	62.0	1.06	26.9	.19	4.8	.88	22.4	1.70	43.2	.34	8.6	.83	21.1
201-400	2.75	69.8	1.33	33.8	.25	6.4	1.00	25.4	1.84	46.7	.41	10.4	.84	21.3
401-600	3.06	77.7	1.62	41.1	.31	7.8	1.25	31.8	2.03	51.6	.48	12.2	.84	21.3
601-800	3.38	85.8	2.08	52.8	.38	9.7	1.75	44.4	2.22	56.4	.55	14.0	.88	22.4
801-1200	4.00	102	2.52	64.0	.44	11.2	2.00	50.8	2.53	64.3	.61	15.5	1.03	26.2
A6T														
1-30	1.50	38.1	.57	14.5	-	-	-	-	-	-	-	-	-	-
31-60	1.57	39.9	.81	20.6	1.51	38.4	1.00	25.4	-	-	-	-	-	-
61-100	2.95	74.9	.82	20.8	.12	3.2	.75	19.1	2.35	59.7	.28	7.1	1.58	40.1
101-200	3.26	82.8	1.07	27.2	.19	4.8	.88	22.4	2.51	63.7	.34	8.6	1.61	41.0
201-400	3.62	92.1	1.62	41.3	.25	6.4	1.00	25.4	2.72	69.1	.41	10.4	1.70	43.2
401-600	3.98	101.2	2.06	52.4	.31	7.9	1.25	31.8	2.95	75.0	.48	12.2	1.70	43.2
601-800	4.33	110.0	2.50	63.5	.37	9.5	1.75	44.4	3.17	80.5	.56	14.1	1.70	43.2

General Purpose US Fuses

American Power Fuses AMP-TRAP® A3T and A6T (Class T FA)

A3T 30 to 1200

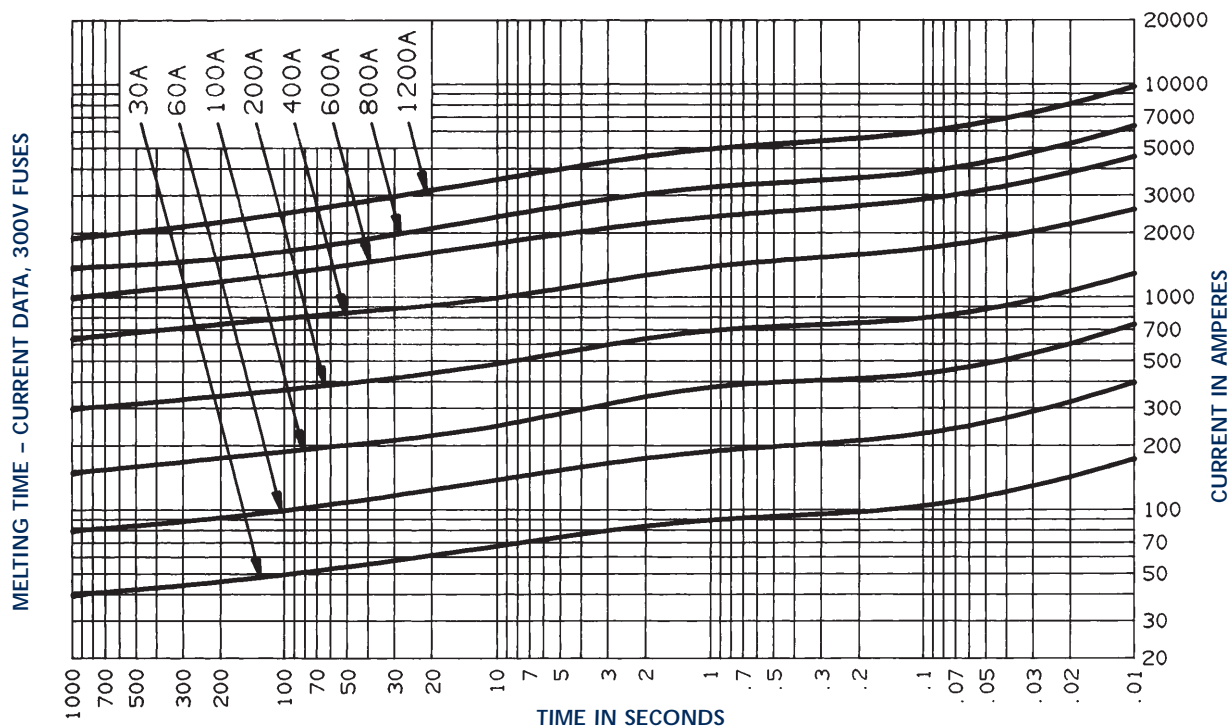

Peak Let-Thru Current Data - A3T 30 to 1200, 300 Volts AC

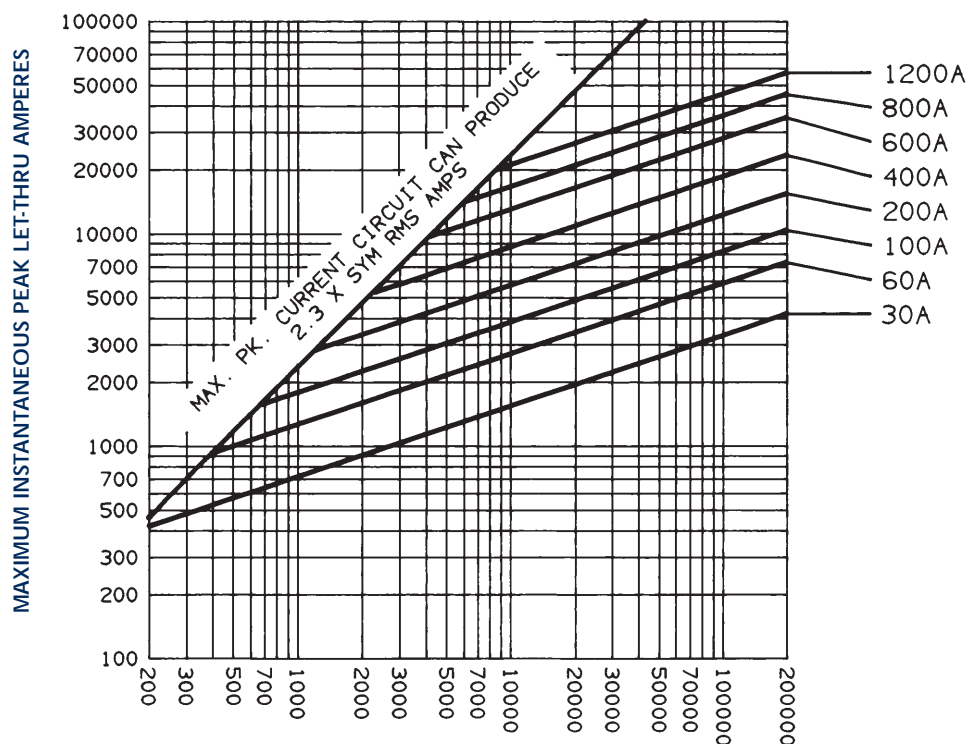

General Purpose US Fuses



American Power Fuses AMP-TRAP® A3T and A6T (Class T FA)

A6T 1 to 800

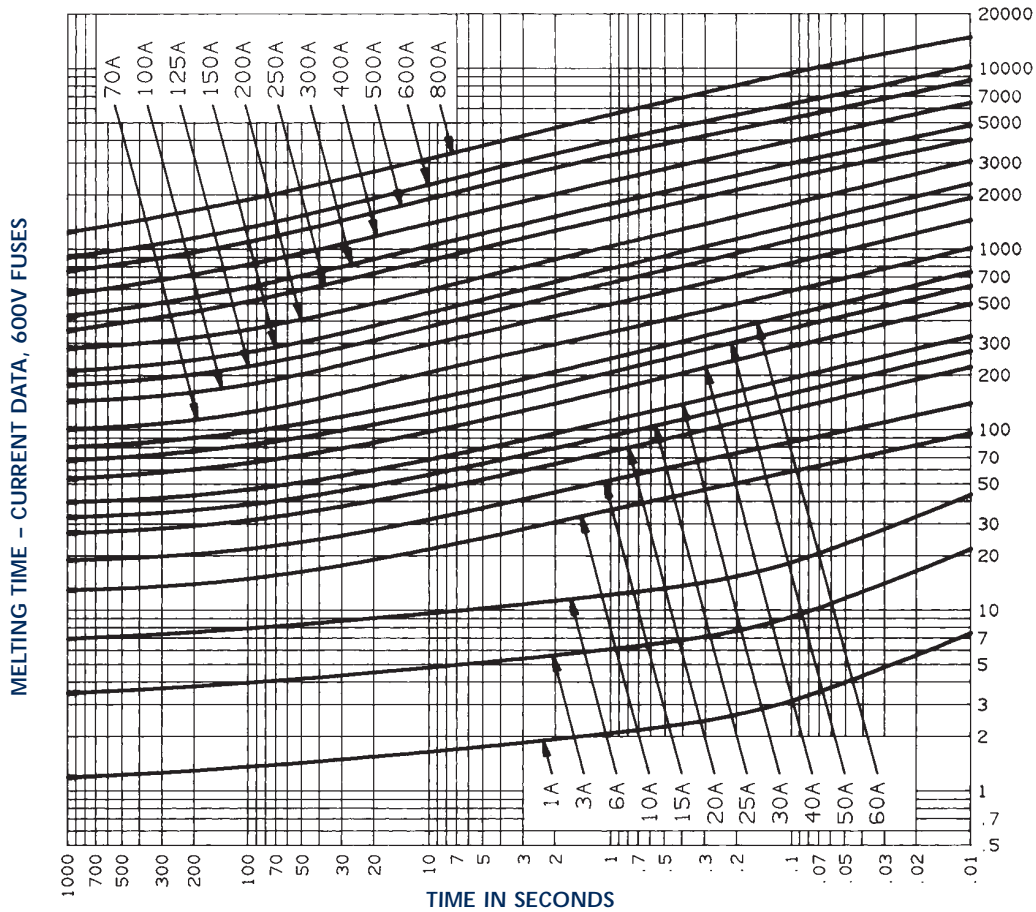

Peak Let-Thru Current Data - A6T 30 to 800, 600 Volts AC

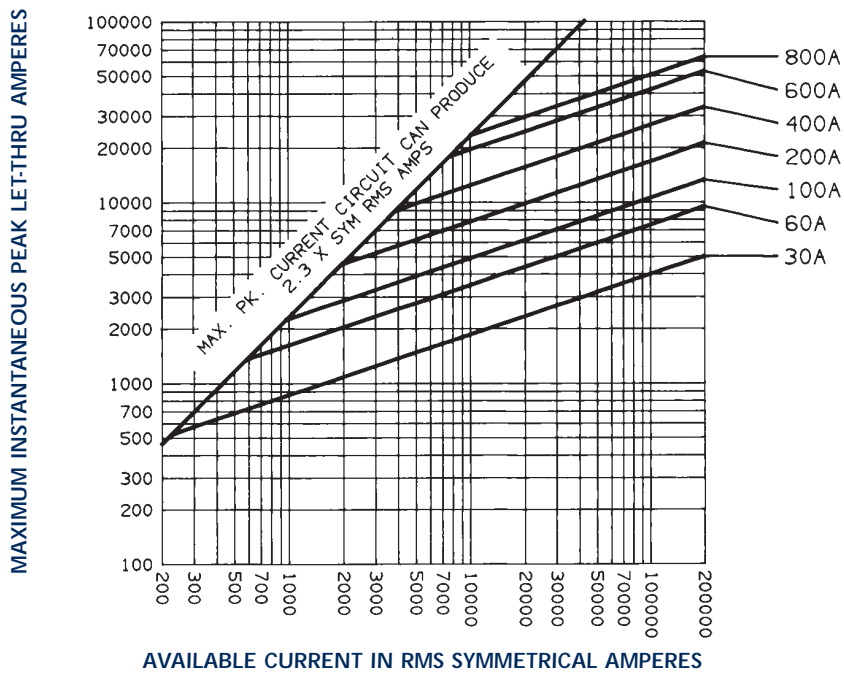

General Purpose US Fuses

American Power Fuses AMP-TRAP® A2K and A6K (Class RK1FA)



These fast-acting fuses deliver a high degree of current limitation where

Current-limiting A2K and A6K fuses provide excellent protection where high available short circuit currents exist. These fast-acting fuses are particularly good for branch/feeder circuits and back-up protection.

Features/Benefits

- Rejection style design prevents replacement by other fuse classes
- Fiberglass body provides dimensional stability in harsh industrial environments
- Easy-to-read imprint label for quick recognition and replacement
- High degree of current limitation for low peak let-thru current

Ratings

A2K

AC: 1 to 600A 250VAC,
200kA I.R.

DC: 1 to 600A 250VDC,
200kA I.R.

A6K

AC: 1 to 600A 600VAC,
200kA I.R.

DC: 1 to 600A 300VDC,
200kA I.R.

Highlights

- Highly Current-Limiting
- Fast Acting
- Rejection Style

Applications

- Loadcenters
- Panelboards
- Switchboards
- Bus Duct
- Feeder Circuits
- Non-inductive Loads
- Lighting Circuits

Approvals



- UL Listed to Standard 248-12
- CSA Certified to Standard C22.2 No. 248.12
- DC tested to UL Standard 198L

General Purpose US Fuses



American Power Fuses AMP-TRAP® A2K and A6K (Class RK1FA)

Standard Fuse Ampere Ratings

Ampere Rating	Catalog Number		Reference Number		Ampere Rating	Catalog Number		Reference Number	
	250V	600V	250V	600V		250V	600V	250V	600V
1	A2K1R	A6K1R	M215245	A219880	70	A2K70R	A6K70R	H211147	K217290
3	A2K3R	A6K3R	N217799	M201928	80	A2K80R	A6K80R	A211669	P217800
4	-	A6K4R	-	H212182	90	A2K90R	A6K90R	F212180	A218316
5	A2K5R	A6K5R	P222561	J213218	100	A2K100R	A6K100R	L215244	Y201409
6	A2K6R	A6K6R	L200869	H214229	110	A2K110R	A6K110R	V216264	L201927
8	-	A6K8R	-	L214738	125	A2K125R	A6K125R	V216770	J211148
10	A2K10R	A6K10R	G213216	N218834	150	A2K150R	A6K150R	H217288	B211670
12	A2K12R	-	F214227	-	175	A2K175R	A6K175R	M217798	G212181
15	A2K15R	A6K15R	J214736	B219352	200	A2K200R	A6K200R	Y218314	Y212702
20	A2K20R	A6K20R	Q215754	Q222562	225	A2K225R	A6K225R	L218832	H213217
25	A2K25R	A6K25R	W216265	G223083	250	A2K250R	A6K250R	Z219350	Z213715
30	A2K30R	A6K30R	W216771	M200870	300	A2K300R	A6K300R	Y219878	G214228
35	A2K35R	A6K35R	J217289	Z201410	350	A2K350R	A6K350R	N222560	K214737
40	A2K40R	A6K40R	Z218315	K211149	400	A2K400R	A6K400R	E223081	N215246
45	A2K45R	A6K45R	M218833	C211671	450	A2K450R	A6K450R	K200868	R215755
50	A2K50R	A6K50R	Z219879	Z212703	500	A2K500R	A6K500R	X201408	X216266
60	A2K60R	A6K60R	F223082	A213716	600	A2K600R	A6K600R	K201926	X216772

Recommended Fuse Blocks With Box Connectors For Amp-trap Class RK1 Fuses

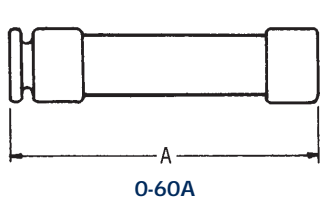

0-60A

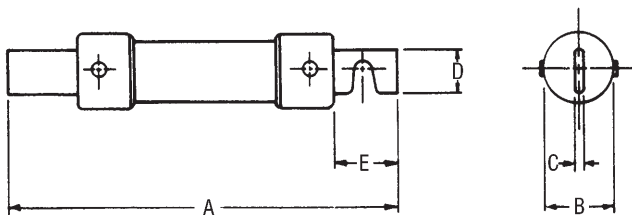
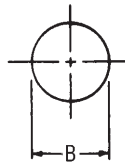

61-600A

Fuse Ampere Rating	Catalog Number		Ref. Number	
	250 V		250 V	
	1 Pole	3 Pole	1 Pole	3 Pole
0-30	20306R	20308R	T213411	K215956
31-60	20606R	20608R	B212383	E214939
61-100	21036R	21038R	D201621	M212899
101-200	22001R	22003R	R213915	G214941
201-400	24001R	24003R	J219566	D222022
401-600	2631R	2633R	H214942	P215960

Fuse Ampere Rating	Catalog Number		Ref. Number	
	600 V		600 V	
	1 Pole	3 Pole	1 Pole	3 Pole
0-30	60306R	60308R	H212389	K214438
31-60	60606R	60608R	K212391	M214440
61-100	61036R	61038R	W204788	Z211875
101-200	62001R	62003R	V212906	B213924
201-400	64001R	64003R	D219055	M222030
401-600	6631R	6633R	J216990	E218021

Dimensions

Ampere Rating	A		B		C		D		E	
	In.	mm	In.	mm	In.	mm	In.	mm	In.	mm

250V-A2K Fuses										
0-30	2	51	9/16	14	-	-	-	-	-	-
31-60	3	76	13/16	21	-	-	-	-	-	-
61-100	5-7/8	149	1-1/16	27	1/8	3	3/4	19	1	25
101-200	7-1/8	181	1-9/16	40	3/16	5	1-1/8	28	1-3/8	35
201-400	8-5/8	219	2-1/16	53	1/4	6	1-5/8	41	1-7/8	48
401-600	10-3/8	264	2-9/16	66	1/4	6	2	51	2-1/4	57

600V-A6K Fuses										
0-30	5	127	13/16	21	-	-	-	-	-	-
31-60	5-1/2	139	1-1/16	27	-	-	-	-	-	-
61-100	7-7/8	200	1-5/16	34	1/8	3	3/4	19	1	25
101-200	9-5/8	244	1-13/16	46	3/16	5	1-1/8	28	1-3/8	35
201-400	11-5/8	295	2-9/16	66	1/4	6	1-5/8	41	1-7/8	48
401-600	13-3/8	340	3-1/8	80	1/4	6	2	51	2-1/4	57

A variety of pole configurations and termination provisions is available. Refer to the fuse block section of this catalog for details.

General Purpose US Fuses

American Power Fuses AMP-TRAP® A2K and A6K (Class RK1FA)

A2K30 to 600

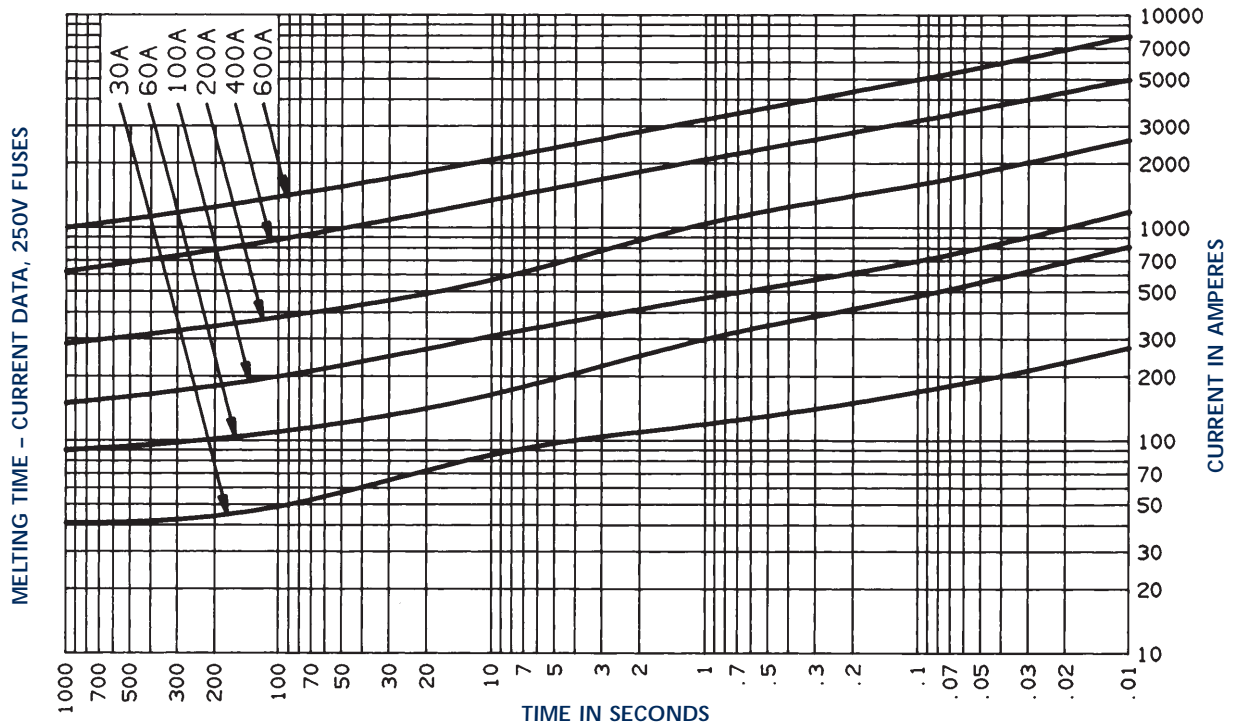

Peak Let-Thru Current Data - A2K30 to 600, 250 Volts AC

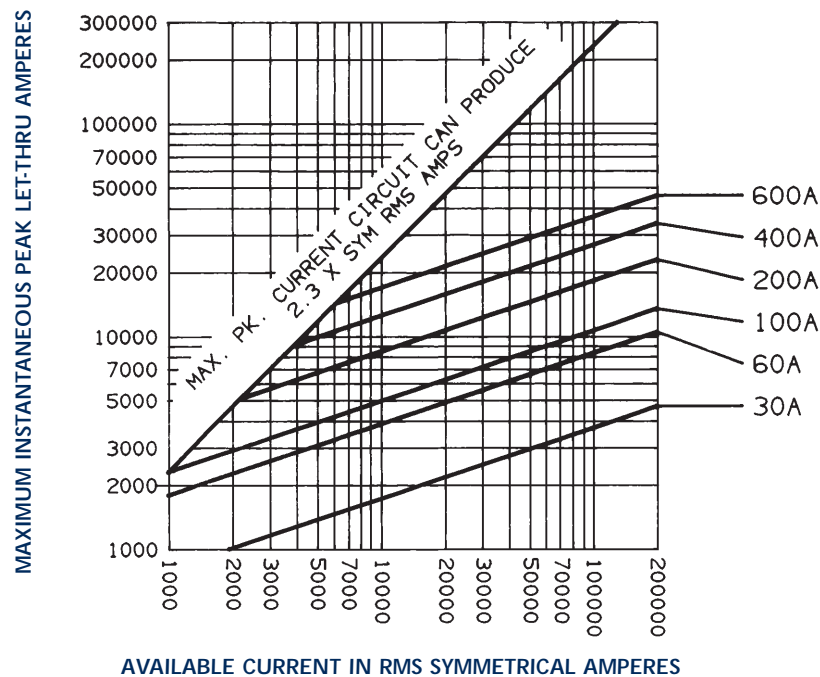

General Purpose US Fuses



American Power Fuses AMP-TRAP® A2K and A6K (Class RK1FA)

A6K 30 to 600

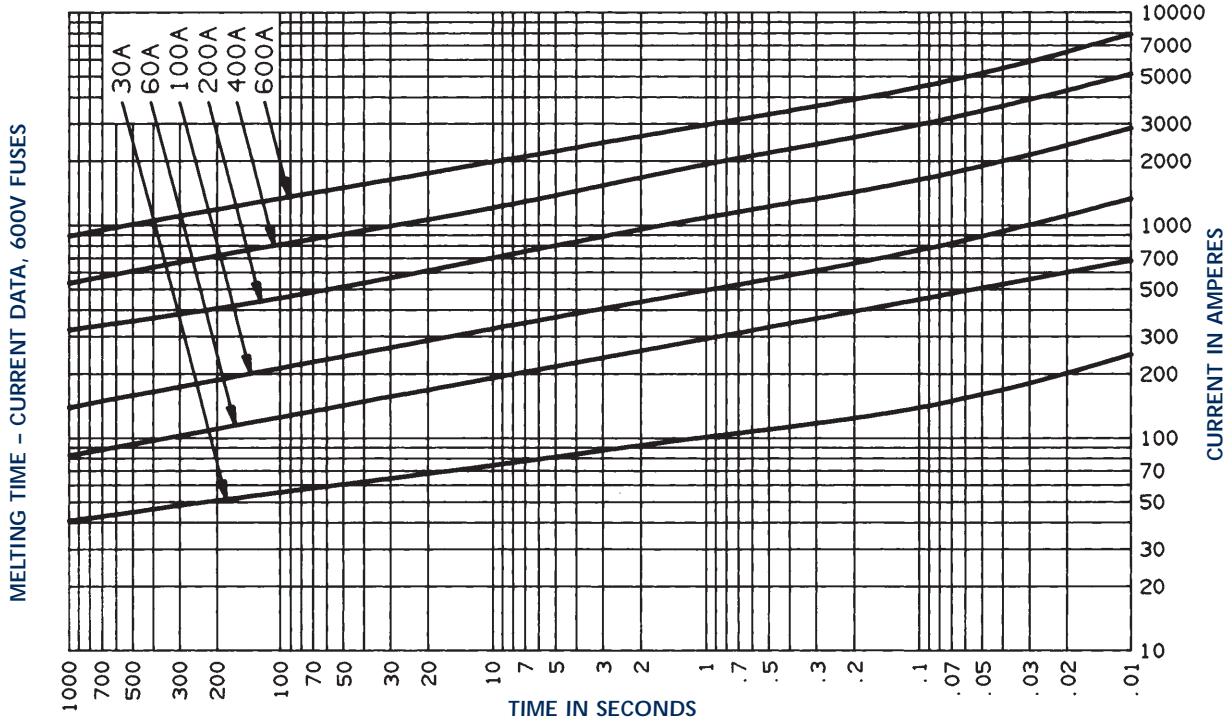

Peak Let-Thru Current Data - A6K 30 to 600, 600 Volts AC

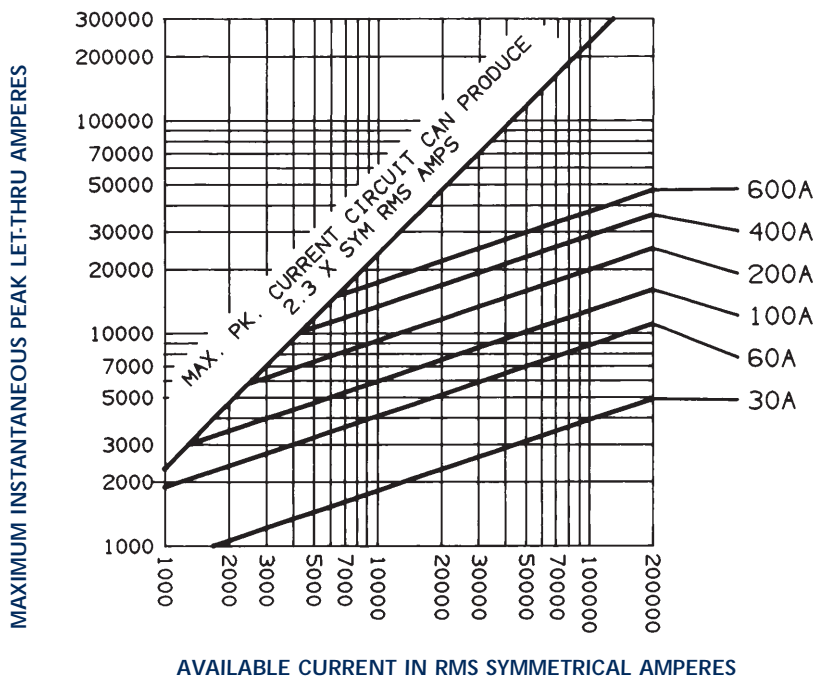

General Purpose US Fuses

American Power Fuses AMP-TRAP® AG (Class G)



AMP-TRAP AG Fuses fit right in to a wide variety of industrial applications

The Ferraz Shawmut Amp-trap AG fuse series is a complete line of Class G fuses. AG fuses safely fit a wide variety of applications. Class G fuses are made in four physical sizes and provide good branch-circuit protection for lighting, heating, and appliance circuits.

Features/Benefits

- Four unique sizes from 1-60 amperes do not allow inter-changeability with other fuse classes
- Fiberglass bodies provide dimensional stability in harsh industrial settings

Applications

- Lighting
- Heating*
- Appliances
- Branch Circuits

* Except in Canada where fuses must be "P" or "D" type.

Approvals



- UL Listed to Standard 248-5
- CSA Certified to Standard C22.2No. 248.5

Ratings

AC: 1/2 to 20A 600VAC, 100K A I.R.
25 to 60A, 480VAC, 100k A I.R.

Highlights

- Current-Limiting
- Time Delay (above 5A)

Standard Fuse Ampere Ratings

Ampere Rating	Catalog Number	Ref. Number
1/2	AG1/2	P201470
1	AG1	T223140
1-1/2	AG1-1/2	B200929
2	AG2	R211730
3	AG3	Y213277
4	AG4	B215304
5	AG5	L216831
6	AG6	H217863
8	AG8	F218896
10	AG10	Z201985
15	AG15	A211209
20	AG20	Z212243
25	AG25	L212760
30	AG30	P213775
35	AG35	Y214289
40	AG40	D215812
45	AG45	H216322
50	AG50	A217350
60	AG60	R218377

Dimensions

AMPERE RATING	A		B		C	
	In.	mm	In.	mm	In.	mm
1/2-15A	1.31	33.3	.406	10.3	.28	7.1
20A	1.41	35.8	.406	10.3	.28	7.1
25, 30A	1.62	41.2	.406	10.3	.28	7.1
35-60A	2.25	57.2	.406	10.3	.50	12.7

Cross Reference:

AG will replace the following fuses: Bussmann SC, Littelfuse SLC

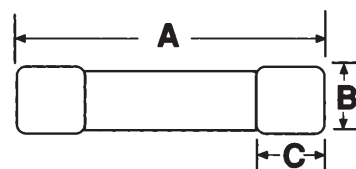

General Purpose US Fuses



American Power Fuses
 AMP-TRAP®
 AG (Class G)

AG 15 to 60

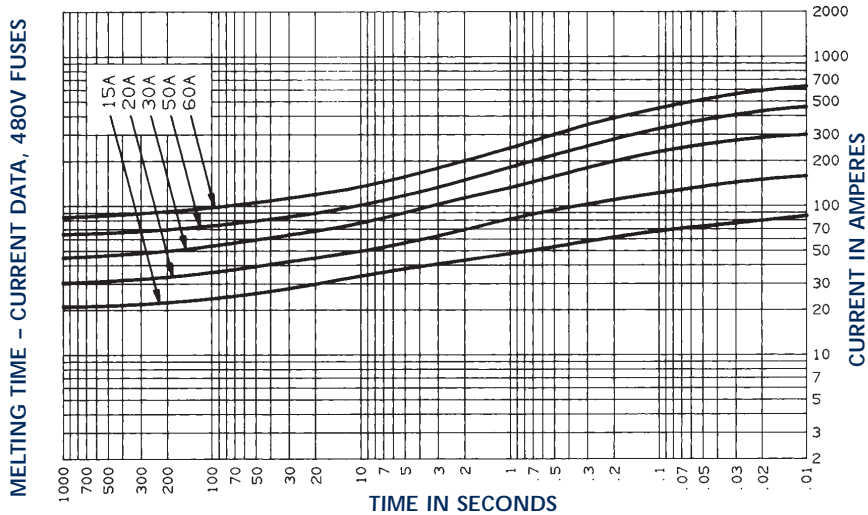

AG 1 to 10

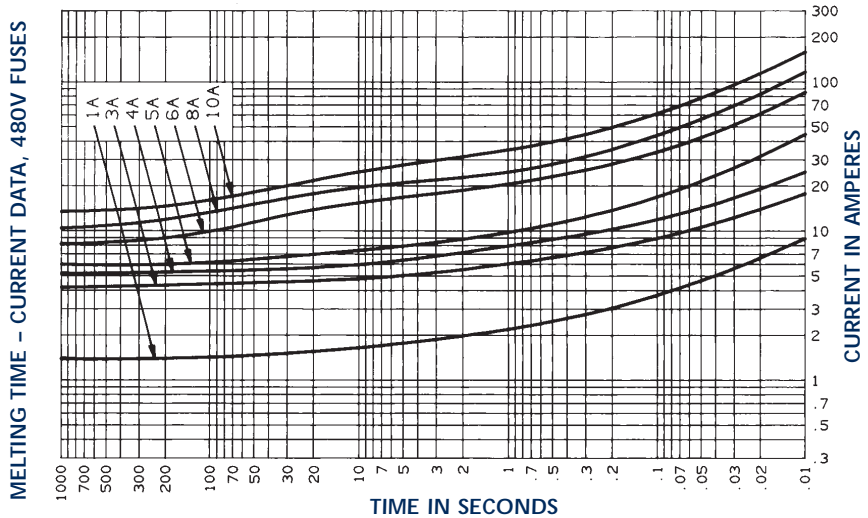

Peak Let-Through Current Data - AG 1 to 60, 480 Volts AC

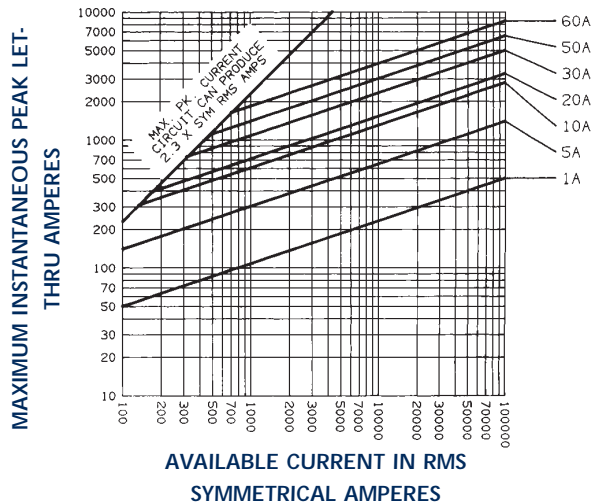

American Power Fuses AMP-TRAP® ATMR (Class CC)

Small Fuse - Big protection for general circuits



Amp-trap ATMR fuses, in the Class CC family, are the smallest dimension 600V fuses suitable for branch circuit protection. The ATMR is a popular choice for economical protection of control circuits and control circuit transformers where available short circuit currents exceed 10,000 amperes. ATMR's rejection dimensions prevent substitution by lesser rated fuses. These fast acting fuses give current limiting protection to general circuits.

Features/Benefits

- Rejection style design prevents replacement errors when used with recommended fuse blocks
- Fiberglass body provides dimensional stability in harsh industrial environments
- Versatile design for individual component and branch circuit protection

Applications

- Control Circuits
- Lighting
- General Loads
- Branch Circuit Protection

Approvals



- UL Listed to Standard 248-4
- CSA Certified to Standard C22.2No. 248.4

Ratings

AC: 1/10 to 30A 600VAC,
200kA I.R.

Highlights

- Fast Acting
- Very Current-Limiting

Primary Fuse Sizing for Control Transformer

Transformer Volt-Amperes	ATMR Rating	
	480V primary	600V primary
50	1/2*	3/10*
75	3/4*	1/2*
100	1	3/4*
150	1-1/2	1*
200	2	1-1/2*
250	2	2
300	3	2
350	3-1/2	2
500	5	4
750	7	6
1000	-	8

All rating will withstand inrush currents of 40 times transformer full load for 1/2 cycle unless otherwise noted.

* These ratings will withstand inrush currents of 35 times transformer full load for 1/2 cycle.

Standard Fuse Ampere Ratings

Ampere Rating	Catalog Number	Reference Number	Ampere Rating	Catalog Number	Reference Number
1/10	ATMR1/10	C217789	3-1/2	ATMR3-1/2	Y213208
1/8	ATMR1/8	P219341	4	ATMR4	G215746
2/10	ATMR2/10	B201918	5	ATMR5	M216257
1/4	ATMR1/4	C218824	6	ATMR6	L216762
3/10	ATMR3/10	W214218	7	ATMR7	Z217280
1/2	ATMR1/2	N218305	8	ATMR8	D217790
3/4	ATMR3/4	Z214727	9	ATMR9	P218306
1	ATMR1	L216256	10	ATMR10	P219870
1-1/4	ATMR1-1/4	Y217279	12	ATMR12	D222551
1-1/2	ATMR1-1/2	K216761	15	ATMR15	V223072
2	ATMR2	A200859	20	ATMR20	Z211139
2-1/2	ATMR2-1/2	N201400	25	ATMR25	Q211660
3	ATMR3	N212693	30	ATMR30	C215236

General Purpose US Fuses



American Power Fuses AMP-TRAP® ATMR (Class CC)

Recommended Fuse Blocks For Amp-Trap® Class CC Fuses

Number of Poles	Catalog Number				Reference Number			
	ULTRA-SAFE Indicating Fuse Holder	Screw Connector w/ Double Quick Connects	Pressure Plate Connector w/ Double Quick Connects	Copper Box Connector	ULTRA-SAFE Indicating Fuse Holder	Screw Connector w/ Double Quick Connects	Pressure Plate Connector w/ Double Quick Connects	Copper Box Connector
ADDER		30310R	30320R	30350R		W204857	Z217510	N213429
1	USCC1I	30311R	30321R	30351R	X213943	R212397	M218534	G213929
2	USCC2I	30312R	30322R	30352R	D217008	Z212910	Y219579	V214447
3	USCC3I	30313R	30323R	30353R	Y218038	M213428	B222779	X214955

Refer to the Class CC Fuse Block section of this catalog for other details.

ATMR 1/10 to 30

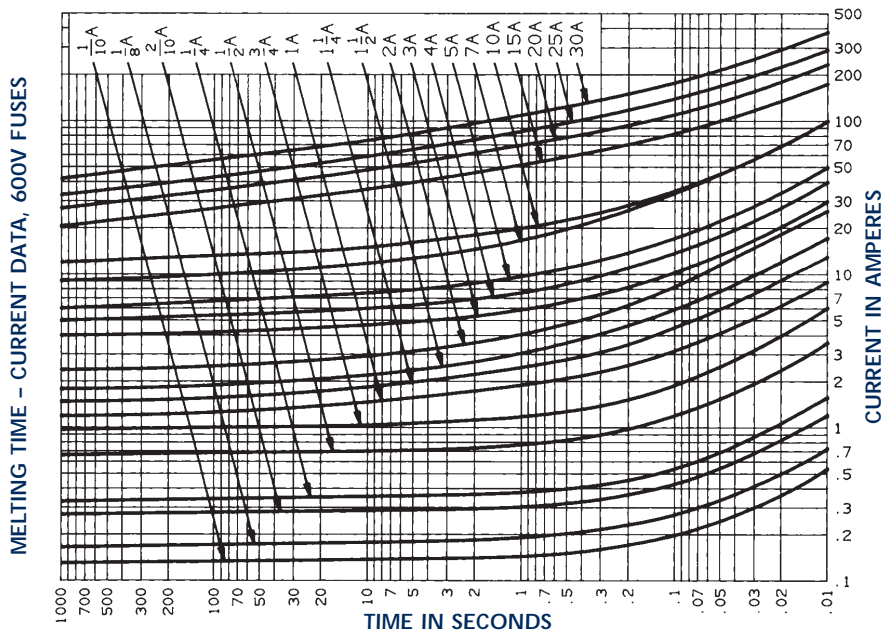

Dimensions

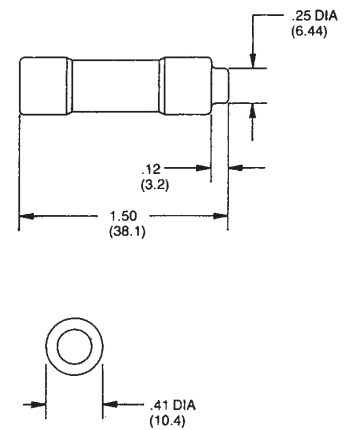

Peak Let-Through Current Data - ATMR 3/4 to 30, 600 Volts AC

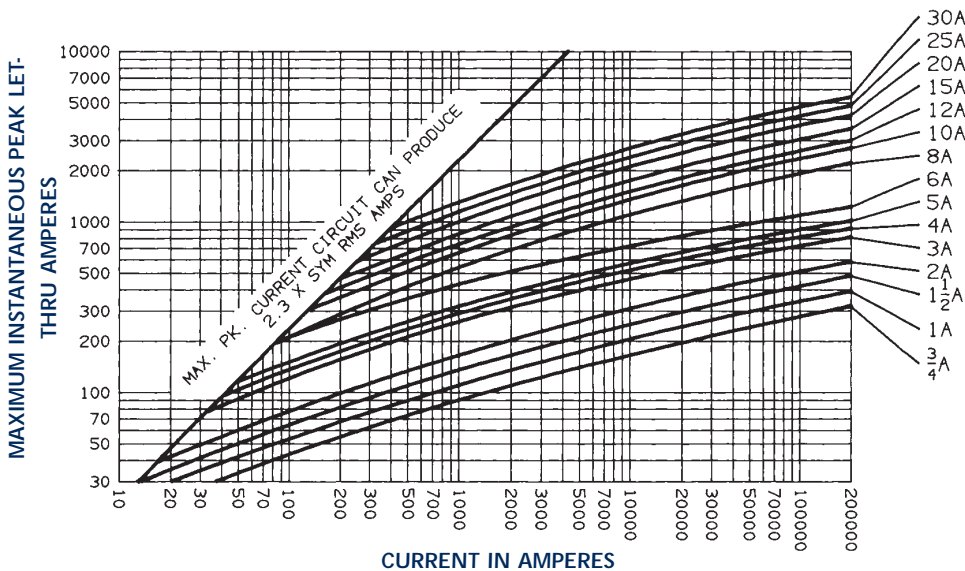

General Purpose US Fuses

American Power Fuses One-Time OT, OTN, OTS (Class K-5)

For versatility and economy, these general purpose fuses are hard to beat



OT, OTN and OTS general purpose fuses provide low cost protection for feeder and branch circuits serving lighting, heating, and other non-motor loads. OT, OTN and OTS fuses will safely interrupt available short circuit currents up to 50,000 amperes in all ratings.

OT, OTN and OTS fuses are not rejection fuses – care should be taken to ensure that replacement fuses do not have lower interrupting ratings than original fuses. OTN 15 through 60 satisfy the Canadian electrical code requirement for Type “P,” low melting-point, non-time delay fuses.

Features/Benefits

- Easy to read imprint label for quick recognition and replacement
- Low cost for high protection value

Ratings

OT

AC: 1 to 600A 250VAC,
50kA I.R.
DC: 1 to 600A 250VDC,
20kA I.R.

OTN (Canada)

AC: 15 to 60A
250VAC, 50kA I.R.

OTS

AC: 1 to 600A 600VAC,
50kA I.R.
DC: 1 to 600A 300VDC,
20kA I.R.

Highlights

- Versatile
- Lowest cost protection for circuits serving non-inductive loads

Applications

- Feeders
- Branch Circuits
- Resistive Heating
- Residential and Small Commercial Installations

Approvals



- UL Listed to Standard 248-9
- CSA Certified to Standard C22.2 No. 248.9*
- DC Tested to UL Standard 198L

* The Canadian Electrical Code requires these fuses in ratings 15 through 60A to be of the low melting point design use OTN 15-60.

General Purpose US Fuses



American Power Fuses One-Time OT, OTN, OTS (Class K-5)



Standard Fuse Ampere Ratings

Ampere Rating	Catalog Number		Reference Number		Ampere Rating	Catalog Number		Reference Number	
	250V	600V	250V	600V		250V	600V	250V	600V
1	OT1	OTS1	H218277	D215720	65	OT65	OTS65	V201889	-
2	OT2	OTS2	Y222523	L218280	70	OT70	OTS70	T211111	A222525
3	OT3	OTS3	K201374	M219845	75	OT75	OTS75	H211630	R223046
4	OT4	OTS4	Q212143	Y200834	80	OT80	OTS80	P212142	X200833
5	OT5	OTS5	W214701	Y211115	90	OT90	OTS90	G212664	M201376
6	OT6	OTS6	H216230	T212146	100	OT100	OTS100	Y215209	T213181
7	OT7	OTS7	Z217763	R223506	110	OT110	OTS110	Z215716	L213680
8	OT8	OTS8	J218278	W213183	125	OT125	OTS125	F216228	S214192
10	OT10	OTS10	X218796	K216232	150	OT150	OTS150	D216732	X214702
12	OT12	OTS12	H219312	H216736	175	OT175	OTS175	S217251	B215212
15	OT15	OTS15	J219842	X217255	200	OT200	OTS200	X217761	C215719
20	OT20	OTS20	P223044	Z218798	225	OT225	OTS225	G218276	J216231
25	OT25	OTS25	V200831	L219315	250	OT250	OTS250	W218795	G216735
30	OT30	OTS30	W201890	B222526	300	OT300	OTS300	G219311	W217254
35	OT35	OTS35	J211631	S223047	350	OT350	OTS350	H219841	A217764
40	OT40	OTS40	H212665	N201377	400	OT400	OTS400	X222522	K218279
45	OT45	OTS45	K213679	Z201893	450	OT450	OTS450	N223043	Y218797
50	OT50	OTS50	A215211	M211634	500	OT500	OTS500	T200830	K219314
60	OT60	OTS60	F216734	L212668	600	OT600	OTS600	J201373	L219844

OTN 15 to 60A: consult us.

Recommended Fuse Blocks With Box Connectors For One-Time Class K-5 Fuses

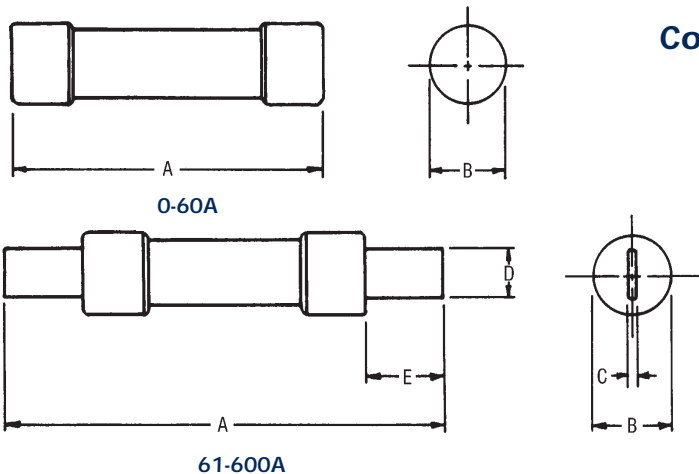

Fuse Ampere Rating	Catalog Number		Ref. Number	
	250 V		250 V	
	1 Pole	3 Pole	1 Pole	3 Pole
0-30	20306	20308	Z212381	F215446
31-60	20606	20608	N211865	C214431
61-100	21036	21038	S201105	Q211867
101-200	22001	22003	Y213415	E214433
201-400	24001	24003	T219046	-
401-600	2631	2633	F214434	K215450

Fuse Ampere Rating	Catalog Number		Ref. Number	
	600 V		600 V	
	1 Pole	3 Pole	1 Pole	3 Pole
0-30	60306	60308	V211871	X213920
31-60	60606	60608	X211873	Z213922
61-100	61036	61038	K201627	S211363
101-200	62001	62003	M212393	H213424
201-400	64001	64003	H218530	T219575
401-600	6631	6633	Z216475	W217507

Dimensions

Ampere Rating	A		B		C		D		E	
	In.	mm	In.	mm	In.	mm	In.	mm	In.	mm
250V-OT, OTN FUSES										
0-30	2	51	9/16	14	-	-	-	-	-	-
31-60	3	76	13/16	21	-	-	-	-	-	-
61-100	5-7/8	149	1-1/16	27	1/8	3	3/4	19	1	25
101-200	7-1/8	181	1-9/16	40	3/16	5	1-1/8	28	1-3/8	35
201-400	8-5/8	219	2-1/16	53	1/4	6	1-5/8	41	1-7/8	48
401-600	10-3/8	264	2-9/16	66	1/4	6	2	51	2-1/4	57
600V-OTS FUSES										
0-30	5	127	13/16	21	-	-	-	-	-	-
31-60	5-1/2	139	1-1/16	27	-	-	-	-	-	-
61-100	7-7/8	200	1-5/16	34	1/8	3	3/4	19	1	25
101-200	9-5/8	244	1-13/16	46	3/16	5	1-1/8	28	1-3/8	35
201-400	11-5/8	295	2-9/16	66	1/4	6	1-5/8	41	1-7/8	48
401-600	13-3/8	340	3-1/8	80	1/4	6	2	51	2-1/4	57

A variety of pole configurations and termination provisions is available. Refer to the fuse block section of this catalog for details.



General Purpose US Fuses

American Power Fuses One-Time OT, OTN, OTS (Class K-5)

OT 30 to 600; OTN 30, 60

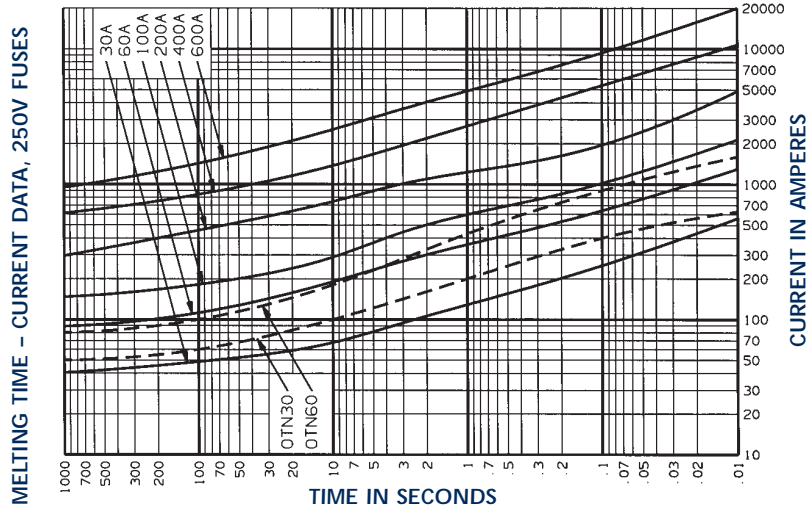

OTS 30 to 600

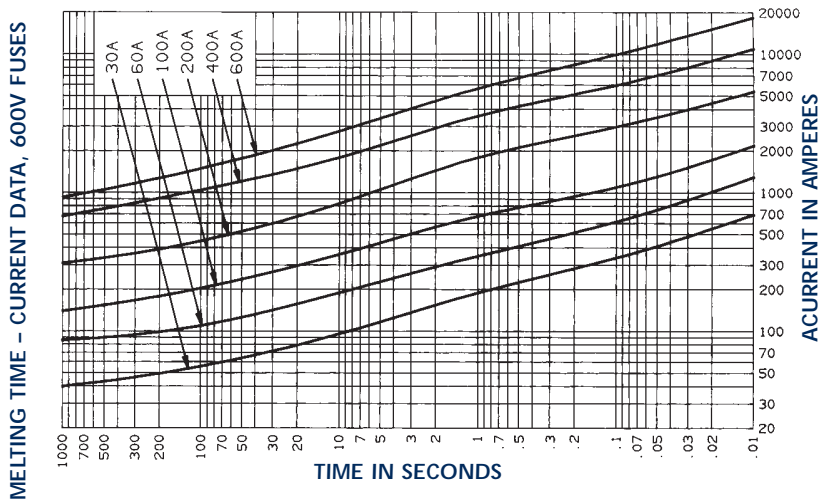

Peak Let-Thru Current Data - OT, OTN & OTS 30 to 600, 250 and 600 Volts AC

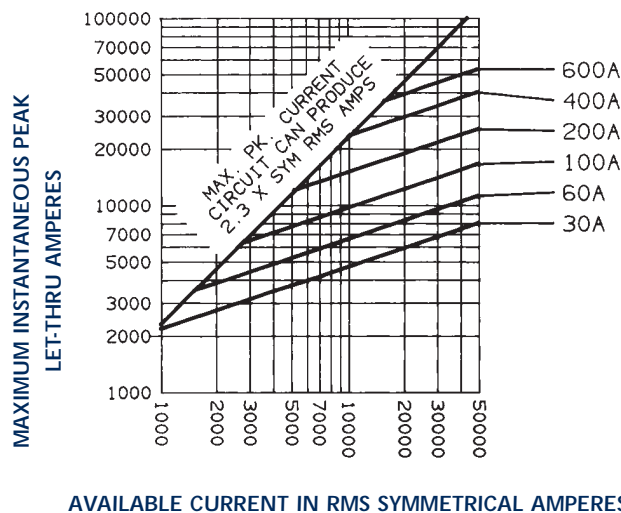



General Purpose US Fuses

American Power Fuses Renewable RF/RFS and RL/RLS (Class H)

Traditional protection for circuits with less than 10,000A Short circuit current

RF and RFS general purpose fuses are suitable for application where available short circuit currents do not exceed 10,000 amperes. RF and RFS renewable fuses use matched RL and RLS die-cut zinc links from 1 to 600 amperes in 32 ratings.



Note: To be replaced by TR (250V) and TRS (600V) compatible class RK5

Features/Benefits

- Knurled bushings for ease of disassembly
- Rugged construction for maximum service life
- Precision die-cut renewal links renew quickly and give repeatable performance

Ratings

RF

AC: 1 to 600A 250VAC,
10kA I.R.

RFS

AC: 1 to 600A 600VAC,
10kA I.R.

Highlights

- Renewable
- 32 Renewal Link Ratings

Applications

- General purpose loads where short circuits are 10,000 amperes or less

Approvals



- UL Listed to Standard 248-7
- CSA Certified to Standard C22.2 No. 248.7



General Purpose US Fuses

Midget Fuses (10x38 US) Time Delay ATQ 500VAC (TD)



Amp-trap® ATQ midget time-delay fuses are rated a full 500 volts AC with 42 ampere ratings from 1/10 to 30A. They are an excellent choice for supplemental protection of circuits up to 30A where the available short circuit current does not exceed 10,000A. (Not for Branch Circuit Protection).

Features/Benefits

- Numerous ratings for a wide variety of applications up to 500VAC
- Time delay (12 seconds at 200% rating) for circuits with high inrush current
- UltraSafe™ fuse holder: refer to Fuse Blocks and Fuse Holders section for details, Catalog Number and Reference Number

Ratings

- AC: 1/10 to 30A 500VAC, 10kA I.R.

Highlights

- Time Delay

Applications

- Supplemental protection of lighting, solenoid, motor, and transformer circuits
- Transformers
- Control Panels
- Circuit Breaker Back-up
- Bus Duct
- Load Centers

Approvals



- UL Listed to Standard 248-14
- CSA Certified to Standard C22.2 No. 248.14

Standard Fuse Ampere Ratings, Catalog Numbers

Ampere Rating	Catalog Number	Ampere Rating	Catalog Number	Ampere Rating	Catalog Number	Ampere Rating	Catalog Number	Ampere Rating	Catalog Number	Ampere Rating	Catalog Number	Ampere Rating	Catalog Number
1/10	ATQ1/10	3/10	ATQ3/10	1-1/8	ATQ1-1/8	2	ATQ2	3-2/10	ATQ3-2/10	6	ATQ6	12	ATQ12
1/8	ATQ1/8	4/10	ATQ4/10	1-1/4	ATQ1-1/4	2-1/8	ATQ2-1/8	3-1/2	ATQ3-1/2	6-1/4	ATQ6-1/4	14	ATQ14
15/100	ATQ15/100	1/2	ATQ1/2	1-4/10	ATQ1-4/10	2-1/4	ATQ2-1/4	4	ATQ4	7	ATQ7	15	ATQ15
3/16	ATQ3/16	6/10	ATQ6/10	1-1/2	ATQ1-1/2	2-1/2	ATQ2-1/2	4-1/2	ATQ4-1/2	8	ATQ8	20	ATQ20
2/10	ATQ2/10	8/10	ATQ8/10	1-6/10	ATQ1-6/10	2-8/10	ATQ2-8/10	5	ATQ5	9	ATQ9	25	ATQ25
1/4	ATQ1/4	1	ATQ1	1-8/10	ATQ1-8/10	3	ATQ3	5-6/10	ATQ5-6/10	10	ATQ10	30	ATQ30

Standard Fuse Ampere Ratings, Reference Numbers

Ampere Rating	Reference Number	Ampere Rating	Reference Number	Ampere Rating	Reference Number	Ampere Rating	Reference Number	Ampere Rating	Reference Number	Ampere Rating	Reference Number	Ampere Rating	Reference Number
1/10	S211662	3/10	Q201402	1-1/8	R219872	2	P216259	3-2/10	D200862	6	Z214221	12	Y214220
1/8	A213210	4/10	R212696	1-1/4	R219343	2-1/8	F217792	3-1/2	Y223075	6-1/4	C214730	14	B214729
15/100	J215748	1/2	Y212173	1-4/10	F222553	2-1/4	B217282	4	T211663	7	P216765	15	E215238
3/16	D201920	6/10	F215239	1-1/2	Q218307	2-1/2	N216764	4-1/2	Z212174	8	C217283	20	S219344
2/10	E218826	8/10	G217793	1-6/10	X223074	2-8/10	R218308	5	B213211	9	S218309	25	S219873
1/4	Q212695	1	E217791	1-8/10	C200861	3	G222554	5-6/10	S213709	10	R213708	30	B211141

General Purpose US Fuses



Midget Fuses (10x38 US)
Time Delay
ATQ 500VAC (TD)

Melting Time - Current Data 1/10 - 3-1/2 Amperes, 500 Volts AC

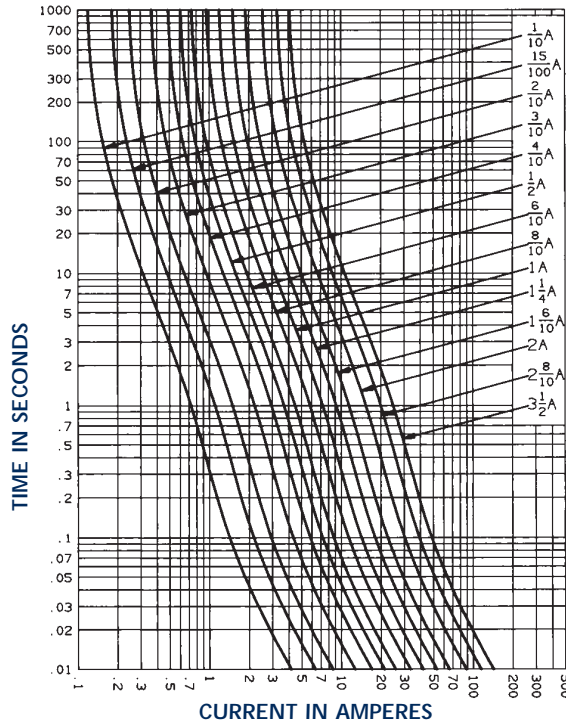

Melting Time - Current Data 4 - 30 Amperes, 500 Volts AC

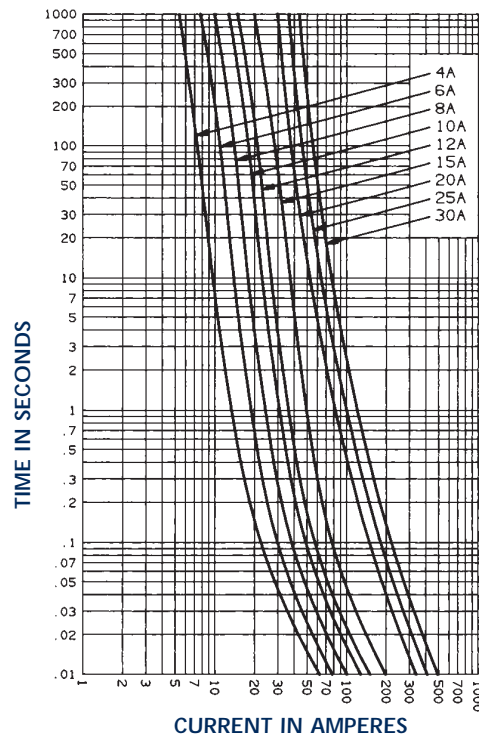



General Purpose US Fuses

Midget Fuses (10x38 US) Time Delay TRM



Tri-onic® TRM time-delay midget fuses are rated 250 volts AC and are offered in 36 ampere ratings from 1/10A to 30A. They have 12 seconds time delay at 200% rating to provide supplemental protection of small motors, small transformers and other high inrush loads, plus many other 250 volt applications. (Not for Branch Circuit Protection).

Features/Benefits

- Numerous ratings for a wide variety of applications
- 250VAC rating in all sizes up to 30A
- Time delay for circuits with high inrush current
- UltraSafe™ fuse holder: refer to Fuse Blocks and Fuse Holders section for details, Catalog Number and Reference Number

Ratings

- AC: 1/10 to 30A
250VAC, 10kA I.R.

Highlights

- Time Delay
- 250 VAC Rated

Applications

- Small Motors
- Small Transformers
- Lighting Circuits
- Control Circuits

Approvals



- UL Listed to Standard 248-14
- CSA Certified to Standard C22.2 No. 248.14

Standard Fuse Ampere Ratings, Catalog Numbers

Ampere Rating	Catalog Number	Ampere Rating	Catalog Number	Ampere Rating	Catalog Number	Ampere Rating	Catalog Number	Ampere Rating	Catalog Number	Ampere Rating	Catalog Number
1/10	TRM1/10	6/10	TRM6/10	1-6/10	TRM1-6/10	3	TRM3	5-6/10	TRM5-6/10	10	TRM10
15/100	TRM15/100	8/10	TRM8/10	1-8/10	TRM1-8/10	3-2/10	TRM3-2/10	6	TRM6	12	TRM12
2/10	TRM2/10	1	TRM1	2	TRM2	3-1/2	TRM3-1/2	6-1/4	TRM6-1/4	15	TRM15
3/10	TRM3/10	1-1/8	TRM1-1/8	2-1/4	TRM2-1/4	4	TRM4	7	TRM7	20	TRM20
4/10	TRM4/10	1-1/4	TRM1-1/4	2-1/2	TRM2-1/2	4-1/2	TRM4-1/2	8	TRM8	25	TRM25
1/2	TRM1/2	1-4/10	TRM1-4/10	2-8/10	TRM2-8/10	5	TRM5	9	TRM9	30	TRM30

Standard Fuse Ampere Ratings, Reference Numbers

Ampere Rating	Reference Number	Ampere Rating	Reference Number	Ampere Rating	Reference Number	Ampere Rating	Reference Number	Ampere Rating	Reference Number	Ampere Rating	Reference Number
1/10	R217273	6/10	X222545	1-6/10	E216250	3	H213700	5-6/10	W218818	10	V218817
15/100	M223065	8/10	G201394	1-8/10	C216754	3-2/10	R214720	6	H219335	12	G219334
2/10	P212165	1	M214210	2	S200852	3-1/2	N214211	6-1/4	H219864	15	W222544
3/10	V215229	1-1/8	T215228	2-1/4	R211132	4	F216251	7	N223066	20	F212686
4/10	W217783	1-1/4	Q214719	2-1/2	T201911	4-1/2	D216755	8	T200853	25	Q213201
1/2	V217782	1-4/10	Y215738	2-8/10	H211653	5	G218299	9	V201912	30	Z215739

General Purpose US Fuses



Midget Fuses (10x38 US)
Time Delay
TRM

Melting Time - Current Data 1/10 - 3-1/2 Amperes, 250 Volts AC

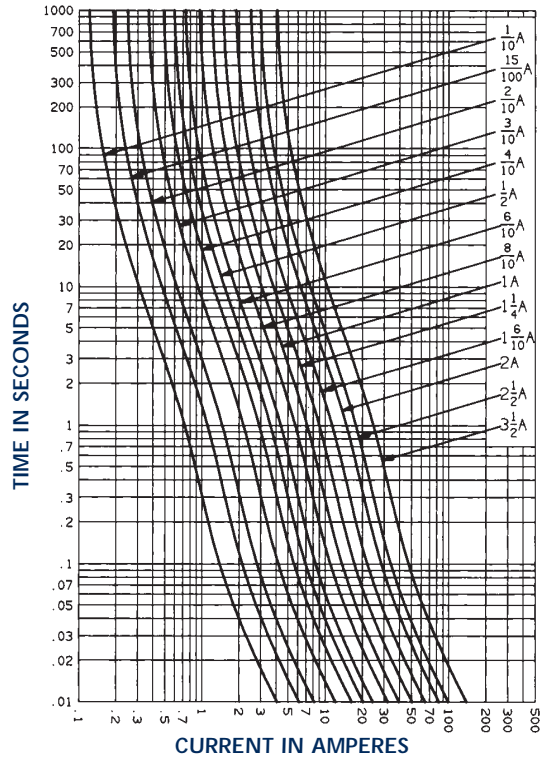

Melting Time - Current Data 4 - 30 Amperes, 250 Volts AC

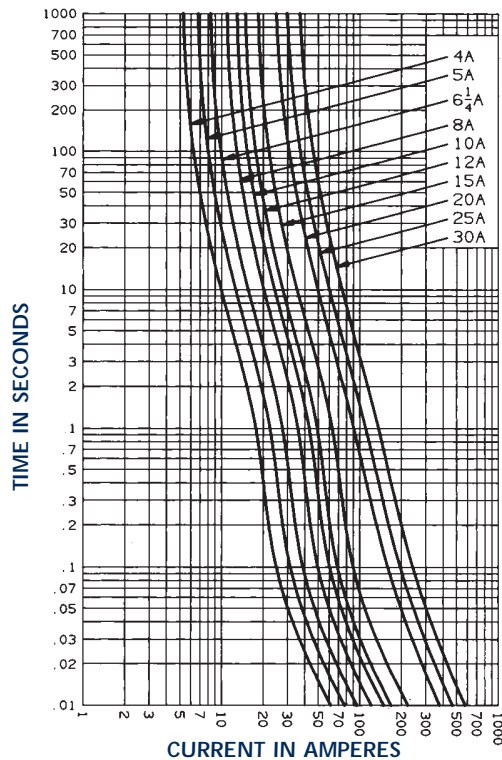



General Purpose US Fuses

Midget Fuses (10x38 US) Time Delay GFN



GFN midget indicating fuses are available in 34 ratings from 1/10A through 30A. These time-delay fuses have built-in blown fuse indicators which pop out at the end of the fuse to visually indicate when the fuse has operated to open the circuit. Indicators may be used to trip a switch for remote as well as visual indication. (Not for Branch Circuit Protection).

Features/Benefits

- Pin indicator provides visual indication of open fuse or actuates switch for remote signaling
- Numerous ratings for a wide variety of applications
- 12 second time delay at 200% rating
- UltraSafe™ fuse holder: refer to Fuse Blocks and Fuse Holders section for details, Catalog Number and Reference Number

Ratings

- AC: 1/10 to 10A 250VAC, 200A I.R., 125VAC, 10kA I.R.;
- 12 to 15A 125VAC, 10kA I.R.;
- 20 to 30A 32VAC, 10kA I.R.

Highlights

- Pin Indicating
- Time Delay

Applications

- For supplemental protection of circuits where time delay and blown fuse indication are required, such as solenoid circuits or control circuits.

Melting Time - Current Data 1 - 30 Amperes, 250 Volts AC

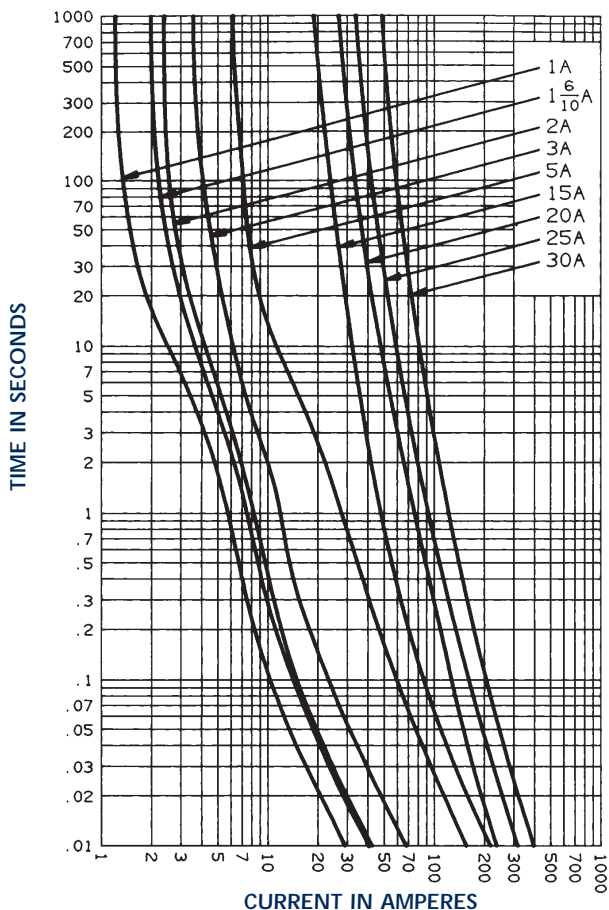

Approvals

- UL Listed to Standard 248-14 (1/10 to 15A)
- CSA Certified to Standard C22.2 No.248.14 (1/10 to 15A)

Standard Fuse Ampere Ratings

Ampere Rating	Catalog Number	Reference Number	Ampere Rating	Catalog Number	Reference Number
1/10	GFN1/10	K222557	2	GFN2	V212699
1/8	GFN1/8	T201405	2-1/4	GFN2-1/4	W213712
15/100	GFN15/100	C212177	2-1/2	GFN2-1/2	E213214
2/10	GFN2/10	C214224	3	GFN3	M215751
1/4	GFN1/4	G200865	3-2/10	GFN3-2/10	S216768
3/10	GFN3/10	F217286	3-1/2	GFN3-1/2	S216262
4/10	GFN4/10	X219348	4	GFN4	W218312
1/2	GFN1/2	B223078	4-1/2	GFN4-1/2	J218830
6/10	GFN6/10	H201924	5	GFN5	L222558
8/10	GFN8/10	Y211667	6-1/4	GFN6-1/4	V201406
1	GFN1	R216767	8	GFN8	F211145
1-1/8	GFN1-1/8	V218311	10	GFN10	G201923
1-1/4	GFN1-1/4	J217795	12	GFN12	E211144
1-4/10	GFN1-4/10	H218829	15	GFN15	X211666
1-1/2	GFN1-1/2	E217285	20	GFN20	F214733
1-6/10	GFN1-6/10	W219347	25	GFN25	J215242
1-8/10	GFN1-8/10	W219876	30	GFN30	J215242

General Purpose US Fuses



Midget Fuses (10x38 US) Fast Acting A6Y-2B

A6Y "Type 2B" Amp-trap® midget fuses are fast acting on short circuits, yet have sufficient time delay to offer supplemental protection for small motors, transformers, and control circuits. (Not for Branch Circuit Protection).



Features/Benefits

- Moderate amount of time delay for circuits with inrush characteristics
- Fast acting on short circuits
- UltraSafe™ fuse holder: refer to Fuse Blocks and Fuse Holders section for details, Catalog Number and Reference Number

Ratings

- AC: 1/4 to 3A 600VAC, 10kA I.R.
- 3-2/10 to 15A 500VAC, 10kA I.R.

Standard Fuse Ampere Ratings

Ampere Rating	Catalog Number	Reference Number
1/4	A6Y1/4-2B	Y222546
1/2	A6Y1/2-2B	J219865
6/10	A6Y6/10-2B	T214722
3/4	A6Y3/4-2B	-
1	A6Y1-2B	X218819
1-1/4	A6Y1-1/4-2B	H218300
1-1/2	A6Y1-1/2-2B	X217784
1-6/10	A6Y1-6/10-2B	J219336
2	A6Y2-2B	T211134
2-1/2	A6Y2-1/2-2B	W201913
3	A6Y3-2B	H212688
3-2/10	A6Y3-2/10-2B	R212167
3-1/2	A6Y3-1/2-2B	K211655
4	A6Y4-2B	S213203
5	A6Y5-2B	K213702
6	A6Y6-2B	Q214213
7	A6Y7-2B	X215231
8	A6Y8-2B	B215741
9	A6Y9-2B	F216757
10	A6Y10-2B	P223067
12	A6Y12-2B	V200854
15	A6Y15-2B	H201395

Highlights

- Fast Acting

Applications

- Supplemental protection of 600V (up to 3A) and 500V (3-2/10-15A) AC circuits
- Small motors, transformers, and control circuits

Approvals

- Ferraz Shawmut Certified

Melting Time - Current Data 1/4 - 3 Amperes, 600 Volts AC 3-2/10 - 15 Amperes, 500 Volts AC

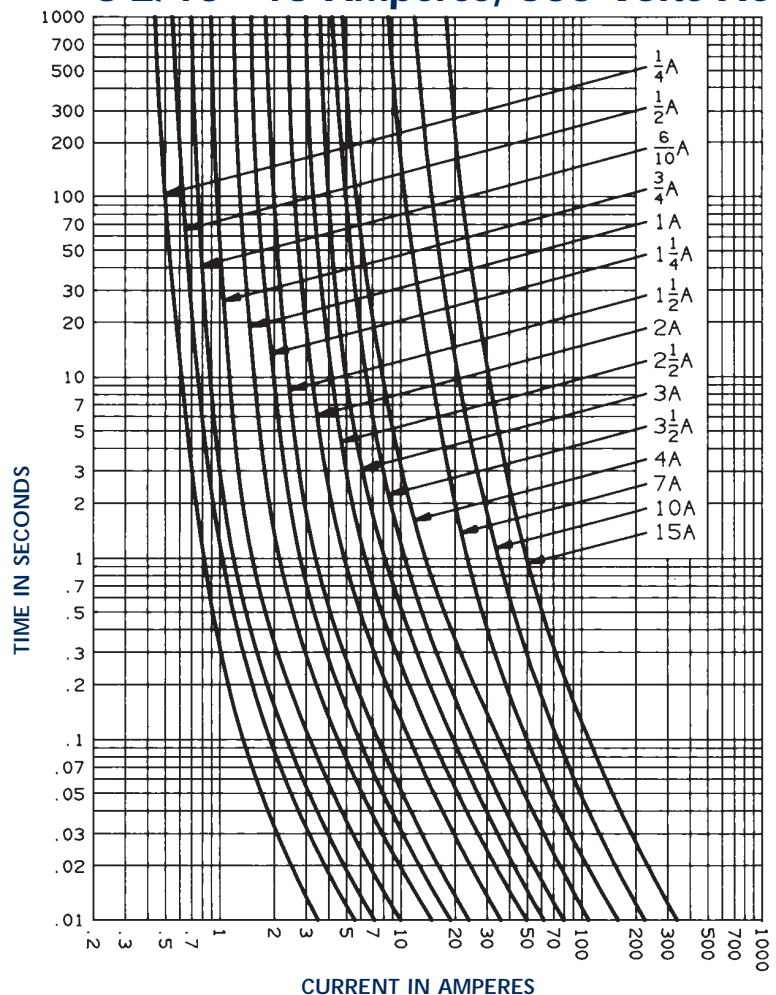



General Purpose US Fuses

Midget Fuses (10x38 US) Fast Acting ATM



Amp-trap® midget fast-acting ATM fuses are rated 600 volts AC, with a 100kA interrupting rating. These ratings give the ATM a wide range of applications not covered by other midget fuses. In addition, ratings of 30/35, 30/40 and 30/50 amperes are offered for specific applications such as capacitor protection. These ATM fuses must still be considered 30A fuses because of their dimensions, but are able to withstand much higher inrush currents and tougher duty cycles. (Not for Branch Circuit Protection).

Features/Benefits

- For supplemental protection of small motors and transformers
- Extended ratings for special protection of capacitors and circuits with high inrush currents
- 500VDC ratings for a wide variety of applications
- UltraSafe™ fuse holder: refer to Fuse Blocks and Fuse Holders section for details, Catalog Number and Reference Number

Ratings

- AC: 1/10 to 30A 600VAC, 100kA I.R.;
35 to 50A 600VAC, 10kA I.R.
- DC: 1/10 to 30A 500VDC, 100kA I.R.

Highlights

- Fast Acting
- Special Ratings (above 30A)

Applications

- Supplemental protection of a wide variety of circuits up to 600VAC and 500VDC with 100kA I.R.

Approvals



- UL Listed to Standard 248-14 (1/10 to 30A)
- DC listed to UL Standard 248-14 (1/10 to 30A)
- CSA Certified to Standard C22.2 No. 248.14 (1/10 to 30A)

Melting Time - Current Data 1/10 30/50 Amperes, 600 Volts AC

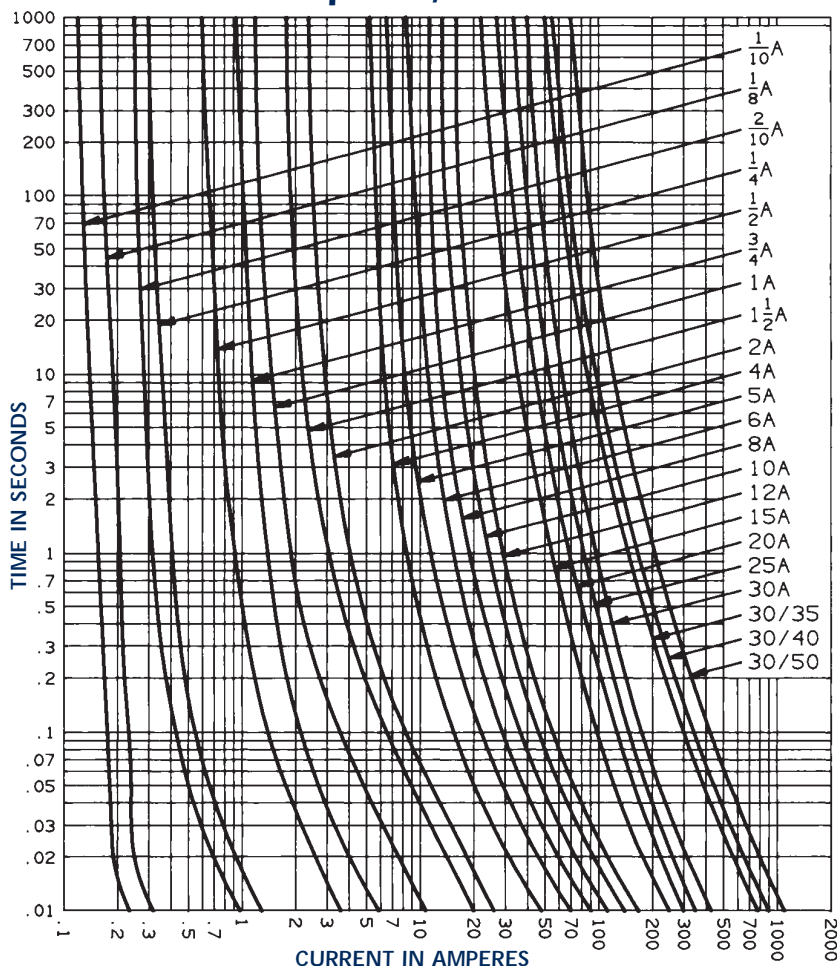

Standard Fuse Ampere Ratings, Reference Numbers

Ampere Rating	Catalog Number	Reference Number
1/10	ATM1/10	L218303
1/8	ATM1/8	M219868
2/10	ATM2/10	X211137
1/4	ATM1/4	M219339
1/2	ATM1/2	A218822
3/4	ATM3/4	W213206
1	ATM1	W217277
1-1/2	ATM1-1/2	A217787
2	ATM2	Z201916
3	ATM3	L212691
4	ATM4	E215744
5	ATM5	K216255
6	ATM6	J216760
8	ATM8	B217788
10	ATM10	B222549
12	ATM12	Y200857
15	ATM15	L201398
20	ATM20	N211658
25	ATM25	V212170
30	ATM30	N213705
30/35	ATM30/35*	T214216*
30/40	ATM30/40*	X214725*
30/50	ATM30/50*	A215234*

*Not continuous current rated devices

General Purpose US Fuses



Midget Fuses (10x38 US) Fast Acting 6JX

600VAC - 500VDC
100000 A.I.R
Current limiting



Ferraz Shawmut 6JX Midget Fuses are recommended for applications requiring very precise operating characteristics and where high available fault currents demand high interrupting capacities. Typical applications include control circuit, lighting circuit, small motor and control transformer protection.

Dimensions

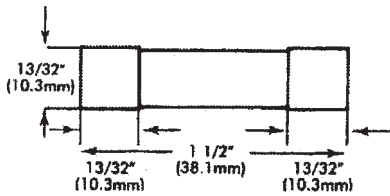

6JX fuses can be mounted in the UltraSafe™ fuse holder. Refer to Fuse Blocks and Fuse Holders section for details, Reference Number and Catalog Number.

Standard Fuse Ampere Ratings, Reference Numbers

Ampere Rating	Reference Number	Catalog Number	Ampere Rating	Reference Number	Catalog Number
0,100	C079651J	6JX0,1	4	E083471J	6JX4
0,125	D079652J	6JX0,125	5	X089398J	6JX5
0,200	K079681J	6JX0,2	6	B082686J	6JX6
0,250	L079682J	6JX0,25	7	W079783J	6JX7
0,300	T082334J	6JX0,3	8	B080294J	6JX8
0,500	R083068J	6JX0,5	9	R079848J	6JX9
0,750	Q079686J	6JX0,75	10	E082689J	6JX10
1	S083069J	6JX1	12	W089397J	6JX12
1,5	S080838J	6JX1,5	15	F082805J	6JX15
2	K082326J	6JX2	20	S079849J	6JX20
2,5	A080293J	6JX2,5	25	K079865J	6JX25
3	F082690J	6JX3	30	S079895J	6JX30
3,5	E079745J	6JX3,5			

Test specifications

$$I_{NF} = 110\% I_N t \text{ } \varnothing \text{ 4 Hours}$$

$$I_F = 135\% I_N t \leq 1 \text{ Hour}$$

$$I_F = 200\% I_N t \leq 120 \text{ Sec.}$$

UL LISTED
CSA CERTIFIED



Metting Time-current Data

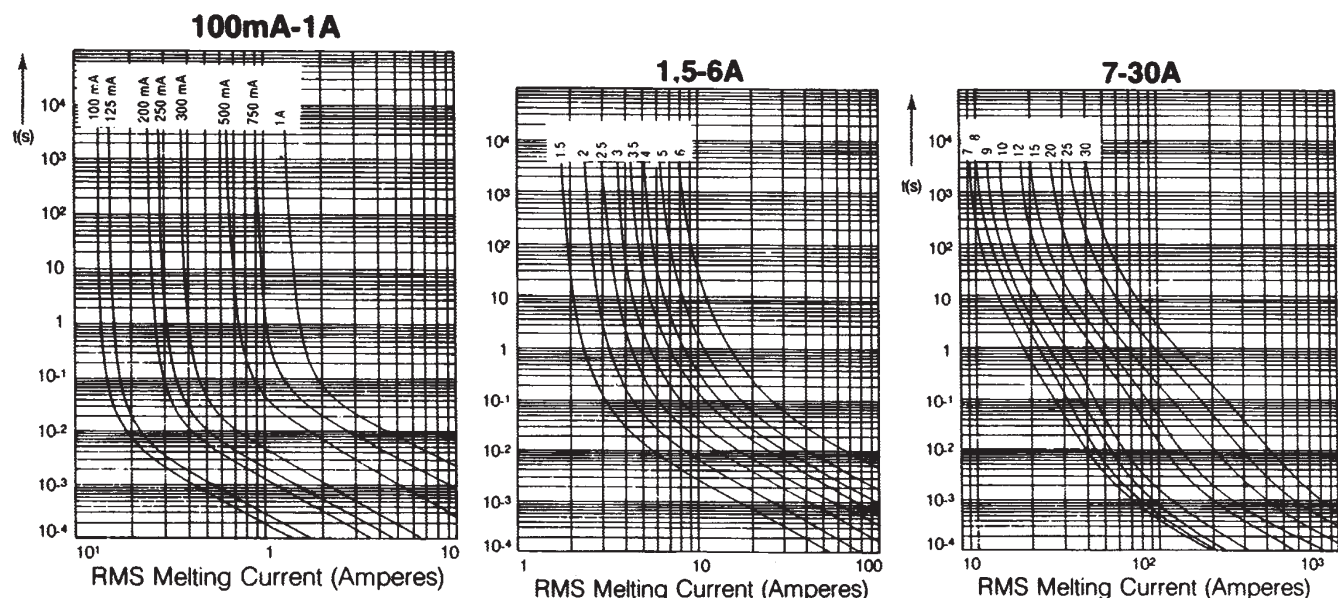



General Purpose US Fuses

Midget Fuses (10x38 US) Fast Acting OTM



One-time OTM midget fuses provide low-cost protection for 250 volt AC general purpose lighting, heating, control circuits, etc. where time delay is not required.

(Not for Branch Circuit Protection).

Features/Benefits

- Low cost and fully rated for economy without compromise
- UltraSafe™ fuse holder: refer to Fuse Blocks and Fuse Holders section for details, Catalog Number and Reference Number

Ratings

- AC: 1 to 30A 250VAC, 10kA I.R.

Melting Time - Current Data 1-30 Amperes, 250 Volts AC

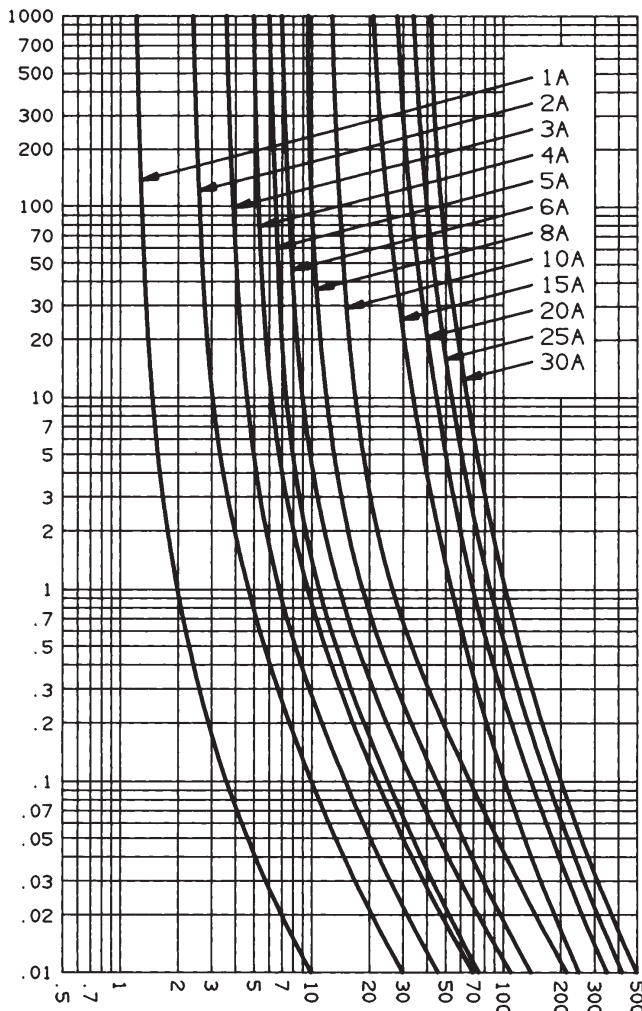

Highlights

- Fast Acting
- 250 VAC Rated

Applications

- Supplemental protection of circuits up to 250VAC and 10kA

Approvals



- UL Listed to Standard 248-14
- CSA Certified to Standard C22.2 No. 248.14

Standard Fuse Ampere Ratings, Reference Numbers

Ampere Rating	Catalog Number	Reference Number
1	OTM1	E215721
2	OTM2	Y217256
3	OTM3	A218799
4	OTM4	N219846
5	OTM5	C222527
6	OTM6	T223048
8	OTM8	Z200835
10	OTM10	L216233
15	OTM15	J216737
20	OTM20	B217765
25	OTM25	M218281
30	OTM30	M219316

General Purpose US Fuses



Midget Fuses (10x38 US) Fast Acting GGU



125 volt AC rated GGU fuses have midget fuse dimensions (1-1/2" long x 13/32" diameter). Ratings 3 through 15 amperes have glass bodies for easy checking of fuse link status. Ratings 20, 25, and 30 amperes have ceramic bodies, allowing use in higher ambient temperature conditions than other similar fuses. (Not for Branch Circuit Protection).



Features/Benefits

- Glass body on 3-15A makes status of fusible element clearly visible
- All ratings 125VAC - higher than competitors
- Ceramic body on 20-30A allows use in higher temperature applications
- Fast acting for protection of circuits up to 30A and 125VAC
- UltraSafe™ fuse holder: refer to Fuse Blocks and Fuse Holders section for details, Catalog Number and Reference Number

Ratings

- AC: 3 to 30A 125VAC, 10kA I.R

Highlights

- Fast Acting

Applications

- General Purpose
- 125 Volt AC Circuits
- Supplemental Protection

Approvals



- UL Listed to Standard 248-14 (3 to 15A)
- UL Recognized Component Guide No. JDYX2 (20 to 30A)

Melting Time - Current Data 3-30 Amperes, 125 Volts AC

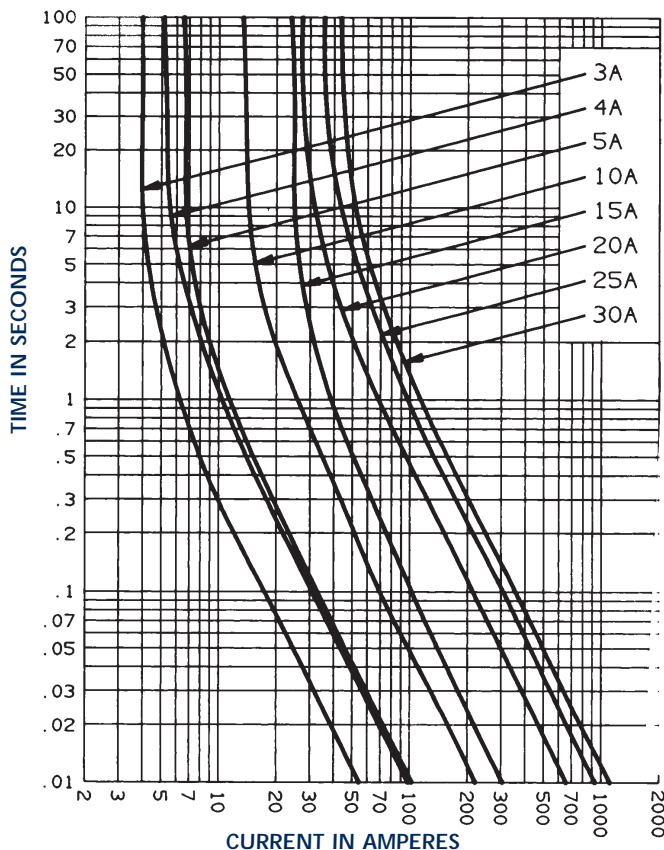

Standard Fuse Ampere Ratings, Reference Numbers

Ampere Rating	Catalog Number	Reference Number
3	GGU3	Q212442
4	GGU4	K213472
5	GGU5	E213973
8	GGU8	Q214489
10	GGU10	K201673
15	GGU15	S205475
20	GGU20	A211416
25	GGU25	C211924
30	GGU30	A212957



General Purpose US Fuses

Midget Fuses (10x35 US) Fast Acting SBS



Unique dimensions for today's smaller equipment and components

Fast-acting general purpose SBS fuses were developed in response to the industry's demand for smaller equipment and components. They are the only fuses in their size with a full 600 volt AC rating for all ampere ratings by Underwriters Laboratories standard 198G and CSA No. 59.2, and are the only fuses of this size with an interrupting rating of 100kA RMS, compared to 10kA on other brands.

SBS fuses are 1-3/8" long, smaller by 1/8" than most standard midget fuses and are available in 22 ampere ratings, from 2/10A to 30A. (Not for Branch Circuit Protection).

Features/Benefits

- Small unique physical size for maximum design flexibility and non-interchangeability with their fuse classes
- Fiberglass body provides dimensional stability in harsh industrial environments
- UltraSafe™ fuse holder: refer to Gear and Fuse Gear section for details, Catalog Number and Reference Number

Standard Fuse Ampere Ratings, Reference Numbers

Ampere Rating	Catalog Number	Reference Number	Ampere Rating	Catalog Number	Reference Number
2/10	SBS2/10	Y219349	4	SBS4	J201925
4/10	SBS4/10	G211146	5	SBS5	Z211668
1/2	SBS1/2	T216769	6	SBS6	E212179
3/4	SBS3/4	J200867	7	SBS7	X212701
8/10	SBS8/10	H214735	8	SBS8	E214226
1	SBS1	G214734	10	SBS10	G217287
1-1/2	SBS1-1/2	K215243	12	SBS12	G217287
1-6/10	SBS1-6/10	N215752	15	SBS15	X218313
1-8/10	SBS1-8/10	T216263	20	SBS20	X219877
2	SBS2	K218831	25	SBS25	M222559
3	SBS3	D223080	30	SBS30	W201407

Cross Reference: SBS will replace Bussmann BBS, Littelfuse BLS fuses

Peak Let-thru Current Data 3/4 - 30 Amperes, 600 Volts AC

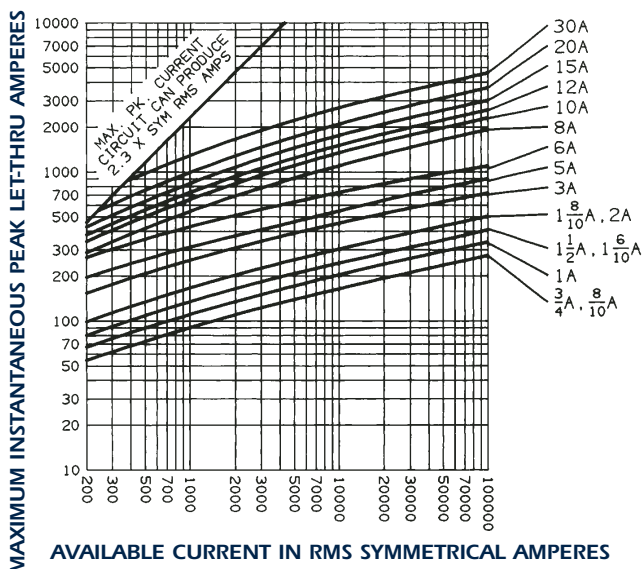

Ratings

- AC: 2/10 to 30A 600VAC, 100kA I.R.

Applications

- Control Circuits
- Lighting Ballasts
- Meter Circuits
- Electronic Circuits

Highlights

- Fast Acting
- General Purpose
- Unique Dimensions

Approvals

- UL Listed to Standard 248-14
- CSA Certified to Standard C22.2 No. 248.14

Melting Time - Current Data 2/10 - 30 Amperes, 600 Volts AC

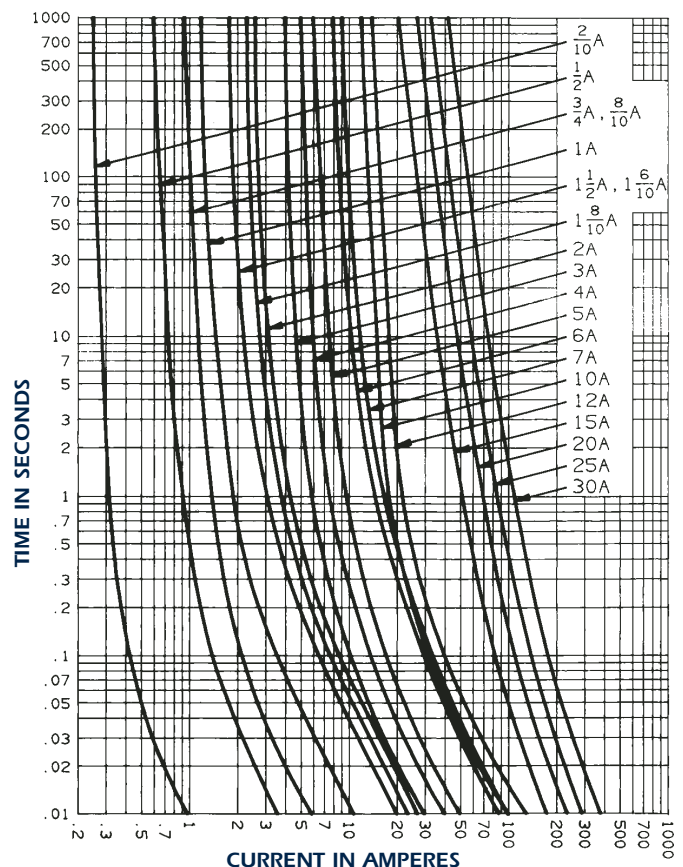

General Purpose US Fuses



Midget Fuses (10x38 US) PC Mount PCF



Fast acting fuses for direct mounting on printed circuit boards

Ferraz Shawmuts new PCF series of fast-acting direct-mountable fuses addresses the increasing need for electrical protection at the PC board as current and voltage requirements push higher. These fuses help printed circuit board manufacturers reduce parts by eliminating clips and fuse blocks and allowing automated assembly. PCF fuses can be used for the protection of main frame power boards, small circuit breakers with low interrupting ratings and other critical components. PCF fuses bring greatly increased ampere, voltage and interrupting ratings to the board itself and are UL Component Recognized.



Ratings

- AC: 1 to 30A 600VAC, 100kA I.R.
- DC: 1 to 30A 500VDC, 100kA I.R. L/R ≤10ms

Highlights

- Fast Acting
- PC Board Mount
- Three Mounting Styles

Applications

- Protection of main frame power boards, circuit breakers, components

Approvals

- UL Recognized Components

Melting Time - Current Data

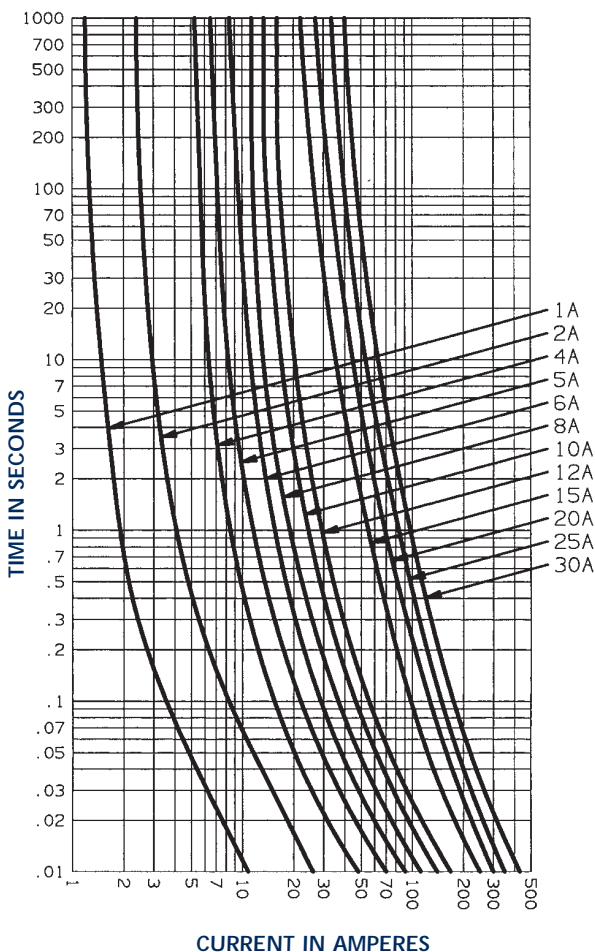

Standard Fuse Ampere Ratings, Ref. Numbers

Ampere Rating	Catalog Number	Reference Number
---------------	----------------	------------------

Slot Mount		
1	PCF1-R	N212256
2	PCF2-R	V218909
3	PCF3-R	P212257
4	PCF4-R	F218390
5	PCF5-R	D219952
6	PCF6-R	G201486
7	PCF7-R	G211744

Double Hole Mount

1	PCF1-H	E211742
2	PCF2-H	E218389
3	PCF3-H	F211743
4	PCF4-H	Z217878
5	PCF5-H	K219429
6	PCF6-H	Q200942
7	PCF7-H	R211224

Surface Mount

1	PCF1-S	A212773
2	PCF2-S	J219428
3	PCF3-S	B212774
4	PCF4-S	W218910
5	PCF5-S	W222636
6	PCF6-S	T202026
7	PCF7-S	Q212258

Ampere Rating	Catalog Number	Reference Number
---------------	----------------	------------------

8	PCF8-R	P213292
10	PCF10-R	E213789
12	PCF12-R	T215826
15	PCF15-R	Q217364
20	PCF20-R	V222635
25	PCF25-R	F201485
30	PCF30-R	Q215317

8	PCF8-H	C212775
10	PCF10-H	N213291
12	PCF12-H	N214809
15	PCF15-H	B216845
20	PCF20-H	C219951
25	PCF25-H	P200941
30	PCF30-H	F213790

8	PCF8-S	G213791
10	PCF10-S	N214303
12	PCF12-S	Y216336
15	PCF15-S	Y217877
20	PCF20-S	J223154
25	PCF25-S	Q211223
30	PCF30-S	V215827

General Purpose US Fuses



Midget Fuses (10x38 US) PC Mount Mechanics PCx

PCF1-R thru PCF30-R
PCS5-R thru PCS30-R
PCT1-R thru PCT30-R

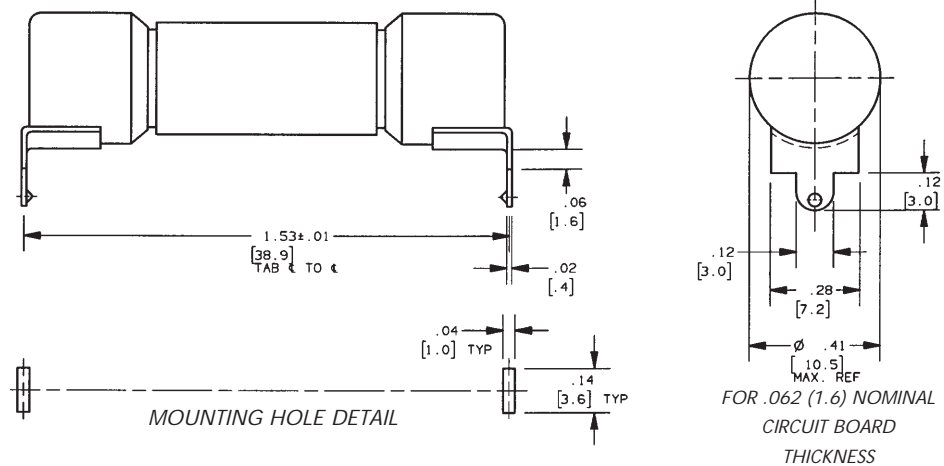

Double Hole Mount (Round Holes) "H" terminal

PCF1-H thru PCF30-H
PCS5-H thru PCS30-H
PCT1-H thru PCT30-H

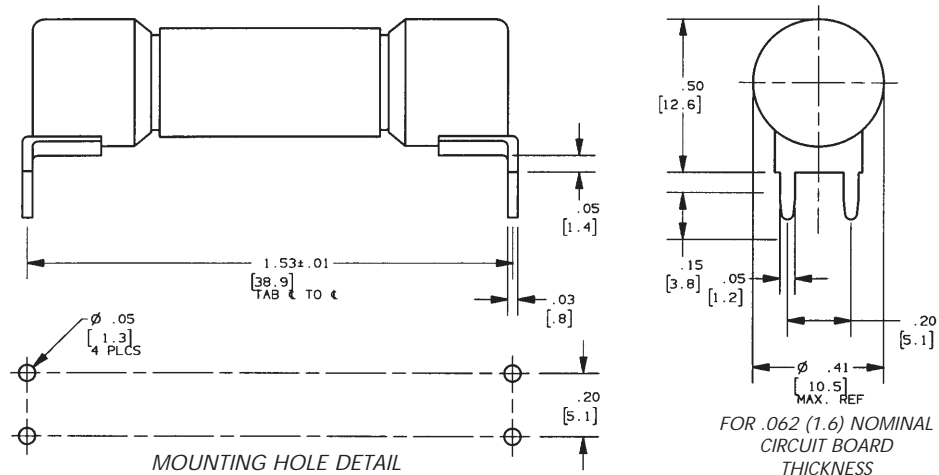

Surface (Screw) Mount "S" terminal

PCF1-S thru PCF30-S
PCS5-S thru PCS30-S
PCT1-S thru PCT30-S

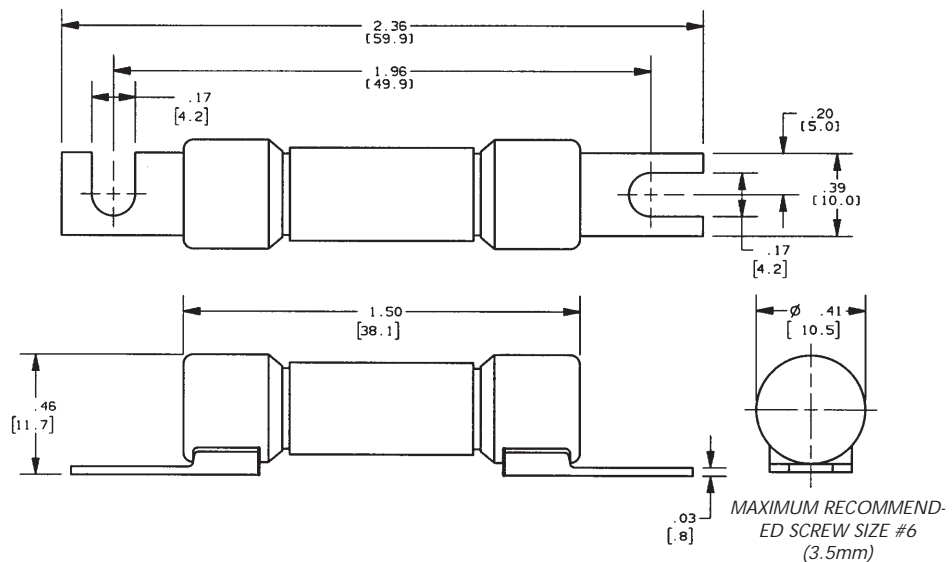



General Purpose US Fuses

Midget Fuses (10x38 US) PC Mount PCS



Semiconductor protection fuses for direct mounting on printed circuit boards

Ferraz Shawmut's new PCS series of extremely fast-acting, direct-mountable fuses addresses the increasing need for electrical protection at the PC board as current and voltage requirements push higher. These fuses help printed circuit board manufacturers reduce parts by eliminating clips and fuse blocks and allowing automated assembly. PCS fuses are AC and DC rated and are extremely current-limiting. They will protect semiconductors, main frame boards, circuit breakers with low interrupting rating and other critical components. PCS fuses bring I2t protection, higher voltage and interrupting ratings to the board itself and are UL Component Recognized.

Ratings

- AC: 5 to 30A 600VAC, 200kA I.R.
- DC: 5 to 30A 600VDC, 100kA I.R.
L/R ≤ 10 ms

Highlights

- Extremely Fast Acting
- PC Board Mount
- Three Mounting Styles

Melting Time - Current Data

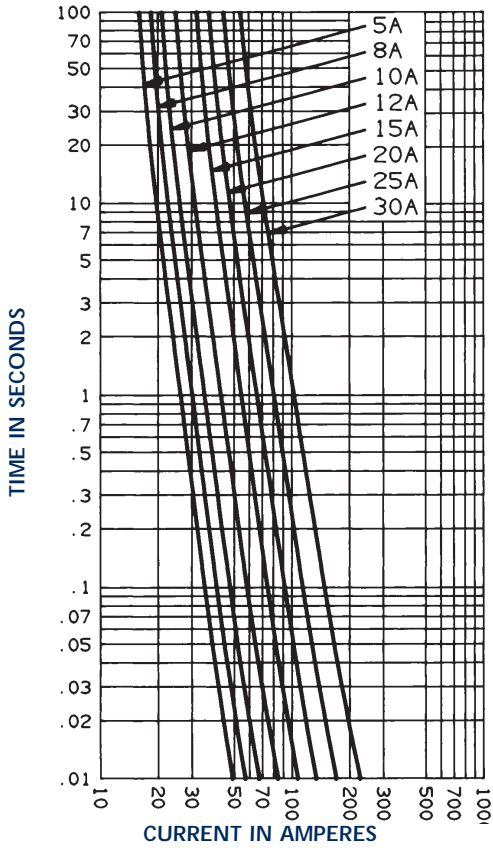

Applications

- Protection of semiconductors, circuit breakers, critical components

Approvals

- UL Recognized Components

Standard Fuse Ampere Ratings

Ampere Rating	Catalog Number	Reference Number
---------------	----------------	------------------

Slot Mount

5	PCS5-R	B217880
8	PCS8-R	M219431
10	PCS10-R	Z216337
12	PCS12-R	A217879
15	PCS15-R	L219430
20	PCS20-R	K223155
25	PCS25-R	V202027
30	PCS30-R	R212259

Double Hole Mount

5	PCS5-H	S217366
8	PCS8-H	Y218912
10	PCS10-H	P214304
12	PCS12-H	R217365
15	PCS15-H	X218911
20	PCS20-H	X222637
25	PCS25-H	H201487
30	PCS30-H	H211745

Surface Mount

5	PCS5-S	H218392
8	PCS8-S	F219954
10	PCS10-S	C216846
12	PCS12-S	G218391
15	PCS15-S	E219953
20	PCS20-S	R200943
25	PCS25-S	S211225
30	PCS30-S	D212776

General Purpose US Fuses



Midget Fuses (10x38 US) PC Mount PCS



I²t at 600VDC, 100kA, L/R = 10 ms

Ampere Rating	Clearing I ² t (A ² s)
5	40
8	42
10	70
12	90
15	110
20	200
25	260
30	520

I²t at 600VAC, 100kA

Ampere Rating	Melting I ² t (A ² s)	Clearing I ² t (A ² s)
5	5	60
8	6.5	70
10	10	110
12	17	150
15	26	180
20	41	330
25	69	440
30	132	860

Watts Loss Data

Ampere Rating	Watts Loss @ 80% Rating (w)	Watts Loss @ 100% Rating (w)
5	0.5	0.7
10	0.9	1.5
15	1.9	3.0
20	2.6	4.4
25	2.9	5.3
30	3.0	5.8

Peak Let-Thru Current Data - PCS5 to 30-R, H or S, 600 Volts AC

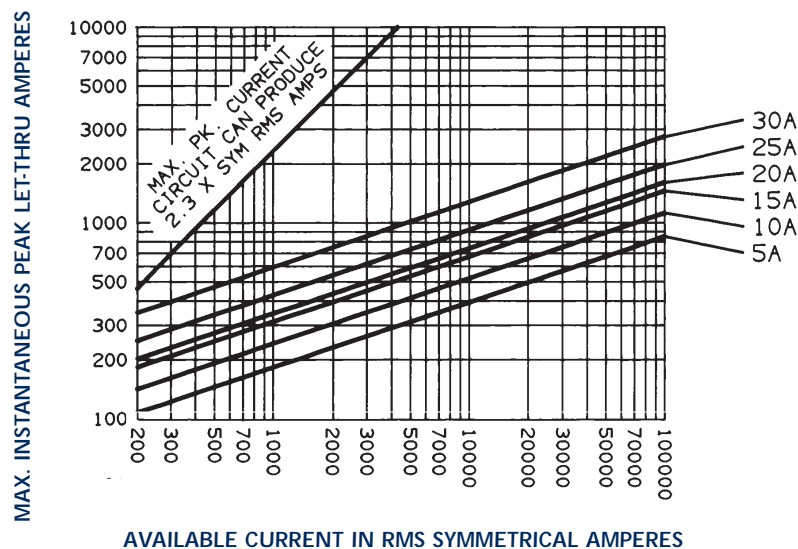

General Purpose US Fuses



Midget Fuses (10x38 US) PC Mount Mechanics PCx

PCF1-R thru PCF30-R
PCS5-R thru PCS30-R
PCT1-R thru PCT30-R

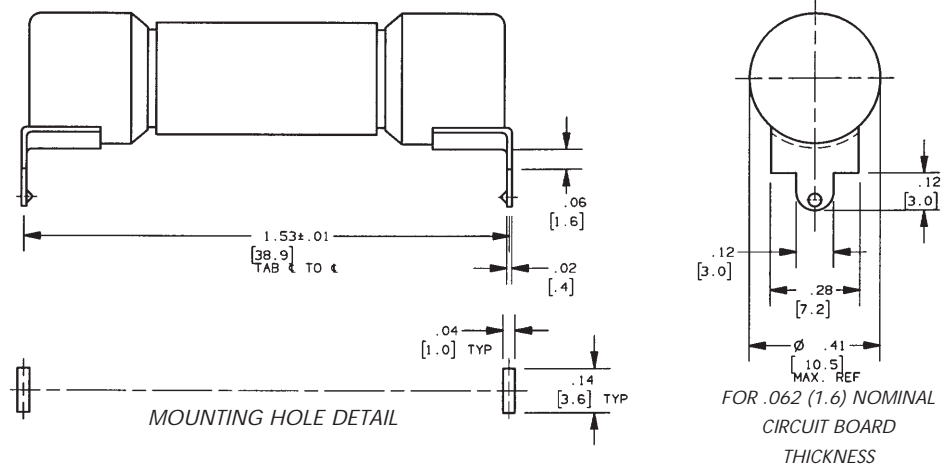

Double Hole Mount (Round Holes) "H" terminal

PCF1-H thru PCF30-H
PCS5-H thru PCS30-H
PCT1-H thru PCT30-H

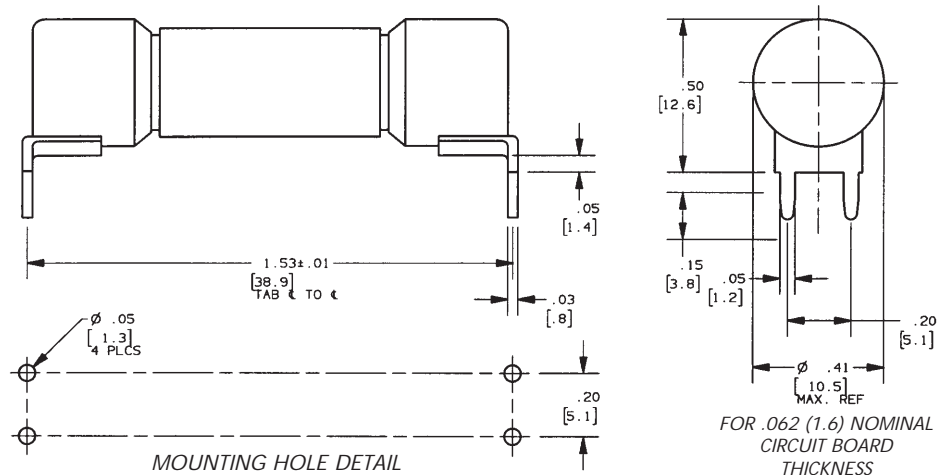

Surface (Screw) Mount "S" terminal

PCF1-S thru PCF30-S
PCS5-S thru PCS30-S
PCT1-S thru PCT30-S

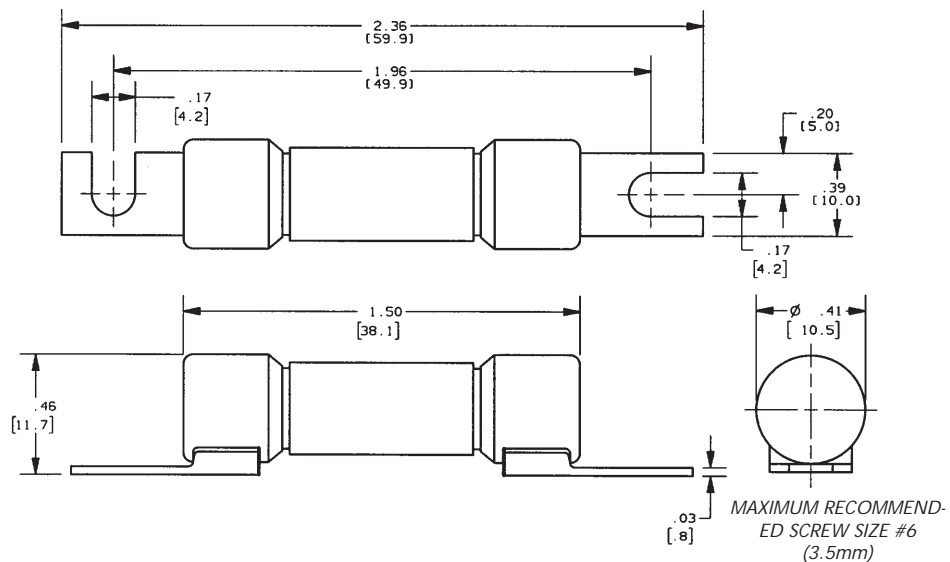

General Purpose US Fuses



Midget Fuses (10x38 US) PC Mount Mechanics PCx

PCF1-R thru PCF30-R
PCS5-R thru PCS30-R
PCT1-R thru PCT30-R

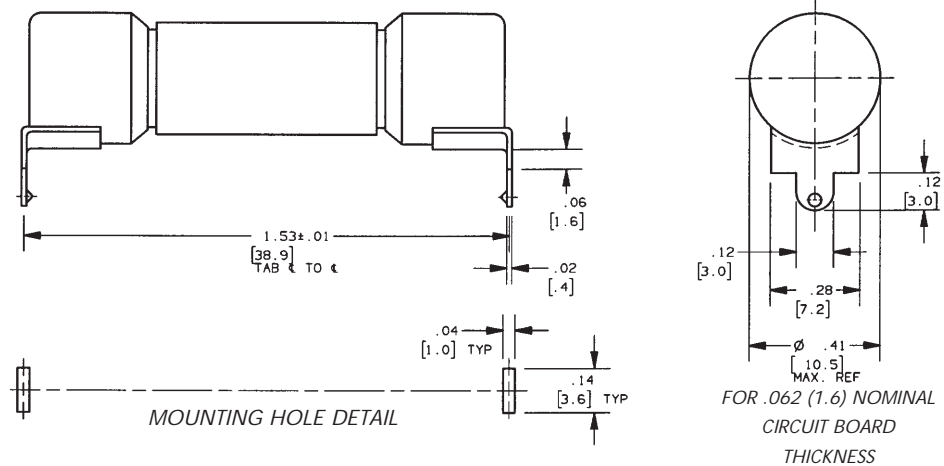

Double Hole Mount (Round Holes) "H" terminal

PCF1-H thru PCF30-H
PCS5-H thru PCS30-H
PCT1-H thru PCT30-H

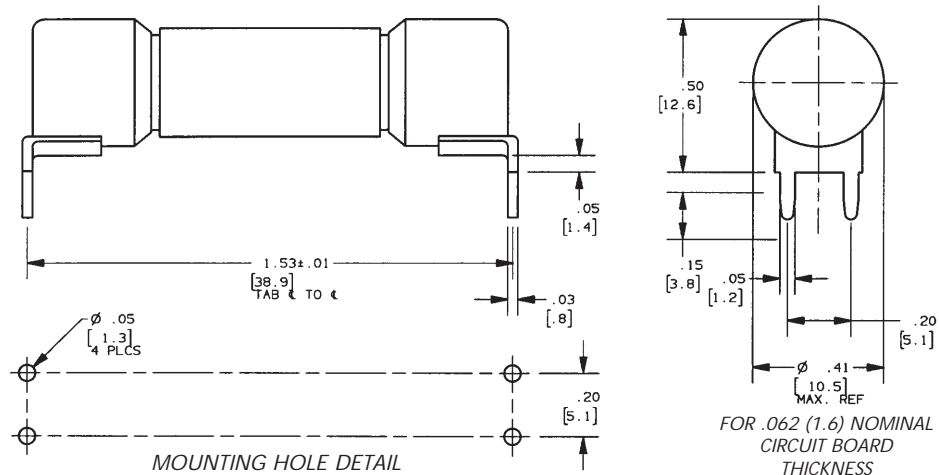

Surface (Screw) Mount "S" terminal

PCF1-S thru PCF30-S
PCS5-S thru PCS30-S
PCT1-S thru PCT30-S

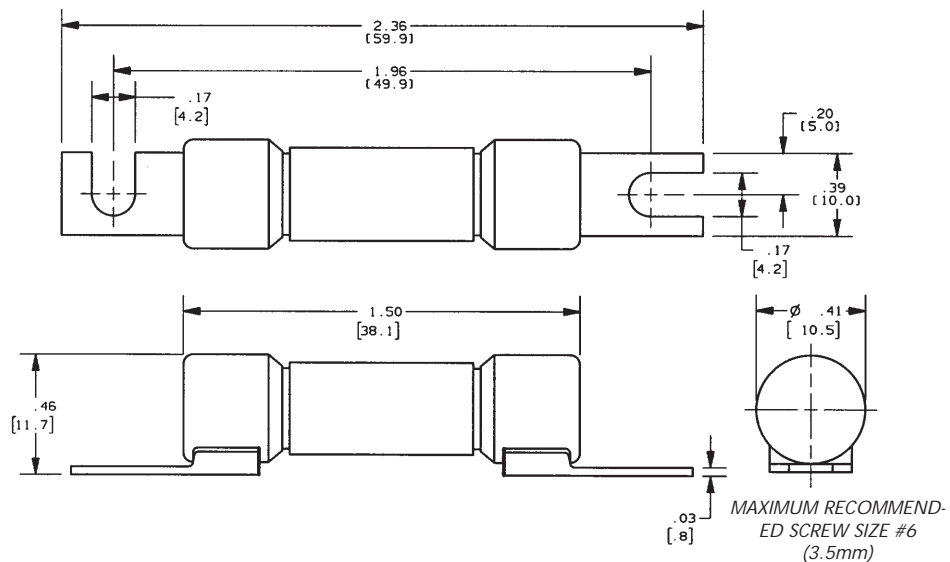



General Purpose US Fuses

Midget Fuses (10x38 US) PC Mount PCT



TIME DELAY FUSES FOR DIRECT MOUNTING ON PRINTED CIRCUIT BOARDS

Ferraz Shawmuts new PCT series of time-delay, direct-mountable fuses addresses the increasing need for electrical protection at the PC board as current and voltage requirements push higher. These fuses help printed circuit board manufacturers reduce parts by eliminating clips and fuse blocks and allowing automated assembly. PCT fuses can be used for the protection of main frame power boards, small circuit breakers with low interrupting ratings and other components. PCT fuses bring protection with time delay, greatly increased ampere, voltage and interrupting ratings to the board itself and are UL Component Recognized

Ratings

- AC: 1 to 30A 500VAC, 100kA

Highlights

- Time Delay
- PC Board Mount
- Three Mounting Styles

Applications

- Protection of main frame power boards, circuit breakers, components

Approvals

- UL Recognized Components

Melting Time – Current Data

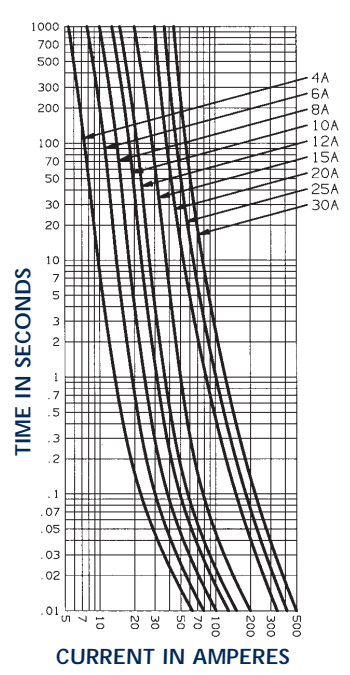
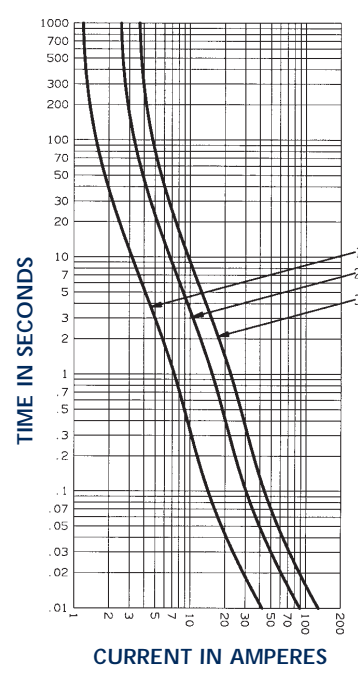

Standard Fuse Ampere Ratings, Ref. Numbers

Ampere Rating	Catalog Number	Reference Number
1	PCT1-R	L223156
2	PCT2-R	S215319
3	PCT3-R	Z222639
4	PCT4-R	K211747
5	PCT5-R	S213295
6	PCT6-R	Q214811
7	PCT7-R	C216340

Ampere Rating	Catalog Number	Reference Number
8	PCT8-R	D217882
10	PCT10-R	D202081
12	PCT12-R	S212260
15	PCT15-R	J213793
20	PCT20-R	T217367
25	PCT25-R	Z218913
30	PCT30-R	K201489

Double Hole Mount

1	PCT1-H	Y222638
2	PCT2-H	P214810
3	PCT3-H	G219955
4	PCT4-H	V211227
5	PCT5-H	F212778
6	PCT6-H	S214307
7	PCT7-H	X215829

8	PCT8-H	V217368
10	PCT10-H	J201488
12	PCT12-H	J211746
15	PCT15-H	R213294
20	PCT20-H	D216847
25	PCT25-H	J218393
30	PCT30-H	T200945

Surface Mount

1	PCT1-S	S200944
2	PCT2-S	B216339
3	PCT3-S	M223157
4	PCT4-S	T212261
5	PCT5-S	K213794
6	PCT6-S	T215320
7	PCT7-S	E216848

8	PCT8-S	K218394
10	PCT10-S	T211226
12	PCT12-S	E212777
15	PCT15-S	R214306
20	PCT20-S	C217881
25	PCT25-S	N219432
30	PCT30-S	N202090

General Purpose US Fuses



Midget Fuses (10x38 US) PC Mount Mechanics PCx

PCF1-R thru PCF30-R
PCS5-R thru PCS30-R
PCT1-R thru PCT30-R

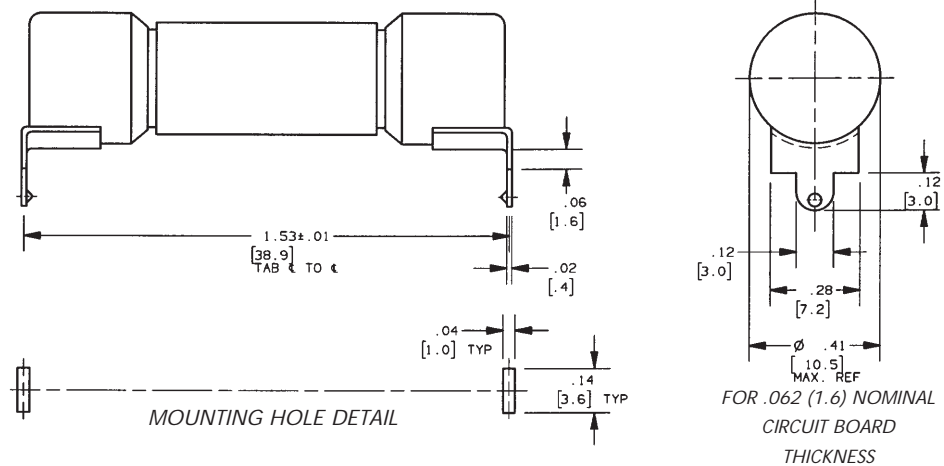

Double Hole Mount (Round Holes) "H" terminal

PCF1-H thru PCF30-H
PCS5-H thru PCS30-H
PCT1-H thru PCT30-H

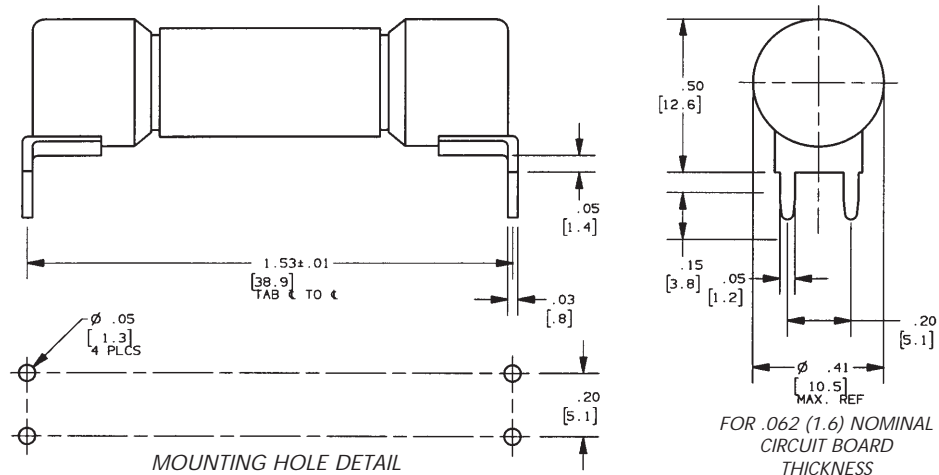

Surface (Screw) Mount "S" terminal

PCF1-S thru PCF30-S
PCS5-S thru PCS30-S
PCT1-S thru PCT30-S

