



Global Cable Gland Solutions

COOPER Crouse-Hinds



Global Cable Gland Solutions

For more than 100 years, companies have come to rely on Cooper Crouse-Hinds for value they can trust to grow their business. Our comprehensive offering of electrical products meet customer application requirements in the most demanding industrial and commercial environments worldwide.

Our customer-first commitment to combine premium quality and reliability with superior technical support successfully minimizes downtime, reduces repair incidence, and improves safety and productivity. Every product we develop and every solution we engineer is clearly focused on lowering our customer's total cost of ownership.

Global termination solutions moving power and signals in the world's most demanding environments



From the deserts of Africa to the icy waters of the North Sea, the world turns to Cooper Crouse-Hinds for its complete gland solutions. Our cable glands are used in industrial and commercial applications throughout the world enhancing safety and productivity in the most severe environmental conditions.



Cooper Crouse-Hinds' global offering provides a termination solution for virtually every cable type used in hazardous and industrial environments. These glands are designed for strict adherence to global specifications meeting North American and International codes & standards including NEC, CEC, ATEX, IECEx and regional certifications.



Cooper Crouse-Hinds cable glands are the easiest and safest solution for your installation and maintenance needs. In any electrical or instrumentation installation, our glands are the reliable and safe way to move power and signals.

Global manufacturing presence and local inventory provides for flexibility in meeting our customers' installation and project coordination schedules. The result is best-in class on-time delivery, customer satisfaction and service. Our first-class technical gland team is available to support product application, technical specification, and onsite installation training on a global basis.



Navigating the Catalog

The catalog is divided into three main product sections so you can quickly find what you need:

- (1) Glands meeting International standards
- (2) Glands meeting North American standards
- (3) Accessories

Pages with **red headers** identify hazardous environment glands while **blue headers** identify industrial / general purpose glands. Additionally, Cooper Crouse-Hinds is always available to answer your simple or complex technical questions with the help of our product experts at any of the customer service numbers or email addresses listed on the back cover.

Key: ■ **Hazardous Area** ■ **Industrial/General Purpose**

Time-tested, quality cable glands from Cooper Crouse-Hinds offer:

- Complete termination solution for global cable applications
- Ease of cable termination providing labor and time management productivity
- Explosion-protected connections contributing to safe operation in harsh & hazardous environments
- Delivery meeting installation and project coordination schedules

Cable Glands

Pg. No.

Quick Selection Guide 6-9

International Standards

Flameproof & Increased Safety

■ ADE 1F	12
■ ADE 4F	13
■ ADE 6F	14
■ TACF	15
■ TWAB	16
■ TWAX	17
■ TWAE	18
■ Ex-e	19
■ Ex-i	20
■ Trumpet	21
■ Enlargement and Multiple	22

Industrial

■ ADE 4I	23
■ TWA	24
■ TUA	25

North American Standards

Explosionproof

■ TMCX	28
■ TULA	29
■ TULU	30
■ CGBS	31
■ EBY	31

General Purpose

■ TMC	32
■ TECK	33
■ CGB	34-35
■ CGD	36
■ CGE	37
■ CGB1013	38
■ CGBFP	39
■ NCG	40
■ NCGB	40

Key: ■ Hazardous Area ■ Industrial/General Purpose





Accessories

Pg. No.

A Series

- Lock Nut 42
- Sealing Washer 42
- Earth Tag 42
- Serrated Lock Washer 43
- Shroud 43
- Clamping Module 43
- Earthing Washer 43
- Adaptors and Reducers 44
- Stopping Plug 45
- Non-Metallic Stopping Plug 45

B Series

- Lock Nut 46
- Sealing Washer 46
- Earth Tag 46
- Shroud 46

C Series

- Lock Nut 47
- Sealing Washer / Gasket 47
- Earth Tag 47
- Shroud 47

D Series

- Lock Nut 48
- Reducing Ring 48
- Screw Plug 48
- Blanking Plug 48

E Series

- Epoxy Seal 49
- Wire Mesh Grip 49
- Cold Shrink Kit 49

Breathers and Drains











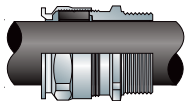

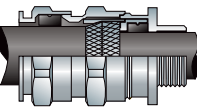
- Breathers and Drains 50

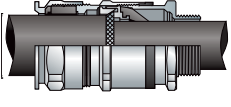
Reference

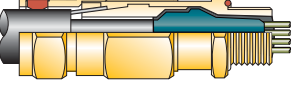

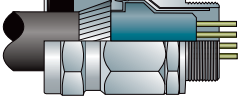
- Guide for Explosive Atmospheres 52-59
- Glossary of Terms and Abbreviations 60-61
- AWG to mm² Conversion Table 61
- Notes 62-63

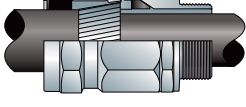
Quick Selection Guide

International Standards

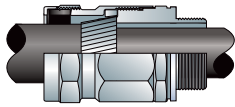
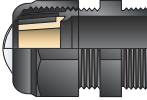
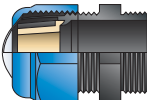
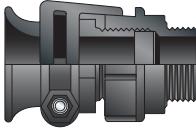

CABLE GLAND	ILLUSTRATION	CABLE TYPE	GLAND TYPE	STANDARD MATERIAL	CERTIFICATION	PROTECTION TYPE
ADE 1F (page 12)		Non-armoured and armoured (does not terminate the armour)	Non-armoured	Nickel-plated brass		Flameproof & Increased Safety
ADE 4F (page 13)		SWA, SWB, STA, braided marine shipboard and lead sheathed (with addition of earthing washer)	Armoured	Nickel-plated brass		Flameproof & Increased Safety
ADE 6F (page 14)		SWA, SWB, STA and braided marine shipboard	Armoured	Nickel-plated brass		Flameproof & Increased Safety
TACF (page 15)		SWA, SWB, STA, braided marine shipboard and lead sheathed (with addition of earthing washer)	Armoured barrier	Brass		Flameproof & Increased Safety
TWAB (page 16)		SWA	Armoured barrier	Nickel-plated brass		Flameproof
TWAX (page 17)		SWA	Armoured	Nickel-plated brass		Flameproof

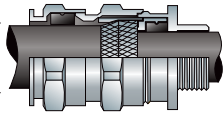
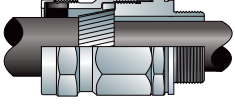
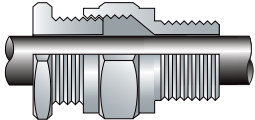





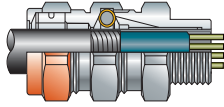
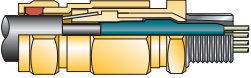

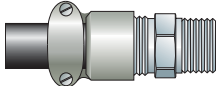
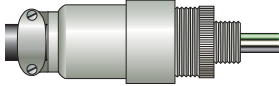
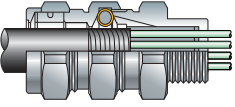
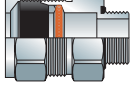
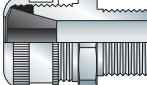

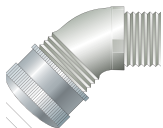

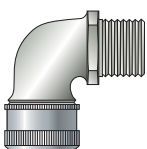

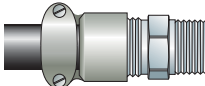
CABLE GLAND	ILLUSTRATION	CABLE TYPE	GLAND TYPE	STANDARD MATERIAL	CERTIFICATION	PROTECTION TYPE
TWAE (page 18)		SWA	Armoured	Nickel-plated brass	<u>IECE_x</u>	Increased Safety
EX-e (page 19)		Non-armoured	Non-armoured	Polyamide	<u>Ex</u> <u>IECE_x</u> CE	Increased Safety
EX-i (page 20)		Non-armoured	Non-armoured	Polyamide	<u>Ex</u> <u>IECE_x</u> CE	Increased Safety
Trumpet (page 21)		Non-armoured	Non-armoured	Polyamide	<u>Ex</u> CE	Increased Safety
Enlargement and Multiple (page 22)		Non-armoured	Non-armoured	Polyamide	<u>Ex</u> <u>IECE_x</u> CE	Increased Safety
ADE 4I (page 23)		SWA, SWB, STA, braided marine shipboard and lead sheathed (with addition of earthing washer) and tray cable	Armoured	Nickel-plated brass	CE	Industrial
TWA (page 24)		SWA	Armoured	Nickel-plated brass		Industrial
TUA (page 25)		Non-armoured	Non-armoured	Nickel-plated brass		Industrial

Quick Selection Guide

North American Standards

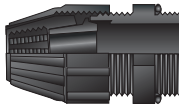
CABLE GLAND	ILLUSTRATION	CABLE TYPE	GLAND TYPE	STANDARD MATERIAL	CERTIFICATION	PROTECTION TYPE
TMCX (page 28)		Metal-clad with interlocked or continuously-welded corrugated, TECK armoured and non-armoured and tray cable	Armoured barrier and non-armoured barrier	Aluminum	UL SF	Explosionproof
TULA (page 29)		Braided marine shipboard	Armoured Barrier	Brass	MARINE UL LISTED	Explosionproof
TULU (page 30)		Non-armoured marine shipboard	Non-armoured Barrier	Brass	MARINE UL LISTED	Explosionproof
CGBS (page 31)		Non-armoured and tray cable	Portable cord connector	Body: steel Gland nut: aluminum	SF	Explosionproof
EBY (page 31)		Non-armoured	Portable cord connector	Aluminum	c UL US LISTED	Explosionproof
TMC (page 32)		Metal-clad with interlocked or continuously-welded corrugated, TECK armoured and non-armoured and tray cable	Armoured or non-armoured	Aluminum	c UL US LISTED	General Purpose
TECK (page 33)		TECK armoured	Armoured	Aluminum	SF	General Purpose
CGB (page 34-35)		Non-armoured and tray cable	Non-armoured	Body steel Form A-D steel Form E-F iron	c UL US LISTED	General Purpose

CABLE GLAND	ILLUSTRATION	CABLE TYPE	GLAND TYPE	STANDARD MATERIAL	CERTIFICATION	PROTECTION TYPE
CGD (page 36)		Non-armoured and tray cable	Non-armoured	Body: iron Gland nut: steel		General Purpose
CGE (page 37)		Non-armoured and tray cable	Non-armoured	Body: iron Gland nut: steel		General Purpose
CGB1013 (page 38)		Non-armoured and tray cable	Portable cord connector	Body: steel Gland nut: aluminum		General Purpose
CGFP (page 39)		Non-armoured and tray cable	Non-armoured	Form B-C: steel Form D-G: iron		General Purpose
NCG (page 40)		Non-armoured and tray cable	Non-armoured	Polyamide		General Purpose
NCGB (page 40)		Non-armoured and tray cable	Non-armoured	Thermoplastic polyester		General Purpose





International Standards

Time-tested, quality cable glands from Cooper Crouse-Hinds offer:

- Complete termination solution for cable applications meeting international standards
- Ease of cable termination providing labor and time management productivity
- Explosion-protected connections contributing to safe operation in harsh & hazardous environments
- Delivery meeting installation and project coordination schedules





Gland Type

Non-armoured

Cable Type

Non-armoured, armoured and tray cable
(does not terminate the armour)

Certifications and Compliances

- ATEX LCIE 97 ATEX 6008X – Exd IIC/Exe II/Ex tD /Ex II 2 GD
- IECEx LCI 05.0004X
- cULus Listed for Class I Zone 2 AEx e II/Ex e II
- cULus Marine Listed for Class I Zone 2 AEx e II /Ex e II
- NEMA 4X and IP68
- CEPEL cepel-EX-558/05X
- GOST-R POCC FR.B02011
- NEPSI N° GYJ071336U & GYJ071337U

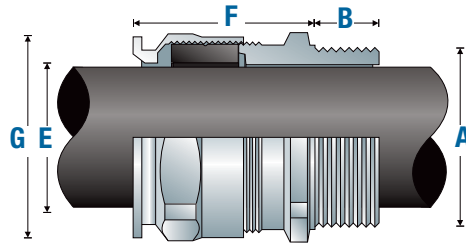

Features

- Standard material is nickel-plated brass for superior corrosion resistance
- Provides a flameproof and weatherproof seal on the outer sheath of the cable
- Standard neoprene seal suitable for use in operating temperatures ATEX (-60°C to 100°C), IECEx and cULus (-40°C to 100°C)
- Available with optional silicone seal for extreme temperatures
- Available with metric or NPT threads
- See pages 42-45 for related accessories

ORDERING EXAMPLE:

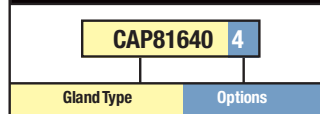

OPTIONS (replace last digit with option number):

- 9 Stainless steel (316L)
- 8 Bronze
- 7 Aluminum
- 5 Silicone sealing ring with temperature range of -70° C to 220° C

SELECTION TABLE

Gland Size	Entry Thread Size 'A'				Thread Length 'B' Metric (NPT)	Cable Acceptance		Gland Length 'F' (less entry)	Hexagon Dimensions	
	Metric Size	Metric Catalog #	NPT Size	NPT Catalog #		Outer Sheath 'E'			Across Flats	Across Corners 'G'
						Min	Max			
4	M12	CAP816404	1/4"	CAP818404	15 (12.0)	4.0	8.0	20	-	16.5
4	M16	CAP816594	3/8"	CAP818594	15 (12.0)	4.0	8.5	20	-	20.9
5	M16	CAP816504	1/2"	CAP818694	15 (12.0)	6.0	12.0	22	-	20.9
4	M20	CAP816674	1/2"	CAP818674	15 (20.2)	4.0	8.5	20	-	26.4
5	M20	CAP816694	1/2"	CAP818694	15 (20.2)	6.0	12.0	22	-	26.4
6	M20	CAP816604	1/2"	CAP818604	15 (20.2)	8.5	16.0	25	-	26.4
5	M25	CAP816774	3/4"	CAP818774	15 (20.2)	6.0	12.0	22	-	33
6	M25	CAP816794	3/4"	CAP818794	15 (20.2)	8.5	16.0	25	-	33
7	M25	CAP816704	3/4"	CAP818704	15 (20.2)	12.0	21.0	27	-	33
7	M32	CAP816894	1"	CAP818894	15 (25.3)	12.0	21.0	27	-	39.6
8	M32	CAP816804	1"	CAP818804	15 (25.3)	16.0	27.5	34	-	45.1
8	M40	CAP816994	1-1/4"	CAP818994	15 (26.0)	16.0	27.5	34	-	48.4
9	M40	CAP816904	1-1/4"	CAP818904	15 (26.0)	21.0	34.0	36	-	52.8
9	M50	CAP817094	1-1/2"	CAP819094	15 (26.5)	21.0	34.0	36	-	60.5
10	M50	CAP817004	1-1/2"	CAP819004	15 (26.5)	27.0	41.0	39	-	60.5
11	M63	CAP817294	2"	CAP819294	17 (27.2)	33.0	48.0	41	-	73.7
12	M63	CAP817204	2"	CAP819204	17 (27.2)	40.0	56.0	43	-	79.2
12	M75	CAP817394	2-1/2"	CAP819494	18 (40.5)	40.0	56.0	43	-	88
13	M75	CAP817304	2-1/2"	CAP819404	18 (40.5)	47.0	65.0	49	-	93.5
14	M90	CAP817594	3"	CAP819594	22 (42.0)	54.0	74.0	56	-	104.5
15	M90	CAP817504	3"	CAP819504	22 (42.0)	63.0	78.0	61	-	121
16	M110	CAP817794	3-1/2"	CAP819604	22 (43.2)	72.0	92.0	62	-	132

All dimensions in millimeters unless otherwise noted



Gland Type

Armoured

Cable Type

Steel wire armoured, steel wire braided, steel tape armoured, braided marine shipboard and lead sheathed (with addition of earthing washer)

Certifications and Compliances

- ATEX LCIE 97 ATEX 6008X – Exd IIC/Exe II/ Ex tD/Ex II 2 GD
- IECEx LCI 05.0004X
- cULus listed for Class I Zone 2 AEx e II/Ex e II
- cULus Marine listed for Class I Zone 1 AEx e II/ Ex e II
- NEMA 4X and IP68
- CEPEL cepel-EX-559/05X
- GOST-R POCC FR.B02011
- NEPSI N° GYJ071336U & GYJ071337U

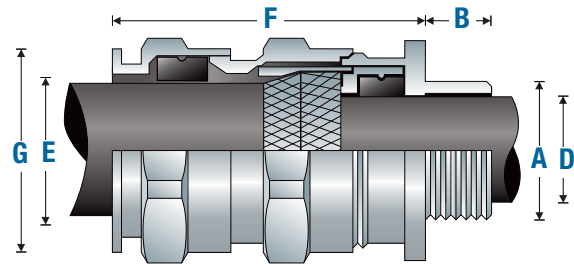

Features

- Standard material is nickel-plated brass for superior corrosion resistance
- Armour clamping and bonding with no reversible components for easy installation, minimizing error
- Provides flameproof seal on inner jacket and weatherproof seal on outer sheath of cable
- Optional earthing washer for use with lead sheathed cable (see page 45)
- Standard neoprene seal suitable for use in operating temperatures ATEX (-60°C to 100°C), IECEx and cULus (-40°C to 100°C)
- Available with optional silicone seal for extreme temperatures
- Available with metric or NPT threads
- See pages 42-45 for related accessories

ORDERING EXAMPLE:

CAP84640 4

Gland Type

Options

OPTIONS (replace last digit with option number):

- 9 Stainless steel (316L)
- 8 Bronze
- 7 Aluminum
- 5 Silicone sealing ring with temperature range of -70° C to 220° C

SELECTION TABLE

Gland Size	Entry Thread Size 'A'				Thread Length 'B' Metric (NPT)	Cable Acceptance				Armour (max)	Gland Length 'F' (less entry)	Hexagon Dimensions	
	Metric Size	Metric Catalog #	NPT Size	NPT Catalog #		Inner Sheath 'D'		Outer Sheath 'E'				Across Flats	Across Corners 'G'
						Min	Max	Min	Max				
5	M12	CAP846404	1/4"	CAP848404	15 (12.0)	4.0	8.0	6.0	12.0	0.9	36	-	20.9
5	M16	CAP846594	3/8"	CAP848594	15 (12.0)	4.0	8.5	6.0	12.0	0.9	36	-	20.9
6	M16	CAP846504	3/8"	CAP848504	15 (12.0)	6.0	12.0	8.5	16.0	1.25	42	-	26.4
5	M20	CAP846674	1/2"	CAP848674	15 (20.2)	4.0	8.5	6.0	12.0	0.9	36	-	26.4
6	M20	CAP846694	1/2"	CAP848694	15 (20.2)	6.0	12.0	8.5	16.0	1.25	42	-	26.4
7	M20	CAP846604	1/2"	CAP848604	15 (20.2)	8.5	16.0	12.0	21.0	1.25	46	-	33
6	M25	CAP846774	3/4"	CAP848774	15 (20.2)	6.0	12.0	8.5	16.0	1.25	42	-	33
7	M25	CAP846794	3/4"	CAP848794	15 (20.2)	8.5	16.0	12.0	21.0	1.25	46	-	33
8	M25	CAP846704	3/4"	CAP848704	15 (20.2)	12.0	20.5	16.0	27.5	1.6	56	-	45.1
8	M32	CAP846894	1"	CAP848894	15 (25.3)	12.0	21.0	16.0	27.5	1.6	56	-	45.1
9	M32	CAP846804	1"	CAP848804	15 (25.3)	16.0	27.5	21.0	34.0	1.6	63	-	52.8
9	M40	CAP846994	1-1/4"	CAP848994	15 (26.0)	16.0	27.5	21.0	34.0	1.6	63	-	52.8
10	M40	CAP846904	1-1/4"	CAP848904	15 (26.0)	21.0	34.0	27.0	41.0	2	68	-	60.5
10	M50	CAP847094	1-1/2"	CAP849094	16 (26.5)	21.0	34.0	27.0	41.0	2	68	-	60.5
11	M50	CAP847004	1-1/2"	CAP849004	16 (26.5)	27.0	41.0	33.0	48.0	2.5	74	-	70.4
12	M63	CAP847294	2"	CAP849294	17 (27.2)	27.0	41.0	33.0	48.0	2.5	77	-	79.2
13	M63	CAP847204	2"	CAP849204	17 (27.2)	33.0	48.0	40.0	56.0	2.5	85	-	93.5
13	M75	CAP847394	2-1/2"	CAP849494	18 (40.5)	40.0	56.0	47.0	65.0	2.5	85	-	93.5
14	M75	CAP847304	2-1/2"	CAP849404	18 (40.5)	47.0	65.0	54.0	74.0	2.5	92	-	104.5
15	M90	CAP847594	3"	CAP849594	22 (42.0)	54.0	74.0	63.0	83.0	3.15	104	-	121
16	M90	CAP847504	3"	CAP849504	22 (42.0)	63.0	82.0	72.0	93.0	3.15	108	-	132
16	M90	CAP847574	3-1/2"	CAP849604	N/A (43.2)	63.0	82.0	72.0*	93.0*	3.15	108	-	132
17	M110	CAP847794	4"	CAP849704	22 (44.5)	72.0	92.0	85.0	107.0	3.15	115	-	148.5

All dimensions in millimeters unless otherwise noted * CAP849604 "outer sheath" min: 85 max: 107

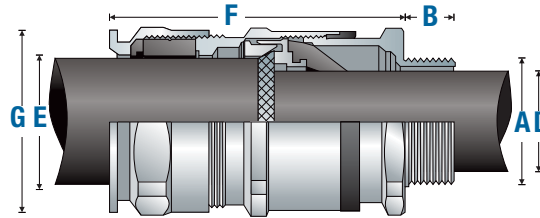

Gland Type

Armoured

Cable Type

Steel wire armoured, steel wire braided, steel tape armoured and braided marine shipboard

Certifications and Compliances

- ATEX LCIE 97 ATEX 6008X – Exd IIC/Exe II/ Ex tD/Ex II 2 GD
- IECEx LCI 05.0004X
- cULus listed for Class I Zone 2 AEx e II/Ex e II
- cULus Marine listed for Class I Zone 1 AEx e II/ Ex e II
- NEMA 4X and IP68
- CEPEL (PENDING)
- GOST-R (PENDING)
- NEPSI (PENDING)

Features

- Standard material is nickel-plated brass for superior corrosion resistance
- Armour clamping and bonding with no reversible components for easy installation, minimizing error
- Provides fully inspectable inner seal after installation
- Flameproof diaphragm seal on inner jacket does not damage cables exhibiting “cold-flow”; weatherproof seal on outer sheath of cable
- Deluge boot provides enhanced protection from water ingress
- Standard neoprene seal suitable for use in operating temperatures ATEX (-60°C to 100°C), IECEx and cULus (-40°C to 100°C)
- Available with metric or NPT threads
- See pages 42-45 for related accessories

ORDERING EXAMPLE:

CAP96559 4

Gland Type

Options

OPTIONS (replace last digit with option number):

- 9 Stainless steel (316L)
- 8 Bronze

SELECTION TABLE

Gland Size	Entry Thread Size 'A'				Thread Length 'B' Metric (NPT)	Cable Acceptance				Armour (max)	Gland Length 'F' (less entry)	Hexagon Dimensions	
	Metric Size	Metric Catalog #	NPT Size	NPT Catalog #		Inner Sheath 'D'		Outer Sheath 'E'				Across Flats	Across Corners 'G'
						Min	Max	Min	Max				
5	M16	CAP965594	3/8"	CAP967594	15 (12.0)	3.0	7.5	6.0	12.0	0.9	46	–	20.9
5	M20	CAP965674	1/2"	CAP967674	15 (20.2)	3.0	7.5	6.0	12.0	0.9	46	–	26.4
6	M20	CAP965694	1/2"	CAP967694	15 (20.2)	6.5	11.0	8.5	16.0	1.25	53	–	26.4
7	M20	CAP965604	1/2"	CAP967604	15 (20.2)	9.0	14.5	12.0	21.0	1.25	59	–	33
7	M25	CAP965794	3/4"	CAP967794	15 (20.2)	9.0	14.5	12.0	21.0	1.25	59	–	33
8	M25	CAP965704	3/4"	CAP967704	15 (20.2)	12.0	19.5	16.0	27.5	1.6	74.5	–	45.1
8	M32	CAP965894	1"	CAP967894	15 (25.3)	12.0	19.5	16.0	27.5	1.6	74.5	–	45.1
9	M32	CAP965804	1"	CAP967804	15 (25.3)	17.5	26.0	21.0	34.0	1.6	83.5	–	52.8
9	M40	CAP965994	1-1/4"	CAP967994	15 (26.0)	17.5	26.0	21.0	34.0	1.6	83.5	–	52.8
10	M40	CAP965904	1-1/4"	CAP967904	15 (26.0)	23.0	33.0	27.0	41.0	2	92	–	60.5
10	M50	CAP966094	1-1/2"	CAP968094	16 (26.5)	23.0	33.0	27.0	41.0	2	92	–	60.5
11	M50	CAP966004	2"	CAP968294	16 (27.2)	28.5	41.0	33.0	48.0	2.5	104	–	70.4

For larger sizes, use ADE 4F design. Please refer back to page 13

All dimensions in millimeters unless otherwise noted

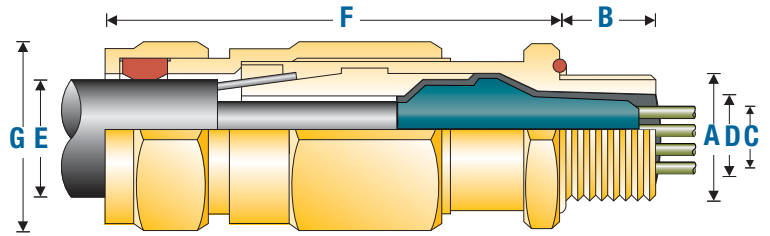

Gland Type

Armoured barrier

Cable Type

Steel-wire armoured, steel-wire braided, steel-tape armoured, braided marine shipboard and lead sheathed (with addition of earthing washer)

Certifications and Compliances

- ATEX EExd IIC with SIRA 03ATEX2077X Mining Equipment Group I, M2 Ex II 2 GD
- CSA Certified for Class I Zone 1 Exd IIC, CSA file 220160
- NEMA 4X and IP66/68 rated at 25 meters
- DTS01 1991 deluge tested

Features

- Standard material is brass
- Armour clamping and bonding for multiple cable types
- Provides flameproof compound seal on conductors and weatherproof seal on outer sheath of cable
- An optional earthing washer for use with lead sheathed cable (contact customer service)
- Standard silicone seal suitable for use in operating temperatures -60° to 85°C
- Available with metric or NPT threads (nickel-plated threads – NPT only)
- An integral o-ring seal on entry threads (metric only)
- See page 46 for related accessories

ORDERING EXAMPLE:

TACFB /NP /20 /075NPT

Gland Type Options Gland Size Thread Size

GLAND TYPES:

- TACFB Silicone seal – brass construction
- TACFS Silicone seal – stainless steel construction

OPTIONS (add after gland type):

- /NP Nickel-plate finish (i.e., TACFB/NP)
- R Reduced bore gland (i.e., TACFBR)
- K1 Polybagged kit including gland, locknut, earth tag, sealing washer and PVC shroud (i.e., TACFBK1)

SELECTION TABLE

Gland Size	Entry Thread Size 'A'				Thread Length 'B' Metric	Cable Acceptance								Hexagon Dimensions		
	Metric Size	Metric Catalog #	NPT Size	NPT Catalog #		Inner Sheath and Cores			Outer Sheath 'E'		Reduced Bore		Armour Range	Gland Length 'F' (less entry)	Across Flats	Across Corners 'G'
						Max Over Cores 'C'	Max Inner 'D'	MaxNo. Cores	Min	Max	Min	Max				
/16	M20	/M20	1/2" or 3/4"	/050NPT OR /075NPT	16	9.0	11.7	7	9.0	13.5	6.7	10.3	0.15 - 1.25	72	25.4	28.0
/20S	M20	/M20	1/2" or 3/4"	/050NPT OR /075NPT	16	10.4	11.7	8	11.5	16.0	9.4	12.5	0.15 - 1.25	72	25.4	28.0
/20	M20	/M20	1/2" or 3/4"	/050NPT OR /075NPT	16	12.5	14.0	14	15.5	21.1	12.0	17.6	0.15 - 1.25	73	30.0	33.0
/25	M25	/M25	3/4" or 1"	/075NPT OR /100NPT	16	17.8	20.0	25	20.3	27.4	16.8	23.9	0.15 - 1.60	83	38.0	41.4
/32	M32	/M32	1" or 1-1/4"	/100NPT OR /125NPT	16	23.5	26.3	50	26.7	34.0	23.2	30.5	0.15 - 2.00	103	46.0	50.6
/40	M40	/M40	1-1/4" or 1-1/2"	/125NPT OR /150NPT	16	28.8	32.2	80	33.0	40.6	28.6	36.2	0.20 - 2.00	105	55.0	60.5
/50S	M50	/M50	2"	/200NPT	16	34.2	38.2	100	39.4	46.8	34.8	42.4	0.20 - 2.50	115	65.0	71.5
/50	M50	/M50	2"	/200NPT	16	39.4	44.1	100	45.7	53.2	41.1	48.5	0.20 - 2.50	115	65.0	71.5
/63S	M63	/M63	2-1/2"	/250NPT	19	44.8	50.1	120	52.1	59.5	47.5	54.8	0.30 - 2.50	115	80.0	88.0
/63	M63	/M63	2-1/2"	/250NPT	19	50.0	56.0	120	58.4	65.8	53.8	61.2	0.30 - 2.50	115	80.0	88.0
/75S	M75	/M75	3"	/300NPT	19	55.4	62.0	140	64.8	72.2	60.2	68.0	0.30 - 2.50	122	90.0	99.0
/75	M75	/M75	3"	/300NPT	19	60.8	68.0	140	71.1	78.0	66.5	73.4	0.30 - 2.50	122	90.0	99.0
/80	M80 x 2	/M80	3" or 3-1/2"	/300NPT OR /350NPT	25	64.4	72.0	160	77.0	84.0	-	-	0.45 - 3.15	162	104.0	115.2
/85	M85 x 2	/M85	3" or 3-1/2"	/300NPT OR /350NPT	25	69.8	78.0	180	79.6	90.0	75.0	85.4	0.45 - 3.15	162	104.0	115.2
/90	M90 x 2	/M90	3-1/2" or 4"	/350NPT OR /400NPT	25	75.1	84.0	200	88.0	96.0	-	-	0.45 - 3.15	162	114.0	125.7
/100	M100 x 2	/M100	3-1/2" or 4"	/350NPT OR /400NPT	25	80.5	90.0	220	92.0	102.0	87.4	97.4	0.45 - 3.15	162	114.0	125.7

All dimensions in millimeters unless otherwise noted

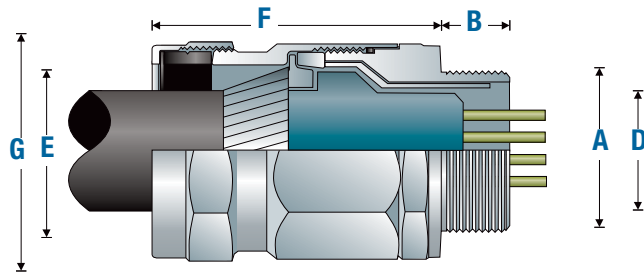

Features

- Standard material is nickel-plated brass
- Armour clamping and bonding for steel wire armoured cable
- Provides flameproof compound seal on conductors and weatherproof seal on outer sheath of cable
- Standard neoprene seal suitable for use in operating temperatures -20° to 40°C
- Available with metric, NPT or BSP threads
- See page 47 for related accessories

Gland Type
Armoured barrier

Cable Type
Steel wire armoured

Certifications and Compliances

- IECEx TSA 08.0004 - Exd IIC
- IP66 and 67

ORDERING EXAMPLE:

TWAB1M16 SS

Gland Type Options

OPTIONS (add after gland type):

- SS Stainless steel – add SS (i.e., TWAB1M16SS)
- B BSP threads – replace M with B (i.e., TWAB1B16)

SELECTION TABLE

Gland Size	Entry Thread Size 'A'				Thread Length 'B' Metric	Cable Acceptance				Armour Range	Gland Length 'F' (less entry)	Hexagon Dimensions	
	Metric Size	Metric Catalog #	NPT Size (in.)	NPT Catalog #		Inner Sheath 'D'		Outer Sheath 'E'				Across Flats	Across Corners 'G'
						Min	Max	Min	Max				
20	M20	TWAB1M16	1/2"	TWAB1N16	14	6.0	8.0	10.2	15.8	0.9 - 1.25	58.0	27.0	31.0
20	M20	TWAB1M20	1/2"	TWAB1N20	14	7.0	12.0	14.0	20.8	0.9 - 1.25	58.0	30.4	34.0
25	M25	TWAB2M27	3/4"	TWAB2N27	16	11.0	18.0	18.0	27.2	1.25 - 1.6	60.0	38.1	43.0
32	M32	TWAB3M34	1"	TWAB3N34	20	17.0	25.0	25.0	33.5	1.6 - 2.0	72.0	47.6	53.0
40	M40	TWAB4M40	1 1/4"	TWAB4N40	20	24.0	31.0	30.0	35.9	1.6 - 2.0	74.0	55.0	63.5
50	M50	TWAB5M53	1 1/2"	TWAB5N53	20	30.0	41.0	36.0	52.6	2.0 - 2.5	82.0	70.0	78.0
63	M63	TWAB6M66	2"	TWAB6N66	22	40.0	54.0	51.0	65.3	2.0 - 2.5	90.0	80.0	88.0
75	M75	TWAB7M78	2 1/2"	TWAB7N78	22	53.0	65.0	63.0	78.0	2.5 - 3.5	98.0	101.0	112.0

All dimensions in millimeters unless otherwise noted

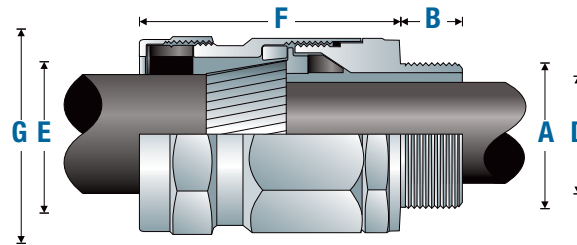

Features

- Standard material is nickel-plated brass
- Armour clamping and bonding for steel wire armour cable
- Flameproof seal on inner jacket and weatherproof seal on outer sheath of cable
- Standard neoprene seal suitable for use in operating temperatures -20° to 40°C
- Available with metric, NPT or BSP threads
- See page 47 for related accessories

Gland Type
Armoured

Cable Type
Steel wire armoured

Certifications and Compliances

- IECEx TSA 08.0004 - Exd IIC
- IP66 and 67

ORDERING EXAMPLE:

TWAX1M13 SS

Gland Type

Options

OPTIONS (add after gland type):

SS Stainless steel – add SS (i.e., TWAB1M16SS)

B BSP threads – replace M with B (i.e., TWAB1B16)

SELECTION TABLE

Gland Size	Entry Thread Size 'A'				Thread Length 'B' Metric	Cable Acceptance				Armour Range	Gland Length 'F' (less entry)	Hexagon Dimensions	
	Metric Size	Metric Catalog #	NPT Size	NPT Catalog #		Inner Sheath 'D'		Outer Sheath 'E'				Across Flats	Across Corners 'G'
						Min	Max	Min	Max				
20	M20	TWAX1M13	1/2"	TWAX1N13	14.0	6.3	8.6	10.2	13.2	0.9 - 1.25	58.0	23.3	26.0
20	M20	TWAX1M16	1/2"	TWAX1N16	14.0	8.4	11.6	13.0	15.8	0.9 - 1.25	58.0	27.0	31.0
20	M20	TWAX1M20	1/2"	TWAX1N20	14.0	11.0	13.9	15.5	19.8	0.9 - 1.25	58.0	30.5	34.0
25	M25	TWAX2M24	3/4"	TWAX2N24	16.0	13.5	16.9	19.5	23.8	1.25 - 1.6	60.0	33.3	37.0
25	M25	TWAX2M27	3/4"	TWAX2N27	16.0	16.5	19.9	23.5	27.2	1.25 - 1.6	60.0	38.1	43.0
32	M32	TWAX3M30	1"	TWAX3N30	20.0	19.5	23.9	27.0	30.5	1.6 - 2.0	72.0	42.2	47.0
32	M32	TWAX3M33	1"	TWAX3N33	20.0	23.5	26.2	30.0	33.5	1.6 - 2.0	72.0	47.0	53.0
40	M40	TWAX4M38	1 1/4"	TWAX4N38	20.0	25.8	31.2	33.0	38.5	1.6 - 2.0	74.0	55.0	64.0
50	M50	TWAX5M43	1 1/2"	TWAX5N43	20.0	30.8	36.2	38.0	43.5	2.0 - 2.5	82.0	57.0	62.0
50	M50	TWAX5M48	1 1/2"	TWAX5N48	20.0	35.5	40.0	43.0	48.5	2.0 - 2.5	82.0	63.5	71.0
50	M50	TWAX5M52	2"	TWAX6N52	22.0	39.5	44.0	48.0	52.6	2.0 - 2.5	82.0	70.0	78.0
63	M63	TWAX6M60	2"	TWAX6N60	22.0	43.5	49.0	52.0	58.9	2.0 - 2.5	90.0	76.0	85.0
63	M63	TWAX6M65	2 1/2"	TWAX7N65	22.0	48.5	55.9	58.0	65.3	2.0 - 2.5	90.0	80.0	88.0
75	M75	TWAX7M71	2 1/2"	TWAX7N71	22.0	55.5	61.9	64.3	71.6	2.5 - 3.15	98.0	89.0	102.0
75	M75	TWAX7M78	3"	TWAX8N78	22.0	61.0	67.9	70.6	78.0	2.5 - 3.15	98.0	101.0	112.0

All dimensions in millimeters unless otherwise noted

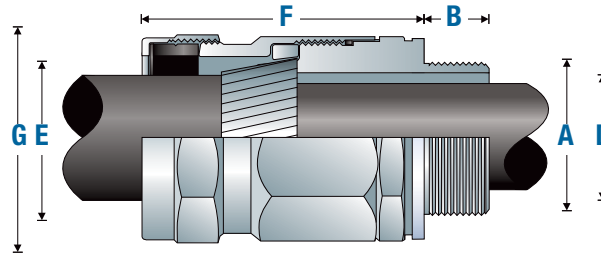

Features

- Standard material is nickel-plated brass
- Armour clamping and bonding for steel wire armour cable
- Forms weatherproof seal on outer sheath of cable
- Standard neoprene seal suitable for use in operating temperatures -20° to 40°C
- Available with metric, NPT or BSP threads
- A captive sealing gasket on entry threads
- See page 47 for related accessories

Gland Type
Armoured

Cable Type
Steel wire armoured

Certifications and Compliances

- IECEx TSA 08.0004 - Ex e II
- IP66 and 67 rated

ORDERING EXAMPLE:

TWAE1M16 SS

Gland Type

Options

OPTIONS (add after gland type):

SS Stainless steel – add SS (i.e., TWAB1M16SS)

B BSP threads – replace M with B (i.e., TWAB1B16)

SELECTION TABLE

Gland Size	Entry Thread Size 'A'				Thread Length 'B' Metric	Cable Acceptance				Armour Range	Gland Length 'F' (less entry)	Hexagon Dimensions	
	Metric Size	Metric Catalog #	NPT Size	NPT Catalog #		Inner Sheath 'D'		Outer Sheath 'E'				Across Flats	Across Corners 'G'
						Min	Max	Min	Max				
20	M20	TWAE1M16	1/2"	TWAE1N16	14.0	6.0	11.0	10.2	15.8	0.9 - 1.25	58.0	27.0	31.0
20	M20	TWAE1M20	1/2"	TWAE1N20	14.0	7.0	13.0	14.0	20.8	0.9 - 1.25	58.0	30.4	34.0
25	M25	TWAE2M27	3/4"	TWAE2N27	16.0	11.0	19.0	18.0	27.2	1.25 - 1.6	60.0	38.5	43.0
32	M32	TWAE3M34	1"	TWAE3N34	20.0	17.0	25.0	25.0	33.5	1.6 - 2.0	72.0	47.2	53.0
40	M40	TWAE4M40	1-1/4"	TWAE4N40	20.0	24.0	31.0	30.0	39.5	1.6 - 2.0	74.0	55.0	62.0
50	M50	TWAE5M53	1-1/2"	TWAE5N53	20.0	30.0	41.0	36.0	52.6	2.0 - 2.5	82.0	70.0	78.0
63	M63	TWAE6M66	2"	TWAE6N66	22.0	40.0	54.0	51.0	65.3	2.0 - 2.5	90.0	80.0	88.0
75	M75	TWAE7M78	2-1/2"	TWAE7N78	22.0	53.0	65.0	63.0	78.0	2.5 - 3.5	98.0	101.0	112.0

All dimensions in millimeters unless otherwise noted

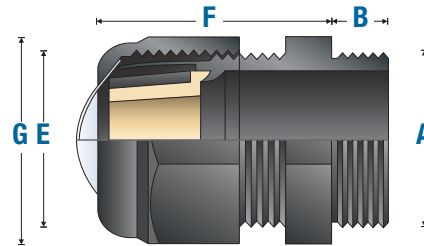

Gland Type
Non-armoured

Cable Type
Non-armoured

Certifications and Compliances

- Sizes M12-M16: PTB 99 ATEX 3101 X
Sizes M20-M63: PTB 99 ATEX 3128 X
Ex II 2 G Ex e II/Ex II 2 D Ex tD A21
- IECEx PTB 05.0004X
- IP66 rated

Features

- Standard material is high-impact resistant polyamide
- Forms weatherproof seal on outer sheath of cable
- Standard silicone seal suitable for use in operating temperatures -55° to 70°C (M12 and M16 for use in operating temperatures -20° to 70°C)
- Available with metric threads
- See page 48 for related accessories

SELECTION TABLE – SHORT THREAD

Gland Size	Entry Thread Size 'A'		Thread Length 'B' Metric	Cable Acceptance Outer Sheath 'E'		Gland Length 'F' (less entry)	Hexagon Dimensions	
	Metric Size	Metric Catalog #		Min	Max		Across Flats	Across Corners 'G'
16	M16	GHG 960 1955 R 0002	8.0	5.5	10.0	23.0	20.0	22.0
20	M20	GHG 960 1955 R 0003	8.0	5.5	13.0	25.0	24.0	26.4
25	M25	GHG 960 1955 R 0004	8.0	8.0	17.0	29.5	29.0	31.9
32	M32	GHG 960 1955 R 0005	10.0	12.0	21.0	35.5	36.0	39.6

SELECTION TABLE – LONG THREAD

Gland Size	Entry Thread Size 'A'		Thread Length 'B' Metric	Cable Acceptance Outer Sheath 'E'		Gland Length 'F' (less entry)	Hexagon Dimensions	
	Metric Size	Metric Catalog #		Min	Max		Across Flats	Across Corners 'G'
16	M16	GHG 960 1955 R 0022	8.0	5.5	10.0	23.0	20.0	22.0
20	M20	GHG 960 1955 R 0023	8.0	5.5	13.0	25.0	24.0	26.4
25	M25	GHG 960 1955 R 0024	8.0	8.0	27.0	29.5	29.0	31.9
32	M32	GHG 960 1955 R 0025	10.0	12.0	21.0	35.5	36.0	39.6
40	M40	GHG 960 1955 R 0026	15.0	17.0	28.0	39.5	46.0	50.6
50	M50	GHG 960 1955 R 0027	16.0	22.0	35.0	44.0	55.0	60.5
63	M63	GHG 960 1955 R 0028	16.0	27.0	48.0	47.0	68.0	74.8

All dimensions in millimeters unless otherwise noted

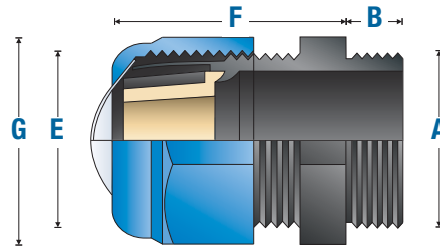

Gland Type
Non-armoured

Cable Type
Non-armoured

Certifications and Compliances

- Sizes M12-M16: PTB 99 ATEX 3101 X
Sizes M20-M63: PTB 99 ATEX 3128 X
Ex II 2 G Ex e II/Ex II 2 D Ex tD A21
- IECEX PTB 05.0004X
- IP66 rated

Features

- Standard material is high-impact resistant polyamide (gland nut is blue for intrinsically safe circuits)
- Forms weatherproof seal on outer sheath of cable
- Standard silicone seal suitable for use in operating temperatures -55° to 70°C (M12 and M16 for use in operating temperatures -20° to 70°C)
- Available with metric threads
- See page 48 for related accessories

SELECTION TABLE – SHORT THREAD								
Gland Size	Entry Thread Size 'A'		Thread Length 'B' Metric	Cable Acceptance Outer Sheath 'E'		Gland Length 'F' (less entry)	Hexagon Dimensions	
	Metric Size	Metric Catalog #		Min	Max		Across Flats	Across Corners 'G'
16	M16	GHG 960 1955 R 0102	8.0	5.5	10.0	23.0	20.0	22.0
20	M20	GHG 960 1955 R 0103	8.0	5.5	13.0	25.0	24.0	26.4
25	M25	GHG 960 1955 R 0104	8.0	8.0	17.0	29.5	29.0	31.9
32	M32	GHG 960 1955 R 0105	10.0	12.0	21.0	35.5	36.0	39.6

SELECTION TABLE – LONG THREAD								
Gland Size	Entry Thread Size 'A'		Thread Length 'B' Metric	Cable Acceptance Outer Sheath 'E'		Gland Length 'F' (less entry)	Hexagon Dimensions	
	Metric Size	Metric Catalog #		Min	Max		Across Flats	Across Corners 'G'
16	M16	GHG 960 1955 R 0122	12.0	5.5	10.0	23.0	20.0	22.0
20	M20	GHG 960 1955 R 0123	13.0	5.5	13.0	25.0	24.0	26.4
25	M25	GHG 960 1955 R 0124	13.0	8.0	17.0	29.5	29.0	31.9
32	M32	GHG 960 1955 R 0125	15.0	12.0	21.0	35.5	36.0	39.6
40	M40	GHG 960 1955 R 0126	15.0	17.0	28.0	39.5	46.0	50.6
50	M50	GHG 960 1955 R 0127	16.0	22.0	35.0	44.0	55.0	60.5
63	M63	GHG 960 1955 R 0128	16.0	27.0	48.0	47.0	68.0	74.8

All dimensions in millimeters unless otherwise noted



Gland Type
Non-armoured

Cable Type
Non-armoured

Certifications and Compliances

- PTB 00 ATEX 3121 X
Ex II 2 G Ex e II/Ex II 2 D Ex tD A21
- IP66 rated

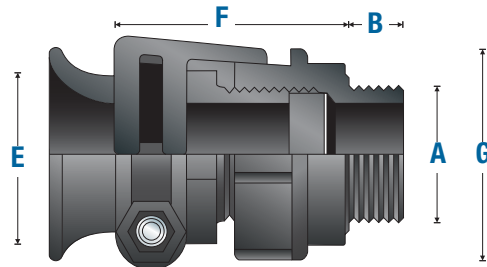

Features

- Standard material is high-impact resistant polyamide
- Forms weatherproof seal on outer sheath of cable
- Flared rear seal provides protection for cable
- Standard neoprene seal suitable for use in operating temperatures -40° to 85°C
- Available with metric threads
- See page 48 for related accessories

SELECTION TABLE

Gland Size	Entry Thread Size 'A'		Thread Length 'B' Metric	Cable Acceptance Outer Sheath 'E'		Gland Length 'F' (less entry)	Hexagon Dimensions	
	Metric Size	Metric Catalog #		Min	Max		Across Flats	Across Corners 'G'
25	M25	GHG 960 1949 R0112	15.0	11.0	16.0	50.0	32.0	35.2
32	M32	GHG 960 1949 R0113	15.0	15.0	20.0	65.0	41.0	45.1
40	M40	GHG 960 1949 R0114	15.0	19.0	27.0	71.0	50.0	55.0
50	M50	GHG 960 1949 R0115	16.0	26.0	34.0	79.0	60.0	66.0
60	M60	GHG 960 1949 R0116	16.0	35.0	46.0	89.0	75.0	82.5

All dimensions in millimeters unless otherwise noted

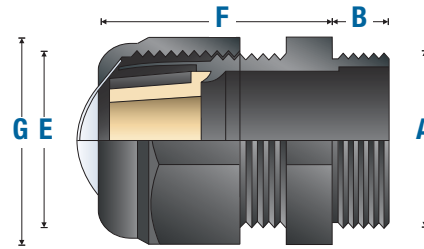

Gland Type
Non-armoured

Cable Type
Non-armoured

Certifications and Compliances

- Sizes M16: PTB 99 ATEX 3101 X
Sizes M20-M63: PTB 99 ATEX 3128 X
Ex II 2 G Ex e II/Ex II 2 D Ex tD A21
- IECEx PTB 05.0004X
- IP66 rated

Features

- Standard material is high-impact resistant polyamide
- Forms weatherproof seal on outer sheath of cable
- Provides reduced entry threads for larger gland size
- Standard silicone seal suitable for use in operating temperatures -55° to 70°C (M16 for use in operating temperatures -20° to 70°C)
- Available with metric threads
- See page 48 for related accessories

SELECTION TABLE – ENLARGEMENT

Gland Size	Entry Thread Size 'A'		Thread Length 'B' Metric	Cable Acceptance		Gland Length 'F' (less entry)	Hexagon Dimensions	
	Metric Size	Metric Catalog #		Outer Sheath 'E'			Across Flats	Across Corners 'G'
				Min	Max			
16/20	M16	GHG 960 1956 R0002	12.0	5.5	13.0	25.0	24.0	26.4
20/25	M20	GHG 960 1956 R0003	13.0	8.0	17.0	29.5	29.0	31.9
25/32	M25	GHG 960 1956 R0004	13.0	12.0	21.0	35.5	36.0	39.6
32/40	M32	GHG 960 1956 R0005	15.0	16.0	28.0	39.5	46.0	50.6
40/50	M40	GHG 960 1956 R0006	15.0	21.0	35.0	44.0	55.0	60.5
50/63	M50	GHG 960 1956 R0007	16.0	27.0	48.0	47.0	68.0	74.8

SELECTION TABLE – MULTIPLE

Gland Size	Entry Thread Size 'A'		Thread Length 'B' Metric	Cable Acceptance		Maximum Number of Conductors	Gland Length 'F' (less entry)	Hexagon Dimensions	
	Metric Size	Metric Catalog #		Outer Sheath 'E'				Across Flats	Across Corners 'G'
				Min	Max				
25	M25	GHG 960 1955 R0054	8.0	4.5	7.0	2	29.5	36.0	39.6
32	M32	GHG 960 1955 R0055	10.0	4.5	7.0	4	39.5	46.0	50.6

All dimensions in millimeters unless otherwise noted



Gland Type
Armoured

Cable Type

Steel wire armoured, steel wire braided, steel tape armoured, braided marine shipboard, lead sheathed (with addition of earthing washer) and tray cable

Certifications and Compliances

- NEMA 4X and IP68

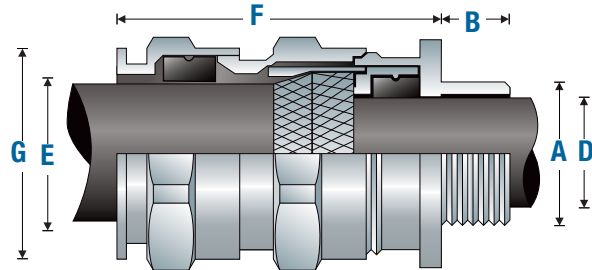

Features

- Standard material is nickel-plated brass for superior corrosion resistance
- Armour clamping and bonding with no reversible components for easy installation, minimizing error
- Provides seal on inner jacket and weatherproof seal on outer sheath of the cable
- An optional earthing washer for use with lead sheathed cable (see page 45)
- Standard neoprene seal suitable for use in operating temperatures of -60°C to 100°C
- Available with optional silicone seal for extreme temperatures
- Available with metric or NPT threads
- See pages 42-45 for related accessories

ORDERING EXAMPLE:	OPTIONS (replace last digit with option number):
<div style="border: 1px solid black; padding: 5px; display: inline-block;"> CAP94640 4 </div>	<ul style="list-style-type: none"> 9 Stainless steel (316L) 8 Bronze 7 Aluminum 5 Silicone sealing ring with temperature range of -70° C to 220° C
Gland Type	Options

Available in stainless steel – contact customer service

SELECTION TABLE													
Gland Size	Entry Thread Size 'A'				Thread Length 'B' Metric (NPT)	Cable Acceptance				Armour (max)	Gland Length 'F' (less entry)	Hexagon Dimensions	
	Metric Size	Metric Catalog #	NPT Size	NPT Catalog #		Inner Sheath 'D'		Outer Sheath 'E'				Across Flats	Across Corners 'G'
						Min	Max	Min	Max				
5	M12	CAP946404	1/4"	CAP948404	15 (12.0)	4.0	8.0	6.0	12.0	0.9	36	–	20.9
5	M16	CAP946594	3/8"	CAP948594	15 (12.0)	4.0	8.5	6.0	12.0	0.9	36	–	20.9
6	M16	CAP946504	3/8"	CAP948504	15 (12.0)	6.0	12.0	8.5	16.0	1.25	42	–	26.4
5	M20	CAP946674	1/2"	CAP948674	15 (20.2)	4.0	8.5	6.0	12.0	0.9	36	–	26.4
6	M20	CAP946694	1/2"	CAP948694	15 (20.2)	6.0	12.0	8.5	16.0	1.25	42	–	26.4
7	M20	CAP946604	1/2"	CAP948604	15 (20.2)	8.5	16.0	12.0	21.0	1.25	46	–	33
6	M25	CAP946774	3/4"	CAP948774	15 (20.2)	6.0	12.0	8.5	16.0	1.25	42	–	33
7	M25	CAP946794	3/4"	CAP948795	15 (20.2)	8.5	16.0	12.0	21.0	1.25	46	–	33
8	M25	CAP946704	3/4"	CAP948704	15 (20.2)	12.0	20.5	16.0	27.5	1.6	56	–	45.1
8	M32	CAP946894	1"	CAP948894	15 (25.3)	12.0	21.0	16.0	27.5	1.6	56	–	45.1
9	M32	CAP946804	1"	CAP948804	15 (25.3)	16.0	27.5	21.0	34.0	1.6	63	–	52.8
9	M40	CAP946994	1-1/4"	CAP948994	15 (26.0)	16.0	27.5	21.0	34.0	1.6	63	–	52.8
10	M40	CAP946904	1-1/4"	CAP948904	15 (26.0)	21.0	34.0	27.0	41.0	2	68	–	60.5
10	M50	CAP947094	1-1/2"	CAP949904	16 (26.5)	21.0	34.0	27.0	41.0	2	68	–	60.5
11	M50	CAP947004	1-1/2"	CAP949004	16 (26.5)	27.0	41.0	33.0	48.0	2.5	74	–	70.4
12	M63	CAP947294	2"	CAP949294	17 (27.2)	27.0	41.0	33.0	48.0	2.5	77	–	79.2
13	M63	CAP947204	2"	CAP949204	17 (27.2)	33.0	48.0	40.0	56.0	2.5	85	–	93.5
13	M75	CAP947394	2-1/2"	CAP949949	18 (40.5)	40.0	56.0	47.0	65.0	2.5	85	–	93.5
14	M75	CAP947304	2-1/2"	CAP949404	18 (40.5)	47.0	65.0	54.0	74.0	2.5	92	–	104.5
15	M90	CAP947594	3"	CAP949564	22 (42.0)	54.0	74.0	63.0	83.0	3.15	104	–	121
16	M90	CAP947504	3"	CAP949504	22 (42.0)	63.0	82.0	72.0	93.0	3.15	108	–	132
16	–	–	3-1/2"	CAP949604	– (43.2)	63.0	82.0	72.0	93.0	3.15	108	–	132
17	M110	CAP947794	4"	CAP949704	22 (44.5)	72.0	92.0	85.0	107.0	3.15	115	–	148.5

All dimensions in millimeters unless otherwise noted



Gland Type
Armoured

Cable Type
Steel wire armoured

Certifications and Compliances

- IP66 and 67 rated

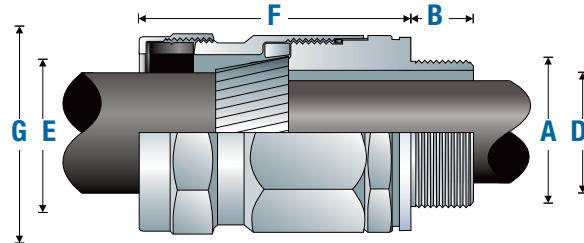

Features

- Standard material is nickel-plated brass
- Armour clamping and bonding for steel wire armoured cable
- Forms weatherproof seal on outer sheath of cable
- Standard neoprene seal suitable for use in operating temperatures -20° to 40°C
- Available with metric, NPT or BSP threads
- See page 47 for related accessories

ORDERING EXAMPLE:	OPTIONS:				
<table border="1" style="margin: auto;"> <tr> <td style="background-color: yellow;">TWA1M13</td> <td style="background-color: blue; color: white;">SS</td> </tr> <tr> <td style="background-color: yellow;">Gland Type</td> <td style="background-color: blue; color: white;">Options</td> </tr> </table>	TWA1M13	SS	Gland Type	Options	SS Stainless steel – add SS (i.e., TWA1M16SS) B BSP threads – replace M with B (i.e., TWA1B16)
TWA1M13	SS				
Gland Type	Options				

SELECTION TABLE													
Gland Size	Entry Thread Size 'A'				Thread Length 'B' Metric	Cable Acceptance				Armour Range	Gland Length 'F' (less entry)	Hexagon Dimensions	
	Metric Size	Metric Catalog #	NPT Size	NPT Catalog #		Inner Sheath 'D'		Outer Sheath 'E'				Across Flats	Across Corners 'G'
						Min	Max	Min	Max				
20	M20	TWA1M13	1/2"	TWA1N13	14.0	3.0	8.0	8.0	13.0	0.5 - 0.9	56.0	27.0	31.0
20	M20	TWA1M16	1/2"	TWA1N16	14.0	6.0	11.0	10.2	15.8	0.9 - 1.25	58.0	27.0	31.0
20	M20	TWA1M20	1/2"	TWA1N20	14.0	7.0	13.0	14.0	20.8	0.9 - 1.25	58.0	30.4	34.0
25	M25	TWA2M27	3/4"	TWA2N27	16.0	11.0	19.0	18.0	27.2	1.25 - 1.6	60.0	38.5	43.0
32	M32	TWA3M34	1"	TWA3N34	20.0	17.0	25.0	25.0	33.5	1.6 - 2.0	72.0	47.2	53.0
40	M40	TWA4M40	1-1/4"	TWA4N40	20.0	24.0	31.0	30.0	39.5	1.6 - 2.0	74.0	57.0	64.0
50	M50	TWA5M53	1-1/2"	TWA5N53	20.0	30.0	41.0	36.0	52.6	2.0 - 2.5	82.0	70.0	78.0
63	M63	TWA6M66	2"	TWA6N66	22.0	40.0	54.0	51.0	65.3	2.0 - 2.5	90.0	80.0	88.0
75	M75	TWA7M78	2-1/2"	TWA7N78	22.0	53.0	65.0	63.0	78.0	2.5 - 3.5	98.0	101.0	112.0

All dimensions in millimeters unless otherwise noted

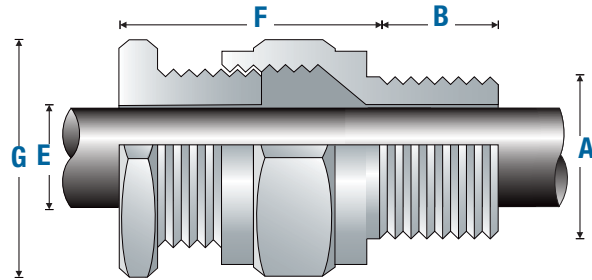

Features

- Standard material is nickel-plated brass
- Forms weatherproof seal on outer sheath of cable
- Standard neoprene seal suitable for use in operating temperatures -20° to 40°C
- Available with metric, NPT or BSP threads
- See page 47 for related accessories

Gland Type
Non-armoured

Cable Type
Non-armoured

Certifications and Compliances

- IP66 and 67 rated

ORDERING EXAMPLE:

TUA16M7 SS

Gland Type

Options

OPTIONS:

SS Stainless steel – add SS (i.e., TUA1M16SS)

B BSP threads – replace M with B (i.e., TUA1B16)

SELECTION TABLE

Gland Size	Entry Thread Size 'A'				Thread Length 'B' Metric	Cable Acceptance		Gland Length 'F' (less entry)	Hexagon Dimensions	
	Metric Size	Metric Catalog #	NPT Size	NPT Catalog #		Outer Sheath 'E'			Across Flats	Across Corners 'G'
						Min	Max			
16	M16	TUA16M7	N/A	N/A	14.0	10.2	13.2	58.0	23.3	26.0
20	M20	TUA1M10	1/2"	TUA1N10	14.0	13.0	15.8	58.0	27.0	31.0
20	M20	TUA1M12	1/2"	TUA1N12	14.0	15.5	19.8	58.0	30.5	34.0
20	M20	TUA1M15	3/4"	TUA1N15	16.0	19.5	23.8	60.0	33.3	37.0
25	M25	TUA2M18	3/4"	TUA2N18	16.0	23.5	27.2	60.0	38.1	43.0
32	M32	TUA3M23	1"	TUA3N23	20.0	27.0	30.5	72.0	42.2	47.0
32	M32	TUA3M25	1"	TUA3N25	20.0	30.0	33.5	72.0	47.0	53.0
40	M40	TUA4M29	1-1/4"	TUA4N29	20.0	33.0	38.5	74.0	55.0	64.0
50	M50	TUA5M34	1-1/2"	TUA5N34	20.0	38.0	43.5	82.0	57.0	62.0
50	M50	TUA5M38	1-1/2"	TUA5N38	20.0	43.0	48.5	82.0	63.5	71.0
50	M50	TUA5M42	2"	TUA5N42	22.0	48.0	52.6	82.0	70.0	78.0
63	M63	TUA6M48	2"	TUA6N48	22.0	52.0	58.9	90.0	76.0	85.0
63	M63	TUA6M54	2-1/2"	TUA7N54	22.0	58.0	65.3	90.0	80.0	88.0
75	M75	TUA7M60	2-1/2"	TUA7N60	22.0	64.3	71.6	98.0	89.0	102.0
75	M75	TUA7M66	3"	TUA8N66	22.0	70.6	78.0	98.0	101.0	112.0

All dimensions in millimeters unless otherwise noted



North American Standards

Time-tested, quality cable glands from Cooper Crouse-Hinds offer:

- Complete termination solution for cable applications meeting North American standards
- Ease of cable termination providing labor and time management productivity
- Explosion-protected connections contributing to safe operation in harsh & hazardous environments
- Delivery meeting installation and project coordination schedules



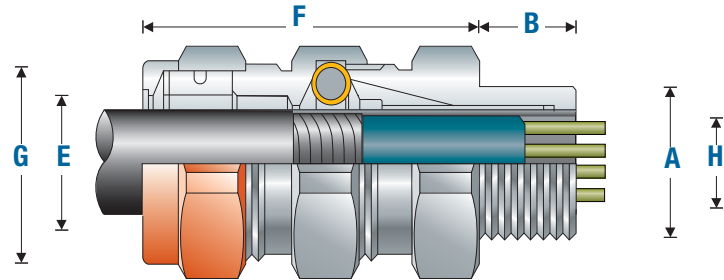

Features

- Standard material is aluminum
- Stainless steel copper-plated spring provides grounding continuity of cable armour (MC cable only)
- Provides explosionproof compound seal on conductors and watertight seal on outer sheath of cable
- Standard neoprene seal suitable for use in operating temperatures -25° to 60°C
- Cold Shrink™ Kit is available for extra protection in aggressive environments (see page 51)
- Available with NPT threads
- See page 49 for related accessories

Gland Type

Armoured barrier, TECK armoured and non-armoured barrier

Cable Type

Metal-clad (interlocked or continuously welded corrugated armoured), non-armoured and tray cable

Certifications and Compliances

- UL Listed, CSA Certified Class I, Div. 1 Groups, A, B, C, D; Class II; Class III – UL File E122485, CSA File LR13046
- NEMA 4 and IP56 rated
- Wet locations

ORDERING EXAMPLE:		OPTIONS (add after gland type):	
TMCX165 -BR		-BR Brass construction (i.e.,TMCX285-BR)	
		-NP Nickel-plate finish (i.e.,TMCX285-BR-NP)	
Gland Type	Options		

SELECTION TABLE									
Entry Thread Size 'A'		Thread Length 'B' NPT	Cable Acceptance				Gland Length 'F' (less entry)	Hexagon Dimensions	
NPT Size	NPT Catalog #		Armour Range 'H'		Outer Sheath 'E'			Across Flats	Across Corners 'G'
			Min	Max	Min	Max			
1/2"	TMCX165	0.750	0.440	0.650	0.490	0.781	2.625	1.250	1.375
3/4"	TMCX285	0.781	0.600	0.850	0.650	1.000	2.875	1.500	1.625
1"	TMCX3112	0.938	0.800	1.120	0.850	1.313	3.125	1.875	2.000
1-1/4"	TMCX4140	0.969	1.100	1.400	1.150	1.625	3.125	2.250	2.438
1-1/2"	TMCX5161	0.969	1.330	1.610	1.380	1.781	3.375	2.500	2.750
2"	TMCX6206	1.000	1.570	2.060	1.630	2.313	5.313	3.250	3.500
2-1/2"	TMCX7247	1.438	1.930	2.470	1.990	2.719	6.063	3.750	4.000
3"	TMCX8302	1.438	2.450	3.020	2.525	3.281	6.063	4.500	4.875
3-1/2"	TMCX9352	1.625	2.950	3.520	3.025	3.781	7.750	5.000	5.375
4"	TMCX10402	1.625	3.500	4.020	3.585	4.281	8.313	5.500	5.875

All dimensions in inches unless otherwise noted



Gland Type
Armoured barrier

Cable Type
Braided marine shipboard

Certifications and Compliances

- UL Marine Listed Class I, Div. 1 Groups, A, B, C, D - UL file E309542
- NEMA 4X and IP66 rated
- DTS 01 1991 Deluge tested

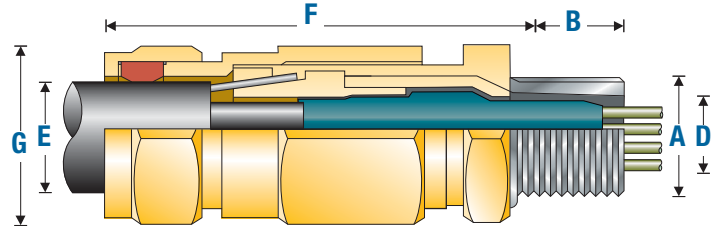

Features

- Standard material is brass
- Armour clamping and bonding for braided armour types
- Provides explosionproof compound seal on conductors and weatherproof seal on outer sheath of cable
- Standard silicone seal suitable for use in operating temperatures -25° to 85°C
- Available with metric or NPT threads (nickel-plated threads – NPT only)
- See page 46 for related accessories

ORDERING EXAMPLE:

TULAB	/NP	/20	/075NPT
Gland Type	Options	Gland Size	Thread Size

GLAND TYPES:

TULAB	Brass construction
TULAS	Stainless steel construction

OPTIONS (add after gland type):

/NP	Nickel-plate finish (i.e., TULAB/NP)
R	Reduced-bore gland (i.e., TULABR)
K1	Polybagged kit including gland, locknut, earth tag, sealing washer and PVC shroud (i.e., TULABK1)

SELECTION TABLE

Gland Size	Entry Thread Size 'A'				Thread Length 'B' Metric (NPT)	Cable Acceptance					Armour Range	Gland Length 'F' (less entry)	Hexagon Dimensions	
	Metric Size	Metric Catalog #	NPT Size	NPT Catalog #		Inner Sheath 'D'	Outer Sheath 'E'		Reduced Bore				Across Flats	Across Corners 'G'
							Max	Min	Max	Min				
/16	M20	/M20	1/2" or 3/4"	/050NPT or /075NPT	— (0.783)	0.461	0.362	0.531	0.264	0.406	0.006-0.049	2.835	1.000	1.102
/20S	M20	/M20	1/2" or 3/4"	/050NPT or /075NPT	— (0.783)	0.461	0.453	0.630	0.370	0.492	0.006-0.049	2.835	1.000	1.102
/20	M20	/M20	1/2" or 3/4"	/050NPT or /075NPT	— (0.783)	0.551	0.610	0.831	0.563	0.693	0.006-0.049	2.874	1.181	1.299
/25	M25	/M25	3/4" or 1"	/075NPT or /100NPT	— (0.795)	0.787	0.799	1.079	0.689	0.941	0.006-0.063	3.268	1.496	1.630
/32	M32	/M32	1" or 1-1/4"	/100NPT or /125NPT	— (0.985)	1.035	1.051	1.339	0.984	1.201	0.006-0.079	4.055	1.811	1.992
/40	M40	/M40	1-1/4" or 1-1/2"	/125NPT or /150NPT	— (1.008)	1.268	1.299	1.598	1.154	1.425	0.008-0.079	4.134	2.165	2.382
/50S	M50	/M50	2"	/200NPT	— (1.059)	1.504	1.551	1.839	1.499	1.669	0.008-0.098	4.528	2.559	2.815
/50	M50	/M50	2"	/200NPT	— (1.059)	1.736	1.799	2.094	1.618	1.909	0.008-0.098	4.528	2.559	2.815
/63	M63	/M63	2-1/2"	/250NPT	— (1.571)	1.972	1.051	2.343	1.846	2.157	0.012-0.098	4.528	3.150	3.465
/63S	M63	/M63	2-1/2"	/250NPT	— (1.571)	2.205	2.299	2.591	2.118	2.409	0.012-0.098	4.528	3.150	3.465
/75S	M75	/M75	3"	/300NPT	— (1.634)	2.441	2.551	2.843	2.469	2.677	0.012-0.098	4.803	4.094	4.134
/75	M75	/M75	3"	/300NPT	— (1.634)	2.677	2.799	3.071	2.618	2.890	0.012-0.098	4.803	4.094	4.134

All dimensions in inches unless otherwise noted



Gland Type
Non-armoured barrier

Cable Type
Non-armoured marine shipboard

Certifications and Compliances

- UL Marine Listed Class I, Div. 2 Groups, A, B, C, D - UL file E309542
- NEMA 4X and IP66 rated
- DTS 01 1991 Deluge tested

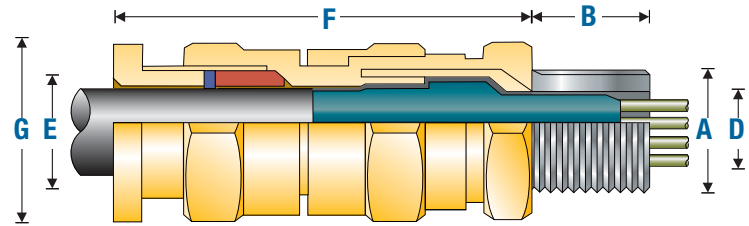

Features

- Standard material is brass
- Provides explosionproof compound seal on conductors and weatherproof seal on outer sheath of cable
- Standard silicone seal suitable for use in operating temperatures -25° to 85°C
- Available with metric or NPT threads (nickel-plated threads – NPT only)
- See page 46 for related accessories

ORDERING EXAMPLE:

TULUB /NP /20 /75NPT			
Gland Type	Options	Gland Size	Thread Size

GLAND TYPES:

TULUB	Brass construction
TULUS	Stainless steel construction

OPTIONS (add after gland type):

/NP	Nickel-plate finish (i.e., TULUB/NP)
K1	Polybagged kit including gland, locknut, earth tag, sealing washer and PVC shroud (i.e., TULUBK1)

SELECTION TABLE

Gland Size	Entry Thread Size 'A'				Thread Length 'B' Metric (NPT)	Cable Acceptance			Gland Length 'F' (less entry)	Hexagon Dimensions	
	Metric Size	Metric Catalog #	NPT Size	NPT Catalog #		Inner Sheath 'D'		Outer Sheath 'E'		Across Flats	Across Corners 'G'
						Max	Min	Max			
/16	M20	/M20	1/2" or 3/4"	/050NPT or /075NPT	– (0.783)	0.331	0.134	0.331	2.835	1.000	1.102
/20S	M20	/M20	1/2" or 3/4"	/050NPT or /075NPT	– (0.783)	0.461	0.189	0.461	2.835	1.000	1.102
/20	M20	/M20	1/2" or 3/4"	/050NPT or /075NPT	– (0.783)	0.551	0.374	0.551	2.874	1.181	1.299
/25	M25	/M25	3/4" or 1"	/075NPT or /100NPT	– (0.795)	0.787	0.461	0.787	3.268	1.496	1.630
/32	M32	/M32	1" or 1-1/4"	/100NPT or /125NPT	– (0.985)	1.035	0.713	1.035	4.055	1.811	1.992
/40	M40	/M40	1-1/4" or 1-1/2"	/125NPT or /150NPT	– (1.008)	1.268	0.890	1.268	4.134	2.165	2.382/
/50S	M50	/M50	2"	/200NPT	– (1.059)	1.504	1.110	1.504	4.528	2.559	2.815
/50	M50	/M50	2"	/200NPT	– (1.059)	1.736	1.303	1.736	4.528	2.559	2.815
/63	M63	/M63	2-1/2"	/250NPT	– (1.571)	1.972	1.547	1.972	4.528	3.150	3.465
/63S	M63	/M63	2-1/2"	/250NPT	– (1.571)	2.205	1.839	2.205	4.528	3.150	3.465
/75S	M75	/M75	3"	/300NPT	– (1.634)	2.441	2.059	2.441	4.803	4.094	4.134
/75	M75	/M75	3"	/300NPT	– (1.634)	2.677	2.283	2.677	4.803	4.094	4.134

All dimensions in inches unless otherwise noted



Gland Type
Portable cord connector

Cable Type
Non-armoured and tray cable

Certifications and Compliances

- CSA Certified Class I, Div 1. Groups C, D
- Class II, Div. 1 & 2, Groups E, F, G
- Class III – CSA File LR13046

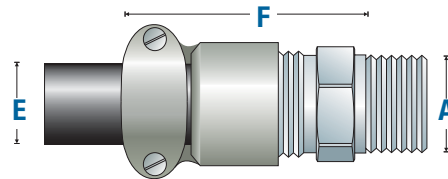

CGBS Features

- Body – steel with zinc electroplate and chromate finish coat
- Gland nut – aluminum
- Body well for Chico A sealing compound (for ordering information please contact customer service)
- Standard neoprene seal suitable for use in operating temperatures -25° to 40°C
- Available with NPT threads

Entry Thread Size 'A'		Form	Outer Sheath 'E'		Gland Length 'F' (less entry)
NPT Size	NPT Catalog #		Min	Max	
1/2"	CGBS1013*	A	0.312	0.437	5-1/4"
3/4"	CGBS2013*	A	0.312	0.437	5-1/4"
3/4"	CGBS2014*	A	0.375	0.500	5-1/4"
1"	CGBS3015*	B	0.500	0.625	2-7/8"
1"	CGBS3016	B	0.625	0.750	2-15/16"
1-1/4"	CGBS4017	B	0.750	0.875	2-13/16"
1-1/4"	CGBS4018	B	0.875	1.000	3-1/2"
1-1/4"	CGBS4019	B	1.000	1.188	3-9/16"

All dimensions in inches unless otherwise noted
* Not CSA Certified



Gland Type
Portable cord connector

Cable Type
Non-armoured

Certifications and Compliances

- UL, cUL Listed Class I, Div. 1 Groups, B, C, D; Class II, Div. 1 Groups, F, G – UL File E10279

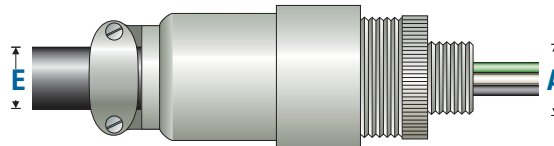

EBY Features

- Standard material is aluminum
- Factory sealed conductors and seal on outer sheath of cable
- Three, 12-inch long, #12 type SF-2 (150°C rating) stranded pigtails; two circuit wires and one identified grounding wire
- Three pressure connectors for 3-conductor cord, range #18 to #12 AWG
- Standard neoprene seal suitable for use in operating temperatures -25° to 40°C
- Available with NPT threads

Entry Thread Size 'A'		Outer Sheath 'E'	
NPT Size	NPT Catalog #	Min	Max
3/4"	EBY2672	0.250	0.437
3/4"	EBY2682	0.375	0.500
3/4"	EBY26102	0.500	0.625

All dimensions in inches unless otherwise noted

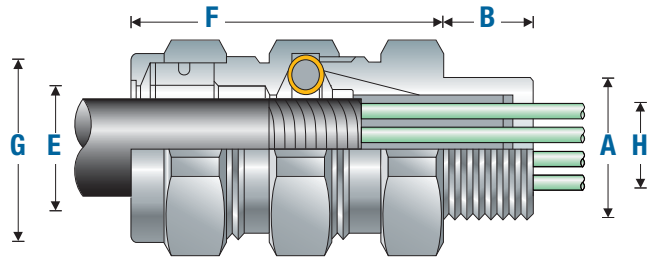

Gland Type

Armoured, TECK armoured and non-armoured

Cable Type

Metal-clad (interlocked or continuously welded corrugated armoured), non-armoured and tray cable.

Certifications and Compliances

- cULus Listed – UL File E36379
- NEMA 4 and IP56
- Wet locations

Features

- Standard material is aluminum
- Stainless steel copper-plated spring provides grounding continuity of cable armour (MC cable only)
- Watertight seal on outer sheath of cable
- Standard neoprene seal suitable for use in operating temperatures -25° to 60°C
- Cold Shrink™ Kit is available for extra protection in aggressive environments (see page 51)
- Available with NPT threads
- See page 49 for related accessories

ORDERING EXAMPLE:

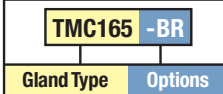

OPTIONS (add after gland type):

- BR Brass construction (i.e.,TMC285-BR)
- NP Nickel-plate finish (i.e.,TMC285-BR-NP)

Entry Thread Size 'A'		Thread Length 'B' NPT	Cable Acceptance				Gland Length 'F' (less entry)	Hexagon Dimensions	
NPT Size	NPT Catalog #		Armour Range 'H'		Outer Sheath 'E'			Across Flats	Across Corners 'G'
			Min	Max	Min	Max			
1/2"	TMC165	0.750	0.440	0.650	0.490	0.781	2.375	1.250	1.375
3/4"	TMC285	0.781	0.600	0.850	0.650	1.000	2.625	1.500	1.625
1"	TMC3112	0.938	0.800	1.120	0.850	1.313	2.625	1.875	2.000
1-1/4"	TMC4140	0.969	1.100	1.400	1.150	1.625	2.750	2.250	2.438
1-1/2"	TMC5161	0.969	1.330	1.610	1.380	1.781	2.750	2.500	2.75
2"	TMC6206	1.000	1.570	2.060	1.630	2.313	4.500	3.250	3.500
2-1/2"	TMC7247	1.438	1.930	2.470	1.990	2.719	4.750	3.750	4.000
3"	TMC8302	1.438	2.450	3.020	2.525	3.281	4.875	4.500	4.875
3-1/2"	TMC9352	1.625	2.950	3.520	3.025	3.781	5.375	5.000	5.375
4"	TMC10402	1.625	3.500	4.020	3.585	4.281	5.500	5.500	5.875

All dimensions in inches unless otherwise noted



Gland Type
Armoured

Cable Type
TECK armoured

Certifications and Compliances

- CSA Certified Class II, Div. 1, Div 2 Groups, E, F, G; Class III – CSA File LR13046
- Type 4 and IP56 rated
- Wet locations

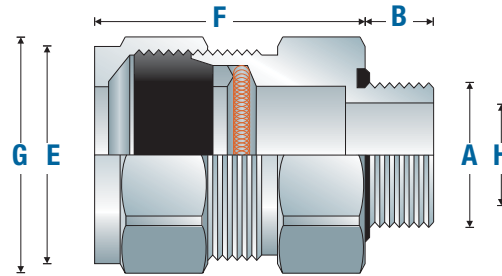

Features

- Standard material is aluminum
- Stainless steel copper-plated spring provides grounding continuity of cable armour (TECK cable only)
- Watertight seal on outer sheath of cable
- Standard neoprene seal suitable for use in operating temperatures -25° to 60°C
- Cold Shrink™ Kit is available for extra protection in aggressive environments (see page 51)
- An integral o-ring seal on entry threads
- Available with NPT threads
- See page 49 for related accessories

SELECTION TABLE

Aluminum Catalog #	Steel Catalog #	Stainless Steel Catalog #	PVC Coated Aluminum Catalog #	Entry Thread Size 'A'		Cable Acceptance				Gland Length 'F' (less entry)	Hexagon Dimensions	
				NPT Size	Thread Length 'B' NPT	Armour Range 'H'		Outer Sheath 'E'			Across Flats	Across Corners 'G'
						Min	Max	Min	Max			
TECK050-1	TECK050-1S	TECK050-1SS	TECK050-1PVC	1/2"	0.630	0.415	0.570	0.525	0.650	2.300	1.250	1.350
TECK050-2	TECK050-2S	TECK050-2SS	TECK050-2PVC	1/2"	0.630	0.490	0.680	0.600	0.760	2.300	1.375	1.500
TECK050-3	TECK050-3S	TECK050-3SS	TECK050-3PVC	1/2"	0.630	0.615	0.805	0.725	0.885	2.300	1.500	1.600
TECK050-4	TECK050-4S	TECK050-4SS	TECK050-4PVC	1/2"	0.630	0.715	0.905	0.825	0.985	2.300	1.500	1.600
TECK075-5	TECK075-5S	TECK075-5SS	TECK075-5PVC	3/4"	0.630	0.770	0.985	0.880	1.065	2.500	2.000	2.125
TECK075-6	TECK075-6S	TECK075-6SS	TECK075-6PVC	3/4"	0.630	0.915	1.125	1.025	1.205	2.500	2.000	2.125
TECK100-7	TECK100-7S	TECK100-7SS	TECK100-7PVC	1"	0.750	1.077	1.295	1.187	1.375	2.625	2.250	2.400
TECK125-8	TECK125-8S	---	TECK125-8PVC	1-1/4"	0.800	1.240	1.545	1.350	1.625	3.500	3.000	3.125
TECK125-9	TECK125-9S	---	TECK125-9PVC	1-1/4"	0.800	1.390	1.545	1.500	1.625	3.400	3.000	3.125
TECK125-10	TECK125-10S	---	TECK125-10PVC	1-1/4"	0.800	1.490	1.795	1.600	1.875	3.500	3.000	3.125
TECK150-11	TECK150-11S	---	TECK150-11PVC	1-1/2"	0.800	1.590	1.885	1.700	1.965	3.800	3.750	3.600
TECK150-12	TECK150-12S	---	TECK150-12PVC	1-1/2"	0.800	1.790	2.107	1.900	2.187	3.900	3.500	3.750
TECK200-13	TECK200-13S	---	TECK200-13PVC	2"	0.825	1.790	2.107	1.900	2.187	4.000	3.750	4.000
TECK200-14	TECK200-14S	---	TECK200-14PVC	2"	0.825	1.990	2.280	2.100	2.375	4.000	3.750	4.000
TECK200-15	TECK200-15S	---	TECK200-15PVC	2"	0.875	2.190	2.485	2.300	2.565	4.000	4.125	4.400
TECK200-16	TECK200-16S	---	TECK200-16PVC	2"	0.875	2.390	2.656	2.500	2.750	4.000	4.125	4.400
TECK250-17	TECK250-17S	---	TECK250-17PVC	2-1/2"	1.300	2.240	2.560	2.380	2.640	5.000	4.500	4.750
TECK250-18	TECK250-18S	---	TECK250-18PVC	2-1/2"	1.300	2.440	2.750	2.580	2.840	5.000	4.500	4.750
TECK300-19	TECK300-19S	---	TECK300-19PVC	3"	1.400	2.640	2.970	2.790	3.060	5.000	4.600	4.900
TECK300-20	TECK300-20S	---	TECK300-20PVC	3"	1.400	2.870	3.190	3.000	3.270	5.000	4.900	5.250
TECK300-21	TECK300-21S	---	TECK300-21PVC	3"	1.400	3.042	3.390	3.210	3.480	5.000	5.000	5.250
TECK350-22	TECK350-22S	---	TECK350-22PVC	3-1/2"	1.400	3.270	3.590	3.420	3.690	5.000	5.600	5.900
TECK350-23	TECK350-23S	---	TECK350-23PVC	3-1/2"	1.400	3.440	3.770	3.610	3.870	5.000	5.500	5.900
TECK400-24	TECK400-24S	---	---	4"	1.400	3.600	3.930	3.810	4.030	5.000	6.125	6.500
TECK400-25	TECK400-25S	---	---	4"	1.400	3.755	4.065	3.965	4.185	5.000	6.125	6.500
TECK400-26	TECK400-26S	---	---	4"	1.400	3.910	4.220	4.120	4.340	5.000	6.125	6.500

All dimensions in inches unless otherwise noted

Gland Type
Non-armoured

Cable Type
Non-armoured and tray cable.

Certifications and Compliances
• cULus Listed – UL File E23223

Features

- Form A - D bodies and gland nuts – steel with zinc electroplate and chromate finish coat
- Form E - F bodies and gland nuts – Feraloy® iron alloy with electrogalvanized and aluminum acrylic paint
- Weatherproof seal on outer sheath of cable
- Standard neoprene seal suitable for use in operating temperatures -25° to 40°C
- Available with NPT threads
- Available in all aluminum construction
- See page 49 for related accessories

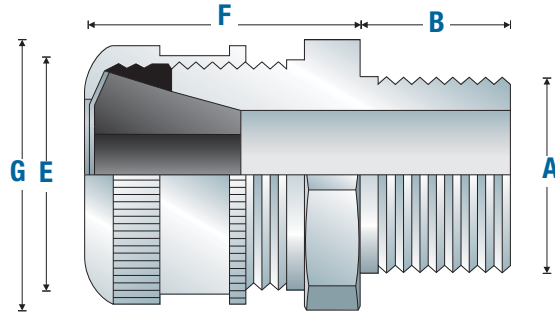

ORDERING EXAMPLE:

CGB192 -SG	
Gland Type	Options

OPTIONS (add after gland type):

- SG Sealing Gasket* – only applies to certain sizes (e.g., CGB192-SG)
- SA Aluminum Construction† – only applies to certain sizes (e.g., CGB114-SA)



SELECTION TABLE									
Entry Thread Size 'A'		Form	Thread Length 'B' NPT	Cable Acceptance		Gland Length 'F' (less entry)	External Diameter 'G'	Hexagon Dimensions	
NPT Size	NPT Catalog #			Outer Sheath 'E'				Across Flats	Across Corners 'G'
				Min	Max				
3/8"	CGB3814	A	0.438	0.125	0.250	1.063	---	0.750	0.875
3/8"	CGB3816	A	0.438	0.250	0.375	1.063	---	0.750	0.875
3/8"	CGB3817	A	0.438	0.375	0.437	1.063	---	0.750	0.875
3/8"	CGB3892	B	0.438	0.125	0.250	1.313	---	1.000	1.188
3/8"	CGB3893	B	0.438	0.250	0.375	1.313	---	1.000	1.188
3/8"	CGB3894	B	0.438	0.375	0.500	1.313	---	1.000	1.188
1/2"	CGB114†	A	0.625†	0.125	0.250	1.000	---	0.875	1.188
1/2"	CGB116†	A	0.625†	0.250	0.375	1.000	---	0.875	1.188
1/2"	CGB117†	A	0.625†	0.375	0.437	1.000	---	0.875	1.188
1/2"	CGB192*†	B	0.750*†	0.125	0.250	1.313	---	1.000	1.188
1/2"	CGB193*†	B	0.750*†	0.250	0.375	1.313	---	1.000	1.188
1/2"	CGB194*†	B	0.750*†	0.375	0.500	1.313	---	1.000	1.188
1/2"	CGB195*†	B	0.750*†	0.500	0.625	1.313	---	1.000	1.188
1/2"	CGB196*	C	0.625*	0.625	0.750	1.750	---	1.500	1.656
1/2"	CGB197*†	C	0.625*†	0.750	0.875	1.750	---	1.500	1.656
3/4"	CGB292†	B	0.625†	0.125	0.250	1.375	---	1.060	1.250
3/4"	CGB293†	B	0.625†	0.250	0.375	1.375	---	1.060	1.250
3/4"	CGB294†	B	0.625†	0.375	0.500	1.375	---	1.060	1.250
3/4"	CGB295†	B	0.625†	0.500	0.625	1.375	---	1.060	1.250
3/4"	CGB296*†	C	0.625*†	0.625	0.750	1.750	---	1.630	1.656
3/4"	CGB297*†	C	0.625*†	0.750	0.875	1.750	---	1.630	1.656
3/4"	CGB298*†	D	0.625*†	0.875	1.000	2.500	2.250	---	---
1"	CGB393†	B	0.688†	0.250	0.375	1.375	---	1.375	1.625
1"	CGB394†	B	0.688†	0.375	0.500	1.375	---	1.375	1.625
1"	CGB395*†	C	0.688*†	0.500	0.625	1.688	---	1.500	1.875
1"	CGB396*†	C	0.688*†	0.625	0.750	1.688	---	1.500	1.875
1"	CGB397*†	C	0.688*†	0.750	0.875	1.688	---	1.500	1.875
1"	CGB3239†	C	0.688†	0.875	1.000	1.688	---	---	1.875
1"	CGB398*†	D	0.625*†	0.875	1.000	2.375	2.375	---	---
1"	CGB399*†	D	0.625*†	1.000	1.188	2.375	2.375	---	---
1"	CGB3911†	D	0.625*†	1.188	1.375	2.375	2.375	---	---
1-1/4"	CGB498	D	0.688	0.875	1.000	2.313	2.250	---	---
1-1/4"	CGB499	D	0.688	1.000	1.188	2.313	2.250	---	---
1-1/4"	CGB4911	D	0.688	1.188	1.375	2.313	2.250	---	---
1-1/4"	CGB4913	E	0.688	1.375	1.625	2.625	3.000	---	---
1-1/4"	CGB4915	E	0.688	1.625	1.875	2.625	3.000	---	---
1-1/2"	CGB598	D	0.813	0.875	1.000	2.313	2.250	---	---
1-1/2"	CGB599	D	0.813	1.000	1.188	2.313	2.250	---	---
1-1/2"	CGB5911	D	0.813	1.188	1.375	2.313	2.250	---	---
1-1/2"	CGB5913	E	0.813	1.375	1.625	2.625	3.000	---	---
1-1/2"	CGB5915	E	0.813	1.625	1.875	2.625	3.000	---	---
2"	CGB6913	E	0.813	1.375	1.625	2.625	3.000	---	---
2"	CGB6915	E	0.813	1.625	1.875	2.625	3.000	---	---
2"	CGB6917	F	0.813	1.875	2.188	2.563	3.750	---	---
2"	CGB6920	F	0.813	2.188	2.500	2.563	3.750	---	---
2-1/2"	CGB7913	E	1.000	1.375	1.625	2.625	3.125	---	---
2-1/2"	CGB7915	E	1.000	1.625	1.875	2.625	3.125	---	---
2-1/2"	CGB7917	F	1.000	1.875	2.188	2.625	3.750	---	---
2-1/2"	CGB7920	F	1.000	2.188	2.500	2.625	3.750	---	---
3"	CGB8917	F	1.000	1.875	2.188	2.625	3.750	---	---
3"	CGB8920	F	1.000	2.188	2.500	2.625	3.750	---	---

All dimensions in inches unless otherwise noted

* With optional Sealing Gasket - see page 36

† With optional Aluminum Construction - see page 36



Gland Type
Non-armoured

Cable Type
Non-armoured and tray cable

Certifications and Compliances

- cULus Listed – UL File E23223

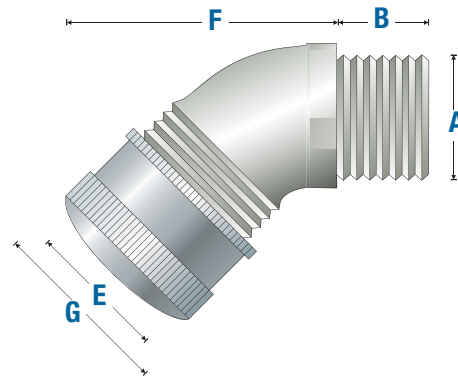

Features

- 45° angle with male thread
- Standard body material is Feraloy® iron alloy
- Standard gland nut material is steel
- Weatherproof seal on outer sheath of cable
- Standard neoprene seal suitable for use in operating temperatures -25° to 40°C
- Available with NPT threads
- See page 49 for related accessories

SELECTION TABLE

Entry Thread Size 'A'		Thread Length 'B' NPT	Cable Acceptance		Gland Length 'F' (less entry)	External Diameter 'G'
NPT Size	NPT Catalog #		Outer Sheath 'E'			
			Min	Max		
1/2"	CGD192	0.630	0.125	0.250	1.688	1.188
1/2"	CGD193	0.630	0.250	0.375	1.688	1.188
1/2"	CGD194	0.630	0.375	0.500	1.688	1.188
1/2"	CGD195	0.630	0.500	0.625	1.688	1.188
1/2"	CGD196	0.630	0.625	0.750	2.063	1.625
1/2"	CGD197	0.630	0.750	0.875	2.063	1.625
3/4"	CGD292	0.630	0.125	0.250	1.938	1.141
3/4"	CGD293	0.630	0.250	0.375	1.938	1.141
3/4"	CGD294	0.630	0.375	0.500	1.938	1.125
3/4"	CGD295	0.630	0.500	0.625	1.938	1.125
3/4"	CGD296	0.630	0.625	0.750	2.000	1.625
3/4"	CGD297	0.630	0.750	0.875	2.000	1.625

All dimensions in inches unless otherwise noted



Gland Type
Non-armoured

Cable Type
Non-armoured and tray cable

Certifications and Compliances

- cULus Listed – UL File E23223

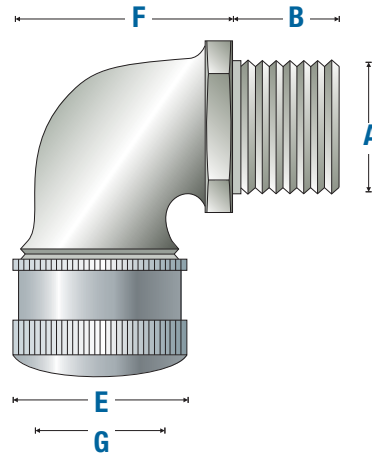

Features

- 90° angle with male thread
- Standard body material is Feraloy® iron alloy
- Standard gland nut material is steel
- Weatherproof seal on outer sheath of cable
- Standard neoprene seal suitable for use in operating temperatures -25° to 40°C
- Available with NPT threads
- See page 49 for related accessories

SELECTION TABLE						
Entry Thread Size 'A'		Thread Length 'B' NPT	Cable Acceptance		Gland Length 'F' (less entry)	External Diameter 'G'
NPT Size	NPT Catalog #		Outer Sheath 'E'			
			Min	Max		
1/2"	CGE192	0.710	0.1250	0.2500	1.438	1.188
1/2"	CGE193	0.710	0.2500	0.3750	1.438	1.188
1/2"	CGE194	0.710	0.3750	0.5000	1.438	1.188
1/2"	CGE195	0.710	0.5000	0.6250	1.438	1.188
1/2"	CGE196	0.710	0.6250	0.7500	2.000	1.625
1/2"	CGE197	0.710	0.7500	0.8750	2.000	1.625
3/4"	CGE292	0.710	0.1250	0.2500	1.406	1.188
3/4"	CGE293	0.710	0.2500	0.3750	1.406	1.188
3/4"	CGE294	0.710	0.3750	0.5000	1.406	1.188
3/4"	CGE295	0.710	0.5000	0.6250	1.406	1.188
3/4"	CGE296	0.710	0.6250	0.7500	1.875	1.625
3/4"	CGE297	0.710	0.7500	0.8750	1.875	1.625
1"	CGE395	0.710	0.5000	0.6250	2.063	1.625
1"	CGE396	0.710	0.6250	0.7500	2.094	1.625
1"	CGE397	0.710	0.7500	0.8750	2.094	1.625
1"	CGE3239	0.710	0.8750	1.0000	2.094	2.250
1"	CGE398	0.710	0.8750	1.0000	2.656	2.250
1"	CGE399	0.710	1.0000	1.1880	2.656	1.625
1"	CGE3911	0.710	1.1880	1.3750	2.656	2.250

All dimensions in inches unless otherwise noted



Gland Type
Portable cord connector

Cable Type
Non-armoured and tray cable

Certifications and Compliances
• cULus Listed – UL File E23223

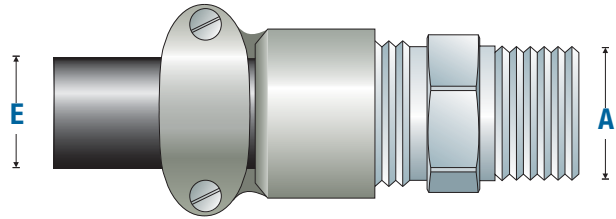

Features

- Body – steel with zinc electroplate and chromate finish coat
- Gland nut – material is aluminum
- Standard neoprene seal suitable for use in operating temperatures -25° to 40°C
- Available with NPT threads
- See page 49 for related accessories

SELECTION TABLE			
Entry Thread Size 'A'		Outer Sheath 'E'	
NPT Size	NPT Catalog #	Min	Max
1/2"	CGB1013	0.312	0.437
1/2"	CGB1014	0.375	0.500
1/2"	CGB1015	0.500	0.625
3/4"	CGB2013	0.312	0.437
3/4"	CGB2014	0.375	0.500
3/4"	CGB2015	0.500	0.625

All dimensions in inches unless otherwise noted



Gland Type
Non-armoured

Cable Type
Non-armoured and tray cable

Certifications and Compliances
• cULus Listed – UL File E23223

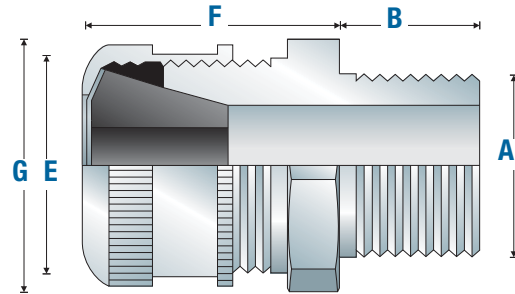

Features

- Form B - C standard body and gland nut are turned steel
- Form D - G standard body and gland nut are Feraloy® iron alloy
- Weatherproof seal on outer sheath of cable
- Standard neoprene seal suitable for use in operating temperatures -25° to 40°C
- Available with NPT threads
- See page 49 for related accessories

SELECTION TABLE							
Entry Thread Size 'A'		Form	Thread Length 'B' NPT	Cable Acceptance		Gland Length 'F' (less entry)	External Diameter 'G'
NPT Size	NPT Catalog #			Outer Sheath 'E'			
				Min	Max		
1/2"	CGFP192	B	0.750	0.1250	0.2500	1.375	1.281
1/2"	CGFP193	B	0.750	0.2500	0.3750	1.375	1.281
1/2"	CGFP194	B	0.750	0.3750	0.5000	1.375	1.281
1/2"	CGFP195	B	0.750	0.5000	0.6250	1.375	1.281
3/4"	CGFP296	C	0.750	0.6250	0.7500	1.750	1.781
3/4"	CGFP297	C	0.750	0.7500	0.8750	1.750	1.781
3/4"	CGFP2239	C	0.750	0.8750	1.0000	1.750	1.781
1"	CGFP396	C	0.938	0.6250	0.7500	1.750	1.781
1"	CGFP397	C	0.938	0.7500	0.8750	1.750	1.781
1"	CGFP3239	C	0.938	0.8750	1.0000	1.750	1.781
1-1/4"	CGFP499	D	0.938	1.0000	1.1880	2.375	2.250
1-1/4"	CGFP4911	D	0.938	1.1880	1.3750	2.375	2.250
1-1/2"	CGFP599	D	0.938	1.0000	1.1880	2.375	2.250
1-1/2"	CGFP5911	D	0.938	1.1880	1.3750	2.375	2.250
2"	CGFP6913	E	1.000	1.3750	1.6250	3.250	3.250
2"	CGFP6915	E	1.000	1.6250	1.8750	3.250	3.250
2-1/2"	CGFP7917	F	1.438	1.8750	2.1880	3.250	3.875
2-1/2"	CGFP7920	F	1.438	2.1880	2.5000	3.250	3.875
3"	CGFP8917	F	1.500	1.8750	2.1880	3.250	3.875
3"	CGFP8920	F	1.500	2.1880	2.5000	3.250	3.875
3-1/2"	CGFP923	G	1.563	2.5000	3.0000	4.250	5.500
3-1/2"	CGFP927	G	1.563	3.0000	3.5000	4.250	5.500
4"	CGFP1023	G	1.625	2.5000	3.0000	4.250	5.500
4"	CGFP1027	G	1.625	3.0000	3.5000	4.250	5.500

All dimensions in inches unless otherwise noted



Gland Type
Non-armoured

Cable Type
Non-armoured and tray cable

Certifications and Compliances
• cULus Listed – UL File E23223

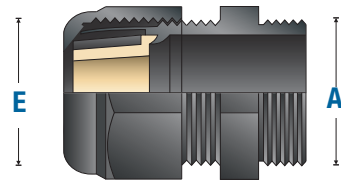

NCG Features

- Standard material is polyamide 6
- Weatherproof seal on outer sheath of cable
- Standard neoprene seal suitable for use in operating temperatures -25° to 40°C
- Available with NPT threads

SELECTION TABLE			
Entry Thread Size 'A'		Outer Sheath 'E'	
NPT Size	NPT Catalog #	Min	Max
3/8"	NCG38-35	0.10	0.35
1/2"	NCG50-50	0.20	0.50
3/4"	NCG75-75	0.35	0.75
1"	NCG100-100	0.55	1.00

All dimensions in inches unless otherwise noted

POLYAMIDE LOCK NUT SELECTION TABLE	
Size	Catalog #
3/8"	10N
1/2"	11N
3/4"	12N
1"	13N



Gland Type
Non-armoured

Cable Type
Non-armoured and tray cable

Certifications and Compliances
• cULus Listed – UL File E23223
• NEMA 3, 4X

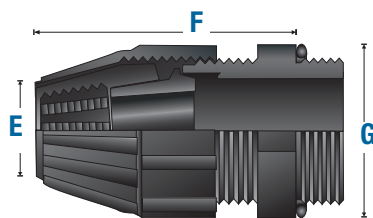

NCGB Features

- Standard material is thermoplastic polyester
- Tightens by hand to create a watertight seal
- Gasket on entry threads included
- Compact design allows close grouping of connectors
- Available with NPT threads

SELECTION TABLE					
NPT Size	NPT Catalog #	Cable Acceptance Range 'E'		Gland Length (Less Entry) 'F'	External Diameter 'G'
		Min	Max		
1/2"	NCGB1231	0.25	0.42	2.25	1.33
1/2"	NCGB1232	0.40	0.57	2.25	1.33
3/4"	NCGB2233	0.54	0.68	2.52	1.58
3/4"	NCGB2234	0.64	0.78	2.52	1.58
1"	NCGB3235	0.76	0.91	3.19	2.02
1"	NCGB3236	0.89	1.03	3.19	2.02

All dimensions in inches unless otherwise noted

Accessories

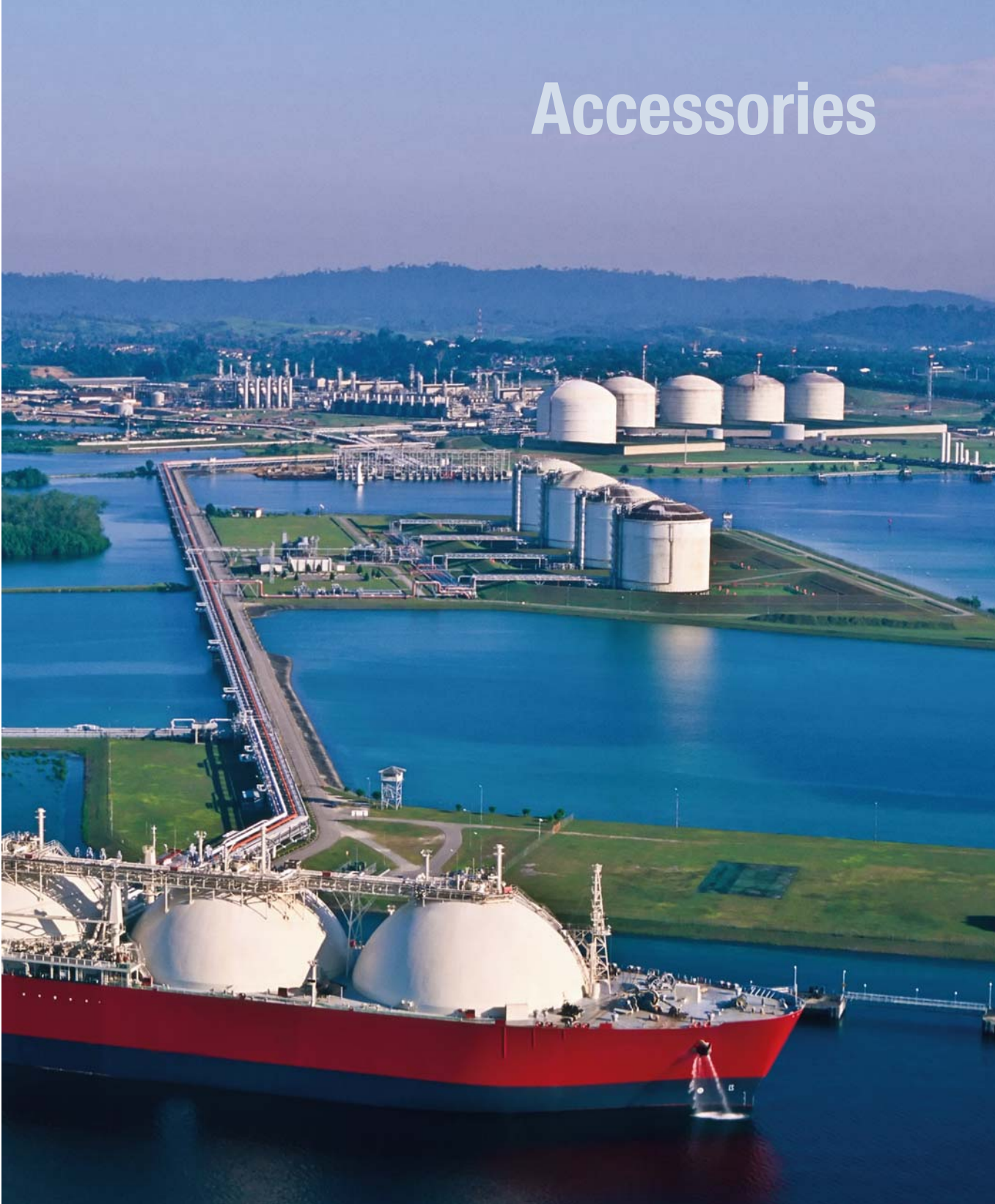

Accessories – A Series



A Series – Lock Nut – Standard material is nickel-plated brass

METRIC SELECTION TABLE			
Entry Thread	A	B	Catalog #
M16	3	18	CAP221694
M20	3	23	CAP222094
M25	3	28	CAP222594
M32	3.5	36	CAP223294
M40	4	44	CAP224094
M50	5	54	CAP225094
M63	6	70	CAP226394
M75	8	85	CAP227594

NPT SELECTION TABLE			
Entry Thread	A	B	Catalog #
1/2"	3.5	24	CAP280124
3/4"	3.5	30	CAP280134
1"	4.5	37	CAP280144
1-1/4"	4.5	47	CAP280154
1-1/2"	5	52	CAP280164
2"	5.5	64	CAP280174
2-1/2"	6.5	77	CAP280184

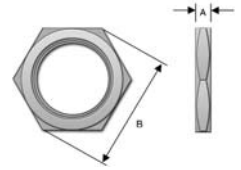

* For stainless steel replace last digit with "9"

A Series – Sealing Washer – Standard material is neoprene

METRIC SELECTION TABLE			
Metric Size	Metric Catalog #	Metric Diam. 'D'	Metric Thickness 'E'
10	CAP221049	15.0	1.2
12	CAP221249	18.0	1.2
16	CAP221649	22.0	1.2
20	CAP222049	24.0	1.2
25	CAP222549	30.0	1.5
32	CAP223249	42.0	1.5
40	CAP224049	52.0	1.5
50	CAP225049	63.0	1.5
63	CAP226349	77.0	2.0
---	---	---	---
---	---	---	---

NPT SELECTION TABLE			
NPT Size	NPT Catalog #	NPT Diam. 'D'	NPT Thickness 'E'
1/4"	CAP229014	20.0	1.5
3/8"	CAP229038	22.0	1.5
1/2"	CAP229012	27.0	1.5
3/4"	CAP229034	33.0	1.5
1"	CAP229010	41.0	1.5
1-1/4"	CAP229114	52.0	1.5
1-1/2"	CAP229112	57.0	1.5
2"	CAP229020	71.0	2.0
2-1/2"	CAP229212	85.0	2.0
3"	CAP229300	104.0	2.0
3-1/2"	CAP229312	120.0	2.0

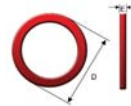

A Series – Earth Tag – Standard material is nickel-plated brass

METRIC SELECTION TABLE					
Entry Thread	A	B	C	D	Catalog #
M16	48.75	30	6.75	24.5	CAP567034
M20	53.8	33	7	28.6	CAP567054
M25	61.5	36	10.5	34	CAP567074
M32	73	41	12.2	42	CAP567094
M40	86.5	44.5	13.5	54	CAP567124
M50	111.5	58	13.5	67	CAP567154
M63	125.5	67	13.5	77	CAP567184
M75	137.5	73	13.5	89	CAP567194

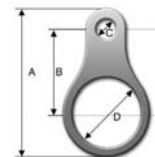

NPT SELECTION TABLE					
Entry Thread	A	B	C	D	Catalog #
1/2"	61.5	36	10.5	34	CAP567064
3/4"	73	41	12.2	42	CAP567084
1"	73	41	12.2	42	CAP567104
1-1/4"	86.5	44.5	13.5	54	CAP567134
1-1/2"	111.5	58	13.5	67	CAP567154
2"	125.5	67	13.5	77	CAP567174
2-1/2"	137.5	73	13.5	89	CAP567194

All dimensions in millimeters unless otherwise noted

A Series – Serrated Lock Washer

– Standard material is stainless steel

SELECTION TABLE		
Metric Size	External Diameter	Catalog #
16	25.5	CAP280069
20	32.5	CAP280029
25	39.5	CAP280259
32	49.5	CAP280329
40	64.5	CAP280409
50	80.5	CAP280509
63	100	CAP280639
75	112	CAP280759
90	123	CAP280099



A-Series – Shroud

– Standard material is PVC

SELECTION TABLE	
Gland Size	Catalog #
4	CAP506040
5	CAP506050
6	CAP506060
7	CAP506070
8	CAP506080
9	CAP506090
10	CAP506100
11	CAP506110
12	CAP506120
13	CAP506130
14	CAP506140
15	CAP506150
16	CAP506160



A Series – Clamping Module

– Standard materials are nickel-plated brass body with stainless steel screws and washers

SELECTION TABLE					
Cable Range	Gland Size	Across Flats	Width	Thickness	Catalog #
4-8.5	4	15	18	5	CAP810434
6-11	5	19	22	5	CAP810534
8.5-16	6	24	27.5	6	CAP810634
12-21	7	30	33.5	8	CAP810734
16-27.5	8	41	45	8	CAP810834
21-34	9	48	52	9.5	CAP810934
27-41	10	55	59	9.5	CAP811034
33-48	11	64	69	12	CAP811134
40-56	12	72	78	12	CAP811234
47-65	13	85	92	16	CAP811334
54-74	14	95	103	16	CAP811434
63-83	15	110	118	18	CAP811534
72-93	16	120	128	18	CAP811634



A Series – Earthing Washer

– Standard material is brass

METRIC SELECTION TABLE				
Gland Size	Lead Sheath Sealing Range		Cable Diameter	Catalog #
	Min	Max		
5	4	7.5	10	CAP560530
6	6	11	13.9	CAP560630
7	9	15	18.3	CAP560730
8	12	20	23.8	CAP560830
9	16	26.5	31	CAP560930
10	21	32.5	38.3	CAP561030
11	28	39.5	45.3	CAP561130
12	33	46.5	52.8	CAP561230
13	40	54.5	60.8	CAP561330
14	46.5	61	71	CAP561430
15	54	72.5	80.5	CAP561530
16	63	81.5	89.5	CAP561630



All dimensions in millimeters unless otherwise noted

Accessories – A Series

A Series – Adaptors and Reducers – Standard material is nickel-plated brass ATEX Exe Exd with LCIE 98 ATEX 00010

ORDERING EXAMPLE: CAP 745334

METRIC x METRIC SELECTION TABLE												
	Female →											
Male	M12	M16	M20	M25	M32	M40	M50	M63	M75	M80	M90	M110
M12		745334										
M16	745834		740274									
M20	745844	740024		740544								
M25		740034	740294		740814							
M32			740304	740564		741084						
M40				740574	740834		741354					
M50					740844	741104		741624				
M63						741114	741374		741894			
M75							741384	741644		745394		
M90									745864			
M110												

METRIC x NPT SELECTION TABLE												
	Female →											
Male	1/4"	3/8"	1/2"	3/4"	1"	1-1/4"	1-1/2"	2"	2-1/2"	3"	3-1/2"	
M12	744104											
M16		744194	744694									
M20	744204	744214	744704	744964								
M25			744714	744974	745234							
M32			744724	744984	745244	745504						
M40				744994	745254	745514	745774					
M50					745264	745524	745784	746044				
M63							745794	746054	746314			
M75								746064	746324	746584		
M90										744304		
M110												

Size available – no part number

Size not available

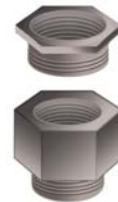

NPT x METRIC SELECTION TABLE												
	Female →											
Male	M12	M16	M20	M25	M32	M40	M50	M63	M75	M90	M100	M110
1/4"	740614	740624										
3/8"	740884	740894	740904									
1/2"	740914	740194	740454	740714								
3/4"		740204	740464	740724	740984							
1"			740474	740734	740994							
1-1/4"				740744	741004	741264	741524					
1-1/2"					741104	741274	741534	741794				
2"						741284	741544	741804	742064			
2-1/2"							741554	741814				
3"								741824				
3-1/2"												
4"												

NPT x NPT SELECTION TABLE												
	Female →											
Male	1/4"	3/8"	1/2"	3/4"	1"	1-1/4"	1-1/2"	2"	2-1/2"	3"	3-1/2"	4"
1/4"												
3/8"	745574		744624									
1/2"		745594		745134								
3/4"			744884		745404							
1"			744894	745154		745674						
1-1/4"				745164	745424		745944					
1-1/2"					745434	745694		746214				
2"						745704	745964		746484			
2-1/2"								746234				
3"								746244	746504			
3-1/2"												
4"												

* For stainless steel replace last digit with "9"

A Series – Stopping Plug – Standard material is nickel-plated brass; ATEX Exe Exd with LCIE 98 ATEX 00010

METRIC SELECTION TABLE				
Metric Size	Metric Catalog # *	Across Flats 'A'	Hex Thickness 'B'	Thread Length 'E'
12	CAP190124	14	2.8	15
16	CAP190164	18	3.0	15
20	CAP190204	23	3.0	15
25	CAP190254	28	3.5	15
32	CAP190324	36	4.0	15
40	CAP190404	44	4.0	15
50	CAP190504	54	5.0	16
63	CAP190634	67	5.5	17
75	CAP190754	80	6.0	18
90	CAP199904	95	8.0	22
100	CAP191004	110	10.0	22

* For stainless steel replace last digit with "9"

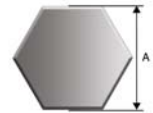

NPT SELECTION TABLE				
NPT Size	NPT Catalog # *	Across Flats 'A'	Hex Thickness 'B'	Thread Length 'E'
1/4"	CAP190194	14	2.8	12
3/8"	CAP109294	18	2.8	12
1/2"	CAP190394	22	3.0	16
3/4"	CAP190494	28	3.0	16
1"	CAP190594	36	3.5	20
1-1/4"	CAP190694	44	4.0	20
1-1/2"	CAP190794	50	5.0	20
2"	CAP190894	64	5.5	20
2-1/2"	CAP190994	75	6.0	28
3"	CAP191094	90	6.0	30
3-1/2"	CAP191194	110	10.0	32

All dimensions in millimeters unless otherwise noted

* For stainless steel replace last digit with "9"

A Series – Non-Metallic Stopping Plug – Standard material is polyamide 6; ATEX certified Ex e II with LCIE 97ATEX6007X

Washer and locknut are required for non-threaded holes (not included) see page 42

POLYAMIDE SELECTION TABLE				
Metric Size	Metric Catalog #	Across flats 'A'	Hex Thickness 'B'	Thread length 'E'
12	CAP191127	15	4	15
16	CAP191167	19	4	15
20	CAP191207	23	4	15
25	CAP191257	28	5	15
32	CAP191327	36	5.5	15
40	CAP191407	44	5.5	15
50	CAP191507	54	6	16
63	CAP191637	67	6.5	17

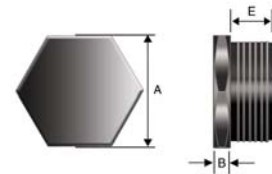

B Series – Lock Nut – Standard material is brass

METRIC SELECTION TABLE	
Metric Entry Thread	Catalog #
M16	BLN/M16
M20	BLN/M20
M25	BLN/M25
M32	BLN/M32
M40	BLN/M40
M50	BLN/M50
M63	BLN/M63
M75	BLN/M75
M80	BLN/M80
M85	BLN/M85
M90	BLN/M90
M100	BLN/M100

NPT SELECTION TABLE	
NPT Entry Thread	Catalog #
1/2"	BLN/050NPT
3/4"	BLN/075NPT
1"	BLN/100NPT
1-1/4"	BLN/125NPT
1-1/2"	BLN/150NPT
2"	BLN/200NPT
2-1/2"	BLN/250NPT
3"	BLN/300NPT
3-1/2"	BLN/350NPT
4"	BLN/400NPT



B Series – Sealing Washer – Standard material is nylon

METRIC SELECTION TABLE	
Metric Entry Thread	Catalog #
M16	RNSW/M16
M20	RNSW/M20
M25	RNSW/M25
M32	RNSW/M32
M40	RNSW/M40
M50	RNSW/M50
M63	RNSW/M63
M75	RNSW/M75
M80	RNSW/M80
M85	RNSW/M85
M90	RNSW/M90
M100	RNSW/M100

NPT SELECTION TABLE	
NPT Entry Thread	Catalog #
1/2"	RNSW/050NPT
3/4"	RNSW/075NPT
1"	RNSW/100NPT
1-1/4"	RNSW/125NPT
1-1/2"	RNSW/150NPT
2"	RNSW/200NPT
2-1/2"	RNSW/250NPT
3"	RNSW/300NPT
3-1/2"	RNSW/350NPT
4"	RNSW/400NPT



B Series – Earth Tag – Standard material is brass

METRIC SELECTION TABLE	
Metric Entry Thread	Catalog #
M16	BET/M16
M20	BET/M20
M25	BET/M25
M32	BET/M32
M40	BET/M40
M50	BET/M50
M63	BET/M63
M75	BET/M75
M80	BET/M80
M85	BET/M85
M90	BET/M90
M100	BET/M100

NPT SELECTION TABLE	
NPT Entry Thread	Catalog #
1/2"	BET/050NPT
3/4"	BET/075NPT
1"	BET/100NPT
1-1/4"	BET/125NPT
1-1/2"	BET/150NPT
2"	BET/200NPT
2-1/2"	BET/250NPT
3"	BET/300NPT
3-1/2"	BET/350NPT
4"	BET/400NPT



B Series – Shroud

PVC SELECTION TABLE	
Size (Gland Size)	Catalog #
L24 (16, 20s)	PVC-L24
L30 (20)	PVC-L30
L38 (25)	PVC-L38
L46 (32)	PVC-L46
L55 (40)	PVC-L55
L65 (50, 50s)	PVC-L65
L80 (63, 63s)	PVC-L80
L90 (75, 75s)	PVC-L90
L104 (80,85)	PVC-L104
L114 (90, 100)	PVC-L114

PCP SELECTION TABLE	
Size	Catalog #
L24 (16, 20s)	PCP-L24
L30 (20)	PCP-L30
L38 (25)	PCP-L38
L46 (32)	PCP-L46
L55 (40)	PCP-L55
L65 (50, 50s)	PCP-L65
L80 (63, 63s)	PCP-L80
L90 (75, 75s)	PCP-L90
L104 (80, 85)	PCP-L104



PVC



PCP

All dimensions in millimeters unless otherwise noted

Accessories – C Series

C Series – Lock Nut – Standard material is brass

METRIC SELECTION TABLE	
Metric Entry Diameter	Catalog #
20	LNM1
25	LNM2
32	LNM3
40	LNM4
50	LNM5
63	LNM6
75	LNM7
80	LNM8

NPT SELECTION TABLE	
NPT Entry Diameter	Catalog #
1/2"	LNN1
3/4"	LNN2
1"	LNN3
1-1/4"	LNN4
1-1/2"	LNN5
2"	LNN6
2-1/2"	LNN7
3"	LNN8



C Series – Sealing Washer/Gaskets – Standard material is nylon

METRIC SELECTION TABLE	
Metric Entry Diameter	Catalog #
20	SGM1
25	SGM2
32	SGM3
40	SGM4
50	SGM5
63	SGM6
75	SGM7
80	SGM8

NPT SELECTION TABLE	
NPT Entry Diameter	Catalog #
1/2"	SGN1
3/4"	SGN2
1"	SGN3
1-1/4"	SGN4
1-1/2"	SGN5
2"	SGN6
2-1/2"	SGN7
3"	SGN8



C Series – Earth Tag – Standard material is nickel-plated brass

SELECTION TABLE		
Metric Entry Diameter	NPT Entry Thread	Catalog #
20	1/2"	ET1
25	3/4"	ET2
32	1"	ET3
40	1-1/4"	ET4
50	1-1/2"	ET5
63	2"	ET6
75	2-1/2"	ET7
80	3"	ET8



C Series – Shroud – Standard material is PVC

Part Number	SELECTION TABLE						
	To Suit Gland						
SH1	TUA1M10	TUA1M12	TUA1M15	TWA1M13	---	TWAX1M13	---
SH2	---	---	---	TWA1M16	TWAE1M16	TWAX1M16	TWAB1M16 TWAB1M20
SH3	---	---	---	TWA1M20	TWAE1M20	TWAX1M20	---
SH4	---	TUA2M18	---	---	---	TWAX2M24	---
SH5	---	TUA3M23	---	TWA2M27	TWAE2M27	TWAX2M27	TWAB2M27
SH6	---	TUA3M25	---	---	---	TWAX3M30	---
SH7	---	---	---	TWA3M34	TWAE3M34	TWAX3M33	TWAB3M34
SH8	---	TUA5M34	---	TWA4M40	TWAE4M40	TWAX4M38 TWAX5M43	TWAB4M40
SH9	---	TUA5M38 TUA5M42	---	---	---	TWAX5M48	---
SH10	---	TUA6M48	---	---	---	TWAX5M52	TWAB5M53
SH11	---	---	---	TWA5M53	TWAE5M53	TWAX6M60 TWAX6M65	TWAB6M66
SH12	---	TUA6M54 TUA7M60	---	TWA6M66	TWAE6M66	TWAX7M71	---
SH13	---	TUA7M66	---	---	---	---	---
SH14	---	---	---	TWA7M78	TWAE7M78	TWAX7M78	TWAB7M78



All dimensions in millimeters unless otherwise noted

D Series – Lock Nut – Standard material is polyamide

SELECTION TABLE			
Metric Entry Diameter	Width	Thickness	Catalog #
M12 x 1.5	17.00	5.00	GHG 960 1941 R0031
M16 x 1.5	22.00	5.00	GHG 960 1941 R0032
M20 x 1.5	26.00	6.00	GHG 960 1941 R0033
M25 x 1.5	32.00	6.00	GHG 960 1941 R0034
M32 x 1.5	41.00	7.00	GHG 960 1941 R0035
M40 x 1.5	50.00	7.00	GHG 960 1941 R0036
M50 x 1.5	60.00	8.00	GHG 960 1941 R0037
M63 x 1.5	75.00	8.00	GHG 960 1941 R0038

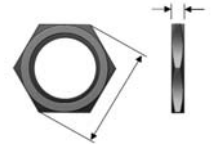

D Series – Reducing Ring – Standard material is polyamide

SELECTION TABLE						
Thread 1	Thread 2	Length 1	Length 2	Length 3	Across Flats	Catalog #
20 x 1.5	M16 x 1.5	12.00	8.00	8.00	24.00	GHG 960 1946 R0071
25 x 1.5	M20 x 1.5	14.00	8.00	8.00	29.00	GHG 960 1946 R0072
32 x 1.5	M20 x 1.5	16.00	10.00	6.00	36.00	GHG 960 1946 R0056
32 x 1.5	M25 x 1.5	16.00	10.00	10.00	36.00	GHG 960 1946 R0074
40 x 1.5	M25 x 1.5	16.00	10.00	8.00	46.00	GHG 960 1946 R0059
40 x 1.5	M32 x 1.5	16.00	10.00	10.00	46.00	GHG 960 1946 R0077
50 x 1.5	M32 x 1.5	18.00	12.00	10.00	55.00	GHG 960 1946 R0062
50 x 1.5	M40 x 1.5	18.00	12.00	10.00	68.00	GHG 960 1946 R0080
63 x 1.5	M40 x 1.5	18.00	12.00	10.00	68.00	GHG 960 1946 R0065
63 x 1.5	M50 x 1.5	18.00	12.00	12.00	68.00	GHG 960 1946 R0083



D Series – Screw Plug – Standard material is polyamide

SELECTION TABLE				
Thread 1	Diameter	Length 1	Length 2	Catalog #
16 x 1.5	21.50	4.00	12.00	GHG 960 1952 R0111
20 x 1.5	25.50	4.00	13.00	GHG 960 1952 R0112
25 x 1.5	30.50	4.00	13.00	GHG 960 1952 R0113
32 x 1.5	37.50	5.50	15.00	GHG 960 1952 R0114
40 x 1.5	45.50	5.50	15.00	GHG 960 1952 R0115
50 x 1.5	55.50	5.50	16.00	GHG 960 1952 R0116
63 x 1.5	85.00	6.50	16.00	GHG 960 1952 R0117



D Series – Blanking Plug – For sealing unused cable glands; Standard material is polyamide

SELECTION TABLE			
Thread 1	Diameter	Length 1	Catalog #
12	6.00	30.30	GHG 960 1944 R0101
16	7.00	33.00	GHG 960 1944 R0102
20	8.50	34.50	GHG 960 1944 R0103
25	11.00	36.00	GHG 960 1944 R0104
32	14.00	39.50	GHG 960 1944 R0105
40	20.00	42.00	GHG 960 1944 R0106
50	26.00	44.00	GHG 960 1944 R0107
63	34.00	45.00	GHG 960 1944 R0108



All dimensions in millimeters unless otherwise noted

E Series – TSC Epoxy Sealing Compound

SELECTION TABLE		
Std. Carton Qty.	Tube Size	Catalog #
10	0.5 oz	TSC05
10	1.0 oz	TSC1
5	4.0 oz.	TSC4



E Series – Wire Mesh Grip

SELECTION TABLE		
Cord Range Diameter	Gland Nut	Wire Mesh Grip Catalog Number
.375 to .500	NUT94	RPE417-115
.500 to .625	NUT94	RPE417-116
.500 to .625	NUT95	RPE417-129
.625 to .750	NUT95	RPE417-117
.750 to .875	NUT95	RPE421-119
.875 to 1.000	NUT98	16676N
.875 to 1.000	NUT98	16676N
.875 to 1.000	NUT95	RPE421-120
.875 to 1.000	NUT98	16676N
1.000 to 1.188	NUT98	RPE421-121
1.188 to 1.375	NUT98	RPE433-122
1.375 to 1.625	NUT913	RPE433-123
1.625 to 1.875	NUT913	17317N



E Series – Cold Shrink™ Kit

SELECTION TABLE	
Entry Thread	Catalog #
1/2"	TMC-K1
3/4"	TMC-K2
1"	TMC-K3
1-1/4"	TMC-K4
1-1/2"	TMC-K5
2"	TMC-K6
2-1/2"	TMC-K7
3"	TMC-K8
3-1/2"	TMC-K9
4"	TMC-K10

All dimensions in inches unless otherwise noted

Cold Shrink™ Corrosion Protection Kits are specially designed for Cooper Crouse-Hinds TMC, TMCX and TECK fittings to provide protection against corrosive elements like salt spray and moisture. The TMC-K kit is made of a Cold Shrink material that is quick and easy to install on the gland. The Cold Shrink material is made of EPDM rubber that contains no chlorides or sulfurs. The protection kit installs easily over the gland without the use of a heat source to shrink the material tightly over the seal. The Cold Shrink material can be removed easily from the gland by simply cutting it off. See ordering information for complete offering of TMC-K Cold Shrink kits for corrosion protection. Cold Shrink is a registered trademark of the 3M Company.

Breather Drain – SIRA 99 ATEX 3050 U
 I M2 II, 2GD, EExe I & II (Stainless steel & brass only)
 II 2GD, EExe II (Nylon only)
 Enclosure type 4x IP66

SELECTION TABLE		
Entry Thread	Material	Catalog #
M20	Brass	ACDPEB/M20/15
M20	Stainless Steel	ACDPES/M20/15
M20	Nylon	ACDPEBN/M20/15
M25	Brass	ACDPEB/M25/15
M25	Stainless Steel	ACDPES/M25/15
M25	Nylon	ACDPEBN/M25/15
1/2"	Brass	ACDPEB/050NPT/15
1/2"	Stainless Steel	ACDPES/050NPT/15
3/4"	Brass	ACDPEB/075NPT/15
3/4"	Stainless Steel	ACDPES/075NPT/15

Drainage Plug – Standard material is polyamide; PTB01 ATEX 1128X Ex 1126 Exe II

SELECTION TABLE				
Thread 1	Diameter	Length 1	Length 2	Catalog #
M25 x 1.5	30.00	19.00	4.50	GHG 960 1927 R0105

Breathing and Drainage Plug – Standard material is glass-filled polyamide; SIRA 99 ATEX 3050 U Ex 1126 Exe II

SELECTION TABLE	
Thread 1	Catalog #
M25 x 1.5	GHG 960 1954 R0002

All dimensions in millimeters unless otherwise noted

Please refer to our full product catalog for additional breather and drain options

Reference Guide

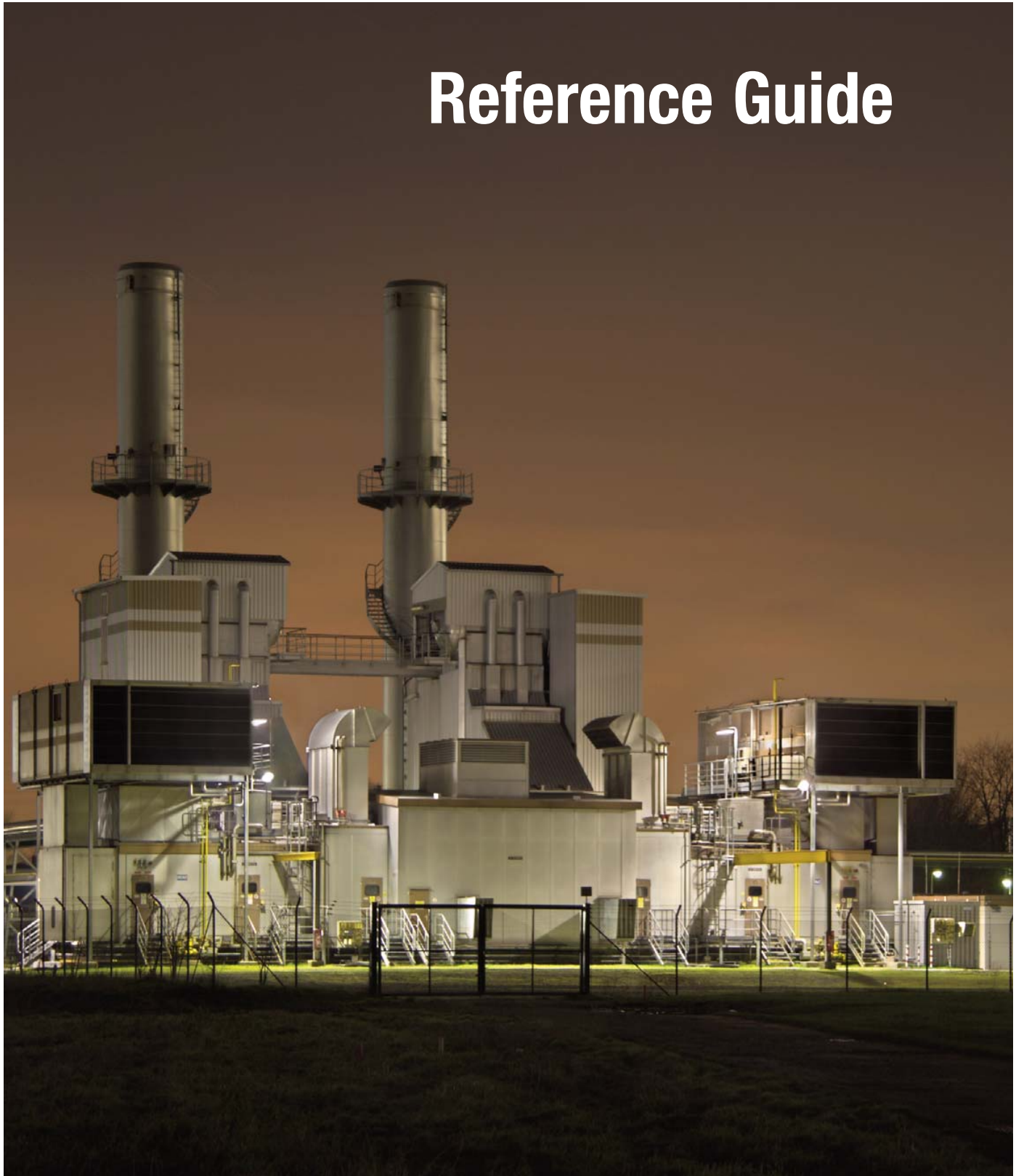

Guide for Explosive Atmospheres

Introduction

The production, processing, transportation and storage of flammable materials produces dusts, gases, mists and vapors, which, if not handled carefully, can create a potentially explosive environment. Examples of industries that create these by-products are: petrochemical, mining, mineral oil production and natural gas production. These flammable gases, vapors, mists and dusts form an explosive atmosphere when mixed with the oxygen in the air. If the atmosphere is ignited, explosions take place which can result in damage to property, bodily injury or even death. Common ignition sources are sparks, hot surfaces and static electricity. When the use of electrical equipment is required in a potentially explosive environment, it must be designed and constructed to circumvent the creation of an ignition source. Before electrical products can be used in a potentially explosive atmosphere, a representative sample must be fully tested and certified by a notified body for ATEX, and/or competent body for IECEx, and/or NRTL in the U.S.A.

This information is intended as a guide only. Further expert guidance should be sought before servicing maintaining or repairing any item of equipment in a potentially explosive atmosphere. When comparisons are made within (i.e. European and North American practices), this may be an approximation and individual standards/codes of practice should be consulted for precise details.

For a guide to the terms used in this section please see pages 62 and 63



Global Certification Philosophies

Under IEC/CENELEC, the philosophy used to classify areas and determine enclosure acceptability is based on normal operation. The NEC/CEC standards assume that abnormal conditions can and will occur. Products must be designed to operate under these conditions. This is why a product that is suitable for Zone 1 in a CENELEC country might not be acceptable for use in a country following NEC/CEC standards.



In addition, the “increased safety” method of protection concept used commonly in IEC/CENELEC does not consider a wire/conductor termination as a potential source of ignition in a Zone 1 area (hazardous in normal operation). In a NEC/CEC Division 1 area, all wire/conductor terminations are considered to be potential sources of ignition and must be enclosed in an explosionproof enclosure. This is the single most significant reason why the design of a product approved to IEC/CENELEC Zone 1 can be, and often is, so dissimilar to the design of a similar product approved for NEC/CEC Division 1.

All equipment intended for use in a potentially explosive atmosphere should be certified as suitable for such use. Methods are different for respective certification bodies.

International Certifications and Standards

ATEX

All equipment, both electrical and mechanical, intended to be put into service within the EU must be certified in accordance with the ATEX directive.

Like IECEx, the ATEX directive consists of two parts: the Product Quality Assurance Notice (PQAN) and the Quality Assurance Notification (QAN).

Unlike IECEx, the ATEX directive allows in certain circumstances for manufacturers to self-certify compliance with the directive.

Category	Equipment	Responsibility	
		Design	QAN
1	Elec	NB	NB
	Non-elec	NB	NB
2	Elec	NB	NB
	Non-elec	M	M
3	Elec	M	M
	Non-elec	M	M

M – Manufacturer
NB – Notified Body

To comply with the ATEX directive (94/9/EC), the manufacturer must:

- Identify the requirements that apply to the product
- Ensure that EHSRs (Essential Health and Safety Requirements) are met
- Apply necessary Conformity Assessment Procedures according to the Category of the equipment (or protective system)
- Label the product with their name, address and the CE Marking
- Create and maintain a technical file for the product
- Issue an **EC Declaration of Conformity**

Marking (EXAMPLE)



II 2 G



Explosion-protected in accordance with ATEX

II – Group II surface industries
2 – Category 2 equipment
G – Suitable for atmospheres containing gas

IECEx

Currently the IECEx scheme covers electrical equipment only.

Samples and appropriate documentation are supplied to the IECEx certification body (ExCB). The ExCB will test the electrical product against all appropriate recognized IEC standards and issue a test report (ExTR). The ExCB will also conduct a quality audit and issue a Quality Assessment Report (QAR). Once both the ExTR and QAR are issued, the ExCB will issue the Certificate of Conformity. There is no manufacturer's self-certification under the IECEx scheme.

Marking (EXAMPLE)

IECEx-LCI05.0004X-ExdIIC ExtD

LCI05.0004X Certificate Number

Exd – Protection Technique

IIC – Gas Group

Regional Certifications

Most countries outside Europe or North America use the IEC Standards as a basis for their own national standards. Examples are: The Russian Federation certifies equipment to GOST 'R' standards, which closely follow CENELEC practices. Kazakhstan has a certification practice (GOST 'K') where approval is normally based on compliance with CENELEC standards. Certification in China is based on compliance with international standards such as CENELEC, UL, CQST (Chinese standards based on IEC).

The table below defines the zones and indicates which category ATEX certificate is required.

Gases, Vapors, Mists		Dusts	
ATEX	IEC	ATEX	IEC
Category 1 G	Zone 0	Category 1 D	Zone 20
Category 2 G	Zone 1	Category 2 D	Zone 21
Category 3 G	Zone 2	Category 3 D	Zone 22

North American Codes and Standards

NEC & CEC

Samples and supporting documentation are submitted to the NRTL e.g. UL, CSA, FM, ETL. The product is tested in accordance with the relevant standards for ordinary and hazardous locations. After successful testing, the NRTL will generate a listing and allow the manufacturer to place the product on the market. Unlike with IECEx and ATEX, the NRTL will conduct periodic follow-up inspections to ensure that the product is still manufactured per the listing.

Marking NEC/CEC Divisions (Example)

CLI Div 1 Gr A,B,C,D

CLI – NEC/CEC Class (gas)

Div 1 – NEC/CEC Divisions

Gr A, B, C, D – Groups

Marking NEC Zones (Example)

CLI Zn 1 AEx d IIC T6

CLI – NEC Class (gas)

Zn1 – Zone 1

AEx – American 60079 series

d – Protection Technique

IIC – Group

T6 – Temperature Code

Marking CEC Zones (Example)

CLI Zn 1 Ex d IIC T6

CLI – NEC Class (gas)

Zn1 – Zone 1

Ex – Canadian 60079 series

d – Protection Technique

IIC – Group

T6 – Temperature Code



Area Classification

Gases, Vapors, Mists		Dusts		Explosive atmosphere is present:
IEC	NEC Divisions	IEC	NEC Divisions	
Zone 0	Class I Div 1	Zone 20	Class II Div 1 Class III	Continuously, long-term or frequently
Zone 1		Zone 21		Occasionally
Zone 2	Class I Div 2	Zone 22	Class II Div 2 Class III	Infrequently or short period

Note: North American legislation now allows Zones to be used to classify areas; where this practice is used it follows the NEC and CEC



Temperature

The selection of electrical equipment for use in hazardous areas must ensure the apparatus's maximum surface temperature does not exceed the auto ignition temperature of the gas present in the surrounding atmosphere. The reference ambient temperature of 40°C will be assumed unless otherwise stated on the apparatus labeling.

The T-rating obtained is based on normal temperature at the most onerous operating conditions.

Temperature Classification		
Zones	Divisions	Maximum Surface Temperature
T1	T1	450° C
T2	T2	300° C
	T2A	280° C
	T2B	260° C
	T2C	230° C
	T2D	215° C
T3	T3	200° C
	T3A	180° C
	T3B	165° C
	T3C	160° C
T4	T4	135° C
	T4A	120° C
T5	T5	100° C
T6	T6	85° C

Example, butane has an ignition temperature of 365° Celsius so equipment used in the vicinity of this gas would need a T rating of T2 or better

Gas Groups

The IEC gas groupings are divided into Group I for mining and Group II for surface industrial applications. Group II gases occurring in surface industries, are sub-grouped according to their volatility. Equipment approved for use in Group IIC is also safe to use with Groups IIB and IIA gases. Equipment approved for use in Group IIB is also safe to use with Group IIA gases. Under the North American system of gas grouping, there is not an official hierarchy as in IEC. Equipment is marked only in accordance with gas groups for which it has been tested. For example, equipment tested with group B, C and D gases would be marked "B, C, D."

Gas/Material	Zone Group	Division Group
Methane	I	-
Acetylene	IIC	A
Hydrogen	IIC	B
Ethylene	IIB	C
Propane	IIA	D
Metal dust	-	E
Coal Dust	-	F
Grain Dust	-	G
Fibers and Flyings		-



ZONE PROTECTION METHOD	SYMBOL	CONCEPT OF PROTECTION	IEC/CEC/NEC ZONE	IEC STANDARD	EN STANDARD	NEC ZONE STANDARD
Flameproof Enclosure An enclosure used to house electrical equipment, which when subjected to an internal explosion will not ignite a surrounding explosive atmosphere	Exd	Contain the explosion	1,2	IEC 60079-1	EN 60079-1	UL 60079-1
Intrinsic Safety A technique whereby electrical energy is limited such that any sparks or heat generated by electrical equipment is sufficiently low as to not ignite an explosive atmosphere	Exi	Limit the energy of spark	0,1,2	IEC 60079-11	EN 60079-11	UL 60079-11
Purged and Pressurized Electrical equipment is housed in an enclosure which is initially purged to remove any explosive mixture; then it is pressurized to prevent ingress of the surrounding atmosphere prior to energization	Exp	Keep flammable gas out	1,2	IEC 60079-2	EN 60079-2	UL 60079-2
Oil Immersion Electrical components are immersed in oil, thus excluding the explosive atmosphere from any sparks or hot surfaces	Exo	Keep flammable gas out	1,2	IEC 60079-6	EN 60079-6	UL 60079-6
Increased Safety Equipment is designed as to eliminate sparks and hot surfaces capable of igniting an explosive atmosphere	Exe	No arc or sparks	1,2	IEC 60079-7	EN 60079-7	UL 60079-7
Non-sparking Sparking contacts are sealed against ingress of the surrounding atmosphere; hot surfaces are eliminated	ExnA	No arc or sparks	2	IEC 60079-15	EN 60079-15	UL 60079-15
Restricted Breathing	ExnR	Keep flammable gas out	2	IEC 60079-15	EN 60079-15	UL 60079-15

DIVISION PROTECTION METHOD	CONCEPT OF PROTECTION	NEC DIVISION	NEC STANDARD
Hermetically Sealed Equipment sealed against the entrance of an external atmosphere where the seal is made by fusion	Keep flammable gas out	2	UL 1604
Explosionproof An enclosure used to house electrical equipment, which when subjected to an internal explosion will not ignite a surrounding explosive atmosphere	Contain the explosion	1,2	UL 1203
Intrinsic Safety A technique whereby electrical energy is limited such that any sparks or heat generated by electrical equipment is sufficiently low as to not ignite an explosive atmosphere	Limit the energy of spark	1,2	UL 913
Purged and Pressurized Electrical equipment is housed in an enclosure which is initially purged to remove any explosive mixture; then it is pressurized to prevent ingress of the surrounding atmosphere prior to energization.	Keep flammable gas out	1,2	NFPA 496
Oil Immersion The electrical components are immersed in oil, thus excluding the explosive atmosphere from any sparks or hot surfaces	Keep flammable gas out	2	UL 1203
Non-Incendive The equipment is so designed as to eliminate sparks and hot surfaces capable of igniting an explosive atmosphere	No arc or sparks	2	UL 1604

Ingress Protection

The **IP Code** classifies the degrees of protection provided against the intrusion of solid objects (including body parts like hands and fingers), dust, accidental contact, and water in electrical enclosures. It consists of the letters **IP** followed by two digits. The standard (IEC 60529) aims to provide users more detailed information than vague marketing terms such as "waterproof".

The digits ('characteristic numerals') indicate conformity with the conditions summarized in the tables below. Where there is no protection rating with regard to one of the criteria, the digit is replaced with the letter **X**.

The first digit indicates the level of protection that the enclosure provides against access to hazardous parts and the ingress of solid foreign objects.

One important note is that IP ratings DO NOT represent a hazardous locations rating. A product can have an IP rating and not have a hazardous locations rating, however a product with a hazardous locations rating must have an IP rating.



First Index - Foreign Bodies Protection, Solids		
Index	Protection Against Human/Tool Contact	Protection Against Solid Objects (Foreign Bodies)
0	No special protection	No protection
1	Back of hand, Fist	Large foreign bodies, diam. >50mm
2	Finger	Medium foreign bodies, diam. >12mm
3	Tools and wires etc. with a thickness >2.5mm	Small foreign bodies, diameter >2.5mm
4	Tools and wires etc. with a thickness >1mm	Granular foreign bodies, diameter >1mm
5	Complete protection (limited ingress permitted)	Dust protected; dust deposits are permitted, but their volume must not affect the function of the unit
6	Complete protection	Dust-proof

Second Index - Water Protection, Liquids		
Index	Protection Against Water	Protection From Condition
0	No special protection	No protection
1	Water dripping/falling vertically	Light rain/Condensation
2	Water sprayed at an angle (up to 15° degrees from the vertical)	Light rain with wind
3	Spray water (any direction up to 60° degrees from the vertical)	Heavy rainstorm
4	Spray water from all directions (limited ingress permitted)	Splashing
5	Low pressure water jets from all directions (limited ingress permitted)	Hosedown, residential
6	High pressure jets from all directions (limited ingress permitted)	Hosedown, commercial, e.g., ship decks
7	Temporary immersion, 15 cm to 1m	Immersion in tank
8	Continuous immersion as agreed upon by the manufacturer	Greater than IP X7

Comparing NEMA and IP Enclosure Ratings

This comparison is only approximate, and it is the responsibility of the user to verify the enclosure rating necessary for the given application.

Enclosure type	IP10	IP52	IP54	IP56	IP65	IP66	IP67
1	●						
3			●				
3R			●				
3S			●				
4				●			
4X				●			
5		●					
6							●
6P							●
7							
8							
9							
10							
12		●					
12K		●					
13			●				

Enclosure types 7, 8, 9, and 10 are U.S.-type enclosures only

NEMA

North American practice is to use NEMA standards to describe ingress protection, e.g.:

NEMA 3 is similar to IP54

NEMA 4 is similar to IP56

NEMA 4X is similar to IP56

NEMA 6 is similar to IP67



Provides a Degree of Protection Against the Following Conditions	Type of Enclosure									
	1	2	4	4X	5	6	6P	12	12K	13
Access to hazardous parts	X	X	X	X	X	X	X	X	X	X
Ingress of solid foreign objects (falling dirt)	X	X	X	X	X	X	X	X	X	X
Ingress of water (Dripping and light splashing)	...	X	X	X	X	X	X	X	X	X
Ingress of solid foreign objects (Circulating dust, lint, fibers, and flyings)	X	X	...	X	X	X	X	X
Ingress of solid foreign objects (Settling airborne dust, lint, fibers, and flyings)	X	X	X	X	X	X	X	X
Ingress of water (Hosedown and splashing water)	X	X	...	X	X
Oil and coolant seepage	X	X	X
Oil or coolant spraying and splashing	X
Corrosive agents	X	X
Ingress of water (Occasional temporary submersion)	X	X
Ingress of water (Occasional prolonged submersion)	X

		CABLE TYPES													
		MC	MC-HL	TC	MI	TECK	PLTC	MV	ITC	ITC-HL	SWA	STA	SWB	Braided marine shipboard	Non-armoured
North America	Div 1		X		X	X*				X				X**	
	Div 2	X	X	X	X	X	X	X	X	X	X			X	X
	Zone 1		X		X	X*				X				X**	
	Zone 2	X	X	X	X	X	X	X	X	X	X			X	X
	IEC			X							X	X	X	X	X

All wiring for Div 1 is suitable for Div 2

All Wiring for Zone 1 is suitable for Zone 2

* Canada Only

** Armoured and sheathed marine shipboard cable can be used in Class I Division 1 locations offshore as mentioned in API RP114F

NEC/CEC Wiring Methods

As shown in the table above the only cables that are permitted for use in Class 1 Div 1 are those that are mechanically protected by armour. The three protection techniques approved for Class 1 Div 1 locations are “Intrinsically Safe,” “Purged and Pressurized” and “Explosionproof.” When using the explosionproof protection technique, the cable must be sealed at the point of entry with an approved sealing device.

IEC Wiring Methods

The following is a decision tree from IEC60079-14 for cable entry devices into flameproof enclosures.

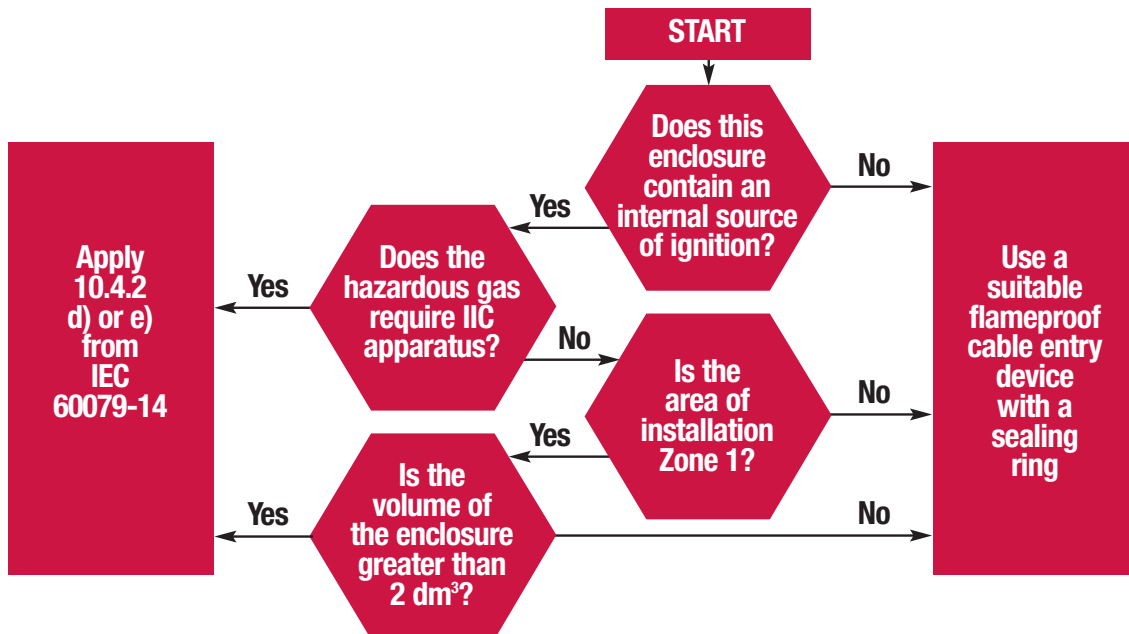

General Terms

Ambient Temperature	– All encompassing temperature within a given area	MC	– Metal-clad Cable
Armour	– Mechanical protection usually accomplished by a metallic layer of tape, braid or served wires; normally found under the outer sheath of a cable	MC-HL	– Metal-clad Cable-Hazardous Location, for Class I Division 1 locations
Armoured Cable	– A cable provided with a wrapping of metal, usually steel wires, flat tapes, or interlocked tapes, primarily for the purpose of mechanical protection	MI	– Mineral Insulated
ATEX	– French term Atmosphères Explosibles (EU directive 94/9/EC)	MV	– Medium Voltage
AWG	– American Wire Gauge	NB	– Notified Body
Braid Armour	– A fibrous or metallic group of filaments interwoven in cylindrical form covering one or more conductors	PLTC	– Power Limited Tray Cable
Cable Gland	– A device used for the entry of cables or cords into electrical equipment providing armour clamping, sealing and/or strain relief	Primary Seal	– A seal that isolates process fluids from an electrical system and has one side of the seal in contact with the process fluid
CB	– Certification Body	QAR	– Quality Assurance Report – quality portion of IECEx certification
Cold Flow	– Any permanent deformation of the inner sheath of a cable due to pressure or mechanical force, without the aid of heat softening	QAN	– Quality Assurance Notice – quality portion of ATEX certification
CWCMC	– Continuously Welded Corrugated Metal-clad Cable	Secondary Seal	– A seal that is designed to prevent the passage of process fluids at the pressure it will be subjected to upon failure of the primary seal (secondary seals are required for sealing conduits and cables in Class I explosive gas atmospheres, where failure of a primary seal could allow flammable process fluids to leak into electrical equipment, with disastrous results)
DTSO1	– Deluge Test developed by Shell, mainly used on off-shore rigs	SWA	– Steel Wire Armour
Directive	– A legislative act of the European Union	STA	– Steel Tape Armour (also DSTA for double steel wire armour)
EHSR	– Essential Health and Safety Requirements – Requirements from new approach Directives, e.g., LVD, ATEX	SWB	– Steel Wire Braid
Hazardous Location	– Location where fire or explosion hazards may exist due to the presence of flammable gases, dusts, or fibers	TC	– Tray Cable
IECEX CB	– IECEX Certifying Body	TC-ER	– Tray Cable Exposed Run
IECEX TR	– IECEX Test Report	TECK	– A type of metal-clad interlocked armour cable (mainly used in Canada)
IP	– Ingress Protection	Wet Locations	– Installations underground or in concrete slabs or masonry in direct contact with the earth; locations subject to saturation with water or other liquids, such as washdown areas; and in unprotected locations exposed to weather
ITC	– Instrument tray cable		
ITC-HL	– Instrument Tray Cable Hazardous location		
LVD	– Low Voltage Directive (EU directive 2006/95/EC)		



Agencies and Associations

- | | | | |
|----------------|--|-------------------------|--|
| ABS | – American Bureau of Shipping | INMETRO | – National Institute of Metrology, Standardization and Industrial Quality (Brazil) |
| ANSI | – American National Standards Institute | ISA | – Instrument Society of America |
| ASTM | – American Society for Testing and Materials | ISO | – International Standards Organization |
| BASEEFA | – British Approvals Service for Electrical Equipment in Flammable Atmospheres (UK) | ITS | – Intertek Testing Service |
| CEC | – Canadian Electrical Code | Lloyd's Register | – Ship Classification and Risk Management Organization |
| CENELEC | – European Committee for Electrotechnical Standardization | MSHA | – Mine Safety and Health Administration |
| CEPEL | – Brazilian Certification Body | NEC | – National Electrical Code |
| CFR | – Code of Federal Regulations (USA) | NEMA | – National Electrical Manufacturers Association |
| CSA | – Canadian Standards Association | NFPA | – National Fire Protection Association |
| DNV | – Det Norske Veritas | NRTL | – Nationally Recognized Testing Laboratory |
| ETL | – Electrical Testing Labs | OSHA | – Occupational Safety and Health Administration |
| FM | – Factory Mutual | PTB | – Physikalisch-Technische Bundesanstalt (Germany) |
| IEC | – International Electrotechnical Commission | TUV | – Technischer Überwachungs-Verein (Germany) |
| IECEX | – IEC scheme for certification to standards relating to equipment for use in explosive atmospheres | UL | – Underwriters Laboratories (USA) |
| IEEE | – Institute of Electronic and Electrical Engineers | USCG | – United States Coast Guard |

AWG to mm² Conversion Table

AWG	Diameter mm	Area mm ²	Diameter in
30	0.252	0.05	0.01
28	0.319	0.08	0.013
26	0.422	0.14	0.017
24	0.564	0.25	0.022
22	0.658	0.34	0.026
20	0.798	0.5	0.031
18	0.977	0.75	0.038
16	1.382	1.5	0.054
14	1.784	2.5	0.07
12	2.257	4	0.089
10	2.764	6	0.109
8	3.568	10	0.14
6	4.514	16	0.178

AWG	Diameter mm	Area mm ²	Diameter in
4	5.642	25	0.222
2	6.676	35	0.263
1	7.979	50	0.314
1/0	8.368	55	0.329
2/0	9.441	70	0.372
3/0	10.998	95	0.433
4/0	12.361	120	0.487
300MCM	13.820	150	0.544
350MCM	15.348	185	0.604
500MCM	17.481	240	0.688
600MCM	19.544	300	0.769
750MCM	22.568	400	0.888
1000MCM	25.231	500	0.993





Global termination solutions moving power and signals in the world’s most demanding environments



For more information:

If further assistance is required, please contact an authorized Cooper Crouse-Hinds Distributor, Sales Office, or Customer Service Department.

U.S. (Global Headquarters):

Cooper Crouse-Hinds
Wolf & Seventh North Streets
Syracuse, NY 13221
(866) 764-5454
FAX: (315) 477-5179
FAX Orders Only: (866) 653-0640
crouse.customerctr@cooperindustries.com

Canada:

Cooper Crouse-Hinds Canada
Toll Free: 800-265-0502
FAX: (800) 263-9504
FAX Orders only: (866) 653-0645

Mexico/Latin America/Caribbean:

Cooper Crouse-Hinds, S.A. de C.V.
52-555-804-4000
FAX: 52-555-804-4020
mxmercadotecnia@cooperindustries.com

Europe (Germany):

Cooper Crouse-Hinds GmbH
49 (0) 6271 806-500
49 (0) 6271 806-476
info-ex@ceag.de

Middle East (Dubai):

Cooper Crouse-Hinds LLC
971 4 4272500
FAX: 971 4 4298521

Singapore:

Cooper Crouse-Hinds Pte. Ltd.
65-6297-4849
FAX: 65-6297-4819
chsi-sales@cooperindustries.com

China:

Cooper Crouse-Hinds Pte. Ltd.
86-21-2899-3600
FAX: 86-21-2899-4055
cchsals@cooperindustries.com

Korea:

Cooper Crouse-Hinds Korea
82-2-3484-6783
82-2-3484-6778
CCHK-sales@cooperindustries.com

Australia:

Cooper Electrical Australia
61-2-8787-2777
FAX: 61-2-9609-2342
CEASales@cooperindustries.com

India:

Cooper India Pvt. Ltd.
91-124-4683888
FAX: 91-124-4683899
cchindia@cooperindustries.com

www.crouse-hinds.com

Cooper Crouse-Hinds is a registered trademark of Cooper Industries, Inc.
©2008 Cooper Industries, Inc.

Your Authorized Cooper Crouse-Hinds Distributor is:

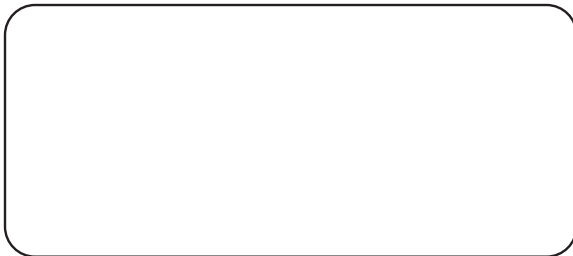

Cooper Industries, Ltd.
600 Travis, Ste. 5800
Houston, TX 77002-1001
P: 713-209-8400
www.cooperindustries.com