

LED Brite Strip festoon bulb in a cove

APPLICATIONS

- ▶ Ceiling coves
- ▶ Wall coves
- ▶ Display cases
- ▶ Under cabinet lighting
- ▶ Shelf lighting
- ▶ Sign backlighting
- ▶ Architectural accents
- ▶ Decorative accents

DESCRIPTION

Flexible light strip featuring LED efficiency and field cutability. Molded festoon bulb sockets located at two, three and four bulbs per foot on listed 12AWG wire. Each socket accepts a 0.5 watt LED festoon bulb. Bulbs are rated at 40,000 hour life. Light strip is dimmable with 0.5 watt festoon bulbs powered by appropriate LED driver and dimming device. See instructions for complete specifications and installation details.

SCHEMATICS

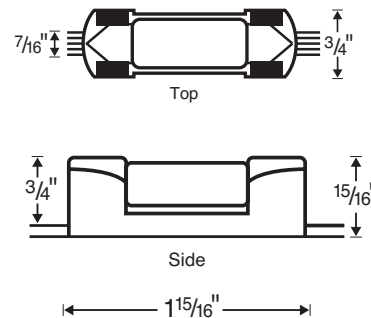

FEATURES

Fixture Design

- Field cutable power strip for custom, hard to estimate applications
- Flexible design allows unlimited applications
- Parallel wiring means loss of a bulb does not affect remaining strip
- Listed 12 AWG wire
- Simple, safe, effective standard terminal block connector with Junction Box

Socket

- Pre-installed on wire for installation ease
- "Snap In" bulb socket design for ease of bulb replacement

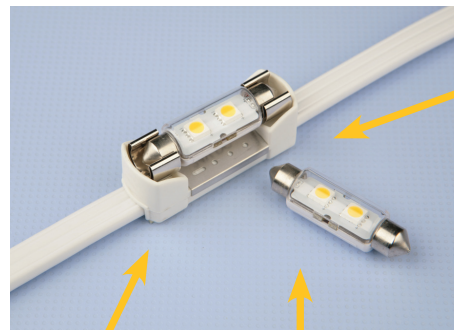

Mounting

- Each socket ships complete with 3M double-sided mounting tape
- Optional nail clips for difficult mounting applications

Bulb

- Low 0.5 watts per LED festoon bulb
- Rated 40,000 hour LED life
- Festoon bulbs dim with appropriate LED driver and dimmer. See instructions.



Suitable for
• Indoor dry locations

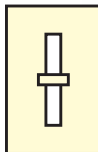

DIMMABLE!

LED BRITE STRIP™

SPECIFICATIONS

Voltage 24VDC

LED Bulb Specifications 0.5W LED Festoon (dimnable)

LED Color Temperature Warm White 2600K +/-200K, Cool White 6000K +/-200K

LED Bulb Life Replaceable LED bulbs rated at 40,000 hours

Socket Spacing 1" between bulb sockets (4 bulbs per foot)
2" between bulb sockets (3 bulbs per foot)
4" between bulb sockets (2 bulbs per foot)

Socket Connection Horizontal individual sockets parallel wired to flat 12AWG power wire.

Wire and Socket Color White or black

Maximum Single Run LED Festoon Bulbs: 180 bulbs with LEDDR-24-120W non-dimmable driver, or 160 bulbs with TR24L96DC dimmable magnetic transformer.

Dimming 0.5W LED Festoon bulbs are dimmable with appropriate magnetic LED driver and dimmer. See instructions for details.

Agency Approval Warranty ETL listed for indoor and other dry location use
Two years. See back cover for details.

**PHOTOMETRICS
ON PAGE 55**

LED PRODUCTS

COLOR OPTIONS



Black/White

PURCHASE OPTIONS

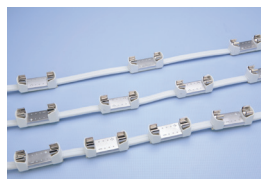

2, 3, 4 Bulbs/Foot



Custom Cuts



100 ft. Spools

ORDERING LOGIC

LBL-Z-XXYY

Z = BULB SPACING

2 = 2 bulbs/foot
3 = 3 bulbs/foot
4 = 4 bulbs/foot

XX = STRIP LENGTH

Custom Length or
100 = 100 foot spool

YY = LIGHT STRIP COLOR

WH = White
BK = Black

Note: When ordering cut lengths, orders are rounded to the nearest foot

LED BULBS



LED Festoon Bulb
LBL-24-.5WW
LBL-24-.5CW
(dimmable)

LED DRIVER OPTIONS



NON DIMMABLE
LEDDR-24-120W
24VDC, 120W, Class 2
11.6" x 3.6" x 2.25"
1-180 Bulbs
See page 58 for details.



DIMMABLE
24VDC, 20-96W, Class 2
5.6" x 2" x 2.14" or
6.55" x 2.25" x 2.55"
See page 58 for details.

	Min. # of Bulbs	Max. # of Bulbs
TR24L20DC	16	32
TR24L40DC	30	60
TR24L60DC	50	100
TR24L96DC	80	160

ACCESSORIES



Assembly Kit
(Required to ship with every cut)
BL-001/WH White
BL-001/BK Black
Includes: Junction Box,
Terminal Block and End cap
2.2"L x 1.8"W x 1"H



End Caps
BL-003/WH
BL-003/BK



Lead Wire
LW-12G/WH
LW-12G/BK

Note:
For mounting options
see page 28.

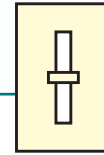

MOUNTING OPTIONS



Double Sided Tape on every socket



Nail Clips
BL-005/BK Black
BL-005/WH White
12 Gauge Wire

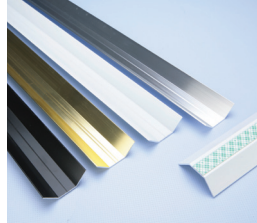

Brite Strip Reflector
BLF-4-BA, BLF-4-PB,
BLF-4-GW, BLF-4-GB.
Sold in 4' lengths only.
Custom cutting for pieces less than 4' available.

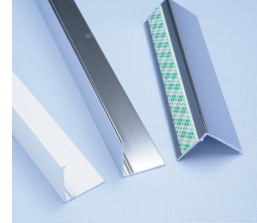

Brite Strip Fascia
BLFAS-4-BA, BLFAS-4-GW
Sold in 4' lengths only.
Custom cutting for pieces less than 4' available.

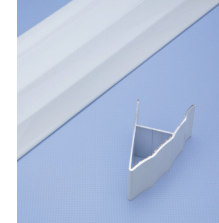

Cove Reflector
BLCOVE-4-GW
Sold in 4' lengths only.
Custom cutting for pieces less than 4' available

BRITE STRIP™ FASCIA EXTRUSION



FEATURES

- ▶ Custom profile shields bulb glare while reflecting light toward work surface. Provides proper spacing between Brite Strip bulb and Fascia surface.
- ▶ Can be used as an accessory with LED eStrip.
- ▶ Sold in two colors: Aluminum and White
- ▶ Aluminum offers the greatest reflectivity.
- ▶ White acts like a primer to allow on-site custom paint matching with hi-temp paint.
- ▶ 3M double sided tape included with every section.
- ▶ Sold in 4 foot lengths only. Custom cuts for pieces less than 4 feet available.

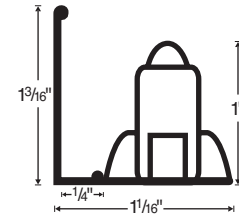

BLFAS-4-XX

APPLICATIONS

- ▶ Cabinets
- ▶ Displays
- ▶ Work Stations
- ▶ Shelves
- ▶ Linear Task Lighting

COVE REFLECTOR



Brite Strip in Cove Reflector (Floor View)

FEATURES

- ▶ An aluminum extrusion in the shape of a standard cove molding, with a white gloss mounting area for the illumination system.
- ▶ Can be used as an accessory with LED eStrip.
- ▶ Pre-engineered with appropriate bulb side clearances.
- ▶ Pre-primed in white for ease of wall match painting, and interior reflective qualities.
- ▶ Cove reflector can be used with Brite Strip or LED eStrip.
- ▶ Sold in 4 foot lengths only. Custom cutting for pieces less than 4 feet available.

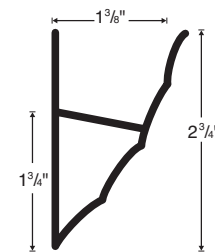

BLCOVE-4-GW