

RECESSED PRECISION LUMINAIRES

Aculux[®]
Precision Recessed Lighting

A comprehensive offering
of high performance
precision luminaires



JUNO LIGHTING GROUP
by Schneider Electric

Contents

Aculux Overview	2-3
Aculux Precision Offering	4-5
Aculux 3 1/4" Round & Square Offering	6-7
NEW 3 1/4" Acu-Aim™ Optics	8-9
NEW 3 1/4" Installation Features	10-13
NEW 3 1/4" Flush Mount Features	14-15
NEW 3 1/4" New Aculux Product Matrix	16-17

NEW



3 1/4" Round	18
Housings	18
LED	18-19
MR16 Halogen	20-21
PAR16/PAR20	22-23
MR16 CMH	24-25
Trims	26
Trim Ring	26-28
Self-Flanged	30
Flush Mount	32-33

NEW



3 1/4" Square	34
Housings	34
LED	34-35
MR16 Halogen	36-37
PAR16/PAR20	38-39
MR16 CMH	40-41
Trims	42
Self-Flanged	42-43
Flush Mount	44-45



5 5/8" – 6" Round	46
PAR36/AR111 Housing & Trims	48
PAR30/38 Housing & Trims	50-51
A-Lamp Housing & Trims	52-53
26W/32W CFL Housings & Trims	54-55

7" Round	56
PAR38 Housings & Trims	56

MR16 Framing Projector	57
-------------------------------------	-----------

Optic Accessories	58
--------------------------------	-----------

Photometrics	59
Rounds	60
Squares	78

Index	88-89
--------------------	--------------



Aculux is Precision



The unseen engineering excellence of Aculux precision luminaires is reflected in the beauty of the spaces they illuminate.

pri-sizh-uhn

Precision (noun) 1. Accuracy; exactness. 2. Made to adhere strictly to a defined standard. 3. Pertaining to or characterized by accuracy in action: *Aculux precision lighting.*

Aculux Precision Lighting

Beautiful spaces begin with
the precision within

The showpiece artfully highlighted.
The wall dramatically awash in light.
The row of downlights in perfect alignment.

The beauty you see begins with the excellence you don't: the precision of Aculux luminaires. Reflectors are hand-polished and feature deep lamp regression to reduce brightness. Precise geometry ensures that the lamp beam shines through the center of the aperture, regardless of the tilt angle, to maximize light output and eliminate glare.

Building on over a quarter century of leadership in recessed lighting, Aculux precision recessed luminaires offer superior optical control and adjustment features that aid professional lighting designers in creating stunning visual effects.

Aculux high-performance architectural-grade recessed luminaires provide highly efficient illumination and dramatic, space-enhancing effects from apertures that quietly blend with the architecture. Whether your interior is contemporary or traditional, Aculux fixtures deliver stunning results quite distinct from standard recessed fixtures. And to further the gap of standard recessed fixtures, Juno Lighting Group has raised the bar once again in the precision lighting community with its re-engineered 3 1/4" Round and Square luminaires - incorporating exclusive features, designs and LED precision lighting that are the result of continuous, industry leading innovation.



Brilliance in all its forms

Our complete offering of Aculux premium luminaires

Even more than before, there's an Aculux precision luminaire designed to cast any commercial or residential setting in a favorable light. Aculux continues to offer 5 5/8", 6" and 7" fixtures that provide a vast range of choices: low voltage halogen, line voltage PAR/A-Lamp and compact fluorescent lamps in various trim color and styles, configured for an infinite variety of uses.

The new 3 1/4" Aculux recessed lighting rises to a whole new level of understated beauty, with a full line of dramatically upgraded round and square adjustable

luminaires (p.6). Aculux luminaires are at the forefront of energy efficient technology with the introduction of the new round and square ceramic metal halide (CMH) fixtures. Furthermore, Aculux luminaires demonstrate major new advances in recessed applications with the introduction of light emitting diode (LED) adjustable fixtures specifically designed for accent, downlighting and wall washing illumination.

In these and other ways, the Aculux brand is meeting the challenge of subdued, precise and high performance lighting in brilliant fashion.



Air-Loc® Rating

Aculux IC and TC* housings meet IECC Energy Code requirements per ASTM E283. Aculux IC and TC housings are Air-Loc® rated for maximum energy savings. The sealed Air-Loc construction eliminates the transfer of conditioned air out of, or unconditioned air into, a living space to maintain maximum energy efficiency and comfort. The sealed Air-Loc construction also helps preserve sound proofing and eliminates the possibility of dirt, dust and insects entering a room through the recessed luminaire.

* 3 1/4" TC housings where noted.



Energy Star Products

Aculux IC CFL downlight is listed as Energy Star qualified product. Energy Star, a government-sponsored program, establishes criteria and testing requirements to ensure energy efficient luminaires meet consistent performance standards. Many local utilities offer builders rebates for installing Energy Star qualified products. Juno Energy Star qualified fixtures comply with California Title 24 Energy Code.



Wet Location

UL Listed for use in wet locations.

Aperture Selection

3 1/4" Round and Square Housings **NEW**

LED Adjustables

Exceptional 50,000 hour lamp life, energy conscious precision lighting for accent, wall wash, and downlight illumination.

MR16 Halogen Adjustables

Precisely controlled and excellent color rendering for accent, wall wash, and downlight illumination.

PAR16/PAR20 Adjustables

Low to medium light level accent and downlight illumination.

CMH MR16 Adjustables

Extended operating life, energy efficient and excellent color rendering for low to medium light level accent, wall wash and downlight illumination.

5 5/8" - 6" Round Housings

PAR36/AR111 Adjustables

Produces a tight, collimated beam of light that provides high-intensity, pinpoint illumination over great distances.

PAR30/PAR38 Adjustables/Wall Wash/Downlights

Provides medium to high light level accent, general, task, and wall wash illumination.

Incandescent/CFL Housings

Diffuse, widespread illumination from economical incandescent A-lamps or energy efficient compact fluorescent lamps.

7" PAR38 Round Housing

For accent, task or downlighting from high flat or sloped mounting heights.

Framing Projector

Produces an adjustable rectangular light pattern to dramatically "frame" art with light.



Round Trims

Designed to blend quietly with architecture, Aculux features a comprehensive selection of hand polished reflectors with deep lamp regression that perform different functions to create a multitude of dramatic lighting effects. Choose from downlights, adjustables, wall wash, pinhole, in an array of reflector finishes or baffle apertures to suit your individual aesthetic preference.



Square Trims **NEW**

Offered with the new Aculux 3 1/4" square luminaires. The die-cast square reflectors maintain perfectly aligned corners, have deep lamp regression and parabolic sidewalls to minimize glare. Choose from self-flanged or flush mount in an inscribable selection of styles and finish options.

3 1/4" round and square luminaires

A new larger line of smaller fixtures



New Aculux 3 1/4" adjustable luminaires pack outsized engineering into some of the industry's smallest, most discreet apertures. These minimalist fixtures come to you in a vast range of styles.

But if these compact luminaires impress with their variety, they positively shine in their performance. Lamp angle and rotation are fine-tuned with precision gears. Housings, transformers, connectors and bar hangers have been rethought for easy, flawless installation. Trims are meticulously engineered to draw attention to the room, not to themselves. In every detail, the truth can be seen: the more Aculux precision luminaires are reduced in size, the more impressive they grow.

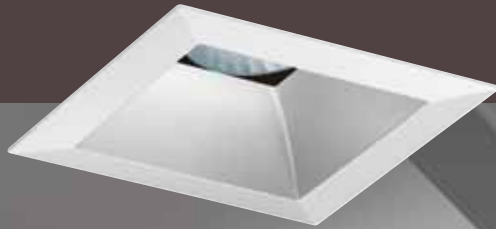

3 1/4" Features **NEW**

Luminaires

3 1/4" Round and Square luminaires are re-engineered to the highest quality in the precision lighting industry. Offering exclusive Tru-Line™ adjustment and Acu-Aim™ optic features in a vast range of lamp choices – LED, MR16 and PAR16/PAR20 Halogen, and CMH MR16 20W & 39W. See pages 18-24 and 34-40.

Tru-Line™ Platform

Patent pending, Tru-Line™ allows +/- 1/2" platform adjustment after installation to ensure fixture-to-fixture alignment prior to finishing the ceiling. See page 10-11.

Acu-Aim™ Precision Geared Optics

Superior optics employ precision gearing with 370° rotation and 45° hot aiming tilt with an effortless turn of a screwdriver. Optimized center lamp beam optics translates lamp forward maximizing light output as it is aimed off of nadir – glare is eliminated at any angle. See page 8-9.

Flush Mount

Smooth installations in every way – the unique lattice flush mount adapter helps to mitigate crack propagation and is die-cast for maximum rigidity and tight tolerances. Add the finishing touches with a vast range of trim styles and colors for a ceiling that's truly tranquil. See page 14-15.

Reflector

Precisely crafted to perfection, the comprehensive selection of the 3 1/4" hand-polished round and die-cast square reflectors are engineered with forethought resulting in efficient illumination and ultra-low brightness that blends quietly with any architectural space. See page 12-13.

New precision in gearing & optics

A new benchmark for excellence

The goal of precision lighting is to illuminate every inch of the space at exactly the level of relative emphasis, intensity and subtlety the room's designer intended. The only way to achieve this is with lighting instruments engineered for each specific task, manufactured to perform flawlessly, and adjustable in so many ways that performance is never compromised. Quite simply, new Aculux 3 1/4" precision luminaires achieve this daunting set of objectives more completely than any recessed lighting ever made — and Juno Lighting Group, yet again, sets a new benchmark for excellence for the entire industry.

Push-in Lamp Holder accepts up to (3) 2" optical media and the Acu-Aim™ gear remains fixed during lamp replacement. Each fixture is supplied with a soft-focus uniformity lens to ensure smooth beam patterns.

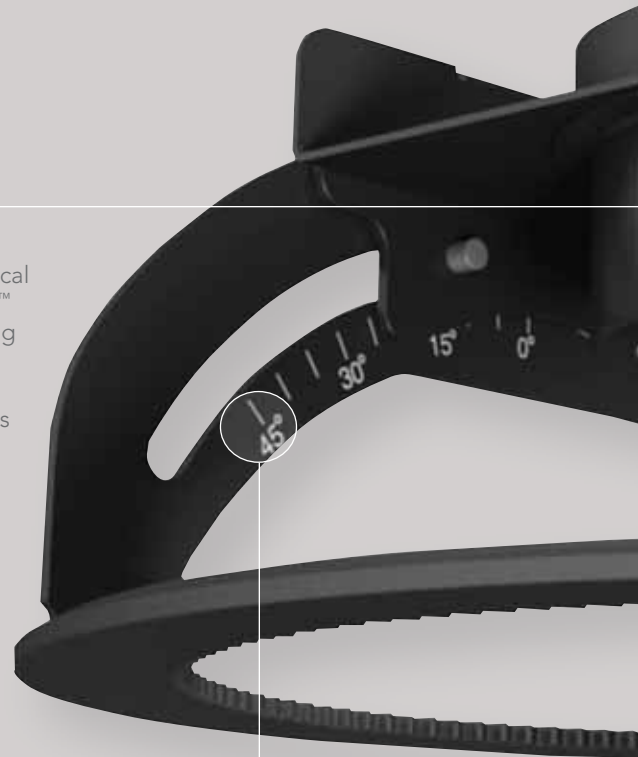

Numerical Degree markings allow the fixtures to be consistently aimed.

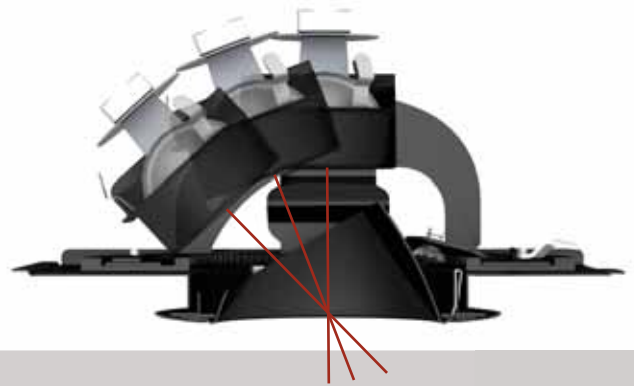
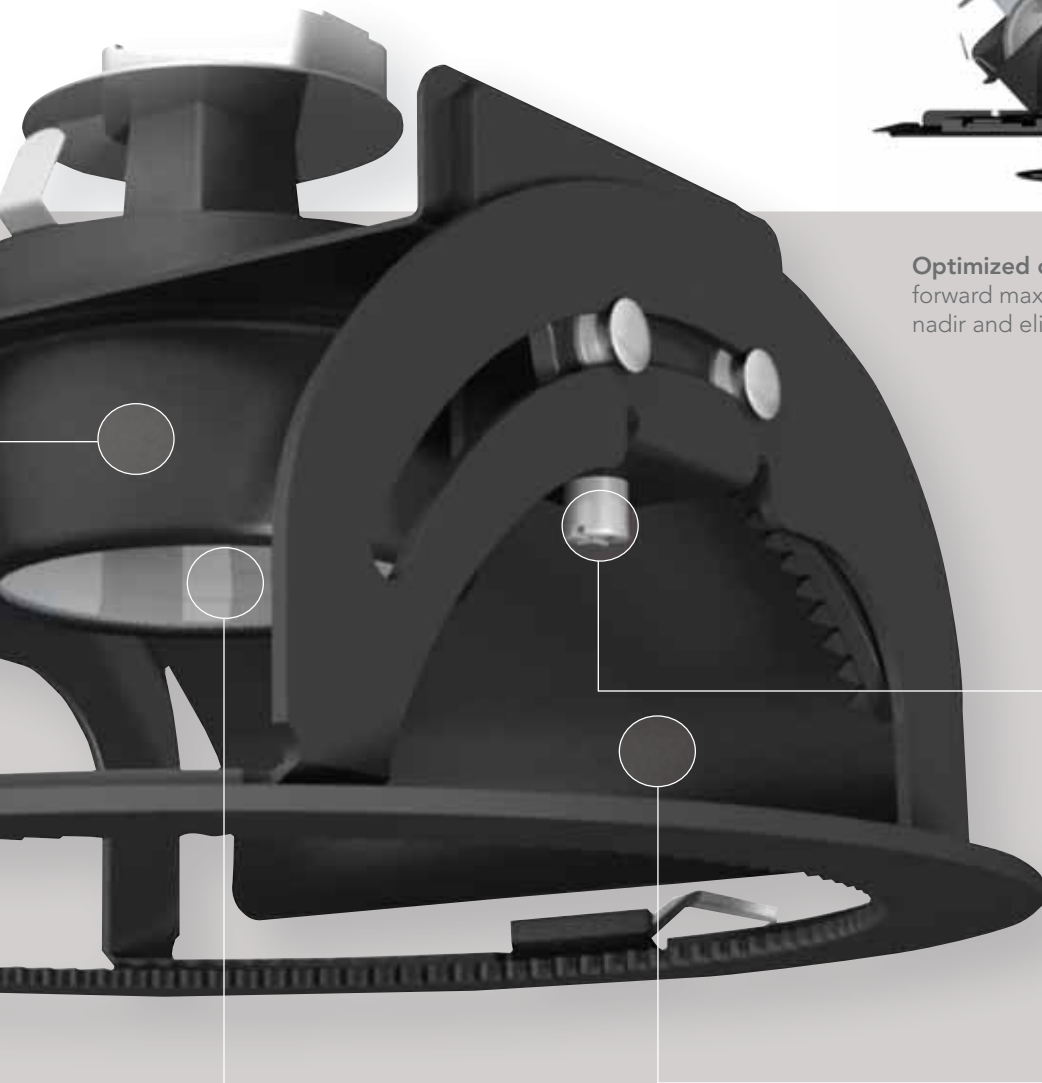

Optimized center lamp beam optics translates lamp forward maximizing light output as lamp is aimed off nadir and eliminates glare at any aiming angle.

Acu-Aim™ Precision Gearing Optics is comprised of two aiming features.



- (1) 45° hot-aiming vertical adjustment is effortless with a turn of a screwdriver. The precision gear tilt is so smooth – simply focus on the lighting object and tilt the lamp for precise aiming. (40 degrees on PAR16/PAR20 fixtures is an industry exclusive).
- (2) Exclusive 370° gear rotation fully eliminates any dead spots in a lighting application.

● **Matte Black Interior** and black lamp shield preserves dark aperture and prevents visibility into the fixture.

- **Lamp Choices** - The new Aculux 3 1/4" fixtures are not only feature-rich, versatile and precise - there's a vast selection of lamp choice to suit the broadest range of any precision lighting environment.
 - 20W LED
 - 20W/39W MR16 Ceramic Metal Halide (CMH)
 - 75W 12V Halogen MR16
 - 75W PAR16/50W PAR20 Incandescent Line Voltage

Precision installation begins with precision design

The harmony of a great design

Even the most sophisticated lighting is only as good as the quality of its installation. Fortunately, new Aculux 3 1/4" precision luminaires leave virtually nothing to chance. Their exhaustive engineering simplifies every aspect of installation, aiming and maintenance. A misaligned housing can be made right with a simple turn of the screwdriver. Lamp sockets, junction boxes, transformers and bar hangers all are comprehensively rethought for ease of use and trouble-free performance. It's a combination of advancements destined not only to illuminate countless rooms, but to enlighten an entire industry.

AIR-LOC IC and TC* housings are Air-Loc® rated and are designed to minimize air leakage and promote building energy efficiency.

Pro-VI™ Bar Hanger System

Engineered with the contractor in mind. The patent pending, Pro-VI™ inter-locking hanger system eliminates flexing and has several features to ensure fixture-to-fixture alignment in the event of any installation mishap.

- Smooth, non-binding bars simplify installation and fixture alignment.
- Integral locking set-screw allows side-to-side fixture adjustment.
- Bar hanger foot aligns to bottom of joist for precise positioning.
- Captive bugle-headed nail for one-step installation.
- Breakaway foot for installation in t-bar eliminates interference with adjacent ceiling tiles.
- Integral t-notch has locking tabs to lock fixture to t-bar without fasteners.

12V Transformer Options

- **Magnetic** 120V or 277V High efficiency (>90 %) dual tap toroidal transformer has a boost tap to compensate for dimmer losses, improving color temperature and lumen output. Potted to eliminate noise and vibration.
- **Electronic** 120V or 277V High efficiency (>94%), high power factor transformer.

CMH Ballast Options

High Power Factor, electronic solid state ballast has transient and short circuit protection with less than 10% THD. Available in 20W or 39W – 120V or 277V.

LED Driver 120V or 277V electronic solid state driver. 20W total system power consumption delivers performance similar to 50W halogen MR16.

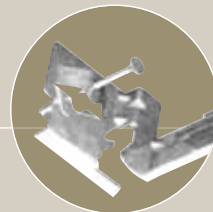
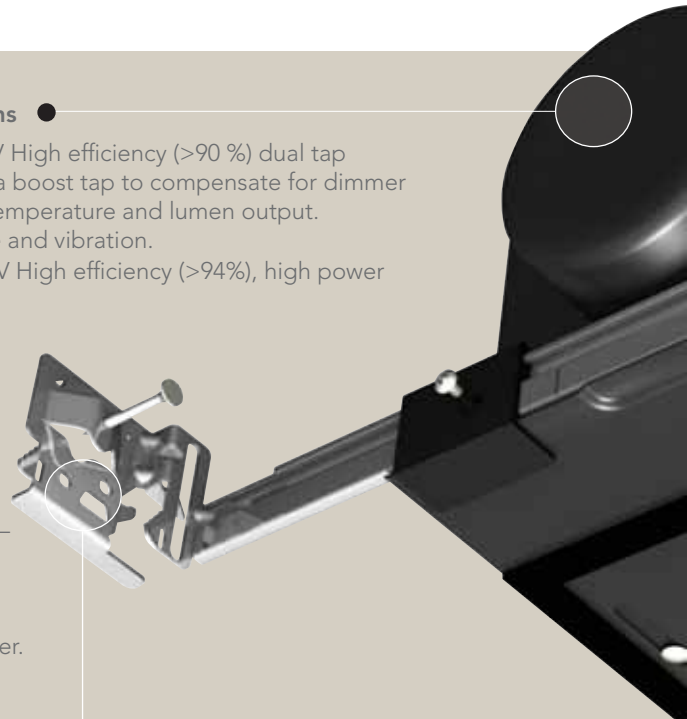

Hinged black lamp shield easily lifts to gain quick access to j-box, transformer or ballast.

* TC housings are Air-Loc® rated only where icon appears.

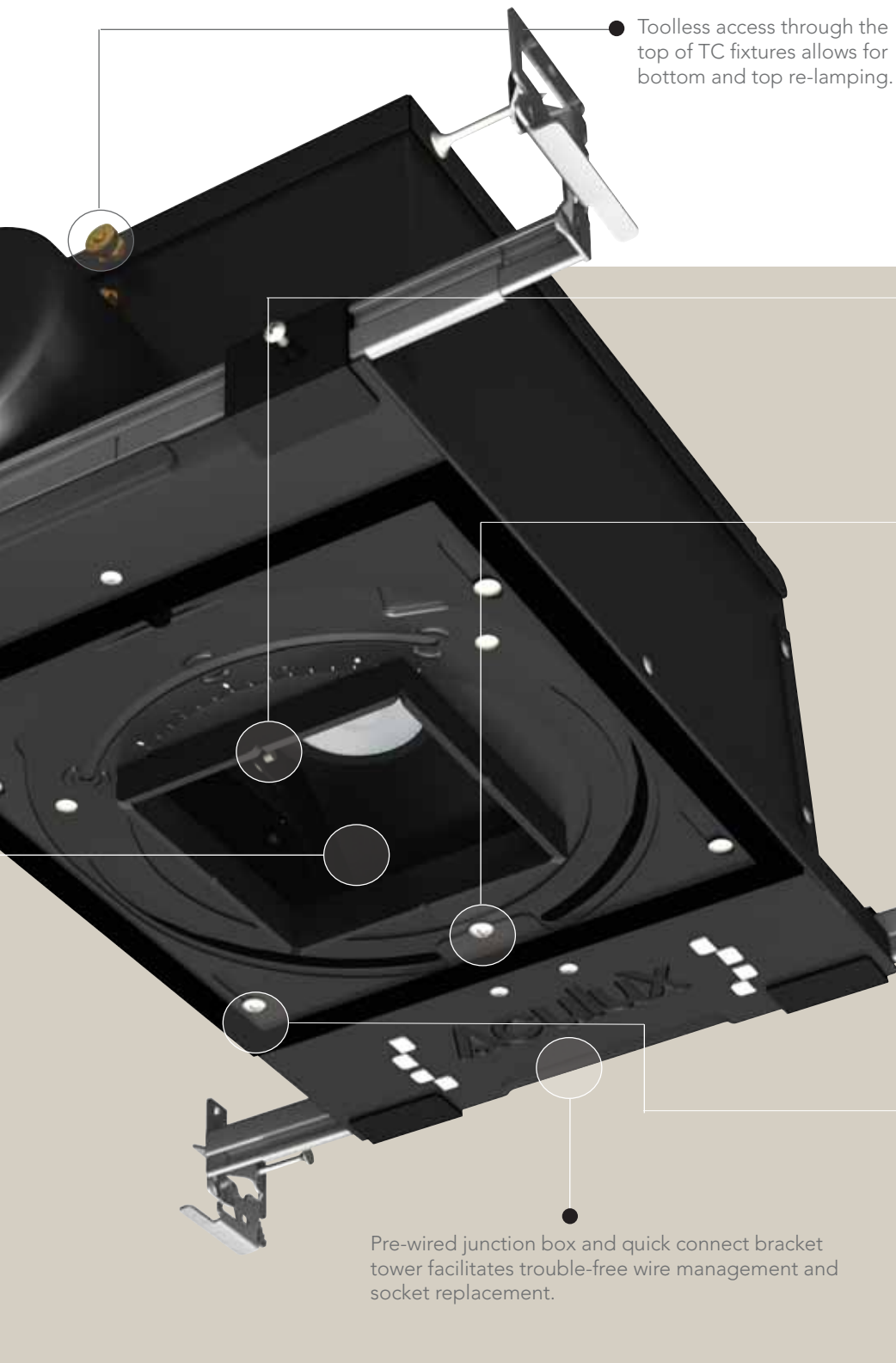

● Toolless access through the top of TC fixtures allows for bottom and top re-lamping.

● Pre-wired junction box and quick connect bracket tower facilitates trouble-free wire management and socket replacement.

Tru-Line™ Platform



● **V-Notch Gunsight** helps contractor align fixtures during installation.

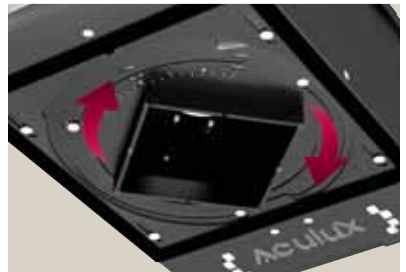

● **Square Aperture Rotation Adjustment** allows aperture to rotate up to 90° to help align fixtures after installation and prior to finishing ceiling. Fixtures feature rotation stops at +/- 45° (squares only).

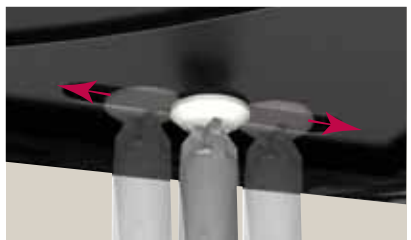

● Patent pending **Aperture Translation** allows +/- 1/2" translation adjustment to ensure fixture-to-fixture alignment after installation prior to finishing ceiling (round and squares).

Our trims speak well of you...quietly

Finishes and mounting styles

One of the foremost luxuries of specifying Aculux luminaires is the luxury of options. Trim Ring, self-flanged or the minimalist look of flush mount in a variety of trim finishes. Downlights, adjustables, pinholes, wall wash and lensed style options. Each of these many variations has been engineered with forethought and all are precision crafted to stand up to the closest scrutiny, while never clamoring for attention. See the trim pages for specific style and finish options.



Rounds

Finishes



Mounting Styles



Squares

Finishes



Mounting Styles

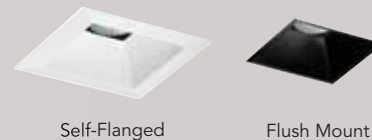

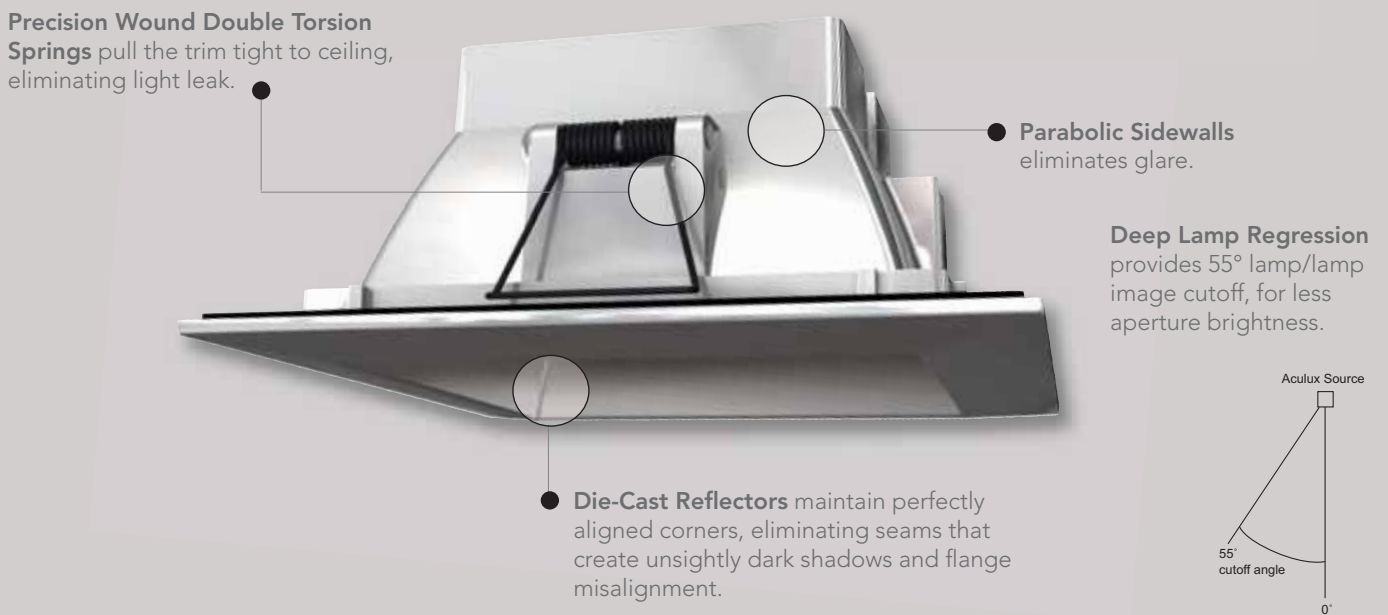
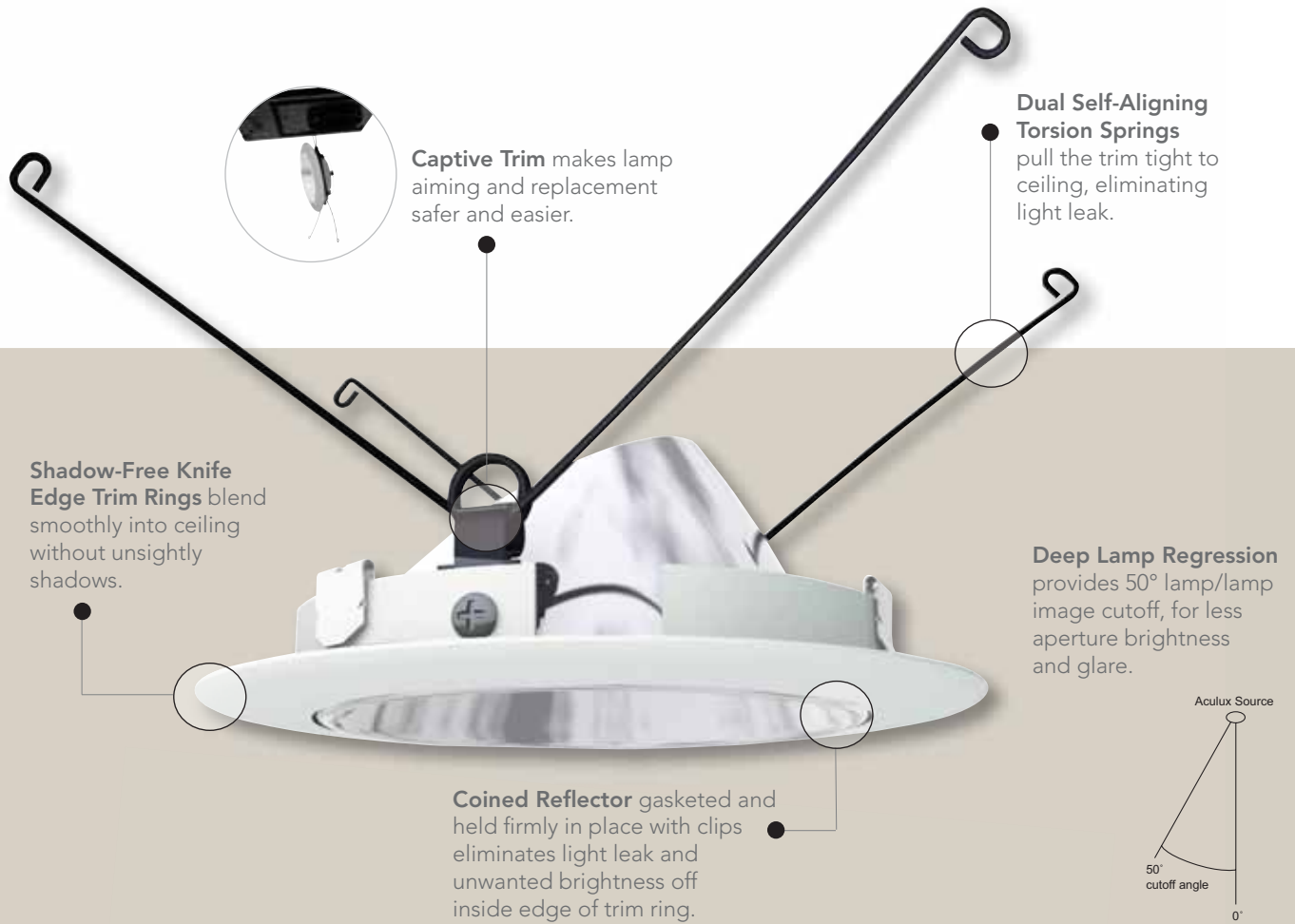

Flush mount installation that's smooth in every way

No one can deny that the quiet elegance of a completely clean ceiling is a compelling argument for trimless fixtures. That is, until the quiet is shattered by unsightly cracks that spread around the luminaires. Aculux luminaires relieve the fear of cracking with thoughtfully designed hardware both on and around the fixture. Which means the uninterrupted beauty you see in your mind's eye is more likely to remain that way on the actual ceiling...creating a lasting tranquil vision.



Two Aculux Flush Mount recessed pinholes (4308N-WH-FM) in the soffit accent the table while the Aculux framing projector precisely frames the artwork.



Five Easy Steps



Prior to dry-wall – Use Tru-Line™ installation features to align fixtures and apertures.



Apply dry-wall. Use a 4 3/8" cutout for round aperture and 4 1/4" cutout for square aperture.



After dry-wall, apply the self-adhesive flush mount adapter. Unique lattice flush mount adapter helps to mitigate crack propagation and is die-cast for maximum rigidity and tight tolerances.

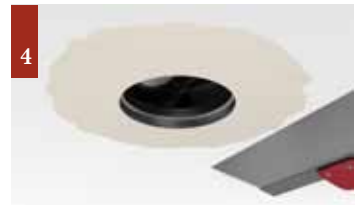

Apply multiple thin layers of a setting-type joint compound according to the Level 4 or Level 5 drywall finishing requirements specified. Sand and finish ceiling as desired.



Install the Aculux flush mount trim.



Trimless Reflector has minimal flange.

Die-Cast Light Trap is ten times deeper than the competition where the reflector mates with the flush mount adapter to eliminate the possibility of light leak.





Flush Mount Pinhole has no flange for a truly trimless appearance that blends seamlessly with the architecture.

Adhesive-Back Trimless Adapter

- Die-cast for maximum rigidity and tight tolerance
- Unique lattice design helps to mitigate crack propagation
- Converts standard housings to flush mount
- Easy to specify, easy to install

3 1/4" Matrix Chart - Rounds & Squares

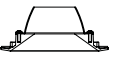
ROUND

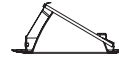
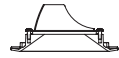
		Downlight				Lensed*				
										
Housing		Cone	Baffle	Pinhole	Regressed Pinhole	Downlight	Pinhole	Adjustable	Regressed Pinhole	
3 1/4" ROUND APERTURE	MR16	IC43N 12V MR16 IC, Air-Loc	437N	434N	4337N	4307N	432N	4331N 4332N	431N	4301N 4302N
		TC43N 12V MR16 Non-IC, Air-Loc	50W-75W MR16	50W-75W MR16	50W-75W MR16	50W-75W MR16	50W-75W MR16	50W-75W MR16	50W-75W MR16	50W-75W MR16
		TC943N 12V MR16 Commercial Non-IC								
		TC43NR 12V MR16 Remodel, Non-IC								
	PAR	IC13N 120V PAR IC, Air-Loc	437N	434N	4337N	4307N	432N	4331N 4332N	431N	4301N 4302N
		TC13N 120V PAR Non-IC, Air-Loc	60W-75W PAR16 50W PAR20	60W-75W PAR16 50W PAR20	60W-75W PAR16 50W PAR20	60W-75W PAR16 50W PAR20	45W-75W PAR16 50W PAR20	45W-75W PAR16 50W PAR20	45W-75W PAR16 50W PAR20	45W-75W PAR16 50W PAR20
	CMH	TC943M - MR16 CMH MR16 Commercial Non-IC	437N	434N	4337N	4307N	432N	4331N 4332N	431N	4301N 4302N
			20W-39W CMH MR16	20W-39W CMH MR16	20W-39W CMH MR16	20W-39W CMH MR16	20W-39W CMH MR16	20W-39W CMH MR16	20W-39W CMH MR16	20W-39W CMH MR16
	LED	IC43L LED IC, Air-Loc	437N	434N	4337N	4307N	432N	4331N 4332N	431N	4301N 4302N
		TC43L LED Non-IC, Air-Loc	20W LED	20W LED	20W LED	20W LED	20W LED	20W LED	20W LED	20W LED
		TC943L LED Commercial Non-IC								

SQUARE

		Downlight			Lensed*				
									
Housing		Downlight Reflector	Pinhole	Regressed Pinhole	Downlight	Pinhole	Adjustable	Regressed Pinhole	
3 1/4" SQUARE APERTURE	MR16	IC43SQ 12V MR16 IC, Air-Loc	437SQ	4337SQ	4307SQ	432SQ	4331SQ 4332SQ	431SQ	4301SQ 4301SQ
		TC43SQ 12V MR16 Non-IC, Air-Loc	50W-75W MR16	50W-75W MR16	50W-75W MR16	50W-75W MR16	50W-75W MR16	50W-75W MR16	50W-75W MR16
		TC943SQ 12V MR16 Commercial Non-IC							
	PAR	IC13SQ 120V PAR IC Air-Loc	437SQ	4337SQ	4307SQ	432SQ	4331SQ 4332SQ	4331SQ 4332SQ	4301SQ 4301SQ
		TC13SQ 120V PAR Non-IC, Air-Loc	60W-75W PAR16 50W PAR20	60W-75W PAR16 50W PAR20	45W-75W PAR16 50W PAR20	45W-60W PAR16 50W PAR20	45W-60W PAR16 50W PAR20	45W-60W PAR16 50W PAR20	45W-60W PAR16 50W PAR20
	CMH	TC943MSQ-MR16 CMH MR16 Commercial Non-IC	437SQ	4337SQ	4307SQ	432SQ	4331SQ 4332SQ	431SQ	4301SQ 4301SQ
			20W-39W CMH MR16	20W-39W CMH MR16	20W-39W CMH MR16	20W-39W CMH MR16	20W-39W CMH MR16	20W-39W CMH MR16	20W-39W CMH MR16
	LED	IC43LSQ LED IC, Air-Loc	437SQ	4337SQ	4307SQ	432SQ	4331SQ 4332SQ	431SQ	4301SQ 4301SQ
		TC43LSQ LED Non-IC, Air-Loc	20W LED	20W LED	20W LED	20W LED	20W LED	20W LED	20W LED
		TC943LSQ LED Commercial Non-IC							



* Wet Location

UL Listed for use in wet locations.

Adjustable Accent					Wall Wash*
Angle-Cut Cone	Angle-Cut Baffle	Pinhole	Regressed Pinhole	Super Adjustable (15° - 75°)	Lensed
438N 430N 436N 50W-75W MR16	435N 50W-75W MR16	433N 4335N 4345N 50W-75W MR16	4308N* 50W-75W MR16	4349N 50W-75W MR16	439N 50W-75W MR16
438N 430N 436N 60W-75W PAR16 50W PAR20	435N 60W-75W PAR16 50W PAR20	4335N 433N 4345N 60W-75W PAR16 50W PAR20	4308N 60W-75W PAR16 50W PAR20	—	439N 45W-75W PAR16 50W PAR20
438N 430N 436N 20W-39W CMH MR16	435N 20W-39W CMH MR16	433N 4335N 4345N 20W-39W CMH MR16	4308N 20W-39W CMH MR16	4349N 20W-39W CMH MR16	439N 20W-39W CMH MR16
438N 430N 436N 20W LED	435N 20W LED	433N 4335N 4345N 20W LED	4308N 20W LED	—	439N 20W LED

Round

See pages 18-33



Adjustable Accent			Wall Wash*
Angle-Cut Reflector	Pinhole	Regressed Pinhole	Lensed
438SQ 50W-75W MR16	433SQ 50W-75W MR16	4308SQ 50W-75W MR16	439SQ 50W-75W MR16
438SQ 60W-75W PAR16 50W PAR20	433SQ 60W-75W PAR16 50W PAR20	4308SQ 45W-60W PAR16 50W PAR20	439SQ 45W-60W PAR16 50W PAR20
438SQ 20W-39W CMH MR16	433SQ 20W-39W CMH MR16	4308SQ 20W-39W CMH MR16	439SQ 20W-39W CMH MR16
438SQ 20W LED	433SQ 20W LED	4308SQ 20W LED	439SQ 20W LED

Square

See pages 34-45

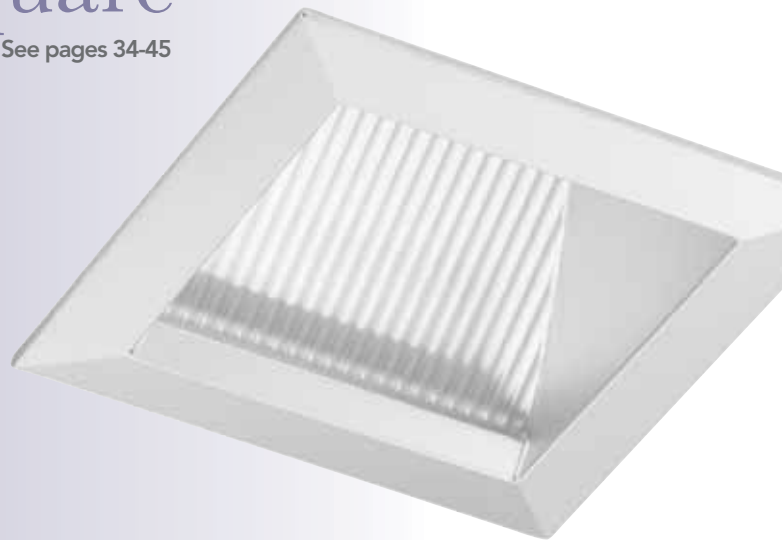

AIR-LOC Air-Loc® Rating

Aculux IC and TC† housings meet IECC Energy Code requirements per ASTM E283. Aculux IC and TC housings are Air-Loc® rated for maximum energy savings. The sealed Air-Loc construction eliminates the transfer of conditioned air out of, or unconditioned air into, a living space to maintain maximum energy efficiency and comfort. The sealed Air-Loc construction also helps preserve sound proofing and eliminates the possibility of dirt, dust and insects entering a room through the recessed luminaire.

† TC housings are Air-Loc® rated only where icon appears.



3 1/4" Round Aperture LED Housings

The Aculux brand is redefining precision lighting with energy efficient, versatile, low wattage LED fixtures. The performance approximates a 50W MR16 while consuming only 20 watts. The LED fixtures are compatible with the new 3 1/4" trim offering and have the same features as the newly redesigned 3 1/4" fixtures – Acu-Aim™ Geared Optics, Tru-Line™ Installation and Pro-VI™ Bar Hangers to name a few. The unique interchangeable beam optics provide the lighting designer with the ultimate flexibility from fixture-to-fixture.

LED IC Rated with Pro-VI™ Telescoping Bar Hangers

AIR-LOC

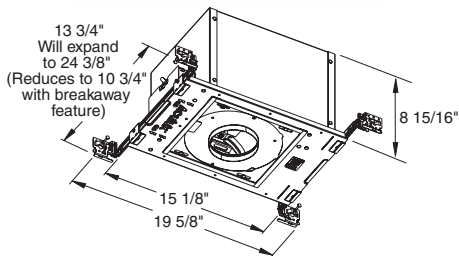

IC43L-3K-S (-N, -F)
3000K Color Temperature,
85 CRI Typical

IC43L-35K-S (-N, -F)
3500K Color Temperature,
85 CRI Typical

IC43L-4K-S (-N, -F)
4100K Color Temperature,
75 CRI Typical

Beam Optics
S = 15° Spot
N = 24° Narrow Flood
F = 35° Flood

Energy Efficient, IC Rated new construction housing for use in direct contact with insulation.

Sealed Air-Loc® housing eliminates air flow and reduces sound transmission through plenum.

Patent Pending, Tru-Line™ platform allows +/- 1/2" aperture translation after installation prior to finished ceiling, aiding fixture-to-fixture alignment.

Acu-Aim™ optics employs precision gearing to achieve 370° rotation, 45° tilt hot aiming with a screwdriver. Optimized center lamp beam optics translates light engine forward as it is aimed off nadir.

120V or 277V electronic solid state driver. 20W total system power consumption delivers performance similar to 50W halogen MR16.

Patent pending, Pro-VI™ telescoping bar hanger system has locking set screws. The captive bugle-headed ring shank nail allows for a quick one-step installation in joist construction while the robust bar eliminates flexing regardless of fixture position. For suspended ceilings, use integral t-notches with locking tabs.

Innovative optic holder allows interchangeable optics and (2) additional 2" beam control lenses and/or filters.

LED Non-IC Rated with Pro-VI™ Telescoping Bar Hangers

AIR-LOC

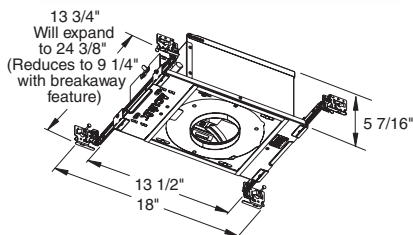

TC43L-3K-S (-N, -F)-E1
3000K Color Temperature,
85 CRI Typical

TC43L-35K-S (-N, -F)-E1
3500K Color Temperature,
85 CRI Typical

TC43L-4K-S (-N, -F)-E1
4100K Color Temperature,
75 CRI Typical

For 277V replace
E1 with E2.

Beam Optics
S = 15° Spot
N = 24° Narrow Flood
F = 35° Flood

Energy Efficient, Non-IC Rated new construction housing for use where insulation is spaced 3" away from fixture.

Sealed Air-Loc® housing eliminates air flow and reduces sound transmission through plenum.

Patent Pending, Tru-Line™ platform allows +/- 1/2" aperture translation after installation prior to finished ceiling, aiding fixture-to-fixture alignment.

Acu-Aim™ optics employs precision gearing to achieve 370° rotation, 45° tilt hot aiming with a screwdriver. Optimized center lamp beam optics translates light engine forward as it is aimed off nadir.

120V or 277V electronic solid state driver. 20W total system power consumption delivers performance similar to 50W halogen MR16.

Patent pending, Pro-VI™ telescoping bar hanger system has locking set screws. The captive bugle-headed ring shank nail allows for a quick one-step installation in joist construction while the robust bar eliminates flexing regardless of fixture position. For suspended ceilings, use integral t-notches with locking tabs.

Innovative optic holder allows interchangeable optics and (2) additional 2" beam control lenses and/or filters.

Mounting Accessories

Catalog #	Description
CTA4N-125	7/8" – 1 1/4" ceiling adapter
CTA4N-163	1 1/4" – 1 5/8" ceiling adapter
CTA4N-200	1 5/8" – 2" ceiling adapter
FMA4	Flush mount adapter for required flush mount trim installations



See Accessories on page 58.

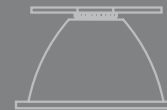

Features

- Concealed LEDs mimic 50W MR16 Performance.
- Accepts up to two beam control lenses and/or filters.
- Available in 3000K, 3500K, 4100K.
- 85 CRI typical for 3000K and 3500K, 75 CRI 4100K.
- 20W total power consumption approximates 50W MR16 performance.
- Reverse phase dimming. Consult factory for dimmer compatibility.
- Solid state driver, 120V or 277V.
- Three interchangeable Optics.



15° Spot LED



24° Narrow Flood



35° Flood



Commercial LED Non-IC Rated with Butterfly Style Mounting Brackets

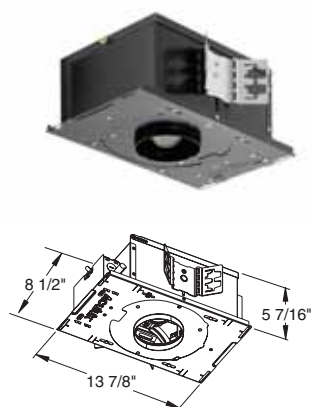

TC943L-3K-S (-N, -F)-E1

3000K Color Temperature,
85 CRI Typical

TC943L-35K-S (-N, -F)-E1

3500K Color Temperature,
85 CRI Typical

TC943L-4K-S (-N, -F)-E1

4100K Color Temperature,
75 CRI Typical

For 277V replace
E1 with E2.

Beam Optics

S = 15° Spot
N = 24° Narrow Flood
F = 35° Flood

Energy Efficient, Non-IC Rated new construction housing for use where insulation is spaced 3" away from fixture.

Patent Pending, Tru-Line™ platform allows +/- 1/2" aperture translation after installation prior to finished ceiling, aiding fixture-to-fixture alignment.

Acu-Aim™ optics employs precision gearing to achieve 370° rotation, 45° tilt hot aiming with a screwdriver. Optimized center lamp beam optics translates light engine forward as it is aimed off nadir.

120V or 277V electronic solid state driver. 20W total system power consumption delivers performance similar to 50W halogen MR16.

Innovative optic holder allows interchangeable optics and (2) additional 2" beam control lenses and/or filters.

Supplied with vertically adjustable mounting brackets that accept 1/2" conduit, "C" channel hangers (HB-26 or HB-50), linear bar hangers (LB-27) or telescoping Juno Real Nail bar hangers (HB-1).

Mounting Accessories

Catalog #	Description
CTA4N-125	7/8" – 1 1/4" ceiling adapter
CTA4N-163	1 1/4" – 1 5/8" ceiling adapter
CTA4N-200	1 5/8" – 2" ceiling adapter
FMA4	Flush mount adapter for required flush mount trim installations



See Accessories
on page 58.

3 1/4" Round Aperture MR16 Low Voltage Housings

Specification grade, adjustable 12-volt MR16 luminaires produce controlled beam spreads and excellent color rendering properties that dramatically emphasize art, textures and architectural elements. Each 3 1/4" housing has the flexibility to accept trims for downlighting, accenting and wall washing, guaranteeing stunning performance in any application.

IC Rated with Pro-VI™ Telescoping Bar Hangers

AIR-LOC



IC43N

120V Magnetic, High efficiency dual tap toroidal transformer.

IC43N-E1

120V Electronic, High efficiency, high power factor transformer.

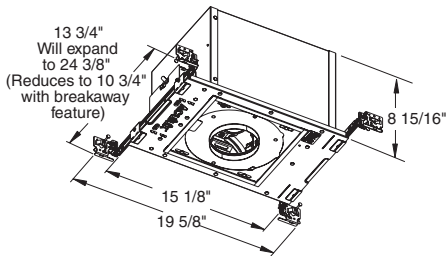

Low Voltage IC Rated new construction housing for use in direct contact with insulation.

Sealed Air Loc® housing eliminates air flow and reduces sound transmission through plenum.

Patent Pending, Tru-Line™ platform allows +/- 1/2" aperture translation after installation prior to finished ceiling, aiding fixture-to-fixture alignment.

Acu-Aim™ optics employs precision gearing to achieve 370° rotation, 45° tilt hot aiming with a screwdriver. Optimized center lamp beam optics translates lamp forward as it is aimed off nadir.

Choose from 120V High efficiency (>90%) dual tap potted magnetic or 120V High efficiency (>94%), high power factor electronic transformer.

Patent pending, Pro-VI™ telescoping bar hanger system has locking set screws. The captive bugle-headed ring shank nail allows for a quick one-step installation in joist construction while the robust bar eliminates flexing regardless of fixture position. For suspended ceilings, use integral t-notches with locking tabs.

Lampholder accepts up to (3) 2" beam control lenses and/or color correction/UV filters. Fixture is supplied with stippled clear uniformity lens.

50W MR16 Maximum Lamp Rating.

UL and C-UL listed for through branch wiring and damp locations. Wet location listed with approved trims.

Commercial Non-IC Rated with Butterfly Style Mounting Brackets

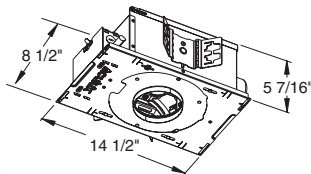
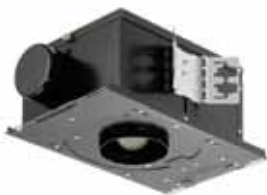

TC943N

120V Magnetic, High efficiency toroidal transformer.

TC943N-E1

120V Electronic, High efficiency, high power factor transformer.

TC943N-V

277V Magnetic, High efficiency toroidal transformer.

TC943N-E2

277V Electronic, High efficiency, high power factor transformer.

Low Voltage, Non-IC Rated new construction housing for use where insulation is spaced 3" away from fixture.

Patent Pending, Tru-Line™ platform allows +/- 1/2" aperture translation after installation prior to finished ceiling, aiding fixture-to-fixture alignment.

Acu-Aim™ optics employs precision gearing to achieve 370° rotation, 45° tilt hot aiming with a screwdriver. Optimized center lamp beam optics translates lamp forward as it is aimed off nadir.

Fixture is available with four premium transformer options – **Magnetic:** 120V or 277V High efficiency (>90%) dual tap, potted magnetic, toroidal transformer. **Electronic:** 120V or 277V High efficiency (>94%), high power factor electronic transformer.

Supplied with vertically adjustable mounting brackets that accept 1/2" conduit, "C" channel hangers (HB-26 or HB-50), linear bar hangers (LB-27) or telescoping Juno Real Nail bar hangers (HB-1).

Lampholder accepts up to (3) 2" beam control lenses and/or color correction/UV filters. Fixture is supplied with stippled clear uniformity lens.

75W MR16 Maximum Lamp Rating.

UL and C-UL listed for through branch wiring and damp locations. Wet location listed with approved trims.

Mounting Accessories

Catalog #	Description
CTA4N-125	7/8" – 1 1/4" ceiling adapter
CTA4N-163	1 1/4" – 1 5/8" ceiling adapter
CTA4N-200	1 5/8" – 2" ceiling adapter
FMA4	Flush mount adapter for required flush mount trim installations



See Accessories on page 58.



Non-IC Rated with Pro-VI™ Telescoping Bar Hangers

AIR-LOC



TC43N

120V Magnetic, High efficiency dual tap toroidal transformer.

TC43N-E1

120V Electronic, High efficiency, high power factor transformer.

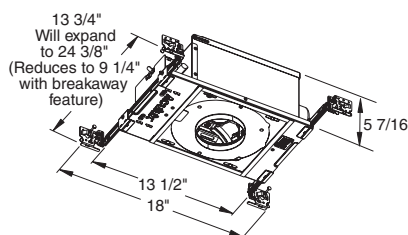

Low Voltage, Non-IC Rated new construction housing for use where insulation is spaced 3" away from fixture.

Sealed Air Loc® housing eliminates air flow and reduces sound transmission through plenum.

Patent Pending, Tru-Line™ platform allows +/- 1/2" aperture translation after installation prior to finished ceiling, aiding fixture-to-fixture alignment.

Acu-Aim™ optics employs precision gearing to achieve 370° rotation, 45° tilt hot aiming with a screwdriver. Optimized center lamp beam optics translates lamp forward as it is aimed off nadir.

Choose from 120V High efficiency (>90%) dual tap potted magnetic or 120V High efficiency (>94%), high power factor electronic transformer.

Patent pending, Pro-VI™ telescoping bar hanger system has locking set screws. The captive bugle-headed ring shank nail allows for a quick one-step installation in joist construction while the robust bar eliminates flexing regardless of fixture position. For suspended ceilings, use integral t-notches with locking tabs.

Lampholder accepts up to (3) 2" beam control lenses and/or color correction/UV filters. Fixture is supplied with stippled clear uniformity lens.

75W MR16 Maximum Lamp Rating.

UL and C-UL listed for through branch wiring and damp locations. Wet location listed with approved trims.

Remodel Non-IC Rated



TC43NR

120V Magnetic transformer.

TC43NR-E1

120V Electronic, High efficiency, high power factor transformer.

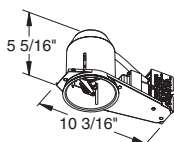

Low Voltage, Non-IC Rated remodel housing features patented "push-pull" system for quick, easy installation. Requires 3" spacing from insulation.

35° adjustable tilt and 361° rotation.

Choose from a magnetic or electronic transformer.
Magnetic: 120V thermally protected transformer is serviceable from below ceiling.
Electronic: 120V High efficiency (>95%), high power factor transformer.

Lampholder accepts up to (3) 2" beam control lenses and/or color correction/UV filters. Fixture is supplied with stippled clear uniformity lens.

50W MR16 Maximum Lamp Rating.

UL and C-UL listed for through branch wiring and damp locations. Wet location listed with approved trims.

Mounting Accessories (for TC43N only)

Catalog #	Description
CTA4N-125	7/8"–1 1/4" ceiling adapter
CTA4N-163	1 1/4" – 1 5/8" ceiling adapter
CTA4N-200	1 5/8" – 2" ceiling adapter
FMA4	Flush mount adapter for required flush mount trim installations



See Accessories on page 58.

3 1/4" Round Aperture PAR16/PAR20 Housings

Aculux 120-volt PAR luminaires produce concentrated beams of light for a variety of lighting applications. PAR16 or PAR20 lamps produce spot or flood patterns for low to moderate light levels over shorter to medium throw distances. These fixtures are well suited for higher-level ambient lighting in a task or an accent lighting environment.

IC Rated with Pro-VI™ Telescoping Bar Hangers

AIR-LOC



IC13N
120V Line Voltage,
IC Housing

Line Voltage, IC Rated new construction housing for use in direct contact with insulation.

Sealed Air Loc® housing eliminates air flow and reduces sound transmission through plenum.

Patent Pending, Tru-Line™ platform allows +/- 1/2" aperture translation after installation prior to finished ceiling, aiding fixture-to-fixture alignment.

Acu-Aim™ optics employs precision gearing to achieve 370° rotation, 40° tilt hot aiming with a screwdriver. Optimized center lamp beam optics translates lamp forward as it is aimed off nadir.

Patent pending, Pro-VI™ telescoping bar hanger system has locking set screws. The captive bugle-headed ring shank nail allows for a quick one-step installation in joist construction while the robust bar eliminates flexing regardless of fixture position. For suspended ceilings, use integral t-notches with locking tabs.

50W PAR20 or 60W PAR16 Maximum Lamp Rating.

UL and C-UL listed for through branch wiring and damp locations. Wet location listed with approved trims.

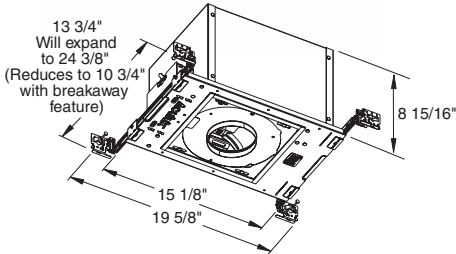

Non-IC Rated with Pro-VI™ Telescoping Bar Hangers

AIR-LOC



TC13N
120V Line Voltage,
Non-IC Housing

Line Voltage, Non-IC Rated new construction housing for use where insulation is spaced 3" away from fixture.

Sealed Air Loc® housing eliminates air flow and reduces sound transmission through plenum.

Patent Pending, Tru-Line™ platform allows +/- 1/2" aperture translation after installation prior to finished ceiling, aiding fixture-to-fixture alignment.

Acu-Aim™ optics employs precision gearing to achieve 370° rotation, 40° tilt hot aiming with a screwdriver. Optimized center lamp beam optics translates lamp forward as it is aimed off nadir.

Patent pending, Pro-VI™ telescoping bar hanger system has locking set screws. The captive bugle-headed ring shank nail allows for a quick one-step installation in joist construction while the robust bar eliminates flexing regardless of fixture position. For suspended ceilings, use integral t-notches with locking tabs.

50W PAR20 or 75W PAR16 Maximum Lamp Rating.

UL and C-UL listed for through branch wiring and damp locations. Wet location listed with approved trims.

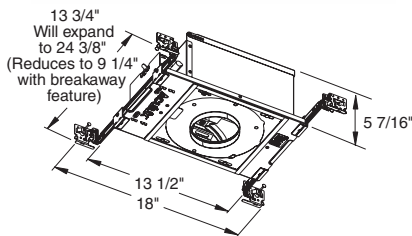

Mounting Accessories

Catalog #	Description
CTA4N-125	7/8" – 1 1/4" ceiling adapter
CTA4N-163	1 1/4" – 1 5/8" ceiling adapter
CTA4N-200	1 5/8" – 2" ceiling adapter
FMA4	Flush mount adapter for required flush mount trim installations



3 1/4" Round Aperture CMH MR16 Housings

Specification grade and energy efficient, the 20W and 39W CMH MR16 lamp replicates the size and performance of a 50W and 75W halogen MR16 lamp respectively – but has up to 12,000 hour lamp life. The crisp, 3000K white light offers the smallest CMH lamp package, making these fixtures perfect for niche display or high-end retail accent lighting.

Commercial Non-IC Rated - CMH MR16 with Butterfly Style Mounting Brackets

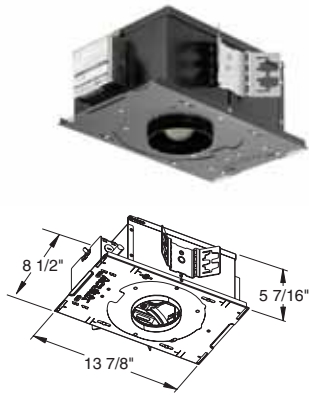

TC943M-MR16-20E1
120V Electronic Solid State Ballast, 20W CMH MR16

TC943M-MR16-20E2
277V Electronic Solid State Ballast, 20W CMH MR16

TC943M-MR16-39E1
120V Electronic Solid State Ballast, 39W CMH MR16

TC943M-MR16-39E2
277V Electronic Solid State Ballast, 39W CMH MR16

Energy Efficient, Non-IC Rated new construction housing for use where insulation is spaced 3" away from fixture.

Patent Pending, Tru-Line™ platform allows +/- 1/2" aperture translation after installation prior to finished ceiling, aiding fixture-to-fixture alignment.

Acu-Aim™ optics employs precision gearing to achieve 370° rotation, 45° tilt hot aiming with a screwdriver. Optimized center lamp beam optics translates lamp forward as it is aimed off nadir.

Supplied with vertically adjustable mounting brackets that accept 1/2" conduit, "C" channel hangers (HB-26 or HB-50), linear bar hangers (LB-27) or telescoping Juno Real Nail bar hangers (HB-1).

Choose from 120V or 277V high power factor, electronic solid state ballast.

Lampholder accepts (2) 2" beam control lenses and/or color correction/UV filters.

20W or 39W CMH MR16, GX10 Base Lamp.

UL and C-UL listed for through branch wiring and damp locations. Wet location listed with approved trims.

Mounting Accessories

Catalog #	Description
CTA4N-125	7/8" – 1 1/4" ceiling adapter
CTA4N-163	1 1/4" – 1 5/8" ceiling adapter
CTA4N-200	1 5/8" – 2" ceiling adapter
FMA4	Flush mount adapter for required flush mount trim installations



See Accessories on page 58.



Downlight

Deep Downlight Cone

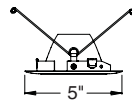
		Catalog #	Description	Lamp Ratings
		437NB-ABZ 437NB-SC 437NB-WH 437NC-WH 437NG-WH 437NHZ-SC 437NHZ-WH 437NWHZ-ABZ 437NWHZ-WH	Black Alzak® Cone, Aged Bronze Trim Ring Black Alzak® Cone, Satin Chrome Trim Ring Black Alzak® Cone, White Trim Ring Clear Alzak® Cone, White Trim Ring Gold Alzak® Cone, White Trim Ring Haze Alzak® Cone, Satin Chrome Ring Haze Alzak® Cone, White Ring Wheat Haze Alzak® Cone, Aged Bronze Ring Wheat Haze Alzak® Cone, White Trim Ring	IC43L: 20W LED TC43L/TC943L: 20W LED IC43N: 50W MR16 TC43N/TC943N: 75W MR16 TC43NR: 50W MR16 IC13N: 60W PAR16/50W PAR20 TC13N: 75W PAR16/50W PAR20 TC943M: 20W/39W CMH MR16 Aperture: 3 1/4"

Deep Downlight Baffle

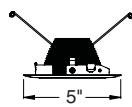
		Catalog #	Description	Lamp Ratings
		434NB-ABZ 434NB-SC 434NB-WH 434NW-WH	Black Baffle, Aged Bronze Trim Ring Black Baffle, Satin Chrome Trim Ring Black Baffle, White Trim Ring White Baffle, White Trim Ring	IC43L: 20W LED TC43L/TC943L: 20W LED IC43N: 50W MR16 TC43N/TC943N: 75W MR16 TC43NR: 50W MR16 IC13N: 60W PAR16/50W PAR20 TC13N: 75W PAR16/50W PAR20 TC943M: 20W/39W CMH MR16 Aperture: 3 1/4"

Downlight 1 1/4" Pinhole

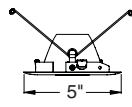
		Catalog #	Description	Lamp Ratings
		4337N-ABZ 4337N-SC 4337N-WH	Black Alzak® Reflector, Aged Bronze Trim Black Alzak® Reflector, Satin Chrome Trim Black Alzak® Reflector, White Trim	IC43L: 20W LED TC43L/TC943L: 20W LED IC43N: 50W MR16 TC43N/TC943N: 75W MR16 TC43NR: 50W MR16 IC13N: 60W PAR16/50W PAR20 TC13N: 75W PAR16/50W PAR20 TC943M: 20W/39W CMH MR16 Aperture: 3 1/4"

Downlight Regressed 1 3/4" Pinhole

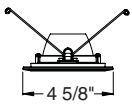
		Catalog #	Description	Lamp Ratings*
		4307N-WH	Black Alzak® Reflector, White Trim	IC43L: 20W LED TC43L/TC943L: 20W LED IC43N: 50W MR16 TC43N/TC943N: 75W MR16 IC13N: 60W PAR16/50W PAR20 TC13N: 75W PAR16/50W PAR20 TC943M: 20W/39W CMH MR16 Aperture: 1 1/4"

Adjustable Accent

Angle-Cut Cone

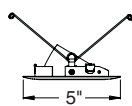
		Catalog #	Description	Lamp Ratings
		438NB-ABZ 438NB-SC 438NB-WH 438NC-WH 438NG-WH 438NHZ-SC 438NHZ-WH 438NWHZ-ABZ 438NWHZ-WH	Black Alzak® Cone, Aged Bronze Trim Ring Black Alzak® Cone, Satin Chrome Trim Ring Black Alzak® Cone, White Trim Ring Clear Alzak® Cone, White Trim Ring Gold Alzak® Cone, White Trim Ring Haze Alzak® Cone, Satin Chrome Ring Haze Alzak® Cone, White Ring Wheat Haze Alzak® Cone, Aged Bronze Ring Wheat Haze Alzak® Cone, White Trim Ring	IC43L: 20W LED TC43L/TC943L: 20W LED IC43N: 50W MR16 TC43N/TC943N: 75W MR16 IC13N: 60W PAR16/50W PAR20 TC13N: 75W PAR16/50W PAR20 TC43NR: 50W MR16 TC943M: 20W/39W CMH MR16 Aperture: 3 1/4"

20° Angle-Cut Cone

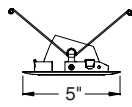
		Catalog #	Description	Lamp Ratings
		430NB-WH 430NC-WH 430NG-WH 430NHZ-SC 430NHZ-WH 430NWHZ-ABZ 430NWHZ-WH	Black Alzak® Cone, White Trim Ring Clear Alzak® Cone, White Trim Ring Gold Alzak® Cone, White Trim Ring Haze Alzak® Cone, Satin Chrome Trim Ring Haze Alzak® Cone, White Trim Ring Wheat Haze Alzak® Cone, Aged Bronze Trim Ring Wheat Haze Alzak® Cone, White Trim Ring	IC43L: 20W LED TC43L/TC943L: 20W LED IC43N: 50W MR16 TC43N/TC943N: 75W MR16 TC43NR: 50W MR16 IC13N: 60W PAR16/50W PAR20 TC13N: 75W PAR16/50W PAR20 TC943M: 20W/39W CMH MR16 Aperture: 3 1/4"

Slot Angle-Cut Cone

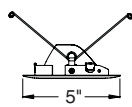
		Catalog #	Description	Lamp Ratings
		436NB-ABZ 436NB-SC 436NB-WH 436NC-WH 436NG-WH 436NHZ-SC 436NHZ-WH 436NWHZ-ABZ 436NWHZ-WH	Black Alzak® Cone, Aged Bronze Trim Ring Black Alzak® Cone, Satin Chrome Trim Ring Black Alzak® Cone, White Trim Ring Clear Alzak® Cone, White Trim Ring Gold Alzak® Cone, White Trim Ring Haze Alzak® Cone, Satin Chrome Ring Haze Alzak® Cone, White Ring Wheat Haze Alzak® Cone, Aged Bronze Ring Wheat Haze Alzak® Cone, White Trim Ring	IC43L: 20W LED TC43L/TC943L: 20W LED IC43N: 50W MR16 TC43N/TC943N: 75W MR16 TC43NR: 50W MR16 IC13N: 60W PAR16/50W PAR20 TC13N: 75W PAR16/50W PAR20 TC943M: 20W/39W CMH MR16 Aperture: 3 1/4"

Adjustable Accent *continued*

Angle-Cut Baffle

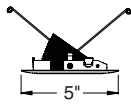

Catalog #
435NB-ABZ
435NB-SC
435NB-WH
435NW-WH

Description
Black Baffle, Aged Bronze Trim Ring
Black Baffle, Satin Chrome Trim Ring
Black Baffle, White Trim Ring
White Baffle, White Trim Ring

Lamp Ratings
IC43L: 20W LED
TC43L/TC943L: 20W LED
IC43N: 50W MR16
TC43N/TC943N: 75W MR16
TC43NR: 50W MR16
IC13N: 60W PAR16/50W PAR20
TC13N: 75W PAR16/50W PAR20
TC943M: 20W/39W CMH MR16
Aperture: 3 1/4"

Adjustable 1 1/4" Pinhole

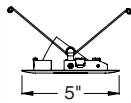

Catalog #
433N-ABZ
433N-SC
433N-WH

Description
Black Alzak® Reflector, Aged Bronze Trim
Black Alzak® Reflector, Satin Chrome Trim
Black Alzak® Reflector, White Trim

Lamp Ratings
IC43L: 20W LED
TC43L/TC943L: 20W LED
IC43N: 50W MR16
TC43N/TC943N: 75W MR16
TC943M: 20W/39W CMH MR16
IC13N: 60W PAR16/50W PAR20
TC13N: 75W PAR16/50W PAR20
TC43NR: 50W MR16
Aperture: 1 1/4"

Adjustable 1 3/4" Pinhole

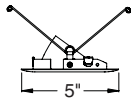

Catalog #
4335N-ABZ
4335N-SC
4335N-WH

Description
Black Alzak® Reflector, Aged Bronze Trim
Black Alzak® Reflector, Satin Chrome Trim
Black Alzak® Reflector, White Trim

Lamp Ratings
IC43L: 20W LED
TC43L/TC943L: 20W LED
IC43N: 50W MR16
TC43N/TC943N: 75W MR16
TC43NR: 50W MR16
IC13N: 60W PAR16/50W PAR20
TC13N: 75W PAR16/50W PAR20
TC943M: 20W/39W CMH MR16
Aperture: 1 3/4"

Slot Pinhole

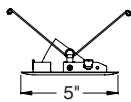

Catalog #
4345N-WH

Description
Black Alzak® Reflector, White Trim

Lamp Ratings
IC43L: 20W LED
TC43L/TC943L: 20W LED
IC43N: 50W MR16
TC43N/TC943N: 75W MR16
TC43NR: 50W MR16
IC13N: 60W PAR16/50W PAR20
TC13N: 75W PAR16/50W PAR20
TC943M: 20W/39W CMH MR16
Aperture: 2 1/2"

Adjustable Regressed 1 3/4" Pinhole

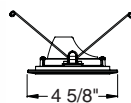

Catalog #
4308N-WH

Description
Black Alzak® Reflector, White Trim

Lamp Ratings*
IC43L: 20W LED
TC43L/TC943L: 20W LED
IC43N: 50W MR16
TC43N/TC943N: 75W MR16
IC13N: 60W PAR16/50W PAR20
TC13N: 75W PAR16/50W PAR20
TC943M: 20W/39W CMH MR16
Aperture: 1 3/4"

Mirrored Super Adjustable

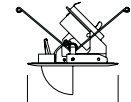

Catalog #
4349NB-BL
4349NB-WH

Description
Black Baffle, Black Trim
Black Baffle, White Trim

Lamp Ratings*
IC43N: 50W MR16
TC43N/TC943N: 75W MR16
TC943M: 20W/39W CMH MR16

continued

*Not compatible with TC43NR

Wall Wash

Lensed Wall Wash

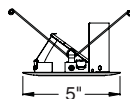

Catalog #	Description
439NB-WH	Black Alzak® Cone, White Trim Ring
439NC-WH	Clear Alzak® Cone, White Trim Ring
439NG-WH	Gold Alzak® Cone, White Trim Ring
439NHZ-SC	Haze Alzak® Cone, Satin Chrome Trim Ring
439NHZ-WH	Haze Alzak® Cone, White Trim Ring
439NWHZ-ABZ	Wheat Haze Alzak® Cone, Aged Bronze Trim Ring
439NWHZ-WH	Wheat Haze Alzak® Cone, White Trim Ring

Lamp Ratings
IC43L: 20W LED
TC43L/TC943L: 20W LED
IC43N: 50W MR16
TC43N/TC943N: 75W MR16
TC43NR: 50W MR16
IC13N: 45W PAR16/50W PAR20
TC13N: 75W PAR16/50W PAR20
TC943M: 20W/39W/CMH MR16
Aperture: 3 1/4"



Lensed

Downlight Lensed Trim

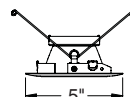

Catalog #	Description
432NB-WH	Black Alzak® Cone, White Trim Ring
432NC-WH	Clear Alzak® Cone, White Trim Ring
432NG-WH	Gold Alzak® Cone, White Trim Ring
432NHZ-SC	Haze Alzak® Cone, Satin Chrome Trim Ring
432NHZ-WH	Haze Alzak® Cone, White Trim Ring
432NWHZ-ABZ	Wheat Haze Alzak® Cone, Aged Bronze Trim Ring
432NWHZ-WH	Wheat Haze Alzak® Cone, White Trim Ring

Lamp Ratings
IC43L: 20W LED
TC43L/TC943L: 20W LED
IC43N: 50W MR16
TC43N/TC943N: 75W MR16
TC43NR: 50W MR16
IC13N: 45W PAR16/50W PAR20
TC13N: 75W PAR16/50W PAR20
TC943M: 20W/39W CMH MR16
Aperture: 3 1/4"



Angle-Cut Lensed Trim

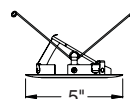

Catalog #	Description
431NB-WH	Black Alzak® Cone, White Trim Ring
431NC-WH	Clear Alzak® Cone, White Trim Ring
431NG-WH	Gold Alzak® Cone, White Trim Ring
431NHZ-SC	Haze Alzak® Cone, Satin Chrome Trim Ring
431NHZ-WH	Haze Alzak® Cone, White Trim Ring
431NWHZ-ABZ	Wheat Haze Alzak® Cone, Aged Bronze Trim Ring
431NWHZ-WH	Wheat Haze Alzak® Cone, White Trim Ring

Lamp Ratings
IC43L: 20W LED
TC43L/TC943L: 20W LED
IC43N: 50W MR16
TC43N/TC943N: 75W MR16
TC43NR: 50W MR16
IC13N: 45W PAR16/50W PAR20
TC13N: 75W PAR16/50W PAR20
TC943M: 20W/39W CMH MR16
Aperture: 3 1/4"



Downlight 1 1/4" Pinhole - Lensed

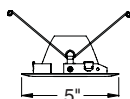

Catalog #	Description
4332N-ABZ	Black Alzak® Reflector, Aged Bronze
4332N-SC	Black Alzak® Reflector, Satin Chrome
4332N-WH	Black Alzak® Reflector, White Trim

Lamp Ratings
IC43L: 20W LED
TC43L/TC943L: 20W LED
IC43N: 50W MR16
TC43N/TC943N: 75W MR16
TC43NR: 50W MR16
TC943M: 20W/39W CMH MR16
IC13N: 45W PAR16/50W PAR20
TC13N: 75W PAR16/50W PAR20
Aperture: 1 1/4"



Adjustable 1 1/4" Pinhole - Lensed

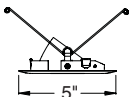

Catalog #	Description
4331N-ABZ	Black Alzak® Reflector, Aged Bronze
4331N-SC	Black Alzak® Reflector, Satin Chrome
4331N-WH	Black Alzak® Reflector, White Trim

Lamp Ratings
IC43L: 20W LED
TC43L/TC943L: 20W LED
IC43N: 50W MR16
TC43N/TC943N: 75W MR16
TC43NR: 50W MR16
TC943M: 20W/39W CMH MR16
IC13N: 45W PAR16/50W PAR20
TC13N: 75W PAR16/50W PAR20
Aperture: 1 1/4"



Downlight Regressed 1 3/4" Pinhole - Lensed

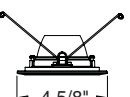

Catalog #	Description
4302N-WH	Black Alzak® Reflector, White Trim

Lamp Ratings*
IC43L: 20W LED
TC43L/TC943L: 20W LED
IC43N: 50W MR16
TC43N/TC943N: 75W MR16
IC13N: 45W PAR16/50W PAR20
TC13N: 75W PAR16/50W PAR20
TC943M: 20W/39W CMH MR16
Aperture: 1 3/4"



Adjustable Regressed 1 3/4" Pinhole - Lensed



Catalog #	Description
4301N-WH	Black Alzak® Reflector, White Trim

Lamp Ratings*
IC43L: 20W LED
TC43L/TC943L: 20W LED
IC43N: 50W MR16
TC43N/TC943N: 75W MR16
IC13N: 45W PAR16/50W PAR20
TC13N: 75W PAR16/50W PAR20
TC943M: 20W/39W CMH MR16
Aperture: 1 3/4"





Downlight

Deep Downlight Cone

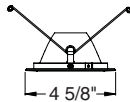

Catalog # †
 437NB-SF
 437NC-SF
 437NG-SF
 437NHZ-SF
 437NWHZ-SF

Description
 Black Alzak® Deep Cone
 Clear Alzak® Deep Cone
 Gold Alzak® Deep Cone
 Haze Alzak® Deep Cone
 Wheat Haze Alzak® Deep Cone

Lamp Ratings*
 IC43L: 20W LED
 TC43L/TC943L: 20W LED
 IC43N: 50W MR16
 TC43N/TC943N Series: 75W MR16
 IC13N: 60W PAR16/50W PAR20
 TC13N: 75W PAR16/50W PAR20
 TC943M: 20W/39W MR16 CMH
Aperture: 3 3/8"

Adjustable Accent

Angle-Cut Cone

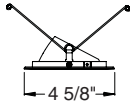

Catalog # †
 438NB-SF
 438NC-SF
 438NG-SF
 438NHZ-SF
 438NWHZ-SF

Description
 Black Alzak® Cone
 Clear Alzak® Cone
 Gold Alzak® Cone
 Haze Alzak® Cone
 Wheat Haze Alzak® Cone

Lamp Ratings*
 IC43L: 20W LED
 TC43L/TC943L: 20W LED
 IC43N: 50W MR16
 TC43N/TC943N: 75W MR16
 IC13N: 60W PAR16/50W PAR20
 TC13N: 75W PAR16/50W PAR20
 TC943M: 20W/39W MR16 CMH
Aperture: 3 3/8"

20° Angle-Cut Cone

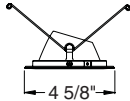

Catalog # †
 430NB-SF
 430NC-SF
 430NG-SF
 430NHZ-SF
 430NWHZ-SF

Description
 Black Alzak® Cone
 Clear Alzak® Cone
 Gold Alzak® Cone
 Haze Alzak® Cone
 Wheat Haze Alzak® Cone

Lamp Ratings*
 IC43L: 20W LED
 TC43L/TC943L: 20W LED
 IC43N: 50W MR16
 TC43N/TC943N: 75W MR16
 IC13N: 60W PAR16/50W PAR20
 TC13N: 75W PAR16/50W PAR20
 TC943M: 20W/39W MR16 CMH
Aperture: 3 3/8"

Slot Angle-Cut Cone

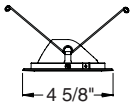

Catalog # †
 436NB-SF
 436NC-SF
 436NG-SF
 436NHZ-SF
 436NWHZ-SF

Description
 Black Alzak® Cone
 Clear Alzak® Cone
 Gold Alzak® Cone
 Haze Alzak® Cone
 Wheat Haze Alzak® Cone

Lamp Ratings*
 IC43L: 20W LED
 TC43L/TC943L: 20W LED
 IC43N: 50W MR16
 TC43N/TC943N: 75W MR16
 IC13N: 60W PAR16/50W PAR20
 TC13N: 75W PAR16/50W PAR20
 TC943M: 20W/39W MR16 CMH
Aperture: 3 3/8"

Wall Wash

Lensed Wall Wash

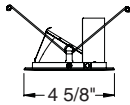

Catalog # †
 439NB-SF
 439NC-SF
 439NG-SF
 439NHZ-SF
 439NWHZ-SF

Description
 Black Alzak® Cone
 Clear Alzak® Cone
 Gold Alzak® Cone
 Haze Alzak® Cone
 Wheat Haze Alzak® Cone

Lamp Ratings*
 IC43L: 20W LED
 TC43L/TC943L: 20W LED
 IC43N: 50W MR16
 TC43N/TC943N: 75W MR16
 IC13N: 45W PAR16/50W PAR20
 TC13N: 75W PAR16/50W PAR20
 TC943M: 20W/39W MR16 CMH
Aperture: 3 3/8"



Lensed

Downlight Lensed Trim

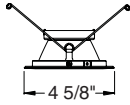

Catalog # †
 432NB-SF
 432NC-SF
 432NG-SF
 432NHZ-SF
 432NWHZ-SF

Description
 Black Alzak® Cone, Lensed
 Clear Alzak® Cone, Lensed
 Gold Alzak® Cone, Lensed
 Haze Alzak® Cone, Lensed
 Wheat Haze Alzak® Cone, Lensed

Lamp Ratings*
 IC43L: 20W LED
 TC43L/TC943L: 20W LED
 IC43N: 50W MR16
 TC43N/TC943N: 75W MR16
 IC13N: 45W PAR16/50W PAR20
 TC13N: 75W PAR16/50W PAR20
 TC943M: 20W/39W MR16 CMH
Aperture: 3 3/8"



Angle-Cut Lensed Trim

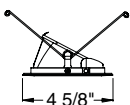

Catalog # †
 431NB-SF
 431NC-SF
 431NG-SF
 431NHZ-SF
 431NWHZ-SF

Description
 Black Alzak® Cone, Lensed
 Clear Alzak® Cone, Lensed
 Gold Alzak® Cone, Lensed
 Haze Alzak® Cone, Lensed
 Wheat Haze Alzak® Cone, Lensed

Lamp Ratings*
 IC43L: 20W LED
 TC43L/TC943L: 20W LED
 IC43N: 50W MR16
 TC43N/TC943N: 75W MR16
 IC13N: 45W PAR16/50W PAR20
 TC13N: 75W PAR16/50W PAR20
 TC943M: 20W/39W MR16 CMH
Aperture: 3 3/8"



† For self-flanged reflector with optional white painted flange, add WH suffix. (example: 437NB-SFWH)



Downlight

Deep Downlight Cone

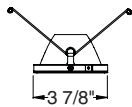

Catalog #	Description
437NB-FM	Black Alzak® Deep Cone
437NC-FM	Clear Alzak® Deep Cone
437NG-FM	Gold Alzak® Deep Cone
437NHZ-FM	Haze Alzak® Deep Cone
437NWHZ-FM	Wheat Haze Alzak® Deep Cone

Lamp Ratings*
IC43L: 20W LED
TC43L/TC943L: 20W LED
IC43N: 50W MR16
TC43N/TC943N: 75W MR16
IC13N: 60W PAR16/50W PAR20
TC13N: 75W PAR16/50W PAR20
TC943M: 20W/39W MR16 CMH
Aperture: 3 3/8"

Downlight 1 1/4" Pinhole

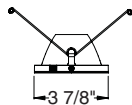

Catalog #	Description
4337N-WH-FM	Black Alzak® Reflector, White Trim

Lamp Ratings*
IC43L: 20W LED
TC43L/TC943L: 20W LED
IC43N: 50W MR16
TC43N/TC943N: 75W MR16
IC13N: 60W PAR16/50W PAR20
TC13N: 75W PAR16/50W PAR20
TC943M: 20W/39W MR16 CMH
Aperture: 1 1/4"

Downlight Regressed 1 3/4" Pinhole

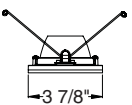

Catalog #	Description
4307N-WH-FM	Black Alzak® Reflector, White Trim

Lamp Ratings*
IC43L: 20W
TC43L/TC943L: 20W LED
IC43N: 50W MR16
TC43N/TC943N: 75W MR16
IC13N: 60W PAR16/50W PAR20
TC13N: 75W PAR16/50W PAR20
TC943M: 20W/39W MR16 CMH
Aperture: 1 3/4"

Adjustable Accent

Angle-Cut Cone

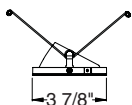

Catalog #	Description
438NB-FM	Black Alzak® Cone
438NC-FM	Clear Alzak® Cone
438NG-FM	Gold Alzak® Cone
438NHZ-FM	Haze Alzak® Cone
438NWHZ-FM	Wheat Haze Alzak® Cone

Lamp Ratings*
IC43L: 20W LED
TC43L/TC943L: 20W LED
IC43N: 50W MR16
TC43N/TC943N: 75W MR16
IC13N: 60W PAR16/50W PAR20
TC13N: 75W PAR16/50W PAR20
TC943M: 20W/39W MR16 CMH
Aperture: 3 3/8"

20° Angle-Cut Cone

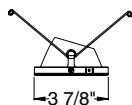

Catalog #	Description
430NB-FM	Black Alzak® Cone
430NC-FM	Clear Alzak® Cone
430NG-FM	Gold Alzak® Cone
430NHZ-FM	Haze Alzak® Cone
430NWHZ-FM	Wheat Haze Alzak® Cone

Lamp Ratings*
IC43L: 20W LED
TC43L/TC943L: 20W LED
IC43N: 50W MR16
TC43N/TC943N: 75W MR16
IC13N: 60W PAR16/50W PAR20
TC13N: 75W PAR16/50W PAR20
TC943M: 20W/39W MR16 CMH
Aperture: 3 3/8"

Slot Angle-Cut Cone

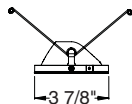

Catalog #	Description
436NB-FM	Black Alzak® Cone
436NC-FM	Clear Alzak® Cone
436NG-FM	Gold Alzak® Cone
436NHZ-FM	Haze Alzak® Cone
436NWHZ-FM	Wheat Haze Alzak® Cone

Lamp Ratings*
IC43L: 20W LED
TC43L/TC943L: 20W LED
IC43N: 50W MR16
TC43N/TC943N: 75W MR16
IC13N: 60W PAR16/50W PAR20
TC13N: 75W PAR16/50W PAR20
TC943M: 20W/39W MR16 CMH
Aperture: 3 3/8"

Adjustable 1 1/4" Pinhole

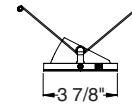

Catalog #	Description
433N-WH-FM	Black Alzak® Reflector, White Trim

Lamp Ratings*
IC43L: 20W LED
TC43L/TC943L: 20W LED
IC13N: 60W PAR16/50W PAR20
TC13N: 75W PAR16/50W PAR20
IC43N: 50W MR16
TC43N/TC943N: 75W MR16
TC943M: 20W/39W MR16 CMH
Aperture: 1 1/4"

continued

Adjustable 1 3/4" Pinhole

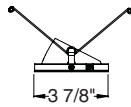

Catalog #
4335N-WH-FM

Description
Black Alzak® Reflector, White Trim

Ratings*
IC43L: 20W LED
TC43L/TC943L: 20W LED
IC43N: 50W MR16
TC43N/TC943N: 75W MR16
IC13N: 60W PAR16/50W PAR20
TC13N: 75W PAR16/50W PAR20
TC943M: 20W/39W MR16 CMH
Aperture: 1 3/4"

Slot Pinhole

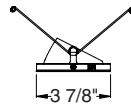

Catalog #
4345N-WH-FM

Description
Black Alzak® Reflector, White Trim

Lamp Ratings*
IC43L: 20W LED
TC43L/TC943L: 20W LED
IC43N: 50W MR16
IC13N: 60W PAR16/50W PAR20
TC13N: 75W PAR16/50W PAR20
TC43N/TC943N: 75W MR16
TC943M: 20W/39W MR16 CMH
Aperture: 2 1/2"

Adjustable Regressed Pinhole

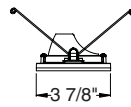

Catalog #
4308N-WH-FM

Description
Black Alzak® Reflector, White Trim

Lamp Ratings*
IC43L: 20W LED
TC43L/TC943L: 20W LED
IC43N: 50W MR16
TC43N/TC943N: 75W MR16
IC13N: 60W PAR16/50W PAR20
TC13N: 75W PAR16/50W PAR20
TC943M: 20W/39W MR16 CMH
Aperture: 1 3/4"

Wall Wash

Lensed Wall Wash

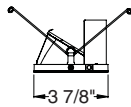

Catalog #
439NB-FM
439NC-FM
439NG-FM
439NHZ-FM
439NWHZ-FM

Description
Black Alzak® Cone
Clear Alzak® Cone
Gold Alzak® Cone
Haze Alzak® Cone
Wheat Haze Alzak® Cone

Lamp Ratings*
IC43L: 20W LED
TC43L/TC943L: 20W LED
IC43N: 50W MR16
TC43N/TC943N: 75W MR16
IC13N: 45W PAR16/50W PAR20
TC13N: 75W PAR16/50W PAR20
TC943M: 20W/39W MR16 CMH
Aperture: 3 3/8"



Lensed

Downlight Lensed Trim

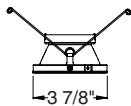

Catalog #
432NB-FM
432NC-FM
432NG-FM
432NHZ-FM
432NWHZ-FM

Description
Black Alzak® Cone, Lensed
Clear Alzak® Cone, Lensed
Gold Alzak® Cone, Lensed
Haze Alzak® Cone, Lensed
Wheat Haze Alzak® Cone, Lensed

Lamp Ratings*
IC43L: 20W LED
TC43L/TC943L: 20W LED
IC43N: 50W MR16
TC43N/TC943N: 75W MR16
IC13N: 45W PAR16/50W PAR20
TC13N: 75W PAR16/50W PAR20
TC943M: 20W/39W MR16 CMH
Aperture: 3 3/8"



Angle-Cut Lensed Trim

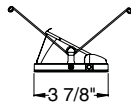

Catalog #
431NB-FM
431NC-FM
431NG-FM
431NHZ-FM
431NWHZ-FM

Description
Black Alzak® Cone, Lensed
Clear Alzak® Cone, Lensed
Gold Alzak® Cone, Lensed
Haze Alzak® Cone, Lensed
Wheat Haze Alzak® Cone, Lensed

Lamp Ratings*
IC43L: 20W LED
TC43L/TC943L: 20W LED
IC43N: 50W MR16
TC43N/TC943N: 75W MR16
IC13N: 45W PAR16/50W PAR20
TC13N: 75W PAR16/50W PAR20
TC943M: 20W/39W MR16 CMH
Aperture: 3 3/8"



Accessories

Catalog #	Description
FMA4	Flush mount adapter required for round flush mount trim installations

*Not compatible with TC43NR

3 1/4" Square Aperture LED Housings

The Aculux brand is redefining precision lighting with energy efficient, versatile, low wattage LED fixtures. The performance approximates a 50W MR16 while consuming only 20 watts. The LED fixtures are compatible with all the new 3 1/4" trim offering and have the same features as the newly redesigned 3 1/4" fixtures – Acu-Aim™ Geared Optics, Tru-Line™ Installation and Pro-VI™ Bar Hangers to name a few. The unique interchangeable beam optics provide the lighting designer with the ultimate flexibility from fixture-to-fixture.

LED IC Rated with Pro-VI™ Telescoping Bar Hangers

AIR-LOC

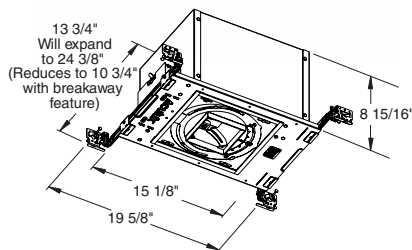

IC43LSQ-3K-S (-N, -F)
3000K Color Temperature,
85 CRI Typical

IC43LSQ-35K-S (-N, -F)
3500K Color Temperature,
85 CRI Typical

IC43LSQ-4K-S (-N, -F)
4100K Color Temperature,
75 CRI Typical

Beam Optics
S = 15° Spot
N = 24° Narrow Flood
F = 35° Flood

Energy Efficient, IC Rated new construction housing for use in direct contact with insulation.

Sealed Air-Loc® housing eliminates air flow and reduces sound transmission through plenum.

Patent Pending, Tru-Line™ platform allows +/- 1/2" aperture translation and +/- 45° aperture rotation after installation prior to finished ceiling, aiding fixture-to-fixture alignment.

Acu-Aim™ optics employs precision gearing to achieve 370° rotation, 45° tilt hot aiming with screwdriver. Optimized center lamp beam optics translates light engine forward as it is aimed off nadir.

120V-277V electronic solid state driver. 20W total system power consumption delivers performance similar to 50W halogen MR16.

Patent pending, Pro-VI™ telescoping bar hanger system has locking set screws. The captive bugle-headed ring shank nail allows for a quick one-step installation in joist construction while the robust bar eliminates flexing regardless of fixture position. For suspended ceilings, use integral t-notches with locking tabs.

Innovative optic holder allows interchangeable optics and (2) additional 2" beam control lenses and/or filters.

LED Non-IC Rated with Pro-VI Telescoping Bar Hangers

AIR-LOC

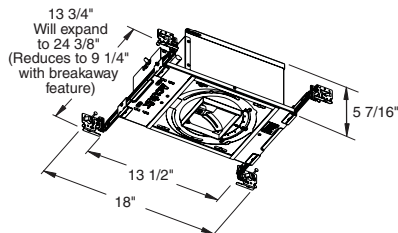

TC43LSQ-3K-S (-N, -F)-E1
3000K Color Temperature,
85 CRI Typical

TC43LSQ-35K-S (-N, -F)-E1
3500K Color Temperature,
85 CRI Typical

TC43LSQ-4K-S (-N, -F)-E1
4100K Color Temperature,
75 CRI Typical

For 277V replace
E1 with E2.

Beam Optics
S = 15° Spot
N = 24° Narrow Flood
F = 35° Flood

Energy Efficient, Non-IC Rated new construction housing for use where insulation is spaced 3" away from fixture.

Sealed Air-Loc® housing eliminates air flow and reduces sound transmission through plenum

Patent Pending, Tru-Line™ platform allows +/- 1/2" aperture translation and +/- 45° aperture rotation after installation prior to finished ceiling, aiding fixture-to-fixture alignment.

Acu-Aim™ optics employs precision gearing to achieve 370° rotation, 45° tilt hot aiming with a screwdriver. Optimized center lamp beam optics translates light engine forward as it is aimed off nadir.

120V or 277V electronic solid state driver. 20W total system power consumption delivers performance similar to 50W halogen MR16.

Patent pending, Pro-VI™ telescoping bar hanger system has locking set screws. The captive bugle-headed ring shank nail allows for a quick one-step installation in joist construction while the robust bar eliminates flexing regardless of fixture position. For suspended ceilings, use integral t-notches with locking tabs.

Innovative optic holder allows interchangeable optics and (2) additional 2" beam control lenses and/or filters.

Mounting Accessories

Catalog #	Description
CTA4SQ-125	7/8" – 1 1/4" ceiling adapter
CTA4SQ-163	1 1/4" – 1 5/8" ceiling adapter
CTA4SQ-200	1 5/8" – 2" ceiling adapter
FMASQ4	Flush mount adapter for required flush mount trim installations



See Accessories on page 58.

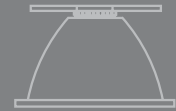

Features

- Concealed LEDs mimic 50W MR16 Performance.
- Accepts up to two beam control lenses and/or filters.
- Available in 3000K, 3500K, 4100K.
- 85 CRI typical for 3000K and 3500K, 75 CRI 4100K.
- 20W total power consumption approximates 50W MR16 performance.
- Reverse phase dimming. Consult factory for dimmer compatibility.
- Solid state driver, 120V or 277V.
- Three interchangeable Optics.



15° Spot LED



24° Narrow Flood



35° Flood



Commercial LED Non-IC Rated with Butterfly Style Mounting Brackets

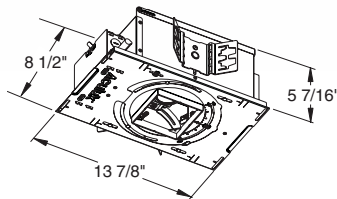
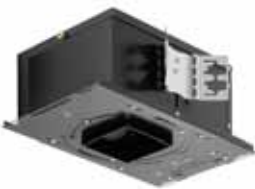

TC943LSQ-3K-S (-N, -F)-E1

3000K Color Temperature,
85 CRI Typical

TC943LSQ-35K-S (-N, -F)-E1

3500K Color Temperature,
85 CRI Typical

TC943LSQ-4K-S (-N, -F)-E1

4100K Color Temperature,
75 CRI Typical

For 277V replace
E1 with E2.

Beam Optics

S = 15° Spot
N = 24° Narrow Flood
F = 35° Flood

Energy Efficient, Non-IC Rated new construction housing for use where insulation is spaced 3" away from fixture.

Patent Pending, Tru-Line™ platform allows +/- 1/2" aperture translation and +/- 45° aperture rotation after installation prior to finished ceiling, aiding fixture-to-fixture alignment.

Acu-Aim™ optics employs precision gearing to achieve 370° rotation, 45° tilt hot aiming with a screwdriver. Optimized center lamp beam optics translates light engine forward as it is aimed off nadir.

120V or 277V electronic solid state driver. 20W total system power consumption delivers performance similar to 50W halogen MR16.

Innovative optic holder allows interchangeable optics and (2) additional 2" beam control lenses and/or filters.

Supplied with vertically adjustable mounting brackets that accept 1/2" conduit, C" channel hangers (HB-26 or HB-50), linear bar hangers (LB-27) or telescoping Juno Real Nail bar hangers (HB-1).

Mounting Accessories

Catalog #	Description
CTA4N-125	1 1/4" ceiling adapter
CTA4N-163	1 1/4" – 1 5/8" ceiling adapter
CTA4N-200	1 5/8" – 2" ceiling adapter
FMA4	Flush mount adapter for required flush mount trim installations



See Accessories
on page 58.

3 1/4" Square Aperture MR16 Low Voltage Housings

Specification grade, adjustable 12-volt MR16 luminaires produce controlled beam spreads, and have excellent color rendering properties that dramatically emphasize art, textures and architectural elements. Aculux 3 1/4" square aperture fixtures make a bold architectural statement while delivering superb downlighting, accent lighting and wall washing.

IC Rated with Pro-VI™ Telescoping Bar Hangers

AIR-LOC



IC43SQ

120V Magnetic, High efficiency dual tap, toroidal transformer.

IC43SQ-E1

120V Electronic, High efficiency, high power factor transformer.

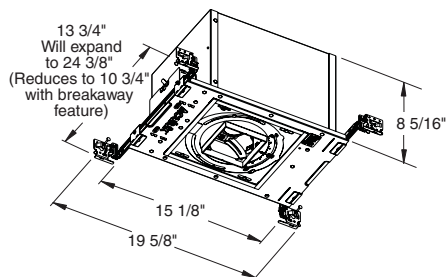

Low Voltage IC Rated new construction housing for use in direct contact with insulation.

Sealed Air-Loc® housing eliminates air flow and reduces sound transmission through plenum.

Patent Pending, Tru-Line™ platform allows +/- 1/2" aperture translation and +/- 45° aperture rotation after installation prior to finished ceiling, aiding fixture-to-fixture alignment.

Acu-Aim™ optics employs precision gearing to achieve 370° rotation, 45° tilt hot aiming with a screwdriver. Optimized center lamp beam optics translates lamp forward as it is aimed off nadir.

Choose from 120V High efficiency (>90%) dual tap potted magnetic or 120V High efficiency (>94%), high power factor electronic transformer.

Patent pending, Pro-VI™ telescoping bar hanger system has locking set screws. The captive bugle-headed ring shank nail allows for a quick one-step installation in joist construction while the robust bar eliminates flexing regardless of fixture position. For suspended ceilings, use integral t-notches with locking tabs.

Lampholder accepts up to (3) 2" beam control lenses and/or color correction/UV filters. Fixture is supplied with stippled clear uniformity lens.

50W MR16 Maximum Lamp Rating.

UL and cUL listed for through branch wiring and damp locations. Wet location listed with approved trims.

Commercial Non-IC Rated with Butterfly Style Mounting Brackets

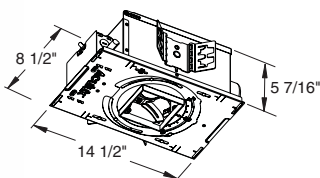
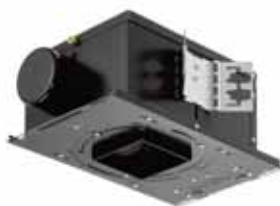

TC943SQ

120V Magnetic, High efficiency dual tap, toroidal transformer.

TC943SQ-E1

120V Electronic, High efficiency, high power factor transformer.

TC943SQ-V

277V Magnetic, High efficiency dual tap, toroidal transformer.

TC943SQ-E2

277V Electronic, High efficiency, high power factor transformer.

Low Voltage, Non-IC Rated new construction housing for use where insulation is spaced 3" away from fixture.

Patent Pending, Tru-Line™ platform allows +/- 1/2" aperture translation and +/- 45° aperture rotation after installation prior to finished ceiling, aiding fixture-to-fixture alignment.

Acu-Aim™ optics employs precision gearing to achieve 370° rotation, 45° tilt hot aiming with a screwdriver. Optimized center lamp beam optics translates lamp forward as it is aimed off nadir.

Fixture is available with four premium transformer options – **Magnetic** 120V or 277V High efficiency (>90%) dual tap magnetic, toroidal transformer. **Electronic:** 120V or 277V High efficiency (>94%), high power factor electronic transformer

Supplied with vertically adjustable mounting brackets that accept 1/2" conduit, "C" channel hangers (HB-26 or HB-50), linear bar hangers (LB-27) or telescoping Juno Real Nail bar hangers (HB-1).

Lampholder accepts up to (3) 2" beam control lenses and/or color correction/UV filters. Fixture is supplied with stippled clear uniformity lens.

75W MR16 Maximum Lamp Rating.

UL and C-UL listed for through branch wiring and damp locations. Wet location listed with approved trims.

Mounting Accessories

Catalog #	Description
CTA4SQ-125	7/8" – 1 1/4" ceiling adapter
CTA4SQ-163	1 1/4" – 1 5/8" ceiling adapter
CTA4SQ-200	1 5/8" – 2" ceiling adapter
FMASQ4	Flush mount adapter for required flush mount trim installations



See Accessories on page 58.

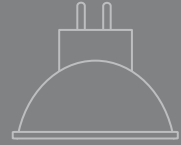

Non-IC Rated with Pro-VI™ Telescoping Bar Hangers

AIR-LOC



TC43SQ

120V Magnetic, High efficiency toroidal transformer.

TC43SQ-E1

120V Electronic, High efficiency, high power factor transformer.

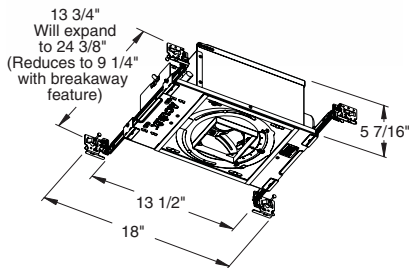

Mounting Accessories

Catalog #	Description
CTA4SQ-125	7/8" – 1 1/4" ceiling adapter
CTA4SQ-163	1 1/4" – 1 5/8" ceiling adapter
CTA4SQ-200	1 5/8" – 2" ceiling adapter
FMASQ4	Flush mount adapter for required flush mount trim installations



See Accessories on page 58.

Low Voltage, Non-IC Rated new construction housing for use where insulation is spaced 3" away from fixture.

Sealed Air-Loc® housing eliminates air flow and reduces sound transmission through plenum.

Patent Pending, Tru-Line™ platform allows +/- 1/2" aperture translation and +/- 45° aperture rotation after installation prior to finished ceiling, aiding fixture-to-fixture alignment.

Acu-Aim™ optics employs precision gearing to achieve 370° rotation, 45° tilt hot aiming with a screwdriver. Optimized center lamp beam optics translates lamp forward as it is aimed off nadir.

Choose from 120V High efficiency (>90%) dual tap potted magnetic or 120V High efficiency (>94%), high power factor electronic transformer.

Patent pending, Pro-VI™ telescoping bar hanger system has locking set screws. The captive bugle-headed ring shank nail allows for a quick one-step installation in joist construction while the robust bar eliminates flexing regardless of fixture position. For suspended ceilings, use integral t-notches with locking tabs.

Lampholder accepts up to (3) 2" beam control lenses and/or color correction/UV filters. Fixture is supplied with stippled clear uniformity lens.

75W MR16 Maximum Lamp Rating.

UL and C-UL listed for through branch wiring and damp locations. Wet location listed with approved trims.



3 1/4" Square Aperture PAR16/PAR20 Housings

Aculux 120-volt PAR luminaires produce concentrated beams of light for a variety of lighting applications. PAR16 or PAR20 lamps produce spot or flood patterns for moderate light levels over shorter to medium throw distances. Aculux 3 1/4" square PAR fixtures are well suited for higher-level ambient lighting in a task or an accent lighting environment.

Residential IC Rated with Pro-VI™ Telescoping Bar Hangers



IC13SQ
120V Line Voltage,
IC Housing

Line Voltage IC rated, new construction housing for use in direct contact with insulation.

Sealed Air-Loc® housing eliminates air flow and reduces sound transmission through plenum.

Patent Pending, Tru-Line™ platform allows +/- 1/2" aperture translation and +/- 45° aperture rotation after installation prior to finished ceiling, aiding fixture-to-fixture alignment.

Acu-Aim™ optics employs precision gearing to achieve 370° rotation, 40° tilt hot aiming with a screwdriver. Optimized center lamp beam optics translates lamp forward as it is aimed off nadir.

Patent pending, Pro-VI™ telescoping bar hanger system has locking set screws. The captive bugle-headed ring shank nail allows for a quick one-step installation in joist construction while the robust bar eliminates flexing regardless of fixture position. For suspended ceilings, use integral t-notches with locking tabs.

50W PAR20 or 60W PAR16 Maximum Lamp Rating.

UL and C-UL listed for through branch wiring and damp locations. Wet location listed with approved trims.

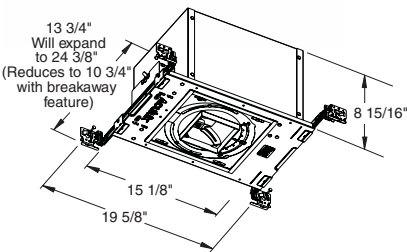

Non-IC Rated with Pro-VI™ Telescoping Bar Hangers



TC13SQ
120V Line Voltage,
Non-IC Housing

Line Voltage, Non-IC Rated new construction housing for use where insulation is spaced 3" away from fixture.

Sealed Air-Loc® housing eliminates air flow and reduces sound transmission through plenum.

Patent Pending, Tru-Line™ platform allows +/- 1/2" aperture translation and +/- 45° aperture rotation after installation prior to finished ceiling, aiding fixture-to-fixture alignment.

Acu-Aim™ optics employs precision gearing to achieve 370° rotation, 40° tilt hot aiming with a screwdriver. Optimized center lamp beam optics translates lamp forward as it is aimed off nadir.

Patent pending, Pro-VI™ telescoping bar hanger system has locking set screws. The captive bugle-headed ring shank nail allows for a quick one-step installation in joist construction while the robust bar eliminates flexing regardless of fixture position. For suspended ceilings, use integral t-notches with locking tabs.

50W PAR20 or 75W PAR16 Maximum Lamp Rating.

UL and C-UL listed for through branch wiring and damp locations. Wet location listed with approved trims.

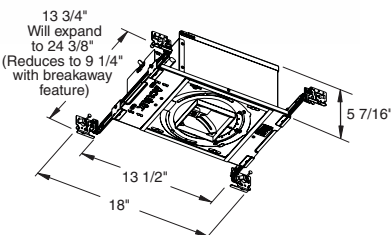

Mounting Accessories

Catalog #	Description
CTA4SQ-125	7/8" – 1 1/4" ceiling adapter
CTA4SQ-163	1 1/4" – 1 5/8" ceiling adapter
CTA4SQ-200	1 5/8" – 2" ceiling adapter
FMASQ4	Flush mount adapter for required flush mount trim installations





3 1/4" Square Aperture CMH MR16 Housings

Specification grade and energy efficient. The 20W to 39W CMH MR16 lamp replicates the size and performance of a 50W and 75W halogen MR16 lamp respectively – but up to 12,000 hour lamp life. The crisp, 3000K white light offers the smallest CMH lamp package, making these fixtures perfect for niche display or accent lighting.

Commercial Non-IC Rated CMH MR16 with Butterfly Mounting Brackets

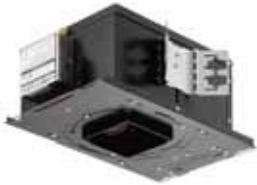

TC943MSQ-MR16-20E1
 120V High Power Factor
 Electronic Solid State Ballast,
 20W CMH MR16

Energy Efficient, Non-IC Rated new construction housing for use where insulation is spaced 3" away from fixture.

Patent Pending, Tru-Line™ platform allows +/- 1/2" aperture translation and +/- 45° aperture rotation after installation prior to finished ceiling, aiding fixture-to-fixture alignment.

Acu-Aim™ optics employs precision gearing to achieve 370° rotation, 45° tilt hot aiming with a screwdriver. Optimized center lamp beam optics translates lamp forward as it is aimed off nadir.

Supplied with vertically adjustable mounting brackets that accept 1/2" conduit, "C" channel hangers (HB-26 or HB-50), linear bar hangers (LB-27) or telescoping Juno Real Nail bar hangers (HB-1).

Choose from 120V or 277V high power factor, electronic solid state ballast.

Lampholder accepts (2) 2" beam control lenses and/or color correction/UV filters.

20W or 39W CMH MR16, GX10 Base Lamp.

UL and C-UL listed for through branch wiring and damp locations. Wet location listed with approved trims.

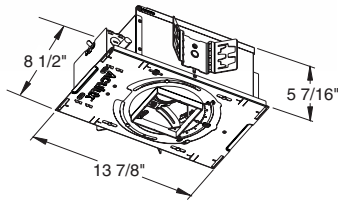

TC943MSQ-MR16-20E2
 277V High Power Factor
 Electronic Solid State Ballast,
 20W CMH MR16

TC943MSQ-MR16-39E1
 120V High Power Factor
 Electronic Solid State Ballast,
 39W CMH MR16

TC943MSQ-MR16-39E2
 277V High Power Factor
 Electronic Solid State Ballast,
 39W CMH MR16

Mounting Accessories

Catalog #	Description
CTA4SQ-125	7/8" – 1 1/4" ceiling adapter
CTA4SQ-163	1 1/4" – 1 5/8" ceiling adapter
CTA4SQ-200	1 5/8" – 2" ceiling adapter
FMASQ4	Flush mount adapter for required flush mount trim installations



See Accessories on page 58.



Downlight

Deep Downlight Reflector



Catalog # †	Description
437SQBHZ-SF	Black Haze Reflector
437SQW-SF	White Reflector
437SQHZ-SF	Haze Reflector
437SQWHZ-SF	Wheat Haze Reflector

Lamp Ratings
IC43LSQ: 20W LED
TC43LSQ/TC943LSQ: 20W LED
IC43SQ: 50W MR16
TC43SQ/TC943SQ: 75W MR16
IC13SQ: 60W PAR16/50W PAR20
TC13SQ: 75W PAR16/50W PAR20
TC943MSQ: 20W/39W MR16 CMH
Aperture: 3 1/4"

Downlight Regressed Pinhole

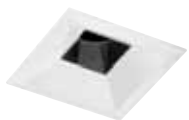

Catalog # †	Description
4307SQ-WH	Black Alzak® Reflector, White Trim

Lamp Ratings
IC43LSQ: 20W LED
TC43LSQ/TC943LSQ: 20W LED
IC43SQ: 50W MR16
TC43SQ/TC943SQ: 75W MR16
IC13SQ: 45W PAR16/50W PAR20
TC13SQ: 60W PAR16/50W PAR20
TC943MSQ: 20W/39W MR16 CMH
Aperture: 1 3/4"

Downlight 1 1/4" Pinhole



Catalog # †	Description
4337SQ-WH	Black Alzak® Reflector, White Trim

Lamp Ratings
IC43LSQ: 20W LED
TC43LSQ/TC943LSQ: 20W LED
IC43SQ: 50W MR16
TC43SQ/TC943SQ: 75W MR16
IC13SQ: 60W PAR16/50W PAR20
TC13SQ: 75W PAR16/50W PAR20
TC943MSQ: 20W/39W MR16 CMH
Aperture: 1 1/4"

Adjustable Accent

Angle-Cut Reflector



Catalog # †	Description
438SQBHZ-SF	Black Haze Reflector
438SQW-SF	White Reflector
438SQHZ-SF	Haze Reflector
438SQWHZ-SF	Wheat Haze Reflector

Lamp Ratings
IC43LSQ: 20W LED
TC43LSQ/TC943LSQ: 20W LED
IC43SQ: 50W MR16
TC43SQ/TC943SQ: 75W MR16
IC13SQ: 60W PAR16/50W PAR20
TC13SQ: 75W PAR16/50W PAR20
TC943MSQ: 20W/39W MR16 CMH
Aperture: 3 1/4"

Adjustable 1 1/4" Pinhole



Catalog #	Description
433SQ-WH	Black Alzak® Reflector, White Trim

Lamp Ratings
IC43LSQ: 20W LED
TC43LSQ/TC943LSQ: 20W LED
IC43SQ: 50W MR16
TC43SQ/TC943SQ: 75W MR16
IC13SQ: 60W PAR16/50W PAR20
TC13SQ: 75W PAR16/50W PAR20
TC943MSQ: 20W/39W MR16 CMH
Aperture: 1 1/4"

Adjustable Regressed 1 3/4" Pinhole

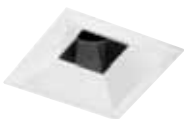

Catalog #	Description
4308SQ-WH	Black Alzak® Reflector, White Trim

Lamp Ratings
IC43LSQ: 20W LED
TC43LSQ/TC943LSQ: 20W LED
IC43SQ: 50W MR16
TC43SQ/TC943SQ: 75W MR16
IC13SQ: 45W PAR16/50W PAR20
TC13SQ: 60W PAR16/50W PAR20
TC943MSQ: 20W/39W MR16 CMH
Aperture: 1 3/4"

Wall Wash

Lensed Wall Wash



Catalog # †	Description
439SQBHZ-SF	Black Haze Reflector
439SQW-SF	White Reflector
439SQHZ-SF	Haze Reflector
439SQWHZ-SF	Wheat Haze Reflector

Lamp Ratings
IC43LSQ: 20W LED
TC43LSQ/TC943LSQ: 20W LED
IC43SQ: 50W MR16
TC43SQ/TC943SQ: 75W MR16
IC13SQ: 45W PAR16/50W PAR20
TC13SQ: 60W PAR16/50W PAR20
TC943MSQ: 20W/39W MR16 CMH
Aperture: 3 1/4"



† For self-flanged reflector with optional white painted flange, add WH suffix. (example: 437SQNB-SFWH)



Lensed

Downlight Lensed Trim



Catalog # †

432SQBHZ-SF
432SQW-SF
432SQHZ-SF
432SQWHZ-SF

Description

Black Haze Reflector
White Reflector
Haze Reflector
Wheat Haze Reflector

Lamp Ratings

IC43LSQ: 20W LED
TC43LSQ/TC943LSQ: 20W LED
IC43SQ: 50W MR16
TC43SQ/TC943SQ: 75W MR16
IC13SQ: 45W PAR16/50W PAR20
TC13SQ: 60W PAR16/50W PAR20
TC943MSQ: 20W/39W MR16 CMH
Aperture: 3 1/4"



Angle-Cut Lensed Trim



Catalog # †

431SQBHZ-SF
431SQW-SF
431SQHZ-SF
431SQWHZ-SF

Description

Black Haze Reflector
White Reflector
Haze Reflector
Wheat Haze Reflector

Lamp Ratings

IC43LSQ: 20W LED
TC43LSQ/TC943LSQ: 20W LED
IC43SQ: 50W MR16
TC43SQ/TC943SQ: 75W MR16
IC13SQ: 45W PAR16/50W PAR20
TC13SQ: 60W PAR16/50W PAR20
TC943MSQ: 20W/39W MR16 CMH
Aperture: 3 1/4"



Downlight 1 1/4" Pinhole-Lensed

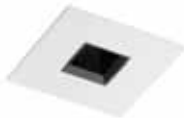

Catalog

432SQ-WH

Description

Black Alzak® Reflector, White Trim

Lamp Ratings

IC43LSQ: 20W LED
TC43LSQ/TC943LSQ: 20W LED
IC43SQ: 50W MR16
TC43SQ/TC943SQ: 75W MR16
IC13SQ: 45W PAR16/50W PAR20
TC13SQ: 60W PAR16/50W PAR20
TC943MSQ: 20W/39W MR16 CMH
Aperture: 1 1/4"



Adjustable 1 1/4" Pinhole-Lensed

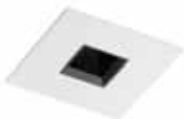

Catalog

4331SQ-WH

Description

Black Alzak® Reflector, White Trim

Lamp Ratings

IC43LSQ: 20W LED
TC43LSQ/TC943LSQ: 20W LED
IC43SQ: 50W MR16
TC43SQ/TC943SQ: 75W MR16
IC13SQ: 45W PAR16/50W PAR20
TC13SQ: 60W PAR16/50W PAR20
TC943MSQ: 20W/39W MR16 CMH
Aperture: 1 1/4"



Downlight Regressed Pinhole-Lensed

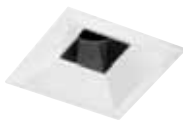

Catalog

4302SQ-WH

Description

Black Alzak® Reflector, White Trim

Lamp Ratings

IC43LSQ: 20W LED
TC43LSQ/TC943LSQ: 20W LED
IC43SQ: 50W MR16
TC43SQ/TC943SQ: 75W MR16
IC13SQ: 45W PAR16/50W PAR20
TC13SQ: 60W PAR16/50W PAR20
TC943MSQ: 20W/39W MR16 CMH
Aperture: 1 3/4"



Adjustable Regressed Pinhole-Lensed

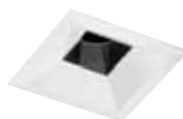

Catalog

4301SQ-WH

Description

Black Alzak® Reflector, White Trim

Lamp Ratings

IC43LSQ: 20W LED
TC43LSQ/TC943LSQ: 20W LED
IC43SQ: 50W MR16
TC43SQ/TC943SQ: 75W MR16
IC13SQ: 45W PAR16/50W PAR20
TC13SQ: 60W PAR16/50W PAR20
TC943MSQ: 20W/39W MR16 CMH
Aperture: 1 3/4"



† For self-flanged reflector with optional white painted flange, add WH suffix. (example: 437SQNB-SFWH)

Downlight

Deep Downlight Reflector

Catalog #

437SQBHZ-FM
437SQW-FM
437SQHZ-FM
437SQWHZ-FM

Description

Black Haze Reflector
White Reflector
Haze Reflector
Wheat Haze Reflector

Lamp Ratings

IC43LSQ: 20W LED
TC43LSQ/TC943LSQ: 20W LED
IC43SQ: 50W MR16
TC43SQ/TC943SQ: 75W MR16
IC13SQ: 60W PAR16/50W PAR20
TC13SQ: 75W PAR16/50W PAR20
TC943MSQ: 20W/39W MR16 CMH
Aperture: 3 1/4"

Downlight 1 1/4" Pinhole

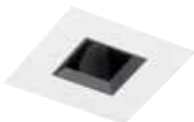
Catalog #

4337SQ-WH-FM

Description

Black Alzak® Reflector, White Trim

Lamp Ratings

IC43LSQ: 20W LED
TC43LSQ/TC943LSQ: 20W LED
IC43SQ: 50W MR16
TC43SQ/TC943SQ: 75W MR16
IC13SQ: 60W PAR16/50W PAR20
TC13SQ: 75W PAR16/50W PAR20
TC943MSQ: 20W/39W MR16 CMH
Aperture: 1 1/4"

Downlight Regressed Pinhole

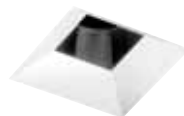
Catalog #

4307SQ-WH-FM

Description

Black Alzak® Reflector, White Trim

Lamp Ratings

IC43LSQ: 20W LED
TC43LSQ/TC943LSQ: 20W LED
IC43SQ: 50W MR16
TC43SQ/TC943SQ: 75W MR16
IC13SQ: 45W PAR16/50W PAR20
TC13SQ: 60W PAR16/50W PAR20
TC943MSQ: 20W/39W MR16 CMH
Aperture: 1 3/4"

Adjustable Accent

Angle-Cut Reflector

Catalog #

438SQBHZ-SF-FM
438SQW-SF-FM
438SQHZ-SF-FM
438SQWHZ-SF-FM

Description

Black Haze Reflector
White Reflector
Haze Reflector
Wheat Haze Reflector

Lamp Ratings

IC43LSQ: 20W LED
TC43LSQ/TC943LSQ: 20W LED
IC43SQ: 50W MR16
TC43SQ/TC943SQ: 75W MR16
IC13SQ: 60W PAR16/50W PAR20
TC13SQ: 75W PAR16/50W PAR20
TC943MSQ: 20W/39W MR16 CMH
Aperture: 3 1/4"

Adjustable 1 1/4" Pinhole

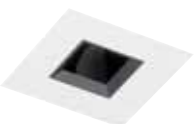
Catalog #

4333SQ-WH-FM

Description

Black Alzak® Reflector, White Trim

Lamp Ratings

IC43LED: 20W LED
TC43LED/TC943LED: 20W LED
IC43SQ: 50W MR16
TC43SQ/TC943SQ: 75W MR16
IC13SQ: 60W PAR16/50W PAR20
TC13SQ: 75W PAR16/50W PAR20
TC943MSQ: 20W/39W MR16 CMH
Aperture: 1 1/4"

Adjustable Regressed Pinhole

Catalog #

4308SQ-WH-FM

Description

Black Alzak® Reflector, White Trim

Lamp Ratings

IC43LSQ: 20W LED
TC43LSQ/TC943LSQ: 20W LED
IC43SQ: 50W MR16
TC43SQ/TC943SQ: 75W MR16
IC13SQ: 45W PAR16/50W PAR20
TC13SQ: 60W PAR16/50W PAR20
TC943MSQ: 20W/39W MR16 CMH
Aperture: 1 3/4"

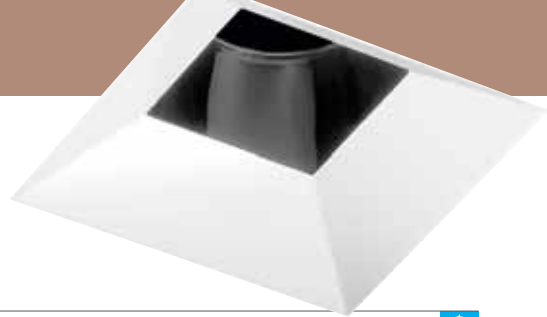

Wall Wash

Lensed Wall Wash



Catalog #
 439SQBHZ-FM
 439SQW-FM
 439SQHZ-FM
 439SQWHZ-FM

Description
 Black Haze Reflector
 White Reflector
 Haze Reflector
 Wheat Haze Reflector

Lamp Ratings
 IC43LSQ: 20W LED
 TC43LSQ/TC943LSQ: 20W LED
 IC43SQ: 50W MR16
 TC43SQ/TC943SQ: 75W MR16
 IC13SQ: 45W PAR16/50W PAR20
 TC13SQ: 60W PAR16/50W PAR20
 TC943MSQ: 20W/39W MR16 CMH
Aperture: 3 1/4"



Lensed

Downlight Lensed Trim

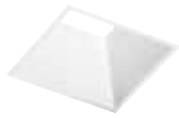

Catalog #
 432SQBHZ-FM
 432SQW-FM
 432SQHZ-FM
 432SQWHZ-FM

Description
 Black Haze Reflector
 White Reflector
 Haze Reflector
 Wheat Haze Reflector

Lamp Ratings
 IC43LSQ: 20W LED
 TC43LSQ/TC943LSQ: 20W LED
 IC43SQ: 50W MR16
 TC43SQ/TC943SQ: 75W MR16
 IC13SQ: 45W PAR16/50W PAR20
 TC13SQ: 60W PAR16/50W PAR20
 TC943MSQ: 20W/39W MR16 CMH
Aperture: 3 1/4"



Angle-Cut Lensed Trim



Catalog #
 431SQBHZ-FM
 431SQW-FM
 431SQHZ-FM
 431SQWHZ-FM

Description
 Black Haze Reflector
 White Reflector
 Haze Reflector
 Wheat Haze Reflector

Lamp Ratings
 IC43LSQ: 20W LED
 TC43LSQ/TC943LSQ: 20W LED
 IC43SQ: 50W MR16
 TC43SQ/TC943SQ: 75W MR16
 IC13SQ: 45W PAR16/50W PAR20
 TC13SQ: 60W PAR16/50W PAR20
 TC943MSQ: 20W/39W MR16 CMH
Aperture: 3 1/4"



Accessories

Catalog #	Description
FMASQ4	Flush mount square adapter required for square flush mount trim installations



5 5/8", 6", 7" Downlights and Adjustables

Whether you're accenting large objects or architectural features, Aculux high-performance luminaires provide excellent beam control in a variety of larger apertures and lamp options to suit any precision lighting applications.

Key Features

- Adjustable fixtures have a locking 0-35° tilt, exclusive 45° on 7" aperture.
- Center lamp beam optical alignment assures full light output and low aperture brightness at any aiming angle.
- 361° rotation with toolless locking capability prevents aiming dead spots.
- Deep lamp regression.
- 50° lamp/lamp image cutoff.
- Adjustable internal lamp shield eliminates sight lines into housing from all angles.

Aperture Selection

5 5/8" - 6" Round Housings

PAR36/AR111 Adjustables

Produces a tight, collimated beam of light that provides high-intensity, pinpoint illumination over great distances.

PAR30/PAR38 Adjustables/Wall Wash/DownLights

Provides medium to high light level accent, general, task, and wall wash illumination.

Incandescent/CFL Housings

Diffuse, widespread illumination from economical incandescent A-lamps or energy efficient compact fluorescent lamps.

7" PAR38

For accent, task or downlighting from high flat or sloped mounting heights.

Framing Projector

Produces an adjustable rectangular light pattern to dramatically "frame" art with light.



Aesthetically Superior Trims

- High-quality, hand-polished, ALZAK® anodized aluminum reflectors.
- Tapered die-formed trim rings inconspicuously blend with the ceiling.
- Low iridescent coating for compact fluorescent lamps to eliminate “rainbow” color separation.
- Low profile trim with self-centering spring retention for clean ceiling interface without light leaks.
- Optional reflector finishes available to suit individual aesthetic preference. Consult factory for specialty finishes.



Downlight



Baffle



Wall Wash



Decorative



A-Lamp/CFL
Wall Wash Series

5 5/8" Round Aperture PAR36/AR111 Low-Voltage Housings

The Adjustable Series recessed housings are ideal for accent lighting over great distances. 12-volt Halogen PAR36 or AR111 lamps produce a collimated light beam with excellent color-rendering properties.

IC Rated with Real Nail™ Bar Hangers



IC64
120V Magnetic thermally protected transformer
Housing dimensions:
20 3/8" L x 10" W x 9 1/2" H
Ceiling cutout: 6 7/8"

Low Voltage, Energy-efficient Air-Loc® Rated, IC Rated for direct contact with insulation, new construction specification grade housing.
Tool-less locking, 361° rotation and 35° tilt.
Deep lamp regression and optimized beam center provides 50° lamp/lamp image cut-off for exceptional low aperture brightness
Premium thermally protected, low voltage magnetic transformer.
Patented telescoping Real Nail™ bar hangers have captive ring shank nails for a quick one-step installation. The quick-loc slots and oversized locking set screws securely hold fixture in any position without bar flexing.
50W PAR36/AR111 Maximum Lamp Rating. Lamp holder accepts two optical media.
UL and C-UL listed for through-branch wiring and damp locations.

Commercial Non- IC Rated with Butterfly Style Mounting Brackets



TC964
120V Magnetic thermally protected transformer
Housing dimensions:
13 1/2" L x 12" W x 9" H
Ceiling cutout: 6 7/8"

Low Voltage, Non-IC new construction specification grade housing for use where insulation is spaced 3" away from fixture.
Tool-less locking, 361° rotation and 35° tilt.
Deep lamp regression and optimized beam center provides 50° lamp/lamp image cut-off for exceptional low aperture brightness
Premium thermally protected, low voltage magnetic transformer.
Supplied with vertically adjustable mounting brackets that accept 1/2" conduit, "C" channel hangers (HB-26 or HB-50), linear bar hangers (LB-27) or telescoping Juno Real Nail bar hangers (HB-1).
75W PAR36/AR111 Maximum Lamp Rating. Lamp holder accepts two optical media.
UL and C-UL listed for through-branch wiring and damp locations.

Adjustable Accents

Angle-Cut Cone

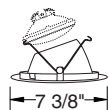

Catalog #	Description	Lamp Ratings
638B-WH	Black Alzak®, White Trim Ring	IC64: 50W PAR36/AR111
638C-WH	Clear Alzak®, White Trim Ring	TC964: 75W PAR36/AR111
638G-WH	Gold Alzak®, White Trim Ring	5 5/8" Aperture
638HZ-SC	Haze, Satin Chrome Trim Ring	
638HZ-WH	Haze, White Trim Ring	
638WHZ-ABZ	Wheat Haze, Aged Bronze Trim Ring	
638WHZ-WH	Wheat Haze, White Trim Ring	

Angle-Cut Baffle

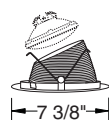

Catalog #	Description	Lamp Ratings
635W-WH	White Baffle, White Trim Ring	IC64: 50W PAR36/AR111
635B-ABZ	Black Baffle, Aged Bronze Trim Ring	TC964: 75W PAR36/AR111
635B-WH	Black Baffle, White Trim Ring	5 5/8" Aperture
635B-SC	Black Baffle, Satin Chrome Trim Ring	

Optional Mounting Accessories

Catalog #	Description
CTA6	Ceiling thickness adapter accommodates ceilings from 1 1/4" to 2" thick
Bar Hangers for TC964	
HB-1	Real Nail™ bar hangers (set of 2)
HB-26	26" C-Channel bar hangers (set of 2)
HB-50	50" C-Channel bar hangers (set of 2)
LB-27	27" Linear bar hangers (set of 2)





5 5/8" Round Aperture PAR30 Housings

Adjustable recessed housing for accent, task, or downlighting. 120-volt PAR30 halogen lamp produces spot or flood patterns for medium to high light levels.

IC Rated with Real Nail™ Bar Hangers

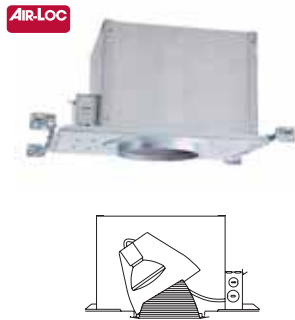

IC63
120V Line Voltage,
IC Housing.
Housing dimensions:
20 3/8" L x 10" W x 9 1/2" H
Ceiling cutout: 6 7/8"

Line Voltage Air-Loc® Rated, specification grade New Construction Housing IC Rated for direct contact with insulation.

Tool-less Locking, 361° rotation and 35° tilt.

Optimized lamp beam optical alignment with trim opening to insure low aperture brightness at any aiming angle.

Patented telescoping Real Nail™ bar hangers have captive ring shank nails for a quick one-step installation. The quick-loc slots and oversized locking set screws securely hold fixture in any position without bar flexing.

75W PAR30 Maximum Lamp Rating.

UL and C-UL listed for through-branch wiring and damp locations.

Commercial Non-IC Rated with Butterfly Style Mounting Brackets

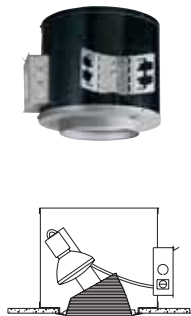

TC963
120V Line Voltage,
Non-IC Housing
Housing dimensions:
13 1/2" L x 12" W x 9" H
Ceiling cutout: 6 7/8"

Line Voltage Non-IC Rated, specification grade New Construction Housing for use where insulation is spaced 3" away from fixture.

Tool-less Locking, 361° rotation and 35° tilt.

Optimized lamp beam optical alignment with trim opening to insure low aperture brightness at any aiming angle.

Supplied with vertically adjustable mounting brackets that accept 1/2" conduit, "C" channel hangers (HB-26 or HB-50), linear bar hangers (LB-27) or telescoping Juno Real Nail™ bar hangers (HB-1).

75W PAR30 Maximum Lamp Rating.

UL and C-UL listed for through-branch wiring and damp locations.

Adjustable Accents

Angle-Cut Cone

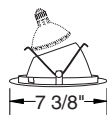

Catalog #
638B-WH
638C-WH
638G-WH
638HZ-SC
638HZ-WH
638WHZ-ABZ
638WHZ-WH

Description
Black Alzak®, White Trim Ring
Clear Alzak®, White Trim Ring
Gold Alzak®, White Trim Ring
Haze, Satin Chrome Trim Ring
Haze, White Trim Ring
Wheat Haze, Aged Bronze Trim Ring
Wheat Haze, White Trim Ring

Lamp Ratings
IC63: 75W PAR30
TC963: 75W PAR30
5 5/8" Aperture

Angle-Cut Baffle



Catalog #
635W-WH
635B-ABZ
635B-WH
635B-SC

Description
White Baffle, White Trim Ring
Black Baffle, Aged Bronze Trim Ring
Black Baffle, White Trim Ring
Black Baffle, Satin Chrome Trim Ring

Lamp Ratings
IC63: 75W PAR30
TC963: 75W PAR30
5 5/8" Aperture

Optional Mounting Accessories

Catalog #	Description
CTA6	Ceiling thickness adapter accommodates ceilings from 1 1/4" to 2" thick
Bar Hangers for TC963	
HB-1	Real Nail™ Bar hangers (set of 2)
HB-26	26" C-Channel bar hangers (set of 2)
HB-50	50" C-Channel bar hangers (set of 2)
LB-27	27" Linear bar hangers (set of 2)

5 5/8" Round Aperture PAR30/PAR38 Housings

Downlight and Wall Wash Series Provides high light level general and task illumination for 7' - 20' ceiling heights. Also accommodates lensed wall wash trims for even illumination of vertical surfaces without light scallops.

IC Rated with Real Nail™ Bar Hangers

AIR-LOC

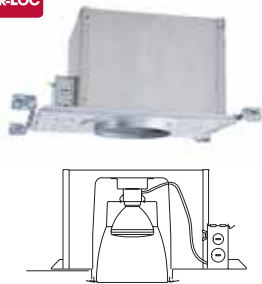

IC62
120V Line Voltage,
IC Housing.
Housing dimensions:
20 3/8" L x 10" W x 9 1/2" H
Ceiling cutout: 6 7/8"

Line Voltage Air-Loc® Rated, New Construction specification grade housing IC Rated for direct contact with insulation.

Patented telescoping Real Nail™ bar hangers have captive ring shank nails for a quick one-step installation. The quick-loc slots and oversized locking set screws securely hold fixture in any position without bar flexing.

75W PAR30 or 100W PAR38 Maximum Lamp Rating.

UL and C-UL listed for through-branch wiring and damp locations.

Non- IC Rated with Real Nail™ Bar Hangers

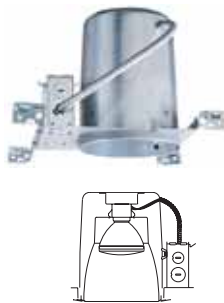

TC62
120V Line Voltage,
Non-IC Housing.
Housing dimensions:
13 1/2" L x 7 3/4" W x 8 3/4" H
Ceiling cutout: 6 7/8"

Line Voltage Non-IC specification grade New Construction Housing for use where insulation is spaced 3" away from fixture.

Patented telescoping Real Nail™ bar hangers have captive ring shank nails for a quick one-step installation. The quick-loc slots and oversized locking set screws securely hold fixture in any position without bar flexing.

75W PAR30 or 120W PAR38 Maximum Lamp Rating.

UL and C-UL listed for through-branch wiring and damp locations. Wet location listed with approved trims.

Downlight Trims

Deep Downlight Cone



Catalog #
627B-WH
627C-WH
627G-WH
627HZ-SC
627HZ-WH
627WHZ-ABZ
627WHZ-WH

Description
Black Alzak®, White Trim Ring
Clear Alzak®, White Trim Ring
Gold Alzak®, White Trim Ring,
Haze, Satin Chrome Trim Ring
Haze, White Trim Ring
Wheat Haze, Aged Bronze Trim Ring
Wheat Haze, White Trim Ring

Lamp Ratings
IC62: 75W PAR30, 100W PAR38
TC62: 75W PAR30, 120W PAR38
5 5/8" Aperture

Deep Downlight Baffle



Catalog #
624W-WH
624B-ABZ
624B-WH
624B-SC

Description
White Baffle, White Trim Ring
Black Baffle, Aged Bronze Trim Ring
Black Baffle, White Trim Ring
Black Baffle, Satin Chrome

Lamp Ratings
IC62: 75W PAR30, 100W PAR38
TC62: 75W PAR30, 120W PAR38
5 5/8" Aperture

Wall Wash Trim

Angle-Cut Lensed Wall Wash



Catalog #
629B-WH
629C-WH
629G-WH
629HZ-SC
629HZ-WH
629WHZ-ABZ
629WHZ-WH

Description
Black Alzak®, White Trim Ring
Clear Alzak®, White Trim Ring
Gold Alzak®, White Trim Ring
Haze, Satin Chrome Trim Ring
Haze, White Trim Ring
Wheat Haze, Aged Bronze Trim Ring
Wheat Haze, White Trim Ring

Lamp Ratings
IC62: 75W PAR30
TC62: 75W PAR38
5 5/8" Aperture



Decorative Trim

Opal Glass

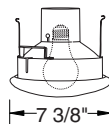

Catalog #
611-WH

Description
Swirled Etched Glass

Lamp Ratings
IC62: 100W A19
TC62: 100W A19





6" Aperture A-Lamp

Recessed downlight housings for general and wall wash illumination in low to medium ceiling heights. Provides diffuse, uniform illumination from economical incandescent A-lamps.

IC Rated with Real Nail™ Bar Hangers

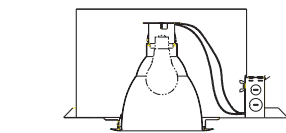

IC906

120V Line Voltage,
IC Housing.

Housing dimensions:
20 3/8" L x 10" W x 9 1/2" H
Ceiling cutout: 6 7/8"

Energy-efficient Air-Loc® Rated, IC Rated new construction specification grade housing for use in direct contact with insulation.

Patented telescoping Real Nail™ bar hangers have captive ring shank nails for a quick one-step installation. The quick-loc slots and oversized locking set screws securely hold fixture in any position without bar flexing.

Fixed socket position to maintain optical integrity independent of housing mounting.

100W A19/MB19/BT15 Maximum Lamp Rating.

UL and C-UL listed for through-branch wiring and damp locations.

Commercial Non- IC Rated with Butterfly Style Mounting Brackets

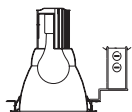

TC906

120V Line Voltage,
Non-IC Housing.

Housing dimensions:
11 3/4" L x 11 3/8" W x 9 1/8" H
Ceiling cutout: 6 7/8"

120V Line Voltage, Non-IC new construction specification grade housing for use where insulation is spaced 3" away from fixture.

Supplied with vertically adjustable mounting brackets that accept 1/2" conduit, "C" channel hangers (HB-26 or HB-50), linear bar hangers (LB-27) or telescoping Juno Real Nail™ bar hangers (HB-1).

Adjustable dual socket positions to accommodate A19 or A21 lamps

100W A19 or 150W A21 Maximum Lamp Rating.

UL and C-UL listed for through-branch wiring and damp locations.

Optional Bar Hangers for TC906

Catalog #	Description
HB-1	Real Nail bar hangers (set of 2)
HB-26	26" C-Channel bar hangers (set of 2)
HB-50	50" C-Channel bar hangers (set of 2)
LB-27	27" Linear bar hangers (set of 2)

Downlight Trim

Deep Downlight Cone



Catalog #
643C-WH
643G-WH
643HZ-WH

Description
Clear Alzak®, White Trim Ring
Gold Alzak®, White Trim Ring
Haze, White Trim Ring

Lamp Ratings
IC906: 100W A19, 100W MB19, 100W BT15
TC906: 100W A19, 150W A21
6" Aperture

Deep Downlight Baffle



Catalog #
633W-WH
633B-WH

Description
White Baffle, White Trim Ring
Black Baffle, White Trim Ring

Lamp Ratings
IC906: 100W A19, 100W MB19, 100W BT15
TC906: 100W A19, 150W A21
6" Aperture

Wall Wash Trim

90° Single Wall Wash



Catalog #
662C-WH
662G-WH
662HZ-WH

Description
Clear Alzak®, White Trim Ring
Gold Alzak®, White Trim Ring
Haze, White Trim Ring

Lamp Ratings
IC906: 100W A19, 100W MB19, 100W BT15
TC906: 100W A19, 150W A21
6" Aperture

180° Double Wall Wash



Catalog #
663C-WH
663G-WH
663HZ-WH

Description
Clear Alzak®, White Trim Ring
Gold Alzak®, White Trim Ring
Haze, White Trim Ring

Lamp Ratings
IC906: 100W A19, 100W MB19, 100W BT15
TC906: 100W A19, 150W A21
6" Aperture

180° Corner Wall Wash



Catalog #
644C-WH
644G-WH
643HZ-WH

Description
Clear Alzak®, White Trim Ring
Gold Alzak®, White Trim Ring
Haze, White Trim Ring

Lamp Ratings
IC906: 100W A19, 100W MB19, 100W BT15
TC906: 100W A19, 150W A21
6" Aperture



6" Aperture 26/32W Compact Fluorescent

Downlight/Wall Wash Series Recessed downlight housings for general and wall wash illumination in low to medium ceiling heights. Provides diffuse, uniform illumination from energy-efficient compact fluorescent lamps. Premium, low-iridescent reflectors eliminate the "rainbow" color separation effect that occurs with fluorescent lamps and standard grade reflectors,

IC Rated with Real Nail™ Bar Hangers

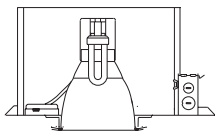

ICV6-126/32T
26W/32W Compact Fluorescent,
120V/277V IC new construction
specification grade housing
Housing dimensions:
20 3/8" L x 10" W x 9 1/2" H
Ceiling cutout: 6 7/8"

ICV6-126/32T-DB120
120V HPF Dimmable Ballast*

Energy-efficient Air-Loc® Rated, IC Rated new construction specification grade housing for use in direct contact with insulation.

120V/277 HPF Electronic Non-Dimmable or 120V Dimmable* Ballast with end-of-life lamp protection.

Patented telescoping Real Nail™ bar hangers have captive ring shank nails for a quick one-step installation. The quick-loc slots and oversized locking set screws securely hold fixture in any position without bar flexing.

26W or 32W Triple Tube CFL lamp, 4-pin.

UL and C-UL listed for through-branch wiring and damp locations. Wet location listed with approved trim.

Commercial Non- IC Rated with Butterfly Style Mounting Brackets

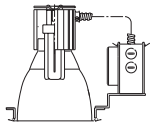

CV6-126/32T
26W/32W Compact Fluorescent,
120V to 277V Non-IC
new construction specification
grade housing
Housing dimensions:
11 3/4" L x 11 3/8" W x 9 1/8" H
Ceiling cutout: 6 7/8"

CV6-126/32T-DB120
120V HPF Dimmable Ballast
CV6-126/32T-DB277
277V HPF Dimmable Ballast

Non-IC Rated new construction specification grade housing for use where insulation is spaced 3" away from fixture.

120V to 277V HPF Electronic Non-Dimmable or Dimmable Ballast with end-of-life lamp protection. Consult factory for 347V.

Supplied with vertically adjustable mounting brackets that accept 1/2" conduit, "C" channel hangers (HB-26 or HB-50), linear bar hangers (LB-27) or telescoping Juno Real Nail™ bar hangers (HB-1).

26W or 32W Triple Tube CFL lamp, 4-pin.

UL and C-UL listed for through-branch wiring and damp locations. Wet location listed with approved trim.

Optional Bar Hangers for CV6-126/32T

Catalog #	Description
HB-1	Real Nail bar hangers (set of 2)
HB-26	26" C-Channel bar hangers (set of 2)
HB-50	50" C-Channel bar hangers (set of 2)
LB-27	27" Linear bar hangers (set of 2)
PLK-E	13-42W Emergency Power Kit

* Dimming ballast is not Energy Star rated.

Downlight

Deep Downlight Cone

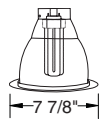

Catalog #
600C-WH
600G-WH
600HZ-WH
600WHZ-WH

Description
Clear Alzak®, White Trim Ring
Gold Alzak®, White Trim Ring
Haze, White Trim Ring
Wheat Haze, White Trim Ring

Lamp Ratings
ICV6 Series: 26W/32W Triple Tube CFL
CV6 Series: 26W/32W Triple Tube CFL
6" Aperture

Deep Downlight Baffle

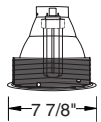

Catalog #
601W-WH
601B-WH

Description
White Baffle, White Trim Ring
Black Baffle, White Trim Ring

Lamp Ratings
ICV6 Series: 26W/32W Triple Tube CFL
CV6 Series: 26W/32W Triple Tube CFL
6" Aperture

Wall Wash

90° Single Wall Wash

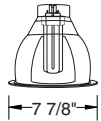

Catalog #
600C-WWS-WH
600G-WWS-WH
600HZ-WWS-WH

Description
Clear Alzak®, White Trim Ring
Gold Alzak®, White Trim Ring
Haze, White Trim Ring

Lamp Ratings
ICV6 Series: 26W/32W Triple Tube CFL
CV6 Series: 26W/32W Triple Tube CFL
6" Aperture

180° Double Wall Wash

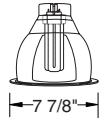

Catalog #
600C-WWD-WH
600G-WWD-WH
600HZ-WWD-WH

Description
Clear Alzak®, White Trim Ring
Gold Alzak®, White Trim Ring
Haze, White Trim Ring

Lamp Ratings
ICV6 Series: 26W/32W Triple Tube CFL
CV6 Series: 26W/32W Triple Tube CFL
6" Aperture

180° Corner Wall Wash

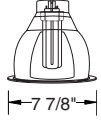

Catalog #
600C-WWC-WH
600G-WWC-WH
600HZ-WWC-WH

Description
Clear Alzak®, White Trim Ring
Gold Alzak®, White Trim Ring
Haze, White Trim Ring

Lamp Ratings
ICV6 Series: 26W/32W Triple Tube CFL
CV6 Series: 26W/32W Triple Tube CFL
6" Aperture

Decorative Trim

Swirled Etched Opal Glass

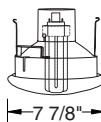

Catalog #
611-WH

Description
Swirled Etched Glass

Lamp Ratings
ICV6 Series: 26W/32W Triple Tube CFL
CV6 Series: 26W/32W Triple Tube CFL
6" Aperture



7" Aperture PAR38

Recessed 0-45° adjustable housing for accent, task or downlighting from high flat or sloped ceiling mounting heights. 120V PAR38 halogen lamp produces spot or flood patterns for medium to high light levels. Features industry exclusive 45° adjustment and 361° rotation.

IC Rated with Real Nail™ Bar Hangers

AIR-LOC

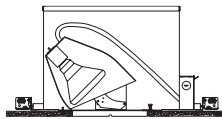

IC73

120V Line Voltage,
IC Housing

Housing dimensions:

21 1/2" L x 13 15/16" W x 11 5/8" H

Ceiling cutout: 8 1/2"

Energy-efficient Air-Loc® Rated, IC Rated new construction specification grade housing for use in direct contact with insulation.

Tool-less Locking, 361° rotation and exclusive 45° tilt.

Patented telescoping Real Nail™ bar hangers have captive ring shank nails for a quick one-step installation. The quick-loc slots and oversized locking set screws securely hold fixture in any position without bar flexing.

100W - 120W PAR38/BR40 Maximum Lamp Rating.

UL and C-UL listed for through-branch wiring and damp locations.

Commercial Non- IC Rated with Butterfly Style Mounting Brackets

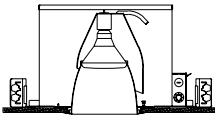

TC973

120V Line Voltage,
Non-IC Housing

Housing dimensions:

21 9/16" L x 13 15/16" W x 11 5/8" H

Ceiling cutout: 8 1/2"

120V Line Voltage, Non-IC new construction specification grade housing for use where insulation is spaced 3" away from fixture.

Supplied with vertically adjustable mounting brackets that accept 1/2" conduit, "C" channel hangers (HB-26 or HB-50), linear bar hangers (LB-27) or telescoping Juno Real Nail™ bar hangers (HB-1).

250W PAR38 and 120W BR40 Maximum Lamp Rating.

UL and C-UL listed for through-branch wiring and damp locations.

Adjustable Accent Trims

Angle-Cut Cone



Catalog

738B-WH
738C-WH
738G-WH
738HZ-ABZ
738WHZ-WH

Description

Black Alzak®, White Trim Ring
Clear Alzak®, White Trim Ring
Gold Alzak®, White Trim Ring
Haze, Aged Bronze Trim Ring
Wheat Haze, White Trim Ring

Lamp Ratings

IC73: 100W PAR38
TC973: 250W PAR38
7" Aperture

Downlight Trim

Deep Downlight Cone

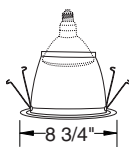

Catalog

727B-WH
727C-WH
727G-WH
727HZ-WH
727WHZ-WH

Description

Black Alzak®, White Trim Ring
Clear Alzak®, White Trim Ring
Gold Alzak®, White Trim Ring
Haze, White Trim Ring
Wheat Haze, White Trim Ring

Lamp Ratings

IC73: 120W PAR38, 120W BR40
TC973: 250W PAR38, 120W BR40
7" Aperture

Optional Bar Hangers for TC973

Catalog

HB-1
HB-26
HB-50
LB-27

Description

Real Nail bar hangers (set of 2)
26" C-Channel bar hangers (set of 2)
50" C-Channel bar hangers (set of 2)
27" Linear bar hangers (set of 2)

MR16 Framing Projector Housings

Aculux framing projector produces an adjustable rectangular light pattern to dramatically "frame" art with light. Choose the slot trim for framing art on vertical surfaces or pinhole trim for framed downlighting.

Non-IC Rated with Real Nail™ Bar Hangers



TC960

120V Magnetic, thermally protected low voltage transformer

Housing dimensions:

20 3/8" L x 11 1/2" W x 9 1/4" H

Ceiling cutout: 8 1/8"

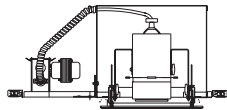

Low Voltage, Non-IC Rated new construction housing for use where insulation is spaced 3" away from fixture.

Tool-less locking, 0° to 45° vertical tilt and 358° horizontal rotation

Four independently operated shutters for precise framing.

Patented telescoping Real Nail™ bar hangers have captive ring shank nails for a quick one-step installation. The quick-loc slots and oversized locking set screws securely hold fixture in any position without bar flexing. Fixture is also supplied with vertically adjustable mounting brackets that accept 1/2" conduit, "C" channel hangers (HB-26 or HB-50), linear bar hangers (LB-27) or telescoping Juno Real Nail™ bar hangers (HB-1).

75W MR16 Maximum Lamp Rating. Lamp holder accepts two optical media.



Adjustable Framing Projector Trims

Slot Pinhole Trim (For wall illumination)



Catalog #
245-WH

Description
White Trim

Lamp Ratings
75W MR16 Flood (EYC)
O.D: 9 3/8"

Downlight Pinhole (For downlight illumination)



Catalog #
246-WH

Description
White Trim

Lamp Ratings
75W MR16 Flood (EYC)
Aperture: 2 3/4"
O.D: 9 3/8"

Optional Mounting Accessory

Catalog #	Description
HB-1	Real Nail bar hangers (set of 2)
HB-26	26" C-Channel bar hangers (set of 2)
HB-50	50" C-Channel bar hangers (set of 2)
LB-27	27" Linear bar hangers (set of 2)

Optical Accessories

The complete range of optical accessories offered with the 3 1/4" and 5 5/8" Aculux luminaires allows the lighting designer to customize any visual effect. Each 3 1/4" MR16 Halogen fixture is supplied with a soft-focus uniformity lens and accepts up to (3) optical accessories. 3 1/4" LED and CMH, and 5 5/8" PAR36/AR111 luminaires accepts (2) optical accessories.



UV Filters



These museum quality lenses filter out ultraviolet radiation below 400 nanometers to protect fade sensitive art and objects.

Dichroic Color Correction Filters



Color Correction Filters correct the light, either to warm it up to approximate incandescent, or cool it down to approximate daylight.

Color Filters



Color Filters change white light into colored light and are available in colored glass and more efficient/saturated dichroic filters.

Light Control Lenses



These alter the light distribution of a given lamp, enlarging or elongating it, softening the beam edge or removing striations.

Louver



Hexcell and Cube Cell louvers reduce perceived fixture brightness.

	2" DIA. For use with 3 1/4" Luminaires	4 11/16" DIA. For use with 5 5/8" PAR36/AR111 Luminaires
UV Filters	T7422	T5722
Dichroic Color Correction Filters	Halogen-to-Incandescent, 2700K	T7418 T5718
	Halogen-to-Daylight, 4250K	T7416
	HID-to-Incandescent for HID Lampholders	T7419 T5719
Color Filters	Colored Glass Filters	
	Medium Pink	T741 T571
	Warm Red	T742 T572
	Daylight Blue	T743 T573
	Medium Blue	T744 T574
	Medium Amber	T745 T575
	Medium Green	T746 T576
	Dichroic Glass Filters	
	Red	T7401
	Medium Green	T7403
	Medium Blue	T7404
	Yellow	T7405
	Magenta	T7406
Blue-Green (Cyan)	T7411	
Light Control Lenses	Uniformity Lens	T7421 T5721
	Diffusion Lens	T7420
	Prismatic Spread Lens	T7477 T5777
	Linear Spread Lens	T7478 T5778
Louver	Hexcell Louver	T7459BL
	Cubed Cell Louver	T579BL

Photometrics - Rounds and Squares

Accent Lighting - Accent lighting creates high contrast on objects of interest such as sculpture, paintings, collectibles and architectural details. For noticeable visual impact, accent lighting should be at least 3 times as bright as a surrounding area. More dramatic accent lighting requires contrast ratios of 5:1 or greater.

Accent lighting of flat artwork

Flat art is ideally illuminated by a source striking its surface at a 30° angle. This eliminates veiling reflection (glare) from bouncing into a viewer's eye, and prevents the casting of a shadow of the viewer onto the artwork. To determine the correct distance from the wall you can use the below listed formula or quick reference chart.

Formula to calculate luminaire distance from the wall for a 30° aiming angle where H = Distance from the ceiling to the aiming point and D = Distance from the wall to the center of the luminaire. (The aiming point is generally selected at 1/3 down from the top of the picture or object.)

$$D = H \times .5774$$

Example: $D = 4.5' \times .5774 = 2.6'$ or approximately 2'-6"

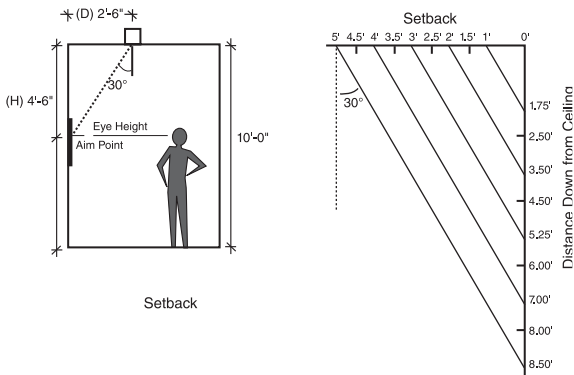

Accent lighting of three dimensional objects

"Key and fill" is an effective technique for accentuating the three-dimensional character of an object. This technique entails the use of key and fill lighting from two sides of the object. Key lighting is a hard accent light used to create shadows and to highlight an object's form and texture. Fill light is a softer light thrown from the opposite side of the object to soften the shadows, making the object appear more natural. Other techniques can also be applied to further accentuate the unique character of an object, such as silhouetting an object from behind.

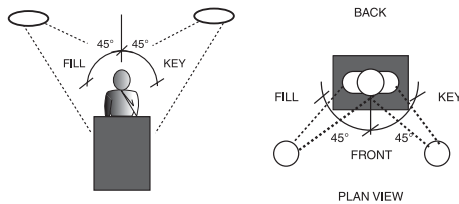

Accent Lighting Fixture/Lamp Choices

12-volt MR16 Adjustables are the fixture of choice for accent lighting due to their small aperture, wide variety of precisely controlled, intense beam spreads, and available range of light control and color correction accessories.

AR111 and PAR36 Adjustable are most useful for longer throw distances, up to 30', where tightly controlled pinspots of light are required.

PAR lamp Adjustables provide less costly accent lighting and are well suited for illuminating larger objects or areas such as fireplaces, coffee tables, large art or murals, potted trees, etc.

INDEX

Round Downlights	60
3 1/4" MR16	60
3 1/4" PAR	61-62
3 1/4" CMH MR16	62
5 5/8" PAR	63
6" A-Lamp	63-64
6" CFL	64
7" PAR	64
Round Wall Wash	65
3 1/4" MR16	65
3 1/4" PAR	66
3 1/4" CMH MR16	66
5 5/8" PAR	67
6" A-Lamp	67
6" CFL	68
Round Lensed Downlight	69
3 1/4" MR16	69
3 1/4" PAR	69
3 1/4" CMH MR16	69
Round Adjustables	70
3 1/4" MR16	70-71
3 1/4" PAR	72
3 1/4" CMH MR16	73
5 5/8" AR111/PAR36	74-75
5 5/8" PAR	76
7" PAR	77
Square Downlights	78
3 1/4" MR16	78
3 1/4" PAR	79
3 1/4" CMH MR16	79
Square Wall Wash	80
3 1/4" MR16	80
3 1/4" PAR	81
3 1/4" CMH MR16	81
Square Lensed Downlight	82
3 1/4" MR16	82
3 1/4" PAR	83
3 1/4" CMH MR16	83
Square Adjustables	84
3 1/4" MR16	84-85
3 1/4" PAR	86
3 1/4" CMH MR16	87

Photometrics - Round Downlights

3-1/4" MR16 Halogen

Reflectors

IC43N-437NC, Clear Specular

37W IR MR16 35° Flood

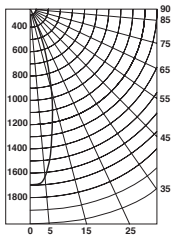

Candlepower Distribution (Candelas)

Angle	Candela	Lumens
0°	1699	
5°	1649	157
15°	957	271
25°	232	107
35°	28	18
45°	0	0
55°	0	0
65°	0	0
75°	0	0
85°	0	0

Initial Footcandles

Distance to Illuminated Plane (Feet)	Footcandles Beam Center	Footcandles Beam Edge	Beam Diameter
6'	47.2	20.8	3.6'
7'	34.7	15.3	4.2'
8'	26.5	11.7	4.7'
9'	21.0	9.3	5.3'
10'	17.0	7.5	5.9'
11'	14.0	6.2	6.5'
12'	11.8	5.2	7.1'
13'	10.1	4.4	7.7'
14'	8.7	3.8	8.3'
15'	7.6	3.3	8.9'

50W IR MR16 35° Flood

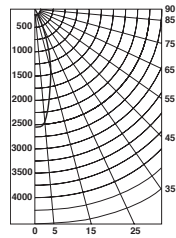

Candlepower Distribution (Candelas)

Angle	Candela	Lumens
0°	2541	
5°	2466	235
15°	1392	395
25°	390	181
35°	44	27
45°	3	2
55°	0	0
65°	0	0
75°	0	0
85°	0	0

Initial Footcandles

Distance to Illuminated Plane (Feet)	Footcandles Beam Center	Footcandles Beam Edge	Beam Diameter
6'	70.6	31.2	3.5'
7'	51.9	23.0	4.1'
8'	39.7	17.6	4.7'
9'	31.4	13.9	5.3'
10'	25.4	11.2	5.8'
11'	21.0	9.3	6.4'
12'	17.6	7.8	7.0'
13'	15.0	6.7	7.6'
14'	13.0	5.7	8.2'
15'	11.3	5.0	8.8'

50W MR16 40° Flood

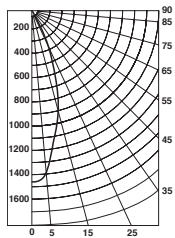

Candlepower Distribution (Candelas)

Angle	Candela	Lumens
0°	1475	
5°	1410	135
15°	891	253
25°	346	160
35°	54	34
45°	4	3
55°	0	0
65°	0	0
75°	0	0
85°	0	0

Initial Footcandles

Distance to Illuminated Plane (Feet)	Footcandles Beam Center	Footcandles Beam Edge	Beam Diameter
6'	41.0	17.6	3.9'
7'	30.1	12.9	4.6'
8'	23.0	9.9	5.2'
9'	18.2	7.8	5.9'
10'	14.7	6.3	6.6'
11'	12.2	5.2	7.2'
12'	10.2	4.4	7.9'
13'	8.7	3.8	8.5'
14'	7.5	3.2	9.2'
15'	6.6	2.8	9.8'

75W MR16 40° Flood

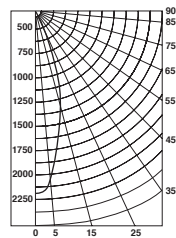

Candlepower Distribution (Candelas)

Angle	Candela	Lumens
0°	2214	
5°	2110	201
15°	1311	372
25°	496	230
35°	66	41
45°	6	5
55°	0	0
65°	0	0
75°	0	0
85°	0	0

Initial Footcandles

Distance to Illuminated Plane (Feet)	Footcandles Beam Center	Footcandles Beam Edge	Beam Diameter
6'	61.5	26.4	3.9'
7'	45.2	19.4	4.6'
8'	34.6	14.9	5.2'
9'	27.3	11.7	5.9'
10'	22.1	9.5	6.5'
11'	18.3	7.9	7.2'
12'	15.4	6.6	7.8'
13'	13.1	5.6	8.5'
14'	11.3	4.9	9.2'
15'	9.8	4.2	9.8'

Baffle

IC43N-434N

Black Baffle 37W IR MR16 35° Flood

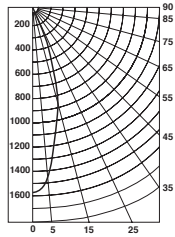

Candlepower Distribution (Candelas)

Angle	Candela	Lumens
0°	1552	
5°	1432	137
15°	852	241
25°	218	101
35°	28	17
45°	0	0
55°	0	0
65°	0	0
75°	0	0
85°	0	0

Initial Footcandles

Distance to Illuminated Plane (Feet)	Footcandles Beam Center	Footcandles Beam Edge	Beam Diameter
6'	43.1	19.0	3.5'
7'	31.7	14.0	4.1'
8'	24.3	10.7	4.7'
9'	19.2	8.5	5.3'
10'	15.5	6.9	5.9'
11'	12.8	5.7	6.5'
12'	10.8	4.8	7.0'
13'	9.2	4.1	7.6'
14'	7.9	3.5	8.2'
15'	6.9	3.0	8.8'

TC43N-434N

White Baffle 50W IR MR16 35° Flood

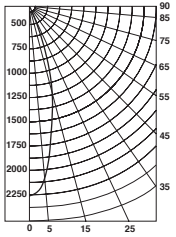

Candlepower Distribution (Candelas)

Angle	Candela	Lumens
0°	2257	
5°	2116	202
15°	1242	352
25°	398	184
35°	55	34
45°	14	11
55°	10	9
65°	6	6
75°	4	4
85°	0	0

Initial Footcandles

Distance to Illuminated Plane (Feet)	Footcandles Beam Center	Footcandles Beam Edge	Beam Diameter
6'	62.7	27.6	3.6'
7'	46.1	20.3	4.2'
8'	35.3	15.5	4.8'
9'	27.9	12.3	5.4'
10'	22.6	9.9	6.0'
11'	18.7	8.2	6.5'
12'	15.7	6.9	7.1'
13'	13.4	5.9	7.7'
14'	11.5	5.1	8.3'
15'	10.0	4.4	8.9'

White Baffle 50W MR16 40° Flood

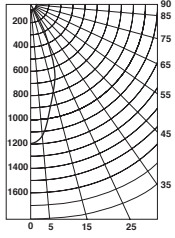

Candlepower Distribution (Candelas)

Angle	Candela	Lumens
0°	1198	
5°	1142	109
15°	774	219
25°	367	170
35°	59	37
45°	11	9
55°	6	6
65°	4	4
75°	3	3
85°	0	0

Initial Footcandles

Distance to Illuminated Plane (Feet)	Footcandles Beam Center	Footcandles Beam Edge	Beam Diameter
6'	33.3	13.8	4.4'
7'	24.4	10.1	5.1'
8'	18.7	7.7	5.9'
9'	14.8	6.1	6.6'
10'	12.0	5.0	7.3'
11'	9.9	4.1	8.1'
12'	8.3	3.4	8.8'
13'	7.1	2.9	9.5'
14'	6.1	2.5	10.3'
15'	5.3	2.2	11.0'

Black Baffle 75W MR16 40° Flood

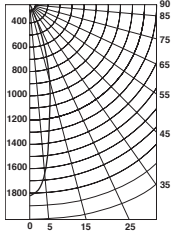

Candlepower Distribution (Candelas)

Angle	Candela	Lumens
0°	1801	
5°	1730	165
15°	1189	337
25°	482	223
35°	62	39
45°	6	4
55°	0	0
65°	0	0
75°	0	0
85°	0	0

Initial Footcandles

Distance to Illuminated Plane (Feet)	Footcandles Beam Center	Footcandles Beam Edge	Beam Diameter
6'	50.0	20.7	4.4'
7'	36.8	15.2	5.1'
8'	28.1	11.7	5.8'
9'	22.2	9.2	6.6'
10'	18.0	7.5	7.3'
11'	14.9	6.2	8.0'
12'	12.5	5.2	8.7'
13'	10.7	4.4	9.5'
14'	9.2	3.8	10.2'
15'	8.0	3.3	10.9'

3-1/4" MR16 Halogen

Flat Pinhole

IC43N-4337N-WH, Black Alzak® Reflector

TC43N-4337N-WH, Black Alzak® Reflector

37W IR MR16 10° Spot

Candlepower Distribution (Candelas)

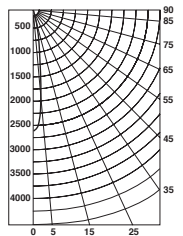

Angle	Candela	Lumens
0°	7581	
5°	2011	192
15°	376	107
25°	15	7
35°	0	0
45°	0	0
55°	0	0
65°	0	0
75°	0	0
85°	0	0

Initial Footcandles

Distance to Illuminated Plane (Feet)	Footcandles Beam Center	Footcandles Beam Edge	Beam Diameter
6'	71.7	34.9	1.6'
7'	52.7	25.7	1.9'
8'	40.3	19.6	2.1'
9'	31.9	15.5	2.4'
10'	25.8	12.6	2.7'
11'	21.3	10.4	2.9'
12'	17.9	8.7	3.2'
13'	15.3	7.4	3.5'
14'	13.2	6.4	3.7'
15'	11.5	5.6	4.0'

50W IR MR16 10° Spot

Candlepower Distribution (Candelas)

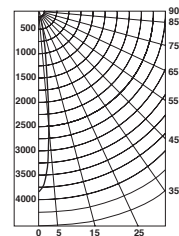

Angle	Candela	Lumens
0°	3831	
5°	2647	253
15°	381	108
25°	18	8
35°	0	0
45°	0	0
55°	0	0
65°	0	0
75°	0	0
85°	0	0

Initial Footcandles

Distance to Illuminated Plane (Feet)	Footcandles Beam Center	Footcandles Beam Edge	Beam Diameter
6'	106.4	52.2	1.4'
7'	78.2	38.3	1.6'
8'	59.9	29.3	1.8'
9'	47.3	23.2	2.1'
10'	38.3	18.8	2.3'
11'	31.7	15.5	2.5'
12'	26.6	13.0	2.8'
13'	22.7	11.1	3.0'
14'	19.5	9.6	3.2'
15'	17.0	8.3	3.4'

50W MR16 15° Narrow Spot

Candlepower Distribution (Candelas)

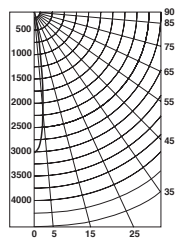

Angle	Candela	Lumens
0°	3004	
5°	2151	205
15°	200	57
25°	17	8
35°	0	0
45°	0	0
55°	0	0
65°	0	0
75°	0	0
85°	0	0

Initial Footcandles

Distance to Illuminated Plane (Feet)	Footcandles Beam Center	Footcandles Beam Edge	Beam Diameter
6'	83.4	40.9	1.4'
7'	61.3	30.0	1.6'
8'	46.9	23.0	1.9'
9'	37.1	18.2	2.1'
10'	30.0	14.7	2.3'
11'	24.8	12.2	2.6'
12'	20.9	10.2	2.8'
13'	17.8	8.7	3.0'
14'	15.3	7.5	3.3'
15'	13.3	6.5	3.5'

75W MR16 15° Narrow Spot

Candlepower Distribution (Candelas)

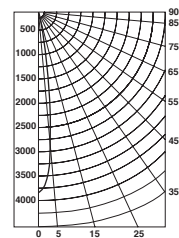

Angle	Candela	Lumens
0°	3852	
5°	2888	276
15°	311	88
25°	23	11
35°	0	0
45°	0	0
55°	0	0
65°	0	0
75°	0	0
85°	0	0

Initial Footcandles

Distance to Illuminated Plane (Feet)	Footcandles Beam Center	Footcandles Beam Edge	Beam Diameter
6'	107.0	52.3	1.5'
7'	78.6	38.4	1.7'
8'	60.2	29.4	2.0'
9'	47.6	23.2	2.2'
10'	38.5	18.8	2.5'
11'	31.8	15.6	2.7'
12'	26.8	13.1	3.0'
13'	22.8	11.1	3.2'
14'	19.7	9.6	3.5'
15'	17.1	8.4	3.7'

3-1/4" PAR

Reflector

IC13N-437NC, Clear Specular

TC13N-437NC, Clear Specular

60W PAR16 30° Narrow Flood

Candlepower Distribution (Candelas)

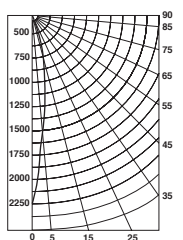

Angle	Candela	Lumens
0°	2249	
5°	1536	147
15°	722	205
25°	227	105
35°	13	8
45°	0	0
55°	0	0
65°	0	0
75°	0	0
85°	0	0

Initial Footcandles

Distance to Illuminated Plane (Feet)	Footcandles Beam Center	Footcandles Beam Edge	Beam Diameter
6'	62.5	29.9	2.1'
7'	45.9	22.0	2.4'
8'	35.1	16.8	2.7'
9'	27.8	13.3	3.1'
10'	22.5	10.8	3.4'
11'	18.6	8.9	3.8'
12'	15.6	7.5	4.1'
13'	13.3	6.4	4.5'
14'	11.5	5.5	4.8'
15'	10.0	4.8	5.2'

75W PAR16 30° Narrow Flood

Candlepower Distribution (Candelas)

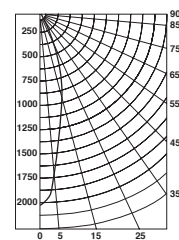

Angle	Candela	Lumens
0°	2024	
5°	1744	166
15°	930	264
25°	352	163
35°	23	15
45°	0	0
55°	0	0
65°	0	0
75°	0	0
85°	0	0

Initial Footcandles

Distance to Illuminated Plane (Feet)	Footcandles Beam Center	Footcandles Beam Edge	Beam Diameter
6'	56.2	25.8	2.9'
7'	41.3	19.0	3.4'
8'	31.6	14.5	3.9'
9'	25.0	11.5	4.3'
10'	20.2	9.3	4.8'
11'	16.7	7.7	5.3'
12'	14.1	6.5	5.8'
13'	12.0	5.5	6.3'
14'	10.3	4.7	6.8'
15'	9.0	4.1	7.2'

Photometrics - Round Downlights (cont.)

3-1/4" PAR (cont.)

Baffle

IC13N-434NW, White Baffle

60W PAR16 30° Narrow Flood

Candlepower Distribution

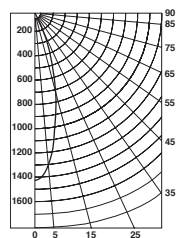

Angle (Candelas)	Candela	Lumens
0°	1437	
5°	1324	126
15°	725	205
25°	222	103
35°	21	13
45°	8	6
55°	6	5
65°	4	4
75°	3	3
85°	0	0

Initial Footcandles

Distance to Illuminated Plane (Feet)	Footcandles Beam Center	Footcandles Beam Edge	Beam Diameter
6'	39.9	18.0	3.2'
7'	29.3	13.2	3.8'
8'	22.4	10.1	4.3'
9'	17.7	8.0	4.9'
10'	14.4	6.5	5.4'
11'	11.9	5.3	5.9'
12'	10.0	4.5	6.5'
13'	8.5	3.8	7.0'
14'	7.3	3.3	7.6'
15'	6.4	2.9	8.1'

TC13N-434NW, White Baffle

75W PAR16 30° Narrow Flood

Candlepower Distribution

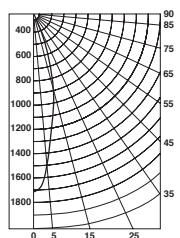

Angle (Candelas)	Candela	Lumens
0°	1702	
5°	1582	151
15°	889	252
25°	348	161
35°	43	27
45°	11	8
55°	9	8
65°	6	6
75°	4	4
85°	0	0

Initial Footcandles

Distance to Illuminated Plane (Feet)	Footcandles Beam Center	Footcandles Beam Edge	Beam Diameter
6'	47.3	21.1	3.4'
7'	34.7	15.5	3.9'
8'	26.6	11.9	4.5'
9'	21.0	9.4	5.0'
10'	17.0	7.6	5.6'
11'	14.1	6.3	6.2'
12'	11.8	5.3	6.7'
13'	10.1	4.5	7.3'
14'	8.7	3.9	7.9'
15'	7.6	3.4	8.4'

Regressed Pinhole

IC13N-4307N, Black Alzak® Reflector

60W PAR16 10° Narrow Spot

Candlepower Distribution

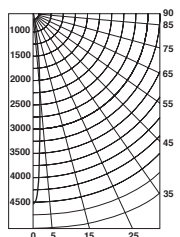

Angle (Candelas)	Candela	Lumens
0°	4538	
5°	2115	202
15°	445	126
25°	66	30
35°	4	2
45°	0	0
55°	0	0
65°	0	0
75°	0	0
85°	0	0

Initial Footcandles

Distance to Illuminated Plane (Feet)	Footcandles Beam Center	Footcandles Beam Edge	Beam Diameter
6'	126.0	62.4	1.0'
7'	92.6	45.8	1.2'
8'	70.9	35.1	1.3'
9'	56.0	27.7	1.5'
10'	45.4	22.5	1.7'
11'	37.5	18.6	1.8'
12'	31.5	15.6	2.0'
13'	26.8	13.3	2.2'
14'	23.2	11.5	2.3'
15'	20.2	10.0	2.5'

TC13N-4307N, Black Alzak® Reflector

75W PAR16 10° Narrow Spot

Candlepower Distribution

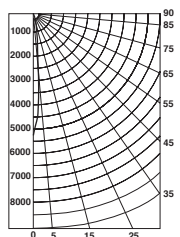

Angle (Candelas)	Candela	Lumens
0°	5200	
5°	2943	281
15°	660	187
25°	215	100
35°	7	4
45°	0	0
55°	0	0
65°	0	0
75°	0	0
85°	0	0

Initial Footcandles

Distance to Illuminated Plane (Feet)	Footcandles Beam Center	Footcandles Beam Edge	Beam Diameter
6'	144.5	71.2	1.2'
7'	106.1	52.3	1.3'
8'	81.3	40.1	1.5'
9'	64.2	31.7	1.7'
10'	52.0	25.6	1.9'
11'	43.0	21.2	2.1'
12'	36.1	17.8	2.3'
13'	30.8	15.2	2.5'
14'	26.5	13.1	2.7'
15'	23.1	11.4	2.9'

3-1/4" CMH MR16

Reflector

TC943M-MR16-39E1-437NC, Clear Specular

CMH MR16 39W 25° Flood

Candlepower Distribution

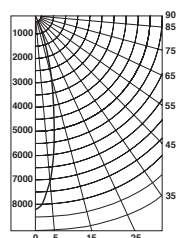

Angle (Candelas)	Candela	Lumens
0°	8243	
5°	7122	680
15°	2768	785
25°	522	242
35°	129	81
45°	18	14
55°	0	0
65°	0	0
75°	0	0
85°	0	0

Initial Footcandles

Distance to Illuminated Plane (Feet)	Footcandles Beam Center	Footcandles Beam Edge	Beam Diameter
6'	229.0	107.6	2.5'
7'	168.2	79.1	2.9'
8'	128.8	60.5	3.3'
9'	101.8	47.8	3.7'
10'	82.4	38.7	4.1'
11'	68.1	32.0	4.5'
12'	57.2	26.9	4.9'
13'	48.8	22.9	5.3'
14'	42.1	19.8	5.7'
15'	36.6	17.2	6.2'

Flat Pinhole

TC943M-MR16-39E1-4337N, Black Alzak® Reflector

CMH MR16 39W 12° Spot

Candlepower Distribution

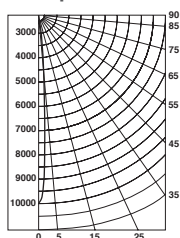

Angle (Candelas)	Candela	Lumens
0°	9981	
5°	4677	446
15°	639	181
25°	74	34
35°	0	0
45°	0	0
55°	0	0
65°	0	0
75°	0	0
85°	0	0

Initial Footcandles

Distance to Illuminated Plane (Feet)	Footcandles Beam Center	Footcandles Beam Edge	Beam Diameter
6'	277.3	137.2	1.0'
7'	203.7	100.8	1.2'
8'	156.0	77.2	1.3'
9'	123.2	61.0	1.5'
10'	99.8	49.4	1.7'
11'	82.5	40.8	1.8'
12'	69.3	34.3	2.0'
13'	59.1	29.2	2.2'
14'	50.9	25.2	2.3'
15'	44.4	22.0	2.5'

5-5/8" PAR

Reflector

IC62-627C, Clear Specular

75W PAR30 35° Flood

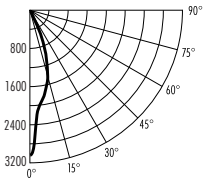

Candlepower Distribution (Candelas)

Angle	Average
0°	3169
5°	2173
15°	1573
25°	559
35°	95
45°	21
55°	0
65°	0
75°	0
85°	0

Initial Footcandles

Distance to Illuminated Plane (Feet)	Footcandles Beam Center	Footcandles Beam Edge	Beam Diameter
6'	88.0	39.8	3.2'
8'	49.5	22.4	4.2'
10'	31.7	14.3	5.3'
12'	22.0	9.9	6.4'
14'	16.2	7.3	7.4'
16'	12.4	5.6	8.5'
18'	9.8	4.4	9.5'
20'	7.9	3.9	10.6'

120W PAR38 30° Flood

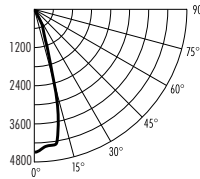

Candlepower Distribution (Candelas)

Angle	Average
0°	4433
5°	4315
15°	2145
25°	579
35°	377
45°	242
55°	48
65°	14
75°	0
85°	0

Initial Footcandles

Distance to Illuminated Plane (Feet)	Footcandles Beam Center	Footcandles Beam Edge	Beam Diameter
6'	123.1	55.6	3.2'
8'	69.3	31.3	4.2'
10'	44.3	20.0	5.3'
12'	30.8	13.9	6.4'
14'	22.6	10.2	7.4'
16'	17.3	7.8	8.5'
18'	13.7	6.2	9.5'
20'	11.1	5.0	10.6'

Baffle

IC62-624B, Black Baffle

75W PAR30 35° Flood

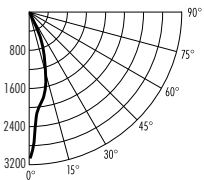

Candlepower Distribution (Candelas)

Angle	Average
0°	3105
5°	2171
15°	1446
25°	305
35°	33
45°	4
55°	0
65°	0
75°	0
85°	0

Initial Footcandles

Distance to Illuminated Plane (Feet)	Footcandles Beam Center	Footcandles Beam Edge	Beam Diameter
6'	8.63	39.4	3.0'
8'	48.5	22.2	4.0'
10'	31.1	14.2	5.0'
12'	21.6	9.9	6.0'
14'	15.8	7.2	7.0'
16'	12.1	5.5	8.0'
18'	9.6	4.4	9.0'
20'	7.8	3.5	9.9'

120W PAR38 30° Flood

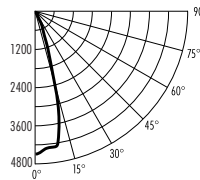

Candlepower Distribution (Candelas)

Angle	Average
0°	4452
5°	4314
15°	2132
25°	524
35°	203
45°	62
55°	10
65°	3
75°	0
85°	0

Initial Footcandles

Distance to Illuminated Plane (Feet)	Footcandles Beam Center	Footcandles Beam Edge	Beam Diameter
6'	123.7	55.9	3.2'
8'	69.6	31.4	4.2'
10'	44.5	20.1	5.3'
12'	30.9	14.0	6.3'
14'	22.7	10.3	7.4'
16'	17.4	7.9	8.4'
18'	13.7	6.2	9.5'
20'	11.1	5.0	10.5'

6" A-Lamps

Reflector

IC906-643C, Clear Specular

100W A19

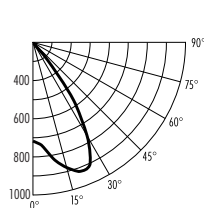

Candlepower Distribution (Candelas)

Angle	Average
0°	722
5°	742
15°	888
25°	923
35°	569
45°	113
55°	3
65°	0
75°	0
85°	0

Initial Footcandles

Distance to Illuminated Plane (Feet)	Footcandles Beam Center	Footcandles Beam Edge	Beam Diameter
6'	20.1	6.7	9.0'
8'	11.3	3.8	12.0'
10'	7.2	2.4	15.0'
12'	5.0	1.7	18.0'
14'	3.7	1.2	21.0'
16'	2.8	0.9	24.0'
18'	2.2	0.7	27.0'

150W A21

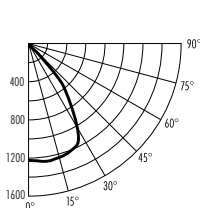

Candlepower Distribution (Candelas)

Angle	Average
0°	1278
5°	1238
15°	1239
25°	1198
35°	751
45°	265
55°	3
65°	0
75°	0
85°	0

Initial Footcandles

Distance to Illuminated Plane (Feet)	Footcandles Beam Center	Footcandles Beam Edge	Beam Diameter
6'	34.1	8.6	9.3'
8'	19.2	4.8	12.4'
10'	12.3	3.1	15.5'
12'	8.5	2.1	18.7'
14'	6.3	1.6	21.8'
16'	4.8	1.2	24.9'
18'	3.8	1.0	28.0'

Photometrics - Round Downlights (cont.)

6" A-Lamps (cont.)

Baffle

IC906-633B, Black Baffle

100W A19

Candlepower Distribution (Candelas)

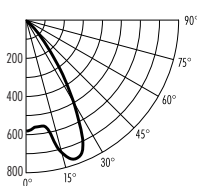

Angle	Average
0°	582
5°	573
15°	727
25°	712
35°	315
45°	72
55°	2
65°	0
75°	0
85°	0

Initial Footcandles

Distance to Illuminated Plane (Feet)	Footcandles Beam Center	Footcandles Beam Edge	Beam Diameter
6'	16.2	6.4	7.8"
8'	9.1	3.6	10.4"
10'	5.8	2.3	13.0"
12'	4.0	1.6	15.7"
14'	3.0	1.2	18.3"
16'	2.3	0.9	20.9"
18'	1.8	0.7	23.5"

TC906-633B, Black Baffle

150W A21

Candlepower Distribution (Candelas)

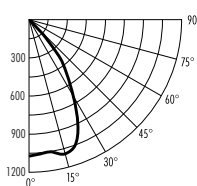

Angle	Average
0°	1058
5°	1040
15°	1079
25°	952
35°	578
45°	207
55°	12
65°	4
75°	0
85°	0

Initial Footcandles

Distance to Illuminated Plane (Feet)	Footcandles Beam Center	Footcandles Beam Edge	Beam Diameter
6'	29.4	8.0	8.7"
8'	16.5	4.5	11.6"
10'	10.6	2.9	14.5"
12'	7.3	2.0	17.4"
14'	5.4	1.5	20.3"
16'	4.1	1.1	23.2"
18'	3.3	0.9	26.1"

6" CFL

Reflector

ICV6-126/32T and CV6-126/32T-600C, Clear Specular

26W Triple Tube CFL

Candlepower Distribution (Candelas)

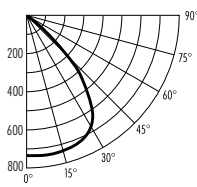

Angle	Average
0°	725
5°	753
15°	765
25°	729
35°	585
45°	342
55°	16
65°	0
75°	0
85°	0

Initial Footcandles

Distance to Illuminated Plane (Feet)	Footcandles Beam Center	Footcandles Beam Edge	Beam Diameter
6'	20.1	5.9	7.9"
8'	11.3	3.3	10.5"
10'	7.3	2.1	13.1"
12'	5.0	1.5	15.7"
14'	3.7	1.1	18.3"
16'	2.8	0.8	21.0"
18'	2.2	0.7	23.6"
20'	1.8	0.5	26.2"

Baffle

ICV6-126/32T and CV6-126/32T-601B, Black Baffle

32W Triple Tube CFL

Candlepower Distribution (Candelas)

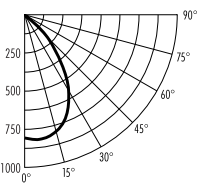

Angle	Average
0°	821
5°	833
15°	813
25°	722
35°	497
45°	237
55°	8
65°	0
75°	0
85°	0

Initial Footcandles

Distance to Illuminated Plane (Feet)	Footcandles Beam Center	Footcandles Beam Edge	Beam Diameter
6'	22.8	5.2	9.9"
8'	12.8	2.9	13.2"
10'	8.2	1.9	16.5"
12'	5.7	1.3	19.8"
14'	4.1	1.0	23.1"
16'	3.2	0.7	26.4"
18'	2.5	0.6	29.7"
20'	2.1	0.5	33.0"

7" PAR

Reflector

IC73-727C, Clear Specular

120W PAR38 Flood

Candlepower Distribution (Candelas)

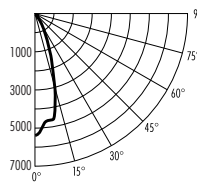

Angle	Average
0°	5483
5°	4829
15°	3124
25°	651
35°	108
45°	40
55°	0
65°	0
75°	0
85°	0

Initial Footcandles

Distance to Illuminated Plane (Feet)	Footcandles Beam Center	Footcandles Beam Edge	Beam Diameter
6'	152.3	67.7	3.4'
8'	85.7	38.1	4.6'
10'	54.8	24.4	5.7'
12'	38.1	16.9	6.8'
14'	28.0	12.4	8.0'
16'	21.4	9.5	9.1'
18'	16.9	7.5	10.3'
20'	13.7	6.1	11.4'

TC973-727C, Clear Specular

250W PAR38 Flood

Candlepower Distribution (Candelas)

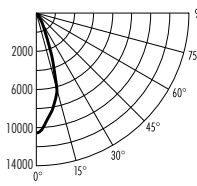

Angle	Average
0°	10811
5°	9776
15°	6344
25°	918
35°	151
45°	55
55°	3
65°	0
75°	0
85°	0

Initial Footcandles

Distance to Illuminated Plane (Feet)	Footcandles Beam Center	Footcandles Beam Edge	Beam Diameter
6'	300.3	133.0	3.5'
8'	168.9	74.8	4.7'
10'	108.1	47.9	5.9'
12'	75.1	33.3	7.0'
14'	55.2	24.4	8.2'
16'	42.2	18.7	9.4'
18'	33.4	14.8	10.6'
20'	27.0	12.0	11.7'

Photometrics - Round Wall Wash

3-1/4" MR16 Halogen

Reflector

IC43N-439NC, Clear Specular

37W IR MR16 35° Flood

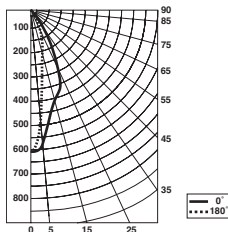

Candlepower Distribution (Candelas)

Degrees Vertical	0° Wall Wash	180° Downlight
0°	603	603
5°	582	481
15°	414	207
25°	281	129
35°	112	41
45°	62	16
55°	15	0
65°	0	0
75°	0	0
85°	0	0

Footcandles on Wall from Multiple Fixtures

Fixture Distance to Wall Fixture Centers (spacing)	18"			24"								
	18"	24"	18"	24"	18"	24"						
1'	18	12	18	16	7	16	7	6	7	6	4	6
2'	38	39	38	31	24	31	25	24	25	20	17	20
3'	37	35	37	30	25	30	28	30	28	22	23	22
4'	30	27	30	22	21	22	28	26	28	21	20	21
5'	21	20	21	16	15	16	24	22	24	18	17	18
6'	15	15	15	11	11	11	19	19	19	14	14	14
7'	11	11	11	8	8	8	14	15	14	11	11	11
8'	9	9	9	7	6	7	11	11	11	9	8	9
9'	7	7	7	5	5	5	9	9	9	7	7	7

50W MR16 40° Flood

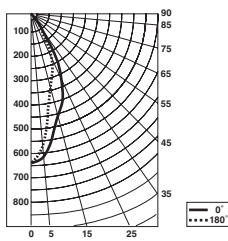

Candlepower Distribution (Candelas)

Degrees Vertical	0° Wall Wash	180° Downlight
0°	645	645
5°	635	588
15°	462	331
25°	311	224
35°	136	80
45°	75	27
55°	12	0
65°	2	0
75°	0	0
85°	0	0

Footcandles on Wall from Multiple Fixtures

Fixture Distance to Wall Fixture Centers (spacing)	18"			24"								
	18"	24"	18"	24"	18"	24"						
1'	19	14	19	17	9	17	10	8	10	8	6	8
2'	29	27	29	23	19	23	21	20	21	16	15	16
3'	28	27	28	23	19	23	21	21	21	17	15	17
4'	24	23	24	18	17	18	21	21	21	16	16	16
5'	18	17	18	13	13	13	19	18	19	14	14	14
6'	13	13	13	10	9	10	16	15	16	12	11	12
7'	10	10	10	7	7	7	12	12	12	9	9	9
8'	7	8	7	6	6	6	10	10	10	7	7	7
9'	6	6	6	5	5	5	8	8	8	6	6	6

TC43N-439NC, Clear Specular

50W IR MR16 35° Flood

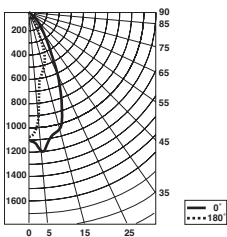

Candlepower Distribution (Candelas)

Degrees Vertical	0° Wall Wash	180° Downlight
0°	1075	1075
5°	1177	924
15°	998	506
25°	606	272
35°	270	112
45°	167	45
55°	77	0
65°	43	0
75°	14	0
85°	0	0

Footcandles on Wall from Multiple Fixtures

Fixture Distance to Wall Fixture Centers (spacing)	18"			24"								
	18"	24"	18"	24"	18"	24"						
1'	26	21	26	22	13	22	14	11	14	11	8	11
2'	38	34	38	30	24	30	27	26	27	21	19	21
3'	35	34	35	29	24	29	26	26	26	21	19	21
4'	34	31	34	25	24	25	27	26	27	20	20	20
5'	26	24	26	19	19	19	26	24	26	20	18	20
6'	19	19	19	14	14	14	22	22	22	17	16	17
7'	14	15	14	11	11	11	18	18	18	14	13	14
8'	11	12	11	9	9	9	14	15	14	11	11	11
9'	10	10	10	7	7	7	12	12	12	9	9	9

75W IR MR16 40° Flood

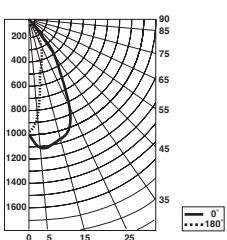

Candlepower Distribution (Candelas)

Degrees Vertical	0° Wall Wash	180° Downlight
0°	965	965
5°	1068	865
15°	1038	445
25°	820	264
35°	387	85
45°	230	35
55°	63	0
65°	27	0
75°	12	0
85°	0	0

Footcandles on Wall from Multiple Fixtures

Fixture Distance to Wall Fixture Centers (spacing)	18"			24"								
	18"	24"	18"	24"	18"	24"						
1'	20	16	20	17	10	17	9	8	9	8	6	8
2'	49	48	49	39	33	39	30	27	30	25	19	25
3'	49	49	49	40	34	40	38	40	38	29	29	29
4'	38	37	38	29	28	29	37	37	37	28	28	28
5'	28	27	28	21	21	21	31	30	31	23	23	23
6'	20	20	20	15	15	15	25	24	25	19	18	19
7'	15	15	15	11	11	11	19	19	19	15	14	15
8'	12	12	12	9	9	9	15	15	15	12	11	12
9'	10	10	10	7	7	7	12	13	12	9	9	9

Photometrics - Round Wall Wash (cont.)

3-1/4" PAR

Reflector

IC13N-439NC, Clear Specular

45W PAR16 27° Flood

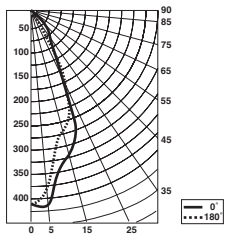

Candlepower Distribution (Candelas)

Degrees Vertical	0° Wall Wash	180° Downlight
0°	380	380
5°	383	305
15°	252	174
25°	135	73
35°	60	35
45°	38	11
55°	16	0
65°	10	0
75°	5	0
85°	0	0

Footcandles on Wall from Multiple Fixtures

Fixture Distance to Wall	18"			24"								
	18"	24"	18"	24"	18"	24"						
1'	6	5	6	5	3	5	4	3	4	3	2	3
2'	9	8	9	7	6	7	6	6	6	5	4	5
3'	8	8	8	7	6	7	6	6	6	5	4	5
4'	8	8	8	6	6	6	6	6	6	5	5	5
5'	7	6	7	5	5	5	6	6	6	5	5	5
6'	5	5	5	4	4	4	6	6	6	4	4	4
7'	4	4	4	3	3	3	5	5	5	4	3	4
8'	3	3	3	2	3	2	4	4	4	3	3	3
9'	3	3	3	2	2	2	3	3	3	2	2	2

TC13N-439NC, Clear Specular

75W PAR16 30° Narrow Flood

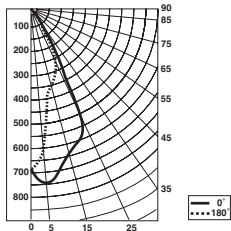

Candlepower Distribution (Candelas)

Degrees Vertical	0° Wall Wash	180° Downlight
0°	667	667
5°	732	571
15°	633	317
25°	399	160
35°	169	72
45°	98	21
55°	46	0
65°	24	0
75°	11	0
85°	1	0

Footcandles on Wall from Multiple Fixtures

Fixture Distance to Wall	18"			24"								
	18"	24"	18"	24"	18"	24"						
1'	16	14	16	13	9	13	8	7	8	7	5	7
2'	22	20	22	18	15	18	15	15	15	12	11	12
3'	24	24	24	19	16	19	17	16	17	13	12	13
4'	21	21	21	16	16	16	18	18	18	13	14	13
5'	16	16	16	12	12	12	17	16	17	12	13	12
6'	12	12	12	9	9	9	14	14	14	11	11	11
7'	9	10	9	7	7	7	12	12	12	8	9	8
8'	7	8	7	6	6	6	9	9	9	7	7	7
9'	6	6	6	5	5	5	8	8	8	6	6	6

3-1/4" CMH MR16

Reflector

TC943M-MR16-39E1-439NC, Clear Specular

39W CMH MR16 40° Wide Flood

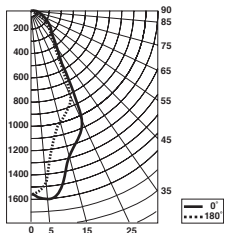

Candlepower Distribution (Candelas)

Degrees Vertical	0° Wall Wash	180° Downlight
0°	1772	1772
5°	1742	1594
15°	1221	1099
25°	691	593
35°	325	293
45°	193	125
55°	119	0
65°	84	0
75°	30	0
85°	2	0

Footcandles on Wall from Multiple Fixtures

Fixture Distance to Wall	18"			24"								
	18"	24"	18"	24"	18"	24"						
1'	45	39	45	36	27	36	27	23	27	21	17	21
2'	48	44	48	39	33	39	34	34	34	27	25	27
3'	45	45	45	36	31	36	35	34	35	27	25	27
4'	41	41	41	32	30	32	33	35	33	26	25	26
5'	33	33	33	24	25	24	32	32	32	24	24	24
6'	25	25	25	18	19	18	29	28	29	21	21	21
7'	20	20	20	15	15	15	23	23	23	18	18	18
8'	16	17	16	12	12	12	19	20	19	15	15	15
9'	14	14	14	11	11	11	16	17	16	12	12	12

5-5/8" PAR

Reflector

IC62/TC62-629C, Clear Specular

75W PAR30 40° Flood

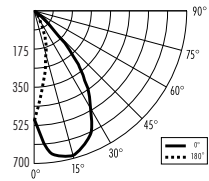

Candlepower Distribution (Candelas)

Degrees Vertical	0° Wall Wash	180° Downlight
0°	509	509
5°	631	376
15°	692	207
25°	608	104
35°	420	42
45°	210	3
55°	94	0
65°	41	0
75°	15	0
85°	1	0

Footcandles on Wall from Multiple Fixtures

Fixture Distance to Wall	2'						3'					
	2'			3'			3'					
Fixture Centers (spacing)	⌢	⌢	⌢	⌢	⌢	⌢	⌢	⌢	⌢			
1'	8	11	8	4	4	4	2	3	2	1	2	1
2'	20	24	20	9	20	9	5	7	5	3	6	3
3'	25	27	25	13	21	13	9	11	9	6	9	6
4'	21	21	21	13	16	13	11	12	11	7	10	7
5'	16	16	16	10	11	10	11	12	11	8	9	8
6'	12	12	12	8	8	8	10	10	10	7	8	7
7'	9	9	9	6	6	6	8	8	8	6	6	6
8'	7	7	7	5	5	5	7	7	7	5	5	5
9'	6	6	6	4	4	4	6	6	6	4	4	4

6" A-Lamps

Reflector

IC906-662C, Clear Specular

100W A19

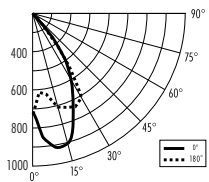

Candlepower Distribution (Candelas)

Degrees Vertical	0° Wall Wash	180° Downlight
0°	734	734
5°	851	617
15°	903	707
25°	703	748
35°	510	547
45°	251	130
55°	122	4
65°	76	0
75°	21	0
85°	0	0

Footcandles on Wall from Multiple Fixtures

Fixture Distance to Wall	2'						3'					
	2'			3'			3'					
Fixture Centers (spacing)	⌢	⌢	⌢	⌢	⌢	⌢	⌢	⌢	⌢			
1'	20	21	20	11	17	11	4	5	4	3	4	3
2'	30	33	30	16	26	16	11	12	11	8	9	8
3'	37	37	37	23	26	23	14	15	14	9	12	9
4'	31	32	31	21	20	21	17	17	17	12	13	12
5'	25	25	25	16	17	16	16	16	16	12	12	12
6'	20	20	20	13	14	13	14	15	14	11	11	11
7'	17	16	17	11	11	11	12	13	12	9	10	9
8'	14	13	14	9	9	9	11	11	11	8	8	8
9'	11	11	11	8	8	8	9	9	9	7	7	7

TC906-662C, Clear Specular

150W A21

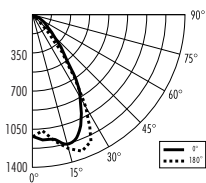

Candlepower Distribution (Candelas)

Degrees Vertical	0° Wall Wash	180° Downlight
0°	1094	1094
5°	1147	1055
15°	1202	1263
25°	1035	1264
35°	660	615
45°	319	87
55°	182	0
65°	90	0
75°	33	0
85°	7	0

Footcandles on Wall from Multiple Fixtures

Fixture Distance to Wall	2'						3'					
	2'			3'			3'					
Fixture Centers (spacing)	⌢	⌢	⌢	⌢	⌢	⌢	⌢	⌢	⌢			
1'	22	25	22	12	21	12	6	6	6	4	5	4
2'	40	42	40	22	32	22	14	15	14	10	13	10
3'	45	46	45	27	34	27	18	19	18	12	15	12
4'	42	43	42	29	28	29	20	21	20	14	17	14
5'	34	35	34	24	23	24	21	21	21	15	16	15
6'	28	28	28	18	19	18	19	20	19	15	14	15
7'	22	22	22	15	15	15	17	17	17	13	13	13
8'	18	18	18	12	13	12	15	15	15	11	11	11
9'	15	15	15	10	10	10	13	13	13	9	10	9

6" CFL

Reflector

ICV6-126/32T and CV6-126/32T-600C-WWS, Clear Specular

26W Triple Tube CFL

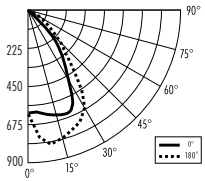

Candlepower Distribution (Candelas)

Degrees	0°	180°
Vertical	Wall Wash	Downlight
0°	644	644
5°	620	790
15°	576	798
25°	481	733
35°	385	578
45°	279	172
55°	194	43
65°	81	12
75°	31	0
85°	6	0

Footcandles on Wall from Multiple Fixtures

Fixture Distance to Wall	2'			3'								
	Fixture Centers (spacing)	2'	3'	3'	4'	5'						
1'	20	22	20	10	19	10	5	6	5	3	5	3
2'	32	33	32	17	26	17	12	14	12	8	13	8
3'	28	30	28	20	20	20	15	15	15	10	13	10
4'	25	25	25	17	16	17	13	15	13	11	10	11
5'	20	20	20	14	13	14	13	13	13	9	10	9
6'	16	16	16	11	11	11	12	11	12	9	9	9
7'	13	13	13	9	9	9	10	10	10	8	7	8
8'	10	10	10	7	7	7	9	9	9	7	6	7
9'	9	8	9	6	6	6	7	7	7	6	5	6

Photometrics - Round Lensed Downlights

3-1/4" MR16 Halogen

Lensed Downlight

IC43N-432NC, Clear Specular

37W IR MR16 35° Flood

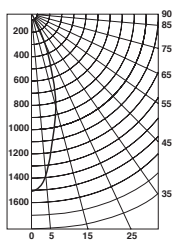

Candlepower Distribution (Candelas)

Angle	Candela	Lumens
0°	1512	
5°	1390	133
15°	875	234
25°	262	121
35°	57	36
45°	20	15
55°	7	7
65°	0	0
75°	0	0
85°	0	0

Initial Footcandles

Distance to Illuminated Plane (Feet)	Footcandles Beam Center	Footcandles Beam Edge	Beam Diameter
6'	42.0	18.6	3.5"
7'	30.9	13.6	4.1"
8'	23.6	10.4	4.7"
9'	18.7	8.2	5.3"
10'	15.1	6.7	5.9"
11'	12.5	5.5	6.5"
12'	10.5	4.6	7.0"
13'	8.9	4.0	7.6"
14'	7.7	3.4	8.2"
15'	6.7	3.0	8.8"

50W IR MR16 35° Flood

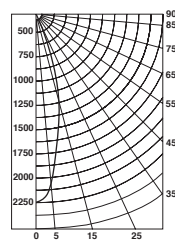

Candlepower Distribution (Candelas)

Angle	Candela	Lumens
0°	2749	
5°	2095	200
15°	1221	346
25°	422	196
35°	89	56
45°	30	23
55°	13	11
65°	0	0
75°	0	0
85°	0	0

Initial Footcandles

Distance to Illuminated Plane (Feet)	Footcandles Beam Center	Footcandles Beam Edge	Beam Diameter
6'	62.5	27.6	3.5"
7'	45.9	20.3	4.1"
8'	35.1	15.5	4.7"
9'	27.8	12.3	5.3"
10'	22.5	9.9	5.9"
11'	18.6	8.2	6.5"
12'	15.6	6.9	7.1"
13'	13.3	5.9	7.7"
14'	11.5	5.1	8.2"
15'	10.0	4.4	8.8"

50W MR16 40° Flood

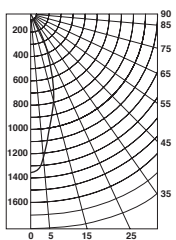

Candlepower Distribution (Candelas)

Angle	Candela	Lumens
0°	1357	
5°	1239	118
15°	783	222
25°	343	159
35°	88	55
45°	25	19
55°	8	7
65°	0	0
75°	0	0
85°	0	0

Initial Footcandles

Distance to Illuminated Plane (Feet)	Footcandles Beam Center	Footcandles Beam Edge	Beam Diameter
6'	37.7	16.3	3.8"
7'	27.7	12.0	4.5"
8'	21.2	9.2	5.1"
9'	16.7	7.2	5.8"
10'	13.6	5.9	6.4"
11'	11.2	4.8	7.0"
12'	9.4	4.1	7.7"
13'	8.0	3.5	8.3"
14'	6.9	3.0	9.0"
15'	6.0	2.6	9.6"

75W MR16 40° Flood

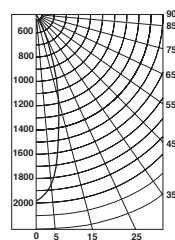

Candlepower Distribution (Candelas)

Angle	Candela	Lumens
0°	1978	
5°	1846	176
15°	1142	324
25°	497	230
35°	110	69
45°	36	28
55°	12	10
65°	0	0
75°	0	0
85°	0	0

Initial Footcandles

Distance to Illuminated Plane (Feet)	Footcandles Beam Center	Footcandles Beam Edge	Beam Diameter
6'	55.0	23.7	3.9"
7'	40.4	17.4	4.5"
8'	30.9	13.3	5.2"
9'	24.4	10.5	5.8"
10'	19.8	8.5	6.5"
11'	16.3	7.0	7.1"
12'	13.7	5.9	7.8"
13'	11.7	5.0	8.4"
14'	10.1	4.3	9.1"
15'	8.8	3.8	9.7"

3-1/4" PAR

Reflector

IC13N-432NC, Clear Specular

45W PAR16 27° Flood

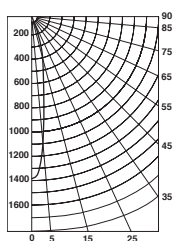

Candlepower Distribution (Candelas)

Angle	Candela	Lumens
0°	1390	
5°	1146	109
15°	414	117
25°	114	53
35°	29	18
45°	15	12
55°	6	5
65°	0	0
75°	0	0
85°	0	0

Initial Footcandles

Distance to Illuminated Plane (Feet)	Footcandles Beam Center	Footcandles Beam Edge	Beam Diameter
6'	38.6	18.5	2.0"
7'	28.4	13.6	2.3"
8'	21.7	10.4	2.7"
9'	17.2	8.2	3.0"
10'	13.9	6.7	3.3"
11'	11.5	5.5	3.7"
12'	9.6	4.6	4.0"
13'	8.2	3.9	4.3"
14'	7.1	3.4	4.6"
15'	6.2	3.0	5.0"

TC13N-432NC, Clear Specular

75W PAR16 30° Narrow Flood

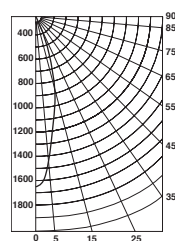

Candlepower Distribution (Candelas)

Angle	Candela	Lumens
0°	1658	
5°	1516	145
15°	908	257
25°	370	171
35°	72	45
45°	28	22
55°	12	11
65°	0	0
75°	0	0
85°	0	0

Initial Footcandles

Distance to Illuminated Plane (Feet)	Footcandles Beam Center	Footcandles Beam Edge	Beam Diameter
6'	46.0	20.2	3.6"
7'	33.8	14.8	4.2"
8'	25.9	11.4	4.8"
9'	20.5	9.0	5.4"
10'	16.6	7.3	6.0"
11'	13.7	6.0	6.7"
12'	11.5	5.0	7.3"
13'	9.8	4.3	7.9"
14'	8.5	3.7	8.5"
15'	7.4	3.2	9.1"

3-1/4" CMH MR16

Lensed Downlight

TC943M-MR16-39E1-432NC, Clear Specular

39W CMH MR16 25° Flood

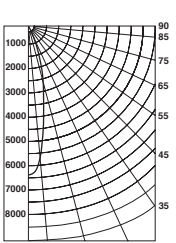

Candlepower Distribution (Candelas)

Angle	Candela	Lumens
0°	6454	
5°	5771	551
15°	2597	736
25°	730	338
35°	192	121
45°	66	51
55°	19	17
65°	0	0
75°	0	0
85°	0	0

Initial Footcandles

Distance to Illuminated Plane (Feet)	Footcandles Beam Center	Footcandles Beam Edge	Beam Diameter
6'	179.3	83.6	2.6"
7'	131.7	61.4	3.1"
8'	100.8	47.0	3.5"
9'	79.7	37.2	3.9"
10'	64.5	30.1	4.4"
11'	53.3	24.9	4.8"
12'	44.8	20.9	5.2"
13'	38.2	17.8	5.7"
14'	32.9	15.4	6.1"
15'	28.7	13.4	6.5"

Lensed Pinhole Downlight

TC943M-MR16-39E1-4332N-WH

39W CMH MR16 30° Spot

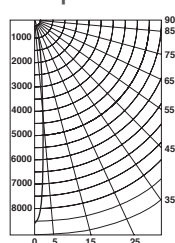

Candlepower Distribution (Candelas)

Angle	Candela	Lumens
0°	8506	
5°	4370	417
15°	619	176
25°	70	32
35°	0	0
45°	0	0
55°	0	0
65°	0	0
75°	0	0
85°	0	0

Initial Footcandles

Distance to Illuminated Plane (Feet)	Footcandles Beam Center	Footcandles Beam Edge	Beam Diameter
6'	236.3	116.7	1.1"
7'	173.6	85.8	1.3"
8'	132.9	65.7	1.4"
9'	105.0	51.9	1.6"
10'	85.1	42.0	1.8"
11'	70.3	34.7	2.0"
12'	59.1	29.2	2.1"
13'	50.3	24.9	2.3"
14'	43.4	21.4	2.5"
15'	37.8	18.7	2.7"

Photometrics - Round Adjustables

The tables on the following pages provide illumination levels, footcandles (FC) and beam size (in feet) for lamps of various wattages and beam patterns. Data is given for lamps aimed at both horizontal and vertical surfaces.

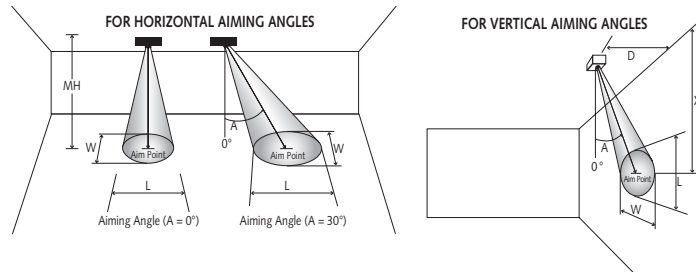

3-1/4" MR16 Halogen

Adjustable

IC43N/TC43N-438N

Horizontal Aiming Angles



Vertical Aiming Angles



Lamp	Beam Type	Beam Spread°	Rated Life	CBCP	0°		30°			30°				45°						
					MH	FC	L	W	FC	L	W	D	FC	X	L	W	FC	X	L	W
37W MR16 Halogen IR	NSP	10°	5000	12500	6	347	1.0	1.0	226	1.4	1.2	3	174	5.2	2.1	1.0	491	3.0	1.1	0.7
					8	195	1.4	1.4	127	1.9	1.6	4	98	6.9	2.9	1.4	276	4.0	1.4	1.0
					10	125	1.7	1.7	81	2.3	2.0	5	63	8.7	3.6	1.7	177	5.0	1.8	1.2
	NFL	25°	5000	4400	4	275	1.8	1.8	179	2.4	2.0	2	138	3.5	4.2	1.8	389	2.0	1.9	1.3
					6	122	2.7	2.7	79	3.6	3.1	3	61	5.2	6.2	2.7	173	3.0	2.8	1.9
					8	69	3.5	3.5	45	4.8	4.1	4	34	6.9	8.3	3.5	97	4.0	3.7	2.5
	FL	35°	5000	2200	3	244	1.9	1.9	159	2.6	2.2	2	69	3.5	7.2	2.5	194	2.0	2.8	1.8
					4	138	2.5	2.5	89	3.5	2.9	3	31	5.2	10.8	3.8	86	3.0	4.2	2.7
					6	61	3.8	3.8	40	5.2	4.4	4	17	6.9	14.4	5.0	49	4.0	5.6	3.6
50W MR16 Halogen	NSP	15°	6000	9100	6	253	1.6	1.6	164	2.1	1.8	3	126	5.2	3.3	1.6	357	3.0	1.6	1.1
					8	142	2.1	2.1	92	2.8	2.4	4	71	6.9	4.4	2.1	201	4.0	2.1	1.5
					10	91	2.6	2.6	59	3.5	3.0	5	46	8.7	5.6	2.6	129	5.0	2.7	1.9
	NFL	25°	6000	3200	4	200	1.8	1.8	130	2.4	2.0	2	100	3.5	4.2	1.8	283	2.0	1.9	1.3
					6	89	2.7	2.7	58	3.6	3.1	3	44	5.2	6.2	2.7	126	3.0	2.8	1.9
					8	50	3.5	3.5	32	4.8	4.1	4	25	6.9	8.3	3.5	71	4.0	3.7	2.5
	FL	40°	6000	1700	3	189	2.2	2.2	123	3.0	2.5	2	53	3.5	9.7	2.9	150	2.0	3.4	2.1
					4	106	2.9	2.9	69	4.1	3.4	3	24	5.2	14.5	4.4	67	3.0	5.0	3.1
					6	47	4.4	4.4	31	6.1	5.0	4	13	6.9	19.3	5.8	38	4.0	6.7	4.1
					8	27	5.8	5.8	17	8.1	6.7	5	9	8.7	24.2	7.3	24	5.0	8.4	5.1

The beam spread in degrees and the beam "L" and "W" in the following tables are computed at 50% of centerbeam candlepower and represent areas of "effective illumination."

3-1/4" MR16 Halogen

Adjustable

TC43N-438N, Black Alzak® Reflector, Lensed

Horizontal Aiming Angles



Vertical Aiming Angles



Beam Type	Beam Spread°	Rated Life	CBCP	0°				30°			30°				45°					
				MH	FC	L	W	FC	L	W	D	FC	X	L	W	FC	X	L	W	
50W MR16 Halogen IR Lensed	SP	10°	5000	15000	6	417	1.0	1.0	217	1.4	1.2	3	208	5.2	2.1	1.0	589	3.0	1.1	0.7
					8	234	1.4	1.4	152	1.9	1.6	4	117	6.9	2.9	1.4	331	4.0	1.4	1.0
					10	150	1.7	1.7	97	2.3	2.0	5	75	8.7	3.6	1.7	212	5.0	1.8	1.2
	NFL	25°	5000	5700	4	356	1.8	1.8	231	2.1	2.0	2	178	3.5	4.2	1.8	504	2.0	1.9	1.3
					6	158	2.7	2.7	103	3.6	3.1	3	79	5.2	6.2	2.7	224	3.0	2.8	1.9
					8	89	3.5	3.5	58	4.8	4.1	4	45	6.9	8.3	3.5	126	4.0	3.7	2.5
	FL	35°	5000	2850	3	317	1.9	1.9	206	2.6	2.2	2	89	3.5	7.2	2.5	252	2.0	2.8	1.8
					4	178	2.5	2.5	116	3.5	2.9	3	40	5.2	10.8	3.8	112	3.0	4.2	2.7
					6	79	3.8	3.8	51	5.2	4.4	4	22	6.9	14.4	5.0	63	4.0	5.6	3.6
71W MR16 Halogen	SP	15°	4000	11500	6	319	1.6	1.6	207	2.1	1.8	3	160	5.2	3.3	1.6	452	3.0	1.6	1.1
					8	180	2.1	2.1	117	2.8	2.4	4	90	6.9	4.4	2.1	254	4.0	2.1	1.5
					10	115	2.6	2.6	75	3.5	3.0	5	58	8.7	5.6	2.6	163	5.0	2.7	1.9
					12	80	3.2	3.2	52	4.2	3.6	6	40	10.4	6.7	3.2	113	6.0	3.2	2.2
	NFL	25°	4000	5500	4	344	1.8	1.8	223	2.4	2.0	2	172	3.5	4.2	1.8	486	2.0	1.9	1.3
					6	153	2.7	2.7	99	3.6	3.1	3	76	5.2	6.2	2.7	216	3.0	2.8	1.9
					8	86	3.5	3.5	56	4.8	4.1	4	43	6.9	8.3	3.5	122	4.0	3.7	2.5
					10	55	4.4	4.4	36	6.0	5.1	5	28	8.7	10.4	4.4	78	5.0	4.7	3.1
	FL	40°	4000	2200	3	244	2.2	2.2	159	3.0	2.5	2	69	3.5	9.7	2.9	194	2.0	3.4	2.1
					4	138	2.9	2.9	89	4.1	3.4	3	31	5.2	14.5	4.4	86	3.0	5.0	3.1
					6	61	4.4	4.4	40	6.1	5.0	4	17	6.9	19.3	5.8	49	4.0	6.7	4.1
					8	34	5.8	5.8	22	8.1	6.7	5	11	8.7	24.2	7.3	31	5.0	8.4	5.1

The beam spread in degrees and the beam "L" and "W" in the following tables are computed at 50% of centerbeam candlepower and represent areas of "effective illumination."

Photometrics - Round Adjustables (cont.)

3-1/4" PAR

Adjustable

IC13N-438N

Horizontal Aiming Angles



Vertical Aiming Angles



Lamp	Beam Type	Beam Spread°	Rated Life	CBCP	0°				30°				30°				40°			
					MH	FC	L	W	FC	L	W	D	FC	X	L	W	FC	X	L	W
45W PAR16 Halogen	NSP	10°	2000	5000	6	139	1.0	1.0	90	1.4	1.2	2	156	3.5	1.4	0.7	332	2.4	0.9	0.5
					8	78	1.4	1.4	51	1.9	1.6	3	69	5.2	2.1	1.0	148	3.6	1.3	0.8
					10	50	1.7	1.7	32	2.3	2.0	4	39	6.9	2.9	1.4	83	4.8	1.7	1.1
					12	35	2.1	2.1	23	2.8	2.4	5	25	8.7	3.6	1.7	53	6.0	2.1	1.4
					14	26	2.4	2.4	17	3.3	2.8	6	17	10.4	4.3	2.1	37	7.2	2.6	1.6
	NFL	27°	2000	1400	3	156	1.4	1.4	101	2.0	1.7	1	175	1.7	2.3	1.0	372	1.2	1.4	0.8
					5	56	2.4	2.4	36	3.3	2.8	2	44	3.5	4.6	1.9	93	2.4	2.9	1.7
					7	29	3.4	3.4	19	4.6	3.9	3	19	5.2	7.0	2.9	41	3.6	4.3	2.5
					9	17	4.3	4.3	11	5.9	5.0	4	11	6.9	9.3	3.8	23	4.8	5.8	3.3
					11	12	5.3	5.3	8	7.2	6.1	5	7	8.7	11.6	4.8	15	6.0	7.2	4.2
60W PAR16 Halogen	NSP	10°	2000	5400	6	150	1.0	1.0	97	1.4	1.2	2	169	3.5	1.4	0.7	359	2.4	0.9	0.5
					8	84	1.4	1.4	55	1.9	1.6	3	75	5.2	2.1	1.0	159	3.6	1.3	0.8
					10	54	1.7	1.7	35	2.3	2.0	4	42	6.9	2.9	1.4	90	4.8	1.7	1.1
					12	38	2.1	2.1	24	2.8	2.4	5	27	8.7	3.6	1.7	57	6.0	2.1	1.4
					14	28	2.4	2.4	18	3.3	2.8	6	19	10.4	4.3	2.1	40	7.2	2.6	1.6
	NFL	30°	2000	1550	4	97	2.1	2.1	63	2.9	2.5	2	48	3.5	5.5	2.1	103	2.4	2.9	1.7
					6	43	3.2	3.2	28	4.4	3.7	3	22	5.2	8.2	3.2	46	3.6	4.3	2.5
					8	24	4.3	4.3	16	5.9	5.0	4	12	6.9	10.9	4.3	26	4.8	5.8	3.3
					10	16	5.4	5.4	10	7.3	6.2	5	8	8.7	13.7	5.4	16	6.0	7.2	4.2
					12	11	6.4	6.4	7	8.8	7.4	6	5	10.4	16.4	6.4	11	7.2	8.7	5.0

The beam spread in degrees and the beam "L" and "W" in the following tables are computed at 50% of centerbeam candlepower and represent areas of "effective illumination."

TC13N-438N

Horizontal Aiming Angles



Vertical Aiming Angles



Lamp	Beam Type	Beam Spread°	Rated Life	CBCP	0°				30°				30°				40°			
					MH	FC	L	W	FC	L	W	D	FC	X	L	W	FC	X	L	W
75W PAR16 Halogen	NSP	10°	2000	7500	6	208	1.0	1.0	135	1.4	1.2	2	234	3.5	1.4	0.7	498	2.4	0.9	0.5
					8	117	1.4	1.4	76	1.9	1.6	3	104	5.2	2.1	1.0	221	3.6	1.3	0.8
					10	75	1.7	1.7	49	2.3	2.0	4	59	6.9	2.9	1.4	124	4.8	1.7	1.1
					12	52	2.1	2.1	34	2.8	2.4	5	38	8.7	3.6	1.7	80	6.0	2.1	1.4
					14	38	2.4	2.4	25	3.3	2.8	6	26	10.4	4.3	2.1	55	7.2	2.6	1.6
	NFL	30°	2000	1900	4	119	2.1	2.1	77	2.9	2.5	2	59	3.5	5.5	2.1	126	2.4	2.9	1.7
					6	53	3.2	3.2	34	4.4	3.7	3	26	5.2	8.2	3.2	56	3.6	4.3	2.5
					8	30	4.3	4.3	19	5.9	5.0	4	15	6.9	10.9	4.3	32	4.8	5.8	3.3
					10	19	5.4	5.4	12	7.3	6.2	5	10	8.7	13.7	5.4	20	6.0	7.2	4.2
					12	13	6.4	6.4	9	8.8	7.4	6	7	10.4	16.4	6.4	14	7.2	8.7	5.0

The beam spread in degrees and the beam "L" and "W" in the following tables are computed at 50% of centerbeam candlepower and represent areas of "effective illumination."

3-1/4" CMH MR16

Adjustable

TC943M-MR16-20E1-438N



Lamp	Beam Type	Beam Spread°	Rated Life	CBCP	0°				30°			30°			45°					
					MH	FC	L	W	FC	L	W	D	FC	X	L	W	FC	X	L	W
20W MR16 Ceramic Metal Halide 	SP	12°	12000	9000	10	90	2.1	2.1	58	2.8	2.4	4	70	6.9	3.5	1.7	199	4.0	1.7	1.2
					12	63	2.5	2.5	41	3.4	2.9	6	31	10.4	5.2	2.5	88	6.0	2.6	1.8
					14	46	2.9	2.9	30	3.9	3.4	8	18	13.9	7.0	3.4	50	8.0	3.4	2.4
					16	35	3.4	3.4	23	4.5	3.9	10	11	17.3	8.7	4.2	32	10.0	4.3	3.0
					18	28	3.8	3.8	18	5.1	4.4	12	8	20.8	10.4	5.0	22	12.0	5.1	3.6
	FL	25°	12000	2900	8	45	3.5	3.5	29	4.8	4.1	2	91	3.5	4.2	1.8	256	2.0	1.9	1.3
					10	29	4.4	4.4	19	6.0	5.1	4	23	6.9	8.3	3.5	64	4.0	3.7	2.5
					12	20	5.3	5.3	13	7.2	6.1	6	10	10.4	12.5	5.3	28	6.0	5.6	3.8
					14	15	6.2	6.2	10	8.4	7.2	8	6	13.9	16.6	7.1	16	8.0	7.5	5.0
					16	11	7.1	7.1	7	9.6	8.2	10	4	17.3	20.8	8.9	10	10.0	9.3	6.3
	WFL	40°	12000	1500	8	23	5.8	5.8	15	8.1	6.7	2	47	3.5	9.7	2.9	133	2.0	3.4	2.1
					10	15	7.3	7.3	10	10.2	8.4	3	21	5.2	14.5	4.4	59	3.0	5.0	3.1
12					10	8.7	8.7	7	12.2	10.1	4	12	6.9	19.3	5.8	33	4.0	6.7	4.1	
14					8	10.2	10.2	5	14.2	11.8	5	8	8.7	24.2	7.3	21	5.0	8.4	5.1	
16					6	11.6	11.6	4	16.2	13.4	6	5	10.4	**	8.7	15	6.0	10.1	6.2	

The beam spread in degrees and the beam "L" and "W" in the following tables are computed at 50% of centerbeam candlepower and represent areas of "effective illumination."
 **Due to steep aiming angle, length of beam extends beyond 25'.

Adjustable

TC943M-MR16-39E1-438N



Lamp	Beam Type	Beam Spread°	Rated Life	CBCP	0°				30°			30°			45°					
					MH	FC	L	W	FC	L	W	D	FC	X	L	W	FC	X	L	W
39W MR16 Ceramic Metal Halide 	SP	12°	12000	16000	10	160	2.1	2.1	104	2.8	2.4	4	125	6.9	3.5	1.7	354	4.0	1.7	1.2
					12	111	2.5	2.5	72	3.4	2.9	6	56	10.4	5.2	2.5	157	6.0	2.6	1.8
					14	82	2.9	2.9	53	3.9	3.4	8	31	13.9	7.0	3.4	88	8.0	3.4	2.4
					16	63	3.4	3.4	41	4.5	3.9	10	20	17.3	8.7	4.2	57	10.0	4.3	3.0
					18	49	3.8	3.8	32	5.1	4.4	12	14	20.8	10.4	5.0	39	12.0	5.1	3.6
	FL	25°	12000	5500	8	86	3.5	3.5	56	4.8	4.1	2	172	3.5	4.2	1.8	486	2.0	1.9	1.3
					10	55	4.4	4.4	36	6.0	5.1	4	43	6.9	8.3	3.5	122	4.0	3.7	2.5
					12	38	5.3	5.3	25	7.2	6.1	6	19	10.4	12.5	5.3	54	6.0	5.6	3.8
					14	28	6.2	6.2	18	8.4	7.2	8	11	13.9	16.6	7.1	30	8.0	7.5	5.0
					16	21	7.1	7.1	14	9.6	8.2	10	7	17.3	20.8	8.9	19	10.0	9.3	6.3
	WFL	40°	12000	3000	8	47	5.8	5.8	30	8.1	6.7	2	94	3.5	9.7	2.9	265	2.0	3.4	2.1
					10	30	7.3	7.3	19	10.2	8.4	3	42	5.2	14.5	4.4	118	3.0	5.0	3.1
12					21	8.7	8.7	14	12.2	10.1	4	23	6.9	19.3	5.8	66	4.0	6.7	4.1	
14					15	10.2	10.2	10	14.2	11.8	5	15	8.7	24.2	7.3	42	5.0	8.4	5.1	
16					12	11.6	11.6	8	16.2	13.4	6	10	10.4	**	8.7	29	6.0	10.1	6.2	

The beam spread in degrees and the beam "L" and "W" in the following tables are computed at 50% of centerbeam candlepower and represent areas of "effective illumination."
 **Due to steep aiming angle, length of beam extends beyond 25'.

5-5/8" AR111/PAR36

Adjustable



IC64-638

Horizontal Aiming Angles



Vertical Aiming Angles



Lamp	Beam Type	Beam Spread°	Rated Life	CBCP	0°		30°			30°			45°							
					MH	FC	L	W	FC	L	W	D	FC	X	L	W	FC	X	L	W
50W PAR36 Halogen 	VNSP	5°	4000	35000	14	179	1.2	1.2	116	1.6	1.4	8	68	13.9	2.8	1.4	193	8.0	1.4	1.0
					18	108	1.6	1.6	70	2.1	1.8	10	44	17.3	3.5	1.7	124	10.0	1.7	1.2
					22	72	1.9	1.9	47	2.6	2.2	12	30	20.8	4.2	2.1	86	12.0	2.1	1.5
					26	52	2.3	2.3	34	3.0	2.6	14	22	24.2	4.9	2.4	63	14.0	2.4	1.7
					30	39	2.6	2.6	25	3.5	3.0	16	17	27.7	5.6	2.8	48	16.0	2.8	2.0
	NSP	8°	4000	30000	12	208	1.7	1.7	135	2.2	1.9	6	104	10.4	3.4	1.4	295	6.0	1.7	1.2
					16	117	2.2	2.2	76	3.0	2.6	8	59	13.9	4.5	2.2	166	8.0	2.2	1.6
					20	75	2.8	2.8	49	3.7	3.2	10	38	17.3	5.7	2.8	106	10.0	2.8	2.0
					24	52	3.4	3.4	34	4.5	3.9	12	26	20.8	6.8	3.4	74	12.0	3.4	2.4
	FL	30°	4000	1300	4	81	2.1	2.1	53	2.9	2.5	2	41	3.5	5.5	2.1	115	2.0	2.3	1.5
					6	36	4.1	4.1	23	5.7	4.8	3	18	5.2	12.8	4.1	51	3.0	4.7	2.9
					8	20	5.5	5.5	13	7.6	6.4	4	10	6.9	17.1	5.5	29	4.0	6.3	3.9
					10	13	6.9	6.9	8	9.6	8.0	5	7	8.7	21.4	6.9	18	5.0	7.8	4.9
	12	9	8.3	8.3	6	11.5	9.5	6	5	10.4	**	8.3	13	6.0	9.4	5.8				
	50W AR111 Halogen 	VNSP	4°	3000	50000	12	347	0.8	0.8	226	1.1	1.0	6	174	10.4	1.7	0.8	491	6.0	0.8
16						195	1.1	1.1	127	1.5	1.3	10	63	17.3	2.8	1.4	177	10.0	1.4	1.0
20						125	1.4	1.4	81	1.9	1.6	14	32	24.2	3.9	2.0	90	14.0	2.0	1.4
24						87	1.7	1.7	56	2.2	1.9	18	19	31.2	5.0	2.5	55	18.0	2.5	1.8
28						64	2.0	2.0	41	2.6	2.3	22	13	38.1	6.2	3.1	37	22.0	3.1	2.2
SP		8°	3000	23000	12	160	1.7	1.7	104	2.2	1.9	4	180	6.9	2.3	1.1	508	4.0	1.1	0.8
					16	90	2.2	2.2	58	3.0	2.6	6	80	10.4	3.4	1.7	226	6.0	1.7	1.2
					20	58	2.8	2.8	37	3.7	3.2	8	45	13.9	4.5	2.2	127	8.0	2.2	1.6
					24	40	3.4	3.4	26	4.5	3.9	10	29	17.3	5.7	2.8	81	10.0	2.8	2.0
28		29	3.9	3.9	19	5.2	4.5	12	20	20.8	6.8	3.4	56	12.0	3.4	2.4				
FL		25°	3000	4000	6	111	2.7	2.7	72	3.6	3.1	2	125	3.5	4.2	1.8	354	2.0	1.9	1.3
					8	63	3.5	3.5	41	4.8	4.1	3	56	5.2	6.2	2.7	157	3.0	2.8	1.9
					10	40	4.4	4.4	26	6.0	5.1	4	31	6.9	8.3	3.5	88	4.0	3.7	2.5
					12	28	5.3	5.3	18	7.2	6.1	5	20	8.7	10.4	4.4	57	5.0	4.7	3.1
					14	20	6.2	6.2	13	8.4	7.2	6	14	10.4	12.5	5.3	39	6.0	5.6	3.8

The beam spread in degrees and the beam "L" and "W" in the following tables are computed at 50% of centerbeam candlepower and represent areas of "effective illumination."

**Due to steep aiming angle, length of beam extends beyond 25'.

5-5/8" AR111/PAR36

Adjustable

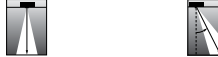

TC964-638

Horizontal Aiming Angles



Vertical Aiming Angles



Lamp	Beam Type	Beam Spread°	Rated Life	CBCP	0°				30°			30°				45°								
					MH	FC	L	W	FC	L	W	D	FC	X	L	W	FC	X	L	W				
75W PAR30 Halogen 	SP	5°	3000	13000	6	361	1.0	1.0	235	1.4	1.2	4	102	6.9	2.9	1.4	287	4.0	1.4	1.0				
					8	203	1.4	1.4	132	1.9	1.6	5	65	8.7	3.6	1.7	184	5.0	1.8	1.2				
					10	130	1.7	1.7	84	2.3	2.0	6	45	10.4	4.3	2.1	128	6.0	2.1	1.5				
					12	90	2.1	2.1	59	2.8	2.4	7	33	12.1	5.0	2.4	94	7.0	2.5	1.7				
					14	66	2.4	2.4	43	3.3	2.8	8	25	13.9	5.7	2.8	72	8.0	2.8	2.0				
	NFL	8°	3000	3100	4	194	1.8	1.8	126	2.4	2.0	2	97	3.5	4.2	1.8	274	2.0	1.9	1.3				
					6	86	2.7	2.7	56	3.6	3.1	3	43	5.2	6.2	2.7	122	3.0	2.8	1.9				
					8	48	3.5	3.5	31	4.8	4.1	4	24	6.9	8.3	3.5	69	4.0	3.7	2.5				
					10	31	4.4	4.4	20	6.0	5.1	5	16	8.7	10.4	4.4	44	5.0	4.7	3.1				
					12	22	5.3	5.3	14	7.2	6.1	6	11	10.4	12.5	5.3	30	6.0	5.6	3.8				
					FL	30°	3000	2000	4	125	2.5	2.5	81	3.5	2.9	2	63	3.5	7.2	2.5	177	2.0	2.8	1.8
									6	56	3.8	3.8	36	5.2	4.4	3	28	5.2	10.8	3.8	79	3.0	4.2	2.7
75W AR111 Halogen 	SP	8°	3000	30000	10	300	1.4	1.4	195	1.9	1.6	4	234	6.9	2.3	1.1	663	4.0	1.1	0.8				
					14	153	2.0	2.0	99	2.6	2.3	6	104	10.4	3.4	1.7	295	6.0	1.7	1.2				
					18	93	2.5	2.5	60	3.4	2.9	8	59	13.9	4.5	2.2	166	8.0	2.2	1.6				
					22	62	3.1	3.1	40	4.1	3.6	10	38	17.3	5.7	2.8	106	10.0	2.8	2.0				
	FL	25°	3000	5300	4	331	1.8	1.8	215	2.4	2.0	2	166	3.5	4.2	1.8	468	2.0	1.9	1.3				
					6	147	2.7	2.7	96	3.6	3.1	3	74	5.2	6.2	2.7	208	3.0	2.8	1.9				
					8	83	3.5	3.5	54	4.8	4.1	4	41	6.9	8.3	3.5	117	4.0	3.7	2.5				
					10	53	4.4	4.4	34	6.0	5.1	5	27	8.7	10.4	4.4	75	5.0	4.7	3.1				
					12	37	5.3	5.3	24	7.2	6.1	6	18	10.4	12.5	5.3	52	6.0	5.6	3.8				
					WFL	45°	3000	1700	3	189	2.5	2.5	123	3.5	2.9	1	213	1.7	6.8	1.7	601	1.0	2.0	1.2
5	68	4.1	4.1	44					5.9	4.8	2	53	3.5	13.7	3.3	150	2.0	4.0	2.3					
7	35	5.8	5.8	23					8.2	6.7	3	24	5.2	20.5	5.0	67	3.0	6.0	3.5					
9	21	7.5	7.5	14					10.5	8.6	4	13	6.9	**	6.6	38	4.0	8.0	4.7					
				11	14	9.1	9.1	9	12.9	10.5	5	9	8.7	**	8.3	24	5.0	10.0	5.9					

The beam spread in degrees and the beam "L" and "W" in the following tables are computed at 50% of centerbeam candlepower and represent areas of "effective illumination."
 **Due to steep aiming angle, length of beam extends beyond 25'.

5-5/8" PAR

Adjustable

IC63/TC63-638

Horizontal Aiming Angles



Vertical Aiming Angles



Lamp	Beam Type	Beam Spread°	Rated Life	CBCP	0°				30°				30°				45°			
					MH	FC	L	W	FC	L	W	D	FC	X	L	W	FC	X	L	W
50W PAR30 Halogen	SP	10°	3000	6900	6	192	1.0	1.0	124	1.4	1.2	3	96	5.2	2.1	1.0	271	3.0	1.1	0.7
					8	108	1.4	1.4	70	1.9	1.6	4	54	6.9	2.9	1.4	152	4.0	1.4	1.0
					10	69	1.7	1.7	45	2.3	2.0	5	35	8.7	3.6	1.7	98	5.0	1.8	1.2
					12	48	2.1	2.1	31	2.8	2.4	6	24	10.4	4.3	2.1	68	6.0	2.1	1.5
	NFL	25°	3000	2000	4	125	1.8	1.8	81	2.4	2.0	2	63	3.5	4.2	1.8	177	2.0	1.9	1.3
					6	56	2.7	2.7	36	3.6	3.1	3	28	5.2	6.2	2.7	79	3.0	2.8	1.9
					8	31	3.5	3.5	20	4.8	4.1	4	16	6.9	8.3	3.5	44	4.0	3.7	2.5
					10	20	4.4	4.4	13	6.0	5.1	5	10	8.7	10.4	4.4	28	5.0	4.7	3.1
	FL	35°	3000	1400	12	14	5.3	5.3	9	7.2	6.1	6	7	10.4	12.5	5.3	20	6.0	5.6	3.8
					3	156	1.9	1.9	101	2.6	2.2	1	175	1.7	3.6	1.3	495	1.0	1.4	0.9
					5	56	3.2	3.2	36	4.3	3.6	2	44	3.5	7.2	2.5	124	2.0	2.8	1.8
					7	29	4.4	4.4	19	6.1	5.1	3	19	5.2	10.8	3.8	55	3.0	4.2	2.7
50W PAR30 Halogen IR	SP	9°	3000	13000	6	361	0.9	0.9	235	1.3	1.1	4	102	6.9	2.6	1.3	287	4.0	1.3	0.9
					8	203	1.3	1.3	132	1.7	1.5	5	65	8.7	3.2	1.6	184	5.0	1.6	1.1
					10	130	1.6	1.6	84	2.1	1.8	6	45	10.4	3.8	1.9	128	6.0	1.9	1.3
					12	90	1.9	1.9	59	2.5	2.2	7	33	12.1	4.5	2.2	94	7.0	2.2	1.6
	NFL	25°	3000	2700	14	66	2.2	2.2	43	2.9	2.5	8	25	13.9	5.1	2.5	72	8.0	2.5	1.8
					4	169	1.8	1.8	110	2.4	2.0	2	84	3.5	4.2	1.8	239	2.0	1.9	1.3
					6	75	2.7	2.7	49	3.6	3.1	3	38	5.2	6.2	2.7	106	3.0	2.8	1.9
					8	42	3.5	3.5	27	4.8	4.1	4	21	6.9	8.3	3.5	60	4.0	3.7	2.5
	FL	35°	3000	1500	10	27	4.4	4.4	18	6.0	5.1	5	14	8.7	10.4	4.4	38	5.0	4.7	3.1
					12	19	5.3	5.3	12	7.2	6.1	6	9	10.4	12.5	5.3	27	6.0	5.6	3.8
					3	167	1.9	1.9	108	2.6	2.2	1	188	1.7	3.6	1.3	530	1.0	1.4	0.9
					5	60	3.2	3.2	39	4.3	3.6	2	47	3.5	7.2	2.5	133	2.0	2.8	1.8
75W PAR30 Halogen	SP	10°	3000	13000	6	361	1.0	1.0	235	1.4	1.2	4	102	6.9	2.9	1.4	287	4.0	1.4	1.0
					8	203	1.4	1.4	132	1.9	1.6	5	65	8.7	3.6	1.7	184	5.0	1.8	1.2
					10	130	1.7	1.7	84	2.3	2.0	6	45	10.4	4.3	2.1	128	6.0	2.1	1.5
					12	90	2.1	2.1	59	2.8	2.4	7	33	12.1	5.0	2.4	94	7.0	2.5	1.7
	NFL	25°	3000	3100	14	66	2.4	2.4	43	3.3	2.8	8	25	13.9	5.7	2.8	72	8.0	2.8	2.0
					4	194	1.8	1.8	126	2.4	2.0	2	97	3.5	4.2	1.8	274	2.0	1.9	1.3
					6	86	2.7	2.7	56	3.6	3.1	3	43	5.2	6.2	2.7	122	3.0	2.8	1.9
					8	48	3.5	3.5	31	4.8	4.1	4	24	6.9	8.3	3.5	69	4.0	3.7	2.5
	FL	35°	3000	2000	10	31	4.4	4.4	20	6.0	5.1	5	16	8.7	10.4	4.4	44	5.0	4.7	3.1
					12	22	5.3	5.3	14	7.2	6.1	6	11	10.4	12.5	5.3	30	6.0	5.6	3.8
					4	125	2.5	2.5	81	3.5	2.9	2	63	3.5	7.2	2.5	177	2.0	2.8	1.8
					6	56	3.8	3.8	36	5.2	4.4	3	28	5.2	10.8	3.8	79	3.0	4.2	2.7
8	31	5.0	5.0	20	7.0	5.8	4	16	6.9	14.4	5.0	44	4.0	5.6	3.6					
10	20	6.3	6.3	13	8.7	7.3	5	10	8.7	18.0	6.3	28	5.0	7.0	4.5					
12	14	7.6	7.6	9	10.4	8.7	6	7	10.4	21.6	7.6	20	6.0	8.4	5.4					

The beam spread in degrees and the beam "L" and "W" in the following tables are computed at 50% of centerbeam candlepower and represent areas of "effective illumination."

7" PAR-IC

Adjustable

IC73-738



Beam Type	Beam Spread°	Rated Life	CBCP	0°				30°			30°				45°					
				MH	FC	L	W	FC	L	W	D	FC	X	L	W	FC	X	L	W	
100W PAR38 Halogen IR	SP	10°	3000	29000	10	290	1.7	1.7	188	2.3	2.0	6	101	10.4	4.3	2.1	285	6.0	2.1	1.5
					14	148	2.4	2.4	96	3.3	2.8	9	45	15.6	6.4	3.1	127	9.0	3.2	2.2
					18	90	3.1	3.1	58	4.2	3.6	12	25	20.8	8.6	4.2	71	12.0	4.2	3.0
					22	60	3.8	3.8	39	5.1	4.4	15	16	26.0	10.7	5.2	46	15.0	5.3	3.7
					26	43	4.5	4.5	28	6.1	5.3	18	11	31.2	12.9	6.3	32	18.0	6.3	4.5
	NFL	25°	3000	6300	6	175	2.7	2.7	114	3.6	3.1	3	88	5.2	6.2	2.7	247	3.0	2.8	1.9
					8	98	3.5	3.5	64	4.8	4.1	4	49	6.9	8.3	3.5	139	4.0	3.7	2.5
					10	63	4.4	4.4	41	6.0	5.1	5	32	8.7	10.4	4.4	89	5.0	4.7	3.1
					12	44	5.3	5.3	28	7.2	6.1	6	22	10.4	12.5	5.3	62	6.0	5.6	3.8
					14	32	6.2	6.2	21	8.4	7.2	7	16	12.1	14.6	6.2	45	7.0	6.5	4.4
	FL	40°	3000	3400	4	213	2.9	2.9	138	4.1	3.4	2	106	3.5	9.7	2.9	301	2.0	3.4	2.1
					6	94	4.4	4.4	61	6.1	5.0	3	47	5.2	14.5	4.4	134	3.0	5.0	3.1
8					53	5.8	5.8	35	8.1	6.7	4	27	6.9	19.3	5.8	75	4.0	6.7	4.1	
10					34	7.3	7.3	22	10.2	8.4	5	17	8.7	24.2	7.3	48	5.0	8.4	5.1	
12					24	8.7	8.7	15	12.2	10.1	6	12	10.4	**	8.7	33	6.0	10.1	6.2	

The beam spread in degrees and the beam "L" and "W" in the following tables are computed at 50% of centerbeam candlepower and represent areas of "effective illumination."
 **Due to steep aiming angle, length of beam extends beyond 25'.

7" PAR-TC

Adjustable

TC973-738



Beam Type	Beam Spread°	Rated Life	CBCP	0°				30°			30°				45°					
				MH	FC	L	W	FC	L	W	D	FC	X	L	W	FC	X	L	W	
120W PAR38 Halogen	SP	9°	3000	25000	10	250	1.6	1.6	162	2.1	1.8	6	87	10.4	3.8	1.9	246	6.0	1.9	1.3
					14	128	2.2	2.2	83	2.9	2.5	9	39	15.6	5.8	2.8	109	9.0	2.9	2.0
					18	77	2.8	2.8	50	3.8	3.3	12	22	10.8	7.7	3.8	61	12.0	3.8	2.7
					22	52	3.5	3.5	34	4.6	4.0	15	14	26.0	9.6	4.7	39	15.0	4.8	3.3
					NFL	30°	3000	5000	6	139	3.2	3.2	90	4.4	3.7	3	69	5.2	8.2	3.2
	8	78	4.3	4.3					51	5.9	5.0	4	39	6.9	10.9	4.3	110	4.0	4.6	3.0
	10	50	5.4	5.4					32	7.3	6.2	5	25	8.7	13.7	5.4	71	5.0	5.8	3.8
	12	35	6.4	6.4					23	8.8	7.4	6	17	10.4	16.4	6.4	49	6.0	6.9	4.5
	FL	50°	3000	2000					4	125	3.7	3.7	81	5.4	4.3	2	63	3.5	21.5	3.7
					6	56	5.6	5.6	36	8.0	6.5	3	28	5.2	**	5.6	79	3.0	7.2	4.0
					8	31	7.5	7.5	20	10.7	8.6	4	16	6.9	**	7.5	44	4.0	9.5	5.3
					10	20	9.3	9.3	13	13.4	10.8	5	10	8.7	**	9.3	28	5.0	11.9	6.6
250W PAR38 Halogen					SP	12°	4200	40000	10	400	1.7	1.7	260	2.3	2.0	6	139	10.4	4.3	2.1
	15	178	2.6	2.6					115	3.5	3.0	9	62	15.6	6.4	3.1	175	9.0	3.2	2.2
	20	100	3.5	3.5					65	4.7	4.0	12	35	20.8	8.6	4.2	98	12.0	4.2	3.0
	25	64	4.4	4.4					42	5.8	5.1	15	22	26.0	10.7	5.2	63	15.0	5.3	3.7
	FL	4200	9000	6					250	3.2	3.2	162	4.4	3.7	3	125	5.2	8.2	3.2	354
				8	141	4.3	4.3	91	5.9	5.0	4	70	6.9	10.9	4.3	199	4.0	4.6	3.0	
	FL	4200	9000	10	90	5.4	5.4	58	7.3	6.2	5	45	8.7	13.7	5.4	127	5.0	5.8	3.8	
12				63	6.4	6.4	41	8.8	7.4	6	31	10.4	16.4	6.4	88	6.0	6.9	4.5		

The beam spread in degrees and the beam "L" and "W" in the following tables are computed at 50% of centerbeam candlepower and represent areas of "effective illumination."
 **Due to steep aiming angle, length of beam extends beyond 25'.

Photometrics - Square Downlights

3-1/4" MR16 Halogen

Reflector

IC43SQ-437SQHZ, Haze Reflector

37W IR MR16 35° Flood

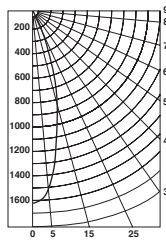

Candlepower Distribution (Candelas)

Angle	Candela	Lumens
0°	1609	
5°	1512	144
15°	866	246
25°	278	129
35°	41	26
45°	6	5
55°	1	1
65°	0	0
75°	0	0
85°	0	0

Initial Footcandles

Distance to Illuminated Plane (Feet)	Footcandles Beam Center	Footcandles Beam Edge	Beam Diameter
6'	44.7	19.8	3.5'
7'	32.8	14.6	4.0'
8'	25.1	11.1	4.6'
9'	19.9	8.8	5.2'
10'	16.1	7.1	5.8'
11'	13.3	5.9	6.4'
12'	11.2	5.0	6.9'
13'	9.5	4.2	7.5'
14'	8.2	3.6	8.1'
15'	7.2	3.2	8.7'

50W IR MR16 35° Flood

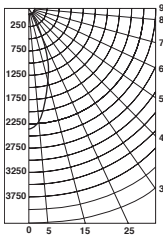

Candlepower Distribution (Candelas)

Angle	Candela	Lumens
0°	2371	
5°	2200	210
15°	1326	376
25°	428	198
35°	69	43
45°	11	8
55°	3	2
65°	0	0
75°	0	0
85°	0	0

Initial Footcandles

Distance to Illuminated Plane (Feet)	Footcandles Beam Center	Footcandles Beam Edge	Beam Diameter
6'	65.9	28.9	3.6'
7'	48.4	21.2	4.2'
8'	37.0	16.2	4.8'
9'	29.3	12.8	5.5'
10'	23.7	10.4	6.1'
11'	19.6	8.6	6.7'
12'	16.5	7.2	7.3'
13'	14.0	6.1	7.9'
14'	12.1	5.3	8.5'
15'	10.5	4.6	9.1'

50W MR16 40° Flood

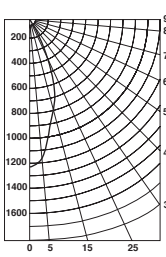

Candlepower Distribution (Candelas)

Angle	Candela	Lumens
0°	1231	
5°	1168	111
15°	796	226
25°	405	187
35°	67	42
45°	10	8
55°	2	2
65°	0	0
75°	0	0
85°	0	0

Initial Footcandles

Distance to Illuminated Plane (Feet)	Footcandles Beam Center	Footcandles Beam Edge	Beam Diameter
6'	34.2	14.0	4.5'
7'	25.1	10.3	5.3'
8'	19.2	7.9	6.1'
9'	15.2	6.2	6.8'
10'	12.3	5.0	7.6'
11'	10.2	4.2	8.3'
12'	8.6	3.5	9.1'
13'	7.3	3.0	9.9'
14'	6.3	2.6	10.6'
15'	5.5	2.2	11.4'

75W MR16 40° Flood

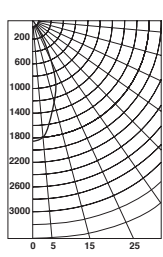

Candlepower Distribution (Candelas)

Angle	Candela	Lumens
0°	1837	
5°	1775	169
15°	1230	349
25°	556	257
35°	82	52
45°	14	11
55°	2	2
65°	0	0
75°	0	0
85°	0	0

Initial Footcandles

Distance to Illuminated Plane (Feet)	Footcandles Beam Center	Footcandles Beam Edge	Beam Diameter
6'	51.0	20.9	4.5'
7'	37.5	15.3	5.3'
8'	28.7	11.7	6.0'
9'	22.7	9.3	6.8'
10'	18.4	7.5	7.6'
11'	15.2	6.2	8.3'
12'	12.8	5.2	9.1'
13'	10.9	4.4	9.8'
14'	9.4	3.8	10.6'
15'	8.2	3.3	11.3'

Flat Pinhole

IC43SQ-4337SQ, Black Alzak® Reflector

37W IR MR16 10° Spot

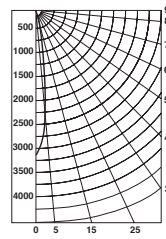

Candlepower Distribution (Candelas)

Angle	Candela	Lumens
0°	3193	
5°	2327	222
15°	387	110
25°	39	18
35°	0	0
45°	0	0
55°	0	0
65°	0	0
75°	0	0
85°	0	0

Initial Footcandles

Distance to Illuminated Plane (Feet)	Footcandles Beam Center	Footcandles Beam Edge	Beam Diameter
6'	88.7	43.3	1.5'
7'	65.2	31.8	1.8'
8'	49.9	24.4	2.0'
9'	39.4	19.3	2.3'
10'	31.9	15.6	2.5'
11'	26.4	12.9	2.8'
12'	22.2	10.8	3.0'
13'	18.9	9.2	3.3'
14'	16.3	8.0	3.5'
15'	14.2	6.9	3.8'

50W IR MR16 10° Spot

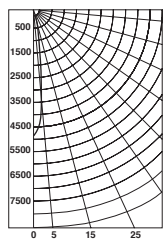

Candlepower Distribution (Candelas)

Angle	Candela	Lumens
0°	4860	
5°	3445	329
15°	431	122
25°	39	18
35°	0	0
45°	0	0
55°	0	0
65°	0	0
75°	0	0
85°	0	0

Initial Footcandles

Distance to Illuminated Plane (Feet)	Footcandles Beam Center	Footcandles Beam Edge	Beam Diameter
6'	135.0	66.1	1.4'
7'	99.2	48.6	1.7'
8'	75.9	37.2	1.9'
9'	60.0	29.4	2.1'
10'	48.6	23.8	2.4'
11'	40.2	19.7	2.8'
12'	33.7	16.5	2.8'
13'	28.8	14.1	3.1'
14'	24.8	12.1	3.3'
15'	21.6	10.6	3.5'

50W MR16 15° Narrow Spot

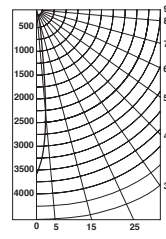

Candlepower Distribution (Candelas)

Angle	Candela	Lumens
0°	3557	
5°	2312	221
15°	246	70
25°	25	11
35°	0	0
45°	0	0
55°	0	0
65°	0	0
75°	0	0
85°	0	0

Initial Footcandles

Distance to Illuminated Plane (Feet)	Footcandles Beam Center	Footcandles Beam Edge	Beam Diameter
6'	98.8	48.5	1.3'
7'	72.6	35.7	1.5'
8'	55.6	27.3	1.7'
9'	43.9	21.6	2.0'
10'	35.6	17.5	2.2'
11'	29.4	14.4	2.4'
12'	24.7	12.1	2.6'
13'	21.0	10.3	2.8'
14'	18.1	8.9	3.1'
15'	15.8	7.8	3.3'

75W MR16 15° Narrow Spot

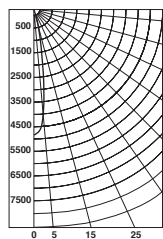

Candlepower Distribution (Candelas)

Angle	Candela	Lumens
0°	4819	
5°	3644	348
15°	443	126
25°	34	16
35°	0	0
45°	0	0
55°	0	0
65°	0	0
75°	0	0
85°	0	0

Initial Footcandles

Distance to Illuminated Plane (Feet)	Footcandles Beam Center	Footcandles Beam Edge	Beam Diameter
6'	133.9	65.4	1.5'
7'	98.3	48.0	1.8'
8'	75.3	36.8	2.0'
9'	59.5	29.1	2.3'
10'	48.2	23.5	2.5'
11'	39.8	19.4	2.8'
12'	33.5	16.3	3.0'
13'	28.5	13.9	3.3'
14'	24.6	12.0	3.5'
15'	21.4	10.5	3.8'

3-1/4" PAR Reflector

IC13SQ-437SQHZ, Haze Reflector

60W PAR16
30° Narrow Flood

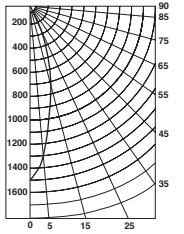

Candlepower Distribution (Candelas)

Angle	Candela	Lumens
0°	1463	
5°	1344	128
15°	736	209
25°	258	120
35°	27	17
45°	3	2
55°	0	0
65°	0	0
75°	0	0
85°	0	0

Initial Footcandles

Distance to Illuminated Plane (Feet)	Footcandles Beam Center	Footcandles Beam Edge	Beam Diameter
6'	40.6	18.3	3.2'
7'	29.9	13.4	3.8'
8'	22.9	10.3	4.3'
9'	18.1	8.1	4.8'
10'	14.6	6.6	5.4'
11'	12.1	5.4	5.9'
12'	10.2	4.6	6.5'
13'	8.7	3.9	7.0'
14'	7.5	3.4	7.5'
15'	6.5	2.9	8.1'

TC13SQ-437SQHZ, Haze Reflector

75W PAR16
30° Narrow Flood

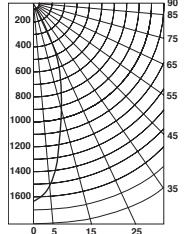

Candlepower Distribution (Candelas)

Angle	Candela	Lumens
0°	1643	
5°	1536	147
15°	925	262
25°	437	202
35°	41	26
45°	5	4
55°	3	2
65°	0	0
75°	0	0
85°	0	0

Initial Footcandles

Distance to Illuminated Plane (Feet)	Footcandles Beam Center	Footcandles Beam Edge	Beam Diameter
6'	45.6	19.9	3.7'
7'	33.5	14.6	4.3'
8'	25.7	11.2	4.9'
9'	20.3	8.9	5.5'
10'	16.4	7.2	6.2'
11'	13.6	5.9	6.8'
12'	11.4	5.0	7.4'
13'	9.7	4.2	8.0'
14'	8.4	3.7	8.6'
15'	7.3	3.2	9.2'

Regressed Pinhole

IC13SQ-4307SQ, Black Alzak® Reflector

45W PAR16
10° Spot

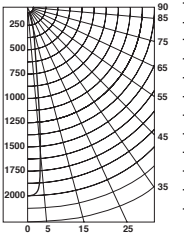

Candlepower Distribution (Candelas)

Angle	Candela	Lumens
0°	2005	
5°	1543	147
15°	238	68
25°	65	30
35°	7	5
45°	6	4
55°	0	0
65°	0	0
75°	0	0
85°	0	0

Initial Footcandles

Distance to Illuminated Plane (Feet)	Footcandles Beam Center	Footcandles Beam Edge	Beam Diameter
6'	55.7	27.3	1.4'
7'	40.9	20.0	1.6'
8'	31.3	15.3	1.9'
9'	24.8	12.1	2.1'
10'	20.0	9.8	2.3'
11'	16.6	8.1	2.6'
12'	13.9	6.8	2.8'
13'	11.9	5.8	3.0'
14'	10.2	5.0	3.3'
15'	8.9	4.4	3.5'

TC13SQ-4307SQ, Black Alzak® Reflector

60W PAR16
10° Narrow Spot

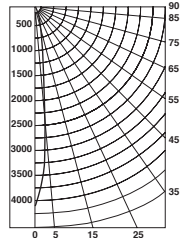

Candlepower Distribution (Candelas)

Angle	Candela	Lumens
0°	4195	
5°	2407	230
15°	452	128
25°	110	51
35°	4	3
45°	0	0
55°	0	0
65°	0	0
75°	0	0
85°	0	0

Initial Footcandles

Distance to Illuminated Plane (Feet)	Footcandles Beam Center	Footcandles Beam Edge	Beam Diameter
6'	116.5	57.4	1.2'
7'	85.6	42.2	1.4'
8'	65.5	32.3	1.6'
9'	51.8	25.5	1.8'
10'	41.9	20.7	2.0'
11'	34.7	17.1	2.1'
12'	29.1	14.4	2.3'
13'	24.8	12.2	2.5'
14'	21.4	10.5	2.7'
15'	18.6	9.2	2.9'

3-1/4" CMH MR16 Reflector

TC943MSQ-MR16-39E1-437SQHZ, Haze Reflector

39W MR16
25° Flood

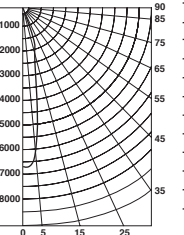

Candlepower Distribution (Candelas)

Angle	Candela	Lumens
0°	6702	
5°	6164	588
15°	2446	693
25°	677	313
35°	162	102
45°	59	46
55°	9	8
65°	5	5
75°	2	3
85°	0	0

Initial Footcandles

Distance to Illuminated Plane (Feet)	Footcandles Beam Center	Footcandles Beam Edge	Beam Diameter
6'	186.2	87.2	2.5'
7'	136.8	64.0	3.0'
8'	104.7	49.0	3.4'
9'	82.7	38.7	3.8'
10'	67.0	31.4	4.2'
11'	55.4	25.9	4.6'
12'	46.5	21.8	5.1'
13'	39.7	18.6	5.5'
14'	34.2	16.0	5.9'
15'	29.8	13.9	6.3'

Flat Pinhole

TC943MSQ-M16-39E1-4337SQ, Black Alzak Reflector

39W MR16
12° Spot

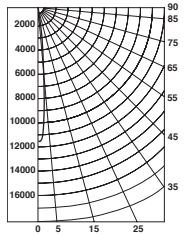

Candlepower Distribution (Candelas)

Angle	Candela	Lumens
0°	11750	
5°	6324	604
15°	778	221
25°	93	43
35°	2	1
45°	0	0
55°	0	0
65°	0	0
75°	0	0
85°	0	0

Initial Footcandles

Distance to Illuminated Plane (Feet)	Footcandles Beam Center	Footcandles Beam Edge	Beam Diameter
6'	326.4	161.1	1.1'
7'	239.8	118.4	1.3'
8'	183.6	90.6	1.5'
9'	145.1	71.6	1.7'
10'	117.5	58.0	1.8'
11'	97.1	47.9	2.0'
12'	81.6	40.3	2.2'
13'	69.5	34.3	2.4'
14'	59.9	29.6	2.6'
15'	52.2	25.8	2.8'

3-1/4" MR16 Halogen

Wall Wash

IC435Q-439SQHZ, Haze Reflector

37W IR MR16 35° Flood

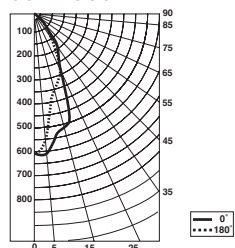

Candlepower Distribution (Candelas)

Degrees Vertical	0° Wall Wash	180° Downlight
0°	580	580
5°	579	543
15°	482	331
25°	247	215
35°	142	79
45°	80	42
55°	41	8
65°	22	2
75°	10	0
85°	0	0

Footcandles on Wall from Multiple Fixtures

Fixture Distance to Wall	18"			24"								
	18"	24"	18"	24"	18"	24"						
1'	13	12	13	11	7	11	7	6	7	5	4	5
2'	20	17	20	16	13	16	13	13	13	10	10	10
3'	17	18	17	13	12	13	14	14	14	11	10	11
4'	15	16	15	12	12	12	13	14	13	9	10	9
5'	13	12	13	9	9	9	12	12	12	9	9	9
6'	10	10	10	7	7	7	11	11	11	8	8	8
7'	7	8	7	6	6	6	9	9	9	7	7	7
8'	6	6	6	5	5	5	7	7	7	6	5	6
9'	5	5	5	4	4	4	6	6	6	5	5	5

50W MR16 40° Flood

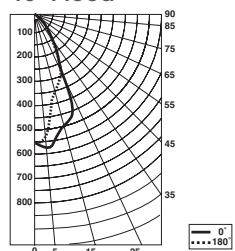

Candlepower Distribution (Candelas)

Degrees Vertical	0° Wall Wash	180° Downlight
0°	535	535
5°	554	489
15°	473	325
25°	301	207
35°	126	90
45°	79	50
55°	40	8
65°	23	3
75°	11	0
85°	0	0

Footcandles on Wall from Multiple Fixtures

Fixture Distance to Wall	18"			24"								
	18"	24"	18"	24"	18"	24"						
1'	12	11	12	11	6	11	7	6	7	6	4	6
2'	19	16	19	14	13	14	12	11	12	9	8	9
3'	19	21	19	15	14	15	14	15	14	11	10	11
4'	17	18	17	13	13	13	15	16	15	11	12	11
5'	14	13	14	10	10	10	14	14	14	10	11	10
6'	10	10	10	8	8	8	12	12	12	9	9	9
7'	8	8	8	6	6	6	10	10	10	7	7	7
8'	6	6	6	5	5	5	8	8	8	6	6	6
9'	5	5	5	4	4	4	6	7	6	5	5	5

TC435Q-439SQHZ, Haze Reflector

50W IR MR16 35° Flood

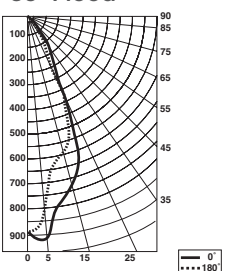

Candlepower Distribution (Candelas)

Degrees Vertical	0° Wall Wash	180° Downlight
0°	864	864
5°	885	794
15°	700	497
25°	412	296
35°	160	129
45°	108	61
55°	60	9
65°	34	3
75°	16	0
85°	2	0

Footcandles on Wall from Multiple Fixtures

Fixture Distance to Wall	18"		24"									
	18"	24"	18"	24"								
1'	19	14	19	17	8	17	10	8	10	8	6	8
2'	23	22	23	18	17	18	16	16	16	13	12	13
3'	26	25	26	20	18	20	18	17	18	14	13	14
4'	24	23	24	18	18	18	19	19	19	15	14	15
5'	19	19	19	14	14	14	19	18	19	14	14	14
6'	14	14	14	11	11	11	16	16	16	12	12	12
7'	11	11	11	8	8	8	13	13	13	10	10	10
8'	9	9	9	7	7	7	11	11	11	8	8	8
9'	8	8	8	6	6	6	9	9	9	7	7	7

75W MR16 40° Flood

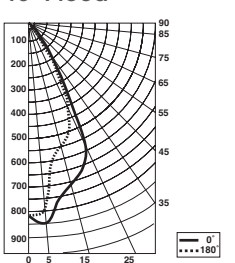

Candlepower Distribution (Candelas)

Degrees Vertical	0° Wall Wash	180° Downlight
0°	800	800
5°	840	723
15°	717	480
25°	456	285
35°	191	135
45°	120	61
55°	56	9
65°	32	3
75°	16	0
85°	2	0

Footcandles on Wall from Multiple Fixtures

Fixture Distance to Wall	18"		24"									
	18"	24"	18"	24"								
1'	18	15	18	15	8	15	10	8	10	8	6	8
2'	27	25	27	21	20	21	18	17	18	14	13	14
3'	30	30	30	23	21	23	21	21	21	16	15	16
4'	26	26	26	20	19	20	22	23	22	17	17	17
5'	20	20	20	15	15	15	20	20	20	15	16	15
6'	15	15	15	11	11	11	17	17	17	13	13	13
7'	12	12	12	9	9	9	14	14	14	11	11	11
8'	9	9	9	7	7	7	11	12	11	9	9	9
9'	8	8	8	6	6	6	9	10	9	7	7	7

3-1/4" PAR

Wall Wash

IC13SQ-439SQHZ, Haze Reflector

45W PAR16 27° Flood

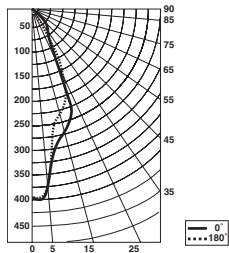

Candlepower Distribution (Candelas)

Degrees Vertical	0° Wall Wash	180° Downlight
0°	384	384
5°	350	374
15°	228	200
25°	123	128
35°	73	42
45°	54	21
55°	27	4
65°	14	0
75°	7	0
85°	0	0

Footcandles on Wall from Multiple Fixtures

Fixture Distance to Wall	18"			24"		
	18"	24"	18"	24"	18"	24"
1'	8 7 8	7 4 7	4 4 4	4 3 4		
2'	11 10 11	8 7 8	8 8 8	6 6 6		
3'	8 8 8	6 6 6	7 7 7	5 5 5		
4'	8 7 8	6 6 6	6 6 6	4 5 4		
5'	6 6 6	4 4 4	6 6 6	4 4 4		
6'	4 5 4	3 3 4	5 5 5	4 4 4		
7'	3 4 3	3 3 3	4 4 4	3 3 3		
8'	3 3 3	2 2 2	3 3 3	3 3 3		
9'	3 3 3	2 2 2	3 3 3	2 2 2		

TC13SQ-439SQHZ, Haze Reflector

60W PAR16 30° Narrow Flood

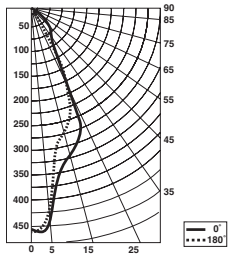

Candlepower Distribution (Candelas)

Degrees Vertical	0° Wall Wash	180° Downlight
0°	445	445
5°	435	422
15°	317	257
25°	166	160
35°	88	59
45°	60	31
55°	28	5
65°	15	0
75°	7	0
85°	0	0

Footcandles on Wall from Multiple Fixtures

Fixture Distance to Wall	18"			24"		
	18"	24"	18"	24"	18"	24"
1'	9 8 9	8 4 8	5 4 5	4 3 4		
2'	12 11 12	10 8 10	9 9 9	7 6 7		
3'	11 11 11	8 8 8	9 8 9	7 6 7		
4'	10 10 10	8 8 8	8 8 8	6 6 6		
5'	8 8 8	6 6 6	8 8 8	6 6 6		
6'	6 6 6	5 5 5	7 7 7	5 5 5		
7'	5 5 5	4 4 4	6 6 6	4 4 4		
8'	4 4 4	3 3 3	5 5 5	4 4 4		
9'	3 4 3	3 3 3	4 4 4	3 3 3		

3-1/4" CMH MR16

Wall Wash

TC943MSQ-MR16-39E1-439SQHZ, Haze Reflector

39W MR16 30° Wide Flood

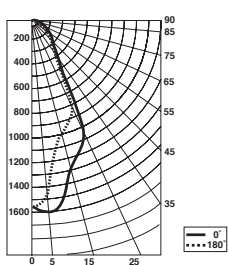

Candlepower Distribution (Candelas)

Degrees Vertical	0° Wall Wash	180° Downlight
0°	1505	1505
5°	1554	1365
15°	1257	983
25°	948	550
35°	347	294
45°	233	122
55°	174	24
65°	108	9
75°	57	0
85°	5	0

Footcandles on Wall from Multiple Fixtures

Fixture Distance to Wall	18"			24"		
	18"	24"	18"	24"	18"	24"
1'	54 41 54	48 23 48	31 27 31	26 18 26		
2'	49 53 49	38 42 38	35 36 35	28 27 28		
3'	61 56 61	48 39 48	42 40 42	31 30 31		
4'	47 48 47	37 35 37	44 44 44	35 32 35		
5'	36 37 36	26 28 26	38 38 38	29 29 29		
6'	28 28 28	20 21 20	32 32 32	24 24 24		
7'	22 22 22	16 16 16	26 26 26	19 20 19		
8'	18 18 18	13 13 13	21 21 21	16 16 16		
9'	15 15 15	11 11 11	18 18 18	13 13 13		

Photometrics - Square Lensed Downlights

3-1/4" MR16 Halogen

Lensed Downlight

IC43SQ-432SQHZ, Haze Reflector

37W IR MR16 35° Flood

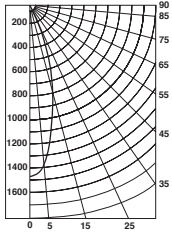

Candlepower Distribution (Candelas)

Angle	Candela	Lumens
0°	1481	
5°	1398	133
15°	812	230
25°	271	126
35°	44	28
45°	7	6
55°	1	1
65°	0	0
75°	0	0
85°	0	0

Initial Footcandles

Distance to Illuminated Plane (Feet)	Footcandles Beam Center	Footcandles Beam Edge	Beam Diameter
6'	41.1	18.1	3.5'
7'	30.2	13.3	4.1'
8'	23.1	10.2	4.7'
9'	18.3	8.1	5.3'
10'	14.8	6.5	5.9'
11'	12.2	5.4	6.5'
12'	10.3	4.5	7.1'
13'	8.8	3.9	7.7'
14'	7.6	3.3	8.3'
15'	6.6	2.9	8.8'

50W IR MR16 35° Flood

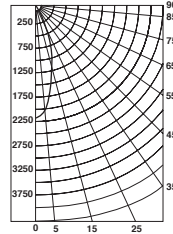

Candlepower Distribution (Candelas)

Angle	Candela	Lumens
0°	2184	
5°	2033	194
15°	1183	335
25°	434	201
35°	66	41
45°	12	10
55°	3	3
65°	0	0
75°	0	0
85°	0	0

Initial Footcandles

Distance to Illuminated Plane (Feet)	Footcandles Beam Center	Footcandles Beam Edge	Beam Diameter
6'	60.7	26.8	3.5'
7'	44.6	19.7	4.1'
8'	34.1	15.1	4.7'
9'	27.0	11.9	5.3'
10'	21.8	9.6	5.9'
11'	18.0	8.0	6.5'
12'	15.2	6.7	7.0'
13'	12.9	5.7	7.6'
14'	11.1	4.9	8.2'
15'	9.7	4.3	8.8'

50W MR16 40° Flood

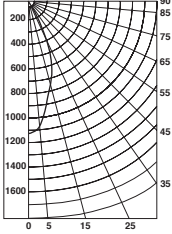

Candlepower Distribution (Candelas)

Angle	Candela	Lumens
0°	1137	
5°	1080	103
15°	741	210
25°	387	179
35°	66	42
45°	12	9
55°	2	2
65°	0	0
75°	0	0
85°	0	0

Initial Footcandles

Distance to Illuminated Plane (Feet)	Footcandles Beam Center	Footcandles Beam Edge	Beam Diameter
6'	31.6	12.9	4.6'
7'	23.2	9.4	5.4'
8'	17.8	7.2	6.1'
9'	14.0	5.7	6.9'
10'	11.4	4.6	7.7'
11'	9.4	3.8	8.4'
12'	7.9	3.2	9.2'
13'	6.7	2.7	10.0'
14'	5.8	2.4	10.7'
15'	5.1	2.1	11.5'

75W MR16 40° Flood

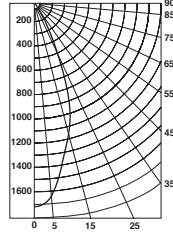

Candlepower Distribution (Candelas)

Angle	Candela	Lumens
0°	1709	
5°	1647	157
15°	1154	327
25°	525	243
35°	86	54
45°	16	13
55°	3	2
65°	0	0
75°	0	0
85°	0	0

Initial Footcandles

Distance to Illuminated Plane (Feet)	Footcandles Beam Center	Footcandles Beam Edge	Beam Diameter
6'	47.5	19.4	4.6'
7'	34.9	14.2	5.3'
8'	26.7	10.9	6.1'
9'	21.1	8.6	6.8'
10'	17.1	7.0	7.6'
11'	14.1	5.8	8.3'
12'	11.9	4.8	9.1'
13'	10.1	4.1	9.9'
14'	8.7	3.6	10.6'
15'	7.6	3.1	11.4'

Lensed Pinhole Downlight

IC43SQ-4332SQ-WH, Black Alzak® Reflector

TC43SQ-4332SQ-WH, Black Alzak® Reflector

37W IR MR16 10° Spot

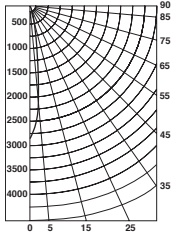

Candlepower Distribution (Candelas)

Angle	Candela	Lumens
0°	2868	
5°	2091	200
15°	362	102
25°	36	17
35°	0	0
45°	0	0
55°	0	0
65°	0	0
75°	0	0
85°	0	0

Initial Footcandles

Distance to Illuminated Plane (Feet)	Footcandles Beam Center	Footcandles Beam Edge	Beam Diameter
6'	79.7	38.9	1.5'
7'	58.5	28.6	1.8'
8'	44.8	21.9	2.0'
9'	35.4	17.3	2.3'
10'	28.7	14.0	2.5'
11'	23.7	11.6	2.8'
12'	19.9	9.7	3.0'
13'	17.0	8.3	3.3'
14'	14.6	7.1	3.5'
15'	12.7	6.2	3.8'

50W IR MR16 10° Spot

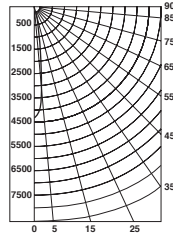

Candlepower Distribution (Candelas)

Angle	Candela	Lumens
0°	4424	
5°	3001	286
15°	432	122
25°	37	17
35°	0	0
45°	0	0
55°	0	0
65°	0	0
75°	0	0
85°	0	0

Initial Footcandles

Distance to Illuminated Plane (Feet)	Footcandles Beam Center	Footcandles Beam Edge	Beam Diameter
6'	122.9	60.3	1.4'
7'	90.3	44.3	1.6'
8'	69.1	33.9	1.8'
9'	54.6	26.8	2.1'
10'	44.2	21.7	2.3'
11'	36.6	17.9	2.5'
12'	30.7	15.1	2.7'
13'	26.2	12.8	3.0'
14'	22.6	11.1	3.2'
15'	22.6	11.1	3.2'

50W MR16 15° Narrow Spot

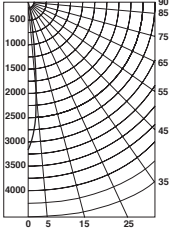

Candlepower Distribution (Candelas)

Angle	Candela	Lumens
0°	3276	
5°	2130	203
15°	234	66
25°	24	11
35°	0	0
45°	0	0
55°	0	0
65°	0	0
75°	0	0
85°	0	0

Initial Footcandles

Distance to Illuminated Plane (Feet)	Footcandles Beam Center	Footcandles Beam Edge	Beam Diameter
6'	89.6	44.0	1.3'
7'	65.8	32.3	1.5'
8'	50.4	24.8	1.8'
9'	39.8	19.6	2.0'
10'	32.3	15.8	2.2'
11'	26.7	13.1	2.4'
12'	22.4	11.0	2.6'
13'	19.1	9.4	2.9'
14'	16.5	8.1	3.1'
15'	14.3	7.0	3.3'

50W MR16 15° Narrow Spot

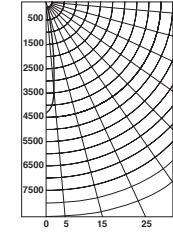

Candlepower Distribution (Candelas)

Angle	Candela	Lumens
0°	4423	
5°	3412	326
15°	410	116
25°	36	17
35°	0	0
45°	0	0
55°	0	0
65°	0	0
75°	0	0
85°	0	0

Initial Footcandles

Distance to Illuminated Plane (Feet)	Footcandles Beam Center	Footcandles Beam Edge	Beam Diameter
6'	122.9	59.9	1.5'
7'	90.3	44.0	1.8'
8'	69.1	33.7	2.0'
9'	54.6	26.6	2.3'
10'	44.2	21.6	2.6'
11'	36.6	17.8	2.8'
12'	30.7	15.0	3.1'
13'	26.2	12.8	3.3'
14'	22.6	11.0	3.6'
15'	19.7	9.6	3.8'

3-1/4" PARs Lensed Downlight

IC13SQ-432SQHZ, Haze Reflector

TC13SQ-432SQHZ, Haze Reflector

45W PAR16 27° Flood

Candlepower Distribution

((Candelas))		
Angle	Candela	Lumens
0°	2088	
5°	1449	138
15°	282	80
25°	115	53
35°	14	9
45°	5	4
55°	0	0
65°	0	0
75°	0	0
85°	0	0

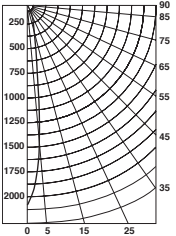

Initial Footcandles

Distance to Illuminated Plane (Feet)	Footcandles Beam Center	Footcandles Beam Edge	Beam Diameter
6'	58.0	28.4	1.4'
7'	42.6	20.9	1.7'
8'	32.6	16.0	1.9'
9'	25.8	12.6	2.2'
10'	20.9	10.2	2.4'
11'	17.3	8.4	2.6'
12'	14.5	7.1	2.9'
13'	12.4	6.0	3.1'
14'	10.7	5.2	3.4'
15'	9.3	4.5	3.6'

60W PAR16 30° Narrow Flood

Candlepower Distribution

((Candelas))		
Angle	Candela	Lumens
0°	1321	
5°	1231	117
15°	653	185
25°	280	130
35°	31	20
45°	3	2
55°	0	0
65°	0	0
75°	0	0
85°	0	0

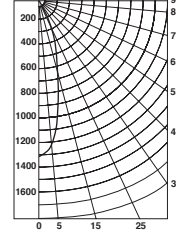

Initial Footcandles

Distance to Illuminated Plane (Feet)	Footcandles Beam Center	Footcandles Beam Edge	Beam Diameter
6'	36.7	16.6	3.2'
7'	27.0	12.2	3.7'
8'	20.6	9.3	4.2'
9'	16.3	7.4	4.8'
10'	13.2	6.0	5.3'
11'	10.9	4.9	5.8'
12'	9.2	4.1	6.4'
13'	7.8	3.5	6.9'
14'	6.7	3.0	7.4'
15'	5.9	2.7	7.9'

3-1/4" CMH MR16 Lensed Downlight

TC943MSQ-MR16-39E1-432SQ

39W MR16 30° Flood

Candlepower Distribution

((Candelas))		
Angle	Candela	Lumens
0°	6064	
5°	5524	527
15°	2251	638
25°	629	291
35°	163	102
45°	72	56
55°	9	8
65°	5	4
75°	2	2
85°	0	0

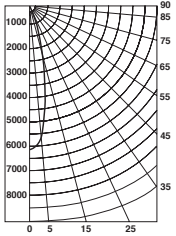

Initial Footcandles

Distance to Illuminated Plane (Feet)	Footcandles Beam Center	Footcandles Beam Edge	Beam Diameter
6'	168.4	78.8	2.6'
7'	123.7	57.9	3.0'
8'	94.7	44.3	3.4'
9'	74.9	35.0	3.8'
10'	60.6	28.4	4.3'
11'	50.1	23.4	4.7'
12'	42.1	19.7	5.1'
13'	35.9	16.8	5.5'
14'	30.9	14.5	6.0'
15'	26.9	12.6	6.4'

Lensed Pinhole Downlight

TC943MSQ-MR16-39E1-4332SQ

39W MR16 12° Spot

Candlepower Distribution

((Candelas))		
Angle	Candela	Lumens
0°	10839	
5°	5562	531
15°	750	213
25°	91	42
35°	3	2
45°	0	0
55°	0	0
65°	0	0
75°	0	0
85°	0	0

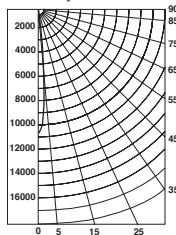

Initial Footcandles

Distance to Illuminated Plane (Feet)	Footcandles Beam Center	Footcandles Beam Edge	Beam Diameter
6'	301.1	148.8	1.1'
7'	221.2	109.3	1.2'
8'	169.4	83.7	1.4'
9'	133.8	66.1	1.6'
10'	108.4	53.6	1.8'
11'	89.6	44.3	2.0'
12'	75.3	37.2	2.1'
13'	64.1	31.7	2.3'
14'	55.3	27.3	2.5'
15'	48.2	23.8	2.7'

Photometrics - Square Adjustables

The tables on the following pages provide illumination levels, footcandles (FC) and beam size (in feet) for lamps of various wattages and beam patterns. Data is given for lamps aimed at both horizontal and vertical surfaces.

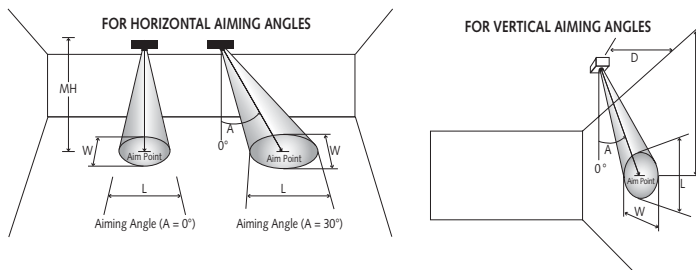

3-1/4" MR16 Halogen

Adjustable

IC43SQ-438SQ

Lamp	Beam Type	Beam Spread ^o	Rated Life	CBCP	Horizontal Aiming Angles						Vertical Aiming Angles									
					0°		30°		30°		45°		30°		45°					
					MH	FC	L	W	FC	L	W	D	FC	X	L	W	FC	X	L	W
37W MR16 Halogen IR	NSP	10°	5000	12500	6	347	1.0	1.0	226	1.4	1.2	3	174	5.2	2.1	1.0	491	3.0	1.1	0.7
					8	195	1.4	1.4	127	1.9	1.6	4	98	6.9	2.9	1.4	276	4.0	1.4	1.0
					10	125	1.7	1.7	81	2.3	2.0	5	63	8.7	3.6	1.7	177	5.0	1.8	1.2
					12	87	2.1	2.1	56	2.8	2.4	6	43	10.4	4.3	2.1	123	6.0	2.1	1.5
	14	64	2.4	2.4	41	3.3	2.8	7	32	12.1	5.0	2.4	90	7.0	2.5	1.7				
	NFL	25°	5000	4400	4	275	1.8	1.8	179	2.4	2.0	2	138	3.5	4.2	1.8	389	2.0	1.9	1.3
					6	122	2.7	2.7	79	3.6	3.1	3	61	5.2	6.2	2.7	173	3.0	2.8	1.9
					8	69	3.5	3.5	45	4.8	4.1	4	34	6.9	8.3	3.5	97	4.0	3.7	2.5
					10	44	4.4	4.4	29	6.0	5.1	5	22	8.7	10.4	4.4	62	5.0	4.7	3.1
	12	31	5.3	5.3	20	7.2	6.1	6	15	10.4	12.5	5.3	43	6.0	5.6	3.8				
	FL	35°	5000	2200	3	244	1.9	1.9	159	2.6	2.2	2	69	3.5	7.2	2.5	194	2.0	2.8	1.8
					4	138	2.5	2.5	89	3.5	2.9	3	31	5.2	10.8	3.8	86	3.0	4.2	2.7
6					61	3.8	3.8	40	5.2	4.4	4	17	6.9	14.4	5.0	49	4.0	5.6	3.6	
8					34	5.0	5.0	22	7.0	5.8	5	11	8.7	18.0	6.3	31	5.0	7.0	4.5	
10	22	6.3	6.3	14	8.7	7.3	6	8	10.4	21.6	7.6	22	6.0	8.4	5.4					
50W MR16 Halogen	NSP	15°	6000	9100	6	253	1.6	1.6	164	2.1	1.8	3	126	5.2	3.3	1.6	357	3.0	1.6	1.1
					8	142	2.1	2.1	92	2.8	2.4	4	71	6.9	4.4	2.1	201	4.0	2.1	1.5
					10	91	2.6	2.6	59	3.5	3.0	5	46	8.7	5.6	2.6	129	5.0	2.7	1.9
					12	63	3.2	3.2	41	4.2	3.6	6	32	10.4	6.7	3.2	89	6.0	3.2	2.2
	14	46	3.7	3.7	30	4.9	4.3	7	23	12.1	7.8	3.7	66	7.0	3.8	2.6				
	NFL	25°	6000	3200	4	200	1.8	1.8	130	2.4	2.0	2	100	3.5	4.2	1.8	283	2.0	1.9	1.3
					6	89	2.7	2.7	58	3.6	3.1	3	44	5.2	6.2	2.7	126	3.0	2.8	1.9
					8	50	3.5	3.5	32	4.8	4.1	4	25	6.9	8.3	3.5	71	4.0	3.7	2.5
					10	32	4.4	4.4	21	6.0	5.1	5	16	8.7	10.4	4.4	45	5.0	4.7	3.1
	12	22	5.3	5.3	14	7.2	6.1	6	11	10.4	12.5	5.3	31	6.0	5.6	3.8				
	FL	40°	6000	1700	3	189	2.2	2.2	123	3.0	2.5	2	53	3.5	9.7	2.9	150	2.0	3.4	2.1
					4	106	2.9	2.9	69	4.1	3.4	3	24	5.2	14.5	4.4	67	3.0	5.0	3.1
6					47	4.4	4.4	31	6.1	5.0	4	13	6.9	19.3	5.8	38	4.0	6.7	4.1	
8					27	5.8	5.8	17	8.1	6.7	5	9	8.7	24.2	7.3	24	5.0	8.4	5.1	
10	17	7.3	7.3	11	10.2	8.4	6	6	10.4	**	8.7	17	6.0	10.1	6.2					

The beam spread in degrees and the beam "L" and "W" in the following tables are computed at 50% of centerbeam candlepower and represent areas of "effective illumination."

**Due to steep aiming angle, length of beam extends beyond 25'.

3-1/4" MR16 Halogen

Adjustable

TC43SQ-438SQ



Lamp	Beam Type	Beam Spread°	Rated Life	CBCP	0°				30°			30°				45°				
					MH	FC	L	W	FC	L	W	D	FC	X	L	W	FC	X	L	W
50W MR16 Halogen IR Lensed	SP	10°	5000	15000	6	417	1.0	1.0	217	1.4	1.2	3	208	5.2	2.1	1.0	589	3.0	1.1	0.7
					8	234	1.4	1.4	152	1.9	1.6	4	117	6.9	2.9	1.4	331	4.0	1.4	1.0
					10	150	1.7	1.7	97	2.3	2.0	5	75	8.7	3.6	1.7	212	5.0	1.8	1.2
	NFL	25°	5000	5700	4	356	1.8	1.8	231	2.1	2.0	2	178	3.5	4.2	1.8	504	2.0	1.9	1.3
					6	158	2.7	2.7	103	3.6	3.1	3	79	5.2	6.2	2.7	224	3.0	2.8	1.9
					8	89	3.5	3.5	58	4.8	4.1	4	45	6.9	8.3	3.5	126	4.0	3.7	2.5
	FL	35°	5000	2850	10	57	4.4	4.4	37	6.0	5.1	5	29	8.7	10.4	4.4	81	5.0	4.7	3.1
					3	317	1.9	1.9	206	2.6	2.2	2	89	3.5	7.2	2.5	252	2.0	2.8	1.8
					4	178	2.5	2.5	116	3.5	2.9	3	40	5.2	10.8	3.8	112	3.0	4.2	2.7
75W MR16 Halogen	SP	15°	4000	11500	6	319	1.6	1.6	207	2.1	1.8	3	160	5.2	3.3	1.6	452	3.0	1.6	1.1
					8	180	2.1	2.1	117	2.8	2.4	4	90	6.9	4.4	2.1	254	4.0	2.1	1.5
					10	115	2.6	2.6	75	3.5	3.0	5	58	8.7	5.6	2.6	163	5.0	2.7	1.9
	NFL	25°	4000	5500	12	80	3.2	3.2	52	4.2	3.6	6	40	10.4	6.7	3.2	113	6.0	3.2	2.2
					4	344	1.8	1.8	223	2.4	2.0	2	172	3.5	4.2	1.8	486	2.0	1.9	1.3
					6	153	2.7	2.7	99	3.6	3.1	3	76	5.2	6.2	2.7	216	3.0	2.8	1.9
	FL	40°	4000	2200	8	86	3.5	3.5	56	4.8	4.1	4	43	6.9	8.3	3.5	122	4.0	3.7	2.5
					10	55	4.4	4.4	36	6.0	5.1	5	28	8.7	10.4	4.4	78	5.0	4.7	3.1
					3	244	2.2	2.2	159	3.0	2.5	2	69	3.5	9.7	2.9	194	2.0	3.4	2.1
					4	138	2.9	2.9	89	4.1	3.4	3	31	5.2	14.5	4.4	86	3.0	5.0	3.1
					6	61	4.4	4.4	40	6.1	5.0	4	17	6.9	19.3	5.8	49	4.0	6.7	4.1
					8	34	5.8	5.8	22	8.1	6.7	5	11	8.7	24.2	7.3	31	5.0	8.4	5.1

The beam spread in degrees and the beam "L" and "W" in the following tables are computed at 50% of centerbeam candlepower and represent areas of "effective illumination."

3-1/4" PAR

Adjustable

IC13SQ-438SQ

Horizontal Aiming Angles



Vertical Aiming Angles

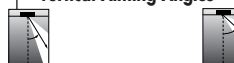

Lamp	Beam Type	Beam Spread°	Rated Life	CBCP	0°				30°				30°				40°							
					MH	FC	L	W	FC	L	W	D	FC	X	L	W	FC	X	L	W				
45W PAR16 Halogen	NSP	10°	2000	5000	6	139	1.0	1.0	90	1.4	1.2	2	156	3.5	1.4	0.7	332	2.4	0.9	0.5				
					8	78	1.4	1.4	51	1.9	1.6	3	69	5.2	2.1	1.0	148	3.6	1.3	0.8				
					10	50	1.7	1.7	32	2.3	2.0	4	39	6.9	2.9	1.4	83	4.8	1.7	1.1				
					12	35	2.1	2.1	23	2.8	2.4	5	25	8.7	3.6	1.7	53	6.0	2.1	1.4				
					14	26	2.4	2.4	17	3.3	2.8	6	17	10.4	4.3	2.1	37	7.2	2.6	1.6				
					NFL	27°	2000	1400	3	156	1.4	1.4	101	2.0	1.7	1	175	1.7	2.3	1.0	372	1.2	1.4	0.8
									5	56	2.4	2.4	36	3.3	2.8	2	44	3.5	4.6	1.9	93	2.4	2.9	1.7
	7	29	3.4	3.4					19	4.6	3.9	3	19	5.2	7.0	2.9	41	3.6	4.3	2.5				
	9	17	4.3	4.3					11	5.9	5.0	4	11	6.9	9.3	3.8	23	4.8	5.8	3.3				
	11	12	5.3	5.3					8	7.2	6.1	5	7	8.7	11.6	4.8	15	6.0	7.2	4.2				
	NSP	10°	2000	5400					6	150	1.0	1.0	97	1.4	1.2	2	169	3.5	1.4	0.7	359	2.4	0.9	0.5
									8	84	1.4	1.4	55	1.9	1.6	3	75	5.2	2.1	1.0	159	3.6	1.3	0.8
					10	54	1.7	1.7	35	2.3	2.0	4	42	6.9	2.9	1.4	90	4.8	1.7	1.1				
					12	38	2.1	2.1	24	2.8	2.4	5	27	8.7	3.6	1.7	57	6.0	2.1	1.4				
14					28	2.4	2.4	18	3.3	2.8	6	19	10.4	4.3	2.1	40	7.2	2.6	1.6					
NFL					30°	2000	1550	4	97	2.1	2.1	63	2.9	2.5	2	48	3.5	5.5	2.1	103	2.4	2.9	1.7	
								6	43	3.2	3.2	28	4.4	3.7	3	22	5.2	8.2	3.2	46	3.6	4.3	2.5	
	8	24	4.3	4.3				16	5.9	5.0	4	12	6.9	10.9	4.3	26	4.8	5.8	3.3					
	10	16	5.4	5.4				10	7.3	6.2	5	8	8.7	13.7	5.4	16	6.0	7.2	4.2					
	12	11	6.4	6.4				7	8.8	7.4	6	5	10.4	16.4	6.4	11	7.2	8.7	5.0					

The beam spread in degrees and the beam "L" and "W" in the following tables are computed at 50% of centerbeam candlepower and represent areas of "effective illumination."

TC13SQ-438SQ

Horizontal Aiming Angles



Vertical Aiming Angles



Lamp	Beam Type	Beam Spread°	Rated Life	CBCP	0°				30°				30°				40°							
					MH	FC	L	W	FC	L	W	D	FC	X	L	W	FC	X	L	W				
75W PAR16 Halogen	NSP	10°	2000	7500	6	208	1.0	1.0	135	1.4	1.2	2	234	3.5	1.4	0.7	498	2.4	0.9	0.5				
					8	117	1.4	1.4	76	1.9	1.6	3	104	5.2	2.1	1.0	221	3.6	1.3	0.8				
					10	75	1.7	1.7	49	2.3	2.0	4	59	6.9	2.9	1.4	124	4.8	1.7	1.1				
					12	52	2.1	2.1	34	2.8	2.4	5	38	8.7	3.6	1.7	80	6.0	2.1	1.4				
					14	38	2.4	2.4	25	3.3	2.8	6	26	10.4	4.3	2.1	55	7.2	2.6	1.6				
					NFL	30°	2000	1900	4	119	2.1	2.1	77	2.9	2.5	2	59	3.5	5.5	2.1	126	2.4	2.9	1.7
									6	53	3.2	3.2	34	4.4	3.7	3	26	5.2	8.2	3.2	56	3.6	4.3	2.5
	8	30	4.3	4.3					19	5.9	5.0	4	15	6.9	10.9	4.3	32	4.8	5.8	3.3				
	10	19	5.4	5.4					12	7.3	6.2	5	10	8.7	13.7	5.4	20	6.0	7.2	4.2				
	12	13	6.4	6.4					9	8.8	7.4	6	7	10.4	16.4	6.4	14	7.2	8.7	5.0				

The beam spread in degrees and the beam "L" and "W" in the following tables are computed at 50% of centerbeam candlepower and represent areas of "effective illumination."

3 1/4" CMH MR16

Adjustable

TC943MSQ-MR16-20E1-438SQ

Horizontal Aiming Angles



Vertical Aiming Angles



Lamp	Beam Type	Beam Spread°	Rated Life	CBCP	0°			30°			30°			45°						
					MH	FC	L	W	FC	L	W	D	FC	X	L	W	FC	X	L	W
20W MR16 Ceramic Metal Halide	SP	12°	12000	9000	10	90	2.1	2.1	58	2.8	2.4	4	70	6.9	3.5	1.7	199	4.0	1.7	1.2
					12	63	2.5	2.5	41	3.4	2.9	6	31	10.4	5.2	2.5	88	6.0	2.6	1.8
					14	46	2.9	2.9	30	3.9	3.4	8	18	13.9	7.0	3.4	50	8.0	3.4	2.4
					16	35	3.4	3.4	23	4.5	3.9	10	11	17.3	8.7	4.2	32	10.0	4.3	3.0
					18	28	3.8	3.8	18	5.1	4.4	12	8	20.8	10.4	5.0	22	12.0	5.1	3.6
	FL	25°	12000	2900	8	45	3.5	3.5	29	4.8	4.1	2	91	3.5	4.2	1.8	256	2.0	1.9	1.3
					10	29	4.4	4.4	19	6.0	5.1	4	23	6.9	8.3	3.5	64	4.0	3.7	2.5
					12	20	5.3	5.3	13	7.2	6.1	6	10	10.4	12.5	5.3	28	6.0	5.6	3.8
					14	15	6.2	6.2	10	8.4	7.2	8	6	13.9	16.6	7.1	16	8.0	7.5	5.0
					16	11	7.1	7.1	7	9.6	8.2	10	4	17.3	20.8	8.9	10	10.0	9.3	6.3
	WFL	40°	12000	1500	8	23	5.8	5.8	15	8.1	6.7	2	47	3.5	9.7	2.9	133	2.0	3.4	2.1
					10	15	7.3	7.3	10	10.2	8.4	3	21	5.2	14.5	4.4	59	3.0	5.0	3.1
12					10	8.7	8.7	7	12.2	10.1	4	12	6.9	19.3	5.8	33	4.0	6.7	4.1	
14					8	10.2	10.2	5	14.2	11.8	5	8	8.7	24.2	7.3	21	5.0	8.4	5.1	
16					6	11.6	11.6	4	16.2	13.4	6	5	10.4	**	8.7	15	6.0	10.1	6.2	

The beam spread in degrees and the beam "L" and "W" in the following tables are computed at 50% of centerbeam candlepower and represent areas of "effective illumination."
 **Due to steep aiming angle, length of beam extends beyond 25'.

TC943MSQ-MR16-39E1-438SQ

Horizontal Aiming Angles



Vertical Aiming Angles



Lamp	Beam Type	Beam Spread°	Rated Life	CBCP	0°			30°			30°			45°						
					MH	FC	L	W	FC	L	W	D	FC	X	L	W	FC	X	L	W
39W MR16 Ceramic Metal Halide	SP	12°	12000	16000	10	160	2.1	2.1	104	2.8	2.4	4	125	6.9	3.5	1.7	354	4.0	1.7	1.2
					12	111	2.5	2.5	72	3.4	2.9	6	56	10.4	5.2	2.5	157	6.0	2.6	1.8
					14	82	2.9	2.9	53	3.9	3.4	8	31	13.9	7.0	3.4	88	8.0	3.4	2.4
					16	63	3.4	3.4	41	4.5	3.9	10	20	17.3	8.7	4.2	57	10.0	4.3	3.0
					18	49	3.8	3.8	32	5.1	4.4	12	14	20.8	10.4	5.0	39	12.0	5.1	3.6
	FL	25°	12000	5500	8	86	3.5	3.5	56	4.8	4.1	2	172	3.5	4.2	1.8	486	2.0	1.9	1.3
					10	55	4.4	4.4	36	6.0	5.1	4	43	6.9	8.3	3.5	122	4.0	3.7	2.5
					12	38	5.3	5.3	25	7.2	6.1	6	19	10.4	12.5	5.3	54	6.0	5.6	3.8
					14	28	6.2	6.2	18	8.4	7.2	8	11	13.9	16.6	7.1	30	8.0	7.5	5.0
					16	21	7.1	7.1	14	9.6	8.2	10	7	17.3	20.8	8.9	19	10.0	9.3	6.3
	WFL	40°	12000	3000	8	47	5.8	5.8	30	8.1	6.7	2	94	3.5	9.7	2.9	265	2.0	3.4	2.1
					10	30	7.3	7.3	19	10.2	8.4	3	42	5.2	14.5	4.4	118	3.0	5.0	3.1
12					21	8.7	8.7	14	12.2	10.1	4	23	6.9	19.3	5.8	66	4.0	6.7	4.1	
14					15	10.2	10.2	10	14.2	11.8	5	15	8.7	24.2	7.3	42	5.0	8.4	5.1	
16					12	11.6	11.6	8	16.2	13.4	6	10	10.4	**	8.7	29	6.0	10.1	6.2	

The beam spread in degrees and the beam "L" and "W" in the following tables are computed at 50% of centerbeam candlepower and represent areas of "effective illumination."
 **Due to steep aiming angle, length of beam extends beyond 25'.

INDEX

3 1/4" Round Housings

IC13N.....	22
IC43L-3K.....	18
IC43L-4K.....	18
IC43L-35K.....	18
IC43N.....	20
IC43N-E1.....	20
TC13N.....	22
TC43L-3K.....	18
TC43L-4K.....	18
TC43L-35K.....	18
TC943M-MR16-20E.....	24
TC943M-MR16-39E.....	24
TC43N.....	21
TC43N-E1.....	21
TC43NR.....	21
TC43NR-E1.....	21
TC943L-3K.....	19
TC943L-4K.....	19
TC943L-35K.....	19
TC943N.....	20
TC943N-E1.....	20
TC943N-E2.....	20
TC943N-V.....	20

3 1/4" Round Trims - Trim Rings

430NB-WH.....	26
430NC-WH.....	26
430NG-WH.....	26
430NHZ-SC.....	26
430NHZ-WH.....	26
430NWHZ-ABZ.....	26
430NWHZ-WH.....	26
431NB-WH.....	28
431NC-WH.....	28
431NG-WH.....	28
431NHZ-SC.....	28
431NHZ-WH.....	28
431NWHZ-ABZ.....	28
431NWHZ-WH.....	28
432NB-WH.....	28
432NC-WH.....	28
432NG-WH.....	28
432NHZ-SC.....	28
432NHZ-WH.....	28
432NWHZ-ABZ.....	28
432NWHZ-WH.....	28
433N-ABZ.....	27
433N-SC.....	27
433N-WH.....	27
434NB-ABZ.....	26
434NB-SC.....	26
434NB-WH.....	26
434NW-WH.....	26
435NB-ABZ.....	27
435NB-SC.....	27
435NB-WH.....	27
435NW-WH.....	27
436NB-ABZ.....	26
436NB-SC.....	26
436NB-WH.....	26
436NC-WH.....	26
436NG-WH.....	26
436NHZ-SC.....	26
436NHZ-WH.....	26
436NWHZ-ABZ.....	26
436NWHZ-WH.....	26

437NB-ABZ.....	26
437NB-SC.....	26
437NB-WH.....	26
437NC-WH.....	26
437NG-WH.....	26
437NHZ-SC.....	26
437NHZ-WH.....	26
437NWHZ-ABZ.....	26
437NWHZ-WH.....	26
438NB-ABZ.....	26
438NB-SC.....	26
438NB-WH.....	26
438NC-WH.....	26
438NG-WH.....	26
438NHZ-SC.....	26
438NHZ-WH.....	26
438NWHZ-ABZ.....	26
438NWHZ-WH.....	26
439NB-WH.....	28
439NC-WH.....	28
439NG-WH.....	28
439NHZ-SC.....	28
439NHZ-WH.....	28
439NWHZ-ABZ.....	28
439NWHZ-WH.....	28
4301N-WH.....	28
4302N-WH.....	28
4307N-WH.....	26
4308N-WH.....	27
4331N-ABZ.....	28
4331N-SC.....	28
4331N-WH.....	28
4332N-ABZ.....	28
4332N-SC.....	28
4332N-WH.....	28
4335N-ABZ.....	27
4335N-SC.....	27
4335N-WH.....	27
4337N-ABZ.....	26
4337N-SC.....	26
4337N-WH.....	26
4345N-WH.....	27
4349NB-BL.....	27
4349NB-WH.....	27

3 1/4" Round Trims - Flush Mount

430NB-FM.....	32
430NC-FM.....	32
430NG-FM.....	32
430NHZ-FM.....	32
430NWHZ-FM.....	32
431NB-FM.....	33
431NC-FM.....	33
431NG-FM.....	33
431NHZ-FM.....	33
431NWHZ-FM.....	33
432NB-FM.....	33
432NC-FM.....	33
432NG-FM.....	33
432NHZ-FM.....	33
432NWHZ-FM.....	33
433N-WH-FM.....	32
436NB-FM.....	32
436NC-FM.....	32
436NG-FM.....	32
436NHZ-FM.....	32
436NWHZ-FM.....	32

437NB-FM.....	32
437NC-FM.....	32
437NG-FM.....	32
437NHZ-FM.....	32
437NWHZ-FM.....	32
438NB-FM.....	32
438NC-FM.....	32
438NG-FM.....	32
438NHZ-FM.....	32
438NWHZ-FM.....	32
439NB-FM.....	33
439NC-FM.....	33
439NG-FM.....	33
439NHZ-FM.....	33
439NWHZ-FM.....	33
4307N-WH-FM.....	32
4308N-WH-FM.....	33
4335N-WH-FM.....	33
4345N-WH-FM.....	33
4337N-WH-FM.....	32

3 1/4" Round Trims - Self-Flanged

430NB-SF.....	30
430NC-SF.....	30
430NG-SF.....	30
430NHZ-SF.....	30
430NWHZ-SF.....	30
431NB-SF.....	30
431NC-SF.....	30
431NG-SF.....	30
431NHZ-SF.....	30
431NWHZ-SF.....	30
432NB-SF.....	30
432NC-SF.....	30
432NG-SF.....	30
432NHZ-SF.....	30
432NWHZ-SF.....	30
436NB-SF.....	30
436NC-SF.....	30
436NG-SF.....	30
436NHZ-SF.....	30
436NWHZ-SF.....	30
437NB-SF.....	30
437NC-SF.....	30
437NG-SF.....	30
437NHZ-SF.....	30
437NWHZ-SF.....	30
438NB-SF.....	30
438NC-SF.....	30
438NG-SF.....	30
438NHZ-SF.....	30
438NWHZ-SF.....	30
439NB-SF.....	30
439NC-SF.....	30
439NG-SF.....	30
439NHZ-SF.....	30
439NWHZ-SF.....	30

3 1/4" Square Housings

IC13SQ.....	38
IC43LSQ-3K.....	34
IC43LSQ-4K.....	34
IC43LSQ-35K.....	34
IC43SQ.....	36
IC43SQ-E1.....	36
TC13SQ.....	38

3 1/4" Square Housings *continued*

TC43LSQ-3K34
TC43LSQ-4K34
TC43LSQ-35K34
TC43SQ37
TC43SQ-E137
TC943LSQ-3K35
TC943LSQ-4K35
TC943LSQ-35K35
TC943MSQ-MR16-20E40
TC943MSQ-MR16-39E40
TC943SQ36
TC943SQ-E136
TC943SQ-E236
TC943SQ-V36

3 1/4" Square Trims - Flush Mount

431SQBHZ-FM45
431SQHZ-FM45
431SQW-FM45
431SQWHZ-FM45
432SQBHZ-FM45
432SQHZ-FM45
432SQW-FM45
432SQWHZ-FM45
433SQWH-FM44
437SQBHZ-FM44
437SQHZ-FM44
437SQW-FM44
437SQWHZ-FM44
438SQBHZ-FM44
438SQHZ-FM44
438SQW-FM44
438SQWHZ-FM44
439SQBHZ-FM45
439SQHZ-FM45
439SQW-FM45
439SQWHZ-FM45
4307SQ-WH-FM44
4308SQ-WH-FM44
4337SQ-WH-FM44

3 1/4" Square Trims - Self-Flanged

431SSQBHZ-SF43
431SQHZ-SF43
431SQWHZ-SF43
431SQW-SF43
432SQBHZ-SF43
432SQHZ-SF43
432SQWHZ-SF43
432SQW-SF43
433SQ-WH42
437SQBHZ-SF42
437SQHZ-SF42
437SQWHZ-SF42
437SQW-SF42
438SQBHZ-SF42
438SQHZ-SF42
438SQWHZ-SF42
438SQW-SF42
439SQBHZ-SF42
439SQW-SF42
439SQHZ-SF42
439SQWHZ-SF42
4301SQ-WH43

4302SQ-WH43
4307SQ-WH42
4308SQ-WH42
4331SQ-WH43
4332SQ-WH43
4337SQ-WH42

5 5/8" Round Housings

IC6251
IC6350
IC6448
TC6251
TC96350
TC96448

5 5/8" Round Trims

611-WH51
624B-ABZ51
624B-SC51
624B-WH51
624W-WH51
627B-WH51
627C-WH51
627G-WH51
627HZ-SC51
627HZ-WH51
627WHZ-ABZ51
627WHZ-WH51
629B-WH51
629C-WH51
629G-WH51
629HZ-SC51
629HZ-WH51
629WHZ-ABZ51
629WHZ-WH51
635B-ABZ48, 50
635B-SC48, 50
635B-WH48, 50
635W-WH48, 50
638B-WH48, 50
638C-WH48, 50
638G-WH48, 50
638HZ-SC48, 50
638HZ-WH48, 50
638WHZ-ABZ48, 50
638WHZ-WH48, 50

6" Round Housings

CV6-126/32T54
CV6-126/32T-DB12054
CV6-126/32T-DB27754
IC90652
ICV6-126/32T54
ICV6-126/32T-DB12054
TC90652

6" Round Trims

600C-WH55
600C-WWD-WH55
600C-WWS-WH55
600G-WH55
600G-WWC-WH55
600G-WWD-WH55
600G-WWS-WH55
600HZ-WH55
600HZ-WWC-WH55

600HZ-WWD-WH55
600HZ-WWS-WH55
600WHZ-WH55
601B-WH55
601W-WH55
611-WH55
633B-WH53
633W-WH53
643C-WH53
643G-WH53
643HZ-WH53
662C-WH53
662G-WH53
662HZ-WH53
663C-WH53
663G-WH53
663HZ-WH53
664C-WH53
664G-WH53
664HZ-WH53

7" Round Housings

IC7356
TC97356

7" Round Trims

727B-WH56
727C-WH56
727G-WH56
727HZ-WH56
727WHZ-WH56
738B-WH56
738C-WH56
738G-WH56
738HZ-WH56
738WHZ-WH56

Framing Projector Housing

TC96057

Framing Projector Trims

245-WH57
246-WH57

Mounting Accessories -

3 1/4" Round

CTA4N-12518, 19, 20, 21, 24
CTA4N-16318, 19, 20, 21, 24
CTA4N-20018, 19, 20, 21, 24
FMA418, 19, 20, 21, 33

3 1/4" Square

CTA4SQ-12534, 35, 36, 37, 38, 40
CTA4SQ-16334, 35, 36, 37, 38, 40
CTA4SQ-20034, 35, 36, 37, 38, 40
FMASQ434, 35, 36, 37, 38, 40, 45

Bar Hangers

HB-148, 50, 52, 54, 56, 57
BH-2648, 50, 52, 54, 56, 57
HB-5048, 50, 52, 54, 56, 57
LB-2748, 50, 52, 54, 56, 57

3 1/4" & 5 5/8" Optics58



juno[®]
Recessed and Trac Lighting

indy[™]
Architectural Recessed Lighting

Alfa[™]
Decorative Lighting Systems

AccuLite[™]
Commercial and Industrial Lighting

AcuLUX[®]
Precision Recessed Lighting

NaviLite[®]
Exit and Emergency Lighting

DanaLite
Architectural Linear Lighting

1300 South Wolf Road • Des Plaines, IL 60018
PHONE (847) 827-9880 • FAX (847) 827-2925 • junolightinggroup.com

Regional Offices & Warehouses:

California, Georgia, Illinois, Indiana, Pennsylvania, Texas, Ontario CN

LIT-ACULUX-CAT



AcuLUX is a registered trademark of Juno Lighting, LLC.
Products shown in this brochure are covered by U.S. and
international patents and patents pending.
Specifications subject to change without notice.
© 2010 JUNO LIGHTING, LLC.

Printed in U.S.A. LIT-ACULUX-CAT 5/10