



## Protection and Control of Electrical Apparatus and Circuits

### **Appleton and O-Z/Gedney**

A complete selection of enclosures, junction boxes and distribution equipment.





## **EMERSON POWERS EQUIPMENT THROUGHOUT YOUR FACILITY.**

Emerson manufactures highly engineered enclosures, junction boxes and distribution equipment your facility requires. Our extensive product offerings are designed to exceed the demands of facilities all over the globe, including severe weather and chemical environments. They are engineered and designed to keep your machinery and the workers using them safe, now and for years into the future.

From a petrochemical plant in Saudi Arabia to a grain processing facility in America's heartland, Appleton and O-Z/Gedney brand distribution equipment is there, providing protection and control of electrical apparatus and circuits in hazardous, damp, wet or corrosive environments according to NEC, CEC, ATEX and IEC standards. The complete range of designs, materials and options - from factory sealed to non-factory sealed and increased safety to flameproof - help ensure you have the flexibility to make the perfect choice. We know what you need from switches, circuit breakers and panelboards: protection, durability, ease of installation and low maintenance costs. We build all of it in, so we can keep earning your trust year after year.

Appleton and O-Z/Gedney enclosures and junction boxes have always provided superior performance for hazardous and corrosive locations. Our products are available in the materials you need, in a complete range of sizes, and some that can be coupled together to suit your installation footprint. They are engineered and proven to continuously withstand the relentless vibrations, severe weather, corrosive environments and flammable atmospheres your facilities face every day. Our enclosures and junction boxes maintain the highest levels of safety and efficiency.

# Notes

---

# Protection and Control of Electrical Apparatus and Circuits

## Table of Contents

Description	Page
Table of Contents	iii
Product Safety Statement	iv
Alphanumeric Index	v
Enclosures and Junction Boxes	1
Distribution Equipment	231

# Product Safety Statement

The information contained in this catalog is based on our experience to date and is believed to be reliable. All weights and dimensions are approximate. This catalog supersedes and voids all previous literature.

Information in this catalog is subject to change without notice. At times, it may be necessary to modify the materials, finishes, or other components of the product. These modifications will meet or exceed the performance or functional requirements of the product.

Appleton Group designs and manufactures a range of electrical products that meet the electrical codes of different geographic markets. Many of these products are evaluated by internationally recognized third-party product safety testing and certification agencies.

As a safety precaution, users of these products must verify the product is appropriate for their application by consulting the electrical code and safety standards for their area.

Appleton Group products should be installed in accordance with the installation instructions provided with the product and all applicable electrical codes. Additional safety requirements are indicated by appropriate Danger, Warning and Caution statements which follow the suggested format of the American National Standards Institute (ANSI).

These statements are intended to inform not only knowledgeable, sophisticated installers and users, but also those who will have casual contact with the product. Failure to follow this information could result in serious personal injury. Where appropriate these statements may appear on:

1. The product carton
2. The label attached to the product carton
3. The instruction sheet
4. The product itself in a conspicuous manner where physical space allows

Any questions with regard these statements or safety should be addressed to:

Product Safety Officer  
Appleton Group  
9377 W. Higgins Road  
Rosemont, IL 60018  
1-800-621-1506  
[www.emerson.com](http://www.emerson.com)

# Alphanumeric Index

Catalog Number	Page	Catalog Number	Page	Catalog Number	Page	Catalog Number	Page
093496	188	097284	222	ADT-50	92	AEBB12460C	253
096039	207	097285	222	ADT-500	92	AEBB12470C	253
096041	207	097286	222	ADT-600	92	AEBB12480C	253
096043	207	097287	222	ADT-75	92	AEBB12490C	253
096044	207	097288	222	AEAB12215C	253	AEBB12610C	253
096115	203	2-ML-0604	93	AEAB12220C	253	AEBB12660C	253
096650	276	2-ML-1204	93	AEAB12225C	253	AEBB12670C	253
097200	222	2-ML-1816	93	AEAB12230C	253	AEBB12680C	253
097201	222	4-ML-0604	93	AEAB12235C	253	AEBB12690C	253
097202	222	4-ML-1204	93	AEAB12240C	253	AEBB13210C	253
097203	203	4-ML-1816	93	AEAB12250C	253	AEBB13260C	253
097203	221	4-ML-3636	93	AEAB12415C	253	AEBB13270C	253
097204	203	737EM2T15	113	AEAB12420C	253	AEBB13280C	253
097204	221	737EM2T25	113	AEAB12425C	253	AEBB13290C	253
097206	222	737EM3T25	113	AEAB12430C	253	AEBB13410C	253
097207	222	737EM3T35	113	AEAB12435C	253	AEBB13460C	253
097209	222	A2-ML-0604	93	AEAB12440C	253	AEBB13470C	253
097230	221	A2-ML-1204	93	AEAB12450C	253	AEBB13480C	253
097231	221	A2-ML-1816	93	AEAB12615C	253	AEBB13490C	253
097232	221	A4-ML-0604	93	AEAB12620C	253	AEBB13610C	253
097233	221	A4-ML-1204	93	AEAB12625C	253	AEBB13610MCS	238
097234	221	A4-ML-1816	93	AEAB12630C	253	AEBB13660C	253
097235	221	A4-ML-3636	93	AEAB12635C	253	AEBB13670C	253
097240	221	ABDT-100	92	AEAB12640C	253	AEBB13680C	253
097241	221	ABDT-125	92	AEAB12650C	253	AEBB13690C	253
097242	221	ABDT-150	92	AEAB13215C	253	AEBB6036FDS	236
097243	221	ABDT-200	92	AEAB13220C	253	AECB10036FDS	236
097244	221	ABDT-250	92	AEAB13225C	253	AECB12212C	253
097245	221	ABDT-300	92	AEAB13230C	253	AECB12215C	253
097246	221	ABDT-350	92	AEAB13235C	253	AECB12412C	253
097247	221	ABDT-400	92	AEAB13240C	253	AECB12415C	253
097250	221	ABDT-450	92	AEAB13250C	253	AECB12612C	253
097251	221	ABDT-50	92	AEAB13415C	253	AECB12615C	253
097252	221	ABDT-500	92	AEAB13420C	253	AECB13212C	253
097253	221	ABDT-600	92	AEAB13425C	253	AECB13215C	253
097254	221	ABDT-75	92	AEAB13430C	253	AECB13412C	253
097255	221	ABWH-100	92	AEAB13435C	253	AECB13415C	253
097263	222	ABWH-125	92	AEAB13440C	253	AECB13612C	253
097264	222	ABWH-150	92	AEAB13450C	253	AECB13615C	253
097265	222	ABWH-200	92	AEAB13615C	253	AEDB62645C	254
097270	203	ABWH-250	92	AEAB13620C	253	AEDB62650C	254
097270	221	ABWH-300	92	AEAB13625C	253	AEDB62660C	254
097271	203	ABWH-350	92	AEAB13630C	253	AEDB63645C	254
097271	221	ABWH-400	92	AEAB13630MCS	238	AEDB63650C	254
097272	203	ABWH-450	92	AEAB13635C	253	AEDB63660C	254
097272	221	ABWH-50	92	AEAB13640C	253	AEDB63660MCS	238
097273	203	ABWH-500	92	AEAB13650C	253	AEEB13615MCS	238
097273	221	ABWH-600	92	AEAB13660MCS	238	AEEB22610C	254
097274	203	ABWH-75	92	AEAB3036DS	236	AEEB22612C	254
097274	221	ADT-100	92	AEAB3036FDS	236	AEEB22617C	254
097275	221	ADT-125	92	AEAB6036DS	236	AEEB22620C	254
097277	222	ADT-150	92	AEBB10036DS	236	AEEB22622C	254
097278	222	ADT-200	92	AEBB12210C	253	AEEB22670C	254
097279	222	ADT-250	92	AEBB12260C	253	AEEB22690C	254
097280	222	ADT-300	92	AEBB12270C	253	AEEB23610C	254
097281	222	ADT-350	92	AEBB12280C	253	AEEB23612C	254
097282	222	ADT-400	92	AEBB12290C	253	AEEB23617C	254
097283	222	ADT-450	92	AEBB12410C	253	AEEB23620C	254

# Alphanumeric Index

Catalog Number	Page	Catalog Number	Page	Catalog Number	Page	Catalog Number	Page
AEEB23622C	254	AFC-555A	53	AJBEW061604	119	ALPFM12C24ML	338
AEEB23622MCS	238	AFC-664A	53	AJBEW071106	119	ALPFM12C30ML	338
AEEB23625MCS	238	AFC-976A	53	AJBEW080806	119	ALPFM15C12MB100	338
AEEB23670C	254	AFC-984A	53	AJBEW081006	119	ALPFM15C18MB100	338
AEEB23690C	254	AGK-04	52	AJBEW081307	119	ALPFM15C24ML	338
AEEB43640MCS	238	AGK-04	92	AJBEW091105	119	ALPFM15C30ML	338
AEFB22625C	254	AGK-10	52	AJBEW091504	119	ALPFM21A18MB225	338
AEFB23625C	254	AGK-10	92	AJBEW101006	119	ALPFM21A18ML	338
AEFB42612C	254	AGK-25	52	AJBEW101406	119	ALPFM21A24ML	338
AEFB42617C	254	AGK-25	92	AJBEW101408	119	ALPFM21A30ML	338
AEFB42620C	254	AGPNA11A04ML	326	AJBEW112005	119	ALPFM22C18MB225	338
AEFB42622C	254	AGPNA11A06ML	326	AJBEW112406	119	ALPFM22C18ML	338
AEFB42625C	254	AGPNA11A12ML	326	AJBEW113006	120	ALPFM22C24ML	338
AEFB42630C	254	AGPNA12C04ML	326	AJBEW121206	120	ALPFM22C30ML	338
AEFB42635C	254	AGPNA12C06ML	326	AJBEW121208	120	ALPFM25C18MB2225	338
AEFB42640C	254	AGPNA12C12ML	326	AJBEW121806	120	ALPFM25C18ML	338
AEFB43612C	254	AGPNB11A18ML	326	AJBEW121808	120	ALPFM25C24ML	338
AEFB43617C	254	AGPNB12C18ML	326	AJBEW122408	120	ALPFM25C30ML	338
AEFB43620C	254	AGPNC11A24ML	326	AJBEW123608	120	ALPFN11A24MB100	338
AEFB43622C	254	AGPNC12C24ML	326	AJBEW133806	120	ALPFN11A30MB100	338
AEFB43625C	254	AGUB10105A	51	AJBEW141406	120	ALPFN12C24MB100	338
AEFB43630C	254	AGUB10106A	51	AJBEW141408	120	ALPFN12C30MB100	338
AEFB43635C	254	AGUB10108A	51	AJBEW142408	120	ALPFN15C24MB100	338
AEFB43640C	254	AGUB1093A	51	AJBEW153707	120	ALPFN15C30MB100	338
AEGB122610C	254	AGUB121212A	51	AJBEW161606	120	ALPFN21A24MB225	338
AEGB122612C	254	AGUB12128A	51	AJBEW161608	120	ALPFN21A30MB225	338
AEGB122660C	254	AGUB443A	51	AJBEW161812	120	ALPFN21A36MB225	338
AEGB122680C	254	AGUB555A	51	AJBEW162206	120	ALPFN21A36ML	338
AEGB123610C	254	AGUB664A	51	AJBEW162408	120	ALPFN21A42ML	338
AEGB123612C	254	AGUB976A	51	AJBEW162806	120	ALPFN22C24MB225	338
AEGB123612MCS	238	AGUB984A	51	AJBEW181806	120	ALPFN22C30MB225	338
AEGB123660C	254	AGUBSW10105A	51	AJBEW181808	121	ALPFN22C36MB225	338
AEGB123680C	254	AGUBSW10106A	51	AJBEW182408	121	ALPFN22C36ML	338
AEGB123680MCS	238	AGUBSW10108A	51	AJBEW182410	121	ALPFN22C42ML	338
AELB82630C	254	AGUBSW1093A	51	AJBEW183008	121	ALPFN25C24MB2225	338
AELB82635C	254	AGUBSW121212A	51	AJBEW183608	121	ALPFN25C30MB225	338
AELB82640C	254	AGUBSW12128A	51	AJBEW183610	121	ALPFN25C36MB225	338
AELB82645C	254	AGUBSW443A	51	AJBEW184207	121	ALPFN25C36ML	338
AELB82650C	254	AGUBSW555A	51	AJBEW206008	121	ALPFN25C42ML	338
AELB82660C	254	AGUBSW664A	51	AJBEW242408	121	ALPFQ21A42MB225	338
AELB82670C	254	AGUBSW976A	51	AJBEW242410	121	ALPFQ22C42MB225	338
AELB82680C	254	AGUBSW984A	51	AJBEW243008	121	ALPFQ25C42MB2225	338
AELB83630C	254	AHNG-22G	57	AJBEW243608	121	ALPNA11A12ML	325
AELB83635C	254	AHNG-22SS	93	AJBEW243610	121	ALPNA12C12ML	325
AELB83640C	254	AHNG-22SS	109	AJBEW303808	121	ALPNA15B12ML	325
AELB83645C	254	AHNG-23G	57	AJBEW303816	121	ALPNB11A18ML	325
AELB83650C	254	AHNG-24G	57	ALPFJ11A12ML	338	ALPNB12C18ML	325
AELB83660C	254	AHNG-34G	57	ALPFJ12C12ML	338	ALPNB15B18ML	325
AELB83670C	254	AHOF12SS	122	ALPFJ15C12ML	338	ALPNC11A12MB100	325
AELB83680C	254	AHOF22SS	122	ALPFK11A18ML	338	ALPNC11A18MB100	325
AELB83680MCS	238	AHOF23SS	122	ALPFK12C18ML	338	ALPNC11A24ML	325
AENGRAVE-1	92	AJBEW040604	119	ALPFK15C18ML	338	ALPNC11A30ML	325
AENGRAVE-2	92	AJBEW050903	119	ALPFM11A12MB100	338	ALPNC12C12MB100	325
AFC-10105A	53	AJBEW060604	119	ALPFM11A18MB100	338	ALPNC12C18MB100	325
AFC-1010A	53	AJBEW060804	119	ALPFM11A24ML	338	ALPNC12C24ML	325
AFC-1093A	53	AJBEW060806	119	ALPFM11A30ML	338	ALPNC12C30ML	325
AFC-1212A	53	AJBEW061004	119	ALPFM12C12MB100	338	ALPNC15B12MB100	325
AFC-443A	53	AJBEW061204	119	ALPFM12C18MB100	338	ALPNC15B18MB100	325



# Alphanumeric Index

Catalog Number	Page	Catalog Number	Page	Catalog Number	Page	Catalog Number	Page
ALPNC15B24ML	325	AMPA-10105	53	APPFR13B30ML	342	APPNE14C12ML	330
ALPNC15B30ML	325	AMPA-10106	53	APPFR14C18MB100	342	APPNE14C18ML	330
ALPNC21A18MB225	325	AMPA-10108	53	APPFR14C24MB100	342	APPNE14C24ML	330
ALPNC21A18ML	325	AMPA-1093	53	APPFR14C30MB100	342	APPNE16C12MB100	330
ALPNC21A24ML	325	AMPA-121212	53	APPFR14C30ML	342	APPNE16C12ML	330
ALPNC21A30ML	325	AMPA-12128	53	APPFR16C18MB100	342	APPNE16C18ML	330
ALPNC22C18MB225	325	AMPA-443	53	APPFR16C24MB100	342	APPNE16C24ML	330
ALPNC22C18ML	325	AMPA-555	53	APPFR16C30MB100	342	APPNE23B18ML	330
ALPNC22C24ML	325	AMPA-664	53	APPFR16C30ML	342	APPNE24C18ML	330
ALPNC22C30ML	325	AMPA-976	53	APPFR23B18MB225	342	APPNE26C18ML	330
ALPNC25B18MB2225	325	AMPA-984	53	APPFR23B24MB225	342	APPNF24C42MB225	328
ALPNC25B18ML	325	AMPG-10105	53	APPFR23B24ML	342	APPNG13B18MB100	330
ALPNC25B24ML	325	AMPG-10106	53	APPFR23B30ML	342	APPNG13B24MB100	330
ALPNC25B30ML	325	AMPG-10108	53	APPFR23B36ML	342	APPNG13B30MB100	330
ALPND11A24MB100	325	AMPG-1093	53	APPFR24C18MB225	342	APPNG13B30ML	330
ALPND11A30MB100	325	AMPG-121212	53	APPFR24C24MB225	342	APPNG14C18MB100	330
ALPND12C24MB100	325	AMPG-12128	53	APPFR24C24ML	342	APPNG14C24MB100	330
ALPND12C30MB100	325	AMPG-443	53	APPFR24C30ML	342	APPNG14C30MB100	330
ALPND15B24MB100	325	AMPG-555	53	APPFR24C36ML	342	APPNG14C30ML	330
ALPND15B30MB100	325	AMPG-664	53	APPFR26C18MB225	342	APPNG16C18MB100	330
ALPND21A24MB225	325	AMPG-976	53	APPFR26C24MB225	342	APPNG16C24MB100	330
ALPND21A30MB225	325	AMPG-984	53	APPFR26C24ML	342	APPNG16C30MB100	330
ALPND21A36MB225	325	APPFJ14C12ML	340	APPFR26C30ML	342	APPNG16C30ML	330
ALPND21A36ML	325	APPFK14C18ML	340	APPFR26C36ML	342	APPNG23B18MB225	330
ALPND21A42ML	325	APPFM14C12MB100	340	APPFS23B30MB225	342	APPNG23B24MB225	330
ALPND22C24MB225	325	APPFM14C18MB100	340	APPFS23B36MB225	342	APPNG23B24ML	330
ALPND22C30MB225	325	APPFM14C24ML	340	APPFS23B42MB225	342	APPNG23B30ML	330
ALPND22C36MB225	325	APPFM14C30ML	340	APPFS24C2MB225	342	APPNG23B36ML	330
ALPND22C36ML	325	APPFM24C18MB225	340	APPFS24C30MB225	342	APPNG24C18MB225	330
ALPND22C42ML	325	APPFM24C18ML	340	APPFS24C36MB225	342	APPNG24C24MB225	330
ALPND25B24MB2225	325	APPFM24C24ML	340	APPFS24C42MB225	342	APPNG24C24ML	330
ALPND25B30MB225	325	APPFM24C30ML	340	APPFS24C42ML	342	APPNG24C30ML	330
ALPND25B36MB225	325	APPFN14C24MB100	340	APPFS26C30MB225	342	APPNG24C36ML	330
ALPND25B36ML	325	APPFN14C30MB100	340	APPFS26C36MB225	342	APPNG26C18MB225	330
ALPND25B42ML	325	APPFN24C24MB225	340	APPFS26C42MB225	342	APPNG26C24MB225	330
ALPNF21A42MB225	325	APPFN24C30MB225	340	APPFS26C42ML	342	APPNG26C24ML	330
ALPNF22C42MB225	325	APPFN24C36MB225	340	APPNA14C12ML	328	APPNG26C30ML	330
ALPNF25B42MB2225	325	APPFN24C36ML	340	APPNB14C18ML	328	APPNG26C36ML	330
AMD-10-10105A	53	APPFN24C42ML	340	APPNC14C12MB100	328	APPNH23B30MB225	330
AMD-10-10105G	53	APPFP13B12MB100	342	APPNC14C18MB100	328	APPNH23B36MB225	330
AMD-10-664A	53	APPFP13B12ML	342	APPNC14C24ML	328	APPNH23B42MB225	330
AMD-10-664G	53	APPFP13B18ML	342	APPNC14C30ML	328	APPNH23B42ML	330
AMD-4-664A	53	APPFP13B24ML	342	APPNC24C18MB225	328	APPNH24C30MB225	330
AMD-4-664G	53	APPFP14C12MB100	342	APPNC24C18ML	328	APPNH24C36MB225	330
AMD-6-984A	53	APPFP14C12ML	342	APPNC24C24ML	328	APPNH24C42MB225	330
AMD-6-984G	53	APPFP14C18ML	342	APPNC24C30ML	328	APPNH24C42ML	330
AMD-8-1093A	53	APPFP14C24ML	342	APPND14C24MB100	328	APPNH26C30MB225	330
AMD-8-1093G	53	APPFP16C12MB100	342	APPND14C30MB100	328	APPNH26C36MB225	330
AMDB-38	92	APPFP16C12ML	342	APPND24C24MB225	328	APPNH26C42ML	330
AMDB-50	92	APPFP16C18ML	342	APPND24C30MB225	328	ASH-100	92
AMH1	122	APPFP16C24ML	342	APPND24C36MB225	328	ASH-125	92
AMH2	122	APPFP23B18ML	342	APPND24C36ML	328	ASH-150	92
AMH3	122	APPFP24C18ML	342	APPND24C42ML	328	ASH-200	92
AMH4	122	APPFP26C18ML	342	APPNE13B12MB100	330	ASH-250	92
AMH5	122	APPFQ24C42MB225	340	APPNE13B12ML	330	ASH-300	92
AMH6	122	APPFR13B18MB100	342	APPNE13B18ML	330	ASH-350	92
AMH7	122	APPFR13B24MB100	342	APPNE13B24ML	330	ASH-400	92
AMH8	122	APPFR13B30MB100	342	APPNE14C12MB100	330		

# Alphanumeric Index

Catalog Number	Page	Catalog Number	Page	Catalog Number	Page	Catalog Number	Page
ASH-450	92	BDT-100	92	CBU410C	276	D2P5C30	320
ASH-50	92	BDT-125	92	CBU416C	276	D2P5C32	320
ASH-500	92	BDT-150	92	CBU420C	276	D2P5C34	320
ASH-600	92	BDT-200	92	CBU425C	276	D2P5C36	320
ASH-75	92	BDT-250	92	CBU432C	276	DA2W2E102	185
ASW-10105A	52	BDT-300	92	CBUN210CR1	276	DER1C	45
ASW-10106A	52	BDT-350	92	CBUN210CR2	276	DER1CA	45
ASW-1093A	52	BDT-400	92	CBUN216CR1	276	DRNB4X	53
ASW-12128	52	BDT-450	92	CBUN216CR2	276	DT-100	92
ASW-443A	52	BDT-50	92	CBUN220CR1	276	DT-125	92
ASW-555A	52	BDT-500	92	CBUN220CR2	276	DT-150	92
ASW-664A	52	BDT-600	92	CC16MM	145	DT-200	92
ASW-976A	52	BDT-75	92	CC50MM	145	DT-250	92
ASW-984A	52	BJE1TA4M20	113	CC6MM	145	DT-300	92
AWG13/1CT	122	BJE1TN4P16	113	CPSK20-50ACN	29	DT-350	92
AZ-10104/6	123	BJE2TA4M20	113	CPSK20-50CN	29	DT-400	92
AZ-10146/8	123	BJE2TA4M25	113	CPSK20-75	28	DT-450	92
AZ-11205	123	BJE2TN3M20	113	CPSK20-75ACN	29	DT-50	92
AZ-11246	123	BJE2TN3M25	113	CPSK20-75CN	29	DT-500	92
AZ-11306	123	BJE2TN4M20	113	CPSK20B	28	DT-600	92
AZ-12126/8	123	BJE2TN4M25	113	CPSK20B-ACN	29	DT-75	92
AZ-12248/10	123	BRTB4X	53	CPSK20B-CN	29	DTX-040403	68
AZ-12368	123	BRTB4X	122	CPU20	28	DTX-040404	68
AZ-13386	123	BWH-100	92	CPU20-50ACN	29	DTX-050504	68
AZ-14146/8	123	BWH-125	92	CPU20-50CN	29	DTX-060403	68
AZ-14248	123	BWH-150	92	CPU20-75	28	DTX-060404	68
AZ-15377	123	BWH-200	92	CPU20-75ACN	29	DTX-060603	68
AZ-16166/8	123	BWH-250	92	CPU20-75CN	29	DTX-060604	68
AZ-161812	123	BWH-300	92	CPU20-ACN	29	DTX-060606	68
AZ-16226	123	BWH-350	92	CPU20-CN	29	DTX-080403	68
AZ-16248	123	BWH-400	92	D2P4A10	320	DTX-080404	68
AZ-16286	123	BWH-450	92	D2P4A12	320	DTX-080603	68
AZ-18186/8	123	BWH-50	92	D2P4A6	320	DTX-080604	68
AZ-18248/10	123	BWH-500	92	D2P4A8	320	DTX-080606	68
AZ-18308	123	BWH-600	92	D2P4B14	320	DTX-080804	68
AZ-18368/10	123	BWH-75	92	D2P4B16	320	DTX-080806	68
AZ-18427	123	CB1M	145	D2P4B18	320	DTX-080808	68
AZ-205610	123	CB205	28	D2P4B20	320	DTX-100604	68
AZ-20608	123	CB205CN	29	D2P4B22	320	DTX-100606	68
AZ-24248/10	123	CBDB0	280	D2P4B24	320	DTX-100804	68
AZ-24308	123	CBDB6	280	D2P4C26	320	DTX-100806	68
AZ-24368/10	123	CBDB7	280	D2P4C28	320	DTX-100808	68
AZ-30388	123	CBDC0	280	D2P4C30	320	DTX-101004	68
AZ-464	123	CBDC6	280	D2P4C32	320	DTX-101006	68
AZ-593	123	CBDC7	280	D2P4C34	320	DTX-101008	68
AZ-6104	123	CBU206C	276	D2P4C36	320	DTX-120404	68
AZ-6124	123	CBU210C	276	D2P5A10	320	DTX-120604	68
AZ-6164	123	CBU216C	276	D2P5A12	320	DTX-120606	68
AZ-664	123	CBU220C	276	D2P5A6	320	DTX-120804	68
AZ-684	123	CBU225C	276	D2P5A8	320	DTX-120806	68
AZ-686	123	CBU232C	276	D2P5B14	320	DTX-120808	68
AZ-7116	123	CBU306C	276	D2P5B16	320	DTX-121004	68
AZ-8106	123	CBU310C	276	D2P5B18	320	DTX-121006	68
AZ-8137	123	CBU316C	276	D2P5B20	320	DTX-121008	68
AZ-886	123	CBU320C	276	D2P5B22	320	DTX-121204	68
AZ-9115	123	CBU325C	276	D2P5B24	320	DTX-121206	68
AZ-9154	123	CBU332C	276	D2P5C26	320	DTX-121207	68
		CBU406C	276	D2P5C28	320	DTX-121208	68

# Alphanumeric Index

Catalog Number	Page	Catalog Number	Page	Catalog Number	Page	Catalog Number	Page
DTX-121210	68	EB1E3W15	263	EB2EH2W100	259	EB3KA3W125	265
DTX-121212	68	EB1E3W20	263	EB2EH2W100	263	EB3KA3W150	265
DTX-140804	68	EB1E3W30	263	EB2EH2W70	259	EB3KA3W175	265
DTX-140806	68	EB1E3W40	263	EB2EH2W90	263	EB3KA3W200	265
DTX-140808	68	EB1EH2W15	259	EB2EH2W90	263	EB3KA3W225	265
DTX-141406	68	EB1EH2W15	263	EB2EH3W100	259	EB4	265
DTX-141408	68	EB1EH2W20	259	EB2EH3W100	263	EB4LA2W250	265
DTX-141410	69	EB1EH2W20	263	EB2EH3W70	259	EB4LA2W300	265
DTX-161204	69	EB1EH2W30	259	EB2EH3W70	263	EB4LA2W350	265
DTX-161206	69	EB1EH2W30	263	EB2EH3W90	259	EB4LA2W400	265
DTX-161208	69	EB1EH2W40	259	EB2EH3W90	263	EB4LA3W250	265
DTX-161606	69	EB1EH2W40	263	EB2F2W100	259	EB4LA3W300	265
DTX-180606	69	EB1EH2W50	259	EB2F2W100	264	EB4LA3W350	265
DTX-180804	69	EB1EH2W50	263	EB2F2W125	259	EB4LA3W400	265
DTX-180806	69	EB1EH2W60	259	EB2F2W125	264	ECD50B4X	122
DTX-181204	69	EB1EH3W15	259	EB2F2W150	259	ECDAB262720	194
DTX-181206	69	EB1EH3W15	263	EB2F2W150	264	ECDAB343223	194
DTX-181210	69	EB1EH3W20	259	EB2F2W70	259	ECDAB372720	194
DTX-181212	69	EB1EH3W20	263	EB2F2W70	264	ECDAB453234	194
DTX-181218	69	EB1EH3W30	259	EB2F2W90	259	ECDAB454434	194
DTX-181806	69	EB1EH3W30	263	EB2F2W90	264	ECDAB684441	194
DTX-181808	69	EB1EH3W40	259	EB2F3W100	259	ECDAB684441	194
DTX-181810	69	EB1EH3W40	263	EB2F3W100	264	ECDAC141610	194
DTX-181812	69	EB1EH3W50	259	EB2F3W125	259	ECDAC212312	194
DTX-241206	69	EB1EH3W50	263	EB2F3W125	264	ECDAC232124	194
DTX-241208	69	EB1EH3W60	259	EB2F3W150	259	ECDAC292619	194
DTX-241212	69	EB1F2W15	259	EB2F3W150	264	ECDAC323423	194
DTX-241806	69	EB1F2W15	264	EB2F3W70	259	ECDAC363320	194
DTX-241808	69	EB1F2W20	259	EB2F3W70	264	ECDAC444534	194
DTX-241810	69	EB1F2W20	264	EB2F3W90	259	ECDAC444534	194
DTX-241812	69	EB1F2W30	259	EB2F3W90	264	ECDFB131309	194
DTX-242406	69	EB1F2W30	264	EB3	259	ECDFB201413	194
DTX-242408	69	EB1F2W40	259	EB3	264	ECDFB271912	194
DTX-242410	69	EB1F2W40	264	EB3	265	ECDFC686445	194
DTX-242412	69	EB1F2W50	259	EB3JA2W175	264	ECDXB105529S	199
DTX-281208	69	EB1F2W50	264	EB3JA2W200	264	ECDXB106329	199
DTX-281212	69	EB1F2W60	259	EB3JA2W225	264	ECDXB106329S	199
DTX-302408	69	EB1F3W15	259	EB3JA3W175	264	ECDXB107029	199
DTX-302410	69	EB1F3W15	264	EB3JA3W200	264	ECDXB107029S	199
DTX-302412	69	EB1F3W20	259	EB3JA3W225	264	ECDXB125529	199
DTX-302418	69	EB1F3W20	264	EB3JB2W125	259	ECDXB125529S	199
DTX-361806	69	EB1F3W30	259	EB3JB2W150	259	ECDXB126329	199
DTX-361808	69	EB1F3W30	264	EB3JB2W175	259	ECDXB126329S	199
DTX-361812	69	EB1F3W40	259	EB3JB2W200	259	ECDXB127029	199
DTX-361818	69	EB1F3W40	264	EB3JB2W225	259	ECDXB127029S	199
DTX-362418	69	EB1F3W50	259	EB3JB2W250	259	ECDXB145529	199
DTX-363608	69	EB1F3W50	264	EB3JB2W250	259	ECDXB145529S	199
DTX-363612	69	EB1F3W60	259	EB3JB3W125	259	ECDXB146329	199
DTX-363618	69	EB2	259	EB3JB3W150	259	ECDXB146329S	199
EB1	259	EB2	263	EB3JB3W175	259	ECDXB302718	199
EB1	263	EB2	264	EB3JB3W200	259	ECDXB302718S	199
EB1	264	EB2E2W100	263	EB3JB3W225	259	ECDXB412628	199
EB1E2W15	263	EB2E2W70	263	EB3JB3W250	259	ECDXB412628S	199
EB1E2W20	263	EB2E2W90	263	EB3KA2W125	265	ECDXB413828	199
EB1E2W30	263	EB2E3W100	263	EB3KA2W150	265	ECDXB413828S	199
EB1E2W40	263	EB2E3W70	263	EB3KA2W175	265	ECDXB633734	199
EB1E2W50	263	EB2E3W90	263	EB3KA2W200	265	ECDXB633734S	199
				EB3KA2W225	265	ECDXB635734	199

# Alphanumeric Index

Catalog Number	Page	Catalog Number	Page	Catalog Number	Page	Catalog Number	Page
ECDXB635734S	199	EHD2080	272	EXB101008	56	FDB3040	272
ECDXB705029	199	EHD2090	272	EXB120804	56	FDB3050	272
ECDXB705029S	199	EHD2100	272	EXB121206	56	FDB3060	272
ECDXB706029	199	EHD3015	272	EXB121208	56	FDB3070	272
ECDXB706029S	199	EHD3020	272	EXB121212	56	FDB3080	272
ECDXB707029	199	EHD3030	272	EXB181206	57	FDB3090	272
ECDXB707029S	199	EHD3040	272	EXB181208	57	FDB3100	272
ECDXB805029	199	EHD3050	272	EXB181806	57	FDB3110	272
ECDXB805029S	199	EHD3060	272	EXB181808	57	FDB3125	272
ECDXB806029	199	EHD3070	272	EXB181812	57	FDB3150	272
ECDXB806029S	199	EHD3080	272	EXB241808	57	FWF2016L	272
ECDXB807029	199	EHD3090	272	EXB241810	57	FWF2020L	272
ECDXB807029S	199	EHD3100	272	EXB242408	57	FWF2025L	272
ECDXB905029	199	ENGRAVE-1	92	EXB242412	57	FWF2032L	272
ECDXB905029S	199	ENGRAVE-2	92	EXB301210	57	FWF2040L	272
ECDXB906029	199	EWP4A10	320	EXB302408	57	FWF2050L	272
ECDXB906029S	199	EWP4A12	320	FD2015	272	FWF2063L	272
ECEA121109#	202	EWP4A6	320	FD2020	272	FWF2080L	272
ECEA171109#	202	EWP4A8	320	FD2030	272	FWF2100L	272
ECEA212013#	202	EWP4B14	320	FD2040	272	FWF2125L	272
ECEA231109#	202	EWP4B16	320	FD2050	272	FWF2160L	272
ECEA322013#	202	EWP4B18	320	FD2060	272	FWF3016L	272
ECEA422013#	202	EWP4B20	320	FD2070	272	FWF3020L	272
ECEA483819#	202	EWP4B22	320	FD2080	272	FWF3025L	272
ECS21151	249	EWP4B24	320	FD2090	272	FWF3032L	272
ECS21201	249	EWP4C26	320	FD2100	272	FWF3040L	272
ECS21301	249	EWP4C28	320	FD2110	272	FWF3050L	272
ECS21401	249	EWP4C30	320	FD2125	272	FWF3063L	272
ECS41151	249	EWP4C32	320	FD2150	272	FWF3080L	272
ECS41201	249	EWP4C34	320	FD3015	272	FWF3100L	272
ECS41301	249	EWP4C36	320	FD3020	272	FWF3125L	272
ECS41401	249	EWP5A10	320	FD3030	272	FWF3160L	272
ECS62151	249	EWP5A12	320	FD3040	272	GK-04	92
ECS62201	249	EWP5A6	320	FD3050	272	GK-10	92
ECS62301	249	EWP5A8	320	FD3060	272	GK-25	92
ECS62401	249	EWP5B14	320	FD3070	272	GRC100	5
ECS82151	249	EWP5B16	320	FD3080	272	GRC100-A	5
ECS82201	249	EWP5B18	320	FD3090	272	GRC125	5
ECS82301	249	EWP5B20	320	FD3100	272	GRC125-A	5
ECS82401	249	EWP5B22	320	FD3110	272	GRC150	5
ECSK1151	249	EWP5B24	320	FD3125	272	GRC150-A	5
ECSK1201	249	EWP5C26	320	FD3150	272	GRC200	5
ECSK1301	249	EWP5C28	320	FDB2015	272	GRC200-A	5
ECSK1401	249	EWP5C30	320	FDB2020	272	GRC50	5
EDS1036	234	EWP5C32	320	FDB2030	272	GRC50-A	5
EDS1036CN	234	EWP5C34	320	FDB2040	272	GRC75	5
EDS3036	234	EWP5C36	320	FDB2050	272	GRC75-A	5
EDS3036CN	234	EXB040404	56	FDB2060	272	GRC A50	6
EDS6036	234	EXB060604	56	FDB2070	272	GRC A50-A	6
EDS6036CN	234	EXB060606	56	FDB2080	272	GRC A75	6
EGSKIT	122	EXB080604	56	FDB2090	272	GRC A75-A	6
EHD2015	272	EXB080606	56	FDB2100	272	GRE100	5
EHD2020	272	EXB080804	56	FDB2110	272	GRE100-A	5
EHD2030	272	EXB080806	56	FDB2125	272	GRE125	5
EHD2040	272	EXB080808	56	FDB2150	272	GRE125-A	5
EHD2050	272	EXB100806	56	FDB3015	272	GRE150	5
EHD2060	272	EXB100808	56	FDB3020	272	GRE150-A	5
EHD2070	272	EXB101006	56	FDB3030	272	GRE50	5

# Alphanumeric Index

Catalog Number	Page	Catalog Number	Page	Catalog Number	Page	Catalog Number	Page
GRE50-A	5	GRJS50-ACN	15	GRLB100-A	5	GRUE-125E-A	13
GRE75	5	GRJS50-CN	15	GRLB125	5	GRUE-125L	13
GRE75-A	5	GRJS75	14	GRLB125-A	5	GRUE-125L-A	13
GRFC100	7	GRJS75-ACN	15	GRLB150	5	GRUE-125LB	13
GRFC100-A	7	GRJS75-CN	15	GRLB150-A	5	GRUE-125LB-A	13
GRFC50	7	GRJSK	14	GRLB200	5	GRUE-125T	13
GRFC50-A	7	GRJSK50	14	GRLB200-A	5	GRUE-125T-A	13
GRFC75	7	GRJSK50-CN	15	GRLB50	5	GRUE-125TB	13
GRFC75-A	7	GRJSKCN	15	GRLB50-A	5	GRUE-125TB-A	13
GRFL100	7	GRJSK-SCCN	15	GRLB75	5	GRUE-125X	13
GRFL100-A	7	GRJT50	16	GRLB75-A	5	GRUE-125X-A	13
GRFL50	7	GRJT75	16	GRN100	5	GRUE-125XB	13
GRFL50-A	7	GRJTA50	16	GRN100-A	5	GRUE-125XB-A	13
GRFL75	7	GRJTA75	16	GRN125	5	GRUE-150C	13
GRFL75-A	7	GRJX50	16	GRN125-A	5	GRUE-150C-A	13
GRFT100	7	GRJX75	16	GRN150	5	GRUE-150CB	13
GRFT100-A	7	GRK-1	8	GRN150-A	5	GRUE-150CB-A	13
GRFT50	7	GRK-1	34	GRN50	5	GRUE-150E	13
GRFT50-A	7	GRK-100C	8	GRN50-A	5	GRUE-150E-A	13
GRFT75	7	GRK-1DC	8	GRN75	5	GRUE-150L	13
GRFT75-A	7	GRK-1M	8	GRN75-A	5	GRUE-150L-A	13
GRFX100	7	GRK-1SC	8	GRSS100	30	GRUE-150LB	13
GRFX100-A	7	GRK-1SC-A	8	GRSS50	30	GRUE-150LB-A	13
GRFX50	7	GRK-2	8	GRSS75	30	GRUE-150T	13
GRFX50-A	7	GRK-2C	46	GRSSA50	30	GRUE-150T-A	13
GRFX75	7	GRK-2M	8	GRSSA75	30	GRUE-150TB	13
GRFX75-A	7	GRK-2SC	8	GRT100	5	GRUE-150TB-A	13
GRG-1	8	GRK-2SC	46	GRT100-A	5	GRUE-150X	13
GRG-2	8	GRK-2SC-A	8	GRT125	5	GRUE-150X-A	13
GRG-3	8	GRK-3	8	GRT125-A	5	GRUE-150XB	13
GRHC100	27	GRK-3M	8	GRT150	5	GRUE-150XB-A	13
GRHC50	27	GRK-3SC	8	GRT150-A	5	GRUE-200C	13
GRHC75	27	GRK-3SC-A	8	GRT200	5	GRUE-200C-A	13
GRHL100	27	GRK-50	8	GRT200-A	5	GRUE-200CB	13
GRHL50	27	GRK-50A	8	GRT50	5	GRUE-200CB-A	13
GRHL75	27	GRK-50C	8	GRT50-A	5	GRUE-200E	13
GRHLB100	27	GRK-75	8	GRT75	5	GRUE-200E-A	13
GRHLB50	27	GRK-75A	8	GRT75-A	5	GRUE-200L	13
GRHLB75	27	GRK-75C	8	GRTA50	6	GRUE-200L-A	13
GRHT100	27	GRK-75U	8	GRTA50-A	6	GRUE-200LB	13
GRHT50	27	GRK-75UA	8	GRTA75	6	GRUE-200LB-A	13
GRHT75	27	GRL100	5	GRTA75-A	6	GRUE-200T	13
GRHX100	27	GRL100-A	5	GRTB12-3	8	GRUE-200T-A	13
GRHX50	27	GRL125	5	GRTB6-12	8	GRUE-200TB	13
GRHX75	27	GRL125-A	5	GRTB6-3	8	GRUE-200TB-A	13
GRJC50	16	GRL150	5	GRU100-A	10	GRUE-200TB-A	13
GRJC75	16	GRL150-A	5	GRU50-A	10	GRUE-200X	13
GRJCA50	16	GRL200	5	GRU75-A	10	GRUE-200X-A	13
GRJCA75	16	GRL200-A	5	GRUC-SC	12	GRUE-200XB	13
GRJEA50	16	GRL50	5	GRUC-SC-F	12	GRUE-200XB-A	13
GRJEA75	16	GRL50-A	5	GRUE100	12	GRUE50	12
GRJK-S	16	GRL75	5	GRUE100-A	11	GRUE50-A	11
GRJL50	16	GRL75-A	5	GRUE100-ACN	12	GRUE50-ACN	12
GRJL75	16	GRLA50	6	GRUE-125C	13	GRUE75	12
GRJS100	14	GRLA50-A	6	GRUE-125C-A	13	GRUE75-A	11
GRJS100-ACN	15	GRLA75	6	GRUE-125CB	13	GRUE75-ACN	12
GRJS100-CN	15	GRLA75-A	6	GRUE-125CB-A	13	GRUJ-1P	32
GRJS50	14	GRLB100	5	GRUE-125E	13	GRUJ-2P	32
						GRUJ-3P	32

# Alphanumeric Index

Catalog Number	Page	Catalog Number	Page	Catalog Number	Page	Catalog Number	Page
GRUK-S	32	GUALB-75MC	18	GUBK-3C	46	GUX75	9
GRUK-S	33	GUASC-1	22	GUBM-1C	46	HNG-22G	63
GRUK-S	34	GUAT100	18	GUBM-1CA	46	HNG-22SS	93
GRU0-2	33	GUAT-100MC	18	GUBM-2C	46	HNG-22SS	109
GRUSE100	34	GUAT-125	18	GUBM-2CA	46	HNG-23G	63
GRUSE50	34	GUAT-150	18	GUBMK-1	42	HNG-24G	63
GRUSE75	34	GUAT-200	18	GUBMK-2	42	HNG-34G	63
GRUT100	34	GUAT-50	18	GUBMK-3	42	JBDAB262720	194
GRUT50	34	GUAT-50MC	18	GUC100	9	JBDAB343223	194
GRUT75	34	GUAT-75	18	GUC50	9	JBDAB372720	194
GRX100	5	GUAT-75MC	18	GUC75	9	JBDAB372720D4	191
GRX100-A	5	GUAX-100	18	GUEB13-50AN4	31	JBDAB453234	194
GRX125	5	GUAX-100MC	18	GUEB13-75AN4	31	JBDAB454434	194
GRX125-A	5	GUAX-125	18	GUEB7-100AN4	31	JBDAB684441	194
GRX150	5	GUAX-150	18	GUEB7-50AN4	31	JBDAB686441	194
GRX150-A	5	GUAX-200	18	GUEB7-75AN4	31	JBDAC141610	194
GRX200	5	GUAX-50	18	GUG1	9	JBDAC212312	194
GRX200-A	5	GUAX-50MC	18	GUJC-100	25	JBDAC232124	194
GRX50	5	GUAX-75	18	GUJC-100CS	25	JBDAC292619	194
GRX50-A	5	GUAX-75MC	18	GUJC-50	25	JBDAC323423	194
GRX75	5	GUB1C	45	GUJC-50CS	25	JBDAC363320	194
GRX75-A	5	GUB1CA	45	GUJC-75	25	JBDAC444534	194
GUAC-100	18	GUB2C	45	GUJC-75CS	25	JBDFB131309	194
GUAC-100MC	18	GUB2CA	45	GUJL-100	25	JBDFB131309D1	191
GUAC-125	18	GUB3C	45	GUJL-100CS	25	JBDFB201413	194
GUAC-150	18	GUB3CA	45	GUJL-50	25	JBDFB201413D2	191
GUAC-200	18	GUBB-11	39	GUJL-50CS	25	JBDFB271912	194
GUAC-50	18	GUBB-11A	39	GUJL-75	25	JBDFB271912D3	191
GUAC-50MC	18	GUBB-22	39	GUJL-75CS	25	JBDFC161612D5	191
GUAC-75	18	GUBB-22A	39	GUJLB-100	26	JBDFC161612D6	191
GUAC-75MC	18	GUBB-33	39	GUJLB-100CS	26	JBDFC686445	194
GUADC-1	23	GUBB-33A	39	GUJLB-50	26	JBDR20	188
GUAE-100	18	GUBBD-1-10	41	GUJLB-50CS	26	JBDR23	188
GUAE-100MC	18	GUBBD-2-12	41	GUJLB-75	26	JBDR25G	188
GUAE-50	18	GUBBD-2-6	41	GUJLB-75CS	26	JBDR30	188
GUAE-50MC	18	GUBBD-3-12	41	GUJT-100	25	JBDR33	188
GUAE-75	18	GUBBD-3-17	41	GUJT-100CS	25	JBDR35G	188
GUAE-75MC	18	GUBBD-3-6	41	GUJT-50	25	JBDR40	188
GUAFC-50	21	GUBBM-1A	40	GUJT-50 CS	25	JBDR41	188
GUAHC-50	21	GUBBM-2A	40	GUJT-75	25	JBDR43	188
GUAHC-75	21	GUBBM-3A	40	GUJT-75CS	25	JBDR45G	188
GUAL-100	18	GUBBMP-11	42	GUJX-100	26	JBEA121109	202
GUAL-100MC	18	GUBBMP-22	42	GUJX-100CS	26	JBEA121109D1	207
GUAL-125	18	GUBBMP-33	42	GUJX-50	26	JBEA171109	202
GUAL-150	18	GUBG-1	42	GUJX-50CS	26	JBEA171109D2	207
GUAL-200	18	GUBG-2	42	GUJX-75	26	JBEA212013	202
GUAL-50	18	GUBG-3	42	GUJX-75CS	26	JBEA212013A01	209
GUAL-50MC	18	GUBK-1	42	GUL100	9	JBEA212013A02	209
GUAL-75	18	GUBK-1-10	42	GUL50	9	JBEA212013A07	209
GUAL-75MC	18	GUBK-1C	46	GUL75	9	JBEA212013A08	209
GUALB-100	18	GUBK-2	42	GULB100	9	JBEA212013A21	209
GUALB-100MC	18	GUBK-2-12	42	GULB50	9	JBEA212013A22	209
GUALB-125	18	GUBK-2-6	42	GULB75	9	JBEA212013A27	209
GUALB-150	18	GUBK-2C	46	GUT100	9	JBEA212013A28	209
GUALB-200	18	GUBK-3	42	GUT50	9	JBEA212013A41	209
GUALB-50	18	GUBK-3-12	42	GUT75	9	JBEA212013A42	209
GUALB-50MC	18	GUBK-3-17	42	GUX100	9	JBEA212013A47	209
GUALB-75	18	GUBK-3-6	42	GUX50	9	JBEA212013A48	209

# Alphanumeric Index

Catalog Number	Page	Catalog Number	Page	Catalog Number	Page	Catalog Number	Page
JBEA212013D5	207	JBEA322013P04	208	JBEP02S	146	JBEP15S	146
JBEA212013L01	210	JBEA322013P05	208	JBEP0407	145	JBEP16B	146
JBEA212013L02	210	JBEA322013P09	208	JBEP05B	146	JBEP16S	146
JBEA212013L07	210	JBEA322013P10	208	JBEP05S	146	JBEP1717090	141
JBEA212013L08	210	JBEA322013P11	208	JBEP06B	146	JBEP171709004	142
JBEA212013L21	210	JBEA322013P23	208	JBEP06S	146	JBEP171709006	142
JBEA212013L22	210	JBEA322013P24	208	JBEP07B	146	JBEP171709014	142
JBEA212013L27	210	JBEA322013P29	208	JBEP07S	146	JBEP171709016	142
JBEA212013L28	210	JBEA322013P30	208	JBEP0808060	141	JBEP171709AE01	164
JBEA212013L41	210	JBEA322013P43	208	JBEP080806003	142	JBEP171709AE02	164
JBEA212013L42	210	JBEA322013P44	208	JBEP080806004	142	JBEP171709AE03	164
JBEA212013L47	210	JBEA322013P49	208	JBEP080806AE03	161	JBEP171709AE04	164
JBEA212013L48	210	JBEA322013P50	208	JBEP080806AE03T	159	JBEP171709AE04T	160
JBEA212013P01	208	JBEA422013	202	JBEP080806AE04T	159	JBEP171709AE05	164
JBEA212013P02	208	JBEA422013A06	209	JBEP080806AE05	161	JBEP171709AE06	164
JBEA212013P07	208	JBEA422013A12	209	JBEP080806AE22	161	JBEP171709AE06T	160
JBEA212013P08	208	JBEA422013A25	209	JBEP080806AE23	161	JBEP171709AE07	164
JBEA212013P21	208	JBEA422013A31	209	JBEP080806AE24	161	JBEP171709AE08	165
JBEA212013P22	208	JBEA422013A45	209	JBEP080806AE25	161	JBEP171709AE09	165
JBEA212013P27	208	JBEA422013A51	209	JBEP080806NE03	161	JBEP171709AE10	165
JBEA212013P28	208	JBEA422013D7	207	JBEP080806NE03T	159	JBEP171709AE11	165
JBEA212013P41	208	JBEA422013L06	210	JBEP080806NE04T	159	JBEP171709AE14T	160
JBEA212013P42	208	JBEA422013L12	210	JBEP080806NE05	161	JBEP171709AE16T	160
JBEA212013P47	208	JBEA422013L25	210	JBEP08B	146	JBEP171709AE46	163
JBEA212013P48	208	JBEA422013L31	210	JBEP08S	146	JBEP171709AE47	163
JBEA231109	202	JBEA422013L45	210	JBEP09B	146	JBEP171709AE48	163
JBEA231109D3	207	JBEA422013L51	210	JBEP09S	146	JBEP171709AE51	166
JBEA322013	202	JBEA422013P06	208	JBEP1008	145	JBEP171709AE52	166
JBEA322013A03	209	JBEA422013P12	208	JBEP10B	146	JBEP171709AE53	166
JBEA322013A04	209	JBEA422013P25	208	JBEP10S	146	JBEP171709AE54	167
JBEA322013A05	209	JBEA422013P31	208	JBEP11B	146	JBEP171709AE55	167
JBEA322013A09	209	JBEA422013P45	208	JBEP11S	146	JBEP171709AE56	167
JBEA322013A10	209	JBEA422013P51	208	JBEP121209003	142	JBEP171709AE57	167
JBEA322013A11	209	JBEA483819	202	JBEP121209004	142	JBEP171709AE58	168
JBEA322013A23	209	JBEA483819A26	209	JBEP121209AE03T	159	JBEP171709AE59	168
JBEA322013A24	209	JBEA483819A32	209	JBEP121209AE04T	159	JBEP171709AE60	168
JBEA322013A29	209	JBEA483819A46	209	JBEP121209AE07	162	JBEP171709AE61	168
JBEA322013A30	209	JBEA483819A52	209	JBEP121209AE25	163	JBEP171709AI01	153
JBEA322013A43	209	JBEA483819D8	207	JBEP121209AE27	163	JBEP171709AI07	153
JBEA322013A44	209	JBEA483819L26	210	JBEP121209AE45	162	JBEP171709LI01	154
JBEA322013A49	209	JBEA483819L32	210	JBEP121209AE47	162	JBEP171709LI07	154
JBEA322013A50	209	JBEA483819L46	210	JBEP121209NE08	162	JBEP171709NE01	164
JBEA322013D6	207	JBEA483819L52	210	JBEP121209NE13T	159	JBEP171709NE02	164
JBEA322013L03	210	JBEA483819P26	208	JBEP121209NE14T	159	JBEP171709NE03	164
JBEA322013L04	210	JBEA483819P32	208	JBEP121209NE26	163	JBEP171709NE04	164
JBEA322013L05	210	JBEA483819P46	208	JBEP121209NE28	163	JBEP171709NE04T	160
JBEA322013L09	210	JBEA483819P52	208	JBEP121209NE46	162	JBEP171709NE05	164
JBEA322013L10	210	JBEL1A4M20	214	JBEP121209NE48	162	JBEP171709NE06	164
JBEA322013L11	210	JBEL1N4P16G	214	JBEP121209S0	141	JBEP171709NE06T	160
JBEA322013L23	210	JBEL2A4M05	214	JBEP12B	146	JBEP171709NE07	164
JBEA322013L24	210	JBEL2A4M06	214	JBEP12S	146	JBEP171709NE08	165
JBEA322013L29	210	JBEL2A4M20	214	JBEP13B	146	JBEP171709NE09	165
JBEA322013L30	210	JBEL2A4M25	214	JBEP13S	146	JBEP171709NE10	165
JBEA322013L43	210	JBEL2N3M20G	214	JBEP14B	146	JBEP171709NE11	165
JBEA322013L44	210	JBEL2N3M25G	214	JBEP14S	146	JBEP171709NE14T	160
JBEA322013L49	210	JBEL2N4M20G	214	JBEP1515	145	JBEP171709NE16T	160
JBEA322013L50	210	JBEL2N4M25G	214	JBEP1518	145	JBEP171709NE46	163
JBEA322013P03	208	JBEP02B	146	JBEP15B	146	JBEP171709NE47	163

# Alphanumeric Index

Catalog Number	Page	Catalog Number	Page	Catalog Number	Page	Catalog Number	Page
JBEP171709NE48	163	JBEP202115NI02	152	JBEP253215LI10	154	JBEP3275230	141
JBEP171709NE51	166	JBEP202115NI08	152	JBEP253215LI11	154	JBEP4826	145
JBEP171709NE52	166	JBEP202115NI21	152	JBEP253215LI12	154	JBEP5032150	141
JBEP171709NE53	166	JBEP202115NI22	152	JBEP253215LI23	154	JBEP503215AP01	175
JBEP171709NE54	167	JBEP202115NI27	152	JBEP253215LI24	154	JBEP503215AP02	175
JBEP171709NE55	167	JBEP202115NI28	152	JBEP253215LI25	154	JBEP503215AP03	176
JBEP171709NE56	167	JBEP202115NI41	152	JBEP253215LI29	154	JBEP503215AP04	176
JBEP171709NE57	167	JBEP202115NI42	152	JBEP253215LI30	154	JBEP503215AP21	177
JBEP171709NE58	168	JBEP202115NI47	152	JBEP253215LI31	154	JBEP503215AP22	177
JBEP171709NE59	168	JBEP202115NI48	152	JBEP253215LI43	154	JBEP503215AP23	178
JBEP171709NE60	168	JBEP202115NP01	170	JBEP253215LI44	154	JBEP503215AP24	178
JBEP171709NE61	168	JBEP202115NP02	170	JBEP253215LI45	154	JBEP503215NP01	175
JBEP171709NI01	152	JBEP202115NP03	170	JBEP253215LI49	154	JBEP503215NP02	175
JBEP171709NI07	152	JBEP202115NP04	170	JBEP253215LI50	154	JBEP503215NP03	176
JBEP17B	146	JBEP202115NP05	170	JBEP253215LI51	154	JBEP503215NP21	177
JBEP17S	146	JBEP202115NP06	170	JBEP253215NI03	152	JBEP503215NP22	177
JBEP2021100	141	JBEP202115NP07	171	JBEP253215NI04	152	JBEP503215NP23	178
JBEP202110AE12	165	JBEP202115NP08	171	JBEP253215NI05	152	JBEP5032230	141
JBEP202110AE62	169	JBEP202115NP09	171	JBEP253215NI06	152	JBEP503223NP04	176
JBEP202110NE12	165	JBEP202115NP10	171	JBEP253215NI09	152	JBEP503223NP24	178
JBEP202110NE62	169	JBEP202115NP11	171	JBEP253215NI10	152	JBEP7326	145
JBEP2021150	141	JBEP202115NP12	171	JBEP253215NI11	152	JBEP7532150	141
JBEP202115AI02	153	JBEP202115NP13	172	JBEP253215NI12	152	JBEP753215AP61	180
JBEP202115AI08	153	JBEP202115NP14	172	JBEP253215NI23	152	JBEP753215AP62	180
JBEP202115AI21	153	JBEP202115NP15	172	JBEP253215NI24	152	JBEP753215AP71	180
JBEP202115AI22	153	JBEP202115NP16	172	JBEP253215NI25	152	JBEP753215AP72	180
JBEP202115AI27	153	JBEP2532150	141	JBEP253215NI29	152	JBEP753215NP01	179
JBEP202115AI28	153	JBEP253215AI03	153	JBEP253215NI30	152	JBEP753215NP03	179
JBEP202115AI41	153	JBEP253215AI04	153	JBEP253215NI31	152	JBEP7532230	141
JBEP202115AI42	153	JBEP253215AI05	153	JBEP253215NI43	152	JBEP753223AP01	179
JBEP202115AI47	153	JBEP253215AI06	153	JBEP253215NI44	152	JBEP753223AP02	179
JBEP202115AI48	153	JBEP253215AI09	153	JBEP253215NI45	152	JBEP753223AP03	179
JBEP202115AP01	170	JBEP253215AI10	153	JBEP253215NI49	152	JBEP753223NP02	179
JBEP202115AP02	170	JBEP253215AI11	153	JBEP253215NI50	152	JBEP753223NP02	179
JBEP202115AP03	170	JBEP253215AI12	153	JBEP253215NI51	152	JBEP753223NP02	179
JBEP202115AP04	170	JBEP253215AI23	153	JBEP253215NP01	173	JBEP753223NP02	179
JBEP202115AP05	170	JBEP253215AI24	153	JBEP253215NP02	173	JBEP753223NP02	179
JBEP202115AP06	170	JBEP253215AI25	153	JBEP253215NP03	174	JBEP753223NP02	179
JBEP202115AP07	171	JBEP253215AI29	153	JBEP253215NP04	174	JBEP753223NP02	179
JBEP202115AP08	171	JBEP253215AI30	153	JBEP253215NP17	172	JBEP753223NP02	179
JBEP202115AP09	171	JBEP253215AI31	153	JBEP253215NP18	172	JBEP753223NP02	179
JBEP202115AP10	171	JBEP253215AI43	153	JBEP2623	145	JBEP753223NP02	179
JBEP202115AP11	171	JBEP253215AI44	153	JBEP3225150	141	JBEP753223NP02	179
JBEP202115AP12	171	JBEP253215AI45	153	JBEP3250150	141	JBEP753223NP02	179
JBEP202115AP13	172	JBEP253215AI49	153	JBEP325015AI26	153	JBEP753223NP02	179
JBEP202115AP14	172	JBEP253215AI50	153	JBEP325015AI32	153	JBEP753223NP02	179
JBEP202115AP15	172	JBEP253215AI51	153	JBEP325015AI46	153	JBEP753223NP02	179
JBEP202115AP16	172	JBEP253215AP01	173	JBEP325015AI52	153	JBEP753223NP02	179
JBEP202115LI02	154	JBEP253215AP02	173	JBEP325015LI26	154	JBEP753223NP02	179
JBEP202115LI08	154	JBEP253215AP03	174	JBEP325015LI32	154	JBEP753223NP02	179
JBEP202115LI21	154	JBEP253215AP04	174	JBEP325015LI46	154	JBEP753223NP02	179
JBEP202115LI22	154	JBEP253215AP17	172	JBEP325015LI52	154	JBEP753223NP02	179
JBEP202115LI27	154	JBEP253215AP18	172	JBEP325015NI26	152	JBEP753223NP02	179
JBEP202115LI28	154	JBEP253215LI03	154	JBEP325015NI32	152	JBEP753223NP02	179
JBEP202115LI41	154	JBEP253215LI04	154	JBEP325015NI46	152	JBEP753223NP02	179
JBEP202115LI42	154	JBEP253215LI05	154	JBEP325015NI52	152	JBEP753223NP02	179
JBEP202115LI47	154	JBEP253215LI06	154	JBEP3250230	141	JBEP753223NP02	179
JBEP202115LI48	154	JBEP253215LI09	154	JBEP3275150	141	JBEP753223NP02	179



# Alphanumeric Index

Catalog Number	Page	Catalog Number	Page	Catalog Number	Page	Catalog Number	Page
JBES1818090	219	JBES5656200	219	JIC-S75	115	NMD-8-1093G	53
JBES2226150	219	JBES5656201	220	MD2DS1034F	241	NMPA-10105	53
JBES2226150F5	229	JBES5656202	220	MD2DS1034U	241	NMPA-10106	53
JBES2226150F6	229	JBES5656203	220	MD2DS3034F	241	NMPA-10108	53
JBES2226151	220	JBES5656204	220	MD2DS6034F	241	NMPA-1093	53
JBES2226152	220	JBES5675200	219	MDB-38	92	NMPA-121212	53
JBES2226153	220	JBES5675201	220	MDB-50	92	NMPA-12128	53
JBES2226154	220	JBES5675202	220	N1D7515B	248	NMPA-443	53
JBES2237200	219	JBES5675203	220	N1D7520B	248	NMPA-555	53
JBES2237200F7	229	JBES5675204	220	N1D7530B	248	NMPA-664	53
JBES2237200F8	229	JBES7537200	219	N1DC7515B	248	NMPA-976	53
JBES2237201	220	JBES7537201	220	N1DC7520B	248	NMPA-984	53
JBES2237202	220	JBES7537202	220	N1DC7530B	248	NMPG-10105	53
JBES2237203	220	JBES7537203	220	NFC-10105A	53	NMPG-10106	53
JBES2237204	220	JBES7537204	220	NFC-1010A	53	NMPG-10108	53
JBES2622150	219	JBES7556200	219	NFC-1093A	53	NMPG-1093	53
JBES2622150F2	229	JBES7556201	220	NFC-1212A	53	NMPG-121212	53
JBES2622151	220	JBES7556202	220	NFC-443A	53	NMPG-12128	53
JBES2622152	220	JBES7556203	220	NFC-555A	53	NMPG-443	53
JBES2622153	220	JBES7556204	220	NFC-664A	53	NMPG-555	53
JBES2622154	220	JBESCF262A	223	NFC-976A	53	NMPG-664	53
JBES2637200	219	JBESCF372A	223	NFC-984A	53	NMPG-976	53
JBES2637201	220	JBESCF372B	223	NGK-04	52	NMPG-984	53
JBES2637202	220	JBESCF373A	223	NGK-04	53	NPW	147
JBES2637203	220	JBESCF373B	223	NGK-10	52	NPY	147
JBES2637204	220	JBESCF562A	223	NGK-10	53	NSW-10105A	52
JBES3722200	219	JBESCF562B	223	NGK-25	52	NSW-10106A	52
JBES3722201	220	JBESCF563A	223	NGUB10105A	51	NSW-1093A	52
JBES3722202	220	JBESCF563B	223	NGUB10106A	51	NSW-12128	52
JBES3722203	220	JBESCF752A	223	NGUB10108A	51	NSW-443A	52
JBES3722204	220	JBESCF752B	223	NGUB1093A	51	NSW-555A	52
JBES372220F3	229	JBESCF753A	223	NGUB121212A	51	NSW-664A	52
JBES3726200	219	JBESCF753B	223	NGUB12128A	51	NSW-976A	52
JBES3726200F4	229	JBESGP221B	223	NGUB443A	51	NSW-984A	52
JBES3726201	220	JBESGP261A	223	NGUB555A	51	PJB108030	132
JBES3726202	220	JBESGP262A	223	NGUB664A	51	PJB403020	132
JBES3726203	220	JBESGP262B	223	NGUB976A	51	PJB504020	132
JBES3726204	220	JBESGP263A	223	NGUB984A	51	PJB604025	132
JBES3737200	219	JBESGP372A	223	NGUBSW10105A	51	PJB806030	132
JBES3737201	220	JBESGP372B	223	NGUBSW10106A	51	PJBDR300	134
JBES3737202	220	JBESGP373A	223	NGUBSW10108A	51	PJBDR400	134
JBES3737203	220	JBESGP373B	223	NGUBSW1093A	51	PJBDR600	134
JBES3737204	220	JBESGP562A	223	NGUBSW121212A	51	PJBDR800	134
JBES3756200	219	JBESGP562B	223	NGUBSW12128A	51	PJBGP114	134
JBES3756201	220	JBESGP563A	223	NGUBSW443A	51	PJBGP130	134
JBES3756202	220	JBESGP563B	223	NGUBSW555A	51	PJBMP100	134
JBES3756203	220	JBESGP752A	223	NGUBSW664A	51	PJBMP400	134
JBES3756204	220	JBESGP752B	223	NGUBSW976A	51	PJBMP500	134
JBES3775200	219	JBESGP753A	223	NGUBSW984A	51	PJBMP600	134
JBES3775201	220	JBESGP753B	223	NMD-10-10105A	53	PJBMP800	134
JBES3775202	220	JIC-1	115	NMD-10-10105G	53	PJBPL	134
JBES3775203	220	JIC-2	115	NMD-10-664A	53	PJBSR100	134
JBES3775204	220	JIC-B	115	NMD-10-664G	53	PJBSR400	134
JBES5637200	219	JIC-C	115	NMD-4-664A	53	PJBSR500	134
JBES5637201	220	JIC-C1	115	NMD-4-664G	53	PJBSR600	134
JBES5637202	220	JIC-H50	115	NMD-6-984A	53	PJBSR800	134
JBES5637203	220	JIC-H75	115	NMD-6-984G	53	PPAL052316C1G030	370
JBES5637204	220	JIC-S50	115	NMD-8-1093A	53	PPAL052316C40N	370

# Alphanumeric Index

Catalog Number	Page	Catalog Number	Page	Catalog Number	Page	Catalog Number	Page
PPAL052316C4G030	370	PPBM054316C10N	372	PPCM063416C4	374	PPDM098316C30N	376
PPAL052316C5	370	PPBM054316C20N	372	PPCM063416C40N	374	PPDM098316C4	376
PPAL052316C50N	370	PPBM054316C30N	372	PPCM063416C4G030	374	PPDM108216C1	376
PPAL052316C5G030	370	PPBM054316C4	372	PPCM063416C5	374	PPDM108216C1G030	376
PPAL052316C60N	370	PPBM062216C5G030	372	PPCM063416C50N	374	PPDM108216C20N	376
PPAL052316C70N	370	PPBM062216C80N	372	PPCM063416C5G030	374	PPDM108216C30N	376
PPAL052316C80N	370	PPBM062416C1	372	PPCM063416C60N	374	PPDM108216C4	376
PPAL052316CG030	370	PPBM062416C1G030	372	PPCM063416C70N	374	PPDM108216C40N	376
PPAL054316C	370	PPBM062416C20N	372	PPCM063416C80N	374	PPDM108216C4G030	376
PPAL054316C1	370	PPBM062416C30N	372	PPCM063416CG030	374	PPDM108216C5	376
PPAL054316C10N	370	PPBM062416C4	372	PPCM066216C1	374	PPDM108216C50N	376
PPAL054316C20N	370	PPBM062416C40N	372	PPCM066216C1G030	374	PPDM108216C60N	376
PPAL054316C30N	370	PPBM062416C4G030	372	PPCM066216C20N	374	PPDM108216C70N	376
PPAL054316C4	370	PPBM062416C5	372	PPCM066216C30N	374	PPDM108216CG030	376
PPAL062216C5G030	370	PPBM062416C50N	372	PPCM066216C4	374	PPDM1416216C	376
PPAL062216C80N	370	PPBM062416C5G030	372	PPCM066216C40N	374	PPDM1416216C10N	376
PPAL062416C1	370	PPBM062416C60N	372	PPCM066216C4G030	374	PPEM056316C1G030	378
PPAL062416C1G030	370	PPBM062416C70N	372	PPCM066216C5	374	PPEM056316C40N	378
PPAL062416C20N	370	PPBM062416C80N	372	PPCM066216C50N	374	PPEM056316C4G030	378
PPAL062416C30N	370	PPBM062416CG030	372	PPCM066216C60N	374	PPEM056316C5	378
PPAL062416C4	370	PPBM064216C1	372	PPCM066216C70N	374	PPEM056316C50N	378
PPAL062416C40N	370	PPBM064216C1G030	372	PPCM066216CG030	374	PPEM056316C5G030	378
PPAL062416C4G030	370	PPBM064216C20N	372	PPCM066416C	374	PPEM056316C60N	378
PPAL062416C5	370	PPBM064216C30N	372	PPCM066416C10N	374	PPEM056316C70N	378
PPAL062416C50N	370	PPBM064216C4	372	PPCM1212216C	374	PPEM056316C80N	378
PPAL062416C5G030	370	PPBM064216C40N	372	PPCM1212216C10N	374	PPEM056316CG030	378
PPAL062416C60N	370	PPBM064216C4G030	372	PPDM054316C1G030	376	PPEM0612416C	378
PPAL062416C70N	370	PPBM064216C5	372	PPDM054316C40N	376	PPEM0612416C10N	378
PPAL062416C80N	370	PPBM064216C50N	372	PPDM054316C4G030	376	PPEM066216C5G030	378
PPAL062416CG030	370	PPBM064216C60N	372	PPDM054316C5	376	PPEM066216C80N	378
PPAL064216C1	370	PPBM064216C70N	372	PPDM054316C50N	376	PPEM066416C1	378
PPAL064216C1G030	370	PPBM064216CG030	372	PPDM054316C5G030	376	PPEM066416C1G030	378
PPAL064216C20N	370	PPBM064416C	372	PPDM054316C60N	376	PPEM066416C20N	378
PPAL064216C30N	370	PPBM064416C10N	372	PPDM054316C70N	376	PPEM066416C30N	378
PPAL064216C4	370	PPBM068216C	372	PPDM054316C80N	376	PPEM066416C4	378
PPAL064216C40N	370	PPBM068216C10N	372	PPDM054316CG030	376	PPEM066416C40N	378
PPAL064216C4G030	370	PPCM053316C1G030	374	PPDM064216C5G030	376	PPEM066416C4G030	378
PPAL064216C5	370	PPCM053316C40N	374	PPDM064216C80N	376	PPEM066416C5	378
PPAL064216C50N	370	PPCM053316C4G030	374	PPDM064416C1	376	PPEM066416C50N	378
PPAL064216C60N	370	PPCM053316C5	374	PPDM064416C1G030	376	PPEM066416C5G030	378
PPAL064216C70N	370	PPCM053316C50N	374	PPDM064416C20N	376	PPEM066416C60N	378
PPAL064216CG030	370	PPCM053316C5G030	374	PPDM064416C30N	376	PPEM066416C70N	378
PPAL064416C	370	PPCM053316C60N	374	PPDM064416C4	376	PPEM066416C80N	378
PPAL064416C10N	370	PPCM053316C70N	374	PPDM064416C40N	376	PPEM066416CG030	378
PPAL068216C	370	PPCM053316C80N	374	PPDM064416C4G030	376	PPEM1112316C	378
PPAL068216C10N	370	PPCM053316CG030	374	PPDM064416C5	376	PPEM1112316C1	378
PPBM052316C1G030	372	PPCM056316C	374	PPDM064416C50N	376	PPEM1112316C10N	378
PPBM052316C40N	372	PPCM056316C1	374	PPDM064416C5G030	376	PPEM1112316C20N	378
PPBM052316C4G030	372	PPCM056316C10N	374	PPDM064416C60N	376	PPEM1112316C30N	378
PPBM052316C5	372	PPCM056316C20N	374	PPDM064416C70N	376	PPEM1112316C4	378
PPBM052316C50N	372	PPCM056316C30N	374	PPDM064416C80N	376	PPEM1212216C1	378
PPBM052316C5G030	372	PPCM056316C4	374	PPDM064416CG030	376	PPEM1212216C1G030	378
PPBM052316C60N	372	PPCM063216C5G030	374	PPDM068416C	376	PPEM1212216C20N	378
PPBM052316C70N	372	PPCM063216C80N	374	PPDM068416C10N	376	PPEM1212216C30N	378
PPBM052316C80N	372	PPCM063416C1	374	PPDM098316C	376	PPEM1212216C4	378
PPBM052316CG030	372	PPCM063416C1G030	374	PPDM098316C1	376	PPEM1212216C40N	378
PPBM054316C	372	PPCM063416C20N	374	PPDM098316C10N	376	PPEM1212216C4G030	378
PPBM054316C1	372	PPCM063416C30N	374	PPDM098316C20N	376	PPEM1212216C5	378

# Alphanumeric Index

Catalog Number	Page	Catalog Number	Page	Catalog Number	Page	Catalog Number	Page
PPFM1212216C50N	378	RFSA171L03	287	RFSI162L18	287	RQSH111M48	287
PPFM1212216C60N	378	RFSC141L06	287	RFSI162M12	287	RQSH112L48	287
PPFM1212216C70N	378	RFSC151L06	287	RFSI171L12	287	RQSH112L54	287
PPFM1212216CG030	378	RFSC161L06	287	RFSI171L18	287	RQSH112M42	287
PPFM1624216C	378	RFSC171L06	287	RFSI171M12	287	RQSH112M48	287
PPFM1624216C10N	378	RFSE141L24	287	RFSI172L18	287	RQSH131L48	287
PPFM099316C1G030	380	RFSE141M18	287	RFSI172M12	287	RQSH131L54	287
PPFM099316C40N	380	RFSE142L24	287	RFSK141L30	287	RQSH131M42	287
PPFM099316C4G030	380	RFSE142M18	287	RFSK141M24	287	RQSH131M48	287
PPFM099316C5	380	RFSE151L24	287	RFSK142L30	287	RQSH132L48	287
PPFM099316C50N	380	RFSE151M18	287	RFSK142M24	287	RQSH132L54	287
PPFM099316C5G030	380	RFSE152L24	287	RFSK151L30	287	RQSH132M42	287
PPFM099316C60N	380	RFSE152M18	287	RFSK151M24	287	RQSH132M48	287
PPFM099316C70N	380	RFSE161L24	287	RFSK152L30	287	RQSH132M54	287
PPFM099316C80N	380	RFSE161M18	287	RFSK152M24	287	RQSH132M42	287
PPFM099316CG030	380	RFSE162L24	287	RFSK161L30	287	RQSH132M48	287
PPFM109216C5G030	380	RFSE162M18	287	RFSK161M24	287	RQSH132L48	287
PPFM109216C80N	380	RFSE171L24	287	RFSK162L30	287	RQSH132L54	287
PPFM109416C1	380	RFSE171M18	287	RFSK162M24	287	RQSH132M42	287
PPFM109416C20N	380	RFSE172L24	287	RFSK162M24	287	RQSH132M48	287
PPFM109416C30N	380	RFSE172M18	287	RFSK171L30	287	RQSH132M54	287
PPFM109416C4	380	RFSG141L36	287	RFSK171M24	287	RQSH132L48	287
PPFM109416C40N	380	RFSG141L42	287	RFSK172L30	287	RQSH132L54	287
PPFM109416C5	380	RFSG141M30	287	RFSK172M24	287	RQSH132M42	287
PPFM109416CG030	380	RFSG141M36	287	RFSK172M24	287	RQSH132M48	287
PPFM1518316C	380	RFSG142L36	287	RQSA111L03	287	RQSH132M54	287
PPFM1518316C1	380	RFSG142M30	287	RQSA111L03	287	RQSH132L48	287
PPFM1518316C10N	380	RFSG151L36	287	RQSB111L06	287	RQSH132L54	287
PPFM1518316C20N	380	RFSG151L42	287	RQSB131L06	287	RQSH132M42	287
PPFM1518316C30N	380	RFSG151M30	287	RQSC111L12	287	RQSH132M48	287
PPFM1518316C4	380	RFSG151M36	287	RQSC111M06	287	RQSH132M54	287
PPFM1618216C1	380	RFSG152L36	287	RQSC131L12	287	RQSH132M42	287
PPFM1618216C1G030	380	RFSG152M30	287	RQSC131M06	287	RQSH132M48	287
PPFM1618216C20N	380	RFSG161L36	287	RQSD111L18	287	RQSH132M54	287
PPFM1618216C30N	380	RFSG161L42	287	RQSD111M12	287	RQSH132L48	287
PPFM1618216C4	380	RFSG161L36	287	RQSD112L18	287	RQSH132L54	287
PPFM1618216C40N	380	RFSG161M30	287	RQSD12M12	287	RQSH132M42	287
PPFM1618216C4G030	380	RFSG161M36	287	RQSD131L18	287	RQSH132M48	287
PPFM1618216C5	380	RFSG162L36	287	RQSD131M12	287	RQSH132M54	287
PPFM1618216C50N	380	RFSG162M30	287	RQSD132L18	287	RQSH132M42	287
PPFM1618216C60N	380	RFSG171L36	287	RQSD132M12	287	RQSH132M48	287
PPFM1618216C70N	380	RFSG171L42	287	RQSF111L36	287	RQSH132M54	287
PPFM1618216CG030	380	RFSG171M30	287	RQSF111M24	287	RQSH132L48	287
PPFM1618416C	380	RFSG171M36	287	RQSF111M30	287	RQSH132L54	287
PPFM1618416C10N	380	RFSG172L36	287	RQSF112L30	287	RQSH132M42	287
PPFM1618416C10N	380	RFSG172M30	287	RQSF112L36	287	RQSH132M48	287
PPFM1836216C	380	RFSH141L12	287	RQSF112M24	287	RQSH132M54	287
PPFM1836216C10N	380	RFSH141L18	287	RQSF112M30	287	RQSH132L48	287
QC2015	272	RFSH141M12	287	RQSF131L30	287	RQSH132L54	287
QC2020	272	RFSH142L18	287	RQSF131L36	287	RQSH132M42	287
QC2030	272	RFSH142M12	287	RQSF131M24	287	RQSH132M48	287
QC2040	272	RFSH151L12	287	RQSF131M30	287	RQSH132M54	287
QC3015H	272	RFSH151L18	287	RQSF132L30	287	RQSH132L48	287
QC3020H	272	RFSH151M12	287	RQSF132L36	287	RQSH132L54	287
QC3030H	272	RFSH152L18	287	RQSF132M24	287	RQSH132M42	287
QC3040H	272	RFSH152M12	287	RQSF132M30	287	RQSH132M48	287
RFSA141L03	287	RFSH161L12	287	RQSF132M24	287	RQSH132M54	287
RFSA151L03	287	RFSH161L18	287	RQSH111L48	287	RQSH132L48	287
RFSA161L03	287	RFSH161M12	287	RQSH111L54	287	RQSH132L54	287
				RQSH111M42	287	RQSH132M42	287

# Alphanumeric Index

Catalog Number	Page	Catalog Number	Page	Catalog Number	Page	Catalog Number	Page
SH-100	92	SJBS100	130	WYF-060604-SUB6P	107	WYS-181210	103
SH-125	92	SJBS500	130	WYF-080806	107	WYS-181806	103
SH-150	92	SJBSCP100	129	WYF-080806-SUB6	107	WYS-181812	103
SH-200	92	SJBSCP1080	129	WYF-080806-SUB6P	107	WYT-060604	110
SH-250	92	SJBSCP160	129	WYF-101004	107	WYT-080604	110
SH-300	92	SJBSCP170	129	WYF-101004-SUB6	107	WYT-080806	110
SH-350	92	SJBSCP200	129	WYF-101004-SUB6P	107	WYT-120808	110
SH-400	92	SJBSCP320	129	WYF-120804	107	WYT-121206	110
SH-450	92	SJBSCP510	129	WYF-120804-SUB6	107	WYT-241208	110
SH-50	92	SJBSCP700	129	WYF-120804-SUB6P	107	WYU-040404	109
SH-500	92	SJBSR1070	129	WYF-121206	107	WYU-060606	109
SH-600	92	SJBSR200	129	WYF-121206-SUB6	107	WYU-080806	109
SH-75	92	SJBSR310	129	WYF-121206-SUB6P	107	WYU-121206	109
SJB117530	127	SJBSR500	129	WYF-161208	107	WYW-080806	105
SJB121295	127	SJBSR690	129	WYF-161208-SUB6	107	WYW-121208	105
SJB121895	127	TBP44	188	WYF-161208-SUB6P	107	XPA11002B	349
SJB181295	127	VCB4	184	WYF-181210	107	XPA11002L	349
SJB181895	127	VCB7	184	WYF-181210-SUB6	107	XPA11002PB	355
SJB222615	127	VCBA	186	WYF-181210-SUB6P	107	XPA11002PL	355
SJB223720	127	VCBHBA	185	WYF-181810	107	XPA11002PR	355
SJB262215	127	WD2S1034	243	WYF-181810-SUB6	107	XPA11002R	349
SJB263720	127	WD2S1034F	243	WYF-181810-SUB6P	107	XPA12252B	349
SJB372220	127	WD2S20034	243	WYF-241812	107	XPA12252L	349
SJB372620	127	WD2S3034	243	WYF-241812-SUB6	107	XPA12252PB	355
SJB373720	127	WD2S3034F	243	WYF-241812-SUB6P	107	XPA12252PL	355
SJB373730	127	WD2S6034	243	WYF-242412	107	XPA31002B	349
SJB375620	127	WD2S6034F	243	WYF-242412-SUB6	107	XPA31002L	349
SJB375630	127	WDS1034	246	WYF-242412-SUB6P	107	XPA31002PB	355
SJB377520	127	WDS1034-NF	246	WYL-040404	104	XPA31002PL	355
SJB377530	127	WDS1034NFW	246	WYL-060604	104	XPA31002PR	355
SJB563720	127	WDS1034W	246	WYL-080804	104	XPA31002R	349
SJB563730	127	WDS3034	246	WYL-080806	104	XPA31004B	350
SJB565620	127	WDS3034-NF	246	WYL-101004	104	XPA31004L	350
SJB565630	127	WDS3034NFW	246	WYL-121208	104	XPA31004PB	356
SJB567520	127	WDS3034W	246	WYL-161208	104	XPA31004PL	356
SJB567530	127	WDS6034	246	WYL-181210	104	XPA31006B	350
SJB753720	127	WDS6034-NF	246	WYL-181806	104	XPA31006L	350
SJB753730	127	WDS6034NFW	246	WYL-181812	104	XPA31006PB	356
SJB755630	127	WDS6034W	246	WYL-242412	104	XPA31006PL	356
SJBACP1080	129	WSAUX1	245	WYL-362412	104	XPA32252B	349
SJBACP170	129	WSAUX1 or 2	246	WYR-040404	108	XPA32252L	349
SJBACP200	129	WSAUX2	245	WYR-060604	108	XPA32252PB	355
SJBACP320	129	WST10035	245	WYR-080806	108	XPA32252PL	355
SJBACP510	129	WST10354	245	WYR-101006	108	XPA32254B	350
SJBACP700	129	WST3035	245	WYR-121208	108	XPA32254L	350
SJBCGB1070	129	WST30354	245	WYR-140806	108	XPA32254PB	356
SJBCGB160	129	WST6035	245	WYR-161208	108	XPA32254PL	356
SJBCGB200	129	WST60354	245	WYR-181206	108	XPA32256B	350
SJBCGB310	129	WY58E-1212	111	WYR-181210	108	XPA32256L	350
SJBCGB500	129	WY58E-2424	111	WYR-181812	108	XPA32256PB	356
SJBCGB690	129	WYF-040404	107	WYR-242412	108	XPA32256PL	356
SJBGBC154	129	WYF-040404-SUB6	107	WYS-040404	103	XPB11002B	349
SJBGBC1616	129	WYF-040404-SUB6P	107	WYS-060604	103	XPB11002L	349
SJBGCP260	130	WYF-060404	107	WYS-080804	103	XPB11002PB	355
SJBGCP370	130	WYF-060404-SUB6	107	WYS-080806	103	XPB11002PL	355
SJBGCP560	130	WYF-060404-SUB6P	107	WYS-101004	103	XPB11002PR	355
SJBGCP750	130	WYF-060604	107	WYS-121208	103	XPB11002R	349
SJBPL	130	WYF-060604-SUB6	107	WYS-161208	103	XPB12252B	349

# Alphanumeric Index

Catalog Number	Page	Catalog Number	Page	Catalog Number	Page	Catalog Number	Page
XPB12252L	349	XPC32254L	350	XPE32258PL	356	YF-101004-SUB6P	107
XPB12252PB	355	XPC32254PB	356	Y58E-1212	111	YF-120804	107
XPB12252PL	355	XPC32254PL	356	Y58E-2424	111	YF-120804-SUB6	107
XPB31002B	349	XPC32256B	350	YE040404	62	YF-120804-SUB6P	107
XPB31002L	349	XPC32256L	350	YE060604	62	YF-121206	107
XPB31002PB	355	XPC32256PB	356	YE060606	62	YF-121206-SUB6	107
XPB31002PL	355	XPC32256PL	356	YE080404	62	YF-121206-SUB6P	107
XPB31002PR	355	XPE11002B	349	YE080604	62	YF-161208	107
XPB31002R	349	XPE11002L	349	YE080606	62	YF-161208-SUB6	107
XPB31004B	350	XPE11002PB	355	YE080804	62	YF-161208-SUB6P	107
XPB31004L	350	XPE11002PL	355	YE080806	62	YF-181210	107
XPB31004PB	356	XPE11002PR	355	YE080808	62	YF-181210-SUB6	107
XPB31004PL	356	XPE11002R	349	YE100804	62	YF-181210-SUB6P	107
XPB31006B	350	XPE12252B	349	YE100806	62	YF-181810	107
XPB31006L	350	XPE12252L	349	YE100808	62	YF-181810-SUB6	107
XPB31006PB	356	XPE12252PB	355	YE101004	62	YF-181810-SUB6P	107
XPB31006PL	356	XPE12252PL	355	YE101006	62	YF-241812	107
XPB32252B	349	XPE31002B	349	YE101008	62	YF-241812-SUB6	107
XPB32252L	349	XPE31002L	349	YE120804	62	YF-241812-SUB6P	107
XPB32252PB	355	XPE31002PB	355	YE121204	62	YF-242412	107
XPB32252PL	355	XPE31002PL	355	YE121206	62	YF-242412-SUB6	107
XPB32254B	350	XPE31002PR	355	YE121208	62	YF-242412-SUB6P	107
XPB32254L	350	XPE31002R	349	YE121210	62	YG-040403	77
XPB32254PB	356	XPE31004B	350	YE121212	62	YG-040404	77
XPB32254PL	356	XPE31004L	350	YE181204	63	YG-050504	77
XPB32256B	350	XPE31004PB	356	YE181206	63	YG-060403	77
XPB32256L	350	XPE31004PL	356	YE181208	63	YG-060404	77
XPB32256PB	356	XPE31006B	350	YE181212	63	YG-060603	77
XPB32256PL	356	XPE31006L	350	YE181806	63	YG-060604	77
XPC11002B	349	XPE31006PB	356	YE181808	63	YG-060606	77
XPC11002L	349	XPE31006PL	356	YE181812	63	YG-080403	77
XPC11002PB	355	XPE31007B	350	YE241208	63	YG-080404	77
XPC11002PL	355	XPE31007L	350	YE241210	63	YG-080603	77
XPC11002PR	355	XPE31007PB	356	YE241212	63	YG-080604	77
XPC11002R	349	XPE31007PL	356	YE241806	63	YG-080606	77
XPC12252B	349	XPE31008B	350	YE241808	63	YG-080804	77
XPC12252L	349	XPE31008L	350	YE241810	63	YG-080806	77
XPC12252PB	355	XPE31008PB	356	YE241812	63	YG-080808	77
XPC12252PL	355	XPE31008PL	356	YE242408	63	YG-100604	77
XPC31002B	349	XPE32252B	349	YE242412	63	YG-100606	77
XPC31002L	349	XPE32252L	349	YE301210	63	YG-100804	77
XPC31002PB	355	XPE32252PB	355	YE302408	63	YG-100806	77
XPC31002PL	355	XPE32252PL	355	YE302410	63	YG-100808	77
XPC31002PR	355	XPE32254B	350	YE302412	63	YG-101004	77
XPC31002R	349	XPE32254L	350	YF-040404	107	YG-101006	77
XPC31004B	350	XPE32254PB	356	YF-040404-SUB6	107	YG-101008	77
XPC31004L	350	XPE32254PL	356	YF-040404-SUB6P	107	YG-120404	77
XPC31004PB	356	XPE32256B	350	YF-060404	107	YG-120604	77
XPC31004PL	356	XPE32256L	350	YF-060404-SUB6	107	YG-120606	77
XPC31006B	350	XPE32256PB	356	YF-060404-SUB6P	107	YG-120804	77
XPC31006L	350	XPE32256PL	356	YF-060604	107	YG-120806	77
XPC31006PB	356	XPE32257B	350	YF-060604-SUB6	107	YG-120808	77
XPC31006PL	356	XPE32257L	350	YF-060604-SUB6P	107	YG-121004	77
XPC32252B	349	XPE32257PB	356	YF-080806	107	YG-121006	77
XPC32252L	349	XPE32257PL	356	YF-080806-SUB6	107	YG-121008	77
XPC32252PB	355	XPE32258B	350	YF-080806-SUB6P	107	YG-121204	77
XPC32252PL	355	XPE32258L	350	YF-101004	107	YG-121206	77
XPC32254B	350	XPE32258PB	356	YF-101004-SUB6	107	YG-121207	77

# Alphanumeric Index

Catalog Number	Page	Catalog Number	Page
YG-121208	77	YL-181210	104
YG-121210	77	YL-181806	104
YG-121212	77	YL-181812	104
YG-140804	77	YL-242412	104
YG-140806	77	YL-362412	104
YG-140808	77	YR-040404	108
YG-141406	77	YR-060604	108
YG-141408	77	YR-080806	108
YG-141410	78	YR-101006	108
YG-161204	78	YR-121208	108
YG-161206	78	YR-140806	108
YG-161208	78	YR-161208	108
YG-161606	78	YR-181206	108
YG-180606	78	YR-181210	108
YG-180804	78	YR-181812	108
YG-180806	78	YR-242412	108
YG-181204	78	YS-040404	103
YG-181206	78	YS-060604	103
YG-181208	78	YS-080804	103
YG-181210	78	YS-080806	103
YG-181212	78	YS-101004	103
YG-181218	78	YS-121208	103
YG-181806	78	YS-161208	103
YG-181808	78	YS-181210	103
YG-181810	78	YS-181806	103
YG-181812	78	YS-181812	103
YG-241206	78	YT-060604	110
YG-241208	78	YT-080604	110
YG-241212	78	YT-080806	110
YG-241806	78	YT-120808	110
YG-241808	78	YT-121206	110
YG-241810	78	YT-241208	110
YG-241812	78	YU-040404	109
YG-242406	78	YU-060606	109
YG-242408	78	YU-080806	109
YG-242410	78	YU-121206	109
YG-242412	78	YW-080806	105
YG-281208	78	YW-121208	105
YG-281212	78		
YG-302408	78		
YG-302410	78		
YG-302412	78		
YG-302418	78		
YG-361806	78		
YG-361808	78		
YG-361812	78		
YG-361818	78		
YG-362418	78		
YG-363608	78		
YG-363612	78		
YG-363618	78		
YL-040404	104		
YL-060604	104		
YL-080804	104		
YL-080806	104		
YL-101004	104		
YL-121208	104		
YL-161208	104		

# Enclosures and Junction Boxes

Description	Page	NEC	CEC	ATEX/ IEC(Ex)
<b>NEC/CEC Explosionproof Outlet Boxes</b>				
GR and GRF Conduit Outlet Boxes	4	X	X	
GU Conduit Outlet Boxes	9	X	X	
GRU Universal Conduit Outlet Boxes	10	X	X	
GRUE Universal Conduit Outlet Boxes	11	X		
GRUE Universal Conduit Outlet Boxes	12		X	
GRJS Universal Conduit Outlet Boxes	14	X		
GRJS Universal Conduit Outlet Boxes	15		X	
GRJ Conduit Outlet Boxes	16	X		
GUA Conduit Outlet Boxes	17	X	X	
GUA Conduit Outlet Box Covers	20	X	X	
GUJ Conduit Outlet Boxes	24	X	X	
GRH Conduit Outlet Boxes	27	X	X	
CPU Universal Conduit Outlet Boxes and Covers	28	X		
CPU Universal Conduit Outlet Boxes and Covers	29		X	
GRSS Conduit Outlet Boxes Multiple Hubs	30	X	X	
GUEB Conduit Outlet Boxes	31	X	X	
GRUJ Conduit Outlet Boxes Multiple Hubs	32	X	X	
GRUO Multiple Hubs Conduit Outlet Boxes	33	X	X	
GRU Conduit Outlet Boxes Union Hubs	34	X	X	
<b>NEC/CEC Explosionproof Enclosures</b>				
GUBB, GUBBD and GUBBM Cast Junction Boxes	36	X	X	
DER, GUB and GUBM Cast Junction Boxes	43		X	
AGUB and NGUB Instrument and Meter Enclosures	49	X	X	
EXB Cast Iron Junction Boxes	56	X	X	
YE Explosionproof Aluminum Cast Iron Junction Boxes	61	X	X	



GR



GRF



GU/GUA



GRU



GRJS



GRJ



GUJ



GRH



CPU



GRSS/GUEB



GRUO



GRUJ



GRU



GUBB, GUBB, GUBBM,  
DER, GUB, GUBM



AGUB/NGUB



EXB/ YE

# Enclosures and Junction Boxes

Description	Page	NEC	CEC	ATEX/ IEC(Ex)
<b>NEC/CEC Weatherproof/Dustproof Junction and Outlet Boxes</b>				
DTX Junction Boxes	67	X		
YG Series Junction Boxes	76	X		
Cast Iron Junction Boxes	85			
• WYS/YS Type Unflanged Junction or Pull Boxes	103	X	X	
• WYL/YL Type Overlapping Cover Boxes	104	X	X	
• WYW/ YW Type Hinged Cover Boxes	105	X	X	
• WYF/ YF Type Flat Flanged Boxes	106	X	X	
• WYR/ YR Outside Flanged Recessed Cover Boxes	108	X	X	
• WYU/ YU Type Inside Flanged Recessed Cover Boxes	109	X	X	
• WYT/ YT Type Checkered Cover Sidewalk Boxes	110	X		
• WY58E/ Y58E Type Checkered Cover Sidewalk Topping Box	111	X		
BJE Series Octagonal Polycarbonate Junction Boxes	112	X	X	
<b>NEC/CEC Ordinary Location Junction and Outlet Boxes</b>				
Liquidtight JIC Boxes and Covers	114	X		
RS Series Malleable Iron Junction Boxes	116	X	X	
<b>NEC/CEC, ATEX/IECEx Explosionproof/Flameproof Enclosures</b>				
AJBEW Cast Junction Boxes	118	X	X	X
SJB 316L Stainless Steel Junction Boxes	125	X	X	
PJB Series Polyester Nonmetallic Enclosures	131	X	X	X



DTX/YG



WYS/YS Type



WYL/YL Type



WYW/YW Type



WYF/YF Type



WYR/YR Type



WYU/YU Type



WYT/YT Type



WY58E/Y58E Type



BJE

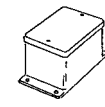

JIC Series



RS Series



AJBEW



SJB



PJB



# Enclosures and Junction Boxes

Description	Page	NEC	CEC	ATEX/IEC(Ex)
-------------	------	-----	-----	--------------

## NEC/CEC, ATEX/IECEx Increased Safety Junction Boxes

ATX™ JBEP Series Undrilled and Pre-Drilled, Empty FRP Junction Boxes	138	X	X	X
ATX™ JBEP Series FRP Terminal Junction Boxes for Instrumentation Applications	149	X	X	X
ATX™ JBEP Series FRP Terminal Junction Boxes for Electrical and Power Applications	156	X	X	X



Reinforced Polyester JBEP



Instrumentation JBEP



Electrical/Power JBEP

## ATEX Flameproof Camera Housing

ATX™ VCB4 and VCB7 Video Camera Housings	184			X
ATX™ DA2W2E102 Video Camera Housing	185			X
ATX™ VCBA Video Camera Housing	186			X



VCB4



DA2W2E102



VCBA

## ATEX/IECEx Flameproof Junction Boxes

ATX™ JBDR Pre-Drilled Round Junction Boxes	187			X
ATX™ JBD Pre-Drilled Terminal Junction Boxes	190			X
ATX™ JBDA JBDF – ECDA ECDF ACSEW Customized Enclosures	192			X
ATX™ ECDX Customized Welded Steel Enclosures	198			X



JBDR



JBD



JBDA



ECDX



JBEA



JBEA/ECEA

## ATEX/IECEx Increased Safety Junction Boxes

ATX™ JBEA and ECEA Aluminum Enclosures	201			X
ATX™ JBEA Pre-Drilled Aluminum Junction Box	206			X
ATX™ JBEL Polycarbonate Junction Boxes	213			X
ATX™ JBES and ECES 316L Stainless Steel Enclosures	216			X
ATX™ JBES Pre-Drilled 316L Stainless Steel Junction Boxes	227			X



JBEL



JBES



JBES and ECES

# GR and GRF Conduit Outlet Boxes

## Explosionproof, Dust-Ignitionproof

UNILETS™ for use with Threaded Metal Conduit. Furnished with Internal Ground Screw and O-ring.

### NEC/CEC:

Class I, Division 1 and 2, Groups B ♦, C, D

Class II, Division 1 and 2, Groups E, F, G

Class III

NEMA 3, 4, 4X ①

Class 1, Zone 1 and 2, IIA, IIB

### Applications

- Complies with a wide range of classified area requirements.
- Corrosion-resistant: ideal indoors or out.
- For pulling of wires.
- Connect conduit lengths and change direction of conduit runs.
- Provide access for maintenance.

### Features

- GR boxes offers ten hub arrangements.
- GRF boxes have integral mounting flange.
- Malleable iron bodies have high tensile strength, ductility and provides great resistance to corrosion, impact, and shock.
- Accurately tapped, tapered hub threads for tight, rigid joints and ground continuity.
- Furnished with covers.
- General purpose wiring.
- Function as sealing fittings when used with sealing covers (see NEC for restrictions).
- Internally threaded body with externally threaded cover.
- Covers have pry notches for bar or wrench.
- Accommodate sealing, dome, hub and union hub covers, and canopies.
- Standard o-rings provide raintight fit. NEMA 3, 4.
- Internal ground screw standard.
- Smooth, rounded integral bushing in each hub type box protects conductor insulation.



### Standard Materials

- Body: malleable iron or copperfree (4/10 of 1% max.) aluminum
- Cover: copperfree (4/10 of 1% max.) aluminum

### Standard Finishes

- Malleable iron bodies and covers: triple-coat — (1) zinc electroplate, (2) chromate, and (3) epoxy powder coat
- Aluminum bodies and covers: epoxy powder coat

### Options

- To order body without cover, add suffix **-LC** to catalog number.
- For malleable iron body and cover, add suffix **-M**.

### NEC/CEC Certifications and Compliances

- UL Listed: E85310, E10444
- CSA Standard: C22.2 No. 25, C22.2 No. 30
- CSA Certified: 025875

♦ In Class I, Division 1, Group B atmospheres, all conduit runs must have a sealing fitting (not supplied) field-installed adjacent to the enclosure.

① Aluminum body and cover only.

# GR Conduit Outlet Boxes

## Explosionproof, Dust-Ignitionproof

UNILETS™ for use with Threaded Metal Conduit. Furnished with Internal Ground Screw and O-ring.

**NEC/CEC:**







Class I, Division 1 and 2, Groups B♦, C, D

Class II, Division 1 and 2, Groups E, F, G

Class III

NEMA 3, 4, 4X ①

Class 1, Zone 1 and 2, IIA, IIB

Hub Type	Conduit Size (Inches)	Cover Opening mm (in)	Volume Capacity dm³ (in³)	Form Number ④	Catalog Number ②	
					Malleable Iron ③ Body With Aluminum Cover	Aluminum Body with Aluminum Cover
	1/2	85.9 (3.38)	0.29 (18.0)	1	GRE50	GRE50-A
	3/4	85.9 (3.38)	0.29 (18.0)	1	GRE75	GRE75-A
	1	85.9 (3.38)	0.29 (18.0)	1	GRE100	GRE100-A
	1-1/4	100.1 (3.94)	0.51 (31.0)	2	GRE125	GRE125-A
	1-1/2	124.0 (4.88)	1.18 (72.0)	3	GRE150	GRE150-A
	1/2	85.9 (3.38)	0.29 (18.0)	1	GRC50	GRC50-A
	3/4	85.9 (3.38)	0.29 (18.0)	1	GRC75	GRC75-A
	1	85.9 (3.38)	0.29 (18.0)	1	GRC100	GRC100-A
	1-1/4	100.1 (3.94)	0.51 (31.0)	2	GRC125	GRC125-A
	1-1/2	124.0 (4.88)	1.18 (72.0)	3	GRC150	GRC150-A
	2	124.0 (4.88)	1.25 (76.0)	3	GRC200	GRC200-A
	1/2	85.9 (3.38)	0.29 (18.0)	1	GRL50	GRL50-A
	3/4	85.9 (3.38)	0.29 (18.0)	1	GRL75	GRL75-A
	1	85.9 (3.38)	0.29 (18.0)	1	GRL100	GRL100-A
	1-1/4	100.1 (3.94)	0.51 (31.0)	2	GRL125	GRL125-A
	1-1/2	124.0 (4.88)	1.18 (72.0)	3	GRL150	GRL150-A
	2	124.0 (4.88)	1.25 (76.0)	3	GRL200	GRL200-A
	1/2	85.9 (3.38)	0.29 (18.0)	1	GRLB50	GRLB50-A
	3/4	85.9 (3.38)	0.29 (18.0)	1	GRLB75	GRLB75-A
	1	85.9 (3.38)	0.29 (18.0)	1	GRLB100	GRLB100-A
	1-1/4	100.1 (3.94)	0.51 (31.0)	2	GRLB125	GRLB125-A
	1-1/2	124.0 (4.88)	1.18 (72.0)	3	GRLB150	GRLB150-A
	2	124.0 (4.88)	1.25 (76.0)	3	GRLB200	GRLB200-A
	1/2	85.9 (3.38)	0.29 (18.0)	1	GRN50	GRN50-A
	3/4	85.9 (3.38)	0.29 (18.0)	1	GRN75	GRN75-A
	1	85.9 (3.38)	0.29 (18.0)	1	GRN100	GRN100-A
	1-1/4	100.1 (3.94)	0.51 (31.0)	2	GRN125	GRN125-A
	1-1/2	124.0 (4.88)	1.18 (72.0)	3	GRN150	GRN150-A
	1/2	85.9 (3.38)	0.29 (18.0)	1	GRT50	GRT50-A
	3/4	85.9 (3.38)	0.29 (18.0)	1	GRT75	GRT75-A
	1	85.9 (3.38)	0.29 (18.0)	1	GRT100	GRT100-A
	1-1/4	100.1 (3.94)	0.51 (31.0)	2	GRT125	GRT125-A
	1-1/2	124.0 (4.88)	1.18 (72.0)	3	GRT150	GRT150-A
	2	124.0 (4.88)	1.25 (76.0)	3	GRT200	GRT200-A
	1/2	85.9 (3.38)	0.29 (18.0)	1	GRX50	GRX50-A
	3/4	85.9 (3.38)	0.29 (18.0)	1	GRX75	GRX75-A
	1	85.9 (3.38)	0.29 (18.0)	1	GRX100	GRX100-A
	1-1/4	100.1 (3.94)	0.51 (31.0)	2	GRX125	GRX125-A
	1-1/2	124.0 (4.88)	1.18 (72.0)	3	GRX150	GRX150-A
	2	124.0 (4.88)	1.25 (76.0)	3	GRX200	GRX200-A

♦ In Class I, Division 1, Group B atmospheres, all conduit runs must have a sealing fitting (not supplied) field-installed adjacent to the enclosure.

① Aluminum body and cover only.

② Other covers available—see GR and GRF Conduit Outlet Box Covers page. Order separately.

③ For malleable iron body and cover, add suffix **-M**.

④ Form number designates body and matching cover sizes. To order body without cover, add suffix **-LC** to catalog number.

# GR Conduit Outlet Boxes

## Explosionproof, Dust-Ignitionproof

UNILETS™ for use with Threaded Metal Conduit. Furnished with Internal Ground Screw and O-ring.

**NEC/CEC:**



Class I, Division 1 and 2, Groups B♦, C, D

Class II, Division 1 and 2, Groups E, F, G

Class III

NEMA 3, 4, 4X ①

Class 1, Zone 1 and 2, IIA, IIB

Hub Type	Conduit Size (Inches)	Cover Opening mm (in)	Volume Capacity dm³ (in³)	Form Number ④	Catalog Number ②	
					Malleable Iron ③ Body With Aluminum Cover	Aluminum Body with Aluminum Cover
	1/2	85.9 (3.38)	0.29 (18.0)	1	<b>GRCA50</b>	<b>GRCA50-A</b>
	3/4	85.9 (3.38)	0.29 (18.0)	1	<b>GRCA75</b>	<b>GRCA75-A</b>
	1/2	85.9 (3.38)	0.29 (18.0)	1	<b>GRLA50</b>	<b>GRLA50-A</b>
	3/4	85.9 (3.38)	0.29 (18.0)	1	<b>GRLA75</b>	<b>GRLA75-A</b>
	1/2	85.9 (3.38)	0.29 (18.0)	1	<b>GRTA50</b>	<b>GRTA50-A</b>
	3/4	85.9 (3.38)	0.29 (18.0)	1	<b>GRTA75</b>	<b>GRTA75-A</b>

**Dimensions in Millimeters (Inches)**

Hub Size (Inches)	Dimensions in Millimeters (Inches)						
	A	B	C	D	E	F	G
<b>GR Series, Form 1</b>							
1/2	95.3 (3.75)	62 (2.44)	73.2 (2.88)	19.1 (0.75)	20.6 (0.81)	57.2 (2.25)	31.8 (1.25)
3/4	95.3 (3.75)	62 (2.44)	73.2 (2.88)	19.1 (0.75)	20.6 (0.81)	57.2 (2.25)	31.8 (1.25)
1	95.3 (3.75)	62 (2.44)	73.2 (2.88)	19.1 (0.75)	20.6 (0.81)	57.2 (2.25)	31.8 (1.25)
<b>GR Series, Forms 2 and 3</b>							
1-1/4	114.3 (4.50)	68.3 (2.69)	90.4 (3.56)	30.2 (1.19)	22.4 (0.88)	69.9 (2.75)	28.7 (1.13)
1-1/2	146.1 (5.75)	95.3 (3.75)	122.2 (4.81)	35.1 (1.38)	23.9 (0.94)	103.1 (4.06)	38.1 (1.50)
2	146.1 (5.75)	101.6 (4.00)	128.5 (5.06)	41.4 (1.63)	25.4 (1.00)	108.0 (4.25)	31.8 (1.25)

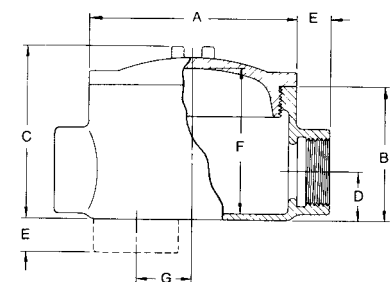
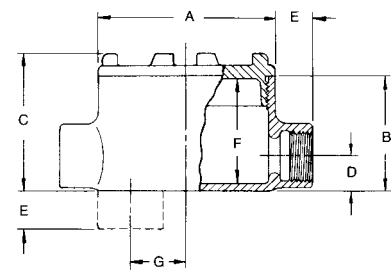

1-1/4" = Form 2  
1-1/2" and 2" = Form 3

♦ In Class I, Division 1, Group B atmospheres, all conduit runs must have a sealing fitting (not supplied) field-installed adjacent to the enclosure.  
 ① Aluminum body and cover only.  
 ② Other covers available—see GR and GRF Conduit Outlet Box Covers page. Order separately.  
 ③ For malleable iron body and cover, add suffix **-M**.  
 ④ Form number designates body and matching cover sizes. To order body without cover, add suffix **-LC** to catalog number.

# GRF Flanged Conduit Outlet Boxes

## Explosionproof, Dust-Ignitionproof

UNILETS™ for use with Threaded Metal Conduit. Furnished with Internal Ground Screw and O-ring.

**NEC/CEC:**





Class I, Division 1 and 2, Groups B♦, C, D

Class II, Division 1 and 2, Groups E, F, G

Class III

NEMA 3, 4, 4X ①

Class 1, Zone 1 and 2, IIA, IIB

	Hub Type	Conduit Size (Inches)	Cover Opening mm (in)	Capacity dm <sup>3</sup> (in <sup>3</sup> )	Form Number ④	Catalog Number ②	
						Malleable Iron ③ Body With Aluminum Cover	Aluminum Body with Aluminum Cover
	GRFC	1/2	85.9 (3.38)	0.29 (18.0)	1	GRFC50	GRFC50-A
		3/4	85.9 (3.38)	0.29 (18.0)	1	GRFC75	GRFC75-A
		1	85.9 (3.38)	0.29 (18.0)	1	GRFC100	GRFC100-A
	GRFL	1/2	85.9 (3.38)	0.29 (18.0)	1	GRFL50	GRFL50-A
		3/4	85.9 (3.38)	0.29 (18.0)	1	GRFL75	GRFL75-A
		1	85.9 (3.38)	0.29 (18.0)	1	GRFL100	GRFL100-A
	GRFT	1/2	85.9 (3.38)	0.29 (18.0)	1	GRFT50	GRFT50-A
		3/4	85.9 (3.38)	0.29 (18.0)	1	GRFT75	GRFT75-A
		1	85.9 (3.38)	0.29 (18.0)	1	GRFT100	GRFT100-A
	GRFX	1/2	85.9 (3.38)	0.29 (18.0)	1	GRFX50	GRFX50-A
		3/4	85.9 (3.38)	0.29 (18.0)	1	GRFX75	GRFX75-A
		1	85.9 (3.38)	0.29 (18.0)	1	GRFX100	GRFX100-A

**Dimensions in Millimeters (Inches)**

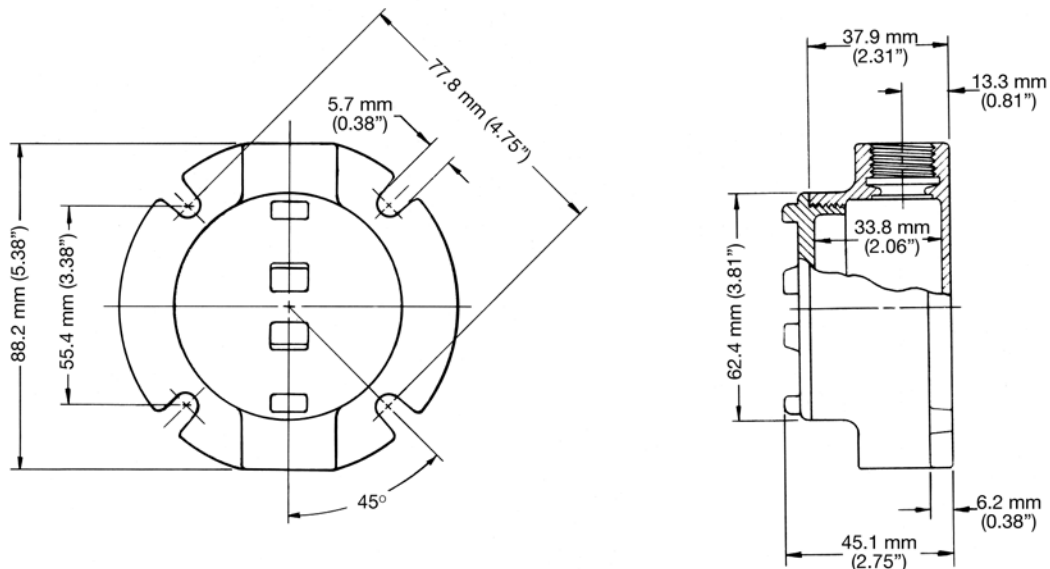

♦ In Class I, Division 1, Group B atmospheres, all conduit runs must have a sealing fitting (not supplied) field-installed adjacent to the enclosure.

① Aluminum body and cover only.

② Other covers available—see GR and GRF Conduit Outlet Box Covers page. Order separately.

③ For malleable iron body and cover, add suffix **-M**.

④ Form number designates body and matching cover sizes. To order body without cover, add suffix **-LC** to catalog number.

Visit our website at [www.emerson.com](http://www.emerson.com) or contact us at (800) 621-1506.

© November 2016

# GR and GRF Conduit Outlet Box Covers

## Explosionproof, Dust-Ignitionproof

Covers and O-rings Fit Bodies with Corresponding Form Numbers.

### NEC/CEC:









Class I, Division 1 and 2, Groups B♦, C, D

Class II, Division 1 and 2, Groups E, F, G

Class III

NEMA 3, 4, 4X ①

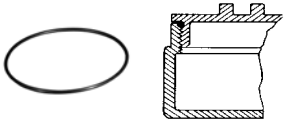
Class 1, Zone 1 and 2, IIA, IIB

Hub Type	Cover Opening mm (in)	Fixture Stem Size mm (in)	Form Number ②	Catalog Number	
				Malleable Iron	Aluminum
 Surface	85.9 (3.38)	—	1	<b>GRK-1M</b>	<b>GRK-1</b>
	100.1 (3.94)	—	2	<b>GRK-2M</b>	<b>GRK-2</b>
	124.0 (4.88)	—	3	<b>GRK-3M</b>	<b>GRK-3</b>
 Sealing Class I, Groups C & D	85.9 (3.38)	—	1	<b>GRK-1SC</b>	<b>GRK-1SC-A</b>
	100.1 (3.94)	—	2	<b>GRK-2SC</b>	<b>GRK-2SC-A</b>
	124.0 (4.88)	—	3	<b>GRK-3SC</b>	<b>GRK-3SC-A</b>
 2" Deep Dome UL Listed: E185964 6 Cubic Inches	85.9 (3.38)	—	1	—	<b>GRK-1DC</b>
 Union Hub	85.9 (3.38)	19.1 (0.75)	1	<b>GRK-75U</b>	<b>GRK-75UA</b>
 Hub	85.9 (3.38)	12.7 (0.50)	1	<b>GRK-50</b>	<b>GRK-50A</b>
	85.9 (3.38)	19.1 (0.75)	1	<b>GRK-75</b>	<b>GRK-75A</b>
 Canopy Length 4-1/2" Class I, Group D 16 Cubic Inches	85.9 (3.38)	12.7 (0.50)	1	<b>GRK-50C</b>	—
	85.9 (3.38)	19.1 (0.75)	1	<b>GRK-75C</b>	—
	85.9 (3.38)	25.4 (1.00)	1	<b>GRK-100C</b>	—
				Catalog Number	
 <b>O-rings — Buna-N</b>  Provide Raintight fit when used on following series: GR (Forms 1, 2 and 3), GRF (Form 1), GRH, and GRU (Form 1).			1	<b>GRG-1</b>	
			2	<b>GRG-2</b>	
			3	<b>GRG-3</b>	
 <b>GRTB Terminal Strip</b>  For use in standard GR series boxes Weidmuller type MK terminal block ③ with wire range of #22-#12 AWG. Mounts on 2 Pre-Drilled and tapped standard holes (furnished in internal GR boxes).	6 position terminal block kit		1+2	<b>GRTB6-12</b>	
	6 position terminal block kit		3	<b>GRTB6-3</b>	
	12 position terminal block kit		3	<b>GRTB12-3</b>	

♦ In Class I, Division 1, Group B atmospheres, all conduit runs must have a sealing fitting (not supplied) field-installed adjacent to the enclosure.

① Aluminum body and cover only.

② Form numbers designate cover and matching body sizes.

③ Terminal block is UL listed for 300 Volt, 25 Amp. CSA certified for 300 Volt, 13 Amp.

# GU Conduit Outlet Boxes

## Explosionproof, Dust-Ignitionproof

UNILETS™ for use with Threaded Metal Conduit. Furnished with Internal Ground Screw.

### NEC/CEC:

Class I, Division 1 and 2, Groups B♦, C, D

Class II, Division 1 and 2, Groups E, F, G

Class III

NEMA 3,4

### Applications

- Complies with a wide range of classified area requirements.
- Corrosion-resistant: ideal indoors or out.
- For pulling of wires.
- Connect conduit lengths and change direction of conduit runs.
- Provide access for maintenance.

### Features

- Ductile iron bodies have high tensile strength and ductility. Provides great resistance to corrosion, impact, and shock.
- Accurately tapped, tapered hub threads for tight, rigid joints and ground continuity.
- Furnished with covers and cover gasket.
- General purpose wiring.
- Externally threaded body with internally threaded cover.
- Smooth, rounded integral bushing in each hub type box protects conductor insulation.
- Internal ground screw standard.

### Standard Materials





- Bodies and covers: ductile iron

### Standard Finishes

- Bodies and covers: triple-coat — (1) zinc electroplate, (2) chromate, and (3) epoxy powder coat

### NEC/CEC Certifications and Compliances

- UL Standard: UL 886 (UL 1203)
- UL Listed: E85310, E10444
- CSA Standard: C22.2 No. 25, C22.2 No. 30
- CSA Certified: 025875

	Hub Type	Conduit Size (Inches)	Cover Opening mm (in)	Capacity dm <sup>3</sup> (in <sup>3</sup> )	Catalog Number ♦
	GUC	1/2	98.6 (3.38)	0.31 (19.0)	<b>GUC50</b>
		3/4	98.6 (3.38)	0.31 (19.0)	<b>GUC75</b>
		1	98.6 (3.38)	0.31 (19.0)	<b>GUC100</b>
	GUL	1/2	98.6 (3.38)	0.31 (19.0)	<b>GUL50</b>
		3/4	98.6 (3.38)	0.31 (19.0)	<b>GUL75</b>
		1	98.6 (3.38)	0.31 (19.0)	<b>GUL100</b>
	GULB	1/2	98.6 (3.38)	0.31 (19.0)	<b>GULB50</b>
		3/4	98.6 (3.38)	0.31 (19.0)	<b>GULB75</b>
		1	98.6 (3.38)	0.31 (19.0)	<b>GULB100</b>
	GUT	1/2	98.6 (3.38)	0.31 (19.0)	<b>GUT50</b>
		3/4	98.6 (3.38)	0.31 (19.0)	<b>GUT75</b>
		1	98.6 (3.38)	0.31 (19.0)	<b>GUT100</b>
	GUX	1/2	98.6 (3.38)	0.31 (19.0)	<b>GUX50</b>
		3/4	98.6 (3.38)	0.31 (19.0)	<b>GUX75</b>
		1	98.6 (3.38)	0.31 (19.0)	<b>GUX100</b>
Cover Gasket (all)					<b>GUG1</b>

### Dimensions in Millimeters (Inches)

Hub Size (Inches)	Dimensions in Millimeters (Inches)					
	A	B	C	D	E	F
1/2	108.7 (4.28)	62.0 (2.44)	75.4 (2.97)	19.1 (0.75)	20.6 (0.81)	57.2 (2.25)
3/4	108.7 (4.28)	62.0 (2.44)	75.4 (2.97)	19.1 (0.75)	20.6 (0.81)	57.2 (2.25)
1	108.7 (4.28)	62.0 (2.44)	75.4 (2.97)	19.1 (0.75)	23.9 (0.94)	57.2 (2.25)

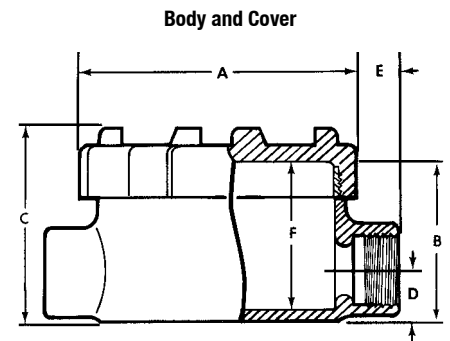

♦ In Class I, Division 1, Group B atmospheres, all conduit runs must have a sealing fitting (not supplied) field-installed adjacent to the enclosure.

# GRU Universal Conduit Outlet Boxes

## Explosionproof, Dust-Ignitionproof

UNILETS™ for use with Threaded Metal Conduit. Furnished with Internal Ground Screw. Furnished with O-ring.

### NEC/CEC:

Class I, Division 1 and 2, Groups C, D  
Class II, Division 1 and 2, Groups E, F, G  
Class III

### Applications

- Complies with a wide range of classified area requirements.
- Corrosion-resistant: ideal indoors or out.
- For pulling of wires.
- Connect conduit lengths and change direction of conduit runs.
- Provide access for maintenance.

### Features

- Accurately tapped, tapered hub threads for tight, rigid joints and ground continuity.
- Furnished with covers.
- General purpose wiring.
- Universal design with five threaded universal hubs and three close-up plugs.
- Copperfree aluminum body and cover provide resistance to corrosive atmospheres.
- Internally threaded body and externally threaded cover with o-ring for raintight fit, NEMA 3, 4.
- Covers have pry notches for bar or wrench.
- Smooth, rounded integral bushing in each hub type box protects conductor insulation.

### Standard Materials

- Bodies and covers: copperfree (4/10 of 1% max.) aluminum

### Standard Finishes

- Bodies and covers: epoxy powder coat

### NEC/CEC Certifications and Compliances

- UL Standard: UL 886 (UL 1203)
- UL Listed: E10444
- CSA Standard: C22.2 No. 25, C22.2 No. 30
- CSA Certified: 025875

Furnished with externally threaded aluminum surface cover, o-ring, five threaded hubs, and three close-up plugs.  
For Form numbers designate body and matching cover sizes.

	Conduit Size (Inches)	Cover Body Opening mm (in)	Capacity dm <sup>3</sup> (in <sup>3</sup> )	Form Number	Catalog Number
	1/2	85.9 (3.38)	0.22 (13.5)	1	GRU50-A
	3/4	85.9 (3.38)	0.22 (13.5)	1	GRU75-A
	1	85.9 (3.38)	0.29 (17.5)	1	GRU100-A ①

### Dimensions in Millimeters (Inches)

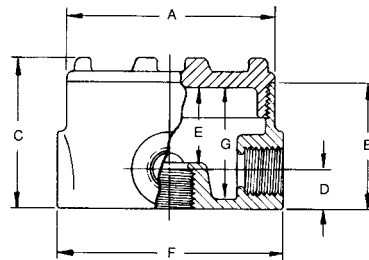

Hub Size Inches	Dimensions in Millimeters (Inches)						
	A	B	C	D	E	F	G
1/2	95.3 (3.75)	57.2 (2.25)	68.3 (2.69)	17.5 (0.69)	35.1 (1.38)	103.1 (4.06)	50.8 (2.00)
3/4	95.3 (3.75)	57.2 (2.25)	68.3 (2.69)	17.5 (0.69)	35.1 (1.38)	103.1 (4.06)	50.8 (2.00)
1	95.3 (3.75)	62.0 (2.44)	73.2 (2.88)	23.9 (0.94)	36.6 (1.44)	138.2 (5.44)	55.6 (2.19)

① Not CSA Certified.



# GRUE Universal Conduit Outlet Boxes

## Explosionproof, Dust-Ignitionproof

UNILETS™ for use with Threaded Metal Conduit. Furnished with Internal Ground Screw.

### NEC:

Class I, Division 1 and 2, Groups C, D  
 Class II, Division 1 and 2, Groups E, F, G  
 Class III

### Applications

- Complies with a wide range of classified area requirements.
- Corrosion-resistant: ideal indoors or out.
- For pulling of wires.
- Connect conduit lengths and change direction of conduit runs.
- Provide access for maintenance.

### Features

- Accurately tapped, tapered hub threads for tight, rigid joints and ground continuity.
- Furnished with covers.
- General purpose wiring.
- Universal design with five threaded universal hubs and three close-up plugs.
- Copperfree aluminum body and cover provide resistance to corrosive atmospheres.
- Covers have pry notches for bar or wrench.
- Smooth, rounded integral bushing in each hub type box protects conductor insulation.

### Standard Materials

- Bodies and covers: copperfree (4/10 of 1% max.) aluminum

### Standard Finishes

- Bodies and covers: epoxy powder coat

### NEC Certifications and Compliances

- UL Standard: UL 886 (UL 1203)
- UL Listed: E10444

Furnished with internally threaded aluminum surface cover, five threaded hubs, and three close-up plugs.  
 For Form numbers designate body and matching cover sizes.

	Conduit Size (Inches)	Cover Body Opening mm (in)	Capacity dm <sup>3</sup> (in <sup>3</sup> )	Catalog Number
	1/2	85.9 (3.38)	0.22 (13.5)	GRUE50-A
	3/4	85.9 (3.38)	0.22 (13.5)	GRUE75-A
	1	85.9 (3.38)	0.29 (17.5)	GRUE100-A

### Dimensions in Millimeters (Inches)

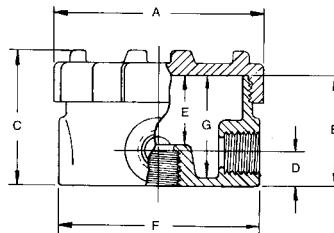

Hub Size Inches	Dimensions in Millimeters (Inches)						
	A	B	C	D	E	F	G
1/2	108.0 (4.25)	57.2 (2.25)	69.9 (2.75)	17.5 (0.69)	36.6 (1.44)	103.1 (4.06)	52.3 (2.06)
3/4	108.0 (4.25)	57.2 (2.25)	69.9 (2.75)	17.5 (0.69)	36.6 (1.44)	103.1 (4.06)	52.3 (2.06)
1	108.0 (4.25)	62.0 (2.44)	76.2 (3.00)	23.9 (0.94)	38.1 (1.50)	138.2 (5.44)	57.2 (2.25)

# GRUE Universal Conduit Outlet Boxes

## Explosionproof, Dust-Ignitionproof

GRUE-100 Series UNILETS™ for 1/2", 3/4" and 1" threaded metal conduit. GRUE-200 Series UNILETS™ for 1-1/4", 1-1/2" and 2" threaded metal conduit.

### CEC:

- Class I, Division 1 and 2, Groups B, C, D
- Class I, Zone 1 and 2, IIB + H<sub>2</sub> T6
- Class II, Division 1 and 2, Groups E, F, G
- Class III, Enclosure 3

### Applications

- Complies with a wide range of classified area requirements.
- Corrosion-resistant: ideal indoors or out.
- For pulling of wires.
- Connect conduit lengths and change direction of conduit runs.
- Provide access for maintenance.

### Features

- Accurately tapped, tapered hub threads for tight, rigid joints and ground continuity.
- Furnished with covers.
- General purpose wiring.
- Universal design with five threaded universal hubs and three close-up plugs.
- Copperfree aluminum body and cover provide resistance to corrosive atmospheres.
- GRUE-100 Series functions as sealing fittings when used with sealing covers (see CEC for restrictions).

- Covers have pry notches for bar or wrench.
- Smooth, rounded integral bushing in each hub type box protects conductor insulation.

### Standard Materials

- Bodies and covers: malleable iron or copperfree (4/10 of 1% max.) aluminum

### Standard Finishes

- Bodies and covers: triple-coat — (1) zinc electroplate, (2) chromate, and (3) epoxy powder coat

### Options

- GRUE-100 Series
  - To order GRUE-100 Series universal junction box complete with sealing cover add suffix **-SC**.

### CEC Certifications and Compliances

- CSA Standard: C22.2 No. 25, C22.2 No. 30
- CSA Certified: 013017

Conduit Size (Inches)	Hub Configuration	Catalog Number	
		Malleable Iron	Aluminum

#### GRUE-100 Series Universal Junction Box

Furnished with internally threaded surface cover, five threaded hubs and three close-up plugs. To order GRUE-100 Series junction box complete with sealing cover add suffix **-SC**.



1/2  
3/4  
1

XB

GRUE50  
GRUE75  
GRUE100

GRUE50-ACN  
GRUE75-ACN  
GRUE100-ACN

#### GRUE-100 Series Sealing Cover

Sealing cover for GRUE-100 Series junction boxes listed above.



GRUC-SC-F

GRUC-SC

### Dimensions in Millimeters (Inches)

Hub Size Inches	Dimensions in Millimeters (Inches)	
		H
1/2	19.1	(0.75)
3/4	19.1	(0.75)
1	22.2	(0.88)

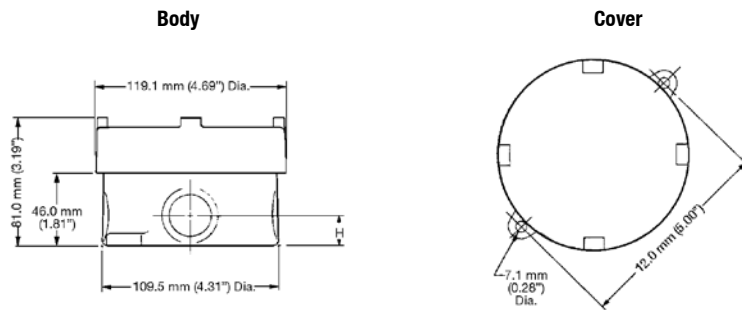

# GRUE Universal Conduit Outlet Boxes

## Explosionproof, Dust-Ignitionproof

GRUE-100 Series UNILETS™ for 1/2", 3/4" and 1" threaded metal conduit. GRUE-200 Series UNILETS™ for 1-1/4", 1-1/2" and 2" threaded metal conduit.

**CEC:**

Class I, Division 1 and 2, Groups B, C, D  
 Class I, Zone 1 and 2, IIB + H<sub>2</sub> T6  
 Class II, Division 1 and 2, Groups E, F, G  
 Class III, Enclosure 3

Conduit Size (Inches)	Hub Configuration	Catalog Number	
		Malleable Iron	Aluminum

**GRUE-200 Series**

Furnished with internally threaded surface cover. Entries are supplied as listed.



1-1/4		GRUE-125C	GRUE-125C-A
1-1/2	C	GRUE-150C	GRUE-150C-A
2		GRUE-200C	GRUE-200C-A
1-1/4		GRUE-125CB	GRUE-125CB-A
1-1/2	CB	GRUE-150CB	GRUE-150CB-A
2		GRUE-200CB	GRUE-200CB-A
1-1/4		GRUE-125E	GRUE-125E-A
1-1/2	E	GRUE-150E	GRUE-150E-A
2		GRUE-200E	GRUE-200E-A
1-1/4		GRUE-125L	GRUE-125L-A
1-1/2	L	GRUE-150L	GRUE-150L-A
2		GRUE-200L	GRUE-200L-A
1-1/4		GRUE-125LB	GRUE-125LB-A
1-1/2	LB	GRUE-150LB	GRUE-150LB-A
2		GRUE-200LB	GRUE-200LB-A
1-1/4		GRUE-125T	GRUE-125T-A
1-1/2	T	GRUE-150T	GRUE-150T-A
2		GRUE-200T	GRUE-200T-A
1-1/4		GRUE-125TB	GRUE-125TB-A
1-1/2	TB	GRUE-150TB	GRUE-150TB-A
2		GRUE-200TB	GRUE-200TB-A
1-1/4		GRUE-125X	GRUE-125X-A
1-1/2	X	GRUE-150X	GRUE-150X-A
2		GRUE-200X	GRUE-200X-A
1-1/4		GRUE-125XB	GRUE-125XB-A
1-1/2	XB	GRUE-150XB	GRUE-150XB-A
2		GRUE-200XB	GRUE-200XB-A

**Dimensions in Millimeters (Inches)**



# GRJS Universal Conduit Outlet Box

## Explosionproof, Dust-Ignitionproof

UNILETS™ for use with Threaded Metal Conduit.

**NEC:**

- Class I, Division 1 and 2, Groups C, D
- Class II, Division 1 and 2, Groups E, F, G
- Class III
- Raintight

### Applications

- Complies with a wide range of classified area requirements.
- Corrosion-resistant: ideal indoors or out.
- For pulling of wires.
- Connect conduit lengths and change direction of conduit runs.
- Provide access for maintenance.

### Features

- Malleable iron bodies have high tensile strength and ductility. Provides great resistance to corrosion, impact, and shock.
- Accurately tapped, tapered hub threads for tight, rigid joints and ground continuity.
- Furnished with covers.
- General purpose wiring.
- Universal design with five threaded openings and three close-up plugs.
- Compact round box for use where space is limited.
- Serve as mounting means for lighting fixtures when used with hub cover.
- Internally threaded body with externally threaded cover.
- Smooth, rounded integral bushing in each hub type box protects conductor insulation.

### Standard Materials

- Bodies: malleable iron
- Covers: copperfree (4/10 of 1% max.) aluminum

### Standard Finishes

- Bodies: triple-coat — (1) zinc electroplate, (2) chromate, and (3) epoxy powder coat
- Covers: epoxy powder coat

### NEC Certifications and Compliances

- UL Standard: UL 886 (UL 1203)
- UL Listed: E10444

Appleton®

ENCLOSURES AND JUNCTION BOXES: NEC/CEC EXPLOSIONPROOF OUTLET BOXES

Box Type	Conduit Size (Inches)	Cover Opening mm (in)	Capacity dm <sup>3</sup> (in <sup>3</sup> )	Catalog Number
----------	-----------------------	-----------------------	---	----------------

#### GRJS Universal Box with Cover

Internally threaded malleable iron body with externally threaded aluminum surface cover. Complete with five threaded universal openings and three close-up plugs.



1/2	65.0 (2.56)	0.12 (7.3)	<b>GRJS50</b>
3/4	65.0 (2.56)	0.12 (7.3)	<b>GRJS75</b>
1	65.0 (2.56)	0.12 (7.3)	<b>GRJS100</b>

#### GRJS Aluminum Covers



Surface	65.0 (2.56)	0.12 (7.3)	<b>GRJSK</b>
---------	-------------	------------	--------------



Hub	1/2	65.0 (2.56)	0.12 (7.3)	<b>GRJSK50</b>
-----	-----	-------------	------------	----------------

### Dimensions in Millimeters (Inches)

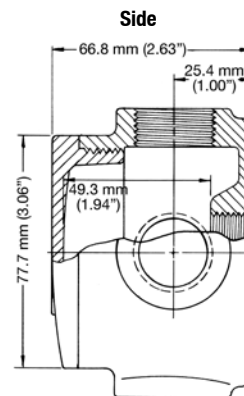
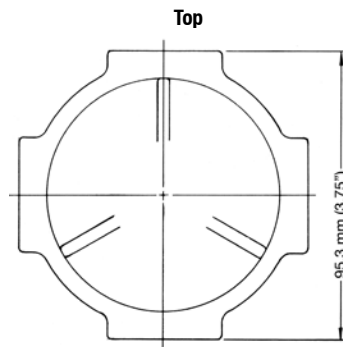

# GRJS Universal Conduit Outlet Boxes

## Explosionproof, Dust-Ignitionproof, Weather Resistant (Raintight)

UNILETS™ for use with Threaded Metal Conduit.

### CEC:

- Class I, Division 1 and 2, Groups C, D
- Class I, Zone 1 and 2, IIB T6
- Class II, Division 1 and 2, Groups E, F, G
- Class III, Enclosure 3

### Applications

- Complies with a wide range of classified area requirements.
- Corrosion-resistant: ideal indoors or out.
- For pulling of wires.
- Connect conduit lengths and change direction of conduit runs.
- Provide access for maintenance.

### Features

- Malleable iron bodies have high tensile strength and ductility. Provides great resistance to corrosion, impact, and shock.
- Accurately tapped, tapered hub threads for tight, rigid joints and ground continuity.
- Furnished with covers.
- General purpose wiring.
- Universal design with five threaded openings and three close-up plugs.
- Compact round box for use where space is limited.
- Serve as mounting means for lighting fixtures when used with hub cover.
- Function as sealing fittings when used with sealing covers (see CEC for restrictions).
- Internally threaded body with externally threaded cover.
- Smooth, rounded integral bushing in each hub type box protects conductor insulation.

### Standard Materials

- Bodies: malleable iron or copperfree (4/10 of 1% max.) aluminum
- Covers: copperfree (4/10 of 1% max.) aluminum

### Standard Finishes

- Bodies: triple-coat — (1) zinc electroplate, (2) chromate, and (3) epoxy powder coat
- Covers: epoxy powder coat

### CEC Certifications and Compliances

- CSA Standard: C22.2 No. 25, C22.2 No. 30
- CSA Certified: 013017

	Conduit Size (Inches)	Catalog Number	
		Malleable Iron	Aluminum
<b>GRJS Universal Box with Cover</b>			
<i>The Unilet has five threaded hubs, one in each of four sides and one in bottom. Three close-up plugs are furnished. Unilet opening is 2-9/16". Furnished with externally threaded blank surface cover and three close-up plugs. Supplied with o-ring.</i>			
	1/2	GRJS50-CN	GRJS50-ACN
	3/4	GRJS75-CN	GRJS75-ACN
	1	GRJS100-CN	GRJS100-ACN

### GRJS Aluminum Covers

Furnished with internal threads.

	Surface Cover	GRJSKCN
	Sealing Cover	GRJSK-SCCN
	1/2" Hub Cover	GRJSK50-CN

### Dimensions in Millimeters (Inches)

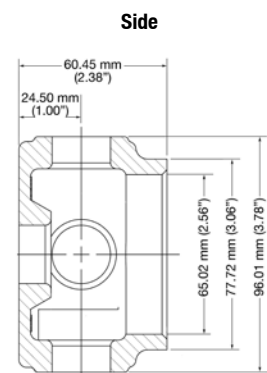
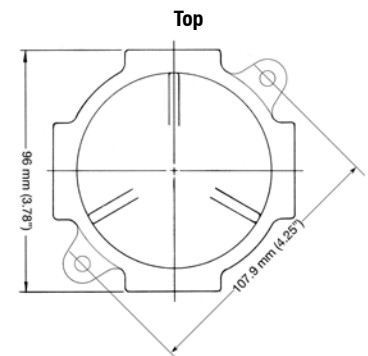

# GRJ Conduit Outlet Boxes

## Explosionproof, Dust-Ignitionproof, Raintight

UNILETS™ for use with Threaded Metal Conduit. Furnished with Internal Ground Screw.

### NEC/CEC:

Class I, Division 1 and 2, Groups C, D  
Class II, Division 1 and 2, Groups E, F, G  
Class III

### Applications

- Complies with a wide range of classified area requirements.
- Corrosion-resistant: ideal indoors or out.
- For pulling of wires.
- Connect conduit lengths and change direction of conduit runs.
- Provide access for maintenance.

### Features

- Malleable iron bodies have high tensile strength and ductility. Provides great resistance to corrosion, impact, and shock.
- Accurately tapped, tapered hub threads for tight, rigid joints and ground continuity.
- Furnished with covers.
- General purpose wiring.
- Small, round conduit outlet boxes.
- Externally threaded body with internally threaded cover.
- Smooth, rounded integral bushing in each hub type box protects conductor insulation.

### Standard Materials

- Bodies and covers: malleable iron

### Standard Finishes







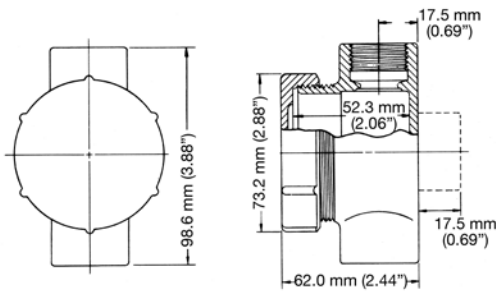

- Bodies and covers: triple-coat — (1) zinc electroplate, (2) chromate, and (3) epoxy powder coat

### NEC/CEC Certifications and Compliances

- UL Standard: UL 886 (UL 1203)
- UL Listed: E85310
- CSA Standard: C22.2 No. 25, C22.2 No. 30
- CSA Certified: 025875

### Dimensions in Millimeters (Inches)



Box Type	Conduit Size (Inches)	Cover Opening mm (in)	Capacity dm <sup>3</sup> (in <sup>3</sup> )	Catalog Number
<b>GRJ Box with Cover</b>				
 GRJC	1/2	54.1 (2.13)	0.12 (7.3)	GRJC50
	3/4	54.1 (2.13)	0.12 (7.3)	GRJC75
 GRJCA	1/2	54.1 (2.13)	0.12 (7.3)	GRJCA50
	3/4	54.1 (2.13)	0.12 (7.3)	GRJCA75
 GRJEA	1/2	54.1 (2.13)	0.12 (7.3)	GRJEA50
	3/4	54.1 (2.13)	0.12 (7.3)	GRJEA75
 GRJL	1/2	54.1 (2.13)	0.12 (7.3)	GRJL50
	3/4	54.1 (2.13)	0.12 (7.3)	GRJL75
 GRJT	1/2	54.1 (2.13)	0.12 (7.3)	GRJT50
	3/4	54.1 (2.13)	0.12 (7.3)	GRJT75
 GRJTA	1/2	54.1 (2.13)	0.12 (7.3)	GRJTA50
	3/4	54.1 (2.13)	0.12 (7.3)	GRJTA75
 GRJX	1/2	54.1 (2.13)	0.12 (7.3)	GRJX50
	3/4	54.1 (2.13)	0.12 (7.3)	GRJX75
<b>GRJ Covers</b>				
	GRJ Surface Covers	54.1 (2.13)		GRJK-S

# GUA Conduit Outlet Boxes

## Explosionproof, Dust-Ignitionproof

### NEC/CEC:

Class I, Division 1 and 2, Groups B♦, C, D  
Class II, Division 1 and 2, Groups E, F, G  
Class III  
NEMA 3, 4

### Applications

- To provide access to conductors for pulling, splicing, maintenance and future changes and upgrades.
- Allows connection of straight conduit runs, branch conduit runs and 90° bends.

### Features

- O-ring gasket provided to assure NEMA 4 rating.
- Internal ground screw.
- Smooth hub bushings protect insulation when pulling conductors.
- Cast-in brackets on cover for use with breaker-bar tools for tightening/loosening.
- Tapered threaded hubs (NPT).
- Threaded for rigid conduit or IMC.

### Standard Materials

- 1/2" thru 1" Body: copperfree (4/10 of 1% max.) aluminum
- 1/2" thru 1" Cover: malleable iron
- 1/2" thru 2" Body and cover: malleable iron

### Standard Finishes

- Malleable iron bodies and covers: triple-coat — (1) zinc electroplate, (2) chromate, and (3) epoxy powder coat
- Aluminum bodies and covers: epoxy powder coat

### NEC/CEC Certifications and Compliances

- UL Standard: 886
- UL Listed: E-85310
- CSA Standard: C22.2 No. 30
- CSA Certified: 020945
- NEMA 7CD, 9EFG
- NEC Articles 500-503 and 505



♦ In Class I, Division 1, Group B atmospheres, all conduit runs must have a sealing fitting (not supplied) field-installed adjacent to the enclosure.







# GUA Conduit Outlet Boxes

## Explosionproof, Dust-Ignitionproof

NEC/CEC:  
 Class I, Division 1 and 2, Groups B♦, C, D  
 Class II, Division 1 and 2, Groups E, F, G  
 Class III  
 NEMA 3, 4

OZGEDNEY

ENCLOSURES AND JUNCTION BOXES: NEC/CEC EXPLOSIONPROOF ENCLOSURES

				Catalog Number	
	Hub Type	Trade Size (Inches)	Form	Malleable Iron Body With Aluminum Cover	Malleable Iron Body and Cover
	GUAE	1/2	1	GUAE-50	GUAE-50MC
		3/4	1	GUAE-75	GUAE-75MC
		1	1	GUAE-100	GUAE-100MC
	GUAC	1/2	1	GUAC-50	GUAC-50MC
		3/4	1	GUAC-75	GUAC-75MC
		1	1	GUAC-100	GUAC-100MC
		1-1/4	2	—	GUAC-125
		1-1/2	3	—	GUAC-150
2	3	—	GUAC-200		
	GUAL	1/2	1	GUAL-50	GUAL-50MC
		3/4	1	GUAL-75	GUAL-75MC
		1	1	GUAL-100	GUAL-100MC
		1-1/4	2	—	GUAL-125
		1-1/2	3	—	GUAL-150
2	3	—	GUAL-200		
	GUALB	1/2	1	GUALB-50	GUALB-50MC
		3/4	1	GUALB-75	GUALB-75MC
		1	1	GUALB-100	GUALB-100MC
		1-1/4	2	—	GUALB-125
		1-1/2	3	—	GUALB-150
2	3	—	GUALB-200		
	GUAT	1/2	1	GUAT-50	GUAT-50MC
		3/4	1	GUAT-75	GUAT-75MC
		1	1	GUAT-100	GUAT-100MC
		1-1/4	2	—	GUAT-125
		1-1/2	3	—	GUAT-150
2	3	—	GUAT-200		
	GUAX	1/2	1	GUAX-50	GUAX-50MC
		3/4	1	GUAX-75	GUAX-75MC
		1	1	GUAX-100	GUAX-100MC
		1-1/4	2	—	GUAX-125
		1-1/2	3	—	GUAX-150
2	3	—	GUAX-200		

♦ In Class I, Division 1, Group B atmospheres, all conduit runs must have a sealing fitting (not supplied) field-installed adjacent to the enclosure.



# GUA Conduit Outlet Boxes

## Explosionproof, Dust-Ignitionproof

NEC/CEC:  
 Class I, Division 1 and 2, Groups B♦, C, D  
 Class II, Division 1 and 2, Groups E, F, G  
 Class III  
 NEMA 3, 4

### Dimensions in Millimeters (Inches)

Hub Size (Inches)	Dimensions in Millimeters (Inches)						
	A	B	C	D	E	F	G
<b>Type GUA, Form 1</b>							
1/2	95.3 (3.75)	62.0 (2.44)	73.2 (2.88)	19.1 (0.75)	20.6 (0.81)	57.2 (2.25)	31.8 (1.25)
3/4	95.3 (3.75)	62.0 (2.44)	73.2 (2.88)	19.1 (0.75)	20.6 (0.81)	57.2 (2.25)	31.8 (1.25)
1	95.3 (3.75)	62.0 (2.44)	73.2 (2.88)	19.1 (0.75)	20.6 (0.81)	57.2 (2.25)	31.8 (1.25)
<b>Type GUA, Form 2</b>							
1-1/4	114.3 (4.50)	68.3 (2.69)	90.4 (3.56)	30.2 (1.19)	22.4 (0.88)	69.9 (2.75)	28.7 (1.13)
<b>Type GUA, Form 3</b>							
1-1/2	146.1 (5.75)	95.3 (3.75)	122.2 (4.81)	35.1 (1.38)	23.9 (0.94)	103.1 (4.06)	38.1 (1.50)
2	146.1 (5.75)	101.6 (4.00)	128.5 (5.06)	41.4 (1.63)	25.4 (1.00)	108.0 (4.25)	31.8 (1.25)

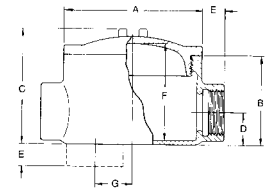
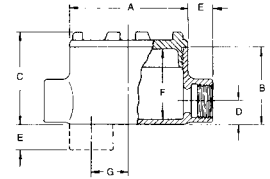

♦ In Class I, Division 1, Group B atmospheres, all conduit runs must have a sealing fitting (not supplied) field-installed adjacent to the enclosure.

# GUA Conduit Outlet Box Covers

## For Pendant Mounting Fixtures. Explosionproof, Dust-Ignitionproof

UNILETS™ for use with Threaded Metal Conduit. Furnished with Internal Ground Screw and O-ring.

### NEC/CEC:

- Class I, Division 1 and 2, Groups C, D
- Class I, Zone 1 and 2, Groups IIA, IIB
- Class II, Division 1 and 2, Groups E, F, G
- Class III

### Applications

- Provides NPT thread hub for mounting pendant light fixtures (luminaires) on 1/2", 3/4" and 1" trade size Type GUA outlet boxes.
- Provides additional wiring space and NPT threaded hub for mounting pendant light fixtures (luminaires) on 1/2", 3/4" and 1" trade size Type GUA outlet boxes.

### Features

- O-ring gasket provided to assure watertightness.
- Increases internal wiring volume (12.5 cu. in.).
- Side port allows access to conductors after fixture is mounted.
- Tapered threaded hub (NPT).
- Provided with anti-rotation set-screws.
- Maximum weight capacity: 22.7 kg (50 lbs.) per NEC Section 314-27(B).

### Standard Materials

- Bodies: malleable Iron
- Screws: steel set screws
- O-ring: buna-n

### Standard Finishes

- Bodies: zinc electroplate

### Options

- Hot dip or mechanical galvanized. Add suffix **-G** to standard catalog number. Contact your local representative for pricing and availability.

### NEC/CEC Certifications and Compliances

- UL Standard: 886
- UL Listed: E-97032
- CSA Standard: C22.2 No. 30
- CSA Certified: 020945
- Fed. Spec: A-A-50563
- NEC Articles 500-503 and 505

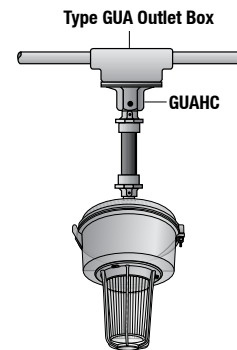
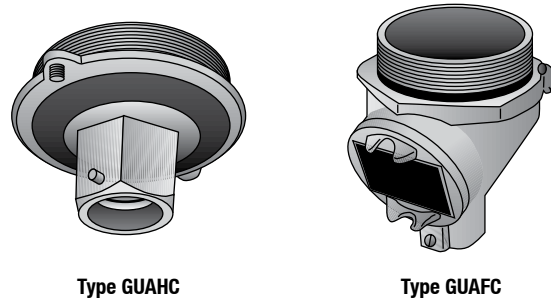



# GUA Conduit Outlet Box Covers

For Pendent Mounting Fixtures. Explosionproof, Dust-Ignitionproof

UNILETS™ for use with Threaded Metal Conduit. Furnished with Internal Ground Screw and O-ring.

**NEC/CEC:**

Class I, Division 1 and 2, Groups C, D  
 Class I, Zone 1 and 2, Groups IIA, IIB  
 Class II, Division 1 and 2, Groups E, F, G  
 Class III

	Hub Type	Conduit Size (Inches)	Catalog Number
	GUAHC	1/2	GUAHC-50
		3/4	GUAHC-75
	GUAFC	1/2	GUAFC-50
		3/4	GUAFC-50

**Dimensions in Millimeters (Inches)**

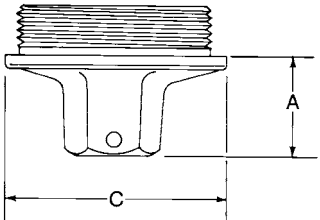
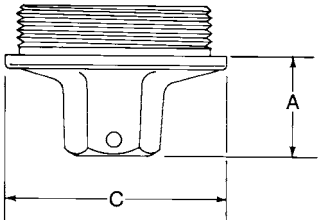
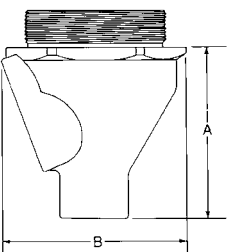
Hub Size (Inches)	Dimensions in Millimeters (Inches)			
	A	B	C Max. Dia	
<b>GUAHC</b>				
1/2	41.4 (1.63)	—	88.9 (3.50)	
3/4	41.4 (1.63)	—	88.9 (3.50)	
<b>GUAFC</b>				
1/2	—	41.4 (1.63)	88.9 (3.50)	
3/4	—	41.4 (1.63)	88.9 (3.50)	

**OZGEDNEY**

ENCLOSURES AND JUNCTION BOXES: NEC/CEC EXPLOSIONPROOF ENCLOSURES

# GUA Conduit Outlet Box Covers

## Sealing Cover

### NEC/CEC:

Class I, Division 1 and 2, Groups C, D  
Class I, Zone 1 and 2, Groups IIA, IIB  
Class II, Division 1 and 2, Groups E, F, G  
Class III

### Applications

- Converts 1/2", 3/4" and 1" trade size Type GUA malleable iron outlet boxes into 25% fill sealing fittings.

### Features

- Removable plug for pouring sealing compound.
- O-ring gasket provided to assure watertightness.
- Can be used with O-Z/Gedney EYC sealing compound.

### Standard Materials

- Body: malleable iron
- Screws: steel set screws
- O-ring: buna-n

### Standard Finishes

- Body: zinc electroplated

### Options

- Hot dip or mechanical galvanized. Add suffix **-G** to standard catalog number. Contact your local representative for pricing and availability.

### NEC/CEC Certifications and Compliances

- UL Standard: 886
- UL Listed: E-97032
- CSA Standard: C22.2 No. 30
- CSA Certified: 020945
- NEC Articles 500-503 and 505
- Fed. Spec: A-A-50563

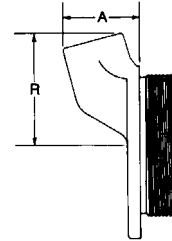
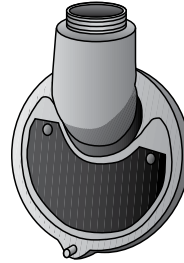

#### Dimensions in Millimeters (Inches)

Turning Radius R	Maximum Body Height A	Catlog Number
63.5 (2.5)	44.5 (1.75)	<b>GUASC-1</b>

# GUA Conduit Outlet Box Covers

## Threaded Extension

### NEC/CEC:

Class I, Division 1 and 2, Groups C, D  
Class I, Zone 1 and 2, Groups IIA, IIB  
Class II, Division 1 and 2, Groups E, F, G  
Class III

### Applications

- Provides for increased internal wiring volume in 1/2", 3/4" and 1" trade size in Type GUA malleable iron outlet boxes

### Features

- O-ring gasket provided to assure watertightness.
- Cast-in brackets for use with breaker bar tools.
- Increases internal wiring volume by 11 cu. in.

### Standard Materials

- Cover: malleable iron
- O-ring: buna-n

### Standard Finishes

- Cover: zinc electroplate

### Options

- Hot dip or mechanical galvanized. Add suffix **-G** to standard catalog number. Contact your local representative for pricing and availability.

### NEC/CEC Certifications and Compliances

- UL Standard: 886
- UL Listed: E-97032
- CSA Standard: C22.2 No. 30
- CSA Certified: 043437
- NEC Articles 500-503 and 505
- Fed. Spec: A-A-50563

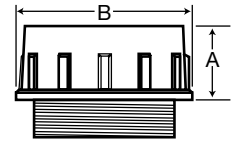

Dimensions in Millimeters (Inches)			
A	Maximum Diameter B	Volume (in <sup>3</sup> )	Catalog Number
69.9 (2.75)	88.9 (3.5)	11	GUADC-1

# GUJ Conduit Outlet Boxes

## Explosionproof, Dust-Ignitionproof

### NEC/CEC:

Class I, Division 1 and 2, Groups B♦, C, D  
Class I, Zone 1 and 2, Groups IIA, IIB  
Class II, Division 1 and 2, Groups E, F, G  
Class III  
NEMA 3, 4

### Applications

- To provide access to conductors for pulling, splicing, maintenance and future changes/ upgrades.
- Allows connection of straight conduit runs, branch conduit runs and 90° bends.

### Features

- Smooth hub bushings protect insulation when pulling conductors.
- Cast-in brackets on cover for use with breaker-bar tools for tightening/loosening.
- No risk of conductor insulation damage from threads on base during pulling.
- No risk of “pinching” conductors during cover installation.
- Improved wiring room
- Tapered threaded hubs (NPT)
- Dome cover available
- Internal ground screw standard
- Suitable for wet locations in upright position only.

### Standard Materials

- Bodies: ductile iron

### Standard Finishes

- Bodies and covers: triple-coat — (1) zinc electroplate, (2) chromate, and (3) epoxy powder coat

### Options

- Hot dip or mechanical galvanized. Add suffix **-G** to standard catalog number. Contact your local representative for pricing and availability.

### NEC/CEC Certifications and Compliances

- UL Standard: UL 886 (UL 1203)
- UL Listed: E-85310
- CSA Standard: CSA: C22.2 No. 30
- CSA Certified: 020945, 025875



GUJT



GUJL



GUJC



GUJLB



GUJX

♦ In Class I, Division 1, Group B atmospheres, all conduit runs must have a sealing fitting (not supplied) field-installed adjacent to the enclosure.

# GUJ Conduit Outlet Boxes

## Explosionproof, Dust-Ignitionproof

**NEC/CEC:**

Class I, Division 1 and 2, Groups B♦, C, D

Class I, Zone 1 and 2, Groups IIA, IIB

Class II, Division 1 and 2, Groups E, F, G

Class III

NEMA 3, 4

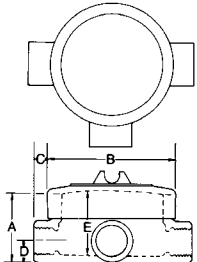
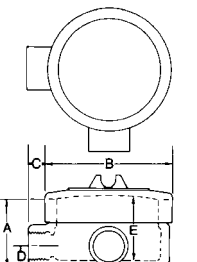
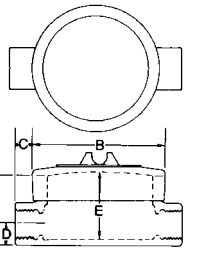
Trade Size (Inches)	Dimensions in Millimeter (Inches)					Cover Opening	Volume dm <sup>3</sup> (in <sup>3</sup> )	Catalog Number		
	A	B	C	D	E			Malleable Iron Cover/Body ①	Malleable Iron Cover/Body with Ground Screw/Lug ②	
<b>Type GUJT</b>										
	1/2	50.80 (2.00)	98.43 (3.88)	19.05 (0.75)	15.88 (0.63)	50.80 (2.00)	76.20 (3.00)	0.22 (13.50)	<b>GUJT-50</b>	<b>GUJT-50 CS</b>
	3/4	57.15 (2.25)	98.43 (3.88)	19.05 (0.75)	19.05 (0.75)	53.98 (2.13)	76.20 (3.00)	0.25 (15.00)	<b>GUJT-75</b>	<b>GUJT-75CS</b>
	1	63.50 (2.50)	98.43 (3.88)	22.25 (0.88)	22.35 (0.88)	60.33 (2.38)	76.20 (3.00)	0.28 (17.00)	<b>GUJT-100</b>	<b>GUJT-100CS</b>
<b>Type GUJL</b>										
	1/2	50.80 (2.00)	98.43 (3.875)	19.05 (0.75)	15.88 (0.63)	50.80 (2.00)	76.20 (3.00)	0.22 (13.50)	<b>GUJL-50</b>	<b>GUJL-50CS</b>
	3/4	57.15 (2.25)	98.43 (3.88)	19.05 (0.75)	19.05 (0.75)	53.98 (2.13)	76.20 (3.00)	0.25 (15.00)	<b>GUJL-75</b>	<b>GUJL-75CS</b>
	1	63.50 (2.50)	98.43 (3.88)	22.25 (0.88)	22.25 (0.88)	60.33 (2.38)	76.20 (3.00)	0.28 (17.00)	<b>GUJL-100</b>	<b>GUJL-100CS</b>
<b>Type GUJC</b>										
	1/2	50.80 (2.00)	98.43 (3.875)	19.05 (0.75)	15.88 (0.63)	50.80 (2.00)	76.20 (3.00)	0.22 (13.50)	<b>GUJC-50</b>	<b>GUJC-50CS</b>
	3/4	57.15 (2.25)	98.43 (3.88)	19.05 (0.75)	19.05 (0.75)	53.98 (2.13)	76.20 (3.00)	0.25 (15.00)	<b>GUJC-75</b>	<b>GUJC-75CS</b>
	1	63.50 (2.50)	98.43 (3.88)	22.25 (0.88)	22.35 (0.88)	60.33 (2.38)	76.20 (3.00)	0.28 (17.00)	<b>GUJC-100</b>	<b>GUJC-100CS</b>

♦ In Class I, Division 1, Group B atmospheres, all conduit runs must have a sealing fitting (not supplied) field-installed adjacent to the enclosure.

① UL Listed outlet box with Malleable Iron Cover and Malleable Iron Body.

② UL Listed and CSA Certified outlet box with Malleable Iron Cover and Malleable Iron Body with Ground Screw/Lug.

# GUJ Conduit Outlet Boxes

## Explosionproof, Dust-Ignitionproof

NEC/CEC:  
 Class I, Division 1 and 2, Groups B♦, C, D  
 Class I, Zone 1 and 2, Groups IIA, IIB  
 Class II, Division 1 and 2, Groups E, F, G  
 Class III  
 NEMA 3, 4

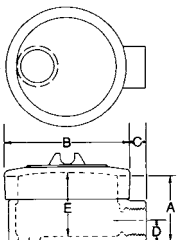
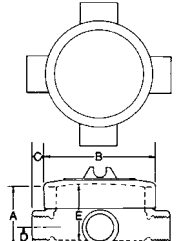
Trade Size (Inches)	Dimensions in Millimeters (Inches)						Cover Opening	Volume dm <sup>3</sup> (in <sup>3</sup> )	Catalog Number	
	A	B	C	D	E	Malleable Iron Cover/Body ①			Malleable Iron Cover/Body with Ground Screw/Lug ②	
<b>Type GUJLB</b>										
	1/2	50.8 (2.00)	98.43 (3.88)	19.05 (0.75)	15.88 (0.63)	15.88 (0.63)	76.20 (3.00)	0.22 (13.50)	<b>GUJLB-50</b>	<b>GUJLB-50CS</b>
	3/4	57.15 (2.25)	98.43 (3.88)	19.05 (0.75)	19.05 (0.75)	19.05 (0.75)	76.20 (3.00)	0.25 (15.00)	<b>GUJLB-75</b>	<b>GUJLB-75CS</b>
	1	63.50 (2.50)	98.43 (3.88)	22.35 (0.88)	22.23 (0.88)	22.23 (0.88)	76.20 (3.00)	0.28 (17.00)	<b>GUJLB-100</b>	<b>GUJLB-100CS</b>
<b>Type GUJX</b>										
	1/2	50.80 (2.00)	98.43 (3.88)	19.05 (0.75)	15.88 (0.63)	50.80 (2.00)	76.20 (3.00)	0.22 (13.50)	<b>GUJX-50</b>	<b>GUJX-50CS</b>
	3/4	57.15 (2.25)	98.43 (3.88)	19.05 (0.75)	19.05 (0.75)	53.98 (2.13)	76.20 (3.00)	0.25 (15.00)	<b>GUJX-75</b>	<b>GUJX-75CS</b>
	1	63.50 (2.50)	98.43 (3.88)	22.35 (0.88)	22.35 (0.88)	60.325 (2.38)	76.20 (3.00)	0.28 (17.00)	<b>GUJX-100</b>	<b>GUJX-100CS</b>

♦ In Class I, Division 1, Group B atmospheres, all conduit runs must have a sealing fitting (not supplied) field-installed adjacent to the enclosure.

① UL Listed outlet box with Malleable Iron Cover and Malleable Iron Body.

② UL Listed and CSA Certified outlet box with Malleable Iron Cover and Malleable Iron Body with Ground Screw/Lug.



# GRH Conduit Outlet Boxes

## Explosionproof, Dust-Ignitionproof

UNILETS™ for use with Threaded Metal Conduit. Furnished with Internal Ground Screw and O-ring.

### NEC/CEC:

Class I, Division 1 and 2, Groups A, B, C, D

Class II, Division 1 and 2, Groups E, F, G

Class III

NEMA 3, 4

### Applications

- Complies with a wide range of classified area requirements.
- Corrosion-resistant: ideal indoors or out.
- For pulling of wires.
- Connect conduit lengths and change direction of conduit runs.
- Provide access for maintenance.

### Features

- Malleable iron bodies have high tensile strength and ductility. Provides great resistance to corrosion, impact, and shock.
- Accurately tapped, tapered hub threads for tight, rigid joints and ground continuity.
- Furnished with covers.
- General purpose wiring.
- Designed for use in Class I, Groups A, B, C, and D; Class II, Groups E, F, and G; and Class III.
- Internally threaded body with externally threaded covers.
- Standard o-rings provide raintight fit. NEMA 3, 4.
- Internal ground screw standard.
- Smooth, rounded integral bushing in each hub type box protects conductor insulation.

### Standard Materials

- Body: malleable iron
- Cover: copperfree (4/10 of 1% max.) aluminum

### Standard Finishes

- Body: triple-coat — (1) zinc electroplate, (2) chromate, and (3) epoxy powder coat
- Cover: epoxy powder coat

### NEC/CEC Certifications and Compliances

- UL Standard: UL 886 (UL 1203)
- UL Listed: E85310
- CSA Standard: C22.2 No. 25, C22.2 No. 30
- CSA Certified: 013017, 025875

	Hub Type	Conduit Size (Inches)	Cover Opening mm (in)	Capacity dm <sup>3</sup> (in <sup>3</sup> )	Catalog Number Malleable Iron
		1/2	85.9 (3.38)	0.23 (13.8)	<b>GRHC50</b>
	GRHC	3/4	85.9 (3.38)	0.23 (13.8)	<b>GRHC75</b>
		1	85.9 (3.38)	0.23 (13.8)	<b>GRHC100</b>
		1/2	85.9 (3.38)	0.23 (13.8)	<b>GRHL50</b>
	GRHL	3/4	85.9 (3.38)	0.23 (13.8)	<b>GRHL75</b>
		1	85.9 (3.38)	0.23 (13.8)	<b>GRHL100</b>
		1/2	85.9 (3.38)	0.23 (13.8)	<b>GRHLB50</b>
	GRHLB	3/4	85.9 (3.38)	0.23 (13.8)	<b>GRHLB75</b>
		1	85.9 (3.38)	0.23 (13.8)	<b>GRHLB100</b>
		1/2	85.9 (3.38)	0.23 (13.8)	<b>GRHT50</b>
	GRHT	3/4	85.9 (3.38)	0.23 (13.8)	<b>GRHT75</b>
		1	85.9 (3.38)	0.23 (13.8)	<b>GRHT100</b>
		1/2	85.9 (3.38)	0.23 (13.8)	<b>GRHX50</b>
	GRHX	3/4	85.9 (3.38)	0.23 (13.8)	<b>GRHX75</b>
		1	85.9 (3.38)	0.23 (13.8)	<b>GRHX100</b>

### Dimensions in Millimeters (Inches)

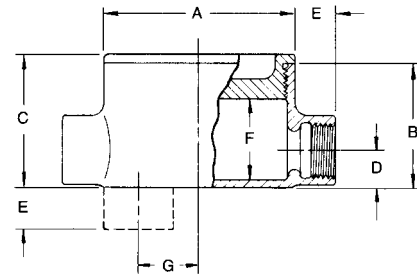

Hub Size (Inches)	A	B	C	D	E	F	G
1/2	95.3 (3.75)	62 (2.44)	66.8 (2.63)	19.1 (0.75)	20.6 (0.81)	41.4 (1.63)	31.8 (1.25)
3/4	95.3 (3.75)	62 (2.44)	66.8 (2.63)	19.1 (0.75)	20.6 (0.81)	41.4 (1.63)	31.8 (1.25)
1	95.3 (3.75)	62 (2.44)	66.8 (2.63)	23.9 (0.94)	23.9 (0.94)	41.4 (1.63)	26.9 (1.06)

# CPU Universal Conduit Outlet Boxes and Covers

## Explosionproof, Dust-Ignitionproof

UNILETS™ for use with Threaded Metal Conduit.

### NEC:

Class I, Division 1 and 2, Groups C, D  
Class II, Division 1 and 2, Groups E, F, G  
Class III

### Applications

- Complies with a wide range of classified area requirements.
- Corrosion-resistant: ideal indoors or out.
- For pulling of wires.
- Connect conduit lengths and change direction of conduit runs.
- Provide access for maintenance.

### Features

- Malleable iron bodies have high tensile strength and ductility. Provides great resistance to corrosion, impact, and shock.
- Accurately tapped, tapered hub threads for tight, rigid joints and ground continuity.
- Furnished with covers.
- General purpose wiring.
- Universal design with four threaded universal hubs and three close-up plugs.
- Serve as mounting outlets for lighting fixtures when used with hub cover.
- Wide, accurately ground explosionproof mating surfaces.
- Smooth, rounded integral bushing in each hub type box protects conductor insulation.

### Standard Materials

- Bodies and covers : malleable iron
- Connection block: phenolic

### Standard Finishes

- Bodies and covers: triple-coat — (1) zinc electroplate, (2) chromate, and (3) epoxy powder coat

### NEC Certifications and Compliances

- UL Standard: UL 886 (UL 1203)
- UL Listed: E85310

Appleton®

ENCLOSURES AND JUNCTION BOXES: NEC/CEC EXPLOSIONPROOF OUTLET BOXES

Box Type	Conduit Size (Inches)	Fixture Stem Size Inches	Cover Opening mm (in)	Capacity dm <sup>3</sup> (in <sup>3</sup> )	Catalog Number
----------	-----------------------	--------------------------	-----------------------	---	----------------

#### CPU Box with Blank Cover

Furnished with four threaded universal 3/4" hubs, four 3/4" to 1/2" reducers, and three 1/2" close-up plugs.



1/2 or 3/4    Blank    96.8 (3.81)    0.39 (24.0)    CPU20

#### CPU Box with Hub Cover

(Supports 112.5 kg (248 lb) Furnished with four threaded universal 3/4" hubs, five 3/4" to 1/2" reducers, and three 1/2" close-up plugs.



1/2 or 3/4    3/4 ①    96.8 (3.81)    0.39 (24.0)    CPU20-75

#### CPU Covers only

Furnished with fastening screws.



Cover    Blank    96.8 (3.81)    —    CPSK20B



Hub Covers    3/4 ①    96.8 (3.81)    —    CPSK20-75

#### CPU Connection Block

Phenolic. With fastening strap and two mounting screws.

5-Wire, 20 Amp, 300 Volt    CB205

### Dimensions in Millimeters (Inches)

#### CPU Box with Cover

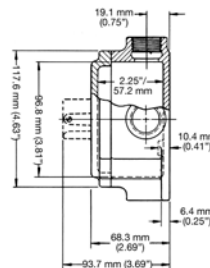
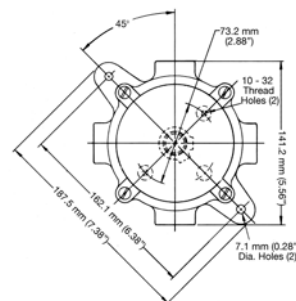

#### Connection Block

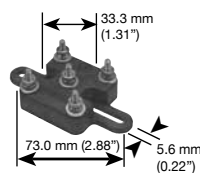

① Supplied with 3/4" to 1/2" reducer.

# CPU Universal Conduit Outlet Boxes and Covers

## Explosionproof, Dust-Ignitionproof

UNILETS™ for use with Threaded Metal Conduit.

### CEC:

- Class I, Division 1 and 2, Groups C, D
- Class I, Zone 1 and 2, IIB T6
- Class II, Division 1 and 2, Groups E, F, G
- Class III, Enclosure 3

### Applications

- Complies with a wide range of classified area requirements.
- Corrosion-resistant: ideal indoors or out.
- For pulling of wires.
- Connect conduit lengths and change direction of conduit runs.
- Provide access for maintenance.

### Features

- Malleable iron bodies have high tensile strength and ductility. Provides great resistance to corrosion, impact, and shock.
- Accurately tapped, tapered hub threads for tight, rigid joints and ground continuity.
- Furnished with covers.
- General purpose wiring.
- Universal design with four threaded universal hubs and three close-up plugs.
- Serve as mounting outlets for lighting fixtures when used with hub cover.
- Wide, accurately ground explosionproof mating surfaces.
- Smooth, rounded integral bushing in each hub type box protects conductor insulation.

### Standard Materials

- Bodies and covers : malleable iron or copperfree (4/10 of 1% max.) aluminum
- Connection block: phenolic

### Standard Finishes

- Bodies and covers: triple-coat — (1) zinc electroplate, (2) chromate, and (3) epoxy powder coat

### Options

- To order with CB205 connection block installed add suffix **-CB**.

### CEC Certifications and Compliances

- CSA Standard: C22.2 No. 25, C22.2 No. 30
- CSA Certified: 013017

Box Type	Conduit Size (Inches)	Fixture Stem Size Inches	Cover Opening mm (in)	Capacity dm <sup>3</sup> (in <sup>3</sup> )	Catalog Number	
					Malleable Iron	Aluminum

#### CPU Box with Blank Cover

Furnished with four threaded universal 3/4" hubs, four 3/4" to 1/2" reducers, and three 1/2" close-up plugs. To order with CB205 connection block installed add suffix **-CB**.



1/2 or 3/4	Blank	96.8 (3.81)	0.34 (21.0)	<b>CPU20-CN</b>	<b>CPU20-ACN</b>
------------	-------	-------------	-------------	-----------------	------------------

#### CPU Box with Hub Cover

(Supports lbs – 112.5 kg. Furnished with four threaded universal 3/4" hubs, four 3/4" to 1/2" reducers, and three 1/2" close-up plugs. To order with CB205 connection block installed add suffix **-CB**.



1/2 or 3/4	1/2	96.8 (3.81)	0.34 (21.0)	<b>CPU20-50CN</b>	<b>CPU20-50ACN</b>
1/2 or 3/4	3/4	96.8 (3.81)	0.34 (21.0)	<b>CPU20-75CN</b>	<b>CPU20-75ACN</b>

#### CPU Covers only

Furnished with fastening screws.



Cover	Blank	96.8 (3.81)	0.34 (21.0)	<b>CPSK20B-CN</b>	<b>CPSK20B-ACN</b>
-------	-------	-------------	-------------	-------------------	--------------------



Hub Covers	1/2	96.8 (3.81)	0.34 (21.0)	<b>CPSK20-50CN</b>	<b>CPSK20-50ACN</b>
	3/4	96.8 (3.81)	0.34 (21.0)	<b>CPSK20-75CN</b>	<b>CPSK20-75ACN</b>

#### CPU Connection Block — With fastening strap and two mounting screws



5-Wire, 20 Amp, 300 Volt	<b>CB205CN</b>
--------------------------	----------------

### Dimensions in Millimeters (Inches)

#### CPU Box with Cover

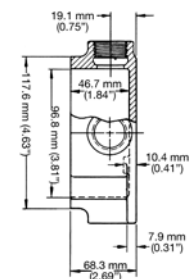
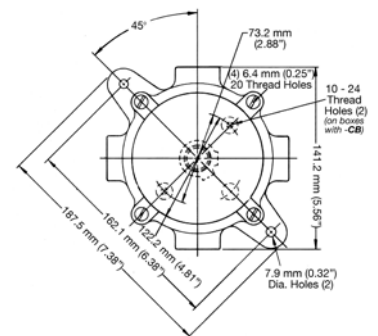

# GRSS Conduit Outlet Boxes with Multiple Hubs

## Explosionproof, Dust-Ignitionproof, Raintight

UNILETS™ for use with Threaded Metal Conduit. Furnished with Internal Ground Screw and O-ring gasket.

### NEC/CEC:

Class I, Division 1 and 2, Groups B♦, C, D  
 Class II, Division 1 and 2, Groups E, F, G  
 Class III

### Applications

- Complies with a wide range of classified area requirements.
- Corrosion-resistant: ideal indoors or out.
- For pulling of wires.
- Connect conduit lengths and change direction of conduit runs.
- Provide access for maintenance.

### Features

- Accurately tapped, tapered hub threads for tight, rigid joints and ground continuity.
- Furnished with covers.
- General purpose wiring.
- Multiple hubs permit flexibility.
- Copperfree aluminum body and cover provide superior corrosion resistance.
- Internal ground screw standard.
- Cover o-ring included.

### Standard Materials

- Bodies and covers: copperfree (4/10 of 1% max.) aluminum

### Standard Finishes



- Epoxy powder coat

### NEC/CEC Certifications and Compliances

- UL Standard: UL 886 (UL 1203)
- UL Listed: E85310
- CSA Standard: C22.2 No. 25, C22.2 No. 30
- CSA Certified: 025875

Appleton®

ENCLOSURES AND JUNCTION BOXES: NEC/CEC EXPLOSIONPROOF OUTLET BOXES

Box Type	Conduit Size (Inches)	Cover Opening mm (in)	Hubs	Plugs	Capacity dm <sup>3</sup> (in <sup>3</sup> )	Catalog Number ♦
<b>GRSS Outlet Box with Cover</b>						
	<i>Internally threaded aluminum bodies with externally threaded aluminum form 1 covers. Has 7 hubs; 2 on each of the sides, 1 on the top, 1 on the bottom and 1 on the center in the back. Furnished with 4 close-up plugs and o-ring.</i>					
GRSS	1/2	85.9 (3.38)	7	4	0.48 (29.0)	<b>GRSS50</b>
	3/4	85.9 (3.38)	7	4	0.48 (29.0)	<b>GRSS75</b>
	1	85.9 (3.38)	7	4	0.48 (29.0)	<b>GRSS100</b>
<b>GRSSA Outlet Box with Cover</b>						
	<i>Internally threaded aluminum bodies with externally threaded aluminum form 1 covers. Has 13 hubs; 2 on each side, 2 each on top and bottom and 5 in the back. Furnished with 5 close-up plugs and o-ring.</i>					
GRSSA	1/2	85.9 (3.38)	13	5	0.48 (29.0)	<b>GRSSA50</b>
	3/4	85.9 (3.38)	13	5	0.48 (29.0)	<b>GRSSA75</b>

### Dimensions in Millimeters (Inches)

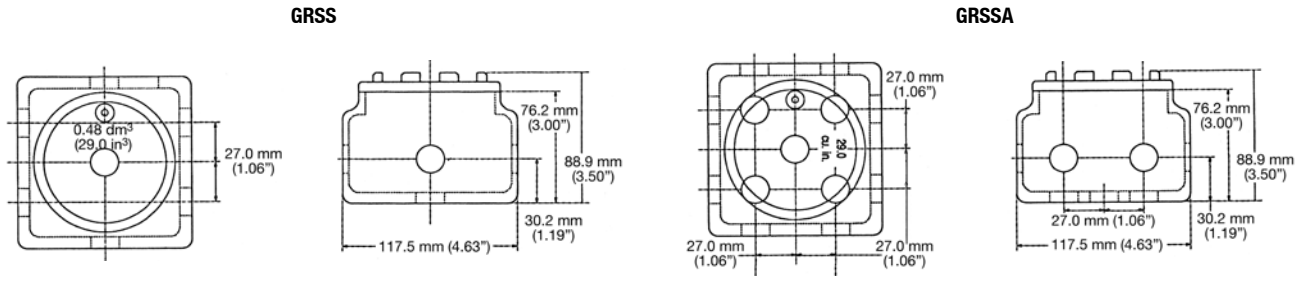

♦ In Class I, Division 1, Group B atmospheres, all conduit runs must have a sealing fitting (not supplied) field-installed adjacent to the enclosure.

# GUEB Conduit Outlet Boxes with Multiple Hubs

Explosionproof, Dust-Ignitionproof, Raintight

**NEC/CEC:**

Class I, Division 1 and 2, Groups B♦, C, D  
 Class II, Division 1 and 2, Groups E, F, G  
 Class III

**Applications**

- To provide access to conductors for pulling, splicing, maintenance and future changes/ upgrades.
- Allows connection of straight conduit runs, branch conduit runs and 90° bends.

**Features**

- 7 to 13 hubs.
- O-ring gasket provided to assure NEMA 4 rating.
- Smooth hub bushings protect insulation when pulling conductors.
- Cast-in brackets on cover for use with breaker-bar tools for tightening/loosening.
- Tapered threaded hubs (NPT)
- Supplied with close-up plugs (see table).
- Furnished with internal ground screw.

**Standard Materials**

- Copperfree (4/10 of 1% max.) aluminum

**Standard Finishes**



- Body and cover: aluminum enamel

**NEC/CEC Certifications and Compliances**

- UL Standard: 886
- UL Listed: E-85310
- CSA Standard: C22.2 No. 30
- CSA Certified: 009795
- Fed. Spec: A-A-50563
- NEMA 4, 7BCD, 9EFG

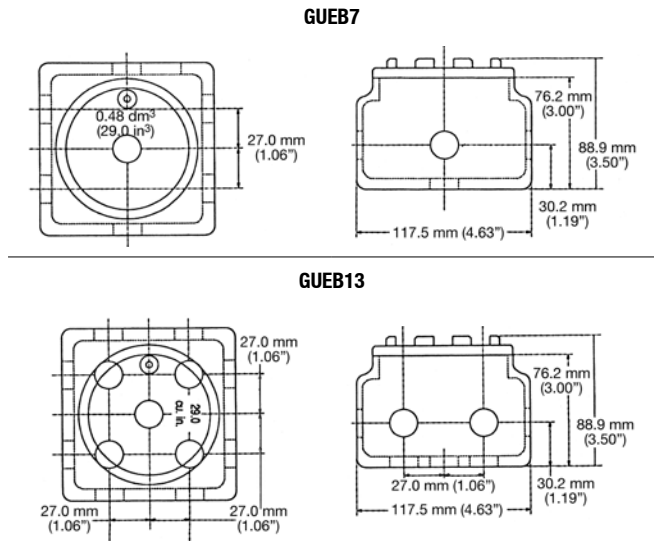
**Dimensions in Millimeters (Inches)**



		Dimensions in Millimeters (Inches)				
	Trade Size (Inches)	No. of Hubs	No. of Plus Supplied	Cover Opening	Volume dm³ (in³)	Catalog Number
	1/2	7	4	85.9 (3.38)	0.48 (29)	GUEB7-50AN4
	3/4	7	4	85.9 (3.38)	0.48 (29)	GUEB7-75AN4
	1	7	4	85.9 (3.38)	0.48 (29)	GUEB7-100AN4
	1/2	13	5	85.9 (3.38)	0.48 (29)	GUEB13-50AN4
	3/4	13	5	85.9 (3.38)	0.48 (29)	GUEB13-75AN4

♦ In Class I, Division 1, Group B atmospheres, all conduit runs must have a sealing fitting (not supplied) field-installed adjacent to the enclosure.

# GRUJ Conduit Outlet Boxes with Multiple Hubs

## Explosionproof, Dust-Ignitionproof

UNILETS™ for use with Threaded Metal Conduit.

### NEC/CEC:

Class I, Division 1 and 2, Groups C, D  
Class II, Division 1 and 2, Groups E, F, G  
Class III

### Applications

- Complies with a wide range of classified area requirements.
- Corrosion-resistant: ideal indoors or out.
- For pulling of wires.
- Connect conduit lengths and change direction of conduit runs.
- Provide access for maintenance.

### Features

- Malleable iron bodies have high tensile strength and ductility. Provides great resistance to corrosion, impact, and shock.
- Accurately tapped, tapered hub threads for tight, rigid joints and ground continuity.
- Furnished with covers.
- General purpose wiring.
- Union hubs permit easy wiring.
- Externally threaded body with internally threaded cover.
- Smooth, rounded integral bushing in each hub type box protects conductor insulation.

### Standard Materials

- Bodies and covers: malleable iron

### Standard Finishes



- Bodies and covers: triple-coat — (1) zinc electroplate, (2) chromate, and (3) epoxy powder coat

### NEC Certifications and Compliances

- UL Standard: UL 886 (UL 1203)
- UL Listed: E10444
- CSA Standard: C22.2 No. 25, C22.2 No. 30
- CSA Certified: 013017

Appleton®

ENCLOSURES AND JUNCTION BOXES: NEC/CEC EXPLOSIONPROOF OUTLET BOXES

	Number and Size of Hubs			Back	Capacity dm <sup>3</sup> (in <sup>3</sup> )	Catalog Number
	Each Side	Top	Bottom			
<b>GRUJ Box with Cover</b>						
<i>Externally threaded malleable iron body complete with internally threaded malleable iron surface cover; choice of hub arrangements, furnished with close-up plugs for all but three 3/4" hubs. Cover opening — 82.6 mm (3.25")</i>						
	2 — 3/4"	2 — 3/4"	1 — 3/4"	None	0.41 (25.0)	<b>GRUJ-1P</b>
	2 — 3/4"	2 — 3/4"	1 — 3/4"	4 — 3/4"	0.41 (25.0)	<b>GRUJ-2P</b>
	2 — 3/4"	2 — 3/4"	1 — 3/4"	4 — 1"	0.41 (25.0)	<b>GRUJ-3P</b>
<b>GRU Covers</b>						
<i>Malleable iron with internal threads. Cover opening — 82.6 mm (3.25")</i>						
	Surface					<b>GRUK-S</b>

### Dimensions in Millimeters (Inches)

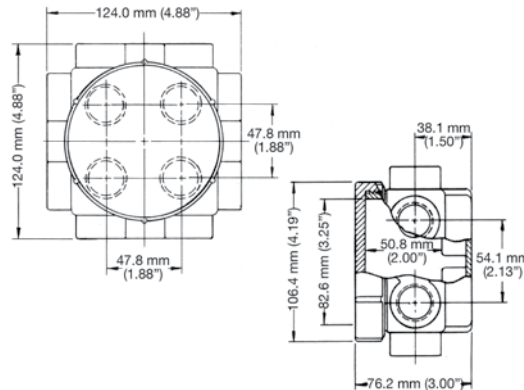

# GRUO with Multiple Hubs Conduit Outlet Boxes

## Explosionproof, Dust-Ignitionproof

UNILETS™ for use with Threaded Metal Conduit.

### NEC/CEC:

Class I, Division 1 and 2, Groups C, D  
Class II, Division 1 and 2, Groups E, F, G  
Class III

### Applications

- Complies with a wide range of classified area requirements.
- Corrosion-resistant: ideal indoors or out.
- For pulling of wires.
- Connect conduit lengths and change direction of conduit runs.
- Provide access for maintenance.

### Features

- Malleable iron bodies have high tensile strength and ductility. Provides great resistance to corrosion, impact, and shock.
- Accurately tapped, tapered hub threads for tight, rigid joints and ground continuity.
- Furnished with covers.
- General purpose wiring.
- Union hubs permit easy wiring.
- Externally threaded body with internally threaded cover.
- Smooth, rounded integral bushing in each hub type box protects conductor insulation.

### Standard Materials



- Bodies and covers: malleable iron

### Standard Finishes

- Bodies and covers: triple-coat — (1) zinc electroplate, (2) chromate, and (3) epoxy powder coat

### NEC/CEC Certifications and Compliances

- UL Standard: UL 886 (UL 1203)
- UL Listed: E10444
- CSA Standard: C22.2 No. 25, C22.2 No. 25
- CSA Certified: 013017, 025875

	Number and Size of Hubs				Capacity dm <sup>3</sup> (in <sup>3</sup> )	Catalog Number
	Each Side	Top	Bottom	Back		
	<b>GRUO Box with Cover</b>					
	Externally threaded malleable iron body complete with internally threaded malleable iron surface cover; eight conduit hubs and close-up plugs for all but three 3/4" hubs. Cover opening — 82.6 mm (3.25")					
	1 — 3/4"	2 — 3/4"	2 — 3/4" 1 — 1"	1 — 3/4"	0.41 (25.0)	<b>GRUO-2</b>
	<b>GRU Covers</b>					
	Malleable iron with internal threads. Cover opening — 82.6 mm (3.25")					
	Surface					<b>GRUK-S</b>

### Dimensions in Millimeters (Inches)

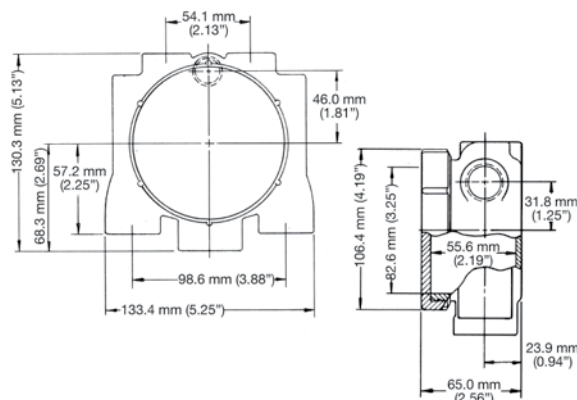

# GRU Conduit Outlet Boxes with Union Hubs

## Explosionproof, Dust-Ignitionproof, Raintight

UNILETS™ for use with Threaded Metal Conduit. Furnished with Internal Ground Screw.

### NEC/CEC:

Class I, Division 1 and 2, Groups C, D  
 Class II, Division 1 and 2, Groups E, F, G  
 Class III

### Applications

- Complies with a wide range of classified area requirements.
- Corrosion-resistant: ideal indoors or out.
- For pulling of wires.
- Connect conduit lengths and change direction of conduit runs.
- Provide access for maintenance.

### Features

- Malleable iron bodies have high tensile strength and ductility. Provides great resistance to corrosion, impact, and shock.
- Accurately tapped, tapered hub threads for tight, rigid joints and ground continuity.
- Furnished with covers.
- General purpose wiring.
- Union hubs permit easy wiring.
- Externally threaded body with internally threaded cover.
- Smooth, rounded integral bushing in each hub type box protects conductor insulation.

### Standard Materials

- GRUT and GRUSE bodies and covers: malleable iron
- GRUSE body and cover: copper free (4/10 of 1% max) aluminum.

### Standard Finishes



- Bodies and covers: triple-coat — (1) zinc electroplate, (2) chromate, and (3) epoxy powder coat

### NEC Certifications and Compliances

- UL Standard: UL 886 (UL 1203)
- UL Listed: E85310
- CSA Standard: C22.2 No. 25, C22.2 No. 30
- CSA Certified: 013017

Appleton®

ENCLOSURES AND JUNCTION BOXES: NEC/CEC EXPLOSIONPROOF OUTLET BOXES

	Box Type	Conduit Size (Inches)	Cover Opening mm (in)	Capacity dm <sup>3</sup> (in <sup>3</sup> )	Catalog Number	
					Malleable Iron	Aluminum
<b>GRU with Union Hubs</b>						
<i>GRUT 1/2" thru 1" and GRUSE 1/2" thru 3/4" — Malleable iron externally threaded body complete with internally threaded malleable iron surface cover.</i>						
<i>GRUSE 1" — Copper free aluminum cover and body with externally threaded cover.</i>						
 <b>GRUT100</b>	GRUT	1/2	82.6 (3.25)	0.31 (19.0)	<b>GRUT50</b>	—
		3/4	82.6 (3.25)	0.31 (19.0)	<b>GRUT75</b>	—
		1	82.6 (3.25)	0.31 (19.0)	<b>GRUT100</b>	—
 <b>GRUSE100</b>	GRUSE	1/2	82.6 (3.25)	0.31 (19.0)	<b>GRUSE50</b>	—
		3/4	82.6 (3.25)	0.31 (19.0)	<b>GRUSE75</b>	—
		1	95.3 (3.75)	0.48 (29.0)	—	<b>GRUSE100</b>
<b>GRU Covers</b>						
<i>Malleable iron with internal threads. For GRUT and GRUSE listed above. Do not use with GRUSE100.</i>						
	Surface			0.05 (3.25)	<b>GRUK-S</b>	—
	Surface for GRUSE100 only			0.05 (3.25)	<b>GRK-1</b>	<b>GRUK-S</b>



# GRU Conduit Outlet Boxes with Union Hubs

## Explosionproof, Dust-Ignitionproof

UNILETS™ for use with Threaded Metal Conduit. Furnished with Internal Ground Screw.

**NEC/CEC:**

Class I, Division 1 and 2, Groups C, D  
 Class II, Division 1 and 2, Groups E, F, G  
 Class III

**Dimensions in Millimeters (Inches)**

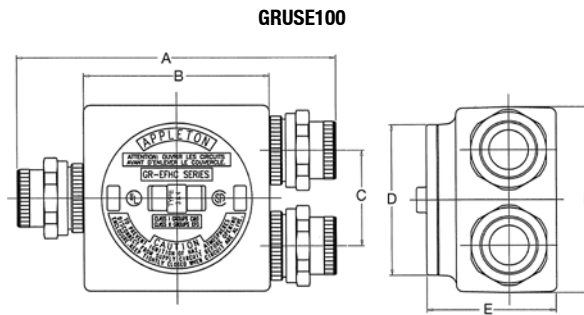
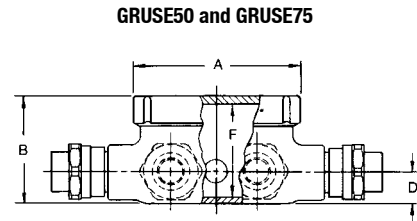
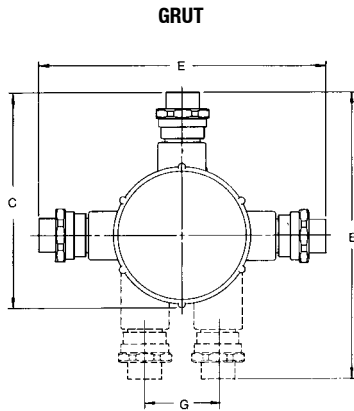

Hub Size (Inches)	Dimensions in Millimeters (Inches)						
	A	B	C	D	E	F	G
<b>GRUT</b>							
1/2	106.4 (4.19)	68.3 (2.69)	158.8 (6.25)	19.1 (0.75)	209.6 (8.25)	58.7 (2.31)	—
3/4	106.4 (4.19)	68.3 (2.69)	158.8 (6.25)	19.1 (0.75)	209.6 (8.25)	58.7 (2.31)	—
1	106.4 (4.19)	68.3 (2.69)	165.1 (6.50)	23.9 (0.94)	222.3 (8.75)	58.7 (2.31)	—
<b>GRUSE50 and GRUSE75</b>							
1/2 and 3/4	106.4 (4.19)	65.0 (2.56)	155.7 (6.13)	23.9 (0.94)	203.2 (8.00)	55.6 (2.19)	54.1 (2.13)
<b>GRUSE100</b>							
—	203.2 (8.00)	117.6 (4.63)	60.5 (2.38)	95.3 (3.75)	88.4 (3.48)	117.6 (4.63)	—

# GUBB, GUBBD and GUBBM Cast Junction Boxes

## Explosionproof, Dust-Ignitionproof

UNILETS™ for Use with Threaded Metal Conduit.

### NEC/CEC — GUBB:

Class I, Division 1 and 2, Groups B, C, D  
Class II, Division 1 and 2, Groups E, F, G  
Class III  
NEMA 3, 3R, 4, 7BCD, 9EFG

### NEC/CEC — GUBBD:

Class I, Division 1 and 2, Group D  
Class II, Division 1 and 2, Groups E, F, G  
Class III  
NEMA 3, 3R, 4

### NEC/CEC — GUBBM:

Class I, Division 1 and 2, Group D  
Class II, Division 1 and 2, Groups E, F, G  
Class III  
NEMA 3, 3R, 4

### Applications

- Explosionproof and dust-ignitionproof, for use in classified locations.
- Corrosion-resistant: ideal indoors or outdoors.
- Junction or pull box for pulling and splicing of wires and as an enclosure for electrical devices.
- Ideal where number and size of conductors require a junction box with additional space.

### Features

- All GUBB/GUBBD/GUBBM Series Boxes
  - Provided with mounting lugs.
  - Furnished with covers.
  - All conduit hubs and openings provide a minimum of five full threads to meet UL requirements.
  - Accurately tapped, tapered conduit threads provide tight, rigid joints and ground continuity.
- GUBB Series
  - Wide selection of sizes and locations for drilled and tapped conduit openings.
  - Suitable for use as an enclosure for relays, instrument and other control apparatus in classified locations.
  - Available in high tensile strength malleable iron or copperfree aluminum bodies.
  - Provided with mounting lugs.
  - O-rings standard for forms 1, 2 and 3 to provide raintight fit.
- GUBBD Series (Dome and Plate)
  - GUBB junction boxes with dome cover and mounting plate provide flexibility for a wide variety of applications.
  - Ideal for housing relays, contactors, terminal blocks and other classified area applications.
  - Mounting plate can be drilled to accommodate a variety of devices.
  - Dome cover has nominal depth of 152 mm (6") or 431 mm (17"), depending upon box selected. Provides significant increase in cubic inch capacity.
  - O-rings standard to provide raintight fit.
  - Provided with mounting lugs.
- GUBBM Series (Instrument)
  - GUBBM junction boxes serve as an enclosure for meters, gauges and similar devices.
  - Complete with round, explosionproof glass window cover. Permits direct reading of enclosed instrument.
  - Furnished with one 3/4" drilled and tapped entry.
  - Mounted bosses provided in back of GUBBM can be drilled and tapped for fastening of instrument mounting bracket.
  - O-rings standard to provide raintight fit.
  - Provided with mounting lugs.

### Standard Materials

- GUBB bodies: copperfree (4/10 of 1% max.) aluminum or malleable iron bodies
- GUBBD bodies: malleable iron bodies
- GUBB, GUBBD covers: copperfree (4/10 of 1% max.) aluminum
- GUBBM bodies: copperfree (4/10 of 1% max.) aluminum
- GUBBM covers: copperfree (4/10 of 1% max.) aluminum and glass
- O-ring: neoprene



GUBB



GUBBM  
Instrument Box



GUBBD  
Dome Cover

### Standard Finishes

- GUBB malleable iron bodies: triple-coat — (1) zinc electroplate, (2) chromate, and (3) epoxy powder coat.
- GUBB aluminum covers and aluminum bodies: epoxy powder coat

### Options

- GUBB
  - Less cover, add suffix —**LC**.
  - Terminal blocks. Information provided upon request.
- Instrument mounting plate and bracket for GUBBM. Information provided upon request (submit complete dimensions of instrument to be used).

### NEC/CEC Certifications and Compliances

- UL Standard: UL 886 (UL 1203)
- UL Listed: E85310
- CSA Standard: C22.2 No. 25, C22.2 No. 30
- CSA Certified: 025875

# GUBB Blank Body Cast Junction Boxes

## Explosionproof, Dust-Ignitionproof

Drilling and tapping ordering information.

### NEC/CEC:

Class I, Division 1 and 2, Groups B, C, D  
 Class II, Division 1 and 2, Groups E, F, G  
 Class III  
 NEMA 3, 3R, 4, 7BCD, 9EFG

Determine catalog number as follows: (1) select GUBB junction box catalog number; (2) select "Conduit Opening Arrangement Diagram" number; and (3) select symbols that represent conduit opening sizes from "Symbol Table."

Where no opening is required, the symbol 0 must be inserted. Add suffix for other Optional Features. The various divisions of the complete catalog number should be separated by dashes.

### Example

The junction box selected is GUBB-33 and the "Conduit Opening Arrangement Diagram" is diagram #1. Opening "a" is to be 3/4", "b", no opening required; "c", 2"; and "d", 1-1/4".

In this example, the complete catalog number is

**GUBB-33-1-BOFD**

Standard Conduit Opening Arrangement Diagrams

Opening "a" is always TOP of box

### Standard Conduit Opening Arrangement Diagrams

Opening "a" is always TOP of box. All conduit openings will be located in centerline of walls and evenly spaced unless otherwise specified.

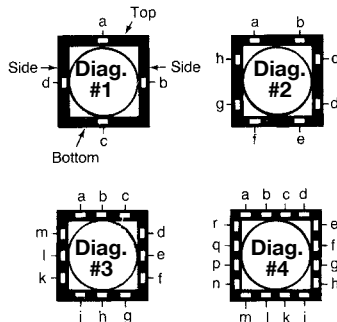

If a "Standard Conduit Opening Arrangement" is not suitable for the application, or when openings are to be more accurately spaced, submit sketch, locating openings (1) from centerlines of box and (2) from outside back of box (or from mounting lug surface if lugs are supplied).

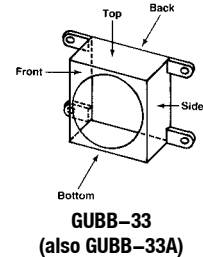
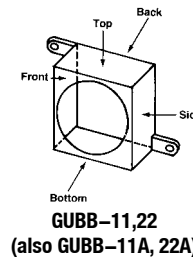

### Symbol Table

Drilling and Tapping (Five Threads Minimum)

Conduit Size Inches	Symbol	Conduit Size Inches	Symbol
0	Blank	-	-
1/2	A	2	F
3/4	B	2-1/2	G
1	C	3	H
1-1/4	D	3-1/2	J
1-1/2	E	4	K

### Minimum Recommended Spacing Between Conduit Openings

Allowance made for clearance over bushings. When unions or seals are used, additional space must be allowed.

Table shows minimum distances between conduit-opening centerlines in various size combinations. For example, if 1-1/2" and 3/4" openings are to be drilled and tapped into one side of box, the minimum spacing between centerlines would be 2.13".

Conduit Size Inches	Minimum Space Between Conduit Opening Centerlines in Millimeters (Inches)									
	1/2	3/4	1	1-1/4	1-1/2	2	2-1/2	3	3-1/2	4
1/2	31.8 (1.25)									
3/4	35.1 (1.38)	38.1 (1.50)								
1	39.6 (1.56)	42.9 (1.69)	47.8 (1.88)							
1-1/4	47.8 (1.88)	50.8 (2.00)	55.6 (2.19)	62.0 (2.44)						
1-1/2	50.8 (2.00)	54.1 (2.13)	58.7 (2.31)	66.8 (2.63)	69.9 (2.75)					
2	60.5 (2.38)	63.5 (2.50)	68.3 (2.69)	74.7 (2.94)	79.5 (3.13)	87.4 (3.44)				
2-1/2	63.5 (2.50)	66.8 (2.63)	71.4 (2.81)	79.5 (3.13)	82.6 (3.25)	92.2 (3.63)	95.3 (3.75)			
3	73.2 (2.88)	76.2 (3.00)	81.0 (3.19)	87.4 (3.44)	92.2 (3.63)	100.1 (3.94)	104.9 (4.13)	112.8 (4.44)		
3-1/2	79.5 (3.13)	82.6 (3.25)	87.4 (3.44)	95.3 (3.75)	98.6 (3.88)	108.0 (4.25)	111.3 (4.38)	120.7 (4.75)	127.0 (5.00)	
4	87.4 (3.44)	90.4 (3.56)	95.3 (3.75)	103.1 (4.06)	106.4 (4.19)	115.8 (4.56)	119.1 (4.69)	128.5 (5.06)	134.9 (5.31)	143.0 (5.63)

# GUBB Blank Body Cast Junction Boxes

## Explosionproof, Dust-Ignitionproof

Drilling and tapping ordering information.

**NEC/CEC:**

Class I, Division 1 and 2, Groups B, C, D

Class II, Division 1 and 2, Groups E, F, G

Class III

NEMA 3, 3R, 4, 7BCD, 9EFG

ENCLOSURES AND JUNCTION BOXES: NEC/CEC EXPLOSIONPROOF ENCLOSURES

### Diameters of Bushings, Unions, Conduit and Seals (in Millimeters (Inches))

Conduit Size Inches	Diameters of fittings for 1/2 through 4" conduit									
	1/2	3/4	1	1-1/4	1-1/2	2	2-1/2	3	3-1/2	4
BBU Bushing	26.9 (1.06)	33.3 (1.31)	39.6 (1.56)	49.3 (1.94)	55.6 (2.19)	68.3 (2.69)	81.0 (3.19)	98.6 (3.88)	111.3 (4.38)	124.0 (4.88)
BU Bushing	28.7 (1.13)	31.8 (1.25)	41.4 (1.63)	52.3 (2.06)	58.7 (2.31)	74.7 (2.94)	82.6 (3.25)	98.6 (3.88)	115.8 (4.56)	128.5 (5.06)
UNY-UNF (R) Union	38.1 (1.50)	44.5 (1.75)	50.8 (2.00)	71.4 (2.81)	77.7 (3.06)	95.3 (3.75)	125.5 (4.94)	138.2 (5.44)	150.9 (5.94)	165.1 (6.50)
Conduit	22.4 (0.88)	26.9 (1.06)	35.1 (1.38)	42.9 (1.69)	49.3 (1.94)	60.5 (2.38)	73.2 (2.88)	88.9 (3.50)	101.6 (4.00)	114.3 (4.50)
EYM-EYF Seals T.R. ①	26.9 (1.06)	30.2 (1.19)	35.1 (1.38)	44.5 (1.75)	52.3 (2.06)	58.7 (2.31)	68.3 (2.69)	79.5 (3.13)	87.4 (3.44)	93.7 (3.69)

### Wall Thickness and Maximum Conduit Size (in Millimeters (Inches))

Box Type	Top, Bottom and Sides		Back	
	Wall Thickness	Maximum Conduit Size	Wall Thickness	Maximum Conduit Size
GUBB-11, GUBB-11A	11.2 (0.44)	2	11.2 (0.44)	2
GUBB-22, GUBB-22A	11.2 (0.44)	2	16.0 (0.63)	4
GUBB-33, GUBB-33A	16.0 (0.63)	2	20.6 (0.81)	4

① T.R. is turning radius.

# GUBB Cast Junction Boxes for Drilling and Tapping

## Explosionproof, Dust-Ignitionproof

Drilled and tapped openings from 1/2" thru 4" as specified.

### NEC/CEC:

Class I, Division 1 and 2, Groups B♦, C♦, D

Class II, Division 1 and 2, Groups E, F, G

Class III

NEMA 3, 3R, 4, 7BCD, 9EFG

	Size L x W x D mm (in)	Cover Opening mm (in)	Form Number	Volume dm <sup>3</sup> (in <sup>3</sup> )	Catalog Number	
					Malleable Iron ①	Aluminum ①
	177.8 x 165.1 x 171.5 (7.00 x 6.50 x 6.75)	136.7 (5.38)	1	2.0 (120)	<b>GUBB-11</b>	<b>GUBB-11A</b>
	254.0 x 203.2 x 174.8 (10.00 x 8.00 x 6.88)	182.6 (7.19)	2	3.7 (224)	<b>GUBB-22</b>	<b>GUBB-22A</b>
	304.8 x 304.8 x 196.9 (12.00 x 12.00 x 7.75)	246.1 (9.69)	3	7.5 (455)	<b>GUBB-33</b>	<b>GUBB-33A</b>

### Class I, Division 1 Sealing Requirements

Box	Group	Seals Required ♦
GUBB	B, C ♦	Yes
GUBB	D	No

Catalog Number	Mounting Lugs
GUBB-11, 11A	2
GUBB-22, 22A	2
GUBB-33, 33A	4

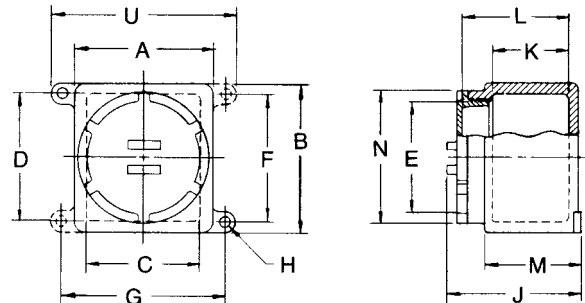

Catalog Number	Dimensions in Millimeters (Inches)													
	A	B	C	D	E	F	G	H	J	K <sup>②</sup>	L	M	N	U
GUBB-11	165.1	177.8	139.7	150.9	163.7	152.4	196.9	12.7	171.5	93.7	133.4	117.6	158.8	222.3
GUBB-11A	(6.50)	(7.00)	(5.50)	(5.94)	(5.38)	(6.00)	(7.75)	(0.50)	(6.75)	(3.69)	(5.25)	(4.63)	(6.25)	(8.75)
GUBB-22	203.2	254.0	181.1	228.6	182.6	228.6	235.0	12.7	174.8	88.9	133.4	117.6	203.2	260.4
GUBB-22A	(8.00)	(10.00)	(7.13)	(9.00)	(7.19)	(9.00)	(9.25)	(0.50)	(6.88)	(3.50)	(5.25)	(4.63)	(8.00)	(10.25)
GUBB-33	304.8	304.8	273.1	273.1	246.1	254.0	333.5	16.0	196.9	100.0	146.1	136.7	279.4	365.3
GUBB-33A	(12.00)	(12.00)	(10.75)	(10.75)	(9.69)	(10.00)	(13.13)	(0.63)	(7.75)	(3.94)	(5.75)	(5.38)	(11.00)	(14.38)

① Malleable iron and aluminum boxes furnished with aluminum cover.

② Inside dimensions.

♦ Sealing fitting must be installed within 2" of each conduit entrance (max. conduit for Group B and C is 2"). Seals not required in Class I, Division 2 areas provided there are no arcing or sparking devices in the box.

# GUBBM Instrument Enclosures



## Explosionproof, Dust-Ignitionproof

GUBBM: Furnished with one 3/4" threaded conduit opening. Aluminum body with aluminum/glass cover.

**NEC/CEC:**

Class I, Division 1 and 2, Group D  
 Class II, Division 1 and 2, Groups E, F, G  
 Class III  
 NEMA 3, 3R, 4

ENCLOSURES AND JUNCTION BOXES: NEC/CEC EXPLOSIONPROOF ENCLOSURES

	Type Box	Conduit Opening Size (Inches-NPT)	Cover Opening mm (in)	Wall Thickness mm (in)	Form Number	Catalog Number
	GUBB-11A	3/4	136.7 (5.38)	11.2 (0.44)	1	<b>GUBBM-1A</b>
	GUBB-22A	3/4	182.6 (7.19)	11.2 (0.44)	2	<b>GUBBM-2A</b>
	GUBB-33A	3/4	246.1 (9.69)	14.2 (0.56)	3	<b>GUBBM-3A</b>

Other drilled and tapped conduit opening arrangements and sizes available in addition to the one 3/4" conduit opening provided.  
 GUBB Cast Junction Boxes for Drilling and Tapping Blank Body Ordering Information  
 For Covers and Mounting Plates, Order from GUBB Surface and Special Purpose Covers page.

Appleton

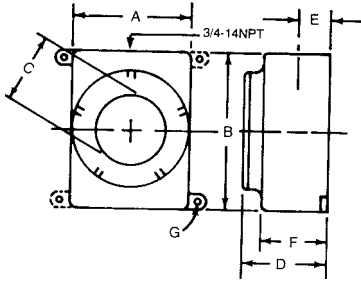
	Type Box	Mounting Lugs	Dimensions in Millimeters (Inches)						
			A	B	C	D	E	F	G
	GUBBM-1A	2	165.1 (6.50)	177.8 (7.00)	79.5 (3.13)	143.0 (5.63)	52.3 (2.06)	117.6 (4.63)	12.7 (0.50)
	GUBBM-2A	2	203.2 (8.00)	254.0 (10.00)	120.7 (4.75)	143.0 (5.63)	52.3 (2.06)	117.6 (4.63)	12.7 (0.50)
	GUBBM-3A	4	304.8 (12.00)	304.8 (12.00)	174.8 (6.88)	227.1 (8.94)	88.9 (3.50)	136.7 (5.38)	16.0 (0.63)



# GUBBD Cast Boxes With Dome Cover and Mounting Plate

## Explosionproof, Dust-Ignitionproof

Malleable iron junction boxes furnished with aluminum cover. For drilling and tapping.

### NEC/CEC:

Class I, Division 1 and 2, Group D  
Class II, Division 1 and 2, Groups E, F, G  
Class III  
NEMA 3, 3R, 4

	Nominal Cover Depth mm (in)	Width of Mounting Plate mm (in)	Adjustment mm (in) ①	Form Number	Catalog Number
 Cover removed, showing mounting plate	254.0 (10.00)	88.9 (3.50)	25.4 (1.00)	1	GUBBD-1-10
	152.4 (6.00)				GUBBD-2-6
 Body with dome cover	304.8 (12.00)	124.0 (4.88)	38.1 (1.50)	2	GUBBD-2-12
	152.4 (6.00)				GUBBD-3-6
	304.8 (12.00)	158.8 (6.25)	54.1 (2.13)	3	GUBBD-3-12
	431.8 (17.00)				GUBBD-3-17

### Dimensions in Millimeters (Inches)

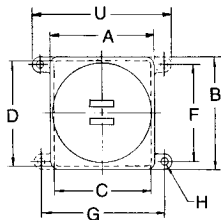

GUBBD-1 (2 Lugs), GUBBD-2 (2 Lugs), GUBBD-3 (4 Lugs)

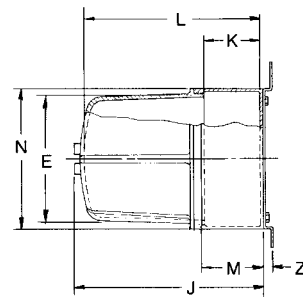

All Types

Catalog Number	Dimensions in Millimeters (Inches)													
	A	B	C ②	D ②	E	F	G	H	J	K ②	L ②	M	N	U
GUBBD-1-10	165.1 (6.50)	177.8 (7.00)	153.9 (6.06)	166.6 (6.56)	136.7 (5.38)	152.4 (6.00)	196.9 (7.75)	12.7 (0.50)	409.7 (16.13)	95.3 (3.75)	374.7 (14.75)	117.6 (4.63)	41.0 (6.25)	222.3 (8.75)
GUBBD-2-6	203.2 (8.00)	254.0 (10.00)	192.0 (7.56)	242.8 (9.56)	182.6 (7.19)	228.6 (9.00)	235.0 (9.25)	12.7 (0.50)	309.6 (12.19)	96.8 (3.81)	273.1 (10.75)	117.6 (4.63)	77.1 (8.06)	260.4 (10.25)
GUBBD-2-12	203.2 (8.00)	254.0 (10.00)	192.0 (7.56)	242.8 (9.56)	182.6 (7.19)	228.6 (9.00)	235.0 (9.25)	12.7 (0.50)	462.0 (18.19)	96.8 (3.81)	425.5 (16.75)	117.6 (4.63)	77.1 (8.06)	260.4 (10.25)
GUBBD-3-6	304.8 (12.00)	304.8 (12.00)	289.1 (11.38)	289.1 (11.38)	246.1 (9.69)	254.0 (10.00)	333.5 (13.13)	16.0 (0.63)	350.8 (13.81)	111.3 (4.38)	293.6 (11.56)	136.7 (5.38)	125.2 (11.00)	365.3 (14.38)
GUBBD-3-12	304.8 (12.00)	304.8 (12.00)	289.1 (11.38)	289.1 (11.38)	246.1 (9.69)	254.0 (10.00)	333.5 (13.13)	16.0 (0.63)	503.2 (19.81)	111.3 (4.38)	446.0 (17.56)	136.7 (5.38)	125.2 (11.00)	365.3 (14.38)
GUBBD-3-17	304.8 (12.00)	304.8 (12.00)	289.1 (11.38)	289.1 (11.38)	246.1 (9.69)	254.0 (10.00)	333.5 (13.13)	16.0 (0.63)	642.9 (25.31)	111.3 (4.38)	585.7 (23.06)	136.7 (5.38)	125.2 (11.00)	365.3 (14.38)

① Mounting plate is adjustable. May be centered or located to one side.

② Inside dimensions.



# GUBB/GUBBD/GUBBM Cast Junction Box Covers

## Explosionproof, Dust-Ignitionproof

Covers provide raintight fit when used with O-rings. Available in malleable iron, aluminum, and aluminum/glass.

NEC/CEC:  
 Class I, Division 1 and 2, Group D  
 Class II, Division 1 and 2, Groups E, F, G  
 Class III  
 NEMA 3, 3R, 4

ENCLOSURES AND JUNCTION BOXES: NEC/CEC EXPLOSIONPROOF ENCLOSURES

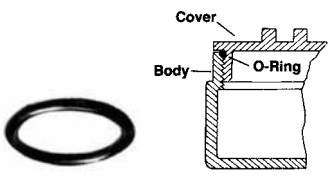
		Fits Box Catalog Number	Nominal Cover Depth mm (in)	Nominal Cover Diameter mm (in)	Window Diameter mm (in)	Form Number	Catalog Number
<b>Covers — Aluminum — O-ring Gasket Included</b>							
 <p>GUBK-1, GUBK-2      GUBK-3</p>	GUBB-11 (11A)		Surface	136.7 (5.38)	53.8 (2.12)	1	<b>GUBK-1</b>
	GUBB-22 (22A)		Surface	182.6 (7.19)	120.7 (4.75)	2	<b>GUBK-2</b>
	GUBB-33 (33A)		Surface	246.1 (9.69)	177.8 (7.00)	3	<b>GUBK-3</b>
<b>Instrument Box Covers — Aluminum and Glass</b>							
 <p>GUBMK-1, GUBMK-2      GUBMK-3</p>	GUBB-11 (11A)		—	136.7 (5.38)		1	<b>GUBMK-1</b>
	GUBB-22 (22A)		—	182.6 (7.19)		2	<b>GUBMK-2</b>
	GUBB-33 (33A)		—	246.1 (9.69)		3	<b>GUBMK-3</b>
<b>Dome Covers for GUBB Boxes — Aluminum — O-ring Gasket Included</b>							
	GUBB-11 (11A)		254.0 (10.00)	136.7 (5.3)		1	<b>GUBK-1-10</b>
	GUBB-22 (22A)		152.4 (6.00)	182.6 (7.19)		2	<b>GUBK-2-6</b>
	GUBB-22 (22A)		304.8 (12.00)	182.6 (7.19)		2	<b>GUBK-2-12</b>
	GUBB-33 (33A)		152.4 (6.00)	246.1 (9.69)		3	<b>GUBK-3-6</b>
	GUBB-33 (33A)		304.8 (12.00)	246.1 (9.69)		3	<b>GUBK-3-12</b>
	GUBB-33 (33A)		431.8 (17.00)	246.1 (9.69)		3	<b>GUBK-3-17</b>
<b>Replacement O-rings — Neoprene</b>							
	Provide raintight fit for GUBB, GUBBM and GUBBD Boxes						
	GUBB-11 (11A)					1	<b>GUBG-1</b>
	GUBB-22 (22A)					2	<b>GUBG-2</b>
	GUBB-33 (33A)					3	<b>GUBG-3</b>
<b>Mounting Plates — 3.3 mm (0.13") Thick Aluminum. 4 standoffs, 4 mounting screws</b>							
	GUBB-11 (11A) ①			114.3 x 114.3 (4.50 x 4.50)		1	<b>GUBBMP-11</b>
	GUBB-22 (22A) ①			165.1 x 165.1 (6.50 x 6.50)		2	<b>GUBBMP-22</b>
	GUBB-33 (33A) ①			228.6 x 228.6 (9.00 x 9.00)		3	<b>GUBBMP-33</b>

① GUBB boxes are Pre-Drilled to accept a mounting plate.



# DER, GUB and GUBM Cast Junction Boxes

## Explosionproof, Dust-Ignitionproof, Watertight

Furnished with surface cover and mounting lugs.

### CEC:

Class I, Division 1 and 2, Groups A, B, C, D

Class I, Zone 1 and 2

Class II, Division 1 and 2, Groups E, F, G

Class III, Enclosure 4

### Applications

- Explosionproof and dust-ignitionproof for use in classified locations.
- Corrosion-resistant: ideal indoors or outdoors.
- Junction or pull box for pulling and splicing of wires and as an enclosure for electrical devices.
- Ideal where number and size of conductors require a junction box with additional space.

### Features

- Provided with mounting lugs.
- Furnished with covers.
- All conduit hubs and openings provide a minimum of five full threads to meet CSA requirements.
- Accurately tapped, tapered conduit threads provide tight, rigid joints and ground continuity.
- DER and GUB Series
  - Wide selection of sizes and locations for drilled and tapped conduit openings.
  - Suitable for use as an enclosure for relays, instrument and other control apparatus in classified locations.
  - Available in high tensile strength malleable iron or copperfree aluminum bodies.
- GUBM Series (Instrument)
  - GUBM junction boxes serve as an enclosure for meters, gauges and similar devices.
  - Complete with round, explosionproof glass window cover. Permits direct reading of enclosed instrument.
  - Furnished with one 3/4" drilled and tapped entry.
  - Mounting bosses are provided in the bottom of GUBM can be drilled and tapped for fastening of instrument mounting bracket.
- Surface covers furnished with DER and GUB junction boxes have lugs to take a bar or wrench. Other style covers, as listed below, are available.
- Sealing covers have a plugged hole through which the box can be filled with sealing cement after installation. See *Fittings Section* for information regarding sealing cement. Note: When sealing covers are used, splices or taps within the Unilets are prohibited by the CEC.
- Dome covers permit conductors to be pulled in with the ends extending well out beyond box body where splices can easily be made. The splices need not be crowded back into the box, but can be left as is when dome cover is used for their enclosure and protection.

### Standard Materials

- Bodies: copperfree (4/10 of 1% max.) aluminum or malleable iron bodies
- DER and GUB covers: copperfree (4/10 of 1% max.) aluminum
- GUBM covers: copperfree (4/10 of 1% max.) aluminum and glass



DER1C

GUB2C



GUBM-2C

### Options

- Other hub arrangements and sizes are available. Contact your local representative for details.
- Other means of instrument fastening are available. Contact your local representative for details.
- Instrument mounting plates or brackets can be furnished. On receipt of complete instrument dimensions, prices will be quoted. Contact your local representative for details.
- To order DER1C or DER1CA without mounting lugs add suffix **-LF**.

### CEC Certifications and Compliances

- CSA Standard: C22.2 No. 25, C22.2 No. 30
- CSA Certified: 013017

# DER, GUB and GUBM Cast Junction Boxes

Explosionproof, Dust-Ignitionproof, Watertight.

Furnished with surface cover and mounting lugs.

**CEC:**

- Class I, Division 1 and 2, Groups A, B, C, D
- Class I, Zone 1 and 2
- Class II, Division 1 and 2, Groups E, F, G
- Class III, Enclosure 4

ENCLOSURES AND JUNCTION BOXES: NEC/CEC EXPLOSIONPROOF ENCLOSURES

**Ordering Information**

**Determining Catalog Numbers**

- To determine the catalog number of junction boxes with entries, the following information should be shown:
  - 1) Junction box catalog number from listings on the following pages
  - 2) Sketch number of hub arrangement selected from the illustration below.
  - 3) Entry symbols taken from the table shown below. Start from the left (at Hub "A") on the top of the junction box and continue in rotation clockwise around its body. Where no entry is required, the symbol X should be inserted. The three various divisions of the catalog number should be separated by dashes.

**Example mm (in)**

GUB2C junction box is required with threaded conduit entries and unions. The arrangement of entries is per sketch #16.

- A — is to be 50.8 (2.00) drilled and tapped entry
- B — 31.8 (1.25)
- C — Blank (no entry)
- D — 50.8 (2.00)
- E — Blank
- F — 25.4 (1.00)
- J — Blank

The catalog number is:

GUB2C-16-64X6X3X.

Unions are required at B and D.

Order UNY male unions from the Fittings Section of the catalog.

**Conduit Entry Symbols**

Drilling and Tapped or Threaded Hubs				Union Hubs (GUB4 only)			
Size mm (in)	Symbol	Size mm (in)	Symbol	Size mm (in)	Symbol	Size mm (in)	Symbol
12.7 (0.50)	1	50.8 (2.00)	6	12.7 (0.50)	1E	50.8 (2.00)	6E
19.1 (0.75)	2	63.5 (2.50)	7	19.1 (0.75)	2E	63.5 (2.50)	7E
25.4 (1.00)	3	76.2 (3.00)	8	25.4 (1.00)	3E	76.2 (3.00)	8E
31.8 (1.25)	4	88.9 (3.50)	9	31.8 (1.25)	4E	88.9 (3.50)	9E
38.1 (1.50)	5	101.6 (4.00)	10	38.1 (1.50)	5E	101.6 (4.00)	10E

Appleton®

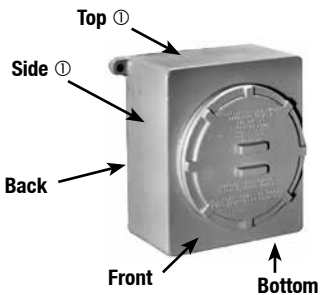
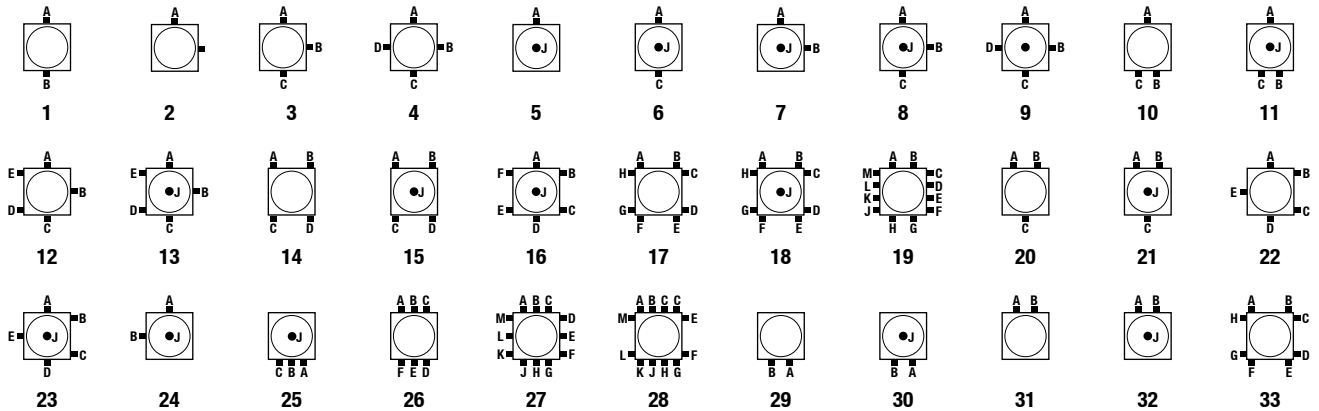

Send sketch and description for other arrangements.

① GUB2C shown. Top and bottom measures 235.0 mm x 139.7 mm (9.25" x 5.25") and sides measure 269.9 mm x 139.7 mm (10.63" x 5.50").

# DER, GUB and GUBM Cast Junction Boxes

## Explosionproof, Dust-Ignitionproof, Watertight

Furnished with surface cover and mounting lugs.

### CEC:





Class I, Division 1 and 2, Groups A, B, C, D

Class I, Zone 1 and 2

Class II, Division 1 and 2, Groups E, F, G

Class III, Enclosure 4

### DER and GUB Junction Boxes

		Dimensions in Millimeters (Inches)		Catalog Number	
		Outside	Cover Dia.	Ferrous Alloy	Aluminum
		130.3 x 130.3 x 103.1 (5.13 x 5.13 x 4.06)	98.8 (3.88)	DER1C ①	DER1CA ①
<b>DER1C</b>	<b>GUB1C</b>	177.8 x 177.8 x 165.1 (7.00 x 7.00 x 6.50)	136.7 (5.38)	<b>GUB1C</b>	<b>GUB1CA</b>
		270.0 x 235.0 x 171.5 (10.63 x 9.25 x 6.75)	182.6 (7.19)	<b>GUB2C</b>	<b>GUB2CA</b>
<b>GUB2C</b>	<b>GUB3C</b>	316.0 x 316.0 x 214.4 (12.44 x 12.44 x 8.44)	249.2 (9.81)	<b>GUB3C</b>	<b>GUB3CA</b>

### Maximum Size and Number of Entries Supplied on Any One Side

Catalog Number	Dimensions in Millimeters (Inches)									
	12.7 (0.50)	19.1 (0.75)	25.4 (1.00)	31.8 (1.25)	38.1 (1.50)	50.8 (2.00)	63.5 (2.50)	76.2 (3.00)	88.9 (3.50)	101.6 (4.00)
<b>Drilled and Tapped - With Clearance for Conduit Seals</b>										
DER1C	3	2	2 ②	1 ②	—	—	—	—	—	—
GUB1C	4	4	4	2	2	1	—	—	—	—
GUB2C	4	4	4	3	3	2	2 ②	—	—	—
GUB3C	4	4	4	3	3	2	2	—	—	—
<b>With UNY Male Unions</b>										
DER1C	3	2	2 ②	1 ②	—	—	—	—	—	—
GUB1C	3	3	4	2	2	—	—	—	—	—
GUB2C	4	4	4	3	3	2	1 ②	—	—	—
GUB3C	4	4	4	3	3	2	1	—	—	—

### Maximum Entry in Back

GUB1C - 2"; GUB2C - 2"; GUB3C - 6"

① To order DER1C or DER1CA without mounting lugs add the suffix **-LF** to the catalog number.

② Requires pad. Available on special order, contact your local sales representative.

# DER, GUB and GUBM Cast Junction Boxes

## Explosionproof, Dust-Ignitionproof, Watertight

Furnished with surface cover and mounting lugs.

**CEC:**

- Class I, Division 1 and 2, Groups A, B, C, D
- Class I, Zone 1 and 2
- Class II, Division 1 and 2, Groups E, F, G
- Class III, Enclosure 4

ENCLOSURES AND JUNCTION BOXES: NEC/CEC EXPLOSIONPROOF ENCLOSURES



### GUBM Instrument Junction Boxes

		Type of Body	Mounting Lugs	Hub Size (Inches)	Cover Opening in Millimeters (Inches)	Catalog Number	
						Ferrous Alloy	Aluminum
	GUB-1C	GUB-1C	2	3/4	136.5 (5.38)	<b>GUBM-1C</b>	<b>GUBM-1CA</b>
	GUB-2C	GUB-2C	2	3/4	188.9 (7.44)	<b>GUBM-2C</b>	<b>GUBM-2CA</b>

### DER, GUB and GUBM Junction Box Covers

DER Form 1 and GR Form 2 have the same cover opening.

DER and GUB junction boxes are furnished with surface covers. Order the remaining below listed covers as follows: Specify junction box catalog number and the catalog number of the cover required from the listings below.  
 Example: GUB-2-16-64EX63E4EX, except with GUBK-2-6 dome cover.

		Type of Body	Type of Cover	Inside Diameter in Millimeters (Inches)	Catalog Number
	DER1C		Surface Covers	90.5 (3.56)	<b>GRK-2C</b>
	GUB1C			117.5 (4.63)	<b>GUBK-1C</b>
	GUB2C			158.8 (6.25)	<b>GUBK-2C</b>
	GUB3C			225.4 (8.88)	<b>GUBK-3C</b>
	DER1C		Sealing Covers	90.5 (3.56)	<b>GRK-2SC</b>

Appleton®

# DER, GUB and GUBM Cast Junction Boxes

## Explosionproof, Dust-Ignitionproof, Watertight

Furnished with surface cover and mounting lugs.

**CEC:**

- Class I, Division 1 and 2, Groups A, B, C, D
- Class I, Zone 1 and 2
- Class II, Division 1 and 2, Groups E, F, G
- Class III, Enclosure 4

### GUBM Dimensions in Millimeters (Inches)

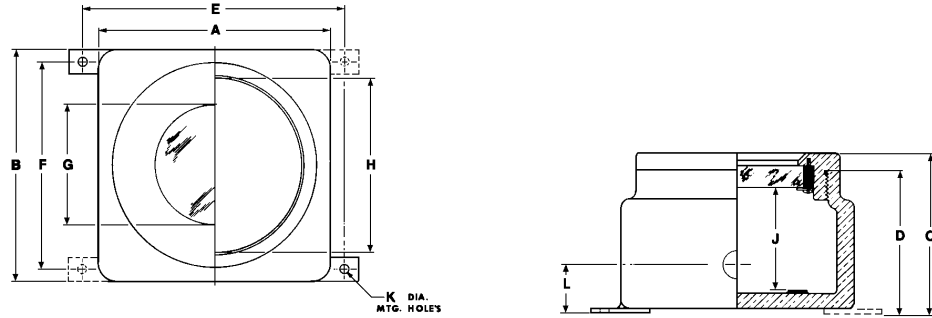

Catalog Number	Mounting Lugs	Dimensions in Millimeters (Inches)										
		A	B	C	D	E	F	G – Dia.	H – Dia.	J	K – Dia.	L
GUBM-1C	2	177.8 (7.00)	177.8 (7.00)	165.1 (6.50)	133.4 (5.25)	209.6 (8.25)	152.4 (6.00)	92.1 (3.63)	136.5 (5.38)	117.5 (4.63)	12.7 (0.50)	52.4 (2.06)
GUBM-2C	2	235.3 (9.27)	269.1 (10.59)	170.7 (6.72)	142.9 (5.63)	263.5 (10.38)	243.4 (9.59)	127.0 (5.00)	185.7 (7.31)	111.1 (4.38)	12.7 (0.50)	52.4 (2.06)

# DER, GUB and GUBM Cast Junction Boxes

## Explosionproof, Dust-Ignitionproof, Watertight

Furnished with surface cover and mounting lugs.

### CEC:

- Class I, Division 1 and 2, Groups A, B, C, D
- Class I, Zone 1 and 2
- Class II, Division 1 and 2, Groups E, F, G
- Class III, Enclosure 4

ENCLOSURES AND JUNCTION BOXES: NEC/CEC EXPLOSIONPROOF ENCLOSURES

### GUB Dimensions in Millimeters (Inches)

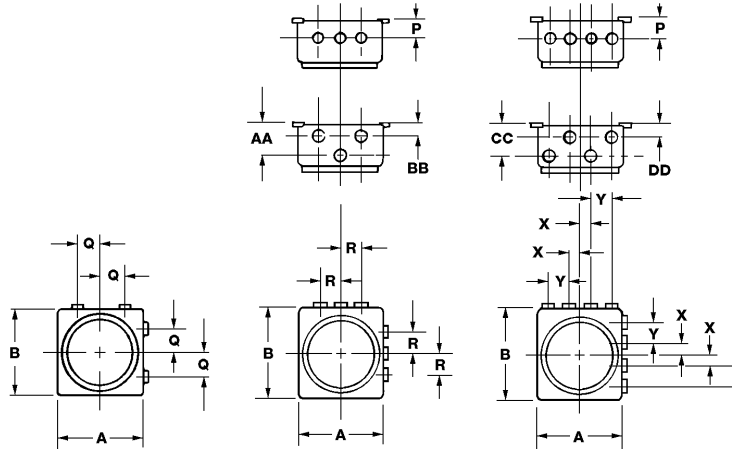

Type	Entry Size	Dimensions in Millimeters (Inches)									
		P	Q	R	X	Y	AA	BB	CC	DD	
Threaded Entries ①	DER1C	1/2	36.5 (1.44)	30.2 (1.19)	36.5 (1.44)	—	—	2	24.6 (0.97)	—	—
		3/4	36.5 (1.44)	30.2 (1.19)	—	—	—	—	—	—	—
		1 ①	36.5 (1.44) ①	30.2 (1.19) ①	—	—	—	—	—	—	—
		1-1/4 ①	36.5 (1.44) ①	—	—	—	—	—	—	—	—
Top or Bottom Side 9-1/4" x 5-1/2"	GUB1C	1/2	52.4 (2.06)	36.5 (1.44)	44.5 (1.75)	17.5 (0.69)	34.9 (1.38)	85.7 (3.38)	44.5 (1.75)	88.9 (3.50)	42.9 (1.69)
		3/4	52.4 (2.06)	36.5 (1.44)	44.5 (1.75)	17.5 (0.69)	34.9 (1.38)	85.7 (3.38)	44.5 (1.75)	88.9 (3.50)	42.9 (1.69)
		1	52.4 (2.06)	36.5 (1.44)	44.5 (1.75)	17.5 (0.69) ③	34.9 (1.38) ③	85.7 (3.38)	44.5 (1.75)	88.9 (3.50) ③	42.9 (1.69) ③
		1-1/4	52.4 (2.06)	36.5 (1.44)	—	—	—	—	—	—	—
		1-1/2	52.4 (2.06)	—	—	—	—	—	—	—	—
		2	63.5 (2.50)	—	—	—	—	—	—	—	—
Top or Bottom Side 9-1/4" x 5-1/2"	GUB2C	1/2	52.4 (2.06)	52.4 (2.06)	71.4 (2.81)	254 (1.00)	50.8 (2.00)	84.1 (3.31)	50.8 (2.00)	90.5 (3.56)	95.3 (3.75)
		3/4	52.4 (2.06)	52.4 (2.06)	71.4 (2.81)	254 (1.00)	50.8 (2.00)	84.1 (3.31)	50.8 (2.00)	90.5 (3.56)	95.3 (3.75)
		1	52.4 (2.06)	52.4 (2.06)	71.4 (2.81)	254 (1.00)	50.8 (2.00)	84.1 (3.31)	50.8 (2.00)	90.5 (3.56)	95.3 (3.75)
		1-1/4	52.4 (2.06)	52.4 (2.06)	71.4 (2.81)	—	—	84.1 (3.31)	50.8 (2.00)	—	—
		1-1/2	52.4 (2.06)	52.4 (2.06)	71.4 (2.81) ③	—	—	84.1 (3.31) ③	50.8 (2.00) ③	—	—
		2	66.8 (2.63)	57.2 (2.25)	—	—	—	—	—	—	—
		2-1/2 ①	66.8 (2.63) ①	57.2 (2.25) ①	—	—	—	—	—	—	—
Top or Bottom Side 9-1/4" x 5-1/2"	GUB3C	1/2	82.6 (3.25)	60.3 (2.38)	82.6 (3.25)	30.2 (1.19)	60.3 (2.38)	98.4 (3.88)	68.3 (2.69)	68.3 (2.69)	98.4 (3.88)
		3/4	82.6 (3.25)	60.3 (2.38)	82.6 (3.25)	30.2 (1.19)	60.3 (2.38)	98.4 (3.88)	68.3 (2.69)	68.3 (2.69)	98.4 (3.88)
		1	82.6 (3.25)	60.3 (2.38)	82.6 (3.25)	30.2 (1.19)	60.3 (2.38)	98.4 (3.88)	68.3 (2.69)	68.3 (2.69)	98.4 (3.88)
		1-1/4	82.6 (3.25)	60.3 (2.38)	82.6 (3.25)	—	—	98.4 (3.88)	68.3 (2.69)	—	—
		1-1/2	82.6 (3.25)	60.3 (2.38)	82.6 (3.25)	—	—	98.4 (3.88)	68.3 (2.69)	—	—
		2	82.6 (3.25)	60.3 (2.38)	—	—	—	—	—	—	—
		2-1/2	82.6 (3.25)	60.3 (2.38) ①	—	—	—	—	—	—	—
Left or Right Side 10-5/8" x 5-1/2"	GUB2C	1/2	52.4 (2.06)	52.4 (2.06)	71.4 (2.81)	254 (1.00)	50.8 (2.00)	84.1 (3.31)	50.8 (2.00)	90.5 (3.56)	44.5 (1.75)
		3/4	52.4 (2.06)	52.4 (2.06)	71.4 (2.81)	254 (1.00)	50.8 (2.00)	84.1 (3.31)	50.8 (2.00)	90.5 (3.56)	44.5 (1.75)
		1	52.4 (2.06)	52.4 (2.06)	71.4 (2.81)	254 (1.00)	50.8 (2.00)	84.1 (3.31)	50.8 (2.00)	90.5 (3.56)	44.5 (1.75)
		1-1/4	52.4 (2.06)	52.4 (2.06)	71.4 (2.81)	30.2 (1.19) ④	58.7 (2.31) ④	84.1 (3.31)	50.8 (2.00)	87.3 (3.44) ④	47.6 (0.88) ④
		1-1/2	52.4 (2.06)	52.4 (2.06)	79.4 (3.13)	—	—	84.1 (3.31)	50.8 (2.00)	—	—
		2	66.8 (2.63)	57.2 (2.25)	—	—	—	—	—	—	—

Caution: Dimensions between hub centres are for use with hubs of the same size. These dimensions will not necessarily hold true for a combination of hubs of extreme sizes. Please consult Engineering Dept. for special combinations of hubs.

① Dimensions permit assembly of seals on adjacent conduit runs.

② Requires pad. Available only on special order from factory.

③ Seals must be staggered for assembly on adjacent conduit runs.

④ Dimensions will not permit assembly of unions on adjacent conduit runs.

# AGUB and NGUB Instrument and Meter Enclosures

## Explosionproof, Dust-Ignitionproof

Furnished with aluminum body and solid or window cover.

### NEC/CEC:

Class I, Division 1 and 2, Groups B, C, D

Class II, Division 1 and 2, Groups E, F, G

Class III

NEMA 4, 4X, 7BCD, 9EFG

### Application

- To pull or splice wires and/or to mount and enclose electrical devices in hazardous locations.

### Features

- Precision threaded flame path between box and cover.
- O-ring gasket provided to seal out moisture, dust, oil, dirt etc. for interior and exterior locations.
- Cast mounting feet provided on all enclosures.
- Large cover opening for easy access.
- Available with solid or window covers.

### Standard Materials

- Bodies: copperfree (4/10 of 1% max.) aluminum
- AGUB and NGUB covers: copperfree (4/10 of 1% max.) aluminum
- AGUBSW and NGUBSW covers: copperfree (4/10 of 1% max.) aluminum and glass
- O-ring: neoprene

### Standard Finishes

- Corrosion resistant gray powder coat epoxy standard

### NEC/CEC Certifications and Compliances

- UL Standard: UL 886 (UL 1203)
- UL Listed: E85310
- CSA Standard: C22.2 No. 25, C22.2 No. 30
- CSA Certified: 020945
- cUL Listed: E84577



# AGUB and NGUB Instrument and Meter Enclosures

## Explosionproof, Dust-Ignitionproof. Drilling and Tapping

Furnished with aluminum body and solid or window cover.

### NEC/CEC:

Class I, Division 1 and 2, Groups B, C, D  
 Class II, Division 1 and 2, Groups E, F, G  
 Class III  
 NEMA 4, 4X, 7BCD, 9EFG

Determine catalog number as follows: (1) select enclosure catalog number; (2) select "Conduit Opening Arrangement Diagram" number; and (3) select symbols that represent conduit opening sizes from "Symbol Table."

Where no opening is required, the symbol 0 must be inserted. Add suffix for other Optional Features. The various divisions of the complete catalog number should be separated by dashes.

### Example

The junction box selected is AGUB443A and the "Conduit Opening Arrangement" is diagram #1. Opening "a" is to be 3/4"; "b", no opening required; "c", 2"; and "d", 1-1/4".

In this example, the complete catalog number is

### AGUB443A-1-BOFD

Standard Conduit Opening Arrangement Diagrams

Opening "a" is always TOP of box

If a "Standard Conduit Opening Arrangement" is not suitable for the application, or when openings are to be more accurately spaced, submit sketch, locating openings (1) from centerlines of box and (2) from outside back of box (or from mounting lug surface if lugs are supplied).

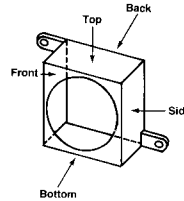

### Standard Conduit Opening Arrangement Diagrams

Opening "a" is always TOP of box. All conduit openings will be located in centerline of walls and evenly spaced unless otherwise specified.

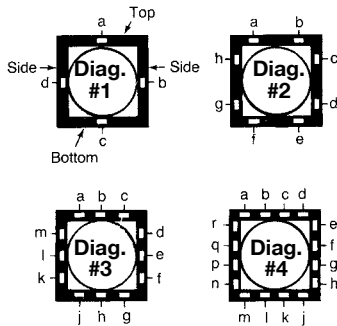

### Symbol Table

Drilling and Tapping (Five Threads Minimum)

Conduit Size Inches	Symbol	Conduit Size Inches	Symbol
0	Blank	-	-
1/2	A	2	F
3/4	B	2-1/2	G
1	C	3	H
1-1/4	D	3-1/2	J
1-1/2	E	4	K

### Minimum Recommended Spacing Between Conduit Openings

Allowance made for clearance over bushings. When unions or seals are used, additional space must be allowed.

Table shows minimum distances between conduit-opening centerlines in various size combinations. For example, if 1-1/2" and 3/4" openings are to be drilled and tapped into one side of box, the minimum spacing between centerlines would be 2.13".

Conduit Size Inches	Minimum Space Between Conduit Opening Centerlines in Millimeters (Inches)									
	1/2	3/4	1	1-1/4	1-1/2	2	2-1/2	3	3-1/2	4
1/2	31.8 (1.25)									
3/4	35.1 (1.38)	38.1 (1.50)								
1	39.6 (1.56)	42.9 (1.69)	47.8 (1.88)							
1-1/4	47.8 (1.88)	50.8 (2.00)	55.6 (2.19)	62.0 (2.44)						
1-1/2	50.8 (2.00)	54.1 (2.13)	58.7 (2.31)	66.8 (2.63)	69.9 (2.75)					
2	60.5 (2.38)	63.5 (2.50)	68.3 (2.69)	74.7 (2.94)	79.5 (3.13)	87.4 (3.44)				
2-1/2	63.5 (2.50)	66.8 (2.63)	71.4 (2.81)	79.5 (3.13)	82.6 (3.25)	92.2 (3.63)	95.3 (3.75)			
3	73.2 (2.88)	76.2 (3.00)	81.0 (3.19)	87.4 (3.44)	92.2 (3.63)	100.1 (3.94)	104.9 (4.13)	112.8 (4.44)		
3-1/2	79.5 (3.13)	82.6 (3.25)	87.4 (3.44)	95.3 (3.75)	98.6 (3.88)	108.0 (4.25)	111.3 (4.38)	120.7 (4.75)	127.0 (5.00)	
4	87.4 (3.44)	90.4 (3.56)	95.3 (3.75)	103.1 (4.06)	106.4 (4.19)	115.8 (4.56)	119.1 (4.69)	128.5 (5.06)	134.9 (5.31)	143.0 (5.63)



# AGUB and NGUB Instrument and Meter Enclosures

## Explosionproof, Dust-Ignitionproof

Furnished with aluminum body and solid or window cover.

### NEC/CEC:

Class I, Division 1 and 2, Groups B, C, D

Class II, Division 1 and 2, Groups E, F, G

Class III

NEMA 4, 4X, 7BCD, 9EFG

### Box with Cover

Inside Dimensions in Millimeters (Inches)			Maximum Conduit Size (In. – NPT)	Seal Distance in Millimeters (Inches)		Cover Opening in Millimeters (Inches)	Catalog Number	
Width	Height	Depth		Group B <sup>◇</sup>	Group C <sup>◇</sup>		Appleton	O–Z/Gedney
108.0 (4.25)	108.0 (4.25)	82.6 (3.25)	3/4	457.2 (18.00)	None	101.6 (4.00)	AGUB443A	NGUB443A
136.5 (5.38)	136.5 (5.38)	127 (5.00)	3/4	76.2 (3.00)	None	114.3 (4.50)	AGUB555A	NGUB555A
155.6 (6.13)	155.6 (6.13)	108.0 (4.25)	2	457.2 (18.00)	457.2 (18.00)	150.8 (5.94)	AGUB664A	NGUB664A
235.0 (9.25)	190.5 (7.50)	152.4 (6.00)	2	457.2 (18.00)	457.2 (18.00)	177.8 (7.00)	AGUB976A	NGUB976A
231.8 (9.13)	206.4 (8.13)	111.1 (4.38)	2	457.2 (18.00)	457.2 (18.00)	201.6 (7.94)	AGUB984A	NGUB984A
254.0 (10.00)	228.6 (9.00)	100.0 (3.94)	2	457.2 (18.00)	457.2 (18.00)	225.4 (8.88)	AGUB1093A	NGUB1093A
269.9 (10.63)	269.9 (10.63)	133.4 (5.25)	3	457.2 (18.00)	457.2 (18.00)	250.8 (9.88)	AGUB10105A	NGUB10105A
257.2 (10.13)	257.2 (10.13)	152.4 (6.00)	3	76.2 (3.00)	76.2 (3.00)	235.0 (9.25)	AGUB10106A	NGUB10106A
257.2 (10.13)	257.2 (10.13)	203.2 (8.00)	4	76.2 (3.00)	76.2 (3.00)	235.0 (9.25)	AGUB10108A	NGUB10108A
308.0 (12.13)	308.0 (12.13)	203.2 (8.00)	4	76.2 (3.00)	76.2 (3.00)	285.8 (11.25)	AGUB12128A	NGUB12128A
308.0 (12.13)	308.0 (12.13)	304.8 (12.00)	4	76.2 (3.00)	76.2 (3.00)	285.8 (11.25)	AGUB121212A	NGUB121212A



### Box with Window Cover

Inside Dimensions in Millimeters (Inches)			Maximum Conduit Size (In. – NPT)	Seal Distance in Millimeters (Inches)		Cover Opening in Millimeters (Inches)	Catalog Number	
Width	Height	Depth		Group B <sup>◇</sup>	Group C <sup>◇</sup>		Appleton	O–Z/Gedney
108.0 (4.25)	108.0 (4.25)	82.6 (3.25)	3/4	457.2 (18.00)	None	101.6 (4.00)	AGUBSW443A	NGUBSW443A
136.5 (5.38)	136.5 (5.38)	127 (5.00)	3/4	76.2 (3.00)	None	114.3 (4.50)	AGUBSW555A	NGUBSW555A
155.6 (6.13)	155.6 (6.13)	108.0 (4.25)	2	457.2 (18.00)	457.2 (18.00)	150.8 (5.94)	AGUBSW664A	NGUBSW664A
235.0 (9.25)	190.5 (7.50)	152.4 (6.00)	2	457.2 (18.00)	457.2 (18.00)	177.8 (7.00)	AGUBSW976A	NGUBSW976A
231.8 (9.13)	206.4 (8.13)	111.1 (4.38)	2	457.2 (18.00)	457.2 (18.00)	201.6 (7.94)	AGUBSW984A	NGUBSW984A
254.0 (10.00)	228.6 (9.00)	100.0 (3.94)	2	457.2 (18.00)	457.2 (18.00)	225.4 (8.88)	AGUBSW1093A	NGUBSW1093A
269.9 (10.63)	269.9 (10.63)	133.4 (5.25)	3	457.2 (18.00)	457.2 (18.00)	250.8 (9.88)	AGUBSW10105A	NGUBSW10105A
257.2 (10.13)	257.2 (10.13)	152.4 (6.00)	3	76.2 (3.00)	76.2 (3.00)	235.0 (9.25)	AGUBSW10106A	NGUBSW10106A
257.2 (10.13)	257.2 (10.13)	203.2 (8.00)	4	76.2 (3.00)	76.2 (3.00)	235.0 (9.25)	AGUBSW10108A	NGUBSW10108A
308.0 (12.13)	308.0 (12.13)	203.2 (8.00)	4	76.2 (3.00)	76.2 (3.00)	285.8 (11.25)	AGUBSW12128A	NGUBSW12128A
308.0 (12.13)	308.0 (12.13)	304.8 (12.00)	4	76.2 (3.00)	76.2 (3.00)	285.8 (11.25)	AGUBSW121212A	NGUBSW121212A



<sup>◇</sup> For Groups B and C, all conduits must be sealed within specified distance of enclosure.

# AGUB and NGUB Instrument and Meter Enclosures

## Explosionproof, Dust-Ignitionproof

Furnished with aluminum body and solid or window cover.

### NEC/CEC:

Class I, Division 1 and 2, Groups B, C, D  
 Class II, Division 1 and 2, Groups E, F, G  
 Class III  
 NEMA 4, 4X, 7BCD, 9EFG

ENCLOSURES AND JUNCTION BOXES: NEC/CEC EXPLOSIONPROOF ENCLOSURES

### Maximum Number of Drilled and Tapped Conduit Entries

Side	Trade Size of Conduit										Catalog Number
	1/2"	3/4"	1"	1-1/4"	1-1/2"	2"	2-1/2"	3"	3-1/2"	4"	
Long	2	2	-	-	-	-	-	-	-	-	443A
Short	2	2	-	-	-	-	-	-	-	-	
Long	3	2	-	-	-	-	-	-	-	-	555A
Short	3	2	-	-	-	-	-	-	-	-	
Long	3	3	2	2	2	1	-	-	-	-	664A
Short	3	3	2	2	2	1	-	-	-	-	
Long	5	4	4	3	3	2	-	-	-	-	976A
Short	4	3	3	2	2	2	-	-	-	-	
Long	5	5	4	3	3	2	-	-	-	-	984A
Short	5	5	4	3	3	2	-	-	-	-	
Long	6	5	4	3	3	2	-	-	-	-	1093A
Short	5	4	4	3	3	2	-	-	-	-	
Long	6	5	5	4	3	3	2	2	-	-	10105A
Short	6	5	5	4	3	3	2	2	-	-	
Long	6	5	4	3	3	2	2	2	-	-	10106A
Short	6	5	4	3	3	2	2	2	-	-	
Long	6	5	4	3	3	2	2	2	1	1	10108A
Short	6	5	4	3	3	2	2	2	1	1	
Long	7	6	5	4	4	3	2	2	2	1	12128A
Short	7	6	5	4	4	3	2	2	2	1	
Long	7	6	5	4	4	3	2	2	2	1	121212A
Short	7	6	5	4	4	3	2	2	2	1	

### Ordering Information for Drilled and Tapped Enclosures

For custom arrangement, see Modifications and Accessories and use the Custom Drill and Tap Schedule.

### Grounding Kits

Catalog Number		Wire Capacity
Appleton	O-Z/Gedney	Al-Cu/Tinned Copper
AGK-04	NGK-04	#14-4 AWG
AGK-10	NGK-10	#8-1/0 AWG
AGK-25	NGK-25	#6 AWG-250MCM

### Replacement Window Covers

Appleton		O-Z/Gedney	
Catalog Number	Use With Box Catalog Number	Catalog Number	Use With Box Catalog Number
ASW-443A	AGUBSW-443A	NSW-443A	NGUBSW-443A
ASW-555A	AGUBSW-555A	NSW-555A	NGUBSW-555A
ASW-664A	AGUBSW-664A	NSW-664A	NGUBSW-664A
ASW-976A	AGUBSW-976A	NSW-976A	NGUBSW-976A
ASW-984A	AGUBSW-984A	NSW-984A	NGUBSW-984A
ASW-1093A	AGUBSW-1093A	NSW-1093A	NGUBSW-1093A
ASW-10105A	AGUBSW-10105A	NSW-10105A	NGUBSW-10105A
ASW-10106A	AGUBSW-10106/8A	NSW-10106A	NGUBSW-10106/8A
ASW-12128	AGUBSW-12128/12A	NSW-12128	NGUBSW-12128/12A

# AGUB and NGUB Instrument and Meter Enclosures

## Explosionproof, Dust-Ignitionproof

### NEC/CEC:

Class I, Division 1 and 2, Groups B, C, D  
 Class II, Division 1 and 2, Groups E, F, G  
 Class III  
 NEMA 4, 4X, 7BCD, 9EFG

### Mounting Plates — Standard

Appleton			O-Z/Gedney		
Catalog Number		Use With	Catalog Number		Use With
Aluminum	Galvanized Steel	Box Catalog Number	Aluminum	Galvanized Steel	Box Catalog Number
AMPA-443	AMPG-443	AGUB-443A	NMPA-443	NMPG-443	NGUB-443A
AMPA-555	AMPG-555	AGUB-555A	NMPA-555	NMPG-555	NGUB-555A
AMPA-664	AMPG-664	AGUB-664A	NMPA-664	NMPG-664	NGUB-664A
AMPA-976	AMPG-976	AGUB-976A	NMPA-976	NMPG-976	NGUB-976A
AMPA-984	AMPG-984	AGUB-984A	NMPA-984	NMPG-984	NGUB-984A
AMPA-1093	AMPG-1093	AGUB-1093A	NMPA-1093	NMPG-1093	NGUB-1093A
AMPA-10105	AMPG-10105	AGUB-10105A	NMPA-10105	NMPG-10105	NGUB-10105A
AMPA-10106	AMPG-10106	AGUB-10106A	NMPA-10106	NMPG-10106	NGUB-10106A
AMPA-10108	AMPG-10108	AGUB-10108A	NMPA-10108	NMPG-10108	NGUB-10108A
AMPA-12128	AMPG-12128	AGUB-12128A	NMPA-12128	NMPG-12128	NGUB-12128A
AMPA-121212	AMPG-121212	AGUB-121212A	NMPA-121212	NMPG-121212	NGUB-121212A

### Mounting Plates — 90°

Appleton			O-Z/Gedney		
Catalog Number		Use With	Catalog Number		Use With
Aluminum	Galvanized Steel	Box Catalog Number	Aluminum	Galvanized Steel	Box Catalog Number
AMD-4-664A	AMD-4-664G	AGUB-664A	NMD-4-664A	NMD-4-664G	NGUB-664A
AMD-10-664A	AMD-10-664G	AGUB-664A	NMD-10-664A	NMD-10-664G	NGUB-664A
AMD-6-984A	AMD-6-984G	AGUB-984A	NMD-6-984A	NMD-6-984G	NGUB-984A
AMD-8-1093A	AMD-8-1093G	AGUB-1093A	NMD-8-1093A	NMD-8-1093G	NGUB-1093A
AMD-10-10105A	AMD-10-10105G	AGUB-10105A	NMD-10-10105A	NMD-10-10105G	NGUB-10105A

### Replacement Flat Covers

Appleton		O-Z/Gedney	
Catalog Number	Use With Box Catalog Number	Catalog Number	Use With Box Catalog Number
AFC-443A	AGUB-443A	NFC-443A	NGUB-443A
AFC-555A	AGUB-555A	NFC-555A	NGUB-555A
AFC-664A	AGUB-664A	NFC-664A	NGUB-664A
AFC-976A	AGUB-976A	NFC-976A	NGUB-976A
AFC-984A	AGUB-984A	NFC-984A	NGUB-984A
AFC-1093A	AGUB-1093A	NFC-1093A	NGUB-1093A
AFC-10105A	AGUB-10105A	NFC-10105A	NGUB-10105A
AFC-1010A	AGUB-10106/8A	NFC-1010A	NGUB-10106/8A
AFC-1212A	AGUB-12128/12A	NFC-1212A	NGUB-12128/12A

### NEMA 4X Breather/Drain Fittings

Description	Suffix Factory-Installed ①	Catalog Number Field-Installed
Drain Fitting	NGK-04	DRNB4X
Breather Fitting	NGK-10	BRTB4X

① Drilled and tapped installation included.

# AGUB and NGUB Instrument and Meter Enclosures

## Custom Drill and Tap Schedule

NEC/CEC:  
 Class I, Division 1 and 2, Groups B, C, D  
 Class II, Division 1 and 2, Groups E, F, G  
 Class III  
 NEMA 4, 4X, 7BCD, 9EFG

ENCLOSURES AND JUNCTION BOXES: NEC/CEC EXPLOSIONPROOF ENCLOSURES

Appleton OZGEDNEY

POSITION	CHECK ONLY IF SHOP IS TO LOCATE			METAL PLUGS
	CONDUIT SIZE	X DIM.	K DIM.	
1				
2				
3				
4				
5				
6				
7				
8				
9				
10				
11				
12				
13				
14				
15				
16				
17				
18				
19				
20				
21				
22				
23				
24				

\* = B&D LOC.

VIEW LOOKING INTO BOX  
WITH SIDES LAID DOWN

\* = BREATHER/DRAIN LOC. 1/2" NPT REQUIRED. LOCATION MAY BE SPECIFIED ON THE CHART OR IF BOX IS CHECKED, SHOP WILL LOCATE.

DIM. X = DISTANCE FROM CENTERLINE TO CENTER OF CONDUIT OPENING.  
 DIM. K = DISTANCE FROM MTG. SURFACE TO CENTER OF CONDUIT OPENING.

CAUTION: IN PLANNING CONDUIT ARRANGEMENTS, REFER TO "USABLE CONDUIT AREA", SHOWN ON SHOWN ON THE APPROPRIATE PRODUCT OUTLINE DRAWINGS AND TO THE CONDUIT SPACING CHARTS.

### ENCLOSURE FIGURES

FIG. 1

AGUB/GUBSW-443  
 AGUB/GUBSW-555  
 AGUB/GUBSW-664  
 AGUB/GUBSW-984

FIG. 2

AGUB/GUBSW-976  
 AGUB/GUBSW-1093  
 AGUB/GUBSW-10105  
 AGUB/GUBSW-10106/8  
 AGUB/GUBSW-12128/12

CONDUIT D&T SCHEDULE

CAT. NO. \_\_\_\_\_

FORM A-12352

REV \_\_\_\_\_

### CHECK LIST

- ASSIGN DRAWING NO.
  - SELECT CORRECT FIG. NUMBER.
  - IF BREATHER & DRAIN ARE REQ'D ARE THEY CLEARLY MARKED AT DESIRED POSITIONS OR IS BOX CHECKED?
  - ARE INDICATED COND. SIZES WITHIN THE PUBLISHED MAXIMUM ON PAGE K-10?
  - CHECK FOR MINIMUM SPACING BETWEEN COND. TO COND. PER COND. SPACING TABLE ON PAGE K-4.
  - SIGN NAME TO DWG.
- NAME \_\_\_\_\_
- DATE \_\_\_\_\_

# AGUB and NGUB Instrument and Meter Enclosures

## Explosionproof, Dust-Ignitionproof

Furnished with aluminum body and solid or window cover

### NEC/CEC:

Class I, Division 1 and 2, Groups B, C, D

Class II, Division 1 and 2, Groups E, F, G

Class III

NEMA 4, 4X, 7BCD, 9EFG

### AGUB and NGUB Solid Cover Series ① Dimensions in Millimeters (Inches)

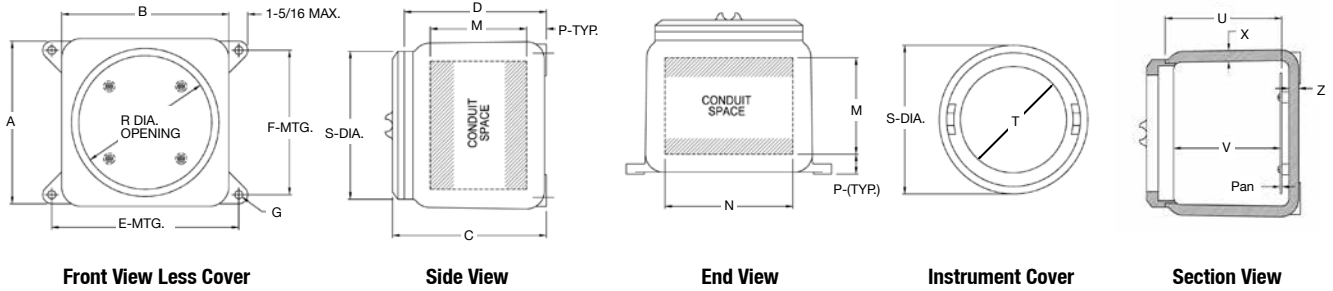

Dimensions in Millimeters (Inches)																	
Outside Dimensions				Mounting Lugs			Conduit Space			Cover Open	Cover Dia.	Window Dia.	Depth		Wall Thickness		Catalog Number
A	B	C	D	E	F	G	M	N	P	R	S	T	U	V	X	Z	
134.9 (5.31)	134.9 (5.31)	131.8 (5.19)	115.9 (4.56)	158.8 (6.25)	98.4 (3.88)	9.5 (0.38)	71.4 (2.81)	95.3 (3.75)	19.1 (0.75)	101.6 (4.00)	117.5 (4.63)	63.5 (2.50)	101.6 (4.00)	76.2 (3.00)	11.1 (0.44)	11.1 (0.44)	443A
158.8 (6.25)	158.8 (6.25)	176.2 (6.94)	158.8 (6.25)	190.5 (7.50)	127.0 (5.00)	9.5 (0.38)	103.2 (4.06)	108.0 (4.25)	23.8 (0.94)	108.0 (4.25)	133.4 (5.25)	81.0 (3.19)	139.7 (5.50)	117.5 (4.63)	11.1 (0.44)	19.1 (0.75)	555A
177.8 (7.00)	177.8 (7.00)	165.1 (6.50)	144.5 (5.69)	206.4 (8.13)	146.1 (5.75)	9.5 (0.38)	95.3 (3.75)	139.7 (5.50)	22.2 (0.88)	150.8 (5.94)	165.1 (6.50)	101.6 (4.00)	127.0 (5.00)	101.6 (4.00)	11.1 (0.44)	11.1 (0.44)	664A
260.4 (10.25)	215.9 (8.50)	214.3 (8.44)	188.9 (7.44)	247.7 (9.75)	228.6 (9.00)	9.5 (0.38)	125.4 (4.94)	165.1 (6.50)	20.6 (0.81)	177.8 (7.00)	196.9 (7.75)	138.1 (5.44)	161.9 (6.38)	139.7 (5.50)	12.7 (0.50)	11.1 (0.44)	976A
254.0 (10.00)	228.6 (9.00)	168.3 (6.63)	149.2 (5.88)	257.2 (10.13)	215.9 (8.50)	9.5 (0.38)	97.1 (3.81)	190.5 (7.50)	23.8 (0.94)	201.6 (7.94)	219.1 (8.63)	142.9 (5.63)	128.6 (5.06)	103.2 (4.06)	11.1 (0.44)	17.5 (0.69)	984A
293.7 (11.56)	268.2 (10.56)	163.5 (6.44)	144.5 (5.69)	304.8 (12.00)	235.0 (9.25)	9.5 (0.38)	87.3 (3.44)	200.1 (7.88)	23.8 (0.94)	227.0 (8.94)	247.7 (9.75)	142.9 (5.63)	117.5 (4.63)	92.1 (3.63)	17.5 (0.69)	17.5 (0.69)	1093A
304.8 (12.00)	304.8 (12.00)	222.3 (8.75)	190.5 (7.50)	346.1 (13.62)	254.0 (10.00)	15.9 (0.63)	122.2 (4.81)	247.7 (9.75)	31.8 (1.25)	250.9 (9.88)	279.4 (11.00)	190.5 (7.50)	165.1 (6.50)	131.8 (5.19)	17.5 (0.69)	17.5 (0.69)	10105A
295.3 (11.62)	295.3 (11.62)	238.1 (9.38)	200.1 (7.88)	330.2 (13.00)	254.0 (10.00)	15.9 (0.63)	119.1 (4.69)	225.4 (8.88)	35.0 (1.38)	235.0 (9.25)	260.4 (10.25)	187.3 (7.38)	166.7 (6.56)	139.7 (5.50)	19.1 (0.75)	17.5 (0.69)	10106A
295.3 (11.62)	295.3 (11.62)	288.9 (11.38)	250.8 (9.88)	330.2 (13.00)	254.0 (10.00)	15.9 (0.63)	169.9 (6.69)	225.4 (8.88)	35.0 (1.38)	235.0 (9.25)	260.4 (10.25)	187.3 (7.38)	217.4 (8.56)	190.5 (7.50)	19.1 (0.75)	17.5 (0.69)	10118A
346.1 (13.62)	346.1 (13.62)	298.5 (11.75)	250.8 (9.88)	381.0 (15.00)	254.0 (10.00)	15.9 (0.63)	169.9 (6.69)	276.2 (10.88)	35.0 (1.38)	285.8 (11.25)	311.2 (12.25)	239.7 (9.44)	217.4 (8.56)	190.5 (7.50)	19.1 (0.75)	17.5 (0.69)	12128A
346.1 (13.62)	346.1 (13.62)	400.1 (15.75)	352.4 (13.88)	381.0 (15.00)	254.0 (10.00)	15.9 (0.63)	271.5 (10.69)	276.2 (10.88)	35.0 (1.38)	285.8 (11.25)	311.2 (12.25)	239.7 (9.44)	319.1 (12.56)	292.1 (11.50)	19.1 (0.75)	17.5 (0.69)	121212A

① AGUB and NGUB Solid Cover Series do not have a window.

# EXB Cast Iron Junction Boxes

## Explosionproof, Dust-Ignitionproof. Integrally Cast Mounting Feet

Drilled and tapped openings 1/2" thru 6" as specified.

### NEC/CEC:

- Class I, Division 1 and 2, Group D
- Class II, Division 1 and 2 Groups E, F, G
- Class III

### Features

- Wide selection of sizes and locations for drilled and tapped openings.
- Extra wide, accurately ground mating surfaces with closely spaced stainless steel hex head cap screws assure a flame-tight joint.
- Provided with mounting lugs.

### Standard Materials

- Bodies and covers: cast iron

### Standard Finishes

- Hot-dip galvanized

### Options

- For factory installed hinges, add suffix **-HNG**.
- For factory installed mounting plate, add suffix **-WYM**
- Refer to *Junction Box Mounting Plate Information* for complete listing of available mounting plates.

### NEC/CEC Certifications and Compliances

- UL Standard: UL 886 (UL 1203)
- UL Listed: E10444
- CSA Standard: C22.2 No. 25, C22.2 No. 30
- CSA Certified: 020945



Nominal Inside Dimensions L x W x D mm (in)	Approximate Side Wall Thickness mm (in)	Maximum Conduit Size (Inches)	Catalog Number ①
101.6 x 101.6 x 101.6 (4 x 4 x 4)	11.9 (0.47)	2	EXB040404
152.4 x 152.4 x 101.6 (6 x 6 x 4)	16.0 (0.63)	2	EXB060604
152.4 x 152.4 x 152.4 (6 x 6 x 6)	16.0 (0.63)	3-1/2	EXB060606
203.2 x 152.4 x 101.6 (8 x 6 x 4)	16.0 (0.63)	2	EXB080604
203.2 x 152.4 x 152.4 (8 x 6 x 6)	16.0 (0.63)	3-1/2	EXB080606
203.2 x 203.2 x 101.6 (8 x 8 x 4)	16.0 (0.63)	2	EXB080804
203.2 x 203.2 x 152.4 (8 x 8 x 6)	16.0 (0.63)	3-1/2	EXB080806
203.2 x 203.2 x 203.2 (8 x 8 x 8)	16.0 (0.63)	5	EXB080808
245.0 x 203.2 x 152.4 (10 x 8 x 6)	16.0 (0.63)	3-1/2	EXB100806
254.0 x 203.2 x 203.2 (10 x 8 x 8)	16.0 (0.63)	5	EXB100808
254.0 x 254.0 x 152.4 (10 x 10 x 6)	16.0 (0.63)	3-1/2	EXB101006
254.0 x 254.0 x 203.2 (10 x 10 x 8)	16.0 (0.63)	5	EXB101008
304.8 x 203.2 x 101.6 (12 x 8 x 4)	16.0 (0.63)	2	EXB120804
304.8 x 304.8 x 152.4 (12 x 12 x 6)	17.5 (0.69)	3-1/2	EXB121206
304.8 x 304.8 x 203.2 (12 x 12 x 8)	17.5 (0.69)	5	EXB121208
304.8 x 304.8 x 304.8 (12 x 12 x 12)	17.5 (0.69)	6	EXB121212

① See EXB Ordering Information page for drilling and tapping options.

# EXB Cast Iron Junction Boxes

Explosionproof, Dust-Ignitionproof. Integrally Cast Mounting Feet

Drilled and tapped openings 1/2" thru 6" as specified.

**NEC/CEC:**

Class I, Division 1 and 2, Group D  
 Class II, Division 1 and 2 Groups E, F, G  
 Class III

Nom. Inside Dimensions LxWxD mm (in)	Approximate Side Wall Thickness mm (in)	Maximum Conduit Size	Catalog Number ①
457.2 x 304.8 x 152.4 (18 x 12 x 6)	20.6 (0.81)	3-1/2	EXB181206
457.2 x 304.8 x 203.2 (18 x 12 x 8)	20.6 (0.81)	5	EXB181208
457.2 x 457.2 x 152.4 (18 x 18 x 6)	20.6 (0.81)	3-1/2	EXB181806
457.2 x 457.2 x 203.2 (18 x 18 x 8)	20.6 (0.81)	5	EXB181808
457.2 x 457.2 x 304.8 (18 x 18 x 12)	20.6 (0.81)	6	EXB181812
609.9 x 457.2 x 203.2 (24 x 18 x 8)	23.9 (0.94)	6	EXB241808
609.9 x 457.2 x 245.0 (24 x 18 x 10)	23.9 (0.94)	6	EXB241810
609.9 x 609.9 x 203.2 (24 x 24 x 8)	23.9 (0.94)	5	EXB242408
609.9 x 609.9 x 304.8 (24 x 24 x 12)	23.9 (0.94)	6	EXB242412
762.0 x 304.8 x 245.0 (30 x 12 x 10)	26.9 (1.06)	6	EXB301210
762.0 x 609.9 x 203.2 (30 x 24 x 8)	26.9 (1.06)	5	EXB302408

**Hinges (Malleable Iron, Hot Dip Galvanized)**

EXB Box Size in mm (in)	Catalog Number	Number of Hinges per set
Up to 304.8 x 304.8 (12 x 12)	AHNG-22G	2
Up to 609.9 x 457.2 (24 x 18)	AHNG-23G	2
Up to 762.0 x 304.8 (30 x 12)	AHNG-24G	2
Larger than 762.0 x 304.8 (30 x 12)	AHNG-34G	3

① See EXB Ordering Information page for drilling and tapping options.

# EXB Series Junction Box Mounting Plate Information

## Dust-Ignitionproof, Watertight

Cast iron box and cover for surface mounting. Cast aluminum box and cover for surface mounting.

### NEC/CEC:

Class I, Division 1 and 2, Group D  
Class II, Division 1 and 2 Groups E, F, G  
Class III

Mounting plates are used for mounting equipment up off the back of an enclosure. Steel Plates are all 3.3 mm (0.13") thick hot dip galvanized material. Aluminum plates are 3.3 mm (0.13") thick material up to and including 304.8 x 304.8 mm (12 x 12") size. All larger sizes are constructed of 4.8 mm (0.19") thick aluminum plate. The catalog numbers shown in the table below include the mounting buttons.

Select mounting plates based on inside length and width of box. Order as a separate item immediately following the catalog number of the box as follows:

Example: Line 1 **EXB181204**  
Line 2 **WYM-1812-1**

For mounting plates in smaller boxes than listed, use similar catalog number logic. Example: A steel mounting plate for a **EXB040404** box would be **WYM-0404-1**. Pricing will be based upon a **WYM-0808-1** price.

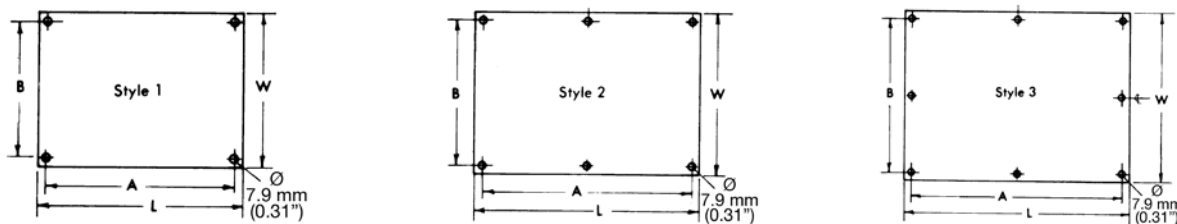

Inside Length and Width of Junction Box in mm (in)	Catalog Number		Style	Dimension in Millimeters (Inches)			
	Steel Plates	Aluminum Plates		L	W	A	B
203.2 x 203.2 (8 x 8)	<b>WYM-0808-1</b>	<b>WYM-0808-1A</b>	1	171.5 (6.75)	171.5 (6.75)	152.4 (6.00)	152.4 (6.00)
254.0 x 203.2 (10 x 8)	<b>WYM-1008-1</b>	<b>WYM-1008-1A</b>	1	222.3 (8.75)	171.5 (6.75)	203.2 (8.00)	203.2 (8.00)
254.0 x 254.0 (10 x 10)	<b>WYM-1010-1</b>	<b>WYM-1010-1A</b>	1	222.3 (8.75)	222.3 (8.75)	203.2 (8.00)	203.2 (8.00)
304.8 x 203.2 (12 x 8)	<b>WYM-1208-1</b>	<b>WYM-1208-1A</b>	1	273.1 (10.75)	171.5 (6.75)	254.0 (10.00)	152.4 (6.00)
304.8 x 254.0 (12 x 10)	<b>WYM-1210-1</b>	<b>WYM-1210-1A</b>	1	273.1 (10.75)	222.3 (8.75)	254.0 (10.00)	203.2 (8.00)
304.8 x 304.8 (12 x 12)	<b>WYM-1212-1</b>	<b>WYM-1212-1A</b>	1	273.1 (10.75)	273.1 (10.75)	254.0 (10.00)	254.0 (10.00)
355.6 x 203.2 (14 x 8)	<b>WYM-1408-1</b>	<b>WYM-1408-1A</b>	1	323.9 (12.75)	171.5 (6.75)	304.8 (12.00)	152.4 (6.00)
355.6 x 355.6 (14 x 14)	<b>WYM-1414-1</b>	<b>WYM-1414-1A</b>	1	323.9 (12.75)	323.9 (12.75)	304.8 (12.00)	304.8 (12.00)
406.4 x 203.2 (16 x 8)	<b>WYM-1608-1</b>	<b>WYM-1608-1A</b>	1	374.7 (14.75)	171.5 (6.75)	355.6 (14.00)	152.4 (6.00)
406.4 x 304.8 (16 x 12)	<b>WYM-1612-1</b>	<b>WYM-1612-1A</b>	1	374.7 (14.75)	273.1 (10.75)	355.6 (14.00)	254.0 (10.00)
406.4 x 406.4 (16 x 16)	<b>WYM-1616-1</b>	<b>WYM-1616-1A</b>	1	374.7 (14.75)	374.7 (14.75)	355.6 (14.00)	355.6 (14.00)
457.2 x 203.2 (18 x 8)	<b>WYM-1808-1</b>	<b>WYM-1808-1A</b>	1	171.5 (6.75)	171.5 (6.75)	152.4 (6.00)	152.4 (6.00)
457.2 x 254.0 (18 x 10)	<b>WYM-1810-1</b>	<b>WYM-1810-1A</b>	1	171.5 (6.75)	222.3 (8.75)	152.4 (6.00)	203.2 (8.00)
457.2 x 304.8 (18 x 12)	<b>WYM-1812-1</b>	<b>WYM-1812-1A</b>	1	171.5 (6.75)	273.1 (10.75)	152.4 (6.00)	254.0 (10.00)
457.2 x 355.6 (18 x 14)	<b>WYM-1814-1</b>	<b>WYM-1814-1A</b>	1	171.5 (6.75)	323.9 (12.75)	152.4 (6.00)	304.8 (12.00)
457.2 x 406.4 (18 x 16)	—	—	—	—	—	—	—
457.2 x 457.2 (18 x 18)	<b>WYM-1818-1</b>	<b>WYM-1818-1A</b>	1	171.5 (6.75)	171.5 (6.75)	152.4 (6.00)	152.4 (6.00)
508.0 x 254.0 (20 x 10)	<b>WYM-2010-1</b>	<b>WYM-2010-1A</b>	1	222.3 (8.75)	222.3 (8.75)	457.2 (18.00)	203.2 (8.00)
609.6 x 304.8 (24.00 x 12.00)	<b>WYM-2412-1</b>	<b>WYM-2412-1A</b>	2	552.5 (21.75)	247.7 (9.75)	533.4 (21.00)	228.6 (9.00)
609.6 x 457.2 (24.00 x 18.00)	<b>WYM-2418-1</b>	<b>WYM-2418-1A</b>	2	552.5 (21.75)	400.1 (15.75)	533.4 (21.00)	381.0 (15.00)
609.6 x 609.6 (24.00 x 24.00)	<b>WYM-2424-1</b>	<b>WYM-2424-1A</b>	3	552.5 (21.75)	552.5 (21.75)	533.4 (21.00)	533.4 (21.00)
711.2 x 304.8 (28.00 x 12.00)	<b>WYM-2812-1</b>	<b>WYM-2812-1A</b>	2	654.1 (25.75)	247.7 (9.75)	635.0 (25.00)	228.6 (9.00)
762.0 x 304.8 (30.00 x 12.00)	<b>WYM-3012-1</b>	<b>WYM-3012-1A</b>	2	704.9 (27.75)	247.7 (9.75)	685.8 (27.00)	228.6 (9.00)
762.0 x 457.2 (30.00 x 18.00)	<b>WYM-3018-1</b>	<b>WYM-3018-1A</b>	2	704.9 (27.75)	400.1 (15.75)	685.8 (27.00)	381.0 (15.00)
762.0 x 609.6 (30.00 x 24.00)	<b>WYM-3024-1</b>	<b>WYM-3024-1A</b>	3	704.9 (27.75)	552.5 (21.75)	685.8 (27.00)	533.4 (21.00)
914.4 x 304.8 (36.00 x 12.00)	<b>WYM-3612-1</b>	<b>WYM-3612-1A</b>	2	857.3 (33.75)	247.7 (9.75)	838.2 (33.00)	228.6 (9.00)
914.4 x 457.2 (36.00 x 18.00)	<b>WYM-3618-1</b>	<b>WYM-3618-1A</b>	2	857.3 (33.75)	400.1 (15.75)	838.2 (33.00)	381.0 (15.00)
914.4 x 609.6 (36.00 x 24.00)	<b>WYM-3624-1</b>	<b>WYM-3624-1A</b>	3	857.3 (33.75)	552.5 (21.75)	838.2 (33.00)	533.4 (21.00)
914.4 x 762.0 (36.00 x 30.00)	<b>WYM-3630-1</b>	<b>WYM-3630-1A</b>	3	857.3 (33.75)	704.9 (27.75)	838.2 (33.00)	685.8 (27.00)
914.4 x 914.4 (36.00 x 36.00)	<b>WYM-3636-1</b>	<b>WYM-3636-1A</b>	3	857.3 (33.75)	857.3 (33.75)	838.2 (33.00)	838.2 (33.00)



# EXB Cast Iron Junction Box Blank Bodies for Drilling and Tapping

## Explosionproof, Dust-Ignitionproof. Integrally Cast Mounting Feet

Drilled and tapped openings 1/2" thru 6" as specified.

### NEC/CEC:

Class I, Division 1 and 2, Group D  
Class II, Division 1 and 2 Groups E, F, G  
Class III

Determine catalog number as follows:

- (1) Select EXB junction box catalog number
- (2) Select "Conduit Opening Arrangement Diagram" number
- (3) Select symbols that represent conduit opening sizes from "Symbol Table."

Where no opening is required, the symbol 0 must be inserted. Add suffix for other optional features. The various divisions of the complete catalog number should be separated by dashes.

### Example:

The junction box selected is **EXB181208** with steel mounting plate and the "Conduit Opening Arrangement" is diagram #1. Opening "a" is to be 1/2"; "b", 1-1/4"; "c", no opening needed; and "d", 1-1/2". In this example, the complete catalog number is:

**EXB181208-1-AD0E-WYM-1812-1**

### Symbol Table

Drilling and Tapping (Five Threads Minimum)			
Symbol	Size	Symbol	Size
O	Blank	F	2
A	1/2	G	2-1/2
B	3/4	H	3
C	1	J	3-1/2
D	1-1/4	K	4
E	1-1/2	L	5
		M	6

### Standard Conduit Opening Arrangement Diagrams

Opening "a" is always TOP of box

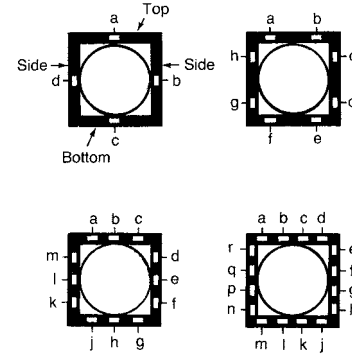

All Conduit Openings will be located in centerline of walls and evenly spaced unless otherwise specified. If a "Standard Conduit Opening Arrangement" is not suitable for the application, or when openings are to be more accurately spaced, submit Drill and Tap Schedule.

### Minimum Recommended Spacing Between Conduit Openings

Allowance made for clearance over bushings. When unions or seals are used, additional space must be allowed. Table shows minimum distances between conduit-opening centerlines in various size combinations. For example, if 1-1/2" and 3/4" openings are to be drilled and tapped into one side of box, the minimum spacing between centerlines would be 54.1 mm (2.13").

Conduit Size Inches	Minimum space between conduit opening centerlines in Millimeters (Inches)									
	1/2	3/4	1	1-1/4	1-1/2	2	2-1/2	3	3-1/2	4
1/2	31.8 (1.25)									
3/4	35.1 (1.38)	38.1 (1.50)								
1	39.6 (1.56)	42.9 (1.69)	47.8 (1.88)							
1-1/4	47.8 (1.88)	50.8 (2.00)	55.6 (2.19)	62.0 (2.44)						
1-1/2	50.8 (2.00)	54.1 (2.13)	58.7 (2.31)	66.8 (2.63)	69.9 (2.75)					
2	60.5 (2.38)	63.5 (2.50)	68.3 (2.69)	74.7 (2.94)	79.5 (3.13)	87.4 (3.44)				
2-1/2	63.5 (2.50)	66.8 (2.63)	71.4 (2.81)	79.5 (3.13)	82.6 (3.25)	92.2 (3.63)	95.3 (3.75)			
3	73.2 (2.88)	76.2 (3.00)	81.0 (3.19)	87.4 (3.44)	92.2 (3.63)	100.1 (3.94)	104.9 (4.13)	112.8 (4.44)		
3-1/2	79.5 (3.13)	82.6 (3.25)	87.4 (3.44)	95.3 (3.75)	98.6 (3.88)	108.0 (4.25)	111.3 (4.38)	120.7 (4.75)	127.0 (5.00)	
4	87.4 (3.44)	90.4 (3.56)	95.3 (3.75)	102.9 (4.05)	106.4 (4.19)	115.8 (4.56)	119.1 (4.69)	128.5 (5.06)	134.9 (5.31)	143.0 (5.63)

### Diameters of Bushings, Unions, Conduit and Seals, in Millimeters (Inches)

Conduit Size Inches	Diameters of Fittings for 1/2" through 4" Conduit									
	1/2	3/4	1	1-1/4	1-1/2	2	2-1/2	3	3-1/2	4
BBU Bushing	26.9 (1.06)	33.3 (1.31)	39.6 (1.56)	49.3 (1.94)	55.6 (2.19)	68.3 (2.69)	81.0 (3.19)	98.6 (3.88)	111.3 (4.38)	124.0 (4.88)
BU Bushing	28.7 (1.13)	31.8 (1.25)	41.4 (1.63)	52.3 (2.06)	58.7 (2.31)	74.7 (2.94)	82.6 (3.25)	98.6 (3.88)	115.8 (4.56)	128.5 (5.06)
UNY/UNF (R) Union	38.1 (1.50)	44.5 (1.75)	50.8 (2.00)	71.4 (2.81)	77.7 (3.06)	95.3 (3.75)	125.5 (4.94)	138.2 (5.44)	150.9 (5.94)	165.1 (6.50)
Conduit	22.4 (0.88)	26.9 (1.06)	35.1 (1.38)	42.9 (1.69)	49.3 (1.94)	60.5 (2.38)	73.2 (2.88)	88.9 (3.50)	101.6 (4.00)	114.3 (4.50)
EYM-EYF Seals Turning Radius	26.9 (1.06)	30.2 (1.19)	35.1 (1.38)	44.5 (1.75)	52.3 (2.06)	58.7 (2.31)	68.3 (2.69)	79.5 (3.13)	87.4 (3.44)	93.7 (3.69)

# EXB Series Junction Box Drill and Tap Schedule

## Dust-Ignitionproof, Watertight

Cast iron box and cover for surface mounting. Cast aluminum box and cover for surface mounting.

NEC/CEC:  
 Class I, Division 1 and 2, Group D  
 Class II, Division 1 and 2 Groups E, F, G  
 Class III

ENCLOSURES AND JUNCTION BOXES: NEC/CEC EXPLOSIONPROOF ENCLOSURES

CONDUIT POSITION	CHECK ONLY IF FACTORY IS TO LOCATE			METAL PLUGS
	CONDUIT SIZE	X DIM.	D DIM.	
1				
2				
3				
4				
5				
6				
7				
8				
9				
10				
11				
12				
13				
14				
15				
16				
17				
18				
19				
20				
21				
22				
23				
24				

\* = B&D LOC.

VIEW LOOKING INTO BOX  
WITH SIDES LAID DOWN

ARE INDICATED CONDUIT SIZES WITHIN THE CATALOG PUBLISHED MAXIMUM ON PAGES K-40 AND K-43?

CHECK FOR MINIMUM SPACING BETWEEN CONDUIT OPENINGS PER CONDUIT SPACING TABLE, ON PAGE K-41.

SIGN NAME TO DWG.

### CHECK LIST

NAME \_\_\_\_\_

DATE \_\_\_\_\_

\* = BREATHER/DRAIN LOC. 1/2" NPT REQUIRED. LOCATION MAY BE SPECIFIED ON THE CHART OR IF BOX IS CHECKED, FACTORY WILL LOCATE IN SIDES A & C.

DIM. X = DISTANCE FROM CENTERLINE TO CENTER OF CONDUIT OPENING.  
 DIM. D = DISTANCE FROM MTG. SURFACE TO CENTER OF CONDUIT OPENING.

HINGED ENCLOSURES WILL BE HINGED ON SIDE "D" AS STANDARD.

CAUTION: IN PLANNING CONDUIT ARRANGEMENTS, REFER TO "USABLE CONDUIT AREA", SHOWN ON THE APPROPRIATE PRODUCT OUTLINE DRAWINGS AND TO THE CONDUIT SPACING CHARTS.

**ENCLOSURE FIGURE**

ENCLOSURE

CONDUIT D&T SCHEDULE

CAT. NO. \_\_\_\_\_

REV \_\_\_\_\_



# YE Cast Iron Junction Boxes

## Explosionproof, Dust-Ignitionproof. Integrally Cast Mounting Feet

Drilled and tapped openings 1/2" thru 6" as specified.

### NEC/CEC:

Class I, Division 1 and 2, Group D  
Class II, Division 1 and 2, Groups E, F, G  
Class III

### Features

- Wide selection of sizes and locations for drilled and tapped openings.
- Extra wide, accurately ground mating surfaces with closely spaced stainless steel hex head cap screws assure a flame-tight joint.
- Provided with mounting lugs.

### Standard Materials

- Bodies and covers: cast iron

### Standard Finishes

- Hot-dip galvanized

### Options

- For factory installed hinges, add suffix **-HNG**.
- For factory installed mounting plate, add suffix **-WYM**
- Refer to *Junction Box Mounting Plate Information* for complete listing of available mounting plates.

### NEC Certifications and Compliances

- UL Standard: UL 886 (UL 1203)
- UL Listed: E10444
- CSA Standard: C22.2 No. 25, C22.2 No. 30
- CSA Certified: 020945



# YE Cast Iron Junction Boxes

## Explosionproof, Dust-Ignitionproof. Integrally Cast Mounting Feet

Drilled and tapped openings 1/2" thru 6" as specified.

**NEC/CEC:**

Class I, Division 1 and 2, Group D  
 Class II, Division 1 and 2, Groups E, F, G  
 Class III

ENCLOSURES AND JUNCTION BOXES: NEC/CEC EXPLOSIONPROOF ENCLOSURES

OZGEDNEY

Nominal Inside Dimensions L x W x D mm (in)	Approximate Side Wall Thickness mm (in)	Maximum Conduit Size (Inches)	Catalog Number ①
101.6 x 101.6 x 101.6 (4 x 4 x 4)	11.9 (0.47)	2	YE040404
152.4 x 152.4 x 101.6 (6 x 6 x 4)	16.0 (0.63)	2	YE060604
152.4 x 152.4 x 152.4 (6 x 6 x 6)	16.0 (0.63)	3-1/2	YE060606
203.2 x 101.6 x 101.6 (8 x 4 x 4)	16.0 (0.63)	2	YE080404
203.2 x 152.4 x 101.6 (8 x 6 x 4)	16.0 (0.63)	2	YE080604
203.2 x 152.4 x 152.4 (8 x 6 x 6)	16.0 (0.63)	3-1/2	YE080606
203.2 x 203.2 x 101.6 (8 x 8 x 4)	16.0 (0.63)	2	YE080804
203.2 x 203.2 x 152.4 (8 x 8 x 6)	16.0 (0.63)	3-1/2	YE080806
203.2 x 203.2 x 203.2 (8 x 8 x 8)	16.0 (0.63)	5	YE080808
254.0 x 203.2 x 101.6 (10 x 8 x 4)	16.0 (0.63)	2	YE100804
245.0 x 203.2 x 152.4 (10 x 8 x 6)	16.0 (0.63)	3-1/2	YE100806
254.0 x 203.2 x 203.2 (10 x 8 x 8)	16.0 (0.63)	5	YE100808
254.0 x 254.0 x 101.6 (10 x 10 x 4)	16.0 (0.63)	2	YE101004
254.0 x 254.0 x 152.4 (10 x 10 x 6)	16.0 (0.63)	3-1/2	YE101006
254.0 x 254.0 x 203.2 (10 x 10 x 8)	16.0 (0.63)	5	YE101008
304.8 x 203.2 x 101.6 (12 x 8 x 4)	16.0 (0.63)	2	YE120804
304.8 x 304.8 x 101.6 (12 x 12 x 4)	17.5 (0.69)	2	YE121204
304.8 x 304.8 x 152.4 (12 x 12 x 6)	17.5 (0.69)	3-1/2	YE121206
304.8 x 304.8 x 203.2 (12 x 12 x 8)	17.5 (0.69)	5	YE121208
304.8 x 304.8 x 254.0 (12 x 12 x 10)	17.5 (0.69)	6	YE121210
304.8 x 304.8 x 304.8 (12 x 12 x 12)	17.5 (0.69)	6	YE121212

① See YE Ordering Information page for drilling and tapping options.

# YE Cast Iron Junction Boxes

## Explosionproof, Dust-Ignitionproof. Integrally Cast Mounting Feet

Drilled and tapped openings 1/2" thru 6" as specified.

**NEC/CEC:**

Class I, Division 1 and 2, Group D  
Class II, Division 1 and 2, Groups E, F, G  
Class III

Nom. Inside Dimensions LxWxD mm (in)	Approximate Side Wall Thickness mm (in)	Maximum Conduit Size	Catalog Number ①
457.2 x 304.8 x 101.6 (18 x 12 x 4)	20.6 (0.81)	2	YE181204
457.2 x 304.8 x 152.4 (18 x 12 x 6)	20.6 (0.81)	3-1/2	YE181206
457.2 x 304.8 x 203.2 (18 x 12 x 8)	20.6 (0.81)	5	YE181208
457.2 x 304.8 x 304.8 (18 x 12 x 12)	20.6 (0.81)	6	YE181212
457.2 x 457.2 x 152.4 (18 x 18 x 6)	20.6 (0.81)	3-1/2	YE181806
457.2 x 457.2 x 203.2 (18 x 18 x 8)	20.6 (0.81)	5	YE181808
457.2 x 457.2 x 304.8 (18 x 18 x 12)	20.6 (0.81)	6	YE181812
609.9 x 304.8 x 203.2 (24 x 12 x 8)	20.6 (0.81)	5	YE241208
609.9 x 304.8 x 245.0 (24 x 12 x 10)	20.6 (0.81)	6	YE241210
609.9 x 304.8 x 304.8 (24 x 12 x 12)	20.6 (0.81)	6	YE241212
609.9 x 457.2 x 152.4 (24 x 18 x 6)	23.9 (0.94)	3	YE241806
609.9 x 457.2 x 203.2 (24 x 18 x 8)	23.9 (0.94)	6	YE241808
609.9 x 457.2 x 245.0 (24 x 18 x 10)	23.9 (0.94)	6	YE241810
609.9 x 457.2 x 304.8 (24 x 18 x 12)	23.9 (0.94)	6	YE241812
609.9 x 609.9 x 203.2 (24 x 24 x 8)	23.9 (0.94)	5	YE242408
609.9 x 609.9 x 304.8 (24 x 24 x 12)	23.9 (0.94)	6	YE242412
762.0 x 304.8 x 245.0 (30 x 12 x 10)	26.9 (1.06)	6	YE301210
762.0 x 609.9 x 203.2 (30 x 24 x 8)	26.9 (1.06)	5	YE302408
762.0 x 609.9 x 245.0 (30 x 24 x 10)	26.9 (1.06)	6	YE302410
762.0 x 609.9 x 304.8 (30 x 24 x 12)	26.9 (1.06)	6	YE302412

### Hinges (Malleable Iron, Hot Dip Galvanized)

EXB Box Size in mm (in)	Catalog Number	Number of Hinges per set
Up to 304.8 x 304.8 (12 x 12)	HNG-22G	2
Up to 609.9 x 457.2 (24 x 18)	HNG-23G	2
Up to 762.0 x 304.8 (30 x 12)	HNG-24G	2
Larger than 762.0 x 304.8 (30 x 12)	HNG-34G	3

① See EXB Ordering Information page for drilling and tapping options.

# YE Series Junction Box Mounting Plate Information

## Dust-Ignitionproof, Watertight

Cast iron box and cover for surface mounting. Cast aluminum box and cover for surface mounting.

### NEC/CEC:

Class I, Division 1 and 2, Group D  
Class II, Division 1 and 2, Groups E, F, G  
Class III

Mounting plates are used for mounting equipment up off the back of an enclosure. Steel Plates are all 3.3 mm (0.13") thick hot dip galvanized material. Aluminum plates are 3.3 mm (0.13") thick material up to and including 304.8 x 304.8 mm (12 x 12") size. All larger sizes are constructed of 4.8 mm (0.19") thick aluminum plate. The catalog numbers shown in the table below include the mounting buttons.

Select mounting plates based on inside length and width of box. Order as a separate item immediately following the catalog number of the box as follows:

Example: Line 1 **YE181204**  
Line 2 **YE-1812-1**

For mounting plates in smaller boxes than listed, use similar catalog number logic. Example: A steel mounting plate for a **EXB040404** box would be **WYM-0404-1**. Pricing will be based upon a **WYM-0808-1** price.

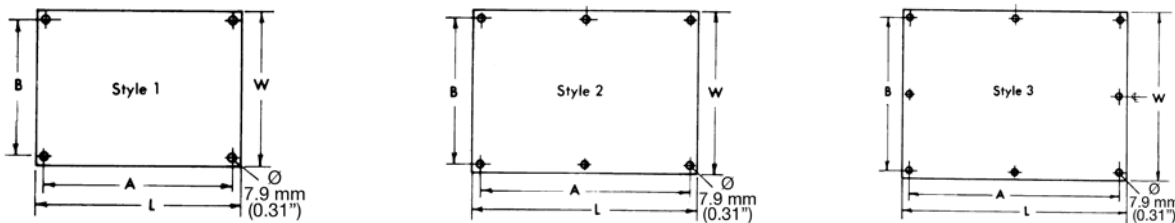

Inside Length and Width of Junction Box in mm (in)	Catalog Number		Style	Dimension in Millimeters (Inches)			
	Steel Plates	Aluminum Plates		L	W	A	B
203.2 x 203.2 (8 x 8)	<b>YE-0808-1</b>	<b>YE-0808-1A</b>	1	171.5 (6.75)	171.5 (6.75)	152.4 (6.00)	152.4 (6.00)
254.0 x 203.2 (10 x 8)	<b>YE-1008-1</b>	<b>YE-1008-1A</b>	1	222.3 (8.75)	171.5 (6.75)	203.2 (8.00)	203.2 (8.00)
254.0 x 254.0 (10 x 10)	<b>YE-1010-1</b>	<b>YE-1010-1A</b>	1	222.3 (8.75)	222.3 (8.75)	203.2 (8.00)	203.2 (8.00)
304.8 x 203.2 (12 x 8)	<b>YE-1208-1</b>	<b>YE-1208-1A</b>	1	273.1 (10.75)	171.5 (6.75)	254.0 (10.00)	152.4 (6.00)
304.8 x 254.0 (12 x 10)	<b>YE-1210-1</b>	<b>YE-1210-1A</b>	1	273.1 (10.75)	222.3 (8.75)	254.0 (10.00)	203.2 (8.00)
304.8 x 304.8 (12 x 12)	<b>YE-1212-1</b>	<b>YE-1212-1A</b>	1	273.1 (10.75)	273.1 (10.75)	254.0 (10.00)	254.0 (10.00)
355.6 x 203.2 (14 x 8)	<b>YE-1408-1</b>	<b>YE-1408-1A</b>	1	323.9 (12.75)	171.5 (6.75)	304.8 (12.00)	152.4 (6.00)
355.6 x 355.6 (14 x 14)	<b>YE-1414-1</b>	<b>YE-1414-1A</b>	1	323.9 (12.75)	323.9 (12.75)	304.8 (12.00)	304.8 (12.00)
406.4 x 203.2 (16 x 8)	<b>YE-1608-1</b>	<b>YE-1608-1A</b>	1	374.7 (14.75)	171.5 (6.75)	355.6 (14.00)	152.4 (6.00)
406.4 x 304.8 (16 x 12)	<b>YE-1612-1</b>	<b>YE-1612-1A</b>	1	374.7 (14.75)	273.1 (10.75)	355.6 (14.00)	254.0 (10.00)
406.4 x 406.4 (16 x 16)	<b>YE-1616-1</b>	<b>YE-1616-1A</b>	1	374.7 (14.75)	374.7 (14.75)	355.6 (14.00)	355.6 (14.00)
457.2 x 203.2 (18 x 8)	<b>YE-1808-1</b>	<b>YE-1808-1A</b>	1	171.5 (16.75)	171.5 (6.75)	152.4 (16.00)	152.4 (6.00)
457.2 x 254.0 (18 x 10)	<b>YE-1810-1</b>	<b>YE-1810-1A</b>	1	171.5 (16.75)	222.3 (8.75)	152.4 (16.00)	203.2 (8.00)
457.2 x 304.8 (18 x 12)	<b>YE-1812-1</b>	<b>YE-1812-1A</b>	1	171.5 (16.75)	273.1 (10.75)	152.4 (16.00)	254.0 (10.00)
457.2 x 355.6 (18 x 14)	<b>YE-1814-1</b>	<b>YE-1814-1A</b>	1	171.5 (16.75)	323.9 (12.75)	152.4 (16.00)	304.8 (12.00)
457.2 x 406.4 (18 x 16)	—	—	—	—	—	—	—
457.2 x 457.2 (18 x 18)	<b>YE-1818-1</b>	<b>YE-1818-1A</b>	1	171.5 (16.75)	171.5 (16.75)	152.4 (16.00)	152.4 (16.00)
508.0 x 254.0 (20 x 10)	<b>YE-2010-1</b>	<b>YE-2010-1A</b>	1	222.3 (18.75)	222.3 (8.75)	457.2 (18.00)	203.2 (8.00)
609.6 x 304.8 (24.00 x 12.00)	<b>YE-2412-1</b>	<b>YE-2412-1A</b>	2	552.5 (21.75)	247.7 (9.75)	533.4 (21.00)	228.6 (9.00)
609.6 x 457.2 (24.00 x 18.00)	<b>YE-2418-1</b>	<b>YE-2418-1A</b>	2	552.5 (21.75)	400.1 (15.75)	533.4 (21.00)	381.0 (15.00)
609.6 x 609.6 (24.00 x 24.00)	<b>YE-2424-1</b>	<b>YE-2424-1A</b>	3	552.5 (21.75)	552.5 (21.75)	533.4 (21.00)	533.4 (21.00)
711.2 x 304.8 (28.00 x 12.00)	<b>YE-2812-1</b>	<b>YE-2812-1A</b>	2	654.1 (25.75)	247.7 (9.75)	635.0 (25.00)	228.6 (9.00)
762.0 x 304.8 (30.00 x 12.00)	<b>YE-3012-1</b>	<b>YE-3012-1A</b>	2	704.9 (27.75)	247.7 (9.75)	685.8 (27.00)	228.6 (9.00)
762.0 x 457.2 (30.00 x 18.00)	<b>YE-3018-1</b>	<b>YE-3018-1A</b>	2	704.9 (27.75)	400.1 (15.75)	685.8 (27.00)	381.0 (15.00)
762.0 x 609.6 (30.00 x 24.00)	<b>YE-3024-1</b>	<b>YE-3024-1A</b>	3	704.9 (27.75)	552.5 (21.75)	685.8 (27.00)	533.4 (21.00)
914.4 x 304.8 (36.00 x 12.00)	<b>YE-3612-1</b>	<b>YE-3612-1A</b>	2	857.3 (33.75)	247.7 (9.75)	838.2 (33.00)	228.6 (9.00)
914.4 x 457.2 (36.00 x 18.00)	<b>YE-3618-1</b>	<b>YE-3618-1A</b>	2	857.3 (33.75)	400.1 (15.75)	838.2 (33.00)	381.0 (15.00)
914.4 x 609.6 (36.00 x 24.00)	<b>YE-3624-1</b>	<b>YE-3624-1A</b>	3	857.3 (33.75)	552.5 (21.75)	838.2 (33.00)	533.4 (21.00)
914.4 x 762.0 (36.00 x 30.00)	<b>YE-3630-1</b>	<b>YE-3630-1A</b>	3	857.3 (33.75)	704.9 (27.75)	838.2 (33.00)	685.8 (27.00)
914.4 x 914.4 (36.00 x 36.00)	<b>YE-3636-1</b>	<b>YE-3636-1A</b>	3	857.3 (33.75)	857.3 (33.75)	838.2 (33.00)	838.2 (33.00)

# YE Cast Iron Junction Box Blank Bodies for Drilling and Tapping

## Explosionproof, Dust-Ignitionproof. Integrally Cast Mounting Feet

Drilled and tapped openings 1/2" thru 6" as specified.

### NEC/CEC:

Class I, Division 1 and 2, Group D  
Class II, Division 1 and 2, Groups E, F, G  
Class III

Determine catalog number as follows:

- (1) Select EXB junction box catalog number
- (2) Select "Conduit Opening Arrangement Diagram" number
- (3) Select symbols that represent conduit opening sizes from "Symbol Table."

Where no opening is required, the symbol 0 must be inserted. Add suffix for other optional features. The various divisions of the complete catalog number should be separated by dashes.

### Example:

The junction box selected is **YE181208** with steel mounting plate and the "Conduit Opening Arrangement" is diagram #1. Opening "a" is to be 1/2"; "b", 1-1/4"; "c", no opening needed; and "d", 1-1/2". In this example, the complete catalog number is:

**YE181208-1-AD0E-YM-1812-1**

### Standard Conduit Opening Arrangement Diagrams

Opening "a" is always TOP of box

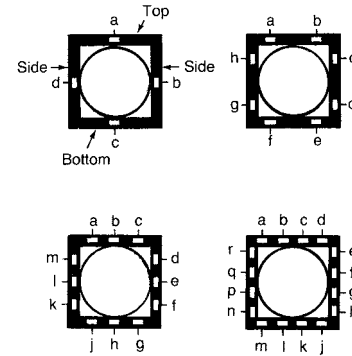

All Conduit Openings will be located in centerline of walls and evenly spaced unless otherwise specified. If a "Standard Conduit Opening Arrangement" is not suitable for the application, or when openings are to be more accurately spaced, submit Drill and Tap Schedule.

### Symbol Table

Drilling and Tapping (Five Threads Minimum)			
Symbol	Size	Symbol	Size
O	Blank	F	2
A	1/2	G	2-1/2
B	3/4	H	3
C	1	J	3-1/2
D	1-1/4	K	4
E	1-1/2	L	5
		M	6

### Minimum Recommended Spacing Between Conduit Openings

Allowance made for clearance over bushings. When unions or seals are used, additional space must be allowed.

Table shows minimum distances between conduit-opening centerlines in various size combinations. For example, if 1-1/2" and 3/4" openings are to be drilled and tapped into one side of box, the minimum spacing between centerlines would be 54.1 mm (2.13").

Conduit Size Inches	Minimum space between conduit opening centerlines in Millimeters (Inches)									
	1/2	3/4	1	1-1/4	1-1/2	2	2-1/2	3	3-1/2	4
1/2	31.8 (1.25)									
3/4	35.1 (1.38)	38.1 (1.50)								
1	39.6 (1.56)	42.9 (1.69)	47.8 (1.88)							
1-1/4	47.8 (1.88)	50.8 (2.00)	55.6 (2.19)	62.0 (2.44)						
1-1/2	50.8 (2.00)	54.1 (2.13)	58.7 (2.31)	66.8 (2.63)	69.9 (2.75)					
2	60.5 (2.38)	63.5 (2.50)	68.3 (2.69)	74.7 (2.94)	79.5 (3.13)	87.4 (3.44)				
2-1/2	63.5 (2.50)	66.8 (2.63)	71.4 (2.81)	79.5 (3.13)	82.6 (3.25)	92.2 (3.63)	95.3 (3.75)			
3	73.2 (2.88)	76.2 (3.00)	81.0 (3.19)	87.4 (3.44)	92.2 (3.63)	100.1 (3.94)	104.9 (4.13)	112.8 (4.44)		
3-1/2	79.5 (3.13)	82.6 (3.25)	87.4 (3.44)	95.3 (3.75)	98.6 (3.88)	108.0 (4.25)	111.3 (4.38)	120.7 (4.75)	127.0 (5.00)	
4	87.4 (3.44)	90.4 (3.56)	95.3 (3.75)	102.9 (4.05)	106.4 (4.19)	115.8 (4.56)	119.1 (4.69)	128.5 (5.06)	134.9 (5.31)	143.0 (5.63)

### Diameters of Bushings, Unions, Conduit and Seals, in Millimeters (Inches)

Conduit Size Inches	Diameters of Fittings for 1/2" through 4" Conduit									
	1/2	3/4	1	1-1/4	1-1/2	2	2-1/2	3	3-1/2	4
BBU Bushing	26.9 (1.06)	33.3 (1.31)	39.6 (1.56)	49.3 (1.94)	55.6 (2.19)	68.3 (2.69)	81.0 (3.19)	98.6 (3.88)	111.3 (4.38)	124.0 (4.88)
BU Bushing	28.7 (1.13)	31.8 (1.25)	41.4 (1.63)	52.3 (2.06)	58.7 (2.31)	74.7 (2.94)	82.6 (3.25)	98.6 (3.88)	115.8 (4.56)	128.5 (5.06)
UNY/UNF (R) Union	38.1 (1.50)	44.5 (1.75)	50.8 (2.00)	71.4 (2.81)	77.7 (3.06)	95.3 (3.75)	125.5 (4.94)	138.2 (5.44)	150.9 (5.94)	165.1 (6.50)
Conduit	22.4 (0.88)	26.9 (1.06)	35.1 (1.38)	42.9 (1.69)	49.3 (1.94)	60.5 (2.38)	73.2 (2.88)	88.9 (3.50)	101.6 (4.00)	114.3 (4.50)
EYM-EYF Seals Turning Radius	26.9 (1.06)	30.2 (1.19)	35.1 (1.38)	44.5 (1.75)	52.3 (2.06)	58.7 (2.31)	68.3 (2.69)	79.5 (3.13)	87.4 (3.44)	93.7 (3.69)

# YE Series Junction Box Drill and Tap Schedule

## Dust-Ignitionproof, Watertight

Cast iron box and cover for surface mounting. Cast aluminum box and cover for surface mounting.

NEC/CEC:

Class I, Division 1 and 2, Group D  
 Class II, Division 1 and 2, Groups E, F, G  
 Class III

ENCLOSURES AND JUNCTION BOXES: NEC/CEC EXPLOSIONPROOF ENCLOSURES

OZGECEDNEY

CONDUIT POSITION	CHECK ONLY IF FACTORY IS TO LOCATE			METAL PLUGS
	CONDUIT SIZE	X DIM.	D DIM.	
1				
2				
3				
4				
5				
6				
7				
8				
9				
10				
11				
12				
13				
14				
15				
16				
17				
18				
19				
20				
21				
22				
23				
24				

\* = B&D LOC.

VIEW LOOKING INTO BOX  
WITH SIDES LAID DOWN

**CHECK LIST**

ARE INDICATED CONDUIT SIZES WITHIN THE CATALOG PUBLISHED MAXIMUM ON PAGES K-40 AND K-43?

CHECK FOR MINIMUM SPACING BETWEEN CONDUIT OPENINGS PER CONDUIT SPACING TABLE, ON PAGE K-41.

SIGN NAME TO DWG.

NAME \_\_\_\_\_

DATE \_\_\_\_\_

**ENCLOSURE FIGURE**

ENCLOSURE

\* = BREATHER/DRAIN LOC. 1/2" NPT REQUIRED. LOCATION MAY BE SPECIFIED ON THE CHART OR IF BOX IS CHECKED, FACTORY WILL LOCATE IN SIDES A & C.

DIM. X = DISTANCE FROM CENTERLINE TO CENTER OF CONDUIT OPENING.  
 DIM. D = DISTANCE FROM MTG. SURFACE TO CENTER OF CONDUIT OPENING.

HINGED ENCLOSURES WILL BE HINGED ON SIDE "D" AS STANDARD.

CAUTION: IN PLANNING CONDUIT ARRANGEMENTS, REFER TO "USABLE CONDUIT AREA", SHOWN ON THE APPROPRIATE PRODUCT OUTLINE DRAWINGS AND TO THE CONDUIT SPACING CHARTS.

CONDUIT D&T SCHEDULE	
CAT. NO. _____	REV _____



# DTX Series Junction Boxes

## Dust-Ignitionproof, Watertight

Cast iron box and cover for surface mounting. Cast aluminum box and cover for surface mounting.

### NEC:

Class II, Division 1 and 2, Groups E, F, G

Class III

NEMA 4, 9EFG

### Applications

- DTX dust tight and watertight boxes are specially designed and constructed for hazardous locations where ignitable dusts, fibers or flyings are present such as:
- Grain elevators
- Grain storage areas
- Paper mills
- Coal storage facilities
- Textile factories

### Features

- Provided with mounting lugs.
- Mechanically attached gaskets.

### Standard Materials

- Bodies and covers: cast iron
- Gasket: vellumoid
- Cover bolts: stainless steel

### Standard Finishes

- Cast iron bodies and covers: hot dip galvanized finish

### Optional Materials

- Cast aluminum box and cover. Add suffix - **A**.
- For factory installed mounting plate, add suffix - **WYM**
- Refer to *Junction Box Mounting Plate Information* for complete listing of available mounting plates.

### NEC Certifications and Compliances

- UL Standard: UL 886 (UL 1203)
- UL Listed: E10444



# DTX Series Junction Boxes

## Dust-Ignitionproof, Watertight

Cast iron box and cover for surface mounting. Cast aluminum box and cover for surface mounting.

NEC:  
Class II, Division 1 and 2, Groups E, F, G  
Class III  
NEMA 4, 9EFG

ENCLOSURES AND JUNCTION BOXES: NEC/CEC WEATHERPROOF/DUSTPROOF JUNCTION AND OUTLET BOXES

Approximate Thickness Side Walls mm (in)	Maximum Conduit Size (In.-NPT)	Inside Dim. in Millimeters (Inches)					Iron Weight kg (lb)	Aluminum Weight kg (lb)	Catalog Number ①
		L	x	W	x	D			
6.4 (0.25)	3/4	101.6 (4.00)	x	101.6 (4.00)	x	76.2 (3.00)	3.2 (7.00)	0.9 (2.00)	DTX-040403
6.4 (0.25)	3/4	101.6 (4.00)	x	101.6 (4.00)	x	101.6 (4.00)	3.6 (8.00)	1.4 (3.00)	DTX-040404
6.4 (0.25)	3/4	127.0 (5.00)	x	127.0 (5.00)	x	101.6 (4.00)	3.6 (8.00)	1.4 (3.00)	DTX-050504
6.4 (0.25)	3/4	152.4 (6.00)	x	101.6 (4.00)	x	76.2 (3.00)	3.6 (8.00)	1.4 (3.00)	DTX-060403
6.4 (0.25)	3/4	152.4 (6.00)	x	101.6 (4.00)	x	101.6 (4.00)	3.6 (8.00)	1.4 (3.00)	DTX-060404
6.4 (0.25)	3/4	152.4 (6.00)	x	152.4 (6.00)	x	76.2 (3.00)	5.0 (11.00)	1.8 (4.00)	DTX-060603
6.4 (0.25)	3/4	152.4 (6.00)	x	152.4 (6.00)	x	101.6 (4.00)	6.8 (15.00)	2.7 (6.00)	DTX-060604
6.4 (0.25)	3/4	152.4 (6.00)	x	152.4 (6.00)	x	152.4 (6.00)	8.2 (18.00)	3.2 (7.00)	DTX-060606
6.4 (0.25)	3/4	203.2 (8.00)	x	101.6 (4.00)	x	76.2 (3.00)	5.0 (11.00)	1.8 (4.00)	DTX-080403
6.4 (0.25)	3/4	203.2 (8.00)	x	101.6 (4.00)	x	101.6 (4.00)	5.4 (12.00)	2.3 (5.00)	DTX-080404
6.4 (0.25)	3/4	203.2 (8.00)	x	152.4 (6.00)	x	76.2 (3.00)	6.8 (15.00)	2.7 (6.00)	DTX-080603
6.4 (0.25)	3/4	203.2 (8.00)	x	152.4 (6.00)	x	101.6 (4.00)	7.3 (16.00)	2.7 (6.00)	DTX-080604
6.4 (0.25)	3/4	203.2 (8.00)	x	152.4 (6.00)	x	152.4 (6.00)	10.00 (22.00)	3.6 (8.00)	DTX-080606
6.4 (0.25)	3/4	203.2 (8.00)	x	203.2 (8.00)	x	101.6 (4.00)	10.9 (24.00)	4.1 (9.00)	DTX-080804
6.4 (0.25)	3/4	203.2 (8.00)	x	203.2 (8.00)	x	152.4 (6.00)	13.2 (29.00)	5.0 (11.00)	DTX-080806
6.4 (0.25)	3/4	203.2 (8.00)	x	203.2 (8.00)	x	203.2 (8.00)	15.0 (33.00)	5.9 (13.00)	DTX-080808
6.4 (0.25)	3/4	254.0 (10.00)	x	152.4 (6.00)	x	101.6 (4.00)	10.00 (22.00)	3.6 (8.00)	DTX-100604
6.4 (0.25)	3/4	254.0 (10.00)	x	152.4 (6.00)	x	152.4 (6.00)	10.9 (24.00)	4.1 (9.00)	DTX-100606
6.4 (0.25)	3/4	254.0 (10.00)	x	203.2 (8.00)	x	101.6 (4.00)	13.2 (29.00)	5.0 (11.00)	DTX-100804
6.4 (0.25)	3/4	254.0 (10.00)	x	203.2 (8.00)	x	152.4 (6.00)	15.4 (34.00)	5.9 (13.00)	DTX-100806
6.4 (0.25)	3/4	254.0 (10.00)	x	203.2 (8.00)	x	203.2 (8.00)	18.6 (41.00)	6.8 (15.00)	DTX-100808
6.4 (0.25)	3/4	254.0 (10.00)	x	254.0 (10.00)	x	101.6 (4.00)	14.1 (31.00)	5.4 (12.00)	DTX-101004
6.4 (0.25)	3/4	254.0 (10.00)	x	254.0 (10.00)	x	152.4 (6.00)	17.7 (39.00)	6.8 (15.00)	DTX-101006
6.4 (0.25)	3/4	254.0 (10.00)	x	254.0 (10.00)	x	203.2 (8.00)	20.4 (45.00)	8.2 (18.00)	DTX-101008
6.4 (0.25)	3/4	304.8 (12.00)	x	101.6 (4.00)	x	101.6 (4.00)	10.4 (23.00)	4.1 (9.00)	DTX-120404
6.4 (0.25)	3/4	304.8 (12.00)	x	152.4 (6.00)	x	101.6 (4.00)	12.2 (27.00)	4.5 (10.00)	DTX-120604
6.4 (0.25)	3/4	304.8 (12.00)	x	152.4 (6.00)	x	152.4 (6.00)	14.5 (32.00)	5.4 (12.00)	DTX-120606
6.4 (0.25)	3/4	304.8 (12.00)	x	203.2 (8.00)	x	101.6 (4.00)	14.1 (31.00)	5.4 (12.00)	DTX-120804
6.4 (0.25)	3/4	304.8 (12.00)	x	203.2 (8.00)	x	152.4 (6.00)	18.1 (40.00)	6.8 (15.00)	DTX-120806
6.4 (0.25)	3/4	304.8 (12.00)	x	203.2 (8.00)	x	203.2 (8.00)	21.8 (48.00)	8.2 (18.00)	DTX-120808
6.4 (0.25)	3/4	304.8 (12.00)	x	254.0 (10.00)	x	101.6 (4.00)	20.0 (44.00)	7.7 (17.00)	DTX-121004
6.4 (0.25)	3/4	304.8 (12.00)	x	254.0 (10.00)	x	152.4 (6.00)	21.3 (47.00)	8.2 (18.00)	DTX-121006
6.4 (0.25)	3/4	304.8 (12.00)	x	254.0 (10.00)	x	203.2 (8.00)	22.7 (50.00)	8.6 (19.00)	DTX-121008
6.4 (0.25)	3/4	304.8 (12.00)	x	304.8 (12.00)	x	101.6 (4.00)	20.4 (45.00)	7.7 (17.00)	DTX-121204
6.4 (0.25)	3/4	304.8 (12.00)	x	304.8 (12.00)	x	152.4 (6.00)	24.5 (54.00)	8.6 (19.00)	DTX-121206
7.9 (0.31)	2	304.8 (12.00)	x	304.8 (12.00)	x	177.8 (7.00)	27.2 (60.00)	10.0 (22.00)	DTX-121207
7.9 (0.31)	2	304.8 (12.00)	x	304.8 (12.00)	x	203.2 (8.00)	29.9 (66.00)	11.3 (25.00)	DTX-121208
7.9 (0.31)	2	304.8 (12.00)	x	304.8 (12.00)	x	254.0 (10.00)	32.7 (72.00)	12.2 (27.00)	DTX-121210
7.9 (0.31)	2	304.8 (12.00)	x	304.8 (12.00)	x	304.8 (12.00)	37.2 (82.00)	14.1 (31.00)	DTX-121212
6.4 (0.25)	3/4	101.6 (4.00)	x	203.2 (8.00)	x	101.6 (4.00)	15.9 (35.00)	5.9 (13.00)	DTX-140804
6.4 (0.25)	3/4	101.6 (4.00)	x	203.2 (8.00)	x	152.4 (6.00)	18.1 (40.00)	6.8 (15.00)	DTX-140806
6.4 (0.25)	3/4	101.6 (4.00)	x	203.2 (8.00)	x	203.2 (8.00)	23.6 (52.00)	9.1 (20.00)	DTX-140808
7.9 (0.31)	2	101.6 (4.00)	x	101.6 (4.00)	x	152.4 (6.00)	34.0 (75.00)	12.7 (28.00)	DTX-141406
7.9 (0.31)	2	101.6 (4.00)	x	101.6 (4.00)	x	203.2 (8.00)	38.6 (85.00)	14.5 (32.00)	DTX-141408

① Type DTX boxes must have a minimum of 3-1/2 full threads at all conduit entrances. The "Max. Conduit Size" listed herein indicates the maximum drilled and tapped conduit entrance which can be machined into the four unbossed sides of a given box to provide these 3-1/2 full threads. If larger conduit openings than those listed herein are required, bosses can be supplied by us at an additional cost to provide the minimum 3-1/2 full thread requirement. In addition to the minimum 3-1/2 full thread requirement, the length of thread at conduit entrances must also be at least 1/4". A 3/8" conduit entrance therefore requires a minimum of a 6.4 mm (0.25") wall thickness. For aluminum box and cover, add suffix -A.

# DTX Series Junction Boxes

## Dust-Ignitionproof, Watertight

Cast iron box and cover for surface mounting. Cast aluminum box and cover for surface mounting.

NEC:  
Class II, Division 1 and 2, Groups E, F, G  
Class III  
NEMA 4, 9EFG

Approximate Thickness Side Walls mm (in)	Maximum Conduit Size (In.-NPT)	Inside Dim. in Millimeters (Inches)					Iron Weight kg (lb)	Aluminum Weight kg (lb)	Catalog Number ①
		L	x	W	x	D			
7.9 (0.31)	2	355.6 (14.00)	x	355.6 (14.00)	x	254.0 (10.00)	41.7 (92.00)	15.4 (34.00)	DTX-141410
7.1 (0.28)	3/4	406.4 (16.00)	x	304.8 (12.00)	x	101.6 (4.00)	28.1 (62.00)	10.4 (23.00)	DTX-161204
7.1 (0.28)	3/4	406.4 (16.00)	x	304.8 (12.00)	x	152.4 (6.00)	33.1 (73.00)	12.2 (27.00)	DTX-161206
7.1 (0.28)	3/4	406.4 (16.00)	x	304.8 (12.00)	x	203.2 (8.00)	36.7 (81.00)	13.6 (30.00)	DTX-161208
7.9 (0.31)	2	406.4 (16.00)	x	406.4 (16.00)	x	152.4 (6.00)	45.4 (100.00)	16.8 (37.00)	DTX-161606
7.1 (0.28)	3/4	457.2 (18.00)	x	152.4 (6.00)	x	152.4 (6.00)	22.7 (50.00)	8.6 (19.00)	DTX-180606
7.1 (0.28)	3/4	457.2 (18.00)	x	203.2 (8.00)	x	101.6 (4.00)	23.6 (52.00)	9.1 (20.00)	DTX-180804
7.1 (0.28)	3/4	457.2 (18.00)	x	203.2 (8.00)	x	152.4 (6.00)	25.9 (57.00)	9.5 (21.00)	DTX-180806
6.4 (0.25)	3/4	457.2 (18.00)	x	304.8 (12.00)	x	101.6 (4.00)	27.7 (61.00)	10.4 (23.00)	DTX-181204
7.1 (0.28)	3/4	457.2 (18.00)	x	304.8 (12.00)	x	152.4 (6.00)	37.2 (82.00)	14.1 (31.00)	DTX-181206
7.9 (0.31)	2	457.2 (18.00)	x	304.8 (12.00)	x	203.2 (8.00)	44.0 (97.00)	16.3 (36.00)	DTX-181208
7.9 (0.31)	2	457.2 (18.00)	x	304.8 (12.00)	x	254.0 (10.00)	48.5 (107.00)	18.1 (40.00)	DTX-181210
7.9 (0.31)	2	457.2 (18.00)	x	304.8 (12.00)	x	304.8 (12.00)	56.7 (125.00)	21.3 (47.00)	DTX-181212
8.6 (0.34)	2	457.2 (18.00)	x	304.8 (12.00)	x	457.2 (18.00)	77.6 (171.00)	29.0 (64.00)	DTX-181218
7.9 (0.31)	2	457.2 (18.00)	x	457.2 (18.00)	x	152.4 (6.00)	59.0 (130.00)	21.8 (48.00)	DTX-181806
7.9 (0.31)	2	457.2 (18.00)	x	457.2 (18.00)	x	203.2 (8.00)	64.0 (141.00)	23.6 (52.00)	DTX-181808
7.9 (0.31)	2	457.2 (18.00)	x	457.2 (18.00)	x	254.0 (10.00)	70.8 (156.00)	26.3 (58.00)	DTX-181810
7.9 (0.31)	2	457.2 (18.00)	x	457.2 (18.00)	x	304.8 (12.00)	82.1 (181.00)	30.4 (67.00)	DTX-181812
7.9 (0.31)	2	609.6 (24.00)	x	304.8 (12.00)	x	152.4 (6.00)	47.6 (105.00)	17.7 (39.00)	DTX-241206
7.9 (0.31)	2	609.6 (24.00)	x	304.8 (12.00)	x	203.2 (8.00)	56.7 (125.00)	21.3 (47.00)	DTX-241208
7.9 (0.31)	2	609.6 (24.00)	x	304.8 (12.00)	x	304.8 (12.00)	72.6 (160.00)	27.2 (60.00)	DTX-241212
8.6 (0.34)	2	609.6 (24.00)	x	457.2 (18.00)	x	152.4 (6.00)	74.8 (165.00)	27.7 (61.00)	DTX-241806
8.6 (0.34)	2	609.6 (24.00)	x	457.2 (18.00)	x	203.2 (8.00)	79.4 (175.00)	29.5 (65.00)	DTX-241808
8.6 (0.34)	2	609.6 (24.00)	x	457.2 (18.00)	x	254.0 (10.00)	86.2 (190.00)	31.8 (70.00)	DTX-241810
8.6 (0.34)	2	609.6 (24.00)	x	457.2 (18.00)	x	304.8 (12.00)	106.6 (235.00)	39.5 (87.00)	DTX-241812
8.6 (0.34)	2	609.6 (24.00)	x	609.6 (24.00)	x	152.4 (6.00)	102.1 (225.00)	38.1 (84.00)	DTX-242406
8.6 (0.34)	2	609.6 (24.00)	x	609.6 (24.00)	x	203.2 (8.00)	106.6 (235.00)	39.5 (87.00)	DTX-242408
9.7 (0.38)	2	609.6 (24.00)	x	609.6 (24.00)	x	254.0 (10.00)	117.9 (260.00)	43.5 (96.00)	DTX-242410
9.7 (0.38)	2	609.6 (24.00)	x	609.6 (24.00)	x	304.8 (12.00)	136.1 (300.00)	50.3 (111.00)	DTX-242412
9.7 (0.38)	2	711.2 (28.00)	x	304.8 (12.00)	x	203.2 (8.00)	68.0 (150.00)	25.4 (56.00)	DTX-281208
9.7 (0.38)	2	711.2 (28.00)	x	304.8 (12.00)	x	304.8 (12.00)	83.9 (185.00)	31.3 (69.00)	DTX-281212
9.7 (0.38)	2	762.0 (30.00)	x	609.6 (24.00)	x	203.2 (8.00)	140.6 (310.00)	52.2 (115.00)	DTX-302408
9.7 (0.38)	2	762.0 (30.00)	x	609.6 (24.00)	x	254.0 (10.00)	152.0 (335.00)	56.2 (124.00)	DTX-302410
9.7 (0.38)	2	762.0 (30.00)	x	609.6 (24.00)	x	304.8 (12.00)	163.3 (360.00)	60.8 (134.00)	DTX-302412
9.7 (0.38)	2	762.0 (30.00)	x	609.6 (24.00)	x	457.2 (18.00)	217.7 (480.00)	72.1 (159.00)	DTX-302418
9.7 (0.38)	2	914.4 (36.00)	x	457.2 (18.00)	x	152.4 (6.00)	111.1 (245.00)	41.3 (91.00)	DTX-361806
9.7 (0.38)	2	914.4 (36.00)	x	457.2 (18.00)	x	203.2 (8.00)	163.3 (360.00)	43.5 (96.00)	DTX-361808
9.7 (0.38)	2	914.4 (36.00)	x	457.2 (18.00)	x	304.8 (12.00)	158.8 (350.00)	59.0 (130.00)	DTX-361812
9.7 (0.38)	2	914.4 (36.00)	x	457.2 (18.00)	x	457.2 (18.00)	249.5 (550.00)	94.8 (209.00)	DTX-361818
10.4 (0.41)	2	914.4 (36.00)	x	609.6 (24.00)	x	457.2 (18.00)	294.8 (650.00)	111.1 (245.00)	DTX-362418
11.2 (0.44)	5	914.4 (36.00)	x	914.4 (36.00)	x	203.2 (8.00)	220.0 (485.00)	83.5 (184.00)	DTX-363608
11.2 (0.44)	6	914.4 (36.00)	x	914.4 (36.00)	x	304.8 (12.00)	240.4 (530.00)	90.7 (200.00)	DTX-363612
11.2 (0.44)	6	914.4 (36.00)	x	914.4 (36.00)	x	457.2 (18.00)	385.6 (850.00)	142.9 (315.00)	DTX-363618

① Type DTX boxes must have a minimum of 3-1/2 full threads at all conduit entrances. The "Max. Conduit Size" listed herein indicates the maximum drilled and tapped conduit entrance which can be machined into the four unbossed sides of a given box to provide these 3-1/2 full threads. If larger conduit openings than those listed herein are required, bosses can be supplied by us at an additional cost to provide the minimum 3-1/2 full thread requirement. In addition to the minimum 3-1/2 full thread requirement, the length of thread at conduit entrances must also be at least 1/4". A 3/8" conduit entrance therefore requires a minimum of a 6.4 mm (0.25") wall thickness. For aluminum box and cover, add suffix -A.

# DTX Series Junction Box Mounting Plate Information

## Dust-Ignitionproof, Watertight

Cast iron box and cover for surface mounting. Cast aluminum box and cover for surface mounting.

**NEC:**  
 Class II, Division 1 and 2, Groups E, F, G  
 Class III  
 NEMA 4, 9EFG

Mounting plates are used for mounting equipment up off the back of an enclosure. Steel Plates are all 3.3 mm (0.13") thick hot dip galvanized material. Aluminum plates are 3.3 mm (0.13") thick material up to and including 304.8 x 304.8 mm (12 x 12") size. All larger sizes are constructed of 4.8 mm (0.19") thick aluminum plate. The catalog numbers shown in the table below include the mounting buttons.

Select mounting plates based on inside length and width of box. Order as a separate item immediately following the catalog number of the box as follows:

Example: Line 1 **DTX-181204**  
 Line 2 **WYM-1812-1**

For mounting plates in smaller boxes than listed, use similar catalog number logic. Example: A steel mounting plate for a **DTX-040404** box would be **WYM-0404-1**. Pricing will be based upon a **WYM-0808-1** price.

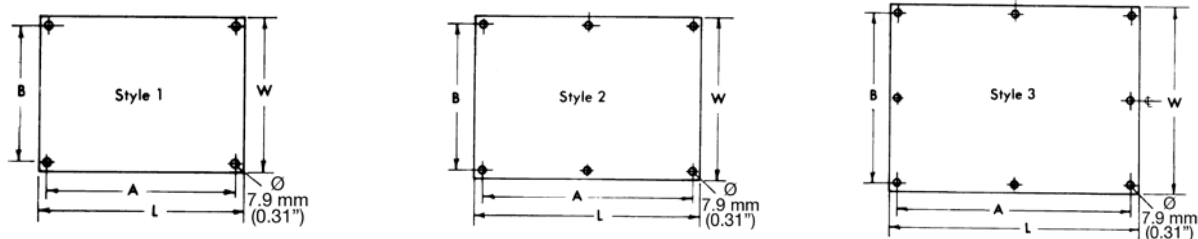

Inside Length and Width of Junction Box in mm (in)	Catalog Number		Style	Dimension in Millimeters (Inches)			
	Steel Plates	Aluminum Plates		L	W	A	B
203.2 x 203.2 (8 x 8)	<b>WYM-0808-1</b>	<b>WYM-0808-1A</b>	1	171.5 (6.75)	171.5 (6.75)	152.4 (6.00)	152.4 (6.00)
254.0 x 203.2 (10 x 8)	<b>WYM-1008-1</b>	<b>WYM-1008-1A</b>	1	222.3 (8.75)	171.5 (6.75)	203.2 (8.00)	203.2 (8.00)
254.0 x 254.0 (10 x 10)	<b>WYM-1010-1</b>	<b>WYM-1010-1A</b>	1	222.3 (8.75)	222.3 (8.75)	203.2 (8.00)	203.2 (8.00)
304.8 x 203.2 (12 x 8)	<b>WYM-1208-1</b>	<b>WYM-1208-1A</b>	1	273.1 (10.75)	171.5 (6.75)	254.0 (10.00)	152.4 (6.00)
304.8 x 254.0 (12 x 10)	<b>WYM-1210-1</b>	<b>WYM-1210-1A</b>	1	273.1 (10.75)	222.3 (8.75)	254.0 (10.00)	203.2 (8.00)
304.8 x 304.8 (12 x 12)	<b>WYM-1212-1</b>	<b>WYM-1212-1A</b>	1	273.1 (10.75)	273.1 (10.75)	254.0 (10.00)	254.0 (10.00)
355.6 x 203.2 (14 x 8)	<b>WYM-1408-1</b>	<b>WYM-1408-1A</b>	1	323.9 (12.75)	171.5 (6.75)	304.8 (12.00)	152.4 (6.00)
355.6 x 355.6 (14 x 14)	<b>WYM-1414-1</b>	<b>WYM-1414-1A</b>	1	323.9 (12.75)	323.9 (12.75)	304.8 (12.00)	304.8 (12.00)
406.4 x 203.2 (16 x 8)	<b>WYM-1608-1</b>	<b>WYM-1608-1A</b>	1	374.7 (14.75)	171.5 (6.75)	355.6 (14.00)	152.4 (6.00)
406.4 x 304.8 (16 x 12)	<b>WYM-1612-1</b>	<b>WYM-1612-1A</b>	1	374.7 (14.75)	273.1 (10.75)	355.6 (14.00)	254.0 (10.00)
406.4 x 406.4 (16 x 16)	<b>WYM-1616-1</b>	<b>WYM-1616-1A</b>	1	374.7 (14.75)	374.7 (14.75)	355.6 (14.00)	355.6 (14.00)
457.2 x 203.2 (18 x 8)	<b>WYM-1808-1</b>	<b>WYM-1808-1A</b>	1	171.5 (16.75)	171.5 (6.75)	152.4 (16.00)	152.4 (6.00)
457.2 x 254.0 (18 x 10)	<b>WYM-1810-1</b>	<b>WYM-1810-1A</b>	1	171.5 (16.75)	222.3 (8.75)	406.4 (16.00)	203.2 (8.00)
457.2 x 304.8 (18 x 12)	<b>WYM-1812-1</b>	<b>WYM-1812-1A</b>	1	171.5 (16.75)	273.1 (10.75)	406.4 (16.00)	254.0 (10.00)
457.2 x 355.6 (18 x 14)	<b>WYM-1814-1</b>	<b>WYM-1814-1A</b>	1	171.5 (16.75)	323.9 (12.75)	406.4 (16.00)	304.8 (12.00)
457.2 x 406.4 (18 x 16)	—	—	—	—	—	—	—
457.2 x 457.2 (18 x 18)	<b>WYM-1818-1</b>	<b>WYM-1818-1A</b>	1	171.5 (16.75)	171.5 (16.75)	406.4 (16.00)	406.4 (16.00)
508.0 x 254.0 (20 x 10)	<b>WYM-2010-1</b>	<b>WYM-2010-1A</b>	1	222.3 (18.75)	222.3 (8.75)	457.2 (18.00)	203.2 (8.00)
609.6 x 304.8 (24.00 x 12.00)	<b>WYM-2412-1</b>	<b>WYM-2412-1A</b>	2	552.5 (21.75)	247.7 (9.75)	533.4 (21.00)	228.6 (9.00)
609.6 x 457.2 (24.00 x 18.00)	<b>WYM-2418-1</b>	<b>WYM-2418-1A</b>	2	552.5 (21.75)	400.1 (15.75)	533.4 (21.00)	381.0 (15.00)
609.6 x 609.6 (24.00 x 24.00)	<b>WYM-2424-1</b>	<b>WYM-2424-1A</b>	3	552.5 (21.75)	552.5 (21.75)	533.4 (21.00)	533.4 (21.00)
711.2 x 304.8 (28.00 x 12.00)	<b>WYM-2812-1</b>	<b>WYM-2812-1A</b>	2	654.1 (25.75)	247.7 (9.75)	635.0 (25.00)	228.6 (9.00)
762.0 x 304.8 (30.00 x 12.00)	<b>WYM-3012-1</b>	<b>WYM-3012-1A</b>	2	704.9 (27.75)	247.7 (9.75)	685.8 (27.00)	228.6 (9.00)
762.0 x 457.2 (30.00 x 18.00)	<b>WYM-3018-1</b>	<b>WYM-3018-1A</b>	2	704.9 (27.75)	400.1 (15.75)	685.8 (27.00)	381.0 (15.00)
762.0 x 609.6 (30.00 x 24.00)	<b>WYM-3024-1</b>	<b>WYM-3024-1A</b>	3	704.9 (27.75)	552.5 (21.75)	685.8 (27.00)	533.4 (21.00)
914.4 x 304.8 (36.00 x 12.00)	<b>WYM-3612-1</b>	<b>WYM-3612-1A</b>	2	857.3 (33.75)	247.7 (9.75)	838.2 (33.00)	228.6 (9.00)
914.4 x 457.2 (36.00 x 18.00)	<b>WYM-3618-1</b>	<b>WYM-3618-1A</b>	2	857.3 (33.75)	400.1 (15.75)	838.2 (33.00)	381.0 (15.00)
914.4 x 609.6 (36.00 x 24.00)	<b>WYM-3624-1</b>	<b>WYM-3624-1A</b>	3	857.3 (33.75)	552.5 (21.75)	838.2 (33.00)	533.4 (21.00)
914.4 x 762.0 (36.00 x 30.00)	<b>WYM-3630-1</b>	<b>WYM-3630-1A</b>	3	857.3 (33.75)	704.9 (27.75)	838.2 (33.00)	685.8 (27.00)
914.4 x 914.4 (36.00 x 36.00)	<b>WYM-3636-1</b>	<b>WYM-3636-1A</b>	3	857.3 (33.75)	857.3 (33.75)	838.2 (33.00)	838.2 (33.00)

ENCLOSURES AND JUNCTION BOXES: NEC/CEC WEATHERPROOF/DUSTPROOF JUNCTION AND OUTLET BOXES



# DTX Series Junction Box Drill and Tap Schedule

## Dust-Ignitionproof, Watertight

Cast iron box and cover for surface mounting. Cast aluminum box and cover for surface mounting.

NEC:  
 Class II, Division 1 and 2, Groups E, F, G  
 Class III  
 NEMA 4, 9EFG

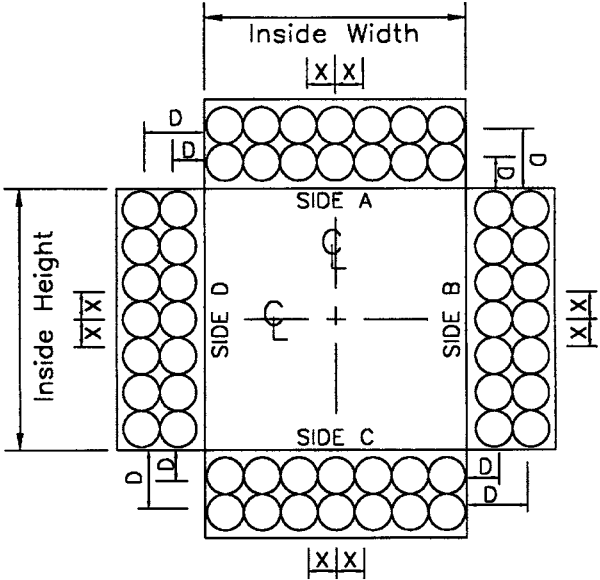
CONDUIT POSITION	CHECK ONLY IF FACTORY IS TO LOCATE			METAL PLUGS	* = B&D LOC.  	CHECK LIST  ARE INDICATED CONDUIT SIZES WITHIN THE CATALOG PUBLISHED MAXIMUM ON PAGES K-40 AND K-43?  CHECK FOR MINIMUM SPACING BETWEEN CONDUIT OPENINGS PER CONDUIT SPACING TABLE, ON PAGE K-41. <input type="checkbox"/> SIGN NAME TO DWG.
	CONDUIT SIZE	X DIM.	D DIM.			
1						
2						
3						
4						
5						
6						
7						
8						
9						
10						
11						
12						
13						
14						
15						
16						
17						
18						
19						
20						
21						
22						
23						
24						

VIEW LOOKING INTO BOX WITH SIDES LAID DOWN

**ENCLOSURE FIGURE**

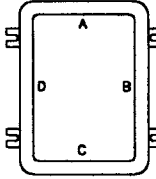

ENCLOSURE

\* = BREATHER/DRAIN LOC. 1/2" NPT REQUIRED. LOCATION MAY BE SPECIFIED ON THE CHART OR IF BOX IS CHECKED, FACTORY WILL LOCATE IN SIDES A & C.  
 DIM. X = DISTANCE FROM CENTERLINE TO CENTER OF CONDUIT OPENING.  
 DIM. D = DISTANCE FROM MTG. SURFACE TO CENTER OF CONDUIT OPENING.  
 HINGED ENCLOSURES WILL BE HINGED ON SIDE "D" AS STANDARD.  
 CAUTION: IN PLANNING CONDUIT ARRANGEMENTS, REFER TO "USABLE CONDUIT AREA", SHOWN ON THE APPROPRIATE PRODUCT OUTLINE DRAWINGS AND TO THE CONDUIT SPACING CHARTS.

	CONDUIT D&T SCHEDULE	
	CAT. NO. _____	REV _____

ENCLOSURES AND JUNCTION BOXES: NEC/CEC WEATHERPROOF/DUSTPROOF JUNCTION AND OUTLET BOXES



# DTX Series Junction Box

## Dust-Ignitionproof, Watertight

Cast iron box and cover for surface mounting. Cast aluminum box and cover for surface mounting.

NEC:  
Class II, Division 1 and 2, Groups E, F, G  
Class III  
NEMA 4, 9EFG

### Outside Flange Dimensional Data in Millimeters (Inches)

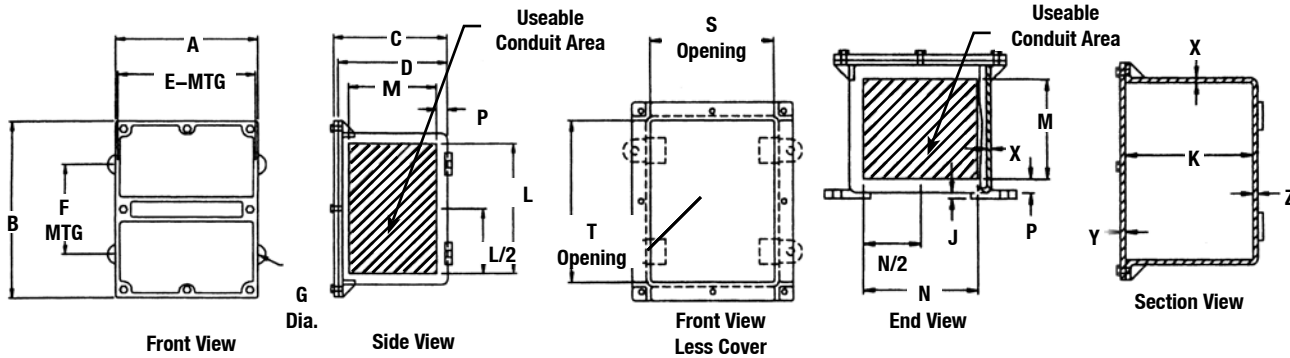

Overall Enclosure				Mounting Enclosure			Mount Thickness	Depth	Conduit Area				Clear Opening		Wall Thickness			Catalog Number
A	B	C	D	E	F	G			J	K	L	M	N	P	S	T	X	
141.20 (5.56)	141.20 (5.56)	84.80 (3.34)	80.30 (3.16)	141.20 (5.56)	76.20 (3.00)	7.90 (0.31)	3.30 (0.13)	76.20 (3.00)	88.90 (3.50)	58.70 (2.31)	88.90 (3.50)	11.20 (0.44)	101.60 (4.00)	101.60 (4.00)	4.10 (0.16)	4.80 (0.19)	4.10 (0.16)	DTX-040403
141.20 (5.56)	141.20 (5.56)	110.20 (4.34)	105.70 (4.16)	141.20 (5.56)	101.60 (4.00)	7.90 (0.31)	3.30 (0.13)	101.60 (4.00)	88.90 (3.50)	58.70 (2.31)	88.90 (3.50)	11.20 (0.44)	101.60 (4.00)	101.60 (4.00)	4.10 (0.16)	4.80 (0.19)	4.10 (0.16)	DTX-040404
173.00 (6.81)	173.00 (6.81)	111.30 (4.38)	106.40 (4.19)	165.10 (6.50)	101.60 (4.00)	7.90 (0.31)	3.30 (0.13)	101.60 (4.00)	114.30 (4.50)	84.10 (3.31)	88.90 (3.50)	11.20 (0.44)	127.00 (5.00)	127.00 (5.00)	4.80 (0.19)	4.80 (0.19)	4.80 (0.19)	DTX-050504
141.20 (5.56)	192.00 (7.56)	84.80 (3.34)	80.30 (3.16)	136.70 (5.38)	127.00 (5.00)	7.90 (0.31)	3.30 (0.13)	76.20 (3.00)	139.70 (5.50)	58.70 (2.31)	88.90 (3.50)	11.20 (0.44)	101.60 (4.00)	152.40 (6.00)	4.10 (0.16)	4.80 (0.19)	4.10 (0.16)	DTX-060403
141.20 (5.56)	192.00 (7.56)	110.20 (4.34)	105.70 (4.16)	136.70 (5.38)	127.00 (5.00)	7.90 (0.31)	3.30 (0.13)	76.20 (3.00)	139.70 (5.50)	84.10 (3.31)	88.90 (3.50)	11.20 (0.44)	101.60 (4.00)	152.40 (6.00)	4.10 (0.16)	4.80 (0.19)	4.10 (0.16)	DTX-060404
198.40 (7.81)	198.40 (7.81)	85.90 (3.38)	81.00 (3.19)	190.50 (7.50)	101.60 (4.00)	9.70 (0.38)	6.40 (0.25)	76.20 (3.00)	139.70 (5.50)	57.20 (2.25)	139.70 (5.50)	11.20 (0.44)	152.40 (6.00)	152.40 (6.00)	4.80 (0.19)	4.80 (0.19)	4.80 (0.19)	DTX-060603
198.40 (7.81)	198.40 (7.81)	112.00 (4.41)	107.20 (4.22)	190.50 (7.50)	101.60 (4.00)	9.70 (0.38)	6.40 (0.25)	101.60 (4.00)	139.70 (5.50)	82.60 (3.25)	139.70 (5.50)	11.20 (0.44)	152.40 (6.00)	152.40 (6.00)	5.60 (0.22)	4.80 (0.19)	5.60 (0.22)	DTX-060604
198.40 (7.81)	198.40 (7.81)	162.80 (6.41)	158.00 (6.22)	190.50 (7.50)	101.60 (4.00)	9.70 (0.38)	6.40 (0.25)	152.40 (6.00)	139.70 (5.50)	158.80 (6.25)	139.70 (5.50)	11.20 (0.44)	152.40 (6.00)	152.40 (6.00)	4.80 (0.19)	4.80 (0.19)	4.80 (0.19)	DTX-060606
147.60 (5.81)	249.20 (9.81)	87.40 (3.44)	81.00 (3.19)	139.70 (5.50)	127.00 (5.00)	9.70 (0.38)	6.40 (0.25)	76.20 (3.00)	190.50 (7.50)	57.20 (2.25)	88.90 (3.50)	11.90 (0.47)	101.60 (4.00)	203.20 (8.00)	4.80 (0.19)	6.40 (0.25)	4.80 (0.19)	DTX-080403
147.60 (5.81)	249.20 (9.81)	112.80 (4.44)	106.40 (4.19)	139.70 (5.50)	127.00 (5.00)	9.70 (0.38)	6.40 (0.25)	101.60 (4.00)	190.50 (7.50)	82.60 (3.25)	88.90 (3.50)	11.90 (0.47)	101.60 (4.00)	203.20 (8.00)	4.80 (0.19)	6.40 (0.25)	4.80 (0.19)	DTX-080404
198.40 (7.81)	249.20 (9.81)	88.10 (3.47)	81.80 (3.22)	193.80 (7.63)	127.00 (5.00)	9.70 (0.38)	6.40 (0.25)	76.20 (3.00)	190.50 (7.50)	57.20 (2.25)	139.70 (5.50)	12.70 (0.50)	152.40 (6.00)	203.20 (8.00)	5.60 (0.22)	6.40 (0.25)	5.60 (0.22)	DTX-080603
198.40 (7.81)	249.20 (9.81)	113.50 (4.47)	107.20 (4.22)	193.80 (7.63)	127.00 (5.00)	9.70 (0.38)	6.40 (0.25)	101.60 (4.00)	190.50 (7.50)	82.60 (3.25)	139.70 (5.50)	12.70 (0.50)	152.40 (6.00)	203.20 (8.00)	5.60 (0.22)	6.40 (0.25)	5.60 (0.22)	DTX-080404
198.40 (7.81)	249.20 (9.81)	164.30 (6.47)	158.00 (6.22)	193.80 (7.63)	127.00 (5.00)	9.70 (0.38)	6.40 (0.25)	152.40 (6.00)	190.50 (7.50)	133.40 (5.25)	139.70 (5.50)	12.70 (0.50)	152.40 (6.00)	203.20 (8.00)	5.60 (0.22)	6.40 (0.25)	5.60 (0.22)	DTX-080606
249.2 (9.81)	249.2 (9.81)	113.5 (4.47)	107.2 (4.22)	244.6 (9.63)	127.00 (5.00)	9.70 (0.38)	6.40 (0.25)	101.60 (4.00)	190.50 (7.50)	82.60 (3.25)	190.50 (7.50)	12.70 (0.50)	203.20 (8.00)	203.20 (8.00)	5.60 (0.22)	6.40 (0.25)	5.60 (0.22)	DTX-080804
249.2 (9.81)	249.2 (9.81)	164.3 (6.47)	158.0 (6.22)	244.6 (9.63)	127.00 (5.00)	9.70 (0.38)	6.40 (0.25)	152.40 (6.00)	190.50 (7.50)	133.40 (5.25)	190.50 (7.50)	12.70 (0.50)	203.20 (8.00)	203.20 (8.00)	5.60 (0.22)	6.40 (0.25)	5.60 (0.22)	DTX-080806
249.2 (9.81)	249.2 (9.81)	215.1 (8.47)	208.8 (8.22)	244.6 (9.63)	127.00 (5.00)	9.70 (0.38)	6.40 (0.25)	203.20 (8.00)	187.50 (7.38)	184.20 (7.25)	187.50 (7.38)	12.70 (0.50)	203.20 (8.00)	203.20 (8.00)	5.60 (0.22)	6.40 (0.25)	5.60 (0.22)	DTX-080808

ENCLOSURES AND JUNCTION BOXES: NEC/CEC WEATHERPROOF/DUSTPROOF JUNCTION AND OUTLET BOXES



# DTX Series Junction Box

## Dust-Ignitionproof, Watertight

Cast iron box and cover for surface mounting. Cast aluminum box and cover for surface mounting.

NEC:  
Class II, Division 1 and 2, Groups E, F, G  
Class III  
NEMA 4, 9EFG

Outside Flange Dimensional Data in Millimeters (Inches)

Overall Enclosure				Mounting Enclosure			Mount Thick- ness	Depth	Conduit Area				Clear Opening		Wall Thickness			Catalog Number
A	B	C	D	E	F	G	J	K	L	M	N	P	S	T	X	Y	Z	
198.40 (7.81)	300.00 (11.81)	113.50 (4.47)	107.20 (4.22)	193.8 (7.63)	177.80 (7.00)	9.70 (0.38)	6.40 (0.25)	101.60 (4.00)	241.30 (9.50)	82.60 (3.25)	139.70 (5.50)	12.70 (0.50)	152.40 (6.00)	254.0 (10.00)	5.60 (0.22)	6.40 (0.25)	5.60 (0.22)	DTX-010604
198.40 (7.81)	300.00 (11.81)	164.30 (6.47)	158.00 (6.22)	193.8 (7.63)	177.80 (7.00)	9.70 (0.38)	6.40 (0.25)	152.40 (6.00)	241.30 (9.50)	133.40 (5.25)	139.70 (5.50)	12.70 (0.50)	152.40 (6.00)	254.0 (10.00)	5.60 (0.22)	6.40 (0.25)	5.60 (0.22)	DTX-100606
255.50 (10.06)	325.40 (12.81)	1029.50 (40.53)	108.00 (4.25)	2305.1 (90.75)	177.80 (7.00)	9.70 (0.38)	6.40 (0.25)	101.60 (4.00)	241.30 (9.50)	82.60 (3.25)	190.50 (7.50)	12.70 (0.50)	203.20 (8.00)	254.0 (10.00)	6.40 (0.25)	7.10 (0.28)	6.40 (0.25)	DTX-100804
255.50 (10.06)	3049.50 (120.06)	215.10 (8.47)	158.80 (6.25)	2305.1 (90.75)	177.80 (7.00)	9.70 (0.38)	6.4 (0.25)	152.40 (6.00)	241.30 (9.50)	133.40 (5.25)	190.50 (7.50)	12.70 (0.50)	203.20 (8.00)	254.0 (10.00)	6.40 (0.25)	7.10 (0.28)	6.40 (0.25)	DTX-100806
255.50 (10.06)	3049.50 (120.06)	2045.50 (80.53)	209.60 (8.25)	2305.1 (90.75)	177.80 (7.00)	9.70 (0.38)	6.4 (0.25)	203.20 (8.00)	238.30 (9.38)	184.20 (7.25)	187.50 (7.38)	12.70 (0.50)	203.20 (8.00)	254.0 (10.00)	6.40 (0.25)	7.10 (0.28)	6.40 (0.25)	DTX-100808
255.50 (10.06)	3049.50 (120.06)	1029.50 (40.53)	108.00 (4.25)	295.4 (11.63)	177.80 (7.00)	9.70 (0.38)	6.40 (0.25)	101.60 (4.00)	241.30 (9.50)	82.60 (3.25)	241.30 (9.50)	12.70 (0.50)	254.0 (10.00)	254.0 (10.00)	6.40 (0.25)	7.10 (0.28)	6.40 (0.25)	DTX-101004
255.50 (10.06)	3049.50 (120.06)	1537.50 (60.53)	158.80 (6.25)	295.4 (11.63)	177.80 (7.00)	9.70 (0.38)	6.40 (0.25)	152.40 (6.00)	241.30 (9.50)	133.40 (5.25)	241.30 (9.50)	12.70 (0.50)	254.0 (10.00)	254.0 (10.00)	6.40 (0.25)	7.10 (0.28)	6.40 (0.25)	DTX-101006
306.30 (12.06)	3049.50 (120.06)	2045.50 (80.53)	209.60 (8.25)	295.4 (11.63)	177.80 (7.00)	9.70 (0.38)	6.40 (0.25)	203.20 (8.00)	238.30 (9.38)	184.20 (7.25)	238.30 (9.38)	12.70 (0.50)	254.0 (10.00)	254.0 (10.00)	6.40 (0.25)	7.10 (0.28)	6.40 (0.25)	DTX-101008
153.90 (6.06)	3557.50 (140.06)	114.30 (4.50)	108.00 (4.25)	136.70 (5.38)	203.20 (8.00)	9.70 (0.38)	6.40 (0.25)	101.60 (4.00)	292.10 (11.50)	82.60 (3.25)	88.90 (3.50)	12.70 (0.50)	101.60 (4.00)	304.8 (12.00)	6.40 (0.25)	6.40 (0.25)	6.40 (0.25)	DTX-120404
204.70 (8.06)	3557.50 (140.06)	1029.50 (40.53)	108.00 (4.25)	212.90 (8.38)	203.20 (8.00)	11.20 (0.44)	6.40 (0.25)	101.60 (4.00)	292.10 (11.50)	82.60 (3.25)	139.70 (5.50)	12.70 (0.50)	152.40 (6.00)	304.8 (12.00)	6.40 (0.25)	7.10 (0.28)	6.40 (0.25)	DTX-120604
204.70 (8.06)	3557.50 (140.06)	1537.50 (60.53)	158.80 (6.25)	212.90 (8.38)	203.20 (8.00)	11.20 (0.44)	6.40 (0.25)	152.40 (6.00)	292.10 (11.50)	133.40 (5.25)	139.70 (5.50)	12.70 (0.50)	152.40 (6.00)	304.8 (12.00)	6.40 (0.25)	7.10 (0.28)	6.40 (0.25)	DTX-120606
255.50 (10.06)	357.10 (14.06)	115.00 (4.53)	108.00 (4.25)	263.70 (10.38)	203.20 (8.00)	10.90 (0.43)	9.70 (0.38)	101.60 (4.00)	292.10 (11.50)	82.60 (3.25)	190.50 (7.50)	12.7 (0.50)	203.20 (8.00)	304.8 (12.00)	6.40 (0.25)	7.10 (0.28)	6.40 (0.25)	DTX-120804
255.50 (10.06)	357.10 (14.06)	165.90 (6.53)	158.80 (6.25)	263.70 (10.38)	203.20 (8.00)	10.90 (0.43)	9.70 (0.38)	152.40 (6.00)	292.10 (11.50)	113.40 (5.25)	190.50 (7.50)	12.70 (0.50)	203.20 (8.00)	304.8 (12.00)	6.40 (0.25)	7.10 (0.28)	6.40 (0.25)	DTX-120806
255.50 (10.06)	357.10 (14.06)	216.70 (8.53)	209.60 (8.25)	263.70 (10.38)	203.20 (8.00)	10.90 (0.43)	9.70 (0.38)	203.20 (8.00)	289.10 (11.38)	184.20 (7.25)	187.50 (7.38)	12.70 (0.50)	203.20 (8.00)	304.8 (12.00)	6.40 (0.25)	7.10 (0.28)	6.40 (0.25)	DTX-120808
306.30 (12.06)	357.10 (14.06)	115.00 (4.53)	108.00 (4.25)	314.50 (12.38)	203.20 (8.00)	10.90 (0.43)	9.70 (0.38)	101.60 (4.00)	292.10 (11.50)	82.60 (3.25)	241.30 (9.50)	12.70 (0.50)	254.0 (10.00)	304.8 (12.00)	6.40 (0.25)	7.10 (0.28)	6.40 (0.25)	DTX-121004
306.30 (12.06)	357.10 (14.06)	165.90 (6.53)	158.80 (6.25)	314.50 (12.38)	203.20 (8.00)	10.90 (0.43)	9.70 (0.38)	152.40 (6.00)	292.10 (11.50)	113.40 (5.25)	241.30 (9.50)	12.70 (0.50)	254.0 (10.00)	304.8 (12.00)	6.40 (0.25)	7.10 (0.28)	6.40 (0.25)	DTX-121006
306.30 (12.06)	357.10 (14.06)	216.70 (8.53)	209.60 (8.25)	314.50 (12.38)	203.20 (8.00)	10.90 (0.43)	9.70 (0.38)	203.20 (8.00)	292.10 (11.50)	184.20 (7.25)	238.30 (9.38)	12.70 (0.50)	254.0 (10.00)	304.8 (12.00)	6.40 (0.25)	7.10 (0.28)	6.40 (0.25)	DTX-121008
357.10 (14.06)	357.10 (14.06)	115.80 (4.56)	108.00 (4.25)	365.30 (14.38)	203.20 (8.00)	10.90 (0.43)	9.70 (0.38)	101.60 (4.00)	289.10 (11.38)	81.00 (3.19)	292.10 (11.50)	12.70 (0.50)	304.8 (12.00)	304.8 (12.00)	6.40 (0.25)	7.90 (0.31)	6.40 (0.25)	DTX-121204
357.10 (14.06)	357.10 (14.06)	166.60 (6.56)	158.80 (6.25)	365.30 (14.38)	203.20 (8.00)	10.90 (0.43)	9.70 (0.38)	127.00 (5.00)	292.10 (11.50)	131.80 (5.19)	292.10 (11.50)	12.70 (0.50)	304.8 (12.00)	304.8 (12.00)	6.40 (0.25)	7.90 (0.31)	6.40 (0.25)	DTX-121206
357.10 (14.06)	357.10 (14.06)	193.80 (7.63)	185.70 (7.31)	365.30 (14.38)	203.20 (8.00)	10.90 (0.43)	9.70 (0.38)	177.80 (7.00)	289.10 (11.38)	157.20 (6.19)	289.10 (11.38)	14.20 (0.56)	304.8 (12.00)	304.8 (12.00)	7.90 (0.31)	7.90 (0.31)	7.90 (0.31)	DTX-121207
357.10 (14.06)	357.10 (14.06)	219.20 (8.63)	211.10 (8.31)	365.30 (14.38)	203.20 (8.00)	10.90 (0.43)	9.70 (0.38)	203.20 (8.00)	289.10 (11.38)	182.60 (7.19)	289.10 (11.38)	14.20 (0.56)	304.8 (12.00)	304.8 (12.00)	7.90 (0.31)	7.90 (0.31)	7.90 (0.31)	DTX-121208
357.10 (14.06)	357.10 (14.06)	270.00 (10.63)	261.90 (10.31)	365.30 (14.38)	203.20 (8.00)	10.90 (0.43)	9.70 (0.38)	254.00 (10.00)	285.80 (11.25)	233.40 (9.19)	285.80 (11.25)	14.20 (0.56)	304.8 (12.00)	304.8 (12.00)	7.90 (0.31)	7.90 (0.31)	7.90 (0.31)	DTX-121210
357.10 (14.06)	357.10 (14.06)	320.80 (12.63)	312.70 (12.31)	365.30 (14.38)	203.20 (8.00)	10.90 (0.43)	9.70 (0.38)	304.80 (12.00)	285.80 (11.25)	284.20 (11.19)	285.80 (11.25)	14.20 (0.56)	304.8 (12.00)	304.8 (12.00)	7.90 (0.31)	7.90 (0.31)	7.90 (0.31)	DTX-121212
255.50 (10.06)	407.90 (16.06)	115.00 (4.53)	108.00 (4.25)	263.70 (10.38)	254.00 (10.00)	10.90 (0.43)	9.70 (0.38)	101.60 (4.00)	336.60 (13.25)	76.20 (3.00)	184.20 (7.25)	16.00 (0.63)	203.20 (8.00)	355.60 (14.00)	6.40 (0.25)	7.10 (0.28)	6.40 (0.25)	DTX-140804

ENCLOSURES AND JUNCTION BOXES: NEC/CEC WEATHERPROOF/DUSTPROOF JUNCTION AND OUTLET BOXES







# DTX Series Junction Box

## Dust-Ignitionproof, Watertight

Cast iron box and cover for surface mounting. Cast aluminum box and cover for surface mounting.

**NEC:**

Class II, Division 1 and 2, Groups E, F, G

Class III

NEMA 4, 9EFG

### Outside Flange Dimensional Data in Millimeters (Inches)

Overall Enclosure				Mounting Enclosure			Mount Thickness Depth		Conduit Area				Clear Opening		Wall Thickness			Catalog Number
A	B	C	D	E	F	G	J	K	L	M	N	P	S	T	X	Y	Z	
538.20 (21.19)	690.60 (27.19)	170.70 (6.72)	161.00 (6.34)	524.00 (20.63)	482.60 (19.00)	14.20 (0.56)	9.70 (0.38)	152.40 (6.00)	590.60 (23.25)	124.00 (4.88)	438.20 (17.25)	19.10 (0.75)	457.20 (18.00)	609.60 (24.00)	7.90 (0.31)	9.70 (0.38)	8.60 (0.34)	DTX-241806
538.20 (21.19)	690.60 (27.19)	221.50 (8.72)	211.80 (8.34)	524.00 (20.63)	482.60 (19.00)	14.20 (0.56)	9.70 (0.38)	203.20 (8.00)	590.60 (23.25)	174.80 (6.88)	438.20 (17.25)	19.10 (0.75)	457.20 (18.00)	609.60 (24.00)	8.60 (0.34)	9.70 (0.38)	8.60 (0.34)	DTX-241808
538.20 (21.19)	690.60 (27.19)	272.30 (10.72)	262.60 (10.34)	524.00 (20.63)	482.60 (19.00)	14.20 (0.56)	9.70 (0.38)	254.00 (10.00)	584.20 (23.00)	225.60 (8.88)	431.80 (17.00)	19.10 (0.75)	457.20 (18.00)	609.60 (24.00)	8.60 (0.34)	9.70 (0.38)	8.60 (0.34)	DTX-241810
538.20 (21.19)	690.60 (27.19)	323.10 (12.72)	313.40 (12.34)	524.00 (20.63)	482.60 (19.00)	14.20 (0.56)	9.70 (0.38)	304.80 (12.00)	584.20 (23.00)	276.40 (10.88)	431.80 (17.00)	19.10 (0.75)	457.20 (18.00)	609.60 (24.00)	8.60 (0.34)	9.70 (0.38)	8.60 (0.34)	DTX-241812
538.20 (21.19)	690.60 (27.19)	475.50 (18.72)	465.8 (18.34)	524.00 (20.63)	482.60 (19.00)	14.20 (0.56)	9.70 (0.38)	457.20 (18.00)	584.20 (23.00)	428.80 (16.88)	431.80 (17.00)	19.10 (0.75)	457.20 (18.00)	609.60 (24.00)	8.60 (0.34)	9.70 (0.38)	8.60 (0.34)	DTX-241818
690.60 (27.19)	690.60 (27.19)	170.70 (6.72)	161.00 (6.34)	268.8 (682.8)	482.60 (19.00)	14.20 (0.56)	9.70 (0.38)	152.40 (6.00)	590.60 (23.25)	124.00 (4.88)	590.6 (23.25)	19.10 (0.75)	609.60 (24.00)	609.60 (24.00)	8.60 (0.34)	9.70 (0.38)	8.60 (0.34)	DTX-242406
690.60 (27.19)	690.60 (27.19)	221.50 (8.72)	211.80 (8.34)	682.80 (26.88)	482.60 (19.00)	14.20 (0.56)	9.70 (0.38)	203.20 (8.00)	584.20 (23.00)	174.80 (6.88)	590.60 (23.25)	19.10 (0.75)	609.60 (24.00)	609.60 (24.00)	8.60 (0.34)	9.70 (0.38)	8.60 (0.34)	DTX-242408
690.60 (27.19)	690.60 (27.19)	273.10 (10.75)	263.70 (10.38)	682.80 (26.88)	482.60 (19.00)	14.20 (0.56)	9.70 (0.38)	254.00 (10.00)	584.20 (23.00)	225.60 (8.88)	584.20 (23.00)	19.10 (0.75)	609.60 (24.00)	609.60 (24.00)	9.70 (0.38)	9.70 (0.38)	9.70 (0.38)	DTX-242410
690.60 (27.19)	690.60 (27.19)	44.50 (1.75)	314.50 (12.38)	682.80 (26.88)	482.60 (19.00)	14.20 (0.56)	9.70 (0.38)	304.80 (12.00)	584.20 (23.00)	276.40 (10.88)	584.20 (23.00)	19.10 (0.75)	609.60 (24.00)	609.60 (24.00)	9.70 (0.38)	9.70 (0.38)	9.70 (0.38)	DTX-242412
385.80 (15.19)	792.20 (31.19)	322.30 (12.69)	313.40 (12.34)	374.70 (14.75)	558.80 (22.00)	14.20 (0.56)	9.70 (0.38)	304.80 (12.00)	685.80 (27.00)	276.40 (10.88)	279.40 (11.00)	19.10 (0.75)	304.80 (12.00)	711.20 (28.00)	8.60 (0.34)	8.60 (0.34)	8.60 (0.34)	DTX-281208
385.80 (15.19)	792.20 (31.19)	322.30 (12.69)	313.40 (12.34)	374.70 (14.75)	558.80 (22.00)	14.20 (0.56)	9.70 (0.38)	304.80 (12.00)	685.80 (27.00)	276.40 (10.88)	279.40 (11.00)	19.10 (0.75)	304.80 (12.00)	711.20 (28.00)	8.60 (0.34)	8.60 (0.34)	8.60 (0.34)	DTX-281212
692.20 (27.25)	844.60 (33.25)	222.30 (8.75)	212.90 (8.38)	682.80 (26.88)	609.60 (24.00)	14.20 (0.56)	9.70 (0.38)	254.00 (10.00)	743.00 (29.25)	225.60 (8.88)	590.60 (23.25)	19.10 (0.75)	609.60 (24.00)	762.00 (30.00)	9.70 (0.38)	9.70 (0.38)	9.70 (0.38)	DTX-302408
692.20 (27.25)	844.60 (33.25)	273.10 (10.75)	263.70 (10.38)	682.80 (26.88)	609.60 (24.00)	14.20 (0.56)	9.70 (0.38)	254.00 (10.00)	743.00 (29.25)	225.60 (8.88)	590.60 (23.25)	19.10 (0.75)	609.60 (24.00)	762.00 (30.00)	9.70 (0.38)	9.70 (0.38)	9.70 (0.38)	DTX-302410
692.20 (27.25)	844.60 (33.25)	323.9 (12.75)	314.5 (12.38)	682.80 (26.88)	609.60 (24.00)	14.20 (0.56)	9.70 (0.38)	304.80 (12.00)	743.00 (29.25)	276.40 (10.88)	590.60 (23.25)	19.10 (0.75)	609.60 (24.00)	762.00 (30.00)	9.70 (0.38)	9.70 (0.38)	9.70 (0.38)	DTX-302412
692.20 (27.25)	844.60 (33.25)	476.30 (18.75)	466.9 (18.38)	682.80 (26.88)	609.60 (24.00)	14.20 (0.56)	9.70 (0.38)	457.20 (18.00)	736.60 (29.00)	428.80 (16.88)	584.20 (23.00)	19.10 (0.75)	609.60 (24.00)	762.00 (30.00)	9.70 (0.38)	9.70 (0.38)	9.70 (0.38)	DTX-302418
539.80 (21.25)	997.00 (39.25)	171.50 (6.75)	162.10 (6.38)	530.40 (20.88)	762.00 (30.00)	14.20 (0.56)	9.70 (0.38)	203.20 (8.00)	819.20 (32.25)	124.00 (4.88)	438.20 (17.25)	19.10 (0.75)	457.20 (18.00)	914.40 (36.00)	9.70 (0.38)	9.70 (0.38)	9.70 (0.38)	DTX-361806
539.80 (21.25)	997.00 (39.25)	222.30 (8.75)	212.90 (8.38)	530.40 (20.88)	762.00 (30.00)	14.20 (0.56)	9.70 (0.38)	203.20 (8.00)	819.20 (32.25)	174.80 (6.88)	438.20 (17.25)	19.10 (0.75)	457.20 (18.00)	914.40 (36.00)	9.70 (0.38)	9.70 (0.38)	9.70 (0.38)	DTX-361808
539.80 (21.25)	997.00 (39.25)	323.90 (12.75)	314.50 (12.38)	530.40 (20.88)	762.00 (30.00)	14.20 (0.56)	9.70 (0.38)	304.80 (12.00)	914.40 (36.00)	276.40 (10.88)	431.80 (17.00)	19.10 (0.75)	457.20 (18.00)	914.40 (36.00)	9.70 (0.38)	9.70 (0.38)	9.70 (0.38)	DTX-361812
539.80 (21.25)	997.00 (39.25)	476.30 (18.75)	466.90 (18.38)	530.40 (20.88)	762.00 (30.00)	14.20 (0.56)	9.70 (0.38)	457.20 (18.00)	914.40 (36.00)	428.80 (16.88)	431.80 (17.00)	19.10 (0.75)	457.20 (18.00)	914.40 (36.00)	9.70 (0.38)	9.70 (0.38)	9.70 (0.38)	DTX-361818
990.60 (39.00)	990.60 (39.00)	225.60 (8.88)	225.60 (8.88)	987.60 (38.88)	762.00 (30.00)	14.20 (0.56)	9.70 (0.38)	203.20 (8.00)	914.40 (36.00)	171.50 (6.75)	914.40 (36.00)	20.60 (0.81)	914.40 (36.00)	914.40 (36.00)	11.20 (0.44)	11.20 (0.44)	11.20 (0.44)	DTX-363608
990.60 (39.00)	990.6 (39.00)	276.40 (10.88)	276.40 (10.88)	987.60 (38.88)	762.00 (30.00)	14.20 (0.56)	9.70 (0.38)	254.00 (10.00)	889.00 (35.00)	222.30 (8.75)	914.40 (36.00)	20.60 (0.81)	914.40 (36.00)	914.40 (36.00)	11.20 (0.44)	11.20 (0.44)	11.20 (0.44)	DTX-363610
990.60 (39.00)	990.60 (39.00)	327.20 (12.88)	327.20 (12.88)	987.60 (38.88)	762.00 (30.00)	14.20 (0.56)	9.70 (0.38)	304.80 (12.00)	914.40 (36.00)	273.10 (10.75)	914.40 (36.00)	20.60 (0.81)	914.40 (36.00)	914.40 (36.00)	11.20 (0.44)	11.20 (0.44)	11.20 (0.44)	DTX-363612
990.60 (39.00)	990.60 (39.00)	479.60 (18.88)	479.60 (18.88)	987.60 (38.88)	762.00 (30.00)	14.20 (0.56)	9.70 (0.38)	457.20 (18.00)	886.00 (34.88)	425.50 (16.75)	886.00 (34.88)	20.60 (0.81)	914.40 (36.00)	914.40 (36.00)	11.20 (0.44)	11.20 (0.44)	11.20 (0.44)	DTX-363618

ENCLOSURES AND JUNCTION BOXES: NEC/CEC WEATHERPROOF/DUSTPROOF JUNCTION AND OUTLET BOXES



# YG Series Junction Boxes

## Dust-Ignitionproof, Watertight

Cast iron box and cover for surface mounting. Cast aluminum box and cover for surface mounting.

**NEC:**

Class II, Division 1 and 2, Groups E, F, G

Class III

NEMA 4, 9EFG

### Applications

- YG dust tight and watertight boxes are specially designed and constructed for hazardous locations where ignitable dusts, fibers or flyings are present such as:
- Grain elevators
- Grain storage areas
- Paper mills
- Coal storage facilities
- Textile factories

### Features

- Provided with mounting lugs.
- Mechanically attached gaskets.

### Standard Materials

- Bodies and covers: cast iron
- Gasket: vellumoid
- Cover bolts: stainless steel

### Standard Finishes

- Cast iron bodies and covers: hot dip galvanized finish

### Optional Materials

- Cast aluminum box and cover. Add suffix - **A**.
- For factory installed mounting plate, add suffix -**YM**
- Refer to *Junction Box Mounting Plate Information* for complete listing of available mounting plates.

### NEC Certifications and Compliances

- UL Standard: UL 886 (UL 1203)
- UL Listed: E10444

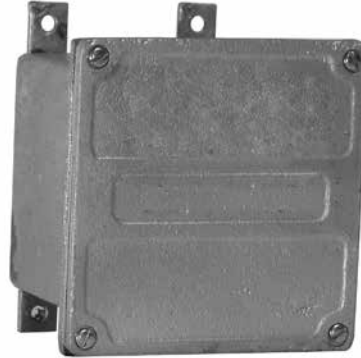

# YG Series Junction Boxes

## Dust-Ignitionproof, Watertight

Cast iron box and cover for surface mounting. Cast aluminum box and cover for surface mounting.

**NEC:**

Class II, Division 1 and 2, Groups E, F, G

Class III

NEMA 4, 9EFG

Approximate Thickness Side Walls mm (in)	Maximum Conduit Size (In.-NPT)	Inside Dim. in Millimeters (Inches)					Iron Weight kg (lb)	Aluminum Weight kg (lb)	Catalog Number ①
		L	x	W	x	D			
6.4 (0.25)	3/4	101.6 (4.00)	x	101.6 (4.00)	x	76.2 (3.00)	3.2 (7.00)	0.9 (2.00)	YG-040403
6.4 (0.25)	3/4	101.6 (4.00)	x	101.6 (4.00)	x	101.6 (4.00)	3.6 (8.00)	1.4 (3.00)	YG-040404
6.4 (0.25)	3/4	127.0 (5.00)	x	127.0 (5.00)	x	101.6 (4.00)	3.6 (8.00)	1.4 (3.00)	YG-050504
6.4 (0.25)	3/4	152.4 (6.00)	x	101.6 (4.00)	x	76.2 (3.00)	3.6 (8.00)	1.4 (3.00)	YG-060403
6.4 (0.25)	3/4	152.4 (6.00)	x	101.6 (4.00)	x	101.6 (4.00)	3.6 (8.00)	1.4 (3.00)	YG-060404
6.4 (0.25)	3/4	152.4 (6.00)	x	152.4 (6.00)	x	76.2 (3.00)	5.0 (11.00)	1.8 (4.00)	YG-060603
6.4 (0.25)	3/4	152.4 (6.00)	x	152.4 (6.00)	x	101.6 (4.00)	6.8 (15.00)	2.7 (6.00)	YG-060604
6.4 (0.25)	3/4	152.4 (6.00)	x	152.4 (6.00)	x	152.4 (6.00)	8.2 (18.00)	3.2 (7.00)	YG-060606
6.4 (0.25)	3/4	203.2 (8.00)	x	101.6 (4.00)	x	76.2 (3.00)	5.0 (11.00)	1.8 (4.00)	YG-080403
6.4 (0.25)	3/4	203.2 (8.00)	x	101.6 (4.00)	x	101.6 (4.00)	5.4 (12.00)	2.3 (5.00)	YG-080404
6.4 (0.25)	3/4	203.2 (8.00)	x	152.4 (6.00)	x	76.2 (3.00)	6.8 (15.00)	2.7 (6.00)	YG-080603
6.4 (0.25)	3/4	203.2 (8.00)	x	152.4 (6.00)	x	101.6 (4.00)	7.3 (16.00)	2.7 (6.00)	YG-080604
6.4 (0.25)	3/4	203.2 (8.00)	x	152.4 (6.00)	x	152.4 (6.00)	10.00 (22.00)	3.6 (8.00)	YG-080606
6.4 (0.25)	3/4	203.2 (8.00)	x	203.2 (8.00)	x	101.6 (4.00)	10.9 (24.00)	4.1 (9.00)	YG-080804
6.4 (0.25)	3/4	203.2 (8.00)	x	203.2 (8.00)	x	152.4 (6.00)	13.2 (29.00)	5.0 (11.00)	YG-080806
6.4 (0.25)	3/4	203.2 (8.00)	x	203.2 (8.00)	x	203.2 (8.00)	15.0 (33.00)	5.9 (13.00)	YG-080808
6.4 (0.25)	3/4	254.0 (10.00)	x	152.4 (6.00)	x	101.6 (4.00)	10.00 (22.00)	3.6 (8.00)	YG-100604
6.4 (0.25)	3/4	254.0 (10.00)	x	152.4 (6.00)	x	152.4 (6.00)	10.9 (24.00)	4.1 (9.00)	YG-100606
6.4 (0.25)	3/4	254.0 (10.00)	x	203.2 (8.00)	x	101.6 (4.00)	13.2 (29.00)	5.0 (11.00)	YG-100804
6.4 (0.25)	3/4	254.0 (10.00)	x	203.2 (8.00)	x	152.4 (6.00)	15.4 (34.00)	5.9 (13.00)	YG-100806
6.4 (0.25)	3/4	254.0 (10.00)	x	203.2 (8.00)	x	203.2 (8.00)	18.6 (41.00)	6.8 (15.00)	YG-100808
6.4 (0.25)	3/4	254.0 (10.00)	x	254.0 (10.00)	x	101.6 (4.00)	14.1 (31.00)	5.4 (12.00)	YG-101004
6.4 (0.25)	3/4	254.0 (10.00)	x	254.0 (10.00)	x	152.4 (6.00)	17.7 (39.00)	6.8 (15.00)	YG-101006
6.4 (0.25)	3/4	254.0 (10.00)	x	254.0 (10.00)	x	203.2 (8.00)	20.4 (45.00)	8.2 (18.00)	YG-101008
6.4 (0.25)	3/4	304.8 (12.00)	x	101.6 (4.00)	x	101.6 (4.00)	10.4 (23.00)	4.1 (9.00)	YG-120404
6.4 (0.25)	3/4	304.8 (12.00)	x	152.4 (6.00)	x	101.6 (4.00)	12.2 (27.00)	4.5 (10.00)	YG-120604
6.4 (0.25)	3/4	304.8 (12.00)	x	152.4 (6.00)	x	152.4 (6.00)	14.5 (32.00)	5.4 (12.00)	YG-120606
6.4 (0.25)	3/4	304.8 (12.00)	x	203.2 (8.00)	x	101.6 (4.00)	14.1 (31.00)	5.4 (12.00)	YG-120804
6.4 (0.25)	3/4	304.8 (12.00)	x	203.2 (8.00)	x	152.4 (6.00)	18.1 (40.00)	6.8 (15.00)	YG-120806
6.4 (0.25)	3/4	304.8 (12.00)	x	203.2 (8.00)	x	203.2 (8.00)	21.8 (48.00)	8.2 (18.00)	YG-120808
6.4 (0.25)	3/4	304.8 (12.00)	x	254.0 (10.00)	x	101.6 (4.00)	20.0 (44.00)	7.7 (17.00)	YG-121004
6.4 (0.25)	3/4	304.8 (12.00)	x	254.0 (10.00)	x	152.4 (6.00)	21.3 (47.00)	8.2 (18.00)	YG-121006
6.4 (0.25)	3/4	304.8 (12.00)	x	254.0 (10.00)	x	203.2 (8.00)	22.7 (50.00)	8.6 (19.00)	YG-121008
6.4 (0.25)	3/4	304.8 (12.00)	x	304.8 (12.00)	x	101.6 (4.00)	20.4 (45.00)	7.7 (17.00)	YG-121204
6.4 (0.25)	3/4	304.8 (12.00)	x	304.8 (12.00)	x	152.4 (6.00)	24.5 (54.00)	8.6 (19.00)	YG-121206
7.9 (0.31)	2	304.8 (12.00)	x	304.8 (12.00)	x	177.8 (7.00)	27.2 (60.00)	10.0 (22.00)	YG-121207
7.9 (0.31)	2	304.8 (12.00)	x	304.8 (12.00)	x	203.2 (8.00)	29.9 (66.00)	11.3 (25.00)	YG-121208
7.9 (0.31)	2	304.8 (12.00)	x	304.8 (12.00)	x	254.0 (10.00)	32.7 (72.00)	12.2 (27.00)	YG-121210
7.9 (0.31)	2	304.8 (12.00)	x	304.8 (12.00)	x	304.8 (12.00)	37.2 (82.00)	14.1 (31.00)	YG-121212
6.4 (0.25)	3/4	101.6 (4.00)	x	203.2 (8.00)	x	101.6 (4.00)	15.9 (35.00)	5.9 (13.00)	YG-140804
6.4 (0.25)	3/4	101.6 (4.00)	x	203.2 (8.00)	x	152.4 (6.00)	18.1 (40.00)	6.8 (15.00)	YG-140806
6.4 (0.25)	3/4	101.6 (4.00)	x	203.2 (8.00)	x	203.2 (8.00)	23.6 (52.00)	9.1 (20.00)	YG-140808
7.9 (0.31)	2	101.6 (4.00)	x	101.6 (4.00)	x	152.4 (6.00)	34.0 (75.00)	12.7 (28.00)	YG-141406
7.9 (0.31)	2	101.6 (4.00)	x	101.6 (4.00)	x	203.2 (8.00)	38.6 (85.00)	14.5 (32.00)	YG-141408

① Type YG boxes must have a minimum of 3-1/2 full threads at all conduit entrances. The "Max. Conduit Size" listed herein indicates the maximum drilled and tapped conduit entrance which can be machined into the four unbossed sides of a given box to provide these 3-1/2 full threads. If larger conduit openings than those listed herein are required, bosses can be supplied by us at an additional cost to provide the minimum 3-1/2 full thread requirement. In addition to the minimum 3-1/2 full thread requirement, the length of thread at conduit entrances must also be at least 1/4". A 3/8" conduit entrance therefore requires a minimum of a 6.4 mm (0.25") wall thickness. For aluminum box and cover, add suffix A.

# YG Series Junction Boxes

## Dust-Ignitionproof, Watertight

Cast iron box and cover for surface mounting. Cast aluminum box and cover for surface mounting.

NEC:  
Class II, Division 1 and 2, Groups E, F, G  
Class III  
NEMA 4, 9EFG

ENCLOSURES AND JUNCTION BOXES: NEC/CEC WEATHERPROOF/DUSTPROOF JUNCTION AND OUTLET BOXES

OZGEDNEY

Approximate Thickness Side Walls mm (in)	Maximum Conduit Size (In.-NPT)	Inside Dim. in Millimeters (Inches)					Iron Weight kg (lb)	Aluminum Weight kg (lb)	Catalog Number ①
		L	x	W	x	D			
7.9 (0.31)	2	355.6 (14.00)	x	355.6 (14.00)	x	254.0 (10.00)	41.7 (92.00)	15.4 (34.00)	YG-141410
7.1 (0.28)	3/4	406.4 (16.00)	x	304.8 (12.00)	x	101.6 (4.00)	28.1 (62.00)	10.4 (23.00)	YG-161204
7.1 (0.28)	3/4	406.4 (16.00)	x	304.8 (12.00)	x	152.4 (6.00)	33.1 (73.00)	12.2 (27.00)	YG-161206
7.1 (0.28)	3/4	406.4 (16.00)	x	304.8 (12.00)	x	203.2 (8.00)	36.7 (81.00)	13.6 (30.00)	YG-161208
7.9 (0.31)	2	406.4 (16.00)	x	406.4 (16.00)	x	152.4 (6.00)	45.4 (100.00)	16.8 (37.00)	YG-161606
7.1 (0.28)	3/4	457.2 (18.00)	x	152.4 (6.00)	x	152.4 (6.00)	22.7 (50.00)	8.6 (19.00)	YG-180606
7.1 (0.28)	3/4	457.2 (18.00)	x	203.2 (8.00)	x	101.6 (4.00)	23.6 (52.00)	9.1 (20.00)	YG-180804
7.1 (0.28)	3/4	457.2 (18.00)	x	203.2 (8.00)	x	152.4 (6.00)	25.9 (57.00)	9.5 (21.00)	YG-180806
6.4 (0.25)	3/4	457.2 (18.00)	x	304.8 (12.00)	x	101.6 (4.00)	27.7 (61.00)	10.4 (23.00)	YG-181204
7.1 (0.28)	3/4	457.2 (18.00)	x	304.8 (12.00)	x	152.4 (6.00)	37.2 (82.00)	14.1 (31.00)	YG-181206
7.9 (0.31)	2	457.2 (18.00)	x	304.8 (12.00)	x	203.2 (8.00)	44.0 (97.00)	16.3 (36.00)	YG-181208
7.9 (0.31)	2	457.2 (18.00)	x	304.8 (12.00)	x	254.0 (10.00)	48.5 (107.00)	18.1 (40.00)	YG-181210
7.9 (0.31)	2	457.2 (18.00)	x	304.8 (12.00)	x	304.8 (12.00)	56.7 (125.00)	21.3 (47.00)	YG-181212
8.6 (0.34)	2	457.2 (18.00)	x	304.8 (12.00)	x	457.2 (18.00)	77.6 (171.00)	29.0 (64.00)	YG-181218
7.9 (0.31)	2	457.2 (18.00)	x	457.2 (18.00)	x	152.4 (6.00)	59.0 (130.00)	21.8 (48.00)	YG-181806
7.9 (0.31)	2	457.2 (18.00)	x	457.2 (18.00)	x	203.2 (8.00)	64.0 (141.00)	23.6 (52.00)	YG-181808
7.9 (0.31)	2	457.2 (18.00)	x	457.2 (18.00)	x	254.0 (10.00)	70.8 (156.00)	26.3 (58.00)	YG-181810
7.9 (0.31)	2	457.2 (18.00)	x	457.2 (18.00)	x	304.8 (12.00)	82.1 (181.00)	30.4 (67.00)	YG-181812
7.9 (0.31)	2	609.6 (24.00)	x	304.8 (12.00)	x	152.4 (6.00)	47.6 (105.00)	17.7 (39.00)	YG-241206
7.9 (0.31)	2	609.6 (24.00)	x	304.8 (12.00)	x	203.2 (8.00)	56.7 (125.00)	21.3 (47.00)	YG-241208
7.9 (0.31)	2	609.6 (24.00)	x	304.8 (12.00)	x	304.8 (12.00)	72.6 (160.00)	27.2 (60.00)	YG-241212
8.6 (0.34)	2	609.6 (24.00)	x	457.2 (18.00)	x	152.4 (6.00)	74.8 (165.00)	27.7 (61.00)	YG-241806
8.6 (0.34)	2	609.6 (24.00)	x	457.2 (18.00)	x	203.2 (8.00)	79.4 (175.00)	29.5 (65.00)	YG-241808
8.6 (0.34)	2	609.6 (24.00)	x	457.2 (18.00)	x	254.0 (10.00)	86.2 (190.00)	31.8 (70.00)	YG-241810
8.6 (0.34)	2	609.6 (24.00)	x	457.2 (18.00)	x	304.8 (12.00)	106.6 (235.00)	39.5 (87.00)	YG-241812
8.6 (0.34)	2	609.6 (24.00)	x	609.6 (24.00)	x	152.4 (6.00)	102.1 (225.00)	38.1 (84.00)	YG-242406
8.6 (0.34)	2	609.6 (24.00)	x	609.6 (24.00)	x	203.2 (8.00)	106.6 (235.00)	39.5 (87.00)	YG-242408
9.7 (0.38)	2	609.6 (24.00)	x	609.6 (24.00)	x	254.0 (10.00)	117.9 (260.00)	43.5 (96.00)	YG-242410
9.7 (0.38)	2	609.6 (24.00)	x	609.6 (24.00)	x	304.8 (12.00)	136.1 (300.00)	50.3 (111.00)	YG-242412
9.7 (0.38)	2	711.2 (28.00)	x	304.8 (12.00)	x	203.2 (8.00)	68.0 (150.00)	25.4 (56.00)	YG-281208
9.7 (0.38)	2	711.2 (28.00)	x	304.8 (12.00)	x	304.8 (12.00)	83.9 (185.00)	31.3 (69.00)	YG-281212
9.7 (0.38)	2	762.0 (30.00)	x	609.6 (24.00)	x	203.2 (8.00)	140.6 (310.00)	52.2 (115.00)	YG-302408
9.7 (0.38)	2	762.0 (30.00)	x	609.6 (24.00)	x	254.0 (10.00)	152.0 (335.00)	56.2 (124.00)	YG-302410
9.7 (0.38)	2	762.0 (30.00)	x	609.6 (24.00)	x	304.8 (12.00)	163.3 (360.00)	60.8 (134.00)	YG-302412
9.7 (0.38)	2	762.0 (30.00)	x	609.6 (24.00)	x	457.2 (18.00)	217.7 (480.00)	72.1 (159.00)	YG-302418
9.7 (0.38)	2	914.4 (36.00)	x	457.2 (18.00)	x	152.4 (6.00)	111.1 (245.00)	41.3 (91.00)	YG-361806
9.7 (0.38)	2	914.4 (36.00)	x	457.2 (18.00)	x	203.2 (8.00)	163.3 (360.00)	43.5 (96.00)	YG-361808
9.7 (0.38)	2	914.4 (36.00)	x	457.2 (18.00)	x	304.8 (12.00)	158.8 (350.00)	59.0 (130.00)	YG-361812
9.7 (0.38)	2	914.4 (36.00)	x	457.2 (18.00)	x	457.2 (18.00)	249.5 (550.00)	94.8 (209.00)	YG-361818
10.4 (0.41)	2	914.4 (36.00)	x	609.6 (24.00)	x	457.2 (18.00)	294.8 (650.00)	111.1 (245.00)	YG-362418
11.2 (0.44)	5	914.4 (36.00)	x	914.4 (36.00)	x	203.2 (8.00)	220.0 (485.00)	83.5 (184.00)	YG-363608
11.2 (0.44)	6	914.4 (36.00)	x	914.4 (36.00)	x	304.8 (12.00)	240.4 (530.00)	90.7 (200.00)	YG-363612
11.2 (0.44)	6	914.4 (36.00)	x	914.4 (36.00)	x	457.2 (18.00)	385.6 (850.00)	142.9 (315.00)	YG-363618

① Type YG boxes must have a minimum of 3-1/2 full threads at all conduit entrances. The "Max. Conduit Size" listed herein indicates the maximum drilled and tapped conduit entrance which can be machined into the four unbossed sides of a given box to provide these 3-1/2 full threads. If larger conduit openings than those listed herein are required, bosses can be supplied by us at an additional cost to provide the minimum 3-1/2 full thread requirement. In addition to the minimum 3-1/2 full thread requirement, the length of thread at conduit entrances must also be at least 1/4". A 3/8" conduit entrance therefore requires a minimum of a 6.4 mm (0.25") wall thickness. For aluminum box and cover, add suffix A.

# YG Series Junction Box Mounting Plate Information

## Dust-Ignitionproof, Watertight

Cast iron box and cover for surface mounting. Cast aluminum box and cover for surface mounting.

**NEC:**

Class II, Division 1 and 2, Groups E, F, G

Class III

NEMA 4, 9EFG

Mounting plates are used for mounting equipment up off the back of an enclosure. Steel Plates are all 3.3 mm (0.13") thick hot dip galvanized material. Aluminum plates are 3.3 mm (0.13") thick material up to and including 304.8 x 304.8 mm (12 x 12") size. All larger sizes are constructed of 4.8 mm (0.19") thick aluminum plate. The catalog numbers shown in the table below include the mounting buttons.

Select mounting plates based on inside length and width of box. Order as a separate item immediately following the catalog number of the box as follows:

Example: Line 1 **YG-181204**  
Line 2 **YG-1812-1**

For mounting plates in smaller boxes than listed, use similar catalog number logic. Example: A steel mounting plate for a **DTX-040404** box would be **WYM-0404-1**. Pricing will be based upon a **WYM-0808-1** price.

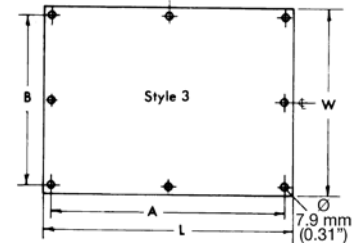
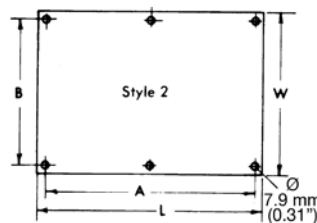
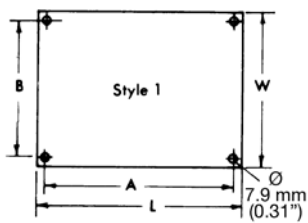

Inside Length and Width of Junction Box in mm (in)	Catalog Number		Style	Dimension in Millimeters (Inches)			
	Steel Plates	Aluminum Plates		L	W	A	B
203.2 x 203.2 (8 x 8)	<b>YG-0808-1</b>	<b>YG-0808-1A</b>	1	171.5 (6.75)	171.5 (6.75)	152.4 (6.00)	152.4 (6.00)
254.0 x 203.2 (10 x 8)	<b>YG-1008-1</b>	<b>YG-1008-1A</b>	1	222.3 (8.75)	171.5 (6.75)	203.2 (8.00)	203.2 (8.00)
254.0 x 254.0 (10 x 10)	<b>YG-1010-1</b>	<b>YG-1010-1A</b>	1	222.3 (8.75)	222.3 (8.75)	203.2 (8.00)	203.2 (8.00)
304.8 x 203.2 (12 x 8)	<b>YG-1208-1</b>	<b>YG-1208-1A</b>	1	273.1 (10.75)	171.5 (6.75)	254.0 (10.00)	152.4 (6.00)
304.8 x 254.0 (12 x 10)	<b>YG-1210-1</b>	<b>YG-1210-1A</b>	1	273.1 (10.75)	222.3 (8.75)	254.0 (10.00)	203.2 (8.00)
304.8 x 304.8 (12 x 12)	<b>YG-1212-1</b>	<b>YG-1212-1A</b>	1	273.1 (10.75)	273.1 (10.75)	254.0 (10.00)	254.0 (10.00)
355.6 x 203.2 (14 x 8)	<b>YG-1408-1</b>	<b>YG-1408-1A</b>	1	323.9 (12.75)	171.5 (6.75)	304.8 (12.00)	152.4 (6.00)
355.6 x 355.6 (14 x 14)	<b>YG-1414-1</b>	<b>YG-1414-1A</b>	1	323.9 (12.75)	323.9 (12.75)	304.8 (12.00)	304.8 (12.00)
406.4 x 203.2 (16 x 8)	<b>YG-1608-1</b>	<b>YG-1608-1A</b>	1	374.7 (14.75)	171.5 (6.75)	355.6 (14.00)	152.4 (6.00)
406.4 x 304.8 (16 x 12)	<b>YG-1612-1</b>	<b>YG-1612-1A</b>	1	374.7 (14.75)	273.1 (10.75)	355.6 (14.00)	254.0 (10.00)
406.4 x 406.4 (16 x 16)	<b>YG-1616-1</b>	<b>YG-1616-1A</b>	1	374.7 (14.75)	374.7 (14.75)	355.6 (14.00)	355.6 (14.00)
457.2 x 203.2 (18 x 8)	<b>YG-1808-1</b>	<b>YG-1808-1A</b>	1	171.5 (16.75)	171.5 (6.75)	152.4 (16.00)	152.4 (6.00)
457.2 x 254.0 (18 x 10)	<b>YG-1810-1</b>	<b>YG-1810-1A</b>	1	171.5 (16.75)	222.3 (8.75)	406.4 (16.00)	203.2 (8.00)
457.2 x 304.8 (18 x 12)	<b>YG-1812-1</b>	<b>YG-1812-1A</b>	1	171.5 (16.75)	273.1 (10.75)	406.4 (16.00)	254.0 (10.00)
457.2 x 355.6 (18 x 14)	<b>YG-1814-1</b>	<b>YG-1814-1A</b>	1	171.5 (16.75)	323.9 (12.75)	406.4 (16.00)	304.8 (12.00)
457.2 x 406.4 (18 x 16)	—	—	—	—	—	—	—
457.2 x 457.2 (18 x 18)	<b>YG-1818-1</b>	<b>YG-1818-1A</b>	1	171.5 (16.75)	171.5 (16.75)	406.4 (16.00)	406.4 (16.00)
508.0 x 254.0 (20 x 10)	<b>YG-2010-1</b>	<b>YG-2010-1A</b>	1	222.3 (18.75)	222.3 (8.75)	457.2 (18.00)	203.2 (8.00)
609.6 x 304.8 (24.00 x 12.00)	<b>YG-2412-1</b>	<b>YG-2412-1A</b>	2	552.5 (21.75)	247.7 (9.75)	533.4 (21.00)	228.6 (9.00)
609.6 x 457.2 (24.00 x 18.00)	<b>YG-2418-1</b>	<b>YG-2418-1A</b>	2	552.5 (21.75)	400.1 (15.75)	533.4 (21.00)	381.0 (15.00)
609.6 x 609.6 (24.00 x 24.00)	<b>YG-2424-1</b>	<b>YG-2424-1A</b>	3	552.5 (21.75)	552.5 (21.75)	533.4 (21.00)	533.4 (21.00)
711.2 x 304.8 (28.00 x 12.00)	<b>YG-2812-1</b>	<b>YG-2812-1A</b>	2	654.1 (25.75)	247.7 (9.75)	635.0 (25.00)	228.6 (9.00)
762.0 x 304.8 (30.00 x 12.00)	<b>YG-3012-1</b>	<b>YG-3012-1A</b>	2	704.9 (27.75)	247.7 (9.75)	685.8 (27.00)	228.6 (9.00)
762.0 x 457.2 (30.00 x 18.00)	<b>YG-3018-1</b>	<b>YG-3018-1A</b>	2	704.9 (27.75)	400.1 (15.75)	685.8 (27.00)	381.0 (15.00)
762.0 x 609.6 (30.00 x 24.00)	<b>YG-3024-1</b>	<b>YG-3024-1A</b>	3	704.9 (27.75)	552.5 (21.75)	685.8 (27.00)	533.4 (21.00)
914.4 x 304.8 (36.00 x 12.00)	<b>YG-3612-1</b>	<b>YG-3612-1A</b>	2	857.3 (33.75)	247.7 (9.75)	838.2 (33.00)	228.6 (9.00)
914.4 x 457.2 (36.00 x 18.00)	<b>YG-3618-1</b>	<b>YG-3618-1A</b>	2	857.3 (33.75)	400.1 (15.75)	838.2 (33.00)	381.0 (15.00)
914.4 x 609.6 (36.00 x 24.00)	<b>YG-3624-1</b>	<b>YG-3624-1A</b>	3	857.3 (33.75)	552.5 (21.75)	838.2 (33.00)	533.4 (21.00)
914.4 x 762.0 (36.00 x 30.00)	<b>YG-3630-1</b>	<b>YG-3630-1A</b>	3	857.3 (33.75)	704.9 (27.75)	838.2 (33.00)	685.8 (27.00)
914.4 x 914.4 (36.00 x 36.00)	<b>YG-3636-1</b>	<b>YG-3636-1A</b>	3	857.3 (33.75)	857.3 (33.75)	838.2 (33.00)	838.2 (33.00)

# YG Series Junction Box Drill and Tap Schedule

## Dust-Ignitionproof, Watertight

Cast iron box and cover for surface mounting. Cast aluminum box and cover for surface mounting.

NEC:  
 Class II, Division 1 and 2, Groups E, F, G  
 Class III  
 NEMA 4, 9EFG

ENCLOSURES AND JUNCTION BOXES: NEC/CEC WEATHERPROOF/DUSTPROOF JUNCTION AND OUTLET BOXES

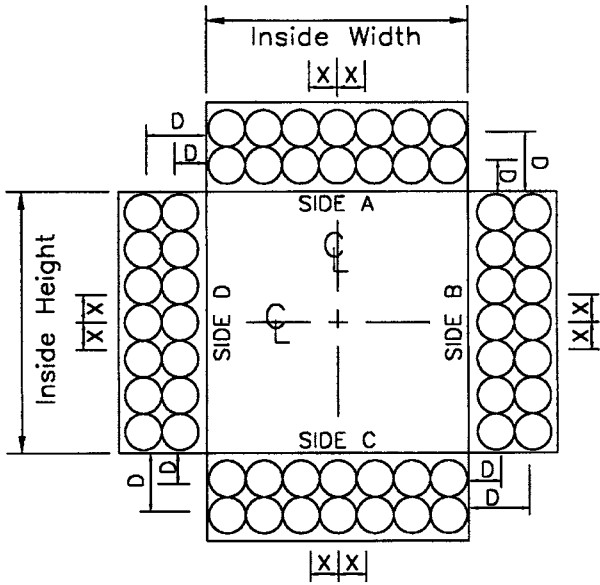
CONDUIT POSITION	CHECK ONLY IF FACTORY IS TO LOCATE			METAL PLUGS	<p>* = B&amp;D LOC.</p>  <p>VIEW LOOKING INTO BOX WITH SIDES LAID DOWN</p>	<h3>CHECK LIST</h3> <p>ARE INDICATED CONDUIT SIZES WITHIN THE CATALOG PUBLISHED MAXIMUM ON PAGES K-40 AND K-43?</p> <p>CHECK FOR MINIMUM SPACING BETWEEN CONDUIT OPENINGS PER CONDUIT SPACING TABLE, ON PAGE K-41.</p> <p><input type="checkbox"/> SIGN NAME TO DWG.</p> <p>NAME _____</p> <p>DATE _____</p>
	CONDUIT SIZE	X DIM.	D DIM.			
1						
2						
3						
4						
5						
6						
7						
8						
9						
10						
11						
12						
13						
14						
15						
16						
17						
18						
19						
20						
21						
22						
23						
24						

**ENCLOSURE FIGURE**

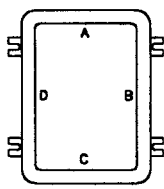

ENCLOSURE

\* = BREATHER/DRAIN LOC. 1/2" NPT REQUIRED. LOCATION MAY BE SPECIFIED ON THE CHART OR IF BOX IS CHECKED, FACTORY WILL LOCATE IN SIDES A & C.

DIM. X = DISTANCE FROM CENTERLINE TO CENTER OF CONDUIT OPENING.  
 DIM. D = DISTANCE FROM MTG. SURFACE TO CENTER OF CONDUIT OPENING.

HINGED ENCLOSURES WILL BE HINGED ON SIDE "D" AS STANDARD.

CAUTION: IN PLANNING CONDUIT ARRANGEMENTS, REFER TO "USABLE CONDUIT AREA", SHOWN ON THE APPROPRIATE PRODUCT OUTLINE DRAWINGS AND TO THE CONDUIT SPACING CHARTS.

	CONDUIT D&T SCHEDULE CAT. NO. _____	REV _____
--	--	-----------

# YG Series Junction Box

## Dust-Ignitionproof, Watertight

Cast iron box and cover for surface mounting. Cast aluminum box and cover for surface mounting.

NEC:  
Class II, Division 1 and 2, Groups E, F, G  
Class III  
NEMA 4, 9EFG

### Outside Flange Dimensional Data in Millimeters (Inches)

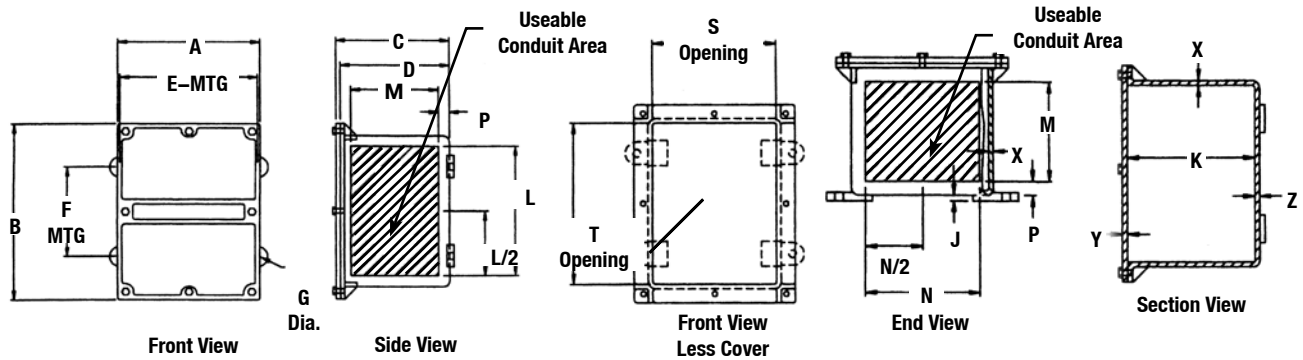

Overall Enclosure				Mounting Enclosure			Mount Thickness	Depth	Conduit Area				Clear Opening		Wall Thickness			Catalog Number
A	B	C	D	E	F	G			L	M	N	P	S	T	X	Y	Z	
141.20 (5.56)	141.20 (5.56)	84.80 (3.34)	80.30 (3.16)	141.20 (5.56)	76.20 (3.00)	7.90 (0.31)	3.30 (0.13)	76.20 (3.00)	88.90 (3.50)	58.70 (2.31)	88.90 (3.50)	11.20 (0.44)	101.60 (4.00)	101.60 (4.00)	4.10 (0.16)	4.80 (0.19)	4.10 (0.16)	YG-040403
141.20 (5.56)	141.20 (5.56)	110.20 (4.34)	105.70 (4.16)	141.20 (5.56)	101.60 (4.00)	7.90 (0.31)	3.30 (0.13)	101.60 (4.00)	88.90 (3.50)	58.70 (2.31)	88.90 (3.50)	11.20 (0.44)	101.60 (4.00)	101.60 (4.00)	4.10 (0.16)	4.80 (0.19)	4.10 (0.16)	YG-040404
173.00 (6.81)	173.00 (6.81)	111.30 (4.38)	106.40 (4.19)	165.10 (6.50)	101.60 (4.00)	7.90 (0.31)	3.30 (0.13)	101.60 (4.00)	114.30 (4.50)	84.10 (3.31)	88.90 (3.50)	11.20 (0.44)	127.00 (5.00)	127.00 (5.00)	4.80 (0.19)	4.80 (0.19)	4.80 (0.19)	YG-050504
141.20 (5.56)	192.00 (7.56)	84.80 (3.34)	80.30 (3.16)	136.70 (5.38)	127.00 (5.00)	7.90 (0.31)	3.30 (0.13)	76.20 (3.00)	139.70 (5.50)	58.70 (2.31)	88.90 (3.50)	11.20 (0.44)	101.60 (4.00)	152.40 (6.00)	4.10 (0.16)	4.80 (0.19)	4.10 (0.16)	YG-060403
141.20 (5.56)	192.00 (7.56)	110.20 (4.34)	105.70 (4.16)	136.70 (5.38)	127.00 (5.00)	7.90 (0.31)	3.30 (0.13)	76.20 (3.00)	139.70 (5.50)	84.10 (3.31)	88.90 (3.50)	11.20 (0.44)	101.60 (4.00)	152.40 (6.00)	4.10 (0.16)	4.80 (0.19)	4.10 (0.16)	YG-060404
198.40 (7.81)	198.40 (7.81)	85.90 (3.38)	81.00 (3.19)	190.50 (7.50)	101.60 (4.00)	9.70 (0.38)	6.40 (0.25)	76.20 (3.00)	139.70 (5.50)	57.20 (2.25)	139.70 (5.50)	11.20 (0.44)	152.40 (6.00)	152.40 (6.00)	4.80 (0.19)	4.80 (0.19)	4.80 (0.19)	YG-060603
198.40 (7.81)	198.40 (7.81)	112.00 (4.41)	107.20 (4.22)	190.50 (7.50)	101.60 (4.00)	9.70 (0.38)	6.40 (0.25)	101.60 (4.00)	139.70 (5.50)	82.60 (3.25)	139.70 (5.50)	11.20 (0.44)	152.40 (6.00)	152.40 (6.00)	5.60 (0.22)	4.80 (0.19)	5.60 (0.22)	YG-060604
198.40 (7.81)	198.40 (7.81)	162.80 (6.41)	158.00 (6.22)	190.50 (7.50)	101.60 (4.00)	9.70 (0.38)	6.40 (0.25)	152.40 (6.00)	139.70 (5.50)	158.80 (6.25)	139.70 (5.50)	11.20 (0.44)	152.40 (6.00)	152.40 (6.00)	4.80 (0.19)	4.80 (0.19)	4.80 (0.19)	YG-060606
147.60 (5.81)	249.20 (9.81)	87.40 (3.44)	81.00 (3.19)	139.70 (5.50)	127.00 (5.00)	9.70 (0.38)	6.40 (0.25)	76.20 (3.00)	190.50 (7.50)	57.20 (2.25)	88.90 (3.50)	11.90 (0.47)	101.60 (4.00)	203.20 (8.00)	4.80 (0.19)	6.40 (0.25)	4.80 (0.19)	YG-080403
147.60 (5.81)	249.20 (9.81)	112.80 (4.44)	106.40 (4.19)	139.70 (5.50)	127.00 (5.00)	9.70 (0.38)	6.40 (0.25)	101.60 (4.00)	190.50 (7.50)	82.60 (3.25)	88.90 (3.50)	11.90 (0.47)	101.60 (4.00)	203.20 (8.00)	4.80 (0.19)	6.40 (0.25)	4.80 (0.19)	YG-080404
198.40 (7.81)	249.20 (9.81)	88.10 (3.47)	81.80 (3.22)	193.80 (7.63)	127.00 (5.00)	9.70 (0.38)	6.40 (0.25)	76.20 (3.00)	190.50 (7.50)	57.20 (2.25)	139.70 (5.50)	12.70 (0.50)	152.40 (6.00)	203.20 (8.00)	5.60 (0.22)	6.40 (0.25)	5.60 (0.22)	YG-080603
198.40 (7.81)	249.20 (9.81)	113.50 (4.47)	107.20 (4.22)	193.80 (7.63)	127.00 (5.00)	9.70 (0.38)	6.40 (0.25)	101.60 (4.00)	190.50 (7.50)	82.60 (3.25)	139.70 (5.50)	12.70 (0.50)	152.40 (6.00)	203.20 (8.00)	5.60 (0.22)	6.40 (0.25)	5.60 (0.22)	YG-080404
198.40 (7.81)	249.20 (9.81)	164.30 (6.47)	158.00 (6.22)	193.80 (7.63)	127.00 (5.00)	9.70 (0.38)	6.40 (0.25)	152.40 (6.00)	190.50 (7.50)	133.40 (5.25)	139.70 (5.50)	12.70 (0.50)	152.40 (6.00)	203.20 (8.00)	5.60 (0.22)	6.40 (0.25)	5.60 (0.22)	YG-080606
249.2 (9.81)	249.2 (9.81)	113.5 (4.47)	107.2 (4.22)	244.6 (9.63)	127.00 (5.00)	9.70 (0.38)	6.40 (0.25)	101.60 (4.00)	190.50 (7.50)	82.60 (3.25)	190.50 (7.50)	12.70 (0.50)	203.20 (8.00)	203.20 (8.00)	5.60 (0.22)	6.40 (0.25)	5.60 (0.22)	YG-080804
249.2 (9.81)	249.2 (9.81)	164.3 (6.47)	158.0 (6.22)	244.6 (9.63)	127.00 (5.00)	9.70 (0.38)	6.40 (0.25)	152.40 (6.00)	190.50 (7.50)	133.40 (5.25)	190.50 (7.50)	12.70 (0.50)	203.20 (8.00)	203.20 (8.00)	5.60 (0.22)	6.40 (0.25)	5.60 (0.22)	YG-080806
249.2 (9.81)	249.2 (9.81)	215.1 (8.47)	208.8 (8.22)	244.6 (9.63)	127.00 (5.00)	9.70 (0.38)	6.40 (0.25)	203.20 (8.00)	187.50 (7.38)	184.20 (7.25)	187.50 (7.38)	12.70 (0.50)	203.20 (8.00)	203.20 (8.00)	5.60 (0.22)	6.40 (0.25)	5.60 (0.22)	YG-080808

# YG Series Junction Box

## Dust-Ignitionproof, Watertight

Cast iron box and cover for surface mounting. Cast aluminum box and cover for surface mounting.

NEC:  
Class II, Division 1 and 2, Groups E, F, G  
Class III  
NEMA 4, 9EFG

### Outside Flange Dimensional Data in Millimeters (Inches)

Overall Enclosure				Mounting Enclosure			Mount Thick-ness Depth		Conduit Area				Clear Opening		Wall Thickness			Catalog Number
A	B	C	D	E	F	G	J	K	L	M	N	P	S	T	X	Y	Z	
198.40 (7.81)	300.00 (11.81)	113.50 (4.47)	107.20 (4.22)	193.8 (7.63)	177.80 (7.00)	9.70 (0.38)	6.40 (0.25)	101.60 (4.00)	241.30 (9.50)	82.60 (3.25)	139.70 (5.50)	12.70 (0.50)	152.40 (6.00)	254.00 (10.00)	5.60 (0.22)	6.40 (0.25)	5.60 (0.22)	YG-010604
198.40 (7.81)	300.00 (11.81)	164.30 (6.47)	158.00 (6.22)	193.8 (7.63)	177.80 (7.00)	9.70 (0.38)	6.40 (0.25)	152.40 (6.00)	241.30 (9.50)	133.40 (5.25)	139.70 (5.50)	12.70 (0.50)	152.40 (6.00)	254.00 (10.00)	5.60 (0.22)	6.40 (0.25)	5.60 (0.22)	YG-100606
255.50 (10.06)	325.40 (12.81)	1029.50 (40.53)	108.00 (4.25)	2305.1 (90.75)	177.80 (7.00)	9.70 (0.38)	6.40 (0.25)	101.60 (4.00)	241.30 (9.50)	82.60 (3.25)	190.50 (7.50)	12.70 (0.50)	203.20 (8.00)	254.00 (10.00)	6.40 (0.25)	7.10 (0.28)	6.40 (0.25)	YG-100804
255.50 (10.06)	3049.50 (120.06)	215.10 (8.47)	158.80 (6.25)	2305.1 (90.75)	177.80 (7.00)	9.70 (0.38)	6.4 (0.25)	152.40 (6.00)	241.30 (9.50)	133.40 (5.25)	190.50 (7.50)	12.70 (0.50)	203.20 (8.00)	254.00 (10.00)	6.40 (0.25)	7.10 (0.28)	6.40 (0.25)	YG-100806
255.50 (10.06)	3049.50 (120.06)	2045.50 (80.53)	209.60 (8.25)	2305.1 (90.75)	177.80 (7.00)	9.70 (0.38)	6.4 (0.25)	203.20 (8.00)	238.30 (9.38)	184.20 (7.25)	187.50 (7.38)	12.70 (0.50)	203.20 (8.00)	254.0 (10.00)	6.40 (0.25)	7.10 (0.28)	6.40 (0.25)	YG-100808
255.50 (10.06)	3049.50 (120.06)	1029.50 (40.53)	108.00 (4.25)	295.4 (11.63)	177.80 (7.00)	9.70 (0.38)	6.40 (0.25)	101.60 (4.00)	241.30 (9.50)	82.60 (3.25)	241.30 (9.50)	12.70 (0.50)	254.00 (10.00)	254.00 (10.00)	6.40 (0.25)	7.10 (0.28)	6.40 (0.25)	YG-101004
255.50 (10.06)	3049.50 (120.06)	1537.50 (60.53)	158.80 (6.25)	295.4 (11.63)	177.80 (7.00)	9.70 (0.38)	6.40 (0.25)	152.40 (6.00)	241.30 (9.50)	133.40 (5.25)	241.30 (9.50)	12.70 (0.50)	254.00 (10.00)	254.0 (10.00)	6.40 (0.25)	7.10 (0.28)	6.40 (0.25)	YG-101006
306.30 (12.06)	3049.50 (120.06)	2045.50 (80.53)	209.60 (8.25)	295.4 (11.63)	177.80 (7.00)	9.70 (0.38)	6.40 (0.25)	203.20 (8.00)	238.30 (9.38)	184.20 (7.25)	238.30 (9.38)	12.70 (0.50)	254.00 (10.00)	254.00 (10.00)	6.40 (0.25)	7.10 (0.28)	6.40 (0.25)	YG-101008
153.90 (6.06)	3557.50 (140.06)	114.30 (4.50)	108.00 (4.25)	136.70 (5.38)	203.20 (8.00)	9.70 (0.38)	6.40 (0.25)	101.60 (4.00)	292.10 (11.50)	82.60 (3.25)	88.90 (3.50)	12.70 (0.50)	101.60 (4.00)	304.80 (12.00)	6.40 (0.25)	6.40 (0.25)	6.40 (0.25)	YG-120404
204.70 (8.06)	3557.50 (140.06)	1029.50 (40.53)	108.00 (4.25)	212.90 (8.38)	203.20 (8.00)	11.20 (0.44)	6.40 (0.25)	101.60 (4.00)	292.10 (11.50)	82.60 (3.25)	139.70 (5.50)	12.70 (0.50)	152.40 (6.00)	304.80 (12.00)	6.40 (0.25)	7.10 (0.28)	6.40 (0.25)	YG-120604
204.70 (8.06)	3557.50 (140.06)	1537.50 (60.53)	158.80 (6.25)	212.90 (8.38)	203.20 (8.00)	11.20 (0.44)	6.40 (0.25)	152.40 (6.00)	292.10 (11.50)	133.40 (5.25)	139.70 (5.50)	12.70 (0.50)	152.40 (6.00)	304.80 (12.00)	6.40 (0.25)	7.10 (0.28)	6.40 (0.25)	YG-120606
255.50 (10.06)	357.10 (14.06)	115.00 (4.53)	108.00 (4.25)	263.70 (10.38)	203.20 (8.00)	10.90 (0.43)	9.70 (0.38)	101.60 (4.00)	292.10 (11.50)	82.60 (3.25)	190.50 (7.50)	12.70 (0.50)	203.20 (8.00)	304.80 (12.00)	6.40 (0.25)	7.10 (0.28)	6.40 (0.25)	YG-120804
255.50 (10.06)	357.10 (14.06)	165.90 (6.53)	158.80 (6.25)	263.70 (10.38)	203.20 (8.00)	10.90 (0.43)	9.70 (0.38)	152.40 (6.00)	292.10 (11.50)	113.40 (5.25)	190.50 (7.50)	12.70 (0.50)	203.20 (8.00)	304.80 (12.00)	6.40 (0.25)	7.10 (0.28)	6.40 (0.25)	YG-120806
255.50 (10.06)	357.10 (14.06)	216.70 (8.53)	209.60 (8.25)	263.70 (10.38)	203.20 (8.00)	10.90 (0.43)	9.70 (0.38)	203.20 (8.00)	289.10 (11.38)	184.20 (7.25)	187.50 (7.38)	12.70 (0.50)	203.20 (8.00)	304.80 (12.00)	6.40 (0.25)	7.10 (0.28)	6.40 (0.25)	YG-120808
306.30 (12.06)	357.10 (14.06)	115.00 (4.53)	108.00 (4.25)	314.50 (12.38)	203.20 (8.00)	10.90 (0.43)	9.70 (0.38)	101.60 (4.00)	292.10 (11.50)	82.60 (3.25)	241.30 (9.50)	12.70 (0.50)	254.00 (10.00)	304.80 (12.00)	6.40 (0.25)	7.10 (0.28)	6.40 (0.25)	YG-121004
306.30 (12.06)	357.10 (14.06)	165.90 (6.53)	158.80 (6.25)	314.50 (12.38)	203.20 (8.00)	10.90 (0.43)	9.70 (0.38)	152.40 (6.00)	292.10 (11.50)	113.40 (5.25)	241.30 (9.50)	12.70 (0.50)	254.00 (10.00)	304.8 (12.00)	6.40 (0.25)	7.10 (0.28)	6.40 (0.25)	YG-121006
306.30 (12.06)	357.10 (14.06)	216.70 (8.53)	209.60 (8.25)	314.50 (12.38)	203.20 (8.00)	10.90 (0.43)	9.70 (0.38)	203.20 (8.00)	292.10 (11.50)	184.20 (7.25)	238.30 (9.38)	12.70 (0.50)	254.00 (10.00)	304.80 (12.00)	6.40 (0.25)	7.10 (0.28)	6.40 (0.25)	YG-121008
357.10 (14.06)	357.10 (14.06)	115.80 (4.56)	108.00 (4.25)	365.30 (14.38)	203.20 (8.00)	10.90 (0.43)	9.70 (0.38)	101.60 (4.00)	289.10 (11.38)	81.00 (3.19)	292.10 (11.50)	12.70 (0.50)	304.80 (12.00)	304.80 (12.00)	6.40 (0.25)	7.90 (0.31)	6.40 (0.25)	YG-121204
357.10 (14.06)	357.10 (14.06)	166.60 (6.56)	158.80 (6.25)	365.30 (14.38)	203.20 (8.00)	10.90 (0.43)	9.70 (0.38)	127.00 (5.00)	292.10 (11.50)	131.80 (5.19)	292.10 (11.50)	12.70 (0.50)	304.80 (12.00)	304.80 (12.00)	6.40 (0.25)	7.90 (0.31)	6.40 (0.25)	YG-121206
357.10 (14.06)	357.10 (14.06)	193.80 (7.63)	185.70 (7.31)	365.30 (14.38)	203.20 (8.00)	10.90 (0.43)	9.70 (0.38)	177.80 (7.00)	289.10 (11.38)	157.20 (6.19)	289.10 (11.38)	14.20 (0.56)	304.80 (12.00)	304.80 (12.00)	7.90 (0.31)	7.90 (0.31)	7.90 (0.31)	YG-121207
357.10 (14.06)	357.10 (14.06)	219.20 (8.63)	211.10 (8.31)	365.30 (14.38)	203.20 (8.00)	10.90 (0.43)	9.70 (0.38)	203.20 (8.00)	289.10 (11.38)	182.60 (7.19)	289.10 (11.38)	14.20 (0.56)	304.80 (12.00)	304.80 (12.00)	7.90 (0.31)	7.90 (0.31)	7.90 (0.31)	YG-121208
357.10 (14.06)	357.10 (14.06)	270.00 (10.63)	261.90 (10.31)	365.30 (14.38)	203.20 (8.00)	10.90 (0.43)	9.70 (0.38)	254.00 (10.00)	285.80 (11.25)	233.40 (9.19)	285.80 (11.25)	14.20 (0.56)	304.80 (12.00)	304.80 (12.00)	7.90 (0.31)	7.90 (0.31)	7.90 (0.31)	YG-121210
357.10 (14.06)	357.10 (14.06)	320.80 (12.63)	312.70 (12.31)	365.30 (14.38)	203.20 (8.00)	10.90 (0.43)	9.70 (0.38)	304.80 (12.00)	285.80 (11.25)	284.20 (11.19)	285.80 (11.25)	14.20 (0.56)	304.80 (12.00)	304.80 (12.00)	7.90 (0.31)	7.90 (0.31)	7.90 (0.31)	YG-121212
255.50 (10.06)	407.90 (16.06)	115.00 (4.53)	108.00 (4.25)	263.70 (10.38)	254.00 (10.00)	10.90 (0.43)	9.70 (0.38)	101.60 (4.00)	336.60 (13.25)	76.20 (3.00)	184.20 (7.25)	16.00 (0.63)	203.20 (8.00)	355.60 (14.00)	6.40 (0.25)	7.10 (0.28)	6.40 (0.25)	YG-140804

ENCLOSURES AND JUNCTION BOXES: NEC/CEC WEATHERPROOF/DUSTPROOF JUNCTION AND OUTLET BOXES

OZGEDNEY





# YG Series Junction Box

## Dust-Ignitionproof, Watertight

Cast iron box and cover for surface mounting. Cast aluminum box and cover for surface mounting.

**NEC:**  
 Class II, Division 1 and 2, Groups E, F, G  
 Class III  
 NEMA 4, 9EFG

### Outside Flange Dimensional Data in Millimeters (Inches)

Overall Enclosure				Mounting Enclosure			Mount Thick- ness Depth		Conduit Area				Clear Opening		Wall Thickness			Catalog Number
A	B	C	D	E	F	G	J	K	L	M	N	P	S	T	X	Y	Z	
538.20 (21.19)	690.60 (27.19)	170.70 (6.72)	161.00 (6.34)	524.00 (20.63)	482.60 (19.00)	14.20 (0.56)	9.70 (0.38)	152.40 (6.00)	590.60 (23.25)	124.00 (4.88)	438.20 (17.25)	19.10 (0.75)	457.20 (18.00)	609.60 (24.00)	7.90 (0.31)	9.70 (0.38)	8.60 (0.34)	YG-241806
538.20 (21.19)	690.60 (27.19)	221.50 (8.72)	211.80 (8.34)	524.00 (20.63)	482.60 (19.00)	14.20 (0.56)	9.70 (0.38)	203.20 (8.00)	590.60 (23.25)	174.80 (6.88)	438.20 (17.25)	19.10 (0.75)	457.20 (18.00)	609.60 (24.00)	8.60 (0.34)	9.70 (0.38)	8.60 (0.34)	YG-241808
538.20 (21.19)	690.60 (27.19)	272.30 (10.72)	262.60 (10.34)	524.00 (20.63)	482.60 (19.00)	14.20 (0.56)	9.70 (0.38)	254.00 (10.00)	584.20 (23.00)	225.60 (8.88)	431.80 (17.00)	19.10 (0.75)	457.20 (18.00)	609.60 (24.00)	8.60 (0.34)	9.70 (0.38)	8.60 (0.34)	YG-241810
538.20 (21.19)	690.60 (27.19)	323.10 (12.72)	313.40 (12.34)	524.00 (20.63)	482.60 (19.00)	14.20 (0.56)	9.70 (0.38)	304.80 (12.00)	584.20 (23.00)	276.40 (10.88)	431.80 (17.00)	19.10 (0.75)	457.20 (18.00)	609.60 (24.00)	8.60 (0.34)	9.70 (0.38)	8.60 (0.34)	YG-241812
538.20 (21.19)	690.60 (27.19)	475.50 (18.72)	465.8 (18.34)	524.00 (20.63)	482.60 (19.00)	14.20 (0.56)	9.70 (0.38)	457.20 (18.00)	584.20 (23.00)	428.80 (16.88)	431.80 (17.00)	19.10 (0.75)	457.20 (18.00)	609.60 (24.00)	8.60 (0.34)	9.70 (0.38)	8.60 (0.34)	YG-241818
690.60 (27.19)	690.60 (27.19)	170.70 (6.72)	161.00 (6.34)	26.88 (682.8)	482.60 (19.00)	14.20 (0.56)	9.70 (0.38)	152.40 (6.00)	590.60 (23.25)	124.00 (4.88)	590.6 (23.25)	19.10 (0.75)	609.60 (24.00)	609.60 (24.00)	8.60 (0.34)	9.70 (0.38)	8.60 (0.34)	YG-242406
690.60 (27.19)	690.60 (27.19)	221.50 (8.72)	211.80 (8.34)	682.80 (26.88)	482.60 (19.00)	14.20 (0.56)	9.70 (0.38)	203.20 (8.00)	584.20 (23.00)	174.80 (6.88)	590.60 (23.25)	19.10 (0.75)	609.60 (24.00)	609.60 (24.00)	8.60 (0.34)	9.70 (0.38)	8.60 (0.34)	YG-242408
690.60 (27.19)	690.60 (27.19)	273.10 (10.75)	263.70 (10.38)	682.80 (26.88)	482.60 (19.00)	14.20 (0.56)	9.70 (0.38)	254.00 (10.00)	584.20 (23.00)	225.60 (8.88)	584.20 (23.00)	19.10 (0.75)	609.60 (24.00)	609.60 (24.00)	9.70 (0.38)	9.70 (0.38)	9.70 (0.38)	YG-242410
690.60 (27.19)	690.60 (27.19)	44.50 (1.75)	314.50 (12.38)	682.80 (26.88)	482.60 (19.00)	14.20 (0.56)	9.70 (0.38)	304.80 (12.00)	584.20 (23.00)	276.40 (10.88)	584.20 (23.00)	19.10 (0.75)	609.60 (24.00)	609.60 (24.00)	9.70 (0.38)	9.70 (0.38)	9.70 (0.38)	YG-242412
385.80 (15.19)	792.20 (31.19)	322.30 (12.69)	313.40 (12.34)	374.70 (14.75)	558.80 (22.00)	14.20 (0.56)	9.70 (0.38)	304.80 (12.00)	685.80 (27.00)	276.40 (10.88)	279.40 (11.00)	19.10 (0.75)	304.80 (12.00)	711.20 (28.00)	8.60 (0.34)	8.60 (0.34)	8.60 (0.34)	YG-281208
385.80 (15.19)	792.20 (31.19)	322.30 (12.69)	313.40 (12.34)	374.70 (14.75)	558.80 (22.00)	14.20 (0.56)	9.70 (0.38)	304.80 (12.00)	685.80 (27.00)	276.40 (10.88)	279.40 (11.00)	19.10 (0.75)	304.80 (12.00)	711.20 (28.00)	8.60 (0.34)	8.60 (0.34)	8.60 (0.34)	YG-281212
692.20 (27.25)	844.60 (33.25)	222.30 (8.75)	212.90 (8.38)	682.80 (26.88)	609.60 (24.00)	14.20 (0.56)	9.70 (0.38)	254.00 (10.00)	743.00 (29.25)	225.60 (8.88)	590.60 (23.25)	19.10 (0.75)	609.60 (24.00)	762.00 (30.00)	9.70 (0.38)	9.70 (0.38)	9.70 (0.38)	YG-302408
692.20 (27.25)	844.60 (33.25)	273.10 (10.75)	263.70 (10.38)	682.80 (26.88)	609.60 (24.00)	14.20 (0.56)	9.70 (0.38)	254.00 (10.00)	743.00 (29.25)	225.60 (8.88)	590.60 (23.25)	19.10 (0.75)	609.60 (24.00)	762.00 (30.00)	9.70 (0.38)	9.70 (0.38)	9.70 (0.38)	YG-302410
692.20 (27.25)	844.60 (33.25)	323.9 (12.75)	314.5 (12.38)	682.80 (26.88)	609.60 (24.00)	14.20 (0.56)	9.70 (0.38)	304.80 (12.00)	743.00 (29.25)	276.40 (10.88)	590.60 (23.25)	19.10 (0.75)	609.60 (24.00)	762.00 (30.00)	9.70 (0.38)	9.70 (0.38)	9.70 (0.38)	YG-302412
692.20 (27.25)	844.60 (33.25)	476.30 (18.75)	466.9 (18.38)	682.80 (26.88)	609.60 (24.00)	14.20 (0.56)	9.70 (0.38)	457.20 (18.00)	736.60 (29.00)	428.80 (16.88)	584.20 (23.00)	19.10 (0.75)	609.60 (24.00)	762.00 (30.00)	9.70 (0.38)	9.70 (0.38)	9.70 (0.38)	YG-302418
539.80 (21.25)	997.00 (39.25)	171.50 (6.75)	162.10 (6.38)	530.40 (20.88)	762.00 (30.00)	14.20 (0.56)	9.70 (0.38)	203.20 (8.00)	819.20 (32.25)	124.00 (4.88)	438.20 (17.25)	19.10 (0.75)	457.20 (18.00)	914.40 (36.00)	9.70 (0.38)	9.70 (0.38)	9.70 (0.38)	YG-361806
539.80 (21.25)	997.00 (39.25)	222.30 (8.75)	212.90 (8.38)	530.40 (20.88)	762.00 (30.00)	14.20 (0.56)	9.70 (0.38)	203.20 (8.00)	819.20 (32.25)	174.80 (6.88)	438.20 (17.25)	19.10 (0.75)	457.20 (18.00)	914.40 (36.00)	9.70 (0.38)	9.70 (0.38)	9.70 (0.38)	YG-361808
539.80 (21.25)	997.00 (39.25)	323.90 (12.75)	314.50 (12.38)	530.40 (20.88)	762.00 (30.00)	14.20 (0.56)	9.70 (0.38)	304.80 (12.00)	914.40 (36.00)	276.40 (10.88)	431.80 (17.00)	19.10 (0.75)	457.20 (18.00)	914.40 (36.00)	9.70 (0.38)	9.70 (0.38)	9.70 (0.38)	YG-361812
539.80 (21.25)	997.00 (39.25)	476.30 (18.75)	466.90 (18.38)	530.40 (20.88)	762.00 (30.00)	14.20 (0.56)	9.70 (0.38)	457.20 (18.00)	914.40 (36.00)	428.80 (16.88)	431.80 (17.00)	19.10 (0.75)	457.20 (18.00)	914.40 (36.00)	9.70 (0.38)	9.70 (0.38)	9.70 (0.38)	YG-361818
990.60 (39.00)	990.60 (39.00)	225.60 (8.88)	225.60 (8.88)	987.60 (38.88)	762.00 (30.00)	14.20 (0.56)	9.70 (0.38)	203.20 (8.00)	914.40 (36.00)	171.50 (6.75)	914.40 (36.00)	20.60 (0.81)	914.40 (36.00)	914.40 (36.00)	11.20 (0.44)	11.20 (0.44)	11.20 (0.44)	YG-363608
990.60 (39.00)	990.6 (39.00)	276.40 (10.88)	276.40 (10.88)	987.60 (38.88)	762.00 (30.00)	14.20 (0.56)	9.70 (0.38)	254.00 (10.00)	889.00 (35.00)	222.30 (8.75)	914.40 (36.00)	20.60 (0.81)	914.40 (36.00)	914.40 (36.00)	11.20 (0.44)	11.20 (0.44)	11.20 (0.44)	YG-363610
990.60 (39.00)	990.60 (39.00)	327.20 (12.88)	327.20 (12.88)	987.60 (38.88)	762.00 (30.00)	14.20 (0.56)	9.70 (0.38)	304.80 (12.00)	914.40 (36.00)	273.10 (10.75)	914.40 (36.00)	20.60 (0.81)	914.40 (36.00)	914.40 (36.00)	11.20 (0.44)	11.20 (0.44)	11.20 (0.44)	YG-363612
990.60 (39.00)	990.60 (39.00)	479.60 (18.88)	479.60 (18.88)	987.60 (38.88)	762.00 (30.00)	14.20 (0.56)	9.70 (0.38)	457.20 (18.00)	886.00 (34.88)	425.50 (16.75)	886.00 (34.88)	20.60 (0.81)	914.40 (36.00)	914.40 (36.00)	11.20 (0.44)	11.20 (0.44)	11.20 (0.44)	YG-363618

ENCLOSURES AND JUNCTION BOXES: NEC/CEC WEATHERPROOF/DUSTPROOF JUNCTION AND OUTLET BOXES

OZGEDNEY

# Cast Iron Junction Boxes

**NEC/CEC:**  
*Rated for Ordinary (Unclassified) Locations*

## I. Purpose of Enclosure

Enclosures are used to protect personnel against accidental contact with enclosed electrical devices or connections and to protect the enclosed devices or connections against specified external conditions. They also serve as intermediate pulling and splicing points in a conduit system.

## II. Design of Enclosures

Enclosures are offered in different designs and construction to permit their use in various locations and areas. These are as follows:

### Non-hazardous Locations:

1. Weatherproof boxes are so constructed as to be suitable for use outdoors under normal conditions. If it is necessary to prevent the entry of water under extreme conditions of weather, boxes listed as watertight or raintight are recommended.
2. Raintight boxes are so constructed as to exclude a beating rain. All boxes in this catalog which are designated as raintight have been so listed by Underwriters Laboratories, Inc. and CSA group.
3. Watertight boxes (NEMA Type 4) are constructed to meet the requirements listed under "NEMA DATA."
4. Submersible boxes are so constructed that they will exclude water when submerged under specified conditions of pressure and time.
5. Dust-tight boxes are so constructed to meet the requirements listed under "NEMA DATA".

### Hazardous Locations:

Consult the Enclosures and Junction Boxes section for our complete offering.

## III. Advantages of Cast Enclosures

Cast metal enclosures have the advantage over formed (fabricated) sheet metal enclosures for the following reasons:

- A. They are of one piece construction and do not have the disadvantages of spot welded seams usually found in formed sheet metal boxes.
- B. They have greater mechanical strength, have thicker walls and are suitable for drilling and tapping at the factory or in the field.
- C. They are corrosion resistant and can withstand more mechanical abuse.

## IV. Cast Metals

CAST IRON BOXES will provide long life, are inherently corrosion resistant and have the lowest initial cost.

## V. Finishes on Cast Enclosures

CAST IRON - The hot-dip galvanized finish which is applied to all our cast iron boxes will conform to ASTM Designation A153-73, Class A and NEMA requirements for rust-resistance.

## VI. Hardware Used on Cast Enclosures

CAST IRON BOXES are furnished with stainless steel screws.

## VII. Specification of Extras on Cast Enclosures

The type of holes to be provided for the entrance of conduit into the enclosure are defined under "Instructions for Ordering Boxes."

## VIII. Specification of Extras on Cast Enclosures

The "Standard Construction" of each type of enclosure is shown on each listing. The extras which are available and must be specified are shown under "Additional Cost Items."

# Cast Iron Junction Boxes — NEMA Data

NEC/CEC:  
Rated for Ordinary (Unclassified) Locations

Our cast junction boxes are designed, constructed and tested to comply with NEMA standards. The following chart has been prepared to provide a quick reference for selecting enclosures to meet specific NEMA requirements.

A brief description of the more common types of enclosures used by the electrical industry relating to their environmental capabilities follows. Please refer to the appropriate sections of NEMA Standards Publication No. 250-2014. Enclosures for Electrical Equipment (1000 Volts Maximum) for complete information regarding applications, features and design tests.

## Definitions Pertaining to Non-hazardous Locations

- **Type 1** enclosures are intended for use primarily to provide a degree of protection against contact with the enclosed equipment.
- **Type 2** enclosures are intended for indoor use primarily to provide a degree of protection against limited amounts of falling water.
- **Type 3** enclosures constructed for either indoor or outdoor use to provide a degree of protection to personnel against incidental contact with the enclosed equipment; to provide a degree of protection against falling dirt, rain, sleet, snow and windblown dust; and that will be undamaged by the external formation of ice on the enclosure.
- **Type 3R** enclosures are intended for outdoor use primarily to provide a degree of protection against falling rain, sleet, and external ice formation.
- **Type 3S** enclosures are intended for outdoor use primarily to provide a degree of protection against windblown dust, rain, sleet, and provide for operation of external mechanisms when ice laden.
- **Type 4** enclosures are intended for indoor or outdoor use primarily to provide a degree of protection against windblown dust and rain, splashing water, and hose-directed water.
- **Type 5** enclosures are intended for indoor use primarily to provide a degree of protection against dust and falling dirt.
- **Type 6** enclosures are intended for indoor or outdoor use primarily to provide a degree of protection against the entry of water during occasional temporary submersion at a limited depth. (30 min. @ 6 ft.)
- **Type 6P** enclosures are intended for indoor or outdoor use primarily to provide a degree of protection against the entry of water during prolonged submersion at a limited depth. (24 hrs. @ 6 ft.)
- **Type 12** enclosures are intended for indoor use primarily to provide a degree of protection against dust, falling dirt, and dripping non-corrosive liquids.
- **Type 12K** enclosures with knockouts are intended for indoor use primarily to provide a degree of protection against dust, falling dirt, and dripping non-corrosive liquids other than at knockouts.
- **Type 13** enclosures are intended for indoor use primarily to provide a degree of protection against dust, spraying of water, oil, and non-corrosive coolant.

## Definitions Pertaining to Hazardous (Classified) Locations

- **Type 7** enclosures are for use indoors in locations classified as Class I, Groups A, B, C, or D, as defined in the National Electrical Code. See Enclosures and Junction Boxes section.
- **Type 9** enclosures are for use in indoor locations classified in Class II, Groups E, F, or G, as defined in the National Electrical Code. Enclosures and Junction Boxes section.

Type of Enclosure	Type 1 Type 5	Type 2	Type 3 Type 3R Type 3S	Type 4	Type 6	Type 12 Type 12K Type 13
WYS/YS	✓	✓	✓	✓		✓
WYL/YL	✓	✓	✓	✓		✓
WYF/YF	✓	✓	✓	✓	✓	✓
WYW/YW	✓	✓	✓	✓		✓
WYR/YR	✓	✓	✓	✓		✓
WYU/YU	✓	✓	✓			✓
WYT/YT	✓	✓	✓	✓		✓
WY58E/Y58E	✓	✓				

# Cast Junction Box Ordering Information

## Boxes Available for Raintight, Watertight, or Submersible Applications

NEC/CEC:  
Rated for Ordinary (Unclassified) Locations

### The following information should be given on all box orders:

**Catalog Number and Inside Dimensions**  
(L x W x D) should be specified

**Sketch** showing size and location of conduit entrances should be furnished similar to Drilling Template, Fig. 2. Tables give recommended spacing between conduits and minimum distance from corner and back of box. When spacings are not specified, they will be located at our discretion.

**Type of Conduit Entrances** (see Fig. 1, below) should be specified as follows:

1. Slip-Hole (ASH) - conduit clearance hole.
2. Drilled and Tapped hole (ADT).
3. Bossed, Drilled and Tapped hole to provide greater thread engagement (ABDT).
4. Boss only (ABWH) - for Drilling and Tapping in field. Specify conduit size.

**Mounting Lugs** (See Fig. 1 below) are provided on all surface mounted boxes. Boxes up to 12" x 6" have 2 mounting lugs. Larger boxes have 4 mounting lugs. All mounting lugs will be located on the long sides of the box, unless otherwise specified. Refer to W-Series Cast Box Mounting Lug data for dimensional information.

### Conduit Entrances:

**Slip Holes:** These are clearance holes for conduit. No threads are provided. Conduits are usually fastened in slip holes by means of locknuts and bushings. *STANDARD LOCKNUT SPACINGS MUST BE ALLOWED BETWEEN THE CONDUITS.*

**Drilled and Tapped Holes** are threaded holes provided in the enclosure wall into which the conduit is screwed. To meet UL requirements, they must conform to the following:

- 1 Enclosures for use in Non-hazardous Locations must have a wall thickness of not less than 1/4" at the tapped holes for the conduit and there shall be not less than 3-1/2 threads in the metal. *Compare the wall thickness shown in the catalog page for these enclosures with the chart below to determine the number of threads which the box wall will provide for the various conduit sizes. If more threads are required, please specify a Bossed, Drilled and Tapped hole, type ABDT.*

**Bossed, Drilled and Tapped Holes** are holes threaded thru the box wall and a boss (or pad) which has been added at the location of the conduit entrance to provide added wall thickness for 5 threads of engagement.

Conduit Size	Wall Inches Required in Millimeters (Inches)		
	No. of Threads Per Inch	3-1/2 Threads	5 Threads
1/2 - 3/4	14	6.35 (0.25)	0.17 (0.38)
1 - 2	11-1/2	0.14 (0.31)	0.2 (0.44)
2-1/2 - 6	8	0.2 (0.44)	0.29 (0.63)

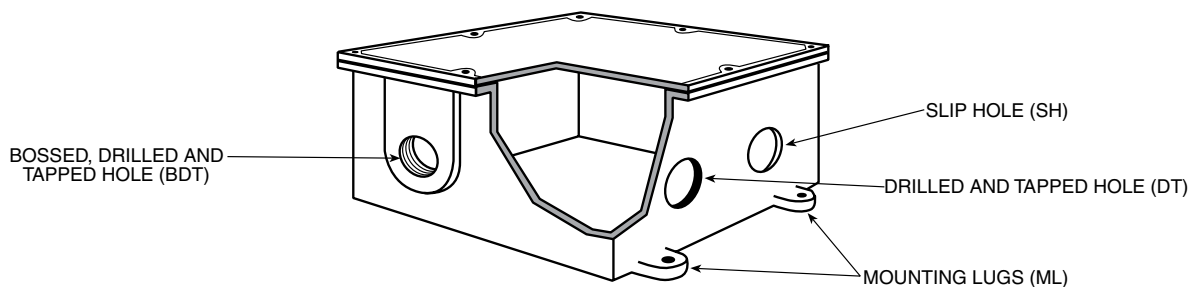

Fig. 1

# Cast Iron Junction Box Ordering Information

## Boxes Available for Raintight, Watertight, or Submersible Applications

NEC/CEC:  
Rated for Ordinary (Unclassified) Locations

### Drilling Template

- View looking into box – sides laid down.
- Dimensions are always understood to be Inside Measurements unless otherwise specified.
- See Drilling Template for Junction Boxes, for copier reproduction or computer scanning.

All boxes of the Type WYS/YS, WYL/YL, WYW/YW, and WYT/YT have a post in each corner and allowance must be made for them, when conduit entrances are to be located close to a corner. Dimension "A" in the table below is the minimum distance allowable from the sidewall of these boxes to the centerline of the conduit entrance, which provides the proper clearance between a locknut and the post. The "B" dimension will provide the proper clearance between a locknut or bushing and the sidewall of all other types of boxes and between a locknut or bushing and the backs of all boxes, including Types WYS/YS, WYL/YL, WYW/YW, and WYT/YT.

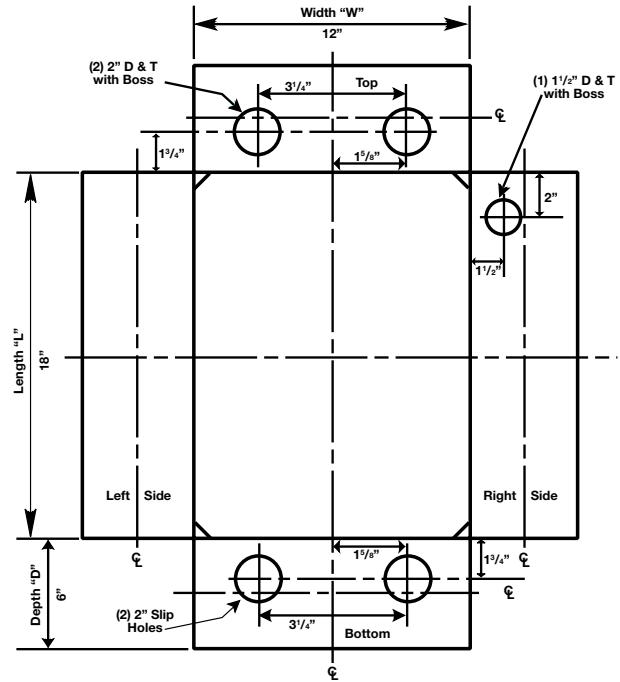
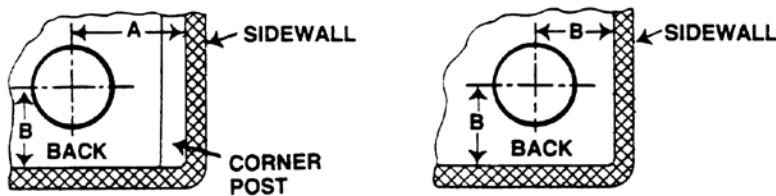

Figure 2

### Minimum Allowable Spacing from Back and Sides

Allowance made for clearance over locknuts and bushings.



Types WYS/YS, WYL/YL, WYW/YW, and WYT/YT

Types WYF/YF, WYR/YR, WYU/YU

Conduit Size	1/2"	3/4"	1"	1-1/4"	1-1/2"	2"	2-1/2"	3"	3-1/2"	4"	5"	6"
Dimension A mm (in)	31.8 (1.25)	35.1 (1.38)	41.4 (1.63)	47.8 (1.88)	50.8 (2.00)	60.5 (2.38)	66.8 (2.63)	76.2 (3.00)	82.6 (3.25)	92.2 (3.63)	107.9 (4.25)	123.9 (4.88)
Dimension B mm (in)	25.4 (1.00)	25.4 (1.00)	28.7 (1.13)	35.1 (1.38)	38.1 (1.50)	44.5 (1.75)	54.1 (2.13)	63.5 (2.50)	73.2 (2.88)	79.5 (3.13)	95.3 (3.75)	111.3 (4.38)

# Cast Iron Junction Box Ordering Information

## Boxes Available for Raintight, Watertight, or Submersible Applications

**NEC/CEC:**  
*Rated for Ordinary (Unclassified) Locations*

### Minimum Recommended Spacing Between Conduit Openings

*Allowance made for clearance over locknuts and bushings.*

When unions are used, additional space must be allowed. Table shows minimum distances between conduit opening centerlines in various size combinations. For example, if 1-1/2" and 3/4" openings are to be drilled and tapped into one side of box, the minimum spacing between centerlines would be 54.1 mm (2.13").

### Space Between Centers of Conduit Millimeters (Inches)

Size of Conduit	Minimum Space Between Centers of Conduits ①											
	6	5	4	3-1/2	3	2-1/2	2	1-1/2	1-1/4	1	3/4	1/2
1/2	127.00 (5.00)	111.25 (4.38)	92.20 (3.63)	85.85 (3.38)	76.20 (3.00)	66.80 (2.63)	60.45 (2.38)	50.80 (2.00)	47.75 (1.88)	44.45 (1.75)	41.40 (1.63)	38.10 (1.50)
3/4	130.30 (5.13)	114.30 (4.50)	95.25 (3.75)	88.90 (3.50)	79.50 (3.13)	69.85 (2.75)	63.50 (2.50)	54.10 (2.13)	50.80 (2.00)	47.75 (1.88)	44.45 (1.75)	
1	133.35 (5.25)	117.60 (4.63)	101.60 (4.00)	92.20 (3.63)	82.55 (3.25)	76.20 (3.00)	66.80 (2.63)	60.45 (2.38)	57.15 (2.25)	50.80 (2.00)		
1-1/4	139.70 (5.50)	123.95 (4.88)	104.90 (4.13)	98.55 (3.88)	88.90 (3.50)	79.50 (3.13)	73.15 (2.88)	63.50 (2.50)	60.45 (2.38)			
1-1/2	136.65 (5.38)	127.00 (5.00)	107.95 (4.25)	101.60 (4.00)	92.20 (3.63)	82.55 (3.25)	76.20 (3.00)	66.80 (2.63)				
2	152.40 (6.00)	136.65 (5.38)	117.60 (4.63)	107.95 (4.25)	98.55 (3.88)	92.20 (3.63)	82.55 (3.25)					
2-1/2	158.75 (6.25)	143.00 (5.63)	123.95 (4.88)	117.60 (4.63)	107.95 (4.25)	98.55 (3.88)						
3	168.40 (6.63)	152.40 (6.00)	136.65 (5.38)	127.00 (5.00)	117.60 (4.63)							
3-1/2	177.80 (7.00)	158.75 (6.25)	143.00 (5.63)	133.35 (5.25)								
4	184.15 (7.25)	168.40 (6.63)	149.35 (5.88)									
5	203.20 (8.00)	184.15 (7.25)										
6	219.20 (8.63)											

① If Conduit Fittings are used additional spacing between conduits will be required. Determine spacings based on fittings being used.

# Cast Iron Junction Box Drilling Template

Boxes Available for Raintight, Watertight, or Submersible Applications

NEC/CEC:  
Rated for Ordinary (Unclassified) Locations

## DRILLING TEMPLATE for JUNCTION BOXES

For copier reproduction or computer scanning. Please send to your local representative for quotation or order confirmation.

Distributor \_\_\_\_\_ P.O. No. \_\_\_\_\_  
 End User \_\_\_\_\_ Date \_\_\_\_\_  
 Req. No. \_\_\_\_\_ Mark Box \_\_\_\_\_

Looking Into Box - Sides Laid Down  
 All dimensions are from inside of box.

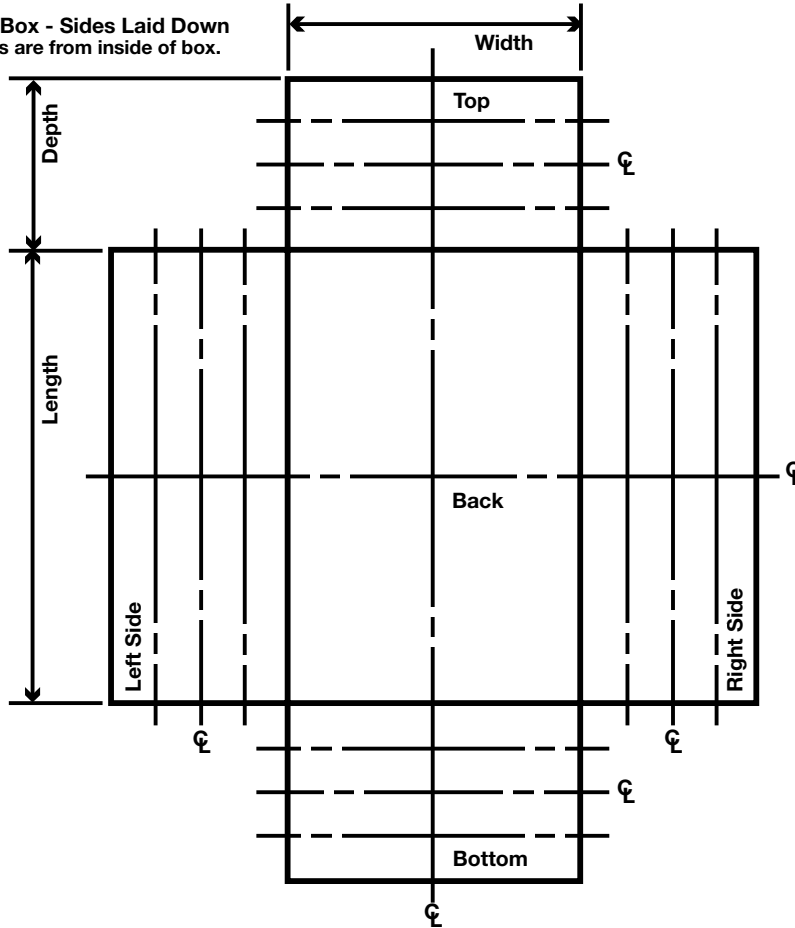

### Drilling Data

NOTE: If location of openings are not definitely dimensioned, they will be located at our discretion.

- Slip-hole Only  Drilled and Tapped   
 Drilled and Tapped with Boss  Boss Only

Catalog No. \_\_\_\_\_  
 Quantity \_\_\_\_\_

### Mounting Lugs

NOTE: Mounting Lugs are provided on all surface-mount boxes.

Additional Specifications: \_\_\_\_\_

Dwg. No. \_\_\_\_\_

Company/Location \_\_\_\_\_

Signature \_\_\_\_\_

Print Name \_\_\_\_\_



# Cast Iron Junction Box Ordering Information

## Boxes Available for Raintight, Watertight, or Submersible Applications

**NEC/CEC:**  
*Rated for Ordinary (Unclassified) Locations*

### Additional Cost Items

The table below shows the additional cost items available on the different types of enclosures shown in this catalog. These cost items are shown in the tables on the adjacent page and when not furnished as standard equipment the cost must be added to the base price of the box.

### Special Equipment Consult Factory for Prices and Availability

- Lettering on Covers can be furnished. These are engraved letters and can be applied to the cover of any type box.
- Submersibility Tests can be made on our Types WYF/YF within the limitations shown on Flat Flanged Boxes catalog page listing these enclosures.
- Certifications can be furnished if specific requirements are provided at time of order.

✓ – Available option at additional charge.

S – Furnished as standard equipment at no additional charge

NA – Not permitted on this type of enclosure by NEMA and Underwriters Laboratories, Inc. standards and specifications, or basic construction of box will not allow or require this item.

ITEM Catalog Designation	Type of Enclosure							
	WYS/YS	WYL/YL	WYF/YF	WYW/YW	WYU/YU	WYR/YR	WYT/YT	WY58E/Y58F
Slip Holes (ASH)	✓	✓	✓	✓	✓	✓	✓	NA
Drill and Tap Holes (ADT)	✓	✓	✓	✓	✓	✓	✓	NA
Bosses Only (ABWH)	✓	✓	✓	✓	✓	✓	✓	NA
Drilled and Tapped Boss (ABDT)	✓	✓	✓	✓	✓	✓	✓	NA
Mtg. Lugs (AML)	S	S	S	S	✓	✓	✓	NA
Mtg. Plates (AYM)	✓	✓	✓	✓	✓	✓	✓	NA
Hinges (AHNG)	NA	NA	NA	S	✓	NA	NA	NA
Drain and Breather (AMDB)	✓	✓	✓	✓	✓	NA	NA	NA

ENCLOSURES AND JUNCTION BOXES: NEC/CEC WEATHERPROOF/DUSTPROOF JUNCTION AND OUTLET BOXES

Appleton® OZGEDNEY

# Cast Iron Junction Box Ordering Information

## Boxes Available for Raintight, Watertight, or Submersible Applications

NEC/CEC:  
Rated for Ordinary (Unclassified) Locations

### Drilling and Tapping

Applies to: Types WYS, WYL, WYF, WYW, WYT, WYU, WYR.

Conduit Size Inches	Appleton Catalog Number			
	Drilling Only Slip Hole	Drilling and Tapping No Boss	Boss Only 5 Threads without Hole	Boss for 4 Threads and Tapping
1/2	ASH-50	ADT-50	ABWH-50	ABDT-50
3/4	ASH-75	ADT-75	ABWH-75	ABDT-75
1	ASH-100	ADT-100	ABWH-100	ABDT-100
1-1/4	ASH-125	ADT-125	ABWH-125	ABDT-125
1-1/2	ASH-150	ADT-150	ABWH-150	ABDT-150
2	ASH-200	ADT-200	ABWH-200	ABDT-200
2-1/2	ASH-250	ADT-250	ABWH-250	ABDT-250
3	ASH-300	ADT-300	ABWH-300	ABDT-300
3-1/2	ASH-350	ADT-350	ABWH-350	ABDT-350
4	ASH-400	ADT-400	ABWH-400	ABDT-400
4-1/2	ASH-450	ADT-450	ABWH-450	ABDT-450
5	ASH-500	ADT-500	ABWH-500	ABDT-500
6	ASH-600	ADT-600	ABWH-600	ABDT-600

Applies to: Types YS, YL, YF, YW, YT, YU, YR.

Conduit Size Inches	O-Z/Gedney Catalog Number			
	Drilling Only Slip Hole	Drilling and Tapping No Boss	Boss Only 5 Threads without Hole	Boss for 5 Threads and Tapping
1/2	SH-50	DT-50	BWH-50	BDT-50
3/4	SH-75	DT-75	BWH-75	BDT-75
1	SH-100	DT-100	BWH-100	BDT-100
1-1/4	SH-125	DT-125	BWH-125	BDT-125
1-1/2	SH-150	DT-150	BWH-150	BDT-150
2	SH-200	DT-200	BWH-200	BDT-200
2-1/2	SH-250	DT-250	BWH-250	BDT-250
3	SH-300	DT-300	BWH-300	BDT-300
3-1/2	SH-350	DT-350	BWH-350	BDT-350
4	SH-400	DT-400	BWH-400	BDT-400
4-1/2	SH-450	DT-450	BWH-450	BDT-450
5	SH-500	DT-500	BWH-500	BDT-500
6	SH-600	DT-600	BWH-600	BDT-600

### Combination Drain and Breather Fittings

D and T and installation included.

Size (Inches)	Appleton Catalog Number	O-Z/Gedney Catalog Number
3/8	AMDB-38	MDB-38
1/2	AMDB-50	MDB-50

### Grounding Kits

Wire Capacity Al-Cu Tinned Copper	Appleton Catalog Number	O-Z/Gedney Catalog Number
#14-4 AWG	AGK-04	GK-04
8-1/0 AWG	AGK-10	GK-10
6 AWG-250kcmil	AGK-25	GK-25

### Letters Engraved on Box Covers

Description	Appleton Catalog Number	O-Z/Gedney Catalog Number
Up to 10 letters, one line	AENGRAVE-1	ENGRAVE-1
Up to 20 letters, two lines	AENGRAVE-2	ENGRAVE-2

ENCLOSURES AND JUNCTION BOXES: NEC/CEC WEATHERPROOF/DUSTPROOF JUNCTION AND OUTLET BOXES

Appleton OZGEDNEY

# Cast Iron Junction Box Ordering Information

## Boxes Available for Raintight, Watertight, or Submersible Applications

**NEC/CEC:**  
*Rated for Ordinary (Unclassified) Locations*

### Optional Mounting Lugs with Bolt Holes (Mounting Lugs are standard equipment on surface mounted boxes)

Maximum Box Size — L x W in mm (in)	No. of Lugs	Appleton Catalog Number	O-Z/Gedney Catalog Number
Sizes up to 152.4 x 101.6 (6 x 4)	2	A2-ML-0604	2-ML-0604
	4	A4-ML-0604	4-ML-0604
Sizes 152.4 x 152.4 up to 304.8 x 101.6 (6 x 6 to 12 x 4)	2	A2-ML-1204	2-ML-1204
	4	A4-ML-1204	4-ML-1204
Sizes 304.8 x 152.4 up to 457.2 x 406.4 (12 x 6 up to 18 x 16)	2	A2-ML-1816	2-ML-1816
	4	A4-ML-1816	4-ML-1816
Sizes 457.2 x 457.2 and larger (18 x 18 and larger)	4	A4-ML-3636	4-ML-3636

### Hinges for WYU/YU Boxes

Type	Box Size in Millimeters (Inches)	Number of Hinges Per Set	Appleton Catalog Number	O-Z/Gedney Catalog Number
Stainless Steel	Up to 304.8 x 304.8 (12 x 12)	2	AHNG-22SS	HNG-22SS

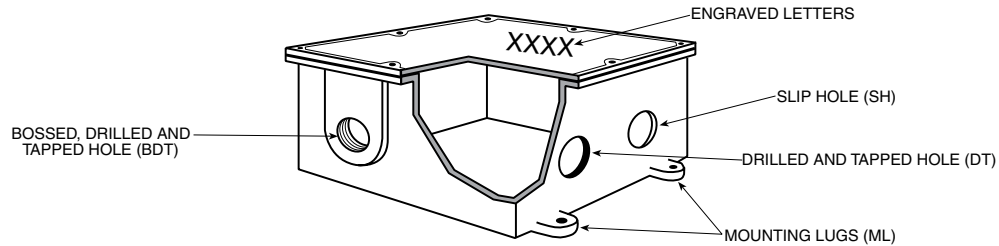

ENCLOSURES AND JUNCTION BOXES: NEC/CEC WEATHERPROOF/DUSTPROOF JUNCTION AND OUTLET BOXES

Appleton® O-Z/GEDNEY

# Cast Iron Junction Box Mounting Plate Information

## Boxes Available for Raintight, Watertight, or Submersible Applications

**NEC/CEC:**  
 Rated for Ordinary (Unclassified) Locations

Mounting plates are used for mounting equipment up off the back of an enclosure. Steel Plates are all 3.3 mm (0.13") thick hot dip galvanized material. Aluminum plates are 3.3 mm (0.13") thick material up to and including 304.8 x 304.8 mm (12 x 12") size. All larger sizes are constructed of 4.8 mm (0.19") thick aluminum plate.

Select mounting plates based on inside length and width of box. Order as a separate item immediately following the catalog number of the box as follows:

Example: Line 1 **WYS-080804**  
 Line 2 **WYM-0808-2**

For mounting plates in smaller boxes than listed, use similar catalog number logic. Example: A steel mounting plate for an Appleton **WYF-040404** box would be **WYM-0404-1**. Pricing will be based upon a **WYM-0808-1** price.

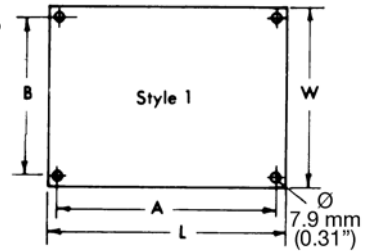

The catalog numbers shown in the table below include the mounting buttons.

Inside Length and Width of Junction Box in mm (in)	Style	Appleton Catalog Number – Steel Plates		O-Z/Gedney Catalog Number – Steel Plates		Dimension in Millimeters (Inches)			
		For use in Types WYT, WYF and WYR Junction Boxes	For use in Types WYS, WYL and WYW Junction Boxes	For use in Types YT, YF and YR Junction Boxes	For use in Types YS, YL and YW Junction Boxes	L	W	A	B
203.2 x 203.2 (8 x 8)	1	<b>WYM-0808-1</b>		<b>YM-0808-1</b>		171.5 (6.75)	171.5 (6.75)	152.4 (6.00)	152.4 (6.00)
			<b>WYM-0808-2</b>		<b>YM-0808-2</b>	152.4 (6.00)	152.4 (6.00)	133.4 (5.25)	133.4 (5.25)
254.0 x 203.2 (10 x 8)	1	<b>WYM-1008-1</b>		<b>YM-1008-1</b>		222.3 (8.75)	171.5 (6.75)	203.2 (8.00)	203.2 (8.00)
			<b>WYM-1008-2</b>		<b>YM-1008-2</b>	203.2 (8.00)	152.4 (6.00)	184.2 (7.25)	133.4 (5.25)
254.0 x 254.0 (10 x 10)	1	<b>WYM-1010-1</b>		<b>YM-1010-1</b>		222.3 (8.75)	222.3 (8.75)	203.2 (8.00)	203.2 (8.00)
			<b>WYM-1010-2</b>		<b>YM-1010-2</b>	203.2 (8.00)	203.2 (8.00)	184.2 (7.25)	184.2 (7.25)
304.8 x 203.2 (12 x 8)	1	<b>WYM-1208-1</b>		<b>YM-1208-1</b>		273.1 (10.75)	171.5 (6.75)	254.0 (10.00)	152.4 (6.00)
			<b>WYM-1208-2</b>		<b>YM-1208-2</b>	254.0 (10.00)	152.4 (6.00)	235.0 (9.25)	133.4 (5.25)
304.8 x 254.0 (12 x 10)	1	<b>WYM-1210-1</b>		<b>YM-1210-1</b>		273.1 (10.75)	222.3 (8.75)	254.0 (10.00)	203.2 (8.00)
			<b>WYM-1210-2</b>		<b>YM-1210-2</b>	254.0 (10.00)	203.2 (8.00)	235.0 (9.25)	133.4 (5.25)
304.8 x 304.8 (12 x 12)	1	<b>WYM-1212-1</b>		<b>YM-1212-1</b>		273.1 (10.75)	273.1 (10.75)	254.0 (10.00)	254.0 (10.00)
			<b>WYM-1212-2</b>		<b>YM-1212-2</b>	254.0 (10.00)	254.0 (10.00)	235.0 (9.25)	235.0 (9.25)
355.6 x 203.2 (14 x 8)	1	<b>WYM-1408-1</b>		<b>YM-1408-1</b>		323.9 (12.75)	171.5 (6.75)	304.8 (12.00)	152.4 (6.00)
			<b>WYM-1408-2</b>		<b>YM-1408-2</b>	304.8 (12.00)	152.4 (6.00)	285.5 (11.25)	133.4 (5.25)
355.6 x 355.6 (14 x 14)	1	<b>WYM-1414-1</b>		<b>YM-1414-1</b>		323.9 (12.75)	323.9 (12.75)	304.8 (12.00)	304.8 (12.00)
			<b>WYM-1414-2</b>		<b>YM-1414-2</b>	304.8 (12.00)	304.8 (12.00)	285.5 (11.25)	285.5 (11.25)
406.4 x 203.2 (16 x 8)	1	<b>WYM-1608-1</b>		<b>YM-1608-1</b>		374.7 (14.75)	171.5 (6.75)	355.6 (14.00)	152.4 (6.00)
			<b>WYM-1608-2</b>		<b>YM-1608-2</b>	304.8 (12.00)	152.4 (6.00)	285.5 (11.25)	133.4 (5.25)

ENCLOSURES AND JUNCTION BOXES: NEC/CEC WEATHERPROOF/DUSTPROOF JUNCTION AND OUTLET BOXES

**Appleton** OZGEDNEY

# Cast Iron Junction Box Mounting Plate Information

## Boxes Available for Raintight, Watertight, or Submersible Applications

NEC/CEC:  
Rated for Ordinary (Unclassified) Locations

Inside Length and Width of Junction Box in mm (in)	Style	Appleton Catalog Number – Aluminum Plates		O-Z/Gedney Catalog Number – Aluminum Plates		Dimension in Millimeters (Inches)			
		For use in Types WYT, WYF and WYR Junction Boxes	For use in Types WYS, WYL and WYW Junction Boxes	For use in Types YT, YF and YR Junction Boxes	For use in Types YS, YL and YW Junction Boxes	L	W	A	B
203.2 x 203.2 (8 x 8)	1	WYM-0808-1A		YM-0808-1A		171.5 (6.75)	171.5 (6.75)	152.4 (6.00)	152.4 (6.00)
		WYM-0808-2A		YM-0808-2A		152.4 (6.00)	152.4 (6.00)	133.4 (5.25)	133.4 (5.25)
254.0 x 203.2 (10 x 8)	1	WYM-1008-1A		YM-1008-1A		222.3 (8.75)	171.5 (6.75)	203.2 (8.00)	203.2 (8.00)
		WYM-1008-2A		YM-1008-2A		203.2 (8.00)	152.4 (6.00)	184.2 (7.25)	133.4 (5.25)
254.0 x 254.0 (10 x 10)	1	WYM-1010-1A		YM-1010-1A		222.3 (8.75)	222.3 (8.75)	203.2 (8.00)	203.2 (8.00)
		WYM-1010-2A		YM-1010-2A		203.2 (8.00)	203.2 (8.00)	184.2 (7.25)	184.2 (7.25)
304.8 x 203.2 (12 x 8)	1	WYM-1208-1A		YM-1208-1A		273.1 (10.75)	171.5 (6.75)	254.0 (10.00)	152.4 (6.00)
		WYM-1208-2A		YM-1208-2A		254.0 (10.00)	152.4 (6.00)	235.0 (9.25)	133.4 (5.25)
304.8 x 254.0 (12 x 10)	1	WYM-1210-1A		YM-1210-1A		273.1 (10.75)	222.3 (8.75)	254.0 (10.00)	203.2 (8.00)
		WYM-1210-2A		YM-1210-2A		254.0 (10.00)	203.2 (8.00)	235.0 (9.25)	133.4 (5.25)
304.8 x 304.8 (12 x 12)	1	WYM-1212-1A		YM-1212-1A		273.1 (10.75)	273.1 (10.75)	254.0 (10.00)	254.0 (10.00)
		WYM-1212-2A		YM-1212-2A		254.0 (10.00)	254.0 (10.00)	235.0 (9.25)	235.0 (9.25)
355.6 x 203.2 (14 x 8)	1	WYM-1408-1A		YM-1408-1A		323.9 (12.75)	171.5 (6.75)	304.8 (12.00)	152.4 (6.00)
		WYM-1408-2A		YM-1408-2A		304.8 (12.00)	152.4 (6.00)	285.5 (11.25)	133.4 (5.25)
355.6 x 355.6 (14 x 14)	1	WYM-1414-1A		YM-1414-1A		323.9 (12.75)	323.9 (12.75)	304.8 (12.00)	304.8 (12.00)
		WYM-1414-2A		YM-1414-2A		304.8 (12.00)	304.8 (12.00)	285.5 (11.25)	285.5 (11.25)
406.4 x 203.2 (16 x 8)	1	WYM-1608-1A		YM-1608-1A		374.7 (14.75)	171.5 (6.75)	355.6 (14.00)	152.4 (6.00)
		WYM-1608-2A		YM-1608-2A		304.8 (12.00)	152.4 (6.00)	285.5 (11.25)	133.4 (5.25)

ENCLOSURES AND JUNCTION BOXES: NEC/CEC WEATHERPROOF/DUSTPROOF JUNCTION AND OUTLET BOXES

Appleton® O-Z/GEDNEY

# Cast Iron Junction Box Mounting Plate Information

## Boxes Available for Raintight, Watertight, or Submersible Applications

NEC/CEC:  
Rated for Ordinary (Unclassified) Locations

Mounting plates are used for mounting equipment up off the back of an enclosure. Steel Plates are all 3.3 mm (0.13") thick hot dip galvanized material. Aluminum plates are 3.3 mm (0.13") thick material up to and including 304.8 x 304.8 mm (12 x 12") size. All larger sizes are constructed of 4.8 mm (0.19") thick aluminum plate.

Select mounting plates based on inside length and width of box. Order as a separate item immediately following the catalog number of the box as follows:

Example: Line 1 **WYS-080804**  
Line 2 **WYM-0808-2**

For mounting plates in smaller boxes than listed, use similar catalog number logic. Example: A steel mounting plate for an Appleton **WYF-040404** box would be **WYM-0404-1**. Pricing will be based upon a **WYM-0808-1** price.

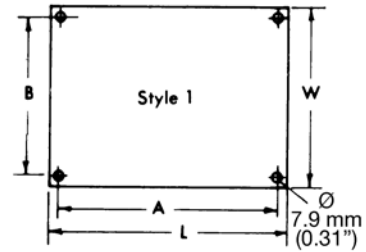

The catalog numbers shown in the table below include the mounting buttons.

Inside Length and Width of Junction Box in mm (in)	Style	Appleton Catalog Number – Steel Plates		O-Z/Gedney Catalog Number – Steel Plates		Dimension in Millimeters (Inches)			
		For use in Types WYT, WYF and WYR Junction Boxes	For use in Types WYS, WYL and WYW Junction Boxes	For use in Types YT, YF and YR Junction Boxes	For use in Types YS, YL and YW Junction Boxes	L	W	A	B
406.4 x 304.8 (16 x 12)	1	<b>WYM-1612-1</b>		<b>YM-1612-1</b>		374.7 (14.75)	273.1 (10.75)	355.6 (14.00)	254.0 (10.00)
			<b>WYM-1612-2</b>		<b>YM-1612-2</b>	355.6 (14.00)	254.0 (10.00)	336.6 (13.25)	235.0 (9.25)
406.4 x 406.4 (16 x 16)	1	<b>WYM-1616-1</b>		<b>YM-1616-1</b>		374.7 (14.75)	374.7 (14.75)	355.6 (14.00)	355.6 (14.00)
			<b>WYM-1616-2</b>		<b>YM-1616-2</b>	355.6 (14.00)	355.6 (14.00)	336.6 (13.25)	336.6 (13.25)
457.2 x 203.2 (18 x 8)	1	<b>WYM-1808-1</b>		<b>YM-1808-1</b>		171.5 (6.75)	171.5 (6.75)	152.4 (6.00)	152.4 (6.00)
			<b>WYM-1808-2</b>		<b>YM-1808-2</b>	152.4 (6.00)	152.4 (6.00)	133.4 (5.25)	133.4 (5.25)
457.2 x 254.0 (18 x 10)	1	<b>WYM-1810-1</b>		<b>YM-1810-1</b>		171.5 (6.75)	222.3 (8.75)	152.4 (6.00)	203.2 (8.00)
			<b>WYM-1810-2</b>		<b>YM-1810-2</b>	152.4 (6.00)	203.2 (8.00)	133.4 (5.25)	184.2 (7.25)
457.2 x 304.8 (18 x 12)	1	<b>WYM-1812-1</b>		<b>YM-1812-1</b>		171.5 (6.75)	273.1 (10.75)	152.4 (6.00)	254.0 (10.00)
			<b>WYM-1812-2</b>		<b>YM-1812-2</b>	152.4 (6.00)	254.0 (10.00)	133.4 (5.25)	235.0 (9.25)
457.2 x 355.6 (18 x 14)	1	<b>WYM-1814-1</b>		<b>YM-1814-1</b>		171.5 (6.75)	323.9 (12.75)	152.4 (6.00)	304.8 (12.00)
			<b>WYM-1814-2</b>		<b>YM-1814-2</b>	152.4 (6.00)	304.8 (12.00)	133.4 (5.25)	285.5 (11.25)
457.2 x 406.4 (18 x 16)	1	—		—		—	—	—	—
			<b>WYM-1816-2</b>		<b>YM-1816-2</b>	152.4 (6.00)	355.6 (14.00)	133.4 (5.25)	336.6 (13.25)
457.2 x 457.2 (18 x 18)	1	<b>WYM-1818-1</b>		<b>YM-1818-1</b>		171.5 (6.75)	171.5 (6.75)	152.4 (6.00)	152.4 (6.00)
			<b>WYM-1818-2</b>		<b>YM-1818-2</b>	152.4 (6.00)	152.4 (6.00)	133.4 (5.25)	133.4 (5.25)
508.0 x 254.0 (20 x 10)	1	<b>WYM-2010-1</b>		<b>YM-2010-1</b>		222.3 (8.75)	222.3 (8.75)	203.2 (8.00)	203.2 (8.00)
			<b>WYM-2020-2</b>		<b>YM-2020-2</b>	203.2 (8.00)	203.2 (8.00)	184.2 (7.25)	184.2 (7.25)

ENCLOSURES AND JUNCTION BOXES: NEC/CEC WEATHERPROOF/DUSTPROOF JUNCTION AND OUTLET BOXES

Appleton OZGEDNEY

# Cast Iron Junction Box Mounting Plate Information

## Boxes Available for Raintight, Watertight, or Submersible Applications

NEC/CEC:  
Rated for Ordinary (Unclassified) Locations

Inside Length and Width of Junction Box in mm (in)	Style	Appleton Catalog Number – Aluminum Plates		O-Z/Gedney Catalog Number – Aluminum Plates		Dimension in Millimeters (Inches)			
		For use in Types WYT, WYF and WYR Junction Boxes	For use in Types WYS, WYL and WYW Junction Boxes	For use in Types YT, YF and YR Junction Boxes	For use in Types YS, YL and YW Junction Boxes	L	W	A	B
406.4 x 304.8 (16 x 12)	1	WYM-1612-1A		YM-1612-1A		374.7 (14.75)	273.1 (10.75)	355.6 (14.00)	254.0 (10.00)
			WYM-1612-2A		YM-1612-2A	355.6 (14.00)	254.0 (10.00)	336.6 (13.25)	235.0 (9.25)
406.4 x 406.4 (16 x 16)	1	WYM-1616-1A		YM-1616-1A		374.7 (14.75)	374.7 (14.75)	355.6 (14.00)	355.6 (14.00)
			WYM-1616-2A		YM-1616-2A	355.6 (14.00)	355.6 (14.00)	336.6 (13.25)	336.6 (13.25)
457.2 x 203.2 (18 x 8)	1	WYM-1808-1A		YM-1808-1A		171.5 (6.75)	171.5 (6.75)	152.4 (6.00)	152.4 (6.00)
			WYM-1808-2A		YM-1808-2A	152.4 (6.00)	152.4 (6.00)	133.4 (5.25)	133.4 (5.25)
457.2 x 254.0 (18 x 10)	1	WYM-1810-1A		YM-1810-1A		171.5 (6.75)	222.3 (8.75)	152.4 (6.00)	203.2 (8.00)
			WYM-1818-2A		YM-1818-2A	152.4 (6.00)	203.2 (8.00)	133.4 (5.25)	184.2 (7.25)
457.2 x 304.8 (18 x 12)	1	WYM-1812-1A		YM-1812-1A		171.5 (6.75)	273.1 (10.75)	152.4 (6.00)	254.0 (10.00)
			WYM-1812-2A		YM-1812-2A	152.4 (6.00)	254.0 (10.00)	133.4 (5.25)	235.0 (9.25)
457.2 x 355.6 (18 x 14)	1	WYM-1814-1A		YM-1814-1A		171.5 (6.75)	323.9 (12.75)	152.4 (6.00)	304.8 (12.00)
			WYM-1814-2A		YM-1814-2A	152.4 (6.00)	304.8 (12.00)	133.4 (5.25)	285.5 (11.25)
457.2 x 406.4 (18 x 16)	1	—		—		—	—	—	—
			WYM-1816-2A		YM-1816-2A	152.4 (6.00)	355.6 (14.00)	133.4 (5.25)	336.6 (13.25)
457.2 x 457.2 (18 x 18)	1	WYM-1818-1A		YM-1818-1A		171.5 (6.75)	171.5 (6.75)	152.4 (6.00)	152.4 (6.00)
			WYM-1818-2A		YM-1818-2A	152.4 (6.00)	152.4 (6.00)	133.4 (5.25)	133.4 (5.25)
508.0 x 254.0 (20 x 10)	1	WYM-2010-1A		YM-2010-1A		222.3 (8.75)	222.3 (8.75)	203.2 (8.00)	203.2 (8.00)
			WYM-2020-2A		YM-2020-2A	203.2 (8.00)	203.2 (8.00)	184.2 (7.25)	184.2 (7.25)

ENCLOSURES AND JUNCTION BOXES: NEC/CEC WEATHERPROOF/DUSTPROOF JUNCTION AND OUTLET BOXES

Appleton® O-Z/GEDNEY

# Cast Iron Junction Box Mounting Plate Information

## Boxes Available for Raintight, Watertight, or Submersible Applications

NEC/CEC:  
Rated for Ordinary (Unclassified) Locations

Mounting plates are used for mounting equipment up off the back of an enclosure. Steel Plates are all 3.3 mm (0.13") thick hot dip galvanized material. Aluminum plates are 3.3 mm (0.13") thick material up to and including 304.8 x 304.8 mm (12 x 12") size. All larger sizes are constructed of 4.8 mm (0.19") thick aluminum plate.

Select mounting plates based on inside length and width of box. Order as a separate item immediately following the catalog number of the box as follows:

Example: Line 1 **WYS-080804**  
Line 2 **WYM-0808-2**

For mounting plates in smaller boxes than listed, use similar catalog number logic. Example: A steel mounting plate for an Appleton **WYF-040404** box would be **WYM-0404-1**. Pricing will be based upon a **WYM-0808-1** price.

The catalog numbers shown in the table below include the mounting buttons.

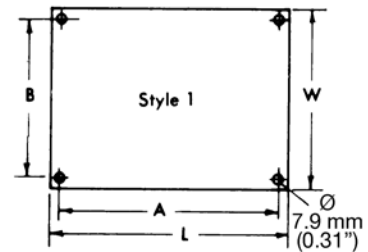

Inside Length and Width of Junction Box in mm (in)	Style	Appleton Catalog Number – Steel Plates		O–Z/Gedney Catalog Number – Steel Plates		Dimension in Millimeters (Inches)			
		For use in Types WYT, WYF and WYR Junction Boxes	For use in Types WYS, WYL and WYW Junction Boxes	For use in Types YT, YF and YR Junction Boxes	For use in Types YS, YL and YW Junction Boxes	L	W	A	B
406.4 x 304.8 (16 x 12)	1	<b>WYM-1612-1</b>		<b>YM-1612-1</b>		374.7 (14.75)	273.1 (10.75)	355.6 (14.00)	254.0 (10.00)
			<b>WYM-1612-2</b>		<b>YM-1612-2</b>	355.6 (14.00)	254.0 (10.00)	336.6 (13.25)	235.0 (9.25)
406.4 x 406.4 (16 x 16)	1	<b>WYM-1616-1</b>		<b>YM-1616-1</b>		374.7 (14.75)	374.7 (14.75)	355.6 (14.00)	355.6 (14.00)
			<b>WYM-1616-2</b>		<b>YM-1616-2</b>	355.6 (14.00)	355.6 (14.00)	336.6 (13.25)	336.6 (13.25)
457.2 x 203.2 (18 x 8)	1	<b>WYM-1808-1</b>		<b>YM-1808-1</b>		171.5 (6.75)	171.5 (6.75)	152.4 (6.00)	152.4 (6.00)
			<b>WYM-1808-2</b>		<b>YM-1808-2</b>	152.4 (6.00)	152.4 (6.00)	133.4 (5.25)	133.4 (5.25)
457.2 x 254.0 (18 x 10)	1	<b>WYM-1810-1</b>		<b>YM-1810-1</b>		171.5 (6.75)	222.3 (8.75)	152.4 (6.00)	203.2 (8.00)
			<b>WYM-1810-2</b>		<b>YM-1810-2</b>	152.4 (6.00)	203.2 (8.00)	133.4 (5.25)	184.2 (7.25)
457.2 x 304.8 (18 x 12)	1	<b>WYM-1812-1</b>		<b>YM-1812-1</b>		171.5 (6.75)	273.1 (10.75)	152.4 (6.00)	254.0 (10.00)
			<b>WYM-1812-2</b>		<b>YM-1812-2</b>	152.4 (6.00)	254.0 (10.00)	133.4 (5.25)	235.0 (9.25)
457.2 x 355.6 (18 x 14)	1	<b>WYM-1814-1</b>		<b>YM-1814-1</b>		171.5 (6.75)	323.9 (12.75)	152.4 (6.00)	304.8 (12.00)
			<b>WYM-1814-2</b>		<b>YM-1814-2</b>	152.4 (6.00)	304.8 (12.00)	133.4 (5.25)	285.5 (11.25)
457.2 x 406.4 (18 x 16)	1	—		—		—	—	—	—
			<b>WYM-1816-2</b>		<b>YM-1816-2</b>	152.4 (6.00)	355.6 (14.00)	133.4 (5.25)	336.6 (13.25)
457.2 x 457.2 (18 x 18)	1	<b>WYM-1818-1</b>		<b>YM-1818-1</b>		171.5 (6.75)	171.5 (6.75)	152.4 (6.00)	152.4 (6.00)
			<b>WYM-1818-2</b>		<b>YM-1818-2</b>	152.4 (6.00)	152.4 (6.00)	133.4 (5.25)	133.4 (5.25)
508.0 x 254.0 (20 x 10)	1	<b>WYM-2010-1</b>		<b>YM-2010-1</b>		222.3 (8.75)	222.3 (8.75)	203.2 (8.00)	203.2 (8.00)
			<b>WYM-2020-2</b>		<b>YM-2020-2</b>	203.2 (8.00)	203.2 (8.00)	184.2 (7.25)	184.2 (7.25)

ENCLOSURES AND JUNCTION BOXES: NEC/CEC WEATHERPROOF/DUSTPROOF JUNCTION AND OUTLET BOXES

Appleton OZGEDNEY



# Cast Iron Junction Box Mounting Plate Information

## Boxes Available for Raintight, Watertight, or Submersible Applications

NEC/CEC:  
Rated for Ordinary (Unclassified) Locations

Inside Length and Width of Junction Box in mm (in)	Style	Appleton Catalog Number – Aluminum Plates		O-Z/Gedney Catalog Number – Aluminum Plates		Dimension in Millimeters (Inches)			
		For use in Types WYT, WYF and WYR Junction Boxes	For use in Types WYS, WYL and WYW Junction Boxes	For use in Types YT, YF and YR Junction Boxes	For use in Types YS, YL and YW Junction Boxes	L	W	A	B
406.4 x 304.8 (16 x 12)	1	WYM-1612-1A		YM-1612-1A		374.7 (14.75)	273.1 (10.75)	355.6 (14.00)	254.0 (10.00)
		WYM-1612-2A		YM-1612-2A		355.6 (14.00)	254.0 (10.00)	336.6 (13.25)	235.0 (9.25)
406.4 x 406.4 (16 x 16)	1	WYM-1616-1A		YM-1616-1A		374.7 (14.75)	374.7 (14.75)	355.6 (14.00)	355.6 (14.00)
		WYM-1616-2A		YM-1616-2A		355.6 (14.00)	355.6 (14.00)	336.6 (13.25)	336.6 (13.25)
457.2 x 203.2 (18 x 8)	1	WYM-1808-1A		YM-1808-1A		171.5 (6.75)	171.5 (6.75)	152.4 (6.00)	152.4 (6.00)
		WYM-1808-2A		YM-1808-2A		152.4 (6.00)	152.4 (6.00)	133.4 (5.25)	133.4 (5.25)
457.2 x 254.0 (18 x 10)	1	WYM-1810-1A		YM-1810-1A		171.5 (6.75)	222.3 (8.75)	152.4 (6.00)	203.2 (8.00)
		WYM-1818-2A		YM-1818-2A		152.4 (6.00)	203.2 (8.00)	133.4 (5.25)	184.2 (7.25)
457.2 x 304.8 (18 x 12)	1	WYM-1812-1A		YM-1812-1A		171.5 (6.75)	273.1 (10.75)	152.4 (6.00)	254.0 (10.00)
		WYM-1812-2A		YM-1812-2A		152.4 (6.00)	254.0 (10.00)	133.4 (5.25)	235.0 (9.25)
457.2 x 355.6 (18 x 14)	1	WYM-1814-1A		YM-1814-1A		171.5 (6.75)	323.9 (12.75)	152.4 (6.00)	304.8 (12.00)
		WYM-1814-2A		YM-1814-2A		152.4 (6.00)	304.8 (12.00)	133.4 (5.25)	285.5 (11.25)
457.2 x 406.4 (18 x 16)	1	—		—		—	—	—	—
		WYM-1816-2A		YM-1816-2A		152.4 (6.00)	355.6 (14.00)	133.4 (5.25)	336.6 (13.25)
457.2 x 457.2 (18 x 18)	1	WYM-1818-1A		YM-1818-1A		171.5 (6.75)	171.5 (6.75)	152.4 (6.00)	152.4 (6.00)
		WYM-1818-2A		YM-1818-2A		152.4 (6.00)	152.4 (6.00)	133.4 (5.25)	133.4 (5.25)
508.0 x 254.0 (20 x 10)	1	WYM-2010-1A		YM-2010-1A		222.3 (8.75)	222.3 (8.75)	203.2 (8.00)	203.2 (8.00)
		WYM-2020-2A		YM-2020-2A		203.2 (8.00)	203.2 (8.00)	184.2 (7.25)	184.2 (7.25)

ENCLOSURES AND JUNCTION BOXES: NEC/CEC WEATHERPROOF/DUSTPROOF JUNCTION AND OUTLET BOXES

Appleton® O-Z/GEDNEY

# Cast Iron Junction Box Mounting Plate Information

## Boxes Available for Raintight, Watertight, or Submersible Applications

NEC/CEC:  
Rated for Ordinary (Unclassified) Locations

Mounting plates are used for mounting equipment up off the back of an enclosure. Steel Plates are all 3.3 mm (0.13") thick hot dip galvanized material. Aluminum plates are 3.3 mm (0.13") thick material up to and including 304.8 x 304.8 mm (12 x 12") size. All larger sizes are constructed of 4.8 mm (0.19") thick aluminum plate.

Select mounting plates based on inside length and width of box. Order as a separate item immediately following the Catalog Number of the box as follows:

Example:  
**WYS-080804 WYM-0808-2**

The catalog numbers shown in the table below include the mounting buttons.

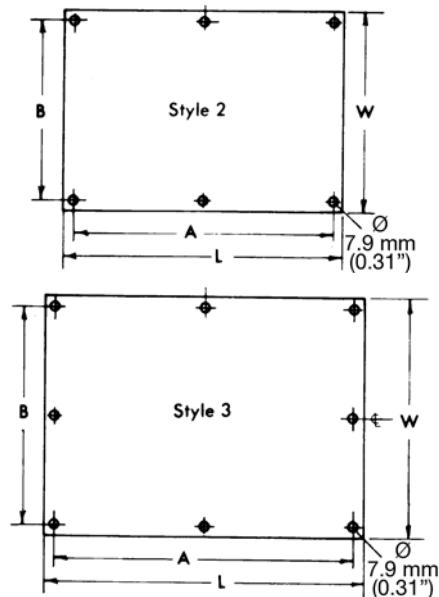

Inside Length and Width of Junction Box in mm (in)	Style	Appleton Catalog Number – Steel Plates		O-Z/Gedney Catalog Number – Steel Plates		Dimension in Millimeters (Inches)			
		For use in Types WYT, WYF and WYR Junction Boxes	For use in Types WYS, WYL and WYW Junction Boxes	For use in Types YT, YF and YR Junction Boxes	For use in Types YS, YL and YW Junction Boxes	L	W	A	B
609.6 x 304.8 (24.00 x 12.00)	2	<b>WYM-2412-1</b>	<b>WYM-2412-1</b>	<b>YM-2412-1</b>	<b>YM-2412-1</b>	552.5 (21.75)	247.7 (9.75)	533.4 (21.00)	228.6 (9.00)
609.6 x 457.2 (24.00 x 18.00)	2	<b>WYM-2418-1</b>	<b>WYM-2418-1</b>	<b>YM-2418-1</b>	<b>YM-2418-1</b>	552.5 (21.75)	400.1 (15.75)	533.4 (21.00)	381.0 (15.00)
609.6 x 609.6 (24.00 x 24.00)	3	<b>WYM-2424-1</b>	<b>WYM-2424-1</b>	<b>YM-2424-1</b>	<b>YM-2424-1</b>	552.5 (21.75)	552.5 (21.75)	533.4 (21.00)	533.4 (21.00)
711.2 x 304.8 (28.00 x 12.00)	2	<b>WYM-2812-1</b>	<b>WYM-2812-1</b>	<b>YM-2812-1</b>	<b>YM-2812-1</b>	654.1 (25.75)	247.7 (9.75)	635.0 (25.00)	228.6 (9.00)
762.0 x 304.8 (30.00 x 12.00)	2	<b>WYM-3012-1</b>	<b>WYM-3012-1</b>	<b>YM-3012-1</b>	<b>YM-3012-1</b>	704.9 (27.75)	247.7 (9.75)	685.8 (27.00)	228.6 (9.00)
762.0 x 457.2 (30.00 x 18.00)	2	<b>WYM-3018-1</b>	<b>WYM-3018-1</b>	<b>YM-3018-1</b>	<b>YM-3018-1</b>	704.9 (27.75)	400.1 (15.75)	685.8 (27.00)	381.0 (15.00)
762.0 x 609.6 (30.00 x 24.00)	3	<b>WYM-3024-1</b>	<b>WYM-3024-1</b>	<b>YM-3024-1</b>	<b>YM-3024-1</b>	704.9 (27.75)	552.5 (21.75)	685.8 (27.00)	533.4 (21.00)
914.4 x 304.8 (36.00 x 12.00)	2	<b>WYM-3612-1</b>	<b>WYM-3612-1</b>	<b>YM-3612-1</b>	<b>YM-3612-1</b>	857.3 (33.75)	247.7 (9.75)	838.2 (33.00)	228.6 (9.00)
914.4 x 457.2 (36.00 x 18.00)	2	<b>WYM-3618-1</b>	<b>WYM-3618-1</b>	<b>YM-3618-1</b>	<b>YM-3618-1</b>	857.3 (33.75)	400.1 (15.75)	838.2 (33.00)	381.0 (15.00)
914.4 x 609.6 (36.00 x 24.00)	3	<b>WYM-3624-1</b>	<b>WYM-3624-1</b>	<b>YM-3624-1</b>	<b>YM-3624-1</b>	857.3 (33.75)	552.5 (21.75)	838.2 (33.00)	533.4 (21.00)
914.4 x 762.0 (36.00 x 30.00)	3	<b>WYM-3630-1</b>	<b>WYM-3630-1</b>	<b>YM-3630-1</b>	<b>YM-3630-1</b>	857.3 (33.75)	704.9 (27.75)	838.2 (33.00)	685.8 (27.00)
914.4 x 914.4 (36.00 x 36.00)	3	<b>WYM-3636-1</b>	<b>WYM-3636-1</b>	<b>YM-3636-1</b>	<b>YM-3636-1</b>	857.3 (33.75)	857.3 (33.75)	838.2 (33.00)	838.2 (33.00)

ENCLOSURES AND JUNCTION BOXES: NEC/CEC WEATHERPROOF/DUSTPROOF JUNCTION AND OUTLET BOXES

Appleton OZGEDNEY

# Cast Iron Junction Box Mounting Plate Information

## Boxes Available for Raintight, Watertight, or Submersible Applications

NEC/CEC:  
Rated for Ordinary (Unclassified) Locations

Inside Length and Width of Junction Box in mm (in)	Style	Appleton Catalog Number – Aluminum Plates		O-Z/Gedney Catalog Number – Aluminum Plates		Dimension in Millimeters (Inches)			
		For use in Types WYT, WYF and WYR Junction Boxes	For use in Types WYS, WYL and WYW Junction Boxes	For use in Types YT, YF and YR Junction Boxes	For use in Types YS, YL and YW Junction Boxes	L	W	A	B
609.6 x 304.8 (24.00 x 12.00)	2	WYM-2412-1A	WYM-2412-1A	YM-2412-1A	YM-2412-1A	552.5 (21.75)	247.7 (9.75)	533.4 (21.00)	228.6 (9.00)
609.6 x 457.2 (24.00 x 18.00)	2	WYM-2418-1A	WYM-2418-1A	YM-2418-1A	YM-2418-1A	552.5 (21.75)	400.1 (15.75)	533.4 (21.00)	381.0 (15.00)
609.6 x 609.6 (24.00 x 24.00)	3	WYM-2424-1A	WYM-2424-1A	YM-2424-1A	YM-2424-1A	552.5 (21.75)	552.5 (21.75)	533.4 (21.00)	533.4 (21.00)
711.2 x 304.8 (28.00 x 12.00)	2	WYM-2812-1A	WYM-2812-1A	YM-2812-1A	YM-2812-1A	654.1 (25.75)	247.7 (9.75)	635.0 (25.00)	228.6 (9.00)
762.0 x 304.8 (30.00 x 12.00)	2	WYM-3012-1A	WYM-3012-1A	YM-3012-1A	YM-3012-1A	704.9 (27.75)	247.7 (9.75)	685.8 (27.00)	228.6 (9.00)
762.0 x 457.2 (30.00 x 18.00)	2	WYM-3018-1A	WYM-3018-1A	YM-3018-1A	YM-3018-1A	704.9 (27.75)	400.1 (15.75)	685.8 (27.00)	381.0 (15.00)
762.0 x 609.6 (30.00 x 24.00)	3	WYM-3024-1A	WYM-3024-1A	YM-3024-1A	YM-3024-1A	704.9 (27.75)	552.5 (21.75)	685.8 (27.00)	533.4 (21.00)
914.4 x 304.8 (36.00 x 12.00)	2	WYM-3612-1A	WYM-3612-1A	YM-3612-1A	YM-3612-1A	857.3 (33.75)	247.7 (9.75)	838.2 (33.00)	228.6 (9.00)
914.4 x 457.2 (36.00 x 18.00)	2	WYM-3618-1A	WYM-3618-1A	YM-3618-1A	YM-3618-1A	857.3 (33.75)	400.1 (15.75)	838.2 (33.00)	381.0 (15.00)
914.4 x 609.6 (36.00 x 24.00)	3	WYM-3624-1A	WYM-3624-1A	YM-3624-1A	YM-3624-1A	857.3 (33.75)	552.5 (21.75)	838.2 (33.00)	533.4 (21.00)
914.4 x 762.0 (36.00 x 30.00)	3	WYM-3630-1A	WYM-3630-1A	YM-3630-1A	YM-3630-1A	857.3 (33.75)	704.9 (27.75)	838.2 (33.00)	685.8 (27.00)
914.4 x 914.4 (36.00 x 36.00)	3	WYM-3636-1A	WYM-3636-1A	YM-3636-1A	YM-3636-1A	857.3 (33.75)	857.3 (33.75)	838.2 (33.00)	838.2 (33.00)

ENCLOSURES AND JUNCTION BOXES: NEC/CEC WEATHERPROOF/DUSTPROOF JUNCTION AND OUTLET BOXES

Appleton® OZ-GEDNEY

# Cast Iron Box Mounting Lug Data

Boxes Available for Raintight, Watertight, or Submersible Applications

NEC/CEC:  
Rated for Ordinary (Unclassified) Locations

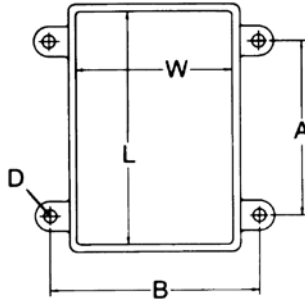

The dimensions listed in these tables are approximate and may vary as much as 6.4 mm (0.25") in any direction.

## Types WYS/YS, WYL/YL, WYW/YW, WYU/YU, and WYW/YW

Box Size in mm (in)			Dimension in mm (in)		Bolt Hole Diameter mm (in)
L	x	W	A	B	D
101.6 (4.00)	x	101.6 (4.00)	76.2 (3.00)	136.7 (5.38)	7.9 (0.31)
152.4 (6.00)	x	152.4 (6.00)	101.6 (4.00)	193.8 (7.63)	9.7 (0.38)
203.2 (8.00)	x	203.2 (8.00)	127.0 (5.00)	247.7 (9.75)	9.7 (0.38)
254.0 (10.00)	x	254.0 (10.00)	177.8 (7.00)	298.5 (11.75)	9.7 (0.38)
304.8 (12.00)	x	304.8 (12.00)	203.2 (8.00)	368.3 (14.50)	11.2 (0.44)

## Types WYS/YS, WYL/YL, WYW/YW, WYU/YU, and WYW/YW

Box Size in mm (in)			Dimension in mm (in)		Bolt Hole Diameter in mm (in)
L	x	W	A	B	D
406.4 (16.00)	x	304.8 (12.00)	304.8 (12.00)	368.3 (14.50)	11.2 (0.44)
457.2 (18.00)	x	457.2 (18.00)	330.2 (13.00)	530.4 (20.88)	14.2 (0.56)
609.6 (24.00)	x	457.2 (18.00)	482.6 (19.00)	527.1 (20.75)	7.1 (0.28)
609.6 (24.00)	x	609.6 (24.00)	482.6 (19.00)	682.8 (26.88)	14.2 (0.56)
914.4 (36.00)	x	609.6 (24.00)	762.0 (30.00)	682.8 (26.88)	14.2 (0.56)

## Types WYF/YF and WYR/YR

Box Size in mm (in)		Dimension in mm (in)		Bolt Hole Diameter in mm (in)
L	x	W	A	D
101.6 (4.00)	x	101.6 (4.00)	76.2 (3.00)	7.9 (0.31)
152.4 (6.00)	x	101.6 (4.00)	127.0 (5.00)	7.9 (0.31)
152.4 (6.00)	x	152.4 (6.00)	101.6 (4.00)	9.7 (0.38)
203.2 (8.00)	x	203.2 (8.00)	127.0 (5.00)	9.7 (0.38)
254.0 (10.00)	x	254.0 (10.00)	177.8 (7.00)	9.7 (0.38)
304.8 (12.00)	x	203.2 (8.00)	203.2 (8.00)	11.2 (0.44)
304.8 (12.00)	x	304.8 (12.00)	203.2 (8.00)	11.2 (0.44)
406.4 (16.00)	x	304.8 (12.00)	304.8 (12.00)	11.2 (0.44)
457.2 (18.00)	x	304.8 (12.00)	330.2 (13.00)	11.2 (0.44)
457.2 (18.00)	x	457.2 (18.00)	330.2 (13.00)	14.2 (0.56)
609.6 (24.00)	x	457.2 (18.00)	482.6 (19.00)	14.2 (0.56)
609.6 (24.00)	x	609.6 (24.00)	482.6 (19.00)	14.2 (0.56)

ENCLOSURES AND JUNCTION BOXES: NEC/CEC WEATHERPROOF/DUSTPROOF JUNCTION AND OUTLET BOXES

Appleton OZGEDNEY

# WYS/YS Type Unflanged Junction or Pull Boxes

## Raintight, Watertight, Dust-Tight

Cast Iron Box For Surface Mounting.

**NEC/CEC:**  
NEMA/CSA Type 1, 2, 3, 3R, 3S, 4, 5, 12, 12K, 13

**CEC:**  
Class II, Division 1 and 2  
Class III

### Applications

- These boxes are listed by Underwriters Laboratories and Canadian Standards Association as Type 4.
- They are suitable for use indoors, outdoors, or where subject to rain, dripping or splashing water or hose-directed water.

### Features

- Mounting lugs are standard.
- Boxes have a post in each corner and allowances must be made for them when conduit entrances are to be located close to a corner.
- Neoprene gasket – between cover and box.
- Suitable for a variety of applications.
- Wide selection of sizes and locations for drilled-and-tapped and slip-hole conduit entrances.

### Standard Materials

- Box and cover: cast iron
- Gasket: neoprene
- Screws: stainless steel

### Standard Finishes

- Box and cover: hot dip galvanized

### Options

- For additional options see *Ordering Information* pages.

### NEC/CEC Certifications and Compliances

- UL Standard: UL 514A, UL 50, UL 50E
- UL Listed: E24824
- CSA Standard: C22.2 No. 18.1, C22.2 No. 94.1, C22.2 No. 94.2, C22.2 No. 25
- CSA Certified: 020945

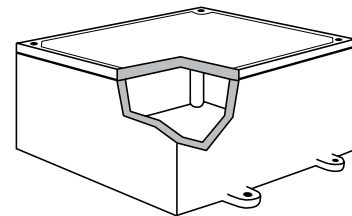

ENCLOSURES AND JUNCTION BOXES: NEC/CEC WEATHERPROOF/DUSTPROOF JUNCTION AND OUTLET BOXES

L	Inside Dimensions mm (in)				Approximate Wall Thickness ① mm (in)	Appleton Catalog Number	O-Z/Gedney Catalog Number
	x	W	x	D			
101.6 (4.00)	x	101.6 (4.00)	x	101.6 (4.00)	6.35 (0.2500)	WYS-040404	YS-040404
152.4 (6.00)	x	152.4 (6.00)	x	101.6 (4.00)	7.94 (0.3125)	WYS-060604	YS-060604
203.2 (8.00)	x	203.2 (8.00)	x	101.6 (4.00)	7.94 (0.3125)	WYS-080804	YS-080804
203.2 (8.00)	x	203.2 (8.00)	x	152.4 (6.00)	7.94 (0.3125)	WYS-080806	YS-080806
254.0 (10.00)	x	254.0 (10.00)	x	101.6 (4.00)	7.94 (0.3125)	WYS-101004	YS-101004
304.8 (12.00)	x	304.8 (12.00)	x	203.2 (8.00)	7.94 (0.3125)	WYS-121208	YS-121208
406.4 (16.00)	x	304.8 (12.00)	x	203.2 (8.00)	7.94 (0.3125)	WYS-161208	YS-161208
457.2 (18.00)	x	304.8 (12.00)	x	254.0 (10.00)	9.53 (0.3750)	WYS-181210	YS-181210
457.2 (18.00)	x	457.2 (18.00)	x	152.4 (6.00)	7.94 (0.3125)	WYS-181806	YS-181806
457.2 (18.00)	x	457.2 (18.00)	x	304.8 (12.00)	11.11 (0.4375)	WYS-181812	YS-181812

① Measured 50.8 mm (2.00") up from back of box.

# WYL/YL Type Unflanged Junction or Pull Boxes

## Raintight, Watertight, Dust-Tight

Cast Iron Box For Surface Mounting.

NEC/CEC:  
NEMA/CSA Type 1, 2, 3, 3R, 3S, 4, 5, 12, 12K,  
13

CEC:  
Class II, Division 1 and 2  
Class III

### Applications

- These boxes are listed by Underwriters Laboratories and Canadian Standards Association as Type 4.
- They are suitable for use indoors, outdoors, or where subject to rain, dripping or splashing water or hose-directed water.

### Features

- Mounting lugs are standard.
- Boxes have a post in each corner and allowances must be made for them when conduit entrances are to be located close to a corner.
- Neoprene gasket – between cover and box.
- Wide selection of sizes and locations for drilled-and-tapped and slip-hole conduit entrances.

### Standard Materials

- Box and cover: cast iron
- Gasket: neoprene
- Screws: stainless steel

### Standard Finishes

- Box and cover: hot dip galvanized

### Options

- For additional options see *Ordering Information* pages.

### NEC/CEC Certifications and Compliances

- UL Standard: UL 514A, UL 50, UL 50E
- UL Listed: E24824
- CSA Standard: C22.2 No. 18.1, C22.2 No. 94.1, C22.2 No. 94.2, C22.2 No. 25
- CSA Certified: 020945

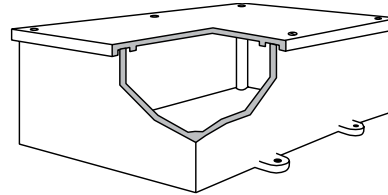

L	Inside Dimensions mm (in)				Approximate Wall Thickness ① mm (in)	Appleton Catalog Number	O-Z/Gedney Catalog Number
	x	W	x	D			
101.6 (4.00)	x	101.6 (4.00)	x	101.6 (4.00)	6.35 (0.2500)	WYL-040404	YL-040404
152.4 (6.00)	x	152.4 (6.00)	x	101.6 (4.00)	7.94 (0.3125)	WYL-060604	YL-060604
203.2 (8.00)	x	203.2 (8.00)	x	101.6 (4.00)	7.94 (0.3125)	WYL-080804	YL-080804
203.2 (8.00)	x	203.2 (8.00)	x	152.4 (6.00)	7.94 (0.3125)	WYL-080806	YL-080806
254.0 (10.00)	x	254.0 (10.00)	x	101.6 (4.00)	7.94 (0.3125)	WYL-101004	YL-101004
304.8 (12.00)	x	304.8 (12.00)	x	203.2 (8.00)	7.94 (0.3125)	WYL-121208	YL-121208
406.4 (16.00)	x	304.8 (12.00)	x	203.2 (8.00)	7.94 (0.3125)	WYL-161208	YL-161208
457.2 (18.00)	x	304.8 (12.00)	x	254.0 (10.00)	9.53 (0.3750)	WYL-181210	YL-181210
457.2 (18.00)	x	457.2 (18.00)	x	152.4 (6.00)	7.94 (0.3125)	WYL-181806	YL-181806
457.2 (18.00)	x	457.2 (18.00)	x	304.8 (12.00)	11.11 (0.4375)	WYL-181812	YL-181812
609.6 (24.00)	x	609.6 (24.00)	x	304.8 (12.00)	11.11 (0.4375)	WYL-242412	YL-242412
914.4 (36.00)	x	609.6 (24.00)	x	304.8 (12.00)	11.11 (0.4375)	WYL-362412	YL-362412

① Measured 50.8 mm (2.00") up from back of box.

# WYW/YW Type Hinged Cover Boxes

## Raintight, Watertight, Dust-Tight

Cast Iron Box for Surface Mounting.

**NEC/CEC:**  
NEMA/CSA Type 1, 2, 3, 3R, 3S, 4, 5, 12, 12K,  
13

**CEC:**  
Class II, Division 1 and 2  
Class III

### Applications

- These boxes are listed by Underwriters Laboratories and Canadian Standards Association as Type 4.
- They are suitable for use indoors, outdoors, or where subject to rain, dripping or splashing water or hose-directed water.
- These hinged cover boxes make ideal enclosures where equipment within the box has to be inspected frequently or easy access is required.
- The hinges are adjusted at the factory for proper gasket pressure, but can be readjusted in the field.

### Features

- Mounting lugs are standard.
- Hinges are always located on the long side of the box and unless otherwise specified on the right side.
- Hinged cover for easy access to wiring for inspection and maintenance.
- Three-rivet anchoring of hinges and bolt/wing nut fasteners.
- Boxes have a post in each corner and allowances must be made for them when conduit entrances are to be located close to a corner.
- Neoprene gasket – between cover and box.
- Wide selection of sizes and locations for drilled-and-tapped and slip-hole conduit entrances.

### Standard Materials

- Box and cover: cast iron
- Gasket: neoprene
- Screws: stainless steel

### Standard Finishes

- Box and cover: hot dip galvanized

### Options

- For additional options see *Ordering Information* pages.

### NEC/CEC Certifications and Compliances

- UL Standard: UL 514A, UL 50, UL 50E
- UL Listed: E24824
- CSA Standard: C22.2 No. 18.1, C22.2 No. 94.1, C22.2 No. 94.2, C22.2 No. 25
- CSA Certified: 020945

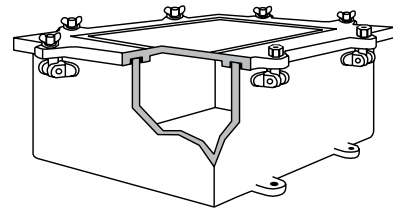
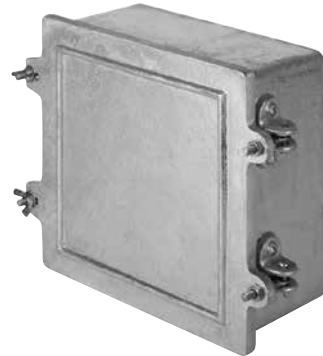

ENCLOSURES AND JUNCTION BOXES: NEC/CEC WEATHERPROOF/DUSTPROOF JUNCTION AND OUTLET BOXES

L	Inside Dimensions mm (in)				Approximate Wall Thickness ① mm (in)	Appleton Catalog Number	O-Z/Gedney Catalog Number
	x	W	x	D			
203.2 (8.00)	x	203.2 (8.00)	x	152.4 (6.00)	7.94 (0.3125)	WYW-080806	YW-080806
304.8 (12.00)	x	304.8 (12.00)	x	203.2 (8.00)	7.94 (0.3125)	WYW-121208	YW-121208

① Measured 50.8 mm (2.00") up from back of box.

# WYF/YF Type Flat Flanged Boxes

## Submersible ①, Watertight, Raintight, Dust-Tight

Cast Iron Box for Surface Mounting.

NEC/CEC:  
NEMA/CSA Type 1, 2, 3, 3R, 3S, 4, 5, 12, 12K,  
13

CEC:  
Class II, Division 1 and 2  
Class III

### Applications

- These boxes are listed by Underwriters Laboratories and Canadian Standards Association as Type 4.
- Submersible Type 6 – see options below.
- They are suitable for use indoors, outdoors, or where subject to rain, dripping or splashing water or hose-directed water.

### Features

- Mounting lugs are standard.
- Wide flange provides greater contact between gasket cover and box.
- Neoprene gasket – between cover and box.

### Standard Materials

- Box and cover: cast iron
- Gasket: neoprene
- Screws: stainless steel

### Standard Finishes

- Box and cover: hot dip galvanized

### Options

- For additional options see *Ordering Information* pages.
- Submersible Applications ①
  - These boxes can be tested to withstand occasional submersion under a 1.83 meter (6 foot) head of water for 30 minutes (NEMA 6 requirements). Add suffix **-SUB6** to standard catalog number.
  - These boxes can be tested to withstand Prolonged submersion under a 1.83 meter (6 foot) head of water for 24 hours (NEMA 6P requirements). Add suffix **-SUB6P** to standard catalog number.
  - These boxes can be tested to withstand submersion up to a 6.10 meter (20 foot) head of water. Add suffix **-SUB\_\_** to standard catalog number, filling in the blank space with the number of **feet** from 7 up to 20, followed by **-P** if prolonged submersion is required.
  - SUB enclosures are subject to a price addition on application and must have:
    1. Mounting lugs
    2. Bossed, drilled, and tapped conduit entrances (ABDT series)

### NEC/CEC Certifications and Compliances

- UL Standard: UL 514A, UL 50, UL 50E
- UL Listed: E-24824
- CSA Standard: C22.2 No. 18.1, C22.2 No. 94.1, C22.2 No. 94.2, C22.2 No. 25
- CSA Certified: 020945

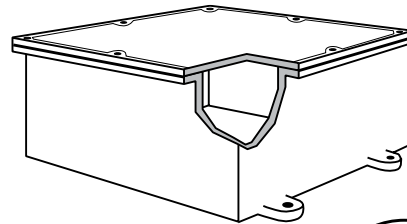

The ridge on the underside of the cover assures a good seal.

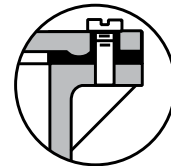

① Intended for indoor or outdoor use primarily to provide a degree of protection against hose-directed water and the entry of water during submersion at a limited depth; and to be undamaged by the formation of ice on the enclosure.



# WYF/YF Type Flat Flanged Boxes

## Submersible ①, Watertight, Raintight, Dust-Tight

Cast Iron or Aluminum Box for Surface Mounting.

NEC/CEC:  
NEMA/CSA Type 1, 2, 3, 3R, 3S, 4, 5, 12, 12K,  
13

CEC:  
Class II, Division 1 and 2  
Class III

Inside Dimensions mm (in)					Approximate Wall Thickness ② mm (in)	Appleton Catalog Number	O-Z/Gedney Catalog Number
L	x	W	x	D			
101.6 (4.00)	x	101.6 (4.00)	x	101.6 (4.00)	6.35 (0.25)	WYF-040404	YF-040404
152.4 (6.00)	x	101.6 (4.00)	x	101.6 (4.00)	7.94 (0.31)	WYF-060404	YF-060404
152.4 (6.00)	x	152.4 (6.00)	x	101.6 (4.00)	7.94 (0.31)	WYF-060604	YF-060604
203.2 (8.00)	x	152.4 (6.00)	x	152.4 (6.00)	7.94 (0.31)	WYF-080806	YF-080806
254.0 (10.00)	x	254.0 (10.00)	x	101.6 (4.00)	7.94 (0.31)	WYF-101004	YF-101004
304.8 (12.00)	x	203.2 (8.00)	x	101.6 (4.00)	6.35 (0.25)	WYF-120804	YF-120804
304.8 (12.00)	x	304.8 (12.00)	x	152.4 (6.00)	7.94 (0.31)	WYF-121206	YF-121206
406.4 (16.00)	x	304.8 (12.00)	x	203.2 (8.00)	7.94 (0.31)	WYF-161208	YF-161208
457.2 (18.00)	x	304.8 (12.00)	x	254.0 (10.00)	7.94 (0.31)	WYF-181210	YF-181210
457.2 (18.00)		457.2 (18.00)		254.0 (10.00)	7.94 (0.31)	WYF-181810	YF-181810
609.6 (24.00)	x	457.2 (18.00)	x	304.8 (12.00)	8.73 (0.34)	WYF-241812	YF-241812
609.6 (24.00)	x	609.6 (24.00)	x	304.8 (12.00)	9.53 (0.38)	WYF-242412	YF-242412

Inside Dimensions mm (in)					Approximate Wall Thickness ② mm (in)	Appleton Catalog Number	O-Z/Gedney Catalog Number
L	x	W	x	D			
101.6 (4.00)	x	101.6 (4.00)	x	101.6 (4.00)	6.35 (0.25)	WYF-040404-SUB6	YF-040404-SUB6
152.4 (6.00)	x	101.6 (4.00)	x	101.6 (4.00)	7.94 (0.31)	WYF-060404-SUB6	YF-060404-SUB6
152.4 (6.00)	x	152.4 (6.00)	x	101.6 (4.00)	7.94 (0.31)	WYF-060604-SUB6	YF-060604-SUB6
203.2 (8.00)	x	152.4 (6.00)	x	152.4 (6.00)	7.94 (0.31)	WYF-080806-SUB6	YF-080806-SUB6
254.0 (10.00)	x	254.0 (10.00)	x	101.6 (4.00)	7.94 (0.31)	WYF-101004-SUB6	YF-101004-SUB6
304.8 (12.00)	x	203.2 (8.00)	x	101.6 (4.00)	6.35 (0.25)	WYF-120804-SUB6	YF-120804-SUB6
304.8 (12.00)	x	304.8 (12.00)	x	152.4 (6.00)	7.94 (0.31)	WYF-121206-SUB6	YF-121206-SUB6
406.4 (16.00)	x	304.8 (12.00)	x	203.2 (8.00)	7.94 (0.31)	WYF-161208-SUB6	YF-161208-SUB6
457.2 (18.00)	x	304.8 (12.00)	x	254.0 (10.00)	7.94 (0.31)	WYF-181210-SUB6	YF-181210-SUB6
457.2 (18.00)		457.2 (18.00)		254.0 (10.00)	7.94 (0.31)	WYF-181810-SUB6	YF-181810-SUB6
609.6 (24.00)	x	457.2 (18.00)	x	304.8 (12.00)	8.73 (0.34)	WYF-241812-SUB6	YF-241812-SUB6
609.6 (24.00)	x	609.6 (24.00)	x	304.8 (12.00)	9.53 (0.38)	WYF-242412-SUB6	YF-242412-SUB6

Inside Dimensions mm (in)					Approximate Wall Thickness ② mm (in)	Appleton Catalog Number	O-Z/Gedney Catalog Number
L	x	W	x	D			
101.6 (4.00)	x	101.6 (4.00)	x	101.6 (4.00)	6.35 (0.25)	WYF-040404-SUB6P	YF-040404-SUB6P
152.4 (6.00)	x	101.6 (4.00)	x	101.6 (4.00)	7.94 (0.31)	WYF-060404-SUB6P	YF-060404-SUB6P
152.4 (6.00)	x	152.4 (6.00)	x	101.6 (4.00)	7.94 (0.31)	WYF-060604-SUB6P	YF-060604-SUB6P
203.2 (8.00)	x	152.4 (6.00)	x	152.4 (6.00)	7.94 (0.31)	WYF-080806-SUB6P	YF-080806-SUB6P
254.0 (10.00)	x	254.0 (10.00)	x	101.6 (4.00)	7.94 (0.31)	WYF-101004-SUB6P	YF-101004-SUB6P
304.8 (12.00)	x	203.2 (8.00)	x	101.6 (4.00)	6.35 (0.25)	WYF-120804-SUB6P	YF-120804-SUB6P
304.8 (12.00)	x	304.8 (12.00)	x	152.4 (6.00)	7.94 (0.31)	WYF-121206-SUB6P	YF-121206-SUB6P
406.4 (16.00)	x	304.8 (12.00)	x	203.2 (8.00)	7.94 (0.31)	WYF-161208-SUB6P	YF-161208-SUB6P
457.2 (18.00)	x	304.8 (12.00)	x	254.0 (10.00)	7.94 (0.31)	WYF-181210-SUB6P	YF-181210-SUB6P
457.2 (18.00)		457.2 (18.00)		254.0 (10.00)	7.94 (0.31)	WYF-181810-SUB6P	YF-181810-SUB6P
609.6 (24.00)	x	457.2 (18.00)	x	304.8 (12.00)	8.73 (0.34)	WYF-241812-SUB6P	YF-241812-SUB6P
609.6 (24.00)	x	609.6 (24.00)	x	304.8 (12.00)	9.53 (0.38)	WYF-242412-SUB6P	YF-242412-SUB6P

① Intended for indoor or outdoor use primarily to provide a degree of protection against hose-directed water and the entry of water during submersion at a limited depth; and to be undamaged by the formation of ice on the enclosure.

② Measured 50.8 mm (2.00") up from back of box.

# WYR/YR Outside Flanged Recessed Cover Boxes

Watertight, Raintight, Dust-Tight

Cast Iron Box for Flush Mounting.

NEC/CEC:  
NEMA/CSA Type 1, 2, 3, 3R, 3S, 4, 5, 12, 12K,  
13

CEC:  
Class II, Division 1 and 2  
Class III

## Applications

- These boxes are listed by Underwriters Laboratories and Canadian Standards Association as Type 4.
- They are suitable for use indoors, or where subject to rain, dripping or splashing water or hose-directed water.
- This type of box is designed especially for flush mounting in masonry in walls or floors or can be used for surface mounting using optional mounting lugs.

## Features

- Neoprene gasket – between cover and box.
- Wide box flange permits greater contact between gasket and box.
- Wide selection of sizes and locations for drilled-and-tapped and slip-hole conduit entrances.

## Standard Materials

- Box and cover: cast iron
- Gasket: neoprene
- Screws: stainless steel

## Standard Finishes

- Box and cover: hot dip galvanized

## Options

- Checkered steel plate covers suitable for pedestrian traffic add suffix **-CS**.
- Checkered steel covers suitable for vehicular traffic (H-25 loading) add suffix **-CSV**.
- For additional options see *Ordering Information* pages.

## NEC/CEC Certifications and Compliances

- UL Standard: UL 514A, UL 50, UL 50E
- UL Listed: E24824
- CSA Standard: C22.2 No. 18.1, C22.2 No. 94.1, C22.2 No. 94.2, C22.2 No. 25
- CSA Certified: 020945

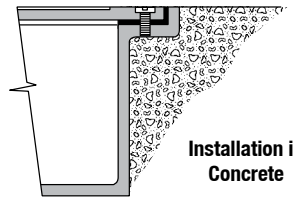

ENCLOSURES AND JUNCTION BOXES: NEC/CEC WEATHERPROOF/DUSTPROOF JUNCTION AND OUTLET BOXES

Appleton OZGEDNEY

L	x	Inside Dimensions mm (in)			Approximate Wall Thickness ① mm (in)	Appleton Catalog Number	O-Z/Gedney Catalog Number
		W	x	D			
101.6 (4.00)	x	101.6 (4.00)	x	101.6 (4.00)	6.35 (0.2500)	WYR-040404	YR-040404
152.4 (6.00)	x	152.4 (6.00)	x	101.6 (4.00)	7.94 (0.3125)	WYR-060604	YR-060604
203.2 (8.00)	x	203.2 (8.00)	x	152.4 (6.00)	7.94 (0.3125)	WYR-080806	YR-080806
254.0 (10.00)	x	254.0 (10.00)	x	152.4 (6.00)	7.94 (0.3125)	WYR-101006	YR-101006
304.8 (12.00)	x	304.8 (12.00)	x	203.2 (8.00)	7.94 (0.3125)	WYR-121208	YR-121208
355.6 (14.00)	x	203.2 (8.00)	x	152.4 (6.00)	7.94 (0.3125)	WYR-140806	YR-140806
406.4 (16.00)	x	304.8 (12.00)	x	203.2 (8.00)	7.94 (0.3125)	WYR-161208	YR-161208
457.2 (18.00)	x	304.8 (12.00)	x	152.4 (6.00)	7.94 (0.3125)	WYR-181206	YR-181206
457.2 (18.00)	x	304.8 (12.00)	x	254.0 (10.00)	7.94 (0.3125)	WYR-181210	YR-181210
457.2 (18.00)	x	457.2 (18.00)	x	304.8 (12.00)	7.94 (0.3125)	WYR-181812	YR-181812
609.6 (24.00)	x	609.6 (24.00)	x	304.8 (12.00)	9.53 (0.3750)	WYR-242412	YR-242412

① Measured 50.8 mm (2.00") up from back of box.

# WYU/YU Type Inside Flanged Recessed Cover Boxes

Raintight, Dust-Tight

Cast Iron Box for Flush Mounting.

**NEC/CEC:**  
NEMA/CSA Type 1, 2, 3, 3R, 3S, 4, 5, 12, 12K,  
13

**CEC:**  
Class II, Division 1 and 2  
Class III

## Applications

- These boxes are listed by Underwriters Laboratories and Canadian Standards Association as Type 3R.
- They are suitable for use indoors, outdoors, or where subject to rain, dripping or splashing water.
- Recessed cover boxes designed for flush mounting in masonry.
- They are furnished with a plain cover as shown but can be supplied with checkered steel plate covers suitable for foot traffic (see options).

## Features

- Neoprene gasket – between cover and box.
- Wide selection of sizes and locations for drilled-and-tapped and slip-hole conduit entrances.

## Standard Materials

- Box and cover: cast iron
- Gasket: neoprene
- Screws: stainless steel

## Standard Finishes

- Box and cover: hot dip galvanized

## Options

- Checkered steel plate covers suitable for pedestrian traffic, add suffix **-CS**.
- See optional hinges below.
- For additional options see *Ordering Information* pages.

## NEC/CEC Certifications and Compliances

- UL Standard: UL 514A, UL 50, UL 50E
- UL Listed: E24824
- CSA Standard: C22.2 No. 18.1, C22.2 No. 94.1, C22.2 No. 94.2, C22.2 No. 25
- CSA Certified: 020945



Installation in Concrete

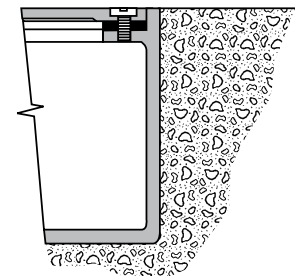

ENCLOSURES AND JUNCTION BOXES: NEC/CEC WEATHERPROOF/DUSTPROOF JUNCTION AND OUTLET BOXES

Inside Dimensions Millimeters (Inches)					Approximate Wall Thickness ① mm (in)	Appleton Catalog Number	O-Z/Gedney Catalog Number
L	x	W	x	D			
101.6 (4.00)	x	101.6 (4.00)	x	101.6 (4.00)	6.35 (0.2500)	<b>WYU-040404</b>	<b>YU-040404</b>
152.4 (6.00)	x	152.4 (6.00)	x	152.4 (6.00)	7.94 (0.3125)	<b>WYU-060606</b>	<b>YU-060606</b>
203.2 (8.00)	x	203.2 (8.00)	x	152.4 (6.00)	7.94 (0.3125)	<b>WYU-080806</b>	<b>YU-080806</b>
304.8 (12.00)	x	304.8 (12.00)	x	152.4 (6.00)	7.94 (0.3125)	<b>WYU-121206</b>	<b>YU-121206</b>

## Optional Hinges (Stainless Steel, Butt Type)

Hinges Per Set	Box Size	Appleton Catalog Number	O-Z/Gedney Catalog Number
2	Up to 304.8 x 304.8 mm (12" x 12")	<b>AHNG-22SS</b>	<b>HNG-22SS</b>

① Measured 50.8 mm (2.00") up from back of box.

# WYT/YT Type Checkered Cover Sidewalk Boxes

## Weatherproof

Cast Iron Box for Flush Mounting.

NEC/CEC:  
Rated for Ordinary (Unclassified) Locations

### Applications

- These boxes are specially designed to be mounted in sidewalks and other flat concrete surfaces. Their checkered covers are made to withstand pedestrian traffic.
- The flanges and covers are interchangeable to permit replacement without disturbing the box or conduit system.
- Heavy checkered steel covers can be furnished which will accommodate vehicular traffic (see *Options*).

### Features

- Type WYT boxes have a post in each corner and allowances must be made for them, when conduit entrances are to be located close to a corner.
- Cross ribbed, heavy duty cover with pry bar slots.
- Checkered cover provides non-slip surface.
- Neoprene gasket – between cover and box.
- Wide selection of locations for drilled and tapped and slip hole conduit entrances.

### Standard Materials

- Box and cover: cast iron
- Gasket: neoprene
- Screws: stainless steel

### Standard Finishes

- Box and cover: hot dip galvanized

### Options

- Checkered steel covers suitable for vehicular traffic H-25 loading, add suffix **-CSV**.
- Engraved lettering on cover per specifications.
- For additional options see *Ordering Information* pages.

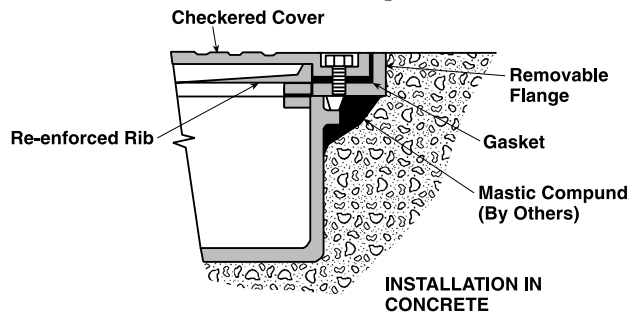

ENCLOSURES AND JUNCTION BOXES: NEC/CEC WEATHERPROOF/DUSTPROOF JUNCTION AND OUTLET BOXES

Appleton OZGEDNEY

L	Inside Dimensions mm (in)				Approximate Wall Thickness ① mm (in)	Appleton Catalog Number	O-Z/Gedney Catalog Number
	x	W	x	D			
152.4 (6.00)	x	152.4 (6.00)	x	101.6 (4.00)	7.94 (0.3125)	WYT-060604	YT-060604
203.2 (8.00)	x	152.4 (6.00)	x	101.6 (4.00)	7.94 (0.3125)	WYT-080604	YT-080604
203.2 (8.00)	x	203.2 (8.00)	x	152.4 (6.00)	7.94 (0.3125)	WYT-080806	YT-080806
304.8 (12.00)	x	203.2 (8.00)	x	203.2 (8.00)	7.94 (0.3125)	WYT-120808	YT-120808
304.8 (12.00)	x	304.8 (12.00)	x	152.4 (6.00)	7.94 (0.3125)	WYT-121206	YT-121206
609.6 (24.00)	x	304.8 (12.00)	x	203.2 (8.00)	7.94 (0.3125)	WYT-241208	YT-241208

① Measured 50.8 mm (2.00") up from back of box.

# WY58E/Y58E Type Checkered Cover Sidewalk Topping Box

## Weatherproof

Cast Iron Box for Flush Mounting.

### NEC/CEC:

Rated for Ordinary (Unclassified) Locations

### Applications

- These open-bottom boxes are designed to top off an underlying concrete pull box.

### Features

- The construction details of the cover and flange are the same as those of a Type WYT.
- Frame and cover are interchangeable and may be replaced if damaged without disturbing the rest of the system.
- Checkered cover provides non-slip surface for pedestrian traffic.
- Cross-ribbed checkered cover with pry bar slots.
- Cover secures to frame with recessed stainless steel hex head cap screws.
- Neoprene gasket – between cover and box.
- Wide selection of locations for drilled and tapped and slip hole conduit entrances.

### Standard Materials

- Box, flange and cover: cast iron
- Neoprene gasket
- Screws: stainless steel

### Standard Finishes

- Box and cover: hot dip galvanized

### Options

- Engraved lettering on cover per specifications.

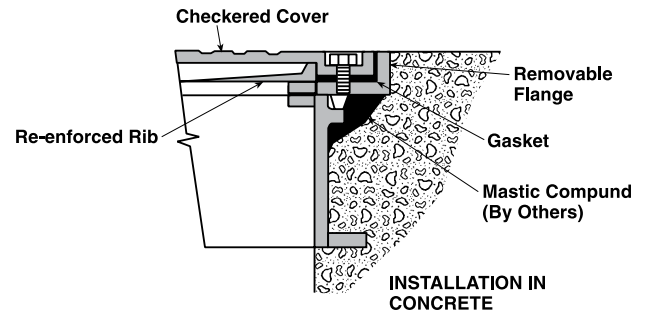

L	Inside Dimensions mm (in)				Approximate Wall Thickness ① mm (in)	Appleton Catalog Number	O-Z/Gedney Catalog Number
	x	W	x	D			
304.8 (12.00)	x	304.8 (12.00)	x	127.0 (5.00)	9.53 (0.3750)	WY58E-1212	Y58E-1212
609.6 (24.00)	x	609.6 (24.00)	x	127.0 (5.00)	9.53 (0.3750)	WY58E-2424	Y58E-2424

① Measured 50.8 mm (2.00") up from back of box.

# BJE Series Octagonal Polycarbonate Junction Boxes

NEC/CEC:  
Class 1, Zone 1 and 2  
A/Exe II T6  
IP66

ATEX:  
Zone 1 and 2 – 21 and 22  
II 2 GD  
IP66 – IK10

## Applications

- Small terminal/junction box enclosure for various electrical connections in hazardous areas.
- Designed for use in Zone 1 or 2 areas, where flammable gases or vapors are present either continuously or intermittently, such as:
  - Petroleum refineries
  - Chemical refineries
  - Other industrial process facilities
- Ideal for wet or corrosive atmospheres.
- Designed for use in Zone 21 or 22 areas (international), where flammable dusts are present either continuously or intermittently, such as:
  - Food processing
  - Dairy
  - Brewing
  - Other commercial facilities

## Features

- High impact resistant black polycarbonate enclosure.
- Choose from two versions; external or internal hubs.
- BJE1: Supplied with 4 interconnected earth terminals. Maximum capacity per terminal: 1 x 4 mm<sup>2</sup> (0.002 x 0.006 in<sup>2</sup>).
- BJE1 is supplied with 4 connection terminals. Maximum capacity per terminal: 4 x 2.5 mm<sup>2</sup> (0.006 x 0.004 in<sup>2</sup>) or 2 x 4 mm<sup>2</sup> (0.003 x 0.006 in<sup>2</sup>) + 2 x 2.5 mm<sup>2</sup> (0.003 x 0.004 in<sup>2</sup>). Minimum capacity per terminal: 2 x 1.5 mm<sup>2</sup> (0.003 x 0.002 in<sup>2</sup>). Available in three depths, 200 mm (7.87”), 250 mm (9.84”) and 300 mm (11.81”).
- BJE2: Supplied with 4 interconnected earth terminals. Maximum capacity per terminal: 1 x 10 mm<sup>2</sup> (0.002 x 0.016 in<sup>2</sup>).
- BJE2 is supplied with 4 connection terminals. Maximum capacity per terminal: 4 x 6mm<sup>2</sup> (0.006 x 0.009 in<sup>2</sup>) or 3 x 10 mm<sup>2</sup> (0.005 x 0.016 in<sup>2</sup>) + 4 mm<sup>2</sup> (0.006 in<sup>2</sup>).
- BJE2 has telescopic cover retaining ring which can be unclipped.
- All hardware 316 Stainless Steel.
- Available for non-armored or armored cable. Armored cable version supplied with ground continuity plate.
- Several entry options available.
- Operating temperature:
  - BJE1: -50 °C to +55 °C (-58 °C to +131 °F)
  - BJE2: -40 °C to +55 °C (-40 °C to +131 °F)
- Poured in place polyurethane door gasket.

## Standard Materials

- Enclosure: static and impact resistant polycarbonate
- Hardware: 316L stainless steel

## NEC/CEC Certifications and Compliances

- UL Standard: 886
- cCSAus Certified: 013017
- CSA Standard: C22.2 No. 25, C22.2 No. 30

## ATEX Certifications and Compliances

- Certification Type BJe1
  - Gas, Zones 1 and 2:
    - Conforming to ATEX 94/9/CE: II 2 G
    - Type of Protection: Ex e II
    - Temperature Class: T6

BJE1



BJE2



BJE1 for Armored Cable



BJE2 for Armored Cable



- Dust, Zones 21 and 22:
  - Conforming to ATEX 94/9/CE: II 2 D
  - Type of Protection: Ex tD A21
  - Surface Temperature: T75 °C (T167 °F)
- Ambient Temperature: -40 °C to +55 °C (-40 °F to +131 °F)
- CE Declaration of Conformity: 50226
- ATEX Certificate: LCIE 02 ATEX 6069
- Certification Type BJe2
  - Gas, Zones 1 and 2:
    - Conforming to ATEX 94/9/CE: II 2 G
    - Type of Protection: Ex e II
    - Temperature Class: T6
  - Dust, Zones 21 and 22:
    - Conforming to ATEX 94/9/CE: II 2 D
    - Type of Protection: Ex tD A21
    - Surface Temperature: T80 °C (176 °F)
  - Ambient Temperature: -40 °C to +55 °C (-40 °F to +131 °F)
  - CE Declaration of Conformity: 50209
  - ATEX Certificate: LCIE 99 ATEX 6003
- Index of Protection according EN/IEC 60529: IP66
- Impact Resistance (shock): IK10

## EURASEC Certification

- Certification Type BJe1
  - EURASEC N° TC RU C-FR.Г505.В.00911
- Certification Type: BJe2
  - EURASEC N° TC RU C-FR.Г505.В.00911

## Other Certifications

- Certification Type BJe1
  - INMETRO Certificate: BVC 11.0479 ①
- Certification Type BJe2
  - INMETRO Certificate: BVC 11.0402-X ①



① INMETRO certification available on special request only. Contact your local sales representative for more information.

# BJE Series Octagonal Polycarbonate Junction Boxes

NEC/CEC:  
Class 1, Zone 1 and 2  
A/Exe II T6  
IP66

ATEX:  
Zone 1 and 2 – 21 and 22  
II 2 GD  
IP66 – IK10

## Armored Enclosures — Supplied with Two Plugs

	Entry	Entries	Size	Plug	Weight kg (lb)	Volume mm <sup>3</sup> (in <sup>3</sup> )	Catalog Number
	No	4	PG16	Knockouts	0.4 (0.88)	2.0 (122.04)	<b>BJE1TN4P16</b>
	Yes	4	M20	2-M20	0.5 (1.10)	2.0 (122.04)	<b>BJE1TA4M20</b>
	No	3	M20	No	0.6 (1.32)	4.5 (274.60)	<b>BJE2TN3M20</b>
	No	4	M20	No	0.6 (1.32)	4.5 (274.60)	<b>BJE2TN4M20</b>
	No	3	M25	No	0.6 (1.32)	4.5 (274.60)	<b>BJE2TN3M25</b>
	No	4	M25	No	0.6 (1.32)	4.5 (274.60)	<b>BJE2TN4M25</b>
	Yes	4	M20	2-M20	0.6 (1.32)	4.5 (274.60)	<b>BJE2TA4M20</b>
	Yes	4	M25	2-M25	0.6 (1.32)	4.5 (274.60)	<b>BJE2TA4M25</b>

## Nickel Plated Adapters

Description	Catalog Number
 M20 to 1/2" NPT adapter for armored box	<b>737EM2T15</b>
M20 to 3/4" NPT adapter for armored box	<b>737EM2T25</b>
M25 to 3/4" NPT adapter for armored box	<b>737EM3T25</b>
M25 to 1" NPT adapter for armored box	<b>737EM3T35</b>

## Dimensions in Millimeters (inches)

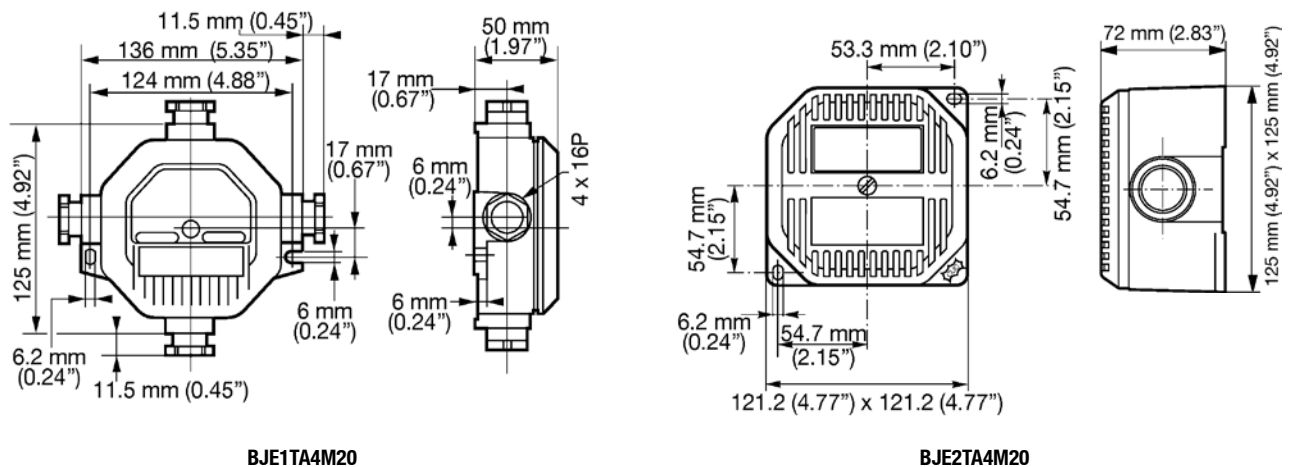

ENCLOSURES AND JUNCTION BOXES: NEC/CEC WEATHERPROOF/DUSTPROOF JUNCTION AND OUTLET BOXES



# Liquidtight JIC Boxes and Covers

NEC/CEC:  
Listed for Ordinary (Unclassified) Locations

## Applications

- Serve as a junction box.
- Accommodate pilot lights and switch devices.

## Features

- Large interior.
- Liquidtight.
- Standard device mounting dimensions.
- Compatible with FS covers (single gang only).

## Standard Materials/Finishes

- Box and cover: Steel, zinc electroplate, epoxy powder coat.
- Screws: Stainless steel.

## NEC Compliances and Compliances

- UL Standard: 514A
- UL Listed: E2527

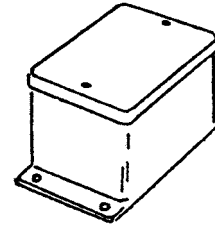

JIC-1

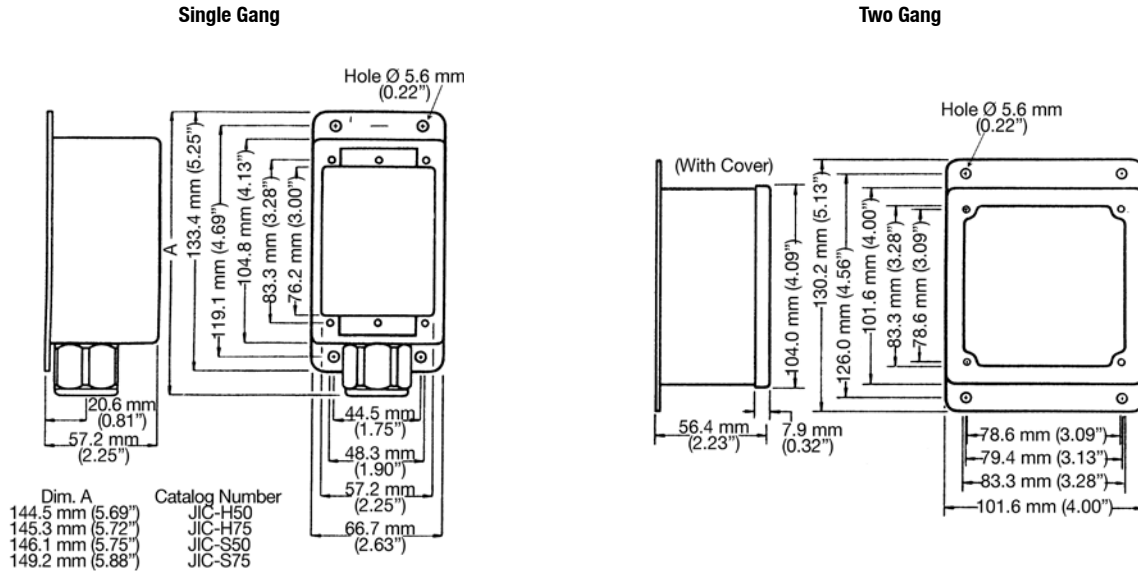

## Dimensions in Millimeters (Inches)



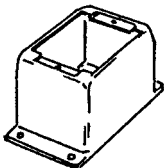
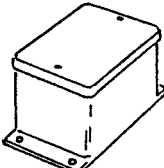
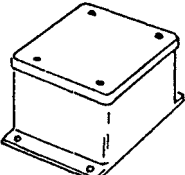
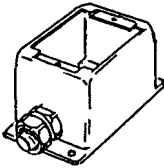
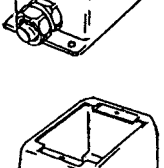
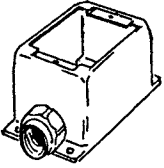
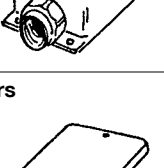
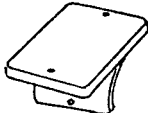

# Liquidtight JIC Boxes and Covers

NEC/CEC:  
Listed for Ordinary (Unclassified) Locations

	Description	Wiring Capacity mm <sup>2</sup> (in <sup>2</sup> )	Catalog Number
<b>Blank Boxes with or without Gasketed Covers</b> ①			
	Blank box 4-1/8" x 2-5/8" x 2-3/16" without cover	13548.4 (21.0)	JIC-B
	Blank 4-1/8" x 2-5/8" x 2-3/16" with cover	13548.4 (21.0)	JIC-1
	Blank 4" x 4" x 2-3/16" with cover	20322.5 (31.5)	JIC-2
<b>Boxes with Connectors, Hubs — Without Covers</b>			
	JIC-B with one 1/2" "STN" connector	13548.4 (21.0)	JIC-S50
	JIC-B with one 3/4" "STN" connector	13548.4 (21.0)	JIC-S75
	JIC-B with one 1/2" Uni-Seal Hub	13548.4 (21.0)	JIC-H50
	JIC-B with one 3/4" Uni-Seal Hub	13548.4 (21.0)	JIC-H75
<b>Covers</b>			
	Blank cover with captive screws and neoprene gasket for use on "JIC" Series boxes (except JIC-2).	—	JIC-C
	Single 30.9 mm (1.218") diameter hole "JIC" cover to take heavy duty oil tight push buttons, pilot lights and selector switches. Accommodates 30.5 mm (1.2") devices.	—	JIC-C1

① Catalog numbers JIC-2, JIC-1 and JIC-B are made in accordance with UL requirements, but this blank box cannot be listed by them as approved unless approved connectors are mounted on the box.

# RS Series Malleable Iron Junction Boxes

## Hub Plates in Four Styles

UNILETS™ for Use with Threaded Rigid Metal Conduit and IMC.

NEC/CEC:  
Rated for Ordinary (Unclassified) Locations

### Applications

- Serve as main cable distribution center, or can be used for adding circuits to existing systems.
- Serve as pull boxes.
- Provide access to conductors for maintenance.

### Features

- Removable hub covers permit variable hub arrangements in a wide range of sizes.
- Furnished with top cover, gaskets, and cover screws for all open sides.
- Side covers available blank or with 1, 2, or 3 hubs.
- Provides visibility while making connections and splices (opens on four sides and top).
- Threads are accurately tapped and tapered for tight, rigid joints and ground continuity.
- Hubs in all covers have integral bushings to protect conductor insulation from damage. Hub plate openings are smooth.

### Standard Materials

- RS boxes and covers: malleable iron.
- Gaskets: composition fiber.

### Standard Finishes

- RS boxes and covers: triple coat – (1) zinc electroplate, (2) chromate, and (3) epoxy powder coat.

### NEC/CEC Compliances and Compliances

- UL Standard: 50, 50E
- CSA Standard: C22.2 No. 40

### Dimensions in Millimeters (Inches)

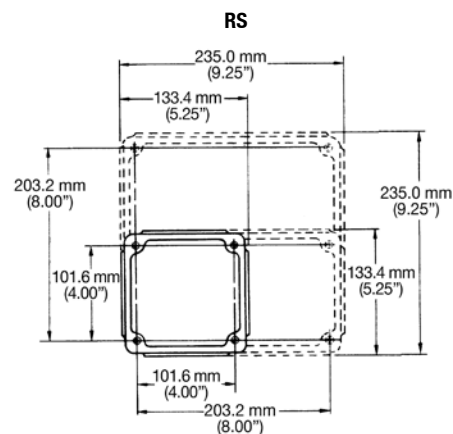
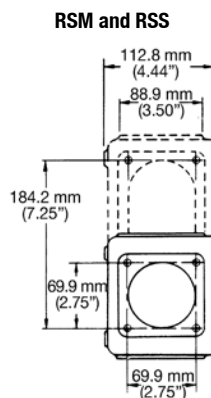

RS Box bottom and side frame construction is one piece malleable iron. Smooth hub cover openings prevent damage to conductor insulation.













RE Junction Boxes come in three sizes, furnished with top cover, gaskets and cover screws for all open sides.

# RS Series Malleable Iron Junction Boxes

## Hub Plates in Four Styles

UNILETS™ for Use with Threaded Rigid Metal Conduit and IMC.

NEC/CEC:  
Rated for Ordinary (Unclassified) Locations

Description		Size (Inches)	Catalog Number
<b>RS – Boxes – Furnished with top gasketed cover plus screws and gaskets for open sides</b>			
	RS	8-1/2 x 8-1/2 x 4 <i>Inside Dimensions</i>	RS-1
	RSM	8-1/2 x 4-1/2 x 4 <i>Inside Dimensions</i>	RSM-1
	RSS	4-1/2 x 4-1/2 x 4 <i>Inside Dimensions</i>	RSS-1
<b>RS, RSM – Covers for 8-1/2" x 4" Sides – Gaskets and Screws Not Included</b>			
	One Hub	1/2	RSK1-50
		3/4	RSK1-75
		1	RSK1-100
		1-1/4	RSK1-125
		1-1/2	RSK1-150
		2	RSK1-200
	Two Hubs	1/2	RSK2-50
		3/4	RSK2-75
		1	RSK2-100
		1-1/4	RSK2-125
		1-1/2	RSK2-150
		2	RSK2-200
	Three Hubs	1/2	RSK3-50
		3/4	RSK3-75
		1	RSK3-100
		1-1/4	RSK3-125
	Blank	Blank	RSK-B
<b>RSS, RSM – Covers for 4-1/2" x 4" Sides – Gaskets and Screws Not Included</b>			
	One Hub	1/2	RSSK-50
		3/4	RSSK-75
		1	RSSK-100
		1-1/4	RSSK-125
		1-1/2	RSSK-150
		2	RSSK-200
	Blank	Blank	RSSK-B
<b>Gaskets – Composition Fiber</b>			
	For RS, RSM 8-1/2" x 4" Sides		RS-GK
	For RSM, RSS 4-1/2" x 4" Sides		RSS-GK

# AJBEW Cast Junction Boxes

## Explosionproof, Dust-Ignitionproof

### NEC/CEC:

Class I, Division 1 and 2, Groups B $\diamond$ , C $\diamond$ , D $\diamond$   
 Class I, Zone 1 and 2, Groups IIA, IIB $\diamond$ +H $\diamond$ <sub>2</sub> $\diamond$   
 Class II, Division 1 and 2, Groups E, F, G  
 Class III  
 IP66

### NEC/CEC:

NEMA 4, 7B $\diamond$ C $\diamond$ D, 9EFG

### ATEX/IECEX:

Zone 1 and 2 – 21 and 22  
 Ⓢ II 2 GD  
 IP66 – IK10

### Application

- Explosionproof junction boxes are used where hazardous materials are handled or stored. These enclosures may be used for:
  - Terminals
  - Splicing wires
  - Pull boxes
  - Bus boxes

### Features

- Precision machined flame path between box and cover.
- Bolt on stainless steel slotted mounting feet for horizontal or vertical mounting.
- Flexible hinge mounting either left or right side is standard on all boxes 12 x 12 x 06 and larger.
- External flange maximizes internal space.
- Wall thickness suitable for minimum of five full threads.
- Provision for mounting pan.
- Wide range of drilled and tapped outlets.
- Ground lug package and installation instructions for termination of ground wires enclosed.
- O-ring gasket insures watertight integrity.

### Standard Materials

- Bodies and covers: sand cast copperfree (4/10 of 1% max.) aluminum
- Cover bolts: stainless steel
- O-ring: neoprene
- Hinges: stainless steel
- Mounting pan: galvanized steel

### Standard Finishes

- Bodies and covers: shot blast finish standard

### Options

- Custom drilling and tapping.
- Set of 4 standoffs 12.7 mm (0.50") high. For factory-installed option add suffix **-AB**.
- Breather, NEMA 4X (includes outlets and installation). For factory-installed option add suffix **-BR**, for field-installed option order catalog number **BRTB4X**.
- Drain, NEMA 4X (includes outlets and installation). For factory-installed option add suffix **-DN** for field-installed option order catalog number **ECD50B4X**.
- Desiccate package. For factory-installed option add suffix **-DP1**, for field-installed option order catalog number **AWG13/1CT**.
- External grounding stud 3/8"-16. For factory-installed option add suffix **-EGS**.
- Gray epoxy powder coat (outside). For factory-installed option add suffix **-G1**.
- Gray epoxy powder coat available to provide NEMA 4X rating (inside and outside). For factory-installed option add suffix **-G2**.
- Internal Ground Stud, #14 - #2. For factory-installed option add suffix **-GNDKIT**.
- Hinges: stainless steel hinge available for boxes up to 11 x 30 x 03. For factory-installed option add suffix **-H**.
- Hinge Kit, 2 light duty SS hinges. For field-installed option order catalog number **AHOF12SS**.
- Hinge Kit, 2 heavy duty SS hinges. For field-installed option order catalog number **AHOF22SS**.



- Hinge Kit, 3 heavy duty SS hinges. For field-installed option order catalog number **AHOF23SS**.
- Terminal blocks 600 Volt, 30 Amp Indicate number of points: example: 5 points = 5K. For factory-installed option add suffix **-K**.
- Plastic nameplate, 50.8 x 101.6 mm (2.00 x 4.00"), 3.3 mm (13") black letters on white surface, 3 lines max, specify legend. For factory-installed option add suffix **-NP**.
- SS captive Quad-Lead bolts. For factory-installed option add suffix **-Q**.
- ATEX complete product certification add suffix **-X**.
- ATEX U component certification add suffix **-XU**.
- Mounting pan. For factory-installed option add suffix **-Z**.

### NEC/CEC Certifications and Compliances

- UL Standard: UL 886 (UL 1203)
- UL Listed: E85310
- CSA Standard: C22.2 No. 25, C22.2 No.30
- CSA Certified: 042129

### ATEX/IECEX Certifications and Compliances

- Certification Type JBEW
  - Gas, Zones 1 and 2
    - Conforming to ATEX 94/9/CE: Ⓢ II 2 G
    - Type of Protection: Ex d IIB + H $\diamond$  GB
  - Dust, Zones 21 and 22
    - Conforming to ATEX 94/9/CE: Ⓢ II 2 D
    - Type of Protection: Ex t Db
- Ambient Temperature: -40 °C to +55 °C (-40 °F to +131 °F)
- CE Declaration of Conformity: 5C239
- ATEX Certificate: LCIE 07 ATEX 6069X
- IECEX Certificate: IECEX LCI 07.0018X
- Internal Volume: > 2dm<sup>3</sup> (122 in<sup>3</sup>) — 2 liters
- Index of Protection according EN/IEC 60529: IP66
- Impact Resistance (shock): IK10

### EURASEC Certification

- Certification Type JBEW
  - EURASEC N° TC RU C-FR.Г505.В.00911

$\diamond$  For Groups B and C, all conduits must be sealed within 50.8 mm (2") of the enclosure.

# AJBEW Cast Junction Boxes

## Explosionproof, Dust-Ignitionproof

**NEC/CEC:**

Class I, Division 1 and 2, Groups B $\diamond$ , C $\diamond$ , D  
 Class I, Zone 1 and 2, Groups IIA, IIB $\diamond$ +H $\diamond$ <sub>2</sub> $\diamond$   
 Class II, Division 1 and 2, Groups E, F, G  
 Class III  
 IP66

**NEC/CEC:**

NEMA 4, 7B $\diamond$ C $\diamond$ D, 9EFG

**ATEX/IECEX:**

Zone 1 and 2 – 21 and 22  
 II 2 GD  
 IP66 – IK10

Overall Dimensions			Dimensions in Millimeters (Inches)										Max. Conduit Size	Ship Weight	Mounting Hardware	Catalog Number
F	E	G	A	AA	B	BB	W	H	Db	Dc	K	Inches	kg (lb)	Catalog Number	Number	
181.1 (7.13)	231.9 (9.13)	155.7 (6.13)	N/A	171.5 (6.75)	N/A	54.1 (2.13)	101.6 (4.00)	152.4 (6.00)	95.3 (3.75)	19.1 (0.75)	63.5 (2.50)	1-1/2	9.1 (20)	AMH2	AJBEW040604	
227.1 (8.94)	342.9 (13.50)	155.7 (6.13)	101.6 (4.00)	N/A	279.4 (11.00)	N/A	128.5 (5.06)	241.3 (9.50)	88.9 (3.50)	28.7 (1.13)	50.8 (2.00)	1-1/2	9.1 (20)	AMH2	AJBEW050903	
244.6 (9.63)	237.0 (9.33)	158.8 (6.25)	N/A	222.3 (8.75)	N/A	308.1 (12.13)	152.4 (6.00)	152.4 (6.00)	101.6 (4.00)	19.1 (0.75)	60.5 (2.38)	2	9.1 (20)	AMH2	AJBEW060604	
264.2 (10.40)	315.0 (12.40)	165.1 (6.50)	114.3 (4.50)	231.9 (9.13)	268.2 (10.56)	114.3 (4.50)	152.4 (6.00)	203.2 (8.00)	95.3 (3.75)	19.1 (0.75)	63.5 (2.50)	2	9.1 (20)	AMH2	AJBEW060804	
264.2 (10.40)	317.5 (12.50)	206.5 (8.13)	N/A	238.3 (9.38)	N/A	114.3 (4.50)	152.4 (6.00)	203.2 (8.00)	146.1 (5.75)	19.1 (0.75)	60.5 (2.38)	2	9.1 (20)	AMH2	AJBEW060806	
270.0 (10.63)	387.4 (15.25)	171.5 (6.75)	139.7 (5.50)	N/A	333.5 (13.13)	N/A	155.7 (6.13)	273.1 (10.75)	96.8 (3.81)	36.6 (1.44)	50.8 (2.00)	2	12.2 (27)	AMH2	AJBEW061004	
270.0 (10.63)	421.6 (16.60)	162.1 (6.38)	N/A	231.9 (9.13)	N/A	215.9 (8.50)	155.7 (6.13)	308.1 (12.13)	103.1 (4.06)	25.4 (1.00)	57.2 (2.25)	2	11.3 (25)	AMH2	AJBEW061204	
279.4 (11.00)	520.7 (20.50)	174.8 (6.88)	152.4 (6.00)	N/A	457.2 (18.00)	N/A	165.1 (6.50)	406.4 (16.00)	104.9 (4.13)	35.1 (1.38)	58.7 (2.31)	2	14.5 (32)	AMH2	AJBEW061604	
311.2 (12.25)	403.4 (15.88)	254.0 (10.00)	162.1 (6.38)	N/A	342.9 (13.50)	N/A	187.5 (7.38)	289.1 (11.38)	149.4 (5.88)	63.5 (2.50)	85.9 (3.38)	2	15.9 (35)	AMH2	AJBEW071106	
311.2 (12.25)	311.2 (12.25)	209.6 (8.25)	114.3 (4.50)	273.1 (10.75)	273.1 (10.75)	114.3 (4.50)	203.2 (8.00)	203.2 (8.00)	146.1 (5.75)	19.1 (0.75)	82.6 (3.25)	2	13.6 (30)	AMH2	AJBEW080806	
317.5 (12.50)	368.3 (14.50)	215.9 (8.50)	177.8 (7.00)	273.1 (10.75)	317.5 (12.50)	165.1 (6.50)	203.2 (8.00)	254.0 (10.00)	146.1 (5.75)	19.1 (0.75)	88.9 (3.50)	2	16.3 (36)	AMH2	AJBEW081006	
317.5 (12.50)	443.0 (17.44)	263.7 (10.38)	N/A	254 (10.00)	N/A	215.9 (8.50)	203.2 (8.00)	331.7 (13.06)	88.9 (3.50)	88.9 (3.50)	69.9 (2.75)	2	13.6 (30)	AMH2	AJBEW081307	
352.6 (13.88)	393.7 (15.50)	220.7 (8.69)	184.2 (7.25)	300.2 (11.82)	333.5 (13.13)	217.4 (8.56)	238.3 (9.00)	282.7 (11.13)	122.2 (4.81)	47.8 (1.88)	82.6 (3.25)	2	10.0 (22)	AMH2	AJBEW091105	
362.0 (14.25)	519.2 (20.44)	215.9 (8.50)	184.2 (7.25)	300.0 (11.81)	454.2 (17.88)	338.1 (13.31)	241.3 (9.50)	395.2 (15.56)	120.7 (4.75)	44.5 (1.75)	76.2 (3.00)	2	15.0 (33)	AMH2	AJBEW091504	
376.2 (14.81)	376.2 (14.81)	231.9 (9.13)	165.1 (6.50)	273.8 (10.78)	330.2 (13.00)	114.3 (4.50)	260.4 (10.25)	260.4 (10.25)	146.1 (5.75)	38.1 (1.50)	85.9 (3.38)	2	20.00 (44)	AMH2	AJBEW101006	
368.3 (14.50)	469.9 (18.50)	214.4 (8.44)	177.8 (7.00)	330.2 (13.00)	422.4 (16.63)	270 (10.63)	254.0 (10.00)	355.6 (14.00)	149.4 (5.88)	19.1 (0.75)	79.5 (3.13)	2	24.9 (55)	AMH4	AJBEW101406	
368.3 (14.50)	469.9 (18.50)	244.6 (9.63)	N/A	330.2 (13.00)	N/A	270 (10.63)	254.0 (10.00)	355.6 (14.00)	196.9 (7.75)	19.1 (0.75)	112.8 (4.44)	4	27.2 (60)	AMH2	AJBEW101408	
416.1 (16.38)	638.3 (25.13)	190.5 (7.50)	260.4 (10.25)	368.3 (14.50)	574.8 (22.63)	428.8 (16.88)	289.1 (11.38)	508.0 (20.00)	124.0 (4.88)	38.1 (1.50)	88.9 (3.50)	3	38.6 (85)	AMH2	AJBEW112005	
400.1 (15.75)	746.3 (29.38)	258.8 (10.19)	215.9 (8.50)	358.9 (14.13)	689.1 (27.13)	508 (20.00)	273.1 (10.75)	619.3 (24.38)	152.4 (6.00)	41.4 (1.63)	101.6 (4.00)	3	32.7 (72)	AMH8	AJBEW112406	

$\diamond$  For Groups B and C, all conduits must be sealed within 50.8 mm (2") of the enclosure.

# AJBEW Cast Junction Boxes

## Explosionproof, Dust-Ignitionproof

**NEC/CEC:**  
 Class I, Division 1 and 2, Groups B $\diamond$ , C $\diamond$ , D  
 Class I, Zone 1 and 2, Groups IIA, IIB $\diamond$ +H $\diamond$   
 Class II, Division 1 and 2, Groups E, F, G  
 Class III  
 IP66

**NEC/CEC:**  
 NEMA 4, 7B $\diamond$ C $\diamond$ D, 9EFG

**ATEX/IECEX:**  
 Zone 1 and 2 – 21 and 22  
 II 2 GD  
 IP66 – IK10

Overall Dimensions			Dimensions in Millimeters (Inches)									Max. Conduit Size	Ship Weight	Mounting Hardware	Catalog Number
F	E	G	A	AA	B	BB	W	H	Db	Dc	K	Inches	kg (lb)	Number	Number
416.1 (16.38)	889.0 (35.00)	260.4 (10.25)	241.3 (9.50)	384.3 (15.13)	835.2 (32.88)	692.2 (27.25)	285.8 (11.25)	759.0 (29.88)	157.2 (6.19)	47.8 (1.88)	106.4 (4.19)	3	51.3 (113)	AMH8	AJBEW113006
441.5 (17.38)	441.5 (17.38)	235 (9.25)	219.2 (8.63)	397.0 (15.63)	397.0 (15.63)	219.2 (8.63)	311.2 (12.25)	311.2 (12.25)	146.1 (5.75)	38.1 (1.50)	95.3 (3.75)	3	29.5 (65)	AMH8	AJBEW121206
441.5 (17.38)	441.5 (17.38)	292.1 (11.50)	219.2 (8.63)	397.0 (15.63)	397.0 (15.63)	219.2 (8.63)	311.2 (12.25)	311.2 (12.25)	196.9 (7.75)	38.1 (1.50)	120.7 (4.75)	3	31.8 (70)	AMH8	AJBEW121208
431.8 (17.00)	584.2 (23.00)	231.9 (9.13)	177.8 (7.00)	400.1 (15.75)	533.4 (21.00)	358.9 (14.13)	311.2 (12.25)	463.6 (18.25)	146.1 (5.75)	38.1 (1.50)	88.9 (3.50)	4	40.8 (90)	AMH5	AJBEW121806
431.8 (17.00)	584.2 (23.00)	282.7 (11.13)	177.8 (7.00)	400.1 (15.75)	533.4 (21.00)	358.9 (14.13)	311.2 (12.25)	463.6 (18.25)	222.3 (8.75)	38.1 (1.50)	108.0 (4.25)	4	45.8 (101)	AMH5	AJBEW121808
425.5 (16.75)	730.3 (28.75)	282.7 (11.13)	N/A	400.1 (15.75)	N/A	466.9 (18.38)	304.8 (12.00)	609.6 (24.00)	196.9 (7.75)	25.4 (1.00)	108.0 (4.25)	4	62.6 (138)	AMH4	AJBEW122408
425.5 (16.75)	1035.1 (40.75)	301.8 (11.88)	N/A	400.1 (15.75)	N/A	736.6 (29.00)	304.8 (12.00)	914.4 (36.00)	196.9 (7.75)	38.1 (1.50)	115.8 (4.56)	4	98.9 (218)	AMH5	AJBEW123608
457.2 (18.00)	1079.5 (42.50)	265.2 (10.44)	409.7 (16.13)	301.8 (11.88)	1035.1 (40.75)	857.3 (33.75)	346.2 (13.63)	962.2 (37.88)	155.7 (6.13)	38.1 (1.50)	109.5 (4.31)	3-1/2	86.2 (190)	AMH8	AJBEW133806
492.3 (19.38)	492.3 (19.38)	242.8 (9.56)	247.7 (9.75)	450.9 (17.75)	450.9 (17.75)	247.7 (9.75)	374.7 (14.75)	374.7 (14.75)	146.1 (5.75)	35.1 (1.38)	98.6 (3.88)	3-1/2	44.5 (98)	AMH8	AJBEW141406
492.3 (19.38)	492.3 (19.38)	293.6 (11.56)	247.7 (9.75)	450.9 (17.75)	450.9 (17.75)	247.7 (9.75)	374.7 (14.75)	374.7 (14.75)	196.9 (7.75)	35.1 (1.38)	101.6 (4.00)	3	47.6 (105)	AMH8	AJBEW141408
498.6 (19.63)	736.6 (29.00)	304.8 (12.00)	333.5 (13.13)	N/A	698.5 (27.50)	N/A	378 (14.88)	616.0 (24.25)	203.2 (8.00)	38.1 (1.50)	101.6 (4.00)	4	59.4 (131)	AMH6	AJBEW142408
539.8 (21.25)	1092.2 (43.00)	306.3 (12.06)	349.3 (13.75)	508.0 (20.00)	1057.4 (41.63)	812.8 (32.00)	397 (15.63)	946.2 (37.25)	189.0 (7.44)	38.1 (1.50)	133.4 (5.25)	4	113.4 (250)	AMH8	AJBEW153707
533.4 (21.00)	533.4 (21.00)	249.2 (9.81)	279.4 (11.00)	501.7 (19.75)	501.7 (19.75)	279.4 (11.00)	419.1 (16.50)	419.1 (16.50)	146.1 (5.75)	38.1 (1.50)	98.6 (3.88)	3-1/2	59.9 (132)	AMH8	AJBEW161606
533.4 (21.00)	533.4 (21.00)	314.7 (12.39)	279.4 (11.00)	501.7 (19.75)	501.7 (19.75)	279.4 (11.00)	419.1 (16.50)	419.1 (16.50)	212.9 (8.38)	38.1 (1.50)	124.0 (4.88)	4	63.5 (140)	AMH8	AJBEW161608
543.1 (21.38)	593.9 (23.38)	382.5 (15.06)	304.8 (12.00)	482.6 (19.00)	533.4 (21.00)	355.6 (14.00)	412.8 (16.25)	463.6 (18.25)	301.8 (11.88)	9.7 (0.38)	177.8 (7.00)	4	68.0 (150)	AMH8	AJBEW161812
546.1 (21.50)	693.7 (27.31)	230.1 (9.06)	330.2 (13.00)	505.0 (19.88)	641.4 (25.25)	393.7 (15.50)	417.6 (16.44)	571.5 (22.50)	146.1 (5.75)	31.8 (1.25)	84.1 (3.31)	3	59.0 (130)	AMH8	AJBEW162206
533.4 (21.00)	711.2 (28.00)	308.1 (12.13)	N/A	501.7 (19.75)	N/A	466.9 (18.38)	412.8 (16.25)	616.0 (24.25)	209.6 (8.25)	38.1 (1.50)	134.9 (5.31)	4	81.6 (180)	AMH6	AJBEW162408
527.1 (20.75)	831.9 (32.75)	219.2 (8.63)	330.2 (13.00)	N/A	781.1 (30.75)	N/A	412.8 (16.25)	717.6 (28.25)	146.1 (5.75)	38.1 (1.50)	79.5 (3.13)	3	68.0 (150)	AMH5	AJBEW162806
593.9 (23.38)	593.9 (23.38)	252.5 (9.94)	330.2 (13.00)	552.5 (21.75)	552.5 (21.75)	330.2 (13.00)	463.6 (18.25)	463.6 (18.25)	146.1 (5.75)	38.1 (1.50)	104.9 (4.13)	3-1/2	85.3 (188)	AMH8	AJBEW181806

$\diamond$  For Groups B and C, all conduits must be sealed within 50.8 mm (2") of the enclosure.

# AJBEW Cast Junction Boxes

## Explosionproof, Dust-Ignitionproof

**NEC/CEC:**

Class I, Division 1 and 2, Groups B $\diamond$ , C $\diamond$ , D  
 Class I, Zone 1 and 2, Groups IIA, IIB $\diamond$ +H $\diamond$ <sub>2</sub> $\diamond$   
 Class II, Division 1 and 2, Groups E, F, G  
 Class III  
 IP66

**NEC/CEC:**

NEMA 4, 7B $\diamond$ C $\diamond$ D, 9EFG

**ATEX/IECEX:**

Zone 1 and 2 – 21 and 22  
 Ⓢ II 2 GD  
 IP66 – IK10

Overall Dimensions			Dimensions in Millimeters (Inches)									Max. Conduit Size	Ship Weight	Mounting Hardware	Catalog Number
F	E	G	A	AA	B	BB	W	H	Db	Dc	K	Inches	kg (lb)	Catalog Number	Catalog Number
593.9 (23.38)	593.9 (23.38)	303.3 (11.94)	330.2 (13.00)	552.5 (21.75)	552.5 (21.75)	330.2 (13.00)	463.6 (18.25)	463.6 (18.25)	196.9 (7.75)	38.1 (1.50)	114.3 (4.50)	4	89.8 (198)	AMH8	AJBEW181808
608.1 (23.94)	762.0 (30.00)	309.4 (12.18)	409.7 (16.13)	552.5 (21.75)	704.9 (27.75)	466.9 (18.38)	463.6 (18.25)	614.4 (24.19)	196.9 (7.75)	38.1 (1.50)	128.5 (5.06)	4	101.6 (224)	AMH8	AJBEW182408
608.1 (23.94)	762.0 (30.00)	360.2 (14.18)	409.7 (16.13)	552.5 (21.75)	704.9 (27.75)	466.9 (18.38)	463.6 (18.25)	614.4 (24.19)	247.7 (9.75)	38.1 (1.50)	146.1 (5.75)	4	106.6 (235)	AMH8	AJBEW182410
574.8 (22.63)	879.6 (34.63)	308.1 (12.13)	N/A	552.5 (21.75)	N/A	584.2 (23.00)	463.6 (18.25)	768.4 (30.25)	196.9 (7.75)	38.1 (1.50)	120.7 (4.75)	4	120.2 (265)	AMH5	AJBEW183008
596.9 (23.50)	1060.5 (41.75)	312.7 (12.31)	279.4 (11.00)	552.5 (21.75)	1003.3 (39.50)	736.6 (29.00)	463.6 (18.25)	927.1 (36.50)	196.9 (7.75)	38.1 (1.50)	120.7 (4.75)	4	113.4 (250)	AMH8	AJBEW183608
596.9 (23.50)	1060.5 (41.75)	363.5 (14.31)	279.4 (11.00)	552.5 (21.75)	1003.3 (39.50)	736.6 (29.00)	463.6 (18.25)	927.1 (36.50)	247.7 (9.75)	38.1 (1.50)	139.7 (5.50)	4	122.5 (270)	AMH8	AJBEW183610
606.6 (23.88)	1216.2 (47.88)	301.8 (11.88)	406.4 (16.00)	584.2 (23.00)	1152.7 (45.38)	974.9 (38.38)	473.2 (18.63)	1073.2 (42.25)	177.8 (7.00)	38.1 (1.50)	127.0 (5.00)	4	140.6 (310)	AMH8	AJBEW184207
635.0 (25.00)	1651.0 (65.00)	323.9 (12.75)	N/A	596.9 (23.50)	N/A	1270.0 (50.00)	508.0 (20.00)	1524.0 (60.00)	174.8 (6.88)	38.1 (1.50)	120.7 (4.75)	4	236.3 (521)	AMH5	AJBEW206008
746.3 (29.38)	746.3 (29.38)	312.7 (12.31)	466.9 (18.38)	711.2 (28.00)	711.2 (28.00)	466.9 (18.38)	622.3 (24.50)	622.3 (24.50)	196.9 (7.75)	38.1 (1.50)	127.0 (5.00)	4	102.1 (225)	AMH8	AJBEW242408
746.3 (29.38)	746.3 (29.38)	363.5 (14.31)	466.9 (18.38)	711.2 (28.00)	711.2 (28.00)	466.9 (18.38)	622.3 (24.50)	622.3 (24.50)	247.7 (9.75)	38.1 (1.50)	155.7 (6.13)	4	108.9 (240)	AMH8	AJBEW242410
736.6 (29.00)	889.0 (35.00)	330.2 (13.00)	457.2 (18.00)	711.2 (28.00)	863.6 (34.00)	584.2 (23.00)	609.6 (24.00)	762.0 (30.00)	203.2 (8.00)	49.3 (1.94)	133.4 (5.25)	4	190.5 (420)	AMH8	AJBEW243008
781.1 (30.75)	1092.2 (43.00)	331.7 (13.06)	463.6 (18.25)	711.2 (28.00)	1016.0 (40.00)	736.6 (29.00)	616.0 (24.25)	920.8 (36.25)	196.9 (7.75)	41.4 (1.63)	130.3 (5.13)	4	190.5 (420)	AMH5	AJBEW243608
781.1 (30.75)	1092.2 (43.00)	382.5 (15.06)	463.6 (18.25)	711.2 (28.00)	1016.0 (40.00)	736.6 (29.00)	616.0 (24.25)	920.8 (36.25)	247.7 (9.75)	41.4 (1.63)	152.4 (6.00)	4	204.1 (450)	AMH5	AJBEW243610
914.4 (36.00)	1117.6 (44.00)	349.3 (13.75)	N/A	889.0 (35.00)	N/A	736.6 (29.00)	762.0 (30.00)	965.2 (38.00)	196.9 (7.75)	50.8 (2.00)	155.7 (6.13)	4	272.2 (600)	AMH6	AJBEW303808
914.4 (36.00)	1117.6 (44.00)	509.5 (20.06)	N/A	889.0 (35.00)	N/A	736.6 (29.00)	762.0 (30.00)	965.2 (38.00)	196.9 (7.75)	196.9 (7.75)	155.7 (6.13)	4	362.9 (800)	AMH6	AJBEW303816 ①

① Cast Junction Box does not have ATEX/IECEX certification.  
 $\diamond$  For Groups B and C, all conduits must be sealed within 50.8 mm (2") of the enclosure.

# AJBEW Cast Junction Box Options and Accessories

## Explosionproof, Dust-Ignitionproof

### NEC/CEC:

Class I, Division 1 and 2, Groups B $\diamond$ , C $\diamond$ , D  
 Class I, Zone 1 and 2, Groups IIA, IIB $\diamond$ +H $\diamond$ <sub>2</sub> $\diamond$   
 Class II, Division 1 and 2, Groups E, F, G  
 Class III  
 IP66

### NEC/CEC:

NEMA 4, 7B $\diamond$ C $\diamond$ D, 9EFG

### ATEX/IECEX:

Zone 1 and 2 – 21 and 22  
 II 2 GD  
 IP66 – IK10

### Options

Factory-Installed Suffix	Field-Installed Catalog Number	Description
AB	Not Available	Set of 4 standoffs 12.7 mm (0.50") high
BR	BRTB4X	Breather, NEMA 4X (includes outlets and installation)
DN	ECD50B4X	Drain, NEMA 4X (includes outlets and installation)
DP1	AWG13/1CT	Desiccate package
EGS	EGSKIT	External grounding stud 3/8"-16
G1	Not Available	Gray powder coat epoxy (outside)
G2	Not Available	Gray powder coat epoxy (inside and outside)
GNDKIT		Internal Ground Stud, #14 - #2
H		Hinges stainless steel
	AHOF12SS	Hinge Kit, 2 light duty SS hinges
	AHOF22SS	Hinge Kit, 2 heavy duty SS hinges
	AHOF23SS	Hinge Kit, 3 heavy duty SS hinges
K	Not Available	Terminal blocks 600 Volt, 30 Amp <i>Indicate number of points: example: 5 points = 5K</i>
NP	Not Available	Plastic nameplate, 50.8 x 101.6 mm (2.00 x 4.00"), 3.3 mm (13") black letters on white surface, 3 lines max, specify legend.
Q	Not Available	SS captive Quad-Lead bolts
X	Not Available	ATEX Certification
XU	Not Available	ATEX Component Certification
Z	See table on following page	Mounting pan

### Drill and Tap Options

(For drill and tap schedule, Drilling and Tapping Guidelines)

Symbol	Conduit Size (NPT) Inches	Symbol	Conduit Size (NPT) Inches
A	1/2	F	2
B	3/4	G	2-1/2
C	1	H	3
D	1-1/4	J	3-1/2
E	1-1/2	K	4

Blind Tapped Holes	
Suffix	Screw Size
BT1	#6 - 1/4"
BT2	5/16" - 1/2"

### Mounting Hardware

Refer to ordering information for Enclosure-Mounting Hardware Correlation.

Factory-Installed Suffix	Field-Installed Catalog Number	Description
MH1	AMH1	1/4" - 20 x 1-1/4" Bolt, 1/4" - 20 Hex Nut, 1/4" Washers
MH2	AMH2	3/8" -16 x 1-1/4" Bolt, 3/8" -16 Hex Nut, 3/8" Washers
MH3	AMH3	7/16" - 14 x 1-3/4" Bolt, 7/16" - 14 Hex Nut, 7/16" Washers
MH4	AMH4	1/2" - 13 x 1-3/4" Bolt, 1/2" - 13 Hex Nut, 1/2" Washers
MH5	AMH5	1/2" - 13 x 2" Bolt, 1/2" - 13 Hex Nut, 1/2" Washers
MH6	AMH6	5/8" - 11 x 2" Bolt, 5/8" - 11 Hex Nut, 5/8" Washers
MH7	AMH7	1/2" - 13 x 1-1/4" Bolt, 1/2" - 13 Hex Nut, 1/2" Washers
MH8	AMH8	5/8" - 11 x 1-1/4" Bolt, 5/8" - 11 Hex Nut, 5/8" Washers

$\diamond$  For Groups B and C, all conduits must be sealed within 50.8 mm (2") of the enclosure.



# AJBEW Cast Junction Box Options and Accessories

## Explosionproof, Dust-Ignitionproof

**NEC/CEC:**  
 Class I, Division 1 and 2, Groups B $\diamond$ , C $\diamond$ , D  
 Class I, Zone 1 and 2, Groups IIA, IIB $\diamond$ +H $\diamond$ <sub>2</sub> $\diamond$   
 Class II, Division 1 and 2, Groups E, F, G  
 Class III  
 IP66

**NEC/CEC:**  
 NEMA 4, 7B $\diamond$ C $\diamond$ D, 9EFG

**ATEX/IECEx:**  
 Zone 1 and 2 – 21 and 22  
 II 2 GD  
 IP66 – IK10

### Mounting Pans

Mounting Pan Catalog Number	Junction Box Catalog Number	Overall Dimensions in Millimeters (Inches)	
		W	H
AZ-464	AJBEW040604	76.2 (3.00)	127.0 (5.00)
AZ-664	AJBEW060604	120.7 (4.75)	120.7 (4.75)
AZ-686	AJBEW060806	114.3 (4.50)	165.1 (6.50)
AZ-593	AJBEW050903	101.6 (4.00)	215.9 (8.50)
AZ-684	AJBEW060804	114.3 (4.50)	165.1 (6.50)
AZ-6104	AJBEW061004	127.0 (5.00)	266.7 (10.50)
AZ-6124	AJBEW061204	139.7 (5.50)	279.4 (11.00)
AZ-6164	AJBEW061604	133.4 (5.25)	381.0 (15.00)
AZ-7116	AJBEW071106	165.1 (6.50)	254.0 (10.00)
AZ-886	AJBEW080806	165.1 (6.50)	165.1 (6.50)
AZ-8106	AJBEW081006	165.1 (6.50)	215.9 (8.50)
AZ-8137	AJBEW081307	152.4 (6.00)	279.4 (11.00)
AZ-9115	AJBEW091105	209.6 (8.25)	254.0 (10.00)
AZ-9154	AJBEW091504	206.5 (8.13)	374.7 (14.75)
AZ-10104/6	AJBEW101006	190.5 (7.50)	190.5 (7.50)
AZ-10146/8	AJBEW101408	228.6 (9.00)	330.2 (13.00)
AZ-10146/8	AJBEW101408	228.6 (9.00)	330.2 (13.00)
AZ-11205	AJBEW112005	266.7 (10.50)	482.6 (19.00)
AZ-11246	AJBEW112406	251.0 (9.88)	590.6 (23.25)
AZ-11306	AJBEW113006	251.0 (9.88)	723.9 (28.50)
AZ-12126/8	AJBEW121206	266.7 (10.50)	266.7 (10.50)
AZ-12126/8	AJBEW121208	266.7 (10.50)	266.7 (10.50)
AZ-12186/8	AJBEW121806	266.7 (10.50)	419.1 (16.50)
AZ-12186/8	AJBEW121808	266.7 (10.50)	419.1 (16.50)
AZ-12248/10	AJBEW122408	273.1 (10.75)	574.8 (22.63)
AZ-12368	AJBEW123608	254.0 (10.00)	863.6 (34.00)
AZ-13386	AJBEW133806	292.1 (11.50)	924.1 (36.38)

Mounting Pan Catalog Number	Junction Box Catalog Number	Overall Dimensions in Millimeters (Inches)	
		W	H
AZ-14146/8	AJBEW141406	311.2 (12.25)	311.2 (12.25)
AZ-14146/8	AJBEW141408	311.2 (12.25)	311.2 (12.25)
AZ-14248	AJBEW142408	355.6 (14.00)	568.5 (22.38)
AZ-15377	AJBEW153707	368.3 (14.50)	901.7 (35.50)
AZ-16166/8	AJBEW161606	381.0 (15.00)	381.0 (15.00)
AZ-16166/8	AJBEW161608	381.0 (15.00)	381.0 (15.00)
AZ-161812	AJBEW161812	381.0 (15.00)	406.4 (16.00)
AZ-16226	AJBEW162206	355.6 (14.00)	508.0 (20.00)
AZ-16248	AJBEW162408	374.7 (14.75)	577.9 (22.75)
AZ-16286	AJBEW162806	355.6 (14.00)	660.4 (26.00)
AZ-18186/8	AJBEW181806	406.4 (16.00)	406.4 (16.00)
AZ-18186/8	AJBEW181808	406.4 (16.00)	406.4 (16.00)
AZ-18248/10	AJBEW182408	406.4 (16.00)	558.8 (22.00)
AZ-18248/10	AJBEW182410	406.4 (16.00)	558.8 (22.00)
AZ-18308	AJBEW183008	406.4 (16.00)	711.2 (28.00)
AZ-18368/10	AJBEW183608	431.8 (17.00)	882.7 (34.75)
AZ-18368/10	AJBEW183610	431.8 (17.00)	882.7 (34.75)
AZ-18427	AJBEW184207	431.8 (17.00)	1016.0 (40.00)
AZ-205610	AJBEW205610	431.8 (17.00)	1371.6 (54.00)
AZ-20608	AJBEW206008	457.2 (18.00)	1460.5 (57.50)
AZ-24248/10	AJBEW242408	558.8 (22.00)	558.8 (22.00)
AZ-24248/10	AJBEW242410	558.8 (22.00)	558.8 (22.00)
AZ-24308	AJBEW243008	571.5 (22.50)	711.2 (28.00)
AZ-24368/10	AJBEW243608	558.8 (22.00)	863.6 (34.00)
AZ-24368/10	AJBEW243610	558.8 (22.00)	863.6 (34.00)
AZ-30388	AJBEW303808	711.2 (28.00)	914.4 (36.00)
AZ-30388	AJBEW303816	711.2 (28.00)	914.4 (36.00)

$\diamond$  For Groups B and C, all conduits must be sealed within 50.8 mm (2") of the enclosure.

# AJBEW Cast Junction Box Drilling and Tapping Guidelines

Explosionproof, Dust-Ignitionproof

**NEC/CEC:**  
 Class I, Division 1 and 2, Groups B $\diamond$ , C $\diamond$ , D  
 Class I, Zone 1 and 2, Groups IIA, IIB $\diamond$ +H $\diamond$   
 Class II, Division 1 and 2, Groups E, F, G  
 Class III  
 IP66

**NEC/CEC:**  
 NEMA 4, 7B $\diamond$ C $\diamond$ D, 9EFG

**ATEX/IECEX:**  
 Zone 1 and 2 – 21 and 22  
 II 2 GD  
 IP66 – IK10

Dimensions — See Catalog Number Tables

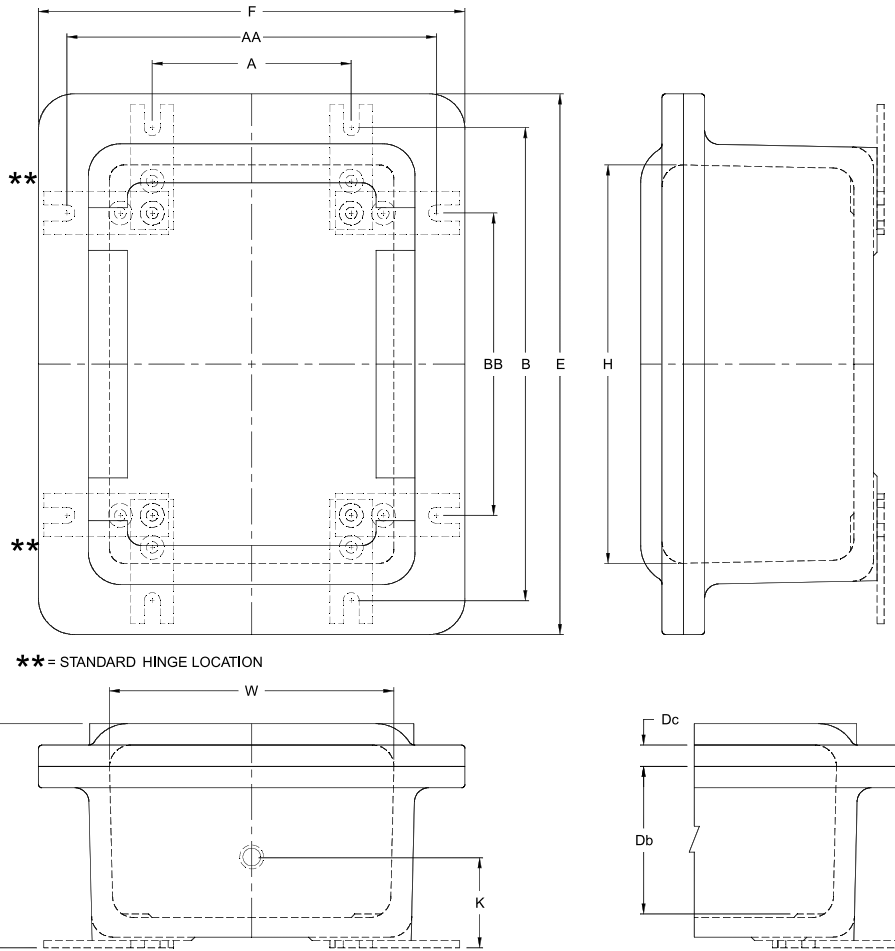

## Drilling and Tapping Guidelines

Conduit Size (NPT)	Minimum Spacing For Conduit Centers in Millimeters (Inches)										
	1/2	3/4	1	1-1/4	1-1/2	2	2-1/2	3	3-1/2	4	
1/2	54.1 (2.13)	54.1 (2.13)	57.2 (2.25)	66.8 (2.63)	71.4 (2.81)	79.5 (3.13)	92.2 (3.63)	101.6 (4.00)	114.3 (4.50)	114.3 (4.50)	
3/4	54.1 (2.13)	54.1 (2.13)	57.2 (2.25)	66.8 (2.63)	71.4 (2.81)	79.5 (3.13)	92.2 (3.63)	101.6 (4.00)	114.3 (4.50)	114.3 (4.50)	
1	57.2 (2.25)	57.2 (2.25)	60.5 (2.38)	71.4 (2.81)	76.2 (3.00)	82.6 (3.25)	95.3 (3.75)	104.9 (4.13)	114.3 (4.50)	117.6 (4.63)	
1-1/4	66.8 (2.63)	66.8 (2.63)	71.4 (2.81)	79.5 (3.13)	84.1 (3.31)	92.2 (3.63)	104.9 (4.13)	114.3 (4.50)	120.7 (4.75)	127.0 (5.00)	
1-1/2	71.4 (2.81)	71.4 (2.81)	76.2 (3.00)	84.1 (3.31)	88.9 (3.50)	96.8 (3.81)	109.5 (4.31)	117.6 (4.63)	125.5 (4.94)	133.4 (5.25)	
2	79.5 (3.13)	79.5 (3.13)	82.6 (3.25)	92.2 (3.63)	96.8 (3.81)	104.9 (4.13)	117.6 (4.63)	127.0 (5.00)	148.1 (5.83)	146.1 (5.75)	
2-1/2	92.2 (3.63)	92.2 (3.63)	95.3 (3.75)	104.9 (4.13)	109.5 (4.31)	117.6 (4.63)	130.3 (5.13)	84.1 (3.31)	146.1 (5.75)	155.7 (6.13)	
3	101.6 (4.00)	101.6 (4.00)	104.9 (4.13)	114.3 (4.50)	117.6 (4.63)	127.0 (5.00)	84.1 (3.31)	146.1 (5.75)	152.4 (6.00)	158.8 (6.25)	
3-1/2	114.3 (4.50)	114.3 (4.50)	114.3 (4.50)	120.7 (4.75)	125.5 (4.94)	136.7 (5.38)	146.1 (5.75)	152.4 (6.00)	158.8 (6.25)	165.1 (6.50)	
4	114.3 (4.50)	114.3 (4.50)	117.6 (4.63)	127.0 (5.00)	133.4 (5.25)	146.1 (5.75)	155.7 (6.13)	158.8 (6.25)	165.1 (6.50)	171.5 (6.75)	

$\diamond$  For Groups B and C, all conduits must be sealed within 50.8 mm (2") of the enclosure.

# SJB Series 316L Stainless Steel Junction Boxes

## Explosion Protected Terminal Enclosure

**NEC/CEC:**  
Class I Zone 1  
Exe/AExe II, T5 or T6  
IP66

**CEC:**  
Type 4X

### Applications

- Terminal, junction box enclosure for various electrical devices.
- Designed for use in areas designed for Zone 1, where flammable gases or vapors are present either continuously or intermittently such as:
  - Petroleum
  - Chemical
  - Refineries
  - Other industrial process facilities.
  - Food processing
  - Dairy
  - Brewing
  - Other commercial facilities.
- Ideal for wet or corrosive atmospheres.

### Features

- Austenitic stainless steel contains at least 10.5% Chrome (Cr). Chrome is a protective layer that shields the material from humidity in the air.
- 316L stainless steel contains Molybdenum (Mo), which provides excellent corrosion resistance especially against chlorides.
- Smooth, continuous welded seams.
- Different sizes and depths to choose from.
- Available in three depths, 95 mm (3.74"), 200 mm (7.87") and 300 mm (11.81").
- Can be supplied with 1, 2, 3 or even 4 neoprene sealed gland plates for ease of cable installation.
- 316L Stainless steel captive screws.
- Hinges standard on all sizes above 370 mm x 260 mm (14.57" x 10.24").
- Poured in place polyurethane door gasket.
- M8 feed-thru earth/ground stud.
- Reversible door, opens 210 degrees, from any location top/bottom, left or right, by means of removable hinges that can be installed in any position.
- Reversible anti vibration mounting brackets, on the top, bottom or side positions.
- Optional patented removable pad locking device.
- Numerous optional accessories.

### Standard Materials

- Enclosure: 316L stainless steel
- Hardware: 316L stainless steel

### Options

- Mounting pan
- Gland plates
- Interior side rails
- DIN rails
- Side rail and DIN rail assembly
- Terminal Blocks (enclosure size varies, based on # terminals blocks, cross section or terminal block, current, ambient temperature and desired T rating, contact your local sales representative.)
- Ground bars
- Terminals for ground bar
- Terminal spacers: 100 mm (3.94") or 50 mm (1.97")
- Padlocking device
- Locking hinge
- Factory drilled entries
- Enclosure coupling kit available, contact your local sales representative.

Without Terminals



Equipped with Terminals



### NEC/CEC Certifications and Compliances

- cCSAus Listed: 013017
- CSA Type 4X with approved breather

# SJB Series 316L Stainless Steel Junction Boxes

## Explosion Protected Terminal Enclosure

NEC/CEC:  
Class I Zone 1  
Exe/AExe II, T5 or T6  
IP66

CEC:  
Type 4X

### Illustrated Features



Optional Patented Removable Locking Device.  
Part Number **097209**.



Patented Reversible Door. Opens to 210°, top, bottom, left or right, by moving the location of the hinges.



Patented Reversible Anti-vibration mounting brackets, can be mounted in top, side or bottom positions.



Polyurethane Poured in Place Door Gasket and Stainless Steel Captive Screws.



M8 Feed-thru Earth/Ground Terminal.



Optional Removable Gland Plate.

### Catalog Numbering Guide

Confirm size and gland plate availability in below table.

<b>SJB</b>	<b>12</b>	<b>12</b>	<b>95</b>	<b>0</b>	<b>N</b>	<b>25</b>	<b>010</b>
SJB Series			Depth Dimensions mm (in): 95 - 95 (3.74) 15 - 150 (5.91) 20 - 200 (7.87) 30 - 300 (11.81)			Terminal Block Size mm (in): 25 - 2.5 (0.10) 04 - 4.0 (0.16) 06 - 6.0 (0.24) 10 - 10.0 (0.39) 16 - 16.0 (0.63) 35 - 35.0 (1.39)	
	Height Dimensions mm (in): 12 - 120 (4.72) 18 - 180 (7.09) 22 - 220 (8.66) 26 - 260 (10.24) 37 - 370 (14.57) 56 - 560 (22.05) 75 - 750 (29.58) 11 - 1130 (44.49)			Gland Plates: 0 - none 1 - one bottom 3 - two sides and bottom 4 - All sides			Terminal Block Quantity: 010 - 10 050 - 50 100 - 100
		Width Dimensions mm (in): 12 - 120 (4.72) 18 - 180 (7.09) 22 - 220 (8.66) 26 - 260 (10.24) 37 - 370 (14.57) 56 - 560 (22.05) 75 - 750 (29.58)			Mounting Pan: N - None P - Mounting pan		

Appleton®

ENCLOSURES AND JUNCTION BOXES: NEC/CEC, ATEX/IECEx INCREASED SAFETY JUNCTION BOXES

# SJB Series 316L Stainless Steel Junction Boxes

## Explosion Protected Terminal Enclosure

NEC/CEC:  
Class I Zone 1  
Exe/AExe II, T5 or T6  
IP66

CSA:  
Type 4X

Height	Dimension in Millimeters (Inches)			Possible Gland Plates					Catalog Number
	Width	Depth		0	1	2	3	4	
120.0 (4.72)	120.0 (4.72)	95.0 (3.74)		✓	—	—	—	—	SJB121295
120.0 (4.72)	180.0 (7.09)	96.0 (3.74)		✓	—	—	—	—	SJB121895
180.0 (7.09)	120.0 (4.72)	97.0 (3.74)		✓	—	—	—	—	SJB181295
180.0 (7.09)	180.0 (7.09)	98.0 (3.74)		✓	—	—	—	—	SJB181895
220.0 (8.66)	260.0 (10.24)	150.0 (5.91)		✓	✓	✓	✓	✓	SJB222615
260.0 (10.24)	220.0 (8.66)	151.0 (5.91)		✓	✓	✓	✓	✓	SJB262215
220.0 (8.66)	370.0 (14.57)	200.0 (7.87)		✓	✓	✓	✓	✓	SJB223720 ①
370.0 (14.57)	220.0 (8.66)	201.0 (7.87)		✓	✓	✓	✓	✓	SJB372220
260.0 (10.24)	370.0 (14.57)	202.0 (7.87)		✓	✓	✓	✓	✓	SJB263720
370.0 (14.57)	260.0 (10.24)	203.0 (7.87)		✓	✓	✓	✓	✓	SJB372620 ①
370.0 (14.57)	370.0 (14.57)	204.0 (7.87)		✓	✓	✓	✓	✓	SJB373720 ①
370.0 (14.57)	560.0 (22.05)	205.0 (7.87)		✓	✓	✓	✓	✓	SJB375620
560.0 (22.05)	370.0 (14.57)	206.0 (7.87)		✓	✓	✓	✓	✓	SJB563720 ①
370.0 (14.57)	750.0 (29.53)	207.0 (7.87)		✓	✓	✓	✓	✓	SJB377520
750.0 (29.53)	370.0 (14.57)	208.0 (7.87)		✓	✓	✓	✓	✓	SJB753720
560.0 (22.05)	560.0 (22.05)	209.0 (7.87)		✓	✓	✓	✓	✓	SJB565620 ②
560.0 (22.05)	750.0 (29.53)	210.0 (7.87)		✓	✓	✓	✓	✓	SJB567520
370.0 (14.57)	370.0 (14.57)	300.0 (11.81)		✓	✓	✓	✓	✓	SJB373730
370.0 (14.57)	560.0 (22.05)	301.0 (11.81)		✓	✓	✓	✓	✓	SJB375630
560.0 (22.05)	370.0 (14.57)	302.0 (11.81)		✓	✓	✓	✓	✓	SJB563730
370.0 (14.57)	750.0 (29.53)	303.0 (11.81)		✓	✓	✓	✓	✓	SJB377530
750.0 (29.53)	370.0 (14.57)	304.0 (11.81)		✓	✓	✓	✓	✓	SJB753730
560.0 (22.05)	560.0 (22.05)	305.0 (11.81)		✓	✓	✓	✓	✓	SJB565630
560.0 (22.05)	750.0 (29.53)	306.0 (11.81)		✓	✓	✓	✓	✓	SJB567530
750.0 (29.53)	560.0 (22.05)	307.0 (11.81)		✓	✓	✓	✓	✓	SJB755630
1130.0 (44.49)	750.0 (29.53)	308.0 (11.81)		—	—	—	—	—	SJB117530

① No gland plates.  
② One gland plate.

# SJB Series 316L Stainless Steel Junction Boxes

## Explosion Protected Terminal Enclosure

NEC/CEC:  
Class I Zone 1  
Exe/AExe II, T5 or T6  
IP66

CSA:  
Type 4X

### Maximum Terminal Block Information

To order terminal blocks: Use nomenclature below. Supplied installed on a mounting pan. Can be installed on uprights and rails. Contact your local sales representative.

Catalog Number	Number Rails Horizontal	Terminal Size mm (in)	Qty. Max. Physical	Terminal Amp	Qty. Max. at Max. Amps	Terminal Amp
SJB121295	1	2.5 (0.10)	10	10	4	15
SJB121295	1	4.0 (0.16)	8	10	5	20
SJB121895	1	2.5 (0.10)	20	10	9	15
SJB121895	1	4.0 (0.16)	18	10	10	20
SJB181295	1	2.5 (0.10)	10	10	4	15
SJB181295	1	4.0 (0.16)	8	10	5	20
SJB181895	1	2.5 (0.10)	21	10	10	15
SJB181895	1	4.0 (0.16)	18	15	11	20
SJB222615	2	2.5 (0.10)	40	10	18	15
SJB222615	2	4.0 (0.16)	30	15	18	20
SJB262215	1	4.0 (0.16)	23	10	15	20
SJB262215	1	6.0 (0.27)	17	20	12	30
SJB223720	3	4.0 (0.16)	48	10	27	20
SJB223720	3	6.0 (0.27)	36	20	15	30
SJB372220	1	4.0 (0.16)	41	15	27	20
SJB372220	1	6.0 (0.27)	31	20	15	30
SJB263720	3	4.0 (0.16)	69	10	30	20
SJB263720	2	6.0 (0.27)	32	20	18	30
SJB372620	2	4.0 (0.16)	82	10	30	20
SJB372620	2	6.0 (0.27)	62	15	18	30
SJB373720	3	6.0 (0.27)	93	10	21	30
SJB373720	2	10.0 (0.39)	74	20	21	40
SJB375620	4	6.0 (0.27)	124	15	30	30
SJB375620	4	10.0 (0.39)	100	20	28	40
SJB563720	3	6.0 (0.27)	165	10	30	30
SJB563720	3	10.0 (0.39)	132	15	27	40

Catalog Number	Number Rails Horizontal	Terminal Size mm (in)	Qty. Max. Physical	Terminal Amp	Qty. Max. at Max. Amps	Terminal Amp
SJB377520	6	10.0 (0.39)	150	15	30	40
SJB377520	5	16.0 (0.63)	100	20	30	50
SJB753720	3	10.0 (0.39)	189	15	33	40
SJB753720	2	16.0 (0.63)	104	20	32	50
SJB565620	4	10.0 (0.39)	176	15	36	40
SJB565620	4	16.0 (0.63)	104	30	36	50
SJB567520	5	16.0 (0.63)	180	20	45	50
SJB567520	4	35.0 (1.38)	116	40	32	90
SJB373730	3	6.0 (0.27)	93	15	27	30
SJB373730	2	10.0 (0.39)	74	20	26	40
SJB375630	4	6.0 (0.27)	124	15	36	30
SJB375630	4	10.0 (0.39)	100	20	32	40
SJB563730	3	6.0 (0.27)	165	10	36	30
SJB563730	3	10.0 (0.39)	132	20	33	40
SJB377530	6	10.0 (0.39)	150	20	42	40
SJB377530	5	16.0 (0.63)	100	30	40	50
SJB753730	3	10.0 (0.39)	189	15	42	40
SJB753730	2	16.0 (0.63)	104	30	42	50
SJB565630	4	10.0 (0.39)	176	20	44	40
SJB565630	4	16.0 (0.63)	104	30	44	50
SJB567530	5	16.0 (0.63)	180	20	55	50
SJB567530	4	35.0 (1.38)	116	40	36	90
SJB755630	3	16.0 (0.63)	104	30	54	50
SJB755630	3	35.0 (1.38)	84	50	36	90
SJB117530	6	35.0 (1.38)	252	40	60	90
SJB117530	4	70.0 (2.76)	112	80	36	145





\* Maximum physical at amperage indicated, capable of accepting more terminals at lower amperage. Contact your local sales representative.

# SJB Series 316L Stainless Steel Junction Boxes

## Explosion Protected Terminal Enclosure

NEC/CEC:  
Class I Zone 1  
Exe/AExe II, T5 or T6  
IP66

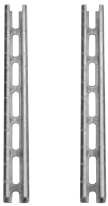
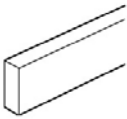
CSA:  
Type 4X



		Catalog Number	
Rail Length mm (in)		Symmetrical	Asymmetrical
<b>Zinc Plated Steel Rail</b>			
<i>For fixing onto uprights with clip nut supplied.</i>			
			
	Symmetrical		
	100 (3.93)	SJBSCP100	—
	160 (6.30)	SJBSCP160	—
	170 (6.69)	SJBSCP170	SJBACP170
	200 (7.87)	SJBSCP200	SJBACP200
	320 (12.60)	SJBSCP320	SJBACP320
	510 (20.08)	SJBSCP510	SJBACP510
	700 (27.56)	SJBSCP700	SJBACP700
	1080 (42.52)	SJBSCP1080	SJBACP1080
<b>Bar Length mm (in)</b>		<b>Catalog Number</b>	
<b>Zinc Plated Steel Uprights</b>			
<i>Set of two.</i>			
	200.0 (7.87)	SJBSR200	
	310.0 (12.20)	SJBSR310	
	500.0 (19.68)	SJBSR500	
	690.0 (27.17)	SJBSR690	
	1070.0 (42.13)	SJBSR1070	
<b>Copper Bar (12 x 4 mm (.47 x .16"))</b>			
<i>Copper bar not perforated for cable clamps.</i>			
	160.0 (6.30)	SJBCGB160	
	200.0 (7.87)	SJBCGB200	
	310.0 (12.20)	SJBCGB310	
	500.0 (19.68)	SJBCGB500	
	690.0 (27.17)	SJBCGB690	
	1070.0 (42.13)	SJBCGB1070	
<b>Cable Clamp for Copper Bar (12 x 4 mm (.47 x .16"))</b>			
	1.5 mm <sup>2</sup> to 4 mm <sup>2</sup> ( 0.002 in <sup>2</sup> to 0.006 in <sup>2</sup> ) Capacity — Set of 100		SJBGBC154
	6 mm <sup>2</sup> to 16 mm <sup>2</sup> ( 0.009 in <sup>2</sup> to 0.025 in <sup>2</sup> ) Capacity — Set of 10		SJBGBC616

# SJB Series 316L Stainless Steel Junction Boxes

## Explosion Protected Terminal Enclosure

NEC/CEC:  
Class I Zone 1  
Exe/AExe II, T5 or T6  
IP66

CSA:  
Type 4X

Dimensions Millimeters (Inches)		Catalog Number
Height	Width	
<b>Mounting Pan – Zinc Plated Steel</b>		
220.0 (8.66)	370.0 (14.57)	<b>SJBGP370</b>
370.0 (14.57)	260.0 (10.24)	<b>SJBGP260</b>
260.0 (10.24)	370.0 (14.57)	<b>SJBGP370</b>
370.0 (14.57)	370.0 (14.57)	<b>SJBGP370</b>
560.0 (22.05)	370.0 (14.57)	<b>SJBGP370</b>
370.0 (14.57)	560.0 (22.05)	<b>SJBGP560</b>
750.0 (29.53)	370.0 (14.57)	<b>SJBGP370</b>
370.0 (14.57)	750.0 (29.53)	<b>SJBGP750</b>
560.0 (22.05)	560.0 (22.05)	<b>SJBGP560</b>
750.0 (29.53)	560.0 (22.05)	<b>SJBGP560</b>
560.0 (22.05)	750.0 (29.53)	<b>SJBGP750</b>
<b>Spacers for Mounting at Back of Box</b>		
<i>Set of two insulated pillars for copper bar 12 x 4 mm (.47 x .16").</i>		
	Height = 100.0 mm (3.94")	<b>SJBS100</b>
	Height = 50.0 mm (1.97")	<b>SJBS500</b>
<b>Additional Door Padlocking Device</b>		
	<i>Padlock not supplied</i>	<b>SJBPL</b>



# PJB Series Polyester Nonmetallic Enclosures

**NEC/CEC:**  
Class 1, Zone 1 and 2 A/Exe II T5 or T6  
IP66

**ATEX/IECEX:**  
Zone 1 and 2 – 21 and 22  
⊕ II 2 GD  
IP66 – IK10

## Applications

- Terminal, junction box enclosure for various electrical devices.
- Designed for use in Class I, Zone 1 areas, where flammable gases or vapors are present either continuously or intermittently, such as:
  - Petroleum refineries
  - Chemical refineries
  - Food processing
  - Dairy
  - Brewing
  - Other industrial process facilities
- Ideal for wet or corrosive atmospheres.

## Features

- Static resistant black fiberglass reinforced polyester enclosure.
- Five different sizes to choose from
- Available in three depths, 200 mm (7.87"), 250 mm (9.84") and 300 mm (11.81").
- Enclosures can be coupled together for added space.
- Protective Flange at top and bottom.
- Pad lockable double bar locks, Key supplied.
- Operating temperature -40 °C to +55 °C (-40 °F to +131 °F).
- Enclosures are rated for 600 Vac, 400 Amp Maximum. Maximum Dissipated power is 125 W.
- A Exe IIC, Exe IIC T6 to T3 depending on the equipment housed in the enclosure.
- The overall IP and Temperature Class rating of the enclosure is governed by the lowest rating of any devices interfacing with the enclosure.
- Poured in place polyurethane door gasket.
- Many optional accessories.

## Standard Materials

- Enclosure: static resistant carbon filled fiberglass reinforced polyester (FRP)
- Hardware: 316L stainless steel

## Options or Accessories

- Mounting Pan.
- Gland Plates.
- Interior side rails.
- Din Rails.
- Side Rail and Din rail assembly.
- See table for several terminal block options and limitations. Supplied installed in enclosure. Other terminal block configurations available. Contact your local sales representative.
- Ground bars.
- Terminals for Ground bar.
- Terminal spacers, 100 mm (3.94") or 50 mm (1.97").
- Padlocking Device.
- Factory drilled entries.
- Earth Continuity Plate.
- Terminal Blocks, see following pages for a guide. Many other configurations and combinations available, contact your local sales representative.
- Enclosure coupling kit, contact your local sales representative.



## NEC/CEC Certifications and Compliances

- UL Standard: 886
- CSA Standard: C22.2 No. 25, C22.2 No. 30
- cCSAus Certified: 013017

## ATEX/IECEX Certifications and Compliances

- Certification Type CAe
  - Gas, Zones 1 and 2
    - Conforming to ATEX 94/9/CE: ⊕ II 2 G
    - Type of Protection: Ex e II, Ex eia IIC, Ex eib IIC, Ex ede IIC, Ex edemb IIC
    - Temperature Class: T6 for  $T_a \leq +40$  °C (+104 °F); T5 for  $+40$  °C  $\leq$  to  $\leq +55$  °C (+104 °F  $\leq$  to  $\leq +131$  °F)
  - Dust, Zones 21 and 22
    - Conforming to ATEX 94/9/CE: ⊕ II 2 D
    - Type of Protection: Ex tD A21
  - Ambient Temperature: T80 °C to T96 °C (T176 °F to T205 °F)
  - CE Declaration of Conformity: 50325
  - ATEX Certificate: LCIE 02 ATEX 6248X
  - IECEX Certificate: IECEX LCI 04.0016X
- Index of Protection according EN/IEC 60529: IP66
- Impact Resistance (shock): IK10

## EURASEC Certification

- EURASEC N° TC RU C-FR.Г505.B.00911

Appleton®

ENCLOSURES AND JUNCTION BOXES: NEC/CEC, ATEX/IECEX INCREASED SAFETY JUNCTION BOXES

# PJB Series Polyester Nonmetallic Enclosures

NEC/CEC:  
Class 1, Zone 1 and 2 A/Exe II T5 or T6  
IP66

ATEX/IECEX:  
Zone 1 and 2 - 21 and 22  
II 2 GD  
IP66 - IK10

## Catalog Numbering Guide

Confirm size and gland plate availability in below table.

<p><b>PJB</b></p> <p>Series</p>	<p><b>40</b></p> <p>Length Dimensions mm (in): 12 - 120.0 (4.72) 17 - 170.0 (6.69) 21 - 210.0 (8.27) 23 - 230.0 (9.06) 32 - 320.0 (12.60) 40 - 400.0 (15.75) 42 - 425.0 (16.75) 50 - 500.0 (19.68) 57 - 575.0 (22.50) 60 - 600.0 (23.62) 80 - 800.0 (31.50) 10 - 1000.0 (39.37)</p>	<p><b>30</b></p> <p>Width Dimensions mm (in): 12 - 120.0 (4.72) 20 - 200.0 (7.87) 30 - 300.0 (11.81) 40 - 400.0 (15.75) 60 - 600.0 (23.62) 80 - 800.0 (31.50)</p>	<p><b>20</b></p> <p>Depth Dimensions mm (in): 09 - 91.0 (3.58) 15 - 150.0 (5.91) 20 - 200.0 (7.87) 25 - 250.0 (9.84) 30 - 300.0 (11.81)</p>	<p><b>0</b></p> <p>Gland Plates: 0 - none 1 - one bottom 3 - two sides and bottom</p>	<p><b>N</b></p> <p>Mounting Pan: N - None P - Mounting pan</p>	<p><b>N</b></p> <p>Earth Continuity Plate: N - None E - Supplied</p>	<p><b>25</b></p> <p>Terminal Block Size mm (in): 25 - 2.5 (0.10) 04 - 4.0 (0.16) 06 - 6.0 (0.24) 10 - 10.0 (0.39) 16 - 16.0 (0.63) 35 - 35.0 (1.378)</p>	<p><b>010</b></p> <p>Terminal Block Quantity: 010 - 10 050 - 50 100 - 100</p>
---------------------------------	---	---	---	---	--	--	--	---

### Confirm Size and Gland Plate Availability

Possible Gland Plates			Dimensions in Millimeters (Inches)			Volume dm <sup>3</sup> (in <sup>3</sup> )	Weight kg (lb)	Catalog Number
0	1	3	Height	Width	Depth			
x	x	x	400.0 (15.78)	300.0 (11.81)	200.0 (7.87)	25.0 (1526.0)	4.8 (10.58)	<b>PJB403020</b>
x	x	x	500.0 (19.68)	400.0 (15.78)	200.0 (7.87)	51.0 (3112.0)	6.2 (13.67)	<b>PJB504020</b>
x	x	x	600.0 (23.62)	400.0 (15.78)	250.0 (9.84)	80.0 (4882.0)	7.7 (16.98)	<b>PJB604025</b>
x	x	x	800.0 (31.50)	600.0 (23.62)	300.0 (11.81)	190.0 (11595.0)	18.3 (40.34)	<b>PJB806030</b>
x	x	x	1000.0 (39.37)	800.0 (31.50)	300.0 (11.81)	313.0 (19100.0)	23.6 (52.03)	<b>PJB108030</b>

# PJB Series Polyester Nonmetallic Enclosures

NEC/CEC:  
Class 1, Zone 1 and 2 A/Exe II T5 or T6  
IP66

ATEX/IECEX:  
Zone 1 and 2 – 21 and 22  
II 2 GD  
IP66 – IK10

## Maximum Terminal Block Information

Number Rails	Terminal Size mm (in)	Qty Max * Physical	Terminal Amp	Qty Max At Max. Amps	Terminal Amp	Catalog Number
3	2.5 (0.10)	100	5	22	15	PJB403020
3	4.0 (0.16)	75	10	20	20	PJB403020
2	6.0 (0.24)	36	15	12	30	PJB403020
4	4.0 (0.16)	100	10	30	20	PJB504020
4	6.0 (0.24)	76	15	18	30	PJB504020
3	10.0 (0.39)	64	20	18	40	PJB504020
4	6.0 (0.24)	136	12	27	30	PJB604025
4	10.0 (0.39)	112	16	25	40	PJB604025
4	16.0 (0.63)	88	20	24	50	PJB604025
6	10.0 (0.39)	190	14	27	40	PJB806030
5	16.0 (0.63)	190	15	24	50	PJB806030
4	35.0 (1.38)	124	30	16	90	PJB806030
7	16.0 (0.63)	364	12	28	50	PJB108030
5	35.0 (1.38)	218	20	20	90	PJB108030
3	70.0 (2.76)	84	40	9	145	PJB108030

## Small Junction Boxes

Type	Quantity	Maximum Amps
	12	15 A
PJB121209 120 x 120 x 91 mm (5 x 5 x 4")	10	20 A
	7	32 A
	4	50 A
	22	13 A
PJB171209 120 x 170 x 91 mm (7 x 5 x 4")	18	19 A
	14	27 A
	6	50 A
	33	12 A
PJB231209 120 x 230 x 91 mm (9 x 5 x 4")	28	16 A
	21	24 A
	8	50 A





\* Maximum physical at amperage indicated, capable of accepting more terminals at lower amperage. Contact your local sales representative.  
To order terminal blocks: Use nomenclature above. Supplied installed on a mounting pan. Can be installed on uprights and rails. Contact your local sales representative.

# PJB Series Polyester Nonmetallic Enclosures

NEC/CEC:  
Class 1, Zone 1 and 2 A/Exe II T5 or T6  
IP66

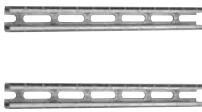
ATEX/IECEX:  
Zone 1 and 2 – 21 and 22  
II 2 GD  
IP66 – IK10

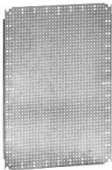
## Accessories and Options – Order as follows for field installed

		Dimensions in Millimeters (Inches)		Catalog Number	
		Height	Length		
<b>Interior Side Rails/Uprights – Set of 2 – Supplied in Packages of 5</b>					
		400 (15.78)	337.0 (13.27)	PJBSR400	
		500 (19.68)	437.0 (17.20)	PJBSR500	
		600 (23.62)	537.0 (21.14)	PJBSR600	
		800 (31.50)	737.0 (29.02)	PJBSR800	
		1000 (39.37)	937.0 (36.89)	PJBSR100	
		Width in Millimeters (Inches)		Catalog Number	
		For Enclosure	Crosspiece		
<b>Cross Piece Din Rails – Set of 10</b>					
		300 (11.81)	243.0 (9.57)	PJBDR300	
		400 (15.78)	343.0 (13.50)	PJBDR400	
		600 (23.62)	543.0 (21.38)	PJBDR600	
		800 (31.50)	743.0 (29.25)	PJBDR800	
		Dimensions in Millimeters (Inches)		Weight	Catalog
		Enclosure H x W	H x W	kg (lb)	Number
<b>Perforated Mounting Plate – To Order Separately</b>					
		400.0 (15.78) x 300.0 (7.87)	350.0 (13.78) x 250.0 (9.84)	1.2 (2.65)	PJBMP400
		500.0 (19.68) x 400.0 (15.75)	450.0 (17.72) x 350.0 (13.78)	1.1 (2.43)	PJBMP500
		600.0 (23.62) x 400.0 (15.75)	550.0 (21.65) x 350.0 (13.78)	1.5 (3.31)	PJBMP600
		800.0 (31.50) x 600.0 (23.62)	750.0 (29.53) x 550.0 (21.65)	3.0 (6.61)	PJBMP800
		1000.0 (39.37) x 800.0 (31.50)	950.0 (37.40) x 750.0 (29.53)	5.5 (12.13)	PJBMP100
		Dimension	Volume	Weight	Catalog
		H x W mm (in)	dm <sup>3</sup> (in <sup>3</sup> )	kg (lb)	Number
<b>Gland Plates – To Order Separately</b>					
		130.0 (5.12) x 264.0 (10.39)	1.3 (79)	0.3 (0.66)	PJBGP130
		114.0 (4.49) x 322.0 (12.68)	1.4 (85)	0.4 (0.88)	PJBGP114
<b>Door Padlocking Device</b>					PJBPL

# PJB Series Polyester Nonmetallic Enclosures

NEC/CEC:  
Class 1, Zone 1 and 2 A/Exe II T5 or T6  
IP66

ATEX/IECEX:  
Zone 1 and 2 – 21 and 22  
II 2 GD  
IP66 – IK10

## JBEP Series for Terminal Junction Box Application Only.

The size of the junction box needed to meet your requirements can be selected based on the table shown below.

### 1. Define maximum cable entries according to number of modules available per side.

Cable Entry Metric Thread	Number of Modules
M20	1
M25	1
M32	1
M40	2
M50	3

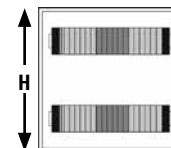
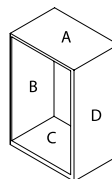

Type	Dimensions mm (in)			B/D	Number of Modules			Allowable Max. Size	Terminal Dim. H — mm (in)
	Length	Width	Depth		A/C	A'/C' (1)			
PJB121209	120.0 (4.72)	120.0 (4.72)	91.0 (3.58)	2	2	—	M25	120.0 (4.72)	
PJB171209	170.0 (6.69)	120.0 (4.72)	91.0 (3.58)	3	2	—	M32	120.0 (4.72)	
PJB231209	230.0 (9.06)	120.0 (4.72)	91.0 (3.58)	4	2	—	M32	120.0 (4.72)	
PJB212015	215.0 (8.46)	200.0 (7.87)	150.0 (5.91)	11	8	—	M50	200.0 (7.87)	
PJB322015	320.0 (12.60)	200.0 (7.87)	150.0 (5.91)	18	8	—	M50	200.0 (7.87)	
PJB422015	425.0 (16.73)	200.0 (7.87)	150.0 (5.91)	26	8	—	M50	200.0 (7.87)	
PJB572015	575.0 (22.64)	200.0 (7.87)	150.0 (5.91)	38	8	—	M50	200.0 (7.87)	
PJB403020	400.0 (15.75)	300.0 (11.81)	206.0 (8.11)	18	18	—	M50	400.0 (15.75)	
PJB504020	500.0 (19.68)	400.0 (15.75)	206.0 (8.11)	24	10	10	M50	500.0 (19.68)	
PJB604025	610.0 (24.02)	400.0 (15.75)	257.0 (10.12)	48	10	10	M75	610.0 (24.02)	
PJB806030	820.0 (32.28)	610.0 (24.02)	300.0 (11.81)	72	54	—	M100	820.0 (32.28)	
PJB108030	1020.0 (40.16)	810.0 (31.89)	300.0 (11.81)	96	78	—	M100	1020.0 (40.16)	

### 2. Maximum rail arrangement according to physical dimensions.

Terminal Capacity mm <sup>2</sup> (in <sup>2</sup> )	Maximum Quantity of Horizontal Rails Per Quantity						
	2.5 (0.004)	4.0 (0.006)	6.0 (0.009)	10.0 (0.016)	16.0 (0.025)	35.0 (0.054)	50.0 (0.078)
PJB 12/17/23 1209	1	1	1	1	0	0	0
PJB 21/32/42/57 2015	1	1	1	1	1	1	0
PJB403020	3	3	3	2	2	2	1
PJB504020	4	4	3	3	3	2	1
PJB604025	4	4	4	4	3	3	2
PJB806030	6	6	5	5	5	4	3
PJB108030	8	8	7	7	6	5	3

# PJB Series Polyester Nonmetallic Enclosures

NEC/CEC:  
Class 1, Zone 1 and 2 A/Exe II T5 or T6  
IP66

ATEX/IECEx:  
Zone 1 and 2 – 21 and 22  
II 2 GD  
IP66 – IK10

### 3. Defining maximum terminal block quantity according to power dissipation:

- Junction boxes used for instrumentation applications have very low current levels, therefore there is no risk of overheating whatever the number of terminals inside the box.
- For applications other than instrumentation, the following tables allow you to define your junction box depending on the number of terminals and the maximum authorized current being carried with feed-through terminals.
- For single feed terminals using cross connection, please consult your local representative for a calculation.

For other terminal block configurations, please consult our drilling guide available online at: [www.appletonelec.com](http://www.appletonelec.com).

#### Small Junction Boxes

T Rating: T6	Type		
	PJB121209	PJB171209	PJB231209
	120 x 120 x 91 mm (5 x 5 x 4")	120 x 170 x 91 mm (7 x 5 x 4")	120 x 230 x 91 mm (9 x 5 x 4")
2.5 mm <sup>2</sup> (0.004 in <sup>2</sup> )	Qty. 12 15 A	Qty. 22 13 A	Qty. 33 12 A
4 mm <sup>2</sup> (0.006 in <sup>2</sup> )	Qty. 10 20 A	Qty. 18 19 A	Qty. 28 16 A
6 mm <sup>2</sup> (0.009 in <sup>2</sup> )	Qty. 7 32 A	Qty. 14 27 A	Qty. 21 24 A
10 mm <sup>2</sup> (0.016 in <sup>2</sup> )	Qty. 4 50 A	Qty. 6 50 A	Qty. 8 50 A

#### Non-Hinged Junction Boxes

T Rating: T6 @ Ta 40 °C (104 °F) T5 @ Ta 55° C (131 °F)	Type			
	PJB212015	PJB322015	PJB422015	PJB572015
	200 x 215 x 150 mm (8 x 9 x 6")	200 x 320 x 150 mm (8 x 13 x 6")	200 x 425 x 150 mm (8 x 17 x 6")	200 x 575 x 150 mm (8 x 23 x 6")
2.5 mm <sup>2</sup> (0.004 in <sup>2</sup> )	Qty. 20 16 A	Qty. 21 16 A	Qty. 23 16 A	Qty. 29 14 A
4 mm <sup>2</sup> (0.006 in <sup>2</sup> )	Qty. 19 20 A	Qty. 20 20 A	Qty. 23 20 A	Qty. 33 16 A
6 mm <sup>2</sup> (0.009 in <sup>2</sup> )	Qty. 12 32 A	Qty. 13 32 A	Qty. 14 32 A	Qty. 18 28 A
10 mm <sup>2</sup> (0.016 in <sup>2</sup> )	Qty. 10 40 A	Qty. 11 40 A	Qty. 18 32 A	Qty. 22 28 A
16 mm <sup>2</sup> (0.024 in <sup>2</sup> )	Qty. 8 28 A	Qty. 10 27 A	Qty. 13 25 A	Qty. 15 26 A
25 mm <sup>2</sup> (0.039 in <sup>2</sup> )	Qty. 8 67 A	Qty. 8 73 A	Qty. 10 69 A	Qty. 10 70 A
35 mm <sup>2</sup> (0.054 in <sup>2</sup> )	Qty. 8 79 A	Qty. 8 86 A	Qty. 10 80 A	Qty. 10 80 A

#### Hinged Junction Boxes

T Rating: T6 @ Ta 40°C (104 °F) T5 @ Ta 55° C (131 °F)	Type				
	PJB403020	PJB504020	PJB604025	PJB806030	PJB108030
	400 x 300 x 206 mm (16 x 12 x 8")	500 x 400 x 206 mm (20 x 16 x 8")	610 x 400 x 257 mm (24 x 16 x 10")	820 x 610 x 300 mm (32 x 24 x 12")	1020 x 810 x 300 mm (40 x 32 x 12")
35 mm <sup>2</sup> (0.054 in <sup>2</sup> )	Qty. 12 100 A	Qty. 16 100 A	Qty. 16 100 A	—	—
50 mm <sup>2</sup> (0.078 in <sup>2</sup> )	Qty. 8 125 A	Qty. 12 125 A	Qty. 16 125 A	—	—
70 mm <sup>2</sup> (0.109 in <sup>2</sup> )	Qty. 8 160 A	Qty. 10 160 A	Qty. 12 160 A	—	—
95 mm <sup>2</sup> (0.147 in <sup>2</sup> )	Qty. 8 200 A	Qty. 10 200 A	Qty. 12 200 A	—	—
120 mm <sup>2</sup> (0.186 in <sup>2</sup> )	Qty. — 1 Max.	Qty. 8 250 A	Qty. 8 250 A	Qty. 12 200 A	Qty. 16 150 A
150 mm <sup>2</sup> (0.233 in <sup>2</sup> )	Qty. — 1 Max.	—	Qty. 6 250 A	Qty. 9 250 A	Qty. 12 190 A
185 mm <sup>2</sup> (0.287 in <sup>2</sup> )	Qty. — 1 Max.	—	—	Qty. 8 300 A	Qty. 10 240 A

# PJB Series Polyester Nonmetallic Enclosures

NEC/CEC:  
Class 1, Zone 1 and 2 A/Exe II T5 or T6  
IP66

ATEX/IECEx:  
Zone 1 and 2 – 21 and 22  
II 2 GD  
IP66 – IK10

## Dimensions in Millimeters (Inches)

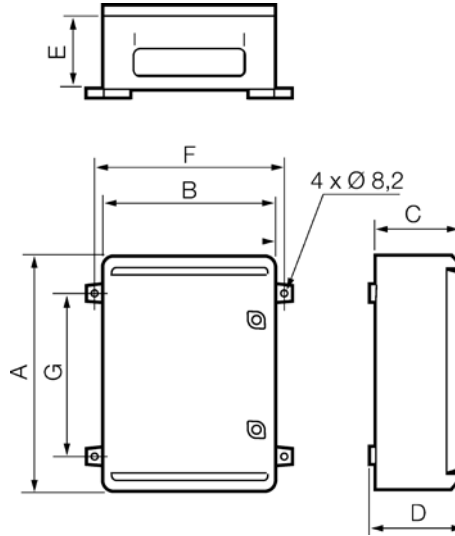

Catalog Number	External			Fitting			
	A	B	C	D	E	F	G
PJB403020	405 (15.94)	305 (12.01)	200 (7.87)	215 (8.46)	180 (7.09)	326 (12.83)	336 (13.23)
PJB504020	500 (19.68)	400 (15.78)	200 (7.87)	215 (8.46)	180 (7.09)	425 (16.73)	465 (18.31)
PJB604025	600 (23.62)	400 (15.78)	250 (9.84)	265 (10.43)	230 (9.06)	425 (16.73)	566 (22.28)
PJB806030	828 (32.60)	618 (24.33)	300 (11.81)	315 (12.40)	280 (11.02)	658 (25.91)	768 (30.24)
PJB108030	1028 (40.47)	818 (32.20)	300 (11.81)	315 (12.40)	280 (11.02)	858 (33.78)	968 (38.11)

# ATX™ JBEP Series Undrilled and Pre-Drilled, FRP Empty Junction Boxes

Fiberglass Reinforced Polyester. Increased Safety. For Field Drilling and Customization.

**NEC/CEC:**  
Class I, Zone 1, AEx e IIC, T5 or T6  
Ex e IIC, T5 or T6  
IP66

**ATEX/IECEx:**  
Zone 1 and 2 – 21 and 22  
Ⓜ II 2 GD  
IP66 – IK10

## Applications

- Designed for Zones 1 or 2 areas, where flammable gases or vapors are present either continuously, often or accidentally such as:
  - Petroleum
  - Chemical
  - Refineries
  - Other industrial process facilities
- Ideal for indoor/outdoor use with wet or corrosive atmospheres.
- Designed for use in Zones 21 or 22 areas where flammables dusts (conductive and non conductive) are present either continuously, often or accidentally such as:
  - Food processing
  - Dairy
  - Brewing
  - Other industrial process facilities
- Designed for Zone 0 and Zone 20 Intrinsically Safe applications when used with rated terminals.

## Features

- Available in a wide range of sizes:
  - For armored, unarmored or armored lead sheathed cable
  - For use with Mantle Clamping (Pillar Terminals) for use as instrumentation, electrical or power terminals
  - For use with a variety of connection and earth terminals
- Optional external hinged enclosures:
  - Reversible door opening 120°.
  - Door with double bar lock.
  - Key locking facility.
- Refer to the technical guide to determine permitted and sizes of terminals and cables entries for self arrangement.

## Standard materials

- Enclosures: Static resistant carbon filled fiberglass reinforced polyester (FRP)
- Hardware: stainless steel
- Gasket for sizes 85 x 85, 120 x 120: silicone
- Gasket for other sizes: EPDM (ethylene propylene diene monomer rubber)

## Options

- External hinges are available on the following sizes:
  - 500 x 320 x 150
  - 500 x 320 x 230
  - 750 x 320 x 150
  - 750 x 320 x 230
- Silicone gasket available for sizes 170 x 170 and 200 x 215
- Removable glands plates
- Nameplates
- Mounting pan
- Terminal rail
- Inside pocket for document
- Consult factory for custom drilling and assembly requirements.

## NEC/CEC Certifications and Compliances

- UL Standard: UL 60079-0; 60079-7
- CSA Standard: C22.2 No. 60079-0: 11; 60079-7: 12
- cCSAus Certified: 2625458
- CSA Listed: 013017

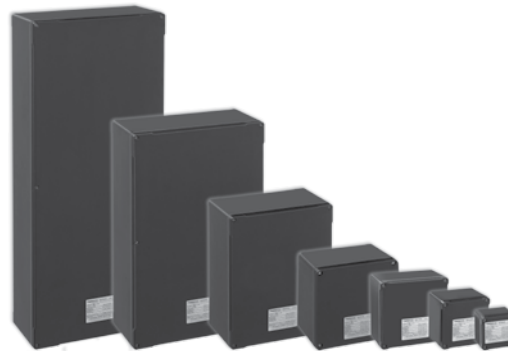

## ATEX/IECEx Certifications and Compliances

- Certification Type JBEP
  - Gas, Zones 1 and 2:
    - Conforming to ATEX 94/9/EC: Ⓜ IIG
    - Conforming to IECEx: EPL Gb
    - Type of Protection: Ex eb IIC, Ex eb ia IIC, Ex eb ib IIC, Ex ib IIC
    - Temperature Class: T6 for  $T_a \leq +40\text{ °C}$  (+104 °F), T5 for  $T_a \leq +60\text{ °C}$  (+140 °F) and T3 for  $T_a \leq +90\text{ °C}$  (+194 °F) for sizes 85 x 85, 120 x 120
  - Dusts, Zones 21 and 22:
    - Conforming to ATEX: Ⓜ IID
    - Conforming to IECEx: EPL Db
    - Type of Protection: Ex tb IIIC
    - Surface Temperature : T60 °C (T140 °F) for  $T_a \leq +40\text{ °C}$  (+104 °F), T90 °C (T194 °F) for  $T_a \leq +60\text{ °C}$  (+140 °F) and T110 °C (T230 °F) for  $T_a \leq +90\text{ °C}$  (+194 °F) for sizes 85 x 85, 120 x 120
  - Gas, Zone 0:
    - Conforming to ATEX 94/9/EC: Ⓜ II 1G
    - Conforming to IECEx : EPL Ga
    - Type of Protection: Ex ia IIC
    - T Rating: T6 for  $T_a \leq +40\text{ °C}$  (+104 °F) and T5 for  $T_a \leq +60\text{ °C}$  (+140 °F) and T3 for  $T_a \leq +90\text{ °C}$  (+194 °F) for sizes 85 x 85, 120 x 120
  - Dusts, Zones 20:
    - Conforming to ATEX: Ⓜ II 1D
    - Conforming to IECEx: EPL Da
    - Type of Protection: Ex ia IIIC
    - Surface Temperature : T60 °C (T140 °F) for  $T_a \leq +40\text{ °C}$  (+104 °F), T90 °C (T194 °F) for  $T_a \leq +60\text{ °C}$  (+140 °F) and T110 °C (T230 °F) for  $T_a \leq +90\text{ °C}$  (+194 °F) for sizes 85 x 85, 120 x 120
- ATEX Certificate: LCIE 12 ATEX 3037X
- EC Declaration of Conformity : 50291
- IECEx Certificate: IECEx LCIE 13.0003X
- Index of Protection according EN/IEC 60529: IP66
- Impact Resistance: IK10

## EURASEC Certification

- EURASEC N° TC RU C-FR.Г505.B.00911

## Other Certification

- INMETRO Certificate: BVC 13.3238 - X Ⓜ

Ⓜ INMETRO certification available on special request only. Contact your local sales representative for more information.



# ATX™ JBEP Series Undrilled and Pre-Drilled, FRP Empty Junction Boxes

Fiberglass Reinforced Polyester. Increased Safety. For Field Drilling and Customization.

**NEC/CEC:**  
 Class I, Zone 1, AEx e IIC, T5 or T6  
 Ex e IIC, T5 or T6  
 IP66

**ATEX/IECEX:**  
 Zone 1 and 2 – 21 and 22  
 II 2 GD  
 IP66 – IK10

## Catalog Numbering Guide - JBEP Undrilled and Pre-Drilled, Empty Junction Boxes

<p><b>JBE</b></p> <p>Series:                  JBE - NEC/CEC                  and ATEX/                  IECEx Certified                  Junction Box</p>	<p><b>P</b></p> <p>Material:                  P - Polyester</p>	<p><b>08</b></p> <p>Dimensions                  Height mm (in):                  08 - 85 (3.35)                  12 - 120 (4.72)                  17 - 170 (6.69)                  20 - 200 (7.87)                  21 - 215 (8.46)                  23 - 230 (9.05)                  25 - 250 (9.84)                  32 - 320 (12.60)                  50 - 500 (19.69)                  75 - 750 (29.53)</p>	<p><b>08</b></p> <p>Dimensions                  Width mm (in):                  08 - 85 (3.35)                  12 - 120 (4.72)                  17 - 170 (6.69)                  20 - 200 (7.87)                  21 - 215 (8.46)                  25 - 250 (9.84)                  32 - 320 (12.60)                  50 - 500 (19.69)                  75 - 750 (29.53)</p>	<p><b>06</b></p> <p>Dimensions                  Depth mm (in):                  06 - 61 (2.36)                  07 - 66 (2.60)                  09 - 91 (3.58)                  09S - 91 (3.58) ①                  11 - 116 (4.57)                  15 - 150 (5.91)                  23 - 230 (9.06)</p>	<p><b>0</b></p> <p>Gland Plates                  (for location see chart below):                  0 - No Gland Plate                  1 - Bottom, Plastic                  2 - Top and Bottom, Plastic                  3 - Bottom and Sides, Plastic                  4 - All Sides Plastic,                  5 - Bottom, Brass                  6 - Top and Bottom, Brass                  7 - Bottom and Sides, Brass                  8 - All Sides, Brass</p>	<p><b>G</b></p> <p>Options:                  (Options must be listed                  alphabetically)                  A - Earth continuity Brass                  Plate                  G - Cable Glands                  M - Mounting Pan                  H - Hinges for sizes 500 or                  750 x 320 x 150 or 230                  mm (19.69" or 29.53" x                  9.06" x 5.91" or 9.06")                  HR - Horizontal DIN-Rail                  VR - Vertical DIN-Rail                  # - Customized at Factory</p>
---	---	---	---	--	--	---

① 09S Internal dimensions are 0.9 mm (0.035 in) less than the 09 internal dimensions.

# ATX™ JBEP Series Undrilled and Pre-Drilled, FRP Empty Junction Boxes

Fiberglass Reinforced Polyester. Increased Safety. For Field Drilling and Customization.

**NEC/CEC:**  
Class I, Zone 1, AEx e IIC, T5 or T6  
Ex e IIC, T5 or T6  
IP66

**ATEX/IECEX:**  
Zone 1 and 2 – 21 and 22  
II 2 GD  
IP66 – IK10

### Gland Plate Location Chart ①

Height x Width x Depth Dimensions in Millimeters (Inches)				
250 x 320 x 150 (9.84 x 12.60 x 5.91)	500 x 320 x 150 or 230 (19.69 x 12.60 x 5.91 or 12.60)	750 x 320 x 150 or 230 (29.53 x 12.60 x 5.91 or 12.60)	320 x 500 x 150 or 230 (12.60 x 19.69 x 5.91 or 12.60)	320 x 750 x 150 or 230 (12.60 x 29.53 x 5.91 or 12.60)
<b>Bottom</b>				
<b>Top and Bottom</b>				
<b>Bottom and Sides</b>				
N/A				
<b>All Sides</b>				
N/A				

### Spare Removable Gland Plate — Supplied with Gasket and Hardware

Description	Size	Weight – kg (lb)	Volume – dm <sup>3</sup> (in <sup>3</sup> )	Size – mm (in)	Catalog Number	
	Plastic	A	0.56 (1.24)	0.8 (48.8)	127 X 268 (5.00 X 10.55)	<b>JBEPGPPA</b>
	Plastic	B	0.51 (1.13)	0.6 (37.0)	127 X 203 (5.00 X 8.00)	<b>JBEPGPPB</b>
	Brass	A	1.5 (3.3)	0.8 (48.8)	127 X 268 (5.00 X 10.55)	<b>JBEPGPBA</b>
	Brass	B	1.30 (2.87)	0.6 (37.0)	127 X 203 (5.00 X 8.00)	<b>JBEPGPBB</b>

① A = 127 x 268 (5" x 10.55").  
B = 127 x 203 (5" x 8").

# ATX™ JBEP Series Undrilled and Pre-Drilled, FRP Empty Junction Boxes





Fiberglass Reinforced Polyester. Increased Safety. For Field Drilling and Customization.

NEC/CEC:  
Class I, Zone 1, AEx e IIC, T5 or T6  
Ex e IIC, T5 or T6  
IP66

ATEX/IECEX:  
Zone 1 and 2 – 21 and 22  
II 2 GD  
IP66 – IK10

## Ex eb IIC Polyester Enclosures

For use with Ex certified terminals only (not supplied). DIN-Rail not supplied.  
For DIN Rail dimensions, see DIN Rail Sizes chart on following page.

	Dimension – H x W x D – mm (in)	Enclosure Weight – kg (lb)	Enclosure Volume – dm <sup>3</sup> (in <sup>3</sup> )	Shipping Carton Volume – dm <sup>3</sup> (in <sup>3</sup> )	Catalog Number ①
	85 x 85 x 60 (3.35 x 3.35 x 2.36)	0.38 (0.84)	0.43 (26.45)	1.35 (82.38)	JBEP0808060 ②
	120 x 120 x 91 (4.75 x 4.75 x 3.58)	0.75 (1.65)	1.31 (79.97)	1.98 (121.10)	JBEP121209S0
	170 x 170 x 91 (6.69 x 6.69 x 3.58)	1.32 (2.91)	2.63 (160.49)	4.04 (246.56)	JBEP1717090
	200 x 215 x 95 (7.87 x 8.47 x 3.74)	2.06 (4.54)	4.09 (249.28)	9.54 (582.17)	JBEP2021100
	200 x 215 x 150 (7.87 x 8.47 x 5.91)	2.67 (5.89)	6.45 (393.60)	9.54 (582.17)	JBEP2021150
	250 x 320 x 150 (9.84 x 12.60 x 5.91)	3.90 (8.60)	12.00 (732.28)	19.35 (1181.01)	JBEP2532150
	500 x 320 x 150 (19.69 x 12.60 x 5.91)	6.39 (14.09)	24.00 (1464.57)	71.63 (4371.33)	JBEP5032150
	750 x 320 x 150 (29.53 x 12.60 x 5.91)	8.69 (19.16)	36.00 (2196.85)	46.41 (2831.84)	JBEP7532150
	320 x 250 x 150 (12.60 x 9.84 x 5.91)	3.90 (8.60)	12.00 (732.28)	19.35 (1181.01)	JBEP3225150
	320 x 500 x 150 (12.60 x 19.69 x 5.91)	6.39 (14.09)	24.00 (1464.57)	71.63 (4371.33)	JBEP3250150
	320 x 750 x 150 (12.60 x 29.53 x 5.91)	8.69 (19.16)	36.00 (2196.85)	46.41 (2831.84)	JBEP3275150
	500 x 320 x 230 (19.69 x 12.60 x 9.06)	8.02 (17.68)	36.80 (2245.67)	71.63 (4371.33)	JBEP5032230
	750 x 320 x 230 (29.53 x 12.60 x 9.06)	11.54 (25.44)	55.20 (3368.51)	82.13 (5011.76)	JBEP7532230
	320 x 500 x 230 (12.60 x 19.69 x 9.06)	8.02 (17.68)	36.80 (2245.67)	71.63 (4371.33)	JBEP3250230
	320 x 750 x 230 (12.60 x 29.53 x 9.06)	11.54 (25.44)	55.20 (3368.51)	82.13 (5011.76)	JBEP3275230

① To order enclosure fitted with removable gland plate as standard, replace last digit of the catalog number 0 with 1 to 8; example: JBEP3275238.  
② Due to the small size of the JBEP0808060, the optional Laminated Plastic Nameplate for Engraving is not recommended for this enclosure.  
The 85 x 85 x 60 mm (3.35 x 3.35 x 2.36 in) dimensions do not allow for mounting space beyond the factory adhered product label.

# ATX™ JBEP Series Undrilled and Pre-Drilled, FRP Empty Junction Boxes

Fiberglass Reinforced Polyester. Increased Safety. For Field Drilling and Customization.



NEC/CEC:  
Class I, Zone 1, AEx e IIC, T5 or T6  
Ex e IIC, T5 or T6  
IP66

ATEX/IECEX:  
Zone 1 and 2 – 21 and 22  
II 2 GD  
IP66 – IK10

Ex eb IIC Factory Drilled JBEP Polyester Junction Boxes Equipped with One horizontal Symmetrical Zinc Plated Rail, Yellow Laminated Plastic Label with Black Lettering, Internal earth terminal, and Earth Continuity Device.

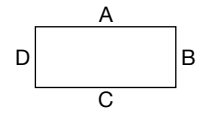
For use with Ex terminals only (not supplied).  
Cable glands and plugs ordered separately.



Enclosure Type	Rail Length Capacity (mm)	Clearance Holes Per Side				Weight kg (lb)	Volume dm <sup>3</sup> (in <sup>3</sup> )	Dimensions H x W x D – mm (in)	Catalog Number
		A	B	C	D				
 JBEP0808060	41	—	1 x M20	1 x M20	1 x M20	0.42 (0.93)	0.44 (26.9)	85 x 85 x 60 (3.35 x 3.35 x 2.36)	JBEP080806003 ①
JBEP0808060	41	1 x M20	1 x M20	1 x M20	1 x M20	0.42 (0.93)	0.44 (26.9)	85 x 85 x 60 (3.35 x 3.35 x 2.36)	JBEP080806004 ①
JBEP121209S0	73	—	1 x M20	1 x M20	1 x M20	0.85 (1.87)	1.31 (80.0)	120 x 120 x 91 (4.72 x 4.72 x 3.58)	JBEP121209003
JBEP121209S0	73	1 x M20	1 x M20	1 x M20	1 x M20	0.85 (1.87)	1.31 (80.0)	120 x 120 x 91 (4.72 x 4.72 x 3.58)	JBEP121209004
 JBEP1717090	122	1 x M20	1 x M20	1 x M20	1 x M20	1.54 (3.40)	2.65 (162.0)	170 x 170 x 91 (6.69 x 6.69 x 3.58)	JBEP171709004
JBEP1717090	122	—	2 x M20	2 x M20	2 x M20	1.54 (3.40)	2.65 (162.0)	170 x 170 x 91 (6.69 x 6.69 x 3.58)	JBEP171709006
JBEP1717090	122	1 x M25	1 x M25	1 x M25	1 x M25	1.54 (3.40)	2.65 (162.0)	170 x 170 x 91 (6.69 x 6.69 x 3.58)	JBEP171709014
JBEP1717090	122	—	2 x M25	2 x M25	2 x M25	1.54 (3.40)	2.65 (162.0)	170 x 170 x 91 (6.69 x 6.69 x 3.58)	JBEP171709016

① Due to the size of JBEP0808060, optional Laminated Plastic Nameplate for Engraving is not recommended for this enclosure.  
The 85 x 85 x 60 mm (3.35 x 3.35 x 2.36 in) dimensions do not allow for mounting space beyond the factory adhered product label.

# ATX™ JBEP Series Undrilled and Pre-Drilled, FRP Empty Junction Boxes

Fiberglass Reinforced Polyester. Increased Safety. For Field Drilling and Customization.

NEC/CEC:  
Class I, Zone 1, AEx e IIC, T5 or T6  
Ex e IIC, T5 or T6  
IP66

ATEX/IECEX:  
Zone 1 and 2 – 21 and 22  
II 2 GD  
IP66 – IK10

## Horizontal Din Rail

Rail size for JBEP080806 15 x 5.5 mm. All other rail sizes are 35 x 15 mm or 35 x 7.5 mm.  
NEC/CEC and ATEX/IECEX: Terminal block WDU used for all sizes.

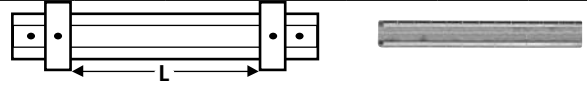

Enclosure Catalog Number	Horizontal Terminal Rail Overall Length	L	Max. Qty	Number of Terminals of the same pitch per rail — Nominal cross section (mm <sup>2</sup> )/pitch (mm)											Earthing Bar
				2.5 / 5.1	4 / 6.1	6 / 7.9	10 / 9.9	16 / 11.9	35 / 16	50 / 18.5	70 / 20.5	95/120 / 27			
JBEP0808060	—	70	41	1	6	4	4	0	0	0	0	0	0	0	N/A
JBEP121209S0	—	94	73	1	14	12	0	0	0	0	0	0	0	0	N/A
JBEP1717090	—	150	122	1	24	20	15	12	9	0	0	0	0	90	
JBEP2021100	—	190	165	1	32	27	20	16	13	9	0	0	0	195	
JBEP2021150	—	199	165	1	32	27	20	16	13	9	0	0	0	155	
JBEP2532150	==	296	245	2	96	80	34	27	22	16	0	0	0	230	
JBEP3225150	==	223	199	2	78	66	50	40	32	12	10	9	0	160	
JBEP3250150	===	476	450	2	176	146	114	90	74	27	23	21	0	470	
JBEP3250230	===	476	450	2	176	146	114	90	74	27	23	21	0	470	
JBEP3275150	===	728	700	2	274	228	176	140	116	43	37	33	0	720	
JBEP3275230	===	728	700	2	274	228	176	140	116	43	37	33	0	720	
JBEP5032150	====	296	270	4	198	168	100	79	64	32	14	12	9	230	
JBEP5032230	====	296	270	4	198	168	100	79	64	32	14	12	9	230	
JBEP7532150	=====	296	270	6	318	264	168	133	88	46	28	24	9	230	
JBEP7532230	=====	296	270	6	318	264	168	133	88	46	28	24	9	230	

# ATX™ JBEP Series Undrilled and Pre-Drilled, FRP Empty Junction Boxes

Fiberglass Reinforced Polyester. Increased Safety. For Field Drilling and Customization.

NEC/CEC:  
Class I, Zone 1, AEx e IIC, T5 or T6  
Ex e IIC, T5 or T6  
IP66

ATEX/IECEX:  
Zone 1 and 2 – 21 and 22  
II 2 GD  
IP66 – IK10

## Vertical Din Rail

Rail size for JBEP080806 15 x 5.5 mm. All other rail sizes are 35 x 15 mm or 35 x 7.5 mm.  
NEC/CEC and ATEX/IECEX: Terminal block WDU used for all sizes.

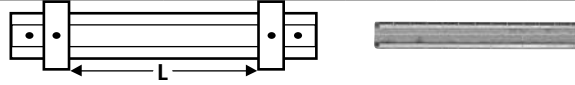

Enclosure Catalog Number	Vertical Terminal Rail	Number of Terminals of the same pitch per rail — Nominal cross section (mm <sup>2</sup> ) and pitch (mm)												
		Length	L	Max. Qty	2.5 / 5.1	4 / 6.1	6 / 7.9	10 / 9.9	16 / 11.9	35 / 16	50 / 18.5	70 / 20.5	95/120 / 27	Earthing Bar
JBEP0808060	I	70	41	1	6	4	4	0	0	0	0	0	0	N/A
JBEP121209S0	I	94	73	1	14	12	0	0	0	0	0	0	0	N/A
JBEP1717090	I	150	122	1	24	20	15	12	9	0	0	0	0	128
JBEP2021100	I	178	149	1	29	24	18	15	11	8	0	0	0	155
JBEP2021150	I	178	149	1	29	24	18	15	11	8	0	0	0	195
JBEP2532150	II	223	199	2	78	66	50	40	32	12	10	9	0	160
JBEP3225150	II	296	245	2	96	80	34	27	22	16	0	0	0	230
JBEP3250150	III	296	270	4	198	168	100	79	64	32	14	12	9	230
JBEP3250230	III	296	270	4	198	168	100	79	64	32	14	12	9	230
JBEP3275150	IIII	296	270	6	318	264	168	133	88	46	28	24	9	230
JBEP3275230	IIII	296	270	6	318	264	168	133	88	46	28	24	9	230
JBEP5032150	III	476	450	2	176	146	114	90	74	27	23	21	0	470
JBEP5032230	III	476	450	2	176	146	114	90	74	27	23	21	0	470
JBEP7532150	III	728	700	2	274	228	176	140	116	43	37	33	9	720
JBEP7532230	III	728	700	2	274	228	176	140	116	43	37	33	9	720

# ATX™ JBEP Series Undrilled and Pre-Drilled, FRP Empty Junction Boxes

Fiberglass Reinforced Polyester. Increased Safety. For Field Drilling and Customization.

NEC/CEC:  
Class I, Zone 1, AEx e IIC, T5 or T6  
Ex e IIC, T5 or T6  
IP66

ATEX/IECEX:  
Zone 1 and 2 – 21 and 22  
II 2 GD  
IP66 – IK10

## Solid Copper Bar – Available in 1 Meter Length Pieces

Enclosure Catalog Number	Horizontal Bar Length – mm	Vertical Bar Length – mm	Catalog Number
For 10 x 3 mm length is 1 meter			<b>CB1M</b>
JBEP1717090	128	90	
JBEP2021100	195	97	
JBEP2021150	195	97	
JBEP2532150	300	230	
JBEP3225150	230	300	
JBEP3250150	480	305	
JBEP3250230	480	305	
JBEP3275150	730	300	
JBEP3275230	730	300	
JBEP5032150	305	480	
JBEP5032230	305	480	
JBEP7532150	300	730	
JBEP7532230	300	730	

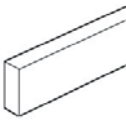

## Cable Clamp for Copper Bar – Pack of 10 – 10 x 3 mm (0.394" x 0.118")

Flexible	Solid	Catalog Number
0.5 to 4 mm <sup>2</sup> (20AWG-10AWG)	6 mm <sup>2</sup> (10AWG)	<b>CC6MM</b>
2.5 to 16 mm <sup>2</sup> (14AWG-4AWG)	16 mm <sup>2</sup> (4AWG)	<b>CC16MM</b>
16 to 35 mm <sup>2</sup> (6AWG-1AWG)	50 mm <sup>2</sup> (1/0)	<b>CC50MM</b>



## Spacer for Copper Bar – Supplied with Mounting Inserts

Description	Height – mm (in)	Catalog Number
Insulated	50 (1.97)	<b>JBEP CBI</b>
Non-Insulated	50 (1.97)	<b>JBEP CBNI</b>



## Mounting Pan – Solid Galvanized Steel – Supplied with Screws

Enclosure Catalog Number	Dimensions – mm (in) Height x Width x Thickness	Catalog Number
JBEP0808060	46 x 75 x 1 (1.8 x 2.95 x 0.04)	<b>JBEP0407</b>
JBEP121209S0	100 x 80 x 1 (3.9 x 3.2 x 0.04)	<b>JBEP1008</b>
JBEP1717090	152 x 150 x 1 (5.98 x 5.9 x 0.04)	<b>JBEP1515</b>
JBEP2021100, JBEP2021150	185 x 170 x 1.5 (7.28 x 6.69 x 0.06)	<b>JBEP1518</b>
JBEP3225150, JBEP2532150	260 x 230 x 2 (10.2 x 9.1 x 0.08)	<b>JBEP2623</b>
JBEP3250150, JBEP3250230, JBEP5032150, JBEP5032230	480 x 260 x 2 (18.9 x 10.2 x 0.08)	<b>JBEP4826</b>
JBEP3275150, JBEP3275230, JBEP7532150, JBEP7532230	730 x 260 x 2 (28.7 x 10.2 x 0.08)	<b>JBEP7326</b>



# ATX™ JBEP Series Undrilled and Pre-Drilled, FRP Empty Junction Boxes

Fiberglass Reinforced Polyester. Increased Safety. For Field Drilling and Customization.

NEC/CEC:  
Class I, Zone 1, AEx e IIC, T5 or T6  
Ex e IIC, T5 or T6  
IP66

ATEX/IECEX:  
Zone 1 and 2 – 21 and 22  
II 2 GD  
IP66 – IK10

## Mounting Screws — Self Tapping — Used for Mounting DIN Rails and Mounting Pan — Pack of 50

Description	Catalog Number
 Sheet metal screw with a drill point and a Phillips pan head	<b>JBEPMS8</b>

## Earth Continuity Brass Plate — Thickness: 3.00 mm (0.12 in)

Enclosure Catalog Number	Side – mm (in)	Catalog Number	Bottom – mm (in)	Catalog Number
JBEP121209S0	58 x 44 (2.28 x 1.73)	<b>JBEP02S</b>	72 x 44 (2.83 x 1.73)	<b>JBEP02B</b>
JBEP1717090	105 x 65 (4.13 x 2.55)	<b>JBEP05S</b>	127 x 65 (5 x 2.56)	<b>JBEP05B</b>
JBEP2021100	105 x 65 (4.13 x 2.56)	<b>JBEP06S</b>	150 x 65 (5.90 x 2.56)	<b>JBEP06B</b>
JBEP2021150	105 x 105 (4.13 x 4.13)	<b>JBEP07S</b>	150 x 105 (5.90 x 4.13)	<b>JBEP07B</b>
JBEP2532150	150 x 116 (5.90 x 4.56)	<b>JBEP08S</b>	250 x 116 (9.84 x 4.57)	<b>JBEP08B</b>
JBEP3225150	250 x 116 (9.84 x 4.56)	<b>JBEP10S</b>	150 x 116 (5.91 x 4.57)	<b>JBEP10B</b>
JBEP3250150	250 x 116 (9.84 x 4.56)	<b>JBEP11S</b>	180 x 116 (7.09 x 4.57)	<b>JBEP11B</b>
JBEP3250230	250 x 196 (9.84 x 7.71)	<b>JBEP16S</b>	180 x 196 (7.09 x 7.72)	<b>JBEP16B</b>
JBEP3275150	250 x 116 (9.84 x 4.56)	<b>JBEP12S</b>	305 x 116 (12.00 x 4.57)	<b>JBEP12B</b>
JBEP3275230	250 x 196 (9.84 x 7.71)	<b>JBEP17S</b>	305 x 196 (12.00 x 7.72)	<b>JBEP17B</b>
JBEP5032150	180 x 116 (7.08 x 4.56)	<b>JBEP09S</b>	250 x 116 (9.84 x 4.57)	<b>JBEP09B</b>
JBEP5032230	180 x 196 (7.08 x 7.71)	<b>JBEP13S</b>	250 x 196 (9.84 x 7.72)	<b>JBEP13B</b>
JBEP7532150	305 x 116 (12.0 x 4.56)	<b>JBEP14S</b>	250 x 116 (9.84 x 4.57)	<b>JBEP14B</b>
JBEP7532230	305 x 196 (12.0 x 7.71)	<b>JBEP15S</b>	250 x 196 (9.84 x 7.72)	<b>JBEP15B</b>



# ATX™ JBEP Series Undrilled and Pre-Drilled, FRP Empty Junction Boxes

Fiberglass Reinforced Polyester. Increased Safety. For Field Drilling and Customization.

**NEC/CEC:**  
Class I, Zone 1, AEx e IIC, T5 or T6  
Ex e IIC, T5 or T6  
IP66

**ATEX/IECEX:**  
Zone 1 and 2 – 21 and 22  
II 2 GD  
IP66 – IK10

## Self Adhesive Pocket for Drawings — Set of 5, A4 Size

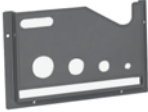
	External Dimension – mm (in)	Internal Dimensions – mm (in)	Catalog Number
	260 x 165 (10 x 6)	230 x 130 x 18 (9 x 5 x 1)	<b>JBEPSAP</b>
Set of 5 — Self adhesive plastic protective sleeve, Size A4.			<b>JBEPSAPS</b>

## Laminated Plastic Nameplate for Engraving ①

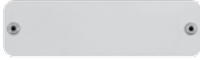
	Description	Size – mm (in)	Catalog Number
	White color with black lettering, two (2) mounting rivets included	65 x 18 (2.56 x 0.709)	<b>NPW</b>
	Yellow color with black lettering, two (2) mounting rivets included	65 x 18 (2.56 x 0.709)	<b>NPY</b>

## Feed-Thru Earth/Ground Terminal

	Description	Size	Catalog Number
	Stainless steel, complete with gasket washer, lock washers, nuts for internal and external cable connections	M8	<b>JBEPET</b>
Set of 10 — Press fit, brass expansion insert		M5	<b>JBPEXI</b>

① Due to the size of JBEP0808060, optional Laminated Plastic Nameplate for Engraving is not recommended for this enclosure.  
The 85 x 85 x 60 mm (3.35 x 3.35 x 2.36 in) dimensions do not allow for mounting space beyond the factory adhered product label.

# ATX™ JBEP Series Undrilled and Pre-Drilled, FRP Empty Junction Boxes

Fiberglass Reinforced Polyester. Increased Safety. For Field Drilling and Customization.

NEC/CEC:  
Class I, Zone 1, AEx e IIC, T5 or T6  
Ex e IIC, T5 or T6  
IP66

ATEX/IECEx:  
Zone 1 and 2 – 21 and 22  
II 2 GD  
IP66 – IK10

## Dimensions in Millimeters (Inches) ①

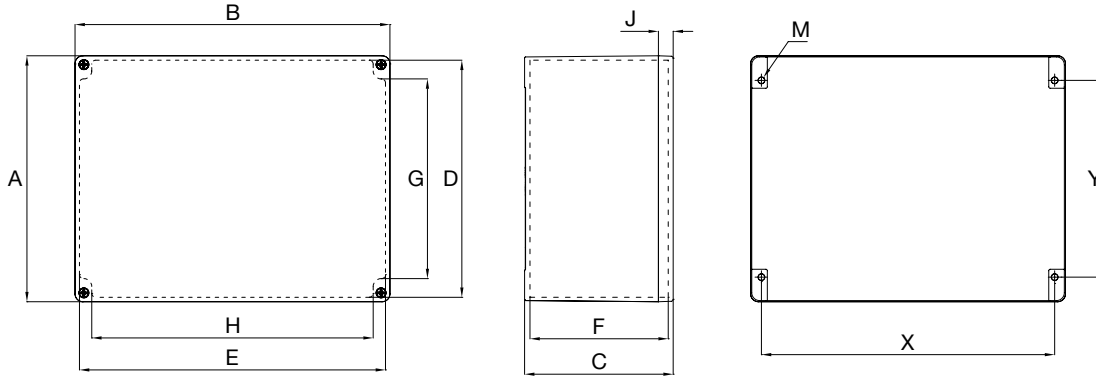

Enclosure Catalog Number	External Dimension				Internal Dimensions				Cover J	Body Thickness	Wall Fixing		
	A	B	C	D	E	F	G	H			X	Y	M ②
JBEP0808060	85 (3.346)	85 (3.346)	61 (2.402)	76.7 (3.020)	76.7 (3.020)	47 (1.850)	41 (1.614)	51 (2.008)	15 (0.591)	3.5 (0.138)	69 (2.717)	49 (1.929)	M4
JBEP1212070	120 (4.724)	120 (4.724)	66 (2.598)	109.5 (4.311)	109.5 (4.311)	50.7 (1.996)	63 (4.528)	85 (3.346)	15 (0.591)	4.5 (0.177)	103 (4.055)	83 (3.268)	M5
JBEP1212090	120 (4.724)	120 (4.724)	91 (3.583)	109.5 (4.311)	109.5 (4.311)	75 (2.953)	63 (4.528)	85 (3.346)	40 (1.575)	4.5 (0.177)	103 (4.055)	83 (3.268)	M5
JBEP121209S0	120 (4.724)	120 (4.724)	91 (3.583)	108.6 (4.276)	108.6 (4.276)	75 (2.953)	63 (4.528)	85 (3.346)	15 (0.591)	4.5 (0.177)	103 (4.055)	83 (3.268)	M5
JBEP1717090	170 (6.693)	170 (6.693)	91 (3.583)	158.5 (6.240)	158.5 (6.240)	72 (2.835)	112.5 (4.429)	137 (5.394)	15 (0.591)	4.5 (0.177)	153 (6.024)	131 (5.157)	M5
JBEP1712090	170 (6.693)	120 (4.724)	91 (3.583)	159.5 (6.280)	109.5 (4.311)	75 (2.953)	107.3 (4.224)	87 (3.425)	40 (1.575)	4.5 (0.177)	103 (4.055)	131 (5.157)	M5
JBEP2021100	200 (7.874)	215 (8.465)	95 (3.740)	185.8 (7.315)	200.8 (7.906)	76 (2.992)	116 (4.567)	159 (6.260)	20 (0.787)	6.1 (0.240)	189 (7.441)	146 (5.748)	M6
JBEP2021150	200 (7.874)	215 (8.465)	145 (5.709)	185.8 (7.315)	200.8 (7.906)	122.5 (4.823)	114.8 (4.519)	159 (6.260)	20 (0.787)	6.1 (0.240)	189 (7.441)	146 (5.748)	M6
JBEP2532150	250 (9.843)	320 (12.598)	150 (5.906)	241 (9.488)	311 (12.244)	133.5 (5.256)	171 (6.732)	267 (10.512)	15 (0.591)	5 (0.197)	200 (7.874)	298 (11.732)	M6
JBEP3225150	320 (12.598)	250 (9.843)	150 (5.906)	311 (12.244)	241 (9.488)	133.5 (5.256)	267 (10.512)	171 (6.732)	15 (0.591)	5 (0.197)	298 (11.732)	200 (7.874)	M6
JBEP3250150	320 (12.598)	500 (19.685)	150 (5.906)	311 (12.244)	491 (19.331)	133.5 (5.256)	267 (10.512)	421 (16.575)	15 (0.591)	5 (0.197)	298 (11.732)	447 (17.598)	M6
JBEP3250230	320 (12.598)	500 (19.685)	230 (9.055)	311 (12.244)	491 (19.331)	213.5 (8.406)	267 (10.512)	421 (16.575)	15 (0.591)	5 (0.197)	298 (11.732)	447 (17.598)	M6
JBEP3275150	320 (12.598)	750 (29.528)	150 (5.906)	311 (12.244)	741 (29.173)	133.5 (5.256)	267 (10.512)	671 (26.417)	15 (0.591)	5 (0.197)	298 (11.732)	698 (27.480)	M6
JBEP3275230	320 (12.598)	750 (29.528)	230 (9.055)	311 (12.244)	741 (29.173)	213.5 (8.406)	267 (10.512)	671 (26.417)	15 (0.591)	5 (0.197)	298 (11.732)	698 (27.480)	M6
JBEP5032150	500 (19.685)	320 (12.598)	150 (5.906)	491 (19.331)	311 (12.244)	133.5 (5.256)	421 (16.575)	267 (10.512)	15 (0.591)	5 (0.197)	447 (17.598)	298 (11.732)	M6
JBEP5032230	500 (19.685)	320 (12.598)	230 (9.055)	491 (19.331)	311 (12.244)	213.5 (8.406)	421 (16.575)	267 (10.512)	15 (0.591)	5 (0.197)	447 (17.598)	298 (11.732)	M6
JBEP7532150	750 (29.528)	320 (12.598)	150 (5.906)	741 (29.173)	311 (12.244)	133.5 (5.256)	671 (26.417)	267 (10.512)	15 (0.591)	5 (0.197)	298 (11.732)	698 (27.480)	M6
JBEP7532230	750 (29.528)	320 (12.598)	230 (9.055)	741 (29.173)	311 (12.244)	213.5 (8.406)	671 (26.417)	267 (10.512)	15 (0.591)	5 (0.197)	698 (27.480)	298 (11.732)	M6

① Wall fixing screw diameter 5 mm (0.20"). Wall fixing screw hole 6 mm (0.24").

② Screw to be used for mounting box.

# ATX™ JBEP Series FRP Terminal Junction Boxes for Instrumentation Applications

## Fiberglass Reinforced Polyester. Increased Safety. Factory Drilled and Equipped.

**NEC/CEC:**  
Class I, Zone 1, AEx e IIC, T5 or T6  
Ex e IIC, T5 or T6  
IP66

**ATEX/IECEx:**  
Zone 1 and 2 – 21 and 22  
Ⓢ II 2 GD  
IP66 – IK10

### Applications

- Instrumentation junction boxes are used to run process or remote information to control room.
- For use in intrinsic safety or non intrinsic safety systems.
- Designed for Zones 1 or 2 areas, where flammable gases or vapors are present either continuously, often or accidentally such as:
  - Petroleum
  - Chemical
  - Refineries
  - Other industrial process facilities
- Ideal for indoor/outdoor use with wet or corrosive atmospheres.
- Designed for use in Zones 21 or 22 areas where flammables dusts (conductive and non conductive) are present either continuously, often or accidentally such as:
  - Food processing
  - Dairy
  - Brewing
  - Other industrial process facilities
- Designed for Zone 0 and Zone 20 Intrinsically Safe applications when used with rated terminals.

### Features

- Available in a wide range of sizes:
  - For armored, unarmored or armored lead sheathed cable
  - For use with a variety of connection and earth terminals
- Optional external hinged enclosures:
  - Reversible door opening 120°.
  - Door with double bar lock.
  - Key locking facility.
- Terminal blocks on DIN rail.

### Standard materials

- Enclosures: Static resistant carbon filled fiberglass reinforced polyester (FRP)
- Hardware: stainless steel
- Gasket for other sizes: EPDM (ethylene propylene diene monomer rubber)

### Options

- External hinges are available on the following sizes:
  - 500 x 320 x 150
  - 500 x 320 x 230
  - 750 x 320 x 150
  - 750 x 320 x 230
- Removable glands plates
- Nameplates
- Mounting pan
- Inside pocket for document
- Consult factory for custom drilling, assembly requirements and other ambient temperatures.

### NEC/CEC Certifications and Compliances

- UL Standard: UL 60079-0; 60079-7
- CSA Standard: C22.2 No. 60079-0: 11; 60079-7: 12
- cCSAus Certified: 2625458
- CSA Listed: 013017

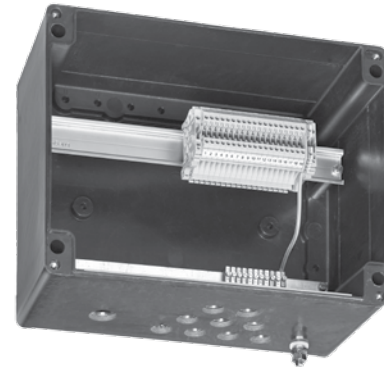

Cable Glands are available as an Option.

### ATEX/IECEx Certifications and Compliances ①

- Certification Type JBEP
  - Gas, Zones 1 and 2:
    - Conforming to ATEX 94/9/EC: Ⓢ II 2G
    - Conforming to IECEx : EPL Gb
    - Type of Protection: Ex eb IIC, Ex eb ia IIC, Ex eb ib IIC, Ex ib IIC
    - Temperature Class: T6 for  $T_a \leq +40\text{ °C}$  (+104 °F) and T5 for  $T_a \leq +60\text{ °C}$  (+140 °F)
  - Dusts, Zones 21 and 22:
    - Conforming to ATEX: Ⓢ II 2D
    - Conforming to IECEx: EPL Db
    - Type of Protection: Ex tb IIIC
    - Surface Temperature : T60 °C for  $T_a \leq +40\text{ °C}$  (+104 °F), T90 °C (T194 °F) for  $T_a \leq +60\text{ °C}$  (+140 °F)
  - Gas, Zone 0:
    - Conforming to ATEX 94/9/EC: Ⓢ II 1G
    - Conforming to IECEx : EPL Ga
    - Type of Protection: Ex ia IIC
    - Temperature Class: T6 for  $T_a \leq +40\text{ °C}$  (+104 °F) and T5 for  $T_a \leq +60\text{ °C}$  (+140 °F)
  - Dusts, Zones 20:
    - Conforming to ATEX: Ⓢ II 1D
    - Conforming to IECEx: EPL Da
    - Type of Protection: Ex ta IIIC
    - Surface Temperature: T60 °C (+140 °F) for  $T_a \leq +40\text{ °C}$  (+104 °F), T90 °C (T194 °F) for  $T_a \leq +60\text{ °C}$  (+140 °F)
- Ambient Temperatures :  $-55\text{ °C} \leq T_a \leq +60\text{ °C}$  ( $-67\text{ °F} \leq T_a \leq +140\text{ °F}$ )
- ATEX Certificate: LCIE 12 ATEX 3037X
- EC Declaration of Conformity: 50291
- IECEx Certificate: IECEx LCIE 13.0003X
- Index of Protection according EN/IEC 60529: IP66
- Impact Resistance: IK10

① The ambient temperature for complete assembly is equal to the lowest ambient temperature of the components used.

# ATX™ JBEP Series FRP Terminal Junction Boxes for Instrumentation Applications

Fiberglass Reinforced Polyester. Increased Safety. Factory Drilled and Equipped.

NEC/CEC:  
Class I, Zone 1, AEx e IIC, T5 or T6  
Ex e IIC, T5 or T6  
IP66

ATEX/IECEX:  
Zone 1 and 2 – 21 and 22  
II 2 GD  
IP66 – IK10

## Components Ambient Temperature ①

- Type : Bve (plastic close up plug)  
– Ambient Temperatures : -40 °C to +55 °C (-40 °F to +131 °F)
- Type : 757 (nickel plated close up plug)  
– Ambient Temperatures : -60 °C to +100 °C (-40 °F to +212 °F)
- Type : EEXe (plastic cable gland)  
– Ambient Temperatures : -20 °C to +55 °C (-4 °F to +131 °F)
- Type : E1FX, E2FX, E1FW, E2FW, T3, A2F (metal cable gland)  
– Ambient Temperatures : -60 °C to +130 °C (-76 °F to +266 °F)
- Type : PX, PX2K (metal cable gland)  
– Ambient Temperatures : -60 °C to +100 °C (-76 °F to +212 °F)
- Type : DBE (drain/breather)  
– Ambient Temperatures : -50 °C to +85 °C (-58 °F to +185 °F)
- Type : WDU, WFF (terminal)  
– Ambient Temperatures : -50 °C to +120 °C (-58 °F to +248 °F)
- Type : SAK, AKZ (terminal)  
– Ambient Temperatures : -50 °C to +100 °C (-58 °F to +212 °F)

## EURASEC Certification

- EURASEC N° TC RU C-FR.Г505.B.00911

## Other Certification

- INMETRO Certificate: BVC 13.3238 - X ②

## Illustrated Features — Sample of JBEP171709NI01

### Description

- |    |   |
|----|---|
| 1  | Body Of Polyester Box 170 x 170 x 90              |
| 2  | Cover Of Polyester Box 170 x 170 x 91             |
| 3  | DIN Rail  |
| 4  | Copper Bar 10 x 3                                 |
| 5  | Terminal Block - ATEX/IECEX: WDU 2.5              |
| 6  | Terminal Block - ATEX/IECEX: WPE 2.5              |
| 7  | Plate - ATEX/IECEX: WAP 2.5/10                    |
| 8  | End Bracket                                       |
| 9  | Cable Clamp 2.5 mm <sup>2</sup> (14AWG)- Capacity |
| 10 | Stainless Steel Rivet 2.5 x 5                     |
| 11 | Serrated Washer 5                                 |
| 12 | Label Gravoply - Yellow                           |
| 13 | Nylons Spacer Lg. 10 Mm                           |
| 14 | Label 54 x 68                                     |
| 15 | Terminal Marker                                   |
| 16 | Screw M6 x 20 x 10                                |
| 17 | Screw M5 x 20                                     |
| 18 | Gasket For Polyester Box 170 x 170 x 91           |
| 19 | G/Y Cable 2.5 mm <sup>2</sup> (14AWG)             |

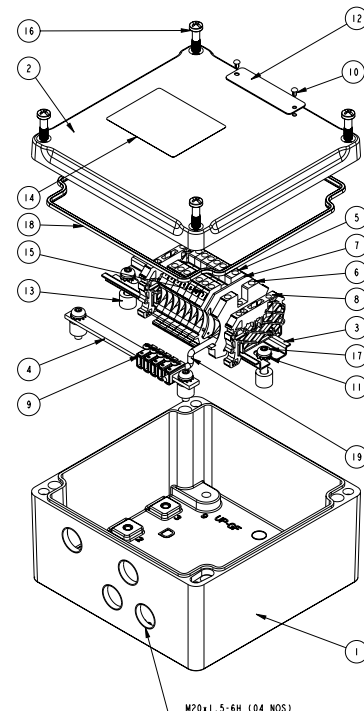

① The ambient temperature for complete assembly is equal to the lowest ambient temperature of the components used.

② INMETRO certification available on special request only. Contact your local sales representative for more information.

# ATX™ JBEP Series FRP Terminal Junction Boxes for Instrumentation Applications

Fiberglass Reinforced Polyester. Increased Safety. Factory Drilled and Equipped.

**NEC/CEC:**  
 Class I, Zone 1, AEx e IIC, T5 or T6  
 Ex e IIC, T5 or T6  
 IP66

**ATEX/IECEX:**  
 Zone 1 and 2 – 21 and 22  
 II 2 GD  
 IP66 – IK10

The Catalog Numbering Guide is a reference tool to explain the make-up of the catalog number. It is not to be used to create a custom product for ordering.

## Catalog Numbering Guide - JBEP Polyester Junction Boxes for Instrumentation Applications

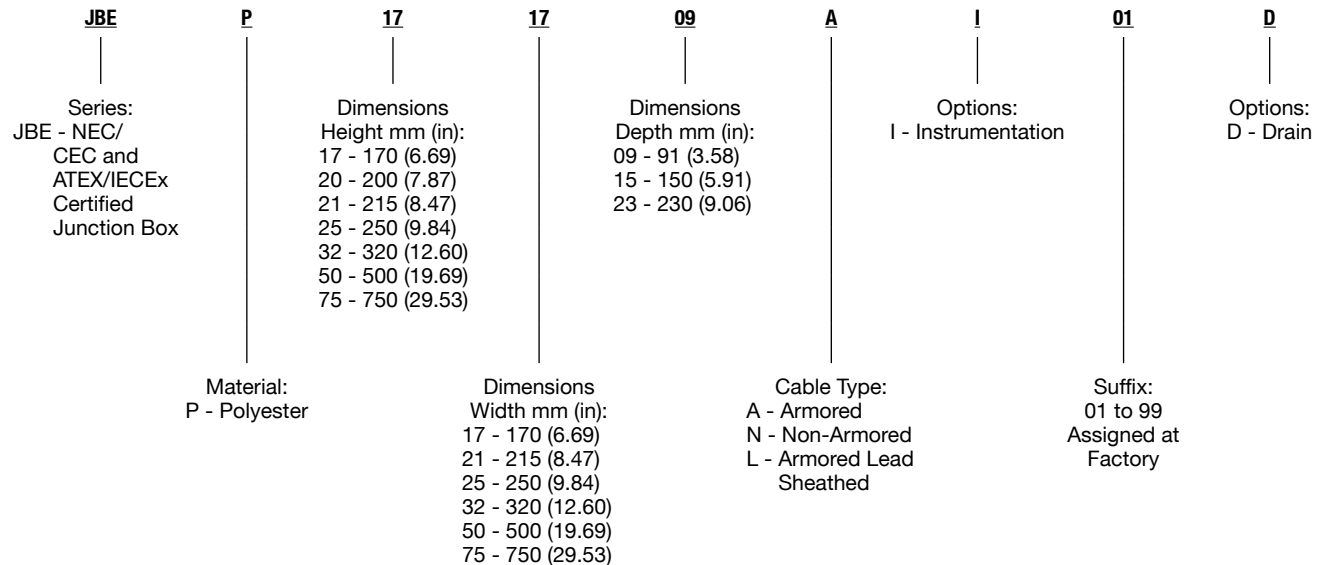

# ATX™ JBEP Series FRP Terminal Junction Boxes for Instrumentation Applications

Fiberglass Reinforced Polyester. Increased Safety. Factory Drilled and Equipped.

NEC/CEC:  
Class I, Zone 1, AEx e IIC, T5 or T6  
Ex e IIC, T5 or T6  
IP66

ATEX/IECEX:  
Zone 1 and 2 – 21 and 22  
II 2 GD  
IP66 – IK10

## Ex eb IIC Factory Drilled JBEP Polyester Junction Boxes Equipped with Terminals for Instrumentation Applications with Unarmored Cables

Fitted with: Horizontal beige terminal block. Copper bar with cable clamps or continuity shields.  
Yellow laminated plastic label with black lettering. M16 to M32 threaded entries. M40 to M50 clearance holes. Cable glands and plugs ordered separately.

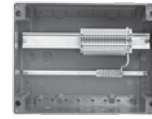

For Cable	Terminal Block	Earth Terminal	Copper Bar	Cable Clamp	Multi-Cable Cable	Single Cable	Catalog
U1000	0.5/2.5 mm <sup>2</sup> Qty.	0.5/2.5 mm <sup>2</sup> Qty.	10 x 3 mm Qty.	0.5/2.5 mm <sup>2</sup> Qty.	Entry Qty. 1	Entries	Number ①
R02V						M20 Qty.	
07G1.5	7	1	1	5	M20	3	JBEP171709NI01
12G1.5	12	1	1	8	M25	6	JBEP202115NI02
19G1.5	19	1	1	11	M25	9	JBEP253215NI03
24G1.5	24	1	1	14	M32	12	JBEP253215NI04
27G1.5	27	1	1	15	M32	13	JBEP253215NI05
37G1.5	37	1	1	20	M32	18	JBEP253215NI06
07G2.5	7	1	1	5	M20	3	JBEP171709NI07
12G2.5	12	1	1	8	M25	6	JBEP202115NI08
19G2.5	19	1	1	11	M32	9	JBEP253215NI09
24G2.5	24	1	1	14	M32	12	JBEP253215NI10
27G2.5	27	1	1	15	M32	13	JBEP253215NI11
37G2.5	37	1	1	20	M40	18	JBEP253215NI12

For Cable	Terminal Block	Continuity	Multi-Cable Cable	Single Cable	Catalog
EGSF	0.5/2.5 mm <sup>2</sup> Qty.	Shield Qty.	Entry Qty. 1	Entries	Number ①
				M16 Qty.	
07IP05	14	7	M20	7	JBEP202115NI21
07IT05	21	7	M20	7	JBEP202115NI22
12IP05	24	12	M25	12	JBEP253215NI23
12IT05	36	12	M25	12	JBEP253215NI24
19IP05	38	19	M32	19	JBEP253215NI25
27IP05	54	27	M32	27	JBEP325015NI26
07IP09	14	7	M25	7	JBEP202115NI27
07IT09	21	7	M25	7	JBEP202115NI28
12IP09	24	12	M32	12	JBEP253215NI29
12IT09	36	12	M32	12	JBEP253215NI30
19IP09	38	19	M32	19	JBEP253215NI31
27IP09	54	27	M40	27	JBEP325015NI32

For Cable	Terminal Block	Continuity	Multi-Cable Cable	Single Cable	Catalog
EISF	0.5/2.5 mm <sup>2</sup> Qty.	Shield Qty.	Entry Qty. 1	Entries	Number ①
				M16 Qty.	
07IP05	15	8	M25	7	JBEP202115NI41
07IT05	22	8	M32	7	JBEP202115NI42
12IP05	25	13	M32	12	JBEP253215NI43
12IT05	37	13	M32	12	JBEP253215NI44
19IP05	39	20	M40	19	JBEP253215NI45
27IP05	55	28	M40	27	JBEP325015NI46
07IP09	15	8	M32	7	JBEP202115NI47
07IT09	22	8	M32	7	JBEP202115NI48
12IP09	25	13	M40	12	JBEP253215NI49
12IT09	37	13	M40	12	JBEP253215NI50
19IP09	39	20	M50	19	JBEP253215NI51
27IP09	55	28	M50	27	JBEP325015NI52

① For JBEP terminal junction box with a drain, add suffix **D** to the end of the catalog number; example: JBEP171709NI01D.

# ATX™ JBEP Series FRP Terminal Junction Boxes for Instrumentation Applications

Fiberglass Reinforced Polyester. Increased Safety. Factory Drilled and Equipped.

NEC/CEC:  
Class I, Zone 1, AEx e IIC, T5 or T6  
Ex e IIC, T5 or T6  
IP66

ATEX/IECEX:  
Zone 1 and 2 – 21 and 22  
II 2 GD  
IP66 – IK10

## Ex eb IIC Factory Drilled JBEP Polyester Junction Boxes Equipped with Terminals for Instrumentation Applications with Armored Cables

Fitted with: Horizontal beige terminal block. Copper bar with cable clamps or continuity shields. Yellow laminated plastic label with black lettering. Earth continuity brass plate. M8 external earth crossing terminal. M20 to M32 threaded entries. M40 to M50 clearance holes. Cable glands and plugs ordered separately.

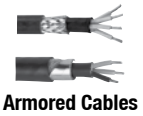
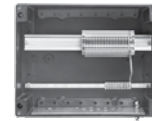

Armored Cables

For Cable U1000 RVFV	Terminal Block 0.5/2.5 mm <sup>2</sup> Qty.	Earth Terminal 0.5/2.5 mm <sup>2</sup> Qty.	Copper Bar 10 x 3 mm Qty.	Cable Clamp 0.5/2.5 mm <sup>2</sup> Qty.	Multi-Cable Cable Entry Qty. 1	Single Cable Entries M20 Qty.	Catalog Number ①
07G1.5	7	1	1	5	M20	3	JBEP171709AI01
12G1.5	12	1	1	8	M20	6	JBEP202115AI02
19G1.5	19	1	1	11	M25	9	JBEP253215AI03
24G1.5	24	1	1	14	M25	12	JBEP253215AI04
27G1.5	27	1	1	15	M25	13	JBEP253215AI05
37G1.5	37	1	1	20	M32	18	JBEP253215AI06
07G2.5	7	1	1	5	M20	3	JBEP171709AI07
12G2.5	12	1	1	8	M25	6	JBEP202115AI08
19G2.5	19	1	1	11	M25	9	JBEP253215AI09
24G2.5	24	1	1	14	M32	12	JBEP253215AI10
27G2.5	27	1	1	15	M32	13	JBEP253215AI11
37G2.5	37	1	1	20	M32	18	JBEP253215AI12

For Cable EGFA	Terminal Block 0.5/2.5 mm <sup>2</sup> Qty.	Continuity Shield Qty.	Multi-Cable Cable Entry Qty. 1	Single Cable Entries M20 Qty.	Catalog Number ①
07IP05	14	7	M20	7	JBEP202115AI21
07IT05	21	7	M20	7	JBEP202115AI22
12IP05	24	12	M25	12	JBEP253215AI23
12IT05	36	12	M25	12	JBEP253215AI24
19IP05	38	19	M25	19	JBEP253215AI25
27IP05	54	27	M32	27	JBEP325015AI26
07IP09	14	7	M25	7	JBEP202115AI27
07IT09	21	7	M25	7	JBEP202115AI28
12IP09	24	12	M25	12	JBEP253215AI29
12IT09	36	12	M32	12	JBEP253215AI30
19IP09	38	19	M32	19	JBEP253215AI31
27IP09	54	27	M40	27	JBEP325015AI32

For Cable EIFA	Terminal Block 0.5/2.5 mm <sup>2</sup> Qty.	Continuity Shield Qty.	Multi-Cable Cable Entry Qty. 1	Single Cable Entries M20 Qty.	Catalog Number ①
07IP05	15	8	M25	7	JBEP202115AI41
07IT05	22	8	M25	7	JBEP202115AI42
12IP05	25	13	M32	12	JBEP253215AI43
12IT05	37	13	M32	12	JBEP253215AI44
19IP05	39	20	M32	19	JBEP253215AI45
27IP05	55	28	M40	27	JBEP325015AI46
07IP09	15	8	M32	7	JBEP202115AI47
07IT09	22	8	M32	7	JBEP202115AI48
12IP09	25	13	M40	12	JBEP253215AI49
12IT09	37	13	M40	12	JBEP253215AI50
19IP09	39	20	M40	19	JBEP253215AI51
27IP09	55	28	M50	27	JBEP325015AI52

① For JBEP terminal junction box with a drain, add suffix **D** to the end of the catalog number; example: JBEP171709NI01D.

# ATX™ JBEP Series FRP Terminal Junction Boxes for Instrumentation Applications

Fiberglass Reinforced Polyester. Increased Safety. Factory Drilled and Equipped.

NEC/CEC:  
Class I, Zone 1, AEx e IIC, T5 or T6  
Ex e IIC, T5 or T6  
IP66

ATEX/IECEx:  
Zone 1 and 2 – 21 and 22  
II 2 GD  
IP66 – IK10

**Ex eb IIC Factory Drilled JBEP Polyester Junction Boxes Equipped with Terminals for Instrumentation Applications with Lead Sheath Armored Cables**  
Fitted with: Horizontal beige terminal block. Copper bar with cable clamps or continuity shields. Yellow laminated plastic label with black lettering. Earth continuity brass plate. M8 external earth crossing terminal. M20 to M32 threaded entries. M40 to M50 clearance holes. Cable glands and plugs ordered separately.

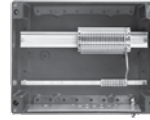

Armored Cables  
With lead sheath

For Cable	Terminal Block	Earth Terminal	Copper Bar	Cable Clamp	Multi-Cable	Single Cable	Catalog
U1000	0.5/2.5 mm <sup>2</sup> Qty.	0.5/2.5 mm <sup>2</sup> Qty.	10 x 3 mm Qty.	0.5/2.5 mm <sup>2</sup> Qty.	Cable	Entries	Number ①
RGPFV					Entry Qty. 1	M20 Qty.	
07G1.5	7	1	1	5	M20	3	JBEP171709LI01
12G1.5	12	1	1	8	M25	6	JBEP202115LI02
19G1.5	19	1	1	11	M25	9	JBEP253215LI03
24G1.5	24	1	1	14	M32	12	JBEP253215LI04
27G1.5	27	1	1	15	M32	13	JBEP253215LI05
37G1.5	37	1	1	20	M32	18	JBEP253215LI06
07G2.5	7	1	1	5	M20	3	JBEP171709LI07
12G2.5	12	1	1	8	M25	6	JBEP202115LI08
19G2.5	19	1	1	11	M32	9	JBEP253215LI09
24G2.5	24	1	1	14	M32	12	JBEP253215LI10
27G2.5	27	1	1	15	M32	13	JBEP253215LI11
37G2.5	37	1	1	20	M40	18	JBEP253215LI12

For Cable	Terminal Block	Continuity	Multi-Cable	Single Cable	Catalog
EGPF	0.5/2.5 mm <sup>2</sup> Qty.	Shield Qty.	Cable	Entries	Number ①
			Entry Qty. 1	M20 Qty.	
07IP05	14	7	M20	7	JBEP202115LI21
07IT05	21	7	M20	7	JBEP202115LI22
12IP05	24	12	M25	12	JBEP253215LI23
12IT05	36	12	M25	12	JBEP253215LI24
19IP05	38	19	M25	19	JBEP253215LI25
27IP05	54	27	M32	27	JBEP325015LI26
07IP09	14	7	M25	7	JBEP202115LI27
07IT09	21	7	M25	7	JBEP202115LI28
12IP09	24	12	M32	12	JBEP253215LI29
12IT09	36	12	M32	12	JBEP253215LI30
19IP09	38	19	M40	19	JBEP253215LI31
27IP09	54	27	M40	27	JBEP325015LI32

For Cable	Terminal Block	Continuity	Multi-Cable	Single Cable	Catalog
EIPF	0.5/2.5 mm <sup>2</sup> Qty.	Shield Qty.	Cable	Entries	Number ①
			Entry Qty. 1	M20 Qty.	
07IP05	15	8	M25	7	JBEP202115LI41
07IT05	22	8	M32	7	JBEP202115LI42
12IP05	25	13	M32	12	JBEP253215LI43
12IT05	37	13	M32	12	JBEP253215LI44
19IP05	39	20	M40	19	JBEP253215LI45
27IP05	55	28	M50	27	JBEP325015LI46
07IP09	15	8	M32	7	JBEP202115LI47
07IT09	22	8	M32	7	JBEP202115LI48
12IP09	25	13	M40	12	JBEP253215LI49
12IT09	37	13	M40	12	JBEP253215LI50
19IP09	39	20	M50	19	JBEP253215LI51
27IP09	55	28	M50	27	JBEP325015LI52

① For JBEP terminal junction box with a drain, add suffix **D** to the end of the catalog number; example: JBEP171709NI01D.



# ATX™ JBEP Series FRP Terminal Junction Boxes for Instrumentation Applications

Fiberglass Reinforced Polyester. Increased Safety. Factory Drilled and Equipped.

NEC/CEC:  
Class I, Zone 1, AEx e IIC, T5 or T6  
Ex e IIC, T5 or T6  
IP66

ATEX/IECEx:  
Zone 1 and 2 – 21 and 22  
II 2 GD  
IP66 – IK10

## Dimensions in Millimeters (Inches) ①

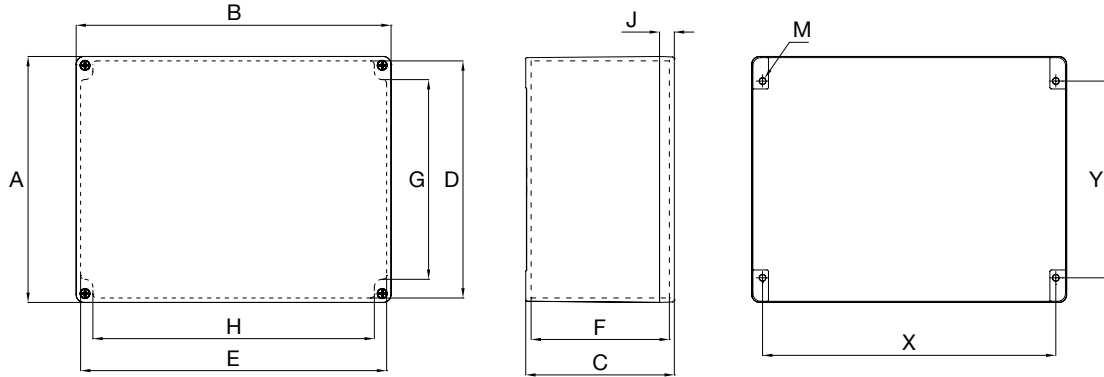

Enclosure Catalog Number	External Dimension				Internal Dimensions				Cover J	Body Thickness	Wall Fixing		
	A	B	C	D	E	F	G	H			X	Y	M ②
JBEP1717090	170 (6.693)	170 (6.693)	91 (3.583)	158.5 (6.240)	158.5 (6.240)	72 (2.835)	112.5 (4.429)	137 (5.394)	15 (0.591)	4.5 (0.177)	153 (6.024)	131 (5.157)	M5
JBEP2021150	200 (7.874)	215 (8.465)	145 (5.709)	185.8 (7.315)	200.8 (7.906)	122.5 (4.823)	114.8 (4.519)	159 (6.260)	20 (0.787)	6.1 (0.240)	189 (7.441)	146 (5.748)	M6
JBEP2532150	250 (9.843)	320 (12.598)	150 (5.906)	241 (9.488)	311 (12.244)	133.5 (5.256)	171 (6.732)	267 (10.512)	15 (0.591)	5 (0.197)	200 (7.874)	298 (11.732)	M6
JBEP3250150	320 (12.598)	500 (19.685)	150 (5.906)	311 (12.244)	491 (19.331)	133.5 (5.256)	267 (10.512)	421 (16.575)	15 (0.591)	5 (0.197)	298 (11.732)	447 (17.598)	M6

① Wall fixing screw diameter 5 mm (0.20"). Wall fixing screw hole 6 mm (0.24").  
② Screw to be used for mounting box.

# ATX™ JBEP Series FRP Terminal Junction Boxes for Electrical and Power Applications

Fiberglass Reinforced Polyester. Increased Safety. Factory Drilled and Equipped.

**NEC/CEC:**  
Class I, Zone 1, AEx e IIC, T5 or T6  
Ex e IIC, T5 or T6  
IP66

**ATEX/IECEX:**  
Zone 1 and 2 – 21 and 22  
Ⓢ II 2 GD  
IP66 – IK10

## Applications

- Electrical junction boxes are used to distribute power to lighting and to other Power and control circuits.
- Power junction boxes are used to connect cables together to supply main lighting circuits, motors, service receptacles and other equipment.
- Designed for Zones 1 or 2 areas, where flammable gases or vapors are present either continuously, often or accidentally such as:
  - Petroleum
  - Chemical
  - Refineries
  - Other industrial process facilities
- Ideal for indoor/outdoor use with wet or corrosive atmospheres.
- Designed for use in Zones 21 or 22 areas where flammables dusts (conductive and non conductive) are present either continuously, often or accidentally such as:
  - Food processing
  - Dairy
  - Brewing
  - Other industrial process facilities

## Features

- Available in multiple terminal configurations.
- Supplied with terminals Size 2.5 mm<sup>2</sup> (14AWG) through 240 mm<sup>2</sup> (474MCM).
- Optional external hinged enclosures:
  - Reversible door opening 120°.
  - Door with double bar lock.
  - Key locking facility.

## Standard materials

- Enclosures: Static resistant carbon filled fiberglass reinforced polyester (FRP)
- Hardware: stainless steel
- Gasket for sizes 85 x 85, 120 x 120: silicone
- Gasket for other sizes: EPDM (ethylene propylene diene monomer rubber)

## Options

- External hinges are available on the following sizes:
  - 500 x 320 x 150
  - 500 x 320 x 230
  - 750 x 320 x 150
  - 750 x 320 x 230
- Removable glands plates
- Nameplates
- Mounting pan
- Inside pocket for document
- Consult factory for custom drilling, assembly requirements and other ambient temperatures.

## NEC/CEC Certifications and Compliances

- UL Standard: UL 60079-0; 60079-7
- CSA Standard: C22.2 No. 60079-0: 11; 60079-7: 12
- cCSAus Certified: 2625458
- CSA Listed: 013017



**Un-Armored Cable Glands are Supplied as Standard.**  
**Armored Cable Glands are available as an Option.**

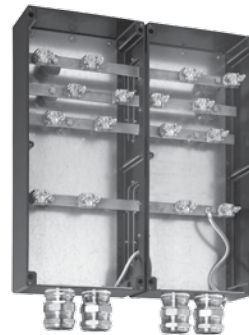

Sample of 2 x JBEP753215

## ATEX/IECEX Certifications and Compliances ①

- Certification Type JBEP
  - Gas, Zones 1 and 2:
    - Conforming to ATEX 94/9/EC: Ⓢ II 2G
    - Conforming to IECEx : EPL Gb
    - Type of Protection: Ex eb IIC
    - Temperature Class: T6 for Ta ≤ +40 °C (+104 °F) and T5 for Ta ≤ +60 °C (+140 °F)
  - Dusts, Zones 21 and 22:
    - Conforming to ATEX: Ⓢ II 2D
    - Conforming to IECEx: EPL Db
    - Type of Protection: Ex tb IIC
    - Surface Temperature : T60 °C (T140 °F) for Ta ≤ +40 °C (+104 °F), T90 °C (+194 °F) for Ta ≤ +60 °C (+140 °F)
- Ambient Temperatures: -55 °C ≤ Ta ≤ +60 °C (-67 °F ≤ Ta ≤ +140 °F)
- ATEX Certificate : LCIE 12 ATEX 3037X
- EC Declaration of Conformity : 50291
- IECEx Certificate : IECEx LCIE 13.0003X
- Index of Protection according EN/IEC 60529: IP66

① The ambient temperature for complete assembly is equal to the lowest ambient temperature of the components used.

# ATX™ JBEP Series FRP Terminal Junction Boxes for Electrical and Power Applications

Fiberglass Reinforced Polyester. Increased Safety. Factory Drilled and Equipped.

NEC/CEC:  
Class I, Zone 1, AEx e IIC, T5 or T6  
Ex e IIC, T5 or T6  
IP66

ATEX/IECEX:  
Zone 1 and 2 – 21 and 22  
II 2 GD  
IP66 – IK10

## Components Ambient Temperature ①

- Type : Bve (plastic close up plug)  
– Ambient Temperatures : -40 °C to +55 °C (-40 °F to +131 °F)
- Type : 757 (nickel plated close up plug)  
– Ambient Temperatures : -60 °C to +100 °C (-40 °F to +212 °F)
- Type : EEXe (plastic cable gland)  
– Ambient Temperatures : -20 °C to +55 °C (-4 °F to +131 °F)
- Type : E1FX, E2FX, E1FW, E2FW, T3, A2F (metal cable gland)  
– Ambient Temperatures : -60 °C to +130 °C (-76 °F to +266 °F)
- Type : PX, PX2K (metal cable gland)  
– Ambient Temperatures : -60 °C to +100 °C (-76 °F to +212 °F)
- Type : DBE (drain/breather)  
– Ambient Temperatures : -50 °C to +85 °C (-58 °F to +185 °F)
- Type : WDU, WFF (terminal)  
– Ambient Temperatures : -50 °C to +120 °C (-58 °F to +248 °F)
- Type : SAK, AKZ (terminal)  
– Ambient Temperatures : -50 °C to +100 °C (-58 °F to +212 °F)

## EURASEC Certification

- Type : JBEP  
– EURASEC N° TC RU C-FR.Г505.B.00911

## Other Certifications

- Type : JBEP  
– INMETRO Certificate: BVC 13.3238-X ②

## Illustrated Features — Sample of JBEP080806NE04T

Description	
1 Screw M5 X 6	
2 JBEP0808060 - Base Holes: 3 x Ø 20.5	
3 Cover Of Polyester Box Type (85 x 85 x 60)	
4 Hood Terminals Compact Set	
8 Nameplate	
9 Gasket Box Type 85 x 85 x 60	
10 Pan Head Screw M4 X 7	
11 Entry Thread Seal M20	
12 Nickel-Plated Brass Locknuts M20 X 1.5	
13 EEx e M20 Cable Gland	
15 Screw M6 X 20 X 10	
16 Hood Term Cover	
17 Earth Plate	

① The ambient temperature for complete assembly is equal to the lowest ambient temperature of the components used.

② INMETRO certification available on special request only. Contact your local sales representative for more information.

**ATX™ JBEP Series FRP Terminal Junction Boxes for Electrical and Power Applications**

Fiberglass Reinforced Polyester. Increased Safety. Factory Drilled and Equipped.

**NEC/CEC:**  
 Class I, Zone 1, AEx e IIC, T5 or T6  
 Ex e IIC, T5 or T6  
 IP66

**ATEX/IECEx:**  
 Zone 1 and 2 – 21 and 22  
 Ⓢ II 2 GD  
 IP66 – IK10

The Catalog Numbering Guide is a reference tool to explain the make-up of the catalog number. It is not to be used to create a custom product for ordering.

**Catalog Numbering Guide - JBEP Polyester Junction Boxes for Electrical and Power Applications**

<b>JBE</b>	<b>P</b>	<b>08</b>	<b>08</b>	<b>06</b>	<b>A</b>	<b>E</b>	<b>01</b>	<b>T</b>
Series: JBE - NEC/ CEC and ATEX/IECEx Certified Junction Box		Dimensions Height mm (in): 08 - 85 (3.35) 12 - 120 (4.72) 17 - 170 (6.69) 20 - 200 (7.87) 25 - 250 (9.84) 32 - 320 (12.60) 50 - 500 (19.69) 75 - 750 (29.53)		Dimensions Depth mm (in): 06 - 60 (2.36) 09 - 91 (3.58) 09S - 91 (3.58) ① 10 - 95 (3.74) 15 - 150 (5.91) 23 - 230 (9.06)		Options: <i>(Options must be listed alphabetically)</i> E - Electrical: 2.5 mm <sup>2</sup> (14AWG) x 10 mm <sup>2</sup> (6AWG) P - Power: 16 mm <sup>2</sup> (6AWG) to 240 mm <sup>2</sup> (474MCM)		Other Suffix: T - Mantle Clamping (Pillar Terminals)
	Material: P - Polyester		Dimensions Width mm (in): 08 - 85 (3.35) 12 - 120 (4.72) 17 - 170 (6.69) 21 - 215 (8.47) 25 - 250 (9.84) 32 - 320 (12.60) 50 - 500 (19.69) 75 - 750 (29.53)		Cable Type: A - Armored N - Non-Armored		Suffix: 01 to 99 Assigned at Factory	

① 09S Internal dimensions are 0.9 mm (0.035 in) less than the 09 internal dimensions.

# ATX™ JBEP Series FRP Terminal Junction Boxes for Electrical and Power Applications

Fiberglass Reinforced Polyester. Increased Safety. Factory Drilled and Equipped.

Maximum Capacity Per Terminal: 4 x 2.5 mm<sup>2</sup> or 2 x 4 mm<sup>2</sup> + 2 x 2.5 mm<sup>2</sup>; 4 x 6 mm<sup>2</sup> or 3 x 10 mm<sup>2</sup> + 4 mm<sup>2</sup>

**NEC/CEC:**  
Class I, Zone 1, AEx e IIC, T5 or T6  
Ex e IIC, T5 or T6  
IP66

**ATEX/IECEX:**  
Zone 1 and 2 – 21 and 22  
II 2 GD  
IP66 – IK10



JBEP080806NE04T

## Ex eb IIC Factory Drilled JBEP Polyester Junction Boxes Equipped with 4 Live Mantle Clamping (Pillar Terminals) and 1 Earth Terminal Per Way

Maximum capacity per terminal:

- 4 x 2.5 mm<sup>2</sup> or 2 x 4 mm<sup>2</sup> + 2 x 2.5 mm<sup>2</sup>, 550 Volts

Maximum capacity per earth terminal:

- 1 x 4 mm<sup>2</sup>

Rating (Amps):

- 28 Amps for 2.5 mm<sup>2</sup>, 38 Amps for 4 mm<sup>2</sup>

Enclosure Type	Equipment	Entry Layout	Weight kg (lb)	Volume dm <sup>3</sup> (in <sup>3</sup> )	Dimensions – mm (in)	Catalog Number
JBEP0808060	3 x M20 with earth continuity sheet		0.42 (0.93)	0.44 (26.9)	85 x 85 x 61 (3.35 x 3.35 x 2.40)	JBEP080806AE03T
JBEP0808060	3 x M20 with three cable glands for unarmored cable – diameter 6.5 to 14.5 mm (0.26 to 0.57 in)		0.45 (0.99)	0.44 (26.9)	85 x 85 x 61 (3.35 x 3.35 x 2.40)	JBEP080806NE03T
JBEP0808060	4 x M20 with earth continuity sheet		0.43 (0.95)	0.44 (26.9)	85 x 85 x 61 (3.35 x 3.35 x 2.40)	JBEP080806AE04T
JBEP0808060	4 x M20 with four cable glands for unarmored cable – diameter 6.5 to 14.5 mm (0.26 to 0.57 in)		0.48 (1.06)	0.44 (26.9)	85 x 85 x 61 (3.35 x 3.35 x 2.40)	JBEP080806NE04T

## Ex eb IIC Factory Drilled JBEP Polyester Junction Boxes Equipped with 5 Live Mantle Clamping (Pillar Terminals) and 1 Earth Terminal Per Way

Maximum capacity per terminal:

- 4 x 6 mm<sup>2</sup> or 3 x 10 mm<sup>2</sup> + 4 mm<sup>2</sup>, 690 Volts

Maximum capacity per earth terminal:

- 1 x 10 mm<sup>2</sup>

Rating (Amps):

- 28 Amps for 2.5 mm<sup>2</sup>, 38 Amps for 4 mm<sup>2</sup>, 42 Amps for 10 mm<sup>2</sup>

Enclosure Type	Equipment	Entry Layout	Weight kg (lb)	Volume dm <sup>3</sup> (in <sup>3</sup> )	Dimensions – mm (in)	Catalog Number
JBEP121209S0	3 x M20 with earth continuity sheet		0.85 (1.87)	1.31 (80.0)	120 x 120 x 91 (4.72 x 4.72 x 3.58)	JBEP121209AE03T
JBEP121209S0	3 x M25 with three cable glands for unarmored cable – diameter 8 to 17 mm (0.31 to 0.67 in) Ⓢ		0.9 (1.98)	1.31 (80.0)	120 x 120 x 91 (4.72 x 4.72 x 3.58)	JBEP121209NE13T
JBEP121209S0	4 x M20 with earth continuity sheet		0.88 (1.94)	1.31 (80.0)	120 x 120 x 91 (4.72 x 4.72 x 3.58)	JBEP121209AE04T
JBEP121209S0	4 x M25 with four cable glands for unarmored cable – diameter 8 to 17 mm (0.31 to 0.67 in) Ⓢ		0.95 (2.09)	1.31 (80.0)	120 x 120 x 91 (4.72 x 4.72 x 3.58)	JBEP121209NE14T

**ATX™ JBEP Series FRP Terminal Junction Boxes for Electrical and Power Applications**

Fiberglass Reinforced Polyester. Increased Safety. Factory Drilled and Equipped.

Maximum Capacity Per Terminal: 4 x 6 mm<sup>2</sup>

NEC/CEC:  
Class I, Zone 1, AEx e IIC, T5 or T6  
Ex e IIC, T5 or T6  
IP66

ATEX/IECEx:  
Zone 1 and 2 – 21 and 22  
II 2 GD  
IP66 – IK10

**Ex eb IIC Factory Drilled JBEP Polyester Junction Boxes Equipped with 8 Live Mantle Clamping (Pillar Terminals) and 1 Earth Terminal Per Way**

Maximum capacity per terminal:









- 4 x 6 mm<sup>2</sup> or 3 x 10 mm<sup>2</sup> + 4 mm<sup>2</sup>, 690 Volts

Maximum capacity per earth terminal:

- 1 x 10 mm<sup>2</sup>

Rating (Amps):

- 28 Amps for 2.5 mm<sup>2</sup>, 38 Amps for 4 mm<sup>2</sup>, 42 Amps for 10 mm<sup>2</sup>

Enclosure Type	Equipment	Entry Layout	Weight kg (lb)	Volume dm <sup>3</sup> (in <sup>3</sup> )	Dimensions – mm (in)	Catalog Number
JBEP1717090	4 x M20 with earth continuity sheet		1.63 (3.59)	8.91 x 10 <sup>8</sup> (54.3)	170 x 170 x 91 (6.69 x 6.69 x 3.58)	JBEP171709AE04T
JBEP1717090	4 x M20 with three cable glands for unarmored cable – diameter 6.5 to 14.5 mm (0.26 to 0.57 in)		1.55 (3.42)	8.91 x 10 <sup>8</sup> (54.3)	170 x 170 x 91 (6.69 x 6.69 x 3.58)	JBEP171709NE04T
JBEP1717090	6 x M20 with earth continuity sheet		1.55 (3.42)	8.91 x 10 <sup>8</sup> (54.3)	170 x 170 x 91 (6.69 x 6.69 x 3.58)	JBEP171709AE06T
JBEP1717090	6 x M20 with three cable glands for unarmored cable – diameter 6.5 to 14.5 mm (0.26 to 0.57 in)		1.65 (3.64)	8.91 x 10 <sup>8</sup> (54.3)	170 x 170 x 91 (6.69 x 6.69 x 3.58)	JBEP171709NE06T
JBEP1717090	4 x M25 with earth continuity sheet		1.62 (3.57)	8.91 x 10 <sup>8</sup> (54.3)	170 x 170 x 91 (6.69 x 6.69 x 3.58)	JBEP171709AE14T
JBEP1717090	4 x M25 with four cable glands for unarmored cable – diameter 8 to 17 mm (0.31 to 0.67 in)		1.60 (3.53)	8.91 x 10 <sup>8</sup> (54.3)	170 x 170 x 91 (6.69 x 6.69 x 3.58)	JBEP171709NE14T
JBEP1717090	6 x M25 with earth continuity sheet		1.55 (3.42)	8.91 x 10 <sup>8</sup> (54.3)	170 x 170 x 91 (6.69 x 6.69 x 3.58)	JBEP171709AE16T
JBEP1717090	6 x M25 with four cable glands for unarmored cable – diameter 8 to 17 mm (0.31 to 0.67 in)		1.65 (3.64)	8.91 x 10 <sup>8</sup> (54.3)	170 x 170 x 91 (6.69 x 6.69 x 3.58)	JBEP171709NE16T

# ATX™ JBEP Series FRP Terminal Junction Boxes for Electrical and Power Applications

Fiberglass Reinforced Polyester. Increased Safety. Factory Drilled and Equipped.

Maximum Capacity Per Terminal: 2 x 4 mm<sup>2</sup>

NEC/CEC:  
Class I, Zone 1, AEx e IIC, T5 or T6  
Ex e IIC, T5 or T6  
IP66

ATEX/IECEx:  
Zone 1 and 2 – 21 and 22  
II 2 GD  
IP66 – IK10



JBEP080806AE05

## Ex eb IIC Factory Drilled JBEP Polyester Junction Boxes Equipped with 4 Screw Terminals and 2 Earth Terminals

- 2 x 4 mm<sup>2</sup> terminals (MBK3), Rating 24 Amps, 275 Volts  
MBK3/E-Z and MSLKG2.5

Enclosure Type	Equipment	Entry Layout	Weight kg (lb)	Volume dm <sup>3</sup> (in <sup>3</sup> )	Dimensions – mm (in)	Terminal Jumped Catalog Number
<b>Configuration: P + N (1PE + 2L + 2N + 1PE)</b>						
JBEP0808060	3 x M20 with earth continuity device		0.40 (0.88)	0.44 (26.9)	85 x 85 x 61 (3.35 x 3.35 x 2.40)	JBEP080806AE03
JBEP0808060	3 x M20 with four cable glands for unarmored cable – diameter 6.5 to 14.5 mm (0.26 to 0.57 in)		0.42 (0.93)	0.44 (26.9)	85 x 85 x 61 (3.35 x 3.35 x 2.40)	JBEP080806NE03
JBEP0808060	4 x M20 with earth continuity device		0.40 (0.88)	0.44 (26.9)	85 x 85 x 61 (3.35 x 3.35 x 2.40)	JBEP080806AE05
JBEP0808060	4 x M20 with four cable glands for unarmored cable – diameter 6.5 to 14.5 mm (0.26 to 0.57 in)		0.45 (0.99)	0.44 (26.9)	85 x 85 x 61 (3.35 x 3.35 x 2.40)	JBEP080806NE05

## Ex eb IIC Factory Drilled JBEP Polyester Junction Boxes Equipped with 4 Screw Terminals and 2 Earth Terminals

- 2 x 4 mm<sup>2</sup> terminals (MBK3)  
MBK3/E-Z and MSLKG2.5

Enclosure Type	Equipment	Entry Layout	Weight kg (lb)	Volume dm <sup>3</sup> (in <sup>3</sup> )	Dimensions – mm (in)	Catalog Number
<b>Configuration: P + N (1PE + 1 + 2 + 3 + 4 + 1PE)</b>						
JBEP0808060	2 x M20 with earth continuity device, rated Ex eb IIC		0.40 (0.88)	0.44 (26.9)	85 x 85 x 60 (3.35 x 3.35 x 2.36)	JBEP080806AE22
JBEP0808060	2 x M20 with earth continuity device, rated Ex ia IIC		0.45 (0.99)	0.44 (26.9)	85 x 85 x 60 (3.35 x 3.35 x 2.36)	JBEP080806AE23

## Ex eb IIC Factory Drilled JBEP Polyester Junction Boxes Equipped with 6 Screw Terminals and 2 Earth Terminals

- 2 x 4 mm<sup>2</sup> terminals (MBK3), Rating 24 Amps, 275 Volts  
MBK3/E-Z and MSLKG2.5

Enclosure Type	Equipment	Entry Layout	Weight kg (lb)	Volume dm <sup>3</sup> (in <sup>3</sup> )	Dimensions – mm (in)	Catalog Number
<b>Configuration: P + N (1PE + 1 + 2 + 3 + 4 + 5 + 6 + 1PE)</b>						
JBEP0808060	4 x M20 with earth continuity device, rated Ex eb IIC		0.40 (0.88)	0.44 (26.9)	85 x 85 x 60 (3.35 x 3.35 x 2.36)	JBEP080806AE24
JBEP0808060	4 x M20 with earth continuity device, rated Ex ia IIC		0.45 (0.99)	0.44 (26.9)	85 x 85 x 60 (3.35 x 3.35 x 2.36)	JBEP080806AE25

# ATX™ JBEP Series FRP Terminal Junction Boxes for Electrical and Power Applications

Fiberglass Reinforced Polyester. Increased Safety. Factory Drilled and Equipped.

Maximum Capacity Per Terminal: 2 x 4 mm<sup>2</sup>; 2 x 6 mm<sup>2</sup>

NEC/CEC:  
Class I, Zone 1, AEx e IIC, T5 or T6  
Ex e IIC, T5 or T6  
IP66

ATEX/IECEX:  
Zone 1 and 2 – 21 and 22  
II 2 GD  
IP66 – IK10



JBEP121209AE07

## Ex eb IIC Factory Drilled JBEP Polyester Junction Boxes Equipped with 4 Screw Terminals and 2 Earth Terminals

- 2 x 4 mm<sup>2</sup> terminals (WDU4N), Rating 27 Amps, 275 Volts

Enclosure Type	Equipment	Entry Layout	Weight kg (lb)	Volume dm <sup>3</sup> (in <sup>3</sup> )	Dimensions – mm (in)	Terminal Jumped Catalog Number
Configuration: P + N (1PE + 2L + 2N + 1PE)						
JBEP121209S0	4 x M20 with earth continuity device		0.89 (1.96)	1.31 (80.0)	120 x 120 x 91 (4.72 x 4.72 x 3.58)	<b>JBEP121209AE07</b>
JBEP121209S0	4 x M25 with four cable glands for unarmored cable – diameter 8 to 17 mm (0.31 to 0.67 in)		0.93 (2.05)	1.31 (80.0)	120 x 120 x 91 (4.72 x 4.72 x 3.58)	<b>JBEP121209NE08</b>

## Ex eb IIC Factory Drilled JBEP Polyester Junction Boxes Equipped with 4 Screw Terminals and 2 Earth Terminals

- 2 x 6 mm<sup>2</sup> terminals (WDU6), Rating 36 Amps, 550 Volts

Enclosure Type	Equipment	Entry Layout	Weight kg (lb)	Volume dm <sup>3</sup> (in <sup>3</sup> )	Dimensions – mm (in)	Terminal Jumped Catalog Number
Configuration: P + N (1PE + 2L + 2N + 1PE)						
JBEP121209S0	4 x M20 with earth continuity device		1.00 (2.20)	1.31 (80.0)	120 x 120 x 91 (4.72 x 4.72 x 3.58)	<b>JBEP121209AE45</b>
JBEP121209S0	4 x M25 with four cable glands for unarmored cable – diameter 8 to 17 mm (0.31 to 0.67 in)		1.00 (2.20)	1.31 (80.0)	120 x 120 x 91 (4.72 x 4.72 x 3.58)	<b>JBEP121209NE46</b>
JBEP121209S0	4 x M20 with earth continuity device		0.96 (2.12)	1.31 (80.0)	120 x 120 x 91 (4.72 x 4.72 x 3.58)	<b>JBEP121209AE47</b>
JBEP121209S0	4 x M25 with four cable glands for unarmored cable – diameter 8 to 17 mm (0.31 to 0.67 in)		1.00 (2.20)	1.31 (80.0)	120 x 120 x 91 (4.72 x 4.72 x 3.58)	<b>JBEP121209NE48</b>



# ATX™ JBEP Series FRP Terminal Junction Boxes for Electrical and Power Applications

Fiberglass Reinforced Polyester. Increased Safety. Factory Drilled and Equipped.

Maximum Capacity Per Terminal: 2 x 4 mm<sup>2</sup>

NEC/CEC:  
Class I, Zone 1, AEx e IIC, T5 or T6  
Ex e IIC, T5 or T6  
IP66

ATEX/IECEX:  
Zone 1 and 2 – 21 and 22  
II 2 GD  
IP66 – IK10



JBEP121209NE26

## Ex eb IIC Factory Drilled JBEP Polyester Junction Boxes Equipped with 6 Screw Terminals and 2 Earth Terminals

- 2 x 4 mm<sup>2</sup> terminals (MBK3/E-Z and MSLKG2.5), Rating 24 Amps, 275 Volts

Enclosure Type	Equipment	Entry Layout	Weight kg (lb)	Volume dm <sup>3</sup> (in <sup>3</sup> )	Dimensions – mm (in)	Terminal Jumped Catalog Number
<b>Configuration: TP (1PE + 2L1 + 2L2 + 2L3 + 1PE)</b>						
JBEP1212090	4 x M20 with earth continuity device		0.88 (1.94)	1.31 (80.0)	120 x 120 x 91 (4.72 x 4.72 x 3.58)	JBEP121209AE25
JBEP1212090	4 x M25 with four cable glands for unarmored cable – diameter 8 to 17 mm (0.31 to 0.67 in)		0.87 (1.92)	1.31 (80.0)	120 x 120 x 91 (4.72 x 4.72 x 3.58)	JBEP121209NE26
JBEP1212090	4 x M20 with earth continuity device		0.84 (1.85)	1.31 (80.0)	120 x 120 x 91 (4.72 x 4.72 x 3.58)	JBEP121209AE27
JBEP1212090	4 x M25 with four cable glands for unarmored cable – diameter 8 to 17 mm (0.31 to 0.67 in)		0.88 (1.94)	1.31 (80.0)	120 x 120 x 91 (4.72 x 4.72 x 3.58)	JBEP121209NE28

## Ex eb IIC Factory Drilled JBEP Polyester Junction Boxes Equipped with 12 Screw Terminals and 3 Earth Terminals

- 2 x 4 mm<sup>2</sup> terminals (WDU4), Rating 22 Amps, 690 Volts

Enclosure Type	Equipment	Entry Layout	Weight kg (lb)	Volume dm <sup>3</sup> (in <sup>3</sup> )	Dimensions – mm (in)	Terminal Jumped Catalog Number
<b>Configuration: TP + N (1PE + 3L1 + 3L2 + 3L3 + 3N + 2PE)</b>						
JBEP1717090	4 x M25 with earth continuity device		1.54 (3.40)	2.63 (160.49)	170 x 170 x 91 (6.69 x 6.69 x 3.58)	JBEP171709AE46
JBEP1717090	4 x M25 with four cable glands for unarmored cable – diameter 8 to 17 mm (0.31 to 0.67 in)		1.54 (3.40)	2.63 (160.49)	170 x 170 x 91 (6.69 x 6.69 x 3.58)	JBEP171709NE46
JBEP1717090	6 x M20 with earth continuity device		1.54 (3.40)	2.63 (160.49)	170 x 170 x 91 (6.69 x 6.69 x 3.58)	JBEP171709AE47
JBEP1717090	6 x M20 with four cable glands for unarmored cable – diameter 6.5 to 14.5 mm (0.26 to 0.57 in)		1.54 (3.40)	2.63 (160.49)	170 x 170 x 91 (6.69 x 6.69 x 3.58)	JBEP171709NE47
JBEP1717090	6 x M25 with earth continuity device		1.54 (3.40)	2.63 (160.49)	170 x 170 x 91 (6.69 x 6.69 x 3.58)	JBEP171709AE48
JBEP1717090	6 x M25 with four cable glands for unarmored cable – diameter 8 to 17 mm (0.31 to 0.67 in)		1.54 (3.40)	2.63 (160.49)	170 x 170 x 91 (6.69 x 6.69 x 3.58)	JBEP171709NE48

**ATX™ JBEP Series FRP Terminal Junction Boxes for Electrical and Power Applications**

Fiberglass Reinforced Polyester. Increased Safety. Factory Drilled and Equipped.

Maximum Capacity Per Terminal: 6 mm<sup>2</sup>

NEC/CEC:  
Class I, Zone 1, AEx e IIC, T5 or T6  
Ex e IIC, T5 or T6  
IP66

ATEX/IECEX:  
Zone 1 and 2 – 21 and 22  
II 2 GD  
IP66 – IK10



JBEP171709AE06

**Ex eb IIC Factory Drilled JBEP Polyester Junction Boxes Equipped with Screw Terminals and Earth Terminals**

- 6 mm<sup>2</sup> terminals (WDU6) and earth terminals (WPE6), Rating 32 Amps, 550 Volts

Enclosure Type	Equipment	Entry Layout	Weight kg (lb)	Volume dm <sup>3</sup> (in <sup>3</sup> )	Dimensions – mm (in)	Terminal Jumped Catalog Number
<b>Configuration: P + N (1PE + 2L + 2N + 1PE)</b>						
JBEP1717090	3 x M20 with earth continuity device		1.54 (3.40)	2.63 (160.49)	170 x 170 x 91 (6.69 x 6.69 x 3.58)	<b>JBEP171709AE01</b>
JBEP1717090	3 x M25 with three cable glands for unarmored cable – diameter 8 to 17 mm (0.31 to 0.67 in)		1.54 (3.40)	2.63 (160.49)	170 x 170 x 91 (6.69 x 6.69 x 3.58)	<b>JBEP171709NE01</b>
JBEP1717090	4 x M20 with earth continuity device		1.54 (3.40)	2.63 (160.49)	170 x 170 x 91 (6.69 x 6.69 x 3.58)	<b>JBEP171709AE02</b>
JBEP1717090	4 x M25 with four cable glands for unarmored cable – diameter 8 to 17 mm (0.31 to 0.67 in)		1.54 (3.40)	2.63 (160.49)	170 x 170 x 91 (6.69 x 6.69 x 3.58)	<b>JBEP171709NE02</b>
JBEP1717090	4 x M20 with earth continuity device		1.54 (3.40)	2.63 (160.49)	170 x 170 x 91 (6.69 x 6.69 x 3.58)	<b>JBEP171709AE03</b>
JBEP1717090	4 x M25 with four cable glands for unarmored cable – diameter 8 to 17 mm (0.31 to 0.67 in)		1.54 (3.40)	2.63 (160.49)	170 x 170 x 91 (6.69 x 6.69 x 3.58)	<b>JBEP171709NE03</b>
<b>Configuration: P + N (1PE + 3L + 3N + 2PE)</b>						
JBEP1717090	6 x M20 with earth continuity device		1.54 (3.40)	2.63 (160.49)	170 x 170 x 91 (6.69 x 6.69 x 3.58)	<b>JBEP171709AE04</b>
JBEP1717090	6 x M25 with six cable glands for unarmored cable – diameter 8 to 17 mm (0.31 to 0.67 in)		1.54 (3.40)	2.63 (160.49)	170 x 170 x 91 (6.69 x 6.69 x 3.58)	<b>JBEP171709NE04</b>
<b>Configuration: TP (1PE + 2L1 + 2L2 + 2L3 + 1PE)</b>						
JBEP1717090	3 x M20 with earth continuity device		1.54 (3.40)	2.63 (160.49)	170 x 170 x 91 (6.69 x 6.69 x 3.58)	<b>JBEP171709AE05</b>
JBEP1717090	3 x M25 with three cable glands for unarmored cable – diameter 8 to 17 mm (0.31 to 0.67 in)		1.54 (3.40)	2.63 (160.49)	170 x 170 x 91 (6.69 x 6.69 x 3.58)	<b>JBEP171709NE05</b>
JBEP1717090	4 x M20 with earth continuity device		1.54 (3.40)	2.63 (160.49)	170 x 170 x 91 (6.69 x 6.69 x 3.58)	<b>JBEP171709AE06</b>
JBEP1717090	4 x M25 with four cable glands for unarmored cable – diameter 8 to 17 mm (0.31 to 0.67 in)		1.54 (3.40)	2.63 (160.49)	170 x 170 x 91 (6.69 x 6.69 x 3.58)	<b>JBEP171709NE06</b>
JBEP1717090	4 x M20 with earth continuity device		1.54 (3.40)	2.63 (160.49)	170 x 170 x 91 (6.69 x 6.69 x 3.58)	<b>JBEP171709AE07</b>
JBEP1717090	4 x M25 with four cable glands for unarmored cable – diameter 8 to 17 mm (0.31 to 0.67 in)		1.54 (3.40)	2.63 (160.49)	170 x 170 x 91 (6.69 x 6.69 x 3.58)	<b>JBEP171709NE07</b>

# ATX™ JBEP Series FRP Terminal Junction Boxes for Electrical and Power Applications

Fiberglass Reinforced Polyester. Increased Safety. Factory Drilled and Equipped.

Maximum Capacity Per Terminal: 6 mm<sup>2</sup>

**NEC/CEC:**  
Class I, Zone 1, AEx e IIC, T5 or T6  
Ex e IIC, T5 or T6  
IP66

**ATEX/IECEX:**  
Zone 1 and 2 – 21 and 22  
II 2 GD  
IP66 – IK10

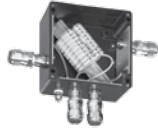

JBEP171709AE10

## Ex eb IIC Factory Drilled JBEP Polyester Junction Boxes Equipped with Screw Terminals and Earth Terminals

- 6 mm<sup>2</sup> terminals (WDU6) and earth terminals (WPE6), Rating 32 Amps, 550 Volts

Enclosure Type	Equipment	Entry Layout	Weight kg (lb)	Volume dm <sup>3</sup> (in <sup>3</sup> )	Dimensions – mm (in)	Terminal Jumped Catalog Number
<b>Configuration: TP (2PE + 3L1 + 3L2 + 3L3 + 1PE)</b>						
JBEP1717090	6 x M20 with earth continuity device		1.54 (3.40)	2.63 (160.49)	170 x 170 x 91 (6.69 x 6.69 x 3.58)	<b>JBEP171709AE08</b>
JBEP1717090	6 x M25 with six cable glands for unarmored cable – diameter 8 to 17 mm (0.31 to 0.67 in)		1.54 (3.40)	2.63 (160.49)	170 x 170 x 91 (6.69 x 6.69 x 3.58)	<b>JBEP171709NE08</b>
<b>Configuration: TP + N (2PE + 2L1 + 2L2 + 2L3 + 2N + 1PE)</b>						
JBEP1717090	3 x M20 with earth continuity device		1.54 (3.40)	2.63 (160.49)	170 x 170 x 91 (6.69 x 6.69 x 3.58)	<b>JBEP171709AE09</b>
JBEP1717090	3 x M25 with three cable glands for unarmored cable – diameter 8 to 17 mm (0.31 to 0.67 in)		1.54 (3.40)	2.63 (160.49)	170 x 170 x 91 (6.69 x 6.69 x 3.58)	<b>JBEP171709NE09</b>
JBEP1717090	4 x M20 with earth continuity device		1.54 (3.40)	2.63 (160.49)	170 x 170 x 91 (6.69 x 6.69 x 3.58)	<b>JBEP171709AE10</b>
JBEP1717090	4 x M25 with four cable glands for unarmored cable – diameter 8 to 17 mm (0.31 to 0.67 in)		1.54 (3.40)	2.63 (160.49)	170 x 170 x 91 (6.69 x 6.69 x 3.58)	<b>JBEP171709NE10</b>
JBEP1717090	4 x M20 with earth continuity device		1.54 (3.40)	2.63 (160.49)	170 x 170 x 91 (6.69 x 6.69 x 3.58)	<b>JBEP171709AE11</b>
JBEP1717090	4 x M25 with four cable glands for unarmored cable – diameter 8 to 17 mm (0.31 to 0.67 in)		1.54 (3.40)	2.63 (160.49)	170 x 170 x 91 (6.69 x 6.69 x 3.58)	<b>JBEP171709NE11</b>
<b>Configuration: TP + N (2PE + 3L1 + 3L2 + 3L3 + 3N + 1PE)</b>						
JBEP2021100	6 x M20 with earth continuity device		2.04 (4.50)	4.09 (249.28)	200 x 215 x 95 (7.87 x 8.46 x 3.74)	<b>JBEP202110AE12</b>
JBEP2021100	6 x M25 with six cable glands for unarmored cable – diameter 8 to 17 mm (0.31 to 0.67 in)		2.04 (4.50)	4.09 (249.28)	200 x 215 x 95 (7.87 x 8.46 x 3.74)	<b>JBEP202110NE12</b>

**ATX™ JBEP Series FRP Terminal Junction Boxes for Electrical and Power Applications**

Fiberglass Reinforced Polyester. Increased Safety. Factory Drilled and Equipped.

Maximum Capacity Per Terminal: 10 mm<sup>2</sup>

NEC/CEC:  
Class I, Zone 1, AEx e IIC, T5 or T6  
Ex e IIC, T5 or T6  
IP66

ATEX/IECEX:  
Zone 1 and 2 – 21 and 22  
II 2 GD  
IP66 – IK10



JBEP171709NE52

**Ex eb IIC Factory Drilled JBEP Polyester Junction Boxes Equipped with Screw Terminals and Earth Terminals**

- 10 mm<sup>2</sup> terminals (WDU10) and earth terminals (WPE10), Rating 50 Amps, 550 Volts

Enclosure Type	Equipment	Entry Layout	Weight kg (lb)	Volume dm <sup>3</sup> (in <sup>3</sup> )	Dimensions – mm (in)	Terminal Jumped Catalog Number
<b>Configuration: P + N (1PE + 2L + 2N + 1PE)</b>						
JBEP1717090	3 x M20 with earth continuity device		2.04 (4.50)	2.63 (160.49)	170 x 170 x 91 (6.69 x 6.69 x 3.58)	<b>JBEP171709AE51</b>
JBEP1717090	3 x M25 with three cable glands for unarmored cable – diameter 8 to 17 mm (0.31 to 0.67 in)		2.04 (4.50)	2.63 (160.49)	170 x 170 x 91 (6.69 x 6.69 x 3.58)	<b>JBEP171709NE51</b>
JBEP1717090	4 x M20 with earth continuity device		2.04 (4.50)	2.63 (160.49)	170 x 170 x 91 (6.69 x 6.69 x 3.58)	<b>JBEP171709AE52</b>
JBEP1717090	4 x M25 with four cable glands for unarmored cable – diameter 8 to 17 mm (0.31 to 0.67 in)		2.04 (4.50)	2.63 (160.49)	170 x 170 x 91 (6.69 x 6.69 x 3.58)	<b>JBEP171709NE52</b>
JBEP1717090	4 x M20 with earth continuity device		2.04 (4.50)	2.63 (160.49)	170 x 170 x 91 (6.69 x 6.69 x 3.58)	<b>JBEP171709AE53</b>
JBEP1717090	4 x M25 with four cable glands for unarmored cable – diameter 8 to 17 mm (0.31 to 0.67 in)		2.04 (4.50)	2.63 (160.49)	170 x 170 x 91 (6.69 x 6.69 x 3.58)	<b>JBEP171709NE53</b>

# ATX™ JBEP Series FRP Terminal Junction Boxes for Electrical and Power Applications

Fiberglass Reinforced Polyester. Increased Safety. Factory Drilled and Equipped.

Maximum Capacity Per Terminal: 10 mm<sup>2</sup>

**NEC/CEC:**  
Class I, Zone 1, AEx e IIC, T5 or T6  
Ex e IIC, T5 or T6  
IP66

**ATEX/IECEX:**  
Zone 1 and 2 – 21 and 22  
II 2 GD  
IP66 – IK10

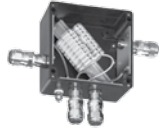

JBEP171709AE57

## Ex eb IIC Factory Drilled JBEP Polyester Junction Boxes Equipped with Screw Terminals and Earth Terminals

- 10 mm<sup>2</sup> terminals (WDU10) and earth terminals (WPE10), Rating 47 Amps, 550 Volts

Enclosure Type	Equipment	Entry Layout	Weight kg (lb)	Volume dm <sup>3</sup> (in <sup>3</sup> )	Dimensions – mm (in)	Terminal Jumped Catalog Number
<b>Configuration: P + N (2PE + 3L + 3N + 1PE)</b>						
JBEP1717090	6 x M20 with earth continuity device		2.04 (4.50)	2.63 (160.49)	170 x 170 x 91 (6.69 x 6.69 x 3.58)	<b>JBEP171709AE54</b>
JBEP1717090	6 x M25 with six cable glands for unarmored cable – diameter 8 to 17 mm (0.31 to 0.67 in)		2.04 (4.50)	2.63 (160.49)	170 x 170 x 91 (6.69 x 6.69 x 3.58)	<b>JBEP171709NE54</b>
<b>Configuration: TP (1PE + 2L1 + 2L2 + 2L3 + 1PE)</b>						
JBEP1717090	3 x M25 with earth continuity device		2.04 (4.50)	2.63 (160.49)	170 x 170 x 91 (6.69 x 6.69 x 3.58)	<b>JBEP171709AE55</b>
JBEP1717090	3 x M25 with three cable glands for unarmored cable – diameter 8 to 17 mm (0.31 to 0.67 in)		2.04 (4.50)	2.63 (160.49)	170 x 170 x 91 (6.69 x 6.69 x 3.58)	<b>JBEP171709NE55</b>
JBEP1717090	4 x M25 with earth continuity device		2.04 (4.50)	2.63 (160.49)	170 x 170 x 91 (6.69 x 6.69 x 3.58)	<b>JBEP171709AE56</b>
JBEP1717090	4 x M25 with four cable glands for unarmored cable – diameter 8 to 17 mm (0.31 to 0.67 in)		2.04 (4.50)	2.63 (160.49)	170 x 170 x 91 (6.69 x 6.69 x 3.58)	<b>JBEP171709NE56</b>
JBEP1717090	4 x M25 with earth continuity device		2.04 (4.50)	2.63 (160.49)	170 x 170 x 91 (6.69 x 6.69 x 3.58)	<b>JBEP171709AE57</b>
JBEP1717090	4 x M25 with four cable glands for unarmored cable – diameter 8 to 17 mm (0.31 to 0.67 in)		2.04 (4.50)	2.63 (160.49)	170 x 170 x 91 (6.69 x 6.69 x 3.58)	<b>JBEP171709NE57</b>

# ATX™ JBEP Series FRP Terminal Junction Boxes for Electrical and Power Applications

Fiberglass Reinforced Polyester. Increased Safety. Factory Drilled and Equipped.

Maximum Capacity Per Terminal: 10 mm<sup>2</sup>

**NEC/CEC:**  
Class I, Zone 1, AEx e IIC, T5 or T6  
Ex e IIC, T5 or T6  
IP66

**ATEX/IECEX:**  
Zone 1 and 2 – 21 and 22  
II 2 GD  
IP66 – IK10

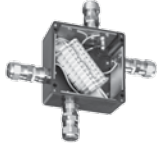

JBEP171709AE61

### Ex eb IIC Factory Drilled JBEP Polyester Junction Boxes Equipped with Screw Terminals and Earth Terminals

- 10 mm<sup>2</sup> terminals (WDU10) and earth terminals (WPE10), Rating 37 Amps, 550 Volts

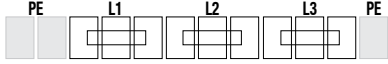
Enclosure Type	Equipment	Entry Layout	Weight kg (lb)	Volume dm <sup>3</sup> (in <sup>3</sup> )	Dimensions – mm (in)	Terminal Jumped Catalog Number
<b>Configuration: TP (2PE + 3L1 + 3L2 + 3L3 + 1PE)</b> 						
JBEP1717090	6 x M25 with earth continuity device		1.60 (3.60)	2.63 (160.49)	170 x 170 x 91 (6.69 x 6.69 x 3.58)	<b>JBEP171709AE58</b>
JBEP1717090	6 x M25 with six cable glands for unarmored cable – diameter 8 to 17 mm (0.31 to 0.67 in)		1.60 (3.60)	2.63 (160.49)	170 x 170 x 91 (6.69 x 6.69 x 3.58)	<b>JBEP171709NE58</b>

### Ex eb IIC Factory Drilled JBEP Polyester Junction Boxes Equipped with Screw Terminals and Earth Terminals

- 10 mm<sup>2</sup> terminals (WDU10) and earth terminals (WPE10), Rating 40 Amps, 550 Volts

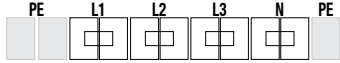
Enclosure Type	Equipment	Entry Layout	Weight kg (lb)	Volume dm <sup>3</sup> (in <sup>3</sup> )	Dimensions – mm (in)	Terminal Jumped Catalog Number
<b>Configuration: TP + N (2PE + 2L1 + 2L2 + 2L3 + 2N + 1PE)</b> 						
JBEP1717090	3 x M25 with earth continuity device		1.60 (3.60)	2.63 (160.49)	170 x 170 x 91 (6.69 x 6.69 x 3.58)	<b>JBEP171709AE59</b>
JBEP1717090	3 x M32 with three cable glands for unarmored cable – diameter 10 to 25 mm (0.39 to 0.98 in)		1.60 (3.60)	2.63 (160.49)	170 x 170 x 91 (6.69 x 6.69 x 3.58)	<b>JBEP171709NE59</b>
JBEP1717090	4 x M25 with earth continuity device		1.60 (3.60)	2.63 (160.49)	170 x 170 x 91 (6.69 x 6.69 x 3.58)	<b>JBEP171709AE60</b>
JBEP1717090	4 x M32 with four cable glands for unarmored cable – diameter 10 to 25 mm (0.39 to 0.98 in)		1.60 (3.60)	2.63 (160.49)	170 x 170 x 91 (6.69 x 6.69 x 3.58)	<b>JBEP171709NE60</b>
JBEP1717090	4 x M25 with earth continuity device		1.60 (3.60)	2.63 (160.49)	170 x 170 x 91 (6.69 x 6.69 x 3.58)	<b>JBEP171709AE61</b>
JBEP1717090	4 x M32 with four cable glands for unarmored cable – diameter 10 to 25 mm (0.39 to 0.98 in)		1.60 (3.60)	2.63 (160.49)	170 x 170 x 91 (6.69 x 6.69 x 3.58)	<b>JBEP171709NE61</b>

# ATX™ JBEP Series FRP Terminal Junction Boxes for Electrical and Power Applications

Fiberglass Reinforced Polyester. Increased Safety. Factory Drilled and Equipped.

Maximum Capacity Per Terminal: 10 mm<sup>2</sup>

**NEC/CEC:**  
Class I, Zone 1, AEx e IIC, T5 or T6  
Ex e IIC, T5 or T6  
IP66

**ATEX/IECEX:**  
Zone 1 and 2 – 21 and 22  
II 2 GD  
IP66 – IK10

## Ex eb IIC Factory Drilled JBEP Polyester Junction Boxes Equipped with Screw Terminals and Earth Terminals

- 10 mm<sup>2</sup> terminals (WDU10) and earth terminals (WPE10), Rating 40 Amps, 550 Volts

Enclosure Type	Equipment	Entry Layout	Weight kg (lb)	Volume dm <sup>3</sup> (in <sup>3</sup> )	Dimensions – mm (in)	Terminal Jumped Catalog Number
<b>Configuration: TP + N (2PE + 3L1 + 3L2 + 3L3 + 3N + 1PE)</b>						
JBEP2021100	6 x M25 with earth continuity device		2.10 (4.60)	4.09 (249.28)	200 x 215 x 95 (7.87 x 8.46 x 3.74)	<b>JBEP202110AE62</b>
JBEP2021100	6 x M32 with six cable glands for unarmored cable – diameter 10 to 25 mm (0.39 to 0.98 in)		2.10 (4.60)	4.09 (249.28)	200 x 215 x 95 (7.87 x 8.46 x 3.74)	<b>JBEP202110NE62</b>

# ATX™ JBEP Series FRP Terminal Junction Boxes for Electrical and Power Applications

Fiberglass Reinforced Polyester. Increased Safety. Factory Drilled and Equipped.

Maximum Capacity Per Terminal: 16 mm<sup>2</sup>

NEC/CEC:  
Class I, Zone 1, AEx e IIC, T5 or T6  
Ex e IIC, T5 or T6  
IP66









ATEX/IECEx:  
Zone 1 and 2 – 21 and 22  
II 2 GD  
IP66 – IK10

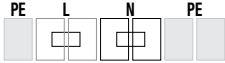

JBEP202115AP06





## Ex eb IIC Factory Drilled JBEP Polyester Junction Boxes Equipped with Screw Terminals, Earth Terminals and Earth Stud

- 16 mm<sup>2</sup> terminals (WDU16) and earth terminals (WPE16), Rating 60 Amps, 690 Volts

Enclosure Type	Equipment	Entry Layout	Weight kg (lb)	Volume dm <sup>3</sup> (in <sup>3</sup> )	Dimensions – mm (in)	Terminal Jumped Catalog Number
<b>Configuration: P + N (1PE + 2L + 2N + 2PE)</b> 						
JBEP2021150	3 x M25 with earth continuity device		4.00 (8.80)	6.45 (393.60)	200 x 215 x 145 (7.87 x 8.46 x 5.71)	<b>JBEP202115AP01</b>
JBEP2021150	3 x M25 with three cable glands for unarmored cable – diameter 8 to 17 mm (0.31 to 0.67 in)		4.00 (8.80)	6.45 (393.60)	200 x 215 x 145 (7.87 x 8.46 x 5.71)	<b>JBEP202115NP01</b>
JBEP2021150	4 x M25 with earth continuity device		4.00 (8.80)	6.45 (393.60)	200 x 215 x 145 (7.87 x 8.46 x 5.71)	<b>JBEP202115AP02</b>
JBEP2021150	4 x M25 with four cable glands for unarmored cable – diameter 8 to 17 mm (0.31 to 0.67 in)		4.00 (8.80)	6.45 (393.60)	200 x 215 x 145 (7.87 x 8.46 x 5.71)	<b>JBEP202115NP02</b>
JBEP2021150	4 x M25 with earth continuity device		4.00 (8.80)	6.45 (393.60)	200 x 215 x 145 (7.87 x 8.46 x 5.71)	<b>JBEP202115AP03</b>
JBEP2021150	4 x M25 with four cable glands for unarmored cable – diameter 8 to 17 mm (0.31 to 0.67 in)		4.00 (8.80)	6.45 (393.60)	200 x 215 x 145 (7.87 x 8.46 x 5.71)	<b>JBEP202115NP03</b>
JBEP2021150	4 x M25 with earth continuity device		4.00 (8.80)	6.45 (393.60)	200 x 215 x 145 (7.87 x 8.46 x 5.71)	<b>JBEP202115AP04</b>
JBEP2021150	4 x M25 with four cable glands for unarmored cable – diameter 8 to 17 mm (0.31 to 0.67 in)		4.00 (8.80)	6.45 (393.60)	200 x 215 x 145 (7.87 x 8.46 x 5.71)	<b>JBEP202115NP04</b>

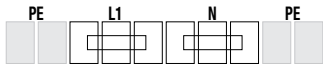
## Ex eb IIC Factory Drilled JBEP Polyester Junction Boxes Equipped with Screw Terminals, Earth Terminals and Earth Stud

- 16 mm<sup>2</sup> terminals (WDU16) and earth terminals (WPE16), Rating 55 Amps, 690 Volts

Enclosure Type	Equipment	Entry Layout	Weight kg (lb)	Volume dm <sup>3</sup> (in <sup>3</sup> )	Dimensions – mm (in)	Terminal Jumped Catalog Number
<b>Configuration: P + N (2PE + 3L + 3N + 2PE)</b> 						
JBEP2021150	6 x M25 with earth continuity device		4.00 (8.80)	6.45 (393.60)	200 x 215 x 145 (7.87 x 8.46 x 5.71)	<b>JBEP202115AP05</b>
JBEP2021150	6 x M25 with six cable glands for unarmored cable – diameter 8 to 17 mm (0.31 to 0.67 in)		4.00 (8.80)	6.45 (393.60)	200 x 215 x 145 (7.87 x 8.46 x 5.71)	<b>JBEP202115NP05</b>
JBEP2021150	6 x M25 with earth continuity device		4.00 (8.80)	6.45 (393.60)	200 x 215 x 145 (7.87 x 8.46 x 5.71)	<b>JBEP202115AP06</b>
JBEP2021150	6 x M25 with six cable glands for unarmored cable – diameter 8 to 17 mm (0.31 to 0.67 in)		4.00 (8.80)	6.45 (393.60)	200 x 215 x 145 (7.87 x 8.46 x 5.71)	<b>JBEP202115NP06</b>



# ATX™ JBEP Series FRP Terminal Junction Boxes for Electrical and Power Applications

Fiberglass Reinforced Polyester. Increased Safety. Factory Drilled and Equipped.

Maximum Capacity Per Terminal: 16 mm<sup>2</sup>

NEC/CEC:  
Class I, Zone 1, AEx e IIC, T5 or T6  
Ex e IIC, T5 or T6  
IP66

ATEX/IECEx:  
Zone 1 and 2 – 21 and 22  
II 2 GD  
IP66 – IK10



JBEP202115AP12

## Ex eb IIC Factory Drilled JBEP Polyester Junction Boxes Equipped with Screw Terminals, Earth Terminals and Earth Stud

- 16 mm<sup>2</sup> terminals (WDU16) and earth terminals (WPE16), Rating 55 Amps, 690 Volts

Enclosure Type	Equipment	Entry Layout	Weight kg (lb)	Volume dm <sup>3</sup> (in <sup>3</sup> )	Dimensions – mm (in)	Terminal Jumped
						Catalog Number
<b>Configuration: TP (1PE + 2L1 + 2L2 + 2L3 + 2PE)</b>						
JBEP2021150	3 x M25 with earth continuity device		4.00 (8.80)	6.45 (393.60)	200 x 215 x 145 (7.87 x 8.46 x 5.71)	<b>JBEP202115AP07</b>
JBEP2021150	3 x M25 with three cable glands for unarmored cable – diameter 8 to 17 mm (0.31 to 0.67 in)		4.00 (8.80)	6.45 (393.60)	200 x 215 x 145 (7.87 x 8.46 x 5.71)	<b>JBEP202115NP07</b>
JBEP2021150	4 x M25 with earth continuity device		4.00 (8.80)	6.45 (393.60)	200 x 215 x 145 (7.87 x 8.46 x 5.71)	<b>JBEP202115AP08</b>
JBEP2021150	4 x M25 with four cable glands for unarmored cable – diameter 8 to 17 mm (0.31 to 0.67 in)		4.00 (8.80)	6.45 (393.60)	200 x 215 x 145 (7.87 x 8.46 x 5.71)	<b>JBEP202115NP08</b>
JBEP2021150	4 x M25 with earth continuity device		4.00 (8.80)	6.45 (393.60)	200 x 215 x 145 (7.87 x 8.46 x 5.71)	<b>JBEP202115AP09</b>
JBEP2021150	4 x M25 with four cable glands for unarmored cable – diameter 8 to 17 mm (0.31 to 0.67 in)		4.00 (8.80)	6.45 (393.60)	200 x 215 x 145 (7.87 x 8.46 x 5.71)	<b>JBEP202115NP09</b>
JBEP2021150	4 x M25 with earth continuity device		4.00 (8.80)	6.45 (393.60)	200 x 215 x 145 (7.87 x 8.46 x 5.71)	<b>JBEP202115AP10</b>
JBEP2021150	4 x M25 with four cable glands for unarmored cable – diameter 8 to 17 mm (0.31 to 0.67 in)		4.00 (8.80)	6.45 (393.60)	200 x 215 x 145 (7.87 x 8.46 x 5.71)	<b>JBEP202115NP10</b>

## Ex eb IIC Factory Drilled JBEP Polyester Junction Boxes Equipped with Screw Terminals, Earth Terminals and Earth Stud

- 16 mm<sup>2</sup> terminals (WDU16) and earth terminals (WPE16), Rating 43 Amps, 690 Volts

Enclosure Type	Equipment	Entry Layout	Weight kg (lb)	Volume dm <sup>3</sup> (in <sup>3</sup> )	Dimensions – mm (in)	Terminal Jumped
						Catalog Number
<b>Configuration: TP (2PE + 3L1 + 3L2 + 3L3 + 2PE)</b>						
JBEP2021150	6 x M25 with earth continuity device		4.00 (8.80)	6.45 (393.60)	200 x 215 x 145 (7.87 x 8.46 x 5.71)	<b>JBEP202115AP11</b>
JBEP2021150	6 x M25 with six cable glands for unarmored cable – diameter 8 to 17 mm (0.31 to 0.67 in)		4.00 (8.80)	6.45 (393.60)	200 x 215 x 145 (7.87 x 8.46 x 5.71)	<b>JBEP202115NP11</b>
JBEP2021150	6 x M25 with earth continuity device		4.00 (8.80)	6.45 (393.60)	200 x 215 x 145 (7.87 x 8.46 x 5.71)	<b>JBEP202115AP12</b>
JBEP2021150	6 x M25 with six cable glands for unarmored cable – diameter 8 to 17 mm (0.31 to 0.67 in)		4.00 (8.80)	6.45 (393.60)	200 x 215 x 145 (7.87 x 8.46 x 5.71)	<b>JBEP202115NP12</b>

# ATX™ JBEP Series FRP Terminal Junction Boxes for Electrical and Power Applications

Fiberglass Reinforced Polyester. Increased Safety. Factory Drilled and Equipped.

Maximum Capacity Per Terminal: 16 mm<sup>2</sup>

**NEC/CEC:**  
Class I, Zone 1, AEx e IIC, T5 or T6  
Ex e IIC, T5 or T6  
IP66

**ATEX/IECEX:**  
Zone 1 and 2 – 21 and 22  
II 2 GD  
IP66 – IK10

## Ex eb IIC Factory Drilled JBEP Polyester Junction Boxes Equipped with Screw Terminals, Earth Terminals and Earth Stud

- 16 mm<sup>2</sup> terminals (WDU16) and earth terminals (WPE16), Rating 45 Amps, 690 Volts

Enclosure Type	Equipment	Entry Layout	Weight kg (lb)	Volume dm <sup>3</sup> (in <sup>3</sup> )	Dimensions – mm (in)	Terminal Jumped
						Catalog Number
<b>Configuration: TP + N (2PE + 2L1 + 2L2 + 2L3 + 2N + PE)</b>						
JBEP2021150	3 x M25 with earth continuity device		4.00 (8.80)	6.45 (393.60)	200 x 215 x 145 (7.87 x 8.46 x 5.71)	<b>JBEP202115AP13</b>
JBEP2021150	3 x M32 with three cable glands for unarmored cable – diameter 10 to 25 mm (0.39 to 0.98 in)		4.00 (8.80)	6.45 (393.60)	200 x 215 x 145 (7.87 x 8.46 x 5.71)	<b>JBEP202115NP13</b>
JBEP2021150	4 x M25 with earth continuity device		4.00 (8.80)	6.45 (393.60)	200 x 215 x 145 (7.87 x 8.46 x 5.71)	<b>JBEP202115AP14</b>
JBEP2021150	4 x M32 with four cable glands for unarmored cable – diameter 10 to 25 mm (0.39 to 0.98 in)		4.00 (8.80)	6.45 (393.60)	200 x 215 x 145 (7.87 x 8.46 x 5.71)	<b>JBEP202115NP14</b>
JBEP2021150	4 x M25 with earth continuity device		4.00 (8.80)	6.45 (393.60)	200 x 215 x 145 (7.87 x 8.46 x 5.71)	<b>JBEP202115AP15</b>
JBEP2021150	4 x M32 with four cable glands for unarmored cable – diameter 10 to 25 mm (0.39 to 0.98 in)		4.00 (8.80)	6.45 (393.60)	200 x 215 x 145 (7.87 x 8.46 x 5.71)	<b>JBEP202115NP15</b>
JBEP2021150	4 x M25 with earth continuity device		4.00 (8.80)	6.45 (393.60)	200 x 215 x 145 (7.87 x 8.46 x 5.71)	<b>JBEP202115AP16</b>
JBEP2021150	4 x M32 with four cable glands for unarmored cable – diameter 10 to 25 mm (0.39 to 0.98 in)		4.00 (8.80)	6.45 (393.60)	200 x 215 x 145 (7.87 x 8.46 x 5.71)	<b>JBEP202115NP16</b>

## Ex eb IIC Factory Drilled JBEP Polyester Junction Boxes Equipped with Screw Terminals, Earth Terminals and Earth Stud

- 16 mm<sup>2</sup> terminals (WDU16) and earth terminals (WPE16), Rating 40 Amps, 690 Volts

Enclosure Type	Equipment	Entry Layout	Weight kg (lb)	Volume dm <sup>3</sup> (in <sup>3</sup> )	Dimensions – mm (in)	Terminal Jumped
						Catalog Number
<b>Configuration: TP + N (2PE + 3L1 + 3L2 + 3L3 + 3N + 2PE)</b>						
JBEP2532150	6 x M25 with earth continuity device		8.20 (18.00)	12.00 (732.28)	250 x 320 x 150 (9.84 x 12.60 x 5.94)	<b>JBEP253215AP17</b>
JBEP2532150	6 x M32 with six cable glands for unarmored cable – diameter 10 to 25 mm (0.39 to 0.98 in)		8.20 (18.00)	12.00 (732.28)	250 x 320 x 150 (9.84 x 12.60 x 5.94)	<b>JBEP253215NP17</b>
JBEP2532150	6 x M25 with earth continuity device		8.20 (18.00)	12.00 (732.28)	250 x 320 x 150 (9.84 x 12.60 x 5.94)	<b>JBEP253215AP18</b>
JBEP2532150	6 x M32 with six cable glands for unarmored cable – diameter 10 to 25 mm (0.39 to 0.98 in)		8.20 (18.00)	12.00 (732.28)	250 x 320 x 150 (9.84 x 12.60 x 5.94)	<b>JBEP253215NP18</b>

# ATX™ JBEP Series FRP Terminal Junction Boxes for Electrical and Power Applications

Fiberglass Reinforced Polyester. Increased Safety. Factory Drilled and Equipped.

Maximum Capacity Per Terminal: 25/35 mm<sup>2</sup>

**NEC/CEC:**  
Class I, Zone 1, AEx e IIC, T5 or T6  
Ex e IIC, T5 or T6  
IP66

**ATEX/IECEX:**  
Zone 1 and 2 – 21 and 22  
II 2 GD  
IP66 – IK10



JBEP253215NP02

## Ex eb IIC Factory Drilled JBEP Polyester Junction Boxes Equipped with Screw Terminals, Earth Terminals and Earth Stud

- 25 mm<sup>2</sup> terminals (WDU35) and earth terminals (WPE35), Rating 80 Amps, 690 Volts
- 35 mm<sup>2</sup> terminals (WDU35) and earth terminals (WPE35), Rating 98 Amps, 690 Volts

Enclosure Type	Equipment	Entry Layout	Weight kg (lb)	Volume dm <sup>3</sup> (in <sup>3</sup> )	Dimensions – mm (in)	Terminal Jumped Catalog Number
<b>Configuration: TP (1PE + 2L1 + 2L2 + 2L3 + 2PE)</b>						
JBEP2532150	4 x M32 with earth continuity device		8.20 (18.00)	12.00 (732.28)	250 x 320 x 151 (9.84 x 12.60 x 5.94)	<b>JBEP253215AP01</b>
JBEP2532150	4 x M32 with four cable glands for unarmored cable – diameter 10 to 25 mm (0.39 to 0.98 in)		8.20 (18.00)	12.00 (732.28)	250 x 320 x 151 (9.84 x 12.60 x 5.94)	<b>JBEP253215NP01</b>

## Ex eb IIC Factory Drilled JBEP Polyester Junction Boxes Equipped with Screw Terminals, Earth Terminals and Earth Stud

- 25 mm<sup>2</sup> terminals (WDU35) and earth terminals (WPE35), Rating 70 Amps, 690 Volts
- 35 mm<sup>2</sup> terminals (WDU35) and earth terminals (WPE35), Rating 80 Amps, 690 Volts

Enclosure Type	Equipment	Entry Layout	Weight kg (lb)	Volume dm <sup>3</sup> (in <sup>3</sup> )	Dimensions – mm (in)	Terminal Jumped Catalog Number
<b>Configuration: TP (2PE + 3L1 + 3L2 + 3L3 + 2PE)</b>						
JBEP2532150	6 x M32 with earth continuity device		8.20 (18.00)	12.00 (732.28)	250 x 320 x 151 (9.84 x 12.60 x 5.94)	<b>JBEP253215AP02</b>
JBEP2532150	6 x M32 with six cable glands for unarmored cable – diameter 10 to 25 mm (0.39 to 0.98 in)		8.20 (18.00)	12.00 (732.28)	250 x 320 x 151 (9.84 x 12.60 x 5.94)	<b>JBEP253215NP02</b>

# ATX™ JBEP Series FRP Terminal Junction Boxes for Electrical and Power Applications

Fiberglass Reinforced Polyester. Increased Safety. Factory Drilled and Equipped.

Maximum Capacity Per Terminal: 25/35 mm<sup>2</sup>

**NEC/CEC:**  
Class I, Zone 1, AEx e IIC, T5 or T6  
Ex e IIC, T5 or T6  
IP66

**ATEX/IECEX:**  
Zone 1 and 2 – 21 and 22  
II 2 GD  
IP66 – IK10



JBEP253215NP04

### Ex eb IIC Factory Drilled JBEP Polyester Junction Boxes Equipped with Screw Terminals, Earth Terminals and Earth Stud

- 25 mm<sup>2</sup> terminals (WDU35) and earth terminals (WPE35), Rating 75 Amps, 690 Volts
- 35 mm<sup>2</sup> terminals (WDU35) and earth terminals (WPE35), Rating 85 Amps, 690 Volts

Enclosure Type	Equipment	Entry Layout	Weight kg (lb)	Volume dm <sup>3</sup> (in <sup>3</sup> )	Dimensions – mm (in)	Terminal Jumped Catalog Number
<b>Configuration: TP + N (2PE + 2L1 + 2L2 + 2L3 + 2N + PE)</b>						
JBEP2532150	4 x M32 with earth continuity device		8.20 (18.00)	12.00 (732.28)	250 x 320 x 150 (9.84 x 12.60 x 5.91)	<b>JBEP253215AP03</b>
JBEP2532150	4 x M32 with four cable glands for unarmored cable – diameter 10 to 25 mm (0.39 to 0.98 in)		8.20 (18.00)	12.00 (732.28)	250 x 320 x 150 (9.84 x 12.60 x 5.91)	<b>JBEP253215NP03</b>

### Ex eb IIC Factory Drilled JBEP Polyester Junction Boxes Equipped with Screw Terminals, Earth Terminals and Earth Stud

- 25 mm<sup>2</sup> terminals (WDU35) and earth terminals (WPE35), Rating 58 Amps, 690 Volts
- 35 mm<sup>2</sup> terminals (WDU35) and earth terminals (WPE35), Rating 68 Amps, 690 Volts

Enclosure Type	Equipment	Entry Layout	Weight kg (lb)	Volume dm <sup>3</sup> (in <sup>3</sup> )	Dimensions – mm (in)	Terminal Jumped Catalog Number
<b>Configuration: TP + N (2PE + 3L1 + 3L2 + 3L3 + 3N + 2PE)</b>						
JBEP2532150	6 x M32 with earth continuity device		8.20 (18.00)	12.00 (732.28)	250 x 320 x 150 (9.84 x 12.60 x 5.91)	<b>JBEP253215AP04</b>
JBEP2532150	6 x M40 with six cable glands for unarmored cable – diameter 24 to 34 mm (0.94 to 1.34 in)		8.20 (18.00)	12.00 (732.28)	250 x 320 x 150 (9.84 x 12.60 x 5.91)	<b>JBEP253215NP04</b>

# ATX™ JBEP Series FRP Terminal Junction Boxes for Electrical and Power Applications

Fiberglass Reinforced Polyester. Increased Safety. Factory Drilled and Equipped.

Maximum Capacity Per Terminal: 10 mm<sup>2</sup> to 50 mm<sup>2</sup>

NEC/CEC:  
Class I, Zone 1, AEx e IIC, T5 or T6  
Ex e IIC, T5 or T6  
IP66

ATEX/IECEX:  
Zone 1 and 2 – 21 and 22  
II 2 GD  
IP66 – IK10



JBEP503215AP02

## Ex eb IIC Factory Drilled JBEP Polyester Junction Boxes Equipped with Screw Terminals, Earth Terminals and Earth Stud

- 10 mm<sup>2</sup> to 50 mm<sup>2</sup> terminals (WDU50N) and earth terminals (WPE35), Rating 125 Amps, 550 Volts

Enclosure Type	Equipment	Entry Layout	Weight kg (lb)	Volume dm <sup>3</sup> (in <sup>3</sup> )	Dimensions – mm (in)	Terminal Jumped Catalog Number
<b>Configuration: TP (1PE + 2L1 + 2L2 + 2L3 + 2PE)</b>						
JBEP5032150	4 x M40 with earth continuity device		8.50 (18.60)	24.00 (1464.57)	500 x 320 x 150 (19.68 x 12.60 x 5.91)	<b>JBEP503215AP01</b>
JBEP5032150	4 x M40 with four cable glands for unarmored cable – diameter 24 to 34 mm (0.94 to 1.34 in)		8.50 (18.60)	24.00 (1464.57)	500 x 320 x 150 (19.68 x 12.60 x 5.91)	<b>JBEP503215NP01</b>

## Ex eb IIC Factory Drilled JBEP Polyester Junction Boxes Equipped with Screw Terminals, Earth Terminals and Earth Stud

- 10 mm<sup>2</sup> to 50 mm<sup>2</sup> terminals (WDU50N) and earth terminals (WPE35), Rating 125 Amps, 550 Volts

Enclosure Type	Equipment	Entry Layout	Weight kg (lb)	Volume dm <sup>3</sup> (in <sup>3</sup> )	Dimensions – mm (in)	Terminal Jumped Catalog Number
<b>Configuration: TP (2PE + 3L1 + 3L2 + 3L3 + 2PE)</b>						
JBEP5032150	6 x M40 with earth continuity device		8.50 (18.60)	24.00 (1464.57)	500 x 320 x 150 (19.68 x 12.60 x 5.91)	<b>JBEP503215AP02</b>
JBEP5032150	6 x M40 with six cable glands for unarmored cable – diameter 24 to 34 mm (0.94 to 1.34 in)		8.50 (18.60)	24.00 (1464.57)	500 x 320 x 150 (19.68 x 12.60 x 5.91)	<b>JBEP503215NP02</b>

# ATX™ JBEP Series FRP Terminal Junction Boxes for Electrical and Power Applications

Fiberglass Reinforced Polyester. Increased Safety. Factory Drilled and Equipped.

Maximum Capacity Per Terminal: 10 mm<sup>2</sup> to 50 mm<sup>2</sup>

**NEC/CEC:**  
Class I, Zone 1, AEx e IIC, T5 or T6  
Ex e IIC, T5 or T6  
IP66



**ATEX/IECEX:**  
Zone 1 and 2 – 21 and 22  
II 2 GD  
IP66 – IK10



JBEP503215AP04

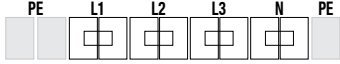

### Ex eb IIC Factory Drilled JBEP Polyester Junction Boxes Equipped with Screw Terminals, Earth Terminals and Earth Stud

- 10 mm<sup>2</sup> to 50 mm<sup>2</sup> terminals (WDU50N) and earth terminals (WPE35), Rating 125 Amps, 550 Volts

Enclosure Type	Equipment	Entry Layout	Weight kg (lb)	Volume dm <sup>3</sup> (in <sup>3</sup> )	Dimensions – mm (in)	Terminal Jumped Catalog Number
<b>Configuration: TP + N (2PE + 2L1 + 2L2 + 2L3 + 2N + PE)</b> 						
JBEP5032150	4 x M40 with earth continuity device		8.50 (18.60)	24.00 (1464.57)	500 x 320 x 150 (19.68 x 12.60 x 5.91)	<b>JBEP503215AP03</b>
JBEP5032150	4 x M40 with four cable glands for unarmored cable – diameter 24 to 34 mm (0.94 to 1.34 in)		8.50 (18.60)	24.00 (1464.57)	500 x 320 x 150 (19.68 x 12.60 x 5.91)	<b>JBEP503215NP03</b>

### Ex eb IIC Factory Drilled JBEP Polyester Junction Boxes Equipped with Screw Terminals, Earth Terminals and Earth Stud

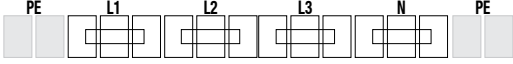
- 10 mm<sup>2</sup> to 50 mm<sup>2</sup> terminals (WDU50N) and earth terminals (WPE35), Rating 100 Amps, 550 Volts

Enclosure Type	Equipment	Entry Layout	Weight kg (lb)	Volume dm <sup>3</sup> (in <sup>3</sup> )	Dimensions – mm (in)	Terminal Jumped Catalog Number
<b>Configuration: TP + N (2PE + 3L1 + 3L2 + 3L3 + 3N + 2PE)</b> 						
JBEP5032150	6 x M40 with earth continuity device		9.30 (20.50)	24.00 (1464.57)	500 x 320 x 150 (19.68 x 12.60 x 5.91)	<b>JBEP503215AP04</b>
JBEP5032230	6 x M50 with six cable glands for unarmored cable – diameter 28 to 42 mm (1.10 to 1.65 in)		10.30 (22.70)	36.80 (2245.67)	500 x 320 x 230 (19.68 x 12.60 x 9.06)	<b>JBEP503223NP04</b>

# ATX™ JBEP Series FRP Terminal Junction Boxes for Electrical and Power Applications

Fiberglass Reinforced Polyester. Increased Safety. Factory Drilled and Equipped.

Maximum Capacity Per Terminal: 10 mm<sup>2</sup> to 70 mm<sup>2</sup>

**NEC/CEC:**  
Class I, Zone 1, AEx e IIC, T5 or T6  
Ex e IIC, T5 or T6  
IP66

**ATEX/IECEX:**  
Zone 1 and 2 – 21 and 22  
Ⓢ II 2 GD  
IP66 – IK10



JBEP503215AP22

## Ex eb IIC Factory Drilled JBEP Polyester Junction Boxes Equipped with Screw Terminals, Earth Terminals and Earth Stud

- 10 mm<sup>2</sup> to 70 mm<sup>2</sup> terminals (WDU70N) and earth terminals (WPE35), Rating 160 Amps, 550 Volts

Enclosure Type	Equipment	Entry Layout	Weight kg (lb)	Volume dm <sup>3</sup> (in <sup>3</sup> )	Dimensions – mm (in)	Terminal Jumped Catalog Number
<b>Configuration: TP (1PE + 2L1 + 2L2 + 2L3 + 2PE)</b>						
JBEP5032150	4 x M40 with earth continuity device		9.30 (20.50)	24.00 (1464.57)	500 x 320 x 150 (19.68 x 12.60 x 5.91)	<b>JBEP503215AP21</b>
JBEP5032150	4 x M40 with four cable glands for unarmored cable – diameter 24 to 34 mm (0.94 to 1.34 in)		9.30 (20.50)	24.00 (1464.57)	500 x 320 x 150 (19.68 x 12.60 x 5.91)	<b>JBEP503215NP21</b>

## Ex eb IIC Factory Drilled JBEP Polyester Junction Boxes Equipped with Screw Terminals, Earth Terminals and Earth Stud

- 10 mm<sup>2</sup> to 70 mm<sup>2</sup> terminals (WDU70N) and earth terminals (WPE35), Rating 140 Amps, 550 Volts

Enclosure Type	Equipment	Entry Layout	Weight kg (lb)	Volume dm <sup>3</sup> (in <sup>3</sup> )	Dimensions – mm (in)	Terminal Jumped Catalog Number ②
<b>Configuration: TP (2PE + 3L1 + 3L2 + 3L3 + 2PE)</b>						
JBEP5032150	6 x M40 with earth continuity device		9.30 (20.50)	24.00 (1464.57)	500 x 320 x 150 (19.68 x 12.60 x 5.91)	<b>JBEP503215AP22</b>
JBEP5032150	6 x M40 with six cable glands for unarmored cable – diameter 24 to 34 mm (0.94 to 1.34 in)		9.30 (20.50)	24.00 (1464.57)	500 x 320 x 150 (19.68 x 12.60 x 5.91)	<b>JBEP503215NP22</b>

# ATX™ JBEP Series FRP Terminal Junction Boxes for Electrical and Power Applications

Fiberglass Reinforced Polyester. Increased Safety. Factory Drilled and Equipped.

Maximum Capacity Per Terminal: 10 mm<sup>2</sup> to 70 mm<sup>2</sup>

**NEC/CEC:**  
Class I, Zone 1, AEx e IIC, T5 or T6  
Ex e IIC, T5 or T6  
IP66

**ATEX/IECEX:**  
Zone 1 and 2 – 21 and 22  
II 2 GD  
IP66 – IK10



JBEP503215AP24

### Ex eb IIC Factory Drilled JBEP Polyester Junction Boxes Equipped with Screw Terminals, Earth Terminals and Earth Stud

- 10 mm<sup>2</sup> to 70 mm<sup>2</sup> terminals (WDU70N) and earth terminals (WPE35), Rating 150 Amps, 550 Volts

Enclosure Type	Equipment	Entry Layout	Weight kg (lb)	Volume dm <sup>3</sup> (in <sup>3</sup> )	Dimensions – mm (in)	Terminal Jumped Catalog Number ②
<b>Configuration: TP + N (2PE + 2L1 + 2L2 + 2L3 + 2N + PE)</b>						
JBEP5032150	4 x M40 with earth continuity device		9.30 (20.50)	24.00 (1464.57)	500 x 320 x 150 (19.68 x 12.60 x 5.91)	<b>JBEP503215AP23</b>
JBEP5032150	4 x M40 with four cable glands for unarmored cable – diameter 24 to 34 mm (0.94 to 1.34 in)		9.30 (20.50)	24.00 (1464.57)	500 x 320 x 150 (19.68 x 12.60 x 5.91)	<b>JBEP503215NP23</b>

### Ex eb IIC Factory Drilled JBEP Polyester Junction Boxes Equipped with Screw Terminals, Earth Terminals and Earth Stud

- 10 mm<sup>2</sup> to 70 mm<sup>2</sup> terminals (WDU70N) and earth terminals (WPE35), Rating 125 Amps, 550 Volts

Enclosure Type	Equipment	Entry Layout	Weight kg (lb)	Volume dm <sup>3</sup> (in <sup>3</sup> )	Dimensions – mm (in)	Terminal Jumped Catalog Number
<b>Configuration: TP + N (2PE + 3L1 + 3L2 + 3L3 + 3N + 2PE)</b>						
JBEP5032150	6 x M40 with earth continuity device		9.30 (20.50)	24.00 (1464.57)	500 x 320 x 150 (19.68 x 12.60 x 5.91)	<b>JBEP503215AP24</b>
JBEP5032230	6 x M50 with six cable glands for unarmored cable – diameter 28 to 42 mm (1.10 to 1.65 in)		10.30 (22.70)	36.80 (2245.67)	500 x 320 x 230 (19.68 x 12.60 x 9.06)	<b>JBEP503223NP24</b>



# ATX™ JBEP Series FRP Terminal Junction Boxes for Electrical and Power Applications

Fiberglass Reinforced Polyester. Increased Safety. Factory Drilled and Equipped.

Maximum Capacity Per Terminal: 120 mm<sup>2</sup>

**NEC/CEC:**  
Class I, Zone 1, AEx e IIC, T5 or T6  
Ex e IIC, T5 or T6  
IP66

**ATEX/IECEX:**  
Zone 1 and 2 – 21 and 22  
II 2 GD  
IP66 – IK10

## Ex eb IIC Factory Drilled JBEP Polyester Junction Boxes Equipped with Screw Terminals, Earth Bar and Earth Stud

- 10 mm<sup>2</sup> to 120 mm<sup>2</sup> terminals (WDU95N/120N) and earth copper bar, Rating 200 Amps, 690 Volts

Enclosure Type	Equipment	Entry Layout	Weight kg (lb)	Volume dm <sup>3</sup> (in <sup>3</sup> )	Dimensions – mm (in)	Terminal Jumped Catalog Number
<b>Configuration: TP (2L1 + 2L2 + 2L3 + 1PE)</b>						
JBEP7532230	4 x M50 with earth continuity device		10.80 (23.80)	55.20 (3368.51)	750 x 320 x 230 (29.53 x 12.60 x 9.06)	<b>JBEP753223AP01</b>
JBEP7532150	4 x M50 with four cable glands for unarmored cable – diameter 28 to 42 mm (1.10 to 1.65 in)		9.75 (21.50)	36.00 (2196.85)	750 x 320 x 150 (29.53 x 12.60 x 5.91)	<b>JBEP753215NP01</b>
<b>Configuration: TP (3L1 + 3L2 + 3L3 + 1PE)</b>						
JBEP7532230	6 x M50 with earth continuity device		10.80 (23.80)	55.20 (3368.51)	750 x 320 x 230 (29.53 x 12.60 x 9.06)	<b>JBEP753223AP02</b>
JBEP7532230	6 x M50 with six cable glands for unarmored cable – diameter 28 to 42 mm (1.10 to 1.65 in)		10.80 (23.80)	55.20 (3368.51)	750 x 320 x 230 (29.53 x 12.60 x 9.06)	<b>JBEP753223NP02</b>
<b>Configuration: TP + N (2L1 + 2L2 + 2L3 + 2N + 1PE)</b>						
JBEP7532230	4 x M50 with earth continuity device		10.80 (23.80)	55.20 (3368.51)	750 x 320 x 230 (29.53 x 12.60 x 9.06)	<b>JBEP753223AP03</b>
JBEP7532150	4 x M50 with four cable glands for unarmored cable – diameter 28 to 42 mm (1.10 to 1.65 in)		9.75 (21.50)	36.00 (2196.85)	750 x 320 x 150 (29.53 x 12.60 x 5.91)	<b>JBEP753215NP03</b>

# ATX™ JBEP Series FRP Terminal Junction Boxes for Electrical and Power Applications

Fiberglass Reinforced Polyester. Increased Safety. Factory Drilled and Equipped.

Maximum Capacity Per Terminal: 240 mm<sup>2</sup>

**NEC/CEC:**  
Class I, Zone 1, AEx e IIC, T5 or T6  
Ex e IIC, T5 or T6  
IP66

**ATEX/IECEX:**  
Zone 1 and 2 – 21 and 22  
II 2 GD  
IP66 – IK10



JBEP753215AP72

### Ex eb IIC Factory Drilled JBEP Polyester Junction Boxes Equipped with Clamping Terminals and Earth Stud

- 35/240 mm<sup>2</sup> clamping terminals on a bus bar and earth terminal (Earth Bus), Rating 400 Amps, 1100 Volts

Enclosure Type	Equipment	Entry Layout	Weight kg (lb)	Volume dm <sup>3</sup> (in <sup>3</sup> )	Dimensions – mm (in)	Standard Bus Bar Catalog Number
<div style="display: flex; justify-content: space-between; align-items: center;"> <div> <p><b>Configuration: (L1 + L2 + L3 + PE All Copper Bars)</b></p> </div> <div style="text-align: right;"> </div> </div>						
2 x JBEP7532150	3 x M50 with earth continuity device, 3 Clamping terminals per bar		40.50 (89.30)	73.13 (4462.36)	750 x 650 x 150 (29.53 x 25.59 x 5.91)	JBEP753215AP61
2 x JBEP7532150	4 x M50 with earth continuity device, 4 Clamping terminals per bar		40.50 (89.30)	73.13 (4462.36)	750 x 650 x 150 (29.53 x 25.59 x 5.91)	JBEP753215AP62
2 x JBEP7532150	3 x M63 with earth continuity device, 3 Clamping terminals per bar		40.50 (89.30)	73.13 (4462.36)	750 x 650 x 150 (29.53 x 25.59 x 5.91)	JBEP753215AP71
2 x JBEP7532150	4 x M63 with earth continuity device, 4 Clamping terminals per bar		40.50 (89.30)	73.13 (4462.36)	750 x 650 x 150 (29.53 x 25.59 x 5.91)	JBEP753215AP72

### Example of Two JBEP753215 Enclosures Coupled

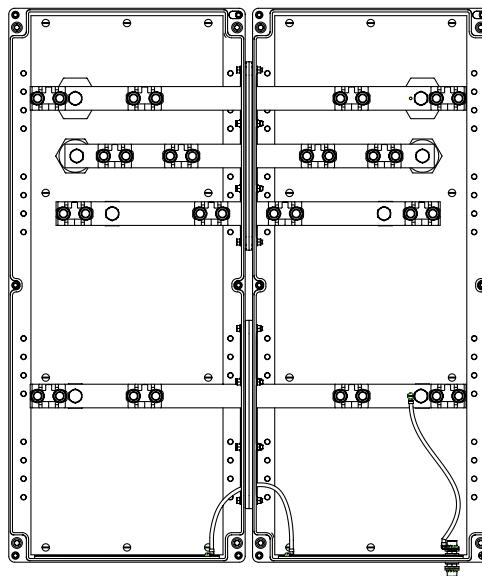

# ATX™ JBEP Series FRP Terminal Junction Boxes for Electrical and Power Applications

Fiberglass Reinforced Polyester. Increased Safety. Factory Drilled and Equipped.

NEC/CEC:  
Class I, Zone 1, AEx e IIC, T5 or T6  
Ex e IIC, T5 or T6  
IP66

ATEX/IECEX:  
Zone 1 and 2 – 21 and 22  
II 2 GD  
IP66 – IK10

Dimensions in Millimeters (Inches) ①

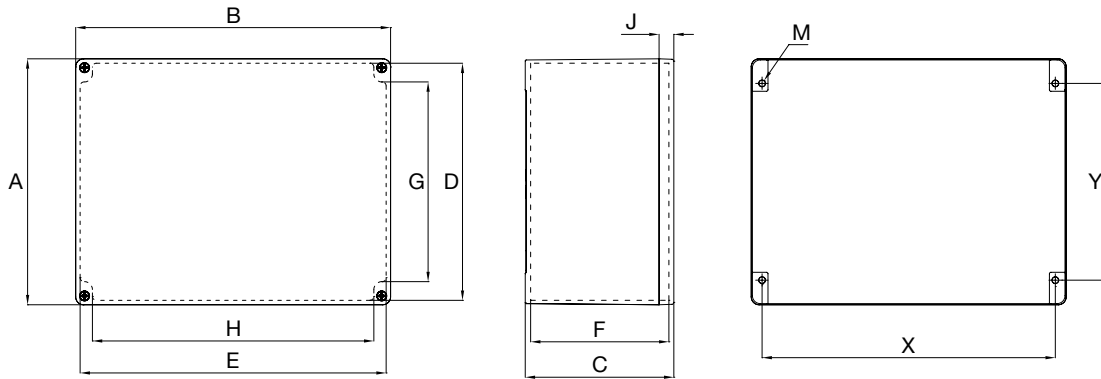

Enclosure Catalog Number	External Dimension				Internal Dimensions				Cover J	Body Thickness	Wall Fixing		
	A	B	C	D	E	F	G	H			X	Y	M ②
JBEP0808060	85.0 (3.346)	85.0 (3.346)	61.0 (2.402)	76.7 (3.020)	76.7 (3.020)	47.0 (1.850)	41.0 (1.614)	51.0 (2.008)	15.0 (0.591)	3.5 (0.138)	69.0 (2.717)	49.0 (1.929)	M4
JBEP1212090	120.0 (4.724)	120.0 (4.724)	91.0 (3.583)	109.5 (4.311)	109.5 (4.311)	75.0 (2.953)	63.0 (4.528)	85.0 (3.346)	40.0 (1.575)	4.5 (0.177)	103.0 (4.055)	83.0 (3.268)	M5
JBEP121209S0	120.0 (4.724)	120.0 (4.724)	91.0 (3.583)	108.6 (4.276)	108.6 (4.276)	75.0 (2.953)	63.0 (4.528)	85.0 (3.346)	15.0 (0.591)	4.5 (0.177)	103.0 (4.055)	83.0 (3.268)	M5
JBEP1717090	170.0 (6.693)	170.0 (6.693)	91.0 (3.583)	158.5 (6.240)	158.5 (6.240)	72.0 (2.835)	112.5 (4.429)	137.0 (5.394)	15.0 (0.591)	4.5 (0.177)	153.0 (6.024)	131.0 (5.157)	M5
JBEP2021100	200.0 (7.874)	215.0 (8.465)	95.0 (3.740)	185.8 (7.315)	200.8 (7.906)	76.0 (2.992)	116.0 (4.567)	159.0 (6.260)	20.0 (0.787)	6.1 (0.240)	189.0 (7.441)	146.0 (5.748)	M6
JBEP2021150	200.0 (7.874)	215.0 (8.465)	145.0 (5.709)	185.8 (7.315)	200.8 (7.906)	122.5 (4.823)	114.8 (4.519)	159.0 (6.260)	20.0 (0.787)	6.1 (0.240)	189.0 (7.441)	146.0 (5.748)	M6
JBEP2532150	250.0 (9.843)	320.0 (12.598)	150.0 (5.906)	241.0 (9.488)	311.0 (12.244)	133.5 (5.256)	171.0 (6.732)	267.0 (10.512)	15.0 (0.591)	5.0 (0.197)	200.0 (7.874)	298.0 (11.732)	M6
JBEP3225150	320.0 (12.598)	250.0 (9.843)	150.0 (5.906)	311.0 (12.244)	241.0 (9.488)	133.5 (5.256)	267.0 (10.512)	171.0 (6.732)	15.0 (0.591)	5.0 (0.197)	298.0 (11.732)	200.0 (7.874)	M6
JBEP3250150	320.0 (12.598)	500.0 (19.685)	150.0 (5.906)	311.0 (12.244)	491.0 (19.331)	133.5 (5.256)	267.0 (10.512)	421.0 (16.575)	15.0 (0.591)	5.0 (0.197)	298.0 (11.732)	447.0 (17.598)	M6
JBEP3250230	320.0 (12.598)	500.0 (19.685)	230.0 (9.055)	311.0 (12.244)	491.0 (19.331)	213.5 (8.406)	267.0 (10.512)	421.0 (16.575)	15.0 (0.591)	5.0 (0.197)	298.0 (11.732)	447.0 (17.598)	M6
JBEP3275150	320.0 (12.598)	750.0 (29.528)	150.0 (5.906)	311.0 (12.244)	741.0 (29.173)	133.5 (5.256)	267.0 (10.512)	671.0 (26.417)	15.0 (0.591)	5.0 (0.197)	298.0 (11.732)	698.0 (27.480)	M6
JBEP3275230	320.0 (12.598)	750.0 (29.528)	230.0 (9.055)	311.0 (12.244)	741.0 (29.173)	213.5 (8.406)	267.0 (10.512)	671.0 (26.417)	15.0 (0.591)	5.0 (0.197)	298.0 (11.732)	698.0 (27.480)	M6

① Wall fixing screw diameter 5 mm (0.20"). Wall fixing screw hole 6 mm (0.24").

② Screw to be used for mounting box.

# ATX™ JBEP Series FRP Terminal Junction Boxes for Electrical and Power Applications

Fiberglass Reinforced Polyester. Increased Safety. Factory Drilled and Equipped.

**NEC/CEC:**  
 Class I, Zone 1, AEx e IIC, T5 or T6  
 Ex e IIC, T5 or T6  
 IP66

**ATEX/IECEX:**  
 Zone 1 and 2 – 21 and 22  
 II 2 GD  
 IP66 – IK10

Dimensions in Millimeters (Inches) ①

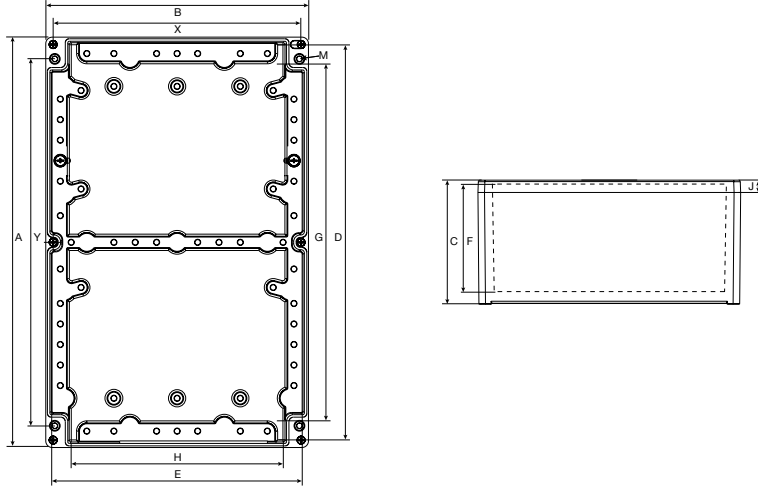

Enclosure Catalog Number	External Dimension		Internal Dimensions						Cover	Body	Wall Fixing		
	A	B	C	D	E	F	G	H	J	Thickness	X	Y	M ②
JBEP5032150	500 (19.685)	320 (12.598)	150 (5.906)	491 (19.331)	311 (12.244)	133.5 (5.256)	421 (16.575)	267 (10.512)	15 (0.591)	5 (0.197)	447 (17.598)	298 (11.732)	M6
JBEP5032230	500 (19.685)	320 (12.598)	230 (9.055)	491 (19.331)	311 (12.244)	213.5 (8.406)	421 (16.575)	267 (10.512)	15 (0.591)	5 (0.197)	447 (17.598)	298 (11.732)	M6
JBEP7532150	750 (29.528)	320 (12.598)	150 (5.906)	741 (29.173)	311 (12.244)	133.5 (5.256)	671 (26.417)	267 (10.512)	15 (0.591)	5 (0.197)	298 (11.732)	698 (27.480)	M6
JBEP7532230	750 (29.528)	320 (12.598)	230 (9.055)	741 (29.173)	311 (12.244)	213.5 (8.406)	671 (26.417)	267 (10.512)	15 (0.591)	5 (0.197)	698 (27.480)	298 (11.732)	M6

① Wall fixing screw diameter 5 mm (0.20"). Wall fixing screw hole 6 mm (0.24").  
 ② Screw to be used for mounting box.

# ATX™ JBEP Series FRP Terminal Junction Boxes for Electrical and Power Applications

Fiberglass Reinforced Polyester. Increased Safety. Factory Drilled and Equipped.

NEC/CEC:  
Class I, Zone 1, AEx e IIC, T5 or T6  
Ex e IIC, T5 or T6  
IP66

ATEX/IECEX:  
Zone 1 and 2 – 21 and 22  
II 2 GD  
IP66 – IK10

Dimensions in Millimeters (Inches) ①

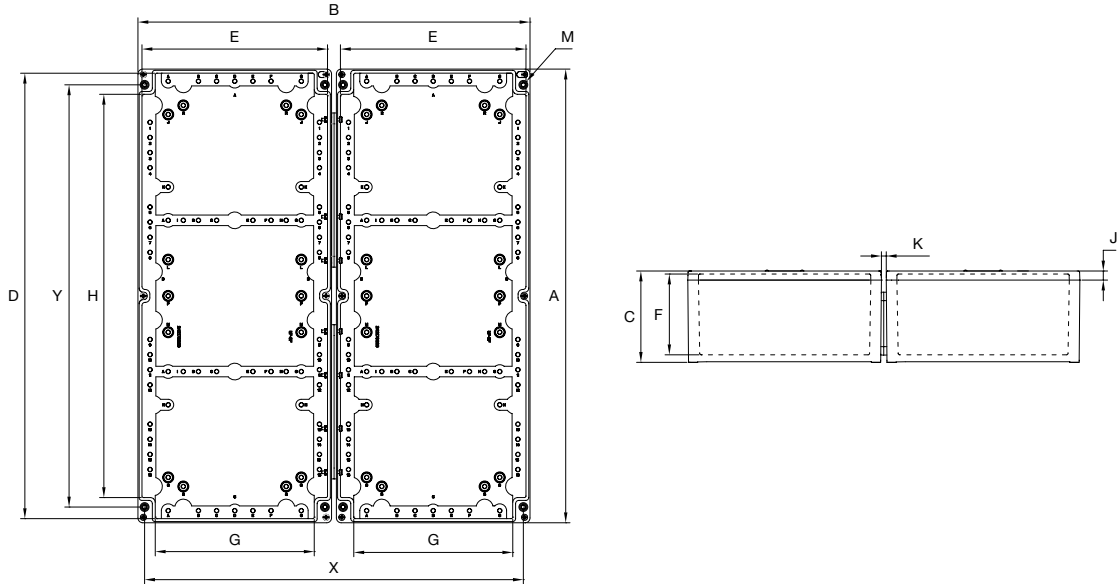

Enclosure Catalog Number	External Dimension			Internal Dimensions						Cover	Body	Wall Fixing		M ②
	A	B	C	D	E (x2)	F	G (x2)	H	J	Thickness	X	Y		
2 X JBEP7532150	750 (29.528)	648 (25.512)	150 (5.906)	741 (29.173)	311 (12.244)	133 (5.256)	267 (10.512)	671 (26.417)	8 (0.315)	15 (0.591)	5 (0.197)	626 (24.646)	698 (27.480)	M6

① Wall fixing screw diameter 5 mm (0.20"). Wall fixing screw hole 6 mm (0.24").  
② Screw to be used for mounting box.

# ATX™ VCB4 and VCB7 Video Camera Housings

## Flameproof

ATEX:  
 Zone 1 and 2 - 21 and 22  
 II 2 GD  
 IP66 - IK10

### Applications

- Flameproof housing to encase video camera used for onshore and offshore site and process supervision.

### Features

- Compatible with any camera model with the following specifications:
  - Length compatible with one of the two sizes:
    - 475 mm (18.70")
    - 735 mm (28.94")
  - Maximum cross section for the camera : < 127 cm<sup>2</sup> (19.6 in<sup>2</sup>).
  - Capacitor's residual energy (after opening) : < 20 μJ.
  - Maximum dissipated power: 14 W.
  - Equipped with back plate.
  - Two M20 threaded cable entries.

### Standard Materials

- Body: gray painted aluminium
- Window: sealed toughened glass

### ATEX Certifications and Compliances

- Certification Type CAM
  - Gas: Zones 1 and 2
  - Conforming to ATEX 94/9/CE: II 2 G
  - Type of Protection: Ex d IIC
  - Temperature Class: T6 for Ta ≤ +40 °C (+104 °F) and T5 for +55 °C (+131 °F)
- Dust: Zone 21 and 22
  - Conforming to ATEX 94/9/CE: II 2 D
  - Type of Protection: Ex tD A21
  - Surface Temperature: T100 °C (T212 °F)
- Ambient Temperature: -40 °C to +55 °C (-40 °F to +131 °F)
- CE Declaration of Conformity: 50255
- ATEX Certificate: LCIE 03 ATEX 6080
- Index of Protection according EN/IEC 60529: IP66
- Impact Resistance (shock): IK10
- Internal Volume: ≤ 2dm<sup>3</sup> (122 in<sup>3</sup>) – 2 liters



**VCB4**  
(475 mm length version)

### Dimensions in Millimeters (Inches)

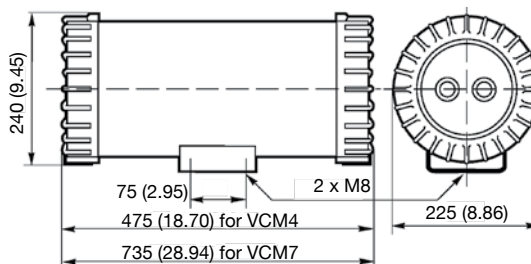

ENCLOSURES AND JUNCTION BOXES: ATEX FLAMEPROOF CAMERA HOUSING

Appleton

Length mm (in)	Weight kg (lb)	Volume dm <sup>3</sup> (in <sup>3</sup> )	Catalog Number
475 (18.70)	14.2 (31.31)	41 (2502)	<b>VCB4</b>
735 (28.94)	18.7 (41.23)	61 (3722)	<b>VCB7</b>

# ATX™ DA2W2E102 Video Camera Housing

## Flameproof

**ATEX:**  
**Zone 1 and 2 - 21 and 22**  
**⊕ II 2 GD**  
**IP66 - IK09**

### Applications

- Flameproof housing to encase video camera used for onshore and offshore site and process supervision.

### Features

- Maximum dissipated power: 10 W.
- Equipped with a back plate.
- One open view glass window, usable Ø 84 mm (3.31").
- Two internal grounding connection: M4 screw. External grounding: M6 screw.
- Two M20 threaded entries at the bottom.

### Standard Materials

- Body: gray painted aluminium
- Window: sealed toughened glass

### ATEX Certifications and Compliances

- Certification Type BR2d
  - Gas: Zones 1 and 2
  - Conforming to ATEX 94/9/CE: ⊕ II 2 G
  - Type of Protection: Ex d IIC
  - Temperature Class: T6
- Dust: Zone 21 and 22
  - Conforming to ATEX 94/9/CE: ⊕ II 2 D
  - Type of Protection: Ex tD A21
  - Surface Temperature: T80 °C (T176 °F)
- Ambient Temperature: -40 °C to +55 °C (-40 °F to +131 °F)
- CE Declaration of Conformity: 50256
- ATEX Certificate: LCIE 03 ATEX 6062
- Index of Protection according EN/IEC 60529: IP66
- Impact Resistance (shock): IK09
- Internal Volume: ≤ 2 dm<sup>3</sup> (122 in<sup>3</sup>) – 2 liters



### Dimensions in Millimeters (Inches)

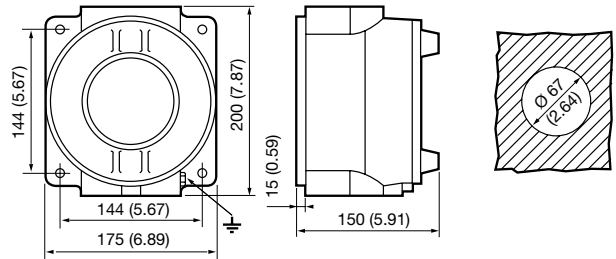

Weight kg (lb)	Volume dm <sup>3</sup> (in <sup>3</sup> )	Catalog Number
3.5 (7.72)	13 (0.00079)	DA2W2E102

### Accessories

	Description	Catalog Number
	Adjustable Mount	VCBHBA

ENCLOSURES AND JUNCTION BOXES: ATEX FLAMEPROOF CAMERA HOUSING

Appleton®

# ATX™ VCBA Video Camera Housing

## Flameproof

**ATEX:**  
**Zone 1 and 2 - 21 and 22**  
 Ⓜ II 2 GD  
 IP66 - IK10

### Applications

- Flameproof housing to encase video camera used for onshore and offshore site and process supervision.

### Features

- Maximum Power: 10 W.
- One open view glass window, usable diameter 155 mm (6.10 in).
- Threaded flameproof joint.
- Two M20 threaded entries with one blanking plug.

### Standard Materials

- Body: gray painted aluminium
- Window: sealed toughened glass

### ATEX Certifications and Compliances

- Certification Type PJ70
  - Gas: Zones 1 and 2
  - Conforming to ATEX 94/9/CE: Ⓜ II 2 G
  - Type of Protection: Ex d IIC
  - Temperature Class: T6
- Dust: Zone 21 and 22
  - Conforming to ATEX 94/9/CE: Ⓜ II 2 D
  - Type of Protection: Ex tD A21
  - Surface Temperature: T80 °C (T176 °F)
- Ambient Temperature: -40 °C to +55 °C (-40 °F to +131 °F)
- CE Declaration of Conformity: 50239
- ATEX Certificate: LCIE 02 ATEX 6227
- Index of Protection according EN/IEC 60529: IP66
- Impact Resistance (shock): IK10
- Internal Volume: ≤ 2 dm<sup>3</sup> (122 in<sup>3</sup>) – 2 liters



Dimensions in Millimeters (Inches)

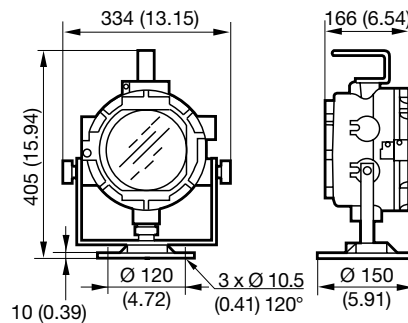

ENCLOSURES AND JUNCTION BOXES: ATEX FLAMEPROOF CAMERA HOUSING

Weight kg (lb)	Volume dm <sup>3</sup> (in <sup>3</sup> )	Catalog Number
8 (17.64)	27 (0.00165)	VCBA

Appleton®



# ATX™ JBDR Series Pre-Drilled Round Junction Boxes

## Flameproof

ATEX:  
Zone 1 and 2 – 21 and 22  
⊕ II 2 GD  
IP66 – IK10

### Applications

- Small terminal junction boxes designed to facilitate electrical connections in hazardous areas.
- Designed for use in Zone 1 or 2 areas, where flammable gases or vapors are present either continuously or intermittently.
- Ideal for use in wet or corrosive atmospheres such as:
  - Petroleum refineries
  - Chemical refineries
  - Other industrial process facilities
- Designed for use in Zone 21 or 22 areas, where flammable dusts are present either continuously or intermittently such as:
  - Food processing
  - Dairy
  - Brewing
  - Silos
  - Other facilities

### Features

- IK10 (20 Joules) high impact resistant box.
- Pillar type terminal block (4 x terminals) for easy connection.
- Terminal capacity: 4 x 4 mm<sup>2</sup> (0.006 x 0.006 in<sup>2</sup>) or 2 x 6 mm<sup>2</sup> (0.003 x 0.009 in<sup>2</sup>).
- Internal Earth: ground plate with 4 x M4 screws for connection to 4 mm diameter lugs.
- External Earth: M5 screw.
- Back plate supplied.
- Operating temperature -40 °C to +55 °C (-40 °F to +131 °F).

### Standard Materials

- Housing: gray painted marine grade aluminum
- Hardware: stainless steel

### ATEX Certifications and Compliances

- Certification Type BR1d
  - Gas, Zones 1 and 2:
    - Conforming to ATEX 94/9/CE: ⊕ II 2 G
    - Type of Protection: Ex d IIC
    - Temperature Class: T6 to T4
  - Dust, Zones 21 and 22:
    - Conforming to ATEX 94/9/CE: ⊕ II 2 D
    - Type of Protection: Ex tD A21
    - Surface Temperature: T95 °C (T203 °F)
- Ambient Temperature: -40 °C to +55 °C (-40 °F to +131 °F)
- CE Declaration of Conformity: 50230
- ATEX Certificate: LCIE 02 ATEX 6056
- Index of Protection according EN/IEC 60529: IP66
- Internal Volume: ≤ 2dm<sup>3</sup> (122 in<sup>3</sup>) – 2 liters
- Index of Protection according EN/IEC 60529: IP66
- Impact Resistance (shock): IK10

### EURASEC Certification

- Certification Type BR1d
  - EURASEC N° TC RU C-FR.Г505.B.00911

2 Entry Version with Cable Glands



3 Entry Version



4 Entry Version











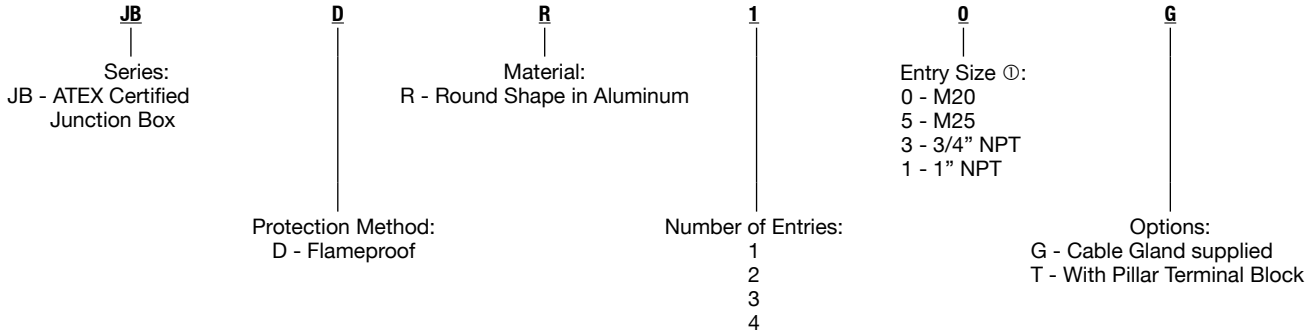

# ATX™ JBDR Series Pre-Drilled Round Junction Boxes

## Flameproof

ATEX:  
 Zone 1 and 2 – 21 and 22  
 II 2 GD  
 IP66 – IK10

### Catalog Numbering Guide — JBDR Series Pre-Drilled Round Junction Boxes



Equipment	Weight kg (lb)	Volume dm <sup>3</sup> (in <sup>3</sup> )	Catalog Number
<b>Threaded Entries with M25 Integrated Cable Gland: For unarmored cable: – sealed Ø: 9 to 15 mm (0.35 to 0.59") (093496)</b>			
 <b>2 Entry</b>	0.8 (1.76)	2 (122.05)	<b>JBDR25G</b>
2 x M25 entries (feed through) 2 integrated cable glands supplied			
 <b>3 Entry</b>	0.8 (1.76)	2 (122.05)	<b>JBDR35G</b>
3 x M25 entries (in a "T") 3 integrated cable glands supplied			
 <b>4 Entry</b>	0.9 (1.98)	2 (122.05)	<b>JBDR45G</b>
4 x M25 entries (in a cross) 4 integrated cable glands supplied			
<b>Threaded Entries for M20 Cable Gland – Not Supplied</b>			
 <b>2 Entry</b>	1.54 (0.70)	2 (122.05)	<b>JBDR20</b>
2 x M20 entries (feed through)			
 <b>3 Entry</b>	1.54 (0.70)	2 (122.05)	<b>JBDR30</b>
3 x M20 entries (in a "T")			
 <b>4 Entry</b>	0.8 (1.76)	2 (122.05)	<b>JBDR40</b>
4 x M20 entries (in a cross)			
<b>Threaded Entries for NPT 3/4" Cable Gland – Not Supplied</b>			
 <b>2 Entry</b>	1.54 (0.7)	2 (122.05)	<b>JBDR23</b>
2 x 3/4" NPT entries (feed through)			
 <b>3 Entry</b>	1.54 (0.70)	2 (122.05)	<b>JBDR33</b>
3 x 3/4" NPT entries (in a "T")			
 <b>4 Entry</b>	0.8 (1.76)	2 (122.05)	<b>JBDR43</b>
4 x 3/4" NPT entries (in a cross)			
<b>Threaded Entries for NPT 1" Cable Gland – Not Supplied</b>			
 <b>4 Entry</b>	0.8 (1.76)	2 (122.05)	<b>JBDR41</b>
4 x 1" NPT entries (in a cross)			

### Accessories

Description	Weight kg (lb)	Volume dm <sup>3</sup> (in <sup>3</sup> )	Catalog Number
<b>Pillar Terminal Block</b>			
4 terminals 4 x 4 mm <sup>2</sup> (0.006 x 0.006 in <sup>2</sup> ) or 2 x 6 mm <sup>2</sup> (0.003 x 0.009 in <sup>2</sup> ) cables	0.1 (0.22)	0.4 (24.41)	<b>TBP44</b>
<b>M25 Integrated Cable Gland</b>			
for unarmored cables — dia. 9 to 15 mm (0.35 to 0.59")	0.6 (1.32)	0.9 (54.92)	<b>093496</b>

① For other entry size, use adaptor.

# ATX™ JBDR Series Pre-Drilled Round Junction Box

## Flameproof

ATEX:  
 Zone 1 and 2 - 21 and 22  
 II 2 GD  
 IP66 - IK10

Dimensions in Millimeters (Inches)

### 2 Entry Version

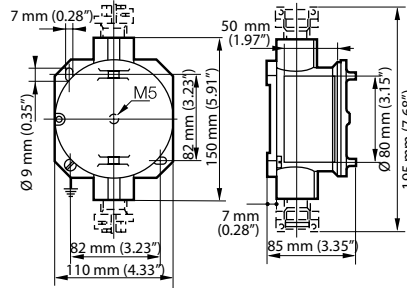

### 3 Entry Version

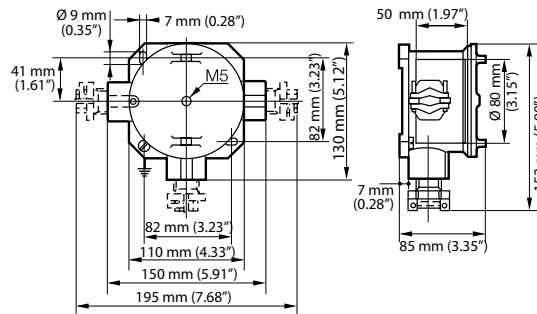

### 4 Entry Version

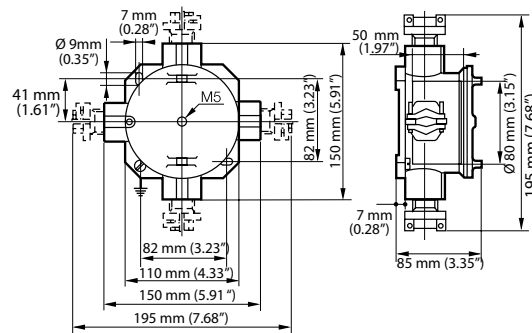

# ATX™ JBD Series Pre-Drilled Terminal Junction Boxes

## Flameproof

ATEX/IECEX:  
Zone 1 and 2 – 21 and 22  
II 2 GD  
IP66 – IK10

### Applications

- Terminal junction boxes to facilitate electrical connections in hazardous areas.
- Ideal for use in wet or corrosive atmospheres.
- Designed for use in Zone 1 or 2 areas, where flammable gases or vapors are present either continuously or intermittently, such as:
  - Petroleum plants
  - Chemical plants
  - Refineries
  - Other industrial process facilities
- Designed for use in Zone 21 or 22 areas where flammable dusts are present either continuously or intermittently, such as:
  - Food processing
  - Dairy
  - Brewing
  - Silos

### Features

- Flanged flameproof joint for square enclosures.
- Screwed flameproof joint for round enclosure.
- External earth crossing terminal.
- Supplied with one symmetrical zinc plated rail.
- Terminal block not supplied.
- Yellow laminated plastic nameplate with black lettering.
- Pre-Drilled entries.
- Operating temperature -40 °C to +55 °C (-40 °F to +131 °F).

### Standard Materials

- Enclosure housing: gray painted cast iron and marine grade aluminum alloy
- Hardware: stainless steel

### ATEX/IECEX Certifications and Compliances

- Certification Type CF2/A/B/C
  - Gas, Zones 1 and 2:
    - Conforming to ATEX 94/9/CE: II 2 G
    - Type of Protection: Ex d IIB
    - Temperature Class: T6 for  $T_a \leq +40$  °C (+104 °F), T5 for  $T_a \leq +55$  °C ( $\leq +131$  °F)
  - Dust, Zones 21 and 22:
    - Conforming to ATEX 94/9/CE: II2 D
    - Type of Protection: Ex tD A21
    - Surface Temperature: T95 °C (T203 °F)
  - CE Declaration of Conformity: 50254
  - ATEX Certificate: LCIE 03 ATEX 6061X
- Certification Type CF1F
  - Gas, Zones 1 and 2:
    - Conforming to ATEX 94/9/CE: II 2 G
    - Type of Protection: Ex d IIC
    - Temperature Class: T6 for  $T_a \leq +40$  °C (+104 °F), T5 for  $T_a \leq +55$  °C ( $\leq +131$  °F)
  - Dust, Zones 21 and 22:
    - Conforming to ATEX 94/9/CE: II2 D
    - Type of Protection: Ex tD A21
    - Surface Temperature: T95 °C (T203 °F)
  - CE Declaration of Conformity: 50257
  - ATEX Certificate: LCIE 03 ATEX 6044X
  - Index of Protection according EN/IEC 60529: IP66
  - Impact Resistance (shock): IK10
  - Internal Volume: > 2dm<sup>3</sup> (122 in<sup>3</sup>) – 2 liters

JBDAB – Aluminum Version



JBDFC – Cast Iron Version



JBDFB – Cast Iron Version



- Certification Type CF20B
  - Gas, Zones 1 and 2:
    - Conforming to ATEX 94/9/CE: II 2 G
    - ATEX/IEC Protection: Ex d IIB
    - Temperature Class: T6
  - Dust, Zones 21 and 22:
    - Conforming to ATEX 94/9/CE: II2 D
    - Type of Protection: Ex tD A21
    - Surface Temperature: T80 °C (T176 °F)
  - Ambient Temperature: -40 °C to +55 °C (-40 °C to +131 °F)
  - CE Declaration of Conformity: 50229
  - ATEX Certificate: LCIE 02 ATEX 6057X
  - IECEx Certificate: IECEx LCI 08.0023X
  - Index of Protection according EN/IEC 60529: IP66
  - Impact Resistance (shock): IK10
  - Internal Volume: > 2dm<sup>3</sup> (122 in<sup>3</sup>) – 2 liters

### EURASEC Certification

- Certification Type CF2/A/B/C
  - EURASEC N° TC RU C-FR.Г505.B.00911
- Certification Type CF1F
  - EURASEC N° TC RU C-FR.Г505.B.00911

### Options

- For use with equipment other than terminal blocks, please consult your local sales representative.

# ATX™ JBD Series Pre-Drilled Terminal Junction Boxes

## Flameproof

ATEX/IECEX:  
 Zone 1 and 2 – 21 and 22  
 II 2 GD  
 IP66 – IK10

Type	Dimensions mm (in)	Threaded Entry Per Side				Rail Length Capacity mm (in)	Weight kg(lb)	Volume dm <sup>3</sup> (in <sup>3</sup> )	Catalog Number	Pack
		A	B	C	D					
<b>Ex d IIB Enclosure in Cast Iron</b>										
CF2C	130 x 130 x 90 (5.12 x 5.12 x 3.54)	1 x M20	1 x M20	2 x M20	1 x M20	64 (2.52)	4 (8.82)	3 (183)	<b>JBDFB131309D1</b>	1
CF2A	205 x 145 x 127 (8.07 x 5.71 x 5.00)	2 x M20	1 x M20	3 x M20	1 x M20	120 (4.72)	9.4 (20.72)	3 (183)	<b>JBDFB201413D2</b>	1
CF2B	270 x 190 x 120 (10.63 x 7.48 x 4.72)	—	2 x M20 1 x M25	3 x M20	2 x M20	162 (6.38)	12.6 (27.78)	7 (427)	<b>JBDFB271912D3</b>	1
<b>Ex d IIB Enclosure in Aluminum</b>										
CF20B	370 x 270 x 208 (14.57 x 10.63 x 8.19)	—	3 x M20	5 x M20 1 x M32	3 x M20	260 (10.24)	12.8 (28.22)	24 (1465)	<b>JBDAB372720D4</b>	1
<b>Ex d IIC Enclosure in Cast Iron</b>										
CF1F	167 x 167 x 126 (6.57 x 6.57 x 4.96)	1 x M32	1 x M32	1 x M32	1 x M32	100 (3.94)	6.7 (14.77)	13 (793)	<b>JBDFC161612D5</b>	1
CF1F	167 x 167 x 126 (6.57 x 6.57 x 4.96)	1 x 1" NPT	1 x 1" NPT	1 x 1" NPT	1 x 1" NPT	100 (3.94)	6.7 (14.77)	13 (793)	<b>JBDFC161612D6</b>	1

### Cast Iron Version Dimensions in Millimeters (Inches)

**CF2C**

**CF1F**

**CF2A/CF2B**

Type	External				Internal				Fixings	
	A	B	C	D	E	F	G	H	K	Ø
CF2C	130 (5.12)	130 (5.12)	90 (3.54)	90 (3.54)	90 (3.54)	65 (2.56)	86 (3.39)	86 (3.39)	10 (0.39)	7 (0.28)
CF2A	202 (7.95)	144 (5.67)	127 (5.00)	155 (6.10)	95 (3.74)	65 (2.56)	156 (6.14)	98 (3.86)	12 (0.47)	7 (0.28)
CF2B	267 (10.51)	187 (7.36)	120 (4.72)	200 (7.87)	120 (4.72)	78 (3.07)	202 (7.95)	122 (4.80)	12 (0.47)	7 (0.28)

### Aluminum Version Dimensions in Millimeters (Inches)

Type	External				Internal				Fixings	
	A	B	C	D	E	F	G	H	K	Ø
CF20B	370 (14.57)	270 (10.63)	208 (8.19)	300 (11.81)	175 (6.89)	159 (6.26)	250 (9.84)	245 (9.65)	15 (0.59)	11 (0.43)

# ATX™ JBDA and JBDF – ECDA and ECDF Series Customized Enclosures

## Flameproof

ATEX/IECEX:  
Zone 1 and 2 – 21 and 22  
II 2 GD  
IP66 – IK10

### Applications

- Designed for use in Zones 1, 2, 21 and 22 in the oil and gas industry such as:
  - Petroleum
  - Chemical
  - Refineries
  - Other industrial process facilities
- Junction box applications:
  - JBD series enclosures may be customized to house terminal blocks.
- Enclosure and control applications:
  - ECD series enclosures may be customized to house a large range of components such as:
    - Control units
    - Breakers
    - Starters
    - Relays
    - Meters
    - Etc.

### Features

- Enclosures are available in a wide range of sizes.
- Precision machined flameproof joint between body and cover.
- Wall thickness suitable for all sizes of cable entries.
- External fixing lugs.
- Internal mounting pan.
- Square and round windows available in a wide range of sizes.
- Machining and drilling must be completed in our workshops.
- Power dissipated calculation including cables must be completed according to each size of certified enclosure.

### Standard Materials

- Enclosures: gray painted cast iron or marine grade aluminum alloy
- Hardware: stainless steel

### Options

- Indirect cable entries available through Ex e connection enclosure.
- Factory assembled and wired.
- Empty enclosure with Ex “U” component marking for re-certification by notified body (CF10B to CF70B).

### ATEX/IECEX Certifications and Compliances

- Certification Type CF2/A/B/C
  - Gas, Zones 1 and 2
  - Conforming to ATEX 94/9/CE: II 2 G
  - Type of Protection: Ex d IIB
  - Temperature Class: T6 to T2
- Dust, Zones 21 and 22
  - Conforming to ATEX 94/9/CE: II 2 D
  - Type of Protection: Ex tD A21
  - Surface Temperature: T95 °C to T290 °C (T203 °F to 554 °F)
  - Ambient Temperature: -40 °C to +55 °C (-40 °F to +131 °F)
  - CE Declaration of Conformity: 50254
  - ATEX Certificate: LCIE 03 ATEX 6061X
  - Internal Volume: ≤ 2dm<sup>3</sup> (122 in<sup>3</sup>) – 2 liters
  - Index of Protection according EN/IEC 60529: IP66
  - Impact Resistance (shock): IK10

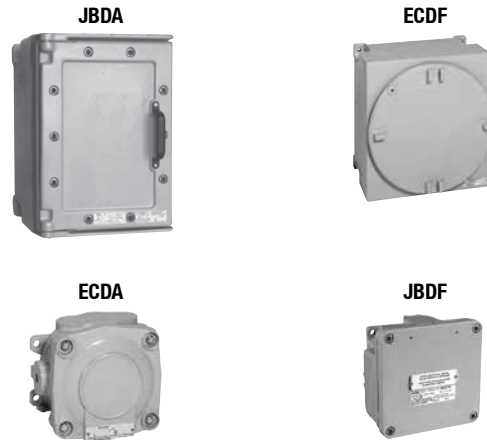

Customized Enclosures

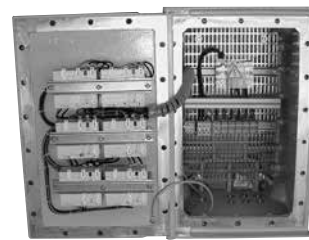

- Certification Type CF10B to CF70B, CF10C to CF70C
  - Gas, Zones 1 and 2
    - Conforming to ATEX 94/9/CE: II 2 G
    - Type of Protection CF10B to CF70B: Ex d IIB
    - Type of Protection CF10C to CF70C: Ex d IIC
    - Temperature Class: T6 to T4
  - Dust, Zones 21 and 22
    - Conforming to ATEX 94/9/CE: II 2 D
    - Type of Protection: Ex tD A21
    - Surface Temperature: T80 °C to T130 °C (T176 °F to T 266 °F)
  - Ambient Temperature
    - CF30B, CF70B, CF70C: -20 °C to +55 °C (-4 °F to +131 °F);
    - CF10B, CF20B, CF40B, CF50B, CF10C, CF30C, CF50C: -40 °C to +55 °C (-40 °F to +131 °F);
    - CF60B: -50 °C to +55 °C (-58 °F to +131 °F)
  - CE Declaration of Conformity: 50229
  - ATEX Certificate: LCIE 02 ATEX 6057X
  - IECEx Certificate: IECEx LCI 08.0023X
  - Internal Volume: > 2dm<sup>3</sup> (122 in<sup>3</sup>) – 2 liters
  - Index of Protection according EN/IEC 60529: IP66
  - Impact Resistance (shock): IK10

# ATX™ and JBDF – ECDA and ECDF Series Customized Enclosures

## Flameproof

ATEX/IECEX:  
 Zone 1 and 2 – 21 and 22  
 Ⓢ II 2 GD  
 IP66 – IK10

- Certification Type CF1A/B/D/E
  - Gas: Zones 1 and 2
  - Conforming to ATEX 94/9/CE: Ⓢ II 2 G
  - Type of Protection: Ex d IIC
  - Temperature Class: T6 to T2
  - Dust: Zones 21 and 22
  - Conforming to ATEX 94/9/CE: Ⓢ II 2 D
  - Type of Protection: Ex tD A21
  - Surface Temperature: T95 °C to T290 °C (T203 °F to 554 °F)
  - Ambient Temperature: -40 °C to +55 °C (-40 °F to +131 °F)
  - CE Declaration of Conformity: 50257
  - ATEX Certificate: LCIE 03 ATEX 6044X
  - IEC Certificate: LCIE Ex 03.003X
  - Internal Volume CF1A/B/D/E: > 2dm<sup>3</sup> (122 in<sup>3</sup>) – 2 liters
  - Internal Volume CF1E: ≤ 2dm<sup>3</sup> (122 in<sup>3</sup>) – 2 liters
  - Index of Protection according EN/IEC 60529: IP66
  - Impact Resistance (shock): IK10
- Certification Type CF10BU to CF70BU
  - Gas: Zones 1 and 2
  - Conforming to ATEX 94/9/CE: Ⓢ II 2 G
  - Type of Protection: Ex d IIB
  - Dust: Zones 21 and 22
  - Conforming to ATEX 94/9/CE: Ⓢ II 2 D
  - Type of Protection: Ex tD A21
  - Ambient Temperature  
 CF30BU, CF60BU, CF70BU: -20 °C to +55 °C  
 (-4 °F to +131 °F),  
 CF10BU, CF20BU, CF40BU, CF50BU: -40 °C to +55 °C  
 (-40 °F to +131 °F)
  - CE Declaration of Conformity: 5C238
  - ATEX Certificate: LCIE 07 ATEX 0005U
- Certification Type JBEW
  - Gas: Zones 1 and 2
  - Conforming to ATEX 94/9/CE: Ⓢ II 2 G
  - Type of Protection: Ex d IIB + H<sub>2</sub>
  - Temperature Class: T6 to T4
  - Dust: Zones 21 and 22
  - Conforming to ATEX 94/9/CE: Ⓢ II 2 D
  - Type of Protection: Ex tD A21
  - Surface Temperature: T80 °C to T130 °C  
 (T176 °F to T 266 °F)
  - Ambient Temperature: -40 °C to +55 °C (-40 °F to +131 °F)
  - CE Declaration of Conformity: 50279
  - ATEX Certificate: LCIE 07 ATEX 6069X
  - Internal Volume: > 2dm<sup>3</sup> (122 in<sup>3</sup>) – 2 liters
  - Index of Protection according EN/IEC 60529: IP66
  - Impact Resistance (shock): IK10

### EURASEC Certification

- Certification Type CF2/A/B/C
  - EURASEC N° TC RU C-FR.Г505.В.00911
- Certification Type CF10B to CF70B, CF10C to CF70C
  - EURASEC N° TC RU C-FR.Г505.В.00911
- Certification Type CF1A/B/D/E
  - EURASEC N° TC RU C-FR.Г505.В.00911

### Catalog Numbering Guide – JBDA and JBDF – ECDA and ECDF Series Customized Enclosures

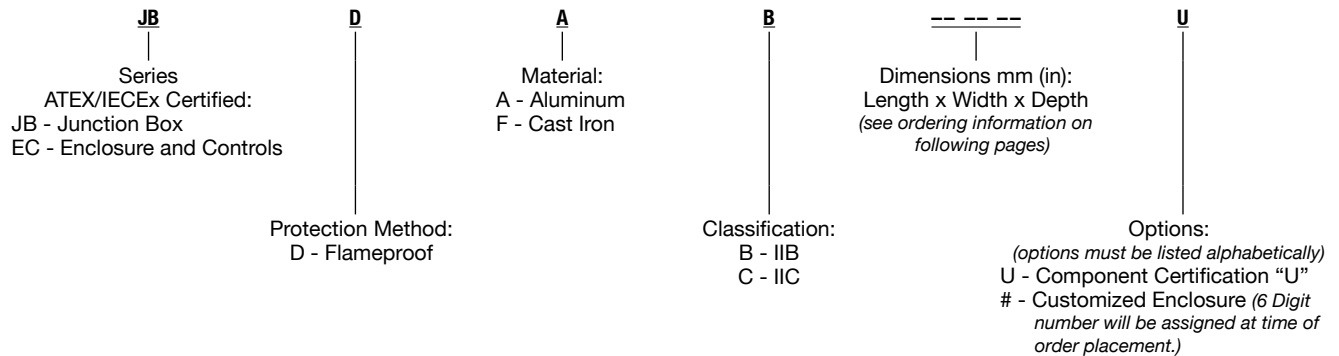





# ATX™ JBDA and JBDF – ECDA and ECDF Series Customized Enclosures

## Flameproof

ATEX/IECEX:  
Zone 1 and 2 – 21 and 22  
II 2 GD  
IP66 – IK10

Appleton

ENCLOSURES AND JUNCTION BOXES: ATEX/IECEX FLAMEPROOF JUNCTION BOXES

Type	Dimensions mm (in) L x W x D	Hinged Door	Weight kg (lb)	Volume dm <sup>3</sup> (in <sup>3</sup> )	Catalog Number ①	
					JBD Series	ECD Series
<b>Ex d IIB Enclosure in Cast Iron with Flanged Flameproof Joint</b>						
 CF2C	130 x 130 x 90 (5.12 x 5.12 x 3.54)	—	4 (8.82)	3 (183.07)	<b>JBDFB131309</b>	<b>ECDFB131309</b>
CF2A	205 x 145 x 127 (8.07 x 5.71 x 5.00)	—	9.4 (20.72)	3 (183.07)	<b>JBDFB201413</b>	<b>ECDFB201413</b>
CF2B	270 x 190 x 120 (10.63 x 7.48 x 4.72)	—	12.6 (27.78)	7 (427.17)	<b>JBDFB271912</b>	<b>ECDFB271912</b>
<b>Ex d IIB Enclosure in Cast Aluminum with Flanged Flameproof Joint</b>						
 CF10B	260 x 270 x 208 (10.24 x 10.63 x 8.19)	—	9 (19.84)	17 (1037.40)	<b>JBDAB262720</b>	<b>ECDAB262720</b>
CF20B	370 x 270 x 208 (15.57 x 10.63 x 8.19)	—	13 (28.66)	24 (1464.57)	<b>JBDAB372720</b>	<b>ECDAB372720</b>
CF30B	340 x 320 x 230 (13.39 x 12.60 x 9.06)	Yes	29 (63.93)	68 (4149.61)	<b>JBDAB343223</b>	<b>ECDAB343223</b>
CF40B	455 x 320 x 347 (17.91 x 12.60 x 13.66)	Yes	50 (110.23)	126 (7688.99)	<b>JBDAB453234</b>	<b>ECDAB453234</b>
CF50B	455 x 440 x 347 (17.97 x 17.32 x 13.66)	Yes	65 (143.30)	240 (14645.70)	<b>JBDAB454434</b>	<b>ECDAB454434</b>
CF60B	680 x 440 x 413 (26.77 x 17.32 x 16.26)	Yes	106 (233.69)	378 (23066.98)	<b>JBDAB684441</b>	<b>ECDAB684441</b>
CF70B	680 x 640 x 413 (26.77 x 25.20 x 16.26)	Yes	130 (286.60)	382 (23311.07)	<b>JBDAB686441</b>	<b>ECDAB686441</b>
<b>Ex d IIC Enclosure in Cast Aluminum with Spigot Flameproof Joint</b>						
 CF1E	140 x 162 x 100 (5.51 x 6.38 x 3.94)	—	1.5 (3.31)	2.2 (134.25)	<b>JBDAC141610</b>	<b>ECDAC141610</b>
CF1B	210 x 230 x 125 (8.27 x 9.06 x 4.92)	—	4.8 (10.58)	5.5 (335.63)	<b>JBDAC212312</b>	<b>ECDAC212312</b>
CF1A	295 x 265 x 195 (11.61 x 10.43 x 7.68)	—	10 (22.05)	9.6 (585.83)	<b>JBDAC292619</b>	<b>ECDAC292619</b>
CF1D	360 x 335 x 200 (14.17 x 13.19 x 7.87)	—	10 (22.05)	14.6 (890.95)	<b>JBDAC363320</b>	<b>ECDAC363320</b>
<b>Ex d IIC Enclosure in Cast Aluminum with Screwed Flameproof Joint</b>						
 CF10C	230 x 215 x 238 (9.05 x 8.46 x 9.37)	—	12 (26.46)	16 (976.38)	<b>JBDAC232124</b>	<b>ECDAC232124</b>
CF30C	320 x 340 x 234 (12.60 x 13.39 x 9.21)	—	28 (61.73)	68 (4149.61)	<b>JBDAC323423</b>	<b>ECDAC323423</b>
CF50C	440 x 455 x 345 (17.32 x 17.91 x 13.58)	—	64 (141.10)	245 (14950.82)	<b>JBDAC444534</b>	<b>ECDAC444534</b>
<b>Ex d IIC Enclosure in Cast Iron with Screwed Flameproof Joint</b>						
CF70C	680 x 640 x 450 (26.77 x 25.20 x 17.72)	Yes	310 (683.43)	382 (23311.07)	<b>JBDFC686445</b>	<b>ECDFC686445</b>

① Options: Component Certification "U" and/or Customized Enclosure # add digits as per examples: JBDAB2627203 #, JBDAB2627203U #.



# ATX™ JBDA and JBDF – ECDA and ECDF Series Customized Enclosure Flameproof

ATEX/IECEX:  
Zone 1 and 2 – 21 and 22  
II 2 GD  
IP66 – IK10

## Dimensions in Millimeters (Inches)

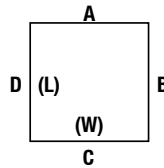

Type	Dimensions mm (in) L x W x D	Maximum Quantity of Threaded Entries Per Side				Max. Size ①	Rail Length Capacity for Terminal Block mm (in)	
		A M20	B M20	C M20	D M20		(L)	(W)
<b>Ex d IIB Enclosure in Cast Iron</b>								
CF2C	130 x 130 x 90 (5.12 x 5.12 x 3.54)	1	2	1	2	M25	–	64 (2.52)
CF2A	205 x 145 x 127 (8.07 x 5.71 x 5.00)	1	3	1	1	M32	–	120 (4.72)
CF2B	270 x 190 x 120 (10.63 x 7.48 x 4.72)	2	4	2	4	M50	–	162 (6.38)
<b>Ex d IIB Enclosure in Cast Aluminum</b>								
CF10B	260 x 270 x 208 (10.24 x 10.63 x 8.19)	8	6	8	6	M75	155 (6.10)	148 (5.83)
CF20B	370 x 270 x 208 (15.57 x 10.63 x 8.19)	6	12	6	12	M75	260 (10.24)	148 (5.83)
CF30B	340 x 320 x 230 (13.39 x 12.60 x 9.06)	8	8	8	8	M75	260 (10.24)	218 (8.58)
CF40B	455 x 320 x 347 (17.91 x 12.60 x 13.66)	16	28	16	28	M75	330 (12.99)	200 (7.87)
CF50B	455 x 440 x 347 (17.97 x 17.32 x 13.66)	26	26	26	26	M75	295 (11.61)	330 (12.99)
CF60B	680 x 440 x 413 (26.77 x 17.32 x 16.26)	26	51	26	51	M100	540 (21.26)	300 (11.81)
CF70B	680 x 640 x 413 (26.77 x 25.20 x 16.26)	38	42	38	42	M100	530 (20.87)	530 (20.87)
<b>Ex d IIC Enclosure in Cast Iron</b>								
CF1E	140 x 162 x 100 (5.51 x 6.38 x 3.94)	1	2	1	2	M32	–	99 (3.90)
CF1B	210 x 230 x 125 (8.27 x 9.06 x 4.92)	1	3	2	3	M32	–	155 (6.10)
CF1A	295 x 265 x 195 (11.61 x 10.43 x 7.68)	6	6	5	6	M63	190 (7.48)	190 (7.48)
CF1D	360 x 335 x 200 (14.17 x 13.19 x 7.87)	16	17	15	17	M63	180 (7.09)	250 (9.84)
<b>Ex d IIC Enclosure in Cast Aluminum</b>								
CF10C	230 x 215 x 238 (9.05 x 8.46 x 9.37)	5	5	5	5	M75	120 (4.72)	105 (4.13)
CF30C	320 x 340 x 234 (12.60 x 13.39 x 9.21)	8	8	8	8	M75	260 (10.24)	215 (8.46)
CF50C	440 x 455 x 345 (17.32 x 17.91 x 13.58)	26	26	26	26	M75	295 (11.61)	330 (12.99)

① Consult your local sales representative for quantity.

# ATX™ JBDA and JBDF – ECDA and ECDF Series Customized Flameproof

ATEX/IECEX:  
Zone 1 and 2 – 21 and 22  
II 2 GD  
IP66 – IK10

## Dimensions in Millimeters (Inches)

**JBDF and ECDF: CF2C**

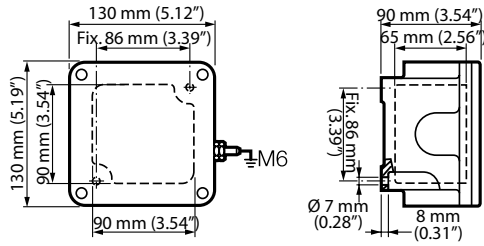

**JBDF and ECDF: CF2A and CF2B**

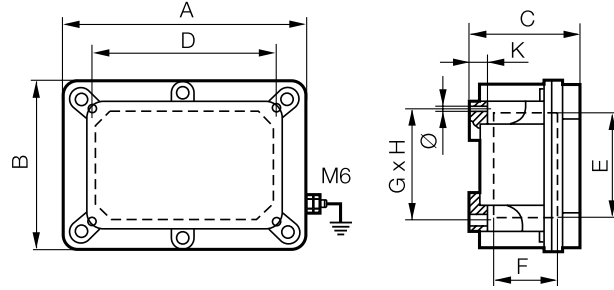

**JBDA and ECDA: CF10B and CF20B**

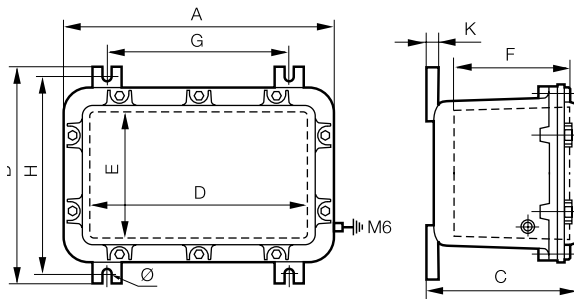

**JBDA and ECDA: CF30B and CF70B**

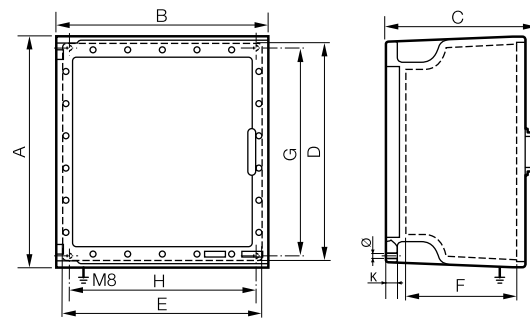

Type	A	B	C	D	E	F	G	H	K	Ø
<b>JBDF and ECDF: CF2A and CF2B</b>										
CF2A	202 (7.95)	144 (5.67)	96 (3.78)	156 (6.14)	154 (6.06)	65.5 (2.58)	98 (3.86)	156 (6.14)	10 (0.39)	7 (0.27)
CF2B	267 (10.51)	187 (7.36)	115 (4.53)	202 (7.95)	200 (7.78)	81 (3.19)	122 (4.80)	202 (7.95)	12 (0.47)	7 (0.27)
<b>JBDA and ECDA: CF10B and CF20B</b>										
CF10B	259 (10.20)	270 (10.63)	207 (8.15)	190 (7.48)	175 (6.89)	161 (6.34)	140 (5.51)	245 (9.65)	15 (0.59)	11 (0.43)
CF20B	369 (14.53)	270 (10.63)	207 (8.15)	300 (11.81)	175 (6.89)	161 (6.34)	250 (9.84)	245 (9.65)	15 (0.59)	11 (0.43)
<b>JBDA and ECDA: CF30B and CF70B</b>										
CF30B	340 (13.39)	320 (12.60)	238 (9.37)	285 (11.22)	265 (10.43)	161 (6.34)	298 (11.73)	278 (10.94)	20 (0.79)	9 (0.35)
CF40B	455 (17.91)	320 (12.60)	377 (14.84)	395 (15.55)	265 (10.43)	253 (9.96)	391 (15.39)	256 (10.08)	25 (0.98)	11 (0.43)
CF50B	455 (17.91)	440 (17.32)	380 (14.96)	400 (15.75)	376 (14.80)	253 (9.96)	391 (15.39)	376 (14.80)	25 (0.98)	11 (0.43)
CF60B	680 (26.77)	440 (17.32)	445 (17.52)	610 (24.02)	376 (14.80)	292 (11.50)	616 (24.25)	376 (14.80)	25 (0.98)	14 (0.55)
CF70B	680 (26.77)	640 (25.20)	445 (17.52)	610 (24.02)	576 (22.68)	292 (11.50)	616 (24.25)	576 (22.68)	25 (0.98)	14 (0.55)

# ATX™ JBDA and JBDF – ECDA and ECDF Series Customized Enclosure Flameproof

ATEX/IECEX:  
Zone 1 and 2 – 21 and 22  
II 2 GD  
IP66 – IK10

Dimensions in Millimeters (Inches)

**JBDA and ECDA CF10C to CF50C  
JBDF and ECDF CF10C to CF70C**

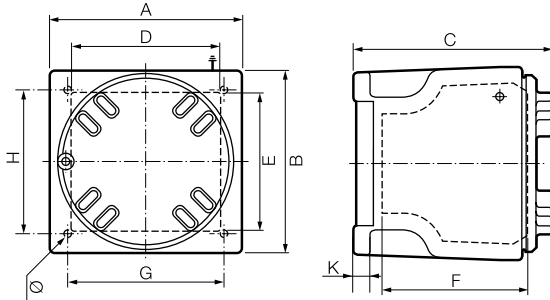

**JBDA and ECDA: CF1D**

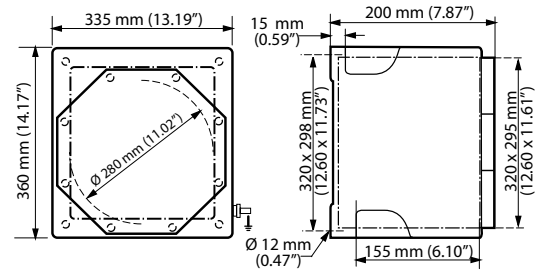

**JBDA and ECDA: CF1B and CF1E Type**

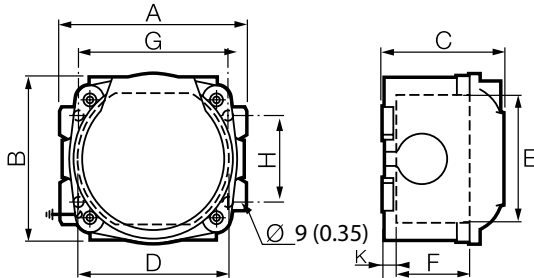

**JBDA and ECDA: CF1A Type**

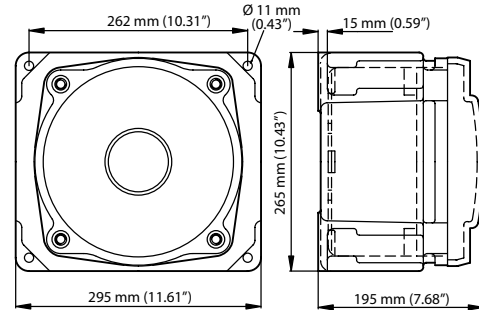

Type	A	B	C	D	E	F	G	H	K	Ø
<b>JBDA and ECDA: CF10C to CF50C JBDF and ECDF: CF10C to CF70C</b>										
CF10C	230 (9.06)	215 (8.46)	238 (9.37)	180 (7.09)	165 (6.50)	175 (6.89)	188 (7.40)	173 (6.81)	20 (0.79)	9 (0.35)
CF30C	320 (12.60)	340 (13.39)	234 (9.21)	271 (10.67)	290 (11.42)	154 (6.06)	278 (10.94)	298 (11.73)	20 (0.79)	9 (0.35)
CF50C	440 (17.32)	455 (17.91)	345 (13.58)	386 (15.20)	401 (15.79)	241 (9.49)	376 (14.80)	391 (15.39)	25 (0.98)	11 (0.43)
CF70C	680 (26.77)	640 (25.20)	450 (17.72)	616 (24.25)	576 (22.68)	290 (11.42)	616 (24.25)	576 (22.68)	25 (0.98)	14 (0.55)
<b>JBDA and ECDA: CF1B and CF1E</b>										
CF1B	230 (9.06)	210 (8.27)	125 (4.92)	175 (6.89)	175 (6.89)	90 (3.54)	210 (8.27)	100 (3.94)	15 (0.59)	9 (0.35)
CF1E	140 (5.51)	162 (6.38)	121 (4.76)	120 (4.72)	120 (4.72)	80 (3.15)	120 (4.72)	120 (4.72)	12 (0.47)	9 (0.35)

# ATX™ ECDX Series Customized Welded Steel Enclosures

## Flameproof

ATEX/IECEX:  
Zone 1 and 2 - 21 and 22  
⊕ II 2 GD  
IP66 - IK10

### Applications

- Designed for use in Zones 1, 2, 21 and 22 in the oil and gas industry; i.e. petroleum, chemical, refineries, and other industrial process facilities.
- Enclosures may be customized to house terminal blocks, and a large range of components; i.e. control units, breakers, starters, relays, meters, etc.

### Features

- Enclosures are available in a wide range of sizes.
- Precision machined flameproof joint between body and cover.
- Hinged door.
- External fixing lugs.
- Internal mounting pan.
- Square and round windows available in a wide range of sizes.
- Machining and drilling must be done at our factory.
- Power dissipated calculation including cables must be completed according to each size of certified enclosure.

### Standard Materials

- Gray painted mechanically welded steel enclosure
- Stainless steel hardware

### Options

- Indirect cable entries available through Ex e connection enclosure.
- Factory assembled and wired.
- Switch rack assembly.
- Empty enclosure with Ex “U” component marking for recertification by notified body (CMS3-4-5-6-7-40-43-44U).

### ATEX/IECEX Certifications and Compliances

- Certification Type CMS
  - Gas, Zones 1 and 2
    - Conforming to ATEX 94/9/CE: ⊕ II 2 G
    - Type of Protection: Ex d IIB
    - Temperature Class: T6 to T4
  - Dust, Zones 21 and 22
    - Conforming to ATEX 94/9/CE: ⊕ II 2 D
    - Type of Protection: Ex tD
    - Surface Temperature: T80 °C to T130 °C (T176 °F to T266 °F)

ECDX Series



Example of Customized Enclosure



- Ambient Temperature: -20 °C to +55 °C (-4 °F to +131 °F)
- CE Declaration of Conformity: 50236
- ATEX Certificate: LCIE 02 ATEX 6247X
- IECEx Certificate: IECEx LCI 080024X
- Internal Volume: > 2dm<sup>3</sup> (122 in<sup>3</sup>) – 2 liters
- Index of Protection according EN/IEC 60529: IP66
- Impact Resistance (shock): IK10
- Certification Type CMS 3U-4U-5U-6U-7U-40U-43U
  - Gas, Zones 1 and 2
    - Conforming to ATEX 94/9/CE: ⊕ II 2 G
    - Type of Protection: Ex d IIB
  - Dust, Zones 21 and 22
    - Conforming to ATEX 94/9/CE: ⊕ II 2 D
    - Type of Protection: Ex tD
  - Ambient Temperature: -20 °C to +55 °C (-4 °F to +131 °F)
  - CE Declaration of Conformity: 5C235
  - ATEX Certificate: LCIE 07 ATEX 0008U
  - Internal Volume: > 2dm<sup>3</sup> (122 in<sup>3</sup>) – 2 liters
  - Index of Protection according EN/IEC 60529: IP66
  - Impact Resistance (shock): IK10

### EURASEC Certification

- Certification Type CMS
  - EURASEC N° TC RU C-FR.Γ505.B.00911

### Other Certification

- Certification Type CMS
  - INMETRO Certificate: BVC 11.0641-X ⊕

### Catalog Numbering Guide – ECDX Customized Enclosures

**ECDX**  
Series:  
ECDX - ATEX/IECEX Certified Enclosure

**B**  
Classification:  
B - IIB

**S**  
Options:  
S - 316L Stainless Steel  
U - Component Certification U  
# - Customized Enclosures  
(6 digit number will be assigned at time of order placement)

Internal Dimensions mm (in):  
Length x Width x Depth  
(see ordering information on following page)

⊕ INMETRO certification available on special request only. Contact your local sales representative for more information.

# ATX™ ECDX Series Customized Welded Steel Enclosures

## Flameproof

ATEX/IECEX:  
 Zone 1 and 2 - 21 and 22  
 II 2 GD  
 IP66 - IK10

Type	Dimensions — L x W x D mm (in)	Weight kg (lb)	Volume dm <sup>3</sup> (in <sup>3</sup> )	Catalog Number
<b>Ex d IIB Enclosure in Welded Steel ①</b>				
CMS3	300 (11.81) x 270 (10.63) x 180 (7.09)	92 (202.83)	234 (14279.6)	ECDXB302718
CMS4	415 (16.34) x 260 (10.24) x 285 (11.22)	152 (335.10)	234 (14279.6)	ECDXB412628S
CMS5	415 (16.34) x 385 (15.16) x 285 (11.22)	180 (396.83)	369 (22517.8)	ECDXB413828S
CMS6	635 (25.00) x 375 (14.76) x 345 (13.58)	336 (740.75)	647 (39482.4)	ECDXB633734S
CMS7	635 (25.00) x 575 (22.64) x 345 (13.58)	384 (846.58)	647 (39482.4)	ECDXB635734S
CMS47	700 (27.56) x 500 (19.69) x 295 (11.61)	268 (590.84)	698 (42594.6)	ECDXB705029S
CMS43	700 (27.56) x 600 (23.62) x 295 (11.61)	298 (656.98)	698 (42594.6)	ECDXB706029S
CMS46	700 (27.56) x 700 (27.56) x 295 (11.61)	318 (701.07)	698 (42594.6)	ECDXB707029S
CMS44	800 (31.50) x 500 (19.69) x 295 (11.61)	298 (656.98)	698 (42594.6)	ECDXB805029S
CMS40	800 (31.50) x 600 (23.62) x 295 (11.61)	318 (701.07)	698 (42594.6)	ECDXB806029S
CMS42	800 (31.50) x 700 (27.56) x 295 (11.61)	308 (679.02)	698 (42594.6)	ECDXB807029S
CMS45	900 (35.43) x 500 (19.69) x 295 (11.61)	348 (767.21)	698 (42594.6)	ECDXB905029S
CMS41	900 (35.43) x 600 (23.62) x 295 (11.61)	348 (767.21)	698 (42594.6)	ECDXB906029S
CMS57	1000 (39.37) x 550 (21.65) x 295 (11.61)	395 (870.83)	1144 (69811.2)	ECDXB105529S
CMS52	1000 (39.37) x 630 (24.80) x 295 (11.61)	430 (947.99)	1144 (69811.2)	ECDXB106329S
CMS55	1000 (39.37) x 700 (27.56) x 295 (11.61)	452 (996.49)	1144 (69811.2)	ECDXB107029S
CMS53	1200 (47.24) x 550 (21.65) x 295 (11.61)	445 (981.06)	1144 (69811.2)	ECDXB125529S
CMS50	1200 (47.24) x 630 (24.80) x 295 (11.61)	485 (1069.24)	1144 (69811.2)	ECDXB126329S
CMS54	1200 (47.24) x 700 (27.56) x 295 (11.61)	515 (1135.38)	1144 (69811.2)	ECDXB127029S
CMS56	1400 (55.12) x 550 (21.65) x 295 (11.61)	495 (1091.29)	1144 (69811.2)	ECDXB145529S
CMS51	1400 (55.12) x 630 (24.80) x 295 (11.61)	540 (1190.50)	1144 (69811.2)	ECDXB146329S
<b>Ex d IIB Enclosure in 316L Stainless Steel ②</b>				
CMS3	300 (11.81) x 270 (10.63) x 180 (7.09)	92 (202.83)	234 (14279.6)	ECDXB302718S
CMS4	415 (16.34) x 260 (10.24) x 285 (11.22)	152 (335.10)	234 (14279.6)	ECDXB412628S
CMS5	415 (16.34) x 385 (15.16) x 285 (11.22)	180 (396.83)	369 (22517.8)	ECDXB413828S
CMS6	635 (25.00) x 375 (14.76) x 345 (13.58)	336 (740.75)	647 (39482.4)	ECDXB633734S
CMS7	635 (25.00) x 575 (22.64) x 345 (13.58)	384 (846.58)	647 (39482.4)	ECDXB635734S
CMS47	700 (27.56) x 500 (19.69) x 295 (11.61)	268 (590.84)	698 (42594.6)	ECDXB705029S
CMS43	700 (27.56) x 600 (23.62) x 295 (11.61)	298 (656.98)	698 (42594.6)	ECDXB706029S
CMS46	700 (27.56) x 700 (27.56) x 295 (11.61)	318 (701.07)	698 (42594.6)	ECDXB707029S
CMS44	800 (31.50) x 500 (19.69) x 295 (11.61)	298 (656.98)	698 (42594.6)	ECDXB805029S
CMS40	800 (31.50) x 600 (23.62) x 295 (11.61)	318 (701.07)	698 (42594.6)	ECDXB806029S
CMS42	800 (31.50) x 700 (27.56) x 295 (11.61)	308 (679.02)	698 (42594.6)	ECDXB807029S
CMS45	900 (35.43) x 500 (19.69) x 295 (11.61)	348 (767.21)	698 (42594.6)	ECDXB905029S
CMS41	900 (35.43) x 600 (23.62) x 295 (11.61)	348 (767.21)	698 (42594.6)	ECDXB906029S
CMS57	1000 (39.37) x 550 (21.65) x 295 (11.61)	395 (870.83)	1144 (69811.2)	ECDXB105529S
CMS52	1000 (39.37) x 630 (24.80) x 295 (11.61)	430 (947.99)	1144 (69811.2)	ECDXB106329S
CMS55	1000 (39.37) x 700 (27.56) x 295 (11.61)	452 (996.49)	1144 (69811.2)	ECDXB107029S
CMS53	1200 (47.24) x 550 (21.65) x 295 (11.61)	445 (981.06)	1144 (69811.2)	ECDXB125529S
CMS50	1200 (47.24) x 630 (24.80) x 295 (11.61)	485 (1069.24)	1144 (69811.2)	ECDXB126329S
CMS54	1200 (47.24) x 700 (27.56) x 295 (11.61)	515 (1135.38)	1144 (69811.2)	ECDXB127029S
CMS56	1400 (55.12) x 550 (21.65) x 295 (11.61)	495 (1091.29)	1144 (69811.2)	ECDXB145529S
CMS51	1400 (55.12) x 630 (24.80) x 295 (11.61)	540 (1190.50)	1144 (69811.2)	ECDXB146329S

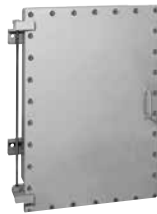

① For component certification and/or customized enclosure add digits as per examples: ECDXB302718# or ECDXB302718U#.  
 ② For component certification and/or customized enclosure add digits as per example: ECDXB302718S# or ECDXB302718SU#.

# ATX™ ECDX Series Customized Welded Steel Enclosures

## Flameproof

ATEX/IECEX:  
 Zone 1 and 2 - 21 and 22  
 II 2 GD  
 IP66 - IK10

### Dimensions in Millimeters (Inches)

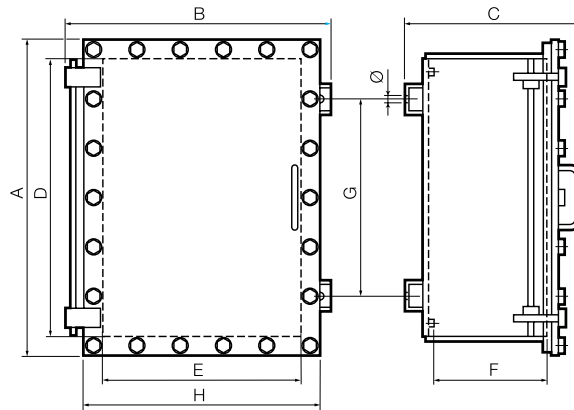

Type	External			Internal			Fixings Lug Thick			
	A	B	C	D	E	F	G	H	mm (in)	Ø
CMS3	388 (15.28)	440 (17.32)	318 (12.52)	300 (11.81)	270 (10.63)	180 (7.09)	200 (7.87)	370 (14.57)	7 (0.28)	16 (0.63)
CMS4	503 (19.80)	429 (16.89)	418 (16.46)	415 (16.34)	260 (10.24)	280 (11.02)	315 (12.40)	360 (14.17)	7 (0.28)	16 (0.63)
CMS5	503 (19.80)	554 (21.81)	418 (16.46)	415 (16.34)	385 (15.16)	280 (11.02)	315 (12.40)	485 (19.09)	7 (0.28)	16 (0.63)
CMS6	723 (28.46)	554 (21.81)	478 (18.82)	635 (25)	375 (14.76)	340 (13.39)	455 (17.91)	475 (18.70)	7 (0.28)	16 (0.63)
CMS7	723 (28.46)	745 (29.33)	478 (18.82)	635 (25)	575 (22.64)	340 (13.39)	470 (18.50)	675 (26.57)	7 (0.28)	16 (0.63)
CMS47	796 (31.34)	650 (25.59)	445 (17.52)	700 (27.56)	500 (19.69)	295 (11.61)	500 (19.69)	600 (23.62)	7 (0.28)	18 (0.71)
CMS43	796 (31.34)	750 (29.53)	445 (17.52)	700 (27.56)	600 (23.62)	295 (11.61)	500 (19.69)	700 (27.56)	7 (0.28)	18 (0.71)
CMS46	796 (31.34)	850 (33.46)	445 (17.52)	700 (27.56)	700 (27.56)	295 (11.61)	500 (19.69)	800 (31.50)	7 (0.28)	18 (0.71)
CMS44	896 (35.28)	650 (25.59)	445 (17.52)	800 (31.50)	500 (19.69)	295 (11.61)	600 (23.62)	600 (23.62)	7 (0.28)	18 (0.71)
CMS40	896 (35.28)	750 (29.53)	445 (17.52)	800 (31.50)	600 (23.62)	295 (11.61)	600 (23.62)	700 (27.56)	7 (0.28)	18 (0.71)
CMS42	896 (35.28)	850 (33.46)	445 (17.52)	800 (31.50)	700 (27.56)	295 (11.61)	600 (23.62)	800 (31.50)	7 (0.28)	18 (0.71)
CMS45	996 (39.21)	650 (25.59)	445 (17.52)	900 (35.43)	500 (19.69)	295 (11.61)	600 (23.62)	600 (23.62)	7 (0.28)	18 (0.71)
CMS41	996 (39.21)	750 (29.53)	445 (17.52)	900 (35.43)	600 (23.62)	295 (11.61)	600 (23.62)	700 (27.56)	7 (0.28)	18 (0.71)
CMS57	1125 (44.29)	730 (28.74)	452 (17.80)	1000 (39.37)	550 (21.65)	295 (11.61)	700 (27.56)	660 (25.98)	7 (0.28)	22 (0.87)
CMS52	1125 (44.29)	810 (31.89)	452 (17.80)	1000 (39.37)	630 (24.80)	295 (11.61)	700 (27.56)	740 (29.13)	7 (0.28)	22 (0.87)
CMS55	1125 (44.29)	880 (34.65)	452 (17.80)	1000 (39.37)	700 (27.56)	295 (11.61)	700 (27.56)	810 (31.89)	7 (0.28)	22 (0.87)
CMS53	1325 (52.17)	730 (28.74)	452 (17.80)	1200 (47.24)	550 (21.65)	295 (11.61)	900 (35.43)	660 (25.98)	7 (0.28)	22 (0.87)
CMS50	1325 (52.17)	810 (31.89)	452 (17.80)	1200 (47.24)	630 (24.80)	295 (11.61)	900 (35.43)	740 (29.13)	7 (0.28)	22 (0.87)
CMS54	1325 (52.17)	880 (34.65)	452 (17.80)	1200 (47.24)	700 (27.56)	295 (11.61)	900 (35.43)	810 (31.89)	7 (0.28)	22 (0.87)
CMS56	1525 (60.04)	730 (28.74)	452 (17.80)	1400 (55.12)	550 (21.65)	295 (11.61)	1100 (43.31)	660 (25.98)	7 (0.28)	22 (0.87)
CMS51	1525 (60.04)	810 (31.89)	452 (17.80)	1400 (55.12)	630 (24.80)	295 (11.61)	1100 (43.31)	740 (29.13)	7 (0.28)	22 (0.87)

# ATX™ JBEA and ECEA Series Aluminum Enclosures

## Increased Safety

ATEX/IECEX:  
Zone 1 and 2 – 21 and 22  
⊕ II 2 GD  
IP66 – IK10

### Applications

- Designed for use in Zone 1 or 2 areas where flammable gases or vapors are present either continuously or intermittently.
- Ideal for use in wet or corrosive atmospheres.
- Petroleum, chemical, refineries and other industrial process facilities.
- Designed for use in Zone 21 or 22 areas where flammable dusts are present either continuously or intermittently.
- Food processing, dairy, brewing and other commercial facilities.
- JBEA Series:
  - Terminal junction boxes for electrical low voltage and instrumentation connections in hazardous areas.
  - Refer to technical data to define permitted number of terminal blocks and cable entries on selected junction boxes.
- ECEA Series:
  - Enclosure for distribution and control applications can be customized at our workshop to house a large range of components; i.e. control units, switches, breakers, transformers, meters, etc.

### Features

- Operating temperature:
  - PCe type: -55 °C to +60 °C (-67 °F to 140 °F)
  - CAe type: -40 °C to +55 °C (-40 °F to 131 °F)
- Rail mounting.
- Refer to technical data to define permitted number and size of terminals and cable entries.

### Standard Materials

- Enclosure: gray painted grade marine aluminum alloy
- Hardware: stainless steel

### Options

- Nameplates.
- Consult your local sales representative for:
  - Enclosures custom drilled and assembled at our factory.
  - Empty enclosure with Ex “U” component marking for re-certification by notified body for CAe type.

### ATEX/IECEX Certifications and Compliances

- Certification Type PCe
  - Gas, Zones 1 and 2:
    - Conforming to ATEX 94/9/CE: ⊕ II 2 G
    - Type of Protection: Ex e II, Ex ia IIC, Ex ib IIC, Ex de IIC
    - Temperature class: T6 for Ta ≤ +40 °C (+104 °F), T5 for Ta ≤ +60 °C (+140 °F)
  - Dust, Zones 21 and 22:
    - Conforming to ATEX 94/9/CE: ⊕ II 2 D
    - Type of Protection: Ex tD A21
    - Surface Temperature: T80 °C to T95 °C (T176 °F to T203 °F)
  - Ambient Temperature: -55 °C to +60 °C (-67 °F to +140 °F)
  - CE Declaration of Conformity: 50221
  - ATEX Certificate: LCIE 00 ATEX 6047
  - Index of Protection according EN/IEC 60529: IP66
  - Impact Resistance (shock): IK10



PCe Type



CAe Type

- Certification Type CAe
  - Gas, Zones 1 and 2:
    - Conforming to ATEX 94/9/CE: ⊕ II 2 G
    - Type of Protection: Ex e II, Ex ia IIC, Ex ib IIC, Ex de IIC
    - Temperature Class: T6 to T2
  - Dust, Zones 21 and 22:
    - Conforming to ATEX 94/9/CE: ⊕ II 2 D
    - Type of Protection: Ex tD A21
    - Surface Temperature: T80 °C to T290 °C (T176 °F to T554 °F)
  - CE Declaration of Conformity: 50325
  - ATEX Certificate: LCIE 02 ATEX 6248X
  - IECEx Certificate: IECEx LCI 04.0016X
  - Index of Protection according EN/IEC 60529: IP66
  - Impact Resistance (shock): IK10
- Certification Type CAe U
  - Gas, Zones 1 and 2:
    - Conforming to ATEX 94/9/CE: ⊕ II 2 G
    - Type of Protection: Ex e II
  - Dust, Zones 21 and 22:
    - Conforming to ATEX 94/9/CE: ⊕ II 2 D
    - Type of Protection: Ex tD A21
  - Ambient Temperature: -40 °C to +55 °C (-40 °F to +131 °F)
  - CE Declaration of Conformity: 5C241
  - ATEX Certificate: LCIE 09 ATEX 3036 U
  - Index of Protection according EN/IEC 60529: IP66
  - Impact Resistance (shock): IK10

### EURASEC Certification

- Certification Type PCe
  - EURASEC N° TC RU C-FR.Γ505.B.00911
- Certification Type CAe
  - EURASEC N° TC RU C-FR.Γ505.B.00911

# ATX™ JBEA and ECEA Series Aluminum Enclosures

## Increased Safety

ATEX/IECEX:  
Zone 1 and 2 – 21 and 22  
II 2 GD  
IP66 – IK10

### Catalog Numbering Guide – JBEA Series Aluminum Junction Box

<b>JBEA</b>	<b>E</b>	<b>A</b>	<b>12</b>	<b>11</b>	<b>09</b>	<b>D1</b>
JB Series ATEX/IECEX Certified Junction Box	Method of Protection: E - Increased Safety I - Intrinsic Safety	Material: A - Aluminum	Length Dimensions mm (in): 12 - 120 (4.72) 17 - 170 (6.69) 21 - 215 (8.47)	Width Dimensions mm (in): 11 - 110 (4.33) 20 - 205 (8.07) 38 - 380 (14.96)	Depth Dimensions mm (in): 09 - 91 (3.58) 13 - 130 (5.12) 19 - 190 (7.48)	Options: <i>(options must be listed alphabetically)</i> U - Component Certification "U" # - Customized Enclosure <i>(Digit number will be assigned at time of order placement)</i>

#### JBEA Series: Ex e II Aluminum Junction Boxes

For use with Ex certified terminals only (not supplied).  
Mounting rails supplied.  
Yellow laminated plastic label with black lettering.



#### ECEA Series: Aluminum Enclosure for Distribution and Control Applications

Designed to house a large range of components; i.e. control units, switches, breakers, transformers, meters, etc.  
Must be customized at our workshop with the following Catalog Number:  
Replace JB with EC, and add last digits and "#" for customized boxes. Example: ECEA 212013 #



Type	Dimensions L x W x D mm (in)	Rail Length Maximum Width mm (in)	Weight kg (lb)	Volume dm <sup>3</sup> (in <sup>3</sup> )	Catalog Number	
					JBEA Series	ECEA Series
PCe1	120.0 x 110.0 x 95.0 (4.72 x 4.33 x 3.74)	94.0 (201.00)	1.0 (2.20)	2.2 (134.25)	JBEA121109	ECEA121109#
PCe2	170.0 x 110.0 x 95.0 (6.69 x 4.33 x 3.74)	144.0 (291.00)	1.3 (2.87)	2.7 (164.76)	JBEA171109	ECEA171109#
PCe3	230.0 x 110.0 x 95.0 (9.10 x 4.33 x 3.74)	204.0 (399.00)	1.6 (3.53)	5.2 (317.32)	JBEA231109	ECEA231109#
CAe1	215.0 x 205.0 x 130.0 (8.47 x 8.07 x 5.12)	191.0 (376.00)	4.0 (8.82)	13.0 (793.30)	JBEA212013	ECEA212013#
CAe2	320.0 x 205.0 x 130.0 (12.60 x 8.07 x 5.12)	293.0 (559.00)	5.0 (11.02)	23.0 (1403.60)	JBEA322013	ECEA322013#
CAe3	425.0 x 205.0 x 130.0 (17.80 x 8.07 x 5.12)	400.0 (752.00)	6.0 (13.28)	33.0 (2013.80)	JBEA422013	ECEA422013#
CAe5	480.0 x 380.0 x 190.0 (18.90 x 14.96 x 7.48)	335.0 (635.00)	11.0 (24.25)	53.0 (3234.30)	JBEA483819	ECEA483819#





# ATX™ JBEA and ECEA Series Aluminum Enclosures

## Increased Safety

ATEX/IECEX:  
 Zone 1 and 2 – 21 and 22  
 II 2 GD  
 IP66 – IK10

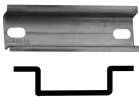
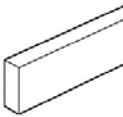
### Accessories

		Enclosure Type	Rail Length mm (in)	Catalog Number	Pack
	<b>Zinc Plated Symmetrical Steel Rail</b> For direct fixing. Set of two 60 mm (2.36") height spacers supplied.	CAe1	191 (7.52)	JBEPDR215	1
		CAe2	293 (11.54)	JBEPDR320	1
		CAe3	400 (15.75)	JBEPDR425	1
	<b>Copper Bar – 12 x 4 mm (0.47 x 0.16")</b> Copper bar not perforated for cable clamps.		Bar Length mm (in)	Catalog Number	Pack
			160 (6.30)	097270	1
			200 (7.87)	097271	1
			310 (12.20)	097272	1
			500 (19.68)	097273	1
	690 (27.17)	097274	1		
	<b>Cable Clamp for Copper Bar – 12 x 4 mm (0.47 x 0.16")</b> 1.5 mm <sup>2</sup> to 4 mm <sup>2</sup> (0.002 in <sup>2</sup> to 0.006 in <sup>2</sup> ) capacity. 6 mm <sup>2</sup> to 16 mm <sup>2</sup> (0.009 in <sup>2</sup> to 0.025 in <sup>2</sup> ) capacity.			097203	1
				097204	1
	<b>Insulated Side Support – Set of Two</b> For mounting symmetrical, asymmetrical rails and copper bar 12 x 2 mm (0.47 x 0.08") or 12 x 4 mm (0.47 x 0.16"). See dimensional data page for more details.			096115	1

### JBEA Series for Junction Box Application Only.

The size of the junction box needed to meet your requirements can be selected based on the table shown below. We also offer you the possibility to drill and equip, please consult our drilling guide available online at: [www.appletonelec.com](http://www.appletonelec.com)

#### 1. Define maximum cable entries according to number of modules available per side.

Cable Entry Metric Thread	Number of Modules
M20	1
M25	1
M32	1
M40	2
M50	3

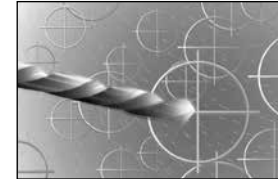
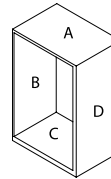

Type	Length	Dimensions mm (in)			Number of Modules		Allowable Max. Size	Terminal Dim. H — mm (in)
		Width	Depth	A/C	B/B			
PCe1	120 (4.72)	110 (4.33)	95 (3.74)	2	2	M25	110 (4.33)	
PCe2	170 (6.69)	110 (4.33)	95 (3.74)	2	3	M32	110 (4.33)	
PCe3	230 (8.46)	110 (4.33)	95 (3.74)	2	4	M32	110 (4.33)	
CAe1	215 (8.47)	205 (8.07)	130 (5.12)	11	8	M50	205 (8.07)	
CAe2	320 (12.60)	205 (8.07)	130 (5.12)	18	8	M50	205 (8.07)	
CAe3	425 (16.73)	205 (8.07)	130 (5.12)	26	8	M50	205 (8.07)	
CAe5	575 (22.64)	380 (14.96)	190 (7.48)	34	25	M50	380 (14.96)	

#### 2. Maximum Rail Arrangement According to Physical Dimensions — Maximum Quantity of Horizontal Rails

Type	Terminal Capacity mm <sup>2</sup> (in <sup>2</sup> )						
	2.5 (0.0039)	4.0 (0.0062)	6.0 (0.0093)	10.0 (0.0155)	16.0 (0.0248)	35.0 (0.0543)	50.0 (0.0775)
PCe1/2/3	1	1	1	1	0	0	0
CAe1/2/3	1	1	1	1	1	1	0
CAe5	3	3	2	2	2	1	1

# ATX™ JBEA and ECEA Series Aluminum Enclosures

## Increased Safety

ATEX/IECEX:  
 Zone 1 and 2 – 21 and 22  
 II 2 GD  
 IP66 – IK10

### 3. Defining maximum terminal block quantity according to power dissipation:

- Junction boxes used for instrumentation applications have very low current levels, therefore there is no risk of overheating whatever the number of terminals inside the box.
- For applications other than instrumentation, the following tables allow you to define your junction box depending on the number of terminals and the maximum authorized current being carried with feed-through terminals.
- For single feed terminals using cross connection, please consult your local representative for a calculation.

For other terminal block configurations, please consult our drilling guide available online at: [www.appletonelec.com](http://www.appletonelec.com)

T Rating: T6		Type		
		CSPe1 120 x 120 x 91 mm (5 x 5 x 4")	CSPe2 120 x 170 x 91 mm (7 x 5 x 4")	CSPe3 120 x 230 x 91 mm (9 x 5 x 4")
2.5 mm <sup>2</sup> (0.004 in <sup>2</sup> )	Quantity	12	22	33
	I Maximum	15 A	13 A	12 A
4.0 mm <sup>2</sup> (0.006 in <sup>2</sup> )	Quantity	10	18	28
	I Maximum	20 A	19 A	16 A
6.0 mm <sup>2</sup> (0.009 in <sup>2</sup> )	Quantity	7	14	21
	I Maximum	32 A	27 A	24 A
10.0 mm <sup>2</sup> (0.016 in <sup>2</sup> )	Quantity	4	6	8
	I Maximum	50 A	50 A	50 A

T Rating: T6 @ Ta +40 °C (+104 °F) T5 @ Ta +55° C (+131 °F)		Type			
		CAe1 200 x 215 x 150 mm (8 x 9 x 6")	CAe2 200 x 320 x 150 mm (8 x 13 x 6")	CAe3 200 x 425 x 150 mm (8 x 17 x 6")	CAe4 200 x 575 x 150 mm (8 x 23 x 6")
2.5 mm <sup>2</sup> (0.004 in <sup>2</sup> )	Quantity	20	21	23	38
	I Maximum	16 A	16 A	16 A	16 A
4.0 mm <sup>2</sup> (0.006 in <sup>2</sup> )	Quantity	19	20	23	38
	I Maximum	20 A	20 A	20 A	20 A
6.0 mm <sup>2</sup> (0.009 in <sup>2</sup> )	Quantity	12	13	14	23
	I Maximum	32 A	32 A	32 A	32 A
10.0 mm <sup>2</sup> (0.016 in <sup>2</sup> )	Quantity	10	11	18	30
	I Maximum	40 A	40 A	32 A	32 A
16.0 mm <sup>2</sup> (0.024 in <sup>2</sup> )	Quantity	8	10	13	22
	I Maximum	28 A	27 A	25 A	26 A
25.0 mm <sup>2</sup> (0.039 in <sup>2</sup> )	Quantity	8	8	10	20
	I Maximum	67 A	73 A	69 A	60 A
35.0 mm <sup>2</sup> (0.054 in <sup>2</sup> )	Quantity	8	8	10	12
	I Maximum	79 A	86 A	80 A	100 A

# ATX™ JBEA and ECEA Series Aluminum Enclosure

## Increased Safety

ATEX/IECEX:  
 Zone 1 and 2 – 21 and 22  
 II 2 GD  
 IP66 – IK10

### Dimensions in Millimeters (Inches)

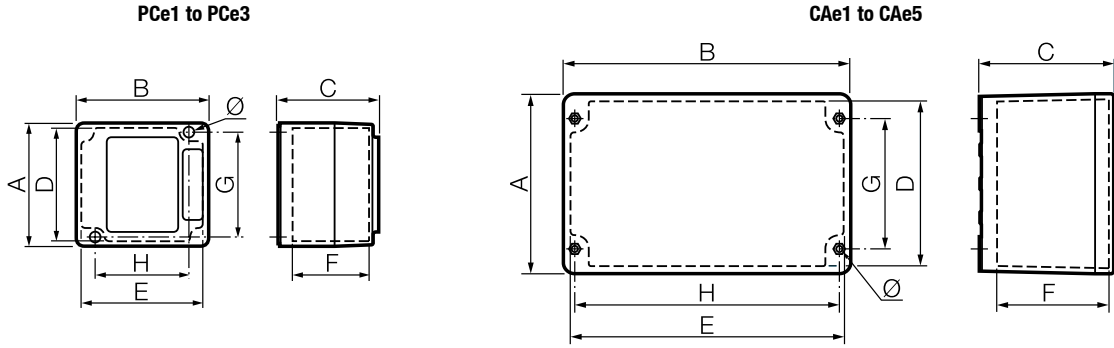

Type	External			Internal				Fixings			
	A	B	C	D	E	F	G	H	Thick	Ø	
PCe1	110 (4.33)	120 (4.72)	95 (3.74)	100 (3.94)	110 (4.33)	70 (2.76)	94 (3.70)	84 (3.31)	20 (0.79)	5.0 (0.20)	
PCe2	110 (4.33)	170 (6.69)	95 (3.74)	100 (3.94)	160 (6.30)	70 (2.76)	94 (3.70)	134 (5.28)	20 (0.79)	5.0 (0.20)	
PCe3	110 (4.33)	230 (9.10)	95 (3.74)	100 (3.94)	220 (8.66)	70 (2.76)	94 (3.70)	194 (7.64)	20 (0.79)	5.0 (0.20)	
CAe1	205 (8.07)	215 (8.47)	130 (5.12)	190 (7.48)	200 (7.87)	105 (4.13)	146 (5.75)	186 (7.32)	10 (0.39)	6.5 (0.26)	
CAe2	205 (8.07)	320 (12.60)	130 (5.12)	190 (7.48)	305 (12.01)	105 (4.13)	146 (5.75)	290 (11.42)	10 (0.39)	6.5 (0.26)	
CAe3	205 (8.07)	425 (17.80)	130 (5.12)	190 (7.48)	410 (16.14)	105 (4.13)	146 (5.75)	398 (15.67)	10 (0.39)	6.5 (0.26)	
CAe5	480 (18.90)	380 (14.96)	190 (7.48)	378 (14.88)	279 (10.98)	132 (5.20)	385 (15.16)	285 (11.22)	13 (0.51)	7.0 (0.28)	

### Insulated Side Support (Rail Holder) 096115

Type	Equipment Capacity	
	L	M
CAe1	105 (4.13)	129 (5.08)
CAe2	206 (8.11)	234 (9.21)
CAe3	310 (12.20)	339 (13.35)
CAe5	315 (12.40)	345 (13.58)

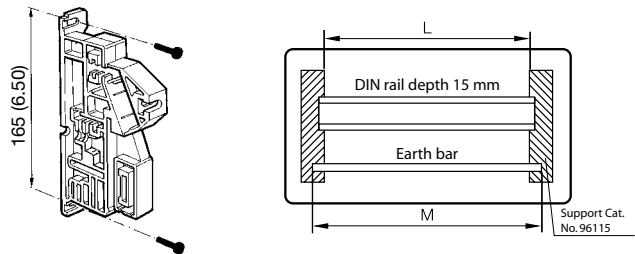

# ATX™ JBEA Series Pre-Drilled Aluminum Junction Box

## Increased Safety

ATEX/IECEX:  
Zone 1 and 2 – 21 and 22  
II 2 GD  
IP66 – IK10

### Applications

- Terminal junction boxes to facilitate electrical connections in hazardous areas.
- Designed for use in Zone 1 or 2 areas, where flammable gases or vapors are present either continuously or intermittently.
- Ideal for wet or corrosive atmospheres.
- Petroleum, chemical, refineries and other industrial process facilities.
- Designed for use in Zone 21 or 22 areas where flammable dusts are present either continuously or intermittently.
- Food processing, dairy, brewing, silos and other facilities.

### Features

- Operating temperature:
  - PCe type: -55 °C to +60 °C (-67 °F to +140 °F)
  - CAe type: -40 °C to +55 °C (-40 °F to +131 °F)
- For use only with Ex certified terminal blocks.
- Stainless steel hardware.
- Yellow laminated plastic label with black lettering.
- Factory drilled and equipped.

### Standard Materials

- Enclosure: gray painted grade marine aluminum alloy
- Hardware: stainless steel

### Options

- For use with equipment other than Ex terminal blocks, see ECEA series enclosures and controls.

### ATEX/IECEX Certifications and Compliances

- Certification Type PCe
  - Gas, Zones 1 and 2
  - Conforming to ATEX 94/9/CE: II 2 G
  - Type of Protection: Ex e II, Ex eia IIC, Ex eib IIC
  - Temperature Class: T6



Without Terminals

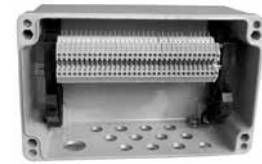

Equipped with Terminals

- Dust, Zones 21 and 22
  - Conforming to ATEX 94/9/CE: II 2 D
  - Type of Protection: Ex tD A21
  - Surface Temperature: T80 °C (T176 °F)
- Ambient Temperature: -50 °C to +60 °C (-58 °F to +140 °F)
- CE Declaration of Conformity: 50221
- ATEX Certificate: LCIE 00 ATEX 6047
- Certification Type CAe
  - Gas, Zones 1 and 2
  - Conforming to ATEX 94/9/CE: II 2 G
  - Type of Protection: Ex e II, Ex eia IIC, Ex eib IIC
  - Temperature Class: T6 for Ta ≤ +40 °C (+104 °F); T5 for +40 °C ≤ Ta ≤ +55 °C (+104 °F ≤ Ta ≤ +131 °F)
- Dust, Zones 21 and 22
  - Conforming to ATEX 94/9/CE: II 2 D
  - Type of Protection: Ex tD A21
  - Ambient Temperature: T80 °C to T96 °C (T176 °F to T205 °F)
  - CE Declaration of Conformity: 50325
  - ATEX Certificate: LCIE 02 ATEX 6248X
  - IECEx Certificate: IECEx LCI 04.0016X
- Index of Protection according EN/IEC 60529: IP66
- Impact Resistance (shock): IK10

### EURASEC Certification

- EURASEC N° TC RU C-FR.Г505.B.00911

### Catalog Numbering Guide – JBEA Series Aluminum Junction Box

<p><b>JBEA</b></p> <p>JB Series ATEX/IECEX Certified Junction Box</p>	<p><b>E</b></p> <p>Method of Protection: E - Increased Safety I - Intrinsic Safety</p>	<p><b>A</b></p> <p>Material: A - Aluminum</p>	<p><b>12</b></p> <p>Length Dimensions mm (in): 12 - 120 (4.72) 17 - 170 (6.69) 21 - 215 (8.47)</p>	<p><b>11</b></p> <p>Width Dimensions mm (in): 11 - 110 (4.33) 20 - 205 (8.07) 38 - 380 (14.96)</p>	<p><b>09</b></p> <p>Depth Dimensions mm (in): 09 - 91 (3.58) 13 - 130 (5.12) 19 - 190 (7.48)</p>	<p><b>D1</b></p> <p>Options: <i>(options must be listed alphabetically)</i> As per Drilling Detail Table D1 - 5 x M20 D2 - 4 x M20 + 1 x M25 D3 - 7 x M20 + 1 x M25 D5 - 7 x M20 + 1 x M25 D6 - 12 x M20 + 1 x M32 D7 - 19 x M20 + 1 x M32 D8 - 27 x M20 + 1 x M40 P-- - Unarmored Cable A-- - Armored Cable L-- - Lead Sheath Armored Cable E - Earth Continuity Brass Plate # - Customized Enclosure <i>(Digit number will be assigned at time of order placement)</i></p>
---	--	---	--	--	--	--

ENCLOSURES AND JUNCTION BOXES: ATEX/IECEX INCREASED SAFETY JUNCTION BOXES

Appleton®

# ATX™ JBEA Series Pre-Drilled Aluminum Junction Box

## Increased Safety

ATEX/IECEX:  
 Zone 1 and 2 – 21 and 22  
 II 2 GD  
 IP66 – IK10

### Factory Drilled Ex e II Aluminum Junction Boxes

Fitted with: One horizontal symmetrical zinc plated rail. For use with Ex terminals only (not supplied). Yellow laminated plastic label with black lettering. Internal earth terminal. M5 external earth screw. Cable glands and plugs ordered separately.

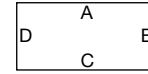

Type	Dimensions L x W x D mm (in)	Rail Length Maximum mm (in)	Threaded Holes Per Side				Weight kg (lb)	Volume dm <sup>3</sup> (in <sup>3</sup> )	Catalog Number
			A	B	C	D			
PCe1	120 x 110 x 95 (4.72 x 4.33 x 3.74)	62.0 (2.44)	1 x M20	1 x M20	2 x M20	1 x M20	1.0 (2.20)	2.2 (134.25)	JBEA121109D1
PCe2	170 x 110 x 95 (6.69 x 4.33 x 3.74)	112.0 (4.41)	—	1 x M20	2 x M20 1 x M25	1 x M20	1.3 (2.87)	2.7 (164.76)	JBEA171109D2
PCe3	230 x 110 x 95 (9.10 x 4.33 x 3.74)	172.0 (6.77)	—	2 x M20	3 x M20 1 x M25	2 x M20	1.6 (3.53)	5.2 (317.32)	JBEA231109D3

### Factory Drilled Ex e II Aluminum Junction Boxes for Instrumentation Applications

Fitted with: Yellow laminated plastic label with black lettering. Set of two insulated side supports (096115). One horizontal symmetrical zinc plated rail. For use with Ex terminals only (not supplied). Also available for use with copper bar 12 x 2 mm (0.47" x 0.08") or 12 x 4 mm (0.47" x 0.16"). Cable glands and plugs ordered separately. M8 external earth crossing terminal.

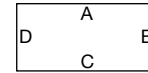

Type	Dimensions L x W x D mm (in)	Cable	Rail Length Maximum mm (in)	Threaded Holes Side C		Weight kg (lb)	Volume dm <sup>3</sup> (in <sup>3</sup> )	Catalog Number
CAe1	215 x 205 x 130 (8.47 x 8.07 x 5.12)	7 Pairs	221 (105)	1 x M25	7 x M20	4 (8.82)	13 (793.3)	JBEA212013D5
CAe2	320 x 205 x 130 (12.60 x 8.07 x 5.12)	12 Pairs	403 (206)	1 x M32	12 x M20	5 (11.02)	23 (1403.6)	JBEA322013D6
CAe3	425 x 205 x 130 (17.80 x 8.07 x 5.12)	19 Pairs	590 (310)	1 x M32	19 x M20	6 (13.28)	33 (2013.8)	JBEA422013D7
CAe5	480 x 380 x 190 (18.90 x 14.96 x 7.48)	27 Pairs	599 (315)	1 x M40	27 x M20	11 (24.25)	53 (3234.3)	JBEA483819D8

### Factory Assembled Ex Terminal Block for Junction Boxes Shown Above

Screwed/Screwed Terminal Block Fitted with Continuity Shield.



For Junction Boxes	Cable	Terminals 0.5/2.5 mm <sup>2</sup> (0.0008/0.004 in <sup>2</sup> ) Qty.	Continuity Shield Qty.	Weight kg (lb)	Volume dm <sup>3</sup> (in <sup>3</sup> )	Catalog Number
215 x 205 x 130 (8.47 x 8.07 x 5.12)	7 Pairs	14	7	0.3 (0.66)	0.5 (30.5)	096039
320 x 205 x 130 (12.60 x 8.07 x 5.12)	12 Pairs	24	12	0.4 (0.88)	1.1 (63.1)	096041
425 x 205 x 130 (17.80 x 8.07 x 5.12)	19 Pairs	38	19	0.5 (1.10)	1.3 (79.3)	096043
480 x 380 x 190 (18.90 x 14.96 x 7.48)	27 Pairs	54	27	0.6 (1.32)	1.7 (103.7)	096044

# ATX™ JBEA Series Pre-Drilled Aluminum Junction Box

## Increased Safety

ATEX/IECEX:  
Zone 1 and 2 – 21 and 22  
II 2 GD  
IP66 – IK10

### Factory Drilled and Equipped with Terminal Ex e II Aluminum Junction Boxes for Instrumentation Applications with Unarmored Cables

Fitted with: Horizontal beige terminal block. Copper bar with cable clamps or continuity shields. Yellow laminated plastic label with black lettering. M16 to M50 threaded entries. Cable glands and plugs ordered separately.



Unarmored cables

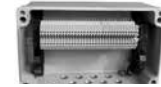

Type		Terminal Block	Earth Terminal	Copper Bar	Cable Clamp	Continuity Shield Qty.	Multi-cable	Single Cable Entries Qty.	Catalog Number
		0.5/2.5 mm <sup>2</sup> (0.0008/0.004 in <sup>2</sup> ) Qty.	0.5/2.5 mm <sup>2</sup> (0.0008/0.004 in <sup>2</sup> ) Qty.	10 x 3 mm (0.39" x 0.12") Qty.	0.5/2.5 mm <sup>2</sup> (0.0008/0.004 in <sup>2</sup> ) Qty.		Cable Entry Qty. 1		
<b>Cable U1000 RO2V – Single Cable Entries M20</b>									
CAe1	07G1.5	7	1	1	5	—	M20	3	JBEA212013P01
CAe1	12G1.5	12	1	1	8	—	M25	6	JBEA212013P02
CAe2	19G1.5	19	1	1	11	—	M25	9	JBEA322013P03
CAe2	24G1.5	24	1	1	14	—	M32	12	JBEA322013P04
CAe2	27G1.5	27	1	1	15	—	M32	13	JBEA322013P05
CAe3	37G1.5	37	1	1	20	—	M32	18	JBEA422013P06
CAe1	07G2.5	7	1	1	5	—	M20	3	JBEA212013P07
CAe1	12G2.5	12	1	1	8	—	M25	6	JBEA212013P08
CAe2	19G2.5	19	1	1	11	—	M32	9	JBEA322013P09
CAe2	24G2.5	24	1	1	14	—	M32	12	JBEA322013P10
CAe2	27G2.5	27	1	1	15	—	M32	13	JBEA322013P11
CAe3	37G2.5	37	1	1	20	—	M40	18	JBEA422013P12
<b>Cable EGSF – Single Cable Entries M16</b>									
CAe1	07IP05	14	—	—	—	7	M20	7	JBEA212013P21
CAe1	07IT05	21	—	—	—	7	M20	7	JBEA212013P22
CAe2	12IP05	24	—	—	—	12	M25	12	JBEA322013P23
CAe2	12IT05	36	—	—	—	12	M25	12	JBEA322013P24
CAe3	19IP05	38	—	—	—	19	M32	19	JBEA422013P25
CAe5	27IP05	54	—	—	—	27	M32	27	JBEA483819P26
CAe1	07IP09	14	—	—	—	7	M25	7	JBEA212013P27
CAe1	07IT09	21	—	—	—	7	M25	7	JBEA212013P28
CAe2	12IP09	24	—	—	—	12	M32	12	JBEA322013P29
CAe2	12IT09	36	—	—	—	12	M32	12	JBEA322013P30
CAe3	19IP09	38	—	—	—	19	M32	19	JBEA422013P31
CAe5	27IP09	54	—	—	—	27	M40	27	JBEA483819P32
<b>Cable EISF – Single Cable Entries M16</b>									
CAe1	07IP05	15	—	—	—	8	M25	7	JBEA212013P41
CAe1	07IT05	22	—	—	—	8	M32	7	JBEA212013P42
CAe2	12IP05	25	—	—	—	13	M32	12	JBEA322013P43
CAe2	12IT05	37	—	—	—	13	M32	12	JBEA322013P44
CAe3	19IP05	39	—	—	—	20	M40	19	JBEA422013P45
CAe5	27IP05	55	—	—	—	28	M40	27	JBEA483819P46
CAe1	07IP09	15	—	—	—	8	M32	7	JBEA212013P47
CAe1	07IT09	22	—	—	—	8	M32	7	JBEA212013P48
CAe2	12IP09	25	—	—	—	13	M40	12	JBEA322013P49
CAe2	12IT09	37	—	—	—	13	M40	12	JBEA322013P50
CAe3	19IP09	29	—	—	—	20	M50	19	JBEA422013P51
CAe5	27IP09	55	—	—	—	28	M50	27	JBEA483819P52

# ATX™ JBEA Series Pre-Drilled Aluminum Junction Box

## Increased Safety

ATEX/IECEX:  
 Zone 1 and 2 – 21 and 22  
 II 2 GD  
 IP66 – IK10

### Factory Drilled and Equipped with Terminals Ex e II Aluminum Junction Boxes for Instrumentation Applications with Armored Cables

Fitted with: Horizontal beige terminal block. Copper bar with cable clamps or continuity shields. Yellow laminated plastic label with black lettering. Earth continuity brass plate. M8 external earth crossing terminal. M20 to M50 threaded entries. Cable glands and plugs ordered separately.



Armored cables

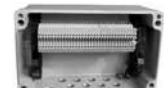

Type	Terminal Block 0.5/2.5 mm <sup>2</sup> (0.0008/0.004 in <sup>2</sup> )	Earth Terminal 0.5/2.5 mm <sup>2</sup> (0.0008/0.004 in <sup>2</sup> )	Copper Bar 10 x 3 mm (0.39" x 0.12")	Cable Clamp 0.5/2.5 mm <sup>2</sup> (0.0008/0.004 in <sup>2</sup> )	Continuity Shield Qty.	Multi-cable Cable Entry Qty. 1	Single Cable Entries Qty.	Catalog Number
<b>Cable U1000 RVFV – Single Cable Entries M20</b>								
CAe1 07G1.5	7	1	1	5	—	M20	3	JBEA212013A01
CAe1 12G1.5	12	1	1	8	—	M20	6	JBEA212013A02
CAe2 19G1.5	19	1	1	11	—	M25	9	JBEA322013A03
CAe2 24G1.5	24	1	1	14	—	M25	12	JBEA322013A04
CAe2 27G1.5	27	1	1	15	—	M25	13	JBEA322013A05
CAe3 37G1.5	37	1	1	20	—	M32	18	JBEA422013A06
CAe1 07G2.5	7	1	1	5	—	M20	3	JBEA212013A07
CAe1 12G2.5	12	1	1	8	—	M25	6	JBEA212013A08
CAe2 19G2.5	19	1	1	11	—	M25	9	JBEA322013A09
CAe2 24G2.5	24	1	1	14	—	M32	12	JBEA322013A10
CAe2 27G2.5	27	1	1	15	—	M32	13	JBEA322013A11
CAe3 37G2.5	37	1	1	20	—	M32	18	JBEA422013A12
<b>Cable EGFA – Single Cable Entries M20</b>								
CAe1 07IP05	14	7	—	—	7	M20	7	JBEA212013A21
CAe1 07IT05	21	7	—	—	7	M20	7	JBEA212013A22
CAe2 12IP05	24	12	—	—	12	M25	12	JBEA322013A23
CAe2 12IT05	36	12	—	—	12	M25	12	JBEA322013A24
CAe3 19IP05	38	19	—	—	19	M25	19	JBEA422013A25
CAe5 27IP05	54	27	—	—	27	M32	27	JBEA483819A26
CAe1 07IP09	14	7	—	—	7	M25	7	JBEA212013A27
CAe1 07IT09	21	7	—	—	7	M25	7	JBEA212013A28
CAe2 12IP09	24	12	—	—	12	M25	12	JBEA322013A29
CAe2 12IT09	36	12	—	—	12	M32	12	JBEA322013A30
CAe3 19IP09	38	19	—	—	19	M32	19	JBEA422013A31
CAe5 27IP09	54	27	—	—	27	M40	27	JBEA483819A32
<b>Cable EIFA – Single Cable Entries M20</b>								
CAe1 07IP05	15	—	—	—	8	M25	7	JBEA212013A41
CAe1 07IT05	22	—	—	—	8	M25	7	JBEA212013A42
CAe2 12IP05	25	—	—	—	13	M32	12	JBEA322013A43
CAe2 12IT05	37	—	—	—	13	M32	12	JBEA322013A44
CAe3 19IP05	39	—	—	—	20	M32	19	JBEA422013A45
CAe5 27IP05	55	—	—	—	28	M40	27	JBEA483819A46
CAe1 07IP09	15	—	—	—	8	M32	7	JBEA212013A47
CAe1 07IT09	22	—	—	—	8	M32	7	JBEA212013A48
CAe2 12IP09	25	—	—	—	13	M40	12	JBEA322013A49
CAe2 12IT09	37	—	—	—	13	M40	12	JBEA322013A50
CAe3 19IP09	39	—	—	—	20	M40	19	JBEA422013A51
CAe5 27IP09	55	—	—	—	28	M50	27	JBEA483819A52

# ATX™ JBEA Series Pre-Drilled Aluminum Junction Box

## Increased Safety

ATEX/IECEX:  
 Zone 1 and 2 – 21 and 22  
 II 2 GD  
 IP66 – IK10

**Factory Drilled and Equipped with Terminals Ex e II Aluminum Junction Boxes for Instrumentation Applications with Lead Sheath Armored Cables**  
 Fitted with: Horizontal beige terminal block. Copper bar with cable clamps or continuity shields. Yellow laminated plastic label with black lettering. Earth continuity brass plate. M8 external earth crossing terminal. M20 to M50 threaded entries. Cable glands and plugs ordered separately.

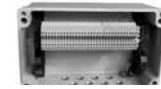

Type	Terminal Block 0.5/2.5 mm <sup>2</sup> (0.0008/0.004 in <sup>2</sup> )	Earth Terminal 0.5/2.5 mm <sup>2</sup> (0.0008/0.004 in <sup>2</sup> )	Copper Bar 10 x 3 mm (0.39" x 0.12")	Cable Clamp 0.5/2.5 mm <sup>2</sup> (0.0008/0.004 in <sup>2</sup> )	Continuity Shield Qty.	Multi-cable Cable Entry Qty. 1	Single Cable Entries Qty.	Catalog Number
<b>U1000 RGPV – Single Cable Entries M20</b>								
CAe1	07 x 1.5	7	1	5	—	M20	3	JBEA212013L01
CAe1	12 x 1.5	12	1	8	—	M25	6	JBEA212013L02
CAe2	19 x 1.5	19	1	11	—	M25	9	JBEA322013L03
CAe2	24 x 1.5	24	1	14	—	M32	12	JBEA322013L04
CAe2	27 x 1.5	27	1	15	—	M32	13	JBEA322013L05
CAe3	37 x 1.5	37	1	20	—	M32	18	JBEA422013L06
CAe1	07 x 2.5	7	1	5	—	M20	3	JBEA212013L07
CAe1	12 x 2.5	12	1	8	—	M25	6	JBEA212013L08
CAe2	19 x 2.5	19	1	11	—	M32	9	JBEA322013L09
CAe2	24 x 2.5	24	1	14	—	M32	12	JBEA322013L10
CAe2	27 x 2.5	27	1	15	—	M32	13	JBEA322013L11
CAe3	37 x 2.5	37	1	20	—	M40	18	JBEA422013L12
<b>Cable EGPF – Single Cable Entries M20</b>								
CAe1	07IP05	14	—	—	7	M20	7	JBEA212013L21
CAe1	07IT05	21	—	—	7	M20	7	JBEA212013L22
CAe2	12IP05	24	—	—	12	M25	12	JBEA322013L23
CAe2	12IT05	36	—	—	12	M25	12	JBEA322013L24
CAe3	19IP05	38	—	—	19	M25	19	JBEA422013L25
CAe5	27IP05	54	—	—	27	M32	27	JBEA483819L26
CAe1	07IP09	14	—	—	7	M25	7	JBEA212013L27
CAe1	07IT09	21	—	—	7	M25	7	JBEA212013L28
CAe2	12IP09	24	—	—	12	M32	12	JBEA322013L29
CAe2	12IT09	36	—	—	12	M32	12	JBEA322013L30
CAe3	19IP09	38	—	—	19	M40	19	JBEA422013L31
CAe5	27IP09	54	—	—	27	M40	27	JBEA483819L32
<b>Cable EIPF – Single Cable Entries M20</b>								
CAe1	07IP05	15	—	—	8	M25	7	JBEA212013L41
CAe1	07IT05	22	—	—	8	M32	7	JBEA212013L42
CAe2	12IP05	25	—	—	13	M32	12	JBEA322013L43
CAe2	12IT05	37	—	—	13	M32	12	JBEA322013L44
CAe3	19IP05	39	—	—	20	M40	19	JBEA422013L45
CAe5	27IP05	55	—	—	28	M50	27	JBEA483819L46
CAe1	07IP09	15	—	—	8	M32	7	JBEA212013L47
CAe1	07IT09	22	—	—	8	M32	7	JBEA212013L48
CAe2	12IP09	25	—	—	13	M40	12	JBEA322013L49
CAe2	12IT09	37	—	—	13	M40	12	JBEA322013L50
CAe3	19IP09	39	—	—	20	M50	19	JBEA422013L51
CAe5	27IP09	55	—	—	28	M50	27	JBEA483819L52



# ATX™ JBEA Series Pre-Drilled Aluminum Junction Box

## Increased Safety

ATEX/IECEX:  
 Zone 1 and 2 – 21 and 22  
 II 2 GD  
 IP66 – IK10

### Defining maximum terminal block quantity according to power dissipation:

- Junction boxes used for instrumentation applications have very low current levels. Therefore there is no risk of overheating whatever the number of terminals inside the box.
- For applications other than instrumentation, the following tables allow you to define your junction box depending on the number of terminals and the maximum authorized current being carried.

For other terminal block configurations, please consult our drilling guide available online at: [www.appletonelec.com](http://www.appletonelec.com)

T Rating: T6		Type		
		PCe1 120 x 110 x 95 mm (4.72 x 4.33 x 3.74")	PCe2 170 x 110 x 95 mm (6.69 x 4.33 x 3.74")	PCe3 230 x 110 x 95 mm (9.10 x 4.33 x 3.74")
2.5 mm <sup>2</sup> (0.004 in <sup>2</sup> )	Quantity	12	22	33
	I Maximum	15 A	13 A	12 A
4 mm <sup>2</sup> (0.006 in <sup>2</sup> )	Quantity	10	18	28
	I Maximum	20 A	19 A	16 A
6 mm <sup>2</sup> (0.009 in <sup>2</sup> )	Quantity	7	14	21
	I Maximum	32 A	27 A	24 A
10 mm <sup>2</sup> (0.016 in <sup>2</sup> )	Quantity	4	6	8
	I Maximum	50 A	50 A	50 A

T Rating: T6 @ Ta 40 °C (104 °F) T5 @ Ta 55° C (131 °F)		Type			
		CAe1 215 x 205 x 130 mm (8.47 x 8.07 x 5.12")	CAe2 320 x 205 x 130 mm (12.60 x 8.07 x 5.12")	CAe3 425 x 205 x 130 mm (17.80 x 8.07 x 5.12")	CAe5 480 x 380 x 190 mm (18.90 x 14.96 x 7.48")
2.5 mm <sup>2</sup> (0.004 in <sup>2</sup> )	Quantity	20	21	23	38
	I Maximum	16 A	16 A	16 A	16 A
4 mm <sup>2</sup> (0.006 in <sup>2</sup> )	Quantity	19	20	23	38
	I Maximum	20 A	20 A	20 A	20 A
6 mm <sup>2</sup> (0.009 in <sup>2</sup> )	Quantity	12	13	14	23
	I Maximum	32 A	32 A	32 A	32 A
10 mm <sup>2</sup> (0.016 in <sup>2</sup> )	Quantity	10	11	18	30
	I Maximum	40 A	40 A	32 A	32 A
16 mm <sup>2</sup> (0.024 in <sup>2</sup> )	Quantity	8	10	13	22
	I Maximum	28 A	27 A	25 A	26 A
25 mm <sup>2</sup> (0.039 in <sup>2</sup> )	Quantity	8	8	10	20
	I Maximum	67 A	73 A	69 A	60 A
35 mm <sup>2</sup> (0.054 in <sup>2</sup> )	Quantity	8	8	10	12
	I Maximum	79 A	86 A	80 A	100 A

# ATX™ JBEA Series Pre-Drilled Aluminum Junction Box

## Increased Safety

ATEX/IECEX:  
 Zone 1 and 2 – 21 and 22  
 II 2 GD  
 IP66 – IK10

Dimensions in Millimeters (Inches)

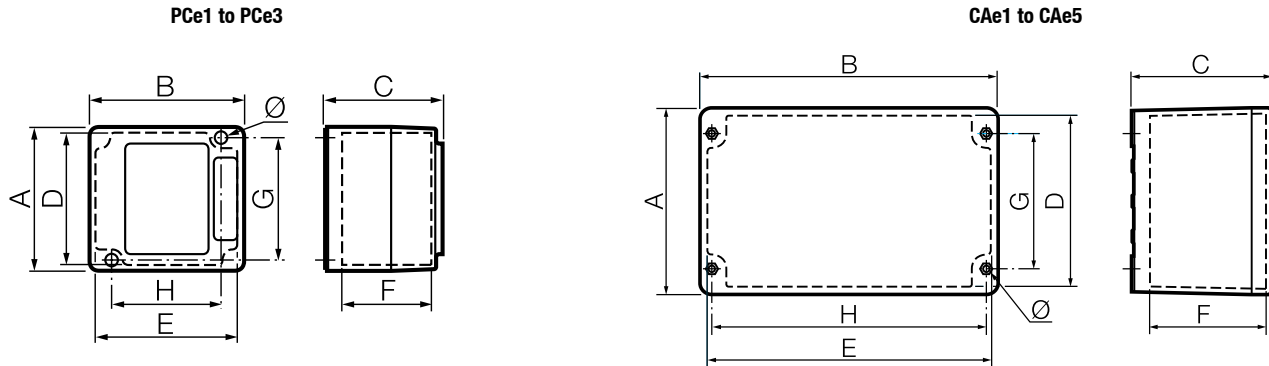

Type	External Dimensions			Internal Dimensions				Fixings		
	A	B	C	D	E	F	G	H	Thick	Ø
PCe1	110 (4.33)	120 (4.72)	95 (3.74)	100 (3.94)	110 (4.33)	70 (2.76)	94 (3.70)	84 (3.38)	20 (0.79)	5 (0.20)
PCe2	110 (4.33)	170 (6.69)	95 (3.74)	100 (3.94)	160 (6.30)	70 (2.76)	94 (3.70)	134 (5.28)	20 (0.79)	5 (0.20)
PCe3	110 (4.33)	230 (9.06)	95 (3.74)	100 (3.94)	220 (8.66)	70 (2.76)	94 (3.70)	194 (7.68)	20 (0.79)	5 (0.20)
CAe1	205 (8.07)	215 (8.46)	130 (5.12)	190 (7.48)	200 (7.87)	105 (4.13)	146 (5.75)	186 (7.32)	10 (0.39)	7 (0.28)
CAe2	205 (8.07)	320 (12.60)	130 (5.12)	190 (7.48)	305 (12.01)	105 (4.13)	146 (5.75)	290 (11.48)	10 (0.39)	7 (0.28)
CAe3	205 (8.07)	425 (16.73)	130 (5.12)	190 (7.48)	410 (16.14)	105 (4.13)	146 (5.75)	398 (15.31)	10 (0.39)	7 (0.28)
CAe5	480 (18.90)	380 (14.96)	190 (7.48)	378 (14.88)	279 (10.98)	132 (5.20)	385 (15.16)	285 (11.22)	13 (0.51)	7 (0.28)

Appleton®

ENCLOSURES AND JUNCTION BOXES: ATEX/IECEX INCREASED SAFETY JUNCTION BOXES

# ATX™ JBEL Series Polycarbonate Junction Boxes

## Increased Safety

Furnished complete with Terminals.

### ATEX:

Zone 1 and 2 – 21 and 22

⊕ II 2 GD

IP66 – IK10

### Applications

- Small terminal junction boxes designed to facilitate electrical connections in hazardous areas.
- Designed for use in Zone 1 or 2 areas, where flammable gases or vapors are present either continuously or intermittently such as:
  - Petroleum
  - Chemical
  - Refineries
  - Other industrial process facilities
- Ideal for wet or corrosive atmospheres.
- Designed for use in Zone 21 or 22 areas where flammable dusts are present either continuously or intermittently such as:
  - Food processing
  - Dairy
  - Brewing
  - Other commercial facilities

### Features

- Pillar type terminal block for easy connection.
- Available in two sizes:
  - 4 mm<sup>2</sup> (0.006 in<sup>2</sup>)
  - 10 mm<sup>2</sup> (0.016 in<sup>2</sup>)
- Unarmored or armored versions with earth continuity brass device.
- Operating temperature: -40 °C to +55 °C (-40 °F to +131 °F).

### Standard Materials

- Enclosure: static and impact resistant polycarbonate
- Cover gasket: polyurethane
- Hardware: stainless steel

### ATEX Certifications and Compliances

- Certification Type BJe1
  - Gas, Zones 1 and 2:
    - Conforming to ATEX 94/9/CE: ⊕ II 2 G
    - Type of Protection: Ex e II
    - Temperature Class: T6
  - Dust, Zones 21 and 22:
    - Conforming to ATEX 94/9/CE: ⊕ II 2 D
    - Type of Protection: Ex tD A21
    - Surface Temperature: T75 °C (T167 °F)
    - Ambient Temperature: -40 °C to +55 °C (-40 °F to +131 °F)
    - CE Declaration of Conformity: 50226
    - ATEX Certificate: LCIE 02 ATEX 6069
- Certification Type BJe2
  - Gas, Zones 1 and 2:
    - Conforming to ATEX 94/9/CE: ⊕ II 2 G
    - Type of Protection: Ex e II
    - Temperature Class: T6
  - Dust, Zones 21 and 22:
    - Conforming to ATEX 94/9/CE: ⊕ II 2 D
    - Type of Protection: Ex tD A21
    - Surface Temperature: T80 °C (176 °F)
    - Ambient Temperature: -40 °C to +55 °C (-40 °F to +131 °F)
    - CE Declaration of Conformity: 50209
    - ATEX Certificate: LCIE 99 ATEX 6003
- Index of Protection according EN/IEC 60529: IP66
- Impact Resistance (shock): IK10



For Unarmored Cable



For Armored Cable

### EURASEC Certification

- Certification Type BJe1
  - EURASEC N° TC RU C-FR.Г505.В.00911
- Certification Type BJe2
  - EURASEC N° TC RU C-FR.Г505.В.00911

### Other Certifications

- Certification Type BJe1
  - INMETRO Certificate: BVC 11.0479 ①
- Certification Type BJe2
  - INMETRO Certificate: BVC 11.0402-X ①











① INMETRO certification available on special request only. Contact your local sales representative for more information.

# ATX™ JBEL Series Polycarbonate Junction Boxes

## Increased Safety

Furnished complete with Terminals.

ATEX:  
Zone 1 and 2 – 21 and 22  
II 2 GD  
IP66 – IK10

Equipment	Rating (Amps)	Weight (kg (lb))	Volume (dm <sup>3</sup> (in <sup>3</sup> ))	Catalog Number
<b>For Unarmored Cables 2.5/4 mm<sup>2</sup> (0.004/0.006 in<sup>2</sup>) 660 V – Certification Type BJe1</b>				
Supplied with 4 connection terminals. Maximum capacity per terminal: 4 x 2.5 mm <sup>2</sup> (0.004 in <sup>2</sup> ) or 2 x 4 mm <sup>2</sup> (0.004 in <sup>2</sup> ) + 2 x 2.5 mm <sup>2</sup> (0.004 in <sup>2</sup> ) and 4 interconnected earth terminals. Maximum capacity per earth terminal: 1 x 4 mm <sup>2</sup> (0.004 in <sup>2</sup> )				
 4 x PG16 entries with knock-out caps ① 4 x Integrated cable glands for unarmored cable; 8 to 16 mm (0.31" to 0.69") diameter <i>Important: Cables must be secured to structure close to box entries</i>	28 A/2.5 mm <sup>2</sup> (0.004 in <sup>2</sup> ) 38 A/4 mm <sup>2</sup> (0.006 in <sup>2</sup> )	0.4 (0.88)	1.7 (103.74)	<b>JBEL1N4P16G</b>
<b>For Armored Cables 2.5/4 mm<sup>2</sup> (0.004/0.006 in<sup>2</sup>) 660 V – Certification Type BJe1</b>				
Supplied with 4 connection terminals. Maximum capacity per terminal: 4 x 2.5 mm <sup>2</sup> (0.004 in <sup>2</sup> ) or 2 x 4 mm <sup>2</sup> (0.004 in <sup>2</sup> ) + 2 x 2.5 mm <sup>2</sup> (0.004 in <sup>2</sup> ) and 4 interconnected earth terminals. Maximum capacity per earth terminal: 1 x 4 mm <sup>2</sup> (0.004 in <sup>2</sup> )				
 4 x M20 entries with earth brass continuity device 2 x blanking plugs	28 A/2.5 mm <sup>2</sup> (0.004 in <sup>2</sup> ) 38 A/4 mm <sup>2</sup> (0.006 in <sup>2</sup> )	0.4 (0.88)	1.7 (103.74)	<b>JBEL1A4M20</b>
<b>For Unarmored Cables 6/10 mm<sup>2</sup> (0.009/0.016 in<sup>2</sup>) 690 V – Certification Type BJe2</b>				
Supplied with 4 connection terminals. Maximum capacity per terminal: 4 x 6 mm <sup>2</sup> (0.009 in <sup>2</sup> ) or 3 x 10 mm <sup>2</sup> (0.016 in <sup>2</sup> ) + 4 mm <sup>2</sup> (0.004 in <sup>2</sup> ) and 4 interconnected earth terminals. Maximum capacity per earth terminal: 1 x 10 mm <sup>2</sup> (0.016 in <sup>2</sup> )				
 3 x M20 entries 3 x cable glands for unarmored cable; 6.5 to 14.5 mm (0.26" to 0.57") diameter		0.7 (1.54)	4.5 (274.60)	<b>JBEL2N3M20G</b>
 4 x M20 entries 4 x cable glands for unarmored cable; 6.5 to 14.5 mm (0.26" to 0.57") diameter	42 A/10 mm <sup>2</sup> (0.016 in <sup>2</sup> ) 30 A/6 mm <sup>2</sup> (0.009 in <sup>2</sup> )	0.7 (1.54)	4.5 (274.60)	<b>JBEL2N4M20G</b>
 3 x M25 entries 3 x cable glands for unarmored cable; 8 to 18.5 mm (0.31" to 0.73") diameter	18 A/4 mm <sup>2</sup> (0.006 in <sup>2</sup> )	0.7 (1.54)	4.5 (274.60)	<b>JBEL2N3M25G</b>
 4 x M25 entries 4 x cable glands for unarmored cable; 8 to 18.5 mm (0.31" to 0.73") diameter		0.7 (1.54)	4.5 (274.60)	<b>JBEL2N4M25G</b>
<b>For Armored Cables 6/10 mm<sup>2</sup> (0.009/0.016 in<sup>2</sup>) 690 V – Certification Type BJe2</b>				
Supplied with 4 connection terminals. Maximum capacity per terminal: 4 x 6 mm <sup>2</sup> (0.009 in <sup>2</sup> ) or 3 x 10 mm <sup>2</sup> (0.016 in <sup>2</sup> ) + 4 mm <sup>2</sup> (0.004 in <sup>2</sup> ) and 4 interconnected earth terminals. Maximum capacity per earth terminal: 1 x 10 mm <sup>2</sup> (0.016 in <sup>2</sup> )				
 4 x M20 entries with earth brass continuity device. 2 x M20 blanking plugs		0.7 (1.54)	4.5 (274.60)	<b>JBEL2A4M20</b>
 4 x M25 entries with earth brass continuity device. 2 x M25 blanking plugs	42 A/10 mm <sup>2</sup> (0.016 in <sup>2</sup> ) 30 A/6 mm <sup>2</sup> (0.009 in <sup>2</sup> )	0.7 (1.54)	4.5 (274.60)	<b>JBEL2A4M25</b>
 2 x M25 + 2 x M20 entries with earth brass continuity device. 1 x M25 + 1 x M20 blanking plugs	18 A/4 mm <sup>2</sup> (0.006 in <sup>2</sup> )	0.7 (1.54)	4.5 (274.60)	<b>JBEL2A4M05</b>
 3 x M25 + 1 x M20 entries with earth brass continuity device. 1 x M25 + 1 x M20 blanking plugs		0.7 (1.54)	4.5 (274.60)	<b>JBEL2A4M06</b>

① Knock-out caps can be used as plugs.

# ATX™ JBEL Series Polycarbonate Junction Boxes

## Increased Safety

Furnished complete with Terminals.

### ATEX:

Zone 1 and 2 – 21 and 22

II 2 GD

IP66 – IK10

Dimensions in Millimeters (Inches)

**BJe1 with Cable Glands for Unarmored Cables**

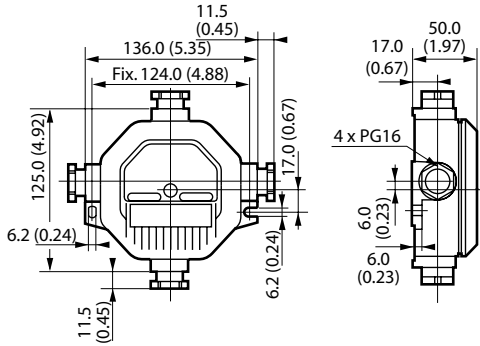

**BJe1 without Cable Glands for Armored Cables**

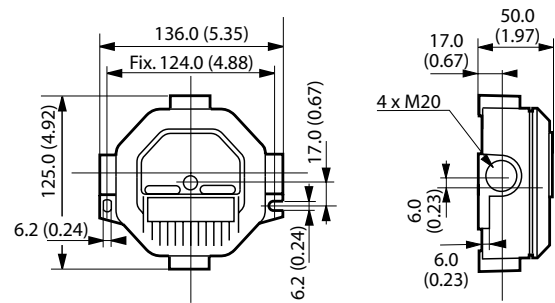

**BJe2 with Cable Glands for Unarmored Cables**

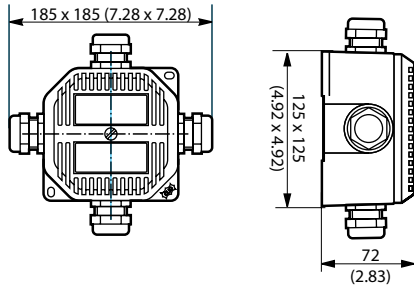

**BJe2 without Cable Glands for Armored Cables**

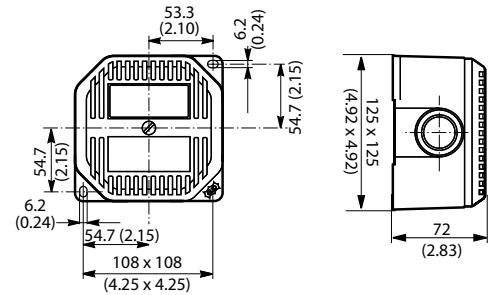

# ATX™ JBES and ECES Series 316L Stainless Steel Enclosures

## Increased Safety

ATEX/IECEX:  
Zone 1 and 2 - 21 and 22  
II 2 GD  
IP66 - IK10

### Applications

- Designed for use in Zone 1 or 2 areas where flammable gases or vapors are present either continuously or intermittently.
- Ideal for use in wet or corrosive atmospheres such as:
  - Petroleum
  - Chemical
  - Refineries
  - Other industrial process facilities
- Designed for use in Zone 21 or 22 areas where flammable dusts are present either continuously or intermittently such as:
  - Food processing
  - Dairy
  - Brewing
  - Pharmaceutical industry
  - Other commercial facilities
- JBES Series
  - Terminal junction box for electrical low voltage and instrumentation connections for use in hazardous areas.
  - Refer to technical data to define permitted number of terminal blocks and cable entries on selected junction boxes.
- ECES Series
  - Enclosure for distribution and control applications must be customized at our workshop to house a large range of components such as control units, switches, breakers, transformers, meters, etc.

### Features

- Smooth, continuously welded seams.
- Available in a wide range of sizes.
- Operating temperature:
  - JBES Series: -50 °C to +70 °C (-58 °F to +158 °F)
  - ECES Series: -50 °C to +55 °C (-58 °F to +131 °F)
- Can be supplied with 1, 2, 3 or even 4 neoprene sealed gland plates for ease of cable installation.
- Hinges standard on all sizes above 370.0 mm x 260.0 mm (14.57" x 10.24").
- Poured-in-place polyurethane door gasket.
- Feed-thru earth grounding stud.
- Reversible door, opens 210 degrees, from any location top; bottom, left or right, by means of removable hinges that can be installed in any position.
- Reversible anti-vibration mounting brackets can be mounted on the top, bottom or side positions.
- Optional removable padlocking device.

### Standard Materials

- Enclosure: 316L stainless steel
- Hardware: 316L stainless steel

### Standard Finishes

- Natural brushed finish

### Accessories

- Mounting pan
- Rail mounting
- Padlocking device
- Door locking bracket for easy access
- Inside pocket
- Refer to technical data to define permitted number of terminals and cable entries acceptance

JBES Series



ECES Series



Closed



Open

### Options

- Removable gland plates.
- Nameplate.
- Factory drilled and assembled, contact your local representative for information.
- Medium voltage application (11 kV max.), contact your local representative for information.
- Intrinsic safety version (JBIS) available with the use of intrinsic terminals.
- cCSAus certified terminal junction box available for NEC/CEC applications with the SJB series of stainless steel enclosures.

### ATEX/IECEX Certifications and Compliances

- Certification Type JBe
  - Gas, Zones 1 and 2:
    - Conforming to ATEX 94/9/CE: II 2 G
    - Type of Protection: Ex e II, Ex ia IIC, Ex ib IIC, Ex de IIC, Ex demb IIC
    - Temperature Class: T6 to T4
  - Dust, Zones 21 and 22:
    - Conforming to ATEX 94/9/CE: II 2 D
    - Type of Protection: Ex tD A21
    - Surface Temperature: T80 °C to T130 °C (T176 °F to T266 °F)
    - Ambient Temperature: -50 °C to +70 °C (-58 °F to +158 °F)
    - CE Declaration of Conformity: 50232
    - ATEX Certificate : LCIE 02 ATEX 6118X
    - IECEx Certificate: IECEx LCI 11.0008X
- Certification Type JBe U
  - Gas, Zones 1 and 2:
    - Conforming to ATEX 94/9/CE: II 2 G
    - Type of Protection: Ex e II
  - Dust, Zones 21 and 22:
    - Conforming to ATEX 94/9/CE: II 2 D
    - Type of Protection: Ex tD A21
    - Ambient Temperature: -40 °C to +70 °C (-40 °F to +158 °F).
    - CE Declaration of Conformity: 5C240
    - ATEX Certificate: LCIE 09 ATEX 3025U
- Index of Protection according EN/IEC 60529: IP66
- Impact Resistance (shock): IK10

# ATX™ JBES and ECES Series 316L Stainless Steel Enclosures

## Increased Safety

ATEX/IECEX:  
 Zone 1 and 2 - 21 and 22  
 II 2 GD  
 IP66 - IK10

### EURASEC Certification

- Certification Type JBe
  - EURASEC N° TC RU C-FR.Г505.B.00911

### Other Certification

- Certification Type JBe
  - INMETRO Certificate: BVC 11.0418-X ①

### Illustrated Features

	<p>Optional removable locking device.          Part Number 097209/N097209</p>		<p>Reversible antivibration mounting brackets,          can be mounted in top, side or bottom          positions.</p>
	<p>M8 feed-thru earth/ground terminal.</p>		<p>Polyurethane poured in place door gasket and          stainless steel captive screws.</p>
	<p>Reversible door. Opens to 210°, top, bottom,          left or right, by moving the location of the          hinges</p>		<p>Optional removable gland plate.</p>



ENCLOSURES AND JUNCTION BOXES: ATEX/IECEX INCREASED SAFETY JUNCTION BOXES

① INMETRO certification available on special request only. Contact your local sales representative for more information.

# ATX™ JBES and ECES Series 316L Stainless Steel Enclosures

## Increased Safety

ATEX/IECEX:  
 Zone 1 and 2 - 21 and 22  
 II 2 GD  
 IP66 - IK10

### Catalog Numbering Guide — JBES and ECES 316L Stainless Steel Enclosures

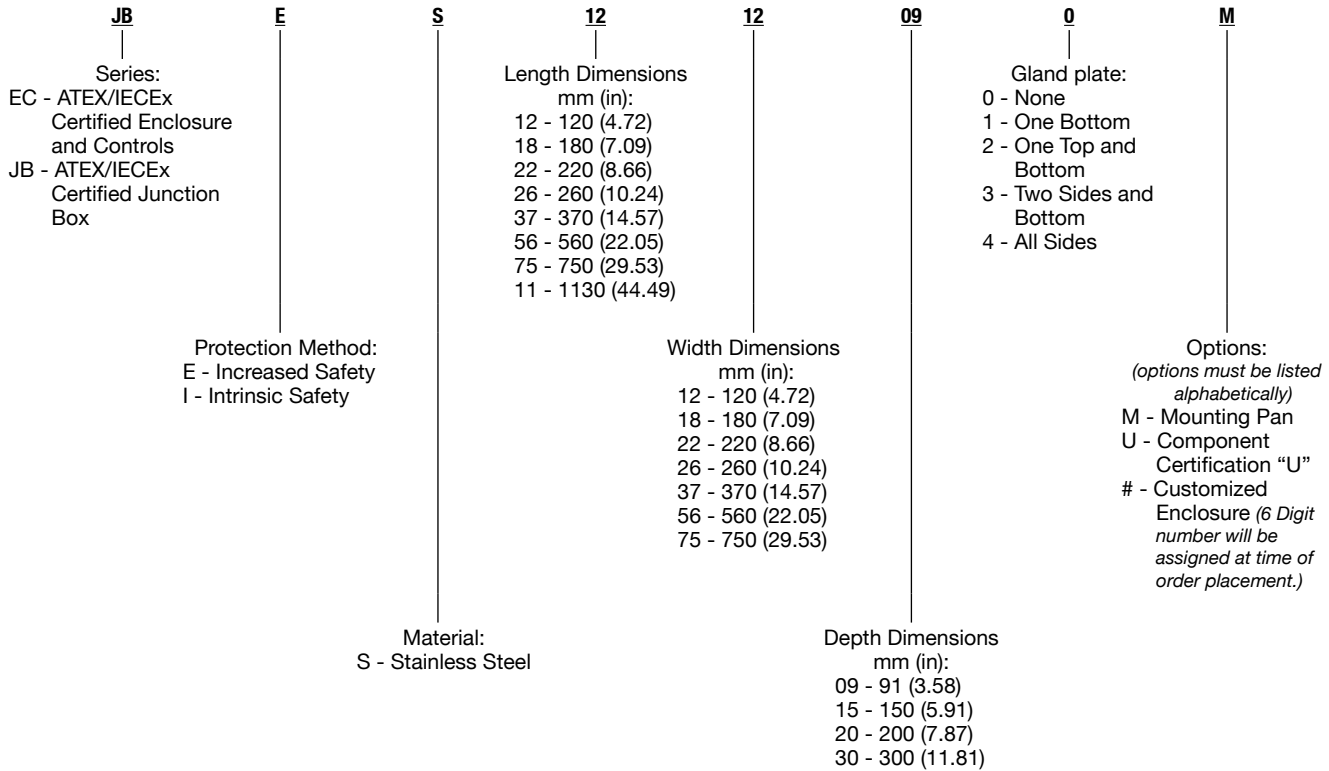



# ATX™ JBES and ECES Series 316L Stainless Steel Enclosures

## Increased Safety

ATEX/IECEX:  
Zone 1 and 2 - 21 and 22  
II 2 GD  
IP66 - IK10

### JBES Series

Type	Dimensions L x W x D mm (in)	Hinged Door ②	Vertical Orientation Rail Length mm (in)	Horizontal Orientation Rail Length mm (in)	Weight kg (lb)	Volume dm³ (in³)	Catalog Number
JBe10	120 x 120 x 95 (4.72 x 4.72 x 3.74)	N	–	100.0 (3.94)	1.0 (2.20)	1.4 (85.43)	JBES1212090
JBe20	120 x 180 x 95 (4.72 x 7.09 x 3.74)	N	–	160.0 (6.30)	1.5 (3.31)	2.0 (122.05)	JBES1218090
JBe30	180 x 180 x 95 (7.09 x 7.09 x 3.74)	N	–	160.0 (6.30)	1.8 (3.97)	3.0 (183.07)	JBES1818090
JBe36	220 x 260 x 150 (8.66 x 10.24 x 5.91)	R	170.0 (6.69)	210.0 (8.27)	5.0 (11.02)	8.6 (524.80)	JBES2226150
JBe36	260 x 220 x 150 (10.24 x 8.66 x 5.91)	R	210.0 (8.27)	170.0 (6.69)	5.0 (11.02)	8.6 (524.80)	JBES2622150
JBe46	220 x 370 x 200 (8.66 x 14.57 x 7.87) ①	R	170.0 (6.69)	320.0 (12.60)	8.5 (18.74)	16.3 (994.69)	JBES2237200
JBe47	260 x 370 x 200 (10.24 x 14.57 x 7.87) ①	Y	210.0 (8.27)	320.0 (12.60)	9.0 (19.84)	19.3 (1177.76)	JBES2637200
JBe46	370 x 220 x 200 (14.57 x 8.66 x 7.87) ①	R	320.0 (12.60)	170.0 (6.69)	8.5 (18.74)	16.6 (1012.99)	JBES3722200
JBe47	370 x 260 x 200 (14.57 x 10.24 x 7.87) ①	Y	320.0 (12.60)	210.0 (8.27)	9.0 (19.84)	19.3 (1177.76)	JBES3726200
JBe55	370 x 370 x 200 (14.57 x 14.57 x 7.87) ①	Y	320.0 (12.60)	320.0 (12.60)	13.0 (28.66)	27.4 (1672.05)	JBES3737200
JBe65	370 x 560 x 200 (14.57 x 22.05 x 7.87) ①	Y	320.0 (12.60)	510.0 (20.08)	19.0 (19.84)	41.5 (2532.49)	JBES3756200
JBe75	370 x 750 x 200 (14.57 x 29.53 x 7.87) ①	Y	320.0 (12.60)	700.0 (27.56)	24.0 (52.91)	55.5 (3386.82)	JBES3775200
JBe65	560 x 370 x 200 (22.05 x 14.57 x 7.87) ①	Y	510.0 (20.08)	320.0 (12.60)	19.0 (19.84)	41.5 (2532.49)	JBES5637200
JBe77	560 x 560 x 200 (22.05 x 22.05 x 7.87) ①	Y	510.0 (20.08)	510.0 (20.08)	28.0 (61.73)	62.8 (3832.29)	JBES5656200
JBe79	560 x 750 x 200 (22.05 x 29.53 x 7.87) ①	Y	510.0 (20.08)	700.0 (27.56)	33.0 (72.75)	84.0 (5125.99)	JBES5675200
JBe75	750 x 370 x 200 (29.53 x 14.57 x 7.87) ①	Y	700.0 (27.56)	320.0 (12.60)	24.0 (52.91)	55.5 (3386.82)	JBES7537200
JBe79	750 x 560 x 200 (29.53 x 22.05 x 7.87) ①	Y	700.0 (27.56)	510.0 (20.08)	33.0 (72.75)	84.0 (5125.99)	JBES7556200
JBe86	1130 x 750 x 300 (44.49 x 29.53 x 11.81)	Y	1080.0 (42.52)	700.0 (27.56)	50.0 (110.23)	235.0 (14340.58)	JBES1175300



① 200.0 mm (7.87") depth enclosure available with 300.0 mm (11.81") depth – replace digit 2 with 3 – Example: JBES3737304.  
② N: Not Available, R: On request or separate accessories, Y: Supplied.

# ATX™ JBES and ECES Series 316L Stainless Steel Enclosures

## Increased Safety





ATEX/IECEX:  
Zone 1 and 2 - 21 and 22  
II 2 GD  
IP66 - IK10

### JBES Series

Type	Dimensions L x W x D mm (in)	Hinged Door ②	One Gland Plate Catalog Number	Two Gland Plates Catalog Number	Three Gland Plate Catalog Number	Four Gland Plates Catalog Number
------	---------------------------------	------------------	-----------------------------------	------------------------------------	-------------------------------------	-------------------------------------

#### Ex e II 316L Stainless Steel Terminal Junction Boxes with Gland Plates 3 mm (0.12") Thick

For use only with Ex terminals (not supplied). M8 External earth crossing terminal. Mounting pan and rails to be ordered separately.

	JBe36	220 x 260 x 150 (8.66 x 10.24 x 5.91)	R	JBES2226151	JBES2226152	JBES2226153	JBES2226154
	JBe36	220 x 260 x 150 (8.66 x 10.24 x 5.91)	R	JBES2622151	JBES2622152	JBES2622153	JBES2622154
 One Gland Plate	JBe46	220 x 370 x 200 (8.66 x 14.57 x 7.87) ①	R	JBES2237201	JBES2237202	JBES2237203	JBES2237204
	JBe47	260 x 370 x 200 (10.24 x 14.57 x 7.87) ①	Y	JBES2637201	JBES2637202	JBES2637203	JBES2637204
 Two Gland Plate	JBe46	370 x 220 x 200 (14.57 x 8.66 x 7.87) ①	R	JBES3722201	JBES3722202	JBES3722203	JBES3722204
	JBe47	370 x 260 x 200 (14.57 x 10.24 x 7.87) ①	Y	JBES3726201	JBES3726202	JBES3726203	JBES3726204
 Gland Plate Three	JBe55	370 x 370 x 200 (14.57 x 14.57 x 7.87) ①	Y	JBES3737201	JBES3737202	JBES3737203	JBES3737204
	JBe65	370 x 560 x 200 (14.57 x 22.05 x 7.87) ①	Y	JBES3756201	JBES3756202	JBES3756203	JBES3756204
 Four Gland Plate	JBe75	370 x 750 x 200 (14.57 x 29.53 x 7.87) ①	Y	JBES3775201	JBES3775202	JBES3775203	JBES3775204
	JBe65	560 x 370 x 200 (22.05 x 14.57 x 7.87) ①	Y	JBES5637201	JBES5637202	JBES5637203	JBES5637204
	JBe77	560 x 560 x 200 (22.05 x 22.05 x 7.87) ①	Y	JBES5656201	JBES5656202	JBES5656203	JBES5656204
	JBe79	560 x 750 x 200 (22.05 x 29.53 x 7.87) ①	Y	JBES5675201	JBES5675202	JBES5675203	JBES5675204
	JBe75	750 x 370 x 200 (29.53 x 14.57 x 7.87) ①	Y	JBES7537201	JBES7537202	JBES7537203	JBES7537204
	JBe79	750 x 560 x 200 (29.53 x 22.05 x 7.87) ①	Y	JBES7556201	JBES7556202	JBES7556203	JBES7556204
	JBe86	1130 x 750 x 300 (44.49 x 29.53 x 11.81)	Y	JBES1175301	JBES1175302	JBES1175303	JBES1175304

① 200 mm (7.87") depth enclosure available with 300 mm (11.81") depth – replace digit 2 with 3 – Example: JBES3737304.







② N: Not Available, R: On request or separate accessories, Y: Supplied.

# ATX™ JBES and ECES Series 316L Stainless Steel Enclosure Accessories

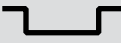
## Increased Safety

ATEX/IECEX:  
 Zone 1 and 2 - 21 and 22  
 II 2 GD  
 IP66 - IK10

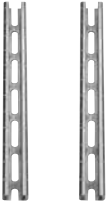
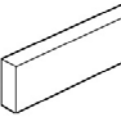
### Mounting Accessories

				Catalog Number	
		Enclosure Length mm (in)	Rail Length mm (in)	 Symmetrical Depth = 15 mm (0.59")	 Asymmetrical
<b>Zinc Plated Steel Rail</b>					
<i>For fixing onto uprights with clip nut supplied.</i>					
	Symmetrical	120 (4.72)	100 (3.93)	097246	—
		180 (7.09)	160 (6.30)	097247	—
	Asymmetrical	220 (8.66)	170 (6.69)	097240	097250
		260 (10.24)	210 (8.27)	097241	097251
		370 (14.57)	320 (12.60)	097242	097252
		560 (22.05)	510 (20.08)	097243	097253
		750 (29.53)	700 (27.56)	097244	097254
		1130 (44.49)	1080 (42.52)	097245	097255
<b>Zinc Plated Steel Uprights</b>					
<i>Set of two.</i>					
		220 (8.66)	160 (6.30)		097230
		260 (10.24)	200 (7.87)		097231
		370 (14.57)	310 (12.20)		097232
		560 (22.05)	500 (19.68)		097233
		750 (29.53)	690 (27.17)		097234
		1130 (44.49)	1070 (42.13)		097235
<b>Copper Bar – 12 x 4 mm (0.47 x 0.16")</b>					
<i>Copper bar not perforated for cable clamps.</i>					
		220 (8.66)	160 (6.30)		097270
		260 (10.24)	200 (7.87)		097271
		370 (14.57)	310 (12.20)		097272
		560 (22.05)	500 (19.68)		097273
		750 (29.53)	690 (27.17)		097274
		1130 (44.49)	1070 (42.13)		097275
<b>Cable Clamp for Copper Bar – 12 x 4 mm (0.47 x 0.16")</b>					
		1.5 mm <sup>2</sup> to 4 mm <sup>2</sup> (0.002 in <sup>2</sup> to 0.006 in <sup>2</sup> ) Capacity			097203
		6 mm <sup>2</sup> to 16 mm <sup>2</sup> Capacity (0.009 in <sup>2</sup> to 0.025 in <sup>2</sup> )			097204

Appleton®







ENCLOSURES AND JUNCTION BOXES: ATEX/IECEX INCREASED SAFETY JUNCTION BOXES

# ATX™ JBES and ECES Series 316L Stainless Steel Enclosure Accessories

## Increased Safety

ATEX/IECEX:  
Zone 1 and 2 - 21 and 22  
II 2 GD  
IP66 - IK10

### Mounting Accessories - Continued



	Enclosure Dimensions mm (in)		Mounting Pan Dimensions mm (in)	Catalog Number
	Height	Width		
<b>Mounting Pan – Zinc Plated Steel</b>				
	120 (4.72)	120 (4.72)	100 x 100 (3.93 x 3.93)	097277
	120 (4.72)	180 (7.09)	100 x 160 (3.93 x 6.30)	097278
	180 (7.09)	180 (7.09)	160 x 160 (6.30 x 6.30)	097279
	220 (8.66)	260 (10.24)	160 x 200 (6.30 x 7.87)	097280
	220 (8.66)	370 (14.57)	160 x 310 (6.30 x 12.20)	097281
	260 (10.24)	370 (14.57)	200 x 310 (7.87 x 12.20)	097282
	370 (14.57)	370 (14.57)	310 x 310 (12.20 x 21.20)	097283
	370 (14.57)	560 (22.05)	310 x 500 (12.20 x 19.68)	097284
	370 (14.57)	750 (29.53)	310 x 690 (12.20 x 27.17)	097285
	560 (22.05)	560 (22.05)	500 x 500 (19.68 x 19.68)	097286
	560 (22.05)	750 (29.53)	500 x 690 (19.68 x 27.17)	097287
	1130 (44.49)	750 (29.53)	690 x 1070 (27.17 x 42.13)	097288
<b>Spacers for Mounting at Back of Box</b>				
	Set of two insulated pillars for copper bar 12 x 4 mm (0.47 x 0.16").			
	Height = 100 mm (3.94")			097206
	Height = 50 mm (1.97")			097207
<b>Conversion Kit – Door to Cover</b>				
	Must be used to remove hinges.			097202
<b>Spare Hinges</b>				
	Set of Two			097201
<b>Spare Mounting Brackets – Set of Two</b>				
	One left and one right.			097200
<b>Self Adhesive Pocket for Drawings</b>				
	External dimensions: 260 x 165 mm (10.24 x 6.50") Internal dimensions: 230 x 130 x 18 mm (9.06 x 5.12 x .071")			097263
	External dimensions: 340 x 235 mm (13.39 x 9.25") Internal dimensions: 310 x 200 x 18 mm (12.20 x 7.87 x 0.71")			097264
<b>Additional Door Padlocking Device</b>				
	Padlock not supplied.			097209
<b>Locking Bracket</b>				
	Locks door in open position during wiring			097265

# ATX™ JBES and ECES Series 316L Stainless Steel Enclosure Accessories

## Increased Safety

ATEX/IECEX:  
 Zone 1 and 2 - 21 and 22  
 II 2 GD  
 IP66 - IK10

### Mounting Accessories - Continued

	Dimensions mm (in)			Gland Plate/Coupling Flange Dimensions mm (in)	Catalog Number
	Enclosure Width	Height			
<b>Spare Gland Plate</b>					
	220 (8.66)	150 (5.91)	B/D	170 x 120 (6.69 x 4.72)	JBESGP221B
	260 (10.24)	150 (5.91)	A/C	250 x 120 (9.84 x 4.72)	JBESGP261A
	260 (10.24)	200 (7.87)	A/C	250 x 170 (9.84 x 6.69)	JBESGP262A
	260 (10.24)	200 (7.87)	B/D	210 x 170 (8.27 x 6.69)	JBESGP262B
	370 (14.57)	200 (7.87)	A/C	360 x 170 (14.17 x 6.69)	JBESGP372A
	370 (14.57)	200 (7.87)	B/D	320 x 170 (12.60 x 6.69)	JBESGP372B
	560 (22.05)	200 (7.87)	A/C	550 x 170 (21.65 x 6.69)	JBESGP562A
	560 (22.05)	200 (7.87)	B/D	510 x 170 (20.08 x 6.69)	JBESGP562B
	750 (29.53)	200 (7.87)	A/C	740 x 170 (29.13 x 6.69)	JBESGP752A
	750 (29.53)	200 (7.87)	B/D	700 x 170 (27.56 x 6.69)	JBESGP752B
	260 (10.24)	300 (11.81)	A/C	250 x 270 (9.84 x 10.63)	JBESGP263A
	370 (14.57)	300 (11.81)	A/C	360 x 270 (14.17 x 10.63)	JBESGP373A
	370 (14.57)	300 (11.81)	B/D	320 x 270 (12.60 x 10.63)	JBESGP373B
	560 (22.05)	300 (11.81)	A/C	550 x 270 (21.65 x 10.63)	JBESGP563A
	560 (22.05)	300 (11.81)	B/D	510 x 270 (20.08 x 10.63)	JBESGP563B
	750 (29.53)	300 (11.81)	A/C	740 x 270 (29.13 x 10.63)	JBESGP753A
	750 (29.53)	300 (11.81)	B/D	700 x 270 (27.56 x 10.63)	JBESGP753B
	<b>Coupling Flange</b>				
	260 (10.24)	200 (7.87)	A/C	250 x 120 (9.84 x 4.72)	JBESCF262A
	370 (14.57)	200 (7.87)	A/C	360 x 170 (14.17 x 6.69)	JBESCF372A
	370 (14.57)	200 (7.87)	B/D	320 x 170 (12.60 x 6.69)	JBESCF372B
	560 (22.05)	200 (7.87)	A/C	550 x 170 (21.65 x 6.69)	JBESCF562A
	560 (22.05)	200 (7.87)	B/D	510 x 170 (20.08 x 6.69)	JBESCF562B
	750 (29.53)	200 (7.87)	A/C	740 x 170 (29.13 x 6.69)	JBESCF752A
	750 (29.53)	200 (7.87)	B/D	700 x 170 (27.56 x 6.69)	JBESCF752B
	370 (14.57)	300 (11.81)	A/C	360 x 270 (14.17 x 10.63)	JBESCF373A
	370 (14.57)	300 (11.81)	B/D	320 x 270 (12.60 x 10.63)	JBESCF373B
	560 (22.05)	300 (11.81)	A/C	550 x 270 (21.65 x 10.63)	JBESCF563A
	560 (22.05)	300 (11.81)	B/D	510 x 270 (20.08 x 10.63)	JBESCF563B
	750 (29.53)	300 (11.81)	A/C	740 x 270 (29.13 x 10.63)	JBESCF753A
	750 (29.53)	300 (11.81)	B/D	700 x 270 (27.56 x 10.63)	JBESCF753B

 **Appleton**

ENCLOSURES AND JUNCTION BOXES: ATEX/IECEX INCREASED SAFETY JUNCTION BOXES

# ATX™ JBES and ECES Series 316L Stainless Steel Enclosures

## Increased Safety

ATEX/IECEX:  
Zone 1 and 2 - 21 and 22  
II 2 GD  
IP66 - IK10

### JBES Series for Terminal Junction Box Application Only.

Use the table shown below to select the proper size junction box based upon your requirements.  
Custom drilled and equipped boxes can be configured using our drilling guide available online at [www.appletonelec.com](http://www.appletonelec.com).

#### 1. Define maximum cable entries according to number of modules available per side.

Cable Entry Metric Thread	Number of Modules
M20	1
M25	1
M32	1
M40	2
M50	3

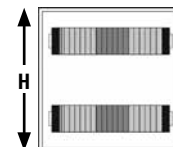
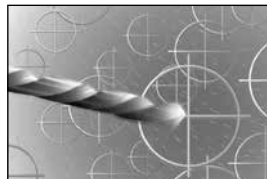
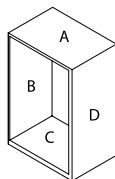

Type	Dimensions mm (in)			Number of Modules		Number of Modules ①		Terminal Dim. H — mm (in)
	Height	Width	Depth	A/C	B/D	A'/C'	B'/D'	
JBe10	120 (4.72)	120 (4.72)	95 (3.74)	5	5	—	—	220 (8.66)
JBe20	120 (4.72)	180 (7.09)	95 (3.74)	9	5	—	—	220 (8.66)
JBe30	180 (7.09)	180 (7.09)	95 (3.74)	9	9	—	—	220 (8.66)
JBe36	220 (8.66)	260 (10.24)	150 (5.91)	11	7	9	5	220 (8.66)
JBe36	260 (10.24)	220 (8.66)	150 (5.91)	7	11	5	9	260 (10.24)
JBe46	220 (8.66)	370 (14.57)	200 (7.87)	31	16	19	7	260 (10.24)
JBe46	370 (14.57)	220 (8.66)	200 (7.87)	16	31	7	9	370 (14.57)
JBe47	370 (14.57)	260 (10.24)	200 (7.87)	20	31	14	20	370 (14.57)
JBe47	260 (10.24)	370 (14.57)	200 (7.87)	31	20	19	10	260 (10.24)
JBe55	370 (14.57)	370 (14.57)	200 (7.87)	31	31	19	18	370 (14.57)
JBe65	560 (22.05)	370 (14.57)	200 (7.87)	31	49	19	31	560 (22.05)
JBe65	370 (14.57)	560 (22.05)	200 (7.87)	49	31	34	18	370 (14.57)
JBe75	750 (29.53)	370 (14.57)	200 (7.87)	31	66	19	47	750 (29.53)
JBe75	370 (14.57)	750 (29.53)	200 (7.87)	66	31	49	18	370 (14.57)
JBe77	560 (22.05)	560 (22.05)	200 (7.87)	49	49	34	31	560 (22.05)
JBe79	750 (29.53)	560 (22.05)	200 (7.87)	49	66	34	45	750 (29.53)
JBe79	560 (22.05)	750 (29.53)	200 (7.87)	66	49	49	31	560 (22.05)
JBe86	1130 (44.49)	750 (29.53)	300 (11.81)	102	—	82	—	1130 (44.49)

#### 2. Maximum rail arrangement according to physical dimensions.

Terminal Capacity mm <sup>2</sup> (in <sup>2</sup> )	Maximum Quantity of Horizontal Rails Per Quantity							
	2.5 (0.004)	4 (0.006)	6 (0.009)	10 (0.016)	16 (0.025)	35 (0.054)	50 (0.078)	70 (0.109)
JBe10/20/30/36	1	1	1	1	1	1	0	0
JBe36/46/47	2	2	2	1	1	1	0	0
JBe46/47/55/65/75	3	3	2	2	2	2	1	1
JBe65/77/79	5	5	4	4	4	3	2	2
JBe75/79	7	7	6	6	5	4	3	2
JBe86	10	10	9	9	8	6	4	4

① Enclosure with gland plate.

# ATX™ JBES and ECES Series 316L Stainless Steel Enclosures

## Increased Safety

ATEX/IECEX:  
 Zone 1 and 2 - 21 and 22  
 II 2 GD  
 IP66 - IK10

### 3. Defining maximum terminal block quantity according to power dissipation:

- Junction boxes used for instrumentation applications carry very low current levels. Therefore there is no risk of overheating whatever the number of terminals inside the box.
- For applications other than instrumentation, the following tables allow you to define your junction box depending on the number of terminals and the maximum authorized current being carried with feed-through terminals.
- For single feed terminals using cross connection, consult factory for calculation.

For other terminal block configurations, please consult our drilling guide available online at [www.appletonelec.com](http://www.appletonelec.com).

T Rating: T6 @ Ta +55° C (+131 °F)		Type		
		JBe10 120 x 120 x 95 mm (5 x 5 x 4")	JBe20 120 x 180 x 95 mm (5 x 7 x 4")	JBe30 180 x 180 x 95 mm (7 x 7 x 4")
2.5 mm <sup>2</sup> (0.004 in <sup>2</sup> )	Quantity	10	21	21
	I Maximum	16 A	16 A	16 A
4 mm <sup>2</sup> (0.006 in <sup>2</sup> )	Quantity	8	17	16
	I Maximum	25 A	25 A	25 A
6 mm <sup>2</sup> (0.009 in <sup>2</sup> )	Quantity	6	13	13
	I Maximum	32 A	32 A	32 A
10 mm <sup>2</sup> (0.016 in <sup>2</sup> )	Quantity	5	10	9
	I Maximum	50 A	50 A	50 A

T Rating: T6 @ Ta +55° C (+131 °F)		Type			
		JBe36 220 x 260 x 150 mm (9 x 10 x 6")	JBe46 220 x 370 x 200 mm (9 x 15 x 8")	JBe47 260 x 370 x 200 mm (10 x 15 x 8")	JBe55 370 x 370 x 200 mm (15 x 15 x 8")
2.5 mm <sup>2</sup> (0.004 in <sup>2</sup> )	Quantity	33	50	70	110
	I Maximum	16 A	14 A	12 A	10 A
4 mm <sup>2</sup> (0.006 in <sup>2</sup> )	Quantity	21	38	62	80
	I Maximum	25 A	20 A	16 A	15 A
6 mm <sup>2</sup> (0.009 in <sup>2</sup> )	Quantity	19	22	23	26
	I Maximum	32 A	32 A	32 A	32 A
10 mm <sup>2</sup> (0.016 in <sup>2</sup> )	Quantity	12	14	15	20
	I Maximum	50 A	50 A	50 A	45 A
16 mm <sup>2</sup> (0.024 in <sup>2</sup> )	Quantity	8	10	17	20
	I Maximum	63 A	63 A	50 A	50 A
25 mm <sup>2</sup> (0.039 in <sup>2</sup> )	Quantity	12	14	16	20
	I Maximum	80 A	80 A	76 A	76 A
35 mm <sup>2</sup> (0.054 in <sup>2</sup> )	Quantity	9	11	12	16
	I Maximum	100 A	100 A	100 A	93 A

T Rating: T6 @ Ta +40 °C (+104 °F) T6 @ Ta +55° C (+131 °F)		Type			
		JBe65 560 x 370 x 200 mm (22 x 15 x 8")	JBe75 750 x 370 x 200 mm (30 x 15 x 8")	JBe77 560 x 560 x 200 mm (22 x 22 x 8")	JBe79 560 x 750 x 200 mm (22 x 30 x 8")
35 mm <sup>2</sup> (0.054 in <sup>2</sup> )	Quantity	15	16	18	—
	I Maximum	100 A	99 A	100 A	—
50 mm <sup>2</sup> (0.078 in <sup>2</sup> )	Quantity	12	16	—	—
	I Maximum	125 A	108 A	—	—
70 mm <sup>2</sup> (0.109 in <sup>2</sup> )	Quantity	12	16	16	16
	I Maximum	150 A	135 A	144 A	150 A
95 mm <sup>2</sup> (0.147 in <sup>2</sup> )	Quantity	9	12	12	16
	I Maximum	200 A	178 A	190 A	173 A
120 mm <sup>2</sup> (0.186 in <sup>2</sup> )	Quantity	—	6	—	12
	I Maximum	—	250 A	—	225 A
150 mm <sup>2</sup> (0.233 in <sup>2</sup> )	Quantity	—	9	—	12
	I Maximum	—	250 A	—	250 A

# ATX™ JBES and ECES Series 316L Stainless Steel Enclosure

## Increased Safety

ATEX/IECEX:  
 Zone 1 and 2 - 21 and 22  
 II 2 GD  
 IP66 - IK10

### Dimensions in Millimeters (Inches)

Box 95 (3.74) Depth

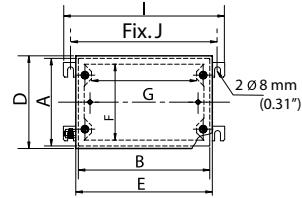
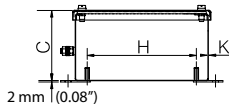

Box 200 (7.87) or 300 (11.81) Depth

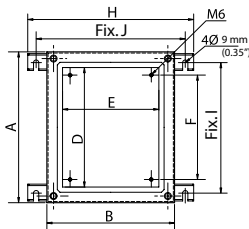
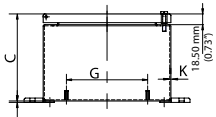

Mounting Bracket

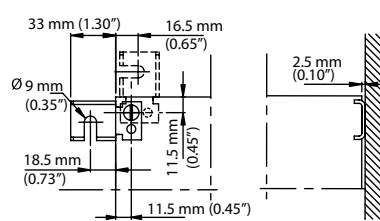

L x W x D mm (in)	A	B	C	D	E	F	G	H	I	J	K
<b>Box Depth 95 (3.74)</b>											
120 x 120 x 95 (4.72 x 4.72 x 3.74)	120 (4.72)	120 (4.72)	95 (3.74)	127 (5.00)	127 (5.00)	104 (4.09)	84 (3.31)	88 (3.46)	160 (6.30)	140 (5.51)	1.5 (0.06)
120 x 180 x 95 (4.72 x 7.09 x 3.74)	120 (4.72)	180 (7.09)	95 (3.74)	127 (5.00)	187 (7.36)	104 (4.09)	144 (5.67)	148 (5.83)	220 (8.66)	200 (7.87)	1.5 (0.06)
180 x 180 x 95 (7.06 x 7.09 x 3.74)	180 (7.09)	180 (7.09)	95 (3.74)	187 (7.36)	187 (7.36)	164 (6.47)	144 (5.67)	148 (5.83)	220 (8.66)	200 (7.87)	1.5 (0.06)
<b>Box Depth 200 (7.87)</b>											
220 x 370 x 200 (8.66 x 14.57 x 7.87)	220 (8.66)	370 (14.57)	200 (7.87)	166 (6.54)	316 (12.44)	140 (5.51)	290 (11.42)	436 (17.17)	185 (7.28)	407 (16.02)	1.5 (0.06)
370 x 260 x 200 (14.57 x 10.24 x 7.87)	370 (14.57)	260 (10.24)	200 (7.87)	316 (12.44)	206 (8.11)	290 (11.42)	180 (7.09)	326 (12.83)	335 (13.19)	297 (11.69)	1.5 (0.06)
370 x 370 x 200 (14.57 x 14.57 x 7.87)	370 (14.57)	370 (14.57)	200 (7.87)	316 (12.44)	316 (12.44)	290 (11.42)	290 (11.42)	436 (17.17)	335 (13.19)	407 (16.02)	2 (0.08)
560 x 370 x 200 (22.05 x 14.57 x 7.87)	560 (22.05)	370 (14.57)	200 (7.87)	506 (19.92)	316 (12.44)	480 (18.90)	290 (11.42)	436 (17.17)	525 (20.67)	407 (16.02)	2 (0.08)
750 x 370 x 200 (29.53 x 14.57 x 7.87)	750 (29.53)	370 (14.57)	200 (7.87)	695 (27.36)	316 (12.44)	670 (26.38)	290 (11.42)	436 (17.17)	715 (28.15)	407 (16.02)	2 (0.08)
560 x 560 x 200 (22.05 x 22.05 x 7.87)	560 (22.05)	560 (22.05)	200 (7.87)	506 (19.92)	506 (19.92)	480 (18.90)	480 (18.90)	626 (24.65)	525 (20.67)	597 (23.50)	2 (0.08)
750 x 560 x 200 (29.53 x 22.05 x 7.87)	750 (29.53)	560 (22.05)	200 (7.87)	696 (24.40)	506 (19.92)	670 (26.38)	480 (18.90)	626 (24.65)	715 (28.15)	597 (23.50)	2 (0.08)
<b>Box Depth 300 (11.81)</b>											
370 x 370 x 300 (14.57 x 14.57 x 11.81)	370 (14.57)	370 (14.57)	300 (11.81)	316 (12.44)	316 (12.44)	290 (11.42)	290 (11.42)	436 (17.17)	335 (13.19)	407 (16.02)	2 (0.08)
560 x 370 x 300 (22.05 x 14.57 x 11.81)	560 (22.05)	370 (14.57)	300 (11.81)	506 (19.92)	316 (12.44)	480 (18.90)	290 (11.42)	436 (17.17)	525 (20.67)	407 (16.02)	2 (0.08)
750 x 370 x 300 (29.53 x 14.57 x 11.81)	750 (29.53)	370 (14.57)	300 (11.81)	695 (27.36)	316 (12.44)	670 (26.38)	290 (11.42)	436 (17.17)	715 (28.15)	407 (16.02)	2 (0.08)
560 x 560 x 300 (22.05 x 22.05 x 11.81)	560 (22.05)	560 (22.05)	300 (11.81)	506 (19.92)	506 (19.92)	480 (18.90)	480 (18.90)	626 (24.65)	525 (20.67)	597 (23.50)	2 (0.08)
750 x 560 x 300 (29.53 x 22.05 x 11.81)	750 (29.53)	560 (22.05)	300 (11.81)	696 (24.40)	506 (19.92)	670 (26.38)	480 (18.90)	626 (24.65)	715 (28.15)	597 (23.50)	2 (0.08)
1130 x 750 x 300 (44.49 x 29.53 x 11.81)	1130 (44.49)	750 (29.53)	300 (11.81)	1076 (42.36)	506 (19.92)	1050 (41.34)	670 (26.38)	816 (32.13)	1095 (43.11)	787 (30.98)	2 (0.08)



# ATX™ JBES Series Pre-Drilled 316L Stainless Steel Junction Boxes

## Increased Safety

ATEX/IECEX:  
Zone 1 and 2 – 21 and 22  
Ⓢ II 2 GD  
IP66 – IK10

### Applications

- Terminal junction boxes designed to facilitate electrical connections in hazardous areas.
- Designed for use in Zone 1 or 2 areas, where flammable gases or vapors are present either continuously or intermittently such as:
  - Petroleum
  - Chemical
  - Refineries
  - Other industrial process facilities
- Ideal for wet or corrosive atmospheres.
- Designed for use in Zone 21 or 22 areas, where flammable dusts are present either continuously or intermittently, such as:
  - Food processing
  - Dairy
  - Brewing
  - Pharmaceutical industry
  - Silos and other facilities

### Features

- Smooth, continuously welded seams.
- Hinges supplied on all boxes from 370 mm x 260 mm (14.57" x 10.24") sizes.
- Poured-in-place polyurethane door gasket.
- Earth crossing terminal.
- Factory drilled and equipped.

### Standard Material

- Enclosure: 316L chrome plated molybdenum stainless steel with natural burnished finish
- Hardware: 316L stainless steel

### Options

- For use with equipment other than Ex terminal blocks, see ECES series enclosures and controls.

### ATEX/IECEX Certifications and Compliances

- Certification Type JBe
  - Gas, Zones 1 and 2
    - Conforming to ATEX 94/9/CE: Ⓢ II 2 G
    - Type of Protection: Ex e II, Ex ia IIC, Ex ib IIC,
    - Temperature Class: T6 to T5
  - Dust, Zones 21 and 22
    - Conforming to ATEX 94/9/CE: Ⓢ II 2 D
    - Type of Protection: Ex tD A21
    - Surface Temperature: T80 °C to T95 °C (T176 °F to T203 °F)
    - Ambient Temperature: -50 °C to +70 °C (-58 °F to +158 °F)
    - CE Declaration of Conformity: 50232
    - ATEX Certificate: LCIE 02 ATEX 6118X
    - IECEX Certificate: IECEX LCI 11.0008X
- Index of Protection according EN/IEC 60529: IP66
- Impact Resistance (shock): IK10

### EURASEC Certification

- Certification Type JBe
  - EURASEC N° TC RU C-FR.Г505.B.00911

### Other Certification

- Certification Type JBe
  - INMETRO Certificate: BVC 11.0418-X ①

JBe10 — Without Terminals



JBe46 — Equipped with Terminals

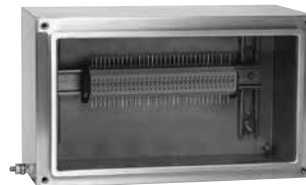

JBe46 — Equipped with Terminals



JBe46 — Equipped with Terminals

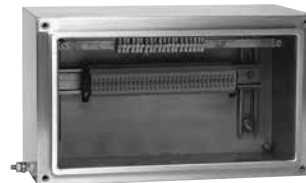

Appleton®

ENCLOSURES AND JUNCTION BOXES: ATEX/IECEX INCREASED SAFETY JUNCTION BOXES

① INMETRO certification available on special request only. Contact your local sales representative for more information.

# ATX™ JBES Series Pre-Drilled 316L Stainless Steel Junction Boxes

## Increased Safety

ATEX/IECEX:  
 Zone 1 and 2 – 21 and 22  
 II 2 GD  
 IP66 – IK10

### Catalog Numbering Guide - JBES Pre-Drilled Stainless Steel Junction Boxes

<p><b>JBES</b></p> <p>Series:                  JBES - ATEX/IECEX Certified                  Increased Safety                  JBIS - ATEX/IECEX Certified                  Intrinsic Safety,</p>	<p><b>12</b></p> <p>Length Dimensions mm (in):                  12 - 120 (4.72)                  18 - 180 (7.09)                  22 - 220 (8.66)                  26 - 260 (10.24)                  37 - 370 (14.57)</p>	<p><b>12</b></p> <p>Width Dimensions mm (in):                  12 - 120 (4.72)                  18 - 180 (7.09)                  22 - 220 (8.66)                  26 - 260 (10.24)                  37 - 370 (14.57)</p>	<p><b>09</b></p> <p>Depth Dimensions mm (in):                  09 - 95 (3.74)                  15 - 150 (5.91)                  20 - 200 (7.87)</p>	<p><b>0</b></p> <p>Gland plate:                  0 - None                  1 - One Bottom                  2 - One Top and Bottom                  3 - Two Sides and Bottom                  4 - All Sides</p>	<p><b>0</b></p> <p>Options: ①  <i>(options must be listed alphabetically)</i>                  D1 - 5 x M20                  D2 - 4 x M20 + 1 x M25                  D3 - 7 x M20 + 1 x M25                  F1 - Fitted with 12 x 2.5 mm<sup>2</sup> (0.019 x 0.004 in<sup>2</sup>) Terminals and Drilled                  F2 - Fitted with 20 x 2.5 mm<sup>2</sup> (0.031 x 0.004 in<sup>2</sup>) Terminals and Drilled                  F3 - Fitted with 40 x 2.5 mm<sup>2</sup> (0.062 x 0.004 in<sup>2</sup>) Terminals and Drilled                  F4 - Fitted with 60 x 2.5 mm<sup>2</sup> (0.093 x 0.004 in<sup>2</sup>) Terminals and Drilled                  F5 - Fitted with 14 x 2.5 mm<sup>2</sup> (0.022 x 0.004 in<sup>2</sup>) Terminals and Drilled                  F6 - Fitted with 24 x 2.5 mm<sup>2</sup> (0.037 x 0.004 in<sup>2</sup>) Terminals and Drilled                  F7 - Fitted with 38 x 2.5 mm<sup>2</sup> (0.057 x 0.004 in<sup>2</sup>) Terminals and Drilled                  F8 - Fitted with 54 x 2.5 mm<sup>2</sup> (0.084 x 0.004 in<sup>2</sup>) Terminals and Drilled                  # - Customized Enclosure (6 Digit number will be assigned at time of order placement.)</p>
--	---	--	---	--	---

### Maximum Rail Arrangement According to Physical Dimensions

Type	Protection	Terminal Size mm <sup>2</sup> (in <sup>2</sup> )	Quantity	Max. Amps
JBe10	T6 @ Ta = +55° C (+131 °F)	2.5 (0.004)	10	16A
		4.0 (0.006)	8	25A
		6.0 (0.009)	6	32A
JBe20	T6 @ Ta = +55° C (+131 °F)	2.5 (0.004)	21	16A
		4.0 (0.006)	18	25A
		6.0 (0.009)	13	32A

① For other terminal block configurations, contact your local sales representative.

# ATX™ JBES Series Pre-Drilled 316L Stainless Steel Junction Boxes

## Increased Safety

ATEX/IECEX:  
Zone 1 and 2 – 21 and 22  
II 2 GD  
IP66 – IK10

Type	Dimensions L x W x D mm (in)	Rail Length Capacity mm (in)	Clearance Holes Per Side				Weight kg (lb)	Volume dm <sup>3</sup> (in <sup>3</sup> )	Catalog Number
			A	B	C	D			

### Factory Drilled Ex e II 316L Stainless Steel Junction Boxes Fitted with:

One horizontal symmetrical zinc plated rail. For use only with Ex terminals (not supplied). M6 external earth crossing terminal.

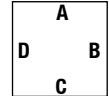

JBe10	120 x 120 x 95 (4.72 x 4.72 x 3.74)	100 (3.94)	1 x M20	1 x M20	2 x M20	1 x M20	1.0 (2.20)	1.4 (85.43)	<b>JBES1212090D1</b>
JBe20	120 x 120 x 95 (4.72 x 4.72 x 3.74)	160 (6.30)	–	1 x M20	2 x M20 1 x M25	1 x M20	1.5 (3.31)	2.0 (122.05)	<b>JBES1218090D2</b>
JBe20	120 x 120 x 95 (4.72 x 4.72 x 3.74)	160 (6.30)	–	2 x M20	3 x M20 1 x M25	2 x M20	1.5 (3.31)	2.0 (122.05)	<b>JBES1218090D3</b>

Type	Dimensions L x W x D mm (in)	Terminals 2.5 mm <sup>2</sup> (0.0039 in <sup>2</sup> )	Insulated Connectors	Clearance Holes Per Side			Weight kg (lb)	Volume dm <sup>3</sup> (in <sup>3</sup> )	Catalog Number
				B	C	D			

### Factory Drilled and Equipped with Terminals Ex e II 316L Stainless Steel Instrumentation Junction Boxes Fitted with:

Vertical beige Exe terminal block. Insulated copper bar with connectors. White laminated plastic tag with black lettering. M8 external earth crossing terminal. Cable glands and plugs to be ordered separately.

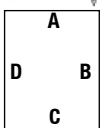

JBe20	180 x 120 x 95 (7.09 x 4.72 x 3.74)	12 (6 Pairs)	8	3 x M20	1 x M25 1 x M20	3 x M20	2.5 (5.51)	2.0 (122.05)	<b>JBES1812090F1</b>
JBe36	260 x 220 x 150 (10.24 x 8.66 x 5.91)	20 (10 Pairs)	12	5 x M20	1 x M32 1 x M20	5 x M20	4.0 (8.82)	8.6 524.80)	<b>JBES2622150F2</b>
JBe46	370 x 220 x 200 (14.57 x 8.66 x 7.87)	40 (20 Pairs)	22	10 x M20	1 x M40 1 x M20	10 x M20	9.0 (19.84)	16.3 (994.69)	<b>JBES372220F3</b>
JBe47	370 x 260 x 200 (14.57 x 10.24 x 7.87)	60 (30 pairs)	32	15 x M20	1 x M50 1 x M20	15 x M20	24.25 (11.0)	19.3 (1177.76)	<b>JBES3726200F4</b>

### Ex ia IIC Version: Replace Third Digit “E” with “I” (Example: JBES1812090F1 becomes JBIS1812090F1) Fitted with:

Vertical blue terminal block. Insulated copper bar with connectors. Blue laminated plastic tag with white lettering. M8 external earth crossing terminal. Cable glands and plugs to be ordered separately.

Type	Dimensions L x W x D mm (in)	Terminals 2.5 mm <sup>2</sup> (0.0039 in <sup>2</sup> )	Continuity Shield	Clearance Holes Per Side		Weight kg (lb)	Volume dm <sup>3</sup> (in <sup>3</sup> )	Catalog Number
				B	C			

### Factory Drilled and Equipped with Terminals Ex e II 316L Stainless Steel Instrumentation Junction Boxes Fitted with:

Horizontal beige Exe terminal block. Continuity shield. White laminated plastic tag with black lettering. M8 External earth crossing terminal. Cable glands and plugs to be ordered separately.

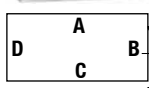

JBe36	220 x 260 x 150 (8.66 x 10.24 x 5.91)	14 (7 Pairs)	7	1 x M25	7 x M20	4.0 (8.82)	8.6 (524.80)	<b>JBES2226150F5</b>
JBe36	220 x 260 x 150 (8.66 x 10.24 x 5.91)	24 (12 pairs)	12	1 x M32	12 x M20	4.0 (8.82)	8.6 (524.80)	<b>JBES2226150F6</b>
JBe46	220 x 370 x 200 (8.66 x 14.57 x 7.87)	38 (19 pairs)	19	1 x M32	19 x M20	9.0 (19.84)	16.3 (994.69)	<b>JBES2237200F7</b>
JBe46	220 x 370 x 200 (8.66 x 14.57 x 7.87)	54 (27 pairs)	27	1 x M40	27 x M20	9.0 (19.84)	16.3 (994.69)	<b>JBES2237200F8</b>

### Ex ia IIC Version: Replace Third Digit “E” with “I” (Example: JBES2226150F5 becomes JBIS2226150F5) Fitted with:

Horizontal blue terminal block. Continuity shield. Blue laminated plastic tag with white lettering. M8 external earth crossing terminal. Cable glands and plugs to be ordered separately.

# ATX™ JBES Series Pre-Drilled 316L Stainless Steel Junction Box

## Increased Safety

ATEX/IECEX:  
 Zone 1 and 2 - 21 and 22  
 II 2 GD  
 IP66 - IK10

### Dimensions in Millimeters (Inches)

Factory Drilled without Terminal Block (DIN rail supplied)

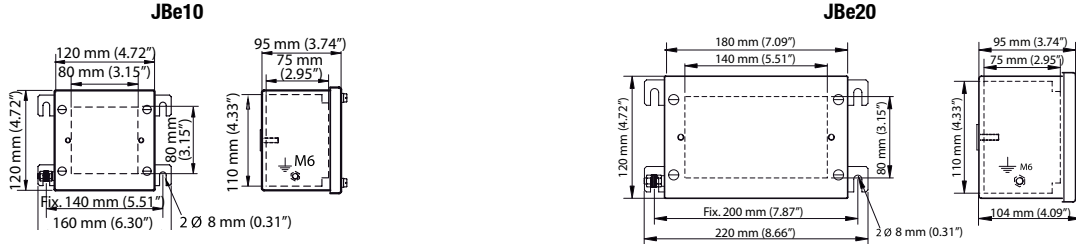

Factory Drilled and Equipped with Vertical Terminal Block



Factory Drilled and Equipped with Vertical Terminal Block

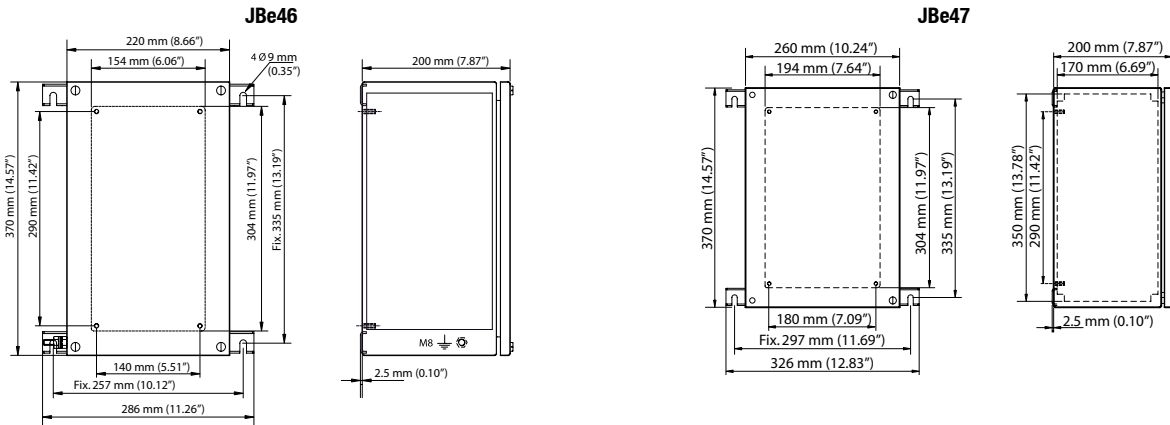

Factory Drilled and Equipped with Horizontal Terminal Block

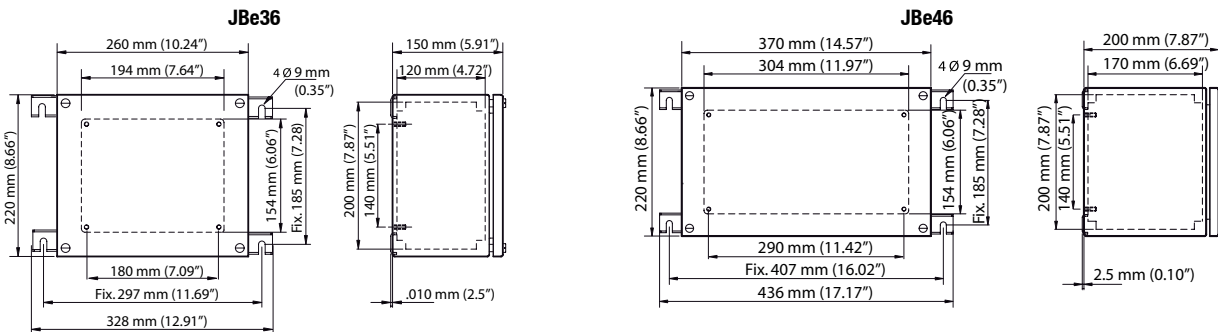

Appleton®

ENCLOSURES AND JUNCTION BOXES: ATEX/IECEX INCREASED SAFETY JUNCTION BOXES

# Distribution Equipment

Description	Page	NEC	CEC	ATEX/ IEC(Ex)
<b>NEC/CEC Hazardous Location Switches</b>				
EDS Heavy Duty Disconnect Switches	233	X	X	
AE Series Disconnect Switches	235	X		
AE Bolted Molded Case Switches and Enclosures	237	X		
MD2DS Series Factory Sealed Disconnect Switches	240	X		
WD2S Series Factory Sealed Disconnect Switches	242	X	X	
<b>NEC/CEC Weatherproof Switches</b>				
WST and WDS Cast Aluminum Enclosed Disconnect Switches	244	X	X	
<b>NEC/CEC Explosionproof Circuit Breakers</b>				
Intraground™ N1 Series Non-Metallic Circuit Breakers and Enclosures	247	X		
ECS Series Breaker Stations	249		X	
AE Series Bolted Circuit Breakers and Enclosures	250	X	X	
EB Series Circuit Breakers and Enclosures	256	X		
EB Series Bolt-ON Series Circuit Breakers and Enclosures	261		X	
Threaded Circuit Breakers and Enclosures	267	X		
<b>NEC/CEC, ATEX/IECEx Flameproof Circuit Breakers</b>				
PlexPower™ Factory Sealed Enclosed Circuit Breakers	270	X	X	X
<b>ATEX/IECEx Increased Safety Circuit Breakers</b>				
ATX™ CBU, SWU, RCU Series Branch Circuit Breakers, Switches, Relays, Contactors	274			X
ATX™ CBD Series Circuit Breakers	278			X



EDS Disconnect Switches



AE Series Switches



WST/WBS/WDS/MD2DS Switches



Intraground™ N1 Series Circuit Breakers



ECS Breaker Stations



AE Series Circuit Breakers



EB Series Circuit Breakers



Threaded Circuit Breakers



PlexPower™ Circuit Breakers



CBU/SWU Circuit Breakers



CBD Circuit Breakers

# Distribution Equipment

Description	Page	NEC	CEC	ATEX/ IEC(Ex)
-------------	------	-----	-----	------------------

NEC/CEC Hazardous Location Panelboards				
PlexPower™ Series Factory Sealed Panelboards	281	X	X	
PlexPower™ Series Fused Factory Sealed Panelboards	310	X	X	
D2P and EWP Factory Sealed Circuit Breaker Panelboards	317	X		
ALPN, APPN and AGPN Series Distribution Panelboards	323	X		
ALPF Factory Sealed Lighting and APPF Power Distribution Panelboards	336	X		
XP Series Non-Factory Sealed Circuit Breaker Panelboards	346	X	X	
XP Series Pre-Wired Factory Sealed Circuit Breaker Panelboards	353	X	X	

ATEX/IECEx Increased Safety Panelboards				
PlexPower™ Series Factory Sealed Panelboards	358			X
ATX™ DPD Distribution Panelboards	385			X

NEC/CEC Switchracks				
Custom Switchracks	391	X		
PlexPower™ Series Portable Power Switchracks	397	X	X	
Portable Power Carts for Hazardous and Non-Hazardous Locations	398	X	X	

ATEX/IECEx Switchracks				
Custom Switchracks	399		X	



PlexPower™ Factory Sealed Panelboards



PlexPower™ Fused Factory Sealed Panelboards



D2P/EWP Circuit Breaker Panelboards



APLN/APPN Distribution Panelboards



AGPN Distribution Panelboards



ALPF/APPF Distribution Panelboards



XP Panelboards



PlexPower™ Factory Sealed Panelboards



DPD Distribution Panelboards

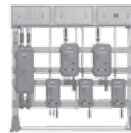

NEC Switchracks



PlexPower™ Switchracks



Portable Power Carts



ATEX/IECEx Switchracks

# EDS Heavy Duty Disconnect Switches

## Explosionproof, Dust-Ignitionproof

30, 60, 100, and 200 Ampere Units for 600 Vac Maximum. UNILETS™ for Use with Threaded Metal Conduit.

### NEC:

Class I, Division 1 and 2, Groups B, C, D  
Class II, Division 1 and 2, Groups E, F, G  
Class III  
NEMA 3R, 4<sup>Y</sup>, 4X<sup>Y</sup>, 7BCD, 9EFG

### CEC

Class I, Division 1 and 2, Groups B, C, D  
Class II, Division 1 and 2, Groups E, F, G  
Class III  
NEMA 4<sup>Y</sup>, 4X<sup>Y</sup>, 7BCD, 9EFG

### Applications

- Functions as load disconnect switch or as individual motor control switch.

### Features

- 600 Vac 3-pole, non-fused motor circuit switch; available in four sizes from 30 to 100 Amp. For 200 Amp, please contact your local sales representative.
- Hinged, removable cover provides instant access for installation and servicing.
- Self-locating, spring-mounted internal handle actuator.
- Rugged handle has stainless steel shaft within a stainless steel bushing; may be locked in ON or OFF position.
- Removable mounting plate simplifies installation.
- Top and bottom standard feed-thru conduit openings. Removable reducer bushing furnished with each opening.
- Additional top and bottom openings for drain and breather; supplied with close-up plugs.
- Covers have captive, slotted, stainless steel screws to prevent “freezing.”
- Grounded neutral lug and insulated neutral lug supplied as standard.

### Standard Materials

- Body and cover: copperfree (4/10 of 1% max.) aluminum
- Handle shaft, bushing, exposed hardware: stainless steel

### Standard Finishes

- Exterior surfaces: epoxy powder coat

### Options

*Must be listed in alphanumeric sequence at the end of the catalog number.*

- Auxiliary switch (1NO, 1NC) add suffix **-AUX**.
- Auxiliary switch (2NO, 2NC) add suffix **-AUX**.
- Drain and breather set add suffix **-DV**.
- NEMA 4, 4X add suffix **-N4**.

### NEC/CEC Certifications and Compliances

- UL Standard: UL 894, UL 1203
- UL Listed: E10523
- CSA Standard: C22.2 No. 4, C22.2 No. 25, C22.2 No.30
- CSA Certified: 039569

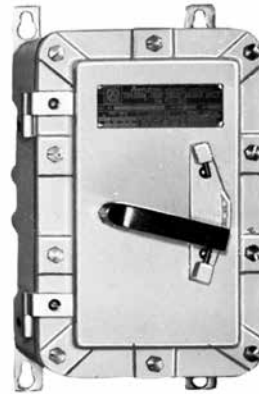

EDS3036



EDS6036

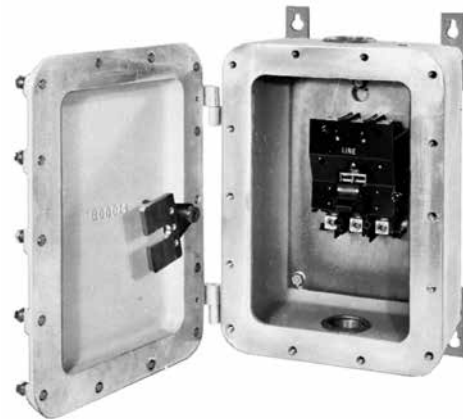

Appleton

DISTRIBUTION EQUIPMENT: NEC/CEC HAZARDOUS LOCATION SWITCHES

▼ Add suffix **N4** for NEMA 4, 4X rating (UL NEMA 4, 4X version is not suitable for Group B, CSA NEMA 4, 4X version is suitable for Group B).

# EDS Heavy Duty Disconnect Switches

## Explosionproof, Dust-Ignitionproof

30, 60, 100, and 200 Ampere Units for 600 Vac Maximum. UNILETS™ for Use with Threaded Metal Conduit.

**NEC:**  
Class I, Division 1 and 2, Groups B, C, D  
Class II, Division 1 and 2, Groups E, F, G  
Class III  
NEMA 3R, 4<sup>+</sup>, 4X<sup>+</sup>, 7BCD, 9EFG

**CEC:**  
Class I, Division 1 and 2, Groups B, C, D  
Class II, Division 1 and 2, Groups E, F, G  
Class III  
NEMA 4<sup>+</sup>, 4X<sup>+</sup>, 7BCD, 9EFG

	Ampere	Conduit Opening (Inches)	Catalog Number ①	
			NEC	CEC
 <p>Bolt-On</p>	30	1-1/2	EDS3036	EDS3036CN
	60	2	EDS6036	EDS6036CN
	100	2	EDS1036	EDS1036CN

*Supplied with Cutler-Hammer<sup>+</sup> disconnect switch.*

### Electrical Ratings Maximum Motor HP

Maximum Amps	Maximum Horsepower Rating				
	120 Vac	240 Vac	480 Vac	600 Vac	250 Vdc
30	5	10	20	25	7-1/2
60	10	20	40	60	15
100	15	30	75	75	25

### Dimensions

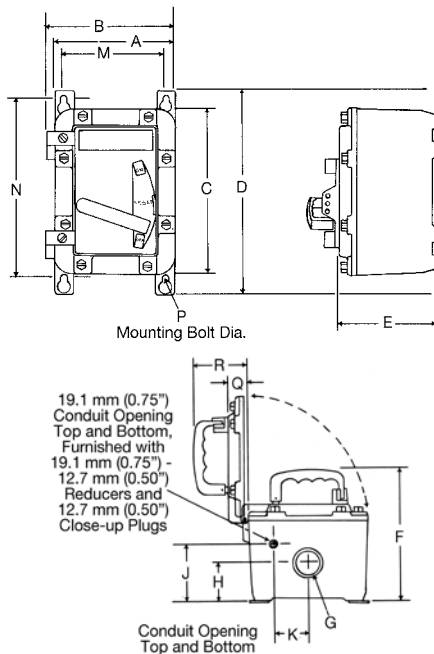

Dimension	Dimensions in Millimeters (Inches)	
	EDS3036	EDS6036/EDS1036
A	196.9 (7.75)	231.9 (9.13)
B	209.6 (8.25)	244.6 (9.63)
C ②	308.1 (12.13)	358.9 (14.13)
D	374.7 (14.75)	425.5 (16.75)
E	165.1 (6.50)	184.2 (7.25)
F	225.6 (8.88)	244.6 (9.63)
G ①	38.1 (1.50)	50.8 (2.00)
H	60.5 (2.38)	69.9 (2.75)
J	95.3 (3.75)	95.3 (3.75)
K	26.9 (1.06)	69.9 (2.75)
M	155.7 (6.13)	190 (5 7.5)
N	336.6 (13.25)	384.3 (15.13)
P	9.7 (0.38)	9.7 (0.38)
Q	38.1 (1.50)	44.5 (1.75)
R	98.6 (3.88)	104.8 (4.13)

① Conduit openings are tapped to size shown. A removable reducer bushing is furnished for each opening which, when installed, makes the conduit opening one size smaller.

② For drains and breathers, add 50.8 mm (2") to dimension C. Close-up plugs furnished when enclosures are ordered without drains and breathers.

▼ Add suffix **N4** for NEMA 4, 4X rating (UL NEMA 4, 4X version is not suitable for Group B, CSA NEMA 4, 4X version is suitable for Group B).

+ Cutler-Hammer is a registered trademark of Eaton Corporation.



# AE Series Disconnect Switches

## Explosionproof, Dust-Ignitionproof

### NEC:

Class I, Division 1 and 2, Groups B, C, D

Class II, Division 1 and 2, Groups E, F, G

Class III

NEMA 4, 4X

### Application

- Explosionproof disconnect enclosures are used where hazardous materials are handled or stored. These units are used for overload and short circuit protection, control of lighting and power circuits.

### Features

- Precision machined flame path between box and cover.
- Bolt on stainless steel slotted mounting feet.
- Stainless steel hinges are standard.
- Stainless steel, captive Quad-Lead® cover bolts are standard (disengaged in 1-1/2 turns).
- Ground lug package and installation instructions for termination of ground wire enclosed.
- External operating handle with stops for limiting handle travel.
- Disconnects and operator shafts are stainless steel.
- Disconnects operators can be locked in the ON or OFF position (up to 3 padlocks).
- External flange maximizes internal space.
- Standard outlets top and bottom for line and load wiring.
- Plugged 1/2" outlets top and bottom for breather and drain.
- Disconnects mounted on a galvanized steel removable pan.
- O-ring gasket ensures watertight integrity.

### Standard Materials

- Bodies and covers: copperfree (4/10 of 1% max.) aluminum
- Cover bolts and hinges: stainless steel
- O-ring: neoprene

### Standard Finishes

- Bodies and covers: gray epoxy powder coat inside and outside standard to provide NEMA 4X rating

### Options

Must be listed in alphanumeric sequence at the end of the catalog number.

- Auxiliary switch (1A or 1B), add suffix —**AS1**.
- Auxiliary switch (2A or 2B), add suffix —**AS2**.
- Breather, NEMA 4X (includes outlet and installation), add suffix —**BR**.
- Drain, NEMA 4X (includes outlet and installation), add suffix —**DN**.
- External grounding stud, add suffix —**EGS**.
- Plastic nameplate, 50.8 mm x 101.6 mm (2" x 4"), 3.2 mm (0.125") black letters on white surface, 3 lines max, specify legend, add suffix —**NP**.
- Shunt trip (specify voltage), add suffix —**ST**.
- Under voltage release (specify voltage), add suffix —**UV**.

### NEC Certifications and Compliances

- UL Standard: UL 1203
- UL Listed: E84577



Appleton®

DISTRIBUTION EQUIPMENT: NEC/CEC HAZARDOUS LOCATION SWITCHES

# AE Series Disconnect Switches

Explosionproof, Dust-Ignitionproof

NEC:  
 Class I, Division 1 and 2, Groups B, C, D  
 Class II, Division 1 and 2, Groups E, F, G  
 Class III  
 NEMA 4, 4X

## Disconnect Switches

Type	Number of Poles	Volts	Amp Rating	Standard Conduit Outlet (Inches)	Catalog Number
<i>Supplied with Cutler-Hammer + disconnect switch. Type J fuses recommended.</i>					
 Fused (fuses not included)	3	600 Vac, 125/250 Vdc	30	1.50	<b>AEAB3036FDS</b>
			60	2.00	<b>AEBB6036FDS</b>
			100	2.50	<b>AECB10036FDS</b>
Non-Fused	3	600 Vac, 125/250 Vdc	30	1.50	<b>AEAB3036DS</b>
			60	1.50	<b>AEAB6036DS</b>
			100	2.00	<b>AEBB10036DS</b>

## Dimensions in Millimeters (Inches)

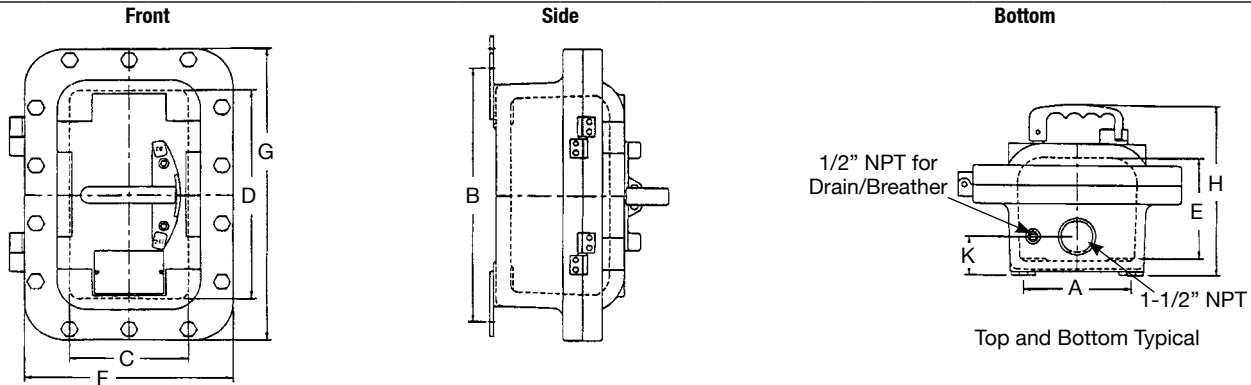

Enclosure Size	Catalog Number	Dimensions in Millimeters (Inches)								Number of Outlets	K Dimension	Approximate Weight kgs (lbs)
		Mounting		Inside			Outside					
		A	B	C	D	E	F	G	H			
A	AEAB	139.7 (5.50)	333.5 (13.13)	155.7 (6.13)	273.1 (10.75)	133.4 (5.25)	270 (10.63)	387.4 (15.25)	224.5 (8.84)	2	50.8 (2.00)	17.24 (38)
B	AEBB	152.4 (6.00)	457.2 (18.00)	165.1 (6.50)	406.4 (16.00)	139.7 (5.50)	279.4 (11.00)	520.7 (20.50)	227.8 (8.97)	2	58.7 (2.31)	25.85 (57)
C	AECB	260.4 (10.25)	574.8 (22.63)	289.1 (11.38)	508 (20.00)	162.1 (6.38)	416.1 (16.38)	638.3 (25.13)	243.6 (9.59)	2	88.9 (3.50)	47.17 (104)

## Electrical Ratings Maximum Motor HP

Maximum Amps	Maximum Horsepower Rating				
	120 Vac	240 Vac	480 Vac	600 Vac	250 Vdc
30	5	10	20	25	7-1/2
60	10	20	40	60	15
100	15	30	75	75	25

+ Cutler-Hammer is a registered trademark of Eaton Corporation.

# AE Bolted Molded Case Switches and Enclosures

## Explosionproof, Dust-Ignitionproof, Watertight

### NEC:

Class I, Division 1 and 2, Groups B, C, D

Class II, Division 1 and 2, Groups E, F, G

Class III

NEMA 4, 4X

### Application

- Explosionproof molded case switch enclosures are used where hazardous materials are handled or stored.
- These units are used to disconnect circuits, control of lighting and power circuits.

### Features

- Precision machined flamepath between box and cover.
- Bolt on stainless steel slotted mounting feet.
- Stainless steel, captive Quad-Lead® cover bolts are standard (disengaged in 1-1/2 turns).
- Ground lug package and installation instructions for termination of ground wire enclosed.
- External operating handle with stops for limiting handle travel.
- Switch operators can be locked in the ON or OFF position (up to 3 padlocks).
- External flange maximizes internal space.
- Standard outlets top and bottom for line and load wiring.
- Plugged 1/2" outlets top and bottom for breather and drain.
- Switches mounted on a galvanized steel removable pan.
- Molded case switches are designed to accept +40 °C (+104 °F) standard circuit breakers.
- O-ring gasket insures watertight integrity.

### Standard Materials

- Bodies and covers: copperfree (4/10 of 1% max.) aluminum
- Cover bolts, hinges switch and operator shafts: stainless steel
- O-ring: neoprene

### Standard Finishes

- Bodies and covers: gray epoxy powder coat inside and outside standard

### Options

Must be listed in alphanumeric sequence at the end of the catalog number.

- Auxiliary switch (1A or 1B), add suffix —**AS1**.
- Auxiliary switch (2A or 2B), add suffix —**AS2**.
- Breather, NEMA 4X (includes outlet and installation), add suffix —**BR**.
- Drain, NEMA 4X (includes outlet and installation), add suffix —**DN**.
- External grounding stud, add suffix —**EGS**.
- Plastic nameplate, 50.8 mm x 101.6 mm (2" x 4"), 3.2 mm (0.125") black letters on white surface, 3 lines max, specify legend, add suffix —**NP**.
- Shunt trip (specify voltage), add suffix —**ST**.
- Under voltage release (specify voltage), add suffix —**UV**.
- For 1200 Amp or 4-pole versions, contact your local representative.

### NEC Certifications and Compliances

- UL Standard: UL 1203
- UL Listed: E84577



Appleton®

DISTRIBUTION EQUIPMENT: NEC/CEC HAZARDOUS LOCATION SWITCHES

# AE Bolted Molded Case Switches and Enclosures

Explosionproof, Dust-Ignitionproof, Watertight

NEC:  
 Class I, Division 1 and 2, Groups B, C, D  
 Class II, Division 1 and 2, Groups E, F, G  
 Class III  
 NEMA 4, 4X

## Catalog Numbering Guide

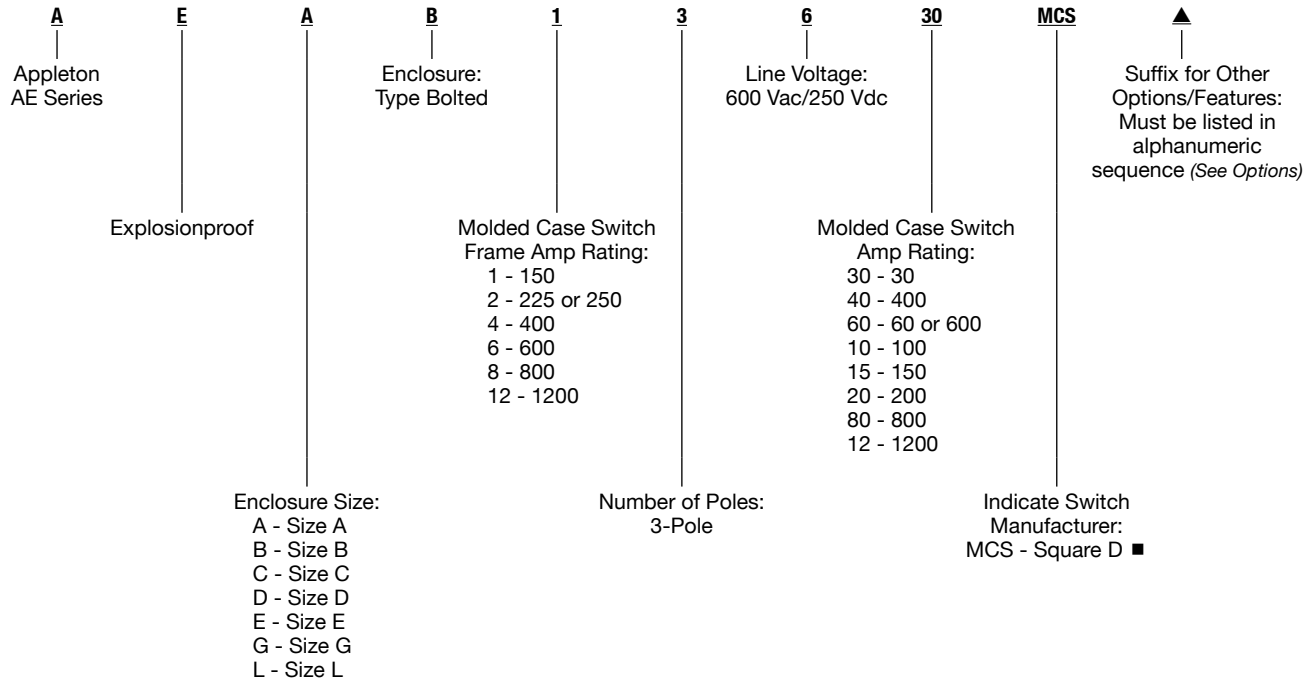

Molded Case Switch Frame Size	Molded Case Switch Type/Interrupting Capacity ①	Volts	Amp Rating	3 Pole Catalog Number	Standard Conduit Outlets (Inches)
150	FHL 18,000 AIC @ 600 Vac (For higher interrupting capacities, contact your local representative)	600 Vac, 120/250 Vdc	30	<b>AEAB13630MCS</b>	1-1/2
			60	<b>AEAB13660MCS</b>	1-1/2
			100	<b>AEBB13610MCS</b>	2
			150	<b>AEEB13615MCS</b>	2-1/2
225	FHL 18,000 AIC @ 600 Vac (For higher interrupting capacities, contact your local representative)	600 Vac, 120/250 Vdc	225	<b>AEEB23622MCS</b>	3
250	KAL 22,000 AIC @ 600 Vac (For higher interrupting capacities, contact your local representative)	600 Vac, 120/250 Vdc	250	<b>AEEB23625MCS</b>	4
400	LAL 22,000 AIC @ 600 Vac (For higher interrupting capacities, contact your local representative)	600 Vac, 120/250 Vdc	400	<b>AEEB43640MCS</b>	4
600	LCL 35,000 AIC @ 600 Vac	600 Vac, 120/250 Vdc	600	<b>AEDB63660MCS</b>	4
800	MHL 25,000 AIC @ 600 Vac (For higher interrupting capacities, contact your local representative)	600 Vac, 120/250 Vdc	800	<b>AELB83680MCS</b>	(2) 4
1200 ①	ND 25,000 AIC @ 600 Vac	600 Vac, 120/250 Vdc	800	<b>AEGB123680MCS</b>	(3) 4
			1200	<b>AEGB123612MCS</b>	(3) 4

▲ To complete the catalog number please add the appropriate suffix for other options/features. These suffixes can be found listed under Options.  
 ■ Square D is a registered trademark of Schneider Electric.  
 ① For 1200 Amp, contact your local representative.

# AE Bolted Molded Case Switches and Enclosures

## Explosionproof, Dust-Ignitionproof, Watertight

NEC:  
 Class I, Division 1 and 2, Groups B, C, D  
 Class II, Division 1 and 2, Groups E, F, G  
 Class III  
 NEMA 4, 4X

### Dimensions in Millimeters (Inches)

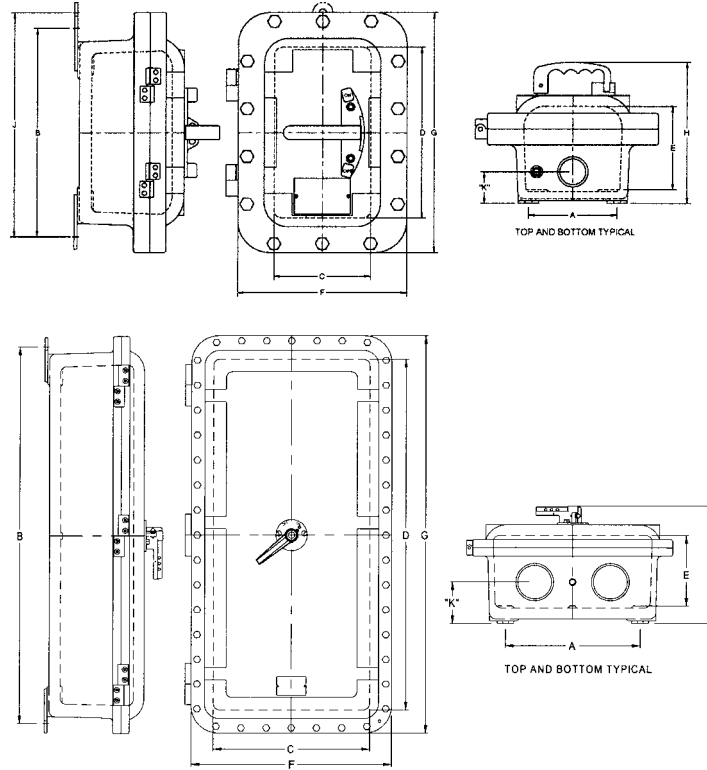

### Enclosure Only

Enclosure Size	Catalog Number	Dia. Number	Dimensions in Millimeters (Inches)										Number of Outlets	K Dimension	Approximate Weight kgs (lbs)
			Mounting			Inside			Outside						
			A	B	J	C	D	E	F	G	H				
A	AEAB	1	139.7 (5.50)	333.5 (13.13)	358.9 (14.13)	155.7 (6.13)	273.0 (10.75)	133.3 (5.25)	270.0 (10.63)	387.3 (15.25)	224.5 (8.84)	2	50.8 (2.00)	17.24 (38)	
B	AEBB	1	152.4 (6.00)	457.2 (18.00)	782.6 (19.00)	165.1 (6.50)	406.4 (16.00)	139.7 (5.50)	279.4 (11.00)	520.7 (20.50)	227.8 (8.97)	2	58.6 (2.31)	25.85 (57)	
C	AECB	1	260.3 (10.25)	574.8 (22.63)	Not Available	289.0 (11.38)	508.0 (20.00)	162.0 (6.38)	162.0 (6.38)	638.3 (25.13)	243.5 (9.59)	2	88.9 (3.50)	47.17 (104)	
E	AEEB	1	215.9 (8.50)	689.1 (27.13)	Not Available	285.7 (11.25)	758.9 (29.88)	183.8 (7.63)	406.4 (16.00)	749.3 (29.50)	311.9 (12.28)	2	101.6 (4.00)	65.77 (145)	
F	AEFB-250	1	241.3 (9.50)	692.1 (27.25)	Not Available	285.7 (11.25)	758.9 (29.88)	204.7 (8.06)	416.0 (16.38)	889.0 (35.00)	313.4 (12.34)	2	106.4 (4.19)	77.11 (170)	
F	AEFB-400	2	241.3 (9.50)	692.1 (27.25)	Not Available	285.7 (11.25)	758.9 (29.88)	204.7 (8.06)	416.0 (16.38)	889.0 (35.00)	320.8 (12.63)	2	106.4 (4.19)	77.11 (170)	
D	AEDB	2	409.7 (16.13)	1035.0 (40.75)	Not Available	457.2 (18.00)	1079.5 (42.50)	193.8 (7.63)	346.2 (13.63)	962.1 (37.88)	325.3 (12.81)	2	109.4 (4.31)	103.42 (228)	
L	AELB	3	406.4 (16.00)	1152.6 (45.38)	Not Available	473.2 (18.63)	1073.1 (42.25)	215.9 (8.50)	606.5 (23.88)	1216.1 (47.88)	361.9 (14.25)	4	127.0 (5.00)	190.06 (419)	
G	AEGB	4	543.1 (21.38)	1270.0 (50.00)	Not Available	508.0 (20.00)	1524.0 (60.00)	254.0 (10.00)	635.0 (25.00)	1651 (65.00)	534.0 (21.38)	6	111.2 (4.38)	257.19 (567)	

# MD2DS Series Factory Sealed Disconnect Switches

No external seals required.

## NEC — Non-Fused:

Class I, Division 2, Groups B, C, D  
Class II, Division 1 and 2, Groups F, G  
Class III  
Class I, Zone 1, AEx de IIC, T3, IP66  
NEMA 3, 3R, 4, 4X, 12

## NEC — Fused:

Class I, Division 2, Groups B, C, D  
Class II, Division 1 and 2, Groups F, G  
Class III  
Class I, Zone 2, Group IIC, T3, IP66  
NEMA 3, 3R, 4, 4X, 12

## Applications

- Functions as load disconnect switch or as individual motor control switch.

## Features

- Factory sealed; no external seals required.
- Available in fused and unfused versions.
- Stainless steel captive cover bolts for easy access and corrosion resistance.
- Standard epoxy powder coating inside and outside delivers exceptional corrosion resistance.
- Insulated, dual-color polymer operating handle clearly indicates the switch being energized. Ergonomically designed handle is made of high-impact polymer material for exceptional ruggedness, durability and corrosion resistance.
- Removable hinged cover allows for ease of installation and maintenance.
- Short circuit withstand rated to 200,000 RMS symmetrical amperes (Class J fusing).
- Short circuit withstand rated to 10,000 RMS symmetrical amperes (unfused).
- Use Class J fusing on fused units (fuses not included).
- Conduit entry is drilled and tapped to 1-1/2". Reducer bushings 1-1/2"-1-1/4" and 1-1/2"-1" provided at no additional cost.
- Stainless steel key-hole mounting feet for easy installation.
- Unit is equipped with defeatable door interlock which allows emergency access when switch is energized.
- Cover can be padlocked closed.
- Operating handle can be locked in the OFF position with provision to lock in the ON position.
- Line side accommodates #8-#4/0 AWG copper wire. Load side unfused accommodates #8-#4/0 AWG copper wire. Load side 30 Amp fused accommodates #14-#6 AWG copper wire. Load side 60 Amp fused accommodates #14-#2 AWG copper wire. Load side 100 Amp fused accommodates #12-#2/0 AWG copper wire.

## Standard Materials

- Enclosure: copperfree (4/10 of 1% max.) aluminum
- Operating handle: high impact polymer
- Hardware: stainless steel

## Standard Finishes

- Enclosure: epoxy powder coating inside and outside

## Options

- One normally opened, one normally closed auxiliary switch, add suffix **-AUX**.

## NEC Certifications and Compliances

- UL Standard: UL 98
- UL Listed: E160652



# MD2DS Series Factory Sealed Disconnect Switches

No external seals required.

**NEC – Non-Fused:**  
 Class I, Division 2, Groups B, C, D  
 Class II, Division 1 and 2, Groups F, G  
 Class III  
 Class I, Zone 1, AEx de IIC, T3, IP66  
 NEMA 3, 3R, 4, 4X, 12

**NEC – Fused:**  
 Class I, Division 2, Groups B, C, D  
 Class II, Division 1 and 2, Groups F, G  
 Class III  
 Class I, Zone 2, Group IIC, T3, IP66  
 NEMA 3, 3R, 4, 4X, 12

Type ①	Amps	Max HP at 600 Vac	Dimension A mm (in)	Catalog Number
 Fused (fuses not included)	30	20	489.0 (19.25)	MD2DS3034F
	60	50	489.0 (19.25)	MD2DS6034F
	100	50	489.0 (19.25)	MD2DS1034F
Non-Fused	100	50	581.2 (22.88)	MD2DS1034U

## Operating Temperatures

Classification	Fused	Unfused
Class I, Division 2	T3C	T3C
Class I, Zone 1	—	T3
Class I, Zone 2	T3	—
Class II, Division 1 and 2	T6	T6

## Dimensions in Millimeters (Inches)

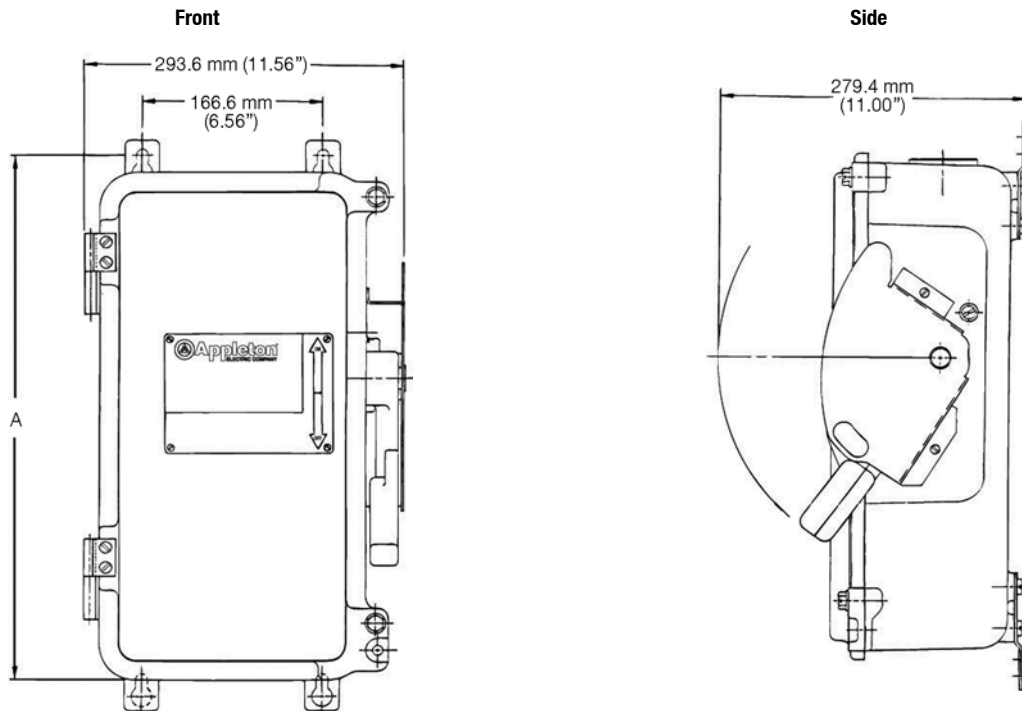

① Fuses not included in fused units. For maximum horsepower please consult fuse manufacturer.

# WD2S Series Factory Sealed Disconnect Switches

## Fused and Non-Fused

No External Seals Required.

### NEC/CEC:

Class I, Division 2, Groups B, C, D  
Class II, Division 1 and 2, Groups E, F, G  
Ex de IIB + H<sub>2</sub>; Class I, Zone 1, AEx de IIB + H<sub>2</sub>  
Types 3, 4, 4X, 5

### NEC:

Class I, Zone 1, AEx de IIB + H<sub>2</sub> T5

### CEC:

Canada: Ex de IIB + H<sub>2</sub> T5

## Applications

- Functions as load disconnect switch or as individual motor control switch.

## Features

- Factory sealed; no external seals required.
- Available fused and non-fused versions.
- Stainless steel latches for easy access and corrosion resistance.
- Standard epoxy powder coating delivers exceptional corrosion resistance.
- Ergonomically designed rugged cast aluminum handle.
- Removable hinged cover allows for ease of installation and maintenance.
- Short circuit withstand rated to 10,000 RMS symmetrical amperes (unfused).
- Single top and bottom conduit entries supplied, drilled and tapped 1-1/4" NPT.
- Key-hole mounting feet for easy installation.
- Unit is equipped with defeatable door interlock which allows emergency access when switch is energized.
- Cover can be padlocked closed.
- Operating handle can be locked in the OFF position with provision to lock in the ON position.
- Line side accommodates #8-#4/0 AWG copper wire. Load side accommodates #8-#4/0 copper wire.
- 100 Amp models and smaller are suitable for use with DC voltages (250 Vdc Max) as well as AC voltages.
- All models are suitable for use with AC voltages to 600 Vac max.

## Standard Materials

- Enclosure: copperfree (4/10 of 1% max.) aluminum
- Operating handle: durable cast aluminum
- Hardware: stainless steel

## Standard Finishes

- Enclosure: epoxy powder coating

## Options

Must be listed in alphanumeric sequence at the end of the catalog number.

- Auxilliary Contacts. One set of NO/NC contacts. Add suffix **-AUX**.
- Breather/Drain. Factory installed. Add suffix **-BD**.
- LED indicator lights: one light indicates there is power to unit and other indicates switch is in ON position add suffix **-IL**.

## NEC/CEC Certifications and Compliances

- CSA Standard: C22.2 No. 4
- UL Standard: UL 698
- cCSAus Certified: 039569

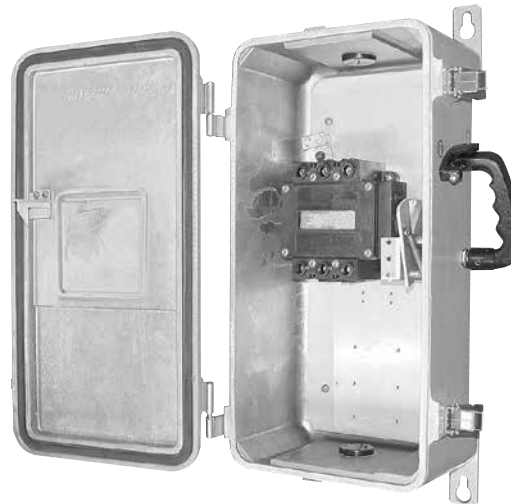



# WD2S Series Factory Sealed Disconnect Switches

## Fused and Non-Fused

No External Seals Required.

**NEC/CEC:**

Class I, Division 2, Groups B, C, D  
 Class II, Division 1 and 2, Groups E, F, G  
 Ex de IIB + H<sub>2</sub>; Class I, Zone 1, AEx de IIB + H<sub>2</sub>  
 Types 3, 4, 4X, 5

**NEC:**

Class I, Zone 1, AEx de IIB + H<sub>2</sub> T5

**CEC:**

Canada: Ex de IIB + H<sub>2</sub> T5

	Amps	Max HP at 600 Vac	Catalog Number	
			Fused ①	Non-Fused
	30	20	WD2S3034F	WD2S3034
	60	50	WD2S6034F	WD2S6034
	100	50	WD2S1034F	WD2S1034
	200	50	—	WD2S20034

### Operating Temperatures

Classification	T Number
Class I, Division 2	T3C
Class II, Division 1 and 2	T6

### Dimensions in Millimeters (Inches)

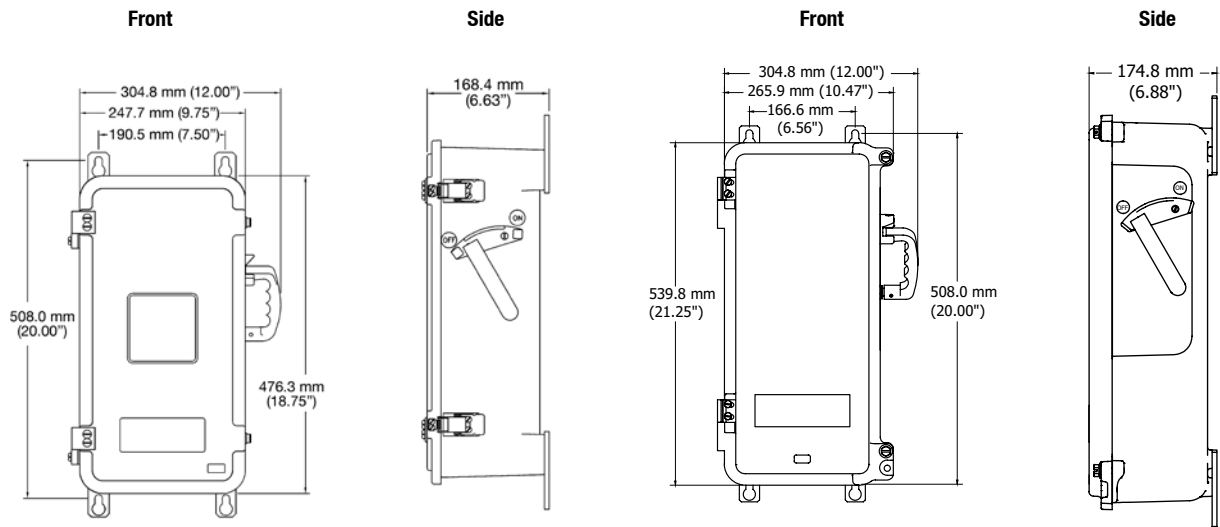

WD2S3034F, WD2S6034F, WD2S3034,  
 WD2S6034, WD2S1034, WD2S20034

WD2S1034F

① Fuses not included in fused units. For maximum horsepower please consult fuse manufacturer.

# WST and WDS Cast Aluminum Enclosed Disconnect Switches

600 Vac, 600 Vdc, 30, 60, 100 Ampere, Fused and Non-fused.

NEC – WST:  
NEMA 3, 3R, 4, 4X, 12

CEC – WDS:  
NEMA 3, 4X, 5

## Applications

- For heavy duty applications where a heavy duty switch is required for disconnecting motors, lighting, or power circuits.
- The WST and WDS can be used to control power to fixed electrical equipment such as:
  - Welders
  - Generators
  - Compressors
  - Infrared ovens
  - Batch feeders
  - Conveyors
  - Truck terminals
  - Marine docks
- Ideally suited for use in:
  - Automotive and steel processing plants
  - Pulp and paper processing plants
  - Milk processing plants and creameries
  - Fabrication yards and shipyards
  - Refrigerated truck terminals
  - Other industrial plant applications

## Features

- Gasketed design allows use in raintight or watertight non-hazardous applications.
- Epoxy powder coated inside and outside to withstand corrosive environments.
- Offers the latest in switch technology:
  - An operating mechanism designed to endure at least three times the number of operations required by NEMA and UL standards
  - Modular componentry designed for quick and easy maintenance
  - Visible blades for an extra measure of safety while the low mass cam allows greater blade operating speed and reduced mechanical wear.
- Insulated, dual-color polymer operating handle clearly indicates the switch being energized. Ergonomically designed handle is made of high-impact polymer material for exceptional ruggedness, durability and corrosion resistance.
- Short circuit withstand rated to 200,000 RMS symmetrical amperes (Class R, J Fusing).
- Class R fusing standard on fusible units. Product can be retrofitted with Class J, K, or S fusing.
- Stainless steel captive cover bolts for easy access and corrosion resistance.
- Removable hinged cover for ease of installation and maintenance.
- Conduit entries are drilled and tapped to 1-1/2". Reducer bushings 1-1/2" – 1-1/4" and 1-1/2" – 1" provided at no extra charge.
- Stainless steel key-hole mounting feet for easy installation.
- Unit is equipped with defeatable door interlock which allows emergency access when switch is energized.
- Cover can be padlocked closed.
- Operating handle can be locked in the OFF position with provision to lock in ON position.
- Not intended for use as a service disconnect (i.e., neutrals not available).
- WDS version available with optional window and/or LED indicator light.



WST



WDS

## Standard Materials

- Enclosure: copperfree (4/10 of 1% max.) aluminum
- WST operating handle: high impact polymer
- WDS operating handle: cast aluminum
- Hardware: stainless steel

## Standard Finishes

- Enclosure: epoxy powder coating inside and outside

## Options

*Must be listed in alphanumeric sequence at the end of the catalog number.*

- Auxiliary Contacts: 1 set of NO, NC.
- Auxiliary Contacts: 2 sets of NO, NC.
- WDS one normally opened, one normally closed auxiliary switch, add suffix **-AUX**.
- WDS LED Indicator lights: one light indicates power unit and other indicates switch is in ON position add suffix **-IL**.

## NEC/CEC Certifications and Compliances

- WST:
  - UL Standard: 98
  - UL Listed: E160652
- WDS:
  - CSA Standard: C22.2 Nos. 0.4, 0.5, 4, 25, 94
  - CSA Certified: LR39569

# WST Cast Aluminum Enclosed Disconnect Switches

600 Vac, 600 Vdc, 30, 60, 100 Ampere, Fused and Non-fused.

NEC:  
NEMA 3, 3R, 4, 4X, 12

## WST Disconnect Switch in Cast Aluminum Enclosure

Type	Amp Rating	HP at 600 Vac Std/Max 3-Phase	HP at 600 Vdc Std/Max	Catalog Number
Fused <i>(fuses not included)</i>	30	7.5/20	10/15	<b>WST3035</b>
	60	15/50	25/30	<b>WST6035</b>
	100	30/75	40/50	<b>WST10035</b>
Non-Fused	30	-/30	-/15	<b>WST30354</b>
	60	-/60	-/30	<b>WST60354</b>
	100	-/75	-/50	<b>WST10354</b>



## Auxiliary Contact for WST Disconnect Switch

Catalog Number	Interlock Type	Vac, 50 or 60 Hz				Vdc		
		Volts	Amps/ Make	Amp/ Break	Amps/ Cont.	Volts	Amps/ Make and Break	Amps/ Cont.
<b>WSAUX1</b>	1 NO/1 NC Contact	120	40.0	15.00	15	115	0.50	15
		240	20.0	10.00	15	230	0.25	15
		480	10.0	6.00	15	—	—	—
		600	8.0	5.00	15	600	0.05	15
<b>WSAUX2</b>	2 NO/2 NC Contact	120	30.0	3.00	10	115	1.00	10
		240	15.0	1.50	10	230	0.30	10
		600	6.0	0.60	10	600	0.10	10

## Dimensions in Millimeters (Inches)

Catalog Number	A
WST3035	489.0 (19.25)
WST30354	489.0 (19.25)
WST6035	489.0 (19.25)
WST60354	489.0 (19.25)
WST10035	489.0 (19.25)
WST10354	581.2 (22.88)

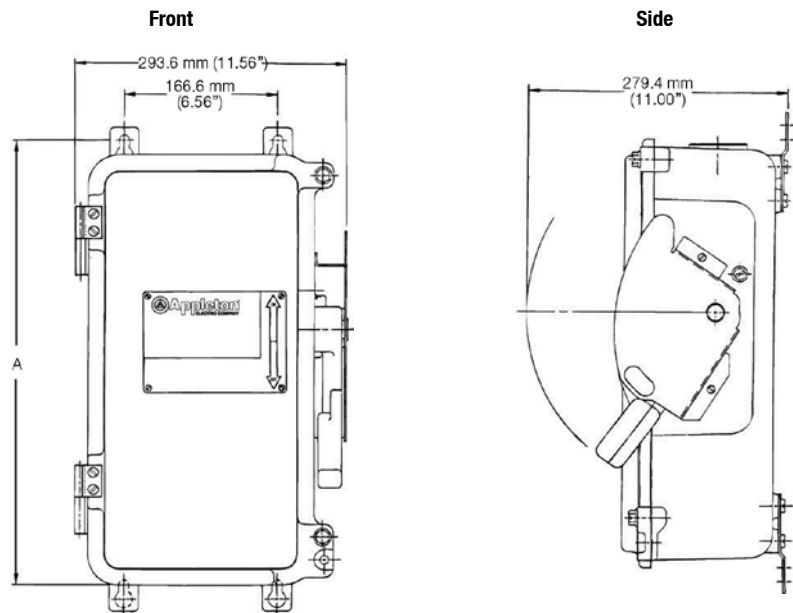

DISTRIBUTION EQUIPMENT: NEC/CEC WEATHERPROOF SWITCHES

Appleton

# WDS Cast Aluminum Enclosed Disconnect Switches

600 Vac, 600 Vdc, 30, 60, 100 Ampere, Fused and Non-fused. With Breaker or Disconnect. Watertight Switch.

CEC:  
NEMA 3, 4X, 5

DISTRIBUTION EQUIPMENT: NEC/CEC WEATHERPROOF SWITCHES

## WDS Cast Aluminum Enclosure



Amp Rating	B—Breaker F—Fusing N—None	HP at 600 Vac 3—Phase	Aux. Contacts ① 1 or 2 NO/NC	Catalog Number	
				Without Viewing Window	With Viewing Window
30	F	7.5/20	WSAUX1 or 2	WDS3034	WDS3034W
60	F	15/50	WSAUX1 or 2	WDS6034	WDS6034W
100	F ②	30/70	WSAUX1 or 2	WDS1034	WDS1034W
30	N	25	WSAUX1 or 2	WDS3034-NF	WDS3034NFW
60	N	60	WSAUX1 or 2	WDS6034-NF	WDS6034NFW
100	N	75	WSAUX1 or 2	WDS1034-NF	WDS1034NFW

## Dimensions in Millimeters (Inches)

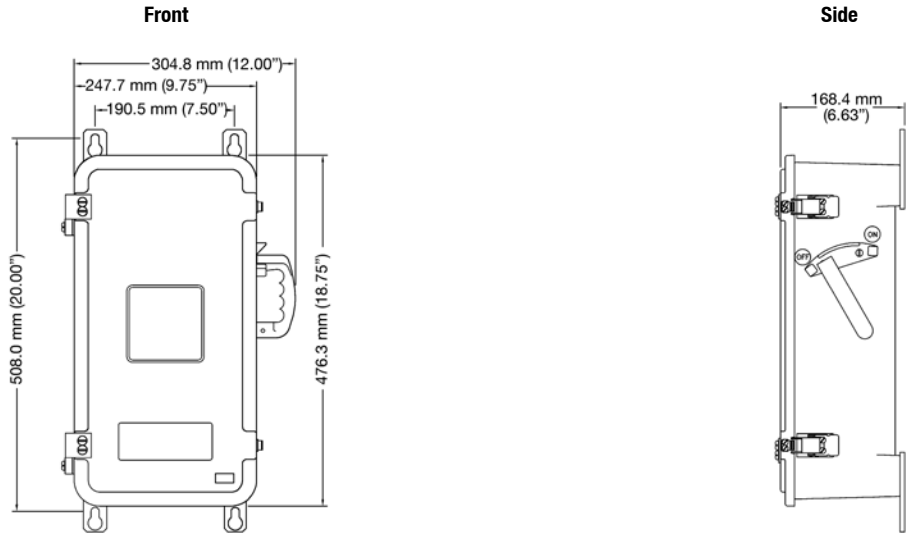

① Auxiliary contacts ordered separately for field installation  
② Use only Type J fuses.

# Intraground™ N1 Series Non-Metallic Circuit Breakers and Enclosures

## Explosionproof, Non-Factory Sealed

### NEC:

Class I, Division 1 and 2, Groups C, D  
NEMA 3R, 4X, 7CD ◆, 12

### Applications

- Short circuit protection and safe disconnect means.
- Thermal time delay overload protection for branch circuits for lighting, appliance and motor circuits.
- Ideal for use in corrosive atmospheres.
- Designed for use in locations made hazardous by the presence of flammable gases or vapors, such as those encountered in
  - Refineries
  - Chemical plants
  - Petrochemical plants
  - Other processing plants

### Features:

- 15, 20, and 30 Amp single pole circuit breakers for 120 Vac operation.
- Dead-end or feed-thru hubs: 1/2" or 3/4".
- Furnished with lead wires for ease of connection.
- Breaker mounted on cover.
- Handle may be locked in ON or OFF position.
- External mounting lugs for ease of installation.
- Smooth, rounded integral bushing in each hub protects conductor insulation.
- Non-metallic construction with metal imbedded grounding grid. No need to install special wires and parts for grounding.
- Corrosion-resistant, strong, stainless steel Teflon® coated hex-head cap screws attach cover and body for approved flame-tight construction.
- Operating handle has close-tolerance threaded stainless steel shaft to meet explosionproof requirements.
- Unique labyrinth-path construction assures flame-tight joint between body and cover.
- Silicone gasket, specially designed for the labyrinth-path joint, prevents entrance of moisture without interfering with the venting of cooled hazardous gases and vapors.
- High strength thermoplastic polyetherimide, together with thick wall (5/16") and sound structural design (rounded corners) provides superior resistance to impact and crushing.
- Excellent resistance to ultraviolet light and water.
- Excellent conduit connection strength.
- Excellent resistance to attack by fungi and mold.
- Excellent heat deflection temperature.
- Superior flammability resistance.
- Furnished with a 3/4" to 1/2" NPT reducer.

### Standard Materials

- Body and cover: 30% glass-reinforced thermoplastic polyetherimide in a neutral color
- Handle: nylon 6/6
- Cover bolts: stainless steel
- Nameplates: aluminum

### Standard Finishes

- Cover bolts: Teflon®
- Nameplates: Mylar®

### NEC Certifications and Compliances

- UL Standard: UL 1203
- UL Listed: E59122



DISTRIBUTION EQUIPMENT: NEC/CEC EXPLOSIONPROOF CIRCUIT BREAKERS

Appleton®

◆ For Class I, Division 1 applications sealing fittings must be field installed adjacent to enclosure on all conduit runs.

# Intraground™ N1 Series Non-Metallic Circuit Breakers and Enclosures

## Explosionproof, Non-Factory Sealed

NEC:  
Class I, Division 1 and 2, Groups C, D  
NEMA 3R, 4X, 7CD ♦, 12

### Enclosures with Square D Type "QOU" Single Pole Breakers for 120/240 Vac Operation

	Amp	Hub Size (Inches)	Catalog Number	
			Dead-End	Feed-Thru
	15 Amp	1/2 or 3/4	N1D7515B	N1DC7515B
	20 Amp	1/2 or 3/4	N1D7520B	N1DC7520B
	30 Amp	1/2 or 3/4	N1D7530B	N1DC7530B

### Dimensions in Millimeters (Inches)

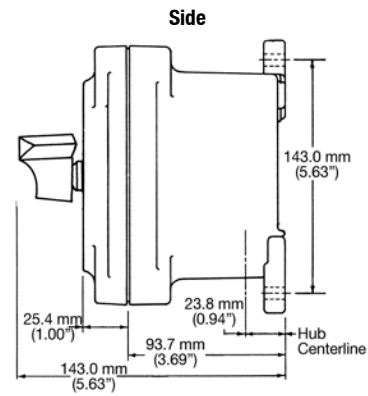
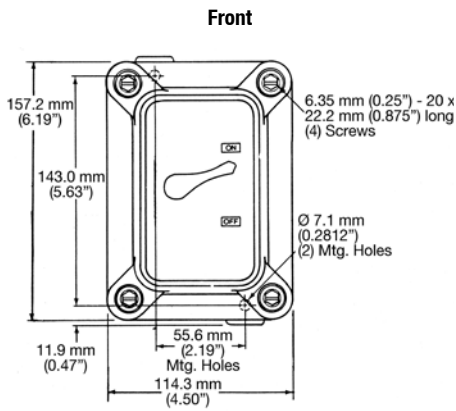

DISTRIBUTION EQUIPMENT: NEC/IEC EXPLOSIONPROOF CIRCUIT BREAKERS



♦ For Class I, Division 1 applications sealing fittings must be field installed adjacent to enclosure on all conduit runs.

# ECS Series Breaker Stations

## Explosionproof, Dust-Ignitionproof

240 Vac Max.

### CEC:

Class I, Division 1 and 2, Groups B, C, D  
 Class I Zone 1 and 2, IIB + H<sub>2</sub> T6  
 Class II, Division 1 and 2, Groups E, F, G  
 Class III, Enclosure Type 3R, Weatherproof  
 EEMAC Type 3R, 4<sup>V</sup>, 4X<sup>V</sup>, 7BCD, 9EFG

### Applications

- Protection and control of electrical apparatus and circuits in hazardous environments, either indoor or outdoor.
- Designed for use in areas designed for Class/Zone 1, where flammable gases or vapors are present either continuously or intermittently.
- Ideal for controlling a small number of circuits. Do not need typical panelboard enclosures.

### Features

- Corrosion resistant captive stainless steel hex-head bolts hold cover to body.
- Smooth rounded integral bushing in hub protects conductor insulation.
- Accurately tapped, tapered hubs for tight, rigid joints and ground continuity.

### Standard Materials

- Cover: aluminum alloy
- Body: cast copperfree (4/10 of 1% max.) aluminum
- Standard Circuit Breakers: Type Cutler-Hammer + QC, single pole only (10,000 rms). 15 to 40 Amps

### Options

Must be listed in alphanumeric sequence at the end of the catalog number.

- For NEMA 4, 4X rating, add suffix **-4X**.
- For 50 °C (122 °F) breaker rating, add suffix **-V**.

### CEC Certifications and Compliances

- CSA Standard: C22.2 No. 25, C22.2 No. 30, C22.2 No. 5.1
- CSA Certified: 052308



ECS41201



ECS62201

Box	No. of Breakers	Hub Size	Catalog Number			
			15 Amps	20 Amps	30 Amps	40 Amps
1-Gang	1	1/2 – 3/4	ECS21151	ECS21201	ECS21301	ECS21401
		1	ECS41151	ECS41201	ECS41301	ECS41401
2-Gang	2	1/2 – 3/4	ECS62151	ECS62201	ECS62301	ECS62401
		1	ECS82151	ECS82201	ECS82301	ECS82401

### Cover and Breaker only

No. of Circuits	Catalog Number			
	15 Amps	20 Amps	30 Amps	40 Amps
1	ECSK1151	ECSK1201	ECSK1301	ECSK1401

▼ Add suffix **4X** for NEMA 4, 4X rating.  
 + Cutler-Hammer is a registered trademark of Eaton Corporation.

DISTRIBUTION EQUIPMENT: NEC/CEC EXPLOSIONPROOF CIRCUIT BREAKERS



# AE Series Bolted Circuit Breakers and Enclosures

## Explosionproof, Dust-Ignitionproof, Watertight

2- and 3-Pole, Non-Interchangeable Trip. Bolted Enclosure Type.

### NEC/CEC:

Class I, Division 1 and 2, Groups B, C, D

Class II, Division 1 and 2, Groups E, F, G

Class III

NEMA 4, 4X

### Application

- Explosionproof circuit breaker enclosures are used where hazardous materials are handled or stored.
- These units are used for overload and short circuit protection, control of lighting and power circuits.

### Features

- Precision machined flame path between box and cover.
- Bolt on stainless steel slotted mounting feet.
- Stainless steel, captive Quad-Lead® cover bolts are standard (disengaged in 1-1/2 turns).
- Ground lug package and installation instructions for termination of ground wire enclosed.
- External operating handle with stops for limiting handle travel.
- Breaker operators can be locked in the ON or OFF position (up to 3 padlocks).
- External flange maximizes internal space.
- Standard outlets top and bottom for line and load wiring.
- Plugged 1/2" outlets top and bottom for breather and drain.
- Breakers mounted on a galvanized steel removable pan.
- Enclosures are designed to accept GE\*, Square D®, Siemens+ and Cutler-Hammer † circuit breakers.
- O-ring gasket insures watertight integrity.
- 2- and 3-pole versions are standard. For 4-pole versions, contact your local representative.

### Standard Materials

- Bodies and covers: copperfree (4/10 of 1% max.) aluminum
- Cover bolts, hinges, breaker and operator shafts: stainless steel
- Hinges: stainless steel
- O-ring: neoprene

### Standard Finishes

- Bodies and covers: gray epoxy powder coat inside and outside standard

### Options

Must be listed in alphanumeric sequence at the end of the catalog number.

- Auxiliary switch (1A or 1B), add suffix —**AS1**.
- Auxiliary switch (2A or 2B), add suffix —**AS2**.
- Breather, NEMA 4X (includes outlet and installation), add suffix —**BR**.
- Drain, NEMA 4X (includes outlet and installation), add suffix —**DN**.
- External grounding stud, add suffix —**EGS**.
- Plastic nameplate, 2" x 4", 1/8" black letters on white surface, 3 lines max, specify legend, add suffix —**NP**.
- Shunt trip (specify voltage), add suffix —**ST**.
- Under voltage release (specify voltage), add suffix —**UV**.
- For +50 °C (+122 °F) breaker rating, add suffix —**V**.
- For UL Listed Circuit Breakers with 65,000 AIC rating, contact your local sales representative.



### NEC/CEC Certifications and Compliances

- UL Standard: UL 1203
- UL Classified: E84577
- CSA Standard: C22.2 No. 0, C22.2 No. 4, C22.2 No. 5, C22.2 No. 25, C22.2 No. 30
- CSA Certified (800A Max): 1324917

► GE is a registered trademark of General Electric Company.

■ Square D is a registered trademark of Schneider Electric.

† Cutler-Hammer is a registered trademark of Eaton Corporation.

+ Siemens is a registered trademark of Siemens AG.



# AE Series Bolted Circuit Breakers and Enclosures

## Explosionproof, Dust-Ignitionproof, Watertight

2- and 3-Pole, Non-Interchangeable Trip. Bolted Enclosure Type.

**NEC/CEC:**

Class I, Division 1 and 2, Groups B, C, D

Class II, Division 1 and 2, Groups E, F, G

Class III

NEMA 4, 4X

### Catalog Numbering Guide

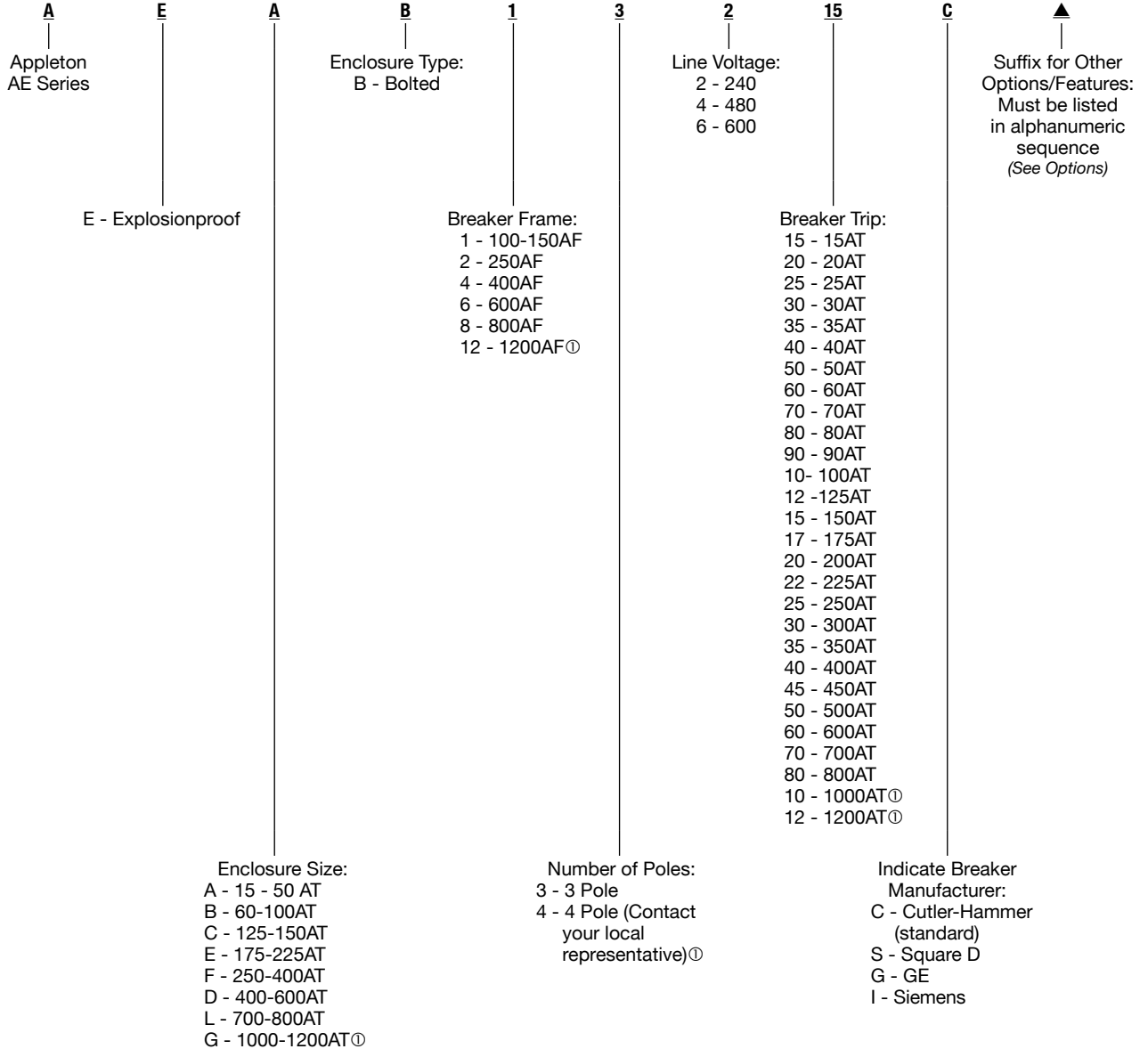

DISTRIBUTION EQUIPMENT: NEC/CEC EXPLOSIONPROOF CIRCUIT BREAKERS



<sup>①</sup> UL Classified. NEC Certification only.

▲ To complete the catalog number please add the appropriate suffix for other options/features. These suffixes can be found in the modifications table in this section.

# AE Series Bolted Circuit Breakers and Enclosures

## Explosionproof, Dust-Ignitionproof, Watertight

2- and 3-Pole, Non-Interchangeable Trip. Bolted Enclosure Type.

**NEC/CEC:**

Class I, Division 1 and 2, Groups B, C, D

Class II, Division 1 and 2, Groups E, F, G

Class III

NEMA 4, 4X

**Circuit Breaker Interrupting Ratings** (Symmetrical RMS Amps)

Breaker Type	240 Vac	480 Vac	600 Vac
<b>Cutler-Hammer</b> <sup>+</sup>			
EHD	18,000	14,000	—
FD	65,000	35,000	18,000
HFD	100,000	65,000	25,000
JD	65,000	35,000	18,000
HJD	100,000	65,000	25,000
KD	65,000	35,000	25,000
HKD	100,000	65,000	35,000
LD	65,000	35,000	22,000
HLD	100,000	65,000	35,000
MDL	65,000	50,000	25,000
HMDL	100,000	65,000	35,000
ND	65,000	50,000	25,000
HND	100,000	65,000	35,000
<b>GE</b> <sup>▶</sup>			
TED	18,000	18,000	14,000
THED	65,000	25,000	18,000
TFK	25,000	22,000	18,000
THFK	65,000	25,000	18,000
TJK4	42,000	30,000	22,000
THJK4	65,000	35,000	25,000
TJK6	42,000	30,000	22,000
THJK6	65,000	35,000	25,000
TKM8	42,000	30,000	22,000
THKM8	65,000	35,000	25,000
TKM12	42,000	30,000	22,000
THKM12	65,000	35,000	25,000

DISTRIBUTION EQUIPMENT: NEC/CEC EXPLOSIONPROOF CIRCUIT BREAKERS



▶ GE is a registered trademark of General Electric Company.  
 + Cutler-Hammer is a registered trademark of Eaton Corporation.



# AE Series Bolted Circuit Breakers and Enclosures

## Explosionproof, Dust-Ignitionproof, Watertight

2- and 3-Pole, Non-Interchangeable Trip. Bolted Enclosure Type.

**NEC/CEC:**

Class I, Division 1 and 2, Groups B, C, D

Class II, Division 1 and 2, Groups E, F, G

Class III

NEMA 4, 4X

Breaker Frame Size	Breaker Type/ Interrupting Capacity ①	Volts	Amp Rating	Catalog Numbers ② ▲		Standard Conduit Outlets (Inches)
				2-Pole	3-Pole	
100	EHD 18,000 AIC @ 240 Vac	480 Vac, 125/250 Vdc	15	AEAB12215C	AEAB13215C	1-1/2
			20	AEAB12220C	AEAB13220C	
			25	AEAB12225C	AEAB13225C	
			30	AEAB12230C	AEAB13230C	
			35	AEAB12235C	AEAB13235C	
			40	AEAB12240C	AEAB13240C	2
			50	AEAB12250C	AEAB13250C	
			60	AEAB12260C	AEAB13260C	
			70	AEAB12270C	AEAB13270C	
			80	AEAB12280C	AEAB13280C	
150	FD 65,000 AIC @ 240 Vac	600 Vac, 125/250 Vdc	125	AECB12212C	AECB13212C	2-1/2
			150	AECB12215C	AECB13215C	
100	EHD 14,000 AIC @ 480 Vac	480 Vac, 125/250 Vdc	15	AEAB12415C	AEAB13415C	1-1/2
			20	AEAB12420C	AEAB13420C	
			25	AEAB12425C	AEAB13425C	
			30	AEAB12430C	AEAB13430C	
			35	AEAB12435C	AEAB13435C	
			40	AEAB12440C	AEAB13440C	2
			50	AEAB12450C	AEAB13450C	
			60	AEAB12460C	AEAB13460C	
			70	AEAB12470C	AEAB13470C	
			80	AEAB12480C	AEAB13480C	
150	FD 35,000 AIC @ 480 Vac	600 Vac, 125/250 Vdc	125	AECB12412C	AECB13412C	2-1/2
			150	AECB12415C	AECB13415C	
150	FD 18,000 AIC @ 600 Vac	600 Vac, 125/250 Vdc	15	AEAB12615C	AEAB13615C	1-1/2
			20	AEAB12620C	AEAB13620C	
			25	AEAB12625C	AEAB13625C	
			30	AEAB12630C	AEAB13630C	
			35	AEAB12635C	AEAB13635C	
			40	AEAB12640C	AEAB13640C	2
			50	AEAB12650C	AEAB13650C	
			60	AEAB12660C	AEAB13660C	
			70	AEAB12670C	AEAB13670C	
			80	AEAB12680C	AEAB13680C	
150			90	AEAB12690C	AEAB13690C	2-1/2
			100	AEAB12610C	AEAB13610C	
			125	AECB12612C	AECB13612C	
150			150	AECB12615C	AECB13615C	

① For higher interrupting capacities, contact your local representative.

② Cutler-Hammer breaker provided as standard. For GE breaker change **C** to **G**; For Square D breaker change **C** to **S**; For Siemens breaker change **C** to **I**.

▲ To complete the catalog number please add the appropriate suffix for other options/features. These suffixes can be found under Options.

DISTRIBUTION EQUIPMENT: NEC/CEC EXPLOSIONPROOF CIRCUIT BREAKERS



# AE Series Bolted Circuit Breakers and Enclosures

## Explosionproof, Dust-Ignitionproof, Watertight

2- and 3-Pole, Non-Interchangeable Trip. Bolted Enclosure Type.

**NEC/CEC:**

Class I, Division 1 and 2, Groups B, C, D

Class II, Division 1 and 2, Groups E, F, G

Class III

NEMA 4, 4X

DISTRIBUTION EQUIPMENT: NEC/CEC EXPLOSIONPROOF CIRCUIT BREAKERS

Breaker Frame Size	Breaker Type/ Interrupting Capacity ②	Volts	Amp Rating	Catalog Numbers ③ ▲		Standard Conduit Outlets (Inches)
				2-Pole	3-Pole	
250	JD 18,000 AIC @ 600 Vac JD 35,000 AIC @ 480 Vac	600 Vac, 125/250 Vdc	70	AEEB22670C	AEEB23670C	3
			90	AEEB22690C	AEEB23690C	
			100	AEEB22610C	AEEB23610C	
			125	AEEB22612C	AEEB23612C	
			175	AEEB22617C	AEEB23617C	
			200	AEEB22620C	AEEB23620C	
			225	AEEB22622C	AEEB23622C	
			250	AEFB22625C	AEFB23625C	
400	KD 25,000 AIC @ 600 Vac KD 35,000 AIC @ 480 Vac	600 Vac, 125/250 Vdc	125	AEFB42612C	AEFB43612C	4
			175	AEFB42617C	AEFB43617C	
			200	AEFB42620C	AEFB43620C	
			225	AEFB42622C	AEFB43622C	
			250	AEFB42625C	AEFB43625C	
			300	AEFB42630C	AEFB43630C	
			350	AEFB42635C	AEFB43635C	
			400	AEFB42640C	AEFB43640C	
600	LD 25,000 AIC @ 600 Vac LD 35,000 AIC @ 480 Vac	600 Vac, 125/250 Vdc	450	AEDB62645C	AEDB63645C	4
			500	AEDB62650C	AEDB63650C	
			600	AEDB62660C	AEDB63660C	
800	MDL 25,000 AIC @ 600 Vac MDL 50,000 AIC @ 480 Vac	600 Vac, 125/250 Vdc	300	AELB82630C	AELB83630C	(2) 4
			350	AELB82635C	AELB83635C	
			400	AELB82640C	AELB83640C	
			450	AELB82645C	AELB83645C	
			500	AELB82650C	AELB83650C	
			600	AELB82660C	AELB83660C	
			700	AELB82670C	AELB83670C	
			800	AELB82680C	AELB83680C	
1200	MDL 25,000 AIC @ 600 Vac MDL 50,000 AIC @ 480 Vac	600 Vac, 125/250 Vdc	600	AEGB122660C ①	AEGB123660C ①	(2) 4
			800	AEGB122680C ①	AEGB123680C ①	
			1000	AEGB122610C ①	AEGB123610C ①	
			1200	AEGB122612C ①	AEGB123612C ①	

① UL Classified. NEC Certification only.

② For higher interrupting capacities, contact your local representative.

③ Cutler-Hammer breaker provided as standard. For GE breaker change **C** to **G**; For Square D breaker change **C** to **S**; For Siemens breaker change **C** to **I**.

▲ To complete the catalog number please add the appropriate suffix for other options/features. These suffixes can be found under Options.

# AE Bolted Circuit Breaker Enclosure

## Explosionproof, Dust-Ignitionproof, Watertight

2- and 3-Pole, Non-Interchangeable Trip. Bolted Enclosure Type.

**NEC/CEC:**

Class I, Division 1 and 2, Groups B, C, D  
 Class II, Division 1 and 2, Groups E, F, G  
 Class III  
 NEMA 4, 4X

**Dimensions in Millimeters (Inches)**

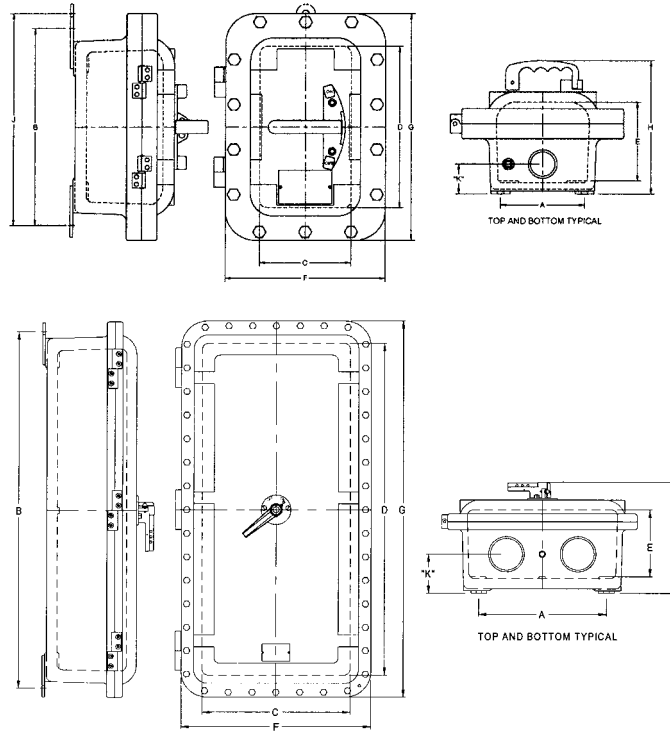

**Enclosure Only**

Enclosure Size	Catalog Number	Dia. Number	Dimensions in Millimeters (Inches)									Number of Outlets	Dimension mm (in) K	Approximate Weight kgs (lbs)
			Mounting			Inside			Outside					
			A	B	J	C	D	E	F	G	H			
A	AEAB	1	139.7 (5.50)	333.5 (13.13)	358.9 (14.13)	155.7 (6.13)	273.0 (10.75)	133.3 (5.25)	270.0 (10.63)	387.3 (15.25)	224.5 (8.84)	2	50.8 (2.00)	17.24 (38)
B	AEBB	1	152.4 (6.00)	457.2 (18.00)	782.6 (19.00)	165.1 (6.50)	406.4 (16.00)	139.7 (5.50)	279.4 (11.00)	520.7 (20.50)	227.8 (8.97)	2	58.6 (2.31)	25.85 (57)
C	AECB	1	260.3 (10.25)	574.8 (22.63)	Not Available	289.0 (11.38)	508.0 (20.00)	162.0 (6.38)	406.4 (16.00)	638.3 (25.13)	243.5 (9.59)	2	88.9 (3.50)	47.17 (104)
E	AEEB	1	215.9 (8.50)	689.1 (27.13)	Not Available	285.7 (11.25)	758.9 (29.88)	183.8 (7.63)	406.4 (16.00)	749.3 (29.50)	311.9 (12.28)	2	101.6 (4.00)	65.77 (145)
F	AEFB-250	1	241.3 (9.50)	692.1 (27.25)	Not Available	285.7 (11.25)	758.9 (29.88)	204.7 (8.06)	416.0 (16.38)	889.0 (35.00)	313.4 (12.34)	2	106.4 (4.19)	77.11 (170)
F	AEFB-400	2	241.3 (9.50)	692.1 (27.25)	Not Available	285.7 (11.25)	758.9 (29.88)	204.7 (8.06)	416.0 (16.38)	889.0 (35.00)	320.8 (12.63)	2	106.4 (4.19)	77.11 (170)
D	AEDB	2	409.7 (16.13)	1035.0 (40.75)	Not Available	457.2 (18.00)	1079.5 (42.50)	193.8 (7.63)	346.2 (13.63)	962.1 (37.88)	325.3 (12.81)	2	109.4 (4.31)	103.42 (228)
L	AELB	3	406.4 (16.00)	1152.6 (45.38)	Not Available	473.2 (18.63)	1073.1 (42.25)	215.9 (8.50)	606.5 (23.88)	1216.1 (47.88)	361.9 (14.25)	4	127.0 (5.00)	190.06 (419)
G <sup>Ⓞ</sup>	AEGB	4	543.1 (21.38)	1270.0 (50.00)	Not Available	508.0 (20.00)	1524.0 (60.00)	254.0 (10.00)	635.0 (25.00)	1651 (65.00)	534.0 (21.38)	6	111.2 (4.38)	257.19 (567)

Ⓞ UL Classified. NEC Certification only.

# EB Series Circuit Breakers and Enclosures

## Explosionproof, Dust-Ignitionproof

### NEC:

Class I, Division 1 and 2, Groups B, C, D

Class II, Division 1 and 2, Groups E, F, G

Class III

NEMA 3R, 4X<sup>†</sup>, 7BCD, 9EFG

### Applications

- Thermal magnetic circuit breaker provides over current and short circuit protection and safe disconnect.
- Thermal time delay overload protection for service entrance, feeder or branch circuits used for lighting, heating, motors and equipment.
- Suitable for use in indoor or outdoor classified locations.

### Features

- Corrosion-resistant, non-sparking copperfree aluminum with two-coat epoxy finish. Shafts and bushings are stainless steel (300 Series).
- Interior components removable as an assembly to facilitate wire pulling.
- Ample space for wiring and installation of accessories.
- Breaker handle has lock bracket that can be padlocked in ON or OFF position—accommodates up to three padlocks.
- Tapped, plugged openings provided as standard for optional drain and breather.
- Hinged (left side), removable covers secured by stainless steel (300 Series) hex-head, screwdriver-slotted captive “quick bolts.”
- Mating surfaces precision milled.
- Easy mounting—four removable mounting brackets have keyhole openings. Straps are steel with triple-coat finish.
- Positive-operating breaker handle has spring steel actuator that self-locates on breaker handle to prevent damage to breaker toggle if door is closed without aligning door with breaker toggle position.
- Each standard feed-thru opening (one at top and one at bottom) has an aluminum reducing bushing to protect conductor insulation.

### Standard Materials

- Housings: copperfree (4/10 or 1% max.) aluminum
- Shaft, bushings and exposed hardware: stainless steel (300 Series)

### Standard Finishes

- Housings: two-coat epoxy enamel
- Stainless steel shaft, bushings and exposed hardware: passivated

### Options

*Must be listed in alphanumeric sequence at the end of the catalog number.*

- Ground stud (grounded neutral or grounding wire), add suffix —**EGS**.
- Grounded neutral lug, add suffix —**GNL**.
- Insulated neutral lug, add suffix —**INL**.
- Drain and breather set, add suffix —**DV**.
- For NEMA 4X (not suitable for Group B), add suffix —**N4**.
- For +50 °C (+122 °F) breaker rating, add suffix —**V**.

### NEC Certifications and Compliances

- UL Standard: UL 1203
- UL Listed: E84577



▼ For NEMA 4X, add —**N4** suffix (not suitable for Group B).

# EB Series Circuit Breakers and Enclosure Options and Accessories

## Explosionproof, Dust-Ignitionproof

**NEC:**

Class I, Division 1 and 2, Groups B, C, D  
 Class II, Division 1 and 2, Groups E, F, G  
 Class III  
 NEMA 3R, 4X\*, 7BCD, 9EFG

**Ordering Instructions**

Provide catalog number from listing tables. Enclosures are supplied with Cutler-Hammer circuit breakers as standard. Table below shows enclosure sizes for Cutler-Hammer and other makes of breakers that can be accommodated, and are available on special order. To order enclosure with other than Cutler-Hammer breaker, replace the **W** in the catalog number with the Manufacturer's Symbol for the desired breaker of another make: **G**—General Electric; **S**—Square D.

**Catalog Number Explanation**

Appleton catalog numbers incorporate a simple, systemized method of designating enclosure and component specifications. For example, an EB Series enclosure with breaker is cataloged as follows:

**Catalog Numbering Guide**

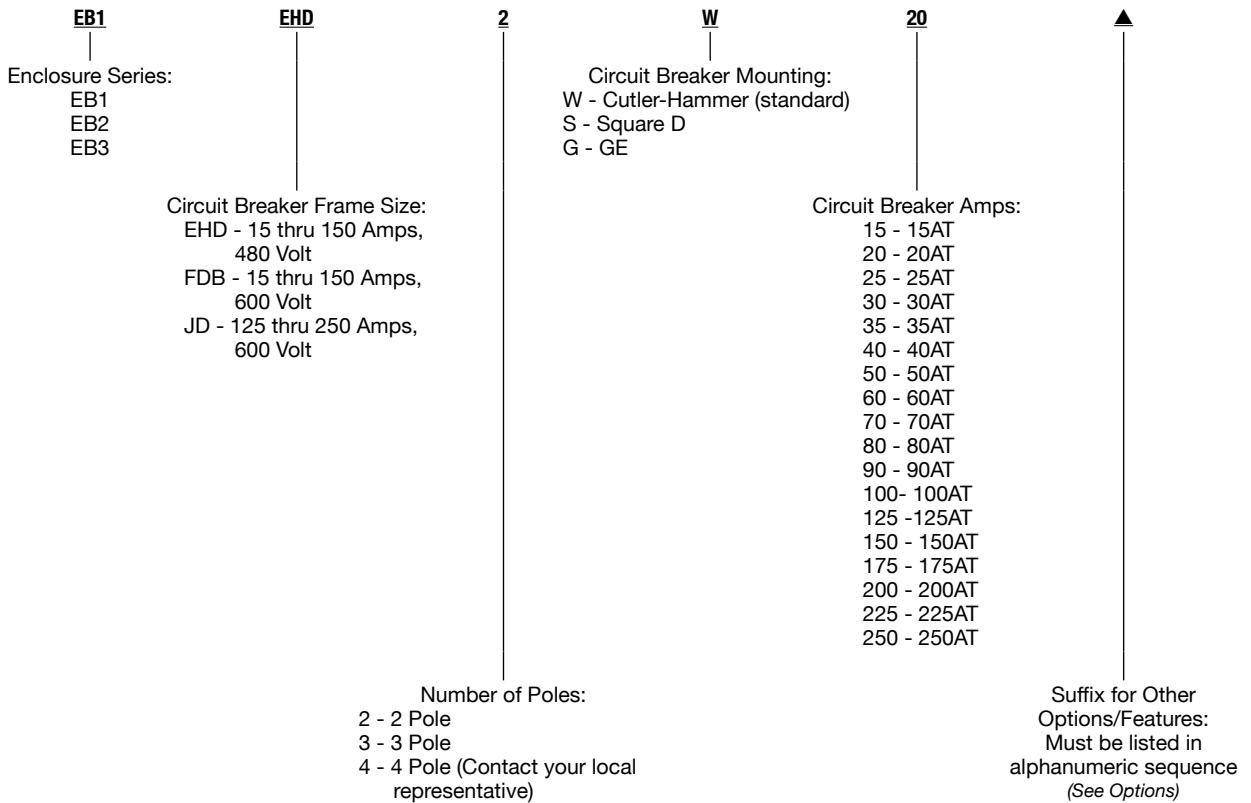

DISTRIBUTION EQUIPMENT: NEC/CEC EXPLOSIONPROOF CIRCUIT BREAKERS



▲ To complete the catalog number please add the appropriate suffix for other options/features. These suffixes can be found in the modifications table in this section.  
 ▼ For NEMA 4X, add **-N4** suffix (not suitable for Group B).

# EB Series Circuit Breakers and Enclosure Accommodation Table

Explosionproof, Dust-Ignitionproof

NEC:  
 Class I, Division 1 and 2, Groups B, C, D  
 Class II, Division 1 and 2, Groups E, F, G  
 Class III  
 NEMA 3R, 4X\*, 7BCD, 9EFG

## Circuit Breaker Options for EB Series Enclosures

Catalog Number Symbol	Breaker Frame Size		Trip Range Amps	Bolt-On (EB) Enclosure	Maximum Volts	Trip Type
	W	GE				
E	—	TEB	15-100	EB1 (15-50A) EB2 (70-100A)	240	Non-Interchangeable
EH	EHD	TED	15-100	EB1 (15-50A) EB2 (70-100A)	480	Non-Interchangeable
F	FDB	THED	15-150	EB1 (15-50A) EB2 (70-150A)	600	Non-Interchangeable
FJ	JD ①	TFJ	70-225 ①	EB3	600	Non-Interchangeable
TFJ	—	TFJ	70-225 ①	EB3	600	Interchangeable

DISTRIBUTION EQUIPMENT: NEC/CEC EXPLOSIONPROOF CIRCUIT BREAKERS



① JD also available in 250 Amp.

▼ For NEMA 4X, add **-N4** suffix (not suitable for Group B).



# EB Series Circuit Breakers and Enclosures

Explosionproof, Dust-Ignitionproof

**NEC:**

Class I, Division 1 and 2, Groups B, C, D  
 Class II, Division 1 and 2, Groups E, F, G  
 Class III  
 NEMA 3R, 4X<sup>Y</sup>, 7BCD, 9EFG

**Bolt-On (Type EB) — EHD and FDB Frames 15 thru 150 Amps. JD Frames 125 thru 250 Amps**

Frame Size	Circuit Breaker			Catalog Numbers		
	Number of Poles	Tap Size (Inches) ①	Amp Rating	Enclosure Only	With Circuit Breaker ②	
<b>EHD Frame — 15 Amps thru 100 Amps; 480 Vac (60 Hz) or 250 Vdc</b>						
EHD	2	1-1/2	15	EB1	EB1EH2W15	
			20		EB1EH2W20	
			30		EB1EH2W30	
		2	40	EB2	EB1EH2W40	
			50		EB1EH2W50	
			60		EB1EH2W60	
EHD	3	1-1/2	70	EB1	EB2EH2W70	
			90		EB2EH2W90	
			100		EB2EH2W100	
		2	70	EB2	EB2EH3W70	
			90		EB2EH3W90	
			100		EB2EH3W100	
<b>FDB Frame — 15 Amps thru 150 Amps; 600 Vac (60 Hz) or 250 Vdc</b>						
FDB	2	1-1/2	15	EB1	EB1F2W15	
			20		EB1F2W20	
			30		EB1F2W30	
		2	40	EB2	EB1F2W40	
			50		EB1F2W50	
			60		EB1F2W60	
FDB	3	1-1/2	70	EB1	EB2F2W70	
			90		EB2F2W90	
			100		EB2F2W100	
		2	125	EB2	EB2F2W125	
			150		EB2F2W150	
			15		EB1	EB1F3W15
20	EB1F3W20					
30	EB1F3W30					
FDB	3	1-1/2	40	EB1	EB1F3W40	
			50		EB1F3W50	
			60		EB1F3W60	
		2	70	EB2	EB2F3W70	
			90		EB2F3W90	
			100		EB2F3W100	
JD Frame — 125 Amps thru 250 Amps; 600 Vac (60 Hz) or 250 Vdc	2	3	125	EB3	EB3JB2W125	
			150		EB3JB2W150	
			175		EB3JB2W175	
		3	200		EB3	EB3JB2W200
			225			EB3JB2W225
			250			EB3JB2W250
JD	3	3	125	EB3	EB3JB3W125	
			150		EB3JB3W150	
			175		EB3JB3W175	
		3	200		EB3	EB3JB3W200
			225			EB3JB3W225
			250			EB3JB3W250



EB2



EB3

① Bolt-On Series conduit openings are tapped to size shown. A removable aluminum reducer bushing is furnished for each opening which, when installed, makes the conduit opening one size smaller.  
 ② Cutler-Hammer breaker provided as standard. For GE breaker change **W** to **G**; For Square D breaker change **C** to **S**.  
 ▼ For NEMA 4X, add **-N4** suffix (not suitable for Group B).

# EB Series Circuit Breaker and Enclosure

Explosionproof, Dust-Ignitionproof

NEC:  
 Class I, Division 1 and 2, Groups B, C, D  
 Class II, Division 1 and 2, Groups E, F, G  
 Class III  
 NEMA 3R, 4X<sup>†</sup>, 7BCD, 9EFG

## Dimensions in Millimeters (Inches)

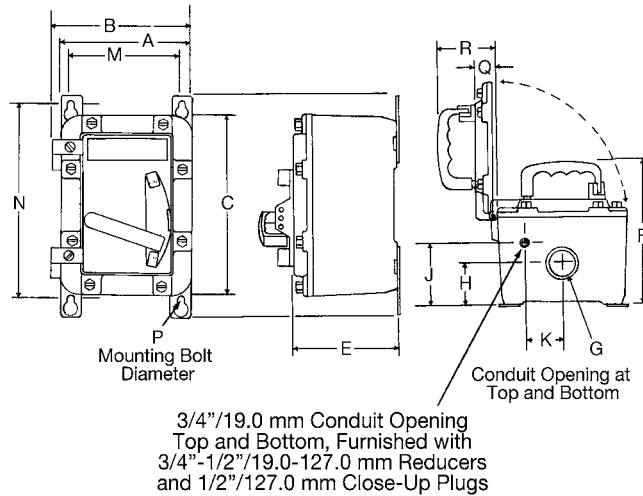

Dimension	EB1	EB2	EB3
A	196.8 (7.75)	231.9 (9.13)	376.6 (14.38)
B	209.5 (8.25)	244.6 (9.63)	387.3 (15.25)
C ①	308.1 (12.13)	358.9 (14.13)	511.3 (20.13)
D	374.6 (14.75)	425.4 (16.75)	625.6 (24.63)
E	165.1 (6.50)	182.6 (7.19)	270.0 (10.63)
F	225.5 (8.88)	244.6 (9.63)	330.2 (13.00)
G ②	38.1 (1.50)	50.8 (2.00)	76.2 (3.00)
H	57.9 (2.38)	69.0 (2.72)	116.5 (4.59)
J	86.6 (3.41)	95.2 (3.75)	169.9 (6.69)
K	65.0 (2.56)	65.0 (2.56)	104.9 (4.13)
M	155.7 (6.13)	190.5 (7.50)	308.1 (12.13)
N	336.5 (13.25)	384.3 (15.13)	581.1 (22.88)
P	9.5 (0.375)	9.5 (0.375)	17.1 (0.675)
Q	26.6 (1.50)	44.4 (1.75)	57.1 (2.25)
R	98.5 (3.88)	104.9 (4.13)	120.6 (4.75)

## Approximate Weight in Kilograms (Pounds)

	EB1	EB2	EB3
Enclosure Only	6.34 (14)	12.23 (27)	27.70 (61)
With Breaker ③	7.70 (17)	14.95 (33)	32.20 (71)

① For Drains and Breathers, add 50.8 mm (2") to dimension C. Close-up plugs furnished when enclosures are ordered without drains and breathers.  
 ② Conduit openings are tapped to size shown. A removable reducer bushing is furnished for each opening which, when installed, makes the conduit opening one size smaller.  
 ③ Approximate weights with breaker reflect largest size that will fit in each respective enclosure.  
 † For NEMA 4X, add -N4 suffix (not suitable for Group B).

DISTRIBUTION EQUIPMENT: NEC/CEC EXPLOSIONPROOF CIRCUIT BREAKERS

Appleton®

# EB Series Bolt-ON Series Circuit Breakers and Enclosures

## Explosionproof, Dust-Ignitionproof

### CEC:

Class I, Groups B, C, D

Class II, Groups E, F, G

Class III

NEMA 3R, 4X, 4X\*, 7BCD, 9EFG, 12

### Application

- These compact, rugged enclosures are used for protection and control of electrical equipment and circuits in:
  - Hazardous locations
  - Damp or wet locations
  - Corrosive locations
- The thermal magnetic breakers provide short circuit protection and thermal time delay overload protection, plus a disconnect means for service entrance, feeder or branch circuits used for lighting, heating, motors and equipment.

### Features

- Enclosure housings feature lightweight, corrosion resistant, spark-proof, copperfree aluminum with an epoxy coat for corrosion resistant construction.
- Enclosures have hinged, removable covers secured by “quick-bolts”. Mating surfaces are precision ground to explosionproof specifications.
- Captive “quick-bolts” allow fast, easy release of cover with a few turns on each. Bolts have hex head with screwdriver slot.
- Covers are hinged on left side and are removable. Provides easy access to interior for installation and maintenance. The hinged cover may be left in place to help protect the explosionproof machined surface during routine maintenance.
- Breaker handles are rugged and positive operating. The breaker actuator is designed to self-locate on the breaker handle. This unique feature prevents damage to the breaker toggle if the door is closed without aligning handle with breaker toggle position.
- Handle will accommodate up to 3 locks.
- Enclosures feature compact, easy to install design. Four removable mounting lugs with key holes, permitting easy installation for rack or individual mounting.
- Standard conduit openings are located top and bottom for line and load. Additional openings on top and bottom for drain and breather are also provided, with close-up plugs.
- Interior components are mounted on easily removable pan. Complete removal of this assembly gives full access to enclosure interior for wire pulling.

### Standard Materials

- Housings: copperfree (4/10ths of 1%) aluminum
- Operating shafts: stainless steel with stainless steel bushings
- Breaker actuator: spring steel
- Bolts: stainless steel

### Standard Finishes

- Exterior housing surfaces: epoxy coated

### Options

Must be listed in alphanumeric sequence at the end of the catalog number.

- Grounded neutral lug, add suffix —**GNL**.
- Insulated neutral lug, add suffix —**INL**.
- Drain and breather set, add suffix —**DV**.
- For CSA 4X, add suffix —**4X**.
- For NEMA 4X (not suitable for Group B), add suffix —**N4**.
- For +50 °C (+122 °F) breaker rating, add suffix —**V**.

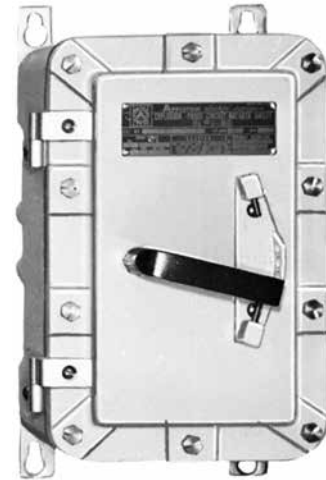

### CEC Certifications and Compliances

- CSA Standard: C22.2 No. 5.1, C22.2 No. 25, No. 30
- CSA Certified: 030391, 052308

DISTRIBUTION EQUIPMENT: NEC/CEC EXPLOSIONPROOF CIRCUIT BREAKERS

Appleton®

▼ For NEMA 4X, add —**N4** suffix.

Visit our website at [www.emerson.com](http://www.emerson.com) or contact us at (800) 621-1506.  
© November 2016

# EB Series Bolt-ON Series Circuit Breakers and Enclosures

## Explosionproof, Dust-Ignitionproof

CEC:  
 Class I, Groups B, C, D  
 Class II, Groups E, F, G  
 Class III  
 NEMA 3R, 4<sup>Y</sup>, 4X<sup>Y</sup>, 7BCD, 9EFG, 12

### Ordering Instructions

Provide catalog number from listing tables. Enclosures are supplied with Cutler-Hammer circuit breakers as standard. Table below shows enclosure sizes for Cutler-Hammer and other makes of breakers that can be accommodated, and are available on special order. To order enclosure with other than Cutler-Hammer breaker, replace the **W** in the catalog number with the Manufacturer's Symbol for the desired breaker of another make: **G**—General Electric; **S**—Square D.

### Catalog Number Explanation

Appleton catalog numbers incorporate a simple, systemized method of designating enclosure and component specifications. For example, an EB Series enclosure with breaker is cataloged as follows:

### Catalog Numbering Guide

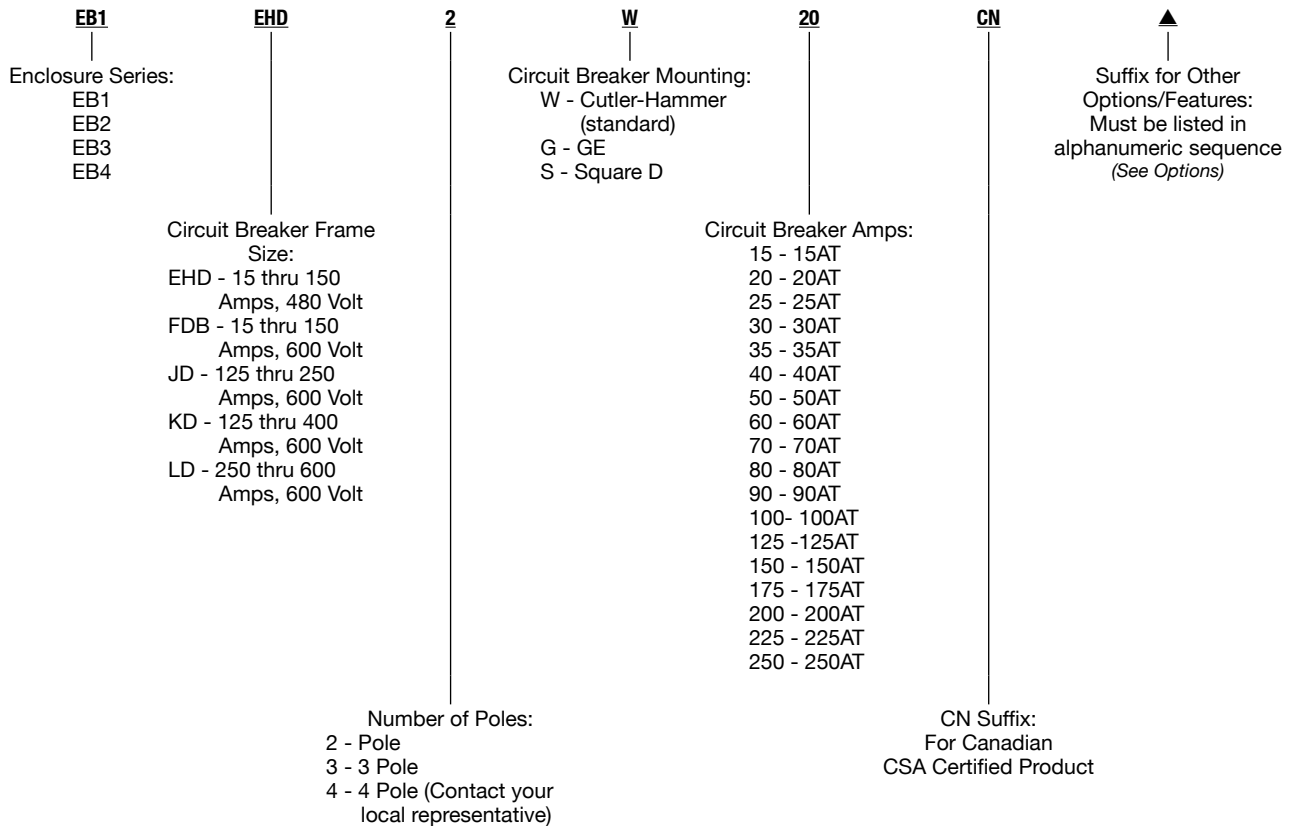

DISTRIBUTION EQUIPMENT: NEC/CEC EXPLOSIONPROOF CIRCUIT BREAKERS



▲ To complete the catalog number please add the appropriate suffix for other options/features. These suffixes can be found in the modifications table in this section.  
 ▼ For NEMA 4X, add **-N4** suffix.  
 † Cutler-Hammer is a registered trademark of Eaton Corporation.



# EB Series Frame Bolt-ON Series Circuit Breakers and Enclosures

Explosionproof, Dust-Ignitionproof

CEC:

Class I, Groups B, C, D

Class II, Groups E, F, G

Class III

NEMA 3R, 4\*, 4X\*, 7BCD, 9EFG, 12

Circuit Breaker				Catalog Numbers				
No. of Poles	Amp. Rating	Tap Size ①	Enclosure Only	With Breaker				
<b>EB Frame — 15 Amps thru 100 Amps 240 Vac or 125-250 Vdc (60 Hz)</b>								
2	15	1-1/2	EB1	EB1E2W15				
	20			EB1E2W20				
	30			EB1E2W30				
	40			EB1E2W40				
	50			EB1E2W50				
	70	2	EB2	EB2E2W70				
	90			EB2E2W90				
	100			EB2E2W100				
	3			15	1-1/2	EB1	EB1E3W15	
				20			EB1E3W20	
30		EB1E3W30						
40		EB1E3W40						
50		EB1E3W50						
70		2	EB2	EB2E3W70				
90				EB2E3W90				
100				EB2E3W100				
<b>EHD Frame — 15 Amps thru 100 Amps 480 Vac or 250 Vdc (60 Hz)</b>								
2				15	1-1/2	EB1	EB1EH2W15	
	20	EB1EH2W20						
	30	EB1EH2W30						
	40	EB1EH2W40						
	50	EB1EH2W50						
	70	2	EB2	EB2EH2W70				
	90			EB2EH2W90				
	100			EB2EH2W100				
	3			15	1-1/2	EB1	EB1EH3W15	
				20			EB1EH3W20	
30		EB1EH3W30						
40		EB1EH3W40						
50		EB1EH3W50						
70		2	EB2	EB2EH3W70				
90				EB2EH3W90				
100				EB2EH3W100				



EB2

DISTRIBUTION EQUIPMENT: NEC/CEC EXPLOSIONPROOF CIRCUIT BREAKERS

Apletton

① Conduit openings are tapped to size shown. A removable reducer bushing is furnished for each opening which, when installed, makes the conduit opening one size smaller.

▼ For NEMA 4X, add —N4 suffix.

# EB Series Bolt-ON Series Circuit Breakers and Enclosures

Explosionproof, Dust-Ignitionproof

CEC:  
 Class I, Groups B, C, D  
 Class II, Groups E, F, G  
 Class III  
 NEMA 3R, 4<sup>▼</sup>, 4X<sup>▼</sup>, 7BCD, 9EFG, 12

DISTRIBUTION EQUIPMENT: NEC/CEC EXPLOSIONPROOF CIRCUIT BREAKERS



EB2

Circuit Breaker			Catalog Numbers	
No. of Poles	Amp. Rating	Tap Size ①	Enclosure Only	With Breaker
<b>FDB Frame — 15 Amps thru 150 Amps 600 Vac or 250 Vdc (60 Hz)</b>				
2	15	1-1/2	EB1	EB1F2W15
	20			EB1F2W20
	30			EB1F2W30
	40			EB1F2W40
	50			EB1F2W50
	70	2	EB2	EB2F2W70
	90			EB2F2W90
	100			EB2F2W100
	125			EB2F2W125
	150			EB2F2W150
3	15	1-1/2	EB1	EB1F3W15
	20			EB1F3W20
	30			EB1F3W30
	40			EB1F3W40
	50			EB1F3W50
	70	2	EB2	EB2F3W70
	90			EB2F3W90
	100			EB2F3W100
	125			EB2F3W125
	150			EB2F3W150
<b>JD Frame — 125 Amps thru 225 Amps 600 Vac or 250 Vdc (60 Hz)</b>				
2	175	2-1/2	EB3	EB3JA2W175
	200			EB3JA2W200
	225			EB3JA2W225
3	175	2-1/2	EB3	EB3JA3W175
	200			EB3JA3W200
	225			EB3JA3W225

① Conduit openings are tapped to size shown. A removable reducer bushing is furnished for each opening which, when installed, makes the conduit opening one size smaller.

▼ For NEMA 4X, add —N4 suffix.

# EB Series Bolt-ON Series Circuit Breakers and Enclosures

Explosionproof, Dust-Ignitionproof

**CEC:**

Class I, Groups B, C, D

Class II, Groups E, F, G

Class III

NEMA 3R, 4\*, 4X\*, 7BCD, 9EFG, 12

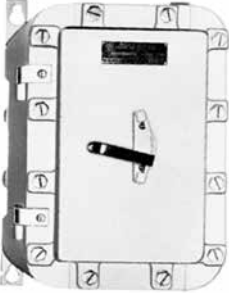
	Circuit Breaker			Catalog Numbers	
	No. of Poles	Amp. Rating	Tap Size ①	Enclosure Only	With Breaker
 <p style="text-align: center;"><b>EB3</b></p>	<b>KD Frame — 125 Amps thru 225 Amps 600 Vac or 250 Vdc (60 Hz)</b>				
	2	125	2-1/2	<b>EB3</b>	EB3KA2W125
		150			EB3KA2W150
		175			EB3KA2W175
		200			EB3KA2W200
		225			EB3KA2W225
	3	125	2-1/2	<b>EB3</b>	EB3KA3W125
		150			EB3KA3W150
		175			EB3KA3W175
		200			EB3KA3W200
225		EB3KA3W225			
<b>LD Frame — 225 Amps thru 400 Amps 600 Vac or 250 Vdc (60 Hz)</b>					
2	250	3	<b>EB4</b>	EB4LA2W250	
	300			EB4LA2W300	
	350			EB4LA2W350	
	400			EB4LA2W400	
3	250	3	<b>EB4</b>	EB4LA3W250	
	300			EB4LA3W300	
	350			EB4LA3W350	
	400			EB4LA3W400	

DISTRIBUTION EQUIPMENT: NEC/CEC EXPLOSIONPROOF CIRCUIT BREAKERS

① Conduit openings are tapped to size shown. A removable reducer bushing is furnished for each opening which, when installed, makes the conduit opening one size smaller.

▼ For NEMA 4X, add **-N4** suffix.

# EB Series Bolt-ON Series Circuit Breakers and Enclosure

Explosionproof, Dust-Ignitionproof

CEC:  
 Class I, Groups B, C, D  
 Class II, Groups E, F, G  
 Class III  
 NEMA 3R, 4 $\nabla$ , 4X $\nabla$ , 7BCD, 9EFG, 12

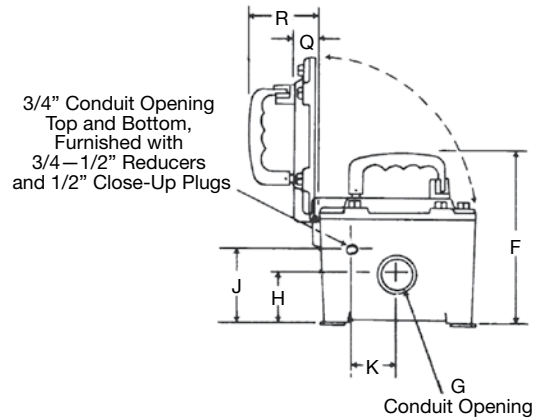
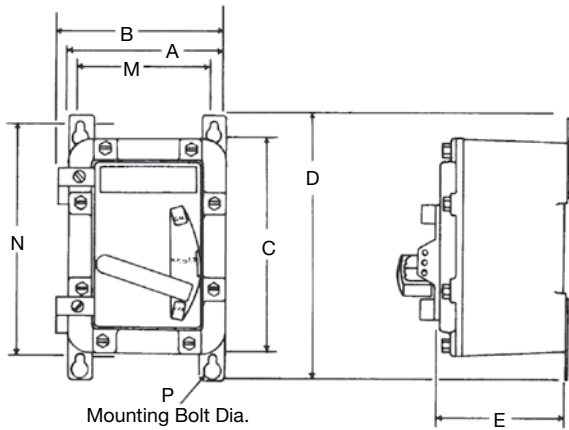

DISTRIBUTION EQUIPMENT: NEC/CEC EXPLOSIONPROOF CIRCUIT BREAKERS

## Dimensions in Millimeters (Inches)

Dim.	Catalog Numbers			
	EB1	EB2	EB3	EB4
A	196.9 (7.75)	231.1 (9.13)	393.7 (15.50)	393.7 (15.50)
B	209.6 (8.25)	244.5 (9.63)	406.4 (16.00)	406.4 (16.00)
C ②	308.0 (12.13)	358.8 (14.13)	596.9 (23.50)	800.1 (31.50)
D	375.7 (14.75)	425.5 (16.75)	614.4 (24.19)	817.6 (32.19)
E	165.1 (6.50)	184.2 (7.25)	289.6 (11.40)	289.6 (11.40)
F	225.4 (8.88)	244.5 (9.63)	323.9 (12.75)	323.9 (12.75)
G ③	38.1 (1.50)	50.8 (2.00)	50.8 (2.00)	76.2 (3.00)
H	60.3 (2.38)	69.9 (2.75)	100.1 (3.94)	100.1 (3.94)
J	95.3 (3.75)	95.3 (3.75)	115.8 (4.56)	115.8 (4.56)
K	44.5 (1.75)	69.9 (2.75)	-	-
M	155.6 (6.13)	190.5 (7.50)	298.5 (11.75)	298.5 (11.75)
N	3636.6 (13.25)	384.2 (15.13)	576.3 (22.69)	779.5 (30.69)
P	9.5 (0.38)	9.5 (0.38)	-	-
Q	38.1 (1.50)	44.5 (1.75)	-	-
R	98.4 (3.88)	104.8 (4.13)	-	-

## Approximate Weight Kilograms (Pounds) ①

	Catalog Numbers			
	EB1	EB2	EB3	EB4
Enclosure Only	6 (14)	12 (27)	46 (101)	57 (126)
With Interior	8 (17)	15 (33)	54 (119)	68 (150)

① Approximate weights with breaker reflect largest size that will fit in each respective enclosure.

② For drain and breather set, add 50.8 mm (2") to dimension "C". Close-up plugs furnished when enclosures are ordered without drains and breathers.

③ Conduit openings are tapped to size shown. A removable reducer bushing is furnished for each opening which, when installed, makes the conduit opening one size smaller.

▼ For NEMA 4X, add -N4 suffix.



# Threaded Circuit Breakers and Enclosures

## Explosionproof, Dust-Ignitionproof, Watertight

2- and 3-Pole, Non-Interchangeable Trip. Threaded Enclosure Type.

### NEC:

Class I, Division 1 and 2, Groups C, D  
Class II, Division 1 and 2, Groups E, F, G  
Class III  
NEMA 4X, 7CD, 9EFG

### Application

- “AE” type circuit breakers are used in areas where hazardous materials are handled or stored.
- These units provide protection against overloading and/or short circuits on power circuit feeder or branch circuits. They also provide disconnect means and thermal time delay overload protection.

### Features

- Cast on slotted mounting feet.
- Ground lug package and installation instruction for termination of ground wire.
- External operating handle with slots for limiting handle travel.
- Breaker operator can be locked in the ON or OFF position.
- Standard outlets for line and load wiring.
- Plugged 1/2” outlets top and bottom for breather and drain.
- Wide range of drilled and tapped outlets.
- Breakers are mounted on a painted removable pan.
- Enclosures are designed to accept GE ▶, Square D ■ and Cutler-Hammer + circuit breakers. For other brands—contact your local representative.
- Enclosures furnished with or without breakers.
- Readily accessible circuit breakers outside the center housing.
- Rated for NEMA 4X (gray epoxy-coated inside and outside).
- Acme screw type square threads designed to prevent seizing.
- Bell threads are located inside the housing—protects against damage or contaminants.

### Standard Materials

- Housing: cast copperfree (4/10 of 1% max.) aluminum
- Breaker shafts, operators, bushings and exposed hardware: stainless steel

### Standard Finishes

- Housing: epoxy coated inside and outside

### Options

Must be listed in alphanumeric sequence at the end of the catalog number.

- Auxiliary switch (1A or 1B), add suffix —**AS1**.
- Auxiliary switch (2A or 2B), add suffix —**AS2**.
- Breather, NEMA 4X (includes outlet and installation), add suffix —**BR**.
- Drain, NEMA 4X (includes outlet and installation), add suffix —**DN**.
- External grounding stud, add suffix —**EGS**.
- Plastic nameplate, add suffix —**NP**.
- Shunt trip (specify voltage), add suffix —**ST**.
- Under voltage release (specify voltage), add suffix —**UV**.
- For +50 °C (+122 °F) breaker rating, add suffix —**V**.

### NEC Certifications and Compliances

- UL Standard: UL 1203
- UL Listed: E84577

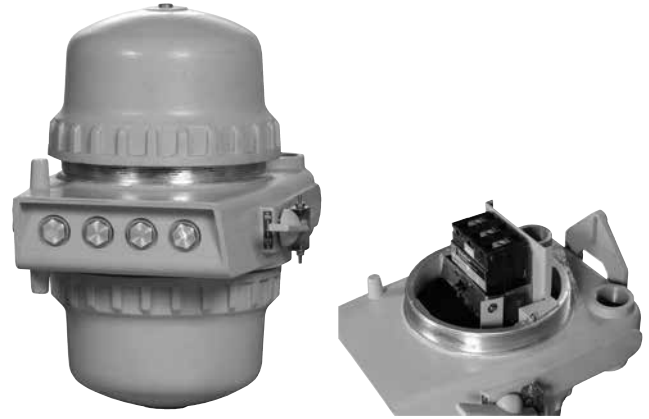

DISTRIBUTION EQUIPMENT: NEC/CEC EXPLOSIONPROOF CIRCUIT BREAKERS

Appleton®

▶ GE is a registered trademark of General Electric Company.

■ Square is a registered trademark of Schneider Electric.

+ Cutler-Hammer is a registered trademark of Eaton Corporation.

# Threaded Circuit Breakers and Enclosures

## Explosionproof, Dust-Ignitionproof, Watertight

2- and 3-Pole, Non-Interchangeable Trip. Threaded Enclosure Type.

**NEC:**  
 Class I, Division 1 and 2, Groups C, D  
 Class II, Division 1 and 2, Groups E, F, G  
 Class III  
 NEMA 4X, 7CD, 9EFG

### Catalog Numbering Guide

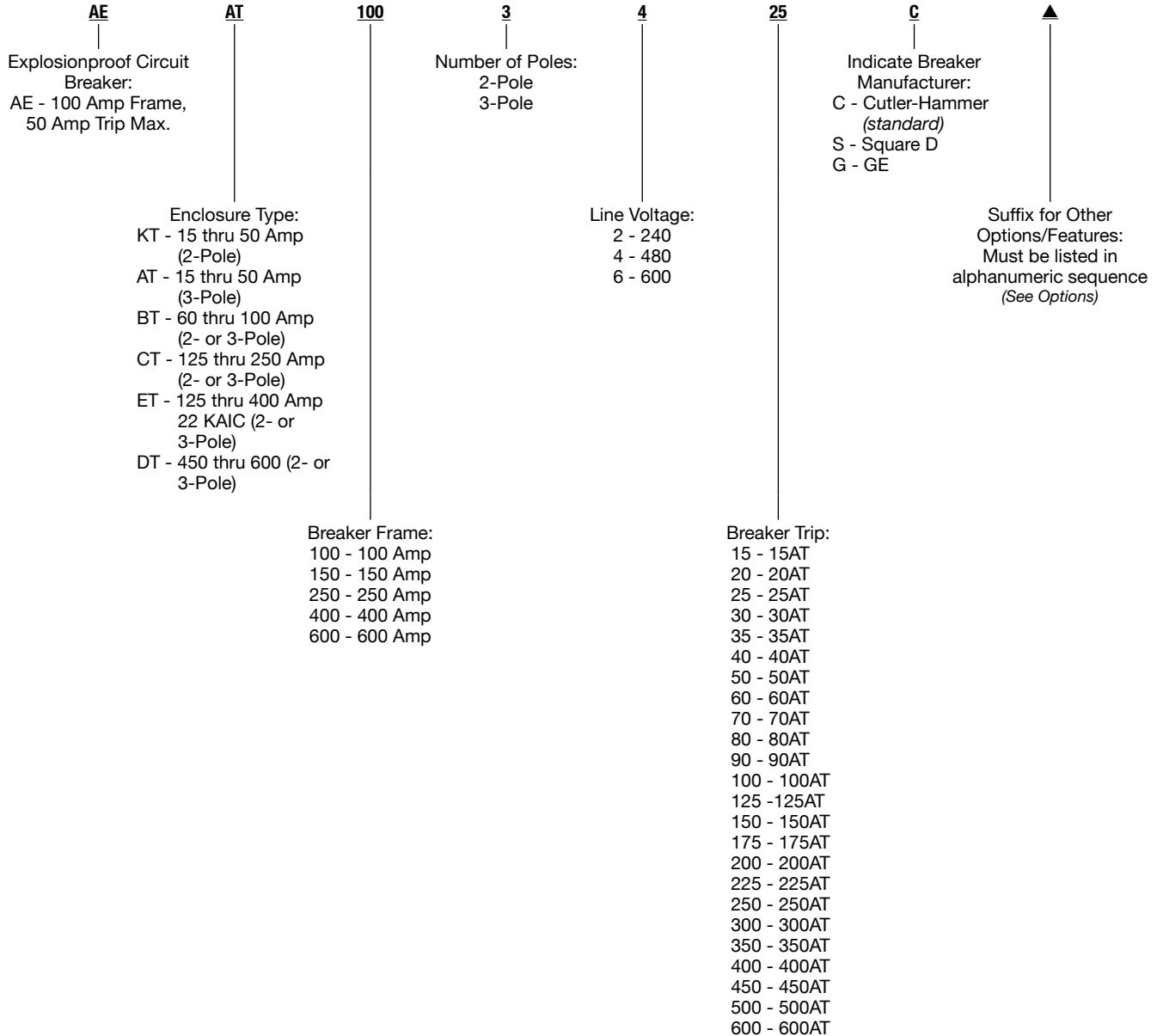

DISTRIBUTION EQUIPMENT: NEC/CEC EXPLOSIONPROOF CIRCUIT BREAKERS



▲ To complete the catalog number please add the appropriate suffix for other options/features. These suffixes can be found under Options in this section.

# Threaded Circuit Breaker and Enclosure

## Explosionproof, Dust-Ignitionproof, Watertight

2- and 3-Pole, Non-Interchangeable Trip. Threaded Enclosure Type.

**NEC:**

Class I, Division 1 and 2, Groups C, D  
 Class II, Division 1 and 2, Groups E, F, G  
 Class III  
 NEMA 4X, 7CD, 9EFG

**Dimensions in Millimeters (Inches)**

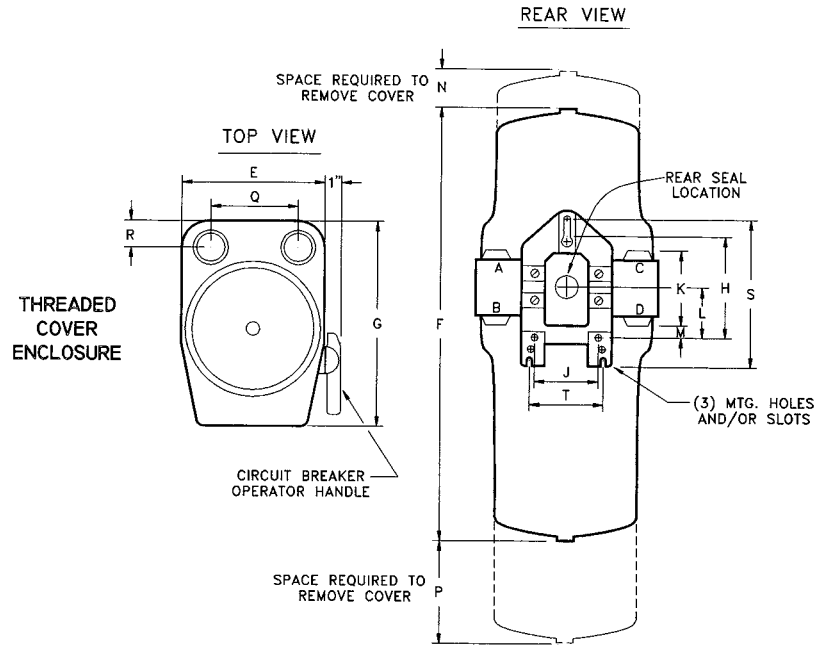

Dimensions	AEKT	AEAT	AEBT	AECT	AEET	AEDT
E	270.0 (10.63)	270.0 (10.63)	270.0 (10.63)	350.0 (13.78)	482.6 (19.00)	482.6 (19.00)
F	571.5 (22.50)	571.5 (22.50)	571.5 (22.50)	698.5 (27.50)	1206.5 (47.50)	1206.5 (47.50)
G	387.3 (15.25)	387.3 (15.25)	387.3 (15.25)	514.35 (20.25)	704.8 (27.75)	704.8 (27.75)
H	203.2 (8.00)	203.2 (8.00)	203.2 (8.00)	203.2 (8.00)	—	—
J	120.6 (4.75)	120.6 (4.75)	120.6 (4.75)	120.6 (4.75)	—	—
K	146.8 (5.78)	146.8 (5.78)	146.8 (5.78)	190.5 (7.50)	285.75 (11.25)	285.75 (11.25)
L	95.5 (3.75)	95.5 (3.75)	95.5 (3.75)	95.2 (3.75)	146.0 (5.75)	146.0 (5.75)
M	26.9 (1.06)	26.9 (1.06)	26.9 (1.06)	—	3.3 (0.13)	3.3 (0.13)
N	190.5 (7.50)	190.5 (7.50)	190.5 (7.50)	270.0 (10.63)	406.4 (16.00)	406.4 (16.00)
P	279.4 (11.00)	279.4 (11.00)	279.4 (11.00)	584.2 (23.00)	524.0 (20.63)	524.0 (20.63)
Q	185.6 (7.31)	185.6 (7.31)	185.6 (7.31)	219.2 (8.63)	299.2 (11.78)	299.2 (11.78)
R	58.6 (2.31)	58.6 (2.31)	58.6 (2.31)	76.2 (3.00)	107.4 (4.32)	107.4 (4.32)
S	—	—	—	—	304.8 (12.00)	304.8 (12.00)
T	—	—	—	—	165.1 (6.50)	165.1 (6.50)

**Approximate Weight in Kilograms (Pounds)**

For Enclosure Only	AEKT	AEAT	AEBT	AECT	AEET	AEDT
	15.75 (35)	15.75 (35)	15.75 (35)	36.00 (80)	90.00 (200)	90.00 (200)

DISTRIBUTION EQUIPMENT: NEC/CEC EXPLOSIONPROOF CIRCUIT BREAKERS



# PlexPower™ Factory Sealed Enclosed Circuit Breakers

## Stainless Steel Enclosures

### NEC/CEC — RQE Series:

Class I, Division 2, Group B, C, D  
Class I, Zone 1 AEx de IIB+H<sub>2</sub> T5  
Class II, Division 1, Group F, G  
Class III

### NEC/CEC — RFE Series:

Class I, Division 2, Group C, D  
Class I, Zone 1 AEx de IIB T5  
Class II, Division 1, Group F, G  
Class III

### ATEX/IECEx — RFE Series:

Ex de IIB+H<sub>2</sub> T6 U  
Type 4X, IP66  
Optional ATEX IECEx - Ex de IIB+H<sub>2</sub> T5

## Applications

- The PlexPower™ enclosed breaker provides indoor and outdoor protection and control of electrical circuits in hazardous environments such as:
  - Petroleum plants
  - Chemical plants
  - Refineries
  - Other process facilities
- Ideal for installation in wet, corrosive environments or where flammable gases or vapors are likely to be present.

## Features

- **No external conduit or cable seals required** making installations faster, easier, and less costly.
- The PlexPower™ enclosed breaker features a ground-breaking design that incorporates the use of a single breaker housing to minimize the downtime and costs associated with servicing circuit breakers in hazardous locations.
- Standard, off-the-shelf breakers are used and the lighter weight enclosures can be quickly opened in the field for easier servicing. There are no special breakers to buy.
- Standard configuration includes external actuator and a non-window door. Factory installed options include window door, internal actuator or alternate enclosure sizes and orientations.
- Enclosure can be easily field punched for cable glands or conduit hubs. Optional gland plates available and must be ordered with the enclosure for factory installation.
- Circuit breaker available in 2- or 3-pole up to 150 Amp range.
- Breaker can be padlocked in either the ON or OFF position.
- Voltage ranges from 120 to 600 volts.
- QC breaker terminal wire range #14-1/0.
- F-Frame breaker terminal wire range #14-4/0.
- Ground terminal bar provided.
- External ground lug.
- Accommodates standard Cutler-Hammer<sup>+</sup> QC Series or F-Frame Series circuit breaker individually contained in its own housing.

## Standard Materials

- Enclosure: 316L stainless steel
- Hardware: stainless steel

## Options

Must be listed in alphanumeric sequence at the end of the catalog number.  
(Contact your local representative for price and availability.)

- Drain and breather add suffix —**DV**.
- LED indicator lights add suffix —**IL**.
- Heater add suffix —**HTR**.
- Ground neutral bar add suffix —**GN**.
- Standard neutral bar add suffix —**NB**.
- Gland plate add suffix —**GPL** = left side, —**GPR** = right side, —**GPT** = top, —**GPB** = bottom.
- HID rated breaker add suffix —**HID**.
- Door padlocking provision add suffix —**P**.
- Phenolic nameplate (specify legend) add suffix —**NP**.
- Stainless steel nameplate (specify legend) add suffix —**SP**.
- Window door add suffix —**W**.
- For +50 °C (+122 °F) breaker rating, add suffix —**V**.



External Actuation Shown

## NEC/CEC Certifications and Compliances

- UL Standard: 67, 1203, 1604
- UL Listed: 60079: 0, 7, 1
- CSA Standard: C22.2: Nos. 29, 213
- CSA Certified: 1788693, 60079-0, 7, 1

## ATEX/IECEx Certifications and Compliances

- ATEX IECEx - Ex de IIB+H<sub>2</sub> T5 approved version available for RF Series only, up to 160 Amp, 1- 2- or 3-pole, add suffix -**X**.

## Related Products

- Additional PlexPower™ products:
  - PlexPower™ Factory Sealed Panelboard with Bus Bar
  - PlexPower™ Fused Factory Sealed Panelboard with Bus Bar

+ Cutler-Hammer is a registered trademark of Eaton Corporation.

# PlexPower™ Factory Sealed Enclosed Circuit Breakers

## Stainless Steel Enclosures

**NEC/CEC – RQE Series:**  
 Class I, Division 2, Group B, C, D  
 Class I, Zone 1 AEx de IIB+H<sub>2</sub> T5  
 Class II, Division 1, Group F, G  
 Class III

**NEC/CEC – RFE Series:**  
 Class I, Division 2, Group C, D  
 Class I, Zone 1 AEx de IIB T5  
 Class II, Division 1, Group F, G  
 Class III

**ATEX/IECEX – RFE Series:**  
 Ex de IIB+H<sub>2</sub> T6 U  
 Type 4X, IP66  
 Optional ATEX IECEX - Ex de IIB+H<sub>2</sub> T5

### Ordering Instructions

1. Determine breaker size using enclosure specification chart.
2. Note if breaker is QC or F-Frame type.
3. Structure catalog string using the logic shown here.
4. Enclosure is stainless steel.

### Catalog Numbering Guide

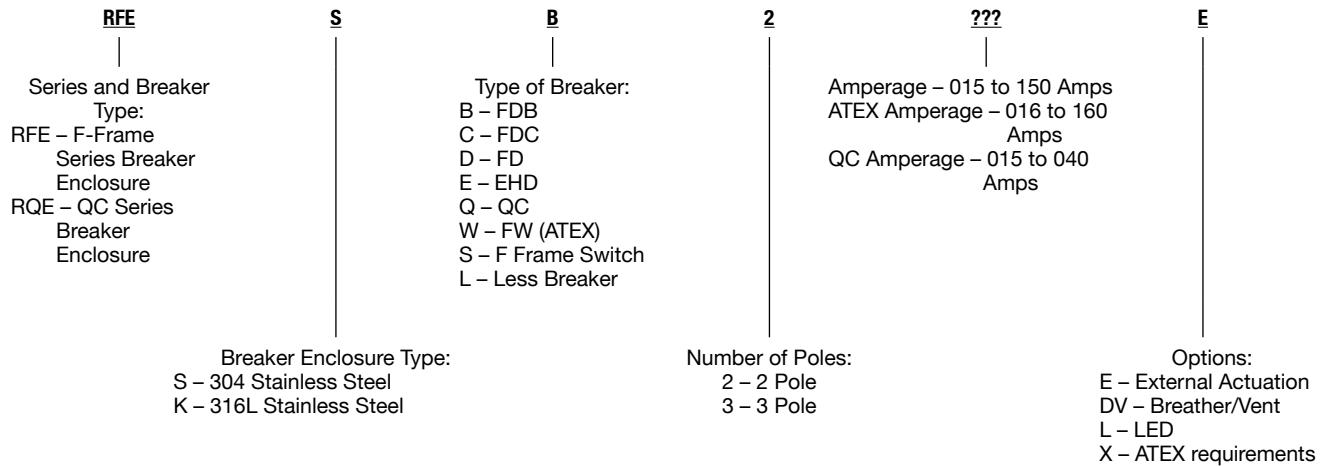

### Enclosure Specifications

Material	Size	Enclosure Dimensions in Millimeters (Inches) (H x W x D)	Max Amperage	Breaker Type
Stainless Steel	A	370 x 370 x 200 (14.5 x 14.5 x 7.9)	40 Amp	QC-Frame
	B	560 x 370 x 200 (22.0 x 14.5 x 7.9)	150 Amp	F-Frame

▲ To complete the catalog number please add the appropriate suffix for other options/features. These suffixes can be found under Options.

# PlexPower™ Factory Sealed Enclosed Circuit Breakers

## Stainless Steel Enclosures

**NEC/CEC – RQE Series:**  
 Class I, Division 2, Group B, C, D  
 Class I, Zone 1 AEx de IIB+H<sub>2</sub> T5  
 Class II, Division 1, Group F, G  
 Class III

**NEC/CEC – RFE Series:**  
 Class I, Division 2, Group C, D  
 Class I, Zone 1 AEx de IIB T5  
 Class II, Division 1, Group F, G  
 Class III

**ATEX/IECEX – RFE Series:**  
 Ex de IIB+H<sub>2</sub> T6 U  
 Type 4X, IP66  
 Optional ATEX IECEX - Ex de IIB+H<sub>2</sub> T5

### QC

Continuous Amp Rating at +40 °C (+104 °F)	2-Pole 120/240 Vac	3-Pole 240 Vac	Enclosure Size
15	QC2015	QC3015H	A
20	QC2020	QC3020H	A
30	QC2030	QC3030H	A
40	QC2040	QC3040H	A

### F-Frame

Maximum Continuous Amp Rating at +40 °C (+104 °F)	2-Pole 480 Vac/250 Vdc	3-Pole 480 Vac/250 Vdc	Enclosure Size	2-Pole 480 Vac/250 Vdc	3-Pole 480 Vac/250 Vdc	Enclosure Size
15	EHD2015	EHD3015	A	FD2015	FD3015	A
20	EHD2020	EHD3020	A	FD2020	FD3020	A
30	EHD2030	EHD3030	A	FD2030	FD3030	A
40	EHD2040	EHD3040	A	FD2040	FD3040	A
50	EHD2050	EHD3050	A	FD2050	FD3050	A
60	EHD2060	EHD3060	A	FD2060	FD3060	A
70	EHD2070	EHD3070	B	FD2070	FD3070	B
80	EHD2080	EHD3080	B	FD2080	FD3080	B
90	EHD2090	EHD3090	B	FD2090	FD3090	B
100	EHD2100	EHD3100	B	FD2100	FD3100	B
110	—	—	—	FD2110	FD3110	B
125	—	—	—	FD2125	FD3125	B
150	—	—	—	FD2150	FD3150	B

Maximum Continuous Amp Rating at +40 °C (+104 °F)	For ATEX Applications Only		Enclosure Size	2-Pole 600 Vac/250 Vdc	3-Pole 600 Vac/250 Vdc	Enclosure Size
	2-Pole 240/415/480/600/690 Vac	3-Pole 240/415/480/600/690 Vac				
15	—	—	—	FDB2015	FDB3015	A
16	FWF2016L	FWF3016L	A	—	—	—
20	FWF2020L	FWF3020L	A	FDB2020	FDB3020	A
25	FWF2025L	FWF3025L	A	—	—	—
30	—	—	—	FDB2030	FDB3030	A
32	FWF2032L	FWF3032L	A	—	—	—
40	FWF2040L	FWF3040L	A	FDB2040	FDB3040	A
50	FWF2050L	FWF3050L	A	FDB2050	FDB3050	A
60	—	—	—	FDB2060	FDB3060	A
63	FWF2063L	FWF3063L	A	—	—	—
70	—	—	—	FDB2070	FDB3070	B
80	FWF2080L	FWF3080L	B	FDB2080	FDB3080	B
90	—	—	—	FDB2090	FDB3090	B
100	FWF2100L	FWF3100L	B	FDB2100	FDB3100	B
110	—	—	—	FDB2110	FDB3110	B
125	FWF2125L	FWF3125L	B	FDB2125	FDB3125	B
150	—	—	—	FDB2150	FDB3150	B
160	FWF2160L	FWF3160L	B	—	—	—

Appleton

DISTRIBUTION EQUIPMENT: NEC/CEC, ATEX/IECEX FLAMEPROOF CIRCUIT BREAKERS

# PlexPower™ Factory Sealed Enclosed Circuit Breaker

## Stainless Steel Enclosures

**NEC/CEC — RQE Series:**  
 Class I, Division 2, Group B, C, D  
 Class I, Zone 1 AEx de IIB+H<sub>2</sub> T5  
 Class II, Division 1, Group F, G  
 Class III

**NEC/CEC — RFE Series:**  
 Class I, Division 2, Group C, D  
 Class I, Zone 1 AEx de IIB T5  
 Class II, Division 1, Group F, G  
 Class III

**ATEX/IECEX — RFE Series:**  
 Ex de IIB+H<sub>2</sub> T6 U  
 Type 4X, IP66  
 Optional ATEX/IECEX - Ex de IIB+H<sub>2</sub> T5

### Dimensions in Millimeters (Inches)

**Size A 3-Pole Circuit QC**

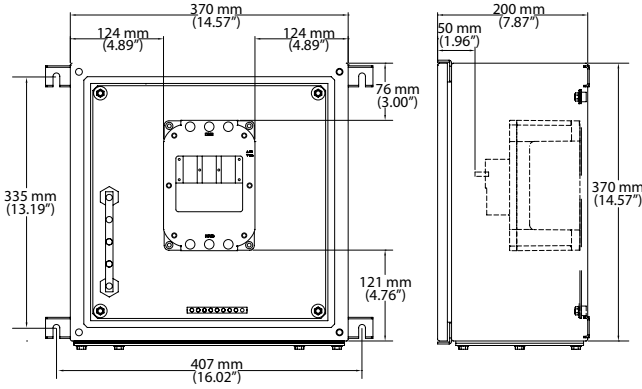

**Size A 3-Pole Circuit F-Frame**

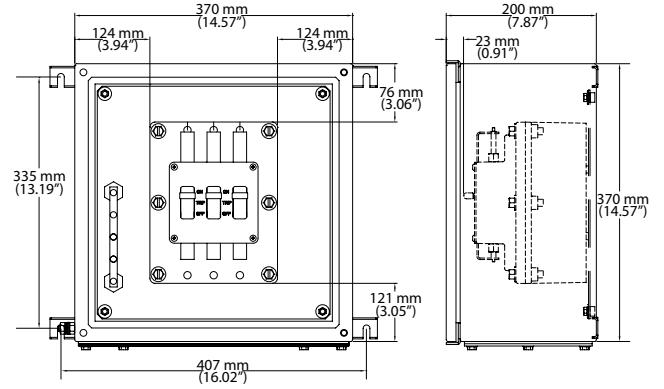

**Size B 3-Pole Circuit F-Frame**

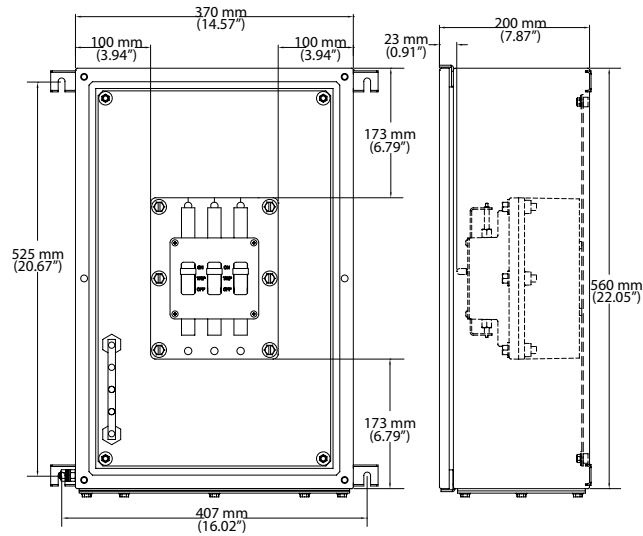

(Used as a main breaker in the position shown)

# ATX™ CBU, SWU, RCU Series Branch Circuit Breakers, Switches, Relays, Contactors

## For Increased Safety Enclosures

ATEX/IECEX:  
Zone 1 and 2  
Ⓢ II 2 GD

### Applications

- Useful as back-up circuit breaker protection or as main circuit breaker protection for hazardous areas.
- To be fitted inside increased safety Ex e enclosures.

### Features

- Up to 40 A for 2-pole circuit breaker versions.
- Up to 63 A for 2-pole with GFI, 3-pole and 4-pole circuit breaker versions.
- Up to 63 A for switch versions.
- Breaking capacity 10 kA – 400 V according to EN/IEC 60947-2 standard.
- Breaking capacity 6 kA-400 V according to EN/IEC 60898 standard.
- Supplied with front rotary control handle padlockable in OFF position.
- Terminal capacity: 1 x 25 mm<sup>2</sup> (0.002 x 0.039 in<sup>2</sup>).
- Mounting in polyester (ECEP series) or in 316L stainless steel (ECES series) enclosures. Can be fixed either on the door or at the back of the enclosure.

### Standard Materials

- Housing: polyamide

### ATEX/IECEX Certifications and Compliances

- Certification Type IT40U (2-pole versions)
  - Gas, Zones 1 and 2 (Authorized to be used in an approved dustproof enclosure)
  - Conforming to ATEX 94/9/CE: Ⓢ II 2 G
  - Type of Protection: Ex de IIC
  - Service Temperature: -20 °C to +55 °C (-4 °F to +131 °F)
  - CE Declaration of Conformity: 5C216
  - ATEX Certificate: LCIE 02 ATEX 0035U
  - IECEx Certificate: IECEx LCI 04.0033U
- Certification Type CBU (2-pole GFI, 3-pole and 4-pole versions)
  - Gas, Zones 1 and 2 (Authorized to be used in an approved dustproof enclosure)
  - Conforming to ATEX 94/9/CE: Ⓢ II 2 G
  - Type of Protection: Ex de IIC
  - Service Temperature: -20 °C to +55 °C (-4 °F to +131 °F)
  - CE Declaration of Conformity: 5C244
  - ATEX Certificate: LCIE 09 ATEX 3068U
  - IECEx Certificate: IECEx LCI 09.0023L

### EURASEC Certification

- Certification Type IT40U (2-pole versions)
  - EURASEC N° TC RU C-FR.ГБ05.В.00909
- Certification Type CBU (2-pole GFI, 3 and 4-pole versions)
  - EURASEC N° TC RU C-FR.ГБ05.В.00909

### Other Certification ①

- Certification Type IT40U (2-pole versions)
  - INMETRO Certificate: BVC 11.0594-U
- Certification Type CBU (2-pole GFI, 3 and 4-pole versions)
  - INMETRO Certificate: BVC 10.0011-U



2-Pole Circuit Breaker with GFI



4-Pole Circuit Breaker



2-Pole Circuit Breaker



4-Pole Switch

DISTRIBUTION EQUIPMENT: ATEX/IECEX INCREASED SAFETY CIRCUIT BREAKERS

Appleton

① INMETRO certification available on special request only. Contact your local sales representative for more information.



# ATX™ CBU, SWU, RCU Series Branch Circuit Breakers, Switches, Relays, Contactors

## For Increased Safety Enclosures

ATEX/IECEX:  
Zone 1 and 2  
II 2 GD

### Catalog Numbering Guide — ATEX/IECEX Certified Branch Circuit Breakers, Switches

<b>CBU</b>   Circuit Breaker Series: <b>CBU</b> - Circuit Breaker 2P, 3P and 4P  <b>CBUN</b> - Circuit Breaker 2P+GFI version  Switch Series: <b>SWU</b> - Switch ①	<b>1</b>   Number of Poles: 1 - 1-Pole 2 - 2-Poles 3 - 3-Poles 4 - 4-Poles 9 - 1-Pole + Neutral	<b>01</b>   Intensity: ① 01 - 1 A 02 - 2 A 03 - 3 A 04 - 4 A 06 - 6 A 10 - 10 A 16 - 16 A 20 - 20 A 25 - 25 A 32 - 32 A 40 - 40 A 50 - 50 A 63 - 63 A	<b>B</b>   Curve Type: B - Curve B C - Curve C D - Curve D	<b>R1</b>   GFI: R1 - 30 mA R2 - 300 mA	<b>5</b>   Options: 5 - 440 Vac 6 - 480 Vac F3 - 1 NO/NC Fault Indication Contact F5 - NO Fault Indication Contact F9 - NC Fault Indication Contact S3 - 1 NO/NC Auxiliary Contact S5 - 2 NO Auxiliary Contact S9 - 2 NC Auxiliary Contact M - 15 kA Breaking Capacity P - 25 kA Breaking Capacity
---	--	--	---	---	---

### Catalog Numbering Guide — ATEX/IECEX Certified Relays and Contactors

<b>RCU</b>   RCU : Relay and Contactor	<b>1</b>   Number of Poles: 2 - 2-Poles 3 - 3-Poles 4 - 4-Poles	<b>01</b>   Intensity: 20 - 20 A 24 - 24 A 40 - 40 A	<b>B</b>   Number of contacts: - For 20 Amps only: 20 - 2NO 02 - 2NC 11 - 1NO+1NC - For 24 Amps only: 40 - 4NO 04 - 4NC 13 - 1NO+3NC 22 - 2NO+2NC 31 - 3NO+1NC - For 40 Amps only: 40 - 4NO 22 - 2NO+2NC 31 - 3NO+1NC	<b>R1</b>   Coil voltage: 24 - 24VAC (for 20,24,40 Amps only) 23 - 230VAC (for 20,24,40 Amp)
--	--	---	---	--

① SWU Series Switches: Up to 40 Amps for 2-pole version. Up to 63 Amps for 3- and 4-pole versions. Example: 3-pole, 25 Amp switch – SWU325.

# ATX™ CBU, SWU, RCU Series Branch Circuit Breakers, Switches, Relays, Contactors

## For Increased Safety Enclosures

ATEX/IECEX:  
Zone 1 and 2  
II 2 GD

### Circuit Breakers – CBU Series

	Weight kg (lbs)	Volume dm <sup>3</sup> (in <sup>3</sup> )	Certified Type	Catalog Number
<b>2-Pole Branch Circuit Breaker – 230/240 Vac – Tripping Curve C</b>				
2 x 6 A	1.9 (4.19)	1.1 (0.002)	IT40U	<b>CBU206C</b>
2 x 10 A	1.9 (4.19)	1.1 (0.002)	IT40U	<b>CBU210C</b>
2 x 16 A	1.9 (4.19)	1.1 (0.002)	IT40U	<b>CBU216C</b>
2 x 20 A	1.9 (4.19)	1.1 (0.002)	IT40U	<b>CBU220C</b>
2 x 25 A	1.9 (4.19)	1.1 (0.002)	IT40U	<b>CBU225C</b>
2 x 32 A	1.9 (4.19)	1.1 (0.002)	IT40U	<b>CBU232C</b>
<b>2-Pole GFI Branch Circuit Breaker – 230/240 Vac – Tripping Curve C</b>				
2 x 10 A/30 mA	1.9 (4.19)	3.1 (0.005)	CBU	<b>CBUN210CR1</b>
2 x 16 A/30 mA	1.9 (4.19)	3.1 (0.005)	CBU	<b>CBUN216CR1</b>
2 x 20 A/30 mA	1.9 (4.19)	3.1 (0.005)	CBU	<b>CBUN220CR1</b>
2 x 10 A/300 mA	1.9 (4.19)	3.1 (0.005)	CBU	<b>CBUN210CR2</b>
2 x 16 A/300 mA	1.9 (4.19)	3.1 (0.005)	CBU	<b>CBUN216CR2</b>
2 x 20 A/300 mA	1.9 (4.19)	3.1 (0.005)	CBU	<b>CBUN220CR2</b>
<b>3-Pole Branch Circuit Breaker – 380/415 Vac – Tripping Curve C</b>				
3 x 6 A	1.9 (4.19)	3.1 (0.005)	CBU	<b>CBU306C</b>
3 x 10 A	1.9 (4.19)	3.1 (0.005)	CBU	<b>CBU310C</b>
3 x 16 A	1.9 (4.19)	3.1 (0.005)	CBU	<b>CBU316C</b>
3 x 20 A	1.9 (4.19)	3.1 (0.005)	CBU	<b>CBU320C</b>
3 x 25 A	1.9 (4.19)	3.1 (0.005)	CBU	<b>CBU325C</b>
3 x 32 A	1.9 (4.19)	3.1 (0.005)	CBU	<b>CBU332C</b>
<b>4-Pole Branch Circuit Breaker – 380/415 Vac – Tripping Curve C</b>				
4 x 6 A	1.9 (4.19)	3.1 (0.005)	CBU	<b>CBU406C</b>
4 x 10 A	1.9 (4.19)	3.1 (0.005)	CBU	<b>CBU410C</b>
4 x 16 A	1.9 (4.19)	3.1 (0.005)	CBU	<b>CBU416C</b>
4 x 20 A	1.9 (4.19)	3.1 (0.005)	CBU	<b>CBU420C</b>
4 x 25 A	1.9 (4.19)	3.1 (0.005)	CBU	<b>CBU425C</b>
4 x 32 A	1.9 (4.19)	3.1 (0.005)	CBU	<b>CBU432C</b>

### Relays and Contactors – RCU Series

2 and 4-pole versions:

- Rated current: 20 A, 24 A, 40 A and 63 A.
- Rated voltage: Up to 415 V - 50/60 Hz.
- Coil voltage: Up to 240 V - 50/60 Hz.
- Consult factory for further details.

### CBU and SWU Bracket

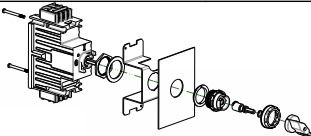
	Description	Catalog Number
	Bracket for door fixing for 2-pole MCB	<b>096650</b>

# ATX™ CBU, SWU, RCU Series Branch Circuit Breakers, Switches, Relays, Contactors

## For Increased Safety Enclosures

ATEX/IECEX:  
Zone 1 and 2  
II 2 GD

Dimensions in Millimeters (Inches)

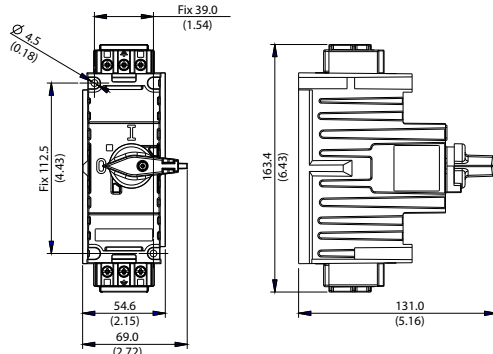

**1 / 2 Poles Circuit Breaker**  
**1 Pole + Aux. Circuit Breaker**

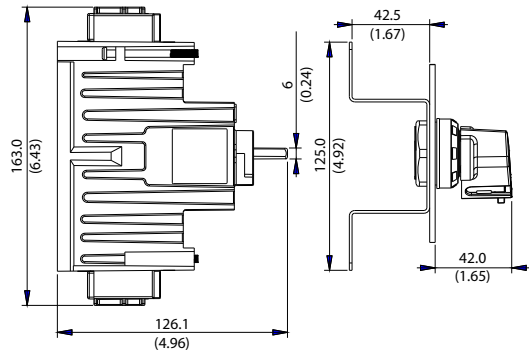

**With fixing kit 2 Poles 096650**

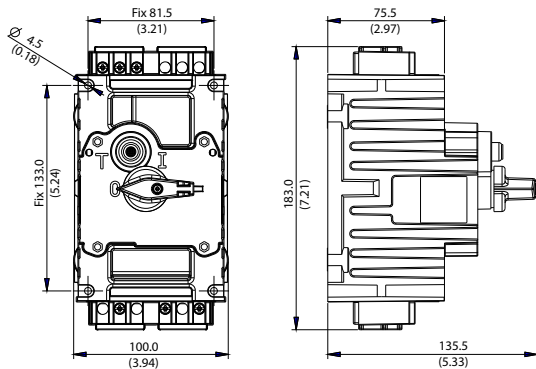

**2 Poles Circuit breaker with GFI**  
**2 Poles + Aux Circuit Breaker with GFI**

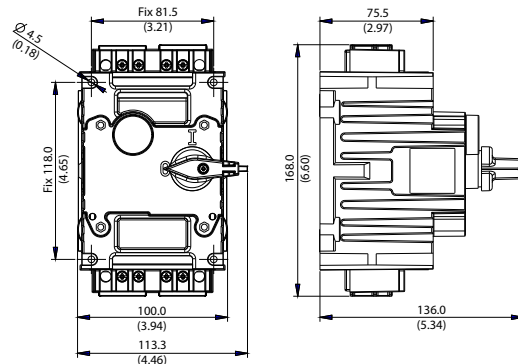

**2 / 3 / 4 Poles + Aux. Circuit Breaker**  
**3 / 4 Poles Circuit Breaker**

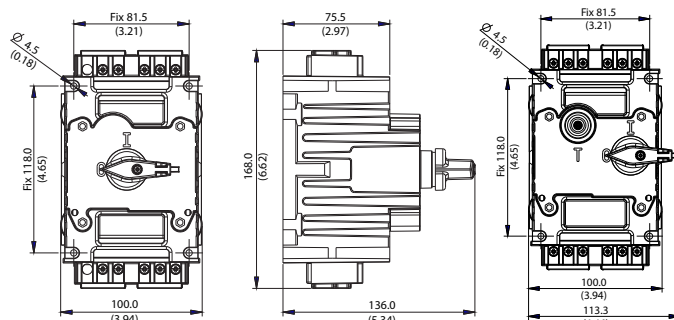

**3 / 4 Poles Switch Breaker**  
**3 / 4 Poles + Aux. Switch Breaker**

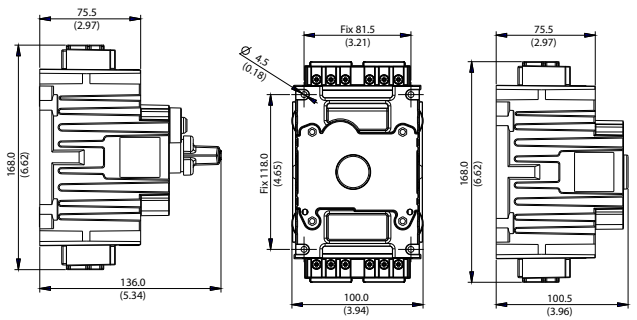

**4 Poles Switch with Earth Leakage**  
**4 Poles + Aux. Switch with Earth Leakage**

**2 / 3 / 4 Poles Contactor**

# ATX™ CBD Series Circuit Breakers

## Flameproof

ATEX:  
Zone 1 and 2  
II 2 GD  
IP66 - IK10

### Applications

- Circuit breakers are used in areas where hazardous materials are handled or stored.
- These units provide thermal-magnetic protection and residual current devices.

### Features

- Supplied with front rotary control switch handle.
- Padlockable in stop position — 3 x dia. 5 mm (0.20 in).
- RCBOs supplied with test push button.
- Yellow laminated plastic legend plate with black lettering.
- Internal earth terminal 2 x 4 mm<sup>2</sup> (0.003 x 0.006 in<sup>2</sup>).
- External ground terminal: M5 for Ex d IIB version.
- Earth crossing terminal M8 for Ex d IIC version.
- 1 x M20 entry on top.
- 2 x M20 entries at bottom with one blanking plug.
- Cable glands to be ordered separately.

### Standard Materials

- Gray painted marine grade aluminum alloy housing (RAL7038).
- Stainless steel cover bolts.

### ATEX Certifications and Compliances

- Certification Type: CF2D
  - Gas: Zone 1 and 2
    - Conforming to ATEX 94/9/CE: II 2 G
    - Type of Protection: Ex d IIB
    - Temperature Class: T3
  - Dust: Zone 21 and 22
    - Conforming to ATEX 94/9/CE: II 2 D
    - Type of Protection: Ex td A21
    - Surface Temperature: T195 °C (T383 °F)
  - Ambient Temperature: -5 °C (+23 °F) / -20 °C (-4 °F) / -25 °C (-13 °F) to +55 °C (+131 °F) (according components)
  - CE Declaration of Conformity: 50254
  - ATEX Certificate: LCIE 02 ATEX 6061X
- Certification Type: CF1C
  - Gas: Zone 1 and 2
    - Conforming to ATEX 94/9/CE: II 2 G
    - Type of Protection: Ex d IIC
    - Temperature Class: T5
  - Dust: Zone 21 and 22
    - Conforming to ATEX 94/9/CE: II 2 D
    - Type of Protection: Ex td A21
    - Surface Temperature: T95 °C (T203 °F)
  - Ambient Temperature: -5 °C (23 °F) / -20 °C (-4 °F) / -25 °C (-13 °F) to +55 °C (131 °F) (according components)
  - CE Declaration of Conformity: 50257
  - ATEX Certificate: LCIE 03 ATEX 6044X
- Index of Protection according EN/IEC 60529: IP66
- Impact Resistance (shock): IK10

### EURASEC Certification

- EURASEC N° TC RU C-FR.Г505.B.00910



Ex d IIB Version



Ex d IIC Version

# ATX™ CBD Series Circuit Breakers

## Flameproof

**ATEX:**  
**Zone 1 and 2**  
 Ⓢ II 2 GD  
 IP66 - IK10

### Catalog Numbering Guide

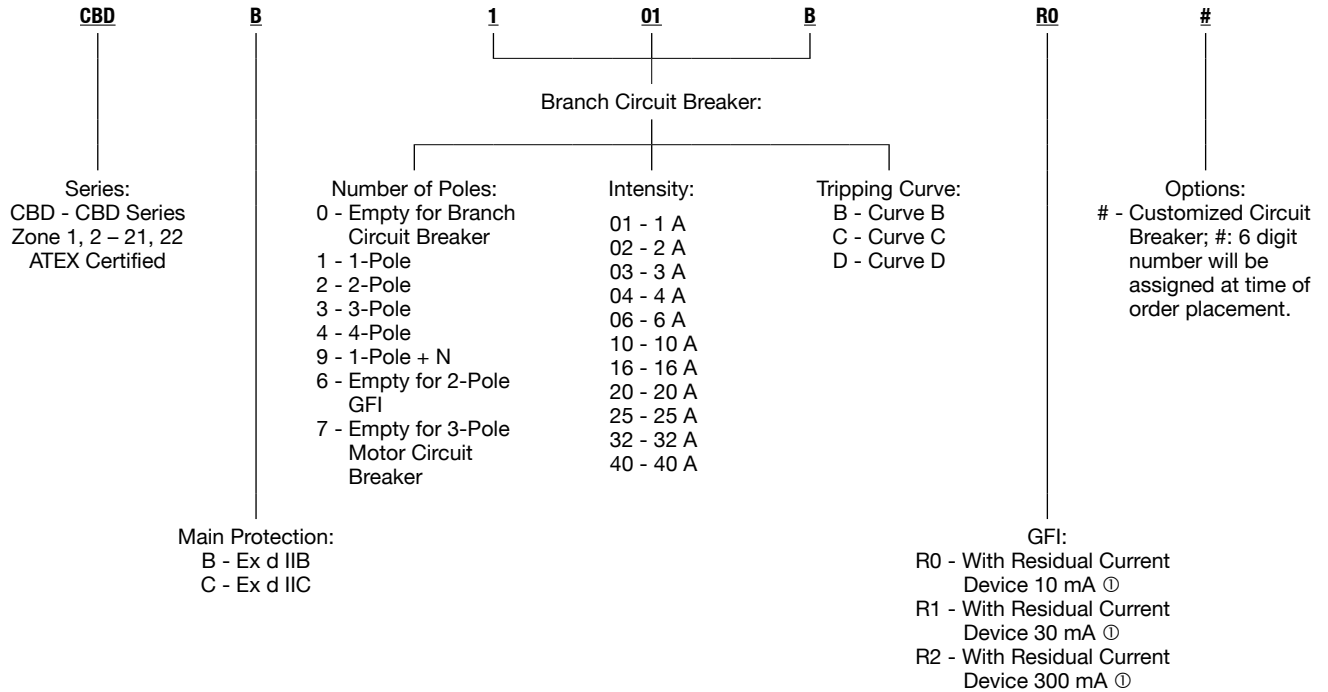

① For Branch Circuit Breaker 2-Poles maximum.

# ATX™ CBD Series Circuit Breakers

## Flameproof

ATEX/IECEX:  
 Zone 1 and 2  
 II 2 GD  
 IP66 - IK10

Type	Description	Weight kg (lb)	Volume dm <sup>3</sup> (in <sup>3</sup> )	Catalog Number
<b>Enclosure for Housing Branch Circuit Breaker up to 40 A – Ex d IIB T3 for -25 °C to +55 °C (-13 °F to +131 °F) Ambient Temperature</b>				
CF2D	For 40 A maximum 2-pole, 3-pole and 4-pole Branch Circuit Breaker (DX from Legrand) not supplied	4 (8.82)	14 (854.3)	<b>CBDB0</b>
CF2D	For 40 A maximum 2-pole, GFI Branch Circuit Breaker (iC60 from Schneider Electric) not supplied	4 (8.82)	14 (854.3)	<b>CBDB6</b> ①
CF2D	For 32 A maximum 3-pole motor circuit breaker (GV2-P or GV2-L from Schneider Electric) not supplied	4 (8.82)	14 (854.3)	<b>CBDB7</b>
<b>Enclosure for Housing MCB up to 40 A – Ex d IIC T5 for -25 °C to +55 °C (-13 °F to +131 °F) Ambient Temperature</b>				
CF1C	For 40 A maximum 2-pole, 3-pole and 4-pole Branch Circuit Breaker (DX from Legrand) not supplied	4 (8.82)	14 (854.3)	<b>CBDC0</b>
CF1C	For 40 A maximum 2-pole, GFI (iC60 from Schneider Electric) not supplied	4 (8.82)	14 (854.3)	<b>CBDC6</b> ①
CF1C	For 32 A maximum 3-pole motor circuit breaker (GV2-P or GV2-L from Schneider Electric) not supplied	4 (8.82)	14 (854.3)	<b>CBDC7</b>

### Dimensions in Millimeters (Inches)

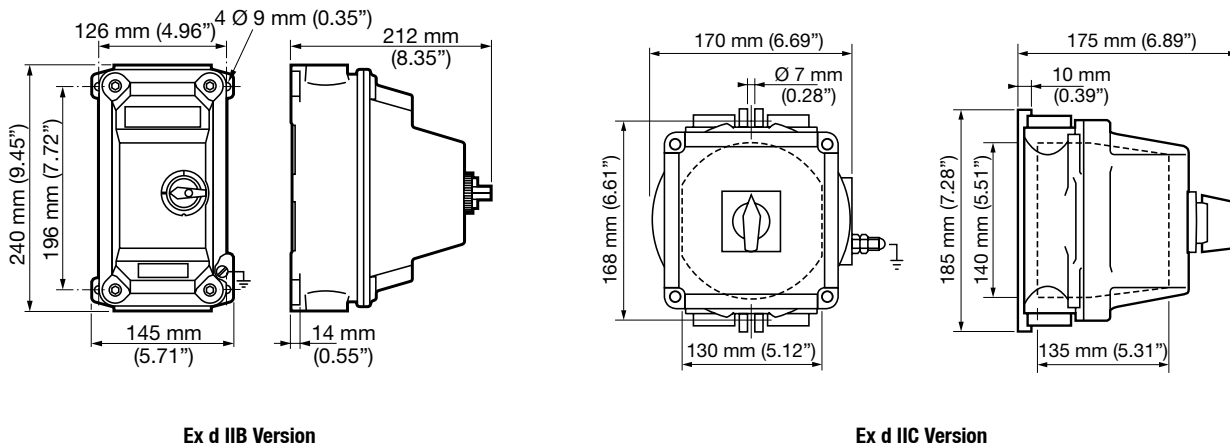

① Options: enclosure fitted with GFI Branch Circuit Breaker available as per catalog number logic.

# PlexPower™ Factory Sealed Panelboard with Bus Bar

## 15 to 150 Amps. Stainless Steel Enclosures

NEC/CEC — Lighting Panels with Main Lugs ①:  
 Class I, Zone 1, AEx de IIB+H<sub>2</sub> T5  
 Ex de IIB+H<sub>2</sub> T5  
 Class I, Division 2, Groups B, C, D  
 Class II, Division 1, Groups F, G ③  
 Class III ③  
 IP66, Type 4X ④

NEC/CEC — Lighting Panels with Main Breaker ①:  
 Class I, Zone 1, AEx de IIB T5  
 Ex de IIB T5  
 Class I, Division 2, Groups C, D  
 Class II, Division 1, Groups F, G ③  
 Class III ③  
 IP66, Type 4X ④

NEC/CEC — Power Panels ②:  
 Class I, Zone 1, AEx de IIB T5  
 Class I, Zone 1, Ex de IIB T5  
 Class I, Division 2, Groups C, D  
 Class II, Division 1, Groups F, G ③  
 Class III ③  
 IP66, Type 4X ④

### Applications

- The PlexPower™ panelboard provides indoor and outdoor protection and control of electrical circuits in hazardous environments such as:
  - Petroleum plants
  - Chemical plants
  - Refineries
  - Wastewater Treatment Plants
  - Paper and Pulp Industries
  - Other process facilities
- Ideal for placement in wet, corrosive environments or where flammable gases or vapors are likely to be present.
- Suitable for use on lighting, heat trace and power circuits.

### Features

- No external conduit or cable seals required thus making installations faster, easier, and less costly.
- Limitless flexibility through horizontal and vertical coupling options.
- The PlexPower™ features a ground-breaking design that uses individual breaker housings to minimize the downtime and costs associated with servicing circuit breakers in hazardous locations.
- PlexPower™ breakers accommodate off-the-shelf breakers, making replacements readily available.
- The lighter weight panelboard enclosure can be quickly opened in the field for easier servicing.
- Supplied with standard hard drawn, tin plated, copper bus bar for superior corrosion resistance.
- Gland plate at the bottom of enclosure can be easily field punched for cable or conduit entries. Additional gland plates available for sides and top must be ordered with the panelboard. See options.
- Models available:
  - RQ: 120 to 240 V panel with QC breakers
  - RF: 480 to 600 V panel with F-Frame breakers
- Standard models offer 3 circuit to 54 circuit panelboard configurations.
- Models are available standard with or without main breaker, depending on the configuration.
- Standard configuration includes internal actuators and a solid door; factory installed options include window door or external actuators.
- Supplied with dead front for internal actuation.
- External actuation with color coded guards (see options):
  - Red color for voltages: 120/208, 120/240, 240.
  - Blue color for voltages: 277/480, 347/600, 480, 600.
- Branch circuit breakers available in 1-, 2- and 3-pole. Current ratings on branch breakers:
  - 1-pole: 120, 277, 347 Volts, 60 Amps maximum.
  - 2- and 3-pole: 240 Volts, 40 Amps maximum.
  - 2- and 3-pole: 480, 600 Volts, 150 Amps maximum.
- Main circuit breakers up to 150 Amps, 2- or 3-pole.
- Breakers can be individually padlocked in either the “On” or “Off” position.
- Breaker modules supplied with stainless steel bolts.
- Ground and or neutral bars provided as standard.
- External/internal ground lug provided as standard.
- 120/240 Volt breaker module terminal wire range #14-1/0.



Panel with Main Breaker, Optional External Actuation and Optional LED Indicators

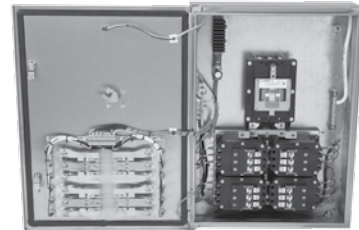

Bus Bar Panel with Main Breaker Internal View



Dead Front

### Illustrated Features

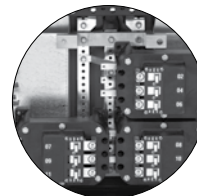

Standard Bus Bar

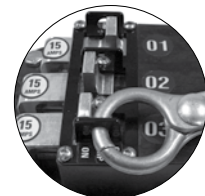

Internal Lock Out with Key

① NEC/CEC Certified lighting panels: 120/240 Volt, 240 Volt, 120/208 Volt.  
 ② NEC/CEC Certified power panels: 277/480 Volt, 480 Volt, 347/600 Volt, 600 Volt.  
 ③ Certification only applies without drain/breather.  
 ④ IP66, Type 4X Certification only applies with drain/breather.

# PlexPower™ Factory Sealed Panelboard with Bus Bar

## 15 to 150 Amps. Stainless Steel Enclosures

DISTRIBUTION EQUIPMENT: NEC/CEC HAZARDOUS LOCATION PANELBOARDS

NEC/CEC — Lighting Panels with Main Lugs ①:  
Class I, Zone 1, AEx de IIB+H<sub>2</sub> T5  
Ex de IIB+H<sub>2</sub> T5  
Class I, Division 2, Groups B, C, D  
Class II, Division 1, Groups F, G ③  
Class III ③  
IP66, Type 4X ④

NEC/CEC — Lighting Panels with Main Breaker ①:  
Class I, Zone 1, AEx de IIB T5  
Ex de IIB T5  
Class I, Division 2, Groups C, D  
Class II, Division 1, Groups F, G ③  
Class III ③  
IP66, Type 4X ④

NEC/CEC — Power Panels ②:  
Class I, Zone 1, AEx de IIB T5  
Class I, Zone 1, Ex de IIB T5  
Class I, Division 2, Groups C, D  
Class II, Division 1, Groups F, G ③  
Class III ③  
IP66, Type 4X ④

- 277/480, 480, 347/600, 600 Volt breaker module terminal wire range #14-4/0.
- Standard model utilizes Cutler-Hammer<sup>+</sup> QC Series or F-Frame Series circuit breakers rated -20 °C to +40 °C (-4 °F to +104 °F).
- Appleton breaker modules accommodate standard off-the-shelf replacement breakers.

### Standard Materials

- Enclosure: 304 stainless steel
- Alternate enclosure: 316L stainless steel.
- Hardware: stainless steel
- Bus bar: hard drawn, tin plated, copper

### Options

Must be listed in alphanumeric sequence at the end of the catalog number.

- 316L stainless steel enclosure material, add suffix — **316L**.
- Drain/breather, add suffix — **DV**. ④
- Ground Fault Interrupter Breakers for 120V, single pole, available in 15, 20, 25 and 30 Amps only:
  - For 5 mA, add suffix — **GFI** after breaker
  - For 30 mA, add suffix — **EPD** after breaker
- External actuation, add suffix — **EXT**.
- Grounded neutral, add suffix — **GN**.
- Gland plate, specify suffix **GPL** = left side, **GPR** = right side, **GPT** = top side, **NGP** = no gland plate).
- Thermostatically controlled heater, ③
  - For Class I, Division 2 and Class I, Zone 2 equivalency, add suffix — **HTR**.
    - For Lighting Panels with Main Lugs, Class I, Division 2, Groups B, C, D and Class I, Zone 2 IIB+H<sub>2</sub>.
    - For Lighting Panels with Main Breaker or Power Panels, Class I, Division 2, Groups C, D and Class I, Zone 2 IIB.
  - For Class I Zone 1 certification, add suffix — **HTRF**.
    - Certifications listed at top of page apply.
- LED indicator lights, add suffix — **IL**.
- Inverted feed, add suffix — **INV**.
- Phenolic/ lamacoid nameplate (specify legend), add suffix — **NP**.
- Door padlocking provision, add suffix — **P**.
- Stainless steel legend plate (specify legend), add suffix — **SP**.
- Terminal blocks instead of direct wiring, add suffix — **TB**.
- Higher ambient temperature rated breakers available (de-rating applies).
  - For +50 °C (+122 °F) breaker rating, add suffix — **V**.
  - For +60 °C (+140 °F) breaker rating, add suffix — **VI**.
  - For +70 °C (+158 °F) breaker rating, add suffix — **VII**.
- Window with internal actuation only, add suffix — **W**.

### NEC/CEC Certifications and Compliances

- UL Standards: ANSI/UL 67, ANSI/ISA 12.12.01, ANSI/UL 1203, ANSI/UL 60079-0, ANSI/UL60079-1, ANSI/UL60079-7
- CSA Standards: C22.2 No. 29, C22.2 No. 0, C22.2 No. 213, CAN E60079-0, CAN E60079-7, CAN E60079-1
- cCSAus Certified: 039199
- UL Recognized Component (US and Canada): E319372

### Related Products

- Additional PlexPower™ products:
  - PlexPower™ Factory Sealed Enclosed Circuit Breakers
  - PlexPower™ Fused Factory Sealed Panelboard with Bus Bar

① NEC/CEC Certified lighting panels: 120/240 Volt, 240 Volt, 120/208 Volt.

② NEC/CEC Certified power panels: 277/480 Volt, 480 Volt, 347/600 Volt, 600 Volt.

③ Certification only applies without drain/breather.

④ IP66, Type 4X Certification only applies with drain/breather.

+ Cutler-Hammer is a registered trademark of Eaton Corporation.



# PlexPower™ Factory Sealed Panelboard with Bus Bar

## 15 to 150 Amps. Stainless Steel Enclosures

NEC/CEC — Lighting Panels with Main Lugs ①:  
 Class I, Zone 1, AEx de IIB+H<sub>2</sub> T5  
 Ex de IIB+H<sub>2</sub> T5  
 Class I, Division 2, Groups B, C, D  
 Class II, Division 1, Groups F, G ③  
 Class III ③  
 IP66, Type 4X ④

NEC/CEC — Lighting Panels with Main Breaker ①:  
 Class I, Zone 1, AEx de IIB T5  
 Ex de IIB T5  
 Class I, Division 2, Groups C, D  
 Class II, Division 1, Groups F, G ③  
 Class III ③  
 IP66, Type 4X ④

NEC/CEC — Power Panels ②:  
 Class I, Zone 1, AEx de IIB T5  
 Class I, Zone 1, Ex de IIB T5  
 Class I, Division 2, Groups C, D  
 Class II, Division 1, Groups F, G ③  
 Class III ③  
 IP66, Type 4X ④

### F-Frame Circuit Breaker Specifications — For Standard Circuit Breakers Only ⑤

Breaker Type	Number of Poles	Interrupting Capacity (Symmetrical Amperes)				
		240	277	Vac 347	480	600
EHD	1	—	14,000	—	—	—
EHD	2, 3	18,000	—	—	14,000	—
FDB	1	—	—	14,000	—	—
FDB	2, 3	18,000	—	—	14,000	14,000
FD	1	—	35,000	18,000	—	—
FD	2, 3	65,000	—	—	35,000	18,000
HFD	1	—	65,000	25,000	—	—
HFD	2, 3	100,000	—	—	65,000	25,000
FDC	1	—	—	30,000	—	—
FDC	2, 3	200,000	—	—	100,000	35,000

### QC-Frame Circuit Breaker Specifications — For Standard Circuit Breakers Only ③

Breaker Type	Number of Poles	Interrupting Capacity (Symmetrical Amperes)	
		Vac 120	240
QC	1 (max 60 Amp)	10,000	10,000
QC	2, 3 (max 40 Amp)	10,000	10,000

① NEC/CEC Certified lighting panels: 120/240 Volt, 240 Volt, 120/208 Volt.  
 ② NEC/CEC Certified power panels: 277/480 Volt, 480 Volt, 347/600 Volt, 600 Volt.  
 ③ Certification only applies without drain/breather.  
 ④ IP66, Type 4X Certification only applies with drain/breather.  
 ⑤ Module Assembly is only rated @ 10,000 AIC.

# PlexPower™ Factory Sealed Panelboard with Bus Bar

## 15 to 150 Amps. Stainless Steel Enclosures

NEC/CEC – Lighting Panels with Main Lugs ①:  
 Class I, Zone 1, AEx de IIB+H<sub>2</sub> T5  
 Ex de IIB+H<sub>2</sub> T5  
 Class I, Division 2, Groups B, C, D  
 Class II, Division 1, Groups F, G ③  
 Class III ③  
 IP66, Type 4X ④

NEC/CEC – Lighting Panels with Main Breaker ①:  
 Class I, Zone 1, AEx de IIB T5  
 Ex de IIB T5  
 Class I, Division 2, Groups C, D  
 Class II, Division 1, Groups F, G ③  
 Class III ③  
 IP66, Type 4X ④

DISTRIBUTION EQUIPMENT: NEC/CEC HAZARDOUS LOCATION PANELBOARDS

### Catalog Numbering Guide for Lighting Panels

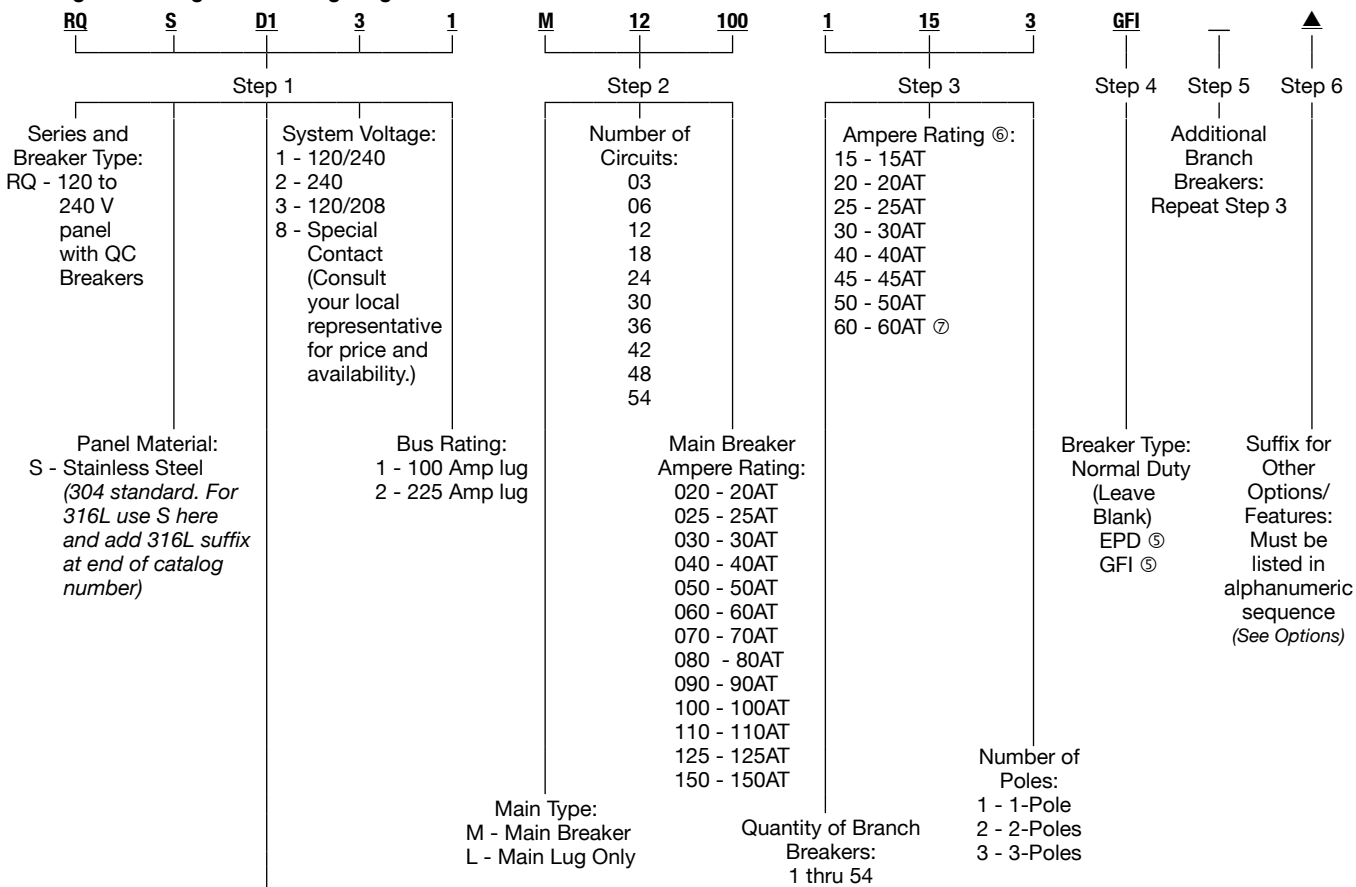

Panel Size: Select A1, B1, C1, D1, J1, F1, L1 or H1 stainless steel enclosure based on number of circuits

Bus Amps	Volts	A1 370x370x250	B1 560x370x250	C1 560x560x250	D1 750x560x250	J1 875x560x250	F1 1130x560x250	L1 1260x560x250	H1 1500x560x250
<b>Main Lugs Only – External Actuation Only</b>									
100	240 Max	3	6	12	18	24	30, 36	42	48, 54
225		—	—	12	18	24	30, 36	42	48, 54
<b>With Main Breaker – External Actuation Only</b>									
100	240 Max	—	3	6	12	18	30	36	42, 48
225		—	—	—	12	18	30	36	42, 48
<b>Main Lugs Only – Internal Actuation Only</b>									
100	240 Max	3	6	12	18	24	30, 36	42	48, 54
225		—	—	—	12	18	24	30, 36	42
<b>With Main Breaker – Internal Actuation Only</b>									
100	240 Max	—	—	6	12	18	30	36	42, 48
225		—	—	—	12	18	30	36	42, 48

Please note the followings:

- Number of circuits shown are non GFI and non EPD breakers.
- GFI and EPD breakers number of circuits are determined as total number of circuits divided by 3 = No of 3 pole modules. Each module will accommodate only 2 GFI or EPD maximum. Example: For 12 Circuits, no of modules = 12/3=4.

① NEC/CEC Certified lighting panels: 120/240 Volt, 240 Volt, 120/208 Volt.

③ Certification only applies without drain/breather.

④ IP66, Type 4X Certification only applies with drain/breather.

⑤ Only 2 per 3 circuits. Only Single pole GFI/EPD available.

⑥ 40A is the maximum amperage for 2 or 3 pole branch breaker.

⑦ Only one 60A branch breaker is allowed per panel.

# PlexPower™ Factory Sealed Panelboard with Bus Bar

## 15 to 150 Amps. Stainless Steel Enclosures

NEC/CEC — Power Panels ②:  
 Class I, Zone 1, AEx de IIB T5  
 Class I, Zone 1, Ex de IIB T5  
 Class I, Division 2, Groups C, D  
 Class II, Division 1, Groups F, G ③  
 Class III ③  
 IP66, Type 4X ④

### Catalog Numbering Guide for Power Panels

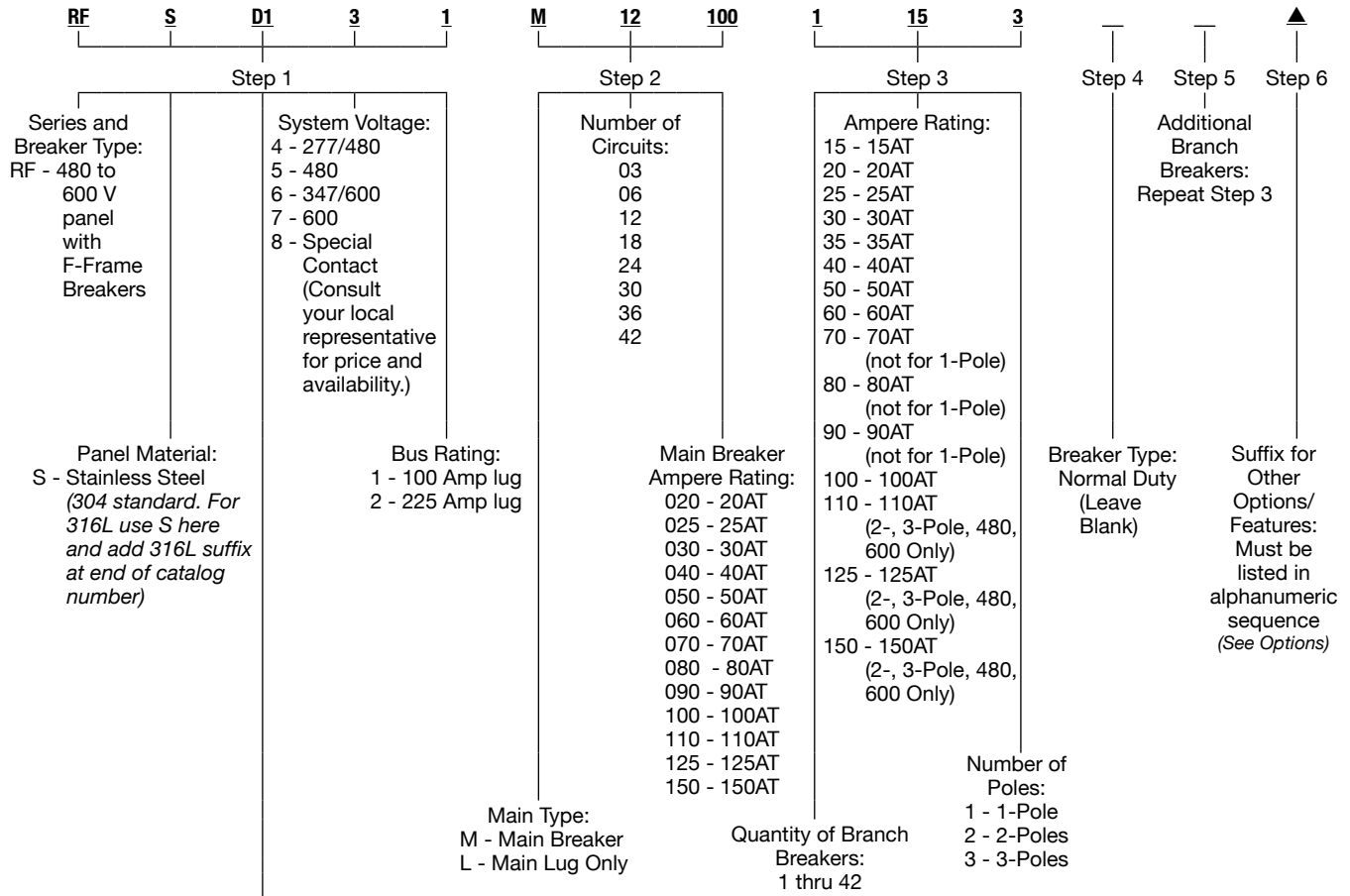

Panel Size: Select A1, C1, I1, E1, K1 or G1 stainless steel enclosure based on number of circuits

Bus Amps	Volts	A1 370x370x250	C1 560x560x250	I1 875x750x250	E1 1130x750x250	K1 1260x750x250	G1 1500x750x250
<b>Main Lugs Only — External Actuation Only</b>							
100	277/480; 480; 347/600; 600	3	6	12, 18	24	30	36, 42
225		—	6	12, 18	24	30	36
<b>With Main Breaker — External Actuation Only</b>							
100	277/480; 480; 347/600; 600	—	—	12	18	24	36, 30
225		—	—	12	18	24	30
<b>Main Lugs Only — Internal Actuation Only</b>							
100	277/480; 480; 347/600; 600	3	6	12, 18	24	30	36, 42
225		—	6	12, 18	24	30	36
<b>With Main Breaker — Internal Actuation Only</b>							
100	277/480; 480; 347/600; 600	—	12	12	18	24	36, 30
225		—	12	12	18	24	30

Please note the followings:

- Alternative arrangement are available as option, consult local sales representative.

② NEC/CEC Certified power panels: 277/480 Volt, 480 Volt, 347/600 Volt, 600 Volt.  
 ③ Certification only applies without drain/breather.  
 ④ IP66, Type 4X certification only applies with drain/breather.

# PlexPower™ Factory Sealed Panelboard with Bus Bar

## 15 to 150 Amps. Stainless Steel Enclosures

DISTRIBUTION EQUIPMENT: NEC/CEC HAZARDOUS LOCATION PANELBOARDS

**NEC/CEC – Lighting Panels with Main Lugs ①:**  
 Class I, Zone 1, AEx de IIB+H<sub>2</sub> T5  
 Ex de IIB+H<sub>2</sub> T5  
 Class I, Division 2, Groups B, C, D  
 Class II, Division 1, Groups F, G ③  
 Class III ③  
 IP66, Type 4X ④

**NEC/CEC – Lighting Panels with Main Breaker ①:**  
 Class I, Zone 1, AEx de IIB T5  
 Ex de IIB T5  
 Class I, Division 2, Groups C, D  
 Class II, Division 1, Groups F, G ③  
 Class III ③  
 IP66, Type 4X ④

**NEC/CEC – Power Panels ②:**  
 Class I, Zone 1, AEx de IIB T5  
 Class I, Zone 1, Ex de IIB T5  
 Class I, Division 2, Groups C, D  
 Class II, Division 1, Groups F, G ③  
 Class III ③  
 IP66, Type 4X ④

### Steps to Creating Catalog Number:

Complete Catalog Number

<b>RQ</b>	<b>S</b>	<b>D1</b>	<b>3</b>	<b>1</b>	<b>M</b>	<b>12</b>	<b>100</b>	<b>1</b>	<b>15</b>	<b>1</b>	<b>GFI</b>	<b>—</b>	<b>▲</b>
<b>Step 1</b>			<b>Step 2</b>			<b>Step 3</b>			<b>Step 4</b>		<b>Step 5</b>		<b>Step 6</b>

**Step 1:** Choose basic catalog number from tables on subsequent pages or from numbering guide on previous page.

**Step 2:** If a main breaker is desired indicate amperage rating.

Example: RQSD131M12 – 100 is a 12 circuit 3 phase panelboard c/w 100 amp main breaker.

**Step 3:** First digits are the quantity of breakers, second the ampere rating, and third the number of poles.

Example: 1151 is 1 breaker, 15 amps, 1 pole breaker

**Step 4:** This is where breaker type is indicated

- Blank - standard breaker
- GFI - 5 mA GFI breaker- single pole only (limited to 2 breakers per 3 circuit module)
- EPD - 30 mA EPD breaker- single pole only (limited to 2 breakers per 3 circuit module)

**Step 5:** Repeat steps 3 and 4 for as many breaker types as required

**Step 6:** Options: Add option in alphanumeric order as listed PlexPower™ introduction page under Options.

### Panel Size

	Dimensions in Millimeters (Inches)											
	A1	B1	C1	D1	E1	F1	G1	H1	I1	J1	K1	L1

### Stainless Steel Enclosure Lighting Panel with External Actuation – Main Breaker

Length	370 (14.50)	370 (14.50)	560 (22.00)	750 (30.00)	1130 (45.00)	1130 (45.00)	1500 (60.00)	1500 (60.00)	875 (34.50)	875 (34.50)	1260 (50.00)	1260 (50.00)
Width	370 (14.50)	560 (22.00)	560 (22.00)	560 (22.00)	750 (30.00)	560 (22.00)	750 (30.00)	560 (22.00)	750 (30.00)	560 (22.00)	750 (30.00)	560 (22.00)
Depth	250 (10.00)	250 (10.00)	250 (10.00)	250 (10.00)	250 (10.00)	250 (10.00)	250 (10.00)	250 (10.00)	250 (10.00)	250 (10.00)	250 (10.00)	250 (10.00)

① NEC/CEC Certified lighting panels: 120/240 Volt, 240 Volt, 120/208 Volt.

② NEC/CEC Certified power panels: 277/480 Volt, 480 Volt, 347/600 Volt, 600 Volt.

③ Certification only applies without drain/breather.

④ IP66, Type 4X Certification only applies with drain/breather.

# PlexPower™ Factory Sealed Panelboard with Bus Bar

## 15 to 150 Amps. Stainless Steel Enclosures

Standard Configuration: No Window, Internal Actuation

NEC/CEC — Lighting Panels with Main Lugs ①:  
Class I, Zone 1, AEX de IIB+H<sub>2</sub> T5  
Ex de IIB+H<sub>2</sub> T5  
Class I, Division 2, Groups B, C, D  
Class II, Division 1, Groups F, G ③  
Class III ③  
IP66, Type 4X ④

NEC/CEC — Lighting Panels with Main Breaker ①:  
Class I, Zone 1, AEX de IIB T5  
Ex de IIB T5  
Class I, Division 2, Groups C, D  
Class II, Division 1, Groups F, G ③  
Class III ③  
IP66, Type 4X ④

NEC/CEC — Power Panels ②:  
Class I, Zone 1, AEX de IIB T5  
Class I, Zone 1, Ex de IIB T5  
Class I, Division 2, Groups C, D  
Class II, Division 1, Groups F, G ③  
Class III ③  
IP66, Type 4X ④

Max No of Circuits	Panel Size	Catalog Number			
		Bus 100 Amps	Bus 225 Amps	Bus 100 Amps	Bus 225 Amps
		1 Phase 120/240		3 Phase 120/208	
<b>Main Lugs — Top Feed (Standard)</b>					
3	A1	RQSA111L03	—	RQSA131L03	—
6	B1	RQSB111L06	—	RQSB131L06	—
12	C1	RQSC111L12	RQSC112L12	RQSC131L12	RQSC132L12
18	D1	RQSD111L18	RQSD112L18	RQSD131L18	RQSD132L18
24	J1	RQSJ111L24	RQSJ112L24	RQSJ131L24	RQSJ132L24
30	F1	RQSF111L30	RQSF112L30	RQSF131L30	RQSF132L30
36	F1	RQSF111L36	RQSF112L36	RQSF131L36	RQSF132L36
42	L1	RQSL111L42	RQSL112L42	RQSL131L42	RQSL132L42
48	H1	RQSH111L48	RQSH112L48	RQSH131L48	RQSH132L48
54	H1	RQSH111L54	RQSH112L54	RQSH131L54	RQSH132L54
<b>Main Breaker — Top Feed (Standard)</b>					
6	C1	RQSC111M06	—	RQSC131M06	—
12	D1	RQSD111M12	RQSD112M12	RQSD131M12	RQSD132M12
18	J1	RQSJ111M18	RQSJ112M18	RQSJ131M18	RQSJ132M18
24	F1	RQSF111M24	RQSF112M24	RQSF131M24	RQSF132M24
30	F1	RQSF111M30	RQSF112M30	RQSF131M30	RQSF132M30
36	L1	RQSL111M36	RQSL112M36	RQSL131M36	RQSL132M36
42	H1	RQSH111M42	RQSH112M42	RQSH131M42	RQSH132M42
48	H1	RQSH111M48	RQSH112M48	RQSH131M48	RQSH132M48
		3 Phase 3 Wire 480		3 Phase 4 Wire 277/480	
<b>Main Lugs — Top Feed (Standard)</b>					
3	A1	RFSA151L03	—	RFSA141L03	—
6	C1	RFSC151L06	RFSC152L06	RFSC141L06	RFSC142L06
12	I1	RFSI151L12	RFSI152L12	RFSI141L12	RFSI142L12
18	I1	RFSI151L18	RFSI152L18	RFSI141L18	RFSI142L18
24	E1	RFSE151L24	RFSE152L24	RFSE141L24	RFSE142L24
30	K1	RFSK151L30	RFSK152L30	RFSK141L30	RFSK142L30
36	G1	RFSG151L36	RFSG152L36	RFSG141L36	RFSG142L36
42	G1	RFSG151L42	—	RFSG141L42	—
<b>Main Breaker — Top Feed (Standard)</b>					
12	I1	RFSI151M12	RFSI152M12	RFSI141M12	RFSI142M12
18	E1	RFSE151M18	RFSE152M18	RFSE141M18	RFSE142M18
24	K1	RFSK151M24	RFSK152M24	RFSK141M24	RFSK142M24
30	G1	RFSG151M30	RFSG152M30	RFSG141M30	RFSG142M30
36	G1	RFSG151M36	—	RFSG141M36	—
		3 Phase 3 Wire 600		3 Phase 4 Wire 347/600	
<b>Main Lugs — Top Feed (Standard)</b>					
3	A1	RFSA171L03	—	RFSA161L03	—
6	C1	RFSC171L06	RFSC172L06	RFSC161L06	RFSC162L06
12	I1	RFSI171L12	RFSI172L12	RFSI161L12	RFSI162L12
18	I1	RFSI171L18	RFSI172L18	RFSI161L18	RFSI162L18
24	E1	RFSE171L24	RFSE172L24	RFSE161L24	RFSE162L24
30	K1	RFSK171L30	RFSK172L30	RFSK161L30	RFSK162L30
36	G1	RFSG171L36	RFSG172L36	RFSG161L36	RFSG162L36
42	G1	RFSG171L42	—	RFSG161L42	—
<b>Main Breaker — Top Feed (Standard)</b>					
12	I1	RFSI171M12	RFSI172M12	RFSI161M12	RFSI162M12
18	E1	RFSE171M18	RFSE172M18	RFSE161M18	RFSE162M18
24	K1	RFSK171M24	RFSK172M24	RFSK161M24	RFSK-162M24
30	G1	RFSG171M30	RFSG172M30	RFSG161M30	RFSG162M30
36	G1	RFSG171M36	—	RFSG161M36	—

① NEC/CEC Certified lighting panels: 120/240 Volt, 240 Volt, 120/208 Volt.  
 ② NEC/CEC Certified power panels: 277/480 Volt, 480 Volt, 347/600 Volt, 600 Volt.  
 ③ Certification only applies without drain/breather.  
 ④ IP66, Type 4X Certification only applies with drain/breather.

# PlexPower™ Factory Sealed Panelboard with Bus Bar

## 15 to 150 Amps. Stainless Steel Enclosures

DISTRIBUTION EQUIPMENT: NEC/CEC HAZARDOUS LOCATION PANELBOARDS

NEC/CEC — Lighting Panels with Main Lugs ①:  
 Class I, Zone 1, AEx de IIB+H<sub>2</sub> T5  
 Ex de IIB+H<sub>2</sub> T5  
 Class I, Division 2, Groups B, C, D  
 Class II, Division 1, Groups F, G ③  
 Class III ③  
 IP66, Type 4X ④

NEC/CEC — Lighting Panels with Main Breaker ①:  
 Class I, Zone 1, AEx de IIB T5  
 Ex de IIB T5  
 Class I, Division 2, Groups C, D  
 Class II, Division 1, Groups F, G ③  
 Class III ③  
 IP66, Type 4X ④

NEC/CEC — Power Panels ②:  
 Class I, Zone 1, AEx de IIB T5  
 Class I, Zone 1, Ex de IIB T5  
 Class I, Division 2, Groups C, D  
 Class II, Division 1, Groups F, G ③  
 Class III ③  
 IP66, Type 4X ④

### QC-Frame with Main Lugs Dimensions in Millimeters (Inches)

#### Size B 6 Circuit – Internal Actuation

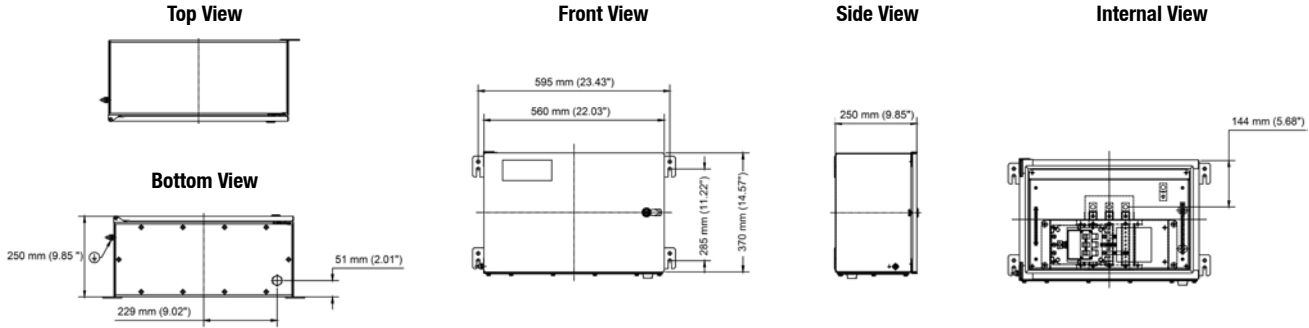

#### Size B 6 Circuit – External Actuation

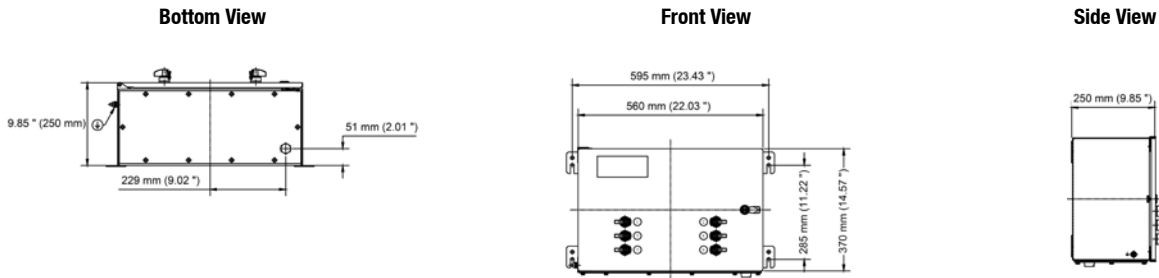

① NEC/CEC Certified lighting panels: 120/240 Volt, 240 Volt, 120/208 Volt.  
 ② NEC/CEC Certified power panels: 277/480 Volt, 480 Volt, 347/600 Volt, 600 Volt.  
 ③ Certification only applies without drain/breather.  
 ④ IP66, Type 4X Certification only applies with drain/breather.

# PlexPower™ Factory Sealed Panelboard with Bus Bar

## 15 to 150 Amps. Stainless Steel Enclosures

NEC/CEC – Lighting Panels with Main Lugs ①:  
 Class I, Zone 1, AEx de IIB+H<sub>2</sub> T5  
 Ex de IIB+H<sub>2</sub> T5  
 Class I, Division 2, Groups B, C, D  
 Class II, Division 1, Groups F, G ③  
 Class III ③  
 IP66, Type 4X ④

NEC/CEC – Lighting Panels with Main Breaker ①:  
 Class I, Zone 1, AEx de IIB T5  
 Ex de IIB T5  
 Class I, Division 2, Groups C, D  
 Class II, Division 1, Groups F, G ③  
 Class III ③  
 IP66, Type 4X ④

NEC/CEC – Power Panels ②:  
 Class I, Zone 1, AEx de IIB T5  
 Class I, Zone 1, Ex de IIB T5  
 Class I, Division 2, Groups C, D  
 Class II, Division 1, Groups F, G ③  
 Class III ③  
 IP66, Type 4X ④

### QC-Frame with Main Lugs Dimensions in Millimeters (Inches)

#### Size C 12 Circuit – Internal Actuation

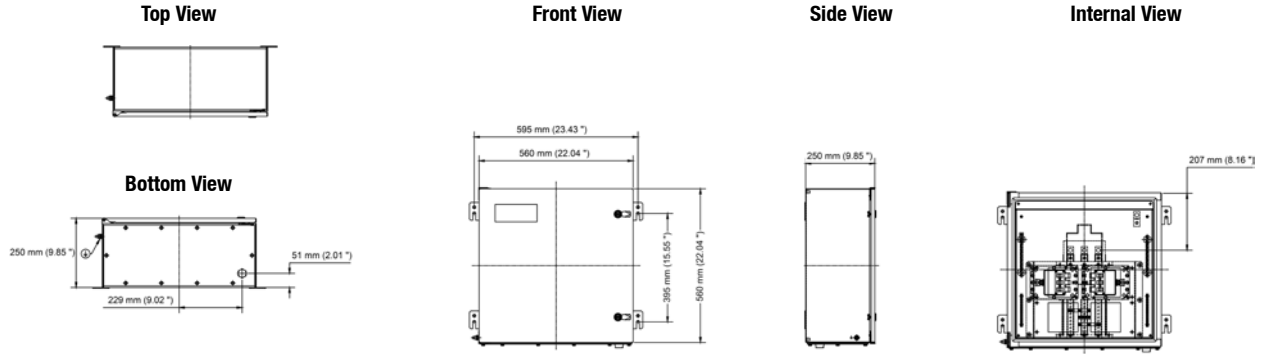

#### Size C 12 Circuit – External Actuation

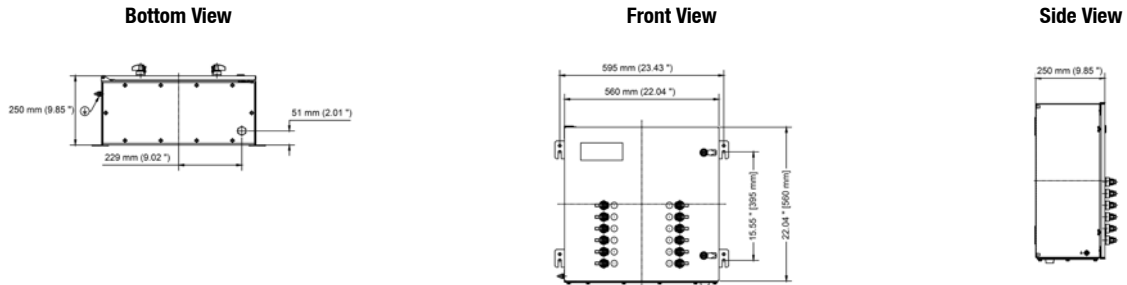

① NEC/CEC Certified lighting panels: 120/240 Volt, 240 Volt, 120/208 Volt.  
 ② NEC/CEC Certified power panels: 277/480 Volt, 480 Volt, 347/600 Volt, 600 Volt.  
 ③ Certification only applies without drain/breather.  
 ④ IP66, Type 4X Certification only applies with drain/breather.

# PlexPower™ Factory Sealed Panelboard with Bus Bar

## 15 to 150 Amps. Stainless Steel Enclosures

DISTRIBUTION EQUIPMENT: NEC/CEC HAZARDOUS LOCATION PANELBOARDS

NEC/CEC — Lighting Panels with Main Lugs ①:  
 Class I, Zone 1, AEx de IIB+H<sub>2</sub> T5  
 Ex de IIB+H<sub>2</sub> T5  
 Class I, Division 2, Groups B, C, D  
 Class II, Division 1, Groups F, G ③  
 Class III ③  
 IP66, Type 4X ④

NEC/CEC — Lighting Panels with Main Breaker ①:  
 Class I, Zone 1, AEx de IIB T5  
 Ex de IIB T5  
 Class I, Division 2, Groups C, D  
 Class II, Division 1, Groups F, G ③  
 Class III ③  
 IP66, Type 4X ④

NEC/CEC — Power Panels ②:  
 Class I, Zone 1, AEx de IIB T5  
 Class I, Zone 1, Ex de IIB T5  
 Class I, Division 2, Groups C, D  
 Class II, Division 1, Groups F, G ③  
 Class III ③  
 IP66, Type 4X ④

### QC-Frame with Main Lugs Dimensions in Millimeters (Inches)

#### Size D 18 Circuit— Internal Actuation

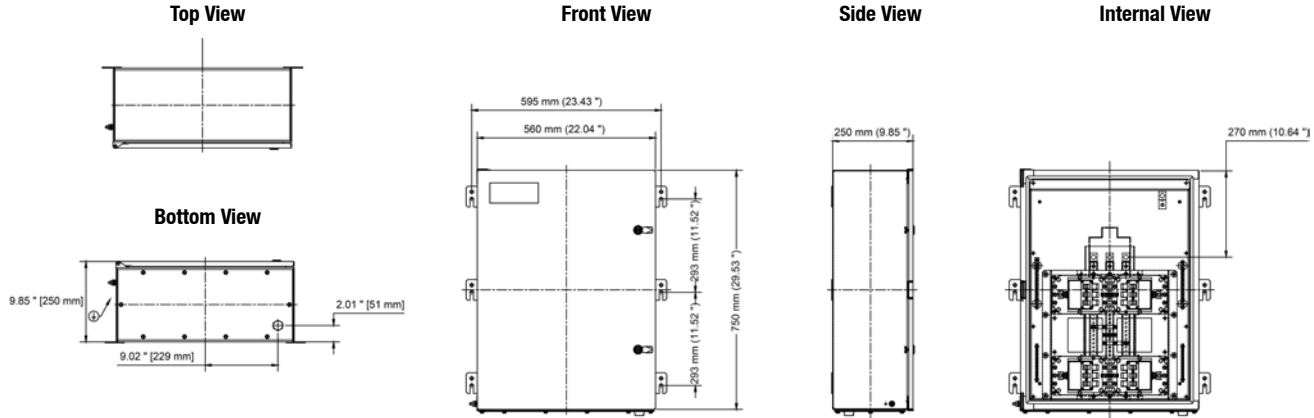

#### Size D 18 Circuit – External Actuation

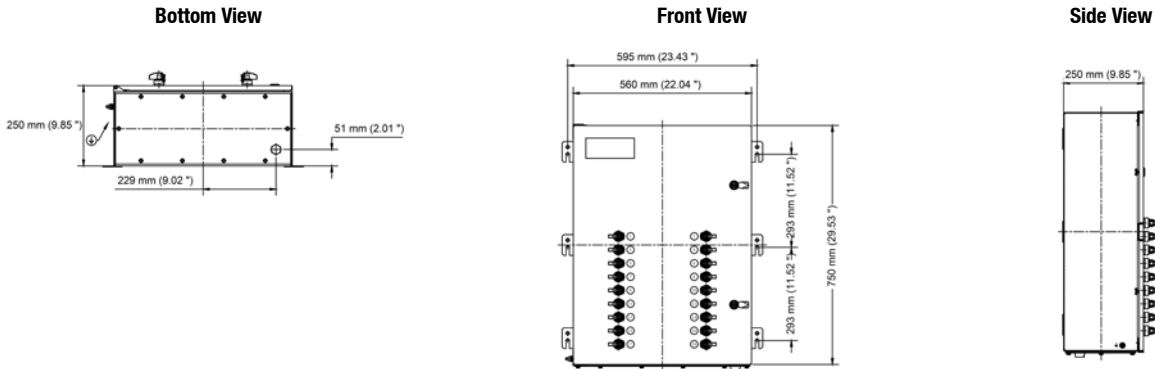

① NEC/CEC Certified lighting panels: 120/240 Volt, 240 Volt, 120/208 Volt.  
 ② NEC/CEC Certified power panels: 277/480 Volt, 480 Volt, 347/600 Volt, 600 Volt.  
 ③ Certification only applies without drain/breather.  
 ④ IP66, Type 4X Certification only applies with drain/breather.



# PlexPower™ Factory Sealed Panelboard with Bus Bar

## 15 to 150 Amps. Stainless Steel Enclosures

NEC/CEC – Lighting Panels with Main Lugs ①:  
 Class I, Zone 1, AEx de IIB+H<sub>2</sub> T5  
 Ex de IIB+H<sub>2</sub> T5  
 Class I, Division 2, Groups B, C, D  
 Class II, Division 1, Groups F, G ③  
 Class III ③  
 IP66, Type 4X ④

NEC/CEC – Lighting Panels with Main Breaker ①:  
 Class I, Zone 1, AEx de IIB T5  
 Ex de IIB T5  
 Class I, Division 2, Groups C, D  
 Class II, Division 1, Groups F, G ③  
 Class III ③  
 IP66, Type 4X ④

NEC/CEC – Power Panels ②:  
 Class I, Zone 1, AEx de IIB T5  
 Class I, Zone 1, Ex de IIB T5  
 Class I, Division 2, Groups C, D  
 Class II, Division 1, Groups F, G ③  
 Class III ③  
 IP66, Type 4X ④

### QC-Frame with Main Lugs Dimensions in Millimeters (Inches)

#### Size J 24 Circuit– Internal Actuation

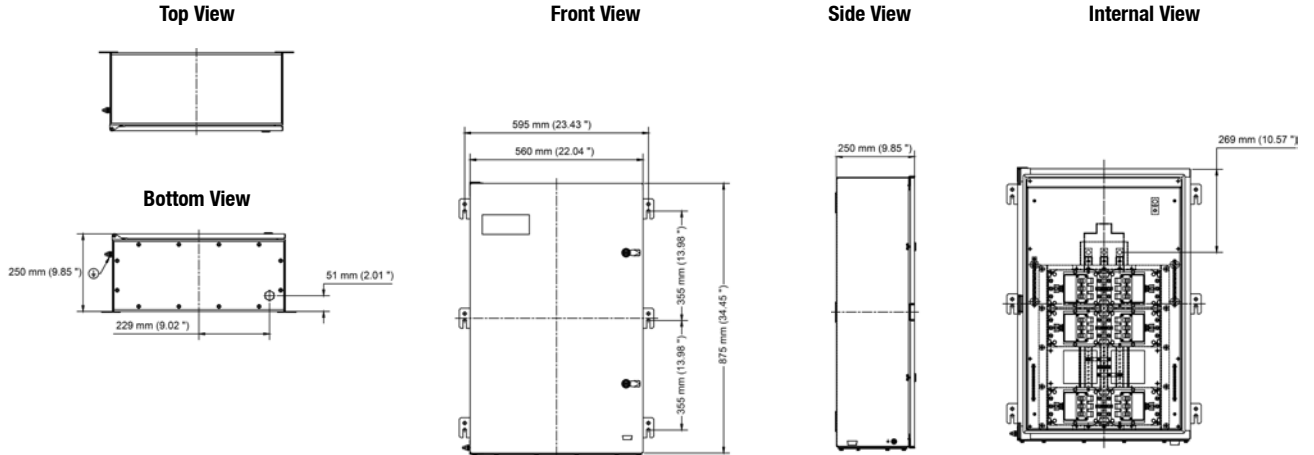

#### Size J 24 Circuit – External Actuation

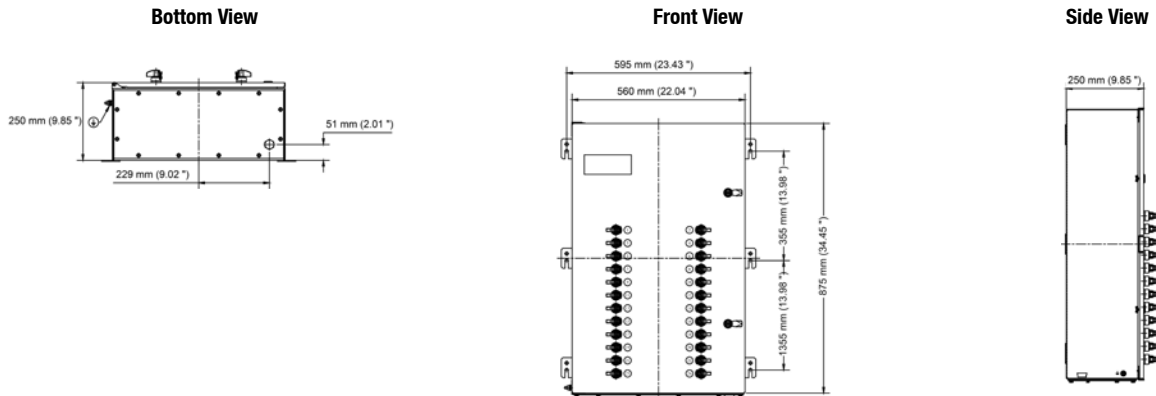

① NEC/CEC Certified lighting panels: 120/240 Volt, 240 Volt, 120/208 Volt.  
 ② NEC/CEC Certified power panels: 277/480 Volt, 480 Volt, 347/600 Volt, 600 Volt.  
 ③ Certification only applies without drain/breather.  
 ④ IP66, Type 4X Certification only applies with drain/breather.

# PlexPower™ Factory Sealed Panelboard with Bus Bar

## 15 to 150 Amps. Stainless Steel Enclosures

DISTRIBUTION EQUIPMENT: NEC/CEC HAZARDOUS LOCATION PANELBOARDS

NEC/CEC — Lighting Panels with Main Lugs ①:  
 Class I, Zone 1, AEx de IIB+H<sub>2</sub> T5  
 Ex de IIB+H<sub>2</sub> T5  
 Class I, Division 2, Groups B, C, D  
 Class II, Division 1, Groups F, G ③  
 Class III ③  
 IP66, Type 4X ④

NEC/CEC — Lighting Panels with Main Breaker ①:  
 Class I, Zone 1, AEx de IIB T5  
 Ex de IIB T5  
 Class I, Division 2, Groups C, D  
 Class II, Division 1, Groups F, G ③  
 Class III ③  
 IP66, Type 4X ④

NEC/CEC — Power Panels ②:  
 Class I, Zone 1, AEx de IIB T5  
 Class I, Zone 1, Ex de IIB T5  
 Class I, Division 2, Groups C, D  
 Class II, Division 1, Groups F, G ③  
 Class III ③  
 IP66, Type 4X ④

### QC-Frame with Main Lugs Dimensions in Millimeters (Inches)

#### Size F 36 Circuit – Internal Actuation

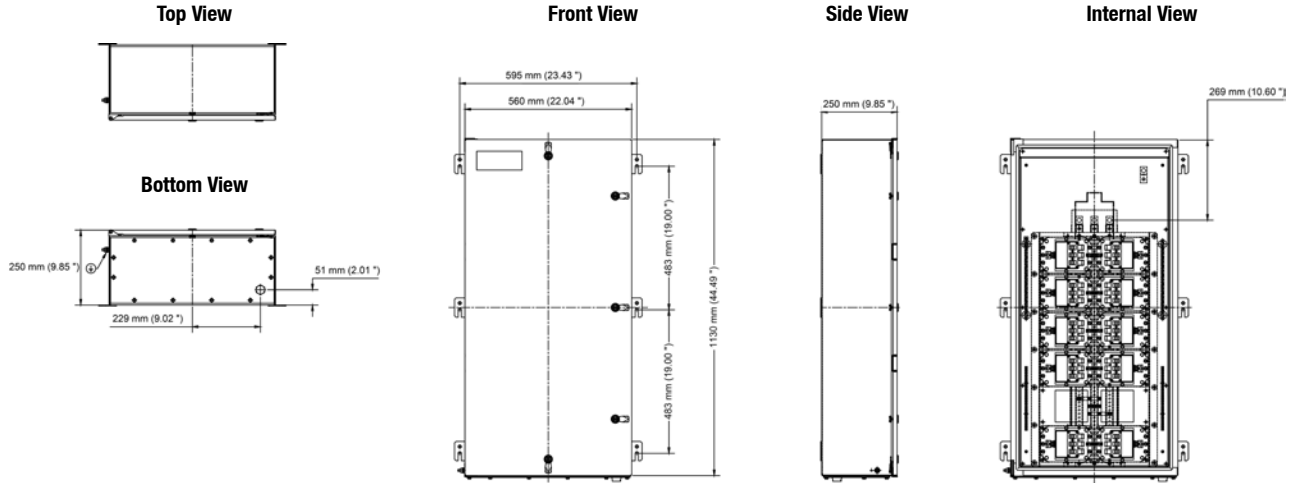

#### Size F 36 Circuit – External Actuation

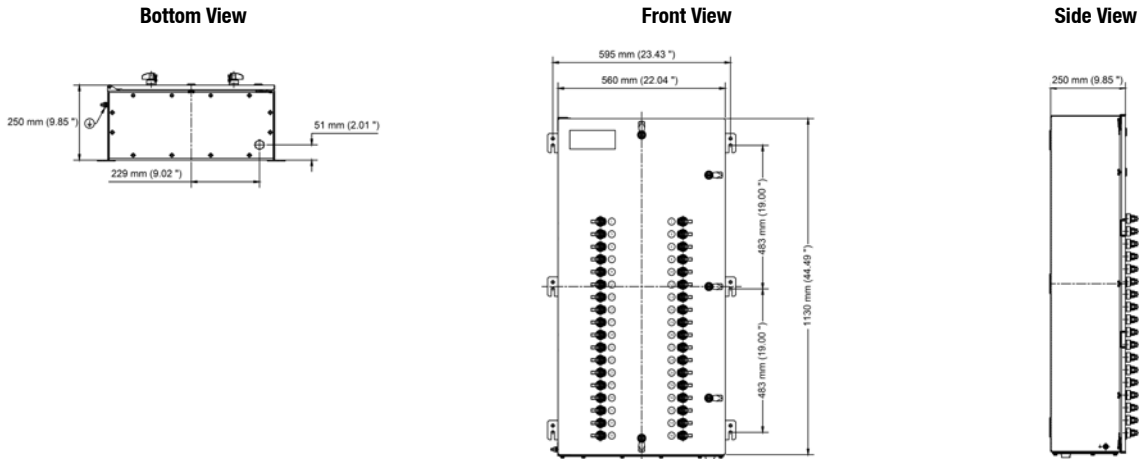

① NEC/CEC Certified lighting panels: 120/240 Volt, 240 Volt, 120/208 Volt.  
 ② NEC/CEC Certified power panels: 277/480 Volt, 480 Volt, 347/600 Volt, 600 Volt.  
 ③ Certification only applies without drain/breather.  
 ④ IP66, Type 4X Certification only applies with drain/breather.

# PlexPower™ Factory Sealed Panelboard with Bus Bar

## 15 to 150 Amps. Stainless Steel Enclosures

NEC/CEC — Lighting Panels with Main Lugs ①:  
 Class I, Zone 1, AEx de IIB+H<sub>2</sub> T5  
 Ex de IIB+H<sub>2</sub> T5  
 Class I, Division 2, Groups B, C, D  
 Class II, Division 1, Groups F, G ③  
 Class III ③  
 IP66, Type 4X ④

NEC/CEC — Lighting Panels with Main Breaker ①:  
 Class I, Zone 1, AEx de IIB T5  
 Ex de IIB T5  
 Class I, Division 2, Groups C, D  
 Class II, Division 1, Groups F, G ③  
 Class III ③  
 IP66, Type 4X ④

NEC/CEC — Power Panels ②:  
 Class I, Zone 1, AEx de IIB T5  
 Class I, Zone 1, Ex de IIB T5  
 Class I, Division 2, Groups C, D  
 Class II, Division 1, Groups F, G ③  
 Class III ③  
 IP66, Type 4X ④

### QC-Frame with Main Lugs Dimensions in Millimeters (Inches)

#### Size L 42 Circuit – Internal Actuation

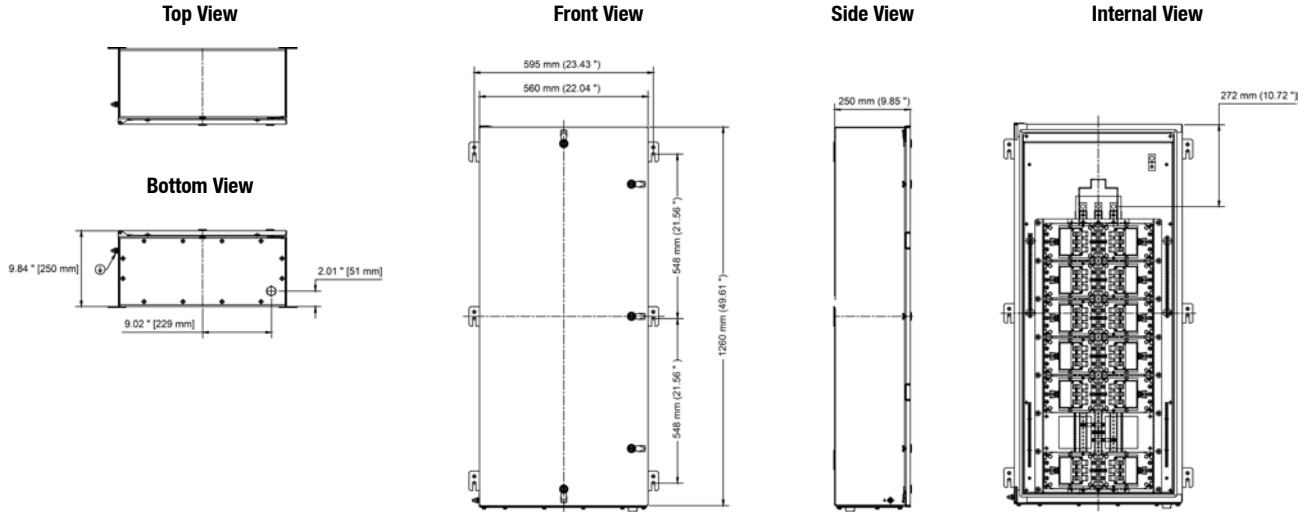

#### Size L 42 Circuit – External Actuation

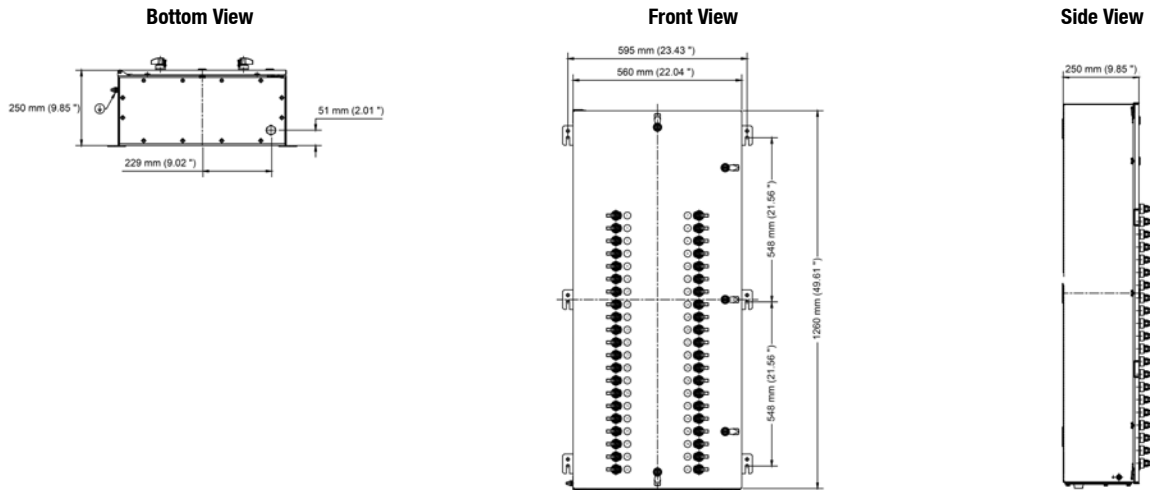

① NEC/CEC Certified lighting panels: 120/240 Volt, 240 Volt, 120/208 Volt.  
 ② NEC/CEC Certified power panels: 277/480 Volt, 480 Volt, 347/600 Volt, 600 Volt.  
 ③ Certification only applies without drain/breather.  
 ④ IP66, Type 4X Certification only applies with drain/breather.

# PlexPower™ Factory Sealed Panelboard with Bus Bar

## 15 to 150 Amps. Stainless Steel Enclosures

DISTRIBUTION EQUIPMENT: NEC/CEC HAZARDOUS LOCATION PANELBOARDS

NEC/CEC – Lighting Panels with Main Lugs ①:  
 Class I, Zone 1, AEx de IIB+H<sub>2</sub> T5  
 Ex de IIB+H<sub>2</sub> T5  
 Class I, Division 2, Groups B, C, D  
 Class II, Division 1, Groups F, G ③  
 Class III ③  
 IP66, Type 4X ④

NEC/CEC – Lighting Panels with Main Breaker ①:  
 Class I, Zone 1, AEx de IIB T5  
 Ex de IIB T5  
 Class I, Division 2, Groups C, D  
 Class II, Division 1, Groups F, G ③  
 Class III ③  
 IP66, Type 4X ④

NEC/CEC – Power Panels ②:  
 Class I, Zone 1, AEx de IIB T5  
 Class I, Zone 1, Ex de IIB T5  
 Class I, Division 2, Groups C, D  
 Class II, Division 1, Groups F, G ③  
 Class III ③  
 IP66, Type 4X ④

### QC-Frame with Main Lugs Dimensions in Millimeters (Inches)

#### Size H 54 Circuit – Internal Actuation

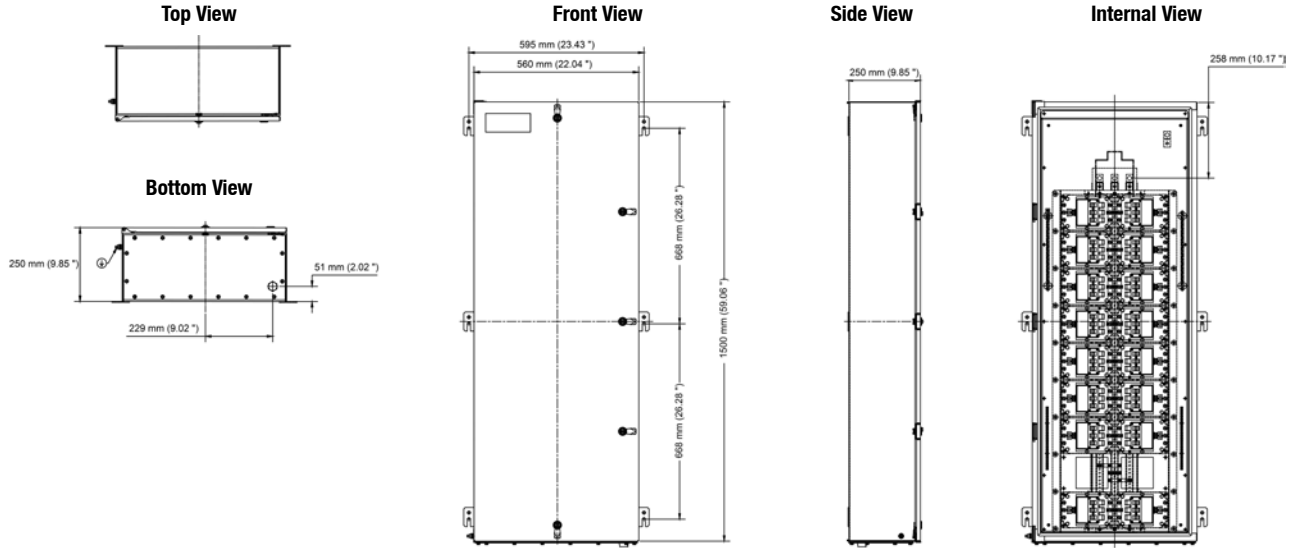

#### Size H 54 Circuit – External Actuation

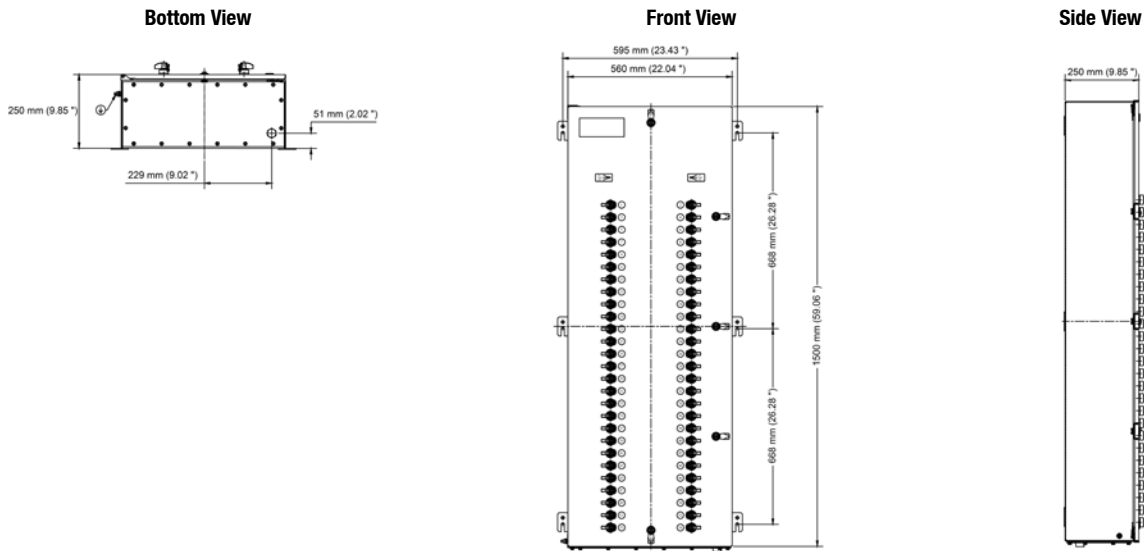

① NEC/CEC Certified lighting panels: 120/240 Volt, 240 Volt, 120/208 Volt.  
 ② NEC/CEC Certified power panels: 277/480 Volt, 480 Volt, 347/600 Volt, 600 Volt.  
 ③ Certification only applies without drain/breather.  
 ④ IP66, Type 4X Certification only applies with drain/breather.

# PlexPower™ Factory Sealed Panelboard with Bus Bar

## 15 to 150 Amps. Stainless Steel Enclosures

NEC/CEC — Lighting Panels with Main Lugs ①:  
 Class I, Zone 1, AEx de IIB+H<sub>2</sub> T5  
 Ex de IIB+H<sub>2</sub> T5  
 Class I, Division 2, Groups B, C, D  
 Class II, Division 1, Groups F, G ③  
 Class III ③  
 IP66, Type 4X ④

NEC/CEC — Lighting Panels with Main Breaker ①:  
 Class I, Zone 1, AEx de IIB T5  
 Ex de IIB T5  
 Class I, Division 2, Groups C, D  
 Class II, Division 1, Groups F, G ③  
 Class III ③  
 IP66, Type 4X ④

NEC/CEC — Power Panels ②:  
 Class I, Zone 1, AEx de IIB T5  
 Class I, Zone 1, Ex de IIB T5  
 Class I, Division 2, Groups C, D  
 Class II, Division 1, Groups F, G ③  
 Class III ③  
 IP66, Type 4X ④

### QC-Frame with Main Breaker Dimensions in Millimeters (Inches)

#### Size C 6 Circuit – Internal Actuation

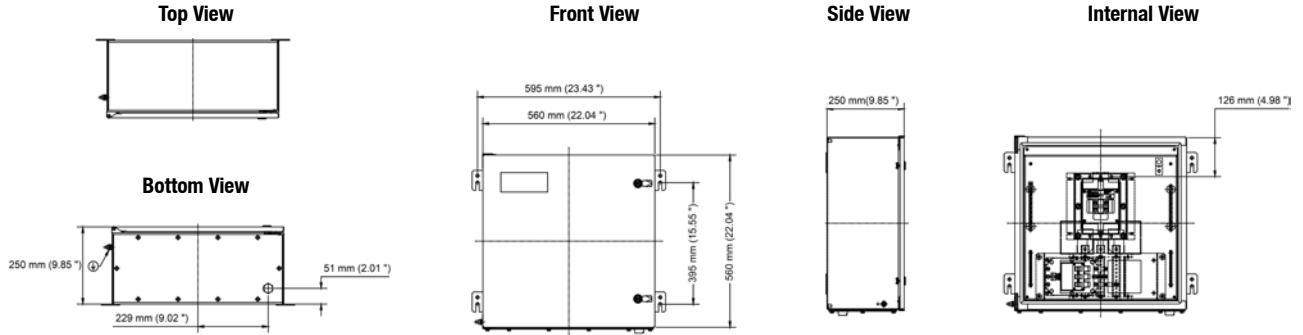

#### Size C 6 Circuit– External Actuation

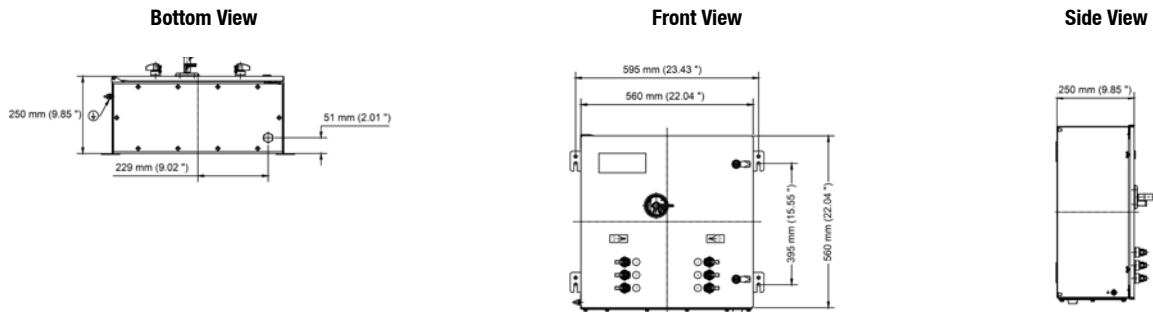

DISTRIBUTION EQUIPMENT: NEC/CEC HAZARDOUS LOCATION PANELBOARDS

Appleton®

① NEC/CEC Certified lighting panels: 120/240 Volt, 240 Volt, 120/208 Volt.  
 ② NEC/CEC Certified power panels: 277/480 Volt, 480 Volt, 347/600 Volt, 600 Volt.  
 ③ Certification only applies without drain/breather.  
 ④ IP66, Type 4X Certification only applies with drain/breather.

# PlexPower™ Factory Sealed Panelboard with Bus Bar

## 15 to 150 Amps. Stainless Steel Enclosures

DISTRIBUTION EQUIPMENT: NEC/CEC HAZARDOUS LOCATION PANELBOARDS

NEC/CEC — Lighting Panels with Main Lugs ①:  
 Class I, Zone 1, AEx de IIB+H<sub>2</sub> T5  
 Ex de IIB+H<sub>2</sub> T5  
 Class I, Division 2, Groups B, C, D  
 Class II, Division 1, Groups F, G ③  
 Class III ③  
 IP66, Type 4X ④

NEC/CEC — Lighting Panels with Main Breaker ①:  
 Class I, Zone 1, AEx de IIB T5  
 Ex de IIB T5  
 Class I, Division 2, Groups C, D  
 Class II, Division 1, Groups F, G ③  
 Class III ③  
 IP66, Type 4X ④

NEC/CEC — Power Panels ②:  
 Class I, Zone 1, AEx de IIB T5  
 Class I, Zone 1, Ex de IIB T5  
 Class I, Division 2, Groups C, D  
 Class II, Division 1, Groups F, G ③  
 Class III ③  
 IP66, Type 4X ④

### QC-Frame with Main Breaker Dimensions in Millimeters (Inches)

#### Size D 12 Circuit – Internal Actuation

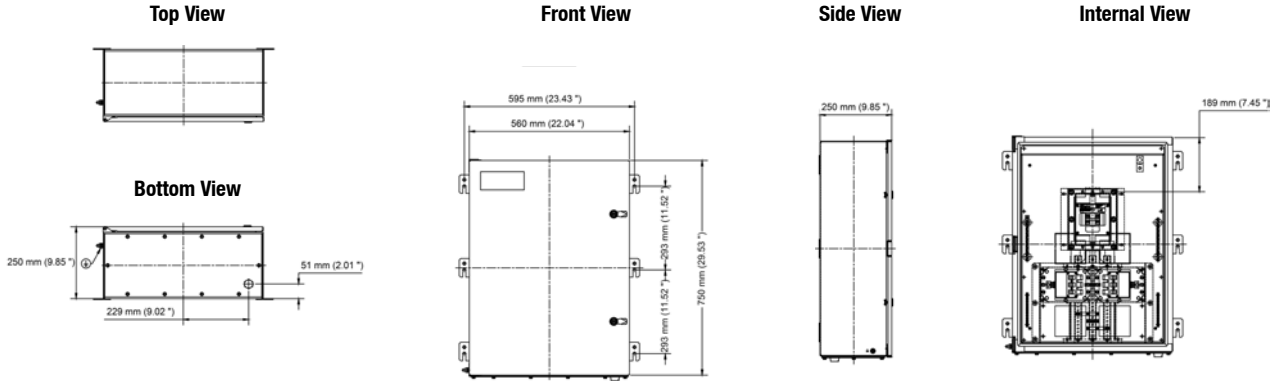

#### Size D 12 Circuit – External Actuation

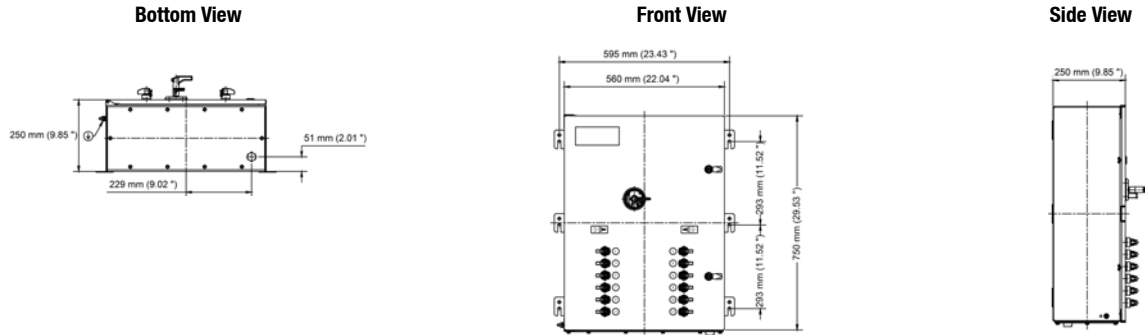

① NEC/CEC Certified lighting panels: 120/240 Volt, 240 Volt, 120/208 Volt.  
 ② NEC/CEC Certified power panels: 277/480 Volt, 480 Volt, 347/600 Volt, 600 Volt.  
 ③ Certification only applies without drain/breather.  
 ④ IP66, Type 4X Certification only applies with drain/breather.

# PlexPower™ Factory Sealed Panelboard with Bus Bar

## 15 to 150 Amps. Stainless Steel Enclosures

NEC/CEC — Lighting Panels with Main Lugs ①:  
 Class I, Zone 1, AEx de IIB+H<sub>2</sub> T5  
 Ex de IIB+H<sub>2</sub> T5  
 Class I, Division 2, Groups B, C, D  
 Class II, Division 1, Groups F, G ③  
 Class III ③  
 IP66, Type 4X ④

NEC/CEC — Lighting Panels with Main Breaker ①:  
 Class I, Zone 1, AEx de IIB T5  
 Ex de IIB T5  
 Class I, Division 2, Groups C, D  
 Class II, Division 1, Groups F, G ③  
 Class III ③  
 IP66, Type 4X ④

NEC/CEC — Power Panels ②:  
 Class I, Zone 1, AEx de IIB T5  
 Class I, Zone 1, Ex de IIB T5  
 Class I, Division 2, Groups C, D  
 Class II, Division 1, Groups F, G ③  
 Class III ③  
 IP66, Type 4X ④

### QC-Frame with Main Breaker Dimensions in Millimeters (Inches)

#### Size J 18 Circuit – Internal Actuation

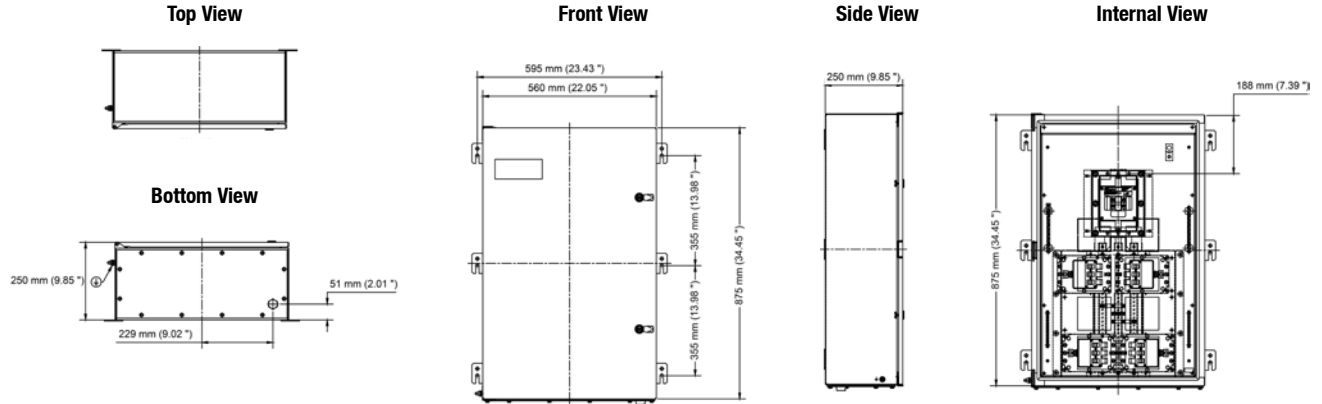

#### Size J 18 Circuit – External Actuation

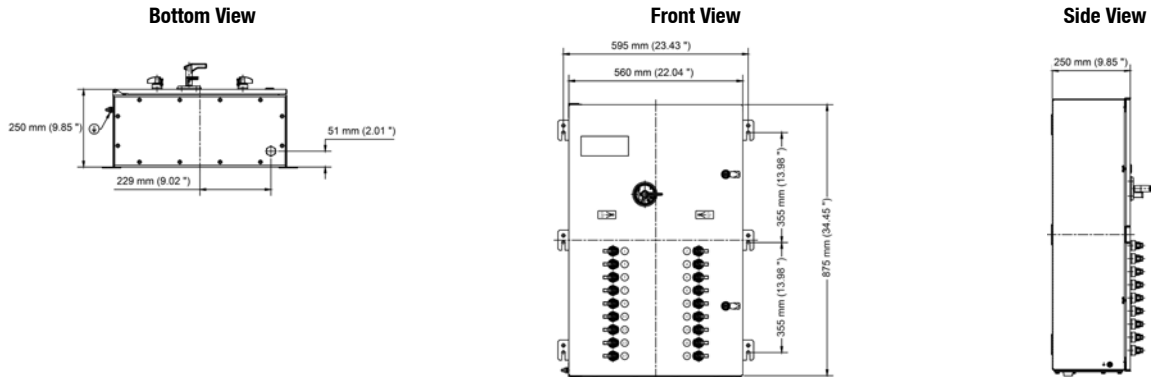

- ① NEC/CEC Certified lighting panels: 120/240 Volt, 240 Volt, 120/208 Volt.
- ② NEC/CEC Certified power panels: 277/480 Volt, 480 Volt, 347/600 Volt, 600 Volt.
- ③ Certification only applies without drain/breather.
- ④ IP66, Type 4X Certification only applies with drain/breather.

# PlexPower™ Factory Sealed Panelboard with Bus Bar

## 15 to 150 Amps. Stainless Steel Enclosures

DISTRIBUTION EQUIPMENT: NEC/CEC HAZARDOUS LOCATION PANELBOARDS

NEC/CEC — Lighting Panels with Main Lugs ①:  
 Class I, Zone 1, AEx de IIB+H<sub>2</sub> T5  
 Ex de IIB+H<sub>2</sub> T5  
 Class I, Division 2, Groups B, C, D  
 Class II, Division 1, Groups F, G ③  
 Class III ③  
 IP66, Type 4X ④

NEC/CEC — Lighting Panels with Main Breaker ①:  
 Class I, Zone 1, AEx de IIB T5  
 Ex de IIB T5  
 Class I, Division 2, Groups C, D  
 Class II, Division 1, Groups F, G ③  
 Class III ③  
 IP66, Type 4X ④

NEC/CEC — Power Panels ②:  
 Class I, Zone 1, AEx de IIB T5  
 Class I, Zone 1, Ex de IIB T5  
 Class I, Division 2, Groups C, D  
 Class II, Division 1, Groups F, G ③  
 Class III ③  
 IP66, Type 4X ④

### QC-Frame with Main Breaker Dimensions in Millimeters (Inches)

#### Size F 30 Circuit— Internal Actuation

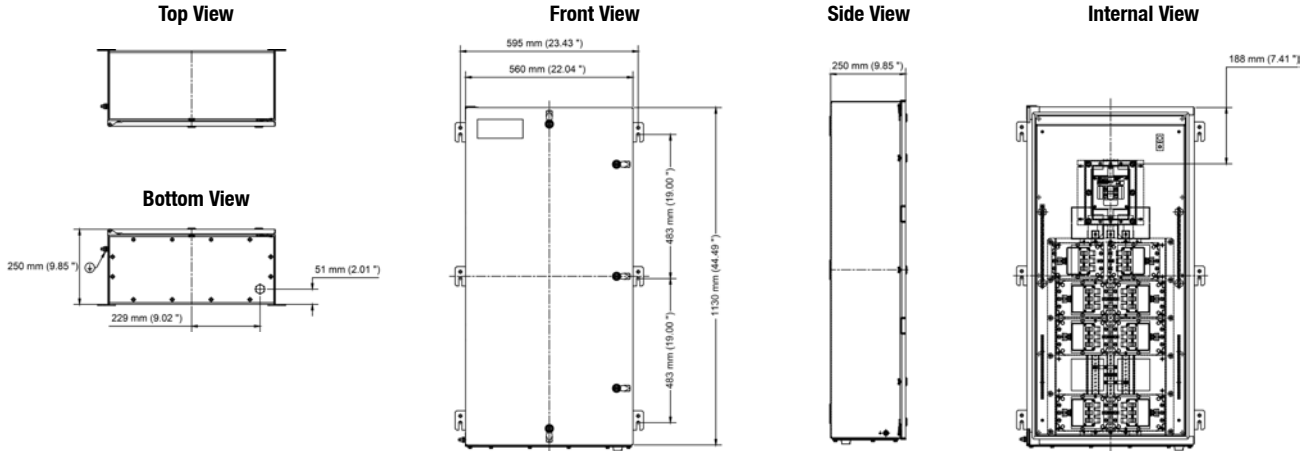

#### Size F 30 Circuit – External Actuation

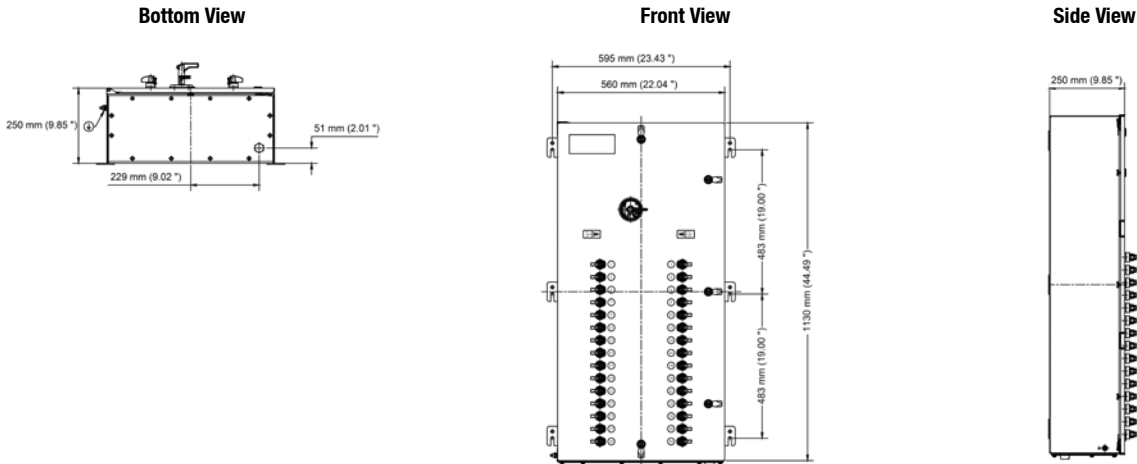

① NEC/CEC Certified lighting panels: 120/240 Volt, 240 Volt, 120/208 Volt.  
 ② NEC/CEC Certified power panels: 277/480 Volt, 480 Volt, 347/600 Volt, 600 Volt.  
 ③ Certification only applies without drain/breather.  
 ④ IP66, Type 4X Certification only applies with drain/breather.



# PlexPower™ Factory Sealed Panelboard with Bus Bar

## 15 to 150 Amps. Stainless Steel Enclosures

NEC/CEC — Lighting Panels with Main Lugs ①:  
 Class I, Zone 1, AEx de IIB+H<sub>2</sub> T5  
 Ex de IIB+H<sub>2</sub> T5  
 Class I, Division 2, Groups B, C, D  
 Class II, Division 1, Groups F, G ③  
 Class III ③  
 IP66, Type 4X ④

NEC/CEC — Lighting Panels with Main Breaker ①:  
 Class I, Zone 1, AEx de IIB T5  
 Ex de IIB T5  
 Class I, Division 2, Groups C, D  
 Class II, Division 1, Groups F, G ③  
 Class III ③  
 IP66, Type 4X ④

NEC/CEC — Power Panels ②:  
 Class I, Zone 1, AEx de IIB T5  
 Class I, Zone 1, Ex de IIB T5  
 Class I, Division 2, Groups C, D  
 Class II, Division 1, Groups F, G ③  
 Class III ③  
 IP66, Type 4X ④

### QC-Frame with Main Breaker Dimensions in Millimeters (Inches)

#### Size L 36 Circuit— Internal Actuation

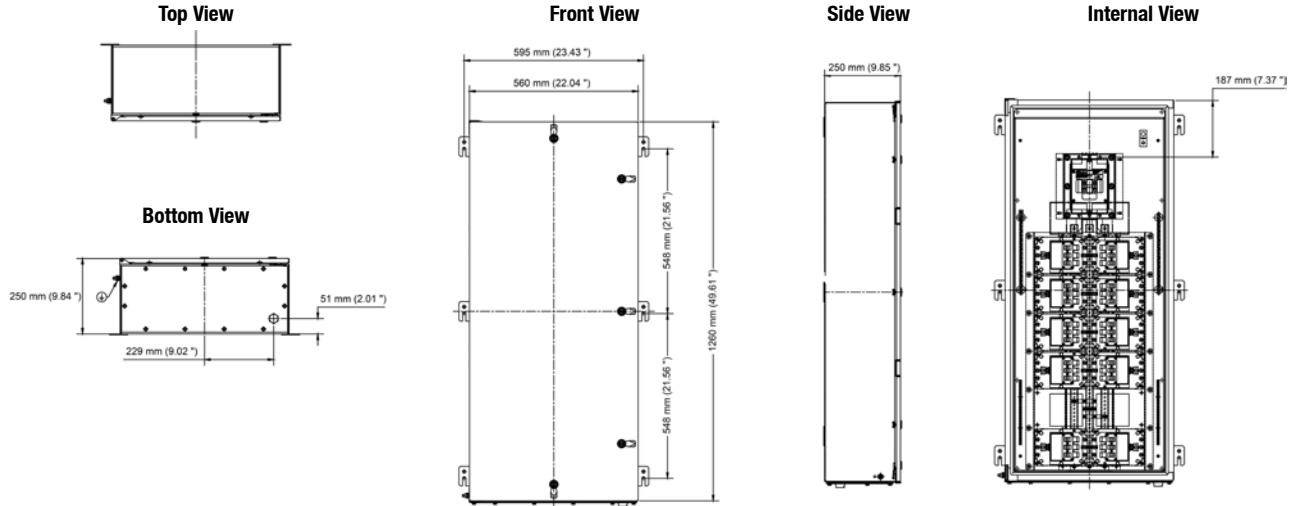

#### Size L 36 Circuit – External Actuation

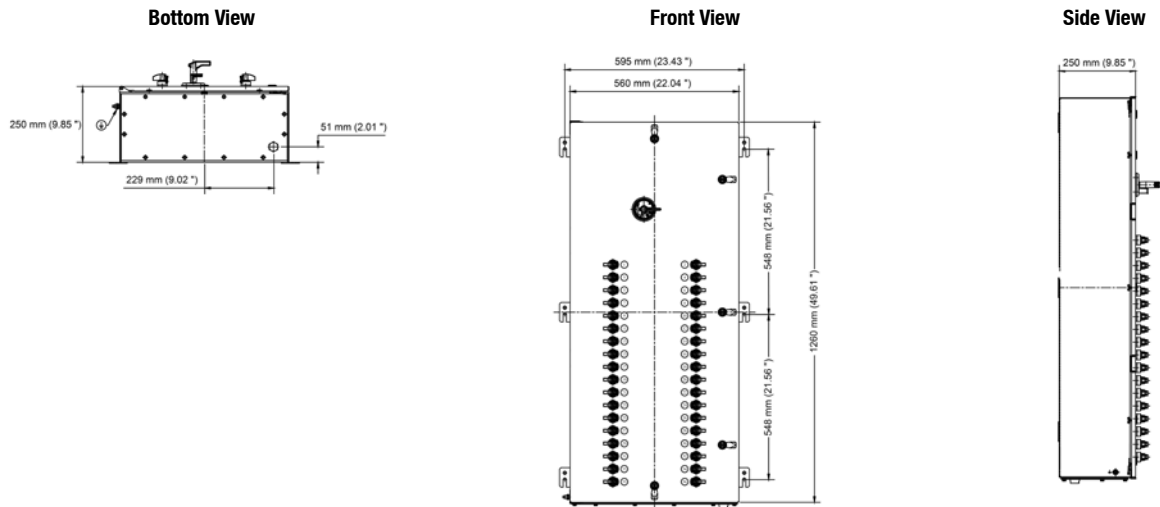

① NEC/CEC Certified lighting panels: 120/240 Volt, 240 Volt, 120/208 Volt.  
 ② NEC/CEC Certified power panels: 277/480 Volt, 480 Volt, 347/600 Volt, 600 Volt.  
 ③ Certification only applies without drain/breather.  
 ④ IP66, Type 4X Certification only applies with drain/breather.

# PlexPower™ Factory Sealed Panelboard with Bus Bar

## 15 to 150 Amps. Stainless Steel Enclosures

DISTRIBUTION EQUIPMENT: NEC/CEC HAZARDOUS LOCATION PANELBOARDS

NEC/CEC – Lighting Panels with Main Lugs ①:  
 Class I, Zone 1, AEx de IIB+H<sub>2</sub> T5  
 Ex de IIB+H<sub>2</sub> T5  
 Class I, Division 2, Groups B, C, D  
 Class II, Division 1, Groups F, G ③  
 Class III ③  
 IP66, Type 4X ④

NEC/CEC – Lighting Panels with Main Breaker ①:  
 Class I, Zone 1, AEx de IIB T5  
 Ex de IIB T5  
 Class I, Division 2, Groups C, D  
 Class II, Division 1, Groups F, G ③  
 Class III ③  
 IP66, Type 4X ④

NEC/CEC – Power Panels ②:  
 Class I, Zone 1, AEx de IIB T5  
 Class I, Zone 1, Ex de IIB T5  
 Class I, Division 2, Groups C, D  
 Class II, Division 1, Groups F, G ③  
 Class III ③  
 IP66, Type 4X ④

### QC-Frame with Main Breaker Dimensions in Millimeters (Inches)

#### Size H 48 Circuit– Internal Actuation

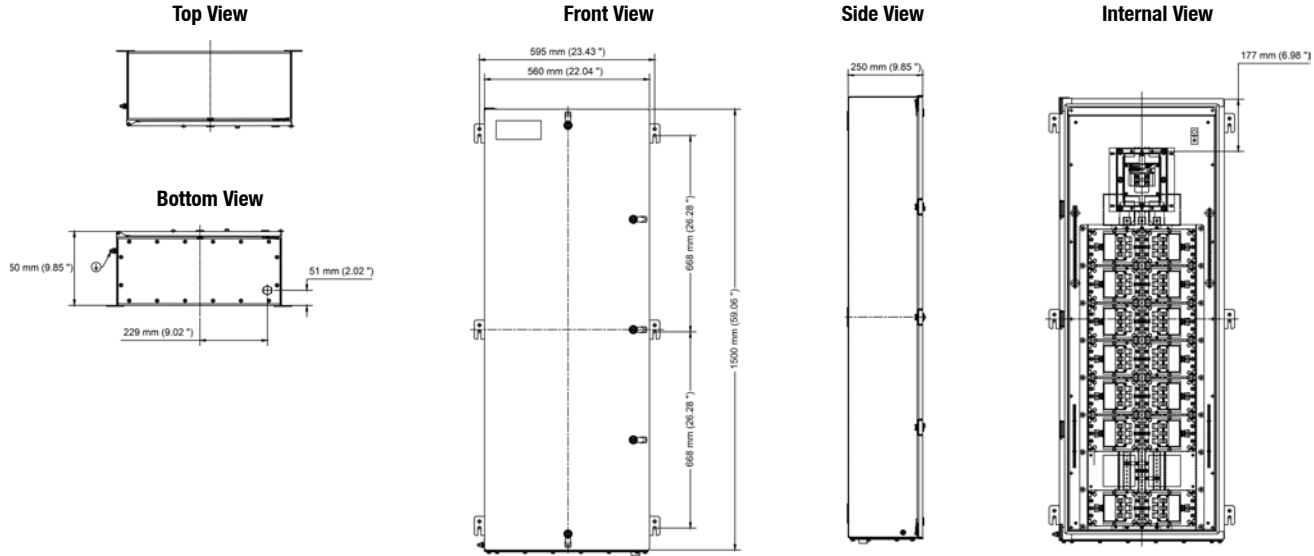

#### Size H 48 Circuit – External Actuation

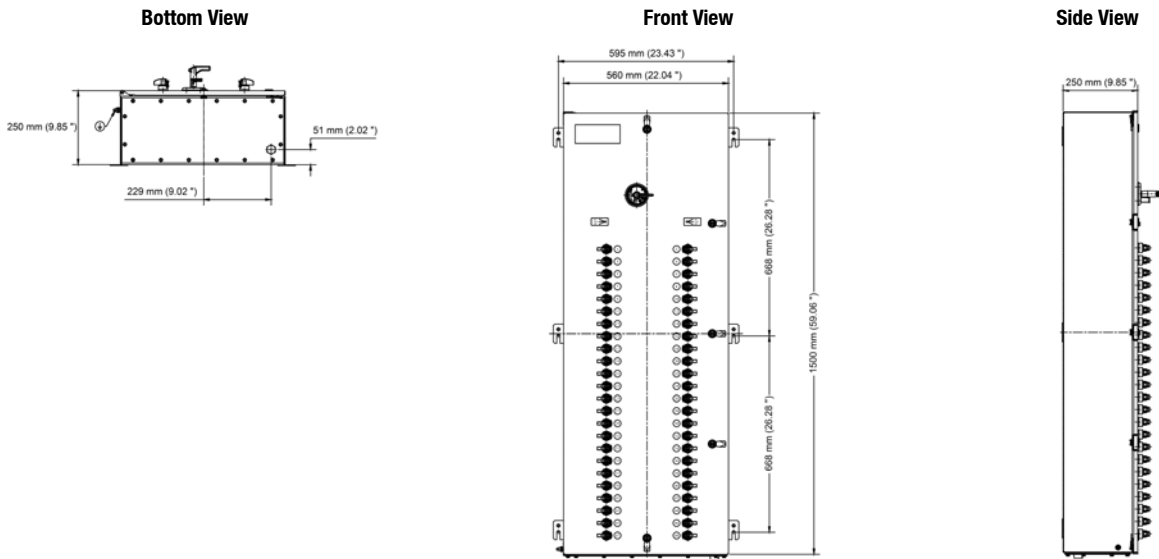

① NEC/CEC Certified lighting panels: 120/240 Volt, 240 Volt, 120/208 Volt.  
 ② NEC/CEC Certified power panels: 277/480 Volt, 480 Volt, 347/600 Volt, 600 Volt.  
 ③ Certification only applies without drain/breather.  
 ④ IP66, Type 4X Certification only applies with drain/breather.

# PlexPower™ Factory Sealed Panelboard with Bus Bar

## 15 to 150 Amps. Stainless Steel Enclosures

NEC/CEC — Lighting Panels with Main Lugs ①:  
 Class I, Zone 1, AEx de IIB+H<sub>2</sub> T5  
 Ex de IIB+H<sub>2</sub> T5  
 Class I, Division 2, Groups B, C, D  
 Class II, Division 1, Groups F, G ③  
 Class III ③  
 IP66, Type 4X ④

NEC/CEC — Lighting Panels with Main Breaker ①:  
 Class I, Zone 1, AEx de IIB T5  
 Ex de IIB T5  
 Class I, Division 2, Groups C, D  
 Class II, Division 1, Groups F, G ③  
 Class III ③  
 IP66, Type 4X ④

NEC/CEC — Power Panels ②:  
 Class I, Zone 1, AEx de IIB T5  
 Class I, Zone 1, Ex de IIB T5  
 Class I, Division 2, Groups C, D  
 Class II, Division 1, Groups F, G ③  
 Class III ③  
 IP66, Type 4X ④

### F-Frame with Main Lugs Dimensions in Millimeters (Inches)

#### Size C 6 Circuit – Internal Actuation

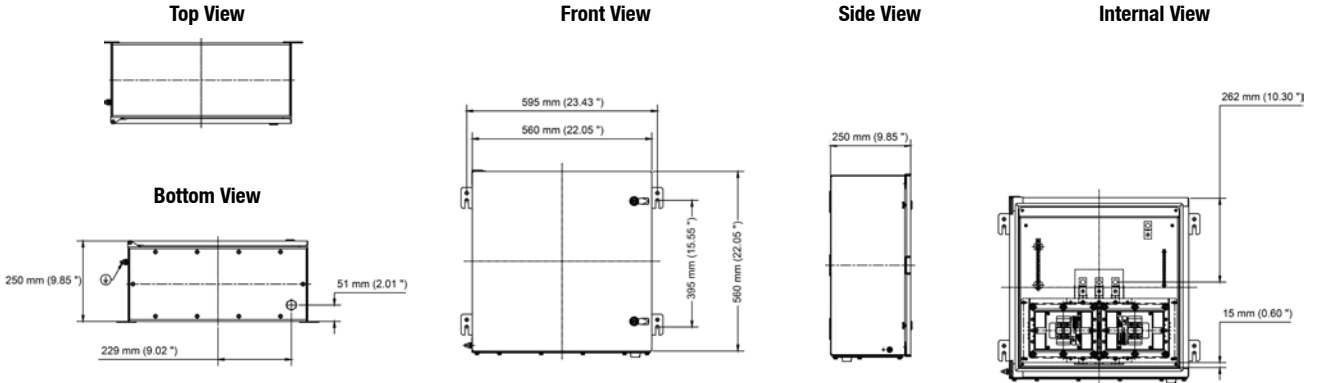

#### Size C 6 Circuit – External Actuation

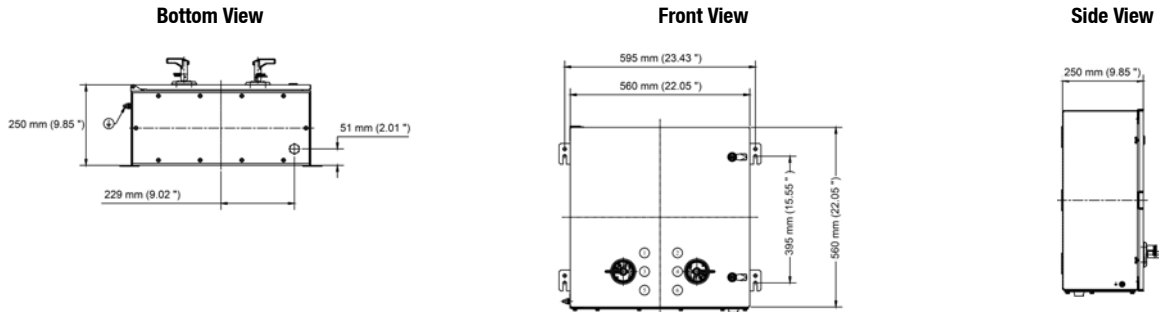

① NEC/CEC Certified lighting panels: 120/240 Volt, 240 Volt, 120/208 Volt.  
 ② NEC/CEC Certified power panels: 277/480 Volt, 480 Volt, 347/600 Volt, 600 Volt.  
 ③ Certification only applies without drain/breather.  
 ④ IP66, Type 4X Certification only applies with drain/breather.

# PlexPower™ Factory Sealed Panelboard with Bus Bar

## 15 to 150 Amps. Stainless Steel Enclosures

DISTRIBUTION EQUIPMENT: NEC/CEC HAZARDOUS LOCATION PANELBOARDS

**NEC/CEC – Lighting Panels with Main Lugs ①:**  
 Class I, Zone 1, AEx de IIB+H<sub>2</sub> T5  
 Ex de IIB+H<sub>2</sub> T5  
 Class I, Division 2, Groups B, C, D  
 Class II, Division 1, Groups F, G ③  
 Class III ③  
 IP66, Type 4X ④

**NEC/CEC – Lighting Panels with Main Breaker ①:**  
 Class I, Zone 1, AEx de IIB T5  
 Ex de IIB T5  
 Class I, Division 2, Groups C, D  
 Class II, Division 1, Groups F, G ③  
 Class III ③  
 IP66, Type 4X ④

**NEC/CEC – Power Panels ②:**  
 Class I, Zone 1, AEx de IIB T5  
 Class I, Zone 1, Ex de IIB T5  
 Class I, Division 2, Groups C, D  
 Class II, Division 1, Groups F, G ③  
 Class III ③  
 IP66, Type 4X ④

### F-Frame with Main Lugs Dimensions in Millimeters (Inches)

#### Size I 18 Circuit – Internal Actuation

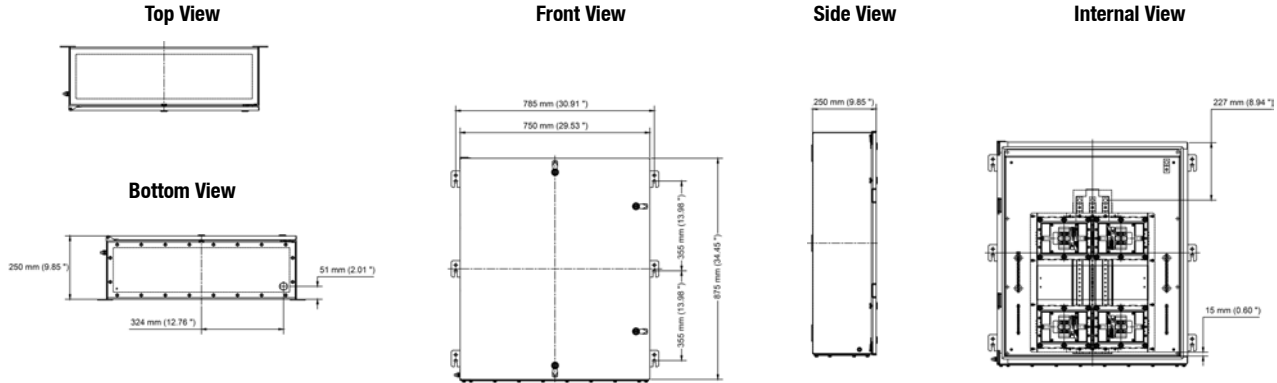

#### Size I 18 Circuit – External Actuation

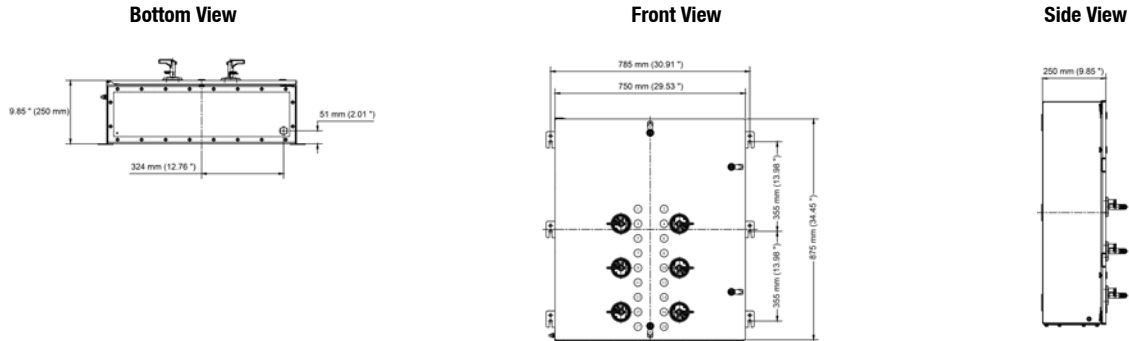

① NEC/CEC Certified lighting panels: 120/240 Volt, 240 Volt, 120/208 Volt.  
 ② NEC/CEC Certified power panels: 277/480 Volt, 480 Volt, 347/600 Volt, 600 Volt.  
 ③ Certification only applies without drain/breather.  
 ④ IP66, Type 4X Certification only applies with drain/breather.

# PlexPower™ Factory Sealed Panelboard with Bus Bar

## 15 to 150 Amps. Stainless Steel Enclosures

NEC/CEC — Lighting Panels with Main Lugs ①:  
 Class I, Zone 1, AEx de IIB+H<sub>2</sub> T5  
 Ex de IIB+H<sub>2</sub> T5  
 Class I, Division 2, Groups B, C, D  
 Class II, Division 1, Groups F, G ③  
 Class III ③  
 IP66, Type 4X ④

NEC/CEC — Lighting Panels with Main Breaker ①:  
 Class I, Zone 1, AEx de IIB T5  
 Ex de IIB T5  
 Class I, Division 2, Groups C, D  
 Class II, Division 1, Groups F, G ③  
 Class III ③  
 IP66, Type 4X ④

NEC/CEC — Power Panels ②:  
 Class I, Zone 1, AEx de IIB T5  
 Class I, Zone 1, Ex de IIB T5  
 Class I, Division 2, Groups C, D  
 Class II, Division 1, Groups F, G ③  
 Class III ③  
 IP66, Type 4X ④

### F-Frame with Main Lugs Dimensions in Millimeters (Inches)

#### Size E 24 Circuit – Internal Actuation

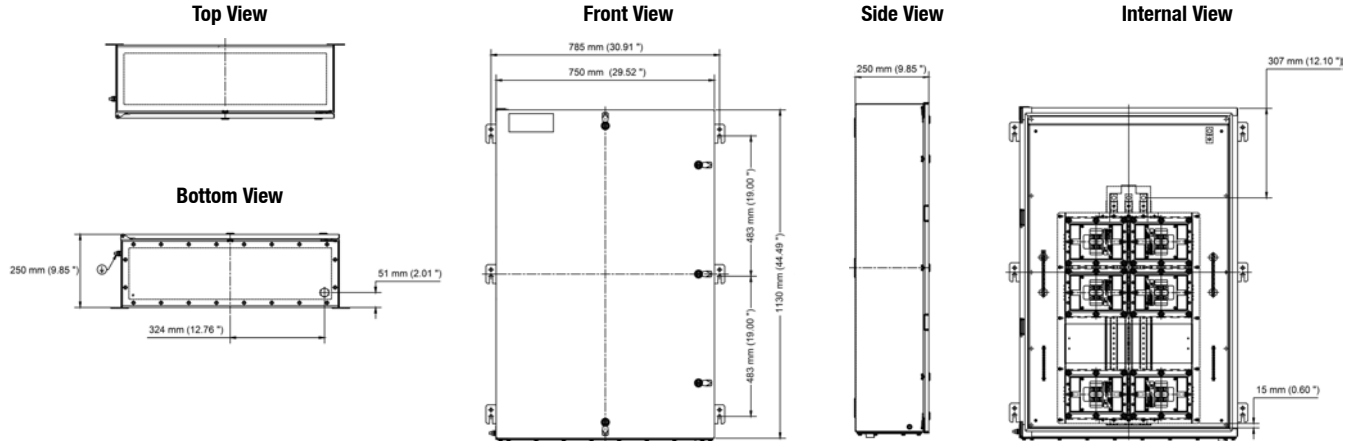

#### Size E 24 Circuit – External Actuation

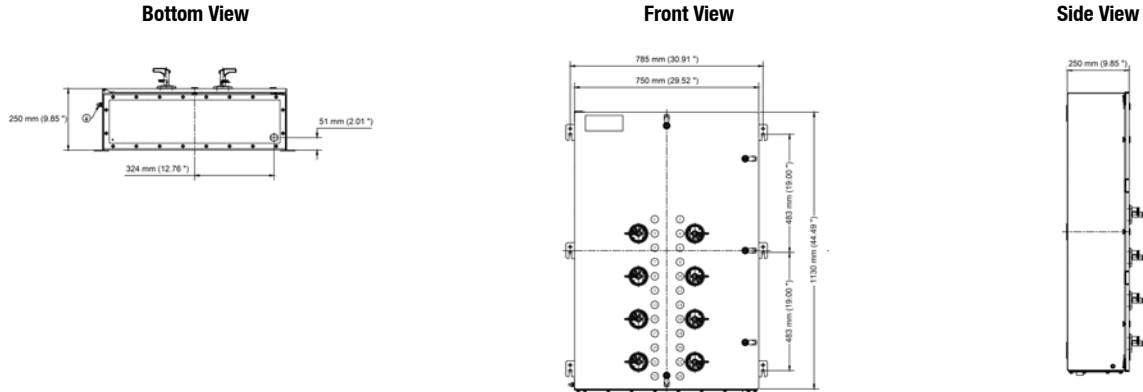

① NEC/CEC Certified lighting panels: 120/240 Volt, 240 Volt, 120/208 Volt.  
 ② NEC/CEC Certified power panels: 277/480 Volt, 480 Volt, 347/600 Volt, 600 Volt.  
 ③ Certification only applies without drain/breather.  
 ④ IP66, Type 4X Certification only applies with drain/breather.

# PlexPower™ Factory Sealed Panelboard with Bus Bar

## 15 to 150 Amps. Stainless Steel Enclosures

DISTRIBUTION EQUIPMENT: NEC/CEC HAZARDOUS LOCATION PANELBOARDS

**NEC/CEC — Lighting Panels with Main Lugs ①:**  
 Class I, Zone 1, AEx de IIB+H<sub>2</sub> T5  
 Ex de IIB+H<sub>2</sub> T5  
 Class I, Division 2, Groups B, C, D  
 Class II, Division 1, Groups F, G ③  
 Class III ③  
 IP66, Type 4X ④

**NEC/CEC — Lighting Panels with Main Breaker ①:**  
 Class I, Zone 1, AEx de IIB T5  
 Ex de IIB T5  
 Class I, Division 2, Groups C, D  
 Class II, Division 1, Groups F, G ③  
 Class III ③  
 IP66, Type 4X ④

**NEC/CEC — Power Panels ②:**  
 Class I, Zone 1, AEx de IIB T5  
 Class I, Zone 1, Ex de IIB T5  
 Class I, Division 2, Groups C, D  
 Class II, Division 1, Groups F, G ③  
 Class III ③  
 IP66, Type 4X ④

### F-Frame with Main Lugs Dimensions in Millimeters (Inches)

#### Size K 30 Circuit – Internal Actuation

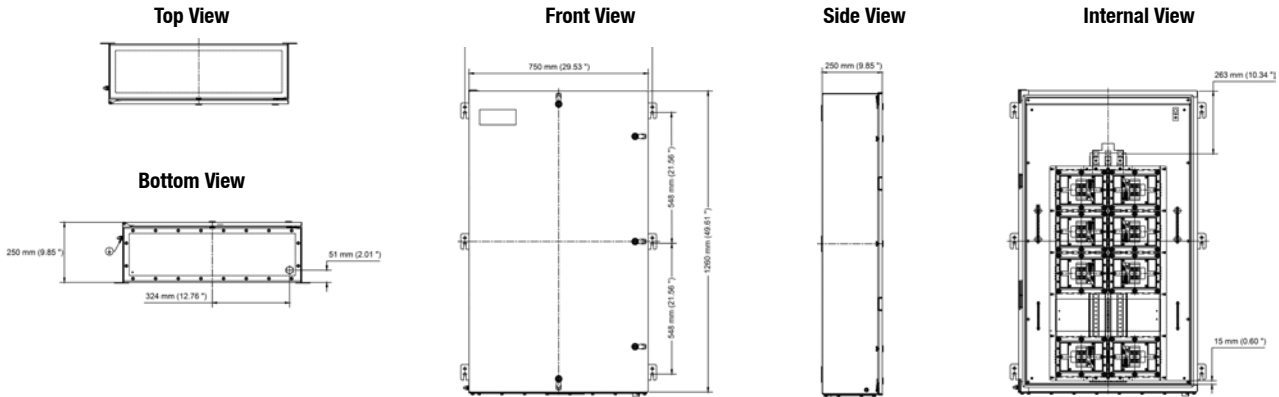

#### Size K 30 Circuit – External Actuation

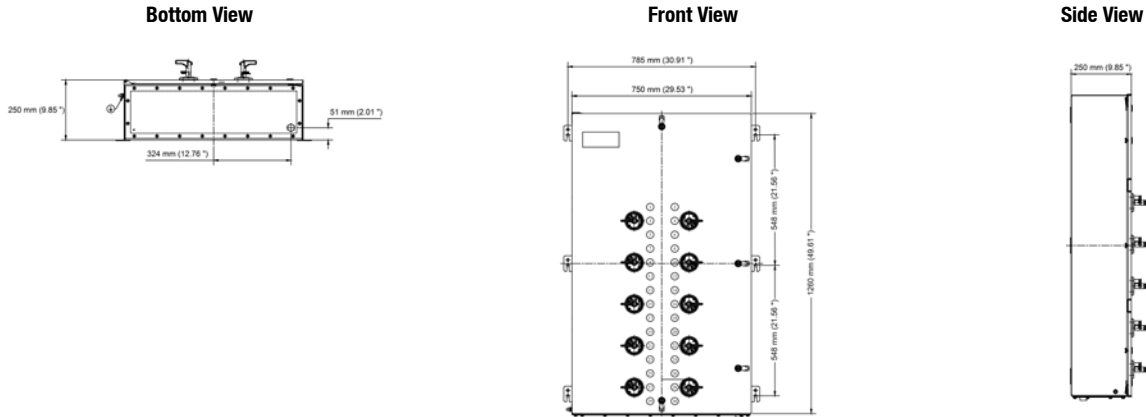

① NEC/CEC Certified lighting panels: 120/240 Volt, 240 Volt, 120/208 Volt.  
 ② NEC/CEC Certified power panels: 277/480 Volt, 480 Volt, 347/600 Volt, 600 Volt.  
 ③ Certification only applies without drain/breather.  
 ④ IP66, Type 4X Certification only applies with drain/breather.

# PlexPower™ Factory Sealed Panelboard with Bus Bar

## 15 to 150 Amps. Stainless Steel Enclosures

NEC/CEC — Lighting Panels with Main Lugs ①:  
 Class I, Zone 1, AEx de IIB+H<sub>2</sub> T5  
 Ex de IIB+H<sub>2</sub> T5  
 Class I, Division 2, Groups B, C, D  
 Class II, Division 1, Groups F, G ③  
 Class III ③  
 IP66, Type 4X ④

NEC/CEC — Lighting Panels with Main Breaker ①:  
 Class I, Zone 1, AEx de IIB T5  
 Ex de IIB T5  
 Class I, Division 2, Groups C, D  
 Class II, Division 1, Groups F, G ③  
 Class III ③  
 IP66, Type 4X ④

NEC/CEC — Power Panels ②:  
 Class I, Zone 1, AEx de IIB T5  
 Class I, Zone 1, Ex de IIB T5  
 Class I, Division 2, Groups C, D  
 Class II, Division 1, Groups F, G ③  
 Class III ③  
 IP66, Type 4X ④

### F-Frame with Main Lugs Dimensions in Millimeters (Inches)

#### Size G 36 Circuit— Internal Actuation

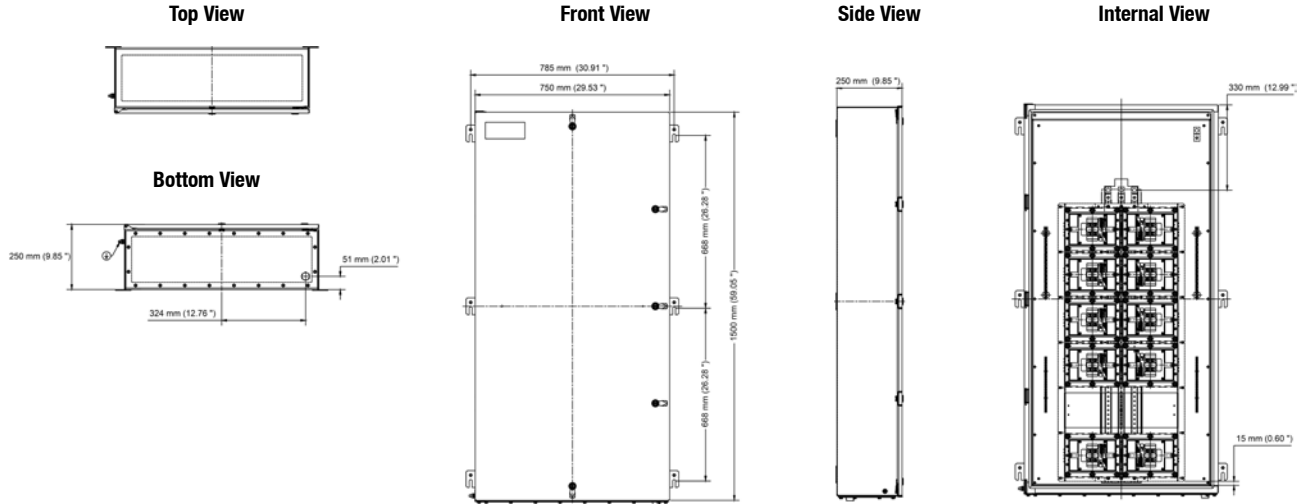

#### Size G 36 Circuit – External Actuation

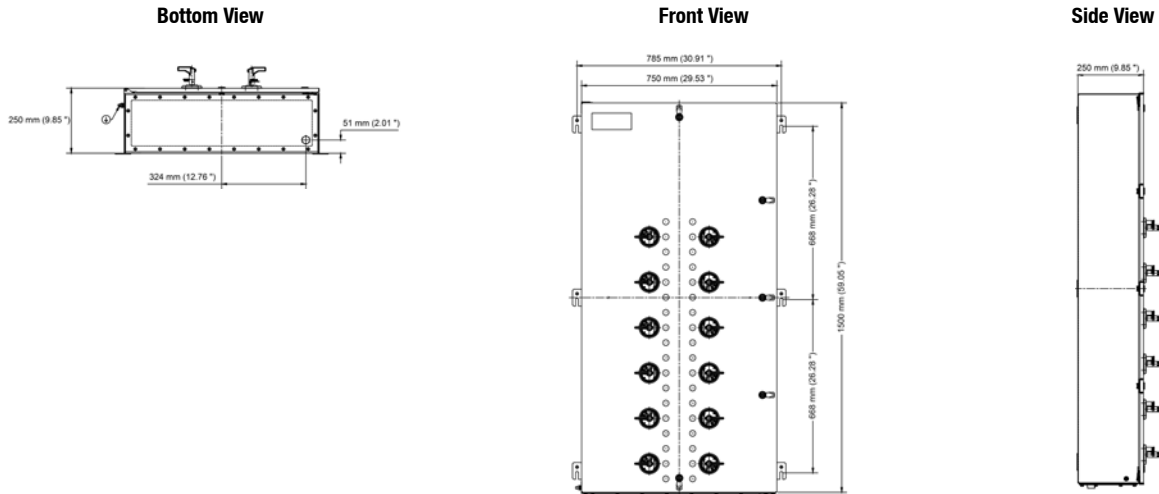

① NEC/CEC Certified lighting panels: 120/240 Volt, 240 Volt, 120/208 Volt.  
 ② NEC/CEC Certified power panels: 277/480 Volt, 480 Volt, 347/600 Volt, 600 Volt.  
 ③ Certification only applies without drain/breather.  
 ④ IP66, Type 4X Certification only applies with drain/breather.

# PlexPower™ Factory Sealed Panelboard with Bus Bar

## 15 to 150 Amps. Stainless Steel Enclosures

DISTRIBUTION EQUIPMENT: NEC/CEC HAZARDOUS LOCATION PANELBOARDS

**NEC/CEC — Lighting Panels with Main Lugs ①:**  
 Class I, Zone 1, AEx de IIB+H<sub>2</sub> T5  
 Ex de IIB+H<sub>2</sub> T5  
 Class I, Division 2, Groups B, C, D  
 Class II, Division 1, Groups F, G ③  
 Class III ③  
 IP66, Type 4X ④

**NEC/CEC — Lighting Panels with Main Breaker ①:**  
 Class I, Zone 1, AEx de IIB T5  
 Ex de IIB T5  
 Class I, Division 2, Groups C, D  
 Class II, Division 1, Groups F, G ③  
 Class III ③  
 IP66, Type 4X ④

**NEC/CEC — Power Panels ②:**  
 Class I, Zone 1, AEx de IIB T5  
 Class I, Zone 1, Ex de IIB T5  
 Class I, Division 2, Groups C, D  
 Class II, Division 1, Groups F, G ③  
 Class III ③  
 IP66, Type 4X ④

### F-Frame with Main Breaker Dimensions in Millimeters (Inches)

#### Size I 12 Circuit – Internal Actuation

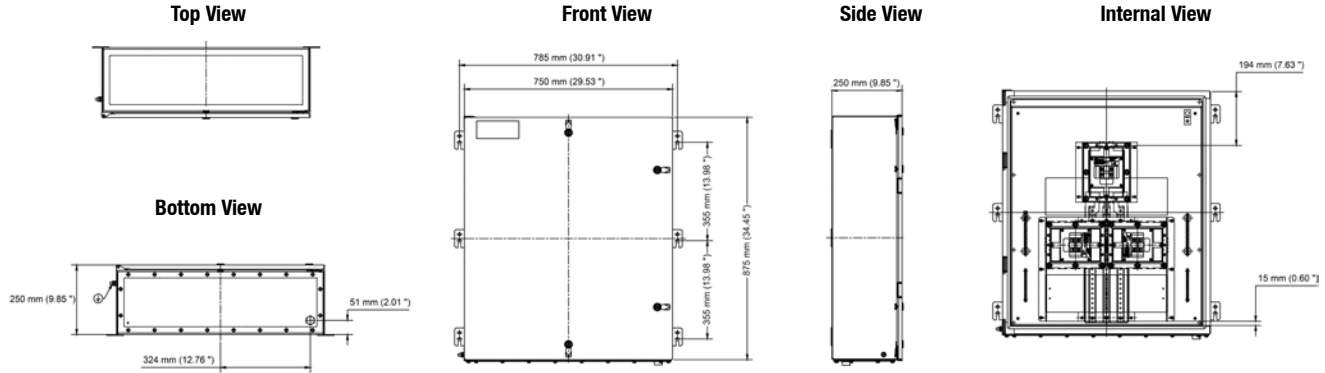

#### Size I 12 Circuit – External Actuation

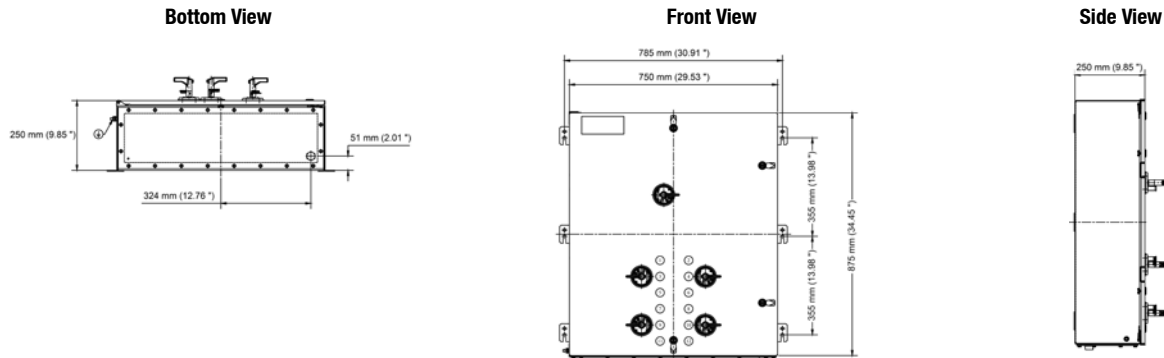

① NEC/CEC Certified lighting panels: 120/240 Volt, 240 Volt, 120/208 Volt.  
 ② NEC/CEC Certified power panels: 277/480 Volt, 480 Volt, 347/600 Volt, 600 Volt.  
 ③ Certification only applies without drain/breather.  
 ④ IP66, Type 4X Certification only applies with drain/breather.



# PlexPower™ Factory Sealed Panelboard with Bus Bar

## 15 to 150 Amps. Stainless Steel Enclosures

NEC/CEC — Lighting Panels with Main Lugs ①:  
 Class I, Zone 1, AEx de IIB+H<sub>2</sub> T5  
 Ex de IIB+H<sub>2</sub> T5  
 Class I, Division 2, Groups B, C, D  
 Class II, Division 1, Groups F, G ③  
 Class III ③  
 IP66, Type 4X ④

NEC/CEC — Lighting Panels with Main Breaker ①:  
 Class I, Zone 1, AEx de IIB T5  
 Ex de IIB T5  
 Class I, Division 2, Groups C, D  
 Class II, Division 1, Groups F, G ③  
 Class III ③  
 IP66, Type 4X ④

NEC/CEC — Power Panels ②:  
 Class I, Zone 1, AEx de IIB T5  
 Class I, Zone 1, Ex de IIB T5  
 Class I, Division 2, Groups C, D  
 Class II, Division 1, Groups F, G ③  
 Class III ③  
 IP66, Type 4X ④

### F-Frame with Main Breaker Dimensions in Millimeters (Inches)

#### Size E 18 Circuit— Internal Actuation

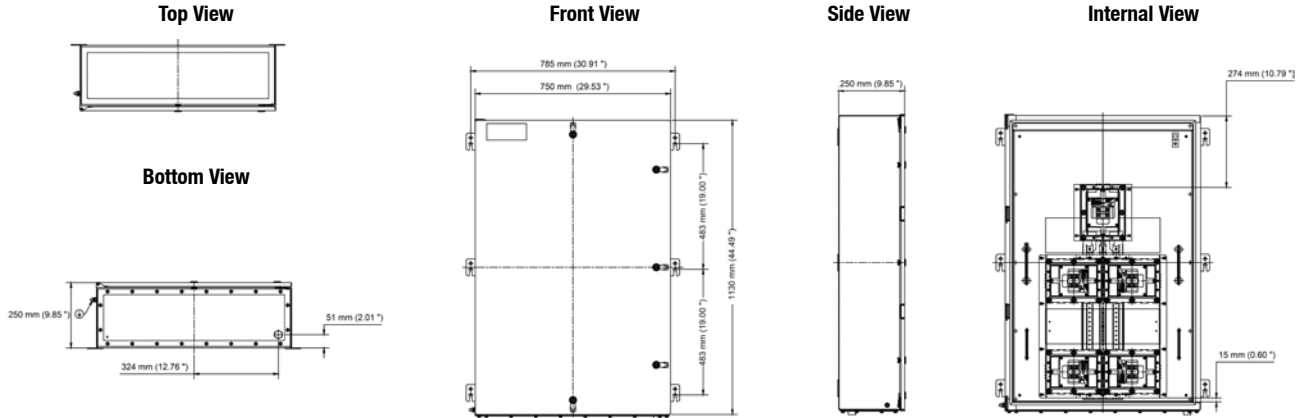

#### Size E 18 Circuit – External Actuation

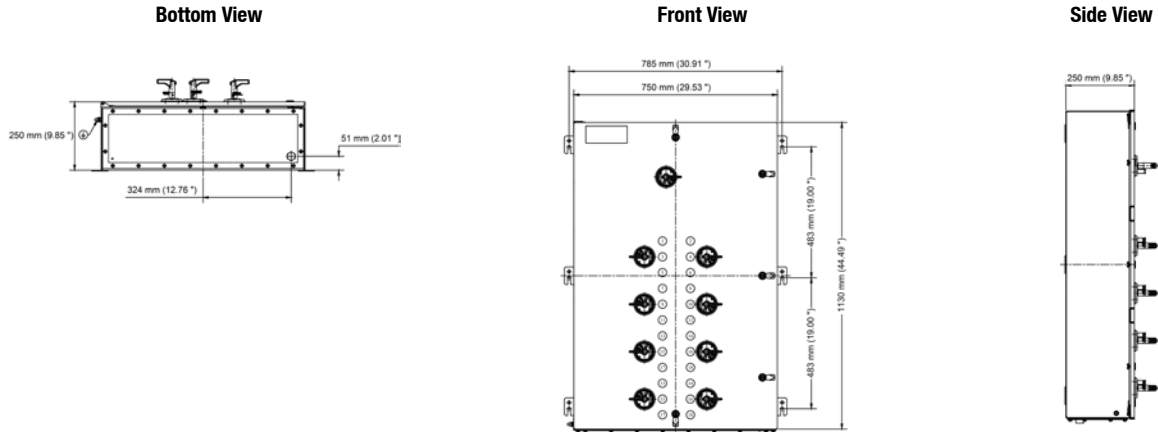

① NEC/CEC Certified lighting panels: 120/240 Volt, 240 Volt, 120/208 Volt.  
 ② NEC/CEC Certified power panels: 277/480 Volt, 480 Volt, 347/600 Volt, 600 Volt.  
 ③ Certification only applies without drain/breather.  
 ④ IP66, Type 4X Certification only applies with drain/breather.

# PlexPower™ Factory Sealed Panelboard with Bus Bar

## 15 to 150 Amps. Stainless Steel Enclosures

DISTRIBUTION EQUIPMENT: NEC/CEC HAZARDOUS LOCATION PANELBOARDS

NEC/CEC — Lighting Panels with Main Lugs ①:  
 Class I, Zone 1, AEx de IIB+H<sub>2</sub> T5  
 Ex de IIB+H<sub>2</sub> T5  
 Class I, Division 2, Groups B, C, D  
 Class II, Division 1, Groups F, G ③  
 Class III ③  
 IP66, Type 4X ④

NEC/CEC — Lighting Panels with Main Breaker ①:  
 Class I, Zone 1, AEx de IIB T5  
 Ex de IIB T5  
 Class I, Division 2, Groups C, D  
 Class II, Division 1, Groups F, G ③  
 Class III ③  
 IP66, Type 4X ④

NEC/CEC — Power Panels ②:  
 Class I, Zone 1, AEx de IIB T5  
 Class I, Zone 1, Ex de IIB T5  
 Class I, Division 2, Groups C, D  
 Class II, Division 1, Groups F, G ③  
 Class III ③  
 IP66, Type 4X ④

### F-Frame with Main Breaker Dimensions in Millimeters (Inches)

#### Size K 24 Circuit – Internal Actuation

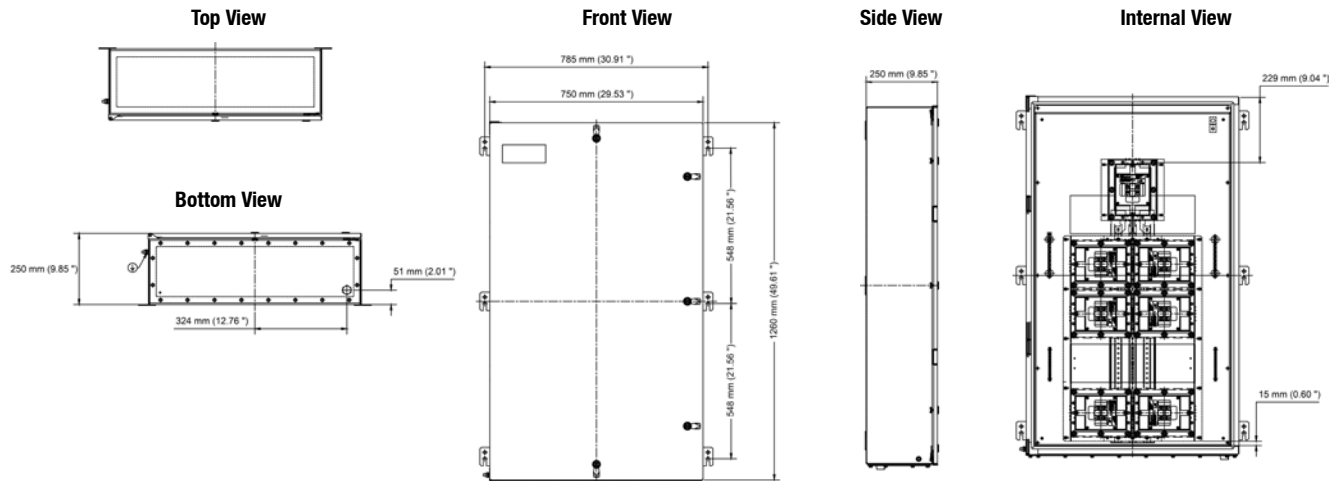

#### Size K 24 Circuit – External Actuation

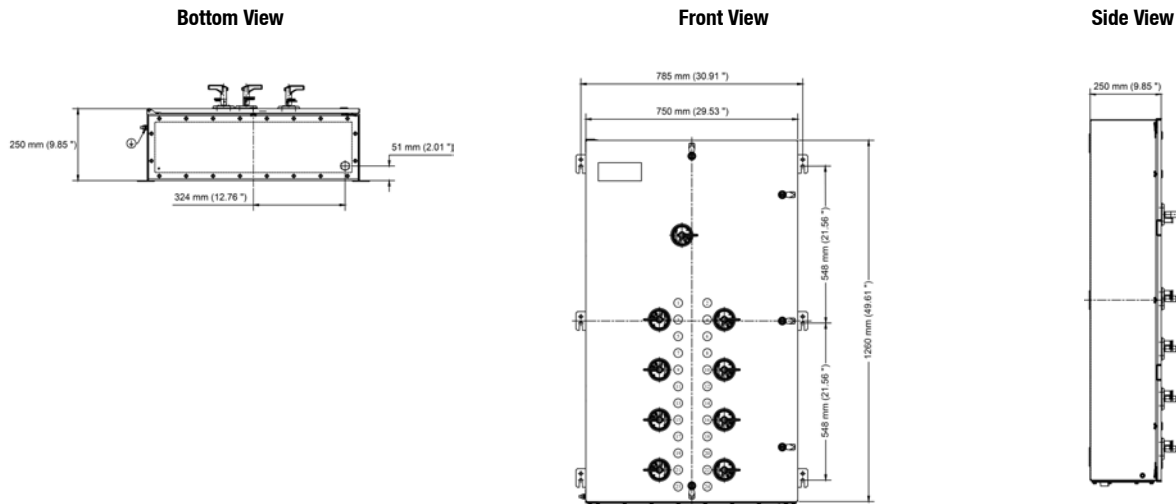

① NEC/CEC Certified lighting panels: 120/240 Volt, 240 Volt, 120/208 Volt.  
 ② NEC/CEC Certified power panels: 277/480 Volt, 480 Volt, 347/600 Volt, 600 Volt.  
 ③ Certification only applies without drain/breather.  
 ④ IP66, Type 4X Certification only applies with drain/breather.

# PlexPower™ Factory Sealed Panelboard with Bus Bar

## 15 to 150 Amps. Stainless Steel Enclosures

NEC/CEC – Lighting Panels with Main Lugs ①:  
 Class I, Zone 1, AEx de IIB+H<sub>2</sub> T5  
 Ex de IIB+H<sub>2</sub> T5  
 Class I, Division 2, Groups B, C, D  
 Class II, Division 1, Groups F, G ③  
 Class III ③  
 IP66, Type 4X ④

NEC/CEC – Lighting Panels with Main Breaker ①:  
 Class I, Zone 1, AEx de IIB T5  
 Ex de IIB T5  
 Class I, Division 2, Groups C, D  
 Class II, Division 1, Groups F, G ③  
 Class III ③  
 IP66, Type 4X ④

NEC/CEC – Power Panels ②:  
 Class I, Zone 1, AEx de IIB T5  
 Class I, Zone 1, Ex de IIB T5  
 Class I, Division 2, Groups C, D  
 Class II, Division 1, Groups F, G ③  
 Class III ③  
 IP66, Type 4X ④

### F-Frame with Main Breaker Dimensions in Millimeters (Inches)

#### Size G 30 Circuit – Internal Actuation

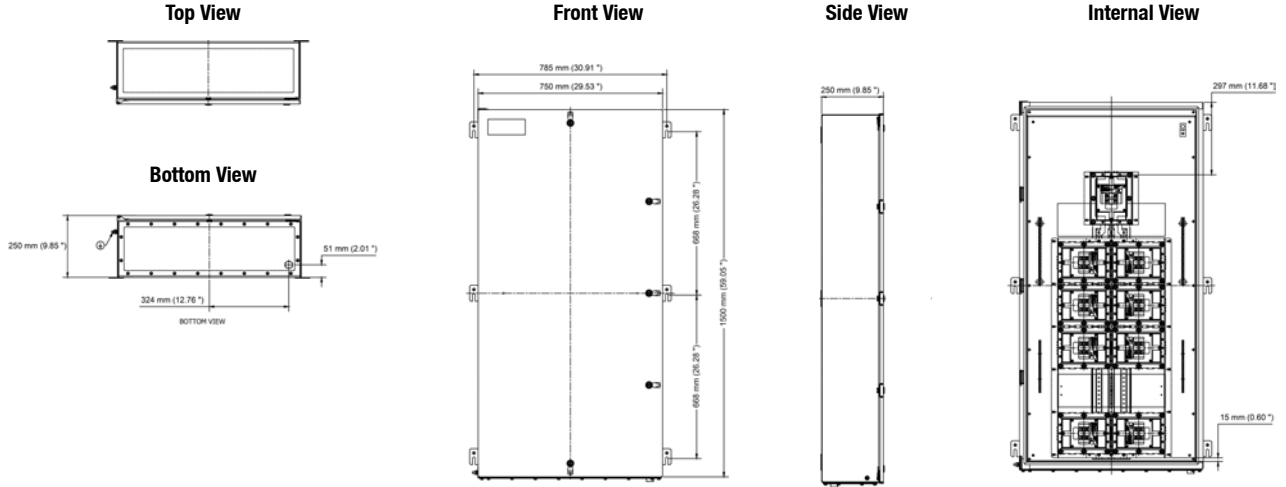

#### Size G 30 Circuit – External Actuation

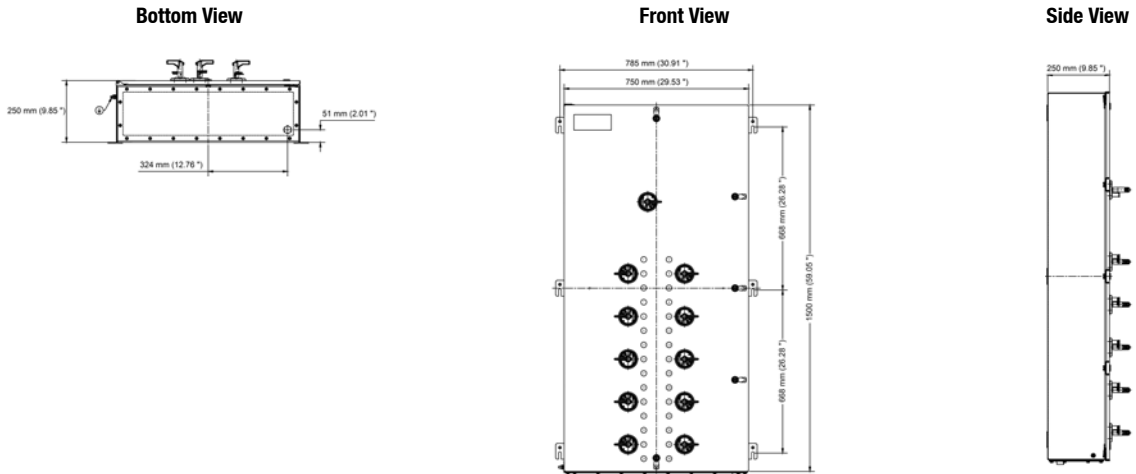

① NEC/CEC Certified lighting panels: 120/240 Volt, 240 Volt, 120/208 Volt.  
 ② NEC/CEC Certified power panels: 277/480 Volt, 480 Volt, 347/600 Volt, 600 Volt.  
 ③ Certification only applies without drain/breather.  
 ④ IP66, Type 4X Certification only applies with drain/breather.

# PlexPower™ Fused Factory Sealed Panelboard with Bus Bar

## Up to 30 Amps. Stainless Steel Enclosures

NEC/CEC:  
Class I, Zone 1, AEx de IIB T5  
Ex de IIB T5  
Class I, Division 2, Groups C, D  
Class II, Division 1, Groups F, G ①  
Class III ①  
IP66, Type 4X ②

DISTRIBUTION EQUIPMENT: NEC/CEC HAZARDOUS LOCATION PANELBOARDS

### Applications

- The PlexPower™ panelboard provides indoor and outdoor protection and control of electrical circuits in hazardous environments such as:
  - Petroleum plants
  - Chemical plants
  - Refineries
  - Wastewater Treatment Plants
  - Paper and Pulp Industries
  - Other process facilities
- Ideal for placement in wet, corrosive environments or where flammable gases or vapors are likely to be present.
- Suitable for use on lighting, heat trace, power circuits and Uninterruptible Power Supply (UPS) applications.

### Features

- No external conduit or cable seals required thus making installations faster, easier, and less costly.
- The PlexPower™ panelboard features a ground-breaking design that uses individual fuse housings to minimize the downtime and costs associated with servicing fuses in hazardous locations.
- PlexPower™ fuses accommodate off-the-shelf fuses and switches making replacements readily available.
- The lighter weight panelboard enclosure can be quickly opened in the field for easier servicing.
- Supplied with standard hard drawn, tin plated, copper bus bar for superior corrosion resistance.
- Gland plate can be easily field punched for cable or conduit entries.
- Standard model includes plate on the same side as the main connection. Additional gland plates must be ordered with the panelboard. See options.
- RFF model up to 600 V panel.
- Standard fused models offer up to 18 circuit panelboard configurations.
- Fused models are available standard with or without main breaker, depending on the configuration; up to 30 Amps per branch circuit.
- Standard configuration includes internal actuators and a solid door; factory installed options include external actuators.
- Supplied with dead front for internal and external actuation.
- Main circuit breaker up to 150 Amps.
- Breakers and switches can be padlocked in either the “On” or “Off” position.
- Breaker, switch and fuse modules supplied with captive bolts.
- Ground bar provided as standard.
- External/internal ground lug provided as standard.
- Main breaker utilizes Cutler-Hammer™ F-Frame Series circuit breakers rated -20 °C to +40 °C (-4 °F to +104 °F).
- Standard model utilizes Cutler-Hammer™ F-Frame Series FD molded case switches for each branch circuit.
- Appleton breaker and fuse modules accommodate standard off-the-shelf replacement breakers and fuses.
- Utilizes standard Marathon® Special Products ③ fuse holder **R6J30A1S** for use with any Class J series fuse.



Fused Factory Sealed Panelboard

### Illustrated Features

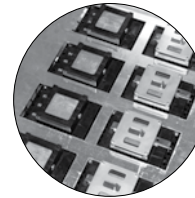

Dead Front

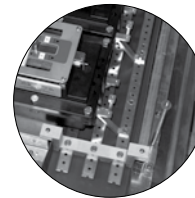

Standard Bus Bar



Off Shelf Fuses and Fuseholders

① Certification only applies without drain/breather.

② Certification only applies with drain/breather.

③ Marathon Special Products is a registered trademark of Regal-Beloit Corporation.

+ Cutler-Hammer is a registered trademark of Eaton Corporation.

# PlexPower™ Fused Factory Sealed Panelboard with Bus Bar

## Up to 30 Amps. Stainless Steel Enclosures

**NEC/CEC:**  
 Class I, Zone 1, AEx de IIB T5  
 Ex de IIB T5  
 Class I, Division 2, Groups C, D  
 Class II, Division 1, Groups F, G ①  
 Class III ①  
 IP66, Type 4X ②

### Standard Materials

- Enclosure: 304 stainless steel
- Alternate enclosure: 316L stainless steel
- Hardware: stainless steel
- Bus bar: hard drawn, tin plated, copper

### Options

Must be listed in alphanumeric sequence at the end of the catalog number.

- 316L stainless steel enclosure material, add suffix — **316L**.
- Drain/breather, add suffix — **DV**.
- External actuation, add suffix — **EXT**.
- Grounded neutral, add suffix — **GN**.
- Gland plate, specify suffix **GPL** = left side, **GPR** = right side, **GPT** = opposite mains, **NGP** = no gland plate).
- LED indicator lights, add suffix — **IL**.
- Bottom feed, add suffix — **INV**.
- Phenolic nameplate (specify legend), add suffix — **NP**.
- Door padlocking provision, add suffix — **P**.
- Stainless steel legend plate (specify legend), add suffix — **SP**.

### NEC/CEC Certifications and Compliances

- UL Standards: ANSI/UL 67, ANSI/ISA 12.12.01, ANSI/UL 1203, ANSI/UL 60079-0, ANSI/UL60079-1, ANSI/UL60079-7
- CSA Standards: C22.2 No. 29, C22.2 No. 0, C22.2 No. 213, CAN E60079-0, CAN E60079-7, CAN E60079-1
- CSA C22.2 No. 248.1-11 (Low-Voltage Fuses – Part 1: General Requirements)
- CSA C22.2 No. 248.1-11 (Low-Voltage Fuses – Part 8: Class J Fuses)
- cCSAus Certified: 039199
- UL Recognized Component (US and Canada): E319372
- Fuse Specific Certifications
  - JLS and JTD Fuses
    - Standard 248-8, Class J
    - UL Listed (File: E81895)
    - CSA Certified (File: LR29862)

### Related Products

- Additional PlexPower™ products:
  - PlexPower™ Factory Sealed Panelboard with Bus Bar
  - PlexPower™ Factory Sealed Enclosed Circuit Breakers

### Fuse Specifications

Series	Type	Amperage Rating	Interrupting Ratings	Voltage Ratings
JLS	Fast Acting	1A–30A	Up to 200 kA rms symmetrical	600
JTD	Time Delay	8/10A–30A	Up to 200 kA rms symmetrical	600

① Certification only applies without drain/breather.

② Certification only applies with drain/breather.

+ Cutler-Hammer is a registered trademark of Eaton Corporation.

# PlexPower™ Fused Factory Sealed Panelboard with Bus Bar

## Up to 30 Amps. Stainless Steel Enclosures

NEC/CEC:  
 Class I, Zone 1, AEx de IIB T5  
 Ex de IIB T5  
 Class I, Division 2, Groups C, D  
 Class II, Division 1, Groups F, G ①  
 Class III ①  
 IP66, Type 4X ②

### Steps to Creating Catalog Number:

Complete Catalog Number

RFF S E1 3 1 | M 12 100 | 1 15 T | — | ▲  
 Step 1 | Step 2 | Step 3 | Step 4 | Step 5

Step 1: Choose basic catalog from numbering guide on subsequent page.

Step 2: If a main breaker is desired indicate amperage rating.

Example: RFFSE131M12 – 100 is a 12 circuit 3 phase panelboard with 100 amp main breaker.

Step 3: First digits are the quantity of fuses, second is the fuse ampere rating, and third is the type of fuse.

Example: 115T is 1 fuse, 15 amps, T for time delay fuse

Step 4: Repeat step 3 for as many fuses as required

Step 5: Options: Add option in alphanumeric order as listed PlexPower™ introduction page under Options.

### Panel Size

	Dimensions in Millimeters (Inches)		
	I1	E1	G1
<b>Enclosure</b>			
Length	875 (34.50)	1130 (45.00)	1500 (60.00)
Width	750 (30.00)	750 (30.00)	750 (30.00)
Depth	250 (10.00)	250 (10.00)	250 (10.00)

DISTRIBUTION EQUIPMENT: NEC/CEC HAZARDOUS LOCATION PANELBOARDS

Appleton®

① Certification only applies without drain/breather.

② Certification only applies with drain/breather.

# PlexPower™ Fused Factory Sealed Panelboard with Bus Bar

## Up to 30 Amps. Stainless Steel Enclosures

NEC/CEC:  
 Class I, Zone 1, AEx de IIB T5  
 Ex de IIB T5  
 Class I, Division 2, Groups C, D  
 Class II, Division 1, Groups F, G ①  
 Class III ①  
 IP66, Type 4X ②

### Catalog Numbering Guide

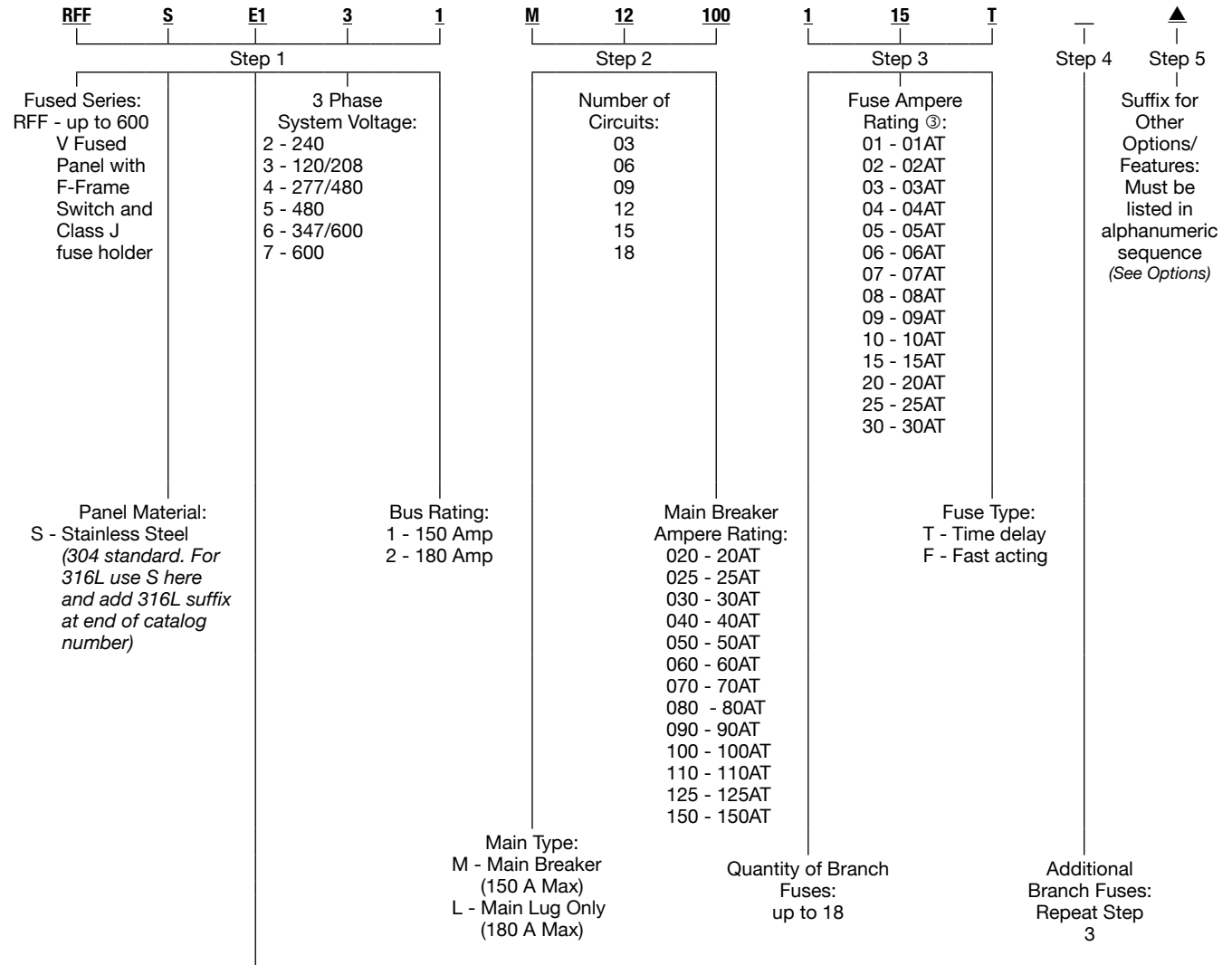

Panel Size: Select enclosure based on number of circuits

Bus Amps	Main Type	I1 875x750x250	E1 1130x750x250	G1 1500x750x250
180	Main Lugs	03, 06, 09	12, 15	18
150	Main Breaker	03, 06	09, 12	15

① Certification only applies without drain/breather.  
 ② Certification only applies with drain/breather.  
 ③ Fast acting fuses are available in the following amperages: 1, 3, 6, 10, 15, 20, 25 and 30.

# PlexPower™ Fused Factory Sealed Panelboard with Bus Bar

## Up to 30 Amps. Stainless Steel Enclosures

NEC/CEC:  
 Class I, Zone 1, AEx de IIB T5  
 Ex de IIB T5  
 Class I, Division 2, Groups C, D  
 Class II, Division 1, Groups F, G ①  
 Class III ①  
 IP66, Type 4X ②

DISTRIBUTION EQUIPMENT: NEC/CEC HAZARDOUS LOCATION PANELBOARDS

Dimensions in Millimeters (Inches)

### Size I 09 Circuit — With Main Lugs

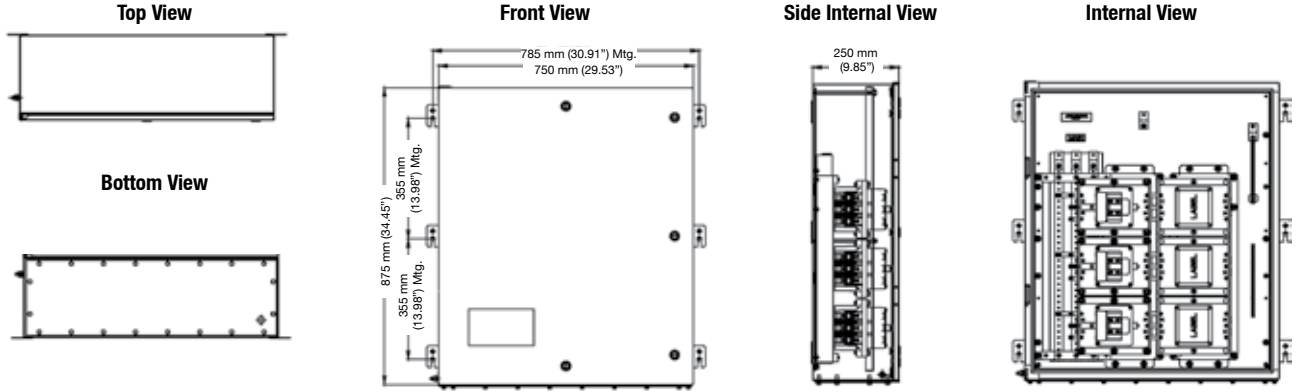

### Size I 06 Circuit — With Main Breaker

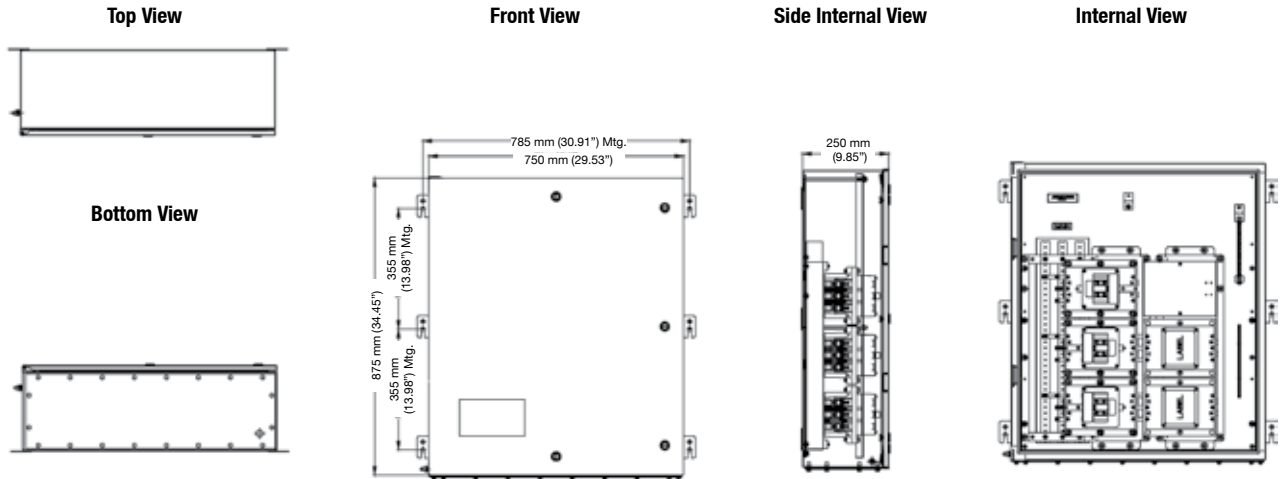

① Certification only applies without drain/breather.  
 ② Certification only applies with drain/breather.



# PlexPower™ Fused Factory Sealed Panelboard with Bus Bar

Up to 30 Amps. Stainless Steel Enclosures

Standard Configuration: No Window, Internal Actuation

**NEC/CEC:**

Class I, Zone 1, AEx de IIB T5  
 Ex de IIB T5  
 Class I, Division 2, Groups C, D  
 Class II, Division 1, Groups F, G ①  
 Class III ①  
 IP66, Type 4X ②

**Dimensions in Millimeters (Inches)**

**Size E 15 Circuit — With Main Lugs**

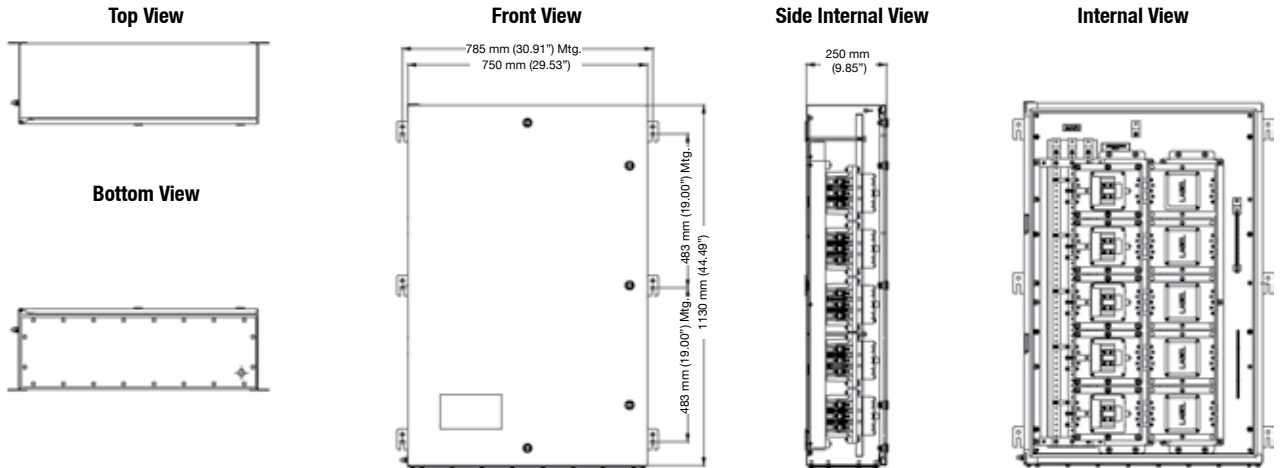

**Size E 12 Circuit — With Main Breaker**

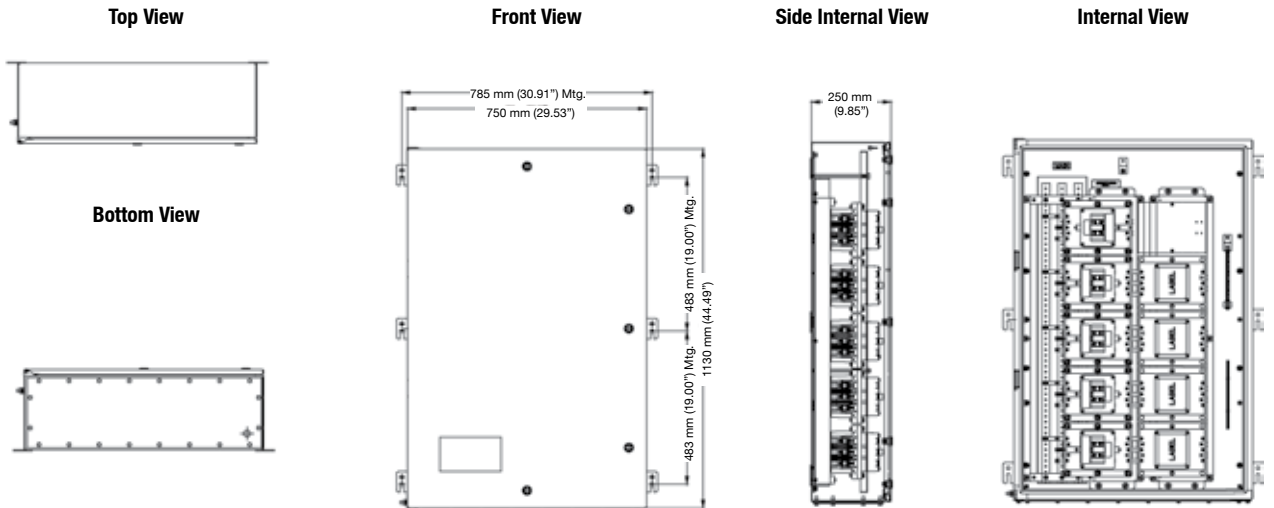

① Certification only applies without drain/breather.

② Certification only applies with drain/breather.

# PlexPower™ Fused Factory Sealed Panelboard with Bus Bar

Up to 30 Amps. Stainless Steel Enclosures

Standard Configuration: No Window, Internal Actuation

**NEC/CEC:**

- Class I, Zone 1, AEx de IIB T5
- Ex de IIB T5
- Class I, Division 2, Groups C, D
- Class II, Division 1, Groups F, G ①
- Class III ①
- IP66, Type 4X ②

DISTRIBUTION EQUIPMENT: NEC/CEC HAZARDOUS LOCATION PANELBOARDS

**Dimensions in Millimeters (Inches)**

**Size G 18 Circuit — With Main Lugs**

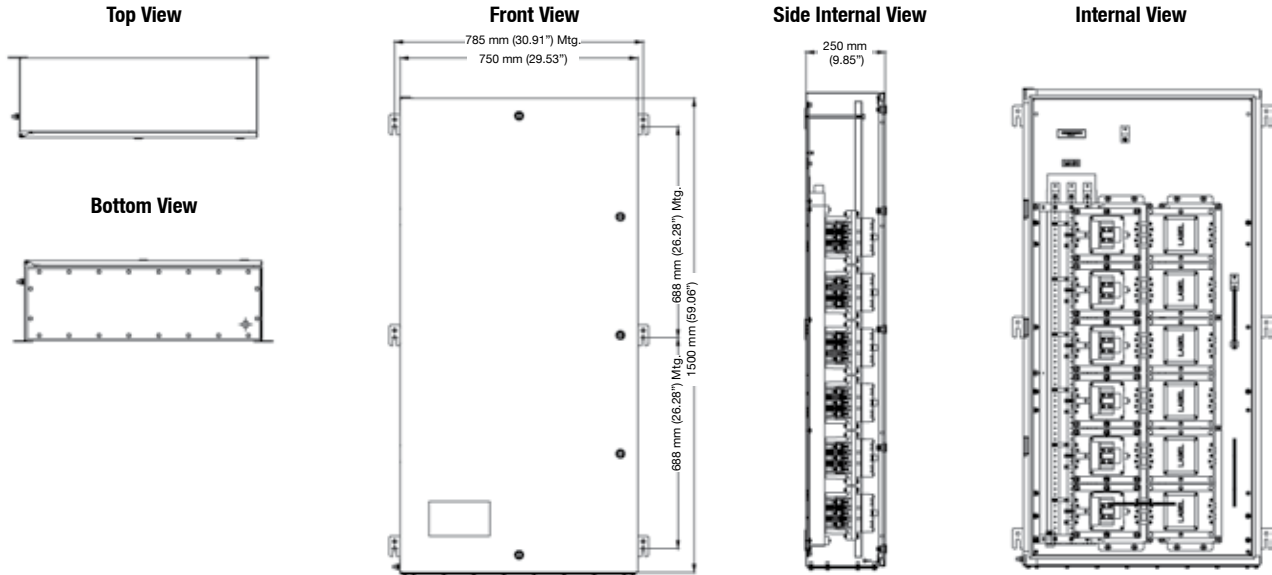

**Size G 15 Circuit — With Main Breaker**

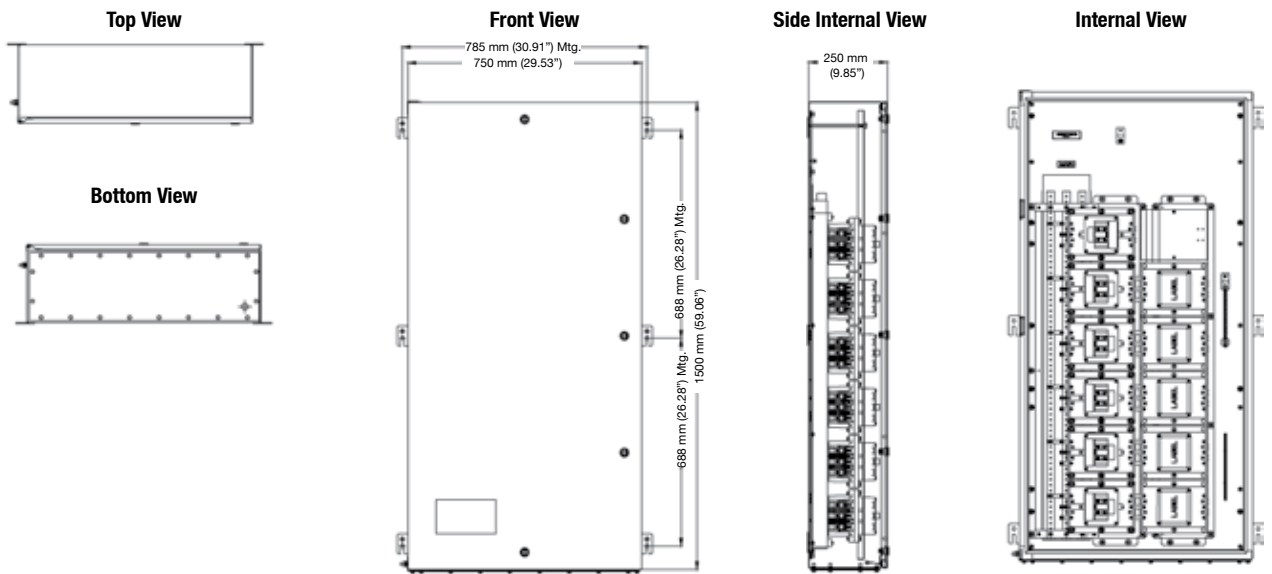

① Certification only applies without drain/breather.  
 ② Certification only applies with drain/breather.

# D2P and EWP Factory Sealed Circuit Breaker Panelboards

## Explosionproof, Dust-Ignitionproof, Watertight, Corrosion-Resistant

### NEC:

Class I, Division 1 and 2, Groups B♦, C♦, D

Class II, Division 1 and 2, Groups E, F, G

Class III

NEMA 3, 3R, 4, 4X, 5, 7BCD, 9EFG, 12

### Applications

- Protection and control of electrical equipment and circuits such as lighting and heat tracing in hazardous locations or in damp, wet or corrosive conditions.
- D2P Series — designed for use in Class I, Division 2 areas where ignitable vapors or gases may be present under unusual conditions, or in Class II, Division 1 areas where combustible dusts are present.
- EWP Series — designed for use in Class I and Class II, Division 1 manufacturing and processing areas where ignitable vapors, gases or combustible dusts are present.
- Group B standard on all D2P and EWP panelboards.

### Features

- Panel sizes:
  - “A” Board: up to 12 1-pole spaces
  - “B” Board: up to 24 1-pole spaces
  - “C” Board: up to 36 1-pole spaces
- 3” Main conduit openings for both top and bottom feed of junction compartment.
- Permits selection of 1-, 2- or 3-pole breakers. 10,000 Amp Vac interrupting capacity is standard. (22,000 AIC also available; contact your local representative.)
- Aluminum breaker actuators — spring loaded, corrosion resistant—feature self-locating design for actuating 1-, 2-, or 3-pole breakers in any sequence. Rotary actuating handles may be individually padlocked.
- Handles lock in either OFF or ON position without interfering with tripping of breakers.
- Double door — one for junction compartment and one for breaker compartment. Both doors are fully gasketed to provide raintight fit for both compartments.
- Two O-ring gaskets on each breaker handle shaft to prevent entrance of water or corrosion.
- Hinges allow the doors to be lifted off.
- Breakers prewired to terminal block minimizes installation time.
- Insulated neutral lug provided as standard.
- Panelboards use standard Cutler-Hammer QUICKLAG® + Industrial circuit breakers.
- Provision for drains/breathers in both compartments.
- Factory sealed — no external branch sealing fittings needed (except Division 1 Groups B and C ①).
- Voltage ratings: 120 Vac for 1-pole and up to 240 Vac for 2- or 3-pole.
- Type THHN minimum size #10 AWG copper wire — 90 °C (194 °F) — used in panelboards. Main lug feeder wires are crimped and installed in single conductor.
- Stainless steel captive, spring-out Quad-Lead® bolts for ease of access.

### Standard Materials

- Housings: copperfree (4/10 of 1% max.) aluminum
- Hardware: stainless steel

### Standard Finishes

- Housings: gray epoxy powder coat

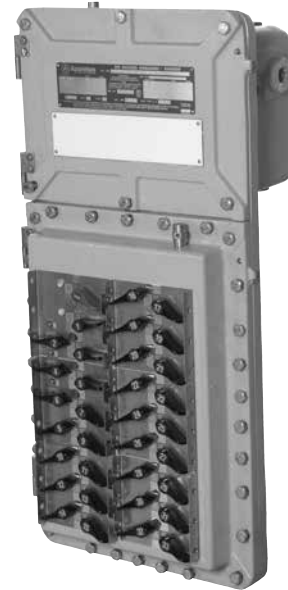

### Options ①

Must be listed in alphanumeric sequence at the end of the catalog number.

- Panel Options
  - Drain and breather sets add suffix — **DV**.
  - Ground Terminal Bar add suffix — **GJ**.
  - Grounded neutral lug add suffix — **GNL**.
  - For bottom and side feed only (no conduit holes drilled in top) add suffix — **NTE**.
  - Factory installed wired provisions for future installation of circuit breakers in the field, on request. Consult contact your local representative for information.
  - For +50 °C (+122 °F) breaker rating, add suffix — **V**.
- Breaker Options
  - Equipment protection devices, 1-pole 40 Amp max. and 2-pole 50 Amp max. (1- or 2-Pole -30 mA sensitivity) add suffix — **EPD**.
  - Ground fault interrupter, 1-pole 40 Amp max. and 2-pole 50 Amp max. (1- or 2-Pole -5 mA sensitivity) circuit breakers add suffix — **GFI** (available on all circuit positions).
  - For auxiliary contacts, contact your local representative for information.
  - For breakers for use in HID lighting applications, add suffix — **HID**.
  - Factory installed main breaker, maximum 100 Amp. Add suffix — **MB** for main breaker. Main circuit breaker occupies branch breaker spaces.

### NEC Certifications and Compliances

- UL Standard: UL 877, UL 1203
- UL Listed: E12108

♦ For Groups B and C, all conduits must be sealed adjacent to enclosure.

① Contact your local representative for more information.

+ Quicklag and Cutler-Hammer are registered trademarks of the Eaton Corporation.

Visit our website at [www.emerson.com](http://www.emerson.com) or contact us at (800) 621-1506.

© November 2016

# D2P and EWP Factory Sealed Circuit Breaker Panelboards

Explosionproof, Dust-Ignitionproof, Watertight, Corrosion-Resistant

## NEC:

Class I, Division 1 and 2, Groups B♦, C♦, D

Class II, Division 1 and 2, Groups E, F, G

Class III

NEMA 3, 3R, 4, 4X, 5, 7BCD, 9EFG, 12

DISTRIBUTION EQUIPMENT: NEC/CEC HAZARDOUS LOCATION PANELBOARDS

## Illustrated Features

### Two Door Design

Breaker compartment and junction compartment can be accessed independently of each other.

### Tamper Proof Construction

Provisions for padlocking individual breakers in either ON or OFF position are provided on the front of the breaker compartment.



### Flexibility in Breaker Selection

In addition to having 36 circuits available, 1-, 2- or 3-pole breakers may also be specified in any combination. Ground-Fault Circuit Interrupters may also be specified for any and all breaker positions, with test buttons located adjacent to the breaker operating handle.

### Factory Sealed

Sealing cement seals and protects wiring where it passes from junction to circuit breaker compartment. Branch hubs do not require external seals to maintain hazardous location ratings (except Division 1, Group B and C ♦).

### Corrosion-Resistant Housing

The junction and breaker housing are constructed of a rugged, one piece, two compartment integral casting of copperfree aluminum. Heavy duty stainless steel mounting brackets allow easy installation. The exterior and interior of the housing and doors have epoxy powder coat finish.

### Watertight Gasketed Doors

Each door has an independent watertight gasket for NEMA 4 performance.



### Improved Patented Actuator Handles

Rotary breaker handles provide dependable performance under heavy corrosion conditions. Handle also gives positive visual indication of breaker position. Improved spring loaded breaker actuators are also designed for corrosion resistance and are completely self-locating.

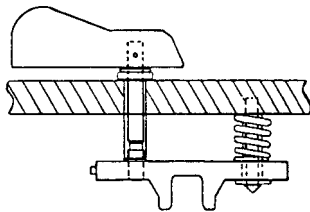

### 12, 24, or 36 Circuits

The EWP/D2P Panelboard lines are available in 12, 24 or 36 circuit versions.

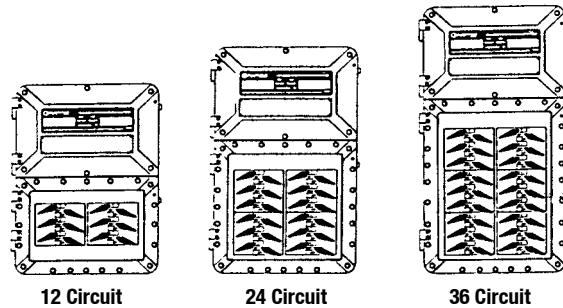

12 Circuit

24 Circuit

36 Circuit

### Wire Management

Breaker wiring in the lower compartment is factory installed, saving installation time on the job site. Individual circuit connections are made to terminal blocks which are conveniently located in the front of the junction compartment. No. 10 wire is used throughout the panelboard breaker compartment. Wire bundles are crimped with a UL Listed method, and insulated for main lug assembly.

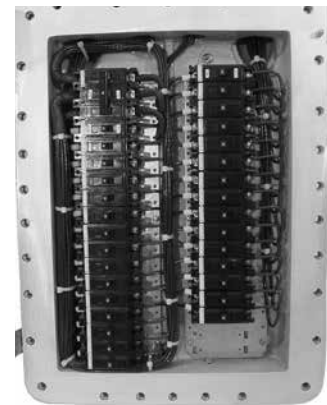

### Removable Doors

Standard hinge position allows either door to be lifted off the enclosure to provide easy access to the interior.



### Main Feed Conduit Openings

3" conduit openings at the top and bottom of the junction compartment permit either top or bottom feed entry. Threaded branch hubs are placed on all four sides for versatility and ease of installation.

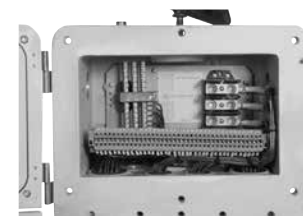

♦ For Groups B and C, all conduits must be sealed adjacent to enclosure.

# D2P and EWP Factory Sealed Circuit Breaker Panelboards

Explosionproof, Dust-Ignitionproof, Watertight, Corrosion-Resistant

**NEC:**

Class I, Division 1 and 2, Groups B♦, C♦, D  
 Class II, Division 1 and 2, Groups E, F, G  
 Class III  
 NEMA 3, 3R, 4, 4X, 5, 7BCD, 9EFG, 12

**Ordering Instructions**

- Step 1: Select Panel Type: D2P.
- Step 2: Select Wiring System Diagram Number (switching neutral, solid neutral or without neutral).
- Step 3: Select Panelboard Size: A (max. 12 1-pole spaces), B (max. 24 1-pole spaces) or C (max. 36 1-pole spaces).
- Step 4: Select Number of Breakers in Panel. If no Main Breaker required skip to number 6. If Main Breaker required, proceed to number 5.
- Step 5: Add MB (Main Breaker). The correct number of poles for the Main Breaker will be supplied automatically, depending on wiring system diagram selected.
- Step 6: Select Breakers as desired in panelboard. First number: quantity of breakers (1 15-60 Amp for 1-pole and 15-100 Amp for 2-pole, 3-pole); second number: ampere rating (continuous); and third number: number of poles. (Indicate only if different from wiring diagram selected). Each breaker pole takes one space. Select Breaker Type (see Options for details).
- Step 7: Repeat step 6 for Additional Breakers as desired.
- Step 8: Add dash preceding each suffix for other options/features (see Options).

NOTE: Main breakers use 2 or 3 branch circuit spaces.

**Catalog Numbering Guide**

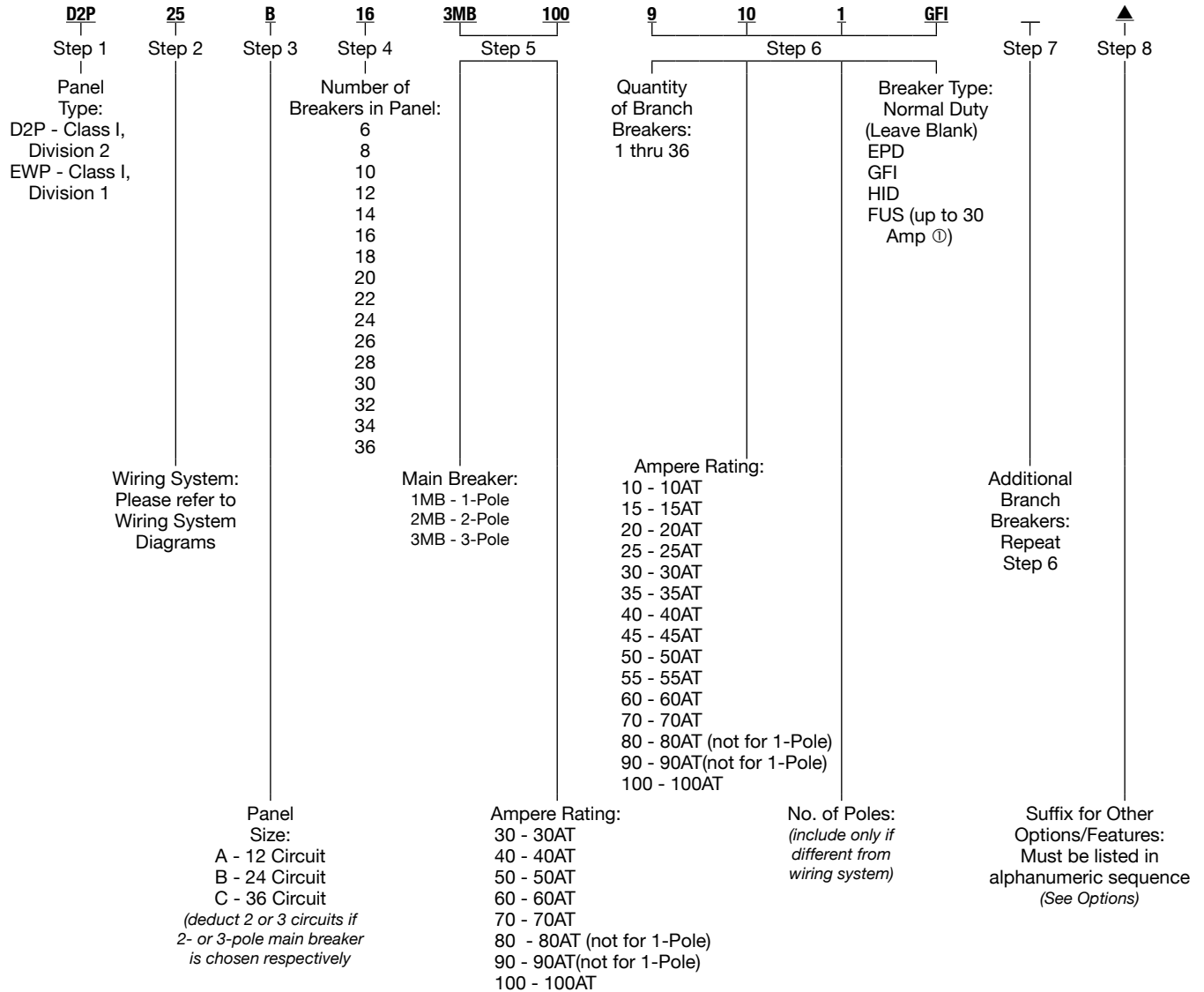

♦ For Groups B and C, all conduits must be sealed adjacent to enclosure.  
 ▲ To complete the catalog number please add the appropriate suffix for other options/features. These suffixes can be found under Options.  
 ① Fused terminal blocks available for branch circuits up to 30 Amps.

# D2P and EWP Factory Sealed Circuit Breaker Panelboards

Explosionproof, Dust-Ignitionproof, Watertight, Corrosion-Resistant

NEC:  
 Class I, Division 1 and 2, Groups B♦, C♦, D  
 Class II, Division 1 and 2, Groups E, F, G  
 Class III  
 NEMA 3, 3R, 4, 4X, 5, 7BCD, 9EFG, 12

DISTRIBUTION EQUIPMENT: NEC/CEC HAZARDOUS LOCATION PANELBOARDS

## EWP and D2P Series Breaker Voltage Specifications

For 22,000 AIC rated breakers contact your local representative.

Breaker Type	No. of Poles	Continuous Current Range (Amps)	Maximum Breaker Voltage Range	Interrupting Capacity Maximum Amps
QC	1	10-100	120/240	10.000
	2	10-100	120/240	10.000
	3	10-100	240	10.000
QPGF (GFI) or QPGFEP (EPD)	1	15-40	120	10.000
	2	15-50	120/240	10.000
QC (HID)	1	15-60	120/240	10.000
	2	15-60	120/240	10.000

## Main Lug — Maximum 250 Amps — Cable Range: 250 MCM to 6

Number of Breakers	Panel Size	D2P Catalog Number ①		Number of Breakers	Panel Size	EWP Catalog Number ①	
		Wiring System Number 4 120/240 Vac	Wiring System Number 5 120/208 Vac			Wiring System Number 4 120/240 Vac	Wiring System Number 5 120/208 Vac
6	A	D2P4A6	D2P5A6	6	A	EWP4A6	EWP5A6
8	A	D2P4A8	D2P5A8	8	A	EWP4A8	EWP5A8
10	A	D2P4A10	D2P5A10	10	A	EWP4A10	EWP5A10
12	A	D2P4A12	D2P5A12	12	A	EWP4A12	EWP5A12
14	B	D2P4B14	D2P5B14	14	B	EWP4B14	EWP5B14
16	B	D2P4B16	D2P5B16	16	B	EWP4B16	EWP5B16
18	B	D2P4B18	D2P5B18	18	B	EWP4B18	EWP5B18
20	B	D2P4B20	D2P5B20	20	B	EWP4B20	EWP5B20
22	B	D2P4B22	D2P5B22	22	B	EWP4B22	EWP5B22
24	B	D2P4B24	D2P5B24	24	B	EWP4B24	EWP5B24
26	C	D2P4C26	D2P5C26	26	C	EWP4C26	EWP5C26
28	C	D2P4C28	D2P5C28	28	C	EWP4C28	EWP5C28
30	C	D2P4C30	D2P5C30	30	C	EWP4C30	EWP5C30
32	C	D2P4C32	D2P5C32	32	C	EWP4C32	EWP5C32
34	C	D2P4C34	D2P5C34	34	C	EWP4C34	EWP5C34
36	C	D2P4C36	D2P5C36	36	C	EWP4C36	EWP5C36

♦ For Groups B and C, all conduits must be sealed adjacent to enclosure.

① Catalog numbers shown are panelboards with 1-pole breakers for wiring systems 4 and 5. To order 1-, 2- and/or 3-pole breakers with different wiring systems, use Catalog Numbering Guide. Add ampere rating (continuous): 15 through 60 for 1-pole, and 15 through 100 for 2-pole and 3-pole.

# D2P and EWP Factory Sealed Circuit Breaker Panelboards

Explosionproof, Dust-Ignitionproof, Watertight, Corrosion-Resistant

**NEC:**

Class I, Division 1 and 2, Groups B♦, C♦, D

Class II, Division 1 and 2, Groups E, F, G

Class III

NEMA 3, 3R, 4, 4X, 5, 7BCD, 9EFG, 12

## Wiring System Diagrams

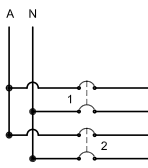
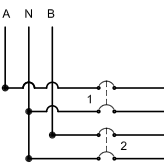
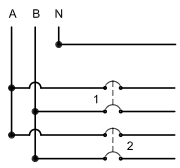
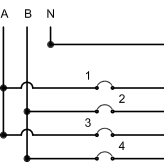
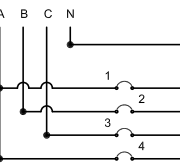
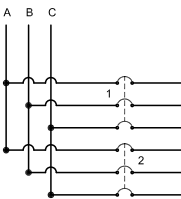
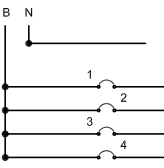
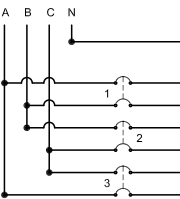
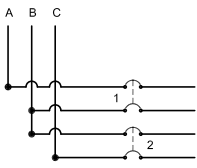
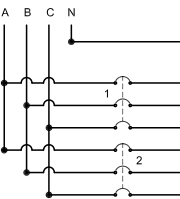
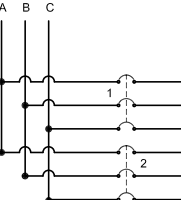
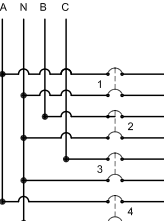
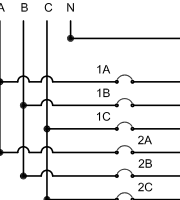
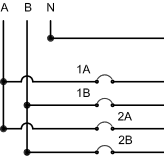
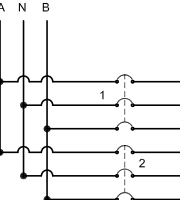
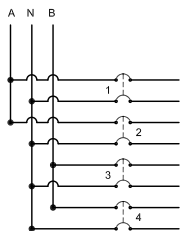
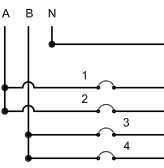
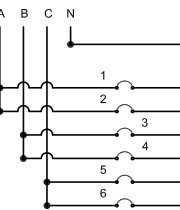
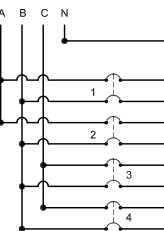
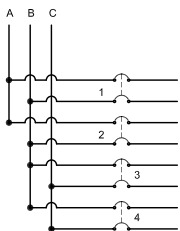
System No. 1	System No. 2	System No. 3	System No. 4	System No. 5
 <p>Mains—2-Wire Branches—2-Wire Breakers—2-Pole</p>	 <p>Mains—3-Wire Branches—2-Wire Breakers—2-Pole</p>	 <p>Mains—3-Wire Branches—3-Wire Breakers—2-Pole Solid Neutral</p>	 <p>Mains—3-Wire Branches—2-Wire Breakers—1-Pole Solid Neutral</p>	 <p>Mains—4-Wire, 3-Phase Branches—2-Wire, 1-Phase Breakers—1-Pole Solid Neutral</p>
System No. 6	System No. 7	System No. 8	System No. 9	System No. 11
 <p>Mains—3-Wire Branches—3-Wire Breakers—3-Pole</p>	 <p>Mains—2 Wire Branches—2-Wire Breakers—1-Pole Solid Neutral</p>	 <p>Mains—4-Wire, 3-Phase Branches—3-Wire, 1-Phase Breakers—2-Pole Solid Neutral</p>	 <p>Mains—3-Wire, 3-Phase Branches—2-Wire, 1-Phase Breakers—2-Pole</p>	 <p>Mains—4-Wire, 3-Phase Branches—4-Wire, 3-Phase Breakers—3-Pole Solid Neutral</p>
System No. 12	System No. 13	System No. 15	System No. 16	System No. 17
 <p>Mains—3-Wire, 3-Phase Branches—3-Wire, 3-Phase Breakers—3-Pole</p>	 <p>Mains—4 Wire, 3-Phase Branches—2-Wire, 1-Phase Breakers—2-Pole</p>	 <p>Mains—4-Wire, 3-Phase Branches—2-Wire, 1-Phase Breakers—1-Pole Solid Neutral</p>	 <p>Mains—3-Wire Branches—2-Wire Breakers—1-Pole Solid Neutral</p>	 <p>Mains—3-Wire Branches—3-Wire Breakers—3-Pole</p>
System No. 22	System No. 24	System No. 25	System No. 28	System No. 29
 <p>Mains—3-Wire Branches—2-Wire Breakers—2-Pole</p>	 <p>Mains—3 Wire Branches—2-Wire Breakers—1-Pole Solid Neutral</p>	 <p>Mains—4-Wire, 3-Phase Branches—2-Wire, 1-Phase Breakers—1-Pole Solid Neutral</p>	 <p>Mains—4-Wire, 3-Phase Branches—3-Wire, 1-Phase Breakers—2-Pole Solid Neutral</p>	 <p>Mains—3-Wire, 3-Phase Branches—2-Wire, 1-Phase Breakers—2-Pole</p>

♦ For Groups B and C, all conduits must be sealed adjacent to enclosure.

# D2P and EWP Factory Sealed Circuit Breaker Panelboards

Explosionproof, Dust-Ignitionproof, Watertight, Corrosion-Resistant

D2P shown. D2P and EWP have same dimensions.

**NEC:**  
 Class I, Division 1 and 2, Groups B♦, C♦, D  
 Class II, Division 1 and 2, Groups E, F, G  
 Class III  
 NEMA 3, 3R, 4, 4X, 5, 7BCD, 9EFG, 12

DISTRIBUTION EQUIPMENT: NEC/IEC HAZARDOUS LOCATION PANELBOARDS

## Dimensions in Millimeters (Inches)

### Drilling Plans for Mounting Bolts

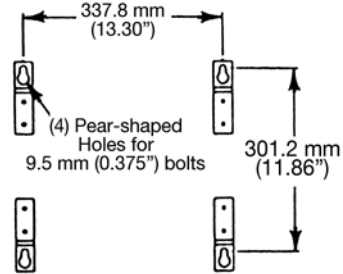

### Side View

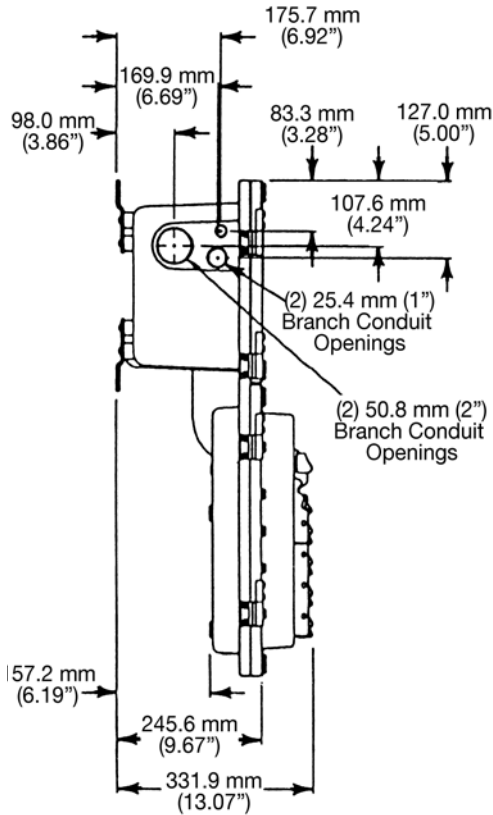

### Top View

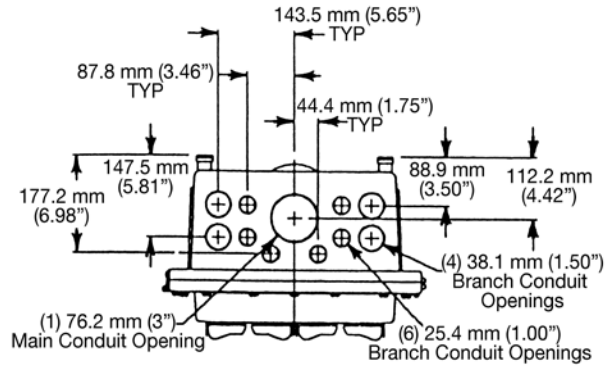

### Front View

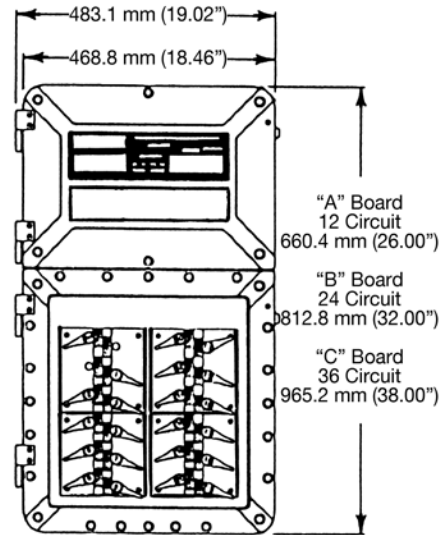

### Bottom View

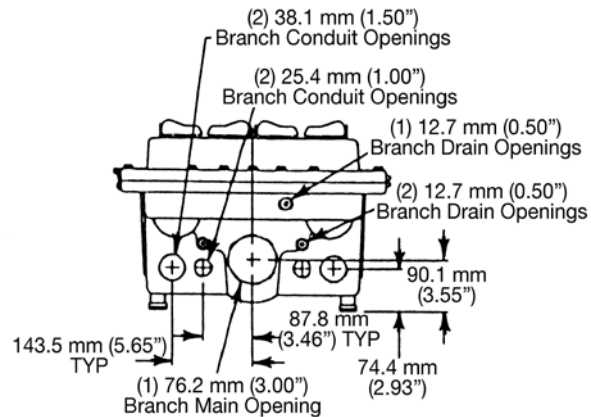

♦ For Groups B and C, all conduits must be sealed adjacent to enclosure.



# ALPN, AGPN and APPN Series Distribution Panelboards

## Explosionproof, Dust-Ignitionproof, Watertight, Non-Factory Sealed

### NEC:

Class I, Division 1 and 2, Groups B, C, D  
 Class II, Division 1 and 2, Groups E, F, G  
 Class III  
 Class I, Zone 1, Group IIB +H<sub>2</sub>  
 NEMA 4, 4X, 7BCD, 9EFG

### Applications

- Distribution panelboards are used to furnish protection and control of electrical equipment in hazardous locations. These compact units provide a centrally controlled switching system for large quantities of branch circuits for:
  - Lighting
  - Heating
  - Small motors
  - Similar electrical equipment

### Features

- Breaker operators included as standard.
- O-ring gasket insures watertight integrity.
- Permits selection of 1-, 2- or 3-pole breakers.
- Precision machined flame path between body and cover.
- Slotted mounting feet.
- Breaker operators can be padlocked in the ON or OFF position.
- All panelboards are supplied with Cutler-Hammer + standard Quicklag® breakers.
- Chassis assemblies with mains at top (bottom optional).
- For standard outlets, see outline dimensions. For custom outlets, contact your local representative.
- Provisions for 12, 18, 24, 30, 36 and 42 circuit 1-pole chassis.
- 100 Amp or 225 Amp main lug.
- Up to 100 Amp backfed main breaker available with main lug chassis.
- Up to 225 Amp main breaker available with main breaker chassis.
- Factory installed ground and neutral bar as standard.

### Standard Materials

- Bodies and covers: copperfree (4/10 of 1% max.) aluminum
- Cover bolts: Quad-Lead®, captive, stainless steel
- Breaker operators: copperfree (4/10 of 1% max.) aluminum
- Hinges: stainless steel
- Bus bars: copper
- O-ring: neoprene

### Standard Finishes

- Corrosion resistant gray epoxy powder coat to provide NEMA 4X rating

### Options

Must be listed in alphanumeric sequence at the end of the catalog number.

- Panel Options
  - Breather, NEMA 4X, 7 and 9, add suffix —**BR**.
  - Drain, NEMA 4X, 7 and 9, add suffix —**DN**.
  - Phenolic nameplate (specify legend), add suffix —**NP**.
  - For +50 °C (+122 °F) breaker rating, add suffix —**V**.
- Main Breaker Options ALPN and APPN Only
  - Auxiliary switch (1A or 1B), add suffix —**AS1**.
  - Auxiliary switch (2A or 2B), add suffix —**AS2**.
  - Main breaker located at bottom, add suffix —**LB**.
  - Shunt trip (specify voltage), add suffix —**ST**.
  - Under voltage release (specify voltage), add suffix —**UV**.

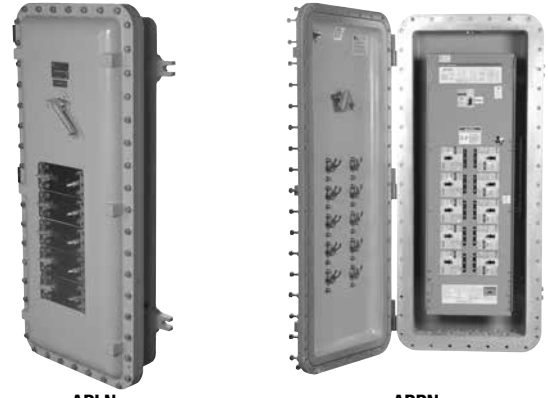

APLN

APPN



AGPN shown with MB and INV options

- Branch Breaker Option ALPN and AGPN Only
  - Equipment Protection Devices (1- or 2-Pole -30 mA sensitivity) ① add suffix —**EPD**.
  - Ground Fault Interrupter (1- or 2-Pole -5 mA sensitivity), ① add suffix —**GFI**.
  - GFI Indicating Light, add suffix —**L5**.
- Branch Breaker Options APPN F-Frame Only
  - Auxiliary switch (1A or 1B), add suffix —**AS1**.
  - Auxiliary switch (2A or 2B), add suffix —**AS2**.
  - Shunt trip (specify voltage), add suffix —**ST**.
  - Under voltage release (specify voltage), add suffix —**UV**.

### NEC Certifications and Compliances

- UL Standard: UL 1203
- UL Listed: E84577

① GFI Push-to-Test Buttons are standard with GFI or EPD options.

+ Cutler-Hammer is a trademark of the Eaton Corporation.

# ALPN Series Lighting Distribution Panelboards

## Explosionproof, Dust-Ignitionproof, Watertight, Non-Factory Sealed

**NEC:**  
 Class I, Division 1 and 2, Groups B, C, D  
 Class II, Division 1 and 2, Groups E, F, G  
 Class III  
 Class I, Zone 1, Group IIB +H<sub>2</sub>  
 NEMA 4, 4X, 7BCD, 9EFG

Select branch breakers as desired in panel. First and second digits are the quantity of breakers, third and fourth digits are ampere rating, the fifth digit is number of poles. Example: An 18-circuit 120/240 V 1-phase 3-wire 100 Amp MLO panel with 12 1-pole 20 Amp and 3 2-pole 30 Amp branch breakers should read ALPNB11A18ML100-10501GFI.

### Catalog Numbering Guide

ALPN	B	1	1	A	18	MB	100	10	50	1	GFI	▲	
Duty: Appleton Non-Factory Sealed Lighting Panel			Voltage: 1 - 120/240 Vac 2 - 120/208 Vac 5 - 240 Vac 7 - 24 Vdc			Main Type: MB - Main Breaker ML - Main Lug Only			Ampere Rating ①: 10 - 10AT 15 - 15AT 20 - 20AT 25 - 25AT 30 - 30AT 35 - 35AT 40 - 40AT 45 - 45AT 50 - 50AT 55 - 55AT 60 - 60AT 70 - 70AT 80 - 80AT (not for 1-Pole) 90 - 90AT (not for 1-Pole) 100 - 100AT			Additional Branch Breakers: Repeat Step ①	
Panel Size: A - 12 Circuit, 100 Amp Main Lug Only B - 18 Circuit, 100 Amp Main Lug Only C - 30 Circuit, 100 or 225 Amp Main Lug Only or 18 Circuit with Main Breaker D - 42 Circuit, 225 Amp Main Lug Only or 36 Circuit with Main Breaker F - 42 Circuit with Main Breaker			Wire System: A - 1P, 3W B - 3P, 3W for 240 Vac C - 3P, 4W D - 2P, 2W for 24 Vdc			Ampere Rating: 020 - 20AT 025 - 25AT 030 - 30AT 040 - 40AT 050 - 50AT 060 - 60AT 070 - 70AT 080 - 80AT 090 - 90AT 100 - 100AT 110 - 110AT 125 - 125AT 150 - 150AT 175 - 175AT 200 - 200AT 225 - 225AT			No. of Poles ①: (include only if different from wiring system)			Suffix for Other Options/ Features: Must be listed in alphanumeric sequence (See Options)	
		Current Rating: 1 - 100 Amp 2 - 225 Amp			Number of Circuits: 12 18 24 30 36 42		Quantity of Branch Breakers ①: 1 thru 42			Breaker Type ①: Normal Duty (Leave Blank) EPD GFI HID			

▲ To complete the catalog number please add the appropriate suffix for other options/features. These suffixes can be found under Options.

# ALPN Series Lighting Distribution Panelboards

## Explosionproof, Dust-Ignitionproof, Watertight, Non-Factory Sealed

**NEC:**  
 Class I, Division 1 and 2, Groups B, C, D  
 Class II, Division 1 and 2, Groups E, F, G  
 Class III  
 Class I, Zone 1, Group IIB +H<sub>2</sub>  
 NEMA 4, 4X, 7BCD, 9EFG

	Number of Circuits	120/240V 1-Phase 3-Wire BAB Type	120/208V 3-Phase 4-Wire BAB Type	240V 3-Phase 3-Wire Delta BAB Type	Panel Size	Approximate Weight kgs (lbs)
100 Amp Main Lug Only	12	ALPNA11A12ML ▲	ALPNA12C12ML ▲	ALPNA15B12ML ▲	A	61.23 (135)
	18	ALPNB11A18ML ▲	ALPNB12C18ML ▲	ALPNB15B18ML ▲	B	74.84 (165)
	24	ALPNC11A24ML ▲	ALPNC12C24ML ▲	ALPNC15B24ML ▲	C	95.25 (210)
	30	ALPNC11A30ML ▲	ALPNC12C30ML ▲	ALPNC15B30ML ▲	C	97.52 (215)
225 Amp Main Lug Only	18	ALPNC21A18ML ▲	ALPNC22C18ML ▲	ALPNC25B18ML ▲	C	81.65 (180)
	24	ALPNC21A24ML ▲	ALPNC22C24ML ▲	ALPNC25B24ML ▲	C	104.33 (230)
	30	ALPNC21A30ML ▲	ALPNC22C30ML ▲	ALPNC25B30ML ▲	C	106.59 (235)
	36	ALPND21A36ML ▲	ALPND22C36ML ▲	ALPND25B36ML ▲	D	131.54 (290)
	42	ALPND21A42ML ▲	ALPND22C42ML ▲	ALPND25B42ML ▲	D	133.81 (295)
Main Breaker 100 Amp F	12	ALPNC11A12MB100 ▲	ALPNC12C12MB100 ▲	ALPNC15B12MB100 ▲	C	74.84 (165)
	18	ALPNC11A18MB100 ▲	ALPNC12C18MB100 ▲	ALPNC15B18MB100 ▲	C	81.65 (180)
	24	ALPND11A24MB100 ▲	ALPND12C24MB100 ▲	ALPND15B24MB100 ▲	D	95.25 (210)
	30	ALPND11A30MB100 ▲	ALPND12C30MB100 ▲	ALPND15B30MB100 ▲	D	142.88 (315)
Main Breaker 225 Amp F	18	ALPNC21A18MB225 ▲	ALPNC22C18MB225 ▲	ALPNC25B18MB225 ▲	C	83.91 (185)
	24	ALPND21A24MB225 ▲	ALPND22C24MB225 ▲	ALPND25B24MB225 ▲	D	133.81 (295)
	30	ALPND21A30MB225 ▲	ALPND22C30MB225 ▲	ALPND25B30MB225 ▲	D	136.08 (300)
	36	ALPND21A36MB225 ▲	ALPND22C36MB225 ▲	ALPND25B36MB225 ▲	D	138.35 (305)
	42	ALPNF21A42MB225 ▲	ALPNF22C42MB225 ▲	ALPNF25B42MB225 ▲	F	156.49 (345)

Note: For Back Fed main, replace **ML**, **MB100**, or **MB225** in part number with **BF**. For 400 Amp Main Lug, contact your local representative. Standard interrupting capacity is 10,000 AIC. For higher interrupt ratings, contact your local representative.

### Typical Panelboard Wiring Diagram

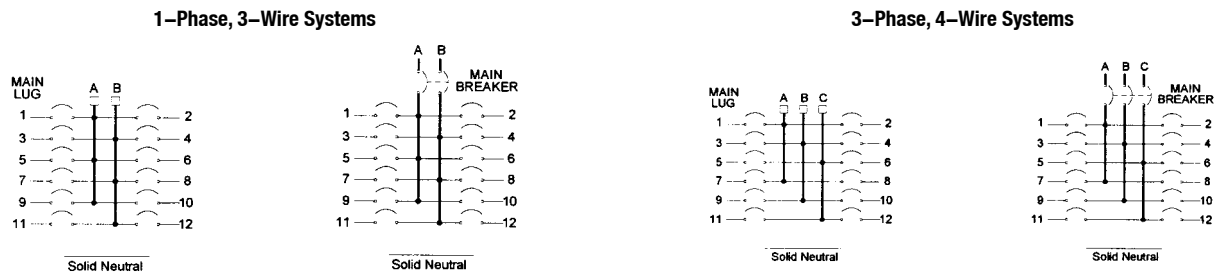

▲ To complete the catalog number please add the appropriate suffix for other options/features. These suffixes can be found under Options.

# AGPN Series Ground Fault Interrupting Distribution Panelboards

Explosionproof, Dust-Ignitionproof, Watertight, Non-Factory Sealed

**NEC:**  
 Class I, Division 1 and 2, Groups B, C, D  
 Class II, Division 1 and 2, Groups E, F, G  
 Class III  
 Class I, Zone 1, Group IIB +H<sub>2</sub>  
 NEMA 4, 4X, 7BCD, 9EFG

Select branch breakers as desired in panel. First and second digits are the quantity of breakers, third and fourth digits are ampere rating, the fifth digit is number of poles. Example: An 18 circuit 120/240 V 1-phase 3-wire 100 Amp MLO panel with 12 1-pole 20 Amp 30 ma GFI and 3 2-pole 30 Amp 5 ma GFI branch breakers should read AGPNB11A18ML-12201EPD-03302GFI.

## Catalog Numbering Guide

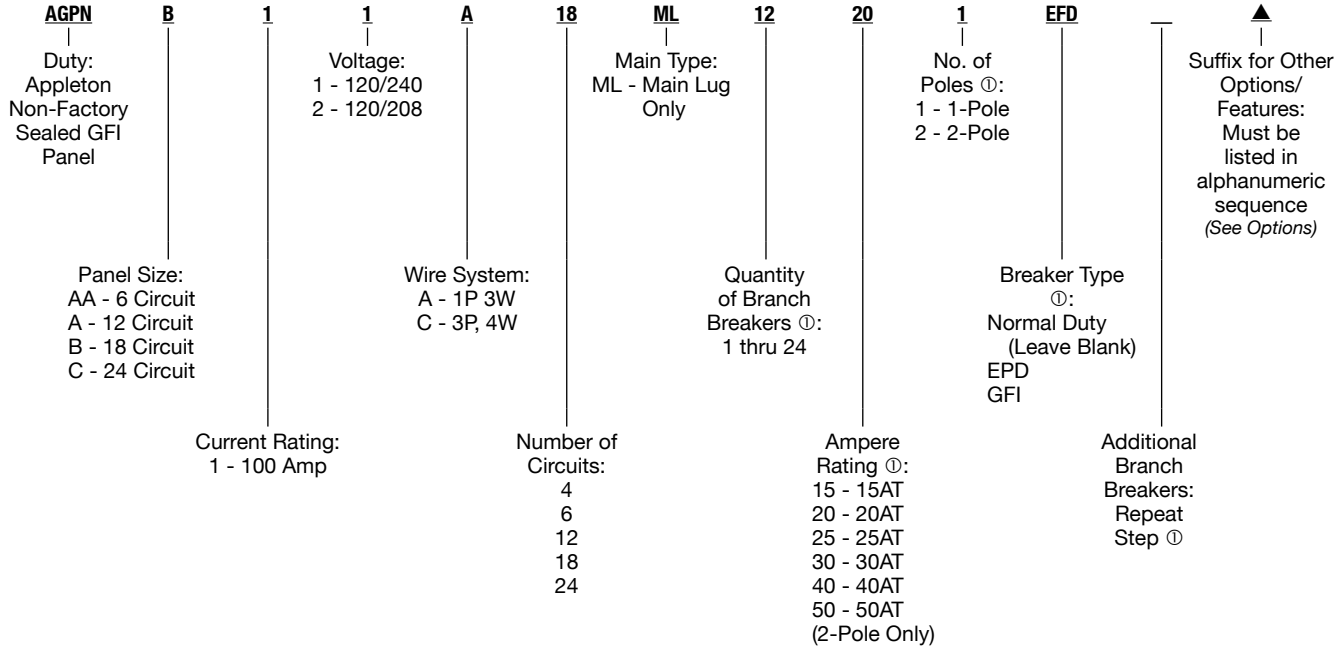

Number of Circuits	120/240 V 1-Phase 3-Wire	120/280 V 3-Phase 4-Wire	Panel Size	Approximate Weight kgs (lbs)
4	AGPNA11A04ML ▲	AGPNA12C04ML ▲	AA	13.61 (30)
6	AGPNA11A06ML ▲	AGPNA12C06ML ▲	AA	15.88 (35)
12	AGPNA11A12ML ▲	AGPNA12C12ML ▲	A	61.23 (135)
18	AGPNB11A18ML ▲	AGPNB12C18ML ▲	B	74.84 (165)
24	AGPNC11A24ML ▲	AGPNC12C24ML ▲	C	95.25 (210)

Note: For Back Fed main, replace last ML in part number with BF. For 100 Amp Main Breaker, contact your local representative. Standard interrupting capacity is 10,000 AIC. For higher interrupt ratings, contact your local representative.

## Typical Panelboard Wiring Diagram

### 1-Phase, 3-Wire Systems

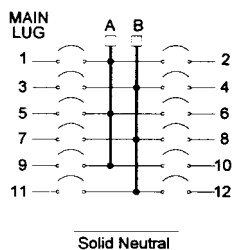

### 3-Phase, 4-Wire Systems

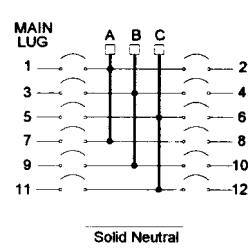

▲ To complete the catalog number please add the appropriate suffix for other options/features. These suffixes can be found under Options.

# APPN Series Power Distribution Panelboards

Explosionproof, Dust-Ignitionproof, Watertight, Non-Factory Sealed

GHB Cutler-Hammer † Circuit Breakers

**NEC:**

Class I, Division 1 and 2, Groups B, C, D

Class II, Division 1 and 2, Groups E, F, G

Class III

Class I, Zone 1, Group IIB +H<sub>2</sub>

NEMA 4, 4X, 7BCD, 9EFG

Select GHB † branch breakers as desired in panel. First and second digits are the quantity of breakers, third and fourth digits are ampere rating, the fifth digit is number of poles. Example: An 18-circuit 277/480 V 3-phase 4-wire 100 A MLO panel with 12 1-pole 20 Amp and 3 2-pole 30 Amp branch breakers should read APPNB14C18ML100-12201EPD-03302.

**Catalog Numbering Guide**

<p><b>APPN</b></p> <p>Duty: Appleton Non-Factory Sealed Power Panel</p>	<p><b>B</b></p> <p>Panel Size: A - 12 Circuit, 100 Amp Main Lug Only B - 18 Circuit, 100 Amp Main Lug Only C - 30 Circuit, 100 or 225 Amp Main Lug Only or 18 Circuit with Main Breaker D - 42 Circuit, 225 Amp Main Lug Only or 36 Circuit with Main Breaker F - 42 Circuit with Main Breaker</p>	<p><b>1</b></p> <p>Current Rating: 1 - 100 Amp 2 - 225 Amp</p>	<p><b>4</b></p> <p>Voltage: 4 - 277/480 (3P 4W Only) 7 - 24 Vdc 8 - 125/250 Vdc</p>	<p><b>C</b></p> <p>Wire System: C - 3P, 4W D - 2P, 2W for 24 Vdc</p>	<p><b>18</b></p> <p>Number of Circuits: 12 18 24 30 36 42</p>	<p><b>ML</b></p> <p>Main Type: MB - Main Breaker ML - Main Lug Only</p>	<p><b>100</b></p> <p>Ampere Rating: 020 - 20AT 025 - 25AT 030 - 30AT 040 - 40AT 050 - 50AT 060 - 60AT 070 - 70AT 080 - 80AT 090 - 90AT 100 - 100AT 110 - 110AT 125 - 125AT 150 - 150AT 175 - 175AT 200 - 200AT 225 - 225AT</p>	<p><b>12</b></p> <p>Quantity of Branch Breakers ①: 1 thru 42</p>	<p><b>20</b></p> <p>Ampere Rating ①: 15 - 15AT 20 - 20AT 25 - 25AT 30 - 30AT 35 - 35AT 40 - 40AT 45 - 45AT 50 - 50AT 55 - 55AT 60 - 60AT 70 - 70AT 80 - 80AT 90 - 90AT 100 - 100AT</p>	<p><b>1</b></p> <p>No. of Poles ①: (include only if different from wiring system)</p>	<p><b>EPD</b></p> <p>Breaker Type ①: Normal Duty (Leave Blank) EPD ①</p>	<p>Additional Branch Breakers: Repeat Step ①</p>	<p>▲</p> <p>Suffix for Other Options/ Features: Must be listed in alphanumeric sequence (See Options)</p>
---	--	--	---	--	---	---	--	--	--	---	--	--	---

① EPD Single Phase (requires 2-Poles) 277 Vac, 30 mA.

▲ To complete the catalog number please add the appropriate suffix for other options/features. These suffixes can be found under Options.

† GHB and Cutler-Hammer are trademarks of the Eaton Corporation.

# APPN Series Power Distribution Panelboards

Explosionproof, Dust-Ignitionproof, Watertight, Non-Factory Sealed

GHB Cutler-Hammer + Circuit Breakers

**NEC:**

Class I, Division 1 and 2, Groups B, C, D

Class II, Division 1 and 2, Groups E, F, G

Class III

Class I, Zone 1, Group IIB +H<sub>2</sub>

NEMA 4, 4X, 7BCD, 9EFG

DISTRIBUTION EQUIPMENT: NEC/CEC HAZARDOUS LOCATION PANELBOARDS

	Number of Circuits	277/480 V 3-Phase 4-Wire GHB Type	Panel Size	Approximate Weight kgs (lbs)
100 Amp Main Lug Only	12	APPNA14C12ML ▲	A	61.23 (135)
	18	APPNB14C18ML ▲	B	74.84 (165)
	24	APPNC14C24ML ▲	C	95.25 (210)
	30	APPNC14C30ML ▲	C	97.52 (215)
225 Amp Main Lug Only	18	APPNC24C18ML ▲	C	81.65 (180)
	24	APPNC24C24ML ▲	C	104.33 (230)
	30	APPNC24C30ML ▲	C	106.59 (235)
	36	APPND24C36ML ▲	D	131.54 (290)
	42	APPND24C42ML ▲	D	133.81 (295)
Main Breaker 100 Amp F	12	APPNC14C12MB100 ▲	C	74.84 (165)
	18	APPNC14C18MB100 ▲	C	81.65 (180)
	24	APPND14C24MB100 ▲	D	95.25 (210)
	30	APPND14C30MB100 ▲	D	142.88 (315)
Main Breaker 225 Amp F	18	APPNC24C18MB225 ▲	C	83.91 (185)
	24	APPND24C24MB225 ▲	D	133.81 (295)
	30	APPND24C30MB225 ▲	D	136.08 (300)
	36	APPND24C36MB225 ▲	D	138.35 (305)
	42	APPNF24C42MB225 ▲	F	156.49 (345)

Note: For Back Fed main, replace **ML**, **MB100**, or **MB225** in part number with **BF**. For 400 Amp Main Lug, contact your local representative. Standard interrupting capacity is 14,000 AIC. For higher interrupt ratings, contact your local representative.

## Typical Panelboard Wiring Diagram

### 3-Phase, 4-Wire Systems

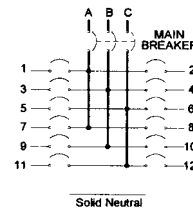
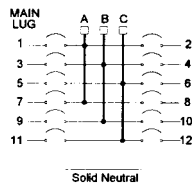

▲ To complete the catalog number please add the appropriate suffix for other options/features. These suffixes can be found under Options.

+ GHB and Cutler-Hammer are trademarks of the Eaton Corporation.

# APPN Series Power Distribution Panelboards

## Explosionproof, Dust-Ignitionproof, Watertight, Non-Factory Sealed

F-Frame Cutler Hammer † Circuit Breakers

**NEC:**

Class I, Division 1 and 2, Groups B, C, D

Class II, Division 1 and 2, Groups E, F, G

Class III

Class I, Zone 1, Group IIB +H<sub>2</sub>

NEMA 4, 4X, 7BCD, 9EFG

Select F-Frame branch breakers as desired in panel. First and second digits are the quantity of breakers, third and fourth digits are ampere rating, the fifth digit is number of poles. Example: An 18-circuit 277/480 V 3-phase 4-wire 100 A MLO panel with 12 1-pole 20 Amp and 3 2-pole 30 Amp branch breakers should read APPNE14C18ML100-12201-03302.

### Catalog Numbering Guide

<b>APPN</b>	<b>E</b>	<b>1</b>	<b>4</b>	<b>C</b>	<b>18</b>	<b>ML</b>	<b>100</b>	<b>12</b>	<b>20</b>	<b>1</b>	<b>▲</b>
Duty: Appleton Non-Factory Sealed Power Panel			Voltage: 3 - 480 4 - 277/480 (3P 4W Only) 6 - 600 7 - 24 Vdc 8 - 125/250 Vdc			Main Type: MB - Main Breaker ML - Main Lug Only			Ampere Rating ①: 10 - 10AT 15 - 15AT 20 - 20AT 25 - 25AT 30 - 30AT 35 - 35AT 40 - 40AT 45 - 45AT 50 - 50AT 60 - 60AT 70 - 70AT 80 - 80AT 90 - 90AT 100 - 100AT 110 - 110AT (2-, 3-Pole Only) 125 - 125AT (2-, 3-Pole Only) 150 - 150AT (2-, 3-Pole Only) 175 - 175AT (2-, 3-Pole Only) 200 - 200AT (2-, 3-Pole Only)		Suffix for Other Options/ Features: Must be listed in alphanumeric sequence (See Options)
	Panel Size: E - 12 Circuit with Main Breaker or 24 Circuit without Main Breaker G - 24 Circuit with Main Breaker or 36 Circuit without Main Breaker or H - 42 Circuit with or without Main Breaker			Wire System: B - 3P, 3W C - 3P, 4W D - 2P, 2W for 24 Vdc			Ampere Rating: 020 - 20AT 025 - 25AT 030 - 30AT 040 - 40AT 050 - 50AT 060 - 60AT 070 - 70AT 080 - 80AT 090 - 90AT 100 - 100AT 110 - 110AT 125 - 125AT 150 - 150AT 175 - 175AT 200 - 200AT 225 - 225AT		No. of Poles ①: (include only if different from wiring system)		
		Current Rating: 1 - 100 Amp 2 - 225 Amp			Number of Circuits: 12 18 24 30 36 42		Quantity of Branch Breakers ①: 1 thru 42			Additional Branch Breakers: Repeat Step ①	

▲ To complete the catalog number please add the appropriate suffix for other options/features. These suffixes can be found under Options.

† Cutler-Hammer is a trademark of the Eaton Corporation.

# APPN Series Power Distribution Panelboards

## Explosionproof, Dust-Ignitionproof, Watertight, Non-Factory Sealed

F-Frame Cutler Hammer † Circuit Breakers

NEC:  
 Class I, Division 1 and 2, Groups B, C, D  
 Class II, Division 1 and 2, Groups E, F, G  
 Class III  
 Class I, Zone 1, Group IIB +H<sub>2</sub>  
 NEMA 4, 4X, 7BCD, 9EFG

DISTRIBUTION EQUIPMENT: NEC/CEC HAZARDOUS LOCATION PANELBOARDS

	Number of Circuits	480 V 3-Phase 3-Wire EHD Type	277/480 V 3-Phase 3-Wire EHD Type	600 V 3-Phase 4-Wire FDB Type	Panel Size	Approximate Weight kgs (lbs)
100 Amp Main Lug Only	12	APPNE13B12ML ▲	APPNE14C12ML ▲	APPNE16C12ML ▲	E	127.01 (280)
	18	APPNE13B18ML ▲	APPNE14C18ML ▲	APPNE16C18ML ▲	E	129.27 (285)
	24	APPNE13B24ML ▲	APPNE14C24ML ▲	APPNE16C24ML ▲	E	131.54 (290)
	30	APPNG13B30ML ▲	APPNG14C30ML ▲	APPNG16C30ML ▲	G	174.63 (385)
225 Amp Main Lug Only	18	APPNE23B18ML ▲	APPNE24C18ML ▲	APPNE26C18ML ▲	E	131.54 (290)
	24	APPNG23B24ML ▲	APPNG24C24ML ▲	APPNG26C24ML ▲	G	176.90 (390)
	30	APPNG23B30ML ▲	APPNG24C30ML ▲	APPNG26C30ML ▲	G	179.17 (395)
	36	APPNG23B36ML ▲	APPNG24C36ML ▲	APPNG26C36ML ▲	G	181.44 (400)
	42	APPNH23B42ML ▲	APPNH24C42ML ▲	APPNH26C42ML ▲	H	247.21 (545)
Main Breaker 100 Amp F	12	APPNE13B12MB100 ▲	APPNE14C12MB100 ▲	APPNE16C12MB100 ▲	E	129.27 (285)
	18	APPNG13B18MB100 ▲	APPNG14C18MB100 ▲	APPNG16C18MB100 ▲	G	176.90 (390)
	24	APPNG13B24MB100 ▲	APPNG14C24MB100 ▲	APPNG16C24MB100 ▲	G	179.17 (395)
	30	APPNG13B30MB100 ▲	APPNG14C30MB100 ▲	APPNG16C30MB100 ▲	G	181.44 (400)
Main Breaker 225 Amp F	18	APPNG23B18MB225 ▲	APPNG24C18MB225 ▲	APPNG26C18MB225 ▲	G	179.17 (395)
	24	APPNG23B24MB225 ▲	APPNG24C24MB225 ▲	APPNG26C24MB225 ▲	G	181.44 (400)
	30	APPNH23B30MB225 ▲	APPNH24C30MB225 ▲	APPNH26C30MB225 ▲	H	249.48 (550)
	36	APPNH23B36MB225 ▲	APPNH24C36MB225 ▲	APPNH26C36MB225 ▲	H	251.74 (555)
	42	APPNH23B42MB225 ▲	APPNH24C42MB225 ▲	APPNH26C42MB225 ▲	H	254.01 (560)

Note: For Back Fed main, replace **ML**, **MB100**, or **MB225** in part number with **BF**. For 400 Amp Main Lug, contact your local representative. Standard interrupting capacity is 14,000 AIC. For higher interrupt ratings, contact your local representative.

### Typical Panelboard Wiring Diagram

1-Phase, 3-Wire Systems

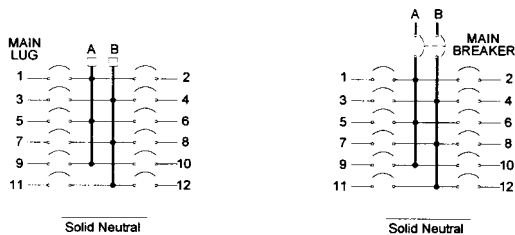

3-Phase, 4-Wire Systems

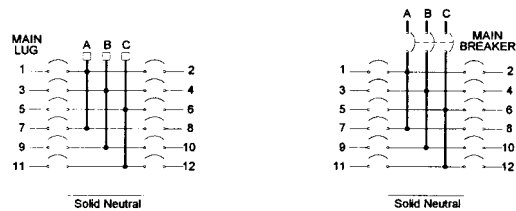

▲ To complete the catalog number please add the appropriate suffix for other options/features. These suffixes can be found under Options.

† Cutler-Hammer is a trademark of the Eaton Corporation.



# ALPN, AGPN and APPN Series Distribution Panelboards

## Explosionproof, Dust-Ignitionproof, Watertight, Non-Factory Sealed

NEC:  
 Class I, Division 1 and 2, Groups B, C, D  
 Class II, Division 1 and 2, Groups E, F, G  
 Class III  
 Class I, Zone 1, Group IIB +H<sub>2</sub>  
 NEMA 4, 4X, 7BCD, 9EFG

### ALPN, APPN Main Lug Panelboard and Mounting Hardware

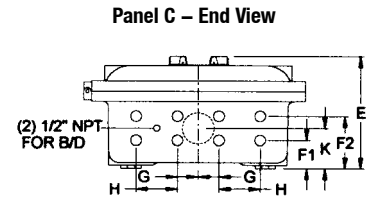
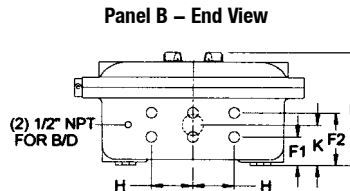
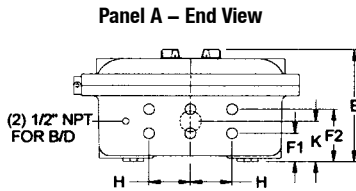
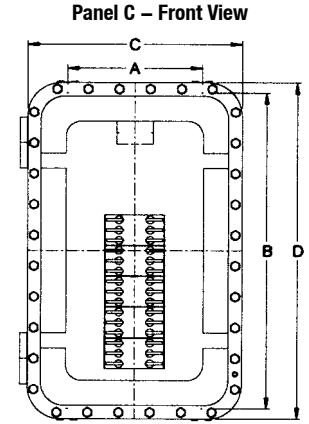
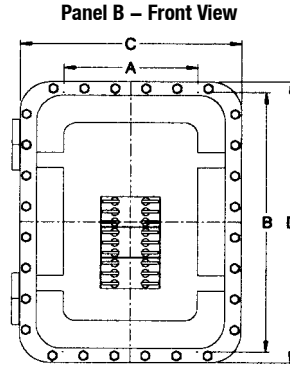
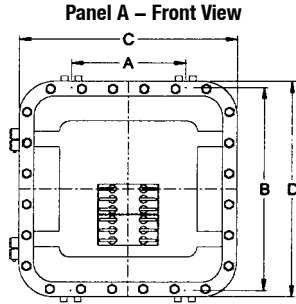

Panel Size	Mounting Dimensions in Millimeters (Inches)										Standard Top	Outlets Bottom	Mounting Hdw. Set
	A	B	C	D	E	F1	F2	G	H	K			
A	279.4 (11.00)	501.6 (19.75)	533.4 (21.00)	533.4 (21.00)	279.4 (11.00)	69.8 (2.75)	130.3 (5.13)	—	101.6 (4.00)	100.0 (3.94)	1 - 50.8 (2.00)	6 - 25.4 (1.00)	AMH8
B	330.2 (13.00)	641.3 (25.25)	544.5 (21.44)	693.6 (27.31)	279.4 (11.00)	69.8 (2.75)	130.3 (5.13)	—	101.6 (4.00)	100.0 (3.94)	1 - 50.8 (2.00)	6 - 25.4 (1.00)	AMH8
C	330.2 (13.00)	781.0 (30.75)	527.0 (20.75)	931.8 (32.75)	279.4 (11.00)	69.8 (2.75)	130.3 (5.13)	50.8 (2.00)	101.6 (4.00)	100.0 (3.94)	1 - 50.8 (2.00)	6 - 25.4 (1.00)	AMH8

Note: All outlets are NPT.

# ALPN, AGPN and APPN Series Distribution Panelboards

## Explosionproof, Dust-Ignitionproof, Watertight, Non-Factory Sealed

NEC:  
 Class I, Division 1 and 2, Groups B, C, D  
 Class II, Division 1 and 2, Groups E, F, G  
 Class III  
 Class I, Zone 1, Group IIB +H<sub>2</sub>  
 NEMA 4, 4X, 7BCD, 9EFG

DISTRIBUTION EQUIPMENT: NEC/CEC HAZARDOUS LOCATION PANELBOARDS

### ALPN, APPN Main Lug Panelboard and Mounting Hardware

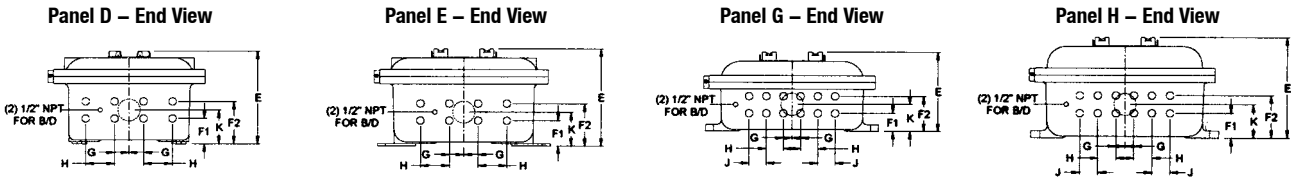
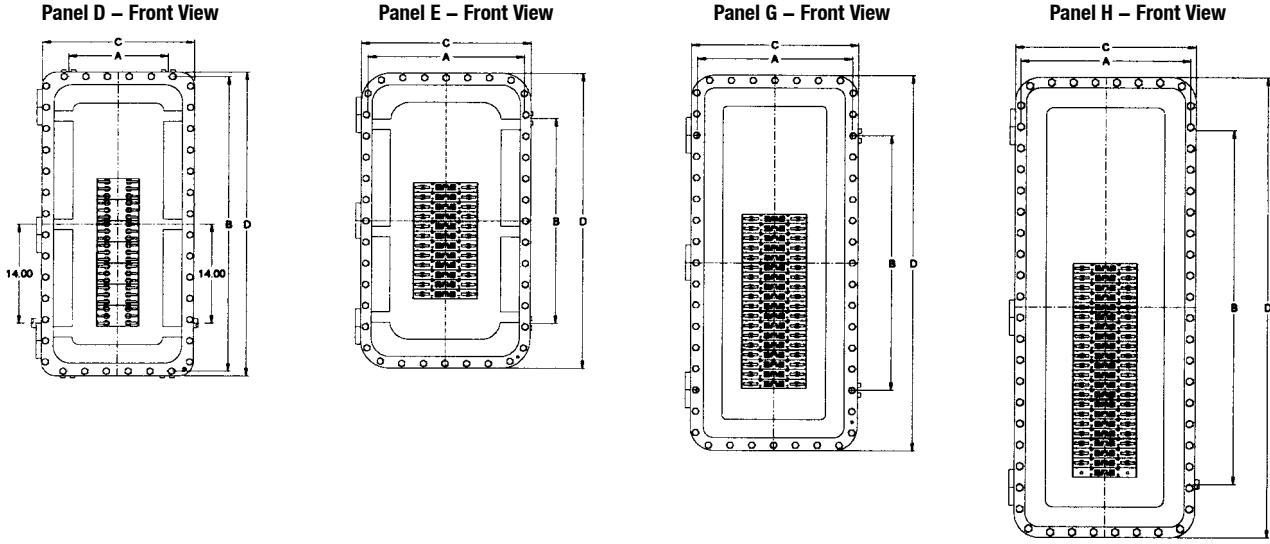

Panel Size	Mounting Dimensions in Millimeters (Inches)											Standard Top	Outlets Bottom	Mounting Hdw. Set
	A	B	C	D	E	F1	F2	G	H	J	K			
D	349.2 (13.75)	1057.4 (41.63)	533.4 (21.00)	1090.6 (42.94)	330.2 (13.00)	90.4 (3.56)	150.8 (5.94)	50.8 (2.00)	—	101.6 (4.00)	120.6 (4.75)	1 - 76.2 (3.00)	8 - 25.4 (1.00)	AMH8
E	552.45 (21.75)	736.6 (29.00)	596.9 (23.50)	1060.4 (41.75)	346.2 (13.63)	90.4 (3.56)	150.8 (5.94)	50.8 (2.00)	—	101.6 (4.00)	120.6 (4.75)	1 - 76.2 (3.00)	8 - 25.4 (1.00)	AMH8
G	543.0 (21.38)	914.4 (36.00)	584.2 (23.00)	1346.3 (53.00)	279.4 (11.00)	63.5 (2.50)	123.9 (4.88)	30.2 (1.19)	60.4 (2.38)	60.4 (2.38)	88.9 (3.50)	1 - 76.2 (3.00)	8 - 25.4 (1.00)	AMH6
H	596.9 (23.50)	1270.0 (50.00)	635.0 (25.00)	1651.0 (65.00)	355.6 (14.00)	87.3 (3.44)	150.8 (5.94)	31.7 (1.25)	63.5 (2.50)	63.5 (2.50)	119.1 (4.69)	1 - 76.2 (3.00)	8 - 25.4 (1.00)	AMH6

Note: All outlets are NPT.

# ALPN, AGPN and APPN Series Distribution Panelboards

## Explosionproof, Dust-Ignitionproof, Watertight, Non-Factory Sealed

**NEC:**  
 Class I, Division 1 and 2, Groups B, C, D  
 Class II, Division 1 and 2, Groups E, F, G  
 Class III  
 Class I, Zone 1, Group IIB +H<sub>2</sub>  
 NEMA 4, 4X, 7BCD, 9EFG

### ALPN, APPN Main Breaker Panelboard and Mounting Hardware

Panel C – Front View

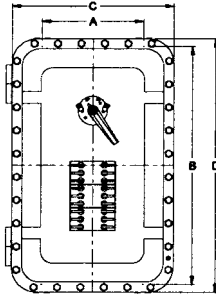

Panel D – Front View

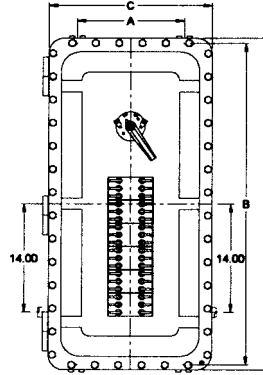

Panel E – Front View

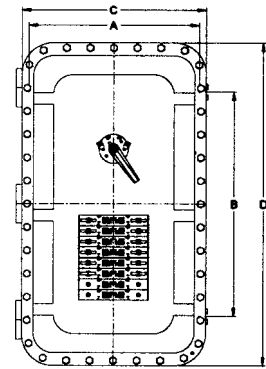

Panel C – End View

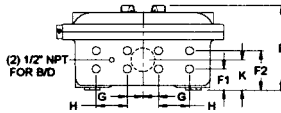

Panel D – End View

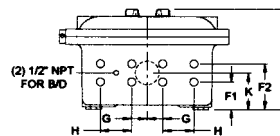

Panel E – End View

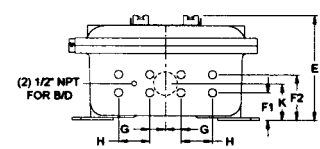

Panel Size	Mounting Dimensions in Millimeters (Inches)										Standard Top	Outlets Bottom	Mounting Hdw. Set
	A	B	C	D	E	F1	F2	G	H	K			
C	349.2 (13.75)	781.0 (30.75)	527.0 (20.75)	931.8 (32.75)	279.4 (11.00)	69.8 (2.75)	130.3 (5.13)	50.8 (2.00)	101.6 (4.00)	100.0 (3.94)	1 - 76.2 (3.00)	8 - 25.4 (1.00)	AMH8
D	349.2 (13.75)	1057.4 (41.63)	533.4 (21.00)	1090.6 (42.94)	330.2 (13.00)	90.4 (3.56)	150.8 (5.94)	50.8 (2.00)	101.6 (4.00)	120.6 (4.75)	1 - 76.2 (3.00)	8 - 25.4 (1.00)	AMH8
E	552.45 (21.75)	736.6 (29.00)	596.9 (23.50)	1060.4 (41.75)	346.2 (13.63)	90.4 (3.56)	150.8 (5.94)	50.8 (2.00)	101.6 (4.00)	120.6 (4.75)	1 - 76.2 (3.00)	8 - 25.4 (1.00)	AMH8

Note: All outlets are NPT.

# ALPN, AGPN and APPN Series Distribution Panelboards

## Explosionproof, Dust-Ignitionproof, Watertight, Non-Factory Sealed

NEC:  
 Class I, Division 1 and 2, Groups B, C, D  
 Class II, Division 1 and 2, Groups E, F, G  
 Class III  
 Class I, Zone 1, Group IIB +H<sub>2</sub>  
 NEMA 4, 4X, 7BCD, 9EFG

DISTRIBUTION EQUIPMENT: NEC/CEC HAZARDOUS LOCATION PANELBOARDS

### ALPN, APPN Main Breaker Panelboard and Mounting Hardware

Panel F – Front View

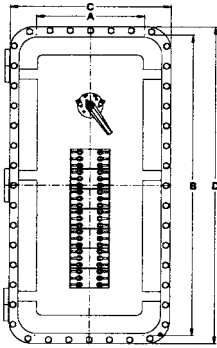

Panel G – Front View

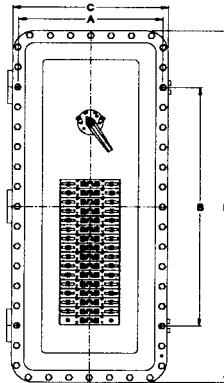

Panel H – Front View

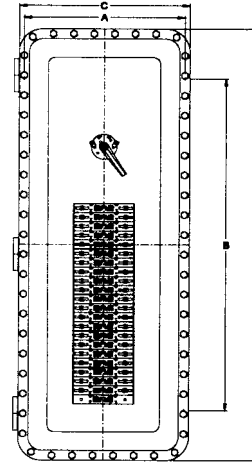

Panel F – End View

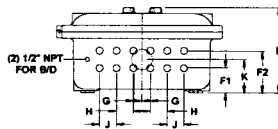

Panel G – End View

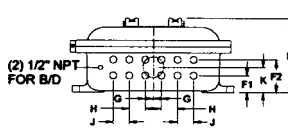

Panel H – End View

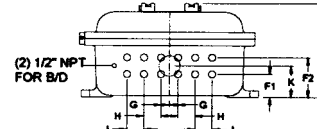

Panel Size	Mounting Dimensions in Millimeters (Inches)											Standard Top	Outlets Bottom	Mounting Hdw. Set
	A	B	C	D	E	F1	F2	G	H	J	K			
F	406.4 (16.00)	1152.6 (45.38)	603.2 (23.75)	1212.8 (47.75)	325.3 (12.81)	93.7 (3.69)	160.2 (6.31)	31.7 (1.25)	63.5 (2.50)	63.5 (2.50)	127.0 (5.00)	1 - 76.2 (3.00)	12 - 25.4 (1.00)	AMH8
G	543.0 (21.38)	914.4 (36.00)	584.2 (23.00)	1346.2 (53.00)	279.4 (11.00)	63.5 (2.50)	123.9 (4.88)	30.2 (1.19)	60.4 (2.38)	60.4 (2.38)	88.9 (3.50)	1 - 76.2 (3.00)	12 - 25.4 (1.00)	AMH6
H	596.9 (23.50)	1270.0 (50.00)	635.0 (25.00)	1651.0 (65.00)	355.6 (14.00)	87.3 (3.44)	150.8 (5.94)	31.7 (1.25)	63.5 (2.50)	63.5 (2.50)	119.1 (4.69)	1 - 76.2 (3.00)	12 - 25.4 (1.00)	AMH6

Note: All outlets are NPT.

# ALPN, AGPN and APPN Series Distribution Panelboards

## Explosionproof, Dust-Ignitionproof, Watertight, Non-Factory Sealed

**NEC:**

Class I, Division 1 and 2, Groups B, C, D  
 Class II, Division 1 and 2, Groups E, F, G  
 Class III  
 Class I, Zone 1, Group IIB +H<sub>2</sub>  
 NEMA 4, 4X, 7BCD, 9EFG

### AGPN Series Ground Fault Interrupting Distribution Panelboard and Mounting Hardware

Panel AA – Front View

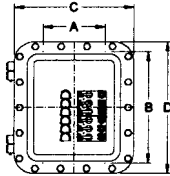

Panel A – Front View

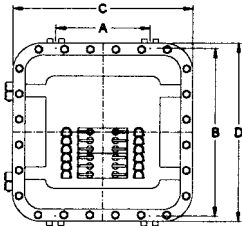

Panel B – Front View

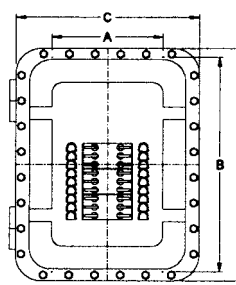

Panel C – Front View

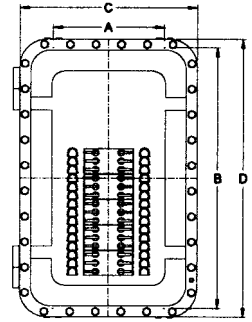

Panel AA – End View

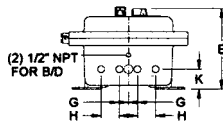

Panel A – End View

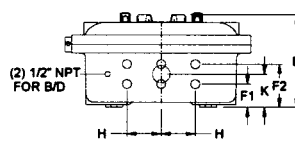

Panel B – End View

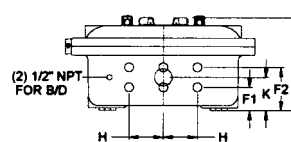

Panel C – End View

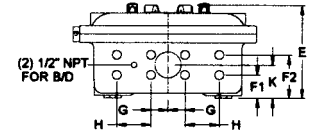

Panel Size	Mounting Dimensions in Millimeters (Inches)										Standard Top	Outlets Bottom	Mounting Hdw. Set
	A	B	C	D	E	F1	F2	G	H	K			
AA	184.1 (7.25)	333.5 (13.13)	352.5 (13.88)	393.7 (15.50)	242.8 (9.56)	60.4 (2.38)	—	26.9 (1.06)	54.1 (2.13)	60.4 (2.38)	1 - 25.4 (1.00)	4 - 19.0 (0.75)	AMH2
A	279.4 (11.00)	501.6 (19.75)	533.4 (21.00)	533.4 (21.00)	279.4 (11.00)	69.8 (2.75)	130.3 (5.13)	—	101.6 (4.00)	100.0 (3.94)	1 - 50.8 (2.00)	6 - 25.4 (1.00)	AMH8
B	330.2 (13.00)	641.3 (25.25)	544.5 (21.44)	693.6 (27.31)	279.4 (11.00)	69.8 (2.75)	130.3 (5.13)	—	101.6 (4.00)	100.0 (3.94)	1 - 50.8 (2.00)	6 - 25.4 (1.00)	AMH8
C	330.2 (13.00)	781.0 (30.75)	527.0 (20.75)	831.8 (32.75)	279.4 (11.00)	69.8 (2.75)	130.3 (5.13)	50.8 (2.00)	101.6 (4.00)	100.0 (3.94)	1 - 50.8 (2.00)	8 - 25.4 (1.00)	AMH8

Note: All outlets are NPT.

# ALPF Factory Sealed Lighting – APPF Power Distribution Panelboards

## Explosionproof, Dust-Ignitionproof, Watertight

NEC:  
 Class I, Division 1 and 2, Groups B♦, C♦, D  
 Class II, Division 1 and 2, Groups E, F, G  
 Class III  
 Class I, Zone 1, Group IIB +H<sub>2</sub>  
 NEMA 4, 4X, 7BCD, 9EFG

DISTRIBUTION EQUIPMENT: NEC/CEC HAZARDOUS LOCATION PANELBOARDS

### Applications

- Distribution panelboards are used to furnish protection and control of electrical equipment in hazardous locations. These compact units provide a centrally controlled switching system for large quantities of branch circuits for:
  - Lighting
  - Heating
  - Small motors
  - Similar electrical equipment

### Features

- Breaker operators included as standard.
- O-ring gasket insures watertight integrity.
- Factory sealed, no external seals are required for most branch circuits. All conduits must be sealed adjacent to enclosure for Class I, Division 1, Groups B and C.
- Breakers are housed in the panel section and prewired to maximum circuit capacity, then wired to numbered terminals in the wiring compartment.
- Terminal compartment is interconnected to panel section with sealing hubs, unions and poured with sealing compound.
- Permits selection of 1-, 2- or 3-pole breakers.
- Precision machined flame path between body and cover.
- Bolt on stainless steel slotted mounting feet.
- Breaker operators can be padlocked in the ON or OFF position.
- All panelboards are supplied with Cutler-Hammer † interiors.
- Chassis assemblies with mains at top (bottom optional).
- Provisions for 12, 18, 24, 30, 36 and 42 circuit 1-pole chassis.
- 100 Amp or 225 Amp main lug.
- Up to 100 Amp backfed main breaker available with main lug chassis.
- Up to 225 Amp main breaker available with main breaker chassis.
- Factory installed ground and neutral bar as standard.

### Standard Materials

- Bodies and covers: copperfree (4/10 of 1% max.) aluminum
- Cover bolts: Quad-Lead®, captive, stainless steel
- Breaker operators: copperfree (4/10 of 1% max.) aluminum
- Hinges: stainless steel
- Bus bars: copper
- O-ring: neoprene

### Standard Finish

- Corrosion resistant gray epoxy powder coat to provide NEMA 4X rating

### Options

Must be listed in alphanumeric sequence at the end of the catalog number.

- Panel Options
  - Breather, NEMA 4X add suffix —**BR**.
  - Drain, NEMA 4X add suffix —**DN**.
  - External ground stud add suffix — **EGS**.
  - Grounding neutral lug add suffix — **GNL**.
  - Terminal breaker located at bottom, add suffix —**INV**.
  - Main breaker located at bottom, add suffix —**LB**.
  - Phenolic nameplate (specify legend) add suffix —**NP**.
  - For 50 °C (122 °F) breaker rating, add suffix —**V**.
  - For stainless steel terminal enclosure for Division 2 applications only, contact your local sales representative.

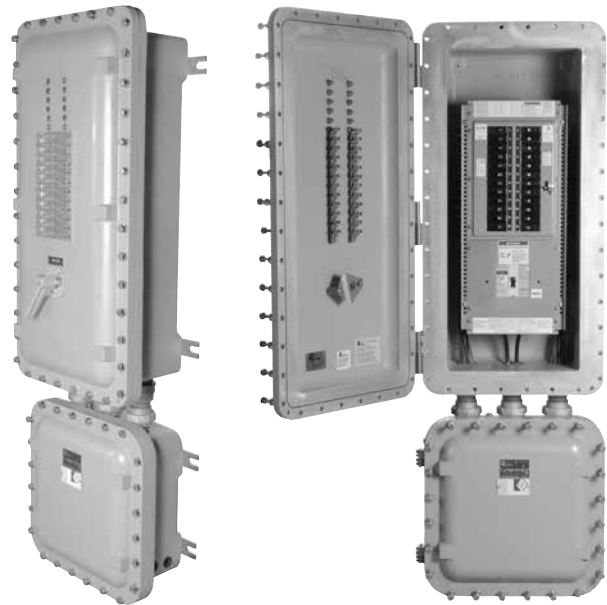

- Main Breaker Options
  - Auxiliary switch (1A or 1B) add suffix —**AS1**.
  - Auxiliary switch (2A or 2B) add suffix —**AS2**.
  - Shunt trip (specify voltage) add suffix —**ST**.
  - Under voltage release (specify voltage) add suffix —**UV**.
- Branch Breaker Option ALPF Only
  - Equipment Protection Devices (1- or 2-Pole -30 mA sensitivity) ① add suffix —**EPD**.
  - Ground Fault Interrupter (1- or 2-Pole -5 mA sensitivity) ① add suffix —**GFI**.
  - GFI Indicating Light add suffix —**L5**.
- Branch Breaker Options APPF GHB Only
  - Equipment Protection Devices (1- or 2-Pole -30 mA sensitivity) ① add suffix —**EPD**.
- Branch Breaker Options APPF F-Frame Only
  - Auxiliary switch (1A or 1B) add suffix —**AS1**.
  - Auxiliary switch (2A or 2B) add suffix —**AS2**.
  - Shunt trip (specify voltage) add suffix —**ST**.
  - Under voltage release (specify voltage) add suffix —**UV**.
- 400 Amp panel available, contact your local sales representative.

### NEC Certifications and Compliances

- UL Standard: UL 1203
- UL Listed: E84577

♦ For Class I, Division 1, Groups B and C, all conduits must be sealed within 50.8 mm (2") of enclosure.

† Cutler-Hammer is a trademark of the Eaton Corporation.

① GFI Push-to-Test Buttons are standard with GFI or EPD options.

# ALPF Lighting Factory Sealed Distribution Panelboards

Explosionproof, Dust-Ignitionproof, Watertight

**NEC:**

Class I, Division 1 and 2, Groups B♦, C♦, D

Class II, Division 1 and 2, Groups E, F, G

Class III

Class I, Zone 1, Group IIB +H<sub>2</sub>

NEMA 4, 4X, 7BCD, 9EFG

Select branch breakers as desired in panel. First and second digits are the quantity of breakers, third and fourth digits are ampere rating, the fifth digit is number of poles. Example: An 18 circuit 120/240 V 1-phase 3-wire 225 Amp Main panel with 12 1-pole 20 Amp and 3 2-pole 30 Amp branch breakers should read ALPFM21A18MB225-10501GFI.

**Catalog Numbering Guide**

<b>ALPF</b>	<b>M</b>	<b>2</b>	<b>1</b>	<b>A</b>	<b>18</b>	<b>MB</b>	<b>225</b>	<b>10</b>	<b>50</b>	<b>1</b>	<b>GFI</b>	<b>▲</b>	
Duty: Appleton Factory Sealed Lighting Panel			Voltage: 1 - 120/240 2 - 120/208 5 - 240 Vdc 7 - 24 Vdc 8 - 125/250 Vdc			Main Type: MB - Main Breaker ML - Main Lug Only			Ampere Rating ①: 10 - 10AT 15 - 15AT 20 - 20AT 25 - 25AT 30 - 30AT 35 - 35AT 40 - 40AT 45 - 45AT 50 - 50AT 55 - 55AT 60 - 60AT 70 - 70AT 80 - 80AT (not for 1-Pole) 90 - 90AT (not for 1-Pole) 100 - 100AT			Additional Branch Breakers: Repeat Step ①	
	Panel Size: J - 12 Circuit, 100 Amp Main Lug Only K - 18 Circuit, 100 Amp Main Lug Only M - 30 Circuit, 100 or 225 Amp Main Lug Only or 18 Circuit with Main Breaker N - 42 Circuit, 225 Amp Main Lug Only or 36 Circuit with Main Breaker Q - 42 Circuit with Main Breaker			Wire System: A - 1P, 3W B - 3P, 3W for 240 Vdc C - 3P, 4W D - 2P, 2W for 24 Vdc			Ampere Rating: 020 - 20AT 025 - 25AT 030 - 30AT 040 - 40AT 050 - 50AT 060 - 60AT 070 - 70AT 080 - 80AT 090 - 90AT 100 - 100AT 110 - 110AT 125 - 125AT 150 - 150AT 175 - 175AT 200 - 200AT 225 - 225AT		No. of Poles ①: (include only if different from wiring system)			Suffix for Other Options/ Features: Must be listed in alphanumeric sequence (See Options)	
	Current Rating: 1 - 100 Amp 2 - 225 Amp				Number of Circuits: 12 18 24 30 36 42		Quantity of Branch Breakers ①: 1 thru 42			Breaker Type ①: Normal Duty (Leave Blank) EPD GFI HID			

♦ For Class I, Division 1, Groups B and C, all conduits must be sealed within 50.8 mm (2") of enclosure.

▲ Suffix for Other Options/Features: Must be listed in alphanumeric sequence. See Options.



# ALPF Lighting Factory Sealed Distribution Panelboards

Explosionproof, Dust-Ignitionproof, Watertight

NEC:  
 Class I, Division 1 and 2, Groups B♦, C♦, D  
 Class II, Division 1 and 2, Groups E, F, G  
 Class III  
 Class I, Zone 1, Group IIB +H<sub>2</sub>  
 NEMA 4, 4X, 7BCD, 9EFG

DISTRIBUTION EQUIPMENT: NEC/CEC HAZARDOUS LOCATION PANELBOARDS

	Number of Circuits	120/240 Volt 1-Phase 3-Wire BAB Type	120/208 Volt 3-Phase 4-Wire BAB Type	240V 3-Phase 3-Wire Delta BAB Type	Panel Size	Approx. Weight (lbs)
100 Amp Main Lug Only	12	ALPFJ11A12ML ▲	ALPFJ12C12ML ▲	ALPFJ15C12ML ▲	J	121.11/267
	18	ALPFK11A18ML ▲	ALPFK12C18ML ▲	ALPFK15C18ML ▲	K	134.72/297
	24	ALPFM11A24ML ▲	ALPFM12C24ML ▲	ALPFM15C24ML ▲	M	155.13/342
	30	ALPFM11A30ML ▲	ALPFM12C30ML ▲	ALPFM15C30ML ▲	M	157.40/347
225 Amp Main Lug Only	18	ALPFM21A18ML ▲	ALPFM22C18ML ▲	ALPFM25C18ML ▲	M	141.52/312
	24	ALPFM21A24ML ▲	ALPFM22C24ML ▲	ALPFM25C24ML ▲	M	164.20/362
	30	ALPFM21A30ML ▲	ALPFM22C30ML ▲	ALPFM25C30ML ▲	M	166.47/367
	36	ALPFN21A36ML ▲	ALPFN22C36ML ▲	ALPFN25C36ML ▲	N	191.42/422
	42	ALPFN21A42ML ▲	ALPFN22C42ML ▲	ALPFN25C42ML ▲	N	193.68/427
Main Breaker 100AF	12	ALPFM11A12MB100 ▲	ALPFM12C12MB100 ▲	ALPFM15C12MB100 ▲	M	134.72/297
	18	ALPFM11A18MB100 ▲	ALPFM12C18MB100 ▲	ALPFM15C18MB100 ▲	M	141.52/312
	24	ALPFN11A24MB100 ▲	ALPFN12C24MB100 ▲	ALPFN15C24MB100 ▲	N	193.68/427
	30	ALPFN11A30MB100 ▲	ALPFN12C30MB100 ▲	ALPFN15C30MB100 ▲	N	202.56/447
Main Breaker 225AF	18	ALPFM21A18MB225 ▲	ALPFM22C18MB225 ▲	ALPFM25C18MB225 ▲	M	143.79/317
	24	ALPFN21A24MB225 ▲	ALPFN22C24MB225 ▲	ALPFN25C24MB225 ▲	N	193.68/427
	30	ALPFN21A30MB225 ▲	ALPFN22C30MB225 ▲	ALPFN25C30MB225 ▲	N	195.95/432
	36	ALPFN21A36MB225 ▲	ALPFN22C36MB225 ▲	ALPFN25C36MB225 ▲	N	198.22/437
	42	ALPFQ21A42MB225 ▲	ALPFQ22C42MB225 ▲	ALPFQ25C42MB225 ▲	Q	202.56/447

Note: For Back Fed main, replace **ML**, **MB100**, or **MB225** in part number with **BF**. For 400 Amp Main Lug, contact your local representative. Standard interrupting capacity is 14,000 AIC. For higher interrupt ratings, contact your local representative.

## Typical Panelboard Wiring Diagram

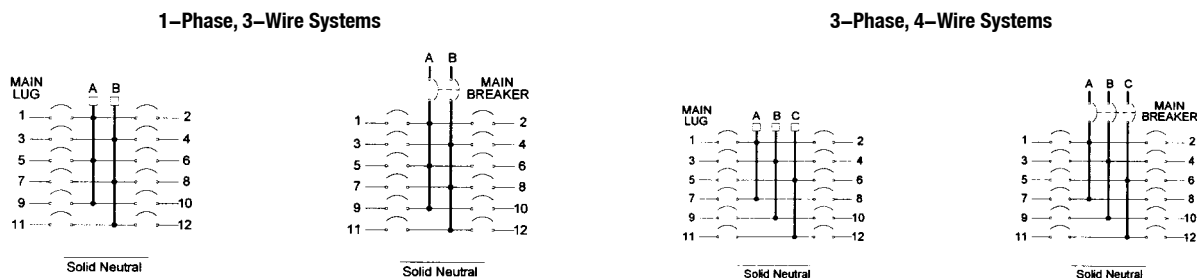

Panel	Sealed Together	
J	161606	161606/08
K	162206	161606/08
M	162806	161606/08
N	153707	161606/08
Q	184207	181806/08

♦ For Class I, Division 1, Groups B and C, all conduits must be sealed within 50.8 mm (2") of enclosure.  
 ▲ Suffix for Other Options/Features: Must be listed in alphanumeric sequence. See Options.



# APPF Series Power Distribution Panelboards

## Explosionproof, Dust-Ignitionproof, Watertight

GHB Cutler-Hammer + Circuit Breakers

**NEC:**

Class I, Division 1 and 2, Groups B♦, C♦, D

Class II, Division 1 and 2, Groups E, F, G

Class III

Class I, Zone 1, Group IIB +H<sub>2</sub>

NEMA 4, 4X, 7BCD, 9EFG

Select GHB + branch breakers as desired in panel. First and second digits are the quantity of breakers, third and fourth digits are ampere rating, the fifth digit is number of poles. Example: An 18-circuit 277/480 V 3-phase 4-wire 100 A MLO panel with 12 1-pole 20 Amp and 3 2-pole 30 Amp branch breakers should read APPFK14C18ML100-12201EPD-03302.

### Catalog Numbering Guide

<b>APPF</b>	<b>K</b>	<b>1</b>	<b>4</b>	<b>C</b>	<b>18</b>	<b>ML</b>	<b>100</b>	<b>12</b>	<b>20</b>	<b>1</b>	<b>EPD</b>		<b>▲</b>
Duty: Appleton Factory Sealed Power Panel			Voltage: 4 - 277/480 (3P 4W Only) 7 - 24 Vdc 8 - 125/250 Vdc			Main Type: MB - Main Breaker ML - Main Lug Only			Ampere Rating ①: 15 - 15AT 20 - 20AT 25 - 25AT 30 - 30AT 35 - 35AT 40 - 40AT 45 - 45AT 50 - 50AT 55 - 55AT 60 - 60AT 70 - 70AT 80 - 80AT 90 - 90AT 100 - 100AT			Additional Branch Breakers: Repeat Step ①	
Panel Size: J - 12 Circuit, 100 Amp Main Lug Only K - 18 Circuit, 100 Amp Main Lug Only M - 30 Circuit, 100 or 225 Amp Main Lug Only or 18 Circuit with Main Breaker N - 42 Circuit, 225 Amp Main Lug Only or 36 Circuit with Main Breaker Q - 42 Circuit with Main Breaker			Wire System: C - 3P, 4W D - 2P, 2W for 24 Vdc			Ampere Rating: 020 - 20AT 025 - 25AT 030 - 30AT 040 - 40AT 050 - 50AT 060 - 60AT 070 - 70AT 080 - 80AT 090 - 90AT 100 - 100AT 110 - 110AT 125 - 125AT 150 - 150AT 175 - 175AT 200 - 200AT 225 - 225AT			No. of Poles ①: (include only if different from wiring system)			Suffix for Other Options/ Features: Must be listed in alphanumeric sequence (See Options)	
		Current Rating: 1 - 100 Amp 2 - 225 Amp			Number of Circuits: 12 18 24 30 36 42			Quantity of Branch Breakers ①: 1 thru 42			Breaker Type ①: Normal Duty (Leave Blank) EPD ①		

① EPD Single Phase (requires 2-Poles) 277 Vac, 30 mA.

♦ For Class I, Division 1, Groups B and C, all conduits must be sealed within 50.8 mm (2") of enclosure.

▲ Suffix for Other Options/Features: Must be listed in alphanumeric sequence. See Options.

+ GHB and Cutler-Hammer are trademarks of the Eaton Corporation.

# APPF Series Power Distribution Panelboards

Explosionproof, Dust-Ignitionproof, Watertight

GHB Cutler-Hammer + Circuit Breakers

**NEC:**

Class I, Division 1 and 2, Groups B♦, C♦, D

Class II, Division 1 and 2, Groups E, F, G

Class III

Class I, Zone 1, Group IIB +H<sub>2</sub>

NEMA 4, 4X, 7BCD, 9EFG

DISTRIBUTION EQUIPMENT: NEC/CEC HAZARDOUS LOCATION PANELBOARDS

	Number of Circuits	277/480 Volt 3-Phase 4-Wire GHB Type	Panel Size	Approximate Weight kgs (lbs)
100 Amp Main Lug Only	12	APPFJ14C12ML ▲	J	61.23 (135)
	18	APPFK14C18ML ▲	K	74.84 (165)
	24	APPFM14C24ML ▲	M	95.25 (210)
	30	APPFM14C30ML ▲	M	97.52 (215)
225 Amp Main Lug Only	18	APPFM24C18ML ▲	M	81.65 (180)
	24	APPFM24C24ML ▲	M	104.33 (230)
	30	APPFM24C30ML ▲	M	106.59 (235)
	36	APPFN24C36ML ▲	N	131.54 (290)
	42	APPFN24C42ML ▲	N	133.81 (295)
Main Breaker 100 Amp F	12	APPFM14C12MB100 ▲	M	74.84 (165)
	18	APPFM14C18MB100 ▲	M	81.65 (180)
	24	APPFN14C24MB100 ▲	N	95.25 (210)
	30	APPFN14C30MB100 ▲	N	142.88 (315)
Main Breaker 225 Amp F	18	APPFM24C18MB225 ▲	M	83.91 (185)
	24	APPFN24C24MB225 ▲	N	133.81 (295)
	30	APPFN24C30MB225 ▲	N	136.08 (300)
	36	APPFN24C36MB225 ▲	N	138.35 (305)
	42	APPFQ24C42MB225 ▲	Q	156.49 (345)

Note: For Back Fed main, replace **ML**, **MB100**, or **MB225** in part number with **BF**. For 400 Amp Main Lug, contact your local representative. Standard interrupting capacity is 14,000 AIC. For higher interrupt ratings, contact your local representative.

## Typical Panelboard Wiring Diagram

### 3-Phase, 4-Wire Systems

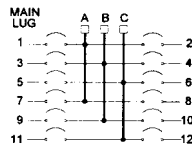

Solid Neutral

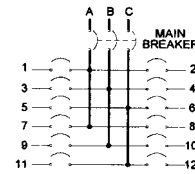

Solid Neutral

♦ For Class I, Division 1, Groups B and C, all conduits must be sealed within 50.8 mm (2") of enclosure.  
 ▲ Suffix for Other Options/Features: Must be listed in alphanumeric sequence. See Options.  
 + GHB and Cutler-Hammer are trademarks of the Eaton Corporation.

# APPF 480, 600 Volt Factory Sealed Power Distribution Panelboards

## Explosionproof, Dust-Ignitionproof, Watertight

F-Frame Cutler Hammer + Circuit Breakers

### NEC:

Class I, Division 1 and 2, Groups B♦, C♦, D

Class II, Division 1 and 2, Groups E, F, G

Class III

Class I, Zone 1, Group IIB +H<sub>2</sub>

NEMA 4, 4X, 7BCD, 9EFG

Select branch breakers as desired in panel. First and second digits are the quantity of breakers, third and fourth digits are ampere rating, the fifth digit is number of poles. Example: An 18-circuit 277/480 V 3-phase 100 A MLO panel with 12 1-pole 20 Amp and 3 2-pole 30 Amp branch breakers should read APPFP14C18ML100-12201-03302.

### Catalog Numbering Guide

APPF	P	1	4	C	18	ML	100	12	20	1	▲
Duty: Appleton Factory Sealed Power Panel			Voltage: 3 - 480 4 - 277/480 6 - 600 7 - 24 Vdc 8 - 125/250 Vdc			Main Type: MB - Main Breaker ML - Main Lug Only			Ampere Rating ①: 10 - 10AT 15 - 15AT 20 - 20AT 25 - 25AT 30 - 30AT 35 - 35AT 40 - 40AT 45 - 45AT 50 - 50AT 60 - 60AT 70 - 70AT 80 - 80AT 90 - 90AT 100 - 100AT 110 - 110AT (2-, 3-Pole Only) 125 - 125AT (2-, 3-Pole Only) 150 - 150AT (2-, 3-Pole Only) 175 - 175AT (2-, 3-Pole Only) 200 - 200AT (2-, 3-Pole Only)		Suffix for Other Options/ Features: Must be listed in alphanumeric sequence (See Options)
	Panel Size: P - 12 Circuit with Main Breaker or 24 Circuit without Main Breaker R - 24 Circuit with Main Breaker or 36 Circuit without Main Breaker or S - 42 Circuit with or without Main Breaker			Wire System: B - 3P, 3W C - 3P, 4W D - 2P, 2W for 24 Vdc			Ampere Rating: 020 - 20AT 025 - 25AT 030 - 30AT 040 - 40AT 050 - 50AT 060 - 60AT 070 - 70AT 080 - 80AT 090 - 90AT 100 - 100AT 110 - 110AT 125 - 125AT 150 - 150AT 175 - 175AT 200 - 200AT 225 - 225AT		No. of Poles ①: (include only if different from wiring system)		
		Current Rating: 1 - 100 Amp 2 - 225 Amp			Number of Circuits: 12 18 24 30 36 42		Quantity of Branch Breakers ①: 1 thru 42			Additional Branch Breakers: Repeat Step ①	

① EPD Single Phase (requires 2-Poles) 277 Vac, 30 mA.

+ Cutler-Hammer is a trademark of the Eaton Corporation.

♦ For Class I, Division 1, Groups B and C, all conduits must be sealed within 50.8 mm (2") of enclosure.

Visit our website at [www.emerson.com](http://www.emerson.com) or contact us at (800) 621-1506.

© November 2016

# APPF 480, 600 Volt Factory Sealed Power Distribution Panelboards

## Explosionproof, Dust-Ignitionproof, Watertight

F-Frame Cutler Hammer + Circuit Breakers

NEC:  
 Class I, Division 1 and 2, Groups B♦, C♦, D  
 Class II, Division 1 and 2, Groups E, F, G  
 Class III  
 Class I, Zone 1, Group IIB +H<sub>2</sub>  
 NEMA 4, 4X, 7BCD, 9EFG

DISTRIBUTION EQUIPMENT: NEC/CEC HAZARDOUS LOCATION PANELBOARDS

	Number of Circuits	480 V 3-Phase 3-Wire EHD Type	277/480 V 3-Phase 4-Wire EHD Type	600 V 3-Phase 4-Wire FDB Type
100 Amp Main Lug Only	12	APPPF13B12ML ▲	APPPF14C12ML ▲	APPPF16C12ML ▲
	18	APPPF13B18ML ▲	APPPF14C18ML ▲	APPPF16C18ML ▲
	24	APPPF13B24ML ▲	APPPF14C24ML ▲	APPPF16C24ML ▲
	30	APPPF13B30ML ▲	APPPF14C30ML ▲	APPPF16C30ML ▲
225 Amp Main Lug Only	18	APPPF23B18ML ▲	APPPF24C18ML ▲	APPPF26C18ML ▲
	24	APPPF23B24ML ▲	APPPF24C24ML ▲	APPPF26C24ML ▲
	30	APPPF23B30ML ▲	APPPF24C30ML ▲	APPPF26C30ML ▲
	36	APPPF23B36ML ▲	APPPF24C36ML ▲	APPPF26C36ML ▲
	42	APPPF23B42ML ▲	APPPF24C42ML ▲	APPPF26C42ML ▲
Main Breaker 100 Amp F	12	APPPF13B12MB100 ▲	APPPF14C12MB100 ▲	APPPF16C12MB100 ▲
	18	APPPF13B18MB100 ▲	APPPF14C18MB100 ▲	APPPF16C18MB100 ▲
	24	APPPF13B24MB100 ▲	APPPF14C24MB100 ▲	APPPF16C24MB100 ▲
	30	APPPF13B30MB100 ▲	APPPF14C30MB100 ▲	APPPF16C30MB100 ▲
Main Breaker 225 Amp F	18	APPPF23B18MB225 ▲	APPPF24C18MB225 ▲	APPPF26C18MB225 ▲
	24	APPPF23B24MB225 ▲	APPPF24C24MB225 ▲	APPPF26C24MB225 ▲
	30	APPPF23B30MB225 ▲	APPPF24C30MB225 ▲	APPPF26C30MB225 ▲
	36	APPPF23B36MB225 ▲	APPPF24C36MB225 ▲	APPPF26C36MB225 ▲
	42	APPPF23B42MB225 ▲	APPPF24C42MB225 ▲	APPPF26C42MB225 ▲

Note: For Back Fed main, replace **ML**, **MB100**, or **MB225** in part number with **BF**. For 400 Amp Main Lug, contact your local representative. Standard interrupting capacity is 14,000 AIC. For higher interrupt ratings, contact your local representative.

### Typical Panelboard Wiring Diagram

3-Phase, 3-Wire Systems

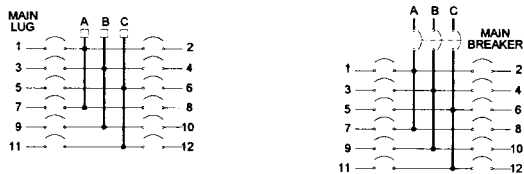

3-Phase, 4-Wire Systems

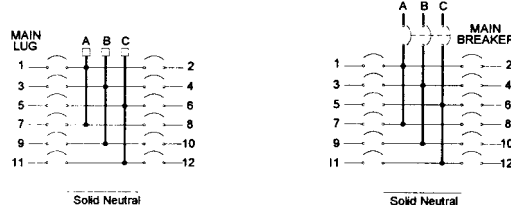

♦ For Class I, Division 1, Groups B and C, all conduits must be sealed within 50.8 mm (2") of enclosure.  
 ▲ Suffix for Other Options/Features: Must be listed in alphanumeric sequence. See Options.

# ALPF Factory Sealed Lighting – APPF Power Distribution Panelboards

Explosionproof, Dust-Ignitionproof, Watertight

F-Frame Cutler Hammer + Circuit Breakers

**NEC:**

Class I, Division 1 and 2, Groups B♦, C♦, D

Class II, Division 1 and 2, Groups E, F, G

Class III

Class I, Zone 1, Group IIB +H<sub>2</sub>

NEMA 4, 4X, 7BCD, 9EFG

**ALPF and APPF (GHB Type) Factory Sealed Distribution Panelboard**

Panel Size	Sealed Together		Top Outlets	Side Outlets	Mounting Hdw. Set
N	153707	161606/08	(1) 3" and (8) 1" NPT	(4) 1" NPT	AMH8
Q	184207	181806/08	(1) 3" and (8) 1" NPT	(4) 1" NPT	AMH8

**Dimensions in Millimeters (Inches)**

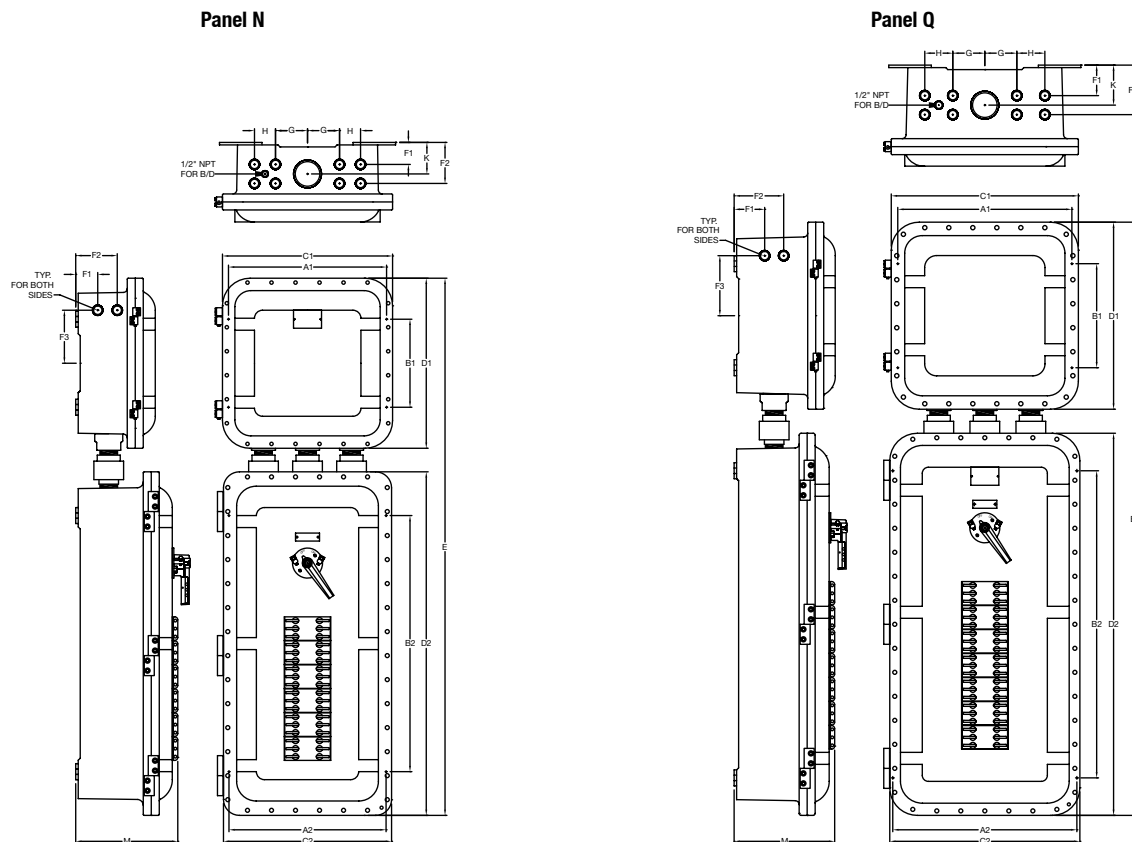

Panel Size	A1	A2	B1	B2	C1	C2	D1	D2	E	F1	F2	G	H	K	M
N	501.7 (19.75)	498.6 (19.63)	279.4 (11.00)	812.8 (32.00)	539.8 (21.25)	533.4 (21.00)	539.8 (21.25)	1090.7 (42.94)	1705.1 (67.13)	69.9 (2.75)	130.3 (5.13)	101.6 (4.00)	66.8 (2.63)	100.1 (3.94)	330.2 (13.00)
Q	552.5 (21.75)	584.2 (23.00)	330.2 (13.00)	974.9 (38.38)	593.9 (23.38)	603.3 (23.75)	593.9 (23.38)	1212.9 (47.75)	1882.9 (74.13)	96.8 (3.81)	157.2 (6.19)	101.6 (4.00)	88.9 (3.50)	127.0 (5.00)	325.4 (12.81)

♦ For Class I, Division 1, Groups B and C, all conduits must be sealed within 50.8 mm (2") of enclosure.

# ALPF Factory Sealed Lighting – APPF Power Distribution Panelboards

Explosionproof, Dust-Ignitionproof, Watertight

NEC:  
 Class I, Division 1 and 2, Groups B♦, C♦, D  
 Class II, Division 1 and 2, Groups E, F, G  
 Class III  
 Class I, Zone 1, Group IIB +H<sub>2</sub>  
 NEMA 4, 4X, 7BCD, 9EFG

DISTRIBUTION EQUIPMENT: NEC/CEC HAZARDOUS LOCATION PANELBOARDS

## ALPF and APPF (GHB Type) Factory Sealed Distribution Panelboard

Panel Size	Sealed Together		Top Outlets	Side Outlets	Mounting Hdw. Set
J	161606	161606/08	(1) 2" and (8) 1" NPT	—	AMH8
K	162206	161606/08	(1) 2" and (8) 1" NPT	—	AMH8
M	162806	161606/08	(1) 3" and (8) 1" NPT	—	AMH8

## Dimensions in Millimeters (Inches)

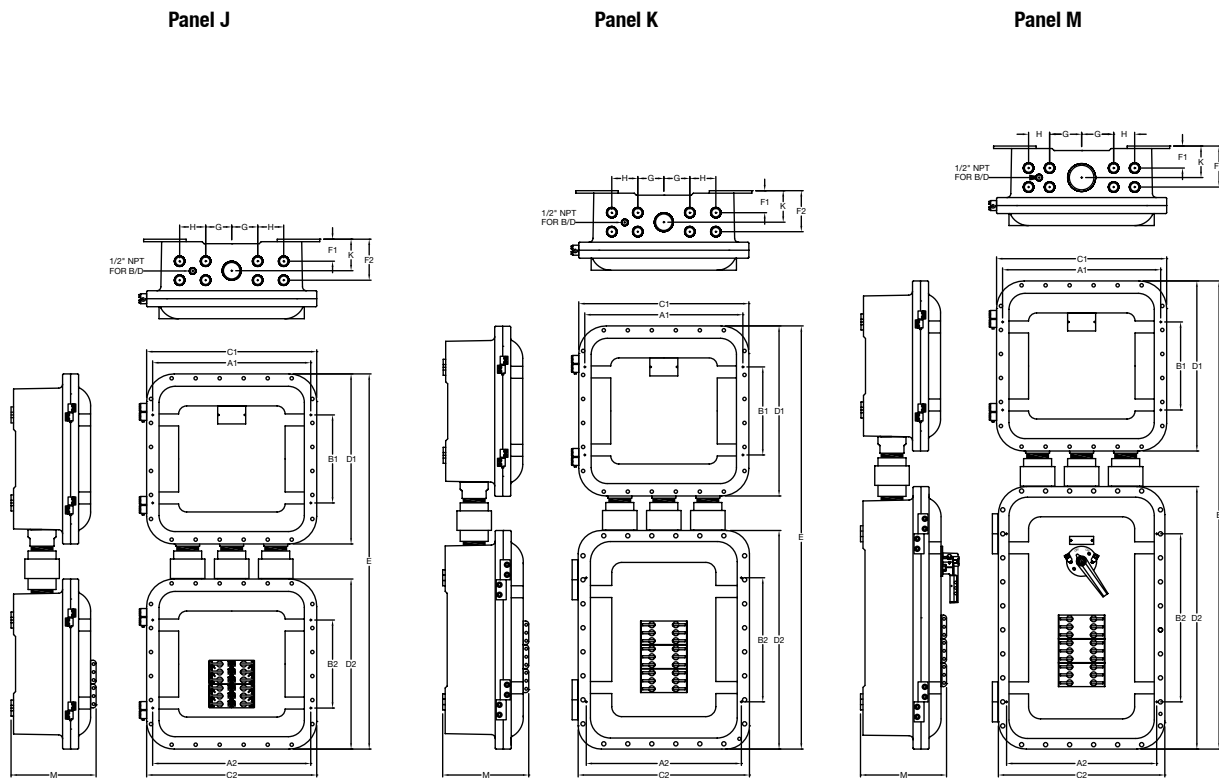

Panel Size	A1	A2	B1	B2	C1	C2	D1	D2	E	F1	F2	G	H	K	M
J	501.7 (19.75)	501.7 (19.75)	279.4 (11.00)	279.4 (11.00)	539.8 (21.25)	539.8 (21.25)	539.8 (21.25)	539.8 (21.25)	1190.8 (46.88)	69.9 (2.75)	130.3 (5.13)	82.6 (3.25)	82.6 (3.25)	100.1 (3.94)	279.4 (11.00)
K	501.7 (19.75)	492.3 (19.38)	279.4 (11.00)	393.7 (15.50)	539.8 (21.25)	543.6 (21.40)	539.8 (21.25)	693.7 (27.31)	1343.2 (52.88)	69.9 (2.75)	130.3 (5.13)	82.6 (3.25)	82.6 (3.25)	100.1 (3.94)	279.4 (11.00)
M	501.7 (19.75)	476.3 (18.75)	279.4 (11.00)	533.4 (21.00)	539.8 (21.25)	528.3 (20.80)	539.8 (21.25)	833.1 (32.80)	1485.9 (58.50)	69.9 (2.75)	130.3 (5.13)	101.6 (4.00)	66.8 (2.63)	100.1 (3.94)	279.4 (11.00)

♦ For Class I, Division 1, Groups B and C, all conduits must be sealed within 50.8 mm (2") of enclosure.

# ALPF Factory Sealed Lighting – APPF Power Distribution Panelboards

Explosionproof, Dust-Ignitionproof, Watertight

F-Frame Cutler Hammer + Circuit Breakers

**NEC:**

Class I, Division 1 and 2, Groups B♦, C♦, D

Class II, Division 1 and 2, Groups E, F, G

Class III

Class I, Zone 1, Group IIB +H<sub>2</sub>

NEMA 4, 4X, 7BCD, 9EFG

## APPF 480, 600 Volt Factory Sealed Power Distribution Panelboard

Panel Size	Sealed Together	Top	Standard Outlets Sides	Mounting Hdw. Set
P	183608	181806/08	(1) 3" and (8) 1" NPT	CMH8 (2)
R	184806	181806/08	(1) 3" and (8) 1" NPT	CMH8 (2)
S	206008	181806/08	(1) 3" and (8) 1" NPT	CMH8 (2)

### Dimensions in Millimeters (Inches)

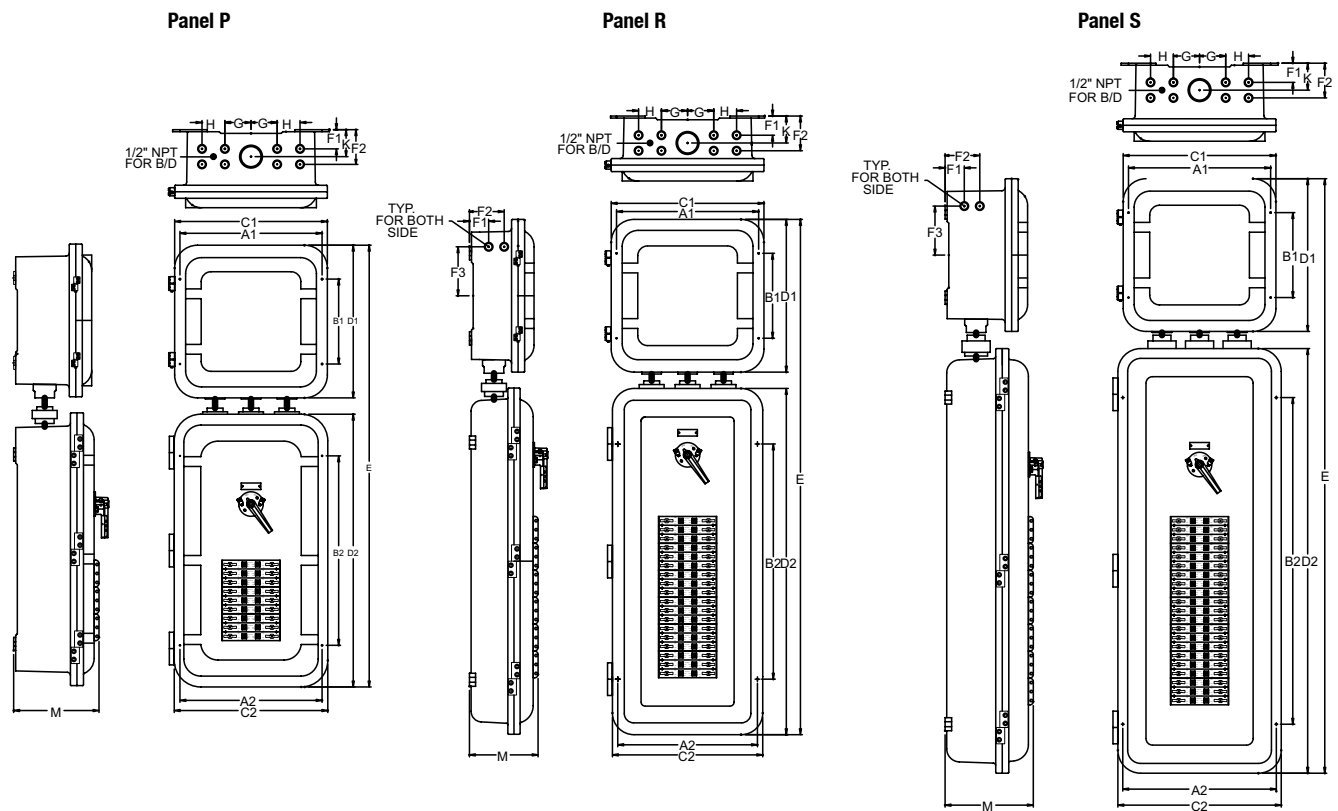

Panel Size	A1	A2	B1	B2	C1	C2	D1	D2	E	F1	F2	F3	G	H	K	M
P	522.5 (21.75)	21.75/ 522.5	330.2 (13.00)	736.6 (29.00)	593.9 (23.38)	596.9 (23.50)	593.9 (23.38)	1060.5 (41.75)	1717.8 (67.63)	74.7 (2.94)	130.3 (5.13)	—	101.6 (4.00)	88.9 (3.50)	104.9 (4.13)	331.7 (13.06)
R	522.5 (21.75)	543.1 (21.38)	330.2 (13.00)	914.4 (36.00)	593.9 (23.38)	584.2 (23.00)	593.9 (23.38)	1346.2 (53.00)	2003.6 (78.88)	74.7 (2.94)	130.3 (5.13)	190.5 (7.50)	101.6 (4.00)	88.9 (3.50)	104.9 (4.13)	266.7 (10.50)
S	522.5 (21.75)	596.9 (23.50)	330.2 (13.00)	1270.0 (50.00)	593.9 (23.38)	635.0 (25.00)	593.9 (23.38)	1651.0 (65.00)	2311.4 (91.00)	74.7 (2.94)	130.3 (5.13)	190.5 (7.50)	101.6 (4.00)	88.9 (3.50)	104.9 (4.13)	331.7 (13.06)

♦ For Class I, Division 1, Groups B and C, all conduits must be sealed within 50.8 mm (2") of enclosure.

# XP Series Non-Factory Sealed Circuit Breaker Panelboards

## Explosionproof, Dust-Ignitionproof

**NEC/CEC:**  
 Class I, Division 1 and 2, Groups B, C, D  
 Zone 1 and 2, Group IIB + H<sub>2</sub>  
 Class II, Division 1 and 2, Groups E, F, G  
 Class III

**CEC:**  
 EMR Canada  
 Exd IIB, T6  
 CSA Type 3, 4, 7BCD, 9EFG, 12  
 CSA Optional Type 3R, 4X

DISTRIBUTION EQUIPMENT: NEC/CEC HAZARDOUS LOCATION PANELBOARDS

### Applications

- Protection and control of electrical apparatus and circuits in hazardous environments, either indoor or outdoor. Designed for Class I areas where flammable gases or vapors are present either continuously or intermittently or under abnormal circumstances.
- 240 Vac system is suitable for use with lighting or heat tracing circuits.

### Features

- Exclusive rotary-slide circuit breaker operators have positive action and will align with breakers in ON or OFF position when cover is closed.
- Design allows breaker to be locked in ON or OFF position (one lock-off supplied with panel). Will not prevent breaker from tripping.
- Panelboard supplied with standard conduit entries. For conduit entries in other locations, contact your local representative.
- 240 Vac system has four sizes of panelboards available.
- Copper bus bars.
- Furnished with bolt on breakers.
- Removable hinged cover gives unobstructed access to interior. Left hand hinges are standard. Right hand hinges are available.
- Detailed circuit directory card is plainly visible for easy circuit identification.
- Main breaker is available, saving time and expense of installing a second enclosure.
- Installation is easy with keyhole mounting lugs to simplify mounting.

### Standard Materials

- Enclosure and cover: copperfree (4/10 of 1%) aluminum
- Operator shafts, cover bolts and fasteners: stainless steel
- Operator knobs: aluminum alloy
- 240 Vac system standard branch circuit breakers: type BAB, 1-, 2- or 3-Pole. 10,000 rms. sym. Interrupting capacity up to 65,000 rms. sym. available. Contact your local representative
- 277/480Y, 347/600Y Vac system standard branch circuit breakers: type GHB or GBH, 1-, 2- or 3-Pole. 10,000 rms. sym. interrupting capacity
- 480/600 Vac system standard branch circuit breakers: type F-Frame, 1-, 2- or 3-Pole. 14,000 rms. sym. interrupting capacity. 600 Vac Max

### Standard Finish

- Enclosure and cover: gray baked epoxy

### Options

*Must be listed in alphanumeric sequence at the end of the catalog number.*

- Panel Options
  - Drain and breather sets add suffix **-DV**.
  - Ferrous alloy, add suffix **-F**.
  - 5 ma GFI people protector (40 Amp Max., 1- or 2-Pole only), add suffix **-GF5**.
  - 30 mA EPD Equipment Protector (30 Amp Max., 1- or 2-Pole only), add suffix **-GF10**.
  - 30 mA With Alarm Circuit, add suffix **-GFA10**.
  - Grounded neutral lug, add suffix **-GNL**.
  - Heater c/w thermostat, add suffix **-HTR**.
  - Bottom feed, add suffix **-INV**.
  - Breaker ON-OFF indicator Light (LED), add suffix **-IL**
  - Operator cover, add suffix **-OC**.
  - Cover hinge on right hand side, add suffix **-RH**.

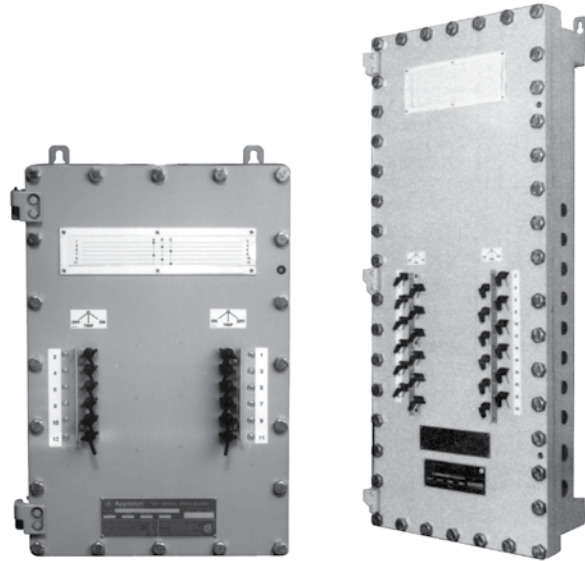

240 Vac

347/600 Vac

- CSA type 4X enclosure, add suffix **-4X**.
- For 50 °C (122 °F) breaker rating, add suffix **-V**.
- For dc rating contact your local representative.
- Main Breaker Options
  - Auxiliary switch (1A or 1B) add suffix **-AS1**.
  - Auxiliary switch (2A or 2B) add suffix **-AS2**.
  - Shunt trip (specify voltage) add suffix **-ST**.
  - Under voltage release (specify voltage) add suffix **-UV**.
- Breaker Options
  - Equipment protection devices, 1-pole 40 Amp max. adn 2-pole 50 Amp max. (1- or 2-Pole -30 mA sensitivity) add suffix **-EPD**.
  - Ground fault interrupter, 1-pole 40 Amp max. adn 2-pole 50 Amp max. (1- or 2-Pole -5 mA sensitivity) circuit breakers add suffix **-GFI** (available on all circuit positions).
  - For breakers for use in HID lighting applications, add suffix **-HID**.
  - Factory installed main breaker, maximum 100 Amp. Two main breakers are permitted as individual over current protective device on the supply side in accordance with NEC Section 408.36 (Exception 2). Add suffix **-MB** for each main breaker. Main circuit breaker occupies branch breaker spaces.

### NEC/CEC Certifications and Compliances

- UL Standard: UL 1203
- UL Listed: E77137
- CSA Standard: C22.2 No. 25, C22.2 No. 29, C22. No. 30
- CSA Certified: 039199



# XP Series Non-Factory Sealed Circuit Breaker Panelboards

Explosionproof, Dust-Ignitionproof

**NEC/CEC:**

Class I, Division 1 and 2, Groups B, C, D  
 Zone 1 and 2, Group IIB + H<sub>2</sub>  
 Class II, Division 1 and 2, Groups E, F, G  
 Class III

**CEC:**

EMR Canada  
 Exd IIB, T6  
 CSA Type 3, 4, 7BCD, 9EFG, 12  
 CSA Optional Type 3R, 4X

## Illustrated Features

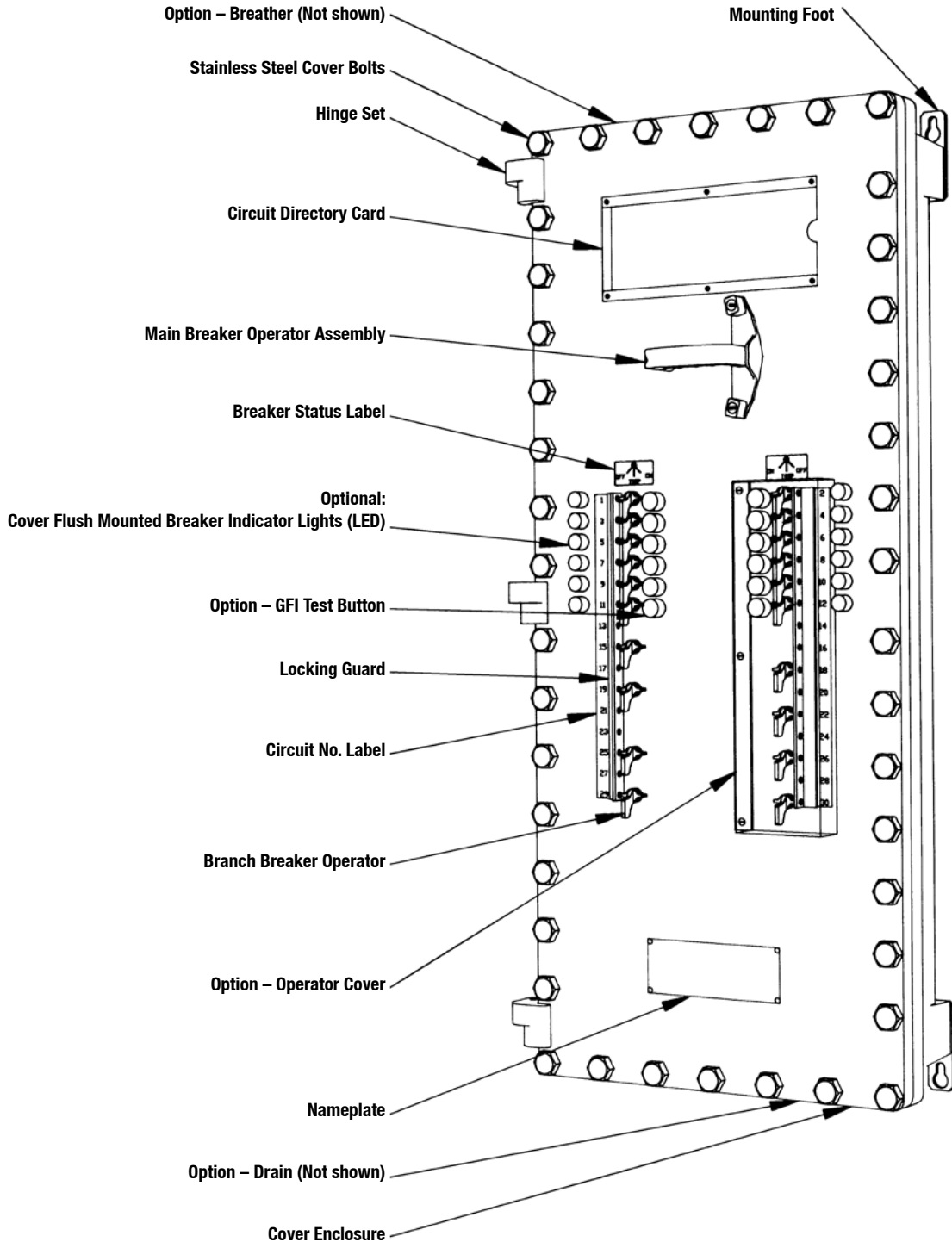

DISTRIBUTION EQUIPMENT: NEC/CEC HAZARDOUS LOCATION PANELBOARDS



# XP Series Non-Factory Sealed Circuit Breaker Panelboards

Explosionproof, Dust-Ignitionproof

**NEC/CEC:**  
 Class I, Division 1 and 2, Groups B, C, D  
 Zone 1 and 2, Group IIB + H<sub>2</sub>  
 Class II, Division 1 and 2, Groups E, F, G  
 Class III

**CEC:**  
 EMR Canada  
 Exd IIB, T6  
 CSA Type 3, 4, 7BCD, 9EFG, 12  
 CSA Optional Type 3R, 4X

DISTRIBUTION EQUIPMENT: NEC/CEC HAZARDOUS LOCATION PANELBOARDS

## Catalog Numbering Guide

<p><b>XP</b></p> <p>Series: XP - Non-Factory Sealed</p>	<p><b>B</b></p>	<p><b>1</b></p>	<p><b>100</b></p>	<p><b>2</b></p>	<p><b>L</b></p> <p>Main Required:                  L - Main lugs only                  B - Main Breaker                  R - Reverse Feed</p>	<p><b>025</b></p>	<p><b>05</b></p>	<p><b>15</b></p>	<p><b>1</b></p> <p>Poles ①:                  1 - 1                  2 - 2                  3 - 3</p>	<p><b>GF5</b></p>	<p>▲</p> <p>Suffix for Other Options/Features: Must be listed in alphanumeric sequence (See Options)</p>																																																					
<p>Size:</p> <table border="1"> <thead> <tr> <th>Volts</th> <th>A</th> <th>B</th> <th>C</th> <th>E</th> </tr> </thead> <tbody> <tr> <td colspan="5"><b>Main Lugs Only</b></td> </tr> <tr> <td>240</td> <td>12</td> <td>24</td> <td>42</td> <td>48</td> </tr> <tr> <td>277/480</td> <td>9</td> <td>12</td> <td>36</td> <td>42</td> </tr> <tr> <td>347/600</td> <td>9</td> <td>12</td> <td>36</td> <td>42</td> </tr> <tr> <td>480/600</td> <td></td> <td></td> <td></td> <td>42</td> </tr> <tr> <td colspan="5"><b>With Main Breaker</b></td> </tr> <tr> <td>240</td> <td>6</td> <td>18</td> <td>36</td> <td>42</td> </tr> <tr> <td>277/480</td> <td>6</td> <td>12</td> <td>30</td> <td>42</td> </tr> <tr> <td>347/600</td> <td>6</td> <td>12</td> <td>30</td> <td>42</td> </tr> <tr> <td>480/600</td> <td></td> <td></td> <td></td> <td>36</td> </tr> </tbody> </table>			Volts	A	B	C	E	<b>Main Lugs Only</b>					240	12	24	42	48	277/480	9	12	36	42	347/600	9	12	36	42	480/600				42	<b>With Main Breaker</b>					240	6	18	36	42	277/480	6	12	30	42	347/600	6	12	30	42	480/600				36	<p>Main Amp Bus:                  100 - 100                  225 - 225</p>	<p>Main Breaker Ampere Rating:                  020 - 20AT                  025 - 25AT                  030 - 30AT                  040 - 40AT                  050 - 50AT                  060 - 60AT                  070 - 70AT                  080 - 80AT                  090 - 90AT                  100 - 100AT                  110 - 110AT                  125 - 125AT                  150 - 150AT                  175 - 175AT                  200 - 200AT                  225 - 225AT</p>	<p>Type of Breaker ①:                  Blank - BAB Standard Branch Breaker                  GF5 - 5 ma GFI people protector (40 Amp Max., 1- or 2-Pole only)                  GF10 - 30 mA EPD Equipment Protector (30 Amp Max., 1- or 2-Pole only)                  GFA10 - 30 mA With Alarm Circuit</p>	<p>Phases:                  1 - 1-Phase                  3 - 3-Phase</p>	<p>Voltage:                  2 - 120/240, 120/208                  4 - 277/480Y (GHB breaker only)                  6 - 347/600Y (GBH breaker only)                  7 - 480 (F-Frame breaker only)                  8 - 600 (F-Frame breaker only)</p>	<p>Quantity of Branch Breakers ①:                  1 thru 48</p>	<p>Additional Branch Breakers: Repeat Step ①</p>
Volts	A	B	C	E																																																												
<b>Main Lugs Only</b>																																																																
240	12	24	42	48																																																												
277/480	9	12	36	42																																																												
347/600	9	12	36	42																																																												
480/600				42																																																												
<b>With Main Breaker</b>																																																																
240	6	18	36	42																																																												
277/480	6	12	30	42																																																												
347/600	6	12	30	42																																																												
480/600				36																																																												
								<p>Ampere Rating ①:                  10 - 10AT                  15 - 15AT                  20 - 20AT                  25 - 25AT                  30 - 30AT                  35 - 35AT                  40 - 40AT                  45 - 45AT                  50 - 50AT                  60 - 60AT                  70 - 70AT                  80 - 80AT (not for 1-Pole)                  90 - 90AT (not for 1-Pole)                  100 - 100AT                  110 - 110AT (2-, 3-Pole, 480, 600 Only)                  125 - 125AT (2-, 3-Pole, 480, 600 Only)                  150 - 150AT (2-, 3-Pole, 480, 600 Only)                  175 - 175AT (2-, 3-Pole, 480, 600 Only)                  200 - 200AT (2-, 3-Pole, 480, 600 Only)</p>																																																								

# XP Series Non-Factory Sealed Circuit Breaker Panelboards

## Explosionproof, Dust-Ignitionproof

**NEC/CEC:**  
 Class I, Division 1 and 2, Groups B, C, D  
 Zone 1 and 2, Group IIB + H<sub>2</sub>  
 Class II, Division 1 and 2, Groups E, F, G  
 Class III

**CEC:**  
 EMR Canada  
 Exd IIB, T6  
 CSA Type 3, 4, 7BCD, 9EFG, 12  
 CSA Optional Type 3R, 4X

Max. No. of Circuits ①	Panel Size	1-Phase 120/240 Vac		3-Phase 120/208 Vac	
		100 Amps	225 Amps	100 Amps	225 Amps
<b>Main Lugs Only</b>					
12	A	XPA11002L	XPA12252L	XPA31002L	XPA32252L
24	B	XPB11002L	XPB12252L	XPB31002L	XPB32252L
42	C	XPC11002L	XPC12252L	XPC31002L	XPC32252L
48	E	XPE11002L	XPE12252L	XPE31002L	XPE32252L
<b>Main Breaker Panelboard</b>					
9	A	XPA11002B	XPA12252B	XPA31002B	XPA32252B
12	B	XPB11002B	XPB12252B	XPB31002B	XPB32252B
36	C	XPC11002B	XPC12252B	XPC31002B	XPC32252B
42	E	XPE11002B	XPE12252B	XPE31002B	XPE32252B

### Reverse Feed Main Breaker Panelboard

Max. No. of Circuits ①	Panel Size	100 Amps	
		1-Phase 120/240 Vac	3-Phase 120/208 Vac
12	A	XPA11002R	XPA31002R
24	B	XPB11002R	XPB31002R
42	C	XPC11002R	XPC31002R
48	E	XPE11002R	XPE31002R

### Main Breaker ②

4-pole main breaker available, contact your local representative.

	Suffix	Amp Rating	Breaker Type	Amps I.R./240 Vac Max.
Standard Breaker	05	50		
	07	70	FDB	18,000
	10	100		
	17	175		
	20	200	FD	65,000
	22	225		
Reversed Breaker	05	50		
	07	70	BAB	10,000
	10	100		

① 18 and 30 circuit panelboards available. Contact your local representative.

② Other Main Breaker Ampere ratings available. Contact your local representative.

# XP Series Non-Factory Sealed Circuit Breaker Panelboards

Explosionproof, Dust-Ignitionproof

**NEC/CEC:**  
Class I, Division 1 and 2, Groups B, C, D  
Zone 1 and 2, Group IIB + H<sub>2</sub>  
Class II, Division 1 and 2, Groups E, F, G  
Class III

**CEC:**  
EMR Canada  
Exd IIB, T6  
CSA Type 3, 4, 7BCD, 9EFG, 12  
CSA Optional Type 3R, 4X

DISTRIBUTION EQUIPMENT: NEC/CEC HAZARDOUS LOCATION PANELBOARDS

Max. No. of Circuits ①	Panel Size	3-Phase 277/480 Vac, GHB Only		3-Phase 347/600 Vac, GBH Only	
		100 Amps	225 Amps	100 Amps	225 Amps
<b>Main Lugs Only — 3 Phase, 4 Wire</b>					
9	A	XPA31004L	XPA32254L	XPA31006L	XPA32256L
12	B	XPB31004L	XPB32254L	XPB31006L	XPB32256L
36	C	XPC31004L	XPC32254L	XPC31006L	XPC32256L
42	E	XPE31004L	XPE32254L	XPE31006L	XPE32256L
<b>Main Breaker Panelboard — 3 Phase, 4 Wire</b>					
6	A	XPA31004B	XPA32254B	XPA31006B	XPA32256B
18	B	XPB31004B	XPB32254B	XPB31006B	XPB32256B
30	C	XPC31004B	XPC32254B	XPC31006B	XPC32256B
42	E	XPE31004B	XPE32254B	XPE31006B	XPE32256B

Max. No. of Circuits ①	Panel Size	3-Phase 480 Vac, F-Frame Only		3-Phase 600 Vac, F-Frame Only	
		100 Amps	225 Amps	100 Amps	225 Amps
<b>Main Lugs Only — 3 Phase, 3 Wire</b>					
42	E	XPE31007L	XPE32257L	XPE31008L	XPE32258L
<b>Main Breaker Panelboard — 3 Phase, 3 Wire</b>					
36	E	XPE31007B	XPE32257B	XPE31008B	XPE32258B

## Main Breaker ②

	Suffix	Amp Rating	Breaker Type
Standard Breaker	05	50	
	07	70	FDB
	10	100	
	15	150	
	17	175	
	20	200	FD
	22	225	

① 12, 24 and 30 circuit panelboards available. Contact your local representative.  
② Other Main Breaker Ampere ratings available. Contact your local representative.

# XP Series Non-Factory Sealed Circuit Breaker Panelboard

## Explosionproof, Dust-Ignitionproof

**NEC/CEC:**  
 Class I, Division 1 and 2, Groups B, C, D  
 Zone 1 and 2, Group IIB + H<sub>2</sub>  
 Class II, Division 1 and 2, Groups E, F, G  
 Class III

**CEC:**  
 EMR Canada  
 Exd IIB, T6  
 CSA Type 3, 4, 7BCD, 9EFG, 12  
 CSA Optional Type 3R, 4X

### Dimensions in Millimeters (Inches)

**XPA — GHB and GBH**

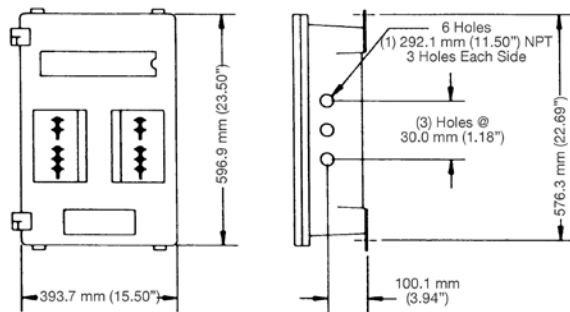
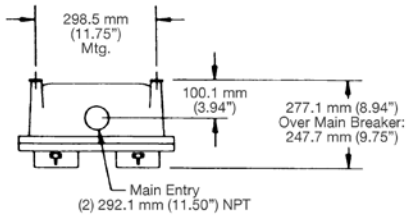

**KPB — GHB and GBH**

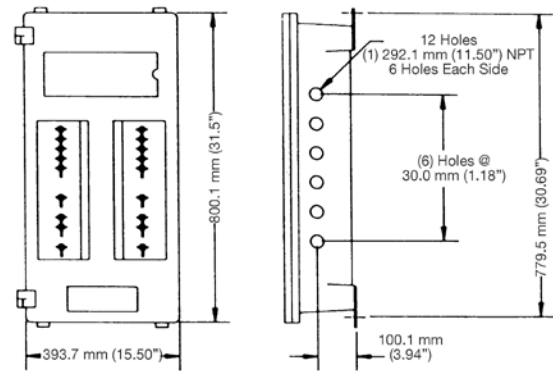
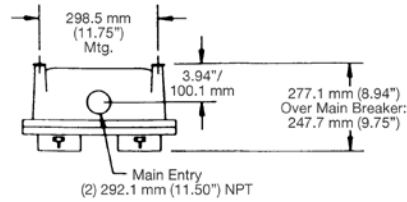

**XPC — GHB and GBH**

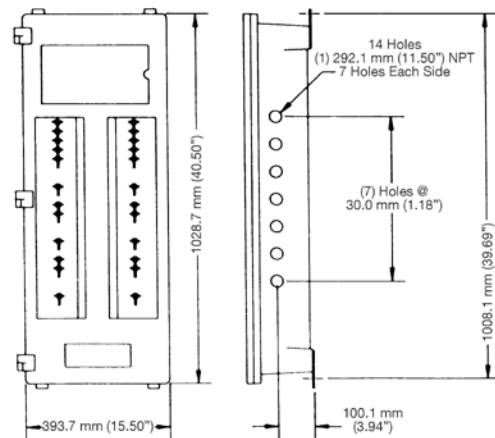
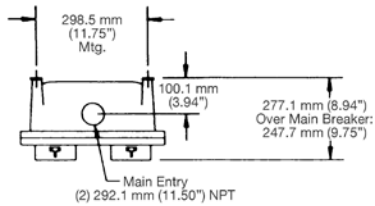

**XPE — GHB and GBH**

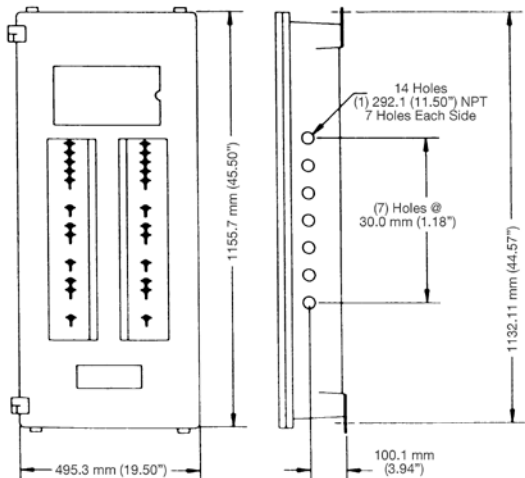
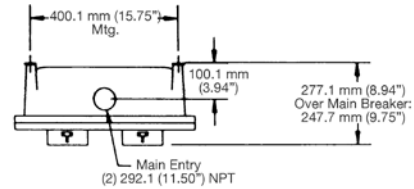

# XP Series Non-Factory Sealed Circuit Breaker Panelboard

## Explosionproof, Dust-Ignitionproof

**NEC/CEC:**  
 Class I, Division 1 and 2, Groups B, C, D  
 Zone 1 and 2, Group IIB + H<sub>2</sub>  
 Class II, Division 1 and 2, Groups E, F, G  
 Class III

**CEC:**  
 EMR Canada  
 Exd IIB, T6  
 CSA Type 3, 4, 7BCD, 9EFG, 12  
 CSA Optional Type 3R, 4X

DISTRIBUTION EQUIPMENT: NEC/CEC HAZARDOUS LOCATION PANELBOARDS

Dimensions in Millimeters (Inches)

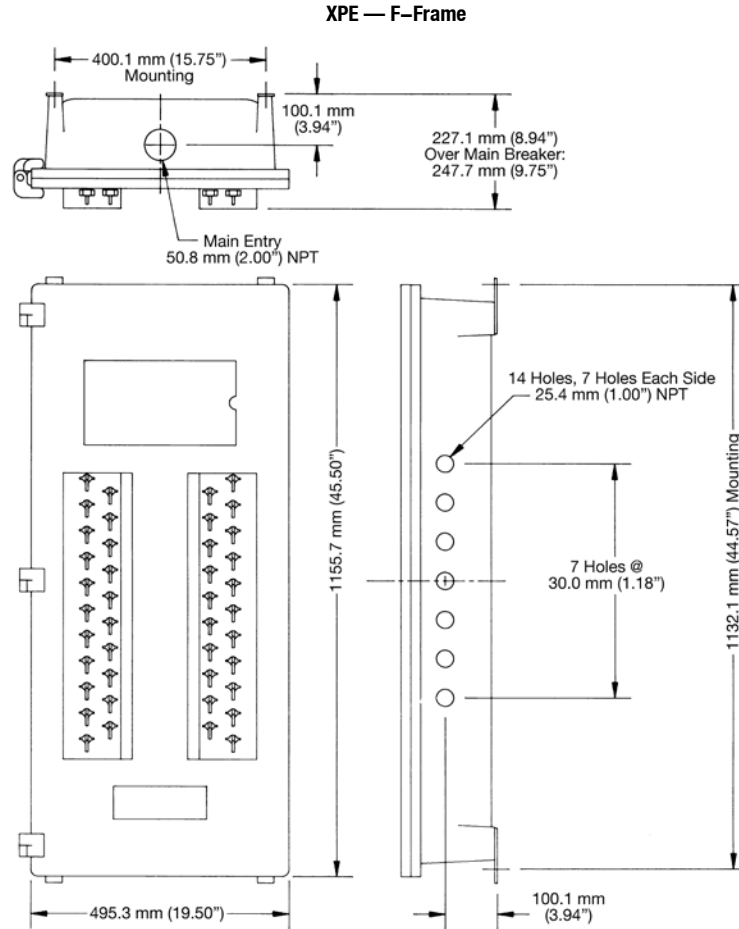

# XP Series Pre-Wired Factory Sealed Circuit Breaker Panelboards

## Explosionproof, Dust-Ignitionproof System

### NEC/CEC:

Class I, Division 2, Groups B, C, D  
Class I, Zone 1 and 2, Groups IIB + H<sub>2</sub>  
Class II, Division 1 and 2, Groups E, F, G  
Class III

### CEC:

EMR Canada approved  
NEMA/IEE MAC 3, 4, 4X, 7BCD, 9EFG, 12  
IP66

### Applications

- Protection and control of electrical apparatus and circuits in hazardous environments, either indoor or outdoor. Designed for Class I, Division 2 areas where flammable gases or vapors are present under abnormal circumstances.
- For use with lighting or heat tracing circuits.

### Features

- Wiring from branch circuit breakers in the panelboard to the terminal blocks in the terminal enclosure are factory sealed, eliminating the need of labour intensive field wiring and use of sealing fittings.
- Exclusive rotary-slide circuit breaker operators have positive action and will align with breakers in ON or OFF position when cover is being closed.
- Design allows breaker to be locked in ON or OFF position. Will not prevent breaker from tripping.
- Conduit entries in top or bottom positioned terminal enclosure can be either field installed or factory installed to customer requirements.
- Four sizes of panelboards available.
- Copper phase bus bars.
- Furnished with bolt on breakers.
- Removable hinged cover gives unobstructed access to interior. Left hand hinges are standard. Right hand hinges are available.
- Detailed marking is plainly visible for easy circuit identification.
- Installation is easy with keyhole mounting lugs to simplify mounting.

### Standard Materials

- Panelboard enclosure and cover: copperfree (4/10 of 1% max.) aluminum
- Operator shafts, cover bolts and fasteners: stainless steel
- Operator knobs: aluminum alloy
- Terminal enclosure: 304 stainless steel
- Standard branch circuit breakers type BAB, 1-, 2- or 3-pole. 10,000 RMS symmetrical (240 Volt Max.)
- Standard branch circuit breakers type GHB, 1-, 2- or 3-pole. 10,000 RMS symmetrical interrupting capacity (80 Volt).
- Standard branch circuit breakers type GBH, 1-, 2- or 3-pole. 10,000 RMS symmetrical interrupting capacity (347/600 Volt).
- F-Frame available in 480 and 600 Volts. Interrupting capacity up to 65,000 RMS symmetrical available. Consult your local representative

### Standard Finish

- Epoxy powder coat electrostatically applied

### Options

*Must be listed in alphanumeric sequence at the end of the catalog number.*

- Breather and drain sets, add suffix **-BD**.
- Ferrous alloy, add suffix **-F**.
- 5 ma GFI people protector (40 Amp Max., 1- or 2-Pole only), add suffix **-GF5**.
- 30 mA EPD Equipment Protector (30 Amp Max., 1- or 2-Pole only), add suffix **-GF10**.
- 30 mA with alarm circuit, add suffix **-GFA10**.
- Grounded neutral lug, add suffix **-GNL**.
- Heater c/w thermostat, add suffix **-HTR**.
- Bottom feed, add suffix **-INV**.
- Breaker ON-OFF indicator Light (LED), add suffix **-IL**.

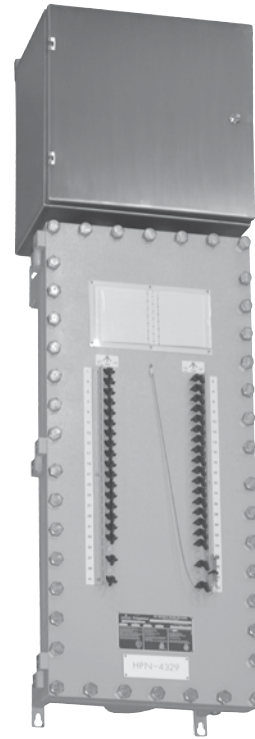

- Operator cover, add suffix **-OC**.
- Cover hinge on right hand side, add suffix **-RH**.
- CSA type 4X enclosure, add suffix **-4X**.
- Main Breaker Options
  - Auxiliary switch (1A or 1B) add suffix **-AS1**.
  - Auxiliary switch (2A or 2B) add suffix **-AS2**.
  - Shunt trip (specify voltage) add suffix **-ST**.
  - Under voltage release (specify voltage) add suffix **-UV**.
  - For +50 °C (+122 °F) breaker rating, add suffix **-V**.
- Lighting contactor 30Amps, 3Poles - 12poles. Contact your local representative.
- High AIC rating F-Frame breakers available. Contact your local representative.
- For dc rating consult your local representative.
- 316L stainless steel terminal enclosure available. Contact your local representative.
- Division I version available. Comes with cast aluminum terminal enclosure. Contact your local representative.

### NEC/CEC Certifications and Compliances

- UL Standard: UL 67, UL 1203
- cUL Certified: 039199
- CSA Standard: C22. 2 No. 25, C22.2 No. 29, C22.2 No. 30
- CSA Certified: 039199

# XP Series Pre-Wired Factory Sealed Circuit Breaker Panelboards

Explosionproof, Dust-Ignitionproof System

**NEC/CEC:**

Class I, Division 2, Groups B, C, D  
 Class I, Zone 1 and 2, Groups IIB + H<sub>2</sub>  
 Class II, Division 1 and 2, Groups E, F, G  
 Class III

**CEC:**

EMR Canada approved  
 NEMA/EEMAC 3, 4, 4X, 7BCD, 9EFG, 12  
 IP66

DISTRIBUTION EQUIPMENT: NEC/CEC HAZARDOUS LOCATION PANELBOARDS

**Catalog Numbering Guide**

<p><b>XP</b></p> <p>Series: XP - Factory Sealed</p>	<p><b>B</b></p> <p>Size:</p> <table border="1"> <thead> <tr> <th>Volts</th> <th>A</th> <th>B</th> <th>C</th> <th>E</th> </tr> </thead> <tbody> <tr> <td colspan="5"><b>Main Lugs Only</b></td> </tr> <tr> <td>240</td> <td>12</td> <td>24</td> <td>42</td> <td>48</td> </tr> <tr> <td>277/ 480</td> <td>9</td> <td>12</td> <td>36</td> <td>42</td> </tr> <tr> <td>347/ 600</td> <td>9</td> <td>12</td> <td>36</td> <td>42</td> </tr> <tr> <td>480/ 600</td> <td></td> <td></td> <td></td> <td>42</td> </tr> <tr> <td colspan="5"><b>With Main Breaker</b></td> </tr> <tr> <td>240</td> <td>6</td> <td>18</td> <td>36</td> <td>42</td> </tr> <tr> <td>277/ 480</td> <td>6</td> <td>12</td> <td>30</td> <td>42</td> </tr> <tr> <td>347/ 600</td> <td>6</td> <td>12</td> <td>30</td> <td>42</td> </tr> <tr> <td>480/ 600</td> <td></td> <td></td> <td></td> <td>36</td> </tr> </tbody> </table>	Volts	A	B	C	E	<b>Main Lugs Only</b>					240	12	24	42	48	277/ 480	9	12	36	42	347/ 600	9	12	36	42	480/ 600				42	<b>With Main Breaker</b>					240	6	18	36	42	277/ 480	6	12	30	42	347/ 600	6	12	30	42	480/ 600				36	<p><b>1</b></p> <p>Phases: 1 - 1-Phase 3 - 3-Phase</p>	<p><b>100</b></p> <p>Main Amp Bus: 100 - 100 225 - 225</p>	<p><b>2</b></p> <p>Voltage: 2 - 120/240, 120/208 4 - 277/480Y (GHB only) 6 - 347/600Y (GBH only) 7 - 480 (F-Frame only) 8 - 600 (F-Frame only)</p>	<p><b>PL</b></p> <p>Main Required: PL - Main lugs only PB - Main Breaker PR - Reverse Feed</p>	<p><b>25</b></p> <p>Main Breaker Ampere Rating: 020 - 20AT 025 - 25AT 030 - 30AT 040 - 40AT 050 - 50AT 060 - 60AT 070 - 70AT 080 - 80AT 090 - 90AT 100 - 100AT 110 - 110AT 125 - 125AT 150 - 150AT 175 - 175AT 200 - 200AT 225 - 225AT</p>	<p><b>10</b></p> <p>Quantity of Branch Breakers ①: 1 thru 48</p>	<p><b>15</b></p> <p>Ampere Rating ①: 10 - 10AT 15 - 15AT 20 - 20AT 25 - 25AT 30 - 30AT 35 - 35AT 40 - 40AT 45 - 45AT 50 - 50AT 60 - 60AT 70 - 70AT 80 - 80AT (not for 1-Pole) 90 - 90AT (not for 1-Pole) 100 - 100AT 110 - 110AT (2-, 3-Pole, 480, 600 Only) 125 - 125AT (2-, 3-Pole, 480, 600 Only) 150 - 150AT (2-, 3-Pole, 480, 600 Only) 175 - 175AT (2-, 3-Pole, 480, 600 Only) 200 - 200AT (2-, 3-Pole, 480, 600 Only)</p>	<p><b>1</b></p> <p>Poles ①: 1 - 1 2 - 2 3 - 3</p>	<p><b>GF5</b></p> <p>Type of Breaker ①: Blank - BAB Standard Branch Breaker GF5 - 5 ma GFI people protector (40 Amp Max., 1- or 2-Pole only) GF10 - 30 mA EPD Equipment Protector (30 Amp Max., 1- or 2-Pole only) GFA10 - 30 mA With Alarm Circuit</p>	<p><b>▲</b></p> <p>Suffix for Other Options/Features: Must be listed in alphanumeric sequence (See Options)</p>
Volts	A	B	C	E																																																														
<b>Main Lugs Only</b>																																																																		
240	12	24	42	48																																																														
277/ 480	9	12	36	42																																																														
347/ 600	9	12	36	42																																																														
480/ 600				42																																																														
<b>With Main Breaker</b>																																																																		
240	6	18	36	42																																																														
277/ 480	6	12	30	42																																																														
347/ 600	6	12	30	42																																																														
480/ 600				36																																																														





# XP Series Pre-Wired Factory Sealed Circuit Breaker Panelboards

## Explosionproof, Dust-Ignitionproof System

**NEC/CEC:**

Class I, Division 2, Groups B, C, D  
 Class I, Zone 1 and 2, Groups IIB + H<sub>2</sub>  
 Class II, Division 1 and 2, Groups E, F, G  
 Class III

**CEC:**

EMR Canada approved  
 NEMA/EEMAC 3, 4, 4X, 7BCD, 9EFG, 12  
 IP66

Max. No. of Circuits ①	Panel Size	1-Phase 120/240 Vac		3-Phase 120/208 Vac	
		100 Amps	225 Amps	100 Amps	225 Amps
<b>Main Lugs Only</b>					
12	A	XPA11002PL	XPA12252PL	XPA31002PL	XPA32252PL
24	B	XPB11002PL	XPB12252PL	XPB31002PL	XPB32252PL
42	C	XPC11002PL	XPC12252PL	XPC31002PL	XPC32252PL
48	E	XPE11002PL	XPE12252PL	XPE31002PL	XPE32252PL
<b>Main Breaker Panelboard</b>					
6	A	XPA11002PB	XPA12252PB	XPA31002PB	XPA32252PB
18	B	XPB11002PB	XPB12252PB	XPB31002PB	XPB32252PB
36	C	XPC11002PB	XPC12252PB	XPC31002PB	XPC32252PB
42	E	XPE11002PB	XPE12252PB	XPE31002PB	XPE32252PB

**Reverse Feed Main Breaker Panelboard**

Max. No. of Circuits ①	Panel Size	100 Amps	
		1-Phase 120/240 Vac	3-Phase 120/208 Vac
12	A	XPA11002PR	XPA31002PR
24	B	XPB11002PR	XPB31002PR
42	C	XPC11002PR	XPC31002PR
48	E	XPE11002PR	XPE31002PR

**Main Breaker ②**

4-pole main breaker available, contact your local representative.

	Suffix	Amp Rating	Breaker Type	Amps I.R./240 Vac Max.
Standard Breaker	05	50		
	07	70	FDB	18,000
	10	100		
	17	175		
	20	200	FD	65,000
Reversed Breaker	22	225		
	05	50		
	07	70	BAB	10,000
	10	100		

① 18 and 30 circuit panelboards available. Contact your local representative.

② Other Main Breaker Ampere ratings available. Contact your local representative.

# XP Series Pre-Wired Factory Sealed Circuit Breaker Panelboards

## Explosionproof, Dust-Ignitionproof System

**NEC/CEC:**

Class I, Division 2, Groups B, C, D  
 Class I, Zone 1 and 2, Groups IIB + H<sub>2</sub>  
 Class II, Division 1 and 2, Groups E, F, G  
 Class III

**CEC:**

EMR Canada approved  
 NEMA/IEEMAC 3, 4, 4X, 7BCD, 9EFG, 12  
 IP66

DISTRIBUTION EQUIPMENT: NEC/CEC HAZARDOUS LOCATION PANELBOARDS

Max. No. of Circuits ①	Panel Size	3-Phase 277/480 Vac, GHB Only		3-Phase 347/600 Vac, GBH Only	
		100 Amps	225 Amps	100 Amps	225 Amps
<b>Main Lugs Only – 3 Phase, 4 Wire</b>					
9	A	XPA31004PL	XPA32254PL	XPA31006PL	XPA32256PL
12	B	XPB31004PL	XPB32254PL	XPB31006PL	XPB32256PL
36	C	XPC31004PL	XPC32254PL	XPC31006PL	XPC32256PL
42	E	XPE31004PL	XPE32254PL	XPE31006PL	XPE32256PL
<b>Main Breaker Panelboard – 3 Phase, 4 Wire</b>					
6	A	XPA31004PB	XPA32254PB	XPA31006PB	XPA32256PB
12	B	XPB31004PB	XPB32254PB	XPB31006PB	XPB32256PB
30	C	XPC31004PB	XPC32254PB	XPC31006PB	XPC32256PB
42	E	XPE31004PB	XPE32254PB	XPE31006PB	XPE32256PB

Max. No. of Circuits ①	Panel Size	3-Phase 480 Vac, F-Frame Only		3-Phase 600 Vac, F-Frame Only	
		100 Amps	225 Amps	100 Amps	225 Amps
<b>Main Lugs Only – 3 Phase, 3 Wire</b>					
42	E	XPE31007PL	XPE32257PL	XPE31008PL	XPE32258PL
<b>Main Breaker Panelboard – 3 Phase, 3 Wire</b>					
36	E	XPE31007PB	XPE32257PB	XPE31008PB	XPE32258PB

**Main Breaker ②**

	Suffix	Amp Rating	Breaker Type
<b>Standard Breaker</b>	05	50	FDB
	07	70	
	10	100	
	15	150	FD
	17	175	
	20	200	
	22	225	

① 12, 24 and 30 circuit panelboards available. Contact your local representative.  
 ② Other Main Breaker Ampere ratings available. Contact your local representative.

# XP Series Pre-Wired Factory Sealed Circuit Breaker Panelboard

## Explosionproof, Dust-Ignitionproof System

**NEC/CEC:**

Class I, Division 2, Groups B, C, D  
 Class I, Zone 1 and 2, Groups IIB + H<sub>2</sub>  
 Class II, Division 1 and 2, Groups E, F, G  
 Class III

**CEC:**

EMR Canada approved  
 NEMA/EEMAC 3, 4, 4X, 7BCD, 9EFG, 12  
 IP66

**Dimensions in Millimeters (Inches)**

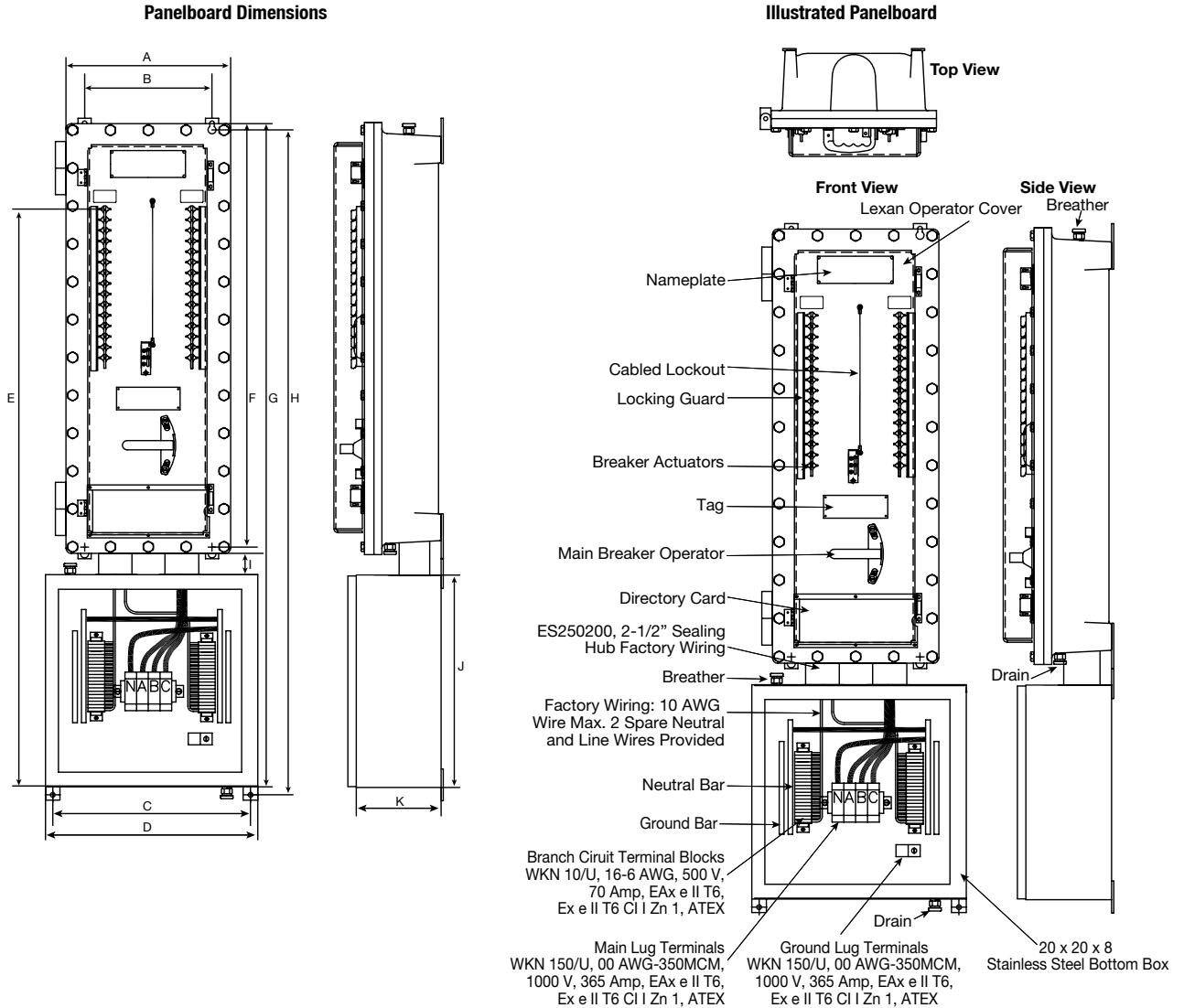

Panel Size	Dimensions in Millimeters (Inches)										
	A	B	C	D	E	F	G	H	I	J	K
A	393.7 (15.50)	304.8 (12.00)	371.6 (14.63)	406.4 (16.00)	810.2 (31.90)	576.3 (22.69)	1003.3 (39.50)	1058.1 (41.66)	50.8 (2.00)	406.4 (16.00)	203.2 (8.00)
B	393.7 (15.50)	304.8 (12.00)	371.6 (14.63)	406.4 (16.00)	1013.4 (39.90)	785.8 (30.94)	1206.5 (47.50)	1261.3 (49.66)	50.8 (2.00)	406.4 (16.00)	203.2 (8.00)
C	393.7 (15.50)	304.8 (12.00)	473.2 (18.63)	508.0 (20.00)	1380.4 (54.35v)	1014.4 (39.94)	1663.7 (62.50)	1591.1 (62.65)	50.8 (2.00)	508.0 (20.00)	203.2 (8.00)
E	495.3 (19.50)	400.0 (15.75)	473.2 (18.63)	508.0 (20.00)	1483.6 (58.41)	1155.7 (45.50)	1715.0 (67.54)	1719.0 (67.68)	50.8 (2.00)	508.0 (20.00)	203.2 (8.00)

# PlexPower™ Factory Sealed Panelboard

## Increased Safety

**ATEX/IECEX:**  
Zone 1 and 2 - 21 and 22  
Ⓢ I/2GD  
EPL Gb Db  
Ex db eb IIB+H<sub>2</sub>  
Ex tb IIIC  
IP66/Ik10

**ATEX/IECEX – Optional:**  
Zone 1 and 2 - 21 and 22  
Ⓢ I/2GD  
EPL Gb Db  
Ex db eb IIC  
Ex tb IIIC  
IP66/Ik10

### Applications

- The IEC PlexPower™ factory sealed panelboard provides indoor and outdoor protection and control of electrical circuits in hazardous environments such as:
  - Petroleum plants
  - Chemical plants
  - Refineries
  - Other process facilities
- Ideal for placement in wet, corrosive environments or where flammable gases or vapors are likely to be present.
- Suitable for use on lighting, heat trace and power circuits.

### Features

- No external conduit or cable seals required thus making installations faster, easier, and less costly.
- Limitless flexibility through horizontal and vertical coupling options.
- The PlexPower™ factory sealed panelboard features a ground-breaking design that uses individual breaker housings to minimize the downtime and costs associated with servicing circuit breakers in hazardous locations.
- The lighter weight panelboard enclosure can be quickly opened in the field for easier servicing.
- Supplied as standard:
  - Bottom entries with brass earth plate
  - Pre-drilled supplied with non Ex certified temporary plastic plugs
  - Standard hard wired, copper cables
  - Color coded wiring for phases; neutral (blue) and ground (yellow/green)
  - Internal actuators
  - Internal wiring duct
  - Phenolic nameplate (specify legend)
- Optional gland plate at the bottom of enclosure can be easily field punched or drilled for cable or conduit entries. *See options.*
- 1 circuit to 72 circuit panelboard configurations are standard, with or without main breaker.
- Schneider Ⓢ breakers are supplied as standard, making replacements readily available.
- PlexPower™ breakers accommodate ABB Ⓢ breakers. For a custom panelboard designed with ABB breakers, contact your local sales representative.
- Branch circuit breakers available in 1-, 2- 3- and 4-pole. Current ratings on branch breakers:
  - 1-pole: 120, 240 Volts, 63 Amps maximum.
  - 2-, 3- and 4-pole: 240 and 415 Volts, 63 Amps maximum.
- Branch breakers are labeled with numbers:
  - Odd numbers for line side
  - Even numbers for load side.
  - Labeled with inside breaker details
- Main circuit breaker:
  - 40 to 250 Amps, 2-, 3- or 4-pole.
- Branch and main breakers can be padlocked in either the “On” or “Off” position.
- Breaker modules supplied with captive bolts.
- Ground bar provided as standard.
- External ground lug provided as standard.



- 240/415 Volt breaker module 8-pole terminal wire range 2.5 mm<sup>2</sup> through 10 mm<sup>2</sup> (standard), 16 mm<sup>2</sup> with special lug.
- 600 Volt main breaker module 4-pole terminal wire range 16 mm<sup>2</sup> through 150 mm<sup>2</sup>.
- Ambient temperature ratings:
  - Standard model: -25 °C to +55 °C (-13 °F to +131 °F).
  - Standard model without switching: -40 °C (-40 °F)

### Standard Materials

- Enclosure: fiberglass reinforced polyester (FRP)
- Hardware: stainless steel
- Bus bar: hard drawn copper
- Chassis: hot dip galvanized for wall mounting use

### Options

*Must be listed in alphanumeric sequence at the end of the catalog number.*

- Drain, add suffix —**D**.
- Drain/breather, add suffix —**DV**.
- Gland plate bottom only, specify suffix —**GPP** = plastic gland plate, —**GPB** = brass gland plate.
- Stainless steel legend plate (specify legend), add suffix —**SP**.
- Voltmeter, add suffix —**VM** Ⓢ.
- Ammeter, add suffix —**AM** Ⓢ.
- Cable glands installed, add suffix —**CG**; (cable details to be provided by customer).
- For Ex de IIC, add suffix —**IIC**.
- Optional frame (structure) for floor mounting, self standing with and without canopy, contact your local sales representative for additional information.

Ⓢ Schneider is a registered trademark of Schneider Electric.

Ⓢ ABB Asea Brown Boveri Ltd is registered with the commercial register of Zurich, Switzerland.

Ⓢ Please contact your local sales representative for Voltmeter and Ammeter options.

# PlexPower™ Factory Sealed Panelboard

## Increased Safety

**ATEX/IECEX:**  
Zone 1 and 2 - 21 and 22  
Ⓢ II2GD  
EPL Gb Db  
Ex db eb IIB+H<sub>2</sub>  
Ex tb IIIC  
IP66/Ik10

**ATEX/IECEX – Optional:**  
Zone 1 and 2 - 21 and 22  
Ⓢ II2GD  
EPL Gb Db  
Ex db eb IIC  
Ex tb IIIC  
IP66/Ik10

### ATEX/IECEX Certifications and Compliances

- Type: PlexPower
  - Gas, Zones 1 and 2:
    - Conforming to ATEX 94/9/EC: Ⓢ II2G
    - Equipment Protection Level: EPL Gb
    - Type of Protection: Ex db eb IIB+H<sub>2</sub>
    - Temperature Class: T5 for Ta ≤ +40 °C (+104 °F) and T4 for Ta ≤ +55 °C (+131 °F)
  - Dusts, Zones 21 and 22:
    - Conforming to ATEX: Ⓢ II2D
    - Equipment Protection Level: EPL Db
    - Type of Protection: Ex tb IIIC
    - Surface Temperature: 95 °C (+203 °F) for Ta ≤ +40 °C (+104 °F) and 130 °C (+266 °F) for Ta ≤ +55 °C (+131 °F)
  - Ambient Temperatures:
    - Standard model: -25 °C to +55 °C (-13 °F to +131 °F)
    - Standard model without switching: -40 °C to +55 °C (-40 °F to +131 °F)
- ATEX Certificate : LCIE 13 ATEX 3083X
- EC Declaration of Conformity: 50304
- IECEx Certificate : IECEx LCIE 13.0073X
- Index of Protection according EN/IEC 60529: IP66
- Impact Resistance: IK10

### EURASEC Certification

- EURASEC N° TC RU C-FR.Г505.B.00911

### Other Certification

- INMETRO Certificate: BVC 14.3755-X ①

DISTRIBUTION EQUIPMENT: ATEX/IECEX INCREASED SAFETY PANELBOARDS

 **Appleton**<sup>®</sup>

① INMETRO certification available on special request only. Contact your local sales representative for more information.

# PlexPower™ Factory Sealed Panelboard

## Increased Safety

ATEX/IECEX:  
 Zone 1 and 2 - 21 and 22  
 Ⓢ II2GD  
 EPL Gb Db  
 Ex db eb IIB+H<sub>2</sub>  
 Ex tb IIIC  
 IP66/IK10

ATEX/IECEX – Optional:  
 Zone 1 and 2 - 21 and 22  
 Ⓢ II2GD  
 EPL Gb Db  
 Ex db eb IIC  
 Ex tb IIIC  
 IP66/IK10

### Catalog Numbering Guide ①

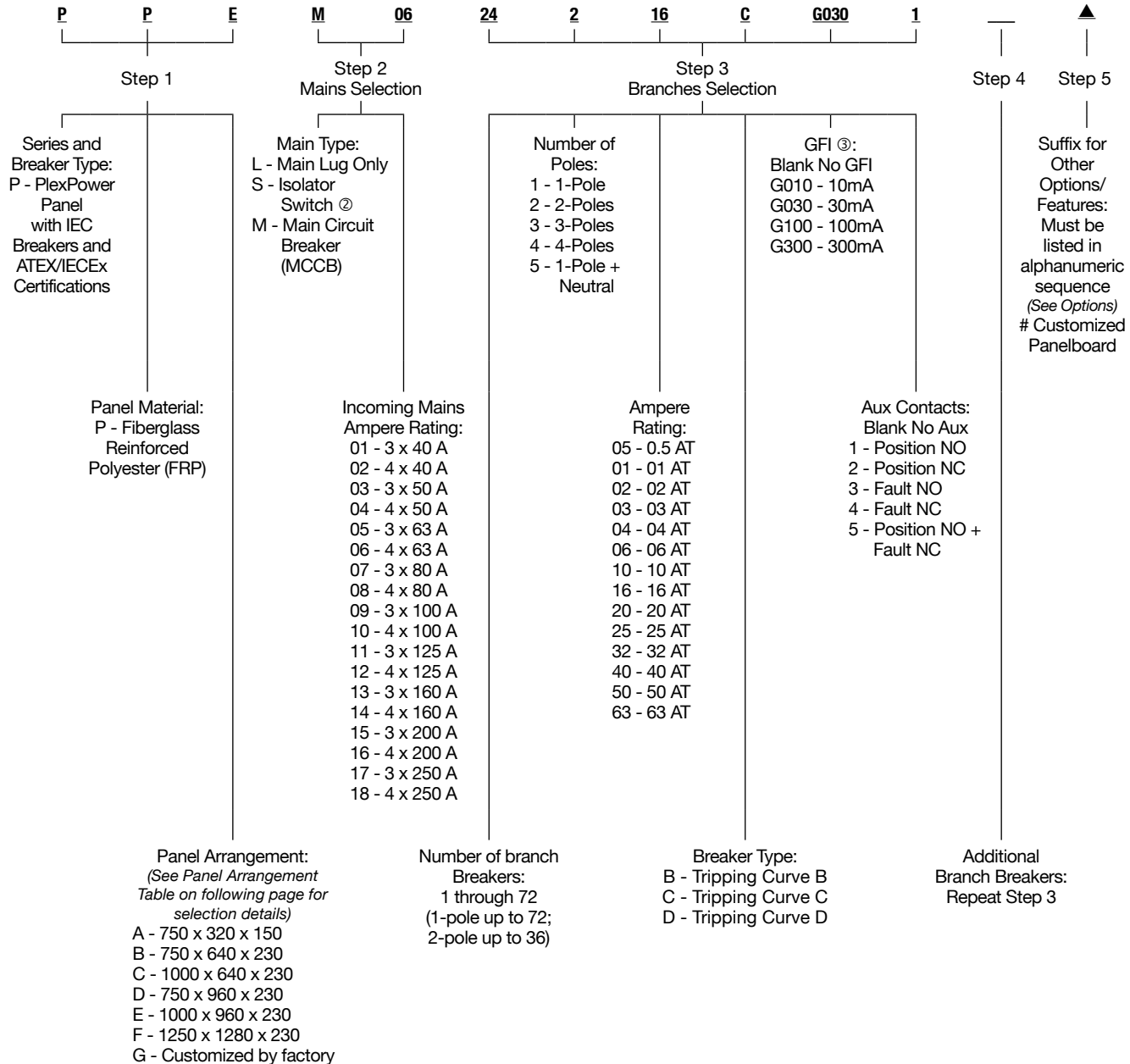

DISTRIBUTION EQUIPMENT: ATEX/IECEX INCREASED SAFETY PANELBOARDS



① Please use step by step catalog number on next page.

② Isolators are molded case Switches (MCS).

③ For detailed information see table "Vigi iC60 Add-On Residual Current Devices (RCD or GFI)" on following pages.



# PlexPower™ Factory Sealed Panelboard

## Increased Safety

ATEX/IECEX:  
 Zone 1 and 2 - 21 and 22  
 II2GD  
 EPL Gb Db  
 Ex db eb IIB+H<sub>2</sub>  
 Ex tb IIC  
 IP66/Ik10

ATEX/IECEX – Optional:  
 Zone 1 and 2 - 21 and 22  
 II2GD  
 EPL Gb Db  
 Ex db eb IIC  
 Ex tb IIC  
 IP66/Ik10

### Steps to Creating Catalog Number:

To create a complete catalog number, refer to the Catalog Numbering Guide on previous page. Product selection information is available within the Guide.

P	P	E	M	06	12	2	16	C	G030	1	▲	—
Step 1			Step 2		Step 3						Step 4	Step 5

**Step 1:** Series is P

Material is P

Choose panel arrangement (A, B, C, D, E or F; see drawing at the end of the section for number of circuits).

**Step 2:** Choose either main lug (L), isolator switch (S) or main circuit breaker (M)

Choose the ampere rating of incoming mains (3 or 4 poles plus ampere: 40, 50, 63, 80, 100, 125, 160, 200, 250)

*If a main breaker is desired indicate amperage rating; Example: PPEM06 – 4-pole 63 Amp main breaker.*

**Step 3:** Choose the number of branch breakers

Choose the number of poles

Choose the ampere rating

Choose the breaker type

Choose OPTIONAL GFI

Choose OPTIONAL auxiliary contacts

*First digit is the number of branch breakers, second digit is the number of poles, third number is the ampere rating, fourth number is the breaker type and the fifth and six are optional GFI and/or auxiliary contacts; Example: 12216CG0301 is a 2-pole 16 Amp breaker 30 mA GFI with one auxiliary position contact with tripping curve C*

**Step 4:** Repeat Step 3 for as many breaker types are required (please refer to standard configurations)

**Step 5:** Panel options: Add options in alphanumeric order as listed Options in the Catalog Numbering Guide or Options in the introductory section.

### To be Noted When Selecting Panelboards

Entries for Mains Lugs, Isolator Switch, Main Circuit Breaker and Branch circuit breakers are based on rated Amps.

Entries

Incoming Rating	Terminal Size mm <sup>2</sup>	AWG	Wire Range mm <sup>2</sup>	AWG	Entry Sizes
40 Amp	10	8	1.5 - 16	16-6	M25
50 Amp	16	6	1.5 - 25	14-6	M32
63 Amp	35	2	2.5 - 50	12-2	M32
80 Amp	35	2	2.5 - 50	12-2	M32
100 Amp	50	1/0	10 - 70	10-1/0	M32/M40
125 Amp	50	1/0	10 - 70	10-1/0	M40/M50
160 Amp	70	2/0	10 - 95	8-2/0	M50/M63
200 Amp	120	4/0	16 - 150	4-4/0	M63/M75
250 Amp	120	4/0	16 - 150	4-4/0	M63/M75

Outgoing Branches ①	Terminal Size mm <sup>2</sup>	AWG	Wire Range mm <sup>2</sup>	AWG	Entry Sizes
20 Amp	6	8	1.5 - 10	22-8	M20
32 Amp	6	8	1.5 - 10	22-8	M25
40 Amp	10	8	1.5 - 16	16-8	M25
50 Amp	16	6	1.5 - 25	14-6	M32
63 Amp	16	6	2.5 - 50	14-6	M32

① All outgoing entries must match respective cable sizes based on outgoing ratings.

# PlexPower™ Factory Sealed Panelboard

## Increased Safety

ATEX/IECEX:  
 Zone 1 and 2 - 21 and 22  
 Ⓢ II2GD  
 EPL Gb Db  
 Ex db eb IIB+H<sub>2</sub>  
 Ex tb IIIC  
 IP66/Ik10

ATEX/IECEX – Optional:  
 Zone 1 and 2 - 21 and 22  
 Ⓢ II2GD  
 EPL Gb Db  
 Ex db eb IIC  
 Ex tb IIIC  
 IP66/Ik10

### Panel Arrangement Size Selection Guide

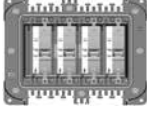
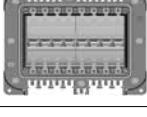
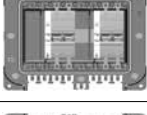
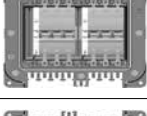
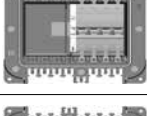
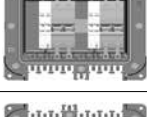
Bus Amps	Volts	Branch Breakers	8 Pole Module	Panel Arrangements ①				
				A/B	C	D	E	F
			Maximum no of 8 Poles modules in each Arrangement	2	3	4	6	9
63-250 V	220-240/ 380-415, 440 V	1 Pole		16	24	32	48	72
		1 Poles + Aux (NO or NC)		8	12	16	24	36
		2 Poles		8	12	16	24	36
		3 Poles		4	6	8	12	18
		4 Poles		4	6	8	12	18
		2 Poles + Aux (NO or NC)		4	6	8	12	18
		3 Poles + Aux (NO or NC)		4	6	8	12	18
		4 Poles + Aux (NO or NC)		2	3	4	6	9
		2 Poles + Aux (NO + NC)		4	6	8	12	18
		3 Poles + Aux (NO + NC)		2	3	4	6	9

① Panel Arrangement A has the same number of circuits as Panel Arrangements B without the Mains.

DISTRIBUTION EQUIPMENT: ATEX/IECEX INCREASED SAFETY PANELBOARDS









# PlexPower™ Factory Sealed Panelboard

## Increased Safety

**ATEX/IECEX:**  
 Zone 1 and 2 - 21 and 22  
 Ⓢ II2GD  
 EPL Gb Db  
 Ex db eb IIB+H<sub>2</sub>  
 Ex tb IIIC  
 IP66/Ik10

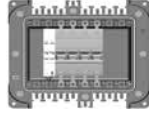
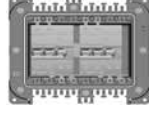
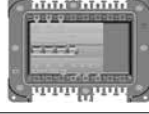
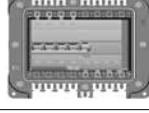
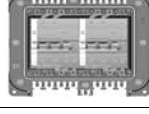
**ATEX/IECEX – Optional:**  
 Zone 1 and 2 - 21 and 22  
 Ⓢ II2GD  
 EPL Gb Db  
 Ex db eb IIC  
 Ex tb IIIC  
 IP66/Ik10

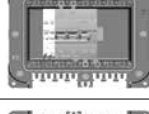
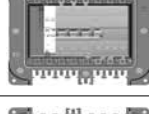
### Panel Arrangement Size Selection Guide (continued)

Bus Amps	Volts	Branch Breakers	8 Pole Module	Circuit configurations Main Lugs, Isolator Switch or Main Breaker Maximum no of 8 Poles modules in each Arrangement					
				A/B 2	C 3	D 4	E 6	F 9	
63-250 V	220-240/ 380-415, 440 V Ⓢ	4 Poles + Aux (NO + NC)		2	3	4	6	9	
		2 Poles + GFI		4	6	8	12	18	
		3 Poles + GFI		2	3	4	6	9	
		4 Poles + GFI		2	3	4	6	9	
		2 Poles + GFI + Aux (NO or NC)		4	6	8	12	18	
		3 Poles + GFI + Aux (NO or NC)		2	3	4	6	9	
		4 Poles + GFI + Aux (NO or NC)		2	3	4	6	9	
		2 Poles + GFI + Aux (NO + NC)		2	3	4	6	9	
		3 Poles + GFI + Aux (NO + NC)		2	3	4	6	9	
		4 Poles + GFI + Aux (NO + NC) ②		2	3	4	6	9	

① Panel Arrangement A has the same number of circuits as Panel Arrangements B without the Mains.

② Up to 25 Amps only.

③ 440 V without GFI.

DISTRIBUTION EQUIPMENT: ATEX/IECEX INCREASED SAFETY PANELBOARDS



# PlexPower™ Factory Sealed Panelboard

## Increased Safety

ATEX/IECEX:  
Zone 1 and 2 - 21 and 22  
Ⓢ II2GD  
EPL Gb Db  
Ex db eb IIB+H<sub>2</sub>  
Ex tb IIIC  
IP66/IK10

ATEX/IECEX – Optional:  
Zone 1 and 2 - 21 and 22  
Ⓢ II2GD  
EPL Gb Db  
Ex db eb IIC  
Ex tb IIIC  
IP66/IK10

### Schneider Mains Circuit Breaker (MCCB) Specifications

#### Common Characteristics

Rated Voltages	Insulation voltage (V)	Ui	800
	Impulse withstand voltage (kV)	Uimp	8
Compliances	Operational voltage (V)	Ue	AC 50/60 Hz 690
	Suitability for isolation		IEC/EN 60947-2 Yes
	Utilisation category		A
	Pollution degree		IEC 60664-1 3

#### Breaking Capacity

Circuit Breakers	NSX100							NSX160							NSX250																				
	B	F	N	H	S	L	R	HB1 ②	HB2	B	F	N	H	S	L	B	F	N	H	S	L	R	HB1 ②	HB2											
Rated current (A) In	100							100							160							250							250						
Number of poles	2 ③, 3, 4							2 ③, 3, 4							2 ③, 3, 4							2 ③, 3, 4							2 ③, 3, 4						
<b>Breaking capacity (kA rms)</b>																																			
Icu AC 50/60 Hz	220/240 V	40	85	90	100	120	150	200	-	-	40	85	90	100	120	150	40	85	90	100	120	150	200	-	-										
	380/415 V	25	36	50	70	100	150	200	-	-	25	36	50	70	100	150	25	36	50	70	100	150	200	-	-										
	440 V	20	35	50	65	90	130	200	-	-	20	35	50	65	90	130	20	35	50	65	90	130	200	-	-										
	500 V	15	25	36	50	65	70	80	85	100	15	30	36	50	65	70	15	30	36	50	65	70	80	85	100										
	525 V	-	22	35	35	40	50	65	80	100	-	22	35	35	40	50	-	22	35	35	40	50	65	80	100										
	660/690 V	-	8	10	10	15	20	45	75	100	-	8	10	10	15	20	-	8	10	10	15	20	45	75	100										
<b>Service breaking capacity (kA rms)</b>																																			
Ics AC 50/60 Hz	220/240 V	40	85	90	100	120	150	200	-	-	40	85	90	100	120	150	40	85	90	100	120	150	200	-	-										
	380/415 V	25	36	50	70	100	150	200	-	-	25	36	50	70	100	150	25	36	50	70	100	150	200	-	-										
	440 V	20	35	50	65	90	130	200	-	-	20	35	50	65	90	130	20	35	50	65	90	130	200	-	-										
	500 V	7.5	12.5	36	50	65	70	80	85	100	15	30	36	50	65	70	15	30	36	50	65	70	80	85	100										
	525 V	-	11	35	35	40	50	65	80	100	-	22	35	35	40	50	-	22	35	35	40	50	65	80	100										
	660/690 V	-	4	10	10	15	20	45	75	100	-	8	10	10	15	20	-	8	10	10	15	20	45	75	100										

① Electrical characteristics as per IEC 60947-2.

② There is no 160 A frame, use 250 A frame with lower amperage trip units for R, HB1, HB2.

③ 2P circuit breaker in 3P case for B and F types, only with thermal-magnetic trip unit.

# PlexPower™ Factory Sealed Panelboard

## Increased Safety

ATEX/IECEX:  
 Zone 1 and 2 - 21 and 22  
 II2GD  
 EPL Gb Db  
 Ex db eb IIB+H<sub>2</sub>  
 Ex tb IIIC  
 IP66/Ik10

ATEX/IECEX – Optional:  
 Zone 1 and 2 - 21 and 22  
 II2GD  
 EPL Gb Db  
 Ex db eb IIC  
 Ex tb IIIC  
 IP66/Ik10

### Schneider Branch Circuit Breaker Specifications

#### iC60N Circuit Breakers – Standard Offering – Curve B, C, D

Alternating current (AC) 50/60 Hz – Breaking capacity (Icu)

	Ph/Ph (2P, 3P, 4P) Ph/N (1P, 1P+N)	Voltage (Ue) ①				Voltage (Ue) ②		Service Breaking Capacity (Ics)
		12 to 133 V	220 to 240 V	380 to 415 V	440 V	400 V	230 V	
Rating (In)	0.5 to 4 A	50 kA	50 kA	50 kA	25 kA	6 kA	100% of Icu	
	6 to 63 A	36 kA	20 kA	10 kA	6 kA	6 kA	75% of Icu	

#### iC60H Circuit Breakers – Optional Offering – Curve B, C, D

Alternating current (AC) 50/60 Hz – Breaking capacity (Icu)

	Ph/Ph (2P, 3P, 4P) Ph/N (1P, 1P+N)	Voltage (Ue) ①				Voltage (Ue) ②		Service Breaking Capacity (Ics)
		12 to 133 V	220 to 240 V	380 to 415 V	440 V	400 V	230 V	
Rating (In)	0.5 to 4 A	70 kA	70 kA	70 kA	50 kA	10 kA	100% of Icu	
	6 to 63 A	42 kA	30 kA	15 kA	10 kA	10 kA	50% of Icu	

#### iC60L Circuit Breakers – Optional Offering – Curve B, C, K, Z

Alternating current (AC) 50/60 Hz – Breaking capacity (Icu) according to IEC/EN 60947-2

	Ph/Ph (2P, 3P, 4P) Ph/N (1P)	Voltage (Ue) ①				Voltage (Ue) ②		Service Breaking Capacity (Ics)
		12 to 133 V	220 to 240 V	380 to 415 V	440 V	400 V	230 V	
Rating (In)	0.5 to 4 A	100 kA	100 kA	100 kA	70 kA	15 kA	100% of Icu	
	6 to 25 A	70 kA	50 kA	25 kA	20 kA	15 kA	50% of Icu	
	32/40 A	70 kA	36 kA	20 kA	15 kA	15 kA	50% of Icu	
	50/63 A	70 kA	30 kA	15 kA	10 kA	—	50% of Icu	

① Breaking capacity (Icu) according to IEC/EN 60947-2.

② Breaking capacity (Icn) according to IEC/EN 60898-1.

# PlexPower™ Factory Sealed Panelboard

## Increased Safety

ATEX/IECEX:  
 Zone 1 and 2 - 21 and 22  
 II2GD  
 EPL Gb Db  
 Ex db eb IIB+H<sub>2</sub>  
 Ex tb IIC  
 IP66/Ik10

ATEX/IECEX – Optional:  
 Zone 1 and 2 - 21 and 22  
 II2GD  
 EPL Gb Db  
 Ex db eb IIC  
 Ex tb IIC  
 IP66/Ik10

### Schneider Branch Circuit Breaker Specifications (continued)

### Vigi iC60 Add-On Residual Current Devices (RCD or GFI) – Optional

Voltage rating (Ue): 230 - 240 V, 400 - 415 V  
 Operating frequency: 50/60 Hz

	Amps	Sensitivity			
		10 mA	30 mA	300 mA	100 mA
2P	0.5 to 25 A	X	X	X	X
	32 to 40 A	—	X	X	—
	50 to 63 A	—	X	X	X
3P	0.5 to 25 A	—	X	X	—
	32 to 40 A	—	X	X	—
	50 to 63 A	—	X	X	—
4P	0.5 to 25 A	—	X	X	X
	32 to 40 A	—	X	X	—
	50 to 63 A	—	X	X	X

### Auxiliary Contact

Maximum	Terminal Size		Wire Range	
	mm <sup>2</sup>	AWG	mm <sup>2</sup>	AWG
6 Amp	2.5	12	1.5 - 4	26 - 12

DISTRIBUTION EQUIPMENT: ATEX/IECEX INCREASED SAFETY PANELBOARDS



# PlexPower™ Factory Sealed Panelboard

## Increased Safety

ATEX/IECEX:  
 Zone 1 and 2 - 21 and 22  
 II2GD  
 EPL Gb Db  
 Ex db eb IIB+H<sub>2</sub>  
 Ex tb IIIC  
 IP66/Ik10

ATEX/IECEX – Optional:  
 Zone 1 and 2 - 21 and 22  
 II2GD  
 EPL Gb Db  
 Ex db eb IIC  
 Ex tb IIIC  
 IP66/Ik10

### Cascading – Panelboard Short Circuit Ratings

Upstream: NSX100 – Downstream: iC60 – Ue: 380-415 V (Ph/N 220-240 V)

Upstream			NSX100					
			NSX100B	NSX100F	NSX100N	NSX100H	NSX100S	NSX100L
Breaking capacity (kA)			25	36	50	70	100	150
Downstream			Reinforced breaking capacity (kA)					
In Max (A)		Icu (kA)						
iC60N	63	10	20	25	30	30	30	30
iC60H	40	15	25	36	40	40	40	40
	63	15	25	36	36	36	36	36
iC60L	25	25	—	36	40	40	40	40
	40	20	25	36	40	40	40	40
	63	15	25	36	36	36	36	36

Upstream: NSX160 – Downstream: C60 – Ue: 380-415 V (Ph/N 220-240 V)

Upstream			NSX160					
			NSX160B	NSX160F	NSX160N	NSX160H	NSX160S	NSX160L
Breaking capacity (kA)			25	36	50	70	100	150
Downstream			Reinforced breaking capacity (kA)					
In Max (A)		Icu (kA)						
iC60N	63	10	20	25	30	30	30	30
iC60H	40	15	25	36	40	40	40	40
	63	15	25	30	30	30	30	30
iC60L	25	25	—	36	40	40	40	40
	40	20	25	36	40	40	40	40
	63	15	25	30	36	36	36	36

Upstream: NSX250 – Downstream: iC60 – Ue: 380-415 V (Ph/N 220-240 V)

Upstream			NSX250					
			NSX250B	NSX250F	NSX250N	NSX250H	NSX250S	NSX250L
Breaking capacity (kA)			25	36	50	70	100	150
Downstream			Reinforced breaking capacity (kA)					
In Max (A)		Icu (kA)						
iC60N	40	10	20	25	30	30	30	30
	63	10	20	25	25	25	25	25
iC60H	40	15	25	30	30	30	30	30
	63	15	25	25	25	25	25	25
iC60L	25	25	—	30	30	30	30	30
	40	20	25	30	30	30	30	30
	63	15	25	25	25	25	25	25

DISTRIBUTION EQUIPMENT: ATEX/IECEX INCREASED SAFETY PANELBOARDS



# PlexPower™ Factory Sealed Panelboard

## Increased Safety

ATEX/IECEX:  
 Zone 1 and 2 - 21 and 22  
 II2GD  
 EPL Gb Db  
 Ex db eb IIB+H<sub>2</sub>  
 Ex tb IIIC  
 IP66/IK10

ATEX/IECEX – Optional:  
 Zone 1 and 2 - 21 and 22  
 II2GD  
 EPL Gb Db  
 Ex db eb IIC  
 Ex tb IIIC  
 IP66/IK10

### Cascading – Panelboard Short Circuit Ratings (continued)

#### Upstream: NSX100 – Downstream: iC60 – Ue: 440 V

Upstream	NSX100					
	NSX100B	NSX100F	NSX100N	NSX100H	NSX100S	NSX100L
Breaking capacity (kA)	20	35	50	65	90	130
Downstream	Breaking Capacity (kA)			Reinforced breaking capacity (kA)		
iC60N	6	15	15	20	20	20
iC60H	10	20	20	25	25	25
iC60L	≤ 25 A	20	–	25	25	25
	32-40 A	15	20	25	25	25
	50-63 A	10	–	–	–	–

#### Upstream: NSX160 – Downstream: iC60 – Ue: 440 V

Upstream	NSX160					
	NSX160B	NSX160F	NSX160N	NSX160H	NSX160S	NSX160L
Breaking capacity (kA)	20	35	50	65	90	130
Downstream	Breaking Capacity (kA)			Reinforced breaking capacity (kA)		
iC60N	6	15	15	20	20	20
iC60H	10	20	20	25	25	25
iC60L	≤ 25 A	20	–	25	25	25
	32-40 A	15	20	25	25	25
	50-63 A	10	–	–	–	–

DISTRIBUTION EQUIPMENT: ATEX/IECEX INCREASED SAFETY PANELBOARDS



# PlexPower™ Factory Sealed Panelboard

## Increased Safety

**ATEX/IECEX:**  
 Zone 1 and 2 - 21 and 22  
 II2GD  
 EPL Gb Db  
 Ex db eb IIB+H<sub>2</sub>  
 Ex tb IIIC  
 IP66/Ik10

**ATEX/IECEX – Optional:**  
 Zone 1 and 2 - 21 and 22  
 II2GD  
 EPL Gb Db  
 Ex db eb IIC  
 Ex tb IIIC  
 IP66/Ik10

**Panel Arrangement A**

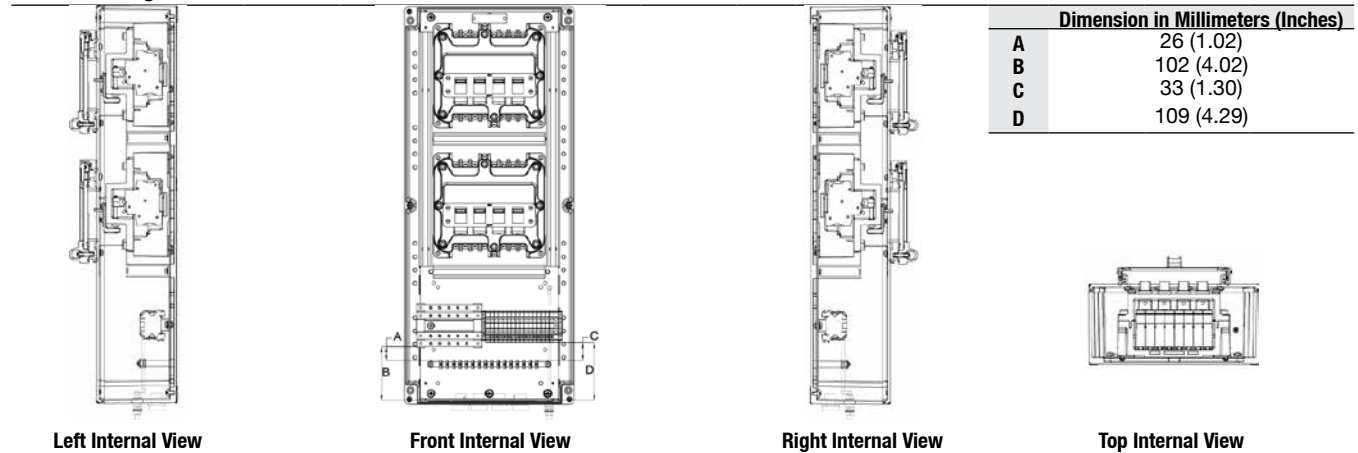

Breaker Curve C	Branch Breakers				Main Lugs Only	Armored Entries				Non-Armored Entries				Armored Auxiliary, Qty 1	Non-Armored Auxiliary, Qty 1
	30mA GFI	1 Position Contact "NO"	1 Trip Contact "NC"	Circuit Breaker Qty		Incoming Size, Qty 1	Outgoing Qty	Outgoing Size	Incoming Size	Outgoing Qty	Outgoing Size, Qty 1				
2-Poles 16 Amp	—	—	—	8	4 x 63 Amp	M32	8	M20	M40	8	M20	—	—		
2-Poles 16 Amp	—	X	—	4	4 x 63 Amp	M32	4	M20	M40	4	M20	M20	M25		
2-Poles 16 Amp	—	—	X	4	4 x 63 Amp	M32	4	M20	M40	4	M20	M20	M25		
2-Poles 16 Amp	—	X	X	4	4 x 63 Amp	M32	4	M20	M40	4	M20	M25	M25		
2-Poles 16 Amp	X	—	—	4	4 x 63 Amp	M32	4	M20	M40	4	M20	—	—		
2-Poles 16 Amp	X	X	—	4	4 x 63 Amp	M32	4	M20	M40	4	M20	M20	M25		
2-Poles 16 Amp	X	—	X	4	4 x 63 Amp	M32	4	M20	M40	4	M20	M20	M25		
2-Poles 16 Amp	X	X	X	2	4 x 63 Amp	M32	2	M20	M40	2	M20	M25	M25		
3-Poles 16 Amp	—	—	—	4	3 x 63 Amp	M32	4	M20	M40	4	M20	—	—		
3-Poles 16 Amp	—	X	—	4	3 x 63 Amp	M32	4	M20	M40	4	M20	M20	M25		
3-Poles 16 Amp	—	—	X	4	3 x 63 Amp	M32	4	M20	M40	4	M20	M20	M25		
3-Poles 16 Amp	—	X	X	2	3 x 63 Amp	M32	2	M20	M40	2	M20	M25	M25		
3-Poles 16 Amp	X	—	—	2	3 x 63 Amp	M32	2	M20	M40	2	M20	—	—		
3-Poles 16 Amp	X	X	—	2	3 x 63 Amp	M32	2	M20	M40	2	M20	M20	M25		
3-Poles 16 Amp	X	—	X	2	3 x 63 Amp	M32	2	M20	M40	2	M20	M20	M25		
3-Poles 16 Amp	X	X	X	2	3 x 63 Amp	M32	2	M20	M40	2	M20	M20	M25		
4-Poles 16 Amp	—	—	—	4	4 x 63 Amp	M32	4	M20	M40	4	M20	—	—		
4-Poles 16 Amp	—	X	—	2	4 x 63 Amp	M32	2	M20	M40	2	M20	M20	M25		
4-Poles 16 Amp	—	—	X	2	4 x 63 Amp	M32	2	M20	M40	2	M20	M20	M25		
4-Poles 16 Amp	—	X	X	2	4 x 63 Amp	M32	2	M20	M40	2	M20	M20	M25		
4-Poles 16 Amp	X	—	—	2	4 x 63 Amp	M32	2	M20	M40	2	M20	—	—		
4-Poles 16 Amp	X	X	—	2	4 x 63 Amp	M32	2	M20	M40	2	M20	M20	M25		
4-Poles 16 Amp	X	—	X	2	4 x 63 Amp	M32	2	M20	M40	2	M20	M20	M25		
4-Poles 16 Amp	X	X	X	2	4 x 63 Amp	M32	2	M20	M40	2	M20	M20	M25		

DISTRIBUTION EQUIPMENT: ATEX/IECEX INCREASED SAFETY PANELBOARDS



# PlexPower™ Factory Sealed Panelboard

## Increased Safety

ATEX/IECEX:  
Zone 1 and 2 - 21 and 22  
Ⓢ I/2GD  
EPL Gb Db  
Ex db eb IIB+H<sub>2</sub>  
Ex tb IIC  
IP66/Ik10

ATEX/IECEX – Optional:  
Zone 1 and 2 - 21 and 22  
Ⓢ I/2GD  
EPL Gb Db  
Ex db eb IIC  
Ex tb IIC  
IP66/Ik10

### Panel Arrangement A

Technical Information			
Panel A Size	750 x 320 x 150 mm		
Panel Weight	40 kg (88 lb)		
Max. No. of Circuits	See Panel Arrangement Size Selection Table		
Voltage	220-240/380-415, 440		
Wiring	See Wiring Diagram Table		
Breaking Capacity in kA			
	Ratings in Amps	380/415 V	440 V ⑧
Mains	63 A	-	-
Bus-bar	100 A	-	-
Branch Breakers ⑦	0.5 to 4 A	50	25
Branch Breakers ⑦	6 to 63 A	10	6
Panel Arrangement	100 A, 3 Ph, 5 W	-	-

Terminals ①								
Qty ②	Incoming	Qty ③	Outgoing	“NO” Position		Auxiliary	Non-Armored ⑥	
				Qty ④	“NC” Fault Qty ⑤		Complete Catalog No	Ordering Catalog No
4	35 mm <sup>2</sup>	16	6 mm <sup>2</sup>	—	—	—	PPAL068216C	PPAL068216C10N
4	35 mm <sup>2</sup>	8	6 mm <sup>2</sup>	8	—	2.5 mm <sup>2</sup>	PPAL064216C1	PPAL064216C20N
4	35 mm <sup>2</sup>	8	6 mm <sup>2</sup>	—	2	2.5 mm <sup>2</sup>	PPAL064216C4	PPAL064216C30N
4	35 mm <sup>2</sup>	8	6 mm <sup>2</sup>	8	2	2.5 mm <sup>2</sup>	PPAL064216C5	PPAL064216C40N
4	35 mm <sup>2</sup>	8	6 mm <sup>2</sup>	—	—	—	PPAL064216CG030	PPAL064216C50N
4	35 mm <sup>2</sup>	8	6 mm <sup>2</sup>	8	—	2.5 mm <sup>2</sup>	PPAL064216C1G030	PPAL064216C60N
4	35 mm <sup>2</sup>	8	6 mm <sup>2</sup>	—	2	2.5 mm <sup>2</sup>	PPAL064216C4G030	PPAL064216C70N
4	35 mm <sup>2</sup>	4	6 mm <sup>2</sup>	8	2	2.5 mm <sup>2</sup>	PPAL062216C5G030	PPAL062216C80N
3	35 mm <sup>2</sup>	12	6 mm <sup>2</sup>	—	—	—	PPAL054316C	PPAL054316C10N
3	35 mm <sup>2</sup>	12	6 mm <sup>2</sup>	8	—	2.5 mm <sup>2</sup>	PPAL054316C1	PPAL054316C20N
3	35 mm <sup>2</sup>	12	6 mm <sup>2</sup>	—	2	2.5 mm <sup>2</sup>	PPAL054316C4	PPAL054316C30N
3	35 mm <sup>2</sup>	6	6 mm <sup>2</sup>	8	2	2.5 mm <sup>2</sup>	PPAL052316C5	PPAL052316C40N
3	35 mm <sup>2</sup>	6	6 mm <sup>2</sup>	—	—	—	PPAL052316CG030	PPAL052316C50N
3	35 mm <sup>2</sup>	6	6 mm <sup>2</sup>	4	—	2.5 mm <sup>2</sup>	PPAL052316C1G030	PPAL052316C60N
3	35 mm <sup>2</sup>	6	6 mm <sup>2</sup>	—	2	2.5 mm <sup>2</sup>	PPAL052316C4G030	PPAL052316C70N
3	35 mm <sup>2</sup>	6	6 mm <sup>2</sup>	4	2	2.5 mm <sup>2</sup>	PPAL052316C5G030	PPAL052316C80N
4	35 mm <sup>2</sup>	16	6 mm <sup>2</sup>	—	—	—	PPAL064416C	PPAL064416C10N
4	35 mm <sup>2</sup>	8	6 mm <sup>2</sup>	4	—	2.5 mm <sup>2</sup>	PPAL062416C1	PPAL062416C20N
4	35 mm <sup>2</sup>	8	6 mm <sup>2</sup>	—	2	2.5 mm <sup>2</sup>	PPAL062416C4	PPAL062416C30N
4	35 mm <sup>2</sup>	8	6 mm <sup>2</sup>	4	2	2.5 mm <sup>2</sup>	PPAL062416C5	PPAL062416C40N
4	35 mm <sup>2</sup>	8	6 mm <sup>2</sup>	—	—	—	PPAL062416CG030	PPAL062416C50N
4	35 mm <sup>2</sup>	8	6 mm <sup>2</sup>	4	—	2.5 mm <sup>2</sup>	PPAL062416C1G030	PPAL062416C60N
4	35 mm <sup>2</sup>	8	6 mm <sup>2</sup>	—	2	2.5 mm <sup>2</sup>	PPAL062416C4G030	PPAL062416C70N
4	35 mm <sup>2</sup>	8	6 mm <sup>2</sup>	4	2	2.5 mm <sup>2</sup>	PPAL062416C5G030	PPAL062416C80N

- ① Ground bar supplied for each connection.
- ② Incoming cables terminates directly to the main breaker.
- ③ Outgoing terminal blocks for branch breakers (provided).
- ④ Each “NO” position contact are individually terminate on the terminal blocks and in pairs.
- ⑤ All “NC” trip contacts must be wired in series and terminated on terminal blocks as one pair only.
- ⑥ For armored version, replace the letter **A** with the letter **N**, in the last position of the Ordering Catalog Number; example: PPBL048216C10A.
- ⑦ For higher kA rating please consult your local sales representative.
- ⑧ Without GFI.

DISTRIBUTION EQUIPMENT: ATEX/IECEX INCREASED SAFETY PANELBOARDS





# PlexPower™ Factory Sealed Panelboard

## Increased Safety

**ATEX/IECEX:**  
 Zone 1 and 2 - 21 and 22  
 II2GD  
 EPL Gb Db  
 Ex db eb IIB+H<sub>2</sub>  
 Ex tb IIIC  
 IP66/IK10

**ATEX/IECEX – Optional:**  
 Zone 1 and 2 - 21 and 22  
 II2GD  
 EPL Gb Db  
 Ex db eb IIC  
 Ex tb IIIC  
 IP66/IK10

### Panel Arrangement B

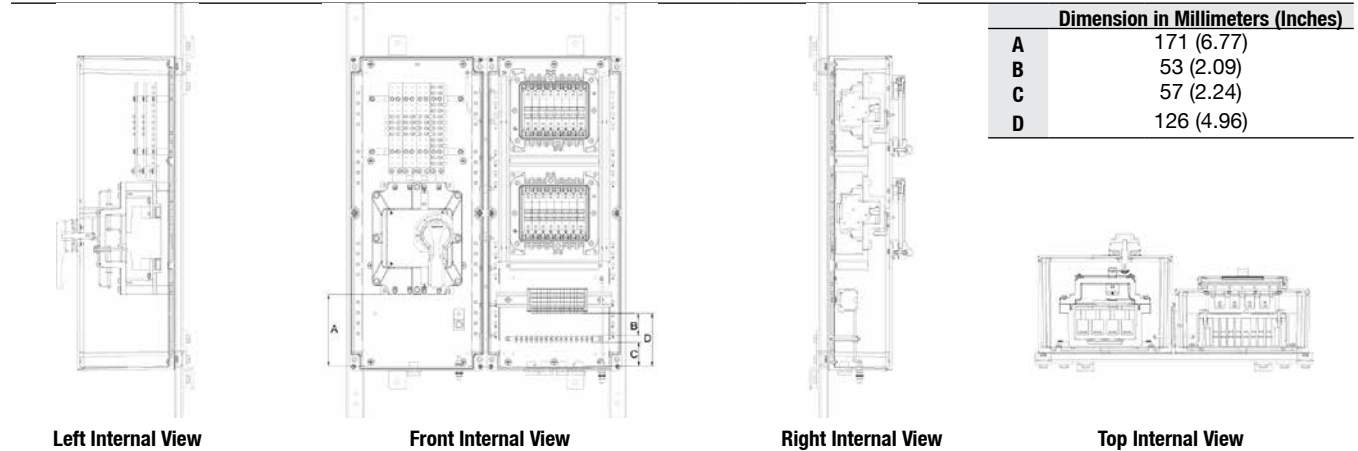

Breaker Curve C	Branch Breakers				Armored Entries				Non-Armored Entries				Armored Auxiliary, Qty 1	Non-Armored Auxiliary, Qty 1
	30mA GFI	1 Position Contact "NO"	1 Trip Contact "NC"	Circuit Breaker Qty	Main Breaker Size	Incoming Size, Qty 1	Outgoing Qty	Outgoing Size	Incoming Size	Outgoing Qty	Outgoing Size, Qty 1			
2-Poles 16 Amp	—	—	—	8	4 x 63 Amp	M32	8	M20	M40	8	M20	—	—	
2-Poles 16 Amp	—	X	—	4	4 x 63 Amp	M32	4	M20	M40	4	M20	M20	M25	
2-Poles 16 Amp	—	—	X	4	4 x 63 Amp	M32	4	M20	M40	4	M20	M20	M25	
2-Poles 16 Amp	—	X	X	4	4 x 63 Amp	M32	4	M20	M40	4	M20	M25	M25	
2-Poles 16 Amp	X	—	—	4	4 x 63 Amp	M32	4	M20	M40	4	M20	—	—	
2-Poles 16 Amp	X	X	—	4	4 x 63 Amp	M32	4	M20	M40	4	M20	M20	M25	
2-Poles 16 Amp	X	—	X	4	4 x 63 Amp	M32	4	M20	M40	4	M20	M20	M25	
2-Poles 16 Amp	X	X	X	2	4 x 63 Amp	M32	2	M20	M40	2	M20	M25	M25	
3-Poles 16 Amp	—	—	—	4	3 x 63 Amp	M32	4	M20	M40	4	M20	—	—	
3-Poles 16 Amp	—	X	—	4	3 x 63 Amp	M32	4	M20	M40	4	M20	M20	M25	
3-Poles 16 Amp	—	—	X	4	3 x 63 Amp	M32	4	M20	M40	4	M20	M20	M25	
3-Poles 16 Amp	—	X	X	2	3 x 63 Amp	M32	2	M20	M40	2	M20	M25	M25	
3-Poles 16 Amp	X	—	—	2	3 x 63 Amp	M32	2	M20	M40	2	M20	—	—	
3-Poles 16 Amp	X	X	—	2	3 x 63 Amp	M32	2	M20	M40	2	M20	M20	M25	
3-Poles 16 Amp	X	—	X	2	3 x 63 Amp	M32	2	M20	M40	2	M20	M20	M25	
3-Poles 16 Amp	X	X	X	2	3 x 63 Amp	M32	2	M20	M40	2	M20	M20	M25	
4-Poles 16 Amp	—	—	—	4	4 x 63 Amp	M32	4	M20	M40	4	M20	—	—	
4-Poles 16 Amp	—	X	—	2	4 x 63 Amp	M32	2	M20	M40	2	M20	M20	M25	
4-Poles 16 Amp	—	—	X	2	4 x 63 Amp	M32	2	M20	M40	2	M20	M20	M25	
4-Poles 16 Amp	—	X	X	2	4 x 63 Amp	M32	2	M20	M40	2	M20	M20	M25	
4-Poles 16 Amp	X	—	—	2	4 x 63 Amp	M32	2	M20	M40	2	M20	—	—	
4-Poles 16 Amp	X	X	—	2	4 x 63 Amp	M32	2	M20	M40	2	M20	M20	M25	
4-Poles 16 Amp	X	—	X	2	4 x 63 Amp	M32	2	M20	M40	2	M20	M20	M25	
4-Poles 16 Amp	X	X	X	2	4 x 63 Amp	M32	2	M20	M40	2	M20	M20	M25	

Please note the followings:  
 • For KAIC ratings for mains, busbar and branch circuit breakers, refer to Coordination Study Chart.  
 • FRP coupled enclosures are mounted on side and top of each other.  
 • Alternative arrangement are available as option, consult local sales representative.  
 • Number of circuits shown are non GFI and without auxiliary contacts equipped breakers.  
 • GFI and auxiliary contact equipped breakers number of circuits are determined as total number of circuits. Standard arrangements for all possibilities are listed in standard catalog pages

DISTRIBUTION EQUIPMENT: ATEX/IECEX INCREASED SAFETY PANELBOARDS



# PlexPower™ Factory Sealed Panelboard

## Increased Safety

ATEX/IECEX:  
 Zone 1 and 2 - 21 and 22  
 Ⓢ II2GD  
 EPL Gb Db  
 Ex db eb IIB+H<sub>2</sub>  
 Ex tb IIIC  
 IP66/Ik10

ATEX/IECEX – Optional:  
 Zone 1 and 2 - 21 and 22  
 Ⓢ II2GD  
 EPL Gb Db  
 Ex db eb IIC  
 Ex tb IIIC  
 IP66/Ik10

### Panel Arrangement B

Technical Information			
Panel B Size	990 x 666 x 230 mm		
Panel Weight	70 kg (154 lb)		
Max. No. of Circuits	See Panel Arrangement Size Selection Table		
Voltage	220-240/380-415, 440		
Wiring	See Wiring Diagram Table		
Breaking Capacity in kA			
	Ratings in Amps	380/415 V	440 V Ⓢ
Mains	100 A	25	20
Bus-bar	125 A	50	50
Branch Breakers ⑦	0.5 to 4 A	50	25
Branch Breakers ⑦	6 to 63 A	10	6
Panel Arrangement	100 A, 3 Ph, 5 W	20	15

Terminals ①								
Qty ②	Incoming	Qty ③	Outgoing	“NO” Position		Auxiliary	Non-Armored ⑥	
				Qty ④	“NC” Fault Qty ⑤		Complete Catalog No	Ordering Catalog No
4	35 mm <sup>2</sup>	16	6 mm <sup>2</sup>	—	—	—	PPBM068216C	PPBM068216C10N
4	35 mm <sup>2</sup>	8	6 mm <sup>2</sup>	8	—	2.5 mm <sup>2</sup>	PPBM064216C1	PPBM064216C20N
4	35 mm <sup>2</sup>	8	6 mm <sup>2</sup>	—	2	2.5 mm <sup>2</sup>	PPBM064216C4	PPBM064216C30N
4	35 mm <sup>2</sup>	8	6 mm <sup>2</sup>	8	2	2.5 mm <sup>2</sup>	PPBM064216C5	PPBM064216C40N
4	35 mm <sup>2</sup>	8	6 mm <sup>2</sup>	—	—	—	PPBM064216CG030	PPBM064216C50N
4	35 mm <sup>2</sup>	8	6 mm <sup>2</sup>	8	—	2.5 mm <sup>2</sup>	PPBM064216C1G030	PPBM064216C60N
4	35 mm <sup>2</sup>	8	6 mm <sup>2</sup>	—	2	2.5 mm <sup>2</sup>	PPBM064216C4G030	PPBM064216C70N
4	35 mm <sup>2</sup>	4	6 mm <sup>2</sup>	8	2	2.5 mm <sup>2</sup>	PPBM062216C5G030	PPBM062216C80N
3	35 mm <sup>2</sup>	12	6 mm <sup>2</sup>	—	—	—	PPBM054316C	PPBM054316C10N
3	35 mm <sup>2</sup>	12	6 mm <sup>2</sup>	8	—	2.5 mm <sup>2</sup>	PPBM054316C1	PPBM054316C20N
3	35 mm <sup>2</sup>	12	6 mm <sup>2</sup>	—	2	2.5 mm <sup>2</sup>	PPBM054316C4	PPBM054316C30N
3	35 mm <sup>2</sup>	6	6 mm <sup>2</sup>	8	2	2.5 mm <sup>2</sup>	PPBM052316C5	PPBM052316C40N
3	35 mm <sup>2</sup>	6	6 mm <sup>2</sup>	—	—	—	PPBM052316CG030	PPBM052316C50N
3	35 mm <sup>2</sup>	6	6 mm <sup>2</sup>	4	—	2.5 mm <sup>2</sup>	PPBM052316C1G030	PPBM052316C60N
3	35 mm <sup>2</sup>	6	6 mm <sup>2</sup>	—	2	2.5 mm <sup>2</sup>	PPBM052316C4G030	PPBM052316C70N
3	35 mm <sup>2</sup>	6	6 mm <sup>2</sup>	4	2	2.5 mm <sup>2</sup>	PPBM052316C5G030	PPBM052316C80N
4	35 mm <sup>2</sup>	16	6 mm <sup>2</sup>	—	—	—	PPBM064416C	PPBM064416C10N
4	35 mm <sup>2</sup>	8	6 mm <sup>2</sup>	4	—	2.5 mm <sup>2</sup>	PPBM062416C1	PPBM062416C20N
4	35 mm <sup>2</sup>	8	6 mm <sup>2</sup>	—	2	2.5 mm <sup>2</sup>	PPBM062416C4	PPBM062416C30N
4	35 mm <sup>2</sup>	8	6 mm <sup>2</sup>	4	2	2.5 mm <sup>2</sup>	PPBM062416C5	PPBM062416C40N
4	35 mm <sup>2</sup>	8	6 mm <sup>2</sup>	—	—	—	PPBM062416CG030	PPBM062416C50N
4	35 mm <sup>2</sup>	8	6 mm <sup>2</sup>	4	—	2.5 mm <sup>2</sup>	PPBM062416C1G030	PPBM062416C60N
4	35 mm <sup>2</sup>	8	6 mm <sup>2</sup>	—	2	2.5 mm <sup>2</sup>	PPBM062416C4G030	PPBM062416C70N
4	35 mm <sup>2</sup>	8	6 mm <sup>2</sup>	4	2	2.5 mm <sup>2</sup>	PPBM062416C5G030	PPBM062416C80N

- ① Ground bar supplied for each connection.  
 ② Incoming cables terminates directly to the main breaker.  
 ③ Outgoing terminal blocks for branch breakers (provided).  
 ④ Each “NO” position contact are individually terminate on the terminal blocks and in pairs.  
 ⑤ All “NC” trip contacts must be wired in series and terminated on terminal blocks as one pair only.  
 ⑥ For armored version, replace the letter **A** with the letter **N**, in the last position of the Ordering Catalog Number; example: PPBM048216C10A.  
 ⑦ For higher kA rating please consult your local sales representative.  
 ⑧ Without GFI.

DISTRIBUTION EQUIPMENT: ATEX/IECEX INCREASED SAFETY PANELBOARDS



# PlexPower™ Factory Sealed Panelboard

## Increased Safety

ATEX/IECEX:  
 Zone 1 and 2 - 21 and 22  
 II2GD  
 EPL Gb Db  
 Ex db eb IIB+H<sub>2</sub>  
 Ex tb IIIC  
 IP66/IK10

ATEX/IECEX – Optional:  
 Zone 1 and 2 - 21 and 22  
 II2GD  
 EPL Gb Db  
 Ex db eb IIC  
 Ex tb IIIC  
 IP66/IK10

### Panel Arrangement C

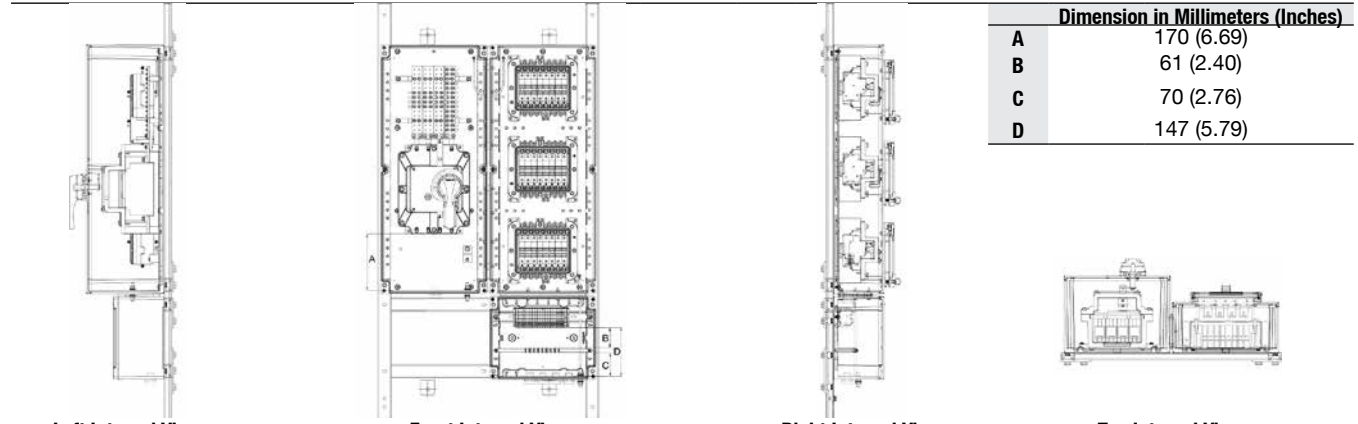

Breaker Curve C	Branch Breakers				Armored Entries				Non-Armored Entries				
	30mA GFI	1 Position Contact "NO"	1 Trip Contact "NC"	Circuit Breaker Qty	Main Breaker Size	Incoming Size, Qty 1	Outgoing Qty	Outgoing Size	Incoming Size	Outgoing Qty	Outgoing Size, Qty 1	Armored Auxiliary, Qty 1	Non-Armored Auxiliary, Qty 1
2-Poles 16 Amp	—	—	—	12	4 x 125 Amp	M40	12	M20	M40	12	M20	—	—
2-Poles 16 Amp	—	X	—	6	4 x 63 Amp	M32	6	M20	M40	6	M20	M25	M25
2-Poles 16 Amp	—	—	X	6	4 x 63 Amp	M32	6	M20	M40	6	M20	M20	M25
2-Poles 16 Amp	—	X	X	6	4 x 63 Amp	M32	6	M20	M40	6	M20	M25	M25
2-Poles 16 Amp	X	—	—	6	4 x 63 Amp	M32	6	M20	M40	6	M20	—	—
2-Poles 16 Amp	X	X	—	6	4 x 63 Amp	M32	6	M20	M40	6	M20	M20	M25
2-Poles 16 Amp	X	—	X	6	4 x 63 Amp	M32	6	M20	M40	6	M20	M20	M25
2-Poles 16 Amp	X	X	X	3	4 x 63 Amp	M32	3	M20	M40	3	M20	M20	M25
3-Poles 16 Amp	—	—	—	6	3 x 63 Amp	M32	6	M20	M40	6	M20	—	—
3-Poles 16 Amp	—	X	—	6	3 x 63 Amp	M32	6	M20	M40	6	M20	M25	M25
3-Poles 16 Amp	—	—	X	6	3 x 63 Amp	M32	6	M20	M40	6	M20	M20	M25
3-Poles 16 Amp	—	X	X	3	3 x 63 Amp	M32	3	M20	M40	3	M20	M20	M25
3-Poles 16 Amp	X	—	—	3	3 x 63 Amp	M32	3	M20	M40	3	M20	—	—
3-Poles 16 Amp	X	X	—	3	3 x 63 Amp	M32	3	M20	M40	3	M20	M20	M25
3-Poles 16 Amp	X	—	X	3	3 x 63 Amp	M32	3	M20	M40	3	M20	M20	M25
3-Poles 16 Amp	X	X	X	3	3 x 63 Amp	M32	3	M20	M40	3	M20	M20	M25
4-Poles 16 Amp	—	—	—	6	4 x 63 Amp	M32	6	M20	M40	6	M20	—	—
4-Poles 16 Amp	—	X	—	3	4 x 63 Amp	M32	3	M20	M40	3	M20	M20	M25
4-Poles 16 Amp	—	—	X	3	4 x 63 Amp	M32	3	M20	M40	3	M20	M20	M25
4-Poles 16 Amp	—	X	X	3	4 x 63 Amp	M32	3	M20	M40	3	M20	M20	M25
4-Poles 16 Amp	X	—	—	3	4 x 63 Amp	M32	3	M20	M40	3	M20	—	—
4-Poles 16 Amp	X	X	—	3	4 x 63 Amp	M32	3	M20	M40	3	M20	M20	M25
4-Poles 16 Amp	X	—	X	3	4 x 63 Amp	M32	3	M20	M40	3	M20	M20	M25
4-Poles 16 Amp	X	X	X	3	4 x 63 Amp	M32	3	M20	M40	3	M20	M20	M25

DISTRIBUTION EQUIPMENT: ATEX/IECEX INCREASED SAFETY PANELBOARDS



# PlexPower™ Factory Sealed Panelboard

## Increased Safety

ATEX/IECEX:  
 Zone 1 and 2 - 21 and 22  
 Ⓢ II2GD  
 EPL Gb Db  
 Ex db eb IIB+H<sub>2</sub>  
 Ex tb IIC  
 IP66/Ik10

ATEX/IECEX – Optional:  
 Zone 1 and 2 - 21 and 22  
 Ⓢ II2GD  
 EPL Gb Db  
 Ex db eb IIC  
 Ex tb IIC  
 IP66/Ik10

### Panel Arrangement C

Technical Information			
Panel C Size	1250 x 666 x 230 mm		
Panel Weight	80 kg (176 lb)		
Max. No. of Circuits	See Panel Arrangement Size Selection Table		
Voltage	220-240/380-415, 440		
Wiring	See Wiring Diagram Table		
Breaking Capacity in kA			
	Ratings in Amps	380/415 V	440 V Ⓢ
Mains	125 A	25	20
Bus-bar	125 A	50	50
Branch Breakers ⑦	0.5 to 4 A	50	25
Branch Breakers ⑦	6 to 63 A	10	6
Panel Arrangement	125 A, 3 Ph, 5 W	20	15

Terminals ①								
Qty ②	Incoming	Qty ③	Outgoing	"NO" Position Qty ④	"NC" Fault Qty ⑤	Auxiliary	Complete Catalog No	Ordering Catalog No
4	50 mm <sup>2</sup>	24	6 mm <sup>2</sup>	—	—	—	PPCM1212216C	PPCM1212216C10N
4	35 mm <sup>2</sup>	12	6 mm <sup>2</sup>	12	—	2.5 mm <sup>2</sup>	PPCM066216C1	PPCM066216C20N
4	35 mm <sup>2</sup>	12	6 mm <sup>2</sup>	—	2	2.5 mm <sup>2</sup>	PPCM066216C4	PPCM066216C30N
4	35 mm <sup>2</sup>	12	6 mm <sup>2</sup>	12	2	2.5 mm <sup>2</sup>	PPCM066216C5	PPCM066216C40N
4	35 mm <sup>2</sup>	12	6 mm <sup>2</sup>	—	—	—	PPCM066216CG030	PPCM066216C50N
4	35 mm <sup>2</sup>	12	6 mm <sup>2</sup>	12	—	2.5 mm <sup>2</sup>	PPCM066216C1G030	PPCM066216C60N
4	35 mm <sup>2</sup>	12	6 mm <sup>2</sup>	—	2	2.5 mm <sup>2</sup>	PPCM066216C4G030	PPCM066216C70N
4	35 mm <sup>2</sup>	6	6 mm <sup>2</sup>	12	2	2.5 mm <sup>2</sup>	PPCM063216C5G030	PPCM063216C80N
3	35 mm <sup>2</sup>	18	6 mm <sup>2</sup>	—	—	—	PPCM056316C	PPCM056316C10N
3	35 mm <sup>2</sup>	18	6 mm <sup>2</sup>	12	—	2.5 mm <sup>2</sup>	PPCM056316C1	PPCM056316C20N
3	35 mm <sup>2</sup>	18	6 mm <sup>2</sup>	—	2	2.5 mm <sup>2</sup>	PPCM056316C4	PPCM056316C30N
3	35 mm <sup>2</sup>	9	6 mm <sup>2</sup>	6	2	2.5 mm <sup>2</sup>	PPCM053316C5	PPCM053316C40N
3	35 mm <sup>2</sup>	9	6 mm <sup>2</sup>	—	—	—	PPCM053316CG030	PPCM053316C50N
3	35 mm <sup>2</sup>	9	6 mm <sup>2</sup>	6	—	2.5 mm <sup>2</sup>	PPCM053316C1G030	PPCM053316C60N
3	35 mm <sup>2</sup>	9	6 mm <sup>2</sup>	—	2	2.5 mm <sup>2</sup>	PPCM053316C4G030	PPCM053316C70N
3	35 mm <sup>2</sup>	9	6 mm <sup>2</sup>	6	2	2.5 mm <sup>2</sup>	PPCM053316C5G030	PPCM053316C80N
4	35 mm <sup>2</sup>	24	6 mm <sup>2</sup>	—	—	—	PPCM066416C	PPCM066416C10N
4	35 mm <sup>2</sup>	12	6 mm <sup>2</sup>	6	—	2.5 mm <sup>2</sup>	PPCM063416C1	PPCM063416C20N
4	35 mm <sup>2</sup>	12	6 mm <sup>2</sup>	—	2	2.5 mm <sup>2</sup>	PPCM063416C4	PPCM063416C30N
4	35 mm <sup>2</sup>	12	6 mm <sup>2</sup>	6	2	2.5 mm <sup>2</sup>	PPCM063416C5	PPCM063416C40N
4	35 mm <sup>2</sup>	12	6 mm <sup>2</sup>	—	—	—	PPCM063416CG030	PPCM063416C50N
4	35 mm <sup>2</sup>	12	6 mm <sup>2</sup>	6	—	2.5 mm <sup>2</sup>	PPCM063416C1G030	PPCM063416C60N
4	35 mm <sup>2</sup>	12	6 mm <sup>2</sup>	—	2	2.5 mm <sup>2</sup>	PPCM063416C4G030	PPCM063416C70N
4	35 mm <sup>2</sup>	12	6 mm <sup>2</sup>	6	2	2.5 mm <sup>2</sup>	PPCM063416C5G030	PPCM063416C80N

- ① Ground bar supplied for each connection.
- ② Incoming cables terminates directly to the main breaker.
- ③ Outgoing terminal blocks for branch breakers (provided).
- ④ Each "NO" position contact are individually terminate on the terminal blocks and in pairs.
- ⑤ All "NC" trip contacts must be wired in series and terminated on terminal blocks as one pair only.
- ⑥ For armored version, replace the letter **A** with the letter **N**, in the last position of the Ordering Catalog Number; example: PPCM0812216C10A.
- ⑦ For higher kA rating please consult your local sales representative.
- ⑧ Without GFI.

DISTRIBUTION EQUIPMENT: ATEX/IECEX INCREASED SAFETY PANELBOARDS



# PlexPower™ Factory Sealed Panelboard

## Increased Safety

**ATEX/IECEX:**  
 Zone 1 and 2 - 21 and 22  
 II2GD  
 EPL Gb Db  
 Ex db eb IIB+H<sub>2</sub>  
 Ex tb IIIC  
 IP66/IK10

**ATEX/IECEX – Optional:**  
 Zone 1 and 2 - 21 and 22  
 II2GD  
 EPL Gb Db  
 Ex db eb IIC  
 Ex tb IIIC  
 IP66/IK10

### Panel Arrangement D

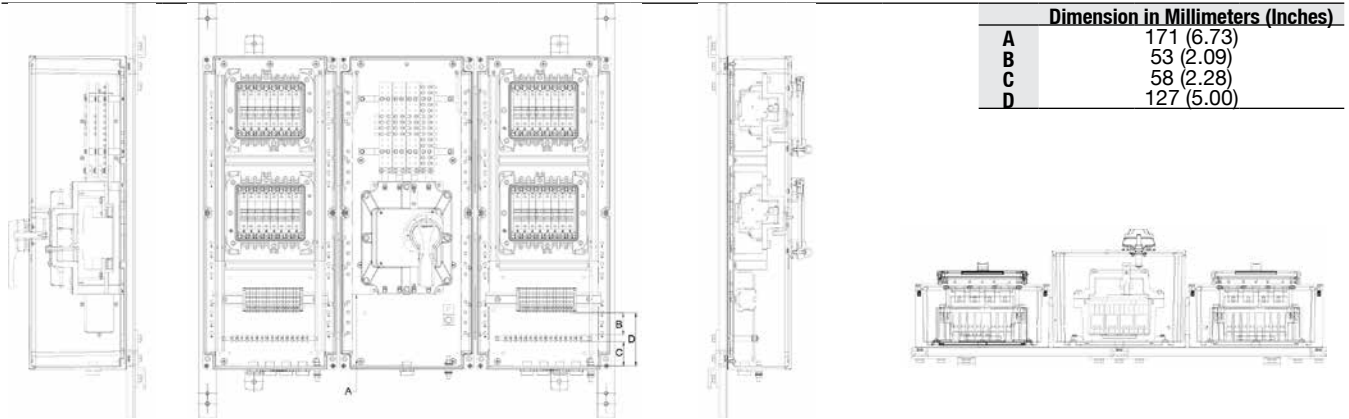

Breaker Curve C	Branch Breakers				Armored Entries				Non-Armored Entries				Armored Auxiliary, Qty 1	Non-Armored Auxiliary, Qty 1
	30mA GFI	1 Position Contact "NO"	1 Trip Contact "NC"	Circuit Breaker Qty	Main Breaker Size	Incoming Size, Qty 1	Outgoing Qty	Outgoing Size	Incoming Size	Outgoing Qty	Outgoing Size, Qty 1			
2-Poles 16 Amp	—	—	—	16	4 x 160 Amp	M50	16	M20	M50	16	M20	—	—	
2-Poles 16 Amp	—	X	—	8	4 x 100 Amp	M40	8	M20	M40	8	M20	M25	M25	
2-Poles 16 Amp	—	—	X	8	4 x 100 Amp	M40	8	M20	M40	8	M20	M20	M25	
2-Poles 16 Amp	—	X	X	8	4 x 100 Amp	M40	8	M20	M40	8	M20	M25	M25	
2-Poles 16 Amp	X	—	—	8	4 x 100 Amp	M40	8	M20	M40	8	M20	—	—	
2-Poles 16 Amp	X	X	—	8	4 x 100 Amp	M40	8	M20	M40	8	M20	M25	M25	
2-Poles 16 Amp	X	—	X	8	4 x 100 Amp	M40	8	M20	M40	8	M20	M20	M25	
2-Poles 16 Amp	X	X	X	4	4 x 63 Amp	M32	4	M20	M40	4	M20	M25	M25	
3-Poles 16 Amp	—	—	—	8	3 x 100 Amp	M40	8	M20	M40	8	M20	—	—	
3-Poles 16 Amp	—	X	—	8	3 x 100 Amp	M40	8	M20	M40	8	M20	M25	M25	
3-Poles 16 Amp	—	—	X	8	3 x 100 Amp	M40	8	M20	M40	8	M20	M20	M25	
3-Poles 16 Amp	—	X	X	4	3 x 63 Amp	M32	4	M20	M40	4	M20	M25	M25	
3-Poles 16 Amp	X	—	—	4	3 x 63 Amp	M32	4	M20	M40	4	M20	—	—	
3-Poles 16 Amp	X	X	—	4	3 x 63 Amp	M32	4	M20	M40	4	M20	M20	M25	
3-Poles 16 Amp	X	—	X	4	3 x 63 Amp	M32	4	M20	M40	4	M20	M20	M25	
3-Poles 16 Amp	X	X	X	4	3 x 63 Amp	M32	4	M20	M40	4	M20	M25	M25	
4-Poles 16 Amp	—	—	—	8	4 x 63 Amp	M32	8	M20	M40	8	M20	—	—	
4-Poles 16 Amp	—	X	—	4	4 x 63 Amp	M32	4	M20	M40	4	M20	M20	M25	
4-Poles 16 Amp	—	—	X	4	4 x 63 Amp	M32	4	M20	M40	4	M20	M20	M25	
4-Poles 16 Amp	—	X	X	4	4 x 63 Amp	M32	4	M20	M40	4	M20	M25	M25	
4-Poles 16 Amp	X	—	—	4	4 x 63 Amp	M32	4	M20	M40	4	M20	—	—	
4-Poles 16 Amp	X	X	—	4	4 x 63 Amp	M32	4	M20	M40	4	M20	M20	M25	
4-Poles 16 Amp	X	—	X	4	4 x 63 Amp	M32	4	M20	M40	4	M20	M20	M25	
4-Poles 16 Amp	X	X	X	4	4 x 63 Amp	M32	4	M20	M40	4	M20	M25	M25	

DISTRIBUTION EQUIPMENT: ATEX/IECEX INCREASED SAFETY PANELBOARDS



# PlexPower™ Factory Sealed Panelboard

## Increased Safety

ATEX/IECEX:  
 Zone 1 and 2 - 21 and 22  
 Ⓢ II2GD  
 EPL Gb Db  
 Ex db eb IIB+H<sub>2</sub>  
 Ex tb IIC  
 IP66/Ik10

ATEX/IECEX – Optional:  
 Zone 1 and 2 - 21 and 22  
 Ⓢ II2GD  
 EPL Gb Db  
 Ex db eb IIC  
 Ex tb IIC  
 IP66/Ik10

### Panel Arrangement D

Technical Information			
Panel D Size	990 x 994 x 230 mm		
Panel Weight	120 kg (265 lb)		
Max. No. of Circuits	See Panel Arrangement Size Selection Table		
Voltage	220-240/380-415, 440		
Wiring	See Wiring Diagram Table		
Breaking Capacity in kA			
	Ratings in Amps	380/415 V	440 V Ⓢ
Mains	160 A	25	20
Bus-bar	160 A	50	50
Branch Breakers ⑦	0.5 to 4 A	50	25
Branch Breakers ⑦	6 to 63 A	10	6
Panel Arrangement	160 A, 3 Ph, 5 W	20	15

Qty ②	Incoming	Terminals ①		Qty ④	Qty ⑤	Auxiliary	Non-Armored ⑥	
		Qty ③	Outgoing				Complete Catalog No	Ordering Catalog No
4	70 mm <sup>2</sup>	32	6 mm <sup>2</sup>	—	—	—	PPDM1416216C	PPDM1416216C10N
4	50 mm <sup>2</sup>	16	6 mm <sup>2</sup>	16	—	2.5 mm <sup>2</sup>	PPDM108216C1	PPDM108216C20N
4	50 mm <sup>2</sup>	16	6 mm <sup>2</sup>	—	2	2.5 mm <sup>2</sup>	PPDM108216C4	PPDM108216C30N
4	50 mm <sup>2</sup>	16	6 mm <sup>2</sup>	16	2	2.5 mm <sup>2</sup>	PPDM108216C5	PPDM108216C40N
4	50 mm <sup>2</sup>	16	6 mm <sup>2</sup>	—	—	—	PPDM108216CG030	PPDM108216C50N
4	50 mm <sup>2</sup>	16	6 mm <sup>2</sup>	16	—	2.5 mm <sup>2</sup>	PPDM108216C1G030	PPDM108216C60N
4	50 mm <sup>2</sup>	16	6 mm <sup>2</sup>	—	2	2.5 mm <sup>2</sup>	PPDM108216C4G030	PPDM108216C70N
4	35 mm <sup>2</sup>	8	6 mm <sup>2</sup>	8	2	2.5 mm <sup>2</sup>	PPDM064216C5G030	PPDM064216C80N
3	50 mm <sup>2</sup>	24	6 mm <sup>2</sup>	—	—	—	PPDM098316C	PPDM098316C10N
3	50 mm <sup>2</sup>	24	6 mm <sup>2</sup>	16	—	2.5 mm <sup>2</sup>	PPDM098316C1	PPDM098316C20N
3	50 mm <sup>2</sup>	24	6 mm <sup>2</sup>	—	2	2.5 mm <sup>2</sup>	PPDM098316C4	PPDM098316C30N
3	35 mm <sup>2</sup>	12	6 mm <sup>2</sup>	8	2	2.5 mm <sup>2</sup>	PPDM054316C5	PPDM054316C40N
3	35 mm <sup>2</sup>	12	6 mm <sup>2</sup>	—	—	—	PPDM054316CG030	PPDM054316C50N
3	35 mm <sup>2</sup>	12	6 mm <sup>2</sup>	8	—	2.5 mm <sup>2</sup>	PPDM054316C1G030	PPDM054316C60N
3	35 mm <sup>2</sup>	12	6 mm <sup>2</sup>	—	2	2.5 mm <sup>2</sup>	PPDM054316C4G030	PPDM054316C70N
3	35 mm <sup>2</sup>	12	6 mm <sup>2</sup>	8	2	2.5 mm <sup>2</sup>	PPDM054316C5G030	PPDM054316C80N
4	35 mm <sup>2</sup>	32	6 mm <sup>2</sup>	—	—	—	PPDM068416C	PPDM068416C10N
4	35 mm <sup>2</sup>	16	6 mm <sup>2</sup>	8	—	2.5 mm <sup>2</sup>	PPDM064416C1	PPDM064416C20N
4	35 mm <sup>2</sup>	16	6 mm <sup>2</sup>	—	2	2.5 mm <sup>2</sup>	PPDM064416C4	PPDM064416C30N
4	35 mm <sup>2</sup>	16	6 mm <sup>2</sup>	8	2	2.5 mm <sup>2</sup>	PPDM064416C5	PPDM064416C40N
4	35 mm <sup>2</sup>	16	6 mm <sup>2</sup>	—	—	—	PPDM064416CG030	PPDM064416C50N
4	35 mm <sup>2</sup>	16	6 mm <sup>2</sup>	8	—	2.5 mm <sup>2</sup>	PPDM064416C1G030	PPDM064416C60N
4	35 mm <sup>2</sup>	16	6 mm <sup>2</sup>	—	2	2.5 mm <sup>2</sup>	PPDM064416C4G030	PPDM064416C70N
4	35 mm <sup>2</sup>	16	6 mm <sup>2</sup>	8	2	2.5 mm <sup>2</sup>	PPDM064416C5G030	PPDM064416C80N

① Ground bar supplied for each connection.

② Incoming cables terminate directly to the main breaker.

③ Outgoing terminal blocks for branch breakers (provided).

④ Each "NO" position contact are individually terminate on the terminal blocks and in pairs.

⑤ All "NC" trip contacts must be wired in series and terminated on terminal blocks as one pair only.

⑥ For armored version, replace the letter **A** with the letter **N**, in the last position of the Ordering Catalog Number; example: PPDM1016216C10A.

⑦ For higher kA rating please consult your local sales representative.

⑧ Without GFI.

DISTRIBUTION EQUIPMENT: ATEX/IECEX INCREASED SAFETY PANELBOARDS



# PlexPower™ Factory Sealed Panelboard

## Increased Safety

**ATEX/IECEX:**  
 Zone 1 and 2 - 21 and 22  
 II2GD  
 EPL Gb Db  
 Ex db eb IIB+H<sub>2</sub>  
 Ex tb IIIC  
 IP66/IK10

**ATEX/IECEX – Optional:**  
 Zone 1 and 2 - 21 and 22  
 II2GD  
 EPL Gb Db  
 Ex db eb IIC  
 Ex tb IIIC  
 IP66/IK10

### Panel Arrangement E

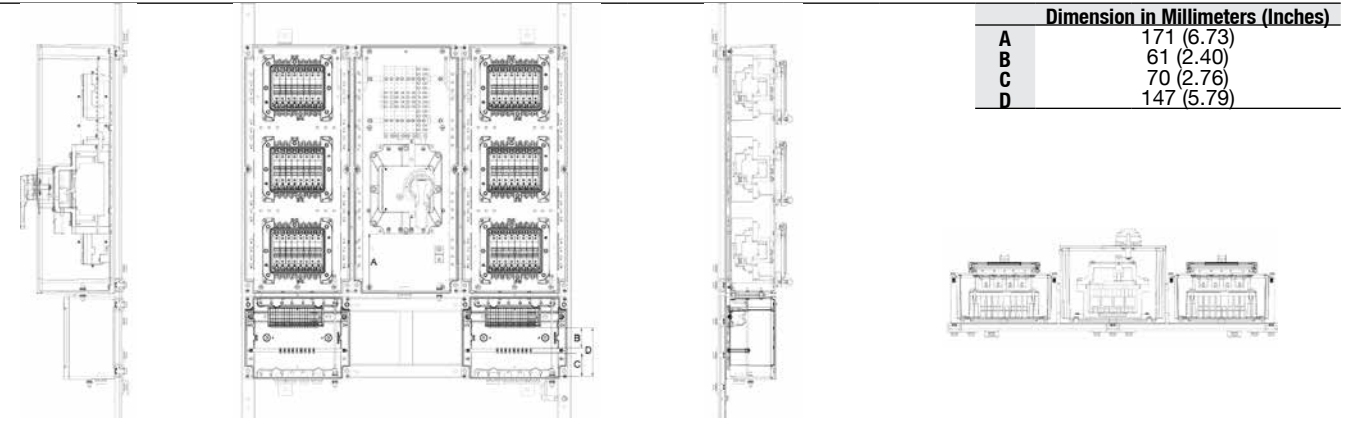

Breaker Curve C	30mA GFI	Branch Breakers				Armored Entries				Non-Armored Entries				Non-Armored Auxiliary, Qty 1
		1 Position Contact "NO"	1 Trip Contact "NC"	Circuit Breaker Qty	Main Breaker Size	Incoming Size, Qty 1	Outgoing Qty	Outgoing Size	Non-Armored Entries Outgoing		Armored Auxiliary, Qty 1			
									Incoming Size	Qty		Size, Qty 1		
2-Poles 16 Amp	—	—	—	24	4 x 200 Amp	M63	24	M20	M63	24	M20	—	—	
2-Poles 16 Amp	—	X	—	12	4 x 125 Amp	M40	12	M20	M40	12	M20	M32	M32	
2-Poles 16 Amp	—	—	X	12	4 x 125 Amp	M40	12	M20	M40	12	M20	M20	M25	
2-Poles 16 Amp	—	X	X	12	4 x 125 Amp	M40	12	M20	M40	12	M20	M32	M32	
2-Poles 16 Amp	X	—	—	12	4 x 125 Amp	M40	12	M20	M40	12	M20	—	—	
2-Poles 16 Amp	X	X	—	12	4 x 125 Amp	M40	12	M20	M40	12	M20	M32	M32	
2-Poles 16 Amp	X	—	X	12	4 x 125 Amp	M40	12	M20	M40	12	M20	M20	M25	
2-Poles 16 Amp	X	X	X	6	4 x 63 Amp	M32	6	M20	M40	6	M20	M25	M25	
3-Poles 16 Amp	—	—	—	12	3 x 125 Amp	M40	12	M20	M40	12	M20	—	—	
3-Poles 16 Amp	—	X	—	12	3 x 125 Amp	M40	12	M20	M40	12	M20	M32	M32	
3-Poles 16 Amp	—	—	X	12	3 x 125 Amp	M40	12	M20	M40	12	M20	M20	M25	
3-Poles 16 Amp	—	X	X	6	3 x 63 Amp	M32	6	M20	M40	6	M20	M25	M25	
3-Poles 16 Amp	X	—	—	6	3 x 63 Amp	M32	6	M20	M40	6	M20	—	—	
3-Poles 16 Amp	X	X	—	6	3 x 63 Amp	M32	6	M20	M40	6	M20	M25	M25	
3-Poles 16 Amp	X	—	X	6	3 x 63 Amp	M32	6	M20	M40	6	M20	M20	M25	
3-Poles 16 Amp	X	X	X	6	3 x 63 Amp	M32	6	M20	M40	6	M20	M25	M25	
4-Poles 16 Amp	—	—	—	12	4 x 63 Amp	M32	12	M20	M40	12	M20	—	—	
4-Poles 16 Amp	—	X	—	6	4 x 63 Amp	M32	6	M20	M40	6	M20	M25	M25	
4-Poles 16 Amp	—	—	X	6	4 x 63 Amp	M32	6	M20	M40	6	M20	M20	M25	
4-Poles 16 Amp	—	X	X	6	4 x 63 Amp	M32	6	M20	M40	6	M20	M25	M25	
4-Poles 16 Amp	X	—	—	6	4 x 63 Amp	M32	6	M20	M40	6	M20	—	—	
4-Poles 16 Amp	X	X	—	6	4 x 63 Amp	M32	6	M20	M40	6	M20	M25	M25	
4-Poles 16 Amp	X	—	X	6	4 x 63 Amp	M32	6	M20	M40	6	M20	M20	M25	
4-Poles 16 Amp	X	X	X	6	4 x 63 Amp	M32	6	M20	M40	6	M20	M25	M25	

DISTRIBUTION EQUIPMENT: ATEX/IECEX INCREASED SAFETY PANELBOARDS



# PlexPower™ Factory Sealed Panelboard

## Increased Safety

ATEX/IECEX:  
 Zone 1 and 2 - 21 and 22  
 Ⓢ II2GD  
 EPL Gb Db  
 Ex db eb IIB+H<sub>2</sub>  
 Ex tb IIC  
 IP66/IK10

ATEX/IECEX – Optional:  
 Zone 1 and 2 - 21 and 22  
 Ⓢ II2GD  
 EPL Gb Db  
 Ex db eb IIC  
 Ex tb IIC  
 IP66/IK10

### Panel Arrangement E

Technical Information			
Panel E Size	1250 x 994 x 230 mm		
Panel Weight	145 kg (320 lb)		
Max. No. of Circuits	See Panel Arrangement Size Selection Table		
Voltage	220-240/380-415		
Wiring	See Wiring Diagram Table		
Breaking Capacity in kA			
	Ratings in Amps	380/415 V	440 V Ⓢ
Mains	200 A	25	20
Bus-bar	250 A	50	50
Branch Breakers ⑦	0.5 to 4 A	50	25
Branch Breakers ⑦	6 to 63 A	10	6
Panel Arrangement	200 A, 3 Ph, 5 W	20	-

Terminals ①							Non-Armored ⑥	
Qty ②	Incoming	Qty ③	Outgoing	“NO” Position Qty ④	“NC” Fault Qty ⑤	Auxiliary	Complete Catalog No	Ordering Catalog No
4	120 mm <sup>2</sup>	48	6 mm <sup>2</sup>	—	—	—	PPEM1624216C	PPEM1624216C10N
4	50 mm <sup>2</sup>	24	6 mm <sup>2</sup>	24	—	2.5 mm <sup>2</sup>	PPEM1212216C1	PPEM1212216C20N
4	50 mm <sup>2</sup>	24	6 mm <sup>2</sup>	—	2	2.5 mm <sup>2</sup>	PPEM1212216C4	PPEM1212216C30N
4	50 mm <sup>2</sup>	24	6 mm <sup>2</sup>	24	2	2.5 mm <sup>2</sup>	PPEM1212216C5	PPEM1212216C40N
4	50 mm <sup>2</sup>	24	6 mm <sup>2</sup>	—	—	—	PPEM1212216CG030	PPEM1212216C50N
4	50 mm <sup>2</sup>	24	6 mm <sup>2</sup>	24	—	2.5 mm <sup>2</sup>	PPEM1212216C1G030	PPEM1212216C60N
4	50 mm <sup>2</sup>	24	6 mm <sup>2</sup>	—	2	2.5 mm <sup>2</sup>	PPEM1212216C4G030	PPEM1212216C70N
4	35 mm <sup>2</sup>	12	6 mm <sup>2</sup>	12	2	2.5 mm <sup>2</sup>	PPEM066216C5G030	PPEM066216C80N
3	50 mm <sup>2</sup>	24	6 mm <sup>2</sup>	—	—	—	PPEM1112316C	PPEM1112316C10N
3	50 mm <sup>2</sup>	24	6 mm <sup>2</sup>	24	—	2.5 mm <sup>2</sup>	PPEM1112316C1	PPEM1112316C20N
3	50 mm <sup>2</sup>	24	6 mm <sup>2</sup>	—	2	2.5 mm <sup>2</sup>	PPEM1112316C4	PPEM1112316C30N
3	35 mm <sup>2</sup>	18	6 mm <sup>2</sup>	12	2	2.5 mm <sup>2</sup>	PPEM056316C5	PPEM056316C40N
3	35 mm <sup>2</sup>	18	6 mm <sup>2</sup>	—	—	—	PPEM056316CG030	PPEM056316C50N
3	35 mm <sup>2</sup>	18	6 mm <sup>2</sup>	12	—	2.5 mm <sup>2</sup>	PPEM056316C1G030	PPEM056316C60N
3	35 mm <sup>2</sup>	18	6 mm <sup>2</sup>	—	2	2.5 mm <sup>2</sup>	PPEM056316C4G030	PPEM056316C70N
3	35 mm <sup>2</sup>	18	6 mm <sup>2</sup>	12	2	2.5 mm <sup>2</sup>	PPEM056316C5G030	PPEM056316C80N
4	35 mm <sup>2</sup>	48	6 mm <sup>2</sup>	—	—	—	PPEM0612416C	PPEM0612416C10N
4	35 mm <sup>2</sup>	24	6 mm <sup>2</sup>	12	—	2.5 mm <sup>2</sup>	PPEM066416C1	PPEM066416C20N
4	35 mm <sup>2</sup>	24	6 mm <sup>2</sup>	—	2	2.5 mm <sup>2</sup>	PPEM066416C4	PPEM066416C30N
4	35 mm <sup>2</sup>	24	6 mm <sup>2</sup>	12	2	2.5 mm <sup>2</sup>	PPEM066416C5	PPEM066416C40N
4	35 mm <sup>2</sup>	24	6 mm <sup>2</sup>	—	—	—	PPEM066416CG030	PPEM066416C50N
4	35 mm <sup>2</sup>	24	6 mm <sup>2</sup>	12	—	2.5 mm <sup>2</sup>	PPEM066416C1G030	PPEM066416C60N
4	35 mm <sup>2</sup>	24	6 mm <sup>2</sup>	—	2	2.5 mm <sup>2</sup>	PPEM066416C4G030	PPEM066416C70N
4	35 mm <sup>2</sup>	24	6 mm <sup>2</sup>	12	2	2.5 mm <sup>2</sup>	PPEM066416C5G030	PPEM066416C80N

- ① Ground bar supplied for each connection.
- ② Incoming cables terminates directly to the main breaker.
- ③ Outgoing terminal blocks for branch breakers (provided).
- ④ Each “NO” position contact are individually terminate on the terminal blocks and in pairs.
- ⑤ All “NC” trip contacts must be wired in series and terminated on terminal blocks as one pair only.
- ⑥ For armored version, replace the letter **A** with the letter **N**, in the last position of the Ordering Catalog Number; example: PPEM1224216C10A.
- ⑦ For higher kA rating please consult your local sales representative.
- ⑧ Without GFI.

DISTRIBUTION EQUIPMENT: ATEX/IECEX INCREASED SAFETY PANELBOARDS





# PlexPower™ Factory Sealed Panelboard

## Increased Safety

ATEX/IECEX:  
 Zone 1 and 2 - 21 and 22  
 II2GD  
 EPL Gb Db  
 Ex db eb IIB+H<sub>2</sub>  
 Ex tb IIIC  
 IP66/IK10

ATEX/IECEX – Optional:  
 Zone 1 and 2 - 21 and 22  
 II2GD  
 EPL Gb Db  
 Ex db eb IIC  
 Ex tb IIIC  
 IP66/IK10

### Panel Arrangement F

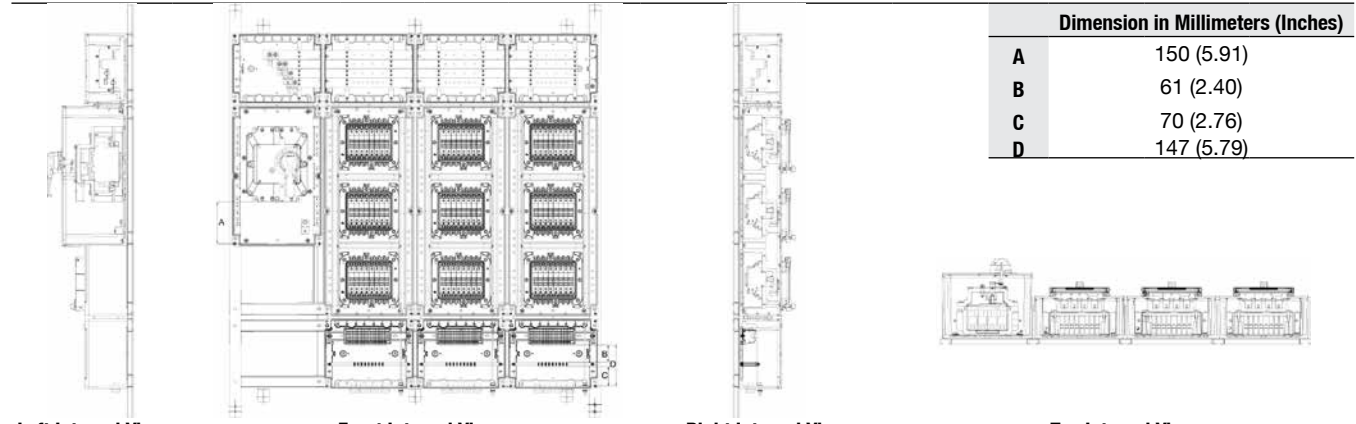

Breaker Curve C	30mA GFI	Branch Breakers		Circuit Breaker Qty	Main Breaker Size	Armored Entries		Non-Armored Entries			Armored Auxiliary, Qty 1	Non-Armored Auxiliary, Qty 1	
		1 Position Contact "NO"	1 Trip Contact "NC"			Incoming Size, Qty 1	Outgoing Qty	Incoming Size	Outgoing Qty	Outgoing Size, Qty 1			
2-Poles 16 Amp	—	—	—	36	4 x 250 Amp	M63	36	M20	M63	36	M20	—	—
2-Poles 16 Amp	—	X	—	18	4 x 200 Amp	M63	18	M20	M63	18	M20	M32	M40
2-Poles 16 Amp	—	—	X	18	4 x 200 Amp	M63	18	M20	M63	18	M20	M20	M25
2-Poles 16 Amp	—	X	X	18	4 x 200 Amp	M63	18	M20	M63	18	M20	M32	M40
2-Poles 16 Amp	X	—	—	18	4 x 200 Amp	M63	18	M20	M63	18	M20	—	—
2-Poles 16 Amp	X	X	—	18	4 x 200 Amp	M63	18	M20	M63	18	M20	M32	M40
2-Poles 16 Amp	X	—	X	18	4 x 200 Amp	M63	18	M20	M63	18	M20	M20	M25
2-Poles 16 Amp	X	X	X	9	4 x 100 Amp	M40	9	M20	M40	9	M20	M32	M25
3-Poles 16 Amp	—	—	—	18	3 x 200 Amp	M63	18	M20	M63	18	M20	—	—
3-Poles 16 Amp	—	X	—	18	3 x 200 Amp	M63	18	M20	M63	18	M20	M32	M40
3-Poles 16 Amp	—	—	X	18	3 x 200 Amp	M63	18	M20	M63	18	M20	M20	M25
3-Poles 16 Amp	—	X	X	9	3 x 100 Amp	M40	9	M20	M40	9	M20	M32	M25
3-Poles 16 Amp	X	—	—	9	3 x 100 Amp	M40	9	M20	M40	9	M20	—	—
3-Poles 16 Amp	X	X	—	9	3 x 100 Amp	M40	9	M20	M40	9	M20	M25	M25
3-Poles 16 Amp	X	—	X	9	3 x 100 Amp	M40	9	M20	M40	9	M20	M20	M25
3-Poles 16 Amp	X	X	X	9	3 x 100 Amp	M40	9	M20	M40	9	M20	M32	M25
4-Poles 16 Amp	—	—	—	18	4 x 200 Amp	M63	18	M20	M63	18	M20	—	—
4-Poles 16 Amp	—	X	—	9	4 x 100 Amp	M40	9	M20	M40	9	M20	M25	M25
4-Poles 16 Amp	—	—	X	9	4 x 100 Amp	M40	9	M20	M40	9	M20	M20	M25
4-Poles 16 Amp	—	X	X	9	4 x 100 Amp	M40	9	M20	M40	9	M20	M32	M25
4-Poles 16 Amp	X	—	—	9	4 x 100 Amp	M40	9	M20	M40	9	M20	—	—
4-Poles 16 Amp	X	X	—	9	4 x 100 Amp	M40	9	M20	M40	9	M20	M25	M25
4-Poles 16 Amp	X	—	X	9	4 x 100 Amp	M40	9	M20	M40	9	M20	M20	M25
4-Poles 16 Amp	X	X	X	9	4 x 100 Amp	M40	9	M20	M40	9	M20	M32	M25

DISTRIBUTION EQUIPMENT: ATEX/IECEX INCREASED SAFETY PANELBOARDS



# PlexPower™ Factory Sealed Panelboard

## Increased Safety

ATEX/IECEX:  
Zone 1 and 2 - 21 and 22  
Ⓢ II2GD  
EPL Gb Db  
Ex db eb IIB+H<sub>2</sub>  
Ex tb IIC  
IP66/IK10

ATEX/IECEX – Optional:  
Zone 1 and 2 - 21 and 22  
Ⓢ II2GD  
EPL Gb Db  
Ex db eb IIC  
Ex tb IIC  
IP66/IK10

### Panel Arrangement F

Technical Information			
Panel A Size	1470 x 1323 x 230 mm		
Panel Weight	200 kg (441 lb)		
Max. No. of Circuits	See Panel Arrangement Size Selection Table		
Voltage	220-240/380-415		
Wiring	See Wiring Diagram Table		
Breaking Capacity in kA			
	Ratings in Amps	380/415 V	440 V Ⓢ
Mains	250 A	25	20
Bus-bar	250 A	50	50
Branch Breakers ⑦	0.5 to 4 A	50	25
Branch Breakers ⑦	6 to 63 A	10	6
Panel Arrangement	250 A, 3 Ph, 5 W	20	-

Terminals ①								
Qty ②	Incoming	Qty ③	Outgoing	Position		Auxiliary	Non-Armored ⑥	
				“NO” Qty ④	“NC” Fault Qty ⑤		Complete Catalog No	Ordering Catalog No
4	120 mm <sup>2</sup>	72	6 mm <sup>2</sup>	—	—	—	PPFM1836216C	PPFM1836216C10N
4	120 mm <sup>2</sup>	36	6 mm <sup>2</sup>	36	—	2.5 mm <sup>2</sup>	PPFM1618216C1	PPFM1618216C20N
4	120 mm <sup>2</sup>	36	6 mm <sup>2</sup>	—	2	2.5 mm <sup>2</sup>	PPFM1618216C4	PPFM1618216C30N
4	120 mm <sup>2</sup>	36	6 mm <sup>2</sup>	36	2	2.5 mm <sup>2</sup>	PPFM1618216C5	PPFM1618216C40N
4	120 mm <sup>2</sup>	36	6 mm <sup>2</sup>	—	—	—	PPFM1618216CG030	PPFM1618216C50N
4	120 mm <sup>2</sup>	36	6 mm <sup>2</sup>	36	—	2.5 mm <sup>2</sup>	PPFM1618216C1G030	PPFM1618216C60N
4	120 mm <sup>2</sup>	36	6 mm <sup>2</sup>	—	2	2.5 mm <sup>2</sup>	PPFM1618216C4G030	PPFM1618216C70N
4	50 mm <sup>2</sup>	18	6 mm <sup>2</sup>	18	2	2.5 mm <sup>2</sup>	PPFM109216C5G030	PPFM109216C80N
3	120 mm <sup>2</sup>	36	6 mm <sup>2</sup>	—	—	—	PPFM1518316C	PPFM1518316C10N
3	120 mm <sup>2</sup>	36	6 mm <sup>2</sup>	36	—	2.5 mm <sup>2</sup>	PPFM1518316C1	PPFM1518316C20N
3	120 mm <sup>2</sup>	36	6 mm <sup>2</sup>	—	2	2.5 mm <sup>2</sup>	PPFM1518316C4	PPFM1518316C30N
3	50 mm <sup>2</sup>	18	6 mm <sup>2</sup>	18	2	2.5 mm <sup>2</sup>	PPFM099316C5	PPFM099316C40N
3	50 mm <sup>2</sup>	18	6 mm <sup>2</sup>	—	—	—	PPFM099316CG030	PPFM099316C50N
3	50 mm <sup>2</sup>	18	6 mm <sup>2</sup>	18	—	2.5 mm <sup>2</sup>	PPFM099316C1G030	PPFM099316C60N
3	50 mm <sup>2</sup>	18	6 mm <sup>2</sup>	—	2	2.5 mm <sup>2</sup>	PPFM099316C4G030	PPFM099316C70N
3	50 mm <sup>2</sup>	18	6 mm <sup>2</sup>	18	2	2.5 mm <sup>2</sup>	PPFM099316C5G030	PPFM099316C80N
4	120 mm <sup>2</sup>	36	6 mm <sup>2</sup>	—	—	—	PPFM1618416C	PPFM1618416C10N
4	50 mm <sup>2</sup>	18	6 mm <sup>2</sup>	18	—	2.5 mm <sup>2</sup>	PPFM109416C1	PPFM109416C20N
4	50 mm <sup>2</sup>	18	6 mm <sup>2</sup>	—	2	2.5 mm <sup>2</sup>	PPFM109416C4	PPFM109416C30N
4	50 mm <sup>2</sup>	18	6 mm <sup>2</sup>	18	2	2.5 mm <sup>2</sup>	PPFM109416C5	PPFM109416C40N
4	50 mm <sup>2</sup>	18	6 mm <sup>2</sup>	—	—	—	PPFM109416CG030	PPFM109416C50N
4	50 mm <sup>2</sup>	18	6 mm <sup>2</sup>	18	—	2.5 mm <sup>2</sup>	PPFM109416C1G030	PPFM109416C60N
4	50 mm <sup>2</sup>	18	6 mm <sup>2</sup>	—	2	2.5 mm <sup>2</sup>	PPFM109416C4G030	PPFM109416C70N
4	50 mm <sup>2</sup>	18	6 mm <sup>2</sup>	18	2	2.5 mm <sup>2</sup>	PPFM109416C5G030	PPFM109416C80N

① Ground bar supplied for each connection.

② Incoming cables terminates directly to the main breaker.

③ Outgoing terminal blocks for branch breakers (provided).

④ Each “NO” position contact are individually terminate on the terminal blocks and in pairs.

⑤ All “NC” trip contacts must be wired in series and terminated on terminal blocks as one pair only.

⑥ For armored version, replace the letter **A** with the letter **N**, in the last position of the Ordering Catalog Number; example: PPFM1436216C10A.

⑦ For higher kA rating please consult your local sales representative.

⑧ Without GFI.

DISTRIBUTION EQUIPMENT: ATEX/IECEX INCREASED SAFETY PANELBOARDS

Appleton

# PlexPower™ Factory Sealed Panelboard

## Increased Safety

**ATEX/IECEX:**  
 Zone 1 and 2 - 21 and 22  
 II2GD  
 EPL Gb Db  
 Ex db eb IIB+H<sub>2</sub>  
 Ex tb IIIC  
 IP66/IK10

**ATEX/IECEX – Optional:**  
 Zone 1 and 2 - 21 and 22  
 II2GD  
 EPL Gb Db  
 Ex db eb IIC  
 Ex tb IIIC  
 IP66/IK10

Wiring Diagrams – Panel Arrangements B, C, D, E, F – For Panel Arrangement A, Remove Main Breaker from Wiring Diagrams

Q1: Main Breaker  
 M1-M8: Module Housing  
 D1-▲: MCB

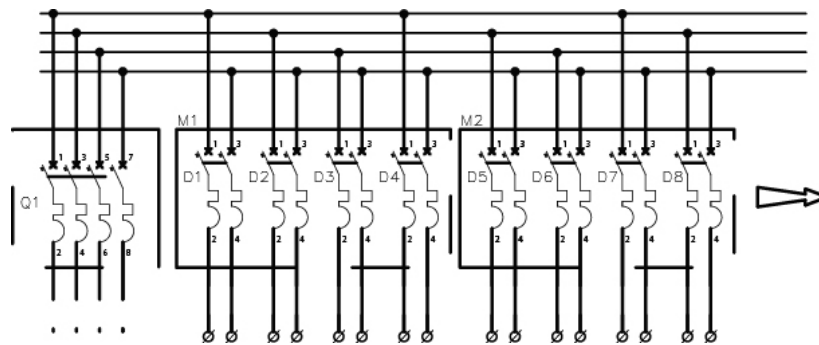

2-Pole

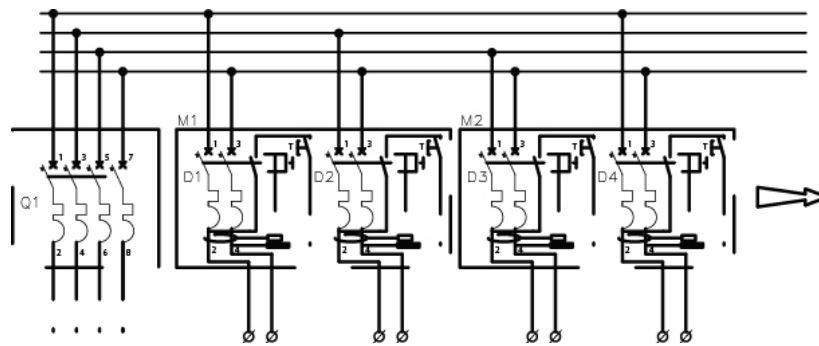

2-Pole + GFI

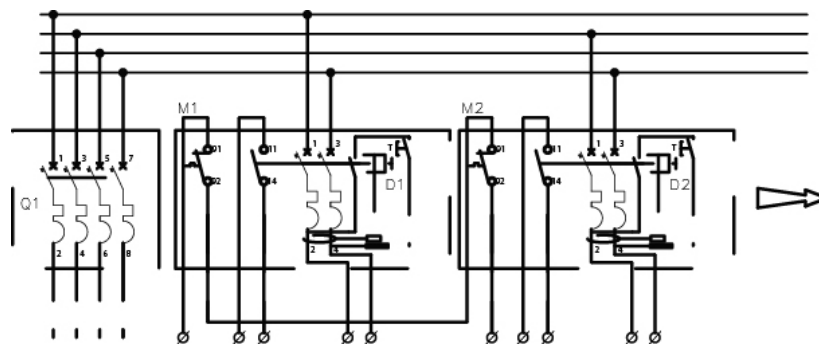

2-Pole + GFI + AUX NO + AUX NC

▲ Number of branch circuit breakers will depend on the number of module housing.

# PlexPower™ Factory Sealed Panelboard

## Increased Safety

**ATEX/IECEX:**  
 Zone 1 and 2 - 21 and 22  
 II2GD  
 EPL Gb Db  
 Ex db eb IIB+H<sub>2</sub>  
 Ex tb IIC  
 IP66/Ik10

**ATEX/IECEX – Optional:**  
 Zone 1 and 2 - 21 and 22  
 II2GD  
 EPL Gb Db  
 Ex db eb IIC  
 Ex tb IIC  
 IP66/Ik10

### Standard Panel Arrangement Layout – Dimensions in Millimeters (Inches)

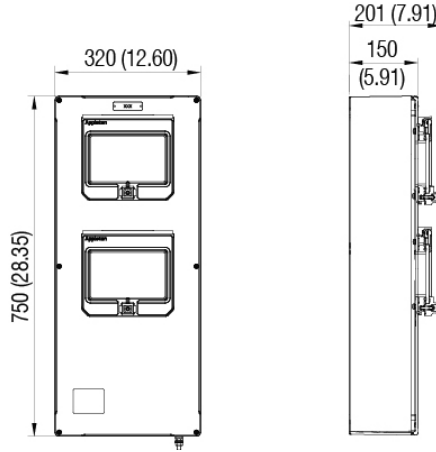

Panel Arrangement A

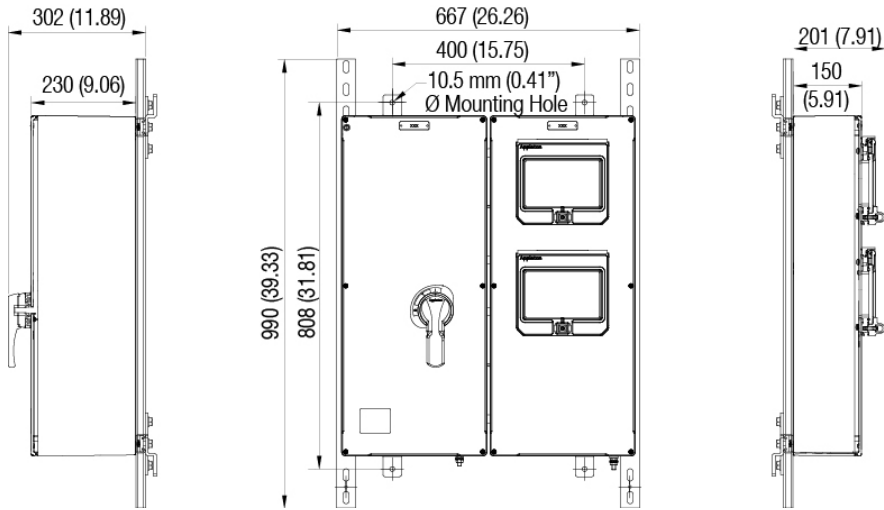

Panel Arrangement B

DISTRIBUTION EQUIPMENT: ATEX/IECEX INCREASED SAFETY PANELBOARDS



# PlexPower™ Factory Sealed Panelboard

## Increased Safety

ATEX/IECEX:  
 Zone 1 and 2 - 21 and 22  
 II2GD  
 EPL Gb Db  
 Ex db eb IIB+H<sub>2</sub>  
 Ex tb IIIC  
 IP66/IK10

ATEX/IECEX – Optional:  
 Zone 1 and 2 - 21 and 22  
 II2GD  
 EPL Gb Db  
 Ex db eb IIC  
 Ex tb IIIC  
 IP66/IK10

### Standard Panel Arrangement Layout – Dimensions in Millimeters (Inches)

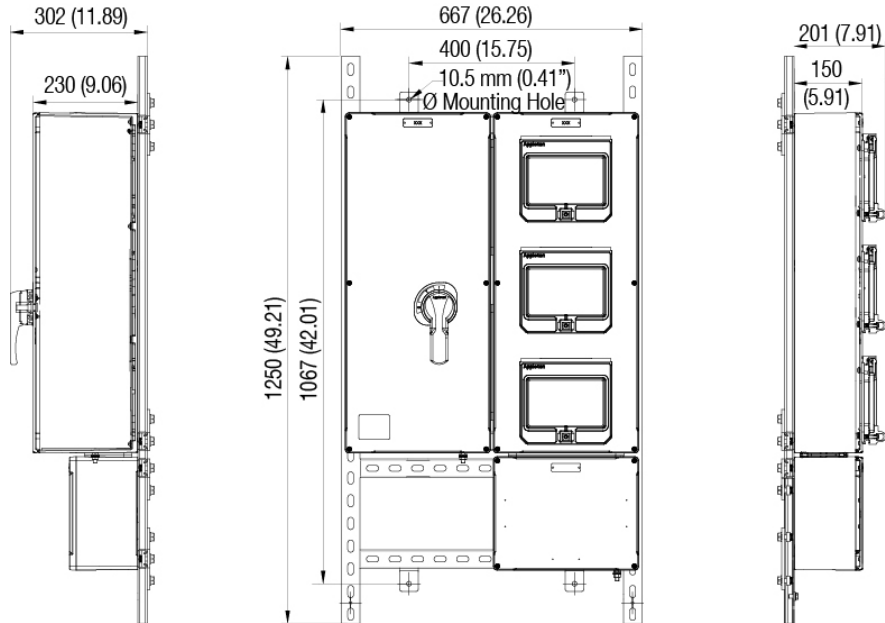

Panel Arrangement C

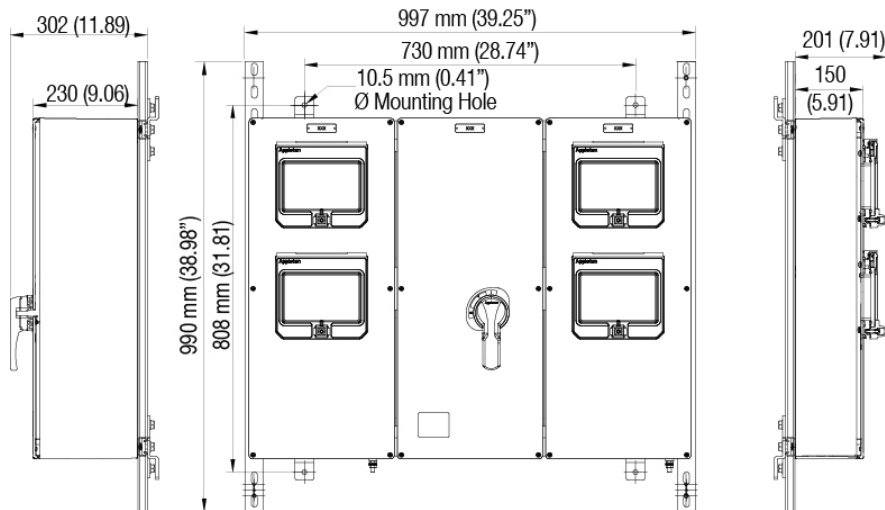

Panel Arrangement D

DISTRIBUTION EQUIPMENT: ATEX/IECEX INCREASED SAFETY PANELBOARDS



# PlexPower™ Factory Sealed Panelboard

Increased Safety

ATEX/IECEX:  
 Zone 1 and 2 - 21 and 22  
 II2GD  
 EPL Gb Db  
 Ex db eb IIB+H<sub>2</sub>  
 Ex tb IIC  
 IP66/Ik10

ATEX/IECEX – Optional:  
 Zone 1 and 2 - 21 and 22  
 II2GD  
 EPL Gb Db  
 Ex db eb IIC  
 Ex tb IIC  
 IP66/Ik10

## Standard Panel Arrangement Layout – Dimensions in Millimeters (Inches)

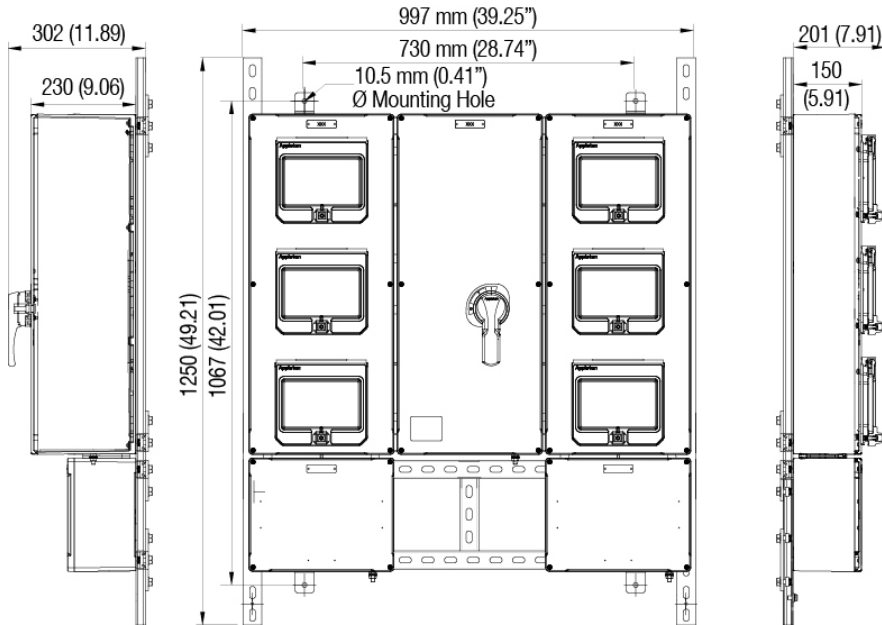

Panel Arrangement E

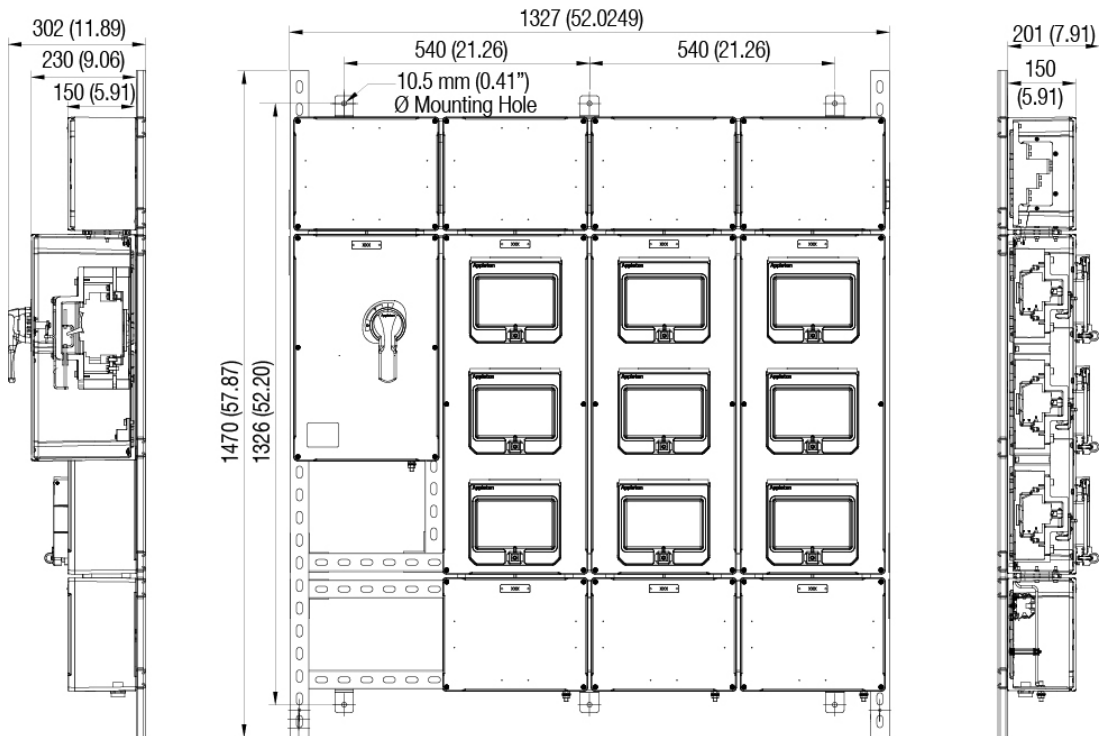

Panel Arrangement F

DISTRIBUTION EQUIPMENT: ATEX/IECEX INCREASED SAFETY PANELBOARDS



# ATX™ DPD Series Distribution Panelboards

## Flameproof

ATEX/IECEX:  
Zone 1 and 2 – 21 and 22  
⊕ II 2 GD  
IP66/IK10

### Applications

- Protection and control of electrical equipment in hazardous areas where ignitable vapors, gases or highly combustible dusts are present.
- For installation in:
  - Chemical plants
  - Petrochemical plants
  - Refineries
  - Other process industries in Zone 1 and 2 and Zone 21 and 22
- These compact units provide a centrally controlled switching system
- Lighting panelboards are available in 6, 12, 18 and 24 circuits.
- Heat tracing panelboards are available in 6, 12, 18 and 20 circuits.

### Features

- Available versions:
- 3- or 4-Pole isolator switch or main breaker.
  - 1, 2, 3, 4 and 1+N poles branch circuit breakers.
    - Branch circuit breaker available with B, C or D tripping curve.
    - GFI branch circuit breaker available with B, C or D tripping curves except for 1+N poles.
  - Isolator and breaker handles included as standard, can be padlocked in OFF position.
  - Copper bus bar as standard.
  - Fully prewired on outgoing terminal block.
  - M8 earth-crossing terminal.
  - Hinged door.
  - 4 fixing lugs.
  - Cable glands and plugs to be ordered separately.

### Standard Materials

- Housing: gray marine grade aluminum alloy
- Hardware: stainless steel
- Bus bar: copper

### Options

- Other rating and tripping curves.
- Other voltage.
- Indirect cable entries available through Ex e connection enclosure.
- Switch rack assembly.

### ATEX/IECEX Certifications and Compliances

- Certification Type CF
- Zones 1 and 2
  - Conforming to ATEX 94/9/CE: ⊕ II 2 G
  - Type of Protection: Ex d IIB
  - Temperature Class: T6 to T4
- Zones 21 and 22
  - Conforming to ATEX 94/9/CE: ⊕ II 2 D
  - Type of Protection: Ex tD A21
  - Surface Temperature: T80 °C to T130 °C (T176 °F to T266 °F)
- Ambient Temperature: CF70B: -20 °C to +55 °C (-4 °F to +131 °F), CF50B: -40 °C to +55 °C (-40 °F to +131 °F), CF60B: -50 °C to +55 °C (-58 °F to +131 °F)
- CE Declaration of Conformity: 50229



8 Circuit Panelboard

- ATEX Certificate: LCIE 02 ATEX 6057X
  - IECEx Certificate: IECEx LCI 08.023X
  - Index of Protection according EN/IEC 60529: IP66
  - Impact Resistance (shock): IK10
  - Internal Volume: > 2 dm<sup>3</sup> (122 in<sup>3</sup>) — 2 liters
- ### EURASEC Certification
- EURASEC N° TC RU C-FR.Г505.B.00911

DISTRIBUTION EQUIPMENT: ATEX/IECEX INCREASED SAFETY PANELBOARDS

Appleton®

# ATX™ DPD Series Distribution Panelboards

## Flameproof

ATEX/IECEx:  
 Zone 1 and 2 – 21 and 22  
 Ⓢ II 2 GD  
 IP66/IK10

### Catalog Numbering Guide

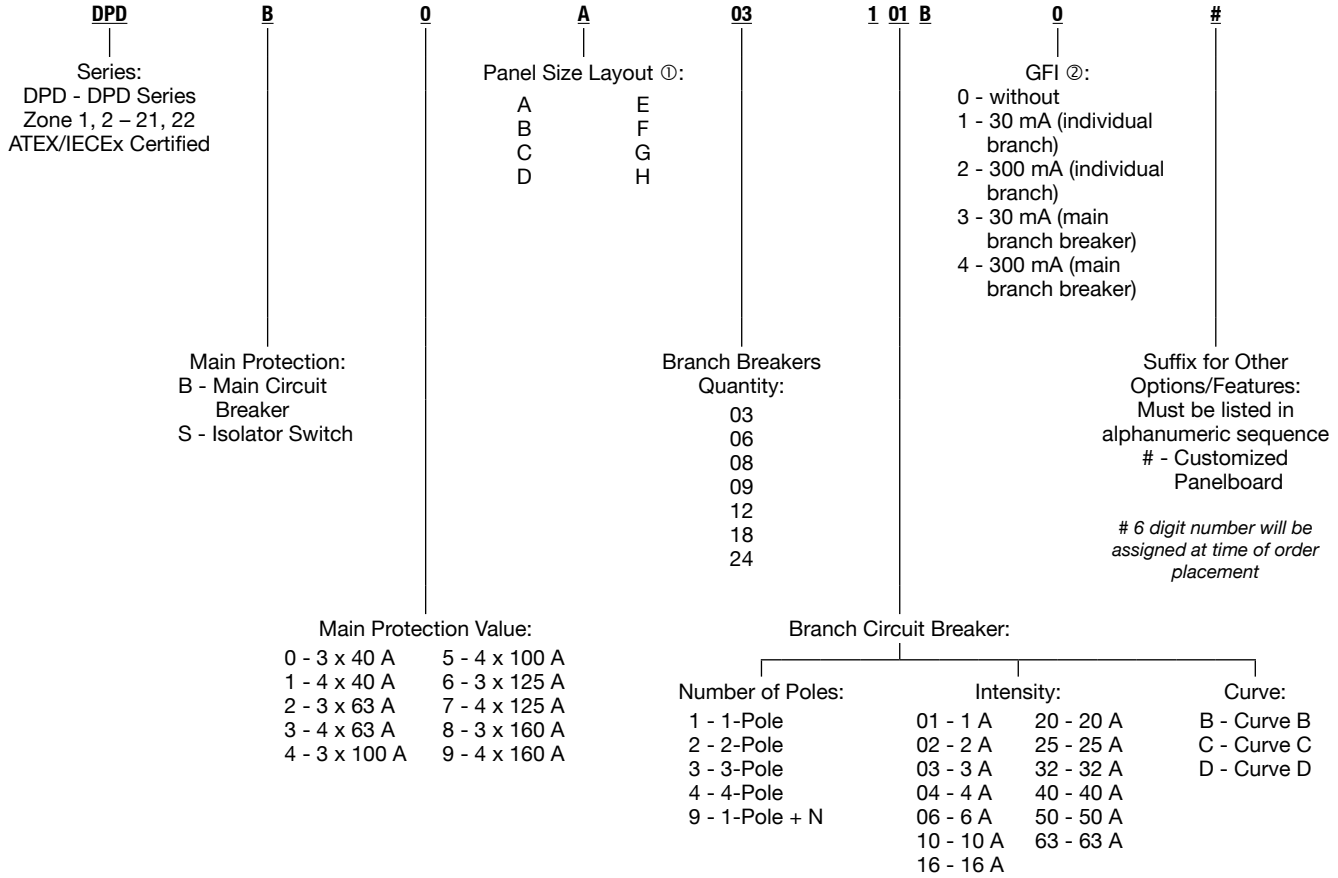

DISTRIBUTION EQUIPMENT: ATEX/IECEX INCREASED SAFETY PANELBOARDS



① See DPD Series Distribution Panelboard Dimensions page for panel size dimensions.  
 ② 1+N pole is not for use with GFI.



# ATX™ DPD Series Distribution Panelboards

## Flameproof

ATEX/IECEX:  
 Zone 1 and 2 – 21 and 22  
 II 2 GD  
 IP66/IK10

### Distribution Panelboard with Branch Circuit Breakers (for Lighting Circuits, etc.)

4-pole main isolator switch and 2-pole Branch Circuit Breakers Tripping Curve C wired on terminals.

Type	Main Switch	Branch Circuit Breakers 2P – Curve C		Layout Panel	Cable Entries	Volume dm <sup>3</sup> (in <sup>3</sup> )	Weight kg (lb)	Catalog Number
		Quantity	Rating					
CF50B	4 x 63 A	6	2P 16 A	A	1 x M32 - 6 x M20	100 (6102)	240 (529)	DPDS3A06216C0
CF60B	4 x 63 A	12	2P 16 A	B	1 x M32 - 12 x M20	150 (9154)	378 (833)	DPDS3B12216C0
CF70B	4 x 125 A	18	2P 16 A	C	1 x M40 - 18 x M20	180 (10984)	382 (942)	DPDS7C18216C0
CF70B	4 x 160 A	24	2P 16 A	D	1 x M50 - 24 x M20	180 (10984)	382 (942)	DPDS9D24216C0

### Distribution Panelboard with GFI Branch Circuit Breakers (for Heat Tracing Circuits, etc.)

4-pole main isolator switch and 1-pole + N branch circuit breakers with GFI Branch Circuit Breakers Tripping Curve C wired on terminals.

Type	Main Switch	Branch Circuit Breakers N by 2–Poles – Curve C		Layout Panel	Cable Entries	Volume dm <sup>3</sup> (in <sup>3</sup> )	Weight kg (lb)	Catalog Number
		Quantity	Rating					
CF50B	4 x 63 A	6	16 A/30 mA	E	1 x M32 - 6 x M20	100 (6102)	240 (529)	DPDS3E06916C1
CF60B	4 x 63 A	12	16 A/30 mA	F	1 x M32 - 12 x M20	150 (9154)	378 (833)	DPDS3F12916C1
CF70B	4 x 125 A	18	16 A/30 mA	G	1 x M40 - 18 x M20	180 (10984)	382 (942)	DPDS7G18916C1
CF70B	4 x 160 A	20	16 A/30 mA	H	1 x M50 - 20 x M20	180 (10984)	382 (942)	DPDS9H20916C1

### Distribution Panelboard with GFI Branch Circuit Breakers (for Heat Tracing Circuits, etc.)

4-pole main isolator switch and 1-pole + N branch circuit breakers with GFI Branch Circuit Breakers Tripping Curve B wired on terminals.

Type	Main Switch	Branch Circuit Breakers N by 2–Poles – Curve B		Layout Panel	Cable Entries	Volume dm <sup>3</sup> (in <sup>3</sup> )	Weight kg (lb)	Catalog Number
		Quantity	Rating					
CF50B	4 x 63 A	6	16 A/30 mA	E	1 x M32 - 6 x M20	100 (6102)	240 (529)	DPDS3E06916B1
CF60B	4 x 63 A	12	16 A/30 mA	F	1 x M32 - 12 x M20	150 (9154)	378 (833)	DPDS3F12916B1
CF70B	4 x 125 A	18	16 A/30 mA	G	1 x M40 - 18 x M20	180 (10984)	382 (942)	DPDS7G18916B1
CF70B	4 x 160 A	20	16 A/30 mA	H	1 x M50 - 20 x M20	180 (10984)	382 (942)	DPDS9H20916B1

DISTRIBUTION EQUIPMENT: ATEX/IECEX INCREASED SAFETY PANELBOARDS



# ATX™ DPD Series Distribution Panelboard Wiring Diagram

Flameproof

ATEX/IECEX:  
Zone 1 and 2 – 21 and 22  
II 2 GD  
IP66/IK10

## Wiring Diagram

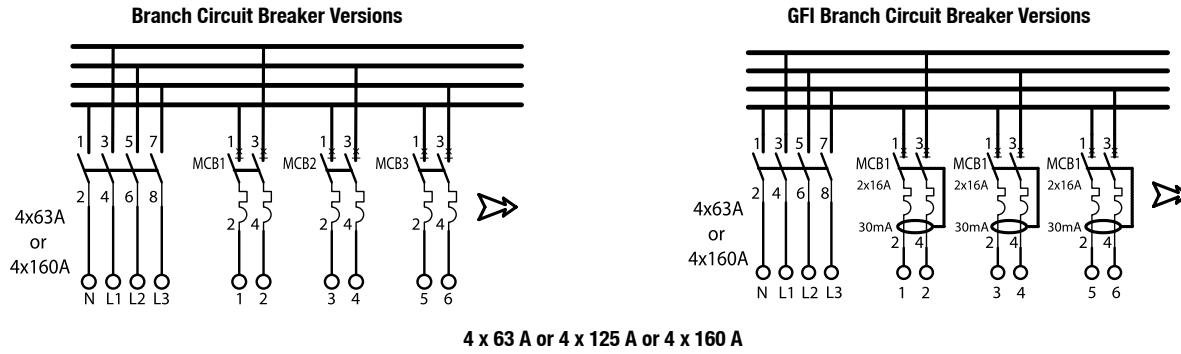

## Technical Data

Main Contacts	Incoming			GFI Branch Circuit Breaker Outgoing	
	63 Amps	125 Amps	160 Amps	16 A	
Rated Insulation Voltage (Ui)	690 V	800 V	800 V	400 Vac	
Rated Operating Voltage (Ue)	415 V/500 V/690 V	415 V/500 V/690 V	415 V/500 V/690 V	230/400 Vac	
Rated Operating Current (Ie)	63 A/63 A/40 A	125 A	160 A/160 A/125 A	16 A/30 amA	
Rated Surge Voltage (Uimp)	8 kV	8 kV	8 kV	4 kV	
Short Circuit Resistance (Icu)	50 kA (with fuse)	63 kA (with fuse)	80 kA (with fuse)	10 kA/400 V IEC 947.2	
Switching Capacity AC 21 A	415 V	63 A	125 A	160 A	—
	500 V	63 A	125 A	160 A	—
	690 V	63 A	125 A	160 A	—
Switching Capacity AC 22 A	415 V	63 A	125 A	160 A	—
	500 V	63 A	125 A	125 A	—
	690 V	40 A	80 A	100 A	—
Switching Capacity AC 23 A	415 V	63 A/30 kW	125 A/55 kW	125 A/75 kW	—
	500 V	63 A/30 kW	100 A/55 kW	100 A/75 kW	—
	690 V	40 A/30 kW	80 A/75 kW	80 A/75 kW	—
Termination (Flexible/Solid)	4 to 35 mm <sup>2</sup> /50 mm <sup>2</sup> (0.006 to 0.054 in <sup>2</sup> / 0.078 in <sup>2</sup> )	4 to 50 mm <sup>2</sup> /70 mm <sup>2</sup> (0.006 to 0.078 in <sup>2</sup> / 0.109 in <sup>2</sup> )	4 to 50 mm <sup>2</sup> /70 mm <sup>2</sup> (0.006 to 0.078 in <sup>2</sup> / 0.109 in <sup>2</sup> )	0.5 to 4 mm <sup>2</sup> /1.5 to 6 mm <sup>2</sup> (0.0008 to 0.006 in <sup>2</sup> / 0.002 to 0.009 in <sup>2</sup> )	

DISTRIBUTION EQUIPMENT: ATEX/IECEX INCREASED SAFETY PANELBOARDS

Appleton®

# ATX™ DPD Series Distribution Panelboard

## Flameproof

ATEX/IECEX:  
 Zone 1 and 2 – 21 and 22  
 II 2 GD  
 IP66/IK10

### Branch Circuit Breaker Version Dimensions in Millimeters (Inches)

Layout Panel A

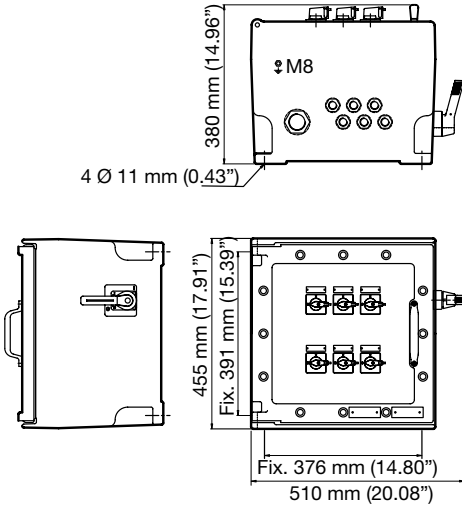

Layout Panel B

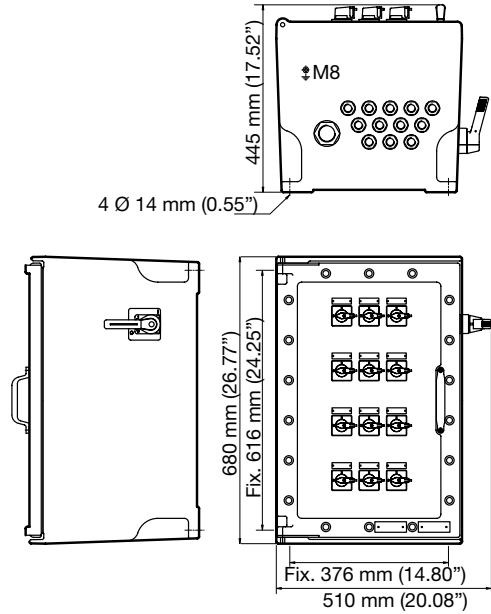

Layout Panel C

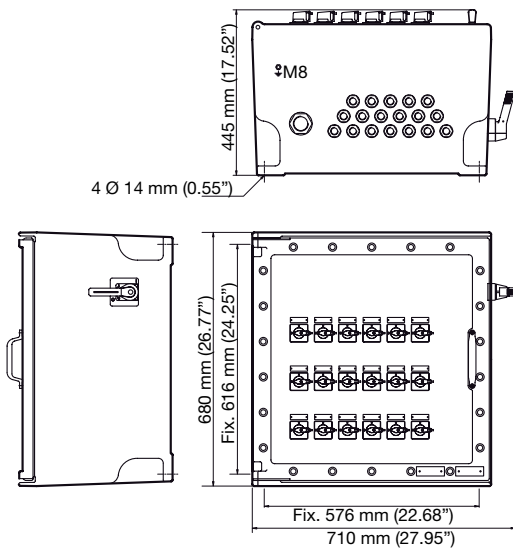

Layout Panel D

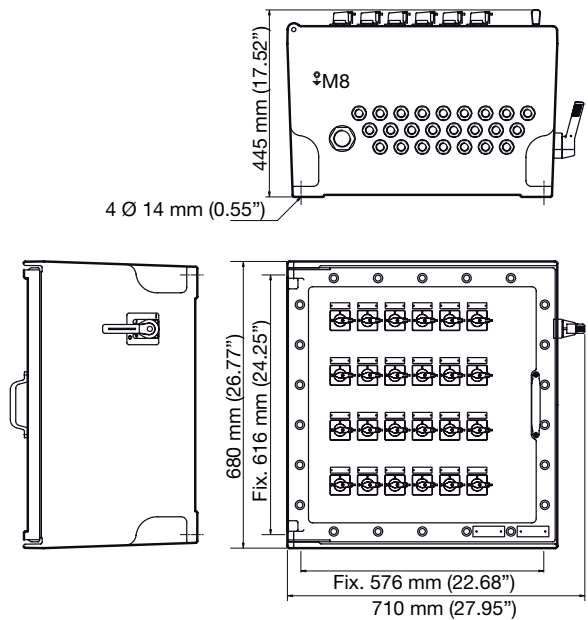

DISTRIBUTION EQUIPMENT: ATEX/IECEX INCREASED SAFETY PANELBOARDS



# ATX™ DPD Series Distribution Panelboard

## Flameproof

ATEX/IECEX:  
 Zone 1 and 2 – 21 and 22  
 II 2 GD  
 IP66/IK10

### GFI Branch Circuit Breaker Version Dimensions in Millimeters (Inches)

Layout Panel E

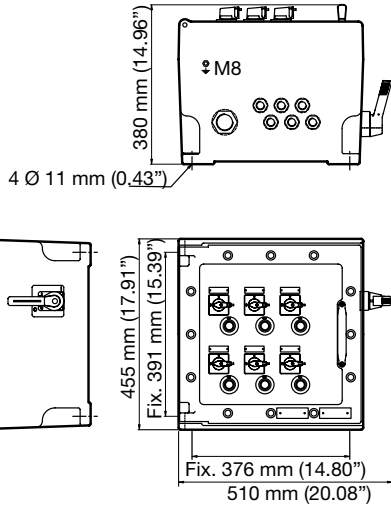

Layout Panel F

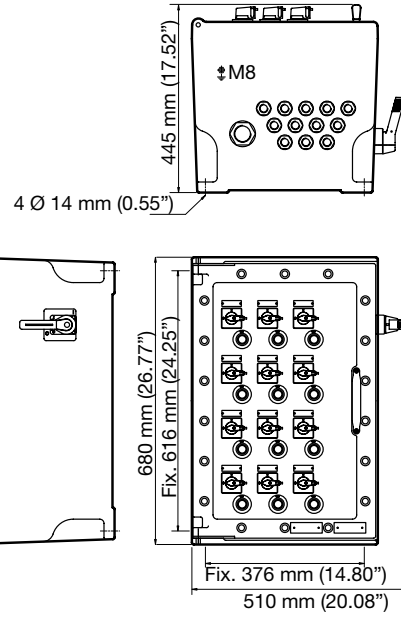

Layout Panel G

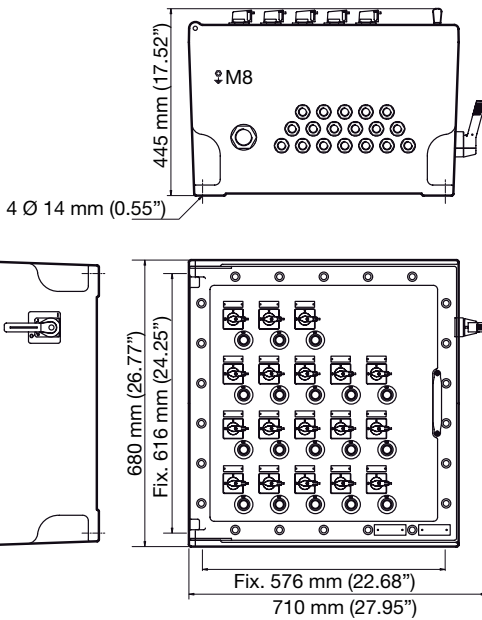

Layout Panel H

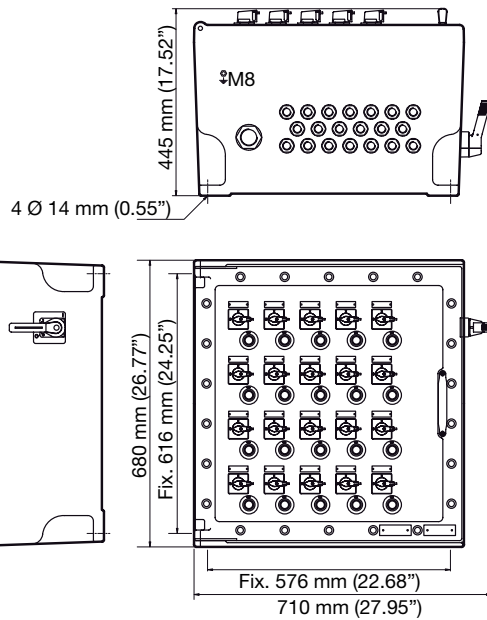

DISTRIBUTION EQUIPMENT: ATEX/IECEX INCREASED SAFETY PANELBOARDS



# Custom Switchracks: Built to Comply with NEC/CEC Standards

## From Design to Installation, Appleton is The Switchrack Authority

**NEC/CEC:**  
*Suitable for use in Class I, Division 1 and 2  
Locations*

With over 80 years in the industry, Appleton is one of the first and the most respected names in custom switchracks for hazardous and adverse locations. Designed for safety and performance, they are built to customer specifications. As a result, every Appleton switchrack offers an innovative, unique solution to the challenges of complex motor control localization.

Beginning in 1935, Appleton has developed its capabilities with attention to the customer's key concerns:

- Custom Design
- Quality Components
- Turnkey Fabrication
- Guaranteed Satisfaction

Together, these qualify Appleton as the Switchrack Authority. It is a hard-earned reputation the company is committed to uphold.

### Customer Design

- The demands of your application are unique. Your switchrack should be too. That's why Appleton engineers use your specifications and engineering drawings as well as all applicable codes and standards to design your custom switchrack solution. It's the only way to guarantee the switchrack will meet your needs today... and tomorrow.
- Through experience, Appleton has learned the value of staying on the cutting edge of design technology. The company's AutoCad workstations allow design files to be shared with your in-house engineers for quick revisions. This saves time and money and it means your switchrack will be up and running faster.

### Quality Components

- Appleton stocks one of the most extensive lines of adverse environment enclosures and accessories in the electrical industry to ensure prompt turnaround of every switchrack order.
- Rigid quality standards mean Appleton components stand up to the harshest applications. Only the highest grade steel and aluminum is used in construction. Testing prior to installation guarantees the quality you expect from the Switchrack Authority, Appleton.

### Turnkey Fabrication

- Every Appleton switchrack is engineered, fabricated and assembled in-house by qualified technicians. This single-source approach allows Appleton complete control over the manufacturing process.
- Following a series of rugged performance examinations, each Appleton switchrack is shipped via Exclusive Use Carrier for immediate field installation.

### Guaranteed Satisfaction

- Appleton's involvement doesn't end with the purchase order. The company backs its switchracks with an exclusive factory warranty. Should any Appleton component fail due to mechanical or electrical defect, Appleton will replace the part for up to one year following installation, or 18 months after shipment.

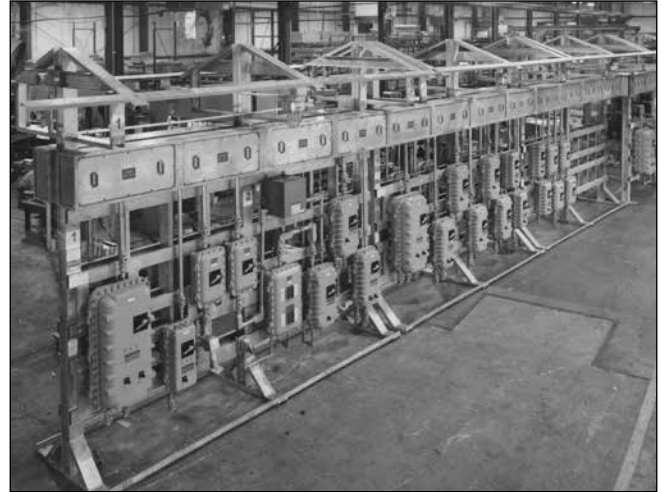

# Custom Switchracks: Built to Comply with NEC/CEC Standards

From Design to Installation, Appleton is The Switchrack Authority

NEC/CEC:  
Suitable for use in Class I, Division 1 and 2  
Locations

## Application

- Appleton switchracks provide complete motor control assemblies in one integrated package. Choose the necessary Appleton components to fit the rating, electrical switching and controlling requirements.

## Features

- Single source responsibility, including engineering, designing, wiring and testing of all components.
- Fabricated and wired to custom specifications.
- Only job site requirements are connection of incoming power to the main bus and load side connections.
- UL Listed bus up to 1500 Amp. For larger requirements, please contact your local representative.
- Heavy grade steel or aluminum frame with all welded construction.

## Optional Components

- Circuit breakers
- Motor starters
- Contactors
- Junction boxes
- Control stations
- Meter/instrument enclosures
- Ground detection
- Panelboards
- Welding and convenience receptacles
- Photo cells
- Light fixtures
- Transformers

## Standard Materials

- Structure: galvanized steel or aluminum
- Bus duct: galvanized steel, aluminum or stainless steel
- Corrugated canopy: galvanized steel or aluminum

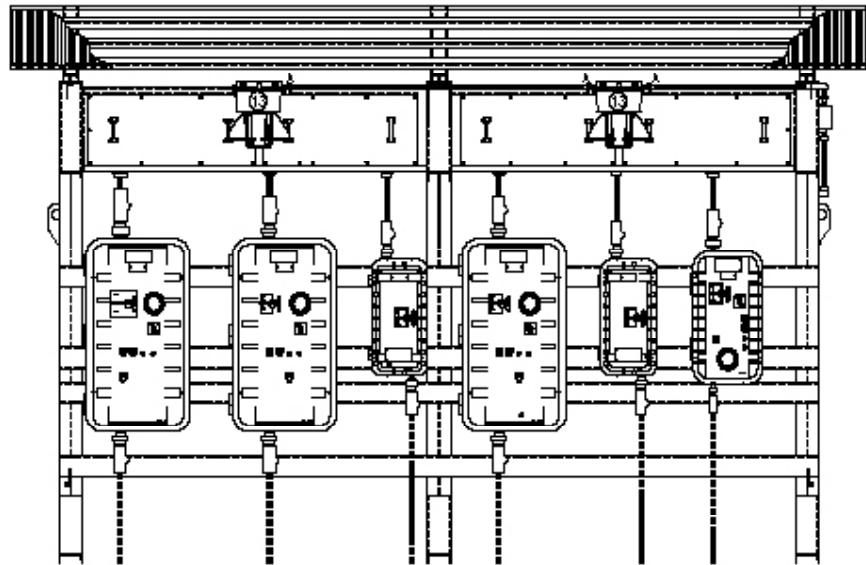
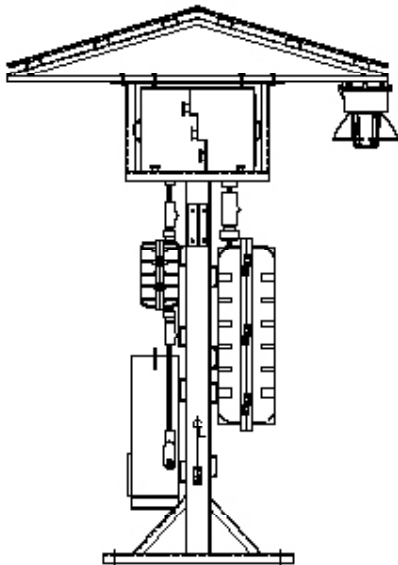
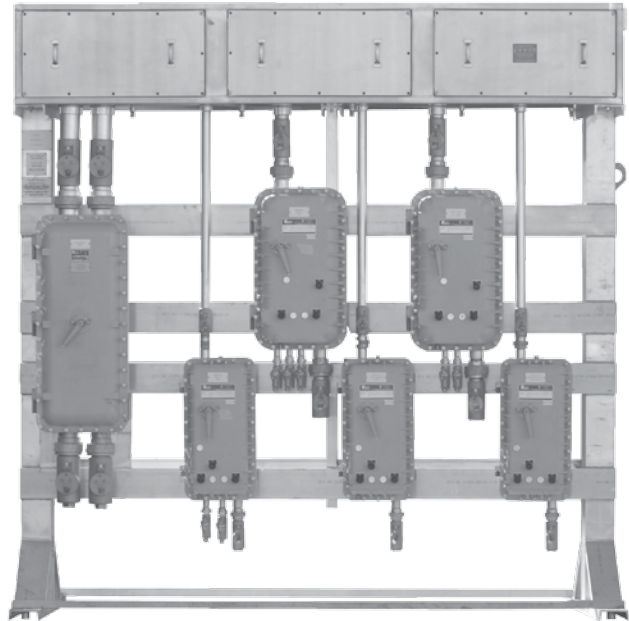

# Custom Switchracks: Built to Comply with NEC/CEC Standards

## Custom Switchrack Data Sheet

NEC/CEC:  
Suitable for use in Class I, Division 1 and 2  
Locations

### Customer Information

Date: \_\_\_\_\_ Quote Number: \_\_\_\_\_  
 Customer: \_\_\_\_\_ Revision: \_\_\_\_\_  
 Location: \_\_\_\_\_ Project Name: \_\_\_\_\_

Area Classification						
<b>Class I</b>	<input type="checkbox"/> Division 1	<input type="checkbox"/> Division 2	<b>Group</b>	<input type="checkbox"/> B	<input type="checkbox"/> C	<input type="checkbox"/> D
<b>Class II</b>	<input type="checkbox"/> Division 1	<input type="checkbox"/> Division 2	<b>Group</b>	<input type="checkbox"/> E	<input type="checkbox"/> F	<input type="checkbox"/> G
<b>Unclassified</b>	<input type="checkbox"/> Outdoor	<input type="checkbox"/> Indoor				
Power Source						
<b>Voltage</b>	<input type="checkbox"/> 120 Vac	<input type="checkbox"/> 240 Vac	<input type="checkbox"/> 380 Vac	<input type="checkbox"/> 480 Vac	<input type="checkbox"/> 575 Vac	<input type="checkbox"/> 600 Vac
<b>Phase</b>	<input type="checkbox"/> Single	<input type="checkbox"/> Three				
<b>Wire</b>	<input type="checkbox"/> 3	<input type="checkbox"/> 4				
Structure						
<b>Material</b>	<input type="checkbox"/> Steel-Galvanized	<input type="checkbox"/> Aluminum				
<b>Design</b>	<input type="checkbox"/> Single Sided	<input type="checkbox"/> Double Sided	<input type="checkbox"/> Single Row	<input type="checkbox"/> Double Row		
Bus Ducts <input type="checkbox"/> Required <input type="checkbox"/> Not Required						
<b>Amp Rating</b>	<input type="checkbox"/> 250 Amp	<input type="checkbox"/> 500 Amp	<input type="checkbox"/> 750 Amp	<input type="checkbox"/> 1000 Amp	<input type="checkbox"/> 1250 Amp	<input type="checkbox"/> 1500 Amp
<b>Material</b>	<input type="checkbox"/> Stainless Steel	<input type="checkbox"/> Steel-Galvanized	<input type="checkbox"/> Aluminum			
<b>Certification</b>	<input type="checkbox"/> UL	<input type="checkbox"/> Non-UL	<input type="checkbox"/> NEMA 3R	<input type="checkbox"/> NEMA 4	<input type="checkbox"/> NEMA 4X	
<b>Type</b>	<input type="checkbox"/> Single Access	<input type="checkbox"/> Dual Access				
<b>Copper Bus Plating</b>	<input type="checkbox"/> Silver	<input type="checkbox"/> Tin				
<b>Bracing</b>	<input type="checkbox"/> 14,000 AIC	<input type="checkbox"/> 22,000 AIC	<input type="checkbox"/> 25,000 AIC	<input type="checkbox"/> 42,000 AIC	<input type="checkbox"/> 65,000 AIC	<input type="checkbox"/> 100,000 AIC
<b>Options</b>	<input type="checkbox"/> Insulated	<input type="checkbox"/> PEM Inserts	<input type="checkbox"/> Weep Holes			
	<input type="checkbox"/> Space Heater	<input type="checkbox"/> Thermostat	<input type="checkbox"/> Drains			
Corrugated Canopy Material <input type="checkbox"/> Required <input type="checkbox"/> Not Required						
	<input type="checkbox"/> Steel-Galvanized	<input type="checkbox"/> Aluminum				
Conduit and Fittings						
	<input type="checkbox"/> Galvanized	<input type="checkbox"/> Aluminum	<input type="checkbox"/> PVC Coated	<input type="checkbox"/> Drain Seals		
Wire Type — Copper, +90 °C (+194 °F)						
<b>Insulation</b>	<input type="checkbox"/> THW	<input type="checkbox"/> THHN	<input type="checkbox"/> THWN	<input type="checkbox"/> THH	<input type="checkbox"/> RHH	<input type="checkbox"/> RHW
	<input type="checkbox"/> XHHW	<input type="checkbox"/> XLPE	<input type="checkbox"/> SIS			

# Custom Switchracks: Built to Comply with NEC/CEC Standards

## Custom Switchrack Data Sheet

NEC/CEC:  
Suitable for use in Class I, Division 1 and 2  
Locations

Component Requirements						
Manufacturer	<input type="checkbox"/> General Electric	<input type="checkbox"/> Square D	<input type="checkbox"/> Cutler-Hammer	<input type="checkbox"/> Allen-Bradley	<input type="checkbox"/> Other	
Component Accessories						
<input type="checkbox"/> Fuses	<input type="checkbox"/> Thermal Board	<input type="checkbox"/> Relays	<input type="checkbox"/> Breather/Drain	<input type="checkbox"/> Stop Push Button	<input type="checkbox"/> Start Push Button	<input type="checkbox"/> HOA Switch
<input type="checkbox"/> Name Plate	<input type="checkbox"/> Red Light	<input type="checkbox"/> Green Light	<input type="checkbox"/> CPT	<input type="checkbox"/> 100 Va Extra	<input type="checkbox"/> Ring Terminal	<input type="checkbox"/> Wire Markers
<input type="checkbox"/> AUX. Contact N.O., N.C.	<input type="checkbox"/> Space Heater	<input type="checkbox"/> Copper Lugs	<input type="checkbox"/> Surge Protector	<input type="checkbox"/> Hi-Break Circuit Breaker		
Optional Components						

Please provide a list of items (including your company's specifications) that the rack will support including quantities and sizes:

Motor Starters: \_\_\_\_\_

Lighting: \_\_\_\_\_

Breakers: \_\_\_\_\_

Transformers: \_\_\_\_\_

Receptacles: \_\_\_\_\_

Ground Indicators: \_\_\_\_\_

Panelboards: \_\_\_\_\_

Control Stations: \_\_\_\_\_

Disconnect Switches: \_\_\_\_\_



# Custom Switchracks: Built to Comply with NEC/CEC Standards

## Estimating Custom Switchrack Weight

NEC/CEC:  
Suitable for use in Class I, Division 1 and 2  
Locations

Add device weight and structure weight from the following tables:

### Combination Starters

Size	Bolted Weight kg (lb)	Threaded Weight kg (lb)
1	56.7 (125)	31.8 (70)
2	59.0 (130)	49.9 (110)
3	88.5 (195)	59.0 (130)
4	90.7 (200)	61.2 (135)
5	254.0 (560)	224.5 (495)
6	362.9 (800)	Not Available

### Transformers

1 Phase	2 Phase	Weight kg (lb)
5 kVA	6 kVA	54.4 (120)
10 kVA	9 kVA	106.6 (235)
15 kVA	15 kVA	136.1 (300)
25 kVA	30 kVA	299.4 (660)
	45 kVA	340.2 (750)

### Circuit Breakers

Size	Bolted Weight kg (lb)	Threaded Weight kg (lb)
EA 150 AF/50AT	15.0 (33)	18.1 (40)
EB 150 AF/100AT	17.2 (38)	18.1 (40)
EC 150 AF/150AT	43.5 (96)	39.9 (88)
EE 225 A Frame	45.8 (101)	95.3 (210)
EF 400 A Frame	66.7 (147)	Not Available
ED 600 A Frame	99.8 (220)	99.8 (220)
EL 800 A Frame	154.2 (340)	Not Available
EG 1200 A Frame	256.3 (565)	Not Available

### Structure

Switchrack Type	Aluminum kg (lb)	Steel kg (lb)	Weight per
Division 2, Single Row	22.7 (50)	45.4 (100)	Foot
Division 2, Double Row	29.5 (65)	59.0 (130)	Foot
Division 1, Single Row	22.7 (50)	45.4 (100)	Foot
Canopy, Corrugated	11.3 (25)	22.7 (50)	Foot
Incoming End Cable Box	22.7 (50)	45.4 (100)	Each

### Miscellaneous Items

Description	Weight kg (lb)
12 Circuit LTG Panelboard	83.9 (185)
18 Circuit LTG Panelboard	88.5 (195)
24 Circuit LTG Panelboard	127.0 (280)
30 Circuit LTG Panelboard	131.5 (290)
HPS Light Fixture	11.3 (25)
120 Vac Receptacle	4.5 (10)
60 AMP Welding Receptacle	13.6 (30)
Photocell, 120 Vac	2.3 (5)

# Custom Switchracks: Built to Comply with NEC/CEC Standards

From Design to Installation, Appleton is The Switchrack Authority

NEC/CEC:  
Suitable for use in Class I, Division 1 and 2  
Locations

Appleton

DISTRIBUTION EQUIPMENT: NEC/CEC SWITCHRACKS

Typical Single Access, Single Sided, Single Row Switchrack with Canopy Dimensions in Millimeters (Inches)

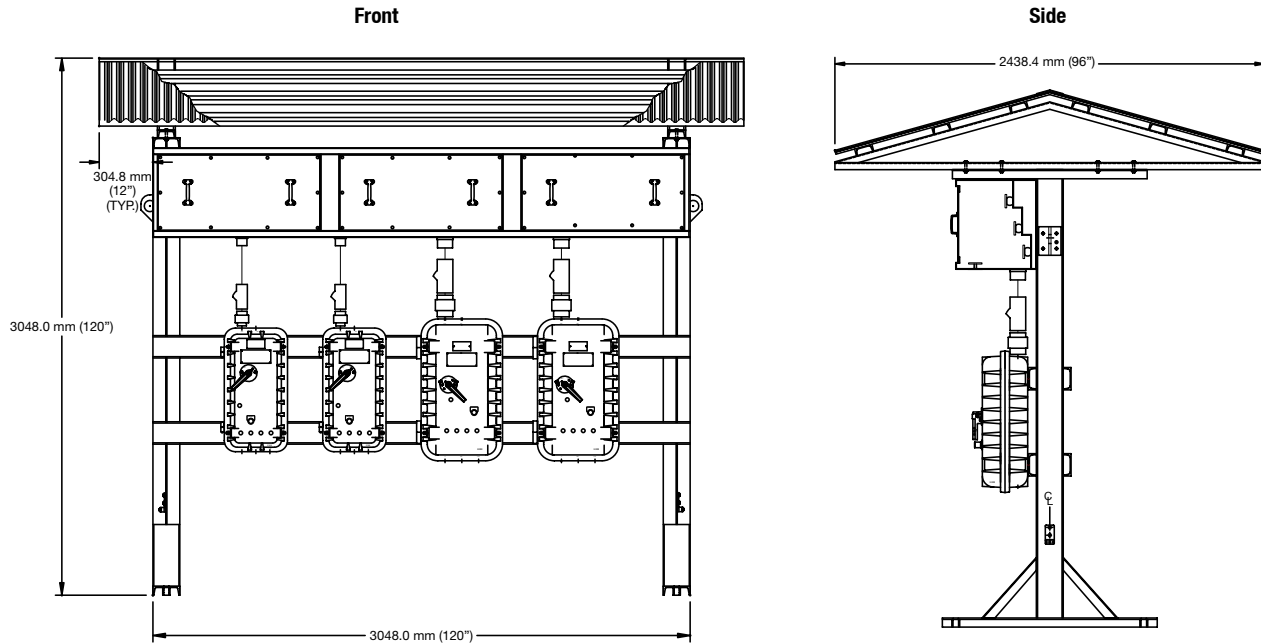

Typical Dual Access, Double Sided, Double Row Switchrack With Canopy

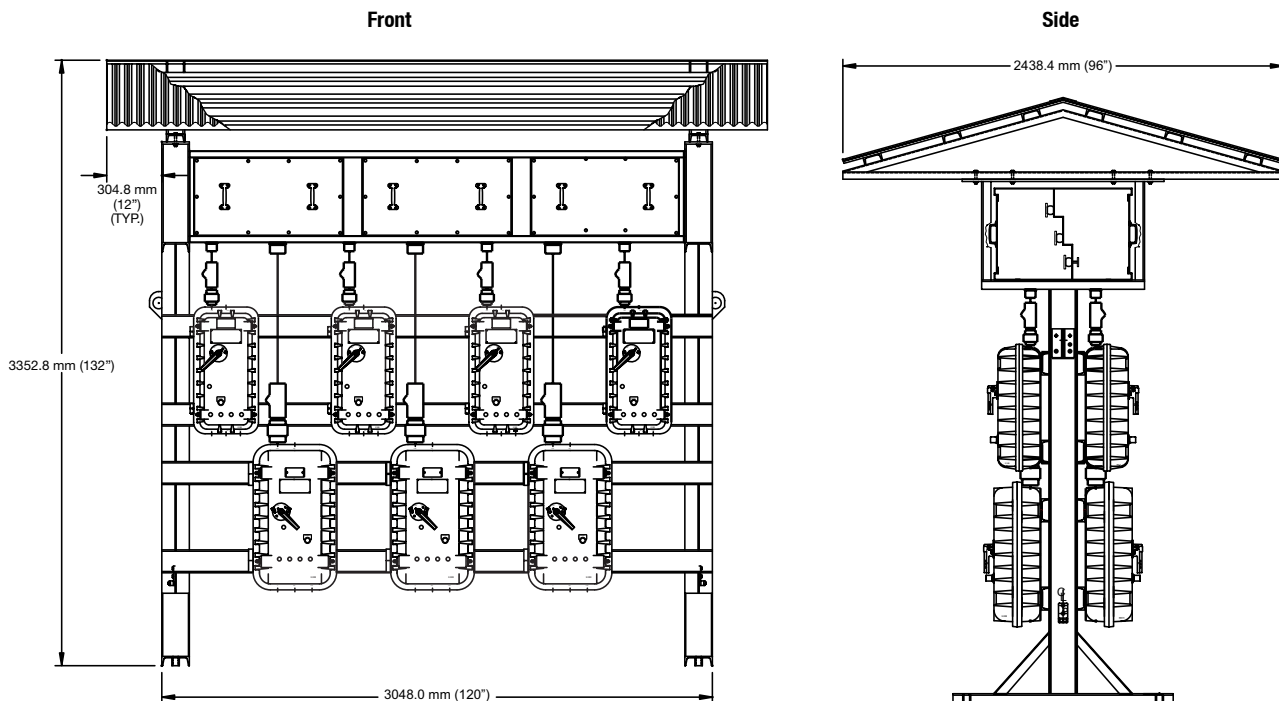

# PlexPower™ Portable Power Switchracks

## NEC/CEC:

Class I Division 2, Groups B, C, D  
Class I Zone 1 A/Exde IIB and H<sub>2</sub>, T6  
Type 3R, Type 4X, IP66

## Applications

- Portable power switchracks provide temporary portable power for indoor or outdoor hazardous locations such as:
  - Petroleum plants
  - Chemical plants
  - Refineries
- Ideal for bringing power to remote locations during plant shutdowns.
- Limitless flexibility with number of circuits and receptacle combinations.

## Features

- Component level protection on the PlexPower™ breaker enclosures and receptacles negating the need for conduit or cable seal fittings.
- GFI ground fault circuit breakers factory wired to U-Line 120 Vac receptacles.
- Standard off the shelf replaceable Cutler-Hammer breakers allow for ease of replacement when required.
- Breaker actuation can be either internal or external.
- Bright safety yellow powder coat textured finish makes units easily identifiable.
- Circuit breakers available in 1-, 2- or 3-pole up to 150 Amp standard or with GFI (5 mA) or EPD (30 mA) protection.
- Light weight aluminum enclosure make this product ideal for clamping to temporary scaffold or other structures.
- Gasketed sheet aluminum enclosures equipped with rain and drip shield.
- Can be equipped with higher amperage receptacles up to 60 Amp.
- Portable power equipment on heavy duty castors using traditional cast enclosure is also available.
- Possible configurations and number and type of receptacles are endless

## Standard Materials

- Structure: steel-galvanized or aluminum
- Enclosures: 316L stainless steel, fiberglass reinforced polyester, sheet aluminum or sheet-steel
- Bus duct: stainless steel, steel-painted, steel-galvanized or aluminum
- Hardware: stainless steel

## Standard Finish

- Epoxy powder coat
- Natural finish

## Options

- External actuation
- LED breaker ON indicator lights

## NEC/CEC Certifications and Compliances

- UL Standard: 67, 1203, 1604
- UL Listed: 60079-0, 7, 1
- CSA Standard: C22.2 Nos 29, 213
- CSA Certified: 1788693

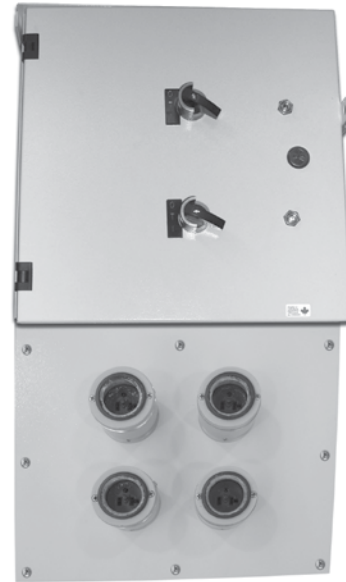

Shown with PlexPower™ External Actuating Enclosed Circuit Breaker and Receptacles

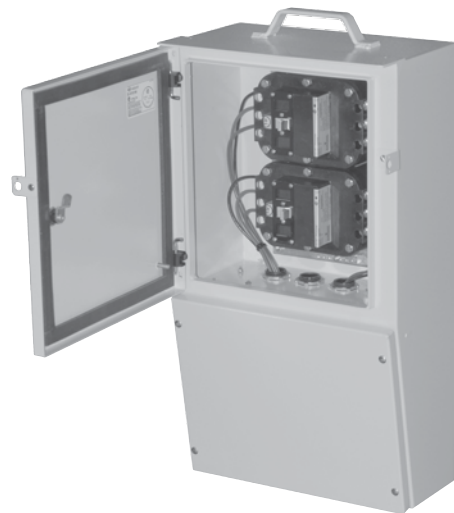

Shown Open with PlexPower™ Breaker Enclosures

# Portable Power Carts for Ordinary and Hazardous Locations

## Custom Design

**NEC/CEC:**  
Suitable for use in Class I, Division 1 and 2  
Locations

Portable Power Carts are made to order per your specifications. Contact your local Appleton representative to create your design, receive a quotation and for availability information.

### Application

- Provides a means of portable power indoors or outdoors in hazardous or non-hazardous locations.

### Features

- Designed to your specification.
- Wide choice of equipment:
  - Panelboards
  - Control stations
  - Plugs and receptacles
  - Junction and terminal boxes
- UL Listed and CSA Certified devices and fittings.
- Easy glide, lockable casters provide easy transportation.

### Standard Materials/Finishes

- Structure: steel/galvanized or aluminum/natural

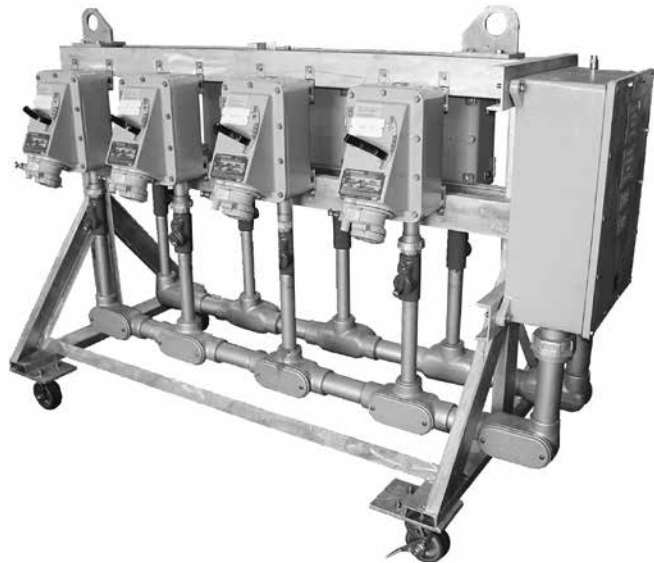

## Illustrated Example of Custom Designed Products

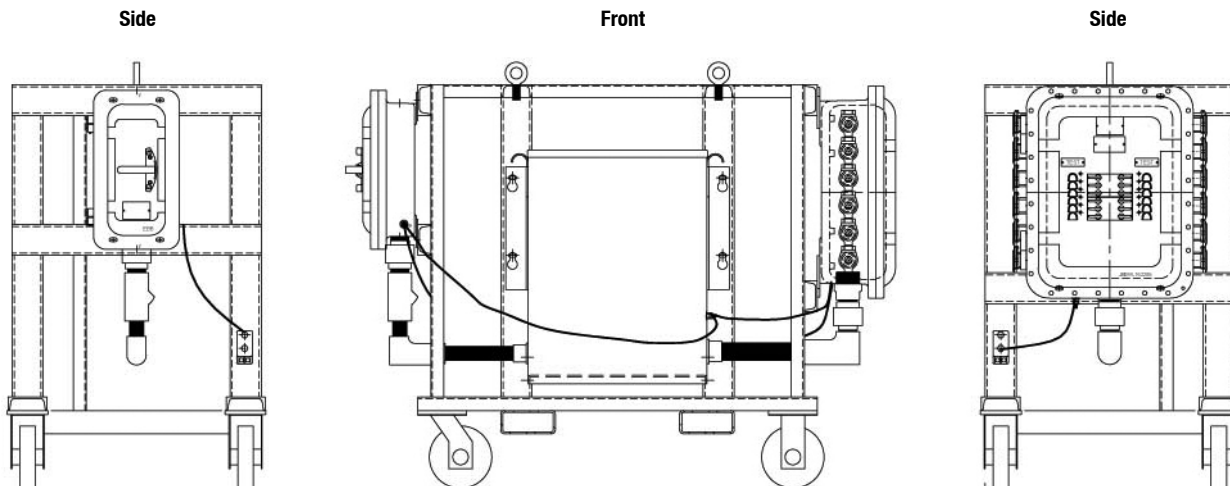

# Custom Switchracks:

## Built to Comply with ATEX/IEC Standards and Certifications

### From Design to Installation, Manufactured Switchracks to Your Specifications

ATEX/IECEX:  
Zones 0, 1 and 2 – 20, 21 and 22

Designed for safety and performance and built to customer specifications. Every switchrack offers an innovative, unique solution to the challenges of complex motor control localization. Our custom switchracks for CENELEC/IEC governed locations comply with Directive 94/9 EC and Directive 99/92 CE. Both important European directives concerning electrical equipment for potentially explosive atmospheres.

We have developed our capabilities with attention to the customer's key concerns:

- Custom Design
- Quality Components
- Turnkey Fabrication
- Guaranteed Satisfaction

#### Customer Design

- The demands of your application are unique. Your switchrack should be too. That's why our engineers use your specifications and engineering drawings as well as all applicable codes and standards to design your custom switchrack solution. It's the only way to guarantee the switchrack will meet your needs today... and tomorrow.
- Through experience, we have learned the value of staying on the cutting edge of design technology. The company's AutoCad workstations allow design files to be shared with your in-house engineers for quick revisions. This saves time and money and it means your switchrack will be up and running faster.

#### Quality Components

- Appleton stocks one of the most extensive lines of adverse environment enclosures and accessories in the electrical industry to ensure prompt turnaround of every switchrack order.
- Rigid quality standards mean our components stand up to the harshest applications. Only the highest grade steel and aluminum is used in construction. Testing prior to installation guarantees the quality you expect.

#### Turnkey Fabrication

- Every switchrack is engineered, fabricated and assembled in-house by qualified technicians. This single-source approach allows us complete control over the manufacturing process.
- Following a series of rugged performance examinations, each switchrack is shipped via Exclusive Use Carrier for immediate field installation.

#### Guaranteed Satisfaction

- Appleton's involvement doesn't end with the purchase order. The company backs its switchracks with an exclusive factory warranty. Should any component fail due to mechanical or electrical defect, we will replace the part for up to one year following installation, or 18 months after shipment.

#### Application

- Switchracks provide complete motor control assemblies in one integrated package. Choose the necessary components to fit the rating, electrical switching and controlling requirements.
- Switchracks are available for Zones 0, 1 and 2 and 20, 21 and 22 gas and dust environments. Built for indoor and/or outdoor locations.
- Determine hazardous areas
- Defining Zone boundaries - volumes
  - If necessary, delimiting Zones
- Know the characteristics of flammable substances present on the site



- Defining the Temperature Class and the explosion group of the equipment
- Choose equipment depending on :
  - the Temperature Class and the explosion group,
  - environmental constraints specific to the site - corrosion, exposure to UV, mechanical strength,
  - protection indexes

#### Features

- Single source responsibility, including engineering, designing, wiring and testing of all components.
- Fabricated and wired to custom specifications.
- Only job site requirements are connection of incoming power to the main bus and load side connections.

#### Optional Components

- Circuit breakers
- Motor starters
- Contactors
- Junction boxes
- Control stations
- Meter/instrument enclosures
- Ground detection
- Panelboards
- Receptacles
- Photo cells
- Light fixtures
- Transformers

#### Standard Materials

- Structure: steel-painted, steel-galvanized or aluminum.
- Bus duct/conduit: steel-painted, galvanized aluminum or stainless steel.
- Canopy/roof: steel-galvanized or aluminum.

Appleton®

DISTRIBUTION EQUIPMENT: ATEX/IECEX SWITCHRACKS

# Custom Switchracks:

## Built to Comply with ATEX/IEC Standards and Certifications

From Design to Installation, Manufactured Switchracks to Your Specifications

ATEX/IECEX:  
Zones 0, 1 and 2 – 20, 21 and 22

### Customer Information

Date: \_\_\_\_\_ Quote Number: \_\_\_\_\_  
 Customer: \_\_\_\_\_ Revision: \_\_\_\_\_  
 Location: \_\_\_\_\_ Project Name: \_\_\_\_\_

Area Classification						
<b>Zone</b>	<input type="checkbox"/> Zone 1	<input type="checkbox"/> Zone 2	<input type="checkbox"/> Zone 21	<input type="checkbox"/> Zone 22		
<b>Group</b>	<input type="checkbox"/> Group IIA	<input type="checkbox"/> Group IIB	<input type="checkbox"/> Group IIC			
Certifications						
<b>Certifications</b>	<input type="checkbox"/> IEC	<input type="checkbox"/> IECEX	<input type="checkbox"/> ATEX			
Power Source						
<b>Voltage</b>	<input type="checkbox"/> 120 Vac	<input type="checkbox"/> 240 Vac	<input type="checkbox"/> 380 Vac	<input type="checkbox"/> 480 Vac	<input type="checkbox"/> 575 Vac	<input type="checkbox"/> 600 Vac
<b>Phase</b>	<input type="checkbox"/> Single	<input type="checkbox"/> Three	<b>Hertz</b>		<input type="checkbox"/> 50 Hz	<input type="checkbox"/> 60 Hz
Structure						
<b>Material</b>	<input type="checkbox"/> Steel-Painted	<input type="checkbox"/> Aluminum				
<b>Design</b>	<input type="checkbox"/> Single Sided	<input type="checkbox"/> Double Sided	<input type="checkbox"/> Single Row	<input type="checkbox"/> Double Row		
Bus Ducts						<input type="checkbox"/> Required <input type="checkbox"/> Not Required
<b>Material</b>	<input type="checkbox"/> Steel-Painted	<input type="checkbox"/> Steel-Galvanized	<input type="checkbox"/> Aluminum	<input type="checkbox"/> Stainless Steel		
<b>Certification</b>	<input type="checkbox"/> IEC	<input type="checkbox"/> IECEX	<input type="checkbox"/> ATEX			
<b>Type</b>	<input type="checkbox"/> Single Access	<input type="checkbox"/> Dual Access				
<b>Cooper Bus Plating</b>	<input type="checkbox"/> Silver	<input type="checkbox"/> Tin				
<b>Bracing</b>	<input type="checkbox"/> 14,000 AIC	<input type="checkbox"/> 22,000 AIC	<input type="checkbox"/> 25,000 AIC	<input type="checkbox"/> 42,000 AIC	<input type="checkbox"/> 65,000 AIC	<input type="checkbox"/> 100,000 AIC
<b>Options</b>	<input type="checkbox"/> Insulated	<input type="checkbox"/> Silver Plated	<input type="checkbox"/> Tin Plated	<input type="checkbox"/> PEM Inserts	<input type="checkbox"/> Glyptol	<input type="checkbox"/> Weep Holess
	<input type="checkbox"/> Space Heater	<input type="checkbox"/> Thermostat	<input type="checkbox"/> Drains			
Corrugated Canopy Material						<input type="checkbox"/> Required <input type="checkbox"/> Not Required
	<input type="checkbox"/> Steel-Galvanized	<input type="checkbox"/> Aluminum	<input type="checkbox"/> Fiberglass Reinforced Polyester (FRP)			
Conduit and Fittings						
	<input type="checkbox"/> Galvanized	<input type="checkbox"/> Aluminum	<input type="checkbox"/> PVC Coated	<input type="checkbox"/> Drain Seals		
Wire Type — Copper, +90 °C (+194 °F)						
<b>Insulation</b>	<input type="checkbox"/> XLPE	<input type="checkbox"/> EPR	<input type="checkbox"/> PVC			
Component Requirements						
<b>Manufacturer</b>	<input type="checkbox"/> General Electric	<input type="checkbox"/> Square D	<input type="checkbox"/> Cutler-Hammer	<input type="checkbox"/> Allen-Bradley	<input type="checkbox"/> Other	
<b>Circuit Breaker</b>	<input type="checkbox"/> Thermal-Mag	<input type="checkbox"/> Mag-Only	<input type="checkbox"/> Non-Auto	<input type="checkbox"/> Other		

Appleton

DISTRIBUTION EQUIPMENT: ATEX/IECEX SWITCHRACKS

# Custom Switchracks:

## Built to Comply with ATEX/IEC Standards and Certifications

From Design to Installation, Manufactured Switchracks to Your Specifications

*ATEX/IECEX:  
Zones 0, 1 and 2 – 20, 21 and 22*

Component Accessories						
<input type="checkbox"/> Fuses	<input type="checkbox"/> Thermal Board	<input type="checkbox"/> Relays	<input type="checkbox"/> Breather/Drain	<input type="checkbox"/> Stop Push Button	<input type="checkbox"/> Start Push Button	<input type="checkbox"/> HOA Switch
<input type="checkbox"/> Name Plate	<input type="checkbox"/> Red Light	<input type="checkbox"/> Green Light	<input type="checkbox"/> CPT	<input type="checkbox"/> 100 Vac Extra	<input type="checkbox"/> Ring Terminal	<input type="checkbox"/> Wire Markers
<input type="checkbox"/> AUX. Contact N.O., N.C.	<input type="checkbox"/> Space Heater	<input type="checkbox"/> Copper Lugs	<input type="checkbox"/> Surge Protector	<input type="checkbox"/> Hi-Break Circuit Breaker		

Optional Components
---------------------

Please provide a list of items (including your company's specifications) that the rack will support including quantities and sizes:

Motor Starters: \_\_\_\_\_

Lighting: \_\_\_\_\_

Breakers: \_\_\_\_\_

Transformers: \_\_\_\_\_

Receptacles: \_\_\_\_\_

Ground Indicators: \_\_\_\_\_

Panelboards: \_\_\_\_\_

Control Stations: \_\_\_\_\_

Disconnect Switches: \_\_\_\_\_



DISTRIBUTION EQUIPMENT: ATEX/IECEX SWITCHRACKS

# Notes

---

NOTES

 **Appleton**



# Notes

---

NOTES

 **Appleton**

# Notes

---

NOTES

 **Appleton**

# Notes

---

NOTES

 **Appleton**

# Notes

---

NOTES

 **Appleton**

# Notes

---

NOTES

 **Appleton**

# Notes

---

NOTES

 **Appleton**

# Notes

---

NOTES

 **Appleton**

# Notes

---

NOTES

 **Appleton**



# Notes

---

NOTES

 **Appleton**

# Notes

---

NOTES

 **Appleton**



# Engineered for safety and reliability in corrosive environments and hazardous atmospheres.



Appleton and O-Z/Gedney are the cornerstone brands of Emerson's Electrical Apparatus and Lighting business; trusted worldwide to make electrical installations safer, more productive and more reliable.

#### United States (Headquarters)

Appleton Grp LLC  
9377 W. Higgins Road  
Rosemont, IL 60018  
United States  
T +1 800 621 1506

#### Europe

ATX SAS  
Espace Industriel Nord  
35, rue André Durouchez,  
CS 98017  
80084 Amiens Cedex 2, France  
T +33 3 2254 1390

#### Canada

EGS Electrical Group Canada Ltd.  
99 Union Street  
Elmira ON, N3B 3L7  
Canada  
T +1 888 765 2226

#### Asia Pacific

EGS Private Ltd.  
Block 4008, Ang Mo Kio Ave 10,  
#04-16 TechPlace 1,  
Singapore 569625  
T +65 6556 1100

#### Latin America

EGS Comercializadora Mexico S  
de RL de CV  
Calle 10 N°145 Piso 3  
Col. San Pedro de los Pinos  
Del. Álvaro Obregon  
Ciudad de México. 01180  
T +52 55 5809 5049

#### Australia Sales Office

Bayswater, Victoria  
T +61 3 9721 0348

#### China Sales Office

Shanghai  
T +86 21 3338 7000

#### Middle East Sales Office

Dammam, Saudi Arabia  
T +966 13 510 3702

#### Chile Sales Office

Las Condes  
T +56 2928 4819

#### India Sales Office

Chennai  
T +91 44 3919 7300

#### Korea Sales Office

Seoul  
T +82 2 3483 1555



Emerson.com



LinkedIn.com/company/emerson

The Emerson logo is a trademark and service mark of Emerson Electric Co. © 2016 Emerson Electric Co. Appleton and O-Z/Gedney brand logos are registered trademarks of Appleton Grp LLC. All other marks are the property of their respective owners. © 2016 Emerson Automation Solutions. All rights reserved.



# EMERSON. CONSIDER IT SOLVED.™