



EC&M Catalog



BURNDY

Experience. Technology. Answers.

BURNDY® offers a variety of products and solutions to serve the following industries: data centers, OEM, oil and gas, renewable energy, power generation and telecommunications

Table of Contents

Products

Mechanical	1-31
Oxide Inhibitor.....	26-27
Grounding.....	32-64
Cable Ties.....	65-70
Small Compression	71-90
Medium and Large Compression.....	91-151
Tooling.....	152-189
Index	190

New Items

BBB Copper BusBar	43-45
BDT BONDIT™	28-29
Blank Tongue HYLUG™ Copper Code Terminals.....	131-133
BREAK-AWAY™ HYLUG™ Copper and Aluminum Compression Terminals	127-130
BURNDYWeld® QIKLITE™ Exothermic Battery Ignition System	57
Ferrules Bare and Insulated	71-81
HYLUG™ Narrow Tongue Copper Compression Terminals	94-95, 102-103, 108-109
PATRIOT® PAT750-LI Lithium-Ion Battery Actuated Tool.....	174
Pool Water Bonding Kit	30
The SmartCart® Modular Wire Management System	186-189
U-BLOK™ Power Distribution System.....	12
U-Die Kits Copper, Aluminum and HYGROUND®	157

Reconnect to www.burndy.com!

TYPES KS & KS-3

SERVIT® Split Bolts

For Copper, Copperweld



Compact, high strength, high copper alloy SERVIT® split-bolt has free-running threads and easy to grip wrench flats. Highly resistant to season cracking and corrosion, the SERVIT® provides maximum pressure and assures a secure connection on all combinations of run and tap conductors. Type KS-3 accommodates 3 maximum size conductors.

Catalog Number	Copper		Recommended ▲ Tightening Torque in-lb
	Range for Equal Run and Tap	Min. Tap with Max. Run	
KS90	12 - 10 str.	16 str.	80
KS15**	10 - 8 str.	14 str.	
KS17**	8 str. - 6 sol.	14 str.	
KS17-3*	8 str. - 6 sol.	16 str.	165
KS20**	8 str. - 4 sol.	14 str.	
KS20-3*	8 str. - 4 sol.	14 str.	
KS22**	6 str. - 2 sol.	14 str.	275
KS22-3*	6 str. - 2 sol.	14 str.	
KS23**	6 - 2 str.	14 str.	
KS25**	4 - 1/0 str.	14 str.	385
KS26**	2 - 2/0 str.	14 str.	
KS27**	1 - 3/0 str.	8 sol.	500
KS29**	1 str. - 250 kcmil	8 str.	650
KS31**	1/0 str. - 350 kcmil	1/0 str.	
KS34**	2/0 str. - 500 kcmil	2/0 str.	825
KS39	4/0 str. - 750 kcmil	4/0 str.	1000
KS44	300 - 1000 kcmil	4/0 str.	1100

* Not UL Listed or CSA Certified. Consult UL486 tables 7-4, 7-5, 7-6 for smaller conductor combinations.
 ** UL Rated for Direct Burial
 ▲ Listed torque values are for maximum conductor combinations accommodated.

TYPE KSU
Universal SERVIT®



Tin plated service connector with spacer bar for all combinations of copper, aluminum, ACSR, 6201, 5005, and steel.

Catalog Number	Run Copper & Aluminum	Run ACSR AAAC, 5005	Tap Copper & Aluminum	Tap ACSR* AAAC, 5005	Recommended Tightening Torque in-lb
KSU17	12 - 6 sol.	8 (6-1)	12 sol. - 6 sol.	8 (6-1)	165
KSU20	10 - 4 sol.	6 (6-1)	10 sol. - 4 sol.	6 (6-1)	
KSU22	10 - 2 sol.	6 (6-1) - 4 (7-1)	10 sol. - 2 sol.	6 (6-1) - 4 (7-1)	275
KSU23	8 - 2 str.	3 (6-1) - 2 (6-1)	8 sol. - 2 str.	6 (6-1) - 2 (6-1)	
KSU25	2 - 1/0 str.	3 (6-1) - 1 (6-1)	10 str. - 1/0 str.	6 (6-1) - 1 (6-1)	385
KSU26	2 - 2/0 str.	2 (6-1) - 1/0 (6-1)	8 str. - 2/0 str.	6(6-1) - 1/0 (6-1)	
KSU27	1 - 3/0 str.	1 (6-1) - 2/0 (6-1)	8 sol. - 3/0 str.	6 (6-1) - 2/0 (6-1)	500
KSU29	1 str. - 250 kcmil	2/0 (6-1) - 4/0 (6-1)	8 str. - 250	6(6-1) - 4/0 (6-1)	650
KSU31	4/0 str. - 350 kcmil	3/0 (6-1) - 4/0 (6-1)	4 str. - 350	4 (6-1) - 4/0 (6-1)	
KSU34	400 - 500 kcmil	336 (30-7) - 477 (18-1)	2 str. - 500	2 (6-1) - 477 (18-1)	825

* Accommodates compressed conductors within conductor ranges.

TYPE KVS
OKLIP™



Mechanical Connector for Copper and Copperweld. Compact, two-piece, high strength, high copper alloy BURNDY® OKLIP™ recommended for heavy duty connections. Neoprene rings hold DURIMUM™ bolts in place during installation. Installed with ordinary wrench.

Catalog Number	Copper		Recommended Tightening Torque in-lb
	Run	Tap	
KVS26	2 - 2/0 str.	6 sol. - 2/0 str.	180
KVS28	1/0 - 4/0 str.	10 - 4/0 str.	250
KVS31	250 - 350 kcmil	10 str. - 350 kcmil	325
KVS34	400 - 500 kcmil	10 str. - 500 kcmil	375
KVS40	400 - 800 kcmil	3/0 str. - 800 kcmil	500
KVS44	500 - 1000 kcmil	3/0 str. - 1000 kcmil	

TYPE KVSU
Universal OKLIP™



Mechanical Connector for all combinations of Copper, Aluminum, ACSR, AAAC and 5005. Compact, high strength, tin plated copper alloy two-piece connector with spacer and tin-plated silicon bronze DURIMUM™ hardware. Recommended for heavy duty connections. Spacer separates dissimilar conductors and provides long contact length. Neoprene ring prevents loss of shorter bolt during installation. Longer peened bolt permits swivel action for easier installation.

Catalog Number	Run		Tap		Recommended Tightening Torque in-lb
	Copper & Aluminum	ACSR, AAAC, & 5005	Copper & Aluminum	ACSR, AAAC, & 5005	
KVSU26	2 - 2/0 str.	3 - 2/0	6 - 2/0 str.	6 - 2/0	180
KVSU28	1/0 - 4/0 str.	1/0 - 4/0	6 - 4/0 str.	6 - 4/0	250
KVSU31	250 - 350 kcmil	4/0 - 300	6 str. - 350 kcmil	6 - 300	325
KVSU34	400 - 500 kcmil	336.4-397.5	4 str. - 500 kcmil	5 - 397.5	375
KVSU40	400 - 800 kcmil	4/0 - 800	4/0 str. - 800 kcmil	3/0 - 715.5	500
KVSU44	500 -1000 kcmil	4/0 -1000	4/0 str. -1000 kcmil	4/0 - 900	

TYPE KSA
TRITAP™ SERVIT® Tap Connector

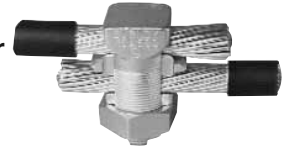

An aluminum tin-plated universal tap connector for all combinations of aluminum to aluminum, aluminum to copper and copper to copper applications. UL486B Listed. 90° C rated.

Catalog Number	Run Min.	Run Max.	Tap Min.	Tap Max.	Recommended Tightening Torque in-lb ▲
KSA6	10 sol.	6 str.	10 sol.	6 str.	165
KSA4	8 sol.	4 str.	10 sol.	4 str.	
KSA2	6 sol.	2 str.	8 str.	2 str.	275
KSA1/0	2 compact	1/0 str.	8 sol.	1/0 str.	385
KSA2/0	2 compact	2/0 str.	8 str.	2/0 str.	
KSA4/0	2 compact	4/0 str.	6 str.	4/0 str.	500
KSA350*	1/0 compact	350 kcmil	4 str.	350 kcmil	650
KSA500*	400 compact	500 kcmil	2 compact	500 kcmil	825

*Not CSA Listed.

▲ Listed torque values are for maximum conductor combinations accommodated.

TYPE SC
SERVIT® Cover



Range-taking, insulating cover for SERVIT® and equivalent split-bolt connectors.

Catalog Number	For Use With
SC4	KS17, KS17-3, KS20, KSU17, KSU20
SC2	KS22, KS20-3, KS23, KS22-3, KSA6, KSA4, KSU22, KSU23
SC2/0	KS25, KS26, KSA2, KSA 1/0, KSU25, KSU26

TYPE QPX
VERSITAP™ Parallel Clamp



Parallel clamp for wide range of copper cable. Makes parallel tap, tees, crosses and end-to-end connections. Rounded edges for easy taping.

Catalog Number	Cable Range				Recommended Tightening Torque in-lb
	Run Min.	Run Max.	Tap Min.	Tap Max.	
QPX2C2C	6 str.	2 str.	6 str.	2 str.	150
QPX282C	1 str.	4/0 str.	6 str.	2 str.	250
QPX282B	1 str.	4/0 str.	1 str.	4/0 str.	
QPX342C	250 kcmil	500 kcmil	6 str.	2 str.	375
QPX342B	250 kcmil	500 kcmil	1 str.	4/0 str.	
QPX3434	250 kcmil	500 kcmil	250 kcmil	500 kcmil	500
QPX442C	500 kcmil	1000 kcmil	6 str.	2 str.	
QPX442B	500 kcmil	1000 kcmil	1 str.	4/0 str.	
QPX4434	500 kcmil	1000 kcmil	250 kcmil	500 kcmil	
QPX4444	500 kcmil	1000 kcmil	500 kcmil	1000 kcmil	

TYPE QPX-Y

Universal VERSITAP™
Parallel Clamp



Universal parallel clamp for copper and aluminum. Tin-plated. Makes parallel taps, tees, crosses or end-to-end connections.

Catalog Number	Conductor Range Aluminum or Copper	
	Run	Tap
QPX2C2C-Y	6 - 2 str.	6 - 2 str.
QPX282C-Y	1 - 4/0 str.	6 - 2 str.
QPX2828-Y	1/0 - 4/0 str.	1/0 - 4/0 str.
QPX342C-Y	250 - 500 kcmil	6 - 2 str.
QPX3428-Y	250 - 500 kcmil	1/0 - 4/0 str.
QPX3434-Y	250 - 500 kcmil	250 - 500 kcmil
QPX4444-Y	750 - 1000 kcmil	750 - 1000 kcmil

TYPES KPA, KPA-UP
SCRULUG™ Terminal

For Copper Cable

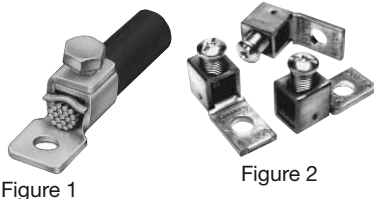

High copper alloy terminal for joining a wide range of cable to equipment pads or terminal blocks. Plain copper finish.

Catalog Number Fig. 1	Catalog Number Fig. 2	Conductor Range
KPA8C	KPA8CUP*	14 sol. - 6 str.
KPA4C	KPA4CUP*	14 sol. - 4 str.
KPA25	—	6 - 1/0 str.
KPA28	—	6 - 4/0 str.
KPA34	—	2/0 str. - 500 kcmil

* For tin plating drop "UP" suffix and add "TP" suffix.

TYPE KLU

SCRULUG™ Terminal

For Copper Cable

Offset Tongue Non-plated



High copper alloy terminal with offset tongue for joining a wide range of cable to equipment pads or bar. Easy to install with screwdriver or wrench. Connector is reusable. Plain copper finish.

Catalog Number	Conductor Range
KLU25	14 - 10 sol.
KLU35	14 sol. - 6 str.
KLU70	8 sol. - 2 str.
KLU125	2 - 1/0 str.
KLU175	4 - 3/0 str.
KLU225	2 - 4/0 str.
KLU300	1/0 str. - 350 kcmil
KLU400	1/0 str. - 500 kcmil

TYPE KA

KA-LUG™ Terminal

For Copper Cable



Compact, economical, high copper alloy terminal for joining a wide range of cable to equipment pads or terminal blocks.

Catalog Number	Conductor Range
KA8C	14 sol. - 8 str.
KA4C	14sol. - 4 str.
KA25	4 - 1/0 str.
KA25-2TC38	4 - 1/0 str.
KA28	1 - 4/0 str.
KA34	4/0 str. - 500 kcmil

TYPE QA

QIKLUG™ Terminal



Heavy-duty terminal for a wide range of copper cables. One-hole tongue.

Catalog Number	Conductor Range	Stud Size
QA8C-B	14 sol. - 8 str.	10
QA4C-B	8 - 4 str.	1/4
QA1C-B	4 - 1 str.	1/4
QA26-B	1/0 - 2/0 str.	3/8
QA28-B	3/0 - 4/0 str.	3/8
QA31-B	250 - 350 kcmil	1/2
QA34-B	400 - 500 kcmil	1/2
QA40-B	600 - 800 kcmil	5/8
QA44-B	850 - 1000 kcmil	5/8
QA46-B	1100 - 1500 kcmil	3/4

TYPES QA-2, QA-4

QIKLUG™ Terminal



Heavy-duty terminal for a wide range of copper cables. Two-hole and four-hole tongues.

Catalog Number	Conductor Range	Stud Hole Size	Stud Hole Centers
QA8C-2B	14 sol. - 8 str.	10	5/8
QA4C-2B	8 - 4 str.	1/4	5/8
QA1C-2B	4 - 1 str.	5/16	7/8
QA26-2B	1/0 - 2/0 str.	3/8	1
QA28-2B	3/0 - 4/0 str.	3/8	1
QA31-2B	250 - 350 kcmil	3/8	1
QA26-2N	1/0 - 2/0 str.	1/2	1-3/4
QA28-2N	3/0 - 4/0 str.	1/2	1 -3/4
QA31-2N	250 - 350 kcmil	1/2	1-3/4
QA34-2B	400 - 500 kcmil	3/8	1
QA34-2N	400 - 500 kcmil	1/2	1-3/4
QA34-4B	400 - 500 kcmil	3/8	1
QA40-2N	600 - 800 kcmil	1/2	1-3/4
QA44-2N	850 - 1000 kcmil		
QA44-4N	850 - 1000 kcmil		
QA46-2N	1100 - 1500 kcmil		

TYPE QDA
QIKLUG™ Terminal



Heavy-duty terminal for a wide range of cable to equipment studs. One-hole tongue finished on both sides.

Catalog Number	Conductor Range	Stud Size
QDA8C	14 sol. - 8 str.	3/8
QDA4C	8 - 4 str.	3/8
QDA1C	4 - 1 str.	3/8
QDA26	1/0 - 2/0 str.	1/2
QDA28	3/0 - 4/0 str.	1/2
QDA31	250 - 500 kcmil	5/8
QDA34	400 - 500 kcmil	3/4
QDA40	600 - 800 kcmil	1

TYPES Q2A-2, Q2A-2N, Q2A-4N
QIKLUG™ Terminal



Heavy-duty terminal for a wide range of copper cable. Joins two cables to equipment pads or bars. Two hole and four hole tongue.

Catalog Number	Conductor Range	Stud Hole Size	Stud Hole Centers
Q2A1C-2	4 - 1 str.	3/8	1
Q2A26-2N	1/0 - 2/0 str.	1/2	1-3/4
Q2A28-2N	3/0 - 4/0 str.		
Q2A31-2N	250 - 350 kcmil		
Q2A34-2N	400 - 500 kcmil		
Q2A40-2N	600 - 800 kcmil		
Q2A28-4N	3/0 - 4/0 str.		
Q2A31-4N	250 - 350 kcmil		
Q2A34-4N	400 - 500 kcmil		
Q2A40-4N	600 - 800 kcmil		
Q2A44-4N	850 - 1000 kcmil		
Q2A46-4N	1100 - 1500 kcmil		

TYPES Q3A-2N, Q3A-4N
QIKLUG™ Terminal



Heavy-duty terminal for a wide range of copper cable. Joins three cables to equipment pads or bars.

Catalog Number	Conductor Range	Stud Hole Size	Stud Hole Centers
Q3A28-2N	3/0 - 4/0 str.	1/2	1-3/4
Q3A31-2N	250 - 350 kcmil		
Q3A34-2N	400 - 500 kcmil		
Q3A28-4N	3/0 - 4/0 str.		
Q3A31-4N	250 - 350 kcmil		
Q3A34-4N	400 - 500 kcmil		
Q3A40-4N	600 - 800 kcmil		
Q3A44-4N	850 - 1000 kcmil		
Q3A46-4N	1100 - 1500 kcmil		
Q3A48-4N	1600 - 2000 kcmil		

TYPE KA-U
Universal Terminal
(1 Conductor)
For Aluminum and Copper Conductors

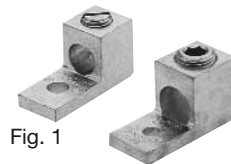

These dual-rated one conductor lugs are constructed from high strength aluminum alloy and electro tin-plated to provide low contact resistance.

Catalog Number	Conductor Range	Figure Number	Recommended Tightening Torque (in-lb) ▲
KA6U	14 - 6 str.	1	45
KA2U	14 - 2 str.	1	50
KA25U	14 - 1/0 str.	1	50
KA26U	6 - 2/0 str.	1	120
KA29U	6 str. - 250 kcmil	2	275
KA30U	6 str. - 300 kcmil	2	275
KA31U	6 str. - 350 kcmil	2	275
KA34U	4 str. - 500 kcmil	2	500
KA36U	2 str. - 600 kcmil	2	500
KA40U	300 - 800 kcmil	2	550
KA44U	500 - 1000 kcmil	2	550

▲ Listed torque values are for maximum conductor size accommodated.

TYPE K2A-U
Universal Terminal
(2 Conductors)
For Aluminum and Copper Conductors

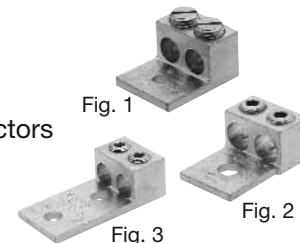

Compact, wide-range, tin-plated aluminum terminal for use with two copper or aluminum cables.

Catalog Number	Conductor Range	Stud Hole Size	Stud Hole Spacing	Fig. No.	Recommended Tightening Torque (in-lb) ▲
K2A25U	Two: 14 - 1/0 str.	1/4	—	1	50
K2A26U	Two: 14 - 2/0 str.	1/4	—	1	120
K2A29U	Two: 6 str. - 250 kcmil	3/8	—	2	275
K2A31U	Two: 4 str. - 350 kcmil	1/2	—	2	275
K2A36U	Two: 2 str. - 600 kcmil	1/2	—	2	375
K2A40U	Two: 300 - 800 kcmil	5/8	—	2	550
K2A44U	Two: 500 - 1000 kcmil	5/8	—	2	550
K2A31U-2N*	Two: 6 str. - 350 kcmil	1/2	1-3/4	3	275
K2A36U-2N*	Two: 2 str. - 600 kcmil	1/2	1-3/4	3	375
K2A40U-2N*	Two: 300 - 800 kcmil	1/2	1-3/4	3	375
K2A44U-2N*	Two: 500 - 1000 kcmil	1/2	1-3/4	3	375

* Tongue holes drilled per NEMA standards.

▲ Listed torque values are for maximum conductor size accommodated.

TYPES K3A-U, KK3A-U

Universal Terminal

(3 Conductor)

For Aluminum & Copper Conductors

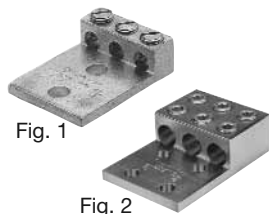

Dual-rated three conductor lugs are constructed from high strength aluminum alloy and electro tin-plated to provide low contact resistance.

Catalog Number	Conductor Range	Stud Hole Size	Fig. No.	Recommended Tightening Torque (in-lb) ▲
K3A2U-2*	Three: 14 - 2 str.	5/16	1	50
K3A25U-2*	Three: 14 - 1/0 str.	3/8	1	50
K3A26U-2N	Three: 14 - 2/0 str.	1/2	1	50
K3A27U-2N	Three: 6 - 3/0 str.	1/2	1	275
K3A29U-2N	Three: 6 str. - 250 kcmil	1/2	1	275
K3A31U-2N	Three: 6 str. - 350 kcmil	1/2	1	275
K3A36U-2N	Three: 2 str. - 600 kcmil	1/2	1	375
KK3A36U-2N	Three: 2 str. - 600 kcmil	1/2	2	375
KK3A40U-2N	Three: 300 - 800 kcmil	1/2	2	375
KK3A44U-2N	Three: 500 - 1000 kcmil	1/2	2	375

* Slotted screw.
 "N" indicates NEMA Standard holes.
 ▲ Listed torque values are for maximum conductor size accommodated.

TYPE K4A-U

Universal Terminal

(4 Conductor)

For Aluminum and Copper Conductors

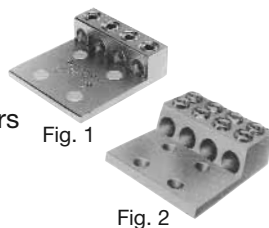

These dual-rated four conductor lugs are constructed from high strength aluminum alloy and electro tin-plated to provide low contact resistance.

Catalog Number	Conductor Range	Stud Hole Size	Fig. No.	Recommended Tightening Torque (in-lb) ▲
K4A29U-4N	Four: 6 str. - 250 kcmil	1/2	1	275
K4A31U-4N	Four: 6 str. - 350 kcmil	1/2	1	275
KK4A36U-4N	Four: 2 str. - 600 kcmil	1/2	2	375
KK4A40U-4N	Four: 300 - 800 kcmil	1/2	2	375

"N" indicates NEMA Standard holes.
 ▲ Listed torque values are for maximum conductor size accommodated.

TYPE BGBL

Lay-In QIKLUG™

*UL Listed 90°C, 600 V



The Lay-In QIKLUG™, type BGBL is manufactured from high strength 6061-T6 aluminum, and is ideally suited for grounding and bonding applications accommodating both copper and aluminum conductor sizes 14 AWG to 250 kcmil.

Catalog Number	Conductor Range	Hex Size
BGBL-4	14 - 4 str.	Slot
BGBL-1/0	14 - 1/0 str.	Slot
BGBL-250	6 str. - 250 kcmil	7/32

TYPE CL50-1

Copper Lay-In QIKLUG™

For Copper



The Lay-In QIKLUG™ is manufactured from high strength pure electrolytic copper to ensure maximum strength and conductivity. UL467 Listed for Direct Burial in earth or concrete. The open-faced design allows for fast lay-in of the conductor without the need for cutting or breaking.

Catalog Number	Conductor Range Copper	Stud Hole
CL50-1	14 - 4 AWG	10

NOTE: Stainless Steel Screws.

TYPE KPB

For Copper



UL467 Listed for direct burial application in earth or concrete.

Catalog Number	Cable Range	Stud Hole
KPB4CG1	10 - 4 str.	10*

* To be assembled with TMH322 stainless steel hardware kit, ordered separately.

TYPE K11A-U

Universal Terminal

For Aluminum and Copper Conductors

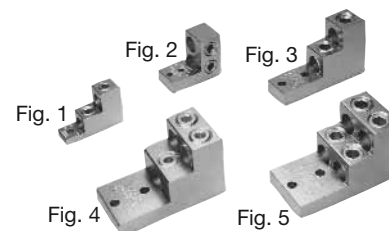

Dual-rated panelboard lugs are constructed from high strength extruded aluminum alloy and electro tin-plated to provide low contact resistance.

Catalog Number	Conductor Range	Stud Hole Size	Fig. No.	Recommended Tightening Torque (in-lb) ▲
K11A30U*	Two: 6 str. - 300 kcmil	5/16	1	275
K11A34U-2	Two: 4/0 str. - 500 kcmil	1/4	2	375
K11A36U-2	Two: 2 str. - 600 kcmil	3/8	3	
K21A36U-2	Three: 2 str. - 600 kcmil	3/8	4	
K22A36U-2	Four: 2 str. - 600 kcmil	3/8	5	
K11A39U-2	Two: 1/0 str. - 750 kcmil	3/8	3	
K22A39U-2	Four: 1/0 str. - 750 kcmil	3/8	5	

* Not CSA listed.
 ▲ Listed torque values are for maximum conductor size accommodated.

TYPE KAU-KIT
Transformer Lug Kit



Each kit contains the UL Listed and CSA certified AL/CU rated aluminum set screw connectors and tongue mounting hardware needed to terminate aluminum or copper cables in “dry type” transformers. The KVA rating gives an approximate cross reference to the appropriate kit.

Catalog Number	Terminals			
	Transformer KVA Rating	Qty	Catalog Number	Conductor Range
KAU-KIT1	15-37.5 1Ø	8	KA2U	14 - 2 str.
	15-45 3Ø	4	KA29U	6 str. - 250 kcmil
KAU-KIT2	50-75 1Ø	12	KA29U	6 str. - 250 kcmil
	75-112.5 3Ø			
KAU-KIT3	100-167 1Ø	6	K2A31U	6 str. - 350 kcmil
	150-300 3Ø	7	K2A40U	300 - 800 kcmil
KAU-KIT4	400-500 3Ø	15	K2A40U	300 - 800 kcmil

Catalog Number	Hardware					
	Qty.	Bolt Size	Qty.	Nut	Qty.	Washer
KAU-KIT1	8	1/4-20 x 3/4 HH	8	1/4 x 20 HN	—	Captive To Nut
KAU-KIT2	8	1/4-20 X 3/4 HH	16	1/4 x 20 HN	—	Captive To Nut
	8	1/4-20 x 2 HH				
KAU-KIT3	5	1/2-13 x 2 HH	11	1/2-13 HN	22	1/2 FW
	6	1/2-13 x 2-1/2 HH			11	1/2 Belleville
KAU-KIT4	7	1/-13 x 2	11	1/2-13 HN	22	1/2 FW
	4	1/2-13 x 2-1/2			11	1/2 Belleville

TYPE AMS
Dual Rated Splicer/Reducer
For Copper and Aluminum Cable



All splicers/reducers are dual rated for use with aluminum and copper conductors and are constructed from high strength, tin-plated aluminum. PENETROX™ oxide inhibiting joint compounds are recommended for all aluminum applications.

Catalog Number	Wire Range	
	Min.	Max.
AMS-2*	14 AWG	2 AWG
AMS-0*	8 AWG	1/0 AWG
AMS-4/0	6 AWG	4/0 AWG
AMS-250	6 AWG	250 kcmil
AMS-350	6 AWG	350 kcmil
AMS-500	3/0 AWG	500 kcmil
AMS-750	250 kcmil	750 kcmil
AMS-1000	500 kcmil	1000 kcmil

* Slotted Screws

TYPE UGSKIT
Watertight/Underground Splice Kit
For all Aluminum or Copper/Aluminum Combinations

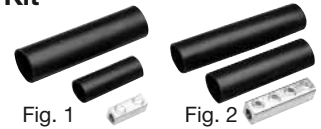

Type UGS Watertight Underground Splice Kit consists of a standard AMS splicer/reducer and two heavy wall heat-shrink sleeves.

Catalog Number	Figure Number	Conductor Range	
		Minimum	Maximum
UGSKIT2*	1	8 AWG	2 AWG
UGSKIT250*	2	1 AWG	250 kcmil

* UL486D Listed for Direct Burial.

TYPE UGSKIT8
UF Direct Burial Splice Kit
For All Aluminum or Copper/Aluminum Combinations



Type UGS UF Splice Kit consists of a UF splice connector and a heavy wall heatshrink sleeve.

Catalog Number	Conductor Range Copper
UGSKIT8*	14 - 8 AWG

* UL486D Listed for Direct Burial.

U-BLOK™ POWER DISTRIBUTION BLOCKS

For Junction Box Applications

The U-BLOK™ system is a modern, state-of-the-art approach to multi-load power distribution applications. Among typical uses are multi-story or multi-unit buildings, HVAC, refrigeration, control panels, motor control, switch gear, elevator systems and materials-handling equipment. U-BLOK™ is UL Listed for Copper or Aluminum conductors and rated for 600-volt applications. U-BLOK™ can be mounted on bases for use in troughs or bolted directly to junction boxes. AL9CU rated.

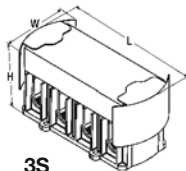

3S

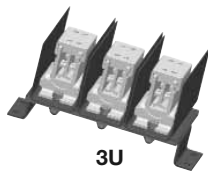

3U



FT4B500



FT3B4/0

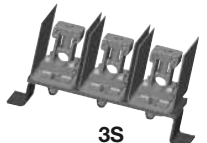

3S

3 WIRE POWER DISTRIBUTION BLOCKS

Catalog Number	Maximum Number of Wires per Phase	Al or Cu Wire Range *		W	L	H	Weight Each	Allen Wrench Size	Torque (in-lb)	Strip Length	
		Run	Tap							Run	Tap
FT3B4/0	2	3/0 - 4/0	6 - 4/0	3-7/8"	5-7/8"	4-1/8"	1-1/4 lbs.	1/4"	200	1-1/2"	
FT3B500		400 - 500	6 - 500							2-1/8 lbs.	3/8"
3S	2	250-350	6 - 350	3-5/8"	9-3/4"	4-7/8"	3 lbs.	1/4"	200	1-3/4"	
3U		Run	Tap	4-3/4"	9-3/4"	5-1/2"	3 lbs.	5/32"	110	Run	Tap
	1	8	3/0-500							6 - 1/0	2-5/16"

4 WIRE POWER DISTRIBUTION BLOCKS

Catalog Number	Maximum Number of Wires per Phase	Al or Cu Wire Range *		W	L	H	Weight Each	Allen Wrench Size	Torque (in-lb)	Strip Length	
		Run	Tap							Run	Tap
FT4B4/0	2	3/0 - 4/0	6 - 4/0	3-7/8"	7-7/8"	4-1/8"	2 lbs.	1/4"	200	1-1/2"	
FT4B500		400 - 500	6 - 500							2-3/4 lbs.	3/8"
4S	2	250-350	6 - 350	3-5/8"	11-3/4"	4-7/8"	3-1/2 lbs.	1/4"	200	1-3/4"	
4U		Run	Tap	4-3/4"	11-3/4"	5-1/2"	3-1/2 lbs.	5/32"	110	Run	Tap
	1	8	3/0-500							6 - 1/0	2-5/16"

PENETROX™ inhibitor is recommended for all aluminum wire connections.

For two wire tap range is 8 through 1/0.

* Aluminum and copper conductors cannot be assembled under the same pressure plate or t-bar.

U-BLOK™ MOUNTING PLATFORMS

For Trough Applications

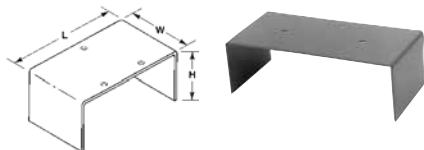

Catalog Number	W	L	H	Gutter Size	Weight Each
TBPT-6*	4-1/4"	5-7/8"	1-1/2"	6"	3/4 lb.
TBPT-8	4-1/4"	7-7/8"	3-1/2"	8"	1-1/4 lb.
TBPT-10	4-1/4"	9-7/8"	4"	10"	1-1/2 lb.
TBPT-12	4-1/4"	11-7/8"	4"	12"	1-3/4 lb.

Hole pattern shown is for reference only.

* Supersedes TBPT4/0-6 and TBPT350/500-6.

SPEC-BLOK™ POWER DISTRIBUTION CONNECTORS

Unique, modular, made-to-order, power-distribution assemblies accommodate any number of supply and load conductors in any number of poles. Capacity matches the conductors accommodated and SPEC-BLOK™ assures uniform loading.

Adjacent poles are separated by easy-to-handle, wrap-around insulating covers which eliminate taping and reduce heat build-up by allowing air to flow freely around connectors. SPEC-BLOK™ is UL Listed for copper or aluminum conductors for 600 volts (AL9CU). Assemblies are mounted on platforms suitable for easy installation in wireway or junction box.

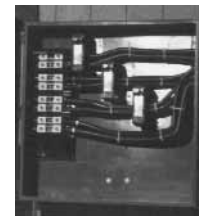

Features and Benefits

- Accommodate unlimited conductors.
 - ◊ Fits wide range of applications.
- Connector elements tin-plated.
 - ◊ Provides high reliability, low-resistance connections.
- User friendly, space-saving design.
 - ◊ Easy to install. Saves labor.
- 94-VO rated insulation folds into place insulating the components.
 - ◊ Saves time and material. Allows easy installation.
- Connector caps removable for easy cable lay-in.
 - ◊ Saves labor. Makes installation easier. Allows installation or straight-through conductors. Eases retrofit.
- Belleville washers built-in on pressure screw assemblies, except in assemblies installed with a 5/32" Allen wrench.
 - ◊ Provides high-integrity connections.
- Conductors can be cut or fed straight through.
 - ◊ Straight through installation ideal for riser applications.

* SPEC-BLOK™ catalog assembly not UL Listed, individual SPEC-BLOK™ connectors are UL Listed. See next page.

Contact BURNDY® Technical Services: 1-800-451-4956,
or BURNDY® Customer Service: 1-800-346-4175

SPEC-BLOK™ POWER DISTRIBUTION CONNECTORS



Features and Benefits

- The SPEC-BLOK™ system includes 12 connector elements
 - ◇ A wide variety of conductor sizes can be accommodated
- Each element can be bolted together in parallel
 - ◇ Provides an efficient flow of current from one element to another
- AL9CU rated for Copper or Aluminum conductors
 - ◇ Dual-rated system, with UL486B's highest temperature rating
- 2 Wire (series), 4 (parallel), and Multi-Tap versions available
 - ◇ Nearly any conductor combination can be terminated
- High-strength, corrosion-resistant connector elements
- All SPEC-BLOKs™ are custom made for nearly any Power Distribution system requirement
 - ◇ Time savings — pre-assembled in our factory for immediate installation!

* SPEC-BLOK™ catalog assembly not UL Listed, individual SPEC-BLOK™ connectors are UL Listed. See next page.

SPEC-BLOK™ CONNECTORS

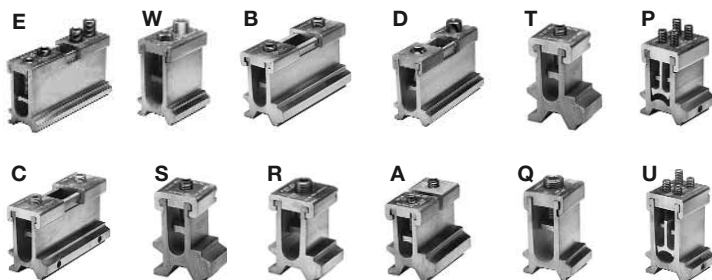

Catalog Designation (Maximum Conductor)		Number of Conductors Accommodated		Al or Cu Wire Range Under Each Cap		Dimensions				Allen Wrench Size
4 Conductor	2 Conductor	4 Conductor	2 Conductor	First Conductors MUST Be	Second Conductor (if required) May Be	Height On Max. Conductors	Length Without Insulator		3/8"	
							4 Conductor	2 Conductor		
A (2/0)	Q	1 to 4 (0, 1, or 2 per cap)	1 or 2 per cap	1/0- 2/0	#12 - 2/0	2-9/16"	1-1/2"	2-1/8"	7/8"	5/32"
B (250)	R			3/0 - 250	#6 - 250	3-1/8"	1-11/16"	4-1/4"	1-3/8"	1/4"
C (350)	S			250 - 350	#6 - 350	3-5/16"	1-13/16"	4-5/8"	1-1/2"	3/8"
D (500)	T			400 - 500	#6 - 500	4-1/16"	2"	5-5/8"	1-3/4"	
E (750)	W			600 - 750	3/0 - 750	4-7/8"	2-1/4"	7-1/4"	2-5/8"	

Catalog Designation (Maximum Conductor)	Number of Conductors Accommodated	Large Groove	Small Grooves**	Height on Maximum Conductors	Width	Length Without Insulator	Allen Wrench Size
P (1/0)	1 to 8 (0, 1 or 2 under each screw)	—	6-1/10	3-1/2"	2"	1-3/4"	5/32"
U (1/0 & 500)	2 to 9 (0, 1 or 2 under each screw plus one large conductor)	3/0 - 500	6-1/10	4-1/8"	2"		

** This range may be expanded to include #8 provided two conductors are being installed in that particular element.

SPEC-BLOK™ Mounting Platforms

SPEC-BLOK™ Mounting Platforms are rigid steel construction with a black finish. They can be supplied for junction box mounting or wireway construction allowing trough conductors to pass underneath the assemblies.

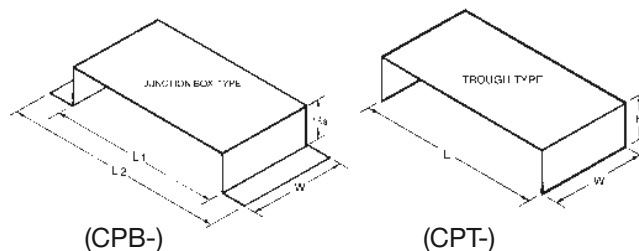

Catalog Number	L (Nominal)	L (Overall)	W (Overall)
CPB6	6"	7-3/4"	2-1/2"
CPB8	8"	9-3/4"	2-1/2"
CPB10	10"	11-3/4"	2-1/2"
CPB12	12"	13-3/4"	3-1/2"
CPB14	14"	15-3/4"	3-1/2"
CPB16-5/8	16-5/8"	18-3/8"	3-1/2"
CPB21-1/4	21-1/4"	23"	3-1/2"

Catalog Number	L	W	H
CPT6	5-7/8"	2-1/2"	2-1/4"
CPT8	7-7/8"	3-1/2"	3"
CPT10	9-7/8"	3-1/2"	3-1/2"
CPT12	11-7/8"	3-1/2"	4"
CPT16	15-7/8"	3-1/2"	4"

**TYPE KPU-AC
POLYTAP™**

Insulated Gutter Tap for All
Copper and Aluminum Combinations



Wide range-taking tin-plated aluminum parallel clamp and insulating cover assembly for industrial and multiple story structure applications. Only six connectors cover the entire 14 sol. - 750 kcmil range. Covers having flexible fingers that conform to conductor, fully insulating the connection. UL486B Listed for 600 volts maximum 90° C service. Cover and connector are packaged together. No taping required.

Catalog Number	Conductor Copper or Aluminum		W	H	L	Recommended Tightening Torque in-lb
	Run	Tap				
KPU29A26AC	1/0 str. - 250 kcmil	14 sol. - 2/0 str.	3-1/8	3-3/8	4-1/4	375
KPU29A29AC	1/0 str. - 250 kcmil	6 str. - 250 kcmil				
KPU34A26AC	4/0 str. - 500 kcmil	14 sol. - 2/0 str.	3-1/2	3-1/2	4-5/8	450
KPU34A34AC	4/0 str. - 500 kcmil	6 str. - 500 kcmil				
KPU39A26AC	500 - 750 kcmil	14 sol. - 2/0 str.	3-1/2	3-7/8	5-1/16	600
KPU39A39AC	500 - 750 kcmil	1/0 str. - 750 kcmil				

**TYPE UCU-AC
Riser Tap**



Parallel-groove riser tap and insulation cover for copper and aluminum. Wide range-taking assembly for apartment house and light industrial applications. Cover and connector are packaged together. Covers having insulating fingers that conform to conductors, fully insulating the connection. UL486B Listed for 600 volts max. 90° C service.

Catalog Number	Conductor		W	H	L	▲ Recommended Tightening Torque In-lb
	Run	Tap				
UCU28AC	2 str. - 4/0 str.	10 sol. - 2 str.	2-1/4	1-13/16	2-5/8	120

▲ Listed torque values are for maximum conductor combinations accommodated. Consult UL486 Tables 7-4, 7-5, and 7-6 for smaller combinations.

**TYPE BIPC
INSULTAP™ Insulated
Piercing Connectors**
UL Listed 90°C, *600 V



The INSULTAP™, Type BIPC, BURNDY® Insulation Piercing Connector is ideally suited for splicing and tapping aluminum and copper conductor wire sizes: 10 AWG to 500 kcmil.

Catalog Number	Conductor Range		Bolt Size	Socket Size	Recom. Torque	Max. Volt Rating
	Run	Tap				
BIPC1/0-2	8 - 1/0 AWG	8 - 2 AWG	5/16-18	1/2	180 in-lb	600V
BIPC4/0-6	1/0 - 4/0 AWG	6 - 1/0 AWG	5/16-18	1/2	250 in-lb	300V
BIPC4/0-1/0	1/0 - 4/0 AWG	1/0 - 4/0 AWG	5/16-18	1/2	250 in-lb	300V
BIPC350-4/0	4/0 - 350 AWG	1/0 - 4/0 AWG	3/8-16	9/16	375 in-lb	300V
BIPC350-350	4/0 - 350 AWG	4/0 - 350 AWG	3/8-16	9/16	300 in-lb	300V
BIPC500-4/0	350 - 500 kcmil	4 - 4/0 AWG	3/8-16	9/16	400 in-lb	600V

**VERSIPOLE™
Power Distribution Blocks**



VERSIPOLE™ Power Distribution Blocks are designed to provide modular solutions to power distribution applications. Each connector element is made from a high conductivity aluminum alloy which is insulated with a high strength polymer housing. One, two, and three pole versions available. "Add a pole" (snap-together) blocks are also available for wire sizes up to 500 kcmil. For use with Cu or Al 600 V, AL9CU rated.

Catalog Number	Connector		Conductor Range Run	Al/Cu Tap	Ampere Rating Per Pole	Number of Poles
	Run	Tap				
BDA-112-350	1	12	6 - 350 kcmil	14 - 4 AWG	350	Adder
BDA-16-350	1	6	6 - 350 kcmil	14 - 2/0 AWG	350	Adder
BDA-16-500	1	6	4 - 500 kcmil	14 - 2/0 AWG	430	Adder
BDA-26-350	2	6	6 - 350 kcmil	14 - 2/0 AWG	700	Adder
BDA-212-500	2	12	4 - 500 kcmil	14 - 4 AWG	860	Adder
BDA-26-500	2	6	4 - 500 kcmil	14 - 2/0 AWG	860	Adder
BDA-24-500	2	4	4 - 500 kcmil	6 - 4/0 AWG	860	Adder
BDA-11-500	1	1	4 - 500 kcmil	4 - 500 kcmil	430	Adder
BDA-22-350	2	2	6 - 350 kcmil	6 - 350 kcmil	700	Adder
BDA-22-500	2	2	4 - 500 kcmil	4 - 500 kcmil	760	Adder

SNAP TOGETHER SPLICER/REDUCER BLOCKS



Catalog Number	Connector		Wire Range Al/Cu		Ampere Rating Per Pole	Number of Poles	Optional Cover
	Run	Tap	Run	Tap			
BDC-14-2/0-1	1	4	14 - 2/0 AWG	14 - 4 AWG	195	1	BDBCVER3
BDA-14-2/0-1	1	4	14 - 2/0 AWG	14 - 4 AWG	195	Adder	BDBCVER3
BDC-11-2/0-1	1	4	14 - 2/0 AWG	14 - 2/0 AWG	195	1	BDBCVER3
BDA-11-2/0-1	1	4	14 - 2/0 AWG	14 - 2/0 AWG	195	Adder	BDBCVER3

VERSIPOLE™

1, 2, 3 Pole Distribution Blocks



Catalog Number	Connector		Wire Range Al/Cu		Ampere Rating Per Pole	Number of Poles	Optional Cover
	Run	Tap	Run	Tap			
BDB-16-2/0-1	1	6	12 - 2/0 AWG	14 - 4 AWG	195	1	BDBCOVER2
BDB-16-2/0-2							
BDB-16-2/0-3							
BDB-26-2/0-1	2	6	14 - 2/0 AWG	14 - 2 AWG	390	1	BDBCOVER2
BDB-26-2/0-2							
BDB-26-2/0-3							
BDB-112-350-1	1	12	6 - 350 kcmil	14 - 4 AWG	350	1	BDBCOVER1
BDB-112-350-2							
BDB-112-350-3							
BDB-16-350-1	1	6	6 - 350 kcmil	14 - 2/0 AWG	350	1	BDBCOVER1
BDB-16-350-2							
BDB-16-350-3							
BDB-14-500-1	1	4	4 - 500 kcmil	14 - 2/0 AWG	430	1	BDBCOVER2
BDB-14-500-2							
BDB-14-500-3							
BDB-16-500-1	1	6	4 - 500 kcmil	14 - 2/0 AWG	430	2	BDBCOVER1
BDB-16-500-2							
BDB-16-500-3							
BDB-162-500-1	1	6	4 - 500 kcmil	14 - 2 AWG	430	1	BDBCOVER2
BDB-162-500-2							
BDB-162-500-3							
BDB-26-350-1	2	6	6 - 350 kcmil	14 - 2/0 AWG	700	1	BDBCOVER1
BDB-26-350-2							
BDB-26-350-3							
BDB-212-500-1	2	12	4 - 500 kcmil	14 - 4 AWG	760	1	BDBCOVER1
BDB-212-500-2							
BDB-212-500-3							
BDB-26-500-1	2	6	4 - 500 kcmil	14 - 2/0 AWG	760	2	BDBCOVER1
BDB-26-500-2							
BDB-26-500-3							
BDB-24-500-1	2	4	4 - 500 kcmil	6 - 4/0 AWG	760	1	BDBCOVER1
BDB-24-500-2							
BDB-24-500-3							

VERSIPOLE™

1, 2, 3 Pole Splicer/Reducer Blocks



Catalog Number	Connector		Wire Range Al/Cu		Ampere Rating Per Pole	Number of Poles	Optional Cover
	Run	Tap	Run	Tap			
BDB-11-2/0-1	1	1	14 - 2/0 AWG	14 - 2/0 AWG	195	1	BDBCOVER2
BDB-11-2/0-2							
BDB-11-2/0-3							
BDB-11-350-1	1	1	6 - 350 kcmil	6 - 350 kcmil	350	1	BDBCOVER2
BDB-11-350-2							
BDB-11-350-3							
BDB-11-500-1	1	1	6 - 500 kcmil	6 - 500 kcmil	430	1	BDBCOVER1
BDB-11-500-2							
BDB-11-500-3							
BDB-22-2/0-1	2	2	14 - 2/0 AWG	14 - 2/0 AWG	390	1	BDBCOVER2
BDB-22-2/0-2							
BDB-22-2/0-3							
BDB-22-350-1	2	2	6 - 350 kcmil	6 - 350 kcmil	700	1	BDBCOVER2
BDB-22-350-2							
BDB-22-350-3							
BDB-22-500-1	2	2	4 - 500 kcmil	4 - 500 kcmil	760	1	BDBCOVER1
BDB-22-500-2							
BDB-22-500-3							

UNITAP™

Insulated Multiple Tap Connectors



Tap connections and in-line splice/reductions are made quickly and easily with the UNITAP™ line of connectors. UL486B Listed. Dual-rated AL9CU for any stranded copper or stranded aluminum applications. 600 V, 90°C.

2 Port 1 or 2 Sided Entry

Catalog Number	Conductor Range	Number of Ports	Dimensions			Hex Key Torque in lbs	Wire Strip Length	
			L	W	H			
BIT4	14 - 4 AWG	2	1.16	1.16	1.25	1/8" (45)	5/8"	
BIT0-4	14 - 4 AWG		1.16	1.50				
BIT2/0	14 - 2/0 AWG		1.52	1.40	1.38	3/16" (120)	11 /16"	
BIT02/0	14 - 2/0 AWG		1.52	1.56				
BIT250	10 AWG-250 kcmil		2.03	2.07	2.13	5/16" (275)	1"	
BIT0250	10 AWG-250 kcmil		2.03	2.64				
BIT350	10 AWG-350 kcmil		2.22	2.32	2.50	5/16" (275)	1-1/8"	
BIT0350	10 AWG-350 kcmil		2.22	3.00				
BIT600	4 AWG - 600 kcmil		2.72	2.38	2.75	3/8" (375)		1-1/2"
BIT0600	4 AWG - 600 kcmil		2.72	3.00				
BIT750	2 AWG - 750 kcmil		2.87	2.70	3.00	3/8" (375)	1-1/2"	
BIT0750	2 AWG - 750 kcmil		2.87	3.38				

BURNDY® UNITAP™
In-line Splicer/Reducer



Catalog Number	Conductor Range	Number of Ports	Dimensions			Hex Key Torque in lbs	Wire Strip Length
			L	W	H		
BISR2	14 - 2 AWG	2	2.38	0.75	1.22	1/8" (45)	3/4"
BISR-1/0	14 - 1/0 AWG		2.91	0.91	1.38	3/16" (120)	1"
BISR250	10 AWG - 250 kcmil		4.01	1.19	2.10		1-3/16"
BISR350	10 AWG - 350 kcmil		4.63	1.34	2.35	5/16" (275)	1-3/8"
BISR500	6 AWG - 500 kcmil		5.00	1.62	2.62	3/8" (375)	1-1/2"

BURNDY® UNITAP™
Multi-Port Double-Sided Entry



Catalog Number	Conductor Range	Number of Ports	Dimensions			Hex Key Torque in lbs	Wire Strip Length
			L	W	H		
BIBD4-2	14 - 4 AWG	2	1.16	1.50	1.25	1/8" (45)	5/8"
BIBD4-3		3	1.59				
BIBD4-4		4	2.03				
BIBD4-5		5	2.47				
BIBD4-6		6	2.91				
BIBD4-8		8	3.78				
BIBD2/0-2	14 - 2/0 AWG	2	1.52	1.56	1.25	3/16" (120)	11/16"
BIBD2/0-3		3	2.19				
BIBD2/0-4		4	2.86				
BIBD2/0-5		5	3.53				
BIBD2/0-6		6	4.20				
BIBD2/0-8		8	5.55				
BIBD2/0-10		10	6.89				
BIBD2/0-12		12	8.24				
BIBD2/0-14	14	9.58					
BIBD250-2	10 AWG - 250 kcmil	2	2.03	2.64	2.13	5/16" (275)	1"
BIBD250-3		3	2.97				
BIBD250-4		4	3.91				
BIBD250-5		5	4.84				
BIBD250-6		6	5.78				
BIBD250-8		8	7.66				
BIBD250-10		10	9.53				
BIBD250-12		12	11.32				
BIBD250-14	14	13.29					
BIBD350-2	10 AWG - 350 kcmil	2	2.22	3.00	2.50	5/16" (275)	1-1/8"
BIBD350-3		3	3.13				
BIBD350-4		4	4.04				
BIBD350-5		5	4.95				
BIBD350-6		6	5.86				
BIBD350-8		8	7.68				
BIBD350-10		10	9.50				
BIBD350-12		12	11.32				
BIBD350-14	14	13.14					

(Multi-Port Double-Sided Entry continued on next page)

BURNDY® UNITAP™
Multi-Port Double-Sided Entry
(Continued)



Catalog Number	Conductor Range	Number of Ports	Dimensions			Hex Key Torque in lbs	Wire Strip Length
			L	W	H		
BIBD600-2	4 AWG - 600 kcmil	2	2.56	3.00	2.75	3/8" (375)	1-1/8"
BIBD600-3		3	3.77				
BIBD600-4		4	4.97				
BIBD600-5		5	6.17				
BIBD600-6		6	7.37				
BIBD600-8		8	9.78				
BIBD600-10		10	12.97				
BIBD600-12		12	15.53				
BIBD600-14	14	18.09					
BIBD750-2*	#2 - 750	2	2.87	3.38	3.00	3/8" (375)	1-1/2"
BIBD750-3*		3	4.25				
BIBD750-4*		4	5.63				
BIBD750-6*		6	8.37				
BIBD750-8*		8	11.13				
BIBD750-10*		10	13.87				
BIBD750-12*		12	16.63				
BIBD750-14*		14	19.37				

*Not UL Listed.

BURNDY® UNITAP™
Multi-Port Single-Sided Entry



Catalog Number	Conductor Range	Number of Ports	Dimensions			Hex Key Torque in lbs	Wire Strip Length
			L	W	H		
BIBS4-3	14 - 4 AWG	3	1.59	1.25	1.25	1/8" (45)	5/8"
BIBS4-4		4	2.03				
BIBS4-5		5	2.47				
BIBS4-6		6	2.91				
BIBS4-8		8	3.78				
BIBS2/0-3	14 - 2/0 AWG	3	2.19	1.31	1.38	3/16" (120)	11/16"
BIBS2/0-4		4	2.86				
BIBS2/0-5		5	3.53				
BIBS2/0-6		6	4.20				
BIBS2/0-8		8	5.55				
BIBS2/0-10		10	6.80				
BIBS2/0-12		12	8.24				
BIBS2/0-14	14	9.58					
BIBS250-3	10 AWG - 250 kcmil	3	2.97	2.07	2.13	5/16" (275)	1"
BIBS250-4		4	3.91				
BIBS250-5		5	4.84				
BIBS250-6		6	5.78				
BIBS250-8		8	7.66				
BIBS250-10		10	9.53				
BIBS250-12		12	11.41				
BIBS250-14		14	13.29				

(Multi-Port Single-Sided Entry continued on next page)

BURNDY® UNITAP™
Multi-Port Single-Sided Entry
(Continued)



Catalog Number	Conductor Range	Number of Ports	Dimensions			Hex Key Torque in lbs	Wire Strip Length
			L	W	H		
BIBS350-3	10 AWG - 350 kcmil	3	3.13	2.32	2.50	5/16" (275)	1-1/8"
BIBS350-4		4	4.04				
BIBS350-5		5	4.95				
BIBS350-6		6	5.86				
BIBS350-8		8	7.68				
BIBS350-10		10	9.50				
BIBS350-12		12	11.32				
BIBS350-14	14	13.14					
BIBS600-3	4 AWG - 600 kcmil	3	4.00	2.32	2.50	5/16" (275)	1-1/8"
BIBS600-4		4	5.28				
BIBS600-5		5	6.56				
BIBS600-6		6	7.84				
BIBS600-8		8	10.41				
BIBS600-10		10	12.97				
BIBS600-12		12	15.53				
BIBS600-14	14	18.09					
BIBS750-3	2 AWG - 750 kcmil	3	4.25	2.79	3.00	3/8" (375)	1-1/2"
BIBS750-4		4	5.63				
BIBS750-6		6	11.13				
BIBS750-8		8	13.87				
BIBS750-10		10	16.63				
BIBS750-12	12	19.37					

TYPES BIBS-MT, BIBD-MT
UNITAP™ Insulated
Multiple Tap Connectors
Mounting Version



The BIBS-MT and BIBD-MT series UNITAP offer the same multi-port capabilities as the standard UNITAP™ connectors except these -MT types are provided with two isolated mounting holes at both ends of the connector for direct mounting to a trough, gutter or wireway. They will accommodate up to standard 1/4" hardware.

Multi-Port Single-Sided Entry

Catalog Number	Conductor Range	Number of Ports	Dimensions			Hex Key Torque in lbs	Wire Strip Length
			L	W	H		
BIBS2/04MT	14 - 2/0 AWG	4	3.95	1.31	1.38	3/16" (120)	11/16"
BIBS2/06MT		6	5.29				
BIBS2/08MT		8	6.64				
BIBS2/010MT		10	7.98				
BIBS2/012MT		12	9.33				
BIBS2504MT	10 AWG - 250 kcmil	4	5.53	2.07	2.13	5/16" (275)	1"
BIBS2506MT		6	7.40				
BIBS2508MT		8	9.28				
BIBS25010MT		10	11.16				
BIBS25012MT	12	13.03					
BIBS3504MT	10 AWG - 350 kcmil	4	5.61	2.32	2.50	5/16" (275)	1-1/8"
BIBS3506MT		6	7.43				
BIBS3508MT		8	9.25				
BIBS35010MT		10	11.07				
BIBS35012MT		12	12.89				
BIBS6004MT	4 AWG - 600 kcmil	4	7.59	2.38	2.75	3/8" (375)	1-1/8"
BIBS6006MT		6	10.16				
BIBS6008MT		8	12.72				
BIBS60010MT		10	15.28				
BIBS60012MT		12	17.84				
BIBD2/04MT	14 - 2/0 AWG	4	3.95	1.56	1.38	3/16" (120)	11/16"
BIBD2/06MT		6	5.29				
BIBD2/08MT		8	6.64				
BIBD2/010MT		10	7.98				
BIBD2/012MT		12	9.33				
BIBD2504MT	10 AWG - 250 kcmil	4	5.53	2.64	2.13	5/16" (275)	1"
BIBD2506MT		6	7.40				
BIBD2508MT		8	9.28				
BIBD25010MT		10	11.16				
BIBD25012MT	12	13.03					
BIBD3504MT	10 AWG - 350 kcmil	4	5.61	3.00	2.50	5/16" (275)	1-1/8"
BIBD3506MT		6	7.43				
BIBD3508MT		8	9.25				
BIBD35010MT		10	11.07				
BIBD35012MT		12	12.89				
BIBD6004MT	4 AWG - 600 kcmil	4	7.59	3.00	2.75	3/8" (375)	1-1/8"
BIBD6006MT		6	10.16				
BIBD6008MT		8	12.72				
BIBD60010MT		10	15.28				
BIBD60012MT		12	17.84				

UV RATED BLACK UNITAP™



Features and Benefits

- UV Rated Plastisol covered AL6061-T6 aluminum body saves time by eliminating the need for taping.
- Oxide inhibitor pre-installed inhibits moisture and contaminants from entering the contact area.
- Range-taking capability reduces the number of connectors carried in inventory.
- UL486B Listed, AL9CU, 600V 90°C.

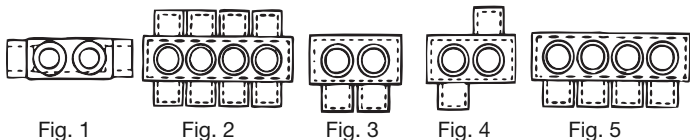

PL=2 Port Single Sided Entry (Fig. 3), 1PLO=2 Port Offset Entry (Fig. 4)				
Catalog Number	Figure Number	Number of Ports	Wire Range (AWG/kcmil)	Hex Key Torque (in lbs)
1PL42	3	2	14 - 4	1/8 (45)
1PLO42	4		14 - 4	1/8 (45)
1PL2/02	3		14 - 2/0	3/16 (120)
1PLO2/02	4		14 - 2/0	3/16 (120)
1PL2502	3		10 - 250	5/16 (275)
1PLO2502	4		10 - 250	5/16 (275)
1PL3502	3		10 - 350	5/16 (275)
1PLO6002	3		4 - 600	3/8 (375)
1PL06002	4		4 - 600	3/8 (375)
1PL06002	4		4 - 600	3/8 (375)
1PBS=In-line Splicer/Reducer (Fig. 1)				
Catalog Number	Figure Number	Number of Ports	Wire Range (AWG/kcmil)	Hex Key Torque (in lbs)
1PBS2	1	2	14 - 2	5/32 (45)
1PBS1/0			14 - 1/0	3/16 (120)
1PBS250			10 - 250	5/16 (120)
1PBS350			10 - 350	5/16 (275)
1PBS500			6 - 500	3/8 (375)
1PL= Multi-Port Single Sided Entry (Fig. 5)				
Catalog Number	Figure Number	Number of Ports	Wire Range (AWG/kcmil)	Hex Key Torque (in lbs)
1PL43	5	3	14 - 4	1/8 (45)
1PL44		4	14 - 4	1/8 (45)
1PL2/03		3	14 - 2/0	3/16 (120)
1PL2503		3	10 - 250	5/16 (275)
1PLD=Multi-Port Double Sided Entry (Fig. 2)				
Catalog Number	Figure Number	Number of Ports	Wire Range (AWG/kcmil)	Hex Key Torque (in lbs)
1PLD43	2	3	14 - 4	1/8 (45)
1PLD44		4		1/8 (45)
1PLD2/02		2	14 - 2/0	3/16 (120)
1PLD2/03		2		3/16 (120)
1PLD2/04		4		3/16 (120)
1PLD2/06		6	3/16 (120)	
1PLD2502		2	10 - 250	5/16 (275)
1PLD2503		3		5/16 (275)
1PLD2504		4		5/16 (275)
1PLD2506		6		5/16 (275)

(Multi-Port Double-Sided Entry — Fig. 2 continued on next page)

UV RATED BLACK UNITAP™

(Continued)

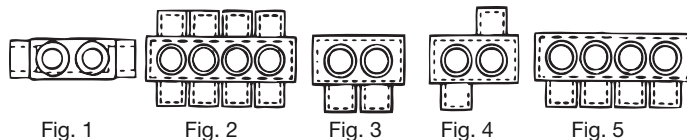

1PLD=Multi-Port Double Sided Entry (Fig. 2)				
Catalog Number	Figure Number	Number of Ports	Wire Range (AWG/kcmil)	Hex Key Torque (in lbs)
1PLD3502	2	2	10 - 350	5/16 (375)
1PLD3503		3		
1PLD3504		4		
1PLD3506		6		
1PLD3508		8		
1PLD6002		2		
1PLD6003		3		
1PLD6004		4		
1PLD6005		5		
1PLD6006		6		
1PLD6008		8		

BURNDY® UNITAP™
THE MOLE™
In-Line Splicer/Reducer
For Direct Burial



Designed specifically for direct burial applications, the MOLE™ is made with a specialized plastisol material that forms a watertight connection and is rugged enough to withstand abrasions that may occur in direct burial applications. Dual-rated AL9CU for stranded copper and aluminum applicators. 600V, 90°C.

Catalog Number	Wire Range	L	W	H	Hex Key
BISR4-DB	6 - 4	4.25	0.68	1.43"	1/8"
BISR1-DB	2 - 1	6.25	0.89	1.70"	5/32"
BISR3/0-DB	1/0 - 3/0	6.25	0.99	1.90"	3/16"
BISR250-DB	4/0 - 250	6.70	1.18	2.15"	5/16"

TYPE UGS350ULDB
In-Line Splicer/Reducer
For Direct Burial



Features and Benefits

- EPDM rubber covered 6061-T6 aluminum connector.
- Dual rated AL9CU for copper or aluminum conductor.
- UL Listed and CSA Certified for Direct Burial.
- Broad range-taking capability.
- Low installation cost.

Catalog Number	Wire Range	Length In. (mm)	Height In. (mm)	Hex Size	Torque (lbs.)
UGS350ULDB	12 AWG - 350 kcmil	8.50 (216)	2.81 (71.4)	5/16"	350

TYPES PENETROX™ A, A-13 and E**Oxide-Inhibiting Joint Compounds**

PENETROX™ oxide-inhibiting compounds produce low initial contact resistance, seal out air and moisture, prevent oxidation or corrosion, exhibit superior weathering characteristics, are usable over wide temperature ranges and provide a high conductivity “gas-tight” joint. All PENETROX™ compounds contain homogeneously suspended metal particles. The suspended metal particles assist in penetrating thin oxide film, act as electrical “bridges” between conductor strands, aid in gripping the conductor, improve electrical conductivity and enhance the integrity of the connection.

The specially formulated PENETROX™ compounds are for use with compression and bolted connectors providing an improved service life for both copper and aluminum connections. Additionally, the non-toxic compounds are an excellent lubricant for threaded applications reducing galling and seizing.

PENETROX™ A-13

PENETROX™ A-13 is a synthetic base compound with evenly suspended zinc particles. It is recommended for aluminum to aluminum, aluminum to copper connections plus aluminum conduit threads. It is compatible with rubber, polyethylene and other insulating materials. UL Listed for all voltages.

**PENETROX™ A**

PENETROX™ A is a natural (petroleum) base compound with evenly suspended zinc particles. It is recommended for aluminum to aluminum, aluminum to copper connections and aluminum conduit threads. It is not recommended for use with rubber or polyethylene insulated conductors. UL Listed to 600V.

**PENETROX™ E**

PENETROX™ E is a synthetic base compound with evenly suspended copper particles. It is recommended for copper to copper, copper threads and all grounding applications. UL Listed.

**PENETROX™ A, A-13 and E****TECHNICAL INFORMATION****Easy to apply:**

1. Scratch brush the conductor surfaces until bright and clean.
2. Immediately apply PENETROX™ to the conductive surfaces.
3. For EHV applications, remove all excess PENETROX™ after installation is complete.

Shelf Life:

When stored in its original container in cool (under 100° F) dry environment, PENETROX™ oxide inhibiting compound will remain workable and functional for five (5) years from the date marked on the container provided it is mixed per instructions prior to use.

Properties of PENETROX™

Property	Value PENETROX™ Definition	PENETROX E & A13	A
Penetration (Unworked)	The value in accordance to ASTM D217 indicates the consistency of a grease. The higher the number, the softer the grease.	250	230
Dropping Point (Min.)	The temperature at which the grease passes from the semi-solid to a liquid state under test conditions.	500°F	230°F
Pour Point (Max.)	The lowest temperature at which the compound will flow. Pour point is the lubricant's ability to perform in cold conditions.	-10°F	-15°F

*MSDS sheets available through Customer Service.

Ordering Information:

Catalog Number			Container Type	Size
PENETROX A	PENETROX A-13	PENETROX E		
PENA1/2	—	—	Tube	1/2 Oz.
PENA-4	PENA13-4	PENE-4	Squeeze Bottle	4 Oz.
P8A	PENA13-8	PENE-8	Squeeze Bottle	8 Oz.
PENACARTRIDGE	PENA13CARTRIDGE	—	Cartridge	1 Lb.*
PENA-QT	PENA13QT	PENE-QT	Plastic Tube	1 Qt.
PENA-GAL	PENA13-GAL	PENE-GAL	Can	1 Gal.
PENA-5GAL	PENA13-5GAL	PENE-5GAL	Pail 5	Gal.
PENA-55GAL	PENA13-55GAL	PENE-55GAL	Drum	55 Gal.

* 1 Lb. Cartridge will fit standard caulking guns.

TYPE BDT**BONDIT™ Intersystem Bonding Connector**

House Mounted or
Meter Socket Mounted

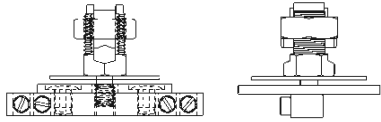

Designed to meet the requirements of 2008 NEC Article 250.94 “Bonding for Other Systems.” Corrosion-resistant stainless steel set screws. Accepts main ground wire (#2-#8) and up to 4 intersystem wires (#6-#14). Same design can be mounted directly to the meter socket or mounted to the house. Innovative design does not damage meter socket and will not void warranty.

Catalog Number: **BDT1**

Features & Benefits

- Made in the USA!
- Meets Intersystem Bonding Requirements: NEC2008 250.94.
- One connector does it all.
- House mount or meter socket mount.
- Incorporates proven BURNDY® SERVIT POST™ design.
- Stainless steel set screws.
- Accepts main ground wire (#2-#8), up to 4 intersystem wires (#6-#14).
- Easily mounts to meter box during new installation or can be wall mounted.
- Easy to follow instructions included.
- Does not damage meter socket; no worries about damaging the paint or voiding warranties.
- Easily installed with a wrench and screwdriver.
- Open design prevents buildup of hornets, bees, spiders.

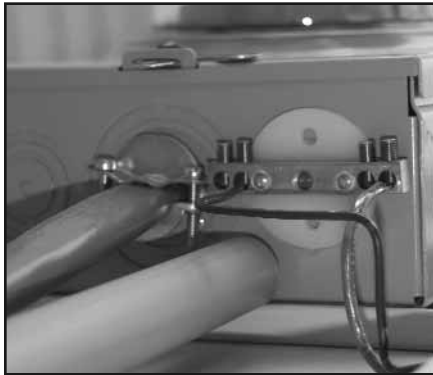
**CONFIGURATION 1 – MOUNTED TO ENCLOSURE**

1. Punch out a 1/2" or 3/4" knock out on the electrical enclosure.
2. Begin assembly by installing the ground electrode conductor in the SERVIT POST™ inside the electrical enclosure. Torque on SERVIT® nut: 275 in-lb max.
3. Install the rest of the connector as shown in figure 1 below, it is not necessary for the bus bar to be aligned parallel with the enclosure. (Note: the split washer is not used in this configuration.)
4. Tighten the intersystem ground wires with set screws in the bus bar to a maximum torque of 35 in-lb.
5. Adhere the BONDIT™ location sticker to the front of the electrical enclosure.

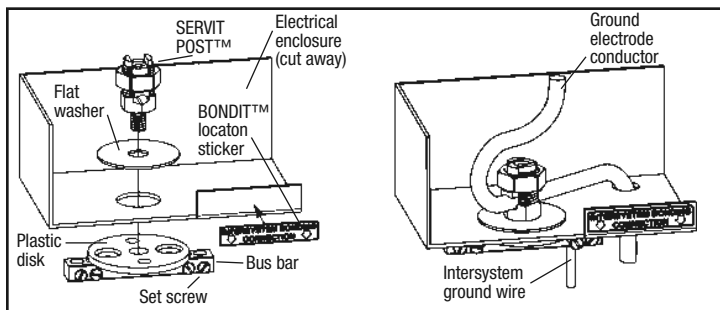
**TYPE BDT****BONDIT™ Intersystem Bonding Connector**

(Continued)

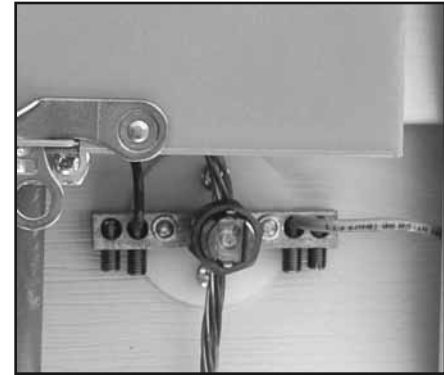
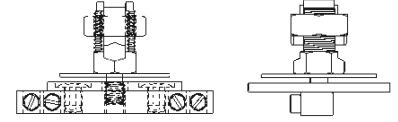
**CONFIGURATION 2 – MOUNTED TO EXTERIOR WALL**

1. Begin by assembling the connector as shown in figure 2 below. Be sure SERVIT POST™ is as tight as it can be while its groove is aligned with the ground electrode conductor. (Note: the flat washer is not used in this configuration.)
2. Use two mounting screws (not included) to secure the connector to the exterior wall so that the set screws in the bus bar face downward.
3. Install the ground electrode conductor into the SERVIT POST™ while turning the nut/pressure bar assembly to a maximum torque of 275 in-lb. (use 2 wrenches if necessary).
4. Tightening the intersystem ground wires with the set screws in the bus bar to a maximum torque of 35 in-lb.
5. If hidden from view, use the BONDIT™ location sticker to indicate the location.

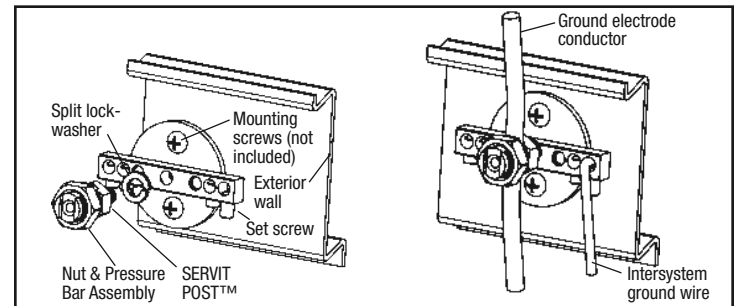

BWB680 SERIES
BURNDY® Pool Water Bonding Kit

NEC 2008 680.26(C) states: "An intentional bond of a minimum conductive surface area of 9" shall be installed in contact with the pool water. This bond shall be permitted to consist of parts that are required to be bonded in 680.26(B)."

In order to comply with this requirement BURNDY® is pleased to introduce the BWB680 Series. Made of non-corrosive stainless steel, the BURNDY® water bonding kit maintains constant contact with pool water to ensure that the pool is effectively bonded at all times.

BURNDY® BWB680 Series is one of the few and the most user friendly, products on the market that complies with this code. Other products that are currently available are placed in the plumbing, which is not always in contact with the water and therefore does not meet the code. Since the BWB680 is placed in the skimmer, it is always in contact with the water.

Some of the features of this product include:

- Easy installation
- Mounting hardware included
- UL Listed
- Placed out of the way on the side wall of the skimmer, below the basket

Catalog Number	Pool Type
BWB680IG	In-Ground
BWB860AG	Above Ground

Included in the BURNDY® BWB680 Series Bonding Kit: One bonding plate, (1) rubber sealing washer, (2) flat washers, (2) lock washers, (2) nuts and (1) BURNDY® CL501-TN

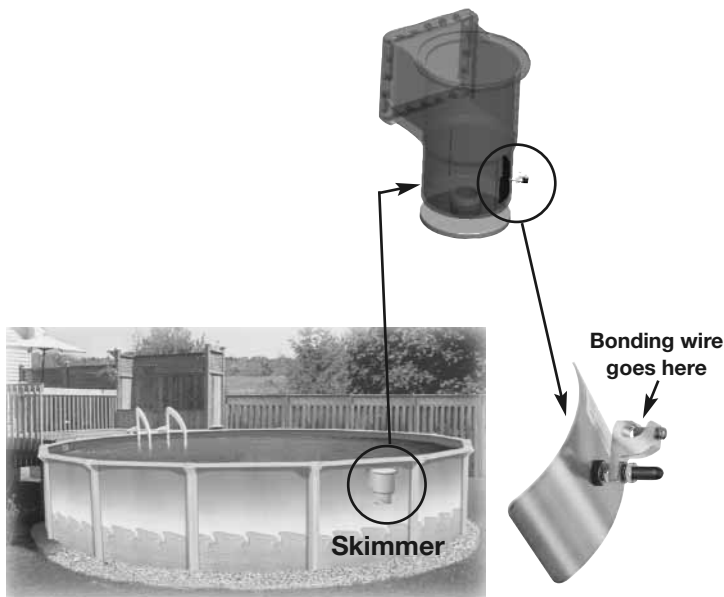

A pool skimmer acts as a water filter at the top of a pool. Because pool water is continuously flowing through the skimmer drain, installing the BURNDY® Pool Water Bonding Kit inside the skimmer is ideal for complying with NEC 2008 680.26(C).

TYPE GRL
Ground Rod Clamp



UL467 Listed. Acceptable for direct burial.

Catalog Number	Rod Size	Conductor Range	
		Min.	Max.
GRL3*	3/8	10 AWG	4 AWG
GRL4	1/2	10 AWG	2 AWG
GRL5	5/8	10 AWG	2 AWG
GRL6	3/4	10 AWG	2 AWG

* Item not UL Listed.

TYPE GRC
Bronze Ground Rod Clamps



High copper alloy ground connector for joining a range of cable to rod. UL467 Listed. Acceptable for direct burial.

Catalog Number	Ground Rod	Conductor Range
GRC12	1/2	10 sol.-2 str.
GRC58	5/8	10 sol.-1 str.
GRC34	3/4	8 sol.-1/0 str.

TYPES KC, K2C
SERVIT® POST™
 For Copper Cable to Flat



SERVIT® POST™ used to ground one or two cables to steel structures, fence posts, and transformers. Also used to tap one or two cables from bus bar. One-wrench installation.

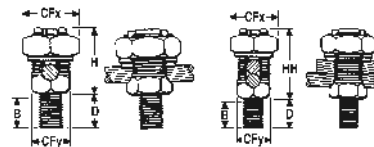

Catalog Number	Conductor	Stud	B	CFx	CFy	D	H	HH		
Type KC*	Type K2C†	Stranded	Solid	Dia.						
KC15	K2C15	12 - 9	12 - 8	1/4-20"	3/8"	1/2"	3/8"	1/2"	5/8"	7/8"
KC15B1	K2C15B1				7/8"			1"		
KC17	K2C17	10 - 7	10 - 6	1/4-20"	3/8"	5/8"	7/16"	1/2"	7/8"	1"
KC17B1	K2C17B1				7/8"			1"		
KC20	K2C20	10 - 5	10 - 4	5/16-18"	13/32"	11/16"	1/2"	5/8"	7/8"	1"
KC20B1	K2C20B1				27/32"			1"		
KC22	K2C22	10 - 3	10 - 2	3/8-16"	15/32"	3/4"	5/8"	5/8"	1"	1-1/4"
KC22B1	K2C22B1				31/32"			1-1/8"		
KC23	K2C23	8 - 2	10 - 1	3/8-16"	15/32"	13/16"	5/8"	5/8"	1"	1-3/8"
KC23B1	K2C23B1				31/32"			1-1/8"		
KC25	K2C25	2 - 1/0	2 - 2/0	1/2-13"	9/16"	15/16"	3/4"	3/4"	1-1/8"	1-5/8"
KC25B1	K2C25B1				1-1/16"			1-1/4"		
KC26	K2C26	2 - 1/0	2 - 3/0	1/2"-13"	17/32"	1"	7/8"	3/4"	1-3/8"	1-7/8"
KC26B1	K2C26B1				1-1/16"			1-1/4"		
KC28	K2C28	1 - 4/0	1 - 4/0	5/8"-11"	3/4"	1-1/2"	1-3/16"	1"	1-3/4"	2-1/4"
KC28B1	K2C28B1				1-1/4"			1-1/2"		
KC31	K2C31	1 - 350	—	5/8"-11"	3/4"	1-11/16"	1-3/8"	1"	2-1/4"	2-7/8"
KC31B1	K2C31B1				1-1/4"			1-1/2"		
KC34	K2C34	3/0 - 500	—	3/4-10	1"	2"	1-5/8"	1-1/4"	2-3/8"	3-1/4"
KC34B1	K2C34B1				1-1/2"			1-3/4"		

* = 1 conductor † = 2 conductors

CAST BRONZE CLAMPS

For Conduit



Pressure bar type conduit hub adjusts for 1/2", 3/4" EMT or 1/2" rigid conduit. Hub swings 360° for easy alignment. Zinc plated hardware.

Catalog Number	Conductor Range		Recommended Screw Torque		
	Water Pipe	Ground	Hub Size	Pipe Clamp	Wire Clamp
C-11JPT	1/2-1	10 - 6 sol.	1/2	50 in-lb	50 in-lb
C-22JPT	1-1/4-2				
C-4JPT	2-1/2-4				

CAST BRONZE GROUND CLAMPS

For connecting grounding conductor to water pipe or copper tube. "D" indicates UL467 Listed for direct burial in earth and concrete and are supplied with silicon bronze hardware. "B" indicates brass hardware.

Catalog Number	Conductor Range		Recommended Screw Torque		
	Water Pipe	Rebar	Ground	Pipe Clamp	Wire Clamp
C-11N	1/2 - 1	—	10 - 2 str.	50 in-lb	50 in-lb
C-11D	1/2 - 1	4 - 6			
C-11B	1/2 - 1	—			
C-22	1-1/4 - 2	—			
C-22D	1-1/4 - 2	—			
C-4	2-1/2 - 4	—			
C-8	4-1/2 - 6	—			
C-5	1/2 - 1	—			

DIE CAST CLAMPS

Die cast zinc with zinc plated screws.

Catalog Number	Conductor Range		Recommended Screw Torque	
	Water Pipe	Ground	Pipe Clamp	Wire Clamp
CZ-11	1/2 - 1	10 - 2 str.	50 in-lb	50 in-lb

CAST BRONZE CLAMPS

To connect armored cable to water pipe. Zinc plated screws. Pressure bar grips armor or outer cable insulation. 360° swing hub for easy alignment.

Catalog Number	Conductor Range		Recommended Screw Torque	
	Water Pipe	Conductor	Pipe Clamp	Wire Clamp
C-11JA	1/2 - 1	10 - 6 sol.	50 in-lb	50 in-lb
C-22JA	1-1/4 - 2	10 - 6 sol.		
C-4JA	2-1/2 - 2	10 - 2 sol.		

CAST BRONZE CLAMPS

For connecting armored cable to water pipe. Zinc plated screws. "D" indicates UL467 for direct burial in earth and concrete, supplied with silicon bronze hardware.

Catalog Number	Conductor Range		Recommended Screw Torque		
	Water Pipe	Conductor	Ground Clamp	Pipe Clamp	Wire Clamp
C-6	1/2 - 1	10 - 2 str.	Bare Armored Unarmored Wire Cables or Cords	50 in-lb	50 in-lb
C-6D	1-1/4 - 2	10 - 2 str.			
C-7	1-1/4 - 2	10 - 2 str.			

CAST BRONZE CLAMPS

For Rigid Conduit



For grounding rigid conduit systems. Zinc plated screws.

Catalog Number	Conductor Range		Recommended Screw Torque		
	Water Pipe	Ground	Hub Size	Pipe Clamp	Wire Clamp
C-61	1/2 - 1	6 sol. Max	1/2	50 in-lb	50 in-lb
C-66	1-1/4 - 2				

CAST BRONZE GROUND CLAMPS

For connecting grounding conductor, EMT or rigid conduit to water pipe, copper tube, ground rod or rebar. Hub swings 360° for easy alignment. Simply reverse bottom clamp for smaller size rebar or rod. Connectors are provided with silicon bronze hardware.

Catalog Number	Conductor Range				Reference Dimensions			Recommended Screw Torque
	Main		Tap		H	L	W	
	Water Pipe	Rebar	Ground Rod	Ground				
C11HD4/ODB	1/2"-1"	4 - 6 AWG	3/8" - 1"	8 - 4/0 AWG	2.25	2.65	1.65	50 in-lb
C22HD4/ODB	1-1/4"-2"	—	—		2.70	3.60	1.56	

CAST BRONZE GROUND CLAMPS

With Lay-In Feature



For connecting grounding conductor to water pipe, copper tube, ground rod or rebar. The open face design allows for fast lay-in of the tap conductor without the need for cutting. Simply reverse bottom clamp for smaller size rebar or rod. Connectors are provided with silicon bronze hardware.

Catalog Number	Fig. No.	Conductor Range				Reference Dimensions			Recommended Screw Torque
		Main		Tap		H	L	W	
		Water Pipe	Rebar	Ground Rod	Ground				
C11K16D	1	1/2" - 1"	4 - 6	3/8" - 1"	10 - 2 str.	1.64	2.28	0.66	50 in-lb
C11K17D	2								

CAST BRONZE CLAMPS

For Conduit



For grounding rigid conduit systems. Continuity from rigid conduit systems to ground provided by cast bronze threaded conduit hub. Zinc plated screws.

Catalog Number	Conductor Range		Recommended Screw Torque		
	Water Pipe	Ground	Hub Size	Pipe Clamp	Wire Clamp
C-11LH-1	1/2 - 1	10 str. - 6 sol.	1/2"	50 in-lb	50 in-lb
C-22LH-1	1-1/4 - 2				
C-4LH-1	2-1/2 - 4				
C-11LH-2	1/2 - 1	10 - 2/0 str.	3/4"		
C-22LH-2	1-1/4 - 2				
C-4LH-2	2-1/2 - 4				
C-11LH-3	1/2 - 1	10 - 3/0 str.	1"		
C-22LH-3	1-1/4 - 2				
C-4LH-3	2-1/2 - 4				

TYPE GC-A

Dual Rated Ground Clamp



Ground clamps are UL Listed for use with either copper or aluminum conductors to copper water pipe, galvanized pipe or steel conduit. All clamps are constructed from tin-plated high strength extruded aluminum alloy. PENE TROX™ oxide inhibiting compounds are recommended for all aluminum.

Catalog Number	Conduit, Pipe or Water Tube Size	Ground Wire Range	Screw Type
GC15A	1/2" - 3/4" - 1"	14 - 1/0 AWG	Slotted
GC18A	1-1/4" - 1-1/2" - 2"	6 str. - 250 kcmil	Hex Socket
GC22A	2-1/2" - 3" - 3-1/2" - 4"		

TYPE GAR

Ground Connector

For Copper Cable to Rod



High copper alloy connector for joining a range of cable, parallel or at right angles, to rod or tube. UL467 Listed. Acceptable for direct burial.

Catalog Number	Conductor Range		Cable Range
	IPS	Rod	
GAR114C	1/4	1/2	8 sol. - 4 str.
GAR1126	1/4	1/2	4 sol. - 2/0 str.
GAR1129	1/4	1/2	2/0 sol. - 250 kcmil
GAR644C	3/8	5/8 - 3/4	8 sol. - 4 str.
GAR6426	3/8	5/8 - 3/4	4 sol. - 2/0 str.
GAR6429	3/8	5/8-3/4	2/0 sol. - 250 kcmil
GAR6434	3/8	5/8 - 3/4	300 - 500 kcmil
GAR144C	1/2 - 3/4	7/8 - 1	8 sol. - 4 str.
GAR1426	1/2 - 3/4	7/8 - 1	4 sol. - 2/0 str.
GAR1429	1/2 - 3/4	7/8 - 1	2/0 sol. - 250 kcmil
GAR1434	1/2 - 3/4	7/8 - 1	300 - 500 kcmil
GAR154C	1	1-1/8 - 1-1/4	8 sol. - 4 str.
GAR1526	1	1-1/8 - 1-1/4	4 sol. - 2/0 str.
GAR1529	1	1-1/8 - 1-1/4	2/0 sol. - 250 kcmil
GAR1534	1	1-1/8 - 1-1/4	300 - 500 kcmil
GAR164C	1-1/4	1-3/8 - 1-1/2	8 sol. - 4 str.
GAR1626	1-1/4	1-3/8 - 1-1/2	4 sol. - 2/0 str.
GAR1629	1-1/4	1-3/8 - 1-1/2	2/0 sol. - 250 kcmil
GAR1634	1-1/4	1-3/8 - 1-1/2	300 - 500 kcmil
GAR174C	1-1/2	1-5/8 - 1-7/8	8 sol. - 4 str.
GAR1726	1-1/2	1-5/8 - 1-7/8	4 sol. - 2/0 str.
GAR1729	1-1/2	1-5/8 - 1-7/8	2/0 sol. - 250 kcmil
GAR1734	1-1/2	1-5/8 - 1-7/8	300 - 500 kcmil
GAR184C	2	2 - 2-3/8	8 sol. - 4 str.
GAR1826	2	2 - 2-3/8	4 sol. - 2/0 str.
GAR1829	2	2 - 2-3/8	2/0 sol. - 250 kcmil
GAR1834	2	2-1/2 - 2-7/8	300 - 500 kcmil
GAR194C	2-1/2	2-1/2 - 2-7/8	8 sol. - 4 str.
GAR1926	2-1/2	2-1/2 - 2-7/8	4 sol. - 2/0 str.
GAR1929	2-1/2	2-1/2 - 2-7/8	2/0 sol. - 250 kcmil
GAR1934	2-1/2	2-1/2 - 2-7/8	300 - 500 kcmil
GAR204C	3	3 - 3-1/2	8 sol. - 4 str.
GAR2026	3	3 - 3-1/2	4 sol. - 2/0 str.
GAR2029	3	3 - 3-1/2	2/0 sol. - 250 kcmil
GAR2034	3	3 - 3-1/2	300 - 500 kcmil
GAR214C	3-1/2	3-1/2 - 4	8 sol. - 4 str.
GAR2126	3-1/2	3-1/2 - 4	4 sol. - 2/0 str.
GAR2129	3-1/2	3-1/2 - 4	2/0 sol. - 250 kcmil
GAR2134	3-1/2	3-1/2 - 4	300 - 500 kcmil
GAR224C	4	4 - 4-1/2	8 sol. - 4 str.
GAR2226	4	4 - 4-1/2	4 sol. - 2/0 str.
GAR2229	4	4 - 4-1/2	2/0 sol. - 250 kcmil

TYPES GAR-BU AND GAR3902 SERIES

Ground Connectors



Type GAR-BU is a high-conductivity copper ground connector for connecting a small to medium range copper ground conductor to water pipe as well as structural and reinforcing rod shapes. Universal acceptance of several sizes of cylindrical shapes makes this suitable for industrial construction and maintenance work as well as cathodic protection. Cable clamp swivels to permit parallel ground of one pipe or 90° cable run for grounding several parallel pipes. Single wrench installation. UL467 Listed and CSA Certified.

Catalog Number*	Cable Range	IPS Size	O.D. Range	H	J	W	Recommended Tightening Torque
GAR3902-BU	4 - 4/0 AWG	1/2" - 1"	.840-1.32	3.50	3/8"-16	3.25	240 in-lb
GAR3903-BU		1-1/4" - 2"	1.66-2.38	4.00		4.25	
GAR3904-BU		2-1/2" - 3-1/2"	2.88-4.00	6.50		6.00	
GAR3905-BU		4" - 5"	4.50-5.56	7.50		7.50	
GAR3906-BU		6"	6.62	8.50		8.62	
GAR3907-BU		8"	8.62	10.00		10.62	
GAR3908-BU		10"	10.75	12.00		12.75	
GAR3909-BU		12"	12.75	14.00		14.75	
GAR3902		1/2" - 1"	.840-1.32	3.50		3.25	
GAR3903		1-1/4" - 2"	1.66-2.38	4.00		4.25	
GAR3904		2-1/2" - 3-1/2"	2.88-4.00	6.50		6.00	
GAR3905		4" - 5"	4.50-5.56	7.50		7.50	
GAR3906	6"	6.62	8.50	8.62			
GAR3907	8"	8.62	10.00	10.62			
GAR3908	10"	10.75	12.00	12.75			
GAR3909	12"	12.75	14.00	14.75			

*Type GAR-BU is supplied with DURIMUM™ silicon bronze hardware and is listed for direct burial.

TYPE GAR-RB

Reinforcement Bar



Catalog Number	Rebar	IPS Size	O.D. Range	Rod	Copper Conductor	
					Min.	Max.
GAR644C-RB	3 - 6 AWG (.375 - .750)	3/8"	.625 - .75	5/8 - 3/4	8 sol.	4 str.

TYPES GB, GBM

Ground Connector

For Copper Cable to Bar



Type GB



Type GBM

High copper alloy ground connectors for joining a range of cable to 1/4" thick bar.

Catalog Number	Conductor	H Type GB/GBL	H Type GBM	J	W Type GB/GBL	W Type GBM
GB4C	8 sol. - 4 str.	1-1/2"	1-1/2"	3/8"	1-1/4"	1-1/4"
GB26	4 sol. - 2/0 str.	2"	1-1/2"	3/8"	1-1/2"	1-1/2"
GBL30*	4 sol. - 300 kcmil	2"	—	1/2"	7/8"	0"
GB29	2/0 sol. - 250 kcmil	2"	2"	1/2"	2"	2"
GB34	300 - 500 kcmil	3"	2-1/4"	1/2"	2-3/8"	2-3/8"

*GBL30 is not UL Listed. Add "GS" suffix for galvanized steel hardware.

TYPES GC, GCM

Ground Connector

For Two Copper Cables to Bar



Type GC



Type GCM

High copper alloy ground connectors for joining a range of two parallel cables to 1/4" thick bar.

Catalog Number	Conductor	H Type GC/GCL	H Type GCM	J	W Type GC/GCL	W Type GCM
GC4C4C	8 sol. - 4 str.	1-1/2"	1-1/2"	3/8"	1-3/8"	1"
GC2626	4 sol. - 2/0 str.	2"	1-1/2"	3/8"	1-3/4"	1-3/8"
GCL30	4 sol. - 300	2"	—	—	1"	—
GC2929	2/0 sol. - 250	2-1/4"	2"	—	2-1/4"	2"
GC3434	300 - 500	2-7/8"	2-1/4"	1/2"	2-7/8"	2-5/8"

Add "GS" suffix for galvanized steel hardware.

TYPE GL

Ground Connector

For Two Copper Cables to Bar



High copper alloy ground connectors for joining a wide range of two parallel cables to 1/4" thick bar.

Catalog Number	Conductor	H	J	W
GL4C4C	8 sol. - 4 str.	1-1/2"	3/8"	1-3/8"
GL2626	4 sol. - 2/0 str.	2"	3/8"	1-3/4"
GL2929	2/0 sol. - 250	2-1/4"	1/2"	2-1/4"
GL3434	300 - 500 kcmil	2-7/8"	1/2"	2-7/8"

TYPE GZ

Ground Connector

For Copper Cable to Bar



High copper alloy ground connectors for joining a wide range of cable to 1/4" thick bar.

Catalog Number	Conductor	H	J	W
GZ4C-38	8 - 4 str.	1-1/2"	3/8"	1-1/8"
GZ4C-12	8 - 4 str.	1-7/8"	1/2"	1-3/4"
GZ4C-58	8 - 4 str.	2"	5/8"	1-3/4"
GZ26-38	3 - 2/0 str.	2"	3/8"	1-5/8"
GZ26-12	3 - 2/0 str.	2-1/8"	1/2"	1-3/4"
GZ26-58	3 - 2/0 str.	2-1/4"	5/8"	1-3/4"
GZ29-38	3/0 str. - 250 kcmil	2-1/4"	3/8"	2-1/4"
GZ29-12	3/0 str. - 250 kcmil	2-3/8"	1/2"	2-1/4"
GZ29-58	3/0 str. - 250 kcmil	2-1/2"	5/8"	2-1/4"

TYPE GC-CT

Cabletray Ground Connector



This unique connector incorporates features which are unmatched. Made of tin-plated cast copper alloy, it accommodates either one or two conductors, copper or aluminum cable.

Catalog Number	Accommodates Cu or Al Conductor in Either Groove	B	CF	H	J	W
GC2525CT	6 sol. - 1/0 str.	1.12	.56	1.95	3/8 - 16	1.45
GC2626CT	2 sol. - 2/0 str.	1.12	.56	1.95	3/8 - 16	1.70
GC2929CT	2/0 str. - 250 kcmil	1.12	.56	2.20	3/8 - 16	1.98

TYPES KC-J, EQC632C

Transformer Ground Connectors

For Copper



Fits all standard EEI NEMA distribution transformers as a tank grounding terminal.

Catalog Number	Ranges
KC22J12T13	8 - 2 sol.
KC34J12T13	3/0 str. - 500 kcmil
EQC632C	8 sol. - 2 str.

TYPE GKA

For Copper



UL467 Listed for direct burial application in earth or concrete.

Catalog Number	Cable Range	B	C	H	J	K	L
GKA8C*	10 sol. - 8 str.	.31	.38	.58	10 - 32	.21	.81
GKA4C**	14 sol. - 4 str.	.46	.54	.71	5/16 - 24	.28	1.13

* To be assembled with TMH322 stainless steel hardware kit, ordered separately.
 ** To be assembled with TMH323 stainless steel hardware kit, ordered separately.

**TYPE CL50-1
COPPER LAY-IN QIKLUG™**

For Copper



The Lay-In QIKLUG™ is manufactured from high strength pure electrolytic copper to ensure maximum strength and conductivity. UL467 Listed for direct burial in earth or concrete. The open-faced design allows for fast lay-in of the conductor without the need for cutting or breaking.

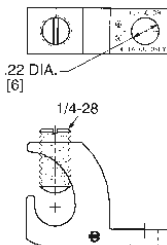

Catalog Number	Wire Range Copper	Stud Hole
CL50-1	#14 - #4 CU	#10
CL50-1TN*	#14 - #4 CU	#10

*-TN Version is tin plated. Commonly used for solar panel grounding.

TYPE GD

Ground Connector

For Copper Cable to Rod/Tube



High copper alloy ground connector for joining a range of two parallel cables to rod or tube. Especially good for grounding fence posts. UL467 Listed. Acceptable for direct burial.

Catalog Number	IPS	Conductor Range	
		Rod	Cable Range
GD1526	1	1-1/8 - 1-1/4	4 sol. - 2/0 str.
GD1529	1	1-1/8 - 1-1/4	2/0 sol. - 250 kcmil
GD1626	1-1/4	1-3/8 - 1-1/2	4 sol. - 2/0 str.
GD1629	1-1/4	1-3/8 - 1-1/2	2/0 sol. - 250 kcmil
GD174C	1-1/2	1-5/8 - 1-7/8	8 sol. - 4 str.
GD1726	1-1/2	1-5/8 - 1-7/8	4 sol. - 2/0 str.
GD1729	1-1/2	1-5/8 - 1-7/8	2/0 sol. - 250 kcmil
GD1734	1-1/2	1-5/8 - 1-7/8	300 - 500 kcmil
GD184C	2	2 - 2-3/8	8 sol. - 4 str.
GD1826	2	2 - 2-3/8	4 sol. - 2/0 str.
GD1829	2	2 - 2-3/8	2/0 sol. - 250 kcmil
GD1834	2	2 - 2-3/8	300 - 500 kcmil
GD194C	2-1/2	2-1/2 - 2-7/8	8 sol. - 4 str.
GD1926	2-1/2	2-1/2 - 2-7/8	4 sol. - 2/0 str.
GD1929	2-1/2	2-1/2 - 2-7/8	2/0 sol. - 250
GD1934	2-1/2	2-1/2 - 2-7/8	300 - 500 kcmil
GD204C	3	3 - 3-1/2	8 sol. - 4 str.
GD2026	3	3 - 3-1/2	4 sol. - 2/0 str.
GD2029	3	3 - 3-1/2	2/0 sol. - 250 kcmil
GD2034	3	3 - 3-1/2	300 - 500 kcmil
GD214C	3-1/2	3-1/2 - 4	8 sol. - 4 str.
GD2126	3-1/2	3-1/2 - 4	4 sol. - 2/0 str.
GD2129	3-1/2	3-1/2 - 4	2/0 sol. - 250 kcmil
GD2134	3-1/2	3-1/2 - 4	300 - 500 kcmil
GD224C	4	4 - 4-1/2	8 sol. - 4 str.
GD2226	4	4 - 4-1/2	4 sol. - 2/0 str.
GD2229	4	4 - 4-1/2	2/0 sol. - 250 kcmil
GD2234	4	4 - 4-1/2	300 - 500 kcmil

All dimensions shown are for reference only.

TYPE GG

Ground Connector

For Copper Bar, Strap, Braid or Cable to Rod or Tube



High copper alloy ground connector for joining bar, strap, braid, or cable to rod or tube.

Catalog Number	Conductor Range		Cable Range
	IPS	Rod	
GG15-1	1	1-1/8 - 1-1/4	
GG16-1	1-1/4	1-3/8 - 1-1/2	
GG17-1	1-1/2	1-5/8 - 1-7/8	
GG17-15	1-1/2	1-5/8 - 1-7/8	
GG18-1	2	2 - 2-3/8	
GG18-15	2	2 - 2-3/8	
GG18-2	2	2 - 2-3/8	
GG19-2	2-1/2	2-1/2 - 2-7/8	
GG19-25	2-1/2	2-1/2 - 2-7/8	
GG20-2	3	3 - 3-1/2	
GG20-25	3	3 - 3-1/2	
GG20-3	3	3 - 3-1/2	
GG21-2	3-1/2	3-1/2 - 4	
GG21-25	3-1/2	3-1/2 - 4	
GG21-3	3-1/2	3-1/2 - 4	
GG21-35	3-1/2	3-1/2 - 4	
GG22-2	4	4 - 4-1/2	
GG22-25	4	4 - 4-1/2	
GG22-3	4	4 - 4-1/2	
GG22-35	4	4 - 4-1/2	
GG22-4	4	4 - 4-1/2	
GG24-2	5	—	

TYPE GK

Ground Connector

For Three Copper Cables to Rod or Pipe



High copper alloy ground connector for joining three equal cables to rod or tube. UL467 Listed. Acceptable for direct burial.

Catalog Number	Conductor Range		Cable Range
	IPS	Rod	
GK114C	1/4	1/2	8 sol. - 4 str.
GK1126	1/4	1/2	4 sol. - 2/0 str.
GK1129	1/4	1/2	2/0 sol. - 250 kcmil
GK644C	3/8	5/8 - 3/4	8 sol. - 4 str.
GK6426	3/8	5/8 - 3/4	4 sol. - 2/0 str.
GK6429	3/8	5/8 - 3/4	2/0 sol. - 250 kcmil
GK6434	3/8	5/8 - 3/4	300 - 500 kcmil
GK1426	1/2 - 3/4	7/8 - 1	4 sol. - 2/0 str.
GK1429	1/2 - 3/4	7/8 - 1	2/0 sol. - 250 kcmil
GK1434	1/2 - 3/4	7/8 - 1	300 - 500 kcmil
GK1526	1	1-1/8 - 1-1/4	4 sol. - 2/0 str.
GK1529	1	1-1/8 - 1-1/4	2/0 sol. - 250 kcmil
GK1626	1-1/4	1-3/8 - 1-1/2	4 sol. - 2/0 str.
GK1629	1-1/4	1-3/8 - 1-1/2	2/0 sol. - 250 kcmil
GK1726	1-1/2	1-5/8 - 1-7/8	4 sol. - 2/0 str.
GK1729	1-1/2	1-5/8 - 1-7/8	2/0 sol. - 250 kcmil
GK1826	2	2 - 2-3/8	4 sol. - 2/0 str.
GK1829	2	2 - 2-3/8	2/0 sol. - 250 kcmil
GK1926	2-1/2	2-1/2 - 2-7/8	4 sol. - 2/0 str.
GK1929	2-1/2	2-1/2 - 2-7/8	2/0 sol. - 250 kcmil

TYPE GP

Ground Connector

For Two Copper Cables to Rod or Pipe



High copper alloy ground connector for joining a range of parallel cables perpendicular to rod, pipe or column. Also used with one groove for run, the other for tap to equipment. UL467 Listed. Acceptable for direct burial.

Catalog Number	Conductor Range		Cable Range
	IPS	Rod	
GP114C	1/4	1/2	8 sol. - 4 str.
GP1126	1/4	1/2	4 sol. - 2/0 str.
GP1129	1/4	1/2	2/0 sol. - 250 kcmil
GP644C	3/8	5/8 - 3/4	8 sol. - 4 str.
GP6426	3/8	5/8 - 3/4	4 sol. - 2/0 str.
GP6429	3/8	5/8 - 3/4	2/0 sol. - 250 kcmil
GP6434	3/8	5/8 - 3/4	300 - 500 kcmil
GP144C	1/2 - 3/4	7/8 - 1	8 sol. - 4 str.
GP1426	1/2 - 3/4	7/8 - 1	4 sol. - 2/0 str.
GP1429	1/2 - 3/4	7/8 - 1	2/0 sol. - 250 kcmil
GP1434	1/2 - 3/4	7/8 - 1	300 - 500 kcmil
GP164C	1-1/4	1-5/8	8 sol. - 4 str.
GP1629	1-1/4	1-5/8	2 sol. - 250 kcmil
GP1726	1-1/2	1-7/8	4 sol. - 2 str.
GP184C	2	2-3/8	8 sol. - 4 str.
GP1826	2	2-3/8	4 sol. - 2/0 str.
GP2026	3	3-1/2	4 sol. - 2/0 str.
GP2226	4	4-1/2	4 sol. - 2/0 str.

TYPES GP-G1, GP-RT

Raised Floor Grounding Clamps

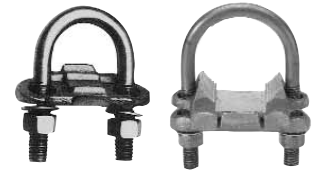

Type GPG1 GP1726RT



High copper alloy ground connector for raised floor computer grounding applications. UL467 Listed.

Catalog Number	Number of Conductors	Conductor	Pedestal Type
			Round or Square
GP654CG1	1 or 2	8 sol. - 4 str.	3/4" - 1" Round 3/4" - 7/8" Square
GP64526G1		4 sol. - 2/0 str.	3/4" - 1" Round 3/4" - 7/8" Square
GP1526G1		4 sol. - 2/0 str.	1-1/4" Round
GP1726RT*		6 sol. - 2/0 str.	2" Round
GP1726G1		6 sol. - 2/0 str.	2" Round

* Special paint-penetrating feature—consult factory for details.

TYPE GRF

**UNIGROUND™ Raised Floor
Grounding Connector**



The BURNDY® UNIGROUND™ is a universal grounding clamp, specifically designed for all raised flooring systems. It can be installed on round or square pedestals and can accommodate one or two grounding wires to make an efficient grid. The underfloor signal reference grid provides the low impedance ground path that attenuates high frequency static and 60 Hz transient noise for cleaner data output. UL467 Listed.

Catalog Number	Number of Conductors	Conductor	Pedestal Type	
			Round	Square
GRF4C-3	1 or 2	8 - 2 AWG	Up to 1"	Up to 7/8"
GRF4C-4			Up to 3/4"	Up to 5/8"

TYPE GX

Ground Connector for Copper Cables



High copper alloy ground connector for cross connecting a wide range of cable. UL467 Listed. Acceptable for direct burial.

Catalog Number	Conductor	
	Groove A	Groove B
GX4C4C	8 sol. - 4 str.	8 sol. - 4 str.
GX264C	4 sol. - 2/0 str.	8 sol. - 4str.
GX2626		4 sol. - 2/0 str.
GX294C	2/0 sol. - 250 kcmil	8 sol. - 4 str.
GX2926		4 sol. - 2/0 str.
GX2929		2/0 sol. - 250
GX344C	300 - 500 kcmil	8 sol. - 4 str.
GX3426		4 sol. - 2/0 str.
GX3429		2/0 sol. - 250
GX3434		300-500 kcmil

TYPE BBB

**BURNDY® BusBar
Copper BusBar**

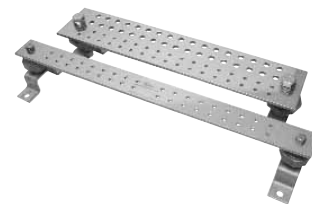

Bare copper BusBar, UL Listed for grounding. Available in many sizes and hole patterns. Brackets and insulators included with most styles. Also available in undrilled, horizontal and vertical versions.

BusBar is used in a variety of applications. Can be used as a common ground point and "power" applications as well.

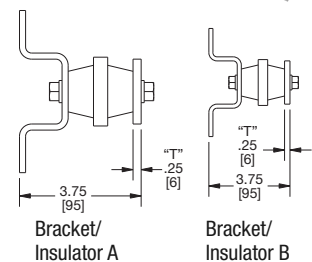

Catalog Number	Fig. No.	Insulator & Bracket	T - Bar Thickness	W - Bar Width	L - Bar Length	E1	E2	E3	F1	F2	No. of Holes	K
BBB14210A	1	A	1/4"	2"	10"	.63	—	—	1.00	—	16	.28
BBB14224B	2	A	1/4"	2"	24"	.625	.75	—	1.00	1.00	36	.28
BBB14410C	3	A	1/4"	4"	10"	.75	1.00	—	1.25	—	6	6-32 .28
BBB14410D	4	A	1/4"	4"	10"	1.25	1.00	—	1.13	1.13	6	6-32 .28
BBB14412E	5	A	1/4"	4"	12"	.75	—	—	2.00	1.25	18	.44
BBB14412F	6	A	1/4"	4"	12"	1.00	.75	—	2.00	1.25	12	.28
BBB14416G	7	B	1/4"	4"	16"	.75	1.00	—	1.69	—	24	.44
BBB14416H	8	B	1/4"	4"	16"	1.00	1.00	.75	1.69	—	16	.44 .25
BBB14420J	9	B	1/4"	4"	20"	1.00	1.00	.75	1.00	—	34	.44 .25
BBB412UD	N/A	A	1/4"	4"	12"	N/A	N/A	N/A	N/A	N/A	N/A	N/A
BBB424UD	N/A	B	1/4"	4"	24"	N/A	N/A	N/A	N/A	N/A	N/A	N/A
BBBHR19*	N/A	N/A	3/16"	3/4"	19"	.38	Contact Factory for Dimensions					
BBBVR36*	N/A	N/A	1/4"	5/8"	36"	.32						

* Not UL Listed.

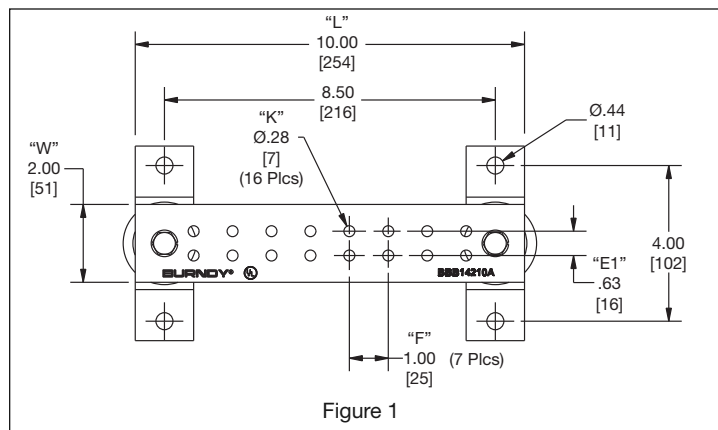

Figure 1

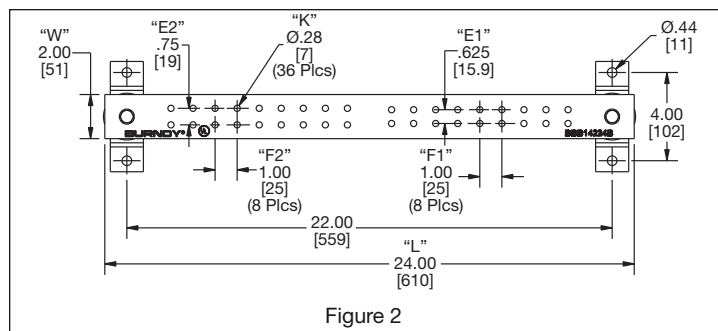
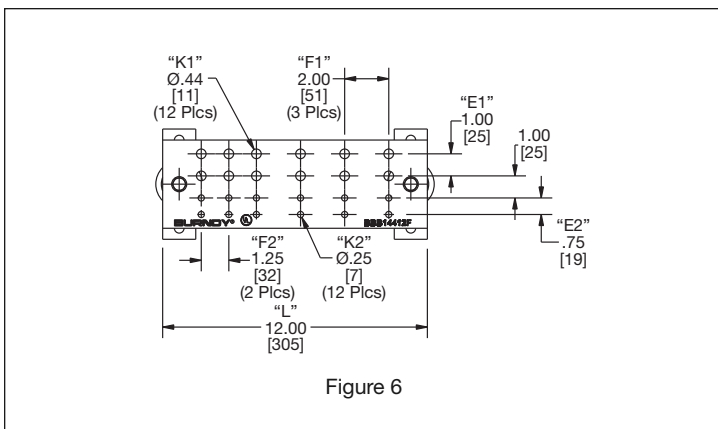
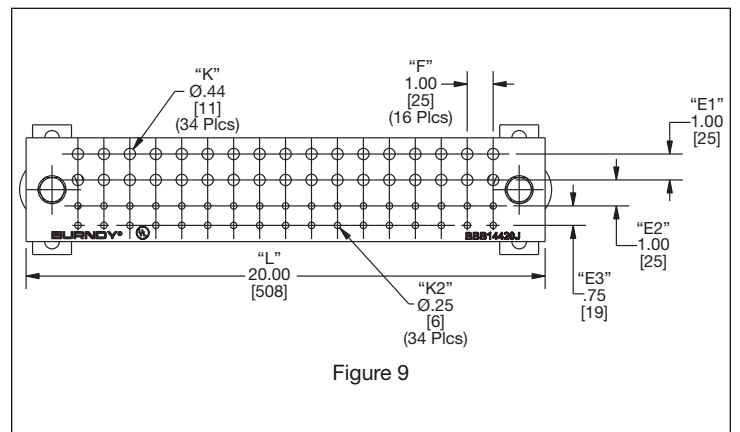
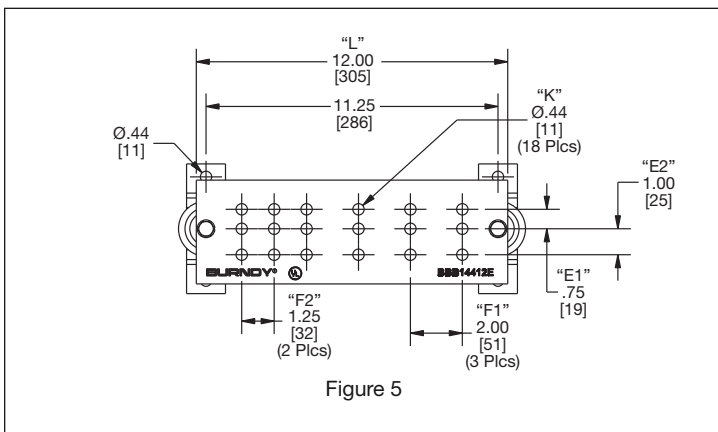
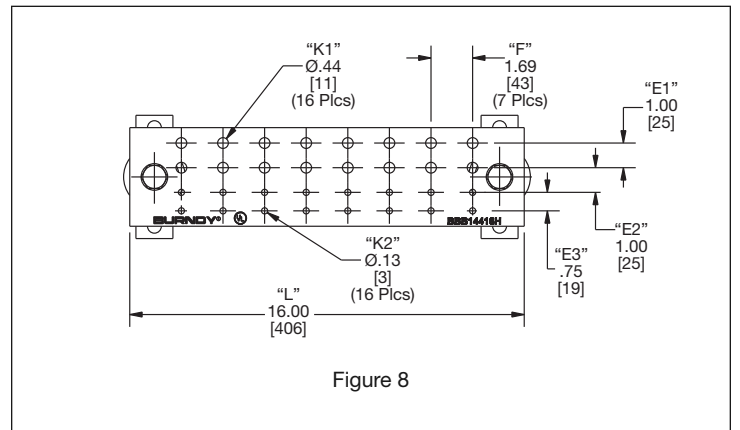
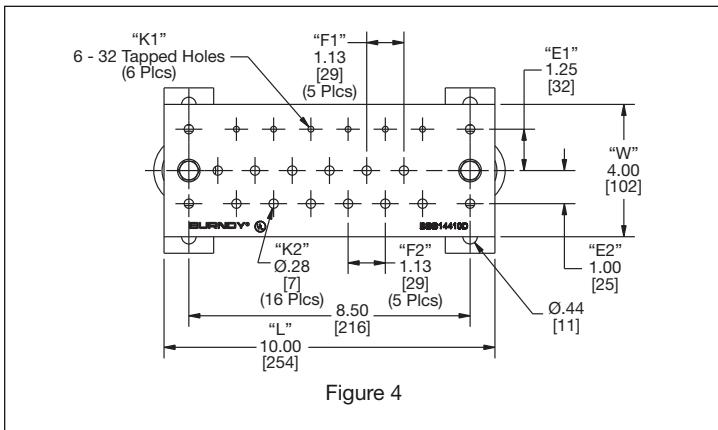
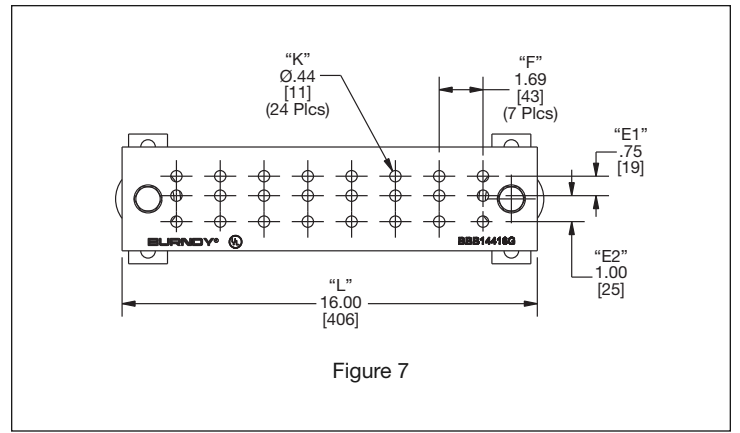
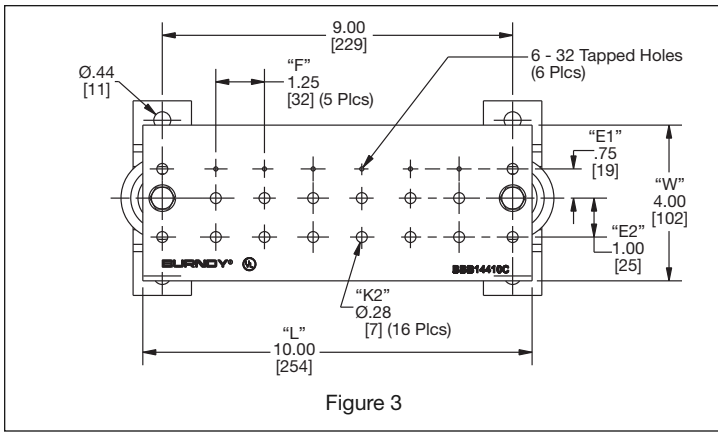

Figure 2

(Figures continued on next 2 pages)



TYPE B

Flexible Copper Braid



Extra-flexible tinned copper braid used on disconnects and switch handle grounds. Also used to ground fence posts and gates.

Catalog Number	No. of Braids in Ferrule	Ampere Rating Indoors
BD12*	1	190
BD12N*	1	190
BD18*	1	190
BD18N*	1	190
BD24*	1	190
BD24N*	1	190
B2D12*	2	380
B2D12N*	2	380
B3D12*	3	470
B3D12N*	3	470
B4D12	4	600
B4D12N	4	600
BE12*	1	340
BE12N*	1	340
BE18*	1	340
BE18N*	1	340
BE24*	1	340
BE24N*	1	340
B2E12	2	530
B2E12N	2	530
B3E12	3	700
B3E12N	3	700
B4E12	4	850
B4E12N	4	850
BF12*	1	360
BF12N*	1	360
B2F12	2	600
BF24*	1	360
BF24N*	1	360
B2F12	2	600
B2F12N	2	600
B3F12	3	820
B3F12N	3	820
B4F12	4	1000
B4F12N	4	1000
BG12	1	415
BG12N	1	415
BG18	1	415
BG18N	1	415
BG24	1	415
BG24N	1	415
B2G12	2	700
B2G12N	2	700
B3G12	3	960
B3G12N	3	960
B4G12	4	1200
B4G12N	4	1200

NOTE: All sizes are listed to UL467 and specific sizes (*) are certified to CSA C22.2, No. 41 Grounding and Bonding Equipment Standards. Equivalent sizes may be designated by suffix letters representing variations in length, mounting configurations, pad size and finish. Contact factory for details.

"N" indicates 2-hole NEMA standard.

THE HYGROUND® IRREVERSIBLE COMPRESSION SYSTEM

BURNDY® has developed an Irreversible Compression Ground System which meets the most stringent safety and performance requirements, including those of OSHA and nuclear power plant design. Performance excellence and long life expectancy are the system's basic design guidelines. It is a complete system which consists of connectors for grid cross connections, taps, splices, cable to ground rod, ground plates and terminations.

Our Irreversible Compression Ground Connectors employ well-proven design principles and technology that have been in existence for over 40 years. Connectors are just one component of our Irreversible Compression Ground System. Installation tooling is also an integral part of this system. BURNDY® pioneered the compression connector principle and continues today to be the leader in compression technology. Our tooling package is the most extensive in the industry and affords the user many options.

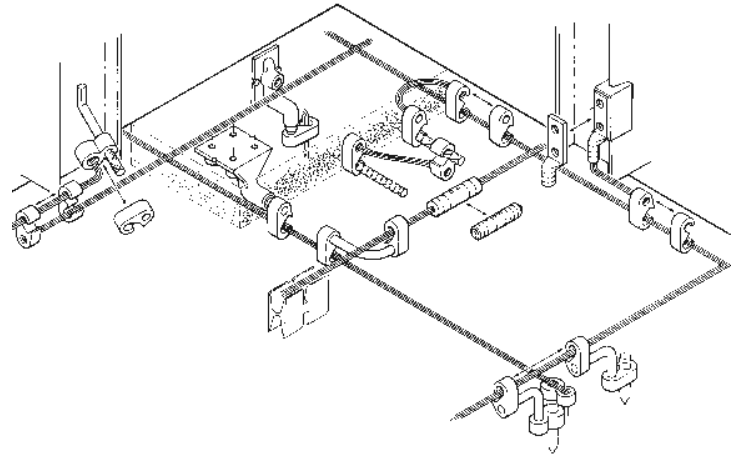

(LEGEND)

YGHP-C	YGL-C	YGHA	YGF-4N
YGHR-C	YGLR-C	YGHS	YGF-2N
YGHC-C	YGA	YGS	GSTUD-HY

TYPE YGL-C
HYGRID™ Cross Connector



Meets IEEE 837 Requirements

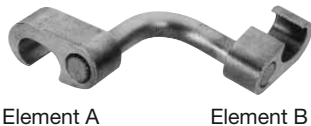

An irreversible compression ground grid cross connector which allows adjustment of the compression elements prior to installation. Only six connectors and four dies are required to install all combinations from 6 solid through 500 kcmil. UL467 Listed. Acceptable for direct burial. Prefilled with PENETROX™ compound and strip sealed.

Catalog Number	Cable to Cable	
	Element "A"	Element "B"
YGL2C2	6 sol. - 2 str.	6 sol. - 2 str.
YGL29C2	1 str. - 250 kcmil	6 sol. - 2 str.
YGL29C29	2 str. - 250 kcmil	2 str. - 250 kcmil
YGL34C2	250 kcmil - 500 kcmil	6 sol. - 2 str.
YGL34C29		2 str. - 250 kcmil
YGL34C34		250 kcmil - 500 kcmil

Catalog Number	Cable to Ground Rod		To Rebar
	Element "A"	Element "B"	Element "A"
YGL29C2	1/2" - 5/8" Rod	6 sol. - 2 str.	3/8"-1/2"
YG29C29		2 str. - 250 kcmil	3 - 4 Rebar
YGL34C2	5/8" - 3/4" Rod	6 sol. - 2 str.	5/8"-3/4"
YGL34C29		2 str. - 250 kcmil	5 - 6 Rebar
YGL34C34		250 kcmil - 500 kcmil	—

TYPE YGLR-C
GRIDLOK™
Ground Grid Connector



Meets IEEE 837 Requirements

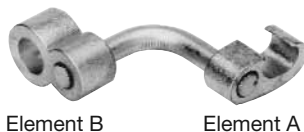

Ground grid connector for a wide range of copper cable to ground rod. Provides high torque strength on ground rod. UL467 Listed. Acceptable for direct burial. Prefilled with PENETROX™ compound and strip sealed.

Catalog Number	Commercial Copper Cable Range Element "A"	Ground Rod Dia. Element "B"
YGLR29C12	2 str. - 250 kcmil	1/2"
YGLR34C12	250 - 500 kcmil	
YGLR29C58	2 str. - 250 kcmil	5/8"
YGLR34C58	250 - 500 kcmil	
YGLR29C34	2 str. - 250 kcmil	3/4"
YGLR34C34	250 - 500 kcmil	
YGLR29C100	2 str. - 250 kcmil	1"
YGLR34C100	250 - 500 kcmil	

Ground Rod Dia.	PRECRIMP Dies	
1/2"	UPRECRIMP 12	U2CABT
5/8"	UPRECRIMP 58	
3/4"	UPRECRIMP 34	

For ground rod to wire applications, ground rod must be precrimped, see above table for appropriate precrimp dies.

See HYGROUND® Tool/Die Chart pages 46-47.

TYPE YGHP-C
HYTAP™ Connector



Meets IEEE 837 Requirements



Irreversible compression ground tap figure "6" connectors. Four die sets and eight connectors can accommodate a conductor range from 8 solid through 500 kcmil plus 1/2", 5/8", and 3/4" copper bonded ground rods. UL467 Listed. Acceptable for direct burial in earth and concrete. Prefilled with PENETROX™ compound and strip sealed.

Catalog Number	Accommodates		Cable to Rebar	
	Run	Tap	Run	Tap
YGHP2C2	6 sol. - 2 str.	6 sol. - 2 str.	—	—
YGHP2C6W6W	6 sol. - 2 str.	8 sol. - 6 str. (2 taps)	—	—
YGHP29C6W6W	1/0 str. - 250 kcmil 1/2" - 5/8" rod	8 sol. - 6 str. (2 taps)	3 Rebar	8 sol. - 6 str.
YGHP29C2		4 sol. - 2 str.	3/8	2 str.
YGHP29C26		1/0 str. - 2/0 str.	through 1/2	1/0 - 2/0 str.
YGHP29C29		3/0 str. - 250 kcmil	4 Rebar	3/0 str. - 250 kcmil
YGHP29C34		4 sol. - 2 str.	5 Rebar	—
YGHP34C26	250 - 500 kcmil	1/0 str. - 2/0 str.	5/8	1/0 str. - 2/0 str.
YGHP34C29	5/8" - 3/4" rod	3/0 str. - 250 kcmil	through 1/2	3/0 str. - 250 kcmil
YGHP34C34	250 - 500 kcmil 5/8" - 3/4" rod	350 kcmil - 500 kcmil	3/4 6 Rebar	350 - 500 kcmil

TYPE YGF
Grounding Plate



Meets IEEE 837 Requirements



The irreversible compression ground plate is designed to withstand the rigors of concrete construction. The ground plates are made of high strength, high conductivity cast copper alloy body with a pure wrought copper compression element. In addition to the tapped NEMA size holes and spacing on the face, the plate comes with a tapped hole on the underside for ease of positioning prior to pouring the concrete. UL467 Listed. Acceptable for direct burial. Prefilled with PENETROX™ compound and strip sealed.

Catalog Number	Copper Conductor Range
YGF29-2N	2 AWG - 250 kcmil
YGF29-4N	
YGF34-2N	250 - 500 kcmil
YGF34-4N	

See HYGROUND® Tool/Die Chart pages 46-47.

TYPE YGHC-C
HYTAP™ Connector



Meets IEEE 837 Requirements

New!
Ground Rod to Wire
UL467 Listed and
CSA Certified
for Direct Burial



Irreversible compression ground tap figure "C" connectors. Accommodates all cable combinations from 6 solid through 500 kcmil. "C" - shaped opening permits placing two continuous parallel cables into conductor groove. UL467 Listed. Acceptable for direct burial. Prefilled with PENETROX™ compound and strip sealed.

Catalog Number	Commercial Copper Cable Range	
	Run	Tap
YGHC2C2	6 sol.	6 sol.
	2 str.	2 str.
YGHC26C2	1 str.	6 sol.
	2/0 str.	2 str.
YGHC26C26	1 str.	1 str.
	2/0 str.	2/0 str.
YGHC29C26	3/0 str.	6 sol.
	250 kcmil	2/0 str.
YGHC29C29	3/0 str.	3/0 str.
	250 kcmil	250 kcmil
YGHC34C26	300 kcmil	6 sol.
	500 kcmil	2/0 str.
YGHC34C29	300 kcmil	3/0 str.
	500 kcmil	250 kcmil
YGHC34C34	300 kcmil	300 kcmil
	500 kcmil	500 kcmil

TYPE YGHR-C
HYTAIL™
Ground Rod Connectors



Meets IEEE 837 Requirements



Catalog Number	Commercial Copper Cable Range	Nominal Ground Rod Dia.
YGHR26C12	2 - 2/0 str.	1/2"
YGHR26C58		5/8"
YGHR26C34		3/4"
YGHR26C100	4/0 str. - 250 kcmil	1"
YGHR29C12		1/2"
YGHR29C58		5/8"
YGHR29C34		3/4"
YGHR29C100	300 - 500 kcmil	1"
YGHR34C58		5/8"
YGHR34C34		3/4"
YGHR34C100		1"

See HYGROUND® Tool/Die Chart pages 46-47.

TYPE YGHR-C
HYTAIL™ Connectors



High strength copper irreversible compression ground rod tap connector.



Catalog Number	Ground Rod Diameter	Tap Conductor
YGHR58C2W-3	5/8"	2 sol. Copper 1, 2, or 3 may be connected.

TYPE YSHG
High Strength Copper
Irreversible Compression
Double H-Tap Connector



Type YSHG Double H-Tap grounding series is comprised of five connectors designed to accommodate wire range sizes 14 AWG through 500 kcmil, including ground rod sizes: 3/4", 1" and Rebar sizes: 6, 8 and 9. Prefilled with PENETROX™ E2 and strip sealed.

Catalog Number	Conductor Sizes			
	Main	Tap 1	Tap 2	Tap 3
YSHG4429	9 & 8 Rebar, 1" (25) Ground Rod	2 AWG - 250 kcmil	—	—
YSHG3939*	1" (25) Cu Clad Ground Rod 500 kcmil Copper	350 - 500 kcmil	—	—
YSHG3931*	6 Rebar, 1" (25) Cu Clad Ground Rod, 3/4" Ground Rod 350 - 500 kcmil Copper	1/0 - 4/0 AWG	6 - 1 AWG	14 - 2 AWG
YSHG3434	6 Rebar, 3/4" (19) Ground Rod 250 - 400 kcmil Copper	4/0 AWG - 400 kcmil		
YSHG3429	6 Rebar, 3/4" (19) Ground Rod 4/0 - 400 kcmil Copper	1/0 - 3/0 AWG	4/0 AWG - 400 kcmil	14 - 8 AWG

*Note: Not for use on 1" steel ground rod.

TYPE YGHP-C
HYTAP™ Connector



Type YGHP-C irreversible compression ground tap figure 6 can be used as a ground rod tap connector for both continuous run and tapping applications. An open groove allows ground rod to be connected to a continuous run or tap. The second groove is for a tap only. Prefilled with PENETROX™ E and strip sealed. UL467 Listed for direct burial.

Catalog Number	Ground Rod Diameter	Tap Conductor
YGHP58C2W-2	1/2" - 5/8"	2 sol. Copper (1) Continuous run and (1) Tap or up to (2) taps may be connected.

See HYGROUND® Tool/Die Chart pages 46-47.

TYPE YGHA
HYLUG™ Terminals



Meets
IEEE
837 Requirements



Heavy duty HYLUG™ irreversible compression terminals designed not only to carry short circuit load but to also withstand high mechanical stress. Each conductor element has an inspection probe hole to ensure proper cable insertion. UL467 Listed. Acceptable for direct burial. UL486A Listed. Prefilled with PENETROX™ compound and strip sealed.

Catalog Number	Copper Conductor Size
YGHA2C-2N	2 str.
YGHA25-2N	1/0 str.
YGHA26-2N	2/0 str.
YGHA28-2N	4/0 str.
YGHA29-2N	250 kcmil
YGHA34-2N	500 kcmil

TYPE YGHS
HYLINK™ Ground Splice



Meets
IEEE
837 Requirements



Heavy duty HYLINK™ ground splice designed not only to carry short circuit load but to also withstand high mechanical stress. Each conductor element has an inspection probe hole and a center stop to ensure proper cable insertion. UL467 Listed. Acceptable for direct burial in earth or concrete. UL486A Listed. Prefilled with PENETROX™ compound and strip sealed.

Catalog Number	Copper Conductor Size
YGHS2C	2 str.
YGHS25	1/0 str.
YGHS26	2/0 str.
YGHS28	4/0 str.
YGHS29	250 kcmil

TYPE YGS
HYLINK™ Ground Splices



Irreversible compression HYLINK™ ground splices are specifically designed for ground applications. Each conductor element has an inspection probe hole and a center stop to ensure proper cable insertion. UL467 Listed. Acceptable for direct burial. UL486A Listed. Prefilled with PENETROX™ compound and strip sealed.



Catalog Number	Copper Conductor Size
YGS2C	2 str.
YGS25	1/0 str.
YGS26	2/0 str.
YGS28	4/0 str.
YGS29	250 kcmil
YGS34	500 kcmil

See HYGROUND® Tool/Die Chart pages 46-47.

TYPE YGA
HYLUG™ Terminals



Irreversible compression HYLUG™ ground terminal specifically designed for ground applications. Each connector has an inspection probe hole to ensure proper cable insertion. UL467 Listed. Acceptable for direct burial. UL486A Listed. Prefilled with PENETROX™ compound and strip sealed.



Catalog Number	Copper Conductor Size
YGA2C-2N	2 str.
YGA25-2N	1/0 str.
YGA26-2N	2/0 str.
YGA28-2N	4/0 str.
YGA29-2N	250 kcmil
YGA34-2N	500 kcmil

TYPE YGIB
GROUNDLINK™ Connector



Meets
IEEE
837 Requirements

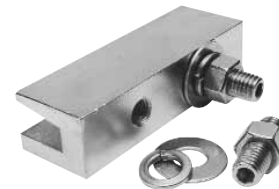

An irreversible compression ground connection which allows attachment to ground structural steel (standard [angled] or wide flange parallel) accomplished with a required 5-piece die set, Catalog PIBEAMKIT or UIBEAMKIT. Made of high conductivity wrought copper and comes prefilled with PENETROX™ compound and strip sealed. Order terminal mounting hardware separately.

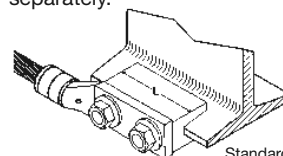

Standard Beams
(Flange Angled)

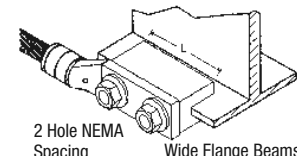

2 Hole NEMA
Spacing
Wide Flange Beams
(Flange Parallel)

Catalog Number	Copper Conductor Range	Length	Beam Flange Thickness
YGIBS28-338-2N	2 - 4/0 AWG 250 - 500 kcmil	3.00	.250" - .338"
YGIBW28-338-2N		3.00	
YGIBS34-338-2N		6.00	
YGIBW34-338-2N		6.00	
YGIBS28-400-2N	2 - 4/0 AWG 250 - 500 kcmil	3.00	.338" - .400"
YGIBW28-400-2N		3.00	
YGIBS34-400-2N		6.00	
YGIBW34-400-2N		6.00	
YGIBS28-462-2N	2 - 4/0 AWG 250 - 500 kcmil	3.00	.400" - .462"
YGIBW28-462-2		3.00	
YGIBS34-462-2N		6.00	
YGIBW34-462-2N		6.00	
YGIBS28-550-2N	2 - 4/0 AWG 250 - 500 kcmil	3.00	.462" - .550"
YGIBW28-502N		3.00	
YGIBS34-550-2N		6.00	
YGIBW34-550-2N		6.00	
YGIBS28-613-2N	2 - 4/0 AWG 250 - 500 kcmil	3.00	.550" - .613"
YGIBW28-613-2N		3.00	
YGIBS34-613-2N		6.00	
YGIBW34-613-2N		6.00	
YGIBS28-675-2N	2 - 4/0 AWG 250 - 500 kcmil	3.00	.613" - .695"
YGIBW28-675-2N		3.00	
YGIBS34-675-2N		6.00	
YGIBW34-675-2N		6.00	

See HYGROUND® Tool/Die Chart pages 46-47.

**TYPE GSTUD-HY
VERSITAIL™**

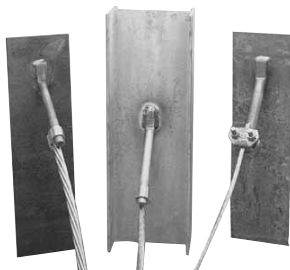

Meets
IEEE
837 Requirements

Catalog Number	Nom. Rod Size	Use with Compression Connector Catalog No. (Order Separately)	GSTUD-HY/YGHP Assembly Conductor Range
GSTUD14HY	1/4"	YGHP2C2	6 sol. - 2 str.
		YGHP29C2	1/0 str. - 250 kcmil
		YGHP34C2	250 - 500 kcmil
GSTUD38HY	3/8"	YGHP29C26	1/0 str. - 250 kcmil
		YGHP34C26	250 - 500 kcmil
GSTUD916HY	5/8"	YGHP29C29	3/0 str. - 250 kcmil
		YGHP34C29	250 - 500 kcmil
GSTUD34HY	3/4"	YGHP34C34	250 - 500 kcmil

HYGROUND® Tool/Die Chart

Catalog Number	Die Index	Y750/39/35	PAT750	Y46**	No. of Crimps
YGA25-2N	12	U25RT	U25RT	U25RT	2
YGA26-2N	13	U26RT	U26RT	U26RT	2
YGA28-2N	15	U28RT	U28RT	U28RT	2
YGA29-2N	16	U29RT	U29RT	U29RT	2
YGA2C-2N	10	U2CRT	U2CRT	U2CRT	2
YGA34-2N	20	U34RT	U34RT	U34RT	4
YGHA25-2N	14	U27RT	U27RT	U27RT	1
YGHA26-2N	15	U28RT	U28RT	U28RT	1
YGHA28-2N	17	U30RT	U30RT	U30RT	2
YGHA29-2N	18	U31RT	U31RT	U31RT	2
YGHA2C-2N	11	U1CRT-1	U1CRT-1	U1CRT-1	1
YGHA34-2N	22	U36RT	U36RT	U36RT	3
YGHC26C2	0	U-0	UOP	U-0	1
YGHC26C26	0	U-0	UOP	U-0	1
YGHC29C26	997	U997	U997P	U997	1
YGHC29C29	997	U997	U997P	U997	1
YGHC2C2	C	U-C	U-C	U-C	1
YGHC34C26	1011	U1011*	U1011*	P1011	2
YGHC34C29	1011	U1011*	U1011*	P1011	2
YGHC34C34	1011	U1011*	U1011*	P1011	3
YGHP29C2	997	U997	U997P	U997	1
YGHP29C26	997	U997	U997P	U997	1
YGHP29C29	997	U997	U997P	U997	1
YGHP29C6W6W	997	U997	U997P	U997	1
YGHP2C2	0	U0	UOP	U0	1
YGHP2C6W6W	0	U0	UOP	U0	1
YGHP34C2	998	U998*	U998P	PU998	1
YGHP34C26	998	U998*	U998P	PU998	1
YGHP34C29	998	U998*	U998P	PU998	1
YGHP34C34	1011	U1011*	U1011*	P1011	3
YGHP58C2W2	997	U997	U997P	U997	1
YGHR26C100	1011	U1011*	U1011*	P1011	2
YGHR26C12	998	PU998	PU998P	P1011	2
YGHR26C34	998	PU998	PU998P	P1011	2
YGHR26C58	998	PU998	PU998P	P1011	2
YGHR29C100	1011	U1011*	U1101*	P1011	2
YGHR29C12	998	PU998	PU998P	P1011	2
YGHR29C34	998	PU998	PU998P	P1011	2
YGHR29C58	998	PU998	PU998P	P1011	2

* Indicates that connector can only be installed with Y750 or Y46. Cannot be installed with Y35 or Y39.
** Where a U-die is recommended with the Y46, a PUADP-1 adaptor must be used.

(HYGROUND® Tool/Die Chart continued on next page)

HYGROUND® Tool/Die Chart

(Continued)

Catalog Number	Die Index	Y750/39/35	PAT750	Y46**	No. of Crimps
YGHR34C100	1011	U1011*	U1011*	P1011	2
YGHR34C34	1011	U1011*	U1011*	P1011	2
YGHR34C58	998	PU998	PU998P	P1011	2
YGHS25	14	U27RT	U27RT	U27RT	1
YGHS26	15	U28RT	U28RT	U28RT	1
YGHS28	17	U30RT	U30RT	U30RT	2
YGHS29	18	U31RT	U31RT	U31RT	2
YGHS2C	11	U1CRT-1	U1CRT-1	U1CRT-1	1
YGHS34	22	U36RT	U36RT	U36RT	3
YGIB (All)	1105	UIBEAMKIT	UIBEAMKIT	PIBEAMKIT	varies
YGL29C2	997/0	U997/U-0	U997P/UOP	U997/U-0	1
YGL29C29	997	U997	U997P	U997	1
YGL2C2	0	U-0	UOP	U-0	1
YGL34C2	998/0	U998/U-0*	U998P/UOP	PU998/U-C	1
YGL34C29	998/0	U998/U-0*	U998P/UOP	PU998/U-C	1
YGL34C34	1011	U1011*	U1011*	P1011	3
YGLR29C100	997/1011	U997/U1011	U997P/U1011	U997/U1011	2
YGLR29C12	997	U997	U997P	U997	1
YGLR29C34	997/1011	U997/U1011*	U997P/U1011	PU998	1
YGLR29C58	997/998	U997/U1011*	U997P/U1011	PU998	1
YGLR34C100	997/1011	U997/U1011	U997P/U1011	U997/U1011	2
YGLR34C12	1011/998	U1011*	U1011*	PU998	1
YGLR34C34	1011	U1011*	U1011*	U1011	2
YGLR34C58	998/1011	U998/U1011*	U998P/U1011	PU998	1
YGS25	12	U25RT	U25RT	U25RT	2
YGS26	13	U26RT	U26RT	U26RT	2
YGS28	15	U28RT	U28RT	U28RT	2
YGS29	16	U29RT	U29RT	U29RT	2
YGS2C	10	U2CRT	U2CRT	U2CRT	2
YGS34	20	U34RT	U34RT	U34RT	4

* Indicates that connector can only be installed with Y750 or Y46. Cannot be installed with Y35 or Y39.
** Where a U-die is recommended with the Y46, a PUADP-1 adaptor must be used.

BURNDYWeld®



The BURNDYWeld® connection process is a simple, efficient method of welding copper to copper or copper to steel. One advantage is that NO outside power is required when using the BURNDYWeld® exothermic process. The BURNDYWeld® process uses high temperature reaction of powdered copper oxide and aluminum. The reaction takes place in a semi-permanent graphite mold. These molds will last for fifty or more welds if proper care is given. The reaction takes place very rapidly, therefore the total amount of heat applied to the conductors or surfaces is considerably less than that of brazing or soldering, it is important to remember this when welding to insulated cable or thin wall pipe.

This system is very field friendly since it is light and portable and requires no outside power source. It requires very little time or skill to obtain an efficient, maintenance free connection when using the BURNDYWeld® process.

For more information visit our website at: www.burndy.com.

WELD METAL

BURNDYWeld® Weld Metal is packed in moisture-resistant plastic cartridges that have tight fitting caps. These cartridges, along with the necessary steel discs, are then packed in boxes that are hermetically sealed. This ensures the powder arriving in good condition, always dry and ready for fast positive ignition.



BURNDYWeld® Weld Metal comes in several types; one for welding copper to copper, copper to steel, copper to rail, copper to cast iron and one for welding copper to steel for cathodic protection. The size and weight (in grams) of the cartridge are marked on each individual cartridge.

Standard Cartridge Size	Cast Iron Cartridge Size	Cathodic Protection Cartridge Size	Rail Cartridge Size	Cartridges Per Box
15	15CI	15CP	15R	20
25	25CI	25CP	25R	20
32	32CI	32CP	32R	10
45	45CI	45CP	45R	20
65	65CI	65CP	65R	20
90	90CI	—	90R	10
115	115CI	—	115R	10
150	—	—	150R	10
200	—	—	200R	10
250	—	—	250R	10
500	—	—	500R	10

BURNDYWeld® Weld Metal is sold in box quantities only.

Steel Discs Sold Separately

Catalog Number	Weld Metal Size	Package Quantity
B370320-01*	15 - 65	20
B370320-02*	90 - 115	10
B370320-03*	150 - 500	10

*Steel Discs Only

BURNDYWeld® QIKLITE™ Battery Ignition System



The self-contained unit offers a built-in battery life indicator, 6' ignitor cord, and separate buttons for power and ignition. Also, no starting powder is used with this system so emissions are greatly reduced. QIKLITE™ works with “off-the-shelf” molds and weld metal, so contractors and installers can continue to use the same quality BURNDYWeld® products.



QIKLITE™ with mold.

Since the unit operates with standard weld metal and molds, installers also have the option of using a traditional flint ignitor or the new QIKLITE™ system. Another feature is the speed of ignition, with virtually no delay between depressing the “push to operate” button and ignition of the weld metal. This instant ignition feature offers quick reassurance to the installer, without the delay.

Features and Benefits

- The QIKLITE™ system allows installers to make exothermic connections remotely
- Uses standard exothermic molds and weld metal
- Use the new BURNDYWeld® QIKLITE™ System or use a flint ignitor, this versatility makes this system better than anything available in the industry
- Installers have virtually 100% confidence that the connection can be completed, and no wasted material or weld metal shots
- No starting material required—which greatly reduces the amount of emissions generated
- Power is supplied by 4 standard “D” Size batteries
- Built-in battery life indicator
- There’s virtually no delay in ignition after depressing the “push to operate” button
- Separate ON/OFF and Operate buttons
- Comes complete with durable 6’ heat resistant cord
- Durable, long-lasting design
- QIKSTIK ignitor sticks are conveniently packaged and available separately or available packaged complete with standard weld metal

Catalog Number	Description
QIKLITE	Battery Ignition System
QIKLITEKIT	QIKLITE™ Battery Ignition System and 20 QIKSTIK Ignitor Sticks

Catalog Number	Cartridges/Ignitors Per Box
Standard Cartridge Size with Ignitor	
15Q	20
25Q	20
32Q	10
45Q	20
65Q	20
90Q	10
115Q	10
150Q	10
200Q	10
250Q	10
500Q	10
QIKSTIK*	10

*Ignitor stick only.

TYPE BCC-1 MOLDS

Horizontal End to End

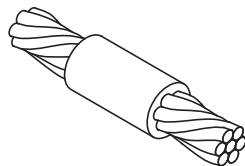

Type BCC-1 Molds are used for horizontal end to end cable connections. Size range is 6 str. through 1000 kcmil solid or concentric stranded copper conductors. Contact BURNDY® for information on molds for conductors not listed below.

Cable	Mold	Price Key	Weld Metal	Handle Clamps
8 str.	Use Type BCC-14			
6 str.	Use Type BCC-14			
4 str.	B-5623	18†*	25	N/A
3 str.	B-5624	18†*	32	N/A
2 str.	B-5625	18†*	32	N/A
1 str.	B-5626	18†*	32	N/A
1/0 str.	B-205	4	45	B-106
2/0 str.	B-206	4	65	B-106
3/0 str.	B-207	4	90	B-106
4/0 str.	B-208	4	90	B-106
250 kcmil	B-209	4	115	B-106
300 kcmil	B-210	4	115	B-106
350 kcmil	B-211	4	150	B-106
500 kcmil	B-213	4	200	B-107
750 kcmil	B-214	5	2 - 150	B-107
1000 kcmil	B-215	5	2 - 200	B-107

- For sizes not listed, contact BURNDY®.
- Molds listed are for concentric stranded cable. Add suffix "-S" to mold number for solid conductors.
- For heavy duty molds, molds with wear plates or molds for Copperweld® cable, contact BURNDY®.
- For expedited service, contact BURNDY®.
- Required Tools:
Handle Clamps (see chart for correct handles)
† Sold complete with handles
* B38-0309-00 Flint Ignitor (included)
- Other recommended accessories:
B38-3922-00 Mold Cleaning Brush
B38-0135-00 Cable Cleaning Brush
B38-0330-00 Cable Clamp

For Sizes Not Listed, Contact Customer Service at 1-800-346-4175.

TYPE BCC-2 MOLDS

Horizontal Cable Tap to Horizontal Cable Run

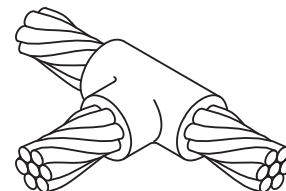

Type BCC-2 Molds are used to join horizontal cable tap to a horizontal run cable. Size range is 6 str. through 750 kcmil solid or concentric stranded copper conductors. Contact BURNDY® for information on molds for conductors not listed below.

Cable		Mold	Price Key	Weld Metal	Handle Clamps
Run	Tap				
6 str.	6 str.	Use Type BCC-14			
4 str.	4 str.	B-221	4	32	B-106
2 str.	2 str.	B-223	4	45	B-106
	4 str.	B-224	4	45	B-106
1 str.	1 str.	B-225	4	45	B-106
	2 str.	B-226	4	45	B-106
	4 str.	B-227	4	45	B-106
1/0 str.	1/0 str.	B-228	4	90	B-106
	1 str.	B-229	4	45	B-106
	2 str.	B-230	4	45	B-106
	4 str.	B-231	4	45	B-106
2/0 str.	2/0 str.	B-232	4	90	B-106
	1/0 str.	B-233	4	90	B-106
	1 str.	B-234	4	45	B-106
	2 str.	B-235	4	45	B-106
3/0 str.	4 str.	B-5475	4	45	B-106
	3/0 str.	B-236	4	115	B-106
	2/0 str.	B-237	4	90	B-106
	1/0 str.	B-238	4	90	B-106
4/0 str.	1 str.	B-239	4	45	B-106
	2 str.	B-240	4	45	B-106
	4 str.	B-5574	4	45	B-106
	4/0 str.	B-241	4	150	B-106
	3/0 str.	B-242	4	115	B-106
	2/0 str.	B-243	4	90	B-106
250 kcmil	1/0 str.	B-244	4	90	B-106
	1 str.	B-245	4	90	B-106
	2 str.	B-246	4	90	B-106
	4 str.	B-5021	4	90	B-106
	250 kcmil	B-247	4	150	B-106
	4/0 str.	B-248	4	150	B-106
	3/0 str.	B-249	4	150	B-106
300 kcmil	2/0 str.	B-250	4	90	B-106
	1/0 str.	B-251	4	90	B-106
	1 str.	B-252	4	90	B-106
	2 str.	B-253	4	90	B-106
	300 kcmil	B-254	4	200	B-106
	250 kcmil	B-255	4	150	B-106
	4/0 str.	B-256	4	150	B-106
	3/0 str.	B-257	4	150	B-106
300 kcmil	2/0 str.	B-258	4	90	B-106
	1/0 str.	B-259	4	90	B-106
	1 str.	B-260	4	90	B-106
	2 str.	B-261	4	90	B-106

- For sizes not listed, contact BURNDY®.
- Molds listed are for concentric stranded cable. Add suffix "-S" to mold number for solid conductors.
- For heavy duty molds, molds with wear plates or molds for Copperweld® cable, contact BURNDY®.
- For expedited service, contact BURNDY®.
- Required Tools:
Handle Clamps (see chart for correct handles)
B38-0309-00 Flint Ignitor
- Other recommended accessories:
B40-0319-01 Mold Cleaner for cartridge sizes 15-65
B40-0319-03 Mold Cleaner for cartridge sizes 90-500
B38-3922-00 Mold Cleaning Brush
B38-0135-00 Cable Cleaning Brush
B38-0330-00 Cable Clamp

(Type BCC-2 Molds continued on next page)

For Sizes Not Listed, Contact Customer Service at 1-800-346-4175.

TYPE BCC-2 MOLDS

(Continued)

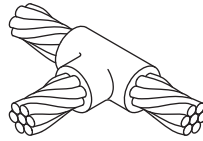

Cable		Mold	Price Key	Weld Metal	Handle Clamps
Run	Tap				
350 kcmil	350 kcmil	B-262	4	200	B-106
	300 kcmil	B-263	4	200	B-106
	250 kcmil	B-264	4	200	B-106
	4/0 str.	B-265	4	150	B-106
	3/0 str.	B-266	4	150	B-106
	2/0 str.	B-267	4	90	B-106
	1/0 str.	B-268	4	90	B-106
	1 str.	B-269	4	90	B-106
500 kcmil	500 kcmil	B-280	4	2-150	B-106
	350 kcmil	B-282	4	200	B-106
	300 kcmil	B-283	4	200	B-106
	250 kcmil	B-284	4	200	B-106
	4/0 str.	B-285	4	150	B-106
	2/0 str.	B-286	4	90	B-106
	1/0 str.	B-287	4	90	B-106
	1 str.	B-288	4	90	B-106
750 kcmil	750 kcmil	B-290	5	500	B-107
	500 kcmil	B-291	5	2-200	B-107
	350 kcmil	B-293	4	250	B-106
	300 kcmil	B-294	4	200	B-106
	250 kcmil	B-295	4	200	B-106
	4/0 str.	B-296	4	150	B-106
	2/0 str.	B-297	4	150	B-106
	1/0 str.	B-298	4	150	B-106

- For sizes not listed, contact BURNDY®.
- Molds listed are for concentric stranded cable. Add suffix "-S" to mold number for solid conductors.
- For heavy duty molds, molds with wear plates or molds for Copperweld® cable, contact BURNDY®.
- For expedited service, contact BURNDY®.
- Required Tools:
Handle Clamps (see chart for correct handles)
B38-0309-00 Flint Ignitor
- Other recommended accessories:
B40-0319-01 Mold Cleaner for cartridge sizes 15-65
B40-0319-03 Mold Cleaner for cartridge sizes 90-500
B38-3922-00 Mold Cleaning Brush
B38-0135-00 Cable Cleaning Brush
B38-0330-00 Cable Clamp

TYPE BCR-1 MOLDS

Horizontal Cable
Terminal to Ground Rod

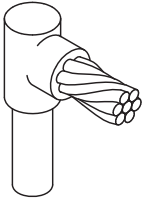

Type BCR-1 Molds are used to terminate horizontal copper cable at the top of a vertical ground rod. Size range is 6 str. through 1000 kcmil solid or concentric stranded copper conductors; 1/2" through 1" for the ground rod. Contact BURNDY® for information on molds for conductors not listed below.

Cable		Mold	Price Key	Weld Metal	Handle Clamps
Ground Rod	Tap				
1/2"	6 str.	B-8402	18†*	25	N/A
	4 str.	B-8403	18†*	25	N/A
	2 str.	B-495	4	65	B-106
	1 str.	B-496	4	65	B-106
	1/0 str.	B-497	4	90	B-106
	2/0 str.	B-498	4	90	B-106
	3/0 str.	B-499	4	90	B-106
	4/0 str.	B-500	4	90	B-106
	250 kcmil	B-501	4	90	B-106
	300 kcmil	B-502	4	90	B-106
5/8"	6 str.	B-8414	18†	32	N/A
	4 str.	B-8415	18†	32	N/A
	2 str.	B-503	4	65	B-106
	1 str.	B-504	4	65	B-106
	1/0 str.	B-505	4	90	B-106
	2/0 str.	B-506	4	90	B-106
	3/0 str.	B-507	4	90	B-106
	4/0 str.	B-508	4	90	B-106
	250 kcmil	B-509	4	90	B-106
	300 kcmil	B-510	4	115	B-106
3/4"	350 kcmil	B-511	4	115	B-106
	500 kcmil	B-513	4	150	B-106
	6 str.	B-8422	18†*	32	N/A
	4 str.	B-8426	19†*	45	N/A
	2 str.	B-5781	4	90	B-106
	1 str.	B-514	4	90	B-106
	1/0 str.	B-515	4	90	B-106
	2/0 str.	B-516	4	90	B-106
	3/0 str.	B-517	4	90	B-106
	4/0 str.	B-518	4	90	B-106
1"	250 kcmil	B-519	4	90	B-106
	300 kcmil	B-520	4	115	B-106
	350 kcmil	B-521	4	115	B-106
	500 kcmil	B-523	4	150	B-106
	750 kcmil	B-524	4	250	B-106
	1/0 str.	B-525	4	150	B-106
	2/0 str.	B-526	4	150	B-106
	3/0 str.	B-527	4	150	B-106
	4/0 str.	B-528	4	150	B-106
	250 kcmil	B-529	4	150	B-106
300 kcmil	B-530	4	200	B-106	
350 kcmil	B-531	4	200	B-106	
500 kcmil	B-533	4	200	B-106	
750 kcmil	B-534	4	250	B-106	
1000 kcmil	B-535	5	2-150	B-107	

- For sizes not listed, contact BURNDY®.
- Molds listed are for concentric stranded cable. Add suffix "-S" to mold number for solid conductors.
- Molds listed are for copperclad ground rods. For welding to steel, stainless steel or galvanized steel ground rods add suffix "-N" to mold number.
- For heavy duty molds, molds with wear plates or molds for Copperweld® cable, contact BURNDY®.
- For expedited service, contact BURNDY®.
- Required Tools:
Handle Clamps (see chart for correct handles)
† Sold complete with handles
***B38-0309-00** Flint Ignitor (included)
- Other recommended accessories:
B38-3922-00 Mold Cleaning Brush
B38-0135-00 Cable Cleaning Brush
B38-0304-00 File
B38-0330-00 Cable Clamp

For Sizes Not Listed, Contact Customer Service at 1-800-346-4175.

For Sizes Not Listed, Contact Customer Service at 1-800-346-4175.

SINGLE SHOT MOLDS

BURNDYWeld® Single Shot Molds are an economical way to make cable connections onto the top of a ground rod. The Single Shot is a disposable single use ceramic mold that comes complete with everything required except the flint ignitor.

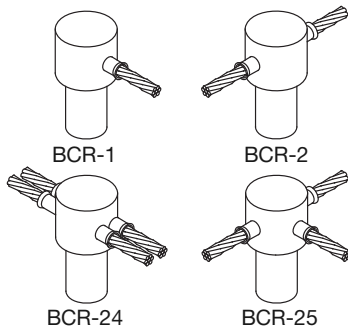

Ground Rod Size	Cable Size		Type	Mold	Cadweld® Part
	Solid	Stranded			
1/2"	6, 8	8	BCR-1	BS-2009	GR1-141G
	3, 4	4, 6	BCR-1	BS-2010	GR1-141L
	1, 2	2, 3	BCR-1	BS-2011	GR1-141V
	6, 8	8	BCR-2	BS-2024	GT1-141G
	3, 4	4, 6	BCR-2	BS-2025	GT1-141L
	1, 2	2, 3	BCR-2	BS-2026	GT1-141V
5/8"	6, 8	8	BCR-1	BS-2012	GR1-161G
	3, 4	4, 6	BCR-1	BS-2013	GR1-141L
	1, 2	2, 3	BCR-1	BS-2014	GR1-161V
	2/0, 1/0	1/0, 1	BCR-1	BS-2015	GR1-162C
	—	2/0	BCR-1	BS-2016	GR1-162G
	6, 8	8	BCR-2	BS-2027	GT1-161G
	3, 4	4, 6	BCR-2	BS-2028	GT1-161L
	1, 2	2, 3	BCR-2	BS-2029	GT1-161V
	2/0, 1/0	1/0, 1	BCR-2	BS-2030	GT1-162C
	6, 8	8	BCR-24	BS-2105	NX1-161G
	3, 4	4, 6	BCR-24	BS-2106	NX1-161L
	1, 2	2, 3	BCR-24	BS-2107	NX1-161V
	6, 8	8	BCR-25	BS-2006	NT1-161G
	3, 4	4, 6	BCR-25	BS-2007	NT1-161L
	1, 2	2, 3	BCR-25	BS-2008	NT1-161V
3/4"	6, 8	8	BCR-1	BS-2017	GR1-181G
	3, 4	4, 6	BCR-1	BS-2018	GR1-181L
	1, 2	2, 3	BCR-1	BS-2019	GR1-181V
	2/1, 1/0	1/0, 1	BCR-1	BS-2020	GR1-182C
	—	2/0	BCR-1	BS-2021	GR1-182G
	6, 8	8	BCR-2	BS-2031	GT1-181G
	3, 4	4, 6	BCR-2	BS-2032	GT1-181L
	1, 2	2, 3	BCR-2	BS-2033	GT1-181V
	2/0, 1/0	1/0, 1	BCR-2	BS-2034	GT1-182C
	6, 8	8	BCR-24	BS-2108	NX1-181G
	3, 4	4, 6	BCR-24	BS-2109	NX1-181L
	1, 2	2, 3	BCR-24	BS-2110	NX1-181V
	6, 8	8	BCR-25	BS-2068	NT1-181G
	3, 4	4, 6	BCR-25	BS-2069	NT1-181L
	1, 2	2, 3	BCR-25	BS-2070	NT1-181V

Cadweld® is a registered trademark of the Erico International Corporation.

TYPE BCS-3 MOLDS

Angular Cable Drop to Vertical Steel Surface

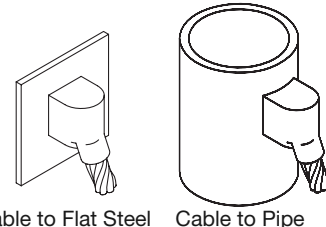

Type BCS-3 Molds are used to join the end of a copper cable at a 45° angle to a vertical steel surface. Size range is 6 sol. through 1000 kcmil solid or concentric stranded copper conductors. Contact BURNDY® for information on molds for conductors not listed below.

Cable to Flat Steel

Cable Size	Mold	Price Key	Weld Metal	Handle Clamps
6	B-585	4	45	B-106
4	B-586	4	45	B-106
3	B-587	4	45	B-106
2	B-588	4	45	B-106
1	B-589	4	65	B-106
1/0	B-590	4	90	B-106
2/0	B-591	4	90	B-106
3/0	B-592	4	115	B-106
4/0	B-593	4	115	B-106
250 kcmil	B-594	4	115	B-106
300 kcmil	B-595	4	150	B-106
350 kcmil	B-596	4	200	B-106
500 kcmil	B-598	4	200	B-106
750 kcmil	B-599	5	2-150	B-107
1000 kcmil	B-600	5	2-200	B-107

Cable to Pipe

Cable Size	Pipe Size	Mold	Price Key	Weld Metal	Handle Clamps
4 sol.	1-1/4" to 4"	B-2476	4	45	B-106
	4" to 6"	B-2477	4	45	B-106
	6" to 10"	B-2478	4	45	B-106
	12" & up	B-586 ‡	4	45	B-106
2 sol.	1-1/4" to 4"	B-9233-S	4	45	B-106
	4" to 6"	B-2480-S	4	45	B-106
	6" to 10"	B-2583-S	4	45	B-106
	12" & up	B-588-S ‡	4	45	B-106
2 sol.	1-1/4" to 4"	B-9233	4	45	B-106
	4" to 6"	B-2480	4	45	B-106
	6" to 10"	B-2688	4	45	B-106
	12" & up	B-588 ‡	4	45	B-106

- For sizes not listed, contact BURNDY®.
- Molds listed are for concentric stranded cable. Add suffix "-S" to mold number for solid conductors.
- For heavy duty molds, molds with wear plates or molds for Copperweld® cable, contact BURNDY®.
- For expedited service, contact BURNDY®.
- Required Tools:
Handle Clamps (see chart for correct handles)
B38-0309-00 Flint Ignitor
- Other recommended accessories:
Magnetic Clamps to hold molds against vertical steel
B38-3922-00 Mold Cleaning Brush
B38-0135-00 Cable Cleaning Brush
B38-0101-00 Rasp
B106-32 Vertical Chain Clamp with B-106 Handles for 4" Pipe and smaller
B40-0106-27 20" Chain Extension for 4" to 10" Pipe
Use (2) 20" Chain Extensions for pipe sizes between 10" and 16"

‡ Flat Surface Mold

(Type BCS-3 Molds continued on next page)

TYPE BCS-3 MOLDS

Angular Cable Drop to Vertical Steel Surface

(Continued)

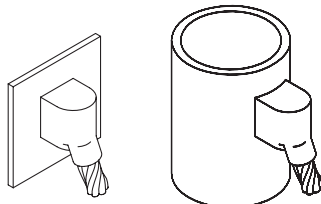

Cable to Flat Steel Cable to Pipe

Cable to Pipe (Continued)

Cable Size	Pipe Size	Mold	Price Key	Weld Metal	Handle Clamps
1 sol.	1-1/4" to 4"	B-2482	4	65	B-106
	4" to 6"	B-2483	4	65	B-106
	6" to 10"	B-2484	4	65	B-106
	12" & up	B-589 ‡	4	65	B-106
1/0 sol.	1-1/4" to 4"	B-2486	4	90	B-106
	4" to 6"	B-2487	4	90	B-106
	6" to 10"	B-2488	4	90	B-106
	12" & up	B-590 ‡	4	90	B-106
2/0 sol.	1-1/4" to 4"	B-8833	4	90	B-106
	4" to 6"	B-2490	4	90	B-106
	6" to 10"	B-2491	4	90	B-106
	12" & up	B-591 ‡	4	90	B-106
3/0 sol.	1-1/4" to 4"	B-2493	4	115	B-106
	4" to 6"	B-2494	4	115	B-106
	6" to 10"	B-2495	4	115	B-106
	12" & up	B-592 ‡	4	115	B-106
4/0 sol.	1-1/4" to 4"	B-9021	4	115	B-106
	4" to 6"	B-2497	4	115	B-106
	6" to 10"	B-2498	4	115	B-106
	12" & up	B-593 ‡	4	115	B-106

- For sizes not listed, contact BURNDY®.
 - Molds listed are for concentric stranded cable. Add suffix "-S" to mold number for solid conductors.
 - For heavy duty molds, molds with wear plates or molds for Copperweld® cable, contact BURNDY®.
 - For expedited service, contact BURNDY®.
 - Required Tools:
 - Handle Clamps (see chart for correct handles)
 - B38-0309-00** Flint Ignitor
 - Other recommended accessories:
 - Magnetic Clamps to hold molds against vertical steel
 - B38-3922-00** Mold Cleaning Brush
 - B38-0135-00** Cable Cleaning Brush
 - B38-0101-00** Rasp
 - B106-32** Vertical Chain Clamp with B-106 Handles for 4" Pipe and smaller
 - B40-0106-27** 20" Chain Extension for 4" to 10" Pipe
 - Use (2) 20" Chain Extensions for pipe sizes between 10" and 16"
- ‡ Flat Surface Mold

UNIRAP™

Nylon Cable Ties



UNIRAP™ cable ties are fabricated of one piece nylon with no metal parts. The straps are tough, resilient, lightweight and abrasion resistant. They offer high tensile strength and are chemically resistive to solvents, alkalies, oils, grease and diluted acids. Self-locking, they secure without twisting or leaving sharp projections.

Std. Pkg. Catalog Number	Length In. (mm)	Minimum Tensile Strength lbs. (N)	Width In. (mm)	Maximum Bundle Diameter In. (mm)	Installation Tools	Bulk Pkg. Catalog Number	
CT18075C	4.00 (102)	18 (80)	.10 (2.5)	.75 (19)	MK7	CT18075M	
CT18125C	5.67 (144)	18 (80)	.10 (2.5)	1.25 (32)		CT18125M	
CT18200C	8.00 (203)	18 (80)	.10 (2.5)	2.00 (51)		CT18200M	
CT30125C	6.00 (152)	30 (133)	.14 (3.6)	1.25 (32)		CT30125M	
CT40200C	8.50 (216)	40 (178)	.14 (3.6)	2.00 (51)		CT40200M	
CT40300C	11.50 (292)	40 (178)	.15 (3.8)	3.00 (76)		CT40300M	
CT40400C	14.50 (368)	40 (178)	.15 (3.8)	4.00 (102)		CT40400M	
CT50175C	8.00 (203)	50 (222)	.18 (4.6)	1.75 (44)		CT50175M	
CT50300C	11.75 (298)	50 (222)	.18 (4.6)	3.00 (76)		CT50300M	
CT50400C	15.50 (394)	50 (222)	.18 (4.6)	4.00 (102)		CT50400M	
CT120200L	8.87 (226)	120 (534)	.30 (7.6)	2.00 (51)		MK9	CT120200D
CT120300L	11.87 (302)	120 (534)	.30 (7.6)	3.00 (76)			CT120300D
CT120400L	15.25 (387)	120 (534)	.30 (7.6)	4.00 (102)			CT120400D
CT120900L	29.75 (776)	120 (534)	.30 (7.6)	9.00 (229)			—
CT175400Q	15.00 (381)	175 (778.35)	.35 (8.9)	4.00 (102)	—		
CT175600Q	21.00 (533)	175 (778.35)	.35 (8.9)	6.00 (152)	—		
CT175900Q	32.00 (813)	175 (778.35)	.35 (8.9)	9.00 (229)	—		
CT1751100Q	36.00 (914)	175 (778.35)	.35 (8.9)	11.00 (279)	—		
CT1751400Q	52.00 (1321)	175 (778.35)	.35 (8.9)	14.00 (356)	—		
CT250600Q	23.00 (584)	250 (1112)	.50 (12.7)	6.00 (152)	—		
CT250800Q	29.00 (737)	250 (1112)	.50 (12.7)	8.00 (203)	—		
CT2501000Q	35.00 (889)	250 (1112)	.50 (12.7)	10.00 (254)	—		
CT2501200Q	40.00 (1016)	250 (1112)	.50 (12.7)	12.00 (305)	—		

*For weather resistant UV UNIRAP ties add suffix "0" to catalog number (example: CT50175C0).

For Sizes Not Listed, Contact Customer Service at 1-800-346-4175.

UNIRAP™
Mounting Hole Cable Ties



Std. Pkg. Catalog Number	Length In. (mm)	Min. Tensile Strength lbs. (N)	Width In. (mm)	Max. Bundle Diameter In. (mm)	Screw Size	Installation Tools	Bulk Pkg. Catalog Number
CT18075MH4C	4.25 (108)	18 (80)	.10 (2.5)	.75 (19)	4 (M2.5)	MK7	CT18075MH4M
CT30125MH8C	6.25 (159)	30 (133)	.14 (3.6)	1.25 (32)	8 (M4)		CT30125MH8M
CT50175MH10C	8.50 (216)	50 (222)	.18 (4.6)	1.75 (44)	10 (M5)		CT50175MH10M
CT50400MH10C	16.00 (406)	50 (222)	.18 (4.6)	4.00 (102)	10 (M5)		CT50400MH10M
CT120400MH14L	16.25 (413)	120 (534)	.30 (7.6)	4.00 (102)	1/4" (M6)	MK9	CT120400MH14D

For weather resistant UV UNIRAP™ ties add suffix "0" to catalog number (example: CT18075MH4C0).

UNIRAP™
Identification Cable Ties

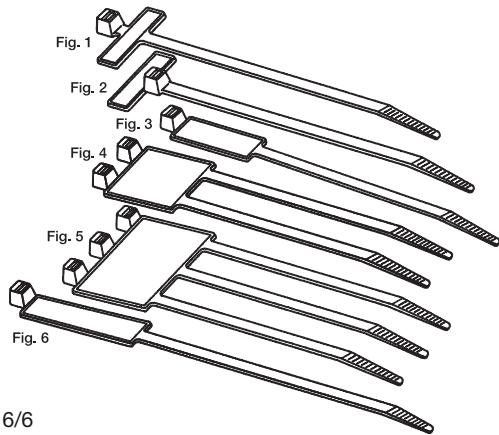

Material Natural Nylon 6/6

Std. Pkg. Catalog Number	Fig. No.	Length In. (mm)	Min. Tensile Strength lbs. (N)	Width In. (mm)	Max. Bundle Diameter In. (mm)	Marking Pad Size In.	Installation Tools
CT18075IDC	1	4.00 (102)	18 (80)	.10 (2.5)	.75 (19)	1.0" x .297"	MK7
CT18075FLC	2	4.25 (108)	18 (80)	.10 (2.5)	.75 (19)	.813" x .313"	
CT50175IDC	3	8.00 (203)	50 (222)	.18 (4.6)	1.75 (44)	1.0" x .438"	
CT50175ID2L	4	8.00 (203)	50 (222)	.18 (4.6)	1.75 (44)	1.142" x 1.037"	
CT50175ID3L	5	8.00 (203)	50 (222)	.18 (4.6)	1.75 (44)	1.813" x .938"	
CT50400IDC	6	15.00 (381)	50 (222)	.18 (4.6)	4.00 (102)	.50" x 2.125"	

For weather resistant UV UNIRAP™ ties add suffix "0" to catalog number.

TYPE UG
UNIRAP™ Cable Ties

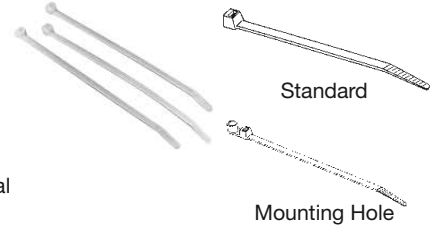

Features and Benefits

- Nylon 6/6 Standard
- Available in Black and Natural
- One piece injection molded
- Maximum strength and adjustability for versatility
- Chemically resistant to solvents, oils, grease, and diluted acids
- Rounded edges and bent tip for easy installation
- Self-Locking

Standard Cable Ties								
Standard Package Catalog Number	Material	Max. Bundle Dia. Inches [mm]	Min. Tensile Strength Lbs. (N)	Length Inches [mm]	Width Inches [mm]	Installation Tool	Tool Setting	Qty. per Pkg.
CT18075CUG	Natural Nylon 6/6	.75	18 (80)	4.00	.10 [2.5]	TWT1, MK7	Mini	100
CT18075C0UG	Black Nylon 6/6 UV	[19]		8.00 [203]				1000
CT18200MUG	Natural Nylon 6/6	2.00 [51]	40 (178)	8.50 [216]	.15 [3.8]		Intermediate	100
CT30125CUG	Natural Nylon 6/6	1.25 [32]		6.00 [152]				100
CT30125C0UG	Black Nylon 6/6 UV	[32]	(133)	[152]	[3.6]		Standard	100
CT40200CUG	Natural Nylon 6/6	2.00 [51]	40 (178)	8.50 [216]	.15 [3.8]			1000
CT50175CUG	Natural Nylon 6/6	1.75 [44]	50 (222)	8.00 [203]	.18 [4.6]		Standard	100
CT50175C0UG	Black Nylon 6/6 UV							100
CT50175MUG	Natural Nylon 6/6	3.00 [76]	11.30 [288]	15.50 [394]	.30 [7.6]		TWT2, MK9	100
CT50175M0UG	Black Nylon 6/6 UV							1000
CT50300CUG	Natural Nylon 6/6	4.00 [102]	120 (534)	15.25 [387]	.30 [7.6]	TWT2, MK9	100	
CT50300C0UG	Black Nylon 6/6 UV						50	
CT50300MUG	Natural Nylon 6/6	4.00 [102]	120 (534)	15.25 [387]	.30 [7.6]	TWT2, MK9	50	
CT50300M0UG	Black Nylon 6/6 UV						50	
CT50400CUG	Natural Nylon 6/6	4.00 [102]	120 (534)	15.25 [387]	.30 [7.6]	TWT2, MK9	50	
CT50400C0UG	Black Nylon 6/6 UV						50	
CT120400LUG	Natural Nylon 6/6	4.00 [102]	120 (534)	15.25 [387]	.30 [7.6]	TWT2, MK9	50	
CT120400L0UG	Black Nylon 6/6 UV						50	

Mounting Hole Cable Ties									
Standard Package Catalog Number	Material	Screw Size	Max. Bundle Dia. Inches [mm]	Min. Tensile Strength Lbs. (N)	Length Inches [mm]	Width Inches [mm]	Installation Tool	Tool Setting	Qty. per Pkg.
CT50175MH10CUG	Nylon 6/6	#10 (M5)	1.75 [44]	50 (222)	8.50 [216]	.18 [4.6]	MK7	Standard	100

Mounting Bases						
Standard Package Catalog Number	Mounting Method	Maximum Tie Slot Width	Dimension A	Dimension B	Dimension C	Package Qty.
CTB125RA4CUG	Rubber Adhesive	0.2	1.125	1.125	0.19	100

UNIRAP™
Cable Tie Variety Pack
UL Listed



Catalog Number: **CTASST**



Contents			
Quantity	Length	Color	Strength
100	40	Natural	18# Strength
100	40	Black	18# Strength
100	80	Black	50# Strength
200	80	Natural	50# Strength
50	110	Natural	50# Strength
50	110	Black	50# Strength

UNIRAP™
Hand Tools



MK7, MK9
For Use On:

MK7, MK9

- MK7** Used on all UNIRAP™ ties with body width of .10" to .19".
- MK9** Used on all UNIRAP™ ties with body width of .10" to .35".

TWT1 & TWT2
Specifications

- Length:** 6.68"
- Width:** .81"
- Weight:** 1.25 oz.



TWT1, TWT2

UNIRAP™
Mounting Bases

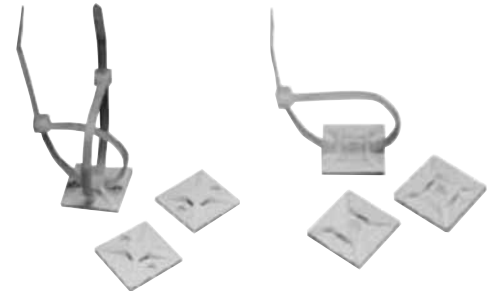

4-Way Mounting Base 2-Way Mounting Base

BURNDY® mounting bases are available in adhesive or screw mount forms. The 4-way mounting bases come in 3 sizes to accommodate UNIRAP™ ties from 18 lbs. tensile strength up to 175 lbs. All bases are made of standard nylon and are offered in weather resistant forms.

4-Way Mounting Bases

Std. Pkg. Catalog Number	Material	Max. Tie Slot Width In. (mm)	Mounting Technique	Bulk Pkg. Catalog Number
CTB075S4C	Nylon 6/6	.14 (3.5)	4 Screw	CTB075S4M
CTB075RA4C			Adhesive	CTB075RA4M
CTB125S4C		.20 (5.1)	8 Screw	CTB125S4D
CTB125RA4C			Adhesive	CTB125RA4D
CTB150S4C		.35 (8.9)	8 Screw	CTB150S4B
CTB150RA4C			Adhesive	CTB150RA4

*For weather resistant UV UNIRAP™ mounts add suffix "0" to catalog number (example: CTB075S4C0).

2-Way Mounting Bases

Std. Pkg. Catalog Number	Material	Max. Tie Slot Width In. (mm)	Mounting Technique
CTB125S2C	Nylon 6/6	.18 (4.5)	6 Screw
CTB125RA2C			Adhesive

*For weather resistant UV UNIRAP™ mounts add suffix "0" to catalog number.

UNIRAP™

Halar® and Tefzel® Cable Ties

Halar® cable ties meet NEC regulations and can be used in applications where low smoke and low flame are a concern, as in air handling spaces. The raw material used to manufacture Halar® cable ties is UL 94V-0 rated. These ties come in a distinct color of red for easy identification.

Halar® is a registered trademark of the Allied Chemical Co.

Tefzel® cable ties provide excellent protection against radiation, ultraviolet light, and a wide range of chemicals. Tefzel® cable ties offer temperature stability to 302°F (150°C) and come in a standard color of blue for easy identification.

Tefzel® is a registered trademark of the E.I. DuPont Corporation.

Std. Pkg. Catalog Number	Material	Length In. (mm)	Min. Tensile Strength lbs. (N)	Width In. (mm)	Max. Bundle In. (mm)	Installation Tools	Bulk Pkg. Catalog Number
CTH18075C	Halar®	4.00 (102)	18 (80)	.10 (2.5)	.75 (19)	MK7	CTH18075M
CTH50175C	Halar®	8.00 (203)	50 (222)	.18 (4.6)	1.75 (44)	MK7	CTH50175M
CTH30200C	Halar®	8.00 (203)	30 (133)	.14 (3.6)	2.00 (51)	MK7	CTH30200M
CTH120400L	Halar®	15.25 (387)	120 (534)	.18 (4.6)	4.00 (102)	MK9	CTH120400D
CTZ18075C	Tefzel®	4.00 (102)	18 (80)	.10 (2.5)	.75 (19)	MK7	CTZ18075M
CTZ50175C	Tefzel®	8.00 (203)	50 (222)	.18 (4.6)	1.75 (44)	MK7	CTZ50175M
CTZ30200C	Tefzel®	8.00 (203)	30 (133)	.14 (3.6)	2.00 (51)	MK7	CTZ30200M
CTZ120400L	Tefzel®	5.25 (387)	120 (534)	.18 (4.6)	4.00 (102)	MK9	CTZ120400D

TYPE CH

NYLOCLIP™ Cable Hanger



NYLOCLIP™ cable hangers are fabricated one-piece nylon with no metal parts. Tough, resilient, lightweight and abrasion resistant, NYLOCLIP™ cable hangers offer high tensile strength and are resistant to solvents, alkalies, oils, grease and diluted acids. Available in white or black UV/weather resistant material. Meets Mil Spec. M-20693, ASTM STD D4066 Group 1 Class 1.

Catalog Number	Material	Mounting Screw	Max. Bundle In. (mm)	Bulk Catalog Number
CH2C	Nylon 6/6	8 (M4)	.125 (3.2)	CH2M
CH3C	Nylon 6/6	8 (M4)	.187 (4.8)	CH3M
CH4C	Nylon 6/6	8 (M4)	.250 (6.4)	CH4M
CH5C	Nylon 6/6	8 (M4)	.312 (7.9)	CH5M
CH6C	Nylon 6/6	8 (M4)	.375 (9.5)	CH6M
CH7C	Nylon 6/6	8 (M4)	.437 (11.1)	CH7M
CH8C	Nylon 6/6	8 (M4)	.500 (12.7)	CH8M
CH9C	Nylon 6/6	8 (M4)	.563 (14.3)	CH9M
CH10C	Nylon 6/6	8 (M4)	.625 (15.9)	CH10M
CH11C	Nylon 6/6	10 (M5)	.625 (15.9)	CH11M
CH12C	Nylon 6/6	10 (M5)	.750 (15.1)	CH12M
CH14C	Nylon 6/6	10 (M5)	.875 (22.2)	CH14M
CH16C	Nylon 6/6	10 (M5)	1.00 (25.4)	CH16M
CH18C	Nylon 6/6	10 (M5)	1.12 (28.5)	CH18M
CH24L	Nylon 6/6	10 (M5)	1.50 (38.1)	CH24C

*For weather resistant UV Nyloclips add suffix "0" to catalog number (example: CH2C0).

TYPE YF

Bare Ferrules

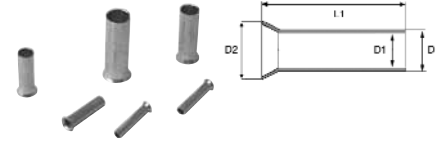

For Use On
Copper Conductor

Made of electrolytic copper, tin plated with a seamless barrel. Ferrules are also known as bootlace ferrules or cord end terminals. Ferrules aid in terminating extra flexible fine stranded conductor. Provide enhanced flexibility relating to wire termination and management. They provide a positive contact surface which helps ensure system integrity.

Catalog Number	Wire Size		Dimensions in Inches				Recommended Tooling
	AWG	mm²	L1	D	D1	D2	
YF2807UI	28	.14	.276	.035	.027	.063	YF3206TOOL
YF2605UI	26	.25	.196	.043	.031	.059	YF3206TOOL YF2610TOOL
YF2607UI	26	.25	.276	.043	.031	.059	
YF2405UI	24	.34	.196	.047	.031	.059	YF3206TOOL YF2610TOOL YF2210TOOL
YF2407UI	24	.34	.276	.047	.031	.059	
YF2206UI	22	.50	.236	.051	.039	.059	YF3206TOOL YF2610TOOL YF2214TOOL YF2210TOOL
YF2208UI	22	.50	.315	.051	.039	.067	
YF2210UI	22	.50	.394	.051	.039	.067	YF3206TOOL YF2610TOOL YF2214TOOL YF2210TOOL
YF2212UI	22	.50	.472	.051	.039	.067	
YF2006UI	20	.75	.236	.059	.047	.067	YF3206TOOL YF2610TOOL YF2214TOOL YF2210TOOL
YF2010UI	20	.75	.394	.059	.047	.075	
YF2012UI	20	.75	.472	.059	.047	.075	YF3206TOOL YF2610TOOL YF2214TOOL YF2210TOOL
YF1806UI	18	1.00	.236	.067	.055	.075	
YF1808UI	18	1.00	.315	.067	.055	.087	YF3206TOOL YF2610TOOL YF2214TOOL YF2210TOOL
YF1810UI	18	1.00	.394	.067	.055	.087	
YF1812UI	18	1.00	.472	.067	.055	.087	YF3206TOOL YF2610TOOL YF2214TOOL YF2210TOOL
YF1607UI	16	1.50	.276	.079	.067	.087	
YF1608UI	16	1.50	.315	.079	.067	.098	YF3206TOOL YF2610TOOL YF2214TOOL YF2210TOOL
YF1610UI	16	1.50	.394	.079	.067	.098	
YF1612UI	16	1.50	.472	.079	.067	.098	YF3206TOOL YF2610TOOL YF2214TOOL YF2210TOOL
YF1618UI	16	1.50	.709	.079	.067	.098	
YF1407UI	14	2.50	.276	.102	.091	.130	YF3206TOOL YF2610TOOL YF2214TOOL YF2210TOOL
YF1408UI	14	2.50	.315	.102	.091	.130	
YF1410UI	14	2.50	.394	.102	.091	.130	YF3206TOOL YF2610TOOL YF2214TOOL YF2210TOOL
YF1412UI	14	2.50	.472	.102	.091	.130	
YF1418UI	14	2.50	.709	.102	.091	.130	YF3206TOOL YF2610TOOL YF2214TOOL YF2210TOOL
YF1209UI	12	4.00	.354	.126	.110	.154	
YF1212UI	12	4.00	.472	.126	.110	.154	YF3206TOOL YF2610TOOL YF2214TOOL YF2210TOOL
YF1215UI	12	4.00	.591	.126	.110	.154	
YF1218UI	12	4.00	.709	.126	.110	.154	YF3206TOOL YF2610TOOL YF2214TOOL YF2210TOOL
YF1010UI	10	6.00	.394	.154	.138	.185	
YF1012UI	10	6.00	.472	.154	.138	.185	YF3206TOOL YF2610TOOL YF2214TOOL YF2210TOOL
YF1015UI	10	6.00	.591	.154	.138	.185	
YF1018UI	10	6.00	.709	.154	.138	.185	YF3206TOOL YF2610TOOL YF2214TOOL YF2210TOOL
YF0812UI	8	10.00	.472	.193	.177	.228	
YF0815UI	8	10.00	.591	.193	.177	.228	YF3206TOOL YF2610TOOL YF2214TOOL YF2210TOOL
YF0818UI	8	10.00	.709	.193	.177	.228	
YF0612UI	6	16.00	.472	.244	.228	.283	YF3206TOOL YF2610TOOL YF2214TOOL YF2210TOOL
YF0615UI	6	16.00	.591	.244	.228	.283	
YF0618UI	6	16.00	.709	.244	.228	.283	YF3206TOOL YF2610TOOL YF2214TOOL YF2210TOOL
YF0625UI	6	16.00	.984	.244	.228	.283	
YF0412UI	4	25.00	.472	.311	.295	.358	YF3206TOOL YF2610TOOL YF2214TOOL YF2210TOOL
YF0415UI	4	25.00	.591	.311	.295	.358	
YF0418UI	4	25.00	.709	.311	.295	.358	YF3206TOOL YF2610TOOL YF2214TOOL YF2210TOOL
YF0420UI	4	25.00	.787	.311	.295	.358	
YF0425UI	4	25.00	.984	.311	.295	.358	YF3206TOOL YF2610TOOL YF2214TOOL YF2210TOOL
YF0432UI	4	25.00	1.260	.311	.295	.358	
YF0215UI	2	35.00	.591	.343	.327	.402	YF3206TOOL YF2610TOOL YF2214TOOL YF2210TOOL
YF0220UI	2	35.00	.787	.343	.327	.402	
YF0225UI	2	35.00	.984	.343	.327	.402	YF3206TOOL YF2610TOOL YF2214TOOL YF2210TOOL
YF0232UI	2	35.00	1.260	.343	.327	.402	
YF0122UI	1	50.00	.866	.429	.406	.500	YF3206TOOL YF2610TOOL YF2214TOOL YF2210TOOL
YF0125UI	1	50.00	.984	.429	.406	.500	

(Type YF Bare Ferrules continued on next page)

TYPE YF
Bare Ferrules

(Continued)

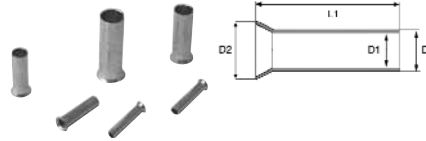

For Use On
Copper Conductor

Catalog Number	Wire Size		Dimensions in Inches				Recommended Tooling
	AWG	mm ²	L1	D	D1	D2	
YF0132UI	1	50.00	1.260	.429	.406	.500	YF0801TOOL YF0401TOOL
YF2/022UI	2/0	70.00	.866	.563	.531	.622	
YF2/025UI	2/0	70.00	.984	.563	.531	.622	YF1/03/0T00L
YF2/032UI	2/0	70.00	1.260	.563	.531	.622	
YF3/025UI	3/0	95.00	.984	.614	.583	.681	
YF3/030UI	3/0	95.00	1.180	.614	.583	.681	
YF3/032UI	3/0	95.00	1.260	.614	.583	.681	
YF4/032UI	4/0	120.00	1.260	.697	.657	.795	
YF4/034UI	4/0	120.00	1.390	.697	.657	.795	YF4/0250T00L
YF4/040UI	4/0	120.00	1.570	.697	.657	.795	
YF25032UI	250	150.00	1.260	.811	.722	.906	Y644HSXT
YF25040UI	250	150.00	1.570	.811	.722	.906	
YF35032UI	350	185.00	1.260	.843	.795	.941	
YF35040UI	350	185.00	1.570	.843	.795	.941	

TYPE YF-I FERRULES

Insulated Ferrules

For Use on Copper Conductor

Offered in Series D, T and W

Made of electrolytic copper, tin plated with a seamless barrel. Ferrules are also known as bootlace ferrules or cord end terminals. Ferrules aid in terminating extra flexible fine stranded conductor. Provide enhanced flexibility relating to wire termination and management. They provide a positive contact surface which helps ensure system integrity.

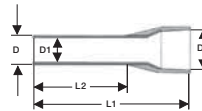

Single Insulated Ferrules

Catalog Number/Color			Wire Size	
W Series	D Series	T Series	AWG	mm ²
YF2806IW Gray	—	—	28	0.14
YF2808IW Gray	—	—	28	0.14
YF2606IW Light Blue	YF2606ID Purple	YF2606IT Yellow	26	0.25
YF2608IW Light Blue	YF2608ID Purple	YF2608IT Yellow	26	0.25
YF2406IW Turquoise	—	—	24	0.34
YF2408IW Turquoise	—	—	24	0.34
YF2205IW Orange	YF2205ID White	YF2205IT White	22	0.50
YF2206IW Orange	YF2206ID White	YF2206IT White	22	0.50
YF2208IW Orange	YF2208ID White	YF2208IT White	22	0.50
YF2210IW Orange	YF2210ID White	YF2210IT White	22	0.50
YF2212IW Orange	YF2212ID White	YF2212IT White	22	0.50

Dimensions in Inches					Tooling
L1 Dim.	L2 Dim.	D Dim.	D1 Dim.	D2 Dim.	
0.409	0.236	0.037	0.031	0.043	YF3206T00L
0.488	0.315	0.037	0.031	0.043	
0.409	0.236	0.043	0.031	0.075	YF2610T00L YF3206T00L
0.488	0.315	0.043	0.031	0.075	
0.409	0.236	0.043	0.031	0.075	
0.488	0.315	0.043	0.031	0.075	YF3206T00L YF2610T00L YF2214T00L YF2210T00L
0.433	0.197	0.051	0.039	0.102	
0.472	0.236	0.051	0.039	0.102	
0.551	0.315	0.051	0.039	0.102	
0.630	0.394	0.051	0.039	0.102	
0.709	0.472	0.051	0.039	0.102	

(Type YF-I Insulated Series W, D, T Ferrules continued on next 6 pages)

TYPE YF-I FERRULES

Insulated Ferrules

(Continued)

For Use on Copper Conductor

Offered in Series W, D, T

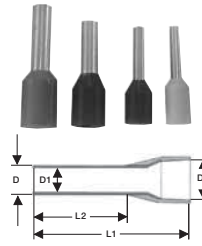

Single Insulated Ferrules

Catalog Number/Color			Wire Size	
W Series	D Series	T Series	AWG	mm ²
YF2006IW White	YF2006ID Gray	YF2006IT Light Blue	20	0.75
YF2008IW White	YF2008ID Gray	YF2008IT Light Blue	20	0.75
YF2010IW White	YF2010ID Gray	YF2010IT Light Blue	20	0.75
YF2012IW White	YF2012ID Gray	YF2012IT Light Blue	20	0.75
YF2018IW White	YF2018ID Gray	YF2018IT Light Blue	20	0.75
YF1806IW Yellow	YF1806ID Red	YF1806IT Red	18	1.00
YF1808IW Yellow	YF1808ID Red	YF1808IT Red	18	1.00
YF1810IW Yellow	YF1810ID Red	YF1810IT Red	18	1.00
YF1812IW Yellow	YF1812ID Red	YF1812IT Red	18	1.00
YF1818IW Yellow	YF1818ID Red	YF1818IT Red	18	1.00
YF1606IW Red	YF1606ID Black	YF1606IT Black	16	1.50
YF1608IW Red	YF1608ID Black	YF1608IT Black	16	1.50
YF1610IW Red	YF1610ID Black	YF1610IT Black	16	1.50
YF1612IW Red	YF1612ID Black	YF1612IT Black	16	1.50
YF1615IW Red	YF1615ID Black	YF1615IT Black	16	1.50
YF1618IW Red	YF1618ID Black	YF1618IT Black	16	1.50
YF1408IW Blue	YF1408ID Blue	YF1408IT Gray	14	2.50
YF1410IW Blue	YF1410ID Blue	YF1410IT Gray	14	2.50
YF1412IW Blue	YF1412ID Blue	YF1412IT Gray	14	2.50
YF1418IW Blue	YF1418ID Blue	YF1418IT Gray	14	2.50
YF1209IW Gray	YF1209ID Gray	YF1209IT Orange	12	4.00
YF1210IW Gray	YF1210ID Gray	YF1210IT Orange	12	4.00
YF1212IW Gray	YF1212ID Gray	YF1212IT Orange	12	4.00
YF1218IW Gray	YF1218ID Gray	YF1218IT Orange	12	4.00
YF1010IW Black	YF1010ID Yellow	YF1010IT Green	10	6.00
YF1012IW Black	YF1012ID Yellow	YF1012IT Green	10	6.00
YF1018IW Black	YF1018ID Yellow	YF1018IT Green	10	6.00

Dimensions in Inches					Tooling
L1 Dim.	L2 Dim.	D Dim.	D1 Dim.	D2 Dim.	
0.472	0.236	0.059	0.047	0.110	YF3206TOOL YF2610TOOL YF2214TOOL YF2210TOOL
0.551	0.315	0.059	0.047	0.110	
0.630	0.394	0.059	0.047	0.110	
0.709	0.472	0.059	0.047	0.110	
0.957	0.709	0.059	0.047	0.110	
0.472	0.236	0.067	0.055	0.118	
0.551	0.315	0.067	0.055	0.118	
0.630	0.394	0.067	0.055	0.118	
0.709	0.472	0.067	0.055	0.118	
0.957	0.709	0.067	0.055	0.118	
0.484	0.236	0.079	0.067	0.138	
0.551	0.315	0.079	0.067	0.138	
0.630	0.394	0.079	0.067	0.138	
0.709	0.472	0.079	0.067	0.138	
0.839	0.591	0.079	0.067	0.138	
0.945	0.709	0.079	0.067	0.138	
0.591	0.315	0.098	0.087	0.165	
0.685	0.394	0.098	0.087	0.165	
0.709	0.472	0.098	0.087	0.165	
0.945	0.709	0.098	0.087	0.165	
0.646	0.315	0.126	0.110	0.189	YF3206TOOL YF2610TOOL YF2210TOOL
0.699	0.394	0.126	0.110	0.189	
0.787	0.472	0.126	0.110	0.189	
1.020	0.709	0.126	0.110	0.189	
0.728	0.394	0.154	0.138	0.248	YF3206TOOL YF2610TOOL YF2210TOOL YF1006TOOL
0.787	0.472	0.154	0.138	0.248	
1.020	0.709	0.154	0.138	0.138	

(Type YF-I Insulated Series W, D, T Ferrules continued on next 4 pages)

TYPE YF-I FERRULES

Insulated Ferrules

(Continued)

For Use on Copper Conductor

Offered in Series W, D, T

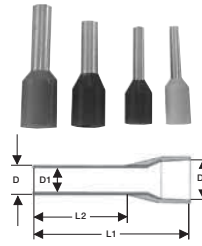

Single Insulated Ferrules

Catalog Number/Color			Wire Size	
W Series	D Series	T Series	AWG	mm ²
YF0812IW Ivory	YF0812ID Red	YF0812IT Brown	8	10.00
YF0815IW Ivory	YF0815ID Red	YF0815IT Brown	8	10.00
YF0818IW Ivory	YF0818ID Red	YF0818IT Brown	8	10.00
YF0612IW Green	YF0612ID Blue	YF0612IT Ivory	6	16.00
YF0618IW Green	YF0618ID Blue	YF0618IT Ivory	6	16.00
YF0412IW Brown	YF0412ID Yellow	YF0412IT Black	4	25.00
YF0415IW Brown	YF0415ID Yellow	YF0415IT Black	4	25.00
YF0416IW Brown	YF0416ID Yellow	YF0416IT Black	4	25.00
YF0418IW Brown	YF0418ID Yellow	YF0418IT Black	4	25.00
YF0422IW Brown	YF0422ID Yellow	YF0422IT Black	4	25.00
YF0425IW Brown	YF0425ID Yellow	YF0425IT Black	4	25.00
YF0216IW Beige	YF0216ID Red	YF0216IT Beige	2	35.00
YF0218IW Beige	YF0218ID Red	YF0218IT Beige	2	35.00
YF0222IW Beige	YF0222ID Red	YF0222IT Beige	2	35.00
YF0225IW Beige	YF0225ID Red	YF0225IT Beige	2	35.00
YF0112IW Olive Green	YF0112ID Blue	YF0112IT Olive Green	1	50.00
YF0116IW Olive Green	YF0116ID Blue	YF0116IT Olive Green	1	50.00
YF0120IW Olive Green	YF0120ID Blue	YF0120IT Olive Green	1	50.00
YF0122IW Olive Green	YF0122ID Blue	YF0122IT Olive Green	1	50.00
YF0125IW Olive Green	YF0125ID Blue	YF0125IT Olive Green	1	50.00
YF0130IW Olive Green	YF0130ID Blue	YF0130IT Olive Green	1	50.00
—	YF2/020ID Yellow	—	2/0	70.00
—	YF2/025ID Yellow	—	2/0	70.00
—	YF2/027ID Yellow	—	2/0	70.00
—	YF3/025ID Red	—	3/0	95.00
—	YF3/030ID Red	—	3/0	95.00

Dimensions in Inches					Tooling
L1 Dim.	L2 Dim.	D Dim.	D1 Dim.	D2 Dim.	
0.866	0.472	0.193	0.177	0.299	YF3206TOOL YF1006TOOL YF0801TOOL
0.929	0.591	0.193	0.177	0.299	
1.100	0.709	0.193	0.177	0.299	
0.945	0.472	0.244	0.228	0.346	
1.100	0.709	0.244	0.228	0.346	
0.945	0.472	0.303	0.287	0.441	YF0801TOOL YF0401TOOL
1.060	0.591	0.303	0.287	0.441	
1.100	0.630	0.303	0.287	0.441	
1.180	0.709	0.303	0.287	0.441	
1.420	0.866	0.303	0.287	0.441	
1.450	0.984	0.303	0.287	0.441	
1.180	0.630	0.343	0.327	0.500	
1.260	0.709	0.343	0.327	0.500	
1.150	0.709	0.343	0.327	0.500	
1.530	0.984	0.343	0.327	0.500	
1.100	0.472	0.429	0.406	0.591	
1.260	0.630	0.429	0.406	0.591	
1.417	0.787	0.429	0.406	0.591	
1.500	0.866	0.429	0.406	0.591	
1.580	0.984	0.429	0.406	0.591	
1.810	1.180	0.429	0.406	0.591	
1.480	0.787	0.563	0.531	0.631	YF1/03/0T00L
1.654	0.984	0.563	0.531	0.631	
1.730	1.060	0.563	0.531	0.631	
1.730	0.984	0.614	0.583	0.725	
1.950	1.180	0.614	0.583	0.725	

(Type YF-I Insulated Series W, D, T Ferrules continued on next 2 pages)

TYPE YF-I FERRULES

Insulated Ferrules

(Continued)

For Use on Copper Conductor

Offered in Series W, D, T

Single Insulated Ferrules

Catalog Number/Color			Wire Size	
W Series	D Series	T Series	AWG	mm ²
—	YF4/027ID Blue	—	4/0	120.00
—	YF4/030ID Blue	—	4/0	120.00
—	YF4/032ID Blue	—	4/0	120.00
—	YF4/034ID Blue	—	4/0	120.00
—	YF25025ID Yellow	—	250	150.00
—	YF25027ID Yellow	—	250	150.00
—	YF25032ID Yellow	—	250	150.00
—	YF25038ID Yellow	—	250	150.00

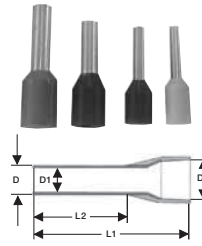

Dimensions in Inches					Tooling
L1 Dim.	L2 Dim.	D Dim.	D1 Dim.	D2 Dim.	
1.870	1.060	0.697	0.657	0.799	YF4/0250T00L
2.090	1.180	0.697	0.657	0.799	
2.070	1.260	0.697	0.657	0.799	
2.150	1.340	0.697	0.657	0.799	
1.990	0.984	0.811	0.772	0.921	
2.070	1.060	0.811	0.772	0.921	
2.270	1.260	0.811	0.772	0.921	
2.500	1.500	0.811	0.772	0.921	

TYPES YFTW, YFTW-I FERRULES

Insulated Twin Ferrules

For Use on Copper Conductor

Offered in Series W, D, T

Made of electrolytic copper, tin plated with a seamless barrel. Ferrules are also known as bootlace ferrules or cord end terminals. Ferrules aid in terminating extra flexible fine stranded conductor. Provide enhanced flexibility relating to wire termination and management. They provide a positive contact surface which helps ensure system integrity. Twin ferrule designs allow two individual stranded conductors to be connected to the same termination. This is most beneficial in jumpering or other similar applications.

Twin Insulated Ferrules

Catalog Number/Color			Wire Size	
W Series	D Series	T Series	AWG	mm ²
YFTW0614W Green	YFTW0614D Blue	YFTW0614T Ivory	6	16.00
YFTW0814W Beige	YFTW0814D Red	YFTW0814T Brown	8	10.00
YFTW1014W Black	YFTW1014D Yellow	YFTW1014T Green	10	6.00
YFTW1212W Gray	YFTW1212D Gray	YFTW1212T Orange	12	4.00
YFTW1410W Blue	YFTW1410D Blue	YFTW1410T Gray	14	2.50
YFTW1413W Blue	YFTW1413D Blue	YFTW1413T Blue	14	2.50
YFTW1608W Red	YFTW1608D Black	YFTW1608T Black	16	1.50
YFTW1612W Red	YFTW1612D Black	YFTW1612T Black	16	1.50
YFTW1808W Yellow	YFTW1808D Red	YFTW1808T Red	18	1.00
YFTW1810W Yellow	YFTW1810D Red	YFTW1810T Red	18	1.00
YFTW2008W White	YFTW2008D Gray	YFTW2008T Light Blue	20	0.75
YFTW2010W White	YFTW2010D Gray	YFTW2010T Light Blue	20	0.75
YFTW2208W Orange	YFTW2208D White	YFTW2208T White	22	0.50



Dimensions in Inches					Tooling
L1 Dim.	L2 Dim.	D Dim.	D1 Dim.	D2 Dim.	
1.230	0.343	0.327	0.748	Green	YF2210TOOL
1.050	0.272	0.256	0.496	Beige	
1.030	0.209	0.193	0.374	Black	
0.909	0.165	0.150	0.346	Gray	
0.728	0.130	0.114	0.315	Blue	
0.846	0.130	0.114	0.315	Blue	
0.610	0.102	0.091	0.252	Red	
0.768	0.102	0.091	0.252	Red	
0.594	0.094	0.083	0.217	Yellow	
0.673	0.094	0.083	0.217	Yellow	
0.579	0.083	0.071	0.217	White	
0.657	0.083	0.071	0.217	White	
0.571	0.071	0.059	0.197	Orange	

TYPES T, YAD
HYLUG™ Terminals



The Type T uninsulated terminals are constructed of pure electrolytic copper. Designed with a long brazed seam barrel, standard neck, deep V groove inner serrations and electro-tin plated. The terminals are ideal for control wiring and other standard duty applications.

Catalog Number	Wire Range	Stud Size	Bulk Catalog Number	Installation Tooling
T18-4	22 - 18	3,4	YAD18-4	Non-Ratchet: Y10D, Y10-22 Ratchet: MR8G98, Y8MRB-1, MR20
T18-6		4-6	YAD18-6	
T18-8		6-8	YAD18-8	
T18-10		8-10	YAD18-10	
T18-14		1/4	YAD18-14	
T18-516		5/16	YAD18-516	
T18-38	3/8	YAD18-38		
T14-4	20 - 14	3,4	YAD14-4	
T14-6		4-6	YAD14-6	
T14-8		6-8	YAD14-8	
T14-10		8-10	YAD14-10	
T14-14		1/4	YAD14-14	
T14-516		5/16	YAD14-516	
T14-38	3/8	YAD14-38		
T10-6	12 - 10*	4-6	YAD10-6	
T10-8		6-8	YAD10-8	
T10-10		8-10	YAD10-10	
T10-14		1/4	YAD10-14	
T10-516		5/16	YAD10-516	
T10-38		3/8	YAD10-38	

*NOTE: UL Listed for 14-10 when installed with MR8G98 and Y8MRB-1 tools only.

TYPES TP, BA
VINYLUG™



VINYLUG™ Type TP is designed for commercial and light duty industrial control and power circuit applications. Supplied with an expanded polyvinyl chloride (PVC) insulation shroud, many tongue variations and rated 600V, makes TP terminals versatile and economical.

Catalog Number	Wire Range	Stud Size	Bulk Catalog Number	Installation Tooling	
TP16-4	22 - 16	3 - 4	BA16E4	Non-Ratchet: Y10-22, Y10D Ratchet: MR8-89-1, MR8-G96, MR15	
TP16-6	Max. Insul.	4 - 6	BA16E6		
TP16-8	Dia. Accom.: .145	6 - 8	BA16E8		
TP16-10	Color Code: Red	8 - 10	BA16E10		
TP16-14		12, 1/4	BA16E14		
TP16-38		3/8	BA16E38		
TP14-4	16-14	3 - 4	BA14E4		
TP14-6	Max. Insul.	4 - 6	BA14E6		
TP14-8	Dia. Accom.: .180	6 - 8	BA14E8		
TP14-10	Color Code: Blue	8 - 10	BA14E10		
TP14-14		12, 1/4	BA14E14		
TP14-516		5/16	BA14E516		
TP14-38		3/8	BA14E38		
TP10-6	12-10 Max. Insul.	4 - 6	BA10E6		Plier Type: Y10D, Y10-22, Ratchet: MR8-89-1, MR8-G96, MR15, M8ND w/N10HET-23
TP10-8	Dia. Accom.: .260	6 - 8	BA10E8		
TP10-10	Color Code: Yellow	8 - 10	BA10E10		
TP10-14		12, 1/4	BA10E14		
TP10-38		3/8	BA10E38		

TYPES TN, YAE, YAES
INSULUG™ Terminals



INSULUG™ Type TN Nylon-insulated terminals are designed for heavy duty industrial, utility and military power and control-circuit applications for wire sizes 22 AWG through 10 AWG. They offer high dielectric strength and stability in oily conditions and meet military CLASS 1 and CLASS 2 requirements per AS25036 and the requirements of military specifications SAE-AS7928 (ASG).

Catalog Number	Wire Range	Stud Size	Bulk Catalog Number	Installation Tooling
TN18-4	22-18 Max. Insul. Dia. Accom.: .120 Color Code: Red	3 - 4	YAES18N48	Non-Ratchet: Y10D, Y1022 Ratchet: MR8-83, MR18
TN18-6		4 - 6	YAES18N1	
TN18-8		6 - 8	YAES18N49	
TN18-10		8 - 10	YAES18N3	
TN18-14		12, 1/4	YAES18N50	
TN18-516		5/16	YAES18N4	
TN18-38	3/8	—		
TN14-4	16-14 Max. Insul. Dia. Accom.: .153 Color Code: Blue	3 - 4	YAE14N52	
TN14-6		4 - 6	YAES14N6	
TN14-8		6 - 8	YAES14N53	
TN14-10		8 - 10	YAES14N8	
TN14-14		12, 1/4	YAES14N54	
TN14-516		5/16	YAES14N9	
TN14-38	3/8	—		
TN10-6	12-10 Max. Insul. Dia. Accom.: .210 Color Code: Yellow	4 - 6	YAES10N11	
TN10-8		6 - 8	YAES10N56	
TN10-10		8 - 10	YAES10N12	
TN10-14		12, 1/4	YAES10N57	
TN10-516		5/16	YAES10N13	
TN10-38		3/8	—	

TYPES T-F, YAD-F
HYLUG™ Terminals



Type T-F is constructed in the same manner as the Type "T" and employs a fork tongue.

Catalog Number	Wire Range	Stud Size	Bulk Catalog Number	Installation Tooling	
T18-6F	22 - 18	4 - 6	YAD18-6F	Non-Ratchet: Y10D, Y10-22 Ratchet: MR8G98, Y8MRB-1, MR20	
T18-8F		6 - 8	YAD18-8F		
T18-10F		8 - 10	YAD18-10F		
T18-14F		1/4	YAD18-14F		
T14-6F		20 - 14	4 - 6		YAD14-6F
T14-8F			6 - 8		YAD14-8F
T14-10F	8 - 10		YAD14-10F		
T14-14F	1/4		YAD14-14F		
T10-6F	12 - 10		4 - 6		YAD10-6F
T10-8F			6 - 8		YAD10-8F
T10-10F		8 - 10	YAD10-10F		
T10-14F		1/4	YAD10-14F		

TYPES TP-F, BA-EF VINYLUG™ Terminal



The Type TP-F is a fork tongue variation of the TP design and makes installation easier.

Catalog Number	Wire Range	Bulk Catalog Number	Installation Tooling
TP16-2F	22 - 16	BA16EF2	Non-Ratchet: Y10-22
TP16-6F	Max. Insul.	BA16EF6	
TP16-8F	Dia. Accom.: .145	BA16EF8	
TP16-10F	Color Code: Red	BA16EF10	
TP14-2F	16 - 14	BA14EF2	Ratchet: MR8-89-1
TP14-6F	Max. Insul.	BA14EF6	
TP14-8F	Dia. Accom.: .180	BA14EF8	
TP14-10F	Color Code: Blue	BA14EF10	
TP10-6F	12 - 10 Max. Insul.	BA10EF6	Ratchet: MR15, M8ND w/N10ET-23
TP10-8F	Dia. Accom.: .260	BA10EF8	
TP10-10F	Color Code: Yellow	BA10EF10	

TYPES TN-F, YAE-F, YAES-F INSULUG™ Terminal



The Type TN-F, nylon insulated fork tongue terminal has the same high quality as the TN. It is designed to meet the heavy-duty requirements of industrial and utility applications.

Catalog Number	Wire Range	Stud Size	Bulk Catalog Number	Installation Tooling
TN20-2F*	26 - 20 Max. Insul. Dia. Accom.: .098	1 - 2	YAE22N65F*	M8ND with N14HET-25V1 Die Set
TN20-6F*	Color Code: Amber	4 - 6	YAE22N66F*	
TN18-6F	22 - 18	4 - 6	YAES18N1F	Non-Ratchet: Y10D, Y10-22
TN18-8F	Max. Insul.	6 - 8	YAES18N49F	
TN18-10F	Dia. Accom.: .120	8 - 10	YAES18N3F	
TN18-14F	Color Code: Red	12, 1/4	YAES18N50F	
TN14-6F	16 - 14	4 - 6	YAES14N6F	Ratchet: MR8-83, MR18
TN14-8F	Max. Insul.	6 - 8	YAES14N53F	
TN14-10F	Dia. Accom.: .153	8 - 10	YAES14N8F	
TN14-14F	Color Code: Blue	12, 1/4	YAES14N54F	
TN10-6F	12 - 10	4 - 6	YAES10N11F	
TN10-8F	Max. Insul.	6 - 8	YAES10N56F	
TN10-10F	Dia. Accom.: .209	8 - 10	YAES10N12F	
TN10-14F	Color Code: Yellow	12, 1/4	YAES10N57F	

* Not UL Listed.

TYPES TP-Z, BA-EZ VINYLUG™ Terminals



VINYLUG™ Type TP-Z is a variation of the Type TP and employs flanged fork tongue for fast installation and security.

Catalog Number	Wire Range	Stud Size	Bulk Catalog Number	Installation Tooling
TP16-2Z	22 - 16	1 - 2	BA16EZ2	Non-Ratchet: Y10-22
TP16-6Z	Max. Insul.	4 - 6	BA16EZ6	
TP16-8Z	Dia. Accom.: .145	6 - 8	BA16EZ8	
TP16-10Z	Color Code: Red	8 - 10	BA16EZ10	
TP14-6Z	16 - 14 Max. Insul.	4 - 6	BA14EZ6	Ratchet: MR8-89-1
TP14-8Z	Dia. Accom.: .145	6 - 8	BA14EZ8	
TP14-10Z	Color Code: Red	8 - 10	BA14EZ10	
TP10-6Z	12 - 10 Max. Insul.	4 - 6	BA10EZ6	Ratchet: MR15, M8ND w/N10ET-23
TP10-8Z	Dia. Accom.: .260	6 - 8	BA10EZ8	
TP10-10Z	Color Code: Yellow	8 - 10	BA10EZ10	

TYPES YAE-Z BOX, YAE-Z INSULUG™ Terminals



INSULUG™ Type YAE-Z employs a flanged fork tongue for faster installation while maintaining security if supporting screw becomes loose.

Catalog Number	Wire Range	Stud Size	Bulk Catalog Number	Installation Tooling
YAE22Z1BOX	26 - 20 Max.	1 - 2	YAE22Z1	Y10D, Y10-22 MR8-33T-1, M8ND with one of following Dies N14HET-15, N14HET-25V1, N10ET-9, N10ET-23
YAE22Z2BOX	Insul. Dia.: .098	4 - 6	YAE22Z2	
YAE22Z3BOX	Sleeve Color: Amber	6 - 8	YAE22Z3	
YAE18Z1BOX	22 - 16 Max.	1 - 2	YAE18Z1	MR33T-1, M8ND with N12HET-1 or Y10D, Y10-22
YAE18Z2BOX	Insul. Dia. Accom.: .125	4 - 6	YAE18Z2	
YAE18Z3BOX	Color Code: Red	6 - 8	YAE18Z3	
YAE18Z4BOX	6 - 14 Max. Insul.	8 - 10	YAE18Z4	
YAE14Z2BOX	Dia. Accom.: .156	4 - 6	YAE14Z2	
YAE14Z3BOX	Color Code: Blue	6 - 8	YAE14Z3	
YAE14Z4BOX		8 - 10	YAE14Z4	
YAE12Z2BOX	14 - 12 Max. Insul.	4 - 6	YAE12Z2	
YAE12Z3BOX	Dia. Accom.: .180	6 - 8	YAE12Z3	
YAE12Z4BOX	Color Code: Green	8 - 10	YAE12Z4	

TYPES YAV-L BOX, YAV-L HYLUG™ Terminals

Large Size Uninsulated Compression Terminals, Seamless Uninsulated Compression Ring Tongue Terminal

8-4/0 Str. Copper



HYLUG™ Type YAV is a seamless, heavy duty uninsulated compression terminal manufactured from electrolytic copper and is for use on Type AN aircraft cable, extra flexible conductors and commercial (code) conductors. The seamless tubing produces a double-thick tongue and seamless barrel design provides a strong connector for demanding applications requiring high reliability.

Applications include aircraft, industrials, hospitals, electric utilities, marine, computers, and other equipment subject to vibration or requiring dependable electrical performance.

The YAV HYLUG™ terminals meet the requirements of ASE-AS7928 and are listed per AS20659 for use with copper aircraft cable per MIL-W-5086.

The benefits of YAV-L connectors are the same as YAV connectors for stranded conductors.

Catalog Number	Wire Size	Stud Size	Bulk Catalog Number	Installation Tooling HYTOOL™
YAV8C-L1BOX	8 AWG	1/4	YAV8C-L1*	Non-Ratchet: MY29-11; Ratchet: MR4C, MR8-9Q, Y8MRB-1, M8ND with N8CT Die Set
YAV8C-L4BOX	8 AWG	1/2	YAV8C-L4*	
YAV6C-L1BOX	6 AWG	8 - 10	YAV6C-L1*	Non-Ratchet: MY28, MY29-11; Ratchet: MR4C
YAV6C-L10BOX	6 AWG	1/2	YAV6C-L10	
YAV2C-L1BOX	2 AWG	1/4	YAV2C-L1 *	Non-Ratchet: MY28, MY29-11
YAV2C-L4BOX	2 AWG	1/2	YAV2C-L4	
YAV1C-L1BOX	1 AWG	1/4	YAV1C-L1*	
YAV1C-L3BOX	1 AWG	1/2	YAV1C-L3	
YAV25-L1BOX	1/0	1/4	YAV25-L1	
YAV25-L3BOX	1/0	1/2	YAV25-L3*	
YAV26-L1BOX	2/0	1/4	YAV26-L1	
YAV26-L2BOX	2/0	5/16	YAV26-L2	
YAV26-L3BOX	2/0	1/2	YAV26-L3*	
YAV26-L12BOX	2/0	5/8	YAV26-L12	
YAV28-L12BOX	4/0	1/2	YAV28-L12	

* Available in (90°) right angle design. Suffix "RS" replaces suffix "L"
Add "NK" suffix for nickel plated HYLUGs for high temperature applications up to 650°F continuous service and 750°F intermittent service.
All dimensions shown are for reference only.

TYPE Q-F FINGRIP™ Terminal

Uninsulated Female Quick Disconnect Terminal



Chamfered barrel opening assures quick and easy wire insertion. Dimpled female socket and male tab detent ensure firm grip.

Catalog Number	Wire Range	NEMA Tab Size	Hand Tool	Wire Strip Length
Q18F18X02D	22 - 18	.187 × .020	Y10D, MR20	9/32"
Q18F25X03D		.250 × .032		
Q14F18X02D	16 - 14	.187 × .020		9/32"
Q14F25X03D		.250 × .032		
Q10F25X03D	12 - 10	.250 × .032		3/8"

TYPE QP-F FINGRIP™ Terminal

Vinyl Insulated Female Quick Disconnect Terminal



Easy entry shroud has smooth funnel which assures no hang up wire insertion. Color coded for quick and easy identification. Two piece construction.

Catalog Number	Wire Range	NEMA Tab Size	Hand Tool	Sleeve Color	Wire Strip Length
QP18F110X02D	22 - 18	.110 × .020	Y10D	Red	3/8"
QP18F18X02D		.187 × .020			
QP18F25X03D	16 - 14	.250 × .032		Blue	3/8"
QP14F110X02D		.110 × .020			
QP14F18X02D	16 - 14	.187 × .020		Yellow	15/32"
QP14F25X03D		.250 × .032			
QP10F25X03D	12 - 10	.250 × .032			

TYPE QN-F FINGRIP™ Terminal

Nylon Insulated Female Quick Disconnect Terminal



Smooth copper funnel wire entry greatly reduces the possibility of wire stubbing and provides maximum wire support.

Catalog Number	Wire Range	NEMA Tab Size	Hand Tool	Sleeve Color	Wire Strip Length
QN18F18X02D	22 - 18	.187 × .020	Y10D	Red	3/8"
QN18F25X03D		.250 × .032			
QN14F18X02D	16 - 14	.187 × .020		Blue	3/8"
QN14F25X03D		.250 × .032			
QN10F25X03D	12 - 10	.250 × .032		Yellow	15/32"

TYPE Q-M**FINGRIP™ Terminal**

Uninsulated Male

Quick Disconnect Terminal



Chamfered barrel opening assures quick and easy wire insertion. Dimpled female socket and male tab detent ensure firm grip.

Catalog Number	Wire Range	NEMA Tab Size	Hand Tool	Wire Strip Length
Q18M18X02D	22 - 8	.187 × .020	MR20, Y10D	7/32"
Q18M25X03D		.250 × .032		
Q14M18X02D	16 - 14	.187 × .020		
Q14M25X03D		.250 × .032		

TYPE QP-M**FINGRIP™ Terminal**

Vinyl Insulated Male

Quick Disconnect Terminal



Easy entry shroud has smooth funnel which assures no hang up wire insertion. Color coded for quick and easy identification. Two piece construction.

Catalog Number	Wire Range	NEMA Tab Size	Hand Tool	Sleeve Color	Wire Strip Length
QP18M18X02D	22 - 18	.187 × .020	Y10D	Red	5/16"
QP18M25X03D		.250 × .032			
QP14M18X02D	16 - 14	.187 × .020			
QP14M25X03D		.250 × .032		Blue	

TYPE QN-M**FINGRIP™ Terminal**

Nylon Insulated Male

Quick Disconnect Terminal



Smooth copper funnel wire entry greatly reduces the possibility of wire stubbing and provides maximum wire support.

Catalog Number	Wire Range	NEMA Tab Size	Hand Tool	Sleeve Color	Wire Strip Length
QN18M18X02D	22 - 18	.187 × .020	Y10D	Red	9/32"
QN18M25X03D		.250 × .032			
QN14M18X02D	16 - 14	.187 × .020			
QN14M2503D		.250 × .032		Blue	

TYPES YSV, YSV-L**HYLINK™ Splices**

600 Volt Maximum

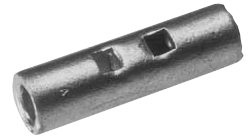

HYLINK™ Type YSV seamless splice connector is used to splice stranded and solid copper conductors in virtually all heavy duty industrial and general purpose applications.

Catalog Number	Wire Range Code AWG Str. and Sol. Aircraft-AN	Bulk Catalog Number	Installation Tooling HYTOOL™
YSV18BOX	22 - 18 str. & sol.	YSV18	Non-Ratchet: Y10D, Y10-22
YSV14BOX	20 - 14 str. 20 - 12 sol.	YSV14	Ratchet: MR20, Y8MRB-1, MR8-9Q*
YSV10BOX	12 - 10 str. & sol.	YSV10	
YSV9C-LBOX	9 str.	YSV9C-L	Non-Ratchet: MY28, MY29-3, MY29-11
YSV8C-LBOX	8 str.	YSV8C-L	Ratchet: Y8MRB-1†, MR8-9Q*, Y1MRTC ▲

*Remove stop plate.

† Use #10 groove.

▲ For 8 str. only.

TYPES SP, BS**VINYLINK™ Splice**

600 Volts



The Type SP VINYLINK™ is a PVC insulated seamless butt splice. Type SP VINYLINK™ is designed to accommodate a broad range of 600 volt cables.

Catalog Number	Wire Range	Color Code	Bulk Catalog Number	Installation Tooling
SP16	22 - 16	Red	BS16	Non-Ratchet: Y10-22, Y10D
SP14	16 - 14	Blue	BS14	Ratchet:
SP10	12 - 10	Yellow	BS10	MR8-89-1, MR15, MR8G-98

TYPES SN, YSE-HN**INSULINK™ Splice**

600 Volt, 105° C



The Type SN INSULINK™ is a high quality nylon-insulated butt splice designed to meet heavy duty application requirements. Meets the functional requirements of MIL-T-7928 (ASG) and conforms to the requirements of NAS1388.

Catalog Number	Wire Range	Color Code	Bulk Catalog Number	Installation Tooling
SN18	22-18	Red	YSE18HN	Non-Ratchet: Y10D
SN14	16-14	Blue	YSE14HN	Ratchet:
SN10	12-10	Yellow	YSE10HN	MR8-85, MR18

TYPE YSM

HYLINK™ Splice

Uninsulated Parallel Splice



HYLINK™ type YSM seamless parallel splice connector permits wires to be laid parallel inside the connector and spliced together with BURNDY's compression HYTOOL™. Each YSM connector accommodates a wide combination of round, square, and rectangular copper conductors that have a total combined circular mil area listed in the table below. The conductors to be spliced must physically fit within the splice without being forced.

Catalog Number	Circular Mil. Range		Wire Strip Length
	Min.	Max.	
YSM18	300	1,909	5/16"
YSM14	477	4,107	5/16"
YSM10	4,107	10,380	7/16"
YSM8C	6,088	16,864	1/2"
YSM6C	10,380	26,83	1/2"
YSM4C	26,813	42,613	9/16"
YSM2C	42,613	66,832	11/16"
YSM1C	66,832	81,807	11/16"
YSM25	81,807	104,110	3/4"
YSM26	104,110	133,650	7/8"
YSM27	133,650	167,332	7/8"
YSM28	167,332	211,954	15/16"

TYPE YSCM

HYLINK™ Splice

Color-Coded

Uninsulated Parallel Splice

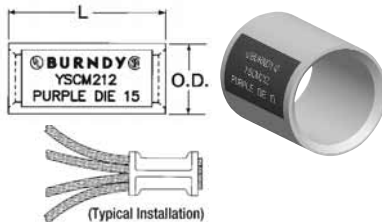

Type YSCM HYLINK™ seamless parallel splice connectors permit stranded wires to be laid parallel inside the connector and spliced together with BURNDY® compression tools. Each YSCM connector accommodates a wide range of conductors and is color-coded to ensure proper tool and die match. YSCM connectors are UL486A Listed for applications up to 600V and CSA Certified.

Catalog Number	Conductor Range Cable		Dimensions Inch		Color Code	Die Index	Recommended Installation Tooling*		Wire Strip Length
	Min.	Max.	L ±.03	O.D. ±.01			OUR840, Y500CTHS, PAT600 Series	Y35, Y750, PAT750 Series	
YSCM17	13,060	16,910	.50	.27	Red	49	X8CRT, W8CRT	U8CRT	11/16"
YSCM27	16,910	26,890	.50	.31	Blue	7	X5CRT, W5CRT	U5CRT	11/16"
YSCM42	29,970	41,520	.50	.38	Gray	8	X4CRT, W4CRT	U4CRT	11/16"
YSCM66	42,750	66,040	.62	.47	Brown	10	X2CRT, W2CRT	U2CRT	3/4"
YSCM80	67,980	80,020	.62	.52	Green	11	X1CRT, W1CRT	U1CRT-1	3/4"
YSCM104	82,870	103,630	.69	.57	Pink	12	X25RT, W25RT	U25RT	15/16"
YSCM133	104,960	133,220	.81	.64	Black	13	X26RT, W26RT	U26RT	1-1/16"
YSCM167	134,340	166,560	.81	.70	Orange	14	X27RT, W27RT	U27RT	1-1/16"
YSCM212	167,380	211,820	.88	.78	Purple	15	X28RT, W28RT	U28RT	1-1/16"
YSCM231	—	230,800	1.05	.81	Yellow	16	X29RT, W29RT	U29RT	1-1/16"

* Recommended strip length. Strip length dependant on size, number of wires and insulation thickness.
 ** Refer to Circular Mil Table per ASTM B8 for total Class B Circular Mil calculations.

TYPE YA-L

One Hole HYLUG™

Standard Barrel Lugs for Copper Cable

UL Listed 90° C

600 Volts to 35 kV ♦

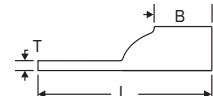

Copper compression terminals for regular-duty applications. Inspection hole ensures proper insertion of cable. Tin-plated. Marked with die index and color code.

Catalog Number	Conductor		Navy	Stud Hole Size	Tongue Width	Figure Dimensions		
	AWG	*** mm²				(B)	(T)	(L)
YA8CL-BOX	37/24 8 Weld	† 10	23	8 - 10	.41	.44	.08	1.16
YA8C-L1-BOX	8 AWG 6 Sol.		23	1/4	.44	.44	.08	1.26
YA6CL-BOX	6 AWG	—	—	1/4	.45	.54	.08	1.18
YA5CL-BOX	5 AWG	—	30	1/4	.44	.81	.07	1.65
YA4CL-BOX	4 AWG	—	40	1/4	.50	.81	.09	1.74
YA4CL6-BOX	4 AWG	—	40	1/2	.71	.81	.06	2.20
YA3CL	3 Str./2 Sol.	25	50	5/16	.55	.88	.09	1.88
YA2CL-BOX	2 AWG	35	60	5/16	.61	.88	.11	1.93
YA2CL6-BOX	2 AWG	35	60	1/2	.73	.88	.09	2.32
YA1CL-BOX	1 AWG	50	75	5/16	.68	.88	.01	1.94
YA1CL6-BOX	1 AWG	50	75	1/2	.73	.88	.09	2.37
YA25L6-BOX	1/0 AWG	—	100	1/2	.75	.88	.12	2.34
YA26L-BOX	2/0 AWG	70	125	3/8	.83	.94	.12	2.19
YA26L6-BOX	2/0 AWG	70	125	1/2	.83	.94	.12	2.44
YA27L-BOX	3/0 AWG	—	150	1/2	.91	1.00	.13	2.54
YA28L-BOX	4/0 AWG	—	200	1/2	1.02	.88	.14	2.46
YA29L-BOX	250 kcmil	—	250	1/2	1.11	1.06	.14	2.67
YA30L	300 kcmil	150	300	1/2	1.20	1.03	.16	2.69
YA31L	350 kcmil	185	350	1/2	1.29	1.06	.18	2.75
YA32L	400 kcmil	—	400	5/8	1.38	1.19	.19	3.18
YA34L	500 kcmil	240	—	5/8	1.55	1.27	.20	3.37
YA36L	600 kcmil	300	—	5/8	1.74	1.38	.27	3.72
YA38L	700 kcmil	—	—	5/8	1.84	1.45	.27	3.66
YA39L	750 kcmil	—	—	5/8	1.91	1.42	.27	3.67
YA40L	800 kcmil	400	—	5/8	1.98	1.42	.30	3.81
YA44L	1000 kcmil	500	—	5/8	2.19	1.65	.33	4.04

*** The mm² conductor sizes listed are the recommendations for Class 2 conductor.
 † The mm² conductor size listed is for both Class 2 and Class 5 conductor.
 For applications greater than 2000 Volts, consult cable manufacturer for voltage stress relief instructions.

Note: All dimensions shown are for reference only.

Catalog Number	Dieless (# of crimps)	▲ Installation Tooling				Color Code	Die Index	Wire Strip Length
		Mechanical		Hydraulic				
		MD6, OUR840, MD7-34R	Y500CTHS	Y35, Y39, Y750, Y46*, PAT750	Y500CTHS			
YA8CL-BOX	Y1MRCT (1) Y8MRB-(1) MY29-11 (1) Y81KFT (1)	W8CVT (1) W8CRT (1) X8CRT (1)	W8CVT (1) W8CRT (1) X8CRT (1)	U8CRT (1)	Red	49	7/16"	
YA8C-L1-BOX	Y81KFTMBH (1) PAT81KFT-18V (1)							
YA6CL-BOX	Y1MRCT (1) MY29-3 (1) MY29-11 (1) MRC840 (1) Y81KFT (1) Y81KFTMBH (1) PAT81KFT-18V (1)	W5CVT (1) W5CRT (1) X5CRT (1) X8CART (1)	W5CVT (1) W5CRT (1) X5CRT (1) X8CART (1)	U5CRT (1)	Blue	7	7/8"	

(One Hole HYLUG™ Standard Barrel Installation Tooling Chart continued on next page)

45° and 90° lugs are available. For more information, please contact Customer Service: 1-800-346-4175.

TYPE YA-L

One Hole HYLUG™

Installation Tooling Chart (Continued)



▲ Installation Tooling							
Catalog Number	Dieless (# of crimps)	Mechanical	Hydraulic		Color Code	Die Index	Wire Strip Length
		MD6, OUR840, MD7-34R	Y500CTHS	Y35, Y39, Y750, Y46*, PAT750			
YA5CL-BOX	Y1MRTC (1) MY29-3 (1) MY29-11 (1) MRC840 (1) Y81KFT (1) Y81KFTMBH (1) PAT81KFT-18V (1)	W5CRT (1) W5CVT (1) X5CRT (1)	W5CRT (1) X5CRT (1) W5CVT (1)	U5CRT (1)	Blue	7	7/8"
YA4CL-BOX	Y1MRTC (2) MY29-3 (1) MY29-11 (1) MRC840 (1) Y644HSXT (1) Y81KFT (1) Y81KFTMBH (1) PAT81KFT-18V (1)	W4CVT (1) W4CRT (1) X4CRT (1)	W4CVT (1) W4CRT (1) X4CRT (1)	U4CRT (1) U6CABT (1)	Gray	8	7/8"
YA4CL6-BOX	Y1MRTC (2) MY29-3 (1) MY29-11 (1) MRC840 (1) Y644HSXT (1) Y81KFT (1) Y81KFTMBH (1) PAT81KFT-18V (1)	W3CRT (1)	W3CRT (1)	U3CRT (1)	White	9	15/16"
YA3CL	Y1MRTC (2) MY29-3 (1) MY29-11 (1) MRC840 (1) Y644HSXT (1) Y81KFT (1) Y81KFTMBH (1) PAT81KFT-18V (1)	W2CVT (1) W2CRT (1) X2CRT (1)	W2CVT (1) W2CRT (1) X2CRT (1)	U2CRT (1)	Brown	10	15/16"
YA2CL-BOX	Y1MRTC (2) MY29-3 (1) MY29-11 (1) MRC840 (1) Y644HSXT (1) Y81KFT (1) Y81KFTMBH (1) PAT81KFT-18V (1)	W1CVT (1) W1CRT-1 (1) X1CRT-1 (1)	W1CVT (1) W1CRT-1 (1) X1CRT-1 (1)	U1CRT-1 (1) U4CABT (1)	Green	11	15/16"
YA1CL-BOX	Y1MRTC (2) MY29-3 (1) MY29-11 (1) MRC840 (1) Y644HSXT (1) Y81KFT (1) Y81KFTMBH (1) PAT81KFT-18V (1)	W25VT (2) W25RT (2) X25RT (2)	W25VT (2) W25RT (2) X25RT (2)	U25RT (1) U2CABT (1)	Pink	12	15/16"
YA25L6-BOX	MY29-3 (1) MY29-11 (1) MRC840 (2) Y644HSXT (1) Y81KFT (1) Y81KFTMBH (1) PAT81KFT-18V (1)	W26VT (2) W26RT (2) X26RT (2)	W26VT (2) W26RT (2) X26RT (2)	U26RT (1)	Black	13	1"
YA26L-BOX	MY29-3 (1) MY29-11 (1) MRC840 (2) Y644HSXT (1) Y81KFT (1) Y81KFTMBH (1) PAT81KFT-18V (1)						
YA26L6-BOX	Y81KFTMBH (1) PAT81KFT-18V (1)						

* Use PUADP-1 adapter with "U" dies in Y46 HYPRESS™
 ** P-RT die sets for use in Y46 HYPRESS™ only. PUADP-1 adapter not required.
 ▲ See tooling section of this catalog for complete tool and die listings.

(One Hole HYLUG™ Standard Barrel Installation Tooling Chart continued on next page)

45° and 90° lugs are available. For more information, please contact Customer Service: 1-800-346-4175.

TYPE YA-L

One Hole HYLUG™

Installation Tooling Chart (Continued)



▲ Installation Tooling							
Catalog Number	Dieless (# of crimps)	Mechanical	Hydraulic		Color Code	Die Index	Wire Strip Length
		MD6, OUR840, MD7-34R	Y500CTHS	Y35, Y39, Y750, Y46*, PAT750			
YA27L-BOX	MY29-3 (1) MY29-11 (1) MRC840 (2) Y644HSXT (1) Y81KFT (2) Y81KFTMBH (2) PAT81KFT-18V (2)	W27VT (2) W27RT (2) X27RT (3)	W27VT (2) W27RT (2) X27RT (3)	U27RT (1)	Orange	14	1-1/16"
YA28L-BOX	MY29-3 (1) MY29-11 (1) MRC840 (2) Y644HSXT (1) Y81KFT (2) Y81KFTMBH (2) PAT81KFT-18V (2)	W28VT (2) W28RT (2) X28RT (2)	W28VT (2) W28RT (2) X28RT (3)	U28RT (1)	Purple	15	1-1/8"
YA29L-BOX	MY29-3 (1) MY29-11 (1) Y644HSXT (1) Y81KFT (2) Y81KFTMBH (2) PAT81KFT-18V (2)	W29VT (2) X29RT (4)	W29VT (2) W29RT (2) X29RT (4)	U29RT (1)	Yellow	16	1-1/8"
YA30L	Y644HSXT (1) Y81KFT (2) Y81KFTMBH (2) PAT81KFT-18V (2)	W30VT (2)	W30VT (2) W30RT (2)	U30RT (2) U28ART (2)	White	17	1-1/16"
YA31L	Y644HSXT (1) Y81KFT (2) Y81KFTMBH (2) PAT81KFT-18V (2)	W31VT (2)	W31VT (2) W31RT (2)	U31RT (2) U29RT (2)	Red	18	1-3/16"
YA32L	Y644HSXT (1) Y81KFT (2) Y81KFTMBH (2) PAT81KFT-18V (2)	W32VT (2)	W32VT (2) W32RT (2)	U32RT (2) U30ART (2)	Blue	19	1-1/4"
YA34L	Y644HSXT (1) Y81KFT (2) Y81KFTMBH (2) PAT81KFT-18V (2)	W34VT (2)	W34VT (2) W34RT (2)	U34RT (2) U31ART (2)	Brown	20	1-7/16"
YA36L	Y644HSXT (1) Y81KFT (2) Y81KFTMBH (2) PAT81KFT-18V (2)	—	—	U36RT (2)	Green	22	1-3/4"
YA38L	Y644HSXT (1) Y81KFT (3) Y81KFTMBH (3) PAT81KFT-18V (3)	—	—	U38RT (2)	Pink	400	1-15/16"
YA39L	Y644HSXT (1) Y81KFT (3) Y81KFTMBH (3) PAT81KFT-18V (3)	—	—	U39RT (2) P39RT (2) **	Black	24	1-15/16"
YA40L	Y644HSXT (1) Y81KFT (3) Y81KFTMBH (3) PAT81KFT-18V (3)	—	—	P40RT (3) **	Orange	25	1-15/16"
YA44L	Y644MBH (1) PAT644-18V (1) Y644HSXT (1) Y81KFT (3) Y81KFTMBH (3) PAT81KFT-18V (3)	—	—	P44RT (3) **	White	27	1-15/16"

* Use PUADP-1 adapter with "U" dies in Y46 HYPRESS™
 ** P-RT die sets for use in Y46 HYPRESS™ only. PUADP-1 adapter not required.
 ▲ See tooling section of this catalog for complete tool and die listings.

TYPE YA-L-NT
HYLUG™ Terminal

Copper Compression Terminal
Standard Length Barrel
Narrow Tongue

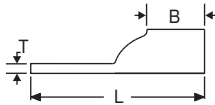

HYLUG™ Type YA-L-NT narrow tongue design permits the termination of conductors into confined spaces and applications including molded case circuit breakers, motor controllers, safety switches, etc. Excellent for termination of larger cables used in applications to minimize voltage drop. Other design features are the same as the BURNDY® HYLUG™ Type YA-L.

Catalog Number	Fig. No.	Conductor		Stud Hole Size	Tongue Width	Figure Dimensions		
		*** AWG	mm ²			(B)	(T)	(L)
YA8CLNT6	1	#8 AWG	**	6	.29"	.44"	.09"	1.08"
YA8CLNT8	1		10	8	.33"	.44"	.09"	1.18"
YA6CLNT6	1	#6 AWG	—	6	.29"	.54"	.09"	1.17"
YA4CLNT10	1	#4 AWG	—	# 10	.40"	.81"	.09"	1.73"
YA3CLNT14	1	#3 AWG	25	1/4"	.41"	.88"	.09"	1.82"
YA3CLNT516	1	#2 Sol.		5/16"	.49"	.88"	.09"	1.80"
YA2CLNT10	1	#2 AWG	35	# 10	.48"	.88"	.11"	1.80"
YA2CLNT14	1			1/4"	.50"	.88"	.11"	1.80"
YA2CLNT516	1			5/16"	.49"	.88"	.11"	1.82"
YA1CLNT10	1	#1 AWG	50	# 10	.50"	.88"	.10"	2.23"
YA1CLNT14	1			1/4"	.50"	.88"	.10"	2.23"
YA25LNT10	1	1/0 AWG	—	# 10	.62"	.88"	.12"	2.28"
YA25LNT14	1			1/4"	.48"	.88"	.12"	1.93"
YA25LNT516	1			5/16"	.62"	.88"	.12"	2.28"
YA25LNT38	1			3/8"	.62"	.88"	.12"	2.18"
YA26LNT10	1	2/0 AWG	70	# 10	.62"	.94"	.13"	2.62"
YA26LNT14	1			1/4"	.48"	.94"	.13"	2.02"
YA26LNT516	1			5/16"	.62"	.94"	.13"	2.62"
YA26LNT38	1			3/8"	.72"	.94"	.12"	2.48"
YA27LNT14	1	3/0 AWG	—	1/4"	.76"	1.00"	.13"	2.10"
YA27LNT516	1			5/16"	.60"	1.00"	.12"	2.17"
YA27LNT38	1			3/8"	.76"	1.00"	.12"	2.73"
YA28LNT14	1	4/0 AWG	—	1/4"	.76"	.88"	.14"	2.60"
YA28LNT516	1			5/16"	.70"	.88"	.14"	2.09"
YA28LNT38	1			3/8"	.76"	.88"	.14"	2.67"
YA29LNT516	1	250 kcmil	—	5/16"	.76"	1.06"	.16"	2.48"
YA29LNT38	1			3/8"	.76"	1.06"	.16"	2.96"
YA29LNT38	1			3/8"	.96"	1.06"	.16"	2.96"
YA30LNT14	1	300 kcmil	150	1/4"	.83"	1.03"	.16"	2.26"
YA30LNT38	1			3/8"	.96"	1.03"	.16"	2.97"
YA31LNT38	1	350 kcmil	185	3/8"	.96"	1.06"	.18"	3.31"
YA31LNT12	1			1/2"	.88"	1.06"	.18"	2.75"
YA32LNT38	1	400 kcmil	—	3/8"	.96"	1.19"	.20"	3.21"
YA32LNT12	1			1/2"	.96"	1.19"	.19"	3.21"
YA34LNT38	1	500 kcmil	240	3/8"	.96"	1.27"	.23"	3.65"
YA34LNT12	1			1/2"	.96"	1.27"	.23"	3.65"
YA36LNT38	1	600 kcmil	300	3/8"	1.12"	1.38"	.27"	4.09"
YA36LNT12	1			1/2"	1.00"	1.38"	.27"	3.29"
YA39LNT38	1	750 kcmil	—	3/8"	1.12"	1.42"	.27"	4.24"
YA39LNT12	1			1/2"	1.63"	1.42"	.27"	4.24"
YA39LNT58	1			5/8"	1.30"	1.42"	.27"	3.67"

** The MM2 conductor size listed is for Class 2 and Class 5 conductor.
*** The MM2 conductor sizes listed are the recommendations for Class 2 conductor.
For applications greater than 2000 Volts consult cable manufacturer for voltage stress relief instructions.
Note: All dimensions shown are for reference only.

(One Hole HYLUG™ Standard Barrel Narrow Tongue Installation Tooling Chart on next page)

45° and 90° lugs are available. For more information, please contact Customer Service: 1-800-346-4175.

TYPE YA-L-NT
One Hole HYLUG™
Installation Tooling Chart



Catalog Number	Dieless (# of crimps)	▲ Installation Tooling					
		Mechanical	Hydraulic		Color Code	Die Index	Wire Strip Length
		MD6, OUR840, MD7-34R	Y500CTHS	Y35, Y39, Y750, Y46*, PAT750			
YA8CLNT6	Y8MRB-1 (1) MY29-3 (1) MY29-11 (1) MRC840 (1) Y81KFT (1)	W8CVT (1)	X8CRT (1)	U8CRT (1)	Red	49	1/2"
YA8CLNT8	Y81KFTMBH (1) PAT81KFT-18V (1)						
YA6CLNT6	Y1MRCT (1)	W5CVT (1)	X5CRT (1)	U5CRT (1)	Blue	7	7/8"
YA4CLNT10	MY29-3 (1)	W4CVT (1)	X4CRT (1)	U4CRT (1)	Gray	8	7/8"
YA3CLNT14	MY29-11 (1)	W3CVT (1)	W3CVT (1)	U3CRT (1)	White	9	15/16"
YA3CLNT516	MRC840						
YA2CLNT10	Y644HS (1)	W2CVT (1)	X2CRT (1)	U2CRT (1)	Brown	10	15/16"
YA2CLNT14	Y81KFT (1)						
YA2CLNT516	Y81KFTMBH (1) PAT81KFT-18V (1)						
YA1CLNT10	MY29-3 (1) MY29-11 (1) MRC840 Y644HS (1) Y81KFT (1) Y81KFTMBH (1) PAT81KFT-18V (2)	W1CVT (1)	X1CRT (1)	U1CRT (1)	Green	11	15/16"
YA1CLNT14							
YA25LNT10		W25VT (2)	X25RT (2)	U25RT (1)	Pink	12	15/16"
YA25LNT14							
YA25LNT38							
YA26LNT10		W26VT (2)	X26RT (2)	U26RT (1)	Black	13	1"
YA26LNT14							
YA26LNT516							
YA26LNT38							
YA27LNT14		W27VT (2)	X27RT (3)	U27RT (1)	Orange	14	1-1/16"
YA27LNT516							
YA27LNT38							
YA28LNT14	W28VT (2)	X28RT (3)	U28RT (1)	Purple	15	1-1/8"	
YA28LNT516							
YA28LNT38							
YA29LNT516							
YA29LNT38	W29VT (2)	X29RT (4)	U29RT (1)	Yellow	16	1-1/8"	
YA29LNT38							
YA30LNT14	W30VT (4)	—	U30RT (2)	White	17	1-1/8"	
YA30LNT38							
YA31LNT38	W31VT (4)	—	U31RT (2)	Red	18	1-3/16"	
YA31LNT12							
YA32LNT38	W32VT (4)	—	U32RT (2)	Blue	19 or 470	1-1/4"	
YA32LNT12							
YA34LNT38	W34VT (4)	—	U34RT (2)	Brown	20 or 299	1-7/16"	
YA34LNT12							
YA36LNT38	—	—	U36RT (2)	Green	22	1-3/4"	
YA36LNT12							
YA39LNT38	Y81KFT (3)						
YA39LNT12	Y81KFTMBH (3)	—	—	U39RT (2)	Black	24	1-15/16"
YA39LNT58	PAT81KFT-18V (3)						

* Use PUADP-1 adapter with "U" dies in Y46 HYPRESS™.
**** Y644M is not recommended for standard barrel length 6 AWG HYLUGs.
▲ See tooling section of this catalog for complete tool and die listings. Use ONLY color-coded die recommendations for "FX" connectors. For nest/indenter system contact factory.

45° and 90° lugs are available. For more information, please contact Customer Service: 1-800-346-4175.

TYPES YA, YA-TC

One Hole HYLUG™

Code Conductor Long Barrel

Uninsulated Copper
Compression Terminal
UL Listed 90° C

600 Volts to 35 kV ♦

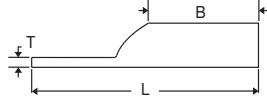

Catalog Number	Conductor		Navy	Stud Hole Size	Tongue Width	Figure Dimensions			
	AWG	*** mm ²				(B)	(T)	(L)	
YA8C-TC10	8 AWG 8 Weld	† 10	23	10	.38	.81	.08	1.57	
YA8C-TC14	37/24 6 Sol.			1/4	.41	.81	.08	1.69	
YA6C	6 AWG	—	—	1/4	.41	1.12	.09	1.81	
YA5C	5 AWG			30	1/4	.44	1.12	.07	1.98
YA4C	4 AWG	—	—	1/4	.50	1.12	.09	1.87	
YA3C	3 AWG			25	5/16	.55	1.25	.09	2.30
YA3CN	2 Sol.	25	50	1/2	.81	1.25	.12	2.86	
YA2C	2 AWG	35	60	5/16	.61	1.25	.11	2.29	
YA1C	1 AWG	50	75	5/16	.68	1.38	.10	2.45	
YA25	1/0 AWG	—	—	100	5/16	.75	1.38	.12	2.48
YA25N	1/0 AWG			100	1/2	.81	1.38	.11	3.05
YA26	2/0 AWG	70	125	3/8	.83	1.50	.12	2.77	
YA26N	2/0 AWG	70	125	1/2	.83	1.50	.12	3.21	
YA27	3/0 AWG	—	—	150	1/2	.91	1.50	.13	3.06
YA28	4/0 AWG			200	1/2	1.02	1.62	.14	3.23
YA29	250 kcmil	—	—	250	1/2	1.11	1.2	.16	3.26
YA30	300 kcmil			150	300	1/2	1.11	1.2	.16
YA31	350 kcmil	185	350	1/2	1.29	2.00	.18	3.73	
YA32N	400 kcmil	—	—	400	1/2	1.20	2.00	.16	3.69
YA32	400 kcmil			400	5/8	1.38	2.12	.19	4.15
YA34N	500 kcmil	240	—	—	1/2	1.52	2.25	.23	4.32
YA34	500 kcmil	240			5/8	1.52	2.25	.23	4.39
YA36N	600 kcmil	300	—	—	1/2	1.69	2.69	.27	4.83
YA36	600 kcmil	300			5/8	1.69	2.69	.27	4.90
YA39N	750 kcmil	—	—	—	1/2	1.89	2.88	.27	5.11
YA39	750 kcmil				5/8	1.89	2.88	.27	5.17
YA44	1000 kcmil	500	—	—	5/8	2.17	3.00	.33	5.45

- *** The MM2 conductor sizes listed are the recommendations for Class 2 conductor.
- † The MM2 conductor size listed is for Class 2 and Class 5 conductor.
- Available undrilled. Add suffix "U" to catalog number (example: YA25U).
- ♦ For applications greater than 2000 Volts consult cable manufacturer for voltage stress relief instructions.

Note: All dimensions shown are for reference only.

(One Hole HYLUG™ Long Barrel Installation Tooling Chart on next 3 pages)

TYPES YA, YA-TC

One Hole HYLUG™

Installation Tooling Chart



Catalog Number	Dieless (# of crimps)	▲ Installation Tooling					Color Code	Die Index	Wire Strip Length
		Mechanical		Hydraulic					
		MD6, OUR840, MD7-34R	Y500CTHS	Y35, Y39, Y750, Y46*, PAT750					
YA8C-TC10	MRC840 (2) Y8MBR-1 (1) Y1MRCT (2) Y81KFT (1)	W8CVT (2) W8CRT (2) X8CRT (2)	X8CRT (2) W8CVT (2) W8CRT (2)	U8CRT (2)		Red	49	1"	
YA8C-TC14	Y81KFTMBH (1) PAT81KFT-18V (1)								
YA6C	MRC840 (2) MY29-3 (2) MY29-11 (2) Y1MRCT (2) Y644HSXT (1) Y81KFT (1) Y81KFTMBH (1) PAT81KFT-18V (1)	W5CVT (2) W5CRT (2) X5CRT (2) X8CART (2)	W5CVT (2) W5CRT (2) X5CRT (2) X8CART (2)	U5CRT (2) U8CABT (2)		Blue	7	1-3/16"	
YA5C	Y1MRCT (2) MRC840 (2) MY29-3 (2) MY29-11 (2) Y644HSXT (1) Y81KFT (1) Y81KFTMBH (1) PAT81KFT-18V (1)	W5CVT (2) W5CRT (2) X5CRT (2)	W5CVT (2) W5CRT (2) X5CRT (2)	U5CRT (2)		Blue	7	1-3/16"	
YA4C	MRC840 (2) MY29-3 (2) MY29-11 (2) Y1MRCT (4) Y644HSXT (1) Y81KFT (1) Y81KFTMBH (1) PAT81KFT-18V (1)	W4CVT (2) W4CRT (2) X4CRT (2)	W4CVT (2) W4CRT (2) X4CRT (2)	U4CRT (2) U6CABT (2)		Gray	8	1-3/16"	
YA3C	MY29-3 (2) MY29-11 (2) Y644HSXT (1) Y81KFT (2)	W3CRT (2)	W3CRT (2)	U3CRT (2)		White	9	1-1/2"	
YA3CN	Y81KFTMBH (2) PAT81KFT-18V (2)								
YA2C	MRC840 (2) MY29-3 (2) MY29-11 (2) Y1MRCT (4) Y644HSXT (1) Y81KFT (2) Y81KFTMBH (2) PAT81KFT-18V (2)	W2CVT (2) W2CRT (2) X2CRT (2)	W2CVT (2) W2CRT (2) X2CRT (2)	U2CRT (2)		Brown	10	1-5/16"	
YA1C	Y1MRCT (4) MRC840 (2) MY29-3 (2) MY29-11 (2) Y644HSXT (1) Y81KFT (2) Y81KFTMBH (2) PAT81KFT-18V (2)	W1CVT (2) W1CRT-1 (2) X1CRT-1 (2)	W1CVT (2) W1CRT-1 (2) X1CRT-1 (2)	U1CRT-1 (2) U4CABT (2)		Green	11	1-7/16"	

- * Use PUADP-1 adapter with "U" dies in Y46 HYPRESS™.
- ** P-RT die sets for use in Y46 HYPRESS™ only. PUADP-1 adapter not required.
- ▲ See tooling section of this catalog for complete tool and die listings. Use ONLY color coded die recommendations for "-FX" connectors. For nest/indenter system contact factory. All dimensions shown are for reference only.

(One Hole HYLUG™ Long Barrel Installation Tooling Chart continued on next page)

45° and 90° lugs are available. For more information, please contact Customer Service: 1-800-346-4175.

45° and 90° lugs are available. For more information, please contact Customer Service: 1-800-346-4175.

TYPES YA, YA-TC

One Hole HYLUG™

Installation Tooling Chart (Continued)



▲ Installation Tooling							
Catalog Number	Dieless (# of crimps)	Mechanical	Hydraulic		Color Code	Die Index	Wire Strip Length
		MD6, OUR840, MD7-34R	Y500CTHS	Y35, Y39, Y750, Y46*, PAT750			
YA25	MRC840 (4) MY29-3 (2) MY29-11 (2) Y644HSXT (1) Y81KFT (2) Y81KFTMBH (2) PAT81KFT-18V (2)	W25VT (4) W25RT (4) X25RT (4)	W25VT (4) W25RT (4) X25RT (4)	U25RT (2) U2CABT (2)	Pink	12	1-7/16"
	YA25N	W25VT(4) W25RT (4) X25RT (4)	W25VT(4) W25RT (4) X25RT (4)	U25RT (2) U2CABT (2)			
YA26	MRC840 (4) MY29-3 (2) MY29-11 (2) Y644HSXT (1) Y81KFT (2) Y81KFTMBH (2) PAT81KFT-18V (2)	W26VT (4) W26RT (4) X26RT (4)	W26VT (4) W26RT (4) X26RT (4)	U26RT (2)	Black	13	1-9/16"
	YA26N	W26VT (4) W26RT (4) X26RT (4)	W26VT (4) W26RT (4) X26RT (4)	U26RT (2)			
YA27	MRC840 (4) MY29-3 (2) MY29-11 (2) Y644HSXT (1) Y81KFT (2) Y81KFTMBH (2) PAT81KFT-18V (2)	W27VT (4) W27RT (4) X27RT (6)	W27VT (4) W27RT (4) X27RT (6)	U27RT (2)	Orange	14	1-9/16"
	YA28	W28VT (4) W28RT (4) X28RT (6)	W28VT (4) W28RT (4) X28RT (6)	U28RT (2)			
YA29	MY29-3 (2) MY29-11 (2) Y644HSXT (1) Y81KFT (2) Y81KFTMBH (2) PAT81KFT-18V (2)	W29VT (4) X29RT(8)	W29VT (4) W29RT (4) X29RT(8)	U29RT (2)	Yellow	16	1-1/16"
	YA30	W30VT (4)	W30VT (4) W30RT (4)	U30RT (4) U28ART (4)			

* Use PUADP-1 adapter with "U" dies in Y46 HYPRESS™.
 ** P-RT die sets for use in Y46 HYPRESS™ only, PUADP-1 adapter not required.
 ▲ See tooling section of this catalog for complete tool and die listings. Use ONLY color coded die recommendations for "-FX" connectors. For nest/indenter system contact factory.
 All dimensions shown are for reference only.

(One Hole HYLUG™ Long Barrel Installation Tooling Chart continued on next page)

45° and 90° lugs are available. For more information, please contact Customer Service: 1-800-346-4175.

TYPES YA, YA-TC

One Hole HYLUG™

Installation Tooling Chart (Continued)



▲ Installation Tooling							
Catalog Number	Dieless (# of crimps)	Mechanical	Hydraulic		Color Code	Die Index	Wire Strip Length
		MD6, OUR840, MD7-34R	Y500CTHS	Y35, Y39, Y750, Y46*, PAT750			
YA31	Y644HSXT (1) Y81KFT (3) Y81KFTMBH (3) PAT81KFT-18V (3) Y644HSXT (1) Y81KFT (3) Y81KFTMBH (3) PAT81KFT-18V (3)	W31VT (4)	W31VT (4) W31RT (4)	U31RT (4) U29ART (4)	Red	18 or 324	2-1/16"
	YA32N	W32VT (4)	W32VT (4) W32RT (4)	U32RT (4) U30ART (4)			
YA32	Y644HSXT (1) Y81KFT (3) Y81KFTMBH (3) PAT81KFT-18V (3)	—	W34RT (4)	U31ART (4)	—	299	2-5/16"
YA34N	Y644HSXT (1) Y81KFT (4) Y81KFTMBH (4) PAT81KFT-18V (4)	—	—	U36RT (4) U32ART (4)	Green	22 or 472	2-3/4"
YA36N	Y644HSXT (1) Y81KFT (4) Y81KFTMBH (4) PAT81KFT-18V (4)	—	—	U39RT (4) P39RT (4)			
YA39N	Y644HSXT (1) Y81KFT (4) Y81KFTMBH (4) PAT81KFT-18V (4)	—	—	P44RT (4) **	White	27	3-1/16"
YA44	Y644HSXT (1) Y81KFT (4) Y81KFTMBH (4) PAT81KFT-18V (4)	—	—	—			

* Use PUADP-1 adapter with "U" dies in Y46 HYPRESS™.
 ** P-RT die sets for use in Y46 HYPRESS™ only, PUADP-1 adapter not required.
 ▲ See tooling section of this catalog for complete tool and die listings. Use ONLY color coded die recommendations for "-FX" connectors. For nest/indenter system contact factory.
 All dimensions shown are for reference only.

45° and 90° lugs are available. For more information, please contact Customer Service: 1-800-346-4175.

TYPES YAV, YAV-L-FX
One Hole HYLUG™ Terminals
Flex Conductor
Standard Barrel Length

Copper Compression Terminal
 for Flexible and Extra Flexible
 Copper Cables

UL Listed 90° C
 600 Volts to 35 kV ♦



HYLUG™ types YAV and YAV-L-FX are made of high conductivity seamless electrolytic wrought copper tubing for excellent conductivity and electro-tin plated to prevent corrosion. The economical standard length barrel is ideal for limited space applications. The color-coded system matches terminals and die sets to provide the correct number and location of crimps for proper installation.



Catalog Number	Flexible Conductor		Size
	Code (AWG)	Bolt Navy	
YAV10 BOX	14 - 10 str.	3 - 9	8 - 10
YAV10-T3 BOX	12 - 10 sol.		1/4
YAV6CL-TC10-FX	61/24	30	8 - 10
YAV6CL-TC14-FX	6 Weld		1/4
YAV6CL-TC516-FX	6 AWG		5/16
YAV4CL-TC14-FX	91/24 105/24	40 & 50	1/4
YAV4CL-TC516-FX	4 Weld 4 AWG		5/16
YAV2CL-TC516-FX	125/24 150/24	60	5/16
YAV2CL-TC38-FX	2 Weld 2 AWG		3/8
YAV1CL-TC516-FX	175/24 225/24	75	5/16
YAV1CL-TC38-FX	1 Weld 1 AWG		3/8
YAV25L-TC516-FX	275/24	100	5/16
YAV25L-TC38-FX	1/0 Weld		3/8
YAV25L-TC12-FX	1/0 AWG		1/2
YAV26L-TC516-FX	325/24	125	5/16
YAV26L-TC38-FX	2/0 Weld		3/8
YAV26L-TC12-FX	2/0 AWG		1/2
YAV27L-TC516-FX	450/24	150	5/16
YAV27L-TC38-FX	3/0 Weld		3/8
YAV27L-TC12-FX	3/0 AWG		
YAV28L-TC12-FX	550/24 4/0 Weld 4/0 AWG	200	1/2

♦ For applications greater than 2000 volts consult cable manufacturer for voltage stress relief instructions.

(One Hole HYLUG™ Standard Barrel Installation Tooling Chart on next page)

45° and 90° lugs are available. For more information, please contact Customer Service: 1-800-346-4175.

TYPES YAV, YAV-L-FX
One Hole HYLUG™
Installation Tooling Chart



Catalog Number	Dieless (# of crimps)	▲ Installation Tooling				Color Code	Die Embossment
		Mechanical		Hydraulic			
		MD7-34R Die (# of crimps)	OUR840, MD6, Die (# of crimps)	Y35, Y39, Y750, Y46*, PAT750 Die (# of crimps)	Y46* Die (# of crimps)		
YAV10 BOX	Y8MRB-1, MR8G9	—	—	—	—	—	—
YAV10-T3 BOX	Y10D, Y14MV						
YAV6CL-TC10-FX	Ratchet: Y1MR (1)	W5CVT (1)	W5CVT (1)	U5CRT (1)	Blue	7 or 374	
YAV6CL-TC14-FX	Mechanical: X5CRT (1)	X5CRT (1)	X5CRT (1)				
YAV6CL-TC516-FX	MY29-11 (1)						
YAV4CL-TC14-FX	Ratchet: Y1MR (2)	W4CVT (1)	W4CVT (1)	U4CRT (1)	Gray	8 or 346	
YAV4CL-TC516-FX	Mechanical: MY29-11 (1)	X4CRT (1)	X4CRT (1)				
YAV2CL-TC516-FX	Hydraulic: Y644HSXT (1)	W2CVT (1)	W2CVT (1)	U2CRT (1)	Brown	10	
YAV2CL-TC38-FX		X2CRT (1)	X2CRT (1)				
YAV1CL-TC516-FX	Mechanical: MY29-11 (1)	W1CVT (1)	W1CVT (1)	U1CRT-1 (1)	Green	11 or 375	
YAV1CL-TC38-FX		X1CRT (1)	X1CRT (1)				
YAV25L-TC516-FX		W25VT (2)	W25VT (2)	U25RT (1)	Pink	12 or 348	
YAV25L-TC38-FX		X25RT (2)	X25RT (2)				
YAV25L-TC2-FX							
YAV26L-TC516-FX		Hydraulic: Y644HSXT (1)	W26VT (2)	W26VT (2)	U26RT (1)	Black	13
YAV26L-TC38-FX			X26RT (2)	X26RT (2)			
YAV26L-T12-FX							
YAV27L-TC516-FX			W27VT (2)	W27VT (2)	U27RT (1)	Orange	14
YAV27L-TC38-FX			X27RT (2)	X27RT (2)			
YAV27L-TC12-FX							
YAV28L-TC12-FX			W28VT (2)	W28VT (2)	U28RT (1)	Purple	15

* Use PUADP-1 adapter with "U" dies in Y46 HYPRESS™.

▲ See Tooling Section of this catalog for complete tool and die listings. Use ONLY color coded die recommendations for "-FX" connectors. For nest/indenter system contact factory.

45° and 90° lugs are available. For more information, please contact Customer Service: 1-800-346-4175.

TYPE YAV-L-NTFX

One Hole HYLUG™
Flex Conductor Terminals

Copper Compression Terminal
Standard Length Barrel
Narrow Tongue

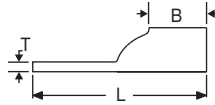

Catalog Number	Fig. No.	Conductor		Stud Hole Size	Tongue Width	Figure Dimensions		
		*** AWG	mm²			(B)	(T)	(L)
YAV4CLNT10FX	1	#4 AWG #4 Weld 91/24 105/24	—	#10	.41"	.50"	.09"	1.32"
YAV2CLNT14FX	1	#2 AWG #2 Weld 125/24 150/24	35	1/4"	.46"	.63"	.10"	1.71"
YAV2CLNT516FX	1			5/16"	.44"	.63"	.10"	1.78"
YAV25LNT14FX	1	1/0 AWG	50	1/4"	.67"	.69"	.12"	1.75"
YAV25LNT516FX	1	1/0 Weld		5/16"	.67"	.69"	.12"	1.81"
YAV25LNT38FX	1	275/24		3/8"	.76"	.69"	.13"	1.94"
YAV26LNT516FX	1	2/0 AWG	70	5/16"	.90"	.81"	.13"	1.98"
YAV26LNT38FX	1	2/0 Weld		3/8"	.90"	.81"	.13"	2.11"
YAV26LNT12FX	1	325/24		1/2"	—	—	—	—
YAV28LNT516FX	1	4/0 AWG		5/16"	.94"	1.03"	.15"	2.29"
YAV28LNT38FX	1	4/0 Weld	—	3/8"	.94"	1.03"	.15"	2.42"
YAV28LNT12FX	1	550/24		1/2"	.76"	1.03"	.15"	2.67"
YA31LNT12FX	1	250 Flex 637/24 Class I,K,M	150	1/2"	.96"	1.06"	.18"	2.75"
YA32LNT516FX	1	313.1 kcmil	185	5/16"	.96"	1.19"	.19"	2.65"
YA32LNT38FX	1	775/24 300 Flex		3/8"	.96"	1.19"	.19"	2.68"
YA38LNT12FX	1	535.3 kcmil	300	1/2"	1.63"	1.45"	.27"	3.41"
YA38LNTM20FX	1	1325/24 500 Flex		M20	1.63"	1.45"	.27"	3.84"
YA44LNT38FX	1	777.7 kcmil	500	3/8"	1.50"	1.65"	.33"	3.79"
YA44LNT12FX	1	1925/24 750 Flex		1/2"	1.62"	1.65"	.33"	3.98"

Consult cable manufacturers for stress relief instructions.
 ◆ For applications greater than 2000 Volts consult cable manufacturer for voltage stress relief instructions.
 * Use PUADP-1 adaptor with "U" -dies in Y46 HYPRESS™.
 ▲ See tooling section of this catalog for complete tool and die listings. Use ONLY color-coded die recommendations for "-FX" connectors.
Note: All dimensions shown are for reference only.

(One Hole HYLUG™ Standard Barrel Narrow Tongue Installation Tooling Chart on next page)

45° and 90° lugs are available. For more information, please contact Customer Service: 1-800-346-4175.

TYPE YAV-L-NTFX

One Hole HYLUG™
Installation Tooling Chart



Catalog Number	Dieless (# of crimps)	▲ Installation Tooling					Wire Strip Length	
		Mechanical		Hydraulic		Color Code		Die Index
		MD6, OUR840, MD7-34R	Y500CTHS	Y35, Y39, Y750, Y46*, PAT750				
YAV4CLNT10FX	MY29-11 (1) Y1MRTC (2) Y81KFT (1) Y81KFTMBH (1) PAT81KFT-18V (1)	W4CRT (1) X4CRT (1) W4CVT (1)	W4CRT (1) W4CVT (1) X4CRT (1)	U4CRT (1)	Gray	8	1/2"	
YAV2CLNT14FX	Y1MRTC (2) MY29-11 (1) Y81KFT (1) Y81KFTMBH (1) PAT81KFT-18V (1)	W2CVT (1) W2CRT (1) X2CRT (1)	W2CVT (1) W2CRT (1) X2CRT (1)	U2CRT (1)	Brown	10	11/16"	
YAV2CLNT516FX	Y1MRTC (2) MY29-11 (1) Y81KFT (1) Y81KFTMBH (1) PAT81KFT-18V (1)	W25VT (2) W25RT (2) X25RT (2)	W25VT (2) W25RT (2) X25RT (2)	U25RT (1)	Pink	12	11/16"	
YAV25LNT14FX	MY29-11 (1) Y81KFT (1) Y81KFTMBH (1) PAT81KFT-18V (1)	W26VT (2) W26RT (2) X26RT (2)	W26VT (2) W26RT (2) X26RT (2)	U26RT (1)	Black	13	13/16"	
YAV25LNT516FX	MY29-11 (1) Y81KFT (1) Y81KFTMBH (1) PAT81KFT-18V (1)	W28VT (2) W28RT (2) X28RT (3)	W28VT (2) W28RT (2) X28RT (3)	U28RT (1)	Purple	15	1-1/16"	
YAV25LNT38FX	MY29-11 (1) Y81KFT (1) Y81KFTMBH (1) PAT81KFT-18V (1)	W30VT (2)	W30VT (2) W30RT (2)	U30RT (2)	White	17	1-1/8"	
YAV26LNT516FX	Y644HS (1) Y81KFT (1) Y81KFTMBH (1) PAT81KFT-18V (1)	W31VT (2)	W31VT (2) W31RT (2)	U31RT (2)	Red	18	1-1/4"	
YAV26LNT38FX	Y644HS (1) Y81KFT (1) Y81KFTMBH (1) PAT81KFT-18V (1)	—	—	U38XRT (2)	Pink	L99	1-7/16"	
YAV26LNT12FX	Y644HS (1) Y81KFT (1) Y81KFTMBH (1) PAT81KFT-18V (1)	—	—	U44XRT (2)	Yellow	L115	1-5/8"	
YAV28LNT516FX	MY29-11 (1) Y644HS (1) Y81KFT (1) Y81KFTMBH (1) PAT81KFT-18V (1)	—	—	—	—	—	—	
YAV28LNT38FX	MY29-11 (1) Y644HS (1) Y81KFT (1) Y81KFTMBH (1) PAT81KFT-18V (1)	—	—	—	—	—	—	
YAV28LNT12FX	MY29-11 (1) Y644HS (1) Y81KFT (1) Y81KFTMBH (1) PAT81KFT-18V (1)	—	—	—	—	—	—	
YA31LNT12FX	Y644HS (1) Y81KFT (1) Y81KFTMBH (1) PAT81KFT-18V (1)	—	—	—	—	—	—	
YA32LNT516FX	Y644HS (1) Y81KFT (1) Y81KFTMBH (1) PAT81KFT-18V (1)	—	—	—	—	—	—	
YA32LNT38FX	Y644HS (1) Y81KFT (1) Y81KFTMBH (1) PAT81KFT-18V (1)	—	—	—	—	—	—	
YA38LNT12FX	Y644HS (1) Y81KFT (1) Y81KFTMBH (1) PAT81KFT-18V (1)	—	—	—	—	—	—	
YA38LNTM20FX	Y644HS (1) Y81KFT (1) Y81KFTMBH (1) PAT81KFT-18V (1)	—	—	—	—	—	—	
YA44LNT38FX	Y644HS (1) Y81KFT (2) Y81KFTMBH (2) PAT81KFT-18V (2)	—	—	—	—	—	—	
YA44LNT12FX	Y644HS (1) Y81KFT (2) Y81KFTMBH (2) PAT81KFT-18V (2)	—	—	—	—	—	—	

Consult cable manufacturers for stress relief instructions.
 ◆ For applications greater than 2000 Volts consult cable manufacturer for voltage stress relief instructions.
 * Use PUADP-1 adaptor with "U" -dies in Y46 HYPRESS™.
 ▲ See tooling section of this catalog for complete tool and die listings. Use ONLY color-coded die recommendations for "-FX" connectors.
Note: All dimensions shown are for reference only.

45° and 90° lugs are available. For more information, please contact Customer Service: 1-800-346-4175.

**TYPES YAV-2TC,
YA-2LN, YA-L-2TC**

Two Hole HYLUG™

Code Conductor Standard Barrel

Copper Compression Terminal

UL Listed 90° C

600 Volts to 35 kV ◆

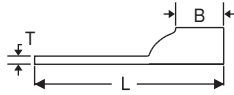

Catalog Number	Conductor			Stud Hole Size	Stud Hole Spacing	Tongue Width	Figure Dimensions		
	AWG	*** mm²	Navy				(B)	(T)	(L)
YAV102TC10	14-10 Str. 12-10 Sol.	6	3-9	10	5/8	.38	.38	.06	1.72
YAV102TC14	14-10 Str. 12-10 Sol.	6	3-9	1/4	5/8	.47	.38	.06	1.81
YA8CL-2TC10	8 AWG 8 Weld	† 10	23	10	5/8	.41	.44	.08	1.83
YA8CL-2TC14	37/24 6 sol.	—	23	1/4	5/8	.41	.44	.08	1.95
YA6C-2L	6 AWG	—	—	1/4	5/8	.41	.45	.08	2.01
YA6C-2LN	6 AWG	—	—	1/2	1-3/4	.81	.54	.12	3.87
YA4C-2L	4 AWG	—	40	1/4	5/8	.49	.81	.09	2.30
YA4C-2LN	4 AWG	—	40	1/2	1-3/4	.83	.81	.12	4.14
YA2C-2L	2 AWG	35	60	5/16	3/4	.60	.88	.11	2.67
YA2C-2LN	2 AWG	35	60	1/2	1-3/4	.83	.88	.11	4.27
YA1C-2LN	1 AWG	50	75	1/2	1-3/4	.81	.88	.12	4.32
YA1C-2L	1 AWG	50	75	5/16	7/8	.68	.88	.10	2.82
YA25-2L	1/0 AWG	—	100	5/16	7/8	.75	.88	.12	2.85
YA252LN	1/0 AWG	—	100	1/2	1-3/4	.83	.88	.11	4.29
YA26-2L	2/0 AWG	70	125	5/16	7/8	.83	.94	.12	2.95
YA262LN	2/0 AWG	70	125	1/2	1-3/4	.83	.94	.12	4.39
YA272LN	3/0 AWG	—	150	1/2	1-3/4	.91	1.00	.13	4.48
YA282LN	4/0 AWG	—	200	1/2	1-3/4	1.02	.88	.14	4.41
YA292LN	250 kcmil	—	250	1/2	1-3/4	1.11	1.06	.16	4.62
YA302LN	300 kcmil	150	300	1/2	1-3/4	1.20	1.03	.16	4.63
YA312LN	350 kcmil	185	350	1/2	1-3/4	1.29	1.06	.18	4.70
YA322LN	400 kcmil	—	400	1/2	1-3/4	1.38	1.19	.19	4.88
YA342LN	500 kcmil	240	—	1/2	1-3/4	1.52	1.27	.23	5.06
YA362LN	600 kcmil	300	—	1/2	1-3/4	1.74	1.38	.27	4.36
YA392LN	750 kcmil	—	—	1/2	1-3/4	1.89	1.42	.27	5.36
YA402LN	800 kcmil	400	—	1/2	1-3/4	1.89	1.42	.30	5.51
YA442LN	1000 kcmil	500	—	1/2	1-3/4	2.17	1.65	.33	5.74

*** The mm² conductor sizes listed are the recommendations for Class 2 conductor.

† The mm² conductor size referenced here is for both Class 2 and Class 5.

◆ For applications greater than 2000 volts consult cable manufacturer for voltage stress relief instructions.

Note: All dimensions shown are for reference only.

(Two Hole HYLUG™ Standard Barrel Installation Tooling Chart on next 3 pages)

TYPES YAV-2TC, YA-2LN, YA-L-2TC

Two Hole HYLUG™

Installation Tooling Chart



Catalog Number	Dieless (# of crimps)	▲ Installation Tooling				Color Code	Die Index	Wire Strip Length
		Mechanical		Hydraulic				
		MD6, OUR840, MD7-34R	Y500CTHS	Y35, Y39, Y750, Y46*, PAT750				
YAV102TC10 YAV102TC14	Y8MRB-1 (1)	—	—	—	—	—	7/16"	
YA8CL-2TC10 YA8CL-2TC14	Y1MRTC (1) Y8MRB-1 (1) MY29-3 (1) MY29-11 (1) MRC840 (1) Y81KFT (1) Y81KFTMBH (1) PAT81KFT-18V (1)	W8CVT (1) W8CRT (1) X8CRT (1)	W8CVT (1) W8CRT (1) X8CRT (1)	U8CRT (1)	Red	49	1/2"	
YA6C-2L YA6C-2LN	Y1MRTC (1) MY29-3 (1) MY29-11 (1) MRC840 (1) Y81KFT (1) Y81KFTMBH (1) PAT81KFT-18V (1)	W5CVT (1) W5CRT (1) X5CRT (1) X8CART (1)	W5CVT (1) W5CRT (1) X5CRT (1) X8CART (1)	U5CRT (1) U8CABT (1)	Blue	7	7/8"	
YA4C-2L	Y1MRTC (2) MY29-3 (1) MY29-11 (1) MRC840 (1) Y644HSXT (1) Y81KFT (1) Y81KFTMBH (1) PAT81KFT-18V (1)	W4CVT (1) W4CRT (1) X4CRT (1)	W4CVT (1) W4CRT (1) X4CRT (1)	U4CRT (1) U6CABT (1)	Gray	8	7/8"	
YA4C-2LN	Y1MRTC (2) MY29-3 (1) MY29-11 (1) MRC840 (1) Y644HSXT (1) Y81KFT (1) Y81KFTMBH (1) PAT81KFT-18V (1)	W4CVT (1)	X4CRT (1)	U4CRT (1)	Gray	8	7/8"	
YA2C-2L YA2C-2LN	Y1MRTC (2) MY29-3 (1) MY29-11 (1) MRC840 (1) Y644HSXT (1) Y81KFT (1) Y81KFTMBH (1) PAT81KFT-18V (1)	W2CVT (1) W2CRT (1) X2CRT (1)	W2CVT (1) W2CRT (1) X2CRT (1)	U2CRT (1)	Brown	10	15/16"	
YA1C-2LN YA1C-2L	Y1MRTC (2) MY29-3 (1) MY29-11 (1) MRC840 (1) Y644HSXT (1) Y81KFT (1) Y81KFTMBH (1) PAT81KFT-18V (1)	W1CVT (1) W1CRT-1 (1) X1CRT-1 (1)	W1CVT (1) W1CRT-1 (1) X1CRT-1 (1)	U1CRT-1 (1) U4CABT (1)	Green	11	15/16"	

* Use PUADP-1 adapter with "U" dies in Y46 HYPRESS™.

** P-RT die sets for use in Y46 HYPRESS™ only, PUADP-1 adapter not required.

▲ See tooling section of this catalog for complete tool and die listings.

(Two Hole HYLUG™ Standard Barrel Installation Tooling Chart continued on next page)

TYPES YAV-2TC, YA-2LN, YA-L-2TC

Two Hole HYLUG™

Installation Tooling Chart (Continued)



▲ Installation Tooling							
Catalog Number	Dieless (# of crimps)	Mechanical	Hydraulic		Color Code	Die Index	Wire Strip Length
		MD6, OUR840, MD7-34R	Y500CTHS	Y35, Y39, Y750, Y46*, PAT750			
YA25-2L	MY29-3 (1) MY29-11 (1) MRC840 (2) Y644HSXT (1) Y81KFT (1)	W25VT (2) W25RT (2) X25RT (2)	W25VT (2) W25RT (2) X25RT (2)	U25RT (1) U2CABT (1)	Pink	12	15/16"
	Y81KFTMBH (1) PAT81KFT-18V (1)						
YA252LN	Y81KFTMBH (1) PAT81KFT-18V (1)						
YA26-2L	MY29-3 (1) MY29-11 (1) MRC840 (2) Y644HSXT (1) Y81KFT (1)	W26VT (2) W26RT (2) X26RT (2)	W26VT (2) W26RT (2) X26RT (2)	U26RT (1)	Black	13	1"
	Y81KFTMBH (1) PAT81KFT-18V (1)						
YA262LN	Y81KFTMBH (1) PAT81KFT-18V (1)						
YA272LN	MY29-3 (1) MY29-11 (1) MRC840 (2) Y644HSXT (1) Y81KFT (1)	W27VT (2) W27RT (2) X27RT (3)	W27VT (2) W27RT (2) X27RT (3)	U27RT (1)	Orange	14	1-1/16"
	Y81KFTMBH (1) PAT81KFT-18V (1)						
YA272LN	Y81KFTMBH (1) PAT81KFT-18V (1)						
YA282LN	MY29-3 (1) MY29-11 (1) MRC840 (2) Y644HSXT (1) Y81KFT (1)	W28VT (2) W28RT (2) X28RT (3)	W28VT (2) W28RT (2) X28RT (3)	U28RT (1)	Purple	15	1-1/8"
	Y81KFTMBH (1) PAT81KFT-18V (1)						
YA282LN	Y81KFTMBH (1) PAT81KFT-18V (1)						
YA292LN	MY29-3 (1) MY29-11 (1) Y644HSXT (1) Y81KFT (1)	W29VT (2) X29RT (4)	W29VT (2) W29RT (2) X29RT (4)	U29RT (1)	Yellow	16	1-1/8"
	Y81KFTMBH (1) PAT81KFT-18V (1)						
YA292LN	Y81KFTMBH (1) PAT81KFT-18V (1)						
YA302LN	MY29-3 (1) MY29-11 (1) Y644HSXT (1) Y81KFT (1)	W30VT (2)	W30VT (2) W30RT (2) X29RT (4)	U30RT (2) U28ART (2)	White	17	1"
	Y81KFTMBH (1) PAT81KFT-18V (1)						
YA302LN	Y81KFTMBH (1) PAT81KFT-18V (1)						
YA312LN	Y644HSXT (1) Y81KFT (1) Y81KFTMBH (1)	W31VT (2)	W31VT (2) W31RT (2)	U31RT (2) U29ART (2)	Red	18	1-1/8"
	PAT81KFT-18V (1)						
YA312LN	PAT81KFT-18V (1)						
YA322LN	Y644HSXT (1) Y81KFT (1)	W32VT (2)	W32VT (2) W32RT (2)	U32RT (2) U30ART (2)	Blue	19	1-1/4"
	Y81KFTMBH (1) PAT81KFT-18V (1)						
YA322LN	Y81KFTMBH (1) PAT81KFT-18V (1)						

* Use PUADP-1 adapter with "U" dies in Y46 HYPRESS™.

** P-RT die sets for use in Y46 HYPRESS™ only, PUADP-1 adapter not required.

▲ See tooling section of this catalog for complete tool and die listings.

(Two Hole HYLUG™ Standard Barrel Installation Tooling Chart continued on next page)

45° and 90° lugs are available. For more information, please contact Customer Service: 1-800-346-4175.

TYPES YAV-2TC, YA-2LN, YA-L-2TC

Two Hole HYLUG™

Installation Tooling Chart (Continued)



▲ Installation Tooling							
Catalog Number	Dieless (# of crimps)	Mechanical	Hydraulic		Color Code	Die Index	Wire Strip Length
		MD6, OUR840, MD7-34R	Y500CTHS	Y35, Y39, Y750, Y46*, PAT750			
YA342LN	Y644HSXT (1) Y81KFT (1) Y81KFTMBH (1) PAT81KFT-18V (1)	W34VT (2)	W34VT (2) W34RT (2)	U34RT (2) U31ART (2)	Brown	20	1-7/16"
	Y81KFTMBH (1) PAT81KFT-18V (1)						
YA362LN	Y81KFTMBH (1) PAT81KFT-18V (1)			U36RT (2) U32ART (2)	Green	22	1-3/4"
YA392LN	Y644HSXT (1) Y81KFT (2) Y81KFTMBH (2) PAT81KFT-18V (2)			U39RT (2) P39RT (2) **	Black	24	1-15/16"
	Y81KFTMBH (2) PAT81KFT-18V (2)						
YA402LN	Y81KFTMBH (2) PAT81KFT-18V (2)			P40RT (3) **	Orange	25	1-15/16"
YA442LN	Y644HSXT (1) Y81KFT (2) Y81KFTMBH (2)			** P44RT (3)	White	27	1-15/16"
	Y81KFTMBH (2) PAT81KFT-18V (2)						
YA442LN	Y81KFTMBH (2) PAT81KFT-18V (2)						

* Use PUADP-1 adapter with "U" dies in Y46 HYPRESS™.

** P-RT die sets for use in Y46 HYPRESS™ only, PUADP-1 adapter not required.

▲ See tooling section of this catalog for complete tool and die listings.

45° and 90° lugs are available. For more information, please contact Customer Service: 1-800-346-4175.

TYPE YA-L-2NT

Two Hole HYLUG™
Standard Barrel Narrow Tongue
Copper Compression Terminal

UL Listed 90° C
600 Volts to 35 kV ♦

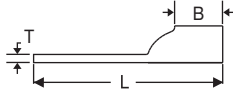

Catalog Number	Fig #	Conductor		Stud Hole Size	Hole Spacing	Tongue Width	Figure Dimensions		
		*** AWG	mm ²				(B)	(T)	(L)
YA2CL2NT14	1	#2 AWG	35	1/4"	5/8"	.48"	.88"	.11"	2.47"
YA2CL2NT14E2	1			1/4"	3/4"	.48"	.88"	.11"	2.60"
YA2CL2NT14E1	1			1/4"	1"	.48"	.88"	.11"	2.84"
YA1CL2NT14	1	#1 AWG	50	1/4"	5/8"	.50"	.88"	.11"	2.55"
YA1CL2NT14E2	1			1/4"	3/4"	.50"	.88"	.10"	2.68"
YA25L2NT14	1	1/0 AWG	—	1/4"	5/8"	.48"	.88"	.10"	2.56"
YA25L2NT14E1	1			1/4"	1"	.48"	.88"	.12"	3.28"
YA26L2NT14	1	2/0 AWG	70	1/4"	5/8"	.48"	.94"	.12"	2.66"
YA26L2NT14E1	1			1/4"	1"	.48"	.94"	.12"	3.03"
YA27L2NT14	1	3/0 AWG	—	1/4"	5/8"	.76"	1.00"	.13"	2.73"
YA27L2NT38	1			3/8"	1"	.60"	1.00"	.13"	3.30"
YA27L2NT516	1			5/16"	1"	.60"	1.00"	.13"	3.26"
YA28L2NT14	1	4/0 AWG	—	1/4"	5/8"	.76"	.88"	.13"	2.65"
YA29L2NT38	1			3/8"	1"	.80"	1.00"	.16"	3.43"
YA29L2NT38E16	1	250 kcmil	—	3/8"	1-3/4"	.80"	1.06"	.16"	4.18"
YA31L2NT38	1			3/8"	1"	.96"	1.06"	.18"	3.51"
YA31L2NT38E16	1	350 kcmil	185	3/8"	1-3/4"	.88"	1.06"	.18"	4.26"
YA34L2NT38	1			3/8"	1"	.96"	1.27"	.23"	3.65"
YA34L2NT38E16	1	500 kcmil	240	3/8"	1-3/4"	.96"	1.27"	.23"	4.63"
YA34L2NT12E1	1			1/2"	1"	.96"	1.27"	.23"	4.13"
YA36L2NNT	1	600 kcmil	300	1/2"	1-3/4"	1.12"	1.38"	.27"	5.43"
YA39L2NT38	1			3/8"	1"	1.63"	1.42"	.27"	4.34"
YA39L2NT38E16	1	750 kcmil	—	3/8"	1-3/4"	1.30"	1.42"	.27"	5.11"
YA39L2NT12E1	1			1/2"	1"	1.30"	1.42"	.27"	4.42"

* Use PUADP-1 adapter with "U" dies in Y46 HYPRESS™.
*** The mm² conductor sizes listed are the recommendations for Class 2 conductor.
Note: All dimensions shown are for reference only.

(Two Hole HYLUG™ Standard Barrel Narrow Tongue Installation Tooling Chart on next page)

TYPE YA-L-2NT

Two Hole HYLUG™
Installation Tooling Chart



Catalog Number	Dieless (# of crimps)	▲ Installation Tooling		Color Code	Die Index	Wire Strip Length	
		Mechanical MD6, OUR840, MD7-34R	Hydraulic Y500CTHS				Y35, Y39, Y750, Y46*, PAT750
YA2CL2NT14	MRC840 (1) MY29-3 (1) MY29-11 (1) Y644HS (1) Y1MRTC (2) Y81KFT (1)	W2CVT (1)	W2CVT (1)	U2CRT (1)	Brown	10	15/16"
YA2CL2NT14E2	Y81KFTMBH (1) PAT81KFT-18V (1)						
YA2CL2NT14E1							
YA1CL2NT14	MRC840 (1) MY29-3 (1) MY29-11 (1) Y1MRTC (2) Y644HS (1) Y81KFT (1) Y81KFTMBH (1) PAT81KFT-18V (1)	W1CVT (1)	W1CRT (1)	U1CRT (1)	Green	11	15/16"
YA1CL2NT14E2							
YA25L2NT14	MRC840 (2) MY29-3 (1) MY29-11 (1) Y644HS (1) Y81KFT (1)	W25VT (2)	W25VT (2)	U25RT (1)	Pink	12	15/16"
YA25L2NT14E1	Y81KFTMBH (1) PAT81KFT-18V (1)						
YA26L2NT14	MRC840 (2) MY29-3 (1) MY29-11 (1) Y644HS (1) Y81KFT (1)	W26VT (2)	W26VT (2) X26RT (2)	U26RT (1)	Black	13	1"
YA26L2NT14E1	Y81KFTMBH (1) PAT81KFT-18V (1)						
YA27L2NT14	MY29-3 (1) MY29-11 (1)	W27VT (2)	W27VT (2)	U27RT (1)	Orange	14	1-1/16"
YA27L2NT38	MRC840 (2) Y644HS (1) Y81KFT (1)						
YA27L2NT516	Y81KFT (1)						
YA28L2NT14	Y81KFTMBH (1) PAT81KFT-18V (1)	W27RT (2)	W28RT (2) X28RT (3)	U28RT (1)	Purple	15	1-1/16"
YA29L2NT38	MY29-3 (1) MY29-11 (1) Y644HS (1) Y81KFT (1)	W29VT (2) X29RT (2)	W29VT (2) W29RT (2) X29RT (2)	U29RT (1)	Yellow	16	1-1/8"
YA29L2NT38E16	Y81KFTMBH (1) PAT81KFT-18V (1)						
YA31L2NT38		W31VT (2)	W31VT (2) W31RT (2)	U31RT (2) U29ART (2)	Red	18	1-1/8"
YA31L2NT38E16							
YA34L2NT38	Y644HS (1) Y81KFT (1)	W34VT (4)	W34VT (4)	U34RT (2)	Brown	20 or 22	1-7/16"
YA34L2NT12E1	Y81KFTMBH (1) PAT81KFT-18V (1)						
YA36L2NNT		—	—	U36RT (2)	Green	472	1-3/4"
YA39L2NT38		—	—	U39RT (2)	Black	24	1-1/2"
YA39L2NT38E16							
YA39L2NT12E1							

* Use PUADP-1 adapter with "U" dies in Y46 HYPRESS™.
*** The mm² conductor sizes listed are the recommendations for Class 2 conductor.
Note: All dimensions shown are for reference only.

TYPES YA-2N, Y-2TC

Two Hole HYLUG™

Code Conductor Long Barrel

UL Listed 90° C

600 Volts to 35 kV ♦



Catalog Number	Conductor			Stud Hole Size	Stud Hole Spacing	Tongue Width	Figure Dimensions		
	AWG	*** mm²	Navy				(B)	(T)	(L)
YA8C2TC14	8 Str. 6 Sol. 37/24	† 10	23	1/4"	5/8"	.400"	.81"	.08"	2.33"
YA6C2N*	6 AWG	—	—	1/2"	1-3/4"	.81"	1.12"	.12"	4.40"
YA4C2N*	4 AWG	—	40	1/2"	1-3/4"	.81"	1.12"	.12"	4.45"
YA3C2N	3 Str. 3 AWG 2 Sol.	25	50	1/2"	1-3/4"	.81"	1.25"	.12"	4.62"
YA2C2N*	2 AWG	35	60	1/2"	1-3/4"	.81"	1.25"	.12"	4.64"
YA1C2N*	1 AWG	50	75	1/2"	1-3/4"	.81"	1.38"	.12"	4.82"
YA252N*	1/0 AWG	—	100	1/2"	1-3/4"	.81"	1.38"	.11"	4.81"
YA262N*	2/0 AWG	70	125	1/2"	1-3/4"	.83"	1.50"	.12"	4.97"
YA272N*	3/0 AWG	—	150	1/2"	1-3/4"	.91"	1.50"	.13"	3.78"
YA282N*	4/0 AWG	—	200	1/2"	1-3/4"	1.02"	1.62"	.14"	5.17"
YA292N*	250 kcmil	—	250	1/2"	1-3/4"	1.11"	1.62"	.16"	5.21"
YA302N*	300 kcmil	150	300	1/2"	1-3/4"	1.20"	2.00"	.16"	5.64"
YA312N*	350 kcmil	185	350	1/2"	1-3/4"	1.29"	2.00"	.18"	5.68"
YA322N*	400 kcmil	—	400	1/2"	1-3/4"	1.38"	2.12"	.19"	5.85"
YA342N*	500 kcmil	240	—	1/2"	1-3/4"	1.55"	2.25"	.23"	6.06"

*** The mm² conductor sizes listed are the recommendations for Class 2 conductor.

† The mm² conductor size listed here is for Class 2 and Class 5 conductor.

* Available undrilled. Add suffix "U" to catalog number (example: YA25U).

For applications greater than 2000 Volts consult cable manufacturer for voltage stress relief instructions.

Note: All dimensions shown are for reference only.

▲ Installation Tooling							
Catalog Number	Dieless (# of crimps)	Mechanical	Hydraulic		Color Code	Die Index	Wire Strip Length
		MD6, OUR840, MD7-34R	Y500C7HS	Y35, Y39, Y750, Y46*, PAT750			
YA8C2TC14	Y1MRTC (2) Y8MRB-1 (2) MY29-3 (2) MY29-11 (2) MRC840 (2) Y81KFT (1) Y81KFTMBH (1) PAT81KFT-18V (1)	W8CVT (2) W8CRT (2) X8CRT (2)	W8CVT (2) W8CRT (2) X8CRT (2)	U8CRT (1)	Red	49	1"
YA6C2N	Y1MRTC (2) MY29-3 (2) MY29-11 (2) MRC840 (2) Y81KFT (1) Y81KFTMBH (1) PAT81KFT-18V (1)	W5CVT (2) W5CRT (2) X5CRT (2) X8CART (2)	W5CVT (2) W5CRT (2) X5CRT (2) X8CART (2)	U5CRT (2) U8CART (2)	Blue	7	1-3/16"

▲ See tooling section of Master Catalog for complete tool and die listings.

* Use PUADP-1 adaptor with "U" -dies in Y46 HYPRESS™.

(Two Hole HYLUG™ Long Barrel Installation Tooling Chart continued on next page)

45° and 90° lugs are available. For more information, please contact Customer Service: 1-800-346-4175.

TYPES YA-2N, Y-2TC

Two Hole HYLUG™

Installation Tooling Chart (Continued)



▲ Installation Tooling							
Catalog Number	Dieless (# of crimps)	Mechanical	Hydraulic		Color Code	Die Index	Wire Strip Length
		MD6, OUR840, MD7-34R	Y500C7HS	Y35, Y39, Y750, Y46*, PAT750			
YA4C2N	Y1MRTC (4) MY29-3 (2) MY29-11 (2) MRC840 (2)	W4CVT (2) W4CRT (2)	W4CVT (2) W4CRT (2)	U4CRT (2) U6CART (2)	Gray	8	1-3/16"
YA3C2N	Y644HSXT (1) Y81KFT (1) Y81KFTMBH (1) PAT81KFT-18V (1)	X4CRT (2) W3CRT (2)	X4CRT (2) W3CRT (2)	U3CRT (2)	White	9	1-5/16"
YA2C2N	Y1MRTC (4) MY29-3 (2) MY29-11 (2) MRC840 (2) Y644HSXT (1) Y81KFT (2) Y81KFTMBH (2) PAT81KFT-18V (2)	W2CVT (2) W2CRT (2) X2CRT (2)	W2CVT (2) W2CRT (2) X2CRT (2)	U2CRT (2)	Brown	10	1-5/16"
YA1C2N	Y1MRTC (4) MY29-3 (2) MY29-11 (2) MRC840 (2) Y644HSXT (1) Y81KFT (2) Y81KFTMBH (2) PAT81KFT-18V (2)	W1CVT (2) W1CRT-1 (2) X1CRT-1 (2)	W1CVT (2) W1CRT-1 (2) X1CRT-1 (2)	U1CRT-1 (2) U4CART (2)	Green	11	1-1/2"
YA252N	MY29-3 (2) MY29-11 (2) MRC840 (4) Y644HSXT (1)	W25VT (4) W25RT (4) X25RT (4)	W25VT (4) W25RT (4) X25RT (4)	U25RT (2) U2CART (2)	Pink	12	1-7/16"
YA262N	Y81KFT (2) Y81KFTMBH (2) PAT81KFT-18V (2)	W26VT (4) W26RT (4) X26RT (4)	W26VT (4) W26RT (4) X26RT (4)	U26RT (2)	Black	13	1-9/16"
YA272N	MY29-3 (2) MY29-11 (2) MRC840 (4) Y644HSXT (1) Y81KFT (2)	W26VT (4) W26RT (4) X26RT (4)	W26VT (4) W26RT (4) X26RT (4)	U26RT (2)	Black	13	1-9/16"
YA282N	Y81KFTMBH (2) PAT81KFT-18V (2)	W27VT (4) W27RT (4) X27RT (6)	W27VT (4) W27RT (4) X27RT (6)	U27RT (2)	Orange	14	1-9/16"
YA292N	MY29-3 (2) MY29-11 (2) Y644HSXT (1) Y81KFT (2) Y81KFTMBH (2) PAT81KFT-18V (2)	W28VT (4) W28RT (4) X28RT (6)	W28VT (4) W28RT (4) X28RT (6)	U28RT (2)	Purple	15	1-11/16"
YA302N	Y644HSXT (1) Y81KFT (3)	W30VT (4) W29RT (4) X29RT (8)	W29VT (4) W29RT (4) X29RT (8)	U29RT (2)	Yellow	16	1-11/16"
YA312N	Y81KFTMBH (3) PAT81KFT-18V (3)	W31VT (4)	W30VT (4) W30RT (4)	U30RT (4) U28ART (4)	White	17	2"
YA322N		W32VT (4)	W31VT (4) W31RT (4)	U31RT (4) U29ART (4)	Red	18	2-1/16"
YA342N	Y644HSXT (1) Y81KFT (4) Y81KFTMBH (4) PAT81KFT-18V (4)	W34VT (4)	W34VT (4) W34RT (4)	U34RT (4) U31ART (4)	Brown	20	2-1/2"

▲ See tooling section of Master Catalog for complete tool and die listings.

* Use PUADP-1 adaptor with "U" -dies in Y46 HYPRESS™.

45° and 90° lugs are available. For more information, please contact Customer Service: 1-800-346-4175.

TYPES YAZ-2N, YAZ-2TC

Two Hole HYLUG™
Code Conductor Long Barrel
With Inspection Window

UL Listed 90° C
600 Volts to 35 kV ♦

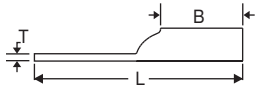

Catalog Number	Conductor		Stud Hole Size	Stud Hole Spacing	Tongue Width	Figure Dimensions		
	AWG	*** mm²				(B)	(T)	(L)
YAZV10-2TC14	14 - 10 AWG	6	1/4"	5/8"	.41"	.69"	.05"	2.16"
YAZV10-2TC14E2			1/4"	3/4"	.41"	.69"	.05"	2.28"
YAZ8C-2TC10	8 str. 6 sol. 37/24	† 10	10	5/8"	.41"	.75"	.08"	2.20"
YAZ8C-2TC10E2			10	3/4"	.41"	.75"	.08"	2.33"
YAZ8C-2TC14			1/4"	5/8"	.44"	.75"	.08"	2.33"
YAZ8C-2TC14E2			1/4"	3/4"	.44"	.75"	.08"	2.45"
YAZ8C-2TC14E1			1/4"	1"	.44"	.75"	.08"	2.70"
YAZ8C-2TC38			3/8"	1"	.58"	.75"	.06"	2.89"
YAZ6C-2N	6 AWG	—	1/2"	1-3/4"	.83"	1.12"	.12"	4.40"
YAZ6C-2TC10E2			10	3/4"	.42"	1.12"	.09"	2.65"
YAZ6C-2TC14	6 AWG	—	1/4"	5/8"	.45"	1.12"	.08"	2.65"
YAZ6C-2TC14E2			1/4"	3/4"	.45"	1.12"	.08"	2.78"
YAZ6C-2TC14E1			1/4"	1"	.45"	1.12"	.08"	3.03"
YAZ6C-2TC38E2			3/8"	3/4"	.58"	1.12"	.06"	2.97"
YAZ6C-2TC38E6			3/8"	7/8"	.58"	1.12"	.06"	3.09"
YAZ6C-2TC38			3/8"	1"	.58"	1.12"	.06"	3.22"
YAZ5C-2N	5 AWG	—	1/2"	1-3/4"	.83"	1.12"	.12"	4.43"
YAZ4C-2N	4 AWG	—	1/2"	1-3/4"	.83"	1.12"	.12"	4.42"
YAZ4C-2TC10-E2			10	3/4"	.49"	1.12"	.09"	2.67"
YAZ4C-2TC14			1/4"	5/8"	.49"	1.12"	.09"	2.67"
YAZ4C-2TC14E2			1/4"	3/4"	.49"	1.12"	.09"	2.80"
YAZ4C-2TC38			3/8"	1"	.58"	1.12"	.08"	3.23"
YAZ3C-2N	3 AWG 2 sol.	25	1/2"	1-3/4"	.83"	1.25"	.12"	4.58"
YAZ3C-2TC14			1/4"	5/8"	.55"	1.25"	.09"	2.83"
YAZ3C-2TC14E2			1/4"	3/4"	.55"	1.25"	.09"	2.95"
YAZ3C-2TC38E2			3/8"	3/4"	.58"	1.25"	.08"	3.14"
YAZ3C-2TC38			3/8"	1"	.58"	1.25"	.08"	3.39"
YAZ2C-2N	2 AWG	35	1/2"	1-3/4"	.83"	1.25"	.12"	4.60"
YAZ2C-2TC10E2			10	3/4"	.60"	1.25"	.11"	2.85"
YAZ2C-2TC14			1/4"	5/8"	.60"	1.25"	.11"	2.85"
YAZ2C-2TC14E2			1/4"	3/4"	.60"	1.25"	.11"	2.97"
YAZ2C-2TC14E1			1/4"	1"	.60"	1.25"	.11"	3.22"
YAZ2C-2TC516E2			5/16"	3/4"	.60"	1.25"	.11"	3.03"
YAZ2C-2TC38E2			3/8"	3/4"	.60"	1.25"	.11"	3.16"
YAZ2C-2TC38E6			3/8"	7/8"	.60"	1.25"	.11"	3.28"
YAZ2C-2TC38			3/8"	1"	.60"	1.25"	.11"	3.41"
YAZ2C-2NTC38			3/8"	1-3/4"	.60"	1.25"	.11"	4.16"
YAZ1C-2N	1 AWG	50	1/2"	1-3/4"	.83"	1.38"	.12"	4.76"
YAZ1C-2TC14			1/4"	5/8"	.67"	1.38"	.10"	3.01"
YAZ1C-2TC14E2			1/4"	3/4"	.67"	1.38"	.10"	3.13"
YAZ1C-2TC38			3/8"	1"	.67"	1.38"	.10"	3.57"
YAZ25-2N	1/0 AWG	—	1/2"	1-3/4"	.83"	1.38"	.11"	4.79"
YAZ25-2TC14			1/4"	5/8"	.75"	1.38"	.12"	3.04"
YAZ25-2TC14E2			1/4"	3/4"	.75"	1.38"	.12"	3.16"
YAZ25-2TC14E1			1/4"	1"	.75"	1.38"	.12"	3.41"
YAZ25-2TC516E6			5/16"	7/8"	.75"	1.38"	.12"	3.35"
YAZ25-2TC516			5/16"	1"	.75"	1.38"	.12"	3.47"
YAZ25-2TC38			3/8"	1"	.75"	1.38"	.12"	3.60"
YAZ25-2NTC38			3/8"	1-3/4"	.75"	1.38"	.12"	4.35"

† The mm² conductor size listed here is for Class 2 and Class 5 conductor.
♦ For applications greater than 2000 Volts consult cable manufacturer for voltage stress relief instructions.
*** The mm² conductor sizes listed are the recommendations for Class 2 conductor.
Note: All dimensions shown are for reference only.

(Two Hole HYLUG™ Code Conductor Long Barrel continued on next page)

45° and 90° lugs are available. For more information, please contact Customer Service: 1-800-346-4175.

TYPES YAZ-2N, YAZ-2TC

Two Hole HYLUG™
Code Conductor Long Barrel
With Inspection Window (Continued)



Catalog Number	Conductor		Stud Hole Size	Stud Hole Spacing	Tongue Width	Figure Dimensions		
	AWG	*** mm²				(B)	(T)	(L)
YAZ26-2N	2/0 AWG	70	1/2"	1-3/4"	.83"	1.50"	.12"	4.95"
YAZ26-2TC14			1/4"	5/8"	.83"	1.50"	.12"	3.20"
YAZ26-2TC14E2			1/4"	3/4"	.83"	1.50"	.12"	3.32"
YAZ26-2TC38			3/8"	1"	.83"	1.50"	.12"	3.76"
YAZ27-2N	3/0 AWG	—	1/2"	1-3/4"	.91"	1.50"	.13"	4.98"
YAZ27-2TC14E2			1/4"	3/4"	.90"	1.50"	.12"	3.36"
YAZ27-2TC38			3/8"	1"	.90"	1.50"	.12"	3.80"
YAZ28-2N	4/0 AWG	—	1/2"	1-3/4"	1.02"	1.62"	.14"	5.15"
YAZ28-2TC14E2			1/4"	3/4"	1.02"	1.62"	.14"	3.55"
YAZ28-2TC38			3/8"	1"	1.02"	1.62"	.14"	3.99"
YAZ28-2NTC38			3/8"	1-3/4"	1.02"	1.62"	.14"	4.74"
YAZ29-2N	250 kcmil	—	1/2"	1-3/4"	1.10"	1.62"	.16"	5.18"
YAZ29-2TC38	300 kcmil	150	3/8"	1"	1.10"	1.62"	.14"	3.99"
YAZ30-2N			1/2"	1-3/4"	1.20"	2.00"	.16"	5.60"
YAZ30-2TC38	3/8"	1"	1.20"	2.00"	.16"	4.42"		
YAZ31-2N	350 kcmil	185	1/2"	1-3/4"	1.29"	2.00"	.18"	5.64"
YAZ31-2TC14E2			1/4"	3/4"	1.29"	2.00"	.18"	4.02"
YAZ31-2TC38			3/8"	1"	1.29"	2.00"	.18"	4.45"
YAZ32-2N	400 kcmil	—	1/2"	1-3/4"	1.40"	2.12"	.19"	5.81"
YAZ32-2TC38	450 kcmil	—	3/8"	1"	1.40"	2.12"	.19"	4.62"
YAZ33-2N			1/2"	1-3/4"	1.48"	2.13"	.21"	5.89"
YAZ34-2N	500 kcmil	240	1/2"	1-3/4"	1.55"	2.25"	.23"	6.04"
YAZ34-2TC14E2			1/4"	3/4"	1.55"	2.25"	.23"	4.42"
YAZ34-2TC38	3/8"	1"	1.55"	2.25"	.23"	4.85"		
YAZ35-2N	550 kcmil	—	1/2"	1-3/4"	1.65"	2.63"	.25"	6.45"
YAZ36-2N	600 kcmil	300	1/2"	1-3/4"	1.74"	2.69"	.27"	6.55"
YAZ36-2TC38			3/8"	1"	1.74"	2.69"	.26"	5.55"
YAZ37-2N	650 kcmil	—	1/2"	1-3/4"	1.80"	2.81"	.27"	6.70"
YAZ38-2N	700 kcmil	—	1/2"	1-3/4"	1.84"	2.81"	.27"	6.72"
YAZ39-2N	750 kcmil	—	1/2"	1-3/4"	1.91"	2.88"	.27"	6.82"
YAZ39-2NT38			3/8"	1"	1.63"	2.88"	.27"	5.82"
YAZ39-2TC38			3/8"	1"	1.91"	2.88"	.27"	5.82"
YAZ39-2NNT			1/2"	1-3/4"	1.63"	2.88"	.27"	6.82"
YAZ40-2N	800 kcmil	400	1/2"	1-3/4"	1.98"	2.94"	.30"	6.89"
YAZ41-2N	850 kcmil	—	1/2"	1-3/4"	2.01"	2.94"	.31"	6.91"
YAZ44-2N	1000 kcmil	500	1/2"	1-3/4"	2.19"	3.00"	.33"	7.08"
YAZ44-2TC38			3/8"	1"	2.19"	3.00"	.33"	6.09"
YAZ45-2N	1250 kcmil	—	1/2"	1-3/4"	2.46"	3.19"	.38"	7.38"
YAZ453-2N	1300 kcmil	—	1/2"	1-3/4"	2.53"	3.19"	.39"	7.41"
YAZ46-2N	1500 kcmil	—	1/2"	1-3/4"	2.69"	3.19"	.40"	7.48"
YAZ47-2N	1750 kcmil	—	1/2"	1-3/4"	2.90"	3.44"	.42"	7.82"
YAZ48-2N	2000 kcmil	—	1/2"	1-3/4"	3.10"	3.44"	.46"	7.89"

† The mm² conductor size listed here is for Class 2 and Class 5 conductor.
♦ For applications greater than 2000 Volts consult cable manufacturer for voltage stress relief instructions.
*** The mm² conductor sizes listed are the recommendations for Class 2 conductor.
Note: All dimensions shown are for reference only.

(Two Hole HYLUG™ Code Conductor Long Barrel Installation Tooling Chart continued on next 4 pages)

45° and 90° lugs are available. For more information, please contact Customer Service: 1-800-346-4175.

TYPES YAZ-2N, YAZ-2TC

Two Hole HYLUG™

Code Conductor Long Barrel

With Inspection Window Installation Chart



▲ Installation Tooling							
Catalog Number	Dieless (# of crimps)	Mechanical	Hydraulic		Color Code	Die Index	Wire Strip Length
		MD6, OUR840, MD7-34R	Y500CTHS	Y35, Y39, Y750, Y46*, PAT750			
YAZV10-2TC14	Y8MRB-1 (2)	—	—	—	—	—	3/4"
YAZV10-2TC14E2	Y8MRB-1 (2)	—	—	—	—	—	3/4"
YAZ8C-2TC10	Y8MRB-1 (2) Y1MRTC (2)	—	—	—	—	—	—
YAZ8C-2TC10E2	MY29-3 (2) MY29-11 (2)	W8CVT (2)	W8CVT (2)	U8CRT (2)	Red	49	7/8"
YAZ8C-2TC14	MRC840 (2)	W8CRT (2)	W8CRT (2)	U8CRT (2)	Red	49	7/8"
YAZ8C-2TC14E2	Y81KFT (1)	X8CRT (2)	X8CRT (2)	—	—	—	—
YAZ8C-2TC14E1	Y81KFTMBH (1) PAT81KFT-18V (1)	—	—	—	—	—	—
YAZ8C-2TC38	MY29-3 (2) MY29-11 (2)	—	—	—	—	—	—
YAZ6C-2N	MRC840 (2) Y644HSXT (1) Y1MRTC (2) Y81KFT (1)	W5CVT (2) W5CRT (2) X5CRT (2) X8CART (2)	W5CVT (2) X5CRT (2) X5CRT (2) X8CART (2)	U5CRT (2) U8CABT (2)	Blue	7 or 374	1-1/16"
YAZ6C-2TC10E2	Y81KFTMBH (1) PAT81KFT-18V (1)	—	—	—	—	—	—
YAZ6C-2TC14	Y1MRTC (2) MY29-3 (2)	—	—	—	—	—	—
YAZ6C-2TC14E2	MY29-11 (2)	W5CVT (2)	W5CVT (2)	U5CRT (2)	Blue	7 or 374	1-1/16"
YAZ6C-2TC14E1	MRC840 (2)	W5CRT (2)	X5CRT (2)	U5CRT (2)	Blue	7 or 374	1-1/16"
YAZ6C-2TC38E2	Y644HSXT (2)	X5CRT (2)	X5CRT (2)	U8CABT (2)	Blue	7 or 374	1-1/16"
YAZ6C-2TC38E6	Y81KFT (1)	X8CART (2)	X8CART (2)	—	—	—	—
YAZ6C-2TC38	Y81KFTMBH (1) PAT81KFT-18V (1)	—	—	—	—	—	—
YAZ5C-2N	Y1MRTC (2) MY29-3 (2) MY29-11 (2) MRC840 (2) Y644HSXT (2) Y81KFT (1) Y81KFTMBH (1) PAT81KFT-18V (1)	W5CRT (2) W5CVT (2) X5CRT (2)	W5CVT (2) W5CRT (2) X5CRT (2)	U5CRT (2)	Blue	7 or 374	1-1/16"
YAZ4C-2N	Y1MRTC (4) MY29-3 (2)	—	—	—	—	—	—
YAZ4C-2TC10-E2	MY29-11 (2) MRC840 (2)	W4CVT (2) W4CRT (2)	W4CVT (2) W4CRT (2)	U4CRT (2) U6CABT (2)	Gray	8 or 346	1-1/16"
YAZ4C-2TC14	Y644HSXT (2) Y81KFT (1)	X4CRT (2)	X4CRT (2)	—	—	—	—
YAZ4C-2TC14E2	Y81KFTMBH (1)	—	—	—	—	—	—
YAZ4C-2TC38	PAT81KFT-18V (1)	—	—	—	—	—	—
YAZ3C-2N	Y1MRTC (4) MY29-3 (2)	—	—	—	—	—	—
YAZ3C-2TC14	MY29-11 (2) MRC840 (2)	W3CRT (2)	W3CRT (2)	U3CRT (2)	White	9	1-5/16"
YAZ3C-2TC14E2	Y644HSXT (2) Y81KFT (2)	—	—	—	—	—	—
YAZ3C-2TC38E2	Y81KFTMBH (2)	—	—	—	—	—	—
YAZ3C-2TC38	PAT81KFT-18V (2)	—	—	—	—	—	—

▲ See tooling section of Master catalog for complete tool and die listings.

* Use PUADP-1 adaptor with "U" -dies in Y46 HYPRESS™.

** P-RT die sets for use in Y46 HYPRESS™ only, PUADP-1 adaptor not required.

Note: All dimensions shown are for reference only.

(Two Hole HYLUG™ Code Conductor Long Barrel Installation Tooling Chart continued on next 3 pages)

45° and 90° lugs are available. For more information, please contact Customer Service: 1-800-346-4175.

TYPES YAZ-2N, YAZ-2TC

Two Hole HYLUG™

Code Conductor Long Barrel

With Inspection Window Installation Chart (Continued)



▲ Installation Tooling							
Catalog Number	Dieless (# of crimps)	Mechanical	Hydraulic		Color Code	Die Index	Wire Strip Length
		MD6, OUR840, MD7-34R	Y500CTHS	Y35, Y39, Y750, Y46*, PAT750			
YAZ2C-2N	Y1MRTC (4)	—	—	—	—	—	—
YAZ2C-2TC10E2	MY29-3 (2)	—	—	—	—	—	—
YAZ2C-2TC14	MY29-11 (2)	—	—	—	—	—	—
YAZ2C-2TC14E2	MRC840 (2)	W2CVT (2)	W2CVT (2)	U2CRT (2)	Brown	10	1-5/16"
YAZ2C-2TC14E1	Y644HSXT (1)	W2CRT (2)	W2CRT (2)	U2CRT (2)	Brown	10	1-5/16"
YAZ2C-2TC516E2	Y81KFT (2)	X2CRT (2)	X2CRT (2)	—	—	—	—
YAZ2C-2TC38E2	Y81KFT (2)	—	—	—	—	—	—
YAZ2C-2TC38E6	Y81KFTMBH (2)	—	—	—	—	—	—
YAZ2C-2TC38	PATKFT-18V (2)	—	—	—	—	—	—
YAZ2C-2NTC38	—	—	—	—	—	—	—
YAZ1C-2N	Y1MRTC (4) MY29-3 (2)	—	—	—	—	—	—
YAZ1C-2TC14	MY29-11 (2) MRC840 (2)	W1CVT (2)	W1CVT (2)	U1CRT-1 (2)	Green	11 or 375	1-7/16"
YAZ1C-2TC14E2	Y644HSXT (1) Y81KFT (2)	W1CRT-1 (2) X1CRT-1 (2)	W1CRT-1 (2) X1CRT-1 (2)	U4CABT (2)	Green	11 or 375	1-7/16"
YAZ1C-2TC38	Y81KFTMBH (2) PATKFT-18V (2)	—	—	—	—	—	—
YAZ27-2N	MY29-3 (2) MY29-11 (2)	—	—	—	—	—	—
YAZ27-2TC14E2	MRC840 (4) Y644HSXT (1) Y81KFT (2)	W27VT (4) W27RT (4) X27RT (6)	W27VT (4) W27RT (4) X27RT (6)	U27RT (2)	Orange	14	1-9/16"
YAZ27-2TC38	Y81KFTMBH (2) PAT81KFT-18V (2)	—	—	—	—	—	—
YAZ28-2N	MY29-3 (2) MY29-11 (2)	—	—	—	—	—	—
YAZ28-2TC14E2	MRC840 (4) Y644HSXT (1) Y81KFT (2)	W28VT (4) W28RT (4) X28RT (6)	W28VT (4) W28RT (4) X28RT (6)	U28RT (2)	Purple	15	1-11/16"
YAZ28-2TC38	Y81KFTMBH (2)	—	—	—	—	—	—
YAZ28-2NTC38	PAT81KFT-18V (2)	—	—	—	—	—	—
YAZ29-2N	MY29-3 (2) MY29-11 (2)	—	—	—	—	—	—
YAZ29-2TC38	Y644HSXT (1) Y81KFT (2) Y81KFTMBH (2) PAT81KFT-18V (2)	W29VT (4) X29RT (8)	X29RT (8) W29VT (4) W29RT (4)	U29RT (2)	Yellow	16	1-11/16"
YAZ30-2N	Y644HSXT (1) Y81KFT (3)	—	—	—	—	—	—
YAZ30-2TC38	Y81KFTMBH (3) PAT81KFT-18V (3)	W30VT (4)	W30VT (4) W30RT (4)	U30RT (4) U28ART (4)	White	17 or 298	2-1/16"
YAZ31-2N	Y644HSXT (1) Y81KFT (3)	—	—	—	—	—	—
YAZ31-2TC14E2	Y81KFTMBH (3)	W31VT (4)	W31VT (4) W31RT (4)	U31RT (4) U29ART (4)	Red	18 or 324	2-1/16"
YAZ31-2TC38	PAT81KFT-18V (3)	—	—	—	—	—	—
YAZ32-2N	Y644HSXT (1) Y81KFT (3)	—	—	—	—	—	—
YAZ32-2TC38	Y81KFTMBH (3) PAT81KFT-18V (3)	W32VT (4)	W32VT (4) W32RT (4)	U32RT (4) U30ART (4)	Blue	19 or 470	2-1/16"

▲ See tooling section of Master catalog for complete tool and die listings.

* Use PUADP-1 adaptor with "U" -dies in Y46 HYPRESS™.

** P-RT die sets for use in Y46 HYPRESS™ only, PUADP-1 adaptor not required.

Note: All dimensions shown are for reference only.

(Two Hole HYLUG™ Code Conductor Long Barrel Installation Tooling Chart continued on next 2 pages)

45° and 90° lugs are available. For more information, please contact Customer Service: 1-800-346-4175.

TYPES YAZ-2N, YAZ-2TC

Two Hole HYLUG™

Code Conductor Long Barrel

With Inspection Window Installation Chart (Continued)



▲ Installation Tooling							
Catalog Number	Dieless (# of crimps)	Mechanical	Hydraulic		Color Code	Die Index	Wire Strip Length
		MD6, OUR840, MD7-34R	Y500CTHS	Y35, Y39, Y750, Y46*, PAT750			
YAZ33-2N	Y644HSXT (1) Y81KFT (4) Y81KFTMBH (4) PAT81KFT-18V (4)	W33VT (4)	W33VT (4) W33RT (4)	U33RT (4)	Gray	326 or 538	2-5/16"
YAZ34-2N	Y644HSXT (1) Y81KFT (4)	W34VT (4)	W34VT (4) W34RT (4)	U34RT (4)	Brown	20 or 299	2-5/16"
YAZ34-2TC14E2	Y81KFTMBH (4)			U31ART (4)			
YAZ34-2TC38	PAT81KFT-18V (4)						
YAZ35-2N	Y644HSXT (1) Y81KFT (4) Y81KFTMBH (4) PAT81KFT-18V (4)	—	—	U35RT (4)	Yellow	21	2-11/16"
YAZ36-2N	Y644HSXT (1) Y81KFT (4)	—	—	U36RT (4)	Green	22 or 472	2-3/4"
YAZ36-2TC38	Y81KFTMBH (4) PAT81KFT-18V (4)			U32ART (4)			
YAZ37-2N	Y644HSXT (1) Y81KFT (4) Y81KFTMBH (4) PAT81KFT-18V (4)	—	—	U37RT (4)	Orange	23	2-7/8"
YAZ38-2N	Y644HSXT (1) Y81KFT (4) Y81KFTMBH (4) PAT81KFT-18V (4)	—	—	U38RT (4)	Pink	400	2-7/8"
YAZ39-2N	Y644HSXT (1)	—	—	U39RT (4)	Black	24	2-15/16"
YAZ39-2NT38	Y81KFT (4)			P39RT (4)			
YAZ39-2TC38	Y81KFTMBH (4)						
YAZ39-2NNT	PAT81KFT-18V (4)						
YAZ40-2N	Y644HSXT (1) Y81KFT (4) Y81KFTMBH (4) PAT81KFT-18V (4)	—	—	P40RT (4) **	Orange	25	3"
YAZ41-2N	Y644HSXT (1) Y81KFT (4) Y81KFTMBH (4) PAT81KFT-18V (4)	—	—	—	Gold		3"
YAZ44-2N	Y644HSXT (1) Y81KFT (4)	—	—	P44RT (4)	White	27	3-1/16"
YAZ44-2TC38	Y81KFTMBH (4) PAT81KFT-18V (4)			P44RT (4) **			
YAZ45-2N	Y644HSXT (1) Y81KFT (4) Y81KFTMBH (4) PAT81KFT-18V (4)	—	—	P45RT (6) **	Yellow	29	3-1/4"
YAZ453-2N	Y644HSXT (1) Y81KFT (4) Y81KFTMBH (4) PAT81KFT-18V (4)	—	—	—	Orange	30	2-1/16"
YAZ46-2N	Y644HSXT (1) Y81KFT (4) Y81KFTMBH (4) PAT81KFT-18V (4)	—	—	P46RT (6) **	Green	31	3-5/16"

▲ See tooling section of Master catalog for complete tool and die listings.

* Use PUADP-1 adaptor with "U" -dies in Y46 HYPRESS™.

** P-RT die sets for use in Y46 HYPRESS™ only, PUADP-1 adaptor not required.

Note: All dimensions shown are for reference only.

(Two Hole HYLUG™ Code Conductor Long Barrel Installation Tooling Chart continued on next page)

45° and 90° lugs are available. For more information, please contact Customer Service: 1-800-346-4175.

TYPES YAZ-2N, YAZ-2TC

Two Hole HYLUG™

Code Conductor Long Barrel

With Inspection Window Installation Chart (Continued)



▲ Installation Tooling							
Catalog Number	Dieless (# of crimps)	Mechanical	Hydraulic		Color Code	Die Index	Wire Strip Length
		MD6, OUR840, MD7-34R	Y500CTHS	Y35, Y39, Y750, Y46*, PAT750			
YAZ47-2N	Y644HSXT (1) Y81KFT (4) Y81KFTMBH (4) PAT81KFT-18V (4)	—	—	—	Gray	33	3-1/2"
YAZ48-2N	Y644HSXT (1) Y81KFT (4) Y81KFTMBH (4) PAT81KFT-18V (4)	—	—	—	Brown	34	3-1/2"

▲ See tooling section of Master catalog for complete tool and die listings.

* Use PUADP-1 adaptor with "U" -dies in Y46 HYPRESS™.

** P-RT die sets for use in Y46 HYPRESS™ only, PUADP-1 adaptor not required.

Note: All dimensions shown are for reference only.

45° and 90° lugs are available. For more information, please contact Customer Service: 1-800-346-4175.

**TYPES YA-2TC-FXB,
YAV-2TC-FXB**

**Two Hole HYLUG™ Flex Conductor
Long Barrel Belled End**
UL Listed 90° C
600 Volts to 35 kV ♦

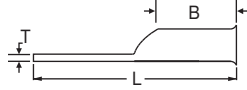

Catalog Number	Conductor		Stud Hole Size	Stud Hole Spacing	Tongue Width	Figure Dimensions		
	AWG	*** mm ²				(B)	(T)	(L)
YA8C2TC14E2-FXB	37/24	†	1/4"	3/4"	.41"	.90"	.08"	2.54"
YA8C2TC14-FXB	8 Weld	10	1/4"	5/8"	.41"	.90"	.08"	2.41"
YA8C2TC38-FXB	8 AWG		3/8"	1"	.57"	.90"	.06"	2.98"
YAV6C2TC14E2-FXB	61/24	†	1/4"	3/4"	.48"	1.22"	.08"	2.88"
YAV6C2TC14-FXB	6 Weld	16	1/4"	5/8"	.48"	1.22"	.08"	2.76"
YAV6C2TC38-FXB	6 AWG		3/8"	1"	.60"	1.22"	.06"	3.32"
YAV6C2N-FXB			1/2"	1-3/4"	.77"	1.22"	.04"	4.51"
YA5C2TC14-FXB	5 AWG	—	1/4"	5/8"	.44"	1.22"	.07"	2.76"
YAV4C2TC14E2-FXB			1/4"	3/4"	.55"	1.22"	.09"	2.93"
YAV4C2TC14E1-FXB	91/24 - 105/24		1/4"	1"	.55"	1.22"	.09"	3.18"
YAV4C2TC14-FXB			1/4"	5/8"	.55"	1.22"	.09"	2.81"
YAV4C2TC516-FXB	4 Weld	—	5/16"	1"	.55"	1.22"	.09"	3.24"
YAV4C2TC38-FXB	4 AWG		3/8"	1"	.63"	1.22"	.09"	3.37"
YAV4C2N-FXB			1/2"	1-3/4"	.77"	1.22"	.09"	4.56"
YA3C2TC516-FXB			5/16"	1"	.55"	1.48"	.09"	3.51"
YA3C2TC38-FXB	105/24 - 125/24	—	3/8"	1"	.58"	1.48"	.09"	3.64"
YA3C2N-FXB			1/2"	1-3/4"	.77"	1.48"	.09"	4.83"
YAV2C2TC14-FXB	3 Weld		1/4"	5/8"	.67"	1.35"	.10"	3.00"
YAV2C2TC14E2-FXB	3 AWG		1/4"	3/4"	.67"	1.35"	.10"	3.13"
YAV2C2TC14E1-FXB			1/4"	1"	.67"	1.35"	.10"	3.38"
YAV2C2TC516-FXB	125/24 - 150/24		5/16"	1"	.67"	1.35"	.10"	3.44"
YAV2C2TC38-FXB	2 Weld	35	3/8"	1"	.67"	1.35"	.10"	3.57"
YAV2C2NT38-FXB	2 AWG		3/8"	1"	.48"	1.35"	.10"	3.57"
YAV2C2N-FXB			1/2"	1-3/4"	.77"	1.35"	.09"	4.76"
YAV1C2TC14-FXB	175/24 - 225/24	—	1/4"	5/8"	.75"	1.50"	.12"	3.17"
YAV1C2TC14E2-FXB			1/4"	3/4"	.75"	1.50"	.12"	3.30"
YAV1C2TC38-FXB	1 Weld		3/8"	1"	.75"	1.50"	.12"	3.74"
YAV1C2N-FXB	1 AWG		1/2"	1-3/4"	.77"	1.50"	.12"	4.92"
YAV252TC14-FXB			1/4"	5/8"	.83"	1.50"	.12"	3.21"
YAV252TC14E2-FXB	275/24	—	1/4"	3/4"	.83"	1.50"	.12"	3.34"
YAV252TC38-FXB	1/0 Weld		3/8"	1"	.83"	1.50"	.12"	3.78"
YAV252N-FXB	1/0 AWG	50	1/2"	1-3/4"	.83"	1.50"	.12"	4.96"
YAV262TC14-FXB			1/4"	5/8"	.93"	1.63"	.13"	3.40"
YAV262TC14E2-FXB			1/4"	3/4"	.93"	1.63"	.13"	3.52"
YAV262TC38-FXB	325/24	70	3/8"	1"	.93"	1.63"	.13"	3.96"
YAV262NTC38-FXB	2/0 Weld		3/8"	1-3/4"	.93"	1.63"	.13"	4.71"
YAV262N-FXB	2/0 AWG		1/2"	1-3/4"	.93"	1.63"	.13"	5.15"
YAV272TC14E2-FXB	450/24		1/4"	3/4"	1.02"	1.64"	.14"	3.58"
YAV272TC38-FXB	3/0 Weld	95	3/8"	1"	1.02"	1.64"	.14"	4.01"
YAV272N-FXB	3/0 AWG		1/2"	1-3/4"	1.02"	1.64"	.14"	5.20"
YAV282TC14E2-FXB			1/4"	3/4"	1.14"	1.77"	.14"	3.76"
YAV282NT38-FXB	550/24	**	3/8"	1"	.75"	1.77"	.14"	4.20"
YAV282TC38-FXB	4/0 Weld	120	3/8"	1"	1.14"	1.77"	.14"	4.20"
YAV282NTC38-FXB	4/0 AWG		3/8"	1-3/4"	1.14"	1.77"	.14"	4.20"
YAV282N-FXB			1/2"	1-3/4"	1.14"	1.77"	.14"	5.39"

† The mm² conductor size listed here is for Class 2 and Class 5 conductor.
♦ For applications greater than 2000 Volts consult cable manufacturer for voltage stress relief instructions.
*** The mm² conductor sizes listed are the recommendations for Class 2 conductor.

(Two Hole HYLUG™ Flex Conductor Long Barrel Belled End continued on next page)

45° and 90° lugs are available. For more information, please contact Customer Service: 1-800-346-4175.

**TYPES YA-2TC-FXB,
YAV-2TC-FXB**

**Two Hole HYLUG™ Flex Conductor
Long Barrel Belled End (Continued)**

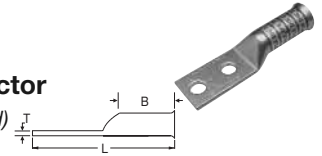

Catalog Number	Conductor		Stud Hole Size	Stud Hole Spacing	Tongue Width	Figure Dimensions		
	AWG	*** mm ²				(B)	(T)	(L)
YAV292TC14E2-FXB			1/4"	3/4"	1.14"	2.00"	.15"	3.76"
YAV292NT38-FXB			3/8"	1"	.75"	2.00"	.15"	4.20"
YAV292TC38-FXB			3/8"	1"	1.14"	2.00"	.15"	4.20"
YAV292NTC38-FXB			3/8"	1-3/4"	1.14"	2.00"	.15"	4.20"
YAV292N-FXB			1/2"	1-3/4"	1.14"	2.00"	.15"	5.39"
YA302TC38-FXB	250 Flex CLASS G 259 Str.	—	3/8"	1"	1.20"	2.16"	.16"	4.61"
YA302N-FXB	CLASS H 427 Str.		1/2"	1-3/4"	1.20"	2.12"	.16"	5.80"
YA312TC38-FXB	250 Flex 637/24	150	3/8"	1"	1.29"	2.18"	.23"	4.66"
YA312N-FXB	CLASS I, K, M		1/2"	1-3/4"	1.29"	2.18"	.23"	5.85"
YA322TC38-FXB	775/24		3/8"	1"	1.40"	2.32"	.23"	4.85"
YA322N-FXB	313.1 kcmil	185	1/2"	1-3/4"	1.40"	2.32"	.23"	6.40"
YA342TC14E2-FXB	925/24		1/4"	3/4"	1.55"	2.48"	.23"	4.66"
YA342TC38-FXB	373.7 kcmil	240	3/8"	1"	1.55"	2.48"	.23"	5.10"
YA342N-FXB	(350 kcmil nom.)		1/2"	1-3/4"	1.55"	2.48"	.23"	6.29"
YA382TC38-FXB	1325/24		3/8"	1"	1.84"	3.80"	.26"	6.10"
YA382N-FXB	535.3 kcmil	300	1/2"	1-3/4"	1.84"	3.80"	.26"	7.10"
YA382-FXBG2	(500 kcmil nom.)		3/8"	2"	1.84"	3.80"	.27"	6.82"
YA382-FXBG3			1/2"	1-7/8"	1.84"	3.80"	.27"	6.26"
YA402N-FXB	1600/24 646 kcmil	400	1/2"	1-3/4"	1.98"	3.24"	.30"	7.22"
YA442TC38-FXB	1925/24 777.7 kcmil	500	3/8"	1"	2.19"	3.33"	.33"	6.44"
YA442N-FXB	(750 kcmil nom.)		1/2"	1-3/4"	2.19"	3.33"	.33"	7.44"
YA462N-FXB	2750/24 1111 kcmil (1000 kcmil nom.)	—	1/2"	1-3/4"	2.69"	3.58"	.39"	7.91"

† The mm² conductor size listed here is for Class 2 and Class 5 conductor.
♦ For applications greater than 2000 Volts consult cable manufacturer for voltage stress relief instructions.
*** The mm² conductor sizes listed are the recommendations for Class 2 conductor.

(Two Hole HYLUG™ Flex Conductor Long Barrel Belled End Installation Chart on next 2 pages)

45° and 90° lugs are available. For more information, please contact Customer Service: 1-800-346-4175.

**TYPES YA-2TC-FXB,
YAV-2TC-FXB**

**Two Hole HYLUG™ Flex Conductor
Long Barrel Belled End Installation Chart**



▲ Installation Tooling								
Catalog Number	Dieless (# of crimps)	Mechanical		Hydraulic		Color Code	Die Index	Wire Strip Length
		MD6, OUR840, MD7-34R	Y500C7HS	Y35, Y39, Y750, Y46*, PAT750				
YA8C2TC14E2-FXB	Y8MRB-1 (2) Y1MRTCTC (2)	W8CRT (2)	W8CVT (2)	U8CRT (2)		Red	49	1"
YA8C2TC14-FXB	MY29-11 (2) Y81KFT (1)	W8CVT (2) X8CRT (2)	W8CRT (2) X8CRT (2)					
YA8C2TC38-FXB	Y81KFTMBH (1) PAT81KFT-18V (1)							
YAV6C2TC14E2-FXB	Y1MRTCTC (2) MY29-11 (2)	W5CVT (2)	W5CVT (2)	U5CRT (2)		Blue	7	1-5/16"
YAV6C2TC14-FXB	Y644HSXT (1) Y81KFT (1)	W5CRT (2) X5CRT (2)	W5CRT (2) X5CRT (2)					
YAV6C2TC38-FXB	Y81KFTMBH (1)							
YAV6C2N-FXB	PAT81KFT-18V (1)							
YA5C2TC14-FXB	Y644HSXT (1) Y81KFT (1) Y81KFTMBH (1) PAT81KFT-18V (1)	W5CVT (2) W5CRT (2) X5CRT (2)	W5CVT (2) W5CRT (2) X5CRT (2)	U5CRT (2)		Blue	7	1-5/16"
YAV4C2TC14E2-FXB	Y1MRTCTC (4)							
YAV4C2TC14E1-FXB	MY29-11 (2)	W4CVT (2)	W4CVT (2)	U4CRT (2)		Gray	8	1-5/16"
YAV4C2TC14-FXB	Y644HSXT (1)	W4CRT (2)	W4CRT (2)					
YAV4C2TC516-FXB	Y81KFT (1)	X4CRT (2)	X4CRT (2)					
YAV4C2TC38-FXB	Y81KFTMBH (1)							
YAV4C2N-FXB	PAT81KFT-18V (1)							
YA3C2TC516-FXB	MY29-11 (2)							
YA3C2TC38-FXB	Y644HSXT (1)	W3CRT (2)	W3CRT (2)	U3CRT (2)		White	9	1-9/16"
YA3C2N-FXB	Y81KFT (1)							
YAV2C2TC14-FXB	Y81KFTMBH (1)							
YAV2C2TC14E2-FXB	PAT81KFT-18V (1)							
YAV2C2TC14E1-FXB	MY29-11 (2)	W2CVT (2)	W2CVT (2)	U2CRT (2)		Brown	10	1-7/16"
YAV2C2TC516-FXB	Y644HSXT (1)	W2CRT (2)	W2CRT (2)					
YAV2C2TC38-FXB	Y81KFT (1)	X2CRT (2)	X2CRT (2)					
YAV2C2NT38-FXB	Y81KFTMBH (1)							
YAV2C2N-FXB	PAT81KFT-18V (1)							
YAV1C2TC14-FXB	MY29-11 (2)	W1CVT (2)	W1CVT (2)	U1CRT-1 (2)		Green	11	1-9/16"
YAV1C2TC14E2-FXB	Y644HSXT (1)	W1CRT-1 (2)	W1CRT-1 (2)					
YAV1C2TC38-FXB	Y81KFT (1)	X1CRT-1 (2)	X1CRT-1 (2)					
YAV1C2N-FXB	Y81KFTMBH (1) PAT81KFT-18V (1)							
YAV252TC14-FXB	MY29-11 (2)	W25RT (4)	W25RT (4)	U25RT (2)		Pink	12	1-9/16"
YAV252TC14E2-FXB	Y644HSXT (1)	W25VT (4)	W25VT (4)					
YAV252TC38-FXB	Y81KFT (2)	X25RT (4)	X25RT (4)					
YAV252N-FXB	Y81KFTMBH (2) PAT81KFT-18V (2)							
YAV262TC14-FXB	MY29-11 (2)	W26VT (4)	W26VT (4)	U26RT (2)		Black	13	1-13/16"
YAV262TC14E2-FXB	Y644HSXT (1)	W26RT (4)	W26RT (4)					
YAV262TC38-FXB	Y81KFT (2)	X26RT (4)	X26RT (4)					
YAV262NTC38-FXB	Y81KFTMBH (2)							
YAV262N-FXB	PAT81KFT-18V (2)							
YAV272TC14E2-FXB	MY29-11 (2)	W27RT (4)	W27RT (4)	U27RT (2)		Orange	14	1-13/16"
YAV272TC38-FXB	Y644HSXT (1)	W27VT (4)	W27VT (4)					
YAV272N-FXB	Y81KFT (2) Y81KFTMBH (2) PAT81KFT-18V (2)	X27RT (4)	X27RT (4)					

* Use PUADP-1 adaptor with "U" -dies in Y46 HYPRESS™.
** P-RT die sets for use in Y46 HYPRESS™ only, PUADP-1 adaptor not required.
▲ See tooling section of this catalog for complete tool and die listings.

(Two Hole HYLUG™ Flex Conductor Long Barrel Belled End Installation Chart continued on next page)

45° and 90° lugs are available. For more information, please contact Customer Service: 1-800-346-4175.

**TYPES YA-2TC-FXB,
YAV-2TC-FXB**

**Two Hole HYLUG™ Flex Conductor
Long Barrel Belled End Installation Chart (Continued)**



▲ Installation Tooling								
Catalog Number	Dieless (# of crimps)	Mechanical		Hydraulic		Color Code	Die Index	Wire Strip Length
		MD6, OUR840, MD7-34R	Y500C7HS	Y35, Y39, Y750, Y46*, PAT750				
YAV282TC14E2-FXB	MY29-11 (2)							
YAV282NT38-FXB	Y644HSXT (1)	W28VT (4)	W28VT (4)	U28RT (2)		Purple	15	1-7/8"
YAV282TC38-FXB	Y81KFT (2)	W28RT (4)	W28RT (4)					
YAV282NTC38-FXB	Y81KFTMBH (2)	X28RT (6)	X28RT (6)					
YAV282N-FXB	PAT81KFT-18V (2)							
YAV292TC14E2-FXB	Y644HSXT (1)	W29VT (4)	W29VT (4)	U29RT (2)		Yellow	16	1-7/8"
YAV292NT38-FXB	Y81KFT (2)	X29RT (6)	W29RT (4)					
YAV292TC38-FXB	Y81KFTMBH (2)		X29RT (6)					
YAV292NTC38-FXB	Y81KFTMBH (2)							
YAV292N-FXB	PAT81KFT-18V (2)							
YA302TC38-FXB	Y644HSXT (1) Y81KFT (2)	W29VT (4) X29RT (6)	W29VT (4) W29RT (4)	U29RT (2)		Yellow	16	1-7/8"
YA302N-FXB	Y81KFTMBH (2) PAT81KFT-18V (2)		X29RT (6)					
YA312TC38-FXB	Y644HSXT (1) Y81KFT (2)	W30VT (4)	W30RT (4)	U30RT (4)		White	17	2-1/4"
YA312N-FXB	Y81KFTMBH (2) PAT81KFT-18V (2)		W30VT (4)					
YA322TC38-FXB	Y644HSXT (1) Y81KFT (2)	W31VT (4)	W31RT (4)	U31RT (4)		Red	18	2-1/4"
YA322N-FXB	Y81KFTMBH (2) PAT81KFT-18V (2)		W31VT (4)					
YA342TC14E2-FXB	Y644HSXT (1) Y81KFT (2)	W32VT (4)	W32VT (4)	U32RT (4)		Blue	19	2-9/16"
YA342TC38-FXB	Y81KFTMBH (2)		W32RT (4)					
YA342N-FXB	PAT81KFT-18V (2)							
YA382TC38-FXB	Y644HSXT (1)			U38XRT (4)		Pink	L99	3-3/16"
YA382N-FXB	Y81KFT (2)							
YA382-FXBG2	Y81KFTMBH (2)							
YA382-FXBG3	PAT81KFT-18V (2)							
YA402N-FXB	Y644HSXT (1) Y81KFT (3)			U39RT (4)		Black	24	3-5/16"
YA442TC38-FXB	Y81KFTMBH (3) PAT81KFT-18V (3)							
YA442N-FXB	Y644HSXT (1) Y81KFT (3)			U44XRT (4)		Yellow	L115	3-7/16"
YA442N-FXB	Y81KFTMBH (3) PAT81KFT-18V (3)							
YA462N-FXB	Y644HSXT (1) Y81KFT (3)			P45RT (4)		Yellow	29	3-11/16"
YA462N-FXB	Y81KFTMBH (3) PAT81KFT-18V (3)			**				

* Use PUADP-1 adaptor with "U" -dies in Y46 HYPRESS™.
** P-RT die sets for use in Y46 HYPRESS™ only, PUADP-1 adaptor not required.
▲ See tooling section of this catalog for complete tool and die listings.

45° and 90° lugs are available. For more information, please contact Customer Service: 1-800-346-4175.

TYPE YAZ-FX

Two Hole HYLUG™ Flex Conductor Long Barrel with Inspection Window

Copper Compression Terminal

UL Listed 90° C

600 Volts to 35 kV ♦

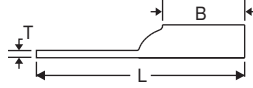

These HYLUG™ YAZ-FX connectors are made of high conductivity seamless electrolytic wrought copper tubing. These two hole copper compression terminals are for flexible and extra flexible copper cables. As with all BURNDY® compression connectors, the color coded system matches terminals and die sets to provide the correct number and location of crimps for the proper installation.

Catalog Number	Conductor		Stud Hole Size	Stud Hole Spacing	Tongue Width	Figure Dimensions			
	AWG	*** mm ²				(B)	(T)	(L)	
YAZ8C2TC10FX	37/24 8 Weld 3 AWG	† 10	10	5/8"	.41"	.75"	.08"	2.20"	
YAZ8C2TC10E2FX			10	3/4"	.41"			2.22"	
YAZ8C2TC14E1FX			1/4"	1"	.44"			2.60"	
YAZ8C2TC14FX			1/4"	5/8"	.44"			2.20"	
YAZ8C2TC14E2FX			1/4"	3/4"	.44"			2.33"	
YAZ8C2TC38FX			3/8"	1"	.58"			.06"	2.72"
YAZV6C2TC10E2FX	61/24 6 Weld 6 AWG	† 16	10	3/4"	.48"	.08"	.06"	2.64"	
YAZV6C2TC14FX			1/4"	5/8"	.48"			2.45"	
YAZV6C2TC14E2FX			1/4"	3/4"	.48"			2.58"	
YAZV6C2TC14E1FX			1/4"	1"	.48"			2.83"	
YAZV6C2TC38FX			3/8"	1"	.58"			.06"	2.97"
YAZV6C2TC38E2FX			3/8"	3/4"	.58"			.06"	2.72"
YAZV6C2TC38E6FX	3/8"	7/8"	.58"	.08"	2.72"				
YAZV4C2TC38E2-FX	91/24 -	—	3/8"	3/4"	.58"	1.25"	.08"	3.14"	
YAZV4C2TC38FX	105/24		3/8"	1"	.58"			.08"	3.13"
YAZV4C2TC14FX	4 Weld		1/4"	5/8"	.55"			.09"	2.59"
YAZV4C2TC14E2FX	4 AWG		1/4"	3/4"	.55"			.09"	2.72"
YAZV2C2TC14FX	125/24 -	35	1/4"	5/8"	.68"	.10"	.10"	2.75"	
YAZV2C2TC14E2FX	150/24		1/4"	3/4"	.68"			2.87"	
YAZV2C2TC38FX	2 Weld		3/8"	1"	.68"			3.31"	
YAZV2C2NTCFX	2 AWG		1/2"	1-3/4"	.68"			4.50"	
YAZV1C2TC14FX	175/24 - 225/24	—	1/4"	5/8"	.75"	1.38"	.12"	3.40"	
YAZV1C2TC14E1FX			1/4"	1"	.75"			3.18"	
YAZV1C2TC14E2FX			1/4"	3/4"	.75"			2.93"	
YAZV1C2TC38FX			1 Weld	3/8"	1"			.75"	3.37"
YAZV1C2TC516E6FX			1 AWG	5/16"	7/8"			.75"	3.12"
YAZV1C2TC516FX			5/16"	1"	.75"			3.24"	
YAZV252TC14FX	275/24 1/0 Weld 1/0 AWG	50	1/4"	5/8"	.83"	.12"	.12"	3.20"	
YAZV252TC14E2FX			1/4"	3/4"	.83"			3.40"	
YAZV252TC38FX			3/8"	1"	.83"			3.48"	
YAZV252NTCFX			1/2"	1-3/4"	.83"			4.67"	
YAZV262TC14FX	325/24 2/0 Weld 2/0 AWG	70	1/4"	5/8"	.93"	1.50"	.13"	3.20"	
YAZV262TC14E2FX			1/4"	3/4"	.93"			3.50"	
YAZV262TC38FX			3/8"	1"	.93"			3.48"	
YAZV262NTCFX			1/2"	1-3/4"	.93"			4.67"	
YAZV272TC14E2FX	450/24 3/0 Weld 3/0 AWG	95	1/4"	3/4"	1.30"	.14"	.14"	3.36"	
YAZV272TC38FX			3/8"	1"	1.30"			3.80"	
YAZV282TC14E2FX	550/24 4/0 Weld 4/0 AWG	** 120	1/4"	3/4"	1.14"	1.62"	.15"	2.25"	
YAZV282NT38FX			3/8"	1"	0.94"			3.52"	
YAZV282TC38FX			3/8"	1"	1.14"			3.23"	
YAZV282NTCFX			1/2"	1-3/4"	1.14"			1.86"	

† The mm² conductor size listed here is for Class 2 and Class 5 conductor.

♦ For applications greater than 2000 Volts consult cable manufacturer for voltage stress relief instructions.

*** The mm² conductor sizes listed are the recommendations for Class 2 conductor.

(Two Hole HYLUG™ Flex Conductor Long Barrel with Inspection Window Chart continued on next page)

45° and 90° lugs are available. For more information, please contact Customer Service: 1-800-346-4175.

TYPE YAZ-FX

Two Hole HYLUG™ Flex Conductor Long Barrel with Inspection Window

(Continued)

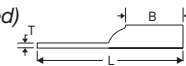

Catalog Number	Conductor		Stud Hole Size	Stud Hole Spacing	Tongue Width	Figure Dimensions		
	AWG	*** mm ²				(B)	(T)	(L)
YAZV292NT516FX	550/24 4/0 Weld	—	5/16"	1-3/4"	1.20"	2.00"	.16"	4.62"
YAZ302TC38FX	250 Flex CLASS G 259 Str. CLASS H 427 Str.	—	3/8"	1"	1.20"			.16"
YAZ312TC38FX	637/24	150	3/8"	1"	1.28"	.18"	.18"	4.10"
YAZ312TC14E2FX	CLASS I, K, M		1/4"	3/4"	1.29"			3.66"
YAZ322TC38FX	775/24 313.1 kcmil	185	3/8"	1"	1.55"	2.12"	.19"	1.97"
YAZ342TC14E2FX	373.3 kcmil 925/24 (350 kcmil nom.)	240	1/4"	3/4"	1.55"	2.25"	.23"	4.42"
YAZ342NT38FX			3/8"	1"	0.96"			4.85"
YAZ342TC38FX			3/8"	1"	1.55"			4.85"
YAZ342NTCFX			1/2"	1-3/4"	1.55"			6.04"
YAZ362TC38FX	1100/24 444.4 kcmil	—	3/8"	1"	1.72"	2.69"	.27"	5.55"
YAZ382NT38FX	535.3 kcmil 1325/24 (500 kcmil nom.)	300	3/8"	1"	1.63"	2.81"	.27"	5.72"
YAZ382TC38FX			3/8"	1"	1.81"			6.72"
YAZ382NNTFX			1/2"	1-3/4"	1.63"			
YAZ382NTCFX			1/2"	1-3/4"	1.84"			

† The mm² conductor size listed here is for Class 2 and Class 5 conductor.

♦ For applications greater than 2000 Volts consult cable manufacturer for voltage stress relief instructions.

*** The mm² conductor sizes listed are the recommendations for Class 2 conductor.

(Two Hole HYLUG™ Flex Conductor Long Barrel with Inspection Window Installation Chart on next 2 pages)

45° and 90° lugs are available. For more information, please contact Customer Service: 1-800-346-4175.

TYPE YAZ-FX

**Two Hole HYLUG™ Flex Conductor
Long Barrel with Inspection Window
Installation Chart**



▲ Installation Tooling								
Catalog Number	Dieless (# of crimps)	Mechanical		Hydraulic		Color Code	Die Index	Wire Strip Length
		MD6, OUR840, MD7-34R	BCT500HS, Y500GTHS	Y35, Y39, Y750, Y46*, PAT750				
YAZ8C2TC10FX	Y8MRB-1 (1)							
YAZ8C2TC10E2FX	MY29-11 (2)							
YAZ8C2TC14E1FX	Y1MRTC (2)	W8CVT (2)	W8CVT (2)					
YAZ8C2TC14FX	Y81KFT (1)	W8CRT (2)	W8CRT (2)	U8CRT (2)	Red	49	1"	
YAZ8C2TC14E2FX	Y81KFTMBH (1)	X8CRT (2)	X8CRT (2)					
YAZ8C2TC38FX	PAT81KFT-18V (1)							
YAZV6C2TC10E2FX	MY29-11 (2)							
YAZV6C2TC14FX	Y644HSXT (1)							
YAZV6C2TC14E2FX	Y1MRTC (2)	W5CVT (2)	W5CVT (2)					
YAZV6C2TC14E1FX	Y81KFT (1)	W5CRT (2)	W5CRT (2)	U5CRT (2)	Blue	7	1-3/16"	
YAZV6C2TC38FX	Y81KFTMBH (1)	X5CRT (2)	X5CRT (2)					
	PAT81KFT-18V (1)							
YAZV6C2TC38E2FX	Y1MRTC (2)							
	MY29-11 (2)	W5CVT (2)	W5CVT (2)	U5CRT (2)	Blue	7	1-3/16"	
	Y644HSXT (1)	W5CRT (2)	W5CRT (2)					
	Y81KFT (1)	X5CRT (2)	X5CRT (2)					
YAZV6C2TC38E6FX	Y81KFTMBH (1)							
	PAT81KFT-18V (1)							
YAZV4C2TC38E2-FX	Y1MRTC (4)							
	Y2MR (4)							
YAZV4C2TC38FX	MY29-11 (2)	W4CVT (2)	W4CVT (2)	U4CRT (2)	Gray	8	1-5/16"	
	Y644HSXT (1)	W4CRT (2)	W4CRT (2)					
YAZV4C2TC14FX	Y81KFT (1)	X4CRT (2)	X4CRT (2)					
YAZV4C2TC14E2FX	Y81KFTMBH (1)							
	PAT81KFT-18V (1)							
YAZV2C2TC14FX	Y1MRTC (4)							
	Y2MR (4)							
YAZV2C2TC14E2FX	MY29-11 (2)	W2CVT (2)	W2CVT (2)	U2CRT (2)	Brown	10	1-7/16"	
	Y644HSXT (1)	W2CRT (2)	W2CRT (2)					
YAZV2C2TC38FX	Y81KFT (1)	X2CRT (2)	X2CRT (2)					
	Y81KFTMBH (1)							
	PAT81KFT-18V (1)							
YAZV1C2TC14FX	MY29-11 (2)							
YAZV1C2TC14E1FX	Y644HSXT (1)	W1CVT (2)	W1CVT (2)					
YAZV1C2TC14E2FX	Y81KFT (1)	W1CRT-1 (2)	W1CRT-1 (2)	U1CRT-1 (2)	Green	11	1-7/16"	
YAZV1C2TC38FX	Y81KFTMBH (1)	X1CRT-1 (2)	X1CRT-1 (2)					
YAZV1C2TC516E6FX	Y81KFTMBH (1)							
	PAT81KFT-18V (1)							
YAZV252TC14FX	MY29-11 (2)							
	Y644HSXT (1)	W25VT (4)	W25VT (4)	U25RT (2)	Pink	12	1-9/16"	
YAZV252TC14E2FX	Y81KFT (2)	W25RT (4)	W25RT (4)					
YAZV252TC38FX	Y81KFTMBH (2)	X25RT (4)	X25RT (4)					
	PAT81KFT-18V (2)							
YAZV262TC14FX	MY29-11 (2)							
	Y644HSXT (1)	W26VT (4)	W26VT (4)	U26RT (2)	Black	13	1-9/16"	
YAZV262TC14E2FX	Y81KFT (2)	W26RT (4)	W26RT (4)					
YAZV262TC38FX	Y81KFTMBH (2)	X26RT (4)	X26RT (4)					
	PAT81KFT-18V (2)							
YAZV272TC14E2FX	MY29-11 (2)							
	Y644HSXT (1)	W27VT (4)	W27VT (4)	U27RT (2)	Orange	14	1-9/16"	
YAZV272TC38FX	Y81KFT (2)	W27RT (4)	W27RT (4)					
	Y81KFTMBH (2)	X27RT (4)	X27RT (4)					
	PAT81KFT-18V (2)							

▲ See tooling section of Master Catalog for complete tool and die listings.
* Use PUADP-1 adaptor with "U" -dies in Y46 HYPRESS™.

(Two Hole HYLUG™ Flex Conductor Long Barrel with Inspection Window Installation Chart continued on next page)

45° and 90° lugs are available. For more information, please contact Customer Service: 1-800-346-4175.

TYPE YAZ-FX

**Two Hole HYLUG™ Flex Conductor
Long Barrel with Inspection Window
Installation Chart (Continued)**



▲ Installation Tooling								
Catalog Number	Dieless (# of crimps)	Mechanical		Hydraulic		Color Code	Die Index	Wire Strip Length
		MD6, OUR840, MD7-34R	BCT500HS, Y500GTHS	Y35, Y39, Y750, Y46*, PAT750				
YAZV282TC14E2FX	MY29-11 (2)							
	Y644HSXT (1)	W28VT (4)	W28VT (4)					
YAZV282NT38FX	Y81KFT (2)	W28RT (4)	W28RT (4)	U28RT (2)	Purple	15	1-11/16"	
YAZV282TC38FX	Y81KFTMBH (2)	X28RT (6)	X28RT (6)					
	PAT81KFT-18V (2)							
YAZV292NT516FX	Y644HSXT (1)							
	Y81KFT (2)	W29VT (4)	W29RT (4)	U29RT (2)	Yellow	16	1-11/16"	
	Y81KFTMBH (2)	X29RT (8)	X29RT (8)					
	PAT81KFT-18V (2)							
YAZ302TC38FX	Y644HSXT (1)							
	Y81KFT (2)	W29VT (4)	W29RT (4)	U29RT (2)	Yellow	16	2-1/16"	
	Y81KFTMBH (2)	X29RT (8)	X29RT (8)					
	PAT81KFT-18V (2)							
YAZ312TC38FX	Y644HSXT (1)							
	Y81KFT (2)	W30VT (4)	W30RT (4)	U30RT (4)	White	17	2-1/16"	
	Y81KFTMBH (2)	W30RT (4)	W30RT (4)					
	PAT81KFT-18V (2)							
YAZ322TC38FX	Y644HSXT (1)							
	Y81KFT (2)	W31VT (4)	W31RT (4)	U31RT (4)	Red	18	2-3/16"	
	Y81KFTMBH (2)	W31RT (4)	W31RT (4)					
	PAT81KFT-18V (2)							
YAZ342TC14E2FX	Y644HSXT (1)							
YAZ342NT38FX	Y81KFT (2)	W32VT (4)	W32RT (4)	U32RT (4)	Blue	19	2-5/16"	
YAZ342TC38FX	Y81KFTMBH (2)	W32RT (4)	W32RT (4)					
	PAT81KFT-18V (2)							
YAZ362TC38FX	Y644HSXT (1)							
	Y81KFT (2)	—	—	U34RT (4)	Brown	20	2-3/4"	
	Y81KFTMBH (2)							
	PAT81KFT-18V (2)							
YAZ382NT38FX	Y644HSXT (1)							
YAZ382TC38FX	Y81KFT (2)			U38XRT (4)	Pink	L99	2-7/8"	
YAZ382NNTFX	Y81KFTMBH (2)							
	PAT81KFT-18V (2)							

▲ See tooling section of Master Catalog for complete tool and die listings.
* Use PUADP-1 adaptor with "U" -dies in Y46 HYPRESS™.

45° and 90° lugs are available. For more information, please contact Customer Service: 1-800-346-4175.

TYPE YA-E
E-Line HYLUG™
Equipment Line

Copper and Aluminum
Compression Terminals
UL Listed to 90°C,
600 Volts to 35 kV

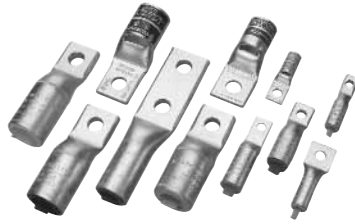

YA-E Equipment terminals are designed to provide replacements for original equipment mechanical or other compression terminals. These narrow tongue terminals are specially designed to fit in tight areas.

Copper E-Line HYLUG™ Compression Terminals

Catalog Number	Wire Size	Bolt Size	Installation Tooling (# of crimps)		
			Dieless	Mechanical MD6, MD7	Hydraulic Y35, Y750, Y46*, PAT750
YA25LN50T14E	1/0 AWG	1/4	Y644HSXT (1) PAT644HS (1)	W25RT (2) W25VT (2)	U25RT (1) U2CABT (1)
YA25LN64T516E	1/0 AWG	5/16	Y81KFT (1)		
YA26LN50T14E	2/0 AWG	1/4	Y81KFTMBH (1) PAT81KFT-18V (1)	W26RT(2) W26VT (2)	U26RT (1)
YA30LN98T516E	300 kcmil	5/16		W30RT (2)	U30RT (2)
YA30L24N100T38E		3/8	Y644HSXT (1) PAT644HS (1)		U28ART (2)
YA342LNN119T12E	500 kcmil	1/2	Y81KFT (2)	—	U34RT (2)
YA342LNN131T12E		1/2	Y81KFTMBH (2)		U31ART (2) P34RT (2)
YA34L6N131T12E		1/2	PAT81KFT-18V (2)		U39RT (2)
YA39L6N131T12E	750 kcmil	1/2			
YA392LNN131T12E					

Aluminum E-Line HYLUG™ Compression Terminals

Catalog Number	Wire Size	Bolt Size	Installation Tooling (# of crimps)		
			Dieless	Mechanical MD6, MD7, Y500CT	Hydraulic Y35, Y750, Y46*, PAT750
YA8CA3S56T14E	8 str.	1/4	Y644HSXT (1)		U8CABT (1)
YA2CA5S53T14E	2 str.	1/4	PAT644HS (1)		U2CABT (1)
YA2CA1S91T516E	2 str.	5/16	Y81KFT (1)		
YA25A1S60T516E	1/0 str.	5/16	Y81KFTMBH (1)		U25ART (1)
YA25A3N69T38E	1/0 str.	3/8	PAT81KFT-18V (1)		
YA27A10S76T516E	3/0 str.	5/16			U27ART (2)
YA28A14N100T516E	4/0 AWG	5/16			U28ART (2)
YA28AN100T38E		3/8	Y644HSXT (1)		
YA30A9N100T516E	300 kcmil	5/16	PAT644HS (1)		
YA30A6N100T38E		3/8	Y81KFT (2)		U30ART (2)
YA30A1N131T12E		1/2	Y81KFTMBH (2)		
YA31A11N100T516E	350 kcmil	5/16	PAT81KFT-18V (2)		
YA31A9N100T38E	350 kcmil	3/8			U31ART (2)
YA32A8N106T516E	400 kcmil	5/16			U32ART (4)
YA34A8N131T38E	500 kcmil	3/8			
YA34A3N131T12E		1/2	Y644HSXT (2)		
YA34A7N131T12E		1/2	PAT644HS (2)		
YA36A9N131TD12E	600 kcmil	1/2	Y81KFT (3)		U34ART (4)
YA36A3N131TD12E	600 kcmil	1/2	Y81KFTMBH (3)		
YA39A5N131TD12E	750 - 900 kcmil	1/2	PAT81KFT-18V (3)		
YA39A1N131TD12E	750 kcmil	1/2			

* Use PUADP-1 adapter with "U" dies in Y46 HYPRESS™, P-RT die sets for use in Y46 HYPRESS™ only. PUADP-1 adapter not required.

**TYPES YBA, YBA-FX,
YBAV-FX, YBA-A**
BREAK-AWAY™ HYLUG™

Copper and Aluminum
Compression Terminals
UL Listed 90° C,
600 Volts to 35 kV

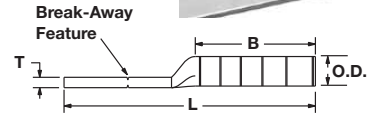
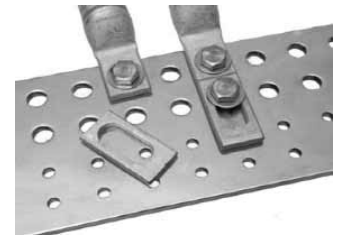

The BREAK-AWAY™ line of Copper and Aluminum HYLUG™ terminals are designed to provide maximum field flexibility by allowing the installer (using the BREAK-AWAY feature) to easily convert two-hole terminals to one-hole terminals to suit the application.

The BREAK-AWAY™ line of terminals encompasses a wide range of features that affords the installer the flexibility in meeting the requirements for challenging projects.

Copper Conductor

Catalog Number	Conductor Size	mm²	Dimensions					
			Stud Hole Spacing	Stud Hole Size	Tongue Width	Figure Dimensions (B) (T) (L)		
YBAV25FX14	1/0 Flex (275/24); 1/0 AWG	50	0.63" to 1.00"	1/4" [6]	.73"	1.50"	.13"	3.69"
YBAV26FX14	2/0 Flex (325/24); 2/0 AWG	70	0.63" to 1.00"	1/4" [6]	.89"	1.50"	.13"	3.74"
YBAV27FX14	3/0 Flex (450/24); 3/0 AWG	95	0.63" to 1.00"	1/4" [6]	.87"	1.50"	.14"	3.78"
YBAV28FX	4/0 Flex (550/24); 4/0 AWG	120	1" to 1.75"	1/2" [12]	.94"	1.62"	.14"	5.24"
YBA29	250 kcmil (Class A & B)	—	1" to 1.75"	1/2" [12]	.96"	1.62"	.16"	5.21"
YBA31FX	250 kcmil (Class I, K & M)	150	1" to 1.75"	1/2" [12]	.96"	2.00"	.18"	5.68"
YBA32FX	313.1 kcmil Flex (775/24)	185	1" to 1.75"	1/2" [12]	.96"	2.12"	.19"	5.85"
YBA34FX	373.7 kcmil Flex (775/24)	240	1" to 1.75"	1/2" [12]	.96"	2.25"	.23"	6.08"

Catalog Number	Dieless	Installation Tooling (# of crimps)				Color Code	Die Index
		MD6, OUR840** MD7-34R	Y500CTHS, BCT500HS, PATMD6	Y35, Y39, Y750, Y46*, PAT750, PAT46*			
YBAV25FX14	MY29 (MY29 platform tools can only be used on Code Conductor), PAT644- & Y644-platforms (1) 4-POINT®	W25VT (4)	W25VT (4)	U25RT (2)	Pink	12 or 348	
YBAV26FX14		X25RT (4)	X25RT (4)				
YBAV27FX14		W25RT (4)	W25RT (4)				
		X26RT (4)	X26RT (4)	U26RT (2)	Black	13	
YBAV28FX	W26RT (4)	W26RT (4)					
	X26RT (4)	X26RT (4)					
YBA29	W27VT (4)	W27VT (4)	U27RT (4)	Orange	14		
	X27RT (4)	X27RT (4)					
YBA31FX	W27RT (4)	W27RT (4)					
	X28RT (6)	X28RT (6)	U28RT (2)	Purple	15		
YBA32FX	W28RT (4)	W28RT (4)					
	W28VT (4)	W28VT (4)					
YBA34FX	W29RT (4)	W29RT (4)	U29RT (2)	Yellow	16		
	W29VT (4)	W29VT (4)					
YBA31FX	W30VT (4)	W30VT (4)	U30RT (4)	White	17 or 298		
	W30RT (4)	W30RT (4)					
YBA32FX	W31VT (4)	W31VT (4)	U31RT (4)	Red	18 or 324		
	W31RT (4)	W31RT (4)					
YBA34FX	W32VT (4)	W34VT (6)	U32RT (4)	Blue	19 or 470		
	W32RT (4)	W34RT (6)					

* Y46 and PAT46 platforms require PUADP-1 adaptor to use "U" dies.

** OUR840 can use X-style dies only.

Dimensions in brackets [] are in mm.

**TYPES YBA, YBA-FX,
YBAV-FX, YBA-A
BREAK-AWAY™ HYLUG™**

(Continued)

Copper and Aluminum
Compression Terminals
UL Listed 90° C,
600 Volts to 35 kV

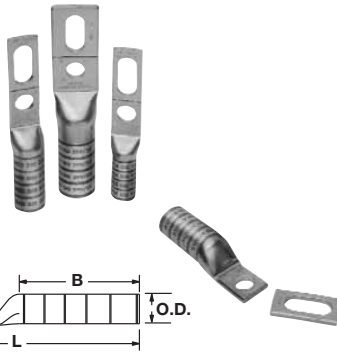

Copper Conductor (Continued)

Catalog Number	Conductor Size	mm ²	Dimensions					
			Stud Hole Spacing	Stud Hole Size	Tongue Width	Figure Dimensions		
						(B)	(T)	(L)
YBA36FX	440 kcmil Flex 444.4 kcmil (1100/24)	—	1" to 1.75"	1/2" [12]	1.47"	2.69"	.27"	6.59"
YBA36FX58			1" to 1.75"	5/8" [16]				
YBA38FX	535.3 Flex (1325/24) 500 kcmil nom.	300	1" to 1.75"	1/2" [12]	1.62"	2.81"	.27"	6.76"
YBA39	750 kcmil (Code Class AA, A & B)	—	1" to 1.75"	1/2" [12]	1.63"	2.88"	.27"	6.87"
YBA44FX	750 kcmil Flex (Class I); 777.7 Flex (1925/24)	500	1" to 1.75"	1/2" [12]	1.62"	3.00"	.32"	7.14"
YBA44FX58			1" to 1.75"	5/8" [16]				

Installation Tooling (# of crimps)

Catalog Number	Dieless	Y35, Y39, Y750, Y46*, PAT750, PAT46*	Color Code	Die Index
YBA36FX	Y644, PAT644 (1), Y81K, PAT81K (2)	U34RT (4)	Brown	20 or 299
YBA36FX58				L99
YBA38FX		U38XRT (4)	Pink	24
YBA39		U39RT (4)	Black	L115
YBA44FX		U44XRT (4)	Yellow	
YBA44FX58				

* Y46 and PAT46 platforms require PUADP-1 adaptor to use "U" dies.
Dimensions in brackets [] are in mm.

**TYPES YBA, YBA-FX,
YBAV-FX, YBA-A
BREAK-AWAY™ HYLUG™**

(Continued)

Copper and Aluminum
Compression Terminals
UL Listed 90° C,
600 Volts to 35 kV

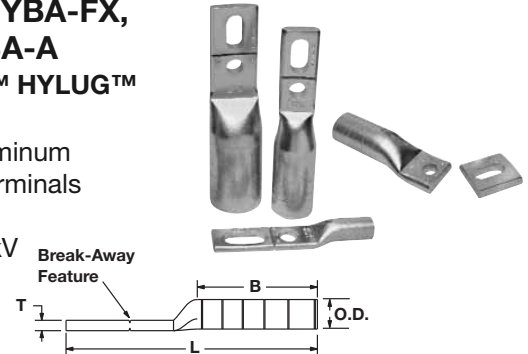

Aluminum Conductor

Catalog Number	Conductor Size (Concentric and Compact)	Dimensions					
		Stud Hole Spacing	Stud Hole Size	Tongue Width	Figure Dimensions		
					(B)	(T)	(L)
YBA25A	1/0	1" to 1.75"	1/2" [12]	1.03"	1.05"	0.17"	4.59"
YBA26A	2/0	1" to 1.75"	1/2" [12]	1.03"	1.17"	0.20"	4.78,,
YBA27A	3/0	1" to 1.75"	1/2" [12]	1.04"	1.31"	0.26"	5.02"
YBA28A	4/0	1" to 1.75"	1/2" [12]	1.17"	1.39"	0.30"	5.19"
YBA29A	250 kcmil	1" to 1.75"	1/2" [12]	1.26"	1.45"	0.33"	5.28"
YBA30A	300 kcmil	1" to 1.75"	1/2" [12]	1.38"	1.53"	0.36"	5.64"
YBA31A	350 kcmil	1" to 1.75"	1/2" [12]	1.52"	1.85"	0.39"	6.07"
YBA32A	400 kcmil	1" to 1.75"	1/2" [12]	1.62"	2.26"	0.43"	6.16"
YBA34A	500 kcmil	1" to 1.75"	1/2" [12]	1.62"	2.34"	0.46"	6.80"
YBA36A	600 kcmil	1" to 1.75"	1/2" [12]	1.31"	2.47"	0.52"	7.09"
YBA39A	700 & 750 kcmil	1" to 1.75"	1/2" [12]	1.62"	2.46"	0.43"	7.07"
YBA44A	1000 kcmil	1" to 1.75"	1/2" [12]	1.65"	2.74"	0.55"	7.76"

† Can only be crimped with PAT46 or Y46 platform tools using the P44ART die.
* Y46 and PAT46 platforms require PUADP-1 adaptor to use "U" dies.
** OUR840 can use X-style dies only.

(BREAK-AWAY™ HYLUG™ Installation Tooling Chart on next page)

**TYPES YBA, YBA-FX,
YBAV-FX, YBA-A
BREAK-AWAY™ HYLUG™
Installation Tooling Chart**



Aluminum Conductor

Installation Tooling (# of crimps)						
Catalog Number	Dieless	Conductor			Color Code	Die Index
		MD6, MD7, OUR840**, MD7-34R	Y500CTHS, PAT60018V, PATMD6	Y35, Y39, Y750, Y46*, PAT750, PAT46*		
YBA25A	MY29 (MY29 platform tools can only be used on Code Conductor), PAT644 & Y644 platforms (1), 4-POINT®	W241 (2) X241 (4)	W241 (2)	U25ART (1)	Tan	296
YBA26A		—	—	U26ART (2)	Olive	297
YBA27A		—	—	U27ART (2)	Ruby	467
YBA28A	Y81K, PAT81K, Y4PC, PAT4PC platforms (2)	W660 (4) X660 (8)	W660 (4)	U28ART (2)	White	298
YBA29A	PAT644 & Y644 platforms (1)	—	—	U29ART (2)	Red	324
YBA30A	4-POINT® Y81K, PAT81K, Y4PC, PAT4PC platforms (2)	—	—	U30ART (2)	Blue	470
YBA31A	PAT644 & Y644 platforms (1), 4-POINT®	—	—	U31ART (2)	Brown	299
YBA32A		—	—	U32ART (4)	Green	472
YBA34A	Y81K, PAT81K, Y4PC, PAT4PC	—	—	U34ART (4)	Pink	300
YBA36A		—	—	U36ART (4)	Black	473
YBA39A	platforms (4)	—	—	U39ART-2 (2)	Yellow	936
YBA44A	Y644MBH (1)	—	—	P44ART† (4)	Brown	302

† Can only be crimped with PAT46 or Y46 platform tools using the P44ART die.
 * Y46 and PAT46 platforms require PUADP-1 adaptor to use "U" dies.
 ** OUR840 can use X-style dies only.

**TYPES YA-2NU, YA-4NU
Blank Tongue HYLUG™**

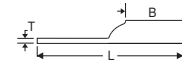

Catalog Number	Conductor		Min. Bolt Hole	Tongue Width	Figure Dimensions		
	AWG	*** mm ²			(B)	(T)	(L)
YA8C2NU	#8 AWG	—	#10	.83"	0.81"	.12"	4.08"
YA6C2NU	#6 AWG	—	#10	.83"	1.12"	.12"	4.40"
YA4C2NU	#4 AWG	—	#10	.83"	1.12"	.12"	4.45"
YA3C2NU	#3 AWG #2 Sol.	25	1/4	.83"	1.25"	.12"	4.62"
YA2C2NU	#2 AWG	35	1/4	.83"	1.25"	.12"	4.64"
YA1C2NU	#1 AWG	50	1/4	.83"	1.38"	.12"	4.82"
YA252NU	1/0 AWG	—	1/4	.83"	1.38"	.11"	4.81"
YA262NU	2/0 AWG	70	1/4	.83"	1.50"	.12"	4.97"
YA272NU	3/0 AWG	—	1/4	.91"	1.50"	.13"	5.01"
YA282NU	4/0 AWG	—	1/4	1.02"	1.62"	.14"	5.17"
YA292NU	250 kcmil	120	1/4	1.11"	1.62"	.16"	5.21"
YA302NU	300 kcmil	150	1/4	1.20"	2.00"	.16"	5.64"
YA312NU	350 kcmil	185	1/4	1.29"	2.00"	.18"	5.68"
YA322NU	400 kcmil	—	3/8	1.40"	2.12"	.19"	5.85"
YA342NU	500 kcmil	240	3/8	1.55"	2.25"	.22"	6.06"
YA362NU	600 kcmil	300	3/8	1.73"	2.69"	.26"	6.59"
YA392NU	750 kcmil	—	3/8	1.91"	2.88"	.26"	6.87"
YA402NU	800 kcmil	400	3/8	1.98"	2.94"	.30"	6.95"
YA442NU	1000 kcmil	500	3/8	2.18"	3.00"	.33"	7.14"
YA452NU	1250 kcmil	—	3/8	2.46"	3.19"	.38"	7.44"
YA462NU	1500 kcmil	800	3/8	2.69"	3.19"	.40"	7.55"
YA472NU ‡	1750 kcmil	—	3/8	2.90"	3.44"	.42"	7.89"
YA482NU ‡	2000 kcmil	1000	3/8	3.10"	3.44"	.46"	7.98"
YA444NU	1000 kcmil	500	3/8	3.00"	3.00"	.23"	7.14"
YA454NU	1250 kcmil	—	3/8	3.00"	3.19"	.30"	7.44"
YA464NU	1500 kcmil	800	3/8	3.00"	3.19"	.34"	7.55"

*** The mm² conductor sizes listed are the recommendations for Class 2 conductor.
 * Use PUADP-1 adaptor with U - dies in Y46 HYPRESS™
 ‡ Requires Y60BHU HYPRESS™
 ** Minimum bolt hole size must be maintained for UL & CSA.

(Blank Tongue HYLUG™ Installation Tooling Chart on next 2 pages)

TYPES YA-2NU, YA-4NU

Blank Tongue HYLUG™
Installation Tooling Chart



▲ Installation Tooling							
Catalog Number	Dieless (# of crimps)	Mechanical	Hydraulic		Color Code	Die Index	Wire Strip Length
		MD6, OUR840, MD7-34R	BCT500HS, Y500CTHS	Y750, Y46*, PAT750			
YA8C2NU	Y1MRTC (2) MY29-11 (1)	W8CRT (1) W8CVT (1) X8CRT (2) W8CVT (1)	W8CRT (1)	U8CRT (1) U8CRT (1)	Red	49	7/8"
YA6C2NU	Y1MRTC (2) MY29-11 (2) MRC840 (2) Y81KFT (1) Y81KFTBMH (1) PAT81KFT-18V (1)	W5CVT (2) W5CRT (2) X5CRT (2) X8CART (2)	W5CVT (2) W5CRT (2) X5CRT (2) X8CART (2)	U5CRT (2) U8CABT (2)	Blue	7	1-3/16"
YA4C2NU	Y1MRTC (4) MY29-3 (2) MY29-11 (2) MRC840 (2) Y644HS (1) Y81KFT (1)	W4CVT (2) W4CRT (2) X4CRT (2)	W4CVT (2) W4CRT (2) X4CRT (2)	U4CRT (2) U6CABT (2)	Gray	8	1-3/16"
YA3C2NU	Y81KFTBMH (1) PAT81KFT-18V (1)	W3CRT (2)	W3CRT (2)	U3CRT (2)	White	9	1-5/16"
YA2C2NU	Y1MRTC (4) MY29-3 (2) MY29-11 (2) MRC840 (2) Y644HS (1) Y81KFT (2) Y81KFTBMH (2) PAT81KFT-18V (2)	W2CVT (2) W2CRT (2) X2CRT (2)	W2CVT (2) W2CRT (2) X2CRT (2)	U2CRT (2)	Brown	10	1-5/16"
YA1C2NU	Y1MRTC (4) MY29-3 (2) MY29-11 (2) MRC840 (2) Y644HS (1) Y81KFT (2) Y81KFTBMH (2) PAT81KFT-18V (2)	W1CVT (2) W1CRT-1 (2) X1CRT-1 (2)	W1CVT (2) W1CRT-1 (2) X1CRT-1 (2)	U1CRT-1 (2) U4CABT (2)	Green	11	1-7/16"
YA252NU	MY29-3 (2) MY29-11 (2) MRC840 (4) Y644HS (1)	W25VT (4) W25RT (4) X25RT (4)	W25VT (4) W25RT (4) X25RT (4)	U25RT (2) U2CABT (2)	Pink	12	1-7/16"
YA262NU	MY29-3 (2) MY29-11 (2) MRC840 (4) Y644HS (1)	W26VT (4) W26RT (4) X26RT (4)	W26VT (4) W26RT (4) X26RT (4)	U26RT (2)	Black	13	1-9/16"
YA272NU	Y81KFT (2) Y81KFTBMH (2) PAT81KFT-18V (2)	W27VT (4) W27RT (4) X27RT (6)	W27VT (4) W27RT (4) X27RT (6)	U27RT (2)	Orange	14	1-9/16"
YA282NU		W28VT (4) W28RT (4) X28RT (6)	W28VT (4) W28RT (4) X28RT (6)	U28RT (2)	Purple	15	1-11/16"

*** The mm² conductor sizes listed are the recommendations for Class 2 conductor.
* Use PUADP-1 adaptor with U -dies in Y46 HYPRESS™
‡ Requires Y60BHU HYPRESS™
** Minimum bolt hole size must be maintained for UL & CSA.

(Blank Tongue HYLUG™ Installation Tooling Chart on next page)

TYPES YA-2NU, YA-4NU

Blank Tongue HYLUG™
Installation Tooling Chart (Continued)



▲ Installation Tooling							
Catalog Number	Dieless (# of crimps)	Mechanical	Hydraulic		Color Code	Die Index	Wire Strip Length
		MD6, OUR840, MD7-34R	BCT500HS, Y500CTHS	Y750, Y46*, PAT750			
YA292NU	MY29-3 (2) MY29-11 (2) Y644HS (1) Y81KFT (2) Y81KFTBMH (2) PAT81KFT-18V (2)	W29VT (4) X29RT (8)	W29VT (4) W29RT (4) X29RT (8)	U29RT (2)	Yellow	16	1-11/16"
YA302NU	Y644HS (1) Y81KFT (3) Y81KFTBMH (3) PAT81KFT-18V (3)	W30VT (4)	W30VT (4) W30RT (4)	U30RT (4) U28ART (4)	White	17	2-1/16"
YA312NU		W31VT (4)	W31VT (4) W31RT (4)	U31RT (4) U29ART (4)	Red	18	2-1/16"
YA322NU		W32VT (4)	W32VT (4) W32RT (4)	U32RT (4) U30ART (4)	Blue	19	2-3/16"
YA342NU	Y644HS (1) Y81KFT (4) Y81KFTBMH (4) PAT81KFT-18V (4)	W34VT (4)	W34VT (4) W34RT (4)	U34RT (4) U31ART (4)	Brown	20	2-5/16"
YA362NU				U36RT (4) U32ART (4)	Green	22	2-3/4"
YA392NU	Y644HS (1) Y81KFT (3) Y81KFTBMH (3)			P39RT (4)**	Black	24	2-15/16"
YA402NU				P40RT (4)	Orange	25	3"
YA442NU				P44RT (4)**	White	27	3-1/16"
YA452NU				P45RT (6)**	Yellow	29	3-1/4"
YA462NU				P46RT (6)**	Green	31	3-1/4"
YA472NU ‡				‡	Gray	33	3-1/2"
YA482NU ‡					Brown	34	3-1/2"
YA444NU				P44RT	White	27	3-1/16"
YA454NU				P45RT	Yellow	29	3-1/4"
YA464NU				P46RT	Green	31	3-1/4"

*** The mm² conductor sizes listed are the recommendations for Class 2 conductor.
* Use PUADP-1 adaptor with U -dies in Y46 HYPRESS™
‡ Requires Y60BHU HYPRESS™
** Minimum bolt hole size must be maintained for UL & CSA.

TYPE YS-L

Butt Splice Standard Barrel

For Copper Cable

Color Coded

UL Listed 90° C

600 Volts to 35 kV ◆



Standard barrel copper compression splices for regular duty applications. Center stop ensures proper insertion of cable. Ideal for limited space applications while providing ample barrel length for proper crimp. Tin-plated. Marked with die index and color code.

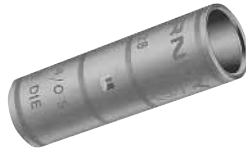

Catalog Number	Conductor		▲ Installation Tooling (# of crimps)		
	Code	Navy	Mechanical HYTOOL™	Hydraulic	Dieless
YS8C-L BOX	8 Str.	N23 (19)	Y8MRB-1, Y1MRTC MY29-3 MY29-11	—	Y81KFT (1) Y81KFTMBH (1) PAT81KFT18V (1)
YS6C-L BOX	6 Str.	—	Y1MRTC	Y644M (1) PAT644 (1)	
YS5C-L BOX	5 Str.	N30 (19)	MY29-3		
YS4C-L BOX	4 Str.	N40 (19)	MY29-11		
YS3C-L	3 Str.	N50 (19)	MY29-3, -11		
YS2C-L BOX	2 Str.	N60 (37)	MY29-3, -11		
YS1C-L BOX	1 Str.	N75 (37)	Y1MRTC MY29-3 or MY29-11 (1)		
YS25-L BOX	1/0 Str.	N100 (61)			
YS26-L BOX	2/0 Str.	N125 (61)	—		
YS27-L BOX	3/0 Str.	N150 (61)			
YS28-L BOX	4/0 Str.	N200 (61)			
YS29-L BOX	250 kcmil	N250 (61)			
YS30-L	300 kcmil	N300 (91)			
YS31-L	350 kcmil	N350 (91)			
YS32-L	400 kcmil	N400 (127)			
YS34-L	500 kcmil	—			
YS36-L	600 kcmil	—			
YS39-L	750 kcmil	—			
YS44-L	1000 kcmil	—			

*** The mm² conductor sizes listed are the recommendations for Class 2 conductor.
◆ For applications greater than 2000 Volts consult cable manufacturer for voltage stress relief instructions.

TYPE YS-L

Butt Splice Standard Barrel

Installation Tooling Chart



Catalog Number	Mechanical		Hydraulic	Color Code	Die Index & Embossment
	MD7-34R	MD6, OUR840	Y35 ■, Y39, Y750, Y46*, PAT750		
YS8C-L BOX	W8CVT (1)	X8CRT (1)	U8CRT (1)	Red	49
YS6C-L BOX	W5CVT (1)	X5CRT (1)	U5CRT (1)	Blue	7 or 374
YS5C-L BOX					
YS4C-L BOX	W4CVT (1)	X4CRT (1)	U4CRT (1)	Gray	8 or 346
YS3C-L	—	—	U3CRT (1)	White	9
YS2C-L BOX	W2CVT (1)	X2CRT (1)	U2CRT (1)	Brown	10
YS1C-L BOX	W1CVT (1)	X1CRT (1)	U1CRT-1 (1)	Green	11 or 375
YS25-L BOX	W25VT (2)	X25RT (2)	U25RT (1)	Pink	12 or 348
YS26-L BOX	W26VT (2)	X26RT (2)	U26RT (1)	Black	13
YS27-L BOX	W27VT (2)	X27RT (2)	U27RT (1)	Orange	14
YS28-L BOX	W28VT (2)	X28RT(2)	U28RT (1)	Purple	15
YS29-L BOX	W29VT (2)	—	U29RT (1)	Yellow	16

▲ See tooling section of this catalog for complete tool and die listings.
* Use PUADP-1 adapter with "U" dies in Y46 HYPRESS™.
** P44RT for use in Y46 HYPRESS™ only, PUADP-1 adapter not required.
■ The maximum size for the Y35 is 400 kcmil insulated code cable.

(Butt Splice Standard Barrel Installation Tooling Chart continued on next page)

TYPE YS-L

Butt Splice Standard Barrel

Installation Tooling Chart (Continued)



Catalog Number	Mechanical		Hydraulic	Color Code	Die Index & Embossment
	MD7-34R	MD6, OUR840	Y35 ■, Y39, Y750, Y46*, PAT750		
YS30-L	W30VT (2)	—	U30RT (2)	White	17 or 298
YS31-L	W31VT (2)	—	U31RT (2)	Red	18 or 324
YS32-L	W32VT (2)	—	U32RT (2)	Blue	19 or 470
YS34-L	W34VT (2)	—	U34RT (2)	Brown	20 or 299
YS36-L	—	—	U36RT (2)	Green	22 or 472
YS39-L	—	—	U39RT (2)	Black	24
YS44-L	—	—	P44RT (2)**	White	27

▲ See tooling section of this catalog for complete tool and die listings.
* Use PUADP-1 adapter with "U" dies in Y46 HYPRESS™.
** P44RT for use in Y46 HYPRESS™ only, PUADP-1 adapter not required.
■ The maximum size for the Y35 is 400 kcmil insulated code cable.

TYPE YS

Butt Splice Long Barrel

For Copper Cable

Color Coded

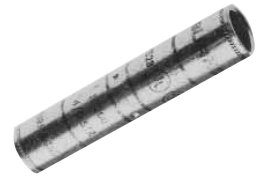
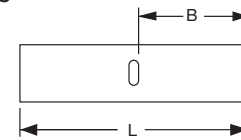

Copper compression splice for heavy-duty applications. Extra barrel length permits additional crimp on all sizes and provides added mechanical strength. Tin-plated. Marked with die index and color code.

Catalog Number	Conductor		Dimensions	
	AWG	***mm ²	L	B
YS8C	8 Str.	10	1.75	.78
YS6C	6 Str.	—	2.38	1.09
YS5C	5 Str.	16	2.55	1.09
YS4C	4 Str.	—	2.55	1.09
YS3C	3 Str./2 Sol.	25	2.80	1.22
YS2C	2 Str.	35	2.82	1.22
YS1C	1 Str.	50	3.07	1.34
YS25	1/0 Str.	—	3.06	1.34
YS26	2/0 Str.	70	3.30	1.45
YS27	3/0 Str.	—	3.30	1.45
YS28	4/0 Str.	—	3.57	1.58
YS29	250 kcmil	120	3.58	1.58
YS30	300 kcmil	150	4.34	1.95
YS31	350 kcmil	185	4.35	1.95
YS32	400 kcmil	—	4.62	2.08
YS34	500 kcmil	240	4.91	2.20
YS36	600 kcmil	300	5.85	2.63
YS39	750 kcmil	—	6.38	2.81
YS44	1000 kcmil	500	6.95	2.94
YS46	1500 kcmil	—	7.01	3.13
YS48	2000 kcmil	—	7.57	3.27

*** The mm² conductor sizes listed are the recommendations for Class 2 conductor.

(Butt Splice Long Barrel Installation Tooling Chart on next page)

TYPE YS

**Butt Splice Long Barrel
Installation Tooling Chart**



▲ Installation Tooling (# of crimps)						
Catalog Number	Dieless	Mechanical		Hydraulic	Color Code	Die Index & Embossment
		MD7-34R	MD6, OUR840	Y35 ■, Y39, Y750, Y46*, PAT750		
YS8C	Y81KFT (1)	W8CVT (2)	X8CRT (2)	U8CRT (2)	Red	49
YS6C	Y81KFTMBH (1)	W5CVT (2)	X5CRT (2)	U5CRT (2)	Blue	7 or 374
YS5C	PAT81KFT-18V (1)	W4CVT (2)	X4CRT (2)	U4CRT (2)	Gray	8 or 346
YS4C		—	—	—	White	9
YS3C	Y81KFT (2) Y81KFTMBH (2) PAT81KFT-18V (2)	W2CVT (2)	X2CRT (2)	U2CRT (2)	Brown	10
YS2C		W1CVT (2)	X1CRT (2)	U1CRT-1 (2)	Green	11 or 375
YS1C		W25VT (4)	X25RT (4)	U25RT (2)	Pink	12 or 348
YS25		W26VT (4)	X26RT (4)	U26RT (2)	Black	13
YS26		W27VT (4)	X27RT (4)	U27RT (2)	Orange	14
YS27		W28VT (4)	X28RT (4)	U28RT (2)	Purple	15
YS28		W29VT (4)	—	U29RT (2)	Yellow	16
YS29		Y81KFT (3)	W30VT (4)	—	U30RT (4)	White
YS30	Y81KFTMBH (3)	W31VT (4)	—	U31RT (4)	Red	18 or 324
YS31	PAT81KFT-18V (3)	W32VT (4)	—	U32RT (4)	Blue	19 or 470
YS32		W34VT (4)	—	U34RT (4)	Brown	20 or 299
YS34	Y81KFT (4) Y81KFTMBH (4) PAT81KFT-18V (4)	—	—	U36RT (4)	Green	22 or 472
YS36		—	—	U39RT (4)	Black	24
YS39		—	—	P44RT (4)**	White	27
YS44		—	—	P46RT (6)**	Green	31
YS46		—	—	L48RT (4) †	Brown	34
YS48		—	—	—	—	—

* Use PUADP-1 adapter with "U" dies in Y46 HYPRESS™.
 ** P44RT and P46RT die sets are for use with Y46 HYPRESS™ only. PUADP-1 adapter not required.
 ▲ The maximum size for the Y35 is 400 kcmil.
 ▲ See tooling section of this catalog for complete tool and die listings.
 † Requires Y60BHU HYPRESS™ with L48RT die set.
Note: All dimensions shown are for reference only.

TYPE YS-FXB

HYLINK™ Splice
 Uninsulated Copper Compression Splice
 Long Barrel-Belled Entry
 UL Listed 90° C
 600 Volts to 35 kV ◆

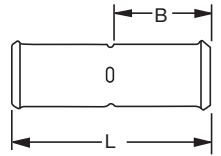

HYLINK™ type YS-FXB splices are designed for heavy duty industrial, petrochemical, telecommunication, utility and commercial applications.

Conductor				
Catalog Number	Flexible Cable Code AWG	Navy	Embossed Die Index	Color Code
YS8C-FXB	8 Str. (37/24) 8 AWG	23	49	Red
YSV6C-FXB	6 Str. (61/24) 6 AWG	30	7	Blue
YS5C-FXB	5 Str. (91/24) 5 AWG	30	7	Blue
YSV4C-FXB	4 Str. (91/24-105/24) 4 AWG	40	8	Gray
YS3C-FXB	3 Str. (105/24-125/24) 3 AWG	50	9	White
YSV2C-FXB	2 Str. (125/24-150/24) 2 AWG	60	10	Brown
YSV1C-FXB	1 Str. (175/24-225/24) 1 AWG	75	11	Green
YSV25-FXB	1/0 Str. (275/24) 1/0 AWG	100	12	Pink
YSV26-FXB	2/0 Str. (325/24) 2/0 AWG	125	13	Black
YSV27-FXB	3/0 Str. (450/24) 3/0 AWG	150	14	Orange
YSV28-FXB	4/0 Str. (550/24) 4/0 AWG	200	15	Purple
YS30-FXB	250 kcmil Flex Class G 259 Str. Class H 427 Sr.	—	16	Yellow
YS31-FXB	263 kcmil (650/24) 250 Flex Class I, K, M		17	White
YS32-FXB	313.1 kcmil (775/24) 300 kcmil nom.		18	Red
YS34-FXB	373.7 kcmil (925/24) 350 kcmil nom.		19	Blue
YS36-FXB	444.4 kcmil (1000/24) 450 kcmil nom.		20	Brown
YS38-FXB	535.3 kcmil (1325/24) 500 kcmil nom.		L99	Pink
YS40-FXB	646 kcmil (1600/24) 600 kcmil nom.		24	Black
YS44-FXB	777.7 kcmil (1925/24) 750 kcmil nom.		L115	Yellow

◆ For applications greater than 2000 Volts consult cable manufacturer for voltage stress relief instructions.
 ** P44RT and P46RT die sets are for use with Y46 HYPRESS™ only. PUADP-1 adapter not required.
 *** The MM2 conductor sizes listed are the recommendations for Class 5 conductor.
 † 16mm2 and 120mm2 referenced are for both Class 2 and Class 5.

(HYLINK™ Splice Installation Tooling Chart on next page)

TYPE YS-FXB

HYLINK™ Splice

Installation Tooling Chart

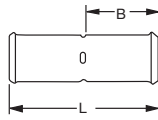

▲ Installation Tooling (# of crimps)					
Catalog Number	Dieless		Y35 ■, Y39, Y750, Y46*, PAT750		
	Mechanical HYTOOL™	Hydraulic HYPRESS™	Embossed Die Index	Color Code	Die Number
YS8C-FXB	MY29-3 (2) MY29-11 (2)	Y81KFT (3) Y81KFTMBH (3) PAT81KFT-18V (3) Y644HSXT (1) Y644MBH (1) PAT644XT-18V (1)	49	Red	U8CRT (2)
YSV6C-FXB	MY29-3 (2) MY29-11 (2)	Y81KFT (1) Y81KFTMBH (1) PAT81KFT-18V (1) Y644HSXT (1) Y644MBH (1) PAT644XT-18V (1)	7	Blue	U5CRT (2)
YS5C-FXB	MY29-3 (2) MY29-11 (2)		7	Blue	U5CRT (2)
YSV4C-FXB	MY29-3 (2) MY29-11 (2)		8	Gray	U4CRT (2)
YS3C-FXB	MY29-3 (2) MY29-11 (2)		9	White	U3CRT (2)
YSV2C-FXB	MY29-3 (2) MY29-11 (2)		10	Brown	U2CRT (2)
YSV1C-FXB	MY29-3 (4) MY29-11 (4)		11	Green	U1CRT-1 (4)
YSV25-FXB	MY29-3 (4) MY29-11 (4)		12	Pink	U25RT (4)
YSV26-FXB	MY29-3 (4) MY29-11 (4)		13	Black	U26RT (4)
YSV27-FXB	MY29-3 (4) MY29-11 (4)		14	Orange	U27RT (4)
YSV28-FXB	MY29-3 (4) MY29-11 (4)		15	Purple	U28RT (4)
YS30-FXB	—		16	Yellow	U29RT (4)
YS31-FXB			17	White	U30RT (4)
YS32-FXB			18	Red	U31RT (4)
YS34-FXB		19	Blue	U32RT (4)	
YS36-FXB		20	Brown	U34RT (4)	
YS38-FXB		—	L99	Pink	U38XRT (4)
YS40-FXB		—	24	Black	U39RT (4)
YS44-FXB	—	L115	Yellow	U44RT (4)	

* Use PUADP-1 adapter with "U" dies in Y46 HYPRESS™.

■ The maximum size for the Y35 is 373.7 kcmil.

▲ See tooling section of this catalog for complete tool and die listings.

Note: All dimensions shown are for reference only.

TYPES YE-P, YE-P-FX

HYPLUG™ For Copper Conductor



Type YE-P copper compression adapters are designed for reliable termination of copper conductor when the current capacity of the conductor is down-sized but larger conductor is utilized. Typical applications are for voltage drop protection. These adapters facilitate the termination into existing mechanical set screw connectors for various stranded copper cables.

Note: Cover is supplied with the connector.

Catalog Number	Accommodates Copper Wire Sizes Flex Cable	Navy	Pin Size Equivalent	Pin Diam.	Color Code
YEV28P46X92FX	4/0 str. (550/24)	200	4/0	0.46" [12]	Purple
Flex Cable Only					
YE34P59X118FX	373.7 kcmil (925/24) (350 kcmil nom.)	—	350 kcmil	0.59" [15]	Blue
YE36P67X134FX	444.4 kcmil (1100/24) (450 kcmil nom.)	—	450 kcmil	0.67" [17]	Brown
YE38P71X142FX	535.3 kcmil (1325/24) (500 kcmil nom.)	—	500 kcmil	0.71" [18]	Pink
YE40P78X156FX	646 kcmil (1600/24) (600 kcmil nom.)	—	600 kcmil	0.78" [20]	Black
YE44P87X174FX	777.7 kcmil (1925/24) (750 kcmil nom.)	—	750 kcmil	0.87" [22]	Yellow
Flex Cable Only					
YE31P46X92FX	262.6 kcmil Flex 250 Flex Class I, K, M	—	4/0	0.46" [12]	White
YE34P55X110FX	373.7 kcmil (925/24) (350 kcmil nom.)	—	300 kcmil	0.55" [14]	Blue
YE36P59X118FX	444.4 kcmil (1100/24) (450 kcmil nom.)	—	350 kcmil	0.59" [15]	Brown
YE38P67X134FX	535.3 kcmil (1325/24) (500 kcmil nom.)	—	450 kcmil	0.67" [17]	Pink
Code Conductor Only AWG					
YE29P46X92	250 kcmil	250	4/0	0.46" [12]	Yellow
YE36P71X142	600 kcmil	—	500 kcmil	0.71" [18]	Green
YE39P78X156	750 kcmil	—	600 kcmil	0.78" [20]	Black
YE29P31X109	250 kcmil	250	1	0.31"	Yellow
YE29P41X82			3/0	0.41" [10]	Yellow
YE30P46X92	300 kcmil	300	4/0	0.46" [12]	White
YE31P50X100	350 kcmil	350	250 kcmil	0.51" [13]	Red
YE32P55X110	400 kcmil	400	300 kcmil	0.55" [14]	Blue
YE34P59X118	500 kcmil	—	350 kcmil	0.59" [15]	Brown
YE36P63X126	600 kcmil	—	400 kcmil	0.63" [16]	Green
YE39P71X142	750 kcmil	—	500 kcmil	0.71" [18]	Black

Dimensions in brackets [] are in mm.

(HYPLUG™ Installation Tooling Chart on next page)

TYPES YE-P, YE-P-FX
HYPLUG™ For Copper Conductor
Installation Tooling Charts



Mechanical Installation Tooling					
Catalog Number	Die Index	Mechanical Tools (# of crimps)			
		MY	Y1MRTC	MD7-34	MD6/MD7
YEV28P46X92FX	15	MY29-11 (2)	—	W28VT (4)	W28RT (2)*
YE34P59X118FX	19	—	—	W32VT (8)	W32RT (8) *
YE36P67X134FX	20	—	—	W34VT (8)	W34RT (8) *
YE38P71X142FX	L99	—	—	—	—
YE40P78X156FX	24	—	—	—	—
YE44P87X174FX	L115	—	—	—	—
YE31P46X92FX	17	—	—	W30VT (8)	W30RT (8)*
YE34P55X110FX	19	—	—	W32VT (8)	W32RT (8)*
YE36P59X118FX	20	—	—	W34VT (8)	W34RT (8)*
YE38P67X134FX	L99	—	—	—	—
YE29P46X92	16	MY29-11 (2)	—	W29VT (1) 4	W29RT (1) 4
YE36P71X142	22	—	—	—	—
YE39P78X156	24	—	—	—	—
YE29P31X109	16	MY29-11 (2)	—	W29VT (4)	W29RT (4)*
YE29P41X82	16	MY29-11 (2)	—	W29VT (4)	W29RT (4)*
YE30P46X92	17	—	—	W30VT (8)	W30RT (8)*
YE31P50X100	18	—	—	W31VT (8)	W31RT (8)*
YE32P55X110	19	—	—	W32VT (8)	W32RT (8)*
YE34P59X118	20	—	—	W34VT (8)	W34RT (8)*
YE36P63X126	22	—	—	—	—
YE39P71X142	24	—	—	—	—

* Requires MD6-6R2 ratchet tool.

Hydraulic Installation Tooling (# of crimps)					
Catalog Number	Y35, Y39, Y750	Y45	Y46	Y60BHU	Y644M
					(Accommodates Expanded Wire Range)
YEV28P46X92FX	U28RT (2)	U28RT (2)	U28RT (2)	—	1 - 4/0 AWG (1)
YE34P59X118FX	U32RT (4)	U32RT (4)	U32RT (4)	L32RT (1)	3/0 AWG - 350 kcmil (1)
YE36P67X134FX	U34RT (4)	U34RT (4)	U34RT (4)	L34RT (2)	4/0 AWG - 450 kcmil (1)
YE38P71X142FX	U38XRT (4)	U38XRT (4)	U38XRT (4)	—	4/0 AWG - 500 kcmil (1)
YE40P78X156FX	U39RT (4)	U39RT (4)	U39RT (4)	L39RT (2)	250 kcmil - 600 kcmil (1)
YE44P87X174FX	U44XRT (4)	U44XRT (4)	U44XRT (4)	—	500 - 750 kcmil (1)
YE31P46X92FX	U30RT (4)	U30RT (4)	U30RT (4)	L30RT (1)	250 kcmil - 1/0 AWG (1)
YE34P55X110FX	U32RT (4)	U32RT (4)	U32RT (4)	L32RT (1)	3/0 AWG - 350 kcmil (1)
YE36P59X118FX	U34RT (4)	U34RT (4)	U34RT (4)	L34RT (2)	4/0 AWG - 450 kcmil (1)
YE38P67X134FX	U38XRT (4)	U38XRT (4)	U38XRT (4)	—	4/0 AWG - 500 kcmil (1)
YE29P46X92	U29RT (2)	U29RT (2)	U29RT (2)	L29RT (2)	1/0 AWG - 250 kcmil (1)
YE36P71X142	U36RT (4)	U36RT (4)	U36RT (4)	L36RT (2)	250 - 600 kcmil (1)
YE39P78X156	U39RT (4)	U39RT (4)	U39RT (4)	L39RT (2)	500 - 750 kcmil (1)
YE29P31X109	U29RT (2)	U29RT (2)	U29RT (2)	L29RT (2)	1/0 AWG - 250 kcmil (1)
YE29P41X82	U29RT (2)	U29RT (2)	U29RT (2)	L29RT (1)	1/0 AWG - 250 kcmil (1)
YE30P46X92	U30RT (4)	U30RT (4)	U30RT (4)	L30RT (1)	2/0 AWG - 300 kcmil (1)
YE31P50X100	U31RT (4)	U31RT (4)	U31RT (4)	L31RT (1)	3/0 AWG - 350 kcmil (1)
YE32P55X110	U32RT (4)	U32RT (4)	U32RT (4)	L32RT (1)	4/0 AWG - 450 kcmil (1)
YE34P59X118	U34RT (4)	U34RT (4)	U34RT (4)	L34RT (2)	4/0 AWG - 500 kcmil (1)
YE36P63X126	U36RT (4)	U36RT (4)	U36RT (4)	L36RT (2)	250 - 600 kcmil (1)
YE39P71X142	U39T (4)	U39RT (4)	U39RT (4)	L39RT (2)	500 - 750 kcmil (1)

Note: All dimensions shown are for reference only.

TYPES AYP, AYPO
HYPLUG™ Adapter
 For Aluminum and Copper Conductors
 UL Listed 90° C
 600 Volts to 35 kV ◆



Straight AYP



Tin-plated aluminum compression adapter prefilled with PENETROX™. Insulating covers eliminate need for taping. UL486B Listed, 90° C rated.

Catalog Number	Aluminum Conductor	Installation Tooling (# of crimps)				Color Code	Die Index & Embossment
		HYTOOL™			Y35, Y39, Y750, Y46*, PAT750		
		Dieless Tools	OH25	MD6			
AYP6	6 Str.	M29-3 (2)	—	—	—	—	—
AYP4	4 Str.	Y644HSXT (1)	—	—	—	—	—
AYP2	2 Str.	Y81KFT (1)	(1)	W241	U25ART (1)	Tan	296
AYP1	1 Str.	Y81KFTMBH (1)	—	—	—	—	—
AYP1/0	1/0 Str.	PAT81KFT-18V (1)	—	—	—	—	—
AYP250	250 kcmil	Y644HSXT (1) Y81KFT (2)	—	—	U31ART (2)	Brown	299
AYP350	350 kcmil	Y81KFTMBH (2) PAT81KFT-18V (2)	—	—	—	—	—
AYP500	500 kcmil	Y644HSXT (1) Y81KFT (2) Y81KFTMBH (2) PAT81KFT-18V (2)	—	—	U34ART (4)	Pink	300
AYP750	700/750 kcmil	Y644HSXT (1) Y81KFT (3) Y81KFTMBH (3) PAT81KFT-18V (3)	—	—	U39ART-2 (4)	Yellow	936

◆ For applications greater than 2000 Volts consult cable manufacturer for voltage stress relief instructions.

* Use PUADP-1 adapter with "U" dies in Y46 HYPRESS™.



Offset AYPO

Catalog Number	Aluminum Conductor	Installation Tooling (# of crimps)			Color Code	Die Index & Embossment
		Y35, Y39, Y750, Y46*, PAT750		Die Number		
		Dieless Tools	Die Number			
AYPO2/0	2/0 Str.	MY29-3 (2) Y644HSXT (1)	—	—	—	—
AYPO3/0	3/0 Str.	Y81KFT (2) Y81KFTMBH (2)	—	U28ART (2)	White	298
AYPO4/0	4/0 Str.	PAT81KFT-18V (2)	—	—	—	—
AYPO250	250 kcmil	Y644HSXT (1)	—	—	—	—
AYPO300	300 kcmil	Y81KFT (2)	—	—	—	—
AYPO350	350 kcmil	Y81KFTMBH (2)	—	—	—	—
AYPO400	400 kcmil	PAT81KFT-18V (2)	—	—	—	—
AYPO500	500 kcmil	—	—	—	—	—
AYPO600	600 kcmil	Y644HSXT (1) Y81KFT (3)	—	—	—	—
AYPO750	700/750 kcmil	Y81KFTMBH (3) PAT81KFT-18V (3)	—	—	—	—

◆ For applications greater than 2000 Volts consult cable manufacturer for voltage stress relief instructions.

* Use PUADP-1 adapter with "U" dies in Y46 HYPRESS™.

TYPE YA-A

HYLUG™ Terminals

One-Hole Uninsulated

Aluminum Compression Terminals

For Aluminum and Copper Conductors

UL Listed 90° C,

600 Volts to 35 kV



Type YA-A aluminum tin plated compression HYLUG™ terminals are dual-rated and designed for use on both aluminum and copper conductors. They are designed for heavy duty applications to 35 kV. YA-A terminals are pre-filled with PENETROX™, and assembled with color-coded end caps.

Catalog Number	Code Conductor	Stud Size	Number of Holes in Pad
YA8CA1	8 Str.	10	1
YA8CA3	8 Str.	1/4	1
YA6CA1	6 Str.	1/4	1
YA4CA1	4 Str.	1/4	1
YA2CA3	2 Str.	3/8	1
YA25A9	1/0 Str.	1/2	1
YA26A1	2/0 Str.	1/2	1
YA28A3	4/0 Str.	1/2	1

▲ Installation Tooling (# of crimps)					
Catalog Number	Dieless		Y35, Y39, Y750, Y46*, PAT750XT-18V		
	Mechanical Tooling	Hydraulic HYPRESS™	Die Number	Color Code	Die Index
YA8CA1	MY29-3 (1)	Y81KFT (1) Y81KFTMBH (1) PAT81KFT-18V (1)	U8CABT (1)	Blue	374
YA8CA3			U6CABT (1)	Gray	346
YA6CA1			U4CABT (1)	Green	375
YA4CA1			U2CABT (1)	Pink	348
YA2CA3			U25ART (1)	Tan	296
YA25A9	MY29-3 (2)	Y81KFT (2) Y81KFTMBH (2) PAT81KFT-18V (2)	U26ART (2)	Olive	297
YA26A1			U28ART (2)	White	298
YA28A3					

▲ See tooling section of this catalog for complete tool and die listings.

TYPE YA-A

HYLUG™ Terminals

Two-Hole Uninsulated

Aluminum Compression Terminals

For Aluminum and Copper Conductors

UL Listed 90° C,

600 Volts to 35 kV



Type YA-A 2- and 4-hole pads inhibit connector rotation and increase area contact. These aluminum terminals have the same design features and benefits as the 1-hole YA-A with an added stud hole for a more secure termination to various types of equipment pads. They are dual-rated for use on both aluminum and copper conductors.

Catalog Number	Code Conductor	Stud Size	Bolt Hole Spacing
YA25A7	1/0 Str.	1/2	1.75
YA26A3	2/0 Str.	1/2	1.75
YA27A5	3/0 Str.	1/2	1.75
YA28A5	4/0 Str.	1/2	1.75
YA29A3	250 kcmil	1/2	1.75
YA30A3	300 kcmil	1/2	1.75
YA31A3	350 kcmil	1/2	1.75
YA34A3	500 kcmil	1/2	1.75
YA36A3	600 kcmil	1/2	1.75
YA39A5	700/750 kcmil	1/2	1.75
YA39AM2	700/750 kcmil	1/2	1.75
YA44A3	1000 kcmil	1/2	1.75
YA46A3	1,500 kcmil	1/2	1.75
YA48A3	2000 kcmil	1/2	1.75

▲ Installation Tooling (# of crimps)					
Catalog Number	Dieless		Y35, Y39, Y750, Y46*, PAT750XT-18V		
	Mechanical Tooling	Hydraulic HYPRESS™	Die Number	Color Code	Die Index
YA25A7	MY29-3 (1)	Y644HSXT (1)	U25ART (1)	Tan	296
YA26A3			U26ART (2)	Olive	297
YA27A5			U27ART (2)	Ruby	467
YA28A5			U28ART (2)	White	298
YA29A3			U29ART (2)	Red	324
YA30A3			U30ART (2)	Blue	470
YA31A3			U31ART (2)	Brown	299
YA34A3			U34ART (4)	Pink	300
YA36A3			U36ART (4)	Black	473
YA39A5			U39ART-2 (4)	Yellow	936
YA39AM2			P39ART (4)**	Red	301
YA44A3			P44ART (4)**	Brown	302
YA46A3			L46ART (2)‡	Red	478
YA48A3			L48ART (2)‡		479

* Use P-UADP-1 Adapter with "U" des in Y46 HYPRESS™.

** Must use Y46.

‡ Must use Y60 BHU HYPRESS™.

▲ See tooling section of this catalog for complete tool and die listings.

TYPE YS-A

HYLINK™ Splice

Uninsulated Aluminum
Compression Splice
UL Listed 90° C,
600 Volts to 35 kV



Type YS-A is a high conductivity aluminum tin-plated compression butt splice for use on all combinations of aluminum to aluminum, aluminum to copper, and copper to copper conductor combinations.

They are designed to accommodate conductors from 12 Str. through 1000 kcmil in standard and heavy duty applications. Prefilled with PENETROX™ oxide inhibiting compounds and assembled with color-coded end caps, the connectors provide a permanent trouble-free electrical splice with flexibility and low installed cost.

Catalog Number	Code Conductor	▲ Installation Tooling (# of crimps per end)					
		Dieless Mechanical HYTOOL™	Y35, Y39, Y750, Y46*, PAT750			Die Index & Embossment	
			Hydraulic HYPRESS™	Die Number	Color Code		
YS8CA1	8 Str.	MY29-3 (1) MRC840AL (1)	Y644HSXT (1) Y81KFT (1)	U8CABT (1)	Blue	374	
YS6CA1	6 Str.		Y81KFTMBH (1)	U6CABT (1)	Gray	346	
YS4CA1	4 Str.		PAT81KFT-18V (1)	U4CABT (1)	Green	375	
YS2CA1	2 Str.		Y644HSXT (1) Y81KFT (2)	U2CABT (1)	Pink	348	
YS1CA1	1 Str.		Y81KFTMBH (2)	U1CART (1)	Gold	471	
YS25A1	1/0 Str.		PAT81KFT-18V (2)	U25ART (1)	Tan	296	
YS26A1	2/0 Str.		MY29-3 (2) MRC840AL (2)	Y644HSXT (1)	U26ART (2)	Olive	297
YS27A1	3/0 Str.			Y81KFT (2)	U27ART (2)	Ruby	467
YS28A1	4/0 Str.			Y81KFTMBH (2)	U28ART (2)	White	298
YS29A1	250 kcmil		MY29-3 (2)	PAT81KFT-18V (2)	U29ART (2)	Red	324
YS30A1	300 kcmil	U30ART (2)		Blue	470		
YS31A1 †	350 kcmil	—	Y644HSXT (1) Y81KFT (4) Y81KFTMBH (4) PAT81KFT-18V (4)	U31ART (2)	Brown	299	
YS32A1	400 kcmil			U32ART (4)	Green	472	
YS34A1	500 kcmil			U34ART (4)	Pink	300	
YS36A1	600 kcmil			U36ART (4)	Black	473	
YS39A1	700 - 750 kcmil			U39ART-2 (4)	Yellow	936	
YS39AM1	700 - 750 kcmil			P39ART** (4)	Red	301	
YS44A1	1000 kcmil			P44ART** (4)	Brown	302	

† 3 crimps only with 4-POINT® tools.

* Use P-UADP-1 Adapter with "U" dies in Y46 HYPRESS™

** P39ART and P44ART for use with Y46 HYPRESS™ only. PUADP-1 adaptor not required.

▲ See tooling section of this catalog for complete tool and die listings.

TYPE YRB

HYREDUCER™ Splice

For Aluminum to Copper and
Aluminum to Aluminum
UL Listed 90° C,
600 Volts to 35 kV

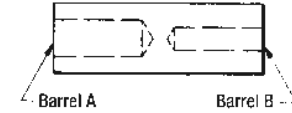

HYREDUCER™ type YRB reducer butt splice is designed to splice two different conductor sizes and is UL Listed for aluminum to copper and aluminum to aluminum applications. The outside diameter is held constant to minimize installation dies and is factory prefilled with PENETROX™.

Catalog Number	Conductor Range Aluminum or Copper Size		Installation Tooling (# of crimps) Hydraulic Tools, Die Sets		
	Barrel A	Barrel B	Y35, Y39, Y750, Y46 *	Color Code	Die Index
YRB2U4	1 - 2 Str.	3 - 4 Str.	U25ART (1)	Tan	296
YRB25U2	1/0 Str.	1 - 2 Str.			
YRB27U25	3/0 Str.	1/0 Str.	U28ART (2)	White	298
YRB27U26	3/0 Str.	2/0 Str.			
YRB28U26	4/0 Str.	2/0 Str.			
YRB29U28	250 kcmil	4/0 Str.	U31ART (2)	Brown	299
YRB31U28	350 kcmil	4/0 Str.			
YRB31U29	350 kcmil	250 kcmil	U34ART (4)	Pink	300
YRB34U31	500 kcmil	350 kcmil			
YRB36U31	600 kcmil	350 kcmil	U39ART-2 (4)	Yellow	936
YRB36U34	600 kcmil	500 kcmil			
YRB39U34	700 - 750 kcmil	500 kcmil			
YRB39U36	700 - 750 kcmil	600 kcmil			

* Use P-UADP-1 Adapter with "U" dies in Y46 HYPRESS™

TYPE YA-A-KIT
Transformer Lug Kit
Connectors



Each kit contains the UL Listed and CSA Certified AL9CU rated aluminum compression connectors and tongue mounting hardware needed to terminate aluminum or copper cables in "dry type" transformers. The KVA rating gives an approximate cross reference to the appropriate kit.

Catalog Number	KVA		Wire Range With Y644HSXT, Y81KFT
YA-A-KIT1	15 - 37.5	1Ø	6 - 2 AWG
	15 - 45	3Ø	2/0 AWG - 300 kcmil
YA-A-KIT2	50 - 75	1Ø	2/0 AWG - 300 kcmil
	75 - 112.5	3Ø	
YA-A-KIT3	100 - 167	1Ø	2/0 AWG - 300 kcmil 500 - 750 kcmil
	150 - 300	3Ø	

TYPE YC-L
Thin-Wall Copper C-Tap



Type YC-L is a thin-wall high conductivity copper connector for making parallel and multiple tap connections. Features range-taking capabilities and easy installation. YC-L connectors are very economical and provide low installation cost.

Catalog Number	Accommodates		Color Key	Installation Tooling (# of crimps)		
	Run	Tap		MD6, OUR840, MD7-34R Die	Y1MRTC	Die Index Embossment
YC8L12	10	10	Blue	W5CVT (1)	Blue (1)	7
	8	12				
YC6L12	8	10 - 8	Gray	W4CVT (1)	Gray (1)	8
	6	12 - 10				
YC4L12	6	8 - 6	Brown	W2CVT (2)	Brown (2)	10
	5, 4	12 - 8				
YC3L12	5, 4	6 - 5	Green	W1CVT (2)	—	11
	3	12 - 6				
YC2L12	4	4	Pink	W25VT (2)	—	12
	3	5				
	2	12 - 6				
YC1L12	3	4 - 3	Black	W26VT (3)	—	13
	2	5 - 4				
	1	12 - 5				
YC25L12	2 str.	2 str. - 2 sol.	Orange	W27VT (3)	—	14
	2 sol.	3 str. - 3 sol.				
	1 str.	4 str. - 4 sol.				
	1 sol.	3 str. - 3 sol.				
	1/0 str.	12 str. - 12 sol.				
1/0 sol.	4 str. - 4 sol.					
YC26L12	1	2 - 1	Purple	W28VT (3)	—	15
	1/0	3 - 2				
	2/0	12 - 3				
YC27L12	1/0	1 - 1/0	Yellow	W29VT (3)	—	16
	2/0	2 - 1				
	3/0	12 - 2				

TYPE YH
H-Tap Copper CRIMPIT™

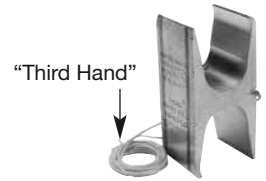

The H style Copper CRIMPIT™ accommodates a wide range of run/tap copper cable combinations. Tap grooves function independently of each other. Use of one tap is required. "Third Hand" constrains conductors while installer completes crimp. "Third Hand" is included with each connector.

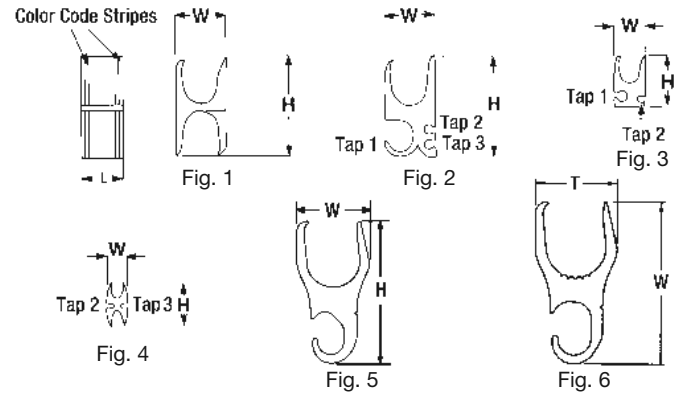

Code Conductor and Metric Equivalent

H-Tap Connector	Kit Catalog Number		Fig.	Conductor Sizes Code/(Flex Cable)			Metric Conductor Sizes (mm²)				
	Flame Retardant Cover	Clear		Main	Tap 1	Tap 2	Tap 3	Main	Tap 1	Tap 2	Tap 3
YH4444	YH4444WCC	YH4444WC	1	1000-750 (750-500)	1000-750 (750-500)	—	—	500-400	500-400	—	—
YH4434*	YH4434WCC*	YH4434WC*	6	(750)	(350)	—	—	500-350 (350 FX)	500-350 (350 FX)	—	—
YH4429	YH4429WCC	YH4429WC	5	1000-750 (777-500)	250-2 (4/0-2)	—	—	500-400	150 - 35	—	—
YH3939	YH3939WCC	YH3939WC	1	750-500 (550-500)	750-350 (550-350)	—	—	300-300	300 - 185	—	—
YH3931	YH3931WCC	YH3931WC	2	750-350 (550-500)	4/0-1/0 (250-1/0)	1-6 Str.-Sol. (1-8)	2-14 (2-14)	300-185	95-70	35-16	35-2.5
YH3434	YH3434WCC	YH3434WC	1	500-250 (350-4/0)	500-4/0 (350-4/0)	—	—	240-150	240-120	—	—
YH3429	YH3429WCC	YH3429WC	2	500-4/0 (350-4/0)	250-1/0 (4/0-1/0)	1-6 Str.-Sol. (1-8)	8-14 (8)	240-120	120-70	35-16	6-2.5
YH2929	YH2929WCC	YH2929WC	1	250-2 (4/0-2)	250-2 (4/0-2)	—	—	120-35	120-35	—	—
YH292C	YH292CWCC	YH292CWC	3	250-2 (4/0-2)	2 Str. - 6 Sol. (2-8)	8-14 (8-14)	—	120-35	35-16	6-2.5	—
YH298C	YH298CWCC	YH298CWC	3	250-2 (4/0-2)	8-14 (8-14)	8-14 (8-14)	—	120-35	6-2.5	6-2.5	—
YH2C2C	YH2C2CWCC	YH2C2CWC	4	2 Str. - 6 Sol. (2 - 8)	6 Sol. (2-8)	8-14 (8-14)	8-14 (8-14)	35-16	35-16	6-2.5	6-2.5
YH6C6C	YH6C6CWCC	YH6C6CWC	1	6-10 (6-10)	6-14 (6-14)	—	—	10-6	10-2.5	—	—
YH8C8C	YH8C8CWCC	YH8C8CWC	1	8-14 (8-14)	8-14 (8-14)	—	—	6-2.5	6-2.5	—	—

* Not CSA approved.
Note: All dimensions shown are for reference only.

(H-Tap Copper CRIMPIT™ Installation Tooling Chart on next page)

TYPE YH

**H-Tap Copper CRIMPIT™
Installation Tooling Chart**

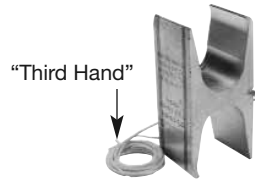

Installation Tooling and Dimensions

Catalog Number	Kit Catalog Number Flame Retardant Cover		▲ Tooling (# of crimps)				▲ Die Index & Embossment	H	W	L	Wire Strip Length	
	Clear	Black	Fig. No.	Y35	Y750	Y46*						Color Code
YH4444	YH4444WCC	YH4444WC	1	—	—	P1102	White	1102	3.38	1.7	1	1/1/8"
YH4434**	YH4434WCC**	YH4434WC**	1	—	—	P1102	White	1102	3.38	1.7	1	1/1/8"
YH4429	YH4429WCC	YH4429WC	5	—	—	PYFR (1)	Yellow	K-R	3.22	1.7	1	1/3/8"
YH3939	YH3939WCC	YH3939WC	1	—	—	PYFR (1)		K-R	2.97	1.5	1.25	1/3/8"
YH3931	YH3931WCC	YH3931WC	2	—	—	PYFR (1)	Brown	K-R	2.97	1.5	0.95	1-1/16"
YH3434	YH3434WCC	YH3434WC	1	—	U1104M (1) U1104 (2)	P1104 (1) U1104M (1)		1104	2.43	1.15	1	1/1/8"
YH3429	YH3429WCC	YH3429WC	2	—	U1104M (1) U1104 (2)	P1104 (1) U1104M (1)	1104	2.23	1.31	1	1/1/8"	
YH2929	YH2929WCC	YH2929WC	1	—	U654 (1)	U654 (1) P654 (1)	Purple	654	1.85	0.9	0.9	1-1/16"
YH292C	YH292CWCC	YH292CWC	3	—	U654 (1)	U654 (1) P654 (1)		654	1.52	0.9	0.9	1-1/16"
YH298C	YH298CWCC	YH298CWC	3	—	U654 (1)	U654 (1) P654 (1)	654	1.52	0.9	0.9	1-1/16"	
YH2C2C	YH2C2CWCC	YH2C2CWC	4	U-C (1)	U-C (1)	U-C (1)	Brown	C	1.25	0.6	0.75	7/8"
YH6C6C	YH6C6CWCC	YH6C6CWC	1	UBGRT (1)	UBGRT (1)	UBGRT (1)	Orange	BG	0.81	0.39	0.6	3/4"
YH8C8C	YH8C8CWCC	YH8C8CWC	1	U11T-1 (1)	U11T-1 (1)	U11T-1 (1)	Green	11	0.63	0.4	0.6	3/4"

▲ See tooling section of Master Catalog for complete tool and die listings.

** Not CSA approved.

* Use PUADP-1 adaptor with "U" dies in Y46.

TYPE CF-FR

H-Tap Flame Retardant Cover

UL Listed to 600 Volts
600 Volt 90° C



Catalog Number	Max. Conductor Accommodated	Matched H Copper CRIMPIT™	Max. Connector Length	Connector Color Code
CFBG-FR	8 AWG	YH8C8C	.65	Green
	6 AWG	YH6C6C		Orange
CFO-FR	2 AWG	YH2C2C	.80	Brown
CFD-FR	250 kcmil	YH292C, YH298C, YH2929	.95	Purple
CFN-FR	500 kcmil	YH3434, YH3429*	1.10	Brown
CFR-FR †	750 kcmil	YH3939, YH3931, YH4429	1.30	Yellow
	1000 kcmil	YH4434, YH4444	1.10	Yellow, White

* Use CFN-FR for single tap installation; use CFR-FR when 2 or more tap conductors are installed.

† Two-piece design packaged together.

Note: All dimensions shown are for reference only.

TYPE CCF-FR

**Clear H-Tap
Flame Retardant Cover**

UL Listed to 600 Volts
600 Volts 90° C

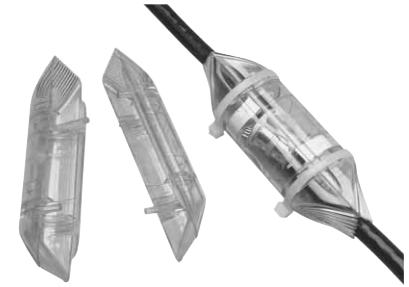

Catalog Number	Max. Conductor Accommodated	Matched H Copper CRIMPIT™	Max. Connector Length	Connector Color Code
CCFBG-FR	8 AWG	YH8C8C	.65	Green
	6 AWG	YH6C6C		Orange
CCFO-FR	2 AWG	YH2C2C	.80	Brown
CCFD-FR	250 kcmil	YH292C, YH298C, YH2929	.95	Purple
CCFDX-FR	250 kcmil	YH2929	.95	Purple
CCFN-FR	500 kcmil	YH3434, YH3429*	1.10	Brown
CCFR-FR	750 kcmil	YH3939, YH3931, YH4429	1.30	Yellow
	1000 kcmil	YH4434, YH4444	1.10	White

* Use CFN-FR for single tap installation; use CFR-FR when 2 or more tap conductors are installed.

Note: All dimensions shown are for reference only.

TYPE HS-FR

**Thin-Wall Heat Shrink
Fire Retardant
Heat Shrink Tubing**
UL Recognized to 600 V



Type HS-FR is a flexible polyvinyl chloride thin-wall heat-shrink. Offering insulating, color identification and strain relieving properties for terminations and splices. The 2:1 shrink ratio allows for faster shrink recovery, covering wire sizes: 16 AWG to 1000 kcmil. UL Recognized, 105° C, 600 V, operating temperatures from -20° C to 105° C with a shrink temperature of 135° C.

How to Order: **B** = Black, **G** = Green, **W** = White, **BLU** = Blue, **R** = Red and **Y** = Yellow (example: HSB18FR).

Catalog Number	I.D. Expanded	I.D. After Recovery	Wall Thickness	Conductor Range		Standard Reel Size (Feet)
				Code	Flex	
HS_18FR	.125	.062	.025	16 - 14	16 - 14	50
HS_18FR250						250
HS_14FR	.25	.125		8 - 12	10 - 12	50
HS_14FR250						250
HS_38FR	.375	.187		6 - 4	8 - 6	50
HS_38FR250						250
HS_12FR	.500	.250		4 - 1	6 - 4	50
HS_12FR250						250
HS_34FR	.750	.375		1/0 - 3/0	2 - 1/0	50
HS_34FR250						250
HS_100FR	1.00	.500	.035	4/0 - 3/0	1/0 - 3/0	25
HS_100FR100						100
HS_112FR	1.50	.750	.040	350 - 750	250 - 500	25
HS_112FR100						100
HS_200FR	2.00	.045	800 - 1000	500 - 750	25	
HS_200FR100					100	

Shrink temperature is 135°C (275°F). For best results, move heat gun along the length of heat shrink to avoid concentrations. To extend useful life, store material below 70°F. For additional Heat Shrinkable Tubing see "URD" section Type RYAC and RK169-2, RK170-2 in this section.

TYPE HSC-FR

**VISI-SHRINK™
Fire Retardant
Clear Heat Shrink Tubing**
UL Listed to 600 V



Type HSC-FR is a flexible polyvinyl chloride clear heat shrink tubing. Excellent flame retardant properties and a 2:1 shrink ratio, the VISI-SHRINK™ tubing enables inspectors to read die index embossments on installed connectors easily. UL Recognized, 105°C, 600V, the operating temperature ranges from -20° C to 105° C with a shrink temperature of 170° C.

Catalog Number	I.D. Expanded	I.D. After Recovery	Wall Thickness	Conductor Range		Standard Reel Size (Feet)
				Code	Flex	
HSC18FR	.125	.062	.025	14 - 16	14 - 16	500
HSC14FR	.25	.125	.025	8 - 12	10 - 12	250
HSC38FR	.375	.187	.025	4 - 6	8	
HSC12FR	.50	.250	.025	1 - 2	4 - 6	150
HSC34FR	.75	.375	.030	3/0-1/0	1 - 2	
HSC100FR	1.00	.50	.035	300 - 4/0	4/0 - 1/0	100
HSC112FR	1.50	.75	.040	750 - 400	500 - 250	
HSC200FR	2.00	1.00	.045	1000 - 800	750 - 500	

TYPE HS-H-PF

Heavy Wall Heat Shrink Tubing
Cross-linked Polyolefin
Cut Lengths and 4 Foot Sticks



Meets MIL-I-23053/5 1000 Volts

Type HS-H-PF is a heavy wall, flame retardant heat shrink tubing made of cross-linked polyolefin. The shrink ratio is 3:1, and the inside diameter is coated with an adhesive sealant to protect against moisture and corrosion. UL486D Listed for direct burial applications. Accommodates 14 AWG-500 kcmil conductors. Operating temperatures from -55° C to 135° C with a shrink temperature of 120° C.

Catalog Number	Length	Nom. Dia. In.	Min. Exp. I.D. In.	Max. Recov. I.D. In.	Nom. Wall Thickness In.	Conductor Range	No. of Pcs. Per Pkg.
HSB35H3PF25	3"	0.35	0.35	0.15	0.07	14 - 10	25
HSB35H6PF25	6"						5
HSB35H48PF5	4'						10
HSB34H6PF10	6"	0.75	0.75	0.22	0.09	6 - 2	10
HSB34H9PF10	9"						5
HSB34H48PF5	4'						5
HSB110H6PF5	6"	1.1	1.1	0.4	0.12	1 - 3/0	5
HSB110H9PF5	9"						5
HSB110H48PF5	4'						5
HSB150H9PF3	9"	1.5	1.5	0.5	0.16	2/0-350	3
HSB150H12PF3	12"						5
HSB150H48PF5	4'						5
HSB200H9PF2	9"	2	2	0.75	0.16	250 - 500	2
HSB200H12PF2	12"						2
HSB200H48PF2	4'						2

Available in Black only.

TYPE HSIC-FR

Heavy Wall Heat Shrinkable End Cap
UL Listed to 600 V



Type HSIC-FR, **Heat Shrink Insulating End Cap Fire Retardant** is a heavy wall, fire retardant end cap made of cross-linked thermally stabilized black polyolefin. Used to insulate exposed conductors in energized applications. The 3:1 shrink ratio offers greater range, accommodating copper wire sizes, 8 AWG through 2500 + kcmil. Performs effectively over lead, aluminum, steel, polyethylene, EPR, and PVC jacketed materials. Blue thermal chromatic lines disappear indicating correct installation temperature and provides inspectability. I.D. adhesive provides superior moisture and weather resistant characteristics.

Catalog Number	600 V Cable Code	Flex	Internal Wall Diameter		Length Thickness Rec.		±20%	
			(Min.) Exp.	(Max.) Rec.	Exp.	±20%	Exp.	Rec.
HSIC8-1FR	8 - 1	8 - 4	.50	.16	.034	.080	3.0	2.50
HSIC4-40FR	4 - 4/0	4 - 2/0	.75	.24	.030	.080	3.0	2.50
HSIC10-500FR	1/0 - 500 kcmil	1 - 313.1 kcmil	1.10	.35	.039	.120	4.0	3.00
HSIC30-1000FR	3/0 - 1000 kcmil	2/0 - 646 kcmil	1.50	.47	.054	.160	4.5	3.25
HSIC200FR	300 - 1750 kcmil	250 - 1111 kcmil	2.00	.63	.050	.160	4.5	3.50
HSIC269FR	600 - 2500 kcmil	—	2.68	.87	.050	.160	5.0	4.00
HSIC350FR	1250 kcmil (min.)	—	3.50	1.18	.051	.160	5.0	4.50

EXPANDED RANGES

The following connectors are range taking when crimped onto code conductor using Y644HSXT family of tools:



COPPER

Copper HYLUG™ & HYLINK™ Connectors Types YA, YA-L, YA-B, YS, YS-L, YST, YS-T, YSP-T			
Catalog Number		Standard Wire Size	Expanded Wire Range
Terminal*	Splice**		
YA6C-	YS6C-	6 AWG	6 AWG
YA5C-	YS5C-	5 AWG	6 - 5 AWG
YA4C-	YS4C-	4 AWG	6 - 4 AWG
YA3C-	YS3C-	3 AWG	6 - 3 AWG
YA2C-	YS2C-	2 AWG	6 - 2 AWG
YA1C-	YS1C-	1 AWG	2 - 1 AWG
YA25-	YS25-	1/0 AWG	1 - 1/0 AWG
YA26-	YS26-	2/0 AWG	1 - 2/0 AWG
YA27-	YS27-	3/0 AWG	1 - 3/0 AWG
YA28-	YS28-	4/0 AWG	1 - 4/0 AWG
YA29-	YS29-	250 kcmil	1/0 AWG - 250 kcmil
YA30-	YS30-	300 kcmil	2/0 AWG - 300 kcmil
YA31-	YS31-	350 kcmil	3/0 AWG - 350 kcmil
YA32-	YS32-	400 kcmil	4/0 AWG - 400 kcmil
YA34-	YS34-	500 kcmil	4/0 AWG - 500 kcmil
YA36-	YS36-	600 kcmil	250 - 600 kcmil
YA39-	YS39-	750 kcmil	500 - 750 kcmil
YA40-	YS40-	800 kcmil	500 - 800 kcmil
YA44-	YS44-	1000 kcmil	750 - 1000 kcmil

* 1 Crimp
** 1 Crimp per side

ALUMINUM

Aluminum HYLUG™ & HYLINK™ Connectors Types YA-A & YS-A			
Catalog Number		Standard Wire Size	Expanded Wire Range
Terminal*	Splice**		
YA6CA-	YS6CA-	6 AWG	6 AWG
YA4CA-	YS4CA-	4 AWG	4 - 6 AWG
YA2CA-	YS2CA-	2 AWG	2 - 6 AWG
YA1CA-	YS1CA-	1 AWG	1 - 2 AWG
YA25A-	YS25A-	1 /0 AWG	1 /0 - 1 AWG
YA26A-	YS26A-	2/0 AWG	2/0 - 1 AWG
YA27A-	YS27A-	3/0 AWG	3/0 - 1 AWG
YA28A-	YS28A-	4/0 AWG	4/0 - 1 AWG
YA29A-	YS29A-	250 kcmil	1/0 AWG - 250 kcmil
YA30A-	YS30A-	300 kcmil	2/0 AWG - 300 kcmil
YA31A-	YS31A-	350 kcmil	3/0 AWG - 350 kcmil
YA32A-	YS32A-	400 kcmil	4/0 AWG - 400 kcmil
YA34A-	YS34A-	500 kcmil	4/0 AWG - 500 kcmil
YA36A-	YS36A-	600 kcmil	250 - 600 kcmil
YA39A-	YS39A-	750 kcmil	500 - 750 kcmil
YA40A-	YS40A-	800 kcmil	500 - 800 kcmil
YA44A-	YS44A-	1000 kcmil	750 - 1000 kcmil

* 1 Crimp
** 1 Crimp per side

EXPANDED RANGES

The following connectors are range taking when crimped onto code & flex conductor using 4-POINT® family of tools:



ALUMINUM CONNECTORS

Aluminum & Copper Conductor (Code & Compact)				
Conductor		Connector		
Wire Size	Expanded Range	Terminal	Splice	Crimps
8 AWG	8 AWG	YA8CA-	YS8CA-	1
6 AWG	6 AWG	YA6CA-	YS6CA-	1
4 AWG	6 - 4 AWG	YA4CA-	YS4CA-	1
2 AWG	6 - 2 AWG	YA2CA-	YS2CA-	2
1 AWG	6 - 1 AWG	YA1CA-	YS1CA-	2
1/0 AWG	6 - 1/0 AWG	YA25A-	YS25A-	2
2/0 AWG	4 - 2/0 AWG	YA26A-	YS26A-	2
3/0 AWG	2 - 3/0 AWG	YA27A-	YS27A-	2
4/0 AWG	1 - 4/0 AWG	YA28A-	YS28A-	2
250 kcmil	1/0 AWG - 250 kcmil	YA29A-	YS29A-	2
300 kcmil	2/0 AWG - 300 kcmil	YA30A-	YS30A-	2
350 kcmil	3/0 AWG - 350 kcmil	YA31A-	YS31A-	3
400 kcmil	4/0 AWG - 400 kcmil	YA32A-	YS32A-	4
500 kcmil	4/0 AWG - 500 kcmil	YA34A-	YS34A-	4
600 kcmil	250 - 600 kcmil	YA36A-	YS36A-	4
750 kcmil	500 - 750 kcmil	YA39A-	YS39A-	4

AYP/AYPO CONNECTORS

Aluminum & Copper (Code & Compact)				
Wire Size	Expanded Range	Pin		Crimps
		Straight	Offset	
6 AWG	6 AWG	AYP6	—	1
4 AWG	4 AWG	AYP4	—	1
2 AWG	4 - 2 AWG	AYP2	—	1
1 AWG	2 - 1 AWG	AYP1	—	1
1/0 AWG	2 - 1/0 AWG	AYP1/0	—	1
2/0 AWG	1 - 2/0 AWG	AYP2/0	AYP02/0	2
3/0 AWG	1/0 - 3/0 AWG	AYP3/0	AYP03/0	2
4/0 AWG	2/0 - 4/0 AWG	AYP4/0	AYP04/0	2
250 kcmil	3/0 - 250 kcmil	AYP250	AYP0250	2
300 kcmil	4/0 - 300 kcmil	AYP300	AYP0300	2
350 kcmil	250 - 350 kcmil	AYP350	AYP0350	2
400 kcmil	350 - 500 kcmil	AYP400	AYP0400	2
500 kcmil	350 - 500 kcmil	AYP500	AYP0500	2
600 kcmil	400 - 600 kcmil	AYP600	AYP0600	3
750 kcmil	500 - 750 kcmil	AYP750	AYP0750	3

(4-POINT® Expanded Ranges Connector Tables continued on next 2 pages)

EXPANDED RANGES (Continued)

The following connectors are range taking when crimped onto code & flex conductor using 4-POINT® family of tools:



COPPER CONNECTORS

Copper Conductor (Code & Compact)							
Conductor		Standard Barrel			Long Barrel		
Wire Size	Expanded Range	Terminal	Splice	Crimps*	Terminal	Splice	Crimps*
8 AWG	8 AWG	YA8CL-	YS8CL-	1	YA8C-	YS8C-	1
6 AWG	6 AWG	YA6CL-	YS6CL-	1	YA6C-	YS6C-	1
4 AWG	6 - 4	YA4CL-	YS4CL-	1	YA4C-	YS4C-	1
2 AWG	6-2	YA2CL-	YS2CL-	1	YA2C-	YS2C-	2
1 AWG	6-1	YA1CL-	YS1CL-	1	YA1C-	YS1C-	2
1/0 AWG	6-1/0	YA25L-	YS25L-	1	YA25-	YS25-	2
2/0 AWG	4 - 2/0	YA26L-	YS26L-	1	YA26-	YS26-	2
3/0 AWG	2 - 3/0	YA27L-	YS27L-	2	YA27-	YS27-	2
4/0 AWG	1 - 4/0	YA28L-	YS28L-	2	YA28-	YS28-	2
250 kcmil	1/0 - 250	YA29L-	YS29L-	2	YA29-	YS29-	2
300 kcmil	2/0 - 300	YA30L-	YS30L-	2	YA30-	YS30-	3
350 kcmil	3/0 - 350	YA31L-	YS31L-	2	YA31-	YS31-	3
400 kcmil	4/0 - 400	YA32L-	YS32L-	2	YA32-	YS32-	3
500 kcmil	4/0 - 500	YA34L-	YS34L-	2	YA34-	YS34-	4
600 kcmil	250 - 600	YA36L-	YS36L-	2	YA36-	YS36-	4
700 kcmil	350-700	YA38L-	YS38L-	3	YA38-	YS38-	4
750 kcmil	500-750	YA39L-	YS39L-	3	YA39-	YS39-	4
800 kcmil	500-800	YA40L-	YS40L-	3	YA40-	YS40-	4
1000 kcmil	750-1000	YA44L-	YS44L-	3	YA44-	YS44-	4

*Same number of recommended crimps for both Standard and Expanded wire ranges.

COPPER CONNECTORS

Copper Conductor (Flex Only)								
Nominal Flex Wire Size		Standard Barrel			Long Barrel			
Expanded Range	Terminal	Splice	Crimps	Expanded Range	Terminal	Splice	Crimps	
8 AWG	8 AWG	YAV8CL-	YSV8CL-	1	8 AWG	YAV8C-	YSV8C-	1
6 AWG	6 AWG	YAV6CL-	YSV6CL-	1	6 AWG	YAV6C-	YSV6C-	1
4 AWG	6 - 4 AWG	YAV4CL-	YSV4CL-	1	6 - 4 AWG	YAV4C-	YSV4C-	1
2 AWG	4-2 AWG	YAV2CL-	YSV2CL-	1	6-2 AWG	YAV2C-	YSV2C-	1
1 AWG	4-1 AWG	YAV1CL-	YSV1CL-	1	4-1 AWG	YAV1C-	YSV1C-	1
1/0 AWG	4-1/0 AWG	YAV25L-	YSV25L-	1	6-1/0 AWG	YAV25-	YSV25-	2
2/0 AWG	2 - 2/0 AWG	YAV26L-	YSV26L-	1	4 - 2/0 AWG	YAV26-	YSV26-	2
3/0 AWG	1 - 3/0 AWG	YAV27L-	YSV27L-	1	2 - 3/0 AWG	YAV27-	YSV27-	2
4/0 AWG	1/0 - 4/0 AWG	YAV28L-	YSV28L-	1	1 - 4/0 AWG	YAV28-	YSV28-	2
250 kcmil	3/0 - 250	YAV29L-	YSV29L-	1	1/0 - 250	YAV29-	YS29-	2
300 kcmil	4/0 - 313.1	YA32L-	YS32L-	1	2/0 - 313.1	YA32-	YS32-	2
350 kcmil	250 - 373.7	YA34L-	YS34L-	1	3/0 - 373.7	YA34-	YS34-	2
450 kcmil	250 - 444.4	YA36L-	YS36L-	1	4/0 - 444.4	YA36-	YS36-	2
500 kcmil	373.7 - 535.3	YA38L-	YS38L-	1	4/0 - 535.3	YA38-	YS38-	2
600 kcmil	373.7 - 600	YA39L-	YS39L-	2	250 - 600	YA39-	YS39-	3
650 kcmil	444.4 - 646	YA40L-	YS40L-	2	373.3 - 646	YA40-	YS40-	3
750 kcmil	535.3 - 777.7	YA44L-	YS44L-	2	535.3 - 777.7	YA44-	YS44-	3

(4-POINT® Expanded Ranges Connector Tables continued on next page)

EXPANDED RANGES (Continued)

The following connectors are range taking when crimped onto code & flex conductor using 4-POINT® family of tools:



COPPER CONNECTORS

E-Line Connectors							
Wire Size		Aluminum			Copper		
Expanded Wire Range	Offset Cat. No.	Center-formed Cat. No.	Crimps	Offset Cat. No.	Center-formed Cat. No.	Crimps	
8 AWG	8 AWG	YA8CA-T-E	—	1	—	—	—
6 AWG	6 AWG	—	—	—	—	—	—
4 AWG	6 - 4	—	—	—	—	—	—
2 AWG	6-2	YA2CA-T-E	YAC2CA-T-E	1	—	—	—
1 AWG	6-1	—	—	—	—	—	—
1/0 AWG	6-1/0	YA25A-T-E	—	1	YA25L-T-E	YAC25L-T-E	1
2/0 AWG	4 - 2/0	YA26A-T-E	—	2	YA26L-T-E	YAC26L-T-E	1
3/0 AWG	2 - 3/0	YA27A-T-E	YAC27A-T-E	2	—	—	—
4/0 AWG	1 - 4/0	YA28A-T-E	—	2	—	—	—
250 kcmil	1/0 - 250	—	—	—	—	—	—
300 kcmil	2/0 - 300	YA30A-T-E	—	2	YA30L-T-E	YAC30L-T-E	2
350 kcmil	3/0 - 350	YA31A-T-E	YAC31A-T-E	2	—	—	—
400 kcmil	4/0 - 400	YA32A-T-E	—	4	—	—	—
500 kcmil	4/0 - 500	YA34A-T-E	—	4	YA34L-T-E	—	2
500 kcmil	4/0-500	—	—	—	YA34L-T-E	—	2
600 kcmil	250 - 600	YA36A-T-E	—	4	YA36L-T-E	—	2
600 kcmil	250 - 600	—	—	—	YA36L-T-E	—	2
700 kcmil	350 - 700	—	—	—	—	—	—
750 kcmil	500 - 750	YA39A-T-E	—	4	YA39L-T-E	—	2
750 kcmil	500 - 750	—	—	—	YA39L-T-E	—	2
800 kcmil	500 - 800	—	—	—	—	—	—
1000 kcmil	750 - 1000	—	—	—	—	—	—

BURNDY® Stainless Steel Dies



BURNDY® now manufactures “W”, “U”, “P”, and “L” type dies in stainless steel. These dies are commonly used in BURNDY® mechanical, ratchet, hydraulic and battery tools.

For generations, tool steel has been the material of choice for dies. Although functional, this required multiple processes including hardening and blackening to ensure durability and rust protection. By switching these dies to stainless steel, the long-term advantages to the end user is that rust is no longer an issue, durability is increased and manufacturing times are reduced from weeks to days.

Additional benefits include laser engraving of the stainless steel dies. The laser engraving is more pronounced making it easier for installers to ensure correct matching of dies and connectors. It also provides better die index embossment for inspectability of each connection after the crimp.

12-TON U DIES*

BURNDY® Die Sets

Fits Y35, Y39, Y750HS, PAT750, Y46
(with PUADP-1 Adapter)

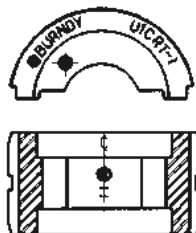

U die case Part **PT29291**, holds up to 15 dies

Wire Size	Copper	Aluminum
8	U8CRT	U8CABT
6	U5CRT	U6CABT
4	U4CRT	U4CABT
3	U3CRT	N/A
2	U2CRT	U2CABT
1	U1CRT-1	U1CART
1/0	U25RT	U25ART
2/0	U26RT	U26ART
3/0	U27RT	U27ART
4/0	U28RT	U28ART
250 kcmil	U29RT	U29ART
300 kcmil	U30RT	U30ART
350 kcmil	U31RT	U31ART
400 kcmil	U32RT	U32ART
500 kcmil	U34RT	U34ART
535 Flex kcmil	U38XRT	N/A
600 kcmil	U36RT	U36ART
750 kcmil	U39RT	U39ART-2
777 Flex	U44XRT	N/A

* Non-tension U-type 12-ton dies for YA, YS, YA-A, YS-A style connectors.
Note: N/A = Not Applicable.

W DIES

BURNDY® Die Sets

Fits Tools MD6, MD7, Y500CTHS,
PAT600-18V, PATMD6 Series

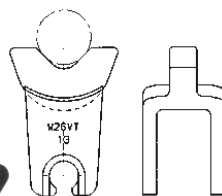

W die case Part **CASEWDIES**, holds up to 24 dies

Wire Size	Copper	Aluminum
8	W8CVT	X8CART
6	W5CVT	W161
4	W4CVT	W162
3	W3CRT	N/A
2	W2CVT	W239
1	W1CVT	W163
1/0	W25VT	W241
2/0	W26VT	W245
3/0	W27VT	W166
4/0	W28VT	W660
250	W29VT*	N/A
300	W30VT*	N/A
350	W31VT*	W31ART*
400	W32VT*	N/A
500	W34VT*	N/A

* These sizes (250-500) for Y500CTHS, MD7-34(R), PAT600-18V, PATMD6 Series.
Note: N/A = Not Applicable.

Suitable for use on YA, YS, YA-A, YS-A type non-tension connectors.

UDIEKITCU, UDIEKITAL,

UDIEKITHYGRD

BURNDY® U Die Kits



Each UDIEKITCU and UDIEKITAL die kit includes 15 sets of “U” dies and the PT29291 die case. These stainless steel color coded dies are for crimping BURNDY® YA, YS, YA-A and YS-A type HYLUG™ and HYLINK™ color coded terminals and splices ranging from #6 AWG through 750 kcmil.

The UDIEKITHYGRD kit includes eight die sets. Seven dies sets are used to install the BURNDY® HYGROUND® irreversible compression grounding connectors, and the U2CABT die set for pre-crimping 1/2", 5/8" and 3/4" ground rods for increased rotational resistance.

BURNDY® “U” dies are used in the Y35, Y39, Y750 series, PAT750-18V series, Y46, and PAT46-18V (with PUADP-1 adapter) tools.

UDIEKITHYGRD Includes
Catalog Number
UC
UO
U997
PU998
U1011
U1104
U1105
U2CABT (Ground rod pre-crimp die)
PT29291 (Die case)

UDIEKITCU Includes		UDIEKITAL Includes	
Copper Wire Size	Catalog Number	Aluminum Wire Size	Catalog Number
#6 AWG	U5CRT	#6 AWG	U6CABT
#4 AWG	U4CRT	#4 AWG	U4CABT
#2 AWG	U2CRT	#2 AWG	U2CABT
#1 AWG	U1CRT-1	#1 AWG	U1CART
1/0 AWG	U25RT	1/0 AWG	U25ART
2/0 AWG	U26RT	2/0 AWG	U26ART
3/0 AWG	U27RT	3/0 AWG	U27ART
4/0 AWG	U28RT	4/0 AWG	U28ART
250 kcmil	U29RT	250 kcmil	U29ART
300 kcmil	U30RT	300 kcmil	U30ART
350 kcmil	U31RT	350 kcmil	U31ART
400 kcmil	U32RT	400 kcmil	U32ART
500 kcmil	U34RT	500 kcmil	U34ART
600 kcmil	U36RT	600 kcmil	U36ART
750 kcmil	U39RT	750 kcmil	U39ART-2
Die Case	PT29291	Die Case	PT29291

INSTALLATION TOOLING SYSTEM

Installation Tooling System														
Conductor		Lugs & Splices One & Two Hole Run=Tap			T&B Index* Code (Flex)	Taps Thin-Wall C-Taps Run=Tap, AWG Only			Taps Heavy Duty C-Taps Run=Tap			Taps H-Taps Run=Tap		
AWG	Flex	Die	Color	Index	(Flex)	Die	Color	Index	Die	Color	Index	Die	Color	Index
8/6 sol.	8	W8CVT U8CRT	Red	49	21	W4CVT	Gray	8	U240	Red	240	U11T-1	Green	11
6	6	W5CVT U5CRT	Blue	7	24	W2CVT	Brown	10	UC	Brown	C	UBGRT	Orange	BG
4	4	W4CVT U4CRT	Gray	8	29	W25VT	Pink	12	UC	Brown	C	UC	Brown	C
3/2 sol.		W3CRT U3CRT	White	9		W26VT	Black	13	UC	Brown	C	UC	Brown	C
2	2	W2CVT U2CRT	Brown	10	33	W27VT	Orange	14	UC	Brown	C	UC	Brown	C
1	1	W1CVT U1CRT-1	Green	11		W28VT	Purple	15	U997	Orange	997	U654	Purple	654
1/0	1/0	W25VT U25RT	Pink	12	42 (45)	W29VT	Yellow	16	U997	Orange	997	U654	Purple	654
2/0	2/0	W26VT U26RT	Black	13	45 (50)		Refer to Catalog		U997	Orange	997	U654	Purple	654
3/0	3/0	W27VT U27RT	Orange	14					U997	Orange	997	U654	Purple	654
4/0	4/0	W28VT U28RT	Purple	15	54 (62)	—	—	—	U997	Orange	997	U654	Purple	654
250	4/0/250 class G & H	W29VT U29RT	Yellow	16		—	—	—	U997	Orange	997	U654	Purple	654
300	262/250 class I, K & M	W30VT U30RT	White	17		—	—	—	U1104	Brown	1104	U1104	Brown	1104
350	313	W31VT U31RT	Red	18	71	—	—	—	U1104	Brown	1104	U1104	Brown	1104
	350/ 373	W32VT U32RT	Blue	19		—	—	—	U1104	Brown	1104	U1104	Brown	1104
500	444	W34VT U34RT	Brown	20	87	—	—	—	U1104	Brown	1104	U1104	Brown	1104
	500/ 535	U38XRT	Pink	L99		—	—	—	P1103	Blue	1103	PYFR	Yellow	KR
600		U36RT	Green	22	(99)	—	—	—	P1103	Blue	1103	PYFR	Yellow	KR
700		U38RT	Pink	400		—	—	—	P1103	Blue	1103	PYFR	Yellow	KR
750	646	U39RT	Black	24	106	—	—	—	P1103	Blue	1103	PYFR	Yellow	KR
	750/ 777	U44XRT	Yellow	L115										
800		P40RT	Orange	25	(115)	—	—	—	P1102	White	1102	PYFR	Yellow	KR
1000		P44RT	White	27		—	—	—	P1102	White	1102	PYFR	Yellow	KR

*Die sets with a dash CK are not UL Listed. Please consult factory for further information.

Bolt Equivalent	
Unified Inch Hole Size	Metric Equivalent
1/4"	M6
5/16"	M8
3/8"	M10
1/2"	M12
5/8"	M16

YF-TOOL

**Installation Ratchet Tool
for Bare and Insulated Ferrules**
For Use On Copper Ferrules



YF4/0250TOOL

These tools have been specifically designed to work with ferrule types.

Catalog Number	Capacity
YF3206TOOL	32-6 AWG
YF2610TOOL	26-10 AWG
YF2214TOOL	22-14 AWG
YF2210TOOL	22-10 AWG
YF1006TOOL	10-6 AWG
YF0801TOOL	8-1 AWG
YF0401TOOL	4-1 AWG
YF/03/0TOOL	1/0-3/0 kcmil
YF4/0250TOOL	4/0-250 kcmil



YF2214TOOL has one groove to accept 22-14 AWG range.



YF2610TOOL, YF2210TOOL, and YF1006TOOL have multiple grooves for range capacity.

Y10D

Plier Type HYTOOL™

Combination Crimping and Cutting Tool

Features and Benefits

- Two tools in one, both a crimper and a cutter
- Saves time and money with only one tool needed to install both nylon insulated and bare connectors
- Installs 22 - 10 AWG nylon and bare terminals and splices
- Heavy-duty forged steel for durability and long life
- Recommended BURNDY® terminals and splices are UL Listed and CSA Certified when installed using the Y10D
- 5-year limited warranty

Specifications

- Weight: 13.5 oz.
- Length: 9-3/4"
- Conductor Range: 22-10 AWG



Y10-22**Plier Type HYTOOL™**

Combination Crimper, Cutter and Stripper

Features and Benefits

- Comfort grip handles fit hands comfortably making the tool easy to use.
- Crimps full range of insulated terminals and splices 22 - 10 AWG
- Crimps full range of uninsulated terminals and splices 22 - 10 AWG
- Full range insulation strippers for wire sizes 22 - 10 AWG
- Cut off dies for common size mild steel and non-ferrous screws
- 5-year limited warranty

Specifications

- Weight: 11 oz.
- Length: 8-5/8"
- Conductor Range: 22-10 AWG

**MR15, MR18, MR20****HYTOOL™**

Full Cycle Ratchet Hand Tools

Features and Benefits

- Heavy-duty forged steel frame
- Full cycle ratchet to assure properly crimped connectors and splices
- Comfort grip handles
- Compact, narrow nose to work in confined areas
- Easy groove identification with color coded dies
- Recommended terminals and splices are UL Listed
- 5-year limited warranty

Specifications

- Weight: 1.10 lbs.
- Length: 8.86"
- Width Open: 5.90"
- Width Closed: 2.50"
- Conductor Range: 22 - 10 AWG

**Y1MR-TC****HYTOOL™**

Full Cycle Ratchet Hand Tool

Features and Benefits

- Molded comfort grips reduce fatigue during continuous use
- Ratchet mechanism assures a complete crimp every time
- Emergency release mechanism allows tool to be opened in case of mistaken die choice or to reposition tool
- Rotating die is color coded to match color coding on connectors
- Die index embossment allows permanent inspectability of installed connectors to ensure consistently reliable and dependable connections
- 5-year limited warranty

Specifications

- Weight: 13.5 oz.
- Length: 9-3/4"
- Width: .73"
- Conductor Range: 8-1 Code Conductor
2 solid & 3 stranded
8-2 Class 1 Flex
Up to 6-6 (Brown)
YC-L Type C-TAP

**Y1MRTCKIT**

Kit Contains:

- Y1MRTC Full-Cycle Ratchet Tool
- Sturdy Metal Carrying Case
- Terminals:
 - YA2C2TC38, YA2CL2TC14,
 - YA2CL2TC38, YA3C2TC38,
 - YA4CL2TC14, YA4CL2TC38,
 - YA6C2TC38, YA6CL2TC14,
 - YA6CL2TC14E1, YA6CL2TC14E2,
 - YA6CL2TC38, YA8CL2TC14,
 - YA8CL2TC38, YAV6CL2TC14E2FX,
 - YAV6CL2TC14
- Thin-Wall C-Taps: YC4L12

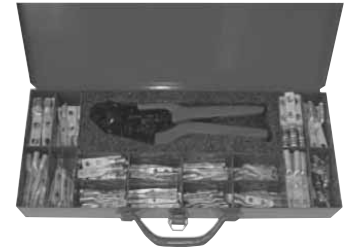
**OUR840****HYTOOL™**

Full Cycle Hand Held Ratchet Tool

Features and Benefits

- One hand, full cycle ratchet tool for Cu, Al, and ACSR
- Great for use in tight spaces where other tools can't fit
- 8 - 4/0 Al and 8 - 250 Cu terminals and splices on code conductor
- W28K cutter die permits use of tool as a cable cutter
- Uses reduced handle force on "X" dies and select "W" dies
- Proper crimps are assured with full cycle ratchet mechanism
- UL Listed connections when color coded dies are used to install recommended BURNDY® terminals and splices
- 5-year limited warranty

Specifications

- Weight: 2 lbs. 14 oz.
- Length: 13"
- Max. Crimp Force: 8,000 lbs.
- Max. Handle Force: 8 lbs. approx.
- Conductor Range: 8 - 4/0 AWG Al
8 - 250 kcmil Cu



MY28, MY29 SERIES HYTOOL™

Dieless Mechanical Tools

Features and Benefits

- High quality rugged design manufactured from heavy duty forged steel with reinforced back and handles
- Covered handles available
- Knurled steel adjusting knob
- Quick and easy nest die adjustment for each connector/conductor combination
- Installs a wide range of HYDENT™ connectors from 8 - 250 kcmil Cu, 8 - 4/0 Al cable, and 3/0-250 Navy cable
- UL Listed connections when color coded dies are used to install recommended BURNDY® terminals and splices
- 5-year limited warranty

Specifications

- Weight: 8 lbs. approx.
- Length: 22.65"
- Depth: 4.86"
- Width: 1.12"
- Conductor Range: 8 - 250 kcmil Cu
8 - 4/0 AWG Al
3/0 - 250 kcmil Navy Cable



MRC840, MRC840AL HYTOOL™

Mechanical Rotating Die Crimp Tool

#8 - 4/0 AWG Non-Insulated Copper and Aluminum Terminals and Splices

Features and Benefits

- Comfort grip handles.
 - ◇ Aids in prevention of hand slippage.
 - Reduces fatigue during continuous use.
- Heat treated steel jaws
 - ◇ Reduces jaw buckling and misalignment under heavy loading.
- Approximately 9,000 crimp cycle life.
 - ◇ Lasts longer than imitations and will still be working when others have worn out.
- Multiple grip selections on rotatable die wheels.
 - ◇ No lost dies, 9 position color-coded rotatable die wheels.
- High strength fasteners.
 - ◇ Increase tool life by reducing tool wear.
- Plated jaws.
 - ◇ Provide enhanced corrosion protection.
- Engraved crimp groove (Die index number).
 - ◇ Die index embossment allows permanent inspectability of installed connectors to ensure consistently reliable and dependable connections.
- 5-year limited warranty.

Specifications

- Weight: 8-1/4 lbs.
- Length: 26"
- Height: 8"
- Conductor range: 8-4/0 AWG Cu

For Use On

MRC840 #8 - 4/0 AWG Copper Terminals and Splices (YA, YA-L, YS, YS-L)

MRC840AL #8 - 4/0 AWG Aluminum Terminals and Splices (YA-A, YS-A)



MCC500, MCC1000 Manual Cable Cutters

Features and Benefits

- High-quality design and construction for easy cutting with minimal cable distortion and long life
- Fiberglass handles with soft grips provide comfortable tool operation
- Rugged high-quality steel blades
- 5-year limited warranty (excluding blades)

Specifications

- | | MCC500 | MCC1000 |
|---------------------|---|------------|
| • Weight: | 3.5 lbs. | 9.0 lbs. |
| • Length: | 21" | 32" |
| • Cutting Capacity: | 500 kcmil
Copper & Aluminum Cable Only | 1000 kcmil |



RCC556, RCC1000

Ratchet Type Cable Cutters

Features and Benefits

- Bi-directional ratchet mechanism provides positive control of blade movement
- Thumb-controlled rapid blade movement provides quick closing or opening of blades when not cutting
- Fiberglass handles with soft grips provide comfortable tool operation
- Stiffener bar on the RCC556 for operator safety when cutting ACSR
- 5-year limited warranty (excluding blades)

Specifications

- | | RCC556 | RCC1000 |
|---------------------|----------------------------------|----------------------------|
| • Weight: | 4 lbs. | 4.5 lbs. |
| • Length: | 21" | 32" |
| • Cutting Capacity: | 500 kcmil
Cu & Al
556 ACSR | 1000 kcmil
Cu & Al only |



RCC600, RCC750HD

Ratchet Type Cable Cutters

Features and Benefits

- Patented high strength steel blades
- Quick release, bi-directional ratchet mechanism
- Rapid blade advance
- Easy cutting with minimal cable distortion
- Excellent cutting edge performance
- Provides comfortable tool operation and long life
- 1-year limited warranty (excluding blades)

Specifications

- | | RCC600 | RCC750HD |
|---------------------|----------------------|----------------------|
| • Weight: | 1.27 lbs. | 2.43 lbs. |
| • Length: | 10" | 10.5" |
| • Cutting Capacity: | 600 kcmil
Cu & Al | 750 kcmil
Cu & Al |



Y500CT-HS L'IL CRIMP™

6-Ton Hand Operated Hydraulic Tool

Features and Benefits

- Light weight latch head design provides enhanced clearance for tap connectors
- 180° head rotation allowing user to crimp in tight spaces
- Audible pressure “pop-off” valve indicates completed crimp
- Permanent “D3” crimp groove accepts all BURNDY® “W” and “X” dies
- High speed ram advance provides faster crimps with less hand strokes
- Handle trigger drain for ram retraction
- 5-year limited warranty

Specifications

- Weight: 7.8 lbs.
 - Length: 17.6”
 - Height: 6”
 - Output Force: 6 (U.S.) tons
 - Total strokes: 7 (w/o connector)
- Installs splices, taps and terminations:
- 8 - 600 kcmil Cu
 - 8 - 350 kcmil flexible cable
 - 8 - 350 kcmil Al

**Y35, Y35-2****HYPRESS™**

12-Ton Hand Operated Hydraulic Tool

Features and Benefits

- Compact “C” shaped head allows easy placement and removal from continuous conductor lengths
- 180° head rotation
- Rapid ram advance reduces installation time by eliminating need to pump handles
- Trigger controlled ram return
- 5-year limited warranty

Specifications

- Weight (less case): 13 lbs.
- Force developed: 12 tons
- Operating pressure: 10,000 psi
- Length: 23-1/4”
- Head width: 4-3/4”
- Conductor range: 8 - 750 kcmil Al/Cu
ACSR—See BURNDY® Master Catalog

**Y750HSXT, Y750CHSXT
HYPRESS™**

12-Ton Hand Operated Hydraulic Tool

Features and Benefits

- Covers a wide range of applications with a light-weight, self-contained system and “C” shaped head with a wide 1.65” opening
- Easy tool positioning with its 355° head rotation
- Patented rapid advance pump for faster crimps
- Handle trigger drain for convenient ram retraction
- Quality assurance is provided with an audible “pop-off” pressure relief valve
- Exposed die lock buttons for easy die change and retention
- Comfort grip handles help ease operator fatigue with continuous use
- Rubber covered head and handles on Y750CHSXT for tool impact protection
- Supplied with high impact plastic carrying case
- 5-year limited warranty

Specifications

- Weight (less case): 14.5 lbs
- Force developed: 12 tons
- Operating Pressure: 10,000 psi
- Length: 23.5”
- Width: 8.0”
- Jaw opening: 1.65”
- Conductor range: 8 - 750 kcmil Al/Cu
4 - 556.5 kcmil ACSR

**Y644HSXT****Dieless HYPRESS™**

11-Ton Hand Operated Hydraulic Tool

Features and Benefits

- Dieless system, eliminates the need to purchase and maintain dies
- Range taking capabilities require only five connectors to cover the entire range
- Patented rapid advance pump for faster crimps
- Handle trigger drain for convenient ram retraction
- 355° head rotation for versatile tool head positioning in tight areas
- Quality assurance is provided with an audible “pop-off” pressure relief valve
- Comfort grip handles help ease operator fatigue with continuous use
- Easy inspection and positive identification is provided with the BURNDY® logo
- 5-year limited warranty

Specifications

- Weight (less case): 15 lbs.
- Force developed: 11 tons
- Operating pressure: 8,800 psi
- Length: 22.5”
- Height: 2.75”
- Width: 8.0”
- Conductor range: 6 - 1000 kcmil Cu
6 - 750 kcmil Al



**4-POINT® Y81KFT,
Y4PC834****Dieless HYPRESS™**

Hydraulic Hand Operated
Crimping Tool

Features and Benefits

- Dieless installation system. Eliminates the need to purchase and maintain dies
- UL Listed and CSA Certified with range taking capabilities
- Audible pressure “pop-off” valve and die embossment providing 360° inspectability
- Y81KFT flip-top head design for easy loading and removal of installed terminals and splices, saving time
- Handle trigger release, convenient ram release located in the handle
- Advanced high speed pump design provides fast crimps, longer life, efficiency and reliability
- 360° head rotation lets user get into tight areas easier
- Durable High Impact Formed carrying case
- 5-year limited warranty

Specifications

- Weight: 12 lbs.
- Height: 7.7”
- Length: 25.6”
- Width: 2.5”
- Output Force: 6 tons
- Conductor range: 8 - 1000 kcmil Cu
8 - 750 kcmil Al



Y81KFT

Y4PC834

**Y35BH
HYPRESS™**

12-Ton Remote Power Operated
Hydraulic Tool

Features and Benefits

- C-shaped head for easy tool removal on continuous conductors
- Easily lifted into working position using the lifting eye
- Mates with universal type hot-stick tooling
- Quick disconnect hydraulic fitting
- 5-year limited warranty

Specifications

- Weight (less case): 8 lbs.
- Force developed: 12 tons
- Operating pressure: 10,000 psi
- Head width: 4-3/4”
- Head height: 9-1/4”
- Conductor range: 8 - 750 kcmil Al/Cu
ACSR—See BURNDY® Master Catalog

**Y750BHXT
HYPRESS™**

12-Ton Remote Power Operated
Hydraulic Tool

Features and Benefits

- Uses all BURNDY® U-Dies
- Covers a wide range of applications
- Provides easy tool removal from continuous conductors with its C-shaped head
- Large 1.65” jaw opening
- Y750CBHXT provides molded rubber covering on head body and fitting
- Infinitely rotatable head
- 5-year limited warranty

Specifications

- Weight (less case): 10.3 lbs.
- Force developed: 12 tons
- Operating pressure: 10,000 psi
- Head width: 5.20”
- Jaw opening: 1.65”
- Conductor range: 8 - 750 kcmil Al/Cu
4 - 556 kcmil ACSR

**Y644MBH
Dieless HYPRESS™**

11-Ton Remote Power Operated
Hydraulic Tool

Features and Benefits

- Dieless system eliminates the need to purchase dies
- Easy tool positioning with its infinitely rotatable head
- Easy inspection and positive identification is provided with the BURNDY® logo
- H-CRIMPIT™ dies to crimp YFO and YFD type taps
- 5-year limited warranty

Specifications

- Weight (less case): 9-1/2 lbs.
- Force developed: 11 tons
- Operating Pressure: 10,000 psi
- Head Width: 3.93”
- Height: 12”
- Conductor range: 6 - 1000 kcmil Al/Cu



**4-POINT® Y81KFTMBH,
Y4PC834MBH**

Dieless HYPRESS™

Remote Operated Crimping Tools

Features and Benefits

- Dieless installation system. Eliminates the need to purchase and maintain dies
- UL Listed and CSA Certified with range taking capabilities provides the installer with UL Listed and CSA Certified crimps when used in conjunction with BURNDY® HYLINK™ Terminals and HYLINK™ Splices
- Y81KFTMBH flip-top head design for easy loading and removal of installed terminals and splices, saving time
- 5-year limited warranty

Specifications

- Weight: 8.5 lbs.
- Height: 7.7"
- Length: 13.9"
- Width: 5.4"
- Output Force: 6 tons
- Operating Pressure: 10,000 psi
- Conductor range: 8 - 1000 kcmil Cu
8 - 750 kcmil Al



Y81KFTMBH

Y4PC834MBH

**Y46, Y46C
HYPRESS™**

15-Ton Remote Operated Hydraulic Tool

Features and Benefits

- Integral "T" slot prevents jamming on asymmetrical connectors
- Uses "P" dies and standard "U" dies with the PUADP-1 adapter
- 15 Ton output force with any 10,000 psi hydraulic pump
- The Y46C has a permanently molded rubber head and rubber boot to cover the hydraulic coupler
- Excellent for HYGROUND® installations
- Compression terminal, tap and splice connectors are UL Listed and CSA Certified when using BURNDY®'s recommended die set.
- 5-year limited warranty

Specifications

	Y46	Y46C
• Weight (less case):	16 lbs.	17-1/2 lbs.
• Force developed:	15 tons	15 tons
• Operating Pressure:	10,000 psi	10,000 psi
• Length:	15"	21-3/4" (Incl. Boot)
• Width:	4-1/2"	4-3/4"
• Jaw Opening:	2"	2"
• Molded Covering:	No	Yes
• Conductor range:	8 - 1500 kcmil Cu 8 - 1250 kcmil Al ACSR—See BURNDY® Master Catalog	



Y46

Y46C

Y46OEM11T

11 Ton HYPRESS™

Remote Operated Hydraulic Tool

Features and Benefits

- Provides same crimp profile as Y644.
 - ◊ Provides a UL Listed connection when used with BURNDY® HYDENT™
- "1" Crimp technology
 - ◊ Faster installations due to less crimps required
- Safety, strength and high quality
 - ◊ Tool is made from strong forged steel and precision machined components
- Die set designed as part of a system
 - ◊ The BURNDY® Engineered System allows for visual inspectability with each crimp — look for the BURNDY® BUG "⊖"
- P644 die set is affixed to tool
 - ◊ No need to change dies as this range taking nest and indenter die covers #6 AWG through 750 kcmil

Specifications

Operating Pressure	7,300 PSI
Force Developed	11 Tons
Weight	34.5 lbs
Length:	14.00"
Width:	10.00"
Height:	12.25"

Not to be used with 10,000 PSI operating pressure. Ensure only 7,300 PSI is used for this 11 ton output force tool.



Y46OEM12T

12 Ton HYPRESS™

Features and Benefits

- Crimp head is mounted at a 45-degree angle to provide visibility to the work area
- Accepts BURNDY® "U" dies for both Copper and Aluminum
- BURNDY® tool, die and connectors are part of the BURNDY® Engineered System allowing for visual inspectability with each crimp — look for the BURNDY® BUG "⊖"
- Safety, strength and high quality design is assured with this forged steel tool and precision machined components
- Operating tool at 8,800 PSI input pressure increases life of tool and decreases wear
- Accessories available to make crimping safer and faster
- Quality assurance is provided with an audible "pop-off" valve indicating crimp completion

Specifications

Operating Pressure	8,800 PSI
Force Developed	12 Tons
Weight	34.5 lbs
Length:	14.00"
Width:	10.00"
Height:	12.25"



RHCC10

Remote Head Cutter

The BURNDY® RHCC10 series C-head cutter is an innovative compact cutting tool that allows users to interchange different cutting blades customized for their application. With a “C”-shaped style head and large opening, it’s easy to scoop and cut without the need to open or close a latch. The RHCC10 blade alignment technology ensures a clean cut and maximum blade life.

The RHCC10 series tool accommodates four different interchangeable blade types: HCCACSR, HCCSOL, HCCCUAL, and HCCGUY. The RHCC10 series tool comes in a variety of options to include a covered version (RHCC10C), and the ability to order the tool with specific blades only.



Blade Table		
Blade Catalog Number	Cutting Material	Max OD
HCCACSR	ACSR	1590 kcmil
HCCCUAL	Cu & Al	1.5" (38 mm)
HCCSOL	Ground Rod	3/4" (19 mm)
	Rebar	5/8" (16 mm)
	Soft Steel Bolts	5/8" (16 mm)
HCCGUY	Std. Guy Wire	9/16" (14 mm)
	EHS Guy Wire	9/16" (14 mm)

Components Each Tool Is Provided With					
Catalog Number	Covered Tool	ACSR Blade Set	CUAL Blade Set	SOL Blade Set	GUY Blade Set
RHCC10		X	X	X	X
RHCC10C	X	X	X	X	X
RHCC10ACSR		X			
RHCC10CUAL			X		
RHCC10SOL				X	
RHCC10GUY					X
RHCC10CACSR	X	X			
RHCC10CCUAL	X		X		
RHCC10CSOL	X			X	
RHCC10CGUY	X				X

RHCC245CUAL

10,000 PSI Remote Power Operated Hydraulic Cable Cutter

Features and Benefits

- Specialized latch head design, interference free closure for mid-span cuts
- Precision cutting blades, cut copper and aluminum up to 2.45"
- Lightweight ergonomic design allows one hand operation, user has one hand free to manipulate material to be cut
- Durable canvas carrying bag provides tool protection and stores all accessories
- Customer satisfaction and support
- 5-year limited warranty on tool (excluding blades)

Specifications

- Weight: 8.3 lbs
- Operating Pressure: 10,000 psi
- Length: 14.8"
- Width: 4.75"
- Cutting Capacity: 2.45" O.D. Cu/Al Cable



RHCC129ACSR

10,000 PSI Remote Power Operated Hydraulic Cable Cutter

Features and Benefits

- Specialized latch head design, interference free closure for mid-span cuts
- Precision cutting blades, for clean cuts on Cu/Al, ACSR, ground rods, rebar, guy strand, and soft steel bolts
- High strength steel cylinder for durability and long life
- Lightweight ergonomic design allows one hand operation, user has one hand free to manipulate material to be cut
- Durable canvas carrying bag, provides tool protection and stores all accessories
- Customer satisfaction and support
- 5-year limited warranty on tool (excluding blades)

Specifications

- Weight: 5.85 lbs
- Operating Pressure: 10,000 psi
- Length: 11.25"
- Width: 3.7"
- Cutting Capacity: Copper Cable: up to 1.29"
Aluminum Cable: up to 1.29"
ACSR: up to 1113 ACSR
Ground Rod: up to 5/8"
Rebar: up to 1/2"
Soft Steel bolts: up to 5/8"
Standard Guy strand: up to 1/2"
EHS Guy strand: up to 3/8"



PATRIOT® PATHCC10-18V Series

Battery Actuated Hydraulic
Self-Contained Cutter

The BURNDY® PATHCC10-18V series C-head cutter is an innovative compact and mobile cutting tool that allows users to interchange different cutting blades customized for their application. With a “C”-shaped style head and large opening, it’s easy to scoop and cut without the need to open or close a latch. The tool head swivels 355° and comes with a retractable assist handle to help maneuver the cutting head into position. The PATHCC10-18V blade alignment technology ensures a clean cut and maximum blade life.

Specifications

- Tool Weight: 20.4 lbs
- Length: 21.4”
- Width: 3.7”
- Height: 12.8”
- Operating Voltage: 18V
- Recharge Time: < 45 minutes

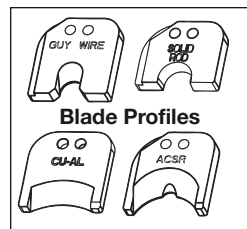

Tool Catalog Number	Blade Provided
PATHCC10-18V	HCCACSR, HCCGUY, HCCSOL, HCCCUAL
PATHCC10ACSR-18V	HCCACSR
PATHCC10GUY-18V	HCCGUY
PATHCC10SOL-18V	HCCSOL
PATHCC10CUAL-18V	HCCCUAL
PATHCC10*	None

*The PATHCC10 is an economical solution for those customers already set up with batteries and chargers. The PATHCC10 is strictly the tool and carrying case; it does not include blades, batteries or a charger. Order blades separately.

Blade Table		
Catalog Number	Cutting Material	Max. O.D.
HCCACSR	ACSR	1590 kcmil
HCCCUAL	Cu & Al	1.5" (38 mm)
HCCSOL	Ground Rod	3/4" (19 mm)
	Rebar	5/8" (16 mm)
	Soft Steel Bolts	5/8" (16 mm)
HCCGUY	Std. Guy Wire	9/16" (14 mm)
	EHS Guy Wire	9/16" (14 mm)

PATRIOT® PATCUT245CUAL-18V ‡

Battery Actuated Hydraulic
Self-Contained Cutter Tool

Features and Benefits

- Battery powered cutting technology, easy tool operation and portability
- Advance design high-speed pump completes tough cuts faster, longer life, efficiency, and reliability
- Specialized latch head design, interference free closure for mid-span cuts
- Ergonomic design allows one hand operation, user has one hand free to manipulate material to be cut
- 180° head rotation, versatile head positioning allows user to get into tight areas easier
- Mechanical ram release (no battery power consumption)
- 18-volt Ni-MH battery eliminates voltage depression (memory issues)
- Durable high impact formed carrying case, provides tool protection and stores all accessories
- 5-year limited warranty on tool (excluding blades)
- 1-year warranty on batteries and charger

Specifications

- Weight: 14.5 lbs.
- Height: 14.75”
- Length: 18”
- Width: 3.75”
- Operating Voltage: 18 V-DC
- Recharge Time: < 45 mins.
- Cutting Capacity: up to 2.45” O.D. Cu/Al Cable

‡ For Copper and Aluminum Cable only. **Do Not cut steel, ground rod, rebar, or guy wire.**



PATRIOT® PATCUT129ACSR-18V

Battery Actuated
Hydraulic Self-Contained
Cutter Tool

Features and Benefits

- Battery powered cutting technology, easy tool operation and portability
- Advance design high-speed pump completes tough cuts faster. Longer life, efficiency, and reliability
- Specialized latch head design interference free closure for mid-span cuts
- Ergonomic design allows one hand operation, user has one hand free to manipulate material to be cut
- 180° head rotation, versatile head positioning allows user to get into tight areas easier
- Mechanical ram release (no battery power consumption)
- 18-volt Ni-MH battery eliminates voltage depression (memory issues)
- Durable high impact formed carrying case. Provides tool protection and stores all accessories
- 5-year limited warranty on tool (excluding blades)
- 1-year warranty on batteries and charger

Specifications

- Weight: 11 lbs.
- Height: 13.5”
- Length: 14.5”
- Width: 3.5”
- Operating Voltage: 18 V-DC
- Recharge Time: < 45 mins.
- Cutting Capacity: Copper Cable: up to 1.29”
Aluminum Cable: up to 1.29”
ACSR: up to 1113 ACSR
Ground Rod: up to 5/8”
Rebar: up to 1/2”
Soft Steel bolts: up to 5/8”
Standard Guy strand: up to 1/2”
EHS Guy strand: up to 3/8”



PATRIOT® HIGH PERFORMANCE PAT750-LI

Lithium-Ion Battery Actuated
Hydraulic Self-Contained
12-Ton Crimping Tool



Features and Benefits

- Refined hydraulic system for ultra performance, speed and reliability
- Field proven electronics for ultimate reliability in the harshest environments
- Overmolded handle for comfort and improved grip; allows for one-handed operation for advance, retract, and hold
- 18 volt Lithium-Ion batteries provide 2.5 times more charge/discharge cycles than traditional Ni-Cd batteries and provide 430% more lifetime work
- 30-minute charger controls current, voltage & temperature to maximize battery life. Forced air cooling fan cools the battery by forcing cool air through the battery's built-in air vents
- State of the art crimping head design, 355° head rotation lets user get into tight areas easier
- Allows use of standard BURNDY® dies already in use
- Ergonomically balanced tool design eases operation
- Durable high impact formed carrying case provides superior protection and stores all accessories
- PAT750C-LI with rubber covered head is available
- 5-year limited warranty on tool
- Lifetime warranty on INFINITY DRIVE®
- 1-year warranty on batteries and charger

Specifications

- Weight: 15.7 lbs.
- Height: 13.5"
- Length: 15.75"
- Width: 3.5"
- Operating Voltage: 18 V-DC
- Recharge Time: 30 mins.

PATRIOT® HIGH PERFORMANCE PAT750XT-18V

Battery Actuated
Hydraulic Self-Contained
12-Ton Crimping Tool



Features and Benefits

- True, one-handed operation for advance, retract and hold
- 12 ton output force
- State-of-the-art crimping head design, 360° head rotation
- Ergonomically balanced tool design
- Durable High Impact Formed carrying case
- PAT750CXT-18V—with rubber covered head is available
- 18V Ni-MH battery eliminates voltage depression (memory issues)
- 5-year limited warranty on tool
- 1-year warranty on battery and charger

Specifications

- Weight: 16.5 lbs.
- Height: 13.5"
- Length: 15.75"
- Width: 3.5"
- Operating Voltage: 18 V-DC
- Recharge Time: < 45 mins.

PATRIOT® PAT46-LI

Lithium-Ion Battery Actuated
Hydraulic Self-Contained
15-Ton Crimping Tool



Features and Benefits

- BURNDY's largest battery actuated crimp tool providing 15-tons of output force with a 2" jaw opening
 - ◇ Allows users to install largest variety of splices, taps and terminals with one tool and provides easy placement and removal from continuous conductor lengths
- Redesigned field proved electronics
 - ◇ Provides the ultimate reliability in the harshest work environments
- Overmolded ergonomic handle
 - ◇ For comfort and improved grip; allows for one handed operation for advance, retract, and hold
- 18-volt (3.0 AH) Li-Ion batteries
 - ◇ Batteries provide 2.5 times more charge/discharge cycles than traditional Ni-Cd batteries and 430% more lifetime work
 - ◇ Less "down-time" due to high capacity (3.0 AH), 18 volt Li-Ion battery
 - ◇ No voltage depression (memory issues)
- 30-minute smart charger
 - ◇ Controls current, voltage and temperature to maximize battery life
 - ◇ Forced air cooling fan cools the battery by forcing cool air through the battery's built-in air vents
- State of the art C-Head crimp design with 355° head rotation
 - ◇ Versatile tool head positioning lets user get into tight areas easier
- Retractable assist handle under head of tool for better handling of tool
 - ◇ Allows for better balance of tool and retractable for getting head into tight areas
- Durable high impact formed carrying case
 - ◇ Provides superior protection and stores all accessories
- PAT46C-LI with rubber covered head is available
- 5-year limited warranty on tool
- Lifetime warranty on INFINITY DRIVE®
- 1-year warranty on batteries and charger

Specifications

- Weight: 25.5 lbs.
- Height: 14.43"
- Length: 20.77"
- Width: 3.70"
- Operating Voltage: 18 V-DC
- Recharge Time: 30 mins.

NOTE: The Ni-MH PATRIOT® PAT46-18V is still available.

FORCEGAUGE12-15 Force Test Gauge

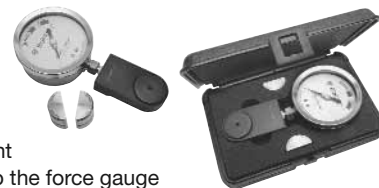

Features and Benefits

- Custom "U" die blanks with detent
 - ◇ Provides secure aligned fit onto the force gauge
- Accommodates 12 ton or 15 ton tools
 - ◇ Just one gauge can accommodate a larger family of tools
- Custom Carry Case
 - ◇ Protects the gauge, "U" die blanks and SOMI in a durable, compact polymer based case

Specifications

Gauge

- Length: 8.3"
- Width: 4.3"
- Height: 1.5"
- Weight: 2.7 lbs

Kit

- Weight: 4.5 lbs

For Use On

The following series of tools: PAT46*, PAT750, BAT750, Y750 and Y35

* The BURNDY® PUADP-1 adaptor will be required to accommodate the "U" die blanks in the 15 ton PAT46 tool.

PATRIOT® HIGH PERFORMANCE PAT644-LI

Lithium-Ion Battery Actuated
Hydraulic Self-Contained
11-Ton Dieless Crimping Tool



Features and Benefits

- Refined hydraulic system for ultra performance, speed and reliability
- Field proven electronics for ultimate reliability in the harshest environments
- Overmolded handle for comfort and improved grip; allows for one-handed operation for advance, retract, and hold
- 18-volt Lithium-Ion batteries provide 2.5 times more charge/discharge cycles than traditional Ni-Cd batteries and provide 430% more lifetime work
- 30-minute charger controls current, voltage & temperature to maximize battery life. Forced air cooling fan cools the battery by forcing cool air through the battery's built-in air vents
- Dieless system eliminates the need to purchase and maintain dies
- Dieless system allows connectors and splices to become range taking
- State of the art crimping head design, 355° head rotation lets user get into tight areas easier
- Ergonomically balanced tool design eases operation
- Durable high impact formed carrying case provides superior protection and stores all accessories
- 5-year limited warranty on tool
- Lifetime warranty on INFINITY DRIVE®
- 1-year warranty on batteries and charger

Specifications

- Weight: 16.3 lbs.
- Height: 14.1"
- Length: 15.6"
- Width: 3.2"
- Operating Voltage: 18 V-DC
- Recharge Time: 30 mins.

PATRIOT® PAT644XT-18V

Battery Actuated
Self-Contained
11-Ton Hydraulic Tool



Features and Benefits

- Dieless system eliminates the need to purchase dies
- True one-handed operation for advance, retract and hold
- 11 tons of output force
- Ni-MH battery eliminates voltage depression (memory issues)
- Audible "pop-off" and green light indicator indicates completion of crimp
- State-of-the-art crimping head design, 360° head rotation
- 5-year limited warranty on tool
- 1-year warranty on battery and charger

Specifications

- Weight: 17 lbs.
- Height: 14"
- Length: 14.9"
- Width: 3.7"
- Output Force: 11 (U.S.) tons
- Operating Voltage: 18 V-DC
- Recharge Time: < 45 mins.

For Use On

- Copper terminals and splices 6 - 1000 kcmil
- Aluminum terminals and splices 6 - 750 kcmil

PATRIOT® IN-LINE® PATMD6-14V Series

Battery Actuated
Hydraulic Self-Contained
6-Ton Crimping Tool



Features and Benefits

- True, one-handed operation for advance, retract, and hold
- 6 ton output force for reliable compression connections
- Pressure "pop-off" valve indicates completion of crimp
- Interchangeable scissor action crimp jaws allow easier access to tight spaces
- Allows the use of standard BURNDY® "W" and "X" dies already in use
- Large hand grip area allows easier operation with gloves
- Ergonomically balanced tool design helps lessen operator fatigue
- Durable High Impact Formed carrying case
- High capacity 2.6 AH batteries
- 14.4 volt Ni-MH battery eliminates voltage depression (memory issues)
- 3-year limited warranty on tool
- 1-year warranty on batteries and charger

Specifications

- Weight: 7.8 lbs with battery
- Height 5.48"
- Length: 20.91"
- Width: 3.69"
- Operating Voltage: 14.4 V-DC
- Output force: 6 tons
- Recharge Time: < 45 minutes

PATRIOT® IN-LINE® Variations:

PATMD6-14V: Permanent "BG" and "D3" grooves

PATMD6-8-14V: Permanent "O" and "D3" grooves

PATMD6-6-14V: "Snub-Nose" version with permanent "D3" groove

PATMD6-K-14V: Accepts KEARNEY™ "O" type dies and BURNDY® "W" and "X" dies with KWADP adapter.

PATRIOT® PAT600-18V

6-Ton Battery Actuated
Hydraulic Self-Contained Tool

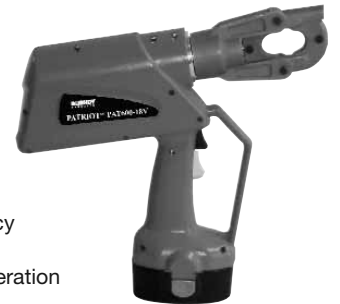

Features and Benefits

- Battery powered crimp technology, easy tool operation and portability
- High speed pump completes crimp in approx. 3 seconds, longer life, efficiency and reliability
- Ergonomic design allows one hand operation for ram advance and ram retraction
- Variable speed trigger provides flexibility in speed of ram advance
- Ram holds position when trigger is released, provides ability to hold the connector between dies and check for proper alignment prior to crimping action
- Mechanical ram release (no battery power consumption)
- Specialized latch head design provides enhanced clearance on tap connectors when compared with competitive designs
- Permanent "D3" groove accepts all "W" and "X" dies
- 5-year limited warranty on tool
- 1-year warranty on batteries and charger

Specifications

- Weight: 10.9 lbs.
- Height: 13.75"
- Length: 14.5"
- Width: 3.5"
- Crimp Force: 6 (U.S.) tons
- Operating Voltage: 18 V-DC
- Crimp Time: Approx. 3 seconds
- Recharge Time: <45 mins.
- Installs splices, taps and terminations: 8 - 600 kcmil Cu
8 - 350 kcmil Flex
8 - 350 kcmil Al

**4-POINT® PATRIOT®
PAT81KFT-18V,
PAT4PC834-18V**
Battery Actuated
Hydraulic Self-Contained
6-Ton Crimping Tools

Features and Benefits

- Dieless installation system, eliminates the need to purchase and maintain dies
- UL Listed and CSA Certified with range taking capabilities
- Audible pressure “pop-off” valve and die embossment providing 360° inspectability
- Battery powered crimp technology, easy tool operation and portability
- Advanced high speed pump design provides faster crimps, longer life, efficiency and reliability
- Ergonomic design allows one hand operation for ram advance
- 360° head rotation lets user get into tight areas easier
- Ram holds position when trigger is released
- 5-year limited warranty on tools
- 1-year warranty on battery and charger

Specifications

- Operating Voltage: 18 V-DC
- Recharge Time: < 45 mins.
- Conductor range: 8 - 1000 kcmil Cu
8 - 750 kcmil Al

PAT81KFT-18V

- Weight: 14 lbs.
- Height: 13.9"
- Length: 17.6"
- Width: 3.5"

PAT4PC834-18V

- Weight: 13.85 lbs. (6.28 kg)
- Length: 17.6" (448 mm)
- Height: 13.9" (354 mm)
- Width: 3.7" (94 mm)



PAT81KFT-18V



PAT4PC834-18V

BCC1000CUAL

Battery Actuated Cable Cutter

Features and Benefits

- Hook head design simplifies conductor cutting and allows working in tight spaces
- Three-way switch allows user to back off of cables, make partial cuts, and make adjustments during cutting
- Ergonomic design for comfortable tool operation
- Wrist loop for added security when cutting conductors overhead
- 90-day limited warranty (excluding blades)

Specifications

- Weight: 6 lbs.
- Height: 14.5"
- Width: 4.5"
- Battery Voltage: 12 Volts DC
- Battery Capacity: 1.2A/hr
- Charge Time: 1 hour
- Cutting Capacity: 750 kcmil hard drawn Cu
1000 kcmil soft drawn Cu
1000 kcmil Al



YCUT129ACSR

Hydraulic Hand Operated Cutter

Features and Benefits

- Patented rapid advance pump, faster cuts with less hand strokes
- Specialized latch head design, interference free closure on mid-span cuts
- Handle trigger drain for convenient blade retraction
- Hardened steel blades, ability to cut ACSR, ground rods, rebar and guy wire
- Comfort grip handles help ease fatigue with continuous use
- 180° head rotation, versatile head positioning to get into tight areas easier
- Durable high impact formed carrying case, provides tool protection and stores accessories
- Customer satisfaction and support
- 5-year limited warranty on tool (excluding blades)

Specifications

- Weight: 11.4 lbs.
- Height: 6.6"
- Length: 22.4"
- Width: 2.5"
- Force Developed: 7 U.S. short tons
- Cutting Capacity: Copper Cable: up to 1.29"
Aluminum Cable: up to 1.29"
ACSR: up to 1113 ACSR
Ground Rod: up to 5/8"
Rebar: up to 1/2"
Soft Steel Bolts: up to 5/8"
Standard Guy strand: up to 1/2"
EHS Guy strand: up to 3/8"



HP, FP SERIES

Manual Hydraulic Pumps

6,000 PSI, 8,800 PSI and
10,000 PSI Hand and Foot Pumps

Features and Benefits

- Maximum mechanical advantage provided with long handle to reduce fatigue
- Built-in factory-set pressure release valve and audible pop to signal completion of crimp
- Equipped with easy-to-operate manual release lever
- Tested to operate over 100,000 cycles
- 5-year limited warranty

Specifications

	HP	FP
• Weight:	18 lbs.	19 lbs.
• Reservoir Volume:	1-1/8 qts.	1-1/8 qts.
• Length:	24-3/4"	24-3/4"
• Width:	5"	5"
• Closed Height:	6-3/4"	6-1/2"
• Height (handle open):	20"	17"
• Output Pressure:	HP6: 6,000 psi HP8: 8,800 psi HP10: 10,000 psi	FP6: 6,000 psi FP8: 8,800 psi FP10: 10,000 psi

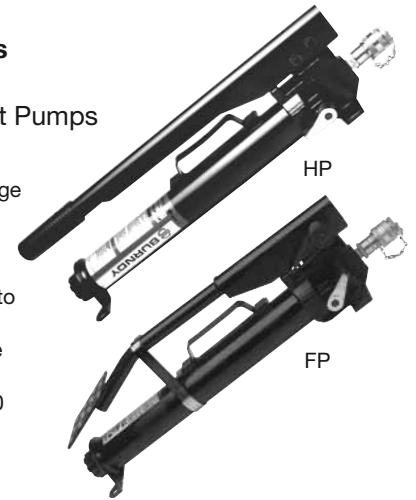

Y10AC9**Electric Hydraulic Pump**

Hydraulic Output Pressure of
10,000 PSI

Features and Benefits

- Lightweight, small size.
 - ◇ Easy to lift, carry and transport tool around job site with lightweight body and handle.
- Factory set relief valve.
 - ◇ High quality crimps are achieved with built-in, factory set pressure relief valve and audible recycling of pump to signal completion of crimp cycle.
- 100,000 (+) life cycles.
 - ◇ Long durable life expectancy with lightweight cast aluminum reservoir body.
- Convenient 115V AC electric powered motor.
- Saves time with quick disconnect hydraulic fitting.
- Sealed electric pendant switch.
 - ◇ Easy operation with durable remote pendant switch with 10-foot cord.
- 5-year limited warranty.

Specifications

- Motor: 115V AC 50/60 Hz
5/8 HP, 10,000 rpm
11 amp current draw
- Reservoir Volume: 1.61 quarts
- Height: 14.38"
- Base: 6.5" × 8.25"
- Weight: 28 lbs. (with oil)

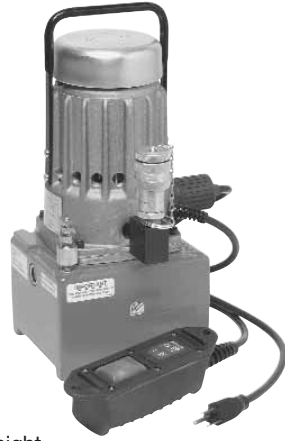
**EPP10, EPP6****Electric Hydraulic Pumps**

Hydraulic Output Pressure of
10,000 and 6,000 PSI

Features and Benefits

- Easy operation controlled with pendant or manual switch
- Audible "pop-off" valve indicates proper pressure has been achieved
- Life cycle tested to 100,000 cycles without failure
- Lightweight and portable
- Optional steel carry case available
- 5-year limited warranty

Specifications

- Weight: 30 lbs.
- Motor: 115 V-AC/60 Hz
1/2 HP @ 3450 RPM
- Max. Current Draw: 12.5 amperes
- Reservoir Volume: 2 qts.
- Height: 16"
- Base: 6" × 8"

**GP10****GP Series Gasoline Engine Driven Hydraulic Pump**

Hydraulic Output Pressures of
10,000 PSI

Features and Benefits

- Portable pump with sturdy steel roll cage.
- Durable heavy-duty 4 H.P. engine for all HYPRESS™ applications and long life expectancy.
- Manual control valve permits easy control of crimping or cutting operations.
- Fast hose assembly with quick disconnect pressure matched hydraulic couplers.
- Ample hydraulic capacity with 8 quart reservoir.
- 5-year limited warranty.

Specifications

- Engine: 4 H.P., 4 cycle
- Reservoir volume: 2 gallons (8 qts.)
- Pump height: 19-3/4"
- Pump width: 13"
- Pump length: 18"
- Overall height: 22-1/4"
- Overall width: 16"
- Overall length: 21"
- Pump and motor dry weight: 64-1/4 lbs.
- Overall dry weight: 77-3/4 lbs.

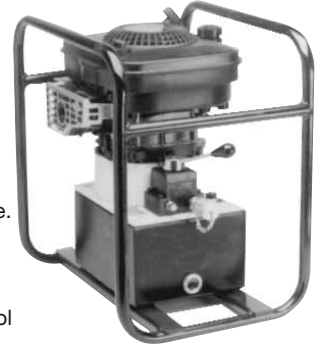
**10,000 PSI****Non-Conductive Hoses**

- **PT29900-10**
10' × 3/16" diameter non-conductive hose with stackable couplers
- **PT29900-15**
15' × 3/16" diameter non-conductive hose with stackable couplers
- **PT29900-25**
25' × 3/16" diameter non-conductive hose with stackable couplers
- **PT29901-10**
10' × 1/4" diameter non-conductive hose with stackable couplers
- **PT29901-15**
15' × 1/4" diameter non-conductive hose with stackable couplers
- **PT29901-25**
25' × 1/4" diameter non-conductive hose with stackable couplers

**Replacement Couplers 10,000 PSI**

- **PT93** (Female)
- **PT94** (Male)



See BURNDY® Master Catalog for a complete listing of crimp tool ranges, crimping dies, and other tooling accessories.

BKOM50125**Knockout Set**

For 1/2" – 1-1/4" Conduit Size

Features and Benefits

- Four-point design allows slug to drop automatically without splitting.
- Punches up to 10-gauge mild steel.
- Set includes the four most popular sizes of punches and dies packed in a sturdy storage case.
- 1-year limited warranty.

Specifications

- Weight: 3 lbs.

**BKOM152****Knockout Set**

For 1-1/2" – 2" Conduit Size

Features and Benefits

- Four-point design allows slug to drop automatically without splitting.
- Punches up to 10-gauge mild steel.
- Durable storage case.
- 1-year limited warranty.

Specifications

- Weight: 4 lbs.

**BKOH2540****Assorted Knockout Kit**

For 2-1/2" – 4" Conduit Size

Features and Benefits

- Expand capability of 1/2" – 2" sets.
- Four-point design allows slug to drop automatically without splitting.
- Punches up to 10-gauge mild steel.
- Packed in metal storage case.
- 1-year limited warranty.

Specifications

- Weight: 22 lbs.

**BKOW520****Knockout Set with Ratchet Wrench**

For 1/2" – 2" Conduit

Features and Benefits

- Four-point design allows slug to drop automatically without splitting.
- Punches up to 10-gauge mild steel.
- Set includes ratchet wrench, six sizes of punches and dies, and two drive screws; all packaged in a rugged storage case.
- 1-year limited warranty.

Specifications

- Weight: 12 lbs.

**BKOS520****Self-Contained Hydraulic Knockout Set**

For 1/2" – 2" Conduit

Features and Benefits

- Hydraulic driver punches up to 10-gauge mild steel or 12-gauge stainless steel.
- Four-point design allows slug to drop automatically without splitting.
- Lightweight and easy to use.
- Hydraulic driver operates in any position.
- 1-year limited warranty.

Specifications

- Weight: 14 lbs.

**BKOS5290****Self-Contained Hydraulic 360° Knockout Set**

For 1/2" – 2" Conduit

Features and Benefits

- Right-angle head swivels 360° for flexible punching in tight work spaces.
- Punches up to 2-1/2" conduit sizes, up to 10-gauge mild steel or 12-gauge stainless steel.
- No cumbersome "spacers" required.
- Compact, lightweight size: 7-1/2 pounds and 13" in length.
- Operating pressure rated at 10,000 psi.
- Set includes the most popular drawstuds, punches, and dies for punching holes for 1/2" to 2" conduit; all packed in a sturdy storage case.
- 1-year limited warranty.

Specifications

- Weight: 7-1/2 lbs.

**BKOF520****Hydraulic Knockout Set**

For 1/2" – 2" Conduit

Features and Benefits

- Four-point design allows slug to drop automatically without splitting.
- Punches up to 10-gauge mild steel or 12-gauge stainless steel.
- Foot-powered hydraulic pump.
- Assortment of punches, dies and accessories.
- Includes metal storage case (11-1/8" x 18-3/4" x 6-1/4").
- Competitors' punches and dies are interchangeable.
- 1-year limited warranty.

Specifications

- Weight: 31 lbs.

**BKOH540A****Hydraulic Knockout Set**

For 1/2" – 4" Conduit

Features and Benefits

- Four-point design allows slug to drop automatically without splitting.
- Punches up to 10-gauge mild steel or 12-gauge stainless steel.
- Hand-powered hydraulic pump.
- Assortment of punches, dies and accessories.
- Includes metal storage case (11-1/8" x 18-3/4" x 6-1/4").
- Competitors' punches and dies are interchangeable.
- 1-year limited warranty.

Specifications

- Weight: 50 lbs.



B12E, B34E12R, B1E34R
Conduit Hand Benders

The BURNDY® Aluminum Hand Bender is designed to bend EMT and Rigid conduit. The size range is 1/2" - 1" EMT.

Features and Benefits

- All models include embossment with sight lines for 10°, 22°, 30°, 45°, 60° and 90°.
- Industry standard markings — 30° bend when handle is straight up.
- The non-slip foot pedal is contoured allowing more foot room.
- 3/4" and 1" bender heads have levels which makes aligning easy.
- Designed with a channel to bend conduit back if you have an over-bend.
- 5-year limited warranty.



B12E



B34E12R



B1E34R



Handles

Bender Part Number	Description	Weight
B12E	1/2" EMT (bender head only)	.90 lbs
B34E12R	3/4" EMT – 1/2" RIGID (bender head only)	1.80 lbs
B1E34R	1" EMT – 3/4" RIGID (bender head only)	3.55 lbs
Handle Part Number	Description	Weight
H12E	Handle for 1/2" bender	3.65 lbs
H34E12R	Handle for 3/4" bender	3.65 lbs
H1E34R	Handle for 1" bender	5.45 lbs
Assembly (Bender & Handle)	Description	Weight
BHA12E	1/2" EMT bender with handle	4.55 lbs
BHA34E12R	3/4" EMT – 1/2" RIGID bender with handle	5.45 lbs
BHA1E34R	1" EMT – 3/4" RIGID bender with handle	9 lbs

BEB122
Electric Conduit Bender
 For 1/2" - 2" Conduit and Pipe



The BURNDY® BEB122 electric conduit bender is designed to bend 1/2" - 2" rigid conduit, IMC, EMT and 2" PVC coated conduit. The BEB122 bender assists the electrical contractor on larger jobs and will save time and labor.

Features and Benefits

- The electric bender is available for Rigid, EMT, IMC or PVC. Bender can also be purchased without shoes.
- Shoes and roller supports interchange with the Gardner Bender® GB2555, Greenlee® 555 and Current Tools® 77 series. (Only exception is using the Greenlee® four groove rigid shoe #00571. You must use roller support #00936.)
- Reliable electrical system that offers ease of repairs (does not contain any circuit boards).
- Proudly "Made in the USA."
- Maximum schedule 40 conduit.
- Will produce 180 degree bends in a single cycle.
- Limit stop control for bend angle settings.
- Operates on 115-120VAC 60Hz.
- Built in bend angle protractor bends 90 degrees quickly and efficiently.
- 2-year limited warranty.

Part Number	Description	Weight
BEB122	Electric Bender Power Unit only, without shoes and roller supports	270 lbs.
BEB122RIG	Electric Bender with shoes and roller supports for 1/2" through 2" RIGID conduit schedule 40 pipe and 1/2" through 1-1/4" IMC conduit	365 lbs.
BEB122EMT*	Electric Bender with shoes and roller supports for 1/2" through 2" EMT conduit	430 lbs.
BEB122PVC*	Electric Bender with shoes and roller supports for 1/2" through 2" PVC coated RIGID conduit	365 lbs.
122RIG	Shoes and roller supports only, for bending 1/2" through 2" RIGID conduit, 1/2" through 1-1/4" IMC conduit and 1/2" through 2" Schedule 40 pipe	74 lbs.
122EMT*	Shoes and roller supports only, for bending 1/2" through 2" EMT (thinwall)	160 lbs.
122IMC*	Shoes and roller supports only, for bending 1-1/2" and 2" IMC	127 lbs.
122PVC*	Shoes and roller supports only, for bending 1/2" through 2" 40 mil PVC coated RIGID	110 lbs.

* Shoes and roller supports come with BEBSHOECASE metal box.

BSC2H, BSC2L

The SmartCart®

Modular Wire Management System

The SmartCart® is a versatile wire management system consisting of 2 wheeled carts, various modular wire racks for carrying spools of wire and wall storage units to organize and store racks with wire when not in use.

The SmartCart® is provided with a 1-year limited warranty.



BSC2H BSC2L

Maximum Weight Capacity:

Heavy Duty 600 lbs.
Light Duty 300 lbs.

Features and Benefits

- Order as standard configuration or customize to your needs with various size racks
- Two holders provided for up to 1" conduit benders
- Built-in tray to hold fish tapes and tools
- Handles are pre-dimpled for mounting material tool boxes (MTB and MTX)
- Cart base plate is pre-punched to accommodate mounting of the extension base plate with built-in wire guide
- Spools are easily changed by placing rack on its side, removing hitch pin and shaft, roll-out and roll-in desired new spool
- Motionless vise attached to the back of cart for cutting 1/2", 3/4" and 1" conduit

Heavy Duty SmartCart®

Catalog Number	Description	Weight
BSC2H	2-Wheel Heavy Duty without racks	37 lbs.
BSC2H5A	2-Wheel Heavy Duty with (5) R17A racks	62 lbs.
BSC2H3A2B	2-Wheel Heavy Duty with (3) R17A racks and (2) R22B racks	64 lbs.
BSC2H5B	2-Wheel Heavy Duty with (5) R22B racks	67 lbs.
BSC2H1C2DEBP	2-Wheel Heavy Duty with (1) R17C rack, (2) R25D racks and (1) EBP	86 lbs.
BSC2H2C1DEBP	2-Wheel Heavy Duty with (2) R17C racks, (1) R25D rack and (1) EBP	82 lbs.
BSC2H2A1B1FEBP	2-Wheel Heavy Duty with (2) R17A racks (1) R22B rack (1) R24F rack and (1) EBP	81 lbs.

Light Duty SmartCart®

Catalog Number	Description	Weight
BSC2L	2-Wheel Light Duty without racks	37 lbs.
BSC2L5A	2-Wheel Light Duty with (5) R17A racks	62 lbs.
BSC2L3A2B	2-Wheel Light Duty with (3) R17A racks and (2) R22B racks	64 lbs.
BSC2L5B	2-Wheel Light Duty with (5) R22B racks	67 lbs.
BSC2L1C2DEBP	2-Wheel Light Duty with (1) R17C rack, (2) R25D racks and (1) EBP	86 lbs.
BSC2L2C1DEBP	2-Wheel Light Duty with (2) R17C racks, (1) R25D rack and (1) EBP	82 lbs.

Modular Racks for 2 Wheel Carts

(sold separately)

- R17A** 17" wide rack for 7-1/2" diameter spools with 1/2" EMT spindles
- R22B** 22" wide rack for 7-1/2" diameter spools with 1/2" EMT spindles
- R17C *** 17" wide rack for 12" diameter spools with 1" EMT spindles
- R25D *** 25" wide rack for 12" diameter spools with 1" EMT spindles
- R24F *** 24" wide rack for 2-16" diameter reels with 1" EMT spindles

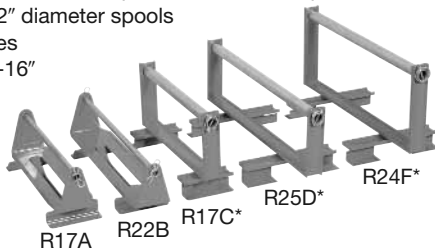

*Note: The R17C, R25D, and R24F racks are designed for oversized reels. The Extension Base Plate (EBP) is required when used on The SmartCart®.

Accessories

- EBP** Extension Base Plate with built-in wire guide
- MTB** Material Tool Box 11" L x 6" W x 5" D
- MTX** Material Tool Box (MTB) with Dividers 6-Pockets: 3-5/8" L x 3" W x 3" D

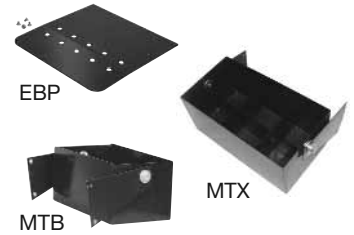

BSCWS40, BSCWS80

The SmartCart®

Wall Wire Reel Storage System

The BSCWS40, 40" high and BSCWS80, 80" high Wall Wire Reel Storage Systems are designed to work in a van, panel truck or shop and handles all 2 wheel SmartCart® racks.

Provides a time saving advantage by storing wire on racks which can be easily moved to 2 wheel carts for transporting and wire pulling.

The SmartCart® is provided with a 1-year limited warranty.

Sizes: 40" high, 17" wide, 2-3/4" deep
80" high, 17" wide, 2-3/4" deep

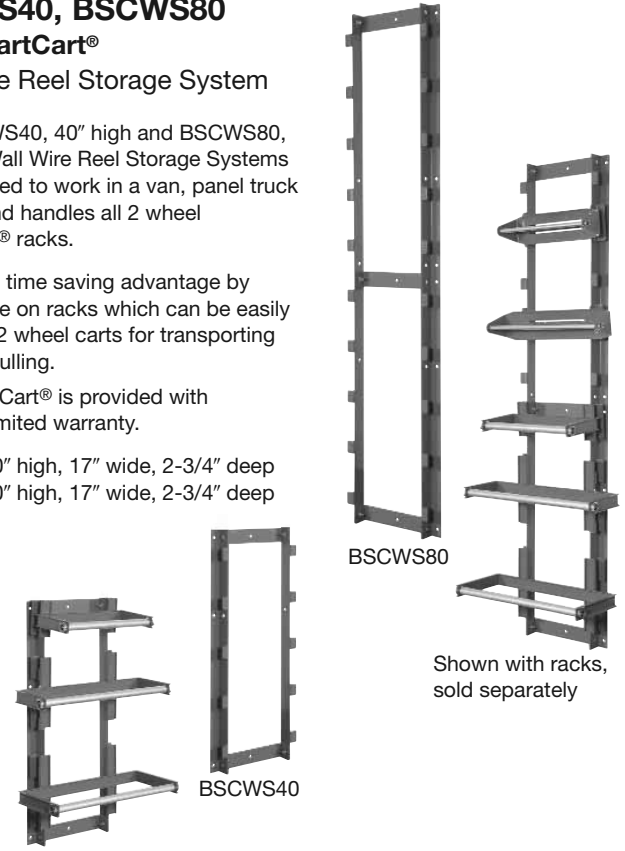

Shown with racks, sold separately

Shown with racks, sold separately



BWC04EHC**BURNDY® Wire Caddies**

Economy Hand Caddy

**Specifications**

- Maximum Weight Capacity: 200 lbs.
- Spool capacity: (8) 500' spools of #12 AWG (4) 500' spools of #10 AWG
- Size: 10-1/2" high, 13-1/2" wide, 21" long
- Weight: 4 lbs.

BWC01CMC**BURNDY® Wire Caddies**

Compact Medium Caddy

**Specifications**

- Maximum Weight Capacity: 300 lbs.
- Spool capacity: 24-1/2" traverse, 30" diameter, 250 lbs.
- Size: 24" high, 35" spindle length
- Weight: 15 lbs.

BWC28FAC with BWC01FCMR**BURNDY® Wire Caddies**

Folding A-Frame Caddy with Folding Caddy Mount Reel

**Specifications: BWC28FAC**

- Maximum Weight Capacity: 400 lbs.
- Spool capacity: 18" traverse, 6-3/4" diameter (per spindle)
- Size: 47" High, 28-1/4" wide, 15-1/2" deep (when folded)
- Weight: 45 lbs.

Specifications: BWC01FCMR

- Maximum Weight Capacity: 100 lbs.
- Capacity: (2) 250' coils of NM-B; (1) 250' coil of MC
- Size: 15" high x 18" wide
- Weight: 8 lbs.
- Caddies sold separately

BWC01FSMC**BURNDY® Wire Caddies**

Folding Stud Mount Caddy For Use on 2" x 4" and 2" x 6" Studs

**Specifications**

- Maximum Weight Capacity: 125 lbs.
- Capacity: (2) 250' coils of NM-B, (1) 250' coil of MC
- Size: 16" high, 20-3/4" (open), 5" (folded) wide
- Weight: 6 lbs.

BWC410RC**BURNDY® Wire Caddies**

10 Spindle Reel Caddy

**Specifications**

- Maximum Weight Capacity: 1200 lbs.
- Reel capacity: 14-3/4" traverse, 15" diameter (per spindle)
- Size: 51-1/2" high, 34-1/2" wide
- Weight: 91 lbs.

BWC00JS**BURNDY® Wire Caddies**

Jack Stand

**Specifications**

- Maximum Height & Weight Capacity: 26-1/2" high, 2500 lbs.
- Capacity: 26" to 52" reel diameter
- Size: 15" high, 20" long, 14-1/2" wide
- Weight: 30 lbs. each

Jack Stands are sold individually.
Note: EMT not included.

BWC43UC**BURNDY® Wire Caddies**

Utility Cart



The BWC43UC Utility Cart is designed with:

- (2) 20-1/2" x 35-1/2" trays
- (2) Pull out supports for ladder transport
- (3) 1/2" solid steel spindles with 16" traverse
- (2) Slots for conduit benders
- (1) Fish tape holder

Trays and bins for fittings and hardware

- (2) 2" x 4" wheels
- (2) 2" x 4" locking swivel casters

Specifications

- Maximum Weight Capacity: 800 lbs.
- Size: 36" high, 44" long, 21" wide
- Weight: 114 lbs.

Note: Chain Vise and Bracket are not included.

BURNDY® Pride with the PATRIOT® Li-ion!

Continuing the BURNDY® reputation for performance, speed and reliability — we have incorporated lithium-ion (Li-ion) technology, enhanced electronics and refined hydraulic systems in the PATRIOT® line of tools.

Advantages of the new 18-volt 3.0 Ah Li-ion:

- Memory effects are eliminated
- 40% lighter than Ni-MH
- 430% more lifetime work than Ni-Cd
- 2X faster charge time over Ni-Cd



All BURNDY® PATRIOT® tools are proudly made in the USA.

About BURNDY®

Founded in 1924, BURNDY® has a history of industry-renowned customer and technical service, along with a reputation of engineering excellence, quality, and reliability.

Here are some company facts:

- Acquired by Hubbell on October 1, 2009
- Serving the commercial and industrial as well as the electric utility markets
- Based in Manchester, NH USA, with manufacturing sites in: Littleton, NH, Lincoln, NH, Bethel, CT, Toluca, Mexico and Sao Paulo, Brazil
- 1,200 employees, including more than 85 BURNDY® Factory Direct Sales Representatives and top manufacturers representatives
- 20 fully equipped demonstration trucks in the United States, Canada, and Mexico

Experience. Technology. Answers.™

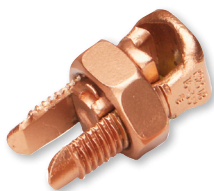
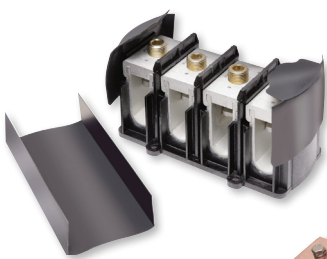

www.burndy.com | 1-800-346-4175

Customer Service Department

7 Aviation Park Drive
Londonderry, NH 03053
1-800-346-4175
1-603-647-5299 (International)

Canada

1-800-361-6975 (Quebec)
1-800-387-6487 (All other provinces)

Mexico

011-52-722-265-4400

Brazil

011-55-11-5515-7200

Tool Repair Center

Littleton Industrial Park
Littleton, NH 03561
1-800-426-8720



BURNDY[®]

