



NORA

LIGHTING

illuminating the *future*

PRODUCT SELECTION GUIDE

SECOND EDITION

LED

RECESSED

MULTIPLE LIGHTING SYSTEM

PENDANTS, SCONCES AND GLASS

NORA RAIL

TRACK

SPECIALTY

MINI TRACK

MINI RAIL

TRANSFORMERS & DRIVERS

EXIT & EMERGENCY

LAMPS

Nora Product Selection Guide

Product Family Color Codes

RECESSED

LED, HID-CMH, CFL, Low Voltage, Incandescent, Step Light, Retrofit



MLS Multiple Lighting Systems

HID-CMH, Low Voltage, Incandescent



PENDANTS AND SCONCES

LED, Low Voltage, CFL, Incandescent



NORA RAIL - Line Voltage

LED, Low Voltage, HID-CMH, CFL, Incandescent



TRACK

LED, HID-CMH, CFL, Low Voltage, Incandescent



SPECIALTY LINEAR AND ACCENT

LED, CFL, Low Voltage, Incandescent



MINI TRACK - Low Voltage

LED, Xenon, Incandescent



MINI RAIL - Low Voltage

LED, Halogen Incandescent



TRANSFORMERS AND DRIVERS

Class II, Electronic, Magnetic



EXIT AND EMERGENCY

LED, Tritium, Incandescent



LAMPS

CFL, HID-CMH, Line Voltage, Low Voltage, LED



Light Source Identification



FLUORESCENT



HID
CERAMIC METAL HALIDE



LOW VOLTAGE



INCANDESCENT



LED

Large enough to do it right, small enough to care.

At Nora Lighting, our clients are at the heart of everything we do. We take their goals seriously, and see their success as our own.

Our commitment to our clients, and our desire to strive for excellence are the base of Nora's corporate culture, as well as the guiding principles in its mission statement that has guided the company since its inception more than 20 years ago.

We support and champion the technological development of lighting products that meet or exceed the highest international standards of design, craftsmanship, quality, performance, and energy-efficiency. We strive to exceed our customers expectations with superior products and exceptional customer service. We pursue these goals with ethical, sound and honest business practices.

Over the past 20 years, Nora Lighting has worked diligently to live up to these goals while offering a product line that continues to set benchmarks for the innovation, quality, and performance that have set us apart from our competitors. We are proud of the long-term relationships we have sustained over the years with our valued customers and dedicated sales team. The entire Nora staff is always ready to respond to their needs in any way possible.

"Nora could never have accomplished so much without the support of our customers, reps and a dedicated staff,"



New Representatives Training Conference

Setting New Standards, Achieving New Goals

Nora Lighting is pleased to present our comprehensive new 2nd Edition Product Selection Guide for lighting professionals. This complete catalog is designed to introduce you to Nora's rapidly expanding line of energy-efficient lighting fixtures, while providing a valuable reference tool for all Nora product categories.

First of all, you will notice many additions and improvements that make it easier to find and specify Nora fixtures and accessories. There are new reference sections to assist when designing a Nora lighting system.

Take a look at some of these new highlights:

- New information on LED, Title 24, Energy Star and LEED certification
- A completely-redesigned section on Recessed Lighting with easy-to-identify trim and reflector finishes and options
- Complete descriptions of reflector and trim finishes
- New Specialty Lighting Section
- New Decorative Glass Section
- New Transformer Section
- New Lamp Section
- New line art and dimensions for all products
- New layout diagrams for all Nora systems
- New "how-to" sections on lighting design
- New Lighting Tips throughout the Guide

Our goal is to make your Nora Lighting experience a pleasant and productive one. The new Nora Product Selection Guide will be a helpful companion in that endeavor.

Thank you for choosing Nora Lighting products.



Table of Contents

INTRODUCTION	1	Emergency Downlight	176
NEW PRODUCTS	6	6" & 8" Horizontal Architectural & Commercial Emergency	178
COMMITTED TO GREEN	15	6" & 8" Vertical Architectural & Commercial Emergency	180
WHAT IS LED & ADVANTAGES	16	6" Single/Dual Lamp Economy Emergency	182
TITLE 24 HIGH EFFICACY	18	HID	185
ENERGY STAR / LEED CERTIFICATION & INFORMATION	20	Overview	187
NORA'S SERVICE & CAPABILITIES	23	8" HID Architectural & Commercial	190
LIGHT APPLICATIONS & SOURCES	26	6" HID Architectural & Commercial	197
		4" HID Architectural	204
		6" HID Economy	206
RECESSED LIGHTING	31	LOW VOLTAGE	215
TRIM FINISHES		Overview	216
Architectural & Commercial Finishes	34	6" Low Voltage Housings & Trims	221
Standard Finishes	36	4" Low Voltage Framing Projector	228
Custom Combinations	38	4" Low Voltage Housings & Trims	229
LED	41	4" Low Voltage Shallow Housings & Trims	232
Overview	42	TRUE 3" Low Voltage Housings and Trims	245
6" LED Housings and Trims	46	LINE VOLTAGE	253
5" LED Housings and Trims	50	Overview	254
4" LED Housings and Trims	54	8" Line Voltage Architectural & Commercial	260
6" LED Retrofit	60	6" Line Voltage Architectural & Commercial	266
5" LED Retrofit	61	6" Line Voltage IC Economy	273
COMPACT FLUORESCENT and GU24 BASE	63	6" Line Voltage IC Shallow Economy	276
Overview	64	6" Line Voltage Non-IC Economy	278
CF Dimming Options & Information	68	6" Line Voltage Non-IC Shallow Economy	280
8" CF Horizontal Architectural & Commercial	74	5" Line Voltage Economy	298
6" CF Horizontal Triple Architectural & Commercial	80	5" Line Voltage Shallow Economy	302
6" CF Horizontal Quad Architectural & Commercial	88	4" Line Voltage Economy	311
8" CF Vertical Architectural & Commercial	96	4" MR16 GU10	321
6" CF Vertical Architectural & Commercial	102	TRUE 3" MR16 GU10	331
6" CF Vertical Economy - 1 Lamp	113	6" Line Voltage Slope Ceiling	337
6" CF Vertical Economy - 2 Lamp	124	RETROFIT RECESSED	346
6" CF Sloped Ceiling	131	Retrofit Overview	347
6" Shallow Horizontal Commercial & Economy	138	6" LED Retrofit	348
5" CF Vertical Economy	144	5" LED Retrofit	349
4" CF Economy	152	6" CF Retrofit	351
6" CF GU24 Base	164	6" Low Voltage Retrofit	356
5" CF GU24 Base	168	Track Monopoint Adaptor Retrofit Kits	360
4" CF GU24 Base	172		

SQUARE RECESSED	362
8" Square HID Housings	363
8" Square IC & Non-IC CF Housings	364
8" Square IC & Non-IC Line Voltage Housings	366
STEP LIGHTING	371
Mini LED Step Lights	372
LED Step Lights	374
Compact Fluorescent Step Lights	375
Mini Incandescent Step Lights	376
Incandescent Step Lights	377
ACCESSORIES	378
MULTIPLE LIGHTING SYSTEM (MLS) 387	
Overview	390
RECESSED MOUNT	
Metal Halide	392
Low Voltage	396
Line Voltage	400
SURFACE MOUNT	
Low Voltage	404
PENDANTS AND SCONCES 407	
Overview	408
GLASS SHADES	415
PENDANT ASSEMBLIES	435
Rail Mount	438
Mini Rail Mount	440
Track Mount	441
Mini Track Mount	443
Monopoint Canopies	444
Multi QuickJack Canopies	449
COMPLETE PENDANTS	450
WALL SCONCES	455
COMPATIBILITIES CHART	458
NORA RAIL 461	
Overview	464
LED FIXTURES	470
LINE VOLTAGE FIXTURES	472
LINE VOLTAGE PAR FIXTURES	479

LOW VOLTAGE FIXTURES	481
QuickJack & Complete Fixtures	482
HID FIXTURES	490
FLUORESCENT FIXTURES	497
SPECIALTY FIXTURES	498
NORA RAIL KITS	499
RAIL PENDANTS	504
NORA RAIL SYSTEM COMPONENTS	510
NORA QUICKJACK COMPONENTS	514
NORA RAIL ACCESSORIES	515
RAIL SYSTEM SAMPLE LAYOUT	516

TRACK 519	
Overview	522
LED TRACK FIXTURES	530
HID TRACK FIXTURES	532
COMPACT FLUORESCENT TRACK FIXTURES	548
LOW VOLTAGE TRACK FIXTURES	555
LINE VOLTAGE TRACK FIXTURES	575
TRACK MOUNT PENDANTS	592
ONE & TWO-CIRCUIT TRACK SYSTEM OVERVIEW	594
TRACK CURRENT LIMITER	596
TRACK SYSTEM ACCESSORIES	597
TRACK SYSTEM SAMPLE LAYOUT	604

SPECIALTY LIGHTING 607	
Overview	610
LED LIGHTBAR	613
LED Lightbar Sample Layout	616
LED TAPE LIGHT	619
LED Tape Light	620
LED Tape Light Sample Layout	622
RGB Color Changing LED Tape Light	625
RGB Color Changing LED Tape Light Sample Layout	627
High Output LED Tape Light	629
High Output LED Tape Light Sample Layout	631
ULTRA SLIM T5 FLUORESCENT	632
Ultra Slim T5 Fluorescent Sample Layout	633

MINI INCH FLUORESCENT	634
1-3/4" FLUORESCENT T8/T12	635
LINE VOLTAGE HALOGEN UNDERCABINET	636
LOW VOLTAGE HALOGEN UNDERCABINET	637
LED PUCK LIGHT	639
LED Puck Light Sample Layout	641
MINI LOW VOLTAGE PUCK LIGHTS	643
MINI SOLUTIONS MINITURE DOWN LIGHTS COLLECTION	645
MINI SOLUTIONS MINITURE DOWN LIGHT KITS	654
Puck & Mini Solutions Sample Layouts	656
PHOTOMETRIC & VOLTAGE INFORMATION	657
DECOLUME FESTOON LAMP LINEAR SYSTEM	658
How To Specify Decolume System	659
Decolume System Accessories	660
Decolume System Lamps	661
Decolume System Sample Layouts	662
DURALIGHT (ROPE LIGHT)	664
Duralight LED System	665
Duralight 2-Wire Line Voltage System	666
Duralight 2-Wire Low Voltage System	667
Duralight 3-Wire Line Voltage System	668
Duralight Installation Tips	669
Duralight Accessories	670
MINI TRACK LIGHTING	673
Overview	676
LINEAR ACCENT LIGHTING FIXTURES	678
HALOGEN SPOT LIGHTS FIXTURES	679
MINI TRACK PENDANTS	681
MINI TRACK ACCESSORIES	682
MINI TRACK SAMPLE LAYOUTS	684
NORA MINI RAIL	687
Overview	690
MINI RAIL FIXTURES	692
MINI RAIL ACCESSORIES	694
MINI RAIL SAMPLE LAYOUTS	696

TRANSFORMERS & DRIVERS	698
Overview	700
CLASS II ELECTRONIC & MAGNETIC TRANSFORMERS	702
ELECTRONIC TRANSFORMERS	703
ENCLOSURE BOXES FOR ELECTRONIC TRANSFORMERS	704
MAGNETIC TRANSFORMERS	704
REPLACEMENT RECESSED TRANSFORMERS	705
REPLACEMENT ELECTRONIC BALLAST TRANSFORMERS	705
CLASS II LED DRIVERS	706
DIRECT PLUG-IN LED DRIVERS	706
CLASS II LED DRIVER ACCESSORIES	707
EXIT AND EMERGENCY	709
Overview	711
LED EDGE-LIT EXIT SIGNS	714
SELF DIAGNOSTIC LED DIE-CAST EXIT SIGN	719
UNIVERSAL LED EXIT SIGNS	721
WET LOCATION EXIT SIGNS	722
SELF-ILLUMINATING TRITIUM EXIT SIGN	723
STEEL EXIT & EMERGENCY (NY APPROVED)	724
WET LOCATION EXIT-EMERGENCY COMBINATIONS	725
DECO EMERGENCY LIGHT	729
EMERGENCY LIGHTS	730
EMERGENCY REMOTE HEADS	738
EXIT & EMERGENCY ACCESSORIES	740
RECESSED EMERGENCY UNITS	
Emergency Low Voltage Downlight	742
Compact Fluorescent Emergency Downlight Retrofit Kit	746
LAMPS	748
Overview	749
COMPACT FLUORESCENT LAMPS	750
HID METAL HALIDE LAMPS	752
LINE VOLTAGE LAMPS	753
LOW VOLTAGE LAMPS	755
INDEX	758

NEW PRODUCTS

New Energy Saving LED

4", 5" & 6" LED PLATINUM RECESSED LIGHTING



ENERGY EFFICIENT, HIGH-PERFORMANCE LED NEW CONSTRUCTION & REMODEL HOUSING & TRIM

Introducing our LED Platinum Recessed family of products. Featuring the latest in high output LED technology and intergrating the warm white color of incandescent lamps with the high performance of an LED recessed product. Our energy efficient luminaires have an advanced thermal management design to ensure long life and optimal performance. LED technology provides light that is absent of projected heat, UV and infrared rays; excellent for heat sensitive installations and an energy efficient product for everyday use. See pages 46-56.

5" & 6" LED RETROFIT DIAMOND RECESSED SERIES



ENERGY EFFICIENT, HIGH-PERFORMANCE LED RETROFIT

Introducing our newest Nora Lighting's LED Diamond Retrofit. The Nora's patent-pending LED unit is available in 4-5/8" and 5-1/4" apertures in various color temperatures and finishes including Bronze, Natural Metal, Copper, Clear, specular Black, White and White Baffle. Adaptable to medium base, GU24 and dedicated housings this is the most flexible unit on the market today. See pages 60-61.

LED TAPE LIGHT (NUTP1)



ENERGY EFFICIENT WET LOCATION LED TAPE

Nora Lighting continues to provide solutions for your linear lighting needs by introducing our Dimmable LED Tape Light using only 1.5W per foot. Offered in a variety of colors including Warm White, Cool White, Blue, Green, Red or Yellow color. This energy efficient and very low profile LED tape is great for use outdoor or indoor type applications. Available in 16' reels that are separate every 12" & cutable every 4". Additional 12" & 4" lengths allow for total flexibility. See pages 620-623.

LED RGB COLOR CHANGING TAPE LIGHT (NUTP3)



ENERGY EFFICIENT COLOR CHANGING WET LOCATION LED TAPE

Nora's addition of RGB (Red, Green, Blue) primary colors tape lighting can handle sereral visual color spectrums. Programmable and selectable at the touch of a button with a 120° viewing angle. A flexible low profile tape with break away connection every 12" and cutable every 6". An excellent choice where you want the option to change colors or program automatic color changing to enhance or highlight an architectural feature. See pages 625-627.

LED HIGH-OUTPUT TAPE (NUTP2)

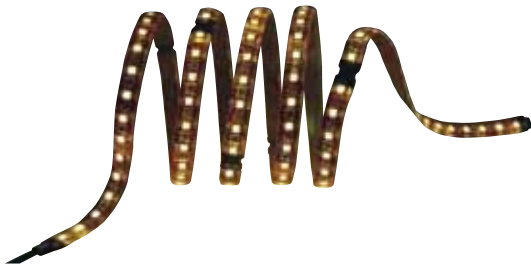

ENERGY EFFICIENT HIGH-OUTPUT WET LOCATION LED TAPE

High Output LED tape light has four times the light output of our standard tape, and is a perfect solution for your LED linear lighting needs. A great choice for use in cove lighting, architectural enhancements, display lighting and other application that require a low profile and unobtrusive lighting. This Dimmable LED light is energy efficient and designed to cast no shadows and boast a desirable seamless glow. Available in 16' reels that are separate every 12" & cutable every 4". Additional 12" & 4" lengths allow for total flexibility. See pages 629-631.

LED LIGHTBAR



ULTRA-LOW PROFILE LINEAR LED SYSTEM

Introducing Nora Lighting's new Low-Profile Dimmable LED Linear lighting fixture. The fixture comes with adjustable mounting brackets and is an excellent choice for display cabinets, cove, under and in cabinet, closet, and discrete general lighting applications. The Lightbar is Tilt 24 compliant and one of the most energy efficient products in the market, using just 3.3W per foot. Nora's Lightbar offers an unprecedented level of installation options. Available in a five different lengths from 6" to 48". See pages 613-617.

NEW PRODUCTS
New Energy Saving LED

LED PUCK LIGHT



ARCHITECTURAL STYLE & ENERGY EFFICIENT

Nora Lighting introduces a new slim LED Puck Light for cabinet, furniture, book shelves, display cases, and niches. The die-cast aluminum low-profile, only 3/8" deep and consumes only 3W while producing 210 Lumens, savings over 70% in energy consumption. See pages 639-641.

SARIA LED MONOPOINT PENDANT



ULTRA-CONTEMPORARY STYLING AND ENERGY EFFICIENCY

Nora Lighting's new Saria LED mini-pendant is a dazzling high-style fixture for residential and commercial applications. Featuring a sleek contemporary design, Saria offers two visual effects - as a 1W downlight or 3W even flood. A colorful glowing edge creates visual impact and is available with Blue, Green, Red or White LEDs. Saria features 3000K CCT, and as with all LED fixtures, is cool to touch - there is no projected forward heat or UV. See page 450.

3W ROBO LED TRACK AND RAIL HEAD



ENERGY EFFICIENT LED TRACK AND RAIL HEAD

Nora Lighting proudly presents it's New energy efficient LED track and rail lighting heads. The powerful LED Track heads provide excellent beam control while producing no forward heat or UV. These heads are designed to go with a variety of architectural designs in commercial, retail, hospitality and residential applications. See page 531.

MINI LED EMERGENCY LIGHT



LED MINI EMERGENCY LIGHT

Nora Lighting's New LED Mini Emergency Light comes with two adjustable heads that produce 200 lumens of reliable long life LED Energy Efficient egress lighting. See page 730.

18W PILLAR LED TRACK HEAD



HIGH OUTPUT ENERGY EFFICIENT TRACK HEAD

Nora's new Pillar LED Track fixture uses a single deep set 18W LED producing high lumens while not creating any forward heat. The unit is styled to go with most architectural designs. Available in 2 beam spreads and 3 finishes. Also available with H, J or L track adaptors. See page 531.

ADJUSTABLE LED EDGE-LIT

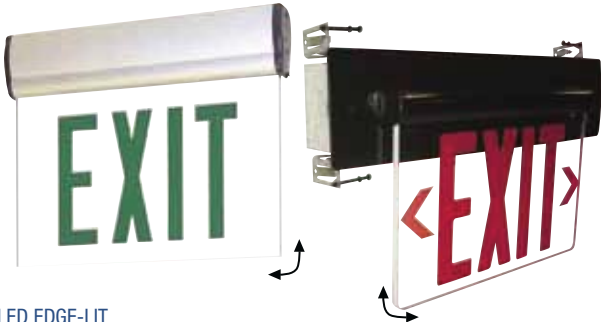

LED EDGE-LIT

Nora new adjustable LED Surface Mount Edge Lit Exit can be used in ceiling, wall or end mount applications. Also available with recessed housing, the flexible design allows designers to specify a single exit for multiple or unknown architectural applications. See pages 714-715.

PRODUCT UPDATES

Recessed Additions

4" LOW VOLTAGE & LINE VOLTAGE SQUARE TRIMS



LOW PROFILE 4" SQUARE TRIMS

New architectural 4" square trims are available in several trim finishes and reflector options. The square trims work with Nora's existing 4" series of housings. Designed for easy alignment and aiming. Used with after market LED lamps and Nora's wattage reduced housings, these are the perfect solution for energy efficient lighting in commercial and residential. See page 235-236, 314-315, 324-325.

4", 5" & 6" GU24 BASED HOUSINGS



SELF BALLASTED LAMP (NO BALLAST IS REQUIRED)

The Nora Lighting energy efficient GU24 housings and reflectors lower the cost of going "Green" by over 50% compared to conventional 4-Pin remote ballast unit, when used with CFL's. Use with Nora LED Retrofit Diamond Series to meet Title 24 and local energy codes. See pages 164-173.

4" SHALLOW LOW VOLTAGE



NEW CONSTRUCTION & REMODEL

New low profile 3-1/2" deep for installation into shallow plenum applications. Available with electronic or magnetic transformer. Does not sacrifice application design criteria with over 100 trim selections. See pages 232-233.

8" SQUARE SHALLOW HID CMH HOUSING



ELECTRONIC HID HOUSING FOR TIGHT INSTALLATIONS

Horizontally mounted HID light sources that provides superior light output and distribution. Trims available with Prismatic, Fresnel or Albalite glass cUL rated for wet location. See page 363.

6" SHALLOW HORIZONTAL CF HOUSING



NEW CONSTRUCTION & REMODEL

The Nora family of economy compact fluorescent housings now offer a new low profile (5" deep) housing for shallow plenum applications. See pages 138-139.

5" SHALLOW LINE VOLTAGE



NEW CONSTRUCTION & REMODEL

New 5" shallow IC rated housings complement Nora's complete line of 5" housings and trims. See pages 302-303.

PRODUCT UPDATES
Recessed Additions

TRUE 3" GU10 HOUSING



IC, NEW CONSTRUCTION & REMODEL

Nora's True 3" housings now offer the choice of using the economical GU10 halogen lamp. Designer specified 2-1/2" aperture trims and easily dimmed makes it an excellent choice for discrete lighting. See pages 331-333.

LOW VOLTAGE WATTAGE REDUCED HOUSINGS



IC, NEW CONSTRUCTION & REMODEL

Nora now offers wattage reduced and labeled housings to meet strict watts per square foot and Title 24 requirements. Use with after market LED lamps for total energy code compliant efficiency. See pages 229-234.

HID, CFL & LINE VOLTAGE REMODEL FRAME-INS



6" & 8" COMMERCIAL REMODEL FRAME-INS

Nora's New Remodel Frame-Ins are available in HID, CFL, and Line Voltage. These frame-ins install in existing ceilings and are excellent for tenant improvement and energy retrofits in commercial, retail, hospitality, and architectural applications. See pages 76, 82, 91, 98, 104, 192, 199, 262, 268.

4", 5", 6" & 8" REFLECTOR FOR GLASS TRIMS



ELEGANT LOW PROFILE GLASS

Add interest and define a space with Nora's elegant low profile glass elements. Available in different colors and frost patterns. See pages 265, 296, 308, 319, 329,

6" 45° SUPER SLOPE TRIMS



45° ADJUSTMENT SLOPE TRIM

Nora's new Super Slope trims incorporate a unique bracket that allows field adjustment of lamp up to 45°. Available in Baffle and Reflector styles. See pages 136 and 342.

FIREBOX WITH HOUSING



ONE HOUR FIRE RATED BOX WITH HOUSING

Nora's Fire Rated box can now be ordered as a complete unit with housing installed at the factory for easy specification and installation. See page 379.

PRODUCT UPDATES

Track Additions

V-TEC LOW VOLTAGE SERIES



VERTICAL TRANSFORMER LOW VOLTAGE TRACK HEADS

The vertical transformer V-Tec line has sharp clean lines for a variety of design styles. See page 557.

CERAMIC METAL HALIDE (VANGUARD)



ARCHITECTURAL DIE-CAST ALUMINUM CMH TRACK

A dynamic line of fixtures featuring precision aiming and locking. Available in MR16GX, T4, T6, and PAR CMH lamp sources in 3 finishes (White, Black and Silver). See pages 533-538.

H, J, & L TRACK HEADS



TRACK HEADS FOR USE IN H, J, & L STYLE TRACK

Nora Lighting now offers over 100 track heads that can be specified with H, J, or L adapters. Available in White, Black and Silver. These adapter options make it possible to update track heads to new styles or energy efficient retro-fits without changing the installed H, J, or L style track. See pages 531-592.

CERAMIC METAL HALIDE (BRILLIANT SERIES)



CMH WALL WASH AND LOW PROFILE SPOT

Wall wash unit provides an optical even spread of light using T6 or ED-17 lamps. The low profile spot has specifiable reflectors for beam spread and accommodates T4 & T6 CMH lamp. Available with H, J, and L adapters. See pages 534-535, and 547.

4" & 6" RETROFIT TRACK ADAPTER



RETRO-FIT FOR EXISTING RECESSED 4" OR 6"

Change an existing recessed housing to a single track fixture for accent lighting or change to a dramatic pendant with Nora art glass with the use of this retrofit adapter. See page 360.

ENERGY EFFICIENT TRACK PENDANTS



GU24 COMPACT FLUORESCENT, CANDLEBRA, & MEDIUM BASE SOCKETS

Offered in 5 different lamp sources, from our energy efficient GU24 to a 100W medium base. Combine Nora Track fixtures with Nora Track Pendants for a complete lighting design. Available with H, J, and L style adapters. See page 592.

Exit & Emergency Additions

LED WET LOCATION EXIT COMBINATION



LED WET LOCATION EXIT COMBINATION

A heavy duty sealed unit completely protect against harsh environment. See page 724.

SINGLE / DOUBLE HEAD WET LABEL REMOTE



UL WET LOCATION LISTED REMOTE HEAD

Flexible remote emergency heads offer excellent performance and aiming for outdoor egress applications. See page 738.

STEEL LED EXIT AND EMERGENCY LIGHTS



STEEL LED EXIT AND EMERGENCY (NEW YORK APPROVED)

Complete family of 20 gauge steel body exit, emergency, and combination units for rugged use (New York Approved). See page 724.

DECO WET LABEL EMERGENCY LIGHT



DECO XENON WITH LED UPLIGHT PHOTSENSOR CONTROLLED (OPTION)

Self diagnostic low profile sealed emergency light. Available in Black, Bronze, Silver and White with an option LED accent. See page 728.

EMERGENCY WET LABEL LIGHT W/REMOTE CAPABILITY



WET LOCATION EMERGENCY LIGHT WITH REMOTE CAPABILITY

Sealed heavy-duty housing protects components from water and corrosive atmospheres. See page 737.

SELF-ILLUMINATING TRITIUM EXIT SIGN



SELF-ILLUMINATING TRITIUM EXIT SIGN

Completely powered by Tritium gas (no electric required). Available in 10, 15 or 20 year life. See page 723.

PRODUCT UPDATES

Nora Rail Additions

NEW 4' NORA RAIL KIT



4' Line Voltage Rail with 3 Mercure Fixtures with Glass

Also available with glass pendants or other fixtures. See pages 500-502.

NEW 2' SUSPENDED CIRCLE NORA RAIL KIT



2' Suspended Circle with Swift Fixtures and Glass

Perfect for a dining room table, island in the kitchen, etc. See page 500.

NEW 6'-6" NORA RAIL KIT



6'-6" Line Voltage Straight Rail with Neptune Glass

Also available with other glass pendants. See page 502.

NEW 8' "S" CURVE NORA RAIL KIT



8' "S" Shape Line Voltage Rail Kit

This Kit compliments our existing 8' Rail Kit. See page 503.

NEW 6'-6" NORA RAIL STARTER KIT



6'-6" Line Voltage Straight Rail Starter Kit

Also available in other finishes. See page 499.

NEW 8' "S" CURVE NORA RAIL STARTER KIT



8' "S" Shape Line Voltage Rail Starter Kit

This Kit is ready for any fixture or pendant to be added. See page 499.

LINE VOLTAGE RAIL KITS

Nora Lighting continues its successful Line Voltage Rail Kits with the introduction of several new styles, shapes and lengths. Now adding Glass pendants, Glass fixtures, and 3 finishes in all Kits, Brushed Nickel (BN), Bronze (BZ), and Silver (S). The incredible benefits to a Line Voltage Kit is the opportunity to add Rails or Fixtures with the capability of easily lengthening the run, increasing the wattage, or achieving an array of different lampings without the worry of system transformers and their restrictions. These are all truly expandable Kits that can easily be bent, curved, or left straight, and can fit almost any design imaginable.

Pendants and Wall Sconce Additions

ENERGY EFFICIENT PENDANTS



GU24 COMPACT FLUORESCENT & MEDIUM BASE SOCKETS

Nora Lighting expands its Pendants lighting offering with the addition of Medium Base, and GU24 Compact Fluorescent. Offered for Canopy Mount, Nora Rail, and Track. See pages 438-444.

NORA WALL SCONCES



ENERGY EFFICIENT GU24 CFL, G9 HALOGEN, CANDELABRA, LOW VOLTAGE BI-PIN & MEDIUM BASE INCANDESCENT LAMP SOURCES

Nora's new sconce family offering 5 different lamps sources, 5 different styles, and 3 finishes. Complimented by telescopic arm extension with an incredible offering of glass to compliment any decor. See pages 456-457.

NORA CONCORD WALL SCONCE (ADA COMPLIANT)



CONCORD WALL SCONCE

Nora Lighting's ADA Compliant Sconce introduction is the first in a new category for Nora. Available in Amber, Blue, Red, and White Glass & Brushed Nickel, Bronze, and Silver finishes and also available in 5 lamp sources. See page 457.

MULTI QUICKJACK CANOPIES



ROUND & LINEAR MULTI QUICKJACK CANOPIES

Nora's New Multi QuickJack canopies allow you to create a dramatic lighting statement using three QuickJack fixtures and/or pendant assemblies. See page 449.

Discover the Green advantage.
It's good for the planet. It's good for you.



Nora Lighting is Committed to Green

Nora goes for the Green...with products that earn LEED points

The worldwide environmental movement to think green / live green has inspired a new generation to create a more sustainable environment.

At Nora Lighting, we believe the lighting industry is leading the way with revolutionary new technologies and products that present viable solutions for energy savings and a more strategic use of our resources.

Nora's commitment to a greener future is evidenced by the leading-edge fixtures we are bringing to market – many incorporating the latest LED, CFL fluorescent and HID Ceramic Metal Halide technology. And we are continuously working with lamp and ballast suppliers to ensure that all components meet rigorous criteria for low energy consumption and reduced carbon emissions.

Nora Lighting is also in the forefront in meeting, and often exceeding, stringent new state of California energy mandates. Our expanding LED line has been approved for listing by the watchdog California Energy Commission, and Nora's newest products are Energy Star-listed and comply with Title 24 requirements.

Recycle and Re-purpose at Nora Facilities

Nora's focus on efficient, energy-saving technologies is not limited to our product lines. At our manufacturing and administrative facilities we have always had a policy to re-purpose and recycle all reusable materials, including paper, plastic, bottles and cans, and we have implemented new processes to cut down on manufacturing waste and minimize the environmental impact to our planet.

Green Solutions for New Construction or Renovations

Lighting designers are at the forefront in specifying energy-efficient Nora fixtures for new and renovation installations. Here are the reasons why they "ask for Nora..."

- LEED points when installing Nora LED fixtures
- Green building compliance (elimination of mercury, lead or PCBs)
- Elimination of projected heat, ultra-violet rays and IR emissions
- Longer-lasting performance life
- Measurable cost savings over the life of the fixtures.



What is LED?

The Light Emitting Diode...LED

Basically, LEDs are tiny light bulbs, or semiconductor diodes, that fit easily into an electrical circuit. But unlike ordinary incandescent lamps, they do not have a filament that burns out or gets hot. The diodes emit light when partnered with an electrical current and are illuminated solely by the movement of electrons in the semiconductor material.

The LED is called solid state lighting or "SSL" because light is emitted from a solid object, the semiconductor diode, instead of a vacuum or gas tube (like an incandescent, fluorescent or HID lamp). The diode itself is a two-terminal crystalline and when an electrical current passes through it, the recombination of positive and negative charges results in the emission of visible light.

Less than one millimeter square, individual LEDs are clustered on a circuit board to create an array, which is then incorporated into a light fixture.

LED Evolution

Back in the 1960s, LEDs were introduced as red and green indicator lights on digital clocks, handheld calculators and household appliances. By the early 1990s, researchers discovered they could fabricate a blue LED. Once the blue LED was on the map, scientists figured out that by introducing phosphors to the blue LED, they could produce a brighter, whiter light.

These phosphors, however, create heat, which is not associated with the LED itself. Solutions for heat management are critical in the design of long-lasting "white" LEDs.

Since discovering the blue LED, manufacturers have worked to produce a warmer LED light... because a warm white color temperature creates a familiar home-like environment. Today LED warm whites are now above 90 on the CRI (Color Rendering Index) scale; incandescent lamps have a CRI of 100, the industry standard for a perfect score.

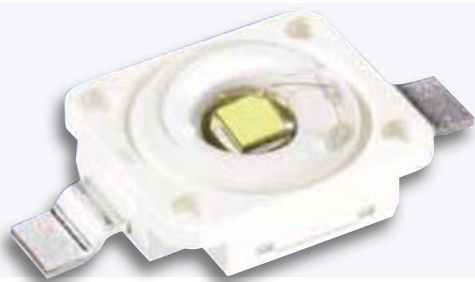

The lighting industry has rarely seen a more compelling dynamic than the nationwide effort to go green with LEDs. Municipalities, airports and civic centers are converting entire public area lighting systems. Cost-conscious institutional and commercial facilities can not retrofit fast enough. And architects and home builders want the coveted LED (and LEED) green designations for the marketing edge.

"...no other lighting technology offers as much potential to save energy and enhance the quality of our building environments, contributing to our nation's energy and climate change solutions."

*Energy Efficiency and Renewable Energy Section
U.S. Department of Energy*

Higher Color Rendering Means Lower Efficacy

By adding warming red to the LED, however, the higher red phosphor coating reduces the overall lumen output. As Kelvin temperature goes down and becomes warmer, overall lumen output is decreased. For example, a 14W Nora fixture with 3000K has a 630 lumen output, while a 14W Nora fixture with 4200K has a 710 lumen output. Efficacy is thus reduced as CRI goes higher.

Longer Performance Life

LEDs have a rated life based on the time it takes for the light output to decrease to 70% of the original output, which is typically about 50,000 hours or 17 years of normal use. A typical incandescent fixture will need to be re-lamped 10 or more times during the life of an LED fixture.

As LED chips increase in lumens and efficacy, the lighting industry is focused on producing better performing products. With higher lumen-per-watt LEDs being introduced everyday, the future for LEDs is bright.

Within the next decade LEDs are expected to be the dominant light source... a clean and green alternative for homes, cities and business.



The Advantages of LED and CFL

LEDs have major advantages over conventional incandescent lamps. LEDs are significantly more efficient and last 25 times longer. Additionally, the enclosed small LED diodes are less susceptible to heat, cold or vibration, making them more durable, and they also fit more easily into modern electronic circuitry. LEDs do not generate heat, infrared wave lengths (IR) or ultraviolet rays. Garments, food and artwork can be illuminated without deterioration and the fixture lens remains entirely cool to the touch.

Compact Fluorecent lamps are significantly more efficient and last 6 times longer than conventional incandescent lamps.



CFL Benefit Checklist

- Energy efficient...CFLs produce equivalent light with 75% less energy than a conventional incandescent lamp
- Extremely low power consumption
- Last up to 6 times longer than incandescent
- Reduced heat compared to Incandescent
- Long term environmental gains, less CO2 emission
- Varied color temperatures for a variety of applications



LED Benefit Checklist

- Energy efficient...LEDs produce equivalent light with 75% less energy than a conventional incandescent lamp
- Extremely low power consumption
- Efficacious...LEDs convert energy to light, not heat
- Long life span...50,000 hours or 17 years
- Durable...resistant to hot, cold or vibration
- Dimmable and programmable in many cases
- Instant-on to full lumen output, unlike CFLs
- Lightweight and compact
- Environmentally friendly and recyclable...reduces carbon emissions, no mercury or other toxins

Business and residential customers are switching to CFLs and LEDs to save money and the environment



	65W BR30 Incandescent	18W Compact Fluorescent	14W LED Source
Cost of energy to run fixture for 50,000 hours	\$3,250	\$900	\$750
Life in hours	2,000	12,000	50,000
Life in year(s)	.67 Year	4.1 Years	17 Years
Number of lamp changes over 50,000 hours	25	4	1
Kilograms of CO2 emitted over 50,000 hours	2600 Kg	820 Kg	600 Kg
Energy Star Qualified	No	Yes	Yes
Meets Title 24	No	Yes	Yes



What is CA Title 24?

And why are more states moving in this direction?

California is the nation's leader when it comes to energy-efficiency. Title 24, originally enacted in 1978, is a mandatory state code for reducing energy consumption. Efficacy is the measurement of the light produced compared with the energy used to produce it. Incandescent lamps are less efficient because they generate so much heat – only about 10% of the energy they use goes to light. For example, a 13-watt CFL (producing about 850 lumens) is roughly equivalent to a 60-watt incandescent. Since it uses less energy, the CFL has a much higher efficacy rate of 65 LPW (lumens per watt) than the incandescent. LEDs have an efficacy between 30 and 80 lumens per watt, and they are rapidly improving.

What is a High Efficacy lamp?

Wattage Range	≤ 5 W	> 5 W to 15 W	>15 W to 40 W	> 40 W
Min. Lumens/Watt	30 L/W	40 L/W	50 L/W	60 L/W

To Achieve High Efficacy

- All ballasts for lamps rated 13 watts or greater must be electronic
- All recessed housings must be Air-Tight (AT) per ASTM E283 to prevent cooled air or heat to escape into the ceiling cavity or attic
- No screw-in medium base sockets are allowed



All Nora Lighting Title 24 energy efficient compact fluorescent luminaires are

- Energy Star Compliant
- Rated for Insulated Ceilings
- Airtight in compliance with ASTM-283
- Comply with Title 24
- Washington State Energy Code
- International Energy Conservation Code



TITLE 24

2008 Residential standards
Individual room requirements

Kitchen

High-efficacy lighting or up to 50% of the total wattage can be low-efficacy. High efficacy and low efficacy must be switched separately.

Bathroom

High-efficacy or manual-on occupancy sensor.

Laundry Room

High-efficacy or manual-on occupancy sensor.

Garage

High-efficacy or manual-on occupancy sensor.

Utility Room

High-efficacy or manual-on occupancy sensor.

Title 24 High Efficacy



Commercial Lighting Zones

While Title 24 does not specify High Efficacy products, it does require specific watts per square foot based on usage of space calculated either by zones or total envelope. Although Title 24 does not eliminate the use of low efficacy sources it can be difficult to meet Title 24 commercial compliance without the use of high efficacy sources.

Residential Lighting Zones

As determined by Title 24 to be rated as high efficacy, a lamp or fixture must produce a certain number of lumens for each watt of electrical power it consumes. Efficacy is therefore measured in lumens per watt. Almost all fluorescent fixtures equipped with electronic ballasts qualify as high efficacy. Incandescent lamps (including any screw-in incandescent lamps or halogen lamps, or low voltage lamps do not qualify.

The new Title-24 residential lighting requirements divide the home into three distinct zones that are treated very differently.



The FIRST ZONE is the kitchen.

- Known as the 50% rule; 50% of the total kitchen lighting watts must be high efficacy luminaires; compact fluorescent, LED, Linear fluorescent
- The balance of the kitchen lighting can be low-efficacy
- Low-efficacy and high-efficacy lighting must be switched separately



The SECOND ZONE includes all the bathrooms, garages, laundry rooms, and utility rooms

- Either high efficacy fixtures or they must have vacancy sensors installed that control the low efficacy fixtures.
- Note that these must be vacancy sensors, not occupancy sensors. With a vacancy sensor you must manually operate the switch to turn the lights on. Then after you leave the room the sensor detects that the room is vacant and will automatically turn the lights off.



The THIRD ZONE includes all the hallways, dining rooms, family rooms, home office, and bedrooms.

These rooms have the most lenient requirements.

- Either high efficacy lighting or low efficacy lighting controlled by a vacancy sensor or be controlled by a dimmer.
- The dimmer option allows the most cost effective way to comply while providing the most flexibility and options in allowable fixtures.



Committed to Green

Nora Lighting Has Hundreds of Fixtures That Have Earned The Energy Star Label

How a Product Earns the ENERGY STAR Label

What is ENERGY STAR? Energy Star is the trusted, government-backed symbol for energy efficient helping us all save money and protect the environment through energy-efficient products and practices.

The ENERGY STAR label was established to: Reduce greenhouse gas emissions and other pollutants caused by the inefficient use of energy; and make it easy for specifiers and consumers to identify energy-efficient products that offer savings on energy bills without sacrificing performance, features, and comfort.

How Does EPA Choose which Products Earn the Label? Products can earn the ENERGY STAR label by meeting the energy efficiency requirements set forth in ENERGY STAR product specifications. EPA established these specifications based on the following set of key guiding principles:

- Product categories must contribute significant energy savings nationwide.
- Qualified products must deliver the features and performance demanded by consumers, in addition to increased energy efficiency.
- If the qualified product costs more than a conventional, less-efficient counterpart, purchasers will recover their investment in increased energy efficiency through utility bill savings, within a reasonable period of time.
- Energy efficiency can be achieved through broadly available, non-proprietary technologies offered by more than one manufacturer.
- Product energy consumption and performance can be measured and verified with testing.
- Labeling would effectively differentiate products and be visible for purchasers.

LEED Certification

Residential and Commercial



The desire to build more sustainable buildings is a worldwide phenomenon. The building green movement is being driven by the U.S. Green Building Council (USGBC), which has developed a national standard for sustainable building design, known as LEED, Leadership in Energy and Environmental Design. LEED is a voluntary program for builders, architects and designers to improve their level of sustainable design. The program is based on a point system, for each “green” element that is designed into the building, it receives a certain point level. It is important to point out that LEED certification requires building designers to incorporate “green technology” in many areas of the structure. Certification is not attained through a single selection of a green product but as a whole for the entire project. Lighting is an important

part of the certification process, the use of compact fluorescent and LED luminaires will provide additional points towards certification that incandescent products cannot.

The LEED program has become widely popular and is the ultimate green designation. End-users are now interested in and demanding that buildings comply with the LEED program. Architects and builders alike strive to earn LEED certifications on their projects, including new commercial and institutional construction and remodels, affordable housing, mass-produced homes, custom residences, apartments, condominiums, duplexes, townhouses and more.

For further information go to www.usgbc.org.

LEED Home: Environmentally Conscious and Money Saving

LEED has recently developed a residential certification program. LEED Home is popular with real estate developers and end-users. Not only is it environmentally friendly but it will reduce the ever increasing energy bills in residential communities.

LEVEL 1	LEVEL 2	LEVEL 3
<p>Minimum Requirement</p> <p>4 ENERGY STAR labeled fixtures installed into high-use rooms such as kitchens, baths, family rooms and living rooms</p>	<p>Improved Lighting</p> <p>Level 1 + 3 additional ENERGY STAR labeled fixtures; Exterior fixtures must have motion sensors or photovaltiac cells</p>	<p>Advanced Lighting</p> <p>60% of all hard-wired lighting will be ENERGY STAR qualified</p>

LEED New Construction Requirements for Commercial Buildings

The minimum levels for LEED certification are based on ASHRAE 90.1-2004. These strict watts per square foot requirements guide the point system for LEED certification regarding lighting and energy consumption.



The benefits of LEED certification include:

- Sustainable building design is good for the environment
- Energy efficient lighting is the best solution to reduce your monthly electric bill
- Increases long term value of the property with LEED certification

Minimum Energy Requirements for Interior Lighting

Meeting ASHRAE/IESNA 90.1-2004. For example:

Office space allows 1.0 w/s.f.

Convention center 1.2 w/s.f.

Health care / Clinic 1.0 w/s.f.

Retail allows 1.5 w/s.f.

Hotel allows 1.0 w/s.f.

Optimized Energy Performance

Additional LEED points are accrued for each percentage that the project is rated UNDER the ASHRAE minimums. For example: a builder will gain an additional 5 LEED points if the energy requirements for the entire project are 24.5% less than the ASHRAE measurement of 1.0 w/s.f. for an office environment.

10.5% reduction in wattage = 1 point

14% reduction in wattage = 2 points

17.5% reduction in wattage = 3 points

21% reduction in wattage = 4 points

24.5% reduction in wattage = 5 points

Up to 42% reduction = 10 points

For further information on LEED point requirements please go to www.usgbc.org.

What are the Advantages of LEED Certification?

For a Homeowner

- Substantially lower energy bills
- The value of the home will increase with a LEED rating
- Reduce greenhouse gas emissions and actively participate in the green movement



For Contractors, Builders and Specifiers

- Differentiate your company from the competition
- Offer an increased value for your services
- Help your clients become more environmentally-aware with reliable green lighting products



For a Lighting Distributors and Showrooms

- An opportunity to offer your customer a full line of proven energy efficient products
- Take advantage of local utility rebates in your area - up to \$47 per fixture change out
- Enhanced public awareness and visibility for your company as sponsors of “green and renewable” energy products



There's no going back. The trend to energy efficient LED and CFL fixtures will only grow more explosive as manufacturers, lighting designers and contractors discover new applications for SSL technology. This is a dynamic time for the electrical industry as technical advances radically change the products available and the way we think about lighting. New opportunities will arise everyday and...

with Nora Lighting you can expand your business in this fast-growing market.

Nora's Services and Capabilities



Nora: World Class Customer Service

At Nora Lighting great customer service is our passion. Whenever you contact our administrative offices, your call is personally answered by a friendly staff member who can respond to your query or direct you to a key contact.

All Nora accounts have a dedicated Customer Care representative who is well-acquainted with your projects and orders, and has current details at their fingertips. Our Customer Care specialists act as your in-house “project manager” and can supply all specification and product data, inventory reports, order status and shipping updates.

Assisting them is our Quotations Department, a team of knowledgeable experts who know the requirements of commercial or residential projects and the best way to obtain the results you want. You can rely on the Nora support team for:

- Project Specifications, Quotations and Sales
- Project Management, Order Status, Processing and Shipping
- Field Support and Technical Services.

The Nora Network: Distribution Channel Partners

Nora Lighting is proud to be represented by a network of professional lighting supply, showroom and specification agencies across the U.S. and Canada. Our complete line of fixtures and accessories can be found nationwide at electrical wholesalers, lighting showrooms and select internet dealers.

That means lighting designers, architects and contractors can count on these industry experts for up-to-date information on what's new and energy-efficient in Nora commercial and residential fixtures and to provide value-added sales support.

To help our sales reps and distributors stay competitive, Nora also offers a variety of distributor programs tailored to meet the goals for growth of our distributor partners. Contact Nora's national sales managers for more details on a program designed for your team.



Nora National Accounts: Customized Programs

Nora is committed to developing long-term relationships with National Accounts and we have expanded our sales programs to better serve large organizations with central purchasing offices. Well-known customers in healthcare, hospitality, retail, industrial, residential and corporate development have discovered the benefits of doing business with us.

Nora's in-house National Accounts Service Team is strictly “hands-on.” From quotation and order placement to shipping and confirmation, a National Account representative oversees every step and has status reports on hand. Our specialists are familiar with your inventory requirements and will replenish stock, based on your corporate needs. With Nora's sophisticated inventory control system, we can pre-allocate and hold inventory until it is time to release your shipment.

Here's what Nora can do for your company:

- Outstanding selection of top quality, energy-efficient products with a range of price points
- Nationwide network of centrally-located distribution facilities, stocked and ready to ship
- Advantage of one-source shopping for all corporate lighting needs and
- Customized purchase programs that meet customer's needs and expectations.

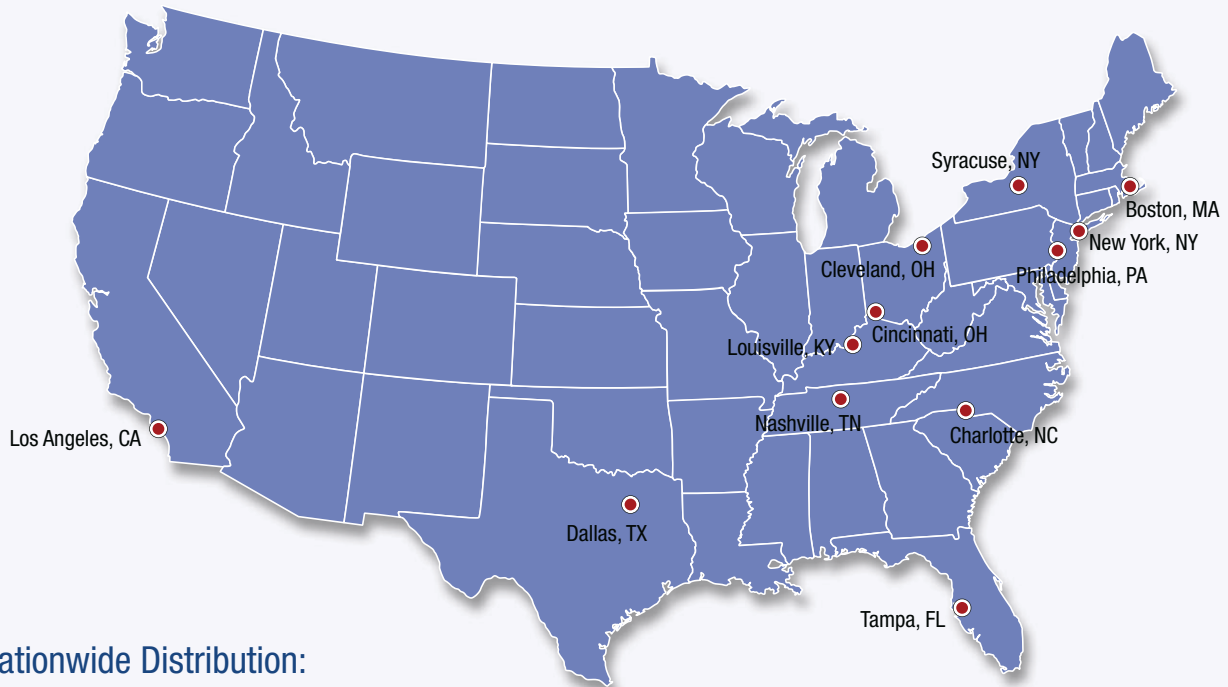

Nationwide Distribution: Faster Shipping

Nora's nationwide network of distribution points allows us to fill orders faster than most manufacturers and ensures that our clients receive products and support in a timely manner.

From our 150,000 square-foot manufacturing/warehouse center in Southern California to 15 key distribution points across the country, Nora products can be sent out and delivered as soon as you need them. Most orders that are received by 12 noon (PST) can be shipped within 24 hours.

New From Nora: Free Point-by-Point Lighting Design

Nora Lighting representatives now offer our customers free Photometric Point-by-Point Lighting Layouts, based on a client's information and using AGI32. With this new service, Nora Lighting sales reps can assist in preparing a lighting design for a new project or verify that a design meets IESNA standards. Most layouts can be completed within a 24-hour time frame.

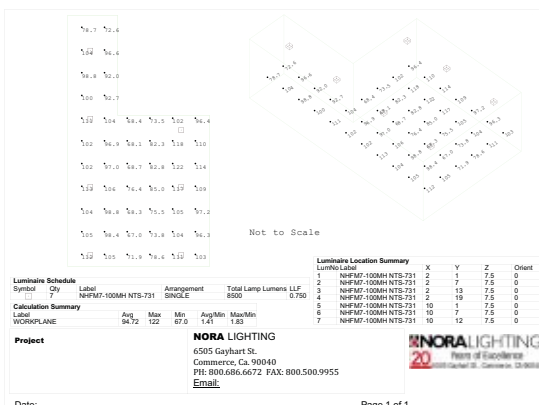

Streamlined Production: Quick Response Assembly

Nora has implemented new support systems and streamlined production and inventory management to provide better, faster fulfillment. The Integrated Assembly Center at Nora's Commerce headquarters is designed for quick response and flexibility. Whether it is a request for an emergency unit, a special dimming ballast or custom reflector / trim combination, Nora manufacturing can complete the order and ship it to a distributor within one to five days.



Easy-to-Navigate: www.noralighting.com

The new Nora website is more user-friendly than ever and has important information at your fingertips. It quickly links to specific fixture lines and one-click product searches bring up related categories. For example, the Nora Recessed Lighting category links to all recessed lighting fixtures, including: LED, incandescent, low voltage, CFL, metal halide HID, square housings, sloped ceiling, retrofit kits, step lighting and accessories.

An updated Resources section has been added that offers all Nora literature and advertising with download-able PDF product catalogs and configurable specification data sheets that can be saved with customer information. Nora order forms and credit applications, along with company news and product updates, are also easily viewed and printable.



Internet Business Site: www.Norainfo.com

The Nora business website (Norainfo.com) can be accessed at any time via the Nora Home Page and is a helpful tool to track orders and view account history. Check in 24 hours a day for updates on order information that you need now.

New FTP Site

The New Nora FTP site can provide distributors with on demand information and files.

Nora's Marketing Department: Keeping You Up-to-Date

Nora's in-house Marketing Department gives the company an edge in providing our customers with current information on product updates, industry trends and developments that affect your business.

Staffed with talented professionals, this integrated department oversees all Nora sales materials, specification sheets, literature, advertisements, online promotions and product publicity..... and gives Nora the ability to address fast-paced changes in the lighting industry.

As new products are introduced and industry standards modified, Nora can respond with useful information for lighting designers, architects, specifiers, sales representatives and customers to help them make better buying decisions.



Lighting Applications

memorable and inviting, practical and functional



Retail and Commercial Lighting

While commercial or retail sites generally depend on uniform ambient lighting to illuminate work, selling and traffic areas, additional accent lighting, such as wall washing and task lighting, can light workstations, set off designated areas, highlight displays and add drama.

With their even illumination, long lamp life and low energy consumption, LED and CFLs (compact fluorescent lamps) are the most commonly installed sources in commercial lighting. For high ceiling applications, HID ceramic metal halide lamps give excellent color rendition, long life and energy efficiency. When dimming is important, LED and fluorescent fixtures can be used, but in many cases a commercial PAR source is a practical choice.

Residential Lighting

Inviting residential lighting layers ambient lighting in living areas with accent lighting to spotlight artwork or display areas, and task lighting for specific activities. Dimmable recessed lighting has become the standard for general lighting in kitchens, baths and family rooms.

Good choices for residential lamp sources include Fluorescent, LED, PAR and A lamps which broadcast the light evenly, and reflector style lamps which concentrate the light downwards.





Ambient or General Lighting

Ambient lighting is the overall illumination of a specific area. It radiates a comfortable level of brightness and can be accomplished with recessed, track or rail light, ceiling or wall-mounted fixtures. Ideal ambient lighting is accomplished by overlapping the illumination from properly positioned fixtures arranged in a symmetrical plan.

Task Lighting

Task lighting illuminates an area for a specific task and is installed as a supplement to ambient/general lighting. Task lighting is directed at a relatively small area, such as a countertop, workshop or office work station.

Linear LED, Fluorescent, Xenon and halogen can be used in undercabinet and work station areas while MR16, PAR and BR Recessed, Track, and Nora Rail sources can spot light a defined task area.



Accent Lighting

Accent lighting introduces drama to a setting by heightening the visual experience. It is often used to focus attention on artwork, architectural details, merchandizing displays, art niches and vignettes. This technique can also be used to highlight the texture of a brick or stone wall or window treatments. It is usually accomplished with track, rail, or adjustable recessed using reflector type sources.

Wall Washing

Wall washing is a design technique used to light vertical surfaces in order to make rooms appear more spacious, lighter and brighter or to highlight unique surfaces.

Recessed downlights combined with wall wash or adjustable trims, Track and Rail lighting can be used to effectively cast even illumination on adjacent walls. Lamp sources include: LED, fluorescent, ceramic metal halide and incandescent.



Wall Grazing

This technique is used to create a dramatic effect or shadows on textured surfaces, such as stone or brick walls. Recessed, Track or Rail lighting is placed close to the wall, equal distance apart and aimed downwards.





Nora Recessed Lighting

Unobtrusive fixtures provide subtle ambient or general lighting for commercial or residential sites. Also increasingly popular for accent lighting or wall washing when used with adjustable fixtures. The wide choice of light sources includes: incandescent, HID ceramic metal halide, low voltage, quartz halogen, compact fluorescents and LED.



Nora Pendant Lighting

Suspended from the ceiling over kitchen center islands, retail counter tops, hospitality lounges or dining tables, pendant lighting can provide focused illumination or a warm ambient glow, depending on the fixtures and light source. Use of a dimmer provides flexibility to vary the light to suit the occasion.



Nora LED LightBar and LEDTape Light

Nora linear LED lightbars and LED tape lights provide both task and accent lighting. Linear lightbars are often mounted under cabinets to illuminate specific sites, such as work stations, and cooking areas. Nora tape lights are a practical solution for lighting kitchen or dining room cabinets, coves, and architectural details. Slim and energy-efficient, Nora lightbars and tape lights offer all the advantages of LEDs, including energy-savings, longer performance life, no projected heat or UV rays.

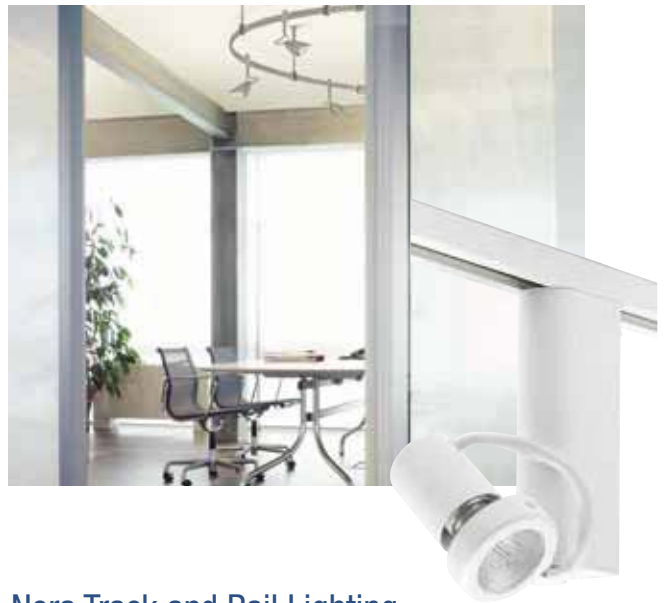

Nora Track and Rail Lighting

Nora Track and Rail Lighting is known for its flexibility and can provide ambient, general, task or accent lighting in a multi-fixture system. Individual fixtures are able to move, swivel, rotate and aim in any direction along the track or rail. The lighting scheme can be altered at any time to suit the requirements of a new design.

Track and Rail Lighting is available with a range of light sources: incandescent, halogen, compact fluorescent and LEDs. Additionally, pendants can be mounted to a track or rail system.



RECESSED

Trim Finishes	34
Custom Combinations	38
LED	41
Compact Fluorescent	63
GU24 Base	162
HID Ceramic Metal Halide	185
Low Voltage	215
Line Voltage	253
Retrofit	346
Square Housings	362
Step Lighting	370
Accessories	378

Nora Recessed Lighting: The Industry's Most Comprehensive Line

Advanced Technology, Versatile Styling, Energy Savings

Sleek, modern recessed lighting stands as one of the truly innovative achievements in contemporary building design. And Nora Lighting is proud to be recognized as a premier manufacturer of this brilliant alternative.

As a leader for more than 20 years in the development and refinement of recessed down lights, Nora can say with confidence that the company offers one of the most extensive selections of housings, lamp sources, sizes and reflector trims than any other manufacturer in the world.

When you add to that list new LED options, low iridescent specification-grade reflectors, open wall wash reflectors, suspended glass trims and fixtures with dimming options and emergency battery backups . . . you soon realize there is a Nora recessed lighting solution for every design project.



End-User Satisfaction

As a benefit to end-users, Nora recessed down lights feature airtight construction to reduce energy costs and they are safety-rated for direct contact with insulation and combustible materials. All Nora housings are also easy to install and accept a wide variety of attractive, high quality trims.

This exceptional selection presents lighting designers, and other industry professionals, many versatile solutions for retail, institutional, hospitality, corporate, educational or residential sites and more.

LED Lighting: New Models and Styles

Nora's new LED recessed downlights can be placed throughout a home, retail or commercial site for the highest-rated energy efficiency. Available in the latest models and styles for new construction, remodeling or retrofits, Nora LEDs exceed Title 24 efficacy requirements and are Energy-Star rated.

Featuring high-output LEDs, the Nora fixtures offer an energy savings of over 75% when compared with a 65W BR30. High lumen output, easy dimming capabilities and a range of apertures present exceptional site versatility.



Energy-Saving Compact Fluorescent Lamps (CFLs)

An energy-efficient alternative, Nora compact fluorescent down lights provide a cost-saving solution for retail, office and residential sites. High quality architectural and commercial reflectors feature maximum efficiency with minimal glare.

Nora's complete line of economical, high-performing reflectors/trims offer a practical, cost-saving solution for many installations. Fixtures include Energy Star-qualified electronic ballasts, horizontal or vertical lamp positions, in addition to several dimming and emergency options.



High Performance HID Metal Halide

Nora HID Ceramic Metal Halide down lights present an architectural lighting solution for large, high ceiling spaces, such as museum galleries, showrooms, lobbies and more. Fixtures direct well-defined illumination into spacious areas and accept electronically-driven, color-accurate ceramic metal halide sources and a wide variety of reflectors.



Pure White Low Voltage Halogen

Crisp, defined quartz and IR halogen brightens both work and living spaces. Pure white light illuminates strategic areas, while MR16, AR111 or PAR36 light sources allow fine-tuned aiming of directional lights. A wide choice of adjustable trims and various beam spreads offer greater design flexibility in large areas or to pinpoint art objects.



The Beauty of Incandescent

At home in a kitchen, dining room, family room, retail or office center, the warm color rendition of incandescent lighting creates an inviting environment. Standard Type A or soft Type R reflector lamps produce a subtle glow, while PAR reflector lamps highlight decorative surfaces, colors or task areas.



Architectural & Commercial Reflector Finishes

Nora Lighting's Architectural and Commercial grade reflectors and trims for incandescent, compact fluorescent and ceramic metal halide sources are available in a variety of color options in specification grade, American-made Alzak® finishes as well as our standard high-quality finishes. See individual reflector listings for available finishes for a particular trim.



Clear Low Iridescent Alzak® Reflector (LI)

Specification-grade, clear semi-specular finish that softens the light while eliminating the rainbow effect of fluorescent sources. Alzak® trims are made in the USA.



Specular Black Low Iridescent Alzak® Reflector (BLI)

Specification-grade, highly-specular finish that eliminates nearly all the aperture brightness. Excellent when little or no ceiling brightness or glare is desired. Alzak® trims are made in the USA.



Bronze Low Iridescent Alzak® Reflector (BZLI)

Specification-grade, semi-specular finish that softens the light at the source and eliminates the rainbow effect of fluorescent sources. Bronze tone creates slightly warmer light output. Alzak® trims are made in the USA.



Haze Low Iridescent Alzak® Reflector (HZLI)

Specification-grade, slightly diffused clear finish that reduces the mirror image associated with specular finishes producing a soft even illumination. Alzak® trims are made in the USA.



Champagne Gold Low Iridescent Alzak® Reflector (CGLI)

Specification-grade, semi-specular finish that softens the light at the source. Casts a warmer tone than the Bronze Low iridescent finish. Alzak® trims are made in the USA.



Gold Low Iridescent Alzak® Reflector (GLI)

Specification-grade, specular finish that slightly tints the light to a warm color. Finish blends well with brass and gold finishes and the warm light compliments darks woods. Alzak® trims are made in the USA.



Pewter Low Iridescent Alzak® Reflector (PELI)

Specification-grade, rich, dark semi-specular finish that produces a distinctive cool, low brightness aperture. Alzak® trims are made in the USA.



Straw Low Iridescent Alzak® Reflector (STLI)

Specification-grade, semi-specular finish that softens the light while eliminating the rainbow effect of fluorescent sources. Alzak® trims are made in the USA.



Wheat Low Iridescent Alzak® Reflector (WHLI)

Specification-grade, specular finish with a warm appearance excellent for fluorescent sources. Alzak® trims are made in the USA.

Architectural & Commercial Reflector Finishes



Specular Clear Reflector with Black Baffle (B)

With a specular clear upper reflector the black baffle is efficient while providing low aperture brightness.



Specular Clear Reflector with White Baffle (W)

With a specular clear upper reflector the white baffle is very efficient. The baffle helps minimize aperture brightness.



Specular Clear Reflector (C)

Specular clear is a high polished reflector and therefore provides the best performance and efficiency.



Specular Clear Low Iridescence Reflector (CLI)

Low iridescent finish helps minimize the rainbow effect caused by fluorescent sources.



Specular Gold Reflector (G)

A specular finish that slightly tints the light to a warm color. Finish blends well with brass and gold finishes and the warm light compliments dark woods.



Specular Black Reflector (B)

A specular finish that best hides aperture brightness. It is often the choice when glare and minimum ceiling brightness are a concern. Consequently, it absorbs light and can be inefficient except when used with reflector style lamps.



Specular White Reflector (W)

Specular white is very efficient, however has high aperture brightness. Blends in well with white ceilings when off.

Architectural & Commercial Trim Flange Options

See individual trim listings for available flange options for a particular trim.



Self Flange (SF)

5/8" integral flange is a part of the reflector and finished in the same finish as the reflector.



White Flange (WF)

5/8" integral flange is a part of the reflector and is painted white.



Reflector with Separate Ring

Two-piece reflector comes standard with a white plastic trim ring. Trim ring can be ordered in custom finishes (Custom Combos) that differ from the reflector finish. For more information on Custom Combos see pages 38-39.

Standard Trim Finishes

Nora Lighting's 3", 4", 5" and 6" reflectors and trims for incandescent, low voltage, compact fluorescent and ceramic metal halide sources feature high-quality finishes in a variety of color options. See individual trim listings for available finishes for a particular trim.



Specular Clear (C)

Specular clear is a highly polished chrome like finish. Specular clear is the most specular finish and therefore provides the best performance and efficiency. It has a low aperture brightness and professional designer appearance.



Bronze (BZ)

A beautiful dark bronze finish with a hint of copper highlights that blend well with all oil rubbed bronze fixture finishes. The finish provides low aperture brightness.



Natural Metal (N)

An industrial, brushed raw metal finish that blends well with all stainless steel and brushed nickel fixtures. The finish provides a soft aperture brightness.



Copper (CO)

A beautiful, full flavor finish similar to an old copper penny. It blends well with period copper fixtures, provides good performance and lower aperture brightness.



Haze (HZ)

A soft platinum finish which casts a soft glow with low aperture brightness. Finish is easy to maintain and blends with multiple metal finishes. Haze does not appear as chrome when off.



Specular Gold (G)

A specular finish that will slightly tint the light to a warm color. The finish blends well with brass and gold fixtures. The warm light works well with dark woods.



Specular Black Reflector (B)

A specular finish that best hides aperture brightness. It is often the top choice by designers when glare and minimum ceiling brightness are a concern. Consequently, it absorbs light and can be inefficient except when used with reflector style lamps.



Specular White Reflector (W)

Specular white creates the highest aperture brightness, yet blends in well with white ceilings when off.

Standard Trim Finishes



White Metal Baffle

White creates the highest aperture brightness, however the baffle minimizes some glare. Blends well with white ceilings when off.



White Phenolic Baffle

The deep groove of the phenolic (plastic) baffle is the best choice to control aperture brightness while still blending well with white ceilings when off. Good for outdoor applications or harsh environments.



Black Metal Baffle

Absorbs light to help hide aperture brightness when on. Gives a "black hole" appearance when off.



Black Phenolic Baffle

The deep groove of the phenolic (plastic) baffle is a good choice to control aperture brightness when on. Gives a "black hole" appearance when off. Good for outdoor applications or harsh environments.



CC Custom Combinations

Custom Combinations of Trim Reflector/Baffle and Ring Finishes

Nora Lighting offers custom combinations of reflector/baffle and ring finishes on any 3", 4", 5" or 6" trim designated with the CC logo **CC**. Custom Combinations allow the specifier, designer, distributor or customer to select both the reflector or baffle finish and the ring finish to meet specific design criteria or personal preference.

Reflector and baffle finishes vary by trim and the selected finish must be available in the trim chosen. All finishes are not available in all trim series. Trim rings come in metal and plastic, standard and oversize widths. Metal ring finishes include Black, Bronze, Chrome, Copper, Gold, Natural Metal and White. Plastic trim rings are available in Black, Chrome, Gold and White. Custom Combinations are modified at the factory to your exact needs. Here's how to order:

STEP 1.

Make sure the trim or reflector you have selected is noted with a CC logo **CC**.

STEP 2.

Select a reflector or baffle finish from among the finishes available in the trim you have chosen.

STEP 3.

Select the trim ring finish. Standard trim rings are available in Metal or Plastic. Architectural and commercial trim rings are available in Plastic only. Trim ring item numbers and full details on sizes, widths, materials and finishes can be found on the following page.

STEP 4.

Add a slash followed by the desired trim ring item number as a suffix to the trim base number.

Example: NTA-97 / NMOR-30N

Ordering Example

Base Trim Number:

NTM-34

6" Bronze Stepped Baffle with Bronze Metal Ring



Change the trim ring to Oversize Gold Plastic Ring:

NTM-34/NOR-30G

6" Bronze Stepped Baffle with 7/8" Gold Plastic Ring



Change the trim ring to Designer White Metal Ring:

NTM-34/NMR-30W

6" Bronze Stepped Baffle with 5/8" White Metal Ring



Change the trim ring to Oversize Chrome Metal Ring:

NTM-34/NMOR-30C

6" Bronze Stepped Baffle with 7/8" Chrome Metal Ring



Custom Combination Trim Ring Options

6" TRIM RINGS

Plastic Ring for ARCHITECTURAL AND COMMERCIAL Trims (NTS-630/650/730 Series)

NRA-106B	5/8" Black Plastic
NRA-106C	5/8" Chrome Plastic
NRA-106G	5/8" Gold Plastic
NRA-106W	5/8" White Plastic

7/8" Oversize Metal Ring for Standard 6" Trims

NMOR-30B	7/8" Black Metal
NMOR-30BZ	7/8" Bronze Metal
NMOR-30C	7/8" Chrome Metal
NMOR-30CO	7/8" Copper Metal
NMOR-30G	7/8" Gold Metal
NMOR-30N	7/8" Natural Metal
NMOR-30W	7/8" White Metal

5/8" Designer Metal Ring for Standard 6" Trims

NMR-30B	5/8" Black Metal
NMR-30BZ	5/8" Bronze Metal
NMR-30C	5/8" Chrome Metal
NMR-30CO	5/8" Copper Metal
NMR-30G	5/8" Gold Metal
NMR-30N	5/8" Natural Metal
NMR-30W	5/8" White Metal

7/8" Oversize Plastic Ring for Standard 6" Trims

NOR-30B	7/8" Black Plastic
NOR-30C	7/8" Chrome Plastic
NOR-30G	7/8" Gold Plastic
NOR-30W	7/8" White Plastic

5/8" Plastic Ring for Standard 6" Trims

NR-30B	5/8" Black Plastic
NR-30C	5/8" Chrome Plastic
NR-30G	5/8" Gold Plastic
NR-30W	5/8" White Plastic

5" TRIM RINGS

7/8" Oversize Metal Ring for 5" Trims

NMOR-501B	7/8" Black Metal
NMOR-501BZ	7/8" Bronze Metal
NMOR-501C	7/8" Chrome Metal
NMOR-501CO	7/8" Copper Metal
NMOR-501G	7/8" Gold Metal
NMOR-501N	7/8" Natural Metal
NMOR-501W	7/8" White Metal

5/8" Metal Ring for 5" Trims

NR-501B	5/8" Black Metal
NR-501BZ	5/8" Bronze Metal
NR-501C	5/8" Chrome Metal
NR-501CO	5/8" Copper Metal
NR-501G	5/8" Gold Metal
NR-501N	5/8" Natural Metal
NR-501W	5/8" White Metal

3" TRIM RINGS

1/2" Metal Ring for 3" Trims

NR-3301B	1/2" Black Metal
NR-3301BZ	1/2" Bronze Metal
NR-3301C	1/2" Chrome Metal
NR-3301CO	1/2" Copper Metal
NR-3301G	1/2" Gold Metal
NR-3301N	1/2" Natural Metal
NR-3301W	1/2" White Metal

4" TRIM RINGS

7/8" Oversize Metal Ring for 4" Trims

NOR-401B	7/8" Black Metal
NOR-401BZ	7/8" Bronze Metal
NOR-401C	7/8" Chrome Metal
NOR-401CO	7/8" Copper Metal
NOR-401G	7/8" Gold Metal
NOR-401N	7/8" Natural Metal
NOR-401W	7/8" White Metal

5/8" Designer Die-Cast Metal Ring for 4" Trims

NR-401DB	5/8" Black Die-Cast Metal
NR-401DBZ	5/8" Bronze Die-Cast Metal
NR-401DC	5/8" Chrome Die-Cast Metal
NR-401DCO	5/8" Copper Die-Cast Metal
NR-401DG	5/8" Gold Die-Cast Metal
NR-401DN	5/8" Natural Die-Cast Metal
NR-401DW	5/8" White Die-Cast Metal

5/8" Designer Metal Ring for 4" Trims

NR-401B	5/8" Black Metal
NR-401BZ	5/8" Bronze Metal
NR-401C	5/8" Chrome Metal
NR-401CO	5/8" Copper Metal
NR-401G	5/8" Gold Metal
NR-401N	5/8" Natural Metal
NR-401W	5/8" White Metal

5/8" Plastic Ring for 4" Trims

NR-401PB	5/8" Black Plastic
NR-401PC	5/8" Chrome Plastic
NR-401PG	5/8" Gold Plastic
NR-401PW	5/8" White Plastic





Efficient. Long Lasting. Versatile.

Nora Lighting is pleased to introduce new LED recessed downlights. These powerfully built, dimmable LED fixtures provide extraordinary light output while producing no forward heat or ultraviolet UV rays. Combined with long lamp life, Nora LED downlights are ideal in a variety of commercial, retail, hospitality and residential applications.

LED Solid State Lighting



Overview LED RECESSED

LED PLATINUM SERIES



6" IC Air-Tight New Construction LED Housing
NHIC-6LEDAT p.46



6" IC Air-Tight Remodel LED Housing
NHRIC-6LEDAT p.47



5" IC Air-Tight New Construction LED Housing
NHIC-5LEDAT p.50



5" IC Air-Tight Remodel LED Housing
NHRIC-5LEDAT p.51



4" IC Air-Tight New Construction LED Housing
NHIC-4LEDAT p.54



4" IC Air-Tight Remodel LED Housing
NHRIC-4LEDAT p.55

LED PLATINUM SERIES FEATURES

- Dimmable
- Mercury free, which is good for the environment
- No flicker or delay
- Title 24 compliant
- LEDs do not emit forward heat like traditional light sources
- No UV wavelengths
- Up to 52 Lumens Per Watt
- LEDs rated at 50,000 hours at 70% lumen maintenance
- Three Year Limited Warranty
- Scientifically designed lens diffuses the LED image while providing high lumen output
- 6" LED Series is Energy Star Rated

Overview LED RECESSED

LED RETROFIT DIAMOND SERIES

			
<p>6" LED Retrofit, Medium Base For IC and Non-IC Housings</p> <p>NLEDR-6 (Retrofit) p.60</p>	<p>6" LED Retrofit, Quick Connect For Dedicated Nora Housing</p> <p>NLEDC-6 (Dedicated) p.60</p>	<p>5" LED Retrofit, Medium Base For IC and Non-IC Housings</p> <p>NLEDR-5 (Retrofit) p.61</p>	<p>5" LED Retrofit, Quick Connect For Dedicated Nora Housing</p> <p>NLEDC-5 (Dedicated) p.61</p>



LED DIAMOND SERIES FEATURES

- Dimmable
- Mercury free, which is good for the environment
- No flicker or delay
- Title 24 compliant (GU24 & Dedicated Version)
- LEDs do not emit forward heat like traditional light sources
- No UV wavelengths
- Up to 650 Lumens
- LEDs rated at 50,000 hours at 70% lumen maintenance
- Seven Year Limited Warranty
- Scientifically designed lens diffuses the LED image while providing high lumen output

LED STEP LIGHTING

		
<p>Mini LED Step Light w/ Photocell</p> <p>NSI-661PC (Louvered) p.372</p> <p>NSI-662PC (Lensed) p.372</p>	<p>Mini LED Step Light</p> <p>NSI-661 (Louvered) p.373</p> <p>NSI-662 (Lensed) p.373</p>	<p>LED Step Light</p> <p>NSI-601 (Louvered w/ Lens) p.374</p> <p>NSI-602 (Frosted Glass) p.374</p>

The Nora Lighting family of LED Platinum Recessed Downlights

Nora's Platinum Series was introduced in 2009 and continues to satisfy the most discriminating specifier for high output and efficient LED lighting with smooth dimming. The Platinum Series use high output Osram® LEDs and an outboard mounted driver for cool operation and long life. Already tested in commercial National Accounts and Residential applications, Nora's Platinum Series LED is the proven choice of many specifiers and end users.

FEATURES

- Dimmable with economical 2-wire dimming down to 3% (56W minimum load requirement). For optimum and minimal loads, use electronic low voltage dimmer
- Three aperture sizes! Our family of recessed products are available in 3-1/2", 4-1/2" and 5-1/2" apertures for all ceiling heights and applications
- UL Listed for Wet Location - standard on all LED Platinum Recessed products
- Exceeds high efficacy requirements of California Title 24 - up to 51 lumens per watt
- Available with 3000K or 4200K CCT, 86 CRI
- Light output is similar to a 65W BR30 with 75% energy savings over incandescent!
- No flicker or delay
- Three-year limited warranty on the complete luminaire backed by Nora Lighting
- Recessed fixtures are tested to ASTM-283 air-tight standards and for insulated ceilings
- Our scientifically designed lens diffuses the LED image while providing high lumen output; standard on all trims
- State of the art Osram® LEDs are rated at 50,000 hours at 70% lumen maintenance
- Mercury free which is good for the environment
- No ultraviolet or infrared wavelengths that cause fading of artwork and perishable merchandise
- Does not emit forward heat like traditional light sources
- Significantly reduces air-conditioning loads and lowers energy demands
- High efficiency driver with a power factor >.90 with input power of 120V, 60Hz
- Available with Emergency Backup
- Trim is standard with a self-flanged die-cast ring. Flange available in White and Platinum Diffused. Reflector available in White, Black and Platinum Diffused

Fixture Performance Comparison			
Fixture	65W BR30	18W CFL	14W LED
Average footcandles at 8' mounting height, 20' x 20', multiple units, spaced at 6' O.C.	24.2 fc*	21.9 fc*	20.4 fc*

* Measured at 2.5' AFF

LED Platinum Recessed Downlight

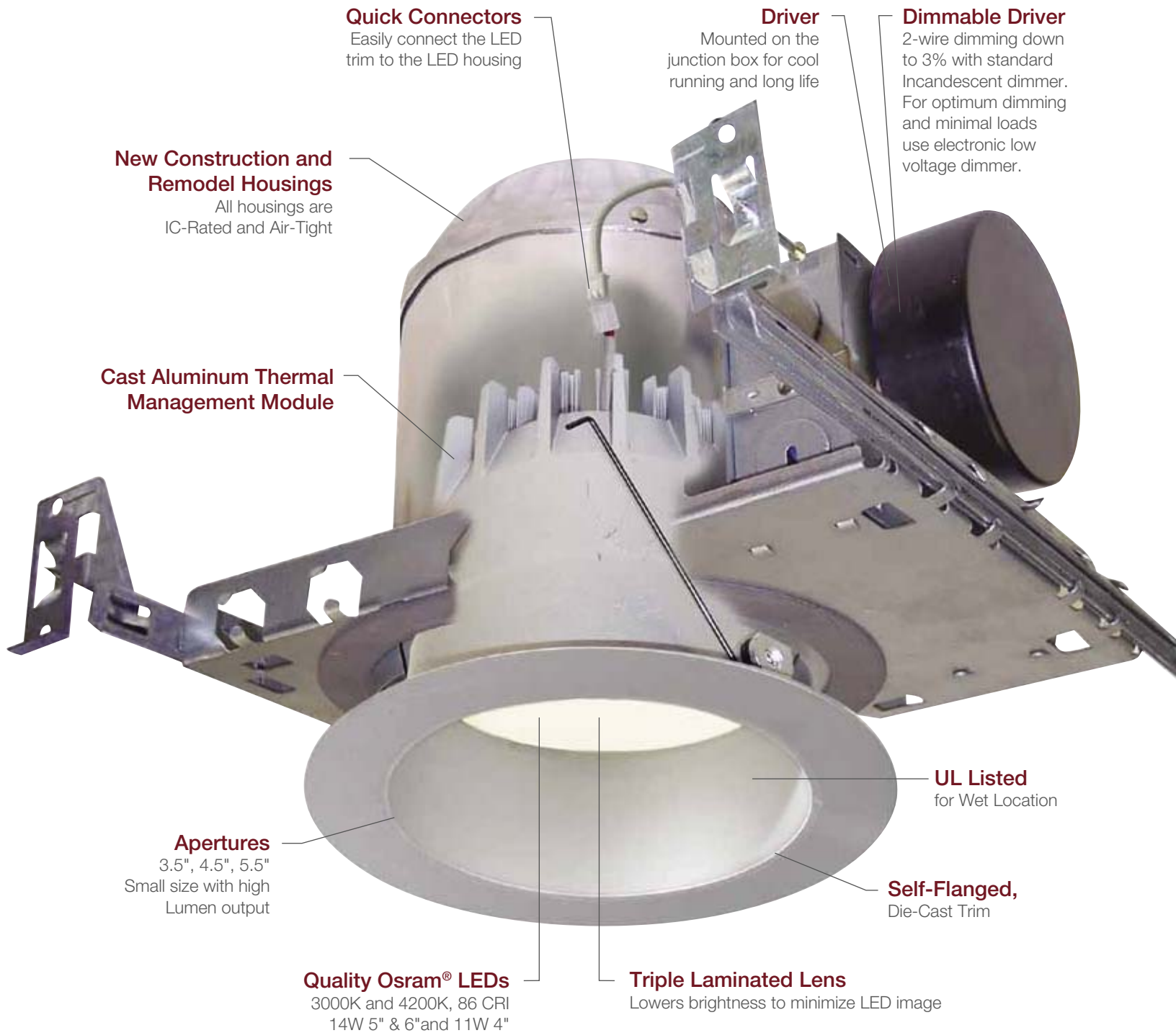

Quick Connectors
Easily connect the LED trim to the LED housing

Driver
Mounted on the junction box for cool running and long life

Dimmable Driver
2-wire dimming down to 3% with standard Incandescent dimmer. For optimum dimming and minimal loads use electronic low voltage dimmer.

New Construction and Remodel Housings
All housings are IC-Rated and Air-Tight

Cast Aluminum Thermal Management Module

UL Listed
for Wet Location

Apertures
3.5", 4.5", 5.5"
Small size with high Lumen output

Self-Flanged, Die-Cast Trim

Quality Osram® LEDs
3000K and 4200K, 86 CRI
14W 5" & 6" and 11W 4"

Triple Laminated Lens
Lowers brightness to minimize LED image



LED PLATINUM RECESSED

6" IC Air-Tight New Construction Housing

Nora Lighting is excited to introduce a new product line to our LED family, LED Recessed Luminaires. Rated for wet location, these housings are ideal for outdoor and wet environments. Compared to a 65W BR30, Nora's LED recessed luminaires offer a savings of over 75%. Air-tight construction provides energy savings by reducing the flow of air through the ceiling, and with its LED trim module available in warm (3000K) or cool white (4200K).

Nora Lighting's internal high-reflectance luminance system is capable of producing up to 710 lumens making its output commensurable with the highest in the industry. The triple laminated lens diffuses the LED image while producing high lumen output and excellent visual cut-off.

With outboard mounted drivers, our recessed housings offer cooler operation and longer life. Each LED Driver comes pre-installed to the housing's junction box, allowing the LED trim to be selected and installed at finish.

LED Driver: 120V AC, 60HZ, Power factor > 0.9 at 120V. Mounted on the junction box cooler operation and easy access.

Dimmable: Dimmable with economical 2-wire dimming down to 3% (56W minimum load requirement). For optimum and minimal loads, use low voltage dimmer.

Emergency Option: Emergency back-up operates LED source for a minimum of 90 minutes. Unit includes battery, charger, and remote test plate with indicator light/test switch.

Ceiling Thickness: Accepts 1-5/8" maximum ceiling thickness.

Installation: Bar hangers are adjustable from 13-5/8" to 24-1/2" with captive nails and can be repositioned 90 degrees. Bar hangers are slotted for T-Bar installations.

Minimum Clearance: "IC" Housings are direct contact rated; no minimum clearance is required.

Junction Box: Pre-wired 25 cu. in. with seven 1/2" knockouts, four Romex® pry-outs and snap on covers. Ground wire connected on bottom of box.

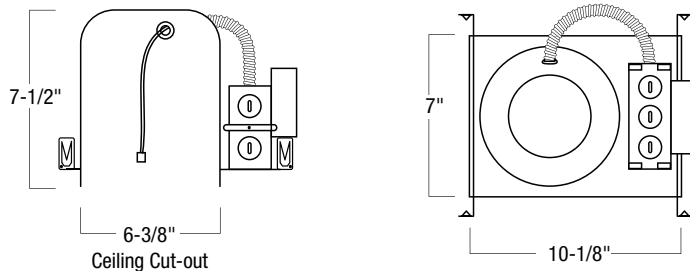

LED PLATINUM NEW CONSTRUCTION HOUSING

CATALOG. NO.	DRIVER	VOLTAGE	WATTAGE	AIR-TIGHT	DIMMABLE	EMERGENCY
NHIC-6LEDAT	Class 2 (Included)	120V	14W	Yes	Down to 3%	EM



Listing:

UL Damp Location w/ Feed Through
 UL Wet Location Listed
 WSEC ASTM E283 for Air-Tight
 California Energy Commission
 Energy Star Rated
 Title 24 Compliant

LED PLATINUM RECESSED 6" IC Air-Tight Remodel Housing

NEW!

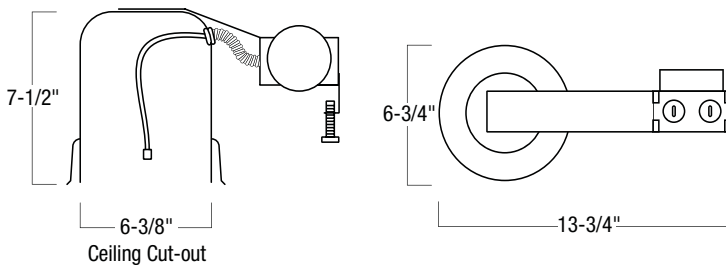

LED PLATINUM REMODEL HOUSING

CATALOG. NO.	DRIVER	VOLTAGE	WATTAGE	AIR-TIGHT	DIMMABLE
NHRIC-6LEDAT	Class 2 (Included)	120V	14W	Yes	Down to 3%



committed to
GREEN

Lighting Tip:

Why do you select LED against less expensive energy efficient CFL fixtures? Dimming! LEDs are similar in cost to a dimmable CFL and much easier to dim. At a minimal price difference, LED is the choice for specifiers and end users.

Nora Lighting is excited to introduce a new product line to our LED family, LED Recessed Luminaires. Rated for wet location, these remodel housings are ideal for outdoor and wet environments. Compared to a 65W BR30, Nora's LED recessed luminaires offer a savings of over 75%. Air-tight construction provides energy savings by reducing the flow of air through the ceiling, and with its LED trim module available in warm (3000K) or cool white (4200K).

Nora Lighting's internal high-reflectance luminance system is capable of producing up to 710 lumens making its output commensurable with the highest in the industry. The triple laminated lens diffuses the LED image while producing high lumen output and excellent visual cut-off.

With outboard mounted drivers, our recessed housings offer cooler operation and longer life. Each LED Driver comes pre-installed to the housing's junction box, allowing the LED trim to be selected and installed at finish.

LED Driver: 120V AC, 60HZ, Power factor > 0.9 at 120V. Mounted on the junction box cooler operation and easy access.

Dimmable: Dimmable with economical 2-wire dimming down to 3% (56W minimum load requirement). For optimum and minimal loads, use low voltage dimmer.

Ceiling Thickness: Accepts 1-5/8" maximum ceiling thickness.

Installation: High tension tempered steel springs secure remodel housings evenly to the ceiling; hole cutout template provided for convenience.

Minimum Clearance: "IC" Housings are direct contact rated; no minimum clearance is required.

Junction Box: Pre-wired 25 cu. in. with seven 1/2" knockouts, four Romex® pry-outs and snap on covers. Ground wire connected on bottom of box.

Listing:
UL Damp Location w/ Feed Through
UL Wet Location Listed
WSEC ASTM E283 for Air-Tight
California Energy Commission
Energy Star Rated
Title 24 Compliant

LED PLATINUM RECESSED

6" LED Trims - 5-1/2" Aperture

Warm White 3000K Reflector



Catalog No.	Description
NTR-6LED30BW	Black Reflector / White Flange
NTR-6LED30PP	Platinum Diffused Reflector / Platinum Diffused Flange
NTR-6LED30PW	Platinum Diffused Reflector / White Flange
NTR-6LED30WW	White Reflector / White Flange

- UL Wet Listed
- Energy Star Rated
- Triple Laminated Lens
- Dimmable down to 3%
- Quick connect supplied
- Up to 630 lumens
- Rated at 50,000 hours at 70% lumens

Wattage: 14W

Color Temp: 3000K

CRI: 86

OD: 7-3/8"

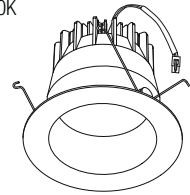

Cool White 4200K Reflector



Catalog No.	Description
NTR-6LED42BW	Black Reflector / White Flange
NTR-6LED42PP	Platinum Diffused Reflector / Platinum Diffused Flange
NTR-6LED42PW	Platinum Diffused Reflector / White Flange
NTR-6LED42WW	White Reflector / White Flange

- UL Wet Listed
- Energy Star Rated
- Triple Laminated Lens
- Dimmable down to 3%
- Quick connect supplied
- Up to 710 lumens
- Rated at 50,000 hours at 70% lumens

Wattage: 14W

Color Temp: 4200K

CRI: 86

OD: 7-3/8"

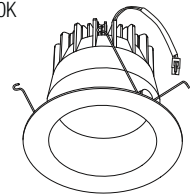

Available Finishes - consult factory for additional finishes (**BP** - Black Reflector / Platinum Diffused Flange, **WP** - White Reflector / Platinum Diffused Flange)



Platinum Diffused Reflector
Platinum Diffused Flange



Black Reflector
White Flange



Platinum Diffused Reflector
White Flange



White Reflector
White Flange

Photometrics

NTR-6LED30WW Warm White 3000K, White Self Flanged Reflector Trim

IESNA: LM-63-1995 Test No.: LLI 0909-04A Spacing Criteria: (0-180) 1.08 (90-270) 1.08
LPW: 44 Lamp: (12) 3000K LEDs Total Watts: 14.4W Lumens: 630

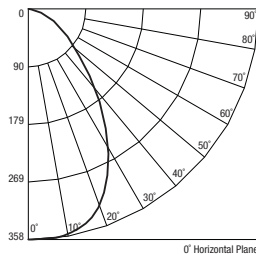

Mounting Height	F.C. at Nadir	Maximum Spacing
4'	22.4	4.3'
6'	9.9	6.5'
8'	5.6	8.6'
9'	4.4	9.7'
10'	3.6	10.8'

NTR-6LED42WW Cool White 4200K, White Self Flanged Reflector Trim

IESNA: LM-63-1995 Test No.: LLI 0809-13A Spacing Criteria: (0-180) 1.12 (90-270) 1.12
LPW: 52 Lamp: (12) 4200K LEDs Total Watts: 13.65W Lumens: 710

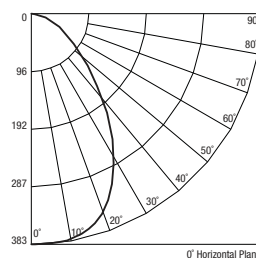

Mounting Height	F.C. at Nadir	Maximum Spacing
4'	23.6	4.5'
6'	10.5	6.7'
8'	5.9	9.0'
9'	4.7	10.1'
10'	3.8	11.2'

LED photometric results may vary from testing data. To assist the lighting designer in using Nora LED in a lighting layout, the following photometric tables have both lab test data and normalized data to illustrate expected typical performance. Typical photometric data is provided to illustrate expectation of typical performance.

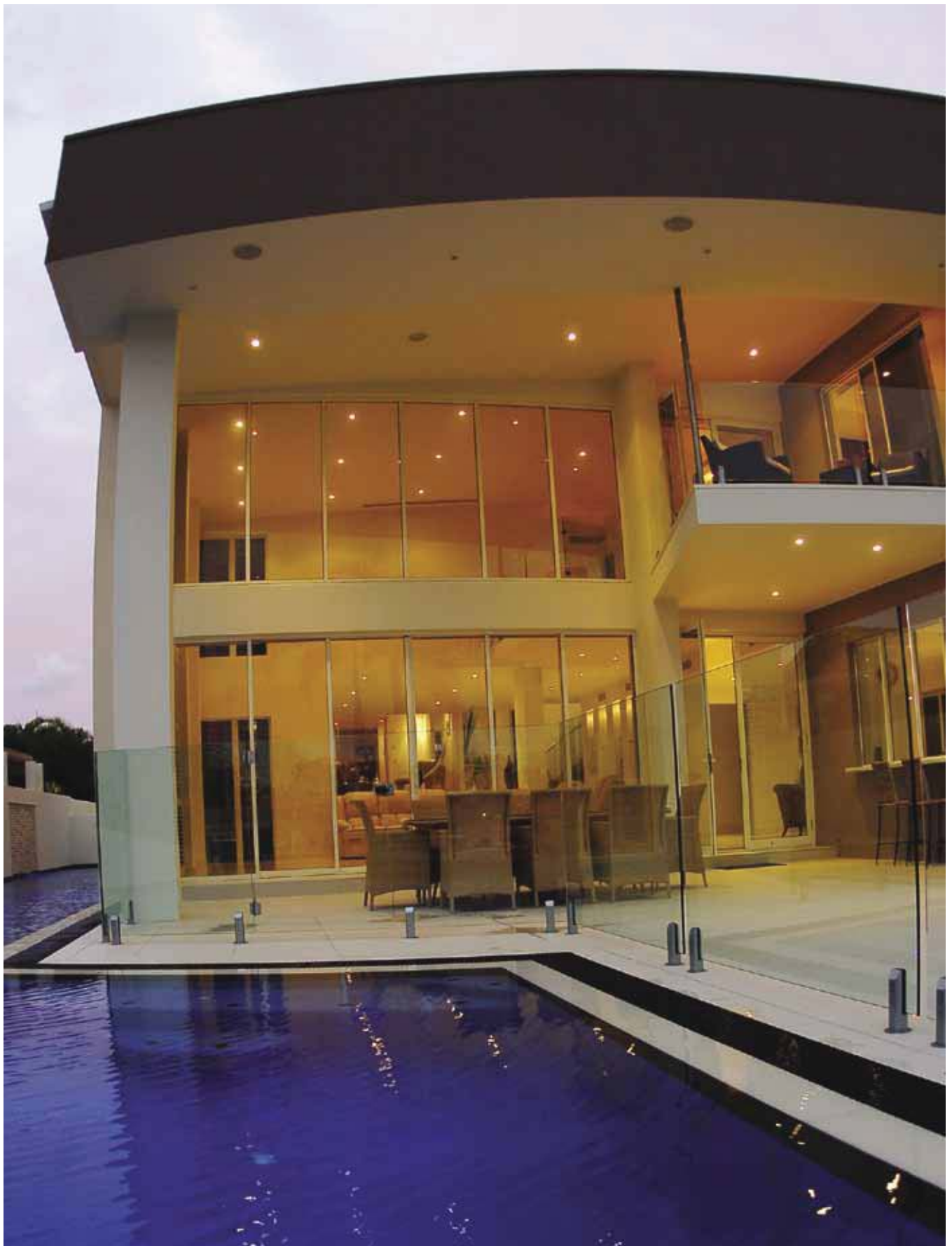

LED PLATINUM RECESSED

5" IC Air-Tight New Construction Housing

Nora Lighting is excited to introduce a new product line to our LED family, LED Recessed Luminaires. Rated for wet location, these housings are ideal for outdoor and wet environments. Compared to a 65W BR30, Nora's LED recessed luminaires offer a savings of over 75%. Air-tight construction provides energy savings by reducing the flow of air through the ceiling, and with its LED trim module available in warm (3000K) or cool white (4200K).

Nora Lighting's internal high-reflectance luminance system is capable of producing up to 705 lumens making its output commensurable with the highest in the industry. The triple laminated lens diffuses the LED image while producing high lumen output and excellent visual cut-off.

With outboard mounted drivers, our recessed housings offer cooler operation and longer life. Each LED Driver comes pre-installed to the housing's junction box, allowing the LED trim to be selected and installed at finish.

LED Driver: 120V AC, 60HZ, Power factor > 0.9 at 120V. Mounted on the junction box cooler operation and easy access.

Dimmable: Dimmable with economical 2-wire dimming down to 3% (56W minimum load requirement). For optimum and minimal loads, use low voltage dimmer.

Emergency Option: Emergency back-up operates LED source for a minimum of 90 minutes. Unit includes battery, charger, and remote test plate with indicator light/test switch.

Ceiling Thickness: Accepts 1-3/4" maximum ceiling thickness.

Installation: Bar hangers are adjustable from 13-5/8" to 24-1/2" with captive nails and can be repositioned 90 degrees. Bar hangers are slotted for T-Bar installations.

Minimum Clearance: "IC" Housings are direct contact rated; no minimum clearance is required.

Junction Box: Pre-wired 25 cu. in. with seven 1/2" knockouts, four Romex® pry-outs and snap on covers. Ground wire connected on bottom of box.

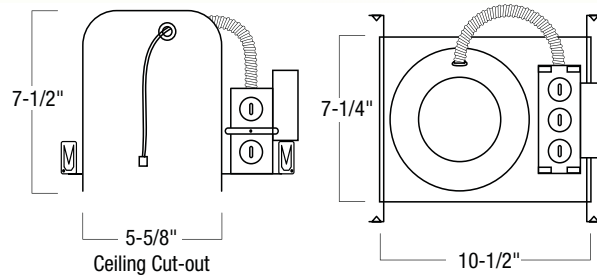

LED PLATINUM NEW CONSTRUCTION HOUSING

CATALOG. NO.	DRIVER	VOLTAGE	WATTAGE	AIR-TIGHT	DIMMABLE	EMERGENCY
NHIC-5LEDAT	Class 2 (Included)	120V	14W	Yes	Down to 3%	EM



Listing:

UL Damp Location w/ Feed Through
 UL Wet Location Listed
 WSEC ASTM E283 for Air-Tight
 California Energy Commission
 Title 24 Compliant

LED PLATINUM RECESSED 5" IC Air-Tight Remodel Housing

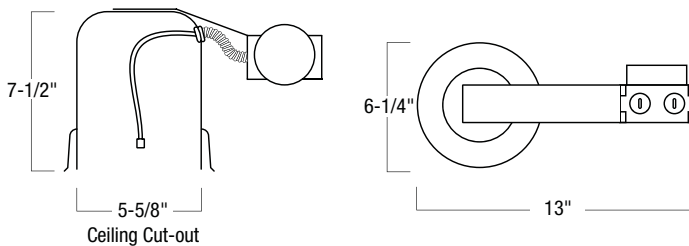

LED PLATINUM REMODEL HOUSING

CATALOG. NO.	DRIVER	VOLTAGE	WATTAGE	AIR-TIGHT	DIMMABLE
NHRIC-5LEDAT	Class 2 (Included)	120V	14W	Yes	Down to 3%



Nora Lighting is excited to introduce a new product line to our LED family, LED Recessed Luminaires. Rated for wet location, these remodel housings are ideal for outdoor and wet environments. Compared to a 65W BR30, Nora's LED recessed luminaires offer a savings of over 75%. Air-tight construction provides energy savings by reducing the flow of air through the ceiling, and with its LED trim module available in warm (3000K) or cool white (4200K).

Nora Lighting's internal high-reflectance luminance system is capable of producing up to 705 lumens making its output commensurable with the highest in the industry. The triple laminated lens diffuses the LED image while producing high lumen output and excellent visual cut-off.

With outboard mounted drivers, our recessed housings offer cooler operation and longer life. Each LED Driver comes pre-installed to the housing's junction box, allowing the LED trim to be selected and installed at finish.

LED Driver: 120V AC, 60HZ, Power factor > 0.9 at 120V. Mounted on the junction box cooler operation and easy access.

Dimmable: Dimmable with economical 2-wire dimming down to 3% (56W minimum load requirement). For optimum and minimal loads, use low voltage dimmer.

Ceiling Thickness: Accepts 1-1/2" maximum ceiling thickness.

Installation: High tension tempered steel springs secure remodel housings evenly to the ceiling; hole cutout template provided for convenience.

Minimum Clearance: "IC" Housings are direct contact rated; no minimum clearance is required.

Junction Box: Pre-wired 25 cu. in. with seven 1/2" knockouts, four Romex® pry-outs and snap on covers. Ground wire connected on bottom of box.

Listing:

UL Damp Location w/ Feed Through
UL Wet Location Listed
WSEC ASTM E283 for Air-Tight
California Energy Commission
Title 24 Compliant

LED PLATINUM RECESSED

5" LED Trims - 4-1/2" Aperture

Warm White 3000K Reflector

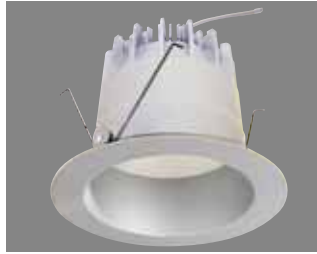

Catalog No.	Description
NTR-5LED30BW	Black Reflector / White Flange
NTR-5LED30PP	Platinum Diffused Reflector / Platinum Diffused Flange
NTR-5LED30PW	Platinum Diffused Reflector / White Flange
NTR-5LED30WW	White Reflector / White Flange

- UL Wet Listed
- Triple Laminated Lens
- Dimmable down to 3%
- Quick connect supplied
- Up to 622 lumens
- Rated at 50,000 hours at 70% lumens

Wattage: 14W
Color Temp: 3000K
CRI: 86
OD: 6-1/2"

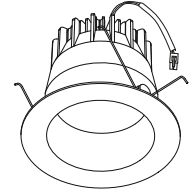

Cool White 4200K Reflector



Catalog No.	Description
NTR-5LED42BW	Black Reflector / White Flange
NTR-5LED42PP	Platinum Diffused Reflector / Platinum Diffused Flange
NTR-5LED42PW	Platinum Diffused Reflector / White Flange
NTR-5LED42WW	White Reflector / White Flange

- UL Wet Listed
- Triple Laminated Lens
- Dimmable down to 3%
- Quick connect supplied
- Up to 705 lumens
- Rated at 50,000 hours at 70% lumens

Wattage: 14W
Color Temp: 4200K
CRI: 86
OD: 6-1/2"

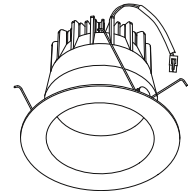

Available Finishes - consult factory for additional finishes (**BP** - Black Reflector / Platinum Diffused Flange, **WP** - White Reflector / Platinum Diffused Flange)

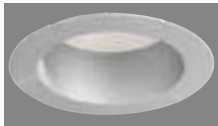

Platinum Diffused Reflector
Platinum Diffused Flange

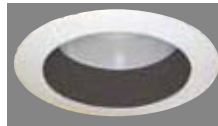

Black Reflector
White Flange



Platinum Diffused Reflector
White Flange



White Reflector
White Flange

Photometrics

NTR-5LED30WW Warm White 3000K, White Self Flanged Reflector Trim

IESNA: LM-63-1995 Test No.: LLI 0909-04B Spacing Criteria: (0-180) 1.02 (90-270) 1.02
 LPW: 43 Lamp: (12) 3000K LEDs Total Watts: 14.4W Lumens: 622

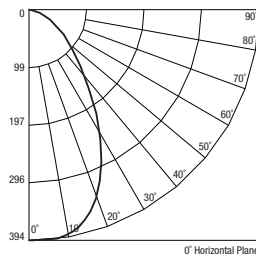

BEAM & CONE DATA

Mounting Height	F.C. at Nadir	Maximum Spacing
4'	24.6	4.1'
6'	10.9	6.1'
8'	6.2	8.2'
9'	4.9	9.2'
10'	3.9	10.2'

Commercial Lighting Tip:

Use Nora LED fixtures in public areas controlled by an occupancy sensor switch. Compared to CFL fixtures, LEDs have higher instant lumen output not requiring warm up to reach full output like CFLs. Use fewer LED fixtures to meet initial lumen code requirements.

LED photometric results may vary from testing data. To assist the lighting designer in using Nora LED in a lighting layout, the following photometric tables have both lab test data and normalized data to illustrate expected typical performance. Typical photometric data is provided to illustrate expectation of typical performance.



The Counter goes green with Nora LED Recessed and LED Tapelight.

LED PLATINUM RECESSED

4" IC Air-Tight New Construction Housing

Nora Lighting is excited to introduce a new product line to our LED family, LED Recessed Luminaires. Rated for wet location, these housings are ideal for outdoor and wet environments. Compared to a 65W BR30, Nora's LED recessed luminaires offer a savings of over 75%. Air-tight construction provides energy savings by reducing the flow of air through the ceiling, and with its LED trim module available in warm (3000K) or cool white (4200K).

Nora Lighting's internal high-reflectance luminance system is capable of producing up to 560 lumens making its output commensurable with the highest in the industry. The triple laminated lens diffuses the LED image while producing high lumen output and excellent visual cut-off.

With outboard mounted drivers, our recessed housings offer cooler operation and longer life. Each LED Driver comes pre-installed to the housing's junction box, allowing the LED trim to be selected and installed at finish.

LED Driver: 120V AC, 60HZ, Power factor > 0.9 at 120V. Mounted on the junction box cooler operation and easy access.

Dimmable: Dimmable with economical 2-wire dimming down to 3% (56W minimum load requirement). For optimum and minimal loads, use low voltage dimmer.

Emergency Option: Emergency back-up operates LED source for a minimum of 90 minutes. Unit includes battery, charger, and remote test plate with indicator light/test switch.

Ceiling Thickness: Accepts 1-5/8" maximum ceiling thickness.

Installation: Bar hangers are adjustable from 13-5/8" to 24-1/2" with captive nails and can be repositioned 90 degrees. Bar hangers are slotted for T-Bar installations.

Minimum Clearance: "IC" Housings are direct contact rated; no minimum clearance is required.

Junction Box: Pre-wired 25 cu. in. with seven 1/2" knockouts, four Romex® pry-outs and snap on covers. Ground wire connected on bottom of box.

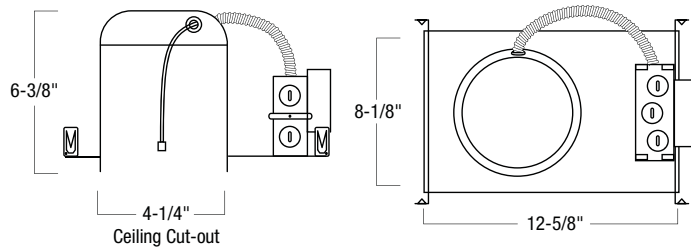

LED PLATINUM NEW CONSTRUCTION HOUSING

CATALOG. NO.	DRIVER	VOLTAGE	WATTAGE	AIR-TIGHT	DIMMABLE	EMERGENCY
NHIC-4LEDAT	Class 2 (Included)	120V	11W	Yes	Down to 3%	EM



committed to GREEN

Listing:
 UL Damp Location w/ Feed Through
 UL Wet Location Listed
 WSEC ASTM E283 for Air-Tight
 California Energy Commission
 Title 24 Compliant

Lighting Tip:

Use Nora LED Wet Label Trims outdoors for excellent, even illumination. Long lamp life, energy efficiency and low maintenance make LED a smart choice. Low visual aperture brightness and no UV wavelengths to attract bugs make Nora LEDs the designer's choice.

LED PLATINUM RECESSED 4" IC Air-Tight Remodel Housing

NEW!

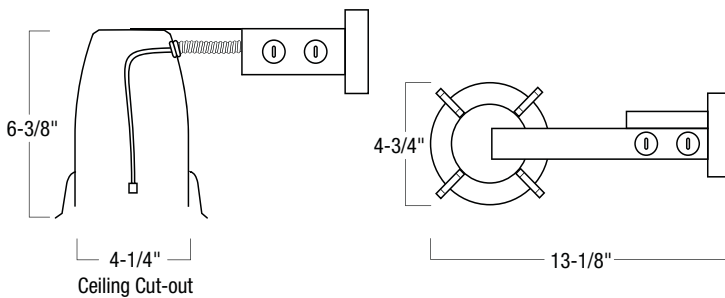

LED PLATINUM REMODEL HOUSING

CATALOG. NO.	DRIVER	VOLTAGE	WATTAGE	AIR-TIGHT	DIMMABLE
NHRIC-4LEDAT	Class 2 (Included)	120V	11W	Yes	Down to 3%



Nora Lighting is excited to introduce a new product line to our LED family, LED Recessed Luminaires. Rated for wet location, these remodel housings are ideal for outdoor and wet environments. Compared to a 65W BR30, Nora's LED recessed luminaires offer a savings of over 75%. Air-tight construction provides energy savings by reducing the flow of air through the ceiling, and with its LED trim module available in warm (3000K) or cool white (4200K).

Nora Lighting's internal high-reflectance luminance system is capable of producing up to 560 lumens making its output commensurable with the highest in the industry. The triple laminated lens diffuses the LED image while producing high lumen output and excellent visual cut-off.

With outboard mounted drivers, our recessed housings offer cooler operation and longer life. Each LED Driver comes pre-installed to the housing's junction box, allowing the LED trim to be selected and installed at finish.

LED Driver: 120V AC, 60HZ, Power factor > 0.9 at 120V. Mounted on the junction box cooler operation and easy access.

Dimmable: Dimmable with economical 2-wire dimming down to 3% (56W minimum load requirement). For optimum and minimal loads, use low voltage dimmer.

Ceiling Thickness: Accepts 1-5/8" maximum ceiling thickness.

Installation: High tension tempered steel springs secure remodel housings evenly to the ceiling; hole cutout template provided for convenience.

Minimum Clearance: "IC" Housings are direct contact rated; no minimum clearance is required.

Junction Box: Pre-wired 25 cu. in. with seven 1/2" knockouts, four Romex® pry-outs and snap on covers. Ground wire connected on bottom of box.

Listing:
UL Damp Location w/ Feed Through
UL Wet Location Listed
WSEC ASTM E283 for Air-Tight
California Energy Commission
Title 24 Compliant

LED PLATINUM RECESSED

4" LED Trims - 3-1/2" Aperture

Warm White 3000K Reflector



Catalog No.	Description
NTR-4LED30BW	Black Reflector / White Flange
NTR-4LED30PP	Platinum Diffused Reflector / Platinum Diffused Flange
NTR-4LED30PW	Platinum Diffused Reflector / White Flange
NTR-4LED30WW	White Reflector / White Flange

- UL Wet Listed
- Triple Laminated Lens
- Dimmable down to 3%
- Quick connect supplied
- Up to 485 lumens
- Rated at 50,000 hours at 70% lumens

Wattage: 11W
Color Temp: 3000K
CRI: 86
OD: 4-7/8"

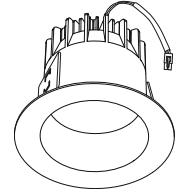

Cool White 4200K Reflector



Catalog No.	Description
NTR-4LED42BW	Black Reflector / White Flange
NTR-4LED42PP	Platinum Diffused Reflector / Platinum Diffused Flange
NTR-4LED42PW	Platinum Diffused Reflector / White Flange
NTR-4LED42WW	White Reflector / White Flange

- UL Wet Listed
- Triple Laminated Lens
- Dimmable down to 3%
- Quick connect supplied
- Up to 560 lumens
- Rated at 50,000 hours at 70% lumens

Wattage: 11W
Color Temp: 4200K
CRI: 86
OD: 4-7/8"

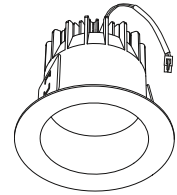

Available Finishes - consult factory for additional finishes (**BP** - Black Reflector / Platinum Diffused Flange, **WP** - White Reflector / Platinum Diffused Flange)

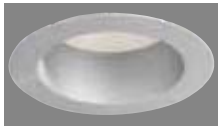

Platinum Diffused Reflector
Platinum Diffused Flange

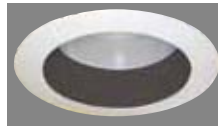

Black Reflector
White Flange



Platinum Diffused Reflector
White Flange



White Reflector
White Flange

Photometrics

NTR-4LED30WW Warm White 3000K, White Self Flanged Reflector Trim

IESNA: LM-63-1995 Test No.: LLI 0909-04C Spacing Criteria: (0-180) 092 (90-270) 0.92
 LPW: 45 Lamp: (9) 3000K LEDs Total Watts: 10.8W Lumens: 485

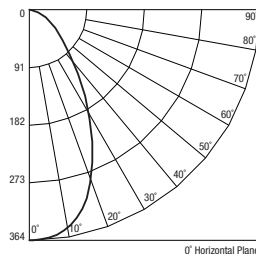

BEAM & CONE DATA

Mounting Height	F.C. at Nadir	Maximum Spacing
4'	22.8	3.7'
6'	10.1	5.5'
8'	5.7	7.4'
9'	4.5	8.3'
10'	3.6	9.2'

Lighting Tip:

Nora's 4" LED series produce about the same usable footcandles as their 5" and 6" counterpoints. At only a 3 1/2" aperture the Nora 4" LED is one of the highest performing small aperture products on the market.

LED photometric results may vary from testing data. To assist the lighting designer in using Nora LED in a lighting layout, the following photometric tables have both lab test data and normalized data to illustrate expected typical performance. Typical photometric data is provided to illustrate expectation of typical performance.



The Nora Lighting family of LED Retrofit Diamond Series Recessed Lighting

Nora introduces our New High Output LED Retrofit Recessed Downlight Series using one of the most respected and time tested LED chips on the market. Incorporating the highest quality Cree LED package and Nora's UTM System, the LED Retrofit Diamond Series exceeds all industry standards. Title 24 and Energy Star qualified, Nora backs the Diamond Series with a 7 Year Limited Warranty. Available in several reflector and baffle finishes, high CRI and dimmable down to 5%, the Nora Retrofit Diamond Series will set a standard for LED Retrofit Energy Efficient Lighting.

FEATURES

- 7 Year Limited Warranty backed by Nora Lighting
- Dimmable down to 5%. Must meet minimum load requirements of dimmer
- Available in 2 sizes! 6" with 5-1/4" Aperture and 5" with 4-5/8" Aperture
- Available in reflector and baffle style in Bronze, Copper, Natural Metal, Haze, Clear, Black, and White Finishes
- Energy Star Rated
- cULus Listed for Damp Location
- Scientifically designed lens diffuses the LED image while providing high lumen output; standard on all trims
- Produces 650 lumens using only 11.8 watts
- Exceeds high efficacy requirements of California Title 24
- Available with 3000K or 4000K CCT, 86 CRI.
- Available in 3 configurations: For medium based housings, GU24 optional socket, and dedicated hardwire with disconnect
- Light output is similar to a 65W BR30 with 75% energy savings over incandescent!
- Tested in accordance with IESNA LM-79 and LM-80
- cULus Listed for use in 6" and 5" IC and Non-IC housings manufactured by Nora and others
- No flicker or delay.
- State of the art LEDs are rated at 50,000 hours at 70% lumen maintenance
- Mercury free which is good for the environment
- No ultraviolet or infrared wavelengths that cause fading of artwork and perishable merchandise
- Does not emit forward heat like traditional light sources
- Significantly reduces air-conditioning loads and lowers energy demands
- High efficiency driver with a power factor >.90 with input power of 120V, 60Hz

Fixture Performance Comparison			
Fixture	65W BR30	18W CFL	12W LED
Average footcandles at 8' mounting height, 20' x 20', multiple units, spaced at 6' O.C.	24.2 fc*	21.9 fc*	22.6 fc*

* Measured at 2.5' AFF

LED Retrofit Diamond Downlight

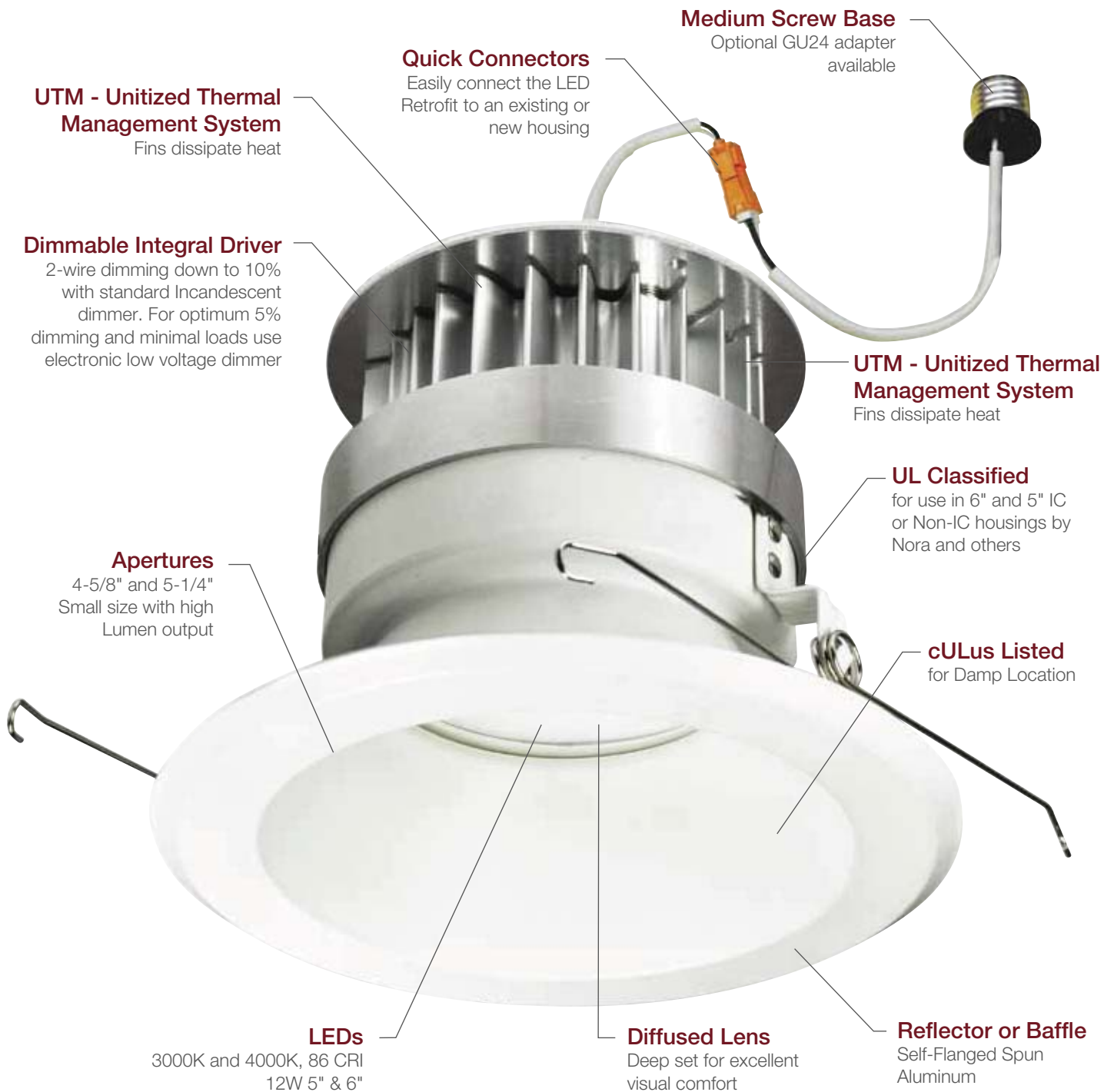

LED RETROFIT DIAMOND RECESSED SERIES

6" LED Retrofit Diamond Series

Nora Lighting is excited to introduce a new product line to our LED family, LED Retrofit Diamond Recessed Luminaires.

The Nora LED Retrofit Diamond is designed and cULus listed for use in existing 6" IC or Non-IC housings manufactured by Nora and others. Providing 650 lumen output and 86 CRI the LED Diamond Retrofit is an obvious choice for Green Energy Efficient Lighting in Commercial and Residential applications.

7 YEAR
LIMITED WARRANTY

Electrical:

Voltage: 120VAC
Current: 100mA
Lumens: 650 lm
Power Consumption: 11.8 Watts
Operating Temperature: 0°C~50°C (32°F~122°F)
Life Expectancy: 50,000 Hours

Socket:

Edison Medium Base Socket (included w/ Retrofit)
Quick Connect (included with dedicated)
GU24 Socket (accessory available)

Installation: Torsion springs

Construction: Scientifically and specifiable "Unitized Thermal Management system" (UTM) provides exceptional cool operation exceeding all industry standards.

Lens: Deep set for excellent glare control scientifically designed for optimal performance.

Dimming: Nora Diamond Retrofit works with standard leading and trailing edge dimming technologies. Dimming with leading-edge dimmers (electronic) are 5-100% and for trailing-edge dimmers (incandescent) 10-100%. There may be some cases that require more than one lighting fixture to be used to meet minimum dimmer load. Consult with dimmer manufacturer.

Listing:

cULus Listed for Damp Location
UL Classified for use with most manufacturers IC and Non-IC housings
WSEC ASTM E283 for Air-Tight (with IC Housing)
Title 24 Compliant (GU24 & Dedicated Version)
Energy Star Rated
RoHS Compliant
7 Year Limited Warranty
Conforms to IESNA LM-79 and LM-80



NRA-212 GU24 Adapter

6" LED RETROFIT DIAMOND UNIT

CATALOG. NO.	TRIM	COLOR TEMP.	REFLECTOR / BAFFLE AND FLANGE FINISH
NLEDC - Dedicated	661 - Reflector	30 - 3000K	See Below
NLEDR -Retrofit	662 - Baffle	40 - 4000K	See Below

661 - Reflector and Flange Finishes

BW - Specular Black Reflector and White Flange
BZBZ - Bronze Reflector and Bronze Flange
COCO - Copper Reflector and Copper Flange
CW - Specular Clear Reflector and White Flange
HZW - Haze Reflector and White Flange
NN - Natural Metal Reflector and Nat. Metal Flange
WW - White Reflector and White Flange

662 - Baffle and Flange Finishes

BW - Black Baffle and White Flange
BZBZ - Bronze Baffle and Bronze Flange
COCO - Copper Baffle and Copper Flange
NN - Natural Metal Baffle and Nat. Metal Flange
WW - White Baffle and White Flange



COMPATIBLE NORA NEW CONSTR. HOUSINGS

NHIC-17QAT 6" ICAT Incand. (Standard)
NHIC-17QNBAT 6" ICAT Incand. (No Bracket)
NH-26Q 6" Incandescent (Standard)
NH-26QNB 6" Incandescent (No Bracket)
NHIC-6G24ATFL 6" ICAT GU24
NHIC-6LMRAT 6" ICAT Dedicated LED



COMPATIBLE NORA REMODEL HOUSINGS

NHRIC-17QAT 6" ICAT Incand. (Standard)
NHRIC-17QNBAT 6" ICAT Incand. (No Bracket)
NHR-26Q 6" Incandescent (Standard)
NHRIC-6G24ATFL 6" ICAT GU24
NHRIC-6LMRAT 6" ICAT Dedicated LED



See pages 34-37 for description of reflector finishes

LED RETROFIT DIAMOND RECESSED SERIES

5" LED Retrofit Diamond Series

7 YEAR
LIMITED WARRANTY



NRA-212 GU24 Adapter

5" LED RETROFIT DIAMOND UNIT

CATALOG. NO.	TRIM	COLOR TEMP.	REFLECTOR / BAFFLE AND FLANGE FINISH
NLEDC - Dedicated	561 - Reflector	30 - 3000K	See Below
NLEDR - Retrofit	562 - Baffle	40 - 4000K	See Below

561 - Reflector and Flange Finishes

BW - Specular Black Reflector and White Flange
BZBZ - Bronze Reflector and Bronze Flange
COCO - Copper Reflector and Copper Flange
CW - Specular Clear Reflector and White Flange
HZW - Haze Reflector and White Flange
NN - Natural Metal Reflector and Nat. Metal Flange
WW - White Reflector and White Flange

562 - Baffle and Flange Finishes

BW - Black Baffle and White Flange
BZBZ - Bronze Baffle and Bronze Flange
COCO - Copper Baffle and Copper Flange
NN - Natural Metal Baffle and Nat. Metal Flange
WW - White Baffle and White Flange



COMPATIBLE NORA NEW CONSTR. HOUSINGS

NHIC-501QAT 5" ICAT Incandescent
NH-501Q 5" Incandescent

NHIC-5G24ATFL 5" ICAT GU24
NHIC-5LMRAT 5" ICAT Dedicated LED



COMPATIBLE NORA REMODEL HOUSINGS

NHRIC-504QAT 5" ICAT Incandescent
NHR-504Q 5" Incandescent

NHRIC-5G24ATFL 5" ICAT GU24
NHRIC-5LMRAT 5" ICAT Dedicated LED

Nora Lighting is excited to introduce a new product line to our LED family, LED Retrofit Diamond Recessed Luminaires. The Nora LED Retrofit Diamond is designed and cULus listed for use in existing 5" IC or Non-IC housings manufactured by Nora and others. Providing 650 lumen output and 86 CRI the LED Diamond Retrofit is an obvious choice for Green Energy Efficient Lighting in Commercial and Residential applications.

Electrical:

Voltage: 120VAC
 Current: 100mA
 Lumens: 650 lm
 Power Consumption: 11.8 Watts
 Operating Temperature: 0°C~50°C (32°F~122°F)
 Life Expectancy: 50,000 Hours

Socket:

Edison Base Socket (included with Retrofit)
 Quick Connect (included with dedicated)
 GU24 Socket (accessory available)

Installation: Torsion springs

Construction: Scientifically and specifiable "Unitized Thermal Management system" (UTM) provides exceptional cool operation exceeding all industry standards.

Lens: Deep set for excellent glare control scientifically designed for optimal performance.

Dimming: Nora Diamond Retrofit works with standard leading and trailing edge dimming technologies. Dimming with leading-edge dimmers (electronic) are 5-100% and for trailing-edge dimmers (incandescent) 10-100%. There may be some cases that require more than one lighting fixture to be used to meet minimum dimmer load. Consult with dimmer manufacturer.

Listing:

cULus Listed for Damp Location
 UL Classified for use with most manufacturers IC and Non-IC housings
 WSEC ASTM E283 for Air-Tight (with IC Housing)
 Title 24 Compliant (GU24 & Dedicated Version)
 Energy Star Rated
 RoHS Compliant
 7 Year Limited Warranty
 Conforms to IESNA LM-79 and LM-80



See pages 34-37 for description of reflector finishes



Efficient. Reliable Consistent.

For energy-efficient applications, Nora Lighting offers a vast array of fixtures that accept 9W to 42W compact fluorescent light sources. Ideal for commercial, office, bath and kitchen applications, Nora Lighting's compact fluorescent fixtures are available as horizontal or vertical with optional architectural dimming features.

Compact Fluorescent



Overview COMPACT FLUORESCENT RECESSED

HORIZONTAL ARCHITECTURAL & COMMERCIAL COMPACT FLUORESCENT FRAME-INS



8" CF Horizontal Architectural
NHP8U Series p.74



8" CF Horizontal Commercial
NH8PU Series p.75



8" CF Horizontal Remodel
NHRP8U Series p.76



6" Triple Tube CF Horizontal
Architectural
NHPT6 Series p.80



6" Triple Tube CF Horizontal
Commercial
NHPT Series p.81



6" Triple Tube CF Horizontal
Architectural Remodel
NHRPT6 Series p.82



6" Quad Tube CF Horizontal
Architectural
NHP6 Series p.88



6" Quad Tube CF Horizontal
Commercial
NHP-1 & NHP-2 Series p.89



6" Quad Tube CF Horizontal IC
Commercial
NHPIC-1 & NHPIC-2 Series p.90



6" Quad Tube CF Horizontal
Architectural Remodel
NHRP6 Series p.91

VERTICAL ARCHITECTURAL & COMMERCIAL COMPACT FLUORESCENT FRAME-INS



8" CF Vertical Architectural Frame-In
NHPV-8 Series p.96



8" CF Vertical Commercial Frame-In
NH8PV Series p.97



8" CF Vertical Architectural Remodel
NHRPV-8 Series p.98



6" CF Vertical Architectural Frame-In
NHPV-6 Series p.102



6" CF Vertical Commercial Frame-In
NHPV Series p.103



6" CF Vertical Architectural Remodel
NHRPV-6 Series p.104

SHALLOW COMPACT FLUORESCENT HOUSINGS

NEW!



6" New Construction Horizontal Shallow Housing
NHPH Series p.138

NEW!



6" Remodel Horizontal Shallow Housing
NHRPH Series p.139

VERTICAL ECONOMY / LIGHT COMMERCIAL ICAT COMPACT FLUORESCENT HOUSINGS



6" Double Wall IC AT Electronic
NHPIC-2642ELAT p.113



6" IC AT Electronic Housing
NHPIC-ELAT Series p.114



6" Remodel IC AT Electronic
NHPIC-ELAT Series p.115



5" IC AT Electronic Housing
NHPIC-5ELAT Series p.144



5" Remodel IC AT Electronic
NHRPIC-5ELAT Series p.145



4" IC AT Electronic Housing
NHPIC-4ELAT Series p.152



4" Remodel IC AT Electronic
NHRPIC-4ELAT Series p.153

VERTICAL ECONOMY / LIGHT COMMERCIAL COMPACT FLUORESCENT HOUSINGS



6" Single CF Economy Housing
NHP Series p.116



6" Remodel Single CF Economy
NHRP Series p.117



6" IC Dual CF Economy Double Wall
NHPIC-2L Series p.124



6" Dual CF Economy Housing
NHP-2L Series p.125



6" Remodel Dual CF Economy
NHRP-2L Series p.126

VERTICAL ECONOMY / LIGHT COMMERCIAL COMPACT FLUORESCENT HOUSINGS *continued*



5" Economy CF Housing
NHP-501 Series p.146



5" Remodel Economy CF
NHRP-504 Series p.147



4" Economy CF Housing
NS-406 p.158



4" Remodel Economy CF
NSR-408 p.159

COMPACT FLUORSCENT HOUSINGS WITH EMERGENCY BALLAST OPTION

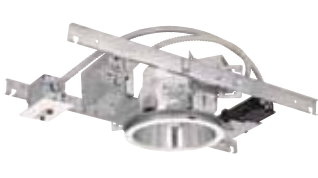

6"-8" Horizontal Architectural
Emergency Frame-ins p.178



6"-8" Horizontal Commercial
Emergency Frame-ins p.179



6"-8" Vertical Architectural
Emergency Frame-ins p.180



6"-8" Vertical Commercial
Emergency Frame-ins p.181



6" Economy Emergency Housings
with Internal Test Switch p.182



6" Economy Emergency Housings
with Remote Test Switch p.183



Emergency Downlight Retrofit Kit
NEPK Series p.746



Test Switch, Indicator Assembly
NRA-123 p.746
NRA-123MAG p.746

GU24 BASE COMPACT FLUORESCENT HOUSINGS



6" IC AT GU24 CF Housing
NHIC-6G24ATFL p.164



6" Remodel IC AT GU24 CF
NHRIC-6G24ATFL p.164



5" IC AT GU24 CF Housing
NHIC-5G24ATFL p.168



5" Remodel IC AT GU24 CF
NHRIC-5G24ATFL p.169



4" IC AT GU24 CF Housing
NHIC-4G24AT p.172



4" Remodel IC AT GU24 CF
NHRIC-4G24AT p.173

SLOPE AND SUPER SLOPE CEILING HOUSINGS



6" Sloped Ceiling IC Rated
Double Wall CF Housing
NHPIC-926/32EAT p.131



6" Sloped Ceiling IC Rated
New Construction CF Housing
NHPIC-926 Series p.132



6" Sloped IC Rated
Remodel CF Housing
NHRPIC-926 Series p.133



6" Sloped Ceiling CF Housing
NHP-926 Series p.134



6" Sloped CF Remodel Housing
NHRP-926 Series p.135

SPECIALTY COMPACT FLUORESCENT LIGHTING



6" Single Lamp CF Retrofit Kit
NPK Series p.351



6" Dual Lamp CF Retrofit Kit
NPK-2L Series p.351



8" Square Double Wall IC CF Housing
NSHPIC-8EL p.364



8" Square CF Housing
NSHP-8 Series p.365



Fluorescent Step Light with
J-Box
NSP-109/JB Series p.375



Fluorescent Step Light
NSP-109 Series p.375

RECESSED ACCESSORIES



Fire-Rated Enclosure
NRA-126 p.379



Hole Cutter
NSC-6500 / NSC-6600 p.380



Trim Accessories
Rings, Glass and more p.381



Housing Accessories
Bar Hangers and more p.383

The Benefits of Dimming

Create the perfect ambiance

Dimming creates a rich visual experience and adds flexibility to any room, providing the right lighting environment for a variety of activities

Save electricity and maintain lamp life

Dimming saves electricity and reduces the demand on HVAC systems. Dimming fluorescent lighting instead of repeated switching helps to maintain expected long lamp life.

Give employees greater personal control

Allowing employees to set preferred light levels for specific tasks results in greater employee comfort and improved performance.

Combine lighting control strategies to enhance building performance

Using occupancy/vacancy sensors, daylight sensors and automated time-based controls with fluorescent dimming helps manage the lighting in an entire building and further reduce electric demand.

Dimming Fluorescent Lights Saves Energy

Fluorescent lighting uses much less power than incandescent lighting. In a typical installation, a 32 watt compact fluorescent lamp provides approximately the same light output as a 100 watt incandescent lamp. As both sources are dimmed, fluorescent lamps continue to be a more energy efficient light source.

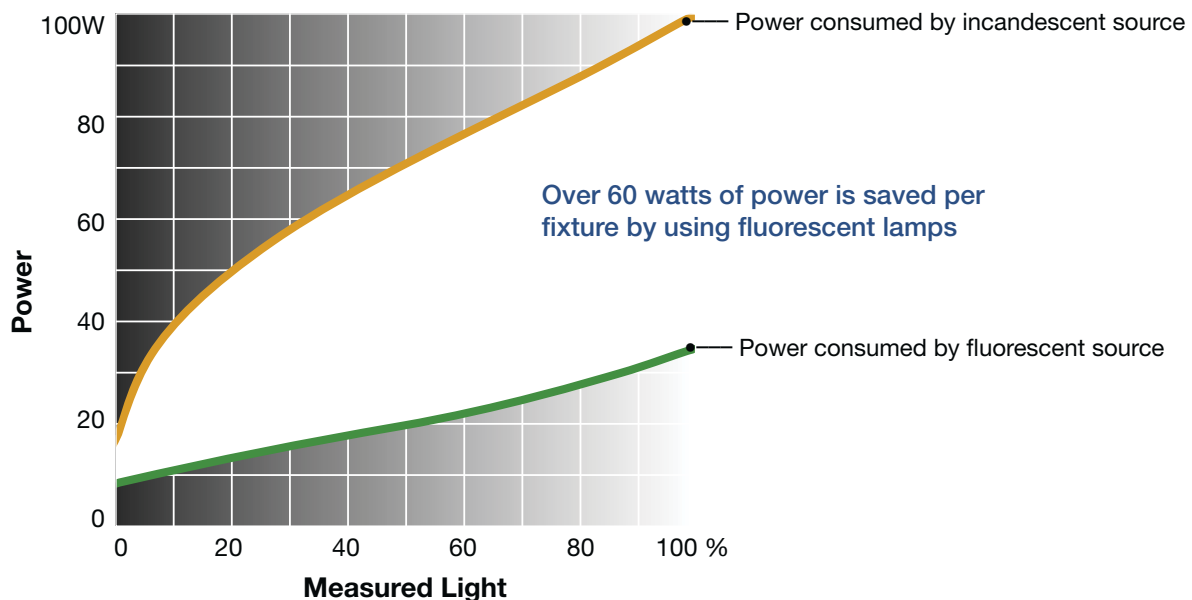

Measured Light vs. Perceived Light

Fluorescent lighting uses much less power than incandescent lighting. In a typical installation, a 32 watt compact fluorescent lamp provides approximately the same light output as a 100 watt incandescent lamp. As both sources are dimmed, fluorescent lamps continue to be a more energy efficient light source.

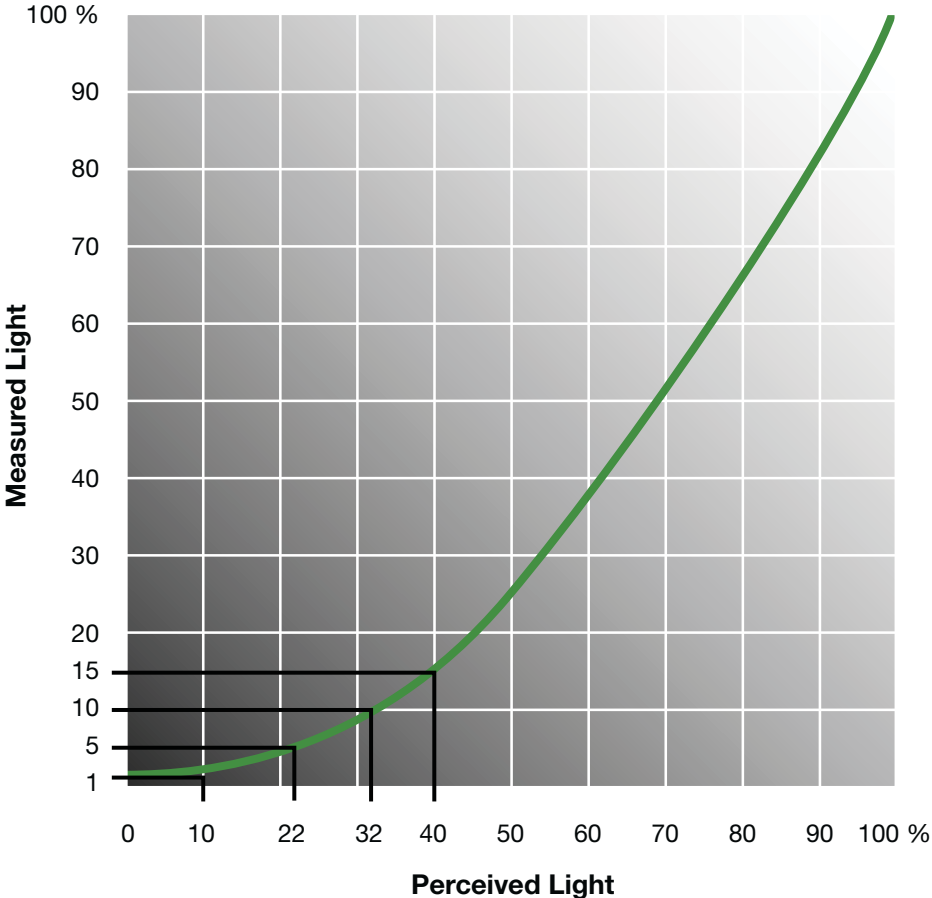

Formula:
 Perceived Light (%) =
 $100 \times \sqrt{\frac{\text{Measured Light (\%)}}{100}}$

Source:
 IESNA lighting Handbook, 9th Edition,
 (New York: IESNA, 2000), 27-4.

Design example

At full brightness, the measured light in a space is 60 footcandles. At the lowest dimmed level, 10% perceived light is desired.

- 1% measured light (0.6 fcd) is perceived as 10% (desired result)
- 5% measured light (3 fcd) is perceived as 22% (2x brighter than desired)
- 10% measured light (6 fcd) is perceived as 32% (3x brighter than desired)
- 15% measured light (9 fcd) is perceived as 40% (3x brighter than desired)

Nora Fluorescent Dimming Options

Universal SuperDim D10 0-10 volt / 4-wire	Advance Mark 7 M7 0-10 volt / 4-wire	Advance Mark 10 Powerline MX1 120 volt / 2-wire MX2 277 volt / 2-wire
<p>Cost effective solution for single zone applications and energy saving requirements. Wide variety of SuperDim ballasts for 4-Pin CFL lamps.</p> <ul style="list-style-type: none"> • SuperDim ballasts provide reliable lighting control down to 3% for compact fluorescent lamps • SuperDim ballasts are compatible with most 0-10 volt manufactured controls • Combine with photocells for daylight harvesting • Ideal for use with 0-10 volt energy management controls • Programmed rapid start technology maximizes lamp life • Universal input voltage (120-277 volts) for installation flexibility • Starts at any level without flashing • Super LampGuard lamp end-of-life protection ensures safe operation • Single and multiple lamp versions are available in a variety of case configurations 	<p>Affordable, flexible and versatile electronic dimming solution for a broad range of commercial, institutional and retail applications. Ideal for energy management systems. Mark 7 0-10V electronic ballasts for 4-Pin CFL lamps.</p> <ul style="list-style-type: none"> • 100% to 5% full range continuous dimming • Direct operation from a 0-10V DC control signal • Programmed Start ignition • IntelliVolt® multiple-voltage technology enabling operation at any input voltage from 120 to 277 volts, 50/60Hz • Increases system flexibility and enhances visual comfort • Enables the need for fewer controls and allows for direct use of daylight harvesting and other low voltage controls • Provides extended lamp life in frequent starting applications 	<p>Mark10 Powerline 2-wire electronic ballasts are flexible and easy to install, with the controllability and full-range dimming capabilities of incandescent systems. Ideal for a broad range of commercial, institutional and retail applications. Mark 10 Powerline ballasts for 4-Pin CFL lamps.</p> <ul style="list-style-type: none"> • 100% to 5% full range continuous dimming • Absence of additional control leads • Programmed Start ignition • Lamp ignition at any light setting, including the 5% level • Increases system flexibility and enhances visual comfort • Enhances ease of installation (as no extra wiring is required) and is also highly flexible and compatible with a wide variety of controls by a broad range of control manufacturers • Provides extended lamp life in frequent starting applications • Eliminates the need to ramp up to 100% light output when starting

Comparison Chart Nora Lighting CFL Dimming Options

BALLAST	NORA ORDERING SUFFIX	VOLTAGE	DIMMING CAPABILITY	WATTAGE
Universal Super Dim	D10	120 to 277	100% to 3%	(1) lamp 13 to 42 or (2) lamp 13 to 26
Advance Mark 7	M7	120 to 277	100% to 5%	(1) or (2) lamp 13 to 42
Advance Mark 10	MX1	120	100% to 5%	(1) or (2) lamp 18 to 42
Advance Mark 10	MX2	277	100% to 5%	(1) or (2) lamp 18 to 42
Advance AmbiStar	DAS	120	100% to 15%	(1) lamp 26 to 42 or (2) lamp 26
Lutron Compast SE 5	L51	120	100% to 5%	(1) or (2) lamp 18 to 42
Lutron Compast SE 6	L52	277	100% to 5%	(1) or (2) lamp 18 to 42
Lutron Hi-lume	L11	120	100% to 1%	(1) or (2) lamp 18 to 42
Lutron Hi-lume	L12	277	100% to 1%	(1) or (2) lamp 18 to 42

Consult factory for dimming ballast not listed above.

Advance AmbiStar

DAS 120 volt / 2-wire

Specifically designed for popular fluorescent applications in homes and other non-commercial environments. AmbiStar ballasts are compact and lightweight, provide quick starting light and energy savings. FCC Class B EMI Compliant and available for 4-Pin CFL lamps.

- Dimmable down to 15%
- Dimmable from any incandescent or Mark 10 Powerline dimmer
- Meets Energy Star requirements
- Utilize simplicity of incandescent dimming
- Enables usage where Energy Star fixtures are required
- Low ballast temperature rise allows for higher ambient applications



Lutron Compact SE 5%

L51 120 volt / 3-wire

L52 277 volt / 3-wire

- High performance dimming from 100% to 5% relative light output
- No visible flicker
- Total Harmonic distortion (THD) less than 10%
- Power factor greater than 0.95
- Ballast factor greater than 0.95 for 4-Pin CFL lamps
- Frequency of operation greater than 42kHz for 4-Pin CFL lamps
- Inaudible in 27 dBA ambient environment
- Inrush current limiting circuitry built-in (max of 7 amps for 120V and 3 amps at 277V)
- Internal fusing
- Minimum lamp starting temperature 10°C (50°F)
- Maximum ballast case temperature 75°C (167°F)

Lutron Hi-Lume 1%

L11 120 volt / 3-wire

L12 277 volt / 3-wire

- Architectural dimming from 100% to 1% relative light output
- No visible flicker
- Total Harmonic distortion (THD) less than 10%
- Power factor greater than 0.95
- Ballast factor greater than 0.95 for 4-Pin CFL lamps.
- Frequency of operation greater than 42kHz for 4-Pin CFL lamps.
- Inaudible in 27 dBA ambient environment
- Inrush current limiting circuitry built-in (max of 7 amps for 120V and 3 amps at 277V)
- Internal fusing
- Minimum lamp starting temperature 10°C (50°F)
- Maximum ballast case temperature 75°C (167°F)

BALLAST	WIRING	DIMMER	COST
Universal Super Dim	4 Wire - (2) Class 1 and (2) Class 2	Specific	\$\$
Advance Mark 7	4 Wire - (2) Class 1 and (2) Class 2	Specific	\$\$\$
Advance Mark 10	2 Wire - (2) Class 1	Specific	\$\$\$
Advance Mark 10	2 Wire - (2) Class 1	Specific	\$\$\$
Advance AmbiStar	2 Wire - (2) Class 1	Standard	\$
Lutron Compast SE 5	3 Wire - (3) Class1	Specific	\$\$\$\$
Lutron Compast SE 6	3 Wire - (3) Class1	Specific	\$\$\$\$
Lutron Hi-lume	3 Wire - (3) Class1	Specific	\$\$\$\$\$
Lutron Hi-lume	3 Wire - (3) Class1	Specific	\$\$\$\$\$

Architectural & Commercial Compact Fluorescent Luminaires



Nora Lighting offers a full line of Architectural and Commercial frame-in fixtures in both horizontal and vertical configurations, 6-inch and 8-inch apertures, utilizing single and double 13W to 42W Quad and Triple Tube Compact Fluorescent sources. Architectural frame-ins feature universal butterfly brackets ideal for suspended ceiling or T-bar installations. Commercial frame-ins have adjustable bar hangers suitable for direct installation to wood joist, steel stud or T-bar constructions. A large selection of high quality specular reflectors with glare reduction, low iridescence, external glass accents, open wall wash and many more options appropriate for any architectural or commercial interior. Photometric and data files are available for applications requiring detailed design layouts and precise lighting calculations.

FEATURES

- Wattages from single 13W - 42W to double 13W-42W
- 6" and 8" apertures, horizontal and vertical configurations
- Over 100 trims available including wall wash, downlights, lensed
- Low-iridescent trim options with Alzak® protective finishes are made in USA
- Electronic ballasts are universal input 120-277V
- Energy Star rated fixtures
- Full range of dimming options
- Integral and remote test switch emergency options
- Non-IC fixture housings- require 3" clearance from insulation
- UL Listed Damp location with Feed Through
- UL Listed Wet location with some lensed trims

DIMMING OPTIONS - A variety of dimming ballast options are available in 13W-26W. Each option requires a controller that is compatible. Specify suffix:

- DAS** Advance Mark X, AMBI Star 120V (2-wire), Residential. 26W-42W
- D10** Universal Technologies 0-10V (4-wire), Universal Voltage (120V-277V). 13W-42W
- MX1** Advance Mark X 120V (2-wire), (Wattage Specific). 18W-42W
- MX2** Advance Mark X 277V (2-wire), (Wattage Specific). 18W-42W
- M7** Advance Mark 7 (4-wire), Universal Voltage (120V-277V). 13W-42W
- L51** Lutron SE 5% 120V (3-wire), (Wattage Specific). 18W-42W
- L52** Lutron SE 5% 277V (3-wire), (Wattage Specific). 18W-42W
- L11** Lutron Hi-Lume 1% 120V (3-wire)
- L12** Lutron Hi-Lume 1% 277V (3-wire)

(See Pages 70-71 for complete descriptions)

EMERGENCY OPTIONS - Emergency back-up operates one or two lamp(s) for a minimum of 90 minutes. Unit includes battery, charger and test plate with indicator light. Specify suffix:

- EM** Emergency battery and remote test switch for one lamp 650 Lumen Emergency ballast.
- EM2** Emergency battery and remote test switch for one lamp up to 1300 Lumen Emergency ballast.
- EMI** Emergency battery and integral test switch for one lamp 650 Lumen with Internal Switch. Also add EMI suffix to trim catalog number (open trims only)

Compact Fluorescent Recessed Downlight

Universal Butterfly Brackets

Adjust vertically and accept C-channel or flat bar hangers or standard 1/2" conduit pipe. Also available in platform version with included hanger bars

Horizontal Socket Cup

Dual set screws allow for quick installation and removal. Optional third locking screw provided.

Electronic Ballast

Dimming & Emergency available

Quick Connects

Provide instant, trouble-free electrical connection



Reflector Flange

Self flange available in white or matching reflector finish

5/8" Plaster Flange

Optional thick ceiling collar is available

High Quality 6" & 8" Reflectors

Architectural & Commercial Reflectors provide maximum efficiency with minimal lamp image or glare. Low Iridescent reflectors in clear and designer finishes available.

Integral Clips

New Reflector Clips are integral to housing, allowing easy reflector installation

Large J-box

Provides seven 1/2" knockouts and four Romex® pryouts with automatic strain relief



COMPACT FLUORESCENT RECESSED

8" Quad/Triple Tube Horizontal Architectural Frame-in

Nora Lighting's energy efficient 8" Architectural Horizontal Quad/Triple Tube Compact Fluorescent frame-in fixture is ideal for suspended ceiling or T-Bar installations. Featuring high quality specular reflectors with glare reduction, low iridescent, external glass accents, open wall wash and many other options suitable for any architectural interior. Photometric and data files are available for applications requiring detailed design layouts and precise lighting calculations.

Ballast: Electronic (EL) with Universal Input (120V-277V).

Lamp Types:

13W – 26W Electronic 4-Pin Quad G24Q base
13W – 42W Electronic 4-Pin Triple Tube GX24Q base

Dimming Options: Variety of Dimming ballast options are available. Please match appropriate fixture with compatible compact fluorescent dimming control. See pages 70-71

Emergency Option: Emergency back-up operates one or two lamp(s) for a minimum of 90 minutes. Unit includes battery, charger, and test plate with indicator light or integral mounted test switch in the reflector. See page 178.

Fuse Option: 2A Fuse may be added to any compact fluorescent frame-in. Add: suffix FS.

Bi-Level Switching Option: Dual or A/B switching is available on Nora dual lamp units. Two ballasts are attached to the J-box allowing separate control of each lamp to meet bi-level code or design requirements. Consult factory.

Minimum Clearances: Non-IC fixtures require minimum clearances of 3" from thermal insulation and 1/2" from adjacent building components.

Installation: Universal brackets adjust vertically and accept C-Channel or flat bar hangers (ordered separately), or simple rigid 1/2" steel conduit for tie-down to ceiling grids.

Listing:

cULus Damp Location w/ Feed Through
cULus Wet Location (Only with designated trims)

Reflector not included

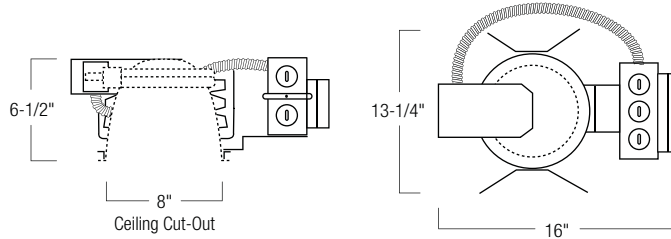

NHP8U SERIES

CATALOG. NO.	LAMP	WATTS	VOLTAGE	DIMMING	EMERGENCY
NHP8U-113EL	1 Q/T	13	120-277	D10, M7	EM, EMI, EM2
NHP8U-118EL	1 Q/T	18	120-277	D10, MX1, MX2, M7, L51, L52, L11, L12	EM, EMI, EM2
NHP8U-12642EL	1 Q/T	26-42	120-277	DAS, D10, MX1, MX2, M7, L51, L52, L11, L12	EM, EMI, EM2
NHP8U-213EL	2 Q/T	13	120-277	D10, M7	EM, EMI, EM2
NHP8U-218EL	2 Q/T	18	120-277	D10, MX1, MX2, M7, L51, L52, L11, L12	EM, EMI, EM2
NHP8U-22642EL	2 Q/T	26-42	120-277	DAS, D10, MX1, MX2, M7, L51, L52, L11, L12	EM, EMI, EM2

Bar hangers ordered separately – see page 383



8" Quad/Triple Tube Horizontal Commercial Frame-in

Reflector not included



Nora Lighting's energy efficient 8" Commercial Horizontal Quad/Triple Tube Compact Fluorescent frame-in fixture allows direct installation to wood joist, steel stud or T-bar constructions. Featuring high quality specular reflectors with glare reduction, low iridescence, external glass accents, open wall wash and many other options suitable for any architectural interior. Photometric and data files are available for applications requiring detailed design layouts and precise lighting calculations.

Ballast: Electronic (EL) with Universal Input (120V-277V).

Lamp Types:
 13W – 26W Electronic 4-Pin Quad G24Q base
 13W – 42W Electronic 4-Pin Triple Tube GX24Q base

Dimming Options: Variety of Dimming ballast options are available. Please match appropriate fixture with compatible compact fluorescent dimming control. See pages 70-71

Emergency Option: Emergency back-up operates one or two lamp(s) for a minimum of 90 minutes. Unit includes battery, charger, and test plate with indicator light or integral mounted test switch in the reflector. See page 179.

Fuse Option: 2A Fuse may be added to any compact fluorescent frame-in. Add: suffix FS.

Bi-Level Switching Option: Dual or A/B switching is available on Nora dual lamp units. Two ballasts are attached to the J-box allowing separate control of each lamp to meet bi-level code or design requirements. Consult factory.

Minimum Clearances: Non-IC fixtures require minimum clearances of 3" from thermal insulation and 1/2" from adjacent building components.

Installation: Bar hangers are adjustable from 13-5/8" to 24-1/2" and can be repositioned 90 degrees. Bar hangers are slotted for T-bar installations.

Listing:
 cULus Damp Location w/ Feed Through
 cULus Wet Location (Only with designated trims)

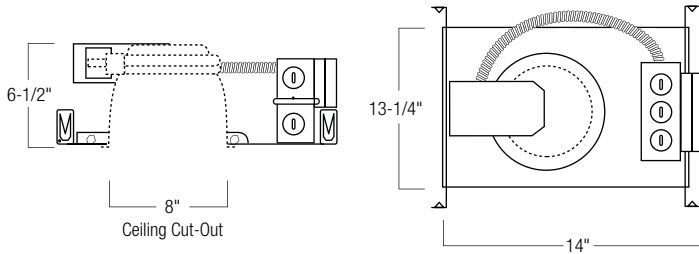

NH8PU SERIES

CATALOG. NO.	LAMP	WATTS	VOLTAGE	DIMMING	EMERGENCY
NH8PU-113EL	1 Q/T	13	120-277	D10, M7	EM, EMI, EM2
NH8PU-118EL	1 Q/T	18	120-277	D10, MX1, MX2, M7, L51, L52, L11, L12	EM, EMI, EM2
NH8PU-12642EL	1 Q/T	26-42	120-277	DAS, D10, MX1, MX2, M7, L51, L52, L11, L12	EM, EMI, EM2
NH8PU-213EL	2 Q/T	13	120-277	D10, M7	EM, EMI, EM2
NH8PU-218EL	2 Q/T	18	120-277	D10, MX1, MX2, M7, L51, L52, L11, L12	EM, EMI, EM2
NH8PU-22642EL	2 Q/T	26-42	120-277	DAS, D10, MX1, MX2, M7, L51, L52, L11, L12	EM, EMI, EM2

Bar hangers included.



COMPACT FLUORESCENT RECESSED

8" Quad/Triple Tube Horizontal Architectural Remodel

Nora's New Compact Fluorescent Remodel Frame-In allows high performance CFL reflectors to be installed in existing ceilings.

Excellent for tenant improvement and energy retrofits in commercial, retail, hospitality, and architectural applications.

Ballast: Electronic (EL) with Universal Input (120V-277V).

Lamp Types:
 13W – 26W Electronic 4-Pin Quad G24Q base
 13W – 42W Electronic 4-Pin Triple Tube GX24Q base

Dimming Options: Variety of Dimming ballast options are available. Please match appropriate fixture with compatible compact fluorescent dimming control. See pages 70-71

Emergency Option: 90-minute battery back-up must be ordered and installed as a self contained kit set apart from the frame-in. See page 746.

Fuse Option: 2A Fuse may be added to any compact fluorescent frame-in. Add: suffix FS.

Bi-Level Switching Option: Dual or A/B switching is available on Nora dual lamp units. Two ballasts are attached to the J-box allowing separate control of each lamp to meet bi-level code or design requirements. Consult factory.

Minimum Clearances: Non-IC fixtures require minimum clearances of 3" from thermal insulation and 1/2" from adjacent building components.

Remodel Installation: High tension tempered steel springs secure remodel housings evenly to ceiling; hole cutout template provided for convenience.

Listing:
 cULus Damp Location w/ Feed Through
 cULus Wet Location (Only with designated trims)

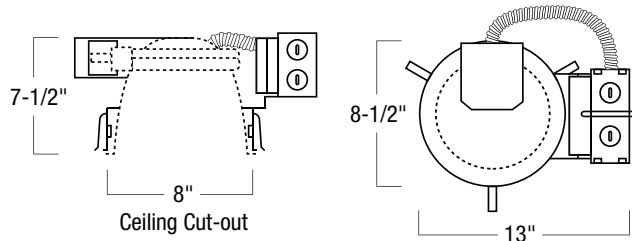

NHRP8U SERIES

CATALOG. NO.	LAMP	WATTS	VOLTAGE	DIMMING
NHRP8U-113EL	1 Q/T	13	120-277	D10, M7
NHRP8U-118EL	1 Q/T	18	120-277	D10, MX1, MX2, M7, L51, L52, L11, L12
NHRP8U-12642EL	1 Q/T	26-42	120-277	DAS, D10, MX1, MX2, M7, L51, L52, L11, L12
NHRP8U-213EL	2 Q/T	13	120-277	D10, M7
NHRP8U-218EL	2 Q/T	18	120-277	D10, MX1, MX2, M7, L51, L52, L11, L12
NHRP8U-22642EL	2 Q/T	26-42	120-277	DAS, D10, MX1, MX2, M7, L51, L52, L11, L12



8" Horizontal Architectural & Commercial Reflectors

LOW IRIDESCENT REFLECTORS

Alzak® reflectors are USA manufactured with protective finishes for architectural and commercial applications requiring the highest grade finishes appropriate for upscale designs. Low Iridescent colors are available in basic clear or new designer Black, Bronze, Champagne Gold, Gold, Haze, Pewter, Straw and Wheat.

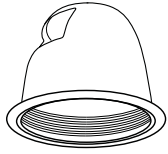

Maximum Wattage
(1-2) 13W-26W Quad
(1-2) 13W-42W Triple
OD: 9"

LOW IRIDESCENT Alzak® Semi-Specular Reflector with Baffle

Catalog No.	Description
NTS-872BLISF	Alzak® Clear Refl. / Black Baffle / Self Flange
NTS-872BLIWF	Alzak® Clear Refl. / Black Baffle / White Flange
NTS-872WLISF	Alzak® Clear Refl. / White Baffle / Self Flange
NTS-872WLIWF	Alzak® Clear Refl. / White Baffle / White Flange

- **Designer Reflector Finishes:** B, BZ, CG, G, HZ, PE, ST, WH

Alzak® Open Reflector with Baffle

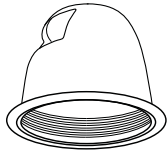

Maximum Wattage
(1-2) 13W-26W Quad
(1-2) 13W-42W Triple
OD: 9"

Catalog No.	Description
NTS-872BC	Specular Clear Refl / Black Baffle / White Flange
NTS-872BG	Specular Gold Refl / Black Baffle / White Flange
NTS-872WC	Specular Clear Refl / White Baffle / White Flange
NTS-872WG	Specular Gold Refl / White Baffle / White Flange

Open Reflector with Baffle

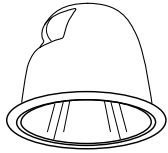

Maximum Wattage
(1-2) 13W-26W Quad
(1-2) 13W-42W Triple
OD: 9"

LOW IRIDESCENT Alzak® Semi-Specular Open Reflector

Catalog No.	Description
NTS-871LISF	Alzak® Clear Reflector / Self Flange
NTS-871LIWF	Alzak® Clear Reflector / White Flange

- **Designer Reflector Finishes:** B, BZ, CG, G, HZ, PE, ST, WH

Alzak® Open Reflector

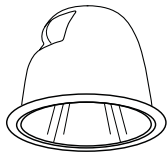

Maximum Wattage
(1-2) 13W-26W Quad
(1-2) 13W-42W Triple
OD: 9"

Catalog No.	Description
NTS-871CLIWF	Clear Low Iridescent Reflector / White Flange NEW!
NTS-871B	Specular Black Reflector / White Flange
NTS-871C	Specular Clear Reflector / White Flange
NTS-871G	Specular Gold Reflector / White Flange
NTS-871W	Specular White Reflector / White Flange

Open Reflector

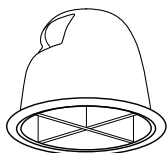

Maximum Wattage
(1-2) 13W-26W Quad
(1-2) 13W-42W Triple
OD: 9"

LOW IRIDESCENT Alzak® Semi-Specular Reflector, Cross Louver

Catalog No.	Description
NTS-874LISF	Alzak® Clear Reflector / Specular Clear Louver / Self Flange
NTS-874LIWF	Alzak® Clear Reflector / Specular Clear Louver / White Flange

- **Designer Reflector Finishes:** B, BZ, CG, G, HZ, PE, ST, WH

Alzak® Reflector with Cross Louver

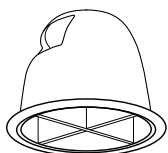

Maximum Wattage
(1-2) 13W-26W Quad
(1-2) 13W-42W Triple
OD: 9"

Catalog No.	Description
NTS-874CLIWF	Specular Clear Low Iridescent Reflector / Specular Clear Louver / White Flange NEW!
NTS-874C	Specular Clear Reflector / Specular Clear Louver / White Flange
NTS-874G	Specular Gold Reflector / Specular Gold Louver / White Flange

Reflector with Cross Louver

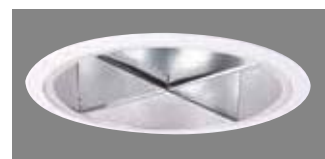

Designer Alzak® Finishes: standard-Clear, B-Black, BZ-Bronze, CG-Champagne Gold, G-Gold, HZ-Haze, PE-Pewter, ST-Straw, WH-Wheat

See pages 34-37 for Description of Reflector Finishes

8" HORIZONTAL ARCHITECTURAL & COMMERCIAL REFLECTORS continued

Alzak® Open Single Wall Wash



LOW IRIDESCENT Alzak® Semi-Specular Single Wall Wash

Catalog No.	Description
NTS-879LISFSC	Alzak® Clear Single Wall Wash / Self Flange
NTS-879LIWFSC	Alzak® Clear Single Wall Wash / White Flange

- Designer Reflector Finishes: B, BZ, CG, G, HZ, PE, ST, WH

Maximum Wattage
(1-2) 13W-26W Quad
(1-2) 13W-42W Triple

OD: 9"

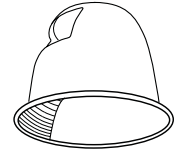

Open Single Wall Wash



Catalog No.	Description
NTS-879SC	Specular Clear Single Wall Wash / White Flange

Maximum Wattage
(1-2) 13W-26W Quad
(1-2) 13W-42W Triple

OD: 9"

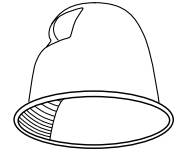

Alzak® Open Double Wall Wash



LOW IRIDESCENT Alzak® Semi-Specular Double Wall Wash

Catalog No.	Description
NTS-879LISFDC	Alzak® Clear Double Wall Wash / Self Flange
NTS-879LIWFDC	Alzak® Clear Double Wall Wash / White Flange

- Designer Reflector Finishes: B, BZ, CG, G, HZ, PE, ST, WH

Maximum Wattage
(1-2) 13W-26W Quad
(1-2) 13W-42W Triple

OD: 9"

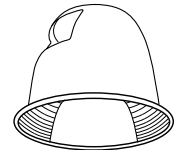

Open Double Wall Wash



Catalog No.	Description
NTS-879DC	Specular Clear Double Wall Wash / White Flange

Maximum Wattage
(1-2) 13W-26W Quad
(1-2) 13W-42W Triple

OD: 9"

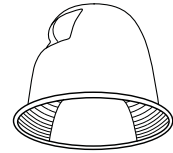

Lensed Reflector Wall Wash



Catalog No.	Description
NTS-873C	Specular Clear Wall Wash / Specular Clear Reflector / White Flange
NTS-873G	Specular Gold Wall Wash / Specular Gold Reflector / White Flange

Maximum Wattage
(1-2) 13W-26W Quad
(1-2) 13W-42W Triple

OD: 9"

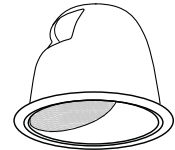

Regressed Lens with Reflector



Catalog No.	Description
NTS-875G	Glass Lens / Specular Clear Refl / White Flange
NTS-875L	Lexan Lens / Specular Clear Refl / White Flange
NTS-875FG	Frosted Lens / Specular Gold Refl / White Flange

- UL Wet Listed

Maximum Wattage
(1-2) 13W-26W Quad
(1-2) 13W-42W Triple

OD: 9"

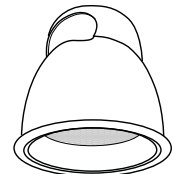

Flush Lens with Reflector



Catalog No.	Description
NTS-876CL	Clear Lens / Specular Clear Reflector / White Flange
NTS-876FL	Frosted Lens / Specular Clear Reflector / White Flange
NTS-877CBG	Frosted Lens / Specular Clear Reflector / Black Baffle / White Flange

Maximum Wattage
(1-2) 13W-26W Quad
(1-2) 13W-42W Triple

OD: 9"

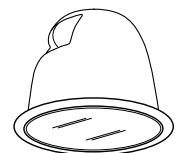

Designer Alzak® Finishes: standard-Clear, B-Black, BZ-Bronze, CG-Champagne Gold, G-Gold, HZ-Haze, PE-Pewter, ST-Straw, WH-Wheat

8" HORIZONTAL ARCHITECTURAL & COMMERCIAL REFLECTORS continued

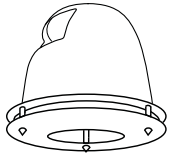

Maximum Wattage
 (1-2) 13W-26W Quad
 (1-2) 13W-42W Triple
OD: 9"

Catalog No. Description
NTS-878C Specular Clear Reflector / White Flange

- Glass sold separately.
- For a layered look, up to two pieces of glass may be used together.

Reflector for Decorative Glass

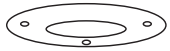

Includes:
 NRA-203 Glass Hardware
 • (3) Stand-offs
 • (3) Cone End Caps
 • (3) Flat End Caps
OD: 9"

Catalog No. Description
NTG-8B/167 Tempered Blue / 167mm (6-5/8") Open Center
NTG-8B/80 Tempered Blue / 80mm (3-1/8") Open Center
NTG-8CF Tempered Frost Center / Clear Outer
NTG-8FC Tempered Clear Center / Frost Outer
NTG-8HC Tempered Clear Outer / Frost Inner / 80mm (3-1/8") Open Center

Decorative Glass for NTS-878C



- Includes NRA-203 Glass Hardware
- 2 decorative glasses can be combined for a tiered look

Photometrics - 8" Horizontal Architectural & Commercial

NTS-871C Clear Reflector, White Flange (2) 32W Triple Tube

IESNA: LM-63-1995 Test No.: 300-2DD Spacing Criteria: (0-180) 1.34 (90-270) 1.36
 Efficiency: 56% Lamp: (2) 32W Triple Tube CFL Total Watts: 64 Lumens: 4800

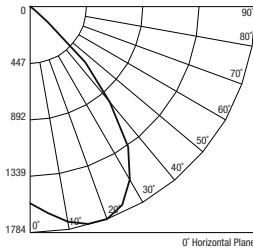

BEAM & CONE DATA

Mounting Height	F.C. at Nadir	Maximum Spacing
8'	24.3	10.8'
10'	15.5	13.6'
12'	10.8	16.3'
14'	7.9	19'
16'	6.1	21.7'

NTS-872BC Clear Reflector with Black Baffle, White Flange

IESNA: LM-63-1995 Test No.: 300-2DD Spacing Criteria: (0-180) 1.34 (90-270) 1.36
 Efficiency: 41% Lamp: (1) 26W Triple Tube CFL Total Watts: 26 Lumens: 1800

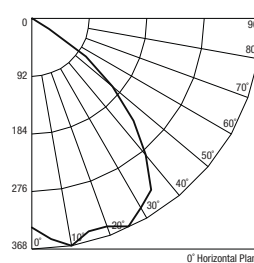

BEAM & CONE DATA

Mounting Height	F.C. at Center	Maximum Spacing
4'	20.9	5.9'
6'	9.3	8.9'
8'	5.2	11.8'
9'	4.1	13.3'
10'	3.3	14.8'

NTS-871C Clear Reflector, White Flange (2) 42W Triple Tube

IESNA: LM-63-1995 Test No.: 300-2DD Spacing Criteria: (0-180) 1.34 (90-270) 1.36
 Efficiency: 56% Lamp: (2) 42W Triple Tube CFL Total Watts: 84 Lumens: 6400

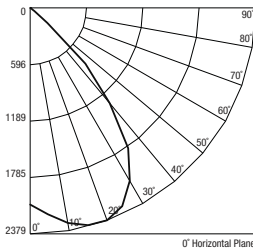

BEAM & CONE DATA

Mounting Height	F.C. at Nadir	Maximum Spacing
8'	32.3	10.8'
10'	20.7	13.6'
12'	14.4	16.3'
14'	10.6	19'
16'	8.1	21.7'

NTS-873C Clear Reflector with Clear Wall Wash, White Flange

IESNA: LM-63-1995 Test No.: 300-2LL Spacing Criteria: (0-180) 1.06 (90-270) 1.1
 Efficiency: 37% Lamp: (2) 42W Triple Tube CFL Total Watts: 84 Lumens: 6400

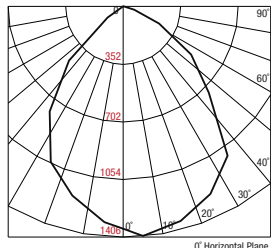

2' FROM WALL - 4' ON CENTER

DISTANCE FROM CEILING IN FEET	1'	2'	3'	4'
1'	58	22	58	
2'	67	51	67	
3'	49	48	49	
4'	34	41	34	
5'	25	29	25	
6'	20	21	20	
7'	15	16	15	
8'	12	13	12	
9'	9	10	9	
10'	8	8	8	

Footcandle values are rounded off and are based on a minimum of five units.

Photometric results may vary from testing data. To assist the lighting designer in using Nora's products in a lighting layout, the following photometric tables have both lab test data and normalized data to illustrate expected typical performance. Typical photometric data is provided to illustrate expectation of typical performance.

COMPACT FLUORESCENT RECESSED

6" Triple Tube Horizontal Architectural Frame-in

Nora Lighting's energy efficient 6" Architectural Horizontal Triple Tube Compact Fluorescent frame-in fixture is ideal for suspended ceiling or T-Bar installations. Featuring high quality specular reflectors with glare reduction, low iridescent, external glass accents, open wall wash and many other options suitable for any architectural interior. Photometric and data files are available for applications requiring detailed design layouts and precise lighting calculations.

Ballast: Electronic (EL) with Universal Input (120V-277V).

Lamp Types:
13W – 42W Electronic 4-Pin Triple Tube GX24Q base

Dimming Options: Variety of Dimming ballast options are available. Please match appropriate fixture with compatible compact fluorescent dimming control. See pages 70-71

Emergency Option: Emergency back-up operates one lamp for a minimum of 90 minutes. Unit includes battery, charger, and test plate with indicator light or integral mounted test switch in the reflector. See page 178.

Fuse Option: 2A Fuse may be added to any compact fluorescent frame-in. Add: suffix FS.

Minimum Clearances: Non-IC fixtures require minimum clearances of 3" from thermal insulation and 1/2" from adjacent building components.

Installation: Universal brackets adjust vertically and accept C-Channel or flat bar hangers (ordered separately), or simple rigid 1/2" steel conduit for tie-down to ceiling grids.

Listing:
cULus Damp Location w/ Feed Through
cULus Wet Location (Only with designated trims)

Reflector not included

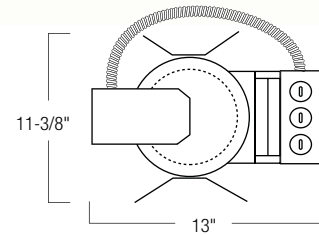
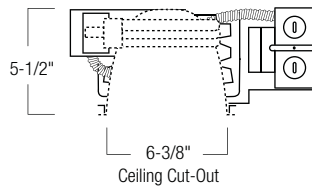

NHPT6 SERIES

CATALOG. NO.	LAMP	WATTS	VOLTAGE	DIMMING	EMERGENCY
NHPT6-13EL	1 Triple	13	120-277	D10, M7	EM, EMI, EM2
NHPT6-18EL	1 Triple	18	120-277	D10, MX1, MX2, M7, L51, L52, L11, L12	EM, EMI, EM2
NHPT6-2642EL	1 Triple	26-42	120-277	DAS, D10, MX1, MX2, M7, L51, L52, L11, L12	EM, EMI, EM2

Bar hangers ordered separately – see page 383.



COMPACT FLUORESCENT RECESSED 6" Triple Tube Horizontal Commercial Frame-in

Reflector not included

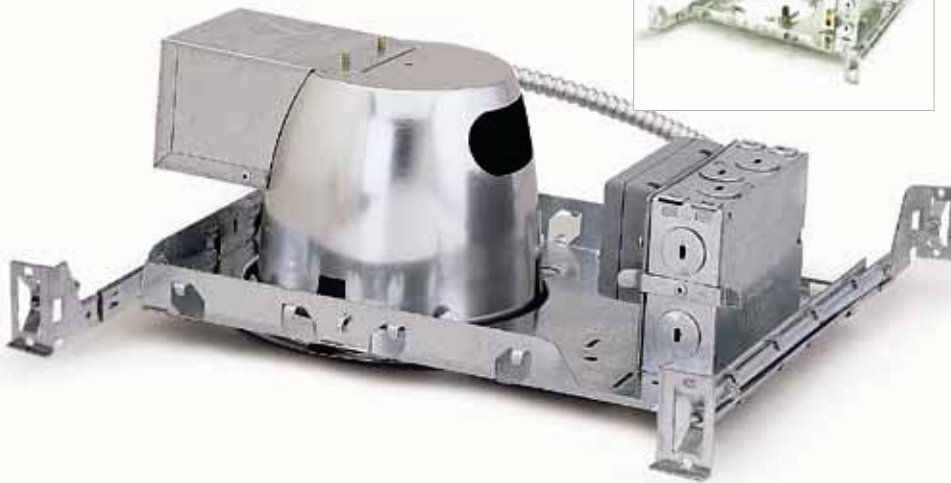

Nora Lighting's energy efficient 6" Commercial Horizontal Triple Tube Compact Fluorescent frame-in fixture allows direct installation to wood joist, steel stud or T-bar constructions. Featuring high quality specular reflectors with glare reduction, low iridescence, external glass accents, open wall wash and many other options suitable for any architectural interior. Photometric and data files are available for applications requiring detailed design layouts and precise lighting calculations.

Ballast: Electronic (EL) with Universal Input (120V-277V).

Lamp Types:
13W – 42W Electronic 4-Pin Triple Tube GX24Q base

Dimming Options: Variety of Dimming ballast options are available. Please match appropriate fixture with compatible compact fluorescent dimming control. See pages 70-71

Emergency Option: Emergency back-up operates one lamp for a minimum of 90 minutes. Unit includes battery, charger, and test plate with indicator light or integral mounted test switch in the reflector. See page 179.

Fuse Option: 2A Fuse may be added to any compact fluorescent frame-in. Add: suffix FS.

Minimum Clearances: Non-IC fixtures require minimum clearances of 3" from thermal insulation and 1/2" from adjacent building components

Installation: Bar hangers are adjustable from 13-5/8" to 24-1/2" and can be repositioned 90 degrees. Bar hangers are slotted for T-bar installations.

Listing:
cULus Damp Location w/ Feed Through
cULus Wet Location (Only with designated trims)

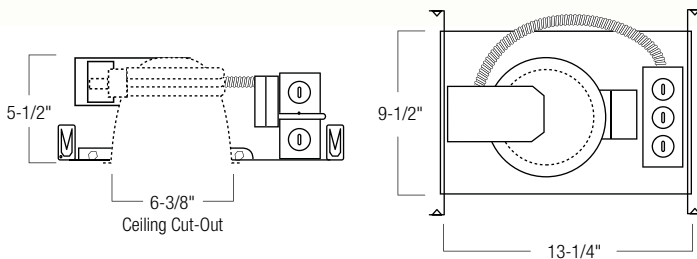

NHPT SERIES

CATALOG. NO.	LAMP	WATTS	VOLTAGE	DIMMING	EMERGENCY
NHPT-13EL	1 Triple	13	120-277	D10, M7	EM, EMI, EM2
NHPT-18EL	1 Triple	18	120-277	D10, MX1, MX2, M7, L51, L52, L11, L12	EM, EMI, EM2
NHPT-2642EL	1 Triple	26-42	120-277	DAS, D10, MX1, MX2, M7, L51, L52, L11, L12	EM, EMI, EM2

Bar hangers included.



COMPACT FLUORESCENT RECESSED

6" Triple Tube Horizontal Architectural Remodel

Nora's New Compact Fluorescent Remodel Frame-In allows high performance CFL reflectors to be installed in existing ceilings.

Excellent for tenant improvement and energy retrofits in commercial, retail, hospitality, and architectural applications.

Ballast: Electronic (EL) with Universal Input (120V-277V).

Lamp Types:
13W – 42W Electronic 4-Pin Triple Tube
GX24Q base

Dimming Options: Variety of Dimming ballast options are available. Please match appropriate fixture with compatible compact fluorescent dimming control. See pages 70-71

Emergency Option: 90-minute battery back-up must be ordered and installed as a self contained kit set apart from the frame-in. See page 746.

Fuse Option: 2A Fuse may be added to any compact fluorescent frame-in. Add: suffix FS.

Minimum Clearances: Non-IC fixtures require minimum clearances of 3" from thermal insulation and 1/2" from adjacent building components.

Remodel Installation: High tension tempered steel springs secure remodel housings evenly to ceiling; hole cutout template provided for convenience.

Listing:
cULus Damp Location w/ Feed Through
cULus Wet Location (Only with designated trims)

NEW!

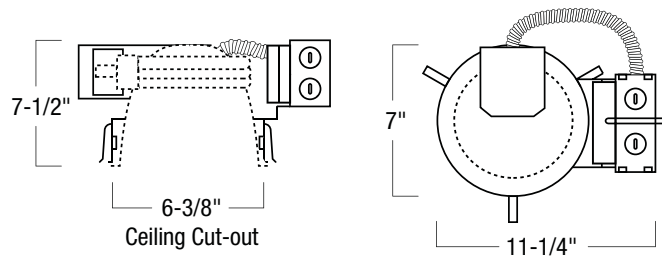

NHRPT6 SERIES

CATALOG. NO.	LAMP	WATTS	VOLTAGE	DIMMING
NHRPT6-13EL	1 Triple	13	120-277	D10, M7
NHRPT6-18EL	1 Triple	18	120-277	D10, MX1, MX2, M7, L51, L52, L11, L12
NHRPT6-2642EL	1 Triple	26-42	120-277	DAS, D10, MX1, MX2, M7, L51, L52, L11, L12





COMPACT FLUORESCENT RECESSED

6" Triple Tube Horizontal Architectural & Commercial Reflectors

LOW IRIDESCENT REFLECTORS

Alzak® reflectors are USA manufactured with protective finishes for architectural and commercial applications requiring the highest grade finishes appropriate for upscale designs. Low Iridescent colors are available in basic clear or new designer Black, Bronze, Champagne Gold, Gold, Haze, Pewter, Straw and Wheat.

Alzak® Open Reflector with Baffle

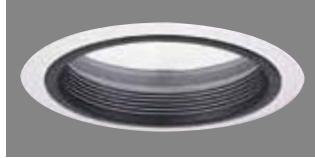

LOW IRIDESCENT Alzak® Semi-Specular Reflector with Baffle

Catalog No.	Description
NTS-650BLI	Alzak® Clear Refl. / Black Baffle / White Ring CC
NTS-650BLISF	Alzak® Clear Refl. / Black Baffle / Self Flange
NTS-650BLIWF	Alzak® Clear Refl. / Black Baffle / White Flange
NTS-650WLI	Alzak® Clear Refl. / White Baffle / White Ring CC
NTS-650WLISF	Alzak® Clear Refl. / White Baffle / Self Flange
NTS-650WLIWF	Alzak® Clear Refl. / White Baffle / White Flange

- Designer Reflector Finishes: B, BZ, CG, G, HZ, PE, ST, WH

Maximum Wattage

(1) 13W-42W Triple CF

OD: 7"

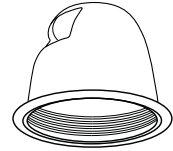

Open Reflector with Baffle



Catalog No.	Description
NTS-650B	Specular Clear Refl / Black Baffle / White Ring
NTS-650W	Specular Clear Refl / White Baffle / White Ring

Maximum Wattage

(1) 13W-42W Triple CF

OD: 7-1/2"

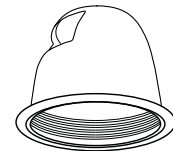

Alzak® Open Reflector



LOW IRIDESCENT Alzak® Semi-Specular Open Reflector

Catalog No.	Description
NTS-651LI	Alzak® Clear Reflector / White Ring CC
NTS-651LISF	Alzak® Clear Reflector / Self Flange
NTS-651LIWF	Alzak® Clear Reflector / White Flange

- Designer Reflector Finishes: B, BZ, CG, G, HZ, PE, ST, WH

Maximum Wattage

(1) 13W-42W Triple CF

OD: 7"

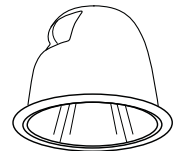

Open Reflector



Catalog No.	Description
NTS-651CLIWF	Clear Low Iridescent Reflector / White Flange NEW!
NTS-651CWF	Specular Clear Reflector / White Flange
NTS-651B	Specular Black Reflector / White Ring
NTS-651C	Specular Clear Reflector / White Ring
NTS-651G	Specular Gold Reflector / White Ring
NTS-651W	Specular White Reflector / White Ring

Maximum Wattage

(1) 13W-42W Triple CF

OD: 7-1/2"

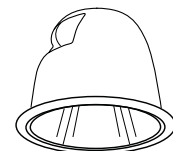

Alzak® Reflector with Cross Louver



LOW IRIDESCENT Alzak® Semi-Specular Reflector, Cross Louver

Catalog No.	Description
NTS-657LI	Alzak® Clear Refl / Spec Clear Louver / White Ring CC
NTS-657LISF	Alzak® Clear Refl / Spec Clear Louver / Self Flange
NTS-657LIWF	Alzak® Clear Refl / Spec Clear Louver / White Flange

- Designer Reflector Finishes: B, BZ, CG, G, HZ, PE, ST, WH

Maximum Wattage

(1) 13W-42W Triple CF

OD: 7"

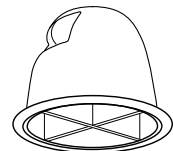

Reflector with Cross Louver

NEW!
LOW IRIDESCENT

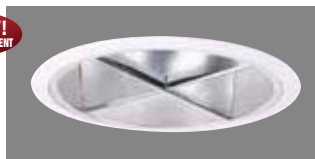

Catalog No.	Description
NTS-657CLIWF	Specular Clear Low Iridescent Reflector / Specular Clear Louver / White Flange NEW!
NTS-657CWF	Specular Clear Reflector / Specular Clear Louver / White Flange
NTS-657C	Specular Clear Reflector / Specular Clear Louver / White Ring CC

Maximum Wattage

(1) 13W-42W Triple CF

OD: 7-1/2"

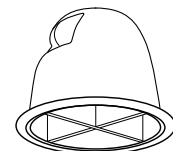

CC Custom Combo: Available with custom combinations of reflector and plastic and metal ring finish. See pages 38-39 for details.

Designer Alzak® Finishes: standard-Clear, B-Black, BZ-Bronze, CG-Champagne Gold, G-Gold, HZ-Haze, PE-Pewter, ST-Straw, WH-Wheat

Ring Finishes for Alzak® Trims: standard-White, B-Black, C-Chrome, G-Gold Ring Finishes for Standard Trims: B-Black, BZ-Bronze, C-Chrome, CO-Copper, G-Gold, N-Natural Metal, W-White

6" TRIPLE TUBE HORIZONTAL ARCHITECTURAL & COMMERCIAL REFLECTORS continued

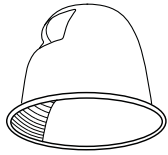

Maximum Wattage
(1) 13W-42W Triple CF
OD: 7"

LOW IRIDESCENT Alzak® Semi-Specular Single Wall Wash

Catalog No.	Description
NTS-659LISC	Alzak® Clear Single Wall Wash / White Ring CC
NTS-659LISFSC	Alzak® Clear Single Wall Wash / Self Flange
NTS-659LIWFSC	Alzak® Clear Single Wall Wash / White Flange

• **Designer Reflector Finishes:** B, BZ, CG, G, HZ, PE, ST, WH

Alzak® Open Single Wall Wash

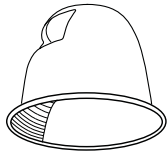

Maximum Wattage
(1) 13W-42W Triple CF
OD: 7"

Catalog No.	Description
NTS-659SC	Specular Clear Single Wall Wash / White Ring

Open Single Wall Wash

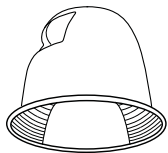

Maximum Wattage
(1) 13W-42W Triple CF
OD: 7"

LOW IRIDESCENT Alzak® Semi-Specular Single Wall Wash

Catalog No.	Description
NTS-659LIDC	Alzak® Clear Double Wall Wash / White Ring CC
NTS-659LISFDC	Alzak® Clear Double Wall Wash / Self Flange
NTS-659LIWFDC	Alzak® Clear Double Wall Wash / White Flange

• **Designer Reflector Finishes:** B, BZ, CG, G, HZ, PE, ST, WH

Alzak® Open Double Wall Wash

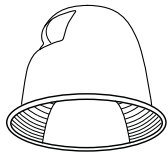

Maximum Wattage
(1) 13W-42W Triple CF
OD: 7"

Catalog No.	Description
NTS-659DC	Specular Clear Double Wall Wash / White Ring

Open Double Wall Wash

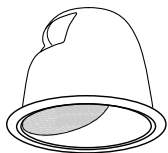

Maximum Wattage
(1) 13W-42W Triple CF
OD: 7-1/2"

Catalog No.	Description
NTS-656C	Specular Clear Wall Wash / Specular Clear Reflector / White Ring

Wall Wash with Lensed Reflector

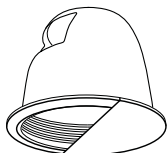

Maximum Wattage
(1) 13W-42W Triple CF
OD: 7-1/2"

Catalog No.	Description
NTS-654B	Wall Wash / Black Baffle / Specular Clear Reflector / White Eyelid & Ring
NTS-654W	Wall Wash / White Baffle / Specular Clear Reflector / White Eyelid & Ring

Wall Wash with Baffle



CC Custom Combo: Available with custom combinations of reflector and plastic and metal ring finish. See pages 38-39 for details.

Designer Alzak® Finishes: standard-Clear, B-Black, BZ-Bronze, CG-Champagne Gold, G-Gold, HZ-Haze, PE-Pewter, ST-Straw, WH-Wheat

Ring Finishes for Alzak® Trims: standard-White, B-Black, C-Chrome, G-Gold **Ring Finishes for Standard Trims:** B-Black, BZ-Bronze, C-Chrome, CO-Copper, G-Gold, N-Natural Metal, W-White

6" TRIPLE TUBE HORIZONTAL ARCHITECTURAL & COMMERCIAL REFLECTORS continued

Regressed Albalite Lens with Baffle



CC

Catalog No.	Description
NTS-652B	Regressed Albalite Lens / Black Baffle / White Plastic Ring
NTS-652W	Regressed Albalite Lens / White Baffle / White Plastic Ring

- UL Wet Listed

Maximum Wattage
(1) 13W-42W Triple CF
OD: 7-1/2"

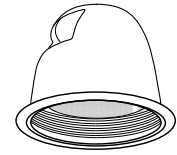

Regressed Drop Opal with Baffle



CC

Catalog No.	Description
NTS-655B	Regressed Drop Opal / Black Baffle / White Plastic Ring
NTS-655W	Regressed Drop Opal / White Baffle / White Plastic Ring

- UL Wet Listed

Maximum Wattage
(1) 13W-42W Triple CF
OD: 7-1/2"

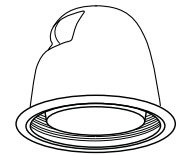

Regressed Albalite Lens w/ Reflector



CC

Catalog No.	Description
NTS-662C	Regressed Albalite Lens / Specular Clear Reflector / White Ring
NTS-663C	Regressed Fresnel Lens / Specular Clear Reflector / White Ring

- UL Wet Listed

Maximum Wattage
(1) 13W-42W Triple CF
OD: 7-1/2"

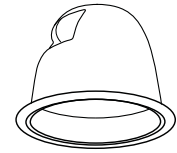

Flush Mount Lens with Reflector



CC

Catalog No.	Description
NTS-653CL	Clear Lens / Specular Clear Reflector / White Ring
NTS-653FL	Frost Lens / Specular Clear Reflector / White Ring

- UL Wet Listed

Maximum Wattage
(1) 13W-42W Triple CF
OD: 7"

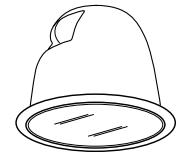

Reflector for Decorative Glass



Catalog No.	Description
NTS-658C	Specular Clear Reflector / White Flange

- Glass sold separately.
- For a layered look, up to two pieces of glass may be used together.

Maximum Wattage
(1) 13W-42W Triple CF
OD: 7"

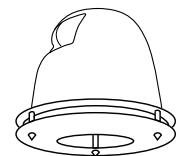

Decorative Glass for NTS-659C



Catalog No.	Description
NTG-6B/120	Tempered Blue / 120mm (4-3/4") Open Center
NTG-6B/80	Tempered Blue / 80mm (3-1/8") Open Center
NTG-6CF	Tempered Frost Center / Clear Outer
NTG-6FC	Tempered Clear Center / Frost Outer
NTG-6HC	Tempered Clear Outer / Frost Inner / 80mm (3-1/8") Open Center

- Includes NRA-203 Glass Hardware
- 2 decorative glasses can be combined for a tiered look

Includes:
NRA-203 Glass Hardware
• (3) Stand-offs
• (3) Cone End Caps
• (3) Flat End Caps
OD: 7"



CC Custom Combo: Available with custom combinations of reflector and plastic and metal ring finish. See pages 38-39 for details.

Ring Finishes for Standard Trims: B-Black, BZ-Bronze, C-Chrome, CO-Copper, G-Gold, N-Natural Metal, W-White

Photometrics - 6" Triple Tube Horizontal Architectural & Commercial

NTS-650B Clear Cone Reflector with Black Baffle 26W

IESNA: LM-63-1995 Test No.: 103-12B Spacing Criteria: (0-180) 1.06 (90-270) 1.06 Efficiency: 47% Lamp: (1) 26W Triple Tube CFL Total Watts: 26 Lumens: 1800

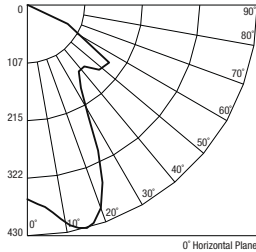

Mounting Height	F.C. at Nadir	Maximum Spacing
4'	22.6	4.2'
6'	10.0	6.4'
8'	5.6	8.5'
9'	4.5	9.5'
10'	3.6	10.6'

NTS-657C Clear Cone Reflector with Chrome Louver 26W

IESNA: LM-63-1995 Test No.: 103-12A Spacing Criteria: (0-180) 1.2 (90-270) 1.2 Efficiency: 44% Lamp: (1) 26W Triple Tube CFL Total Watts: 26 Lumens: 1800

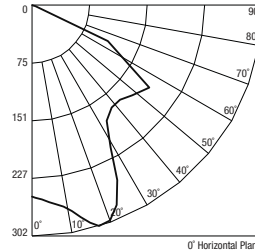

Mounting Height	F.C. at Nadir	Maximum Spacing
4'	15.6	4.8'
6'	6.9	7.2'
8'	3.9	9.6'
9'	3.1	10.8'
10'	2.5	12.0'

NTS-650B Clear Cone Reflector with Black Baffle 42W

IESNA: LM-63-1995 Test No.: 103-12B Spacing Criteria: (0-180) 1.06 (90-270) 1.06 Efficiency: 47% Lamp: (1) 42W Triple Tube CFL Total Watts: 42 Lumens: 3200

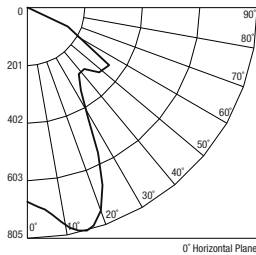

Mounting Height	F.C. at Nadir	Maximum Spacing
4'	42.3	4.2'
6'	18.8	6.4'
8'	10.6	8.5'
9'	8.4	9.5'
10'	6.8	10.6'

NTS-657C Clear Cone Reflector with Chrome Louver 42W

IESNA: LM-63-1995 Test No.: 103-12A Spacing Criteria: (0-180) 1.2 (90-270) 1.2 Efficiency: 44% Lamp: (1) 42W Triple Tube CFL Total Watts: 42 Lumens: 3200

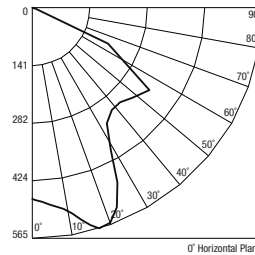

Mounting Height	F.C. at Nadir	Maximum Spacing
4'	29.2	4.8'
6'	13.0	7.2'
8'	7.3	9.6'
9'	5.8	10.8'
10'	4.7	12.0'

NTS-651C Clear Cone Reflector with White Plastic Ring 26W

IESNA: LM-63-1995 Test No.: 103-12A Spacing Criteria: (0-180) 1.2 (90-270) 1.2 Efficiency: 74% Lamp: (1) 26W Triple Tube CFL Total Watts: 26 Lumens: 1800

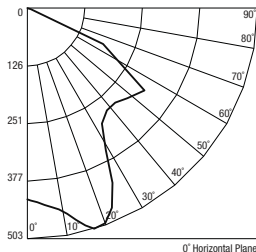

Mounting Height	F.C. at Nadir	Maximum Spacing
4'	26.0	4.8'
6'	11.6	7.2'
8'	6.5	9.6'
9'	5.1	10.8'
10'	4.2	12.0'

NTS-659SC Clear Single Wall Wash with White Plastic Ring 26W

IESNA: LM-63-1995 Test No.: 103-12C Spacing Criteria: (0-180) 1.30 (90-270) 1.14 Efficiency: 73% Lamp: (1) 26W Triple Tube CFL Total Watts: 26 Lumens: 1800

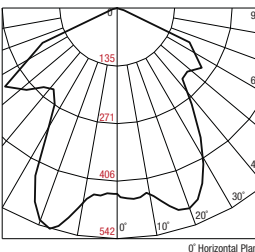

2' FROM WALL - 4' ON CENTER

DISTANCE FROM CEILING IN FEET	1'	2'	3'	4'	5'	6'	7'	8'	9'	10'
1'	26	8	26							
2'	23	23	23							
3'	18	15	18							
4'	13	11	13							
5'	9	9	9							
6'	7	7	7							
7'	5	5	5							
8'	4	4	4							
9'	3	3	3							
10'	2	2	2							

Footcandle values are rounded off and are based on a minimum of five units.

NTS-651C Clear Cone Reflector with White Plastic Ring 42W

IESNA: LM-63-1995 Test No.: 103-12A Spacing Criteria: (0-180) 1.2 (90-270) 1.2 Efficiency: 74% Lamp: (1) 42W Triple Tube CFL Total Watts: 42 Lumens: 3200

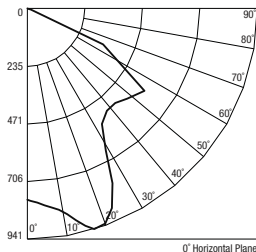

Mounting Height	F.C. at Nadir	Maximum Spacing
4'	48.7	4.8'
6'	21.7	7.2'
8'	12.2	9.6'
9'	9.6	10.8'
10'	7.8	12.0'

NTS-659SC Clear Single Wall Wash with White Plastic Ring 42W

IESNA: LM-63-1995 Test No.: 103-12C Spacing Criteria: (0-180) 1.30 (90-270) 1.14 Efficiency: 73% Lamp: (1) 42W Triple Tube CFL Total Watts: 42 Lumens: 3200

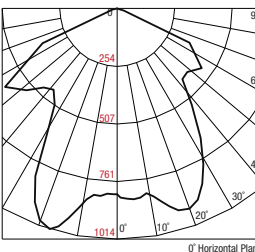

2' FROM WALL - 4' ON CENTER

DISTANCE FROM CEILING IN FEET	1'	2'	3'	4'	5'	6'	7'	8'	9'	10'
1'	46	14	46							
2'	41	40	41							
3'	33	27	33							
4'	23	20	23							
5'	17	15	17							
6'	12	12	12							
7'	9	9	9							
8'	7	7	7							
9'	5	5	5							
10'	4	4	4							

Footcandle values are rounded off and are based on a minimum of five units.

Photometric results may vary from testing data. To assist the lighting designer in using Nora's products in a lighting layout, the following photometric tables have both lab test data and normalized data to illustrate expected typical performance. Typical photometric data is provided to illustrate expectation of typical performance.

COMPACT FLUORESCENT RECESSED

6" Quad Horizontal Architectural Frame-in

Nora Lighting's energy efficient 6" Architectural Horizontal Quad Compact Fluorescent frame-in fixture is ideal for suspended ceiling or T-Bar installations. Featuring high quality specular reflectors with glare reduction, low iridescent, external glass accents, open wall wash and many other options suitable for any architectural interior. Photometric and data files are available for applications requiring detailed design layouts and precise lighting calculations.

Ballast: Electronic (EL) with Universal Input (120V-277V).

Lamp Types:
13W – 26W Electronic 4-Pin Quad G24Q base

Dimming Options: Variety of Dimming ballast options are available. Please match appropriate fixture with compatible compact fluorescent dimming control. See pages 70-71.

Emergency Option: Emergency back-up operates one or two lamp(s) for a minimum of 90 minutes. Unit includes battery, charger, and test plate with indicator light or integral mounted test switch in the reflector. See page 178.

Fuse Option: 2A Fuse may be added to any compact fluorescent frame-in. Add: suffix FS.

Bi-Level Switching Option: Dual or A/B switching is available on Nora dual lamp units. Two ballasts are attached to the J-box allowing separate control of each lamp to meet bi-level code or design requirements. Consult factory.

Minimum Clearances: Non-IC fixtures require minimum clearances of 3" from thermal insulation and 1/2" from adjacent building components.

Installation: Universal brackets adjust vertically and accept C-Channel or flat bar hangers (ordered separately), or simple rigid 1/2" steel conduit for tie-down to ceiling grids.

Listing:
cULus Damp Location w/ Feed Through
cULus Wet Location (Only with designated trims)

Reflector not included

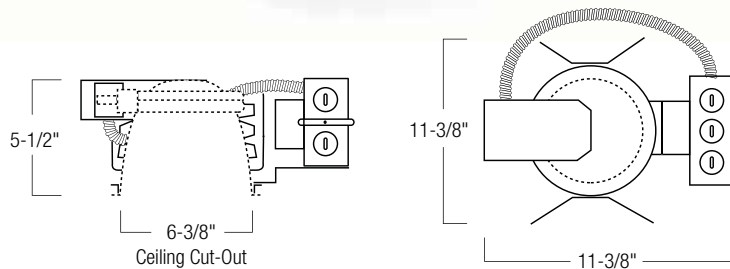

NHP6 SERIES

CATALOG. NO.	LAMP(S)	WATTS	VOLTAGE	DIMMING	EMERGENCY
NHP6-113EL	1 Quad	13	120-277	D10, M7	EM, EMI, EM2
NHP6-118EL	1 Quad	18	120-277	D10, MX1, MX2, M7, L51, L52, L11, L12	EM, EMI, EM2
NHP6-126EL	1 Quad	26	120-277	DAS, D10, MX1, MX2, M7, L51, L52, L11, L12	EM, EMI, EM2
NHP6-213EL	2 Quad	13	120-277	D10, M7	EM, EMI, EM2
NHP6-218EL	2 Quad	18	120-277	D10, MX1, MX2, M7, L51, L52, L11, L12	EM, EMI, EM2
NHP6-226EL	2 Quad	26	120-277	DAS, D10, MX1, MX2, M7, L51, L52, L11, L12	EM, EMI, EM2

Bar hangers ordered separately – see page 383.



COMPACT FLUORESCENT RECESSED 6" Quad Horizontal Commercial Frame-in

Reflector not included

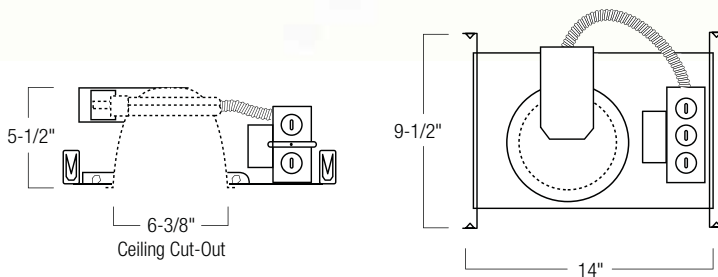

NHP-1 & NHP-2 SERIES

CATALOG. NO.	LAMP(S)	WATTS	VOLTAGE	DIMMING	EMERGENCY
NHP-113EL	1 Quad	13	120-277	D10, M7	EM, EMI, EM2
NHP-118EL	1 Quad	18	120-277	D10, MX1, MX2, M7, L51, L52, L11, L12	EM, EMI, EM2
NHP-126EL	1 Quad	26	120-277	DAS, D10, MX1, MX2, M7, L51, L52, L11, L12	EM, EMI, EM2
NHP-213EL	2 Quad	13	120-277	D10, M7	EM, EMI, EM2
NHP-218EL	2 Quad	18	120-277	D10, MX1, MX2, M7, L51, L52, L11, L12	EM, EMI, EM2
NHP-226EL	2 Quad	26	120-277	DAS, D10, MX1, MX2, M7, L51, L52, L11, L12	EM, EMI, EM2

Bar hangers included.



committed to
GREEN

Nora Lighting's energy efficient 6" Commercial Horizontal Quad Compact Fluorescent frame-in fixture allows direct installation to wood joist, steel stud or T-bar constructions. Featuring high quality specular reflectors with glare reduction, low iridescence, external glass accents, open wall wash and many other options suitable for any architectural interior. Photometric and data files are available for applications requiring detailed design layouts and precise lighting calculations.

Ballast: Electronic (EL) with Universal Input (120V-277V).

Lamp Types:
13W – 26W Electronic 4-Pin Quad G24Q base

Dimming Options: Variety of Dimming ballast options are available. Please match appropriate fixture with compatible compact fluorescent dimming control. See page 70-71.

Emergency Option: Emergency back-up operates one or two lamp(s) for a minimum of 90 minutes. Unit includes battery, charger, and test plate with indicator light or integral mounted test switch in the reflector. See page 179.

Fuse Option: 2A Fuse may be added to any compact fluorescent frame-in. Add: suffix FS.

Bi-Level Switching Option: Dual or A/B switching is available on Nora dual lamp units. Two ballasts are attached to the J-box allowing separate control of each lamp to meet bi-level code or design requirements. Consult factory.

Minimum Clearances: Non-IC fixtures require minimum clearances of 3" from thermal insulation and 1/2" from adjacent building components

Installation: Bar hangers are adjustable from 13-5/8" to 24-1/2" and can be repositioned 90 degrees. Bar hangers are slotted for T-bar installations.

Listing:
cULus Damp Location w/ Feed Through
cULus Wet Location (Only with designated trims)

COMPACT FLUORESCENT RECESSED

6" Quad Horizontal Commercial IC Frame-in

Nora Lighting's energy efficient 6" IC Commercial Horizontal Quad Compact Fluorescent frame-in fixture allows direct installation to wood joist, steel stud or T-bar constructions. Featuring high quality specular reflectors with glare reduction, low iridescence, external glass accents, open wall wash and many other options suitable for any architectural interior. Photometric and data files are available for applications requiring detailed design layouts and precise lighting calculations.

Ballast: Electronic (EL) with Universal Input (120V-277V).

Lamp Types:
13W – 18W Electronic 4-Pin Quad G24Q base

Dimming Options: Variety of Dimming ballast options are available. Please match appropriate fixture with compatible compact fluorescent dimming control. See page 70-71.

Emergency Option: 90-minute battery back-up must be ordered and installed as a self contained kit set apart from the frame-in. See page 746.

Fuse Option: 2A Fuse may be added to any compact fluorescent frame-in. Add: suffix FS.

Minimum Clearances: IC rated fixtures are rated for direct contact.

Installation: Bar hangers are adjustable from 13-5/8" to 24-1/2" and can be repositioned 90 degrees. Bar hangers are slotted for T-bar installations.

Listing:
cULus Damp Location w/ Feed Through
cULus Wet Location (Only with designated trims)

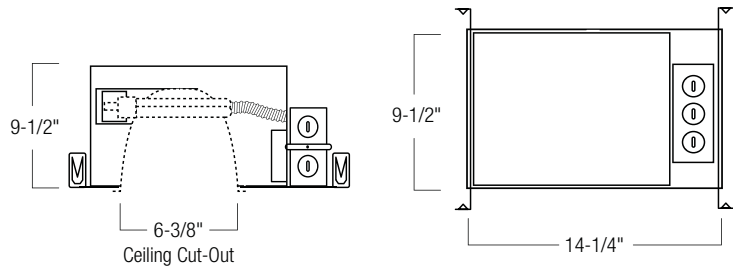

NHPIC-1 & NHPIC-2 SERIES

CATALOG. NO.	LAMP(S)	WATTS	VOLTAGE	DIMMING
NHPIC-113EL	1 Quad	13	120-277	D10, M7
NHPIC-118EL	1 Quad	18	120-277	D10, MX1, MX2, M7, L51, L52, L11, L12
NHPIC-213EL	2 Quad	13	120-277	D10, M7

Bar hangers included.



COMPACT FLUORESCENT RECESSED 6" Quad Horizontal Architectural Remodel

NEW!



Nora's New Compact Fluorescent Remodel Frame-In allows high performance CFL reflectors to be installed in existing ceilings.

Excellent for tenant improvement and energy retrofits in commercial, retail, hospitality, and architectural applications.

Ballast: Electronic (EL) with Universal Input (120V-277V).

Lamp Types:
13W – 26W Electronic 4-Pin Quad G24Q base

Dimming Options: Variety of Dimming ballast options are available. Please match appropriate fixture with compatible compact fluorescent dimming control. See page 70-71.

Emergency Option: 90-minute battery back-up must be ordered and installed as a self contained kit set apart from the frame-in. See page 746.

Fuse Option: 2A Fuse may be added to any compact fluorescent frame-in. Add: suffix FS.

Bi-Level Switching Option: Dual or A/B switching is available on Nora dual lamp units. Two ballasts are attached to the J-box allowing separate control of each lamp to meet bi-level code or design requirements. Consult factory.

Minimum Clearances: Non-IC fixtures require minimum clearances of 3" from thermal insulation and 1/2" from adjacent building components

Remodel Installation: High tension tempered steel springs secure remodel housings evenly to ceiling; hole cutout template provided for convenience.

Listing:
cULus Damp Location w/ Feed Through
cULus Wet Location (Only with designated trims)

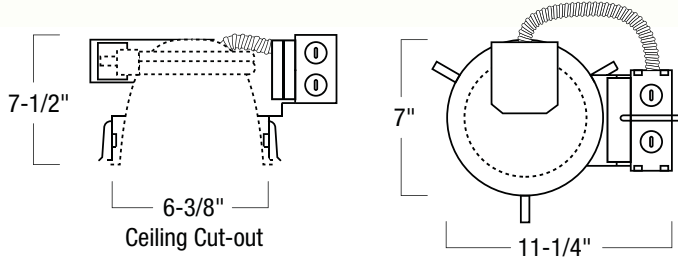

NHRP6 SERIES

CATALOG. NO.	LAMP(S)	WATTS	VOLTAGE	DIMMING
NHRP6-113EL	1 Quad	13	120-277	D10, M7
NHRP6-118EL	1 Quad	18	120-277	D10, MX1, MX2, M7, L51, L52, L11, L12
NHRP6-126EL	1 Quad	26	120-277	DAS, D10, MX1, MX2, M7, L51, L52, L11, L12
NHRP6-213EL	2 Quad	13	120-277	D10, M7
NHRP6-218EL	2 Quad	18	120-277	D10, MX1, MX2, M7, L51, L52, L11, L12
NHRP6-226EL	2 Quad	26	120-277	DAS, D10, MX1, MX2, M7, L51, L52, L11, L12



committed to
GREEN

COMPACT FLUORESCENT RECESSED

6" Quad Horizontal Architectural & Commercial Reflectors

LOW IRIDESCENT ALZAK® REFLECTOR REFLECTORS

Alzak® reflectors are USA manufactured with protective finishes for architectural and commercial applications requiring the highest grade finishes appropriate for upscale designs. Low Iridescent colors are available in basic clear or new designer Black, Bronze, Champagne Gold, Gold, Haze, Pewter, Straw and Wheat.

Alzak® Open Reflector Baffle

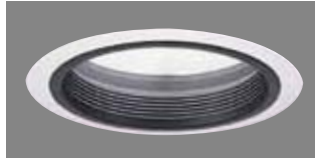

LOW IRIDESCENT Alzak® Semi-Specular Reflector with Baffle

Catalog No.	Description
NTS-630BLI	Alzak® Clear Refl. / Black Baffle / White Ring CC
NTS-630BLISF	Alzak® Clear Refl. / Black Baffle / Self Flange
NTS-630BLIWF	Alzak® Clear Refl. / Black Baffle / White Flange
NTS-630WLI	Alzak® Clear Refl. / White Baffle / White Ring CC
NTS-630WLISF	Alzak® Clear Refl. / White Baffle / Self Flange
NTS-630WLIWF	Alzak® Clear Refl. / White Baffle / White Flange

- Designer Reflector Finishes: B, BZ, CG, G, HZ, PE, ST, WH

Maximum Wattage
(1-2) 13W-26W Quad

OD: 7"

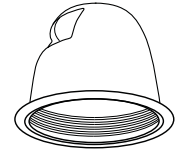

Open Reflector with Baffle



Catalog No.	Description
NTS-630B	Specular Clear Reflector / Black Baffle / White Ring
NTS-630W	Specular Clear Reflector / White Baffle / White Ring

Maximum Wattage
(1-2) 13W-26W Quad

OD: 7-1/2"

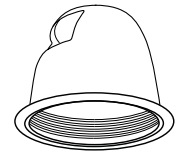

Alzak® Open Reflector



LOW IRIDESCENT Alzak® Semi-Specular Open Reflector

Catalog No.	Description
NTS-631LI	Alzak® Clear Reflector / White Ring CC
NTS-631LISF	Alzak® Clear Reflector / Self Flange
NTS-631LIWF	Alzak® Clear Reflector / White Flange

- Designer Reflector Finishes: B, BZ, CG, G, HZ, PE, ST, WH

Maximum Wattage
(1-2) 13W-26W Quad

OD: 7"

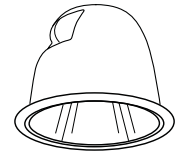

Open Reflector



Catalog No.	Description
NTS-631CLIWF	Clear Low Iridescent Reflector / White Flange NEW!
NTS-631CWF	Specular Clear Reflector / White Flange
NTS-631B	Specular Black Reflector / White Ring
NTS-631C	Specular Clear Reflector / White Ring
NTS-631G	Specular Gold Reflector / White Ring
NTS-631W	Specular White Reflector / White Ring

Maximum Wattage
(1-2) 13W-26W Quad

OD: 7-1/2"

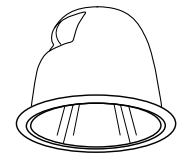

Alzak® Reflector with Cross Louver

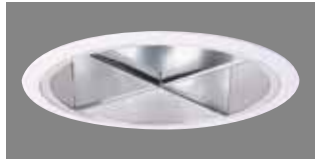

LOW IRIDESCENT Alzak® Semi-Specular Reflector, Cross Louver

Catalog No.	Description
NTS-637LI	Alzak® Clear Refl. / Spec Clear Louver / White Ring CC
NTS-637LISF	Alzak® Clear Refl. / Spec Clear Louver / Self Flange
NTS-637LIWF	Alzak® Clear Refl. / Spec Clear Louver / White Flange

- Designer Reflector Finishes: B, BZ, CG, G, HZ, PE, ST, WH

Maximum Wattage
(1-2) 13W-26W Quad

OD: 7"

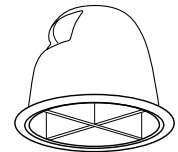

Reflector with Cross Louver



Catalog No.	Description
NTS-637CLIWF	Clear Low Iridescent Reflector / Specular Clear Louver / White Flange NEW!
NTS-637CWF	Spec Clear Reflector / Specular Clear Louver / White Flange NEW!
NTS-637C	Spec Clear Refl / Spec Clear Louver / White Ring CC
NTS-637G	Spec Gold Refl / Spec Gold Louver / White Ring CC
NTS-637W	Spec White Refl / Spec Clear Louver / White Ring CC

Maximum Wattage
(1-2) 13W-26W Quad

OD: 7-1/2"

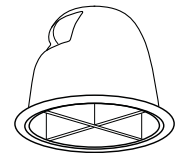

CC Custom Combo: Available with custom combinations of reflector and plastic and metal ring finish. See pages 38-39 for details.

Designer Alzak® Finishes: standard-Clear, B-Black, BZ-Bronze, CG-Champagne Gold, G-Gold, HZ-Haze, PE-Pewter, ST-Straw, WH-Wheat

Ring Finishes for Alzak® Trims: standard-White, B-Black, C-Chrome, G-Gold Ring Finishes for Standard Trims: B-Black, BZ-Bronze, C-Chrome, CO-Copper, G-Gold, N-Natural Metal, W-White

6" QUAD HORIZONTAL ARCHITECTURAL & COMMERCIAL REFLECTORS continued

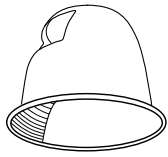

Maximum Wattage
(1-2) 13W-26W Quad
OD: 7"

LOW IRIDESCENT Alzak® Semi-Specular Open Wall Wash

Catalog No.	Description
NTS-639LISC	Alzak® Clear Single Wall Wash / White Ring CC
NTS-639LISFSC	Alzak® Clear Single Wall Wash / Self Flange
NTS-639LIWFSC	Alzak® Clear Single Wall Wash / White Flange

- **Designer Reflector Finishes:** B, BZ, CG, G, HZ, PE, ST, WH

Alzak® Open Single Wall Wash

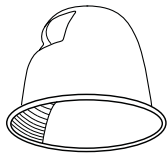

Maximum Wattage
(1-2) 13W-26W Quad
OD: 7"

Catalog No.	Description
NTS-639SC	Specular Clear Single Wall Wash / White Ring

Open Single Wall Wash

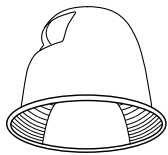

Maximum Wattage
(1-2) 13W-26W Quad
OD: 7"

LOW IRIDESCENT Alzak® Semi-Specular Open Wall Wash

Catalog No.	Description
NTS-639LIDC	Alzak® Clear Double Wall Wash / White Ring CC
NTS-639LISFDC	Alzak® Clear Double Wall Wash / Self Flange
NTS-639LIWFDC	Alzak® Clear Double Wall Wash / White Flange

- **Designer Reflector Finishes:** B, BZ, CG, G, HZ, PE, ST, WH

Alzak® Open Double Wall Wash

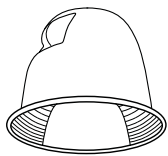

Maximum Wattage
(1-2) 13W-26W Quad
OD: 7"

Catalog No.	Description
NTS-639DC	Specular Clear Double Wall Wash / White Ring

Open Double Wall Wash

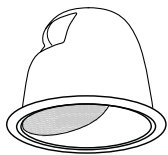

Maximum Wattage
(1-2) 13W-26W Quad
OD: 7-1/2"

Catalog No.	Description
NTS-636C	Specular Clear Wall Wash / Specular Clear Reflector / White Ring
NTS-636G	Specular Gold Wall Wash / Specular Gold Reflector / White Ring

Wall Wash with Lensed Reflector

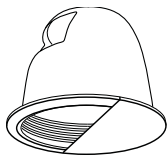

Maximum Wattage
(1-2) 13W-26W Quad
OD: 7-1/2"

Catalog No.	Description
NTS-634B	Wall Wash / Black Baffle / Specular Clear Reflector / White Eyelid & Ring
NTS-634W	Wall Wash / White Baffle / Specular Clear Reflector / White Eyelid & Ring

Wall Wash with Baffle



CC Custom Combo: Available with custom combinations of reflector and plastic and metal ring finish. See pages 38-39 for details.

Designer Alzak® Finishes: standard-Clear, B-Black, BZ-Bronze, CG-Champagne Gold, G-Gold, HZ-Haze, PE-Pewter, ST-Straw, WH-Wheat

Ring Finishes for Alzak® Trims: standard-White, B-Black, C-Chrome, G-Gold **Ring Finishes for Standard Trims:** B-Black, BZ-Bronze, C-Chrome, CO-Copper, G-Gold, N-Natural Metal, W-White

6" QUAD HORIZONTAL ARCHITECTURAL & COMMERCIAL REFLECTORS continued

Regressed Albalite Lens with Baffle



Catalog No.	Description
NTS-632B	Regressed Albalite Lens / Black Baffle / Specular Clear Reflector / White Plastic Ring
NTS-632W	Regressed Albalite Lens / White Baffle / Specular Clear Reflector / White Plastic Ring

- UL Wet Listed

Maximum Wattage
(1-2) 13W-26W Quad

OD: 7-1/2"

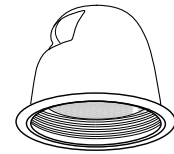

Regressed Drop Opal with Baffle



Catalog No.	Description
NTS-635B	Regressed Drop Opal / Black Baffle / Specular Clear Reflector / White Plastic Ring
NTS-635W	Regressed Drop Opal / White Baffle / Specular Clear Reflector / White Plastic Ring

- UL Wet Listed

Maximum Wattage
(1-2) 13W-26W Quad

OD: 7-1/2"

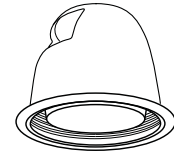

Flush Mount Lens with Reflector



Catalog No.	Description
NTS-633CL	Clear Lens / Specular Clear Reflector / White Ring
NTS-633FL	Frosted Lens / Specular Clear Reflector / White Ring

- UL Wet Listed

Maximum Wattage
(1-2) 13W-26W Quad

OD: 7-1/2"

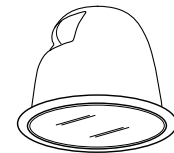

Reflector for Decorative Glass



Catalog No.	Description
NTS-638C	Specular Clear Reflector / White Flange

- **Glass sold separately.**
- For a layered look, up to two pieces of glass may be used together.

Maximum Wattage
(1-2) 13W-26W Quad

OD: 7-1/2"

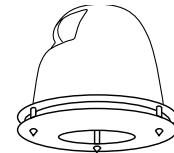

Decorative Glass for NTS-638C



Catalog No.	Description
NTG-6B/120	Tempered Blue / 120mm (4-3/4") Open Center
NTG-6B/80	Tempered Blue / 80mm (3-1/8") Open Center
NTG-6CF	Tempered Frost Center / Clear Outer
NTG-6FC	Tempered Clear Center / Frost Outer
NTG-6HC	Tempered Clear Outer / Frost Inner / 80mm (3-1/8") Open Center

- **Includes NRA-203 Glass Hardware**
- 2 decorative glasses can be combined for a tiered look

Includes:
NRA-203 Glass Hardware

- (3) Stand-offs
- (3) Cone End Caps
- (3) Flat End Caps

OD: 7

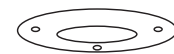

CC Custom Combo: Available with custom combinations of reflector and plastic and metal ring finish. See pages 38-39 for details.

Ring Finishes for Standard Trims: B-Black, BZ-Bronze, C-Chrome, CO-Copper, G-Gold, N-Natural Metal, W-White

Photometrics - 6" Quad Horizontal Architectural & Commercial

NTS-630B Clear Reflector with Black Baffle, White Plastic Ring

IESNA: LM-63-1995 Test No.: 1099-1GG Spacing Criteria: (0-180) 1.16 (90-270) 1.52 Efficiency: 42% Lamps: **(1) 18W Quad CFL** Total Watts: 18 Lumens: 1250

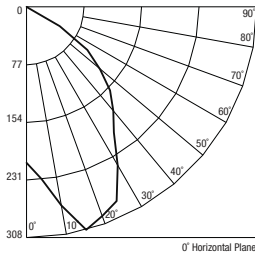

BEAM & CONE DATA

Mounting Height	F.C. at Nadir	Maximum Spacing
4'	13.0	6.1'
6'	5.8	9.1'
8'	3.3	12.2'
9'	2.6	13.7'
10'	2.1	15.2'

NTS-632W White Baffle with Regressed Albalite Lens, White Plastic Ring

IESNA: LM-63-1995 Test No.: 1099-1DD Spacing Criteria: (0-180) 1.16 (90-270) 1.22 Efficiency: 32% Lamps: **(2) 13W Quad CFL** Total Watts: 26 Lumens: 1800

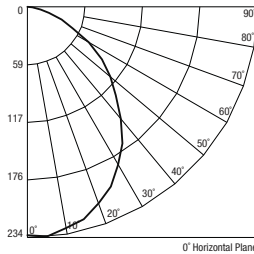

BEAM & CONE DATA

Mounting Height	F.C. at Nadir	Maximum Spacing
4'	14.5	4.9'
6'	6.4	7.3'
8'	3.6	9.8'
9'	2.9	11.0'
10'	2.3	12.2'

NTS-630B Clear Reflector with Black Baffle, White Plastic Ring

IESNA: LM-63-1995 Test No.: 1099-1GG Spacing Criteria: (0-180) 1.16 (90-270) 1.52 Efficiency: 42% Lamps: **(2) 18W Quad CFL** Total Watts: 36 Lumens: 2500

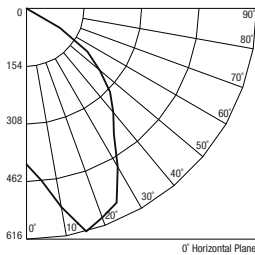

BEAM & CONE DATA

Mounting Height	F.C. at Nadir	Maximum Spacing
4'	26.0	6.1'
6'	11.6	9.1'
8'	6.5	12.2'
9'	5.1	13.7'
10'	4.2	15.2'

NTS-634B Black Baffle Wall Wash, White Plastic Ring

IESNA: LM-63-1995 Test No.: 1099-1AA Spacing Criteria: (0-180) 1.18 (90-270) 1.36 Efficiency: 21% Lamps: **(2) 18W Quad CFL** Total Watts: 36 Lumens: 2500

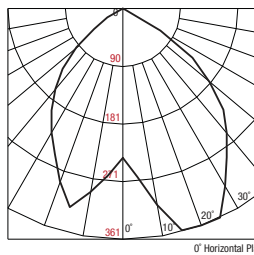

2' FROM WALL - 4' ON CENTER

DISTANCE FROM CEILING IN FEET	1'	2'	3'	4'	5'	6'	7'	8'	9'	10'
1'	5	1	5							
2'	7	11	7							
3'	10	9	10							
4'	8	8	8							
5'	7	7	7							
6'	5	6	5							
7'	4	4	4							
8'	3	3	3							
9'	3	3	3							
10'	2	2	2							

NTS-631C Clear Reflector with White Plastic Ring (1) 18W

IESNA: LM-63-1995 Test No.: LRL 299-4X Spacing Criteria: (0-180) 1.42 (90-270) 1.64 Efficiency: 53% Lamps: **(1) 18W Quad CFL** Total Watts: 18 Lumens: 1250

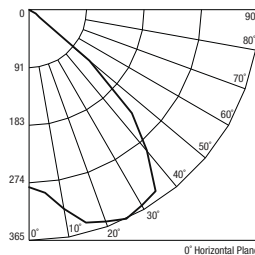

BEAM & CONE DATA

Mounting Height	F.C. at Nadir	Maximum Spacing
4'	17.6	6.6'
6'	7.8	9.8'
8'	4.4	13.1'
9'	3.5	14.8'
10'	2.8	16.4'

NTS-636C Clear Reflector with Clear Wall Wash, White Plastic Ring

IESNA: LM-63-1995 Test No.: 1099-1W Spacing Criteria: (0-180) 1.06 (90-270) 1.1 Efficiency: 37% Lamp: **(1) 18W Quad CFL** Total Watts: 18 Lumens: 1250

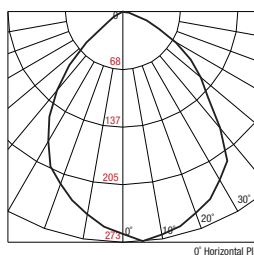

2' FROM WALL - 4' ON CENTER

DISTANCE FROM CEILING IN FEET	1'	2'	3'	4'	5'	6'	7'	8'	9'	10'
1'	11	4	11							
2'	13	10	13							
3'	10	9	10							
4'	7	8	7							
5'	5	6	5							
6'	4	4	4							
7'	3	3	3							
8'	2	2	2							
9'	2	2	2							
10'	1	2	1							

Footcandle values are rounded off and are based on a minimum of five units.

NTS-631C Clear Reflector with White Plastic Ring (2) 18W

IESNA: LM-63-1995 Test No.: LRL 299-4X Spacing Criteria: (0-180) 1.42 (90-270) 1.64 Efficiency: 53% Lamps: **(2) 18W Quad CFL** Total Watts: 36 Lumens: 2500

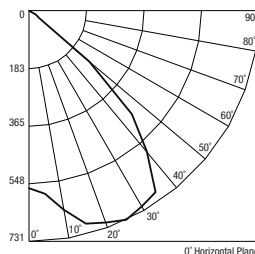

BEAM & CONE DATA

Mounting Height	F.C. at Nadir	Maximum Spacing
4'	35.2	6.6'
6'	15.6	9.8'
8'	8.8	13.1'
9'	6.9	14.8'
10'	5.6	16.4'

NTS-636C Clear Reflector with Clear Wall Wash, White Plastic Ring

IESNA: LM-63-1995 Test No.: 1099-1W Spacing Criteria: (0-180) 1.06 (90-270) 1.1 Efficiency: 37% Lamp: **(1) 26W Quad CFL** Total Watts: 26 Lumens: 2400

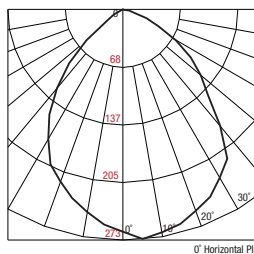

2' FROM WALL - 4' ON CENTER

DISTANCE FROM CEILING IN FEET	1'	2'	3'	4'	5'	6'	7'	8'	9'	10'
1'	16	6	16							
2'	19	14	19							
3'	14	13	14							
4'	9	11	9							
5'	7	8	7							
6'	5	6	5							
7'	4	4	4							
8'	3	3	3							
9'	3	3	3							
10'	2	2	2							

Footcandle values are rounded off and are based on a minimum of five units.

Photometric results may vary from testing data. To assist the lighting designer in using Nora's products in a lighting layout, the following photometric tables have both lab test data and normalized data to illustrate expected typical performance. Typical photometric data is provided to illustrate expectation of typical performance.

COMPACT FLUORESCENT RECESSED

8" Quad/Triple Tube Vertical Architectural Frame-in

Nora Lighting's energy efficient 8" Architectural Vertical Quad/Triple Tube Compact Fluorescent frame-in fixture is ideal for suspended ceiling or T-Bar installations. Featuring high quality specular reflectors with glare reduction, low iridescent, external glass accents, open wall wash and many other options suitable for any architectural interior. Photometric and data files are available for applications requiring detailed design layouts and precise lighting calculations.

Ballast: Electronic (EL) with Universal Input (120V-277V).

Lamp Types:
 13W – 42W Electronic 4-Pin Quad G24Q base
 13W – 42W Electronic 4-Pin Triple Tube GX24Q base

Socket Cup: Slots on neck of each reflector allow vertical adjustment of socket cup for optimum light distribution and output.

Dimming Options: Variety of Dimming ballast options are available. Please match appropriate fixture with compatible compact fluorescent dimming control. See pages 70-71.

Emergency Option: Emergency back-up operates one lamp for a minimum of 90 minutes. Unit includes battery, charger, and test plate with indicator light or integral mounted test switch in the reflector. See page 180.

Fuse Option: 2A Fuse may be added to any compact fluorescent frame-in – Add: suffix FS.

Minimum Clearances: Non-IC fixtures require minimum clearances of 3" from thermal insulation and 1/2" from adjacent building components.

Installation: Universal brackets adjust vertically and accept C-Channel or flat bar hangers (ordered separately), or simple rigid 1/2" steel conduit for tie-down to ceiling grids.

Listing:
 cULus Damp Location w/ Feed Through
 cULus Wet Location (Only with designated trims)

Reflector not included

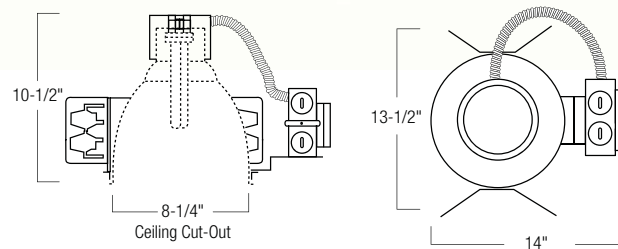

NHPV-8 SERIES

CATALOG. NO.	LAMP	WATTS	VOLTAGE	DIMMING	EMERGENCY
NHPV-813EL	1 Q/T	13	120-277	D10, M7	EM, EMI, EM2
NHPV-818EL	1 Q/T	18	120-277	D10, MX1, MX2, M7, L51, L52, L11, L12	EM, EMI, EM2
NHPV-82642EL	1 Q/T	26-42	120-277	DAS, D10, MX1, MX2, M7, L51, L52, L11, L12	EM, EMI, EM2

Bar hangers ordered separately – see page 383.



8" Quad/Triple Tube Vertical Commercial Frame-in



Nora Lighting's energy efficient 8" Commercial Vertical Quad/Triple Tube Compact Fluorescent frame-in fixture allows direct installation to wood joist, steel stud or T-bar constructions. Featuring high quality specular reflectors with glare reduction, low iridescence, external glass accents, open wall wash and many other options suitable for any architectural interior. Photometric and data files are available for applications requiring detailed design layouts and precise lighting calculations.

Ballast: Electronic (EL) with Universal Input (120V-277V).

Lamp Types:
 13W – 42W Electronic 4-Pin Quad G24Q base
 13W – 42W Electronic 4-Pin Triple Tube GX24Q base

Socket Cup: Slots on neck of each reflector allow vertical adjustment of socket cup for optimum light distribution and output.

Dimming Options: Variety of Dimming ballast options are available. Please match appropriate fixture with compatible compact fluorescent dimming control. See pages 70-71.

Emergency Option: Emergency back-up operates one lamp for a minimum of 90 minutes. Unit includes battery, charger, and test plate with indicator light or integral mounted test switch in the reflector. See page 181.

Fuse Option: 2A Fuse may be added to any compact fluorescent frame-in – Add: suffix FS.

Minimum Clearances: Non-IC fixtures require minimum clearances of 3" from thermal insulation and 1/2" from adjacent building components.

Installation: Bar hangers are adjustable from 13-5/8" to 24-1/2" and can be repositioned 90 degrees. Bar hangers are slotted for T-bar installations.

Listing:
 cULus Damp Location w/ Feed Through
 cULus Wet Location (Only with designated trims)

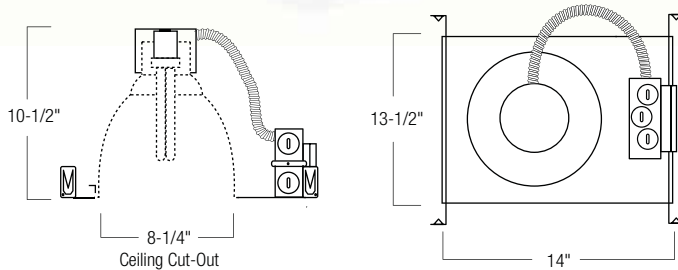

NH8PV SERIES

CATALOG. NO.	LAMP	WATTS	VOLTAGE	DIMMING	EMERGENCY
NH8PV-13EL	1 Q/T	13	120-277	D10, M7	EM, EMI, EM2
NH8PV-18EL	1 Q/T	18	120-277	D10, MX1, MX2, M7, L51, L52, L11, L12	EM, EMI, EM2
NH8PV-2642EL	1 Q/T	26-42	120-277	DAS, D10, MX1, MX2, M7, L51, L52, L11, L12	EM, EMI, EM2

Bar hangers included



COMPACT FLUORESCENT RECESSED

8" Quad/Triple Tube Vertical Architectural Remodel

Nora's New Compact Fluorescent Remodel Frame-In allows high performance CFL reflectors to be installed in existing ceilings.

Excellent for tenant improvement and energy retrofits in commercial, retail, hospitality, and architectural applications.

Ballast: Electronic (EL) with Universal Input (120V-277V).

Lamp Types:

13W – 42W Electronic 4-Pin Quad G24Q base
13W – 42W Electronic 4-Pin Triple Tube GX24Q base

Socket Cup: Slots on neck of each reflector allow vertical adjustment of socket cup for optimum light distribution and output.

Dimming Options: Variety of Dimming ballast options are available. Please match appropriate fixture with compatible compact fluorescent dimming control. See pages 70-71.

Emergency Option: 90-minute battery back-up must be ordered and installed as a self contained kit set apart from the frame-in. See page 746.

Fuse Option: 2A Fuse may be added to any compact fluorescent frame-in – Add: suffix FS.

Minimum Clearances: Non-IC fixtures require minimum clearances of 3" from thermal insulation and 1/2" from adjacent building components.

Remodel Installation: High tension tempered steel springs secure remodel housings evenly to ceiling; hole cutout template provided for convenience.

Listing:

cULus Damp Location w/ Feed Through
cULus Wet Location (Only with designated trims)

NEW!

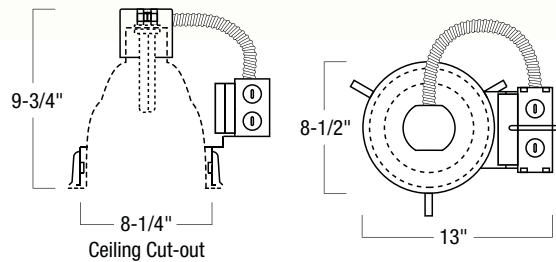

NHRPV-8 SERIES

CATALOG. NO.	LAMP	WATTS	VOLTAGE	DIMMING
NHRPV-813EL	1 Q/T	13	120-277	D10, M7
NHRPV-818EL	1 Q/T	18	120-277	D10, MX1, MX2, M7, L51, L52, L11, L12
NHRPV-82642EL	1 Q/T	26-42	120-277	DAS, D10, MX1, MX2, M7, L51, L52, L11, L12



8" Vertical Architectural & Commercial Reflectors

LOW IRIDESCENT REFLECTORS

Alzak® reflectors are USA manufactured with protective finishes for architectural and commercial applications requiring the highest grade finishes appropriate for upscale designs. Low Iridescent colors are available in basic clear or new designer Black, Bronze, Champagne Gold, Gold, Haze, Pewter, Straw and Wheat.

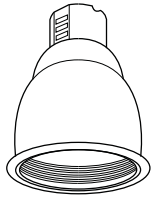

Maximum Wattage
 (1) 13W-26W Quad
 (1) 13W-42W Triple
OD: 9"

LOW IRIDESCENT Alzak® Semi-Specular Reflector with Baffle

Catalog No.	Description
NTS-932BLISF	Alzak® Clear Refl. / Black Baffle / Self Flange
NTS-932BLIWF	Alzak® Clear Refl. / Black Baffle / White Flange
NTS-932WLISF	Alzak® Clear Refl. / White Baffle / Self Flange
NTS-932WLIWF	Alzak® Clear Refl. / White Baffle / White Flange

- Designer Reflector Finishes: B, BZ, CG, G, HZ, PE, ST, WH

Alzak® Open Reflector with Baffle

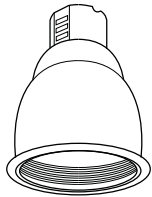

Maximum Wattage
 (1) 13W-26W Quad
 (1) 13W-42W Triple
OD: 9"

Catalog No.	Description
NTS-932CB	Specular Clear Refl / Black Baffle / White Flange
NTS-932CW	Specular Clear Refl / White Baffle / White Flange
NTS-932GB	Specular Gold Refl / Black Baffle / White Flange
NTS-932GW	Specular Gold Refl / White Baffle / White Flange

Open Reflector with Baffle

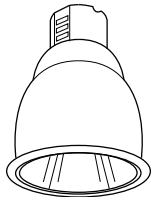

Maximum Wattage
 (1) 13W-26W Quad
 (1) 13W-42W Triple
OD: 9"

LOW IRIDESCENT Alzak® Semi-Specular Open Reflector

Catalog No.	Description
NTS-931LISF	Alzak® Clear Reflector / Self Flange
NTS-931LIWF	Alzak® Clear Reflector / White Flange

- Designer Reflector Finishes: B, BZ, CG, G, HZ, PE, ST, WH

Alzak® Open Reflector

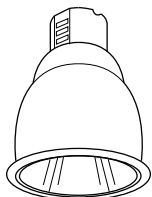

Maximum Wattage
 (1) 13W-26W Quad
 (1) 13W-42W Triple
OD: 9"

Catalog No.	Description
NTS-931CLIWF	Low Iridescent Clear Reflector / White Flange NEW!
NTS-931B	Specular Black Reflector / White Flange
NTS-931C	Specular Clear Reflector / White Flange
NTS-931G	Specular Gold Reflector / White Flange
NTS-931W	Specular White Reflector / White Flange

Open Reflector

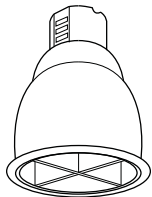

Maximum Wattage
 (1) 13W-26W Quad
 (1) 13W-42W Triple
OD: 9"

LOW IRIDESCENT Alzak® Semi-Specular Reflector, Cross Louver

Catalog No.	Description
NTS-934LISF	Alzak® Clear Refl. / Spec Clear Louver / Self Flange
NTS-934LIWF	Alzak® Clear Refl. / Spec Clear Louver / White Flange

- Designer Reflector Finishes: B, BZ, CG, G, HZ, PE, ST, WH

Alzak® Reflector with Cross Louver

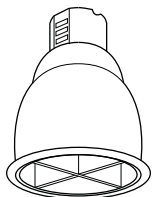

Maximum Wattage
 (1) 13W-26W Quad
 (1) 13W-42W Triple
OD: 9"

Catalog No.	Description
NTS-934CLIWF	Low Iridescent Clear Reflector / Specular Clear Louver / White Flange NEW!
NTS-934C	Specular Clear Reflector / Specular Clear Louver / White Flange
NTS-934G	Specular Gold Reflector / Specular Gold Louver / White Flange

Reflector with Cross Louver



Designer Alzak® Finishes: standard-Clear, B-Black, BZ-Bronze, CG-Champagne Gold, G-Gold, HZ-Haze, PE-Pewter, ST-Straw, WH-Wheat

See pages 34-35 for Description of Reflector Finishes

8" VERTICAL ARCHITECTURAL & COMMERCIAL REFLECTORS continued

Alzak® Open Single Wall Wash



LOW IRIDESCENT Alzak® Semi-Specular Single Wall Wash

Catalog No.	Description
NTS-939LISFSC	Alzak® Clear Single Wall Wash / Self Flange
NTS-939LIWFSC	Alzak® Clear Single Wall Wash / White Flange

- Designer Reflector Finishes: B, BZ, CG, G, HZ, PE, ST, WH

Maximum Wattage

- (1) 13W-26W Quad
- (1) 13W-42W Triple

OD: 9"

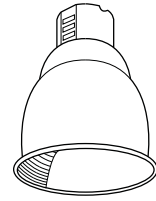

Open Single Wall Wash



Catalog No.	Description
NTS-939SC	Specular Clear Single Wall Wash / White Flange

Maximum Wattage

- (1) 13W-26W Quad
- (1) 13W-42W Triple

OD: 9"

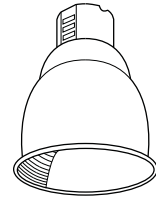

Alzak® Open Double Wall Wash



LOW IRIDESCENT Alzak® Semi-Specular Double Wall Wash

Catalog No.	Description
NTS-939LISFDC	Alzak® Clear Double Wall Wash / Self Flange
NTS-939LIWFDC	Alzak® Clear Double Wall Wash / White Flange

- Designer Reflector Finishes: B, BZ, CG, G, HZ, PE, ST, WH

Maximum Wattage

- (1) 13W-26W Quad
- (1) 13W-42W Triple

OD: 9"

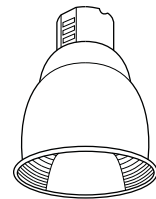

Open Double Wall Wash



Catalog No.	Description
NTS-939DC	Specular Clear Double Wall Wash / White Flange

Maximum Wattage

- (1) 13W-26W Quad
- (1) 13W-42W Triple

OD: 9"

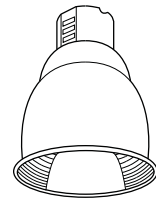

Lensed Reflector Wall Wash

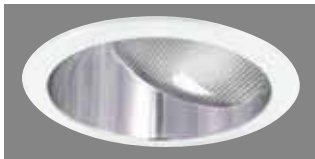

Catalog No.	Description
NTS-933C	Specular Clear Wall Wash / Specular Clear Reflector / White Flange
NTS-933G	Specular Gold Wall Wash / Specular Gold Reflector / White Flange
NTS-933W	Specular Clear Wall Wash / Specular White Reflector / White Flange

- Glass Lens

Maximum Wattage

- (1) 13W-26W Quad
- (1) 13W-42W Triple

OD: 9"

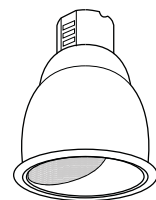

Regressed Lens with Reflector



Catalog No.	Description
NTS-935G	Glass Lens / Specular Clear Refl / White Flange
NTS-935L	Lexan Lens / Specular Clear Refl / White Flange
NTS-935FG	Frosted Lens / Specular Clear Refl / White Flange

- UL Listed Wet Label

Maximum Wattage

- (1) 13W-26W Quad
- (1) 13W-42W Triple

OD: 9"

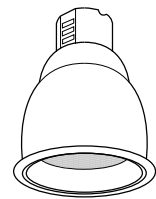

Flush Lens with Reflector



Catalog No.	Description
NTS-936CL	Clear Lens / Specular Clear Reflector / White Flange
NTS-936FL	Frosted Lens / Specular Clear Reflector / White Flange

Maximum Wattage

- (1) 13W-26W Quad
- (1) 13W-42W Triple

OD: 9"

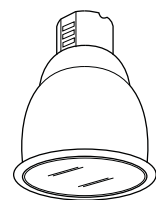

Designer Alzak® Finishes: standard-Clear, B-Black, BZ-Bronze, CG-Champagne Gold, G-Gold, HZ-Haze, PE-Pewter, ST-Straw, WH-Wheat

8" VERTICAL ARCHITECTURAL & COMMERCIAL REFLECTORS continued

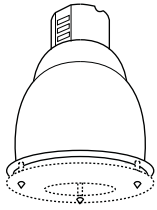

Maximum Wattage
 (1-2) 13W-26W Quad
 (1-2) 13W-42W Triple
OD: 9"

Catalog No. Description
NTS-938C Specular Clear Reflector / White Flange

- Glass sold separately.
- For a layered look, up to two pieces of glass may be used together.

Reflector for Decorative Glass

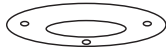

Includes:
 NRA-203 Glass Hardware
 • (3) Stand-offs
 • (3) Cone End Caps
 • (3) Flat End Caps
OD: 9"

Catalog No. Description
NTG-8B/167 Tempered Blue / 167mm (6-5/8") Open Center
NTG-8B/80 Tempered Blue / 80mm (3-1/8") Open Center
NTG-8CF Tempered Frost Center / Clear Outer
NTG-8FC Tempered Clear Center / Frost Outer
NTG-8HC Tempered Clear Outer / Frost Inner / 80mm (3-1/8") Open Center

- Includes NRA-203 Glass Hardware
- 2 decorative glasses can be combined for a tiered look

Decorative Glass for NTS-938C



Photometrics - 8" Horizontal Architectural & Commercial

NTS-931C Clear Reflector, White Self Flanged 26W

IESNA: LM-63-1995 Test No.: LRL 1099-1A Spacing Criteria: (0-180) 1.48 (90-270) 1.48
 Efficiency: 60% Lamp: (1) 26W Triple Tube CFL Total Watts: 26 Lumens: 1800

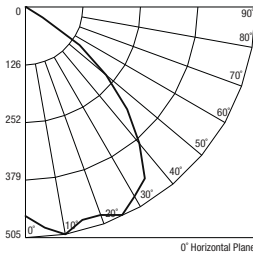

BEAM & CONE DATA

Mounting Height	F.C. at Nadir	Maximum Spacing
4'	28.6	5.9'
6'	12.7	8.9'
8'	7.1	11.8'
9'	5.6	13.3'
10'	4.6	14.8'

NTS-933C Lexan Lens with Clear Reflector, Clear Wall Wash 42W

IESNA: LM-63-1995 Test No.: 300-2MM Spacing Criteria: (0-180) 1.3 (90-270) 1.08
 Efficiency: 44% Lamp: (1) 42W Triple Tube CFL Total Watts: 42 Lumens: 3200

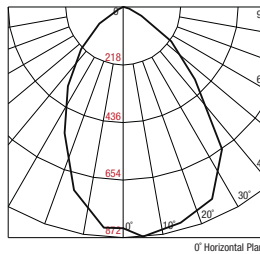

2' FROM WALL - 4' ON CENTER

DISTANCE FROM CEILING IN FEET	1'	2'	3'	4'
1'	19	7	19	
2'	39	22	39	
3'	35	26	35	
4'	24	24	24	
5'	17	18	17	
6'	13	13	13	
7'	10	10	10	
8'	8	8	8	
9'	6	6	6	
10'	5	5	5	

Footcandle values are rounded off & are based on a minimum of 5 units

NTS-931C Clear Reflector, White Self Flanged 42W

IESNA: LM-63-1995 Test No.: LRL 1099-1A Spacing Criteria: (0-180) 1.48 (90-270) 1.48
 Efficiency: 60% Lamp: (1) 42W Triple Tube CFL Total Watts: 42 Lumens: 3200

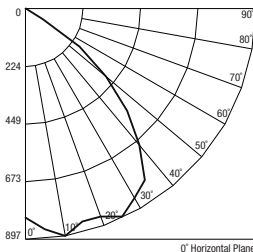

BEAM & CONE DATA

Mounting Height	F.C. at Nadir	Maximum Spacing
4'	50.8	5.9'
6'	22.6	8.9'
8'	12.7	11.8'
9'	10	13.3'
10'	8.1	14.8'

NTS-936CL Clear Flush Lens with Clear Reflector 42W

IESNA: LM-63-1995 Test No.: 1099-1A Spacing Criteria: (0-180) 1.48 (90-270) 1.48
 Efficiency: 60% Lamp: (1) 42W Triple Tube CFL Total Watts: 42 Lumens: 3200

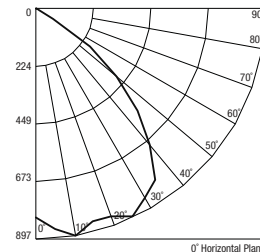

BEAM & CONE DATA

Mounting Height	F.C. at Nadir	Maximum Spacing
4'	50.8	5.9'
6'	22.6	8.9'
8'	12.7	11.8'
9'	10.0	13.3'
10'	8.1	14.8'

NTS-932CB Clear Reflector with Black Baffle, White Self Flanged

IESNA: LM-63-1995 Test No.: LRL 1099-1A Spacing Criteria: (0-180) 1.48 (90-270) 1.48
 Efficiency: 44% Lamp: (1) 42W Triple Tube CFL Total Watts: 42 Lumens: 3200

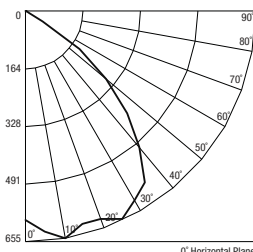

BEAM & CONE DATA

Mounting Height	F.C. at Center	Maximum Spacing
4'	37.1	5.9'
6'	16.5	8.9'
8'	9.3	11.8'
9'	7.3	13.3'
10'	5.9	14.8'

NTS-939SC Clear Single Wall Wash, White Self Flanged 42W

IESNA: LM-63-1995 Test No.: 702-12C Spacing Criteria: (0-180) 1.12 (90-270) 1.00
 Efficiency: 59% Lamp: (1) 42W Triple Tube CFL Total Watts: 42 Lumens: 3200

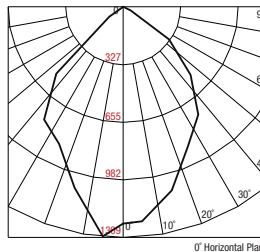

2' FROM WALL - 4' ON CENTER

DISTANCE FROM CEILING IN FEET	1'	2'	3'	4'
1'	17	3	17	
2'	56	21	56	
3'	41	26	41	
4'	28	23	28	
5'	20	18	20	
6'	15	15	15	
7'	12	12	12	
8'	9	10	9	
9'	8	8	8	
10'	6	6	6	

Footcandle values are rounded off & are based on a minimum of 5 units

Photometric results may vary from testing data. To assist the lighting designer in using Nora's products in a lighting layout, the following photometric tables have both lab test data and normalized data to illustrate expected typical performance. Typical photometric data is provided to illustrate expectation of typical performance.

COMPACT FLUORESCENT RECESSED

6" Quad/Triple Tube Vertical Architectural Frame-in

Nora Lighting's 6" Architectural Compact Fluorescent frame-in fixtures feature high quality specular reflectors with glare reduction, low iridescence, external glass accents, open wall wash and more. Architectural frame-ins are suitable for suspended or T-Bar high ceilings. Photometric and data files are available for applications requiring detailed design layouts and precise lighting calculations.

Ballast: Electronic (EL) with Universal Input (120V-277V).

Lamp Types:
 13W – 42W Electronic 4-Pin Quad G24Q base
 13W – 42W Electronic 4-Pin Triple Tube GX24Q base

Socket Cup: Slots on neck of each reflector allow vertical adjustment of socket cup for optimum light distribution and output.

Dimming Options: Variety of Dimming ballast options are available. Please match appropriate fixture with compatible compact fluorescent dimming control. See pages 70-71.

Emergency Option: Emergency back-up operates one lamp for a minimum of 90 minutes. Unit includes battery, charger, and test plate with indicator light or integral mounted test switch in the reflector. See page 180.

Fuse Option: 2A Fuse may be added to any compact fluorescent frame-in – Add: suffix FS.

Minimum Clearances: Non-IC fixtures require minimum clearances of 3" from thermal insulation and 1/2" from adjacent building components.

Installation: Universal brackets adjust vertically and accept C-Channel or flat bar hangers (ordered separately), or simple rigid 1/2" steel conduit for tie-down to ceiling grids.

Listing:
 cULus Damp Location w/ Feed Through
 cULus Wet Location (Only with designated trims)

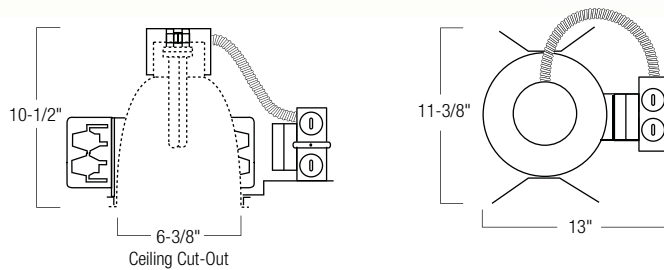

NHPV-6 SERIES

CATALOG. NO.	LAMP	WATTS	VOLTAGE	DIMMING	EMERGENCY
NHPV-613EL	1 Quad	13	120-277	D10, M7	EM, EMI, EM2
NHPV-618EL	1 Quad	18	120-277	D10, MX1, MX2, M7, L51, L52, L11, L12	EM, EMI, EM2
NHPV-62642EL	1 Quad	26-42	120-277	DAS, D10, MX1, MX2, M7, L51, L52, L11, L12	EM, EMI, EM2

Bar hangers ordered separately – see page 383.



6" Quad/Triple Tube Vertical Commercial Frame-in

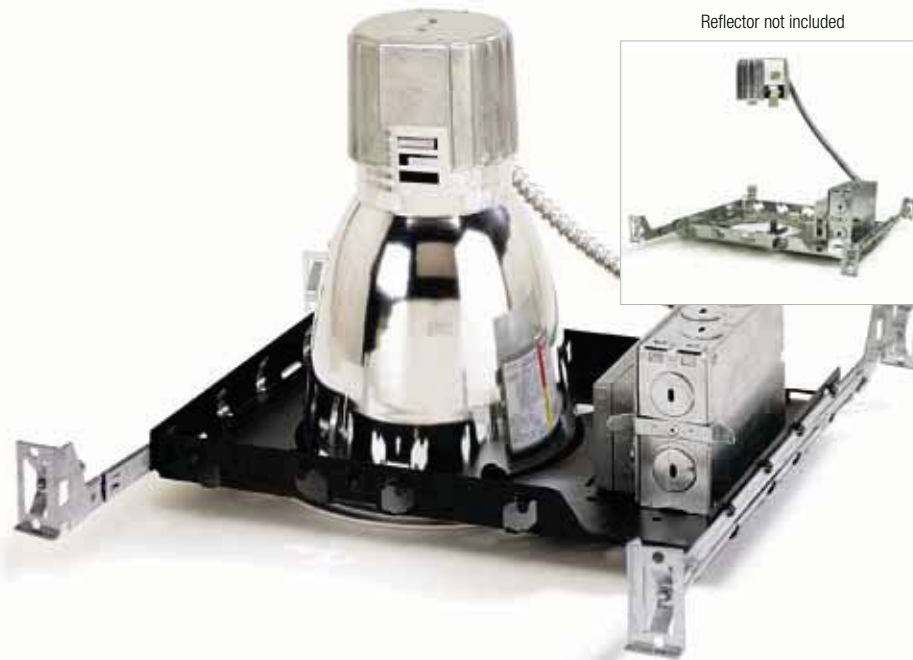

Nora Lighting's 6" Commercial Compact Fluorescent frame-in fixtures feature high quality specular reflectors with glare reduction, low iridescence, external glass accents, open wall wash and more. Architectural frame-ins are suitable for suspended or T-Bar high ceilings. Photometric and data files are available for applications requiring detailed design layouts and precise lighting calculations.

Ballast: Electronic (EL) with Universal Input (120V-277V).

Lamp Types:
 13W – 42W Electronic 4-Pin Quad G24Q base
 13W – 42W Electronic 4-Pin Triple Tube GX24Q base

Socket Cup: Slots on neck of each reflector allow vertical adjustment of socket cup for optimum light distribution and output.

Dimming Options: Variety of Dimming ballast options are available. Please match appropriate fixture with compatible compact fluorescent dimming control. See pages 70-71.

Emergency Option: Emergency back-up operates one lamp for a minimum of 90 minutes. Unit includes battery, charger, and test plate with indicator light or integral mounted test switch in the reflector. See page 181.

Fuse Option: 2A Fuse may be added to any compact fluorescent frame-in – Add: suffix FS.

Minimum Clearances: Non-IC fixtures require minimum clearances of 3" from thermal insulation and 1/2" from adjacent building components.

Installation: Bar hangers are adjustable from 13-5/8" to 24-1/2" and can be repositioned 90 degrees. Bar hangers are slotted for T-bar installations.

Listing:
 cULus Damp Location w/ Feed Through
 cULus Wet Location (Only with designated trims)

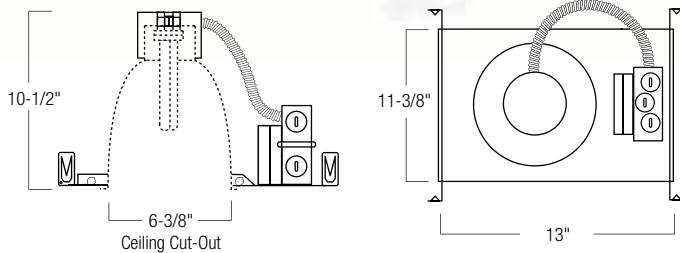

NHPV SERIES

CATALOG. NO.	LAMP	WATTS	VOLTAGE	DIMMING	EMERGENCY
NHPV-13EL	1 Quad	13	120-277	D10, M7	EM, EMI, EM2
NHPV-18EL	1 Quad	18	120-277	D10, MX1, MX2, M7, L51, L52, L11, L12	EM, EMI, EM2
NHPV-2642EL	1 Quad	26-42	120-277	DAS, D10, MX1, MX2, M7, L51, L52, L11, L12	EM, EMI, EM2

Bar hangers included



COMPACT FLUORESCENT RECESSED

6" Quad/Triple Tube Vertical Architectural Remodel

Nora's New Compact Fluorescent Remodel Frame-In allows high performance CFL reflectors to be installed in existing ceilings.

Excellent for tenant improvement and energy retrofits in commercial, retail, hospitality, and architectural applications.

Ballast: Electronic (EL) with Universal Input (120V-277V).

Lamp Types:

13W – 42W Electronic 4-Pin Quad G24Q base
13W – 42W Electronic 4-Pin Triple Tube GX24Q base

Socket Cup: Slots on neck of each reflector allow vertical adjustment of socket cup for optimum light distribution and output.

Dimming Options: Variety of Dimming ballast options are available. Please match appropriate fixture with compatible compact fluorescent dimming control. See pages 70-71.

Emergency Option: 90-minute battery back-up must be ordered and installed as a self contained kit set apart from the frame-in. See page 746.

Fuse Option: 2A Fuse may be added to any compact fluorescent frame-in – Add: suffix FS.

Minimum Clearances: Non-IC fixtures require minimum clearances of 3" from thermal insulation and 1/2" from adjacent building components.

Remodel Installation: High tension tempered steel springs secure remodel housings evenly to ceiling; hole cutout template provided for convenience.

Listing:

cULus Damp Location w/ Feed Through
cULus Wet Location (Only with designated trims)

NEW!

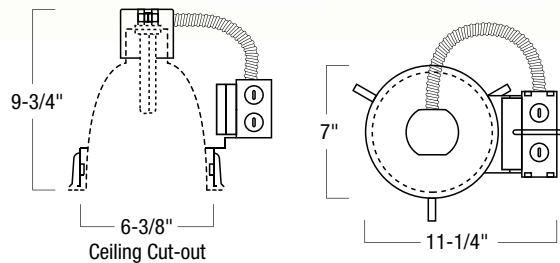

NHRPV-6 SERIES

CATALOG. NO.	LAMP	WATTS	VOLTAGE	DIMMING
NHRPV-613EL	1 Q/T	13	120-277	D10, M7
NHRPV-618EL	1 Q/T	18	120-277	D10, MX1, MX2, M7, L51, L52, L11, L12
NHRPV-62642EL	1 Q/T	26-42	120-277	DAS, D10, MX1, MX2, M7, L51, L52, L11, L12





COMPACT FLUORESCENT RECESSED

6" Vertical Architectural & Commercial Reflectors

LOW IRIDESCENT REFLECTORS

Alzak® reflectors are USA manufactured with protective finishes for architectural and commercial applications requiring the highest grade finishes appropriate for upscale designs. Low Iridescent colors are available in basic clear or new designer Black, Bronze, Champagne Gold, Gold, Haze, Pewter, Straw and Wheat.

Alzak® Open Reflector with Baffle



LOW IRIDESCENT Alzak® Semi-Specular Reflector with Baffle

Catalog No.	Description
NTS-730BLI	Alzak® Clear Refl. / Black Baffle / White Ring CC
NTS-730BLISF	Alzak® Clear Refl. / Black Baffle / Self Flange
NTS-730BLIWF	Alzak® Clear Refl. / Black Baffle / White Flange
NTS-730WLI	Alzak® Clear Refl. / White Baffle / White Ring CC
NTS-730WLISF	Alzak® Clear Refl. / White Baffle / Self Flange
NTS-730WLIWF	Alzak® Clear Refl. / White Baffle / White Flange

- Designer Reflector Finishes: B, BZ, CG, G, HZ, PE, ST, WH

Maximum Wattage

- (1) 13W-26W Quad
- (1) 13W-42W Triple Tube

OD: 7"

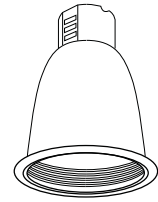

Open Reflector with Baffle



Catalog No.	Description
NTS-730B	Specular Clear Reflector / Black Baffle / White Ring
NTS-730W	Specular Clear Reflector / White Baffle / White Ring

Maximum Wattage

- (1) 13W-26W Quad
- (1) 13W-42W Triple Tube

OD: 7"

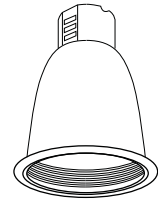

Alzak® Open Reflector



LOW IRIDESCENT Alzak® Semi-Specular Open Reflector

Catalog No.	Description
NTS-731LI	Alzak® Clear Reflector / White Ring CC
NTS-731LISF	Alzak® Clear Reflector / Self Flange
NTS-731LWF	Alzak® Clear Reflector / White Flange

- Designer Reflector Finishes: B, BZ, CG, G, HZ, PE, ST, WH

Maximum Wattage

- (1) 13W-26W Quad
- (1) 13W-42W Triple Tube

OD: 7"

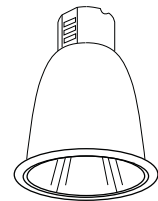

Open Reflector



Catalog No.	Description
NTS-731B	Specular Black Reflector / White Ring
NTS-731C	Specular Chrome Reflector / White Ring
NTS-731CLIWF	Low Iridescent Clear Reflector / White Flange NEW!
NTS-731CWF	Specular Clear Reflector / White Flange NEW!
NTS-731G	Specular Gold Reflector / White Ring
NTS-731W	Specular White Reflector / White Ring

Maximum Wattage

- (1) 13W-26W Quad
- (1) 13W-42W Triple Tube

OD: 7-1/2"

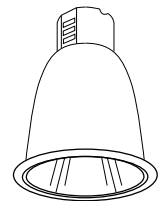

Alzak® Reflector with Cross Louver

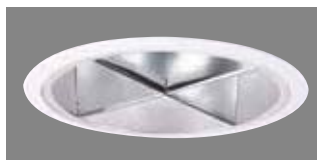

LOW IRIDESCENT Alzak® Semi-Specular Reflector, Cross Louver

Catalog No.	Description
NTS-737LI	Alzak® Clear Refl / Spec Clear Louver / White Ring CC
NTS-737LISF	Alzak® Clear Refl / Spec Clear Louver / Self Flange
NTS-737LWF	Alzak® Clear Refl / Spec Clear Louver / White Flange

- Designer Reflector Finishes: B, BZ, CG, G, HZ, PE, ST, WH

Maximum Wattage

- (1) 13W-26W Quad
- (1) 13W-42W Triple Tube

OD: 7"

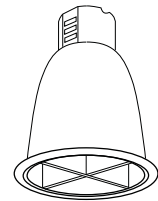

Reflector with Cross Louver

NEW!
SELF FLANGE



Catalog No.	Description
NTS-737C	Specular Clear Reflector / Specular Clear Louver / White Ring CC
NTS-737CLIWF	Low Iridescent Clear Reflector / Specular Clear Louver / White Flange NEW!
NTS-737CWF	Spec Clear Refl / Spec Clear Louver / Wh Flange NEW!
NTS-737G	Spec Gold Refl / Spec Gold Louver / White Ring CC

Maximum Wattage

- (1) 13W-26W Quad
- (1) 13W-42W Triple Tube

OD: 7"

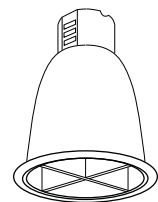

CC Custom Combo: Available with custom combinations of reflector and plastic and metal ring finish. See pages 38-39 for details.

Designer Alzak® Finishes: standard-Clear, B-Black, BZ-Bronze, CG-Champagne Gold, G-Gold, HZ-Haze, PE-Pewter, ST-Straw, WH-Wheat

Ring Finishes for Alzak® Trims: standard-White, B-Black, C-Chrome, G-Gold Ring Finishes for Standard Trims: B-Black, BZ-Bronze, C-Chrome, CO-Copper, G-Gold, N-Natural Metal, W-White

6" VERTICAL ARCHITECTURAL & COMMERCIAL REFLECTORS continued

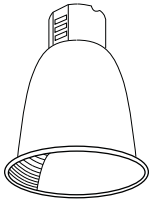

Maximum Wattage
 (1) 13W-26W Quad
 (1) 13W-42W Triple Tube
OD: 7"

LOW IRIDESCENT Alzak® Semi-Specular Single Wall Wash

Catalog No.	Description
NTS-739LISC	Alzak® Clear Single Wall Wash / White Ring CC
NTS-739LISFSC	Alzak® Clear Single Wall Wash / Self Flange
NTS-739LIWFSC	Alzak® Clear Single Wall Wash / White Flange

- Designer Reflector Finishes: B, BZ, CG, G, HZ, PE, ST, WH

Alzak® Open Single Wall Wash

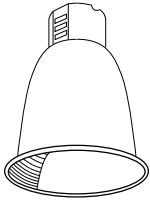

Maximum Wattage
 (1) 13W-26W Quad
 (1) 13W-42W Triple Tube
OD: 7"

Catalog No.	Description
NTS-739SC	Specular Clear Single Wall Wash / White Ring

Open Single Wall Wash

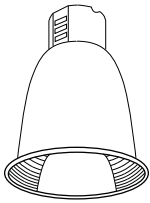

Maximum Wattage
 (1) 13W-26W Quad
 (1) 13W-42W Triple Tube
OD: 7"

LOW IRIDESCENT Alzak® Semi-Specular Double Wall Wash

Catalog No.	Description
NTS-739LIDC	Alzak® Clear Double Wall Wash / White Ring CC
NTS-739LISFDC	Alzak® Clear Double Wall Wash / Self Flange
NTS-739LIWFDC	Alzak® Clear Double Wall Wash / White Flange

- Designer Reflector Finishes: B, BZ, CG, G, HZ, PE, ST, WH

Alzak® Open Double Wall Wash

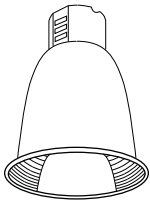

Maximum Wattage
 (1) 13W-26W Quad
 (1) 13W-42W Triple Tube
OD: 7"

Catalog No.	Description
NTS-739DC	Specular Clear Double Wall Wash / White Ring

Open Double Wall Wash

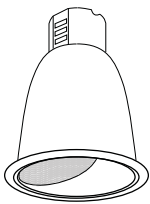

Maximum Wattage
 (1) 13W-26W Quad
 (1) 13W-42W Triple Tube
OD: 7"

Catalog No.	Description
NTS-736C	Specular Clear Wall Wash / Specular Clear Reflector / White Ring
NTS-736G	Specular Gold Wall Wash / Specular Gold Reflector / White Ring

Lensed Reflector Wall Wash

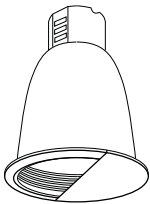

Maximum Wattage
 (1) 13W-26W Quad
 (1) 13W-42W Triple Tube
OD: 7"

Catalog No.	Description
NTS-734B	Wall Wash / Black Baffle / Specular Clear Reflector / White Eyelid & Ring
NTS-734W	Wall Wash / White Baffle / Specular Clear Reflector / White Eyelid & Ring

Wall Wash with Baffle

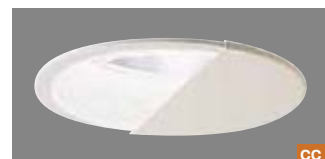

CC Custom Combo: Available with custom combinations of reflector and plastic and metal ring finish. See pages 38-39 for details.

Designer Alzak® Finishes: standard-Clear, B-Black, BZ-Bronze, CG-Champagne Gold, G-Gold, HZ-Haze, PE-Pewter, ST-Straw, WH-Wheat

Ring Finishes for Alzak® Trims: standard-White, B-Black, C-Chrome, G-Gold Ring Finishes for Standard Trims: B-Black, BZ-Bronze, C-Chrome, CO-Copper, G-Gold, N-Natural Metal, W-White

6" VERTICAL ARCHITECTURAL & COMMERCIAL REFLECTORS continued

Regressed Albalite Lens with Baffle



Catalog No.	Description
NTS-732B	Regressed Albalite Lens / Black Baffle / Specular Clear Reflector / White Ring
NTS-732W	Regressed Albalite Lens / White Baffle / Specular Clear Reflector / White Ring

- UL Wet Listed

Maximum Wattage
 (1) 13W-26W Quad
 (1) 13W-42W Triple Tube

OD: 7"

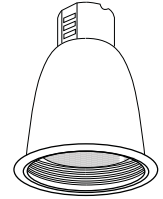

Regressed Fresnel Lens with Baffle



Catalog No.	Description
NTS-743W	Regressed Fresnel Lens / White Baffle / Specular Clear Reflector / White Ring

- UL Wet Listed

Maximum Wattage
 (1) 13W-26W Quad
 (1) 13W-42W Triple Tube

OD: 7-1/2"

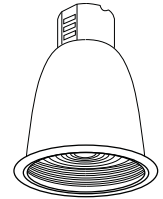

Regressed Drop Opal with Baffle



Catalog No.	Description
NTS-735B	Regressed Drop Opal / Black Baffle / Specular Clear Reflector / White Ring
NTS-735W	Regressed Drop Opal / White Baffle / Specular Clear Reflector / White Ring

- UL Wet Listed

Maximum Wattage
 (1) 13W-26W Quad
 (1) 13W-42W Triple Tube

OD: 7"

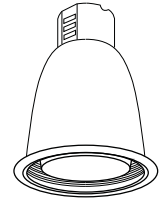

Flush Mount Lens with Reflector



Catalog No.	Description
NTS-733CL	Clear Lens / Specular Clear Reflector / White Ring
NTS-733FL	Frosted Lens / Specular Clear Reflector / White Ring

Maximum Wattage
 (1) 13W-26W Quad
 (1) 13W-42W Triple Tube

OD: 7"

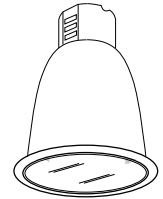

Reflector for Decorative Glass



Catalog No.	Description
NTS-738C	Specular Clear Reflector / White Ring

- Glass sold separately
- For a layered look, up to two pieces of glass may be used together.

Maximum Wattage
 (1) 13W-26W Quad
 (1) 13W-42W Triple Tube

OD: 7"

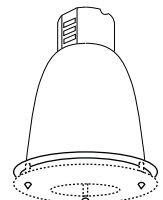

Decorative Glass for NTS-738C

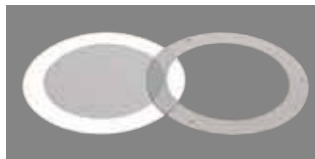

Catalog No.	Description
NTG-6B/120	Tempered Blue / 120mm (4-3/4") Open Center
NTG-6B/80	Tempered Blue / 80mm (3-1/8") Open Center
NTG-6CF	Tempered Frost Center / Clear Outer
NTG-6FC	Tempered Clear Center / Frost Outer
NTG-6HC	Tempered Clear Outer / Frost Inner / 80mm (3-1/8") Open Center

- Includes NRA-203 Glass Hardware
- 2 decorative glasses can be combined for a tiered look

Includes:
 NRA-203 Glass Hardware
 • (3) Stand-offs
 • (3) Cone End Caps
 • (3) Flat End Caps

OD: 7"

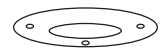

CC Custom Combo: Available with custom combinations of reflector and plastic and metal ring finish. See pages 38-39 for details.

Available Ring Finishes: B-Black, BZ-Bronze, C-Chrome, CO-Copper, G-Gold, N-Natural Metal, W-White

Photometrics - 6" Vertical Architectural & Commercial

NTS-730B Clear Reflector with Black Metal Baffle, White Plastic Ring 42W

IESNA: LM-63-1995 Test No.: 1099-1G Spacing Criteria: (0-180) 1.2 (90-270) 1.2
Efficiency: 31% Lamp: (1) 42W Triple Tube CFL Total Watts: 42 Lumens: 3200

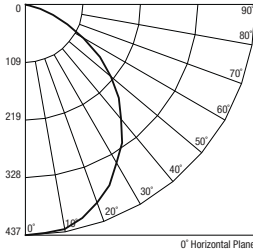

BEAM & CONE DATA

Mounting Height	F.C. at Nadir	Maximum Spacing
4'	27.3	4.8'
6'	12.1	7.2'
8'	6.8	9.6'
9'	5.4	10.8'
10'	4.4	12'

NTS-734B Black Metal Baffle Wall Wash, White Plastic Ring

IESNA: LM-63-1995 Test No.: 1099-1V Spacing Criteria: (0-180) 1.84 (90-270) 1.56
Efficiency: 26% Lamp: (1) 42W Triple Tube CFL Total Watts: 42 Lumens: 3200

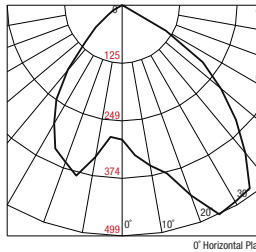

2' FROM WALL - 4' ON CENTER

DISTANCE FROM CEILING IN FEET	1'	2'	3'	4'
1'	7	1	7	1
2'	31	18	31	18
3'	22	20	22	20
4'	15	17	15	15
5'	10	12	10	10
6'	8	8	8	8
7'	6	6	6	6
8'	4	4	4	4
9'	3	3	3	3
10'	3	3	3	3

Footcandle values are rounded off and are based on a minimum of five units.

NTS-731C Clear Reflector, White Plastic Ring 32W

IESNA: LM-63-1995 Test No.: LRL 299-4Z Spacing Criteria: (0-180) 1.76 (90-270) 1.76
Efficiency: 73% Lamp: (1) 32W Triple Tube CFL Total Watts: 32 Lumens: 2400

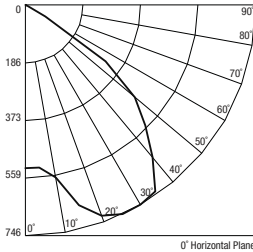

BEAM & CONE DATA

Mounting Height	F.C. at Nadir	Maximum Spacing
4'	32.9	7'
6'	14.6	10.6'
8'	8.2	14.1'
9'	6.5	15.8'
10'	5.3	17.6'

NTS-736C Clear Reflector Wall Wash, Regressed Lexan Lens, White Plastic Ring

IESNA: LM-63-1995 Test No.: 1099-1N Spacing Criteria: (0-180) 1.30 (90-270) 1.08
Efficiency: 44% Lamp: (1) 42W Triple Tube CFL Total Watts: 42 Lumens: 3200

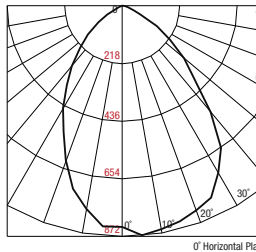

2' FROM WALL - 4' ON CENTER

DISTANCE FROM CEILING IN FEET	1'	2'	3'	4'
1'	19	7	19	7
2'	39	22	39	22
3'	35	26	35	26
4'	24	24	24	24
5'	17	18	17	17
6'	13	13	13	13
7'	10	10	10	10
8'	8	8	8	8
9'	6	6	6	6
10'	5	5	5	5

Footcandle values are rounded off and are based on a minimum of five units.

NTS-731C Clear Reflector, White Plastic Ring 42W

IESNA: LM-63-1995 Test No.: LRL 299-4Z Spacing Criteria: (0-180) 1.76 (90-270) 1.76
Efficiency: 73% Lamp: (1) 42W Triple Tube CFL Total Watts: 42 Lumens: 3200

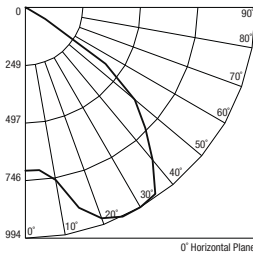

BEAM & CONE DATA

Mounting Height	F.C. at Nadir	Maximum Spacing
4'	43.9	7'
6'	19.5	10.6'
8'	11	14.1'
9'	8.7	15.8'
10'	7	17.6'

NTS-737C Clear Reflector with Clear Louver, White Plastic Ring 42W

IESNA: LM-63-1995 Test No.: 1099-1K Spacing Criteria: (0-180) 1.44 (90-270) 1.46
Efficiency: 43% Lamp: (1) 42W Triple Tube CFL Total Watts: 42 Lumens: 3200

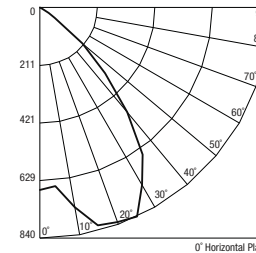

BEAM & CONE DATA

Mounting Height	F.C. at Nadir	Maximum Spacing
4'	41.5	5.8'
6'	18.4	8.8'
8'	10.4	11.7'
9'	8.2	13.1'
10'	6.6	14.6'

NTS-732W White Baffle with Regressed Albalite Lens, White Plastic Ring

IESNA: LM-63-1995 Test No.: 1099-1D Spacing Criteria: (0-180) 1.24 (90-270) 1.24
Efficiency: 37% Lamp: (1) 42W Triple Tube CFL Total Watts: 42 Lumens: 3200

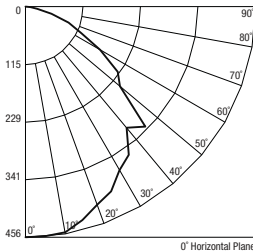

BEAM & CONE DATA

Mounting Height	F.C. at Nadir	Maximum Spacing
4'	28.5	5'
6'	12.7	7.4'
8'	7.1	9.9'
9'	5.6	11.2'
10'	4.6	12.4'

NTS-739SC Clear Single Wall Wash, White Self Flanged 42W

IESNA: LM-63-1995 Test No.: 702-1A Spacing Criteria: (0-180) 2.26 (90-270) 2.24
Efficiency: 58% Lamp: (1) 42W Triple Tube CFL Total Watts: 42 Lumens: 3200

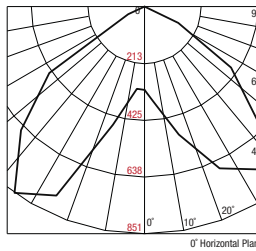

2' FROM WALL - 4' ON CENTER

DISTANCE FROM CEILING IN FEET	1'	2'	3'	4'
1'	32	8	32	8
2'	54	35	54	35
3'	39	33	39	33
4'	25	25	25	25
5'	17	17	17	17
6'	12	12	12	12
7'	9	9	9	9
8'	7	7	7	7
9'	6	5	6	5
10'	4	4	4	4

Footcandle values are rounded off and are based on a minimum of five units.

Photometric results may vary from testing data. To assist the lighting designer in using Nora's products in a lighting layout, the following photometric tables have both lab test data and normalized data to illustrate expected typical performance. Typical photometric data is provided to illustrate expectation of typical performance.

Light Commercial, Economy, and Energy Code Compliant Compact Fluorescent Luminaires

Nora Lighting's extensive line of economy compact fluorescent recessed fixtures offer affordable solutions for energy savings. Our compact fluorescent housings with electronic ballasts are Energy Star qualified and are available with 4", 5" and 6" apertures, new construction and remodel configurations. The NHPIC and NHRPIC series of air-tight, IC-rated housings with electronic ballasts meet stringent energy code requirements including California's Title 24. A large variety of attractive high performance reflectors and trims are available in a choice of finishes.

FEATURES

NEW! "No Tools Required" (*Patent Pending*) Convertible Socket (5" and 6")

- Electronic ballast with output frequency of not less than 20kHz.
- Internal Quick-Connectors provide instant, trouble-free electrical connection, eliminating the need for wire nuts. Reduces labor time per fixture.
- Hanger bars extend 24-1/2" and include captive nails, alignment foot, and are slotted for T-Bar installation. Hanger bars can also be repositioned 90° for flexible installation
- Accepts Quad, Triple Tube or other 4-pin compact fluorescent lamps.
- Air-Tight fixtures meet ASTM E283 standards.
- Energy Star qualified.
- Energy code compliant, including CA Title 24 fixtures which are air-tight, IC-rated and have electronic ballasts.
- Available with integral and remote test switch emergency batteries.

DIMMING OPTIONS - A variety of dimming ballast option are available in 13W-42W. Each option requires a compatible lighting control. Specify suffix:

- DAS** Advance Mark X, AMBI Star 120V (2-wire), Residential
D10 Universal Technologies 0-10V (4-wire), Universal Voltage (120V-277V)
MX1 Advance Mark X 120V (2-wire), (Wattage Specific)
MX2 Advance Mark X 277V (2-wire), (Wattage Specific)
M7 Advance Mark 7 (4-wire), Universal Voltage (120V-277V)
L51 Lutron SE 5% 120V (3-wire), (Wattage Specific)
L52 Lutron SE 5% 277V (3-wire), (Wattage Specific)
L11 Lutron Hi Lume 1% 120V (3-wire), (Wattage Specific)
L12 Lutron Hi Lume 1% 277V (3-wire), (Wattage Specific)

(See Pages 70-71 for complete descriptions)

EMERGENCY OPTIONS - Emergency back-up operates one or two lamp(s) for a minimum of 90 minutes. Unit includes battery, charger and test plate with indicator light. Specify suffix:

- EM** Emergency battery and remote test switch for one lamp 650 Lumen Emergency ballast.
EM2 Emergency battery and remote test switch for one lamp up to 1300 Lumen Emergency ballast.
NEW! EMI Emergency battery and integral test switch for one lamp 650 Lumen with Internal Switch. Must be used with dual PL trims.

Light Commercial / Economy CFL Downlight

New-Patent Pending Convertible Socket

Convertible socket can be removed without tools to convert socket into floating socket. Socket clips into reflectors for perfect lamp position for optimal performance



Fixed



Floating

Electronic Ballast

Output frequency of no less than 20kHz
Dimming and Emergency available

Aluminum Housing

Thermally protected

Quad/Triple Tube

Accepts Quad, Triple Biax or other 4-pin compact fluorescent lamps

Air-Tight

Meets ASTM E283 standards for Air-Tight requirements

Quick Connects

Provide instant, trouble-free electrical connection

Captive Nails

Hanger bars include internal spikes and captive nails

T-Bar Notch

Hanger bars are slotted for T-bar installation

Alignment Foot





6" High Wattage, Single Lamp IC Double Wall Housings

NEW CONVERTIBLE SOCKET!



Nora Lighting's 6" Compact Fluorescent IC AT double wall new construction housings offer affordable solutions for energy savings in insulated ceiling environments where high wattages are required. New construction configurations meet the strict CA Title 24 Energy Code requirements and are Energy Star compliant. Rated for direct contact with thermal insulation and adjacent structural components, IC housings accept a wide variety of attractive finishing trims suitable for any interior. Light sources are available in warm or cool colors.

Ballast:
26W-42W 120V-277V Electronic

Lamp Types:
26W – 26W Electronic 4-Pin Quad G24Q base
26W – 42W Electronic 4-Pin Triple Tube GX24Q base

Dimming Options: Variety of Electronic Dimming ballast options are available. Please match appropriate fixture with compatible compact fluorescent dimming control. See pages 70-71.

Emergency Option: 90 minute battery back-up must be ordered and installed as a self contained kit set apart from the housing.

Fuse Option: 2A Fuse may be added to any compact fluorescent frame-in — Add suffix FS.

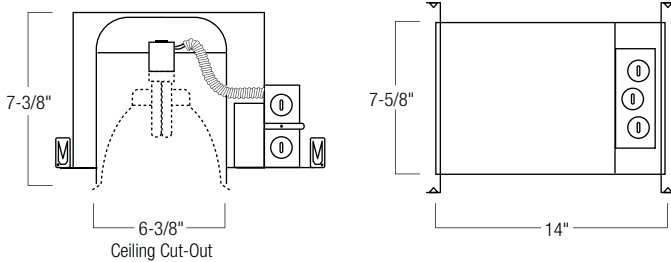

NHPIC ECONOMY DOUBLE WALL SERIES

CATALOG. NO.	LAMP	WATTS	VOLTAGE	DIMMING
ELECTRONIC				
TITLE 24 NHPIC-2642ELAT	1 Q/T	26-42	120-277	DAS, D10, MX1, MX2, M7, L51, L52, L11, L12



NEW! **Socket:** New Patent Pending Convertible Socket. Socket can be converted from fixed to floating without tools.

Minimum Clearances: IC housings are rated for direct contact and do not have any minimum clearance requirements.

New Construction Bar Hangers: Bar hangers are adjustable from 13-5/8" to 24-1/2" and can be repositioned 90 degrees. Bar hangers are slotted for T-bar installation.

Listing:
cULus Damp Location w/ Feed Through
cULus Wet Location (Only with designated trims)
WSEC ASTM E283 for Air Tight (AT)

COMPACT FLUORESCENT RECESSED

6" Single Lamp IC Economy New Construction Housings

Nora Lighting's 6" Compact Fluorescent IC new construction housings offer affordable solutions for energy savings in insulated ceiling environments. New construction electronic airtight configurations meet the strict CA Title 24 Energy Code requirements and are Energy Star compliant. Rated for direct contact with thermal insulation and adjacent structural components, IC housings accept a wide variety of attractive finishing trims suitable for any interior. Light sources are available in warm and cool colors.

Ballast Types:

13W-18W 120V-277V Electronic (EL)
 13W-26W 120V Electronic (ELAT)
 26W 120V-277V Electronic (ATE2)
 13W 120V Magnetic (M).

Lamp Types:

13W – 26W Electronic 4-Pin Quad G24Q base
 13W – 26W Electronic 4-Pin Triple Tube GX24Q base
 13W Magnetic 2-Pin Quad

Dimming Options: Variety of Electronic Dimming ballast options are available. Please match appropriate fixture with compatible compact fluorescent dimming control. See pages 70-71.

Emergency Option: Emergency back-up operates lamp for a minimum of 90 minutes. Unit includes battery, charger, and test plate with indicator light or integral mounted test switch in the reflector. See pages 182-183.

Fuse Option: 2A Fuse may be added to any compact fluorescent frame-in — Add suffix FS.

NEW! **Socket:** New Patent Pending Convertible Socket. Socket can be converted from fixed to floating without tools.

Minimum Clearances: IC housings are rated for direct contact and do not have any minimum clearance requirements

New Construction Bar Hangers: Bar hangers are adjustable from 13-5/8" to 24-1/2" and can be repositioned 90 degrees. Bar hangers are slotted for T-bar installation.

Listing:

cULus Damp Location w/ Feed Through
 cULus Wet Location (Only with designated trims)
 WSEC ASTM E283 for Air Tight (AT)



Fire Rated Enclosure - see page 379

NEW CONVERTIBLE SOCKET!

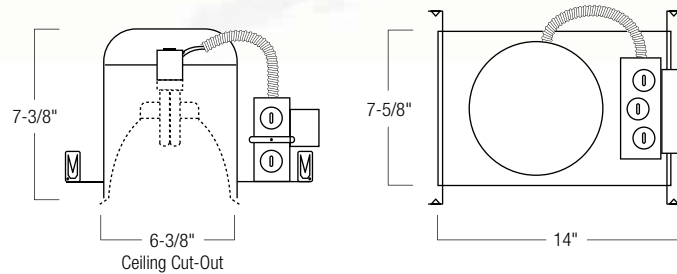

NHPIC ECONOMY SERIES

CATALOG. NO.	LAMP	WATTS	VOLTAGE	DIMMING	EMERGENCY
ELECTRONIC					
NHPIC-13EL	1 Q/T	13	120-277	D10, M7	EM, EMI, EM2
NHPIC-13ELAT	1 Q/T	13	120	D10, M7	EM, EMI, EM2
NHPIC-18EL	1 Q/T	18	120-277	D10, MX1, MX2, M7, L51, L52, L11, L12	EM, EMI, EM2
NHPIC-18ELAT	1 Q/T	18	120	D10, MX1, M7, L51, L11	EM, EMI, EM2
NHPIC-26ELAT	1 Q/T	26	120	DAS, D10, MX1, M7, L51, L11	EM, EMI, EM2
NHPIC-26ATE2	1 Q/T	26	120-277	D10, MX2, M7, L52, L12	EM, EMI, EM2
MAGNETIC *Magnetic Ballast is not Energy Star Qualified					
NHPIC-13MQ*	1 Q	13	120	N/A	EM, EMI, EM2



Applies only to Electronic, Air-Tight



CHANGE FOR THE BETTER WITH ENERGY STAR



Energy Saving Recessed Light



6" Single Lamp IC Economy Remodel Housing

NEW CONVERTIBLE SOCKET!



Nora Lighting's 6" Compact Fluorescent IC remodel housings offer affordable solutions for energy savings in existing insulated ceiling environments with no above access. Electronic, air-tight remodel configurations meet the strict CA Title 24 Energy Code requirements and are Energy Star compliant. Rated for direct contact with thermal insulation and adjacent structural components, IC housings accept a wide variety of attractive finishing trims suitable for any interior. Light sources are available in warm and cool colors.

Ballast Types:

- 13W-18W 120V-277V Electronic (EL)
- 13W-26W 120V Electronic (ELAT)
- 26W 120V-277V Electronic (ATE2)
- 13W 120V Magnetic (M).

Lamp Types:

- 13W – 26W Electronic 4-Pin Quad G24Q base
- 13W – 26W Electronic 4-Pin Triple Tube GX24Q base
- 13W Magnetic 2-Pin Quad

Dimming Options: Variety of Electronic Dimming ballast options are available. Please match appropriate fixture with compatible compact fluorescent dimming control. See pages 70-71.

Emergency Option: 90-minute battery back-up must be ordered and installed as a self contained kit set apart from the frame-in. See page 746.

Fuse Option: 2A Fuse may be added to any compact fluorescent frame-in — Add suffix FS.

NEW! **Socket:** New Patent Pending Convertible Socket. Socket can be converted from fixed to floating without tools.

Minimum Clearances: IC housings are rated for direct contact and do not have any minimum clearance requirements

Remodel Installation: High tension tempered steel springs secure remodel housings evenly to ceiling; hole cutout template provided for convenience.

Listing:
cULus Damp Location w/ Feed Through
cULus Wet Location (Only with designated trims)
WSEC ASTM E283 for Air Tight (AT)

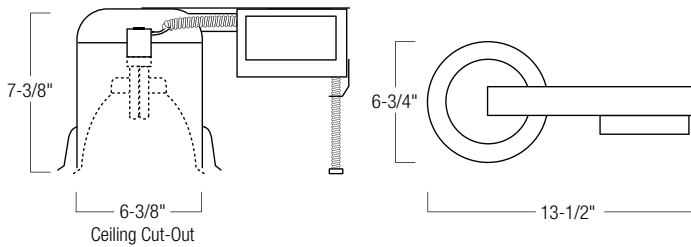

NHRPIC ECONOMY SERIES

CATALOG. NO.	LAMP	WATTS	VOLTAGE	DIMMING
ELECTRONIC				
NHRPIC-13EL	1 Q/T	13	120-277	D10, M7
NHRPIC-13ELAT	1 Q/T	13	120	D10, M7
NHRPIC-18EL	1 Q/T	18	120-277	D10, MX1, MX2, M7, L51, L52, L11, L12
NHRPIC-18ELAT	1 Q/T	18	120	D10, MX1, M7, L51, L11
NHRPIC-26ELAT	1 Q/T	26	120	DAS, D10, MX1, M7, L51, L11
NHRPIC-26ATE2	1 Q/T	26	120-277	D10, MX2, M7, L52, L12
MAGNETIC *Magnetic Ballast is not Energy Star Qualified				
NHRPIC-13MQ*	1 Q	13	120	N/A



COMPACT FLUORESCENT RECESSED

6" Single Lamp Economy New Construction Housings Non-IC

Nora Lighting's 6" Compact Fluorescent new construction housings offer affordable solutions for energy savings. Electronic new construction configurations are Energy Star compliant. A wide variety of attractive finishing trims suitable for any interior is available. Light sources are available in warm or cool colors.

Ballast Types:

13W-42W 120V-277V Electronic (EL)
13W 120V Magnetic (M).

Lamp Types:

13W – 26W Electronic 4-Pin Quad G24Q base
13W – 42W Electronic 4-Pin Triple Tube GX24Q base
13W Magnetic 2-Pin Quad

Dimming Options: Variety of Electronic Dimming ballast options are available. Please match appropriate fixture with compatible compact fluorescent dimming control. See pages 70-71.

Emergency Option: Emergency back-up operates lamp for a minimum of 90 minutes. Unit includes battery, charger, and test plate with indicator light or integral mounted test switch in the reflector. See pages 182-183.

Fuse Option: 2A Fuse may be added to any compact fluorescent frame-in — Add suffix FS.

NEW! Socket: New Patent Pending Convertible Socket. Socket can be converted from fixed to floating without tools.

Minimum Clearances: Non-IC housings require minimum clearances of 3" from thermal insulation and 1/2" from adjacent building components.

New Construction: Bar hangers are adjustable from 13-5/8" to 24-1/2" and can be repositioned 90 degrees. Bar hangers are slotted for T-bar installation.

Listing:
cULus Damp Location w/ Feed Through
cULus Wet Location (Only with designated trims)



Fire Rated Enclosure - see page 379

NEW CONVERTIBLE SOCKET!

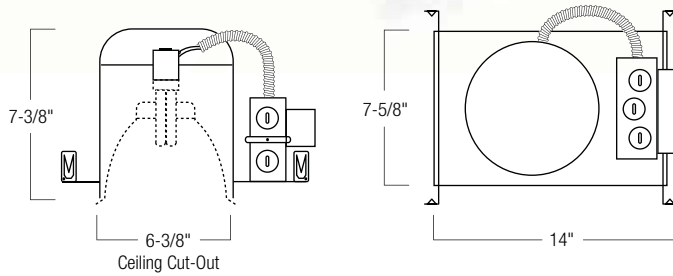

NHP ECONOMY SERIES

CATALOG. NO.	LAMP	WATTS	VOLTAGE	DIMMING	EMERGENCY
ELECTRONIC					
NHP-13EL	1 Q/T	13	120-277	D10, M7	EM, EMI, EM2
NHP-18EL	1 Q/T	18	120-277	D10, MX1, MX2, M7, L51, L52, L11, L12	EM, EMI, EM2
NHP-26EL	1 Q/T	26	120-277	DAS, D10, MX1, MX2, M7, L51, L52, L11, L12	EM, EMI, EM2
NHP-26EL/FB^A	1 Q/T	26	120-277	DAS, D10, MX1, MX2, M7, L51, L52, L11, L12	EM, EMI, EM2
NHP-2642EL	1 Q/T	26-42	120-277	DAS, D10, MX1, MX2, M7, L51, L52, L11, L12	EM, EMI, EM2
NHP-2642EL/FB^A	1 Q/T	26-42	120-277	DAS, D10, MX1, MX2, M7, L51, L52, L11, L12	EM, EMI, EM2
MAGNETIC *Magnetic Ballast is not Energy Star Qualified					
NHP-13M*	1 Q	13	120	N/A	EM, EMI, EM2

^A See page 379 for Fire Rated Enclosure specifications.



6" Single Lamp Economy Remodel Housing Non-IC

**NEW CONVERTIBLE
SOCKET!**

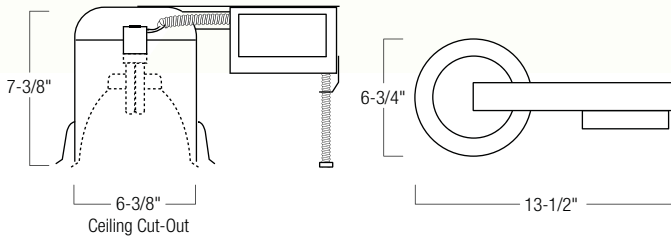

Nora Lighting's 6" Compact Fluorescent remodel housings offer affordable solutions for energy savings in existing drywall ceilings with no above access. Electronic remodel configurations are Energy Star compliant and accept a wide variety of attractive finishing trims suitable for any interior. Light sources are available in warm or cool colors.

Ballast Types:

13W-42W 120V-277V Electronic (EL)
13W 120V Magnetic (M).

Lamp Types:

13W – 26W Electronic 4-Pin Quad G24Q base
13W – 42W Electronic 4-Pin Triple Tube G24Q base
13W Magnetic 2-Pin Quad

Dimming Options: Variety of Electronic Dimming ballast options are available. Please match appropriate fixture with compatible compact fluorescent dimming control. See pages 70-71.

Emergency Option: 90-minute battery back-up must be ordered and installed as a self contained kit set apart from the frame-in. See page 746.

Fuse Option: 2A Fuse may be added to any compact fluorescent frame-in — Add suffix FS.

NHRP SERIES

CATALOG. NO.	LAMP	WATTS	VOLTAGE	DIMMING
ELECTRONIC				
NHRP-13EL	1 Q/T	13	120-277	D10, M7
NHRP-18EL	1 Q/T	18	120-277	D10, MX1, MX2, M7, L51, L52, L11, L12
NHRP-2642EL	1 Q/T	26-42	120-277	DAS, D10, MX1, MX2, M7, L51, L52, L11, L12
MAGNETIC *Magnetic Ballast is not Energy Star Qualified				
NHRP-13MQ*	1 Q	13	120	N/A

NEW! Socket: New Patent Pending Convertible Socket. Socket can be converted from fixed to floating without tools.

Minimum Clearances: Non-IC housings require minimum clearances of 3" from thermal insulation and 1/2" from adjacent building components.

Remodel Installation: High tension tempered steel springs secure remodel housings evenly to ceiling; hole cutout template provided for convenience.

Listing:
cULus Damp Location w/ Feed Through
cULus Wet Location (Only with designated trims)



COMPACT FLUORESCENT RECESSED

6" Economy Single Lamp Reflectors & Trims

BAFFLE - REFLECTOR

Airtight Cone Baffle



Catalog No.	Description
NTM-713W/PL	White Baffle / White Flange

Maximum Wattage

- (1) 13W-26W Quad
- (1) 13W-42W Triple Tube

OD: 7"

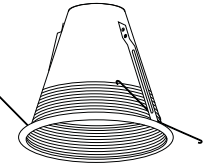

Airtight Cone Reflector with Baffle



Catalog No.	Description
NTA-730B/PL	Black Metal Baffle / Specular Clear Reflector / White Flange
NTA-730W/PL	White Metal Baffle / Specular Clear Reflector / White Flange

Maximum Wattage

- (1) 13W-26W Quad
- (1) 13W-42W Triple Tube

OD: 7"

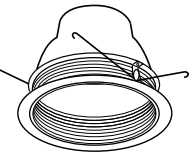

Clear Cone Reflector with Baffle



Catalog No.	Description
NTA-101	Black Baffle / Spec Clear Refl / White Plastic Ring
NTA-101BZ	Bronze Baffle / Spec Clear Refl / Bronze Metal Ring
NTA-101CO	Copper Baffle / Spec Clear Refl / Copper Metal Ring
NTA-101NN	Natural Metal Baffle / Spec Clear Reflector / Natural Metal Ring
NTA-102	White Baffle / Spec Clear Refl / White Plastic Ring

Maximum Wattage

- (1) 13W-26W Quad
- (1) 13W-42W Triple Tube

OD: 7"

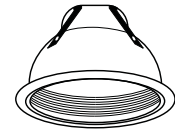

Airtight Cone Reflector



Catalog No.	Description
NTS-714B	Specular Black Reflector / White Plastic Ring
NTS-714C	Specular Clear Reflector / White Plastic Ring
NTS-714G	Specular Gold Reflector / White Plastic Ring
NTS-714W	Specular White Reflector / White Plastic Ring

Maximum Wattage

- (1) 13W-26W Quad
- (1) 13W-42W Triple Tube

OD: 7"

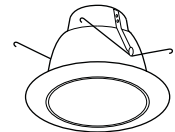

Cone Reflector

NEW!
LOW IRIDESCENT



Catalog No.	Description
NTA-96	Specular Gold Reflector / White Plastic Ring
NTA-96C	Specular Gold Reflector / Chrome Plastic Ring
NTA-96G	Specular Gold Reflector / Gold Plastic Ring
NTA-97	Specular Clear Reflector / White Plastic Ring
NTA-97C	Specular Clear Reflector / Chrome Plastic Ring
NTA-97CLI	Clear Low Iridescent Refl / White Plastic Ring
NTA-97G	Specular Clear Reflector / Gold Plastic Ring
NTA-97AHZ	Haze Alzak® Reflector / White Plastic Ring
NTA-97HZ	Haze Reflector / White Plastic Ring
NTA-98	Specular Black Reflector / White Plastic Ring
NTA-98B	Specular Black Reflector / Black Plastic Ring
NTA-98BZBZ	Bronze Reflector / Bronze Metal Ring
NTA-98COCO	Copper Reflector / Copper Metal Ring
NTA-98NN	Natural Metal Reflector / Natural Metal Ring
NTA-99	Specular White Reflector / White Plastic Ring

Maximum Wattage

- (1) 13W-26W Quad
- (1) 13W-42W Triple Tube

OD: 7"

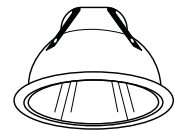

CC Custom Combo: Available with custom combinations of reflector and plastic and metal ring finish. See pages 38-39 for details.

Available Ring Finishes: B-Black, BZ-Bronze, C-Chrome, CO-Copper, G-Gold, N-Natural Metal, W-White

See pages 34-37 for Description of Reflector Finishes

REFLECTOR - WALL WASH

6" ECONOMY SINGLE LAMP REFLECTORS AND TRIMS continued

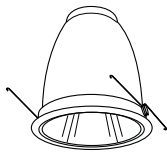

Maximum Wattage
 (1) 13W-26W Quad
 (1) 13W-42W Triple Tube
OD: 7"

Catalog No.	Description
NTS-6231BB	Specular Black Reflector / Black Metal Ring
NTS-6231BW	Specular Black Reflector / White Metal Ring
NTS-6231BZBZ	Bronze Reflector / Bronze Metal Ring
NTS-6231CC	Specular Clear Reflector / Chrome Metal Ring
NTS-6231COCO	Copper Reflector / Copper Metal Ring
NTS-6231CW	Specular Chrome Reflector / White Metal Ring
NTS-6231GG	Specular Gold Reflector / Gold Metal Ring
NTS-6231GW	Specular Gold Reflector / White Metal Ring
NTS-6231HZW	Haze Reflector / White Metal Ring
NTS-6231NN	Natural Metal Reflector / Natural Metal Ring
NTS-6231WW	Specular White Reflector / White Metal Ring

Cone Reflector with Metal Ring

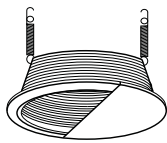
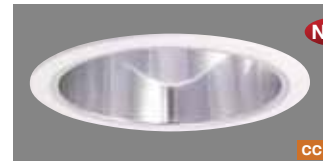

Maximum Wattage
 (1) 13W-26W Quad
 (1) 13W-42W Triple Tube
OD: 7"

Catalog No.	Description
NT-45	Wall Wash / Black Baffle / White Eyelid and Ring
NT-46	Wall Wash / White Baffle / White Eyelid and Ring

Baffle Wall Wash

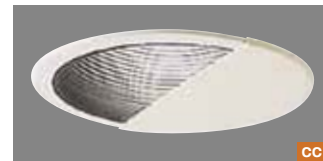

Maximum Wattage
 (1) 13W-26W Quad
 (1) 13W-42W Triple Tube
OD: 7"

Catalog No.	Description
NTA-103B	Wall Wash / Black Baffle / White Eyelid and Ring
NTA-103BZ	Wall Wash / Bronze Baffle / Bronze Eyelid and Ring
NTA-103CO	Wall Wash / Copper Baffle / Copper Eyelid and Ring
NTA-103N	Wall Wash / Natural Metal Baffle / Natural Metal Eyelid and Ring
NTA-103W	Wall Wash / White Baffle / White Eyelid and Ring

Cone Reflector Baffle Wall Wash



- Includes full specular clear reflector

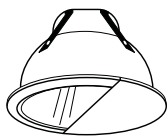

Maximum Wattage
 (1) 13W-26W Quad
 (1) 13W-42W Triple Tube
OD: 7"

Catalog No.	Description
NTA-86	Wall Wash / Specular Gold Reflector / White Eyelid and Ring
NTA-87	Wall Wash / Specular Clear Reflector / White Eyelid and Ring
NTA-88	Wall Wash / Specular Black Reflector / White Eyelid and Ring
NTA-88BZ	Wall Wash / Bronze Refl / Bronze Eyelid and Ring
NTA-88CO	Wall Wash / Copper Refl / Copper Eyelid and Ring
NTA-88N	Wall Wash / Natural Metal Reflector / Natural Metal Eyelid and Ring
NTA-89	Wall Wash / Specular White Reflector / White Eyelid and Ring

Cone Reflector Wall Wash

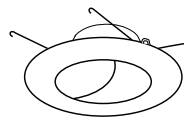

Maximum Wattage
 (1) 13W-26W Quad
 (1) 13W-42W Triple Tube
OD: 7"

Catalog No.	Description
NT-25	White Metal Wall Wash
NT-25B	Black Metal Wall Wash

Wall Wash



CC Custom Combo: Available with custom combinations of reflector and plastic and metal ring finish. See pages 38-39 for details.
 Available Ring Finishes: B-Black, BZ-Bronze, C-Chrome, CO-Copper, G-Gold, N-Natural Metal, W-White

Reflector for Decorative Glass

NEW!

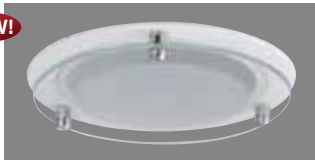

Catalog No.	Description
NTS-6238BZ	Specular Clear Reflector / Bronze Trim
NTS-6238C	Specular Clear Reflector / Chrome Trim
NTS-6238N	Specular Clear Reflector / Natural Metal Trim
NTS-6238W	Specular Clear Reflector / White Trim

- Glass sold separately
- For a layered look, up to two pieces of glass may be used together.

Maximum Wattage
 (1) 13W-26W Quad
 (1) 13W-42W Triple Tube
OD: 8"

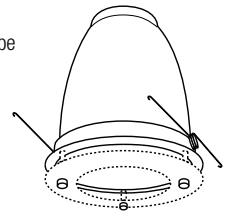

Decorative Glass for NTS-6238

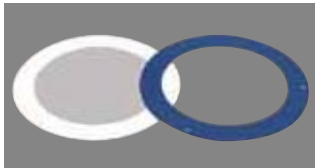

Catalog No.	Description
NTG-6B/120	Tempered Blue / 120mm (4-3/4") Open Center
NTG-6B/80	Tempered Blue / 80mm (3-1/8") Open Center
NTG-6CF	Tempered Frost Center / Clear Outer
NTG-6FC	Tempered Clear Center / Frost Outer
NTG-6HC	Tempered Clear Outer / Frost Inner / 80mm (3-1/8") Open Center

- Includes NRA-203 Glass Hardware
- 2 decorative glasses can be combined for a tiered look

Includes:
 NRA-203 Glass Hardware
 • (3) Stand-offs
 • (3) Cone End Caps
 • (3) Flat End Caps
OD: 7"



Cone Reflector Regressed Albalite Lens with Baffle

NEW!

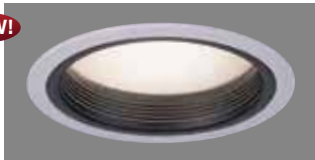

Catalog No.	Description
NTS-6242B	Albalite Lens / Black Baffle / White Flange
NTS-6242BZ	Albalite Lens / Bronze Baffle / Bronze Flange
NTS-6242C	Albalite Lens / Chrome Baffle / Chrome Flange
NTS-6242CO	Albalite Lens / Copper Baffle / Copper Flange
NTS-6242G	Albalite Lens / Gold Baffle / Gold Flange
NTS-6242N	Albalite Lens / Nat Metal Baffle / Nat Metal Flange
NTS-6242W	Albalite Lens / White Baffle / White Flange

- Full specular clear reflector for optimum light output
- UL Wet Listed

Maximum Wattage
 (1) 13W-26W Quad
 (1) 13W-26W Triple Tube
OD: 8"

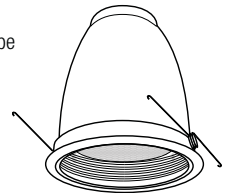

Regressed Albalite Lens with Baffle

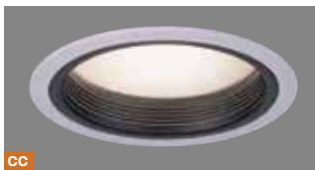

CC

Catalog No.	Description
NTM-42	Albalite Lens / Black Baffle / White Plastic Ring
NTM-42BZ	Albalite Lens / Bronze Baffle / Bronze Metal Ring
NTM-42CO	Albalite Lens / Copper Baffle / Copper Metal Ring
NTM-42N	Albalite Lens / Natural Metal Baffle / Natural Metal Ring
NTM-42W	Albalite Lens / White Baffle / White Plastic Ring

- UL Wet Listed

Maximum Wattage
 (1) 13W-26W Quad
 (1) 13W-26 W Triple Tube
OD: 8"

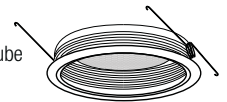

Albalite Lens with Reflector

NEW!



Catalog No.	Description
NTS-6222	Albalite Lens / Spec Clear Refl / White Metal Trim
NTS-6222B	Albalite Lens / Spec Clear Refl / Black Metal Trim
NTS-6222BZ	Albalite Lens / Spec Clear Refl / Bronze Metal Trim
NTS-6222C	Albalite Lens / Spec Clear Refl / Chrome Metal Trim
NTS-6222CO	Albalite Lens / Spec Clear Refl / Copper Metal Trim
NTS-6222G	Albalite Lens / Spec Clear Refl / Gold Metal Trim
NTS-6222N	Albalite Lens / Spec Clear Refl / Natural Metal Trim

- Full specular clear reflector for optimum light output
- UL Wet Listed

Maximum Wattage
 (1) 13W-26W Quad
 (1) 13W-42W Triple Tube
OD: 8"

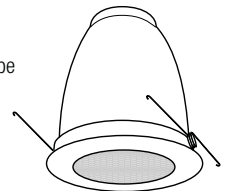

CC Custom Combo: Available with custom combinations of reflector and plastic and metal ring finish. See pages 38-39 for details.
 Available Ring Finishes: B-Black, BZ-Bronze, C-Chrome, CO-Copper, G-Gold, N-Natural Metal, W-White

LENSED

6" ECONOMY SINGLE LAMP REFLECTORS AND TRIMS continued



Maximum Wattage
 (1) 13W-26W Quad
 (1) 13W-26W Triple Tube
OD: 8"



Catalog No.	Description
NP-22	Albalite Lens / White Plastic Trim
NT-22	Albalite Lens / White Metal Trim
NT-22B	Albalite Lens / Black Metal Trim
NT-22BZ	Albalite Lens / Bronze Metal Trim
NT-22C	Albalite Lens / Chrome Metal Trim
NT-22CO	Albalite Lens / Copper Metal Trim
NT-22G	Albalite Lens / Gold Metal Trim
NT-22N	Albalite Lens / Natural Metal Trim

- UL Classified for use with other manufacturer's housings
- UL Wet Listed

Albalite Lens

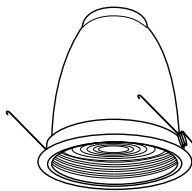

Maximum Wattage
 (1) 13W-26W Quad
 (1) 13W-26W Triple Tube
OD: 8"



Catalog No.	Description
NTS-6245B	Frosted Dome / Black Baffle / White Flange
NTS-6245BZ	Frosted Dome / Bronze Baffle / Bronze Flange
NTS-6245C	Frosted Dome / Chrome Baffle / Chrome Flange
NTS-6245CO	Frosted Dome / Copper Baffle / Copper Flange
NTS-6245G	Frosted Dome / Gold Baffle / Gold Flange
NTS-6245N	Frosted Dome / Natural Metal Baffle / Natural Flange
NTS-6245W	Frosted Dome / White Baffle / White Flange

- Full specular clear reflector for optimum light output
- Simulates the look of a BR40
- UL Wet Listed

Cone Reflector Regressed
Fresnel Lens with Baffle

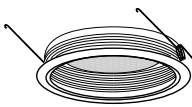

Maximum Wattage
 (1) 13W-26W Quad
 (1) 13W-26W Triple Tube
OD: 8"



Catalog No.	Description
NTM-43	Fresnel Lens / Black Baffle / White Plastic Ring
NTM-43BZ	Fresnel Lens / Bronze Baffle / Bronze Metal Ring
NTM-43CO	Fresnel Lens / Copper Baffle / Copper Metal Ring
NTM-43N	Fresnel Lens / Natural Metal Baffle / Natural Ring
NTM-43W	Fresnel Lens / White Baffle / White Plastic Ring

- UL Wet Listed

Regressed Fresnel Lens with Baffle

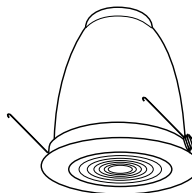

Maximum Wattage
 (1) 13W-26W Quad
 (1) 13W-42W Triple Tube
OD: 8"



Catalog No.	Description
NTS-6223	Fresnel Lens / Spec Clear Refl / White Metal Trim
NTS-6223B	Fresnel Lens / Spec Clear Refl / Black Metal Trim
NTS-6223BZ	Fresnel Lens / Spec Clear Refl / Bronze Metal Trim
NTS-6223C	Fresnel Lens / Spec Clear Refl / Chrome Metal Trim
NTS-6223CO	Fresnel Lens / Spec Clear Refl / Copper Metal Trim
NTS-6223G	Fresnel Lens / Spec Clear Refl / Gold Metal Trim
NTS-6223N	Fresnel Lens / Spec Clear Refl / Natural Metal Trim

- Full specular clear reflector for optimum light output
- UL Wet Listed

Fresnel Lens with Reflector



Maximum Wattage
 (1) 13W-26W Quad
 (1) 13W-42W Triple Tube
OD: 8"



Catalog No.	Description
NP-23	Fresnel Lens / White Plastic Trim
NT-23	Fresnel Lens / White Metal Trim
NT-23B	Fresnel Lens / Black Metal Trim
NT-23BZ	Fresnel Lens / Bronze Metal Trim
NT-23C	Fresnel Lens / Chrome Metal Trim
NT-23CO	Fresnel Lens / Copper Metal Trim
NT-23G	Fresnel Lens / Gold Metal Trim
NT-23N	Fresnel Lens / Natural Metal Metal Trim

- UL Wet Listed

Fresnel Lens



CC Custom Combo: Available with custom combinations of reflector and plastic and metal ring finish. See pages 38-39 for details.
 Available Ring Finishes: B-Black, BZ-Bronze, C-Chrome, CO-Copper, G-Gold, N-Natural Metal, W-White

Cone Reflector Regressed Drop Opal Lens with Baffle

NEW!



Catalog No.	Description
NTS-6244B	Drop Opal / Black Baffle / White Flange
NTS-6244BZ	Drop Opal / Bronze Baffle / Bronze Flange
NTS-6244C	Drop Opal / Chrome Baffle / Chrome Flange
NTS-6244CO	Drop Opal / Copper Baffle / Copper Flange
NTS-6244G	Drop Opal / Gold Baffle / Gold Flange
NTS-6244N	Drop Opal / Natural Metal Baffle / Natural Metal Flange
NTS-6244W	Drop Opal / White Baffle / White Flange

- Full specular clear reflector for optimum light output
- UL Wet Listed

Maximum Wattage
 (1) 13W-26W Quad
 (1) 13W-26W Triple Tube
 OD: 8"

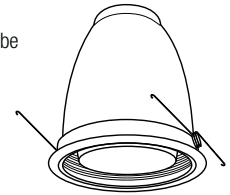

Regressed Drop Opal Lens with Baffle



CC

Catalog No.	Description
NTM-46M	Drop Opal / Black Metal Baffle / White Plastic Ring
NTM-46BZ	Drop Opal / Bronze Baffle / Bronze Metal Ring
NTM-46CO	Drop Opal / Copper Baffle / Copper Metal Ring
NTM-46N	Drop Opal / Natural Metal Baffle / Natural Metal Ring
NTM-46W	Drop Opal / White Baffle / White Plastic Ring

- UL Wet Listed

Maximum Wattage
 (1) 13W-26W Quad
 (1) 13W-26W Triple Tube
 OD: 8"

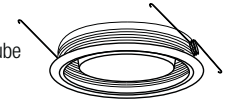

Drop Opal Lens with Reflector

NEW!



Catalog No.	Description
NTS-6224	Drop Opal / Spec Clear Refl / White Metal Trim
NTS-6224B	Drop Opal / Spec Clear Refl / Black Metal Trim
NTS-6224BZ	Drop Opal / Spec Clear Refl / Bronze Metal Trim
NTS-6224C	Drop Opal / Spec Clear Refl / Chrome Metal Trim
NTS-6224CO	Drop Opal / Spec Clear Refl / Copper Metal Trim
NTS-6224G	Drop Opal / Spec Clear Refl / Gold Metal Trim
NTS-6224N	Drop Opal / Spec Clear Refl / Natural Metal Trim

- Full specular clear reflector for optimum light output
- UL Wet Listed

Maximum Wattage
 (1) 13W-26W Quad
 (1) 13W-42W Triple Tube
 OD: 8"

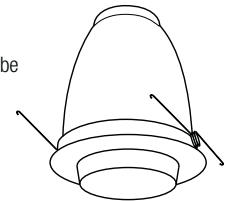

Drop Opal Lens Shower Trim



Catalog No.	Description
NP-24	Drop Opal / White Plastic Trim
NP-24/PC	Polycarbonate Drop Opal / White Plastic Trim
NT-24	Drop Opal / White Metal Trim
NT-24B	Drop Opal / Black Metal Trim
NT-24BZ	Drop Opal / Bronze Metal Trim
NT-24C	Drop Opal / Chrome Metal Trim
NT-24CO	Drop Opal / Copper Metal Trim
NT-24G	Drop Opal / Gold Metal Trim
NT-24N	Drop Opal / Natural Metal Trim

- UL Wet Listed

Maximum Wattage
 (1) 13W-26W Quad
 (1) 13W-42W Triple Tube
 OD: 8"

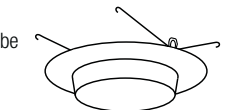

CC Custom Combo: Available with custom combinations of reflector and plastic and metal ring finish. See pages 38-39 for details.
 Available Ring Finishes: B-Black, BZ-Bronze, C-Chrome, CO-Copper, G-Gold, N-Natural Metal, W-White

LENSED

6" ECONOMY SINGLE LAMP REFLECTORS AND TRIMS continued

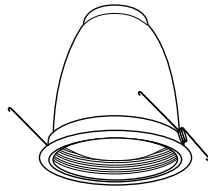

Maximum Wattage
 (1) 13W-26W Quad
 (1) 13W-26W Triple Tube
OD: 8"



Lighting Tip: Use NTS-6245 with a warm color CFL to give the visually accepted appearance of a BR40.

Catalog No.	Description
NTS-6245B	Frosted Dome / Black Baffle / White Flange
NTS-6245BZ	Frosted Dome / Bronze Baffle / Bronze Flange
NTS-6245C	Frosted Dome / Chrome Baffle / Chrome Flange
NTS-6245CO	Frosted Dome / Copper Baffle / Copper Flange
NTS-6245G	Frosted Dome / Gold Baffle / Gold Flange
NTS-6245N	Frosted Dome / Natural Metal Baffle / Natural Flange
NTS-6245W	Frosted Dome / White Baffle / White Flange

- Full specular clear reflector for optimum light output
- Simulates the look of a BR40
- UL Wet Listed

Cone Reflector Regressed Frosted Dome with Baffle



NEW!

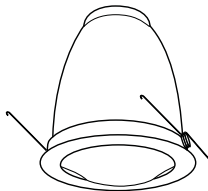

Maximum Wattage
 (1) 13W-26W Quad
 (1) 13W-42W Triple Tube
OD: 8"



Catalog No.	Description
NTS-6225	Frosted Dome / White Metal Trim
NTS-6225B	Frosted Dome / Black Metal Trim
NTS-6225BZ	Frosted Dome / Bronze Metal Trim
NTS-6225C	Frosted Dome / Chrome Metal Trim
NTS-6225CO	Frosted Dome / Copper Metal Trim
NTS-6225G	Frosted Dome / Gold Metal Trim
NTS-6225N	Frosted Dome / Natural Metal Trim

- Full specular clear reflector for optimum light output
- UL Wet Listed

Frosted Dome Lens with Reflector



NEW!

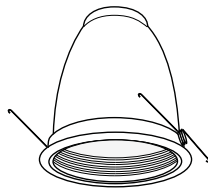

Maximum Wattage
 (1) 13W-26W Quad
 (1) 13W-26W Triple Tube
OD: 8"



Catalog No.	Description
NTS-6246B	Frosted Flat Lens / Black Baffle / White Flange
NTS-6246BZ	Frosted Flat Lens / Bronze Baffle / Bronze Flange
NTS-6246C	Frosted Flat Lens / Chrome Baffle / Chrome Flange
NTS-6246CO	Frosted Flat Lens / Copper Baffle / Copper Flange
NTS-6246G	Frosted Flat Lens / Gold Baffle / Gold Flange
NTS-6246N	Frosted Flat Lens / Nat Metal Baffle / Nat Metal Flange
NTS-6246W	Frosted Flat Lens / White Baffle / White Flange

- Full specular clear reflector for optimum light output
- UL Wet Listed

Cone Reflector Regressed Frosted Flat Lens with Baffle



NEW!

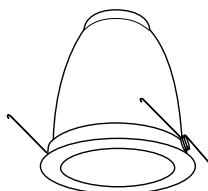

Maximum Wattage
 (1) 13W-26W Quad
 (1) 13W-42W Triple Tube
OD: 8"



Catalog No.	Description
NTS-6226	Frosted Flat Lens / White Metal Trim
NTS-6226B	Frosted Flat Lens / Black Metal Trim
NTS-6226BZ	Frosted Flat Lens / Bronze Metal Trim
NTS-6226C	Frosted Flat Lens / Chrome Metal Trim
NTS-6226CO	Frosted Flat Lens / Copper Metal Trim
NTS-6226G	Frosted Flat Lens / Gold Metal Trim
NTS-6226N	Frosted Flat Lens / Natural Metal Trim

- Full specular clear reflector for optimum light output
- UL Wet Listed

Frosted Flat Lens with Reflector



NEW!

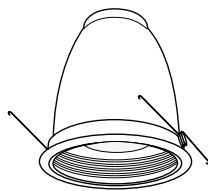

Maximum Wattage
 (1) 13W-26W Quad
 (1) 13W-26W Triple Tube
OD: 8"



Catalog No.	Description
NTS-6247B	Center Frosted Lens / Black Baff / White Flange
NTS-6247BZ	Center Frosted Lens / Bronze Baff / Bronze Flange
NTS-6247C	Center Frosted Lens / Chrome Baff / Chrome Flange
NTS-6247CO	Center Frosted Lens / Copper Baff / Copper Flange
NTS-6247G	Center Frosted Lens / Gold Baffle / Gold Flange
NTS-6247N	Center Frosted Lens/ Nat Metal Baffle / Nat Flange
NTS-6247W	Center Frosted Lens / White Baffle / White Flange

- Full specular clear reflector for optimum light output
- UL Wet Listed

Cone Reflector with Regressed Center Frosted Flat Lens with Baffle



NEW!

COMPACT FLUORESCENT RECESSED

6" Dual Lamp IC New Construction Housings

Nora Lighting's 6" economy Compact Fluorescent new construction dual vertical lamp housings offer affordable high-performance solutions for energy savings in insulated ceiling environments. Electronic configurations are Energy Star compliant. Rated for direct contact with thermal insulation and adjacent structural components, IC housings accept a wide variety of attractive finishing trims suitable for any interior. Light sources are available in warm and cool colors.

Ballast Types:

- 13W 120V-277V Electronic (EL)
- 13W 120V Magnetic (Q).

Lamp Types:

- (2) 13W Electronic 4-Pin Quad G24Q base
- (2) 13W Magnetic 2-Pin Quad or Twin

Dimming Options: Variety of Electronic Dimming ballast options are available. Please match appropriate fixture with compatible compact fluorescent dimming control. See pages 70-71.

Emergency Option: 90-minute battery back-up must be ordered and installed as a self contained kit set apart from the frame-in. See page 746.

Fuse Option: 2A Fuse may be added to any compact fluorescent frame-in — Add suffix FS.

Minimum Clearances: IC housings are rated for direct contact and do not have any minimum clearance requirements

New Construction: Bar hangers are adjustable from 13-5/8" to 24-1/2" and can be repositioned 90 degrees. Bar hangers are slotted for T-bar installation.

Listing:

cULus Damp Location w/ Feed Through;
cULus Wet Location (Only with designated trims)

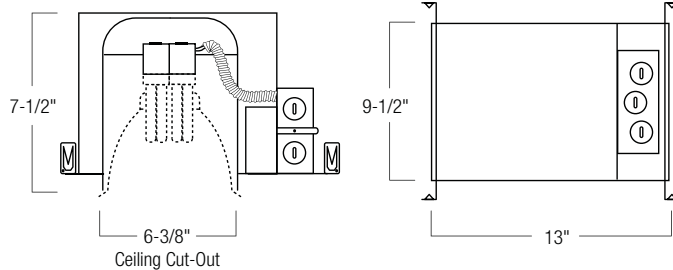

NHPIC-2L SERIES

CATALOG. NO.	LAMP(S)	WATTAGE	VOLTAGE	DIMMING
ELECTRONIC				
NHPIC-13/2LEL	2 Quad	13	120-277	D10, M7
MAGNETIC *Magnetic Ballast is not Energy Star Qualified				
NHPIC-13/2LQ*	2 Quad/Twin	13	120	N/A



COMPACT FLUORESCENT RECESSED 6" Dual Lamp Economy New Construction Housings Non-IC

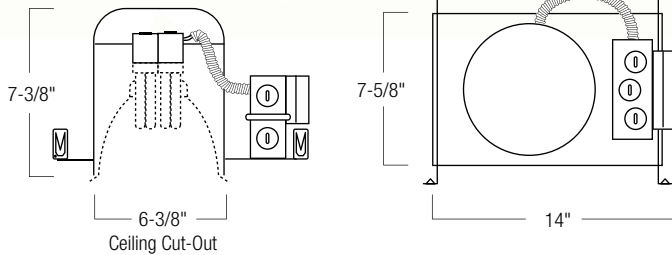

NHP-2L SERIES

CATALOG. NO.	LAMP	WATTS	VOLTAGE	DIMMING	EMERGENCY
ELECTRONIC					
NHP-13/2LEL	2 Q	13	120-277	D10, M7	EM, EM2
NHP-18/2LEL	2 Q	18	120-277	D10, MX1, MX2, M7, L51, L52, L11, L12	EM, EM2
NHP-26/2LEL	2 Q	26	120-277	DAS, D10, MX1, MX2, M7, L51, L52, L11, L12	EM, EM2
MAGNETIC *Magnetic Ballast is not Energy Star Qualified					
NHP-13/2LQ*	2 Q/Twin	13	120	N/A	EM, EM2



Nora Lighting's 6" economy Compact Fluorescent new construction dual vertical lamp housings offer affordable high-performance solutions for energy savings. Electronic configurations are Energy Star compliant. A wide variety of attractive finishing trims suitable for any interior is available. Light sources are available in warm and cool colors.

Ballast Types:

13W-26W 120V-277V Electronic (EL)
13W 120V Magnetic (Q).

Lamp Types:

(2) 13W-26W Electronic 4-Pin Quad
G24Q base
(2) 13W Magnetic 2-Pin Quad or Twin

Dimming Options: Variety of Electronic Dimming ballast options are available. Please match appropriate fixture with compatible compact fluorescent dimming control. See pages 70-71.

Emergency Option: Emergency back-up operates two lamps for a minimum of 90 minutes. Unit includes battery, charger, and test plate with indicator light. See page 183.

Fuse Option: 2A Fuse may be added to any compact fluorescent frame-in — Add suffix FS.

Bi-Level Switching Option: Dual or A/B switching is available on Nora dual lamp units. Two ballasts are attached to the J-box allowing separate control of each lamp to meet bi-level code or design requirements. Consult factory.

Minimum Clearances: Non-IC housings require minimum clearances of 3" from thermal insulation and 1/2" from adjacent building components.

New Construction: Bar hangers are adjustable from 13-5/8" to 24-1/2" and can be repositioned 90 degrees. Bar hangers are slotted for T-bar installation.

Listing:

cULus Damp Location w/ Feed Through;
cULus Wet Location (Only with designated trims)

COMPACT FLUORESCENT RECESSED

6" Dual Lamp Economy Remodel Housings Non-IC

Nora Lighting's 6" economy Compact Fluorescent new construction dual vertical lamp housings offer affordable high-performance solutions for energy savings in existing drywall ceilings with no above access. Electronic configurations are Energy Star compliant. A wide variety of attractive finishing trims suitable for any interior is available. Light sources are available in warm and cool colors.

Ballast Types:

13W-26W 120V-277V Electronic (EL)
13W 120V Magnetic (M).

Lamp Types:

(2) 13W-26W Electronic 4-Pin Quad G24Q base
(2) 13W Magnetic 2-Pin Quad or Twin

Dimming Options: Variety of Electronic Dimming ballast options are available. Please match appropriate fixture with compatible compact fluorescent dimming control. See pages 70-71.

Emergency Option: 90-minute battery back-up must be ordered and installed as a self contained kit set apart from the frame-in. See page 746.

Fuse Option: 2A Fuse may be added to any compact fluorescent frame-in — Add suffix FS.

Bi-Level Switching Option: Dual or A/B switching is available on Nora dual lamp units. Two ballasts are attached to the J-box allowing separate control of each lamp to meet bi-level code or design requirements. Consult factory.

Minimum Clearances: Non-IC housings require minimum clearances of 3" from thermal insulation and 1/2" from adjacent building components.

Remodel Installation: High tension tempered steel springs secure remodel housings evenly to ceiling; hole cutout template provided for convenience.

Listing:

cULus Damp Location w/ Feed Through;
cULus Wet Location (Only with designated trims)

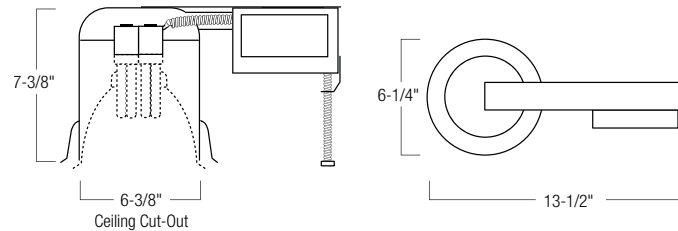
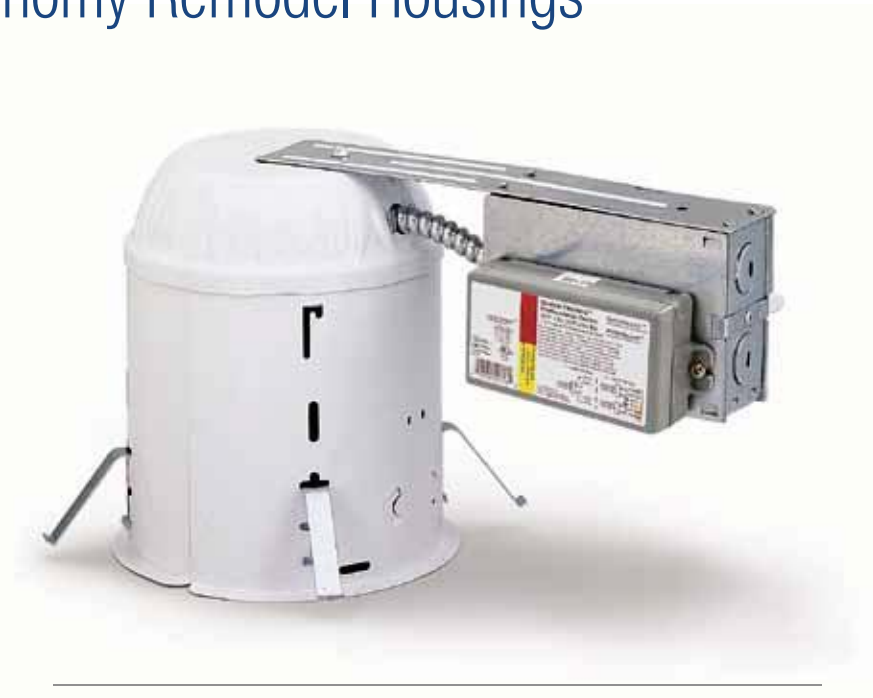

NHRP-2L SERIES

CATALOG. NO.	LAMP	WATTS	VOLTAGE	DIMMING
ELECTRONIC				
NHRP-13/2LEL	2 Q	13	120-277	D10, M7
NHRP-18/2LEL	2 Q	18	120-277	D10, MX1, MX2, M7, L51, L52, L11, L12
NHRP-26/2LEL	2 Q	26	120-277	DAS, D10, MX1, MX2, M7, L51, L52, L11, L12
MAGNETIC *Magnetic Ballast is not Energy Star Qualified				
NHRP-13/2LQ*	2Q/Twin	120	13	N/A



6" Dual Lamp Economy Reflectors and Trims



Maximum Wattage
(2) 13W-26W Quad
OD: 7"

Catalog No.	Description
NTA-101/2PL	Black Baffle / Specular Clear Reflector / White Plastic Ring
NTA-102/2PL	White Baffle / Specular Clear Reflector / White Plastic Ring

Cone Reflector with Baffle



Maximum Wattage
(2) 13W-26W Quad
OD: 7"

Catalog No.	Description
NTA-96/2PL	Specular Gold Reflector / White Plastic Ring
NTA-97/2PL	Specular Clear Reflector / White Plastic Ring
NTA-97C/2PL	Specular Clear Reflector / Chrome Plastic Ring
NTA-98/2PL	Specular Black Reflector / White Plastic Ring
NTA-99/2PL	Specular White Reflector / White Plastic Ring

Cone Reflector



Maximum Wattage
(2) 13W-26W Quad
OD: 7"

Catalog No.	Description
NTS-30	Specular Gold Reflector / White Plastic Ring
NTS-30A	Gold Alzak® Reflector / White Plastic Ring
NTS-30C	Specular Gold Reflector / Chrome Plastic Ring
NTS-30G	Specular Gold Reflector / Gold Plastic Ring
NTS-31	Specular Clear Reflector / White Plastic Ring
NTS-31A	Clear Alzak® Reflector / White Plastic Ring
NTS-31C	Specular Clear Reflector / Chrome Plastic Ring
NTS-31N	Specular Clear Reflector / Natural Metal Ring
NTS-31HZ	Haze Reflector / White Plastic Ring
NTS-31AHZ	Haze Alzak® Reflector / White Plastic Ring
NTS-32	Specular Black Reflector / White Plastic Ring
NTS-32B	Specular Black Reflector / Black Plastic Ring
NTS-32CO	Specular Black Reflector / Copper Metal Ring
NTS-32G	Specular Black Reflector / Gold Plastic Ring
NTS-32BZBZ	Bronze Reflector / Bronze Metal Ring
NTS-32COCO	Copper Reflector / Copper Metal Ring
NTS-32NN	Natural Metal Reflector / Natural Metal Ring
NTS-33	Specular White Reflector / White Plastic Ring

Reflector



Maximum Wattage
(2) 13W-26W Quad
OD: 7"

Catalog No.	Description
NTA-103B/2PL	Wall Wash / Black Baffle / White Eyelid and Ring
NTA-103W/2PL	Wall Wash / White Baffle / White Eyelid and Ring

- All include full specular clear reflector

Cone Reflector Baffle Wall Wash



Maximum Wattage
(2) 13W-26W Quad
OD: 7"

Catalog No.	Description
NTA-86/2PL	Wall Wash / Specular Gold Reflector / White Eyelid
NTA-87/2PL	Wall Wash / Specular Clear Reflector / White Eyelid
NTA-88/2PL	Wall Wash / Specular Black Reflector / White Eyelid
NTA-89/2PL	Wall Wash / Specular White Reflector / White Eyelid

Cone Reflector Wall Wash



CC Custom Combo: Available with custom combinations of reflector and plastic and metal ring finish. See pages 38-39 for details.

Available Ring Finishes: B-Black, BZ-Bronze, C-Chrome, CO-Copper, G-Gold, N-Natural Metal, W-White

See pages 34-37 for Description of Trim Finishes

6" DUAL LAMP ECONOMY REFLECTORS AND TRIMS continued

Baffle Regressed Albalite

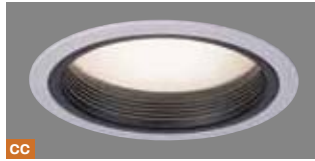

CC

Catalog No.	Description
NTM-42	Albalite Lens / Black Baffle / White Plastic Ring
NTM-42BZ	Albalite Lens / Bronze Baffle / Bronze Metal Ring
NTM-42CO	Albalite Lens / Copper Baffle / Copper Metal Ring
NTM-42N	Albalite Lens / Natural Metal Baffle / Natural Metal Ring
NTM-42W	Albalite Lens / White Baffle / White Plastic Ring

- UL Wet Listed

Maximum Wattage
(2) 13W-26W Quad

OD: 8"

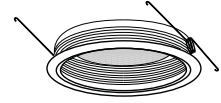

Reflector Albalite Shower



Catalog No.	Description
NTS-22/2PL	Albalite Lens / Specular Clear Reflector / White Metal Trim
NTS-22B/2PL	Albalite Lens / Chrome Refl. / Black Metal Trim
NTS-22C/2PL	Albalite Lens / Chrome Refl. / Chrome Metal Trim

- Full specular clear reflector for optimum light output
- UL Wet Listed

Maximum Wattage
(2) 13W-26W Quad

OD: 8"

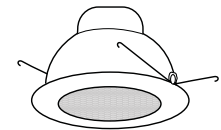

Albalite Shower Trim



Catalog No.	Description
NP-22	Albalite Lens / White Plastic Trim
NT-22	Albalite Lens / White Metal Trim
NT-22B	Albalite Lens / Black Metal Trim
NT-22BZ	Albalite Lens / Bronze Metal Trim
NT-22C	Albalite Lens / Chrome Metal Trim
NT-22CO	Albalite Lens / Copper Metal Trim
NT-22G	Albalite Lens / Gold Metal Trim
NT-22N	Albalite Lens / Natural Metal Metal Trim

- UL Classified for use with other manufacturer's housings
- UL Wet Listed

Maximum Wattage
(2) 13W-26W Quad

OD: 8"

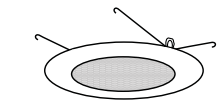

Baffle Regressed Fresnel



CC

Catalog No.	Description
NTM-43	Fresnel Lens / Black Baffle / White Plastic Ring
NTM-43BZ	Fresnel Lens / Bronze Baffle / Bronze Metal Ring
NTM-43CO	Fresnel Lens / Copper Baffle / Copper Metal Ring
NTM-43N	Fresnel Lens / Natural Metal Baffle / Natural Metal Ring
NTM-43W	Fresnel Lens / White Baffle / White Plastic Ring

- UL Wet Listed

Maximum Wattage
(2) 13W-26W Quad

OD: 8"

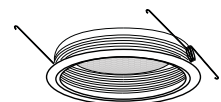

Reflector Fresnel Shower



Catalog No.	Description
NTS-23/2PL	Fresnel Lens / Specular Clear Reflector / White Metal Trim
NTS-23C/2PL	Fresnel Lens / Specular Clear Reflector / Chrome Metal Trim
NTS-23G/2PL	Fresnel Lens / Specular Clear Reflector / Gold Metal Trim

- Full specular clear reflector for optimum light output
- UL Wet Listed

Maximum Wattage
(2) 13W-26W Quad

OD: 8"



CC Custom Combo: Available with custom combinations of reflector and plastic and metal ring finish. See pages 38-39 for details.

Available Ring Finishes: B-Black, BZ-Bronze, C-Chrome, CO-Copper, G-Gold, N-Natural Metal, W-White

6" DUAL LAMP ECONOMY REFLECTORS AND TRIMS continued



Maximum Wattage
(2) 13W-26W Quad

OD: 8"



Catalog No.	Description
NP-23	Fresnel Lens / White Plastic Trim
NT-23	Fresnel Lens / White Metal Trim
NT-23B	Fresnel Lens / Black Metal Trim
NT-23BZ	Fresnel Lens / Bronze Metal Trim
NT-23C	Fresnel Lens / Chrome Metal Trim
NT-23CO	Fresnel Lens / Copper Metal Trim
NT-23G	Fresnel Lens / Gold Metal Trim
NT-23N	Fresnel Lens / Natural Metal Metal Trim

- UL Wet Listed

Fresnel Shower Trim

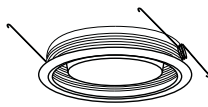
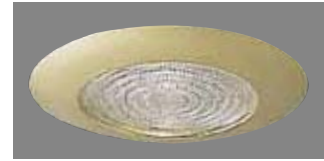

Maximum Wattage
(2) 13W-26W Quad

OD: 8"



Catalog No.	Description
NTM-46M	Drop Opal / Black Metal Baffle / White Plastic Ring
NTM-46BZ	Drop Opal / Bronze Metal Baffle / Bronze Metal Ring
NTM-46CO	Drop Opal / Copper Metal Baffle / Copper Metal Ring
NTM-46N	Drop Opal / Natural Metal Baffle / Natural Metal Ring
NTM-46W	Drop Opal / White Metal Baffle / White Plastic Ring

- UL Wet Listed

Baffle Regressed Drop Opal

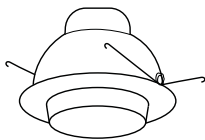

Maximum Wattage
(2) 13W-26W Quad

OD: 8"



Catalog No.	Description
NTS-24/2PL	Drop Opal / Specular Clear Reflector / White Metal Trim

- Full specular clear reflector for optimum light output
- UL Wet Listed

Reflector Drop Opal Shower



Maximum Wattage
(2) 13W-26W Quad

OD: 8"



Catalog No.	Description
NP-24	Drop Opal / White Plastic Trim
NP-24PC	Polycarbonate Drop Opal / White Plastic Trim
NT-24	Drop Opal / White Metal Trim
NT-24B	Drop Opal / Black Metal Trim
NT-24BZ	Drop Opal / Bronze Metal Trim
NT-24C	Drop Opal / Chrome Metal Trim
NT-24CO	Drop Opal / Copper Metal Trim
NT-24G	Drop Opal / Gold Metal Trim
NT-24N	Drop Opal / Natural Metal Metal Trim

- UL Wet Listed

Drop Opal Shower Trim



CC Custom Combo: Available with custom combinations of reflector and plastic and metal ring finish. See pages 38-39 for details.
Available Ring Finishes: B-Black, BZ-Bronze, C-Chrome, CO-Copper, G-Gold, N-Natural Metal, W-White



COMPACT FLUORESCENT RECESSED 6" IC Sloped Ceiling Double Wall Housing (Higher Wattage)

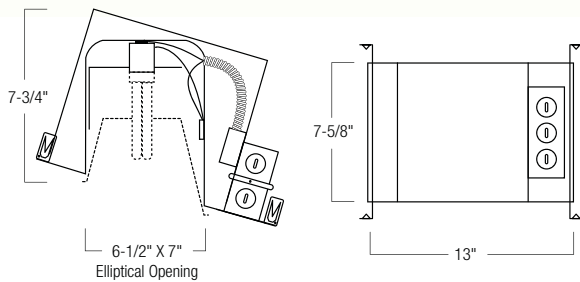

NHPIC-926/32EAT SERIES

CATALOG. NO.	LAMP(S)	WATTS	VOLTAGE	DIMMING
ELECTRONIC				
NHPIC-926/32EAT	1 Q/T	26-32	120-277	DAS, D10, MX1, MX2, M7, L51, L52, L11, L12



Nora's IC Double Wall Housing for high wattage fluorescent's offers a clear path of unobstructed light from a maximum 6/12 pitch (22-1/2 degrees) ceiling to any floor or surface or 12/12 pitch (45 degrees) with designated trims. . Double wall construction allows the use of a larger CFL light source to deliver more illumination and provide a better finished appearance. Rated for direct contact with insulation and adjacent ceiling structures. Quick and easy to install and accepts a variety of trims.

Maximum Slope Angle:

Pitch: 12/12; Angle: 45° (with designated trim)

Ballast:

26W-32W 120V-277V Electronic

Lamp Types:

26W Electronic 4-Pin Quad G24Q base
26W – 32W Electronic 4-Pin Triple Tube GX24Q base

Dimming Options: Variety of Electronic Dimming ballast options are available. Please match appropriate fixture with compatible compact fluorescent dimming control. See pages 70-71.

Emergency Option: 90-minute battery back-up must be ordered and installed as a self contained kit set apart from the frame-in. See page 746.

Fuse Option: 2A Fuse may be added to any compact fluorescent frame-in — Add suffix FS.

Minimum Clearances: IC housings are rated for direct contact and do not have any minimum clearance requirements

New Construction Bar Hangers: Bar hangers are adjustable from 13-5/8" to 24-1/2" and can be repositioned 90 degrees. Bar hangers are slotted for T-bar installation.

Listing:

cULus Damp Location w/ Feed Through
cULus Wet Location (Only with designated trims)
WSEC ASTM E283 for Air Tight (AT)

COMPACT FLUORESCENT RECESSED

6" IC Sloped Ceiling New Construction Housings

Nora Lighting's family of 6" Compact Fluorescent IC new construction housings for sloped ceilings offer affordable solutions for energy savings in insulated ceiling environments. Sloped ceiling housings create a clear path of unobstructed light from a maximum 6/12 pitch (22-1/2 degrees) ceiling to any floor or surface or 12/12 pitch (45 degrees) with designated trims. Electronic configurations are Energy Star compliant. Rated for direct contact with thermal insulation and adjacent structural components, IC housings accept a wide variety of attractive finishing trims suitable for any interior. Light sources are available in warm and cool colors.

Maximum Slope Angle:

Pitch: 12/12; Angle: 45° (with designated trim)

Ballast: 13W-26W 120V-277V Electronic

Lamp Types:

13W – 26W Electronic 4-Pin Quad G24Q base
 13W – 26W Electronic 4-Pin Triple Tube GX24Q base

Dimming Options: Variety of Electronic Dimming ballast options are available. Please match appropriate fixture with compatible compact fluorescent dimming control. See pages 70-71.

Emergency Option: Emergency back-up operates lamp for a minimum of 90 minutes. Unit includes battery, charger, and test plate with indicator light. See page 183.

Fuse Option: 2A Fuse may be added to any compact fluorescent frame-in — Add suffix FS.

Minimum Clearances: IC housings are rated for direct contact and do not have any minimum clearance requirements

New Construction Bar Hangers: Bar hangers are adjustable from 13-5/8" to 24-1/2" and can be repositioned 90 degrees. Bar hangers are slotted for T-bar installation.

Listing:

cULus Damp Location w/ Feed Through
 cULus Wet Location (Only with designated trims)
 WSEC ASTM E283 for Air Tight (AT)

**NEW AIR TIGHT
 26 WATT MAX.**

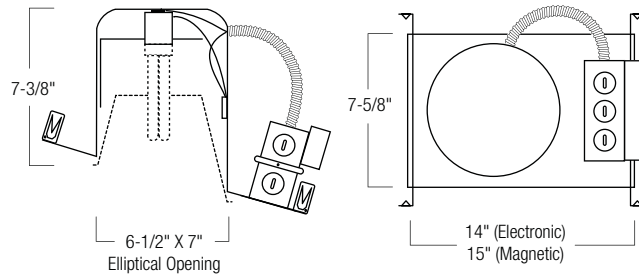

NHPIC-926 SERIES

CATALOG. NO.	LAMP(S)	WATTS	VOLTAGE	DIMMING	EMERGENCY
ELECTRONIC					
TITLE 24 ROOM NHPIC-926/13EAT	1 Q/T	13	120-277	D10, M7	EM, EM2
TITLE 24 ROOM NHPIC-926/18EAT	1 Q/T	18	120-277	D10, MX1, MX2, M7, L51, L52, L11, L12	EM, EM2
TITLE 24 ROOM NHPIC-926/26EAT	1 Q/T	26	120-277	DAS, D10, MX1, MX2, M7, L51, L52, L11, L12	EM, EM2



COMPACT FLUORESCENT RECESSED 6" IC Sloped Ceiling Remodel Housing

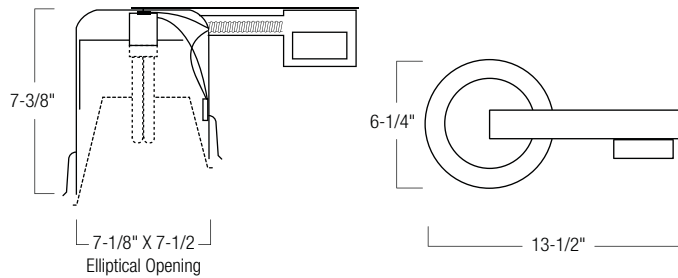

NHRPIC-926 SERIES

CATALOG. NO.	LAMP(S)	WATTS	VOLTAGE	DIMMING
ELECTRONIC				
TITLE 24 2008 NHRPIC-92613EAT	1 Q/T	13	120-277	D10, M7
TITLE 24 2008 NHRPIC-92618EAT	1 Q/T	18	120-277	D10, MX1, MX2, M7, L51, L52, L11, L12
TITLE 24 2008 NHRPIC-92626EAT	1 Q/T	26	120-277	DAS, D10, MX1, MX2, M7, L51, L52, L11, L12



Nora Lighting's family of 6" Compact Fluorescent IC remodel housings for sloped ceilings offer affordable solutions for energy savings in insulated ceiling environments. Sloped ceiling housings create a clear path of unobstructed light from a maximum 6/12 pitch (22-1/2 degrees) ceiling to any floor or surface or 12/12 pitch (45 degrees) with designated trims. Electronic configurations are Energy Star compliant. Rated for direct contact with thermal insulation and adjacent structural components, IC housings accept a wide variety of attractive finishing trims suitable for any interior. Light sources are available in warm and cool colors.

Maximum Slope Angle:

Pitch: 12/12; Angle: 45° (with designated trim)

Ballast: 13W-26W 120V-277V Electronic

Lamp Types:

13W – 26W Electronic 4-Pin Quad G24Q base
13W – 26W Electronic 4-Pin Triple Tube GX24Q base

Dimming Options: Variety of Electronic Dimming ballast options are available. Please match appropriate fixture with compatible compact fluorescent dimming control. See pages 70-71.

Emergency Option: 90-minute battery back-up must be ordered and installed as a self contained kit set apart from the frame-in. See page 746.

Fuse Option: 2A Fuse may be added to any compact fluorescent frame-in — Add suffix FS.

Minimum Clearances: IC housings are rated for direct contact and do not have any minimum clearance requirements

Remodel Installation: High tension tempered steel springs secure remodel housings evenly to ceiling; hole cutout template provided for convenience.

Listing:

cULus Damp Location w/ Feed Through
cULus Wet Location (Only with designated trims)
WSEC ASTM E283 for Air Tight (AT)

COMPACT FLUORESCENT RECESSED

6" Sloped Ceiling New Construction Housings Non-IC

Nora Lighting's family of 6" Compact Fluorescent remodel housings for sloped ceilings offer affordable solutions for energy savings. Sloped ceiling housings create a clear path of unobstructed light from a maximum 6/12 pitch (22-1/2 degrees) ceiling to any floor or surface or 12/12 pitch (45 degrees) with designated trims. Electronic configurations are Energy Star compliant. A wide variety of attractive finishing trims suitable for any interior is available. Light sources are available in warm or cool colors.

Maximum Slope Angle:

Pitch: 12/12; Angle: 45° (with designated trim)

Ballast: 13W-42W 120V-277V Electronic

Lamp Types:

13W – 26W Electronic 4-Pin Quad G24Q base
13W – 42W Electronic 4-Pin Triple Tube G24Q base

Dimming Options: Variety of Electronic Dimming ballast options are available. Please match appropriate fixture with compatible compact fluorescent dimming control. See pages 70-71.

Emergency Option: Emergency back-up operates lamp for a minimum of 90 minutes. Unit includes battery, charger, and test plate with indicator light. See page 183.

Fuse Option: 2A Fuse may be added to any compact fluorescent frame-in — Add suffix FS.

Minimum Clearances: Non-IC housings require minimum clearances of 3" from thermal insulation and 1/2" from adjacent building components.

New Construction: Bar hangers are adjustable from 13-5/8" to 24-1/2" and can be repositioned 90 degrees. Bar hangers are slotted for T-bar installation.

Listing:

cULus Damp Location w/ Feed Through;
cULus Wet Location (Only with designated trims)

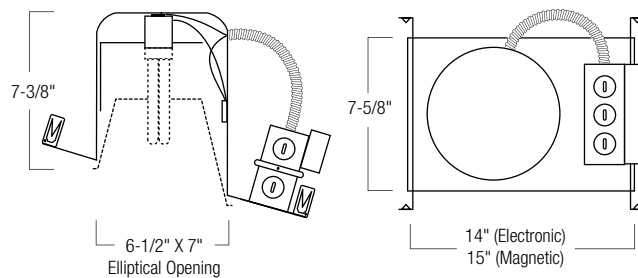

NHP-926 SERIES

CATALOG. NO.	LAMP	WATTS	VOLTAGE	DIMMING	EMERGENCY
ELECTRONIC					
NHP-926/13EL	1 Q/T	13	120-277	D10, M7	EM, EM2
NHP-926/18EL	1 Q/T	18	120-277	D10, MX1, MX2, M7, L51, L52, L11, L12	EM, EM2
NHP-926/2642EL	1 Q/T	26-42	120-277	DAS, D10, MX1, MX2, M7, L51, L52, L11, L12	EM, EM2



COMPACT FLUORESCENT RECESSED 6" Sloped Ceiling Remodel Housing Non-IC

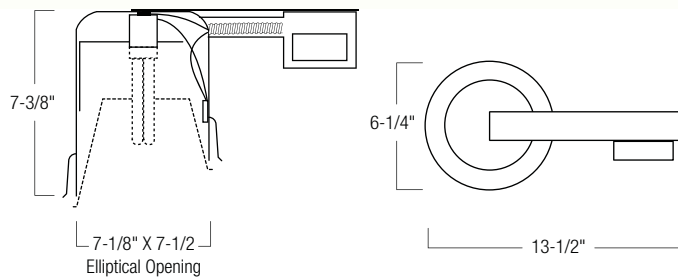

NHRP-926 SERIES

CATALOG. NO.	LAMP	WATTS	VOLTAGE	DIMMING
ELECTRONIC				
NHRP-926/13EL	1 Q/T	13	120-277	D10, M7
NHRP-926/18EL	1 Q/T	18	120-277	D10, MX1, MX2, M7, L51, L52, L11, L12
NHRP-926/2642EL	1 Q/T	26-42	120-277	DAS, D10, MX1, MX2, M7, L51, L52, L11, L12



Nora Lighting's family of 6" Compact Fluorescent remodel housings for sloped ceilings offer affordable solutions for energy savings in existing drywall ceilings with no above access. Sloped ceiling housings create a clear path of unobstructed light from a maximum 6/12 pitch (22-1/2 degrees) ceiling to any floor or surface or 12/12 pitch (45 degrees) with designated trims. Electronic configurations are Energy Star compliant. A wide variety of attractive finishing trims suitable for any interior is available. Light sources are available in warm or cool colors.

Maximum Slope Angle:

Pitch: 12/12; Angle: 45° (with designated trim)

Ballast: 13W-42W 120V-277V Electronic

Lamp Types:

13W – 26W Electronic 4-Pin Quad G24Q base
13W – 42W Electronic 4-Pin Triple Tube GX24Q base

Dimming Options: Variety of Electronic Dimming ballast options are available. Please match appropriate fixture with compatible compact fluorescent dimming control. See pages 70-71.

Emergency Option: 90-minute battery back-up must be ordered and installed as a self contained kit set apart from the frame-in. See page 746.

Fuse Option: 2A Fuse may be added to any compact fluorescent frame-in — Add suffix FS.

Minimum Clearances: Non-IC housings require minimum clearances of 3" from thermal insulation and 1/2" from adjacent building components.

Remodel Installation: High tension tempered steel springs secure remodel housings evenly to ceiling; hole cutout template provided for convenience.

Listing:

cULus Damp Location w/ Feed Through;
cULus Wet Location (Only with designated trims)

COMPACT FLUORESCENT RECESSED

6" Slope Trims

Sloped Baffle



Catalog No.	Description
NTM-615B	Black Metal Baffle / White Flange
NTM-615W	White Metal Baffle / White Flange

- Maximum Wattage: IC & Non-IC Housing: 13W-26W Quad
Non-IC Housing: 13W-42W Triple Tube
IC Housing: 13W-32W Triple Tube

Maximum Wattage
See Description
OD: 7-1/2" x 7-7/8"

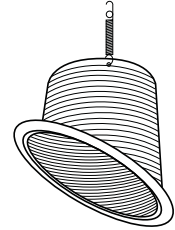

45° Super Sloped Baffle

NEW!
SUPER SLOPE



Catalog No.	Description
NTM-615/45B	45° Black Metal Baffle / White Flange
NTM-615/45W	45° White Metal Baffle / White Flange

- Maximum Wattage: IC & Non-IC Housing: 13W-26W Quad
Non-IC Housing: 13W-42W Triple Tube
IC Housing: 13W-32W Triple Tube

Maximum Wattage
See Description
OD: 7-1/2" x 7-7/8"

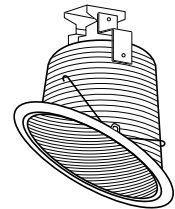

Sloped Phenolic Baffle



Catalog No.	Description
NTP-614B	Black Phenolic Baffle / White Flange
NTP-614W	White Phenolic Baffle / White Flange

- Maximum Wattage: IC & Non-IC Housing: 13W-26W Quad
Non-IC Housing: 13W-42W Triple Tube
IC Housing: 13W-32W Triple Tube

Maximum Wattage
See Description
OD: 7-1/2" x 7-7/8"

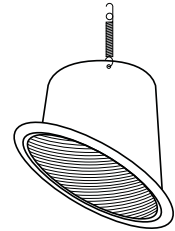

45° Super Sloped Phenolic Baffle

NEW!
SUPER SLOPE



Catalog No.	Description
NTP-614/45B	45° Black Phenolic Baffle / White Flange
NTP-615/45W	45° White Phenolic Baffle / White Flange

- Maximum Wattage: IC & Non-IC Housing: 13W-26W Quad
Non-IC Housing: 13W-42W Triple Tube
IC Housing: 13W-32W Triple Tube

Maximum Wattage
See Description
OD: 7-1/2" x 7-7/8"

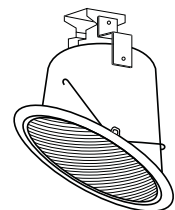

Sloped Reflector



Catalog No.	Description
NTS-615B	Specular Black Reflector / White Ring
NTS-615C	Specular Clear Reflector / White Ring
NTS-615G	Specular Gold Reflector / White Ring
NTS-615W	Specular White Reflector / White Ring

- Maximum Wattage: IC & Non-IC Housing: 13W-26W Quad
Non-IC Housing: 13W-42W Triple Tube
IC Housing: 13W-32W Triple Tube

Maximum Wattage
See Description
OD: 7-1/2" x 7-7/8"

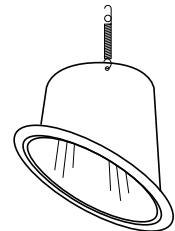

45° Super Sloped Reflector

NEW!
SUPER SLOPE



Catalog No.	Description
NTS-615/45B	45° Specular Black Reflector / White Ring
NTS-615/45C	45° Specular Clear Reflector / White Ring
NTS-615/45G	45° Specular Gold Reflector / White Ring
NTS-615/45W	45° Specular White Reflector / White Ring

- Maximum Wattage: IC & Non-IC Housing: 13W-26W Quad
Non-IC Housing: 13W-42W Triple Tube
IC Housing: 13W-32W Triple Tube

Maximum Wattage
See Description
OD: 7-1/2" x 7-7/8"

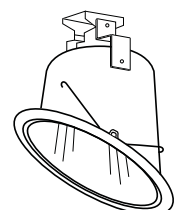

See pages 36-37 for Description of Reflector Finishes

6" SLOPE TRIMS continued

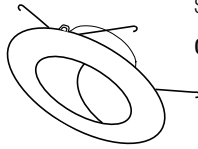

Maximum Wattage
See Description

OD: 8"

Catalog No.	Description
NT-25	White Metal Wal Wash
NT-25B	Black Metal Wall Wash

- **Maximum Wattage:** IC & Non-IC Housing: 13W-26W Quad
Non-IC Housing: 13W-42W Triple Tube
IC Housing: 13W-32W Triple Tube

Wall Wash

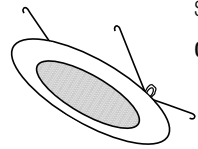

Maximum Wattage
See Description

OD: 8"



Catalog No.	Description
NP-22	Albalite Lens / White Plastic Trim
NT-22	Albalite Lens / White Metal Trim
NT-22B	Albalite Lens / Black Metal Trim
NT-22BZ	Albalite Lens / Bronze Metal Trim
NT-22C	Albalite Lens / Chrome Metal Trim
NT-22CO	Albalite Lens / Copper Metal
NT-22G	Albalite Lens / Gold Metal Trim
NT-22N	Albalite Lens / Natural Metal Trim

- UL Wet Listed
- **Maximum Wattage:** Non-IC Housing: 13W-26W Quad / Triple
IC Housing: 13W-18W Quad / Triple

Albalite Shower

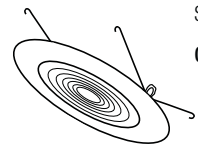

Maximum Wattage
See Description

OD: 8"



Catalog No.	Description
NP-23	Fresnel Lens / White Plastic Trim
NT-23	Fresnel Lens / White Metal Trim
NT-23B	Fresnel Lens / Black Metal Trim
NT-23BZ	Fresnel Lens / Bronze Metal Trim
NT-23C	Fresnel Lens / Chrome Metal Trim
NT-23CO	Fresnel Lens / Copper Metal Trim
NT-23G	Fresnel Lens / Gold Metal Trim
NT-23N	Fresnel Lens / Natural Metal Trim

- UL Wet Listed
- **Maximum Wattage:** Non-IC Housing: 13W-26W Quad / Triple
IC Housing: 13W-18W Quad / Triple

Fresnel Shower

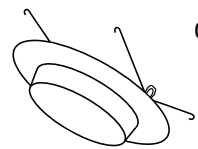
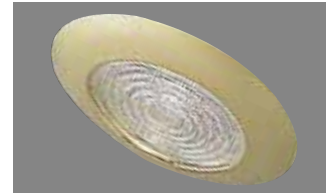

Maximum Wattage
See Description

OD: 8"



Catalog No.	Description
NP-24	Drop Opal / White Plastic Trim
NT-24	Drop Opal / White Metal Trim
NT-24B	Drop Opal / Black Metal Trim
NT-24BZ	Drop Opal / Bronze Metal Trim
NT-24C	Drop Opal / Chrome Metal Trim
NT-24CO	Drop Opal / Copper Metal Trim
NT-24G	Drop Opal / Gold Metal Trim
NT-24N	Drop Opal / Natural Metal Trim

- UL Wet Listed
- **Maximum Wattage:** Non-IC Housing: 13W-42W Quad / Triple
IC Housing: 13W-18W Quad / Triple

Drop Opal Shower



COMPACT FLUORESCENT RECESSED

6" Shallow Horizontal Light Commercial & Economy New Construction Non-IC Housing (Only 5" Deep!)

Nora Lighting's 6" shallow Compact Fluorescent new construction dual lamp housing offers affordable high-performance solutions for energy savings in applications with limited space. Electronic configurations are Energy Star compliant. A wide variety of attractive finishing trims suitable for any interior is available. Light sources are available in warm and cool colors.

Ballast: 13W-26W 120V-277V Electronic (EL)

Lamp Types:

- (1-2) 13W – 26W Electronic 4-Pin Quad G24Q base
- (1) 13W – 42W Electronic 4-Pin Triple Tube GX24Q base

Dimming Options: Variety of Electronic Dimming ballast options are available. Please match appropriate fixture with compatible compact fluorescent dimming control. See pages 70-71.

Emergency Option: Emergency back-up operates two lamps for a minimum of 90 minutes. Unit includes battery, charger, and test plate with indicator light. See page 185.

Fuse Option: 2A Fuse may be added to any compact fluorescent frame-in — Add suffix FS.

Bi-Level Switching Option: Dual or A/B switching is available on Nora dual lamp units. Two ballasts are attached to the J-box allowing separate control of each lamp to meet bi-level code or design requirements. Consult factory.

Minimum Clearances: Non-IC housings require minimum clearances of 3" from thermal insulation and 1/2" from adjacent building components.

New Construction: Bar hangers are adjustable from 13-5/8" to 24-1/2" and can be repositioned 90 degrees. Bar hangers are slotted for T-bar installation.

Listing:

cULus Damp Location w/ Feed Through;
cULus Wet Location (Only with designated trims)

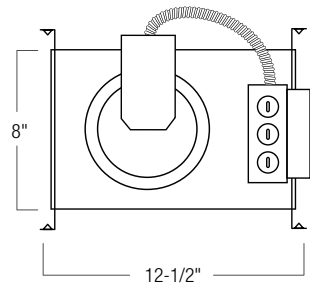
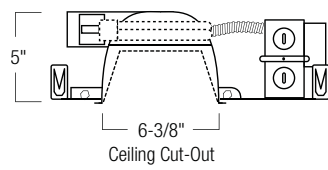

NHPH SERIES

CATALOG. NO.	LAMP(S)	WATTS	VOLTAGE	DIMMING	EMERGENCY
NHPH-113SEL	1 Q/T	13	120-277	D10, M7	EM, EM2
NHPH-118SEL	1 Q/T	18	120-277	D10, MX1, MX2, M7, L51, L52, L11, L12	EM, EM2
NHPH-2642SEL	1 Q/T	26-42	120-277	DAS, D10, MX1, MX2, M7, L51, L52, L11, L12	EM, EM2
NHPH-213SEL	2 Quad	13	120-277	D10, M7	EM, EM2
NHPH-218SEL	2 Quad	18	120-277	D10, MX1, MX2, M7, L51, L52, L11, L12	EM, EM2
NHPH-226SEL	2 Quad	26	120-277	DAS, D10, MX1, MX2, M7, L51, L52, L11, L12	EM, EM2



COMPACT FLUORESCENT RECESSED

6" Shallow Horizontal Light Commercial & Economy Remodel Non-IC Housing (Only 5" Deep!)

NEW!



Nora Lighting's 6" shallow Compact Fluorescent remodel dual lamp housing offers affordable high-performance solutions for energy savings in applications with limited space. Electronic configurations are Energy Star compliant. A wide variety of attractive finishing trims suitable for any interior is available. Light sources are available in warm and cool colors.

Ballast: 13W–26W 120V-277V Electronic (EL)

Lamp Types:

(1-2) 13W – 26W Electronic 4-Pin Quad G24Q base

(1) 13W – 42W Electronic 4-Pin Triple Tube GX24Q base

Dimming Options: Variety of Electronic Dimming ballast options are available. Please match appropriate fixture with compatible compact fluorescent dimming control. See pages 70-71.

Emergency Option: 90-minute battery back-up must be ordered and installed as a self contained kit set apart from the frame-in. See page 746.

Fuse Option: 2A Fuse may be added to any compact fluorescent frame-in — Add suffix FS.

Minimum Clearances: Non-IC housings require minimum clearances of 3" from thermal insulation and 1/2" from adjacent building components.

Remodel Installation: High tension tempered steel springs secure remodel housings evenly to ceiling; hole cutout template provided for convenience.

Listing:
cULus Damp Location w/ Feed Through;
cULus Wet Location (Only with designated trims)

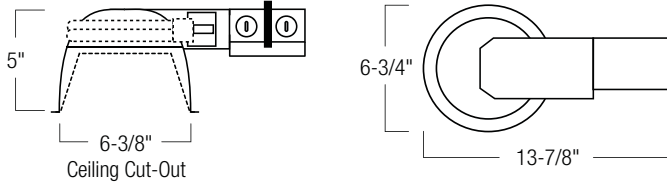

NHRPH SERIES

CATALOG. NO.	LAMP(S)	WATTS	VOLTAGE	DIMMING
NHRPH-113SEL	1 Q/T	13	120-277	D10, M7
NHRPH-118SEL	1 Q/T	18	120-277	D10, MX1, MX2, M7, L51, L52, L11, L12
NHRPH-2642SEL	1 Q/T	26-42	120-277	DAS, D10, MX1, MX2, M7, L51, L52, L11, L12
NHRPH-213SEL	2 Quad	13	120-277	D10, M7
NHRPH-218SEL	2 Quad	18	120-277	D10, MX1, MX2, M7, L51, L52, L11, L12
NHRPH-226SEL	2 Quad	26	120-277	DAS, D10, MX1, MX2, M7, L51, L52, L11, L12



COMPACT FLUORESCENT RECESSED

6" Shallow Economy Reflectors and Trims

Stepped Baffle



CC

Catalog No.	Description
NTM-40	Black Stepped Baffle / White Ring
NTM-40/OV	Black Stepped Baffle / Oversize White Ring
NTM-40/2R*	Black Stepped Baffle / Two White Rings*
NTM-41	White Stepped Baffle / White Ring
NTM-41/OV	White Stepped Baffle / Oversize White Ring
NTM-41/2R*	White Stepped Baffle / Two White Rings*

- **UL Classified** for use with other manufacturer's housings
- * **Includes:** (1) standard and (1) oversize ring

Maximum Wattage
(1-2) 13W-26W Quad
(1) 26W-42W Triple

OD: 7"

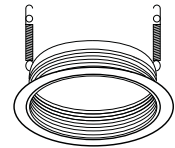

Stepped Baffle with Ring

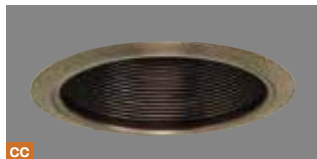

CC

Catalog No.	Description
NTM-40B	Black Stepped Baffle / Black Ring
NTM-40C	Black Stepped Baffle / Chrome Ring
NTM-40G	Black Stepped Baffle / Gold Ring
NTM-40N	Black Stepped Baffle / Natural Metal Ring
NTM-41BZ	Bronze Stepped Baffle / Bronze Ring
NTM-41C	White Stepped Baffle / Chrome Ring
NTM-41CO	Copper Stepped Baffle / Copper Ring
NTM-41G	White Stepped Baffle / Gold Ring
NTM-41N	Natural Metal Stepped Baffle / Natural Ring

- **UL Classified** for use with other manufacturer's housings

Maximum Wattage
(1-2) 13W-26W Quad
(1) 26W-42W Triple

OD: 7"

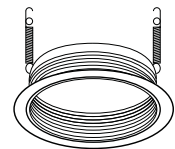

Phenolic Stepped Baffle



CC

Catalog No.	Description
NTP-40	Black Phenolic Stepped Baffle / White Ring
NTP-41	White Phenolic Stepped Baffle / White Ring

Maximum Wattage
(1-2) 13W-26W Quad
(1) 26W-42W Triple

OD: 7"

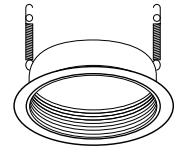

Reflector



CC

Catalog No.	Description
NTS-40	Specular Gold Reflector / White Plastic Ring
NTS-40G	Specular Gold Reflector / Gold Ring
NTS-41	Specular Clear Reflector / White Plastic Ring
NTS-41C	Specular Clear Reflector / Chrome Ring
NTS-41HZ	Haze Reflector / White Plastic Ring
NTS-42	Specular Black Reflector / White Plastic Ring
NTS-42B	Specular Black Reflector / Black Ring
NTS-42CO	Specular Black Reflector / Copper Ring
NTS-42G	Specular Black Reflector / Gold Ring
NTS-43	Specular White Reflector / White Plastic Ring

Maximum Wattage
(1-2) 13W-26W Quad
(1) 26W-42W Triple

OD: 7"



Cross Louver

NEW!



CC

Catalog No.	Description
NTS-67C	Specular Clear Reflector / Specular Clear Louver / White Ring
NTS-67G	Specular Gold Reflector / Specular Gold Louver / White Ring

Maximum Wattage
(1-2) 13W-26W Quad
(1) 26W-42W Triple

OD: 7"

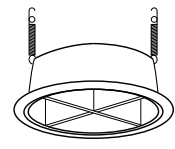

CC Custom Combo: Available with custom combinations of reflector and plastic and metal ring finish. See pages 38-39 for details.

Available Ring Finishes: B-Black, BZ-Bronze, C-Chrome, CO-Copper, G-Gold, N-Natural Metal, W-White

See pages 36-37 for Description of Reflector Finishes

6" SHALLOW ECONOMY REFLECTORS AND TRIMS continued

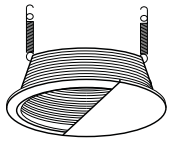

Maximum Wattage
 (1-2) 13W-26W Quad
 (1) 26W-42W Triple
OD: 7"

Catalog No.	Description
NT-45	Wall Wash / Black Baffle / White Eyelid and Ring
NT-46	Wall Wash / White Baffle / White Eyelid and Ring

Baffle Wall Wash

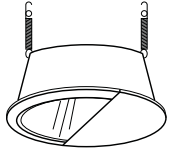
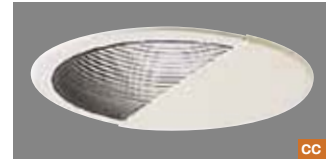

Maximum Wattage
 (1-2) 13W-26W Quad
 (1) 26W-42W Triple
OD: 7"

Catalog No.	Description
NTS-35B	Wall Wash / Specular Black Reflector / White Eyelid and Ring
NTS-35C	Wall Wash / Specular Clear Reflector / White Eyelid and Ring
NTS-35G	Wall Wash / Specular Gold Reflector / White Eyelid and Ring
NTS-35W	Wall Wash / Specular White Reflector / White Eyelid and Ring

Reflector Wall Wash

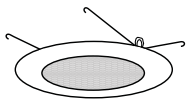

Maximum Wattage
 (1-2) 13W-26W Quad
 (1) 26W-42W Triple
OD: 8"



Catalog No.	Description
NP-22	Albalite Lens / White Plastic Trim
NT-22	Albalite Lens / White Metal Trim
NT-22B	Albalite Lens / Black Metal Trim
NT-22BZ	Albalite Lens / Bronze Metal Trim
NT-22C	Albalite Lens / Chrome Metal Trim
NT-22CO	Albalite Lens / Copper Metal Trim
NT-22G	Albalite Lens / Gold Metal Trim
NT-22N	Albalite Lens / Natural Metal Trim

Albalite Shower



- UL Classified for use with other manufacturer's housings
- UL Wet Listed

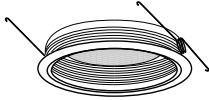

Maximum Wattage
 (1-2) 13W-26W Quad
 (1) 26W-42W Triple
OD: 8"



Catalog No.	Description
NTM-42	Albalite Lens / Black Baffle / White Plastic Ring
NTM-42BZ	Albalite Lens / Bronze Baffle / Bronze Metal Ring
NTM-42CO	Albalite Lens / Copper Baffle / Copper Metal Ring
NTM-42N	Albalite Lens / Natural Metal Baffle / Nat Metal Ring
NTM-42W	Albalite Lens / White Baffle / White Plastic Ring

Regressed Albalite Lens with Baffle

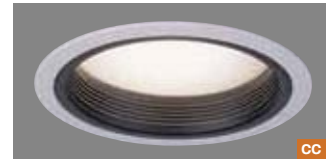

- UL Wet Listed



Maximum Wattage
 (1-2) 13W-26W Quad
 (1) 26W-42W Triple
OD: 8"



Catalog No.	Description
NP-23	Fresnel Lens / White Plastic Trim
NT-23	Fresnel Lens / White Metal Trim
NT-23B	Fresnel Lens / Black Metal Trim
NT-23BZ	Fresnel Lens / Bronze Metal Trim
NT-23C	Fresnel Lens / Chrome Metal Trim
NT-23CO	Fresnel Lens / Copper Metal Trim
NT-23G	Fresnel Lens / Gold Metal Trim
NT-23N	Fresnel Lens / Natural Metal Trim

Fresnel Shower



- UL Wet Listed

CC Custom Combo: Available with custom combinations of reflector and plastic and metal ring finish. See pages 38-39 for details.
 Available Ring Finishes: B-Black, BZ-Bronze, C-Chrome, CO-Copper, G-Gold, N-Natural Metal, W-White

6" SHALLOW ECONOMY REFLECTORS AND TRIMS continued

Regressed Fresnel Lens with Baffle

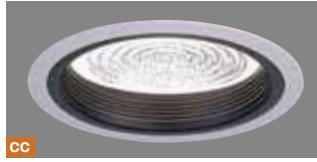

Catalog No.	Description
NTM-43	Fresnel Lens / Black Baffle / White Plastic Ring
NTM-43BZ	Fresnel Lens / Bronze Baffle / Bronze Metal Ring
NTM-43CO	Fresnel Lens / Copper Baffle / Copper Metal Ring
NTM-43N	Fresnel Lens / Natural Metal Baffle / Natural Ring
NTM-43W	Fresnel Lens / White Baffle / White Plastic Ring

- UL Wet Listed

Maximum Lamp:
(1-2) 13W-26W Quad
(1) 26W-42W Triple

OD: 8"

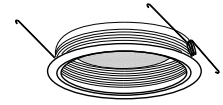

Drop Opal



Catalog No.	Description
NP-24	Drop Opal / White Plastic Trim
NP-24PC	Polycarbonate Drop Opal / White Plastic Trim
NT-24	Drop Opal / White Metal Trim
NT-24B	Drop Opal / Black Metal Trim
NT-24BZ	Drop Opal / Bronze Metal Trim
NT-24C	Drop Opal / Chrome Metal Trim
NT-24CO	Drop Opal / Copper Metal Trim
NT-24G	Drop Opal / Gold Metal Trim
NT-24N	Drop Opal / Natural Metal Trim

- UL Wet Listed

Maximum Lamp:
(1-2) 13W-26W Quad
(1) 26W-42W Triple

OD: 8"



Regressed Drop Opal Lens w/Baffle



Catalog No.	Description
NTM-46M	Drop Opal / Black Metal Baffle / White Plastic Ring
NTM-46BZ	Drop Opal / Bronze Baffle / Bronze Metal Ring
NTM-46CO	Drop Opal / Copper Baffle / Copper Metal Ring
NTM-46N	Drop Opal / Natural Metal Baffle / Natural Metal Ring
NTM-46W	Drop Opal / White Baffle / White Plastic Ring

- UL Wet Listed

Maximum Lamp:
(1-2) 13W-26W Quad
(1) 26W-42W Triple

OD: 8"

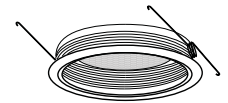

CC Custom Combo: Available with custom combinations of reflector and plastic and metal ring finish. See pages 38-39 for details.
Available Ring Finishes: B-Black, BZ-Bronze, C-Chrome, CO-Copper, G-Gold, N-Natural Metal, W-White



COMPACT FLUORESCENT RECESSED

5" IC AT Economy New Construction Housings

Nora Lighting's 5" Compact Fluorescent IC new construction housings offer affordable, decorative solutions for energy savings in insulated ceiling environments. Air-tight construction reduces the flow of air through the ceiling, saving energy. Electronic air-tight configurations meet the strict CA Title 24 Energy Code requirements and are Energy Star compliant. Rated for direct contact with thermal insulation and adjacent structural components, IC housings accept a wide variety of attractive finishing trims suitable for any interior. Light sources are available in warm and cool colors.

Ballast Types:

13W-26W 120V Electronic (ELAT)
13W-26W 120V-277V Electronic (ATE2)
13W 120V Magnetic (QAT).

Lamp Types:

13W – 26W Electronic 4-Pin Quad G24Q base
13W – 26W Electronic 4-Pin Triple Tube GX24Q base
13W Magnetic 2-Pin Quad

Dimming Options: Variety of Electronic Dimming ballast options are available. Please match appropriate fixture with compatible compact fluorescent dimming control. See pages 70-71.

Emergency Option: Emergency back-up operates one lamp for a minimum of 90 minutes. Unit includes battery, charger, and test plate with indicator light. See page 183.

Fuse Option: 2A Fuse may be added to any compact fluorescent frame-in — Add suffix FS.

NEW!

Socket: New Patent Pending Convertible Socket. Socket can be converted from fixed to floating without tools.

Minimum Clearances: IC housings are rated for direct contact and do not have any minimum clearance requirements

New Construction: Bar hangers are adjustable from 13-5/8" to 24-1/2" and can be repositioned 90 degrees. Bar hangers are slotted for T-bar installation.

Listing:

cULus Damp Location w/ Feed Through;
cULus Wet Location (Only with designated trims)



Fire Rated Enclosure - see page 379

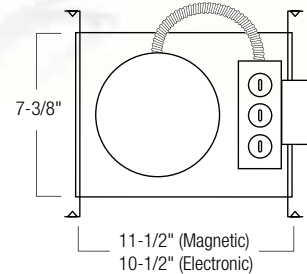
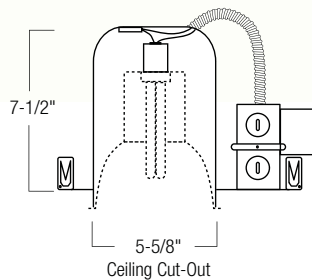

NHPIC-5 SERIES

CATALOG. NO.	LAMP(S)	WATTS	VOLTAGE	DIMMING	EMERGENCY
ELECTRONIC					
TITLE 24 NHPIC-513ELAT	1 Q/T	13	120	D10, M7	EM, EM2
TITLE 24 NHPIC-513ATE2	1 Q/T	13	120-277	D10, M7	EM, EM2
TITLE 24 NHPIC-518ELAT	1 Q/T	18	120	D10, MX1, M7, L51, L11	EM, EM2
TITLE 24 NHPIC-518ATE2	1 Q/T	18	120-277	D10, MX2, M7, L52, L12	EM, EM2
TITLE 24 NHPIC-526ELAT	1 Q/T	26	120	DAS, D10, MX1, M7, L51, L11	EM, EM2
TITLE 24 NHPIC-526ATE2	1 Q/T	26	120-277	D10, MX2, M7, L52, L12	EM, EM2
MAGNETIC *Magnetic Ballast is not Energy Star Qualified					
NHPIC-501QAT13*	1 Q	13	120	N/A	EM, EM2



COMPACT FLUORESCENT RECESSED 5" IC AT Economy Remodel Housing

NEW CONVERTIBLE SOCKET!

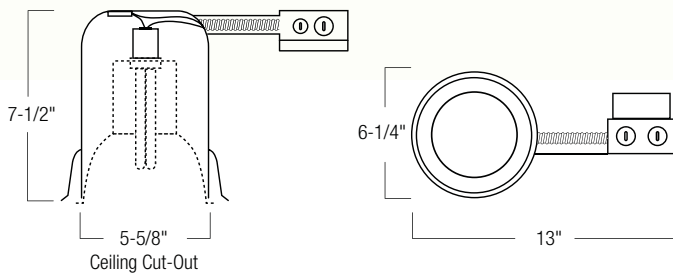

Nora Lighting's 5" Compact Fluorescent IC remodel housings offer affordable solutions for energy savings in existing insulated ceiling environments with no above access. Air-tight construction reduces the flow of air through the ceiling, saving energy. Electronic air-tight configurations meet the strict CA Title 24 Energy Code requirements and are Energy Star compliant. Rated for direct contact with thermal insulation and adjacent structural components, IC housings accept a wide variety of attractive finishing trims suitable for any interior. Light sources are available in warm and cool colors.

Ballast Types:

13W-26W 120V Electronic (ELAT)
13W-26W 120V-277V Electronic (ATE2)
13W 120V Magnetic (AT).

Lamp Types:

13W – 26W Electronic 4-Pin Quad G24Q base
13W – 26W Electronic 4-Pin Triple Tube GX24Q base
13W Magnetic 2-Pin Quad

Dimming Options: Variety of Electronic Dimming ballast options are available. Please match appropriate fixture with compatible compact fluorescent dimming control. See pages 70-71.

Emergency Option: 90-minute battery back-up must be ordered and installed as a self contained kit set apart from the frame-in. See page 746.

Fuse Option: 2A Fuse may be added to any compact fluorescent frame-in — Add suffix FS.

NEW! **Socket:** New Patent Pending Convertible Socket. Socket can be converted from fixed to floating without tools.

Minimum Clearances: IC housings are rated for direct contact and do not have any minimum clearance requirements

Remodel Installation: High tension tempered steel springs secure remodel housings evenly to ceiling; hole cutout template provided for convenience.

Listing:
cULus Damp Location w/ Feed Through;
cULus Wet Location (Only with designated trims)

NHPIC-5 SERIES

CATALOG. NO.	LAMP(S)	WATTS	VOLTAGE	DIMMING
ELECTRONIC				
TITLE 24 NHRPIC-513ELAT	1 Q/T	13	120	D10, M7
TITLE 24 NHRPIC-513ATE2	1 Q/T	13	120-277	D10, M7
TITLE 24 NHRPIC-518ELAT	1 Q/T	18	120	D10, MX1, M7, L51, L11
TITLE 24 NHRPIC-518ATE2	1 Q/T	18	120-277	D10, MX2, M7, L52, L12
TITLE 24 NHRPIC-526ELAT	1 Q/T	26	120	DAS, D10, MX1, M7, L51, L11
TITLE 24 NHRPIC-526ATE2	1 Q/T	26	120-277	D10, MX2, M7, L52, L12
MAGNETIC *Magnetic Ballast is not Energy Star Qualified				
NHRPIC-504AT13*	1 Q	13	120	N/A



COMPACT FLUORESCENT RECESSED

5" Economy New Construction Housings

Nora Lighting's 5" Compact Fluorescent new construction housings offer affordable solutions for energy savings combined with a smaller decorative profile. Electronic new construction configurations are Energy Star compliant. A wide variety of attractive finishing trims suitable for any interior is available. Light sources are available in warm or cool colors.

Ballast Types:

13W-18W 120V-277V Electronic (EL)
13W 120V Magnetic (M).

Lamp Types:

13W – 18W Electronic 4-Pin Quad G24Q base
13W – 18W Electronic 4-Pin Triple Tube GX24Q base
13W Magnetic 2-Pin Quad

Dimming Options: Variety of Electronic Dimming ballast options are available. Please match appropriate fixture with compatible compact fluorescent dimming control. See pages 70-71.

Emergency Option: Emergency back-up operates one lamp for a minimum of 90 minutes. Unit includes battery, charger, and test plate with indicator light. See page 183.

Fuse Option: 2A Fuse may be added to any compact fluorescent frame-in — Add suffix FS.

NEW! **Socket:** New Patent Pending Convertible Socket. Socket can be converted from fixed to floating without tools.

Minimum Clearances: Non-IC housings require minimum clearances of 3" from thermal insulation and 1/2" from adjacent building components.

New Construction: Bar hangers are adjustable from 13-5/8" to 24-1/2" and can be repositioned 90 degrees. Bar hangers are slotted for T-bar installation.

Listing:

cULus Damp Location w/ Feed Through;
cULus Wet Location (Only with designated trims)

NEW CONVERTIBLE SOCKET!

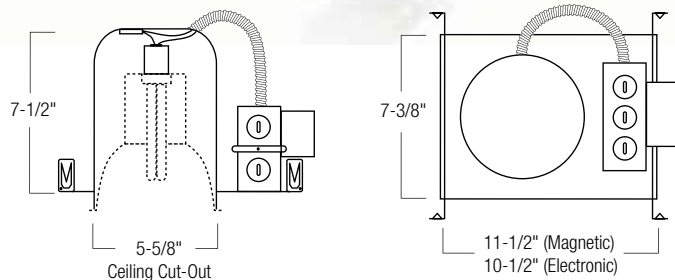

NHP-501 SERIES

CATALOG. NO.	LAMP(S)	WATTS	VOLTAGE	DIMMING	EMERGENCY
ELECTRONIC					
NHP-501/13EL	1 Q/T	13	120-277	D10, M7	EM, EM2
NHP-501/18EL	1 Q/T	18	120-277	D10, MX1, MX2, M7, L51, L52, L11, L12	EM, EM2
MAGNETIC *Magnetic Ballast is not Energy Star Qualified					
NHP-501/13*	1 Q	13	120	N/A	EM, EM2



COMPACT FLUORESCENT RECESSED 5" Economy Remodel Housing

NEW CONVERTIBLE SOCKET!



Nora Lighting's 5" Compact Fluorescent remodel housings offer affordable solutions for energy savings in existing drywall ceilings with no above access combined with a smaller decorative profile. Electronic configurations are Energy Star compliant. A wide variety of attractive finishing trims suitable for any interior is available. Light sources are available in warm and cool colors.

Ballast Types:

13W-18W 120V-277V Electronic (EL)
13W 120V Magnetic (M).

Lamp Types:

13W – 18W Electronic 4-Pin Quad G24Q base
13W – 18W Electronic 4-Pin Triple Tube
GX24Q base
13W Magnetic 2-Pin Quad

Dimming Options: Variety of Electronic Dimming ballast options are available. Please match appropriate fixture with compatible compact fluorescent dimming control. See pages 70-71.

Emergency Option: 90-minute battery back-up must be ordered and installed as a self contained kit set apart from the frame-in. See page 746.

Fuse Option: 2A Fuse may be added to any compact fluorescent frame-in — Add suffix FS.

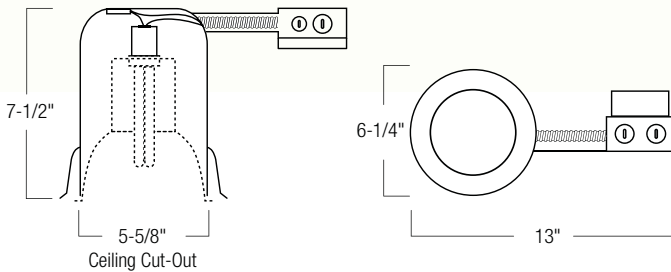

NHRP-504 SERIES

CATALOG. NO.	LAMP(S)	WATTS	VOLTAGE	DIMMING
ELECTRONIC				
NHRP-504/13EL	1 Q/T	13	120-277	D10, M7
NHRP-504/18EL	1 Q/T	18	120-277	D10, MX1, MX2, M7, L51, L52, L11, L12
MAGNETIC *Magnetic Ballast is not Energy Star Qualified				
NHRP-504/13*	1 Q	13	120	N/A

NEW! Socket: New Patent Pending Convertible Socket. Socket can be converted from fixed to floating without tools.

Minimum Clearances: Non-IC housings require minimum clearances of 3" from thermal insulation and 1/2" from adjacent building components.

Remodel Installation: High tension tempered steel springs secure remodel housings evenly to ceiling; hole cutout template provided for convenience.

Listing:
cULus Damp Location w/ Feed Through;
cULus Wet Location (Only with designated trims)



COMPACT FLUORESCENT RECESSED

5" Economy CF Reflectors and Trims

Baffle Splay

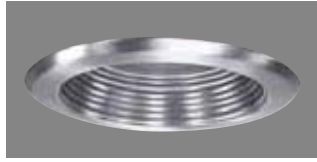

Catalog No.	Description
NT-5001B	Black Aluminum Baffle / White Flange
NT-5001BZ	Bronze Aluminum Baffle / Bronze Flange
NT-5001CO	Copper Aluminum Baffle / Copper Flange
NT-5001N	Natural Metal Aluminum Baffle / Natural Flange
NT-5001W	White Aluminum Baffle / White Flange
NT-5001MW	White Metal Baffle / White Flange

Maximum Wattage
 (1) 13W-26W Quad
 (1) 13W-26W Triple Tube
OD: 6-1/2"

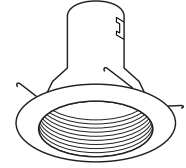

Airtight Cone Baffle



Catalog No.	Description
NTM-513B	Black Aluminum Baffle / White Flange
NTM-513W	White Aluminum Baffle / White Flange
NTM-513WM	White Metal Baffle / White Flange

Maximum Wattage
 (1) 13W-26W Quad
 (1) 13W-26W Triple Tube
OD: 6-1/2"

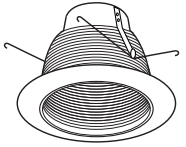

Cone Reflector with Baffle

NEW!



CC

Catalog No.	Description
NTS-5230BZ	Bronze Baffle / Specular Clear Reflector / Bronze Flange
NTS-5230CO	Copper Baffle / Specular Clear Reflector / Copper Flange
NTS-5230N	Natural Metal Baffle / Specular Clear Reflector / Natural Metal Flange
NTS-5230W	White Baffle / Specular Clear Reflector / White Flange

Maximum Wattage
 (1) 13W-26W Quad
 (1) 13W-26W Triple Tube
OD: 6-1/2"

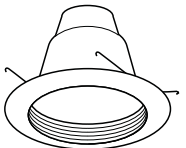

Cone Reflector

NEW!



CC

Catalog No.	Description
NTS-5231B	Specular Black Reflector / White Metal Ring
NTS-5231BZ	Bronze Reflector / Bronze Metal Ring
NTS-5231C	Specular Clear Reflector / White Metal Ring
NTS-5231CO	Copper Reflector / Copper Metal Ring
NTS-5231G	Specular Gold Reflector / White Metal Ring
NTS-5231HZ	Haze Reflector / White Metal Ring
NTS-5231N	Natural Metal Reflector / Natural Metal Ring
NTS-5231W	Specular White Reflector / White Metal Ring

Maximum Wattage
 (1) 13W-26W Quad
 (1) 13W-26W Triple Tube
OD: 6-1/2"

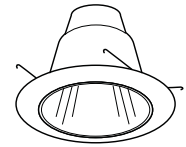

Reflector Regressed Albalite Lens Shower Trim with Baffle

NEW!



Catalog No.	Description
NTS-5242B	Albalite Lens / Black Baffle / White Flange
NTS-5242BZ	Albalite Lens / Bronze Baffle / Bronze Flange
NTS-5242C	Albalite Lens / Chrome Baffle / Chrome Flange
NTS-5242CO	Albalite Lens / Copper Baffle / Copper Flange
NTS-5242G	Albalite Lens / Gold Baffle / Gold Flange
NTS-5242N	Albalite Lens / Natural Metal Baffle / Natural Metal Flange
NTS-5242W	Albalite Lens / White Baffle / White Flange

Maximum Wattage
 (1) 13W-26W Triple Tube
OD: 6-1/2"

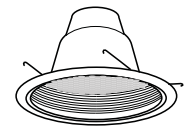

- Full specular clear reflector for optimum light output
- UL Wet Listed

CC Custom Combo: Available with custom combinations of reflector and ring finish. See pages 38-39 for details.

Available Ring Finishes: B-Black, BZ-Bronze, C-Chrome, CO-Copper, G-Gold, N-Natural Metal, W-White

See pages 36-37 for Description of Reflector Finishes

5" ECONOMY CF REFLECTORS AND TRIMS continued

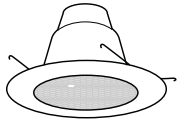

Maximum Wattage
(1) 13W-26W Triple Tube
OD: 6-1/2"



Catalog No.	Description
NTS-5222B	Albalite Lens / Spec Clear Refl / Black Metal Trim
NTS-5222BZ	Albalite Lens / Spec Clear Refl / Bronze Metal Trim
NTS-5222C	Albalite Lens / Spec Clear Refl / Chrome Metal Trim
NTS-5222CO	Albalite Lens / Spec Clear Refl / Copper Metal Trim
NTS-5222G	Albalite Lens / Spec Clear Refl / Gold Metal Trim
NTS-5222N	Albalite Lens / Spec Clear Refl / Natural Metal Trim
NTS-5222W	Albalite Lens / Spec Clear Refl / White Metal Trim

- Full specular clear reflector for optimum light output
- UL Wet Listed

Reflector Albalite Shower Trim



NEW!

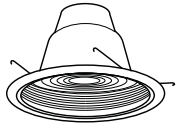

Maximum Wattage
(1) 13W-26W Triple Tube
OD: 6-1/2"



Catalog No.	Description
NTS-5243B	Fresnel Lens / Black Baffle / White Flange
NTS-5243BZ	Fresnel Lens / Bronze Baffle / Bronze Flange
NTS-5243C	Fresnel Lens / Chrome Baffle / Chrome Flange
NTS-5243CO	Fresnel Lens / Copper Baffle / Copper Flange
NTS-5243G	Fresnel Lens / Gold Baffle / Gold Flange
NTS-5243N	Fresnel Lens / Natural Metal Baffle / Natural Flange
NTS-5243W	Fresnel Lens / White Baffle / White Flange

- Full specular clear reflector for optimum light output
- UL Wet Listed

Reflector Regressed Fresnel Lens Shower Trim with Baffle



NEW!

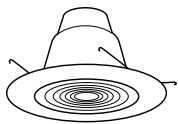

Maximum Wattage
(1) 13W-26W Triple Tube
OD: 6-1/2"



Catalog No.	Description
NTS-5223B	Fresnel Lens / Spec Clear Refl / Black Metal Trim
NTS-5223BZ	Fresnel Lens / Spec Clear Refl / Bronze Metal Trim
NTS-5223C	Fresnel Lens / Spec Clear Refl / Chrome Metal Trim
NTS-5223CO	Fresnel Lens / Spec Clear Refl / Copper Metal Trim
NTS-5223G	Fresnel Lens / Spec Clear Refl / Gold Metal Trim
NTS-5223N	Fresnel Lens / Spec Clear Refl / Natural Metal Trim
NTS-5223W	Fresnel Lens / Spec Clear Refl / White Metal Trim

- Full specular clear reflector for optimum light output
- UL Wet Listed

Reflector Fresnel Shower Trim



NEW!

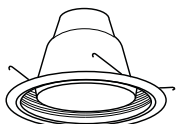

Maximum Wattage
(1) 13W-26W Triple Tube
OD: 6-1/2"



Catalog No.	Description
NTS-5244B	Drop Opal / Black Baffle / White Flange
NTS-5244BZ	Drop Opal / Bronze Baffle / Bronze Flange
NTS-5244C	Drop Opal / Chrome Baffle / Chrome Flange
NTS-5244CO	Drop Opal / Copper Baffle / Copper Flange
NTS-5244G	Drop Opal / Gold Baffle / Gold Flange
NTS-5244N	Drop Opal / Natural Metal Baffle / Natural Flange
NTS-5244W	Drop Opal / White Baffle / White Flange

- Full specular clear reflector for optimum light output
- UL Wet Listed

Reflector Regressed Drop Opal Shower Trim with Baffle



NEW!

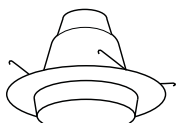

Maximum Wattage
(1) 13W-26W Triple Tube
OD: 6-1/2"



Catalog No.	Description
NTS-5224B	Drop Opal / Spec Clear Refl / Black Metal Trim
NTS-5224BZ	Drop Opal / Spec Clear Refl / Bronze Metal Trim
NTS-5224C	Drop Opal / Spec Clear Refl / Chrome Metal Trim
NTS-5224CO	Drop Opal / Spec Clear Refl / Copper Metal Trim
NTS-5224G	Drop Opal / Spec Clear Refl / Gold Metal Trim
NTS-5224N	Drop Opal / Spec Clear Refl / Natural Metal Trim
NTS-5224W	Drop Opal / Spec Clear Refl / White Metal Trim

- Full specular clear reflector for optimum light output
- UL Wet Listed

Reflector Drop Opal Shower Trim



5" ECONOMY CF REFLECTORS AND TRIMS continued

Reflector Regressed Frosted Dome Shower Trim with Baffle

NEW!



Catalog No.	Description
NTS-5245B	Frosted Dome / Black Baffle / White Flange
NTS-5245BZ	Frosted Dome / Bronze Baffle / Bronze Flange
NTS-5245C	Frosted Dome / Chrome Baffle / Chrome Flange
NTS-5245CO	Frosted Dome / Copper Baffle / Copper Flange
NTS-5245G	Frosted Dome / Gold Baffle / Gold Flange
NTS-5245N	Frosted Dome / Natural Metal Baffle / Natural Flange
NTS-5245W	Frosted Dome / White Baffle / White Flange

- Full specular clear reflector for optimum light output
- Gives the appearance of a BR30
- UL Wet Listed

Maximum Wattage

(1) 13W-26W Triple Tube

OD: 6-1/2"

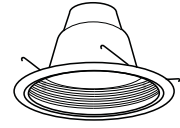

Lighting Tip: Use NTS-5245 with a warm color CFL to give the visually accepted appearance of a BR30.

Reflector Frosted Dome Shower Trim

NEW!



Catalog No.	Description
NTS-5225B	Frosted Dome / Spec Clear Refl / Black Metal Trim
NTS-5225BZ	Frosted Dome / Spec Clear Refl / Bronze Metal Trim
NTS-5225C	Frosted Dome / Spec Clear Refl / Chrome Metal Trim
NTS-5225CO	Frosted Dome / Spec Clear Refl / Copper Metal Trim
NTS-5225G	Frosted Dome / Spec Clear Refl / Gold Metal Trim
NTS-5225N	Frosted Dome / Spec Clear Refl / Natural Metal Trim
NTS-5225W	Frosted Dome / Spec Clear Refl / White Metal Trim

- Full specular clear reflector for optimum light output
- UL Wet Listed

Maximum Wattage

(1) 13W-26W Triple Tube

OD: 6-1/2"

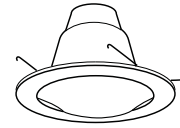

Reflector Dome Shower Trim



Catalog No.	Description
NT-5050B	Frosted Dome / Spec Clear Refl / Black Trim
NT-5050BZ	Frosted Dome / Spec Clear Refl / Bronze Trim
NT-5050CO	Frosted Dome / Spec Clear Refl / Copper Trim
NT-5050N	Frosted Dome / Spec Clear Refl / Natural Metal Trim
NT-5050W	Frosted Dome / Spec Clear Refl / White Trim

- Full specular clear reflector for optimum light output
- UL Wet Listed

Maximum Wattage

(1) 13W-26W Triple Tube

OD: 6-1/2"

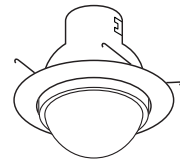

Reflector Frosted Lens Shower Trim

NEW!



Catalog No.	Description
NTS-5226B	Frosted Lens / Spec Clear Refl / Black Metal Trim
NTS-5226BZ	Frosted Lens / Spec Clear Refl / Bronze Metal Trim
NTS-5226C	Frosted Lens / Spec Clear Refl / Chrome Metal Trim
NTS-5226CO	Frosted Lens / Spec Clear Refl / Copper Metal Trim
NTS-5226G	Frosted Lens / Spec Clear Refl / Gold Metal Trim
NTS-5226N	Frosted Lens / Spec Clear Refl / Natural Metal Trim
NTS-5226W	Frosted Lens / Spec Clear Refl / White Metal Trim

- Full specular clear reflector for optimum light output
- UL Wet Listed

Maximum Wattage

(1) 13W-26W Triple Tube

OD: 6-1/2"



Reflector Regressed Frosted Flat Lens Shower Trim with Baffle

NEW!



Catalog No.	Description
NTS-5246B	Frosted Flat Lens / Black Baffle / White Flange
NTS-5246BZ	Frosted Flat Lens / Bronze Baffle / Bronze Flange
NTS-5246C	Frosted Flat Lens / Chrome Baffle / Chrome Flange
NTS-5246CO	Frosted Flat Lens / Copper Baffle / Copper Flange
NTS-5246G	Frosted Flat Lens / Gold Baffle / Gold Flange
NTS-5246N	Frosted Flat Lens / Natural Metal Baffle / Natural Metal Flange
NTS-5246W	Frosted Flat Lens / White Baffle / White Flange

- Full specular clear reflector for optimum light output
- UL Wet Listed

Maximum Wattage

(1) 13W-26W Triple Tube

OD: 6-1/2"

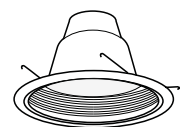

5" ECONOMY CF REFLECTORS AND TRIMS continued

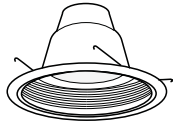

Maximum Wattage
(1) 13W-26W Triple Tube
OD: 6-1/2"



Catalog No.	Description
NTS-5247B	Center Frosted Flat Lens / Black Baffle / White Flange
NTS-5247BZ	Center Frosted Flat Lens / Bronze Baffle / Bronze Flange
NTS-5247C	Center Frosted Flat Lens / Chrome Baffle / Chrome Flange
NTS-5247CO	Center Frosted Flat Lens / Copper Baffle / Copper Flange
NTS-5247G	Center Frosted Flat Lens / Gold Baffle / Gold Flange
NTS-5247N	Center Frosted Flat Lens / Natural Metal Baffle / Natural Metal Flange
NTS-5247W	Center Frosted Flat Lens / White Baffle / White Flange

- Full specular clear reflector for optimum light output
- Frosted center lens hides CFL while clear outer lens provides greater output
- UL Wet Listed

Reflector Regressed Center Frosted Flat Lens Shower Trim with Baffle

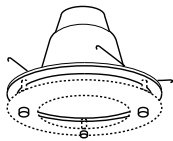

Maximum Wattage
(1) 13W-26W Quad
(1) 13W-26W Triple Tube
OD: 6-1/2"

Catalog No.	Description
NTS-5238BZ	Specular Clear Reflector / Bronze Trim
NTS-5238C	Specular Clear Reflector / Chrome Trim
NTS-5238N	Specular Clear Reflector / Natural Metal Trim
NTS-5238W	Specular Clear Reflector / White Trim

- Glass sold separately
- For a layered look, up to two pieces of glass may be used together.

Reflector for Decorative Glass

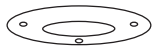
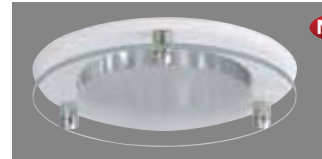

Includes:
NRA-203 Glass Hardware
• (3) Stand-offs
• (3) Cone End Caps
• (3) Flat End Caps
OD: 6-1/2"

Catalog No.	Description
NTG-5B/80	Tempered Blue / 80mm (3-1/8") Open Center
NTG-5CF	Tempered Frost Center / Clear Outer
NTG-5FC	Tempered Clear Center / Frost Outer
NTG-5HC	Tempered Clear Outer / Frost Inner / 80mm (3-1/8") Open Center

- Includes NRA-203 Glass Hardware
- 2 decorative glasses can be combined for a tiered look

Decorative Glass for NTS-5238



COMPACT FLUORESCENT RECESSED

4" IC AT High Performance New Construction Housings

Nora Lighting's family of 4" Economy Compact Fluorescent IC housings offer affordable, solutions for energy savings in insulated ceiling environments. Air-tight construction reduces the flow of air through the ceiling, saving energy. Electronic air-tight configurations meet the strict CA Title 24 Energy Code requirements and are Energy Star compliant. Rated for direct contact with thermal insulation and adjacent structural components, IC housings accept a wide variety of attractive finishing trims suitable for any interior. Light sources are available in warm and cool colors.

Ballast Types:

13W-26W 120V Electronic (ELAT)
13W-26W 120V-277V Electronic (ATE2)

Lamp Types:

13W – 26W Electronic 4-Pin Quad G24Q base
13W – 26W Electronic 4-Pin Triple Tube GX24Q base

Dimming Options: Variety of Electronic Dimming ballast options are available. Please match appropriate fixture with compatible compact fluorescent dimming control. See pages 70-71.

Emergency Option: Emergency back-up operates one lamp for a minimum of 90 minutes. Unit includes battery, charger, and test plate with indicator light. See page 183.

Minimum Clearances: IC housings are rated for direct contact and do not have any minimum clearance requirements

New Construction: Bar hangers are adjustable from 13-5/8" to 24-1/2" and can be repositioned 90 degrees. Bar hangers are slotted for T-bar installation.

Listing:





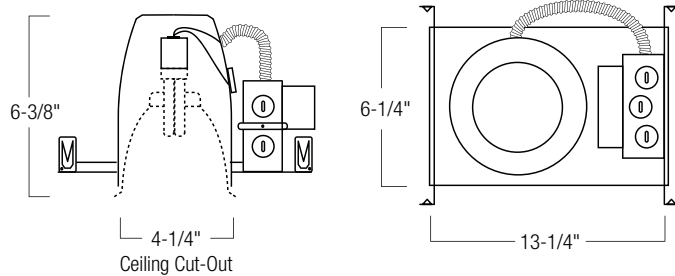

cULus Damp Location w/ Feed Through;
cULus Wet Location (Only with designated trims)
WSEC ASTM E283 for Air Tight (AT)



Fire Rated Enclosure - see page 379



NHPIC-4 SERIES

CATALOG. NO.	LAMP(S)	WATTS	VOLTAGE	DIMMING	EMERGENCY
 NHPIC-413ELAT	1 Q/T	13	120	D10, M7	EM, EM2
 NHPIC-413ATE2	1 Q/T	13	120-277	D10, M7	EM, EM2
 NHPIC-418ELAT	1 Q/T	18	120	D10, MX1, M7, L51, L11	EM, EM2
 NHPIC-418ATE2	1 Q/T	18	120-277	D10, MX2, M7, L52, L12	EM, EM2
 NHPIC-426ELAT	1 Q/T	26	120	DAS, D10, MX1, M7, L51, L11	EM, EM2
 NHPIC-426ATE2	1 Q/T	26	120-277	D10, MX2, M7, L52, L12	EM, EM2



Applies only to Electronic, Air-Tight



4" IC AT High Performance Remodel Housings



Nora Lighting's family of 4" Economy Compact Fluorescent IC remodel housings offer affordable solutions for energy savings in existing insulated ceiling environments with no above access. Air-tight construction reduces the flow of air through the ceiling, saving energy. Electronic air-tight configurations meet the strict CA Title 24 Energy Code requirements and are Energy Star compliant. Rated for direct contact with thermal insulation and adjacent structural components, IC housings accept a wide variety of attractive finishing trims suitable for any interior. Light sources are available in warm and cool colors.

Ballast Types:

- 13W-26W 120V Electronic (ELAT)
- 13W-26W 120V-277V Electronic (ATE2)

Lamp Types:

- 13W – 26W Electronic 4-Pin Quad G24Q base
- 13W – 26W Electronic 4-Pin Triple Tube GX24Q base

Dimming Options:

Variety of Electronic Dimming ballast options are available. Please match appropriate fixture with compatible compact fluorescent dimming control. See pages 70-71.

Emergency Option:

90-minute battery back-up must be ordered and installed as a self contained kit set apart from the frame-in. See page 746.

Minimum Clearances:

IC housings are rated for direct contact and do not have any minimum clearance requirements

Remodel Installation:





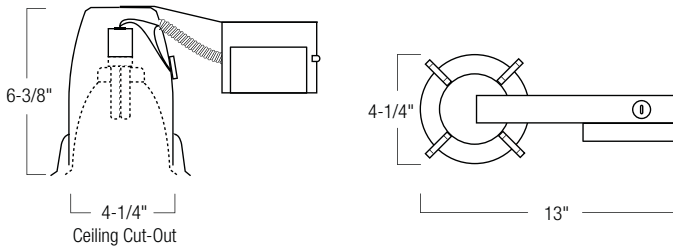

High tension tempered steel springs secure remodel housings evenly to ceiling; hole cutout template provided for convenience.

Listing:

cULus Damp Location w/ Feed Through;
cULus Wet Location (Only with designated trims)
WSEC ASTM E283 for Air Tight (AT)



NHRPIC-4 SERIES

CATALOG. NO.	LAMP(S)	WATTS	VOLTAGE	DIMMING
 NHRPIC-413ELAT	1 Q/T	13	120	D10, M7
 NHRPIC-413ATE2	1 Q/T	13	120-277	D10, M7
 NHRPIC-418ELAT	1 Q/T	18	120	D10, MX1, M7, L51, L11
 NHRPIC-418ATE2	1 Q/T	18	120-277	D10, MX2, M7, L52, L12
 NHRPIC-426ELAT	1 Q/T	26	120	DAS, D10, MX1, M7, L51, L11
 NHRPIC-426ATE2	1 Q/T	26	120-277	D10, MX2, M7, L52, L12



Applies only to Electronic, Air-Tight

COMPACT FLUORESCENT RECESSED

4" IC AT High Performance CF Reflectors and Trims

Cone Reflector with Baffle



CC

Catalog No.	Description
NTS-4230BB	Black Baffle / Specular Clear Refl / Black Ring
NTS-4230BZBZ	Bronze Baffle / Specular Clear Refl / Bronze Ring
NTS-4230BW	Black Baffle / Specular Clear Refl / White Ring
NTS-4230COCO	Copper Baffle / Specular Clear Refl / Copper Ring
NTS-4230NN	Nat Metal Baffle / Spec Clear Refl / Nat Metal Ring
NTS-4230WW	White Baffle / Specular Clear Refl / White Ring

- Full specular clear reflector for optimum light output
- Available with Square Trim Rings, Consult Factory

Maximum Wattage
 (1) 13W-26W Quad
 (1) 13W-26W Triple Tube
OD: 5"

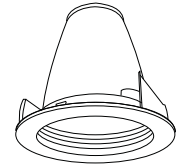

Cone Reflector



CC

Catalog No.	Description
NTS-4231BW	Specular Black Reflector / White Ring
NTS-4231CW	Specular Clear Reflector / White Ring
NTS-4231GW	Specular Gold Reflector / White Ring
NTS-4231HZW	Haze Reflector / White Ring
NTS-4231WW	Specular White Reflector / White Ring

- Full specular clear reflector for optimum light output
- Available with Square Trim Rings, Consult Factory

Maximum Wattage
 (1) 13W-26W Quad
 (1) 13W-26W Triple Tube
OD: 5"

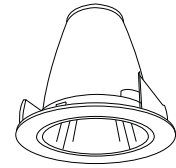

Reflector



CC

Catalog No.	Description
NS-52	Natural Metal Reflector / Natural Metal Ring
NS-53	Copper Reflector / Copper Ring
NS-53BZ	Bronze Reflector / Bronze Ring

- Available with Square Trim Rings, Consult Factory

Maximum Wattage
 (1) 13W-26W Quad
 (1) 13W-26W Triple Tube
OD: 4-3/4"

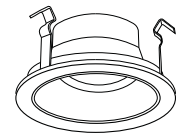

Cone Reflector Wall Wash



Catalog No.	Description
NTS-4255CW	Specular Clear Refl / White Eyelid / White Ring

- Full specular clear reflector for optimum light output
- Available with Square Trim Rings, Consult Factory

Maximum Wattage
 (1) 13W-26W Quad
 (1) 13W-26W Triple Tube
OD: 4-3/4"

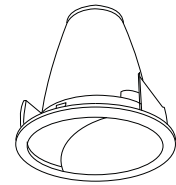

Cone Reflector Albalite Shower Trim



Catalog No.	Description
NTS-4222B	Albalite Lens / Spec Clear Refl / Black Ring
NTS-4222BZ	Albalite Lens / Spec Clear Refl / Bronze Ring
NTS-4222C	Albalite Lens / Spec Clear Refl / Chrome Ring
NTS-4222CO	Albalite Lens / Spec Clear Refl / Copper Ring
NTS-4222G	Albalite Lens / Spec Clear Refl / Gold Ring
NTS-4222N	Albalite Lens / Spec Clear Refl / Natural Metal Ring
NTS-4222W	Albalite Lens / Spec Clear Refl / White Ring

- Full specular clear reflector for optimum light output
- Available with Square Trim Rings, Consult Factory
- UL Wet Listed

Maximum Wattage
 (1) 13W-18W Quad
 (1) 13W-18W Triple Tube
OD: 5"

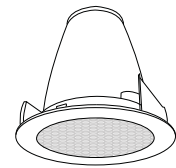

Cone Reflector Fresnel Shower Trim



Catalog No.	Description
NTS-4223B	Fresnel Lens / Spec Clear Refl / Black Ring
NTS-4223BZ	Fresnel Lens / Spec Clear Refl / Bronze Ring
NTS-4223C	Fresnel Lens / Spec Clear Refl / Chrome Ring
NTS-4223CO	Fresnel Lens / Spec Clear Refl / Copper Ring
NTS-4223G	Fresnel Lens / Spec Clear Refl / Gold Ring
NTS-4223N	Fresnel Lens / Spec Clear Refl / Natural Metal Ring
NTS-4223W	Fresnel Lens / Spec Clear Refl / White Ring

- Full specular clear reflector for optimum light output
- Available with Square Trim Rings, Consult Factory
- UL Wet Listed

Maximum Wattage
 (1) 13W-18W Quad
 (1) 13W-18W Triple Tube
OD: 5"

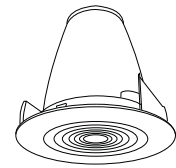

CC Custom Combo: Available with custom combinations of reflector and plastic and metal ring finish. See pages 38-39 for details.

Available Ring Finishes: B-Black, BZ-Bronze, C-Chrome, CO-Copper, G-Gold, N-Natural Metal, W-White

See pages 36-37 for Description of Reflector Finishes

4" IC AT HIGH PERFORMANCE CF REFLECTORS AND TRIMS continued

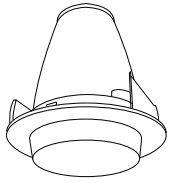

Maximum Wattage
 (1) 13W-18W Quad
 (1) 13W-18W Triple Tube
OD: 5"



Catalog No.	Description
NTS-4224B	Drop Opal / Specular Clear Refl / Black Ring
NTS-4224BZ	Drop Opal / Specular Clear Refl / Bronze Ring
NTS-4224C	Drop Opal / Specular Clear Refl / Chrome Ring
NTS-4224CO	Drop Opal / Specular Clear Refl / Copper Ring
NTS-4224G	Drop Opal / Specular Clear Refl / Gold Ring
NTS-4224N	Drop Opal / Specular Clear Refl / Natural Metal Ring
NTS-4224W	Drop Opal / Specular Clear Refl / White Ring

- Full specular clear reflector for optimum light output
- Available with Square Trim Rings, Consult Factory
- UL Wet Listed

Cone Reflector Drop Opal Shower Trim

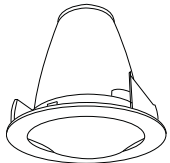

Maximum Wattage
 (1) 13W-18W Quad
 (1) 13W-18W Triple Tube
OD: 5"



Catalog No.	Description
NTS-4225B	Frosted Dome / Specular Clear Refl / Black Ring
NTS-4225BZ	Frosted Dome / Specular Clear Refl / Bronze Ring
NTS-4225C	Frosted Dome / Specular Clear Refl / Chrome Ring
NTS-4225CO	Frosted Dome / Specular Clear Refl / Copper Ring
NTS-4225G	Frosted Dome / Specular Clear Refl / Gold Ring
NTS-4225N	Frosted Dome / Spec Clear Refl / Natural Metal Ring
NTS-4225W	Frosted Dome / Specular Clear Refl / White Ring

- Full specular clear reflector for optimum light output
- Available with Square Trim Rings, Consult Factory
- UL Wet Listed

Cone Reflector Frosted Dome Shower Trim

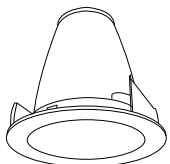

Maximum Wattage
 (1) 13W-18W Quad
 (1) 13W-18W Triple Tube
OD: 5"



Catalog No.	Description
NTS-4226B	Frosted Flat Lens / Spec Clear Refl / Black Ring
NTS-4226BZ	Frosted Flat Lens / Spec Clear Refl / Bronze Ring
NTS-4226C	Frosted Flat Lens / Spec Clear Refl / Chrome Ring
NTS-4226CO	Frosted Flat Lens / Spec Clear Refl / Copper Ring
NTS-4226G	Frosted Flat Lens / Spec Clear Refl / Gold Ring
NTS-4226N	Frosted Flat Lens / Spec Clear Refl / Natural Metal Ring
NTS-4226W	Frosted Flat Lens / Spec Clear Refl / White Ring

- Full specular clear reflector for optimum light output
- Available with Square Trim Rings, Consult Factory
- UL Wet Listed

Cone Reflector Frosted Flat Lens Shower Trim

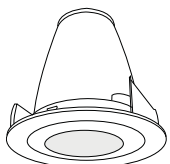

Maximum Wattage
 (1) 13W-18W Quad
 (1) 13W-18W Triple Tube
OD: 5"



Catalog No.	Description
NTS-4227B	Center Frosted Flat Lens / Specular Clear Reflector / Black Ring
NTS-4227BZ	Center Frosted Flat Lens / Specular Clear Reflector / Bronze Ring
NTS-4227C	Center Frosted Flat Lens / Specular Clear Reflector / Chrome Ring
NTS-4227CO	Center Frosted Flat Lens / Specular Clear Reflector / Copper Ring
NTS-4227G	Center Frosted Flat Lens / Specular Clear Reflector / Gold Ring
NTS-4227N	Center Frosted Flat Lens / Specular Clear Reflector / Natural Metal Ring
NTS-4227W	Center Frosted Flat Lens / Specular Clear Reflector / White Ring

- Full specular clear reflector for optimum light output
- Available with Square Trim Rings, Consult Factory
- Frosted center lens hides CFL while clear outer lens provides greater output
- UL Wet Listed

Cone Reflector Center Frosted Flat Lens Shower Trim



4" IC AT HIGH PERFORMANCE CF REFLECTORS AND TRIMS continued

Metropolitan Glass Moon

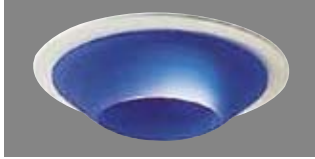

Catalog No.	Description
NL-495B/PL	Blue Metropolitan Glass Moon
NL-495F/PL	White Frosted Metropolitan Glass Moon
NL-495P/PL	Pink Metropolitan Glass Moon

Maximum Wattage
 (1) 13W-26W Quad
 (1) 13W-26W Triple Tube
OD: 4-3/4"

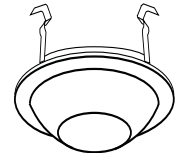

Metropolitan Glass Stepped

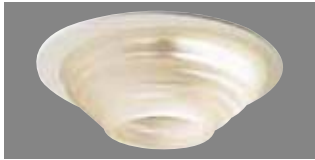

Catalog No.	Description
NL-496B/PL	Blue Metropolitan Glass Stepped
NL-496F/PL	White Frosted Metropolitan Glass Stepped
NL-496P/PL	Pink Metropolitan Glass Stepped

Maximum Wattage
 (1) 13W-26W Quad
 (1) 13W-26W Triple Tube
OD: 4-3/4"



Metropolitan Glass Ice Light



Catalog No.	Description
NL-497B/PL	Blue Metropolitan Glass Ice Light
NL-497F/PL	White Frosted Metropolitan Glass Ice Light
NL-497P/PL	Pink Metropolitan Glass Ice Light

Maximum Wattage
 (1) 13W-26W Quad
 (1) 13W-26W Triple Tube
OD: 4-3/4"

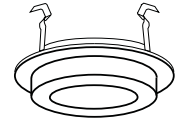

Reflector for Decorative Glass

NEW!



Catalog No.	Description
NTS-4238BZ	Specular Clear Reflector / Black Trim
NTS-4238C	Specular Clear Reflector / Bronze Trim
NTS-4238N	Specular Clear Reflector / Chrome Trim
NTS-4238W	Specular Clear Reflector / Copper Trim

Maximum Wattage
 (1) 13W-26W Quad
 (1) 13W-26W Triple Tube
OD: 4-3/4"

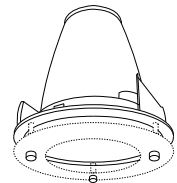

- Glass sold separately
- For a layered look, up to two pieces of glass may be used together.

Decorative Glass for NTS-4238

NEW!



Catalog No.	Description
NTG-4B/80	Tempered Blue / 80mm (3-1/8") Open Center
NTG-4CF	Tempered Frost Center / Clear Outer
NTG-4FC	Tempered Clear Center / Frost Outer
NTG-4HC	Tempered Clear Outer / Frost Inner / 80mm (3-1/8") Open Center

Includes:
 NRA-203 Glass Hardware
 • (3) Stand-offs
 • (3) Cone End Caps
 • (3) Flat End Caps
OD: 4-3/4"

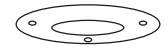

- Includes NRA-203 Glass Hardware
- 2 decorative glasses can be combined for a tiered look



COMPACT FLUORESCENT RECESSED

4" Economy New Construction Housings Non-IC

Nora Lighting's family of 4" Economy Compact Fluorescent housings offer affordable, solutions for energy savings combined with a minimal 4" aperture. Electronic new construction configurations are Energy Star compliant. A wide variety of attractive finishing trims suitable for any interior is available. Light sources are available in warm or cool colors.



Fire Rated Enclosure - see page 379

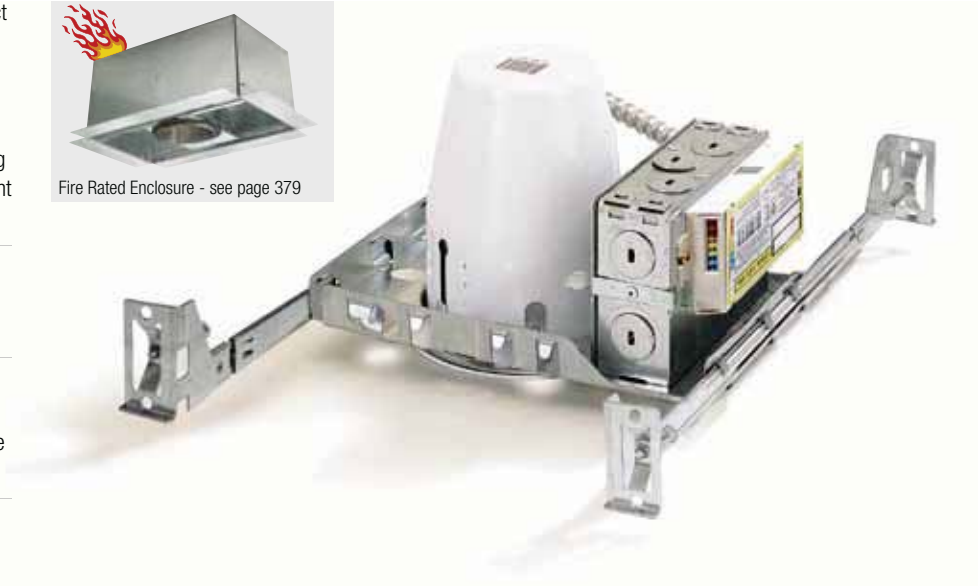

Ballast Types:

- 13W 120V-277V Electronic (EL)
- 13W 120V Magnetic

Lamp Types:

- 13W Electronic 4-Pin Quad G24Q base
- 13W Electronic 4-Pin Triple Tube GX24Q base
- 13W Magnetic 2-Pin Quad

Dimming Options: 13W Electronic D10 or M7 ballast option is available. Please match appropriate fixture with compatible compact fluorescent dimming control. See pages 70-71.

Emergency Option: Emergency back-up operates lamp for a minimum of 90 minutes. Unit includes battery, charger, and test plate with indicator light. See page 183.

Minimum Clearances: Non-IC housings require minimum clearances of 3" from thermal insulation and 1/2" from adjacent building components.

New Construction: Bar hangers are adjustable from 13-5/8" to 24-1/2" and can be repositioned 90 degrees. Bar hangers are slotted for T-bar installation.

Listing:

- cULus Damp Location w/ Feed Through;
- cULus Wet Location (Only with designated trims)

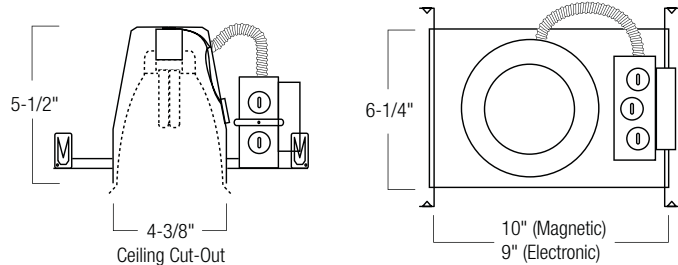

NS-406 SERIES

CATALOG. NO.	LAMP(S)	WATTAGE	VOLTAGE	DIMMING	EMERGENCY
ELECTRONIC					
NS-406/EL	1 Quad/Triple	13	120-277	D10, M7	EM, EM2
MAGNETIC *Magnetic Ballast is not Energy Star Qualified					
NS-406Q*	1 Quad/Triple	13	120	N/A	EM, EM2



COMPACT FLUORESCENT RECESSED 4" Economy Remodel Housings Non-IC

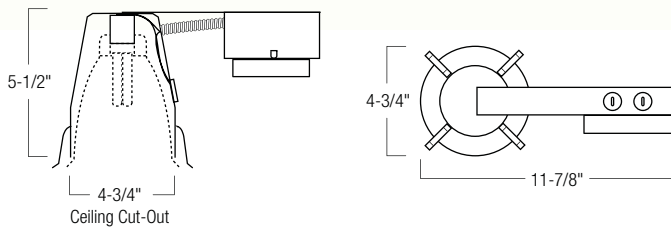

NSR-408 SERIES

CATALOG. NO.	LAMP(S)	WATTAGE	VOLTAGE	DIMMING
ELECTRONIC				
NSR-408/EL	1 Quad/Triple	13	120-277	D10, M7
MAGNETIC *Magnetic Ballast is not Energy Star Qualified				
NSR-408Q*	1 Quad/Triple	13	120	N/A



Nora Lighting's family of 4" Economy Compact Fluorescent remodel housings offer affordable solutions for energy savings combined with a minimal 4" aperture. Electronic remodel configurations are Energy Star compliant. A wide variety of attractive finishing trims suitable for any interior is available. Light sources are available in warm or cool colors.

Ballast Types:

13W 120V-277V Electronic (EL)
13W 120V Magnetic

Lamp Types:

13W Electronic 4-Pin Quad G24Q base
13W Electronic 4-Pin Triple Tube GX24Q base
13W Magnetic 2-Pin Quad

Dimming Options: 13W Electronic D10 or M7 ballast option is available. Please match appropriate fixture with compatible compact fluorescent dimming control. See pages 70-71.

Emergency Option: 90-minute battery back-up must be ordered and installed as a self contained kit set apart from the frame-in. See page 746.

Minimum Clearances: Non-IC housings require minimum clearances of 3" from thermal insulation and 1/2" from adjacent building components.

Remodel Installation: High tension tempered steel springs secure remodel housings evenly to ceiling; hole cutout template provided for convenience.

Listing:

cULus Damp Location w/ Feed Through;
cULus Wet Location (Only with designated trims)

COMPACT FLUORESCENT RECESSED

4" Economy CF Trims

Stepped Baffle

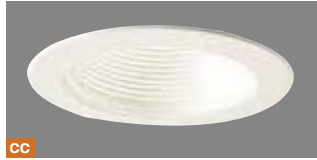

Catalog No.	Description
NS-40	White Baffle / White Metal Ring
NS-40C	White Baffle / Chrome Metal Ring
NS-40G	White Baffle / Gold Metal Ring
NS-40BZBZ	Bronze Baffle / Bronze Metal Ring
NS-40COCO	Copper Baffle / Copper Metal Ring
NS-40N	Natural Metal Baffle / Natural Metal Ring
NS-41	Black Baffle / White Metal Ring
NS-41B	Black Baffle / Black Metal Ring
NS-41C	Black Baffle / Chrome Metal Ring
NS-41G	Black Baffle / Gold Metal Ring
NS-41N	Black Baffle / Natural Metal Ring

- Available with Square Trim Rings, Consult Factory

Maximum Wattage

- (1) 13W Quad
- (1) 13W Triple Tube

OD: 4-3/4"

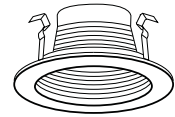

Reflector



Catalog No.	Description
NS-42	Specular Gold Reflector / White Metal Ring
NS-42G	Specular Gold Reflector / Gold Ring
NS-43	Specular Black Reflector / White Metal Ring
NS-43B	Specular Black Reflector / Black Metal Ring
NS-44	Specular Clear Reflector / White Metal Ring
NS-44C	Specular Clear Reflector / Chrome Ring
NS-44N	Specular Clear Reflector / Natural Metal Ring
NS-44HZ	Haze Reflector / White Metal Ring
NS-46	Specular White Reflector / White Metal Ring
NS-52	Natural Metal Reflector / Natural Metal Ring
NS-53	Copper Reflector / Copper Ring
NS-53BZ	Bronze Reflector / Bronze Ring

- Available with Square Trim Rings, Consult Factory

Maximum Wattage

- (1) 13W Quad
- (1) 13W Triple Tube

OD: 4-3/4"

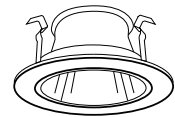

Wall Wash



Catalog No.	Description
NS-50	Specular White Reflector / White Eyelid

- Available with Square Trim Rings, Consult Factory

Maximum Wattage

- (1) 13W Quad
- (1) 13W Triple Tube

OD: 4-3/4"

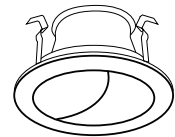

Albalite Shower



Catalog No.	Description
NS-22B	Albalite Lens / Black Metal Trim
NS-22BZ	Albalite Lens / Bronze Metal Trim
NS-22C	Albalite Lens / Chrome Metal Trim
NS-22CO	Albalite Lens / Copper Metal Trim
NS-22G	Albalite Lens / Gold Metal Trim
NS-22N	Albalite Lens / Natural Metal Trim
NS-22W	Albalite Lens / White Metal Trim

- UL Wet Listed
- Available with Square Trim Rings, Consult Factory

Maximum Wattage

- (1) 13W Quad
- (1) 13W Triple Tube

OD: 4-3/4"

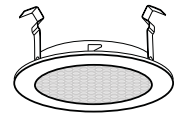

Fresnel Shower



Catalog No.	Description
NS-23B	Fresnel Lens / Black Metal Trim
NS-23BZ	Fresnel Lens / Bronze Metal Trim
NS-23C	Fresnel Lens / Chrome Metal Trim
NS-23CO	Fresnel Lens / Copper Metal Trim
NS-23G	Fresnel Lens / Gold Metal Trim
NS-23N	Fresnel Lens / Natural Metal Trim
NS-23W	Fresnel Lens / White Metal Trim

- UL Wet Listed
- Available with Square Trim Rings, Consult Factory

Maximum Wattage

- (1) 13W Quad
- (1) 13W Triple Tube

OD: 4-3/4"



CC Custom Combo: Available with custom combinations of reflector and plastic and metal ring finish. See pages 38-39 for details.

Available Ring Finishes: B-Black, BZ-Bronze, C-Chrome, CO-Copper, G-Gold, N-Natural Metal, W-White

See pages 36-37 for Description of Reflector Finishes

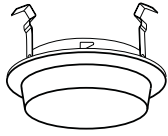

Maximum Wattage
 (1) 13W Quad
 (1) 13W Triple Tube
OD: 4-3/4"



Catalog No.	Description
NS-24B	Drop Opal / Black Metal Trim
NS-24BZ	Drop Opal / Bronze Metal Trim
NS-24C	Drop Opal / Chrome Metal Trim
NS-24CO	Drop Opal / Copper Metal Trim
NS-24G	Drop Opal / Gold Metal Trim
NS-24N	Drop Opal / Natural Metal Trim
NS-24W	Drop Opal / White Metal Trim

- UL Wet Listed

Drop Opal Shower

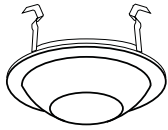
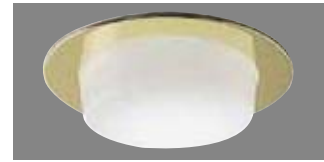

Maximum Wattage
 (1) 13W Quad
 (1) 13W Triple Tube
OD: 4-3/4"

Catalog No.	Description
NL-495B/PL	Blue Metropolitan Glass Moon
NL-495F/PL	White Frosted Metropolitan Glass Moon
NL-495P/PL	Pink Metropolitan Glass Moon

Metropolitan Glass Moon

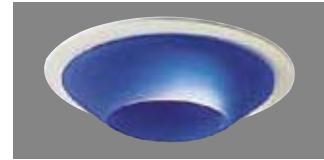

Maximum Wattage
 (1) 13W Quad
 (1) 13W Triple Tube
OD: 4-3/4"

Catalog No.	Description
NL-496B/PL	Blue Metropolitan Glass Stepped
NL-496F/PL	White Frosted Metropolitan Glass Stepped
NL-496P/PL	Pink Metropolitan Glass Stepped

Metropolitan Glass Stepped

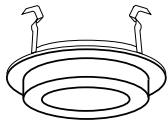

Maximum Wattage
 (1) 13W Quad
 (1) 13W Triple Tube
OD: 4-3/4"

Catalog No.	Description
NL-497B/PL	Blue Metropolitan Glass Ice Light
NL-497F/PL	White Frosted Metropolitan Glass Ice Light
NL-497P/PL	Pink Metropolitan Glass Ice Light

Metropolitan Glass Ice Light

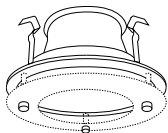

Maximum Lamp:
 (1) 13W Quad
 (1) 13W Triple Tube
OD: 4-3/4"

Catalog No.	Description
NS-4238BZ	Specular Clear Reflector / Black Trim
NS-4238C	Specular Clear Reflector / Bronze Trim
NS-4238N	Specular Clear Reflector / Chrome Trim
NS-4238W	Specular Clear Reflector / Copper Trim

- **Glass sold separately**
- For a layered look, up to two pieces of glass may be used together.

Reflector for Decorative Glass



Includes:
 NRA-203 Glass Hardware
 • (3) Stand-offs
 • (3) Cone End Caps
 • (3) Flat End Caps
OD: 4-3/4"

Catalog No.	Description
NTG-4B/80	Tempered Blue / 80mm (3-1/8") Open Center
NTG-4CF	Tempered Frost Center / Clear Outer
NTG-4FC	Tempered Clear Center / Frost Outer
NTG-4HC	Tempered Clear Outer / Frost Inner 80mm (3-1/8") Open Center

- **Includes NRA-203 Glass Hardware**
- 2 decorative glasses can be combined for a tiered look

Decorative Glass for NS-4238



The Nora Lighting family of GU24 Based Compact Fluorescent

Nora Lighting was the first in the industry to introduce a complete line of "Green" energy efficient GU24 based CFL housings and reflectors. Available in 6", 5" and 4" apertures, Nora's GU24 products lower the cost of dedicated energy efficient lighting. Using self ballasted lamps available in wattages from 13 to 26 watts, the proper wattage can be selected at the time of final installation. Nora's family of GU24 reflectors and trims are available in a variety of finishes. Whether residential or light commercial, Nora has just lowered the cost of going GREEN!

FEATURES



- **Substantial Energy Savings**

Save up to 75% in energy cost over incandescent.

- **Long Life Lamp**

GU24 lamps are rated for up to 10,000 hours

- **Substantial Material Savings**

A complete Nora GU24 fixture package can save over 50% versus a comparable dedicated 4-pin remote mount ballasted fixture.

- **Selectable Lamp Wattage Flexibility**

Unlike dedicated conventional 4-pin CFL with dedicated wattage specification, GU24 end users can select the proper wattage for the application at the time of lamp installation.

- **Self Ballasted Lamps**

Nora's GU24 based housings use GU24 self ballasted twist and lock lamps available in spirals in 13 to 26 watt and in reflector bulbs giving the appearance and output of a BR65 watt lamp.

- **NEW! 2 in 1 Socket**

"No Tools Required" (*Patent Pending*)

Convertible Socket

- **Maintenance Free**

Because the ballast is located in the GU24 CFL lamp a new ballast is installed every time you re-lamp. Conversely a 4 pin conventional fixture uses a remote mounted ballast that requires housing removal to service.

- **Energy Star**

Nora's 6" GU24 housing is Energy Star rated.

- **Complete Package**

Nora Lighting offers 4", 5", and 6" Housings, Reflectors and compatible GU24 lamps for a complete, single source, GU24 package.

- **Title 24**

California Title 24 compliant when used with Nora's and other manufacturers LED Retrofit modules that meet Title 24 Efficacy standards. (See LED Retrofit on pages 60-61)

- **cUL Listed**

GU24 Based Compact Fluorescent Downlight

New-Patent Pending Convertible Socket
 Convertible socket can be removed without tools to convert socket into floating socket. Socket clips into reflectors for perfect lamp position for optimal performance



Fixed



Floating

Self Ballasted Lamp
 Variable wattage from 13W to 26W with the same fixture housing because the ballast is in the lamp!

Captive Nails
 Hanger bars include internal spikes and captive nails. 24-1/2" long and can be repositioned 90°

NEW!

Long Life Lamps
 GU24 CFL lamps are rated for up to 10,000 hours

T-Bar Notch
 Hanger bars are slotted for T-bar installation

Alignment Foot

Air-Tight
 Meets ASTM E283 standards for Air-Tight requirements



When used with LED Retrofit pg. 60-61



(6" Only)



committed to GREEN

COMPACT FLUORESCENT RECESSED

6" IC AT GU24 Base New Construction Housings

Nora Lighting's new 6" GU24 Housings save 40% over the cost of 4-pin dedicated wattage fixtures. The ballast is in the lamp! Never remove a housing to change or service a ballast again! Plus, end users can select the desired wattage when the lamp is to be installed. Wattages are from 13W up to 26W. Now available in recessed downlights rated for insulated ceiling and air-tight applications. Available in new construction and remodel recessed housings.

Ballast: Self-ballasted lamp allows same fixture to accept from 13W to 26W.

Lamp Types:
 13W – 26W Self-Ballasted GU24 Spiral
 15 Watt Self-Ballasted GU24 R30
 12 Watt LED (See page 60)

Dimming: Dimming a GU24 self-ballasted compact fluorescent lamp is not recommended by Nora, unless specifically stated by lamp manufacturer.

LED Retrofit is Dimmable.

NEW! **Socket:** New Patent Pending Convertible Socket. Socket can be converted from fixed to floating without tools.

Minimum Clearances: IC housings are rated for direct contact and do not have any minimum clearance requirements

New Construction: Bar hangers are adjustable from 13-5/8" to 24-1/2" and can be repositioned 90 degrees. Bar hangers are slotted for T-bar installation.

Listing:
 cULus Listed for Dry Location
 Energy Star Rated
 Title 24 Compliant when used with
 Nora's LED Retrofit

NEW!

NEW CONVERTIBLE SOCKET!

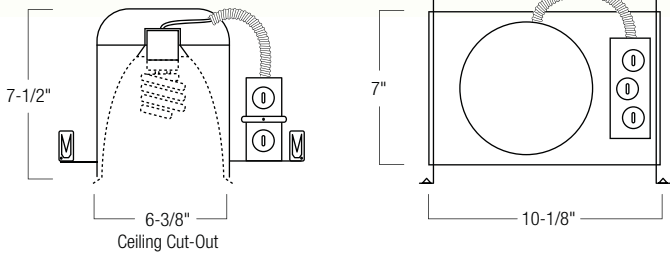

NHIC-6G24ATFL

CATALOG. NO.	LAMP(S)	WATTAGE	VOLTAGE	DIMMING
NHIC-6G24ATFL	1 GU24 CF	13-26	120V	not recommended
	LED Retrofit*	12	120V	Dimmable down to 5%

* LED Retrofit available on page 60



When used with
 Nora's LED Retrofit
 (See Page 60)

COMPACT FLUORESCENT RECESSED 6" IC AT GU24 Base Remodel Housing

NEW CONVERTIBLE SOCKET!

NEW!



Nora Lighting's new 6" GU24 Housings save 40% over the cost of 4-pin dedicated wattage fixtures. The ballast is in the lamp! Never remove a housing to change or service a ballast again! Plus, end users can select the desired wattage when the lamp is to be installed. Wattages are from 13W up to 26W. Now available in recessed downlights rated for insulated ceiling and air-tight applications. Available in new construction and remodel recessed housings.

Ballast: Self-ballasted lamp allows same fixture to accept from 13W to 26W.

Lamp Types:
13W– 26W Self-Ballasted GU24 Spiral
15 Watt Self-Ballasted GU24 R30
12 Watt LED (See page 60)

Dimming: Dimming a GU24 self-ballasted compact fluorescent lamp is not recommended by Nora, unless specifically stated by lamp manufacturer.

LED Retrofit is Dimmable.

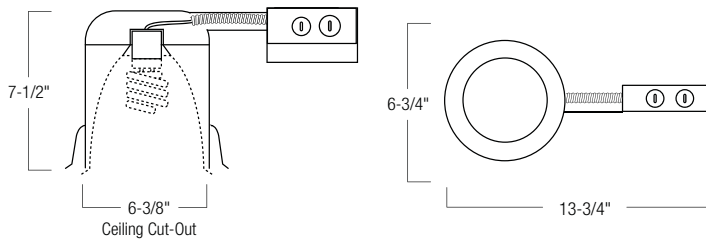

NEW! **Socket:** New Patent Pending Convertible Socket. Socket can be converted from fixed to floating without tools.

Minimum Clearances: IC housings are rated for direct contact and do not have any minimum clearance requirements

Remodel Installation: High tension tempered steel springs secure remodel housings evenly to ceiling; hole cutout template provided for convenience.

Listing:
cULus Listed for Dry Location
Energy Star Rated
Title 24 Compliant when used with
Nora's LED Retrofit

NHRIC-6G24ATFL

CATALOG. NO.	LAMP(S)	WATTAGE	VOLTAGE	DIMMING
NHRIC-6G24ATFL	1 GU24 CF	13-26	120V	not recommended
	LED Retrofit*	12	120V	Dimmable down to 5%

* LED Retrofit available on page 60



When used with
Nora's LED Retrofit
(See Page 60)

COMPACT FLUORESCENT RECESSED

6" IC AT GU24 Base Trims

Airtight Cone Baffle



Catalog No.	Description
NTM-713B/PL	Black Baffle / White Flange
NTM-713W/PL	White Baffle / White Flange

- Full specular clear reflector for maximum performance
- Deep reflector cone for visual comfort

Maximum Wattage
 (1) 13W-26W GU24 Spiral
 (1) 15W GU24 R30

OD: 7"

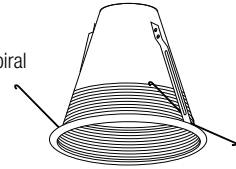

Airtight Cone Reflector with Baffle



Catalog No.	Description
NTA-730B/PL	Specular Clear Refl / Black Baffle / White Flange
NTA-730W/PL	Specular Clear Refl / White Baffle / White Flange

- Full specular clear reflector for maximum performance
- Deep reflector cone for visual comfort

Maximum Wattage
 (1) 13W-26W GU24 Spiral
 (1) 15W GU24 R30

OD: 7"

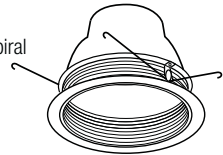

Cone Reflector with Baffle



Catalog No.	Description
NTS-6230BB	Specular Clear Refl / Black Baffle / Black Flange
NTS-6230BW	Specular Clear Refl / Black Baffle / White Flange
NTS-6230BZBZ	Specular Clear Refl / Bronze Baffle / Bronze Flange
NTS-6230BZW	Specular Clear Refl / Bronze Baffle / White Flange
NTS-6230CC	Specular Clear Refl / Chrome Baffle / Chrome Flange
NTS-6230CW	Specular Clear Refl / Chrome Baffle / White Flange
NTS-6230COCO	Specular Clear Refl / Copper Baffle / Copper Flange
NTS-6230COW	Specular Clear Refl / Copper Baffle / White Flange
NTS-6230GG	Specular Clear Refl / Gold Baffle / Gold Flange
NTS-6230GW	Specular Clear Refl / Gold Baffle / White Flange
NTS-6230HZW	Specular Clear Refl / Haze Baffle / White Flange
NTS-6230NN	Specular Clear Refl / Nat Metal Baffle / Nat Metal Flange
NTS-6230NW	Specular Clear Refl / Nat Metal Baffle / White Flange
NTS-6230WW	Specular Clear Refl / White Baffle / White Flange

- Full specular clear reflector for maximum performance
- Deep reflector cone for visual comfort

Maximum Wattage
 (1) 13W-26W GU24 Spiral
 (1) 15W GU24 R30

OD: 7"

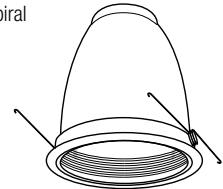

Cone Reflector



Catalog No.	Description
NTS-6231BB	Specular Black Reflector / Black Ring
NTS-6231BW	Specular Black Reflector / White Ring
NTS-6231BZBZ	Bronze Reflector / Bronze Ring
NTS-6231BZW	Bronze Reflector / White Ring
NTS-6231CC	Specular Clear Reflector / Chrome Ring
NTS-6231CW	Specular Clear Reflector / White Ring
NTS-6231COCO	Copper Reflector / Copper Ring
NTS-6231COW	Copper Reflector / White Ring
NTS-6231GG	Specular Gold Reflector / Gold Ring
NTS-6231GW	Specular Gold Reflector / White Ring
NTS-6231HZW	Haze Reflector / White Ring
NTS-6231NN	Natural Metal Reflector / Natural Metal Ring
NTS-6231NW	Natural Metal Reflector / White Ring
NTS-6231WW	Specular White Reflector / White Ring

Maximum Wattage
 (1) 13W-26W GU24 Spiral
 (1) 15W GU24 R30

OD: 7"

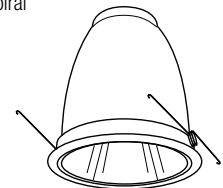

CC Custom Combo: Available with custom combinations of reflector and plastic and metal ring finish. See pages 38-39 for details.

Available Ring Finishes: B-Black, BZ-Bronze, C-Chrome, CO-Copper, G-Gold, N-Natural Metal, W-White

See pages 36-37 for Description of Reflector Finishes

COMPACT FLUORESCENT RECESSED 6" GU24 Base Lamps



Catalog No.	Description
CFS13WGU24WW	13W Self-Ballasted Spiral GU24 CFL, Warm White
CFS18WGU24WW	18W Self-Ballasted Spiral GU24 CFL, Warm White
CFS23WGU24WW	23W Self-Ballasted Spiral GU24 CFL, Warm White
CFS26WGU24WW	26W Self-Ballasted Spiral GU24 CFL, Warm White

- Base: Twist and Lock
- Lamp Type: Self-Ballasting GU24 CFL

Self-Ballasted Spiral GU24 CFL

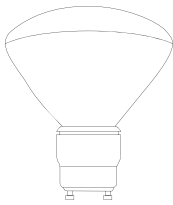

Catalog No.	Description
CFW15WGU24WW	15W Self-Ballasted R30 GU24 CFL, Warm White

- Base: Twist and Lock
- Lamp Type: Self-Ballasting GU24 CFL

Self-Ballasted R30 GU24 CFL



(See LED Diamond Retrofit on Page 60)



COMPACT FLUORESCENT RECESSED

5" IC AT GU24 Base New Construction Housings

Nora Lighting's new 5" GU24 Housings save 40% over the cost of 4-pin dedicated wattage fixtures. The ballast is in the lamp! Never remove a housing to change or service a ballast again! Plus, end users can select the desired wattage when the lamp is to be installed. Wattages are from 13W up to 26W. Now available in recessed downlights rated for insulated ceiling and air-tight applications. Available in new construction and remodel recessed housings.

Ballast: Self-ballasted lamp allows same fixture to accept from 13W to 26W.

Lamp Types:

- 13W – 26W Self-Ballasted GU24 Spiral
- 15 Watt Self-Ballasted GU24 R30
- 12 Watt LED (See page 61)

Dimming: Dimming a GU24 self-ballasted compat fluorescent lamp is not recommended by Nora, unless specifically stated by lamp manufacturer.

LED Retrofit is Dimmable.

NEW! **Socket:** New Patent Pending Convertible Socket. Socket can be converted from fixed to floating without tools.

Minimum Clearances: IC housings are rated for direct contact and do not have any minimum clearance requirements

New Construction: Bar hangers are adjustable from 13-5/8" to 24-1/2" and can be repositioned 90 degrees. Bar hangers are slotted for T-bar installation.

Listing:

cULus Listed for Dry Location
Title 24 Compliant when used with Nora's LED Retrofit

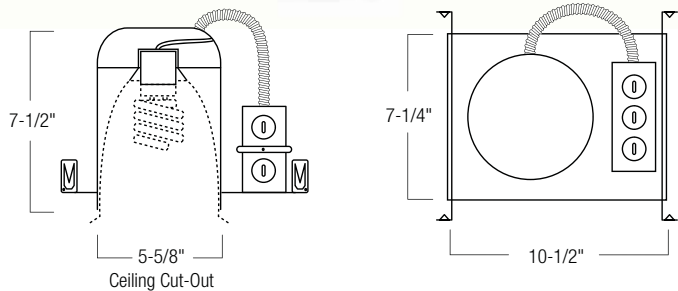

NHIC-5G24ATFL

CATALOG. NO.	LAMP(S)	WATTAGE	VOLTAGE	DIMMING
NHIC-5G24ATFL	1 GU24 CF	13-26	120V	not recommended
	LED Retrofit*	12	120V	Dimmable down to 5%

* LED Retrofit available on page 61



When used with Nora's LED Retrofit (See Page 61)

COMPACT FLUORESCENT RECESSED 5" IC AT GU24 Base Remodel Housing

**NEW CONVERTIBLE
SOCKET!**

NEW!



Nora Lighting's new 5" GU24 Housings save 40% over the cost of 4-pin dedicated wattage fixtures. The ballast is in the lamp! Never remove a housing to change or service a ballast again! Plus, end users can select the desired wattage when the lamp is to be installed. Wattages are from 13W up to 26W. Now available in recessed downlights rated for insulated ceiling and air-tight applications. Available in new construction and remodel recessed housings.

Ballast: Self-ballasted lamp allows same fixture to accept from 13W to 26W.

Lamp Types:
13W– 26W Self-Ballasted GU24 Spiral
15 Watt Self-Ballasted GU24 R30
12 Watt LED (See page 61)

Dimming: Dimming a GU24 self-ballasted compact fluorescent lamp is not recommended by Nora, unless specifically stated by lamp manufacturer.

LED Retrofit is Dimmable.

NEW! **Socket:** New Patent Pending Convertible Socket. Socket can be converted from fixed to floating without tools.

Minimum Clearances: IC housings are rated for direct contact and do not have any minimum clearance requirements

Remodel Installation: High tension tempered steel springs secure remodel housings evenly to ceiling; hole cutout template provided for convenience.

Listing:
cULus Listed for Dry Location
Title 24 Compliant when used with
Nora's LED Retrofit

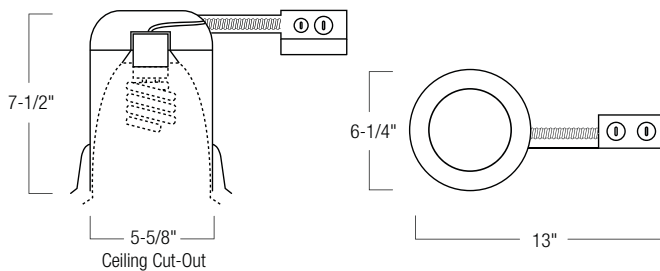

NHRIC-5G24ATFL

CATALOG. NO.	LAMP(S)	WATTAGE	VOLTAGE	DIMMING
NHRIC-5G24ATFL	1 GU24 CF	13-26	120V	not recommended
	LED Retrofit*	12	120V	Dimmable down to 5%

* LED Retrofit available on page 61



When used with
Nora's LED Retrofit
(See Page 61)

COMPACT FLUORESCENT RECESSED

5" IC AT GU24 Base Trims and Lamps

Baffle Splay

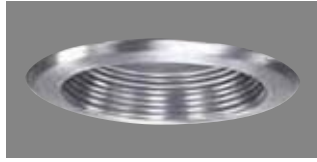

Catalog No.	Description
NT-5001B	Black Aluminum Baffle / White Flange
NT-5001BZ	Bronze Aluminum Baffle / Bronze Flange
NT-5001CO	Copper Aluminum Baffle / Copper Flange
NT-5001N	Natural Metal Aluminum Baffle / Natural Flange
NT-5001W	White Aluminum Baffle / White Flange
NT-5001MW	White Metal Baffle / White Flange

- Full specular clear reflector cone for maximum performance
- Deep reflector cone for visual comfort

Maximum Wattage
(1) 13W-26W GU24 Spiral
OD: 6-1/2"

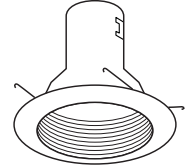

Splay with Bracket



Catalog No.	Description
NT-5000BZ	Bronze Splay / Bronze Flange
NT-5000CO	Copper Splay / Copper Flange
NT-5000N	Natural Metal Splay / Natural Flange
NT-5000W	White Splay / White Flange

Maximum Wattage
(1) 13W-26W GU24 Spiral
(1) 15W GU24 R30
OD: 6-1/2"

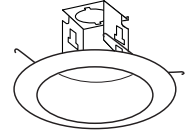

Airtight Cone Baffle



Catalog No.	Description
NTM-513B	Black Aluminum Baffle / White Flange
NTM-513W	White Aluminum Baffle / White Flange
NTM-513WM	White Metal Baffle / White Flange

- Deep cone for visual comfort

Maximum Wattage
(1) 13W-26W GU24 Spiral
(1) 15W GU24 R30
OD: 6-1/2"

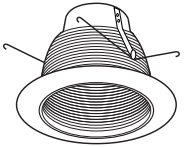

Deep Phenolic Baffle with Bracket



Catalog No.	Description
NT-5012B	Black Baffle / White Ring
NT-5012BZ	Black Baffle / Bronze Ring
NT-5012CO	Black Baffle / Copper Ring
NT-5012N	Black Baffle / Natural Metal Ring
NT-5012W	White Baffle / White Ring

- Deep cone for visual comfort

Maximum Wattage
(1) 13W-26W GU24 Spiral
(1) 15W GU24 R30
OD: 6-1/2"

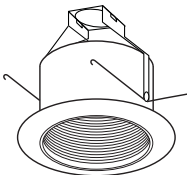

Cone Reflector with Baffle



Catalog No.	Description
NTS-5230BZ	Bronze Baffle / Bronze Flange
NTS-5230CO	Copper Baffle / Copper Flange
NTS-5230N	Natural Metal Baffle / Natural Metal Flange
NTS-5230W	White Baffle / White Flange

- Deep cone for visual comfort

Maximum Wattage
(1) 13W-26W GU24 Spiral
(1) 15W GU24 R30
OD: 6-1/2"

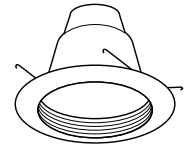

CC Custom Combo: Available with custom combinations of reflector and ring finish. See pages 38-39 for details.

Available Ring Finishes: B-Black, BZ-Bronze, C-Chrome, CO-Copper, G-Gold, N-Natural Metal, W-White

See pages 36-37 for Description of Reflector Finishes

5" IC AT GU24 BASE CF TRIMS AND LAMPS continued

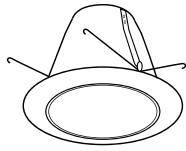

Maximum Wattage
 (1) 13W-26W GU24 Spiral
 (1) 15W GU24 R30
OD: 6-1/2"

Catalog No.	Description
NT-5014B	Specular Black Reflector / White Ring
NT-5014BZ	Bronze Reflector / Bronze Ring
NT-5014C	Specular Clear Reflector / White Ring
NT-5014CO	Copper Reflector / Copper Ring
NT-5014G	Specular Gold Reflector / White Ring
NT-5014N	Natural Metal Reflector / Natural Metal Ring
NT-5014W	Specular White Reflector / White Ring

- Deep cone for visual comfort

Airtight Cone Reflector

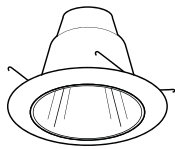

Maximum Wattage
 (1) 13W-26W GU24 Spiral
 (1) 15W GU24 R30
OD: 6-1/2"

Catalog No.	Description
NTS-5231B	Specular Black Reflector / White Ring
NTS-5231BZ	Bronze Reflector / Bronze Ring
NTS-5231C	Specular Clear Reflector / White Ring
NTS-5231CO	Copper Reflector / Copper Ring
NTS-5231G	Specular Gold Reflector / White Ring
NTS-5231HZ	Haze Reflector / White Ring
NTS-5231N	Natural Metal Reflector / Natural Metal Ring
NTS-5231W	Specular White Reflector / White Ring

- Deep cone for visual comfort

Cone Reflector

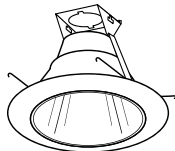

Maximum Wattage
 (1) 13W-26W GU24 Spiral
OD: 6-1/2"

Catalog No.	Description
NT-5021B	Specular Black Reflector / White Ring
NT-5021BZ	Bronze Reflector / Bronze Ring
NT-5021C	Specular Clear Reflector / White Ring
NT-5021CO	Copper Reflector / Copper Ring
NT-5021G	Specular Gold Reflector / White Ring
NT-5021N	Natural Metal Reflector / Natural Metal Ring
NT-5021W	Specular White Reflector / White Ring

- Deep cone for visual comfort

Cone Reflector with Bracket

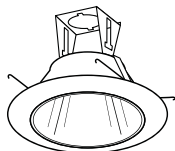

Maximum Wattage
 (1) 13W-26W GU24 Spiral
 (1) 15W GU24 R30
OD: 6-1/2"

Catalog No.	Description
NT-5020B	Specular Black Reflector / White Ring
NT-5020C	Specular Clear Reflector / White Ring
NT-5020G	Specular Gold Reflector / White Ring
NT-5020W	Specular White Reflector / White Ring

Reflector with Bracket

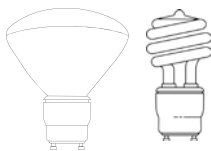

Catalog No.	Description
CFS13WGU24WW	13W Self-Ballasted Spiral GU24 CFL, Warm White
CFS18WGU24WW	18W Self-Ballasted Spiral GU24 CFL, Warm White
CFS23WGU24WW	23W Self-Ballasted Spiral GU24 CFL, Warm White
CFS26WGU24WW	26W Self-Ballasted Spiral GU24 CFL, Warm White
CFW15WGU24WW	15W Self-Ballasted R30 GU24 CFL, Warm White

- Base: Twist and Lock
- Lamp Type: Self-Ballasting GU24 CFL

Self-Ballasted Spiral GU24 CFL
 Self-Ballasted R30 GU24 CFL



(See LED Diamond Retrofit on Page 61)

CC Custom Combo: Available with custom combinations of reflector and ring finish. See pages 38-39 for details.
 Available Ring Finishes: B-Black, BZ-Bronze, C-Chrome, CO-Copper, G-Gold, N-Natural Metal, W-White

COMPACT FLUORESCENT RECESSED

4" IC AT GU24 Base New Construction Housings

Nora Lighting's new 4" GU24 Housings save 40% over the cost of 4-pin dedicated wattage fixtures. The ballast is in the lamp! Never remove a housing to change or service a ballast again! Plus, end users can select the desired wattage when the lamp is to be installed. Wattages are from 13W up to 26W. Now available in recessed downlights rated for insulated ceiling and air-tight applications. Available in new construction and remodel recessed housings.

Ballast: Self-ballasted lamp allows same fixture to accept from 13W to 26W.

Lamp Types:
13W– 26W GU24 Self-Ballasted Spiral

Dimming: Dimming a GU24 self-ballasted compact fluorescent lamp is not recommended by Nora, unless specifically stated by lamp manufacturer.

Minimum Clearances: IC housings are rated for direct contact and do not have any minimum clearance requirements

New Construction: Bar hangers are adjustable from 13-5/8" to 24-1/2" and can be repositioned 90 degrees. Bar hangers are slotted for T-bar installation.

Listing: cULus Listed for Dry Location

NEW!

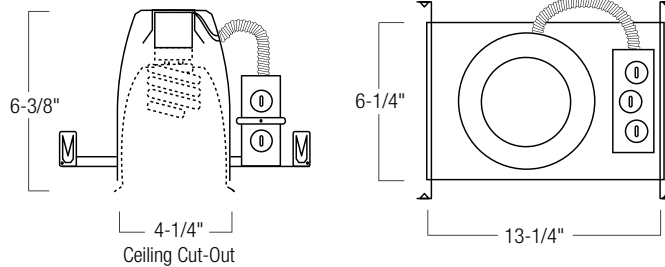

NHIC-4G24AT

CATALOG. NO.	LAMP(S)	WATTAGE	VOLTAGE	DIMMING
NHIC-4G24AT	1 GU24 CF	13-26	120V	not recommended



COMPACT FLUORESCENT RECESSED 4" IC AT GU24 Base Remodel Housing

NEW!

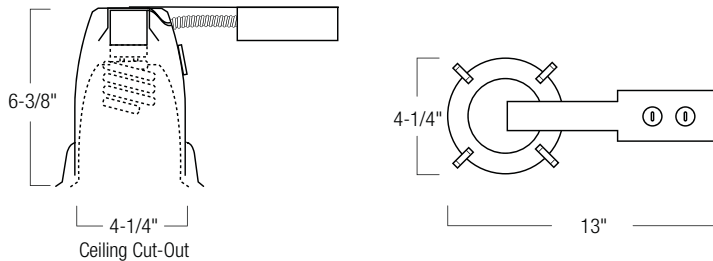

Nora Lighting's new 4" GU24 Housings save 40% over the cost of 4-pin dedicated wattage fixtures. The ballast is in the lamp! Never remove a housing to change or service a ballast again! Plus, end users can select the desired wattage when the lamp is to be installed. Wattages are from 13W up to 26W. Now available in recessed downlights rated for insulated ceiling and air-tight applications. Available in new construction and remodel recessed housings.

Ballast: Self-ballasted lamp allows same fixture to accept from 13W to 26W.

Lamp Types:
13W– 26W Self-Ballasted GU24 Spiral

Dimming: Dimming a GU24 self-ballasted compact fluorescent lamp is not recommended by Nora, unless specifically stated by lamp manufacturer.

Minimum Clearances: IC housings are rated for direct contact and do not have any minimum clearance requirements

Remodel Installation: High tension tempered steel springs secure remodel housings evenly to ceiling; hole cutout template provided for convenience.

Listing: cULus Listed for Dry Location

NHRIC-4G24AT

CATALOG. NO.	LAMP(S)	WATTAGE	VOLTAGE	DIMMING
NHRIC-4G24AT	1 GU24 CF	13-26	120V	not recommended



COMPACT FLUORESCENT RECESSED

4" IC AT GU24 Base Trims

Cone Reflector with Baffle



CC

Catalog No.	Description
NTS-4230BB	Black Baffle / Black Ring
NTS-4230BW	Black Baffle / White Ring
NTS-4230BZBZ	Bronze Baffle / Bronze Ring
NTS-4230COCO	Copper Baffle / Copper Ring
NTS-4230NN	Natural Metal Baffle / Natural Metal Ring
NTS-4230WW	White Baffle / White Ring

- Full specular clear reflector cone for maximum performance

Maximum Wattage
(1) 13W-26W GU24 Spiral
OD: 5"

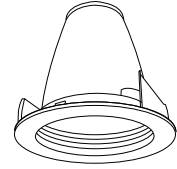

Cone Reflector



CC

Catalog No.	Description
NTS-4231BW	Specular Black Reflector / White Ring
NTS-4231CW	Specular Clear Reflector / White Ring
NTS-4231GW	Specular Gold Reflector / White Ring
NTS-4231HZW	Haze Reflector / White Ring
NTS-4231WW	Specular White Reflector / White Ring

- Full reflector cone for maximum performance

Maximum Wattage
(1) 13W-26W GU24 Spiral
OD: 5"

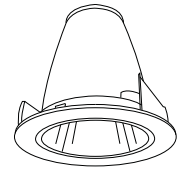

Reflector



CC

Catalog No.	Description
NS-42	Specular Gold Reflector / White Metal Ring
NS-42G	Specular Gold Reflector / Gold Metal Ring
NS-43	Specular Black Reflector / White Metal Ring
NS-43B	Specular Black Reflector / Black Metal Ring
NS-44	Specular Clear Reflector / White Metal Ring
NS-44C	Specular Clear Reflector / Chrome Metal Ring
NS-44N	Specular Clear Reflector / Natural Metal Ring
NS-44HZ	Haze Reflector / White Metal Ring
NS-46	Specular White Reflector / White Metal Ring
NS-52	Natural Metal Reflector / Natural Metal Ring
NS-53	Copper Reflector / Copper Metal Ring
NS-53BZ	Bronze Reflector / Bronze Metal Ring

Maximum Wattage
(1) 13W-26W GU24 Spiral
OD: 4-3/4"

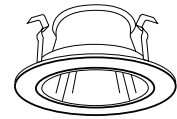

CC Custom Combo: Available with custom combinations of reflector and plastic and metal ring finish. See pages 38-39 for details.

Available Ring Finishes: B-Black, BZ-Bronze, C-Chrome, CO-Copper, G-Gold, N-Natural Metal, W-White

See pages 36-37 for Description of Reflector Finishes

COMPACT FLUORESCENT RECESSED 4" GU24 Base Lamps



Catalog No.	Description
CFS13WGU24WW	13W Self-Ballasted Spiral GU24 CFL, Warm White
CFS18WGU24WW	18W Self-Ballasted Spiral GU24 CFL, Warm White
CFS23WGU24WW	23W Self-Ballasted Spiral GU24 CFL, Warm White
CFS26WGU24WW	26W Self-Ballasted Spiral GU24 CFL, Warm White

- Base: Twist and Lock
- Lamp Type: Self-Ballasting GU24 CFL

Self-Ballasted Spiral GU24 CFL



COMPACT FLUORESCENT RECESSED Emergency Downlight

Nora Lighting offers an emergency option for our family of Compact Fluorescent Downlights.

We can supply any of our 6-inch or 8-inch new construction housings with factory installed Emergency ballasts for simple, trouble-free installation. The emergency ballast comes pre-wired with a remote test switch box or an optional integral test switch. The integral test switch functions as both a test switch and an indicator light and is discreetly mounted to the top of the reflector. In the event of power interruption, fixtures will continue to work for a minimum of 90 minutes, allowing for safe egress of the building's occupants. These high quality downlights are suitable for use in corridors, hospitals, or any public area. Simply use the suffix "/EM" in the part number and we'll do the rest.

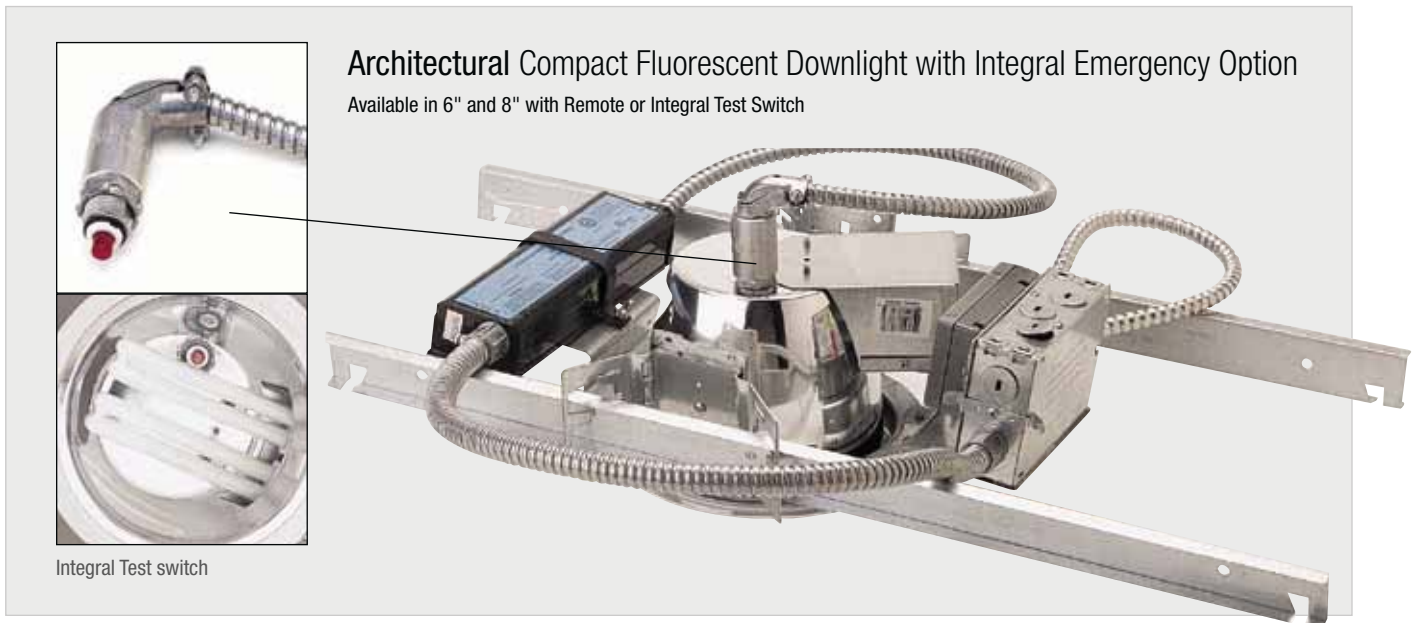

COMPACT FLUORESCENT RECESSED Emergency Downlight

Description: Nora emergency fixtures are equipped with an extended plaster frame that secures an emergency battery (optional on economy fixtures). Flexible metal conduit completely encloses all wiring, connects the battery to the fixture via the fixture's junction box, and also connects the battery to either a remote switch or an integral test switch (optional on commercial and architectural fixtures only). The remote switch plate, with charging indicator light and test switch, is mounted directly into the ceiling within a few inches of the fixture itself. The integral test switch functions as both a test switch and an indicator light and is discreetly mounted to the top of the reflector. All necessary hardware is provided with the fixture.

Wiring: All wiring connections are completed at Nora Lighting. The only open wires inside the junction box are those to be connected with a 277V or 120V electrical source - positive, neutral, and in rare cases - grounding, although in the majority of applications, grounding is automatically provided via steel conduit connected to the fixture.

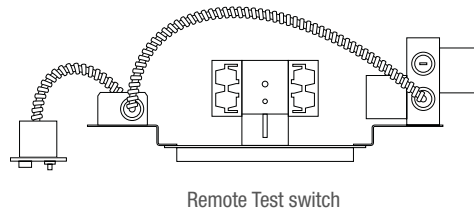

Remote Test switch

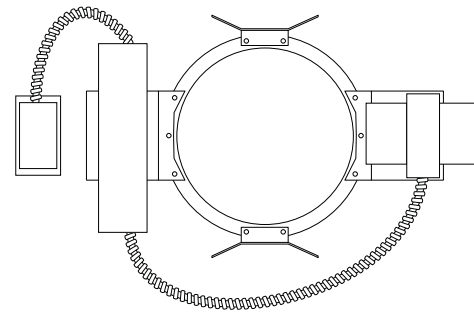

Optional Integral Test switch

120V NPF, 120V HPF, 277V HPF

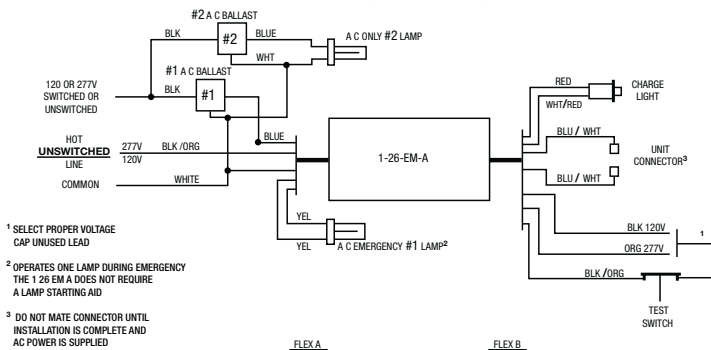

How to Specify: To order a fixture with the emergency option, simply select the desired compact fluorescent fixture, then add the suffix "/EM." For example, to specify a horizontal, 2 lamp 6" fixture with an 18 watt 277V high power factor ballast, with some having the emergency option:

- NHP6-218EL 2x18W Fixture
- NHP6-218EL/EM (with emergency)

Example only - consult wiring diagrams included with emergency ballast

Operation: Under normal operation, the fixture will operate from the standard ballast at full capacity. The indicator light is on during normal operation as well. During emergency operation, a single lamp fixture, or one lamp from a double-lamp unit will operate at 650 lumens (slightly above the normal output of a 9W lamp) initially, then at a gradually reducing output for 90 minutes. During emergency operation, the red indicator light is extinguished. The fixture will automatically switch to emergency operation when the main power source is interrupted. When normal power is restored, the fixture automatically returns to normal operation by the standard ballast on the fixture. The red indicator light will activate to confirm that the emergency battery is in charge mode. If the fixture has been operating in emergency mode for 90 minutes or more, it will take 24 hours for the battery to completely recharge.

Technical Data:

Input Voltage:	120V or 277V, 60Hz
Input Wattage:	3.5VA
Lamps Operated:	9 - 42W Compact Fluorescent
Battery:	Long life, high heat rated Ni-Cad construction.
Initial Illumination:	650 Lumens (1000 lumen option available - consult factory)
Approvals:	UL Listed. Meets or exceeds all applicable NFPA, NEC, LSC requirements for emergency lighting.
Emergency Operation:	90 minutes
Req. Charging Time:	24 hours (with battery completely drained)

COMPACT FLUORESCENT RECESSED

6" & 8" Horizontal Architectural Emergency Frame-in

Nora Lighting's Horizontal Compact Fluorescent downlights with pre-wired emergency ballast are ideal for high-performance and efficiency in high traffic areas with higher ceilings such as offices, corridors, entrances and many other applications. Horizontal Architectural fixtures are available in 6" or 8" single or double lamp (8" only), Electronic or Dimming ballast. The emergency ballast comes pre-wired with a remote test switch box or an optional integral test switch. The integral test switch functions as both a test switch and an indicator light and is discreetly mounted to the top of the reflector. A wide variety of trims are available.

Ballast: Electronic (EL) with Universal Input (120V-277V).

Lamp Types:

13W – 26W Electronic 4-Pin Quad G24Q base
 13W – 42W Electronic 4-Pin Triple Tube GX24Q base

Dimming Options: Variety of Dimming ballast options are available. Please match appropriate fixture with compatible compact fluorescent dimming control. See pages 70-71.

Emergency Operation: Automatically transfers during power loss and returns fixture to normal operation when power is restored. Battery operates one lamp at 650 lumens for 90 minutes during power interruption.

Test Switch: Available as remote test switch (EM) or integral test switch mounted directly to inside of the reflector.

Fuse Option: 2A Fuse may be added to any compact fluorescent frame-in. Add: suffix FS.

Minimum Clearances: Non-IC fixtures require minimum clearances of 3" from thermal insulation and 1/2" from adjacent building components.

Installation: Universal brackets adjust vertically and accept C-Channel or flat bar hangers (ordered separately), or simple rigid 1/2" steel conduit for tie-down to ceiling grids.

Listing:

cULus Damp Location w/ Feed Through
 cULus Wet Location (Only with designated trims)



Integral Test switch



Remote Test switch

HORIZONTAL ARCHITECTURAL EMERGENCY SERIES

CATALOG. NO.	APER.	LAMP	WATTS	VOLTAGE	DIMMING
INTEGRAL TEST SWITCH					
NHP8U-113EL/EMI	8"	1 Q/T	13	120-277	D10
NHP8U-118EL/EMI	8"	1 Q/T	18	120-277	D10, MX1, MX2, M7, L51, L52, L11, L12
NHP8U-12642EL/EMI	8"	1 Q/T	26-42	120-277	DAS, D10, MX1, MX2, M7, L51, L52, L11, L12
NHP8U-213EL/EMI	8"	2 Q/T	13	120-277	D10
NHP8U-218EL/EMI	8"	2 Q/T	18	120-277	D10, MX1, MX2, M7, L51, L52, L11, L12
NHP8U-22642EL/EMI	8"	2 Q/T	26-42	120-277	DAS, D10, MX1, MX2, M7, L51, L52, L11, L12
NHP6-113EL/EMI	6"	1 Quad	13	120-277	D10
NHP6-118EL/EMI	6"	1 Quad	18	120-277	D10, MX1, MX2, M7, L51, L52, L11, L12
NHP6-126EL/EMI	6"	1 Quad	26	120-277	DAS, D10, MX1, MX2, M7, L51, L52, L11, L12
NHP6-213EL/EMI	6"	2 Quad	13	120-277	D10
NHP6-218EL/EMI	6"	2 Quad	18	120-277	D10, MX1, MX2, M7, L51, L52, L11, L12
NHP6-226EL/EMI	6"	2 Quad	26	120-277	DAS, D10, MX1, MX2, M7, L51, L52, L11, L12
NHPT6-13EL/EMI	6"	1 Triple	13	120-277	D10
NHPT6-18EL/EMI	6"	1 Triple	18	120-277	D10, MX1, MX2, M7, L51, L52, L11, L12
NHPT6-2642EL/EMI	6"	1 Triple	26-42	120-277	DAS, D10, MX1, MX2, M7, L51, L52, L11, L12
REMOTE TEST SWITCH					
NHP8U-113EL/EM	8"	1 Q/T	13	120-277	D10
NHP8U-118EL/EM	8"	1 Q/T	18	120-277	D10, MX1, MX2, M7, L51, L52, L11, L12
NHP8U-12642EL/EM	8"	1 Q/T	26-42	120-277	DAS, D10, MX1, MX2, M7, L51, L52, L11, L12
NHP8U-213EL/EM	8"	2 Q/T	13	120-277	D10
NHP8U-218EL/EM	8"	2 Q/T	18	120-277	D10, MX1, MX2, M7, L51, L52, L11, L12
NHP8U-22642EL/EM	8"	2 Q/T	26-42	120-277	DAS, D10, MX1, MX2, M7, L51, L52, L11, L12
NHP6-113EL/EM	6"	1 Quad	13	120-277	D10
NHP6-118EL/EM	6"	1 Quad	18	120-277	D10, MX1, MX2, M7, L51, L52, L11, L12
NHP6-126EL/EM	6"	1 Quad	26	120-277	DAS, D10, MX1, MX2, M7, L51, L52, L11, L12
NHP6-213EL/EM	6"	2 Quad	13	120-277	D10
NHP6-218EL/EM	6"	2 Quad	18	120-277	D10, MX1, MX2, M7, L51, L52, L11, L12
NHP6-226EL/EM	6"	2 Quad	26	120-277	DAS, D10, MX1, MX2, M7, L51, L52, L11, L12
NHPT6-13EL/EM	6"	1 Triple	13	120-277	D10
NHPT6-18EL/EM	6"	1 Triple	18	120-277	D10, MX1, MX2, M7, L51, L52, L11, L12
NHPT6-2642EL/EM	6"	1 Triple	26-42	120-277	DAS, D10, MX1, MX2, M7, L51, L52, L11, L12



6" & 8" Horizontal Commercial Emergency Frame-in



Nora Lighting's 6" & 8" Horizontal Compact Fluorescent Downlights with emergency ballast combine the energy savings of fluorescent lighting with the compact size and attractive appearance of recessed lighting. These commercial fixtures are ideal for any application which requires high-performance light levels and distribution such as office spaces, hospitals, schools and many others. Available in 6" and 8," single or double (8" only) lamp, Electronic or Dimming ballast and come with a pre-wired emergency ballast, charging indicator light and test switch box. An integral test switch is available and is mounted directly to the top of the reflector. Emergency option provides a minimum of 90 minutes of operation from integral battery unit.

HORIZONTAL COMMERCIAL EMERGENCY SERIES

CATALOG. NO.	APER.	LAMP	WATTS	VOLTAGE	DIMMING
INTEGRAL TEST SWITCH					
NH8PU-113EL/EMI	8"	1 Q/T	13	120-277	D10
NH8PU-118EL/EMI	8"	1 Q/T	18	120-277	D10, MX1, MX2, M7, L51, L52, L11, L12
NH8PU-12642EL/EMI	8"	1 Q/T	26-42	120-277	DAS, D10, MX1, MX2, M7, L51, L52, L11, L12
NH8PU-213EL/EMI	8"	2 Q/T	13	120-277	D10
NH8PU-218EL/EMI	8"	2 Q/T	18	120-277	D10, MX1, MX2, M7, L51, L52, L11, L12
NH8PU-22642EL/EMI	8"	2 Q/T	26-42	120-277	DAS, D10, MX1, MX2, M7, L51, L52, L11, L12
NHP-113EL/EMI	6"	1 Quad	13	120-277	D10
NHP-118EL/EMI	6"	1 Quad	18	120-277	D10, MX1, MX2, M7, L51, L52, L11, L12
NHP-126EL/EMI	6"	1 Quad	26	120-277	DAS, D10, MX1, MX2, M7, L51, L52, L11, L12
NHP-213EL/EMI	6"	2 Quad	13	120-277	D10
NHP-218EL/EMI	6"	2 Quad	18	120-277	D10, MX1, MX2, M7, L51, L52, L11, L12
NHP-226EL/EMI	6"	2 Quad	26	120-277	DAS, D10, MX1, MX2, M7, L51, L52, L11, L12
NHPT-13EL/EMI	6"	1 Triple	13	120-277	D10
NHPT-18EL/EMI	6"	1 Triple	18	120-277	D10, MX1, MX2, M7, L51, L52, L11, L12
NHPT-2642EL/EMI	6"	1 Triple	26-42	120-277	DAS, D10, MX1, MX2, M7, L51, L52, L11, L12
REMOTE TEST SWITCH					
NH8PU-113EL/EM	8"	1 Q/T	13	120-277	D10
NH8PU-118EL/EM	8"	1 Q/T	18	120-277	D10, MX1, MX2, M7, L51, L52, L11, L12
NH8PU-12642EL/EM	8"	1 Q/T	26-42	120-277	DAS, D10, MX1, MX2, M7, L51, L52, L11, L12
NH8PU-213EL/EM	8"	2 Q/T	13	120-277	D10
NH8PU-218EL/EM	8"	2 Q/T	18	120-277	D10, MX1, MX2, M7, L51, L52, L11, L12
NH8PU-22642EL/EM	8"	2 Q/T	26-42	120-277	DAS, D10, MX1, MX2, M7, L51, L52, L11, L12
NHP-113EL/EM	6"	1 Quad	13	120-277	D10
NHP-118EL/EM	6"	1 Quad	18	120-277	D10, MX1, MX2, M7, L51, L52, L11, L12
NHP-126EL/EM	6"	1 Quad	26	120-277	DAS, D10, MX1, MX2, M7, L51, L52, L11, L12
NHP-213EL/EM	6"	2 Quad	13	120-277	D10
NHP-218EL/EM	6"	2 Quad	18	120-277	D10, MX1, MX2, M7, L51, L52, L11, L12
NHP-226EL/EM	6"	2 Quad	26	120-277	DAS, D10, MX1, MX2, M7, L51, L52, L11, L12
NHPIC-113EL/EM	6"	1 Quad	13	120-277	D10
NHPIC-118EL/EM	6"	1 Quad	18	120-277	D10, MX1, MX2, M7, L51, L52, L11, L12
NHPIC-213EL/EM	6"	2 Quad	13	120-277	D10
NHPT-13EL/EM	6"	1 Triple	13	120-277	D10
NHPT-18EL/EM	6"	1 Triple	18	120-277	D10, MX1, MX2, M7, L51, L52, L11, L12
NHPT-2642EL/EM	6"	1 Triple	26-42	120-277	DAS, D10, MX1, MX2, M7, L51, L52, L11, L12

Ballast: Electronic (EL) with Universal Input (120V-277V).

Lamp Types:
 13W – 26W Electronic 4-Pin Quad G24Q base
 13W – 42W Electronic 4-Pin Triple Tube GX24Q base

Dimming Options: Variety of Dimming ballast options are available. Please match appropriate fixture with compatible compact fluorescent dimming control. See pages 70-71.

Emergency Operation: Automatically transfers during power loss and returns fixture to normal operation when power is restored. Battery operates one lamp at 650 lumens for 90 minutes during power interruption.

Test Switch: Available as remote test switch (/EM) or integral test switch mounted directly to inside of the reflector.

Fuse Option: 2A Fuse may be added to any compact fluorescent frame-in. Add: suffix FS.

Minimum Clearances: Non-IC fixtures require minimum clearances of 3" from thermal insulation and 1/2" from adjacent building components. IC rated fixtures are rated for direct contact.

Installation: Bar hangers are adjustable from 13-5/8" to 24-1/2" and can be repositioned 90 degrees. Bar hangers are slotted for T-bar installations.

Listing:
 cULus Damp Location w/ Feed Through
 cULus Wet Location (Only with designated trims)



COMPACT FLUORESCENT RECESSED

6" & 8" Vertical Architectural Emergency Frame-in

Nora Lighting's Vertical Compact Fluorescent Architectural downlights with pre-wired emergency ballast are ideal for use in any application where optimal lighting appearance and performance is required for high traffic areas with higher ceilings. Architectural fixtures are available in 6" or 8" apertures, 110V, 277V, Electronic or Dimming ballast. The emergency ballast comes pre-wired with a remote test switch box or an optional integral test switch. The integral test switch functions as both a test switch and an indicator light and is discreetly mounted to the top of the reflector. Emergency option provides a minimum of 90 minutes of operation from integral battery unit.

Ballast: Electronic (EL) with Universal Input (120V-277V). Pre-mounted and wired emergency ballast.

Lamp Types:
 13W – 26W Electronic 4-Pin Quad G24Q base
 13W – 42W Electronic 4-Pin Triple Tube GX24Q base

Socket Cup: Slots on neck of each reflector allow vertical adjustment of socket cup for optimum light distribution and output.

Dimming Options: Variety of Dimming ballast options are available. Please match appropriate fixture with compatible compact fluorescent dimming control. See pages 70-71

Emergency Operation: Automatically transfers during power loss and returns fixture to normal operation when power is restored. Battery operates one lamp at 650 lumens for 90 minutes during power interruption.

Test Switch: Available as remote test switch (/EM) or integral test switch mounted directly to inside of the reflector.

Fuse Option: 2A Fuse may be added to any compact fluorescent frame-in. Add: suffix FS.

Minimum Clearances: Non-IC fixtures require minimum clearances of 3" from thermal insulation and 1/2" from adjacent building components.

Installation: Universal brackets adjust vertically and accept C-Channel or flat bar hangers (ordered separately), or simple rigid 1/2" steel conduit for tie-down to ceiling grids.

Listing:
 cULus Damp Location w/ Feed Through
 cULus Wet Location (Only with designated trims)



Integral Test switch

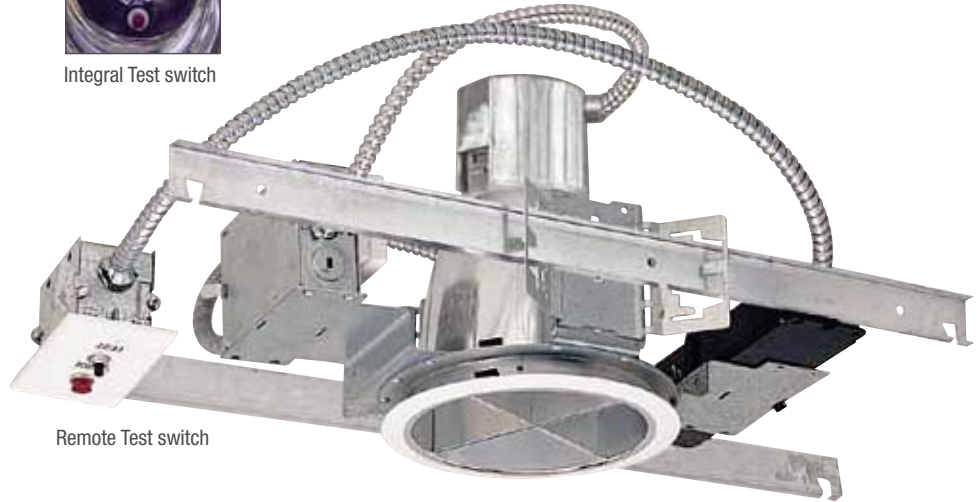

Remote Test switch

VERTICAL ARCHITECTURAL EMERGENCY SERIES

CATALOG. NO.	APER.	LAMP	WATTS	VOLTAGE	DIMMING
INTEGRAL TEST SWITCH					
NHPV-813EL/EMI	8"	1 Q/T	13	120-277	D10
NHPV-818EL/EMI	8"	1 Q/T	18	120-277	D10, MX1, MX2, M7, L51, L52, L11, L12
NHPV-82642EL/EMI	8"	1 Q/T	26-42	120-277	DAS, D10, MX1, MX2, M7, L51, L52, L11, L12
NHPV-613EL/EMI	6"	1 Quad	13	120-277	D10
NHPV-618EL/EMI	6"	1 Quad	18	120-277	D10, MX1, MX2, M7, L51, L52, L11, L12
NHPV-62642EL/EMI	6"	1 Quad	26-42	120-277	DAS, D10, MX1, MX2, M7, L51, L52, L11, L12
REMOTE TEST SWITCH					
NHPV-813EL/EM	8"	1 Q/T	13	120-277	D10
NHPV-818EL/EM	8"	1 Q/T	18	120-277	D10, MX1, MX2, M7, L51, L52, L11, L12
NHPV-82642EL/EM	8"	1 Q/T	26-42	120-277	DAS, D10, MX1, MX2, M7, L51, L52, L11, L12
NHPV-613EL/EM	6"	1 Quad	13	120-277	D10
NHPV-618EL/EM	6"	1 Quad	18	120-277	D10, MX1, MX2, M7, L51, L52, L11, L12
NHPV-62642EL/EM	6"	1 Quad	26-42	120-277	DAS, D10, MX1, MX2, M7, L51, L52, L11, L12



6" & 8" Vertical Commercial Emergency Frame-in



Integral Test switch

Remote Test switch

Nora Lighting's 6" & 8" Vertical Compact Fluorescent Downlights with emergency ballast are ideal for any application which requires specific light levels and distribution such as office spaces, hospitals, schools and many others. All of Nora's Commercial Emergency Compact Fluorescent units are available with 6" and 8" apertures, 110V, 277V, Electronic or Dimming ballast and come with pre-wired emergency ballast, charging indicator light and test switch box. An integral test switch is available and is mounted directly to the top of the reflector. Emergency option provides a minimum of 90 minutes of operation from integral battery unit.

Ballast: Electronic (EL) with Universal Input (120V-277V). Pre-mounted and wired emergency ballast.

Lamp Types:
 13W – 26W Electronic 4-Pin Quad G24Q base
 13W – 42W Electronic 4-Pin Triple Tube GX24Q base

Socket Cup: Slots on neck of each reflector allow vertical adjustment of socket cup for optimum light distribution and output.

Dimming Options: Variety of Dimming ballast options are available. Please match appropriate fixture with compatible compact fluorescent dimming control. See pages 70-71

Emergency Operation: Automatically transfers during power loss and returns fixture to normal operation when power is restored. Battery operates one lamp at 650 lumens for 90 minutes during power interruption.

Test Switch: Available as remote test switch (/EM) or integral test switch mounted directly to inside of the reflector.

Fuse Option: 2A Fuse may be added to any compact fluorescent frame-in. Add: suffix FS.

Minimum Clearances: Non-IC fixtures require minimum clearances of 3" from thermal insulation and 1/2" from adjacent building components.

Installation: Bar hangers are adjustable from 13-5/8" to 24-1/2" and can be repositioned 90 degrees. Bar hangers are slotted for T-bar installations.

Listing:
 cULus Damp Location w/ Feed Through
 cULus Wet Location (Only with designated trims)

VERTICAL COMMERCIAL EMERGENCY SERIES

CATALOG. NO.	APER.	LAMP	WATTS	VOLTAGE	DIMMING
INTEGRAL TEST SWITCH					
NHPV-13EL/EMI	8"	1 Q/T	13	120-277	D10
NHPV-18EL/EMI	8"	1 Q/T	18	120-277	D10, MX1, MX2, M7, L51, L52, L11, L12
NHPV-2642EL/EMI	8"	1 Q/T	26-42	120-277	DAS, D10, MX1, MX2, M7, L51, L52, L11, L12
NHPV-13EL/EMI	6"	1 Quad	13	120-277	D10
NHPV-18EL/EMI	6"	1 Quad	18	120-277	D10, MX1, MX2, M7, L51, L52, L11, L12
NHPV-2642EL/EMI	6"	1 Quad	26-42	120-277	DAS, D10, MX1, MX2, M7, L51, L52, L11, L12
REMOTE TEST SWITCH					
NHPV-13EL/EM	8"	1 Q/T	13	120-277	D10
NHPV-18EL/EM	8"	1 Q/T	18	120-277	D10, MX1, MX2, M7, L51, L52, L11, L12
NHPV-2642EL/EM	8"	1 Q/T	26-42	120-277	DAS, D10, MX1, MX2, M7, L51, L52, L11, L12
NHPV-13EL/EM	6"	1 Quad	13	120-277	D10
NHPV-18EL/EM	6"	1 Quad	18	120-277	D10, MX1, MX2, M7, L51, L52, L11, L12
NHPV-2642EL/EM	6"	1 Quad	26-42	120-277	DAS, D10, MX1, MX2, M7, L51, L52, L11, L12



COMPACT FLUORESCENT RECESSED

6" Single Lamp Economy Emergency Housing with Integral Test Switch

Nora Lighting's family of 6" Economy Compact Fluorescent single lamp housings now offer a new emergency option with integral test switch. The EMI emergency option includes a pre-installed battery and a test switch added to the inside top of the can for a complete integral unit, reducing costly installation time. The single lamp housings utilize dual lamp open baffle trims and reflectors to accommodate the test switch. Light sources are available in warm or cool colors.

Ballast Types:

- 13W-42W 120V-277V Electronic (EL)
- 13W-26W 120V Electronic (ELAT)
- 26W 120V-277V Electronic (ATE2)

Lamp Types:

- 13W – 26W Electronic 4-Pin Quad G24Q base
- 13W – 42W Electronic 4-Pin Triple Tube GX24Q base

Dimming Options: Variety of Electronic Dimming ballast options are available. Please match appropriate fixture with compatible compact fluorescent dimming control. See pages 70-71.

Emergency Operation: Automatically transfers during power loss and returns fixture to normal operation when power is restored. Battery operates one lamp at 650 lumens for 90 minutes during power interruption.

Fuse Option: 2A Fuse may be added to any compact fluorescent frame-in — Add suffix FS.

Minimum Clearances: Non-IC housings require minimum clearances of 3" from thermal insulation and 1/2" from adjacent building components. IC housings are rated for direct contact and do not have any minimum clearance requirements.

New Construction: Bar hangers are adjustable from 13-5/8" to 24-1/2" and can be repositioned 90 degrees. Bar hangers are slotted for T-bar installation.

Listing:

- cULus Damp Location w/ Feed Through
- cULus Wet Location (Only with designated trims)



NEW!

Visual Test switch is mounted to the inside top of the housing for easy access with a discreet appearance.

Use with dual lamp open baffle trims and reflectors found on pages 127-129.

EMERGENCY SERIES WITH INTEGRAL TEST SWITCH

CATALOG. NO.	LAMP	WATTS	VOLTAGE	DIMMING
ELECTRONIC				
NHP-13EL/EMI	1 Q/T	13	120/277	D10
NHP-18EL/EMI	1 Q/T	18	120/277	D10, MX1, MX2, M7, L51, L52, L11, L12
NHP-26EL/EMI	1 Q/T	26	120/277	DAS, D10, MX1, MX2, M7, L51, L52, L11, L12
NHP-2642EL/EMI	1 Q/T	26	120/277	DAS, D10, MX1, MX2, M7, L51, L52, L11, L12
NHPIC-13EL/EMI	1 Q/T	13	120/277	D10
TITLE 24 2008 NHPIC-13ELAT/EMI	1 Q/T	13	120	D10
NHPIC-18EL/EMI	1 Q/T	18	120/277	D10, MX1, MX2, M7, L51, L52, L11, L12
TITLE 24 2008 NHPIC-18ELAT/EMI	1 Q/T	18	120	DAS, D10, MX1, M7, L51, L11
TITLE 24 2008 NHPIC-26ELAT/EMI	1 Q/T	26	120	DAS, D10, MX1, M7, L51, L11
TITLE 24 2008 NHPIC-26ATE2/EMI	1 Q/T	26	120-277	D10, MX2, M7, L52, L12



Applies only to Electronic, Air-Tight

6" Single/Dual Lamp Economy Emergency Housing with Remote Test Switch

Remote charging indicator light and test switch allows user to easily test system.



Nora Economy Emergency Compact Fluorescent Downlights bring you great quality and design at an affordable price. Ideal for residential and commercial applications, all Nora economy CF emergency housings include a pre-wired nickel-cadmium battery, remote charging indicator light and test switch and provide a minimum 90-minute emergency operation. A mounted battery pack is available upon request. The economy downlight series is available in 6" aperture, single and double lamp, 120V, 277V, electronic, electronic dimming ballast and magnetic. To order, add suffix /EM to any economy compact fluorescent housing item number. Light sources are available in warm or cool colors.

Ballast Types:

- 13W-42W 120V-277V Electronic (EL)
- 13W-26W 120V Electronic (ELAT)
- 26W 277V Electronic (ATE2)

Lamp Types:

- 13W – 26W Electronic 4-Pin Quad G24Q base
- 13W – 42W Electronic 4-Pin Triple Tube GX24Q base

Dimming Options: Variety of Electronic Dimming ballast options are available. Please match appropriate fixture with compatible compact fluorescent dimming control. See pages 70-71.

Emergency Operation: Automatically transfers during power loss and returns fixture to normal operation when power is restored. Battery operates one lamp at 650 lumens for 90 minutes during power interruption.

Fuse Option: 2A Fuse may be added to any compact fluorescent frame-in — Add suffix FS.

Minimum Clearances: Non-IC housings require minimum clearances of 3" from thermal insulation and 1/2" from adjacent building components. IC housings are rated for direct contact and do not have any minimum clearance requirements.

New Construction: Bar hangers are adjustable from 13-5/8" to 24-1/2" and can be repositioned 90 degrees. Bar hangers are slotted for T-bar installation.

Listing:
cULus Damp Location w/ Feed Through
cULus Wet Location (Only with designated trims)

EMERGENCY SERIES WITH REMOTE TEST SWITCH

CATALOG. NO.	LAMP	WATTS	VOLTAGE	DIMMING
ELECTRONIC				
NHP-13EL/EM	1 Quad/Triple	13	120/277	D10
NHP-13/2LEL/EM	2 Quad	13	120/277	D10
NHP-18EL/EM	1 Quad/Triple	18	120/277	D10, MX1, MX2, M7, L51, L52, L11, L12
NHP-18/2LEL/EM	2 Quad	18	120/277	D10, MX1, MX2, M7, L51, L52, L11, L12
NHP-26EL/EM	1 Quad/Triple	26	120/277	DAS, D10, MX1, MX2, M7, L51, L52, L11, L12
NHP-26/2LEL/EM	2 Quad	26	120/277	DAS, D10, MX1, MX2, M7, L51, L52, L11, L12
NHP-2642EL/EM	1 Quad/Triple	26	120/277	DAS, D10, MX1, MX2, M7, L51, L52, L11, L12
NHPIC-13EL/EM	1 Quad/Triple	13	120/277	D10
TITLE 24 2008 NHPIC-13ELAT/EM	1 Quad/Triple	13	120	D10
NHPIC-13/2LEL/EM	2 Quad	13	120/277	D10
NHPIC-18EL/EM	1 Quad/Triple	18	120/277	D10, MX1, MX2, M7, L51, L52, L11, L12
TITLE 24 2008 NHPIC-18ELAT/EM	1 Quad/Triple	18	120	D10, MX1, M7, L51, L11
TITLE 24 2008 NHPIC-26ELAT/EM	1 Quad/Triple	26	120	DAS, D10, MX1, M7, L51, L11
TITLE 24 2008 NHPIC-26ATE2/EM	1 Quad/Triple	26	277	D10, MX2, M7, L52, L12

CONSULT FACTORY FOR REMODEL EMERGENCY



Applies only to Electronic, Air-Tight



High Performance. Efficiency. Accuracy.

For high performance illumination from high ceilings, Nora Lighting's HID fixtures are ideal for lobbies, museums, showrooms and any other application requiring brilliant, well-defined lighting in a large area. Fixtures accept a wide variety of trims ranging from economy to high-end architectural, including the addition of adjustable gimbal rings for PAR Metal Halide lamps. Nora HID fixtures accept electronically driven color accurate Ceramic Metal Halide sources. Nora Lighting's HID fixtures can be installed in new or existing ceilings.

Ceramic Metal Halide HID





Overview HID RECESSED

8" ARCHITECTURAL & COMMERCIAL CERAMIC METAL HALIDE



8" CMH Architectural Frame-in
NHFM8 Series p.190



8" CMH Commercial Frame-in
NHFM-9 Series p.191



8" CMH Architectural Remodel
NHRFM8 Series p.192

6" ARCHITECTURAL & COMMERCIAL CERAMIC METAL HALIDE



6" CMH Architectural Frame-in
NHFM6 Series p.197



6" CMH Commercial Frame-in
NHFM-7 Series p.198



6" CMH Architectural Remodel
NHRFM6 Series p.199

4" ARCHITECTURAL CERAMIC METAL HALIDE



4" CMH Universal
Architectural Housing
NHID-4 Series p.204

6" ECONOMY CERAMIC METAL HALIDE



6" CMH Economy Housing
NHFM Series p.206



6" CMH Remodel Housing
NHRPM Series p.207



8" CMH Square Housing
NSD-8 Series p.362



Recessed Accessories
Bar Hangers, Rings, Glass p.378

Ceramic Metal Halide Recessed TECHNOLOGY

The Nora Lighting family of Ceramic Metal Halide recessed frame-in fixtures provide a clean architectural look and are designed for commercial applications ranging from retail stores to health care facilities, offices, educational, government and hospitality settings. Time tested ceramic metal halide technology is energy efficient providing maximum lumens per watt. Featuring high color rendering capabilities, metal halide lamps are specified in the toughest retail environments where it is vital that colors are vibrant and precise. Many retailers throughout the country are moving to ceramic metal halide sources to save electricity and radically reduce maintenance costs.

Why Ceramic Metal Halide?

- Long rated lamp life, over 15,000 hours
- Selectable beam spreads for critical foot candle requirements
- Color critical applications
- More energy efficient than halogen
- Better color quality than Standard Metal Halide
- Better lumen maintenance
- Lower operating costs than halogen for retail applications
- When combining energy efficiency with lower maintenance cost and long life lamps, CMH is an excellent selection.

FEATURES

- New Quartz Restrike Option
- 4" HID only 6-3/8" deep
- Wattages from 20W - 150W
- Architectural grade reflectors
- Up to 7 lamp styles
- Wall wash, downlights, lensed, and adjustable
- Electronic ballasts with universal input 120/277V
- New 8" Square HID housing
- UL Listed

Lamp Performance Comparison				
Fixture	50W MR16	39W MR16 CMH	75W PAR	39W PAR20 CMH
Average Lamp Hours	6,000 Hrs.	12,000 Hrs.	3,000 Hrs.	12,500 Hrs.
Distribution	10° - 50°	12° - 40°	10° - 30°	10° - 30°
Average Lumens Per Watt	19 lm	56 lm	13 lm	51 lm
Lamp CRI	n/a	90 CRI	n/a	85 CRI
CBCP (Spot)	13,000 cd	16,000 cd	12,300 cd	23,000 cd
FC @ Nadir 8' MH	234 fc	250 fc	203 fc	344 fc
FC @ Nadir 10' MH	150 fc	160 fc	130 fc	220 fc

Ceramic Metal Halide Recessed Downlight

Die-cast socket cup
Featuring heat dissipating fins reduces lamp base temperatures for a longer life

Socket
Pulse rated E26 medium base

Quartz Restrike
Current sensing device to automatically relight lamp when the main HID lamp is extinguished

Electronic ballast
with universal voltage input of 120-277V, provides noise free operation, improved efficiency and increased lamp life as compared with magnetic ballast. Power factor > 90%, ballast life expectancy > 64,000 hours

Adjustable lamp position
Vertical adjustment provides optimal lamp position for highest fixture efficiency and desired light distribution

Universal Hanger Brackets
accept 'C' Channel rigid 1/2" steel conduit or flat bar hangers (ordered separately).

High grade spun reflectors
provide excellent cut-off, high efficiency and minimal glare or lamp image. Spun .050" aluminum

Plaster frame
Die stamped .050" galvanized steel plaster frame

Integral Clips
New Reflector Clips are integral to housing, allowing easy reflector installation

Junction Box
is listed for through branch circuit wiring and contains seven 1/2" knockouts and four Romex® with strain relief and ground lead

Internal quick connects
provide instant, trouble-free electrical connection, eliminating the need for wire nuts and reducing labor costs



HID METAL HALIDE RECESSED

8" Architectural Electronic HID Frame-In

Nora Lighting's family of HID Architectural Frame-In fixtures are ideal for suspended ceiling or T-Bar installations requiring high quality architectural grade reflectors in high ceilings for ceramic metal halide sources. A complete selection of high grade spun aluminum reflectors including specular finish reflector, baffle glare reduction, cross baffle louvers, lenses, wall wash, and decorative glass accents. Photometrics and IES files are available where precise calculations and fixtures layout planning is necessary.

Ballast: Electronic Ballast (EL) with Universal Input (120V to 277V)

Socket: Steel shell porcelain jacketed 4KV pulse rated socket mounted inside a die-cast heat dissipating aluminum socket cup.

Lamp Types:

Ceramic Metal Halide ED17
Ceramic Metal Halide PAR20
Ceramic Metal Halide PAR30
Ceramic Metal Halide PAR38

NEW! Quartz Restrike Option: DC Bayonet Base Quartz lamp not included with housings. Compatible with PAR20 and ED17 lamps only, add suffix "QS" to applicable housings. (39W, 70W, 100W housings only)
40W Quartz Lamp for 39W PAR20: QR40WXENF/DCB (ordered separately)
60W Quartz Lamp for 70W/100W ED17: QR60WXENF/DCB (ordered separately)

Ceiling Thickness: Accepts 5/8" maximum ceiling thickness. See page 385 for extension collar.

Selectable Lamp Position: Reflectors have three adjustment slots for optimal light distribution.

Installation: Universal brackets accepts C-Channel or flat bar hangers (ordered separately), or simple rigid 1/2" steel conduit for tie-down to ceiling grids.

Minimum Clearance: Requires a minimum clearance of 3" from thermal insulation and 1/2" from any adjacent building components.

Junction Box: Pre wired 29 cu. in. with seven 1/2" knockouts, 4 pry-outs and snap on covers. Ground wire connected on bottom of box.

Listing:

cULus Damp Location w/ Feed Through
cULus Wet Location (Only with designated trims)

Reflector not included

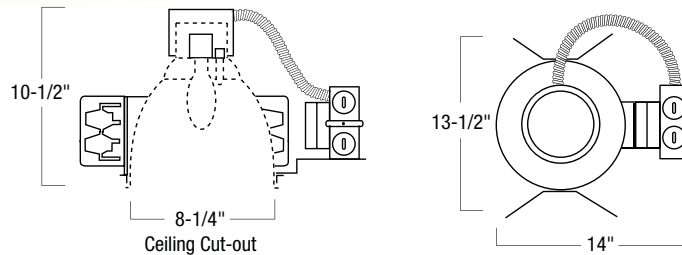

NHFM8 SERIES

CATALOG. NO.	VOLTAGE	WATTAGE	LAMP	BALLAST	QUARTZ RESTRIKE
NHFM8-935/EL	120V to 277V	39W	PAR20 / PAR30	Electronic	No
NHFM8-935/ELQS	120V to 277V	39W	PAR20	Electronic	Yes
NHFM8-950/EL	120V to 277V	50W	ED17	Electronic	No
NHFM8-970/EL	120V to 277V	70W	ED17 / PAR30 / PAR38	Electronic	No
NHFM8-970/ELQS	120V to 277V	70W	ED17	Electronic	Yes
NHFM8-9100/EL	120V to 277V	100W	ED17 / PAR38	Electronic	No
NHFM8-9100/ELQS	120V to 277V	100W	ED17	Electronic	Yes
NHFM8-9150/EL	120V to 277V	150W	ED17 / PAR38	Electronic	No

Channel bar hangers ordered separately. See page 383.
Quartz restrike lamp ordered separately. See page 753.



8" Commercial Electronic HID Frame-In

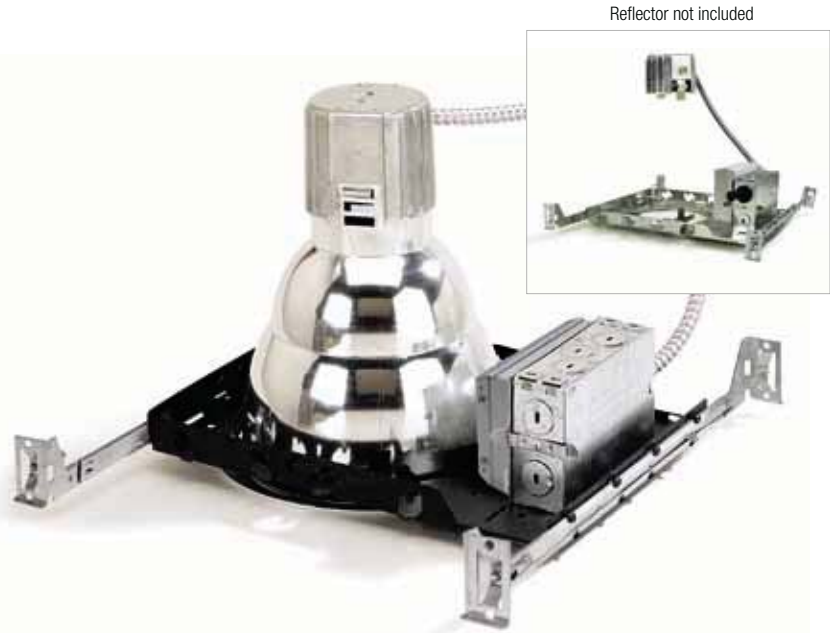

Nora Lighting's family of HID Commercial Frame-In fixtures are ideal for joist or stud or T-Bar installations requiring high quality architectural grade reflectors in high ceilings for ceramic metal halide light sources. A complete selection of high grade spun aluminum reflectors including specular finish reflector, baffle glare reduction, cross baffle louvers, lenses, wall wash, and decorative glass accents. Photometrics and IES files are available where precise calculations and fixtures layout planning is necessary.

Ballast: Electronic Ballast (EL) with Universal Input (120V to 277V)

Socket: Steel shell porcelain jacketed 4KV pulse rated socket mounted inside a die-cast heat dissipating aluminum socket cup.

Lamp Types:

- Ceramic Metal Halide ED17
- Ceramic Metal Halide PAR20
- Ceramic Metal Halide PAR30
- Ceramic Metal Halide PAR38

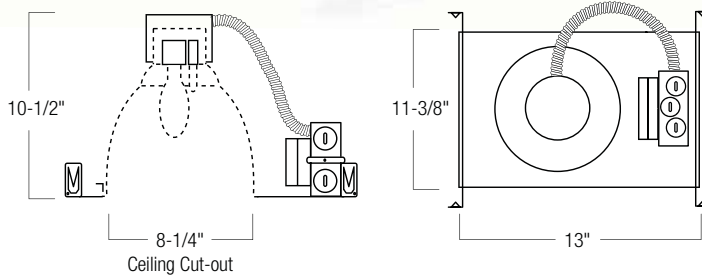

NEW! **Quartz Restrike Option:** DC Bayonet Base Quartz lamp not included with housings. Compatible with PAR20 and ED17 lamps only, add suffix "QS" to applicable housings. (39W, 70W, 100W housings only)
 40W Quartz Lamp for 39W PAR20: QR40WXENF/DCB (ordered separately)
 60W Quartz Lamp for 70W/100W ED17: QR60WXENF/DCB (ordered separately)

Ceiling Thickness: Accepts 5/8" maximum ceiling thickness.

Selectable Lamp Position: Reflectors have three adjustment slots for optimal light distribution.

Installation: Bar hangers are adjustable from 13-5/8" to 24-1/2" with captive nails and can be repositioned 90 degrees. Bar hangers are slotted for T-Bar installations.

Minimum Clearance: Requires a minimum clearance of 3" from thermal insulation and 1/2" from any adjacent building components.

Junction Box: Pre wired 29 cu. in. with seven 1/2" knockouts, 4 pry-outs and snap on covers. Ground wire connected on bottom of box.

Listing:
 cULus Damp Location w/ Feed Through
 cULus Wet Location (Only with designated trims)

NHFM-9 SERIES

CATALOG. NO.	VOLTAGE	WATTAGE	LAMP	BALLAST	QUARTZ RESTRIKE
NHFM-935/EL	120V to 277V	39W	PAR20 / PAR30	Electronic	No
NHFM-935/ELQS	120V to 277V	39W	PAR20	Electronic	Yes
NHFM-950/EL	120V to 277V	50W	ED17	Electronic	No
NHFM-970/EL	120V to 277V	70W	ED17 / PAR30 / PAR38	Electronic	No
NHFM-970/ELQS	120V to 277V	70W	ED17	Electronic	Yes
NHFM-9100/EL	120V to 277V	100W	ED17 / PAR38	Electronic	No
NHFM-9100/ELQS	120V to 277V	100W	ED17	Electronic	Yes
NHFM-9150/EL	120V to 277V	150W	ED17 / PAR38	Electronic	No

Includes bar hangers
 Quartz restrike lamp ordered separately. See page 753.



HID METAL HALIDE RECESSED

8" Architectural Remodel Electronic HID

Nora's New HID Remodel Frame-In allows high performance CMH Reflectors to be installed in existing ceilings.

Excellent for tenant improvement and energy retrofit in commercial, retail, hospitality, and architectural applications.

Ballast: Electronic Ballast (EL) with Universal Input (120V to 277V)

Socket: Steel shell porcelain jacketed 4KV pulse rated socket mounted inside a die-cast heat dissipating aluminum socket cup.

Lamp Types:

Ceramic Metal Halide ED17
Ceramic Metal Halide PAR20
Ceramic Metal Halide PAR30
Ceramic Metal Halide PAR38

Quartz Restrike Option: DC Bayonet Base Quartz lamp not included with housings. Compatible with PAR20 and ED17 lamps only, add suffix "QS" to applicable housings. (39W, 70W, 100W housings only)
40W Quartz Lamp for 39W PAR20: QR40WXENF/DCB (ordered separately)
60W Quartz Lamp for 70W/100W ED17: QR60WXENF/DCB (ordered separately)

Ceiling Thickness: Accepts 1/2" to 3/4" ceiling thickness.

Selectable Lamp Position: Reflectors have three adjustment slots for optimal light distribution.

Remodel Installation: High tension tempered steel springs secure remodel housings evenly to the ceiling; hole cutout template provided for convenience.

Minimum Clearance: Requires a minimum clearance of 3" from thermal insulation and 1/2" from any adjacent building components.

Junction Box: Pre wired 29 cu. in. with seven 1/2" knockouts, 4 pry-outs and snap on covers. Ground wire connected on bottom of box.

Listing:

cULus Damp Location w/ Feed Through
cULus Wet Location (Only with designated trims)

NEW!

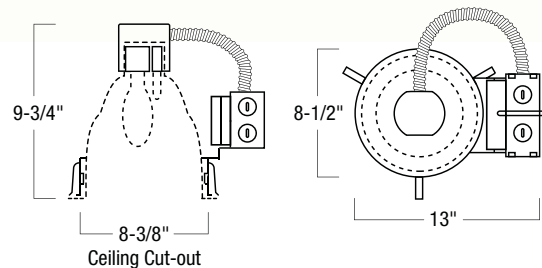

NHRFM8 SERIES

CATALOG. NO.	VOLTAGE	WATTAGE	LAMP	BALLAST	QUARTZ RESTRIKE
NHRFM8-935EL	120V to 277V	39W	PAR20 / PAR30	Electronic	No
NHRFM8-935ELQS	120V to 277V	39W	PAR20	Electronic	Yes
NHRFM8-950EL	120V to 277V	50W	ED17	Electronic	No
NHRFM8-970EL	120V to 277V	70W	ED17 / PAR30 / PAR38	Electronic	No
NHRFM8-970ELQS	120V to 277V	70W	ED17	Electronic	Yes
NHRFM8-9100EL	120V to 277V	100W	ED17 / PAR38	Electronic	No
NHRFM8-9100ELQS	120V to 277V	100W	ED17	Electronic	Yes
NHRFM8-9150EL	120V to 277V	150W	ED17 / PAR38	Electronic	No

Quartz restrike lamp ordered separately. See page 753.





HID METAL HALIDE RECESSED

8" Architectural & Commercial HID Reflectors

Open Reflector with Baffle



Catalog No.	Description
NTS-932CB	Specular Clear Reflector / Black Baffle / White Self Flanged
NTS-932CW	Specular Clear Reflector / White Baffle / White Self Flanged
NTS-932GB	Specular Gold Reflector / Black Baffle / White Self Flanged
NTS-932GW	Specular Gold Reflector / White Baffle / White Self Flanged

- High grade spun 0.050" aluminum

Maximum Wattage
150W CMH
OD: 9"

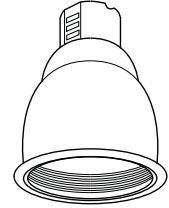

Open Reflector



Catalog No.	Description
NTS-931B	Specular Black Reflector / White Self Flanged
NTS-931C	Specular Clear Reflector / White Self Flanged
NTS-931G	Specular Gold Reflector / White Self Flanged
NTS-931W	Specular White Reflector / White Self Flanged

- High grade spun 0.050" aluminum

Maximum Wattage
150W CMH
OD: 9"

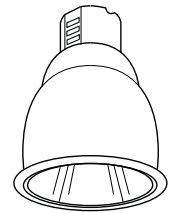

Reflector with Cross Louver

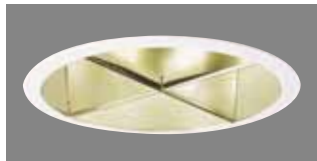

Catalog No.	Description
NTS-934C	Specular Clear Reflector / Specular Clear Louver / White Flange
NTS-934G	Specular Gold Reflector / Specular Gold Louver / White Flange

- High grade spun 0.050" aluminum

Maximum Wattage
100W CMH
OD: 9"

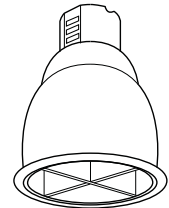

Lensed Reflector Wall Wash



Catalog No.	Description
NTS-933C	Specular Clear Wall Wash / Specular Clear Reflector / White Flange
NTS-933G	Specular Gold Wall Wash / Specular Gold Reflector / White Flange
NTS-933W	Specular White Wall Wash / Specular White Reflector / White Flange

- High grade spun 0.050" aluminum
- Glass Lens

Maximum Wattage
100W CMH
OD: 9"

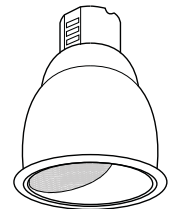

Open Single Wall Wash



Catalog No.	Description
NTS-939SC	Specular Clear Single Wall Wash / White Self Flange

- High grade spun 0.050" aluminum

Maximum Wattage
150W CMH
OD: 9"

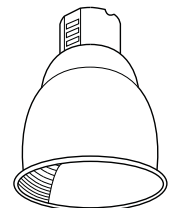

See pages 34-35 for Description of Reflector Finishes

8" ARCHITECTURAL & COMMERCIAL HID REFLECTORS continued

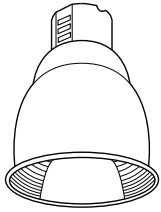

Maximum Wattage
150W CMH
OD: 9"

Catalog No.	Description
NTS-939DC	Specular Clear Double Wall Wash / White Self Flanged
<ul style="list-style-type: none"> • High grade spun 0.050" aluminum 	

Open Double Wall Wash

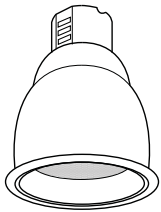

Maximum Wattage
100W CMH
OD: 9"

Catalog No.	Description
NTS-935G	Regressed Glass Lens / Specular Clear Reflector / White Self Flanged
NTS-935FG	Regressed Frosted Lens / Specular Clear Reflector / White Self Flanged
<ul style="list-style-type: none"> • High grade spun 0.050" aluminum • UL Wet Listed 	

Regressed Lens with Reflector

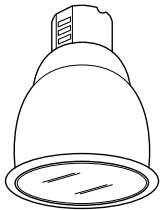

Maximum Wattage
100W CMH
OD: 9"

Catalog No.	Description
NTS-936CL	Clear Lens / Specular Clear Reflector / White Self Flanged
NTS-936FL	Frosted Lens / Specular Clear Reflector / White Self Flanged
<ul style="list-style-type: none"> • High grade spun 0.050" aluminum 	

Flush Lens with Reflector

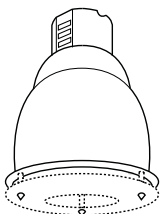

Maximum Wattage
100W CMH
OD: 9"

Catalog No.	Description
NTS-938C	Specular Clear Reflector / White Self Flanged
<ul style="list-style-type: none"> • Glass sold separately. • For a layered look, up to two pieces of glass may be used together. 	

Reflector for Decorative Glass

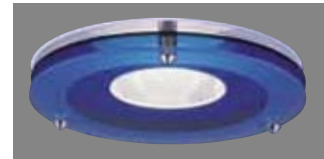

Includes:
NRA-203 Glass Hardware
• (3) Stand-offs
• (3) Cone End Caps
• (3) Flat End Caps
OD: 9"

Catalog No.	Description
NTG-8B/167	Tempered Blue, 167mm (6-5/8") Open Center
NTG-8B/80	Tempered Blue / 80mm (3-1/8") Open Center
NTG-8CF	Tempered Frost Center, Clear Outer
NTG-8FC	Tempered Clear Center, Frost Outer
NTG-8HC	Tempered Clear Outer, Frost Inner, 80mm (3-1/8") Open Center

Decorative Glass for NTS-938C



- **Includes NRA-203 Glass Hardware**
- 2 decorative glasses can be combined for a tiered look

HID METAL HALIDE RECESSED

Photometrics - 8" Architectural & Commercial HID

NTS-931C Clear Reflector, White Self Flanged **39W PAR20**

IESNA: LM-63-1995 Test No.: LRL 300-2N Spacing Criteria: (0-180) 0.66 (90-270) 0.66
Efficiency: 100% Lamp: (1) 39W PAR20 SP CMH Total Watts: 45 Lumens: 2300

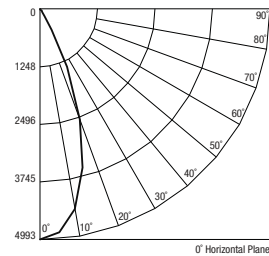

BEAM & CONE DATA

Mounting Height	F.C. at Nadir	Maximum Spacing
6'	138.7	4'
8'	78	5.3'
10'	49.9	6.6'
12'	34.7	7.9'
15'	22.2	9.9'

NTS-932CB Clear Reflector with Black Baffle, White Self Flanged

IESNA: LM-63-1995 Test No.: LRL 300-2O Spacing Criteria: (0-180) 0.62 (90-270) 0.62
Efficiency: 87% Lamp: (1) **39W PAR20** SP CMH Total Watts: 45 Lumens: 2300

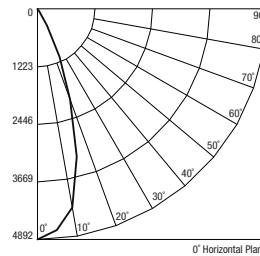

BEAM & CONE DATA

Mounting Height	F.C. at Nadir	Maximum Spacing
6'	135.9	3.7'
8'	76.4	5.0'
10'	48.9	6.2'
12'	34	7.4'
15'	21.7	9.3'

NTS-931C Clear Reflector, White Self Flanged **39W PAR30**

IESNA: LM-63-1995 Test No.: LRL 300-2Q Spacing Criteria: (0-180) 0.6 (90-270) 0.6
Efficiency: 104% Lamp: (1) 39W PAR30 SP CMH Total Watts: 44 Lumens: 2400

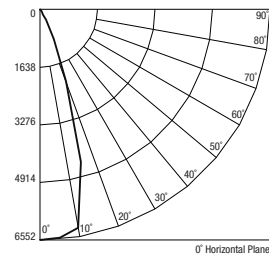

BEAM & CONE DATA

Mounting Height	F.C. at Nadir	Maximum Spacing
6'	182	3.6'
8'	102.4	4.8'
10'	65.5	6'
12'	45.5	7.2'
15'	29.1	9'

NTS-932CB Clear Reflector with Black Baffle, White Self Flanged

IESNA: LM-63-1995 Test No.: LRL 300-2X Spacing Criteria: (0-180) 1.6 (90-270) 1.6
Efficiency: 48% Lamp: (1) **100W ED17** CMH Total Watts: 100 Lumens: 8500

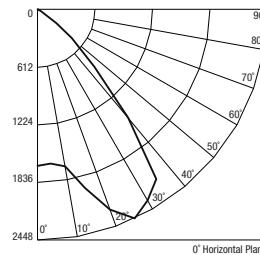

BEAM & CONE DATA

Mounting Height	F.C. at Nadir	Maximum Spacing
6'	46.1	9.6'
8'	25.9	12.8'
10'	16.6	16'
12'	11.5	19.2'
15'	7.4	24'

NTS-931C Clear Reflector, White Self Flanged **100W ED17**

IESNA: LM-63-1995 Test No.: LRL 300-2W Spacing Criteria: (0-180) 1.64 (90-270) 1.64
Efficiency: 61% Lamp: (1) 100W ED17 CMH Total Watts: 100 Lumens: 8500

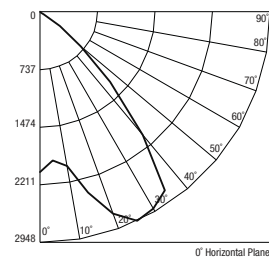

BEAM & CONE DATA

Mounting Height	F.C. at Nadir	Maximum Spacing
6'	56.9	9.8'
8'	32	13.1'
10'	20.5	16.4'
12'	14.2	19.7'
15'	9.1	24.6'

NTS-933C Clear Reflector with Chrome Wall Wash, White Self Flanged

IESNA: LM-63-1995 Test No.: LRL 300-2Y Spacing Criteria: (0-180) 1.86 (90-270) 1.68
Efficiency: 27% Lamp: (1) **70W ED17** CMH Total Watts: 70 Lumens: 5700

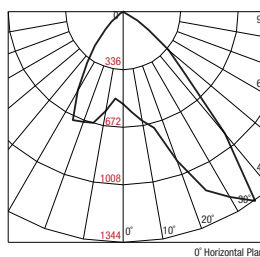

2' FROM WALL - 4' ON CENTER

DISTANCE FROM CEILING IN FEET	1'	2'	1	2
1'	2	40	12	40
2'	66	31	66	
3'	38	45	38	
4'	24	30	24	
5'	18	19	18	
6'	13	13	13	
7'	9	9	9	
8'	7	7	7	
9'	6	6	6	
10'				

Footcandle values are rounded off and are based on a minimum of five units.

NTS-931C Clear Reflector, White Self Flanged **100W PAR38**

IESNA: LM-63-1995 Test No.: LRL 300-2T Spacing Criteria: (0-180) 0.42 (90-270) 0.42
Efficiency: 104% Lamp: (1) 100W PAR38 SP CMH Total Watts: 100 Lumens: 6800

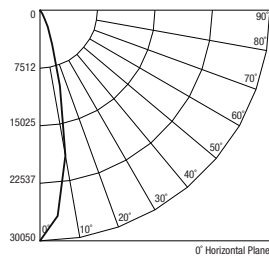

BEAM & CONE DATA

Mounting Height	F.C. at Nadir	Maximum Spacing
8'	469.5	3.4'
10'	300.5	4.2'
12'	208.7	5'
15'	133.6	6.3'
20'	75.1	8.4'

NTS-933C Clear Reflector with Chrome Wall Wash, White Self Flanged

IESNA: LM-63-1995 Test No.: LRL 300-2Y Spacing Criteria: (0-180) 1.86 (90-270) 1.68
Efficiency: 27% Lamp: (1) **100W ED17** CMH Total Watts: 100 Lumens: 8500

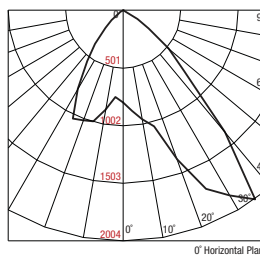

2' FROM WALL - 4' ON CENTER

DISTANCE FROM CEILING IN FEET	1'	3	1	3
1'	59	18	59	
2'	99	46	99	
3'	57	66	57	
4'	35	45	35	
5'	26	28	26	
6'	20	19	20	
7'	14	14	14	
8'	10	11	10	
9'	8	8	8	
10'				

Footcandle values are rounded off and are based on a minimum of five units.

LED photometric results may vary from testing data. To assist the lighting designer in using Nora LED in a lighting layout, the following photometric tables have both lab test data and normalized data to illustrate expected typical performance. Typical photometric data is provided to illustrate expectation of typical performance.

6" Architectural Electronic HID Frame-In



Nora Lighting's family of HID Architectural Frame-In fixtures are ideal for suspended ceiling or T-Bar installations requiring high quality architectural grade reflectors in high ceilings for ceramic metal halide sources. A complete selection of high grade spun aluminum reflectors including specular finish reflector, baffle glare reduction, cross baffle louvers, lenses, wall wash, and decorative glass accents. Photometrics and IES files are available where precise calculations and fixtures layout planning is necessary.

Ballast: Electronic Ballast (EL) with Universal Input (120V to 277V)

Socket: Steel shell porcelain jacketed 4KV pulse rated socket mounted inside a die-cast heat dissipating aluminum socket cup.

Lamp Types:

- Ceramic Metal Halide ED17
- Ceramic Metal Halide PAR20
- Ceramic Metal Halide PAR30
- Ceramic Metal Halide PAR38

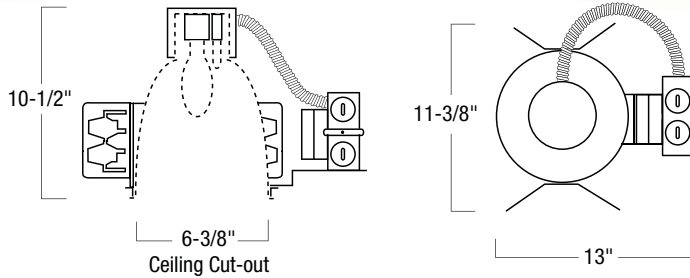

NEW! Quartz Restrike Option: DC Bayonet Base Quartz lamp not included with housings. Compatible with PAR20 and ED17 lamps only, add suffix "QS" to applicable housings. (39W, 70W, 100W housings)
 40W Quartz Lamp for 39W PAR20: QR40WXENF/DCB (ordered separately)
 60W Quartz Lamp for 70W/100W ED17: QR60WXENF/DCB (ordered separately)

Ceiling Thickness: Accepts 5/8" maximum ceiling thickness. See page 385 for extension collar.

Selectable Lamp Position: Reflectors have three adjustment slots for optimal light distribution.

Installation: Universal brackets accepts C-Channel or flat bar hangers (ordered separately), or simple rigid 1/2" steel conduit for tie-down to ceiling grids.

Minimum Clearance: Requires a minimum clearance of 3" from thermal insulation and 1/2" from any adjacent building components.

Junction Box: Pre wired 29 cu. in. with seven 1/2" knockouts, 4 pry-outs and snap on covers. Ground wire connected on bottom of box.

Listing:
 cULus Damp Location w/ Feed Through
 cULus Wet Location (Only with designated trims)

NHFM6 SERIES

CATALOG. NO.	VOLTAGE	WATTAGE	LAMP	BALLAST	QUARTZ RESTRIKE
NHFM6-735/EL	120V to 277V	39W	PAR20 / PAR30	Electronic	No
NHFM6-735/ELQS	120V to 277V	39W	PAR20	Electronic	Yes
NHFM6-750/EL	120V to 277V	50W	ED17	Electronic	No
NHFM6-770/EL	120V to 277V	70W	ED17 / PAR30 / PAR38	Electronic	No
NHFM6-770/ELQS	120V to 277V	70W	ED17	Electronic	Yes
NHFM6-7100/EL	120V to 277V	100W	ED17 / PAR38	Electronic	No
NHFM6-7100/ELQS	120V to 277V	100W	ED17	Electronic	Yes

Channel bar hangers ordered separately. See page 383.
 Quartz restrike lamp ordered separately. See page 753.



HID METAL HALIDE RECESSED

6" Commercial Electronic HID Frame-In

Nora Lighting's family of HID Commercial Frame-In fixtures are ideal for joist, stud, or T-Bar installations requiring high quality architectural grade reflectors in high ceilings for ceramic metal halide light sources. A complete selection of high grade spun aluminum reflectors including specular finish reflector, baffle glare reduction, cross baffle louvers, lenses, wall wash, and decorative glass accents. Photometrics and IES files are available where precise calculations and fixtures layout planning is necessary.

Ballast: Electronic Ballast (EL) with Universal Input (120V to 277V)

Socket: Steel shell porcelain jacketed 4KV pulse rated socket mounted inside a die-cast heat dissipating aluminum socket cup.

Lamp Types:

Ceramic Metal Halide ED17
Ceramic Metal Halide PAR20
Ceramic Metal Halide PAR30
Ceramic Metal Halide PAR38

NEW!

Quartz Restrike Option: DC Bayonet Base Quartz lamp not included with housings. Compatible with PAR20 and ED17 lamps only, add suffix "QS" to applicable housings. (39W, 70W, 100W housings)
40W Quartz Lamp for 39W PAR20: QR40WXENF/DCB (ordered separately)
60W Quartz Lamp for 70W/100W ED17: QR60WXENF/DCB (ordered separately)

Ceiling Thickness: Accepts 5/8" maximum ceiling thickness.

Selectable Lamp Position: Reflectors have three adjustment slots for optimal light distribution.

Installation: Bar hangers are adjustable from 13-5/8" to 24-1/2" with captive nails and can be repositioned 90 degrees. Bar hangers are slotted for T-Bar installations.

Minimum Clearance: Requires a minimum clearance of 3" from thermal insulation and 1/2" from any adjacent building components.

Junction Box: Pre wired 29 cu. in. with seven 1/2" knockouts, 4 pry-outs and snap on covers. Ground wire connected on bottom of box.

Listing:

cULus Damp Location w/ Feed Through
cULus Wet Location (Only with designated trims)

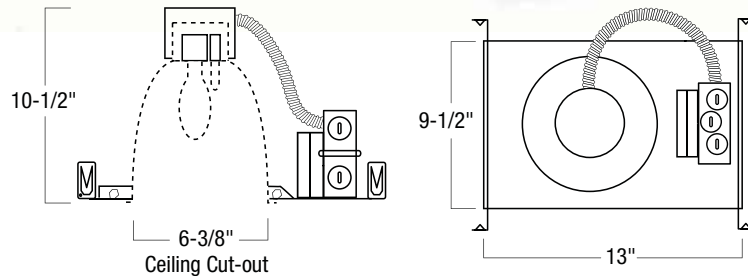
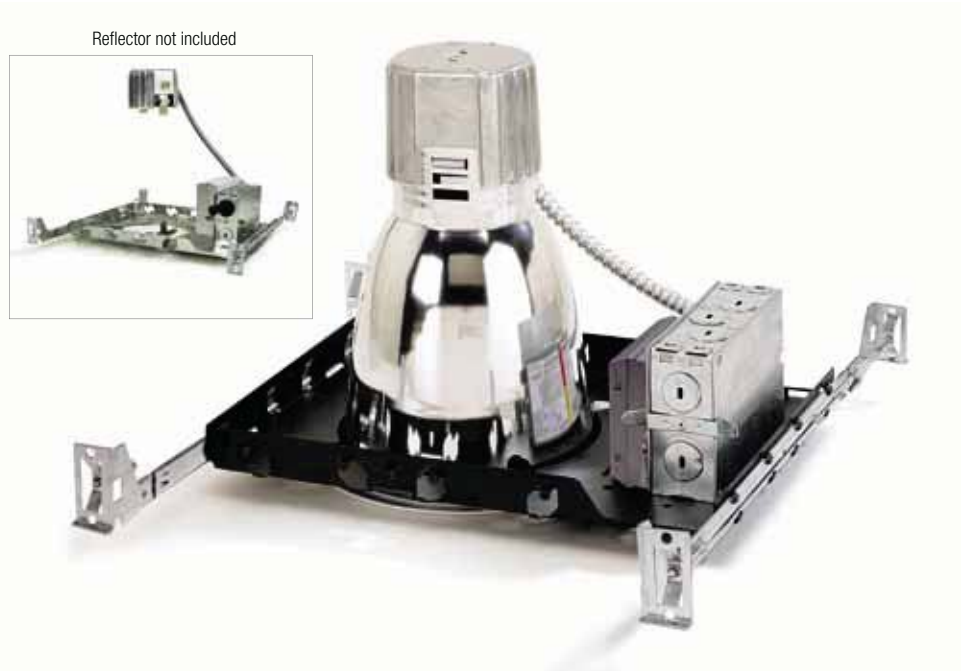

NHFM-7 SERIES

CATALOG. NO.	VOLTAGE	WATTAGE	LAMP	BALLAST	QUARTZ RESTRIKE
NHFM-735/EL	120V to 277V	39W	PAR20 / PAR30	Electronic	No
NHFM-735/ELQS	120V to 277V	39W	PAR20	Electronic	Yes
NHFM-750/EL	120V to 277V	50W	ED17	Electronic	No
NHFM-770/EL	120V to 277V	70W	ED17 / PAR30 / PAR38	Electronic	No
NHFM-770/ELQS	120V to 277V	70W	ED17	Electronic	Yes
NHFM-7100/EL	120V to 277V	100W	ED17 / PAR38	Electronic	No
NHFM-7100/ELQS	120V to 277V	100W	ED17	Electronic	Yes

Includes bar hangers
Quartz restrike lamp ordered separately. See page 753.



HID METAL HALIDE RECESSED

6" Architectural Remodel Electronic HID

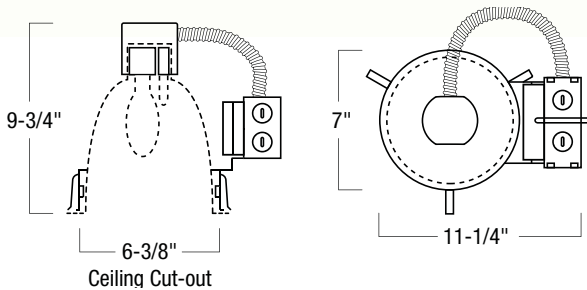

NHRFM6 SERIES

CATALOG. NO.	VOLTAGE	WATTAGE	LAMP	BALLAST	QUARTZ RESTRIKE
NHRFM6-735EL	120V to 277V	39W	PAR20 / PAR30	Electronic	No
NHRFM6-735ELQS	120V to 277V	39W	PAR20	Electronic	Yes
NHRFM6-750EL	120V to 277V	50W	ED17	Electronic	No
NHRFM6-770EL	120V to 277V	70W	ED17 / PAR30 / PAR38	Electronic	No
NHRFM6-770ELQS	120V to 277V	70W	ED17	Electronic	Yes
NHRFM6-7100EL	120V to 277V	100W	ED17 / PAR38	Electronic	No
NHRFM6-7100ELQS	120V to 277V	100W	ED17	Electronic	Yes

Quartz restrrike lamp ordered separately. See page 753.



Nora's New HID Remodel Frame-In allows high performance CMH Reflectors to be installed in existing ceilings.

Excellent for tenant improvement and energy retrofit in commercial, retail, hospitality, and architectural applications.

Ballast: Electronic Ballast (EL) with Universal Input (120V to 277V)

Socket: Steel shell porcelain jacketed 4KV pulse rated socket mounted inside a die-cast heat dissipating aluminum socket cup.

Lamp Types:

- Ceramic Metal Halide ED17
- Ceramic Metal Halide PAR20
- Ceramic Metal Halide PAR30
- Ceramic Metal Halide PAR38

Quartz Restrike Option: DC Bayonet Base Quartz lamp not included with housings. Compatible with PAR20 and ED17 lamps only, add suffix "QS" to applicable housings. (39W, 70W, 100W housings)
 40W Quartz Lamp for 39W PAR20: QR40WXENF/DCB (ordered separately)
 60W Quartz Lamp for 70W/100W ED17: QR60WXENF/DCB (ordered separately)

Ceiling Thickness: Accepts 1/2" to 3/4" ceiling thickness.

Selectable Lamp Position: Reflectors have three adjustment slots for optimal light distribution.

Remodel Installation: High tension tempered steel springs secure remodel housings evenly to the ceiling; hole cutout template provided for convenience.

Minimum Clearance: Requires a minimum clearance of 3" from thermal insulation and 1/2" from any adjacent building components.

Junction Box: Pre wired 29 cu. in. with seven 1/2" knockouts, 4 pry-outs and snap on covers. Ground wire connected on bottom of box.

Listing:
 cULus Damp Location w/ Feed Through
 cULus Wet Location (Only with designated trims)

HID METAL HALIDE RECESSED

6" Architectural & Commercial HID Reflectors

Open Reflector with Baffle



CC

Catalog No.	Description
NTS-730B	Specular Clear Reflector / Black Baffle / White Plastic Ring
NTS-730W	Specular Clear Reflector / White Baffle / White Plastic Ring

- High grade spun 0.050" aluminum

Maximum Wattage	100W CMH
OD:	7"

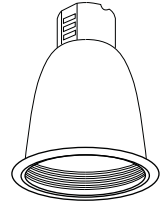

Open Reflector



CC

Catalog No.	Description
NTS-731B	Specular Black Reflector / White Plastic Ring
NTS-731C	Specular Clear Reflector / White Plastic Ring
NTS-731CWF	Specular Clear Reflector / White Self Flanged NEW!
NTS-731G	Specular Gold Reflector / White Plastic Ring
NTS-731W	Specular White Reflector / White Plastic Ring

- High grade spun 0.050" aluminum

Maximum Wattage	100W CMH
OD:	7"

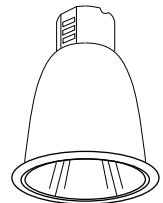

Reflector with Cross Louver



CC

Catalog No.	Description
NTS-737C	Spec Clear Refl / Spec Clear Louver / White Plastic Ring
NTS-737CWF	Specular Clear Reflector / Specular Clear Louver / White Self Flange NEW!
NTS-737G	Specular Gold Reflector / Specular Gold Louver / White Plastic Ring

- High grade spun 0.050" aluminum

Maximum Wattage	100W CMH
OD:	7"

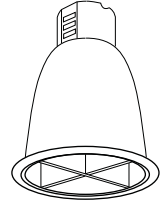

Lensed Reflector Wall Wash



CC

Catalog No.	Description
NTS-736C	Specular Clear Wall Wash / Specular Clear Reflector / White Ring
NTS-736G	Specular Gold Wall Wash / Specular Gold Reflector / White Ring

- High grade spun 0.050" aluminum
- Glass Lens

Maximum Wattage	70W CMH
OD:	7"

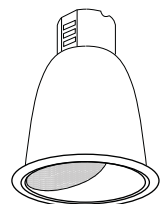

Open Single Wall Wash



CC

Catalog No.	Description
NTS-739SC	Specular Clear Single Wall Wash / White Plastic Ring

- High grade spun 0.050" aluminum

Maximum Wattage	100W CMH
OD:	7"

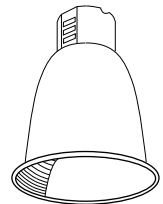

Open Double Wall Wash



CC

Catalog No.	Description
NTS-739DC	Specular Clear Double Wall Wash / White Plastic Ring

- High grade spun 0.050" aluminum

Maximum Wattage	100W CMH
OD:	7"

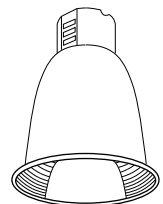

Wall Wash with Baffle



CC

Catalog No.	Description
NTS-734B	Wall Wash / Black Baffle / Specular Clear Reflector / White Eyelid / White Plastic Ring
NTS-734W	Wall Wash / White Baffle / Specular Clear Reflector / White Eyelid / White Plastic Ring

- High grade spun 0.050" aluminum

Maximum Wattage	70W CMH
OD:	7"

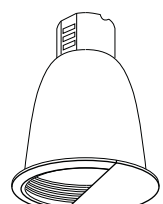

CC Custom Combo: Available with custom combinations of trim and plastic or metal ring finish. See pages 38-39 for details. See pages 34-35 for Description of Reflector Finishes

6" ARCHITECTURAL & COMMERCIAL HID REFLECTORS continued

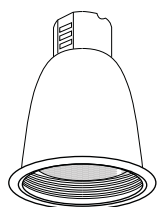

Maximum Wattage
70W CMH

OD: 7"



Catalog No.	Description
NTS-732B	Regressed Albalite Lens / Black Baffle / Specular Clear Reflector / White Plastic Ring
NTS-732W	Regressed Albalite Lens / White Baffle / Specular Clear Reflector / White Plastic Ring

- High grade spun 0.050" aluminum
- UL Wet Listed

Regressed Albalite Lens with Baffle

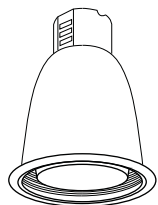
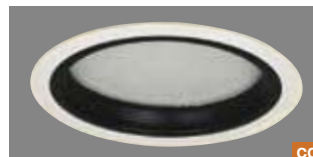

Maximum Wattage
70W CMH

OD: 7"



Catalog No.	Description
NTS-735B	Regressed Drop Opal Lens / Black Baffle / Specular Clear Reflector / White Plastic Ring
NTS-735W	Regressed Drop Opal Lens / White Baffle / Specular Clear Reflector / White Plastic Ring

- High grade spun 0.050" aluminum
- UL Wet Listed

Regressed Drop Opal Lens w/ Baffle

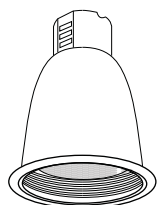

Maximum Wattage
70W CMH

OD: 7"



Catalog No.	Description
NTS-743W	Regressed Fresnel Lens / White Baffle / Specular Clear Reflector / White Plastic Ring

- High grade spun 0.050" aluminum
- UL Wet Listed

Regressed Fresnel Lens w/ Baffle

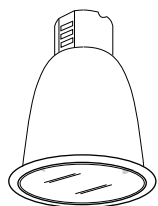

Maximum Wattage
70W CMH

OD: 7-1/2"

Catalog No.	Description
NTS-733CL	Flush Mount Clear Lens / Specular Clear Reflector White Plastic Ring
NTS-733FL	Flush Mount Frosted Lens / Specular Clear Reflector White Plastic Ring

- High grade spun 0.050" aluminum

Flush Mount Lens with Reflector

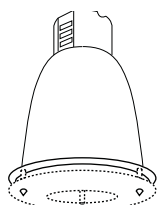

Maximum Wattage
100W CMH

OD: 7"

Catalog No.	Description
NTS-738C	Specular Clear Reflector / White Plastic Ring

- **Glass sold separately**
- For a layered look, up to two pieces of glass may be used together.

Reflector for Decorative Glass

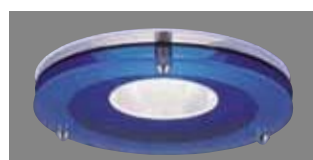

Includes:
NRA-203 Glass Hardware
• (3) Stand-offs
• (3) Cone End Caps
• (3) Flat End Caps

OD: 7"

Catalog No.	Description
NTG-6B/120	Tempered Blue, 120mm (4-3/4") Open Center
NTG-6B/80	Tempered Blue, 80mm (3-1/8") Open Center
NTG-6CF	Tempered Frost Center / Clear Outer
NTG-6FC	Tempered Clear Center / Frost Outer
NTG-6HC	Tempered Clear Center / Frost Inner, 80mm (3-1/8") Open Center

- **Includes NRA-203 Glass Hardware**
- 2 decorative glasses can be combined for a tiered look

Decorative Glass for NTS-738C



CC Custom Combo: Available with custom combinations of trim and plastic or metal ring finish. See pages 38-39 for details.

HID METAL HALIDE RECESSED

Photometrics - 6" Architectural & Commercial HID

NTS-730B Clear Reflector with Black Metal Baffle, White Plastic Ring

IESNA: LM-63-1995 Test No.: LRL 300-2R Spacing Criteria: (0-180) 0.58 (90-270) 0.58 Efficiency: 90% Lamp: (1) **39W PAR30** SP CMH Total Watts: 44 Lumens: 2400

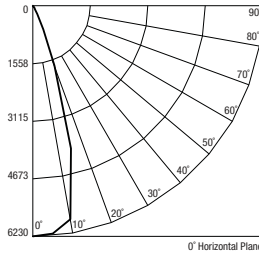

BEAM & CONE DATA

Mounting Height	F.C. at Nadir	Maximum Spacing
6'	173.1	3.5'
8'	97.3	4.6'
10'	62.3	5.8'
12'	43.3	7'
15'	27.7	8.7'

NTS-731C Clear Reflector, White Plastic Ring

50W ED17

IESNA: LM-63-1995 Test No.: LRL 300-2W Spacing Criteria: (0-180) 1.64 (90-270) 1.64 Efficiency: 58% Lamp: (1) 50W ED17 CMH Total Watts: 50 Lumens: 3300

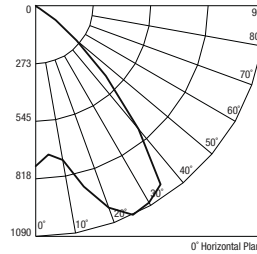

BEAM & CONE DATA

Mounting Height	F.C. at Nadir	Maximum Spacing
6'	21	9.8'
8'	11.8	13.1'
10'	7.6	16.4'
12'	5.3	19.7'
15'	3.4	24.6'

NTS-730B Clear Reflector with Black Metal Baffle, White Plastic Ring

IESNA: LM-63-1995 Test No.: LRL 300-2X Spacing Criteria: (0-180) 1.6 (90-270) 1.6 Efficiency: 46% Lamp: (1) **70W ED17** CMH Total Watts: 70 Lumens: 5700

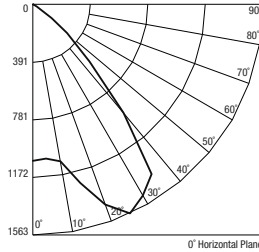

BEAM & CONE DATA

Mounting Height	F.C. at Nadir	Maximum Spacing
6'	29.5	9.6'
8'	16.6	12.8'
10'	10.6	16'
12'	7.4	19.2'
15'	4.7	24'

NTS-731C Clear Reflector, White Plastic Ring

100W PAR38

IESNA: LM-63-1995 Test No.: LRL 300-2T Spacing Criteria: (0-180) 0.42 (90-270) 0.42 Efficiency: 99% Lamp: (1) 100W PAR38 CMH Total Watts: 100 Lumens: 6800

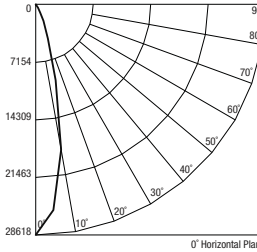

BEAM & CONE DATA

Mounting Height	F.C. at Nadir	Maximum Spacing
8'	447.2	3.4'
10'	286.2	4.2'
12'	198.7	5'
15'	127.2	6.3'
20'	71.5	8.4'

NTS-730B Clear Reflector with Black Metal Baffle, White Plastic Ring

IESNA: LM-63-1995 Test No.: LRL 300-2U Spacing Criteria: (0-180) 0.42 (90-270) 0.42 Efficiency: 93% Lamp: (1) **100W PAR38** SP CMH Total Watts: 100 Lumens: 6800

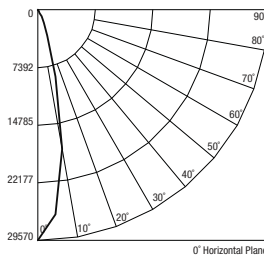

BEAM & CONE DATA

Mounting Height	F.C. at Nadir	Maximum Spacing
8'	462	3.4'
10'	295.7	4.2'
12'	205.3	5'
15'	131.4	6.3'
20'	73.9	8.4'

NTS-734B Black Metal Baffle Wall Wash, White Plastic Ring

IESNA: LM-63-1995 Test No.: LRL 300-2Y Spacing Criteria: (0-180) 1.86 (90-270) 1.88 Efficiency: 25% Lamp: (1) **100W ED17** CMH Total Watts: 100 Lumens: 8500

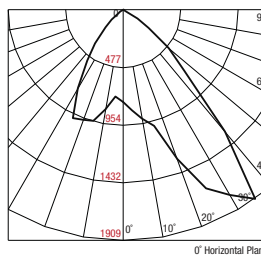

2' FROM WALL - 4' ON CENTER

DISTANCE FROM CEILING IN FEET	1'	3'	5'
1'	3	1	3
2'	56	17	56
3'	94	44	94
4'	54	63	54
5'	33	43	33
6'	25	27	25
7'	19	18	19
8'	13	13	13
9'	10	10	10
10'	8	8	8

Footcandle values are rounded off and are based on a minimum of five units.

NTS-731C Clear Reflector, White Plastic Ring

39W PAR20

IESNA: LM-63-1995 Test No.: LRL 300-2N Spacing Criteria: (0-180) 0.66 (90-270) 0.66 Efficiency: 95% Lamp: (1) 39W PAR20 SP CMH Total Watts: 45 Lumens: 2300

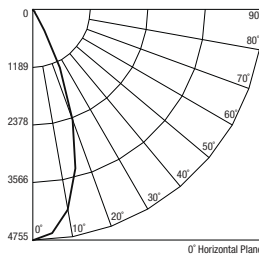

BEAM & CONE DATA

Mounting Height	F.C. at Nadir	Maximum Spacing
6'	132.1	4'
8'	74.3	5.3'
10'	47.6	6.6'
12'	33	7.9'
15'	21.1	9.9'

Photometric results may vary from testing data. To assist the lighting designer in using Nora's products in a lighting layout, the following photometric tables have both lab test data and normalized data to illustrate expected typical performance. Typical photometric data is provided to illustrate expectation of typical performance.



HID METAL HALIDE RECESSED

4" Architectural Electronic HID Housing (Universal Mounting)

Nora Lighting's four-inch aperture, vertical HID new construction downlight is designed for use with T4, T6, PAR20 or GX10 ceramic metal halide sources. Equipped with an electronic ballast and thermal protector. At only 6-3/8" deep, our compact ceramic metal halide housing is one of the lowest profiles in the industry.

Ballast: Electronic Ballast (EL) with Universal Input (120V to 277V)

Socket: 4KV pulse rated, porcelain socket is supplied with each trim. Eight inch lead with mollex connector connects trim to the housing.

Lamp Types:

Ceramic Metal Halide MR16 GX10
Ceramic Metal Halide PAR20
Ceramic Metal Halide T4
Ceramic Metal Halide T6

Ceiling Thickness: Varies from 1/2" to 1-1/4" ceiling thickness.

Installation: Universal mounting brackets adjusts 3-1/8" vertically, and 3-7/8" horizontally, accepts flat bar hangers, C-Channel or 1/2" EMT conduit pipe. Also includes adjustable bar hangers from 13-5/8" to 24-1/2" with captive nails and can be repositioned 90 degrees. Bar hangers are slotted for T-Bar installations.

Minimum Clearance: Requires a minimum clearance of 3" from thermal insulation and 1/2" from any adjacent building components.

Junction Box: Contains six 1/2" knockouts, two 3/4" knockouts, and four Romex® pryouts and snap-on covers with strain relief. Ground wire connected on bottom of box.

Listing:

cULus Damp Location w/ Feed Through

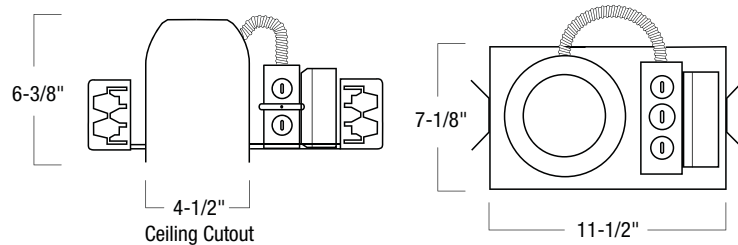

NHID-4 SERIES

CATALOG. NO.	VOLTAGE	WATTAGE	LAMP	BALLAST
NHID-420	120V to 277V	20W	MR16 GX10 / PAR20 / T4	Electronic
NHID-439	120V to 277V	39W	MR16 GX10 / PAR20 / T4 / T6	Electronic
NHID-470	120V to 277V	70W	T4 / T6	Electronic

Bar hangers included, Channel bar hangers ordered separately. See page 383.



HID METAL HALIDE RECESSED 4" Architectural HID Reflectors

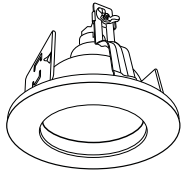

Maximum Wattage:
70W T4 CMH
OD: 4-3/4"

Catalog No.	Description
NHID-4T415W	Clear Reflector / White Ring / 15° Beam Spread
NHID-4T423W	Clear Reflector / White Ring / 23° Beam Spread
NHID-4T432W	Clear Reflector / White Ring / 32° Beam Spread

- Clear Glass Lens included
- Adjustable socket for precise light distribution

Reflector

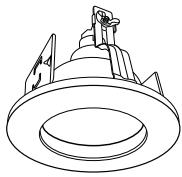

Maximum Wattage:
70W T6 CMH
OD: 4-3/4"

Catalog No.	Description
NHID-4T615W	Clear Reflector / White Ring / 15° Beam Spread

- Clear Glass Lens included
- Adjustable socket for precise light distribution

Faceted Reflector

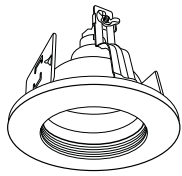

Maximum Wattage:
39W PAR20 CMH
OD: 4-3/4"

Catalog No.	Description
NHID-4P20W	Black Stepped Baffle / White Ring

- Adjustable socket for precise light distribution

Black Stepped Baffle

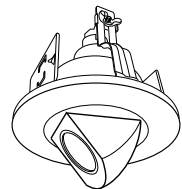

Maximum Wattage:
39W MR16 GX10 CMH
OD: 4-3/4"

Catalog No.	Description
NHID-4GX10W	White Adjustable Elbow

- Adjustable: 90° Vertical, 358° Horizontal
- Front re-lamping

Fully Adjustable Surface Elbow



HID METAL HALIDE RECESSED

6" Economy New Construction HID Housing

Nora Lighting's family of Economy HID housings are ideal for joist, stud, or T-Bar installations requiring use of ceramic metal halide sources. Housings accept economy grade reflectors and finishing trims for finished appearance. Photometrics and IES files are available where precise calculations and fixtures layout planning is necessary.

Ballast: Electronic Ballast (EL) with Universal Input (120V to 277V)

Socket: Steel shell porcelain jacketed 4KV pulse rated socket mounted on adjustable socket plate within housing.

Lamp Types:

Ceramic Metal Halide ED17
Ceramic Metal Halide PAR20
Ceramic Metal Halide PAR30
Ceramic Metal Halide PAR38

NEW! Quartz Restrike Option: DC Bayonet Base Quartz lamp not included with housings. Compatible with PAR20 and ED17 lamps only, add suffix "/QS" to applicable housings. (39W, 70W, 100W housings)
40W Quartz Lamp for 39W PAR20:
QR40WXENF/DCB
60W Quartz Lamp for 70W/100W ED17:
QR60WXENF/DCB

Ceiling Thickness: Varies from 5/8" - 1-3/8" ceiling thickness.

Lamp Adjustable: Adjustable socket mounting plate allows different types of lamps to be used for best possible light distribution.

Installation: Bar hangers are adjustable from 13-5/8" to 24-1/2" with captive nails and can be repositioned 90 degrees. Bar hangers are slotted for T-Bar installations.

Minimum Clearance: Requires a minimum clearance of 3" from thermal insulation and 1/2" from any adjacent building components.

Junction Box: Contains five 1/2", one 3/4" knockouts, four Romex® pryouts and snap-on covers with strain relief. Ground wire connected on bottom of box.

Listing:

cULus Damp Location w/ Feed Through
cULus Wet Location (Only with designated trims)



Fire Rated Enclosure - See page 379

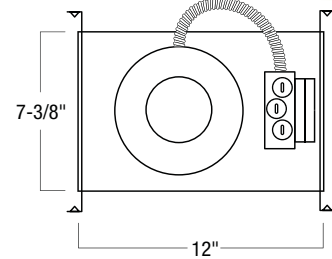
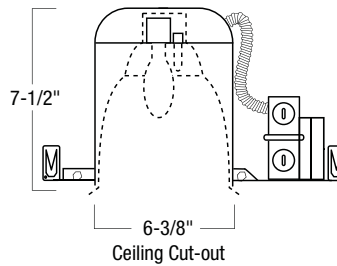

NHPM SERIES

CATALOG. NO.	VOLTAGE	WATTAGE	LAMP	BALLAST	QUARTZ RESTRIKE
NHPM-735/EL	120V to 277V	39W	PAR20 / PAR30	Electronic	No
NHPM-735/ELQS	120V to 277V	39W	PAR20	Electronic	Yes
NHPM-750/EL	120V to 277V	50W	ED17	Electronic	No
NHPM-770/EL	120V to 277V	70W	ED17 / PAR30 / PAR38	Electronic	No
NHPM-770/ELQS	120V to 277V	70W	ED17	Electronic	Yes
NHPM-7100/EL	120V to 277V	100W	ED17 / PAR38	Electronic	No
NHPM-7100/ELQS	120V to 277V	100W	ED17	Electronic	Yes

Includes bar hangers



HID METAL HALIDE RECESSED 6" Economy Remodel HID Housing



Nora Lighting's family of Economy HID housings are ideal for existing ceiling applications requiring use of ceramic metal halide sources. Housings accept economy grade reflectors and finishing trims for finished appearance. Photometrics and IES files are available where precise calculations and fixtures layout planning is necessary.

Ballast: Electronic Ballast (EL) with Universal Input (120V to 277V)

Socket: Steel shell porcelain jacketed 4KV pulse rated socket mounted on adjustable socket plate within housing.

Lamp Types:

Ceramic Metal Halide ED17
Ceramic Metal Halide PAR20
Ceramic Metal Halide PAR30
Ceramic Metal Halide PAR38

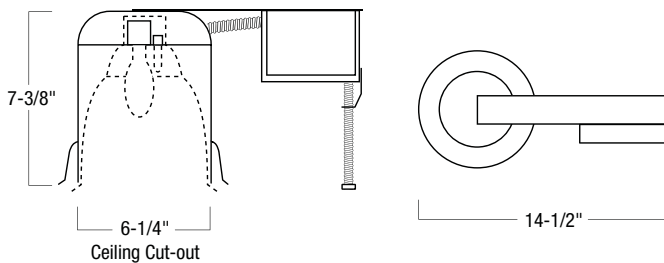

NEW!

Quartz Restrike Option: DC Bayonet Base Quartz lamp included with housings. Compatible with PAR20 and ED17 lamps only, add suffix "/QS" to applicable housings. (39W, 70W, 100W housings)
40W Quartz Lamp for 39W PAR20: QR40WXENF/DCB
60W Quartz Lamp for 70W/100W ED17: QR60WXENF/DCB

Ceiling Thickness: Varies from 5/8" - 1-3/8" ceiling thickness.

Lamp Adjustable: Adjustable socket mounting plate allows different types of lamps to be used for best possible light distribution.

Installation: High tension tempered steel springs secure remodel housings evenly to the ceiling; hole cutout template provided for convenience.

Minimum Clearance: Requires a minimum clearance of 3" from thermal insulation and 1/2" from any adjacent building components.

Junction Box: Contains five 1/2", one 3/4" knockouts, four Romex® pryouts and snap-on covers with strain relief. Ground wire connected on bottom of box.

Listing:

cULus Damp Location w/ Feed Through
cULus Wet Location (Only with designated trims)

NHRPM SERIES

CATALOG. NO.	VOLTAGE	WATTAGE	LAMP	BALLAST	QUARTZ RESTRIKE
NHRPM-735/EL	120V to 277V	39W	PAR20 / PAR30	Electronic	No
NHRPM-735/ELQS	120V to 277V	39W	PAR20	Electronic	Yes
NHRPM-750/EL	120V to 277V	50W	ED17	Electronic	No
NHRPM-770/EL	120V to 277V	70W	ED17 / PAR30 / PAR38	Electronic	No
NHRPM-770/ELQS	120V to 277V	70W	ED17	Electronic	Yes
NHRPM-7100/EL	120V to 277V	100W	ED17 / PAR38	Electronic	No
NHRPM-7100/ELQS	120V to 277V	100W	ED17	Electronic	Yes



HID METAL HALIDE RECESSED

6" Economy HID Reflectors and Trims

Chrome Cone Reflector with Baffle



Catalog No.	Description
NTA-101	Black Baffle / Specular Clear Refl / White Plastic Ring
NTA-101BZ	Bronze Baffle / Specular Clear Refl / Bronze Metal Ring
NTA-101CO	Copper Baffle / Specular Clear Refl / Copper Metal Ring
NTA-101N	Natural Metal Baffle / Specular Clear Refl / Nat Metal Ring
NTA-102	White Baffle / Specular Clear Refl / White Plastic Ring

Maximum Wattage

39W PAR20
70W PAR30
100W PAR38
100W ED17

OD: 7"

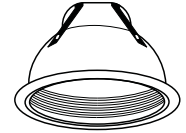

- Add suffix "QS" when using with quartz restrike housing

Cone Reflector

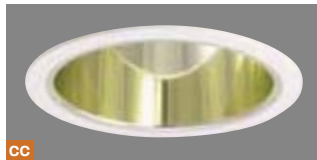

Catalog No.	Description
NTA-96	Specular Gold Reflector / White Plastic Ring
NTA-96C	Specular Gold Reflector / Chrome Plastic Ring
NTA-96G	Specular Gold Reflector / Gold Plastic Ring
NTA-97	Specular Clear Reflector / White Plastic Ring
NTA-97AHZ	Haze Alzak® Reflector / White Plastic Ring
NTA-97C	Specular Clear Reflector / Chrome Plastic Ring
NTA-97G	Specular Clear Reflector / Gold Plastic Ring
NTA-97HZ	Haze Reflector / White Plastic Ring
NTA-98	Specular Black Reflector / White Plastic Ring
NTA-98B	Specular Black Reflector / Black Plastic Ring
NTA-98BZBZ	Bronze Reflector / Bronze Metal Ring
NTA-98COCO	Copper Reflector / Copper Metal Ring
NTA-98NN	Natural Reflector / Natural Metal Ring
NTA-99	Specular White Reflector / White Plastic Ring

Maximum Wattage

39W PAR20
70W PAR30
100W PAR38
100W ED17

OD: 7"

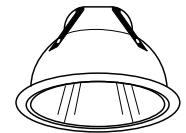

- Add suffix "QS" when using with quartz restrike housing

Reflector



Catalog No.	Description
NTS-30	Specular Gold Reflector / White Plastic Ring
NTS-30A	Specular Gold Alzak® Reflector / White Plastic Ring
NTS-30C	Specular Gold Reflector / Chrome Ring
NTS-30G	Specular Gold Reflector / Gold Ring
NTS-31	Specular Clear Reflector / White Plastic Ring
NTS-31A	Clear Alzak® Reflector / White Plastic Ring
NTS-31AHZ	Haze Alzak® Reflector / White Plastic Ring
NTS-31C	Specular Clear Reflector / Chrome Ring
NTS-31HZ	Haze Reflector / White Plastic Ring
NTS-31N	Natural Metal Reflector / White Plastic Ring
NTS-32	Specular Black Reflector / White Plastic Ring
NTS-32B	Specular Black Reflector / Black Ring
NTS-32BZBZ	Bronze Reflector / Bronze Ring
NTS-32CO	Specular Black Reflector / Copper Ring
NTS-32COCO	Copper Reflector / Copper Ring
NTS-32G	Specular Black Reflector / Gold Ring
NTS-32NN	Natural Metal Reflector / Natural Metal Ring
NTS-33	Specular White Reflector / White Plastic Ring

Maximum Wattage

39W PAR20
70W PAR30

OD: 7"



CC Custom Combo: Available with custom combinations of trim and plastic or metal ring finish. See pages 38-39 for details.
See Pages 34-37 for Description of Trim Finishes

6" ECONOMY HID REFLECTORS & TRIMS continued

Maximum Wattage
70W PAR30

OD: 8"

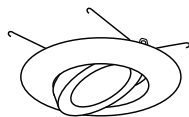

Catalog No.	Description
NTM-52B	Black Open Gimbal / Metal Ring
NTM-52BZ	Bronze Open Gimbal / Metal Ring
NTM-52C	Chrome Open Gimbal / Metal Ring
NTM-52CO	Copper Open Gimbal / Metal Ring
NTM-52G	Gold Open Gimbal / Metal Ring
NTM-52N	Natural Metal Open Gimbal / Metal Ring
NTM-52W	White Open Gimbal / Metal Ring

- 30° Adjustment

PAR30 Open Gimbal



Maximum Wattage
100W PAR38

OD: 8"



Catalog No.	Description
NTM-53B	Black Open Gimbal / Metal Ring
NTM-53BZ	Bronze Open Gimbal / Metal Ring
NTM-53C	Chrome Open Gimbal / Metal Ring
NTM-53CO	Copper Open Gimbal / Metal Ring
NTM-53G	Gold Open Gimbal / Metal Ring
NTM-53N	Natural Metal Open Gimbal / Metal Ring
NTM-53W	White Open Gimbal / Metal Ring

- 25° Adjustment

PAR38 Open Gimbal



Maximum Wattage
70W PAR30

OD: 7"

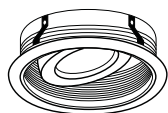

Catalog No.	Description
NTM-54B	Black Baffle / Adjustable Gimbal / White Metal Ring
NTM-54BZ	Bronze Baffle / Adjustable Gimbal / Bronze Metal Ring
NTM-54CO	Copper Baffle / Adjustable Gimbal / Copper Metal Ring
NTM-54N	Natural Metal Baffle / Adj. Gimbal / Natural Metal Ring
NTM-54W	White Baffle / Adjustable Gimbal / White Metal Ring

- 20° Adjustment

PAR30 Baffle w/ Adjustable Gimbal



Maximum Wattage
100W PAR38

OD: 7"

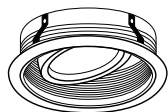

Catalog No.	Description
NTM-55B	Black Baffle / Adjustable Gimbal / White Metal Ring
NTM-55BZ	Bronze Baffle / Adjustable Gimbal / Bronze Metal Ring
NTM-55CO	Copper Baffle / Adjustable Gimbal / Copper Metal Ring
NTM-55N	Natural Metal Baffle / Adj. Gimbal / Natural Metal Ring
NTM-55W	White Baffle / Adjustable Gimbal / White Metal Ring

- 20° Adjustment

PAR38 Baffle w/ Adjustable Gimbal



Maximum Wattage
70W PAR30

OD: 7"

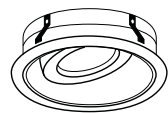

Catalog No.	Description
NTM-56B	Spec Black Refl / Black Adj. Gimbal / White Metal Ring
NTM-56BG	Spec Gold Refl / Black Adj. Gimbal / White Metal Ring
NTM-56C	Spec Clear Refl / Chrome Adj. Gimbal / White Metal Ring
NTM-56G	Spec Gold Refl / Gold Adj. Gimbal / White Metal Ring
NTM-56W	Spec White Refl / White Adj. Gimbal / White Metal Ring

- 20° Adjustment

PAR30 Reflector w/ Adjustable Gimbal

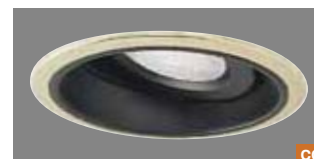

Maximum Wattage
100W PAR38

OD: 7"

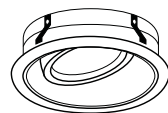

Catalog No.	Description
NTM-57B	Adjustable Gimbal / Spec Black Refl / White Metal Ring
NTM-57C	Adj. Gimbal / Specular Clear Refl / White Metal Ring
NTM-57G	Adjustable Gimbal / Spec Gold Refl / White Metal Ring
NTM-57W	Adjustable Gimbal / Spec White Refl / White Metal Ring

- 20° Adjustment

PAR38 Reflector w/ Adjustable Gimbal



CC Custom Combo: Available with custom combinations of trim and plastic or metal ring finish. See pages 38-39 for details.

6" ECONOMY HID REFLECTORS & TRIMS continued

Cone Reflector Baffle Wall Wash



CC

Catalog No.	Description
NTA-103B	Wall Wash / Black Baffle / Specular Clear Reflector / White Eyelid / White Plastic Ring
NTA-103BZ	Wall Wash / Bronze Baffle / Specular Clear Reflector / Bronze Eyelid / Bronze Metal Ring
NTA-103CO	Wall Wash / Copper Baffle / Specular Clear Reflector / Copper Eyelid / Copper Metal Ring
NTA-103N	Wall Wash / Natural Metal Baffle / Specular Clear Refl / Natural Metal Eyelid / Natural Metal Ring
NTA-103W	Wall Wash / White Baffle / Specular Clear Reflector / White Eyelid / White Plastic Ring

- Add suffix "QS" when using with quartz restrike housing

Maximum Wattage

39W PAR20
70W PAR30
100W PAR38
100W ED17

OD: 7"



Cone Reflector Wall Wash



CC

Catalog No.	Description
NTA-86	Wall Wash / Spec Gold Refl / White Eyelid / White Ring
NTA-87	Wall Wash / Spec Clear Refl / White Eyelid / White Ring
NTA-88	Wall Wash / Spec Black Refl / White Eyelid / White Ring
NTA-88BZ	Wall Wash / Bronze Refl / Bronze Eyelid / Bronze Ring
NTA-88CO	Wall Wash / Copper Refl / Copper Eyelid / Copper Ring
NTA-88N	Wall Wash / Natural Metal Reflector / Natural Metal Eyelid / Natural Metal Ring
NTA-89	Wall Wash / Spec White Refl / White Eyelid / White Ring

- Add suffix "QS" when using with quartz restrike housing

Maximum Wattage

39W PAR20
70W PAR30
100W PAR38
100W ED17

OD: 7"



Albalite Lens with Reflector



CC

Catalog No.	Description
NTS-22	Albalite Lens / Specular Clear Refl / White Metal Trim
NTS-22B	Albalite Lens / Specular Clear Refl / Black Metal Trim
NTS-22BZ	Albalite Lens / Specular Clear Refl / Bronze Metal Trim
NTS-22C	Albalite Lens / Specular Clear Refl / Chrome Metal Trim
NTS-22CO	Albalite Lens / Specular Clear Refl / Copper Metal Trim
NTS-22G	Albalite Lens / Specular Clear Refl / Gold Metal Trim
NTS-22N	Albalite Lens / Specular Clear Refl / Natural Metal Trim

- More than double the light output of standard non-reflector trims
- Add suffix "QS" when using with quartz restrike housing
- UL Wet Listed

Maximum Wattage

39W PAR20
70W PAR30
70W PAR38
70W ED17

OD: 8"

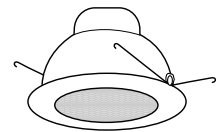

Regressed Albalite Lens w/ Baffle

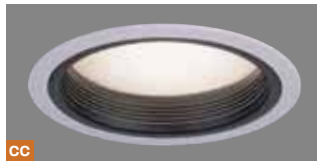

CC

Catalog No.	Description
NTM-42	Regressed Albalite Lens / Black Baffle / White Plastic Ring
NTM-42BZ	Regressed Albalite Lens / Bronze Baffle / Bronze Metal Ring
NTM-42CO	Regressed Albalite Lens / Copper Baffle / Copper Metal Ring
NTM-42N	Regressed Albalite Lens / Natural Baffle / Natural Metal Ring
NTM-42W	Regressed Albalite Lens / White Baffle / White Plastic Ring

- UL Wet Listed

Maximum Wattage

39W PAR20
70W PAR30
70W PAR38
70W ED17

OD: 8"

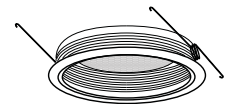

Albalite Lens



CC

Catalog No.	Description
NT-22	Albalite Lens / White Metal Trim
NT-22B	Albalite Lens / Black Metal Trim
NT-22BZ	Albalite Lens / Bronze Metal Trim
NT-22C	Albalite Lens / Chrome Metal Trim
NT-22CO	Albalite Lens / Copper Metal Trim
NT-22G	Albalite Lens / Gold Metal Trim
NT-22N	Albalite Lens / Natural Metal Trim

- UL Wet Listed

Maximum Wattage

39W PAR20
70W PAR30
70W PAR38
70W ED17

OD: 8"

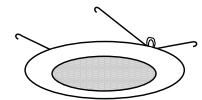

CC Custom Combo: Available with custom combinations of trim and plastic or metal ring finish. See pages 38-39 for details.

6" ECONOMY HID REFLECTORS & TRIMS continued

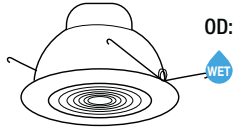

Maximum Wattage
 39W PAR20
 70W PAR30
 70W PAR38
 70W ED17

OD: 8"

Catalog No.	Description
NTS-23	Fresnel Lens / Specular Clear Refl / White Metal Trim
NTS-23B	Fresnel Lens / Specular Clear Refl / Black Metal Trim
NTS-23BZ	Fresnel Lens / Specular Clear Refl / Bronze Metal Trim
NTS-23C	Fresnel Lens / Specular Clear Refl / Chrome Metal Trim
NTS-23CO	Fresnel Lens / Specular Clear Refl / Copper Metal Trim
NTS-23G	Fresnel Lens / Specular Clear Refl / Gold Metal Trim
NTS-23N	Fresnel Lens / Specular Clear Refl / Natural Metal Trim

- More than double the light output of standard non-reflector trims
- **Add suffix "QS"** when using with quartz restrike housing
- UL Wet Listed

Fresnel Lens with Reflector

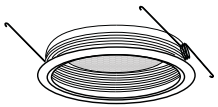

Maximum Wattage
 39W PAR20
 70W PAR30
 70W PAR38
 70W ED17

OD: 8"

Catalog No.	Description
NTM-43	Regressed Fresnel Lens / Black Baffle / White Plastic Ring
NTM-43BZ	Regressed Fresnel Lens / Bronze Baffle / Bronze Metal Ring
NTM-43CO	Regressed Fresnel Lens / Copper Baffle / Copper Metal Ring
NTM-43N	Regressed Fresnel Lens / Natural Baffle / Natural Metal Ring
NTM-43W	Regressed Fresnel Lens / White Baffle / White Plastic Ring

- UL Wet Listed

Regressed Fresnel Lens w/ Baffle

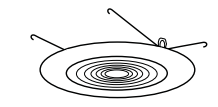

Maximum Wattage
 39W PAR20
 70W PAR30
 70W PAR38
 70W ED17

OD: 8"

Catalog No.	Description
NT-23	Fresnel Lens / White Metal Trim
NT-23B	Fresnel Lens / Black Metal Trim
NT-23BZ	Fresnel Lens / Bronze Metal Trim
NT-23C	Fresnel Lens / Chrome Metal Trim
NT-23CO	Fresnel Lens / Copper Metal Trim
NT-23G	Fresnel Lens / Gold Metal Trim
NT-23N	Fresnel Lens / Natural Metal Trim

- UL Wet Listed

Fresnel Lens

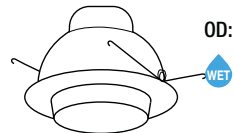

Maximum Wattage
 39W PAR20
 70W PAR30
 70W PAR38
 70W ED17

OD: 8"

Catalog No.	Description
NTS-24	Drop Opal Lens / Specular Clear Refl / White Metal Trim
NTS-24B	Drop Opal Lens / Specular Clear Refl / Black Metal Trim
NTS-24BZ	Drop Opal Lens / Specular Clear Refl / Bronze Metal Trim
NTS-24C	Drop Opal Lens / Specular Clear Refl / Chrome Metal Trim
NTS-24CO	Drop Opal Lens / Specular Clear Refl / Copper Metal Trim
NTS-24G	Drop Opal Lens / Specular Clear Refl / Gold Metal Trim
NTS-24N	Drop Opal Lens / Spec Clear Refl / Natural Metal Trim

- More than double the light output of standard non-reflector trims
- **Add suffix "QS"** when using with quartz restrike housing
- UL Wet Listed

Drop Opal Lens with Reflector

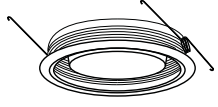

Maximum Wattage
 39W PAR20
 70W PAR30
 70W PAR38
 70W ED17

OD: 8"

Catalog No.	Description
NTM-46BZ	Drop Opal Lens / Bronze Baffle / Bronze Metal Ring
NTM-46CO	Drop Opal Lens / Copper Baffle / Copper Metal Ring
NTM-46M	Drop Opal Lens / Black Metal Baffle / White Plastic Ring
NTM-46N	Drop Opal Lens / Natural Metal Baffle / Natural Metal Ring
NTM-46W	Drop Opal Lens / White Baffle / White Plastic Ring

- UL Wet Listed

Regressed Drop Opal Lens w/ Baffle



CC Custom Combo: Available with custom combinations of trim and plastic or metal ring finish. See pages 38-39 for details.

6" ECONOMY HID REFLECTORS & TRIMS continued

Drop Opal Lens



Catalog No.	Description
NT-24	Drop Opal Lens / White Metal Trim
NT-24B	Drop Opal Lens / Black Metal Trim
NT-24BZ	Drop Opal Lens / Bronze Metal Trim
NT-24C	Drop Opal Lens / Chrome Metal Trim
NT-24CO	Drop Opal Lens / Copper Metal Trim
NT-24G	Drop Opal Lens / Gold Metal Trim
NT-24N	Drop Opal Lens / Natural Metal Trim

- UL Wet Listed

Maximum Wattage

39W PAR20
70W PAR30
70W PAR38
70W ED17

OD: 8"

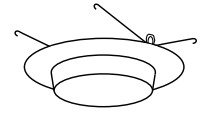

Frosted Dome Lens with Reflector



Catalog No.	Description
NTS-25	Frosted Dome Lens / Specular Clear Refl / White Trim
NTS-25B	Frosted Dome Lens / Specular Clear Refl / Black Trim
NTS-25BZ	Frosted Dome Lens / Specular Clear Refl / Bronze Trim
NTS-25C	Frosted Dome Lens / Specular Clear Refl / Chrome Trim
NTS-25CO	Frosted Dome Lens / Specular Clear Refl / Copper Trim
NTS-25G	Frosted Dome Lens / Specular Clear Refl / Gold Trim
NTS-25N	Frosted Dome Lens / Spec Clear Refl / Natural Metal Trim

- More than double the light output of standard non-reflector trims
- UL Wet Listed

Maximum Wattage

39W PAR20
70W PAR30
70W PAR38
70W ED17

OD: 8"

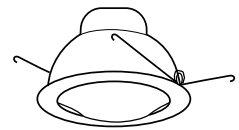

Frosted Flat Lens with Reflector



Catalog No.	Description
NTS-26	Frosted Flat Lens / Specular Clear Refl / White Trim
NTS-26B	Frosted Flat Lens / Specular Clear Refl / Black Trim
NTS-26BZ	Frosted Flat Lens / Specular Clear Refl / Bronze Trim
NTS-26C	Frosted Flat Lens / Specular Clear Refl / Chrome Trim
NTS-26CO	Frosted Flat Lens / Specular Clear Refl / Copper Trim
NTS-26G	Frosted Flat Lens / Specular Clear Refl / Gold Trim
NTS-26N	Frosted Flat Lens / Spec Clear Refl / Natural Metal Trim

- More than double the light output of standard non-reflector trims
- UL Wet Listed

Maximum Wattage

39W PAR20
70W PAR30
70W PAR38
70W ED17

OD: 8"

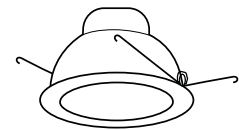

Reflector for Decorative Glass

NEW!

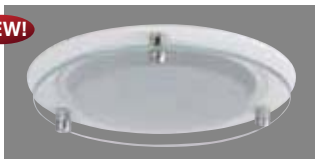

Catalog No.	Description
NTA-638BZ	Specular Clear Reflector / Bronze Trim
NTA-638C	Specular Clear Reflector / Chrome Trim
NTA-638N	Specular Clear Reflector / Natural Metal Trim
NTA-638W	Specular Clear Reflector / White Trim

- Glass sold separately
- For a layered look, up to two pieces of glass may be used together.

Maximum Wattage

39W PAR20
70W PAR30
100W PAR38
100W ED17

OD: 7"

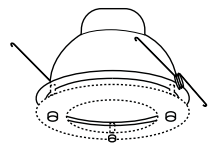

Decorative Glass for NTA-638

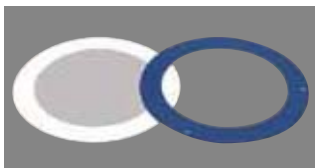

Catalog No.	Description
NTG-6B/120	Tempered Blue / 120mm (4-3/4") Open Center
NTG-6B/80	Tempered Blue / 80mm (3-1/8") Open Center
NTG-6CF	Tempered Frost Center / Clear Outer
NTG-6FC	Tempered Clear Center / Frost Outer
NTG-6HC	Tempered Clear Outer / Frost Inner / 80mm (3-1/8") Open Center

- Includes NRA-203 Glass Hardware
- 2 decorative glasses can be combined for a tiered look

Includes:

- NRA-203 Glass Hardware
- (3) Stand-offs
- (3) Cone End Caps
- (3) Flat End Caps

OD: 7"



HID METAL HALIDE RECESSED Photometrics - 6" Economy HID

NTA-97 Clear Cone Reflector with White Plastic Ring 39W PAR30

IESNA: LM-63-1995 Test No.: 300-2K Spacing Criteria: (0-180) 0.58 (90-270) 0.58
Efficiency: 96% Lamp: (1) 39W PAR30 SP CMH Total Watts: 45 Lumens: 2400

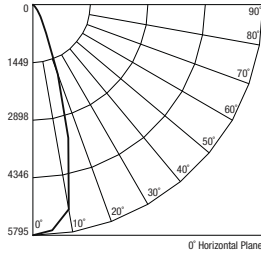

BEAM & CONE DATA

Mounting Height	F.C. at Nadir	Maximum Spacing
6'	161	3.5'
8'	90.5	4.6'
10'	58	5.8'
12'	40.2	7'
15'	25.8	8.7'

NTA-101 Clear Reflector w/ Black Metal Baffle Insert, White Plastic Ring

IESNA: LM-63-1995 Test No.: 300-2B Spacing Criteria: (0-180) 1.24 (90-270) 1.24
Efficiency: 55% Lamp: (1) 100W ED17 CMH Total Watts: 100 Lumens: 8500

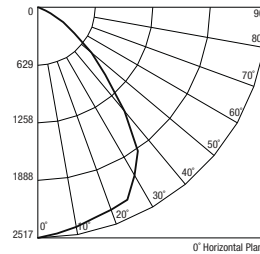

BEAM & CONE DATA

Mounting Height	F.C. at Nadir	Maximum Spacing
6'	69.9	7.4'
8'	39.3	9.9'
10'	25.2	12.4'
12'	17.5	14.9'
15'	11.2	18.6'

NTA-97 Clear Cone Reflector with White Plastic Ring 70W ED17

IESNA: LM-63-1995 Test No.: 300-2A Spacing Criteria: (0-180) 1.54 (90-270) 1.54
Efficiency: 66% Lamp: (1) 70W ED17 CMH Total Watts: 80 Lumens: 5700

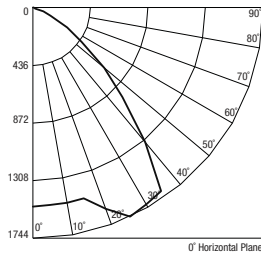

BEAM & CONE DATA

Mounting Height	F.C. at Nadir	Maximum Spacing
6'	41.8	9.2'
8'	23.5	12.3'
10'	15	15.4'
12'	10.4	18.5'
15'	6.7	23.1'

NTA-101 Clear Reflector w/ Black Metal Baffle Insert, White Plastic Ring

IESNA: LM-63-1995 Test No.: 300-2E Spacing Criteria: (0-180) 0.4 (90-270) 0.4
Efficiency: 79% Lamp: (1) 100W PAR38 SP CMH Total Watts: 100 Lumens: 6800

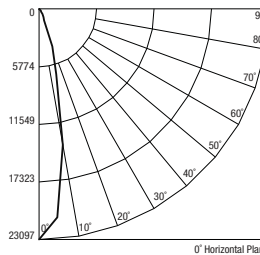

BEAM & CONE DATA

Mounting Height	F.C. at Nadir	Maximum Spacing
8'	360.9	3.2'
10'	231	4'
12'	160.4	4.8'
15'	102.7	6'
20'	57.7	8'

NTA-97 Clear Cone Reflector with White Plastic Ring 100W PAR38

IESNA: LM-63-1995 Test No.: 300-2D Spacing Criteria: (0-180) 0.42 (90-270) 0.42
Efficiency: 87% Lamp: (1) 100W PAR38 SP CMH Total Watts: 100 Lumens: 6800

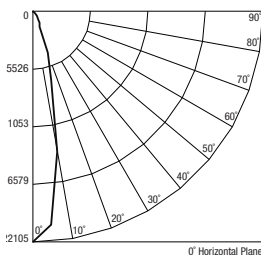

BEAM & CONE DATA

Mounting Height	F.C. at Nadir	Maximum Spacing
8'	345.4	3.4'
10'	221.1	4.2'
12'	153.5	5'
15'	98.2	6.3'
20'	55.3	8.4'

NTA-103B Clear Reflector, Black Baffle, White Wall Wash & Plastic Ring

IESNA: LM-63-1995 Test No.: LRL 300-2C Spacing Criteria: (0-180) 1.24 (90-270) 1.18
Efficiency: 40% Lamp: (1) 100W ED17 CMH Total Watts: 100 Lumens: 8500

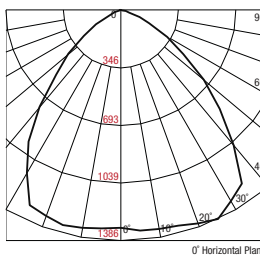

2' FROM WALL - 4' ON CENTER

DISTANCE FROM CEILING IN FEET	1'	2'	3'	4'
1'	23	7	23	
2'	63	41	63	
3'	62	54	62	
4'	43	47	43	
5'	31	34	31	
6'	23	24	23	
7'	18	18	18	
8'	14	14	14	
9'	11	11	11	
10'	9	9	9	

Footcandle values are rounded off and are based on a minimum of five units.

NTA-101 Clear Reflector w/ Black Metal Baffle Insert, White Plastic Ring

IESNA: LM-63-1995 Test No.: 300-2L Spacing Criteria: (0-180) 0.56 (90-270) 0.56
Efficiency: 94% Lamp: (1) 39W PAR30 SP CMH Total Watts: 44 Lumens: 2400

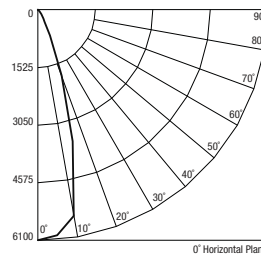

BEAM & CONE DATA

Mounting Height	F.C. at Nadir	Maximum Spacing
6'	169.4	3.4'
8'	95.3	4.5'
10'	61	5.6'
12'	42.4	6.7'
15'	27.1	8.4'

Photometric results may vary from testing data. To assist the lighting designer in using Nora's products in a lighting layout, the following photometric tables have both lab test data and normalized data to illustrate expected typical performance. Typical photometric data is provided to illustrate expectation of typical performance.



Brilliant. Sharp. Focused. Elegant.

Nora Lighting's low voltage halogen offering uses highly efficient halogen sources delivering pure white regions of light to strategic areas within any interior. Various beam spreads allow highlights of large areas or pinpointing small objects. Low voltage halogen fixtures create elegance in any design setting.

Low Voltage



Overview LOW VOLTAGE RECESSED

LOW VOLTAGE HOUSINGS



6" IC Air-Tight New Construction
Low Voltage Housing
NLIC-601 Series p.221



6" New Construction
Low Voltage Housing
NL-601 Series p.222



6" Remodel
Low Voltage Housing
NLR-604 Series p.223



4" IC Air-Tight New Construction
Low Voltage Housing
NLIC-401 Series p.229



4" Air-Tight New Construction
Low Voltage Housing
NL-401 Series p.230



4" Air-Tight Remodel
Low Voltage Housing
NLR-404 Series p.231



4" Air-Tight Remodel Remote
Low Voltage Housing
NLR-405 Series p.234

NEW!



4" Shallow New Construction
Low Voltage Housing
NL-402S Series p.232

NEW!



4" Shallow Remodel
Low Voltage Housing
NLR-403S Series p.233



4" Recessed Framing Projector
w/ Low Voltage Housing
NL-471W with Housing p.228



True 3" IC Air-Tight
New Construction
Low Voltage Housing
NLIC-301 Series p.245



True 3" Air-Tight
New Construction
Low Voltage Housing
NL-301 Series p.246



True 3" Air-Tight Remodel
Low Voltage Housing
NLR-304 Series p.247

SMALL APERTURE LOW VOLTAGE DOWNLIGHT FOR REMOTE TRANSFORMER



4" Remodel Remote
Low Voltage Housing
NLR-405 Series p.234

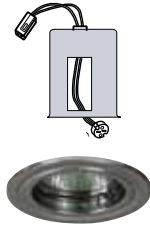

Small Reflector Downlights
NM-242 p.649

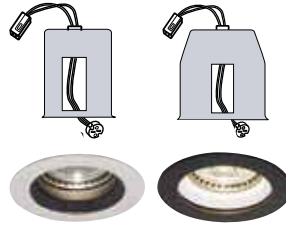

Small Baffle Downlights
NM-243 MR11 p.650
NM-244 MR11 p.650
NM-247 MR16 p.651
NM-248 MR16 p.651

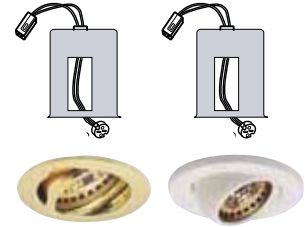

Small Adjustable Downlights
NM-245 MR11 p.652
NM-246 MR11 p.652
NM-249 MR16 p.653
NM-129 MR16 p.648
NM-130 MR11 p.648

LOW VOLTAGE RETROFIT KITS



6" MR16 Retrofit Kit for
Existing Non-IC Housings
NLK-2600 Series p.356



6" PAR36 / AR111 Retrofit Kit
for Existing Non-IC Housings
NLK-2636 Series p.356

LOW VOLTAGE EMERGENCY RECESSED LIGHTING



Emergency Option for Low Volt.
New Construction Housings
NELK-50 p.744



6" New Construction Low
Voltage Emergency Downlight
NEH-826 Series p.745



6" Remodel Low Voltage
Emergency Downlight
NERH-826 Series p.745

RECESSED ACCESSORIES



Fire Rated Enclosure
NRA-126 p.379



Hole Cutter
NSC-6500 / NSC-6600 p.380



Accessories
Filters, Rings and more p.381

Low Voltage Recessed

Nora Lighting's family of low voltage recessed fixtures includes 2", 3", 4" and 6" housings in new construction, remodel, remote and retro-fit configurations. Apertures from 1" to 5". While low voltage lighting has been used for years in commercial applications it is now common in residential applications. The small source is often the choice of lighting designers to create dramatic lighting effects.

LIGHTING TIP:

MR lamps are available at a variety of price points. It is always recommended to use a quality MR lamp. Although they may cost a little more, there is a significant difference in performance and projected color of light over the life of the lamp. Quality lamps can last twice as long as the rated life if simply dimmed 10%.

THE TECHNOLOGY

- **Precise beam control** – Low voltage lighting converts 120 or 277 volt to a typical 12 volts. The 12 volts allows for the use of a smaller filament which creates greater beam control and brightness. The lamps used in these fixtures are typically MR lamps. These lamps have CRI ratings typically in the 90s and produce true color renditions.
- **Smaller lamp source** – Because of the smaller 12 volt filament the lamp itself is smaller and can be used in smaller aperture recessed fixtures. Low voltage fixtures are often adjustable allowing the ultimate in lighting design.
- **Precise beam spreads** – Because of the smaller filament these MR (Multifaceted Reflector) lamps are available in wide selection of beam spreads and wattages. Wattages range for 20 to 75 with as many as 5 beam spreads within each wattage. Beam spreads, often referred to in degrees, allow for pinpoint lighting with a very narrow spot to general or wall wash lighting with a wide flood distribution.
- **Minimal Forward Heat** - Low voltage MR lamps, unlike PAR or BR lamps, create a minimal amount of forward heat. This feature alone can be the reason for selecting low voltage lighting to illuminate fine pieces of art, fabric or even in low ceiling applications where the proximity of the lamp will not create uncomfortable heat on a person directly below.
- **Minimal UV** – The MR lamps produce very little UV, which can be harmful in many aspects. Additionally, this UV can be reduced to almost zero with a UV lens. All Nora low voltage fixtures include this UV lens.
- **Efficiency** – Low voltage fixtures typically use an MR lamp. A 50 watt MR lamp will produce 40% more than a 50 watt PAR30 lamp and 5 times the light of 65 watt BR30. Technology has even improved the output of the MR lamp. New IR MR lamps now produce 25% more than their halogen counterparts.
- **Transformer Voltage Conversion** – Low Voltage fixtures convert 120 or 277 volts supplies to a typical 12 volts. This is done by a transformer either mounted in the fixture or remotely located. The transformers are either magnetic or electronic. Magnetic transformers are usually use in commercial applications and in most residential applications as well. Where silent operation is needed, electronic transformers should be used.
- **Dimming** – Low voltage fixtures are easily dimmed and recommended. Both low voltage and magnetic transformers can be dimmed. Low voltage magnetic dimmers are recommended for magnetic transformer fixtures and come in a wide variety of wattages. Electronic transformer fixtures should be dimmed with a electronic low voltage dimmer, however their wattages are more limited and should be considered in the layout.

Low Voltage Halogen

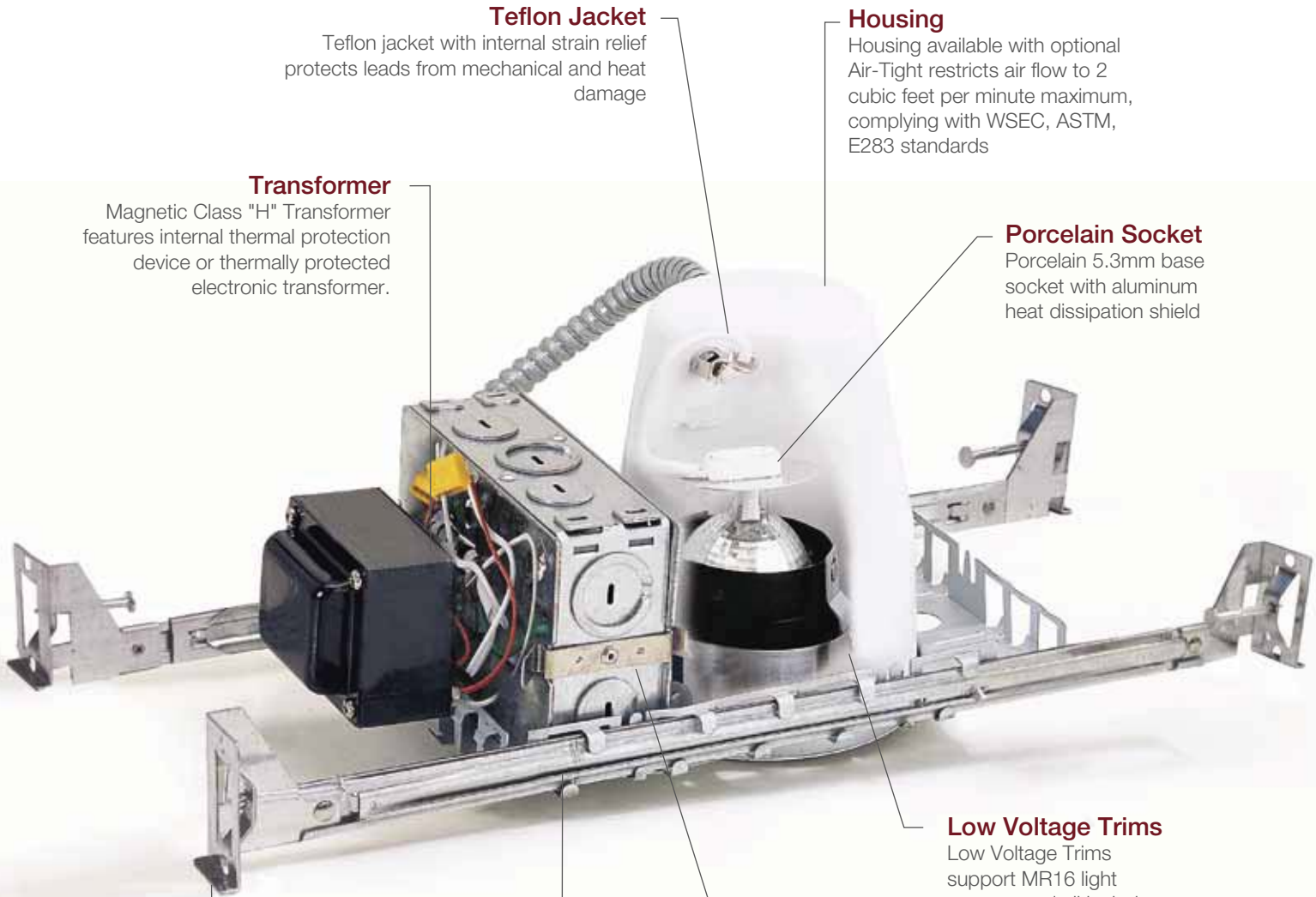

Teflon Jacket

Teflon jacket with internal strain relief protects leads from mechanical and heat damage

Housing

Housing available with optional Air-Tight restricts air flow to 2 cubic feet per minute maximum, complying with WSEC, ASTM, E283 standards

Transformer

Magnetic Class "H" Transformer features internal thermal protection device or thermally protected electronic transformer.

Porcelain Socket

Porcelain 5.3mm base socket with aluminum heat dissipation shield

Low Voltage Trims

Low Voltage Trims support MR16 light sources and all include tempered UV glass lens

Self Aligning Foot

For consistent and quick installation. Foot stops at bottom of stud.

Junction Box

Large Junction Box provides two 3/4", three 1/2" knockouts and four Romex® pry-outs with automatic strain relief. Allows maximum of 8 #12AWG conductors rated for 90°C. Internal quick connects provide instant, trouble-free electrical connection.

Bar Hangers

24-1/2" Adjustable Bar Hangers are slotted for T-bar installations with a captive nail. Knockouts on corners for tie-down to ceiling grid. Brackets on plaster frame allow bar hangers to be repositioned 90 degrees, if desired.





LOW VOLTAGE RECESSED 6" IC Air-Tight New Construction Housing

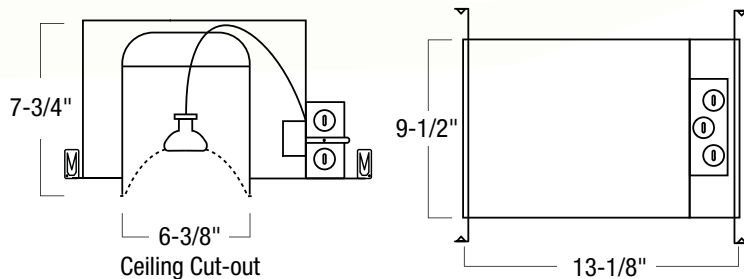

NLIC-601 SERIES

CATALOG. NO.	TRANSFORMER	VOLTAGE	MAX. WATTAGE	AIR-TIGHT
NLIC-601QAT	Magnetic	120V	50W	Yes
NLIC-601/1EL	Electronic	120V	50W	Yes
NLIC-601/2EL	Electronic	277V	50W	Yes



Nora Lighting's IC Air-Tight series of 6" low voltage housings provide crisp, defined halogen illumination from MR16, AR111, or PAR36 light sources in any insulated ceiling application. Double wall Air-Tight construction provides energy savings by reducing the flow of air through the ceiling. A wide variety of attractive adjustable trims allows fine-tuned aiming of directional light sources.

Transformer: 120V Magnetic or Electronic (EL) available in 120V or 277V.

Dimming Options: Use a magnetic low voltage dimmer with a magnetic transformer or an electronic low voltage dimmer with an electronic transformer.

Lamp Types: 50 Watt PAR36 / AR111 / MR16

Ceiling Thickness: Varies from 5/8" - 1-3/8"

Lamp Adjustable: Circular bracket on low voltage trims provides a secure snap-in hold and friction-locked aiming adjustment.

UV / Shatter Guard Shield: All low voltage trims include a tempered UV glass lens (unless noted).

Installation: Bar hangers are adjustable from 13-5/8" to 24-1/2" with captive nails and can be repositioned 90 degrees. Bar hangers are slotted for T-Bar installations.

Minimum Clearance: "IC" Housing is direct contact rated; no minimum clearance is required.

Junction Box: Contains seven 1/2" knockouts and four Romex® pry-outs with strain relief.

Electrical: Quick connector provided.

Listing:
cULus Damp Location w/ Feed Through
WSEC ASTM E283 for Air-Tight

LOW VOLTAGE RECESSED

6" New Construction Housing

Nora Lighting's series of 6" low voltage housings provide crisp, defined halogen illumination from MR16, AR111 or PAR36 light sources for any application. A wide variety of attractive adjustable trims allow fine-tuned aiming of directional light sources.

Transformer: Magnetic or Electronic (EL) available in 120V or 277V.

Dimming Options: Use a magnetic low voltage dimmer with a magnetic transformer or an electronic low voltage dimmer with an electronic transformer.

Lamp Types:
50 Watt PAR36 / AR111 / MR16
75 Watt PAR36 / AR111 / MR16

Ceiling Thickness: Ceiling thickness varies from 5/8" - 1-3/8"

Lamp Adjustable: Circular bracket on low voltage trims provides a secure snap-in hold and friction-locked aiming adjustment.

UV / Shatter Guard Shield: All low voltage trims include a tempered UV glass lens (unless noted).

Installation: Bar hangers are adjustable from 13-5/8" to 24-1/2" with captive nails and can be repositioned 90 degrees. Bar hangers are slotted for T-Bar installations.

Minimum Clearance: Requires minimum clearance of 3" from thermal insulation and 1/2" from adjacent building components.

Junction Box: Contains seven 1/2" knockouts and four Romex® pry-outs with strain relief.

Electrical: Quick connector provided.

Emergency: Low Voltage Emergency Relay available see pages 742-744

Listing: cULus Damp Location w/ Feed Through

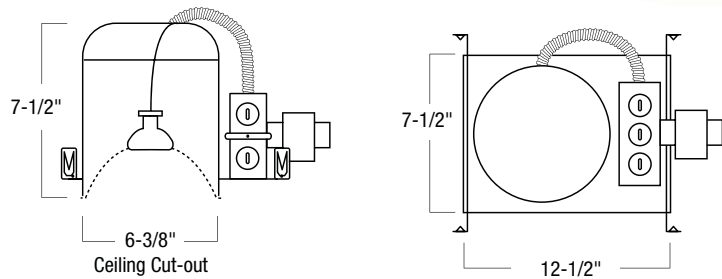

NL-601 SERIES

CATALOG. NO.	TRANSFORMER	VOLTAGE	MAX. WATTAGE	AIR-TIGHT
NL-601Q	Magnetic	120V	50W	No
NL-601Q/277V	Magnetic	277V	50W	No
NL-601/1EL	Electronic	120V	50W	No
NL-601/2EL	Electronic	277V	50W	No
NL-601/75Q	Magnetic	120V	75W	No
NL-601/277/75Q	Magnetic	277V	75W	No
NL-601/75/1EL	Electronic	120V	75W	No
NL-601/75/2EL	Electronic	277V	75W	No



LOW VOLTAGE RECESSED 6" Remodel Housing

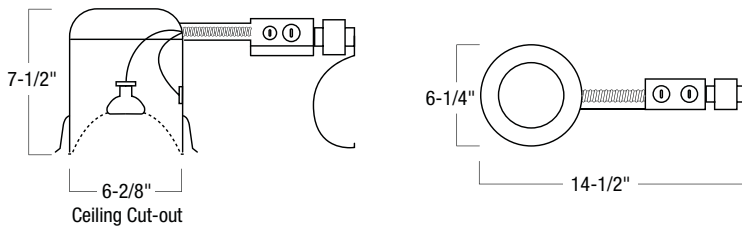

NLR-604 SERIES

CATALOG. NO.	TRANSFORMER	VOLTAGE	MAX. WATTAGE	AIR-TIGHT
NLR-604Q	Magnetic	120V	50W	No
NLR-604/277Q	Magnetic	277V	50W	No
NLR-604/1EL	Electronic	120V	50W	No
NLR-604/2EL	Electronic	277V	50W	No
NLR-604/75Q	Magnetic	120V	75W	No
NLR-604/277/75Q	Magnetic	277V	75W	No
NLR-604/75/1EL	Electronic	120V	75W	No
NLR-604/75/2EL	Electronic	277V	75W	No



Nora Lighting's 6" remodel low voltage housings allow installation in existing sheet rock ceilings. Each low voltage housing provides crisp, defined halogen illumination from MR16, AR111 or PAR36 light sources to any application. A wide variety of attractive adjustable trims allow fine-tuned aiming of directional light sources.

Transformer: Magnetic (Q) or Electronic (EL) available in 120V or 277V.

Dimming Options: Use a magnetic low voltage dimmer with a magnetic transformer or an electronic low voltage dimmer with an electronic transformer.

Lamp Types:
50 Watt PAR36 / AR111 / MR16
75 Watt PAR36 / AR111 / MR16

Ceiling Thickness: Ceiling thickness varies from 5/8" - 1-3/8"

Lamp Adjustable: Circular bracket on low voltage trims provides a secure snap-in hold and friction-locked aiming adjustment.

UV / Shatter Guard Shield: All low voltage trims include a tempered UV glass lens (unless noted).

Installation: High tension tempered steel springs secure remodel housings evenly to the ceiling; hole cutout template provided for convenience.

Support: Magnetic transformer includes support spring to maintain transformer height.

Minimum Clearance: Requires minimum clearance of 3" from thermal insulation and 1/2" from adjacent building components.

Junction Box: Contains seven 1/2" knockouts and four Romex® pry-outs with strain relief.

Electrical: Quick connector provided.

Listing: cULus Damp Location w/ Feed Through

Lighting Tip:

Nora's 6" Low Voltage trims can also be used to convert an existing medium base housing into a dramatic low voltage source. See page 356.

LOW VOLTAGE RECESSED 6" Low Voltage Trims

Adjustable Baffle

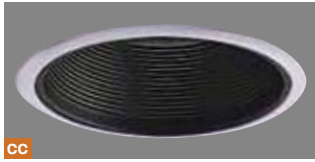

Catalog No.	Description
NL-610W	White Stepped Baffle / White Plastic Ring
NL-611B	Black Stepped Baffle / White Plastic Ring

- Downlight or 35° adjustable
- Can be used to convert existing 6" housing into low voltage, see page 356

Maximum Wattage:
75W MR16
50W MR16 (IC)
OD: 7"

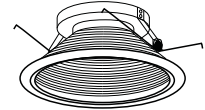

Designer Baffle



Catalog No.	Description
NL-641	Black Step Baffle / White Ring
NL-641W	White Step Baffle / White Ring

- Downlight or 35° adjustable
- 3-1/2" Aperture
- Can be used to convert existing 6" housing into low voltage, see page 356

Maximum Wattage:
75W MR16
50W MR16 (IC)
OD: 7"

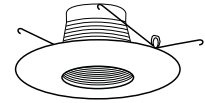

Regressed Stepped Baffle



Catalog No.	Description
NL-675B	Black Stepped Baffle / Regressed Baffle / White Ring
NL-675W	White Stepped Baffle / Regressed Baffle / White Ring

- Downlight or 35° adjustable

Maximum Wattage:
75W MR16
50W MR16 (IC)
OD: 7"

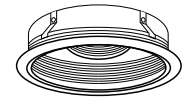

Cone Reflector



Catalog No.	Description
NL-612	Specular Gold Reflector / White Plastic Ring
NL-613	Specular Black Reflector / White Plastic Ring
NL-613BZ	Bronze Reflector / Bronze Metal Ring
NL-613CO	Copper Reflector / Copper Metal Ring
NL-614	Specular Clear Reflector / White Plastic Ring
NL-616	Specular White Reflector / White Plastic Ring

- Downlight or 35° adjustable
- Can be used to convert existing 6" housing into low voltage, see page 356

Maximum Wattage:
75W MR16
50W MR16 (IC)
OD: 7"



Designer Reflector



Catalog No.	Description
NL-642	Specular Gold Reflector / White Ring
NL-643	Specular Black Reflector / White Ring
NL-644	Specular Clear Reflector / White Ring
NL-646	Specular White Reflector / White Ring

- Downlight or 35° adjustable
- 3-1/2" Aperture
- Can be used to convert existing 6" housing into low voltage, see page 356

Maximum Wattage:
75W MR16
50W MR16 (IC)
OD: 7"

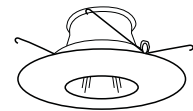

CC Custom Combo: Available with custom combinations of trim and plastic or metal ring finish. See pages 38-39 for details.
See pages 36-37 for Description of Reflector Finishes

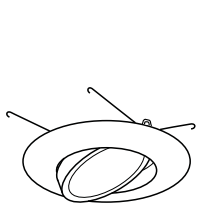

Maximum Wattage:
50W PAR36/AR111

OD: 7"

Catalog No.	Description
NL-671B	Black Surface Gimbal Ring
NL-671BZ	Bronze Surface Gimbal Ring
NL-671C	Chrome Surface Gimbal Ring
NL-671CO	Copper Surface Gimbal Ring
NL-671G	Gold Surface Gimbal Ring
NL-671N	Natural Metal Surface Gimbal Ring
NL-671W	White Surface Gimbal Ring

- Downlight or 35° Adjustable
- Can be used to convert existing 6" housing into low voltage, see page 356

Surface Gimbal

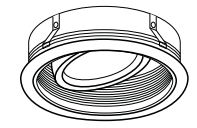

Maximum Wattage:
50W PAR36/AR111

OD: 7"

Catalog No.	Description
NL-672B	Regressed Gimbal / Black Baffle / White Ring
NL-672N	Regressed Gimbal / Natural Metal Baffle and Ring
NL-672W	Regressed Gimbal / White Baffle / White Ring

- Downlight or 35° Adjustable
- Can be used to convert existing 6" housing into low voltage, see page 356

Regressed Gimbal with Baffle

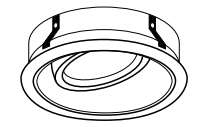

Maximum Wattage:
50W PAR36/AR111

OD: 7"

Catalog No.	Description
NL-673B	Regressed Gimbal / Specular Black Reflector / White Ring
NL-673C	Regressed Gimbal / Specular Clear Reflector / White Ring
NL-673G	Regressed Gimbal / Specular Gold Reflector / White Ring
NL-673W	Regressed Gimbal / Specular White Reflector / White Ring

- Downlight or 35° Adjustable
- Can be used to convert existing 6" housing into low voltage, see page 356

Regressed Gimbal with Reflector

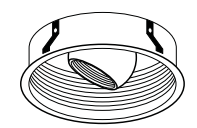

Maximum Wattage:
75W MR16
50W MR16 (IC)

OD: 7"

Catalog No.	Description
NL-628B	Black Regressed Eyeball / Black Baffle / White Plastic Ring
NL-628W	White Regressed Eyeball / White Baffle / White Plastic Ring

- Downlight or 35° Adjustable
- Can be used to convert existing 6" housing into low voltage, see page 356

Regressed Eyeball with Baffle

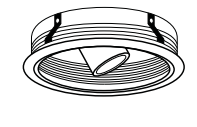

Maximum Wattage:
75W MR16
50W MR16 (IC)

OD: 7"

Catalog No.	Description
NL-670B	Black Regressed Spot Cylinder / Black Baffle
NL-670BZ	Bronze Regressed Spot Cylinder / Bronze Baffle
NL-670CO	Copper Regressed Spot Cylinder / Copper Baffle
NL-670N	Natural Metal Reg. Spot Cylinder / Natural Metal Baffle
NL-670W	White Regressed Spot Cylinder / White Baffle

- Downlight or 35° Adjustable
- Can be used to convert existing 6" housing into low voltage, see page 356

Regressed Spot Cylinder w/ Baffle

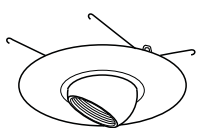
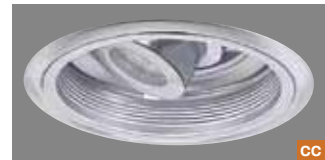

Maximum Wattage:
75W MR16
50W MR16 (IC)

OD: 7"

Catalog No.	Description
NL-618B	White Eyeball / Black Baffle / White Metal Trim
NL-618BB	Black Eyeball / Black Baffle / Black Metal Trim
NL-618W	White Eyeball / White Baffle / White Metal Trim
NL-619C	Chrome Eyeball / Black Baffle / Chrome Metal Trim
NL-619G	Gold Eyeball / Black Baffle / Gold Metal Trim

- Downlight or 35° Adjustable
- Can be used to convert existing 6" housing into low voltage, see page 356

Eyeball with Baffle



CC Custom Combo: Available with custom combinations of trim and plastic or metal ring finish. See pages 38-39 for details.

6" LOW VOLTAGE TRIMS continued

Gimbal with Baffle



Catalog No.	Description
NL-663B	Black Gimbal / Black Baffle
NL-663BZ	Bronze Gimbal / Black Baffle
NL-663C	Chrome Gimbal / Black Baffle
NL-663CO	Copper Gimbal / Black Baffle
NL-663G	Gold Gimbal / Black Baffle
NL-663N	Natural Metal Gimbal / Black Baffle
NL-663W	White Gimbal / Black Baffle
NL-663WW	White Gimbal / White Baffle

Maximum Wattage:

75W MR16
50W MR16 (IC)

OD: 7-1/4"



- Downlight or 45° Adjustable
- Can be used to convert existing 6" housing into low voltage, see page 356

Surface Round Spot

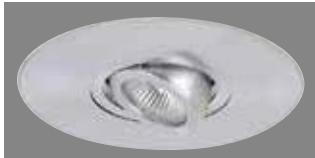

Catalog No.	Description
NL-665B	Black Adjustable Round Spot
NL-665BZ	Bronze Adjustable Round Spot
NL-665C	Chrome Adjustable Round Spot
NL-665CO	Copper Adjustable Round Spot
NL-665G	Gold Adjustable Round Spot
NL-665N	Natural Metal Adjustable Round Spot
NL-665W	White Adjustable Round Spot

Maximum Wattage:

75W MR16
50W MR16 (IC)

OD: 7"



- Downlight or 45° Adjustable
- Can be used to convert existing 6" housing into low voltage, see page 356

Fully Adjustable Elbow



Catalog No.	Description
NL-680B	Black Adjustable Elbow
NL-680BZ	Bronze Adjustable Elbow
NL-680C	Chrome Adjustable Elbow
NL-680CO	Copper Adjustable Elbow
NL-680G	Gold Adjustable Elbow
NL-680N	Natural Metal Adjustable Elbow
NL-680W	White Adjustable Elbow

Maximum Wattage:

75W MR16
50W MR16 (IC)

OD: 7-1/4"

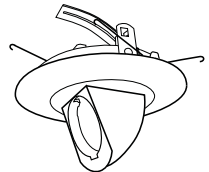

- Adjustable: 90° Vertically, 358° Horizontally
- Can be used to convert existing 6" housing into low voltage, see page 356

Wall Wash with Baffle



Catalog No.	Description
NL-648	Black Baffle / White Trim
NL-649	White Baffle / White Trim

Maximum Wattage:

75W MR16
50W MR16 (IC)

OD: 7"

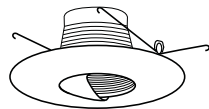

- Downlight or 35° Adjustable
- Can be used to convert existing 6" housing into low voltage, see page 356

Wall Wash with Reflector



Catalog No.	Description
NL-650	Specular White Reflector / White Trim

Maximum Wattage:

75W MR16
50W MR16 (IC)

OD: 7"



- Downlight or 35° Adjustable
- Can be used to convert existing 6" housing into low voltage, see page 356

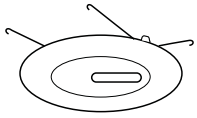

Maximum Wattage:	Catalog No.	Description
75W MR16	NL-645	White Adjustable Slot Aperture
50W MR16 (IC)	NL-645B	Black Adjustable Slot Aperture
	NL-645BZ	Bronze Adjustable Slot Aperture
	NL-645CO	Copper Adjustable Slot Aperture
	NL-645N	Natural Metal Adjustable Slot Aperture

OD: 7-1/2"

- Downlight or 35° Adjustable
- Can be used to convert existing 6" housing into low voltage, see page 356



Slot Aperture

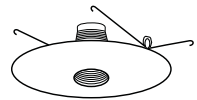

Maximum Wattage:	Catalog No.	Description
75W MR16	NL-620B	Pinhole / Black Baffle / White Trim
50W MR16 (IC)	NL-620W	Pinhole / White Baffle / White Trim

OD: 7"

- 2" Aperture
- Can be used to convert existing 6" housing into low voltage, see page 356



2" Pinhole with Baffle



Maximum Wattage:	Catalog No.	Description
75W MR16	NL-640	White Pinhole

OD: 7"

- Downlight or 35° Adjustable
- 1-3/4" Aperture
- Can be used to convert existing 6" housing into low voltage, see page 356



1-3/4" Pinhole

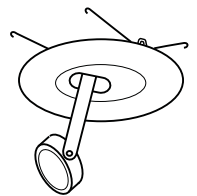

Maximum Wattage:	Catalog No.	Description
75W MR16	NL-690B	Black Drop Gimbal Ring
50W MR16 (IC)	NL-690W	White Drop Gimbal Ring

OD: 7"

- 90° Adjustable



Adjustable Drop Gimbal

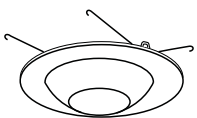

Maximum Wattage:	Catalog No.	Description
75W MR16	NL-695B	Blue Metropolitan Moon Glass / White Ring
50W MR16 (IC)	NL-695F	Frosted Metropolitan Moon Glass / White Ring
	NL-695P	Pink Metropolitan Moon Glass / White Ring

OD: 7"



Metropolitan Moon Glass



Maximum Wattage:	Catalog No.	Description
75W MR16	NL-696B	Blue Metropolitan Stepped Glass / White Ring
50W MR16 (IC)	NL-696F	Frosted Metropolitan Stepped Glass / White Ring
	NL-696P	Pink Metropolitan Stepped Glass / White Ring

OD: 7"



Metropolitan Stepped Glass

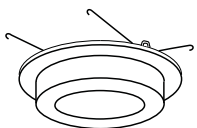

Maximum Wattage:	Catalog No.	Description
75W MR16	NL-697B	Blue Metropolitan Ice Light Glass / White Ring
50W MR16 (IC)	NL-697F	Frosted Metropolitan Ice Light Glass / White Ring
	NL-697P	Pink Metropolitan Ice Light Glass / White Ring

OD: 7"

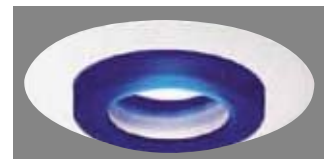

Metropolitan Ice Light Glass

See pages 36-37 for Description of Reflector Finishes

LOW VOLTAGE RECESSED

4" Recessed Framing Projector

Nora Lighting's history of innovation carries over into recessed projection lighting through a recessed framing and gobo projector that fits into a standard 4" low voltage housing.

Several key features set Nora's NL-471W projector far apart from similar units:

Low Profile: Nora's projector optics are positioned into a streamlined scoop that protrudes no more than 1-3/8" below the ceiling, while a faceplate completely conceals the inside of projector and housing.

Patented Superior Optics: Nora's NL-471W is the only projector in its class that uses genuine optical grade ground elements rather than standard glass. Also, the position of the light source itself is precision set so the exact focal point of the lamp intersects first lens so almost no light output is lost or captured within the lens. Additionally, the quality of the lenses and their position with the adjustable scoop virtually eliminates all glare outside the direct path of the actual beam.

High Performance Energy Savings: The NL-471W's patented optics actually result in a noticeably higher level of illumination and more uniform beam than similar projectors using 75W light sources - more light with less than half the energy.

Easy Use: Unlike other miniature projectors, there are no plates requiring precision framing cutouts. The NL-471W has four independent framing shutters that allow precision framing to any rectangular object that can be permanently locked so that the light source can be changed without having to reset the shutters. The shutters are set by lowering the projector, then adjusting the scoop angle after the unit is reinserted into the recessed housing.

Flexibility: The NL-471 can be installed anywhere a standard 4" is used. Nora offers standard non-IC, remodel non-IC, and IC Air-Tight units that can be used with the NL-471.

Design Friendly: The NL-471 can be used to create virtually any effect. When placed within 4' to 9' of any artwork or surface, the strong illumination will give artwork or gobo images a high contrast to the surrounding environment. For a subtler effect in simply bringing sparkle to artwork that would normally lose its life under standard ambient illumination, the projector may be dimmed with an approved low voltage rated dimmer - or the fixture may be placed as far as 21' away from the object to draw the user's complete attention to the artwork rather than the projector itself.

Also: 1mm dichroic filters may be placed in front of the light source to create unique color themes - consult factory for details.

Gobo Projection: A gobo holding frame is included with all units and can be installed by removing the framing shutter assembly. Consult factory for details on custom gobo images.

Lamp: 35W MR11FTH, flood (for best results, order separately)

Listing: cULus Listed

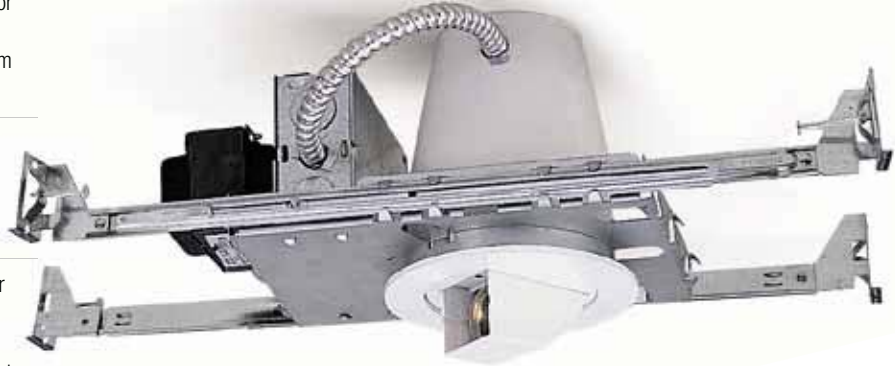

NL-471 FRAMING PROJECTOR

CATALOG. NO.	TRIM FINISH	VOLTAGE	MAX. WATTAGE	LAMP
NL-471W	White	12V	35W	MR11

COMPATIBLE HOUSINGS (INCLUDED SELECT ONE)

CATALOG. NO.	HOUSING TYPE	TRANSFORMER	VOLTAGE	AIR-TIGHT
NL-401/RFP	New Construction	Magnetic	120V	No
NL-401/277/RFP	New Construction	Magnetic	277V	No
NL-401/1EL/RFP	New Construction	Electronic	120V	No
NL-401/2EL/RFP	New Construction	Electronic	277V	No
NLR-404/RFP	Remodel	Magnetic	120V	No
NLR-404/277/RFP	Remodel	Magnetic	277V	No
NLR-404/1EL/RFP	Remodel	Electronic	120V	No
NLR-404/2EL/RFP	Remodel	Electronic	277V	No
NLIC-401SAT/RFP	IC New Construction	Magnetic	120V	Yes
NLIC-401/277/RFP	IC New Construction	Magnetic	277V	Yes
NLIC-401/1EL/RFP	IC New Construction	Electronic	120V	Yes
NLIC-401/2EL/RFP	IC New Construction	Electronic	277V	Yes

Photometrics NL-471

Dist. from Wall (Feet)	Horiz. Length (Inches)	Vert. Length (Inches)	FC at Nadir	FC Outer Vert. Edge	FC Outer Horiz. Edge
3'	20"	16"	50 fc	35 fc	25 fc
6'	36"	26"	30 fc	20 fc	18 fc
9'	50"	37"	12 fc	8 fc	8 fc
12'	66"	48"	7 fc	5 fc	5 fc
15'	73"	58"	4 fc	4 fc	4 fc
18'	75"	60"	5 fc	3 fc	3 fc
21'	90"	71"	5 fc	3 fc	2 fc



LOW VOLTAGE RECESSED 4" IC Air-Tight New Construction Housing 1" to 3-1/4" Aperture

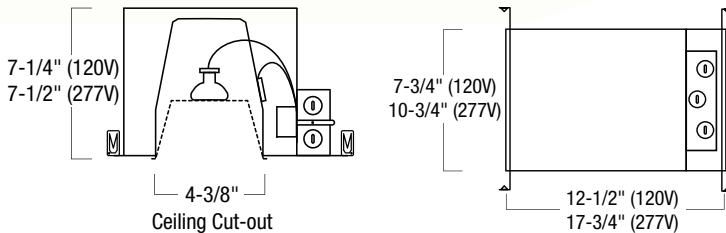

NLIC-401 SERIES

CATALOG. NO.	TRANSFORMER	VOLTAGE	MAX. WATTAGE	AIR-TIGHT
NEW! NLIC-401QSAT/20	Magnetic	120V	20W	Yes
NEW! NLIC-401QSAT/37	Magnetic	120V	37W	Yes
NLIC-401QSAT	Magnetic	120V	50W	Yes
NLIC-401AT/277V	Magnetic	277V	50W	Yes
NLIC-401AT/1EL*	Electronic	120V	50W	Yes
NLIC-401AT/2EL*	Electronic	277V	50W	Yes

* Lower Wattage housing available



Nora Lighting's IC Air-Tight series of 4" low voltage housings provide crisp, defined MR16 halogen illumination in any insulated ceiling application and provides energy savings by reducing the flow of air through the ceiling. 277V input option makes this housing ideal for commercial applications. A wide variety of attractive adjustable trims allows fine-tuned aiming of directional light sources.

Transformer: Magnetic or Electronic (EL) available with 120V or 277V.

Dimming Options: Use a magnetic low voltage dimmer with a magnetic transformer or an electronic low voltage dimmer with an electronic transformer.

Lamp Types: MR16 - 50 Watt max.

Ceiling Thickness: Varies from 5/8" - 1-3/8".

Lamp Adjustable: Circular bracket on low voltage trims provides a secure snap-in hold and friction-locked aiming adjustment.

UV / Shatter Guard Shield: All low voltage trims include a tempered UV glass lens (unless noted).

Installation: Bar hangers are adjustable from 13-5/8" to 24-1/2" with captive nails and can be repositioned 90 degrees. Bar hangers are slotted for T-Bar installations.

Minimum Clearance: "IC" Housing is direct contact rated; no minimum clearance is required.

Junction Box: Contains two 3/4", three 1/2" knockouts and four Romex® pry-outs with strain relief.

Electrical: Quick connector provided.

Listing:
cULus Damp Location w/ Feed Through
cULus Wet Location (Only with designated trims)
WSEC ASTM E283 for Air-Tight

LOW VOLTAGE RECESSED

4" New Construction Housing

1" to 3-1/4" Aperture

Nora Lighting's series of 4" low voltage housings provide crisp, defined MR16 halogen illumination for any application. Air-Tight unit provides energy savings to non-IC applications by reducing the flow of air through the ceiling. A wide variety of attractive adjustable trims allows fine-tuned aiming of directional light sources.

Transformer: Magnetic or Electronic (EL) available with 120V or 277V.

Dimming Options: Use a magnetic low voltage dimmer with a magnetic transformer or an electronic low voltage dimmer with an electronic transformer.

Lamp Types:
MR16 - 50 Watt max.
MR16 - 75 Watt max.

Ceiling Thickness: Varies from 5/8" - 1-3/8".

Lamp Adjustable: Circular bracket on low voltage trims provides a secure snap-in hold and friction-locked aiming adjustment.

UV / Shatter Guard Shield: All low voltage trims include a tempered UV glass lens (unless noted).

Installation: Bar hangers are adjustable from 13-5/8" to 24-1/2" with captive nails and can be repositioned 90 degrees. Bar hangers are slotted for T-Bar installations.

Minimum Clearance: Requires minimum clearance of 3" from thermal insulation and 1/2" from adjacent building components.

Junction Box: Contains two 3/4", three 1/2" knockouts and four Romex® pry-outs with strain relief.

Electrical: Quick connector provided.

Emergency: Low Voltage Emergency Relay available see pages 742-744.

Listing:
cULus Damp Location w/ Feed Through
cULus Wet Location (Only with designated trims)
WSEC ASTM E283 for Air-Tight (AT only)



NL-401QAT/FX - Fire Rated (See pg 379)

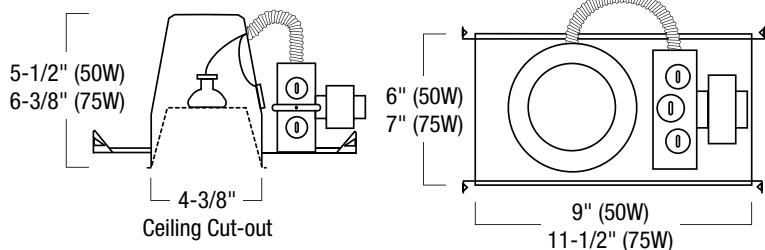

NL-401 SERIES

CATALOG. NO.	TRANSFORMER	VOLTAGE	MAX. WATTAGE	AIR-TIGHT
NEW! NL-401QAT/20	Magnetic	120V	20W	Yes
NEW! NL-401QAT/37	Magnetic	120V	37W	Yes
NL-401QAT	Magnetic	120V	50W	Yes
NEW! NL-401QAT/FX ¹	Magnetic	120V	50W	Yes
NL-401/50/277V	Magnetic	277V	50W	No
NL-401AT/1EL ²	Electronic	120V	50W	Yes
NL-401AT/2EL	Electronic	277V	50W	Yes
NL-401/75	Magnetic	120V	75W	No
NL-401/75/277V	Magnetic	277V	75W	No
NL-401/75/1EL ²	Electronic	120V	75W	No
NL-401/75/2EL	Electronic	277V	75W	No

¹ See page 379 for Fire Enclosure specifications
² Lower Wattage housing available



Lighting Tip:

New IR MR16 lamps can produce as much as 25% more light. Use Nora's new wattage reduced housings to meet Title 24 and wattage per square foot requirements without sacrificing illumination design criteria.

LOW VOLTAGE RECESSED 4" Remodel Housing 1" to 3-1/4" Aperture

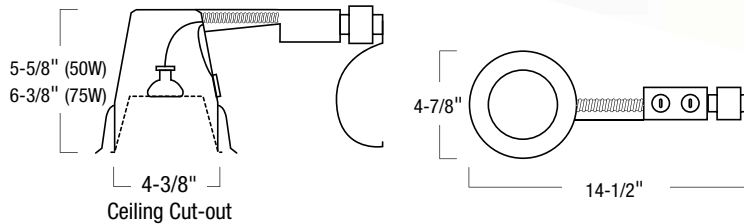

NLR-404 SERIES

CATALOG. NO.	TRANSFORMER	VOLTAGE	MAX. WATTAGE	AIR-TIGHT
NEW! NLR-404QAT/20	Magnetic	120V	20W	Yes
NEW! NLR-404QAT/37	Magnetic	120V	37W	Yes
NLR-404QAT	Magnetic	120V	50W	Yes
NLR-404/50/277V	Magnetic	277V	50W	No
NLR-404AT/1EL*	Electronic	120V	50W	Yes
NLR-404AT/2EL	Electronic	277V	50W	Yes
NLR-404/75	Magnetic	120V	75W	No
NLR-404/75/277V	Magnetic	277V	75W	No
NLR-404/75/1EL*	Electronic	120V	75W	No
NLR-404/75/2EL	Electronic	277V	75W	No

* Lower Wattage housing available



Nora Lighting's 4" remodel low voltage housings allow consumers to install in existing sheet rock ceilings. Each low voltage housing provides crisp, defined MR16 halogen illumination for any application. A wide variety of attractive adjustable trims allow fine-tuned aiming of directional light sources.

Transformer: Magnetic or Electronic (EL) available in 120V or 277V.

Dimming Options: Use a magnetic low voltage dimmer with a magnetic transformer or an electronic low voltage dimmer with an electronic transformer.

Lamp Types:

MR16 - 50 Watt max.
MR16 - 75 Watt max.

Ceiling Thickness: Ceiling thickness varies from 5/8" - 1-3/8".

Lamp Adjustable: Circular bracket on low voltage trims provides a secure snap-in hold and friction-locked aiming adjustment.

UV / Shatter Guard Shield: All low voltage trims include a tempered UV glass lens (unless noted).

Installation: High tension tempered steel springs secure remodel housings evenly to the ceiling; hole cutout template provided for convenience.

Support: Magnetic transformer includes support spring to maintain transformer height.

Minimum Clearance: Requires minimum clearance of 3" from thermal insulation and 1/2" from adjacent building components.

Junction Box: Contains two 3/4", three 1/2" knockouts and four Romex® pry-outs with strain relief.

Electrical: Quick connector provided.

Listing:

cULus Damp Location w/ Feed Through
cULus Wet Location (Only with designated trims)
WSEC ASTM E283 for Air-Tight (AT only)

LOW VOLTAGE RECESSED

4" Shallow New Construction Housing

Only 3-1/2" Deep! – 1" to 3-1/4" Aperture

Nora Lighting's new series of shallow 4" low voltage housings are one of the lowest profile housings in the industry. Shallow housings provides crisp, defined MR16 halogen illumination for any application. New low profile housings allow for installations into shallow plenum applications. Compatible with a wide variety of attractive adjustable trims allows fine-tuned aiming of directional light sources.

NEW!



Transformer: Magnetic or Electronic (EL) available with 120V.

Dimming Options: Use a magnetic low voltage dimmer with a magnetic transformer or an electronic low voltage dimmer with an electronic transformer.

Lamp Types: MR16 - 50 Watt max.

Ceiling Thickness: Varies from 1/2" - 7/8".

Lamp Adjustable: Circular bracket on low voltage trims provides a secure snap-in hold and friction-locked aiming adjustment.

UV / Shatter Guard Shield: All low voltage trims include a tempered UV glass lens (unless noted).

Installation: Bar hangers are adjustable from 13-5/8" to 24-1/2" with captive nails and can be repositioned 90 degrees. Bar hangers are slotted for T-Bar installations.

Minimum Clearance: Requires minimum clearance of 3" from thermal insulation and 1/2" from adjacent building components.

Junction Box: Contains two 3/4", three 1/2" knockouts and four Romex® pry-outs with strain relief.

Electrical: Quick connector provided.

Emergency: Low Voltage Emergency Relay available see pages 742-746.

Listing:
cULus Damp Location w/ Feed Through
cULus Wet Location (Only with designated trims)

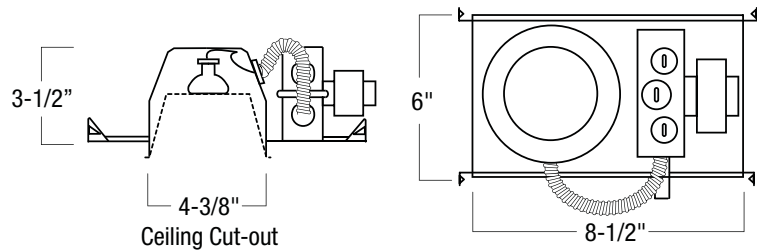

NL-402S SERIES

CATALOG. NO.	TRANSFORMER	VOLTAGE	MAX. WATTAGE	AIR-TIGHT
NEW! NL-402S/20	Magnetic	120V	20W	No
NEW! NL-402S/37	Magnetic	120V	37W	No
NL-402S	Magnetic	120V	50W	No
NL-402S/1EL*	Electronic	120V	50W	No

* Lower Wattage housing available

SH Designates trims compatible with shallow housings



LOW VOLTAGE RECESSED

4" Shallow Remodel Housing

Only 3-1/2" Deep! – 1" to 3-1/4" Aperture

NEW!



Nora Lighting's new series of shallow 4" remodel housings are one of the lowest profile housings in the industry. Shallow housings provides crisp, defined MR16 halogen illumination for any application. New low profile housings allow consumers to install in existing shallow plenum applications. Compatible with a wide variety of attractive adjustable trims allows fine-tuned aiming of directional light sources.

Transformer: Magnetic or Electronic (EL) available with 120V.

Dimming Options: Use a magnetic low voltage dimmer with a magnetic transformer or an electronic low voltage dimmer with an electronic transformer.

Lamp Types: MR16 - 50 Watt max.

Ceiling Thickness: Varies from 1/2" - 7/8".

Lamp Adjustable: Circular bracket on low voltage trims provides a secure snap-in hold and friction-locked aiming adjustment.

UV / Shatter Guard Shield: All low voltage trims include a tempered UV glass lens (unless noted).

Installation: High tension tempered steel springs secure remodel housings evenly to the ceiling; hole cutout template provided for convenience.

Support: Magnetic transformer includes support spring to maintain transformer height.

Minimum Clearance: Requires minimum clearance of 3" from thermal insulation and 1/2" from adjacent building components.

Junction Box: Contains two 3/4", three 1/2" knockouts and four Romex® pry-outs with strain relief.

Electrical: Quick connector provided.

Listing:
cULus Damp Location w/ Feed Through
cULus Wet Location (Only with designated trims)

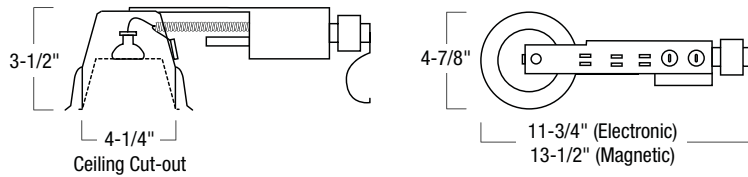

NLR-403S SERIES

CATALOG. NO.	TRANSFORMER	VOLTAGE	MAX. WATTAGE	AIR-TIGHT
NEW! NLR-403S/20	Magnetic	120V	20W	No
NEW! NLR-403S/37	Magnetic	120V	37W	No
NLR-403S	Magnetic	120V	50W	No
NLR-403S/1EL*	Electronic	120V	50W	No

* Lower Wattage housing available

SH Designates trims compatible with shallow housings



LOW VOLTAGE RECESSED

4" Remodel Housing for Remote Transformer

1" to 3-1/4" Aperture

For applications requiring MR16 illumination in noise sensitive areas. Nora offers our remodel housing with the capability of receiving 12V power from a remotely mounted Class 2 rated transformer. One to several fixtures can be connected to one single transformer, greatly reducing the number of transformers and allowing the choice between an ultra quiet electronic transformer or a magnetic unit that can be isolated as far as 50 feet away from any housing. A wide variety of attractive adjustable trims allows fine-tuned aiming of directional light sources.

Transformer: NEC Class 2 fused transformer is required (order separately - see pages 702-706)

Dimming Options: Use a magnetic low voltage dimmer with a magnetic transformer or an electronic low voltage dimmer with an electronic transformer.

Lamp Types: MR16 - 50 Watt max.

Ceiling Thickness: Ceiling thickness varies from 3/8" - 1-3/8".

Lamp Adjustable: Circular bracket on low voltage trims provides a secure snap-in hold and friction-locked aiming adjustment.

UV / Shatter Guard Shield: All low voltage trims include a tempered UV glass lens (unless noted).

Installation: High tension tempered steel springs secure remodel housings evenly to the ceiling; hole cutout template provided for convenience.

Minimum Clearance: Requires minimum clearance of 3" from thermal insulation and 1/2" from adjacent building components.

Electrical: Thermally protected

Listing:

cULus Damp Location
cULus Wet Location (Only with designated trims)
WSEC ASTM E283 for Air-Tight (AT only)

See pages 648-653 for additional remote transformer small aperture housings and trims.

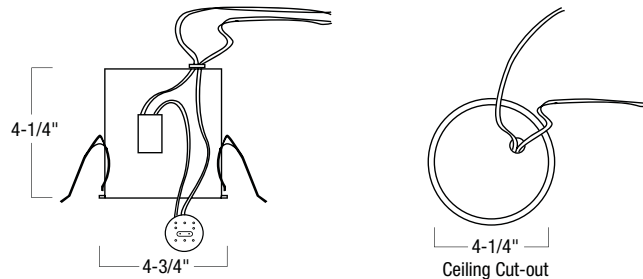

NLR-405AT SERIES

CATALOG. NO.	TRANSFORMER	MAX. WATTAGE	AIR-TIGHT
NEW! NLR-405AT/20	Class 2 Required	20W	Yes
NEW! NLR-405AT/37	Class 2 Required	37W	Yes
NLR-405AT	Class 2 Required	50W	Yes

Transformers Ordered Separately, see pages 702-706



4" Low Voltage Square Trims

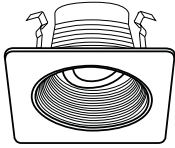

Maximum Wattage:
75W MR16
50W MR16 (IC/Shallow)
OD: 4-3/4"
Aperture: 3-5/8"

SH

Catalog No.	Description
NL-4810BB	Black Baffle / Black Square Trim
NL-4810BBZ	Black Baffle / Bronze Square Trim
NL-4810BCO	Black Baffle / Copper Square Trim
NL-4810WC	White Baffle / Chrome Square Trim
NL-4810WG	White Baffle / Gold Square Trim
NL-4810WN	White Baffle / Natural Metal Square Trim
NL-4810WW	White Baffle / White Square Trim

- 35° Adjustable

Square Trim with Baffle



NEW!

CC

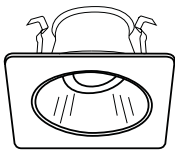

Maximum Wattage:
75W MR16
50W MR16 (IC/Shallow)
OD: 4-3/4"
Aperture: 3-5/8"

SH

Catalog No.	Description
NL-4814BW	Specular Black Reflector / White Square Trim
NL-4814BZBZ	Bronze Reflector / Bronze Square Trim
NL-4814CB	Specular Clear Reflector / Black Square Trim
NL-4814CC	Specular Clear Reflector / Chrome Square Trim
NL-4814CG	Specular Clear Reflector / Gold Square Trim
NL-4814COCO	Copper Reflector / Copper Square Trim
NL-4814CW	Specular Clear Reflector / White Square Trim
NL-4814GW	Specular Gold Reflector / White Square Trim
NL-4814HZW	Haze Reflector / White Square Trim
NL-4814NN	Natural Metal Reflector / Natural Metal Square Trim

- 35° Adjustable

Square Trim with Reflector



NEW!

CC

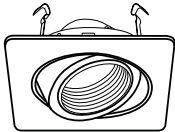

Maximum Wattage:
75W MR16
50W MR16 (IC/Shallow)
OD: 4-3/4"

SH

Catalog No.	Description
NL-4863BB	Black Gimbal / Black Baffle / Black Square Trim
NL-4863BC	Chrome Gimbal / Black Baffle / Chrome Square Trim
NL-4863BG	Gold Gimbal / Black Baffle / Gold Square Trim
NL-4863BW	White Gimbal / Black Baffle / White Square Trim
NL-4863BZBZ	Bronze Gimbal / Bronze Baffle / Bronze Square Trim
NL-4863COCO	Copper Gimbal / Copper Baffle / Copper Square Trim
NL-4863NN	Nat. Metal Gimbal / Nat. Metal Baffle / Nat. Metal Trim
NL-4863WW	White Gimbal / White Baffle / White Square Trim

- 35° Adjustable

Square Trim w/ Gimbal and Baffle



NEW!

CC

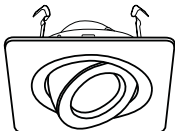

Maximum Wattage:
75W MR16
50W MR16 (IC/Shallow)
OD: 4-3/4"

SH

Catalog No.	Description
NL-4865B	Black Surface Adjustable
NL-4865BZ	Bronze Surface Adjustable
NL-4865C	Chrome Surface Adjustable
NL-4865CO	Copper Surface Adjustable
NL-4865G	Gold Surface Adjustable
NL-4865N	Natural Metal Surface Adjustable
NL-4865W	White Surface Adjustable

- 35° Adjustable

Square Trim w/ Surface Adjustable



NEW!

CC

Lighting Tip:

When lighting home theaters, outdoor living areas or other areas where aperture brightness is a visual distraction, use Nora Black Baffles or Specular Black Reflectors (Ex. NL-4814BW, NL-413, or NL-411)

CC Square Trims and Reflectors can be combined. Example: If designer want a Natural Metal Reflector with a Black Square trim, specify NL-4814NB

SH Shallow: Designated trims for shallow housings

See pages 36-37 for Description of Reflector Finishes

4" LOW VOLTAGE SQUARE TRIMS continued

Square Trim with Adjustable Elbow

NEW!



CC

Catalog No.	Description
NL-4870B	Black Adjustable Elbow
NL-4870BZ	Bronze Adjustable Elbow
NL-4870C	Chrome Adjustable Elbow
NL-4870CO	Copper Adjustable Elbow
NL-4870G	Gold Adjustable Elbow
NL-4870N	Natural Metal Adjustable Elbow
NL-4870W	White Adjustable Elbow

- Adjustable: 90° Vertically, 358° Horizontally
- Excellent for slope ceiling applications

Maximum Wattage:

75W MR16
50W MR16 (IC/Shallow)

OD: 4-3/4"

SH

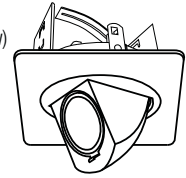

Square Trim with 1" Pinhole

NEW!



Catalog No.	Description
NL-4840B	Black Pinhole
NL-4840BZ	Bronze Pinhole
NL-4840C	Chrome Pinhole
NL-4840CO	Copper Pinhole
NL-4840G	Gold Pinhole
NL-4840N	Natural Metal Pinhole
NL-4840W	White Pinhole

- 35° Adjustable

Maximum Wattage:

50W MR16

OD: 4-3/4"

SH

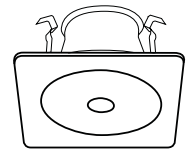

Square Trim w/ Frosted Dome

NEW!



Catalog No.	Description
NL-4825B	Frosted Dome Lens / Black Square Trim
NL-4825BZ	Frosted Dome Lens / Bronze Square Trim
NL-4825C	Frosted Dome Lens / Chrome Square Trim
NL-4825CO	Frosted Dome Lens / Copper Square Trim
NL-4825G	Frosted Dome Lens / Gold Square Trim
NL-4825N	Frosted Dome Lens / Natural Metal Square Trim
NL-4825W	Frosted Dome Lens / White Square Trim

- UL Wet Listed

Maximum Wattage:

50W MR16

OD: 4-3/4"

WET

SH

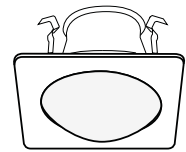

Square Trim w/ Frosted Shower Trim

NEW!



Catalog No.	Description
NL-4826B	Flat Frosted Lens / Black Square Trim
NL-4826BZ	Flat Frosted Lens / Bronze Square Trim
NL-4826C	Flat Frosted Lens / Chrome Square Trim
NL-4826CO	Flat Frosted Lens / Copper Square Trim
NL-4826G	Flat Frosted Lens / Gold Square Trim
NL-4826N	Flat Frosted Lens / Natural Metal Square Trim
NL-4826W	Flat Frosted Lens / White Square Trim

- UL Wet Listed

Maximum Wattage:

50W MR16

OD: 4-3/4"

WET

SH

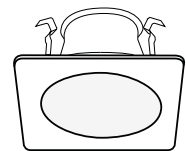

Square Trim w/ Frosted Shower Trim w/ Clear Center

NEW!



Catalog No.	Description
NL-4827B	Flat Frosted Lens w/ Clear Center / Black Square Trim
NL-4827BZ	Flat Frosted Lens w/ Clear Center / Bronze Square Trim
NL-4827C	Flat Frosted Lens w/ Clear Center / Chrome Square Trim
NL-4827CO	Flat Frosted Lens w/ Clear Center / Copper Square Trim
NL-4827G	Flat Frosted Lens w/ Clear Center / Gold Square Trim
NL-4827N	Flat Frosted Lens w/ Clear Center/Natural Metal Square Trim
NL-4827W	Flat Frosted Lens w/ Clear Center / White Square Trim

- UL Wet Listed

Maximum Wattage:

50W MR16

OD: 4-3/4"

WET

SH

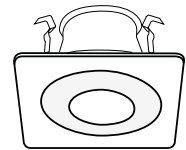

CC Square Trims and Elbow can be combined. Example: If designer want a Natural Metal Elbow with a Black Square trim, specify NL-4870NB

SH Shallow: Designated trims for shallow housings

Lighting Tip:

Use Nora's phenolic (plastic) baffle with plastic ring for outdoor or harsh environment applications (Ex. NL-410P, NL-411P, or NL-486W)

4" LOW VOLTAGE TRIMS continued

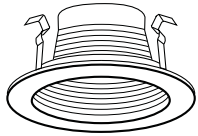

Maximum Wattage:	Catalog No.	Description
75W MR16	NL-410	White Stepped Baffle / White Ring
50W MR16 (IC/Shallow)	NL-410BZ	Bronze Stepped Baffle / Bronze Ring
OD: 4-3/4"	NL-410CO	Copper Stepped Baffle / Copper Ring
Aperture: 3-1/4"	NL-410N	Natural Metal Stepped Baffle / Natural Metal Ring
SH	NL-410P	White Phenolic Stepped Baffle / White Plastic Ring 

- 35° Adjustable

Adjustable Baffle

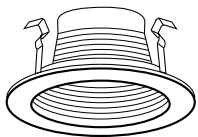

Maximum Wattage:	Catalog No.	Description
75W MR16	NL-411	Black Stepped Baffle / White Ring
50W MR16 (IC/Shallow)	NL-411B	Black Stepped Baffle / Black Ring
OD: 4-3/4"	NL-411BZ	Black Stepped Baffle / Bronze Ring
Aperture: 3-1/4"	NL-411C	Black Stepped Baffle / Chrome Ring
SH	NL-411CO	Black Stepped Baffle / Copper Ring
	NL-411G	Black Stepped Baffle / Gold Ring
	NL-411N	Black Stepped Baffle / Natural Metal Ring
	NL-411P	Black Phenolic Stepped Baffle / White Plastic Ring 

- 35° Adjustable

Black Adjustable Baffle

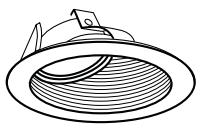
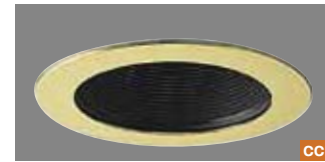

Maximum Wattage:	Catalog No.	Description
75W MR16	NL-468B	Black Baffle / White Ring
50W MR16 (IC/Shallow)	NL-468W	White Baffle / White Ring
OD: 4-3/4"		
Aperture: 3-1/4"		
SH		

- 45° Adjustable
- Bias cut baffle for full lamp distribution

45° Adjustable Baffle

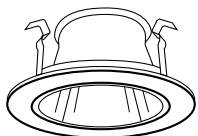

Maximum Wattage:	Catalog No.	Description
75W MR16	NL-412	Specular Gold Reflector / White Ring
50W MR16 (IC/Shallow)	NL-412G	Specular Gold Reflector / Gold Ring
OD: 4-3/4"	NL-413	Specular Black Reflector / White Ring
Aperture: 3-1/4"	NL-413B	Specular Black Reflector / Black Ring
SH	NL-414	Specular Clear Reflector / White Ring
	NL-414C	Specular Clear Reflector / Chrome Ring
	NL-414HZ	Haze Reflector / White Ring
	NL-416	Specular White Reflector / White Ring
	NL-452	Natural Metal Reflector / Natural Metal Ring
	NL-453	Copper Reflector / Copper Ring
	NL-453BZ	Bronze Reflector / Bronze Ring

- 35° Adjustable

Adjustable Reflector



Maximum Wattage:	Catalog No.	Description
75W MR16	NL-469B	Specular Black Reflector / White Ring
50W MR16 (IC/Shallow)	NL-469BZ	Bronze Reflector / Bronze Ring
OD: 4-3/4"	NL-469C	Specular Clear Reflector / White Ring
Aperture: 3-1/4"	NL-469CO	Copper Reflector / Copper Ring
SH	NL-469G	Specular Gold Reflector / White Ring
	NL-469HZ	Haze Reflector / White Ring
	NL-469N	Natural Metal Reflector / Natural Metal Ring
	NL-469W	Specular White Reflector / White Ring

- 45° Adjustable
- Bias cut baffle for full lamp distribution

45° Adjustable Reflector



CC Custom Combo: Available with custom combinations of trim and plastic or metal ring finish. See pages 38-39 for details.

SH Shallow: Designated trims for shallow housings

See pages 36-37 for Description of Reflector Finishes

4" LOW VOLTAGE TRIMS continued

Cross Louver with Reflector

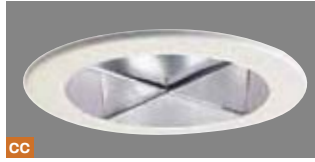

CC

Catalog No.	Description
NL-417CW	Chrome Louver / Specular Clear Reflector / White Ring
NL-417GW	Chrome Louver / Specular Gold Reflector / White Ring

Maximum Wattage:
75W MR16
50W MR16 (IC/Shallow)
OD: 4-3/4"
Aperture: 3-1/4"
SH

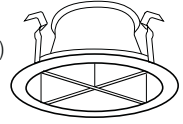

Adjustable Eyeball with Baffle

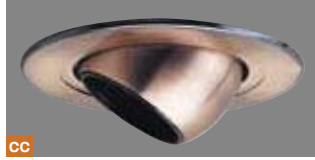

CC

Catalog No.	Description
NL-418BB	Black Eyeball / Black Baffle
NL-418BZ	Bronze Eyeball / Black Baffle
NL-418CO	Copper Eyeball / Black Baffle
NL-418N	Natural Metal Eyeball / Black Baffle
NL-418WB	White Eyeball / Black Baffle
NL-418WW	White Eyeball / White Baffle
NL-419C	Chrome Eyeball / Black Baffle
NL-419G	Gold Eyeball / Black Baffle

- 35° Adjustable

Maximum Wattage:
75W MR16
50W MR16 (IC/Shallow)
OD: 4-3/4"
SH

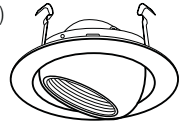

Gimbal with Baffle



CC

Catalog No.	Description
NL-463BB	Black Gimbal / Black Baffle / Black Ring
NL-463BC	Chrome Gimbal / Black Baffle / Chrome Ring
NL-463BG	Gold Gimbal / Black Baffle / Gold Ring
NL-463BN	Natural Metal Gimbal / Black Baffle / Natural Metal Ring
NL-463BW	White Gimbal / Black Baffle / White Ring
NL-463BZ	Bronze Gimbal / Black Baffle / Bronze Ring
NL-463CO	Copper Gimbal / Black Baffle / Copper Ring
NL-463WB	Black Gimbal / White Baffle / Black Ring
NL-463WC	Chrome Gimbal / White Baffle / Chrome Ring
NL-463WG	Gold Gimbal / White Baffle / Gold Ring
NL-463WW	White Gimbal / White Baffle / White Ring

- 35° Adjustable

Maximum Wattage:
75W MR16
50W MR16 (IC/Shallow)
OD: 4-3/4"
SH

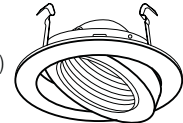

Surface Adjustable



CC

Catalog No.	Description
NL-465B	Black Surface Adjustable
NL-465BZ	Bronze Surface Adjustable
NL-465C	Chrome Surface Adjustable
NL-465CO	Copper Surface Adjustable
NL-465G	Gold Surface Adjustable
NL-465N	Natural Metal Surface Adjustable
NL-465W	White Surface Adjustable

- 35° Adjustable

Maximum Wattage:
75W MR16
50W MR16 (IC/Shallow)
OD: 4-3/4"
SH

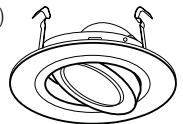

Surface Adjustable with Baffle



CC

Catalog No.	Description
NL-467BC	Surface Adjustable / Chrome Trim / Black Baffle
NL-467BG	Surface Adjustable / Gold Trim / Black Baffle
NL-467BN	Surface Adjustable / Natural Metal Trim / Black Baffle
NL-467BW	Surface Adjustable / White Trim / Black Baffle
NL-467WW	Surface Adjustable / White Trim / White Baffle

- 35° Adjustable

Maximum Wattage:
75W MR16
50W MR16 (IC/Shallow)
OD: 4-3/4"
SH



CC Custom Combo: Available with custom combinations of trim and plastic or metal ring finish. See pages 38-39 for details.

SH Shallow: Designated trims for shallow housings

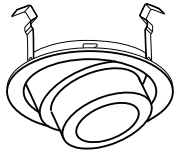

Maximum Wattage:
50W MR16

OD: 4-3/4"

SH

Catalog No.	Description
NL-491B	Black Adjustable Spot
NL-491N	Natural Metal Adjustable Spot
NL-491W	White Adjustable Spot

- 30° Adjustable

Adjustable Spot

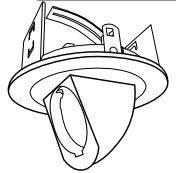

Maximum Wattage:
75W MR16
50W MR16 (IC/Shallow)

OD: 4-3/4"

SH

Catalog No.	Description
NL-470B	Black Adjustable Elbow
NL-470BZ	Bronze Adjustable Elbow
NL-470C	Chrome Adjustable Elbow
NL-470CO	Copper Adjustable Elbow
NL-470G	Gold Adjustable Elbow
NL-470N	Natural Metal Adjustable Elbow
NL-470W	White Adjustable Elbow

- Adjustable: 90° Vertically, 358° Horizontally
- Excellent for slope ceiling applications

Fully Adjustable Elbow



Lighting Tip:

The proper angle to light a picture or object is 30°. When plans don't specify placement, Nora's 90° adjustable elbow can solve the problem.

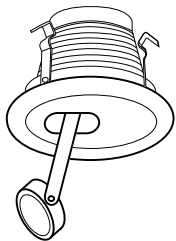

Maximum Wattage:
75W MR16

OD: 4-3/4"

SH

Catalog No.	Description
NL-490B	Black Adjustable Drop Gimbal Ring
NL-490W	White Adjustable Drop Gimbal Ring

- 90° Adjustment

Adjustable Drop Gimbal

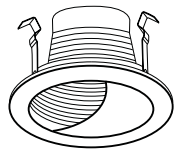

Maximum Wattage:
75W MR16
50W MR16 (IC/Shallow)

OD: 4-3/4"

SH

Catalog No.	Description
NL-448	White Wall Wash / Black Baffle
NL-448BZ	Bronze Wall Wash / Bronze Baffle
NL-448CO	Copper Wall Wash / Copper Baffle
NL-448N	Natural Metal Wall Wash / Natural Metal Baffle
NL-449	White Wall Wash / White Baffle

- 35° Adjustable

Adjustable Wall Wash with Baffle

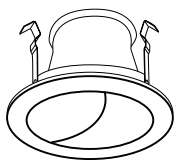

Maximum Wattage:
75W MR16
50W MR16 (IC/Shallow)

OD: 4-3/4"

SH

Catalog No.	Description
NL-450	White Wall Wash / White Reflector

- 35° Adjustable

Adjustable Wall Wash w/ Reflector

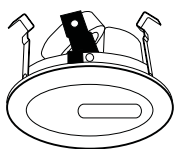

Maximum Wattage:
75W MR16
50W MR16 (IC/Shallow)

OD: 4-3/4"

SH

Catalog No.	Description
NL-445	White Slot Aperture
NL-445B	Black Slot Aperture
NL-445BZ	Bronze Slot Aperture
NL-445CO	Copper Slot Aperture
NL-445N	Natural Metal Slot Aperture

- 35° Adjustable

Adjustable Slot Aperture



CC Custom Combo: Available with custom combinations of trim and plastic or metal ring finish. See pages 38-39 for details.

SH Shallow: Designated trims for shallow housings

Lighting Tip:

Lighting granite counter tops with under cabinet lighting can be difficult because of the mirror finish. Place low voltage recessed directly over counter tops to light the work area and graze the wall cabinets. Use Nora LED Lightbar angled to light the backsplash.

4" LOW VOLTAGE TRIMS continued

2" Pinhole with Baffle



Catalog No.	Description
NL-420	Black Baffle / White Trim
NL-421	White Baffle / White Trim

- Downlight
- 2" Aperture

Maximum Wattage:
50W MR16

OD: 4-3/4"

SH

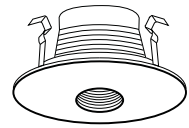

1" Pinhole



Catalog No.	Description
NL-440	White Pinhole
NL-440B	Black Pinhole
NL-440BZ	Bronze Pinhole
NL-440C	Chrome Pinhole
NL-440CO	Copper Pinhole
NL-440G	Gold Pinhole
NL-440N	Natural Metal Pinhole

- Downlight or 35° Adjustable
- 1" Aperture

Maximum Wattage:
50W MR16

OD: 4-3/4"

SH

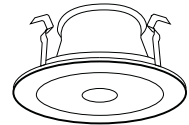

Louver with Reflector



Catalog No.	Description
NL-441B	Black Louver / Black Reflector / Black Ring
NL-441BZ	Bronze Louver / Bronze Reflector / Bronze Ring
NL-441C	Chrome Louver / Chrome Reflector / Chrome Ring
NL-441CO	Copper Louver / Copper Reflector / Copper Ring
NL-441G	Gold Louver / Gold Reflector / Gold Ring
NL-441N	Natural Metal Louver / Natural Metal Reflector / Natural Metal Ring
NL-441W	White Louver / White Reflector / White Ring

- 35° Adjustment

Maximum Wattage:
75W MR16
50W MR16 (IC/Shallow)

OD: 4-3/4"

SH

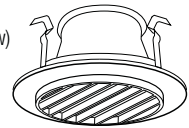

Albalite Shower Trim



Catalog No.	Description
NL-422B	Black Shower Trim
NL-422BZ	Bronze Shower Trim
NL-422C	Chrome Shower Trim
NL-422CO	Copper Shower Trim
NL-422G	Gold Shower Trim
NL-422N	Natural Metal Shower Trim
NL-422W	White Shower Trim

- UL Wet Listed

Maximum Wattage:
50W MR16

OD: 4-3/4"

WET

SH

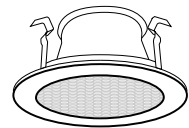

Fresnel Shower Trim



Catalog No.	Description
NL-423B	Black Shower Trim
NL-423BZ	Bronze Shower Trim
NL-423C	Chrome Shower Trim
NL-423CO	Copper Shower Trim
NL-423G	Gold Shower Trim
NL-423N	Natural Metal Shower Trim
NL-423W	White Shower Trim

- UL Wet Listed

Maximum Wattage:
50W MR16

OD: 4-3/4"

WET

SH

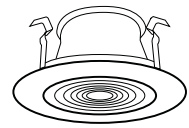

SH Shallow: Designated trims for shallow housings



Maximum Wattage:
50W MR16
OD: 4-3/4"



Catalog No.	Description
NL-424B	Drop Opal Lens / Black Trim
NL-424BZ	Drop Opal Lens / Bronze Trim
NL-424C	Drop Opal Lens / Chrome Trim
NL-424CO	Drop Opal Lens / Copper Trim
NL-424G	Drop Opal Lens / Gold Trim
NL-424N	Drop Opal Lens / Natural Metal Trim
NL-424W	Drop Opal Lens / White Trim

- UL Wet Listed

Drop Opal Shower Trim

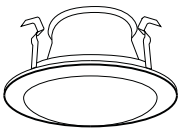

Maximum Wattage:
50W MR16
OD: 4-3/4"



Catalog No.	Description
NL-425B	Frosted Dome Lens / Black Trim
NL-425BZ	Frosted Dome Lens / Bronze Trim
NL-425C	Frosted Dome Lens / Chrome Trim
NL-425CO	Frosted Dome Lens / Copper Trim
NL-425G	Frosted Dome Lens / Gold Trim
NL-425N	Frosted Dome Lens / Natural Metal Trim
NL-425W	Frosted Dome Lens / White Trim

- UL Wet Listed

Shower Trim with Frosted Dome

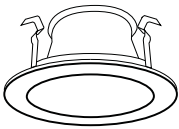

Maximum Wattage:
50W MR16
OD: 4-3/4"



Catalog No.	Description
NL-426B	Flat Frosted Lens / Black Trim
NL-426BZ	Flat Frosted Lens / Bronze Trim
NL-426C	Flat Frosted Lens / Chrome Trim
NL-426CO	Flat Frosted Lens / Copper Trim
NL-426G	Flat Frosted Lens / Gold Trim
NL-426N	Flat Frosted Lens / Natural Metal Trim
NL-426W	Flat Frosted Lens / White Trim

- UL Wet Listed

Flat Frosted Shower Trim

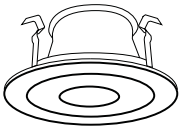

Maximum Wattage:
50W MR16
OD: 4-3/4"



Catalog No.	Description
NL-427W	Flat Frosted Lens with Clear Center / White Trim

- UL Wet Listed

Frosted Shower Trim w/ Clear Center

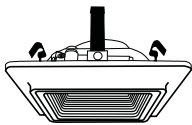

Maximum Wattage:
75W MR16
50W MR16 (IC/Shallow)
OD: 4-3/4"



Catalog No.	Description
NL-486W	White Plastic Baffle / White Plastic Square Trim

- Plastic trim and baffle makes this excellent for harsh environment applications

Square Baffle

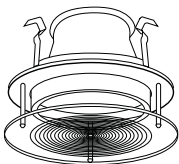

Maximum Wattage:
75W MR16
50W MR16 (IC/Shallow)
OD: 4-3/4"



Catalog No.	Description
NL-498B	Concentric Glass / Specular Clear Refl / Black Trim
NL-498BZ	Concentric Glass / Specular Clear Refl / Bronze Trim
NL-498C	Concentric Glass / Specular Clear Refl / Chrome Trim
NL-498CO	Concentric Glass / Specular Clear Refl / Copper Trim
NL-498G	Concentric Glass / Specular Clear Refl / Gold Trim
NL-498N	Concentric Glass / Specular Clear Refl / Natural Metal Trim
NL-498W	Concentric Glass / Specular Clear Refl / White Trim

- Tempered Glass

Floating Concentric Glass



SH Shallow: Designated trims for shallow housings

Lighting Tip:

Visually outline or identify a bar, cash wrap, or path of light with Nora low voltage Glass Element trims.

4" LOW VOLTAGE TRIMS continued**Round Acrylic with Accent**

Catalog No.	Description
NL-461	Round Acrylic / Gold Accent
NL-461C	Round Acrylic / Chrome Accent

Maximum Wattage:
75W MR16
50W MR16 (IC/Shallow)

OD: 4-3/4"

SH

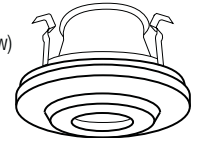
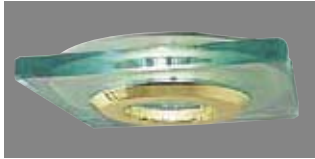
**Square Acrylic with Accent**

Catalog No.	Description
NL-462	Square Acrylic / Gold Accent

Maximum Wattage:
75W MR16
50W MR16 (IC/Shallow)

OD: 4-3/4"

SH

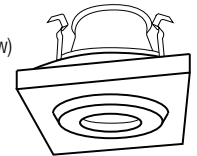
**Metropolitan Moon Glass**

CC

Catalog No.	Description
NL-495B	Blue Metropolitan Moon Glass / White Ring
NL-495P	Pink Metropolitan Moon Glass / White Ring
NL-495F	White Frosted Metropolitan Moon Glass / White Ring

Maximum Wattage:
50W MR16

OD: 4-3/4"

SH

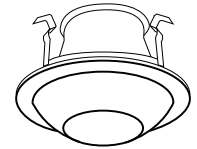
**Metropolitan Stepped Glass**

CC

Catalog No.	Description
NL-496B	Blue Metropolitan Stepped Glass / White Ring
NL-496P	Pink Metropolitan Stepped Glass / White Ring
NL-496F	White Frosted Metropolitan Stepped Glass / White Ring

Maximum Wattage:
50W MR16

OD: 4-3/4"

SH

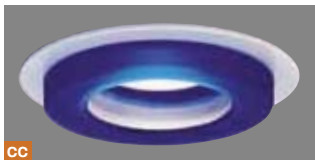
**Metropolitan Ice Light Glass**

CC

Catalog No.	Description
NL-497B	Blue Metropolitan Ice Light Glass / White Ring
NL-497P	Pink Metropolitan Ice Light Glass / White Ring
NL-497F	White Frosted Metropolitan Ice Light Glass / White Ring

Maximum Wattage:
50W MR16

OD: 4-3/4"

SH

**Reflector for Decorative Glass**

NEW!



Catalog No.	Description
NL-438BZ	Specular Clear Reflector / Bronze Trim
NL-438C	Specular Clear Reflector / Chrome Trim
NL-438N	Specular Clear Reflector / Copper Trim
NL-438W	Specular Clear Reflector / White Trim

- Glass sold separately.
- For a layered look, up to two pieces of glass may be used together.

Maximum Wattage:
75W MR16
50W MR16 (IC/Shallow)

OD: 4-3/4"

SH

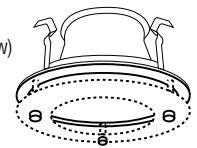
**Decorative Glass for NL-438**

NEW!



Catalog No.	Description
NTG-4B/80	Tempered Blue, 80mm (3-1/8") Open Center
NTG-4CF	Tempered Frosted Center / Clear Outer
NTG-4FC	Tempered Clear Center / Frosted Outer
NTG-4HC	Tempered Clear Outer / Frosted Inner / 80mm (3-1/8") Open Center

- Includes NRA-203 Glass Hardware
- 2 decorative glasses can be combined for a tiered look

Includes:
NRA-203 Glass Hardware
• (3) Stand-offs
• (3) Cone End Caps
• (3) Flat End Caps

OD: 4-3/4"



CC Custom Combo: Available with custom combinations of trim and plastic or metal ring finish. See pages 38-39 for details.

SH Shallow: Designated trims for shallow housings

RECESSED

NORALIGHTING.

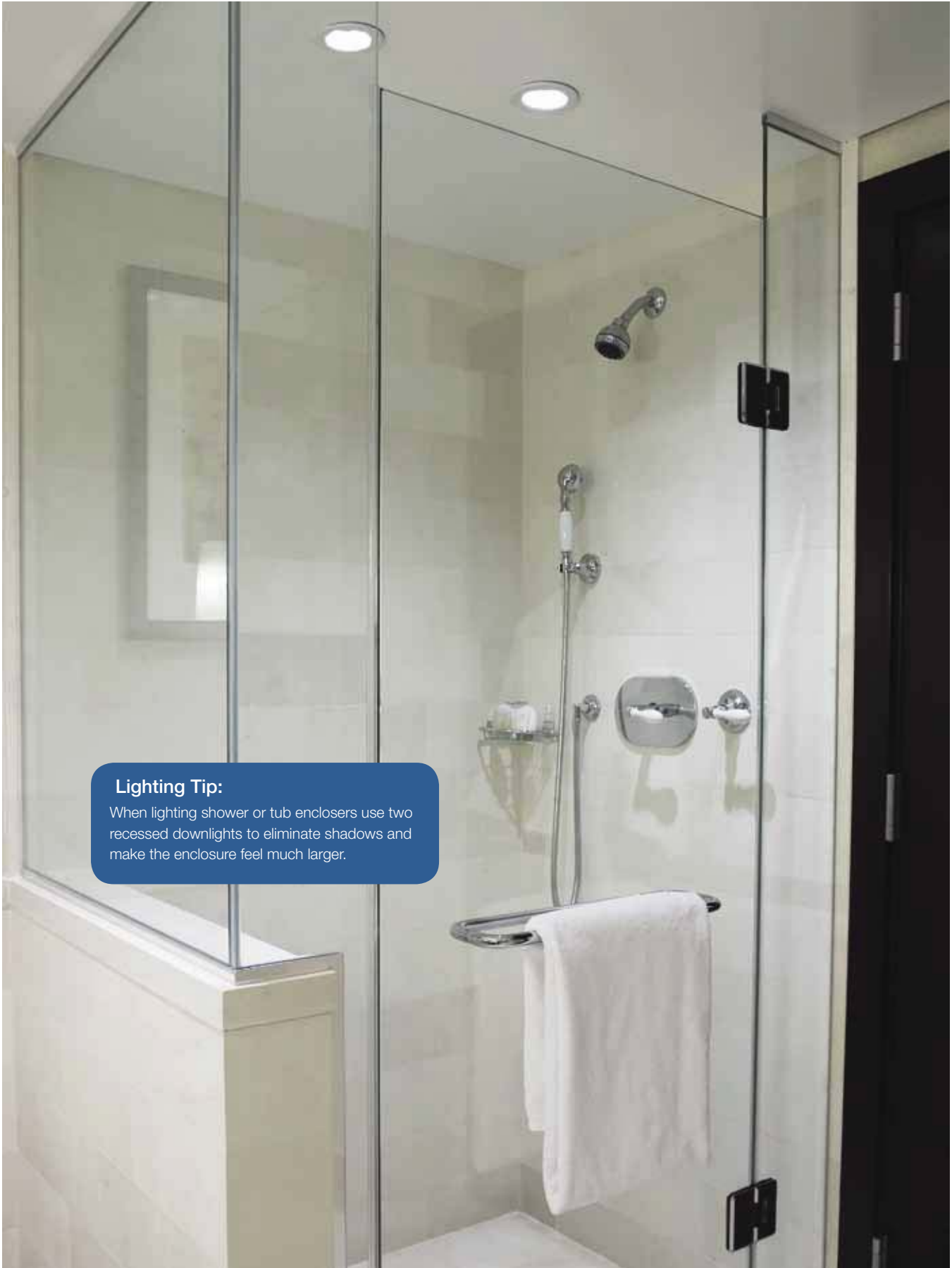

Lighting Tip:

When lighting shower or tub enclosures use two recessed downlights to eliminate shadows and make the enclosure feel much larger.



LOW VOLTAGE RECESSED True 3" IC New Construction Housing 1" to 2-1/2" Aperture

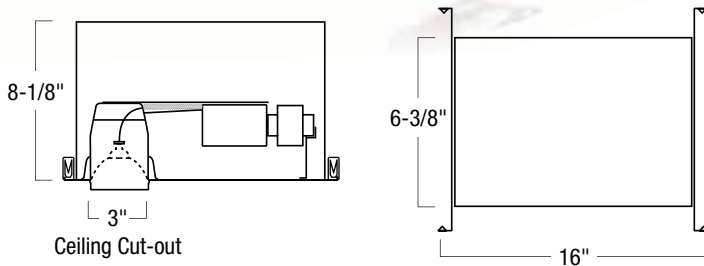

NLIC-301 SERIES

CATALOG. NO.	TRANSFORMER	VOLTAGE	MAX. WATTAGE	AIR-TIGHT
NEW! NLIC-301QAT/20	Magnetic	120V	20W	Yes
NEW! NLIC-301QAT/37	Magnetic	120V	37W	Yes
NLIC-301QAT	Magnetic	120V	50W	Yes
NLIC-301AT/1EL*	Electronic	120V	50W	Yes

* Lower Wattage housing available



Product Note:

While other manufacturers may call their 3", Nora's 3" low voltage is a true 3". Compare! Lighting specifiers looking for small aperture down lighting should spec Nora TRUE 3".

Nora Lighting's True 3" low voltage IC double wall housings provide soft, defined JC or crisp, defined MR16 halogen illumination in any insulated ceiling application. A wide variety of attractive adjustable trims allows fine-tuned aiming of directional light sources.

Transformer: 120V Magnetic or Electronic (EL) available.

Dimming Options: Use a magnetic low voltage dimmer with a magnetic transformer or an electronic low voltage dimmer with an electronic transformer.

Lamp Types:

MR16 - 50 Watt max.
JC Bi-Pin - 50 Watt max.

Ceiling Thickness: Accommodates a ceiling thickness of 1/2".

Lamp Adjustable: Circular bracket on low voltage trims provides a secure snap-in hold and friction-locked aiming adjustment.

UV / Shatter Guard Shield: All low voltage trims include a tempered UV glass lens.

Installation: Bar hangers are adjustable from 13-5/8" to 24-1/2" with captive nails. Bar hangers are slotted for T-Bar installations.

Minimum Clearance: "IC" Housing is direct contact rated; no minimum clearance is required.

Junction Box: Contains one 3/4", two 1/2" knockouts and four Romex® pry-outs with strain relief.

Electrical: Quick connector provided.

Listing:

cULus Damp Location w/ Feed Through
cULus Wet Location (Only with designated trims)
WSEC ASTM E283 for Air Tight

LOW VOLTAGE RECESSED

True 3" New Construction Housing 2-1/2" to 1" Aperture

Nora Lighting's series of True 3" low voltage housings provide soft, brilliant or crisp, defined MR16 halogen illumination for any application. A wide variety of attractive adjustable trims allows fine-tuned aiming of directional light sources.

Transformer: 120V Magnetic or Electronic (EL) available.

Dimming Options: Use a magnetic low voltage dimmer with a magnetic transformer or an electronic low voltage dimmer with an electronic transformer.

Lamp Types:

MR16 - 50 Watt max.
JC Bi-Pin - 50 Watt max.

Ceiling Thickness: Accommodates a ceiling thickness of 1/2".

Lamp Adjustable: Circular bracket on low voltage trims provides a secure snap-in hold and friction-locked aiming adjustment.

UV / Shatter Guard Shield: All low voltage trims include a tempered UV glass lens.

Installation: Bar hangers are adjustable from 13-5/8" to 24-1/2" with captive nails. Bar hangers are slotted for T-Bar installations.

Minimum Clearance: Requires minimum clearance of 3" from thermal insulation and 1/2" from adjacent building components.

Junction Box: Contains one 3/4", two 1/2" knockouts and four Romex® pry-outs with strain relief.

Electrical: Quick connector provided.

Listing:

cULus Damp Location w/ Feed Through
cULus Wet Location (Only with designated trims)
WSEC ASTM E283 for Air Tight

Lighting Tip:

Use Nora's New Wattage reduced LV Housings to meet watts per square foot requirements.

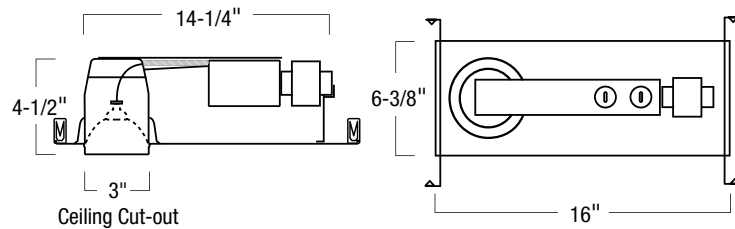

NL-301AT SERIES

CATALOG. NO.	TRANSFORMER	VOLTAGE	MAX. WATTAGE	AIR-TIGHT
NEW! NL-301QAT/20	Magnetic	120V	20W	Yes
NEW! NL-301QAT/37	Magnetic	120V	37W	Yes
NL-301QAT	Magnetic	120V	50W	Yes
NL-301AT/1EL*	Electronic	120V	50W	Yes

* Lower Wattage housing available



LOW VOLTAGE RECESSED True 3" Remodel Housing 2-1/2" to 1" Aperture

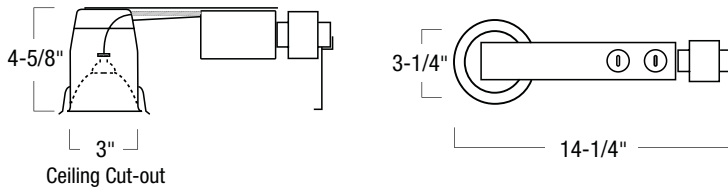

NLR-304AT SERIES

CATALOG. NO.	TRANSFORMER	VOLTAGE	MAX. WATTAGE	AIR-TIGHT
NEW! NLR-304QAT/20	Magnetic	120V	20W	Yes
NEW! NLR-304QAT/37	Magnetic	120V	37W	Yes
NLR-304QAT	Magnetic	120V	50W	Yes
NLR-304AT/1EL*	Electronic	120V	50W	Yes

* Lower Wattage housing available



See pages 648-653 for remote transformer small aperture housings and trims.

Nora Lighting's series of True 3" low voltage housings provide soft, brilliant or crisp, defined MR16 halogen illumination for any application. A wide variety of attractive adjustable trims allows fine-tuned aiming of directional light sources.

Transformer: 120V Magnetic or Electronic (EL) available.

Dimming Options: Use a magnetic low voltage dimmer with a magnetic transformer or an electronic low voltage dimmer with an electronic transformer.

Lamp Types:
MR16 - 50 Watt max.
JC Bi-Pin - 50 Watt max.

Ceiling Thickness: Accommodates a ceiling thickness of 1/2".

Lamp Adjustable: Circular bracket on low voltage trims provides a secure snap-in hold and friction-locked aiming adjustment.

UV / Shatter Guard Shield: All low voltage trims include a tempered UV glass lens.

Installation: High tensions tempered steel springs secure remodel housing evenly to the ceiling; hole cutout provided for convenience.

Support: Magnetic transformer includes support leg to maintain transformer height.

Minimum Clearance: Requires minimum clearance of 3" from thermal insulation and 1/2" from adjacent building components.

Junction Box: Contains one 3/4", two 1/2" knockouts and four Romex® pry-outs with strain relief.

Electrical: Quick connector provided.

Listing:
cULus Damp Location w/ Feed Through
cULus Wet Location (Only with designated trims)
WSEC ASTM E283 for Air Tight

LOW VOLTAGE RECESSED

True 3" Low Voltage Trims

Adjustable Baffle with Ring



CC

Catalog No.	Description
NL-3310BB	Black Baffle / Black Ring
NL-3310BC	Black Baffle / Chrome Ring
NL-3310BG	Black Baffle / Gold Ring
NL-3310BW	Black Baffle / White Ring
NL-3310BZBZ	Bronze Baffle / Bronze Ring
NL-3310COCO	Copper Baffle / Copper Ring
NL-3310NN	Natural Metal Baffle / Natural Metal Ring
NL-3310WB	White Baffle / Black Ring
NL-3310WBZ	White Baffle / Bronze Ring
NL-3310WC	White Baffle / Chrome Ring
NL-3310WG	White Baffle / Gold Ring
NL-3310WW	White Baffle / White Ring

- Downlight or 35° Adjustable

Maximum Wattage:

50W MR16

OD: 3-1/2"

Aperture: 2-1/2"

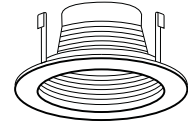

Adjustable Reflector with Ring



CC

Catalog No.	Description
NL-3312BB	Specular Black Reflector / Black Ring
NL-3312BW	Specular Black Reflector / White Ring
NL-3312BZBZ	Bronze Reflector / Bronze Ring
NL-3312CBZ	Specular Clear Reflector / Bronze Ring
NL-3312CC	Specular Clear Reflector / Chrome Ring
NL-3312CG	Specular Clear Reflector / Gold Ring
NL-3312COCO	Copper Reflector / Copper Ring
NL-3312CW	Specular Clear Reflector / White Ring
NL-3312GG	Specular Gold Reflector / Gold Ring
NL-3312GW	Specular Gold Reflector / White Ring
NL-3312HZW	Haze Reflector / White Ring
NL-3312NN	Natural Metal Reflector / Natural Metal Ring
NL-3312WW	Specular White Reflector / White Ring

- Downlight or 35° Adjustable

Maximum Wattage:

50W MR16

OD: 3-1/2"

Aperture: 2-1/2"

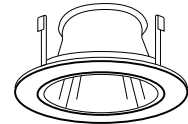

Cross Louver with Reflector



CC

Catalog No.	Description
NL-3337CW	Chrome Louver / Specular Clear Reflector / White Ring
NL-3337GW	Chrome Louver / Specular Gold Reflector / White Ring

Maximum Wattage:

50W MR16

OD: 3-1/2"

Aperture: 2-1/2"

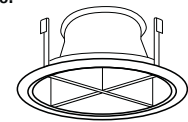

Adjustable Gimbal Ring



CC

Catalog No.	Description
NL-3365B	Black Adjustable Gimbal
NL-3365BZ	Bronze Adjustable Gimbal
NL-3365C	Chrome Adjustable Gimbal
NL-3365CO	Copper Adjustable Gimbal
NL-3365G	Gold Adjustable Gimbal
NL-3365N	Natural Metal Adjustable Gimbal
NL-3365W	White Adjustable Gimbal

- 35° Adjustable

Maximum Wattage:

50W MR16

OD: 3-1/2"

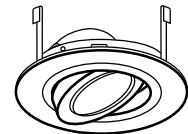

CC Custom Combo: Available with custom combinations of trim and plastic or metal ring finish. See pages 38-39 for details.
See page 36-37 for Description of Trim Finishes

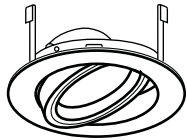

Maximum Wattage:
50W MR16
OD: 3-1/2"

Catalog No.	Description
NL-3366B	Black Adjustable Gimbal
NL-3366BZ	Bronze Adjustable Gimbal
NL-3366C	Chrome Adjustable Gimbal
NL-3366CO	Copper Adjustable Gimbal
NL-3366G	Gold Adjustable Gimbal
NL-3366N	Natural Metal Adjustable Gimbal
NL-3366W	White Adjustable Gimbal

- 35° Adjustable
- Not for use with NLR-304Q
- Replace lamp without removing the trim

Front Loading Gimbal Ring

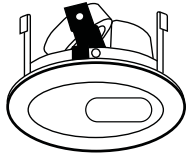
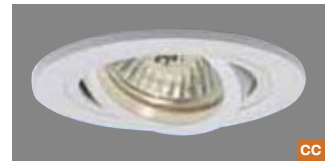

Maximum Wattage:
50W MR16
OD: 3-1/2"

Catalog No.	Description
NL-3345B	Black Slot Aperture
NL-3345BZ	Bronze Slot Aperture
NL-3345C	Chrome Slot Aperture
NL-3345CO	Copper Slot Aperture
NL-3345G	Gold Slot Aperture
NL-3345N	Natural Metal Slot Aperture
NL-3345W	White Slot Aperture

- Downlight or 35° Adjustable

Adjustable Slot Aperture

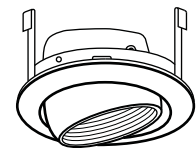
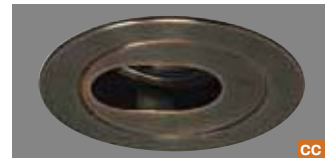

Maximum Wattage:
50W MR16
OD: 3-1/2"

Catalog No.	Description
NL-3318B	Black Eyeball / Black Baffle
NL-3318BZ	Bronze Eyeball / Black Baffle
NL-3318C	Chrome Eyeball / Black Baffle
NL-3318CO	Copper Eyeball / Black Baffle
NL-3318G	Gold Eyeball / Black Baffle
NL-3318N	Natural Metal Eyeball / Black Baffle
NL-3318W	White Eyeball / White Baffle

- 10° Adjustable

Eyeball with Baffle

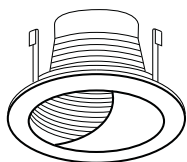

Maximum Wattage:
50W MR16
OD: 3-1/2"

Catalog No.	Description
NL-3348BB	Black Wall Wash / Black Baffle
NL-3348BW	White Wall Wash / Black Baffle
NL-3348WW	White Wall Wash / White Baffle

Wall Wash with Baffle

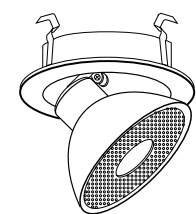

Maximum Wattage:
50W Bi-Pin GY6.35
OD: 3-1/2"

Catalog No.	Description
NL-311G	Gold Perforated Pull Down

- Adjustable: 358° Horizontal, 80° Vertical

Hi-Tech Perforated Pull Down



TRUE 3" LOW VOLTAGE TRIMS continued

Hi-Tech Pull Down



Catalog No.	Description
NL-320B	Black Pull Down
NL-320G	Gold Pull Down

- Adjustable: 358° Horizontal, 80° Vertical

Maximum Wattage:
50W Bi-Pin GY6.35
OD: 3-1/2"

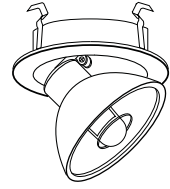

Hi-Tech Focus Beam

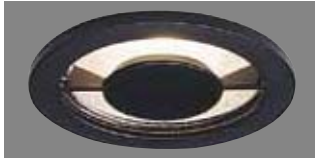

Catalog No.	Description
NL-318B	Black Focus Beam
NL-318C	Chrome Focus Beam
NL-318G	Gold Focus Beam
NL-318W	White Focus Beam

- Field adjustable beam spread
- Vertically adjustable socket

Maximum Wattage:
50W Bi-Pin GY6.35
OD: 3-1/2"

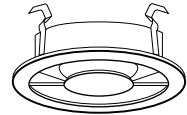

Hi-Tech Wall Wash with Reflector

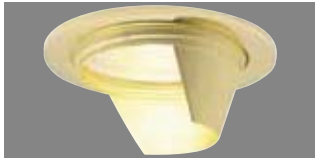

Catalog No.	Description
NL-317B	Black Wall Wash / Specular Clear Reflector
NL-317C	Chrome Wall Wash / Specular Clear Reflector
NL-317G	Gold Wall Wash / Specular Clear Reflector
NL-317W	White Wall Wash / Specular Clear Reflector

Maximum Wattage:
50W Bi-Pin GY6.35
OD: 3-1/2"



Frosted Dome Shower Trim

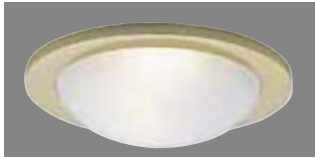

Catalog No.	Description
NL-3325B	Black Shower Trim
NL-3325BZ	Bronze Shower Trim
NL-3325C	Chrome Shower Trim
NL-3325CO	Copper Shower Trim
NL-3325G	Gold Shower Trim
NL-3325N	Natural Metal Shower Trim
NL-3325W	White Shower Trim

Maximum Wattage:
50W Bi-Pin GY6.35
OD: 3-1/2"

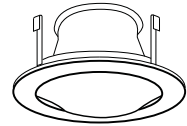

- UL Wet Listed

Flat Frosted Shower Trim



Catalog No.	Description
NL-3326B	Black Shower Trim
NL-3326BZ	Bronze Shower Trim
NL-3326C	Chrome Shower Trim
NL-3326CO	Copper Shower Trim
NL-3326G	Gold Shower Trim
NL-3326N	Natural Metal Shower Trim
NL-3326W	White Shower Trim

Maximum Wattage:
50W Bi-Pin GY6.35
OD: 3-1/2"

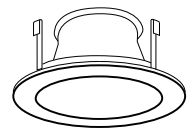

- UL Wet Listed

TRUE 3" LOW VOLTAGE TRIMS continued

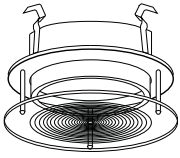

Maximum Wattage:
50W MR16
OD: 3-7/8"

Catalog No.	Description
NL-319G	Specular Gold Reflector / White Trim
NL-319W	Specular Clear Reflector / White Trim

Hi-Tech Floating Glass Reflector

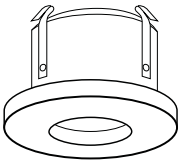

Maximum Wattage:
50W MR16
OD: 3-7/8"

Catalog No.	Description
NL-324BU	Blue Flat Glass
NL-324P	Pink Flat Glass
NL-324W	White Flat Glass

Hi-Tech Flat Glass Trim

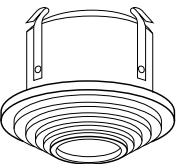
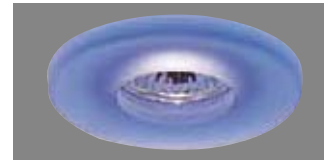

Maximum Wattage:
50W MR16
OD: 3-7/8"

Catalog No.	Description
NL-325BU	Blue Stepped Glass
NL-325P	Pink Stepped Glass
NL-325W	White Stepped Glass

Hi-Tech Stepped Glass Trim

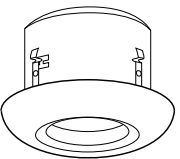

Maximum Wattage:
50W MR16
OD: 3-7/8"

Catalog No.	Description
NL-326BU	Blue Donut Glass
NL-326P	Pink Donut Glass
NL-326W	White Donut Glass

Hi-Tech Donut Glass Trim

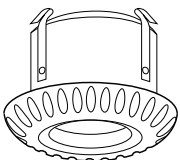

Maximum Wattage:
50W MR16
OD: 3-7/8"

Catalog No.	Description
NL-327BU	Blue Flower Glass
NL-327P	Pink Flower Glass
NL-327W	White Flower Glass

Hi-Tech Flower Glass Trim

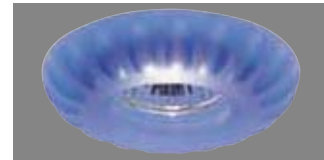

Lighting Tip:

Visually outline or identify a bar, cash wrap, or path of light with Nora low voltage Glass Element trims.



Warm. Bright. Inviting.

Nora Lighting's family of line voltage fixtures provides a warm, bright atmosphere for any interior. Standard lamps or soft "R" type reflector lamps can be used to provide a brilliant glow. PAR type reflector lamps provide accents to important tasks, surfaces and colors.

Line Voltage



Overview LINE VOLTAGE RECESSED

ARCHITECTURAL AND COMMERCIAL LINE VOLTAGE FRAME-INS



8" Line Voltage
Architectural Frame-In
NHAV-8300 p.260



8" Line Voltage
Commercial Frame-In
NH-300 p.261



8" Line Voltage
Architectural Remodel
NHR-300 p.262



6" Line Voltage
Architectural Frame-In
NHAV-6150 p.266



6" Line Voltage
Commercial Frame-In
NH-150 p.267



6" Line Voltage
Architectural Remodel
NHR-150 p.268

6" IC AND NON-IC LINE VOLTAGE HOUSINGS



6" IC Air-Tight Double Wall
High Wattage
NHIC-17/100DWQA p.273



6" IC AT New Construction
NHIC-17QAT Standard p.274
NHIC-17QNBAT No Bracket p.274



6" IC AT Remodel
NHRIC-17QAT Standard p.275
NHRIC-17QNBAT No Bracket p.275



6" Line Voltage
IC AT Shallow New Construction
NHIC-27QAT p.276



6" Line Voltage
IC AT Shallow Remodel
NHRIC-27QAT p.277

6" IC AND NON-IC LINE VOLTAGE HOUSINGS *continued*



6" Non-IC New Construction
 NH-26Q Standard p.278
 NH-26QNB No Bracket p.278



6" Non-IC Remodel
 NHR-26Q Standard p.279



6" Shallow New Construction
 NH-27Q Non-IC p.280



6" Shallow Remodel
 NHR-27Q Non-IC p.281

5" IC AND NON-IC LINE VOLTAGE HOUSINGS



5" Line Voltage
 IC AT New Construction Housing
 NHIC-501QAT p.298



5" Line Voltage
 IC AT Remodel Housing
 NHRIC-504QAT p.299



5" Line Voltage
 IC AT Shallow New Construction
 NHIC-527QAT p.302



5" Line Voltage
 IC AT Shallow Remodel
 NHRIC-527QAT p.303



5" Non-IC Line Voltage
 New Construction Housing
 NH-501Q p.300



5" Non-IC Line Voltage
 Remodel Housing
 NHR-504Q p.301

4" IC AND NON-IC LINE VOLTAGE HOUSINGS



4" Line Voltage IC AT
 Double Wall Housing
 NSIC-401QAT p.311



4" Line Voltage Non-IC AT
 New Construction Housing
 NS-401QAT p.312



4" Line Voltage Non-IC AT
 Remodel Housing
 NSR-404QAT p.313



4" Line Voltage MR16 GU10
 IC AT Double Wall Housing
 NSLIC-401AT/10 p.321



4" Line Voltage MR16 GU10
 Non-IC AT New Construction
 NSL-401AT/10 p.322



4" Line Voltage MR16 GU10
 Non-IC AT Remodel Housing
 NSLR-404AT/10 p.323

Overview LINE VOLTAGE RECESSED *continued*

TRUE 3" IC AND NON-IC LINE VOLTAGE HOUSINGS



True 3" Line Voltage MR16 GU10 IC AT Double Wall Housing
NHIC-350AT p.331



True 3" Line Voltage MR16 GU10 AT New Construction Housing
NH-350AT p.332



True 3" Line Voltage MR16 GU10 AT Remodel Housing
NHR-354AT p.333

SLOPE AND SUPER SLOPE CEILING HOUSINGS



6" Line Voltage (High Wattage) IC AT Double Wall Sloped Housing
NHIC-926/DWQAT p.337



6" Line Voltage IC AT New Construction Sloped Housing
NHIC-926QAT p.338



6" Line Voltage IC AT Remodel Sloped Housing
NHRIC-926QAT p.339



6" Line Voltage Non-IC New Construction Sloped Housing
NH-926Q p.340



6" Line Voltage Non-IC Remodel Sloped Housing
NHR-926Q p.341

SPECIALTY LINE VOLTAGE RECESSED LIGHTING



8" Line Voltage Square IC Housing
NSHIC-8 p.366



8" Line Voltage Square Non-IC Housing
NSH-8 p.367

STEP LIGHTING



Incandescent Step Light
Louvered Face
NSI-140 p.377



Incandescent Step Light
Louvered Face with Lens
NSI-1401 p.377



Incandescent Step Light
Lensed Face
NSI-1402 p.377



Incandescent Step Light
Louvered Face w/ J-Box
NSI-125/JB p.377



Incandescent Step Light
Louvered Face w/ Lens & J-Box
NSI-1251/JB p.377



Incandescent Step Light
Lensed Face w/ J-Box
NSI-1252/JB p.377



Incandescent Mini Step Light
Louvered Face
NSI-161 p.376



Incandescent Mini Step Light
Lensed Face
NSI-162 p.376

RECESSED ACCESSORIES



One Hour Fire Rated Enclosure
For use with single wall
economy grade fixtures p.379



Hole Cutter
NSC-6500 p.380
NSC-6600 p.380



Trim Accessories
Filters, Rings, Glass
and more p.381



Housing Accessories
Bar Hangers, Sockets,
and more p.383

Line Voltage Recessed

Nora Lighting's family of line voltage fixtures are one of the largest in the industry offering 8", 6", 5", 4" and 3" apertures, using wattages up to 300 watts. Our wide variety of trims in designer finishes and intended for specific applications makes Nora a single source for all incandescent lighting needs. Easy to use and specify housing and trims are described in full on separate pages. The housings are listed first followed by the available trims and reflectors with maximum wattages. The trims selection is listed in the following order: Baffles, Open Reflectors, Shower Trim, Adjustable Reflector, Wall Wash and specialty trims. All Wet location trims are noted with a teardrop icon (🌧️).



FEATURES

- Commercial, Architectural and Residential housings
- Non-IC, IC, High-Wattage IC and Air-Tight housings
- New construction and remodel
- Fixed and floating socket
- All housings are UL Listed for damp location
- 8", 6", 5", 4" & 3" apertures
- 24-1/2" Hanger Bars with captive nail, alignment foot and notched T-Bar installation (most)
- 20W – 300W for R, BR, PAR, A-Lamp and GU10
- Easy to install trims
- Custom Combinations of reflector finish and trim finish
- Over 100 trims to choose from:

Cone Baffles	Regressed Adjustable
Lens-less Wet Label	Cross Blades
Baffles	Adjustable Gimbal
Decorative Glass	Slot Aperture
Reflector Baffles	Eyeball
Wall Wash	Cone Reflectors
Lenses	Pinhole
- Large Finish selection:

NEW Bronze	White Baffle
Haze	Black
NEW Copper	Black Baffle
Gold	Low Iridescent Alzak®
Natural Metal	Clear
White	



Architectural Line Voltage

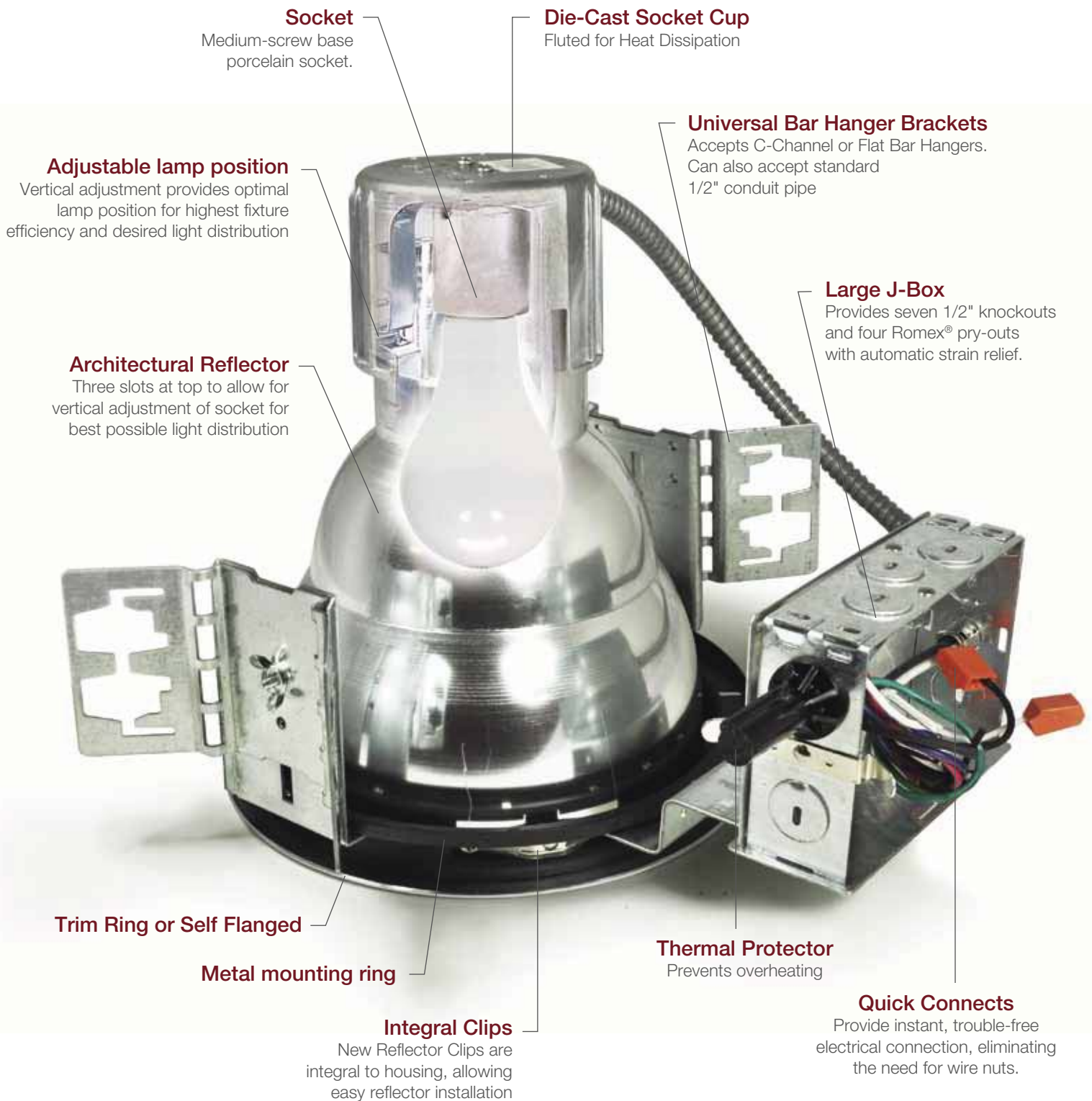

LINE VOLTAGE RECESSED

8" Architectural Frame-in

Nora Lighting's Architectural Frame-in is ideal for suspended ceiling or T-Bar installations requiring high quality architectural grade reflectors. Reflectors have a wide variety of applications.

Minimum Clearances: Non-IC fixture requires minimum clearances of 3" from thermal insulation and 1/2" from adjacent building components.

Ceiling Thickness: Accepts 5/8" maximum ceiling thickness. See page 385 for extension collar.

Lamp:
Medium base 250W PAR38
Medium base 300W PS25

Lamp Adjustment: Reflector have three adjustment slots for optimal light distributor and control

Installation: Universal brackets accept C-Channel or flat bar hangers (ordered separately), or simple rigid 1/2" steel conduit for tie-down to ceiling grids.

Junction Box: Junction box is listed for through branch circuit wiring and contains seven 1/2" knockouts and four Romex® with strain relief.

Electrical: Quick connect on leads.

Socket: Steel shell porcelain housed inside die-cast socket cup provided to dissipate heat and maximize lamp life. Medium screw-in base.

Listing:
cULus Damp Location w/ Feed Through
cULus Wet Location (Only with designated trims)

Reflector not included

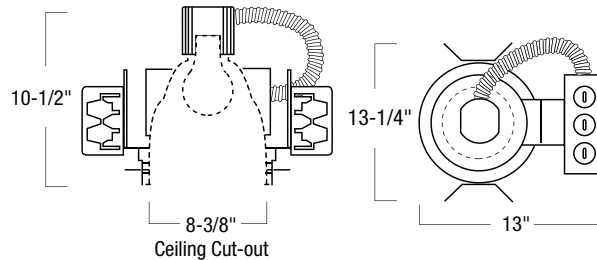

8" ARCHITECTURAL FRAME-IN

CATALOG. NO.	TYPE	SOCKET	LAMP	WATTAGE
NHAV-8300	Non-IC	Medium Base	PAR38 / PS25	250W / 300W

Bar hangers ordered separately. See page 383



LINE VOLTAGE RECESSED 8" Commercial Frame-in

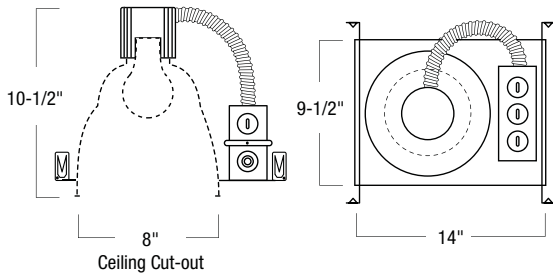
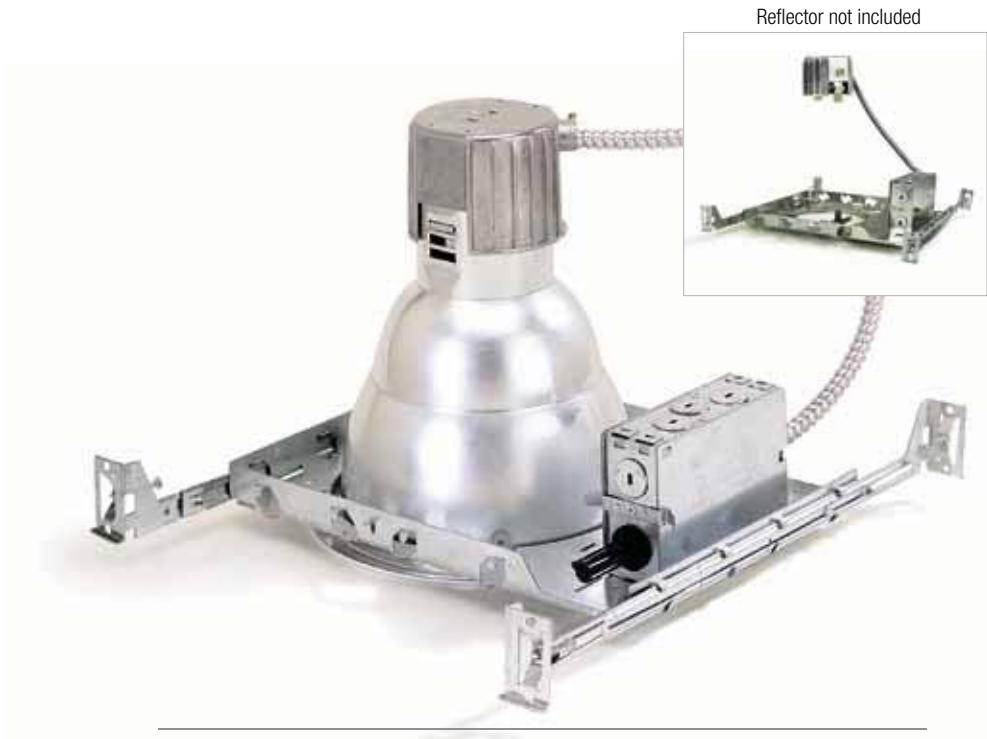

8" COMMERCIAL FRAME-IN

CATALOG. NO.	TYPE	SOCKET	LAMP	WATTAGE
NH-300	Non-IC	Medium Base	PAR38 / PS25	250W / 300W

Includes bar hangers



Nora Lighting's Commercial Frame-in is ideal for joist, stud or T-Bar installations requiring high quality architectural grade reflectors. Reflectors have a wide variety of applications.

Minimum Clearances: Non-IC fixture requires minimum clearances of 3" from thermal insulation and 1/2" from adjacent building components.

Ceiling Thickness: Accepts 5/8" maximum ceiling thickness.

Lamp:
Medium base 250W PAR38
Medium base 300W PS25

Lamp Adjustment: Reflector have three adjustment slots for optimal light distributor and control

Installation: Bar hangers are adjustable from 13-5/8" to 24-1/2" with captive nails and can be repositioned 90 degrees. Bar hangers are slotted for T-bar installations.

Junction Box: Junction box is listed for through branch circuit wiring and contains seven 1/2" knockouts and four Romex® with strain relief.

Electrical: Quick connect on leads.

Socket: Steel shell porcelain housed inside die-cast socket cup provided to dissipate heat and maximize lamp life. Medium screw-in base.

Listing:
cULus Damp Location w/ Feed Through
cULus Wet Location (Only with designated trims)

LINE VOLTAGE RECESSED

8" Architectural Remodel Frame-In

Nora's New Line Voltage Remodel Frame-In allows high performance line voltage reflectors to be installed in existing ceilings.

Easily dimmed, these housings are excellent for commercial, retail, hospitality and architectural applications.

Minimum Clearances: Non-IC fixture requires minimum clearances of 3" from thermal insulation and 1/2" from adjacent building components.

Ceiling Thickness: Accepts 1/2" to 3/4" ceiling thickness.

Lamp:
Medium base 250W PAR38
Medium base 300W PS25

Lamp Adjustment: Reflector have three adjustment slots for optimal light distributor and control

Remodel Installation: High tension tempered steel springs secure remodel housings evenly to ceiling; hole cutout template provided for convenience.

Junction Box: Junction box is listed for through branch circuit wiring and contains seven 1/2" knockouts and four Romex® with strain relief.

Electrical: Standard wire nuts (not included).

Socket: Steel shell porcelain housed inside die-cast socket cup provided to dissipate heat and maximize lamp life. Medium screw-in base.

Listing:
cULus Damp Location w/ Feed Through
cULus Wet Location (Only with designated trims)

Lighting Tip:

Nora's New 8" Remodel Frame-In and Commercial Reflectors can be used with High Output after market LED Medium Base Lamps for Energy Retrofit applications.

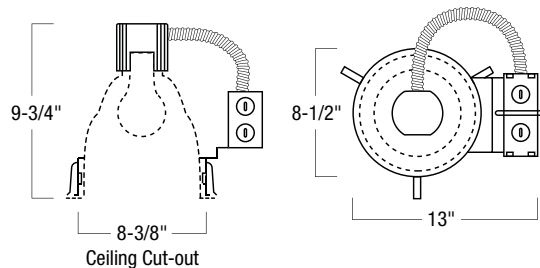

8" ARCHITECTURAL REMODEL

CATALOG. NO.	TYPE	SOCKET	LAMP	WATTAGE
NHR-300	Non-IC	Medium Base	PAR38 / PS25	250W / 300W





LINE VOLTAGE RECESSED

8" Architectural & Commercial Frame-in Reflectors

Open Reflector w/Baffle



Catalog No.	Description
NTS-932CB	Specular Clear Reflector / Black Baffle / White Self Flanged
NTS-932CW	Specular Clear Reflector / White Baffle / White Self Flanged
NTS-932GB	Specular Gold Reflector / Black Baffle / White Self Flanged
NTS-932GW	Specular Gold Reflector / White Baffle / White Self Flanged

- Excellent performance and low aperture brightness

Maximum Wattage

300W PS25
250W PAR38

OD: 9"

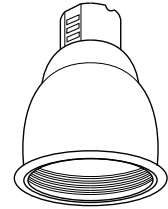

Open Reflector



Catalog No.	Description
NTS-931B	Specular Black Reflector / White Self Flanged
NTS-931C	Specular Clear Reflector / White Self Flanged
NTS-931G	Specular Gold Reflector / White Self Flanged
NTS-931W	Specular White Reflector / White Self Flanged

Maximum Wattage

300W PS25
250W PAR38

OD: 9"

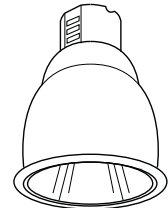

Reflector with Cross Louver

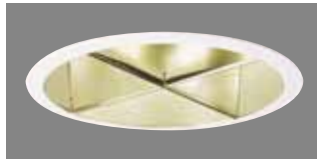

Catalog No.	Description
NTS-934C	Specular Clear Reflector / Specular Clear Louver / White Self Flanged
NTS-934G	Specular Gold Reflector / Specular Gold Louver / White Self Flanged

- Low aperture brightness

Maximum Wattage

300W PS25
250W PAR38

OD: 9"

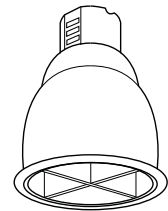

Open Single Wall Wash



Catalog No.	Description
NTS-939SC	Specular Clear Single Wall Wash / White Self Flanged

Maximum Wattage

300W PS25
250W PAR38

OD: 9"

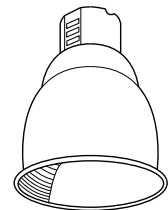

Open Double Wall Wash



Catalog No.	Description
NTS-939DC	Specular Clear Double Wall Wash / White Self Flanged

Maximum Wattage

300W PS25
250W PAR38

OD: 9"

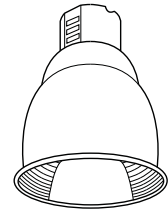

Lensed Reflector Wall Wash



Catalog No.	Description
NTS-933C	Specular Clear Wall Wash / Specular Clear Reflector / White Self Flanged
NTS-933G	Specular Gold Wall Wash / Specular Gold Reflector / White Self Flanged
NTS-933W	Specular White Wall Wash / Specular White Reflector / White Self Flanged

- Glass Lens

Maximum Wattage

150W A21

OD: 9"

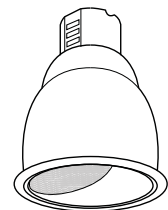

See pages 34-35 for Description of Reflector Finishes

8" ARCHITECTURAL & COMMERCIAL FRAME-IN REFLECTORS continued

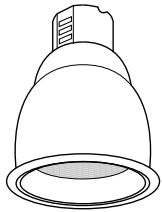

Maximum Wattage
175W PAR38
150W PS25
OD: 9"



Catalog No.	Description
NTS-935G	Regressed Glass Lens / Specular Clear Reflector / White Self Flanged
NTS-935FG	Regressed Frosted Lens / Specular Clear Reflector / White Self Flanged

- UL Wet Listed

Regressed Lens with Reflector

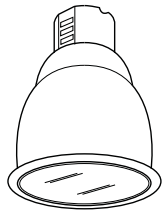
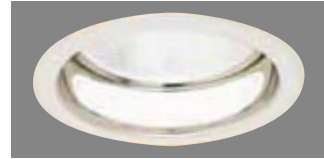

Maximum Wattage
175W PAR38
150W PS25
OD: 9"

Catalog No.	Description
NTS-936CL	Clear Lens / Specular Clear Reflector / White Self Flanged
NTS-936FL	Frosted Lens / Specular Clear Reflector / White Self Flanged

Flush Lens with Reflector

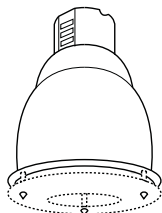

Maximum Wattage
300W PS25
250W PAR38
OD: 9"

Catalog No.	Description
NTS-938C	Specular Clear Reflector / White Self Flanged

- Glass sold separately
- For a layered look, up to two pieces of glass may be used together.

Reflector for Decorative Glass

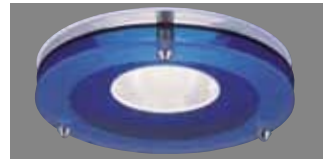

Includes:
NRA-203 Glass Hardware
• (3) Stand-offs
• (3) Cone End Caps
• (3) Flat End Caps
OD: 9"

Catalog No.	Description
NTG-8B/167	Tempered Blue, 167mm (6-5/8") Open Center
NTG-8B/80	Tempered Blue, 80mm (3-1/8") Open Center
NTG-8CF	Tempered Frost Center, Clear Outer
NTG-8FC	Tempered Clear Center, Frost Outer
NTG-8HC	Tempered Clear Outer, Frost Inner, 80mm (3-1/8") Open Center

- Includes NRA-203 Glass Hardware
- 2 decorative glasses can be combined for a tiered look

Decorative Glass for NTS-938C



LINE VOLTAGE RECESSED

6" Architectural Frame-in

Nora Lighting's Architectural Frame-in is ideal for suspended ceiling or T-Bar installations requiring high quality architectural grade reflectors. Reflectors have a wide variety of applications.

Minimum Clearances: Non-IC fixture requires minimum clearances of 3" from thermal insulation and 1/2" from adjacent building components.

Ceiling Thickness: Accepts 5/8" maximum ceiling thickness. See page 385 for extension collar.

Lamp:
 Medium Base 150W A21
 Medium Base 150W PAR38

Lamp Adjustment: Reflectors have three adjustment slots for optimal light distributor and control

Installation: Universal brackets accept C-Channel or flat bar hangers (ordered separately), or simple rigid 1/2" steel conduit for tie-down to ceiling grids.

Junction Box: Junction box is listed for through branch circuit wiring and contains seven 1/2" knockouts and four Romex® with strain relief.

Electrical: Quick connect on leads.

Socket: Steel shell porcelain housed inside die-cast socket cup provided to dissipate heat and maximize lamp life. Medium screw-in base.

Listing:
 cULus Damp Location w/ Feed Through
 cULus Wet Location (Only with designated trims)

Reflector not included

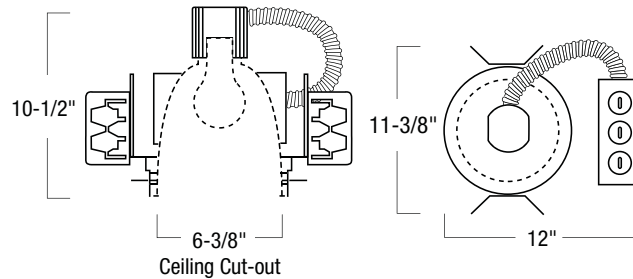

6" ARCHITECTURAL FRAME-IN

CATALOG. NO.	TYPE	SOCKET	LAMP	WATTAGE
NHAV-6150	Non-IC	Medium Base	A21 / PAR38	150W

Bar hangers ordered separately. See page 383



LINE VOLTAGE RECESSED 6" Commercial Frame-in

Reflector not included



Nora Lighting's Commercial Frame-in is ideal for joist, stud or T-Bar installations requiring high quality architectural grade reflectors. Reflectors have a wide variety of applications.

Minimum Clearances: Non-IC fixture requires minimum clearances of 3" from thermal insulation and 1/2" from adjacent building components.

Ceiling Thickness: Accepts 5/8" maximum ceiling thickness.

Lamp:
Medium Base 150W A21
Medium Base 150W PAR38

Lamp Adjustment: Reflectors have three adjustment slots for optimal light distributor and control

Installation: Bar hangers are adjustable from 13-5/8" to 24-1/2" with captive nails and can be repositioned 90 degrees. Bar hangers are slotted for T-Bar installations.

Junction Box: Junction box is listed for through branch circuit wiring and contains seven 1/2" knockouts and four Romex® with strain relief.

Electrical: Quick connect on leads.

Socket: Steel shell porcelain housed inside die-cast socket cup provided to dissipate heat and maximize lamp life. Medium screw-in base.

Listing:
cULus Damp Location w/ Feed Through
cULus Wet Location (Only with designated trims)

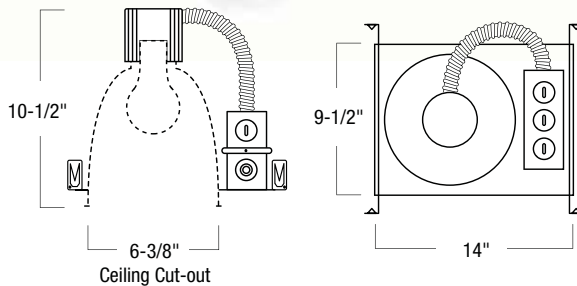

6" COMMERCIAL FRAME-IN

CATALOG. NO.	TYPE	SOCKET	LAMP	WATTAGE
NH-150	Non-IC	Medium Base	A21 / PAR38	150W

Includes bar hangers



LINE VOLTAGE RECESSED

6" Architectural Remodel

Nora's New Line Voltage Remodel Frame-In allows high performance line voltage reflectors to be installed in existing ceilings.

Easily dimmed, these housings are excellent for commercial, retail, hospitality and architectural applications.

Minimum Clearances: Non-IC fixture requires minimum clearances of 3" from thermal insulation and 1/2" from adjacent building components.

Ceiling Thickness: Accepts 1/2" to 3/4" ceiling thickness.

Lamp:

Medium Base 150W A21
Medium Base 150W PAR38

Lamp Adjustment: Reflector have three adjustment slots for optimal light distributor and control

Remodel Installation: High tension tempered steel springs secure remodel housings evenly to ceiling; hole cutout template provided for convenience.

Junction Box: Junction box is listed for through branch circuit wiring and contains seven 1/2" knockouts and four Romex® with strain relief.

Electrical: Standard wire nuts (not included).

Socket: Steel shell porcelain housed inside die-cast socket cup provided to dissipate heat and maximize lamp life. Medium screw-in base.

Listing:

cULus Damp Location w/ Feed Through
cULus Wet Location (Only with designated trims)

NEW!

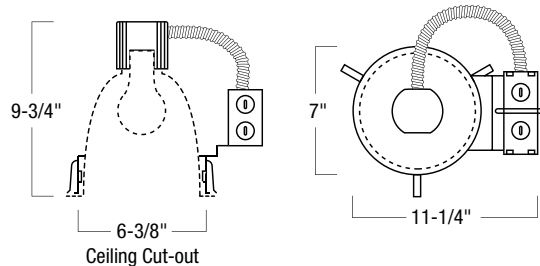

6" ARCHITECTURAL REMODEL

CATALOG. NO.	TYPE	SOCKET	LAMP	WATTAGE
NHR-150	Non-IC	Medium Base	A21 / PAR38	150W





LINE VOLTAGE RECESSED

6" Architectural & Commercial Frame-in Reflectors

Open Reflector with Baffle



CC

Catalog No.	Description
NTS-730B	Specular Clear Reflector / Black Baffle / White Plastic Ring
NTS-730W	Specular Clear Reflector / White Baffle / White Plastic Ring

- Excellent performance and low aperture brightness

Maximum Wattage
150W A21/PAR38
OD: 7"

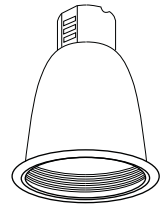

Open Reflector



CC

Catalog No.	Description
NTS-731B	Specular Black Reflector / White Plastic Ring
NTS-731C	Specular Clear Reflector / White Plastic Ring
NTS-731CWF	Specular Clear Reflector / White Self Flanged NEW!
NTS-731G	Specular Gold Reflector / White Plastic Ring
NTS-731W	Specular White Reflector / White Plastic Ring

Maximum Wattage
150W A21/PAR38
OD: 7"

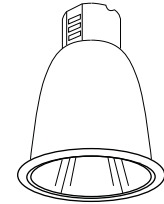

Reflector with Cross Louver

NEW!
SELF FLANGE



CC

Catalog No.	Description
NTS-737C	Specular Clear Reflector / Specular Chrome Louver / White Plastic Ring
NTS-737CWF	Specular Clear Reflector / Specular Chrome Louver / White Self Flanged NEW!
NTS-737G	Specular Gold Reflector / Specular Gold Louver / White Plastic Ring

- Low aperture brightness

Maximum Wattage
150W A21/PAR38
OD: 7"

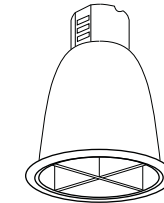

Open Single Wall Wash



CC

Catalog No.	Description
NTS-739SC	Specular Clear Single Wall Wash / White Plastic Ring

Maximum Wattage
150W A21/PAR38
OD: 7"

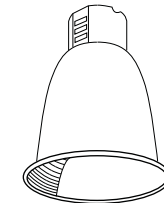

Open Double Wall Wash



CC

Catalog No.	Description
NTS-739DC	Specular Clear Double Wall Wash / White Plastic Ring

Maximum Wattage
150W A21/PAR38
OD: 7"

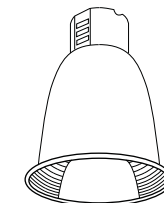

Lensed Reflector Wall Wash



CC

Catalog No.	Description
NTS-736C	Specular Clear Wall Wash / Specular Clear Reflector / White Plastic Ring
NTS-736G	Specular Gold Wall Wash / Specular Clear Reflector / White Plastic Ring

- Glass Lens

Maximum Wattage
150W A21/PAR38
OD: 7"

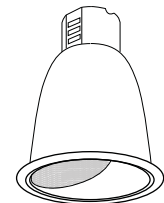

Wall Wash with Baffle

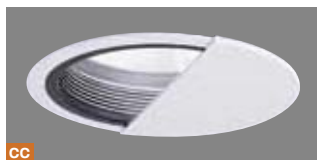

CC

Catalog No.	Description
NTS-734B	Wall Wash / Black Baffle / Specular Clear Reflector / White Eyelid / White Plastic Ring
NTS-734W	Wall Wash / White Baffle / Specular Clear Reflector / White Eyelid / White Plastic Ring

Maximum Wattage
150W A21/PAR38
OD: 7"

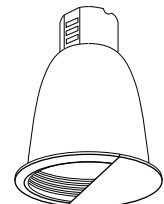

CC Custom Combo: Available with custom combinations of trim and plastic or metal ring finish. See pages 38-39 for details.
See pages 34-35 for Description of Reflector Finishes

6" ARCHITECTURAL & COMMERCIAL FRAME-IN REFLECTORS continued

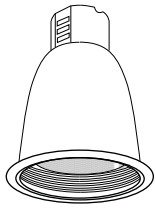

Maximum Wattage
150W A21/PAR38

OD: 7"



Catalog No.	Description
NTS-732B	Regressed Albalite Lens / Black Baffle / White Plastic Ring
NTS-732W	Regressed Albalite Lens / White Baffle / White Plastic Ring

- UL Wet Listed

Regressed Albalite Lens with Baffle

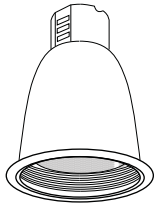
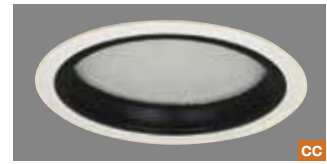

Maximum Wattage
150W A21/PAR38

OD: 7"



Catalog No.	Description
NTS-743W	Regressed Fresnel Lens / White Baffle / White Plastic Ring

- UL Wet Listed

Regressed Fresnel Lens with Baffle

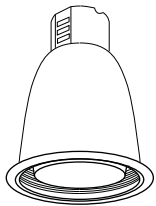

Maximum Wattage
150W A21/PAR38

OD: 7"



Catalog No.	Description
NTS-735B	Regressed Drop Opal / Black Baffle / Specular Clear Reflector / White Plastic Ring
NTS-735W	Regressed Drop Opal / White Baffle / Specular Clear Reflector / White Plastic Ring

- UL Wet Listed

Regressed Drop Opal with Baffle

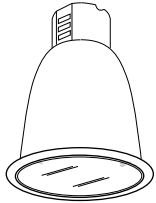

Maximum Wattage
150W A21/PAR38

OD: 7"

Catalog No.	Description
NTS-733CL	Specular Clear Reflector / Flush Mount Clear Lens / White Plastic Ring
NTS-733FL	Specular Clear Reflector / Flush Mount Frosted Lens / White Plastic Ring

Flush Mount Lens with Reflector

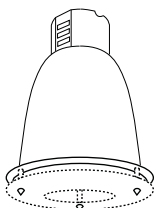

Maximum Wattage
150W A21/PAR38

OD: 7"

Catalog No.	Description
NTS-738C	Specular Clear Reflector / White Plastic Ring

- Glass sold separately
- For a layered look, up to two pieces of glass may be used together.

Reflector for Decorative Glass

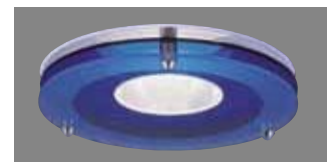

Includes:
NRA-203 Glass Hardware
• (3) Stand-offs
• (3) Cone End Caps
• (3) Flat End Caps

OD: 7"

Catalog No.	Description
NTG-6B/120	Tempered Blue, 120mm (4-3/4") Open Center
NTG-6B/80	Tempered Blue, 80mm (3-1/8") Open Center
NTG-6CF	Tempered Frost Center / Clear Outer
NTG-6FC	Tempered Clear Center / Frost Outer
NTG-6HC	Tempered Clear Outer / Frost Inner, 80mm (3-1/8") Open Center

- Includes NRA-203 Glass Hardware
- 2 decorative glasses can be combined for a tiered look

Decorative Glass for NTS-738C



CC Custom Combo: Available with custom combinations of trim and plastic or metal ring finish. See pages 38-39 for details.

Line Voltage Recessed

Clip In Socket

May be removed in field to convert to a floating socket

Adjustable Socket Plate

Adjust vertically for best possible light distribution. (Also available in floating socket.)

Riveted Cap

Adjustable Bar Hanger

Adjustable from 13-5/8" to 24-1/2" with slots for T-bar grid.

Self Aligning Foot

Air-tight Gaskets

are pre-installed on "AT" Models. Restricts air flow to 2 cubic feet per minute maximum.

Large J-Box

Provides seven 1/2" knockouts and four Romex® pry-outs with automatic strain relief.

Quick Connects

Provide instant, trouble-free electrical connection, eliminating the need for wire nuts.



6" IC Double Wall New Construction Housing (High Wattage)

LINE VOLTAGE RECESSED

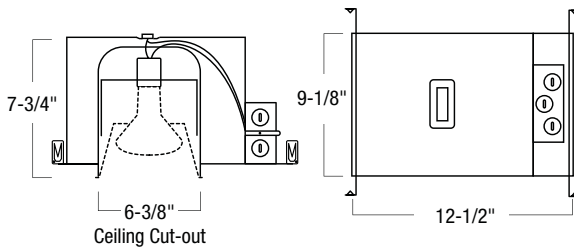

6" IC DOUBLE WALL NEW CONSTRUCTION HOUSING

CATALOG. NO.	TYPE	SOCKET	AIR-TIGHT
NHIC-17/100DWQA	IC	Adjustable Bracket, Medium Base	Yes



Nora Lighting's 100W IC Air-Tight housing allows the use of higher wattage light sources necessary for high ceilings containing thermal insulation. Rated for direct contact with insulation and combustible material, Nora's 100W IC Air-Tight housing's double wall construction provides energy savings by reducing the flow of air through the ceiling and accept a wide variety of high quality, attractive finishing trims.

Minimum Clearances: IC housings are direct contact rated; no minimum clearance is required.

Air-Tight: Air-tight gasket comes pre-installed

Ceiling Thickness: Accepts 5/8" - 1-3/8" to accommodate various ceiling thicknesses.

Lamp: Trim determines maximum wattage
60W A19
75W BR30 / PAR30
100W A19 / BR40 / PAR38

Lamp Adjustment: Adjustable socket mounting plate allows different types of lamps to be used for best possible light distribution.

Installation: Bar hangers are adjustable from 13-5/8" to 24-1/2" with captive nails and can be repositioned 90 degrees. Bar hangers are slotted for T-Bar installations.

Junction Box: Junction box is listed for through branch circuit wiring and contains seven 1/2" knockouts and four Romex® with strain relief and ground lead.

Electrical: Quick connector provided.

Socket: Medium screw-in base with protective plug.

Listing:
cULus Damp Location w/ Feed Through
WSEC ASTM E283 for Air-Tight (AT)
cULus Wet Location (Only with designated trims)

LINE VOLTAGE RECESSED

6" IC New Construction Housings

Nora Lighting's recessed IC housings are high quality, light weight units ideal for use in insulated ceilings. Air-tight construction also reduces energy costs by reducing the amount of air escaping through the ceiling. Rated for direct contact with insulation and quick to install and accept a wide variety of high quality, attractive finishing trims.

Minimum Clearances: IC housings are direct contact rated; no minimum clearance is required.

Air-Tight: Air-tight gasket comes pre-installed

Ceiling Thickness: Accepts 5/8" - 1-3/8" to accommodate various ceiling thicknesses.

Lamp: Trim determines maximum wattage
 40W A19
 50W R20 / PAR20
 60W A19
 75W BR30 / PAR30
 100W BR40 / PAR38

Lamp Adjustment:

Standard: Adjustable socket mounting plate allows different types of lamps to be used for best possible light distribution.

Snap-in (Floating Socket - NB): Socket is automatically positioned for optimum performance and lamp position consistency when socket is installed on trim or reflector.

Installation: Bar hangers are adjustable from 13-5/8" to 24-1/2" with captive nails and can be repositioned 90 degrees. Bar hangers are slotted for T-Bar installations.

Junction Box: Junction box is listed for through branch circuit wiring and contains seven 1/2" knockouts and four Romex® with strain relief and ground lead.

Electrical: Quick connector provided.

Socket: Medium screw-in base with protective plug.

Listing:

cULus Damp Location w/ Feed Through
 WSEC ASTM E283 for Air-Tight (AT)
 cULus Wet Location (Only with designated trims)

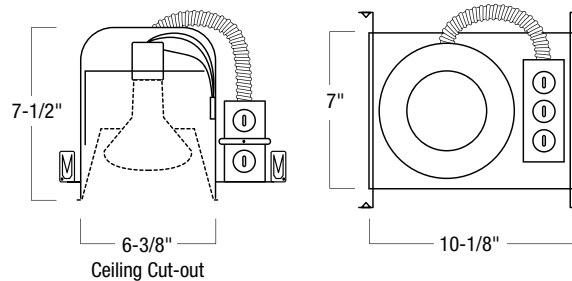

6" IC NEW CONSTRUCTION SERIES

CATALOG. NO.	TYPE	SOCKET	AIR-TIGHT
NHIC-17QAT	IC	Adjustable Bracket, Medium Base	Yes
NHIC-17QAT/FX*	IC	Fire Rated, Adjustable Bracket, Medium Base	Yes
NHIC-17QNBAT	IC	Floating (No Bracket), Medium Base	Yes

* Housing comes mounted in fire rated enclosure. See page 379 for specifications.

NB Designates trims compatible with floating socket or no bracket housings



LINE VOLTAGE RECESSED 6" IC Remodel Housings



Nora Lighting's recessed IC housings are high quality, light weight units ideal for use in insulated ceilings. Air-tight construction also reduces energy costs by reducing the amount of air escaping through the ceiling. Rated for direct contact with insulation and quick to install and accept a wide variety of high quality, attractive finishing trims.

Minimum Clearances: IC housings are direct contact rated; no minimum clearance is required.

Air-Tight: Air-tight gasket comes pre-installed

Ceiling Thickness: Accepts 3/8" - 1-3/8" to accommodate various ceiling thicknesses.

Lamp: Trim determines maximum wattage
40W A19
50W R20 / PAR20
60W A19
75W BR30 / PAR30
100W BR40 / PAR38

Lamp Adjustment:

Standard: Adjustment socket mounting plate allows different types of lamps to be used for best possible light distribution

Snap-in (Floating Socket - NB): Socket is automatically positioned for optimum performance and lamp position consistency when socket is installed on trim or reflector.

Installation: High tension tempered steel springs secure remodel housings evenly to ceiling; hole cutout template provided for convenience.

Junction Box: Junction box is listed for through branch circuit wiring and contains seven 1/2" knockouts and four Romex® with strain relief and ground lead.

Electrical: Quick connector provided.

Socket: Medium screw-in base with protective plug.

Listing:

cULus Damp Location w/ Feed Through
WSEC ASTM E283 for Air-Tight (AT)
cULus Wet Location (Only with designated trims)

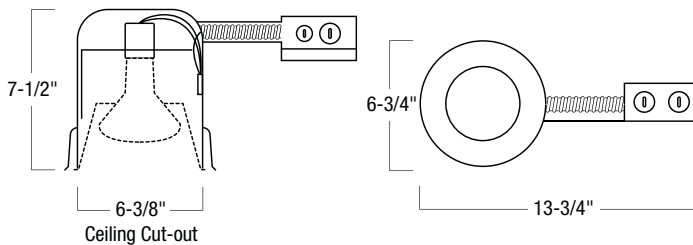

6" IC REMODEL SERIES

CATALOG. NO.	TYPE	SOCKET	AIR-TIGHT
NHRIC-17QAT	IC	Adjustable Bracket, Medium Base	Yes
NHRIC-17QNBAT	IC	Floating (No Bracket), Medium Base	Yes

NB Designates trims compatible with floating socket or no bracket housings



LINE VOLTAGE RECESSED

6" IC New Construction Shallow Housing

Nora Lighting's shallow ceiling housings are ideal for locations with 6" joists and tighter ceiling clearance. Nora's shallow ceiling housings accept a wide variety of low profile trims.

Minimum Clearances: IC housings are direct contact rated; no minimum clearance is required.

Air-Tight: Air-tight gasket comes pre-installed

Ceiling Thickness: Accepts 5/8" - 1-3/8" to accommodate various ceiling thicknesses.

Lamp: Trim determines maximum wattage
 25W A19
 50W R20 / PAR20
 60W A19
 75W BR30 / PAR30

Lamp Adjustment: Adjustment socket mounting plate allows different types of lamps to be used for best possible light distribution

Installation: Bar hangers are adjustable from 13-5/8" to 24-1/2" with captive nails and can be repositioned 90 degrees. Bar hangers are slotted for T-Bar installations.

Junction Box:
 Junction box is listed for through branch circuit wiring and contains seven 1/2" knockouts and four Romex® with strain relief and ground lead.

Electrical: Quick connector provided.

Socket: Medium screw-in base with protective plug.

Listing:
 cULus Damp Location w/ Feed Through
 WSEC ASTM E283 for Air-Tight (AT)
 cULus Wet Location (Only with designated trims)

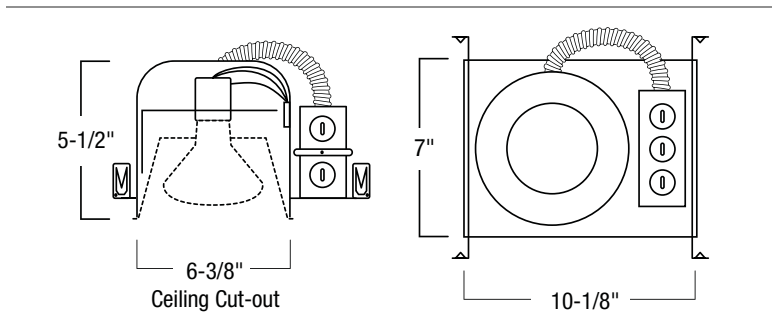

6" IC SHALLOW NEW CONSTRUCTION HOUSING

CATALOG. NO.	TYPE	SOCKET	AIR-TIGHT
NHIC-27QAT	IC	Adjustable Bracket, Medium Base	Yes

SH Designates trims compatible with shallow housings



LINE VOLTAGE RECESSED 6" IC Remodel Shallow Housing



Nora Lighting's shallow ceiling housings are ideal for locations with 6" joists and tighter ceiling clearance. Nora's shallow ceiling housings accept a wide variety of low profile trims.

Minimum Clearances: IC housings are direct contact rated; no minimum clearance is required.

Air-Tight: Air-tight gasket comes pre-installed.

Ceiling Thickness: Accepts 3/8" - 1-3/8" to accommodate various ceiling thicknesses.

Lamp: Trim determines maximum wattage
25W A19
50W R20 / PAR20
60W A19
75W BR30 / PAR30

Lamp Adjustment: Adjustment socket mounting plate allows different types of lamps to be used for best possible light distribution

Installation: High tension tempered steel springs secure remodel housings evenly to ceiling; hole cutout template provided for convenience.

Junction Box: Junction box is listed for through branch circuit wiring and contains seven 1/2" knockouts and four Romex® with strain relief.

Electrical: Quick connector provided.

Socket: Medium screw-in base with protective plug.

Listing:
cULus Damp Location w/ Feed Through
WSEC ASTM E283 for Air-Tight (AT)
cULus Wet Location (Only with designated trims)

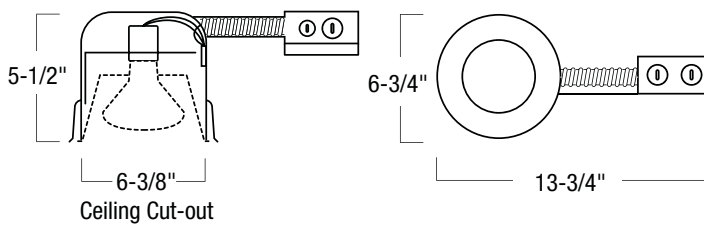

6" IC SHALLOW REMODEL HOUSING

CATALOG. NO.	TYPE	SOCKET	AIR-TIGHT
NHRIC-27QAT	IC	Adjustable Bracket, Medium Base	Yes

SH Designates trims compatible with shallow housings



LINE VOLTAGE RECESSED

6" Non-IC New Construction Housings

Nora Lighting's universal recessed housing is the base standard for line voltage recessed fixtures. Designed for non-IC applications, it offers the widest range and variety of high quality, attractive finishing trims for lamps ranging from simple A-type to larger PAR sources.

Minimum Clearances: Non-IC housings require minimum clearances of 3" from thermal insulation and 1/2" from adjacent building components.

Ceiling Thickness: Accepts 5/8" - 1-3/8" to accommodate various ceiling thicknesses.

Lamp: Trim determines maximum wattage
 50W R20 / PAR20
 60W A19
 75W BR30 / PAR30
 100W A19
 150W BR40 / PAR38

Lamp Adjustment:

Standard: Adjustment socket mounting plate allows different types of lamps to be used for best possible light distribution

Snap-in (Floating Socket - NB): Socket is automatically positioned for optimum performance and lamp position consistency when socket is installed on trim or reflector.

Installation: Bar hangers are adjustable from 13-5/8" to 24-1/2" with captive nails and can be repositioned 90 degrees. Bar hangers are slotted for T-Bar installations.

Junction Box: Junction box is listed for through branch circuit wiring and contains seven 1/2" knockouts and four Romex® with strain relief and ground lead.

Electrical: Quick connector provided.

Socket: Medium screw-in base with protective plug.

Listing:

cULus Damp Location w/ Feed Through
 cULus Wet Location (Only with designated trims)



NH-26Q/FX - Fire Rated Enclosure

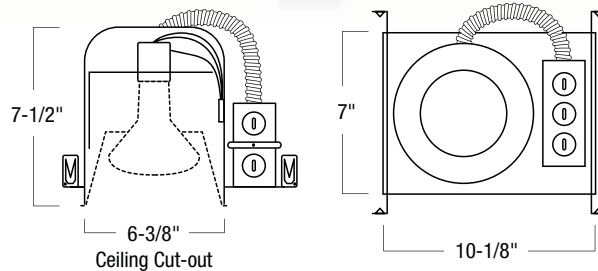

6" NON-IC NEW CONSTRUCTION SERIES

CATALOG. NO.	TYPE	SOCKET	AIR-TIGHT
NH-26Q	Non-IC	Adjustable Bracket, Medium Base	No
NH-26Q/FX*	Non-IC	Fire Rated, Adjustable Bracket, Medium Base	No
NH-26QNB	Non-IC	Floating (No Bracket), Medium Base	No

* Housing comes mounted in fire rated enclosure. See page 379 for specifications.

NB Designates trims compatible with floating socket or no bracket housings



LINE VOLTAGE RECESSED 6" Non-IC Remodel Housing



Nora Lighting's universal recessed housing is the base standard for line voltage remodel fixtures. Designed for non-IC applications, it offers the widest range and variety of high quality, attractive finishing trims for lamps ranging from simple A-type to larger PAR sources.

Minimum Clearances: Non-IC housings require minimum clearances of 3" from thermal insulation and 1/2" from adjacent building components.

Ceiling Thickness: Accepts 3/8" - 1-3/8" to accommodate various ceiling thicknesses.

Lamp: Trim determines maximum wattage
50W R20 / PAR20
60W A19
75W BR30 / PAR30
100W A19
150W BR40 / PAR38

Lamp Adjustment: Adjustment socket mounting plate allows different types of lamps to be used for best possible light distribution

Installation: High tension tempered steel springs secure remodel housings evenly to ceiling; hole cutout template provided for convenience.

Junction Box: Junction box is listed for through branch circuit wiring and contains seven 1/2" knockouts and four Romex® with strain relief and ground lead.

Electrical: Quick connector provided.

Socket: Medium screw-in base with protective plug.

Listing:
cULus Damp Location w/ Feed Through
cULus Wet Location (Only with designated trims)

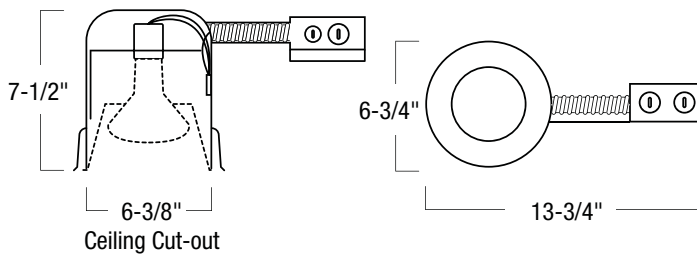

6" NON-IC REMODEL HOUSING

CATALOG. NO.	TYPE	SOCKET	AIR-TIGHT
NHR-26Q	Non-IC	Adjustable Bracket, Medium Base	No



LINE VOLTAGE RECESSED

6" Non-IC New Construction Shallow Housings

Nora Lighting's shallow ceiling housings are ideal for locations with 6" joists and tighter ceiling clearance. Nora's shallow ceiling housings accept a wide variety of low profile trims.

Minimum Clearances: Non-IC housings require minimum clearances of 3" from thermal insulation and 1/2" from adjacent building components.

Ceiling Thickness: Accepts 5/8" - 1-3/8" to accommodate various ceiling thicknesses.

Lamp: Trim determines maximum wattage
 25W A19
 50W R20 / PAR20
 60W A19
 75W BR30 / PAR30

Lamp Adjustment: Adjustment socket mounting plate allows different types of lamps to be used for best possible light distribution

Installation: Bar hangers are adjustable from 13-5/8" to 24-1/2" with captive nails and can be repositioned 90 degrees. Bar hangers are slotted for T-Bar installations.

Junction Box: Junction box is listed for through branch circuit wiring and contains seven 1/2" knockouts and four Romex® with strain relief and ground lead.

Electrical: Quick connector provided.

Socket: Medium screw-in base with protective plug.

Listing:
 cULus Damp Location w/ Feed Through
 cULus Wet Location (Only with designated trims)

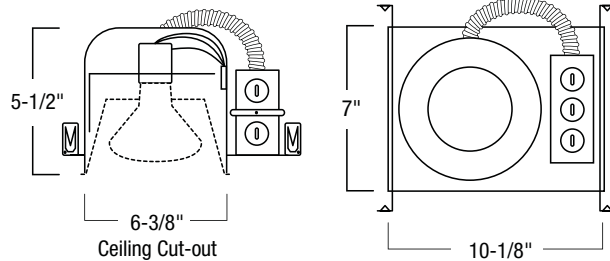

6" NON-IC NEW CONSTRUCTION SHALLOW HOUSING

CATALOG. NO.	TYPE	SOCKET	AIR-TIGHT
NH-27Q	Non-IC	Adjustable Bracket, Medium Base	No

SH Designates trims compatible with shallow housings



LINE VOLTAGE RECESSED

6" Non-IC Remodel Shallow housings



Nora Lighting's shallow ceiling housings are ideal for locations with 6" joists and tighter ceiling clearance. Nora's shallow ceiling housings accept a wide variety of low profile trims.

Minimum Clearances: Non-IC housings require minimum clearances of 3" from thermal insulation and 1/2" from adjacent building components.

Ceiling Thickness: Accepts 3/8" - 1-3/8" to accommodate various ceiling thicknesses.

Lamp: Trim determines maximum wattage
 25W A19
 50W R20 / PAR20
 60W A19
 75W BR30 / PAR30

Lamp Adjustment: Adjustment socket mounting plate allows different types of lamps to be used for best possible light distribution

Installation: High tension tempered steel springs secure remodel housings evenly to ceiling; hole cutout template provided for convenience.

Junction Box: Junction box is listed for through branch circuit wiring and contains seven 1/2" knockouts and four Romex® with strain relief.

Electrical: Quick connector provided.

Socket: Medium screw-in base

Listing:
 cULus Damp Location w/ Feed Through
 cULus Wet Location (Only with designated trims)

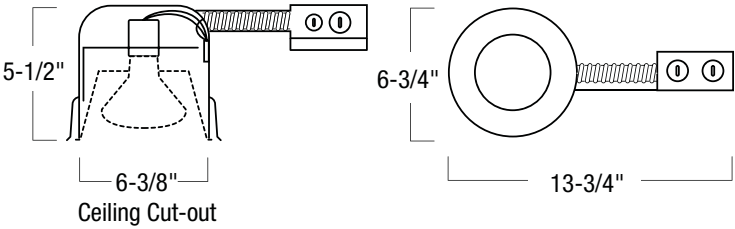

6" NON-IC REMODEL SHALLOW HOUSING

CATALOG. NO.	TYPE	SOCKET	AIR-TIGHT
NHR-27Q	Non-IC	Adjustable Bracket, Medium Base	No

SH Designates trims compatible with shallow housings



LINE VOLTAGE RECESSED

6" IC & Non-IC Rated Trims

BAFFLE

BR/PAR30 Stepped Baffle

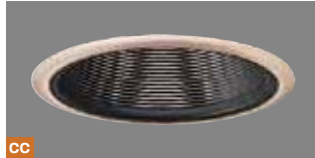

CC

Catalog No.	Description
NTM-30	Black Stepped Baffle with White Plastic Ring
NTM-30/OV	Black Stepped Baffle with Oversize White Plastic Ring
NTM-30B	Black Stepped Baffle with Black Plastic Ring
NTM-30C	Black Stepped Baffle with Chrome Plastic Ring
NTM-30CO	Black Stepped Baffle with Copper Metal Ring
NTM-30G	Black Stepped Baffle with Gold Plastic Ring
NTM-30N	Black Stepped Baffle with Natural Metal Ring
NTM-31	White Stepped Baffle with White Plastic Ring
NTM-31/OV	White Stepped Baffle with Oversize White Plastic Ring
NTM-31B	White Stepped Baffle with Black Plastic Ring
NTM-31BZ	White Stepped Baffle with Bronze Metal Ring
NTM-31C	White Stepped Baffle with Chrome Plastic Ring
NTM-31G	White Stepped Baffle with Gold Plastic Ring
NTM-31N	White Stepped Baffle with Natural Metal Ring
NTM-32	Natural Metal Stepped Baffle with Natural Metal Ring
NTM-33	Copper Stepped Baffle with Copper Metal Ring
NTM-34	Bronze Stepped Baffle with Bronze Metal Ring

Maximum Wattage
75W BR30/PAR30

OD: 7"

SH

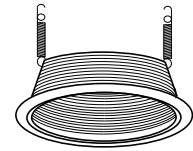

- **UL Classified** for use with most manufacturers' housings
- Maximum Wattage
75W BR30/PAR30: NH-26Q; NHR-26Q; NHIC-27QAT; NHRIC-27QAT; NHIC-17/100DWQA; NHIC-17QAT; NHRIC-17QAT; NH-27Q; NHR-27Q

BR/PAR30 Stepped Baffle with 2 Rings



CC

Catalog No.	Description
NTM-30/2R	Black Stepped Baffle with Two Plastic Rings
NTM-31/2R	White Stepped Baffle with Two Plastic Rings

Maximum Wattage
75W BR30/PAR30

OD: 7"

SH

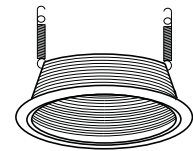

- **UL Classified** for use with most manufacturers' housings
- **Includes:** (1) standard and (1) oversize ring
- Maximum Wattage
75W BR30/PAR30: NH-26Q; NHR-26Q; NHIC-27QAT; NHRIC-27QAT; NHIC-17/100DWQA; NHIC-17QAT; NHRIC-17QAT; NH-27Q; NHR-27Q

BR40/PAR38 Stepped Baffle



CC

Catalog No.	Description
NTM-40	Black Stepped Baffle with White Plastic Ring
NTM-40/OV	Black Stepped Baffle with Oversize Plastic Ring
NTM-40B	Black Stepped Baffle with Black Plastic Ring
NTM-40C	Black Stepped Baffle with Chrome Plastic Ring
NTM-40G	Black Stepped Baffle with Gold Plastic Ring
NTM-40N	Black Stepped Baffle with Natural Metal Ring
NTM-41	White Stepped Baffle with White Plastic Ring
NTM-41/OV	White Stepped Baffle with Oversize Plastic Ring
NTM-41BZ	Bronze Stepped Baffle with Bronze Metal Ring
NTM-41C	White Stepped Baffle with Chrome Plastic Ring
NTM-41CO	Copper Stepped Baffle with Copper Metal Ring
NTM-41G	White Stepped Baffle with Gold Plastic Ring
NTM-41N	Natural Metal Stepped Baffle with Natural Metal Ring

Maximum Wattage
See description

OD: 7"

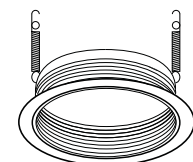

- **UL Classified** for use with most manufacturers' housings
- Maximum Wattage
150W BR40/PAR38: NH-26Q; NHR-26Q
100W BR40/PAR38: NHIC-17/100DWQA

CC Custom Combo: Available with custom combinations of trim and plastic or metal ring finish. See pages 38-39 for details.

SH Shallow: Designated trims for shallow housings

See page 36-37 for Description of Reflector Finishes

BAFFLE

6" LINE VOLTAGE IC & NON-IC RATED TRIMS continued

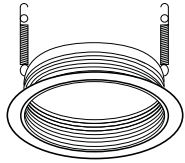

Maximum Wattage
See description
OD: 7"

Catalog No.	Description
NTM-40/2R	Black Stepped Baffle with Two Plastic Rings
NTM-41/2R	White Stepped Baffle with Two Plastic Rings

- **UL Classified** for use with most manufacturers' housings
- **Includes:** (1) standard and (1) oversize ring
- **Maximum Wattage** - 150W BR40/PAR38: NH-26Q; NHR-26Q
100W BR40/PAR38: NHIC-17/100DWQA

BR40/PAR38 Stepped Baffle with 2 Rings

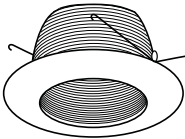

Maximum Wattage
75W BR30/PAR30
OD: 8"

Catalog No.	Description
NTM-29BC	Black Open Stepped Baffle with Chrome Metal Ring
NTM-29BG	Black Open Stepped Baffle with Gold Metal Ring
NTM-29BW	Black Open Stepped Baffle with White Metal Ring
NTM-29WC	White Open Stepped Baffle with Chrome Metal Ring
NTM-29WG	White Open Stepped Baffle with Gold Metal Ring
NTM-29WW	White Open Stepped Baffle with White Metal Ring

- **Maximum Wattage**
75W BR30/PAR30: NH-26Q; NHR-26Q; NHIC-27QAT; NHRIC-27QAT
NHIC-17/100DWQA; NHIC-17QAT; NHRIC-17QAT; NH-27Q; NHR-27Q

Open Stepped Baffle Metal Trim

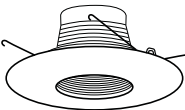
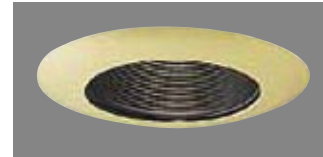

Maximum Wattage
50W R20/PAR20
Aperture: 3-1/2"
OD: 8"

Catalog No.	Description
NT-641B	Black Stepped Baffle with White Metal Trim
NT-641CO	Copper Stepped Baffle with White Metal Trim
NT-641W	White Stepped Baffle with White Metal Trim

- **Maximum Wattage**
50W R20/PAR20: NHIC-17QAT; NHRIC-17QAT; NHIC-27QAT; NHRIC-27QAT; NHIC-17/100DWQA; NH-26Q; NHR-26Q; NH-27Q; NHR-27Q

Stepped Baffle w/ White Metal Trim

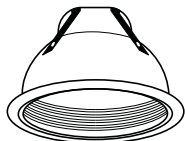
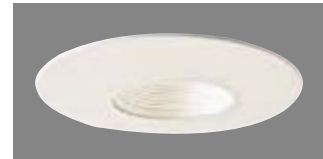

Maximum Wattage
See description
OD: 7"

Catalog No.	Description
NTA-101	Specular Clear Refl / Black Metal Baffle / White Plastic Ring
NTA-101BZ	Specular Clear Refl / Bronze Metal Baffle / Bronze Metal Ring
NTA-101CO	Specular Clear Refl / Copper Metal Baffle / Copper Metal Ring
NTA-101N	Specular Clear Refl / Natural Metal Baffle / Natural Metal Ring
NTA-102	Specular Clear Refl / White Metal Baffle / White Plastic Ring

- **Maximum Wattage**
100W A19: NH-26Q; NHR-26Q; NHIC-17/100DWQA
60W A19: NHIC-17QAT; NHRIC-17QAT; NH-26Q; NHR-26Q

Cone Reflector with Baffle Insert

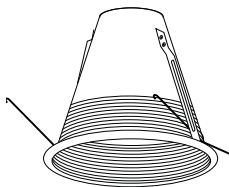

Maximum Wattage
100W BR40/PAR38
75W BR/PAR30
OD: 7"

NB
AIR TIGHT

Catalog No.	Description
NTM-713BAL	Black Air-Tight Aluminum Baffle Cone / White Trim Ring
NTM-713WAL	White Air-Tight Aluminum Baffle Cone / White Self Flanged

- **Maximum Wattage**
150W BR40/PAR38: NH-26Q; NH-26QNB; NHR-26Q
100W BR40/PAR38: NHIC-17/100DWQA; NHIC-17QAT;
NHIC-17QNBAT; NHRIC-17QNBAT; NHRIC-17QAT; NH-26Q;
NH-26QNB; NHR-26Q;

Air-Tight Aluminum Baffle Cone

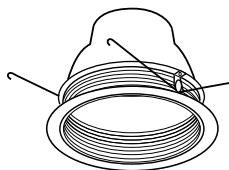

Maximum Wattage
See description
OD: 7"

NB
AIR TIGHT

Catalog No.	Description
NTA-730B	Specular Clear Air-Tight Refl / Black Baffle / White Metal Flange
NTA-730W	Specular Clear Air-Tight Refl / White Baffle / White Metal Flange

- **Maximum Wattage**
150W BR40/PAR38: NH-26Q; NH-26QNB; NHR-26Q
100W A19/BR40/PAR38: NH-26Q; NH-26QNB; NHR-26Q; NHIC-17/100DWQA;
75 BR/PAR30 / 60W A19: NHIC-17QAT; NHIC-17QNBAT;
NHRIC-17QNBAT; NHRIC-17QAT; NH-26Q; NH-26QNB; NHR-26Q;

Specular Clear Reflector w/ Baffle



CC Custom Combo: Available with custom combinations of trim and plastic or metal ring finish. See pages 38-39 for details.

NB No Bracket: Designated trims for floating socket or no bracket housings

SH Shallow: Designated trims for shallow housings

Lighting Tip:

Use Nora's phenolic (plastic) baffle with plastic ring for outdoor or harsh environment applications (Ex. NTP-30, NTP-41)

6" LINE VOLTAGE IC & NON-IC RATED TRIMS continued

BR/PAR30 Phenolic Stepped Baffle



CC

Catalog No.	Description
NTP-30	Black Phenolic Stepped Baffle / White Plastic Ring
NTP-31	White Phenolic Stepped Baffle / White Plastic Ring

- Maximum Wattage
75W BR30/PAR30: NH-26Q; NHR-26Q; NHIC-27QAT; NHRIC-27QAT; NHIC-17/100DWQA; NH-27Q; NHR-27Q; NHIC-17QAT; NHRIC-17QAT

Maximum Wattage
75W BR30/PAR30

OD: 7"

SH

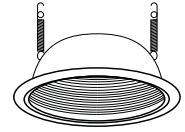

BR40/PAR38 Phenolic Stepped Baffle



CC

Catalog No.	Description
NTP-40	Black Phenolic Stepped Baffle / White Plastic Ring
NTP-41	White Phenolic Stepped Baffle / White Plastic Ring

- Maximum Wattage
150W PAR38: NH-26Q; NHR-26Q; NHIC-17/100DWQA
100W PAR38: NH-26Q; NHR-26Q; NHIC-17/100DWQA; NHIC-17QAT

Maximum Wattage
See description

OD: 7"

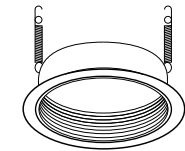

BR/PAR30 Reflector



CC

Catalog No.	Description
NTS-30	Specular Gold Reflector / White Plastic Ring
NTS-30A	Gold Alzak® Reflector / White Plastic Ring
NTS-30C	Specular Gold Reflector / Chrome Plastic Ring
NTS-30G	Specular Gold Reflector / Gold Plastic Ring
NTS-31	Specular Clear Reflector / White Plastic Ring
NTS-31A	Clear Alzak® Reflector / White Plastic Ring
NTS-31AHZ	Haze Alzak® Reflector / White Plastic Ring
NTS-31C	Specular Clear Reflector / Chrome Plastic Ring
NTS-31HZ	Haze Reflector / White Plastic Ring
NTS-31N	Natural Metal Reflector / White Plastic Ring
NTS-32	Specular Black Reflector / White Plastic Ring
NTS-32B	Specular Black Reflector / Black Plastic Ring
NTS-32BZBZ	Bronze Reflector / Bronze Metal Ring
NTS-32CO	Specular Black Reflector / Copper Metal Ring
NTS-32COCO	Copper Reflector / Copper Metal Ring
NTS-32G	Specular Black Reflector / Gold Plastic Ring
NTS-32NN	Natural Metal Reflector / Natural Metal Ring
NTS-33	Specular White Reflector / White Plastic Ring

- Maximum Wattage
75W BR30/PAR30: NH-26Q; NHR-26Q; NHIC-27QAT; NHRIC-27QAT; NHIC-17/100DWQA; NH-27Q; NHR-27Q; NHIC-17QAT; NHRIC-17QAT

Maximum Wattage
75W BR30/PAR30

OD: 7"

SH

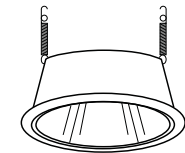

BR40/PAR38 Reflector



CC

Catalog No.	Description
NTS-40	Specular Gold Reflector / White Plastic Ring
NTS-40G	Specular Gold Reflector / Gold Plastic Ring
NTS-41	Specular Clear Reflector / White Plastic Ring
NTS-41C	Specular Clear Reflector / Chrome Plastic Ring
NTS-41HZ	Haze Reflector / White Plastic Ring
NTS-42	Specular Black Reflector / White Plastic Ring
NTS-42B	Specular Black Reflector / Black Plastic Ring
NTS-42CO	Specular Black Reflector / Copper Metal Ring
NTS-42G	Specular Black Reflector / Gold Plastic Ring
NTS-43	Specular White Reflector / White Plastic Ring

- Maximum Wattage
150W BR40/PAR38: NH-26Q; NHR-26Q
100W BR40/PAR38: NHIC-17/100DWQA

Maximum Wattage
See description

OD: 7"

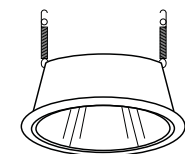

CC Custom Combo: Available with custom combinations of trim and plastic or metal ring finish. See pages 38-39 for details.

SH Shallow: Designated trims for shallow housings

See pages 36-37 for Description of Trim Finishes

REFLECTOR - ADJUSTABLE

6" LINE VOLTAGE IC & NON-IC RATED TRIMS continued

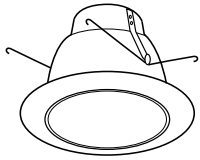

Maximum Wattage
See description

OD: 7"



Catalog No.	Description
NTS-714B	Specular Black Air-Tight Cone Refl / White Plastic Ring
NTS-714C	Specular Clear Air-Tight Cone Refl / White Plastic Ring
NTS-714G	Specular Gold Air-Tight Cone Refl / White Plastic Ring
NTS-714W	Specular White Air-Tight Cone Refl / White Plastic Ring

- Maximum Wattage
150W BR40/PAR38: NH-26Q; NH-26QNB; NHR-26Q
100W BR40/PAR38: NHIC-17/100DWQA; NH-26Q; NH-26QNB; NHR-26Q
75W BR/PAR30: NHIC-17/100DWQA; NHIC-17QAT; NHRIC-17QAT
60W A19: NH-26Q; NH-26QNB; NHR-26Q; NHIC-17QAT; NHRIC-17QAT; NHIC-17QNBAT; NHRIC-17QNBAT

Air-Tight Cone Reflector



CC

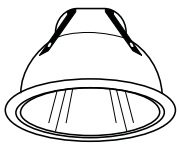

Maximum Wattage
See description

OD: 7"

Catalog No.	Description
NTA-96	Specular Gold Cone Reflector / White Plastic Ring
NTA-96C	Specular Gold Cone Reflector / Chrome Plastic Ring
NTA-96G	Specular Gold Cone Reflector / Gold Plastic Ring
NTA-97	Specular Clear Cone Reflector / White Plastic Ring
NTA-97AHZ	Haze Alzak® Cone Reflector / White Plastic Ring
NTA-97C	Specular Clear Cone Reflector / Chrome Plastic Ring
NTA-97G	Specular Clear Cone Reflector / Gold Plastic Ring
NTA-97HZ	Haze Cone Reflector / White Plastic Ring
NTA-98	Specular Black Cone Reflector / White Plastic Ring
NTA-98B	Specular Black Cone Reflector / Black Plastic Ring
NTA-98BZBZ	Bronze Cone Reflector / Bronze Metal Ring
NTA-98COCO	Copper Cone Reflector / Copper Metal Ring
NTA-98NN	Natural Metal Cone Reflector / Natural Metal Ring
NTA-99	Specular White Cone Reflector / White Plastic Ring

- Maximum Wattage
100W A19: NH-26Q; NHR-26Q; NHIC-17/100DWQA;
60W A19: NHIC-17QAT; NHRIC-17QAT; NH-26Q; NHR-26Q

Cone Reflector

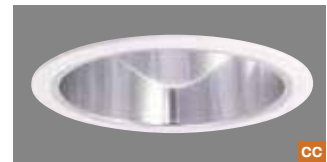

CC



Maximum Wattage
50W R20/PAR20

OD: 8"



Catalog No.	Description
NT-642	Specular Gold Reflector with White Metal Trim
NT-643	Specular Black Reflector with White Metal Trim
NT-643C	Specular Black Reflector with Chrome Metal Trim
NT-644	Specular Clear Reflector with White Metal Trim
NT-646	Specular White Reflector with White Metal Trim

- 3-1/2" Aperture
- Maximum Wattage
50W R20/PAR20: NH-26Q; NHR-26Q; NH-27Q; NHR-27Q; NHIC-17/100DWQA; NHIC-17QNBAT; NHIC-27QAT; NHRIC-27QAT; NHIC-17QAT; NHRIC-17QAT

Reflector with Metal Trim

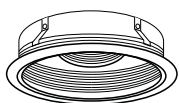
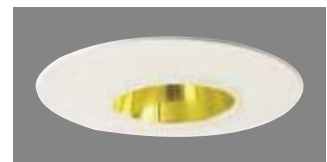

Maximum Wattage
50W PAR16

OD: 7"

Catalog No.	Description
NL-675	Black Stepped Baffle / Regressed Baffle / White Ring
NL-675W	White Stepped Baffle / Regressed Baffle / White Ring

- Downlight or 35° Adjustable
- Maximum Wattage
50W PAR16: NH-26Q; NHR-26Q; NHIC-17QNBAT; NHIC-17/100DWQA; NHIC-17QAT; NHRIC-17QAT

PAR16 Adjustable Stepped Baffle

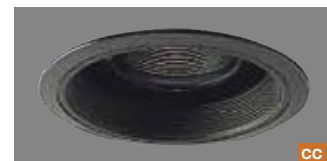

CC

CC Custom Combo: Available with custom combinations of trim and plastic or metal ring finish. See pages 38-39 for details.

NB No Bracket: Designated trims for floating socket or no bracket housings

SH Shallow: Designated trims for shallow housings

Eyeball w/ Stepped Baffle



Catalog No.	Description
NTM-38	Black Baffle / White Eyeball and Ring
NTM-39	White Baffle / White Eyeball and Ring

- 30° Adjustment
- Maximum Wattage
75W BR30/PAR30: NH-26Q; NH-26QNB; NHR-26Q; NHIC-17QNBAT; NHRIC-17QNBAT; NHIC-17/100DWQA; NHIC-17QAT; NHRIC-17QAT

Maximum Wattage
75W BR30/PAR30

OD: 8"

NB

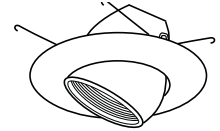

Eyeball Metal Trim



Catalog No.	Description
NT-28	White Eyeball / Metal Trim
NT-28B	Black Eyeball / Metal Trim
NT-28BZ	Bronze Eyeball / Metal Trim
NT-28CO	Copper Eyeball / Metal Trim
NT-28N	Natural Metal Eyeball / Metal Trim
NT-29C	Chrome Eyeball / Metal Trim
NT-29G	Gold Eyeball / Metal Trim

Maximum Wattage
75W BR30/PAR30

OD: 8"

NB

SH

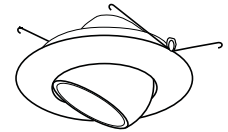

- UL® Classified for use with most manufacturers' housings
- Maximum Wattage
75W BR30/PAR30: NH-26Q; NHR-26Q; NH-26QNB; NH-27Q; NHR-27Q; NHIC-17/100DWQA; NHIC-17QAT; NHIC-17QNBAT; NHRIC-17QAT; NHRIC-17QNBAT; NHIC-27QAT; NHRIC-27QAT

PAR30 Open Gimbal



Catalog No.	Description
NTM-52B	Black Open Gimbal / Metal Ring
NTM-52BZ	Bronze Open Gimbal / Metal Ring
NTM-52C	Chrome Open Gimbal / Metal Ring
NTM-52CO	Copper Open Gimbal / Metal Ring
NTM-52G	Gold Open Gimbal / Metal Ring
NTM-52N	Natural Metal Open Gimbal / Metal Ring
NTM-52W	White Open Gimbal / Metal Ring

Maximum Wattage
75W PAR30

OD: 8"

NB

SH

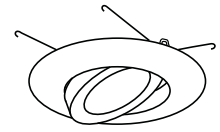

- 30° Adjustment
- Maximum Wattage
75W PAR30: NH-26Q; NH-26QNB; NHR-26Q; NHIC-27QAT; NHRIC-27QAT; NHIC-17/100DWQA; NH-27Q; NHR-27Q; NHIC-17QNBAT; NHRIC-17NBQAT;

BR40/PAR38 Open Gimbal



Catalog No.	Description
NTM-53B	Black Open Gimbal / Metal Ring
NTM-53BZ	Bronze Open Gimbal / Metal Ring
NTM-53C	Chrome Open Gimbal / Metal Ring
NTM-53CO	Copper Open Gimbal / Metal Ring
NTM-53G	Gold Open Gimbal / Metal Ring
NTM-53N	Natural Metal Open Gimbal / Metal Ring
NTM-53W	White Open Gimbal / Metal Ring

Maximum Wattage
See Description

OD: 8"

NB

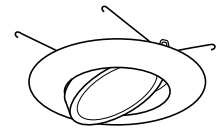

- 25° Adjustment
- Maximum Wattage
150W PAR38: NH-26Q; NH-26QNB; NHR-26Q
100W PAR38: NHIC-17/100DWQA; NH-26Q; NH-26QNB; NHR-26Q

NB No Bracket: Designated trims for floating socket or no bracket housings

SH Shallow: Designated trims for shallow housings

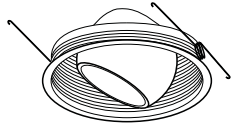

Maximum Wattage
75W BR30/PAR30

OD: 7"

NB
SH

Catalog No.	Description
NTM-48	White Regressed Eyeball / Black Phenolic Baffle / White Ring
NTM-48BB	Black Regressed Eyeball / Black Baffle / Black Ring
NTM-49	White Regressed Eyeball / White Phenolic Baffle / White Ring
NTM-49BZ	Bronze Regressed Eyeball / Bronze Baffle / Bronze Ring
NTM-49CO	Copper Regressed Eyeball / Copper Baffle / Copper Ring
NTM-49N	Natural Metal Regressed Eyeball / Natural Metal Baffle / Natural Metal Ring

- 35° Adjustment
- Maximum Wattage
75W BR30/PAR30: NH-26Q; NH-26QNB; NHR-26Q; NHIC-27QAT; NHRIC-27QAT; NHIC-17/100DWQA; NHIC-17QAT; NHRIC-17QAT; NH-27Q; NHR-27Q; NHIC-17QNBAT; NHRIC-17NBQAT

Regressed Eyeball with Baffle



CC

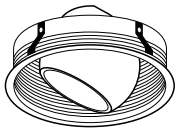

Maximum Wattage
75W BR30/PAR30

OD: 7"

NB
SH

Catalog No.	Description
NTM-50C	Chrome Regressed Eyeball / Black Baffle / White Plastic Ring
NTM-50G	Gold Regressed Eyeball / Black Baffle / White Plastic Ring

- 35° Adjustment
- Maximum Wattage
75W BR30/PAR30: NH-26Q; NH-26QNB; NHR-26Q; NHIC-27QAT; NHRIC-27QAT; NHIC-17/100DWQA; NHIC-17QAT; NHRIC-17QAT; NH-27Q; NHR-27Q; NHIC-17QNBAT; NHRIC-17NBQAT

Regressed Eyeball w/ Black Baffle



CC



Maximum Wattage
75W PAR30

OD: 7"

NB
SH

Catalog No.	Description
NTM-54B	Black Baffle / Adjustable Gimbal / White Plastic Ring
NTM-54BZ	Bronze Baffle / Adjustable Gimbal / Bronze Metal Ring
NTM-54CO	Copper Baffle / Adjustable Gimbal / Copper Metal Ring
NTM-54N	Natural Metal Baffle / Adjustable Gimbal / Natural Metal Ring
NTM-54W	White Baffle / Adjustable Gimbal / White Plastic Ring

- 30° Adjustment
- Maximum Wattage
75W PAR30: NH-26Q; NH-26QNB; NHR-26Q; NHIC-27QAT; NHRIC-27QAT; NHIC-17/100DWQA; NH-27Q; NHR-27Q; NHIC-17QAT; NHIC-17QNBAT; NHRIC-17QAT; NHRIC-17QNBAT

Baffle with Adjustable Gimbal

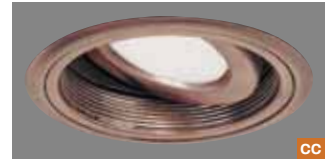

CC

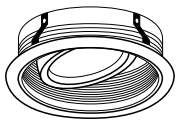

Maximum Wattage
See description

OD: 7"

NB

Catalog No.	Description
NTM-55B	Black Baffle / Adjustable Gimbal / White Plastic Ring
NTM-55BZ	Bronze Baffle / Adjustable Gimbal / Bronze Metal Ring
NTM-55CO	Copper Baffle / Adjustable Gimbal / Copper Metal Ring
NTM-55N	Natural Metal Baffle / Adjustable Gimbal / Natural Metal Ring
NTM-55W	White Baffle / Adjustable Gimbal / White Plastic Ring

- 20° Adjustment
- Maximum Wattage
150W PAR38: NH-26Q; NH-26QNB; NHR-26Q
100W PAR38: NHIC-17/100DWQA; NH-26Q; NH-26QNB; NHR-26Q

Baffle with Adjustable Gimbal

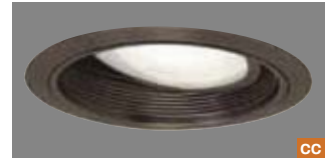

CC

CC Custom Combo: Available with custom combinations of trim and plastic or metal ring finish. See pages 38-39 for details.

NB No Bracket: Designated trims for floating socket or no bracket housings

SH Shallow: Designated trims for shallow housings

Reflector with Adjustable Gimbal

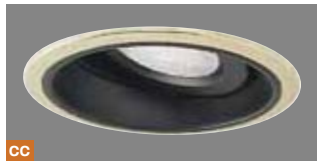

CC

Catalog No.	Description
NTM-56B	Black Adjustable Gimbal / Spec Black Refl / White Plastic Ring
NTM-56BG	Black Adjustable Gimbal / Spec Gold Refl / White Plastic Ring
NTM-56C	Chrome Adjustable Gimbal / Spec Clear Refl / White Plastic Ring
NTM-56G	Gold Adjustable Gimbal / Spec Gold Refl / White Plastic Ring
NTM-56W	White Adjustable Gimbal / Spec White Refl / White Plastic Ring

- 20° Adjustment
- Maximum Wattage
75W PAR30: NH-26Q; NH-26QNB; NHR-26Q; NHIC-27QAT; NHRIC-27QAT; NHIC-17/100DWQA; NH-27Q; NHR-27Q; NHIC-17QAT; NHIC-17QNBAT; NHRIC-17QAT; NHRIC-17NBQAT

Maximum Wattage
75W PAR30

OD: 7"

NB
SH

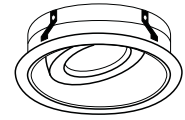

Reflector with Adjustable Gimbal

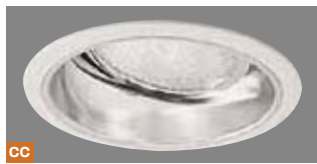

CC

Catalog No.	Description
NTM-57B	Adjustable Gimbal / Spec Black Refl / White Plastic Ring
NTM-57C	Adjustable Gimbal / Spec Clear Refl / White Plastic Ring
NTM-57G	Adjustable Gimbal / Spec Gold Refl / White Plastic Ring
NTM-57W	Adjustable Gimbal / Spec White Refl / White Plastic Ring

- 20° Adjustment
- Maximum Wattage
150W PAR38: NH-26Q; NH-26QNB; NHR-26Q
100W PAR38: NHIC-17/100DWQA; NH-26Q; NH-26QNB; NHR-26Q

Maximum Wattage
See description

OD: 7"

NB

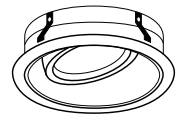

Reflector with Regressed Eyeball



CC

Catalog No.	Description
NTS-49B	Spec Black Refl / Black Regress Eyeball / White Plastic Ring
NTS-49C	Spec Clear Refl / Chrome Regress Eyeball / White Plastic Ring
NTS-49G	Spec Gold Refl / Gold Regress Eyeball / White Plastic Ring
NTS-49W	Spec White Refl / White Regress Eyeball / White Plastic Ring

- 20° Adjustment
- Maximum Wattage
75W BR30/PAR30: NH-26Q; NH-26QNB; NHR-26Q; NH-27Q; NHR-27Q; NHIC-27QAT; NHRIC-27QAT; NHIC-17QNBAT; NHRIC-17QNBAT; NHIC-17/100DWQA

Maximum Wattage
75W BR30/PAR30

OD: 7"

NB
SH

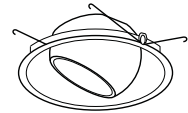

Baffle Regressed Eyeball



CC

Catalog No.	Description
NTM-628B	Black Baffle / White Regressed Eyeball / White Plastic Ring
NTM-628W	White Baffle / White Regressed Eyeball / White Plastic Ring

- 20° Adjustment
- Maximum Wattage
50W R20/PAR20: NH-26Q; NH-26QNB; NHR-26Q; NHIC-27QAT; NHRIC-27QAT; NHIC-17/100DWQA; NH-27Q; NHR-27Q; NHIC-17QAT; NHIC-17QNBAT; NHRIC-17QAT; NHRIC-17QNBAT

Maximum Wattage
See Description

OD: 7"

NB
SH

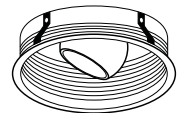

Surface Round Spot



Catalog No.	Description
NL-665	Black Adjustable Round Spot
NL-665BZ	Bronze Adjustable Round Spot
NL-665C	Chrome Adjustable Round Spot
NL-665CO	Copper Adjustable Round Spot
NL-665G	Gold Adjustable Round Spot
NL-665N	Natural Metal Adjustable Round Spot
NL-665W	White Adjustable Round Spot

- Downlight or 45° Adjustable
- Maximum Wattage
50W PAR16: NH-26Q; NH-26QNB; NHR-26Q; NH-27Q; NHR-27Q; NHIC-17/100DWQA; NHIC-17QAT; NHIC-17QNBAT; NHRIC-17QAT; NHRIC-17QNBAT; NHIC-27QAT; NHRIC-27QAT

Maximum Wattage
50W PAR16

OD: 7"

NB
SH



CC Custom Combo: Available with custom combinations of trim and plastic or metal ring finish. See pages 38-39 for details.

NB No Bracket: Designated trims for floating socket or no bracket housings

SH Shallow: Designated trims for shallow housings



Maximum Wattage
50W PAR16

OD: 7"

NB
SH

Catalog No.	Description
NL-670B	Black Baffle / Black Plastic Trim
NL-670BZ	Bronze Baffle / Bronze Metal Trim
NL-670CO	Copper Baffle / Copper Metal Trim
NL-670N	Natural Metal Baffle / Natural Metal Trim
NL-670W	White Baffle / White Plastic Trim

- Downlight or 35° Adjustable
- Maximum Wattage
50W PAR16: NH-26Q; NH-26QNB; NHR-26Q; NH-27Q; NHR-27Q;
NHIC-17/100DWQA; NHIC-17QAT; NHIC-17QNBAT; NHRIC-17QAT;
NHRIC-17QNBAT; NHIC-27QAT; NHRIC-27QAT

Baffle with Spot Cylinder

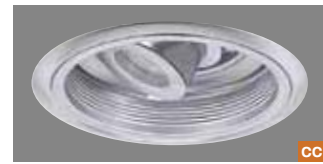

CC



Maximum Wattage
See description

OD: 8"

SH

Catalog No.	Description
NT-25	White Wall Wash / Metal Trim
NT-25B	Black Wall Wash / Metal Trim

- Maximum Wattage
60W A19: NH-26Q; NHR-26Q; NHIC-17/100DWQA; NH-27Q; NHR-27Q
40W A19: NHIC-17QAT; NHRIC-17QAT; NHIC-27QAT; NHRIC-27QAT

Wall Wash with Metal Trim

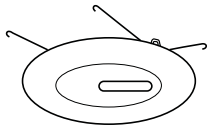

Maximum Wattage
See description

OD: 8"

SH

Catalog No.	Description
NT-51	White Slot Aperture
NT-51B	Black Slot Aperture
NT-51BZ	Bronze Slot Aperture
NT-51CO	Copper Slot Aperture

- Maximum Wattage
60W A19: NH-26Q; NHR-26Q; NHIC-17/100DWQA; NH-27Q; NHR-27Q
40W A19: NHIC-17QAT; NHRIC-17QAT; NHIC-27QAT; NHRIC-27QAT

Slot Aperture

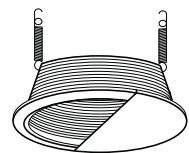

Maximum Wattage
See description

OD: 8"

SH

Catalog No.	Description
NT-45	Wall Wash / Black Baffle / White Eyelid and Ring
NT-46	Wall Wash / White Baffle / White Eyelid and Ring

- Maximum Wattage
75W BR30/PAR30: NH-26Q; NHR-26Q; NH-27Q; NHR-27Q;
NHIC-17/100DWQA; NHIC-17QAT; NHRIC-17QAT; NHIC-27QAT;
NHRIC-27QAT

Baffle Wall Wash

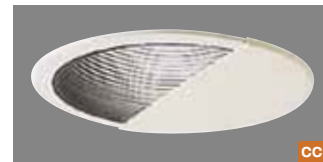

CC

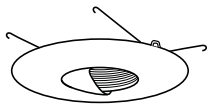

Maximum Wattage
50W R20/PAR20

OD: 7"

SH

Catalog No.	Description
NT-648B	Wall Wash with Black Baffle
NT-648W	Wall Wash with White Baffle

- Maximum Wattage
50W R20/PAR20: NH-26Q; NHR-26Q; NH-27Q; NHR-27Q;
NHIC-17/100DWQA; NHIC-27QAT; NHRIC-27QAT; NHIC-17QAT;
NHRIC-17QAT

Wall Wash Baffle

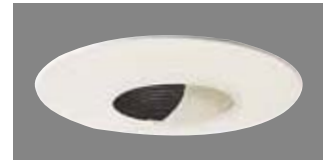

Maximum Wattage
50W R20/PAR20

OD: 7"

SH

Catalog No.	Description
NT-650	Wall Wash / Specular White Reflector with Metal Trim

- Maximum Wattage
50W R20/PAR20: NH-26Q; NHR-26Q; NH-27Q; NHR-27Q;
NHIC-17/100DWQA; NHIC-27QAT; NHRIC-27QAT; NHIC-17QAT;
NHRIC-17QAT

Wall Wash Reflector Metal Trim



CC Custom Combo: Available with custom combinations of trim and plastic or metal ring finish. See pages 38-39 for details.

NB No Bracket: Designated trims for floating socket or no bracket housings

SH Shallow: Designated trims for shallow housings

Wall Wash Cone Reflector



Catalog No.	Description
NTA-86	Specular Gold Cone Refl / White Wall Wash / White Ring
NTA-87	Specular Clear Cone Refl / White Wall Wash / White Ring
NTA-88	Black Cone Refl / White Wall Wash / White Ring
NTA-88BZ	Bronze Cone Refl / Bronze Wall Wash / Bronze Ring
NTA-88CO	Copper Cone Refl / Copper Wall Wash/ Copper Ring
NTA-88N	Natural Metal Cone Refl / N Metal Wall Wash / N Metal Ring
NTA-89	Specular White Cone Refl / White Wall Wash / White Ring

Maximum Wattage

See description

OD: 7"



- Maximum Wattage
100W A19: NH-26Q; NHR-26Q; NHIC-17/100DWQA
60W A19: NHIC-17QAT; NHRIC-17QAT; NH-26Q; NHR-26Q

Wall Wash Baffle Cone Reflector



Catalog No.	Description
NTA-103B	Specular Clear Reflector Wall Wash / Black Baffle / White Plastic Ring
NTA-103BZ	Specular Spec Clear Reflector Wall Wash / Bronze Baffle / Bronze Metal Ring
NTA-103CO	Specular Clear Reflector Wall Wash / Copper Baffle / Copper Metal Ring
NTA-103N	Specular Clear Reflector Wall Wash / Natural Metal Baffle / Natural Metal Ring
NTA-103W	Specular Clear Reflector Wall Wash / White Baffle / White Plastic Ring

Maximum Wattage

See description

OD: 7"

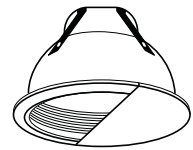

- Maximum Wattage
100W A19: NH-26Q; NHR-26Q; NHIC-17/100DWQA
60W A19: NHIC-17QAT; NHRIC-17QAT; NH-26Q; NHR-26Q

Reflector Wall Wash



Catalog No.	Description
NTS-35B	Wall Wash / Specular Black Refl / White Eyelid & Ring
NTS-35C	Wall Wash / Specular Clear Refl / White Eyelid & Ring
NTS-35G	Wall Wash / Specular Gold Refl / White Eyelid & Ring
NTS-35W	Wall Wash / Specular White Refl / White Eyelid & Ring

Maximum Wattage

75W BR30/PAR30

OD: 7"

SH

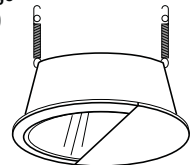

- Maximum Wattage
75W BR30/PAR30: NH-26Q; NHR-26Q; NHIC-27QAT; NHRIC-27QAT; NHIC-17/100DWQA; NH-27Q; NHR-27Q; NHIC-17QAT; NHRIC-17QAT

Lensless Shower Trim

NEW!



Catalog No.	Description
NTM-726B	Black Air-Tight Baffle / Lensless Shower / White Flange
NTM-726BZ	Bronze Air-Tight Baffle / Lensless Shower / Bronze Flange
NTM-726CO	Copper Air-Tight Baffle / Lensless Shower / Copper Flange
NTM-726N	Natural Metal Air-Tight Baffle / Lensless Shower / Natural Metal Flange
NTM-726W	White Air-Tight Baffle / Lensless Shower / White Flange

Maximum Wattage

See description

OD: 7"

WET

NB

AIR TIGHT

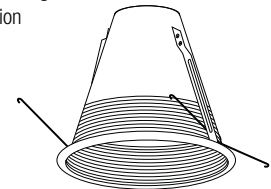

- UL Wet Listed
- Cone includes water tight gasket
- Maximum Wattage
150W PAR38: NH-26Q; NH-26QNB; NHR-26Q; NHIC-17/100DWQA
100W PAR38: NHIC-17QAT; NHRIC-17QAT; NHIC-17QNBAT; NHRIC-17NBQAT; NH-26Q; NH-26QNB; NHR-26Q; NHIC-17/100DWQA;
75W PAR30: NHIC-17QAT; NHRIC-17QAT; NHIC-17QNBAT; NHRIC-17NBQAT; NH-26Q; NH-26QNB; NHR-26Q; NHIC-17/100DWQA

Lighting Tip:

Use new Lensless Wet Label Trims in shower and outdoor applications. The open PAR lamp will not collect bugs and makes lamp replacement simple. Available in 6", 5" & 4".

NB No Bracket: Designated trims for floating socket or no bracket housings

SH Shallow: Designated trims for shallow housings

Lighting Tip:

Nora's lensed trims with full cone reflectors are more efficient and produce more usable light.

6" LINE VOLTAGE IC & NON-IC RATED TRIMS continued

Maximum Wattage
See description

OD: 8"

WET

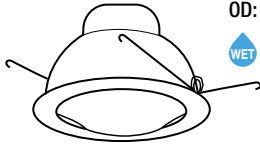

Catalog No.	Description
NTS-25	Frosted Dome Lens / Specular Clear Refl / White Trim
NTS-25B	Frosted Dome Lens / Specular Clear Refl / Black Trim
NTS-25BZ	Frosted Dome Lens / Specular Clear Refl / Bronze Trim
NTS-25C	Frosted Dome Lens / Specular Clear Refl / Chrome Trim
NTS-25CO	Frosted Dome Lens / Specular Clear Refl / Copper Trim
NTS-25G	Frosted Dome Lens / Specular Clear Refl / Gold Trim
NTS-25N	Frosted Dome Lens / Specular Clear Reflector / Natural Metal Trim

Frosted Dome Lens with Reflector



- UL Wet Listed
- Cone reflector for maximum output
- Maximum Wattage
60W A19: NHIC-17/100DWQA; NH-26Q; NHR-26Q
40W A19: NHIC-17QAT; NHRIC-17QAT; NH-26Q; NHR-26Q

Maximum Wattage
See description

OD: 8"

WET

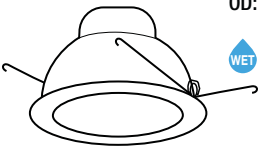

Catalog No.	Description
NTS-26	Frosted Flat Lens / Specular Clear Refl / White Trim
NTS-26B	Frosted Flat Lens / Specular Clear Refl / Black Trim
NTS-26BZ	Frosted Flat Lens / Specular Clear Refl / Bronze Trim
NTS-26C	Frosted Flat Lens / Specular Clear Refl / Chrome Trim
NTS-26CO	Frosted Flat Lens / Specular Clear Refl / Copper Trim
NTS-26G	Frosted Flat Lens / Specular Clear Refl / Gold Trim
NTS-26N	Frosted Flat Lens / Specular Clear Reflector / Natural Metal Trim

Frosted Flat Lens with Reflector



- UL Wet Listed
- Cone reflector for maximum output
- Maximum Wattage
60W A19: NHIC-17/100DWQA; NH-26Q; NHR-26Q
40W A19: NHIC-17QAT; NHRIC-17QAT; NH-26Q; NHR-26Q

Maximum Wattage
See description

OD: 8"

WET

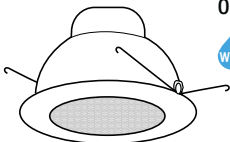

Catalog No.	Description
NTS-22	Albalite Lens / Specular Clear Reflector / White Trim
NTS-22B	Albalite Lens / Specular Clear Reflector / Black Trim
NTS-22BZ	Albalite Lens / Specular Clear Reflector / Bronze Trim
NTS-22C	Albalite Lens / Specular Clear Reflector / Chrome Trim
NTS-22CO	Albalite Lens / Specular Clear Reflector / Copper Trim
NTS-22G	Albalite Lens / Specular Clear Reflector / Gold Trim
NTS-22N	Albalite Lens / Specular Clear Refl / Natural Metal Trim

Albalite Lens with Reflector



- UL Wet Listed
- Cone reflector for maximum output
- Maximum Wattage
60W A19: NHIC-17/100DWQA; NH-26Q; NHR-26Q
40W A19: NHIC-17QAT; NHRIC-17QAT; NH-26Q; NHR-26Q

Maximum Wattage
See description

OD: 7"

WET

SH

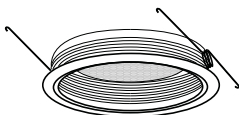

Catalog No.	Description
NTM-42	Regressed Albalite Lens / Black Baffle / White Plastic Ring
NTM-42BZ	Regressed Albalite Lens / Bronze Baffle / Bronze Metal Ring
NTM-42CO	Regressed Albalite Lens / Copper Baffle / Copper Metal Ring
NTM-42N	Regressed Albalite Lens / N Metal Baffle / N Metal Ring
NTM-42W	Regressed Albalite Lens / White Baffle / White Plastic Ring

Regressed Albalite Lens with Baffle

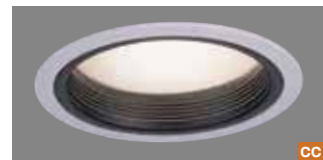

- UL Wet Listed
- Maximum Wattage
60W A19: NH-26Q; NHR-26Q; NHIC-17/100DWQA
40W A19: NHIC-17QAT; NHRIC-17QAT; NHIC-27QAT; NHRIC-27QAT; NH-27Q; NHR-27Q

CC Custom Combo: Available with custom combinations of trim and plastic or metal ring finish. See pages 38-39 for details.

SH Shallow: Designated trims for shallow housings

Albalite Lens



Catalog No.	Description
NP-22	Albalite Lens / White Plastic Trim
•	UL Wet Listed
•	Maximum Wattage
60W A19:	NH-26Q; NHR-26Q; NHIC-17/100DWQA; NH-27Q; NHR-27Q
40W A19:	NHIC-17QAT; NHRIC-17QAT
25W A19:	NHIC-27QAT; NHRIC-27QAT

Maximum Wattage
See description

OD: 8"

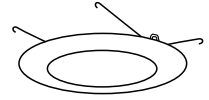

Albalite Lens with Metal Trim



Catalog No.	Description
NT-22	Albalite Lens / White Metal Trim
NT-22B	Albalite Lens / Black Metal Trim
NT-22BZ	Albalite Lens / Bronze Metal Trim
NT-22C	Albalite Lens / Chrome Metal Trim
NT-22CO	Albalite Lens / Copper Metal Trim
NT-22G	Albalite Lens / Gold Metal Trim
NT-22N	Albalite Lens / Natural Metal Trim
•	UL Wet Listed
•	UL® Classified for use with most manufacturers' housings
•	Maximum Wattage
60W A19:	NH-26Q; NHR-26Q; NHIC-17/100DWQA; NH-27Q; NHR-27Q
40W A19:	NHIC-17QAT; NHRIC-17QAT
25W A19:	NHIC-27QAT; NHRIC-27QAT

Maximum Wattage
See description

OD: 8"



Albalite Lens Designer Metal Trim



Catalog No.	Description
NT-622B	2" Dia. Albalite Lens / Black Designer Metal Trim
NT-622C	2" Dia. Albalite Lens / Chrome Designer Metal Trim
NT-622G	2" Dia. Albalite Lens / Gold Designer Metal Trim
NT-622W	2" Dia. Albalite Lens / White Designer Metal Trim
•	UL Wet Listed
•	Maximum Wattage
60W A19:	NH-26Q; NHR-26Q; NHIC-17/100DWQA
40W A19:	NHIC-17QAT; NHRIC-17QAT; NH-27Q; NHR-27Q
25W A19:	NHIC-27QAT; NHRIC-27QAT

Maximum Wattage
See description

OD: 8"

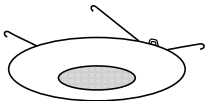

Albalite Lens with Bracket



Catalog No.	Description
NP-322	Albalite Lens / White Plastic Trim with Bracket
•	UL Wet Listed
•	Maximum Wattage
60W A19:	NH-26Q; NH-26QNB; NHR-26Q; NHIC-17/100DWQA
40W A19:	NHIC-17QAT; NHRIC-17QAT; NHIC-17QNBAT; NHRIC-17QNBAT

Maximum Wattage
See description

OD: 8"

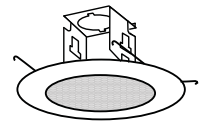

Albalite Lens with Bracket



Catalog No.	Description
NTM-322B	Albalite Lens / Black Trim with Bracket
NTM-322BZ	Albalite Lens / Bronze Trim with Bracket
NTM-322C	Albalite Lens / Chrome Trim with Bracket
NTM-322CO	Albalite Lens / Copper Trim with Bracket
NTM-322G	Albalite Lens / Gold Trim with Bracket
NTM-322N	Albalite Lens / Natural Metal Trim with Bracket
NTM-322W	Albalite Lens / White Trim with Bracket
•	UL Wet Listed
•	Maximum Wattage
60W A19:	NH-26Q; NH-26QNB; NHR-26Q; NHIC-17/100DWQA
40W A19:	NHIC-17QAT; NHRIC-17QAT; NHIC-17QNBAT; NHRIC-17QNBAT

Maximum Wattage
See description

OD: 8"

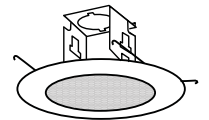

NB No Bracket: Designated trims for floating socket or no bracket housings

SH Shallow: Designated trims for shallow housings

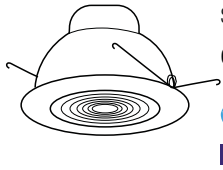

Maximum Wattage
See description

OD: 8"



Catalog No.	Description
NTS-23	Fresnel Lens / Specular Clear Reflector / White Trim
NTS-23B	Fresnel Lens / Specular Clear Reflector / Black Trim
NTS-23BZ	Fresnel Lens / Specular Clear Reflector / Bronze Trim
NTS-23C	Fresnel Lens / Specular Clear Reflector / Chrome Trim
NTS-23CO	Fresnel Lens / Specular Clear Reflector / Copper Trim
NTS-23G	Fresnel Lens / Specular Clear Reflector / Gold Trim
NTS-23N	Fresnel Lens / Specular Clear Refl / Natural Metal Trim

Fresnel Lens with Reflector



- UL Wet Listed
- Cone reflector for maximum output
- Maximum Wattage
60W A19: NHIC-17/100DWQA; NH-26Q; NHR-26Q
40W A19: NHIC-17QAT; NHRIC-17QAT; NH-26Q; NHR-26Q

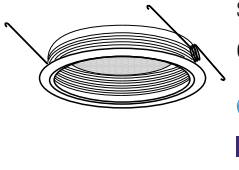

Maximum Wattage
See description

OD: 7"



Catalog No.	Description
NTM-43	Regressed Fresnel Lens / Black Baffle / White Plastic Ring
NTM-43BZ	Regressed Fresnel Lens / Bronze Baffle / Bronze Metal Ring
NTM-43CO	Regressed Fresnel Lens / Copper Baffle / Copper Metal Ring
NTM-43N	Regressed Fresnel Lens / N Metal Baffle / N Metal Ring
NTM-43W	Regressed Fresnel Lens / White Baffle / White Plastic Ring

Regressed Fresnel Lens with Baffle

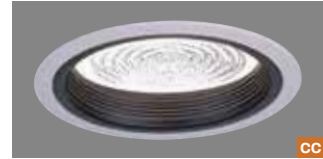

- UL Wet Listed
- Maximum Wattage
60W A19: NH-26Q; NHR-26Q; NHIC-17/100DWQA
40W A19: NHIC-17QAT; NHRIC-17QAT; NHIC-27QAT; NHRIC-27QAT;
NH-27Q; NHR-27Q

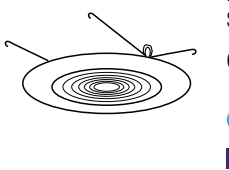

Maximum Wattage
See description

OD: 8"



Catalog No.	Description
NP-23	Fresnel Lens / White Plastic Trim

- UL Wet Listed
- Maximum Wattage
60W A19: NH-26Q; NHR-26Q; NHIC-17/100DWQA; NH-27Q; NHR-27Q
40W A19: NHIC-17QAT; NHRIC-17QAT
25W A19: NHIC-27QAT; NHRIC-27QAT

Fresnel Lens

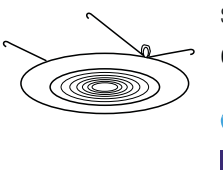

Maximum Wattage
See description

OD: 8"



Catalog No.	Description
NT-23	Fresnel Lens / White Metal Trim
NT-23B	Fresnel Lens / Black Metal Trim
NT-23BZ	Fresnel Lens / Bronze Metal Trim
NT-23C	Fresnel Lens / Chrome Metal Trim
NT-23CO	Fresnel Lens / Copper Metal Trim
NT-23G	Fresnel Lens / Gold Metal Trim
NT-23N	Fresnel Lens / Natural Metal Metal Trim

Fresnel Lens with Metal Trim



- UL Wet Listed
- Maximum Wattage
60W A19: NH-26Q; NHR-26Q; NHIC-17/100DWQA; NH-27Q; NHR-27Q
40W A19: NHIC-17QAT; NHRIC-17QAT
25W A19: NHIC-27QAT; NHRIC-27QAT

CC Custom Combo: Available with custom combinations of trim and plastic or metal ring finish. See pages 38-39 for details.

SH Shallow: Designated trims for shallow housings

Fresnel Lens with Bracket



Catalog No. **Description**
NP-323 Fresnel Lens / White Plastic Trim with Bracket

- UL Wet Listed
- Maximum Wattage
 60W A19: NH-26Q; NH-26QNB; NHR-26Q; NHIC-17/100DWQA
 40W A19: NHIC-17QAT; NHRIC-17QAT; NHIC-17QNBAT; NHRIC-17QNBAT

Maximum Wattage
 See description

OD: 8"





Fresnel Lens with Bracket



Catalog No. **Description**
NTM-323B Fresnel Lens / Black Trim with Bracket
NTM-323BZ Fresnel Lens / Bronze Trim with Bracket
NTM-323C Fresnel Lens / Chrome Trim with Bracket
NTM-323CO Fresnel Lens / Copper Trim with Bracket
NTM-323G Fresnel Lens / Gold Trim with Bracket
NTM-323N Fresnel Lens / Natural Metal Trim with Bracket
NTM-323W Fresnel Lens / White Trim with Bracket

- UL Wet Listed
- Maximum Wattage
 60W A19: NH-26Q; NH-26QNB; NHR-26Q; NHIC-17/100DWQA
 40W A19: NHIC-17QAT; NHRIC-17QAT; NHIC-17QNBAT; NHRIC-17QNBAT

Maximum Wattage
 See description

OD: 7"



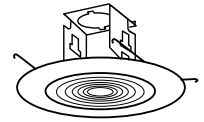

Drop Opal Lens with Reflector



Catalog No. **Description**
NTS-24 Drop Opal Lens / Specular Clear Reflector / White Trim
NTS-24B Drop Opal Lens / Specular Clear Reflector / Black Trim
NTS-24BZ Drop Opal Lens / Specular Clear Reflector / Bronze Trim
NTS-24C Drop Opal Lens / Specular Clear Reflector / Chrome Trim
NTS-24CO Drop Opal Lens / Specular Clear Reflector / Copper Trim
NTS-24G Drop Opal Lens / Specular Clear Reflector / Gold Trim
NTS-24N Drop Opal Lens / Specular Clear Refl / Natural Metal Trim

- UL Wet Listed
- Cone reflector for maximum output
- Maximum Wattage
 60W A19: NHIC-17/100DWQA; NH-26Q; NHR-26Q
 40W A19: NHIC-17QAT; NHRIC-17QAT; NH-26Q; NHR-26Q

Maximum Wattage
 See description

OD: 8"

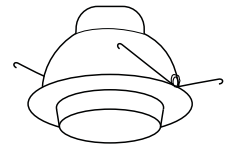
Regressed Drop Opal Lens w/Baffle



Catalog No. **Description**
NTM-46BZ Regressed Drop Opal Lens / Bronze Baffle / Bronze Metal Ring
NTM-46CO Regressed Drop Opal Lens / Copper Baffle / Copper Metal Ring
NTM-46M Regressed Drop Opal Lens / Black Baffle / White Plastic Ring
NTM-46N Regressed Drop Opal Lens / Natural Metal Baffle / N Metal Ring
NTM-46W Regressed Drop Opal Lens / White Baffle / White Plastic Ring

- UL Wet Listed
- Maximum Wattage
 60W A19: NH-26Q; NHR-26Q; NHIC-17/100DWQA
 40W A19: NHIC-17QAT; NHRIC-17QAT; NHIC-27QAT; NHRIC-27QAT; NH-27Q; NHR-27Q

Maximum Wattage
 See description

OD: 7"



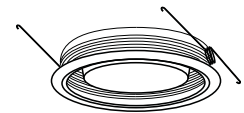

Drop Opal Lens



Catalog No. **Description**
NP-24 Drop Opal Lens / White Plastic Trim
NP-24/PC Drop Opal Polycarbonate Lens / White Plastic Trim

- UL Wet Listed
- Maximum Wattage
 60W A19: NH-26Q; NHR-26Q; NHIC-17/100DWQA; NH-27Q; NHR-27Q
 40W A19: NHIC-17QAT; NHRIC-17QAT
 25W A19: NHIC-27QAT; NHRIC-27QAT

Maximum Wattage
 See description

OD: 8"



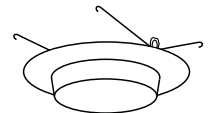

CC Custom Combo: Available with custom combinations of trim and plastic or metal ring finish. See pages 38-39 for details.

NB No Bracket: Designated trims for floating socket or no bracket housings

SH Shallow: Designated trims for shallow housings

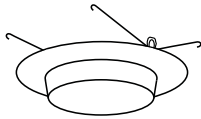

Maximum Wattage
See description

OD: 8"



Catalog No.	Description
NT-24	Drop Opal Lens / White Metal Trim
NT-24B	Drop Opal Lens / Black Metal Trim
NT-24BZ	Drop Opal Lens / Bronze Metal Trim
NT-24C	Drop Opal Lens / Chrome Metal Trim
NT-24CO	Drop Opal Lens / Copper Metal Trim
NT-24G	Drop Opal Lens / Gold Metal Trim
NT-24N	Drop Opal Lens / Natural Metal Trim

- UL Wet Listed
- Maximum Wattage
60W A19: NH-26Q; NHR-26Q; NHIC-17/100DWQA; NH-27Q; NHR-27Q
40W A19: NHIC-17QAT; NHRIC-17QAT
25W A19: NHIC-27QAT; NHRIC-27QAT

Drop Opal Lens with Metal Trim

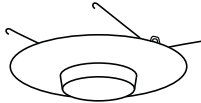

Maximum Wattage
See description

OD: 8"



Catalog No.	Description
NT-624B	2" Dia. Drop Opal Lens / Black Designer Metal Trim
NT-624C	2" Dia. Drop Opal Lens / Chrome Designer Metal Trim
NT-624G	2" Dia. Drop Opal Lens / Gold Designer Metal Trim
NT-624W	2" Dia. Drop Opal Lens / White Designer Metal Trim

- UL Wet Listed
- Maximum Wattage
60W A19: NH-26Q; NHR-26Q; NHIC-17/100DWQA
40W A19: NHIC-17QAT; NHRIC-17QAT; NH-27Q; NHR-27Q
25W A19: NHIC-27QAT; NHRIC-27QAT

Drop Opal Designer Metal Trim

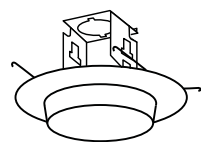

Maximum Wattage
See description

OD: 8"



Catalog No.	Description
NP-324	Drop Opal Lens / White Plastic Trim with Bracket

- UL Wet Listed
- Maximum Wattage
60W A19: NH-26Q; NH-26QNB; NHR-26Q; NHIC-17/100DWQA
40W A19: NHIC-17QAT; NHRIC-17QAT; NHIC-17QNBAT; NHRIC-17QNBAT

Drop Opal Lens with Bracket

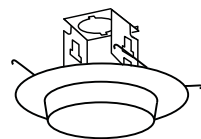

Maximum Wattage
See description

OD: 7"



Catalog No.	Description
NTM-324B	Drop Opal Lens / Black Trim with Bracket
NTM-324BZ	Drop Opal Lens / Bronze Trim with Bracket
NTM-324C	Drop Opal Lens / Chrome Trim with Bracket
NTM-324CO	Drop Opal Lens / Copper Trim with Bracket
NTM-324G	Drop Opal Lens / Gold Trim with Bracket
NTM-324N	Drop Opal Lens / Natural Metal Trim with Bracket
NTM-324W	Drop Opal Lens / White Trim with Bracket

- UL Wet Listed
- Maximum Wattage
60W A19: NH-26Q; NH-26QNB; NHR-26Q; NHIC-17/100DWQA
40W A19: NHIC-17QAT; NHRIC-17QAT; NHIC-17QNBAT; NHRIC-17QNBAT

Drop Opal Lens with Bracket



NB No Bracket: Designated trims for floating socket or no bracket housings

SH Shallow: Designated trims for shallow housings

Reflector for Decorative Glass

NEW!



Catalog No.	Description
NTA-638BZ	Specular Clear Reflector / Bronze Trim
NTA-638C	Specular Clear Reflector / Chrome Trim
NTA-638N	Specular Clear Reflector / Natural Metal Trim
NTA-638W	Specular Clear Reflector / White Trim

- **Glass sold separately.**
- For a layered look, up to two pieces of glass may be used together.
- Maximum Wattage
 100W A19: NH-26Q; NHR-26Q; NHIC-17/100DWQA; NHIC-17QAT; NHRIC-17QAT; NH-26Q; NHR-26Q
 60W A19: NHIC-17QAT; NHRIC-17QAT; NH-26Q; NHR-26Q

Maximum Wattage
See description

OD: 8"

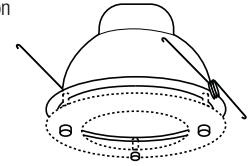

Decorative Glass for NTA-638

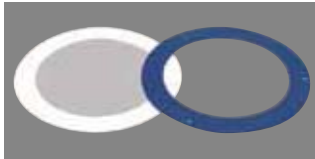

Catalog No.	Description
NTG-6B/120	Tempered Blue / 120mm (4-3/4") Open Center
NTG-6B/80	Tempered Blue / 80mm (3-1/8") Open Center
NTG-6CF	Tempered Frost Center / Clear Outer
NTG-6FC	Tempered Clear Center / Frost Outer
NTG-6HC	Tempered Clear Outer / Frost Inner / 80mm (3-1/8") Open Center

- **Includes NRA-203 Glass Hardware**
- 2 decorative glasses can be combined for a tiered look

Includes:

- NRA-203 Glass Hardware
- (3) Stand-offs
- (3) Cone End Caps
- (3) Flat End Caps



OD: 7"

BR/PAR30 Open Metal Trim



Catalog No.	Description
NT-30	White Open / Metal Trim
NT-30BZ	Bronze Open / Metal Trim
NT-30CO	Copper Open / Metal Trim
NT-30N	Natural Metal Open / Metal Trim
NT-31	Gold Open / Metal Trim
NT-32	Chrome Open / Metal Trim
NT-33	Black Open / Metal Trim

- Maximum Wattage
 75W BR30/PAR30: NH-26Q; NHR-26Q; NH-27Q; NHR-27Q; NHIC-17/100DWQA; NHIC-17QAT; NHRIC-17QAT; NHIC-27QAT; NHRIC-27QAT

Maximum Wattage
75W BR30/PAR30

OD: 7"

SH

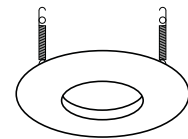

BR/PAR30 Open Trim with Bracket

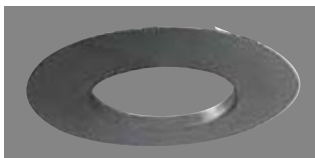

Catalog No.	Description
NTM-300B	Black Open Trim with Bracket
NTM-300BZ	Bronze Open Trim with Bracket
NTM-300CO	Copper Open Trim with Bracket
NTM-300N	Natural Metal Open Trim with Bracket
NTM-300W	White Open Trim with Bracket

- Maximum Wattage
 75W BR30/PAR30: NH-26Q; NHR-26Q; NHIC-17/100DWQA; NHIC-17QAT; NHRIC-17QAT; NHIC-17QNBAT; NHRIC-17NBQAT; NH-26QNB; NHR-26QNB

Maximum Wattage
75W BR30/PAR30

OD: 7"

NB

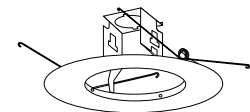

NB No Bracket: Designated trims for floating socket or no bracket housings

SH Shallow: Designated trims for shallow housings

OPEN TRIMS

6" LINE VOLTAGE IC & NON-IC RATED TRIMS continued

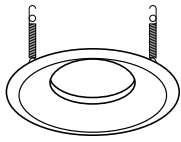

Maximum Wattage
See description

OD: 8"

SH

Catalog No.	Description
NT-30D	White Splay Metal Trim
NT-30DBZ	Bronze Splay Metal Trim
NT-30DCO	Copper Splay Metal Trim
NT-30DN	Natural Metal Splay Metal Trim
NT-33D	Black Splay Metal Trim

- Maximum Wattage
75W BR30/PAR30: NH-26Q; NHR-26Q; NH-27Q; NHR-27Q;
NHIC-17/100DWQA; NHIC-17QAT; NHRIC-17QAT; NHIC-27QAT;
NHRIC-27QAT

BR/PAR30 Splay Metal Trim

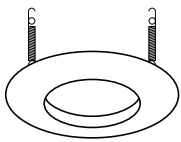

Maximum Wattage
See description

OD: 8"

SH

Catalog No.	Description
NT-40	White Open Metal Trim
NT-40N	Natural Open Metal Trim
NT-41	Gold Open Metal Trim
NT-42	Chrome Open Metal Trim
NT-43	Black Open Metal Trim

- Maximum Wattage
150W BR40/PAR38: NH-26Q; NHR-26Q; NH-27Q; NHR-27Q
100W BR40/PAR38: NHIC-17/100DWQA

BR40/PAR38 Open Metal Trim

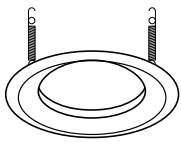

Maximum Wattage
See description

OD: 7-3/4"

SH

Catalog No.	Description
NT-40D	White Splay Metal Trim
NT-43D	Black Splay Metal Trim

- Maximum Wattage
150W BR40/PAR38: NH-26Q; NHR-26Q; NH-27Q; NHR-27Q
100W BR40/PAR38: NHIC-17/100DWQA

BR40/PAR38 Splay Metal Trim

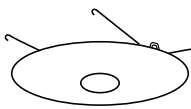

Maximum Wattage
See description

OD: 8"

SH

Catalog No.	Description
NT-50	1-3/4" White Metal Pinhole
NT-50B	1-3/4" Black Metal Pinhole
NT-50BZ	1-3/4" Bronze Metal Pinhole
NT-50CO	1-3/4" Copper Metal Pinhole
NT-50N	1-3/4" Natural Metal Pinhole

- Maximum Wattage
60W A19: NH-26Q; NHR-26Q; NHIC-17/100DWQA; NH-27Q; NHR-27Q
40W A19: NHIC-17QAT; NHRIC-17QAT; NHIC-27QAT; NHRIC-27QAT

Metal Pinhole

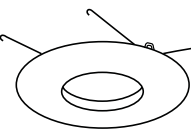

Maximum Wattage
See description

OD: 8"

SH

Catalog No.	Description
NT-620B	Black Designer Open Metal Trim
NT-620C	Chrome Designer Open Metal Trim
NT-620G	Gold Designer Open Metal Trim
NT-620W	White Designer Open Metal Trim

- Maximum Wattage
50W R20/PAR20: NH-26Q; NHR-26Q; NH-27Q; NHR-27Q;
NHIC-17QAT; NHRIC-17QAT; NHIC-27QAT; NHRIC-27QAT; NHIC-17/100DWQA

Designer Open Metal Trim



SH Shallow: Designated trims for shallow housings

LINE VOLTAGE RECESSED

5" IC New Construction Housing

Nora Lighting's recessed 5" housing improve the appearance of standard height ceilings with their reduced aperture. Available in IC and standard non-IC, Nora's 5" housings are easy and quick to install and accept a wide variety of high quality, attractive finishing trims.

Minimum Clearances: Direct contact rated; no minimum clearance is required.

Air-Tight: Air-tight gasket comes pre-installed.

Ceiling Thickness: Accepts 5/8" - 1-3/8" to accommodate various ceiling thicknesses.

Lamp Adjustment: Socket clips directly to back of trim for perfect 90 degrees vertical alignment of lamp socket. Socket is automatically positioned for optimum performance and lamp position consistency when socket is installed on trim or reflector.

Installation: Bar hangers are adjustable from 13-5/8" to 24-1/2" with captive nails and can be repositioned 90 degrees. Bar hangers are slotted for T-Bar installations.

Junction Box: Junction box is listed for through branch circuit wiring and contains seven 1/2" knockouts and four Romex® with strain relief.

Electrical: Quick connector provided.

Socket: Medium screw-in base

Listing:
 cULus Damp Location w/ Feed Through
 WSEC ASTM E283 for Air-Tight (AT)
 cULus Wet Location (Only with designated trims)

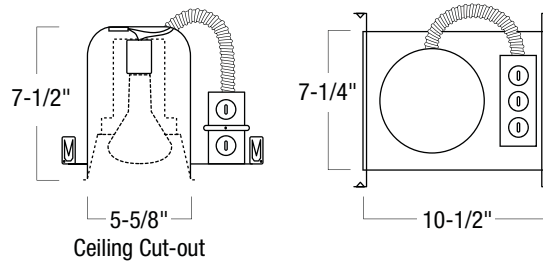

5" IC NEW CONSTRUCTION SERIES

CATALOG. NO.	TYPE	SOCKET	WATTAGE	AIR-TIGHT
NHIC-501QAT	IC	Floating (No Bracket), Medium Screw-in Base	75W	Yes

See page 379 for fire rated enclosure.



LINE VOLTAGE RECESSED 5" IC Remodel Housing



Nora Lighting's recessed 5" housing improve the appearance of standard height ceilings with their reduced aperture. Available in IC and standard non-IC, Nora's 5" housings are easy and quick to install and accept a wide variety of high quality, attractive finishing trims.

Minimum Clearances: Direct contact rated; no minimum clearance is required.

Air-Tight: Air-tight gasket comes pre-installed.

Ceiling Thickness: Accepts 3/8" - 1-3/8" to accommodate various ceiling thicknesses.

Lamp Adjustment: Socket clips directly to back of trim for perfect 90 degrees vertical alignment of lamp socket. Socket is automatically positioned for optimum performance and lamp position consistency when socket is installed on trim or reflector.

Installation: High tension tempered steel springs secure remodel housings evenly to ceiling; hole cutout template provided for convenience.

Junction Box: Junction box is listed for through branch circuit wiring and contains seven 1/2" knockouts and four Romex® with strain relief.

Electrical: Quick connector provided.

Socket: Medium screw-in base

Listing:
cULus Damp Location w/ Feed Through
WSEC ASTM E283 for Air-Tight (AT)
cULus Wet Location (Only with designated trims)

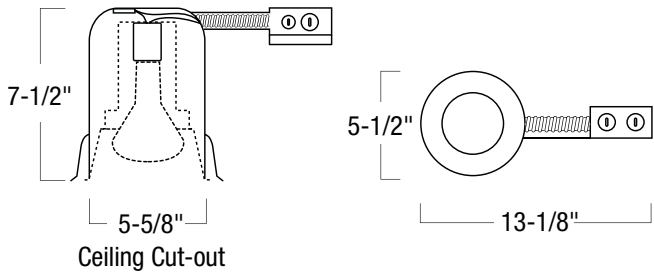

5" IC REMODEL SERIES

CATALOG. NO.	TYPE	SOCKET	AIR-TIGHT
NHRIC-504QAT	IC	Floating (No Bracket), Medium Screw-in Base	Yes



LINE VOLTAGE RECESSED

5" Non-IC New Construction Housing

Nora Lighting's recessed 5" housing improve the appearance of standard height ceilings with their reduced aperture. Available in IC and standard non-IC, Nora's 5" housings are easy and quick to install and accept a wide variety of high quality, attractive finishing trims.

Minimum Clearances: 3" from thermal insulation, 1/2" from adjacent building components.

Ceiling Thickness: Accepts 5/8" - 1-3/8" to accommodate various ceiling thicknesses.

Lamp Adjustment: Socket clips directly to back of trim for perfect 90 degrees vertical alignment of lamp socket. Socket is automatically positioned for optimum performance and lamp position consistency when socket is installed on trim or reflector.

Installation: Bar hangers are adjustable from 13-5/8" to 24-1/2" with captive nails and can be repositioned 90 degrees. Bar hangers are slotted for T-Bar installations.

Junction Box: Junction box is listed for through branch circuit wiring and contains seven 1/2" knockouts and four Romex® with strain relief.

Electrical: Quick connector provided.

Socket: Medium screw-in base

Listing:

cULus Damp Location w/ Feed Through
cULus Wet Location (Only with designated trims)

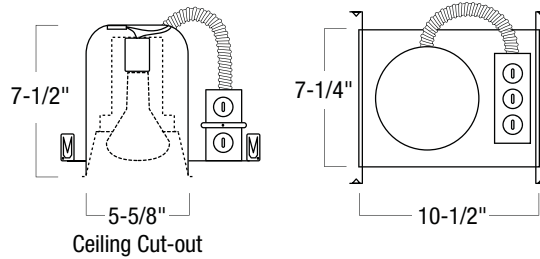

5" NON-IC NEW CONSTRUCTION SERIES

CATALOG. NO.	TYPE	SOCKET	WATTAGE	AIR-TIGHT
NH-501Q	Non-IC	Floating (No Bracket), Medium Screw-in Base	75W	No

See page 379 for fire rated enclosure.



LINE VOLTAGE RECESSED 5" Non-IC Remodel Housing



Nora Lighting's recessed 5" housing improve the appearance of standard height ceilings with their reduced aperture. Available in IC and standard non-IC, Nora's 5" housings are easy and quick to install and accept a wide variety of high quality, attractive finishing trims.

Minimum Clearances: 3" from thermal insulation, 1/2" from adjacent building components.

Ceiling Thickness: Accepts 3/8" - 1-3/8" to accommodate various ceiling thicknesses.

Lamp Adjustment: Socket clips directly to back of trim for perfect 90 degrees vertical alignment of lamp socket. Socket is automatically positioned for optimum performance and lamp position consistency when socket is installed on trim or reflector.

Installation: High tension tempered steel springs secure remodel housings evenly to ceiling; hole cutout template provided for convenience.

Junction Box: Junction box is listed for through branch circuit wiring and contains seven 1/2" knockouts and four Romex® with strain relief.

Electrical: Quick connector provided.

Socket: Medium screw-in base

Listing:
cULus Damp Location w/ Feed Through
cULus Wet Location (Only with designated trims)

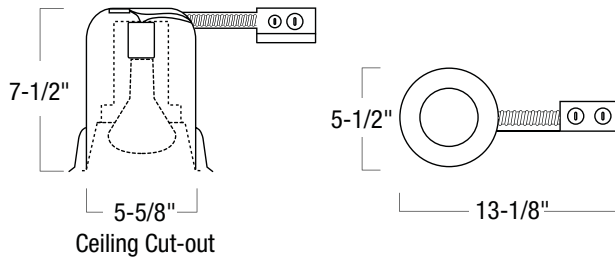

5" NON-IC REMODEL SERIES

CATALOG. NO.	TYPE	SOCKET	AIR-TIGHT
NHR-504Q	Non-IC	Floating (No Bracket), Medium Screw-in Base	No



LINE VOLTAGE RECESSED 5" IC Shallow Housing

Nora Lighting's universal recessed housing is the base standard for line voltage recessed fixtures. Designed for non-IC applications, it offers the widest range and variety of high quality, attractive finishing trims for lamps ranging from simple A-type to larger PAR sources.

Minimum Clearances: IC housings are direct contact rated; no minimum clearance is required.

Air-Tight: Air-tight gasket comes pre-installed

Ceiling Thickness: Accepts 5/8" - 1-3/8" to accommodate various ceiling thicknesses.

Lamp Adjustment: Socket clips directly to back of trim for perfect 90 degree vertical alignment of lamp socket. Socket is automatically positioned for optimum performance and lamp position consistency when socket is installed on trim or reflector.

Installation: New construction: Bar hangers are adjustable from 13-5/8" to 24-1/2" with captive nails and can be repositioned 90 degrees.

Junction Box: Junction box is listed for through branch circuit wiring and contains seven 1/2" knockouts and four Romex® with strain relief.

Electrical: Quick connector provided.

Socket: Medium screw-in base

Listing:

cULus Damp Location w/ Feed Through
WSEC ASTM E283 for Air-Tight (AT)
cULus Wet Location (Only with designated trims)



NEW!

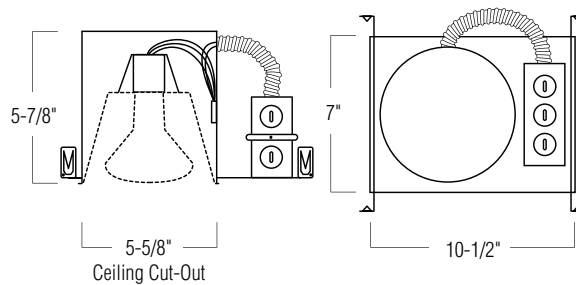

5" IC SHALLOW

CATALOG. NO.	TYPE	SOCKET	AIR-TIGHT
NHIC-527QAT	IC	Medium Screw-in Base	Yes

SH Designates trims compatible with shallow housings



LINE VOLTAGE RECESSED 5" IC Remodel Shallow housings

NEW!

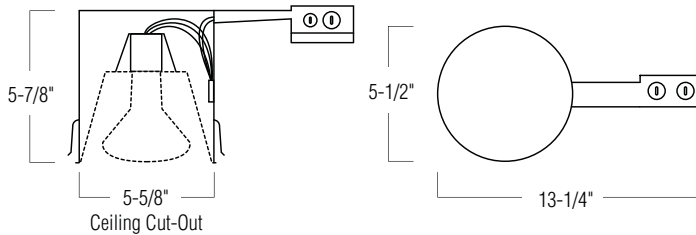

5" IC SHALLOW REMODEL

CATALOG. NO.	TYPE	SOCKET	AIR-TIGHT
NHRIC-527QAT	IC	Medium Screw-in Base	Yes

SH Designates trims compatible with shallow housings



Nora Lighting's universal recessed housing is the base standard for line voltage recessed fixtures. Designed for non-IC applications, it offers the widest range and variety of high quality, attractive finishing trims for lamps ranging from simple A-type to larger PAR sources.

Minimum Clearances: IC housings are direct contact rated; no minimum clearance is required.

Air-Tight: Air-tight gasket comes pre-installed

Ceiling Thickness: Accepts 3/8" - 1-3/8" to accommodate various ceiling thicknesses.

Lamp Adjustment: Socket clips directly to back of trim for perfect 90 degrees vertical alignment of lamp socket. Socket is automatically positioned for optimum performance and lamp position consistency when socket is installed on trim or reflector.

Installation: Remodel: High tension tempered steel springs secure remodel housings evenly to ceiling; hole cutout template provided for convenience.

Junction Box: Junction box is listed for through branch circuit wiring and contains seven 1/2" knockouts and four Romex® with strain relief.

Electrical: Quick connector provided.

Socket: Medium screw-in base

Listing:
cULus Damp Location w/ Feed Through
WSEC ASTM E283 for Air-Tight (AT)
cULus Wet Location (Only with designated trims)

LINE VOLTAGE RECESSED

5" IC & Non-IC Rated Trims

Baffle Splay

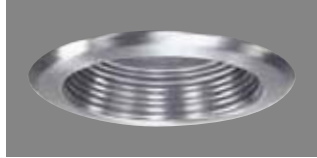

Catalog No.	Description
NT-5001B	Black Aluminum Baffle Splay / White Self Flanged
NT-5001BZ	Bronze Aluminum Baffle Splay / Bronze Self Flanged
NT-5001CO	Copper Aluminum Baffle Splay / Copper Self Flanged
NT-5001MW	White Metal Baffle Splay / White Self Flanged (50W Max.)
NT-5001N	Natural Metal Aluminum Baffle Splay / N Metal Self Flanged
NT-5001W	White Aluminum Baffle Splay / White Self Flanged

- Not suitable for shallow housing
- Maximum Wattage: IC & Non-IC Housing: 75W BR30/PAR30
NT-5001NM: 50W BR30/PAR30

Maximum Wattage
See description

OD: 6-1/2"

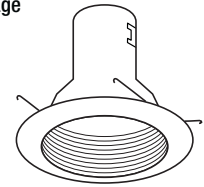

Baffle Splay



Catalog No.	Description
NT-5010B	Black Baffle Splay / White Ring
NT-5010BZ	Bronze Baffle Splay / Bronze Ring
NT-5010CO	Copper Baffle Splay / Copper Ring
NT-5010N	Natural Metal Baffle Splay / Natural Metal Ring
NT-5010W	White Baffle Splay / White Ring

- Not suitable for shallow housing
- Maximum Wattage: IC Housing: 50W BR30/PAR30
Non-IC Housing: 75W BR30/PAR30

Maximum Wattage
See description

OD: 6-1/2"

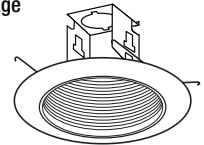

Deep Phenolic Baffle



Catalog No.	Description
NT-5012B	Black Deep Phenolic Baffle / White Ring
NT-5012BZ	Black Deep Phenolic Baffle / Bronze Ring
NT-5012CO	Black Deep Phenolic Baffle / Copper Ring
NT-5012N	Black Deep Phenolic Baffle / Natural Metal Ring
NT-5012W	Black Deep Phenolic Baffle / White Ring

- Not suitable for shallow housing
- Maximum Wattage: IC & Non-IC Housing: 75W BR30/PAR30

Maximum Wattage
75W BR30/PAR30

OD: 6-1/2"

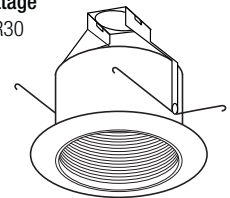

Air-Tight Baffle Cone



Catalog No.	Description
NTM-513B	Black Aluminum Air-Tight Baffle Cone / White Self Flanged
NTM-513W	White Aluminum Air-Tight Baffle Cone / White Self Flanged
NTM-513WM	White Metal Air-Tight Baffle Cone / White Self Flanged

- Suitable for standard and shallow housing
- Maximum Wattage: IC & Non-IC Housing: 75W BR30/PAR30
NTM-513WM: 50W BR30/PAR30 Maximum
Shallow Housing: 50W PAR30

Maximum Wattage
See description

OD: 6-1/2"

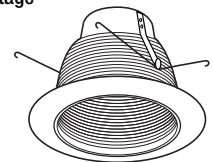

Splay Trim with Self Flanged



Catalog No.	Description
NT-5000BZ	Bronze Splay / Bronze Self Flanged
NT-5000CO	Copper Splay / Copper Self Flanged
NT-5000N	Natural Metal Splay / Natural Metal Self Flanged
NT-5000W	White Splay / White Self Flanged

- Not suitable for shallow housing
- Maximum Wattage: IC & Non-IC Housing: 75W BR30/PAR30

Maximum Wattage
75W BR30/PAR30

OD: 6-1/2"

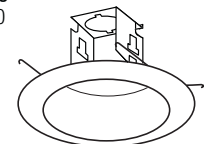

Reflector



Catalog No.	Description
NT-5020B	Specular Black Reflector / White Ring
NT-5020C	Specular Clear Reflector / White Ring
NT-5020G	Specular Gold Reflector / White Ring
NT-5020W	Specular White Reflector / White Ring

- Not suitable for shallow housing
- Maximum Wattage: IC & Non-IC Housing: 75W BR30/PAR30

Maximum Wattage
75W BR30/PAR30

OD: 6-1/2"

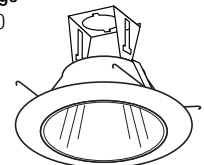

CC Custom Combo: Available with custom combinations of trim and plastic or metal ring finish. See pages 38-39 for details.

SH Shallow: Designated trims for shallow housings

See pages 36-37 for Description of Reflector Finishes

5" LINE VOLTAGE IC & NON-IC RATED TRIMS continued

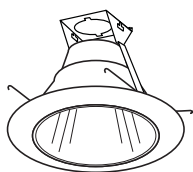

Maximum Wattage
See description
OD: 6-1/2"

Catalog No.	Description
NT-5021B	Specular Black Cone Reflector / White Metal Ring
NT-5021BZ	Bronze Cone Reflector / White Metal Ring
NT-5021C	Specular Clear Cone Reflector / White Metal Ring
NT-5021CO	Copper Cone Reflector / Copper Metal Ring
NT-5021G	Specular Gold Cone Reflector / White Metal Ring
NT-5021HZ	Haze Cone Reflector / White Metal Ring
NT-5021N	Natural Metal Cone Reflector / Natural Metal Ring
NT-5021W	Specular White Cone Reflector / White Metal Ring

- Not suitable for shallow housing
- Maximum Wattage: IC Housing: 40W A19
Non-IC Housing: 60W A19

Cone Reflector

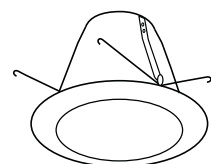

Maximum Wattage
35W PAR30
OD: 6-1/2"
SH

Catalog No.	Description
NT-5002B	Specular Black Air-Tight Cone Reflector / White Ring
NT-5002BZ	Bronze Air-Tight Cone Reflector / Bronze Ring
NT-5002C	Specular Clear Air-Tight Cone Reflector / White Ring
NT-5002CO	Copper Air-Tight Cone Reflector / Copper Ring
NT-5002G	Specular Gold Air-Tight Cone Reflector / White Ring
NT-5002HZ	Haze Air-Tight Cone Reflector / White Ring
NT-5002N	Natural Metal Air-Tight Cone Reflector / N Metal Ring
NT-5002W	Specular White Air-Tight Cone Reflector / White Ring

- **Only suitable for shallow housing**
- Maximum Wattage: Shallow Housing: 35W BR30/PAR30

Shallow Cone Reflector, Self Flanged

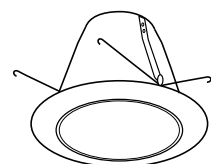

Maximum Wattage
75W BR30/PAR30
OD: 6-1/2"
AIR TIGHT

Catalog No.	Description
NT-5014B	Specular Black Air-Tight Cone Reflector / White Ring
NT-5014BZ	Bronze Air-Tight Cone Reflector / Bronze Ring
NT-5014C	Specular Clear Air-Tight Cone Reflector / White Ring
NT-5014CO	Copper Air-Tight Cone Reflector / Copper Ring
NT-5014G	Specular Gold Air-Tight Cone Reflector / White Ring
NT-5014HZ	Haze Air-Tight Cone Reflector / White Ring
NT-5014N	Natural Metal Air-Tight Cone Reflector / N Metal Ring
NT-5014W	Specular White Air-Tight Cone Reflector / White Ring

- Not suitable for shallow housing
- Maximum Wattage: IC & Non-IC Housing: 75W BR30/PAR30

Air-Tight Cone Reflector



Maximum Wattage
See description
OD: 6-1/2"

Catalog No.	Description
NT-5060B	Black Gimbal Ring
NT-5060BZ	Bronze Gimbal Ring
NT-5060CO	Copper Gimbal Ring
NT-5060N	Natural Metal Gimbal Ring
NT-5060W	White Gimbal Ring

- 30° Adjustment
- Not suitable for shallow housing
- Maximum Wattage: IC Housing: 50W PAR30
Non-IC Housing: 75W PAR30

PAR30 Gimbal



Maximum Wattage
See description
OD: 6-1/2"

Catalog No.	Description
NT-5071B	Black PAR20 Eyeball & Trim
NT-5071BZ	Bronze PAR20 Eyeball & Trim
NT-5071CO	Copper PAR20 Eyeball & Trim
NT-5071N	Natural Metal PAR20 Eyeball & Trim
NT-5071W	White PAR20 Eyeball & Trim

- 30° Adjustment
- Not suitable for shallow housing
- Maximum Wattage: IC & Non-IC Housing: 50W R20/PAR20

PAR30 Eyeball



CC Custom Combo: Available with custom combinations of trim and plastic or metal ring finish. See pages 38-39 for details.

SH Shallow: Designated trims for shallow housings

See pages 36-37 for Description of Reflector Finishes

5" LINE VOLTAGE IC & NON-IC RATED TRIMS continued

PAR30 Eyeball



Catalog No.	Description
NT-5070B	Black PAR30 Eyeball & Trim
NT-5070BZ	Bronze PAR30 Eyeball & Trim
NT-5070CO	Copper PAR30 Eyeball & Trim
NT-5070N	Natural Metal PAR30 Eyeball & Trim
NT-5070W	White PAR30 Eyeball & Trim

- 30° Adjustment
- Suitable for standard and shallow housing
- Maximum Wattage: IC & Non-IC Housing: 75W BR30/PAR30
Shallow Housing: 50W PAR30

Maximum Wattage

See description

OD: 7"

SH



Baffle with Regressed Gimbal

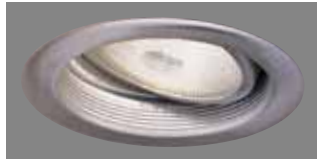

Catalog No.	Description
NT-5061B	Black Baffle / Adjustable Gimbal / White Metal Flange
NT-5061BZ	Bronze Baffle / Adjustable Gimbal / Bronze Metal Flange
NT-5061CO	Copper Baffle / Adjustable Gimbal / Copper Metal Flange
NT-5061N	Natural Metal Baffle / Adjustable Gimbal / N Metal Flange
NT-5061W	White Baffle / Adjustable Gimbal / White Metal Flange

- 30° Adjustment
- Not suitable for shallow housing
- Maximum Wattage: IC & Non-IC Housing: 75W PAR30

Maximum Wattage

See description

OD: 6-1/2"

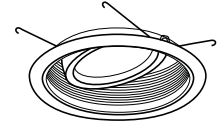

Baffle with Regressed Eyeball



CC

Catalog No.	Description
NT-5048B	Black Metal Baffle / White Regressed Eyeball / White Ring
NT-5048N	Natural Metal Baffle / Natural Metal Regressed Eyeball & Ring
NT-5048W	White Metal Baffle / White Regressed Eyeball / White Ring

- 35° Adjustment
- Suitable for standard and shallow housing
- Maximum Wattage: IC & Non-IC Housing: 75W BR30/PAR30
Shallow Housing: 50W PAR30

Maximum Wattage

See description

OD: 6-1/2"

SH

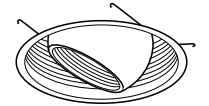

Reflector with Regressed Eyeball



CC

Catalog No.	Description
NTS-5049C	Specular Clear Refl / Regressed Chrome Eyeball / White Ring
NTS-5049G	Specular Gold Reflector / Regressed Gold Eyeball / White Ring

- Not suitable for shallow housing
- Maximum Wattage: IC & Non-IC Housing: 75W BR30/PAR30
Shallow Housing: 50W PAR30

Maximum Wattage

See description

OD: 6-1/2"



Wall Wash with Baffle Cone



Catalog No.	Description
NT-5045W	White Wall Wash / White Baffle Cone / White Flanged

- Not suitable for shallow housing
- Maximum Wattage: IC & Non-IC Housing: 75W BR30/PAR30
Shallow Housing: 35W PAR30

Maximum Wattage

See description

OD: 6-1/2"

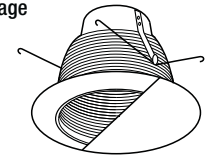

Open Trim



Catalog No.	Description
NT-5030BZ	Bronze Open Trim
NT-5030C	Chrome Open Trim
NT-5030CO	Copper Open Trim
NT-5030N	Natural Metal Open Trim
NT-5030W	White Open Trim

- Not suitable for shallow housing
- Maximum Wattage: IC & Non-IC Housing: 75W BR30/PAR30

Maximum Wattage

75W BR30/PAR30

OD: 6-1/2"



CC Custom Combo: Available with custom combinations of trim and plastic or metal ring finish. See pages 38-39 for details.

SH Shallow: Designated trims for shallow housings

5" LINE VOLTAGE IC & NON-IC RATED TRIMS continued

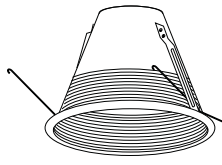

Maximum Wattage
75W PAR30

OD: 6-1/2"



Catalog No.	Description
NTM-526B	Black Air-Tight Baffle Lensless Shower / White Self Flanged
NTM-526BZ	Bronze Air-Tight Baffle Lensless Shower / Bronze Self Flanged
NTM-526CO	Copper Air-Tight Baffle Lensless Shower / Copper Self Flanged
NTM-526N	Black Air-Tight Baffle Lensless Shower / Black Self Flanged
NTM-526W	White Air-Tight Baffle Lensless Shower / White Self Flanged

- Not suitable for shallow housing
- UL Wet Listed
- Cone includes water tight gasket
- Maximum Wattage: IC & Non-IC Housing: 75W PAR30

Lensless Open Shower Baffle Cone

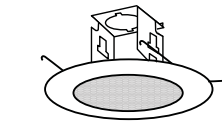
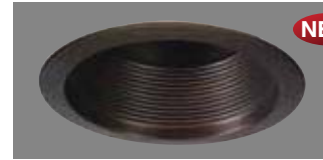

Maximum Wattage
See description

OD: 6-1/2"



Catalog No.	Description
NT-5022B	Albalite Lens / Black Metal Trim
NT-5022BZ	Albalite Lens / Bronze Metal Trim
NT-5022C	Albalite Lens / Chrome Metal Trim
NT-5022CO	Albalite Lens / Copper Metal Trim
NT-5022G	Albalite Lens / Gold Metal Trim
NT-5022N	Albalite Lens / Natural Metal Trim
NT-5022W	Albalite Lens / White Metal Trim

- Not suitable for shallow housing
- UL Wet Listed
- Maximum Wattage: IC Housing: 40W A19
Non-IC Housing: 60W A19

Albalite Lens

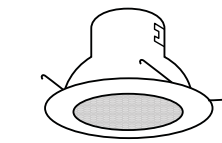

Maximum Wattage
See description

OD: 6-1/2"



Catalog No.	Description
NTS-5022B	Albalite Lens / Black Metal Trim
NTS-5022BZ	Albalite Lens / Bronze Metal Trim
NTS-5022C	Albalite Lens / Chrome Metal Trim
NTS-5022CO	Albalite Lens / Copper Metal Trim
NTS-5022G	Albalite Lens / Gold Metal Trim
NTS-5022N	Albalite Lens / Natural Metal Trim
NTS-5022W	Albalite Lens / White Metal Trim

- Suitable for standard and shallow housing
- UL Wet Listed
- Maximum Wattage: IC Housing: 25W A19, 35W PAR30
Non-IC Housing: 60W A19
Shallow Housing: 35W PAR30

Front Loading Albalite Lens

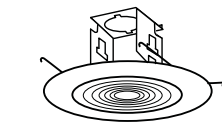

Maximum Wattage
See description

OD: 6-1/2"



Catalog No.	Description
NT-5023B	Fresnel Lens / Black Metal Trim
NT-5023BZ	Fresnel Lens / Bronze Metal Trim
NT-5023C	Fresnel Lens / Chrome Metal Trim
NT-5023CO	Fresnel Lens / Copper Metal Trim
NT-5023G	Fresnel Lens / Gold Metal Trim
NT-5023N	Fresnel Lens / Natural Metal Trim
NT-5023W	Fresnel Lens / White Metal Trim

- Not suitable for shallow housing
- UL Wet Listed
- Maximum Wattage: IC Housing: 40W A19
Non-IC Housing: 60W A19

Fresnel Lens

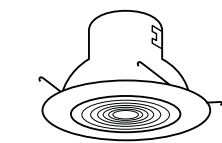

Maximum Wattage
See description

OD: 6-1/2"



Catalog No.	Description
NTS-5023B	Front Loading Fresnel Lens / Black Metal Trim
NTS-5023BZ	Front Loading Fresnel Lens / Bronze Metal Trim
NTS-5023C	Front Loading Fresnel Lens / Chrome Metal Trim
NTS-5023CO	Front Loading Fresnel Lens / Copper Metal Trim
NTS-5023G	Front Loading Fresnel Lens / Gold Metal Trim
NTS-5023N	Front Loading Fresnel Lens / Natural Metal Trim
NTS-5023W	Front Loading Fresnel Lens / White Metal Trim

- Suitable for standard and shallow housing
- Easy lift and turn lens removal
- UL Wet Listed
- Maximum Wattage: IC Housing: 25W A19, 35W PAR30
Non-IC Housing: 60W A19
Shallow Housing: 35W PAR30

Front Loading Fresnel Lens



5" LINE VOLTAGE IC & NON-IC RATED TRIMS continued

Drop Opal Lens



Catalog No.	Description
NT-5024B	Drop Opal Lens / Black Metal Trim
NT-5024BZ	Drop Opal Lens / Bronze Metal Trim
NT-5024C	Drop Opal Lens / Chrome Metal Trim
NT-5024CO	Drop Opal Lens / Copper Metal Trim
NT-5024G	Drop Opal Lens / Gold Metal Trim
NT-5024N	Drop Opal Lens / Natural Metal Trim
NT-5024W	Drop Opal Lens / White Metal Trim

- Not suitable for shallow housing
- UL Wet Listed
- Maximum Wattage: IC Housing: 40W A19
Non-IC Housing: 60W A19

Maximum Wattage
See description

OD: 6-1/2"

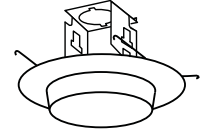

Front Loading Drop Opal Lens

NEW!



Catalog No.	Description
NTS-5024B	Front Loading Drop Opal Lens / Black Metal Trim
NTS-5024BZ	Front Loading Drop Opal Lens / Bronze Metal Trim
NTS-5024C	Front Loading Drop Opal Lens / Chrome Metal Trim
NTS-5024CO	Front Loading Drop Opal Lens / Copper Metal Trim
NTS-5024G	Front Loading Drop Opal Lens / Gold Metal Trim
NTS-5024N	Front Loading Drop Opal Lens / Natural Metal Trim
NTS-5024W	Front Loading Drop Opal Lens / White Metal Trim

- Suitable for standard and shallow housing
- Easy lift and turn lens removal
- Maximum Wattage: IC Housing: 25W A19, 35W PAR30
Non-IC Housing: 60W A19
Shallow Housing: 35W PAR30

Maximum Wattage
See description

OD: 6-1/2"

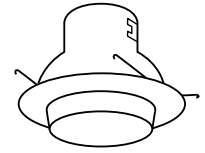

Dome Lens with Reflector



Catalog No.	Description
NT-5050B	Dome Lens / Specular Clear Reflector / Black Trim
NT-5050BZ	Dome Lens / Specular Clear Reflector / Bronze Trim
NT-5050CO	Dome Lens / Specular Clear Reflector / Copper Trim
NT-5050N	Dome Lens / Specular Clear Refl / Natural Metal Trim
NT-5050W	Dome Lens / Specular Clear Reflector / White Trim

- Reflector produces more usable light
- UL Wet Listed
- Suitable for standard or shallow housing
- Maximum Wattage: IC Housing: 40W A19
Non-IC Housing: 60W A19
Shallow Housing: 35W PAR30

Maximum Wattage
See description

OD: 6-1/2"

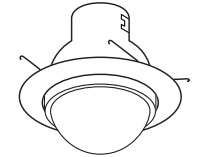

Frosted Dome Lens



Catalog No.	Description
NT-5025B	Frosted Dome Lens / Black Metal Trim
NT-5025BZ	Frosted Dome Lens / Bronze Metal Trim
NT-5025C	Frosted Dome Lens / Chrome Metal Trim
NT-5025CO	Frosted Dome Lens / Copper Metal Trim
NT-5025G	Frosted Dome Lens / Gold Metal Trim
NT-5025N	Frosted Dome Lens / Natural Metal Metal Trim
NT-5025W	Frosted Dome Lens / White Metal Trim

- Not suitable for shallow housing
- UL Wet Listed
- Maximum Wattage: IC Housing: 40W A19
IC & Non-IC Housing: 60W A19

Maximum Wattage
See description

OD: 6-1/2"

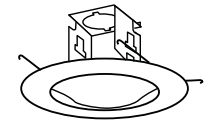

Front Loading Frosted Dome Lens

NEW!



Catalog No.	Description
NTS-5025B	Front Loading Frosted Dome Lens / Black Metal Trim
NTS-5025BZ	Front Loading Frosted Dome Lens / Bronze Metal Trim
NTS-5025C	Front Loading Frosted Dome Lens / Chrome Metal Trim
NTS-5025CO	Front Loading Frosted Dome Lens / Copper Metal Trim
NTS-5025G	Front Loading Frosted Dome Lens / Gold Metal Trim
NTS-5025N	Front Loading Frosted Dome Lens / Natural Metal Trim
NTS-5025W	Front Loading Frosted Dome Lens / White Metal Trim

- Not suitable for shallow housing
- Easy lift and turn lens removal
- Maximum Wattage: IC Housing: 25W A19, 35W PAR30
Non-IC Housing: 60W A19

Maximum Wattage
See description

OD: 6-1/2"

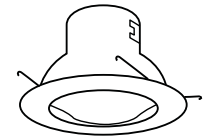

SH Shallow: Designated trims for shallow housings

5" LINE VOLTAGE IC & NON-IC RATED TRIMS continued

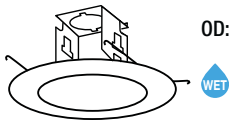

Maximum Wattage
See description

OD: 6-1/2"



Catalog No.	Description
NT-5026B	Flat Frosted Lens / Black Metal Trim
NT-5025BZ	Flat Frosted Lens / Bronze Metal Trim
NT-5026C	Flat Frosted Lens / Chrome Metal Trim
NT-5026CO	Flat Frosted Lens / Copper Metal Trim
NT-5026G	Flat Frosted Lens / Gold Metal Trim
NT-5026N	Flat Frosted Lens / Natural Metal Trim
NT-5026W	Flat Frosted Lens / White Metal Trim

- Not suitable for shallow housing
- UL Wet Listed
- Maximum Wattage: IC Housing: 40W A19
Non-IC Housing: 60W A19

Flat Frosted Lens

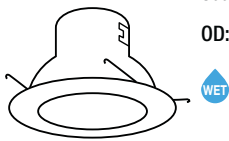

Maximum Wattage
See description

OD: 6-1/2"



Catalog No.	Description
NTS-5026B	Front Loading Flat Frosted Lens / Black Metal Trim
NTS-5025BZ	Front Loading Flat Frosted Lens / Bronze Metal Trim
NTS-5026C	Front Loading Flat Frosted Lens / Chrome Metal Trim
NTS-5026CO	Front Loading Flat Frosted Lens / Copper Metal Trim
NTS-5026G	Front Loading Flat Frosted Lens / Gold Metal Trim
NTS-5026N	Front Loading Flat Frosted Lens / Natural Metal Trim
NTS-5026W	Front Loading Flat Frosted Lens / White Metal Trim

- Not suitable for shallow housing
- UL Wet Listed
- Easy lift and turn lens removal
- Maximum Wattage: IC Housing: 25W A19, 35W PAR30
Non-IC Housing: 60W A19

Front Loading Flat Frosted Lens

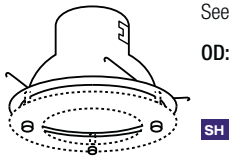

Maximum Wattage
See description

OD: 6-1/2"



Catalog No.	Description
NTS-5038BZ	Specular Clear Reflector / Bronze Trim
NTS-5038C	Specular Clear Reflector / Chrome Trim
NTS-5038N	Specular Clear Reflector / Natural Metal Trim
NTS-5038W	Specular Clear Reflector / White Trim

- Suitable for shallow housing
- **Glass sold separately**
- For a layered look, up to two pieces of glass may be used together.
- Maximum Wattage: IC Housing: 25W A19, 35W PAR30
Non-IC Housing: 60W A19

Reflector for Decorative Glass

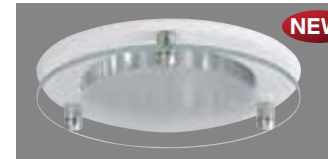

Includes:
NRA-203 Glass Hardware
• (3) Stand-offs
• (3) Cone End Caps
• (3) Flat End Caps

OD: 6-1/2"

Catalog No.	Description
NTG-5B/80	Tempered Blue / 80mm (3-1/8") Open Center
NTG-5CF	Tempered Frost Center / Clear Outer
NTG-5FC	Tempered Clear Center / Frost Outer
NTG-5HC	Tempered Clear Outer / Frost Inner / 80mm (3-1/8") Open Center

- **Includes NRA-203 Glass Hardware**
- 2 decorative glasses can be combined for a tiered look

Decorative Glass for NTS-5038



SH Shallow: Designated trims for shallow housings



LINE VOLTAGE RECESSED

4" IC Double Wall New Construction Housings

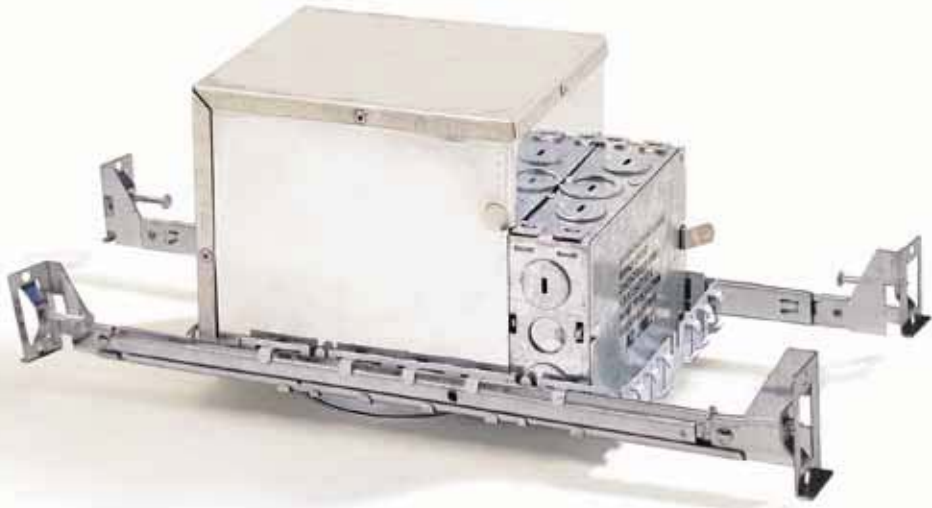

Nora Lighting's IC recessed 4" housing allows the use of R20/PAR16/PAR20 designer light sources in insulated ceiling environments. Rated for direct contact with thermal insulation, Nora's 4" IC housing is quick to install, accepts a wide variety of high quality trims, and is air-tight built for energy saving.

Minimum Clearances: Direct contact rated; no minimum clearance is required.

Air-Tight: Air-tight gasket comes pre-installed

Ceiling Thickness: Accepts 5/8" - 1-3/8" to accommodate various ceiling thicknesses.

Lamp Adjustment: Adjustable socket mounting plate allows different types of lamps to be used for best possible light distribution.

Installation: Bar hangers are adjustable from 13-5/8" to 24-1/2" with captive nails and can be repositioned 90 degrees. Bar hangers are slotted for T-Bar installations.

Junction Box: Contains two 3/4", three 1/2" knockouts and four Romex® with strain relief.

Electrical: Quick connector provided.

Socket: Medium screw-in base

Listing:
 cULus Damp Location w/ Feed Through
 WSEC ASTM E283 for Air-Tight (AT)
 cULus Wet Location (Only with designated trims)

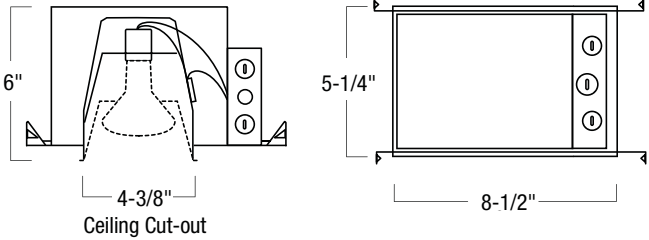

4" IC DOUBLE WALL NEW CONSTRUCTION HOUSING

CATALOG. NO.	TYPE	SOCKET	WATTAGE	AIR-TIGHT
NSIC-401QAT	IC	Adjustable Bracket, Medium Base	50W	Yes



LINE VOLTAGE RECESSED

4" Non-IC New Construction Housing

Nora Lighting's recessed 4" housings deliver ultra-high design quality in any application with minimal apertures. Ideal for R20/PAR16/PAR20 designer light sources. Rated for air-tight applications, Nora's products are quick to install and accept a wide variety of high quality, attractive finishing trims.

Minimum Clearances: Housing requires a minimum 3" from thermal insulation, 1/2" from adjacent building components.

Air-Tight: Air-tight gasket comes pre-installed

Ceiling Thickness: Accepts 5/8" - 1-3/8" to accommodate various ceiling thicknesses.

Lamp Adjustment: Adjustable socket mounting plate allows different types of lamps to be used for best possible light distribution.

Installation: Bar hangers are adjustable from 13-5/8" to 24-1/2" with captive nails and can be repositioned 90 degrees. Bar hangers are slotted for T-Bar installations.

Junction Box: Contains two 3/4", three 1/2" knockouts and four Romex® with strain relief.

Electrical: Quick connector provided.

Socket: Medium screw-in base

Listing:

cULus Damp Location w/ Feed Through
WSEC ASTM E283 for Air-Tight (AT)
cULus Wet Location (Only with designated trims)

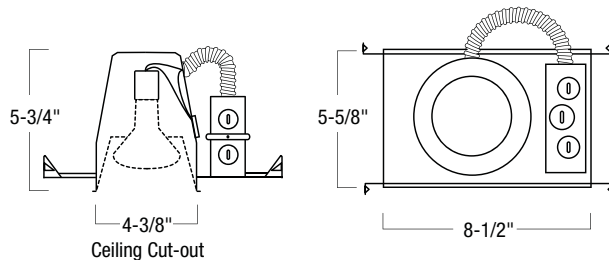

4" NON-IC NEW CONSTRUCTION SERIES

CATALOG. NO.	TYPE	SOCKET	WATTAGE	AIR-TIGHT
NS-401QAT	Non-IC	Adjustable Bracket, Medium Base	50W	Yes

See page 379 for fire rated enclosure.



LINE VOLTAGE RECESSED 4" Non-IC Remodel Housings



Nora Lighting's recessed 4" housings deliver ultra-high design quality in any application with minimal apertures. Ideal for R20/PAR16/PAR20 designer light sources. Rated for air-tight applications, Nora's products are quick to install and accept a wide variety of high quality, attractive finishing trims.

Minimum Clearances: Housing requires a minimum 3" from thermal insulation, 1/2" from adjacent building components.

Air-Tight: Air-tight gasket comes pre-installed

Ceiling Thickness: Accepts 3/8" - 1-3/8" to accommodate various ceiling thicknesses.

Lamp Adjustment: Adjustable socket mounting plate allows different types of lamps to be used for best possible light distribution.

Installation: High tension tempered steel springs secure remodel housings evenly to ceiling; hole cut-out template provided for convenience.

Junction Box: Contains two 3/4", three 1/2" knockouts and four Romex® with strain relief.

Electrical: Quick connector provided.

Socket: Medium screw-in base

Listing:
cULus Damp Location w/ Feed Through
WSEC ASTM E283 for Air-Tight (AT)
cULus Wet Location (Only with designated trims)

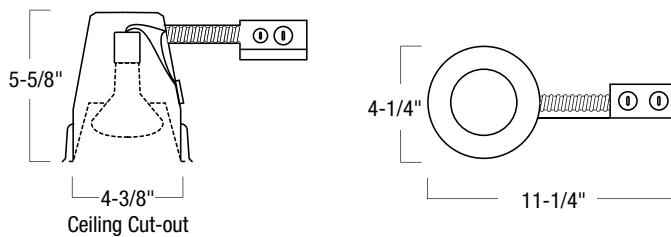

4" NON-IC REMODEL SERIES

CATALOG. NO.	TYPE	SOCKET	WATTAGE	AIR-TIGHT
NSR-404QAT	Non-IC	Adjustable Bracket, Medium Base	50W	Yes



LINE VOLTAGE RECESSED

4" IC & Non-IC Rated Trims

Square Trim with Baffle

NEW!



Catalog No.	Description
NS-4910BB	Black Baffle / Black Square Trim
NS-4910BBZ	Black Baffle / Bronze Square Trim
NS-4910BCO	Black Baffle / Copper Square Trim
NS-4910WC	White Baffle / Chrome Square Trim
NS-4910WG	White Baffle / Gold Square Trim
NS-4910WN	White Baffle / Natural Metal Square Trim
NS-4910WW	White Baffle / White Square Trim

- Downlight

Maximum Wattage
50W R20/PAR20

W x L: 4-3/4"

Aperture: 3-5/8"

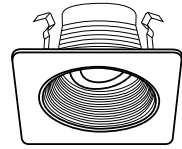

Square Trim with Reflector

NEW!



Catalog No.	Description
NS-4914BW	Specular Black Reflector / White Square Trim
NS-4914BZBZ	Bronze Reflector / Bronze Square Trim
NS-4914CB	Specular Clear Reflector / Black Square Trim
NS-4914CC	Specular Clear Reflector / Chrome Square Trim
NS-4914CG	Specular Clear Reflector / Gold Square Trim
NS-4914COCO	Copper Reflector / Copper Square Trim
NS-4914CW	Specular Clear Reflector / White Square Trim
NS-4914GW	Specular Gold Reflector / White Square Trim
NS-4914HZW	Haze Reflector / White Square Trim
NS-4914NN	Natural Metal Reflector / Natural Metal Square Trim

- Downlight

Maximum Wattage
50W R20/PAR20

W x L: 4-3/4"

Aperture: 3-5/8"



Square Trim with Gimbal

NEW!



Catalog No.	Description
NS-4912BZ	Bronze Gimbal / Bronze Square Trim
NS-4912CO	Copper Gimbal / Copper Square Trim
NS-4912N	Natural Metal Gimbal / Natural Metal Square Trim
NS-4912W	White Gimbal / White Square Trim

- 20° Adjustable

Maximum Wattage:
50W PAR20

W x L: 4-3/4"

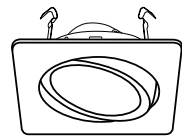

Square Trim with 1" Pinhole

NEW!



Catalog No.	Description
NS-4940B	Black Pinhole
NS-4940BZ	Bronze Pinhole
NS-4940C	Chrome Pinhole
NS-4940CO	Copper Pinhole
NS-4940G	Gold Pinhole
NS-4940N	Natural Metal Pinhole
NS-4940W	White Pinhole

- Downlight

Maximum Wattage
50W R20/ PAR20

W x L: 4-3/4"

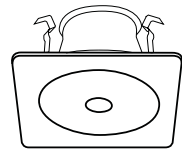

CC Square Trims and Reflectors can be combined. Example: If designer want a Natural Metal Reflector with a Black Square trim, specify NS-4914NB
See pages 36-37 for Description of Reflector Finishes

4" LINE VOLTAGE IC & NON-IC RATED TRIMS continued

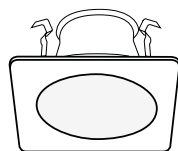

Maximum Wattage
50W R20/PAR20

W x L: 4-3/4"



Catalog No.	Description
NS-4926B	Flat Frosted Lens / Black Square Trim
NS-4926BZ	Flat Frosted Lens / Bronze Square Trim
NS-4926C	Flat Frosted Lens / Chrome Square Trim
NS-4926CO	Flat Frosted Lens / Copper Square Trim
NS-4926G	Flat Frosted Lens / Gold Square Trim
NS-4926N	Flat Frosted Lens / Natural Metal Square Trim
NS-4926W	Flat Frosted Lens / White Square Trim

- UL Wet Listed

Square Trim w/ Frosted Shower Trim



NEW!



Maximum Wattage
50W R20/PAR20

W x L: 4-3/4"



Catalog No.	Description
NS-4927B	Flat Frosted Lens w/ Clear Center / Black Square Trim
NS-4927BZ	Flat Frosted Lens w/ Clear Center / Bronze Square Trim
NS-4927C	Flat Frosted Lens w/ Clear Center / Chrome Square Trim
NS-4927CO	Flat Frosted Lens w/ Clear Center / Copper Square Trim
NS-4927G	Flat Frosted Lens w/ Clear Center / Gold Square Trim
NS-4927N	Flat Frosted Lens w/ Clear Center/Natural Metal Square Trim
NS-4927W	Flat Frosted Lens w/ Clear Center / White Square Trim

- UL Wet Listed

Square Trim w/Frosted Shower Trim
w/ Clear Center



NEW!



Lighting Tip:

Use Nora's phenolic (plastic) baffle with plastic ring for outdoor or harsh environment applications (Ex. NS-40P, NS-41P)

4" LINE VOLTAGE IC & NON-IC RATED TRIMS continued

Stepped Baffle



CC

Catalog No.	Description
NS-40	White Stepped Baffle / White Metal Ring
NS-40BZBZ	Bronze Stepped Baffle / Bronze Metal Ring
NS-40C	White Stepped Baffle / Chrome Metal Ring
NS-40CO	Copper Stepped Baffle / Copper Metal Ring
NS-40G	White Stepped Baffle / Gold Metal Ring
NS-40N	Natural Metal Stepped Baffle / Natural Metal Ring
NS-41	Black Stepped Baffle / White Metal Ring
NS-41B	Black Stepped Baffle / Black Metal Ring
NS-41C	Black Stepped Baffle / Chrome Metal Ring
NS-41G	Black Stepped Baffle / Gold Metal Ring
NS-41N	Black Stepped Baffle / Natural Metal Ring

Maximum Wattage
50W R20/PAR20

OD: 4-3/4"

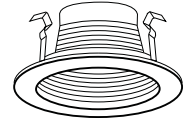

Adjustable Stepped Baffle



CC

Catalog No.	Description
NS-40A	White Adjustable Stepped Baffle / White Metal Ring
NS-41A	Black Adjustable Stepped Baffle / White Metal Ring

- 15° Adjustment

Maximum Wattage
50W R20/PAR20

OD: 4-3/4"

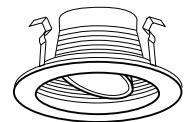

Phenolic Stepped Baffle



CC

Catalog No.	Description
NS-40P	Phenolic White Stepped Baffle / White Plastic Ring
NS-41P	Phenolic Black Stepped Baffle / White Plastic Ring

PLASTIC RING!

PLASTIC RING!

Maximum Wattage
50W R20/PAR20

OD: 4-3/4"

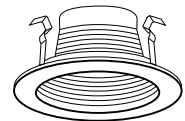

Reflector



CC

Catalog No.	Description
NS-42	Specular Gold Reflector / White Metal Ring
NS-42G	Specular Gold Reflector / Gold Metal Ring
NS-43	Specular Black Reflector / White Metal Ring
NS-43B	Specular Black Reflector / Black Metal Ring
NS-44	Specular Clear Reflector / White Metal Ring
NS-44C	Specular Clear Reflector / Chrome Metal Ring
NS-44HZ	Haze Reflector / White Metal Ring
NS-44N	Specular Clear Reflector / Natural Metal Ring
NS-46	Specular White Reflector / White Metal Ring
NS-52	Natural Metal Reflector / Natural Metal Ring
NS-53	Copper Reflector / Copper Ring
NS-53BZ	Bronze Reflector / Bronze Ring

Maximum Wattage
50W R20/PAR20

OD: 4-3/4"

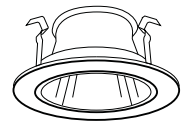

Adjustable Reflector



CC

Catalog No.	Description
NS-42A	Specular Gold Adjustable Reflector / White Metal Ring
NS-43A	Specular Black Adjustable Reflector / White Metal Ring
NS-44A	Specular Clear Adjustable Reflector / White Metal Ring
NS-46A	Specular White Adjustable Reflector / White Metal Ring

- 15° Adjustment

Maximum Wattage
50W R20/PAR20

OD: 4-3/4"

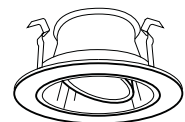

Cross Louver Reflector



CC

Catalog No.	Description
NS-57CW	Specular Clear Cross Louver Reflector / White Ring
NS-57GW	Specular Gold Cross Louver Reflector / White Ring

- Low aperture brightness

Maximum Wattage
50W R20/PAR20

OD: 4-3/4"

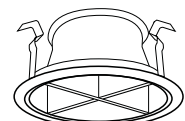

CC Custom Combo: Available with custom combinations of trim and plastic or metal ring finish. See pages 38-39 for details.

See page 36-37 for Description of Reflector Finishes

4" LINE VOLTAGE IC & NON-IC RATED TRIMS continued



Maximum Wattage
50W PAR20
OD: 4-3/4"

Catalog No.	Description
NS-12BZ	Bronze Surface Gimbal Ring
NS-12CO	Copper Surface Gimbal Ring
NS-12N	Natural Metal Surface Gimbal Ring
NS-12W	White Surface Gimbal Ring

- 20° Adjustment

Surface Gimbal Ring

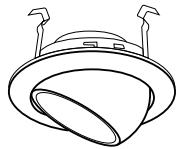
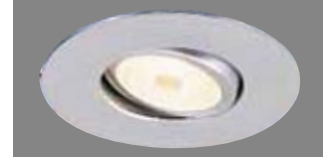

Maximum Wattage
50W PAR20
OD: 5"

Catalog No.	Description
NS-18	White Eyeball / White Trim
NS-18B	Black Eyeball / Black Trim
NS-18BZ	Bronze Eyeball / Bronze Trim
NS-18CO	Copper Eyeball / Copper Trim
NS-18N	Natural Metal Eyeball / Natural Metal Trim
NS-19C	Chrome Eyeball / Chrome Trim
NS-19G	Gold Eyeball / Gold Trim

- 15° Adjustment

Eyeball Trim

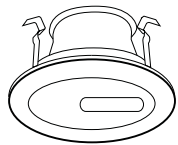

Maximum Wattage
50W R20/PAR20
OD: 4-3/4"

Catalog No.	Description
NS-47	White Adjustable Slot Aperture
NS-47B	Black Adjustable Slot Aperture
NS-47BZ	Bronze Adjustable Slot Aperture
NS-47CO	Copper Adjustable Slot Aperture
NS-47N	Natural Metal Adjustable Slot Aperture

- 10° Adjustment

Adjustable Slot Aperture

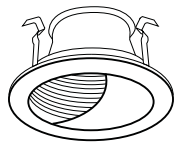

Maximum Wattage
50W R20/PAR20
OD: 4-3/4"

Catalog No.	Description
NS-48	White Wall Wash / White Baffle / White Ring
NS-48BZ	Bronze Wall Wash / Bronze Baffle / Bronze Ring
NS-48CO	Copper Wall Wash / Copper Baffle / Copper Ring
NS-48N	Natural Metal Wall Wash / Natural Metal Baffle & Ring
NS-49	White Wall Wash / Black Baffle / White Ring

Wall Wash Baffle



Maximum Wattage
50W R20/PAR20
OD: 4-3/4"

Catalog No.	Description
NS-50	White Wall Wash / Specular White Reflector / White Ring
NS-58	White Wall Wash / Specular Clear Reflector / Chrome Ring

Wall Wash Reflector

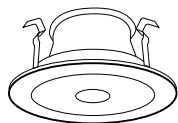

Maximum Wattage
50W R20/ PAR20
OD: 4-3/4"

Catalog No.	Description
NS-45	1" White Pinhole
NS-45B	1" Black Pinhole
NS-45BZ	1" Bronze Pinhole
NS-45CO	1" Copper Pinhole
NS-45N	1" Natural Metal Pinhole

1" Pinhole

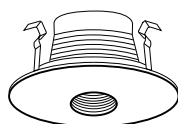

Maximum Wattage
45W PAR16
OD: 4-3/4"

Catalog No.	Description
NL-420	2" White Pinhole / Black Baffle
NL-421	2" White Pinhole / White Baffle

2" Pinhole with Baffle



4" LINE VOLTAGE IC & NON-IC RATED TRIMS continued

Lensless Open Shower Baffle Cone

NEW!



Catalog No.	Description
NS-76B	Black Air-Tight Baffle Lensless Shower / White Flange
NS-76BZ	Bronze Air-Tight Baffle Lensless Shower / Bronze Flange
NS-76CO	Copper Air-Tight Baffle Lensless Shower / Copper Flange
NS-76N	Natural Air-Tight Baffle Lensless Shower / Natural Flange
NS-76W	White Air-Tight Baffle Lensless Shower / White Flange

- UL Wet Listed
- Cone includes water tight gasket

Maximum Wattage

50W PAR20

OD: 4-3/4"

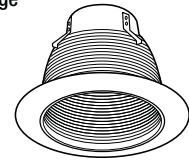

Albalite Lens



Catalog No.	Description
NS-22B	Albalite Lens / Black Metal Trim
NS-22BZ	Albalite Lens / Bronze Metal Trim
NS-22C	Albalite Lens / Chrome Metal Trim
NS-22CO	Albalite Lens / Copper Metal Trim
NS-22G	Albalite Lens / Gold Metal Trim
NS-22N	Albalite Lens / Natural Metal Trim
NS-22W	Albalite Lens / White Metal Trim

- UL Wet Listed

Maximum Wattage

50W R20/PAR20

OD: 4-3/4"

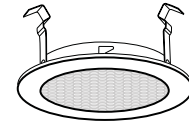

Fresnel Lens



Catalog No.	Description
NS-23B	Fresnel Lens / Black Metal Trim
NS-23BZ	Fresnel Lens / Bronze Metal Trim
NS-23C	Fresnel Lens / Chrome Metal Trim
NS-23CO	Fresnel Lens / Copper Metal Trim
NS-23G	Fresnel Lens / Gold Metal Trim
NS-23N	Fresnel Lens / Natural Metal Trim
NS-23W	Fresnel Lens / White Metal Trim

- UL Wet Listed

Maximum Wattage

50W R20/PAR20

OD: 4-3/4"



Drop Opal Lens



Catalog No.	Description
NS-24B	Drop Opal Lens / Black Metal Trim
NS-24BZ	Drop Opal Lens / Bronze Metal Trim
NS-24C	Drop Opal Lens / Chrome Metal Trim
NS-24CO	Drop Opal Lens / Copper Metal Trim
NS-24G	Drop Opal Lens / Gold Metal Trim
NS-24N	Drop Opal Lens / Natural Metal Trim
NS-24W	Drop Opal Lens / White Metal Trim

- UL Wet Listed

Maximum Wattage

50W R20/PAR20

OD: 4-3/4"

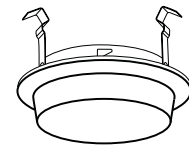

Frosted Dome Lens



Catalog No.	Description
NS-25B	Frosted Dome Lens / Black Metal Trim
NS-25BZ	Frosted Dome Lens / Bronze Metal Trim
NS-25C	Frosted Dome Lens / Chrome Metal Trim
NS-25CO	Frosted Dome Lens / Copper Metal Trim
NS-25G	Frosted Dome Lens / Gold Metal Trim
NS-25N	Frosted Dome Lens / Natural Metal Trim
NS-25W	Frosted Dome Lens / White Metal Trim

- UL Wet Listed

Maximum Wattage

50W R20/PAR20

OD: 4-3/4"

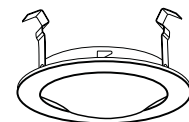

4" LINE VOLTAGE IC & NON-IC RATED TRIMS continued

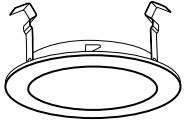

Maximum Wattage
50W R20/PAR20

OD: 4-3/4"



Catalog No.	Description
NS-26B	Frosted Flat Lens / Black Metal Trim
NS-26BZ	Frosted Flat Lens / Bronze Metal Trim
NS-26C	Frosted Flat Lens / Chrome Metal Trim
NS-26CO	Frosted Flat Lens / Copper Metal Trim
NS-26G	Frosted Flat Lens / Gold Metal Trim
NS-26N	Frosted Flat Lens / Natural Metal Trim
NS-26W	Frosted Flat Lens / White Metal Trim

- UL Wet Listed

Frosted Flat Lens

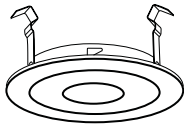

Maximum Wattage
50W R20/PAR20

OD: 4-3/4"



Catalog No.	Description
NS-27B	Frosted Flat Outer / Clear Center Lens / Black Metal Trim
NS-27BZ	Frosted Flat Outer / Clear Center Lens / Bronze Metal Trim
NS-27C	Frosted Flat Outer / Clear Center Lens / Chrome Metal Trim
NS-27CO	Frosted Flat Outer / Clear Center Lens / Copper Metal Trim
NS-27G	Frosted Flat Outer / Clear Center Lens / Gold Metal Trim
NS-27N	Frosted Flat Outer / Clear Center Lens / Natural Metal Trim
NS-27W	Frosted Flat Outer / Clear Center Lens / White Metal Trim

- UL Wet Listed

Frosted Flat / Clear Center Lens

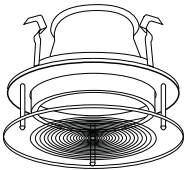

Maximum Wattage
45W PAR16

OD: 4-3/4"

Catalog No.	Description
NL-498B	Concentric Glass / Specular Clear Refl / Black Trim
NL-498BZ	Concentric Glass / Specular Clear Refl / Bronze Trim
NL-498C	Concentric Glass / Specular Clear Refl / Chrome Trim
NL-498CO	Concentric Glass / Specular Clear Refl / Copper Trim
NL-498G	Concentric Glass / Specular Clear Refl / Gold Trim
NL-498N	Concentric Glass / Specular Clear Refl / Natural Metal Trim
NL-498W	Concentric Glass / Specular Clear Refl / White Trim

Floating Concentric Glass

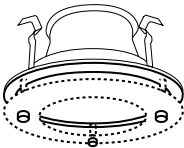

Maximum Wattage
50W R20/PAR20

OD: 4-3/4"

Catalog No.	Description
NS-38BZ	Specular Clear Reflector / Bronze Trim
NS-38C	Specular Clear Reflector / Chrome Trim
NS-38N	Specular Clear Reflector / Natural Metal Trim
NS-38W	Specular Clear Reflector / White Trim

- Glass sold separately.
- For a layered look, up to two pieces of glass may be used together.

Reflector for Decorative Glass

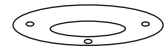

Includes:

NRA-203 Glass Hardware

- (3) Stand-offs
- (3) Cone End Caps
- (3) Flat End Caps

OD: 4-3/4"

Catalog No.	Description
NTG-4B/80	Tempered Blue / 80mm (3-1/8") Open Center
NTG-4CF	Tempered Frost Center / Clear Outer
NTG-4FC	Tempered Clear Center / Frost Outer
NTG-4HC	Tempered Clear Outer / Frost Inner / 80mm (3-1/8") Open Center

- Includes NRA-203 Glass Hardware
- 2 decorative glasses can be combined for a tiered look

Decorative Glass for NS-38



4" LINE VOLTAGE IC & NON-IC RATED TRIMS continued

Round Acrylic with Accent



Catalog No.	Description
NL-461	Round Acrylic with Gold Accent
NL-461C	Round Acrylic with Chrome Accent

Maximum Wattage
45W PAR16
OD: 4-3/4"

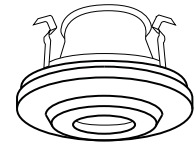

Square Acrylic with Accent

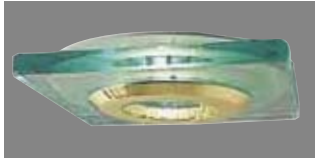

Catalog No.	Description
NL-462	Square Acrylic with Gold Accent

Maximum Wattage
45W PAR16
OD: 4-3/4"

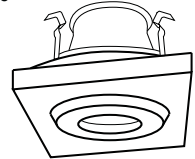

Square Baffle



Catalog No.	Description
NL-486W	White Plastic Baffle / White Plastic Square Trim
<ul style="list-style-type: none"> Plastic trim and baffle makes this excellent for harsh environment applications 	

Maximum Wattage
45W PAR16
OD: 4-3/4"

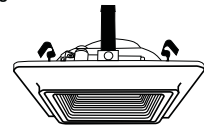

Metropolitan Moon Glass

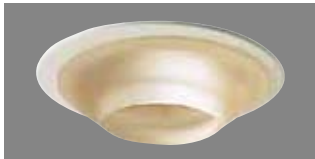

Catalog No.	Description
NL-495B	Blue Metropolitan Moon Glass / White Ring
NL-495P	Pink Metropolitan Moon Glass / White Ring
NL-495F	White Frosted Metropolitan Moon Glass / White Ring

Maximum Wattage
45W PAR16
OD: 4-3/4"



Metropolitan Stepped Glass



Catalog No.	Description
NL-496B	Blue Metropolitan Stepped Glass / White Ring
NL-496P	Pink Metropolitan Stepped Glass / White Ring
NL-496F	White Frosted Metropolitan Stepped Glass / White Ring

Maximum Wattage
45W PAR16
OD: 4-3/4"



Metropolitan Ice Light Glass



Catalog No.	Description
NL-497B	Blue Metropolitan Ice Light Glass / White Ring
NL-497P	Pink Metropolitan Ice Light Glass / White Ring
NL-497F	White Frosted Metropolitan Ice Light Glass / White Ring

Maximum Wattage
45W PAR16
OD: 4-3/4"



LINE VOLTAGE RECESSED

4" IC MR16 GU10 Double Wall New Construction Line Voltage Housing



Nora Lighting's Line Voltage MR16 GU10 housing provides the crisp reflectance of MR16 light sources in insulated ceiling environments. GU10 lamps are shielded and feature solid, heavy duty turn-and-lock contacts. Nora's GU10 fixture is quick to install, operates on standard incandescent dimming controls, and accepts a wide variety of high quality, finished trims.

Minimum Clearances: Direct contact rated; no minimum clearance is required.

Air-Tight: Air-tight gasket comes pre-installed

Ceiling Thickness: Accepts 5/8" - 1-3/8" to accommodate various ceiling thicknesses.

Lamp: 50W MR16 GU10 (included)

Lamp Adjustment: MR16 GU10 trims have adjustment bracket providing a secure friction hold for any desired angle 50W MR16 GU10 twist and lock base line voltage (lamp included).

Installation: Bar hangers are adjustable from 13-5/8" to 24-1/2" with captive nails and can be repositioned 90 degrees. Bar hangers are slotted for T-Bar installations.

Junction Box: Contains two 3/4", three 1/2" knockouts and four Romex® with strain relief.

Electrical: Quick connector provided.

Socket: GU10 base

Listing:
cULus Damp Location w/ Feed Through
WSEC ASTM E283 for Air-Tight (AT)
cULus Wet Location (Only with designated trims)

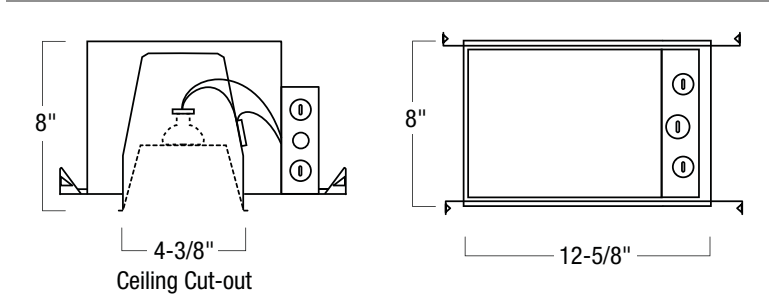

4" IC MR16 DOUBLE WALL NEW CONSTRUCTION HOUSING

CATALOG. NO.	TYPE	SOCKET	WATTAGE	AIR-TIGHT
NSLIC-401AT/10	IC	GU10 Base	50W	Yes



LINE VOLTAGE RECESSED

4" Non-IC MR16 GU10 New Construction Line Voltage Housing

Nora Lighting's Line Voltage MR16 GU10 housing provides the crisp reflectance of MR16 light sources while operating on line voltage without transformers. GU10 lamps are shielded and feature solid, heavy duty turn-and-lock contacts. Nora's GU10 fixture is quick to install, operates on standard incandescent dimming controls, and accepts a wide variety of high quality, finished trims.



Fire Rated Enclosure

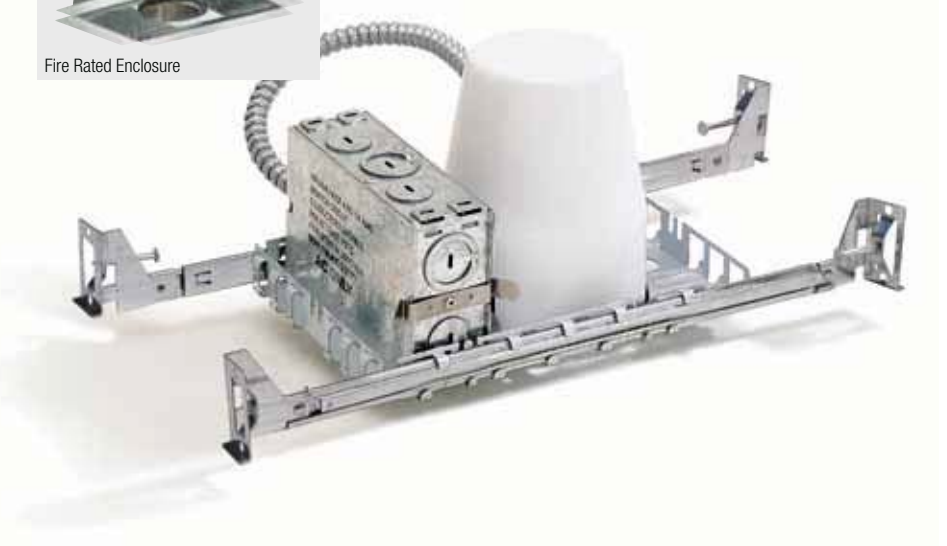

Minimum Clearances: Housing require minimum 3" from thermal insulation, 1/2" from adjacent building components.

Air-Tight: Air-tight gasket comes pre-installed

Ceiling Thickness: Accepts 5/8" - 1-3/8" to accommodate various ceiling thicknesses.

Lamp: 50W MR16 GU10 (included)

Lamp Adjustment: MR16 trims have adjustment bracket providing a secure friction hold for any desired angle.

Installation: Bar hangers are adjustable from 13-5/8" to 24-1/2" with captive nails and can be repositioned 90 degrees. Bar hangers are slotted for T-Bar installations.

Junction Box: Contains two 3/4", three 1/2" knockouts and four Romex® with strain relief.

Electrical: Quick connector provided.

Socket: GU10 base

Listing:

cULus Damp Location w/ Feed Through
WSEC ASTM E283 for Air-Tight (AT)
cULus Wet Location (Only with designated trims)

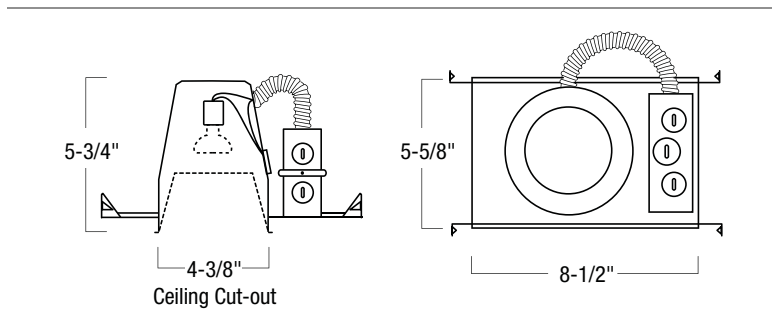

4" NON-IC MR16 GU10 NEW CONSTRUCTION SERIES

CATALOG. NO.	TYPE	SOCKET	WATTAGE	AIR-TIGHT
NSL-401AT/10	Non-IC	GU10 Base	50W	Yes

See page 379 for fire rated enclosure.



LINE VOLTAGE RECESSED 4" Non-IC MR16 GU10 Remodel Line Voltage Housing



Nora Lighting's Line Voltage MR16 GU10 housing provides the crisp reflectance of MR16 light sources while operating on line voltage without transformers. GU10 lamps are shielded and feature solid, heavy duty turn-and-lock contacts. Nora's GU10 fixture is quick to install, operates on standard incandescent dimming controls, and accepts a wide variety of high quality, finished trims.

Minimum Clearances: Housing require minimum 3" from thermal insulation, 1/2" from adjacent building components.

Air-Tight: Air-tight gasket comes pre-installed

Ceiling Thickness: Accepts 3/8" - 1-3/8" to accommodate various ceiling thicknesses.

Lamp: 50W MR16 GU10 (included)

Lamp Adjustment: MR16 trims have adjustment bracket providing a secure friction hold for any desired angle.

Installation: High tension tempered steel springs secure remodel housings evenly to ceiling; hole cut-out template provided for convenience.

Junction Box: Contains two 3/4", three 1/2" knockouts and four Romex® with strain relief.

Electrical: Quick connector provided.

Socket: GU10 base

Listing:
cULus Damp Location w/ Feed Through
WSEC ASTM E283 for Air-Tight (AT)
cULus Wet Location (Only with designated trims)

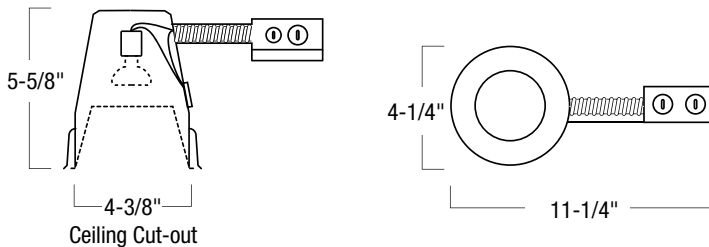

4" NON-IC MR16 GU10 REMODEL SERIES

CATALOG. NO.	TYPE	SOCKET	WATTAGE	AIR-TIGHT
NSLR-404AT/10	Non-IC	GU10 Base	50W	Yes



LINE VOLTAGE RECESSED

4" MR16 GU10 IC & Non-IC Rated Trims

Square Trim with Baffle

NEW!



Catalog No.	Description
NL-4810BB	Black Baffle / Black Square Trim
NL-4810BBZ	Black Baffle / Bronze Square Trim
NL-4810BCO	Black Baffle / Copper Square Trim
NL-4810WC	White Baffle / Chrome Square Trim
NL-4810WG	White Baffle / Gold Square Trim
NL-4810WN	White Baffle / Natural Metal Square Trim
NL-4810WW	White Baffle / White Square Trim

- 35° Adjustable

Maximum Wattage
50W 120V MR16 GU10

W x L: 4-3/4"

Aperture: 3-5/8"

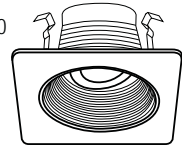

Square Trim with Reflector

NEW!



Catalog No.	Description
NL-4814BW	Specular Black Reflector / White Square Trim
NL-4814BZBZ	Bronze Reflector / Bronze Square Trim
NL-4814CB	Specular Clear Reflector / Black Square Trim
NL-4814CC	Specular Clear Reflector / Chrome Square Trim
NL-4814CG	Specular Clear Reflector / Gold Square Trim
NL-4814COCO	Copper Reflector / Copper Square Trim
NL-4814CW	Specular Clear Reflector / White Square Trim
NL-4814GW	Specular Gold Reflector / White Square Trim
NL-4814HZW	Haze Reflector / White Square Trim
NL-4814NN	Natural Metal Reflector / Natural Metal Square Trim

- 35° Adjustable

Maximum Wattage
50W 120V MR16 GU10

W x L: 4-3/4"

Aperture: 3-5/8"

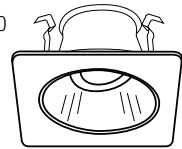

Square Trim w/ Gimbal and Baffle

NEW!



Catalog No.	Description
NL-4863BB	Black Gimbal / Black Baffle
NL-4863BC	Chrome Gimbal / Black Baffle
NL-4863BG	Gold Gimbal / Black Baffle
NL-4863BW	White Gimbal / Black Baffle
NL-4863BZBZ	Bronze Gimbal / Bronze Baffle
NL-4863COCO	Copper Gimbal / Copper Baffle
NL-4863NN	Natural Metal Gimbal / Natural Metal Baffle
NL-4863WW	White Gimbal / White Baffle

- 35° Adjustable

Maximum Wattage:
50W 120V MR16 GU10

W x L: 4-3/4"

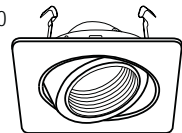

Square Trim with Gimbal

NEW!



Catalog No.	Description
NL-4865B	Black Surface Adjustable
NL-4865BZ	Bronze Surface Adjustable
NL-4865C	Chrome Surface Adjustable
NL-4865CO	Copper Surface Adjustable
NL-4865G	Gold Surface Adjustable
NL-4865N	Natural Metal Surface Adjustable
NL-4865W	White Surface Adjustable

- 35° Adjustable

Maximum Wattage
50W 120V MR16 GU10

W x L: 4-3/4"

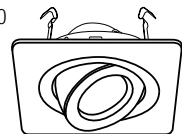

Lighting Tip:

Use Nora's GU10 Line Voltage Housings and Trims to give an economical MR16 low voltage visually acceptable appearance. GU10 lamps can also be easily dimmed with standard incandescent dimmers.

CC Square Trims and Reflectors can be combined. Example: If designer want a Natural Metal Reflector with a Black Square trim, specify NL-4814NB
See page 36-37 for Description of Reflector Finishes

4" MR16 GU10 IC & NON-IC RATED TRIMS continued

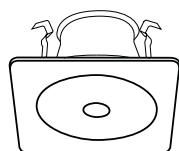

Maximum Wattage:
50W 120V MR16 GU10

W x L: 4-3/4"

Aperture: 1"

Catalog No.	Description
NL-4840B	Black Pinhole
NL-4840BZ	Bronze Pinhole
NL-4840C	Chrome Pinhole
NL-4840CO	Copper Pinhole
NL-4840G	Gold Pinhole
NL-4840N	Natural Metal Pinhole
NL-4840W	White Pinhole

- 35° Adjustable

Square Trim with 1" Pinhole

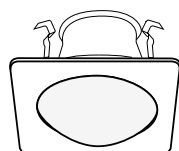

Maximum Wattage:
50W 120V MR16 GU10

W x L: 4-3/4"



Catalog No.	Description
NL-4825B	Frosted Dome Lens / Black Square Trim
NL-4825BZ	Frosted Dome Lens / Bronze Square Trim
NL-4825C	Frosted Dome Lens / Chrome Square Trim
NL-4825CO	Frosted Dome Lens / Copper Square Trim
NL-4825G	Frosted Dome Lens / Gold Square Trim
NL-4825N	Frosted Dome Lens / Natural Metal Square Trim
NL-4825W	Frosted Dome Lens / White Square Trim

- UL Wet Listed

Square Trim w/ Frosted Dome

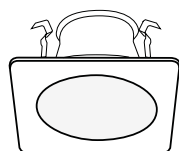

Maximum Wattage:
50W 120V MR16 GU10

W x L: 4-3/4"



Catalog No.	Description
NL-4826B	Flat Frosted Lens / Black Square Trim
NL-4826BZ	Flat Frosted Lens / Bronze Square Trim
NL-4826C	Flat Frosted Lens / Chrome Square Trim
NL-4826CO	Flat Frosted Lens / Copper Square Trim
NL-4826G	Flat Frosted Lens / Gold Square Trim
NL-4826N	Flat Frosted Lens / Natural Metal Square Trim
NL-4826W	Flat Frosted Lens / White Square Trim

- UL Wet Listed

Square Trim w/ Frosted Shower Trim



Maximum Wattage:
50W 120V MR16 GU10

W x L: 4-3/4"



Catalog No.	Description
NL-4827B	Flat Frosted Lens w/ Clear Center / Black Square Trim
NL-4827BZ	Flat Frosted Lens w/ Clear Center / Bronze Square Trim
NL-4827C	Flat Frosted Lens w/ Clear Center / Chrome Square Trim
NL-4827CO	Flat Frosted Lens w/ Clear Center / Copper Square Trim
NL-4827G	Flat Frosted Lens w/ Clear Center / Gold Square Trim
NL-4827N	Flat Frosted Lens w/ Clear Center / Natural Metal Square Trim
NL-4827W	Flat Frosted Lens w/ Clear Center / White Square Trim

- UL Wet Listed

Square Trim w/ Frosted Shower Trim w/ Clear Center



Lighting Tip:

Nora's GU10 Line Voltage Housings and Trims can be used with after market LED GU10 lamps for longer life and energy efficient lighting.

4" MR16 GU10 IC & NON-IC RATED TRIMS continued

Adjustable Baffle



CC

Catalog No.	Description
NL-410	White Stepped Baffle / White Ring
NL-410BZ	Bronze Stepped Baffle / Bronze Ring
NL-410CO	Copper Stepped Baffle / Copper Ring
NL-410N	Natural Metal Stepped Baffle / Natural Metal Ring
NL-410P	White Phenolic Stepped Baffle / White Plastic Ring 

Maximum Wattage
50W MR16 GU10

OD: 4-3/4"

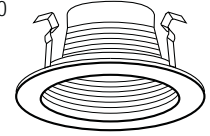

- Downlight or 35° Adjustable

Black Adjustable Baffle

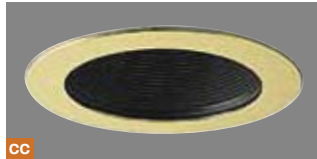

CC

Catalog No.	Description
NL-411	Black Stepped Baffle / White Ring
NL-411B	Black Stepped Baffle / Black Ring
NL-411BZ	Black Stepped Baffle / Bronze Ring
NL-411C	Black Stepped Baffle / Chrome Ring
NL-411CO	Black Stepped Baffle / Copper Ring
NL-411G	Black Stepped Baffle / Gold Ring
NL-411N	Black Stepped Baffle / Natural Metal Ring
NL-411P	Black Phenolic Stepped Baffle / White Plastic Ring 

Maximum Wattage
50W MR16 GU10

OD: 4-3/4"

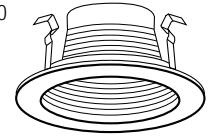

- Downlight or 35° Adjustable

45° Adjustable Baffle



CC

Catalog No.	Description
NL-468B	Black Baffle / White Ring
NL-468W	White Baffle / White Ring

Maximum Wattage
50W MR16 GU10

OD: 4-3/4"

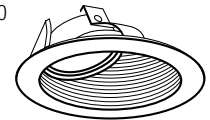

- 45° Adjustable
- Bias cut baffle

Adjustable Reflector



CC

Catalog No.	Description
NL-412	Specular Gold Reflector / White Ring
NL-412G	Specular Gold Reflector / Gold Ring
NL-413	Specular Black Reflector / White Ring
NL-413B	Specular Black Reflector / Black Ring
NL-414	Specular Clear Reflector / White Ring
NL-414C	Specular Clear Reflector / Chrome Ring
NL-414HZ	Haze Reflector / White Ring
NL-416	Specular White Reflector / White Ring
NL-452	Natural Metal Reflector / Natural Metal Ring
NL-453	Copper Reflector / Copper Ring
NL-453BZ	Bronze Reflector / Bronze Ring

Maximum Wattage
50W MR16 GU10

OD: 4-3/4"

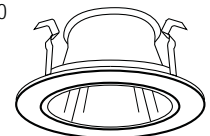

- Downlight or 35° Adjustable

Lighting Tip:

Use Nora's phenolic (plastic) baffle with plastic ring for outdoor or harsh environment applications (Ex. NL-410P, NL-411P)

CC Custom Combo: Available with custom combinations of trim and plastic or metal ring finish. See pages 38-39 for details. See pages 36-37 for Description of Reflector Finishes

4" MR16 GU10 IC & NON-IC RATED TRIMS continued

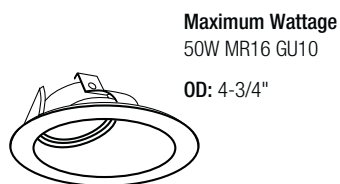

Maximum Wattage
50W MR16 GU10
OD: 4-3/4"

Catalog No.	Description
NL-469B	Specular Black Reflector / White Ring
NL-469BZ	Bronze Reflector / Bronze Ring
NL-469C	Specular Clear Reflector / White Ring
NL-469CO	Copper Reflector / Copper Ring
NL-469G	Specular Gold Reflector / White Ring
NL-469HZ	Haze Reflector / White Ring
NL-469N	Natural Metal Reflector / Natural Metal Ring
NL-469W	Specular White Reflector / White Ring

- 45° Adjustable
- Bias cut reflector

45° Adjustable Reflector

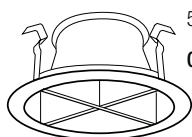
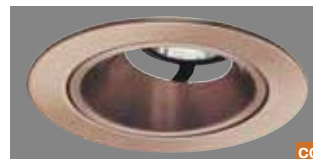

Maximum Wattage
50W MR16 GU10
OD: 4-3/4"

Catalog No.	Description
NL-417CW	Chrome Louver / Specular Clear Reflector / White Ring
NL-417GW	Chrome Louver / Specular Gold Reflector / White Ring

- Low aperture brightness

Cross Louver with Reflector

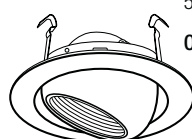

Maximum Wattage
50W MR16 GU10
OD: 4-3/4"

Catalog No.	Description
NL-418BB	Black Eyeball and Ring / Black Baffle
NL-418BZ	Bronze Eyeball and Ring / Black Baffle
NL-418CO	Copper Eyeball and Ring / Black Baffle
NL-418N	Natural Metal Eyeball and Ring / Black Baffle
NL-418WB	White Eyeball and Ring / Black Baffle
NL-418WW	White Eyeball and Ring / White Baffle
NL-419C	Chrome Eyeball and Ring / Black Baffle
NL-419G	Gold Eyeball and Ring / Black Baffle

- Downlight or 35° Adjustable

Adjustable Eyeball with Baffle

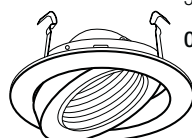

Maximum Wattage
50W MR16 GU10
OD: 4-3/4"

Catalog No.	Description
NL-463BB	Black Gimbal / Black Baffle / Black Ring
NL-463BC	Chrome Gimbal / Black Baffle / White Ring
NL-463BG	Gold Gimbal / Black Baffle / White Ring
NL-463BN	Natural Metal Gimbal / Black Baffle / Natural Metal Ring
NL-463BW	White Gimbal / Black Baffle / White Ring
NL-463BZ	Bronze Gimbal / Black Baffle / Bronze Ring
NL-463CO	Copper Gimbal / Black Baffle / Copper Ring
NL-463WB	Black Gimbal / White Baffle / Black Ring
NL-463WC	Chrome Gimbal / White Baffle / White Ring
NL-463WG	Gold Gimbal / White Baffle / White Ring
NL-463WW	White Gimbal / White Baffle / White Ring

- 35° Adjustable

Gimbal with Baffle

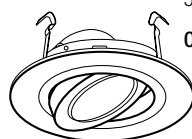

Maximum Wattage
50W MR16 GU10
OD: 4-3/4"

Catalog No.	Description
NL-465B	Black Surface Adjustable
NL-465BZ	Bronze Surface Adjustable
NL-465C	Chrome Surface Adjustable
NL-465CO	Copper Surface Adjustable
NL-465G	Gold Surface Adjustable
NL-465N	Natural Metal Surface Adjustable
NL-465W	White Surface Adjustable

- 35° Adjustable

Surface Adjustable



CC Custom Combo: Available with custom combinations of trim and plastic or metal ring finish. See pages 38-39 for details.

4" MR16 GU10 IC & NON-IC RATED TRIMS continued

Adjustable Spot



Catalog No.	Description
NL-491B	Black Adjustable Spot
NL-491N	Natural Metal Adjustable Spot
NL-491W	White Adjustable Spot

- 30° Adjustable

Maximum Wattage
50W MR16 GU10

OD: 4-3/4"

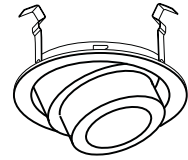

Adjustable Wall Wash with Baffle



Catalog No.	Description
NL-448	White Wall Wash / Black Baffle
NL-448BZ	Bronze Wall Wash / Bronze Baffle
NL-448CO	Copper Wall Wash / Copper Baffle
NL-448N	Natural Metal Wall Wash / Natural Metal Baffle
NL-449	White Wall Wash / White Baffle

Maximum Wattage
50W MR16 GU10

OD: 4-3/4"

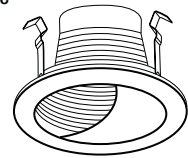

Adjustable Wall Wash w/ Reflector



Catalog No.	Description
NL-450	White Wall Wash / White Reflector

Maximum Wattage
50W MR16 GU10

OD: 4-3/4"

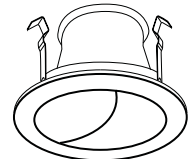

Adjustable Slot Aperture



Catalog No.	Description
NL-445	White Slot Aperture
NL-445B	Black Slot Aperture
NL-445BZ	Bronze Slot Aperture
NL-445CO	Copper Slot Aperture
NL-445N	Natural Metal Slot Aperture

- Downlight or 35° Adjustable

Maximum Wattage
50W MR16 GU10

OD: 4-3/4"

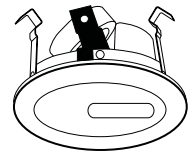

2" Pinhole with Baffle



Catalog No.	Description
NL-420	2" White Pinhole / Black Baffle
NL-421	2" White Pinhole / White Baffle

- Downlight
- 2" Aperture

Maximum Wattage
50W MR16 GU10

OD: 4-3/4"

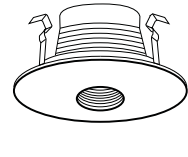

1" Pinhole



Catalog No.	Description
NL-440	White Pinhole
NL-440B	Black Pinhole
NL-440BZ	Bronze Pinhole
NL-440C	Chrome Pinhole
NL-440CO	Copper Pinhole
NL-440G	Gold Pinhole
NL-440N	Natural Metal Pinhole

- Downlight or 35° Adjustable
- 1" Aperture

Maximum Wattage
50W MR16 GU10

OD: 4-3/4"

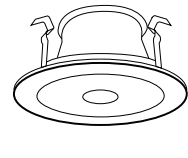

Adjustable Drop Gimbal



Catalog No.	Description
NL-490B	Black Adjustable Drop Gimbal Ring
NL-490W	White Adjustable Drop Gimbal Ring

- 90° Adjustment

Maximum Wattage
50W MR16 GU10

OD: 4-3/4"

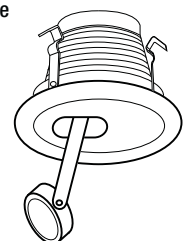

4" MR16 GU10 IC & NON-IC RATED TRIMS continued

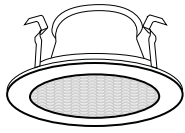

Maximum Wattage
50W MR16 GU10
OD: 4-3/4"



Catalog No.	Description
NL-422B	Black Shower Trim
NL-422BZ	Bronze Shower Trim
NL-422C	Chrome Shower Trim
NL-422CO	Copper Shower Trim
NL-422G	Gold Shower Trim
NL-422N	Natural Metal Shower Trim
NL-422W	White Shower Trim

- UL Wet Listed

Albalite Shower Trim

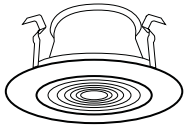

Maximum Wattage
50W MR16 GU10
OD: 4-3/4"



Catalog No.	Description
NL-423B	Black Shower Trim
NL-423BZ	Bronze Shower Trim
NL-423C	Chrome Shower Trim
NL-423CO	Copper Shower Trim
NL-423G	Gold Shower Trim
NL-423N	Natural Metal Shower Trim
NL-423W	White Shower Trim

- UL Wet Listed

Fresnel Shower Trim



Maximum Wattage
50W MR16 GU10
OD: 4-3/4"



Catalog No.	Description
NL-424B	Black Shower Trim
NL-424BZ	Bronze Shower Trim
NL-424C	Chrome Shower Trim
NL-424CO	Copper Shower Trim
NL-424G	Gold Shower Trim
NL-424N	Natural Metal Shower Trim
NL-424W	White Shower Trim

- UL Wet Listed

Drop Opal Shower Trim

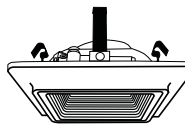

Maximum Wattage
50W MR16 GU10
OD: 4-3/4"

Catalog No.	Description
NL-486W	White Plastic Baffle / White Plastic Square Trim

- Plastic trim and baffle makes this excellent for harsh environment applications

Square Baffle

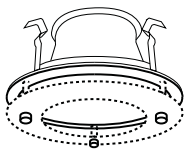

Maximum Wattage
50W MR16 GU10
OD: 4-3/4"

Catalog No.	Description
NL-438B	Specular Clear Reflector / Bronze Trim
NL-438C	Specular Clear Reflector / Chrome Trim
NL-438N	Specular Clear Reflector / Natural Metal Trim
NL-438W	Specular Clear Reflector / White Trim

- Glass sold separately.
- For a layered look, up to two pieces of glass may be used together.

Reflector for Decorative Glass



Includes:
NRA-203 Glass Hardware
• (3) Stand-offs
• (3) Cone End Caps
• (3) Flat End Caps
OD: 4-3/4"

Catalog No.	Description
NTG-4B/80	Tempered Blue / 80mm (3-1/8") Open Center
NTG-4CF	Tempered Frost Center / Clear Outer
NTG-4FC	Tempered Clear Center / Frost Outer
NTG-4HC	Tempered Clear Outer / Frost Inner 80mm (3-1/8") Open Center

- Includes NRA-203 Glass Hardware
- 2 decorative glasses can be combined for a tiered look

Decorative Glass for NL-438



4" MR16 GU10 IC & NON-IC RATED TRIMS continued

Round Acrylic with Accent



Catalog No.	Description
NL-461	Round Acrylic with Gold Accent
NL-461C	Round Acrylic with Chrome Accent

Maximum Wattage
50W MR16 GU10
OD: 4-3/4"

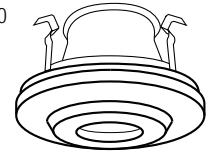

Square Acrylic with Accent

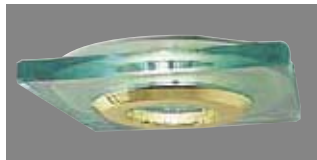

Catalog No.	Description
NL-462	Square Acrylic with Gold Accent

Maximum Wattage
50W MR16 GU10
OD: 4-3/4"

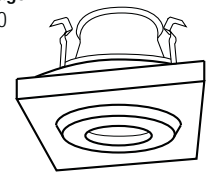

Metropolitan Moon Glass



Catalog No.	Description
NL-495B	Blue Metropolitan Moon Glass / White Ring
NL-495P	Pink Metropolitan Moon Glass / White Ring
NL-495F	White Frosted Metropolitan Moon Glass / White Ring

Maximum Wattage
50W MR16 GU10
OD: 4-3/4"

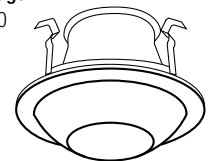

Metropolitan Stepped Glass



Catalog No.	Description
NL-496B	Blue Metropolitan Stepped Glass / White Ring
NL-496P	Pink Metropolitan Stepped Glass / White Ring
NL-496F	White Frosted Metropolitan Stepped Glass / White Ring

Maximum Wattage
50W MR16 GU10
OD: 4-3/4"



Metropolitan Ice Light Glass



Catalog No.	Description
NL-497B	Blue Metropolitan Ice Light Glass / White Ring
NL-497P	Pink Metropolitan Ice Light Glass / White Ring
NL-497F	White Frosted Metropolitan Ice Light Glass / White Ring

Maximum Wattage
50W MR16 GU10
OD: 4-3/4"

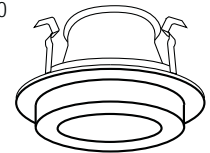

Floating Concentric Glass



Catalog No.	Description
NL-498B	Concentric Glass / Specular Clear Refl / Black Trim
NL-498BZ	Concentric Glass / Specular Clear Refl / Bronze Trim
NL-498C	Concentric Glass / Specular Clear Refl / Chrome Trim
NL-498CO	Concentric Glass / Specular Clear Refl / Copper Trim
NL-498G	Concentric Glass / Specular Clear Refl / Gold Trim
NL-498N	Concentric Glass / Specular Clear Refl / Natural Metal Trim
NL-498W	Concentric Glass / Specular Clear Refl / White Trim

Maximum Wattage
50W MR16 GU10
OD: 4-3/4"

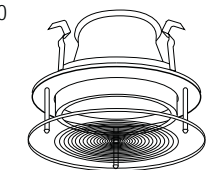

- Tempered Glass

LINE VOLTAGE RECESSED

True 3" Non-IC MR16 GU10 Double Wall New Construction Line Voltage Housing

NEW!



Nora Lighting's Line Voltage **True 3"** MR16 GU10 housing provides the crisp reflectance of MR16 light sources while operating on line voltage without transformers. GU10 lamps are shielded and feature solid, heavy duty turn-and-lock contacts. Nora's GU10 fixture is quick to install, operates on standard incandescent dimming controls, and accepts a wide variety of high quality, finished trims.

Minimum Clearances: Housing require minimum 3" from thermal insulation, 1/2" from adjacent building components.

Air-Tight: Air-tight gasket comes pre-installed

Ceiling Thickness: Accepts 3/8" - 1-3/8" to accommodate various ceiling thicknesses.

Lamp: 50W MR16 GU10 (included)

Lamp Adjustment: MR16 trims have adjustment bracket providing a secure friction hold for any desired angle.

Installation: High tension tempered steel springs secure remodel housings evenly to ceiling; hole cut-out template provided for convenience.

Junction Box: Contains two 3/4", three 1/2" knockouts and four Romex® with strain relief.

Electrical: Quick connector provided.

Socket: GU10 base

Listing:
cULus Damp Location w/ Feed Through
WSEC ASTM E283 for Air-Tight (AT)
cULus Wet Location (Only with designated trims)

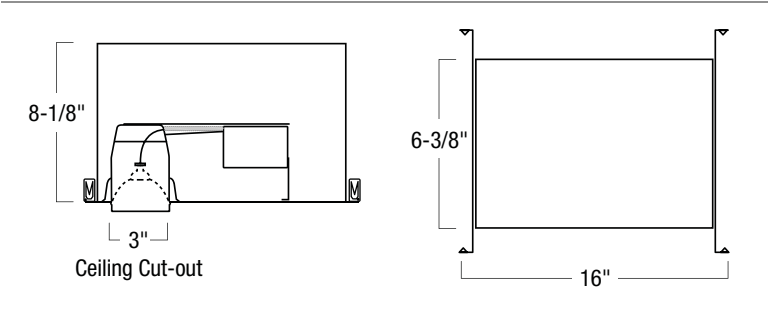

3" IC AIR-TIGHT MR16 GU10 DOUBLE WALL SERIES

CATALOG. NO.	TYPE	SOCKET	WATTAGE	AIR-TIGHT
NHIC-350AT	Non-IC	GU10 Base	50W	Yes



LINE VOLTAGE RECESSED

True 3" Non-IC MR16 GU10 New Construction Line Voltage Housing

Nora Lighting's Line Voltage **True 3"** MR16 GU10 housing provides the crisp reflectance of MR16 light sources while operating on line voltage without transformers. GU10 lamps are shielded and feature solid, heavy duty turn-and-lock contacts. Nora's GU10 fixture is quick to install, operates on standard incandescent dimming controls, and accepts a wide variety of high quality, finished trims.

Minimum Clearances: Housing require minimum 3" from thermal insulation, 1/2" from adjacent building components.

Air-Tight: Air-tight gasket comes pre-installed

Ceiling Thickness: Accepts 3/8" - 1-3/8" to accommodate various ceiling thicknesses.

Lamp: 50W MR16 GU10 (included)

Lamp Adjustment: MR16 trims have adjustment bracket providing a secure friction hold for any desired angle.

Installation: High tension tempered steel springs secure remodel housings evenly to ceiling; hole cut-out template provided for convenience.

Junction Box: Contains two 3/4", three 1/2" knockouts and four Romex® with strain relief.

Electrical: Quick connector provided.

Socket: GU10 base

Listing:

cULus Damp Location w/ Feed Through
WSEC ASTM E283 for Air-Tight (AT)
cULus Wet Location (Only with designated trims)

NEW!

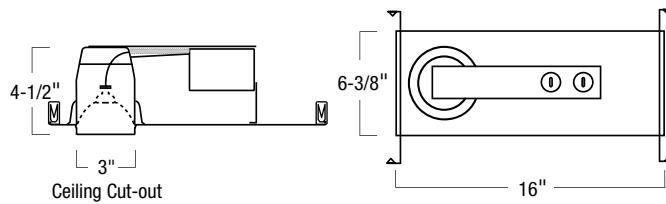

3" NON-IC AT MR16 GU10 NEW CONSTRUCTION SERIES

CATALOG. NO.	TYPE	SOCKET	WATTAGE	AIR-TIGHT
NH-350AT	Non-IC	GU10 Base	50W	Yes



LINE VOLTAGE RECESSED True 3" Non-IC MR16 GU10 Remodel Line Voltage Housing

NEW!



Nora Lighting's Line Voltage **True 3"** MR16 GU10 housing provides the crisp reflectance of MR16 light sources while operating on line voltage without transformers. GU10 lamps are shielded and feature solid, heavy duty turn-and-lock contacts. Nora's GU10 fixture is quick to install, operates on standard incandescent dimming controls, and accepts a wide variety of high quality, finished trims.

Minimum Clearances: Housing require minimum 3" from thermal insulation, 1/2" from adjacent building components.

Air-Tight: Air-tight gasket comes pre-installed

Ceiling Thickness: Accepts 3/8" - 1-3/8" to accommodate various ceiling thicknesses.

Lamp: 50W MR16 GU10 (included)

Lamp Adjustment: MR16 trims have adjustment bracket providing a secure friction hold for any desired angle.

Installation: High tension tempered steel springs secure remodel housings evenly to ceiling; hole cut-out template provided for convenience.

Junction Box: Contains two 3/4", three 1/2" knockouts and four Romex® with strain relief.

Electrical: Quick connector provided.

Socket: GU10 base

Listing:
cULus Damp Location w/ Feed Through
WSEC ASTM E283 for Air-Tight (AT)
cULus Wet Location (Only with designated trims)

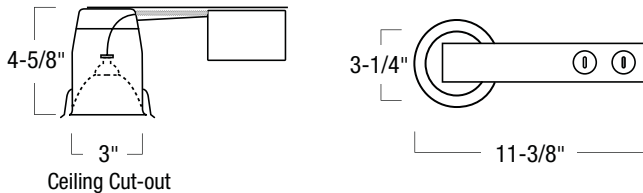

3" NON-IC AIR-TIGHT MR16 GU10 REMODEL SERIES

CATALOG. NO.	TYPE	SOCKET	WATTAGE	AIR-TIGHT
NHR-354AT	Non-IC	GU10 Base	50W	Yes



LINE VOLTAGE RECESSED

True 3" MR16 GU10 IC & Non-IC Rated Trims

Adjustable Baffle with Ring



CC

Catalog No.	Description
NL-3310BB	Black Baffle / Black Ring
NL-3310BC	Black Baffle / Chrome Ring
NL-3310BG	Black Baffle / Gold Ring
NL-3310BW	Black Baffle / White Ring
NL-3310BZBZ	Bronze Baffle / Bronze Ring
NL-3310COCO	Copper Baffle / Copper Ring
NL-3310NN	Natural Metal Baffle / Natural Metal Ring
NL-3310WB	White Baffle / Black Ring
NL-3310WBZ	White Baffle / Bronze Ring
NL-3310WC	White Baffle / Chrome Ring
NL-3310WG	White Baffle / Gold Ring
NL-3310WW	White Baffle / White Ring

- Downlight or 35° Adjustable

Maximum Wattage:
50W MR16 GU10

OD: 3-1/2"

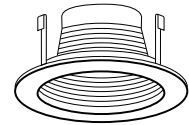

Adjustable Reflector with Ring



CC

Catalog No.	Description
NL-3312BB	Specular Black Reflector / Black Ring
NL-3312BW	Specular Black Reflector / White Ring
NL-3312BZBZ	Bronze Reflector / Bronze Ring
NL-3312CBZ	Specular Clear Reflector / Bronze Ring
NL-3312CC	Specular Clear Reflector / Chrome Ring
NL-3312CG	Specular Clear Reflector / Gold Ring
NL-3312COCO	Copper Reflector / Copper Ring
NL-3312CW	Specular Clear Reflector / White Ring
NL-3312GG	Specular Gold Reflector / Gold Ring
NL-3312GW	Specular Gold Reflector / White Ring
NL-3312HZW	Haze Reflector / White Ring
NL-3312NN	Natural Metal Reflector / Natural Metal Ring
NL-3312WW	Specular White Reflector / White Ring

- Downlight or 35° Adjustable

Maximum Wattage:
50W MR16 GU10

OD: 3-1/2"

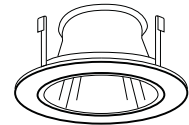

Cross Louver with Reflector



CC

Catalog No.	Description
NL-3337CW	Specular Clear Louver / Specular Clear Reflector / White Ring
NL-3337GW	Specular Clear Louver / Specular Gold Reflector / White Ring

Maximum Wattage:
50W MR16 GU10

OD: 3-1/2"

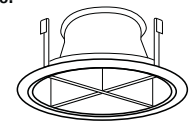

Adjustable Slot Aperture

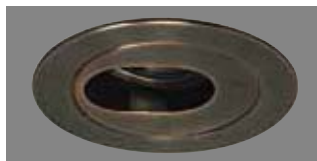

Catalog No.	Description
NL-3345B	Black Slot Aperture
NL-3345BZ	Bronze Slot Aperture
NL-3345C	Chrome Slot Aperture
NL-3345CO	Copper Slot Aperture
NL-3345G	Gold Slot Aperture
NL-3345N	Natural Metal Slot Aperture
NL-3345W	White Slot Aperture

- Downlight or 35° Adjustable

Maximum Wattage:
50W MR16 GU10

OD: 3-1/2"

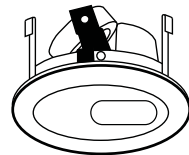

CC Custom Combo: Available with custom combinations of trim and ring finish. See pages 38-39 for details.

See pages 36-37 for Description of Reflector Finishes

TRUE 3" MR16 GU10 IC & NON-IC RATED TRIMS continued

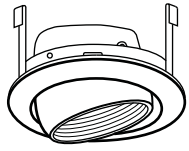

Maximum Wattage:
50W MR16 GU10
OD: 3-1/2"

Catalog No.	Description
NL-3318B	Black Eyeball / Black Baffle
NL-3318BZ	Bronze Eyeball / Black Baffle
NL-3318C	Chrome Eyeball / Black Baffle
NL-3318CO	Copper Eyeball / Black Baffle
NL-3318G	Gold Eyeball / Black Baffle
NL-3318N	Natural Metal Eyeball / Black Baffle
NL-3318W	White Eyeball / White Baffle

- 10° Adjustable

Eyeball with Baffle

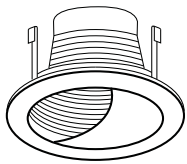

Maximum Wattage:
50W MR16 GU10
OD: 3-1/2"

Catalog No.	Description
NL-3348BB	Black Wall Wash / Black Baffle
NL-3348BW	White Wall Wash / Black Baffle
NL-3348WW	White Wall Wash / White Baffle

Wall Wash with Baffle

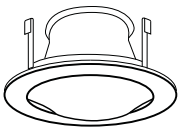

Maximum Wattage:
50W MR16 GU10
OD: 3-1/2"



Catalog No.	Description
NL-3325B	Black Shower Trim
NL-3325BZ	Bronze Shower Trim
NL-3325C	Chrome Shower Trim
NL-3325CO	Copper Shower Trim
NL-3325G	Gold Shower Trim
NL-3325N	Natural Metal Shower Trim
NL-3325W	White Shower Trim

- UL Wet Listed

Frosted Dome Shower Trim

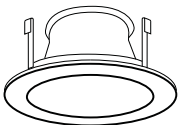

Maximum Wattage:
50W MR16 GU10
OD: 3-1/2"



Catalog No.	Description
NL-3326B	Black Shower Trim
NL-3326BZ	Bronze Shower Trim
NL-3326C	Chrome Shower Trim
NL-3326CO	Copper Shower Trim
NL-3326G	Gold Shower Trim
NL-3326N	Natural Metal Shower Trim
NL-3326W	White Shower Trim

- UL Wet Listed

Flat Frosted Shower Trim



Lighting Tip:

Use Nora's True 3" GU10 Line Voltage Housings and Trims with an after market LED GU10 lamps for small aperture, longer life, energy efficiency, and discrete lighting.

CC Custom Combo: Available with custom combinations of trim and ring finish. See pages 38-39 for details.



6" IC Air-Tight Double Wall Sloped Ceiling (High Wattage)

LINE VOLTAGE RECESSED

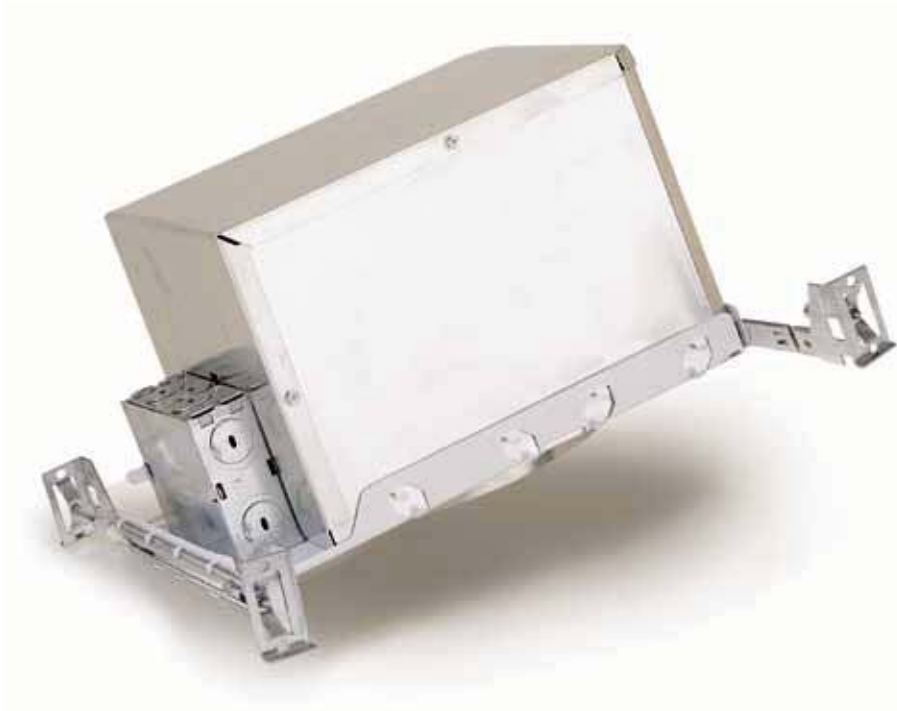

Nora Lighting's IC double wall housing for sloped ceilings offer a clear path of unobstructed light from a 6/12 pitch (22-1/2 degrees) ceiling to any floor or surface or 12/12 pitch (45 degrees) with designated trims. Double wall construction allows use of larger PAR38/R40 light source to deliver more illumination and provide a better finished appearance. Rated for direct contact with insulation and adjacent ceiling structures. Nora's sloped IC housings are easy and quick to install and accepts standard down light or adjustable finishing trims.

Maximum Slope Angle:

Pitch: 12/12; Angle: 45° (with designated trim)

Air-Tight: Air-tight gasket comes pre-installed

Minimum Clearances: No minimum clearance is required; may come in direct contact with insulation.

Ceiling Thickness: Varies from 5/8" - 1-3/8".

Lamp Adjustment: Three adjustment points allow slight tilt of housing cylinder with slide and tilt adjustments for the socket.

Installation: Bar hangers are adjustable from 13-5/8" to 24-1/2" with captive nails and can be repositioned 90 degrees. Bar hangers are slotted for T-Bar installations.

Junction Box:

Junction box is listed for through branch circuit wiring and contains seven 1/2" knockouts and four Romex® with strain relief.

Electrical: Quick Connector provided.

Socket: Steel shell porcelain housed inside die-cast socket cup provided to dissipate heat and maximize lamp life. Medium screw-in base.

Listing:

cULus Damp Location w/ Feed Through
WSEC ASTM E283 for Air-Tight (AT only)
cULus Wet Location (Only with designated trims)

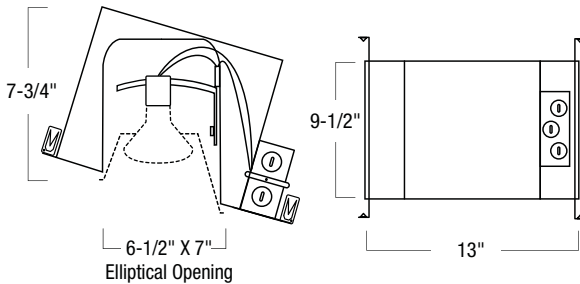

6" IC DOUBLE WALL SLOPED CEILING HOUSING

CATALOG. NO.	TYPE	SOCKET	MAXIMUM WATTAGE	AIR-TIGHT
NHIC-926/DWQAT	IC	Medium Screw-in Base	100W	Yes



LINE VOLTAGE RECESSED

6" IC Air-Tight New Construction Sloped Ceiling

Nora Lighting's IC new construction housing for sloped ceilings offer a clear path of unobstructed light from a 6/12 pitch (22-1/2 degrees) ceiling to any floor or surface or 12/12 pitch (45 degrees) with designated trims. Air-tight housing additionally reduces energy costs by decreasing the flow or air escaping through the ceiling. Rated for direct contact with insulation and adjacent ceiling structures. Nora's sloped IC housings are easy and quick to install and accepts standard down light or adjustable finishing trims.

Maximum Slope Angle:

Pitch: 12/12; Angle: 45° (with designated trim)

Air-Tight: Air-tight gasket comes pre-installed

Minimum Clearances: No minimum clearance is required; may come in direct contact with insulation.

Ceiling Thickness: Varies from 5/8" - 1-3/8".

Lamp Adjustment: Three adjustment points allow slight tilt of housing cylinder with slide and tilt adjustments for the socket.

Installation: Bar hangers are adjustable from 13-5/8" to 24-1/2" with captive nails and can be repositioned 90 degrees. Bar hangers are slotted for T-Bar installations.

Junction Box: Junction box is listed for through branch circuit wiring and contains seven 1/2" knockouts and four Romex® with strain relief.

Electrical: Quick Connector provided.

Socket: Steel shell porcelain housed inside die-cast socket cup provided to dissipate heat and maximize lamp life. Medium screw-in base.

Listing:

cULus Damp Location w/ Feed Through
WSEC ASTM E283 for Air-Tight (AT only)
cULus Wet Location (Only with designated trims)

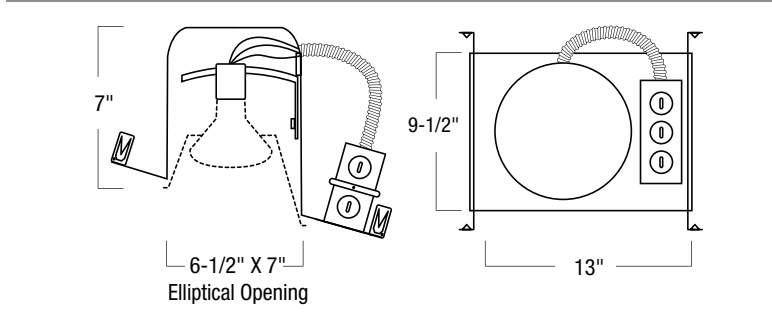

6" IC NEW CONSTRUCTION SLOPED CEILING HOUSING

CATALOG. NO.	TYPE	SOCKET	MAXIMUM WATTAGE	AIR-TIGHT
NHIC-926QAT	IC	Medium Screw-in Base	75W	Yes



LINE VOLTAGE RECESSED 6" IC Air-Tight Remodel Sloped Ceiling



Nora Lighting's IC remodel housing for sloped ceilings offer a clear path of unobstructed light from a 6/12 pitch (22-1/2 degrees) ceiling to any floor or surface or 12/12 pitch (45 degrees) with designated trims. Air-tight housing additionally reduces energy costs by decreasing the flow of air escaping through the ceiling. Rated for direct contact with insulation and adjacent ceiling structures. Nora's sloped IC housings are easy and quick to install and accepts standard down light or adjustable finishing trims.

Maximum Slope Angle:

Pitch: 12/12; Angle: 45° (with designated trim)

Air-Tight: Air-tight gasket comes pre-installed

Minimum Clearances: No minimum clearance is required; may come in direct contact with insulation.

Ceiling Thickness: Varies from 3/8" - 1-3/8".

Lamp Adjustment: Three adjustment points allow slight tilt of housing cylinder with slide and tilt adjustments for the socket.

Installation: High tension tempered steel springs secure remodel housings evenly to ceiling; hole cutout template provided for convenience.

Junction Box: Junction box is listed for through branch circuit wiring and contains seven 1/2" knockouts and four Romex® with strain relief.

Electrical: Quick Connector provided.

Socket: Steel shell porcelain housed inside die-cast socket cup provided to dissipate heat and maximize lamp life. Medium screw-in base.

Listing:

cULus Damp Location w/ Feed Through
WSEC ASTM E283 for Air-Tight (AT only)
cULus Wet Location (Only with designated trims)

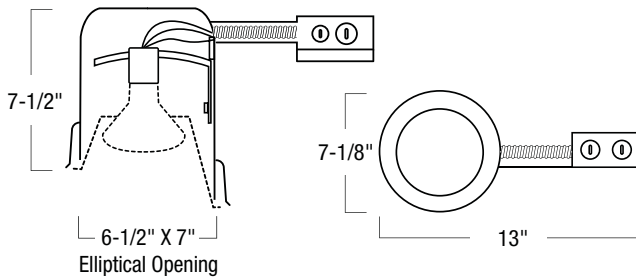

6" IC REMODEL SLOPED CEILING HOUSING

CATALOG. NO.	TYPE	SOCKET	MAXIMUM WATTAGE	AIR-TIGHT
NHRIC-926QAT	IC	Medium Screw-in Base	75W	Yes



LINE VOLTAGE RECESSED

6" Non-IC New Construction Sloped Ceiling Housing

Nora Lighting's housing for sloped ceilings offer a clear path of unobstructed light from a 6/12 pitch (22-1/2 degrees) ceiling to any floor or surface or 12/12 pitch (45 degrees) with designated trims. Standard construction allows use of larger higher wattage PAR38/R40 light sources to deliver the greatest amount of illumination necessary for high ceilings and provides a clean finished appearance. . Nora's sloped housings are easy and quick to install and accepts standard down light or adjustable finishing trims.

Maximum Slope Angle:

Pitch: 12/12; Angle: 45° (with designated trim)

Minimum Clearances: Requires a minimum clearance of 3" from thermal insulation and 1/2" from adjacent building components.

Ceiling Thickness: Varies from 5/8" - 1-3/8".

Lamp Adjustment: Three adjustment points allow slight tilt of housing cylinder with slide and tilt adjustments for the socket.

Installation: Bar hangers are adjustable from 13-5/8" to 24-1/2" with captive nails and can be repositioned 90 degrees. Bar hangers are slotted for T-Bar installations.

Junction Box: Junction box is listed for through branch circuit wiring and contains seven 1/2" knockouts and four Romex® with strain relief.

Electrical: Quick Connector provided.

Socket: Steel shell porcelain housed inside die-cast socket cup provided to dissipate heat and maximize lamp life. Medium screw-in base.

Listing:

cULus Damp Location w/ Feed Through
cULus Wet Location (Only with designated trims)

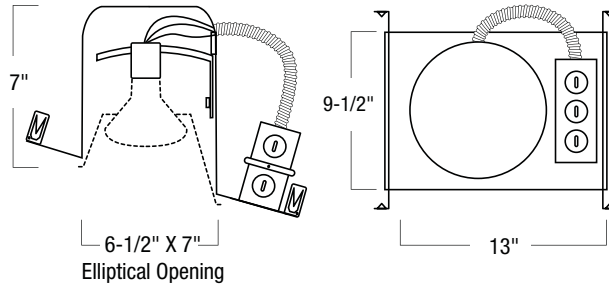

6" NEW CONSTRUCTION SLOPED CEILING HOUSING

CATALOG. NO.	TYPE	SOCKET	MAXIMUM WATTAGE	AIR-TIGHT
NH-926Q	Non-IC	Medium Screw-in Base	150W	No



LINE VOLTAGE RECESSED 6" Non-IC Remodel Sloped Ceiling



Nora Lighting's remodel housing for sloped ceilings offer a clear path of unobstructed light from a 6/12 pitch (22-1/2 degrees) ceiling to any floor or surface or 12/12 pitch (45 degrees) with designated trims. Standard construction allows use of larger higher wattage PAR38/R40 light sources to deliver the greatest amount of illumination necessary for high ceilings and provides a clean finished appearance. Nora's sloped housings are easy and quick to install and accepts standard down light or adjustable finishing trims.

Maximum Slope Angle:
Pitch: 12/12; Angle: 45° (with designated trim)

Minimum Clearances: Requires a minimum clearance of 3" from thermal insulation and 1/2" from adjacent building components.

Ceiling Thickness: Varies from 3/8" - 1-3/8".

Lamp Adjustment: Three adjustment points allow slight tilt of housing cylinder with slide and tilt adjustments for the socket.

Installation: High tension tempered steel springs secure remodel housings evenly to ceiling; hole cutout template provided for convenience.

Junction Box: Junction box is listed for through branch circuit wiring and contains seven 1/2" knockouts and four Romex® with strain relief.

Electrical: Quick Connector provided.

Socket: Steel shell porcelain housed inside die-cast socket cup provided to dissipate heat and maximize lamp life. Medium screw-in base.

Listing:
cULus Damp Location w/ Feed Through
cULus Wet Location (Only with designated trims)

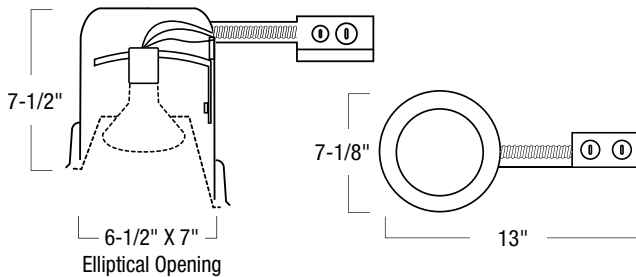

6" REMODEL SLOPED CEILING HOUSING

CATALOG. NO.	TYPE	SOCKET	MAXIMUM WATTAGE	AIR-TIGHT
NHR-926Q	Non-IC	Medium Screw-in Base	150W	No



LINE VOLTAGE RECESSED

6" Sloped Ceiling Trims

Sloped Baffle



Catalog No.	Description
NTM-615B	Black Baffle / White Flange
NTM-615W	White Baffle / White Flange

- Maximum Wattage
150W BR40/PAR38 (Non-IC): NH-926Q; NHR-926Q
100W BR40/PAR30 (IC): NHIC-926/DWQAT
75W BR/PAR30 (IC): NHIC-926QAT; NHRIC-926QAT

Maximum Wattage:
See Description

OD: 7-1/2" x 7-7/8"

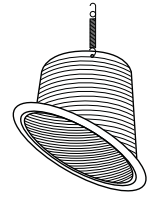

45° Super Sloped Baffle

NEW!
SUPER SLOPE



Catalog No.	Description
NTM-615/45B	45° Black Baffle / White Flange
NTM-615/45W	45° White Baffle / White Flange

- Maximum Wattage
150W BR40/PAR38 (Non-IC): NH-926Q; NHR-926Q
100W BR40/PAR30 (IC): NHIC-926/DWQAT
75W BR/PAR30 (IC): NHIC-926QAT; NHRIC-926QAT

Maximum Wattage:
See Description

OD: 7-1/2" x 7-7/8"

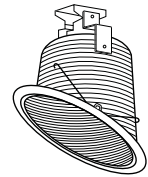

Sloped Phenolic Baffle



Catalog No.	Description
NTP-614B	Black Phenolic Baffle / White Flange
NTP-614W	White Phenolic White / White Flange

- Maximum Wattage
150W BR40/PAR38 (Non-IC): NH-926Q; NHR-926Q
100W BR40/PAR30 (IC): NHIC-926/DWQAT
75W BR/PAR30 (IC): NHIC-926QAT; NHRIC-926QAT

Maximum Wattage:
See Description

OD: 7-1/2" x 7-7/8"

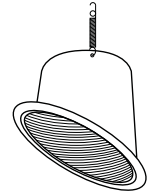

45° Super Sloped Phenolic Baffle

NEW!
SUPER SLOPE



Catalog No.	Description
NTP-614/45B	45° Black Phenolic Baffle / White Flange
NTP-614/45W	45° White Phenolic White / White Flange

- Maximum Wattage
150W BR40/PAR38 (Non-IC): NH-926Q; NHR-926Q
100W BR40/PAR30 (IC): NHIC-926/DWQAT
75W BR/PAR30 (IC): NHIC-926QAT; NHRIC-926QAT

Maximum Wattage:
See Description

OD: 7-1/2" x 7-7/8"

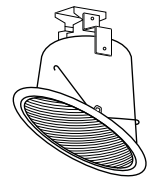

Sloped Reflector



Catalog No.	Description
NTS-615B	Specular Black Reflector / White Flange
NTS-615C	Specular Clear Reflector / White Flange
NTS-615G	Specular Gold Reflector / White Flange
NTS-615W	Specular White Reflector / White Flange

- Maximum Wattage
150W BR40/PAR38 (Non-IC): NH-926Q; NHR-926Q
100W BR40/PAR30 (IC): NHIC-926/DWQAT
75W BR/PAR30 (IC): NHIC-926QAT; NHRIC-926QAT

Maximum Wattage:
See Description

OD: 7-1/2" x 7-7/8"

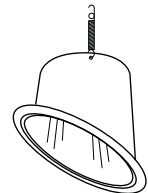

45° Super Sloped Reflector

NEW!
SUPER SLOPE



Catalog No.	Description
NTS-615/45B	45° Specular Black Reflector / White Ring
NTS-615/45C	45° Specular Clear Reflector / White Ring
NTS-615/45G	45° Specular Gold Reflector / White Ring
NTS-615/45W	45° Specular White Reflector / White Ring

- Maximum Wattage
150W BR40/PAR38 (Non-IC): NH-926Q; NHR-926Q
100W BR40/PAR30 (IC): NHIC-926/DWQAT
75W BR/PAR30 (IC): NHIC-926QAT; NHRIC-926QAT

Maximum Lamp:
See Description

OD: 7-1/2" x 7-7/8"

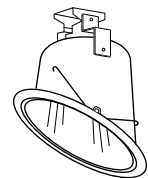

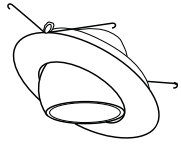

Maximum Wattage:
75W BR/PAR30
OD: 8"

Catalog No.	Description
NT-28	White Eyeball
NT-28B	Black Eyeball
NT-28BZ	Bronze Eyeball
NT-28CO	Copper Eyeball
NT-28N	Natural Metal Eyeball
NT-29C	Chrome Eyeball
NT-29G	Gold Eyeball

- 45° Adjustable

Eyeball

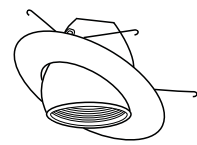

Maximum Wattage:
75W PAR30
OD: 8"

Catalog No.	Description
NTM-38	White Eyeball / Black Baffle / White Ring
NTM-39	White Eyeball / White Baffle / White Ring

- 25° Adjustable

Eyeball with Baffle

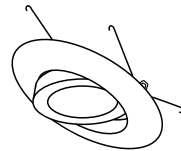

Maximum Wattage:
75W PAR30
OD: 8"

Catalog No.	Description
NTM-52B	Black Open Gimbal
NTM-52BZ	Bronze Open Gimbal
NTM-52C	Chrome Open Gimbal
NTM-52CO	Copper Open Gimbal
NTM-52G	Gold Open Gimbal
NTM-52N	Natural Metal Open Gimbal
NTM-52W	White Open Gimbal

- 23° Adjustable (Long Neck)
- 32° Adjustable (Short neck)

PAR30 Open Gimbal

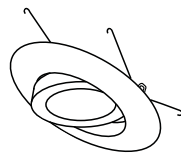

Maximum Wattage:
See Description
OD: 8"

Catalog No.	Description
NTM-53B	Black Open Gimbal
NTM-53BZ	Bronze Open Gimbal
NTM-53C	Chrome Open Gimbal
NTM-53CO	Copper Open Gimbal
NTM-53G	Gold Open Gimbal
NTM-53N	Natural Metal Open Gimbal
NTM-53W	White Open Gimbal

- 25° Adjustable
- Maximum Wattage
150W PAR38 (Non-IC): NH-926Q; NHR-926Q
100W PAR38 (IC): NHIC-926/DWQAT

PAR38 Open Gimbal

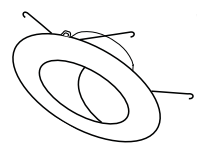
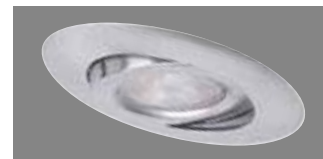

Maximum Wattage:
See Description
OD: 8"

Catalog No.	Description
NT-25	White Wall Wash
NT-25B	Black Wall Wash

- Maximum Wattage
60W A19 (Non-IC): NH-926Q; NHR-926Q
40W A19 (IC): NHIC-926QAT; NHRIC-926QAT

Wall Wash



CC Custom Combo: Available with custom combinations of trim and ring finish. See pages 38-39 for details.

6" SLOPED CEILING TRIMS continued

Albalite Shower Trim



Catalog No.	Description
NT-22	White Shower Trim
NT-22B	Black Shower Trim
NT-22BZ	Bronze Shower Trim
NT-22C	Chrome Shower Trim
NT-22CO	Copper Shower Trim
NT-22G	Gold Shower Trim
NT-22N	Natural Metal Shower Trim

- UL Wet Listed
- Maximum Wattage
60W A19 (Non-IC): NH-926Q; NHR-926Q
40W A19 (IC): NHIC-926QAT; NHRIC-926QAT

Maximum Wattage:
See Description

OD: 8"

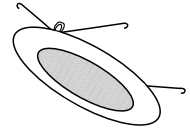

Fresnel Shower Trim



Catalog No.	Description
NT-23	White Shower Trim
NT-23B	Black Shower Trim
NT-23BZ	Bronze Shower Trim
NT-23C	Chrome Shower Trim
NT-23CO	Copper Shower Trim
NT-23G	Gold Shower Trim
NT-23N	Natural Metal Shower Trim

- UL Wet Listed
- Maximum Wattage
60W A19 (Non-IC): NH-926Q; NHR-926Q
40W A19 (IC): NHIC-926QAT; NHRIC-926QAT

Maximum Wattage:
See Description

OD: 8"

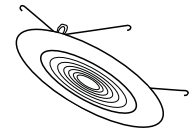

Drop Opal Shower Trim



Catalog No.	Description
NT-24	White Shower Trim
NT-24B	Black Shower Trim
NT-24BZ	Bronze Shower Trim
NT-24C	Chrome Shower Trim
NT-24CO	Copper Shower Trim
NT-24G	Gold Shower Trim
NT-24N	Natural Metal Shower Trim

- UL Wet Listed
- Maximum Wattage
60W A19 (Non-IC): NH-926Q; NHR-926Q
40W A19 (IC): NHIC-926QAT; NHRIC-926QAT

Maximum Wattage:
See Description

OD: 8"

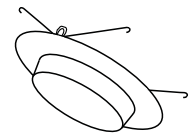



The Nora Lighting family of Retrofit Products

Nora Lighting's Retro Products offer a solution to improving the quality and efficiency of light in an existing recessed housings. Nora Retro-Fit products offer the customer the opportunity to change their lighting without expensive remodeling. The LED Diamond Retrofits change a 6" or 5" existing housing into an energy efficient, green, long life source. The 6" low voltage retro-fits easily change a medium based 6" housing into a more efficient MR16 or AR111 adjustable fixture. Electronic Fluorescent Retro-Fits convert a medium base fixture into a energy saving CFL. Track Retro-Fits convert an existing recessed housing into a mono point adaptor that can accommodate one of over 100 track heads or a pendant assembly with over 100 glass choices. Nora Retro Fits makes changing a lighting design from ordinary to dramatic as simple as unscrewing a light bulb.

6" and 5" LED Retrofit Diamond Series

- 6" or 5" Retrofits
- 7 Year Limited Warranty
- 650 Lumen Output, 86 CRI
- Dimmable down to 5%
- Easy Installation
- Several Trim Finishes
- Rated for IC and Non-IC Housings



6" Low Voltage Retrofit Kits

- Over 20 trim selections
- 7 Trim finishes
- Quiet Electronic or Magnetic Transformers
- Easy installation
- Compatible with most 6" Non-IC Housings
- No Tools or rewiring required



6" Compact Fluorescent Retrofit Kits

- Title 24 when hardwired in IC AT Rated housing
- Can qualify for Energy Rebate
- Available in 13, 18, Double 13 and 26 watts
- UL listed for hardwire applications
- Electronic Transformers
- Can be used with existing Trims or Update with over 100 trims offered by Nora
- No tools or rewiring required



Track Mono-Point Retrofit

- 6" converts medium based 6" housing into a track mono-point
- 4" converts medium based 4" housing into a track mono-point
- Over 100 track head selections in 5 light sources.
- Pendant adaptors in 5 light sources and over 100 glass styles
- No tools or rewiring required



Overview RECESSED RETROFIT

LED RETROFIT DIAMOND SERIES



NEW! **LED!**
6" LED Retrofit, Medium Base
For IC and Non-IC Housings
NLEDR-6 p.348



NEW! **LED!**
5" LED Retrofit, Medium Base
For IC and Non-IC Housings
NLEDR-5 p.349

COMPACT FLUORESCENT RECESSED RETROFIT



6" Single Lamp CF Retrofit Kit
NPK Series p.351



6" Dual Lamp CF Retrofit Kit
NPK-13/2L p.351

LOW VOLTAGE RECESSED RETROFIT



6" MR16 Retrofit Kit for
Existing Non-IC Housings
NLK-2600 Series p.356



6" PAR36 / AR111 Retrofit Kit
for Existing Non-IC Housings
NLK-2636 Series p.356

HOUSING-TO-TRACK RETROFIT LIGHTING



NEW!
6" Housing-to-Track Monopoint
Retrofit
NT-376 p.360



NEW!
4" Housing-to-Track Monopoint
Retrofit
NT-374 p.360

LIGHTING TIP:

Replace outdated 6" trims with low profile low voltage adjustable regressed retrofit trims that give the appearance of designer specified 3" and 4" aperture light fixtures. Replace slope ceiling trims with a 90 degree adjustable elbow and light pictures or focal points on the wall.

LED RETROFIT DIAMOND RECESSED SERIES

6" LED Retrofit Diamond Series

Nora Lighting is excited to introduce a new product line to our LED family, LED Retrofit Diamond Recessed Luminaires.

The Nora LED Retrofit Diamond is designed and cULus listed for use in existing 6" IC or Non-IC housings manufactured by Nora and others. Providing 650 lumen output and 86 CRI the LED Diamond Retrofit is an obvious choice for Green Energy Efficient Lighting in Commercial and Residential applications.

7 YEAR
LIMITED WARRANTY

Electrical:

Voltage: 120VAC
Current: 100mA
Lumens: 650 lm
Power Consumption: 11.8 Watts
Operating Temperature: 0°C~50°C (32°F~122°F)
Life Expectancy: 50,000 Hours

Socket:

Edison Medium Base Socket (included w/ Retrofit)
Quick Connect (included with dedicated)
GU24 Socket (accessory available)

Installation: Torsion springs

Construction: Scientifically and specifiable "Unitized Thermal Management system" (UTM) provides exceptional cool operation exceeding all industry standards.

Lens: Deep set for excellent glare control scientifically designed for optimal performance.

Dimming: Nora Diamond Retrofit works with standard leading and trailing edge dimming technologies. Dimming with leading-edge dimmers (electronic) are 5-100% and for trailing-edge dimmers (incandescent) 10-100%. There may be some cases that require more than one lighting fixture to be used to meet minimum dimmer load. Consult with dimmer manufacturer.

Listing:

cULus Listed for Damp Location
UL Classified for use with most manufacturers IC and Non-IC housings
WSEC ASTM E283 for Air-Tight (with IC Housing)
Title 24 Compliant (GU24 & Dedicated Version)
Energy Star Rated
RoHS Compliant
7 Year Limited Warranty
Conforms to IESNA LM-79 and LM-80



NRA-212 GU24 Adapter

6" LED RETROFIT DIAMOND UNIT

CATALOG. NO.	TRIM	COLOR TEMP.	REFLECTOR / BAFFLE AND FLANGE FINISH
NLEDC - Dedicated	661 - Reflector	30 - 3000K	See Below
NLEDR -Retrofit	662 - Baffle	40 - 4000K	See Below

661 - Reflector and Flange Finishes

BW - Specular Black Reflector and White Flange
BZBZ - Bronze Reflector and Bronze Flange
COCO - Copper Reflector and Copper Flange
CW - Specular Clear Reflector and White Flange
HZW - Haze Reflector and White Flange
NN - Natural Metal Reflector and Nat. Metal Flange
WW - White Reflector and White Flange

662 - Baffle and Flange Finishes

BW - Black Baffle and White Flange
BZBZ - Bronze Baffle and Bronze Flange
COCO - Copper Baffle and Copper Flange
NN - Natural Metal Baffle and Nat. Metal Flange
WW - White Baffle and White Flange



COMPATIBLE NORA NEW CONSTR. HOUSINGS

NHIC-17QAT 6" ICAT Incand. (Standard)
NHIC-17QNBAT 6" ICAT Incand. (No Bracket)
NH-26Q 6" Incandescent (Standard)
NH-26QNB 6" Incandescent (No Bracket)
NHIC-6G24ATFL 6" ICAT GU24
NHIC-6LMRAT 6" ICAT Dedicated LED



COMPATIBLE NORA REMODEL HOUSINGS

NHRIC-17QAT 6" ICAT Incand. (Standard)
NHRIC-17QNBAT 6" ICAT Incand. (No Bracket)
NHR-26Q 6" Incandescent (Standard)
NHRIC-6G24ATFL 6" ICAT GU24
NHRIC-6LMRAT 6" ICAT Dedicated LED



See pages 34-37 for description of reflector finishes

LED RETROFIT DIAMOND RECESSED SERIES

5" LED Retrofit Diamond Series

7 YEAR
LIMITED WARRANTY



NRA-212 GU24 Adapter

5" LED RETROFIT DIAMOND UNIT

CATALOG. NO.	TRIM	COLOR TEMP.	REFLECTOR / BAFFLE AND FLANGE FINISH
NLEDC - Dedicated	561 - Reflector	30 - 3000K	See Below
NLEDR - Retrofit	562 - Baffle	40 - 4000K	See Below

561 - Reflector and Flange Finishes

BW - Specular Black Reflector and White Flange
BZBZ - Bronze Reflector and Bronze Flange
COCO - Copper Reflector and Copper Flange
CW - Specular Clear Reflector and White Flange
HZW - Haze Reflector and White Flange
NN - Natural Metal Reflector and Nat. Metal Flange
WW - White Reflector and White Flange

562 - Baffle and Flange Finishes

BW - Black Baffle and White Flange
BZBZ - Bronze Baffle and Bronze Flange
COCO - Copper Baffle and Copper Flange
NN - Natural Metal Baffle and Nat. Metal Flange
WW - White Baffle and White Flange



COMPATIBLE NORA NEW CONSTR. HOUSINGS

NHIC-501QAT 5" ICAT Incandescent
NH-501Q 5" Incandescent

NHIC-5G24ATFL 5" ICAT GU24
NHIC-5LMRAT 5" ICAT Dedicated LED



COMPATIBLE NORA REMODEL HOUSINGS

NHRIC-504QAT 5" ICAT Incandescent
NHR-504Q 5" Incandescent

NHRIC-5G24ATFL 5" ICAT GU24
NHRIC-5LMRAT 5" ICAT Dedicated LED

Nora Lighting is excited to introduce a new product line to our LED family, LED Retrofit Diamond Recessed Luminaires.

The Nora LED Retrofit Diamond is designed and cULus listed for use in existing 5" IC or Non-IC housings manufactured by Nora and others. Providing 650 lumen output and 86 CRI the LED Diamond Retrofit is an obvious choice for Green Energy Efficient Lighting in Commercial and Residential applications.

Electrical:

Voltage: 120VAC
 Current: 100mA
 Lumens: 650 lm
 Power Consumption: 11.8 Watts
 Operating Temperature: 0°C~50°C (32°F~122°F)
 Life Expectancy: 50,000 Hours

Socket:

Edison Base Socket (included with Retrofit)
 Quick Connect (included with dedicated)
 GU24 Socket (accessory available)

Installation:

Torsion springs

Construction: Scientifically and specifiable "Unitized Thermal Management system" (UTM) provides exceptional cool operation exceeding all industry standards.

Lens: Deep set for excellent glare control scientifically designed for optimal performance.

Dimming: Nora Diamond Retrofit works with standard leading and trailing edge dimming technologies. Dimming with leading-edge dimmers (electronic) are 5-100% and for trailing-edge dimmers (incandescent) 10-100%. There may be some cases that require more than one lighting fixture to be used to meet minimum dimmer load. Consult with dimmer manufacturer.

Listing:

cULus Listed for Damp Location
 UL Classified for use with most manufacturers IC and Non-IC housings
 WSEC ASTM E283 for Air-Tight (with IC Housing)
 Title 24 Compliant (GU24 & Dedicated Version)
 Energy Star Rated
 RoHS Compliant
 7 Year Limited Warranty
 Conforms to IESNA LM-79 and LM-80



See pages 34-37 for description of reflector finishes



RETROFIT RECESSED/TRACK

6" Compact Fluorescent Retrofit Kits (For Existing Housings)

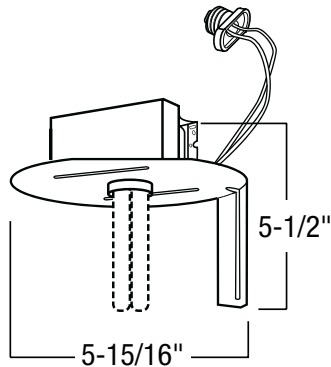

Nora Lighting's Compact Fluorescent Retrofit Kits provide an easy and affordable solution to convert existing standard 6" incandescent housings to energy efficient compact fluorescent. Kits are available in 13W, 18W, and 26W Electronic ballast, 120V. Retrofit kits are suitable for either residential or commercial applications.

Ballast:

NPK-13: 13W 120V Magnetic Ballast
 NPK-13/2L: (2) 13W 120V Magnetic Ballast
 NPK-13EL: 13W 120V Electronic Ballast
 NPK-18EL: 18W 120V Electronic Ballast
 NPK-26EL: 26W 120V Electronic Ballast

Lamp:

NPK-13: 13W Twin Tube (GX23 Base)
 NPK-13/2L: (2) 13W Twin Tube (GX23 Base)
 NPK-13EL: 13W Quad / Triple Tube
 (G24Q / GX24Q Base)
 NPK-18EL: 18W Quad / Triple Tube
 (G24Q / GX24Q Base)
 NPK-26EL: 26W Quad / Triple Tube
 (G24Q / GX24Q Base)

Minimum Clearances:

Non-IC: Non-IC Retrofit Kits are intended for use in Non-IC components and upon installation, the housing used for the kit must maintain minimum clearances of 3" from thermal insulation and 1/2" from adjacent building components.

IC: IC Retrofit Kits are rated for use with IC components are rated for direct contact and does not have any minimum clearance requirements.

Listing:

UL Classified for use with Nora, Halo, Capri and many other housings.

Title 24 Compliant if hardwired in an IC - Airtight Housing (NPK-13EL & NPK-18EL only)

NPK SERIES WITH RETRO BALLAST ASSEMBLY

CATALOG. NO.	LAMP(S)	WATTAGE (EA.)	VOLTAGE	BALLAST	RATED
NPK-13	(1) Twin Tube	13W	120V	Magnetic	Non-IC
NPK-13/2L	(2) Twin Tube	13W	120V	Magnetic	Non-IC
NPK-13EL	(1) Quad / Triple Tube	13W	120V	Electronic	IC
NPK-18EL	(1) Quad / Triple Tube	18W	120V	Electronic	IC
NPK-26EL	(1) Quad / Triple Tube	26W	120V	Electronic	Non-IC



LIGHTING TIP:

Nora CFL Electronic Ballast Retrofits are UL Listed for hardwire application qualifying them for local energy company rebates. Check with your local energy provider.

RETROFIT RECESSED

6" Compact Fluorescent Retrofit Trims

Specular Clear Cone Reflector with Baffle



CC

Catalog No.	Description
NTA-101	Specular Clear Refl / Black Baffle / White Plastic Ring
NTA-101BZ	Specular Clear Refl / Bronze Baffle / Bronze Metal Ring
NTA-101CO	Specular Clear Refl / Copper Baffle / Copper Metal Ring
NTA-101N	Specular Clear Reflector / Natural Metal Baffle / Natural Metal Ring
NTA-102	Specular Clear Refl / White Baffle / White Plastic Ring

- Single Lamp only

Maximum Wattage:
(1) 26W Quad / Triple Tube

OD: 7"

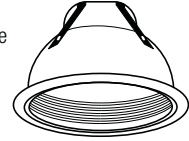

Specular Clear Cone Reflector with Baffle



CC

Catalog No.	Description
NTA-101/2PL	Specular Clear Refl / Black Baffle / White Plastic Ring
NTA-102/2PL	Specular Clear Refl / White Baffle / White Plastic Ring

- Will accept two lamps

Maximum Wattage:
(1) 26W Quad / Triple Tube
(2) 13W Twin Tube

OD: 7"

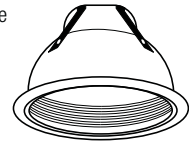

Cone Reflector with Ring



CC

Catalog No.	Description
NTA-96	Specular Gold Cone Reflector / White Plastic Ring
NTA-96C	Specular Gold Cone Reflector / Chrome Plastic Ring
NTA-96G	Specular Gold Cone Reflector / Gold Plastic Ring
NTA-97	Specular Clear Cone Reflector / White Plastic Ring
NTA-97AHZ	Haze Alzak® Cone Reflector / White Plastic Ring
NTA-97C	Specular Clear Cone Reflector / Chrome Plastic Ring
NTA-97G	Specular Clear Cone Reflector / Gold Plastic Ring
NTA-97HZ	Haze Cone Reflector / White Plastic Ring
NTA-98	Specular Black Cone Reflector / White Plastic Ring
NTA-98B	Specular Black Cone Reflector / Black Plastic Ring
NTA-98BZBZ	Bronze Cone Reflector / Bronze Metal Ring
NTA-98COCO	Copper Cone Reflector / Copper Metal Ring
NTA-98NN	Natural Cone Reflector / Natural Metal Ring
NTA-99	Specular White Cone Reflector / White Plastic Ring

- Single Lamp only

Maximum Wattage:
(1) 26W Quad / Triple Tube

OD: 7"

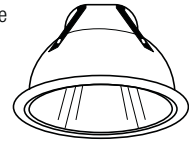

Cone Reflector with Ring



CC

Catalog No.	Description
NTA-96/2PL	Specular Gold Cone Reflector / White Plastic Ring
NTA-97/2PL	Specular Clear Cone Reflector / White Plastic Ring
NTA-97C/2PL	Specular Clear Cone Reflector / Chrome Plastic Ring
NTA-98/2PL	Specular Black Cone Reflector / White Plastic Ring
NTA-99/2PL	Specular White Cone Reflector / White Plastic Ring

- Will accept two lamps

Maximum Wattage:
(1) 26W Quad / Triple Tube
(2) 13W Twin Tube

OD: 7"

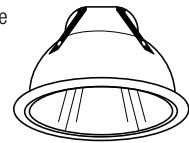

CC Custom Combo: Available with custom combinations of trim and ring finish. See pages 38-39 for details.
See pages 34-37 for Description of Reflector Finishes

6" COMPACT FLUORESCENT RETROFIT TRIMS continued

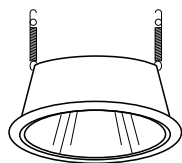

Maximum Wattage:
(1) 26W Quad / Triple Tube
(2) 13W Twin Tube

OD: 8"

Catalog No.	Description
NTS-30	Specular Gold Reflector / White Plastic Ring
NTS-30A	Gold Alzak® Reflector / White Plastic Ring
NTS-30C	Specular Gold Reflector / Chrome Plastic Ring
NTS-30G	Specular Gold Reflector / Gold Plastic Ring
NTS-31	Specular Clear Reflector / White Plastic Ring
NTS-31A	Chrome Alzak® Reflector / White Plastic Ring
NTS-31C	Specular Clear Reflector / Chrome Plastic Ring
NTS-31N	Specular Clear Reflector / Natural Metal Ring
NTS-31HZ	Haze Reflector / White Plastic Ring
NTS-31AHZ	Haze Alzak® Reflector / White Plastic Ring
NTS-32	Specular Black Reflector / White Plastic Ring
NTS-32B	Specular Black Reflector / Black Plastic Ring
NTS-32CO	Specular Black Reflector / Copper Metal Ring
NTS-32G	Specular Black Reflector / Gold Plastic Ring
NTS-32BZBZ	Bronze Reflector / Bronze Metal Ring
NTS-32COCO	Copper Reflector / Copper Metal Ring
NTS-32NN	Natural Metal Reflector / Natural Metal Ring
NTS-33	Specular White Reflector / White Plastic Ring

- Will accept two lamps



Reflector Trim

CC



Maximum Wattage:
(1) 26W Quad / Triple Tube

OD: 8"

Catalog No.	Description
NTA-103B	Specular Clear Cone Reflector / Black Baffle / White Wall Wash / White Plastic Ring
NTA-103BZ	Specular Clear Cone Reflector / Bronze Baffle / Bronze Wall Wash / Bronze Metal Ring
NTA-103CO	Specular Clear Cone Reflector / Copper Baffle / Copper Wall Wash / Copper Metal Ring
NTA-103N	Specular Clear Cone Reflector / Natural Metal Baffle / Natural Metal Wall Wash / Natural Metal Ring
NTA-103W	Specular Clear Cone Reflector / White Baffle / White Wall Wash / White Plastic Ring

- Single Lamp only



Specular Clear Reflector with Baffle and Wall Wash

CC

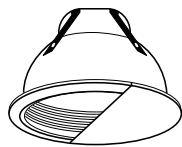

Maximum Wattage:
(1) 26W Quad / Triple Tube
(2) 13W Twin Tube

OD: 7"

Catalog No.	Description
NTA-103B/2PL	Specular Clear Cone Reflector / Black Baffle / White Wall Wash / White Plastic Ring
NTA-103W/2PL	Specular Clear Cone Reflector / White Baffle / White Wall Wash / White Plastic Ring

- Will accept two lamps



Specular Clear Reflector with Baffle and Wall Wash

CC

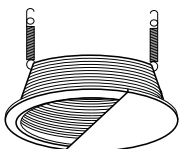

Maximum Wattage:
(1) 26W Quad / Triple Tube
(2) 13W Twin Tube

OD: 7"

Catalog No.	Description
NT-45	Black Baffle / White Wash
NT-46	White Baffle / White Wash

- Will accept two lamps

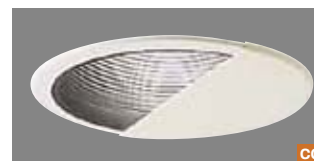

Baffle Wall Wash

CC

CC Custom Combo: Available with custom combinations of trim and ring finish. See pages 38-39 for details. See pages 34-37 for Description of Reflector Finishes

6" COMPACT FLUORESCENT RETROFIT TRIMS continued

Cone Reflector Wall Wash



Catalog No.	Description
NTA-86	Specular Gold Refl / White Wall Wash / White Ring
NTA-87	Specular Clear Refl / White Wall Wash / White Ring
NTA-88	Specular Black Refl / White Wall Wash / White Ring
NTA-88BZ	Bronze Reflector / White Wall Wash / White Ring
NTA-88CO	Copper Reflector / White Wall Wash / White Ring
NTA-88N	Natural Metal Refl / White Wall Wash / White Ring
NTA-89	Specular White Refl / White Wall Wash / White Ring

- Single Lamp only

Maximum Wattage:
(1) 26W Quad / Triple Tube

OD: 7"

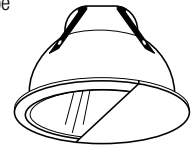

Cone Reflector Wall Wash



Catalog No.	Description
NTA-86/2PL	Specular Gold Reflector / White Wash / White Ring
NTA-87/2PL	Specular Clear Reflector / White Wash / White Ring
NTA-88/2PL	Specular Black Reflector / White Wash / White Ring
NTA-89/2PL	Specular White Reflector / White Wash / White Ring

- Two Lamp only

Maximum Wattage:
(1) 26W Quad / Triple Tube
(2) 13W Twin Tube

OD: 7"



Wall Wash



Catalog No.	Description
NT-25	White Wash / White Ring
NT-25B	Black Wash / White Ring

- Single Lamp only

Maximum Wattage:
(1) 26W Quad / Triple Tube

OD: 7"

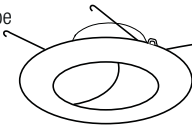

Albalite Shower Trim with Reflector



Catalog No.	Description
NTS-22/2PL	Specular Clear Reflector / White Metal Shower Trim
NTS-22B/2PL	Specular Clear Reflector / Black Metal Shower Trim
NTS-22C/2PL	Specular Clear Reflector / Chrome Metal Shower Trim

- UL Wet Listed
- Will accept two lamps

Maximum Wattage:
(1) 26W Quad / Triple Tube
(2) 13W Twin Tube

OD: 7"

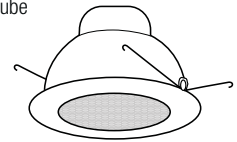

Baffle Regressed Albalite

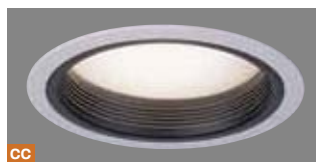

Catalog No.	Description
NTM-42	Black Baffle / White Plastic Ring
NTM-42BZ	Bronze Baffle / Bronze Metal Ring
NTM-42CO	Copper Baffle / Copper Metal Ring
NTM-42N	Natural Metal Baffle / Natural Metal Ring
NTM-42W	White Baffle / White Plastic Ring

Maximum Wattage:
(1) 26W Quad / Triple Tube
(2) 13W Twin Tube

OD: 7"

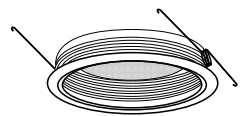

Albalite Shower Trim



Catalog No.	Description
NT-22	White Metal Shower Trim
NT-22B	Black Metal Shower Trim
NT-22BZ	Bronze Metal Shower Trim
NT-22C	Chrome Metal Shower Trim
NT-22CO	Copper Metal Shower Trim
NT-22G	Gold Metal Shower Trim
NT-22N	Natural Metal Metal Shower Trim
NP-22	White Plastic Shower Trim

- UL Wet Listed

Maximum Wattage:
(1) 26W Quad / Triple Tube
(2) 13W Twin Tube

OD: 7"

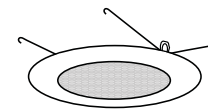

CC Custom Combo: Available with custom combinations of trim and ring finish. See pages 38-39 for details.

6" COMPACT FLUORESCENT RETROFIT TRIMS continued

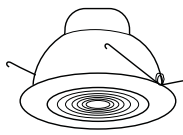

Maximum Wattage:
(2) 13W Twin Tube
OD: 8"



Catalog No.	Description
NTS-23/2PL	Specular Clear Reflector / White Metal Shower Trim
NTS-23C/2PL	Specular Clear Refl / Chrome Metal Shower Trim
NTS-23C/2PL	Specular Clear Reflector / Gold Metal Shower Trim

- UL Wet Listed
- Will accept two lamps

Fresnel Shower Trim with Reflector

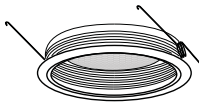
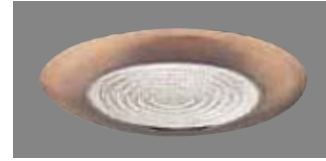

Maximum Wattage:
(1) 26W Quad / Triple Tube
(2) 13W Twin Tube
OD: 8"



Catalog No.	Description
NTM-43	Black Baffle / White Plastic Ring
NTM-43BZ	Bronze Baffle / Bronze Metal Ring
NTM-43CO	Copper Baffle / Copper Metal Ring
NTM-43N	Natural Metal Baffle / Natural Metal Ring
NTM-43W	White Baffle / White Plastic Ring

Baffle Regressed Fresnel

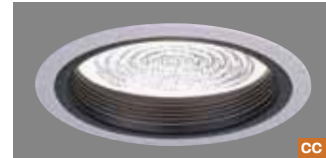

CC

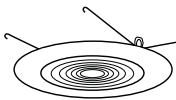

Maximum Wattage:
(1) 26W Quad / Triple Tube
(2) 13W Twin Tube
OD: 8"



Catalog No.	Description
NT-23	White Metal Shower Trim
NT-23B	Black Metal Shower Trim
NT-23BZ	Bronze Metal Shower Trim
NT-23C	Chrome Metal Shower Trim
NT-23CO	Copper Metal Shower Trim
NT-23G	Gold Metal Shower Trim
NT-23N	Natural Metal Metal Shower Trim
NP-23	White Plastic Shower Trim

- UL Wet Listed

Fresnel Shower Trim

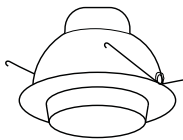

Maximum Wattage:
(1) 26W Quad / Triple Tube
(2) 13W Twin Tube
OD: 8"



Catalog No.	Description
NTS-24/2PL	Specular Clear Reflector / White Metal Shower Trim

- UL Wet Listed
- Will accept two lamps

Drop Opal Shower Trim with Reflector

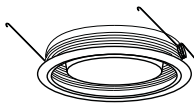

Maximum Wattage:
(1) 26W Quad / Triple Tube
(2) 13W Twin Tube
OD: 8"



Catalog No.	Description
NTM-46BZ	Bronze Baffle / Bronze Metal Ring
NTM-46CO	Copper Baffle / Copper Metal Ring
NTM-46M	Black Baffle / White Plastic Ring
NTM-46N	Natural Metal Baffle / Natural Metal Ring
NTM-46W	White Baffle / White Plastic Ring

Baffle Regressed Drop Opal



CC



Maximum Wattage:
(1) 26W Quad / Triple Tube
(2) 13W Twin Tube
OD: 8"



Catalog No.	Description
NT-24	White Metal
NT-24B	Black Metal
NT-24BZ	Bronze Metal
NT-24C	Chrome Metal
NT-24CO	Copper Metal
NT-24G	Gold Metal
NT-24N	Natural Metal Metal
NP-24	White Plastic
NP-24/PC	White Plastic / Polycarbonate Lens

- UL Wet Listed

Fresnel Shower Trim



CC Custom Combo: Available with custom combinations of trim and ring finish. See pages 38-39 for details.

RETROFIT RECESSED

6" Low Voltage Retrofit Kits (For Existing Non-IC Housings only)

Nora Lighting's Low Voltage Retrofit Kits provide an easy and affordable solution to convert existing standard 6" incandescent housings to high performance low voltage halogen fixtures. Kits are available either for MR16 or PAR36/AR111 light sources and require the use of a low voltage trim for either light source. Ideal for instantly changing general lighting to halogen spot and accent effects.

Transformer:

- NLK-2600: 50W 120V Magnetic Transformer
- NLK-2600EL: 50W 120V Electronic Transformer
- NLK-2636: 50W 120V Magnetic Transformer

Lamp:

- NLK-2600: 50W 12V MR16 (GU5.3 Base)
- NLK-2600EL: 50W 12V MR16 (GU5.3 Base)
- NLK-2636: 50W 12V AR111 (Spade Terminal)
50W 12V PAR36 (Spade Terminal)

Minimum Clearances:

NLK Retrofit kits are intended for use in Non-IC components and upon installation, the housing used for the kit must maintain minimum clearances of 3" from thermal insulation and 1/2" from adjacent building components.



Trim ordered separately



Trim ordered separately

MR16 GU10 RETROFIT	
	
CATALOG. NO.	DESCRIPTION
NRA-34/10	without Lamp
NRA-37/10	with Lamp
Use as an economical solution to convert a medium base Non-IC housing into a GU10 MR16.	
<ul style="list-style-type: none"> • No Transformer • Easy Dimming • Uses 6" Low Voltage MR16 Retrofit Trims 	

NLK SERIES WITH RETRO TRANSFORMER ASSEMBLY

CATALOG. NO.	TRANSFORMER	VOLTAGE	LAMP	WATTAGE
NLK-2600	Magnetic	120V	MR16	50W
NLK-2600EL	Electronic	120V	MR16	50W
NLK-2636	Magnetic	120V	AR111/PAR36	50W

Order trims separately

RETROFIT RECESSED 6" Low Voltage Retrofit Trims

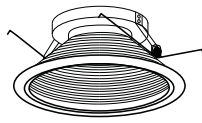

Maximum Wattage:
50W MR16
OD: 7"

Catalog No.	Description
NL-610W	White Stepped Baffle / White Plastic Ring
NL-611B	Black Stepped Baffle / White Plastic Ring

- Downlight or 35° adjustable

Adjustable Baffle

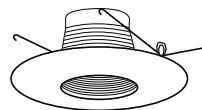
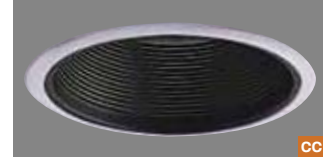

Maximum Wattage:
50W MR16
OD: 7"

Catalog No.	Description
NL-641B	Black Step Baffle / White Ring
NL-641W	White Step Baffle / White Ring

- Downlight or 35° adjustable
- 3-1/2" Aperture

Designer Baffle



Maximum Wattage:
50W MR16
OD: 7"

Catalog No.	Description
NL-612	Specular Gold Reflector / White Plastic Ring
NL-613	Specular Black Reflector / White Plastic Ring
NL-613BZ	Bronze Reflector / Bronze Metal Ring
NL-613CO	Copper Reflector / Copper Metal Ring
NL-614	Specular Clear Reflector / White Plastic Ring
NL-616	Specular White Reflector / White Plastic Ring

- Downlight or 35° adjustable

Adjustable Reflector

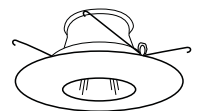

Maximum Wattage:
50W MR16
OD: 7"

Catalog No.	Description
NL-642	Specular Gold Reflector / White Ring
NL-643	Specular Black Reflector / White Ring
NL-644	Specular Clear Reflector / White Ring
NL-646	Specular White Reflector / White Ring

- Downlight or 35° adjustable
- 3-1/2" Aperture

Designer Reflector



Maximum Wattage:
50W PAR36/AR111
OD: 7"

Catalog No.	Description
NL-671B	Black Surface Gimbal Ring
NL-671BZ	Bronze Surface Gimbal Ring
NL-671C	Chrome Surface Gimbal Ring
NL-671CO	Copper Surface Gimbal Ring
NL-671G	Gold Surface Gimbal Ring
NL-671N	Natural Metal Surface Gimbal Ring
NL-671W	White Surface Gimbal Ring

- Downlight or 35° Adjustable
- Incompatible with MR16 GU10 lamp

Surface Gimbal

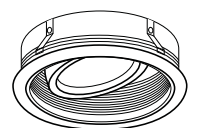

Maximum Wattage:
50W PAR36/AR111
OD: 7"

Catalog No.	Description
NL-672B	Black Baffle / White Ring
NL-672N	Natural Metal Baffle / Natural Metal Ring
NL-672W	White Baffle / White Ring

- Downlight or 35° Adjustable
- Incompatible with MR16 GU10 lamp

Baffle with Gimbal



CC Custom Combo: Available with custom combinations of trim and ring finish. See pages 38-39 for details.
See pages 36-37 for Description of Reflector Finishes

6" LOW VOLTAGE RETROFIT TRIMS continued

Reflector with Gimbal

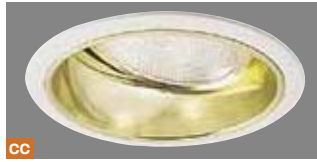

CC

Catalog No.	Description
NL-673B	Specular Black Reflector / White Ring
NL-673C	Specular Clear Reflector / White Ring
NL-673G	Specular Gold Reflector / White Ring
NL-673W	Specular White Reflector / White Ring

- Downlight or 35° Adjustable
- Incompatible with MR16 GU10 lamp

Maximum Wattage:
50W PAR36/AR111

OD: 7"

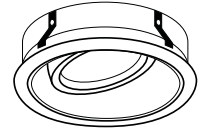

Baffle with Eyeball



CC

Catalog No.	Description
NL-628B	Black Baffle / Black Eyeball / White Plastic Ring
NL-628W	White Baffle / White Eyeball / White Plastic Ring

- Downlight or 35° Adjustable

Maximum Wattage:
50W MR16

OD: 7"

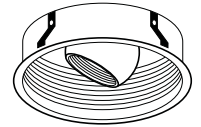

Regressed Spot Cylinder w/ Baffle

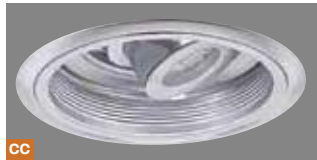

CC

Catalog No.	Description
NL-670B	Black Baffle / Black Trim
NL-670BZ	Bronze Baffle / Bronze Trim
NL-670CO	Copper Baffle / Copper Trim
NL-670N	Natural Metal Baffle / Natural Metal Trim
NL-670W	White Baffle / White Trim

- Downlight or 35° Adjustable

Maximum Wattage:
50W MR16

OD: 7"



Eyeball with Baffle



Catalog No.	Description
NL-618B	White Eyeball / Black Baffle / White Metal Ring
NL-618BB	Black Eyeball / Black Baffle / White Metal Ring
NL-618W	White Eyeball / White Baffle / White Metal Ring
NL-619C	Chrome Eyeball / Black Baffle / Chrome Metal Ring
NL-619G	Gold Eyeball / Black Baffle / Gold Metal Ring

- Downlight or 35° Adjustable

Maximum Wattage:
50W MR16

OD: 7"

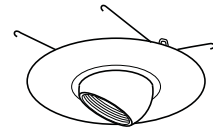

Gimbal with Black Baffle



Catalog No.	Description
NL-663B	Black Gimbal / Black Baffle
NL-663BZ	Bronze Gimbal / Black Baffle
NL-663C	Chrome Gimbal / Black Baffle
NL-663CO	Copper Gimbal / Black Baffle
NL-663G	Gold Gimbal / Black Baffle
NL-663N	Natural Metal Gimbal / Black Baffle
NL-663W	White Gimbal / Black Baffle

- Downlight or 45° Adjustable

Maximum Wattage:
50W MR16

OD: 7-1/4"

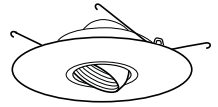

Round Spot

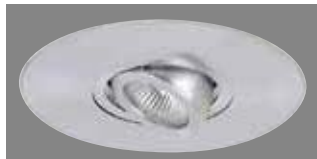

Catalog No.	Description
NL-665B	Black Round Spot
NL-665BZ	Bronze Round Spot
NL-665C	Chrome Round Spot
NL-665CO	Copper Round Spot
NL-665G	Gold Round Spot
NL-665N	Natural Metal Round Spot
NL-665W	White Round Spot

- Downlight or 45° Adjustable

Maximum Wattage:
50W MR16

OD: 7-1/4"



CC Custom Combo: Available with custom combinations of trim and ring finish. See pages 38-39 for details.

6" LOW VOLTAGE RETROFIT TRIMS continued

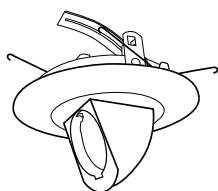

Maximum Wattage:
50W MR16

OD: 7"

Catalog No.	Description
NL-680B	Black Adjustable Elbow
NL-680BZ	Bronze Adjustable Elbow
NL-680C	Chrome Adjustable Elbow
NL-680CO	Copper Adjustable Elbow
NL-680G	Gold Adjustable Elbow
NL-680N	Natural Metal Adjustable Elbow
NL-680W	White Adjustable Elbow

- Adjustable: 90° Vertically, 358° Horizontally
- Incompatible with MR16 GU10 lamp

Fully Adjustable Elbow

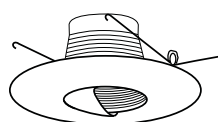

Maximum Wattage:
50W MR16

OD: 7"

Catalog No.	Description
NL-648	Black Baffle / White Trim
NL-649	White Baffle / White Trim

- Downlight or 35° Adjustable

Wall Wash with Baffle



Maximum Wattage:
50W MR16

OD: 7"

Catalog No.	Description
NL-650	White Reflector / White Trim

- Downlight or 35° Adjustable

Wall Wash with Reflector

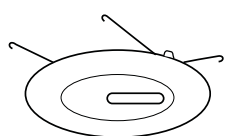

Maximum Wattage:
50W MR16

OD: 7"

Catalog No.	Description
NL-645	White Adjustable Slot Aperture
NL-645B	Black Adjustable Slot Aperture
NL-645BZ	Bronze Adjustable Slot Aperture
NL-645CO	Copper Adjustable Slot Aperture
NL-645N	Natural Metal Adjustable Slot Aperture

- Downlight or 35° Adjustable

Slot Aperture

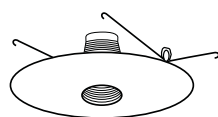

Maximum Wattage:
50W MR16

OD: 7"

Catalog No.	Description
NL-620B	Black Baffle / White Trim
NL-620W	White Baffle / White Trim

- 2" Aperture
- Downlight

2" Pinhole with Baffle



Maximum Wattage:
50W MR16

OD: 7"

Catalog No.	Description
NL-640	White Pinhole

- Downlight or 35° Adjustable
- 1-3/4" Aperture

1-3/4" Pinhole



CC Custom Combo: Available with custom combinations of trim and ring finish. See pages 38-39 for details.

RETROFIT RECESSED

Track Monopoint Adapter Retrofit Kits (For Existing Housings)

Nora Lighting's new Adapters will convert almost any 4" and 6" line voltage, medium based socket, recessed housing into a monopoint pendant or line voltage track fixture.

Now you can easily adapt the old recessed housing into a magnificent pendant with a decorative glass for ambiance lighting, or create directional lighting that can illuminate that special art piece with Nora's array of beautiful line voltage track fixtures. Your recessed light can come alive and provide you the specific design lighting element you have been looking for.

- Converts 4" and 6" standard line voltage housings into line voltage track monopoints (5 lbs. maximum supported weight)
- Extremely easy installation without no difficult wiring
- Available in Black or White finish
- See pages 531-589 for track fixtures
- See page 592 for track pendant adapters
- UL Approved

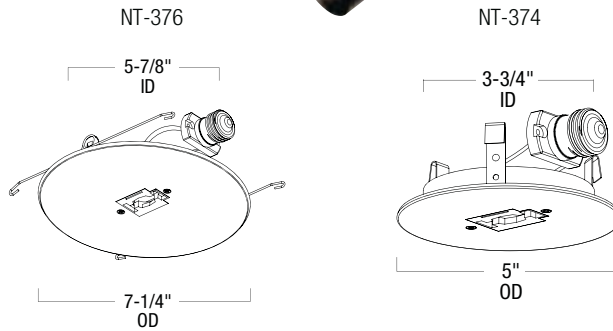

TRACK MONOPOINT RETROFIT SERIES

CATALOG. NO.	SIZE	WATTAGE	FINISH
NT-376B	fits 6" most housing	250W max.	Black
NT-376W	fits 6" most housing	250W max.	White
NT-374B	fits 4" most housing	250W max.	Black
NT-374W	fits 4" most housing	250W max.	White





Square Recessed Lighting

Nora's line of squares provide uniform general lighting in retail, commercial, hospitality, and some residential applications. Available in Energy Saving HID Ceramic Metal Halide and CFL Florescent as well as Line Voltage sources, these Wet label units are an excellent choice for low maintenance outdoor lighting. Non IC units only measure 4-1/2" deep making them ideal for shallow plenum installations. Nora Lighting squares offer 3 different lens choices to meet visual preference or various light distributions.

Overview SQUARE

SQUARE RECESSED LIGHTING

NEW!



8" Ceramic Metal Halide
Square Housing
NSD-8 Series p.363



8" IC Square Double CF Wall Housing
NSHPIC-8EL p.364



8" Square CF Housing
NSHP-8 Series p.365



8" Line Voltage
Square IC Housing
NSHIC-8 p.366



8" Line Voltage
Square Non-IC Housing
NSH-8 p.367



WET

cULus Wet Location

Nora's square lensed trims are cULus Wet Location listed. Choose from Prismatic, Albalite or Fresnel lens.



WET



WET

SQUARE RECESSED

8" Square Ceramic Metal Halide Housing

NEW!

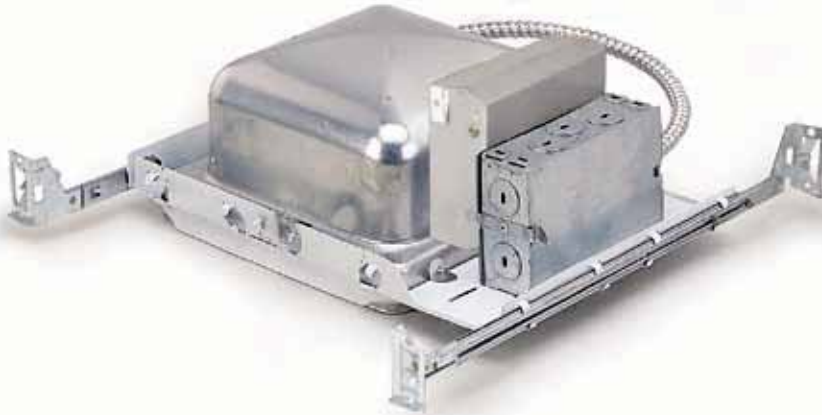

Nora Lighting is pleased to introduce our new 8" square HID housing with a horizontally mounted ceramic metal halide light source that provides superior light output, distribution and easy maintenance. Use of high wattage ED17 source provides higher levels of illumination necessary for covered outdoor ceilings, high ceilings, or other applications requiring extra performance. High quality Prismatic, Fresnel or Albalite diffusion glass trims make the housing ideal for outdoor, damp environments. Non-IC housings have low profile constructions ideal for installation into shallow ceilings.

Ballast: Electronic Ballast with Universal Input (120V to 277V)

Lamp Types:
 NSD-850EL: 50W CMH ED17 (Medium base)
 NSD-870EL: 70W CMH ED17 (Medium base)

Ceiling Thickness: Accepts 5/8" maximum ceiling thickness.

Installation: Bar hangers are adjustable from 13-5/8" to 24-1/2" and can be repositioned 90 degrees. Bar hangers are slotted for T-bar installations.

Minimum Clearance: Non-IC fixtures require a 3" clearance from thermal insulation and 1/2" from any combustive material.

Junction Box: Contains seven 1/2" knockouts, four Romex® pry-outs with strain relief.

Listing:
 cULus Damp Location w/ Feed Through
 cULus Wet Location (Only NST-21, 22, 23)

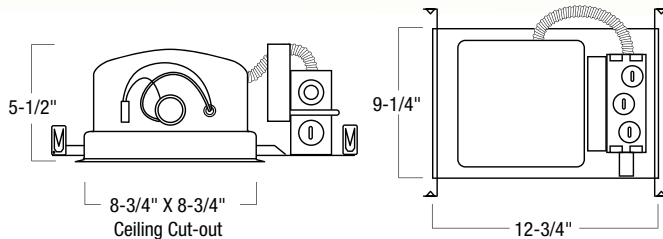

NSD-8 SERIES

CATALOG. NO.	LAMP	WATTAGE	VOLTAGE	BALLAST
NSD-850EL	ED17	50W	120V to 277V	Electronic
NSD-870EL	ED17	70W	120V to 277V	Electronic



SQUARE RECESSED

8" Square IC Compact Fluorescent Housing

The 8" square housing from Nora Lighting provides superior light output and can be used with a horizontally mounted compact fluorescent light source. High quality Prismatic, Fresnel or Albalite diffusion glass trims make the housing ideal for outdoor, damp environments. IC construction allows fixtures to be installed in direct contact with thermal insulation and combustible material to simplify the installation process.

Ballast:

NSHPIC-8: 13W 120V Magnetic Ballast

NSHPIC-8EL: 13W 120V to 277V Electronic Ballast

Lamp Types:

NSHPIC-8: (2) 13W 2-Pin Quad Tube (GX23 Base)

NSHPIC-8EL: (2) 13W 4-Pin Quad / Triple Tube (G24Q / GX24Q Base)

Ceiling Thickness: Accepts 5/8" maximum ceiling thickness.

Emergency Option: 90 minute battery back-up must be ordered and installed as a self contained kit set apart from the housing.

Installation: Bar hangers are adjustable from 13-5/8" to 24-1/2" and can be repositioned 90 degrees. Bar hangers are slotted for T-bar installations.

Minimum Clearance: IC rated fixture allows direct contact with insulation; no clearances are required.

Junction Box: Contains seven 1/2" knockouts, four Romex® pry-outs with strain relief.

Listing:

cULus Damp Location w/ Feed Through
cULus Wet Location (Only NST-21, 22, 23)

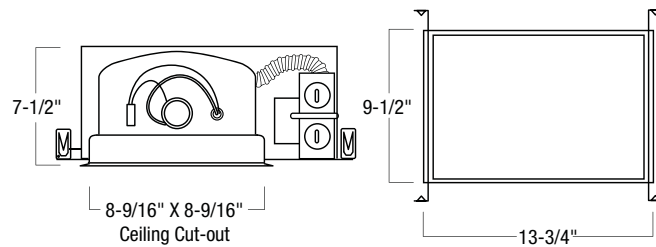

NSHPIC SERIES

CATALOG. NO.	LAMP	WATTAGE	VOLTAGE	BALLAST	EMERGENCY
NSHPIC-8	(2) 2-Pin Quad Tube	(2) 13W	120V	Magnetic	Order Separately
NSHPIC-8EL	(2) 4-Pin Quad / Triple	(2) 13W	120V to 277V	Electronic	Order Separately



SQUARE RECESSED

8" Square Compact Fluorescent Housing Non-IC

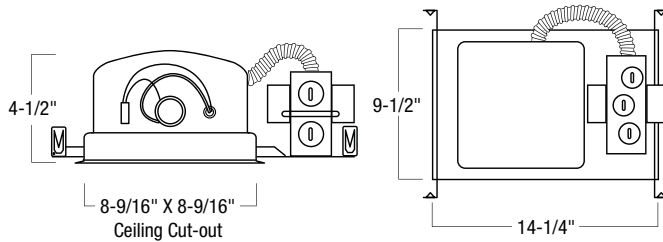

The 8" square compact fluorescent housing with a horizontally mounted compact fluorescent light source from Nora Lighting provides superior light output, distribution and easy maintenance. Use of high wattage compact fluorescent light source provides higher levels of illumination necessary for covered outdoor ceilings, high ceilings, or other applications requiring extra performance. High quality Prismatic, Fresnel or Albalite diffusion glass trims make the housing ideal for outdoor damp environments. Non-IC housings have low profile constructions ideal for installation into shallow ceilings.

Ballast:

NSHP-8Q: (2) 13W 120V Magnetic
 NSHP-8/EL: 26W 120V to 277V Electronic
 NSHP-82642EL: 26W-42W 120V to 277V
 Electronic Ballast
 Electronic ballast are thermally protected

Lamp Types:

NSHP-8Q: (2) 13W 2-Pin Quad (GX23 Base)
 NSHP-8/EL: (2) 13W 4-Pin Quad / Triple Tube
 (G24Q / GX24Q Base)
 NSHP-82642EL: (1) 26W-42W Quad / Triple
 Tube (G24Q / GX24Q Base)

Ceiling Thickness: Accepts 5/8" maximum ceiling thickness.

Emergency Option: 90 minute battery back-up must be ordered and installed as a self contained kit set apart from the housing.

Installation: Bar hangers are adjustable from 13-5/8" to 24-1/2" and can be repositioned 90 degrees. Bar hangers are slotted for T-bar installations.

Minimum Clearance: Non-IC fixtures require a 3" clearance from thermal insulation and 1/2" from any combustive material.

Junction Box: Contains seven 1/2" knockouts, four Romex® pry-outs with strain relief.

Listing:

cULus Damp Location w/ Feed Through
 cULus Wet Location (Only NST-21, 22, 23)

NSHP-8 SERIES

CATALOG. NO.	LAMP(S)	WATTAGE (EA.)	VOLTAGE	BALLAST	EMERGENCY
NSHP-8Q	(2) 2-Pin Quad	13W	120V	Magnetic	No
NSHP-8QEM	(2) 2-Pin Quad	13W	120V	Magnetic	Yes
NSHP-8/EL	(2) 4-Pin Quad / Triple	13W	120V to 277V	Electronic	No
NSHP-8/ELEM	(2) 4-Pin Quad / Triple	13W	120V to 277V	Electronic	Yes
NSHP-82642EL	(1) 4-Pin Quad / Triple	26W-42W	120V to 277V	Electronic	No
NSHP-82642ELEM	(1) 4-Pin Quad / Triple	26W-42W	120V to 277V	Electronic	Yes



SQUARE RECESSED

8" Square IC Line Voltage Housing

The 8" square housing from Nora Lighting provides superior light output and can be used with a horizontally mounted incandescent light source. High quality Prismatic, Fresnel or Albalite diffusion glass trims make the housing ideal for outdoor, damp environments. IC construction allows fixtures to be installed in direct contact with thermal insulation and combustible material to simplify the installation process.

Lamp Types:

60W A19 Incandescent (Medium base)

Ceiling Thickness: Accepts 5/8" maximum ceiling thickness.

Installation: Bar hangers are adjustable from 13-5/8" to 24-1/2" and can be repositioned 90 degrees. Bar hangers are slotted for T-bar installations.

Minimum Clearance: IC rated fixture allows direct contact with insulation; no clearances are required.

Junction Box: Contains seven 1/2" knockouts, four Romex® pry-outs with strain relief.

Listing:

cULus Damp Location w/ Feed Through
cULus Wet Location (Only NST-21, 22, 23)

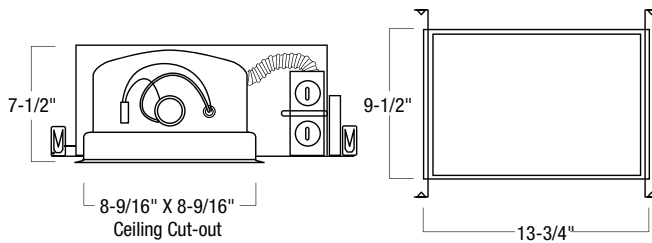

NSHIC SERIES

CATALOG. NO.	LAMP	WATTAGE	VOLTAGE
NSHIC-8	A19	60W	120V



SQUARE RECESSED

8" Square Line Voltage Housing Non-IC



The 8" square incandescent housing with a horizontally mounted incandescent light source from Nora Lighting provides superior light output, distribution and easy maintenance. Use of high wattage incandescent light source provides higher levels of illumination necessary for covered outdoor ceilings, high ceilings, or other applications requiring extra performance. High quality Prismatic, Fresnel or Albalite diffusion glass trims make the housing ideal for outdoor damp environments. Non-IC housings have low profile constructions ideal for installation into shallow ceilings.

Lamp Type:

100W A19 Incandescent (Medium base)

Ceiling Thickness: Accepts 5/8" maximum ceiling thickness.

Installation: Bar hangers are adjustable from 13-5/8" to 24-1/2" and can be repositioned 90 degrees. Bar hangers are slotted for T-bar installations.

Minimum Clearance: Non-IC fixtures require a 3" clearance from thermal insulation and 1/2" from any combustive material.

Junction Box: Contains seven 1/2" knockouts, four Romex® pry-outs with strain relief.

Listing:

cULus Damp Location w/ Feed Through
cULus Wet Location (Only NST-21, 22, 23)

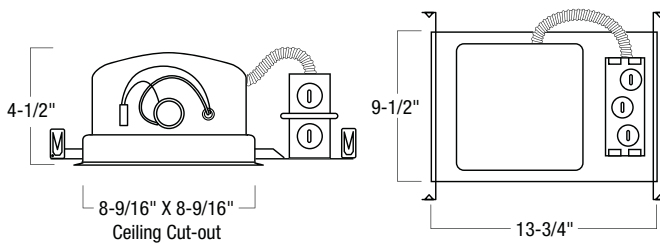

NSH-8 SERIES

CATALOG. NO.	WATTAGE	LAMP
NSH-8Q	100W	A19





SQUARE RECESSED 8" Square Lensed Trims



Maximum Wattage
100W A19
70W CMH ED17
42W Triple Tube
OD: 9-1/2" x 9-1/2"



Catalog No.	Description
NST-21	Prismatic Lens with White Trim

- UL Wet Listed

Prismatic Lens



Maximum Wattage
100W A19
70W CMH ED17
42W Triple Tube
OD: 9-1/2" x 9-1/2"



Catalog No.	Description
NST-22	Albalite Lens with White Trim

- UL Wet Listed

Albalite Lens



Maximum Wattage
100W A19
70W CMH ED17
42W Triple Tube
OD: 9-1/2" x 9-1/2"



Catalog No.	Description
NST-23	Fresnel Lens with White Trim

- UL Wet Listed

Fresnel Lens



The Nora Lighting family of Step Lighting

Nora step lights create a safe path of light or warn of elevation change in residential and commercial applications. The completely recessed fixtures blend with any architectural design. Available in maintenance free LED, long life CFL and economical incandescent, with louvers or lens and rated for wet label. Nora steps lights offer solutions for pathway and stair safety lighting in patio, deck, hospital, hotel, school, airport, and residential applications.

FEATURES

- New LED Mini Step Light with Photocell
- LED, Compact Fluorescent, and Incandescent sources
- Lensed and louvered styles
- Discrete mini and high output large styles
- Available in Wet location styles



Overview STEP LIGHTS

STEP LIGHTING



LED Step Light
Louvered Face with Lens
NSI-601 p.374



LED Step Light
Frosted Glass Face
NSI-602 p.374



Fluorescent Step Light
with J-Box
NSP-109/JB p.375
NSP-1091/JB p.375
NSP-1092/JB p.375



Fluorescent Step Light
NSP-109 p.375
NSP-1091 p.375
NSP-1092 p.375



Incandescent Step Light
with J-Box
NSI-125/JB p.377
NSI-1251/JB p.377
NSI-1252/JB p.377



Incandescent Step Light
NSI-140 p.377
NSI-1401 p.377
NSI-1402 p.377

Lighting Tip:

Stair lighting is subject to vibration and can cause premature failure of incandescent sources. Use Nora LED, filament free, step lights for reliable long life, low maintenance, safety pathway lighting.

MINI STEP LIGHTING



Mini LED Step Light
Louvered Face
NSI-661 p.373



Mini LED Step Light
Lensed Face
NSI-662 p.373



Mini LED Step Light with
Photocell - Louvered Face
NSI-661PC p.372



Mini LED Step Light with
Photocell - Lensed Face
NSI-662PC p.372



Incandescent Mini Step Light
Louvered Face
NSI-161 p.376



Incandescent Mini Step Light
Lensed Face
NSI-162 p.376

LED RECESSED

Mini LED Step Lights with Photocell

Nora's New Mini LED Step Lights with an integrated Photocell use the latest in technology in solid state lighting. The energy saving photocell allows the step light to turn on in the dark and off in the morning or at presence of light. Mini Step Lights are available with louvered or lensed face and can be easily installed in a standard single gang switch box. Louvered unit includes both a horizontal and vertical louver.

Integral LED Driver: 120VAC, 50/60Hz.

LED Source: 9 LEDs for a total of 1.08 Watts (0.12W each)

LED Life Span: 30,000 Hours

Photocell: Photocell sensor comes pre-installed in step light's face. The energy saving dusk to dawn feature turns the LEDs on in the dark and off in the morning or the presence of light.

Glass Lens: Lensed plates include a tempered glass face and can be mounted horizontally or vertically.

Louver Lens: Louvered units include both a horizontal and vertical louver for mounting horizontally or vertically.

Applications: Hallways, entrances, stairways, wall bases, or any application requiring a low profile, recessed fixture providing safe illumination in indoor dark areas.

Finishes: Brushed Nickel, Primer (ready to paint), and White

Listing: UL and CUL Damp Location Listed

NEW!

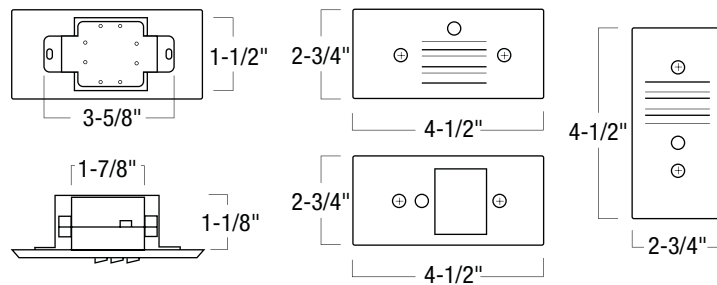

NSI-660PC SERIES

CATALOG. NO.	WATTAGE	VOLTAGE	FACE PLATE	FINISH
NSI-661PC/BN	1.08W	120V	Louver	Brushed Nickel
NSI-661PC/P	1.08W	120V	Louver	Primer
NSI-661PC/W	1.08W	120V	Louver	White
NSI-662PC/BN	1.08W	120V	Lensed	Brushed Nickel
NSI-662PC/P	1.08W	120V	Lensed	Primer
NSI-662PC/W	1.08W	120V	Lensed	White

Mounts in standard single gang box by others



LED RECESSED Mini LED Step Lights



Nora's Mini LED Step Lights use the latest in technology in solid state lighting. Mini Step Lights are available with louvered or lensed face and can be easily installed in a standard single gang switch box. Louvered unit includes both a horizontal and vertical louver.

Integral LED Driver: 120VAC, 50/60Hz.

LED Source: 12 LEDs for a total of 1.44 Watts (0.12W each)

LED Life Span: 30,000 Hours

Glass Lens: Lensed plates include a tempered glass face and can be mounted horizontally or vertically.

Louver Lens: Louvered units include both a horizontal and vertical louver to be mounted horizontally or vertically.

Applications: Hallways, entrances, stairways, wall bases, or any application requiring a low profile, recessed fixture providing safe illumination in indoor dark areas.

Finishes: Brushed Nickel, Primer (ready to paint), and White

Listing: UL and CUL Damp Location Listed

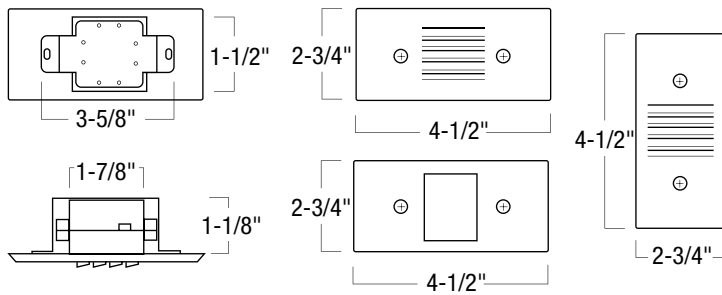

NSI-660 SERIES

CATALOG. NO.	WATTAGE	VOLTAGE	FACE PLATE	FINISH
NSI-661BN	1.44W	120V	Louver	Brushed Nickel
NSI-661P	1.44W	120V	Louver	Primer
NSI-661W	1.44W	120V	Louver	White
NSI-662BN	1.44W	120V	Lensed	Brushed Nickel
NSI-662P	1.44W	120V	Lensed	Primer
NSI-662W	1.44W	120V	Lensed	White

Mounts in standard single gang box by others



LED RECESSED

LED Step Lights

Nora is pleased to introduce LED technology in our newest generation of step lights. This innovative and practical design uses bright energy efficient LED light sources which provide a 30,000 hour life and are maintenance free. For outdoor applications, Nora has added both a louver lensed face and tempered glass face with gaskets that are UL Wet Location listed. The light source is shielded for excellent glare control.

Housing: Sturdy galvanized steel construction, white power coated housing. Side brackets for mounting to dry wall. Driver has separate compartment.

Integral LED Driver: 120VAC, 50/60Hz.

LED Source: 18 LEDs for a total of 2 Watts (0.12W each)

LED Life Span: 30,000 Hours

Minimum Clearance: Non-IC fixture requires a minimum clearance of 3" from thermal insulation and 1/2" from adjacent building components.

Surface Thickness: Step Lights accept 5/8" standard drywall thickness.

Bar Hangers: Bar hanger brackets accept flat bar hangers for installing to joist or stud constructions (Ordered separately). Two pre-held mounting plates for vertical walls.

Junction Box: Prewired junction box contains three 1/2" knockouts for an easy power feed.

Applications: Hallways, entrances, stairways, wall bases, outdoors or any application requiring a low profile, recessed fixture providing safe illumination in indoor dark areas.

Listing: UL and CUL Damp Location Listed
UL and CUL Wet Location Listed (NSI-602 only)

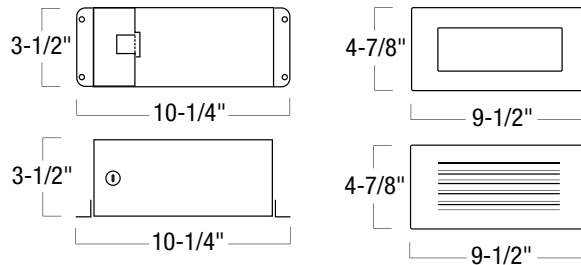

NSI-600 SERIES

CATALOG. NO.	WATTAGE	VOLTAGE	FACE PLATE	FINISH	UL LISTING
NSI-601	2W	120V	Louver	White	Damp
 NSI-602	2W	120V	Frosted Lens	White	Wet

Includes housing



COMPACT FLUORESCENT RECESSED Compact Fluorescent Step Lights

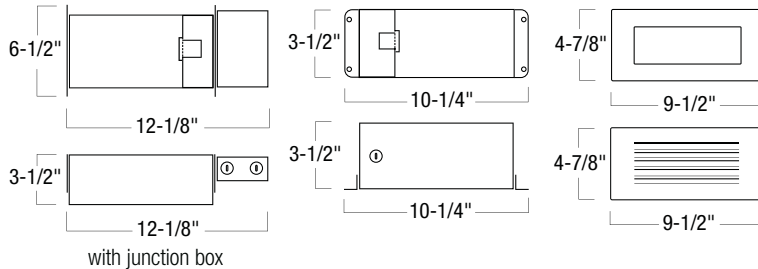

For indoor, damp, or wet location applications, Nora's offerings include standard step lights and feed-through junction boxes which enable fixtures to be chained together to one common power feed. Fixtures are available in a 9W compact fluorescent for energy savings. A high quality white powder coated finished face is included with each housing. For outdoor applications, Nora has added both a louver lensed face and tempered glass face with gaskets that are UL Wet Location listed. Low profile of louver and lens faces easily comply with OSHA specifications.

Ballast: 120V NPF Ballast

Lamp: 9W PL, G23 Base

Minimum Clearance: Non-IC fixture requires a minimum clearance of 3" from thermal insulation and 1/2" from adjacent building components.

Surface Thickness: Step Lights accept 5/8" standard drywall thickness.





Bar Hangers: Bar hanger brackets accept flat bar hangers for installing to joist or stud constructions.

Junction Box (/JB): Contains seven 1/2" knockouts and four Romex® pryouts with strain relief.

Applications: Hallways, entrances, stairways, wall bases, outdoors or any application requiring a low profile, recessed fixture providing safe illumination in indoor dark areas.

Listing: OSHA Compliant
UL and CUL Damp Location
UL and CUL Damp Location w/ Feed Through for Step Lights with Junction Box
UL and CUL Wet Location Listed for fixtures with Lens

COMPACT FLUORSCENT STEP LIGHTS

CATALOG. NO.	WATTAGE	VOLTAGE	FACE PLATE	FINISH	UL LISTING
NSP-109	9W	120V	Louver	White	Damp
 NSP-1091	9W	120V	Louver w/ Lens	White	Wet
 NSP-1092	9W	120V	Lens	White	Wet
NSP-109/JB	9W	120V	Louver	White	Damp / Feed Through
 NSP-1091/JB	9W	120V	Louver w/ Lens	White	Wet / Feed Through
 NSP-1092/JB	9W	120V	Lens	White	Wet / Feed Through

Includes housing



INCANDESCENT RECESSED

Mini Incandescent Step Lights

Nora Lighting's Mini Step Light is a perfect Mini light for illuminating architectural features. Mini Step Lights are available with louvered or lensed faces and can be easily installed in a standard single gang box. Louvered units include both a horizontal and vertical louver.

Electrical: 120VAC Input

Socket: Standard candelabra screw base

Lamp: 7W Incandescent (included)

Glass Lens: Lensed plates include a tempered glass face and can be mounted horizontally or vertically.

Louver Lens: Louvered units include both a horizontal and vertical louver to be mounted horizontally or vertically.

Applications: Hallways, entrances, stairways, wall bases, or any application requiring a low profile, recessed fixture providing safe illumination in indoor dark areas.

Finishes: Brushed Nickel, Primer (ready to paint), and White

Listing: UL and CUL Damp Location Listed

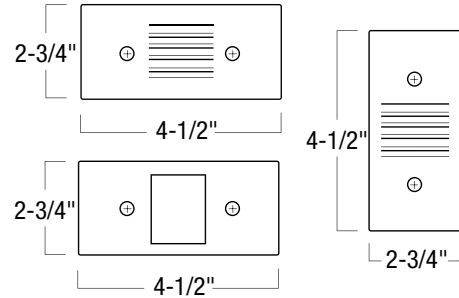

NSI-660 SERIES

CATALOG. NO.	WATTAGE	VOLTAGE	FACE PLATE	FINISH
NSI-161BN	7W	120V	Louver	Brushed Nickel
NSI-161P	7W	120V	Louver	Primer
NSI-161W	7W	120V	Louver	White
NSI-162BN	7W	120V	Lensed	Brushed Nickel
NSI-162P	7W	120V	Lensed	Primer
NSI-162W	7W	120V	Lensed	White

Mounts in standard single gang box by others



INCANDESCENT RECESSED Incandescent Step Lights



For step lighting applications, Nora's offering of standard step lights are ideal for installation to either joist or stud constructions. Fixtures are available in 25W or 40W incandescent lamp. A high quality white powder coated finished face is included with each housing. For outdoor applications, Nora has added both a louver lensed face and tempered glass face with gaskets that are UL Wet Location listed. Low profile of louver and lens faces easily comply with OSHA specifications.

Lamp: 40W A19

Minimum Clearance: Non-IC fixture requires a minimum clearance of 3" from thermal insulation and 1/2" from adjacent building components.

Surface Thickness: Step Lights accept 5/8" standard drywall thickness.

Bar Hangers: Bar hanger brackets accept flat bar hangers for installing to joist or stud constructions.



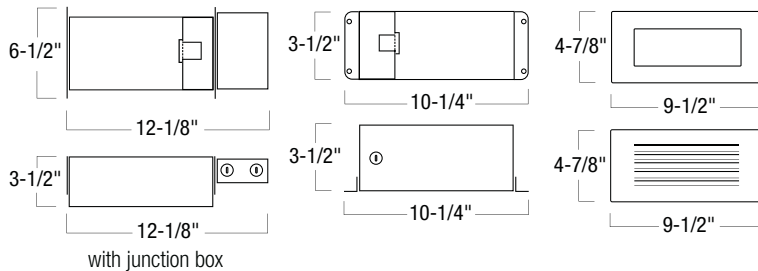

Junction Box (/JB): Contains seven 1/2" knockouts and four Romex® pryouts with strain relief.

Applications: Hallways, entrances, stairways, wall bases, outdoors or any application requiring a low profile, recessed fixture providing safe illumination in indoor dark areas.

Listing: OSHA Compliant
UL and CUL Damp Location
UL and CUL Damp Location w/ Feed Through for Step Lights with Junction Box
UL and CUL Wet Location Listed for fixtures with Lens



INCANDESCENT STEP LIGHTS

CATALOG. NO.	WATTAGE	VOLTAGE	FACE PLATE	FINISH	UL LISTING
NSI-140	40W	120V	Louver	White	Damp
 NSI-1401	40W	120V	Louver with Lens	White	Wet
 NSI-1402	40W	120V	Lens	White	Wet
NSI-125/JB	25W	120V	Louver	White	Damp / Feed Through
 NSI-1251/JB	25W	120V	Louver with Lens	White	Wet / Feed Through
 NSI-1252/JB	25W	120V	Lens	White	Wet / Feed Through

Includes housing



Recessed Accessories

Nora Lighting offers a full line of accessories to complement our recessed lighting housings, reflectors and trims. Find everything you need to complete the job from hole cutters to replacement parts, adapters, decorative elements and more.



Replacement Parts



Decorative Elements



Retrofit kits
and Adapters



Ancillary Products

Fire-Rated Recessed Light Enclosure



ONE HOUR FIRE RATED ENCLOSURE

CATALOG. NO.	TYPE	COMPATIBLE HOUSING
NRA-126	Non-IC or IC	LED / HID / Economy Compact Fluorescent / Line Voltage

FEATURES

- Fits both 16" and 24" on-center applications; one size fits most applications.
- Attaches quickly with drywall screws, saving time and labor.
- Features 4 knockouts for wiring flexibility with easy access from any direction.
- Provides sound reduction.
- Tapered design.
- 24GA galvanized steel construction
- Maintains vapor barrier integrity to meet new "air-tight building" codes.
- Maintenance free.
- Can be used on either interior or exterior applications.
- Can be used with either Non-IC rated or IC rated fixtures.
- Maintains air space even when using blow-in insulation to eliminate light fixture cycling.
- Affixed directly to the structure.
- No product modifications required. Reduces risk of incorrect product installation or movement during or after construction.

Nora Lighting's Fire Rated Recessed Light Enclosure allows architects, specifiers and installers to easily maintain the integrity of fire-rated ceilings for one-hour.

The Fire Rated Enclosure can be used with 3", 4", 5" and 6" economy grade, single wall Line Voltage and Compact Fluorescent fixtures and 6" electronic HID economy fixtures.

With the one-hour fire-rated enclosure, recessed lights can be installed in a fraction of the time that it would take to hand-build an enclosure. Once you fasten the four screws, your enclosure is ready to go. Simply install your light and you're on to the next one. You'll reduce time and labor costs while ensuring compliance to building codes.

Specifications:

- Flanges: 2-5/8" wide for easy mounting.
- Material: Corrosion-resistant metal.
- Internal Dimensions: 20-1/8" x 12" x 9-1/2"
- Stackable and packed 6 per case for easy shipping and handling.

Listing:

ASTM E119-05a
 UL 263
 UBC 7-1
 NFPA 251
 ANSI A2.1
 Certified by Omega Point Laboratories
 Certified by Intertek & Warnock Hersey



Consult factory for complete units with housing installed.

RECESSED ACCESSORIES

Hole Cutter

Nora Lighting's Hole Cutter is a versatile tool that every installer and contractor should own. Fully adjustable to fit virtually every recessed requirement, the hole cutter can reduce your cutting time in half and save you money.

With the hole cutter, there is no mess to clean up since dust and shavings are caught in the basket. There is also no need to use oversized trim rings to hide mistakes, you get a perfect round hole every time.

- Can cut drywall, plywood, plaster and acrylic sheeting up to 7/8" (2.3cm) thick. 1-3/4" (4.5cm) thick if opposite side can also be drilled.
- It can also be used for cutting aluminum, brass, and metal sheets up to 1/16" (1.00cm) thick.
- The patented product is equipped with a transparent cowl which prevents chips from injuring the user.
- Can work with either variable speed hand drills or drill press.

ALL REPLACEMENT PARTS ARE AVAILABLE



NSC SERIES

CATALOG. NO.	CUTTING DIAMETER	DESCRIPTION
NSC-6500	1-3/4" to 6-3/8"	Round Hole Cutter with Adjustable Blade up to 6"
NSC-6600	1-3/4" to 7-1/2"	Round Hole Cutter with Adjustable Blade up to 8"

NSC SERIES Replacement Parts

CATALOG. NO.	DESCRIPTION
NSC-6501	Cutting Blade A for 6" and 8" Hole Cutter - cuts drywall, wood and soft material
NSC-6502	Cutting Blade B for 6" Hole Cutter - cuts metal and stucco
NSC-6503	Drill Bit for 6" and 8" Hole Cutter
NSC-6504	Upright Axle for 6" and 8" Hole Cutter
NSC-6505	Traverse Axle for 6" Hole Cutter
NSC-6605	Traverse Axle for 8" Hole Cutter
NSC-6506	Fixed Disk for 6" Hole Cutter
NSC-6606	Fixed Disk for 8" Hole Cutter
NSC-6507	Fixed Adjusting Disk for 6" Hole Cutter
NSC-6607	Fixed Adjusting Disk for 8" Hole Cutter
NSC-6508	Adjusting Rod for 6" Hole Cutter
NSC-6608	Adjusting Rod for 8" Hole Cutter
NSC-6509	Balance Bar Set for 6" Hole Cutter
NSC-6609	Balance Bar Set for 8" Hole Cutter
NSC-6710	Replacement Hexadon Nut for NCC-6500/NSC-6600
NSC-6711	Replacement Compression Spring for NCC-6500/NSC-6600

RECESSED ACCESSORIES

Trim Accessories

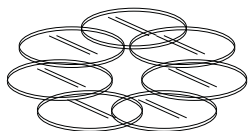

Catalog No.	Description
NM-100B	Blue Lens / Filter
NM-100C	Clear UV Lens / Filter
NM-100F	Frosted Lens / Filter
NM-100G	Green Lens / Filter
NM-100L	Linear Lens / Filter
NM-100P	Pink Lens / Filter
NM-100R	Red Lens / Filter
NM-100S	Spread Lens / Filter
NM-100Y	Yellow Lens / Filter

- For use with open or flat lens or covered lamps
- Add suffix "/MR11" for use with MR11 lamp
- Add suffix "/MR16" for use with MR16 lamp
- Add suffix "/PAR30" for use with PAR30 lamp
- Add suffix "/470" for use with NL-470
- Add suffix "/127" for use with NM-126, NM-127, NM-240, NM-254, NMK-3240
- Add suffix "/128" for use with NM-128, NM-241, NMK-3241

Colored and Optical Filters



Catalog No.	Description
NT-362	Honeycomb Louver for MR16)

- Excellent for glare control

MR16 Honeycomb Louver

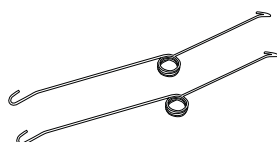
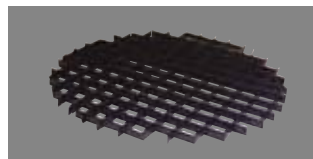

Catalog No.	Description
NRA-86	"V" Torsion Springs

"V" Torsion Springs

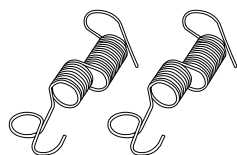
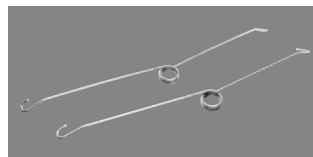

Catalog No.	Description
NRA-22	Coil Springs for NTM-30, NTM- 31, NTM- 40, NTM- 41

Coil Springs



CUSTOM COMBINATION OF REFLECTOR AND RING:

For a complete selection of recessed trim ring in die-cast aluminum, metal, plastic, designer, and oversize, see pages 38-39

Ring Options

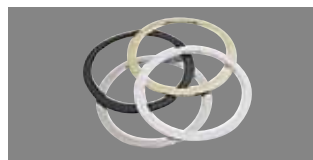

TRIM ACCESSORIES continued

4" Decorative Glass

NEW!



Catalog No.	Description
-------------	-------------

NTG-4B/80	4" Tempered Blue Glass, 80mm (3-1/8") Open center
NTG-4CF	4" Tempered Frosted Center, Clear Outer
NTG-4FC	4" Tempered Clear Center, Frosted Outer
NTG-4HC	4" Tempered Clear Outer, Frosted Inner, 80mm (3-1/8") Center Opening

- For NL-438, NS-38, NS-4238, NTS-4238
- NRA-203 Glass Hardware included

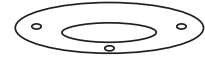

5" Decorative Glass

NEW!



Catalog No.	Description
-------------	-------------

NTG-5B/80	5" Tempered Blue Glass, 80mm (3-1/8") Open center
NTG-5CF	5" Tempered Frosted Center, Clear Outer
NTG-5FC	5" Tempered Clear Center, Frosted Outer
NTG-5HC	5" Tempered Clear Outer, Frosted Inner, 80mm (3-1/8") Center Opening

- For NTS-5038, NTS-5238
- NRA-203 Glass Hardware included

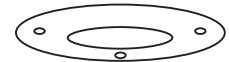

6" Decorative Glass



Catalog No.	Description
-------------	-------------

NTG-6B/120	6" Tempered Blue Glass, 120mm (4-3/4") Open center
NTG-6B/80	6" Tempered Blue Glass, 80mm (3-1/8") Open center
NTG-6CF	6" Tempered Frosted Center, Clear Outer
NTG-6FC	6" Tempered Clear Center, Frosted Outer
NTG-6HC	6" Tempered Clear Outer, Frosted Inner, 80mm (3-1/8") Center Opening

- For NTA-638, NTS-6238, NTS-638, NTS-658, NTS-738
- NRA-203 Glass Hardware included



8" Decorative Glass

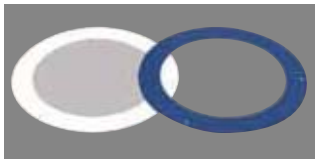

Catalog No.	Description
-------------	-------------

NTG-8B/167	8" Tempered Blue Glass, 167mm (6-5/8") Open center
NTG-8B/80	8" Tempered Blue Glass, 80mm (3-1/8") Open center
NTG-8CF	8" Tempered Frosted Center, Clear Outer
NTG-8FC	8" Tempered Clear Center, Frosted Outer
NTG-8HC	8" Tempered Clear Outer, Frosted Inner, 80mm (3-1/8") Center Opening

- For NTS-878, NTS-938
- NRA-203 Glass Hardware included



Glass Hardware Kit

NEW!



Catalog No.	Description
-------------	-------------

NRA-203	Glass Hardware Kit (Set of 3)
----------------	-------------------------------

- **INCLUDES:**
 - (3) Stand-offs for Decorative Multiple Glass Rings
 - (3) Flat End Caps for Decorative Glass
 - (3) Cone End Caps for Decorative Glass
- (1) Set is included with NTG-4, NTG-5, NTG-6, NTG-8

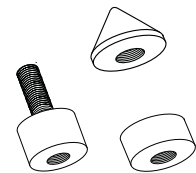

RECESSED ACCESSORIES

Housing Accessories

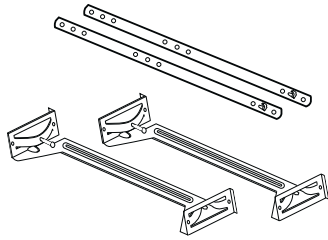

Catalog No.	Description
NRA-28	27" Flat Bar Hangers (Set of 2)
NRA-60	24-1/2" Adjustable Bar Hangers (Set of 2)

Bar Hangers

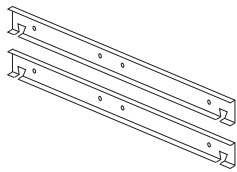
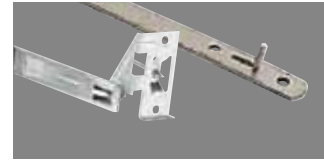

Catalog No.	Description
NRA-38	25" Channel Bar Hangers (Set of 2)

- For Architectural Frame-Ins

Channel Bar Hanger

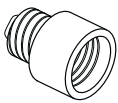
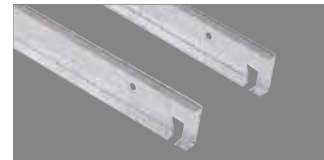

Catalog No.	Description
NRA-10	Socket Extender

- Allows use of a short neck lamp were a long neck is desired

Socket Extender

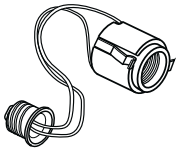

Catalog No.	Description
NRA-11	Eyeball Socket Adapter

- For use with eyeball and adjustable trims

Eyeball Socket Adapter

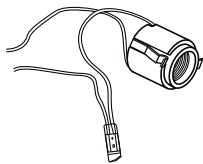

Catalog No.	Description
NRA-14	Replacement Socket with Thermal Protector - 6" Economy Housing
NRA-14/5	Replacement Socket with Thermal Protector - 5" Housing

- For Line Voltage Housings

Socket with Thermal Protector

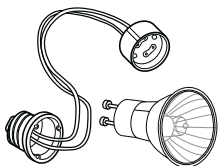

Catalog No.	Description
NRA-34/10	Halogen Retrofit Kit without Lamp
NRA-37/10	Halogen Retrofit Kit with Lamp

- Converts Medium Base Socket to MR16 GU10
- 50W MR16 GU10 lamp

Halogen Retrofit Kit

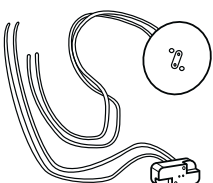

Catalog No.	Description
NRA-34	6" Low Voltage MR16 Socket Lead - without Shield
NRA-36	24" Low Voltage MR16 Socket Lead - with Shield

- Socket Base: GU5.3
- Low Voltage 12V Output

Low Voltage MR16 Socket Leads



HOUSING ACCESSORIES continued

Socket Plate / Bracket

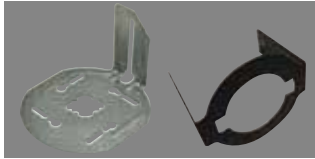

Catalog No. Description

NRA-15	Adjustable Socket Plate with Wing Nut - 6" CF Housing
NRA-151	Socket Bracket - 4" CF Housing

- For Compact Fluorescent Housings

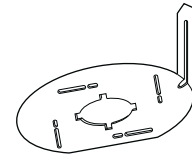

Remodel Housing Clip



Catalog No. Description

NRA-21	Remodel Housing Clip
---------------	----------------------

- For 4", 5" and 6" housings

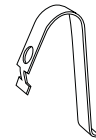

Monopoint Adapter

NEW!



Catalog No. Description

NT-374B	Black Monopoint Adapter for 4" Housing
NT-374W	White Monopoint Adapter for 4" Housing
NT-376B	Black Monopoint Adapter for 6" Housing
NT-376W	White Monopoint Adapter for 6" Housing

- Converts Incandescent housing into a track monopoint
- Retrofit style

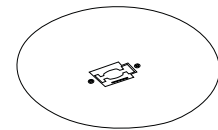

Magnetic Transformer



Catalog No. Description

NRA-29/50W	4.2A 50W Magnetic Transformer - 120V to 12V
NRA-29/277V	4.2A 50W Magnetic Transformer - 277V to 12V
NRA-29/75W	6.3A 75W Magnetic Transformer - 120V to 12V
NRA-29/75/277V	6.3A 75W Magnetic Transformer - 277V to 12V

- Class I transformer for Low Voltage Housings
- Dimensions: Length 2-1/4" Width: 1-7/8" Height: 2-5/8"
- Includes thermal protection
- UL Recognized

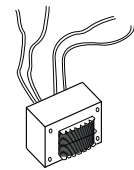

Magnetic Transformer w/ J-Box Plate



Catalog No. Description

NRA-6037	4.2A 50W Magnetic Transformer w/ J-Box Plate - 120V to 12V
-----------------	--

- Class I transformer for Low Voltage Housings
- Bottom feed
- Dimensions: Length 5-1/8" Width: 2-5/8" Height: 3-3/8"
- Includes thermal protection
- UL Recognized

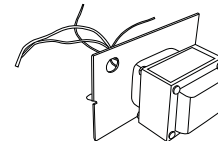

Electronic Transformer w/ J-Box Plate



Catalog No. Description

NRA-6061	50W Electronic Transformer w/ J-Box Plate - 120V to 12V
-----------------	---

- Lightech® Class II transformer for Low Voltage Housings
- Bottom feed
- Dimensions: Length 5-1/8" Width: 7/8" Height: 3-3/8"
- Short circuit and overload protection
- UL Recognized

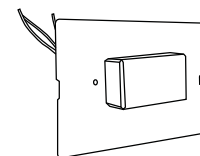

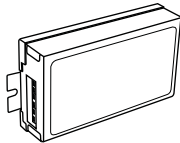

Catalog No.	Description
BAEQF013TQ411AD	(1) 13W Compact Fluorescent Electronic Ballast - 120V
BAEBF013TQ43UUN	(1 or 2) 13W Compact Fluorescent Electronic Ballast - 120V-277V
BAEQF018TQ431AD	(1) 18W Compact Fluorescent Electronic Ballast - 120V
BAEBF018TQ43UUN	(1 or 2) 18W Compact Fluorescent Electronic Ballast - 120V-277V

- Lamp Type: (1) or (2) 13W-18W 4-Pin Quad, (1) or (2) 13W- 18W 4-Pin Triple
- Class A sound rating
- UL Listed

18W CF Electronic Ballast

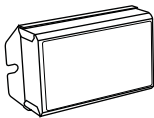

Catalog No.	Description
BAEQF026TQ411UN	26W Compact Fluorescent Electronic Ballast - 120V 60Hz

- Lamp Type: (1) CFQ26W/Gx24Q, (1) CFTR26W/Gx24Q, (1) CFTR32W/Gx24Q, (1) FC9T5, (1) FT18W/2G11, (1) FT24W/2G11, (1) F24T5
- Wattage: 18W-32W
- Class A sound rating
- cULus Listed

26W 120V CF Electronic Ballast

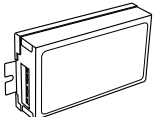

Catalog No.	Description
BAEQF018TQ431AD	26W-42W CF Electronic Ballast - 120V-277V 50/60Hz

- Lamp Type: (1) or (2) CFQ/TR26W/Gx24Q, (1) CFTR32W/Gx24Q, (1) CFM36W/2G10, (1) CFM42W/Gx24Q, (1) CFS28W/GR10Q, (1)FC9T5-22W, (1) FC12T5-40W, (1) FT24W/2G11, (2) FT24WG11, (1) CFS38W/GR10Q
- Wattage: 26W- 42W
- Class A sound rating
- cULus Listed

26W-42W CF Electronic Ballast

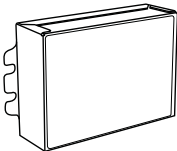

Catalog No.	Description
BAEBF908TQ43UAD	26W-42W CF Electronic Ballast - 120V-277V 50/60Hz

- Lamp Type: (2) 26W 4-Pin Quad, (2) 26W Triple, (2) 32W Triple, (2) 42W Triple, (1) or (2) 40W Long Twin Tube, (2) 24/72W Long Twin Tube, (2) 28W 2D, (2) 38W 2D, (1) 57W CFL, (1) 70W CFL, [(1) 22W and (1) 40W] T5 Circline
- Wattage: 26W- 42W
- Class A sound rating
- cULus Listed

26W-42W CF Electronic Ballast

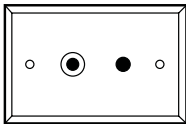

Catalog No.	Description
NRA-123	Emergency Switch Plate with Indicator Light - Electronic
NRA-123MAG	Emergency Switch Plate with Indicator Light - Magnetic

Emergency Switch Plate

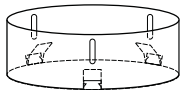

Catalog No.	Description
NRA-130	Extension Collar for 6" Architectural Frame-In
NRA-160	Extension Collar for 8" Architectural Frame-In

- Allows installation to double-thick ceilings

Extension Collar





MULTIPLE LIGHTING SYSTEM

Introduction	389
Overview	390
Ceramic Metal Halide Recessed	392
Low Voltage Recessed	396
Line Voltage PAR Recessed	400
Low Voltage Surface Mount	404



The Nora Lighting

Multiple Lighting System (MLS)



Nora Lighting Multiple Lighting System (MLS) is a multi-point lighting system providing many options and architectural flexibility. A single ceiling opening can have 1 to 5 independently adjusted and switched fixtures. Retail and Commercial applications will appreciate the look and the ability to change direction of aiming up to 5 Ceramic Metal Halide lamps on a single trip up the ladder. Nora MLS is also available in low voltage, line voltage, and custom capability for residential, commercial, retail, and gallery applications.



FEATURES

- Flexible - One Opening with up to 5 independently adjustable and controlled fixtures
- Control - One Opening can provide flood (general lighting) and spot (accent lighting)
- Complete Selection - Available in single row 1 to 5 light, "L" shape 2 or 3 light, and a square 4 light configurations
- Lower Construction Cost - One Opening with 3 lights vs 3 openings, means lower installation cost
- Architecturally Appealing - Nora MLS fixtures have a 2-1/4" regressed closed face for a finished look and multiple lights in a single opening creates a cleaner less cluttered ceiling appearance
- Lower Maintenance Cost - Multiple lights in a single opening means fewer trips up the ladder, saving time and labor
- Low Temperature - Housings are vented on the top for cool operation, extending lamp life
- Lamp Sources - Available in Energy Saving, High Color Rendition HID Ceramic Metal Halide, Low Voltage, and PAR Halogen Incandescent
- Finishes - Available in white face and white fixtures with white flange, black face and fixtures with white flange, and silver face and silver fixtures with silver flange
- Easy Maintenance - Ballast or Transformers are easily accessible from below, and do not require top access
- Custom Capabilities - Mix sources and trims in the same MLS fixture
- 32° - 90° Tilt and 355° Rotation
- Nora MLS - Flexible, Architectural, and Smart

Overview MULTIPLE LIGHTING SYSTEM

CERAMIC METAL HALIDE HID RECESSED MULTIPLE LIGHTING SYSTEM COMPLETE UNITS



NMRH-11 Series
1 Row / 1 Lamp

Linear Configuration p.392



NMRH-12 Series
1 Row / 2 Lamps

Linear Configuration p.392



NMRH-13 Series
1 Row / 3 Lamps

Linear Configuration p.392



NMRH-14 Series
1 Row / 4 Lamps

Linear Configuration p.392



NMRH-15 Series
1 Row / 5 Lamps

Linear Configuration p.392



NMRH-24 Series
Square / 4 Lamps

Square Configuration p.392



NMRH-L2 Series
"L" Shape / 2 Lamps

"L" Shape Configuration p.392



NMRH-L3 Series
"L" Shape / 3 Lamps

"L" Shape Configuration p.392

LOW VOLTAGE RECESSED MULTIPLE LIGHTING SYSTEM COMPLETE UNITS



NMRL-11 Series
1 Row / 1 Lamp

Linear Configuration p.396



NMRL-12 Series
1 Row / 2 Lamps

Linear Configuration p.396



NMRL-13 Series
1 Row / 3 Lamps

Linear Configuration p.396



NMRL-14 Series
1 Row / 4 Lamps

Linear Configuration p.396



NMRL-15 Series
1 Row / 5 Lamps

Linear Configuration p.396



NMRL-24 Series
Square / 4 Lamps

Square Configuration p.396



NMRL-L2 Series
"L" Shape / 2 Lamps

"L" Shape Configuration p.396



NMRL-L3 Series
"L" Shape / 3 Lamps

"L" Shape Configuration p.396

Lighting Tip:

Use Nora Low Voltage Magnetic MLS units with after market LED MR16s for energy savings.

LINE VOLTAGE RECESSED MULTIPLE LIGHTING SYSTEM COMPLETE UNITS



NMRI-11 Series
1 Row / 1 Lamp
Linear Configuration p.400



NMRI-12 Series
1 Row / 2 Lamps
Linear Configuration p.400



NMRI-13 Series
1 Row / 3 Lamps
Linear Configuration p.400



NMRI-14 Series
1 Row / 4 Lamps
Linear Configuration p.400



NMRI-15 Series
1 Row / 5 Lamps
Linear Configuration p.400



NMRI-24 Series
Square / 4 Lamps
Square Configuration p.400



NMRI-L2 Series
"L" Shape / 2 Lamps
"L" Shape Configuration p.400



NMRI-L3 Series
"L" Shape / 3 Lamps
"L" Shape Configuration p.400

Lighting Tip:

Use Nora Line Voltage
MLS units with after market
PAR LEDs to reduce
energy consumptions.

LOW VOLTAGE SURFACE MOUNT (75W AR111)



NMS12175E1S1674
1 Row / 2 Lamps
Linear Configuration p.404



NMS13175E1S1674
1 Row / 3 Lamps
Linear Configuration p.404



NMS14175E1S1674
1 Row / 4 Lamps
Linear Configuration p.405



NMS15175E1S1674
1 Row / 5 Lamps
Linear Configuration p.405



NMS16175E1S1674
1 Row / 6 Lamps
Linear Configuration p.405



NMS22175E1S1674
2 Rows / 2 Lamps
Square Configuration p.405

MULTIPLE LIGHTING SYSTEM

Metal Halide HID Multiple Lighting System housings

Nora Lighting's family of Ceramic Metal Halide MLS fixtures are excellent for commercial and retail applications. Nora's MLS fixtures allow a single ceiling opening to have up to 5 independently adjustable trims. The housings can be installed in drywall, plaster, and suspended ceilings.

Ballast: Electronic Ballast with Universal Input (120V to 277V)

Socket: Steel shell porcelain jacketed 4KV pulse rated socket. Medium screw-in base.

Lamp Types:

20W PAR30 CMH 39W PAR30 CMH 70W PAR30 CMH

Custom Configuration: CMH PAR30 units can have a combination of line voltage PAR30 and CMH PAR30. Consult factory.

Wiring: Each unit has a wiring channel with leads from each ballast, there by allowing independent switching or dimming. Configure as Bi-Level switching for energy savings. (A second switch leg is required).

Ceiling Thickness: Accepts 1" maximum ceiling thickness.

Installation: Universal brackets accepts C-Channel or flat bar hangers (ordered separately - see page 383), or simple rigid 1/2" steel conduit for tie-down to ceiling grids.

Minimum Clearance: Requires a minimum clearance of 3" from thermal insulation and 1/2" from any adjacent building components.

Housing: Heavy gauge post painted steel. Vented on top for cool operation. Ballast(s) may be accessed from below.

Knockouts: Six 3/4" knockouts included - 2 each on 3 sides.

Listing: cULus Damp Location



How to order METAL HALIDE HID MLS HOUSING - Trim Ordered Separately

SERIES	LIGHT SOURCE	NUMBER OF ROWS	NO. OF LAMPS	BALLAST	VOLTAGE	LAMP TYPE	WATTAGE	
NMR	H = HID	1 = 1 Row (1 to 5 Lamps only) 2 = Square (4 Lamps only) L = "L" Shaped (2 or 3 Lamps only)	1 = 1 Lamp 2 = 2 Lamps 3 = 3 Lamps 4 = 4 Lamps 5 = 5 Lamps	E = Electronic	3 = Universal (120-277V)	0 = PAR30	20 = 20W 39 = 39W 70 = 70W	
NMR	H	-	2	4	E	3	0	70

ORDER EXAMPLE: NMRH-24E3070 - Metal Halide HID Square Configuration / 4 Lamps; 120V-277V Electronic Ballast; 70W PAR30 CMH

How to order METAL HALIDE HID MLS TRIM - Housing Ordered Separately

SERIES	NUMBER OF ROWS	NUMBER OF LAMPS	TRIMS	FACE / FLANGE FINISH	
NMRT	1 = 1 Row (1 to 5 Lamps only) 2 = Square (4 Lamps only) L = "L" Shaped (2 or 3 Lamps only)	1 = 1 Lamp 2 = 2 Lamps 3 = 3 Lamps 4 = 4 Lamps 5 = 5 Lamps	628 652	BW = Black Face & Fixture, White Flange SS = Silver Face & Fixture, Silver Flange WW = White Face & Fixture, White Flange	
NMRT	-	2	4	628	BW

ORDER EXAMPLE: NMRT-24628BW - Metal Halide HID Square Configuration / 4 Lamps; 628 Trim; Black Face, White Flange



Lighting Tip:

A Nora MLS can be wired in the field for independent switching or dimming. On a three light unit, one fixture can highlight a focal point and on a separate switch or dimmer the other two can provide general lighting. (A second switch leg must be pulled to housing)

MULTIPLE LIGHTING SYSTEM

Metal Halide HID MLS Housings

METAL HALIDE HID MLS HOUSINGS - TRIMS SOLD SEPARATELY

	CONFIGURATION	20W PAR30 CMH LAMP	39W PAR30 CMH LAMP	70W PAR30 CMH LAMP
	<p>1 Row / 1 Lamp HID MLS Housing Dimensions: 11" W x 10-1/2" L x 6-3/4" H</p> <ul style="list-style-type: none"> Housing only - trims sold separately 	NMRH-11E3020	NMRH-11E3039	NMRH-11E3070
	<p>1 Row / 2 Lamps HID MLS Housing Dimensions: 11" W x 19" L x 6-3/4" H</p> <ul style="list-style-type: none"> Housing only - trims sold separately 	NMRH-12E3020	NMRH-12E3039	NMRH-12E3070
	<p>1 Row / 3 Lamps HID MLS Housing Dimensions: 11" W x 24-1/2" L x 6-3/4" H</p> <ul style="list-style-type: none"> Housing only - trims sold separately 	NMRH-13E3020	NMRH-13E3039	NMRH-13E3070
	<p>1 Row / 4 Lamps HID MLS Housing Dimensions: 11" W x 30-1/2" L x 6-3/4" H</p> <ul style="list-style-type: none"> Housing only - trims sold separately 	NMRH-14E3020	NMRH-14E3039	NMRH-14E3070
	<p>1 Row / 5 Lamps HID MLS Housing Dimensions: 11" W x 36" L x 6-3/4" H</p> <ul style="list-style-type: none"> Housing only - trims sold separately 	NMRH-15E3020	NMRH-15E3039	NMRH-15E3070
	<p>Square / 4 Lamps HID MLS Housing Dimensions: 22-1/2" W x 20-1/2" L x 6-3/4" H</p> <ul style="list-style-type: none"> Housing only - trims sold separately 	NMRH-24E3020	NMRH-24E3039	NMRH-24E3070
	<p>"L" Shape / 2 Lamps HID MLS Housing Dimensions: 16-1/2" W x 16-1/2" L x 6-3/4" H</p> <ul style="list-style-type: none"> Housing only - trims sold separately 	NMRH-L2E3020	NMRH-L2E3039	NMRH-L2E3070
	<p>"L" Shape / 3 Lamps HID MLS Housing Dimensions: 20-1/4" W x 20-1/4" L x 6-3/4" H</p> <ul style="list-style-type: none"> Housing only - trims sold separately 	NMRH-L3E3020	NMRH-L3E3039	NMRH-L3E3070

MULTIPLE LIGHTING SYSTEM
Metal Halide HID MLS Trims

METAL HALIDE HID MLS TRIMS - HOUSINGS SOLD SEPARATELY



628 TRIM
PAR30 EYEBALL
45° ADJUSTABLE
20-70W PAR30 CMH Lamp Max.



652 TRIM
PAR30 GIMBAL
45° ADJUSTABLE
20-70W PAR30 CMH Lamp Max.



<p>NMRT-11628BW NMRT-11628SS NMRT-11628WW</p>	<p>NMRT-11652BW NMRT-11652SS NMRT-11652WW</p>	<p>1 Row / 1 Lamp Metal Halide HID MLS Trim Dimensions: 9-3/4" W x 9-7/8" L x 2-1/4" D • Trim only - housing sold separately</p> 
<p>NMRT-12628BW NMRT-12628SS NMRT-12628WW</p>	<p>NMRT-12652BW NMRT-12652SS NMRT-12652WW</p>	<p>1 Row / 2 Lamps Metal Halide HID MLS Trim Dimensions: 9-3/4" W x 18" L x 2-1/4" D • Trim only - housing sold separately</p> 
<p>NMRT-13628BW NMRT-13628SS NMRT-13628WW</p>	<p>NMRT-13652BW NMRT-13652SS NMRT-13652WW</p>	<p>1 Row / 3 Lamps Metal Halide HID MLS Trim Dimensions: 9-3/4" W x 23-3/4" L x 2-1/4" D • Trim only - housing sold separately</p> 
<p>NMRT-14628BW NMRT-14628SS NMRT-14628WW</p>	<p>NMRT-14652BW NMRT-14652SS NMRT-14652WW</p>	<p>1 Row / 4 Lamps Metal Halide HID MLS Trim Dimensions: 9-3/4" W x 29-1/2" L x 2-1/4" D • Trim only - housing sold separately</p> 
<p>NMRT-15628BW NMRT-15628SS NMRT-15628WW</p>	<p>NMRT-15652BW NMRT-15652SS NMRT-15652WW</p>	<p>1 Row / 5 Lamps Metal Halide HID MLS Trim Dimensions: 9-3/4" W x 35-1/4" L x 2-1/4" D • Trim only - housing sold separately</p> 
<p>NMRT-24628BW NMRT-24628SS NMRT-24628WW</p>	<p>NMRT-24652BW NMRT-24652SS NMRT-24652WW</p>	<p>Square / 4 Lamps Metal Halide HID MLS Trim Dimensions: 19-3/4" W x 19-3/4" L x 2-1/4" D • Trim only - housing sold separately</p> 
<p>NMRT-L2628BW NMRT-L2628SS NMRT-L2628WW</p>	<p>NMRT-L2652BW NMRT-L2652SS NMRT-L2652WW</p>	<p>"L" Shape / 2 Lamps Metal Halide HIDMLS Trim Dimensions: 14-7/8" W x 14-7/8" L x 2-1/4" D • Trim only - housing sold separately</p> 
<p>NMRT-L3628BW NMRT-L3628SS NMRT-L3628WW</p>	<p>NMRT-L3652BW NMRT-L3652SS NMRT-L3652WW</p>	<p>"L" Shape / 3 Lamps Metal Halide HID MLS Trim Dimensions: 19-1/4" W x 19-3/8" L x 2-1/4" D • Trim only - housing sold separately</p> 

Trim Finishes: **BW** = Black Face & Fixture, White Flange; **SS** = Silver Face & Fixture, Silver Flange; **WW** = White Face & Fixture, White Flange

MULTIPLE LIGHTING SYSTEM

Low Voltage Multiple Lighting System

Nora Lighting's family of Low Voltage MLS fixtures can be used in residential, commercial and retail applications. Nora's MLS fixtures allow a single ceiling opening to have 5 independently adjustable trims. The housings can be installed in drywall, plaster, and suspended ceilings.

Transformer: Electronic Transformer available in 120V or 277V
Magnetic Transformer available in 120V or 277V

Lamp Types:
50W 12V MR16 75W 12V AR111

Custom Configuration: Low voltage MLS units can have a combination of trims. Example: 2 slots and 3 eyeballs in a 5 light unit. Consult factory.

Wiring: Each unit has a wiring channel with leads from each transformer, there by allowing independent switching or dimming.

Ceiling Thickness: Accepts 1" maximum ceiling thickness.

Installation: Universal brackets accepts C-Channel or flat bar hangers (ordered separately - see page 383), or simple rigid 1/2" steel conduit for tie-down to ceiling grids.

Minimum Clearance: Requires a minimum clearance of 3" from thermal insulation and 1/2" from any adjacent building components.

Housing: Heavy gauge post painted steel. Vented on top for cool operation. Transformer(s) may be accessed from below.

Knockouts: Six 3/4" knockouts included - 2 each on 3 sides.

Listing: cULus Damp Location



How to order LOW VOLTAGE MLS HOUSING - Trim Ordered Separately

SERIES	LIGHT SOURCE	NUMBER OF ROWS	NO. OF LAMPS	TRANSFORMER	VOLTAGE	LAMP TYPE	WATTAGE	
NMR	L = Low Voltage	1 = 1 Row (1 to 5 Lamps only)	1 = 1 Lamp	E = Electronic M = Magnetic	1 = 120V 2 = 277V	1 = AR111* 6 = MR16	50 = 50W (MR16 only) 75 = 75W (AR111*)	
		2 = Square (4 Lamps only)	2 = 2 Lamps					
		L = "L" Shaped (2 or 3 Lamps only)	3 = 3 Lamps					
			4 = 4 Lamps					
			5 = 5 Lamps					
NMR	L	-	2	4	E	1	6	50

ORDER EXAMPLE: NMRL-24E1650 - Low Voltage Square Configuration, 4 Lamps; 120V/12V Electronic Transformer; 50W MR16

* AR111 only accepts an electronic transformer

How to order LOW VOLTAGE MLS TRIM - Housing Ordered Separately

SERIES	NUMBER OF ROWS	NUMBER OF LAMPS	TRIMS	FACE / FLANGE FINISH	
NMRT	1 = 1 Row (1 to 5 Lamps only)	1 = 1 Lamp	418 (MR16 only)	BW = Black Face & Fixture, White Flange SS = Silver Face & Fixture, Silver Flange WW = White Face & Fixture, White Flange	
	2 = Square (4 Lamps only)	2 = 2 Lamps	445 (MR16 only)		
	L = "L" Shaped (2 or 3 Lamps only)	3 = 3 Lamps	463 (MR16 only)		
		4 = 4 Lamps	465 (MR16 only)		
		5 = 5 Lamps	470 (MR16 only) 674 (AR111 only)		
NMRT	-	2	4	418	BW

ORDER EXAMPLE: NMRT-24418BW - Low Voltage Square Configuration, 4 Lamps; 418 Trim; Black Face, White Flange

MULTIPLE LIGHTING SYSTEM
Low Voltage MLS Housings

LOW VOLTAGE MLS HOUSINGS - TRIMS SOLD SEPARATELY

50W MR16 LAMP	75W AR111 LAMP	CONFIGURATION	
<p>NMRL-11E1650 - 120V Electronic NMRL-11E2650 - 277V Electronic NMRL-11M1650 - 120V Magnetic NMRL-11M2650 - 277V Magnetic</p>	<p>NMRL-11E1175 - 120V Electronic NMRL-11E2175 - 277V Electronic</p>	<p>1 Row / 1 Lamp Low Voltage MLS Housing Dimensions: 10-3/8" W x 10-1/2" L x 6-3/4" H (Electronic) 12-3/8" W x 10-1/2" L x 6-3/4" H (Magnetic)</p> <ul style="list-style-type: none"> Housing only - trims sold separately 	
<p>NMRL-12E1650 - 120V Electronic NMRL-12E2650 - 277V Electronic NMRL-12M1650 - 120V Magnetic NMRL-12M2650 - 277V Magnetic</p>	<p>NMRL-12E1175 - 120V Electronic NMRL-12E2175 - 277V Electronic</p>	<p>1 Row / 2 Lamps Low Voltage MLS Housing Dimensions: 10-3/8" W x 19" L x 6-3/4" H (Electronic) 12-3/8" W x 19" L x 6-3/4" H (Magnetic)</p> <ul style="list-style-type: none"> Housing only - trims sold separately 	
<p>NMRL-13E1650 - 120V Electronic NMRL-13E2650 - 277V Electronic NMRL-13M1650 - 120V Magnetic NMRL-13M2650 - 277V Magnetic</p>	<p>NMRL-13E1175 - 120V Electronic NMRL-13E2175 - 277V Electronic</p>	<p>1 Row / 3 Lamps Low Voltage MLS Housing Dimensions: 10-3/8" W x 24-1/2" L x 6-3/4" H (Electronic) 12-3/8" W x 24-1/2" L x 6-3/4" H (Magnetic)</p> <ul style="list-style-type: none"> Housing only - trims sold separately 	
<p>NMRL-14E1650 - 120V Electronic NMRL-14E2650 - 277V Electronic NMRL-14M1650 - 120V Magnetic NMRL-14M2650 - 277V Magnetic</p>	<p>NMRL-14E1475 - 120V Electronic NMRL-14E2475 - 277V Electronic</p>	<p>1 Row / 4 Lamps Low Voltage MLS Housing Dimensions: 10-3/8" W x 30-1/2" L x 6-3/4" H (Electronic) 12-3/8" W x 30-1/2" L x 6-3/4" H (Magnetic)</p> <ul style="list-style-type: none"> Housing only - trims sold separately 	
<p>NMRL-15E1650 - 120V Electronic NMRL-15E2650 - 277V Electronic NMRL-15M1650 - 120V Magnetic NMRL-15M2650 - 277V Magnetic</p>	<p>NMRL-15E1175 - 120V Electronic NMRL-15E2175 - 277V Electronic</p>	<p>1 Row / 5 Lamps Low Voltage MLS Housing Dimensions: 10-3/8" W x 36" L x 6-3/4" H (Electronic) 12-3/8" W x 36" L x 6-3/4" H (Magnetic)</p> <ul style="list-style-type: none"> Housing only - trims sold separately 	
<p>NMRL-24E1650 - 120V Electronic NMRL-24E2650 - 277V Electronic NMRL-24M1650 - 120V Magnetic NMRL-24M2650 - 277V Magnetic</p>	<p>NMRL-24E1175 - 120V Electronic NMRL-24E2175 - 277V Electronic</p>	<p>Square / 4 Lamps Low Voltage MLS Housing Dimensions: 21-1/4" W x 20-1/2" L x 6-3/4" H (Electronic) 25-1/4" W x 20-1/2" L x 6-3/4" H (Magnetic)</p> <ul style="list-style-type: none"> Housing only - trims sold separately 	
<p>NMRL-L2E1650 - 120V Electronic NMRL-L2E2650 - 277V Electronic NMRL-L2M1650 - 120V Magnetic NMRL-L2M2650 - 277V Magnetic</p>	<p>NMRL-L2E1175 - 120V Electronic NMRL-L2E2175 - 277V Electronic</p>	<p>"L" Shape / 2 Lamps Low Voltage MLS Housing Dimensions: 15-7/8" W x 15-7/8" L x 6-3/4" H (Electronic) 17-7/8" W x 17-7/8" L x 6-3/4" H (Magnetic)</p> <ul style="list-style-type: none"> Housing only - trims sold separately 	
<p>NMRL-L3E1650 - 120V Electronic NMRL-L3E2650 - 277V Electronic NMRL-L3M1650 - 120V Magnetic NMRL-L3M2650 - 277V Magnetic</p>	<p>NMRL-L3E1175 - 120V Electronic NMRL-L3E2175 - 277V Electronic</p>	<p>"L" Shape / 3 Lamps Low Voltage MLS Housing Dimensions: 20-5/8" W x 20-5/8" L x 6-3/4" H (Electronic) 22-5/8" W x 22-5/8" L x 6-3/4" H (Magnetic)</p> <ul style="list-style-type: none"> Housing only - trims sold separately 	

MULTIPLE LIGHTING SYSTEM

Low Voltage MLS Trims

LOW VOLTAGE MLS TRIMS - HOUSINGS SOLD SEPARATELY



418 TRIM
EYEBALL
32° ADJUSTABLE
50W MR16 Lamp Max.



445 TRIM
SLOT APERTURE
35° ADJUSTABLE
50W MR16 Lamp Max.



463 TRIM
REGRESSED BAFFLED GIMBAL
35° ADJUSTABLE
50W MR16 Lamp Max.



1 Row / 1 Lamp Low Voltage MLS Trim
Dimensions: 9-3/4" W x 9-7/8" L x 2-1/4" D
• Trim only - housing sold separately

NMRT-11418BW
NMRT-11418SS
NMRT-11418WW

NMRT-11445BW
NMRT-11445SS
NMRT-11445WW

NMRT-11463BW
NMRT-11463SS
NMRT-11463WW

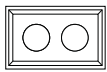

1 Row / 2 Lamps Low Voltage MLS Trim
Dimensions: 9-3/4" W x 18" L x 2-1/4" D
• Trim only - housing sold separately

NMRT-12418BW
NMRT-12418SS
NMRT-12418WW

NMRT-12445BW
NMRT-12445SS
NMRT-12445WW

NMRT-12463BW
NMRT-12463SS
NMRT-12463WW

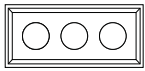

1 Row / 3 Lamps Low Voltage MLS Trim
Dimensions: 9-3/4" W x 23-3/4" L x 2-1/4" D
• Trim only - housing sold separately

NMRT-13418BW
NMRT-13418SS
NMRT-13418WW

NMRT-13445BW
NMRT-13445SS
NMRT-13445WW

NMRT-13463BW
NMRT-13463SS
NMRT-13463WW



1 Row / 4 Lamps Low Voltage MLS Trim
Dimensions: 9-3/4" W x 29-1/2" L x 2-1/4" D
• Trim only - housing sold separately

NMRT-14418BW
NMRT-14418SS
NMRT-14418WW

NMRT-14445BW
NMRT-14445SS
NMRT-14445WW

NMRT-14463BW
NMRT-14463SS
NMRT-14463WW



1 Row / 5 Lamps Low Voltage MLS Trim
Dimensions: 9-3/4" W x 35-1/4" L x 2-1/4" D
• Trim only - housing sold separately

NMRT-15418BW
NMRT-15418SS
NMRT-15418WW

NMRT-15445BW
NMRT-15445SS
NMRT-15445WW

NMRT-15463BW
NMRT-15463SS
NMRT-15463WW

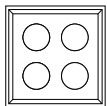

Square / 4 Lamps Low Voltage MLS Trim
Dimensions: 19-3/4" W x 19-3/4" L x 2-1/4" D
• Trim only - housing sold separately

NMRT-24418BW
NMRT-24418SS
NMRT-24418WW

NMRT-24445BW
NMRT-24445SS
NMRT-24445WW

NMRT-24463BW
NMRT-24463SS
NMRT-24463WW

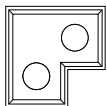

"L" Shape / 2 Lamps Low Voltage MLS Trim
Dimensions: 14-7/8" W x 14-7/8" L x 2-1/4" D
• Trim only - housing sold separately

NMRT-L2418BW
NMRT-L2418SS
NMRT-L2418WW

NMRT-L2445BW
NMRT-L2445SS
NMRT-L2445WW

NMRT-L2463BW
NMRT-L2463SS
NMRT-L2463WW

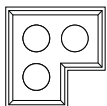

"L" Shape / 3 Lamps Low Voltage MLS Trim
Dimensions: 19-1/4" W x 19-3/8" L x 2-1/4" D
• Trim only - housing sold separately

NMRT-L3418BW
NMRT-L3418SS
NMRT-L3418WW





NMRT-L3445BW
NMRT-L3445SS
NMRT-L3445WW

NMRT-L3463BW
NMRT-L3463SS
NMRT-L3463WW

Trim Finishes: BW = Black Face & Fixture, White Flange; SS = Silver Face & Fixture, Silver Flange; WW = White Face & Fixture, White Flange
Different Low Voltage Trims can be used in a single unit - Consult Factory

MULTIPLE LIGHTING SYSTEM
Low Voltage MLS Trims continued

LOW VOLTAGE MLS TRIMS - HOUSINGS SOLD SEPARATELY

			
465 TRIM SURFACE GIMBAL 35° ADJUSTABLE 50W MR16 Lamp Max.	470 TRIM FRONT LOAD ELBOW 90° ADJUSTABLE 50W MR16 Lamp Max.	674 TRIM GIMBAL 45° ADJUSTABLE 75W AR111 Lamp Max.	
NMRT-11465BW NMRT-11465SS NMRT-11465WW	NMRT-11470BW NMRT-11470SS NMRT-11470WW	NMRT-11674BW NMRT-11674SS NMRT-11674WW	1 Row / 1 Lamp Low Voltage MLS Trim Dimensions: 9-3/4" W x 9-7/8" L x 2-1/4" D • Trim only - housing sold separately
NMRT-12465BW NMRT-12465SS NMRT-12465WW	NMRT-12470BW NMRT-12470SS NMRT-12470WW	NMRT-12674BW NMRT-12674SS NMRT-12674WW	1 Row / 2 Lamps Low Voltage MLS Trim Dimensions: 9-3/4" W x 18" L x 2-1/4" D • Trim only - housing sold separately
NMRT-13465BW NMRT-13465SS NMRT-13465WW	NMRT-13470BW NMRT-13470SS NMRT-13470WW	NMRT-13674BW NMRT-13674SS NMRT-13674WW	1 Row / 3 Lamps Low Voltage MLS Trim Dimensions: 9-3/4" W x 23-3/4" L x 2-1/4" D • Trim only - housing sold separately
NMRT-14465BW NMRT-14465SS NMRT-14465WW	NMRT-14470BW NMRT-14470SS NMRT-14470WW	NMRT-14674BW NMRT-14674SS NMRT-14674WW	1 Row / 4 Lamps Low Voltage MLS Trim Dimensions: 9-3/4" W x 29-1/2" L x 2-1/4" D • Trim only - housing sold separately
NMRT-15465BW NMRT-15465SS NMRT-15465WW	NMRT-15470BW NMRT-15470SS NMRT-15470WW	NMRT-15674BW NMRT-15674SS NMRT-15674WW	1 Row / 5 Lamps Low Voltage MLS Trim Dimensions: 9-3/4" W x 35-1/4" L x 2-1/4" D • Trim only - housing sold separately
NMRT-24465BW NMRT-24465SS NMRT-24465WW	NMRT-24470BW NMRT-24470SS NMRT-24470WW	NMRT-24674BW NMRT-24674SS NMRT-24674WW	Square / 4 Lamps Low Voltage MLS Trim Dimensions: 19-3/4" W x 19-3/4" L x 2-1/4" D • Trim only - housing sold separately
NMRT-L2465BW NMRT-L2465SS NMRT-L2465WW	NMRT-L2470BW NMRT-L2470SS NMRT-L2470WW	NMRT-L2674BW NMRT-L2674SS NMRT-L2674WW	"L" Shape / 2 Lamps Low Voltage MLS Trim Dimensions: 14-7/8" W x 14-7/8" L x 2-1/4" D • Trim only - housing sold separately
NMRT-L3465BW NMRT-L3465SS NMRT-L3465WW	NMRT-L3470BW NMRT-L3470SS NMRT-L3470WW	NMRT-L3674BW NMRT-L3674SS NMRT-L3674WW	"L" Shape / 3 Lamps Low Voltage MLS Trim Dimensions: 19-1/4" W x 19-3/8" L x 2-1/4" D • Trim only - housing sold separately

Trim Finishes: **BW** = Black Face & Fixture, White Flange; **SS** = Silver Face & Fixture, Silver Flange; **WW** = White Face & Fixture, White Flange
Different Low Voltage Trims can be used in a single unit - Consult Factory

MULTIPLE LIGHTING SYSTEM

Line Voltage Multiple Lighting System

Nora Lighting's family of Line Voltage MLS fixtures can be used in residential, commercial and retail applications. Nora's MLS fixtures allow a single ceiling opening to have 5 independently adjustable trims. The housings can be installed in drywall, plaster, and suspended ceilings.

Socket: Steel shell porcelain socket. Medium screw-in base.

Lamp Types:
75W PAR30 150W PAR38

Custom Configuration: Incandescent PAR30 units can have a combination of Incandescent PAR30 and CMH PAR30 trims. Consult factory.

Wiring: Each unit has a wiring channel with leads from each socket, there by allowing independent switching or dimming. (Additional switch legs are required).

Ceiling Thickness: Accepts 1" maximum ceiling thickness.

Installation: Universal brackets accepts C-Channel or flat bar hangers (ordered separately - see page 383), or simple rigid 1/2" steel conduit for tie-down to ceiling grids.

Minimum Clearance: Requires a minimum clearance of 3" from thermal insulation and 1/2" from any adjacent building components.

Housing: Heavy gauge post painted steel. Vented on top for cool operation. Transformer(s) may be accessed from below.

Knockouts: Six 3/4" knockouts included - 2 each on 3 sides.

Listing: cULus Damp Location

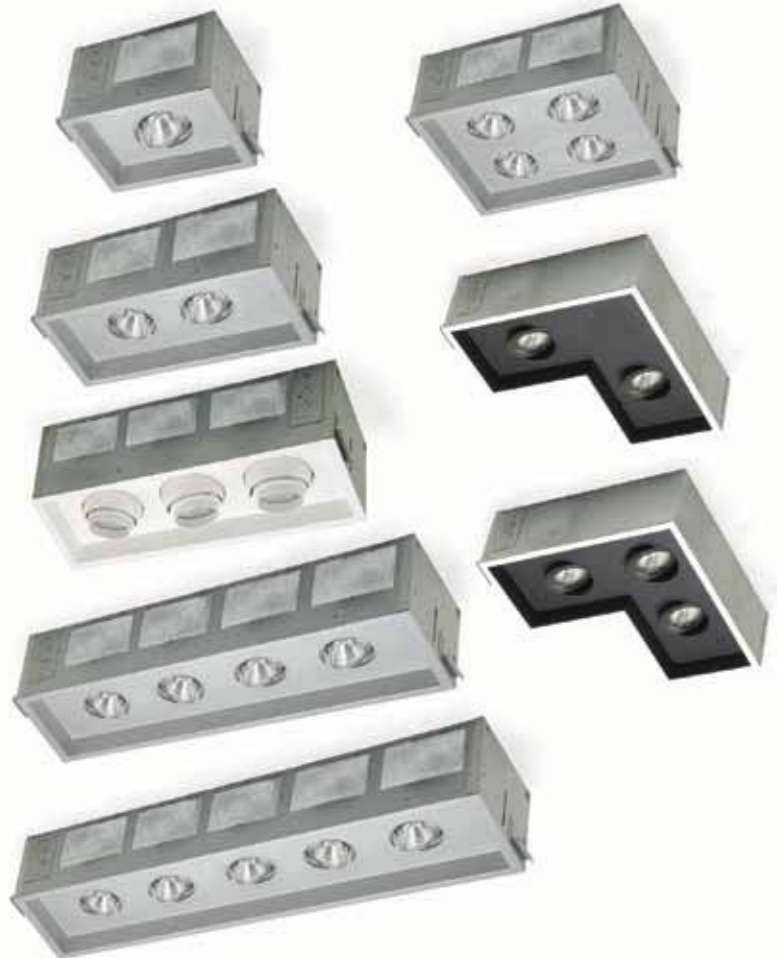

How to order LINE VOLTAGE MLS HOUSING - Trim Ordered Separately

SERIES	LIGHT SOURCE	NUMBER OF ROWS	NO. OF LAMPS	BALLAST	VOLTAGE	LAMP TYPE	WATTAGE
NMR	I = Incandescent	1 = 1 Row (1 to 5 Lamps only) 2 = Square (4 Lamps only) L = "L" Shaped (2 or 3 Lamps only)	1 = 1 Lamp 2 = 2 Lamps 3 = 3 Lamps 4 = 4 Lamps 5 = 5 Lamps	N = None	1 = 120V	0 = PAR30 8 = PAR38	75 = 75W (PAR30 only) 150 = 150W (PAR38 only)
NMR	I	-	2	4	N	1	0

ORDER EXAMPLE: NMRI-24N1075 - Line Voltage Square Configuration, 4 Lamps; 120V Input; 75W PAR30

How to order LINE VOLTAGE MLS TRIM - Housing Ordered Separately

SERIES	NUMBER OF ROWS	NUMBER OF LAMPS	TRIMS	FACE / FLANGE FINISH
NMRT	1 = 1 Row (1 to 5 Lamps only) 2 = Square (4 Lamps only) L = "L" Shaped (2 or 3 Lamps only)	1 = 1 Lamp 2 = 2 Lamps 3 = 3 Lamps 4 = 4 Lamps 5 = 5 Lamps	628 (PAR30 only) 652 (PAR30 only) 653 (PAR38 only)	BW = Black Face, White Flange SS = Silver Face, Silver Flange WW = White Face, White Flange
NMRT	-	2	4	628
				BW

ORDER EXAMPLE: NMRT-24628BW - Line Voltage Square Configuration, 4 Lamps; 628 Trim; Black Face, White Flange

Lighting Tip:

Using a 4 light unit, provide even illumination with two 75W PAR30 floods and precise spot illumination on focal points with two 75W PAR30 spots. Control separately for total lighting control. (A second switch leg is required)



MULTIPLE LIGHTING SYSTEM

Line Voltage MLS Housings

LINE VOLTAGE MLS HOUSINGS - TRIMS SOLD SEPARATELY

	CONFIGURATION	75W PAR30 LAMP	150W PAR38 LAMP
	<p>1 Row / 1 Lamp Line Voltage MLS Housing Dimensions: 9-1/2" W x 10-1/2" L x 8" H</p> <ul style="list-style-type: none"> Housing only - trims sold separately 	NMRI-11N1075	NMRI-11N18150
	<p>1 Row / 2 Lamps Line Voltage MLS Housing Dimensions: 9-1/2" W x 19" L x 8" H</p> <ul style="list-style-type: none"> Housing only - trims sold separately 	NMRI-12N1075	NMRI-12N18150
	<p>1 Row / 3 Lamps Line Voltage MLS Housing Dimensions: 9-1/2" W x 24-1/2" L x 8" H</p> <ul style="list-style-type: none"> Housing only - trims sold separately 	NMRI-13N1075	NMRI-13N18150
	<p>1 Row / 4 Lamps Line Voltage MLS Housing Dimensions: 9-1/2" W x 30-1/2" L x 8" H</p> <ul style="list-style-type: none"> Housing only - trims sold separately 	NMRI-14N1075	NMRI-14N18150
	<p>1 Row / 5 Lamps Line Voltage MLS Housing Dimensions: 9-1/2" W x 36" L x 8" H</p> <ul style="list-style-type: none"> Housing only - trims sold separately 	NMRI-15N1075	NMRI-15N18150
	<p>Square / 4 Lamps Line Voltage MLS Housing Dimensions: 19-1/2" W x 20-1/2" L x 8" H</p> <ul style="list-style-type: none"> Housing only - trims sold separately 	NMRI-24N1075	NMRI-24N18150
	<p>"L" Shape / 2 Lamps Line Voltage MLS Housing Dimensions: 15" W x 15" L x 8" H</p> <ul style="list-style-type: none"> Housing only - trims sold separately 	NMRI-L2N1075	NMRI-L2N18150
	<p>"L" Shape / 3 Lamps Line Voltage MLS Housing Dimensions: 19-3/4" W x 19-3/4" L x 8" H</p> <ul style="list-style-type: none"> Housing only - trims sold separately 	NMRI-L3N1075	NMRI-L3N18150

MULTIPLE LIGHTING SYSTEM

Line Voltage MLS Trims

LINE VOLTAGE MLS TRIMS - HOUSINGS SOLD SEPARATELY



628 TRIM
PAR30 EYEBALL
45° ADJUSTABLE
75W PAR30L Lamp Max.



652 TRIM
PAR30 GIMBAL
45° ADJUSTABLE
75W PAR30 Lamp Max.



653 TRIM
PAR38 GIMBAL
45° ADJUSTABLE
150W PAR38 Lamp Max.



<p>NMRT-11628BW NMRT-11628SS NMRT-11628WW</p>	<p>NMRT-11652BW NMRT-11652SS NMRT-11652WW</p>	<p>NMRT-11653BW NMRT-11653SS NMRT-11653WW</p>	<p>1 Row / 1 Lamp Line Voltage MLS Trim Dimensions: 9-3/4" W x 9-7/8" L x 2-1/4" D</p> <ul style="list-style-type: none"> Trim only - housing sold separately 
<p>NMRT-12628BW NMRT-12628SS NMRT-12628WW</p>	<p>NMRT-12652BW NMRT-12652SS NMRT-12652WW</p>	<p>NMRT-12653BW NMRT-12653SS NMRT-12653WW</p>	<p>1 Row / 2 Lamps Line Voltage MLS Trim Dimensions: 9-3/4" W x 18" L x 2-1/4" D</p> <ul style="list-style-type: none"> Trim only - housing sold separately 
<p>NMRT-13628BW NMRT-13628SS NMRT-13628WW</p>	<p>NMRT-13652BW NMRT-13652SS NMRT-13652WW</p>	<p>NMRT-13653BW NMRT-13653SS NMRT-13653WW</p>	<p>1 Row / 3 Lamps Line Voltage MLS Trim Dimensions: 9-3/4" W x 23-3/4" L x 2-1/4" D</p> <ul style="list-style-type: none"> Trim only - housing sold separately 
<p>NMRT-14628BW NMRT-14628SS NMRT-14628WW</p>	<p>NMRT-14652BW NMRT-14652SS NMRT-14652WW</p>	<p>NMRT-14653BW NMRT-14653SS NMRT-14653WW</p>	<p>1 Row / 4 Lamps Line Voltage MLS Trim Dimensions: 9-3/4" W x 29-1/2" L x 2-1/4" D</p> <ul style="list-style-type: none"> Trim only - housing sold separately 
<p>NMRT-15628BW NMRT-15628SS NMRT-15628WW</p>	<p>NMRT-15652BW NMRT-15652SS NMRT-15652WW</p>	<p>NMRT-15653BW NMRT-15653SS NMRT-15653WW</p>	<p>1 Row / 5 Lamps Line Voltage MLS Trim Dimensions: 9-3/4" W x 35-1/4" L x 2-1/4" D</p> <ul style="list-style-type: none"> Trim only - housing sold separately 
<p>NMRT-24628BW NMRT-24628SS NMRT-24628WW</p>	<p>NMRT-24652BW NMRT-24652SS NMRT-24652WW</p>	<p>NMRT-24653BW NMRT-24653SS NMRT-24653WW</p>	<p>Square / 4 Lamps Line Voltage MLS Trim Dimensions: 19-3/4" W x 19-3/4" L x 2-1/4" D</p> <ul style="list-style-type: none"> Trim only - housing sold separately 
<p>NMRT-L2628BW NMRT-L2628SS NMRT-L2628WW</p>	<p>NMRT-L2652BW NMRT-L2652SS NMRT-L2652WW</p>	<p>NMRT-L2653BW NMRT-L2653SS NMRT-L2653WW</p>	<p>"L" Shape / 2 Lamps Line Voltage MLS Trim Dimensions: 14-7/8" W x 14-7/8" L x 2-1/4" D</p> <ul style="list-style-type: none"> Trim only - housing sold separately 
<p>NMRT-L3628BW NMRT-L3628SS NMRT-L3628WW</p>	<p>NMRT-L3652BW NMRT-L3652SS NMRT-L3652WW</p>	<p>NMRT-L3653BW NMRT-L3653SS NMRT-L3653WW</p>	<p>"L" Shape / 3 Lamps Line Voltage MLS Trim Dimensions: 19-1/4" W x 19-3/8" L x 2-1/4" D</p> <ul style="list-style-type: none"> Trim only - housing sold separately 

Trim Finishes: **BW** = Black Face & Fixture, White Flange; **SS** = Silver Face & Fixture, Silver Flange; **WW** = White Face & Fixture, White Flange

MULTIPLE LIGHTING SYSTEM

Low Voltage Surface Mount MLS

Nora Lighting's surface mounted Multiple Lighting System (MLS) is a family of fixtures providing flexibility and versatility. Designed with 2 to 6 lamps per fixture, the architectural design offers independent aiming of each lamp for maximum flexibility and accent. A dual gimbal lamp holder mechanism allows for full rotation and 45° aiming. Often used for display, galleries, hospitality and residential applications, the surface MLS fixtures can be mounted on a wall or ceiling surface. Fixtures are available in a matte silver finish using 12V 75W AR111 lamps.

EXAMPLE: How to order Surface Mount Lighting System

NMS	1	3	1	75	E	1	S	1	674
SERIES	ROWS	LAMPS PER ROW	LAMP TYPE	WATTAGE	TRANSFORMER	VOLTAGE	FINISH	MOUNT	TRIM
	1 = 1 Row 2 = Square*	2 = 2 Lamps 3 = 3 Lamps 4 = 4 Lamps 5 = 5 Lamps 6 = 6 Lamps	1 = AR111	75 = 75W	E = Electronic	1 = 120/12V	S = Silver	1 = Ceiling/Wall	674

* Note: Square available in 2 lamp per row only



Aircraft Cable Suspension Available - Consult Factory

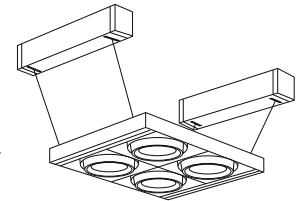

Linear Configuration - 1 Row / 2 Lamps

NMS12175E1S1674 75W

Lamp: 75W AR111 (not included)
Finish: Silver (S)
Dimensions: Length: 13-3/4" Width: 9-1/2" Max Ext.: 17-7/8" Dia.: 2-1/4"
Features: Universal Gimbal - Ring Aiming
 120V/12V Integral Electronic Transformer
 Clutch Angle Locking
 Clear Clip-On Lens (included)
Mounting: Wall or Ceiling Mounted - for Cable Mount consult factory

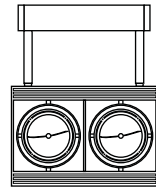

Linear Configuration - 1 Row / 3 Lamps

NMS13175E1S1674 75W

Lamp: 75W AR111 (not included)
Finish: Silver (S)
Dimensions: Length: 20-1/2" Width: 9-1/2" Max Ext.: 17-7/8" Dia.: 2-1/4"
Features: Universal Gimbal - Ring Aiming
 120V/12V Integral Electronic Transformer
 Clutch Angle Locking
 Clear Clip-On Lens (included)
Mounting: Wall or Ceiling Mounted - for Cable Mount consult factory

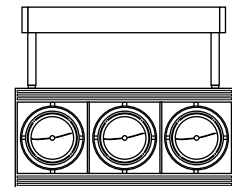

Low Voltage Surface Mount MLS continued

Linear Configuration - 1 Row / 4 Lamps

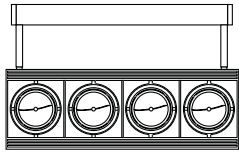

NMS14175E1S1674 75W

Lamp: 75W AR111 (not included)
Finish: Silver (S)
Dimensions: Length: 27-1/4" Width: 9-1/2" Max Ext.: 17-7/8"
 Dia.: 2-1/4"
Features: Universal Gimbal - Ring Aiming
 120V/12V Integral Electronic Transformer
 Clutch Angle Locking
 Clear Clip-On Lens (included)
Mounting: Wall or Ceiling Mounted - for Cable Mount consult factory



Linear Configuration - 1 Row / 5 Lamps

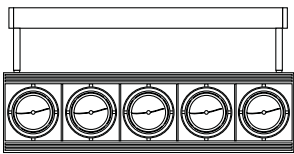

NMS15175E1S1674 75W

Lamp: 75W AR111 (not included)
Finish: Silver (S)
Dimensions: Length: 34" Width: 9-1/2" Max Ext.: 17-7/8"
 Dia.: 2-1/4"
Features: Universal Gimbal - Ring Aiming
 120V/12V Integral Electronic Transformer
 Clutch Angle Locking
 Clear Clip-On Lens (included)
Mounting: Wall or Ceiling Mounted - for Cable Mount consult factory



Linear Configuration - 1 Row / 6 Lamps

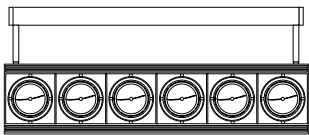

NMS16175E1S1674 75W

Lamp: 75W AR111 (not included)
Finish: Silver (S)
Dimensions: Length: 40-7/8" Width: 9-1/2" Max Ext.: 17-7/8"
 Dia.: 2-1/4"
Features: Universal Gimbal - Ring Aiming
 120V/12V Integral Electronic Transformer
 Clutch Angle Locking
 Clear Clip-On Lens (included)
Mounting: Wall or Ceiling Mounted - for Cable Mount consult factory



Square Configuration - 2 Rows / 2 Lamps

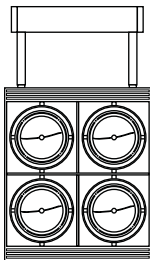

NMS22175E1S1674 75W

Lamp: 75W AR111 (not included)
Finish: Silver (S)
Dimensions: Length: 13-3/4" Width: 16-1/4" Max Ext.: 24-5/8"
 Dia.: 2-1/4"
Features: Universal Gimbal - Ring Aiming
 120V/12V Integral Electronic Transformer
 Clutch Angle Locking
 Clear Clip-On Lens (included)
Mounting: Wall or Ceiling Mounted - for Cable Mount consult factory





GLASS SHADES

PENDANTS & SCONCES

Overview	408
Glass Shades	415
Pendant Assemblies	435
Complete Pendants	450
Sconces	455
Compatibility Charts	458

Overview PENDANTS, SCONCES & GLASS

GLASS SHADES



NG-10
Round Glass p.432



NG-50
Conical Glass p.432



NG-66
Fluted Glass p.432



NG-70
Split Glass p.432



NG-80
Cylinder Glass p.432



NG-90
Stepped Glass p.432



NMRS80-478
Cassandra Glass p.440



NRS70-601
Oval Beaded Glass p.422



NRS70-602
Cylinder Beaded Glass p.422



NRS70-603
Round Beaded Glass p.422



NRS70-604
Flare Beaded Glass p.422



NRS70-605
Hourglass Beaded Glass p.422



NRS70-606
Tapered Beaded Glass p.423



NRS70-607
Bell Beaded Glass p.423



NRS70-608
Empire Beaded Glass p.423



NRS80-204
Swift Glass p.431



NRS80-401
Ice Cube Glass p.421



NRS80-402
Dual Spot Glass p.431



NRS80-403
Dual Frost Glass p.431



NRS80-404
Dual Clear Glass p.431



NRS80-406
Silk Glass p.428



NRS80-407
Sophia Glass p.428



NRS80-408
Sheer Glass p.428



NRS80-411
Mega Ice Cube Glass p.421



NRS80-451
Neptune Glass p.426



NRS80-452
Andromeda Glass p.426



NRS80-453
Sol Glass p.425



NRS80-454
Orion Glass p.430



NRS80-455
Venus Glass p.430



NRS80-456
Mercure Glass p.430



NRS80-457
Saturn Glass p.430



NRS80-458
Roba-M Glass p.432



NRS80-459
Roba-L Glass p.432



NRS80-461
Jupiter Glass p.430



NRS80-462
Casie Glass p.426



NRS80-463
Reflections Glass p.428



NRS80-465
Tanner Glass p.428



NRS80-466
Elvin Glass p.425



NRS80-467
Bonita Cube Glass p.425



NRS80-468
Duo Cube Glass p.429



NRS80-469
Duo Dome Glass p.429



NRS80-470
Feather Glass p.426



NRS80-471
Ferus Glass p.427



NRS80-472
Sean Glass p.424



NRS80-473
Cocoon Glass p.424

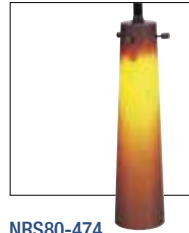

NRS80-474
Eric Glass p.431



NRS80-475
Bonita Cone Glass p.425



NRS80-476
Grant Glass p.429



NRS80-477
Bolla Glass p.427



NRS80-480
Rain Glass p.416



NRS80-482
Tear Drop Glass p.420



NRS80-483
Pool Glass p.421



NRS80-484
River Glass p.420



NRS80-485
Tsunami Glass p.417



NRS80-486
Closed Pond Glass p.417



NRS80-487
Open Pond Glass p.417



NRS80-490
Trumpet Glass p.419



NRS80-491 / 891
Snow Glass p.419



NRS80-492 / 892
Rain Fall Glass p.419



NRS80-493 / 893
Water Fall Glass p.418



NRS82-201
Paris Glass p.433



NRS82-202
Monte Glass p.433



NRS82-203
Chicago Glass p.433



NRS82-204
Madeleine Glass p.433

Overview PENDANTS, SCONCES & GLASS

NORA RAIL PENDANTS



NRS48-468 8.5' Rail Pendant
13W-26W GU24 Base Self-Ballasting
Compact Fluorescent Lamp p.438



NRS19-465 8.5' Rail Pendant
60W Candelabra Base
Line Voltage p.438



NRS10-466 8.5' Rail Pendant
100W Medium Base
Line Voltage p.438



NRS19-450 8.5' Rail Pendant
NRS19-456 20' Rail Pendant
40W G9 Base Line Voltage p.438

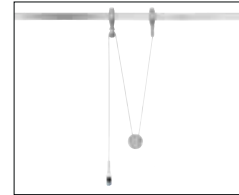

NRS19-551 Yoyo Rail Pendant
40W G9 Base Line Voltage p.439



NRS34-450 8.5' Rail Pendant
NRS34-456 20' Rail Pendant
20-50W Bi-Pin Low Voltage p.439

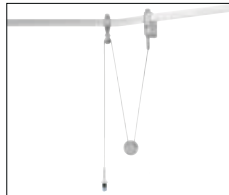

NRS34-551 Yoyo Rail Pendant
20-50W Bi-Pin Low Voltage p.439



NRS90-P32 QuickJack
Nora Rail Pendant Adapter
20-50W Bi-Pin Low Voltage p.439

MINI RAIL PENDANTS



NMRS32-450 6' Pendant
50W Bi-Pin Low Voltage p.440



NMRS32-524 Yoyo Pendant
50W Bi-Pin Low Voltage p.440



NMRS90-P32 QuickJack
Mini Rail Pendant Adapter
50W Bi-Pin Low Voltage p.440

MINI TRACK PENDANTS



NLMP-734 4' Mini Pendant
NLMP-738 8' Mini Pendant
20W-50W JC 6.35 Low Volt. p.443



NLMT-760 QuickJack
Mini Track Pendant Adapter
Low Voltage p.443

TRACK PENDANTS



NTF-163 8.5' Pendant
13W-26W GU24 Base Compact
Fluor. Self Ballasting Lamp p.441



NTH-160 8.5' Pendant
60W Candelabra Base
Line Voltage p.441



NTH-161 8.5' Pendant
100W Medium Base
Line Voltage p.441



NTH-162 8.5' Pendant
40W G9 Base Line Voltage p.441



NTL-309 8.5' Pendant
50W JC 6.35 Low Voltage p.442



NTL-310 Cona Pendant
35W JC 6.35 Low Voltage p.442



NTL-311 Cylindrica Pendant
35W JC 6.35 Low Voltage p.442

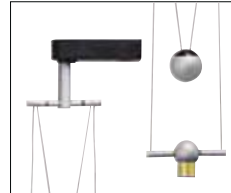

NTL-312 Sphera Pendant
35W JC 6.35 Low Voltage p.442



NT-370 QuickJack
Track Pendant Adapter
Low Voltage p.443

MONOPOINT PENDANTS



NRS98-P58 8.5' Pendant
13W-26W GU24 Base Self-Ballasting
Compact Fluorescent Lamp p.444



NRS99-P55 8.5' Pendant
60W Candelabra Base
Line Voltage p.444



NRS90-P56 8.5' Pendant
100W Medium Base
Line Voltage p.444



NRS99-P45 8.5' Pendant
NRS99-P46 20' Pendant
40W G9 Base Low Voltage p.444



NRS99-P45/12 8.5' Pendant
NRS99-P46/12 20' Pendant
50W JC 6.35 Low Voltage p.445



NCL-309 Pila Pendant
50W JC 6.35 Low Voltage p.446



NCL-310 Cona Pendant
35W JC 6.35 Low Voltage p.446



NCL-311 Cylindrica Pendant
35W JC 6.35 Low Voltage p.446

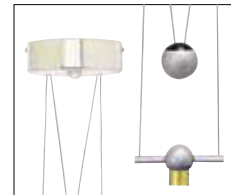

NCL-312 Sphera Pendant
35W JC 6.35 Low Voltage p.446

QUICKJACK PENDANTS



NP66-103
Multi QuickJack Linear Canopy
3 x 20-50W Low Voltage p.449



NP66-203
Multi QuickJack Round Canopy
3 x 20-50W Low Voltage p.449



NRS99-P12
Sloped QuickJack Canopy
20W-50W Low Voltage p.445



NRS99-P47/12
QuickJack Canopy
20W-50W Low Voltage p.445



NRS99-P51
Shallow QuickJack Canopy
20W-50W Low Voltage p.445

Overview PENDANTS, SCONCES & GLASS

LED COMPLETE PENDANTS



NCE-830 1W LED Pendant
1W LED p.450



NCE-830 3W LED Pendant
3W LED p.450



Biba Frosted Glass Pendant
NRS19-464FR Rail
NRS99-464FR Canopy
40W G9 p.453



Biba Semi-Frosted Glass Pendant
NRS19-464SF Rail
NRS99-464SF Canopy
40W G9 p.453



Biba Clear Glass Pendant
NRS19-464CL Rail
NRS99-464CL Canopy
40W G9 p.453

PORCELAIN COMPLETE PENDANTS



Ambra Porcelain Pendant
NRS19-462PW Line Volt
NRS34-462PW Low Volt
NRS66-462PW QuickJack
120V 40W G9
12V 50W Bi-Pin p.452

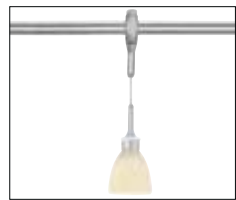

Petra Porcelain Pendant
NRS19-463PW Line Volt
NRS34-463PW Low Volt
NRS66-463PW QuickJack
120V 40W G9
12V 50W Bi-Pin p.452

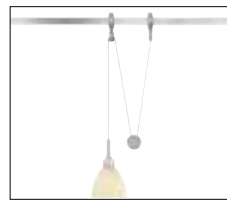

Ambra Porcelain Yoyo Pendant
NRS19-562PW Line Volt
NRS34-562PW Low Volt
NRS66-562PW QuickJack
120V 40W G9
12V 50W Bi-Pin p.452

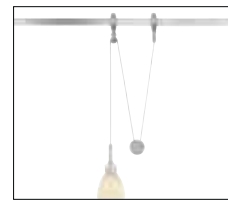

Petra Porcelain Yoyo Pendant
NRS19-563PW Line Volt
NRS34-563PW Low Volt
NRS66-563PW QuickJack
120V 40W G9
12V 50W Bi-Pin p.452

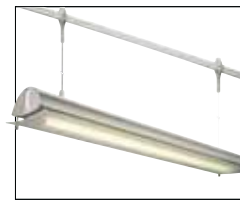

Nepro Fluorescent Pendant
NRS45-401 Rail
NRS45-301 Canopy
2 x 24W T5 HO p.451

WALL SCONCES

TELESCOPING ARM



NWE Series Elbow
60W Candelabra
120V 40W G9 Base
12V 50W Bi-Pin p.456



NWF Series Flex
60W Candelabra
120V 40W G9 Base
12V 50W Bi-Pin p.456



NWT Series Torch
13W-26W GU24 Base
60W Candelabra / 100W Medium
120V 40W G9 Base
12V 50W Bi-Pin p.457



NWC Series Chic
13W-26W GU24 Base
60W Candelabra / 100W Medium
120V 40W G9 Base
12V 50W Bi-Pin p.456



NWS Series Sphere
60W Candelabra
120V 40W G9 Base
12V 50W Bi-Pin p.457



NWO Series Concord (ADA Compliant)
13W-26W GU24 Base
60W Candelabra / 100W Medium
40W G9 Base / 50W Bi-Pin p.457

Hand-blown, artisan glass shades.

Nora's hand-blown, artisan glass shades look stunning, on and off.



*NRS80-492BU Rain Fall Glass shown illuminated (R) and off (L)
Glass information on page 419.*



*NRS80-491AM Snow Glass shown illuminated (R) and off (L)
Glass information on page 419.*



*NRS80-493AM Water Fall Glass shown illuminated (R) and off (L)
Glass information on page 418.*



*NRS80-485RF Tsunami Glass shown illuminated (R) and off (L)
Glass information on page 417.*



*NRS80-490R Trumpet Glass shown illuminated (R) and off (L)
Glass information on page 419.*



*NRS80-483W Pool Glass shown illuminated (R) and off (L)
Glass information on page 421.*

(ON)

(OFF)



Glass Shades

Most glass fixtures on the market come as complete units with no option to interchange shades, hardware or sources. Nora has taken a different approach by offering choice and reciprocity. Nora's glass shades interact with 5 different lamp sources - Line Voltage G9, Candelabra, and Medium base; Low Voltage Bi-Pin; and Fluorescent GU24. They can be used on 8 Nora Lighting systems - Nora Rail, Mini Rail, Track, Mini Track, QuickJack, Canopy Mount Pendants, Multi QuickJack Canopies, and Wall Sconces. Finding the perfect glass fixture has never been easier: 1.) Select your desired mounting system; 2.) Choose a lamping source; 3.) Select a glass shade. With hundreds of shades to choose from, the possibilities abound.

1. LIGHTING SYSTEMS

- Nora Rail
- Track
- Mini Rail
- Mini Track
- Mono Point
- Multi QuickJack Canopies
- QuickJack
- Wall Sconces

2. LAMP SOURCES

- GU24 - self-ballasting compact fluorescent
- G9 - line voltage halogen
- Candelabra base - line voltage
- Medium base - line voltage
- Bi-Pin - low voltage

3. GLASS SHADES

Hundreds of colors, textures and styles to choose from

Nora Glass interacts
with **5 lamp sources**
and **8 lighting systems!**

Mix and match to get the complete
fixture that's right for you!



Coordinate
pendants
and sconces!

GLASS SHADES, PENDANTS & WALL SCONCES

Glass Shades



BU Blue R Red W White

NEW!

RAIN

Item No.	NRS80-480
Diameter	5-1/4" (133 mm)
Length	10" (254 mm)
Color	BU, R, W
Lamp Type and Wattage	1 2 3 4 5
Mounting Systems	ABCDEFGHIJK



LAMP KEY

- 1 40W G9 Line Voltage
- 2 60W E12 Candelabra Base Line Voltage
- 3 50W Bi-Pin G5.3/6.35 Low Voltage
- 4 100W E26 Medium Base A19 Line Voltage
- 5 13W-26W GU24 CFL Self Ballasted

MOUNTING SYSTEMS

- A Nora Rail Pendants
- B Mini Rail Pendants
- C Track Pendants
- D Mini Track Pendants
- E Canopy Mount Pendants
- F Quick Jack Pendants
- G Elbow Wall Sconce
- H Flex Wall Sconce
- I Torch Wall Sconce
- J Chic Wall Sconce
- K Sphere Wall Sconce



*Not all lamp types work with all mounting systems. See Compatibility chart on pages 458-459.



OPEN POND
R Red
NRS80-487

NEW! POND
BU Blue
NRS80-486



HAND-BLOWN ARTISAN GLASS



NEW! TSUNAMI
W White

Colors shown illuminated (R) and off (L)



POND

Item No.	NRS80-486 Closed
	NRS80-487 Open
Diameter	4-1/2" (114 mm)
Length	19-1/2" (495 mm) Closed
	15" (381 mm) Open
Color	BE, BU, R, W
Lamp Type and Wattage	1 2 3 4 5 *
Mounting Systems	A C E F *

TSUNAMI

Item No.	NRS80-485
Diameter	8-1/2" (216 mm)
Length	5" (127 mm)
Color	BU, RF, W
Lamp Type and Wattage	1 2 3 *
Mounting Systems	A B C D E F H I J K *

*Not all lamp types work with all mounting systems. See Compatibility chart on pages 458-459.

HAND-CRAFTED
ITALIAN
 ART GLASS

NEW!

WATER FALL
 AM Amber

BU Blue

RF Red Fire



Colors shown illuminated (R) and off (L)



AM
 Amber

BU
 Blue

RB
 Red Burnt

W
 White

WATER FALL SHADES

Item No.	NRS80-493	NRS80-893
Diameter	5-1/4" (133 mm)	5-1/4" (133 mm)
Length	6-1/4" (159 mm)	6-1/4" (159 mm)
Socket Hole Diameter	7/8" (22 mm)	1-5/8" (41 mm)**
Color	AM, BU, RB, W	AM, BU, RB, W
Lamp Type and Wattage	1 2 3 4 5 *	4 5
Mounting Systems	A B C D E F H I J K *	I J

*Not all lamp types work with all mounting systems. See Compatibility chart on pages 458-459.

** Larger socket hole for GU24 and Medium base sconces.

LAMP KEY

- 1 40W G9 Line Voltage
- 2 60W E12 Candelabra Base Line Voltage
- 3 50W Bi-Pin G5.3/6.35 Low Voltage
- 4 100W E26 Medium Base A19 Line Voltage
- 5 13W-26W GU24 CFL Self Ballasted

MOUNTING SYSTEMS

- A Nora Rail Pendants
- B Mini Rail Pendants
- C Track Pendants
- D Mini Track Pendants
- E Canopy Mount Pendants
- F Quick Jack Pendants
- G Elbow Wall Sconce
- H Flex Wall Sconce
- I Torch Wall Sconce
- J Chic Wall Sconce
- K Sphere Wall Sconce



NEW!

SNOW
R Red

NEW!

TRUMPET
W White

NEW!

RAIN FALL
AM Amber

Colors shown illuminated (R) and off (L)



Colors shown illuminated (R) and off (L)



	SNOW SHADES		TRUMPET	RAIN FALL SHADES	
Item No.	NRS80-491	NRS80-891	NRS80-490	NRS80-492	NRS80-892
Diameter	5-1/4" (133 mm)	5-1/4" (133 mm)	4-1/2" (114 mm)	6-1/2" (165 mm)	6-1/2" (165 mm)
Length	6-1/4" (159 mm)	6-1/4" (159 mm)	8-1/2" (216 mm)	7-1/2" (191 mm)	7-1/2" (191 mm)
Socket Hole Diameter	7/8" (22 mm)	1-5/8" (41 mm)**	7/8" (22 mm)	7/8" (22 mm)	1-5/8" (41 mm)**
Color	AM, BU, R, W	AM, BU, R, W	AM, BU, R, W	AM, BU, W	AM, BU, W
Lamp Type and Wattage	1 2 3 4 5 *	4 5	1 2 3 *	1 2 3 4 5 *	4 5
Mounting Systems	ABCDEFGHIJK*	IJ	ABCDEFGHIJK*	ACEFHIJK*	IJ

*Not all lamp types work with all mounting systems. See Compatibility chart on pages 458-459.

** Larger socket hole for GU24 and Medium base sconces.

INNOVATIVE DESIGN

HAND-CRAFTED IN USA

NEW!

RIVER
GBR Granite Brown

LAMP KEY

- 1 40W G9 Line Voltage
- 2 60W E12 Candelabra Base Line Voltage
- 3 50W Bi-Pin G5.3/6.35 Low Voltage
- 4 100W E26 Medium Base A19 Line Voltage
- 5 13W-26W GU24 CFL Self Ballasted

MOUNTING SYSTEMS

- A Nora Rail Pendants
- B Mini Rail Pendants
- C Track Pendants
- D Mini Track Pendants
- E Canopy Mount Pendants
- F Quick Jack Pendants
- G Elbow Wall Sconce
- H Flex Wall Sconce
- I Torch Wall Sconce
- J Chic Wall Sconce
- K Sphere Wall Sconce

NEW!

TEAR DROP
GBR Granite Brown



BE Beige DB Deep Blue GBR Granite Brown SA Salmon W White



BE Beige BU Blue GBR Granite Brown W White

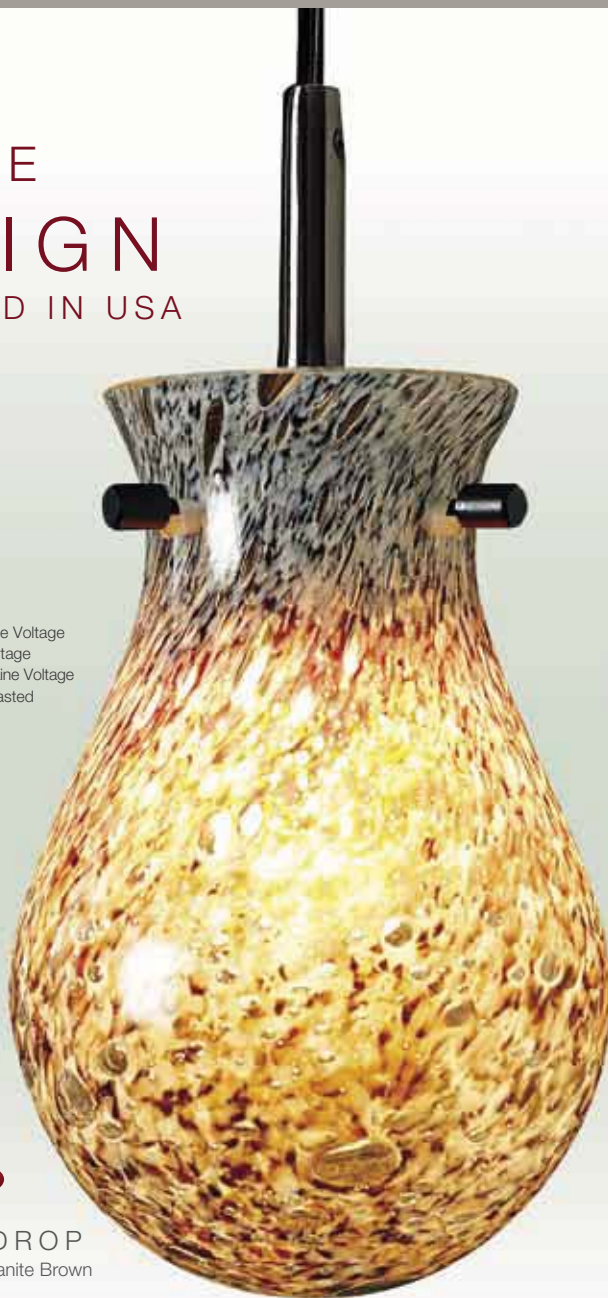

	TEAR DROP	RIVER
Item No.	NRS80-482	NRS80-484
Diameter	4-1/4" (108 mm)	2-5/8" (67 mm)
Length	6-1/4" (159 mm)	11" (279 mm)
Color	BE, DB, GBR, SA, W	BE, BU, GBR, W
Lamp Type and Wattage	1 2 3 *	1 2 3 *
Mounting Systems	A B C D E F H K *	A B C D E F G H K *

*Not all lamp types work with all mounting systems. See Compatibility chart on pages 458-459.

Glass Shades

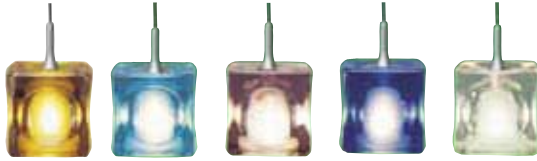

AM Amber AQ Aqua AY Amethyst BU Blue CL Clear



ICE CUBE

Item No.	NRS80-401
Height & Width	2-7/8" (73 mm)
Length	2-7/8" (73 mm)
Color	AM, AQ, AY, BU, CL
Lamp Type and Wattage	1 3 *
Mounting Systems	A B C D E F G H I J K *

MEGA ICE CUBE

Item No.	NRS80-411
Height & Width	3-1/2" (89 mm)
Length	3-1/2" (89 mm)
Color	AM, AQ, AY, BU, CL
Lamp Type and Wattage	1 3 *
Mounting Systems	A B C D E F H I J K *



NEW!

BU Blue W White

POOL

Item No.	NRS80-483
Diameter	6" (152 mm)
Length	9-1/16" (230 mm)
Socket Hole Diameter	1-5/8" (41 mm)
Color	BU, W
Lamp Type and Wattage	1 2 3 4 5 *
Mounting Systems	A B C D E F H I J K *



Color shown illuminated (R) and off (L)

*Not all lamp types work with all mounting systems. See Compatibility chart on pages 458-459.

HAND-MADE GLASS

BEADED SHADES

CYLINDER
AQ Aqua



ROUND
CL Clear



OVAL
R Red



NEW!

HOURLASS
CL Clear



FLARE
AM Amber

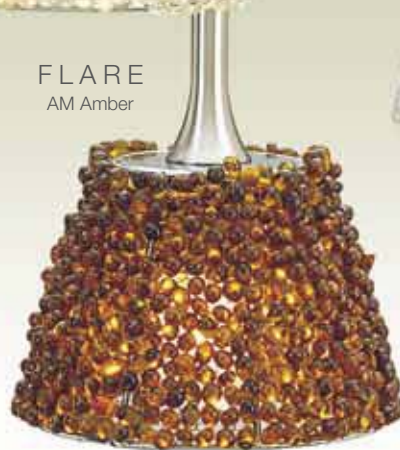

	CYLINDER	ROUND	FLARE	OVAL	HOURLASS
Item No.	NRS70-602	NRS70-603	NRS70-604	NRS70-601	NRS70-605
Diameter	4-1/2" (114 mm)	5" (127 mm)	4-1/2" (114 mm)	4" (102 mm)	4-1/2" (114 mm)
Length	7-1/2" (191 mm)	3-1/4" (83 mm)	3-1/2" (89 mm)	3-1/4" (83 mm)	5-1/2" (140 mm)
Color	AM, AQ, CL, R	AM, AQ, CL, R	AM, AQ, CL, R	AM, AQ, CL, R	AM, BG, CL, R
Lamp Type and Wattage	1 2 3 4 5*	1 3 *	1 3 *	1 3 *	1 2 3 4 5*
Mounting Systems	ABCDEFHIJK*	ABCDEFHIJK*	ABCDEFHIJK *	ABCDEFHIJK*	ABCDEFHIJK *

*Not all lamp types work with all mounting systems. See Compatibility chart on pages 458-459.



NEW!
TAPERED
 AM Amber

NEW!
EMPIRE
 BG Blue Green

NEW!
BELL
 R Red

LAMP KEY

- 1 40W G9 Line Voltage
- 2 60W E12 Candelabra Base Line Voltage
- 3 50W Bi-Pin G5.3/6.35 Low Voltage
- 4 100W E26 Medium Base A19 Line Voltage
- 5 13W-26W GU24 CFL Self Ballasted

MOUNTING SYSTEMS

- A Nora Rail Pendants
- B Mini Rail Pendants
- C Track Pendants
- D Mini Track Pendants
- E Canopy Mount Pendants
- F Quick Jack Pendants
- G Elbow Wall Sconce
- H Flex Wall Sconce
- I Torch Wall Sconce
- J Chic Wall Sconce
- K Sphere Wall Sconce

	TAPERED	EMPIRE	BELL
Item No.	NRS70-606	NRS70-608	NRS70-607
Diameter	6-1/2" (165 mm)	4-1/2" (114 mm)	5" (127 mm)
Length	6" (152 mm)	3-3/4" (95 mm)	6-1/2" (165 mm)
Color	AM, BG, CL, R	AM, BG, R, S	AM, BG, R, S
Lamp Type and Wattage	1 2 3 4 5 *	1 3	1 2 3 4 5 *
Mounting Systems	ABCDEFGHIJK*	ABCDEFGHIJK	ABCDEFGHIJK*

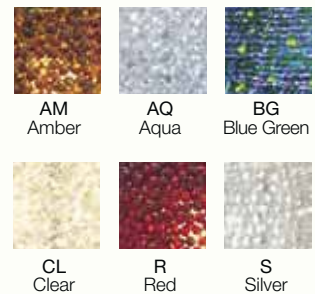

*Not all lamp types work with all mounting systems. See Compatibility chart on pages 458-459.

COCOON
White

MAKE A **BOLD**
STATEMENT
WITH GLASS

COCOON

Item No.	NRS80-473
Diameter	10-1/4" (260 mm)
Length	6-1/4" (158 mm)
Color	White
Lamp Type and Wattage	1 2 3 4 5 *
Mounting Systems	A B C D E F *

SEAN

Item No.	NRS80-472
Diameter	Middle 6" (152 mm)
	Bottom 2-3/4" (70 mm)
Length	9-1/16" (230 mm)
Color	Magna
Lamp Type and Wattage	1 2 3 4 5 *
Mounting Systems	A B C D E F H I J K *

*Not all lamp types work with all mounting systems. See Compatibility chart on pages 458-459.



SEAN Magna
shown illuminated (L) and off (R)

GLASS SHADES, PENDANTS & WALL SCONCES

Glass Shades



AM Amber BU Blue R Red W White

AM Amber

BONITA CUBE

Item No.	NRS80-467
Diameter	3-1/8" (79 mm)
Length	3-15/16" (100 mm)
Color	AM, BU, R, W
Lamp Type and Wattage	1 3 *
Mounting Systems	A B C D E F H I J K *



BU Blue

RF Red Fire

SOL

Item No.	NRS80-453
Diameter	4-7/8" (124 mm)
Length	3-3/4" (95 mm)
Color	BU, RF
Lamp Type and Wattage	1 3 *
Mounting Systems	A B C D E F H I J K *

LAMP KEY

- 1 40W G9 Line Voltage
- 2 60W E12 Candelabra Base Line Voltage
- 3 50W Bi-Pin G5.3/6.35 Low Voltage
- 4 100W E26 Medium Base A19 Line Voltage
- 5 13W-26W GU24 CFL Self Ballasted

MOUNTING SYSTEMS

- A Nora Rail Pendants
- B Mini Rail Pendants
- C Track Pendants
- D Mini Track Pendants
- E Canopy Mount Pendants
- F Quick Jack Pendants
- G Elbow Wall Sconce
- H Flex Wall Sconce
- I Torch Wall Sconce
- J Chic Wall Sconce
- K Sphere Wall Sconce



AM Amber BU Blue R Red W White

BU Blue

ELVIN

Item No.	NRS80-466
Diameter	3-1/8" (79 mm)
Length	3-9/16" (91 mm)
Color	AM, BU, R, W
Lamp Type and Wattage	1 3 *
Mounting Systems	A B C D E F G H I J K *



AM Amber MG Magna W White

R Red

BONITA CONE

Item No.	NRS80-475
Diameter	5-7/8" (149 mm)
Length	7-1/16" (181 mm)
Color	AM, MG, R, W
Lamp Type and Wattage	1 2 3 4 5 *
Mounting Systems	A C E F G H I J K *

*Not all lamp types work with all mounting systems. See Compatibility chart on pages 458-459.

GLASS SHADES, PENDANTS & WALL SCONCES

Glass Shades



FR Frost
GR Green
PK Peacock Blue
RF Red Fire



SN Sun

ANDROMEDA

Item No.	NRS80-452
Diameter	4-7/8" (124 mm)
Length	10-1/4" (260 mm)
Color	FR, GR, PK, RF, SN
Lamp Type and Wattage	1 2 3 4 5 *
Mounting Systems	A C E F H I J K *



BU Blue
O Orange
W White



P Purple

CASIE

Item No.	NRS80-462
Diameter	5" (127 mm)
Length	10-3/4" (273 mm)
Color	BU, O, P, W
Lamp Type and Wattage	1 2 3 4 5 *
Mounting Systems	A C E F G H I J K *

LAMP KEY

- 40W G9 Line Voltage
- 60W E12 Candelabra Base Line Voltage
- 50W Bi-Pin G5.3/6.35 Low Voltage
- 100W E26 Medium Base A19 Line Voltage
- 13W-26W GU24 CFL Self Ballasted

MOUNTING SYSTEMS

- Nora Rail Pendants
- Mini Rail Pendants
- Track Pendants
- Mini Track Pendants
- Canopy Mount Pendants
- Quick Jack Pendants
- Elbow Wall Sconce
- Flex Wall Sconce
- Torch Wall Sconce
- Chic Wall Sconce
- Sphere Wall Sconce

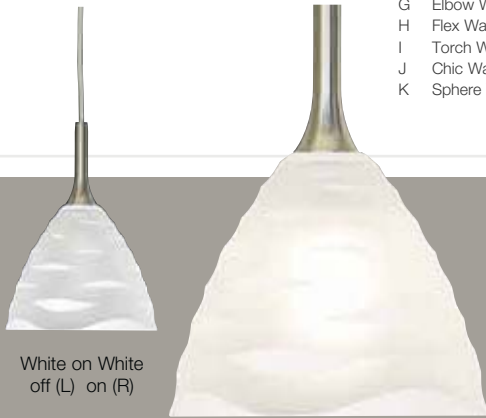

White on White
off (L) on (R)

FEATHER

Item No.	NRS80-470
Diameter	5-1/8" (130 mm)
Length	4-5/16" (110 mm)
Color	White on White
Lamp Type and Wattage	1 2 3 *
Mounting Systems	A B C D E F G H I J K *



CF Confetti
WV Wave
TC Tri-Color

NEPTUNE

Item No.	NRS80-451
Diameter	5-7/8" (149 mm)
Length	6-3/4" (171 mm)
Color	CF, TC, WV
Lamp Type and Wattage	1 2 3 4 5 *
Mounting Systems	A B C D E F H I J K *

*Not all lamp types work with all mounting systems. See Compatibility chart on pages 458-459.

DRAMATIC LAYERED GLASS

BOLLA
White on White

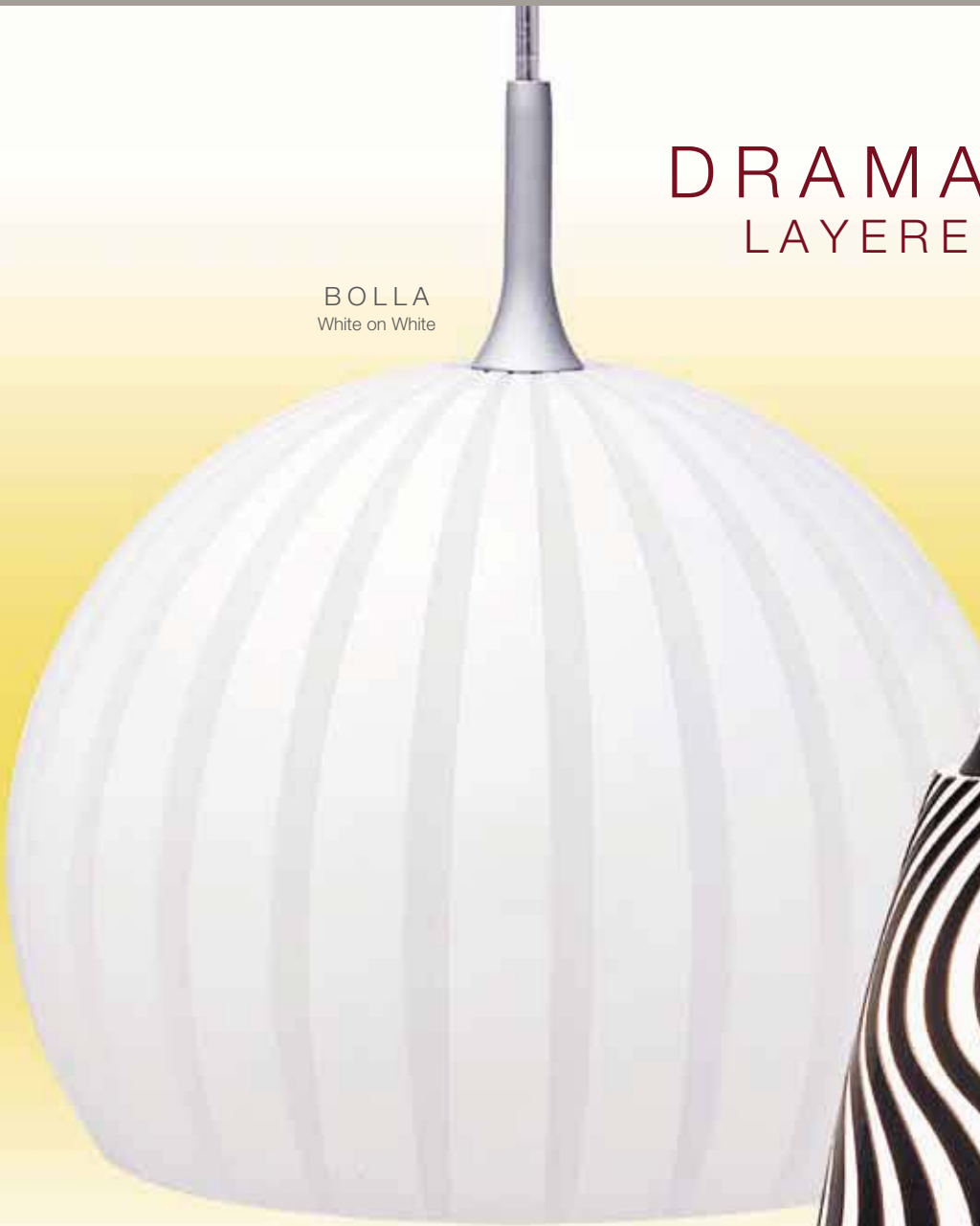

FERUS
Black on White

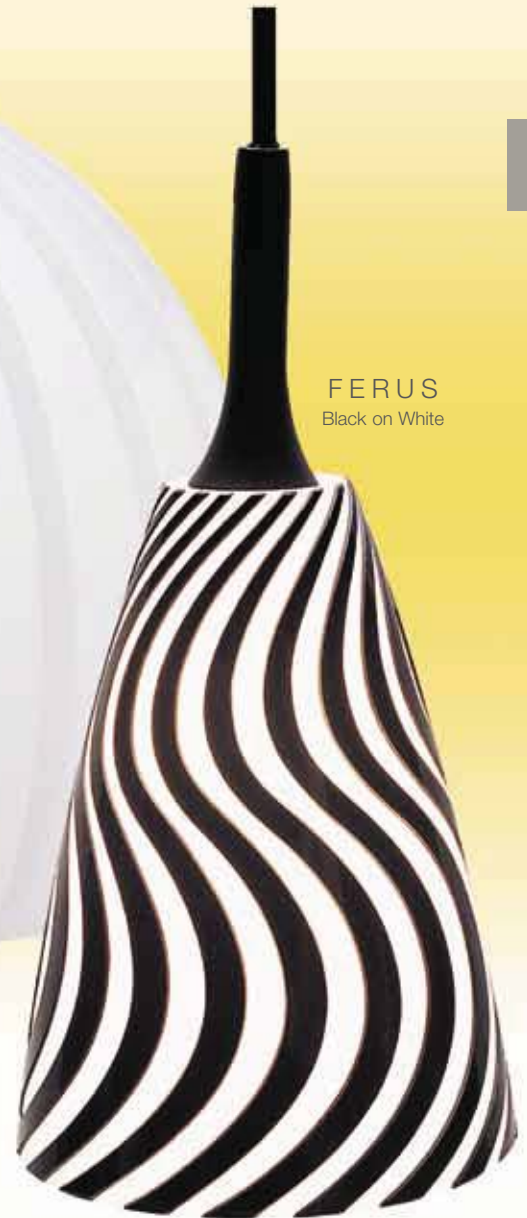

BOLLA

Item No.	NRS80-477
Diameter	10-1/4" (260 mm)
Length	7-7/8" (200 mm)
Color	White on White
Lamp Type and Wattage	1 2 3 4 5 *
Mounting Systems	A C E F *

FERUS

Item No.	NRS80-471
Diameter	4-1/4" (108 mm)
Length	5-5/8" (143 mm)
Color	Black on White
Lamp Type and Wattage	1 2 3 4 5 *
Mounting Systems	A B C D E F G H I J K *

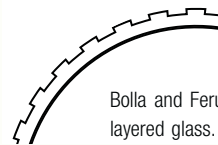

Bolla and Ferus glass shades feature the distinctive look of layered glass. The top layer of glass is applied in a pattern, raising the surface where it is present and leaving grooves where it is not. The end result is a sensuous, tactile finish that is both beautiful and dramatic.

*Not all lamp types work with all mounting systems. See Compatibility chart on pages 458-459.

GLASS SHADES, PENDANTS & WALL SCONCES

Glass Shades



SOPHIA

Item No.	NRS80-407
Diameter	4-15/16" (125 mm)
Length	2-13/16" (71 mm)
Color	Dichroic
Lamp & Wattage	1 3 *
Mounting Systems	ABCDEFGHIJK*



REFLECTIONS

Item No.	NRS80-463
Diameter	5-3/4" (146 mm)
Length	4-3/4" (121 mm)
Color	Mirror In / Clear Out
Lamp & Wattage	1 *
Mounting Systems	ABCDEFGHIJK*



S Silver
G Gold

TANNER

Item No.	NRS80-465
Diameter	3-9/16" (90 mm)
Length	3-5/16" (85 mm)
Color	G, S
Lamp & Wattage	1 3 *
Mounting Systems	ABCDEFGHIJK*



SILK

Item No.	NRS80-406
Diameter	2-5/16" (59 mm)
Length	4" (102 mm)
Color	Dichroic
Lamp & Wattage	1 3
Mounting Systems	AEGHIJK



SHEER

Item No.	NRS80-408
Diameter	1-1/2" (39 mm)
Length	3-1/2" (89 mm)
Color	Dichroic
Lamp & Wattage	1 3
Mounting Systems	AEGHIJK

LAMP KEY

- 1 40W G9 Line Voltage
- 2 60W E12 Candelabra Base Line Voltage
- 3 50W BI-Pin G5.3/6.35 Low Voltage
- 4 100W E26 Medium Base A19 Line Voltage
- 5 13W-26W GU24 CFL Self Ballasted

MOUNTING SYSTEMS

- A Nora Rail Pendants
- B Mini Rail Pendants
- C Track Pendants
- D Mini Track Pendants
- E Canopy Mount Pendants
- F Quick Jack Pendants
- G Elbow Wall Sconce
- H Flex Wall Sconce
- I Torch Wall Sconce
- J Chic Wall Sconce
- K Sphere Wall Sconce

*Not all lamp types work with all mounting systems. See Compatibility chart on pages 458-459.



DUO CUBE
BU Blue



DUO DOME
BZ Bronze



GRANT
R Red



AQ Aqua AY Amethyst BU Blue BZ Bronze CL Clear R Red

AQ Aqua AY Amethyst BU Blue BZ Bronze R Red

AM Amber BU Blue BZ Bronze GR Green R Red

	DUO CUBE	DUO DOME	GRANT
Item No.	NRS80-468	NRS80-469	NRS80-476
Diameter	4-9/16" (115 mm)	7-1/2" (190 mm)	5-1/8" (130 mm)
Length	3-5/16" (85 mm)	7" (180 mm)	4-1/4" (108 mm)
Color	** AQ, AY, BU, BZ, CL, R	** AQ, AY, BU, BZ, R	** AM, BU, BZ, GR, R
Lamp Type and Wattage	1 *	1 *	1 2 3 *
Mounting Systems	ABCDEFHIJK *	ABCDEFHIJK *	ABCDEF GHIJK *

*Not all lamp types work with all mounting systems. See Compatibility chart on pages 458-459.
** Color indicates outer glass; inner glass is white

GLASS SHADES, PENDANTS & WALL SCONCES

Glass Shades



ORION

Item No.	NRS80-454
Diameter	5" (127 mm)
Length	4" (102 mm)
Color	BU, O, W, Y
Lamp & Wattage	1 3 *
Mounting Systems	ABCDEFHIJK*



VENUS

Item No.	NRS80-455
Diameter	4" (102 mm)
Length	5-1/8" (130 mm)
Color	BU, W, Y
Lamp & Wattage	1 3 *
Mounting Systems	ABCDEFHIJK*



MERCURE

Item No.	NRS80-456
Diameter	3-1/2" (89 mm)
Length	2-7/8" (73 mm)
Color	BU, CL, O
Lamp & Wattage	1 3 *
Mounting Systems	ABCDEFHIJK*



SATURN

Item No.	NRS80-457
Diameter	5" (127 mm)
Length	2-5/8" (67 mm)
Color	BU, W
Lamp & Wattage	1 3 *
Mounting Systems	ABCDEFHIJK*



JUPITER

Item No.	NRS80-461
Diameter	5" (127 mm)
Length	4" (102 mm)
Color	BU, W, Y
Lamp & Wattage	1 3 *
Mounting Systems	ABCDEFHIJK*

LAMP KEY

- 1 40W G9 Line Voltage
- 2 60W E12 Candelabra Base Line Voltage
- 3 50W Bi-Pin G5.3/6.35 Low Voltage
- 4 100W E26 Medium Base A19 Line Voltage
- 5 13W-26W GU24 CFL Self Ballasted

MOUNTING SYSTEMS

- A Nora Rail Pendants
- B Mini Rail Pendants
- C Track Pendants
- D Mini Track Pendants
- E Canopy Mount Pendants
- F Quick Jack Pendants
- G Elbow Wall Sconce
- H Flex Wall Sconce
- I Torch Wall Sconce
- J Chic Wall Sconce
- K Sphere Wall Sconce

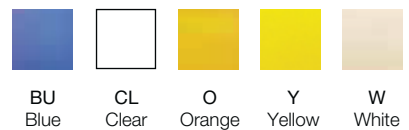

*Not all lamp types work with all mounting systems. See Compatibility chart on pages 458-459.

Glass Shades



ERIC

Item No.	NRS80-474
Diameter	2-1/2" (63 mm)
Length	9-7/8" (251 mm)
Color	BZ, W
Lamp & Wattage	1 2 3 *
Mounting Systems	ABCDEFGHIJK*



SWIFT

Item No.	NRS80-204
Diameter	2-3/8" (60 mm)
Length	4" (102 mm)
Color	AM, FR, O
Lamp & Wattage	1 3 *
Mounting Systems	ABCDEFGHIJK*



FROST
GR Green



DUAL EFFECT

Item No.	NRS80-402 Spot
	NRS80-403 Frost
	NRS80-404 Clear
Diameter	3-5/16" (84 mm)
Length	7-3/16" (183 mm)
Color	BU, GR, O, R, Y
Lamp Type and Wattage	1 3 *
Mounting Systems	ABCDEFGHIJK*



SPOT
R Red

CLEAR
BU Blue

*Not all lamp types work with all mounting systems. See Compatibility chart on pages 458-459.

GLASS SHADES, PENDANTS & WALL SCONCES

Glass Shades



	ROUND	CONICAL	FLUTED	SPLIT	CYLINDRICAL
Item No.	NG-10	NG-50	NG-66	NG-70	NG-80
Diameter	6-1/4" (159 mm)	5-1/4" (133 mm)	3-1/4" (83 mm)	4-3/8" (111 mm)	2-1/4" (57 mm)
Length	2-1/4" (57 mm)	2-1/2" (64 mm)	3-1/8" (79 mm)	2-1/4" (57 mm)	5" (127 mm)
Color	A, B, G, W	A, B, G, W	A, B, G, W	A, B, G, W	A, B, G, W
Lamp & Wattage	1 3 *	1 3 *	1 3 *	1 3 *	2 3 *
Mounting Systems	ABCDEFHIJK*	ABCDEFHIJK*	ABCDEFHIJK*	ABCDEFHIJK*	ABCDE*



	STEPPED	ROBA-M	ROBA-L
Item No.	NG-90	NRS80-458	NRS80-459
Diameter	4" (102 mm)	2-13/16" (71 mm)	4" (102 mm)
Length	2-1/8" (54 mm)	3-5/8" (92 mm)	4-1/16" (103 mm)
Color	A, B, G, W	BU, FR	BU, FR
Lamp & Wattage	1 3 *	1 3 *	1 3 *
Mounting Systems	ABCDEFHIJK*	ABCDEFHIJK*	ABCDEFHIJK*

LAMP KEY

- 1 40W G9 Line Voltage
- 2 60W E12 Candelabra Base Line Voltage
- 3 50W Bi-Pin G5.3/6.35 Low Voltage
- 4 100W E26 Medium Base A19 Line Voltage
- 5 13W-26W GU24 CFL Self Ballasted

MOUNTING SYSTEMS

- A Nora Rail Pendants
- B Mini Rail Pendants
- C Track Pendants
- D Mini Track Pendants
- E Canopy Mount Pendants
- F Quick Jack Pendants
- G Elbow Wall Sconce
- H Flex Wall Sconce
- I Torch Wall Sconce
- J Chic Wall Sconce
- K Sphere Wall Sconce

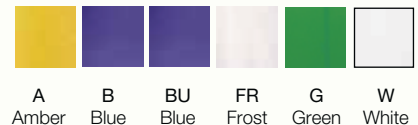

*Not all lamp types work with all mounting systems. See Compatibility chart on pages 458-459.

GLASS SHADES, PENDANTS & WALL SCONCES

Glass Shades

BR
Brown

BU
Blue

R
Red

W
White

NEW! AM Amber

PARIS

Item No.	NRS82-201
Diameter	2-3/4" (70 mm)
Length	3-1/4" (83 mm)
Color	AM, BR, BU, R, W
Lamp Type and Wattage	1 3 *
Mounting Systems	A B C D E F G H I J K *

AM
Amber

BR
Brown

BU
Blue

W
White

NEW! R Red

MONTE

Item No.	NRS82-202
Diameter	2-5/8" (67 mm)
Length	3-1/4" (83 mm)
Color	AM, BR, BU, R, W
Lamp Type and Wattage	1 3 *
Mounting Systems	A B C D E F G H I J K *

LAMP KEY

- 1 40W G9 Line Voltage
- 2 60W E12 Candelabra Base Line Voltage
- 3 50W Bi-Pin G5.3/6.35 Low Voltage
- 4 100W E26 Medium Base A19 Line Voltage
- 5 13W-26W GU24 CFL Self Ballasted

MOUNTING SYSTEMS

- A Nora Rail Pendants
- B Mini Rail Pendants
- C Track Pendants
- D Mini Track Pendants
- E Canopy Mount Pendants
- F Quick Jack Pendants
- G Elbow Wall Sconce
- H Flex Wall Sconce
- I Torch Wall Sconce
- J Chic Wall Sconce
- K Sphere Wall Sconce

AM
Amber

BR
Brown

R
Red

W
White

NEW! BU Blue

CHICAGO

Item No.	NRS82-203
Diameter	2-1/2" (64 mm)
Length	3-1/4" (83 mm)
Color	AM, BR, BU, R, W
Lamp Type and Wattage	1 3 *
Mounting Systems	A B C D E F G H I J K *

AM
Amber

BR
Brown

BU
Blue

R
Red

NEW! W White

MADELEINE

Item No.	NRS82-204
Diameter	2-5/8" (67 mm)
Length	3-1/4" (83 mm)
Color	AM, BR, BU, R, W
Lamp Type and Wattage	1 3 *
Mounting Systems	A B C D E F G H I J K *

*Not all lamp types work with all mounting systems. See Compatibility chart on pages 458-459.



Pendants

Nora Lighting now offers pendants in five different lamp sources! Our line of pendants has been expanded to include energy saving 13-26W GU24 Compact Fluorescent and Medium Base Line Voltage. Pendants are available in Rail, Mini Rail, Track, Mini Track, Multi QuickJack Canopy and Monopoint Canopy mounts in a variety of finishes. With hundreds of glass shades in an array of colors to choose from, Nora Lighting's pendants offer the utmost in style and versatility.

- 5 lamp sources now offered - with 13W-26W GU24 Compact Fluorescent and Medium Base Incandescent added to our collection
- Large assortment of new Hand-Blown Domestic and Italian Art Glass featuring appealing textures and patterns
- Pendants available in Rail, Mini Rail, Track, Mini Track, Multi QuickJack and Monopoint Canopy mount



PENDANT MOUNT	RAIL	MINI RAIL	TRACK	MINI TRACK	CANOPY
COMPACT FLUORESCENT* 13W-26W GU24 Base	NRS48-468 (8.5')	—	NTF-163 (8.5')	—	NRS98-P58 (8.5')
LINE VOLTAGE					
60W E12 Candelabra Base	NRS19-465 (8.5')	—	NTH-160 (8.5')	—	NRS99-P55 (8.5')
100W E26 Medium Base A19	NRS10-466 (8.5')	—	NTH-161 (8.5')	—	NRS90-P56 (8.5')
40W G9 Base	NRS19-450 (8.5') NRS19-456 (20')	—	NTH-162 (8.5')	—	NRS99-P45 (8.5') NRS99-P46 (20')
LOW VOLTAGE					
50W Bi-Pin - Standard	NRS34-450 (8.5') NRS34-456 (20')	NMRS32-450 (6')	NTL-309 (8.5')	NLMP-734 (4') NLMP-738 (8')	NRS99-P45/12 (8.5') NRS99-P46/12 (20')
50W Bi-Pin - QUICKJACK**	NRS90-P32**	NMRS90-P32**	NT-370**	NLMT-760**	NRS99-P47/12** NP66-103** / NP66-203**
FINISH***	BN, BZ, S	C, MG, MN	B, S, W	B, W	BN, BZ, S
GLASS SHADE	Ordered separately. See pages 416-433 for glass options. Compatibility chart on page 458.				
CORD LENGTH	Field adjustable 8.5' maximum cord length except where noted.				

* Utilizes self-ballasted lamp.

** Must be used with NRS66-457(8.5') or NRS66-458 (20') QuickJack Pendant assemblies.

*** Finishes: B Black; BN Brushed Nickel; BZ Bronze; C Chrome; MG Matte Gold, MN Matte Nickel; S Silver; W White

QuickJack System Pendants

A culmination of design and technology, Nora Lighting's QuickJack System is simple and versatile. Nora's QuickJack pendant attaches to QuickJack mounts for Nora Rail, Mini Rail, Track, Mini Track, Multi Quickjack and Monopoint Canopies. Just insert the metal fitting into the receptacle and hand-tighten the threaded collar. NO WIRES - NO HASSLE. The individual elements provide unlimited options in readily building or changing out your system.

- Pendant includes male Nora QuickJack and socket assembly
- Easily hand-tightens into Nora QuickJack mount for Rail, Mini Rail, Track, Mini Track, Monopoint and Multi QuickJack Canopies
- Nora Universal QuickJack is interchangeable with most non-Nora QuickJack systems
- Uses Low Voltage 20W-50W JC 6.35/MR16 lamp (not included)
- Accepts attractive glass shade (ordered separately)
- Two cable lengths
- Can be field shortened

TO ORDER,
CHOOSE THREE PARTS:

1. QuickJack mount to system
2. QuickJack pendant assembly
3. Glass shade

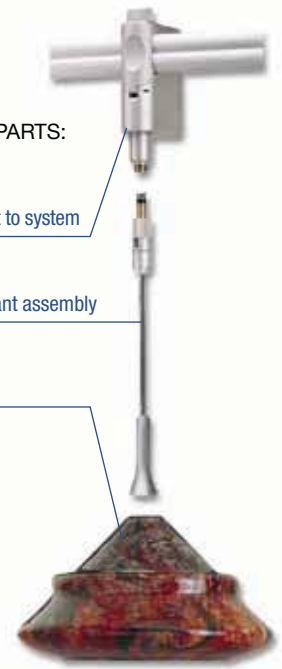

ORDER EXAMPLE:

NRS90-P32S +
NRS66-457S +
NRS80-485RF

Nora Rail QuickJack Pendant Mount, Silver finish +
8.5' Quickjack Pendant Assembly, Silver finish +
Tsunami Glass, Bamboo Brown

PRODUCT	ITEM NO.	DESCRIPTION
1. QUICKJACK PENDANT MOUNTS		
NORA RAIL	NRS90-P32	Rail 50W Electronic Transformer with female QuickJack adapter Finishes: Silver, Bronze and Brushed Nickel
MINI RAIL	NMRS90-P32	Mini Rail female QuickJack adapter Finishes: Chrome, Matte Gold and Matte Silver
TRACK	NT-370	Track 50W Electronic Transformer with female QuickJack adapter Finishes: White, Black, Silver
MINI TRACK	NLMT-760	Mini Track female QuickJack adapter Finishes: White, Black
MULTI QUICKJACK & MONOPOINT	NP66-103 NP66-203	Multi QuickJack Canopy with (3) female QuickJack adapters and (3) integral electronic transformers Finishes: Bronze and Brushed Nickel
	NRS99-P47/12	Monopoint Canopy with female QuickJack adapter and integral electronic transformer Finishes: Silver, Bronze or Brushed Nickel
	NRS99-P51	Monopoint Canopy with female QuickJack adapter for remote class II transformer Finishes: Silver, Bronze or Brushed Nickel
MONOPOINT SLOPED CEILING	NRS90-P12	Monopoint Sloped Ceiling Canopy with female QuickJack adapter and integral electronic transformer Finishes: Silver, Bronze or Brushed Nickel
2. LOW VOLTAGE QUICKJACK PENDANT ASSEMBLIES		
8.5' PENDANT	NRS66-457	8.5' QuickJack pendant assembly with male QuickJack on one end and Low Voltage Bi-Pin socket assembly on the other. Finishes: Silver, Bronze and Brushed Nickel
20' PENDANT	NRS66-458	20' QuickJack pendant assembly with male QuickJack on one end and Low Voltage Bi-Pin socket assembly on the other. Finishes: Silver, Bronze and Brushed Nickel
3. GLASS SHADES		
GLASS	Ordered separately. See pages 416-433 for glass options. Compatibility chart on page 458.	



**LOW VOLTAGE QUICKJACK
PENDANT ASSEMBLY**
 NRS66-457 8.5' Pendant
 NRS66-458 20' Pendant
 shown with NRS80-480BU
 Rain Glass Shade



NORA RAIL
 1. NRS90-P32 Rail
 QuickJack Mount
 2. NRS66-457 QuickJack
 Pendant Assembly and
 3. NRS80-484RF
 River Glass Shade



TRACK
 1. NT-370 Track
 QuickJack Mount
 2. NRS66-457 QuickJack
 Pendant Assembly and
 3. NRS80-490BU
 Trumpet Glass Shade



MULTI QUICKJACK
 1. NP66-203 Multi QuickJack Canopy
 with (3) electronic transformers
 2. (3) NRS66-457 QuickJack
 Pendant Assemblies and
 3. (3) NRS80-451TC
 Neptune Glass Shades



MINI RAIL
 1. NMRS90-P32 Mini Rail
 QuickJack Mount
 2. NRS66-457 QuickJack
 Pendant Assembly and
 3. NRS80-493BU
 Water Fall Glass Shade



MINI TRACK
 1. NLMT-760 Mini Track
 QuickJack Mount
 2. NRS66-457 QuickJack
 Pendant Assembly and
 3. NRS80-485RF
 Tsunami Glass Shade



**MONOPOINT
Sloped Ceiling**
 1. NRS90-P12 Sloped Ceiling
 Monopoint QuickJack Mount
 2. NRS66-457 QuickJack
 Pendant Assembly and
 3. NRS80-491R
 Snow Glass Shade

NORA RAIL

Nora Rail Mount Pendant Assemblies



NEW!



Compact Fluorescent Nora Rail Pendant Assembly GU24 Socket

NRS48-468 8.5' Pendant 13W-26W

- Lamp:** 13W-26W max. GU24 Self Ballasting CFL (not included)
Finish: Brushed Nickel (BN), Bronze (BZ), Silver (S)
Cord Length: 8.5' Cord is field adjustable to any length
- Accepts attractive glass shades, ordered separately. (Pages 416-433)
 - 7/8" opening glass must be gravity hung

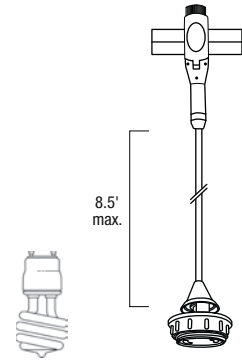

Line Voltage Nora Rail Pendant Assembly Candelabra Socket

NRS19-465 8.5' Pendant 60W

- Lamp:** 60W max. Line Voltage Candelabra Base (not included)
Finish: Brushed Nickel (BN), Bronze (BZ), Silver (S)
Cord Length: 8.5' Cord is field adjustable to any length
- Accepts attractive glass shades, ordered separately. (Pages 416-433)
 - Accepts custom glass or other decorative element with 7/8" top opening

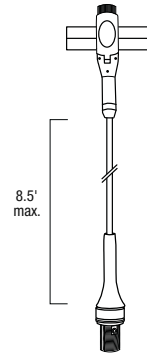

NEW!



Line Voltage Nora Rail Pendant Assembly Medium Base Socket

NRS10-466 8.5' Pendant 100W

- Lamp:** 100W max. Line Voltage Medium Base (not included)
Finish: Brushed Nickel (BN), Bronze (BZ), Silver (S)
Cord Length: 8.5' Cord is field adjustable to any length
- Accepts attractive glass shades, ordered separately. (Pages 416-433)
 - 7/8" opening glass must be gravity hung

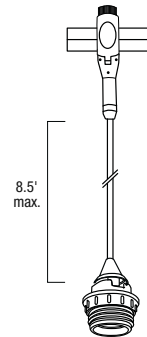

Line Voltage Nora Rail Pendant Assembly G9 Halogen Socket

NRS19-450 8.5' Pendant 40W
NRS19-456 20' Pendant 40W

- Lamp:** 40W max. Line Voltage G9 Halogen (included)
Finish: Brushed Nickel (BN), Bronze (BZ), Silver (S)
Cord Length: 8.5' and 20' Cords are field adjustable to any length
- Accepts attractive glass shades, ordered separately. (Pages 416-433)
 - Accepts custom glass or other decorative element with 7/8" top opening
 - Frosted lamp shield included

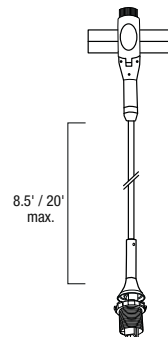

Glass ordered separately. See pages 416-433 for glass options. Compatibility chart on page 458.



Nora Rail Mount Pendant Assemblies continued

NORA RAIL

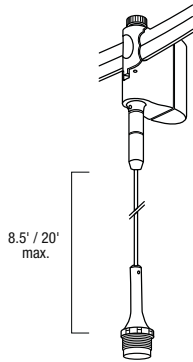

Low Voltage Nora Pendant Assembly Bi-Pin Socket

NRS34-450	8.5' Pendant	20W-50W
NRS34-456	20' Pendant	20W-50W

- Lamp:** 20W-50W max. JC, MR11 or MR16 (not included)
Finish: Brushed Nickel (BN), Bronze (BZ), Silver (S)
Cord Length: 8.5' and 20' Cords are field adjustable to any length
- Integral electronic transformer
 - Accepts attractive glass shades, ordered separately. (Pages 416-433)
 - Accepts custom glass or other decorative element with 7/8" top opening
 - Lamp shield included

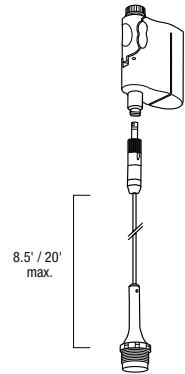

Low Voltage Nora Rail QuickJack Pendant Assembly QuickJack / Bi-Pin Socket

NRS90-P32	QuickJack Nora Rail Adapter only (Integral Transformer)	
NRS66-457	QuickJack 8.5' Cord and Socket	
NRS66-458	QuickJack 20' Cord and Socket	

- Lamp:** 50W max. JC 6.35/MR16 (not included)
Finish: Brushed Nickel (BN), Bronze (BZ), Silver (S)
Cord Length: 8.5' and 20' cords are field adjustable to any length
- **NRS90-P32** QuickJack Adapter must be used with NRS66-457 or NRS66-458 QuickJack Pendant Assembly, ordered separately.
 - Lamp shield included

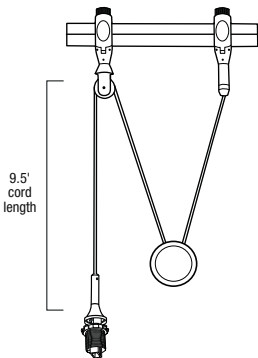

Line Voltage Nora Rail Yoyo Pendant Assembly G9 Halogen Socket

NRS19-551	9.5' Yoyo	40W
------------------	-----------	-----

- Lamp:** 40W max. Line Voltage G9 Halogen (included)
Finish: Brushed Nickel (BN), Bronze (BZ), Silver (S)
Cord Length: 9.5' Cord is field adjustable to any length
- Accepts attractive glass shades, ordered separately. (Pages 416-433)
 - Accepts custom glass or other decorative element with 7/8" top opening
 - Pulley and counter weight provide unique, glass positioning by hand
 - Frosted lamp shield included

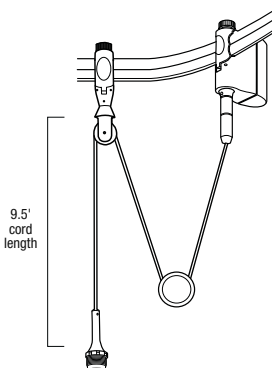

Low Voltage Nora Rail Yoyo Pendant Assembly Bi-Pin Socket

NRS34-551	9.5' Yoyo	40W
------------------	-----------	-----

- Lamp:** 20W-50W max. JC, MR11 or MR16 (not included)
Finish: Brushed Nickel (BN), Bronze (BZ), Silver (S)
Cord Length: 9.5' Cord is field adjustable to any length
- Integral electronic transformer
 - Accepts attractive glass shades, ordered separately. (Pages 416-433)
 - Accepts custom glass or other decorative element with 7/8" top opening
 - Pulley and counter weight provide unique, glass positioning by hand
 - Lamp shield included



Glass ordered separately. See pages 416-433 for glass options. Compatibility chart on page 458.

Mini Rail Mount Pendants



Low Voltage Mini Rail Pendant Assembly Bi-Pin Socket

NMRS32-450 6' Pendant 35W

- Lamp:** 35W max. JC 6.35 max (included)
Finish: Chrome (C), Matte Gold (MG), Matte Nickel (MN)
Cord Length: 6' Cord may be field cut to desired length
- Accepts attractive glass shades, ordered separately. (Pages 416-433)

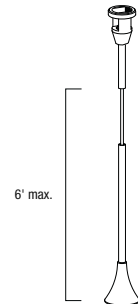

Low Voltage Mini Rail Yoyo Pendant Assembly Bi-Pin Socket

NMRS32-524 Yoyo Pendant 35W

- Lamp:** 35W max. JC 6.35 max (included)
Finish: Chrome (C), Matte Gold (MG), Matte Nickel (MN)
Cord Length: 6' Cord may be field cut to desired length
- Accepts attractive glass shades, ordered separately. (Pages 416-433)
 - Pulley and counter weight provide unique, glass positioning by hand

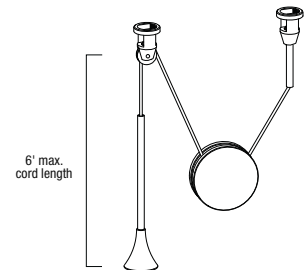

Low Voltage Mini Rail QuickJack Pendant Assembly QuickJack / Bi-Pin Socket

NMRS90-P32 QuickJack Mini Rail Adapter only
NRS66-457 QuickJack 8.5' Cord and Socket
NRS66-458 QuickJack 20' Cord and Socket

- Lamp:** 50W max. JC 6.35/MR16 (not included)
Finish: Chrome (C), Matte Gold (MG), Matte Nickel (MN)
Cord Length: 8.5' and 20' cords are field adjustable to any length
- **NMRS90-P32** QuickJack Adapter must be used with NRS66-457 or NRS66-458 QuickJack Pendant Assembly, ordered separately.
 - Accepts attractive glass shades, ordered separately. (Pages 416-433)

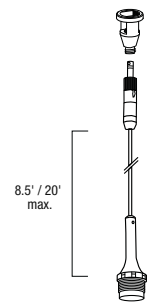

Cassandra Mini Rail Glass Shade, Frost White

NMRS80-478

- Lamp:** Accomodates JC 6.35 Bi-Pin
Finish: Frost White
Dimensions: Dia.: 2-1/8" (54mm) L: 3-1/2" (89mm)
- Integral JC lamp shield
 - Can only be used with MiniRail. See all Nora Glass Shades on pages 416-433.

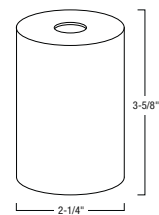



GLASS SHADES, PENDANTS & WALL SCONCES

Track Mount Pendants

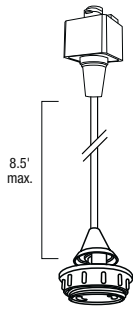

Compact Fluorescent Track Pendant Assembly GU24 Socket

NTF-163	8.5' H-Style Pendant	13W-26W
NTF-163(finish)/J	8.5' J-Style Pendant	13W-26W
NTF-163(finish)/L	8.5' L-Style Pendant	13W-26W

Lamp: 13W-26W max. GU24 Self Ballasting CFL (not included)
Finish: Black (B), Silver (S), White (W)

Cord Length: 8.5' Cord is field adjustable to any length

- Accepts attractive glass shades, ordered separately. (Pages 416-433)
- 7/8" opening glass must be gravity hung

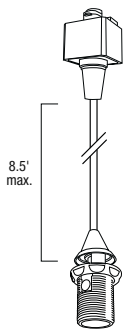

Line Voltage Track Pendant Assembly Candelabra Socket

NTH-160	8.5' H-Style Pendant	60W
NTH-160(finish)/J	8.5' J-Style Pendant	60W
NTH-160(finish)/L	8.5' L-Style Pendant	60W

Lamp: 60W max. Line Voltage Candelabra Base (not included)
Finish: Black (B), Silver (S), White (W)

Cord Length: 8.5' Cord is field adjustable to any length

- Accepts attractive glass shades, ordered separately. (Pages 416-433)
- Accepts custom glass or other decorative element with 7/8" top opening

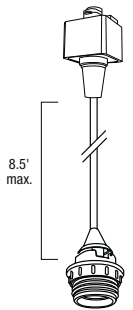

Line Voltage Track Pendant Assembly Medium Base Socket

NTH-161	8.5' H-Style Pendant	100W
NTH-161(finish)/J	8.5' J-Style Pendant	100W
NTH-161(finish)/L	8.5' L-Style Pendant	100W

Lamp: 100W max. Line Voltage Medium Base (not included)
Finish: Black (B), Silver (S), White (W)

Cord Length: 8.5' Cord is field adjustable to any length

- Accepts attractive glass shades, ordered separately. (Pages 416-433)
- 7/8" opening glass must be gravity hung

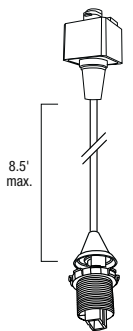

Line Voltage Track Pendant Assembly G9 Halogen Socket

NTH-162	8.5' H-Style Pendant	40W
NTH-162(finish)/J	8.5' J-Style Pendant	40W
NTH-162(finish)/L	8.5' L-Style Pendant	40W

Lamp: 40W max. Line Voltage G9 Halogen (included)
Finish: Black (B), Silver (S), White (W)

Cord Length: 8.5' Cord is field adjustable to any length

- Accepts attractive glass shades, ordered separately. (Pages 416-433)
- Accepts custom glass or other decorative element with 7/8" top opening
- Frosted lamp shield included



Glass ordered separately. See pages 416-433 for glass options. Compatibility chart on page 458.

Track Mount Pendants continued



Pila Low Voltage Track Pendant Assembly Bi-Pin Socket

NTL-309 8.5' Pendant 35W max.

- Lamp:** 35W max. JC 6.35 (not included)
Finish: Black (B), Chrome (C), White (W)
Cord Length: 8.5' Cord is field adjustable to any length
Accessories: **NT-365** Replacement lamp shield
QI50JC/12 50W JC 6.35 lamp
- 50W Integral electronic transformer
 - Accepts attractive glass shades, ordered separately. (Pages 416-433)
 - Also available with Canopy Mount. See pages 446.

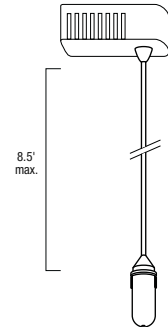

Cona™ Low Voltage Track Pendant Assembly Bi-Pin Socket

NTL-310 Pulley Pendant 35W max.

- Lamp:** 35W max. JC 6.35 (not included)
Finish: Chrome (C), Silver (S)
Cord Length: Adjustable cable length drops from 1' to 4'
Accessories: **NT-365** Replacement lamp shield
QI35JC/12 35W JC 6.35 lamp
- Integral electronic transformer
 - Accepts attractive glass shades, ordered separately. (Pages 416-433)
 - Also available with Canopy Mount. See pages 446.

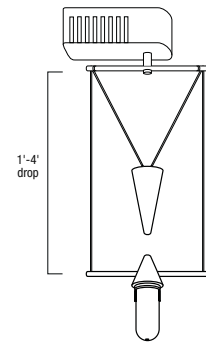

Cylindrica™ Low Voltage Track Pendant Assembly Bi-Pin Socket

NTL-311 Pulley Pendant 35W max.

- Lamp:** 35W max. JC 6.35 (not included)
Finish: Chrome (C), Silver (S)
Cord Length: Adjustable cable length drops from 1' to 4'
Accessories: **NT-365** Replacement lamp shield
QI35JC/12 35W JC 6.35 lamp
- Integral electronic transformer
 - Accepts attractive glass shades, ordered separately. (Pages 416-433)
 - Also available with Canopy Mount. See pages 446.

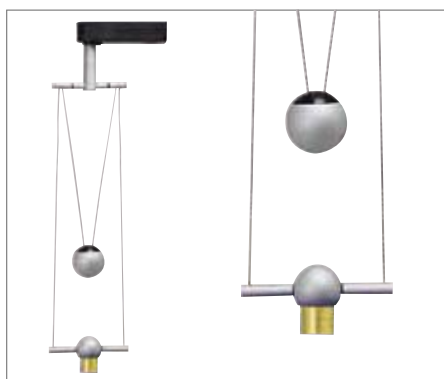
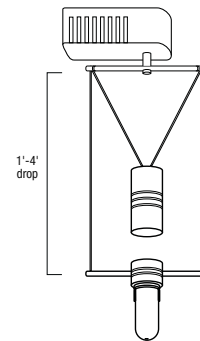

Sphera™ Low Voltage Track Pendant Assembly Bi-Pin Socket

NTL-312 Pulley Pendant 35W max.

- Lamp:** 35W max. JC 6.35 (not included)
Finish: Chrome (C), Silver (S)
Cord Length: Adjustable cable length drops from 1' to 4'
Accessories: **NT-365** Replacement lamp shield
QI35JC/12 35W JC 6.35 lamp
- Integral electronic transformer
 - Accepts attractive glass shades, ordered separately. (Pages 416-433)
 - Also available with Canopy Mount. See pages 446.

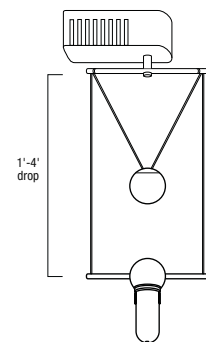

Glass ordered separately. See pages 416-433 for glass options. Compatibility chart on page 458.



GLASS SHADES, PENDANTS & WALL SCONCES

Track Mount Pendants continued

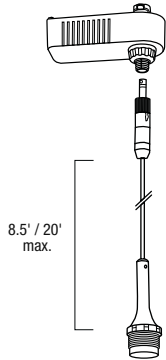

Low Voltage Track QuickJack Pendant Assembly QuickJack / Bi-Pin Socket

NT-370	QuickJack Track Adapter only
NRS66-457	QuickJack 8.5' Cord and Socket
NRS66-458	QuickJack 20' Cord and Socket

- Lamp:** 50W max. JC 6.35/MR16 (not included)
- NT-370 Finish:** Black (B), Silver (S), White (W)
- NRS66-457 Finish:** Brushed Nickel (BN), Bronze (BZ), Silver (S)
- NRS66-458 Finish:** Brushed Nickel (BN), Bronze (BZ), Silver (S)
- Cord Length:** 8.5' and 20' cords are field adjustable to any length
- 50W Electronic Transformer
 - **NT-370** QuickJack Adapter must be used with NRS66-457 or NRS66-458 QuickJack Pendant Assembly, ordered separately.
 - Accepts attractive glass shades, ordered separately. (Pages 416-433)



GLASS SHADES, PENDANTS & WALL SCONCES

Mini Track Mount Pendants

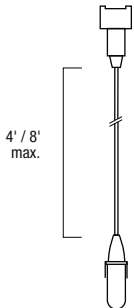

Polaris™ Low Voltage Mini Track Pendant Assembly Bi-Pin Socket

NLMP-734	4' Pendant	20W-50W
NLMP-738	8' Pendant	20W-50W

- Lamp:** 12/24V 20W-50W JC 6.35 (not included)
- Finish:** Black (B), White (W)
- Cord Length:** Cord may be field cut to desired length
- Accessories:** Q150JC/12 50W JC 6.35 lamp
- 50W max. Integral electronic transformer
 - Accepts attractive glass shades, ordered separately. (Pages 416-433)
 - Locking frosted JC lamp shield included

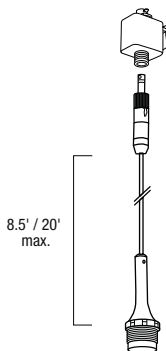

Low Voltage Mini Track QuickJack Pendant Assembly QuickJack / Bi-Pin Socket

NLMT-760	QuickJack Mini Track Adapter only
NRS66-457	QuickJack 8.5' Cord and Socket
NRS66-458	QuickJack 20' Cord and Socket

- Lamp:** 12/24V 20W-50W max. JC 6.35 (not included)
- NLMT-760 Finish:** Black (B), White (W)
- NRS66-457 Finish:** Brushed Nickel (BN), Bronze (BZ), Silver (S)
- NRS66-458 Finish:** Brushed Nickel (BN), Bronze (BZ), Silver (S)
- Cord Length:** 8.5' and 20' cords are field adjustable to any length
- **NLMT-760** QuickJack Adapter must be used with NRS66-457 or NRS66-458 QuickJack Pendant Assembly, ordered separately.
 - Accepts attractive glass shades, ordered separately. (Pages 416-433)



Glass ordered separately. See pages 416-433 for glass options. Compatibility chart on page 458.

Monopoint Canopies



NEW!

Compact Fluorescent Monopoint Pendant Assembly GU24 Socket

NRS98-P58 8.5' Pendant 13W-26W max.

Lamp: 13W-26W GU24 Self Ballasting CFL (not included)

Finish: Brushed Nickel (BN), Bronze (BZ), Silver (S)

Cord Length: 8.5' Cord is field adjustable to any length

- Accepts attractive glass shades, ordered separately. (Pages 416-433)
- 7/8" opening glass must be gravity hung

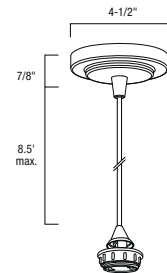

Line Voltage Monopoint Pendant Assembly Candelabra Socket

NRS99-P55 8.5' Pendant 60W max.

Lamp: 60W Line Voltage Candelabra Base (not included)

Finish: Brushed Nickel (BN), Bronze (BZ), Silver (S)

Cord Length: 8.5' Cord is field adjustable to any length

- Accepts attractive glass shades, ordered separately. (Pages 416-433)
- Accepts custom glass or other decorative element with 7/8" top opening

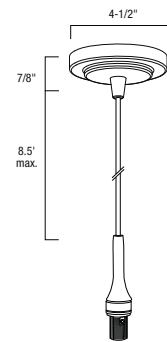

NEW!

Line Voltage Monopoint Pendant Assembly Medium Base Socket

NRS90-P56 8.5' Pendant 100W max.

Lamp: 100W Line Voltage Medium Base (not included)

Finish: Brushed Nickel (BN), Bronze (BZ), Silver (S)

Cord Length: 8.5' Cord is field adjustable to any length

- Accepts attractive glass shades, ordered separately. (Pages 416-433)
- 7/8" opening glass must be gravity hung

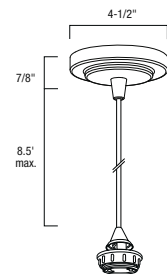

Line Voltage Monopoint Pendant Assembly G9 Halogen Socket

NRS99-P45 8.5' Pendant 40W max.

NRS99-P46 20' Pendant 40W max.

Lamp: 40W Line Voltage G9 Halogen (included)

Finish: Brushed Nickel (BN), Bronze (BZ), Silver (S)

Cord Length: 8.5' and 20' Cords are field adjustable to any length

- Accepts attractive glass shades, ordered separately. (Pages 416-433)
- Accepts custom glass or other decorative element with 7/8" top opening
- Frosted lamp shield included

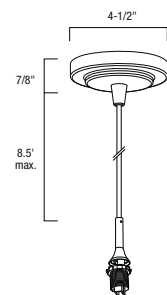

Glass ordered separately. See pages 416-433 for glass options. Compatibility chart on page 458.



GLASS SHADES, PENDANTS & WALL SCONCES

Monopoint Canopies continued

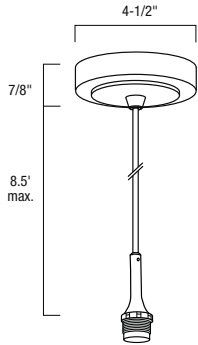

Low Voltage Monopoint Pendant Assembly Bi-Pin Socket

NRS99-P45/12V 8.5' Pendant 20W-50W max.

NRS99-P46/12V 20' Pendant 20W-50W max.

Lamp: 20W-50W JC, MR11 or MR16 (not included)

Finish: Brushed Nickel (BN), Bronze (BZ), Silver (S)

Cord Length: 8.5' and 20' Cords are field adjustable to any length

- Integral electronic transformer
- Accepts attractive glass shades, ordered separately. (Pages 416-433)
- Dimmable with electronic low voltage dimmer.

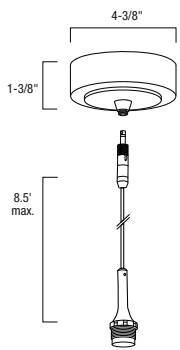

Low Voltage Monopoint QuickJack Pendant Assembly QuickJack / Bi-Pin Socket

NRS99-P47/12V QuickJack Monopoint Canopy only

NRS66-457 QuickJack 8.5' Cord and Socket

NRS66-458 QuickJack 20' Cord and Socket

Lamp: 50W max. JC 6.35/MR16 (not included)

Finish: Brushed Nickel (BN), Bronze (BZ), Silver (S)

Cord Length: 8.5' and 20' cords are field adjustable to any length

- Canopy with integral transformer and female QuickJack adapter
- **NRS99-P47/12V** QuickJack Adapter must be used with NRS66-457 or NRS66-458 QuickJack Pendant Assembly, ordered separately.
- Accepts attractive glass shades, ordered separately. (Pages 416-433)
- Dimmable with electronic low voltage dimmer.

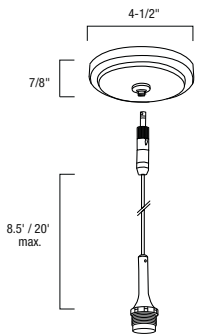

Low Volt. Shallow Monopoint QuickJack Pendant Assembly QuickJack / Bi-Pin Socket

NRS99-P51 QuickJack Monopoint Shallow Canopy only

NRS66-457 QuickJack 8.5' Cord and Socket

NRS66-458 QuickJack 20' Cord and Socket

Lamp: 50W max. JC 6.35/MR16 (not included)

Finish: Brushed Nickel (BN), Bronze (BZ), Silver (S)

Cord Length: 8.5' and 20' cords are field adjustable to any length

- Canopy requires remote transformer and female QuickJack adapter
- **NRS99-P51** QuickJack Adapter must be used with NRS66-457 or NRS66-458 QuickJack Pendant Assembly, ordered separately.
- Accepts attractive glass shades, ordered separately. (Pages 416-433)
- For complete selection of transformers, see pages 702-704.

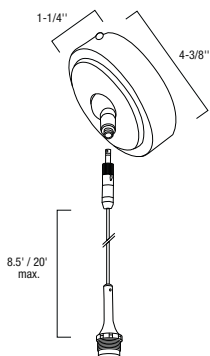

Low Voltage Monopoint Sloped Ceiling Canopy QuickJack Pendant

NRS90-P12 QuickJack Sloped Monopoint Canopy only

NRS66-457 QuickJack 8.5' Cord and Socket

NRS66-458 QuickJack 20' Cord and Socket

Lamp: 50W max. JC 6.35/MR16 (not included)

Finish: Brushed Nickel (BN), Bronze (BZ), Silver (S)

Cord Length: 8.5' and 20' cords are field adjustable to any length

- Canopy with integral electronic transformer and female QuickJack adapter
- **NRS90-P12** QuickJack Adapter must be used with NRS66-457 or NRS66-458 QuickJack Pendant Assembly, ordered separately.
- Accepts attractive glass shades, ordered separately. (Pages 416-433)
- Dimmable with electronic low voltage dimmer.



Glass ordered separately. See pages 416-433 for glass options. Compatibility chart on page 458.

Monopoint Canopies continued



Pila Low Voltage Monopoint Pendant Assembly Bi-Pin Socket

NCL-309 8.5' Pendant 50W max.

Lamp: 50W max. JC 6.35 (not included)

Finish: Black (B), Chrome (C), White (W)

Cord Length: 8.5' cord is field adjustable to any length

Accessories: **NT-365** Replacement lamp shield
QI35JC/12 35W JC 6.35 lamp

- Integral electronic transformer
- Accepts attractive glass shades, ordered separately. (Pages 416-433)
- Dimmable with electronic low voltage dimmer.
- Also available with Track Mount. See pages 442.

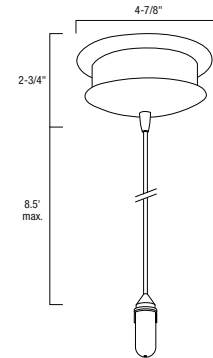

Cona™ Low Voltage Monopoint Pendant Assembly Bi-Pin Socket

NCL-310 Pulley Pendant 35W max.

Lamp: 35W JC 6.35 (not included)

Finish: Chrome (C), Silver (S)

Cord Length: Adjustable cable length drops from 1' to 4'

Accessories: **NT-365** Replacement lamp shield
QI35JC/12 35W JC 6.35 lamp

- Integral electronic transformer
- Accepts attractive glass shades, ordered separately. (Pages 416-433)
- Dimmable with electronic low voltage dimmer.
- Also available with Track Mount. See pages 442.

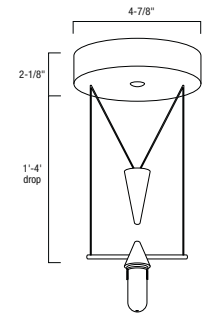

Cylindrica™ Low Voltage Monopoint Pendant Assembly Bi-Pin Socket

NCL-311 Pulley Pendant 35W max.

Lamp: 35W JC 6.35 (not included)

Finish: Chrome (C), Silver (S)

Cord Length: Adjustable cable length drops from 1' to 4'

Accessories: **NT-365** Replacement lamp shield
QI35JC/12 35W JC 6.35 lamp

- Integral electronic transformer
- Accepts attractive glass shades, ordered separately. (Pages 416-433)
- Dimmable with electronic low voltage dimmer.
- Also available with Track Mount. See pages 442.

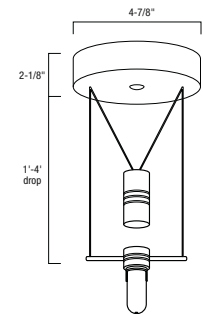

Sphera™ Low Voltage Monopoint Pendant Assembly Bi-Pin Socket

NCL-312 Pulley Pendant 35W max.

Lamp: 35W JC 6.35 (not included)

Finish: Chrome (C), Silver (S)

Cord Length: Adjustable cable length drops from 1' to 4'

Accessories: **NT-365** Replacement lamp shield
QI35JC/12 35W JC 6.35 lamp

- Integral electronic transformer
- Accepts attractive glass shades, ordered separately. (Pages 416-433)
- Dimmable with electronic low voltage dimmer.
- Also available with Track Mount. See pages 442.

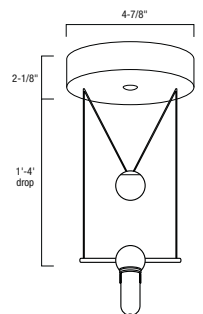

Glass ordered separately. See pages 416-433 for glass options. Compatibility chart on page 458.





Multi QuickJack Canopies

Round & Linear QuickJack Canopies

NEW!

Nora Lighting's new Multi QuickJack Low Voltage Canopies allow you to create a dramatic lighting statement using three QuickJack fixtures and/or pendants over a single existing junction box. Available in round or linear in brushed nickel or bronze finishes. The new Multi QuickJacks can be used for multi-directional lighting and/or used as a linear or circular chandelier.



FEATURES

- **Eclectic Style** - Architectural low profile design with a depth of 1-3/4"
- **Flexible** - Capable of creating multiple lighting effects with either Nora Rail fixtures, Low Voltage Pendants, or a combination of both. Use QuickJack stems to customize lengths of fixtures (See Page 514).
- **Two Different Finishes** - Available in Bronze and Brushed Nickel.
- **QuickJack** - Allows the use of any NRS66 Nora Rail QuickJack fixture to be used as a directional spot light or NRS66-456 or NRS66-457 pendant drop and glass. Glass available on pages 416-433.
- **Dimmable** - Dimmable with electronic low voltage dimmer(s). Note: each female QuickJack can be separately controlled if supplied with individual switch legs.



Linear Low Voltage Multi QuickJack Canopy

NP66-103 50W

Transformer: (3) 60W Electronic Transformers
Wattage: 20W-50W Bi-Pin MR16 or JC 6.35
Finish: Brushed Nickel (BN), Bronze (BZ)
Dimensions: Width: 4-1/2" (114mm)
 Length: 26" (660mm)
 Depth: 1-3/4" (44.5mm)

- Canopy with (3) integral transformers and (3) female QuickJack adapters
- Must be used with NRS66-457 or NRS66-458 QuickJack Pendant Assembly, or NRS66 Nora Rail QuickJack Fixtures (See Pages 485, 484-489)
- Dimmable with electronic low voltage dimmer.

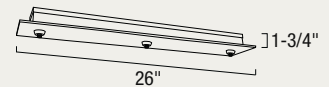

Round Low Voltage Multi QuickJack Canopy

NP66-203 50W

Transformer: (3) 60W Electronic Transformers
Wattage: 20W-50W Bi-Pin MR16 or JC 6.35
Finish: Brushed Nickel (BN), Bronze (BZ)
Dimensions: Diameter: 11-7/8" (302mm)
 Depth: 1-3/4" (44.5mm)

- Canopy with (3) integral transformers and (3) female QuickJack adapters
- Must be used with NRS66-457 or NRS66-458 QuickJack Pendant Assembly, or NRS66 Nora Rail QuickJack Fixtures (See Pages 485, 484-489)
- Dimmable with electronic low voltage dimmer.

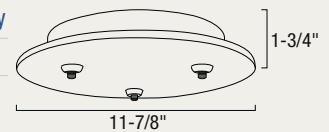

Saria LED

Complete Pendant

with colorful glowing glass edge

Nora Lighting's new Saria LED mini-pendant is a dazzling high-style fixture for residential and commercial applications. Featuring a sleek, contemporary design, Saria offers two visual effects - as a 1-watt with a spot downlight or a 3-watt with an even flood downlight. A colorful glowing edge creates visual impact and is available with Blue, Green, Red or White LEDs. Saria features 3000K CCT downlight and, as with all LED fixtures, is cool to the touch - there is no projected forward heat or UV.

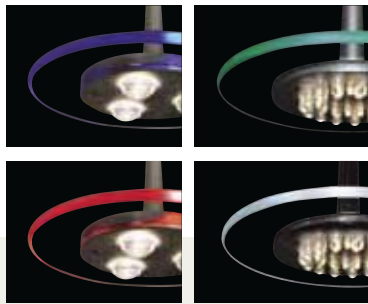

FEATURES

- **Ultra-contemporary styling** - Architectural low profile design with a glass diameter of 4-3/4" and less than a 1/4" thick.
- **Two distinct visual effects** - 1-watt LED with multiple modules create a soft spot downlight glow; or a 3-watt LED source including (3) one-watt LED modules that produce an even flood of concentrated light without glare.
- **Four glowing LED edge colors** - Available in Blue, Green, Red or White.
- **Designer finish** - Fixture hardware is available in Brushed Nickel.
- **Versatile and attention getting** - Saria's architectural design makes this pendant well-suited for a wide range of applications, including residential or commercial sites, hospitality, retail and other trend-setting locations.
- **No projected forward heat** or harmful UV rays
- **LED Driver** mounted in canopy

Saria 1W 3000K LED Pendant with Glowing Glass Edge and Monopoint Mount

NCE-830LBU1BN	Blue Edge-Lit	1W LED
NCE-830LGR1BN	Green Edge-Lit	1W LED
NCE-830LR1BN	Red Edge-Lit	1W LED
NCE-830LW1BN	White Edge-Lit	1W LED

Lamp: Multiple LED modules with total load of 1W
LED Color: Blue (BU), Green (GR), Red (R), White (W)
Finish: Brushed Nickel (BN)
Canopy: Includes integral LED driver
Dimensions: Glass Dia: 4-3/4" (121mm)
 Glass Depth: 3/16" (5mm)
 Cord: 8' 6" (259cm), field adjustable to any length

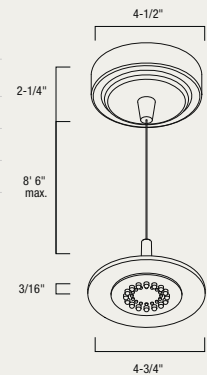

Saria 3W 3000K LED Pendant with Glowing Glass Edge and Monopoint Mount

NCE-830LBU3BN	Blue Edge-Lit	3W LED
NCE-830LGR3BN	Green Edge-Lit	3W LED
NCE-830LR3BN	Red Edge-Lit	3W LED
NCE-830LW3BN	White Edge-Lit	3W LED

Lamp: (3) 1W LED modules for a total load of 3W
LED Color: Blue (BU), Green (GR), Red (R), White (W)
Finish: Brushed Nickel (BN)
Canopy: Includes integral LED driver
Dimensions: Glass Dia: 4-3/4" (121mm)
 Glass Depth: 3/16" (5mm)
 Cord: 8' 6" (259cm), field adjustable to any length

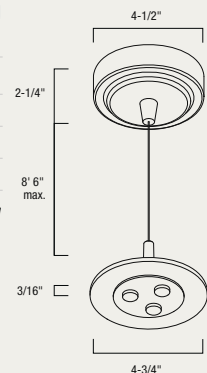

includes Pendant Assembly and Glass Cover **Rail & Canopy Complete Pendants**

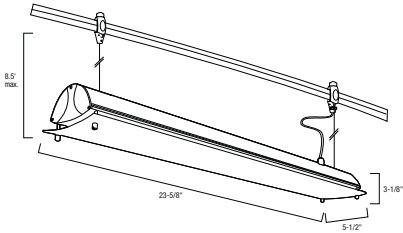

Nepro Fluorescent Rail Mount Pendant

NRS45-401 Rail Mount 2 x 24W T5 HO

Lamp: 2 x 24W T5 HO (not included)
Finish: Brushed Nickel (BN), Bronze (BZ), Silver (S)
Glass: Frosted Glass
Dimensions: Length: 23-5/8" (60cm) Width: 5-1/2" (140mm)
 Height: 3-1/8" (79mm) Max Drop: 8' 6" (259cm)

• Cord is field adjustable



committed to GREEN

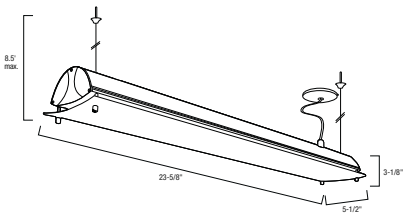

Nepro Fluorescent Canopy Mount Pendant

NRS45-301 Canopy Mount 2 x 24W T5 HO

Lamp: 2 x 24W T5 HO (not included)
Finish: Brushed Nickel (BN), Bronze (BZ), Silver (S)
Glass: Frosted Glass
Dimensions: Length: 23-5/8" (60cm) Width: 5-1/2" (140mm)
 Height: 3-1/8" (79mm) Max Drop: 8' 6" (259cm)

• Cord is field adjustable



committed to GREEN



GLASS SHADES, PENDANTS & WALL SCONCES

Nora Rail Complete Pendants *includes Pendant Assembly and Porcelain Shade*



Ambra Pendant with Porcelain White Shade

NRS19-462PW	Line Voltage	40W G9 max.
NRS34-462PW	Low Voltage	50W JC 6.35/MR16 max.
NRS66-462PW*	Low Volt. QuickJack	50W JC 6.35/MR16 max.

Lamp: **NRS19-462** - 40W G9 (included)
NRS34-462 - 50W JC 6.35/MR16 (not included)
NRS66-462* - 50W JC 6.35/MR16 (not included)

Finish: Brushed Nickel (BN), Bronze (BZ), Silver (S)

Dimensions: Diameter: 3-3/4" (95mm) Length: 6-3/4" (171mm)
 Max Extension: 9' (274cm) includes cord length

*NRS66-462 Male QuickJack pendant assembly with glass. Unit must be used with Female Rail QuickJack adapter, NRS90-P32, ordered separately. See page 439.

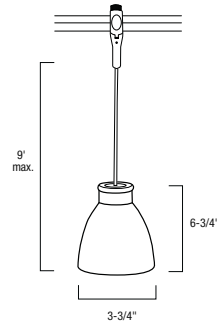

Petra Pendant with Porcelain White Shade

NRS19-463PW	Line Voltage	40W G9 max.
NRS34-463PW	Low Voltage	50W JC 6.35/MR16 max.
NRS66-463PW*	Low Volt. QuickJack	50W JC 6.35/MR16 max.

Lamp: **NRS19-463** - 40W G9 (included)
NRS34-463 - 50W JC 6.35/MR16 (not included)
NRS66-463* - 50W JC 6.35/MR16 (not included)

Finish: Brushed Nickel (BN), Bronze (BZ), Silver (S)

Dimensions: Diameter: 2-15/16" (75mm) Length: 5-3/4" (146mm)
 Max Extension: 9' (274cm) includes cord length

*NRS66-463 Male QuickJack pendant assembly with glass. Unit must be used with Female Rail QuickJack adapter, NRS90-P32, ordered separately. See page 439.

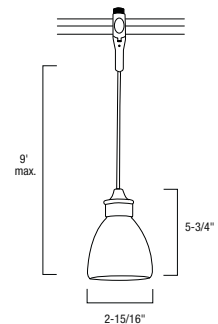

Ambra Yoyo Pendant with Porcelain White Shade

NRS19-562PW	Line Voltage	40W G9 max.
NRS34-562PW	Low Voltage	50W JC 6.35/MR16 max.
NRS66-562PW*	Low Volt. QuickJack	50W JC 6.35/MR16 max.

Lamp: **NRS19-562** - 40W G9 (included)
NRS34-562 - 50W JC 6.35/MR16 (not included)
NRS66-562* - 50W JC 6.35/MR16 (not included)

Finish: Brushed Nickel (BN), Bronze (BZ), Silver (S)

Dimensions: Diameter: 3-3/4" (95mm) Length: 6-3/4" (171mm)
 Cord Length: 9' 6" (290cm)

*NRS66-562 Male QuickJack pendant assembly with glass. Unit must be used with Female Rail QuickJack adapter, NRS90-P32, ordered separately. See page 439.

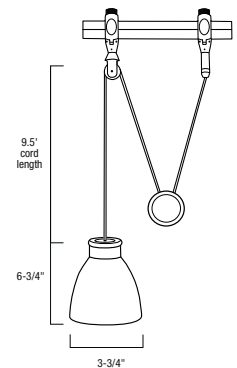

Petra Yoyo Pendant with Porcelain White Shade

NRS19-563PW	Line Voltage	40W G9 max.
NRS34-563PW	Low Voltage	50W JC 6.35/MR16 max.
NRS66-563PW*	Low Volt. QuickJack	50W JC 6.35/MR16 max.

Lamp: **NRS19-563** - 40W G9 (included)
NRS34-563 - 50W JC 6.35/MR16 (not included)
NRS66-563* - 50W JC 6.35/MR16 (not included)

Finish: Brushed Nickel (BN), Bronze (BZ), Silver (S)

Dimensions: Diameter: 2-15/16" (75mm) Length: 5-3/4" (146mm)
 Cord Length: 9' 6" (290cm)

*NRS66-563 Male QuickJack pendant assembly with glass. Unit must be used with Female Rail QuickJack adapter, NRS90-P32, ordered separately. See page 439.

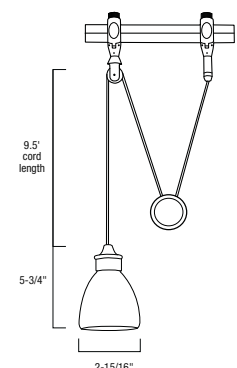

includes Pendant Assembly and Glass Shade **Rail & Canopy Complete Pendants**

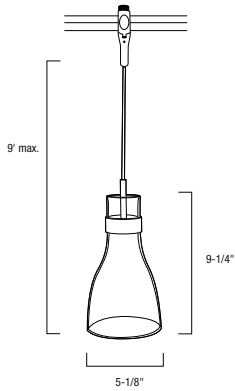

Line Voltage Biba Pendant with Frosted Outer Shade

NRS19-464FR	Rail Mount	40W G9 max.
NRS99-464FR	Canopy Mount	40W G9 max.

Lamp: 40W max. G9 (included)
Finish: Brushed Nickel (BN), Bronze (BZ), Silver (S)
Glass: Frosted Outer Shade (FR)
Dimensions: Diameter: 5-1/8" (130mm) Length: 9-1/4" (234mm)
 Max Drop: 8' 6" (259cm)

- cULus Listed

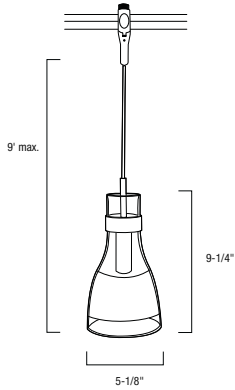

Line Voltage Biba Pendant with Semi-Frosted Outer Shade

NRS19-464SF	Rail Mount	40W G9 max.
NRS99-464SF	Canopy Mount	40W G9 max.

Lamp: 40W max. G9 (included)
Finish: Brushed Nickel (BN), Bronze (BZ), Silver (S)
Glass: Semi-Frosted Outer Shade (SF)
Dimensions: Diameter: 5-1/8" (130mm) Length: 9-1/4" (234mm)
 Max Drop: 8' 6" (259cm)

- cULus Listed

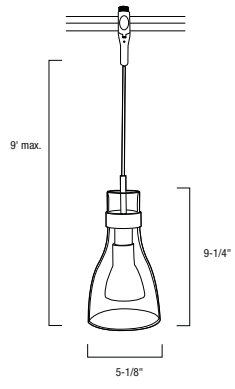

Line Voltage Biba Pendant with Clear Outer Shade and Frosted White Inner Shade

NRS19-464CL	Rail Mount	40W G9 max.
NRS99-464CL	Canopy Mount	40W G9 max.

Lamp: 40W max. G9 (included)
Finish: Brushed Nickel (BN), Bronze (BZ), Silver (S)
Glass: Clear Outer Shade and White Frosted Inner Shade (CL)
Dimensions: Diameter: 5-1/8" (130mm) Length: 9-1/4" (234mm)
 Max Drop: 8' 6" (259cm)

- NRS80-405 Frosted Inner Shade available in 5 colors. See below.
- cULus Listed



Biba Frosted Inner Shade (sold separately)
 for NRS19-464CL and NRS99-464CL only

NRS80-405BU	Blue
NRS80-405GR	Green
NRS80-405O	Orange
NRS80-405R	Red
NRS80-405Y	Yellow

- For use with NRS19-464CL and NRS99-464CL only.

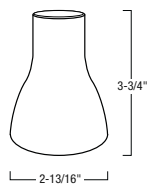

ELBOW

NWE Series shown in
Bronze finish with
NRS80-490AM
Trumpet Glass Shade



FLEX

NWF Series shown
in Bronze finish with
NRS80-493AM
Water Fall Glass Shade



SPHERE

NWS Series shown in
Brushed Nickel finish with
NRS70-605CL
Hourglass Angoor
Beaded Glass Shade



CONCORD

NWO Series shown in
Brushed Nickel finish with
NWG-201W
ADA Compliant Glass Shade



CHIC

NWC Series shown in
Silver finish with
NRS80-891AM
Snow Glass Shade

Bottom stem of chic may be
removed for alternate look!



TORCH

NWT Series shown in
Brushed Nickel finish with
NRS80-883RF
Pool Glass Shade

Wall Sconces

Nora Lighting is pleased to announce its new line of Wall Sconces, available in five lamp sources including the new GU24 socket base that accommodates self-ballasted compact fluorescent lamps from 13W to 26W. **Innovative telescopic horizontal arms** accommodate a range of glass sizes and styles to easily match pendant glass for a beautiful, coordinated design.

- 6 stylish new designs
- 5 Lamp sources as shown below
- Telescoping horizontal arm provides extension from 2" to 4" from the canopy on most designs.
- 3 Quality finishes - Brushed Nickel, Bronze, and Silver
- Impeccable focus on detail and quality
- Sconce glass may be mounted facing up or down (except for Concord)
- Accepts a large assortment of new Domestic and Italian glass, ordered separately.

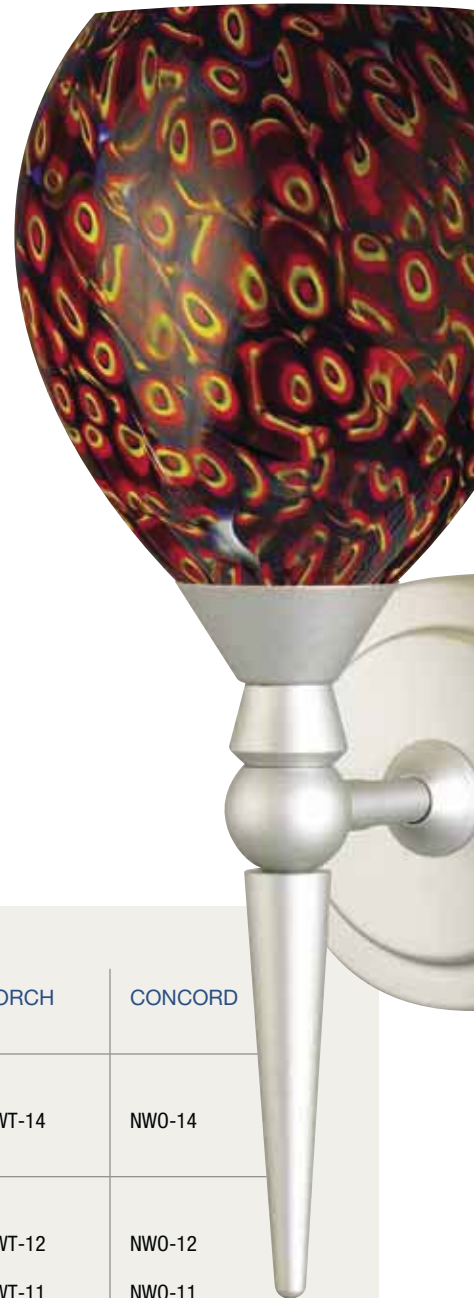

STYLE	CHIC	ELBOW	FLEX	SPHERE	TORCH	CONCORD
COMPACT FLUORESCENT* 13W-26W max. GU24 Base	NWC-14	—	—	—	NWT-14	NWO-14
LINE VOLTAGE						
60W max. E12 Candelabra Base	NWC-12	NWE-12	NWF-12	NWS-12	NWT-12	NWO-12
100W max. E26 Medium Base A19	NWC-11	—	—	—	NWT-11	NWO-11
40W max. G9 Base	NWC-19	NWE-19	NWF-19	NWS-19	NWT-19	NWO-19
LOW VOLTAGE						
50W max. Bi-Pin - Standard	NWC-46	NWE-46	NWF-46	NWS-46	NWT-46	NWO-46
TELESCOPING ARM	Yes	No	Yes	Yes	Yes	No
FINISH***	Brushed Nickel (BN), Bronze (BZ), Silver (S)					BN, BZ, S
GLASS SHADE	Ordered separately. See pages 416-433 for glass options. Compatibility chart on page 459.					NWG-201 AM, BU, R, W

* Utilizes self-ballasted lamp.

GLASS SHADES, PENDANTS & WALL SCONCES

Wall Sconces



NEW!



Chic Wall Sconce

NWC-14	Compact Fluor.	26W GU24 Self Ballasting max.
NWC-12	Line Voltage	60W Candelabra max.
NWC-11	Line Voltage	100W Medium Base max.
NWC-19	Line Voltage	40W G9 Halogen max.
NWC-46	Low Voltage	50W Bi-Pin G5.3/6.35 max.

Finish: Brushed Nickel (BN), Bronze (BZ), Silver (S)

Dimensions: Canopy Dia.: 4-1/2" Canopy Depth: 7/8"
Minimum Ext.: 4-1/2" Max Ext.: 5-7/8"

- NWC-46 includes 60W electronic transformer.
- NWC-19 and NWC-46 include lamp shield.
- Telescoping arm
- Bottom stem of Chic may be removed for alternate look
- Accepts attractive glass shades, ordered separately. (Pages 416-433)
- Please refer to Sconce-Glass-Lamp compatibility chart on page 459.

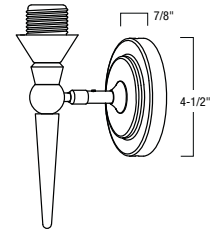

4-1/2" min
5-7/8" max

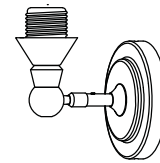

NEW!



Elbow Wall Sconce

NWE-12	Line Voltage	60W Candelabra max.
NWE-19	Line Voltage	40W G9 Halogen max.
NWE-46	Low Voltage	50W Bi-Pin G5.3/6.35 max.

Finish: Brushed Nickel (BN), Bronze (BZ), Silver (S)

Dimensions: Canopy Dia.: 4-1/2" Canopy Depth: 7/8" Ext.: 4-1/4"

- NWE-46 includes 60W electronic transformer.
- NWE-19 and NWE-46 include lamp shield.
- Accepts attractive glass shades, ordered separately. (Pages 416-433)
- Please refer to Sconce-Glass-Lamp compatibility chart on page 459.

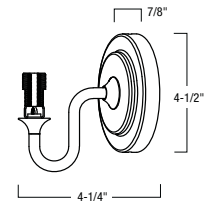

4-1/4"

NEW!



Flex Wall Sconce

NWF-12	Line Voltage	60W Candelabra max.
NWF-19	Line Voltage	40W G9 Halogen max.
NWF-46	Low Voltage	50W Bi-Pin G5.3/6.35 max.

Finish: Brushed Nickel (BN), Bronze (BZ), Silver (S)

Dimensions: Canopy Dia.: 4-1/2" Canopy Depth: 7/8"
Minimum Ext.: 4" Max Ext.: 5-3/8"

- NWF-46 includes 60W electronic transformer.
- NWF-19 and NWF-46 include lamp shield.
- Telescoping arm
- Accepts attractive glass shades, ordered separately. (Pages 416-433)
- Please refer to Sconce-Glass-Lamp compatibility chart on page 459.

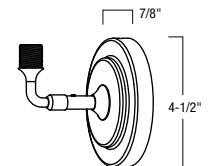

4" min
5-3/8" max

Glass ordered separately. See pages 416-433 for glass options. Compatibility chart on page 459.



Wall Sconces

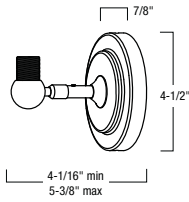

Sphere Wall Sconce

NWS-12	Line Voltage	60W Candelabra max.
NWS-19	Line Voltage	40W G9 Halogen max.
NWS-46	Low Voltage	50W Bi-Pin G5.3/6.35 max.

Finish: Brushed Nickel (BN), Bronze (BZ), Silver (S)

Dimensions: Canopy Dia.: 4-1/2" Canopy Depth: 7/8"
Minimum Ext.: 4-1/16" Max Ext.: 5-3/8"

- NWS-46 includes 60W electronic transformer.
- NWS-19 and NWS-46 include lamp shield.
- Telescoping arm
- Accepts attractive glass shades, ordered separately. (Pages 416-433)
- Please refer to Sconce-Glass-Lamp compatibility chart on page 459.

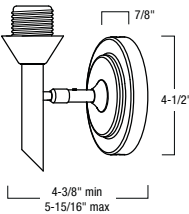

Torch Wall Sconce

NWT-14	Compact Fluor.	26W GU24 Self Ballasting max.
NWT-12	Line Voltage	60W Candelabra max.
NWT-11	Line Voltage	100W Medium Base max.
NWT-19	Line Voltage	40W G9 Halogen max.
NWT-46	Low Voltage	50W Bi-Pin G5.3/6.35 max.

Finish: Brushed Nickel (BN), Bronze (BZ), Silver (S)

Dimensions: Canopy Dia.: 4-1/2" Canopy Depth: 7/8"
Minimum Ext.: 4-3/8" Max Ext.: 5-15/16"

- NWT-46 includes 60W electronic transformer.
- NWT-19 and NWT-46 include lamp shield.
- Telescoping arm
- Accepts attractive glass shades, ordered separately. (Pages 416-433)
- Please refer to Sconce-Glass-Lamp compatibility chart on page 459.

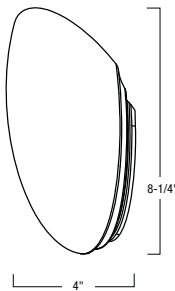

Concord Wall Sconce (ADA Compliant)

NWO-14	Compact Fluor.	26W GU24 Self Ballasting max.
NWO-12	Line Voltage	60W Candelabra max.
NWO-11	Line Voltage	100W Medium Base max.
NWO-19	Line Voltage	40W G9 Halogen max.
NWO-46	Low Voltage	50W Bi-Pin G5.3/6.35 max.
NWG-201	ADA Compliant Glass Shade	

Finish: Brushed Nickel (BN), Bronze (BZ), Silver (S)

Glass: Beautifully diffused soft form with an open top

Glass Color: Amber (AM), Blue (BU), Red (R), White (W)

Dimensions: Canopy Dia.: 4-1/2" Canopy Depth: 7/8" Max Ext.: 4"

- NWO-46 includes 60W electronic transformer.
- NWO-19 and NWO-46 include lamp shield.
- Accepts NWG-201 glass shade only.

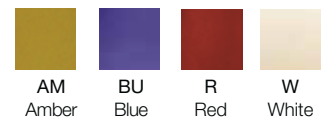

Glass ordered separately. See pages 416-433 for glass options. Compatibility chart on page 459.

Pendant-Glass-Lamp Compatibility Chart

PENDANTS	STYLE	RAIL					TRACK					CANOPY					MINI RAIL	MINI TRACK	QUICK JACK
	LAMP	G9	Bi-Pin	Cand	Med	GU24	G9	Bi-Pin	Cand	Med	GU24	G9	Bi-Pin	Cand	Med	GU24	Bi-Pin	Bi-Pin	Bi-Pin
	ITEM NO.	NRS19-450	NRS34-450	NRS19-465	NRS10-466	NRS48-468	NTH-162	NTH-309	NTH-160	NTH-161	NTH-163	NRS99-P45	NRS99-P45/12	NRS99-P55	NRS99-P56	NRS99-P58	NMRS32-450	NLMT-734	NRS86-457
NG-10																			
NG-50																			
NG-66																			
NG-70																			
NG-80																			
NG-90																			
NMRS80-478																			
NRS70-601																			
NRS70-602																			
NRS70-603																			
NRS70-604																			
NRS70-605																			
NRS70-606																			
NRS70-607																			
NRS70-608																			
NRS80-204																			
NRS80-401																			
NRS80-402																			
NRS80-403																			
NRS80-404																			
NRS80-406																			
NRS80-407																			
NRS80-408																			
NRS80-411																			
NRS80-451																			
NRS80-452																			
NRS80-453																			
NRS80-454																			
NRS80-455																			
NRS80-456																			
NRS80-457																			
NRS80-458																			
NRS80-459																			
NRS80-461																			
NRS80-462																			
NRS80-463																			
NRS80-465																			
NRS80-466																			
NRS80-467																			
NRS80-468																			
NRS80-469																			
NRS80-470																			
NRS80-471																			
NRS80-472																			
NRS80-473																			
NRS80-474																			
NRS80-475																			
NRS80-476																			
NRS80-477																			
NRS80-480																			
NRS80-482																			
NRS80-483																			
NRS80-484																			
NRS80-485																			
NRS80-486																			
NRS80-487																			
NRS80-490																			
NRS80-491																			
NRS80-492																			
NRS80-493																			
NRS82-201																			
NRS82-202																			
NRS82-203																			
NRS82-204																			

LAMP KEY	
G9	40W G9 Line Voltage
Bi-Pin	50W Bi-Pin G5.3/6.35 Low Voltage
Cand	60W E12 Candelabra Base Line Voltage
Med	100W E26 Medium Base Line Voltage
GU24	13W-26W Self Ballasting GU24 CFL

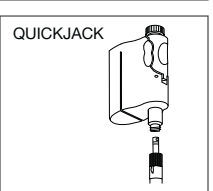
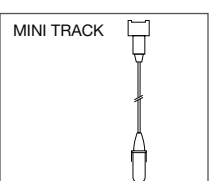
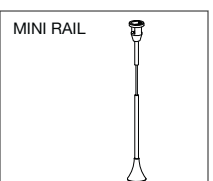
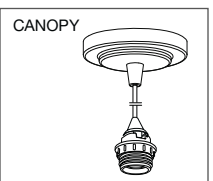
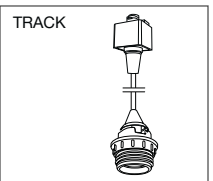
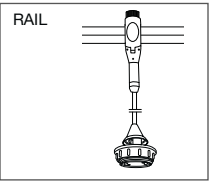

Order Example: NRS10-466S + NRS80-480BU (Rail Mounted Pendant Cord, Med. Base Incan., Silver Finish + Rain Glass, Blue Finish)

1 - 13W Self-Ballasting GU24 CFL Max 2 - 18W Self-Ballasting GU24 CFL Max

Sconce·Glass·Lamp Compatibility Chart

SCONCES	STYLE	ELBOW			FLEX			TORCH					CHIC					SPHERE		
	LAMP	G9	Bi-Pin	Cand	G9	Bi-Pin	Cand	G9	Bi-Pin	Cand	Med	GU24	G9	Bi-Pin	Cand	Med	GU24	G9	Bi-Pin	Cand
	ITEM NO.	NWE-19	NWE-46	NWE-12	NWF-19	NWF-46	NWF-12	NWT-19	NWT-46	NWT-12	NWT-11	NWT-14	NWC-19	NWC-46	NWC-12	NWC-11	NWC-14	NWS-19	NWS-46	NWS-12
NG-10					*	*		*	*				*	*				*	*	
NG-50		*	*		*	*		*	*				*	*				*	*	
NG-66		*	*		*	*		*	*				*	*				*	*	
NG-70		*	*		*	*		*	*				*	*				*	*	
NG-90		*	*		*	*		*	*				*	*				*	*	
NRS70-601					*	*		*	*				*	*				*	*	
NRS70-602					*	*	*	*	*	*			*	*	*			*	*	*
NRS70-603					*	*		*	*				*	*				*	*	
NRS70-604					*	*		*	*				*	*				*	*	
NRS70-605					*	*	*	*	*	*			*	*	*			*	*	*
NRS70-606					*	*	*	*	*	*			*	*	*			*	*	*
NRS70-607					*	*	*	*	*	*			*	*	*			*	*	*
NRS70-608					*	*		*	*				*	*				*	*	
NRS80-204		*	*		*	*		*	*				*	*				*	*	
NRS80-401		*	*		*	*		*	*				*	*				*	*	
NRS80-402					*	*		*	*				*	*				*	*	
NRS80-403					*	*		*	*				*	*				*	*	
NRS80-404					*	*		*	*				*	*				*	*	
NRS80-406		*	*		*	*		*	*				*	*				*	*	
NRS80-407					*	*	*	*	*	*			*	*	*			*	*	*
NRS80-408		*	*		*	*		*	*				*	*				*	*	
NRS80-411					*	*		*	*				*	*				*	*	
NRS80-451					*	*	*	*	*	*			*	*	*			*	*	*
NRS80-452					*	*	*	*	*	*			*	*	*			*	*	*
NRS80-453					*	*		*	*				*	*				*	*	
NRS80-454					*	*		*	*				*	*				*	*	
NRS80-455					*	*		*	*				*	*				*	*	
NRS80-456		*	*		*	*		*	*				*	*				*	*	
NRS80-457					*	*		*	*				*	*				*	*	
NRS80-458		*	*		*	*		*	*				*	*				*	*	
NRS80-459		*	*		*	*		*	*				*	*				*	*	
NRS80-461					*	*		*	*				*	*				*	*	
NRS80-462		*	*	*	*	*	*	*	*	*			*	*	*			*	*	*
NRS80-463		*	*		*	*		*	*				*	*				*	*	
NRS80-465		*	*		*	*		*	*				*	*				*	*	
NRS80-466		*	*		*	*		*	*				*	*				*	*	
NRS80-467					*	*		*	*				*	*				*	*	
NRS80-468					*	*		*	*				*	*				*	*	
NRS80-469					*	*		*	*				*	*				*	*	
NRS80-470		*	*	*	*	*	*	*	*	*			*	*	*			*	*	*
NRS80-471		*	*	*	*	*		*	*	*			*	*	*			*	*	*
NRS80-472					*	*		*	*				*	*				*	*	
NRS80-474		*	*	*	*	*		*	*				*	*				*	*	
NRS80-475		*	*	*	*	*		*	*				*	*				*	*	
NRS80-476		*	*	*	*	*		*	*				*	*				*	*	
NRS80-480		*	*	*	*	*		*	*				*	*				*	*	
NRS80-482					*	*		*	*				*	*				*	*	
NRS80-483					*	*		*	*	*			*	*				*	*	
NRS80-484		*	*	*	*	*		*	*				*	*				*	*	
NRS80-485					*	*		*	*				*	*	*			*	*	
NRS80-490		*	*	*	*	*		*	*				*	*	*			*	*	*
NRS80-491					*	*		*	*				*	*				*	*	
NRS80-492					*	*		*	*				*	*				*	*	
NRS80-493					*	*		*	*				*	*				*	*	
NRS80-891											*2	*2				*2	*2			
NRS80-892											*	*				*	*			
NRS80-893											*2	*2				*2	*2			
NRS82-201		*	*		*	*		*	*				*	*				*	*	
NRS82-202		*	*		*	*		*	*				*	*				*	*	
NRS82-203		*	*		*	*		*	*				*	*				*	*	
NRS82-204		*	*		*	*		*	*				*	*				*	*	

LAMP KEY	
G9	40W G9 Line Voltage
Bi-Pin	50W Bi-Pin G5.3/6.35 Low Voltage
Cand	60W E12 Candelabra Base Line Voltage
Med	100W E26 Medium Base Line Voltage
GU24	13W-26W Self Ballasting GU24 CFL

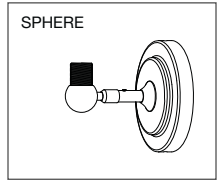
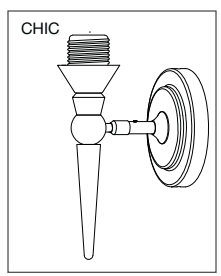
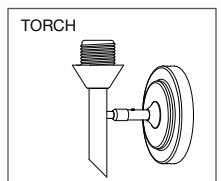
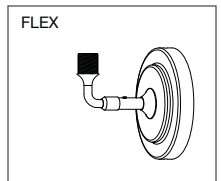
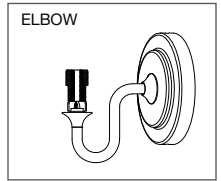

Order Example: NWT-14S + NRS80-891BU (Torch Wall Sconce, Silver Finish + Snow Glass, Blue Finish)

2 - 18W Self-Ballasting GU24 CFL Max



NORA RAIL

Introduction	463
Overview	464
LED Robo Cylinder	471
Line Voltage Fixtures	472
Incandescent PAR Fixtures	478
Low Voltage Fixtures & QuickJack	481
Metal Halide Fixtures	490
Fluorescent Fixtures	496
Specialty Rail Fixtures	498
Nora Rail Kits	499
Nora Rail Complete Pendants	505
Nora Rail Pendant Assemblies	507
Nora Rail Components	510
QuickJack Components	514
Nora Rail Accessories	515
Nora Rail Sample Layouts	516



The Nora Lighting family of

NORA



Award winning Nora Rail is the premiere Line Voltage Rail System in the marketplace, featuring all the lamping dynamics of conventional track with the curve appeal of low voltage rail. And since Nora Rail is a line voltage system it does not limit the user to single source of light or other limitations found in similar looking low voltage systems. Our large assortment of finely detailed, die-cast fixtures are complimented by an array of beautiful glass pendants. The capabilities are endless.

FEATURES

- Line voltage
- No transformer for system
- No voltage drop
- Design longer runs
- Accommodates 2400 watts on a single run from a single power point.
- Utilizes line voltage, low voltage, high-output fluorescent, metal halide and LED fixtures simultaneously on the same line voltage system if desired.
- Easily accepts line voltage LED Lamping.
- cU.L.us listed for 20 amps
- Field bendable to a 2ft. diameter circle
- Field cut-able
- Easier to design
- Telescoping supports for easy in the field leveling
- Simpler and faster to install
- No expensive dimming controls
- Available in Brushed Nickel, Bronze or Silver finishes
- cULus Listed



Overview NORA RAIL SYSTEM

LED FIXTURE

NEW!

LED!



NRE-820LED Robo Cylinder
9W LED p.471

LINE VOLTAGE RAIL FIXTURES - GU10



NRS11-101 Argon Curve
50W GU10 p.473



NRS11-102 Argon Swivel
50W GU10 p.473

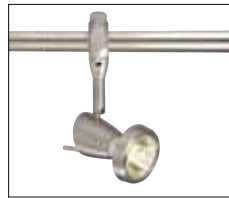

NRS11-103 Sienna w/Ring
50W GU10 p.473

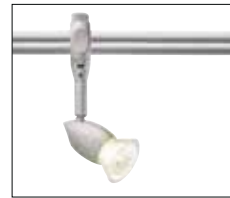

NRS11-104 Neat
50W GU10 p.473



NRS11-105 Satellit Curve
50W GU10 p.474



NRS11-106 Satellit Swivel
50W GU10 p.474



NRS11-107 Neon
50W GU10 p.474



NRS11-108 Lika
50W GU10 p.474



NRS11-112 Skyteam
75W R111 p.475

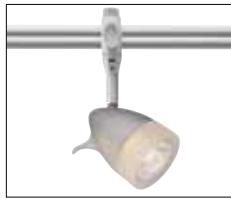

NRS11-251 Kano Spot
50W GU10 p.475



NRS11-252 New Mirage
50W GU10 p.475



NRS11-253 Lima
50W GU10 p.475



NRS11-310 Fili Display
50W GU10 p.478

NRS11-302 Ives Gooseneck
50W GU10 p.478

LINE VOLTAGE RAIL FIXTURES - G9



NRS11-260 Mercure Swivel
40W G9 p.476



NRS19-501 Pin Glass Fixture
40W G9 p.476



NRS19-201 Petra Curve
40W G9 p.476

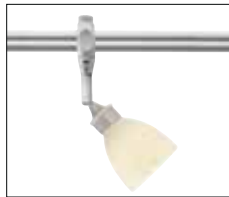

NRS19-202 Petra Swivel
40W G9 p.477

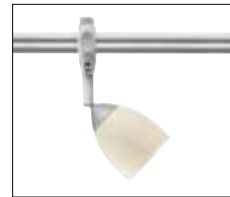

NRS19-203 Melody
40W G9 p.477

LINE VOLTAGE RAIL FIXTURES - INCANDESCENT PAR



NRS19-204 Swiftec
40W G9 p.477



NRS19-474 Eric
40W G9 p.477



NRS18-122 PAR20 Ulysses
NRS18-123 PAR30 Ulysses
NRS18-128 PAR38 Ulysses
50W PAR20 / 75W PAR30 /
250W PAR38 p.479



NRS18-133 PAR30 Belgium
NRS18-138 PAR38 Belgium
75W PAR30 / 250W PAR38 p.479



NRS18-176 PAR20
NRS18-177 PAR30
NRS18-178 PAR38
High-Tech Wire
50W PAR20 / 75W PAR30 /
250W PAR38 p.480

LOW VOLTAGE RAIL FIXTURES



NRS33-901 Penumbra
20W-50W AR111 p.487



NRS33-902 Skyteam
20W- 50W AR111 p.488

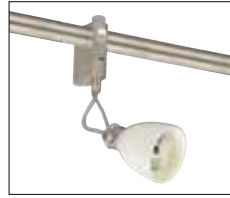

NRS34-201PW Petra Curve
20W- 50W MR16 p.488



NRS34-202PW Petra Swivel
20W- 50W MR16 p.488



NRS34-203PW Melody
20W- 50W MR16 p.488



NRS34-204 Swiftec
20W- 50W MR16 p.489



NRS36-101 Argon Curve
20W- 50W MR16 p.484



NRS36-102 Argon Swivel
20W- 50W MR16 p.484

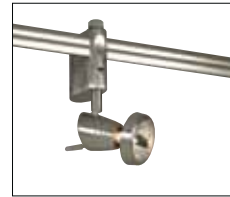

NRS36-103 Sienna with Ring
20W- 50W MR16 p.484



NRS36-104 Neat
20W- 50W MR16 p.485



NRS36-105 Satellit Curve
20W- 50W MR16 p.485



NRS36-106 Satellit Swivel
20W- 50W MR16 p.485



NRS36-107 Neon
20W- 50W MR16 p.485



NRS36-251 Kano Spot
20W- 50W MR16 p.489



NRS36-252 New Mirage
20W- 50W MR16 p.489

LOW VOLTAGE QUICKJACK FIXTURES



NRS90-P32 QuickJack Adapter with Integral Transformer
20W- 50W Electronic Trans. p.485

Needed for all NRS66 series to attach to Rail



NRS66-101 Argon Curve
20W- 50W MR16 p.484



NRS66-102 Argon Swivel
20W- 50W MR16 p.484



NRS66-103 Sienna with Ring
20W- 50W MR16 p.484



NRS66-104 Neat
20W- 50W MR16 p.484



NRS66-105 Satellit Curve
20W- 50W MR16 p.485



NRS66-106 Satellit Swivel
20W- 50W MR16 p.485

Overview NORA RAIL SYSTEM continued

LOW VOLTAGE QUICKJACK FIXTURES *continued*



NRS66-107 Neon
20W- 50W MR16 p.485



NRS66-108 Lika
20W- 50W MR16 p.485



NRS66-109 Nica
20W- 50W MR16 p.487



NRS66-901 Penumbra
20W- 50W AR111 p.487



NRS66-902 Skyteam
20W- 50W AR111 p.488

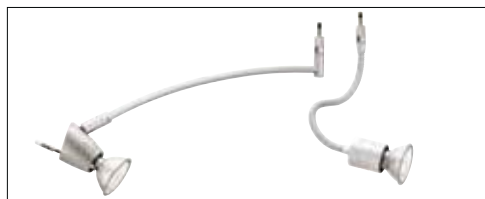

NRS66-310 Fili Display
20W- 50W MR16 p.487



NRS66-302 Ives Gooseneck
20W- 50W MR16 p.487



NRS66-201PW Petra Curve
20W- 50W MR16 p.488



NRS66-202PW Petra Swivel
20W- 50W MR16 p.488

NRS66-203PW Melody
20W- 50W MR16 p.488



NRS66-204 Swiftec
20W- 50W Bi-Pin / MR16 p.489



NRS66-251 Kano Spot
20W- 50W MR16 p.489



NRS66-252 New Mirage
20W- 50W MR16 p.489



NRS66-253 Lima
20W- 50W MR16 p.489



NRS66-457 8.5' Pendant
20W- 50W Bi-Pin / MR16 p.509



NRS66-458 20' Pendant
20W- 50W Bi-Pin / MR16 p.509



NRS66-462 Ambra Pendant
20W- 50W Bi-Pin p.506



NRS66-463 Petra Pendant
20W- 50W Bi-Pin p.506

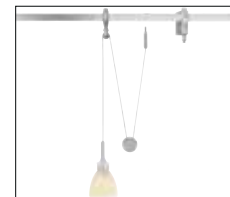

NRS66-562 Ambra Yoyo Pendant
20W- 50W Bi-Pin p.506

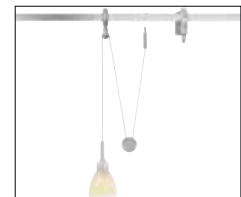

NRS66-563 Petra Yoyo Pendant
20W- 50W Bi-Pin p.506



NRS99-P51 Shallow QuickJack Monopoint Ceiling Canopy
20W- 50W Bi-Pin / MR16 p.514



NMRS90-P32 Mini Rail QuickJack Adapter
20W- 50W Bi-Pin / MR16 p.514



NT-370 QuickJack Track Adapter with Transformer
20W- 50W Bi-Pin / MR16 p.514



NLMT-760 Mini Track QuickJack Adapter
20W- 50W Bi-Pin / MR16 p.514



Multi QuickJack Canopy NP66-103 Linear Canopy NP66-203 Round Canopy
20W- 50W Bi-Pin / MR16 p.514

CERAMIC METAL HALIDE RAIL FIXTURES



NRS51-103 HID Sienna w/ Ring
39W MR16 CMH p.491

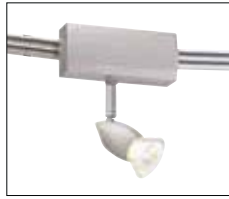

NRS51-104 HID Neat
39W MR16 CMH p.491

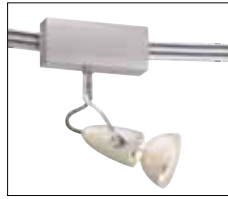

NRS51-105 HID Satelit Curve
39W MR16 CMH p.491

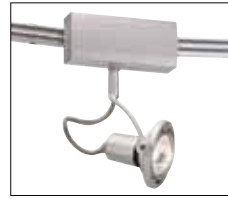

NRS51-108 HID Lika
39W MR16 CMH p.492

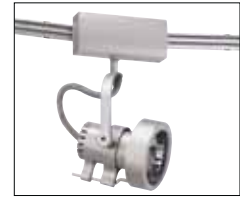

NRS52-155 HID Ulysses
Bi-Pin 20-70W T4-5 CMH p.492



NRS52-156 HID Ulysses
Bi-Pin 39W T4-5 CMH p.492



NRS52-157 HID Ulysses
Bi-Pin 70W T4-5 CMH p.492



NRS54-220 T4 Q-Tech
20W/39W/70W T4 CMH p.491



NRS56-220 T6 Q-Tech
39W/70W T6 CMH p.491



NRS59-158 HID Skyteam
39W ES36 CMH p.493



NRS58-152 HID Ulysses
20W-39W PAR20 CMH p.492



NRS58-153 HID Ulysses
39W-70W PAR30 CMH p.493



NRS58-154 HID Ulysses
70W PAR38 CMH p.493



NRS61-101 HID Argon
20W MR16 CMH p.493



NRS61-103 HID Sienna
20W MR16 CMH p.494



NRS61-104 HID Neat
20W MR16 CMH p.494



NRS61-105 HID Satelit Curve
20W MR16 CMH p.494



NRS61-108 HID Lika
20W MR16 CMH p.494



NRS61-110 HID Dallas
20W MR16 CMH p.495



NRS61-253 HID Lima
20W MR16 CMH p.495

FLUORESCENT HIGH OUTPUT FIXTURES



NRS45-201 Nepro Wall Wash
2 x 24W T5 HO p.497

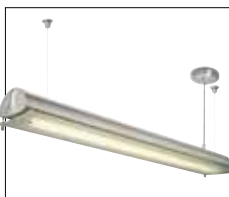

NRS45-301 Nepro Canopy Mount Pendant
2 x 24W T5 HO p.497

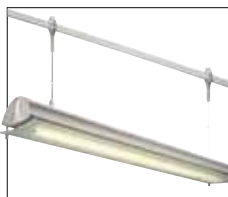

NRS45-401 Nepro Rail Pendant
2 x 24W T5 HO p.497

Overview NORA RAIL SYSTEM continued

SPECIALTY RAIL FIXTURES

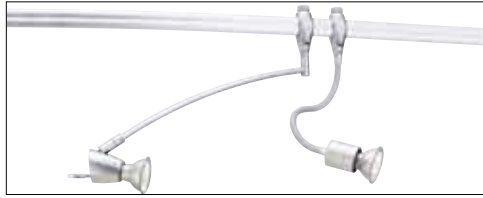

NRS11-310 Fili Display
50W GU10 p.478

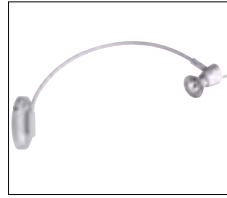

NRS11-302 Ives Gooseneck
50W GU10 p.478



NRS17-301 Nepro
150W-300W R7S p.498



NRS55-301 HID Nepro
39W T4 CMH p.492

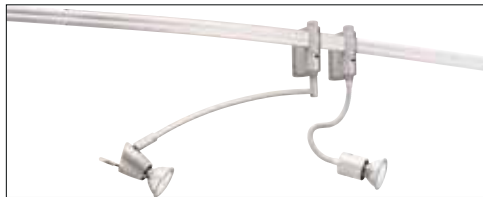

NRS36-310 Fili Display
20W- 50W MR16 p.487



NRS36-302 Ives Gooseneck
20W- 50W MR16 p.487



NRS36-320 Exhibit Display
with Canopy
20W- 50W MR16 p.498

NORA RAIL KIT FIXTURES



NRS29-C204 2' Circle Rail Kit
with Swift Glass Fixture
3 X 40W G9 Halogen p.500



NRS21-4104 4' Straight Rail
Kit with Neat Fixture
3 X 50W MR16 GU10 p.500



NRS29-4201 4' Straight Rail
Kit with Paris Glass Fixture
3 X 40W G9 p.500



NRS29-4202 4' Straight Rail
Kit with Monte Glass Fixture
3 X 40W G9 p.501



NRS29-4203 4' Straight Rail
Kit with Chicago Glass Fixture
3 X 40W G9 p.501



NRS29-4204 4' Straight Rail
Kit with Madeline Glass Fixture
3 X 40W G9 p.501



NRS29-4411 4' Straight Rail
Kit with Ice Cube Glass Pendant
3 X 40W G9 p.502



NRS29-6451 6'6" Straight Rail
Kit w/ Neptune Glass Pendant
3 X 40W G9 p.502



NRS29-6462 6'6" Straight
Rail Kit with Casie Glass Pendant
3 X 40W G9 p.502



NRS21-8104 8' S-Curve Rail
Kit with Neat Fixture
4 X 50W MR16 GU10 p.503



NRS21-102 8' S-Curve Rail
Kit with Argon Swivel Fixture
4 X 50W GU10 p.503



NRS21-252 8' S-Curve Rail
Kit with Mirage Fixture
4 X 50W GU10 p.503



NRS90-K663 6'-6" Straight
Rail Starter Kit
Starter Kit p.499



NRS90-K833 8' S-Curve Rail
Starter Kit
Starter Kit p.499

RAIL MOUNT COMPLETE PENDANTS - includes Pendant Assembly and Shade

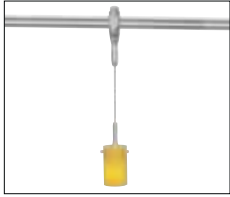

NRS19-460 Swift Pendant
40W G9 Halogen p.505



NRS19-462 Line Voltage 40W
NRS34-462 Low Voltage 50W
NRS66-462 QuickJack 40W
Ambra Porcelain Pendant
G9 Halogen / Bi-Pin / MR16 p.506



NRS19-463 Line Voltage 40W
NRS34-463 Low Voltage 50W
NRS66-463 QuickJack 40W
Petra Porcelain Pendant
G9 Halogen / Bi-Pin / MR16 p.506

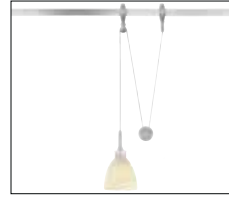

NRS19-562 Line Voltage 40W
NRS34-562 Low Voltage 50W
NRS66-562 QuickJack 40W
Ambra Porcelain Yoyo Pendant
G9 Halogen / Bi-Pin / MR16 p.506

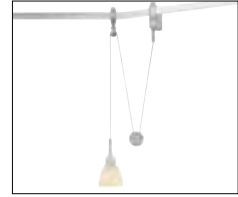

NRS19-563 Line Voltage 40W
NRS34-563 Low Voltage 50W
NRS66-563 QuickJack 40W
Petra Porcelain Yoyo Pendant
G9 Halogen / Bi-Pin / MR16 p.506



NRS19-464CL Line Voltage
Biba Clear Pendant
40W G9 Halogen p.505



NRS19-464FR Line Voltage
Biba Frost Pendant
40W G9 Halogen p.505



NRS19-464SF Line Voltage
Biba Semi-Frost Pendant
40W G9 Halogen p.505

RAIL MOUNT PENDANTS ASSEMBLIES - order glass shade separately on p.416-433



NRS10-466 Line Voltage 8.5'
Medium Base Rail Mount Pendant
100W Medium Base p.508



NRS19-450 Line Voltage 8.5'
NRS19-456 Line Voltage 20'
G9 Halogen Rail Mount Pendant
40W G9 Halogen p.508



NRS19-465 Line Voltage 8.5'
Candelabra Rail Mount Pendant
60W Candelabra p.508



NRS48-468 Com. Fluor 8.5'
GU24 CFL Rail Mount Pendant
13W-26W GU24 CFL p.508



NRS34-450 Low Voltage 8.5'
NRS34-456 Low Voltage 20'
Bi-Pin Rail Mount Pendant
20W-50W Bi-Pin p.509



NRS66-457 Low Voltage 8.5'
NRS66-458 Low Voltage 20'
Bi-Pin QuickJack Pendant
20W-50W Bi-Pin

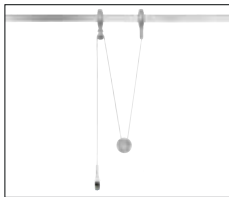

p.XX509 **NRS19-551** Line
Voltage
Rail Mount Yoyo Pendant
40W G9 Halogen p.509

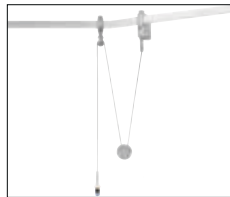

NRS34-551 Low Voltage Rail
Mount Yoyo Pendant
20-50W JC/MR11/MR16 p.509



NRS19-501 Line Voltage
G9 Rail Fixture for Pin Glass
40W G9 Halogen p.507



NRS90-P86 Line Voltage
Universal Pendant Adapter
p.507

RAIL SYSTEM AND ACCESSORIES



Nora Rail Components
Rail, Power Feeds, etc. p.510

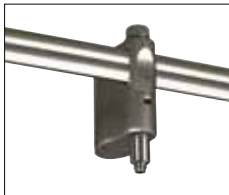

Nora QuickJack Components
p.514



Nora Rail Accessories
p.515



LED

Nora Lighting is pleased to introduce the incredible new Robo Cylinder 9 watt LED fixture to our Line Voltage Rail System. This extremely energy efficient fixture is also beautifully styled, and fully adjustable. Combined with Robo Cylinder's extraordinary light output, this fixture can accommodate almost any design imaginable.

LED lighting is setting the energy standard. Nora's Line Voltage system can accommodate a variety of LED lamps without the inherent problems realized with low voltage systems.

Robo Cylinder LED Rail Fixture

NEW!

Nora Lighting's new Robo LED rail fixture is an energy efficient light source utilizing only 9 watts and producing no forward heat, U.V. or ultraviolet rays. Ideal for highlighting fine art and fabrics, the Robo features a clean, architectural low profile design. With savings of up to 80% over conventional 50W incandescent lamp sources and 70% over 35W Low voltage MR16 lamp sources, Nora's LED Robo rail fixture is an excellent lighting choice for energy conservation.



FEATURES

- **Ultra-contemporary styling** - Architectural low profile design.
- **9 Watts** - utilizes three 3 Watt LEDs
- **Two color temperatures** - 3000K Warm White and 4200K Cool White
- **Two beam spreads** - 30° Flood or 45° Wide.
- **Versatile Adjustability** - 345° Rotation. Driver and diode casting both pivot 180° independently of each other.

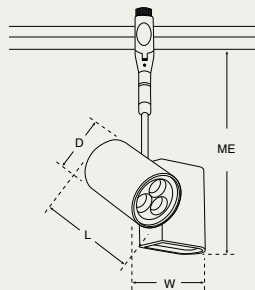

Robo Cylinder

NRE-820L	9W Max
Lamp:	3 x 3W LED (included)
Color Temp:	3000K Warm White (30), 4200K Cool White (42)
Beam Spread:	30° Flood (F), 45° Wide (W)
Finish:	Brushed Nickel (BN), Bronze (BZ), Silver (S)
Dimensions:	W: 5-5/8" L: 3-1/2" D: 2-3/8" Max Ext.: 8-1/2"
Adjustability:	345° Rotation. Both driver and diode castings pivot 180° independent of each other
Listing:	cULus Listed

HOW TO SPECIFY ORDER EXAMPLE: NRE-820L30F9BN

NRE-820L	30	F	9	BN
SERIES	COLOR TEMPERATURE	BEAM SPREAD	WATTAGE	FINISH
NRE-820L	30 = 3000K Warm White 42 = 4200K Cool White	F = 30° Flood W = 45° Wide	9	BN = Brushed Nickel BZ = Bronze S = Silver



Line Voltage Pendant Assemblies
and Complete Pendants available.
See pages 505-509

Line Voltage

Nora Rail MR16 GU10 and G9 fixtures offer the latest in sculptured aluminum design, with intense attention to detail and clean shaping elements that blend into any contemporary design. Nora Rail Line Voltage fixtures accept GU10 base lamps that operate on 120V, requiring only standard, simple dimming controls while delivering crisp white light to any object or surface. The sturdy GU10 turn-and-lock base delivers long fixture and lamp life with unparalleled reliability.



NORA RAIL Line Voltage Fixtures

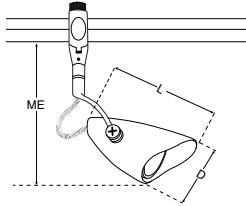

Argon Curve

NRS11-101 50W Max

- Lamp:** 50W GU10 (included)
- Finish:** Brushed Nickel (BN), Bronze (BZ), Silver (S)
- Dimensions:** Length: 4-1/2" Dia.: 2-3/8" Max Ext.: 7-1/8"
- Mobility:** 345° Rotation, 90° Pivoting Head

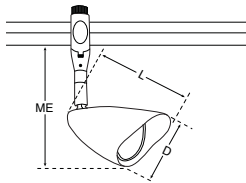

Argon Swivel

NRS11-102 50W Max

- Lamp:** 50W GU10 (included)
- Finish:** Brushed Nickel (BN), Bronze (BZ), Silver (S)
- Dimensions:** Length: 4-1/2" Dia.: 2-3/8" Max Ext.: 6-1/4"
- Mobility:** 345° Rotation, 90° Pivoting Head

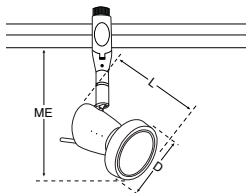

Sienna with Ring

NRS11-103 50W Max

- Lamp:** 50W GU10 (included)
- Finish:** Brushed Nickel (BN), Bronze (BZ), Silver (S)
- Dimensions:** Length: 4" Dia.: 2-5/16" Max Ext.: 5-3/4"
- Mobility:** 345° Rotation, 90° Pivoting Head
- Accessories:** NRS90-N32, NT-362, NM-100/MR16

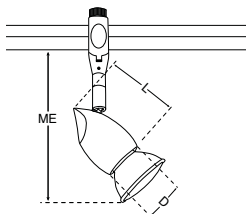

Neat

NRS11-104 50W Max

- Lamp:** 50W GU10 (included)
- Finish:** Brushed Nickel (BN), Bronze (BZ), Silver (S)
- Dimensions:** Length: 2-3/8" Dia.: 1-1/2" Max Ext.: 4-5/8"
- Mobility:** 345° Rotation, 90° Pivoting Head
- Accessories:** NRS90-N32, NT-362, NM-100/MR16



Line Voltage Fixtures continued



Satellit Curve

NRS11-105 50W Max

Lamp: 50W GU10 (included)
Finish: Brushed Nickel (BN), Bronze (BZ), Silver (S)
Dimensions: Length: 4-3/8" Dia.: 2-5/8" Max Ext.: 7-1/4"
Mobility: 345° Rotation, 90° Pivoting Head

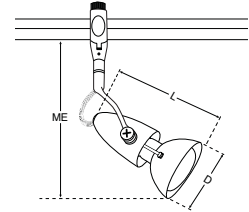

Satellit Swivel

NRS11-106 50W Max

Lamp: 50W GU10 (included)
Finish: Brushed Nickel (BN), Bronze (BZ), Silver (S)
Dimensions: Length: 4-3/8" Dia.: 2-5/8" Max Ext.: 7-1/4"
Mobility: 345° Rotation, 90° Pivoting Head

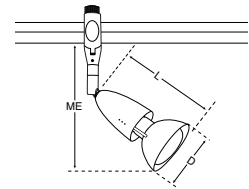

Neon

NRS11-107 50W Max

Lamp: 50W GU10 (included)
Finish: Brushed Nickel (BN), Bronze (BZ), Silver (S)
Dimensions: Length: 3-1/8" Dia.: 2-7/16" Max Ext.: 5-3/4"
Mobility: 345° Rotation, 90° Pivoting Head

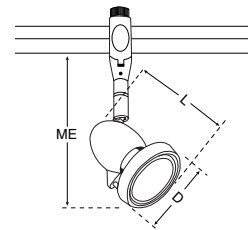

Lika

NRS11-108 50W Max

Lamp: 50W GU10 (included)
Finish: Brushed Nickel (BN), Bronze (BZ), Silver (S)
Dimensions: Length: 2-3/4" Dia.: 3" Max Ext.: 6-1/4"
Mobility: 345° Rotation, 90° Pivoting Head and 45° Lamp/Socket movement

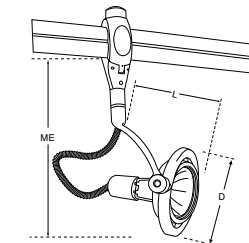



Line Voltage Fixtures continued

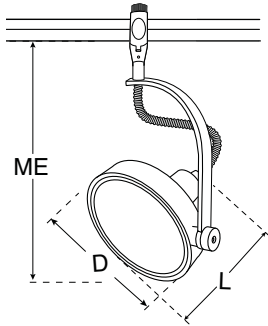

Skyteam

NRS11-112 75W Max

- Lamp:** 75W R111 (included)
- Finish:** Brushed Nickel (BN), Bronze (BZ), Silver (S)
- Dimensions:** Length: 3-1/2" Dia.: 4-7/8" Max Ext.: 9-5/8"
- Mobility:** 345° Rotation, 90° Pivoting Head

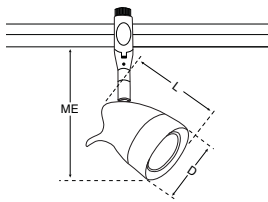

Kano Spot

NRS11-251 50W Max

- Lamp:** 50W GU10 (included)
- Finish:** Brushed Nickel (BN), Bronze (BZ), Silver (S)
- Dimensions:** Length: 3-5/8" Dia.: 2-5/8" Max Ext.: 6-1/8"
- Glass:** Frost (FR) or Blue (BU)
- Mobility:** 345° Rotation, 90° Pivoting Head

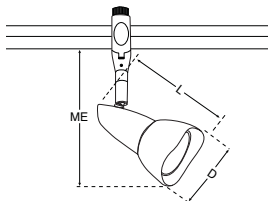
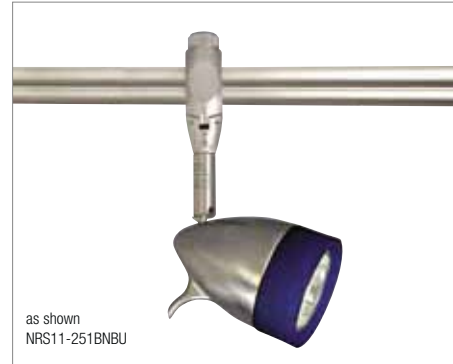

New Mirage

NRS11-252 50W Max

- Lamp:** 50W GU10 (included)
- Finish:** Brushed Nickel (BN), Bronze (BZ), Silver (S)
- Dimensions:** Length: 4-1/4" Dia.: 2-3/8" Max Ext.: 8-7/8"
- Glass:** Frost (FR), Blue (BU) or Porcelain White (PW)
- Mobility:** 345° Rotation, 90° Pivoting Head

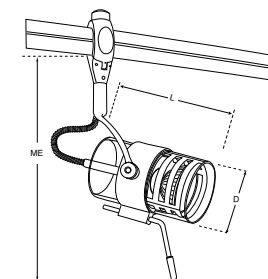

Lima

NRS11-253 50W Max

- Lamp:** 50W GU10 (included)
- Finish:** Brushed Nickel (BN), Bronze (BZ), Silver (S)
- Dimensions:** Length: 4-1/4" Dia.: 2-3/8" Max Ext.: 8-7/8"
- Mobility:** 345° Rotation, 90° Pivoting Head



Line Voltage Fixtures continued



NEW!



as shown
NRS11-260BZ with
NRS82-201AM

Mercure Swivel Spot

NRS11-260 40W Max

Lamp: 40W G9 Halogen (included)
Finish: Brushed Nickel (BN), Bronze (BZ), Silver (S)
Dimensions: Dia.: 1-1/4" Max Ext.: 7-1/4"
Mobility: 345° Rotation, 120° Pivoting Head

- For use with NG-10, NG-50, NG-66, NG-70, NG-80, NG-90, NRS70-601, NRS70-604, NRS70-608, NRS80-401, NRS80-407, NRS80-411, NRS80-453, NRS80-454, NRS80-455, NRS80-456, NRS80-457, NRS80-458, NRS80-459, NRS80-465, NRS80-466, NRS80-467, NRS80-468, NRS82-201, NRS82-202, NRS82-203, NRS82-204 (Glass sold separately. See p.422-433)

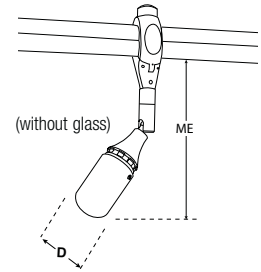

NEW!

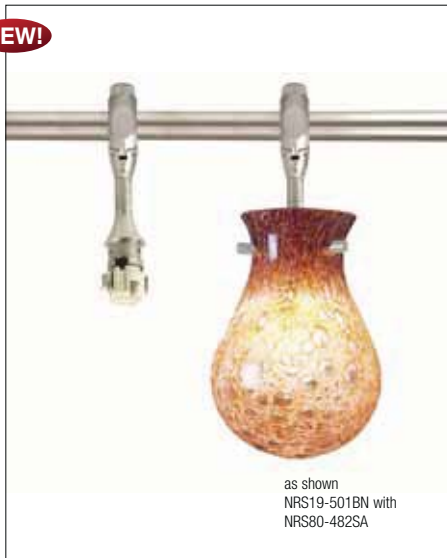

as shown
NRS19-501BN with
NRS80-482SA

G9 Rail Fixture for PIN Glass

NRS19-501 40W Max

Lamp: 40W G9 Halogen (included)
Finish: Brushed Nickel (BN), Bronze (BZ), Silver (S)
Dimensions: Dia.: 1-1/8" Max Ext.: 4-3/8"

- For use with NRS80-204, NRS80-474, NRS80-482, NRS80-484, NRS80-486, NRS80-487 (Glass sold separately. See p.417-431)

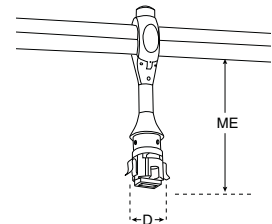
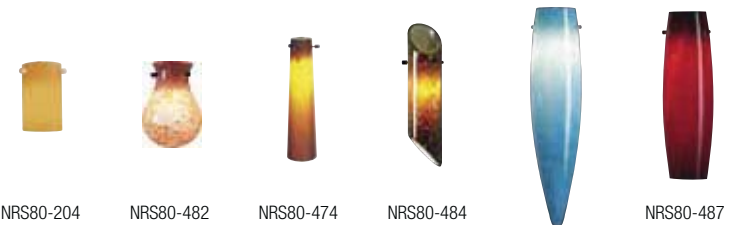

NRS80-486



Petra Curve

NRS19-201 40W Max

Lamp: 40W G9 (included)
Finish: Brushed Nickel (BN), Bronze (BZ), Silver (S)
Dimensions: Length: 4-1/8" Dia.: 2-15/16" Max Ext.: 8"
Glass: Porcelain White (PW) included
Mobility: 345° Rotation, 90° Pivoting Head

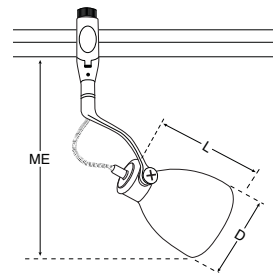



Line Voltage Fixtures continued

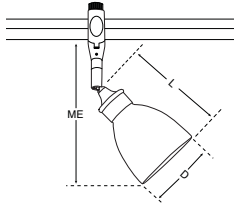

Petra Swivel

NRS19-202 40W Max

- Lamp:** 40W G9 (included)
- Finish:** Brushed Nickel (BN), Bronze (BZ), Silver (S)
- Dimensions:** Length: 4-1/4" Dia.: 2-15/16" Max Ext.: 6-1/2"
- Glass:** Porcelain White (PW) included
- Mobility:** 345° Rotation, 90° Pivoting Head

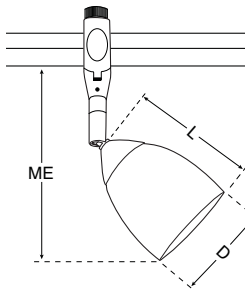
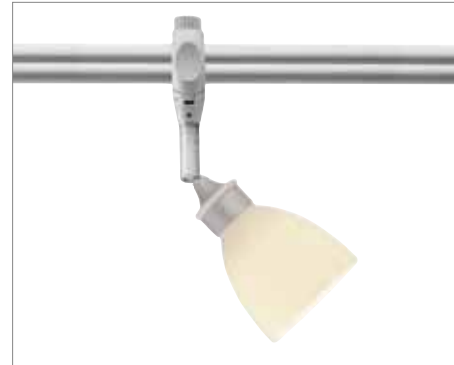

Melody

NRS19-203 40W Max

- Lamp:** 40W G9 (included)
- Finish:** Brushed Nickel (BN), Bronze (BZ), Silver (S)
- Dimensions:** Length: 3-3/8" Dia.: 2-11/16" Max Ext.: 6"
- Glass:** Porcelain White (PW) included
- Mobility:** 345° Rotation, 90° Pivoting Head

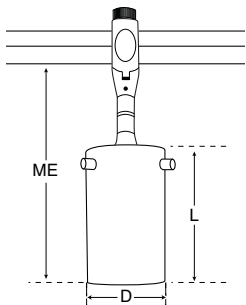

Swiftec

NRS19-204 40W Max

- Lamp:** 40W G9 (included)
- Finish:** Brushed Nickel (BN), Bronze (BZ), Silver (S)
- Dimensions:** Length: 4" Dia.: 2-3/8" Max Ext.: 6-1/2"
- Glass:** Frost (FR), Amber (AM) or Orange (O) included
- Note:** Also available as Rail Pendant, see page 505



as shown
NRS19-204SFR

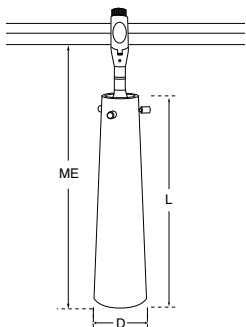

Eric

NRS19-474 40W Max

- Lamp:** 40W G9 (included)
- Finish:** Brushed Nickel (BN), Bronze (BZ), Silver (S)
- Dimensions:** Length: 9-7/8" Dia.: 2-5/8" Max Ext.: 12-3/8"
- Glass:** Amber (AM) or Frost (FR) included



as shown
NRS19-474BZAM

NORA RAIL

Line Voltage Fixtures continued



Ives Gooseneck

NRS11-302 50W Max

- Lamp:** 50W GU10 (included)
- Finish:** Brushed Nickel (BN), Bronze (BZ), Silver (S)
- Dimensions:** Length: 1-5/8" Dia.: 1-3/8" Max Ext.: 12"
- Mobility:** Flex can move in all direction
- Accessories:** NRS90-N32, NT-362, NM-100/MR16

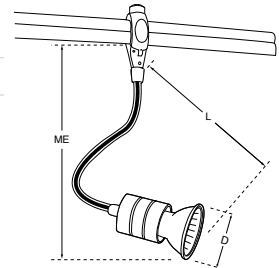

Fili Display

NRS11-310 50W Max

- Lamp:** 50W GU10 (included)
- Finish:** Brushed Nickel (BN), Bronze (BZ), Silver (S)
- Dimensions:** Height: 7" Max Ext.: 16"
- Mobility:** 345° Rotation, 90° Pivoting Head
- Accessories:** NRS90-N32, NT-362, NM-100/MR16

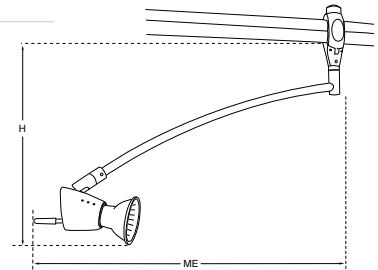

Incandescent PAR



Elegant European design elements coupled with precise engineering are features of the Nora Rail PAR fixtures. The fixtures are available in 50W PAR20, 75W PAR30, and 250W PAR38.



Line Voltage Incandescent PAR Fixtures continued

NORA RAIL

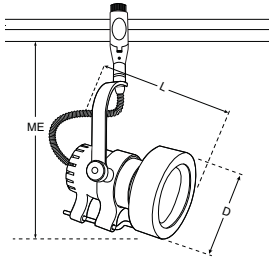

PAR20 Ulysses

NRS18-122 50W Max

Lamp: 50W PAR20 (not included)
Finish: Brushed Nickel (BN), Bronze (BZ), Silver (S)
Dimensions: Length: 4-3/4" Dia.: 3-9/16" Max Ext.: 8-3/4"
Mobility: 345° Rotation, 90° Pivoting Head

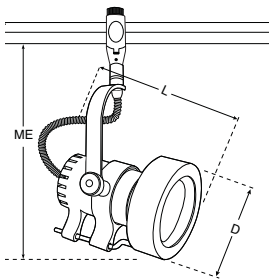

PAR30 Ulysses

NRS18-123 75W Max

Lamp: 75W PAR30 (not included)
Finish: Brushed Nickel (BN), Bronze (BZ), Silver (S)
Dimensions: Length: 5-1/2" Dia.: 4-3/4" Max Ext.: 9-3/4"
Mobility: 345° Rotation, 90° Pivoting Head

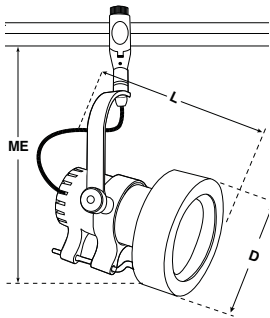

PAR38 Ulysses

NRS18-128 250W Max

Lamp: 250W PAR38 (not included)
Finish: Brushed Nickel (BN), Bronze (BZ), Silver (S)
Dimensions: Length: 6-3/4" Dia.: 5-3/4" Max Ext.: 11-1/4"
Mobility: 345° Rotation, 90° Pivoting Head

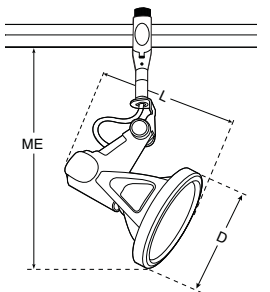

PAR30 Belgium

NRS18-133 75W Max

Lamp: 75W PAR30 (not included)
Finish: Brushed Nickel (BN), Bronze (BZ), Silver (S)
Dimensions: Length: 5-3/8" Dia.: 4-1/4" Max Ext.: 8-3/4"
Mobility: 345° Rotation, 90° Pivoting Head





PAR38 Belgium

NRS18-138 250W Max

Lamp: 250W PAR38 (not included)
Finish: Brushed Nickel (BN), Bronze (BZ), Silver (S)
Dimensions: Length: 6-1/2" Dia.: 5-3/8" Max Ext.: 9-3/4"
Mobility: 345° Rotation, 90° Pivoting Head

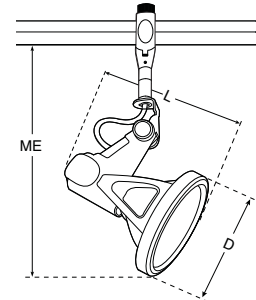

PAR20 High-Tech Wire

NRS18-176 50W Max

Lamp: 50W PAR20 (not included)
Finish: Brushed Nickel (BN), Bronze (BZ), Silver (S)
Dimensions: Length: 4" Dia.: 3-3/8" Max Ext.: 7-1/4"
Mobility: 345° Rotation, 90° Pivoting Head

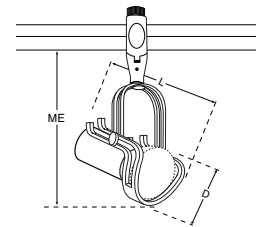

PAR30 High-Tech Wire

NRS18-177 75W Max

Lamp: 75W PAR30 (not included)
Finish: Brushed Nickel (BN), Bronze (BZ), Silver (S)
Dimensions: Length: 4-1/8" Dia.: 4-3/8" Max Ext.: 7-1/2"
Mobility: 345° Rotation, 90° Pivoting Head

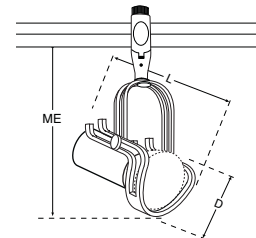

PAR38 High-Tech Wire

NRS18-178 250W Max

Lamp: 250W PAR38 (not included)
Finish: Brushed Nickel (BN), Bronze (BZ), Silver (S)
Dimensions: Length: 5-7/8" Dia.: 5-3/8" Max Ext.: 9-1/2"
Mobility: 345° Rotation, 90° Pivoting Head

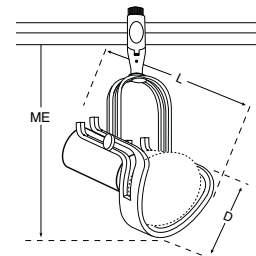

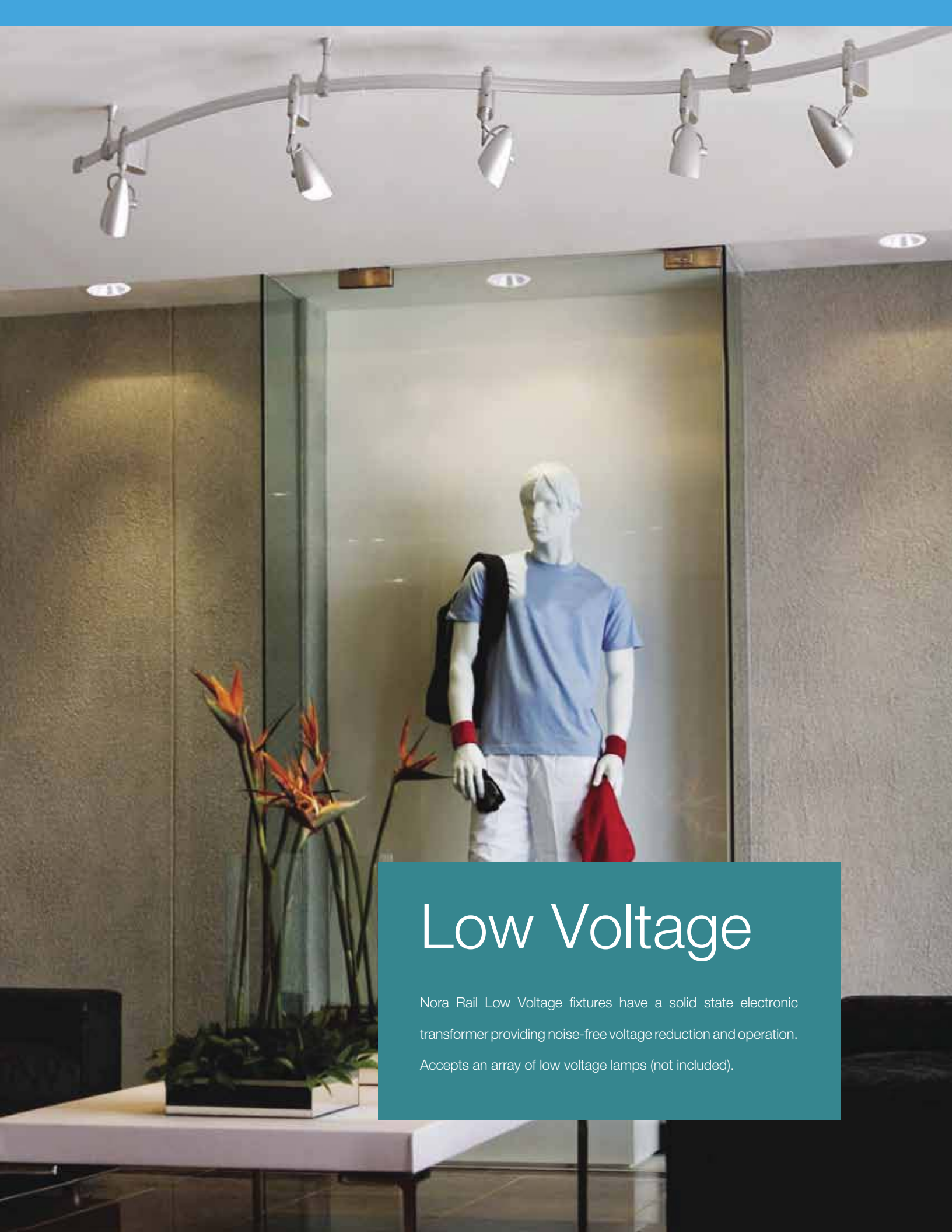

Low Voltage

Nora Rail Low Voltage fixtures have a solid state electronic transformer providing noise-free voltage reduction and operation.

Accepts an array of low voltage lamps (not included).

Nora QuickJack

Low Voltage System

A culmination of design and technology, the Nora QuickJack System offers simplicity and versatility. Nora Lighting's entire collection of low voltage Rail fixtures and pendants now have the capacity to attach to the transformer, or canopy, just by inserting the metal fitting into the receptacle and hand-tightening the threaded collar. NO WIRES - NO HASSLE. The individual elements provide unlimited options for your system. Nora offers QuickJack adapters for Nora Rail, Monopoint Canopy, Multi QuickJack Canopy, Track, Mini Rail and Mini Track allowing the entire Nora Rail NRS66 QuickJack series to be used on all of these systems. QuickJack accessories can be found on pages 514.



Rail Mount Nora QuickJack



Fixture Utilizing the Nora QuickJack System
Two parts are needed:

NRS90-P32 Rail QuickJack Adapter

- Patent-pending housing with integral transformer
- Attaches to the Rail
- Contains female Nora QuickJack adapter

NRS66-Series QuickJack Fixture

- All fixtures with male Nora QuickJack adapters
- Easily hand-tightens into NRS90-P32

*Finishes: S, BZ, BN

Pendants Utilizing the Nora QuickJack System
Three parts are needed:

NRS90-P32

Rail QuickJack Adapter

- Patent-pending housing with integral transformer
- Attaches to the Rail
- Contains female Nora QuickJack adapter

NRS66-457 Low Voltage, 8.5'

NRS66-458 Low Voltage, 20'
Pendant Cord Assembly

- Both cable lengths include the male Nora QuickJack and socket assembly
- Easily hand-tightens into NRS90-P32
- 50W JC 6.35/MR16 lamp (not included)
- Accepts attractive glass shade ordered separately

NRS80 or NRS70 Series

Glass Shade

- Glass shade series available in a variety of shapes, sizes and colors. (pages 416-433)

*Finishes: S, BZ, BN



Monopoint and Multi QuickJack Canopies



Fixture Utilizing the Nora QuickJack System
Two parts are needed:

NRS99-P47/12 Canopy QuickJack Adapter

NRS90-P12 Sloped Canopy QuickJack Adapter
NRS99-P51 Shallow Canopy QuickJack Adapter for Remote Transformer

- Canopy with integral transformer (P47/12 and P12 only)
- Contains female Nora QuickJack adapter

NRS66-Series QuickJack Fixture or Pendants

- All fixtures or pendants with male Nora QuickJack adapters
- Easily hand-tightens into NRS99-P47/12

*Finishes: S, BZ, BN

Pendant Utilizing the Nora Multi QuickJack Canopy System.
For use with any combination of NRS66 Series QuickJack pendants or fixtures.

1.) **NP66-103** Low Volt. Linear Multi QuickJack
NP66-203 Low Volt. Round Multi QuickJack
Canopy QuickJack Adapters

- (3) 60W Integral transformers
- Contains female Nora QuickJack adapter

2.) **NRS66-457** Low Voltage, 8.5'
NRS66-458 Low Voltage, 20'
Pendant Cord Assembly

- Both cable length include the male Nora QuickJack and socket assembly
- Easily hand-tightens into NP66 Series
- 50W JC 6.35/MR16 lamp (not included)
- Accepts attractive glass shade ordered separately

3.) **NRS80 or NRS70 Series**
Glass Shade

- Glass shade series available in a variety of shapes, sizes and colors. (pages 416-433)



*FINISHES: S-Silver, BZ-Bronze, BN-Brushed Nickel (specify)

Low Voltage Complete Fixtures & QuickJack

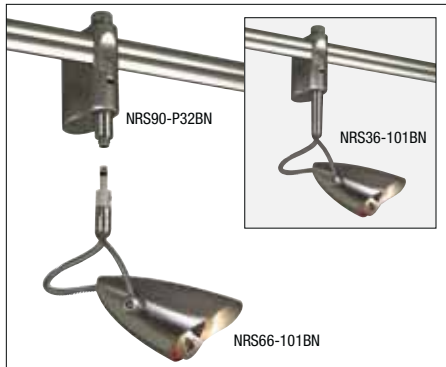

Argon Curve

NRS36-101 Complete Fixture	20W-50W
NRS66-101 QuickJack	20W-50W

Lamp: 20W-50W MR16 (not included)
Finish: Brushed Nickel (BN), Bronze (BZ), Silver (S)
Dimensions: Length: 4-1/2" Dia.: 2-3/8" Max Ext.: 8"
Mobility: 345° Rotation, 90° Pivoting Head

- **QuickJack fixture** consists of fixture head with male fitter and must be used with a QuickJack adapter (NRS90-P32). See page 483 for details.

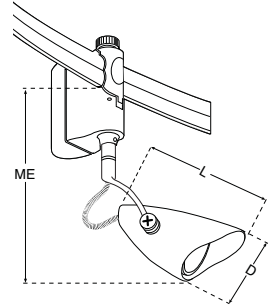

Argon Swivel

NRS36-102 Complete Fixture	20W-50W
NRS66-102 QuickJack	20W-50W

Lamp: 20W-50W MR16 (not included)
Finish: Brushed Nickel (BN), Bronze (BZ), Silver (S)
Dimensions: Length: 4-1/2" Dia.: 2-3/8" Max Ext.: 6-1/4"
Mobility: 345° Rotation, 90° Pivoting Head

- **QuickJack fixture** consists of fixture head with male fitter and must be used with a QuickJack adapter (NRS90-P32). See page 483 for details.

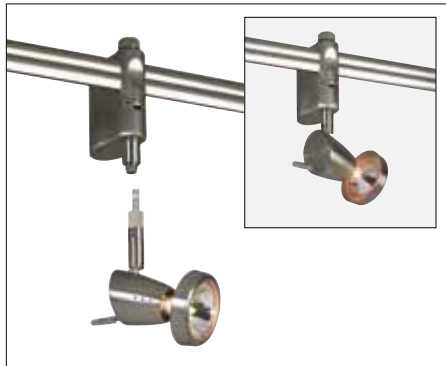
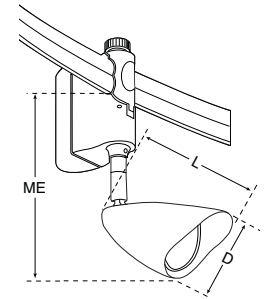

Sienna with Ring

NRS36-103 Complete Fixture	20W-50W
NRS66-103 QuickJack	20W-50W

Lamp: 20W-50W MR16 (not included)
Finish: Brushed Nickel (BN), Bronze (BZ), Silver (S)
Dimensions: Length: 4" Dia.: 2-5/16" Max Ext.: 5-3/4"
Mobility: 345° Rotation, 90° Pivoting Head

- **QuickJack fixture** consists of fixture head with male fitter and must be used with a QuickJack adapter (NRS90-P32). See page 483 for details.

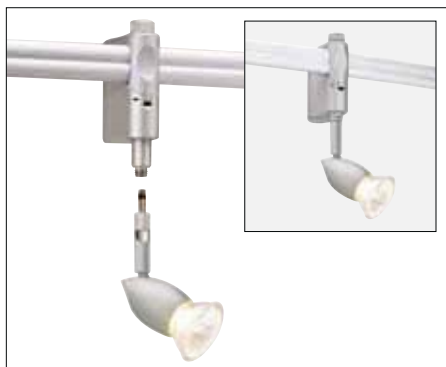
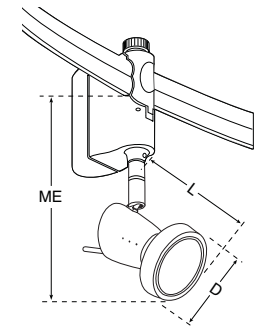

Neat

NRS36-104 Complete Fixture	20W-50W
NRS66-104 QuickJack	20W-50W

Lamp: 20W-50W MR16 (not included)
Finish: Brushed Nickel (BN), Bronze (BZ), Silver (S)
Dimensions: Length: 2-3/8" Dia.: 1-1/2" Max Ext.: 4-5/8"
Mobility: 345° Rotation, 90° Pivoting Head

- **QuickJack fixture** consists of fixture head with male fitter and must be used with a QuickJack adapter (NRS90-P32). See page 483 for details.

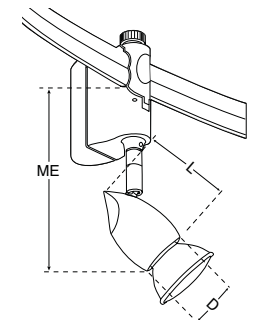



Low Voltage Complete Fixtures & QuickJack continued

NORA RAIL

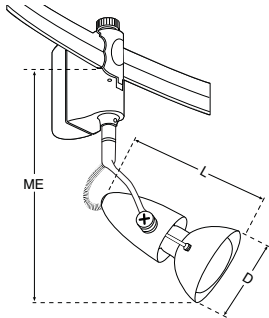

Satellit Curve

NRS36-105	Complete Fixture	20W-50W
NRS66-105	QuickJack	20W-50W

Lamp: 20W-50W MR16 (not included)
Finish: Brushed Nickel (BN), Bronze (BZ), Silver (S)
Dimensions: Length: 4-3/8" Dia.: 2-5/8" Max Ext.: 7-1/4"
Mobility: 345° Rotation, 90° Pivoting Head

- **QuickJack fixture** consists of fixture head with male fitter and must be used with a QuickJack adapter (NRS90-P32). See page 483 for details.

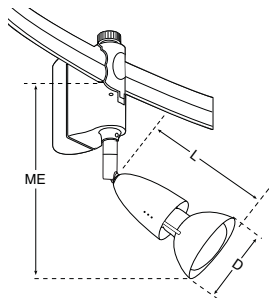
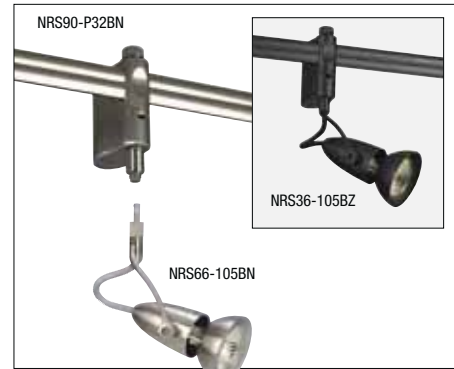

Satellit Swivel

NRS36-106	Complete Fixture	20W-50W
NRS66-106	QuickJack	20W-50W

Lamp: 20W-50W MR16 (not included)
Finish: Brushed Nickel (BN), Bronze (BZ), Silver (S)
Dimensions: Length: 4-3/8" Dia.: 2-5/8" Max Ext.: 7-1/4"
Mobility: 345° Rotation, 90° Pivoting Head

- **QuickJack fixture** consists of fixture head with male fitter and must be used with a QuickJack adapter (NRS90-P32). See page 483 for details.

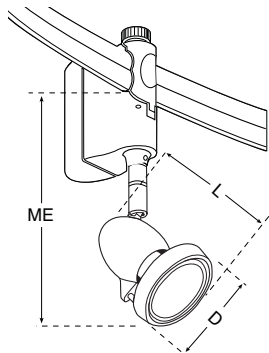
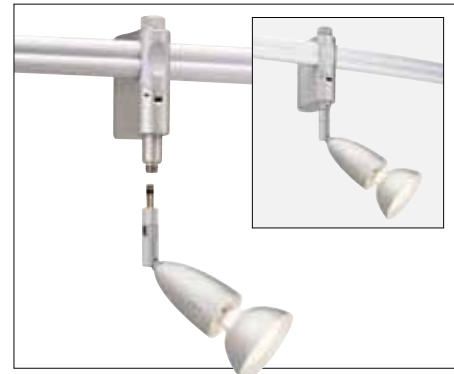

Neon

NRS36-107	Complete Fixture	20W-50W
NRS66-107	QuickJack	20W-50W

Lamp: 20W-50W MR16 (not included)
Finish: Brushed Nickel (BN), Bronze (BZ), Silver (S)
Dimensions: Length: 3-1/8" Dia.: 2-7/16" Max Ext.: 5-3/4"
Mobility: 345° Rotation, 90° Pivoting Head

- **QuickJack fixture** consists of fixture head with male fitter and must be used with a QuickJack adapter (NRS90-P32). See page 483 for details.

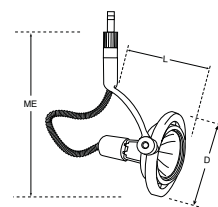

Lika

NRS66-108	QuickJack	20W-50W
------------------	-----------	---------

Lamp: 20W-50W MR16 (not included)
Finish: Brushed Nickel (BN), Bronze (BZ), Silver (S)
Dimensions: Length: 2-3/4" Dia.: 3" Max Ext.: 6-1/4"
Accessories: NRS90-P32 is required if attaching to Rail
Mobility: 345° Rotation, 90° Pivoting Head

- **QuickJack fixture** consists of fixture head with male fitter and must be used with a QuickJack adapter (NRS90-P32). See page 483 for details.







Low Voltage Complete Fixtures & QuickJack continued

NORA RAIL

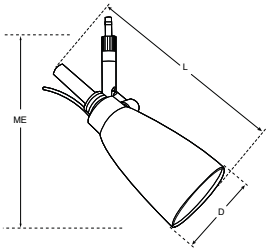

Nica

NRS66-109 QuickJack 20W-50W

Lamp: 20W-50W MR16 (not included)
Finish: Brushed Nickel (BN), Bronze (BZ), Silver (S)
Dimensions: Length: 6-7/8" Dia.: 2-3/8" Max Ext.: 7"
Mobility: 345° Rotation, 90° Pivoting Head
Accessories: NRS90-P32 is required if attaching to Rail

- **QuickJack fixture** consists of fixture head with male fitter and must be used with a QuickJack adapter (NRS90-P32). See page 483 for details.

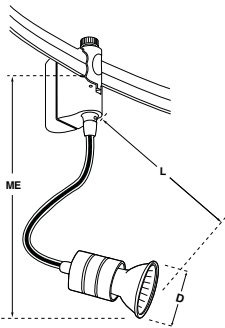
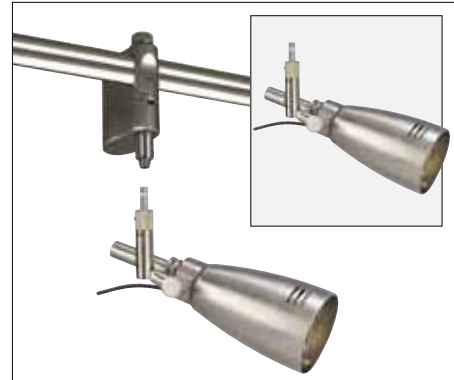

Ives Gooseneck

NRS36-302 Complete Fixture 20W-50W

NRS66-302 QuickJack 20W-50W

Lamp: 20W-50W MR16 (not included)
Finish: Brushed Nickel (BN), Bronze (BZ), Silver (S)
Dimensions: Length: 1-5/8" Dia.: 1-3/8" Max Ext.: 12"
Mobility: 345° Rotation, 90° Pivoting Head

- Accessories:** NRS90-N31, NRS90-N32, NT-362, NM-100/MR16
- **QuickJack fixture** consists of fixture head with male fitter and must be used with a QuickJack adapter (NRS90-P32). See page 483 for details.

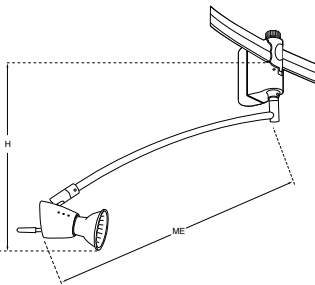
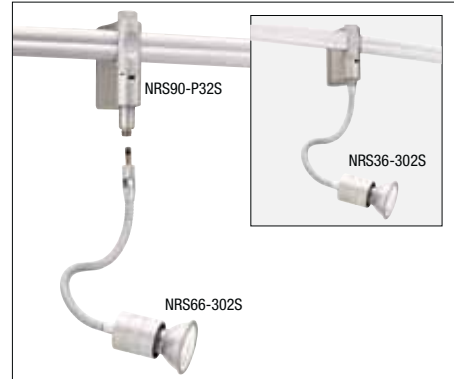

Fili Display

NRS36-310 Complete Fixture 20W-50W

NRS66-310 QuickJack 20W-50W

Lamp: 20W-50W MR16 (not included)
Finish: Brushed Nickel (BN), Bronze (BZ), Silver (S)
Dimensions: Height: 7" Max Ext.: 16"
Mobility: 345° Rotation, 90° Pivoting Head

- Accessories:** NRS90-N31, NRS90-N32, NT-362, NM-100/MR16
- **QuickJack fixture** consists of fixture head with male fitter and must be used with a QuickJack adapter (NRS90-P32). See page 483 for details.

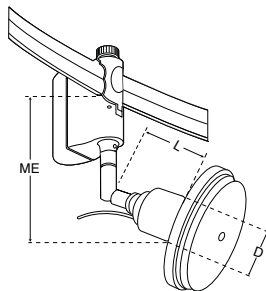
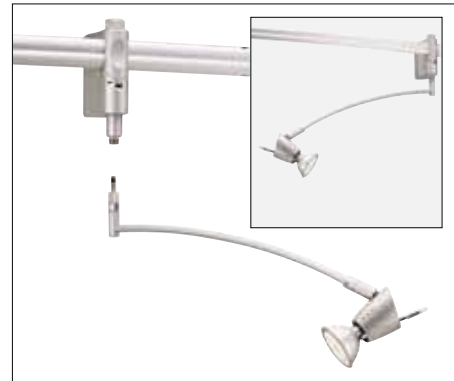

Penumbra

NRS33-901 Complete Fixture 20W-50W

NRS66-901 QuickJack 20W-50W

Lamp: 20W-50W AR111 (not included)
Finish: Brushed Nickel (BN), Bronze (BZ), Silver (S)
Dimensions: Length: 4" Dia.: 1-5/8" x 2-3/8" Max Ext.: 5"
Mobility: 345° Rotation, 90° Pivoting Head

- **QuickJack fixture** consists of fixture head with male fitter and must be used with a QuickJack adapter (NRS90-P32). See page 483 for details.





Skyteam

NRS33-902 Complete Fixture	20W-50W
NRS66-902 QuickJack	20W-50W

Lamp: 20W-50W AR111 (not included)
Finish: Brushed Nickel (BN), Bronze (BZ), Silver (S)
Dimensions: Length: 3-1/2" Dia.: 4-7/8" Max Ext.: 9-5/8"
Mobility: 345° Rotation, 90° Pivoting Head

- **QuickJack fixture** consists of fixture head with male fitter and must be used with a QuickJack adapter (NRS90-P32). See page 483 for details.

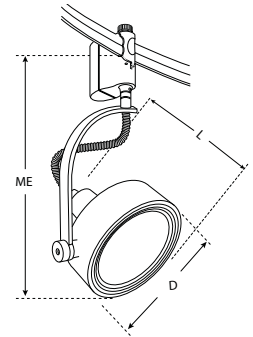

Petra Curve

NRS34-201 Complete Fixture	20W-50W
NRS66-201 QuickJack	20W-50W

Lamp: 20W-50W MR16 (not included)
Finish: Brushed Nickel (BN), Bronze (BZ), Silver (S)
Dimensions: Length: 4-1/8" Dia.: 2-15/16" Max Ext.: 9"
Mobility: 345° Rotation, 90° Pivoting Head
Glass: Porcelain White (PW) included

- **QuickJack fixture** consists of fixture head with male fitter and must be used with a QuickJack adapter (NRS90-P32). See page 483 for details.

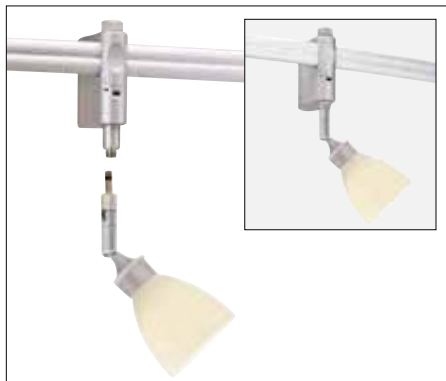
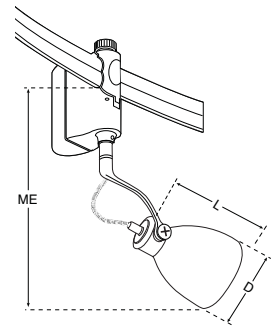

Petra Swivel

NRS34-202 Complete Fixture	20W-50W
NRS66-202 QuickJack	20W-50W

Lamp: 20W-50W MR16 (not included)
Finish: Brushed Nickel (BN), Bronze (BZ), Silver (S)
Dimensions: Length: 4-1/4" Dia.: 2-15/16" Max Ext.: 7-5/8"
Mobility: 345° Rotation, 90° Pivoting Head
Glass: Porcelain White (PW) included

- **QuickJack fixture** consists of fixture head with male fitter and must be used with a QuickJack adapter (NRS90-P32). See page 483 for details.

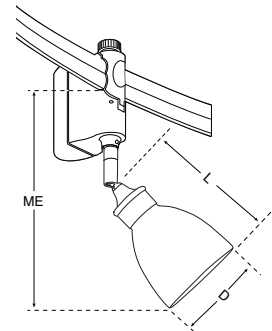

Melody

NRS34-203 Complete Fixture	20W-50W
NRS66-203 QuickJack	20W-50W

Lamp: 20W-50W MR16 (not included)
Finish: Brushed Nickel (BN), Bronze (BZ), Silver (S)
Dimensions: Length: 3-3/8" Dia.: 2-11/16" Max Ext.: 7"
Mobility: 345° Rotation, 90° Pivoting Head
Glass: Porcelain White (PW) included

- **QuickJack fixture** consists of fixture head with male fitter and must be used with a QuickJack adapter (NRS90-P32). See page 483 for details.

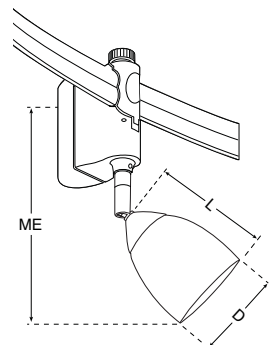



Low Voltage Complete Fixtures & QuickJack continued

NORA RAIL

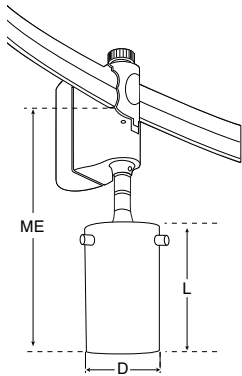

Swiftec

NRS34-204 Complete Fixture 20W-50W

NRS66-204 QuickJack 20W-50W

Lamp: 20W-50W Bi-Pin / MR16 (not included)

Finish: Brushed Nickel (BN), Bronze (BZ), Silver (S)

Dimensions: Length: 4" Dia.: 2-3/8" Max Ext.: 7"

Mobility: 345° Rotation, 90° Pivoting Head

Glass: Amber (AM), Orange (O), Frost (FR) included

- **QuickJack fixture** consists of fixture head with male fitter and must be used with a QuickJack adapter (NRS90-P32). See page 483 for details.

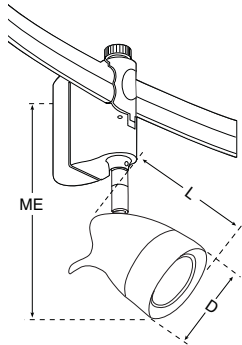
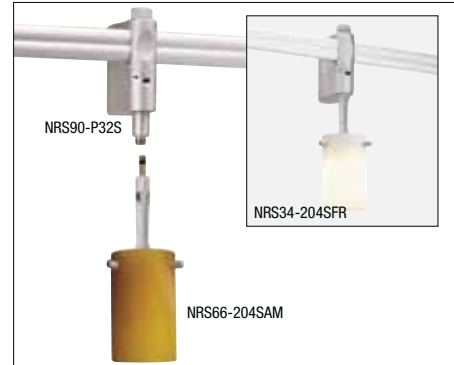

Kano Spot

NRS36-251 Complete Fixture 20W-50W

NRS66-251 QuickJack 20W-50W

Lamp: 20W-50W MR16 (not included)

Finish: Brushed Nickel (BN), Bronze (BZ), Silver (S)

Dimensions: Length: 3-5/8" Dia.: 2-5/8" Max Ext.: 6"

Glass: Blue (BU), Frost (FR) - included

Mobility: 345° Rotation, 90° Pivoting Head

- **QuickJack fixture** consists of fixture head with male fitter and must be used with a QuickJack adapter (NRS90-P32). See page 483 for details.

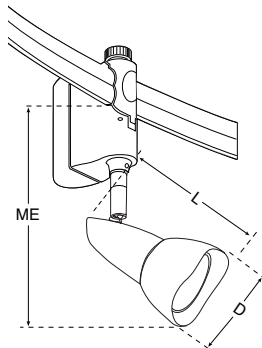
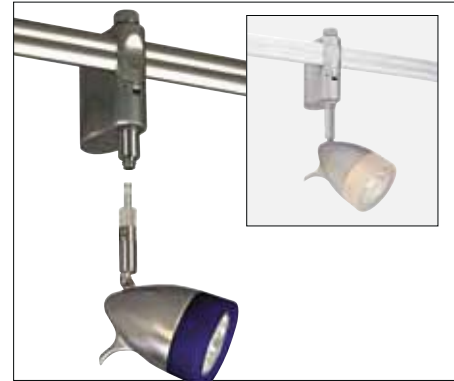

New Mirage

NRS36-252 Complete Fixture 20W-50W

NRS66-252 QuickJack 20W-50W

Lamp: 20W-50W MR16 (not included)

Finish: Brushed Nickel (BN), Bronze (BZ), Silver (S)

Dimensions: Length: 4-1/4" Dia.: 2-1/2" Max Ext.: 7"

Mobility: 345° Rotation, 90° Pivoting Head

Glass: Porcelain White (PW), Blue (BU), Frost (FR) - included

- **QuickJack fixture** consists of fixture head with male fitter and must be used with a QuickJack adapter (NRS90-P32). See page 483 for details.

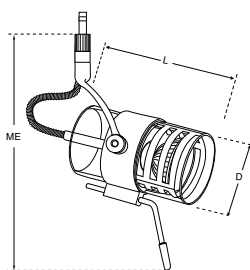
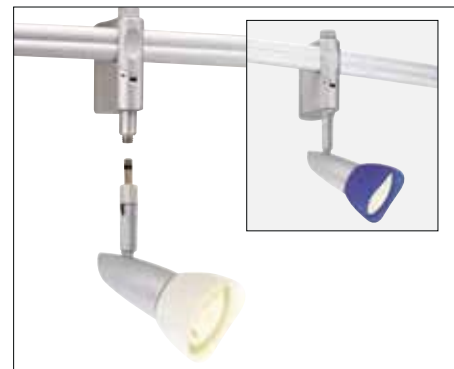

Lima

NRS66-253 QuickJack 20W-50W

Lamp: 20W-50W MR16 (not included)

Finish: Brushed Nickel (BN), Bronze (BZ), Silver (S)

Dimensions: Length: 4-1/4" Dia.: 2-3/8" Max Ext.: 8-1/8"

Mobility: 345° Rotation, 90° Pivoting Head

Accessories: NRS90-P32 is required if attaching to Rail

- **QuickJack fixture** consists of fixture head with male fitter and must be used with a QuickJack adapter (NRS90-P32). See page 483 for details.

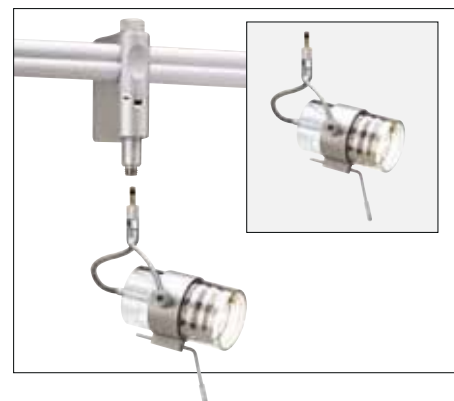



Metal Halide

Nora Lighting Metal Halide fixtures offer sleek, low-profile housings and accommodate numerous wattages and lamp sizes. Metal Halide's longer lamp life, excellent color rendition and unparalleled design culminate in unlimited design capabilities.

HID fixture with the smallest ballast in the industry and HID lamps the size of an MR16. Now you can accomplish the delicate sculptures of a rail system with the phenomenal light output of HID.

Lamp Performance Comparison

Fixture	50W MR16	39W MR16 CMH	75W PAR	39W PAR20 CMH
Average Lamp Hours	6,000 Hrs.	12,000 Hrs.	3,000 Hrs.	12,500 Hrs.
Distribution	10° - 50°	12° - 40°	10° - 30°	10° - 30°
Average Lumens Per Watt	19 lm	56 lm	13 lm	51 lm
Lamp CRI	n/a	90 CRI	n/a	85 CRI
CBCP (Spot)	13,000 cd	16,000 cd	12,300 cd	23,000 cd
FC @ Nadir 8' MH	234 fc	250 fc	203 fc	344 fc
FC @ Nadir 10' MH	150 fc	160 fc	130 fc	220 fc



HID Metal Halide Fixtures

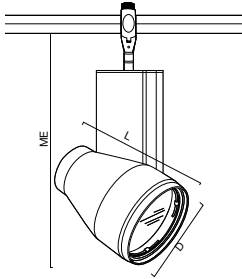

HID Q-Tech

NRS54-220 T4 (20W/39W/70W)

NRS56-220 T6 (39W/70W)

- Lamp:** T4 & T6 Bi-Pin CMH (not included)
- Finish:** Silver (S)
- Dimensions:** Length: 4-1/2" Dia.: 2-3/8" Max Ext.: 7-1/8"
- Mobility:** 345° Rotation, 90° Pivoting Head
- Accessories:** **NA-100** Cross Louver; **NA-101** Honeycomb Louver, **NA-200** Shroud; **NA-300** Clear Replacement Lens



How to specify T4 & T6 CMH Q-Tech Series

SERIES	LIGHT SOURCE	WATTAGE	BEAM SPREAD	FINISH	
NRS	54-220 = T4 Bi-Pin CMH	20 = 20 Watts (T4 only)	24 = 24°	S = Silver	
	56-220 = T6 Bi-Pin CMH	39 = 39 Watts	44 = 44°		
		70 = 70 Watts	60 = 60°		
NRS	54-220	/	20	24	S

ORDER EXAMPLE: NRS54-220/2024S

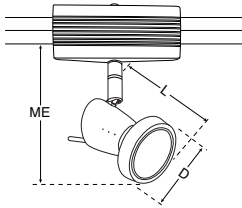

39W HID Sienna with Ring

NRS51-103 39W

- Lamp:** 39W CMH MR16 GX10 (not included)
- Finish:** Brushed Nickel (BN), Bronze (BZ), Silver (S)
- Dimensions:** Length: 4" Dia.: 2-5/16" Max Ext.: 5-3/8"
- Mobility:** 345° Rotation, 90° Pivoting Head

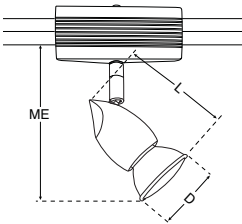

39W HID Neat

NRS51-104 39W

- Lamp:** 39W CMH MR16 GX10 (not included)
- Finish:** Brushed Nickel (BN), Bronze (BZ), Silver (S)
- Dimensions:** Length: 2-3/8" Dia.: 1-1/2" Max Ext.: 5-1/2"
- Mobility:** 345° Rotation, 90° Pivoting Head

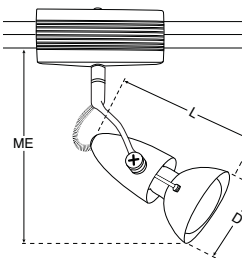

39W HID Satelit Curve

NRS51-105 39W

- Lamp:** 39W CMH MR16 GX10 (not included)
- Finish:** Brushed Nickel (BN), Bronze (BZ), Silver (S)
- Dimensions:** Length: 4-3/8" Dia.: 2-5/8" Max Ext.: 7-1/8"
- Mobility:** 345° Rotation, 90° Pivoting Head



HID Metal Halide Fixtures



39W HID Lika

NRS51-108 39W

Lamp: 39W CMH MR16 GX10 (not included)
Finish: Brushed Nickel (BN), Bronze (BZ), Silver (S)
Dimensions: Length: 2-3/4" Dia.: 3" Max Ext.: 6-1/4"
Mobility: 345° Rotation, 90° Pivot head

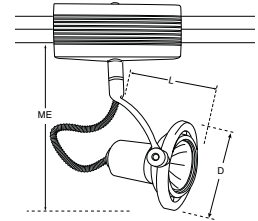

T4.5 HID Ulysses

NRS52-155 20W
NRS52-156 39W
NRS52-157 70W

Lamp: 20W/39W/70W Bi-Pin T4.5 CMH (not included)
Finish: Brushed Nickel (BN), Bronze (BZ), Silver (S)
Dimensions: Length: 6" Dia.: 4-5/8" Max Ext.: 10-1/4"
Mobility: 345° Rotation, 90° Pivot head
Reflector: 60° Beam Spread
Accessories: Dichroic Filters in Blue, Green, Red, and Yellow Sold separately (NRS90-N66 - see page 515)

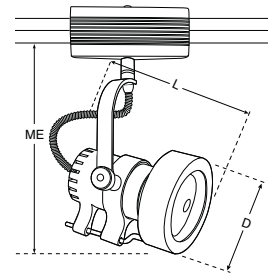

39W T6 HID Nepro

NRS55-301 39W

Lamp: 39W T4 G8.5 CMH (not included)
Finish: Brushed Nickel (BN), Bronze (BZ), Silver (S)
Dimensions: Length: 7-1/2" Height: 4-5/16" Width: 2-1/4" Max Ext.: 7-1/2"
Mobility: 345° Rotation, 90° Pivoting Head

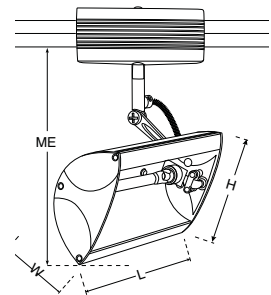

PAR20 HID Ulysses

NRS58-152/20 20W
NRS58-152/39 39W

Lamp: 20W/39W PAR20 CMH (not included)
Finish: Brushed Nickel (BN), Bronze (BZ), Silver (S)
Dimensions: Length: 4-3/4" Dia.: 3-9/16" Max Ext.: 8-3/4"
Mobility: 345° Rotation, 90° Pivoting Head

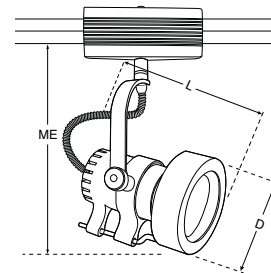



HID Metal Halide Fixtures continued

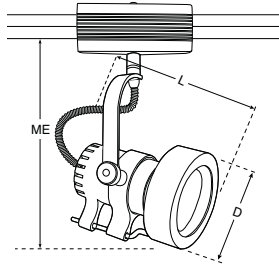

PAR30 HID Ulysses

NRS58-153/39	39W
NRS58-153/70	70W

Lamp: 39W/70W PAR30 CMH (not included)
Finish: Brushed Nickel (BN), Bronze (BZ), Silver (S)
Dimensions: Length: 5-1/2" Dia.: 4-3/4" Max Ext.: 9-3/4"
Mobility: 345° Rotation, 90° Pivoting Head

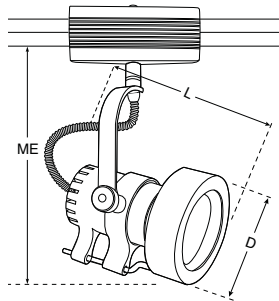

PAR38 HID Ulysses

NRS58-154	70W
------------------	-----

Lamp: 70W PAR38 CMH (not included)
Finish: Brushed Nickel (BN), Bronze (BZ), Silver (S)
Dimensions: Length: 6-3/4" Dia.: 5-3/4" Max Ext.: 11-1/4"
Mobility: 345° Rotation, 90° Pivoting Head

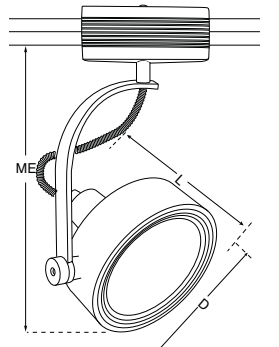

39W HID Skyteam

NRS59-158	39W
------------------	-----

Lamp: 39W ES36 8" Spread CMH GX10 Base (not included)
Finish: Brushed Nickel (BN), Bronze (BZ), Silver (S)
Dimensions: Length: 3-1/2" Dia.: 4-7/8" Max Ext.: 10"
Mobility: 345° Rotation, 90° Pivoting Head

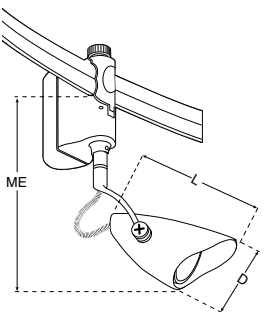

20W MR16 HID Argon

NRS61-101	20W
------------------	-----

Lamp: 20W CMH MR16 GX10 Base (not included)
Finish: Brushed Nickel (BN), Bronze (BZ), Silver (S)
Dimensions: Length: 4-1/2" Dia.: 2-3/8" Max Ext.: 7-5/8"
Mobility: 345° Rotation, 90° Pivoting Head



HID Metal Halide Fixtures



20W MR16 HID Sienna with Ring

NRS61-103 20W

Lamp: 20W CMH MR16 GX10 Base (not included)
Finish: Brushed Nickel (BN), Bronze (BZ), Silver (S)
Dimensions: Length: 4" Dia.: 2-5/16" Max Ext.: 6-1/2"
Mobility: 345° Rotation, 90° Pivoting Head

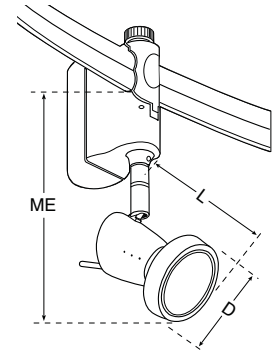

20W MR16 HID Neat

NRS61-104 20W

Lamp: 20W CMH MR16 GX10 Base (not included)
Finish: Brushed Nickel (BN), Bronze (BZ), Silver (S)
Dimensions: Length: 2-3/8" Dia.: 1-1/2" Max Ext.: 6-5/8"
Mobility: 345° Rotation, 90° Pivoting Head

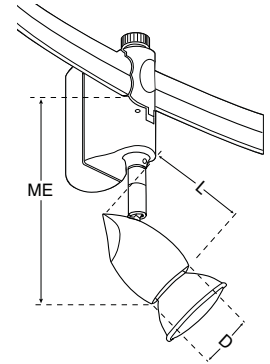

20W MR16 HID Satelit Curve

NRS61-105 20W

Lamp: 20W CMH MR16 GX10 Base (not included)
Finish: Brushed Nickel (BN), Bronze (BZ), Silver (S)
Dimensions: Length: 4-3/8" Dia.: 2-5/8" Max Ext.: 8-1/4"
Mobility: 345° Rotation, 90° Pivoting Head

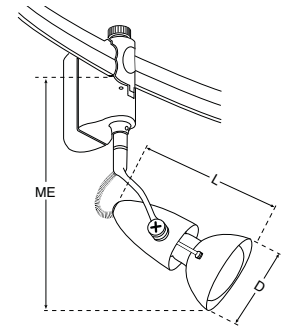

20W MR16 HID Lika

NRS61-108 20W

Lamp: 20W CMH MR16 GX10 Base (not included)
Finish: Brushed Nickel (BN), Bronze (BZ), Silver (S)
Dimensions: Length: 2-1/4" Dia.: 3" Max Ext.: 7-1/4"
Mobility: 345° Rotation, 90° Pivoting Head

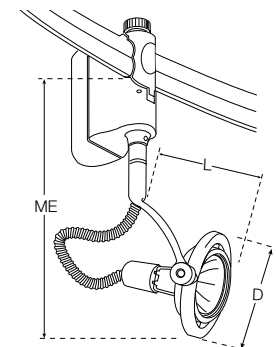

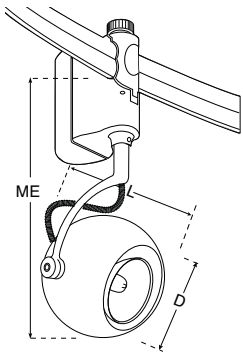

20W MR16 HID Dallas

NRS61-110 20W

Lamp: 20W CMH MR16 GX10 Base (not included)

Finish: Brushed Nickel (BN), Bronze (BZ), Silver (S)

Dimensions: Length: 3-1/4" Dia.: 3-1/2" Max Ext.: 6"

Mobility: 345° Rotation, 90° Pivoting Head

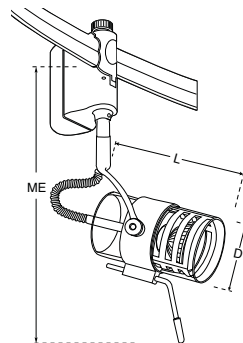

20W MR16 HID Lima

NRS61-253 20W

Lamp: 20W CMH MR16 GX10 Base (not included)

Finish: Brushed Nickel (BN), Bronze (BZ), Silver (S)

Dimensions: Length: 4-1/4" Dia.: 2-3/8" Max Ext.: 7-3/4"

Mobility: 345° Rotation, 90° Pivoting Head



A photograph of an office interior. On the left, a green wall features a large, stylized leaf graphic. A window with horizontal blinds is in the center. To the right, a desk with a yellow office chair is visible. A fluorescent light fixture is mounted on the ceiling. A dark green semi-transparent box is overlaid on the lower-left portion of the image, containing white text.

Fluorescent

The Nepro fluorescent fixtures are available in three styles: an adjustable Wall Wash/Direct Light rail fixture, and a rail or canopy mount drop pendant that can provide direct lighting over a desk or table. The Nepro utilizes 2 x 24W T5 High-Output (HO) fluorescent lamps and electronic ballasts, which capture the design excellence of the award-winning Nora Rail system. Higher lumen output, energy-efficient capabilities and longer lamp life make these incredibly designed fixtures a must for your lighting needs.

New GU24 Compact Fluorescent pendants for Rail or Canopy Mount are now available, see page 444, 508.



T5 High Output Fluorescent Fixtures

Nepro High Output Fluorescent Rail Wall Wash

NRS45-201 2 x 24W

- Lamp:** 2 x 24W T5 HO (not included)
- Finish:** Brushed Nickel (BN), Bronze (BZ), Silver (S)
- Dimensions:** Length: 23-5/8" Height: 3-1/8" Width: 5-1/2"
Max Ext.: 8-1/4"
- Mobility:** Arms allow shade 260° movement

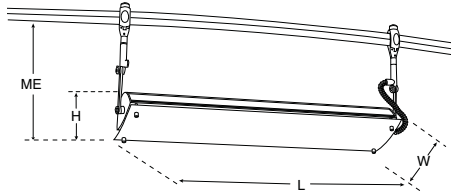

committed to GREEN



Nepro High Output Fluorescent Ceiling Canopy Mount

NRS45-301 2 x 24W

- Lamp:** 2 x 24W T5 HO (not included)
- Finish:** Brushed Nickel (BN), Bronze (BZ), Silver (S)
- Dimensions:** Length: 23-5/8" Height: 3-1/8" Width: 5-1/2"
Max Ext.: 8'6"

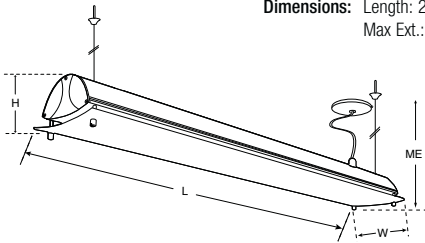

committed to GREEN



Nepro High Output Fluorescent Rail Pendant

NRS45-401 2 x 24W

- Lamp:** 2 x 24W T5 HO (not included)
- Finish:** Brushed Nickel (BN), Bronze (BZ), Silver (S)
- Dimensions:** Length: 23-5/8" Height: 3-1/8" Width: 5-1/2"
Max Ext.: 8'6"

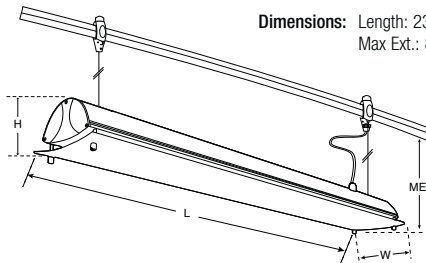

committed to GREEN

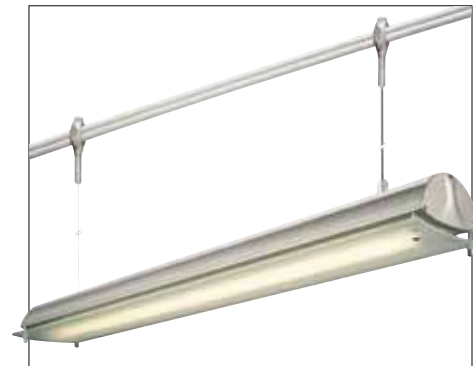

NORA RAIL
Specialty Fixtures



Line Voltage Exhibit Display with Slim Canopy

NRS11-320 50W Max

Lamp: 50W GU10 (included)
Finish: Brushed Nickel (BN), Bronze (BZ), Silver (S)
Dimensions: Height: 10" Max Ext.: 17"

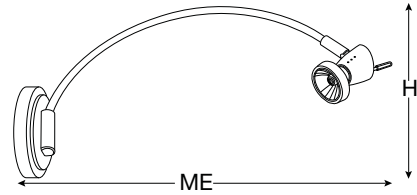

Low Voltage Exhibit Display with Canopy

NRS36-320 20W-50W

Lamp: 20W-50W MR16 (not included)
Finish: Brushed Nickel (BN), Bronze (BZ), Silver (S)
Dimensions: Height: 10" Max Ext.: 17-1/2"

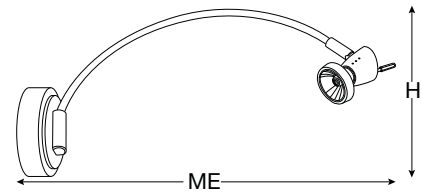

Nepro Rail Mount

NRS17-301 150W-300W Max

Lamp: 150W-300W R7S (included)
Finish: Brushed Nickel (BN), Bronze (BZ), Silver (S)
Dimensions: Length: 7-1/2" Width: 2-1/4" Height: 4-5/16"
Max Ext.: 8"
Mobility: 345° Arm rotation, 180° shade rotation

- Excellent for indirect or wall wash lighting

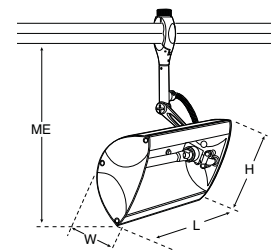



Nora Rail Kits

Nora's line voltage Rail Kits include everything you need for a complete system: rail, fixtures, standoffs, power components, and even lamps!

These versatile kits allow the user to place the fixtures, standoffs, and power supply anywhere on the Rail as needed. Nora Rail is line voltage, so there are no concerns with too much wattage or distance. These kits can easily accommodate additional rail, fixtures, and/or pendants up to 2400 watts.

Nora Rail Kits are now available in twelve styles, with Brushed Nickel, Bronze or Silver finishes, and a variety of glass colors. Rail lighting has never been easier!

NORA RAIL

Nora Rail Starter Kits *include rail, standoffs and power components*

Nora Rail Straight Starter Kit - 6'-6" Straight Rail

NRS90-K633

Finish: Brushed Nickel (BN), Bronze (BZ), Silver (S)

Dimensions: Length: 6'

Kit included: (1) 6' Rail (NRS90-P06)
 (1) 3" Power Stem (NRS90-P11)
 (1) Canopy for Power Stem (NRS90-P13)
 (2) 3" Standoff Support (NRS90-N73)

- Kit can accommodate any fixtures, pendants and/or additional rail up to 2400 watts.
- Fixtures, standoffs, and power stem/canopy are moveable and can be placed anywhere on the rail.

Nora Rail Curved Starter Kit - 8' "S" Curve Rail

NRS90-K833

Finish: Brushed Nickel (BN), Bronze (BZ), Silver (S)

Dimensions: Length: 8'

Kit included: (1) 4 ft. Pre-Bent Rail (NRS90-R24-I: Inside Bars)
 (1) 4 ft. Pre-Bent Rail (NRS90-R24-O: Outside Bars)
 (1) 3" Power Stem (NRS90-P11)
 (1) Canopy for Power Stem (NRS90-P13)
 (2) 3" Standoff Support (NRS90-N73)
 (1) Straight Rail Live Connector (NRS90-P81)

- Kit can accommodate any fixtures, pendants and/or additional rail up to 2400 watts.
- Fixtures, standoffs, and power stem/canopy are moveable and can be placed anywhere on the rail.

NORA RAIL

Nora Rail Kits

Kits can easily accommodate additional rail, fixtures, and pendants!



NEW!



Swift Nora Rail Kit - Line Voltage Kit with 2' Circle Rail and 3 Swift Glass Fixtures

NRS29-C204

- Lamp:** (3) 40W G9 (included) total 120 Watts
Finish: Brushed Nickel (BN), Bronze (BZ), Silver (S)
Glass Color: Amber (AM), Orange (O), or Frost (FR)
Dimensions: Dia.: 24"
Kit includes: (1) 24" Circle Rail (NRS90-C12I)
 (1) Cable Power w/Canopy (NRS90-P90)
 (3) Cable Support (NRS90-N91)
 (3) Swift Fixtures (NRS19-204) with choice of color Amber (AM), Orange (O), or Frost (FR)

- Kit can accommodate additional fixtures and/or pendants up to 2400 watts.
- Fixtures, standoffs, and power stem/canopy are moveable and can be placed anywhere on the rail.

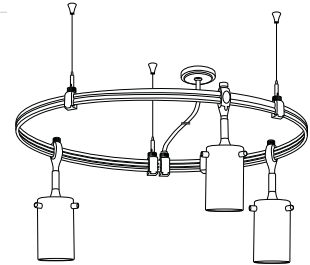

NEW!



Neat Nora Rail Kit - Line Voltage Kit with 4' Straight Rail and 3 Neat Fixtures

NRS21-4104

- Lamp:** (3) 50W MR16 GU10 (included) total 150 Watts
Finish: Brushed Nickel (BN), Bronze (BZ), Silver (S)
Dimensions: Length: 4'
Kit included: (1) 4 ft. Rail (NRS90-P04)
 (1) 3" Power Stem (NRS90-P11)
 (1) Canopy for Power Stem (NRS90-P13)
 (2) 3" Standoff Support (NRS90-N73)
 (3) Neat fixtures (NRS11-104)

- Kit can accommodate additional rail, fixtures and/or pendants up to 2400 watts.
- Fixtures, standoffs, and power stem/canopy are moveable and can be placed anywhere on the rail.

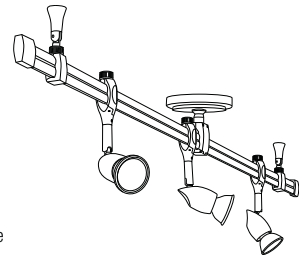

NEW!



Paris Nora Rail Kit - Line Voltage Kit with 4' Straight Rail and 3 Mercure Fixtures with Paris Glass

NRS29-4201

- Lamp:** (3) 40W G9 (included) total 120 Watts
Finish: Brushed Nickel (BN), Bronze (BZ), Silver (S)
Glass Color: Amber (AM), Blue (BU), Red (R) or White (W)
Dimensions: Length: 4'
Kit includes: (1) 4' Rail (NRS90-P04)
 (1) 3" Power Stem (NRS90-P11)
 (1) Canopy for Power Stem (NRS90-P13)
 (2) 3" Standoff Support (NRS90-N73)
 (3) Mercure Fixtures (NRS11-260)
 (3) Paris Glass (NRS82-201) with choice of color Amber (AM), Blue (BU), Red (R) or White (W)

- Kit can accommodate additional rail, fixtures and/or pendants up to 2400 watts.
- Fixtures, standoffs, and power stem/canopy are moveable and can be placed anywhere on the rail.

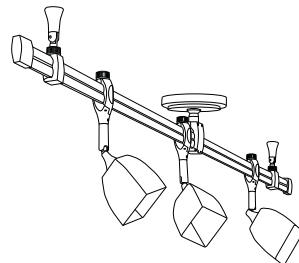

Note: All Nora Rail Kits are Line Voltage and do not require a Transformer. All kits can accommodate additional Rail, Fixtures, and/or Pendants up to 2400W.



Place fixtures, standoffs, and power supply anywhere on the Rail!

NORA RAIL

Nora Rail Kits cont.

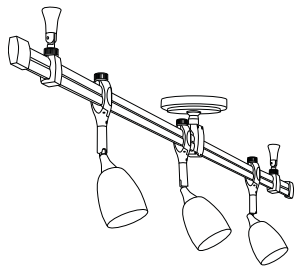

Monte Nora Rail Kit - Line Voltage Kit with 4' Straight Rail and 3 Mercure Fixtures with Monte Glass

NRS29-4202

- Lamp:** (3) 40W G9 (included) total 120 Watts
- Finish:** Brushed Nickel (BN), Bronze (BZ), Silver (S)
- Glass Color:** Amber (AM), Blue (BU), Red (R) or White (W)
- Dimensions:** Length: 4'
- Kit included:** (1) 4' Rail (NRS90-P04)
(1) 3" Power Stem (NRS90-P11)
(1) Canopy for Power Stem (NRS90-P13)
(2) 3" Standoff Support (NRS90-N73)
(3) Mercure Fixtures (NRS11-260)
(3) Monte Glass (NRS82-202) with choice of color Amber (AM), Blue (BU), Red (R), or White (W)

- Kit can accommodate additional rail, fixtures and/or pendants up to 2400 watts.
- Fixtures, standoffs, and power stem/canopy are moveable and can be placed anywhere on the rail.

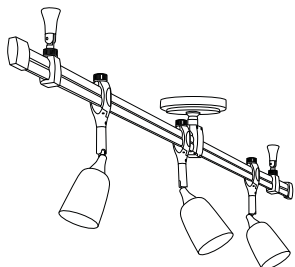

Chicago Nora Rail Kit - Line Voltage Kit with 4' Straight Rail and 3 Mercure Fixtures with Chicago Glass

NRS29-4203

- Lamp:** (3) 40W G9 (included) total 120 Watts
- Finish:** Brushed Nickel (BN), Bronze (BZ), Silver (S)
- Glass Color:** Amber (AM), Blue (BU), Red (R) or White (W)
- Dimensions:** Length: 4'
- Kit included:** (1) 4 ft. Rail (NRS90-P04)
(1) 3" Power Stem (NRS90-P11)
(1) Canopy for Power Stem (NRS90-P13)
(2) 3" Standoff Support (NRS90-N73)
(3) Mercure fixtures (NRS11-260)
(3) Chicago Glass (NRS82-203) with choice of color Amber (AM), Blue (BU), Red (R), or White (W)

- Kit can accommodate additional rail, fixtures and/or pendants up to 2400 watts.
- Fixtures, standoffs, and power stem/canopy are moveable and can be placed anywhere on the rail.

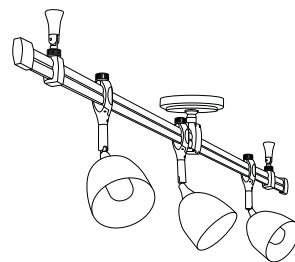

Madeleine Nora Rail Kit - Line Voltage Kit with 4' Straight Rail and 3 Mercure Fixtures with Madeline Glass

NRS29-4204

- Lamp:** (3) 40W G9 (included) total 120 Watts
- Finish:** Brushed Nickel (BN), Bronze (BZ), Silver (S)
- Glass Color:** Amber (AM), Blue (BU), Red (R) or White (W)
- Dimensions:** Length: 4'
- Kit included:** (1) 4 ft. Rail (NRS90-P04)
(1) 3" Power Stem (NRS90-P11)
(1) Canopy for Power Stem (NRS90-P13)
(2) 3" Standoff Support (NRS90-N73)
(3) Mercure fixtures (NRS11-260)
(3) Madeleine Glass (NRS82-204) with choice of color Amber (AM), Blue (BU), Red (R), or White (W)

- Kit can accommodate additional rail, fixtures and/or pendants up to 2400 watts.
- Fixtures, standoffs, and power stem/canopy are moveable and can be placed anywhere on the rail.



Note: All Nora Rail Kits are Line Voltage and do not require a Transformer. All kits can accommodate additional Rail, Fixtures, and/or Pendants as needed.

NORA RAIL
Nora Rail Kits cont.

Place fixtures, standoffs, and power supply anywhere on the Rail!



Mega Ice Cube Pendant Nora Rail Kit - Line Volt. Kit with 4' Straight Rail and 3 Pendant Assemblies with Mega Ice Cube Glass

NRS29-4411

- Lamp:** (3) 40W G9 (included) total 120 Watts
Finish: Brushed Nickel (BN), Bronze (BZ), Silver (S)
Glass Color: Amber (AM), Aqua (AQ), Amethyst (AY) Blue (BU), or Clear (CL)
Dimensions: Length: 4'
Kit included: (1) 4 ft. Rail (NRS90-P04)
 (1) 3" Power Stem (NRS90-P11)
 (1) Canopy for Power Stem (NRS90-P13)
 (2) 3" Standoff Support (NRS90-N73)
 (3) Pendant Cord/Socket Assemblies (NRS19-450)
 (3) Mega Ice Cube Glass (NRS80-411) with choice of color Amber (AM), Aqua (AQ), Amethyst (AY) Blue (BU), or Clear (CL)

- Kit can accommodate additional rail, fixtures and/or pendants up to 2400W.
- Fixtures, standoffs, and power stem/canopy are moveable and can be placed anywhere on the rail.

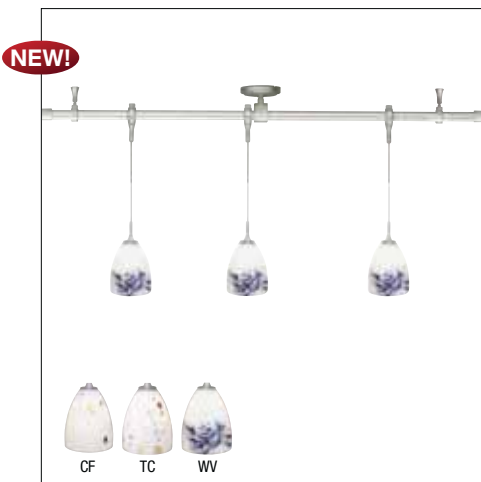
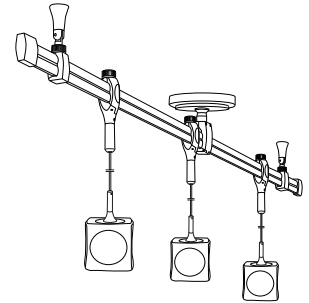

Neptune Pendant Nora Rail Kit - Line Voltage Kit with 6'6" Straight Rail and 3 Pendant Assemblies with Neptune Glass

NRS29-6451

- Lamp:** (3) 40W G9 (included) total 120 Watts
Finish: Brushed Nickel (BN), Bronze (BZ), Silver (S)
Glass Color: Confetti (CF), Wave (WV), or Tri-Color (TC)
Dimensions: Length: 6'6"
Kit included: (1) 6'6" Rail (NRS90-P06)
 (1) 3" Power Stem (NRS90-P11)
 (1) Canopy for Power Stem (NRS90-P13)
 (2) 3" Standoff Support (NRS90-N73)
 (3) Pendant Cord/Socket Assemblies (NRS19-450)
 (3) Neptune Glass (NRS80-451) with choice of color Confetti (CF), Wave (WV), or Tri-Color (TC)

- Kit can accommodate additional rail, fixtures and/or pendants up to 2400 watts.
- Fixtures, standoffs, and power stem/canopy are moveable and can be placed anywhere on the rail.

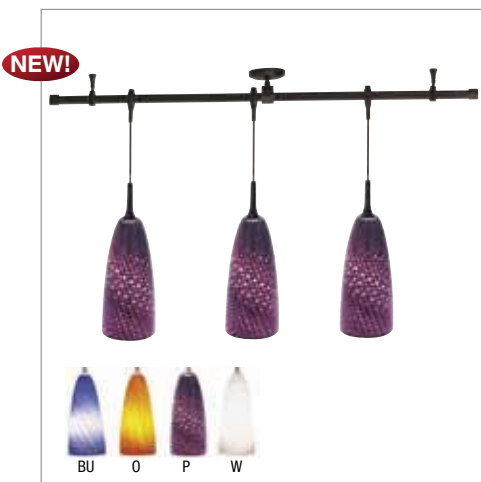
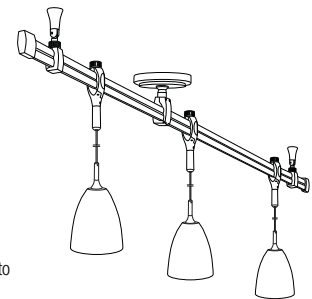

Casie Pendant Nora Rail Kit - Line Voltage Kit with 6'6" Straight Rail and 3 Pendant Assemblies with Casie Glass

NRS29-6462

- Lamp:** (3) 40W G9 (included) total 120 Watts
Finish: Brushed Nickel (BN), Bronze (BZ), Silver (S)
Glass Color: Blue (BU), Orange (O), White (W), or Purple (P)
Dimensions: Length: 6'6"
Kit included: (1) 6'6" Rail (NRS90-P06)
 (1) 3" Power Stem (NRS90-P11)
 (1) Canopy for Power Stem (NRS90-P13)
 (2) 3" Standoff Support (NRS90-N73)
 (3) Pendant Cord/Socket Assemblies (NRS19-450)
 (3) Casie Glass (NRS80-462) with choice of color Blue (BU), Orange (O), White (W), or Purple (P)

- Kit can accommodate additional rail, fixtures and/or pendants up to 2400 watts.
- Fixtures, standoffs, and power stem/canopy are moveable and can be placed anywhere on the rail.

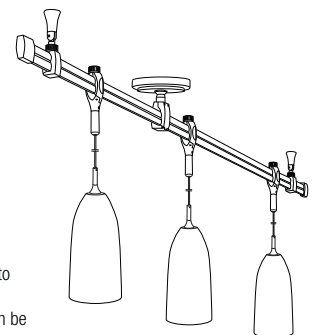

Note: All Nora Rail Kits are Line Voltage and do not require a Transformer. All kits can accommodate additional Rail, Fixtures, and/or Pendants up to 2400W.



Kits can easily accommodate additional rail, fixtures, and pendants!

NORA RAIL

Nora Rail Kits cont.

Neat "S" Curve Nora Rail Kit - Line Voltage Kit with 8' "S" Curve Rail and 4 Neat Fixtures

NRS21-8104

Lamp: (4) 50W MR16 GU10 (included) total 200 Watts

Finish: Brushed Nickel (BN), Bronze (BZ), Silver (S)

Dimensions: Length: 8'

Kit included: (1) 4 ft. Pre-Bent Rail (NRS90-R24-I: Inside Bars)
 (1) 4 ft. Pre-Bent Rail (NRS90-R24-O: Outside Bars)
 (1) 3" Power Stem (NRS90-P11)
 (1) Canopy for Power Stem (NRS90-P13)
 (2) 3" Standoff Support (NRS90-N73)
 (1) Straight Rail Live Connector (NRS90-P81)
 (4) Neat fixtures (NRS11-104)

- Kit can accommodate additional rail, fixtures and/or pendants up to 2400 watts.
- Fixtures, standoffs, and power stem/canopy are moveable and can be placed anywhere on the rail.

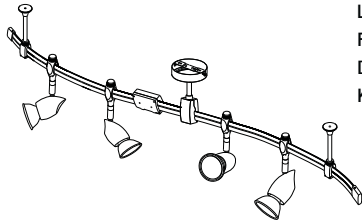

Argon Swivel "S" Curve Nora Rail Kit - Line Voltage Kit with 8' "S" Curve Rail and 4 Argon Swivel Fixtures

NRS21-102

Lamp: (4) 50W MR16 GU10 (included) total 200 Watts

Finish: Brushed Nickel (BN), Bronze (BZ), Silver (S)

Dimensions: Length: 8'

Kit includes: (1) 4 ft. Pre-Bent Rail (NRS90-R24-I: Inside Bars)
 (1) 4 ft. Pre-Bent Rail (NRS90-R24-O: Outside Bars)
 (2) 3" Standoff Support (NRS90-N73)
 (1) 3" Power Stem (NRS90-P11)
 (1) Canopy for Power Stem (NRS90-P13)
 (1) Straight Rail Live Connector (NRS90-P81)
 (4) Argon Swivel fixtures (NRS11-102)

- Kit can accommodate additional rail, fixtures and/or pendants up to 2400 watts.
- Fixtures, standoffs, and power stem/canopy are moveable and can be placed anywhere on the rail.

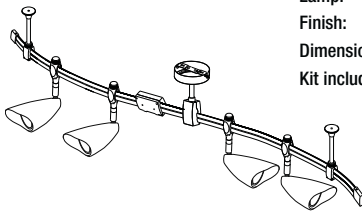

Now available in three finishes!

New Mirage "S" Curve Nora Rail Kit - Line Volt. Kit with 8' "S" Curve Rail and 4 New Mirage Fixtures with Frosted Glass

NRS21-252

Lamp: (4) 50W MR16 GU10 (included) total 200 Watts

Finish: Brushed Nickel (BN), Bronze (BZ), Silver (S)

Dimensions: Length: 8'

Kit included: (1) 4 ft. Pre-Bent Rail (NRS90-R24-I: Inside Bars)
 (1) 4 ft. Pre-Bent Rail (NRS90-R24-O: Outside Bars)
 (2) 3" Standoff Support (NRS90-N73)
 (1) 3" Power Stem (NRS90-P11)
 (1) Canopy for Power Stem (NRS90-P13)
 (1) Straight Rail Live Connector (NRS90-P81)
 (4) New Mirage Frosted Glass fixtures (NRS11-252FR)

- Kit can accommodate additional rail, fixtures and/or pendants up to 2400 watts.
- Fixtures, standoffs, and power stem/canopy are moveable and can be placed anywhere on the rail.

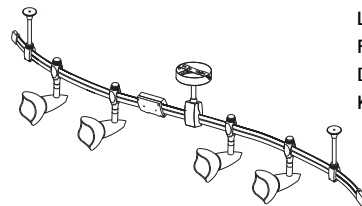

Now available in three finishes!

Note: All Nora Rail Kits are Line Voltage and do not require a Transformer. All kits can accommodate additional Rail, Fixtures, and/or Pendants as needed.



Rail Pendants

Nora Rail Pendants are offered in two styles: complete pendants and pendant assemblies. Complete pendants include the pendant assembly and glass shade. Pendant assemblies are also sold separately from the shade allowing the consumer to choose the best pendant lamp source, finish, shade style and color to fit the application and personal preference. Glass Shades on pages 416-433. Pendants are also available for Track (pg. 441-443), Mini Track (pg. 443), Mini Rail (pg. 440), Monopoint Canopy (pg. 444-446), and Multi QuickJack Canopy (pg. 449).



includes Pendant Assembly and Shade

NORA RAIL

Rail Mount Complete Pendants

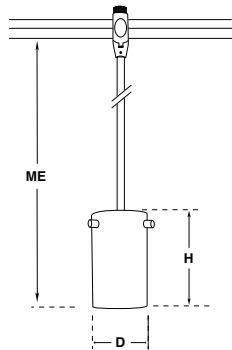

Line Voltage Swift Rail Pendant

NRS19-460 40W Max

Lamp: 40W G9 Halogen (included)
Finish: Brushed Nickel (BN), Bronze (BZ), Silver (S)
Glass: Amber (AM), Frost (FR), Orange (O)
Dimensions: Height: 4" Dia.: 2-3/8" Max Ext.: 9"
Note: Also available as Rail Fixture, see page 477

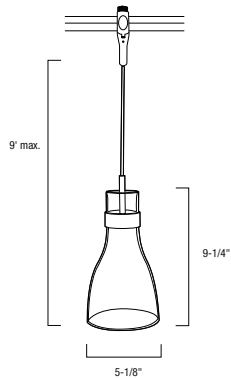

Line Voltage Biba Pendant with Frosted Outer Shade

NRS19-464FR Rail Mount 40W G9 max.
NRS99-464FR Canopy Mount 40W G9 max.

Lamp: 40W max. G9 (included)
Finish: Brushed Nickel (BN), Bronze (BZ), Silver (S)
Glass: Frosted Outer Shade (FR)
Dimensions: Diameter: 5-1/8" (130mm) Length: 9-1/4" (234mm)
 Max Drop: 8' 6" (259cm)

• cULus Listed

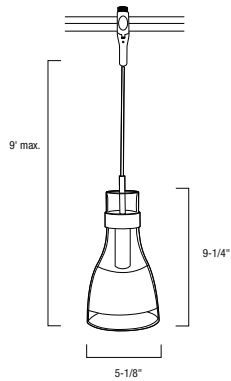

Line Voltage Biba Pendant with Semi-Frosted Outer Shade

NRS19-464SF Rail Mount 40W G9 max.
NRS99-464SF Canopy Mount 40W G9 max.

Lamp: 40W max. G9 (included)
Finish: Brushed Nickel (BN), Bronze (BZ), Silver (S)
Glass: Semi-Frosted Outer Shade (SF)
Dimensions: Diameter: 5-1/8" (130mm) Length: 9-1/4" (234mm)
 Max Drop: 8' 6" (259cm)

• cULus Listed

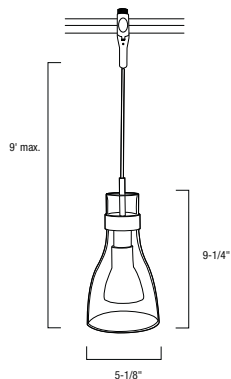

Line Voltage Biba Pendant with Clear Outer Shade and Frosted White Inner Shade

NRS19-464CL Rail Mount 40W G9 max.
NRS99-464CL Canopy Mount 40W G9 max.

Lamp: 40W max. G9 (included)
Finish: Brushed Nickel (BN), Bronze (BZ), Silver (S)
Glass: Clear Outer Shade and White Frosted Inner Shade (CL)
Dimensions: Diameter: 5-1/8" (130mm) Length: 9-1/4" (234mm)
 Max Drop: 8' 6" (259cm)

• Frosted Inner Shade also available in Blue (BU), Green (GR), Orange (O), Red (R), Yellow (Y), (NRS80-405 sold separately).
 • cULus Listed



For matching canopy mount pendant, see page 453

Rail Mount Complete Pendants includes Pendant Assembly and Shade



Ambra Pendant with Porcelain White Shade

NRS19-462PW	Line Voltage	40W G9 max.
NRS34-462PW	Low Voltage	50W JC 6.35/MR16 max.
NRS66-462PW*	Low Volt. QuickJack	50W JC 6.35/MR16 max.

Lamp: **NRS19-462** - 40W G9 (included)
NRS34-462 - 50W JC 6.35/MR16 (not included)
NRS66-462 - 50W JC 6.35/MR16 (not included)

Finish: Brushed Nickel (BN), Bronze (BZ), Silver (S)

Dimensions: Diameter: 3-3/4" (95mm) Length: 6-3/4" (171mm)
 Max Extension: 9' (274cm) includes cord length

*NRS66-462 Male QuickJack pendant assembly with glass. Unit must be used with Female Rail QuickJack adapter, NRS90-P32, ordered separately. See page 514.

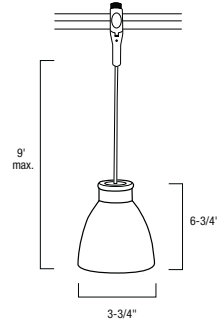

Petra Pendant with Porcelain White Shade

NRS19-463PW	Line Voltage	40W G9 max.
NRS34-463PW	Low Voltage	50W JC 6.35/MR16 max.
NRS66-463PW*	Low Volt. QuickJack	50W JC 6.35/MR16 max.

Lamp: **NRS19-463** - 40W G9 (included)
NRS34-463 - 50W JC 6.35/MR16 (not included)
NRS66-463 - 50W JC 6.35/MR16 (not included)

Finish: Brushed Nickel (BN), Bronze (BZ), Silver (S)

Dimensions: Diameter: 2-15/16" (75mm) Length: 5-3/4" (146mm)
 Max Extension: 9' (274cm) includes cord length

*NRS66-463 Male QuickJack pendant assembly with glass. Unit must be used with Female Rail QuickJack adapter, NRS90-P32, ordered separately. See page 514.

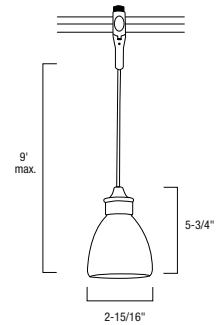

Ambra Yoyo Pendant with Porcelain White Shade

NRS19-562PW	Line Voltage	40W G9 max.
NRS34-562PW	Low Voltage	50W JC 6.35/MR16 max.
NRS66-562PW*	Low Volt. QuickJack	50W JC 6.35/MR16 max.

Lamp: **NRS19-562** - 40W G9 (included)
NRS34-562 - 50W JC 6.35/MR16 (not included)
NRS66-562 - 50W JC 6.35/MR16 (not included)

Finish: Brushed Nickel (BN), Bronze (BZ), Silver (S)

Dimensions: Diameter: 3-3/4" (95mm) Length: 6-3/4" (171mm)
 Cord Length: 9' 6" (290cm)

*NRS66-562 Male QuickJack pendant assembly with glass. Unit must be used with Female Rail QuickJack adapter, NRS90-P32, ordered separately. See page 514.

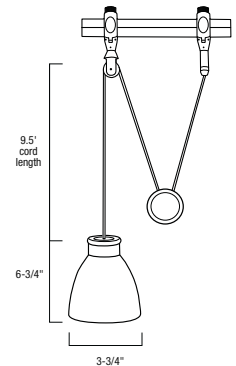

Petra Yoyo Pendant with Porcelain White Shade

NRS19-563PW	Line Voltage	40W G9 max.
NRS34-563PW	Low Voltage	50W JC 6.35/MR16 max.
NRS66-563PW*	Low Volt. QuickJack	50W JC 6.35/MR16 max.

Lamp: **NRS19-563** - 40W G9 (included)
NRS34-563 - 50W JC 6.35/MR16 (not included)
NRS66-563 - 50W JC 6.35/MR16 (not included)

Finish: Brushed Nickel (BN), Bronze (BZ), Silver (S)

Dimensions: Diameter: 2-15/16" (75mm) Length: 5-3/4" (146mm)
 Cord Length: 9' 6" (290cm)

*NRS66-563 Male QuickJack pendant assembly with glass. Unit must be used with Female Rail QuickJack adapter, NRS90-P32, ordered separately. See page 514.

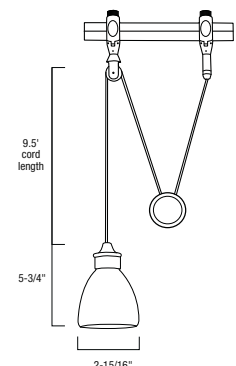



Nora's Universal Rail Adapter allows non-Nora pendants to be used on the Nora Rail System.



Universal Pendant Adaptor

NRS90-P86

Finish: Brushed Nickel (BN), Bronze (BZ), Silver (S)

- Allows any Line Voltage Pendant with support wire diameter of 1/4" or less, weighing under 10lbs. and 300W max. to adapt to the Nora Rail System

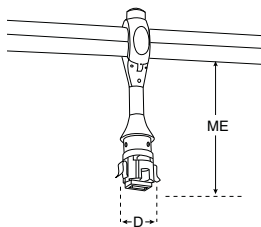

G9 Rail Fixture for PIN Glass

NRS19-501

40W Max

Lamp: 40W G9 Halogen (included)
Finish: Brushed Nickel (BN), Bronze (BZ), Silver (S)
Dimensions: Dia.: 1-1/8" Max Ext.: 4-3/8"

- For use with NRS80-204, NRS80-474, NRS80-482, NRS80-484, NRS80-486, NRS80-487 (Glass sold separately. See page 416-433)



Rail Mount Pendant Assemblies



NEW!



Compact Fluorescent Nora Rail Pendant Assembly GU24 Socket

NRS48-468 8.5' Pendant 13W-26W Max.

Lamp: 13W-26W max. GU24 Self Ballasting CFL (not included)

Finish: Brushed Nickel (BN), Bronze (BZ), Silver (S)

Cord Length: 8.5' Cord is field adjustable to any length

- Accepts attractive glass shades, ordered separately. (Pages 416-433)
- 7/8" opening glass must be gravity hung

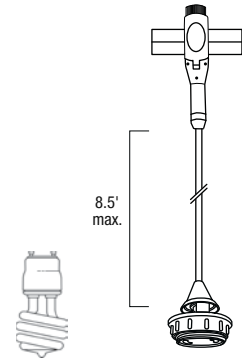

Line Voltage Nora Rail Pendant Assembly Candelabra Socket

NRS19-465 8.5' Pendant 60W Max.

Lamp: 60W max. Line Voltage Candelabra Base (not included)

Finish: Brushed Nickel (BN), Bronze (BZ), Silver (S)

Cord Length: 8.5' Cord is field adjustable to any length

- Accepts attractive glass shades, ordered separately. (Pages 416-433)
- Accepts custom glass or other decorative element with 7/8" top opening

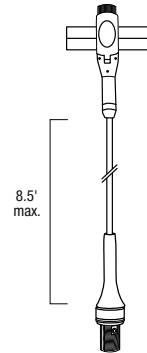

NEW!



Line Voltage Nora Rail Pendant Assembly Medium Base Socket

NRS10-466 8.5' Pendant 100W Max.

Lamp: 100W max. Line Voltage Medium Base (not included)

Finish: Brushed Nickel (BN), Bronze (BZ), Silver (S)

Cord Length: 8.5' Cord is field adjustable to any length

- Accepts attractive glass shades, ordered separately. (Pages 416-433)
- 7/8" opening glass must be gravity hung

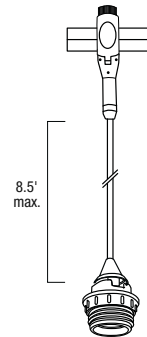

Line Voltage Nora Rail Pendant Assembly G9 Halogen Socket

NRS19-450 8.5' Pendant 40W Max.

NRS19-456 20' Pendant 40W Max.

Lamp: 40W max. Line Voltage G9 Halogen (included)

Finish: Brushed Nickel (BN), Bronze (BZ), Silver (S)

Cord Length: 8.5' and 20' Cords are field adjustable to any length

- Accepts attractive glass shades, ordered separately. (Pages 416-433)
- Accepts custom glass or other decorative element with 7/8" top opening
- Frosted lamp shield included

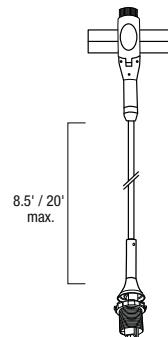

Glass ordered separately. See pages 416-433 for glass options. Compatibility chart on page 458.
For matching canopy mount version, see page 444.



Rail Mount Pendant Assemblies continued

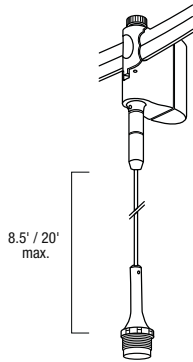

Low Voltage Nora Pendant Assembly Bi-Pin Socket

NRS34-450	8.5' Pendant	20W-50W Max.
NRS34-456	20' Pendant	20W-50W Max.

- Lamp:** 20W-50W max. JC, MR11 or MR16 (not included)
Finish: Brushed Nickel (BN), Bronze (BZ), Silver (S)
Cord Length: 8.5' and 20' Cords are field adjustable to any length
- Integral electronic transformer
 - Accepts attractive glass shades, ordered separately. (Pages 416-433)
 - Accepts custom glass or other decorative element with 7/8" top opening
 - Lamp shield included

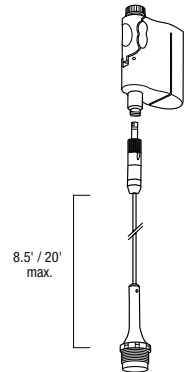

Low Voltage Nora Rail QuickJack Pendant Assembly QuickJack / Bi-Pin Socket

NRS90-P32	QuickJack Nora Rail Adapter only (Integral Transformer)	20-50W Max.
NRS66-457	QuickJack 8.5' Cord and Socket	20-50W Max.
NRS66-458	QuickJack 20' Cord and Socket	20-50W Max.

- Lamp:** 20W-50W max. JC 6.35/MR16 (not included)
Finish: Brushed Nickel (BN), Bronze (BZ), Silver (S)
Cord Length: 8.5' and 20' cords are field adjustable to any length
- **NRS90-P32** QuickJack Adapter must be used with NRS66-457 or NRS-458 QuickJack Pendant Assembly, ordered separately.
 - Lamp shield included

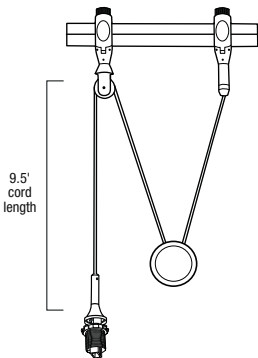

Line Voltage Nora Rail Yoyo Pendant Assembly G9 Halogen Socket

NRS19-551	9.5' Yoyo	40W Max.
------------------	-----------	----------

- Lamp:** 40W max. Line Voltage G9 Halogen (included)
Finish: Brushed Nickel (BN), Bronze (BZ), Silver (S)
Cord Length: 9.5' Cord is field adjustable to any length
- Accepts attractive glass shades, ordered separately. (Pages 416-433)
 - Accepts custom glass or other decorative element with 7/8" top opening
 - Pulley and counter weight provide unique, glass positioning by hand
 - Frosted lamp shield included

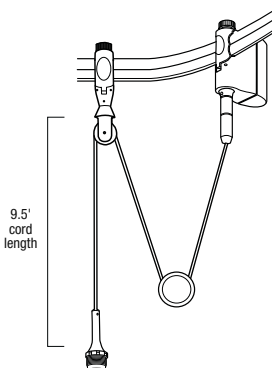

Low Voltage Nora Rail Yoyo Pendant Assembly Bi-Pin Socket

NRS34-551	9.5' Yoyo	20W-50W Max.
------------------	-----------	--------------

- Lamp:** 20W-50W max. JC, MR11 or MR16 (not included)
Finish: Brushed Nickel (BN), Bronze (BZ), Silver (S)
Cord Length: 9.5' Cord is field adjustable to any length
- Integral electronic transformer
 - Accepts attractive glass shades, ordered separately. (Pages 416-433)
 - Accepts custom glass or other decorative element with 7/8" top opening
 - Pulley and counter weight provide unique, glass positioning by hand
 - Lamp shield included



Glass ordered separately. See pages 416-433 for glass options. Compatibility chart on page 458.

Nora Rail System Components



Nora Lighting offers attractive, low profile slim rails for use with any combination of Line Voltage, Low Voltage, Fluorescent, PAR, Metal Halide Fixtures or Pendants. The small blade design makes Nora Rail suitable for residential applications. Internal 20A conductors deliver long runs necessary for commercial and architectural application, allowing 2400 watts on a single, low profile power feed. May be bent to 12-1/2" minimum radius.

Easy installation, attractive finishing elements, and low system cost delivers high-tech design elements within reach of virtually any contemporary design.

Two end caps and one locking Allen key are provided with each section of rail.

Slim, Low Profile Rails

NRS90-P04	4' (1.2M)
NRS90-P06	6'-6" (2M)
NRS90-P08	8' (2.4M)

Finish: Brushed Nickel (BN), Bronze (BZ), Silver (S)

Dimensions: Length: 4', 6'-6", and 8'

- Two end caps included

Line Voltage Pre-Bent Rails

Nora Rail can be purchased in straight lengths that are easily cut with a hacksaw and/or field bent to as small as 2ft. diameter circle. Factory pre-bent curves and circles are also available. cULus listed for up to 2400 watts on a single run. Nora Rail is smooth on one side and has bus bars and insulators on the other. On pre-bent rail "I" is used for bus bars on the inside of the curve and "O" for outside of the curve.

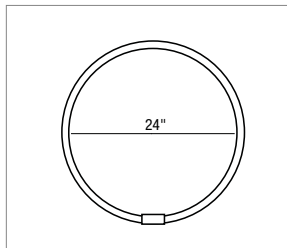

Complete Circle Pre-Bent Rails

NRS90-C12-I 24" Diameter

Finish: Brushed Nickel (BN), Bronze (BZ), Silver (S)

- One non-power connector included (NRS90-N89)
- Bus bar on inside curve (I)

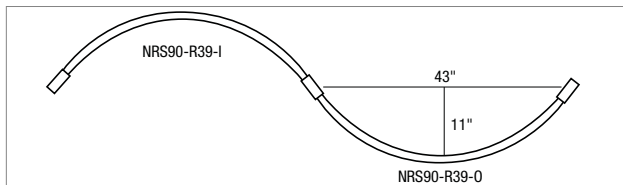

Curve Pre-bent Rails

NRS90-R24-I 4' (1.2M)

NRS90-R24-O 4' (1.2M)

Finish: Brushed Nickel (BN), Bronze (BZ), Silver (S)

- Two dead end caps included (NRS90-N01)
- **To create an "S" shape** (80" length), order (1) NRS90-R24-I, (1) NRS90-24-O, and (1) NRS90-P81 connector.
- **To create a circle** (48" diameter), order (3) NRS90-R24-I, (2) NRS90-P81 connector, and (1) NRS90-N89

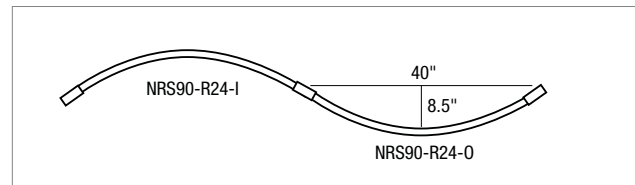
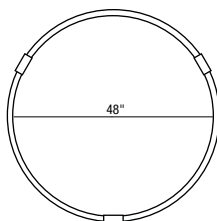

Soft Curve Pre-Bent Rails

NRS90-R39-I 4' (1.2M)

NRS90-R39-O 4' (1.2M)

Finish: Brushed Nickel (BN), Bronze (BZ), Silver (S)

- Two dead end caps included (NRS90-N01)
- **To create a soft "S" shape** (86" length), order (1) NRS90-R39-I, (1) NRS90-R39-O, and (1) NRS90-P81 connector.
- **To create a circle** (78" diameter), order (5) NRS90-R39-I, (4) NRS90-P81 connector, and (1) NRS90-N89

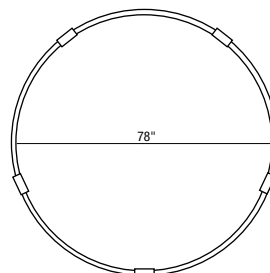



Nora Rail System Components



Power Canopy and Stem

NRS90-P13	Canopy for Power Stem
NRS90-P11	3" Power Stem
NRS90-P14	4" Power Stem
NRS90-P17	7-1/2" - 11-1/2" Adj. Power Stem

- **NRS90-P13** must use with NRS90-P11, NRS90-P14, NRS90-P17



NRS90-P15 Canopy (Heavy duty) for Longer Power Stem

NRS90-P87	12" - 24" Adj. Power Stem
NRS90-P88	25-1/4" - 48" Adj. Power Stem
NRS90-P89	49-3/4" - 96" Adj. Power Stem

- **NRS90-P15** must use with NRS90-P87, NRS90-P88, NRS90-P89
 - Heavy Cast Iron construction for longer stem application
- Finish:** Brushed Nickel (BN), Bronze (BZ), Silver (S)

Canopy and Power Stem sold separately. Rigid power stems with canopy deliver 120V power to rail while providing a clean, streamlined appearance by eliminating bulky, flexible cords. New low profile canopy includes bracket to attach to a standard 4" junction box.



Adjustable Power Cord w/Canopy

NRS90-P90	10'-6"
------------------	--------

- Finish:** Brushed Nickel (BN), Bronze (BZ), Silver (S)
- Cord is field adjustable



Adjustable Power Cord w/Canopy and Support Cable

NRS90-P91	10'-6"
NRS90-P91-M1	20'

- Finish:** Brushed Nickel (BN), Bronze (BZ), Silver (S)
- Cord and cable are field adjustable



Adjustable Power Cord with Rail Connector and Side Feed to Canopy

NRS90-P80	18" cord length
------------------	-----------------

- Finish:** Brushed Nickel (BN), Bronze (BZ), Silver (S)
- To connect rail to line voltage power
 - Affixes to wall mount or ceiling mount standard junction box



Rail Current Limiter w/Circuit Breaker

NRS90-P37(finish)/1	1A / 120W
NRS90-P37(finish)/2.5	2.5A / 300W
NRS90-P37(finish)/5	5A / 600W
NRS90-P37(finish)/7.5	7.5A / 900W
NRS90-P37(finish)/10	10A / 1200W
NRS90-P37(finish)/12	12A / 1440W
NRS90-P37(finish)/14	14A / 1680W

ORDER EXAMPLE: NRS90-P37BN/14

Finish: Brushed Nickel (BN), Bronze (BZ), Silver (S) - finish designation placed after "P37"
For use with NRS90-P11, NRS90-P14, NRS90-P17, NRS90-P87, NRS90-P88, NRS90-P89 power stem or NRS90-P90 power canopy with 10'6" cord



Rail Wall Mount Power Canopy

NRS90-P40

- Finish:** Brushed Nickel (BN), Bronze (BZ), Silver (S)
- Rail feeds directly into canopy from wall mounted J-Box



Line Voltage Adjustable Slope Canopy for use with Power Stem

NRS90-P10

- Finish:** Brushed Nickel (BN), Bronze (BZ), Silver (S)
- For use with NRS90-P17, NRS90-P87, NRS90-P88 and NRS90-P89 only.



Grounded Cord and Plug with Rail Connector

NRS90-P99	10'
------------------	-----

- Finish:** Brushed Nickel (BN), Bronze (BZ), Silver (S)
- To power Track from a standard 3-prong grounded receptacle

Lighting Tip:

To meet stringent watts per square foot requirements use Nora Rail Current Limiter Power Canopy. NEC will rate line voltage rail at 45 watts per foot regardless of load. Use a 2.5A Current Limiter and system will be rated at 300 watts.



Straight/Slope Ceiling Rail Standoff

NRS90-N73	3"
NRS90-N74	4"
NRS90-N77 ¹	8-1/4" - 11-1/2"
NRS90-N70 ¹	12" - 24"
NRS90-N71 ¹	25-1/4" - 48"
NRS90-N72 ¹	49-3/4" - 96"

Finish: Brushed Nickel (BN), Bronze (BZ), Silver (S)

¹ Telescoping supports allow for easy in the field leveling of rail system



Straight Connector

NRS90-P81	Power (live)
NRS90-N89	Non-power

Finish: Brushed Nickel (BN), Bronze (BZ), Silver (S)

- Connects two rails together and will conduct power or not.



Straight Ceiling Rail Support (Standoff)

NRS90-N14	4"
NRS90-N17 ¹	7-1/2" - 11-1/2"

Finish: Brushed Nickel (BN), Bronze (BZ), Silver (S)

¹ Telescoping supports allow for easy in the field leveling of rail system



Flexible Live Corner Connector

NRS90-P85	9-1/2"
------------------	--------

Finish: Brushed Nickel (BN), Bronze (BZ), Silver (S)

- Attractive, enclosed flexible electrical connection between two rails



T-Bar Clip and Cover

NRS90-N21	15/16"
NRS90-N22	9/16"

Finish: Brushed Nickel (BN), Bronze (BZ), Silver (S)

- Attaches to all Rail supports:



Flexible Rail Power Connector

NRS90-P82	20"
------------------	-----

Finish: Brushed Nickel (BN), Bronze (BZ), Silver (S)

20" Flexible Rail Connector connects two sections rail where sharp angles prohibit the use of rail bending or for extending power connection through beams or drywall (cable cannot be shortened)



Adjustable Aircraft Cable Ceiling Rail Support

NRS90-N91	10'
NRS90-N91-M1	20'

Finish: Brushed Nickel (BN), Bronze (BZ), Silver (S)

- Cable can be easily adjusted in the field with cutting cable and locking cable device.



Track Fixture Adapter for Rail

NRS90-P31	
------------------	--

Finish: Brushed Nickel (BN), Bronze (BZ), Silver (S)

- Allows Line Voltage track fixtures to be mounted to the Rail



Adjustable Wall Rail Support (No Power)

NRS90-N18	5-1/2" - 8-1/2"
NRS90-N26	8-1/4" - 11-1/2"
NRS90-N27	13-1/4" - 24"

Finish: Brushed Nickel (BN), Bronze (BZ), Silver (S)



Three Prong Plug Adapter for Rail

NRS90-P30	
------------------	--

Finish: Brushed Nickel (BN), Bronze (BZ), Silver (S)

- Allows a power outlet on the Rail



Universal Pendant Adaptor

NRS90-P86	
------------------	--

Finish: Brushed Nickel (BN), Bronze (BZ), Silver (S)

- Allows any Line Voltage Pendant with support wire diameter of 1/4" or less, weighing under 10lbs. and 300W max. to adapt to the Nora Rail System



Nora Rail System Components



Live L-Connector Power Stem

NRS90-P03 7-1/2" - 11-1/2"

Finish: Brushed Nickel (BN), Bronze (BZ), Silver (S)

- Conducts power from J-Box to Rail
- Connects and conducts power to two Rails in a "L" pattern



Live L-Connector

NRS90-N03

Finish: Brushed Nickel (BN), Bronze (BZ), Silver (S)

- Use with standard non-power stems NRS90-N70 series
- Connects and conducts power to two Rails in an "L" pattern



Live T-Connector Power Stem

NRS90-P01 7-1/2" - 11-1/2"

Finish: Brushed Nickel (BN), Bronze (BZ), Silver (S)

- Conducts power from J-Box to Rail
- Connects and conducts power to multiple Rails in a "T" pattern



Live X-Connector

NRS90-N02

Finish: Brushed Nickel (BN), Bronze (BZ), Silver (S)

- Use with standard non-power stems NRS90-N70 series
- Connects and conducts power to multiple Rails in an "X" pattern



Live X-Connector Power Stem

NRS90-P02 7-1/2" - 11-1/2"

Finish: Brushed Nickel (BN), Bronze (BZ), Silver (S)

- Conducts power from J-Box to Rail
- Connects and conducts power to multiple Rails in a "X" pattern



Live T-Connector

NRS90-N04

Finish: Brushed Nickel (BN), Bronze (BZ), Silver (S)

- Use with standard non-power stems NRS90-N70 series
- Connects and conducts power to multiple Rails in a "T" pattern



Nora QuickJack Components



QuickJack Rail Adapter with Electronic Transformer

NRS90-P32

- Finish:** Brushed Nickel (BN), Bronze (BZ), Silver (S)
- Use with NRS66 series. Patent pending.
 - See QuickJack detail on pages 482-483



QuickJack Mini Rail Adapter

NMRS90-P32

- Finish:** Bronze (BZ), Chrome (C), Matte Gold (MG), Matte Nickel (MN)
- Allows NRS66 Nora Rail series to be put on Nora Mini Rail.
 - See QuickJack detail on pages 482-483



Extension Rods for QuickJack

NRS90-P33	6" extension
NRS90-P34	12" extension
NRS90-P35	24" extension

- Finish:** Brushed Nickel (BN), Bronze (BZ), Silver (S)
- Rod can be attached to one another
 - Use with NRS66 series
 - See QuickJack detail on pages 482-483



QuickJack Track Adapter with Electronic Transformer

NT-370 50W

- Finish:** Black (B), Silver (S), White (W)
- Allows NRS66 Nora Rail series to be put on the standard Track
 - See QuickJack detail on pages 482-483



QuickJack Canopy with Integral Transformer

NRS90-P47/12

- Finish:** Brushed Nickel (BN), Bronze (BZ), Silver (S)
- Includes (1) 60W transformer
 - For use with NRS66 Series
 - See QuickJack detail on pages 482-483



QuickJack Mini Track Adapter

NLMT-760

- Finish:** Black (B), White (W)
- Allows NRS66 Nora Rail series to be put on the Mini track
 - See QuickJack detail on pages 482-483



QuickJack Slope Canopy with Integral Transformer

NRS90-P12

- Finish:** Brushed Nickel (BN), Bronze (BZ), Silver (S)
- Includes (1) 60W transformer
 - For use with NRS66 Series
 - See QuickJack detail on pages 482-483



Multi QuickJack Linear Canopy with Integral Transformers (3 QuickJacks)

NP66-103

- Finish:** Brushed Nickel (BN), Bronze (BZ)
- W: 26" L: 4-1/2" H: 1-3/4"
 - Includes (3) 60W transformers
 - For use with NRS66 Series
 - See QuickJack detail on pages 482-483



QuickJack Shallow Canopy (No Transformer)

NRS90-P51

- Finish:** Brushed Nickel (BN), Bronze (BZ), Silver (S)
- Requires remote transformer (See pages 702-704)
 - For use with NRS66 Series
 - See QuickJack detail on pages 482-483



Multi QuickJack Round Canopy with Integral Transformers (3 QuickJacks)

NP66-203

- Finish:** Brushed Nickel (BN), Bronze (BZ)
- D: 11-7/8" H: 1-3/4"
 - Includes (3) 60W transformers
 - For use with NRS66 Series
 - See QuickJack detail on pages 482-483



Nora Rail Accessories



End Cap

NRS90-N01

Finish: Brushed Nickel (BN), Bronze (BZ), Silver (S)

- Two end caps included with each rail section



Dichroic Filter

NRS90-N66

Finish: Blue(BU), Green (GR), Red (R), Yellow (Y)

- Use with NRS52-155, NRS52-156, NRS52-157



Metal Clamp-on Ring for MR16 lamps

NRS90-N31

Finish: Brushed Nickel (BN), Bronze (BZ), Silver (S)

- For use with any fixture with a completely exposed MR16 lamp



MR16, GU10 Twist and Lock Base, Lensed, Floodlight

50MR16EXN/L10 50W

MR16, GX10 Twist and Lock Base, Floodlight

CMH20MR16/FL 20W

Finish: Silver (S)



MR16 Decorative Ring with Lamp Spring

NRS90-N32

Finish: Brushed Nickel (BN), Bronze (BZ), Silver (S)

- For use with NRS11-103, NRS11-104, NRS11-302, NRS11-310, NRS36-103, NRS36-104, NRS36-302, NRS36-310, NRS66-103, NRS66-104, NRS66-302, NRS66-310



Halogen, G9 Base (Frosted Open Rated)

40G9 40W

40G9F/O 40W

Halogen, Double Ended Base

150R7S 150W

300R7S 300W

MR16 Honeycomb

NT-362 Black (B)

- For use with NRS90-N32



Glass Shield

NRA-136

- For use with NRS33-901, NRS66-901



MR16 Colored Lenses

NM-100/MR16

Finish: Blue, Yellow, Green, Red, Frosted, Linear, Spread

- For use with NRS90-N32



Frosted Finger Glass Shield

NRS90-N34 Line Voltage

NRS90-N35 Low Voltage

NRA-6040 (no thread)

- **NRA-6040** Use with NRS19-202, NRS19-203, NRS19-204, NRS19-474, NRS19-501



Suction Cup Lamp Changer

NRS90-N20

- For easy changing of GU10, MR16 lamps



Rail Bending Device

NRS90-N33

- Allows custom bending of rail in field

Rail System Sample Layout

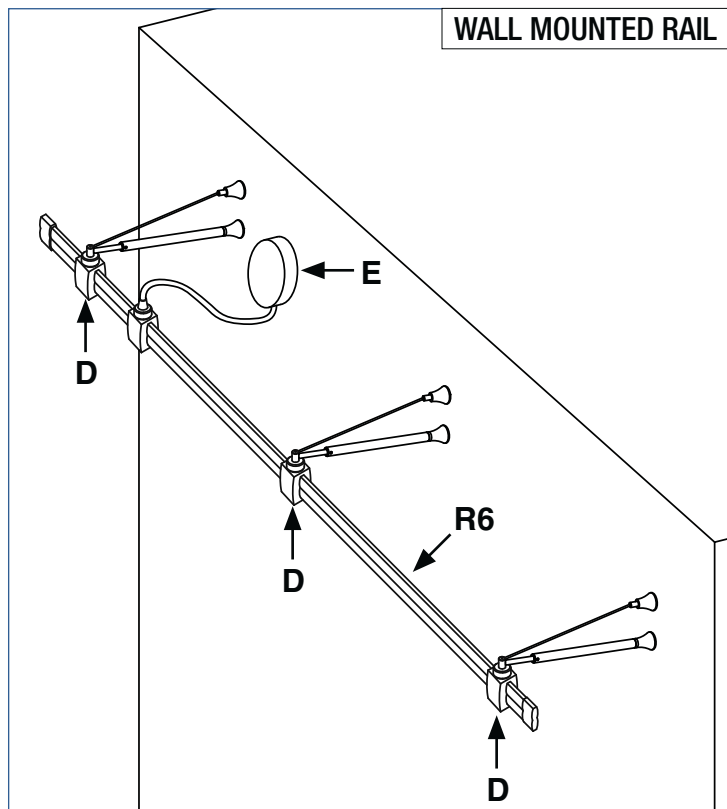
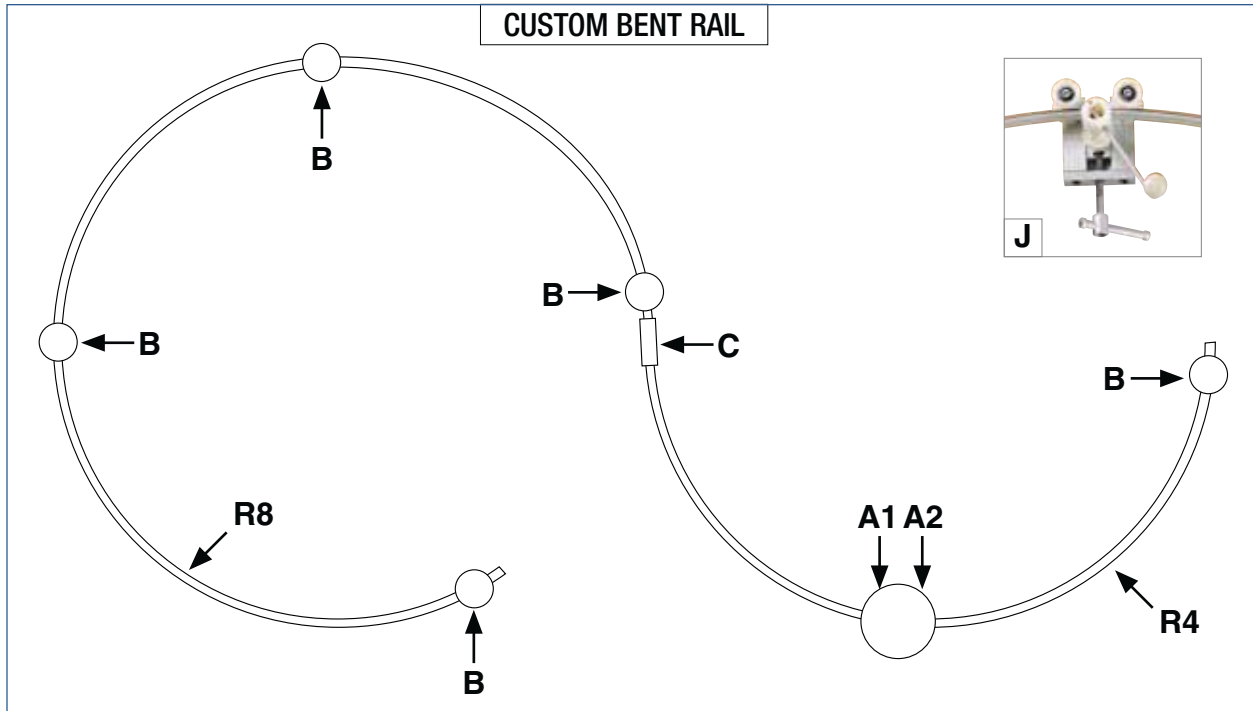

	DESCRIPTION	ITEM #
R4	4' Rail	NRS90-P04
R6	6'-6" Rail	NRS90-P06
R8	8' Rail	NRS90-P08
A1	Canopy for Power Stem	NRS90-P13
A2	4" Power Stem	NRS90-P14
B	4" Ceiling Connector	NRS90-N14
C	Straight Rail Connector - Power (Live)	NRS90-P81
D	5-1/2" - 8-1/2" Adjustable Wall Connector	NRS90-N18
E	Round Power Canopy w/ Rail Connector	NRS90-P80
J	Rail Bending Device (Rail can be bent in field)	NRS90-N33

NORA RAIL Rail System Sample Layout

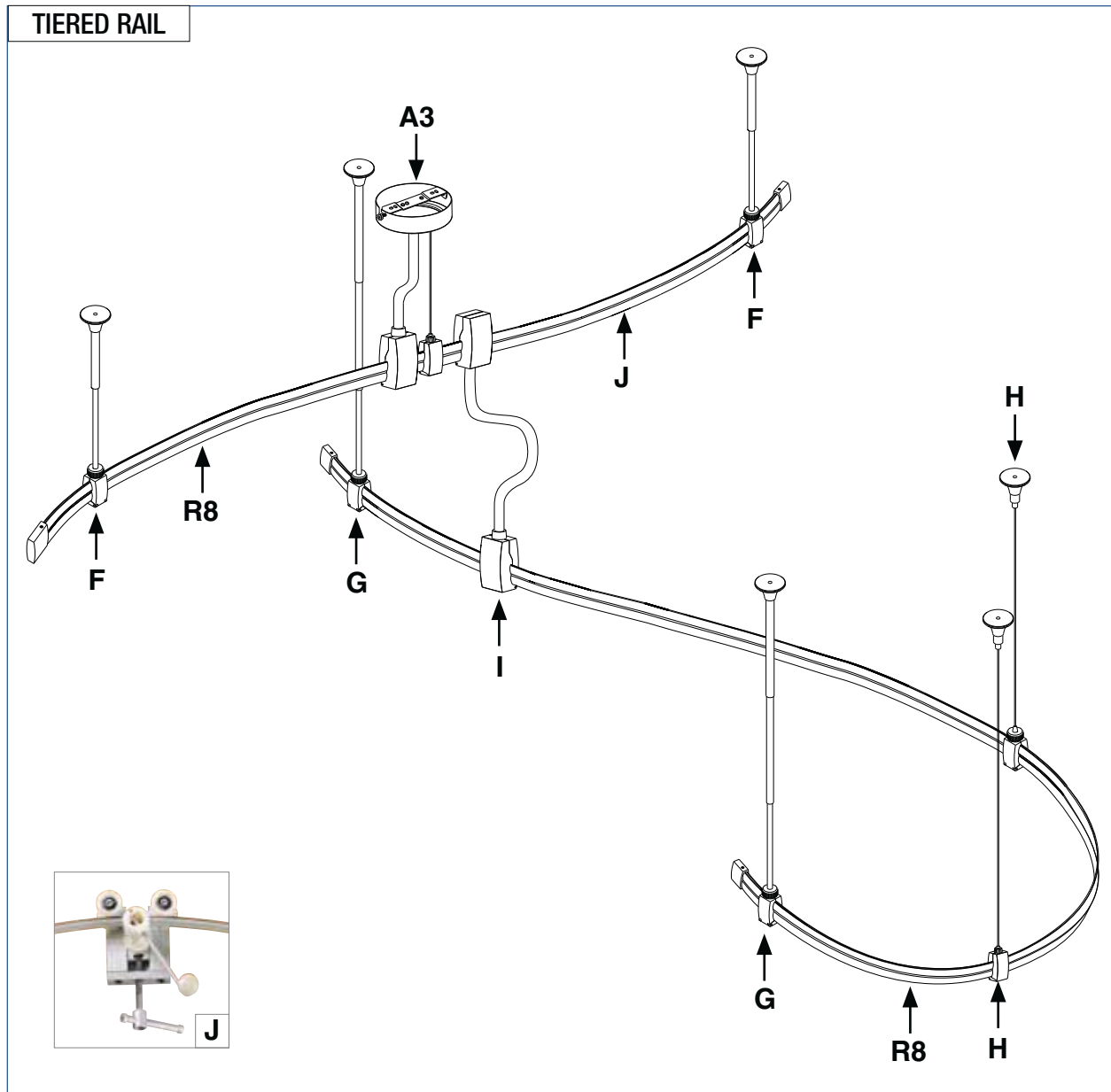

	DESCRIPTION	ITEM #
R8	8' Rail	NRS90-P08
A3	Round Power Canopy, 10'-6" Cord & Suspended Cable	NRS90-P91
F	12" - 24" Adjustable Straight/Soped Ceiling Connector	NRS90-N70
G	25-1/4" - 48" Adjustable Straight/Soped Ceiling Connector	NRS90-N71
H	Rail Connector, 10' Aircraft Cable, Ceiling mount	NRS90-N91
I	Flexible Rail to Rail Connector	NRS90-P82
J	Rail Bending Device (Rail can be bent in field)	NRS90-N33



TRACK

Introduction	521
Overview	522
LED Fixtures	530
Ceramic Metal Halide Fixtures	532
Fluorescent Fixtures	548
Low Voltage Fixtures	555
Line Voltage Fixtures	575
Track Packs	590
Track Pendants	592
One and Two Circuit Track Systems	594
Current Limiter	596
Track System Accessories	597
Track Sample Layouts	604



The Nora Lighting family of Track Lighting

Nora's single and two circuit line voltage track is rated to handle up to 2400W on single circuit and 4800W on the two circuit, making our track very versatile in the architectural and residential applications. Handling a variety of light sources including: LED, HID, Fluorescent, Incandescent and Low Voltage, each of these light sources has an extensive variety of styles to accommodate your individual design needs. The Nora Track can accommodate track fixtures as well as our latest line of pendant drops in 5 light sources with Nora's new art glass collection.



FEATURES

- LED!** • Two new LED track fixtures: Pillar and Robo Cylinder
- NEW!** • "J" and "L" style track fixtures
- Track available in five finishes
- All Nora track fixtures are available in "H" style and can be used with 1 or 2-circuit track
- Lamps Sources - LED, HID Ceramic Metal Halide, Compact Fluorescent, T5 HO Fluorescent, GU24 Fluorescent, Low Voltage, GU10 Line Voltage Halogen, Line Voltage
- Complete selection of track connectors and accessories
- 2-circuit and single circuit available
- Field cuttable
- Meets watts per square requirements with Nora's Current Limiting Power Feeds
- cULus Listed



Commercial Lighting Tip:

Using 2-circuit track can reduce the cost of labor and wire on large scale jobs while also adding flexibility. Dual A/B switching can reduce energy costs when not all lights are required to be on.

Residential Lighting Tip:

2-Circuit Track provides the same flexibility as recessed lighting while reducing the cost of installation and adding only minimally to material cost. Use one circuit to light focal points and the second circuit for general lighting.

Overview TRACK LIGHTING

LED TRACK FIXTURES



NTE-810 Pillar

18W LED

p.531



NTE-820 Robo

9W LED

p.531

Nora Lighting's new LED Track fixtures provide over **75% energy savings** when compared to incandescent! Integral LED Driver performs at the level of a 50W MR16!

T4 & T6 CERAMIC METAL HALIDE TRACK FIXTURES



NTM-27T Series

20W/39W/70W T4 CMH
39W/70W T6 CMH

p.533



NTM-27U30

20W T4 CMH

p.533



NTM-55T Series

20W/39W T4 CMH
39W/70W T6 CMH

p.534



NTM-77T Series

20W/39W/70W T4 CMH
39W/70W T6 CMH

p.534



NTM-17T Series

20W/39W/70W T4 CMH
39W/70W T6 CMH

p.535

MR16 CERAMIC METAL HALIDE TRACK FIXTURES



NTM-27X15

20W MR16 CMH

p.537



NTM-27X35

20W MR16 CMH

p.537



NTM-27X45

20W MR16 CMH

p.537



NTM-27P Series

20W/39W PAR20 / 39W/70W
PAR30 / 70W PAR38 CMH

p.538



NTM-6200 Series

39W PAR20 / 20W/39W/70W
PAR30 / 70W PAR38 CMH

p.538

PAR CERAMIC METAL HALIDE TRACK FIXTURES



NTM-6600 Series

39W PAR20 CMH
70W PAR38 CMH

p.539



NTM-6300 Series

39W PAR20 / 20W/39W/70W
PAR30L / 70W PAR38 CMH

p.540



NTM-6400 Series

39W PAR20 / 20W/39W/70W
PAR30L / 70W PAR38 CMH

p.540



NTM-5300 Series

35W PAR20 / 35W/70W PAR30 /
70W/100W PAR38 CMH

p.541



NTM-5400 Series

35W PAR20 / 35W/70W PAR30 /
70W PAR38 CMH

p.542

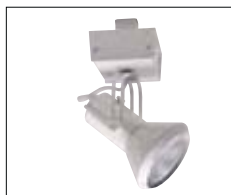

NTM-5200 Series

35W PAR20 / 35W/70W PAR30 /
70W/100W PAR38 CMH

p.543



NTM-6038 Round Back

70W PAR38 CMH

p.544



NTM-6138 Flat Back

70W PAR38 CMH

p.544



NTM-5038 Round Back

70W PAR38 CMH

p.544



NTM-5138 Flat Back

70W PAR38 CMH

p.544

ED17 CERAMIC METAL HALIDE TRACK FIXTURES

WALL WASH CERAMIC METAL HALIDE FIXTURES



NTM-6617 Series
50W / 70W / 100W
ED17 CMH p.546



NTM-5617 Series
50W / 70W / 100W
ED17 CMH p.546



NTM-5517 Series
50W / 70W / 100W
ED17 CMH p.546



NTM-59T6
39W/70W T6 CMH p.547



NTM-58DE
70W T6 DE CMH p.547



NTM-5717
50W / 70W / 100W
ED17 CMH p.547

T5 HIGH OUTPUT LINEAR FLUORESCENT TRACK FIXTURES



NTF-4124 1-Lamp HO
NTF-4224 2-Lamp HO
24W T5 HO p.549

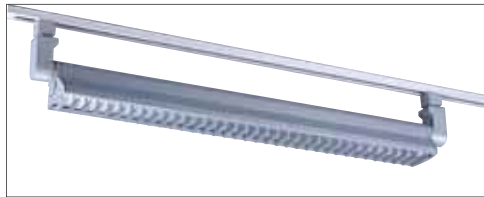

NTF-4139 1-Lamp HO
NTF-4239 2-Lamp HO
39W T5 HO p.549



NTF-4154 1-Lamp HO
NTF-4254 2-Lamp HO
54W T5 HO p.549

COMPACT FLUORESCENT TRACK FIXTURES



NTF-2642T Triple Tube
26W-42W Triple Tube p.550



NTF-3218 F18 Twin Tube
(2) 18W F18 Twin Tube p.551



NTF-3227 F27 Twin Tube
(2) 27W F27 Twin Tube p.551



NTF-3229 F39 Twin Tube
(2) 39W F39 Twin Tube p.551



NTF-3240 F40 Twin Tube
(2) 40W F40 Twin Tube p.551

GU24 COMPACT FLUORESCENT TRACK FIXTURES



NTH-101G24 Flat Back Cyl.
18W Spiral GU24 p.552



NTH-102G24 Flat Back Cyl.
26W Spiral GU24
15W R30 GU24 p.552



NTH-104G24 Step Cylinder
18W Spiral GU24
15W R30 GU24 p.552



NTH-105G24 Round Back Cyl.
18W Spiral GU24 p.553



NTH-106G24 Round Back Cyl.
26W Spiral GU24
15W R30 GU24 p.553



NTH-111G24 Classic Cylinder
26W Spiral GU24
15W R30 GU24 p.553



NTH-149G24 Shroud
13W Spiral GU24
15W R30 GU24 p.553

Select track fixtures now available for use in H, J and L style track!

Overview TRACK LIGHTING continued

MR16 LOW VOLTAGE TRACK FIXTURES



NTL-27M84 Vanguard
20W-75W MR16 12V p.556



NTL-27M85 Vanguard
20W-50W MR16 12V p.556



NTL-27M86 Vanguard
20W- 50W MR16 12V p.556



NTL-262 V-Tec Cylinder
20W- 50W MR16 12V p.557



NTL-263 V-Tec Cross Blade
20W- 50W MR16 12V p.557



NTL-264 V-Tec Gimbal
20W- 50W MR16 12V p.557



NTL-301 Micro II Gooseneck
20W- 50W MR16 12V p.557



NTL-302 Delta
20W- 50W MR16 12V p.558



NTL-303 Retro Holder
20W- 50W MR16 12V p.558



NTL-304 Retro II Holder
20W- 50W MR16 12V p.558



NTL-305 Spike I
20W- 50W MR16 12V p.558



NTL-306 Spike II
20W- 50W MR16 12V p.559



NTL-307 Vetro II Stem
20W- 50W MR16 12V p.559



NTL-313 Michaelangelo™
20W- 50W MR16 12V p.559



NTL-314 Galileo™
20W- 50W MR16 12V p.559



NTL-315 Newton™
20W- 50W MR16 12V p.560



NTL-316 Copernicus™
20W- 50W MR16 12V p.560



NTL-317 Roma™
20W- 50W MR16 12V p.560



NTL-318 Italia™
20W- 50W MR16 12V p.560



NTL-319 Metro™
20W- 50W MR16 12V p.561



NTL-320 Stockholm™
20W- 50W MR16 12V p.561



NTL-321 Paris™
20W- 50W MR16 12V p.561



NTL-322 Cabral II™
20W- 35W MR11 12V p.561



NTL-323 Cabral™
20W- 50W MR16 12V p.563



NTL-201 / NTL-2201 Studio Series
20W-75W MR16 12V p.563

MR16 LOW VOLTAGE TRACK FIXTURES *continued*



NTL-202 / NTL-2202
Cube Series

20W-75W MR16 12V p.564



NTL-203 / NTL-2203
Cylinder Series

20W-75W MR16 12V p.564



NTL-205 / NTL-2205
High-Tech

20W-50W MR16 12V p.565



NTL-207 / NTL-2207
Gimbal Ring

20W-75W MR16 12V p.565



NTL-208 / NTL-2208
Barndoor

20W-75W MR16 12V p.566



NTL-209 / NTL-2209
Spotlight

20W-50W MR16 12V p.566



NTL-210 / NTL-2210
Clasp

20W-75W MR16 12V p.567



NTL-211 / NTL-2211
Pinchback

20W-50W MR16 12V p.567



NTL-212 / NTL-2212
Continental

20W-75W MR16 12V p.568



NTL-213 / NTL-2213
Wireback

20W-75W MR16 12V p.568



NTL-214 / NTL-2214
Roundback

20W-75W MR16 12V p.569



NTL-215 / NTL-2215
Telescope

20W-75W MR16 12V p.569



NTL-221 Magnetic
Roundback Cylinder

50W max. MR16 12V p.570



NTL-222 Magnetic
Flatback Cylinder

50W max. MR16 12V p.570



NTL-226 3-In-1
Combination Projector

20W-75W MR16 12V p.571

LOW VOLTAGE QUICKJACK FIXTURES



Shown with
NRS66-253

NT-370 QuickJack Adapter
with Intergral Trans.

Required for NRS66 series fixtures



NRS66-101 Argon Curve

20W- 50W MR16 12V p.484



NRS66-102 Argon Swivel

20W- 50W MR16 12V p.484



NRS66-103 Sienna w/Ring

20W- 50W MR16 12V p.484



NRS66-104 Neat

20W- 50W MR16 12V p.484



NRS66-105 Satelit Curve

20W- 50W MR16 12V p.485



NRS66-106 Satelit Swivel

20W- 50W MR16 12V p.485



NRS66-107 Neon

20W- 50W MR16 12V p.485



NRS66-108 Lika

20W- 50W MR16 12V p.485

Overview TRACK LIGHTING continued

LOW VOLTAGE QUICKJACK FIXTURES *continued*



NT-370 QuickJack Adapter with Integral Trans.

Required for NRS66 series fixtures

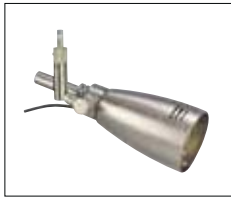

NRS66-109 Nica

20W- 50W MR16 12V p.487

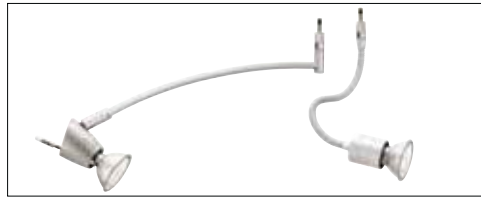

NRS66-310 Fili Display

20W- 50W MR16 12V p.487



NRS66-302 Ives Gooseneck

20W- 50W MR16 12V p.487



NRS66-201PW Petra Curve

20W- 50W JC 6.35/MR16 p.488



NRS66-202PW Petra Swivel

20W- 50W JC 6.35/MR16 p.488



NRS66-203PW Melody

20W- 50W JC 6.35/MR16 p.488



NRS66-204 Swiftec

20W- 50W JC 6.35/MR16 p.489



NRS66-251 Kano Spot

20W-50W MR16 p.489



NRS66-252 New Mirage

20W- 50W JC 6.35/MR16 p.489



NRS66-253 Lima

20W-50W MR16 12V p.489



NRS66-462 Ambra Pendant

20W-50W Bi-Pin 12V p.506



NRS66-457 8.5' Pendant

20W- 50W JC 6.35/MR16 p.509

Pendant assembly only. Glass ordered separately, see pages 416-433.



NRS66-901 Penumbra

20W-50W AR111 p.487



NRS66-902 Skyteam

20W-50W AR111 p.488

AR111/PAR36 LOW VOLTAGE TRACK FIXTURES



NTL-27A11 Vanguard

20W-50W AR111 p.572



NTL-225 Low Profile Gimbal

20W-50W AR111 p.572



NTL-250 / NTL-2250 AR111 Sail

20W-50W AR111 p.572



NTL-220 / NTL-2210 Gimbal Ring

20W-50W PAR36 p.573

MR16 GU10 LENSED LINE VOLTAGE TRACK FIXTURES



NTH-613 Michaelangelo Framing Projector

50W MR16 GU10 p.576



NTH-614 Galileo Dual Ring Face

50W MR16 GU10 p.576



NTH-615 Newton Ring Face

50W MR16 GU10 p.576



NTH-616 Copernicus Glass Disk Face

50W MR16 GU10 p.576



NTH-618 Italia

50W MR16 GU10 p.577

MR16 GU10 LENSED LINE VOLTAGE TRACK FIXTURES *continued*



NTH-619 Metro
50W MR16 GU10 p.577



NTH-620 Stockholm
50W MR16 GU10 p.577



NTH-621 Paris
50W MR16 GU10 p.577



NTH-694 Round Back
50W MR16 GU10 p.578



NTH-695 Telescope
50W MR16 GU10 p.578



NTH-697 Gimbal Ring
50W MR16 GU10 p.578

MR16 GU10 Line Voltage track fixtures can be used with **LED after market GU10 lamps!**

R/PAR LINE VOLTAGE TRACK FIXTURES



NTH-132 Belgium PAR30
75W PAR30 p.579



NTH-133 Belgium PAR38
90W PAR38 p.579



NTH-134 Orbit
50W PAR20 / 75W PAR30 p.579



NTH-135 Leopold PAR20
50W PAR20 p.579



NTH-136 Leopold PAR30
75W PAR30 p.580



NTH-137 Leopold PAR38
150W PAR38 p.580



NTH-176 PAR20 High-Tech Wire
50W PAR20 p.580



NTH-177 PAR30 High-Tech Wire
75W PAR30 p.580



NTH-178 PAR38 High-Tech Wire
250W PAR38 p.581



NTH-123 Wireback Cone
50W R/PAR20 p.581



NTH-124 Cone R/PAR20
50W R/PAR20 p.581



NTH-125 Cone R/PAR30
75W R/PAR30 p.581



NTH-126 Cone R/PAR38
150W R/PAR38 p.582



NTH-127 Wire Mount Wireback Cone
50W R/PAR20 p.582



NTH-128 Wire Mount Cone R/PAR20
50W R/PAR20 p.582



NTH-129 Wire Mount Cone R/PAR30
75W R/PAR30 p.582



NTH-130 Wire Mount Cone R/PAR38
150W R/PAR38 p.583



NTH-110 Classic Cylinder
50W R/PAR20 p.583



NTH-111 Classic Cylinder
75W R/PAR30 p.583



NTH-122 Designer Step Cylinder
50W R/PAR20 p.583

Overview TRACK LIGHTING continued

BR/PAR LINE VOLTAGE TRACK FIXTURES *continued*



NTH-103 Step Cylinder with Black Baffle
50W R/PAR20 p.584



NTH-104 Step Cylinder with Black Baffle
50W R/PAR30 p.584



NTH-149 PAR30 Shroud
75W R/PAR30 p.584



NTH-150 PAR38 Shroud
250W R/PAR38 p.584



NTH-151 PAR38 Cone
250W R40/PAR38 p.585



NTH-115 Lamp Holder
250W PAR38 p.585



NTH-109 Universal Lamp Holder
250W PAR38 / 300W R40 p.585



NTH-138 Universal Lamp Holder w/Retractable Shroud
35W PAR16 / 250W PAR38 p.585



NTH-119 Designer Roundback Universal
250W PAR38 / 300W R40 p.586



NTH-112 Gimbal Ring PAR20
50W PAR20 p.586



NTH-107 Gimbal Ring PAR30
75W PAR30 p.586



NTH-108 Gimbal Ring PAR38
250W PAR38 p.586



NTH-146 Front Load Gimbal Ring PAR20
50W PAR20 p.587



NTH-147 Front Load Gimbal Ring PAR30
75W PAR30 p.587



NTH-148 Front Load Gimbal Ring PAR38
150W PAR38 p.587



NTH-101 Flatback Cylinder
50W R/PAR20 p.587



NTH-102 Flatback Cylinder
75W R/PAR30 p.588



NTH-113 Flatback Cylinder
150W PAR38 p.588



NTH-120 Designer Flatback Cylinder
55W PAR16 p.588



NTH-121 Designer Roundback Cylinder
55W PAR16 p.588



NTH-105 Roundback Cylinder
50W R/PAR20 p.589



NTH-106 Roundback Cylinder
75W R/PAR30 p.589



NTH-131 Roundback Cylinder
150W PAR38 p.589



NTH-216 Barn Door Wall Wash
150W T3 Lamp p.589

LINE VOLTAGE TRACK PACKS

LOW VOLTAGE TRACK PACK



NTL-150 Series Step Cylinder
3 Fixtures p.590

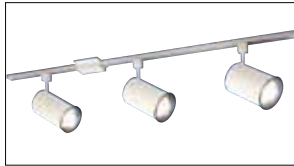

NTL-151 Series Flat Back
2 or 3 Fixtures p.590

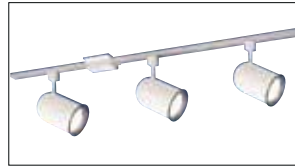

NTL-156 Series Round Back
2, 3 or 4 Fixtures p.590



NTL-181 Series Low Voltage Gimbal Ring
3 Fixtures p.591



NTL-158 Series Gimbal Ring
3 or 4 Fixtures p.591

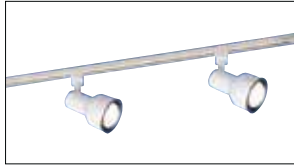

NTL-172 Series Step Cylinder
2 Fixtures p.591



NTL-180 Series Step Cylinder
2 Fixtures p.591

TRACK PENDANTS (order glass separately)



NTH-160 Candelabra Track Pendant
60W Candelabra Socket p.592



NTH-161 Medium Base Track Pendant
100W Medium Base Socket p.592



NTH-162 G9 Line Voltage Track Pendant
40W G9 Halogen Socket p.592



NTF-163 GU24 CFL Track Pendant
13W-26W GU24 CFL Socket p.592



NTL-309 Low Voltage Track Pendant
35W 12V JC GY6.35 p.593



NTL-310 Cona™ Pendina Cable Track Fixture
35W 12V JC 6.35 p.593



NTL-311 Cylindrica™ Pendina Cable Track Fixture
35W 12V JC 6.35 p.593

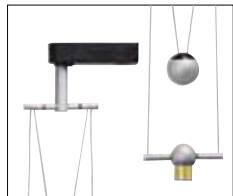

NTL-312 Sphera™ Pendina Cable Track Fixture
35W 12V JC 6.35 p.593



NT-370 QuickJack Track Pendant Adapter
50W Low Voltage p.600

Pendant assembly only. Glass ordered separately, see pages 416-433.

TRACK SYSTEM AND ACCESSORIES



Single Circuit Track
p.594



2-Circuit Track
p.595



Current Limiter
Feed with Circuit Breaker p.596



Track System Accessories
Feeds, Connectors, Support p.594



Track Fixture Accessories
Lenses, Barndoors, etc. p.601



LED Track

Nora Lighting is pleased to introduce new LED Track fixtures: 18W Pillar and 9W Robo Cylinder. These beautifully styled, powerfully built LED Track fixtures provide excellent beam control while producing no forward heat or ultraviolet UV rays. Extraordinary light output combined with architectural design make these fixtures ideal in a variety of commercial, retail, hospitality and residential applications.

LED TRACK LED Track Fixtures

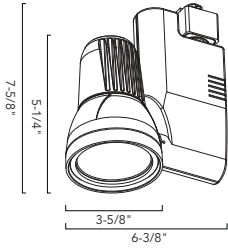

Pillar LED Track Fixture

NTE-810L Series* 18W Max

- Features:** Up to 742 lumens and 80 CRI
Lamp: 18W LED (included)
Color Temp: 3000K Warm White (30), 4200K Cool White (42)
Beam Spread: 15° Spot (S), 30° Flood (F)
Finish: Black (B), Silver (S), White (W)
Style: H-Style, J-Style, L-Style
Dimensions: Width: 6-3/8" Length: 5-1/4"
 Diameter: 3-5/8" Maximum Extension: 7-5/8"
Warranty: Three year Limited Warranty

Over 75% energy savings when compared to incandescent!
 Integral LED Driver performs at the level of a 50W MR16! *committed to GREEN*



*How to specify Pillar LED Track Fixture

NTE-810	L	42	F	18	B	
SERIES	LIGHT SOURCE	COLOR TEMP.	BEAM SPREAD	WATTAGE	FINISH	STYLE
NTE-810	L = LED	30 = 3000K 42 = 4200K	S = 15° (Spot) F = 30° (Flood)	18 = 18W	B = Black S = Silver W = White	(blank) = H-Style /J = J-Style /L = L-Style

Order Example: NTE-810L42F15B - 15W Pillar LED Track Fixture, 4200 Kelvin Temperature, 30° Flood Beam Spread, Black Finish (H-Style)

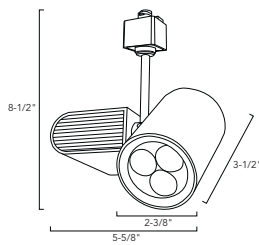

Robo Cylinder LED Track Fixture

NTE-820L Series* 9W Max

- Features:** Up to 314 lumens and 82 CRI
Lamp: 3 x 3W LED (included)
Color Temp: 3000K Warm White (30), 4200K Cool White (42)
Beam Spread: 30° Flood (F), 45° Wide (W)
Finish: Black (B), Silver (S), White (W)
Style: H-Style, J-Style, L-Style
Dimensions: Width: 5-5/8" Length: 3-1/2"
 Diameter: 2-3/8" Maximum Extension: 8-1/2"
Adjustability: 345° Rotation. Both driver and diode castings pivot
 180° independent of each other
Warranty: Three year Limited Warranty

Over 75% energy savings when compared to incandescent!
 Integral LED Driver performs at the level of a 35W MR16! *committed to GREEN*



*How to specify Robo Cylinder LED Track Fixture

NTE-820	L	42	W	9	W	
SERIES	LIGHT SOURCE	COLOR TEMP.	BEAM SPREAD	WATTAGE	FINISH	STYLE
NTE-820	L = LED	30 = 3000K 42 = 4200K	F = 30° (Flood) W = 45° (Wide Flood)	9 = 9W	B = Black S = Silver W = White	(blank) = H-Style /J = J-Style /L = L-Style

Order Example: NTE-820L42W9W - 9W Robo Cylinder LED Track Fixture, 4200 Kelvin Temperature, 45° Wide Flood Beam Spread, White Finish (H-Style)

Ceramic Metal Halide

For applications requiring the highest possible color and lumen performance with the flexibility of track lighting, Nora offers a complete family of Ceramic Metal Halide track fixtures. Our newest fixtures, Vanguard Vertical Ballast Series, feature a minimal profile and architectural design.

T4 & T6 CMH

Fixtures provide excellent beam control with dedicated and specifiable reflectors. Lamps are rated for as much as 15,000 hours and CRIs in the high 80s. Ideal for color critical commercial, retail, and hospitality applications requiring low energy consumption.

PAR & ED17 CMH

Nora offers one of the most complete selections of PAR and ED17 CMH Track fixtures in the industry. Lamps provide excellent color rendition and long life, utilizing 50-70% less energy than incandescent sources. Ideal choice for high ceilings in retail and commercial applications.

MR16 GX10 CMH

Small MR16 lamp size allows for more refined fixture design. With 12,000 rated hours and CRI as high as 90, this lamp is the perfect solution for architectural retail lighting. Fixtures available in several styles and price points.

Wall Wash CMH

Nora's Brilliance Wall Wash fixture is specifically designed to provide even illumination without elliptical light patterns. Available in two sizes, three finishes, Brilliance can accommodate T6, T6 Double Ended, and ED17 lamps up to 100 watts. Excellent choice for broad even illumination in retail, commercial, and hospitality applications.



HID CERAMIC METAL HALIDE TRACK T4 & T6 CMH Fixtures

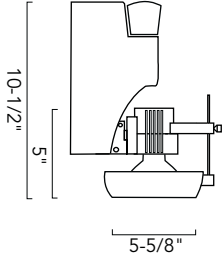

T4 CMH Vanguard Series with 24° Beam Spread

NTM-27T4/20	H-Style	20W
NTM-27T4/39	H-Style	39W
NTM-27T4/70	H-Style	70W

Features: Low profile, integral electronic ballast 358° horizontal and 180° vertical adjustment. Individual On/Off switch Positive vertical locking with hot aiming handle. Die-cast construction

Lamp: 20W, 39W, 70W G8.35 T4 CMH (not included)

Reflector: 24° Beam Spread

Finish: Black (B), Silver (S), White (W)

Dimensions: Length: 5" Dia.: 5-5/8" Max Ext.: 10-1/2"

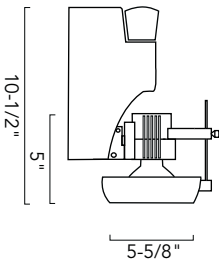

T6 CMH Vanguard Series with 24° Beam Spread

NTM-27T6/39	H-Style	39W
NTM-27T6/70	H-Style	70W

Features: Low profile, integral electronic ballast 358° horizontal and 180° vertical adjustment. Individual On/Off switch Positive vertical locking with hot aiming handle. Die-cast construction

Lamp: 39W, 70W G12 T6 CMH (not included)

Reflector: 24° Beam Spread

Finish: Black (B), Silver (S), White (W)

Dimensions: Length: 5" Dia.: 5-5/8" Max Ext.: 10-1/2"

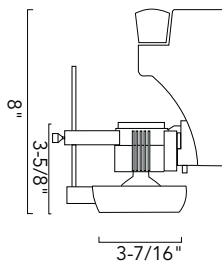

T4 CMH Vanguard with 12° Beam Spread

NTM-27U30/20	H-Style	20W
---------------------	---------	-----

Features: Low profile, integral electronic ballast 358° horizontal and 180° vertical adjustment. Individual On/Off switch positive vertical locking with hot aiming handle. Die-cast construction

Lamp: 20W GU6.5 T4 CMH (not included)

Reflector: 12° Beam Spread

Finish: Black (B), Silver (S), White (W)

Dimensions: Length: 3-7/16" Dia.: 3-5/8" Max Ext.: 8"



Lamps ordered separately, see page 752.

HID CERAMIC METAL HALIDE TRACK T4 & T6 CMH Fixtures cont.

Lighting Tip:

HID Ceramic Metal Halide produce excellent color rendition with long life and low energy use thereby making them the designer's choice in retail applications.



CMH Low Profile Brilliance Series

NTM-55T Series* 20W / 39W / 70W

- Features:** Integral electronic ballast
Die-cast construction
Protective glass lens included
On/Off switch
- Lamp:** 20W, 39W G8.5 T4 CMH (not included)
39W, 70W G12 T6 CMH (not included)
- Reflector:** 15°, 45° Beam Spread
- Finish:** Black (B), Silver (S), White (W)
- Style:** H-Style, J-Style, L-Style
- Dimensions:** Length: 6-3/4" Dia.: 6-1/4" Max Ext.: 6-3/8"
- Accessories:** NA-301, NT-342 (must be used with NT-345)

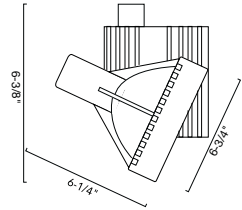

committed to
GREEN

*How to specify CMH Low Profile Brilliance Series

NTM-55	T4	/39	-45	B	STYLE
SERIES	LIGHT SOURCE	WATTAGE	BEAM SPREAD	FINISH	STYLE
NTM-55	T4 = G8.5 T4 CMH T6 = G12 T6 CMH	/20 = 20 Watts (T4 only) /39 = 39 Watts /70 = 70 Watts (T6 only)	-15 = 15° -45 = 45°	B = Black S = Silver W = White	(BLANK) = H-Style /J = J-Style NEW! /L = L-Style NEW!

Order Example: NTM-55T4/39-45B = 39W T4 Brilliance Track Fixture with 45° Beam Spread, Black Fixture (H-Style)



CMH Q-Tech Series

NTM-77T Series* 20W / 39W / 70W

- Features:** Vertical integral electronic ballast
On/Off switch
Positive vertical locking
Protective glass lens included
- Lamp:** 20W, 39W, 70W G8.5 T4 CMH (not included)
39W, 70W G12 T6 CMH (not included)
- Reflector:** 24°, 44°, 60° Beam Spread
- Finish:** Black (B), Silver (S), White (W)
- Style:** H-Style, J-Style, L-Style
- Dimensions:** Length: 6-1/8" Dia.: 4-3/4" Max Ext.: 12-5/8"
- Accessories:** NA-100, NA-101, NA-200, NA-300

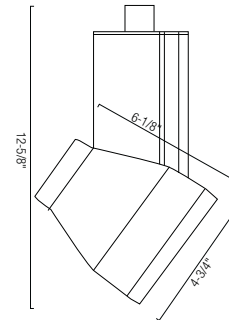

committed to
GREEN

*How to specify CMH Q-Tech Series

NTM-77	T6	/70	-60	B	STYLE
SERIES	LIGHT SOURCE	WATTAGE	BEAM SPREAD	FINISH	STYLE
NTM-77	T4 = G8.5 T4 CMH T6 = G12 T6 CMH	/20 = 20 Watts (T4 only) /39 = 39 Watts /70 = 70 Watts	-15 = 15° -45 = 45° -60 = 60°	B = Black S = Silver W = White	(BLANK) = H-Style /J = J-Style NEW! /L = L-Style NEW!

Order Example: NTM-77T6/70-60B = 70W T6 Brilliance Track Fixture with 60° Beam Spread, Black Fixture (H-Style)

Lamps ordered separately, see pages 752.

HID CERAMIC METAL HALIDE TRACK T4 & T6 CMH Fixtures continued

CMH NTM-17T Series

NTM-17T Series* 20W / 39W / 70W

- Features:** Low profile
Integral electronic ballast
On/Off switch
- Lamp:** 20W, 39W, 70W G8.5 T4/T4.5 CMH (not included)
39W, 70W G12 T6 CMH (not included)
- Reflector:** 15°, 45° Beam Spread
- Finish:** Black (B), Silver (S), White (W)
- Style:** H-Style
- Dimensions:** Dia: 2-3/16" Length: 3-1/4" Max Ext.: 5-3/4"
- Accessories:** Accepts louvers and filters

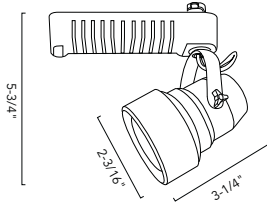

committed to
GREEN

*How to specify CMH NTM-17T Series

NTM-17	T4			15	
SERIES	LIGHT SOURCE	WATTAGE	BEAM SPREAD	FINISH	STYLE
NTM-17	T4 = G8.5 T4 CMH T6 = G12 T6 CMH	/20 = 20 Watts (T4 only) /39 = 39 Watts /70 = 70 Watts	-15 = 15° -45 = 45°	B = Black S = Silver W = White	(BLANK) = H-Style

Order Example: NTM-17T4/70-45B = 70W T4 Track Fixture with 45° Beam Spread, Black Fixture (H-Style)



Lighting Tip:

CMH sources can produce two to three times the illumination of an equal wattage incandescent halogen source

Lamps ordered separately, see pages 752.



HID CERAMIC METAL HALIDE TRACK MR16 GX10 CMH

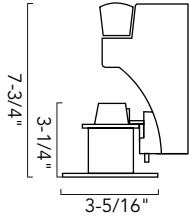

MR16 CMH Vanguard

NTM-27X15/20 H-Style 20W

Features: Low profile, integral electronic ballast 358° horizontal and 180° vertical adjustment. Individual On/Off switch. Positive vertical locking. Die-cast construction.

Lamp: 20W MR16 GX10 CMH (not included)

Finish: Black (B), Silver (S), White (W)

Dimensions: Length: 3-1/4" Dia.: 3-5/16" Max Ext.: 7-3/4"

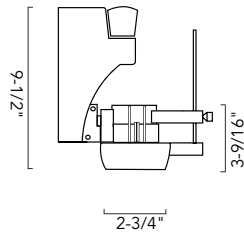

MR16 CMH Vanguard

NTM-27X45/20 H-Style 20W

Features: Low profile, integral electronic ballast 358° horizontal and 180° vertical adjustment. Individual On/Off switch. Positive vertical locking. Die-cast construction. Hot aiming handle

Lamp: 20W MR16 GX10 CMH (not included)

Finish: Black (B), Silver (S), White (W)

Dimensions: Length: 3-9/16" Dia.: 2-3/4" Max Ext.: 9-1/2"

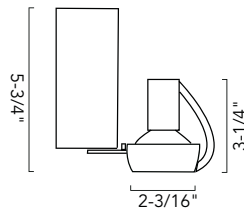

MR16 CMH Vanguard

NTM-27X35/20 H-Style 20W

Features: Low profile, integral electronic ballast 358° horizontal and 180° vertical adjustment. Individual On/Off switch. Slim vertical ballast. Die-cast construction.

Lamp: 20W MR16 GX10 CMH (not included)

Finish: Black (B), Silver (S), White (W)

Dimensions: Height: 3-1/4" Dia.: 2-3/16" Max Ext.: 5-3/4"



Lighting Tip:

NEC rates track at 45 watts per foot regardless of the amount of wattage being consumed on the track. Use Nora's current limiting track feeds to meet stringent watts per square foot requirements.

Lamps ordered separately, see pages 752.

HID CERAMIC METAL HALIDE TRACK

PAR CMH Fixtures continued



PAR20 CMH Vanguard Series

NTM-27P20/20	H-Style	20W
NTM-27P20/39	H-Style	39W

- Features:** Low profile
Integral electronic ballast
358° horizontal and 180° vertical adjustment
On/Off switch
Positive vertical locking with hot aiming handle
Die-cast construction

Lamp: 20W, 39W PAR20 CMH (not included)

Finish: Black (B), Silver (S), White (W)

Dimensions: Length: 4-9/16" Dia.: 3-7/16" Max Ext.: 9-3/4"

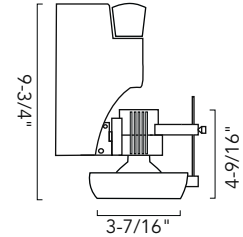

PAR30 CMH Vanguard Series

NTM-27P30/39	H-Style	39W
NTM-27P30/70	H-Style	70W

- Features:** Low profile
Integral electronic ballast
358° horizontal and 180° vertical adjustment
On/Off switch
Positive vertical locking with hot aiming handle
Die-cast construction

Lamp: 39W, 70W PAR30 CMH (not included)

Finish: Black (B), Silver (S), White (W)

Dimensions: Length: 5-3/4" Dia.: 4-9/16" Max Ext.: 11-1/4"

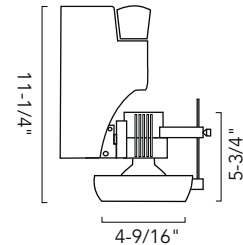

PAR38 CMH Vanguard Series

NTM-27P38/70	H-Style	70W
---------------------	---------	-----

- Features:** Low profile
Integral electronic ballast
358° horizontal and 180° vertical adjustment
On/Off switch
Positive vertical locking with hot aiming handle
Die-cast construction

Lamp: 70W PAR38 CMH (not included)

Finish: Black (B), Silver (S), White (W)

Dimensions: Length: 6-1/2" Dia.: 5-5/8" Max Ext.: 11-3/4"

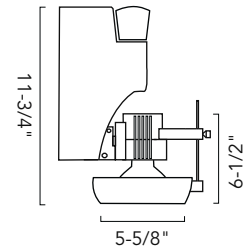

PAR20 CMH Track Gimbal Ring

NTM-6220/35	H-Style	39W
--------------------	---------	-----

- Features:** Front loading gimbal ring
On/Off switch

Lamp: 39W PAR20 CMH (not included)

Finish: Black (B), Silver (S), White (W)

Dimensions: Length: 4-7/8" Dia.: 4-5/8" Max Ext.: 9"

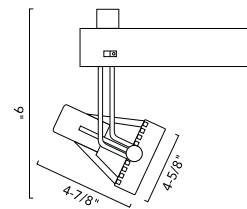

Lamps ordered separately, see pages 752.

HID CERAMIC METAL HALIDE TRACK PAR CMH Fixtures continued

PAR30 CMH Track Gimbal Ring

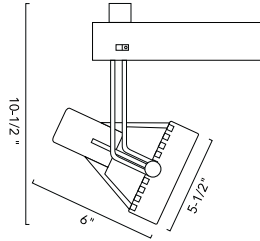

NTM-6230/35	H-Style	39W
NTM-6230/70	H-Style	70W

Features: Front loading gimbal ring
On/Off switch

Lamp: 39W, 70W PAR30 CMH (not included)

Finish: Black (B), Silver (S), White (W)

Dimensions: Length: 6" Dia.: 5-1/2" Max Ext.: 10-1/2"



PAR38 CMH Track Gimbal Ring

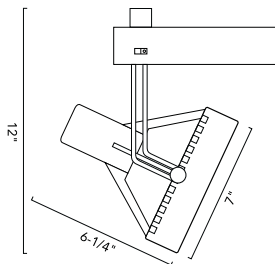

NTM-6238/70	H-Style	70W
--------------------	---------	-----

Features: Front loading gimbal ring
On/Off switch

Lamp: 70W PAR38 CMH (not included)

Finish: Black (B), Silver (S), White (W)

Dimensions: Length: 6-1/4" Dia.: 7" Max Ext.: 12"



PAR30 CMH Reflector Shroud Series

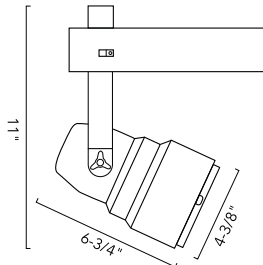

NTM-6630/35	H-Style	39W
NTM-6630/70	H-Style	70W

Features: On/Off switch
Deep set lamp position for excellent glare control

Lamp: 39W, 70W PAR30 CMH (not included)

Finish: Black (B), Silver (S), White (W)

Dimensions: Length: 6-3/4" Dia.: 4-3/8" Max Ext.: 11"



PAR38 CMH Reflector Shroud

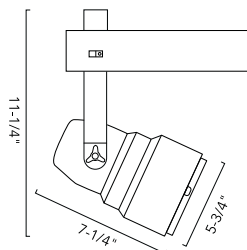

NTM-6638/70	H-Style	70W
--------------------	---------	-----

Feature: On/Off switch
Deep set lamp position for excellent glare control

Lamp: 70W PAR38 CMH (not included)

Finish: Black (B), Silver (S), White (W)

Dimensions: Length: 7-1/4" Dia.: 5-3/4" Max Ext.: 11-1/4"



Lamps ordered separately, see pages 752.

HID CERAMIC METAL HALIDE TRACK

PAR CMH Fixtures continued



PAR20 CMH Track Cone

NTM-6320/35	H-Style	39W
--------------------	---------	-----

Feature: On/Off switch
Lamp: 39W PAR20 CMH (not included)
Finish: Black (B), Silver (S), White (W)
Dimensions: Length: 5-1/8" Dia.: 4-1/4" Max Ext.: 9"

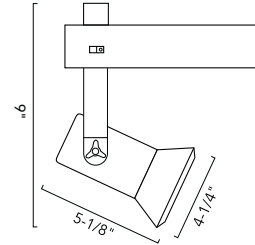

PAR30 CMH Track Cone

NTM-6330/20	H-Style	20W
NTM-6330/35	H-Style	39W
NTM-6330/70	H-Style	70W

Feature: On/Off switch
Lamp: 20W, 39W, 70W PAR30L CMH (not included)
Finish: Black (B), Silver (S), White (W)
Dimensions: Length: 6-1/4" Dia.: 4-7/8" Max Ext.: 10"

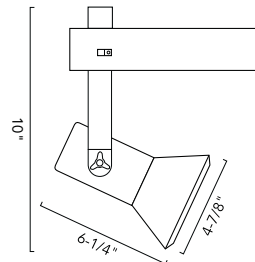

PAR38 CMH Track Cone

NTM-6338/70	H-Style	70W
--------------------	---------	-----

Feature: On/Off switch
Lamp: 70W PAR38 CMH (not included)
Finish: Black (B), Silver (S), White (W)
Dimensions: Length: 6-3/4" Dia.: 5-7/8" Max Ext.: 11-1/2"

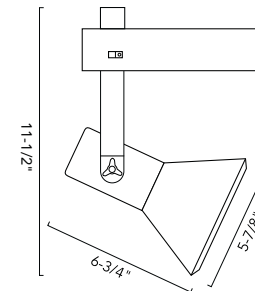

PAR20 CMH Track Lamp Holder

NTM-6420/35	H-Style	39W
--------------------	---------	-----

Feature: On/Off switch
Lamp: 39W PAR20 CMH (not included)
Finish: Black (B), Silver (S), White (W)
Dimensions: Length: 4" Dia.: 2-1/2" Max Ext.: 9"

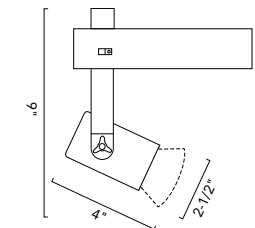

Lamps ordered separately, see pages 752.

HID CERAMIC METAL HALIDE TRACK PAR CMH Fixtures continued

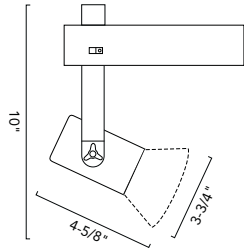

PAR30 CMH Track Lamp Holder

NTM-6430/35	H-Style	39W
NTM-6430/70	H-Style	70W

Feature: On/Off switch
Lamp: 39W, 70W PAR30 CMH (not included)
Finish: Black (B), Silver (S), White (W)
Dimensions: Length: 4-5/8" Dia.: 3-3/4" Max Ext.: 10"

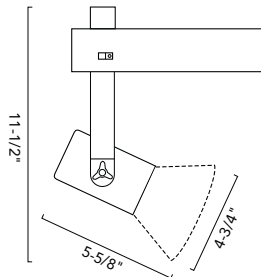

PAR38 CMH Track Lamp Holder

NTM-6438/70	H-Style	70W
--------------------	---------	-----

Feature: On/Off switch
Lamp: 70W PAR38 CMH (not included)
Finish: Black (B), Silver (S), White (W)
Dimensions: Length: 5-5/8" Dia.: 4-3/4" Max Ext.: 11-1/4"

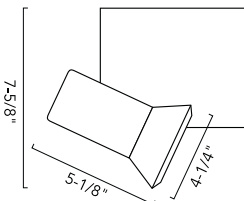

PAR20 CMH Track Cone

NTM-5320/35	H-Style	39W
--------------------	---------	-----

Lamps: 39W PAR20 CMH (not included)
Finish: Black (B), White (W)
Dimensions: Length: 5-1/8" Dia.: 4-1/4" Max Ext.: 7-5/8"

- Removable Cone

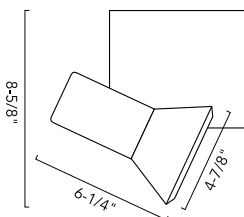

PAR30 CMH Track Cone

NTM-5330/35	H-Style	39W
NTM-5330/70	H-Style	70W

Lamp: 39W, 70W PAR30 CMH (not included)
Finish: Black (B), White (W)
Dimensions: Length: 4-7/8" Dia.: 6-1/4" Max Ext.: 8-5/8"

- Removable Cone



Lamps ordered separately, see pages 752.

HID CERAMIC METAL HALIDE TRACK

PAR CMH Fixtures continued



PAR38 CMH Track Cone

NTM-5338/70	H-Style	70W
NTM-5338/100	H-Style	100W

Lamp: 70W, 100W PAR38 CMH (not included)
Finish: Black (B), White (W)
Dimensions: Length: 5-7/8" Dia.: 6-3/4" Max Ext.: 10"
 • Removable Cone

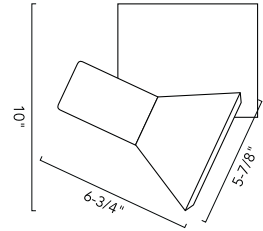

PAR20 CMH Track Lamp Holder

NTM-5420/35	H-Style	39W
--------------------	---------	-----

Lamp: 39W PAR20 CMH (not included)
Finish: Black (B), White (W)
Dimensions: Length: 4" Dia.: 2-1/2" Max Ext.: 7-5/8"

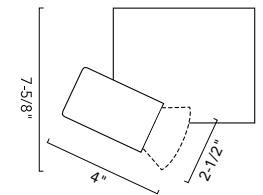

PAR30 CMH Track Lamp Holder

NTM-5430/35	H-Style	39W
NTM-5430/70	H-Style	70W

Lamp: 39W, 70W PAR30 CMH (not included)
Finish: Black (B), White (W)
Dimensions: Length: 4-5/8" Dia.: 3-3/4" Max Ext.: 8-5/8"

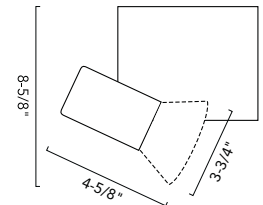

PAR38 CMH Track Lamp Holder

NTM-5438/70	H-Style	70W
NTM-5438/100	H-Style	100W

Lamp: 70W, 100W PAR38 CMH (not included)
Finish: Black (B), White (W)
Dimensions: Length: 5-5/8" Dia.: 4-3/4" Max Ext.: 10"

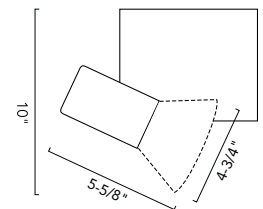

Lamps ordered separately, see pages 752.

HID CERAMIC METAL HALIDE TRACK
PAR CMH Fixtures continued

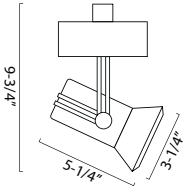

Now available with
H, J and L-style adapters

PAR20 CMH High-Tech Wire Track

NTM-5220/35	H-Style	39W
NTM-5220/35(finish)/J	J-Style	39W
NTM-5220/35(finish)/L	L-Style	39W

Lamp: 39W PAR20 CMH (not included)
Finish: Black (B), White (W)
Dimensions: Length: 5-1/4" Dia.: 3-1/4" Max Ext.: 9-3/4"

- Removable Cone

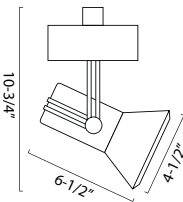

Now available with
H, J and L-style adapters

PAR30 CMH High-Tech Wire Track

NTM-5230/35	H-Style	39W
NTM-5230/35(finish)/J	J-Style	39W
NTM-5230/35(finish)/L	L-Style	39W
NTM-5230/70	H-Style	70W
NTM-5230/70(finish)/J	J-Style	70W
NTM-5230/70(finish)/L	L-Style	70W

Lamp: 39W, 70W PAR30 CMH (not included)
Finish: Black (B), White (W)
Dimensions: Length: 6-1/2" Dia.: 4-1/2" Max Ext.: 10-3/4"

- Removable Cone

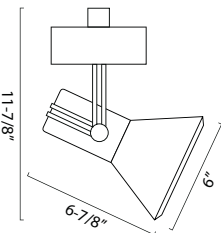

Now available with
H, J and L-style adapters

PAR38 CMH High-Tech Wire Track

NTM-5238/70	H-Style	70W
NTM-5238/70(finish)/J	J-Style	70W
NTM-5238/70(finish)/L	L-Style	70W
NTM-5238/100	H-Style	100W
NTM-5238/100(finish)/J	J-Style	100W
NTM-5238/100(finish)/L	L-Style	100W

Lamp: 70W, 100W PAR38 CMH (not included)
Finish: Black (B), White (W)
Dimensions: Length: 6-7/8" Dia.: 6" Max Ext.: 11-7/8"

- Removable Cone



Select track fixtures
now available for use in
H, J and L style track!

Lamps ordered separately, see pages 752.

HID CERAMIC METAL HALIDE TRACK

PAR CMH Fixtures continued



PAR38 CMH Round Back Cylinder Track

NTM-6038/70	H-Style	70W
--------------------	---------	-----

Lamp: 70W PAR38 CMH (not included)
Finish: Black (B), Silver (S), White (W)
Dimensions: Length: 7-1/8" Dia.: 5-5/8" Max Ext.: 12-1/4"
Accessories: NT-340, NT-343 (must be used with NT-346)

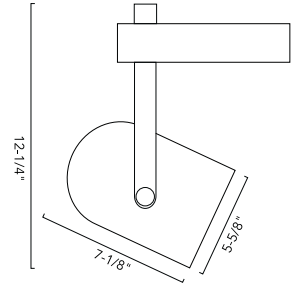

PAR38 CMH Flat Back Cylinder Track

NTM-6138/70	H-Style	70W
--------------------	---------	-----

Lamp: 70W PAR38 CMH (not included)
Finish: Black (B), White (W)
Dimensions: Length: 4-5/8" Dia.: 6-5/8" Max Ext.: 12-1/4"
Accessories: NT-340, NT-343 (must be used with NT-346)

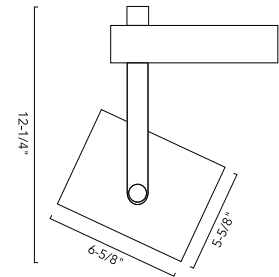

PAR38 CMH Round Back Cylinder Track

NTM-5038/70	H-Style	70W
NTM-5038/70(finish)/J	J-Style	70W
NTM-5038/70(finish)/L	L-Style	70W
NTM-5038/100	H-Style	100W
NTM-5038/100(finish)/J	J-Style	100W
NTM-5038/100(finish)/L	L-Style	100W

Lamp: 70W, 100W PAR38 CMH (not included)
Finish: Black (B), White (W)
Dimensions: Length: 7-1/4" Dia.: 5-1/2" Max Ext.: 11-1/4"
Accessories: NT-340, NT-343 (must be used with NT-346)

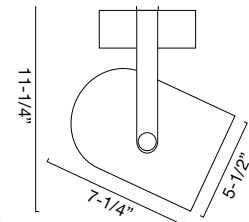

Now available with
H, J and L-style adapters



PAR38 CMH Flat Back Cylinder Track

NTM-5138/70	H-Style	70W
NTM-5138/70(finish)/J	J-Style	70W
NTM-5138/70(finish)/L	L-Style	70W
NTM-5138/100	H-Style	100W
NTM-5138/100(finish)/J	J-Style	100W
NTM-5138/100(finish)/L	L-Style	100W

Lamp: 70W, 100W PAR38 CMH (not included)
Finish: Black (B), White (W)
Dimensions: Length: 6-5/8" Dia.: 5-5/8" Max Ext.: 11-1/4"
Accessories: NT-340, NT-343 (must be used with NT-346)

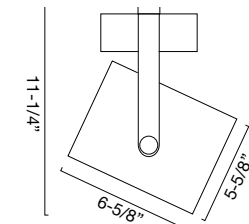

Now available with
H, J and L-style adapters

Lamps ordered separately, see pages 752.



HID CERAMIC METAL HALIDE TRACK ED17 CMH Fixtures



ED17 CMH Reflector Shroud Track

NTM-6617/70	H-Style	70W
--------------------	---------	-----

Features: Internal reflector converts ED17 to 35° narrow flood beam. Ballast made in USA
Lamp: 70W ED17 CMH (not included)
Finish: Black (B), Silver (S), White (W)
Dimensions: Length: 5-3/4" Dia.: 7-1/4" Max Ext.: 11-1/4"

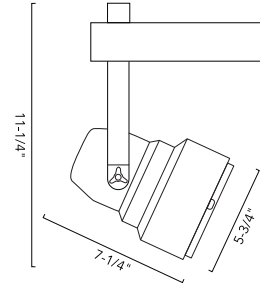

ED17 CMH Reflector Shroud Track

NTM-5617/50	H-Style	50W
NTM-5617/50(finish)/J	J-Style	50W
NTM-5617/50(finish)/L	L-Style	50W
NTM-5617/70	H-Style	70W
NTM-5617/70(finish)/J	J-Style	70W
NTM-5617/70(finish)/L	L-Style	70W
NTM-5617/100	H-Style	100W
NTM-5617/100(finish)/J	J-Style	100W
NTM-5617/100(finish)/L	L-Style	100W

Features: Internal reflector converts ED17 to 35° narrow flood beam. Ballast made in USA
Lamp: 50W, 70W, 100W ED17 CMH (not included)
Finish: Black (B), Silver (S), White (W)
Dimensions: Length: 6" Dia.: 10" Max Ext.: 11-1/2"

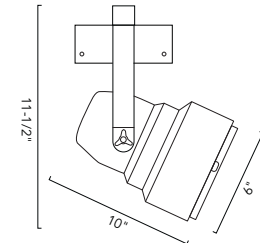

Now available with
H, J and L-style adapters



ED17 CMH Reflector Cone Track

NTM-5517/50	H-Style	50W
NTM-5517/70	H-Style	70W

Features: Internal reflector converts ED17 to 35° narrow flood beam. Ballast made in USA
Lamp: 50W, 70W, ED17 CMH (not included)
Finish: Black (B), Silver (S), White (W)
Dimensions: Length: 5-7/8" Dia.: 13" Max Ext.: 10-1/2"

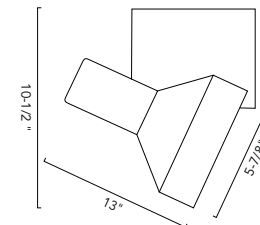

Select track fixtures are now available for use in H, J, and L Style Track

Lamps ordered separately, see pages 752.

HID CERAMIC METAL HALIDE TRACK Wall Wash CMH Fixtures

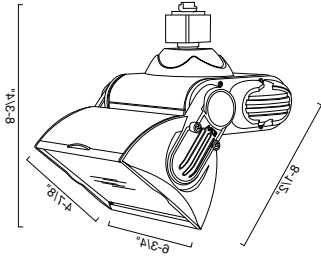

Now available with
H, J and L-style adapters

T6 CMH Brilliance Wall Wash Track

NTM-59T6/39	H-Style	39W
NTM-59T6/39(finish)/J	J-Style	39W
NTM-59T6/39(finish)/L	L-Style	39W
NTM-59T6/70	H-Style	70W
NTM-59T6/70(finish)/J	J-Style	70W
NTM-59T6/70(finish)/L	L-Style	70W

Features: Integral electronic HID ballast
Die-cast construction

Lamp: 39W, 70W T6 CMH (not included)

Finish: Black (B), Silver (S), White (W)

Dimensions: Length: 8-1/2" Width: 6-3/4" Depth: 4-7/8"
Max Ext.: 8-3/4"

Accessories: NAT-380, NAT-381, NAT-383

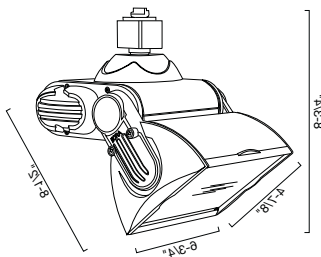

Now available with
H, J and L-style adapters

T6 Double Ended CMH Brilliance Wall Wash Track

NTM-58DE/70	H-Style	70W
NTM-58DE/70(finish)/J	J-Style	70W
NTM-58DE/70(finish)/L	L-Style	70W

Features: Integral electronic HID ballast
Die-cast construction.

Lamp: 70W T6 Double Ended CMH (not included)

Finish: Black (B), Silver (S), White (W)

Dimensions: Length: 8-1/2" Width: 6-3/4" Depth: 4-7/8"
Max Ext.: 8-3/4"

Accessories: NAT-380, NAT-381, NAT-383

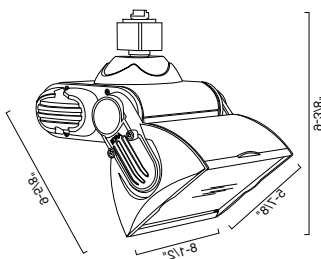

Now available with
H, J and L-style adapters

ED17 CMH Brilliance Wall Wash Track

NTM-5717/50	H-Style	50W
NTM-5717/50(finish)/J	J-Style	50W
NTM-5717/50(finish)/L	L-Style	50W
NTM-5717/70	H-Style	70W
NTM-5717/70(finish)/J	J-Style	70W
NTM-5717/70(finish)/L	L-Style	70W
NTM-5717/100	H-Style	100W
NTM-5717/100(finish)/J	J-Style	100W
NTM-5717/100(finish)/L	L-Style	100W

Features: Integral electronic HID ballast
Die-cast construction.

Lamp: 50W, 70W, 100W ED17 CMH (not included)

Finish: Black (B), Silver (S), White (W)

Dimensions: Length: 9-5/8" Width: 8-1/2" Depth: 5-7/8"
Max Ext.: 9-3/8"

Accessories: NAT-398, NAT-399



Select track fixtures are now available for use in H, J, and L Style Track

Lamps ordered separately, see pages 752.



Fluorescent

Nora Lighting offers a complete family of compact fluorescent and linear fluorescent wall wash fixtures with electronic ballasts, ranging from 24 to 108 watts, to meet all possible energy and performance requirements. Nora's fluorescent track fixtures available in T5 High Output, Compact Fluorescent, and New GU24 are the ideal solution to high performance energy efficient lighting in commercial, retail, hospitality, and residential applications.



GU24



CFL



LINEAR

LINEAR FLUORESCENT T5 HIGH OUTPUT

High performance, low profile, louver fixtures available in three lengths, with single or dual lamps from 24W to 108W. Ideal for menu boards, wall washing, or general lighting in commercial, retail, hospitality, and residential applications.

COMPACT FLUORESCENT

Perfect solution for energy efficient wall wash or general lighting. Available in wattages from 26W to 80W.

GU24 COMPACT FLUORESCENT

New GU24 fixtures provide an economical solution to energy efficient lighting in retail, commercial, and residential applications. Self-ballasted CFLs allow the end user to select desired wattage at installation.

Lighting Tip:

Nora's T5 HO fixtures provide excellent, glare free, general lighting when pointed downward.

LINEAR FLUORESCENT TRACK T5 High Output Slim Track

24W T5 HO Slim Track Fixture

NTF-4124	H-Style	(1) 24W
NTF-4124(finish)/J	J-Style	(1) 24W
NTF-4124(finish)/L	L-Style	(1) 24W
NTF-4224	H-Style	(2) 24W
NTF-4224(finish)/J	J-Style	(2) 24W
NTF-4224(finish)/L	L-Style	(2) 24W

Features: High output electronic ballast
Includes matching louver

Lamp: (1 or 2) 24W T5 High Output (not included)

Finish: Black (B), Silver (S), White (W)

Dimensions: Width: 3-3/4" Length: 26-1/2" Depth: 3-3/4"
Maximum Extension: 7"

Accessories: NTF-4224-LENS: Plastic Snap-on Lamp Shield for NTF-4224
NTFL-4124: Replacement Louver (B, S, W)

committed to
GREEN



39W T5 HO Slim Track Fixture

NTF-4139	H-Style	(1) 39W
NTF-4139(finish)/J	J-Style	(1) 39W
NTF-4139(finish)/L	L-Style	(1) 39W
NTF-4239	H-Style	(2) 39W
NTF-4239(finish)/J	J-Style	(2) 39W
NTF-4239(finish)/L	L-Style	(2) 39W

Features: High output electronic ballast
Includes matching louver

Lamp: (1 or 2) 39W T5 High Output (not included)

Finish: Black (B), Silver (S), White (W)

Dimensions: Width: 3-3/4" Length: 38-3/8" Depth: 3-3/4"
Maximum Extension: 7"

Accessories: NTF-4239-LENS: Plastic Snap-on Lamp Shield for NTF-4239
NTFL-4139: Replacement Louver (B, S, W)

committed to
GREEN



54W T5 HO Slim Track Fixture

NTF-4154	H-Style	(1) 54W
NTF-4154(finish)/J	J-Style	(1) 54W
NTF-4154(finish)/L	L-Style	(1) 54W
NTF-4254	H-Style	(2) 54W
NTF-4254(finish)/J	J-Style	(2) 54W
NTF-4254(finish)/L	L-Style	(2) 54W

Features: High output electronic ballast
Includes matching louver

Lamp: (1 or 2) 54W T5 High Output (not included)

Finish: Black (B), Silver (S), White (W)

Dimensions: Width: 3-3/4" Length: 50-1/8" Depth: 3-3/4"
Maximum Extension: 7"

Accessories: NTF-4254-LENS: Plastic Snap-on Lamp Shield for NTF-4254
NTFL-4154: Replacement Louver (B, S, W)

committed to
GREEN



Lighting Tip: For food preparation areas, use optional T5 HO Lens Accessory. See page 603.

COMPACT FLUORESCENT TRACK

Compact Fluorescent Fixtures

Now available with
H, J and L-style adapters



Triple Tube CF Track Fixture

NTF-2642T/finish)	H-Style	(1) 26W-42W
NTF-2642T/finish)/J	J-Style	(1) 26W-42W
NTF-2642T/finish)/L	L-Style	(1) 26W-42W

Features: Electronic ballast
Includes matching louver

Lamp: (1) 26W-42W Triple Tube (not included)

Finish: Black (B), Silver (S), White (W)

Dimensions: L: 11-1/4" W: 5-7/8" D: 3-1/4" ME: 7-3/4"

Accessories: NTFL-2642 Replacement Louver (Chrome, Black, White)

committed to
GREEN

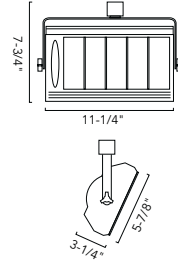

Lighting Tip:

Combine the uniform general and wall wash illumination of Nora's CFL track fixtures with the highlighting capabilities of Nora's HID CMH track fixtures to create interest while maintaining energy efficiency.



Now available with
H, J and L-style adapters

COMPACT FLUORESCENT TRACK Compact Fluorescent Fixtures cont.

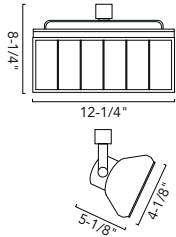

Fluorescent Track Fixture

NTF-3218	H-Style	(2) 18W
NTF-3218(finish)/J	J-Style	(2) 18W
NTF-3218(finish)/L	L-Style	(2) 18W

Features: Electronic ballast
Includes chrome louver

Lamp: (2) 18W F18 Biax, Base 2G11 (not included)

Finish: Black (B), Silver (S), White (W)

Dimensions: L: 12-1/4" W: 4-1/8" D: 5-1/8" ME: 8-1/4"

Accessories: NTFL-3218: Replacement Louver (B, C, W)

committed to
GREEN

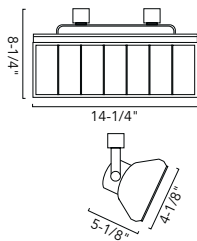

Fluorescent Track Fixture

NTF-3227	H-Style	(2) 27W
NTF-3227(finish)/J	J-Style	(2) 27W
NTF-3227(finish)/L	L-Style	(2) 27W

Features: Electronic ballast
Includes chrome louver

Lamp: (2) 27W F27 Biax, Base 2G11 (not included)

Finish: Black (B), Silver (S), White (W)

Dimensions: L: 14-1/4" W: 4-1/8" D: 5-1/8" ME: 8-1/4"

Accessories: NTFL-3227: Replacement Louver (B, C, W)

committed to
GREEN

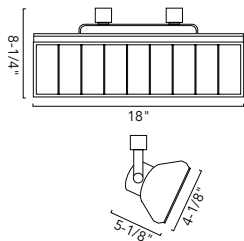

Fluorescent Track Fixture

NTF-3239	H-Style	(2) 39W
NTF-3239(finish)/J	J-Style	(2) 39W
NTF-3239(finish)/L	L-Style	(2) 39W

Features: Electronic ballast
Includes chrome louver

Lamp: (2) 39W F39 Biax, Base 2G11 (not included)

Finish: Black (B), Silver (S), White (W)

Dimensions: L: 18" W: 4-1/8" D: 5-1/8" ME: 8-1/4"

Accessories: NTFL-3239: Replacement Louver (B, C, W)

committed to
GREEN

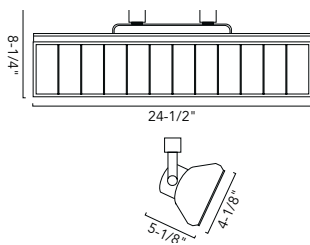

Fluorescent Track Fixture

NTF-3240	H-Style	(2) 40W
NTF-3240(finish)/J	J-Style	(2) 40W
NTF-3240(finish)/L	L-Style	(2) 40W

Features: Electronic ballast
Includes chrome louver

Lamp: (2) 39W F39 Biax, Base 2G11 (not included)

Finish: Black (B), Silver (S), White (W)

Dimensions: L: 24-1/2" W: 4-1/8" D: 5-1/8" ME: 8-1/4"

Accessories: NTFL-3240: Replacement Louver (B, C, W)

committed to
GREEN

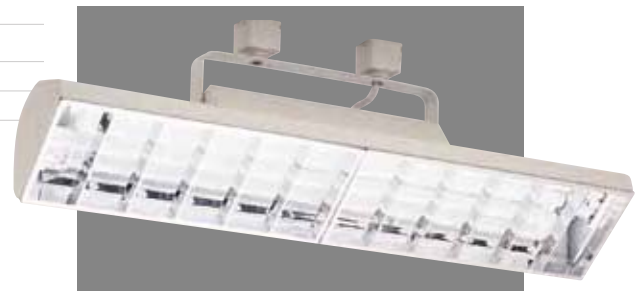

See pages 603 for optional Louver finishes.

COMPACT FLUORESCENT TRACK GU24 Fixtures

Now available with
H, J and L-style adapters

7 Different GU24 CFL Fixture styles - up to 26W maximum

Nora is pleased to introduce our new selection of energy efficient GU24 compact fluorescent track fixtures. These fixtures have no bulky ballast housing because the ballast is in the lamp! In addition, the end user can select and change the desired wattage at any time before or after installation. GU24 CFL fixtures are an excellent solution for stringent watts per square foot applications when used with Nora current limiting power feeds. Available in a variety of styles to suit any décor or retail environment. Each fixture includes convex frosted lens.



NEW!



Flatback Cylinder

NTH-101G24	H-Style	18W
NTH-101G24(finish)/J	J-Style	18W
NTH-101G24(finish)/L	L-Style	18W

Feature: Includes convex frosted lens for even illumination and BR lamp appearance

Lamp: 18W Spiral GU24 Max. (not included)

Finish: Black (B), White (W)

Dimensions: Length: 6" Dia.: 3-1/2" Max Ext.: 7-1/8"

- Lamps sold separately - see page 751

committed to
GREEN

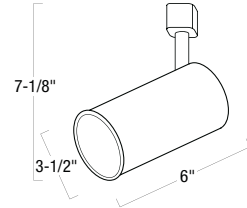

NEW!



Flatback Cylinder

NTH-102G24	H-Style	26W
NTH-102G24(finish)/J	J-Style	26W
NTH-102G24(finish)/L	L-Style	26W

Feature: Includes convex frosted lens for even illumination and BR lamp appearance

Lamp: 26W Spiral GU24 Max. (not included)
15W R30 GU24 Max. (not included)

Finish: Black (B), White (W)

Dimensions: Length: 6-3/4" Dia.: 4-3/8" Max Ext.: 10-1/2"

- Lamps sold separately - see page 751

committed to
GREEN

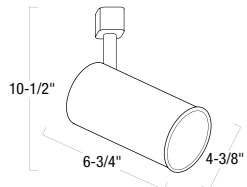

NEW!



Step Cylinder

NTH-104G24	H-Style	18W
NTH-104G24(finish)/J	J-Style	18W
NTH-104G24(finish)/L	L-Style	18W

Feature: Includes convex frosted lens for even illumination and BR lamp appearance

Lamp: 18W Spiral GU24 Max. (not included)
15W R30 GU24 Max. (not included)

Finish: Black (B), Bronze (BZ), White (W)

Dimensions: Length: 6" Dia.: 4-3/8" Max Ext.: 9"

- Lamps sold separately - see page 751

committed to
GREEN

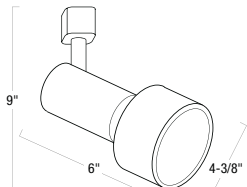

Now available with
H, J and L-style adapters

COMPACT FLUORESCENT TRACK GU24 Fixtures continued

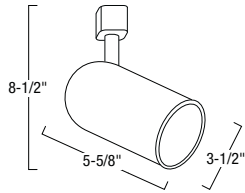

Roundback Cylinder

NTH-105G24	H-Style	18W
NTH-105G24(finish)/J	J-Style	18W
NTH-105G24(finish)/L	L-Style	18W

Feature: Includes convex frosted lens for even illumination and BR lamp appearance

Lamp: 18W Spiral GU24 Max. (not included)

Finish: Black (B), Natural Metal (N), White (W)

Dimensions: Length: 5-5/8" Dia.: 3-1/2" Max Ext.: 8-1/2"

- Lamps sold separately - see page 751

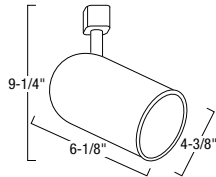

Roundback Cylinder

NTH-106G24	H-Style	26W
NTH-106G24(finish)/J	J-Style	26W
NTH-106G24(finish)/L	L-Style	26W

Feature: Includes convex frosted lens for even illumination and BR lamp appearance

Lamp: 26W Spiral GU24 Max. (not included)

15W R30 GU24 Max. (not included)

Finish: Black (B), Bronze (BZ), Natural Metal (N), White (W)

Dimensions: Length: 6-1/8" Dia.: 4-3/8" Max Ext.: 9-1/4"

- Lamps sold separately - see page 751

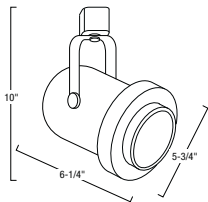

Classic Cylinder

NTH-111G24	H-Style	26W
NTH-111G24(finish)/J	J-Style	26W
NTH-111G24(finish)/L	L-Style	26W

Feature: Includes convex frosted lens for even illumination and BR lamp appearance

Lamp: 26W Spiral GU24 Max. (not included)

15W R30 GU24 Max. (not included)

Finish: Black (B), White (W)

Dimensions: Length: 6-1/4" Dia.: 5-3/4" Max Ext.: 10"

- Lamps sold separately - see page 751

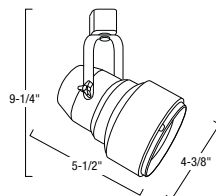

Shroud

NTH-149G24	H-Style	15W
NTH-149G24(finish)/J	J-Style	15W
NTH-149G24(finish)/L	L-Style	15W

Feature: Includes convex frosted lens for even illumination and BR lamp appearance

Lamp: 13W Spiral GU24 Max. (not included)

15W R30 GU24 Max. (not included)

Finish: Black (B), Silver (S), White (W)

Dimensions: Length: 5-1/2" Dia.: 4-3/8" Max Ext.: 9-1/4"

- Lamps sold separately - see page 751





Low Voltage

Nora Lighting's low voltage track fixtures are an outstanding, state-of-the-art solution for energy efficient task and accent lighting. Used where color rendition and high resolution are desired, low voltage track features precise beam control, a crisp "white" light and longer lamp life. Nora Lighting presents six series of low voltage track fixtures: V-Tec, Vanguard Series, European Collection, QuickJack Custom Series, 2000 Series, and 200 Series.

MR16 Extension Stems

For truly outstanding style and appearance, Nora Lighting is pleased to offer factory-installed extension stems for most line-voltage GU10 and low voltage MR16 fixtures upon request. The result is sleek, streamlined assembly. Lengths are available from 12" to 48" in 6-inch increments. Stems are finished to match the fixture.

Fixtures available with extension

Factory installed extensions are available with the following:

- **European Collection Low Voltage MR16**
NTL-300 Series (except NTL-301, NTL-307, NTL-317)
- **European Collection Line Voltage GU10 MR16**
NTH-600 Series
- **Nora Standard Low Voltage MR16**
NTL-200 Series (except NTL-221, NTL-222, NTL-225, NTL-226)

How to order:

Fixtures with factory installed extensions are custom manufactured; at the time of specification or order, please add (/) and the stem length you desire, example NTH-619S/36. Consult factory for pricing and availability.

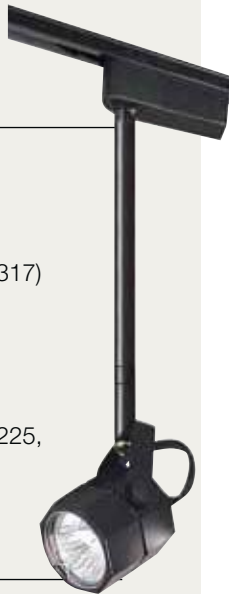

V-TEC SERIES

Nora's new V-Tec Series features a vertical transformer and clean sharp lines that blend with any architectural style. The vertical design keeps lamp generated heat away from the transformer thereby extending its life.

VANGUARD SERIES

Nora's architectural Vanguard Series features a powerful vertical transformer in a sleek, die-cast aluminum housing with lockable 360° horizontal and 180° vertical adjustment. Ideal for applications requiring precision aiming. The Vanguard Series includes low voltage and ceramic metal halide fixtures.

EUROPEAN COLLECTION

A line of modern, contemporary track fixtures featuring clean lines, and streamlined shapes with attractive silver finishes and glass and chrome accents. Customize your design with unique accessories, including glass shades, mesh shield, louvers and more!

2000 SERIES

Hi-tech designs suitable for a wide range of commercial, merchandising and residential applications. Detachable track fixtures must be used with the NTL-2200 Electronic Low Voltage Transformer, available in 50 or 75 watts.

200 SERIES

Featuring top quality and great design at an affordable price, all 200 Series track fixtures are energy efficient and have a built-in 50 or 75 watt transformer. Use different sized beams of halogen MR16 lamps to customize your lighting effects, highlight furnishings and illuminate favorite decorations.

QUICKJACK SERIES

Nora's QuickJack adapter allows the specifier to create their own low voltage track fixture or pendant using Nora Rail fixtures and pendants.

LOW VOLTAGE TRACK MR16 Fixtures



Low Voltage Vanguard

NTL-27M84/75 H-Style 20W - 75W

Features: Low profile, integral electronic transformer
358° horizontal and 180° vertical adjustment
Positive vertical locking with On/Off switch
Die-cast construction

Lamp: 20W-75W MR16 12V (not included)

Finish: Black (B), Silver (S), White (W)

Lens: UV lens included with fixture

Dimensions: Length: 2-15/16" Dia.: 2-3/4" Max Ext.: 7-1/4"

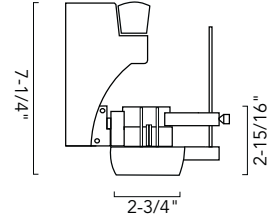

Low Voltage Vanguard

NTL-27M85/50 H-Style 20W - 50W

Features: Low profile, integral electronic transformer
358° horizontal and 180° vertical adjustment
Positive vertical locking with On/Off switch
Die-cast construction

Lamp: 20W-50W MR16 12V (not included)

Finish: Black (B), Silver (S), White (W)

Dimensions: Length: 2-3/4" Dia.: 3" Max Ext.: 6-1/2"

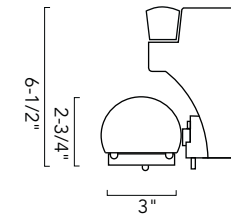

Low Voltage Vanguard

NTL-27M86/50 H-Style 20W - 50W

Features: Low profile, integral electronic transformer
358° horizontal and 180° vertical adjustment
Positive vertical locking with On/Off switch
Die-cast construction

Lamp: 20W-50W MR16 12V (not included)

Finish: Black (B), Silver (S), White (W)

Dimensions: Length: 3-1/4" Dia.: 3-5/16" Max Ext.: 7-3/4"

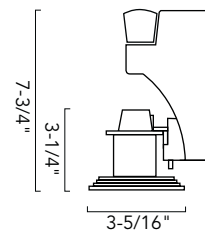

Lighting Tip:

Low voltage MR16's produce minimal forward heat and UV so they are an excellent choice for lighting fine artwork.

All Nora Low Voltage MR16 fixtures include UV protection lens, unless otherwise noted.

LOW VOLTAGE TRACK

MR16 Fixtures continued

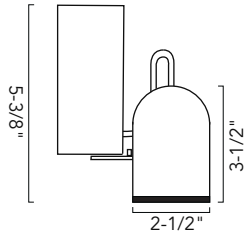

Low Voltage V-Tec Cylinder

NTL-262 H-Style 20W - 50W

- Features:** Vertical design extends life of transformer
Deep set lamp and baffle provide excellent glare control
- Lamp:** 20W-50W MR16 12V (not included)
- Finish:** Black (B), Silver (S), White (W)
- Dimensions:** Length: 3-1/2" Dia.: 2-1/2" Max Ext.: 5-3/8"

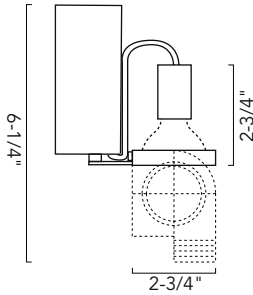

Low Voltage V-Tec Cross Blade

NTL-263 H-Style 20W - 50W

- Features:** Vertical design extends life of transformer
Hot aiming handle
Cross blade provides visual interest and glare control
- Lamp:** 20W-50W MR16 12V (not included)
- Finish:** Black (B), Silver (S), White (W)
- Dimensions:** Length: 2-3/4" Fixture Width.: 2-3/4" Max Ext.: 6-1/4"

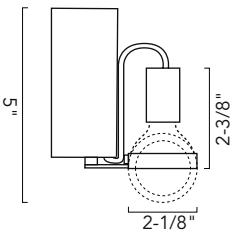

Low Voltage V-Tec Gimbal

NTL-264 H-Style 20W - 50W

- Features:** Vertical design extends life of transformer
Low profile, simple and clean gimbal appearance
- Lamp:** 20W-50W MR16 12V (not included)
- Finish:** Black (B), Silver (S), White (W)
- Dimensions:** Length: 2-3/8" Dia.: 2-1/8" Max Ext.: 5"

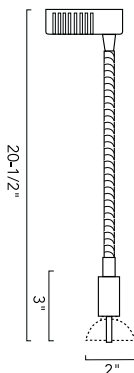

Micro II Gooseneck

NTL-301 H-Style 20W - 50W

- Lamp:** Lensed 20W-50W MR16 12V (not included)
- Finish:** Silver (S)
- Dimensions:** Length: 3" Dia.: 2" Max Ext.: 20-1/2"
- Accessories:** NT-360, QU50MR16EXN/CS
- UV protection lens not included



All Nora Low Voltage MR16 fixtures include UV protection lens, unless otherwise noted.

LOW VOLTAGE TRACK

MR16 Fixtures continued



Delta

NTL-302 H-Style 20W - 50W

Lamp: 20W-50W MR16 12V (not included)

Finish: Silver (S)

Dimensions: Length: 3-1/2" Dia.: 2-1/4" Max Ext.: 7-1/8"

- Custom stem lengths available in six-inch increments from 12" to 48"
See page 555 to order or specify custom lengths

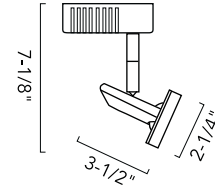

Retro Holder

NTL-303 H-Style 20W - 50W

Feature: Hot aiming handle

Lamp: Lensed 20W-50W MR16 12V (not included)

Finish: Silver (S)

Dimensions: Length: 3-1/2" Dia.: 2" Max Ext.: 5-1/2"

Accessories: NTR-100, NT-362, NT-360, NT-361, NT-361X, NT-363, QU50MR16EXN/CS

- UV protection lens not included
- Custom stem lengths available in six-inch increments from 12" to 48"
See page 555 to order or specify custom lengths

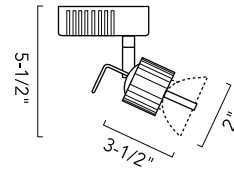

Retro II Holder for Accessory Reflector

NTL-304 H-Style 20W - 50W

NTL-304DC Dichroic Reflector

Feature: Hot aiming handle

Lamp: Lensed 20W-50W MR16 12V (not included)

Finish: Silver (S)

Dimensions: Length: 4-7/8" Dia.: 2-7/8" Max Ext.: 6-3/4"

Accessories: NT-360, NTR-100, NT-361, NT-361X, QU50MR16EXN/CS, NGD-17

- UV protection lens not included
- Custom stem lengths available in six-inch increments from 12" to 48"
See page 555 to order or specify custom lengths

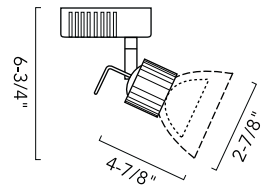

Shown with NTL-304DC Accessory



Spike I (with Chrome handle)

NTL-305 H-Style 20W - 50W

Feature: Hot aiming handle

Lamp: Lensed 20W-50W MR16 12V (not included)

Finish: Silver (S) with Chrome handle

Dimensions: Length: 4-3/4" Dia.: 2" Max Ext.: 7"

Accessories: NTR-100, NT-362, NT-360, NT-361, NT-361X, QU50MR16EXN/CS

- UV protection lens not included
- Custom stem lengths available in six-inch increments from 12" to 48"
See page 555 to order or specify custom lengths

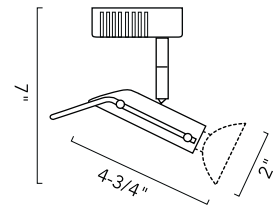

All Nora Low Voltage MR16 fixtures include UV protection lens, unless otherwise noted.

LOW VOLTAGE TRACK
MR16 Fixtures continued

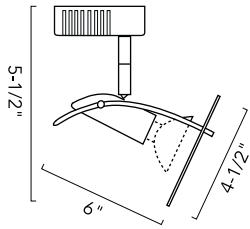

Spike II (with Chrome handle & Glass disk)

NTL-306 H-Style 20W - 50W

- Feature:** Hot aiming handle
Lamp: Lensed 20W-50W MR16 12V (not included)
Finish: Silver (S)
Dimensions: Length: 6" Dia.: 4-1/2" Max Ext.: 5-1/2"
Accessories: NTL-304DC, NGD-17, NTR-100, NT-362, NT-360, NT-361, NT-361X, QU50MR16EXN/CS
- UV protection lens not included
 - Custom stem lengths available in six-inch increments from 12" to 48"
See page 555 to order or specify custom lengths

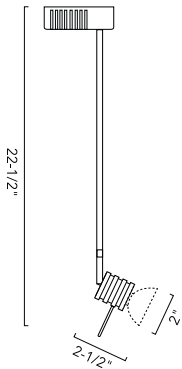

Vetro II Stem

NTL-307 H-Style 20W - 50W

- Feature:** Hot aiming handle
Lamp: Lensed 20W-50W MR16 12V (not included)
Finish: Silver (S)
Dimensions: Length: 2-1/2" Dia.: 2" Max Ext.: 22-1/2"
Accessories: NT-360, , NT-361, NT-361X, NT-362, NTR-100, QU50MR16EXN/CS
- UV protection lens not included
 - Custom stem lengths available in six-inch increments from 12" to 48"
See page 555 to order or specify custom lengths

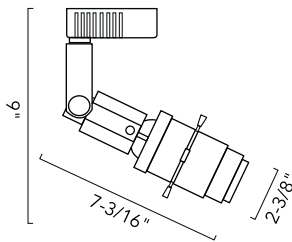

Michaelangelo™ Framing Projector

NTL-313 H-Style 20W - 50W

- Lamp:** 20W-50W MR16 12V (not included)
For best result use 8" - 15" narrow spot lamps
Finish: Silver (S)
Dimensions: Length: 7-3/16" Dia.: 2-3/8" Max Ext.: 9"

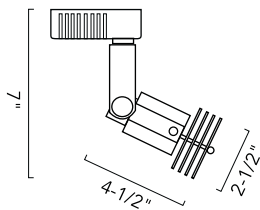

Galileo™ Dual Ring Face

NTL-314 H-Style 20W - 50W

- Lamp:** Lensed 20W-50W MR16 12V (not included)
Finish: Silver (S)
Dimensions: Length: 4-1/2" Dia.: 2-1/2" Max Ext.: 7"
Accessories: QU50MR16S
- UV protection lens not included



All Nora Low Voltage MR16 fixtures include UV protection lens, unless otherwise noted.

Lighting Tip:

The recommended placement of track lighting on standard residential ceiling heights is 2' to 3' from the wall around the perimeter of the room.

LOW VOLTAGE TRACK MR16 Fixtures continued



Newton™ Ring Face

NTL-315 H-Style 20W - 50W

Lamp: 20W-50W MR16 12V (not included)
Finish: Silver (S)
Dimensions: Length: 3-3/4" Dia.: 3" Max Ext.: 6-1/2"
Accessories: NT-362, NT-361, QU50MR16EXN/CS

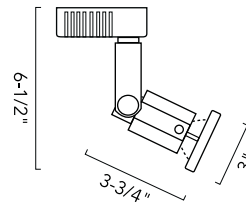

Copernicus™ Glass Disk Face

NTL-316 H-Style 20W - 50W

Lamp: Lensed 20W-50W MR16 12V (not included)
Finish: Silver (S)
Dimensions: Height: 4-1/2" Dia.: 4-3/4" Max Ext.: 7-3/4"
Accessories: NTR-100, NT-362, NT-360, NT-361, NT-361X, QU50MR16EXN/CS

- UV protection lens not included

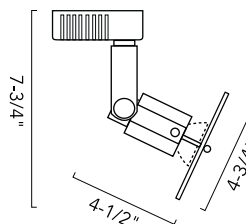

Roma™

NTL-317 H-Style 20W - 50W

Feature: Hot aiming handle
Lamp: Lensed 20W-50W MR16 12V (not included)
Finish: Silver (S)
Dimensions: Length: 5-7/8" Dia.: 2-3/8" Max Ext.: 9-1/4"
Accessories: NT-360, NT-361, NT-361X, QU50MR16EXN/CS

- UV protection lens not included

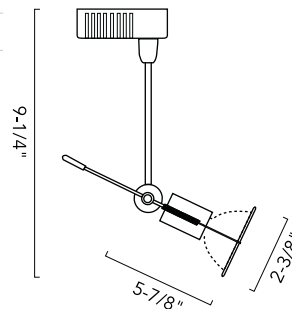

Italia™

NTL-318 H-Style 20W - 50W

Lamp: Lensed 20W-50W MR16 12V (not included)
Finish: Silver (S)
Dimensions: Length: 2-7/8" Dia.: 2-3/16" Max Ext.: 6"
Accessories: QU50MR16EXN/CS

- UV protection lens not included

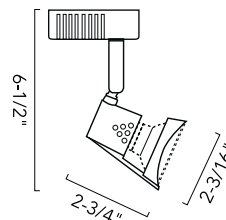

All Nora Low Voltage MR16 fixtures include UV protection lens, unless otherwise noted.

MR11/MR16 Fixtures continued

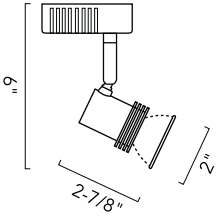

Metro™

NTL-319	H-Style	20W - 50W
----------------	---------	-----------

- Lamp:** Lensed 20W-50W MR16 12V (not included)
Finish: Silver (S)
Dimensions: Length: 2-7/8" Dia.: 2" Max Ext.: 6"
Accessories: NTR-100, QU50MR16EXN/CS
- UV protection lens not included
 - Custom stem lengths available in six-inch increments from 12" to 48"
See page 555 to order or specify custom lengths

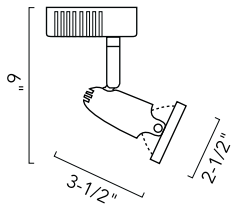

Stockholm™

NTL-320	H-Style	20W - 50W
----------------	---------	-----------

- Lamp:** 20W-50W MR16 12V (not included)
Finish: Silver (S)
Dimensions: Length: 3-1/2" Dia.: 2-1/2" Max Ext.: 6"
Accessories: QU50MR16EXN/CS
- Custom stem lengths available in six-inch increments from 12" to 48"
See page 555 to order or specify custom lengths

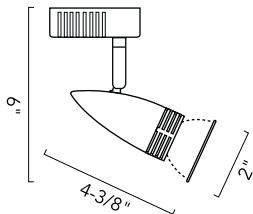

Paris™

NTL-321	H-Style	20W - 50W
----------------	---------	-----------

- Lamp:** Lensed 20W-50W MR16 12V (not included)
Finish: Silver (S)
Dimensions: Length: 4-3/8" Dia.: 2" Max Ext.: 6"
Accessory: NTR-100
- UV protection lens not included
 - Custom stem lengths available in six-inch increments from 12" to 48"
See page 555 to order or specify custom lengths

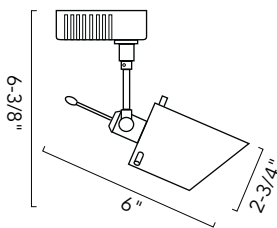

Cabral II™

NTL-322 (MR11)	H-Style	20W - 35W MR11
-----------------------	---------	----------------

- Features:** ClutchLoc™ secure angle locking mechanism
Hot aiming handle
Lamp: Lensed 20W-35W MR11 12V (not included)
Finish: Silver (S)
Dimensions: Length: 6" Dia.: 2-3/4" Max Ext.: 6-3/8"
Accessories: QU50MR16EXN/CS
- UV protection lens not included
 - Custom stem lengths available in six-inch increments from 12" to 48"
See page 555 to order or specify custom lengths



All Nora Low Voltage MR16 fixtures include UV protection lens, unless otherwise noted.



Lighting Tip:

2-Circuit track can separate accent lighting from general lighting on a single run.

LOW VOLTAGE TRACK

MR16 Fixtures continued

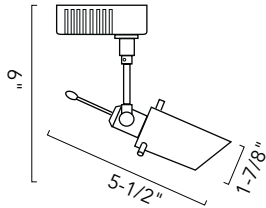

Cabral™

NTL-323	H-Style	20W - 50W
----------------	---------	-----------

Features: ClutchLoc™ secure angle locking mechanism
Hot aiming handle

Lamp: Lensed 20W-50W MR16 12V (not included)

Finish: Silver (S)

Dimensions: Length: 5-1/2" Dia.: 1-7/8" Max Ext.: 6"

Accessories: QU50MR16S

- UV protection lens not included
- Custom stem lengths available in six-inch increments from 12" to 48"
See page 555 to order or specify custom lengths

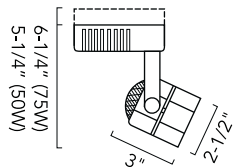

Studio with Integral Electronic Transformer

NTL-201	H-Style	20W - 50W
----------------	---------	-----------

NTL-201/75	H-Style	20W - 75W
-------------------	---------	-----------

Lamp: 20W-75W MR16 (not included)

Finish: Black (B), White (W)

Dimensions: Length: 3" Dia.: 2-1/2"
Max Ext.: 6-1/4" (75W), 5-1/4" (50W)

- Custom stem lengths available in six-inch increments from 12" to 48"
See page 555 to order or specify custom lengths

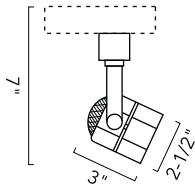

Studio Octagon

NTL-2201	H-Style	20W - 50W
-----------------	---------	-----------

Lamp: 20W-50W MR16 (not included)

Finish: Black (B), White (W)

Dimensions: Length: 3" Dia.: 2-1/2" Max Ext.: 7"

Requires: 50W Electronic Transformer

NTL-2200/50: 50W Electronic Transformer

Accessories: 18" Flexible Extension Rod (NT-330)
18" to 48" Extension Rods (NT-322, 323, 324, 325)



Low Voltage 2000 Series

Nora's Low Voltage 2000 Series brings you to the 21st century with bright lights and high-tech designs. The 2000 Series is ideal for a wide range of commercial, merchandising and residential applications. Detachable track fixtures give you the flexibility of many available options (example: use stems to drop fixture away from track or monopoint). The NTL 2000 series track fixtures must be used with the NTL-2200 electronic transformer when used on track or NT-337 monopoint. Additionally the NTL-2000 series can be used with NT-347 integral transformer monopoint, eliminating the NTL-2200.

All Nora Low Voltage MR16 fixtures include UV protection lens, unless otherwise noted.

LOW VOLTAGE TRACK

MR16 Fixtures continued



Cube with Integral Electronic Transformer

NTL-202	H-Style	20W - 50W
NTL-202/75	H-Style	20W - 75W

Lamp: 20W-75W MR16 (not included)
Finish: Black (B), White (W)
Dimensions: Length: 3" Dia.: 2-7/8" Max Ext.: 6" (75W), 5" (50W)
 • Custom stem lengths available in six-inch increments from 12" to 48"
 See page 555 to order or specify custom lengths

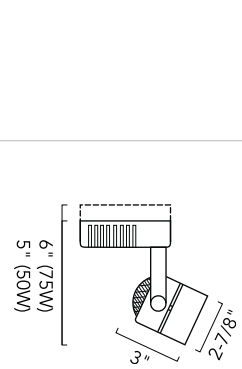

Cube

NTL-2202	H-Style	20W - 50W
-----------------	---------	-----------

Lamp: 20W-50W MR16 (not included)
Finish: Black (B), White (W)
Dimensions: Length: 3" Dia.: 2-7/8" Max Ext.: 6-7/8"
Requires: 50W Electronic Transformer
NTL-2200/50: 50W Electronic Transformer
Accessories: 18" Flexible Extension Rod (NT-330)
 18" to 48" Extension Rods (NT-322, 323, 324, 325)

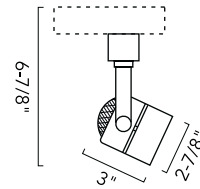

NOW IN BRONZE



Cylinder with Integral Electronic Transformer

NTL-203	H-Style	20W - 50W
NTL-203/75	H-Style	20W - 75W

Lamp: 20W-75W MR16 (not included)
Finish: Black (B), Bronze (BZ), Natural Metal (NM), White (W)
Dimensions: Length: 3" Dia.: 2-1/4" Max Ext.: 5-7/8" (75W), 4-7/8" (50W)
 • Custom stem lengths available in six-inch increments from 12" to 48"
 See page 555 to order or specify custom lengths

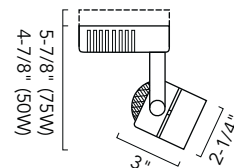

Cylinder

NTL-2203	H-Style	20W - 50W
-----------------	---------	-----------

Lamp: 20W-50W MR16 (not included)
Finish: Black (B), White (W), Natural Metal (NM)
Dimensions: Length: 3" Dia.: 2-1/4" Max Ext.: 7"
Requires: 50W Electronic Transformer
NTL-2200/50: 50W Electronic Transformer
Accessories: 18" Flexible Extension Rod (NT-330)
 18" to 48" Extension Rods (NT-322, 323, 324, 325)

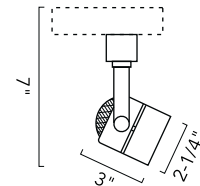

All Nora Low Voltage MR16 fixtures include UV protection lens, unless otherwise noted.

LOW VOLTAGE TRACK MR16 Fixtures continued

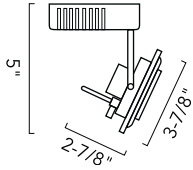

Hi-Tech with Integral Electronic Transformer

NTL-205	H-Style	20W - 50W
----------------	---------	-----------

Lamp: 20W-50W MR16 (not included)
Finish: Black (B), Gold (G), White (W)
Dimensions: Length: 2-7/8" Dia.: 3-7/8" Max Ext.: 5"

- Custom stem lengths available in six-inch increments from 12" to 48"
 See page 555 to order or specify custom lengths

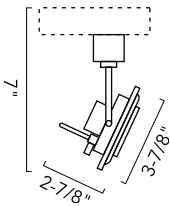

Hi-Tech

NTL-2205	H-Style	20W - 50W
-----------------	---------	-----------

Lamp: 20W-50W MR16 (not included)
Finish: Black (B), Gold (G), White (W)
Dimensions: Length: 2-7/8" Dia.: 3-7/8" Max Ext.: 7"

Requires: 50W Electronic Transformer
NTL-2200/50: 50W Electronic Transformer

Accessories: 18" Flexible Extension Rod (NT-330)
 18" to 48" Extension Rods (NT-322, 323, 324, 325)

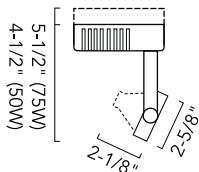

Gimbal Ring with Integral Electronic Transformer

NTL-207	H-Style	20W - 50W
----------------	---------	-----------

NTL-207/75	H-Style	20W - 75W
-------------------	---------	-----------

Lamp: 20W-75W MR16 (not included)
Finish: Black (B), Bronze (BZ), Natural Metal (NM), White (W)
Dimensions: Length: 2-1/8" Dia.: 2-5/8"
 Max Ext.: 5-1/2" (75W), 4-1/2" (50W)

- Custom stem lengths available in six-inch increments from 12" to 48"
 See page 555 to order or specify custom lengths

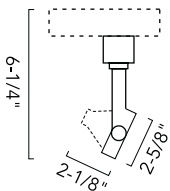

Gimbal Ring

NTL-2207	H-Style	20W - 75W
-----------------	---------	-----------

Lamp: 20W-75W MR16 (not included)
Finish: Black (B), Natural Metal (NM), White (W)
Dimensions: Length: 2-1/8" Dia.: 2-5/8" Max Ext.: 6-1/4"

Requires: 50W or 75W Electronic Transformer
NTL-2200/50: 50W Electronic Transformer
NTL-2200/75: 75W Electronic Transformer

Accessories: 18" Flexible Extension Rod (NT-330)
 18" to 48" Extension Rods (NT-322, 323, 324, 325)



All Nora Low Voltage MR16 fixtures include UV protection lens, unless otherwise noted.

LOW VOLTAGE TRACK

MR16 Fixtures continued



Barndoor with Integral Electronic Transformer

NTL-208 H-Style 20W - 50W

Lamp: Lensed 20W-50W MR16 (not included)
Finish: Black (B), White (W)
Dimensions: Length: 4-1/8" Dia.: 2-7/8" Max Ext.: 6-1/2"

- UV protection lens not included
- Custom stem lengths available in six-inch increments from 12" to 48"
 See page 555 to order or specify custom lengths

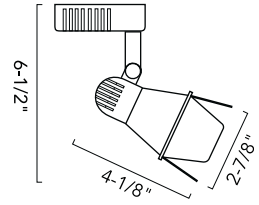

Barndoor

NTL-2208 H-Style 20W - 75W

Lamp: Lensed 20W-75W MR16 (not included)
Finish: Black (B), White (W)
Dimensions: Length: 4-1/8" Dia.: 2-7/8" Max Ext.: 8-1/2"

Requires: 50W or 75W Electronic Transformer
NTL-2200/50: 50W Electronic Transformer
NTL-2200/75: 75W Electronic Transformer
Accessories: 18" Flexible Extension Rod (NT-330)
 18" to 48" Extension Rods (NT-322, 323, 324, 325)

- UV protection lens not included

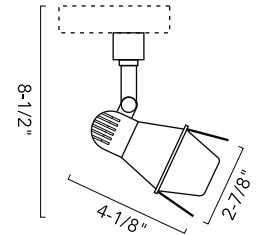

Spotlight with Integral Electronic Transformer

NTL-209 H-Style 20W - 50W

Lamp: 20W-50W MR16 (not included)
Finish: Black (B) only
Dimensions: Length: 2-7/8" Dia.: 3-1/4" Max Ext.: 6"

- Custom stem lengths available in six-inch increments from 12" to 48"
 See page 555 to order or specify custom lengths

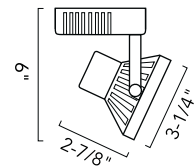

Spotlight

NTL-2209 H-Style 20W - 75W

Lamp: 20W-75W MR16 (not included)
Finish: White (W) only
Dimensions: Length: 2-7/8" Dia.: 3-1/4" Max Ext.: 6-1/2"

Requires: 50W or 75W Electronic Transformer
NTL-2200/50: 50W Electronic Transformer
NTL-2200/75: 75W Electronic Transformer
Accessories: 18" Flexible Extension Rod (NT-330)
 18" to 48" Extension Rods (NT-322, 323, 324, 325)

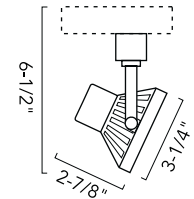

All Nora Low Voltage MR16 fixtures include UV protection lens, unless otherwise noted.

LOW VOLTAGE TRACK MR16 Fixtures continued

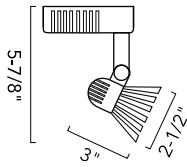

Clasp with Integral Electronic Transformer

NTL-210 H-Style 20W - 50W

Lamp: Lensed 20W-50W MR16 (not included)

Finish: Black (B), White (W)

Dimensions: Length: 3" Dia.: 2-1/2" Max Ext.: 5-7/8"

- UV protection lens not included
- Custom stem lengths available in six-inch increments from 12" to 48"
See page 555 to order or specify custom lengths

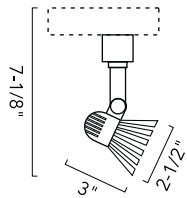

Clasp

NTL-2210 H-Style 20W - 75W

Lamp: Lensed 20W-75W MR16 (not included)

Finish: Black (B), White (W)

Dimensions: Length: 3" Dia.: 2-1/2" Max Ext.: 7-1/8"

Requires: 50W or 75W Electronic Transformer

NTL-2200/50: 50W Electronic Transformer

NTL-2200/75: 75W Electronic Transformer

Accessories: 18" Flexible Extension Rod (NT-330)

18" to 48" Extension Rods (NT-322, 323, 324, 325)

- UV protection lens not included

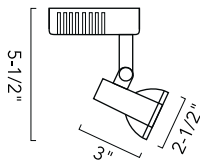

Pinchback with Integral Electronic Transformer

NTL-211 H-Style 20W - 50W

Lamp: 20W-50W MR16 (not included)

Finish: Black (B), White (W)

Dimensions: Length: 3" Dia.: 2-1/2" Max Ext.: 5-1/2"

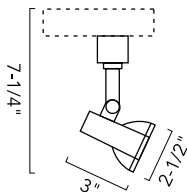

Pinchback

NTL-2211 H-Style 20W - 75W

Lamp: 20W-75W MR16 (not included)

Finish: Black (B), White (W)

Dimensions: Length: 3" Dia.: 2-1/2" Max Ext.: 7-1/4"

Requires: 50W or 75W Electronic Transformer

NTL-2200/50: 50W Electronic Transformer

NTL-2200/75: 75W Electronic Transformer

Accessories: 18" Flexible Extension Rod (NT-330)

18" to 48" Extension Rods (NT-322, 323, 324, 325)



All Nora Low Voltage MR16 fixtures include UV protection lens, unless otherwise noted.

LOW VOLTAGE TRACK

MR16 Fixtures continued



Continental with Integral Electronic Transformer

NTL-212	H-Style	20W - 50W
NTL-212/75	H-Style	20W - 75W

Lamp: 20W-75W MR16 (not included)
Finish: Black (B), Natural Metal (NM), White (W)
Dimensions: Length: 3" Dia.: 2-1/2"
 Max Ext.: 6-1/2" (75W), 5-1/2" (50W)

- Custom stem lengths available in six-inch increments from 12" to 48"
 See page 555 to order or specify custom lengths

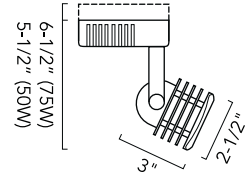

Continental

NTL-2212	H-Style	20W - 75W
-----------------	---------	-----------

Lamp: 20W-75W MR16 (not included)
Finish: Black (B), Natural Metal (NM), White (W)
Dimensions: Length: 3" Dia.: 2-1/2" Max Ext.: 7-1/2"
Requires: 50W or 75W Electronic Transformer

- Accessories:** 18" Flexible Extension Rod (NT-330)
 18" to 48" Extension Rods (NT-322, 323, 324, 325)

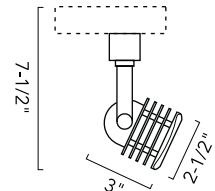

Wireback with Integral Electronic Transformer

NTL-213	H-Style	20W - 50W
----------------	---------	-----------

Lamp: Lensed 20W-50W MR16 (not included)
Finish: Black (B), Natural Metal (NM), White (W)
Dimensions: Length: 3" Dia.: 2-7/8" Max Ext.: 6"

- UV protection lens not included
- Custom stem lengths available in six-inch increments from 12" to 48"
 See page 555 to order or specify custom lengths

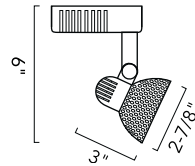

Wireback

NTL-2213	H-Style	20W - 75W
-----------------	---------	-----------

Lamp: Lensed 20W-75W MR16 (not included)
Finish: Black (B), Natural Metal (NM), White (W)
Dimensions: Length: 3" Dia.: 2-7/8" Max Ext.: 7-3/4"

- Requires:** 50W or 75W Electronic Transformer
Accessories: 18" Flexible Extension Rod (NT-330)
 18" to 48" Extension Rods (NT-322, 323, 324, 325)

- UV protection lens not included

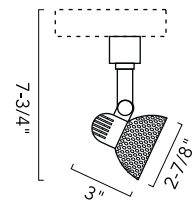

All Nora Low Voltage MR16 fixtures include UV protection lens, unless otherwise noted.

LOW VOLTAGE TRACK MR16 Fixtures continued

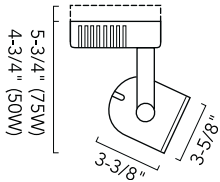

Roundback with Integral Electronic Transformer

NTL-214	H-Style	20W - 50W
NTL-214/75	H-Style	20W - 75W

Feature: Deep die-cast baffle for excellent glare control
Lamp: 20W-75W MR16 (not included)
Finish: Black (B), White (W)
Dimensions: Length: 3-3/8" Dia.: 3-5/8"
 Max Ext.: 5-3/4" (75W), 4-3/4" (50W)

- Custom stem lengths available in six-inch increments from 12" to 48"
 See page 555 to order or specify custom lengths

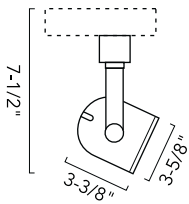

Roundback

NTL-2214	H-Style	20W - 50W
-----------------	---------	-----------

Feature: Deep die-cast baffle for excellent glare control
Lamp: 20W-50W MR16 (not included)
Finish: Black (B), White (W)
Dimensions: Length: 3-3/8" Dia.: 3-5/8" Max Ext.: 7-1/2"
Requires: 50W or 75W Electronic Transformer
NTL-2200/50: 50W Electronic Transformer

- Accessories:** 18" Flexible Extension Rod (NT-330)
 18" to 48" Extension Rods (NT-322, 323, 324, 325)

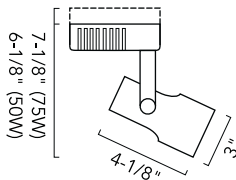

Telescope with Integral Electronic Transformer

NTL-215	H-Style	20W - 50W
NTL-215/75	H-Style	20W - 75W

Feature: Deep set lamp position for excellent glare control
Lamp: 20W-75W MR16 (not included)
Finish: Black (B), White (W)
Dimensions: Length: 4-1/8" Dia.: 3"
 Max Ext.: 7-1/8" (75W), 6-1/8" (50W)

- Accessory:** Beam Concentrator (NT-352 - sold separately)
 • Custom stem lengths available in six-inch increments from 12" to 48"
 See page 555 to order or specify custom lengths

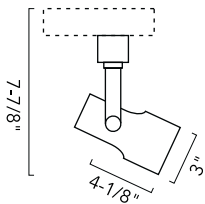

Telescope

NTL-2215	H-Style	20W - 75W
-----------------	---------	-----------

Feature: Deep set lamp position for excellent glare control
Lamp: 20W-75W MR16 (not included)
Finish: Black (B), White (W)
Dimensions: Length: 4-1/8" Dia.: 3" Max Ext.: 7-7/8"
Requires: 50W or 75W Electronic Transformer
NTL-2200/50: 50W Electronic Transformer
NTL-2200/75: 75W Electronic Transformer

- Accessories:** Beam Concentrator (NT-352 - sold separately)
 18" Flexible Extension Rod (NT-330)
 18" to 48" Extension Rods (NT-322, 323, 324, 325)



All Nora Low Voltage MR16 fixtures include UV protection lens, unless otherwise noted.

LOW VOLTAGE TRACK

MR16 Fixtures with Magnetic Transformer

Compatible with after market LED MR16 Bi-Pin lamps.



Roundback Cylinder with Integral Magnetic Transformer

NTL-221	H-Style	50W Max.
NTL-221(finish)/J	J-Style	50W Max
NTL-221(finish)/L	L-Style	50W Max

- Features:** Excellent for large commercial applications requiring dimming.
Deep die-cast baffle for excellent glare control.
- Lamp:** 50W MR16 Max. (not included)
- Finish:** Black (B), White (W)
- Dimensions:** Length: 6-5/8" Dia.: 4-1/4" Max Ext.: 9-3/8"
- Accessories:** 18" to 48" Extension Rods (NT-322, 323, 324, 325)

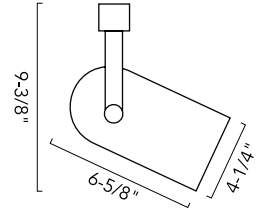

Now available with H, J and L-style adapters



Flatback Cylinder with Integral Magnetic Transformer

NTL-222	H-Style	50W Max
NTL-222(finish)/J	J-Style	50W Max
NTL-222(finish)/L	L-Style	50W Max

- Features:** Excellent for large commercial applications requiring dimming.
Deep die-cast baffle for excellent glare control.
- Lamp:** 50W MR16 Max. (not included)
- Finish:** Black (B), White (W)
- Dimensions:** Length: 6-1/8" Dia.: 4-1/4" Max Ext.: 9"
- Accessories:** 18" to 48" Extension Rods (NT-322, 323, 324, 325)

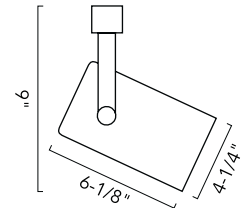

Now available with H, J and L-style adapters

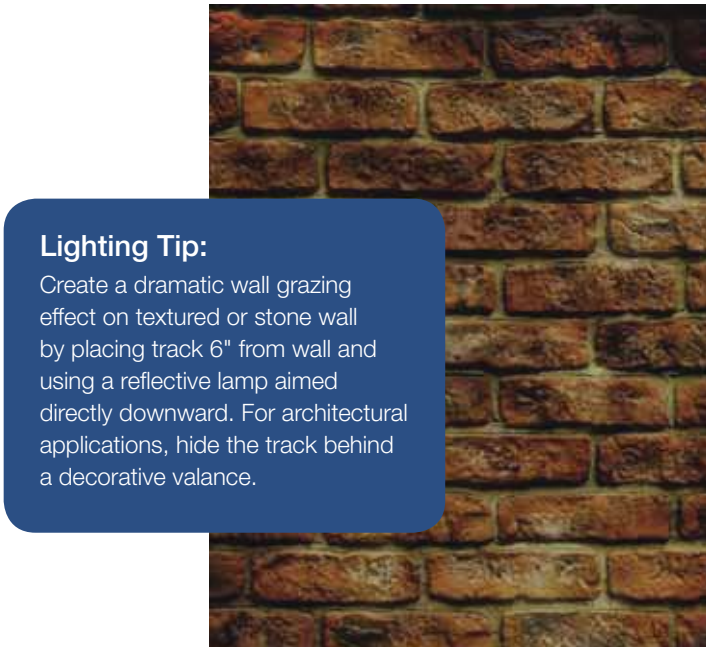

Lighting Tip:
Create a dramatic wall grazing effect on textured or stone wall by placing track 6" from wall and using a reflective lamp aimed directly downward. For architectural applications, hide the track behind a decorative valance.

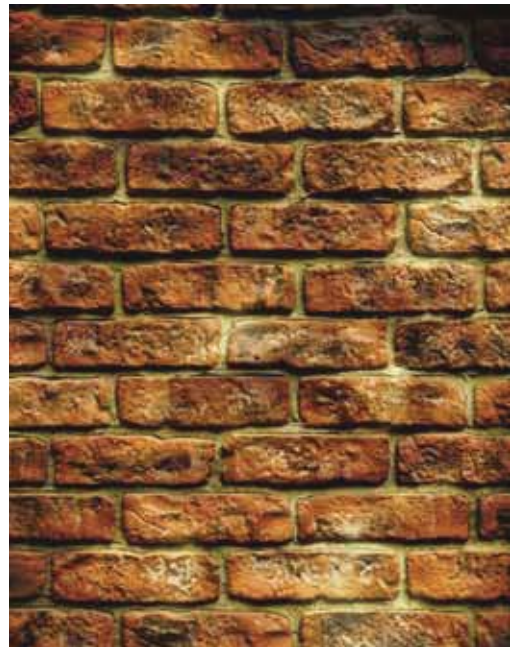

All Nora Low Voltage MR16 fixtures include UV protection lens, unless otherwise noted.

Now available with
H, J and L-style adapters

LOW VOLTAGE TRACK 3-in-1 Combination Projector

One projector functions as a **framing projector**,
beam concentrator or **gobo projector**.

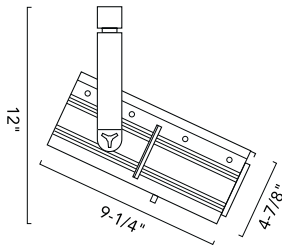

3-in-1 Combination Projector with
Integral Electronic Transformer

NTL-226	H-Style	20W-75W
NTL-226(finish)/J	J-Style	20W-75W
NTL-226(finish)/L	L-Style	20W-75W

Lamp: 75W MR16 (not included)
Finish: Black (B)
Dimensions: Length: 9-1/4" Dia.: 4-7/8" Max Ext.: 12"
Note: For best result, use 8° - 15° beam angle



FRAMING PROJECTOR

Four independent shutters create a sharp border around any picture frame. Focus control can either soften the border to blend with any wall texture, or sharpened to make the picture appear backlit.

BEAM CONCENTRATOR

Four templates reduce the beam from an MR16 to a variety of sizes, allowing any size object to be illuminated with no residual light spill.

GOBO PROJECTOR

Gobo holder allows the use of a variety of ready made graphics to be projected onto a floor, wall or ceiling. Gobo function also allows user to create any custom image, including company logos.



LOW VOLTAGE TRACK AR111 Fixtures

Lighting Tip:

AR111 fixtures are excellent for pin spot lighting from high ceilings with minimal glare.



Low Voltage Vanguard

NTL-27A11/75 H-Style 20W - 75W

Features: Low profile, integral electronic ballast 358° horizontal and 180° vertical adjustment. Positive vertical locking with hot aiming handle. Die-cast construction

Lamp: 20W-75W AR111 (not included)

Finish: Black (B), Silver (S), White (W)

Dimensions: Length: 3-5/16" Dia.: 5-5/16" Max Ext.: 8-1/4"

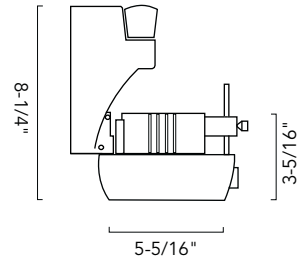

Low Profile Gimbal with Integral Electronic Transformer

NTL-225 H-Style 20W - 50W

NTL-225(finish)/J J-Style 20W - 50W

NTL-225(finish)/L L-Style 20W - 50W

Lamp: 20W-50W AR111 (not included)

Finish: Black (B), Silver (S), White (W)

Dimensions: Length: 3-1/4" Dia.: 5-1/8" Max Ext.: 5-1/2"
Span: 7-3/8"

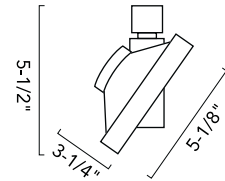

Now available with
H, J and L-style adapters



AR111 Sail™ with Integral Electronic Transformer

NTL-250 H-Style 20W - 50W

Lamp: 20W-50W AR111 (not included)

Finish: Black (B), Silver (S), White (W), Natural Metal (NM)

Dimensions: Length: 2-1/4" Dia.: 7-1/4" Max Ext.: 7-1/4"

• Custom stem lengths available from 12" to 48" in six inch increments

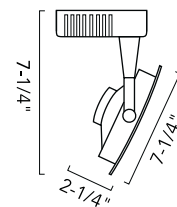

AR111 Sail™

NTL-2250 H-Style 20W - 50W

Lamp: 20W-50W AR111 (not included)

Finish: Black (B), Silver (S), White (W), Natural Metal (NM)

Dimensions: Length: 2-1/4" Dia.: 7-1/4" Max Ext.: 8-1/2"

Requires: 50W Electronic Transformer

NTL-2200/50: 50W Electronic Transformer

Accessories: 18" Flexible Extension Rod (NT-330)

18" to 48" Extension Rods (NT-322, 323, 324, 325)

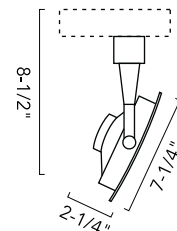

Lamps ordered separately, see page 755

LOW VOLTAGE TRACK PAR36 Fixtures

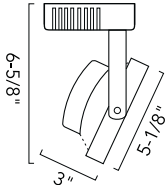

Gimbal Ring with Integral Electronic Transformer

NTL-220 H-Style 20W - 50W

Lamp: 20W-50W PAR36 (not included)
Finish: Black (B), White (W)
Dimensions: Length: 3" Dia.: 5-1/8" Max Ext.: 6-5/8"
 • Custom stem lengths available from 12" to 48" in six inch increments

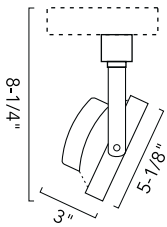

Gimbal Ring

NTL-2220 H-Style 20W - 50W

Lamp: 20W-50W PAR36 (not included)
Finish: Black (B), White (W)
Dimensions: Length: 3" Dia.: 5-1/8" Max Ext.: 8-1/4"
Requires: 50W Electronic Transformer
 NTL-2200/50: 50W Electronic Transformer



Lamps ordered separately, see page 755





Line Voltage

Nora Lighting has a complete offering of Line Voltage track fixtures. From the simplest lamp holder to high-tech designs, these track fixtures can be used on one-circuit or two-circuit, H, J and L style track systems. A complete line of accessories allows you to customize your design to meet your specific lighting needs.

MR16 GU10

MR16 GU10 fixtures give the appearance and crisp, white halogen light of a standard low voltage MR16. Without a transformer, GU10 fixtures cost less and are easily dimmed with standard incandescent dimmers. The sturdy twist and lock base makes positive contact for long socket life.

BR / PAR

Nora offers one of the industry's most comprehensive selections of BR/PAR track fixtures, from high-end architectural die-cast aluminum styles to simple, cost effective lamp holders. While BR/PAR track fixtures are typically used with PAR halogen lights, designers and specifiers are now using these for after market LED lamps.

MR16 Extension Stems

For truly outstanding style and appearance, Nora Lighting is pleased to offer factory-installed extension stems for most line-voltage GU10 and low voltage MR16 fixtures upon request.

The result is sleek, streamlined assembly. Lengths are available from 12" to 48" in 6-inch increments. Stems are finished to match the fixture.

Fixtures available with extension

Factory installed extensions are available with the following:

- **European Collection Low Voltage MR16**
NTL-300 Series (except NTL-301, NTL-307, NTL-317)
- **European Collection Line Voltage GU10 MR16**
NTH-600 Series
- **Nora Standard Low Voltage MR16**
NTL-200 Series (except NTL-221, NTL-222, NTL-225, NTL-226)

How to order:

Fixtures with factory installed extensions are custom manufactured; at the time of specification or order, please add (/) and the stem length you desire, example NTH-619S/36. Consult factory for pricing and availability.



LINE VOLTAGE TRACK MR16 GU10 Fixtures

Now available with
H, J and L-style adapters



Michaelangelo™ Framing Projector

NTH-613	H-Style	50W Max.
NTH-613(finish)/J	J-Style	50W Max.
NTH-613(finish)/L	L-Style	50W Max.

Lamp: 50W MR16 GU10 Lensed (included)
Finish: Silver (S)

Dimensions: Length: 7-3/16" Dia.: 2-3/8" Max Ext.: 9-1/2"
Note: For best results, use 8" - 15" narrow spot lamps

- Custom stem lengths available in six-inch increments from 12" to 48"
See page 575 to order or specify custom lengths

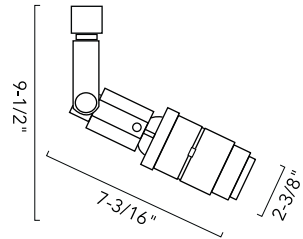

Galileo™ Dual Ring Face

NTH-614	H-Style	50W Max.
NTH-614(finish)/J	J-Style	50W Max.
NTH-614(finish)/L	L-Style	50W Max.

Lamp: 50W MR16 GU10 Lensed (included)
Finish: Silver (S)

Dimensions: Length: 4-1/2" Dia.: 2-1/2" Max Ext.: 7-1/2"

- Custom stem lengths available in six-inch increments from 12" to 48"
See page 575 to order or specify custom lengths

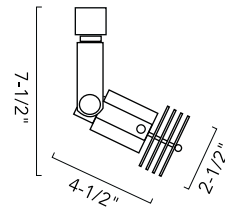

Newton™ Ring Face

NTH-615	H-Style	50W Max.
NTH-615(finish)/J	J-Style	50W Max.
NTH-615(finish)/L	L-Style	50W Max.

Lamp: 50W MR16 GU10 Lensed (included)
Finish: Silver (S)

Dimensions: Length: 3-3/4" Dia.: 3" Max Ext.: 7"

- Custom stem lengths available in six-inch increments from 12" to 48"
See page 575 to order or specify custom lengths

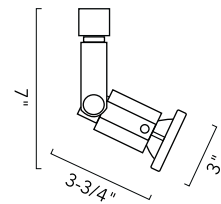

Copernicus™ Glass Disk Face

NTH-616	H-Style	50W Max.
NTH-616(finish)/J	J-Style	50W Max.
NTH-616(finish)/L	L-Style	50W Max.

Lamp: 50W MR16 GU10 Lensed (included)
Finish: Silver (S)

Dimensions: Length: 4-1/2" Dia.: 4-3/4" Max Ext.: 8-1/4"

Accessories: NTR-100

- Custom stem lengths available in six-inch increments from 12" to 48"
See page 575 to order or specify custom lengths

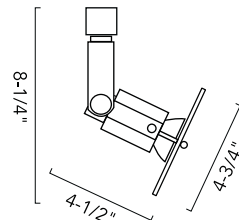

Now available with
H, J and L-style adapters

MR16 GU10 Fixtures continued

LINE VOLTAGE TRACK

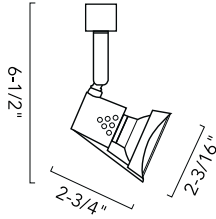

Italia™

NTH-618	H-Style	50W Max.
NTH-618(finish)/J	J-Style	50W Max.
NTH-618(finish)/L	L-Style	50W Max.

Lamp: 50W MR16 GU10 Lensed (included)

Finish: Silver (S)

Dimensions: Length: 2-3/4" Dia.: 2-3/16" Max Ext.: 6-1/2"

- Custom stem lengths available in six-inch increments from 12" to 48"
See page 575 to order or specify custom lengths

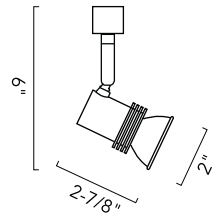

Metro™

NTH-619	H-Style	50W Max.
NTH-619(finish)/J	J-Style	50W Max.
NTH-619(finish)/L	L-Style	50W Max.

Lamp: 50W MR16 GU10 Lensed (included)

Finish: Silver (S)

Dimensions: Length: 2-7/8" Dia.: 2" Max Ext.: 6"

Accessories: NTR-100

- Custom stem lengths available in six-inch increments from 12" to 48"
See page 575 to order or specify custom lengths

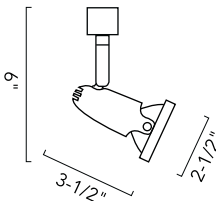

Stockholm™

NTH-620	H-Style	50W Max.
NTH-620(finish)/J	J-Style	50W Max.
NTH-620(finish)/L	L-Style	50W Max.

Lamp: 50W MR16 GU10 Lensed (included)

Finish: Silver (S)

Dimensions: Length: 3-1/2" Dia.: 2-1/2" Max Ext.: 6"

- Custom stem lengths available in six-inch increments from 12" to 48"
See page 575 to order or specify custom lengths

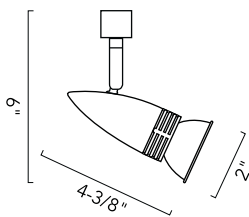

Paris™

NTH-621	H-Style	50W Max.
NTH-621(finish)/J	J-Style	50W Max.
NTH-621(finish)/L	L-Style	50W Max.

Lamp: 50W MR16 GU10 Lensed (included)

Finish: Silver (S)

Dimensions: Length: 4-3/8" Dia.: 2" Max Ext.: 6"

Accessories: NTR-100

- Custom stem lengths available in six-inch increments from 12" to 48"
See page 575 to order or specify custom lengths



LINE VOLTAGE TRACK

MR16 GU10 Fixtures continued

Now available with
H, J and L-style adapters



Round Back with Black Baffle

NTH-694	H-Style	50W Max.
NTH-694(finish)/J	J-Style	50W Max.
NTH-694(finish)/L	L-Style	50W Max.

Feature: Deep die-cast baffle for excellent glare control
Lamp: 50W MR16 GU10 Lensed (included)
Finish: Black (B), White (W)
Dimensions: Length: 3-3/8" Dia.: 3/5/8" Max Ext.: 5-3/4"

- Custom stem lengths available in six-inch increments from 12" to 48"
 See page 575 to order or specify custom lengths

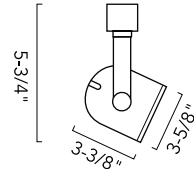

Telescope

NTH-695	H-Style	50W Max.
NTH-695(finish)/J	J-Style	50W Max.
NTH-695(finish)/L	L-Style	50W Max.

Feature: Deep set lamp position for excellent glare control
Lamp: 50W MR16 GU10 Lensed (included)
Finish: Black (B), White (W)
Dimensions: Length: 4-1/8" Dia.: 3" Max Ext.: 6-1/4"

Accessories: NT-351

- Custom stem lengths available in six-inch increments from 12" to 48"
 See page 575 to order or specify custom lengths

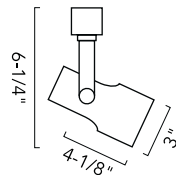

Gimbal Ring

NTH-697	H-Style	50W Max.
NTH-697(finish)/J	J-Style	50W Max.
NTH-697(finish)/L	L-Style	50W Max.

Lamp: 50W MR16 GU10 Lensed (included)
Finish: Black (B), White (W)
Dimensions: Length: 2-1/8" Dia.: 2-5/8" Max Ext.: 4-7/8"

- Custom stem lengths available in six-inch increments from 12" to 48"
 See page 575 to order or specify custom lengths

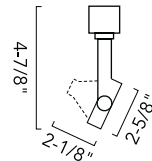

Lighting Tip:

GU10 fixtures are a good economical choice for a low voltage appearance, and can be easily dimmed with standard dimmers. Additionally, they can be used with GU10 LED after market lamps.

Now available with
H, J and L-style adapters

LINE VOLTAGE TRACK PAR Fixtures

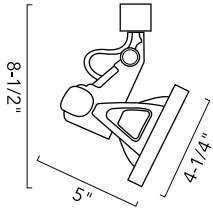

Belgium™ PAR30 Front Load Die-Cast Gimbal

NTH-132	H-Style	75W Max.
NTH-132(finish)/J	J-Style	75W Max.
NTH-132(finish)/L	L-Style	75W Max.

Feature: Architectural die-cast construction
Lamp: 75W PAR30 (not included)
Finish: Black (B), Silver (S), White (W)
Dimensions: Length: 5" Dia.: 4-1/4" Max Ext.: 8-1/2"

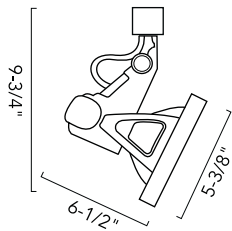

Belgium™ PAR38 Front Load Die-Cast Gimbal

NTH-133	H-Style	90W Max.
NTH-133(finish)/J	J-Style	90W Max.
NTH-133(finish)/L	L-Style	90W Max.

Feature: Architectural die-cast construction
Lamp: 90W PAR38 (not included)
Finish: Black (B), Silver (S), White (W)
Dimensions: Length: 6-1/2" Dia.: 5-3/8" Max Ext.: 9-3/4"

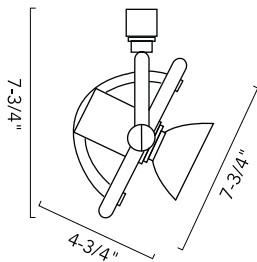

Orbit™ Double Gimbal

NTH-134	H-Style	75W Max.
NTH-134(finish)/J	J-Style	75W Max.
NTH-134(finish)/L	L-Style	75W Max.

Feature: Architectural die-cast construction
Lamp: 50W PAR20, 75W PAR30 (not included)
Finish: Black (B), White (W)
Dimensions: Length: 4-3/4" Dia.: 7-3/4" Max Ext.: 7-3/4"

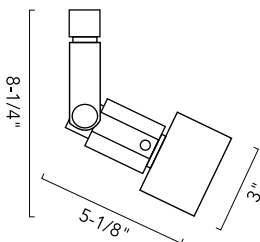

Leopold™ PAR20 Cylinder

NTH-135	H-Style	50W Max.
NTH-135(finish)/J	J-Style	75W Max.
NTH-135(finish)/L	L-Style	75W Max.

Feature: Architectural die-cast construction
Lamp: 50W PAR20 (not included)
Finish: Silver (S)
Dimensions: Length: 5-1/8" Dia.: 3" Max Ext.: 8-1/4"



LINE VOLTAGE TRACK
PAR Fixtures continued

Now available with
H, J and L-style adapters



Leopold™ PAR30 Cylinder

NTH-136	H-Style	75W Max.
NTH-136(finish)/J	J-Style	75W Max.
NTH-136(finish)/L	L-Style	75W Max.

Feature: Architectural die-cast construction
Lamp: 75W PAR30 (not included)
Finish: Silver (S)
Dimensions: Length: 6-1/4" Dia.: 4-1/8" Max Ext.: 9-1/4"

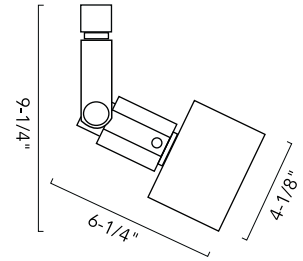

Leopold™ PAR38 Cylinder

NTH-137	H-Style	150W Max.
NTH-137(finish)/J	J-Style	150W Max.
NTH-137(finish)/L	L-Style	150W Max.

Feature: Architectural die-cast construction
Lamp: 150W PAR38 (not included)
Finish: Silver (S)
Dimensions: Length: 6-3/4" Dia.: 5-1/4" Max Ext.: 10-1/2"

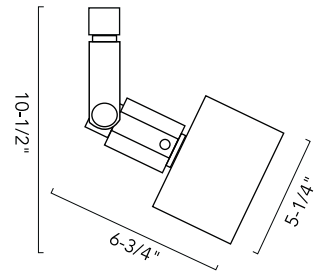

High-Tech Wire PAR20

NTH-176	H-Style	50W Max.
NTH-176(finish)/J	J-Style	50W Max.
NTH-176(finish)/L	L-Style	50W Max.

Lamp: 50W PAR20 (not included)
Finish: Black (B), White (W)
Dimensions: Length: 3-7/8" Dia.: 4-1/8" Max Ext.: 7-1/2"

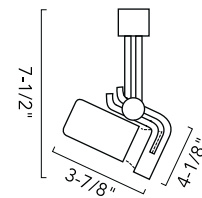

High-Tech Wire PAR30

NTH-177	H-Style	75W Max.
NTH-177(finish)/J	J-Style	75W Max.
NTH-177(finish)/L	L-Style	75W Max.

Lamp: 75W PAR30 (not included)
Finish: Black (B), White (W)
Dimensions: Length: 4-1/8" Dia.: 5" Max Ext.: 7-7/8"

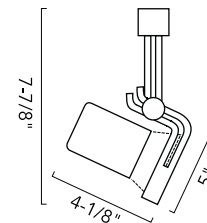

Lighting Tip:

For wall washing, place track 2' to 3' from the wall and space fixtures evenly, 2' to 3' apart. Use flood style lamps.

LINE VOLTAGE TRACK PAR Fixtures continued

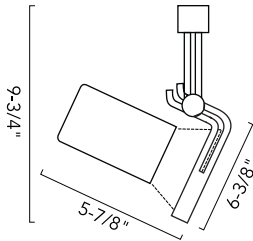

High-Tech Wire PAR38

NTH-178	H-Style	250W Max.
NTH-178(finish)/J	J-Style	250W Max.
NTH-178(finish)/L	L-Style	250W Max.

Lamp: 250W PAR38 (not included)
Finish: Black (B), White (W)
Dimensions: Length: 5-7/8" Dia.: 6-3/8" Max Ext.: 9-3/4"

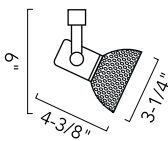

Wireback Cone

NTH-123	H-Style	50W Max.
NTH-123(finish)/J	J-Style	50W Max.
NTH-123(finish)/L	L-Style	50W Max.

Lamp: 50W R/PAR20 (not included)
Finish: Black (B), White (W)
Dimensions: Length: 4-3/8" Dia.: 3-1/4" Max Ext.: 6"

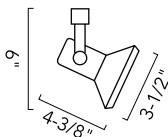

Cone PAR20

NTH-124	H-Style	50W Max.
NTH-124(finish)/J	J-Style	50W Max.
NTH-124(finish)/L	L-Style	50W Max.

Feature: Low profile
Lamp: 50W R/PAR20 (not included)
Finish: Black (B), White (W)
Dimensions: Length: 4-3/8" Dia.: 3-1/2" Max Ext.: 6"

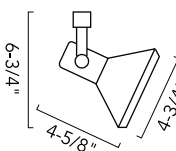

Cone PAR30

NTH-125	H-Style	75W Max.
NTH-125(finish)/J	J-Style	75W Max.
NTH-125(finish)/L	L-Style	75W Max.

Feature: Low profile
Lamp: 75W BR/PAR30 (not included)
Finish: Black (B), White (W)
Dimensions: Length: 4-5/8" Dia.: 4-3/4" Max Ext.: 6-3/4"



LINE VOLTAGE TRACK BR / PAR Fixtures

Now available with
H, J and L-style adapters



Cone PAR38

NTH-126	H-Style	150W Max.
NTH-126(finish)/J	J-Style	150W Max.
NTH-126(finish)/L	L-Style	150W Max.

Feature: Low profile
Lamp: 150W BR/PAR38 (not included)
Finish: Black (B), White (W)
Dimensions: Length: 6-1/2" Dia.: 6" Max Ext.: 8-1/8"

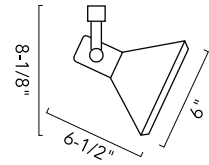

Wire Mount Wireback Cone

NTH-127	H-Style	50W Max.
NTH-127(finish)/J	J-Style	50W Max.
NTH-127(finish)/L	L-Style	50W Max.

Feature: Hot aiming handle
Lamp: 50W R/PAR20 (not included)
Finish: Black (B), White (W)
Dimensions: Length: 4-3/8" Dia.: 3-1/4" Max Ext.: 6"

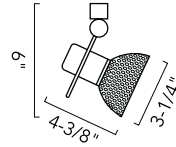

Wire Mount Cone PAR20

NTH-128	H-Style	50W Max.
NTH-128(finish)/J	J-Style	50W Max.
NTH-128(finish)/L	L-Style	50W Max.

Feature: Hot aiming handle
Lamp: 50W R/PAR20 (not included)
Finish: Black (B), White (W)
Dimensions: Length: 4-3/8" Dia.: 3-1/2" Max Ext.: 6"

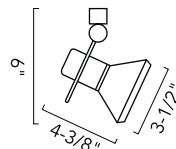

Wire Mount Cone PAR30

NTH-129	H-Style	75W Max.
NTH-129(finish)/J	J-Style	75W Max.
NTH-129(finish)/L	L-Style	75W Max.

Feature: Hot aiming handle
Lamp: 75W BR/PAR30 (not included)
Finish: Black (B), White (W)
Dimensions: Length: 4-5/8" Dia.: 4-3/4" Max Ext.: 6-3/4"

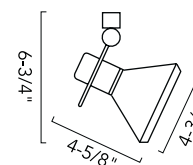

Lighting Tip:

Renting or leasing? Use Nora's cord and plug live end to install track. Simply install the track and plug into an existing wall outlet. Create dramatic lighting that is not permanent.

LINE VOLTAGE TRACK

BR / PAR Fixtures continued

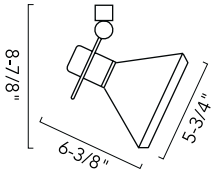

Wire Mount Cone PAR38

NTH-130	H-Style	150W Max.
NTH-130(finish)/J	J-Style	150W Max.
NTH-130(finish)/L	L-Style	150W Max.

Feature: Hot aiming handle
Lamp: 150W BR/PAR38 (not included)
Finish: Black (B), White (W)
Dimensions: Length: 6-3/8" Dia.: 5-3/4" Max Ext.: 8-7/8"

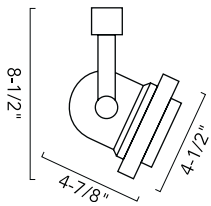

Classic Cylinder PAR20

NTH-110	H-Style	50W Max.
NTH-110(finish)/J	J-Style	50W Max.
NTH-110(finish)/L	L-Style	50W Max.

Lamp: 50W R/PAR20 (not included)
Finish: Black (B), White (W)
Dimensions: Length: 4-7/8" Dia.: 4-1/2" Max Ext.: 8-1/2"

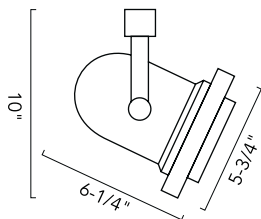

Classic Cylinder PAR30

NTH-111	H-Style	75W Max.
NTH-111(finish)/J	J-Style	75W Max.
NTH-111(finish)/L	L-Style	75W Max.

Lamp: 75W BR/PAR30 (not included)
Finish: Black (B), White (W)
Dimensions: Length: 6-1/4" Dia.: 5-3/4" Max Ext.: 10"

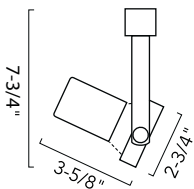

Designer Step Cylinder PAR20

NTH-122	H-Style	50W Max.
NTH-122(finish)/J	J-Style	50W Max.
NTH-122(finish)/L	L-Style	50W Max.

Lamp: 50W R/PAR20 (not included)
Finish: Black (B), Bronze (BZ), White (W)
Dimensions: Length: 5" Dia.: 2-7/8" Max Ext.: 7-3/4"



LINE VOLTAGE TRACK
BR / PAR Fixtures continued

Now available with
H, J and L-style adapters



Step Cylinder with Black Baffle PAR20

NTH-103	H-Style	50W Max.
NTH-103(finish)/J	J-Style	50W Max.
NTH-103(finish)/L	L-Style	50W Max.

Lamp: 50W R/PAR20 (not included)
Finish: Black (B), White (W)
Dimensions: Length: 5-3/8" Dia.: 3-1/2" Max Ext.: 8-3/8"

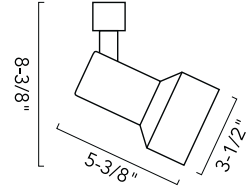

Step Cylinder with Black Baffle PAR30

NTH-104	H-Style	75W Max.
NTH-104(finish)/J	J-Style	75W Max.
NTH-104(finish)/L	L-Style	75W Max.

Lamp: 75W BR/PAR30 (not included)
Finish: Black (B), Bronze (BZ), White (W)
Dimensions: Length: 6" Dia.: 4-3/8" Max Ext.: 9"

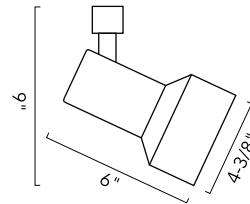

Shroud PAR30

NTH-149	H-Style	75W Max.
NTH-149(finish)/J	J-Style	75W Max.
NTH-149(finish)/L	L-Style	75W Max.

Lamp: 75W BR/PAR30 (not included)
Finish: Black (B), Silver (S), White (W)
Dimensions: Length: 5-1/2" Dia.: 4-3/8" Max Ext.: 9-1/4"
Accessories: Accepts louvers and filters (by others)

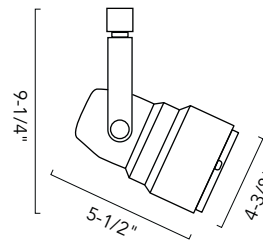

Shroud PAR38

NTH-150	H-Style	250W Max.
NTH-150(finish)/J	J-Style	250W Max.
NTH-150(finish)/L	L-Style	250W Max.

Lamp: 250W BR/PAR38 (not included)
Finish: Black (B), Silver (S), White (W)
Dimensions: Length: 7-1/2" Dia.: 5-3/4" Max Ext.: 11-1/4"
Accessories: Accepts louvers and filters (by others)

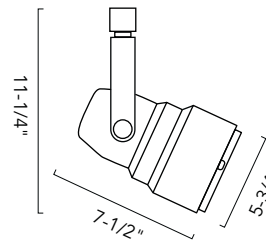

Now available with
H, J and L-style adapters

LINE VOLTAGE TRACK BR / PAR Fixtures continued

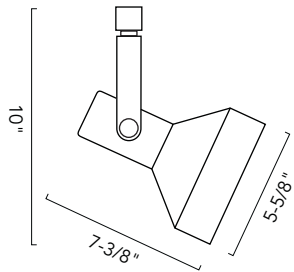

Line Voltage Cone PAR38

NTH-151	H-Style	250W Max.
NTH-151(finish)/J	J-Style	250W Max.
NTH-151(finish)/L	L-Style	250W Max.

Lamp: 250W BR/R40/PAR38 (not included)
Finish: Black (B), Silver (S), White (W)
Dimensions: Length: 7-3/8" Dia.: 5-5/8" Max Ext.: 10"

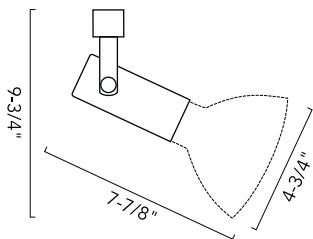

Universal Lamp Holder

NTH-109	H-Style	300W Max.
NTH-109(finish)/J	J-Style	300W Max.
NTH-109(finish)/L	L-Style	300W Max.

Feature: Adjustable socket
Lamp: 50W PAR20, 75W PAR30, 250W PAR38, 300W BR/R40 (not included)
Finish: Black (B), Natural Metal (N), White (W)
Dimensions: Length: 7-7/8" Dia.: 4-3/4" Max Ext.: 9-3/4"

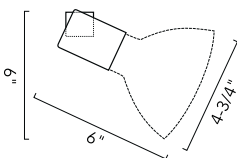

Line Voltage Universal Lamp Holder

NTH-115	H-Style	300W Max.
NTH-115(finish)/J	J-Style	300W Max.
NTH-115(finish)/L	L-Style	300W Max.

Feature: Low profile
Lamp: 250W PAR38, 300W BR/R40 (not included)
Finish: White (W)
Dimensions: Length: 6" Dia.: 4-3/4" Max Ext.: 6"

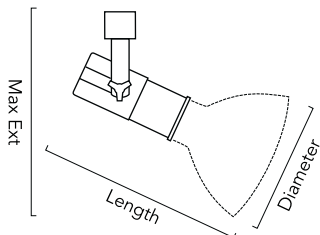

Truly Universal™ PAR Holder with Retractable Shroud

NTH-138	H-Style	250W Max.
NTH-138(finish)/J	J-Style	250W Max.
NTH-138(finish)/L	L-Style	250W Max.

Lamp: 50W PAR20, 60W PAR16, 75W PAR30, 250W PAR38 (not included)
Finish: Black (B), White (W)
Dimensions: **PAR20** - Length: 5" Dia.: 2-7/8" Max Ext.: 7-3/4"
PAR16 - Length: 3-3/4" Dia.: 3-1/4" Max Ext.: 5-3/8"
PAR30 - Length: 4-1/4" Dia.: 4-1/8" Max Ext.: 6-1/8"
PAR38 - Length: 6" Dia.: 4-3/4" Max Ext.: 7-3/4"



LINE VOLTAGE TRACK
BR / PAR Fixtures continued

Now available with
H, J and L-style adapters



Designer Roundback Universal

NTH-119	H-Style	300W Max.
NTH-119(finish)/J	J-Style	300W Max.
NTH-119(finish)/L	L-Style	300W Max.

Feature: Adjustable socket
Lamp: 50W R20, 250W PAR38, 300W BR/R40 (not included)
Finish: Black (B), White (W)
Dimensions: Length: 8" Dia.: 4-3/4" Max Ext.: 10-5/8"

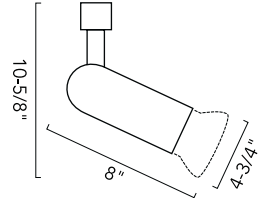

Line Voltage Gimbal Ring PAR20

NTH-112	H-Style	50W Max.
NTH-112(finish)/J	J-Style	50W Max.
NTH-112(finish)/L	L-Style	50W Max.

Lamp: 50W PAR20 (not included)
Finish: Black (B), Natural Metal (N), White (W)
Dimensions: Length: 3-5/8" Dia.: 2-3/4" Max Ext.: 7-3/4"

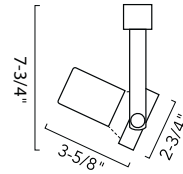

NOW IN
BRONZE



Line Voltage Gimbal Ring PAR30

NTH-107	H-Style	75W Max.
NTH-107(finish)/J	J-Style	75W Max.
NTH-107(finish)/L	L-Style	75W Max.

Lamp: 75W PAR30 (not included)
Finish: Black (B), Bronze (BZ), Natural Metal (N), White (W)
Dimensions: Length: 4" Dia.: 4-5/8" Max Ext.: 8-1/8"

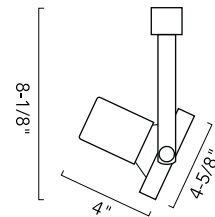

NOW IN
BRONZE



Line Voltage Gimbal Ring PAR38

NTH-108	H-Style	250W Max.
NTH-108(finish)/J	J-Style	250W Max.
NTH-108(finish)/L	L-Style	250W Max.

Lamp: 250W PAR38 (not included)
Finish: Black (B), Bronze (BZ), Natural Metal (N), White (W)
Dimensions: Length: 4" Dia.: 5-3/4" Max Ext.: 9-3/4"

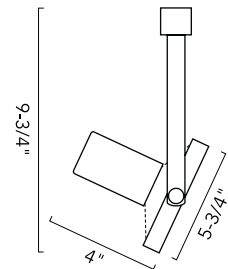

Now available with
H, J and L-style adapters

LINE VOLTAGE TRACK PAR Fixtures continued

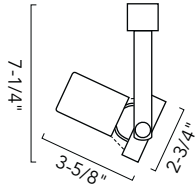

Front Load Gimbal Ring PAR20

NTH-146	H-Style	50W Max.
NTH-146(finish)/J	J-Style	50W Max.
NTH-146(finish)/L	L-Style	50W Max.

Lamp: 50W PAR20 (not included)
Finish: Black (B), White (W)
Dimensions: Length: 3-5/8" Dia.: 2-3/4" Max Ext.: 7-1/4"

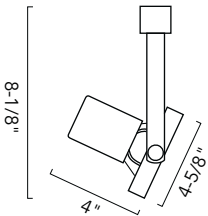

Front Load Gimbal Ring PAR30

NTH-147	H-Style	75W Max.
NTH-147(finish)/J	J-Style	75W Max.
NTH-147(finish)/L	L-Style	75W Max.

Lamp: 75W PAR30 (not included)
Finish: Black (B), White (W)
Dimensions: Length: 4" Dia.: 4-5/8" Max Ext.: 8-1/8"

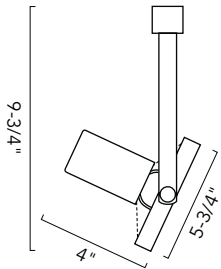

Front Load Gimbal Ring PAR38

NTH-148	H-Style	150W Max.
NTH-148(finish)/J	J-Style	150W Max.
NTH-148(finish)/L	L-Style	150W Max.

Lamp: 150W PAR38 (not included)
Finish: Black (B), White (W)
Dimensions: Length: 4" Dia.: 5-3/4" Max Ext.: 9-3/4"

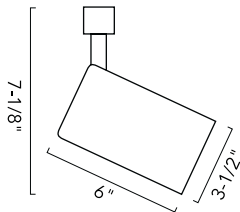

Flatback Cylinder with Black Baffle PAR20

NTH-101	H-Style	50W Max.
NTH-101(finish)/J	J-Style	50W Max.
NTH-101(finish)/L	L-Style	50W Max.

Lamp: 50W R/PAR20 (not included)
Finish: Black (B), White (W)
Dimensions: Length: 6" Dia.: 3-1/2" Max Ext.: 7-1/8"



LINE VOLTAGE TRACK
BR / PAR Fixtures continued

Now available with
H, J and L-style adapters



Flatback Cylinder with Black Baffle PAR30

NTH-102	H-Style	75W Max.
NTH-102(finish)/J	J-Style	75W Max.
NTH-102(finish)/L	L-Style	75W Max.

Lamp: 75W BR/PAR30 (not included)
Finish: Black (B), White (W)
Dimensions: Length: 6-3/4" Dia.: 4-3/8" Max Ext.: 10-1/2"

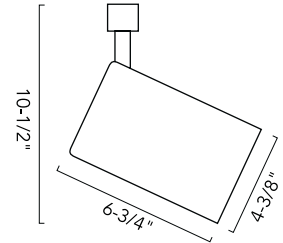

Flatback Cylinder with Black Baffle PAR38

NTH-113	H-Style	150W Max.
NTH-113(finish)/J	J-Style	150W Max.
NTH-113(finish)/L	L-Style	150W Max.

Lamp: 150W BR/PAR38 (not included)
Finish: Black (B), White (W)
Dimensions: Length: 8" Dia.: 6" Max Ext.: 12-1/4"

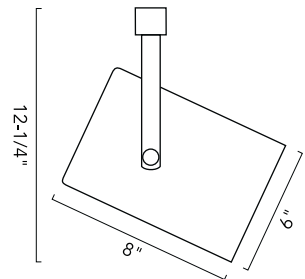

Designer Flatback with Black Baffle Cylinder

NTH-120	H-Style	55W Max.
NTH-120(finish)/J	J-Style	55W Max.
NTH-120(finish)/L	L-Style	55W Max.

Lamp: 55W PAR16 (not included)
Finish: Black (B), White (W)
Dimensions: Length: 5" Dia.: 2-1/2" Max Ext.: 8"

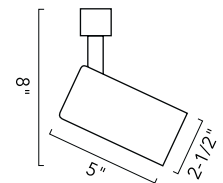

Designer Roundback Cylinder with Black Baffle

NTH-121	H-Style	55W Max.
NTH-121(finish)/J	J-Style	55W Max.
NTH-121(finish)/L	L-Style	55W Max.

Lamp: 55W PAR16 (not included)
Finish: Black (B), White (W)
Dimensions: Length: 5" Dia.: 2-1/2" Max Ext.: 7"

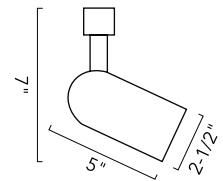

Now available with
H, J and L-style adapters

LINE VOLTAGE TRACK BR / PAR Fixtures continued

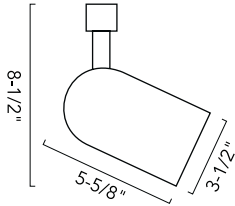

Roundback Cylinder with Black Baffle PAR20

NTH-105	H-Style	50W Max.
NTH-105(finish)/J	J-Style	50W Max.
NTH-105(finish)/L	L-Style	50W Max.

Lamp: 50W R/PAR20 (not included)
Finish: Black (B), Natural Metal (N), White (W)
Dimensions: Length: 5-5/8" Dia.: 3-1/2" Max Ext.: 8-1/2"

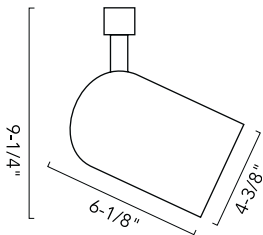

Roundback Cylinder with Black Baffle PAR30

NTH-106	H-Style	75W Max.
NTH-106(finish)/J	J-Style	75W Max.
NTH-106(finish)/L	L-Style	75W Max.

Lamp: 75W BR/PAR30 (not included)
Finish: Black (B), Bronze (BZ), Natural Metal (N), White (W)
Dimensions: Length: 6-1/8" Dia.: 4-3/8" Max Ext.: 9-1/4"



**NOW IN
BRONZE**

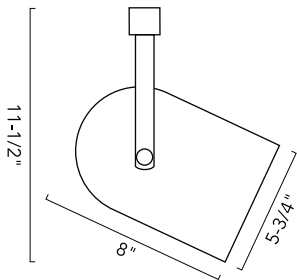

Roundback Cylinder with Black Baffle PAR38

NTH-131	H-Style	150W Max.
NTH-131(finish)/J	J-Style	150W Max.
NTH-131(finish)/L	L-Style	150W Max.

Lamp: 150W BR/PAR38 (not included)
Finish: Black (B), White (W)
Dimensions: Length: 8" Dia.: 5-3/4" Max Ext.: 11-1/2"

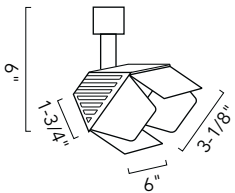

Barn Door Wall Wash T3 Lamp

NTL-216	H-Style	150W Max.
NTL-216(finish)/J	J-Style	150W Max.
NTL-216(finish)/L	L-Style	150W Max.

Feature: Adjustable barn doors (included)
Lamp: 150W T3 Lamp (included)
Finish: Black (B), White (W)
Dimensions: Length: 3-18" Width: 6" Depth: 1-3/4" Max Ext.: 6"



LINE VOLTAGE AND LOW VOLTAGE TRACK

Track Packs

Nora Lighting Track Packs offer an economical solution to track lighting by including in one carton all the necessary components to install a 2', 3', or 4' section of track over an existing junction box. Excellent for simple lighting jobs or multiple unit job applications. Track packs are now available with 2, 3, and 4 fixtures, in white, black, bronze and natural metal finishes.



Line Voltage Step Cylinder Track Pack

NTL-150	3 Fixtures	75W Max. Ea.
----------------	------------	--------------

- Lamp:** 75W BR/PAR30 (not included)
Finish: Black (B), Bronze (BZ), White (W)
Listing: cULus Listed
Includes: (1) 4' Track with End Caps
 (3) Step Cylinder Track Fixtures
 (1) Floating Canopy
 Mounting hardware

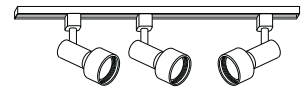

Line Voltage Flat Back Cylinder Track Pack

NTL-151	3 Fixtures	75W Max. Ea.
NTL-151/2H*	2 Fixtures	75W Max. Ea.

- Lamp:** 75W BR/PAR30 (not included)
Finish: Black (B), White (W)
Listing: cULus Listed
Includes: (1) 4' Track with End Caps
 (2 or 3) Flat Back Cylinder Track Fixtures
 (1) Floating Canopy
 Mounting hardware

* Available in White only

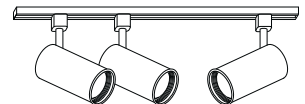

Line Voltage Round Back Cylinder Track Pack

NTL-156	3 Fixtures	75W Max. Ea.
NTL-156/2H	2 Fixtures	75W Max. Ea.
NTL-156/4H	4 Fixtures	75W Max. Ea.

- Lamp:** 75W BR/PAR30 (not included)
Finish: White
Listing: cULus Listed
Includes: (1) 4' Track with End Caps
 (2, 3 or 4) Round Back Cylinder Track Fixtures
 (1) Floating Canopy
 Mounting hardware

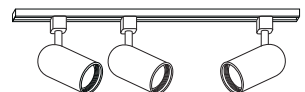

LINE VOLTAGE AND LOW VOLTAGE TRACK Track Packs

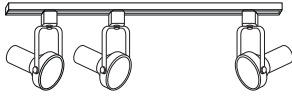

Line Voltage Gimbal Ring Track Pack

NTL-158	3 Fixtures	75W Max. Ea.
NTL-158/4H*	4 Fixtures	75W Max. Ea.

Lamp: 75W BR/PAR30 (not included)
Finish: Black (B), Bronze (BZ), Natural Metal (N), White (W)
Listing: cULus Listed
Includes: (1) 4' Track with End Caps
 (3 or 4) Gimbal Ring Track Fixtures
 (1) Floating Canopy
 Mounting hardware

* Available in Black or White only

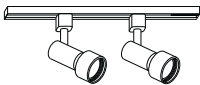

Line Voltage Designer Step Cylinder Track Pack

NTL-172	2 Fixtures	50W Max. Ea.
----------------	------------	--------------

Lamp: 50W R20 (not included)
Finish: White
Listing: cULus Listed
Includes: (1) 2' Track with End Caps
 (2) Designer Step Cylinder Track Fixtures
 (1) Floating Canopy
 Mounting hardware

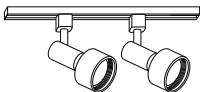

Line Voltage Designer Step Cylinder Track Pack

NTL-180	2 Fixtures	75W Max. Ea.
----------------	------------	--------------

Lamp: 75W BR/PAR30 (not included)
Finish: White
Listing: cULus Listed
Includes: (1) 2' Track with End Caps
 (2) Designer Step Cylinder Track Fixtures
 (1) Floating Canopy
 Mounting hardware

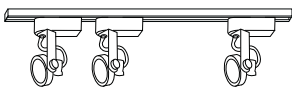

Low Voltage Gimbal Ring Track Pack

NTL-181	3 Fixtures	20W - 50W Ea.
----------------	------------	---------------

Lamp: 20W-50W 12V MR16 (not included)
Finish: Black (B), Bronze (BZ), Natural Metal (N), White (W)
Listing: cULus Listed
Includes: (1) 3' Track with End Caps
 (3) Gimbal Ring Track Fixtures
 (1) Floating Canopy
 Mounting hardware



TRACK Track Mount Pendants

Now available with
H, J and L-style adapters



NEW!

Compact Fluorescent Track Pendant Assembly GU24 Socket

NTF-163	8.5' H-Style Pendant	13W - 26W
NTF-163(finish)/J	8.5' J-Style Pendant	13W - 26W
NTF-163(finish)/L	8.5' L-Style Pendant	13W - 26W

- Lamp:** 13W-26W max. GU24 Self Ballasting CFL (not included)
Finish: Black (B), Silver (S), White (W)
Cord Length: 8.5' Cord is field adjustable to any length
- Accepts attractive glass shades, ordered separately. (Pages 416-433)
 - 7/8" opening glass must be gravity hung

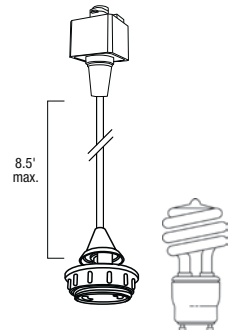

NEW!

Line Voltage Track Pendant Assembly Candelabra Socket

NTH-160	8.5' H-Style Pendant	60W Max.
NTH-160(finish)/J	8.5' J-Style Pendant	60W Max.
NTH-160(finish)/L	8.5' L-Style Pendant	60W Max.

- Lamp:** 60W max. Line Voltage Candelabra Base (not included)
Finish: Black (B), Silver (S), White (W)
Cord Length: 8.5' Cord is field adjustable to any length
- Accepts attractive glass shades, ordered separately. (Pages 416-433)
 - Accepts custom glass or other decorative element with 7/8" top opening

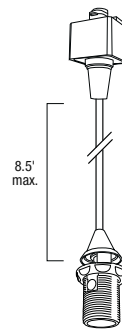

NEW!

Line Voltage Track Pendant Assembly Medium Base Socket

NTH-161	8.5' H-Style Pendant	100W Max.
NTH-161(finish)/J	8.5' J-Style Pendant	100W Max.
NTH-161(finish)/L	8.5' L-Style Pendant	100W Max.

- Lamp:** 100W max. Line Voltage Medium Base (not included)
Finish: Black (B), Silver (S), White (W)
Cord Length: 8.5' Cord is field adjustable to any length
- Accepts attractive glass shades, ordered separately. (Pages 416-433)
 - 7/8" opening glass must be gravity hung

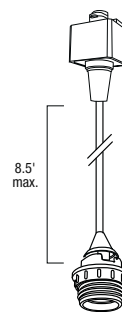

NEW!

Line Voltage Track Pendant Assembly G9 Halogen Socket

NTH-162	8.5' H-Style Pendant	40W Max.
NTH-162(finish)/J	8.5' J-Style Pendant	40W Max.
NTH-162(finish)/L	8.5' L-Style Pendant	40W Max.

- Lamp:** 40W max. Line Voltage G9 Halogen (included)
Finish: Black (B), Silver (S), White (W)
Cord Length: 8.5' Cord is field adjustable to any length
- Accepts attractive glass shades, ordered separately. (Pages 416-433)
 - Accepts custom glass or other decorative element with 7/8" top opening
 - Frosted lamp shield included

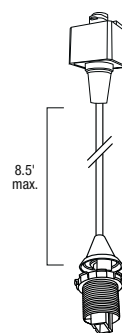

Glass ordered separately. See pages 416-433 for glass options. Compatibility chart on page 458.

Track Mounted Pendants

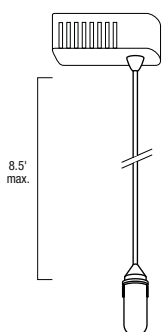

Pila Low Voltage Track Pendant Assembly Bi-Pin Socket

NTL-309 8.5' Pendant 35W max.

- Lamp:** 35W max. JC 6.35 (not included)
Finish: Black (B), Chrome (C), White (W)
Cord Length: 8.5' Cord is field adjustable to any length
Accessories: **NT-365:** Replacement lamp shield
QI35JC/12: 35W JC 6.35 lamp
- 50W Integral electronic transformer
 - Frosted glass shield included
 - Accepts attractive glass shades, ordered separately. (Pages 416-433)
 - Also available with Canopy Mount. See pages 446.

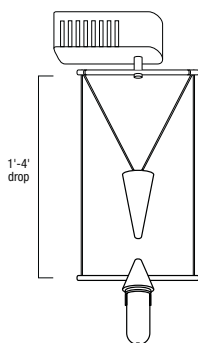

Cona™ Low Voltage Track Pendant Assembly Bi-Pin Socket

NTL-310 Pulley Pendant 35W max.

- Lamp:** 35W max. JC 6.35 (not included)
Finish: Chrome (C), Silver (S)
Cord Length: Adjustable cable length drops from 1' to 4'
Accessories: **NT-365:** Replacement lamp shield
QI35JC/12: 35W JC 6.35 lamp
- Integral electronic transformer
 - Frosted glass shield included
 - Accepts NG-10, NG-50, NG-66, NG-70, NG-80, NG-90, NRS82-201, NRS82-202, NRS82-203, and NRS82-204
 - Also available with Canopy Mount. See pages 446.

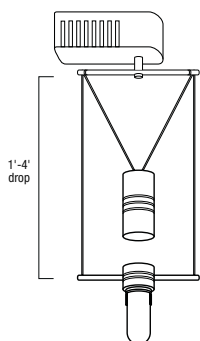

Cylindrica™ Low Voltage Track Pendant Assembly Bi-Pin Socket

NTL-311 Pulley Pendant 35W max.

- Lamp:** 35W max. JC 6.35 (not included)
Finish: Chrome (C), Silver (S)
Cord Length: Adjustable cable length drops from 1' to 4'
Accessories: **NT-365:** Replacement lamp shield
QI35JC/12: 35W JC 6.35 lamp
- Integral electronic transformer
 - Frosted glass shield included
 - Accepts NG-10, NG-50, NG-66, NG-70, NG-80, NG-90, NRS82-201, NRS82-202, NRS82-203, and NRS82-204
 - Also available with Canopy Mount. See pages 446.

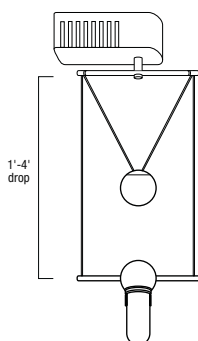

Sphera™ Low Voltage Track Pendant Assembly Bi-Pin Socket

NTL-312 Pulley Pendant 35W max.

- Lamp:** 35W max. JC 6.35 (not included)
Finish: Chrome (C), Silver (S)
Cord Length: Adjustable cable length drops from 1' to 4'
Accessories: **NT-365:** Replacement lamp shield
QI35JC/12: 35W JC 6.35 lamp
- Integral electronic transformer
 - Frosted glass shield included
 - Accepts NG-10, NG-50, NG-66, NG-70, NG-80, NG-90, NRS82-201, NRS82-202, NRS82-203, and NRS82-204
 - Also available with Canopy Mount. See pages 446.

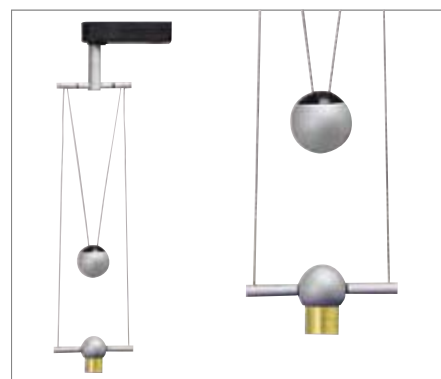

Glass ordered separately. See pages 416-433 for glass options. Compatibility chart on page 458.

TRACK LIGHTING

One-Circuit Track



One-Circuit Track

NT-301	H-Style	2' Track (24-1/4" actual length*)	
NT-302	H-Style	4' Track (48-1/4" actual length*)	
NT-303	H-Style	6' Track (72-1/4" actual length*)	<i>not available in BZ</i>
NT-304	H-Style	8' Track (96-1/4" actual length*)	
NT-331	H-Style	12' Track (144-1/4" actual length*)	<i>not available in BZ, N</i>

* measurement includes end caps

Rating: 120V, 20A Circuit, 2400W

Finish: Black (B), Bronze (BZ), Natural Metal (N), Silver (S), White (W)

Dimensions: Width: 1-3/4" Height: 5/8"

Includes: Dead-end caps and mounting hardware

Nora Lighting's One-Circuit Track System

With its miniature size and push in connectors, Nora's one-circuit track system provides versatility for every lighting application. The system is designed and engineered for safety and ease of installation.

Specifications

- Miniature extruded aluminum channel
- Push-in connections
- Solid, 12-gauge copper conductors in PVC insulators
- Separate, full-length ground conductor
- Available in black, bronze, natural metal, silver, white
- Available in 2', 4', 6', 8' and 12' lengths
- Compatible with most common 3-wire systems
- Rated for maximum of 2400 watts
- Visual polarity groove indicates proper electrical installation
- Size is only 5/8" high x 1-3/4" wide
- Can be field cut to desired length
- 120V Line Voltage only

Single Circuit Track System

Nora Lighting's Single-Circuit Track is the perfect choice when you need only one lighting circuit. It is rated for a maximum of 2400 watts and is supported by a full line of accessories. If you require more control, additional switched feed points can be made with additional connectors.

To use a track fixture on a single-circuit track system, the line contact at the top of the track fixture must be in the lower position. To move the lever from the upper to the lower position, simply push lever down with the edge of a standard screwdriver.

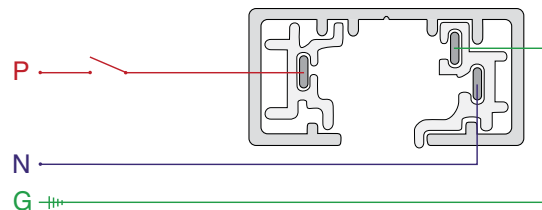
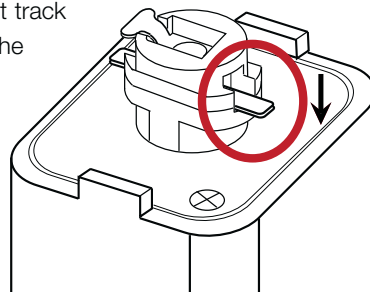

Wiring for one switch and one circuit

Nora Lighting's Two-Circuit Track System

Providing versatility for every lighting need, two-circuit track's miniature size, contemporary finishes, and push-in connectors combine to make it perfect for residential or commercial use. This track system is ideal for single or double switching, allowing greater control for various illumination levels. Dual dimming is allowed with use of a single-phase neutral circuit.

Specifications

- Miniature extruded aluminum channel
- Push-in connections
- Separate, full-length ground conductor
- Available in black, silver, white
- Available in 4', 6', 8' and 12' lengths
- Can be field cut to desired length
- Size is only 5/8" high x 1-3/4" wide
- Compatible with most common 2-circuit, 4-wire systems
- Rated for double capacity 4800W of maximum performance
- Dual dimming (requires single-phase only neutral circuit)
- Ideal for single or double switching
- Visual polarity groove indicates proper electrical installation
- Solid, 12-gauge copper conductors in PVC insulators
- 120V Line Voltage only

TRACK LIGHTING

Two-Circuit Track

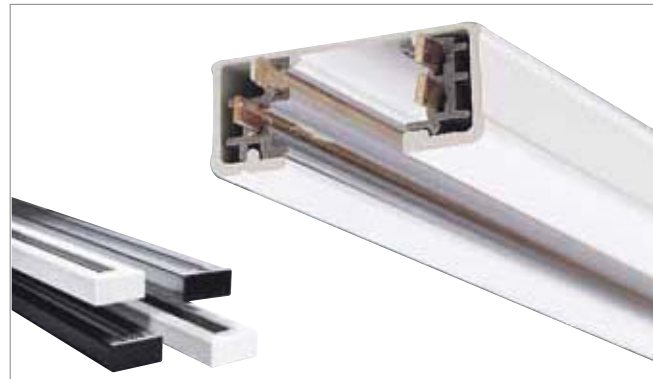

Two-Circuit Track

NT-2302	H-Style	4' Track (48-1/4" Actual Length*)
NT-2303	H-Style	6' Track (not available in S) / (72-1/4" Actual Length*)
NT-2304	H-Style	8' Track (96-1/4" Actual Length*)
NT-2331	H-Style	12' Track (not available in S) / (144-1/4" Actual Length*)

* includes end caps in measurement

Rating: 120V, (2) 20A Circuits, 2400W each circuit

Finish: Black (B), Silver (S), White (W)

Dimensions: Width: 1-3/4" Height: 5/8"

Includes: Dead-end caps and mounting hardware

Two-Circuit Track System

Nora Lighting's Two-Circuit Track System is designed for use when two separately controlled circuits are required on one section of track. Each circuit is rated for 2400 watts and will allow you to control two individual sets of fixtures.* The use of two-circuit track eliminates the need for long, separate fed runs, thus saving installation costs. A full line of fixtures and accessories enhance the flexibility of design and installation.

To use a track fixture on a two-circuit track system, the line contact at the top of the track fixture must be in the upper position for one-circuit or the lower position for the 2nd circuit. To move the lever from the lower to the upper position, push the lever up with edge of standard screw driver.

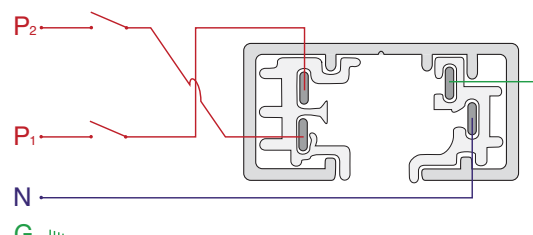
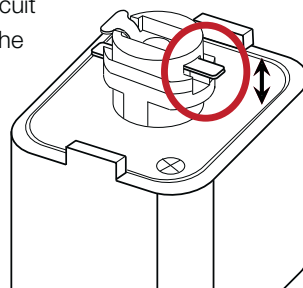

Two Switches - One Circuit

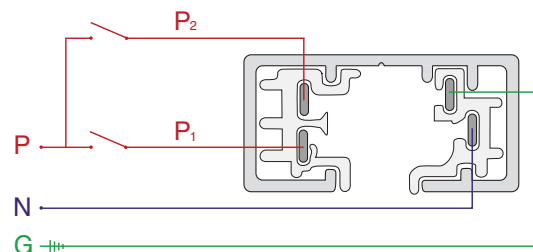

Two Switches - Two Circuits

*Note: If dimming two-circuit track to different levels, shared neutral circuit must be connected to a single-phase neutral source for clean, noise-free operation

TRACK LIGHTING

Current Limiter

Nora Lighting's new Current Limiter is the solution you've been looking for to comply with code required watts per square foot restrictions including California Energy Code Title 24 Energy Efficient Standards. Nora's Current Limiter is a UL Listed line voltage Track power feed with an integral circuit breaker that limits the current load on the track to a specified amperage/wattage.

Seven different available breaker amperages allow you to customize your design to match the actual wattage being consumed by the specified fixtures, instead of the standard 45 Watts per linear foot of track. Circuit breakers are available from 1 Amp to 14 Amps.

Nora's Current Limiter replaces standard End Feeds and In-Line Track Feeds and is extremely easy to install right out of the box. No assembly required. Available in Black, Silver, or White finish.

Advantages

- Available for one or two circuit track
- Single end feed or in-line feed
- Illuminated rocker switch indicates power to track
- Eight different breaker amperages to match the load
- Ready to install, no assembly required
- UL Listed

How To Order

1. Decide if you need one or two circuits.
2. Determine if you need an end or in-line feed.
3. Choose the finish of the current limiter.
4. Select the appropriate size circuit breaker based on the load consumed on the run.

Why and when to use a Nora Current Limiter?

Use Nora's track current limiter in tough watts per square foot and Title 24 applications. Commercially and residentially, Title 24 and the NEC calculate the wattage of a line voltage track or rail run by the length of the run, not by wattage consumed. NEC applies 45 watts per foot regardless of actual load.

Example: (3) 39W Fixtures on a 20' run would be calculated at 900W (20' at 45 watts)

With Nora's 1 amp current limiting track feed, this run is now limited to 120 watts. A savings of 780 watts in the watts per square foot and Title 24 calculations.



Ordering Example: NT-2348W/2.5A

Two Circuit, End Feed, White Finish, 2.5A Circuit Breaker

Current Limiter End Feeds

ONE CIRCUIT		TWO CIRCUIT*	
CATALOG #	AMPS/WATTS	CATALOG #	AMPS/WATTS
NT-348/1A	1A / 120W	NT-2348/1A	1A / 120W
NT-348/2.5A	2.5A / 300W	NT-2348/2.5A	2.5A / 300W
NT-348/4.5A	4.5A / 540W	NT-2348/4.5A	4.5A / 540W
NT-348/5A	5A / 600W	NT-2348/5A	5A / 600W
NT-348/7.5A	7.5A / 850W	NT-2348/7.5A	7.5A / 850W
NT-348/10A	10A / 1200W	NT-2348/10A	10A / 1200W
NT-348/12A	12A / 1440W	NT-2348/12A	12A / 1440W
NT-348/14A	14A / 1680W	NT-2348/14A	14A / 1680W

Current Limiter In-Line Feeds

ONE CIRCUIT		TWO CIRCUIT*	
CATALOG #	AMPS/WATTS	CATALOG #	AMPS/WATTS
NT-358/1A	1A / 120W	NT-2358/1A	1A / 120W
NT-358/2.5A	2.5A / 300W	NT-2358/2.5A	2.5A / 300W
NT-358/4.5A	4.5A / 540W	NT-2358/4.5A	4.5A / 540W
NT-358/5A	5A / 600W	NT-2358/5A	5A / 600W
NT-358/7.5A	7.5A / 850W	NT-2358/7.5A	7.5A / 850W
NT-358/10A	10A / 1200W	NT-2358/10A	10A / 1200W
NT-358/12A	12A / 1440W	NT-2358/12A	12A / 1440W
NT-358/14A	14A / 1680W	NT-2358/14A	14A / 1680W

*Note: Includes 2 Breakers of equal size - consult factory for options.

Track System Accessories



Live End Feed with Canopy

NT-311	One-Circuit
NT-2311	Two-Circuit

Finish: Black (B), Silver (S), White (W)

- Live ends to start a run
- Mounting hardware included



Live End Feed

NT-316	One-Circuit
NT-2316*	Two-Circuit

Finish: Black (B), Silver (S), White (W)

- To start a run
- Adds 2-3/4" to length



Floating Canopy Feed

NT-307	One-Circuit
NT-2307	Two-Circuit

Finish: Black (B), Silver (S), White (W)

- Connects track to existing outlet box anywhere along the track



Live End with Cord and Plug Set

NT-321	One-Circuit
---------------	-------------

Finish: Black (B), Silver (S), White (W)

- With live end
- 10 Amp, 1200 Watts Maximum
- 12 feet grounded cord



Live End Feed with Canopy

NT-352	One-Circuit
NT-2352	Two-Circuit

Finish: Black (B), Silver (S), White (W)

- Live ends to start a run
- Mounting hardware include



Live End Conduit Connector

NT-328	One-Circuit
NT-2328*	Two-Circuit

Finish: Black (B), Silver (S), White (W)

- Accepts standard 1/2" conduit fitting. Use with surface conduit feed.
- Left hand polarity available for daisy chain applications (NT-328L)



Current Limiting Live End Feed with Circuit Breaker

NT-348 / _ _	One-Circuit
NT-2348 / _ _	Two-Circuit

Finish: Black (B), Silver (S), White (W)

Available: 1A, 2.5A, 5A, 7.5A, 10A, 12A, 14A

- Current limiter
- To start a run
- On/Off switch
- See Page 596



Current Limiting In-Line Feed with Circuit Breaker

NT-358 / _ _	One-Circuit
NT-2358 / _ _	Two-Circuit

Finish: Black (B), Silver (S), White (W)

Available: 1A, 2.5A, 5A, 7.5A, 10A, 12A, 14A

- Current limiter
- On/Off switch
- See Page 596



T-Bar End Feed

NT-348	One-Circuit
NT-2348	Two-Circuit

Finish: Black (B), Silver (S), White (W)

- To start a run
- Top 3 knock-outs

* Note: All two-circuit track connectors are supplied as right polarity, for left polarity add "L" suffix.

TRACK

Track System Accessories continued



Straight Connector

NT-310	One-Circuit
NT-2310	Two-Circuit

Finish: Black (B), Silver (S), White (W)

- Joins two track sections end to end
- Cannot be used as a feed point



I-Connector

NT-312	One-Circuit
NT-2312	Two-Circuit

Finish: Black (B), Silver (S), White (W)

- Can be power feed
- Joins two track sections end to end
- Adds 4" to length



Flexible Connector

NT-309	One-Circuit
NT-2309	Two-Circuit

Finish: Black (B), Silver (S), White (W)

- Connects two tracks at any angle up to 90° or wall to ceiling or pitched ceiling application
- Can be power feed



L-Connector

NT-313	One-Circuit
NT-2313*	Two-Circuit

Finish: Black (B), Silver (S), White (W)

- Can be power feed
- Connects two track sections at 90° angle
- Field adjustable for right or left hand application
- Cover included to change to I-Connector application



T-Connector

NT-314	One-Circuit
NT-2314*	Two-Circuit

Finish: Black (B), Silver (S), White (W)

- Can be power feed
- Connects three track sections in a T-configuration



X-Connector

NT-315	One-Circuit
NT-2315*	Two-Circuit

Finish: Black (B), Silver (S), White (W)

- Can be power feed
- To connect 4 track sections in a cross configuration



Outlet Box Cover

NT-320

Finish: Black (B), Silver (S), White (W)

- Can be used at any feed connection live, straight, L, T or X.
- Screws included

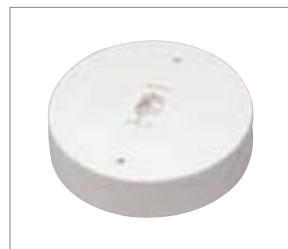

Monopoint with Integral Transformer

NT-347

Finish: Black (B), Silver (S), White (W)

- Allows the installation of one NTL-2200 series track fixture without a track
- Mounts permanently to outlet box
- 50W maximum
- Includes 50W Electronic Transformer
- 10 lbs. Maximum Weight



Monopoint with Power Feeder

NT-319	Square Monopoint
NT-366	Round Monopoint

Finish: Black (B), Silver (S), White (W)

- Allows the installation of one track fixture/pendant without a track - not suitable for all products
- Mounts permanently to outlet box



Monopoint with Power Feeder for Low Voltage Track

NT-337

Finish: Black (B), Silver (S), White (W)

- Allows the installation of one NTL-200 series low-voltage track fixture without a track
- Mounts permanently to outlet box
- 10 lbs. Maximum Weight

* Note: All two-circuit track connectors are supplied as right polarity, for left polarity add "/L" suffix.

Track Fixture Accessories continued



Wire Way Cover

NT-326	One or Two Circuit
---------------	--------------------

Finish: Black (B), Silver (S), White (W)

- For track to be wired through stem
- Use one for each live end used



Slope Pendant Adapter

NT-349	
---------------	--

Finish: Black (B), Silver (S), White (W)

- Allows pendant assembly kit (NT-305, NT-306, NT-329) to hang straight down from ceiling
- Can be used to feed power to track



Pendant Assembly Kit

NT-305	18"
NT-306	24"
NT-336	36"
NT-329	48"

Finish: Black (B), Silver (S), White (W)

- Suspends track from ceiling, 3/8" inside Dia.
- Use NRA-82 stem coupler to join two or more stems together
- 4' maximum between pendants



Aircraft Cable Suspension Kit

NT-355/8	8'
NT-355/20	20'

- Suspends track from high ceiling applications
- Suspends with 1/4" - 20 threaded coupling
- Supplied with T-Bar mounting clip, ceiling plate, aircraft cable and couplers



Replacement Stem

NRA-132/24	24"
NRA-132/48	48"
NRA-132/72	72"
NRA-132/96	96"

Finish: Black (B), Silver (S), White (W)

- To replace existing or field damaged stem in a pendant assembly kit
- Use NRA-82 coupler to join two stems together



Stem Coupler

NRA-82	
---------------	--

Finish: Black (B), Silver (S), White (W)

- Used to join NRA-132 Series together or to pendant assembly (NT-305, 306, 336, 329)



Slope Adapter for Nora Track Fixtures

NT-333	H Fixture to H Track
---------------	----------------------

Finish: Black (B), Silver (S), White (W)

- For use on slope ceiling
- For use on H-Style Nora Track System with H-Style Nora Track Fixtures



Slope Adapter for J-Style Track Fixtures

NT-334	J Fixture to H Track
---------------	----------------------

Finish: Black (B), Silver (S), White (W)

- For use on slope ceiling
- For use on H-Style Nora Track System with J-Style Track Fixtures



Slope Adapter for J-Style Track

NT-335	H Fixture to J Track
---------------	----------------------

Finish: Black (B), Silver (S), White (W)

- For use on slope ceiling
- For use on J-Style Track System with H-Style Nora Track Fixtures



Track Fixture Extension Rods

NT-322	18" w/Connectors
NT-323	24" w/Connectors
NT-324	36" w/Connectors
NT-325	48" w/Connectors

Finish: Black (B), Silver (S), White (W)

- Extends track fixture from track
- Also available by special order, factory installed extension rods to 48".

TRACK

Track System Accessories continued



18" Flexible Extension Rod

NT-330 18"

Finish: Black (B), White (W)

- For use with NTL-2000 Series, NTH-613, NTH-614, NTH-615, NTH-616, NTH-618, NTH-621, NTH-694, NTH-695 track fixtures
- Extends track fixture from track
- Can NOT be used with NTL-200 series low voltage track fixtures



Transformer with QuickJack

NT-370

Finish: Black (B), Silver (S), White (W)

- Contains female QuickJack adapter
- Accepts all fixtures with male QuickJack adapter. See pages 484-489.
- Includes electronic transformer rated for 20W-50W



Electronic Transformer

NTL-2200/50 50W

NTL-2200/75 75W

Finish: Black (B), Silver (S), White (W)

- For use with NTL-2000 series track fixtures
- Can be dimmed with electronic low voltage dimmer



Retrofit Monopoint Adapter

NT-374 4"

NT-376 6"

Finish: Black (B), White (W)

- 75W max
- Converts a 4" or 6" housing into a track monopoint
- Retro-fit style



T-Bar Attachment Clip

NT-332 15/16"

- To attach track to T-Bar drop ceiling



Dead End Caps

NT-318 One-Circuit

NT-2318* Two-Circuit

Finish: Black (B), Silver (S), White (W)

- To end a run
- Two are included with each track



Strain Relief

NRA-84 Black, Silver

NRA-85 White

Finish: Black (B), Silver (S), White (W)

- Use with NT-317



Track Adapter

NT-317

Finish: Black (B), Silver (S), White (W)

- Extends from track 1"



Utility Hook

NT-308

Finish: Black (B), Silver (S), White (W)

- For chain hung fixture up to 30lbs.
- Can be used as power feed



Outlet Adapter

NT-327

Finish: Black (B), Silver (S), White (W)

- Allows a power outlet on the track



Track Clamp Adapter

NT-364

Finish: Black (B), White (W)

- Clamps onto round or flat surface, 12' cord plugs into any convenient 3-prong outlet
- Accepts 1 track fixture



Track Clamp Adapter with Coil Cord

NT-364C

Finish: White (W)

- Clamps onto round or flat surface, 12' curly cord plugs into any convenient 3-prong outlet

Track Fixture Accessories



MR16 Glass Shield

NGD-17

Finish: Amber (A), Blue (B), Green (G), Frosted White (F), Red (R)

- For use with NTL-304, NTL-305, NTL-306
- **Must be factory installed**



MR16 Mesh Shield

NT-360

- For use with NTL-301, NTL-303, NTL-304, NTL-305, NTL-306, NTL-307, NTL-315, NTL-316, NTL-317



MR16 Silicone Flange Ring

NTR-100

Finish: Blue (BU), Green (GR), Red (R), White (W), Yellow (Y)

- For use with NTL-304, NTL-305, NTL-306, NTL-307, NTL-316, NTH-616, NTH-618, NTH-619, NTH-621



MR16 Flange/Ring Holder

NT-361

- For use with NTL-304, NTL-305, NTL-306, NTL-307, NTL-316



Lenses for MR16 Lamps

NM-100B/MR16	Blue
NM-100Y/MR16	Yellow
NM-100G/MR16	Green
NM-100R/MR16	Red
NM-100F/MR16	Frosted Lens
NM-100L/MR16	Linear Spread
NM-100S/MR16	Spread Lens

- for MR11 lens, change suffix to /MR11



MR16 Mesh/Ring Combo

NT-361X

- For use with NTL-304, NTL-305, NTL-306, NTL-307, NTL-316



Lensed 50W MR16 with Silver Back

QU50MR16EXN/CS	GU5.3 12V
50MR16/L10S	GU10.0 120V

- Silver Back
- See complete lamp selection on pages 750-757.



Dichroic Reflector

NT-304DC

- For use with NTL-304



MR16 Accessory Louver

NT-362

Finish: Black



Socket Extender

NRA-10

- Medium Base

TRACK

Track Fixture Accessories continued



Barn Door for BR/PAR

NT-338	R/PAR20
NT-339	BR/PAR30
NT-340	BR/PAR38

- NT-338 may hold NT-341 louver or 3-11/16" glass filter (by others)
- NT-339 may hold NT-342 louver or 4-9/16" glass filter (by others)
- NT-340 may hold NT-343 louver or 5-9/16" glass filter (by others)



Beam Concentrator

NT-351

- For use with MR16/FL lamp
- Concentrates beam produce well defined round spot of light
- Includes 4 round beam templates for choice of beam size
- For use only with NTH-695, NTL-215, NTL-2215



Louver for BR/PAR

NT-341	R/PAR20
NT-342	BR/PAR30
NT-343	BR/PAR38

- NT-341 to be used with NT-344 or NT-338
- NT-342 to be used with NT-345 or NT-339
- NT-343 to be used with NT-346 or NT-340



Vertical Louver

NA-100

Finish: Black (B), Silver (S), White (W)

- For use with NTM-77T4, NTM-77T6



Holder for BR/PAR

NT-344	R/PAR20
NT-345	BR/PAR30
NT-346	BR/PAR38

- NT-344 may hold NT-341 louver or 3-11/16" glass filter (by others)
- NT-345 may hold NT-342 louver or 4-9/16" glass filter (by others)
- NT-346 may hold NT-343 louver or 5-9/16" glass filter (by others)



Black Honeycomb Louver

NA-101B

Finish: Black (B)

- For use with NTM-77T4, NTM-77T6



MR16 Relamping Tool

NT-363



Shroud

NA-200

Finish: Black (B), Silver (S), White (W)

- For use with NTM-77T4, NTM-77T6



Suction Cup MR16 GU10 Relamping Tool

NRS90-N20



Clear Replacement Lens

NA-300 NTM-77T4, NTM-77T6
NA-301 NTM-55T4, NTM-55T6

Finish: Black (B), Silver (S), White (W)

- For use with NTM-77T4, NTM-77T6

Track Fixture Accessories continued



Lamp Shield

NAT-380

Finish: Black (B), Silver (S), White (W)

- For use with NTM-58DE, NTM-59T6
- Minimal adjustment

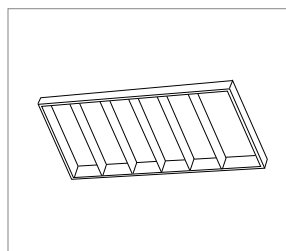

Replacement CFL Louver

NTFL-2642

Finish: Chrome (C)

- Matching louver included with each fixture



Vertical Louver

NAT-381

Finish: Black (B), Silver (S), White (W)

- For use with NTM-58DE, NTM-59T6



Replacement Fluorescent Louver

NTFL-3218 NTF-3218

NTFL-3227 NTF-3227

NTFL-3229 NTF-3229

NTFL-3240 NTF-3240

Finish: Black (B), Chrome (C), White (W)

- Chrome louver included with each fixture



Clear Replacement Lens

NA-382 NTM-58DE, NTM-59

NA-398 NTM-5717



Plastic Snap-On Lamp Shield

NTFL-4224-LENS NTF-4224

NTFL-4239-LENS NTF-4239

NTFL-4254-LENS NTF-4254

- For use with two lamp fixtures only



Prismatic Lens

NA-383 NTM-58DE, NTM-59

NA-399 NTM-5717



Replacement T5 HO Louver

NTFL-4124 NTF-4124 / NTF-4224

NTFL-4139 NTF-4139 / NTF-4239

NTFL-4154 NTF-4154 / NTF-4254

Finish: Black (B), Silver (S), White (W)

- Matching louver included with each fixture



Black Accessory Snoot

NT-350

- For use with NTL-211
- Reduces glare and spill light



Frosted JC6.35 Lamp Shield

NT-365

- For use with European pendants

TRACK

Track System Sample Layout

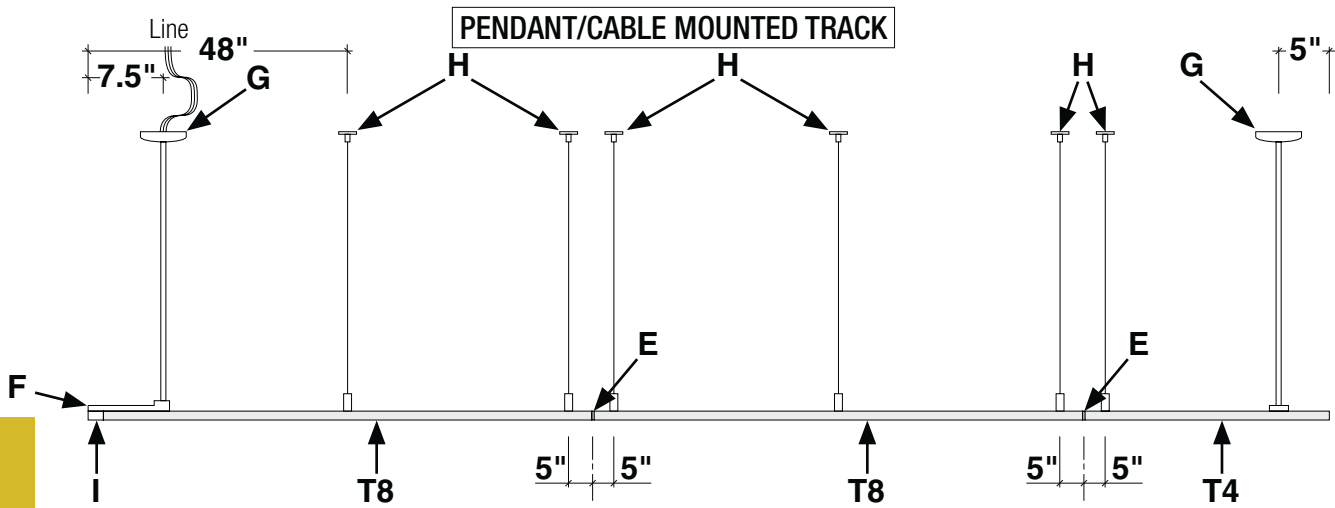

Sample suspended track layout using solid stems and cable suspensions. The system is powered through the stem and into the top of the live end connector.

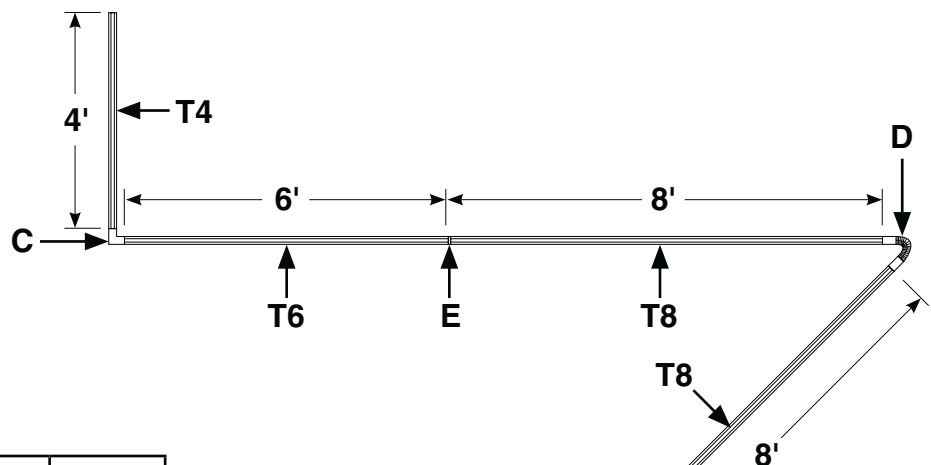

Sample track layout showing different connectors and variable angle connectors. The system is shown powered with a floating canopy.

	DESCRIPTION	ONE CIRCUIT ITEM #	TWO CIRCUIT ITEM #
T8	8' Track	NT-304	NT-2304
T6	6' Track	NT-303	NT-2303
T4	4' Track	NT-302	NT-2302
B	Floating Canopy Feed	NT-307	NT-2307
C	"L" Connector	NT-313	NT-2313
D	Flexible Connector	NT-309	NT-2309
E	Straight Connector (Mini Coupler)	NT-310	NT-2310
F	Wire Way Cover	NT-326	NT-326
G	18" Pendant Assembly Kit 24" Pendant Assembly Kit 36" Pendant Assembly Kit 48" Pendant Assembly Kit	NT-305 NT-306 NT-336 NT-329	NT-305 NT-306 NT-336 NT-329
H	8' Suspension Kit, Aircraft Cable 20' Suspension Kit, Aircraft Cable	NT-355/8 NT-355/20	NT-355/8 NT-355/20
I	Live End Feed	NT-316	NT-2307

Track System Sample Layout

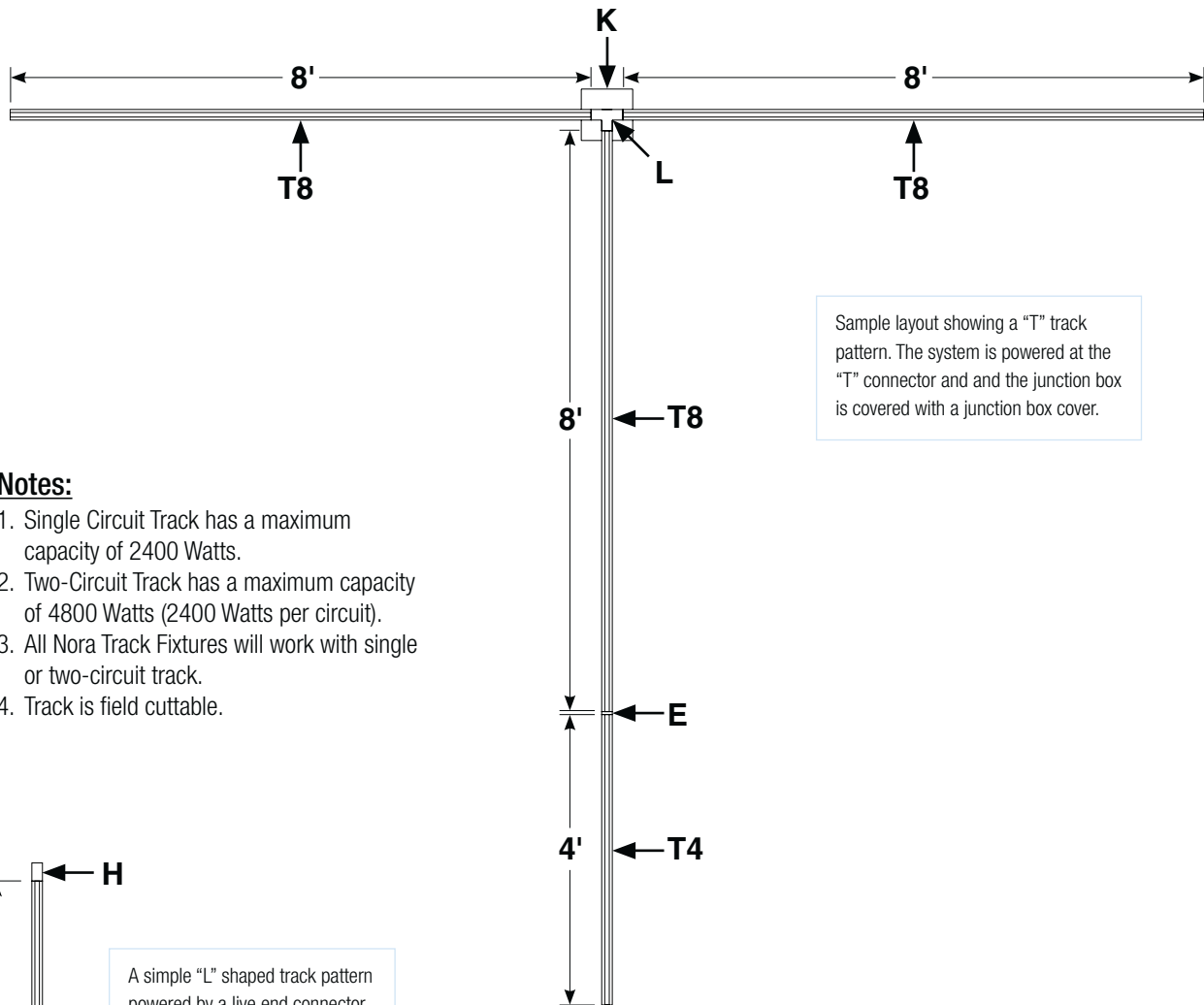

Sample layout showing a "T" track pattern. The system is powered at the "T" connector and the junction box is covered with a junction box cover.

Notes:

1. Single Circuit Track has a maximum capacity of 2400 Watts.
2. Two-Circuit Track has a maximum capacity of 4800 Watts (2400 Watts per circuit).
3. All Nora Track Fixtures will work with single or two-circuit track.
4. Track is field cuttable.

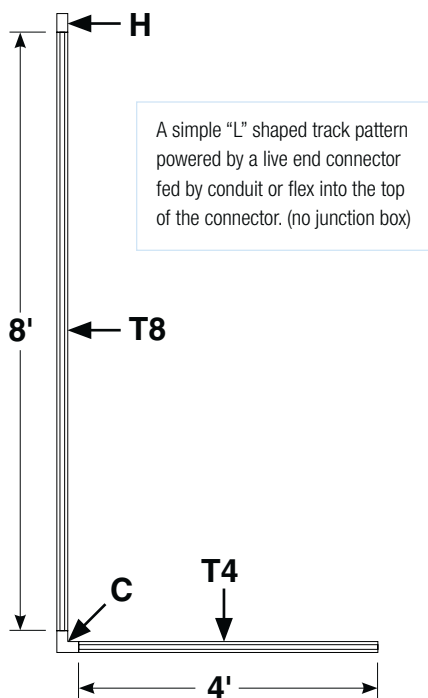

A simple "L" shaped track pattern powered by a live end connector fed by conduit or flex into the top of the connector. (no junction box)

	DESCRIPTION	ONE-CIRCUIT ITEM #	TWO-CIRCUIT ITEM #
T8	8' Track	NT-304	NT-2304
T4	4' Track	NT-302	NT-2302
C	"L" Connector	NT-313	NT-2313
E	Straight Connector (Mini Coupler)	NT-310	NT-2310
H	Live End Feed Live End Feed with Canopy Live End Feed with Cord & Plug Live End Feed with Conduit Connector Live End Feed for T-Bar Live End Feed with Current Limiter	NT-316 NT-311 NT-321 NT-328 NT-348 NT-348/_A	NT-2307 NT-2311 N/A NT-2328 NT-2348 NT-2348/_A
K	Junction Box Cover	NT-320	NT-320
L	"T" Connector	NT-314	NT-2314



SPECIALTY

Introduction	609
Overview	610
LED Lightbar	613
LED Tapelight (RGB, High Output and Standard)	619
Ultra-Slim T5 Fluorescent	632
Linear Fluorescent	634
Linear Halogen	636
LED Puck Light	639
Mini Puck Lights	643
Mini Solutions Miniature Downlights	645
Decolume (Festoon Strip Lighting)	658
Duralight (Rope)	665

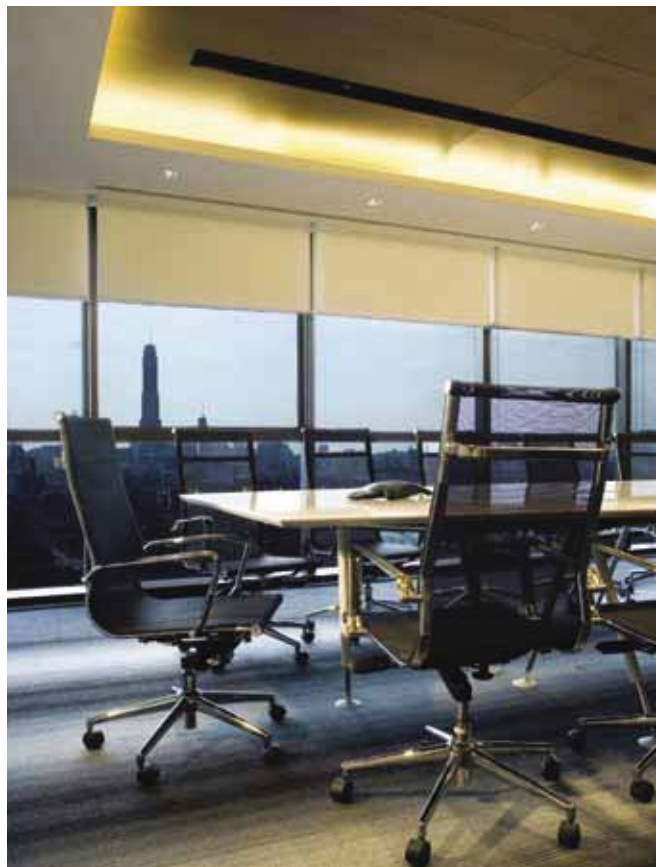

The Nora Lighting family of Specialty Lighting



Nora's family of Specialty Lighting products is a group of fixtures used for linear, accent or discrete general lighting limited in application only by the lighting designer's imagination. These fixtures are miniature in design and meet various energy requirements while not sacrificing desired lighting effects. Nora's specialty lighting can be specified in a variety of applications including, under cabinet, niche, display, cabinet, shelf, closet, furniture, cove, under bar top, toe-kick or other applications where drama and accent lighting are used to define a space. Linear applications are solved with LED Lightbar, LED Tape Light, three Fluorescent under cabinet styles, Halogen Lightbars, flexible Decolume and economical Duralight. Nora's Puck Lights and Miniature Solutions downlights are excellent choices for accent lighting. Light sources include LED, fluorescent, incandescent, halogen and xenon.

NORA'S SPECIALTY LIGHTING BY SOURCE

LED - LIGHT EMITTING DIODE

LED Lightbar

High-output extruded aluminum low profile linear LED

LED Tape Light

Flexible, wet label tape available in six light output colors

LED High Output Tape Light

Flexible, wet label tape producing over 250 lumens per foot

LED RGB Tape Light

Flexible, wet label tape which can change color at the press of a button

LED Puck Light

High performance, low energy, low profile, discrete light source

LED Decolume

Flexible low voltage wire system using LED festoon lamps

LED Duralight

Economical LED rope light



FLUORESCENT

Ultra Slim Fluorescent

An economical connectable T5 source

Mini Inch Fluorescent

A high performance T5 low-profile under cabinet available in Bronze, Aluminum, and White

1-3/4" Fluorescent

High lumen output T8/T12 now cULus rated for general use

INCANDESCENT

Halogen Lightbar

Available in both line and low voltage

Xenon Puck Light

Available in standard, low profile, and decorative glass in 7 finishes

Miniature Downlights

For use in cabinets, coves and ceilings. Available in reflector, baffled, and adjustable styles

Decolume (Festoon Strip Light)

Flexible low voltage wire system utilizing 3W to 10W festoon Xenon lamps

Duralight (Rope Light)

Economical rope light available in line and low voltage

Overview SPECIALTY LIGHTING

LED LIGHTBAR AND ACCESSORIES



NEW!
LED Lightbar
NULB Series p.613



NEW!
LED Lightbar Accessories
Connectors p.615
Mounting Clips p.615
Power Feeds, etc. p.615



NEW!
LED Lightbar Drivers
Direct Plug-In Drivers p.615
Class II Drivers p.615
Hardwire Dimmable Driver p.615

LED TAPE LIGHT AND ACCESSORIES



NEW!
LED Tape Light
Tape Light p.620
RGB Tape Light (Color Changing) p.625
High Output Tape Light p.629



NEW!
LED Tape Light Kit
Tape Light Kit p.620



NEW!
LED Tape Light Accessories
Tape Light Accessories p.621
RGB Tape Light Accessories p.626
High Output Accessories p.630



NEW!
LED Tape Light Drivers
Direct Plug-In Drivers p.621
Class II Drivers p.621
Hardwire Dimmable Driver p.621

UNDER CABINET LIGHTING



Ultra Slim T5 Fluorescent p.632



T5 Mini Inch Fluorescent p.634



T8-T12 1-3/4" Fluorescent p.635



Line Voltage Halogen p.636



Low Voltage Halogen p.637

LED PUCK LIGHTING



NEW!
LED Puck Light
NMPK1 Series p.639
NMPK2 Series Kit p.639



NEW!
LED Puck Light Accessories
Connectors p.640
Power Feeds, etc. p.640



NEW!
LED Puck Light Drivers
Direct Plug-In Drivers p.640
Hardwire Dimmable Driver p.640

PUCK LIGHTS AND MINI DOWNLIGHTS



Xenon Puck Light

NM-127	p.643
NM-128	p.643
NM-254	p.644



Xenon Puck Light Collection

NM-240	p.645
NM-241	p.645



Xenon Decorative Puck Lights

NM-251 Diamond	p.646
NM-252 Sapphire	p.646
NM-253 Emerald	p.646



Xenon Decorative Puck Lights

NM-250	p.647
--------	-------



Low Voltage Adjustable

NM-129 MR11	p.648
NM-130 MR16	p.648



MR11 Reflector Downlight

NM-242	p.654
--------	-------



Baffle Downlight Collection

NM-243 MR11	p.650
NM-244 MR11	p.650
NM-247 MR16	p.651
NM-248 MR16	p.651



Adjustable Collection

NM-245 MR11	p.652
NM-246 MR11	p.652
NM-249 MR16	p.653



4" Air-Tight Remodel Remote Low Voltage Housing

NLR-405 Series	p.234
----------------	-------



Grooved Mini Solution Puck Light Kit

NMK-3240	p.654
----------	-------



Smooth Mini Solution Puck Light Kit

NMK-3241	p.654
----------	-------



Xenon Puck Light Kit

NM-126	p.655
--------	-------

DECOLUME FESTOON STRIP LIGHTING

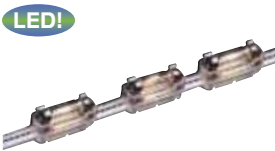

Decolume System Festoon Strip Lighting

NDSC Series	p.658
-------------	-------



Decolume Accessories

Mounting	p.660
Connectors	p.660
Sockets and Others	p.660

TRANSFORMERS



Class I Transformers

Electronic Transformers	p.703
Magnetic Transformers	p.704



Class II Transformers

Electronic Class II	p.702
Magnetic Class II	p.702

DURALIGHT™ ROPE LIGHT SYSTEM AND ACCESSORIES



LED Duralight™ Rope Light

NFL-4400 Linkable	p.665
-------------------	-------



2-Wire Line Volt. Duralight™ Rope Light

NFL-500 Custom Cut	p.666
NFL-5500 Linkable	p.666



2-Wire Low Volt. Duralight™ Rope Light

NFL-200 Series	p.667
----------------	-------



3-Wire Line Volt. Duralight™ Rope Light

NFL-600 Single Color	p.668
NFL-700 Bi-Color	p.668



Duralight™ Accessories

Mounting	p.670
Power Connections	p.670
Connectors, Others	p.671

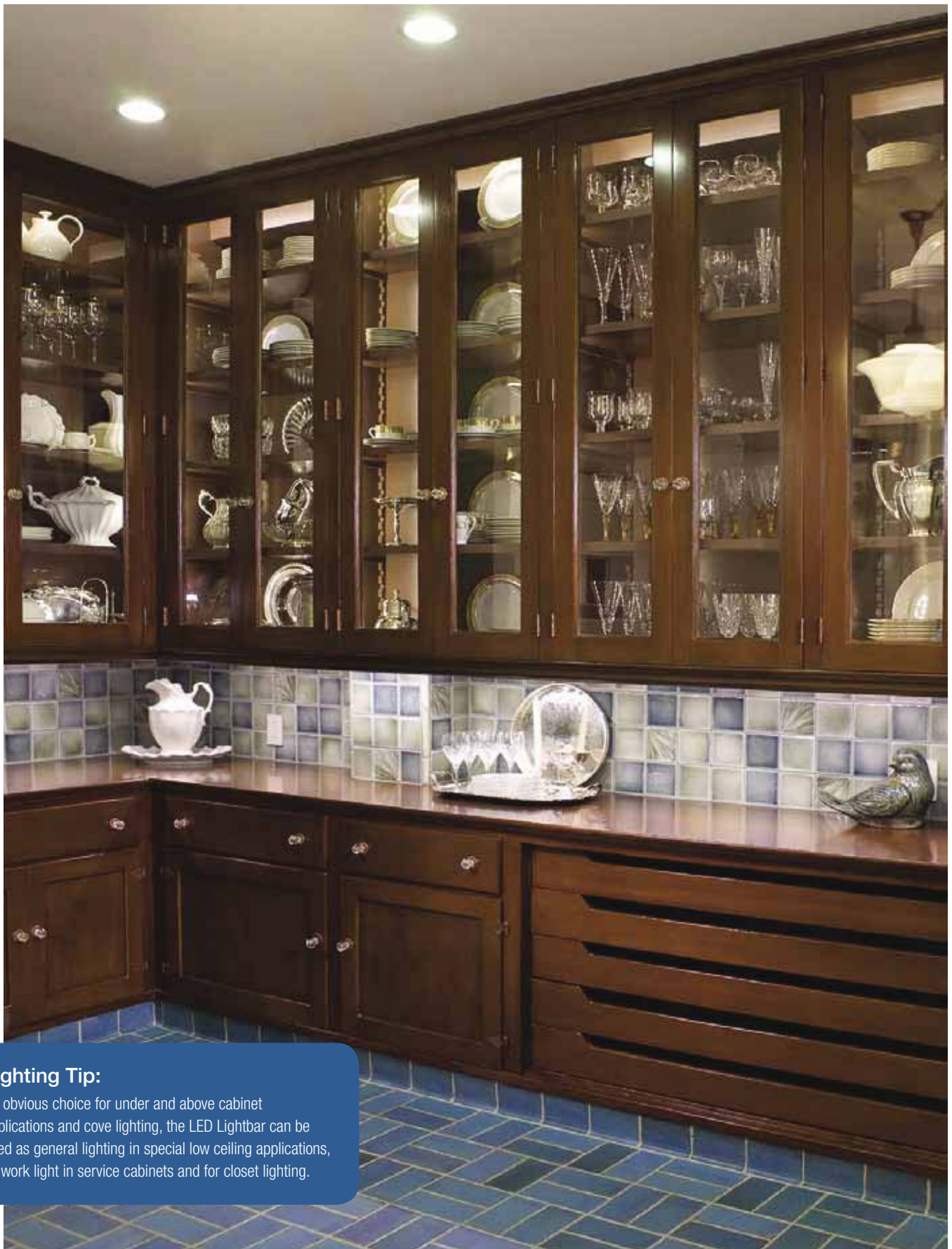

Lighting Tip:

An obvious choice for under and above cabinet applications and cove lighting, the LED Lightbar can be used as general lighting in special low ceiling applications, as work light in service cabinets and for closet lighting.

ACCENT, UNDER CABINET, LINEAR, COVE LIGHTING

LED Lightbar

NEW!

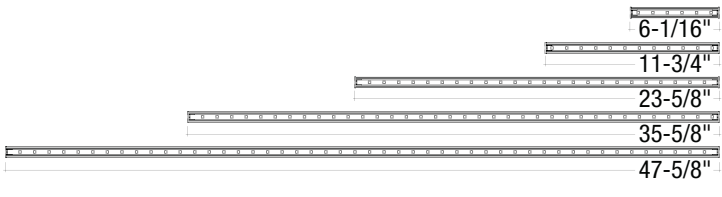

LED LIGHTBAR

Sample Order Number: NULB-12LED30A

CATALOG. NO.	VOLTAGE	LENGTH	SOURCE	COLOR TEMP.	FINISH
NULB-6LED30	24V DC	6"	LED	3000K	Aluminum, Bronze
NULB-6LED42	24V DC	6"	LED	4200K	Aluminum, Bronze
NULB-12LED30	24V DC	12"	LED	3000K	Aluminum, Bronze
NULB-12LED42	24V DC	12"	LED	4200K	Aluminum, Bronze
NULB-24LED30	24V DC	24"	LED	3000K	Aluminum, Bronze
NULB-24LED42	24V DC	24"	LED	4200K	Aluminum, Bronze
NULB-36LED30	24V DC	36"	LED	3000K	Aluminum, Bronze
NULB-36LED42	24V DC	36"	LED	4200K	Aluminum, Bronze
NULB-48LED30	24V DC	48"	LED	3000K	Aluminum, Bronze
NULB-48LED42	24V DC	48"	LED	4200K	Aluminum, Bronze

A - Aluminum, BZ - Bronze



Ideal for applications with tight space requirements. These low-profile, Title 24 compliant LED systems provide excellent and even illumination for all surfaces. At only 3.3W per foot, the Lightbar is one of the most energy efficient products in the market. The ultra low profile Lightbar comes in your choice of 5 different lengths. The assortment of drivers, cable options, and accessories makes this adaptable for your application. Can be used in cabinet, cove, display, furniture, or general lighting applications.

Features:

- Title 24 Compliant: Up to 50 Lumens per watt
- Up to 8' runs with 30W driver or 16' runs with 60W driver
- Available in (Warm) 3000K and (Cool) 4200K CCT
- Easy installation with adjustable aiming mounting brackets
- Flush end connectors
- Dimmable with Dimmable Power Supply
- Lightbars and Class II Drivers are rated for -20°C operation
- 30,000 hours of rated lamp life

Housing: Solid aluminum extrusion available in 5 different lengths, includes flush mounted end caps.

Finish: Bronze (anodized) or Natural Aluminum.

Mounting: Each Lightbar includes flat mounting clips and angled mounting clips. Allowing different aiming angles from 0° to 65°.

Driver: A wide variety of drivers are available from direct plug-ins, Class II, and Hardwire Dimmable Class II Drivers. Drivers sold separately, see page 615.

Electrical:

Power: 24V DC Input / 3.3 Watts per Foot
Light Source: 12 LEDs Per Foot
Operating Temperature: -20°C
Life Expectancy: 30,000 Hours of rated lamp life
Maximum Run Length: 16'

Included with every Lightbar:

- (1) Lightbar
- (2*) Flat Mounting Clips [NAL-201]
- (2*) Angled Mounting Clips [NAL-245]
- (1) End to End Connector [NAL-200]
- * 36" and 48" Lightbars include 3 mounting clips

Listings:

ETL and cETL Listed for Dry Location
 Title 24 Compliant
 California Energy Commission Certified
 3 Year Limited Warranty





ACCENT, UNDER CABINET, LINEAR, COVE LIGHTING

LED Lightbar Accessories and Drivers

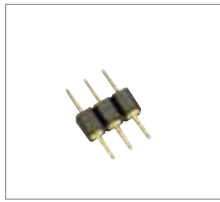

End to End Connector

NAL-200

Finish: Black Insulator
Description: Miniature interconnector for seamless end to end transitions. NAL-200 is included with every Lightbar.



Flat Mounting Clip

NAL-201

Aiming Degree: 0°, 10°, 23°
Description: Align clip into the different grooves in the extruded body of the Lightbar. Two included with every Bar (three with 36" & 48").



Angled Mounting Clip

NAL-245

Aiming Degree: 45°, 53°, 65°
Description: Align clip into the different grooves in the extruded body of the Lightbar. Two included with every Bar (three with 36" & 48").



Power Line Interconnector

NAL-208 20" Cable

NAL-208/72 72" Cable

Description: To connect Lightbar run directly to LED Driver



90° Power Line Interconnector

NAL-207 20" Cable

NAL-207/72 72" Cable

Description: Allows for easy installation in a limited space application. Connects Lightbar run directly to driver.



Power Line Interconnector with Switch

NAL-212 12" Cable

Description: Allows individual switching on any Lightbar run. Connects Lightbar run directly to LED Driver.



Interconnection Cables

NAL-202 2" Cable

NAL-206 6" Cable

NAL-218 18" Cable

NAL-238 38" Cable

NAL-258 58" Cable

Description: Easy linking of two Lightbars in any direction.



Mini Coupler

NAL-220

Finish: Black

Description: Extends interconnection cables and power line interconnectors.

Dim.: 3/8" W; 1/8" L; 3/16" D



Mini Power Feed Splitter

NAL-221

Finish: Black

Description: Allows one driver to be split into 4 separate, simultaneous runs. Requires one interconnection cable for each Lightbar.

Dim.: 1-1/2" W; 3/4" L; 3/16" D



Hardwired Class II Driver*

NATL-530HW 30W

NATL-560HW 60W

Voltage: 24V DC
Cable Length: 3-1/4"
Input Wire: 4"

***Requires:** NUSP-JBox; Power line interconnection cable to connect to Lightbar run except when used with NAL-250



Class II LED Driver*

NATL-5100 100W

Voltage: 24V DC

Input Wire: 6' Cord and Plug

Output Wire: 3-1/4" Out Wire

***Requires:** Power line interconnection cable to connect to Lightbar run except when used with NAL-250

Hardwiring: Cable can be cut to be hardwired, requires NUSP-JBox for hardwiring.



Class II Dimmable Magnetic Driver*

NMT-60/24C2 60W

NMT-96/24C2 96W

Voltage: 24V DC

Cable Length: 10 Foot incl. (30' Cable ordered separately)

***Requires:** Power line interconnection cable to connect to Lightbar run, except when used with NAL-250



Direct Plug-In Driver*

NATL-524 24W

NATL-545 45W

Voltage: 24V DC

Cable Length: 6 Feet

***Requires:** Power line interconnection cable to connect to Lightbar run except when used with NAL-250



Power Line Connector

NALTL-10 10' Cable

NALTL-30 30' Cable

Description: To be used with NMT-60/24C2 Class II LED Driver. Replaces included 10' lead wire, to allow for 30' or less length between Lightbar run and LED Driver.



Dimmer

NAL-250

Includes: (2) 6" Interconnection Cables [NAL-206], (2) End to End Connectors [NAL-200], On/Off Switch, and 6 mounting screws.

Modes: Dimming, Auto-Fading, and Flashing

Description: Capable of dimming two separate runs simultaneously. Installs between Lightbar and Driver.

Note: Does not require power line interconnector.



Junction Box for Hard Wiring

NUSP-JBox

Description: To be used with NATL-530HW or NATL-560HW Drivers. Capable of feeding two separate runs. Accepts Romex® or flex.



Flexible Power Cord

NRA-6035W/6 6' Cable

NRA-6035W/10 10' Cable

Description: Used to convert NATL-530HW and NATL-560HW into a direct plug-in driver.



Flexible Extension Cord

NRA-125/6 6" Cable

NRA-125/12 12" Cable

NRA-125/18 18" Cable

NRA-125/72 72" Cable

Description: Used to extend length between NUSP-JBox and NATL-530HW & NATL-560HW. Can be joined together to create custom lengths.

* Specifications for Drivers on page 706

ACCENT, UNDER CABINET, LINEAR, COVE LIGHTING

LED Lightbar Sample Layouts

5.5' / 18.2 Watts

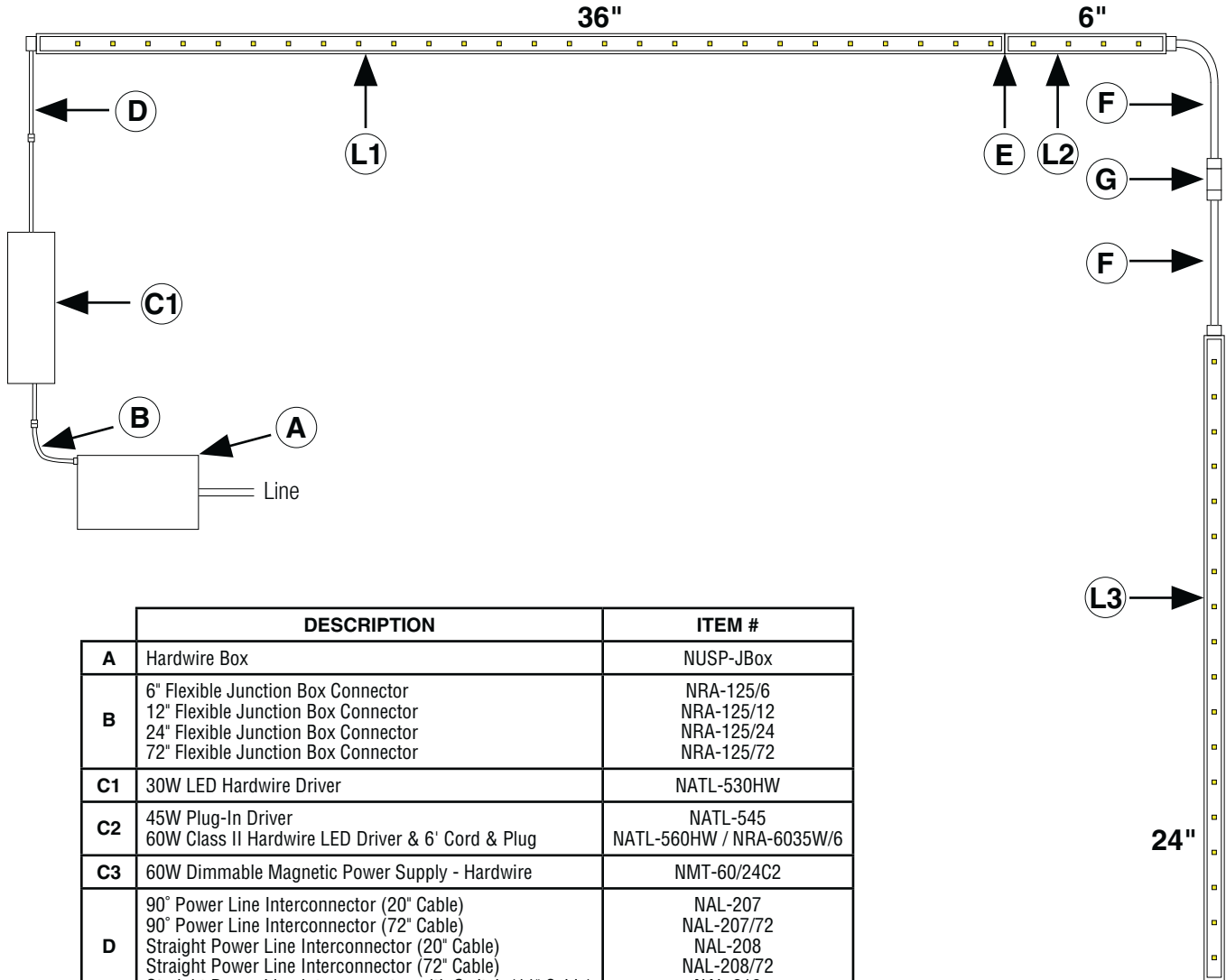

	DESCRIPTION	ITEM #
A	Hardwire Box	NUSP-JBox
B	6" Flexible Junction Box Connector 12" Flexible Junction Box Connector 24" Flexible Junction Box Connector 72" Flexible Junction Box Connector	NRA-125/6 NRA-125/12 NRA-125/24 NRA-125/72
C1	30W LED Hardwire Driver	NATL-530HW
C2	45W Plug-In Driver 60W Class II Hardwire LED Driver & 6' Cord & Plug	NATL-545 NATL-560HW / NRA-6035W/6
C3	60W Dimmable Magnetic Power Supply - Hardwire	NMT-60/24C2
D	90° Power Line Interconnector (20" Cable) 90° Power Line Interconnector (72" Cable) Straight Power Line Interconnector (20" Cable) Straight Power Line Interconnector (72" Cable) Straight Power Line Interconnector with Switch (11" Cable)	NAL-207 NAL-207/72 NAL-208 NAL-208/72 NAL-212
E	End-to-End Connector (included with each Lightbar)	NAL-200
F	2" Interconnection Cable 6" Interconnection Cable 18" Interconnection Cable 38" Interconnection Cable 58" Interconnection Cable	NAL-202 NAL-206 NAL-218 NAL-238 NAL-258
G	Mini Coupler	NAL-220
H	Mini Power Feed Splitter (1 in & 4 out)	NAL-221
I	10' Power Line Connector (included with NMT-60/24C2) 30' Power Line Connector	NALTL-10 NALTL-30
L1	36" LED Lightbar	NULB-36LED(Kelvin)(Finish)
L2	6" LED Lightbar	NULB-6LED(Kelvin)(Finish)
L3	24" LED Lightbar	NULB-24LED(Kelvin)(Finish)
L4	48" LED Lightbar	NULB-48LED(Kelvin)(Finish)

ACCENT, UNDER CABINET, LINEAR, COVE LIGHTING
LED Lightbar Sample Layouts

10.5' / 34.7 Watts

14' / 46.3 Watts

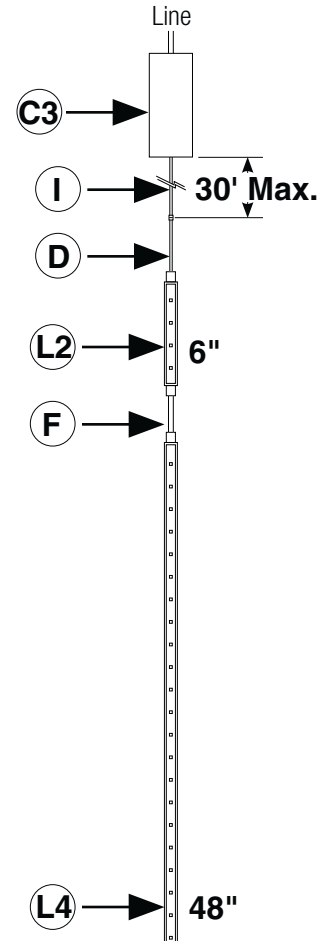
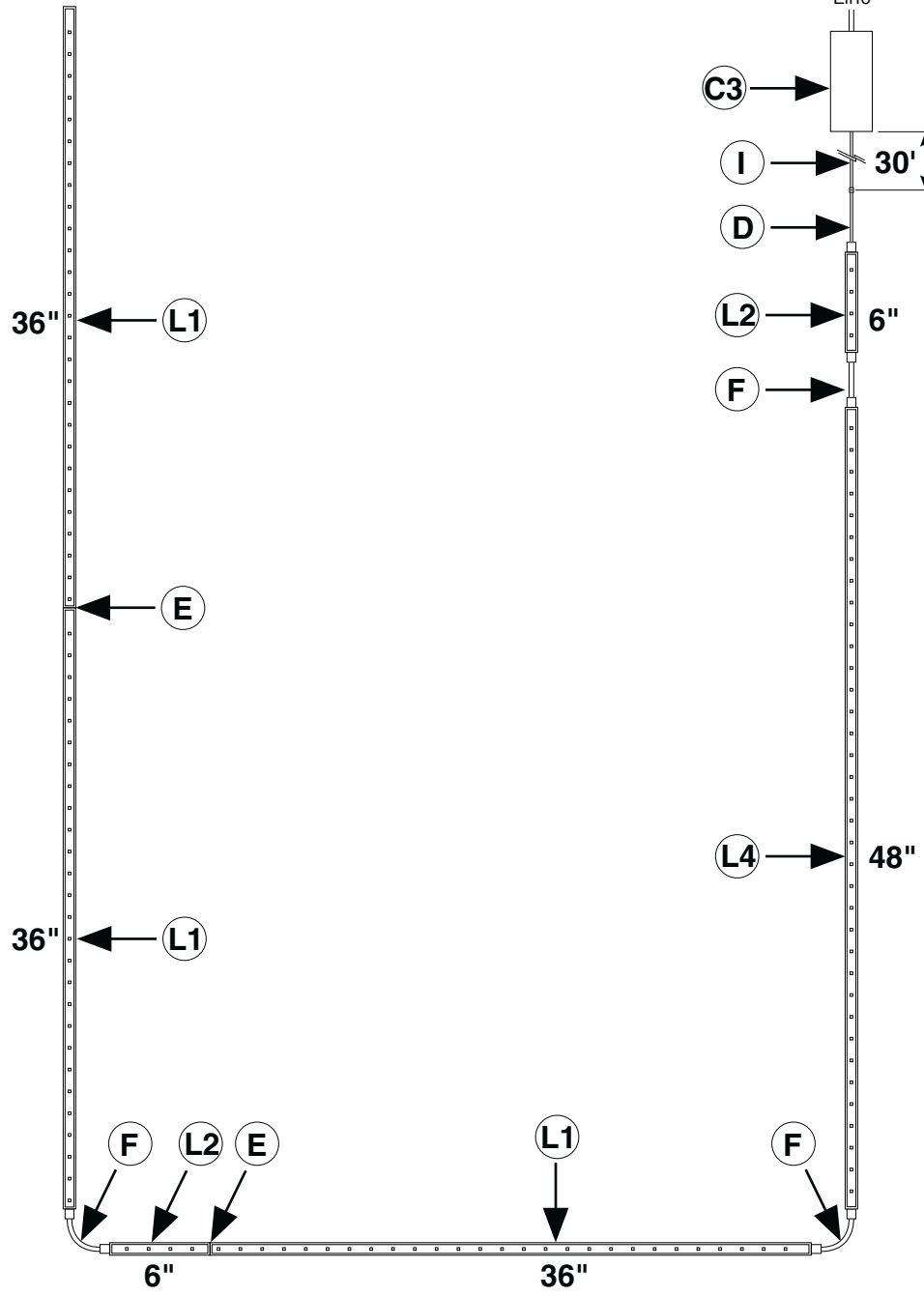
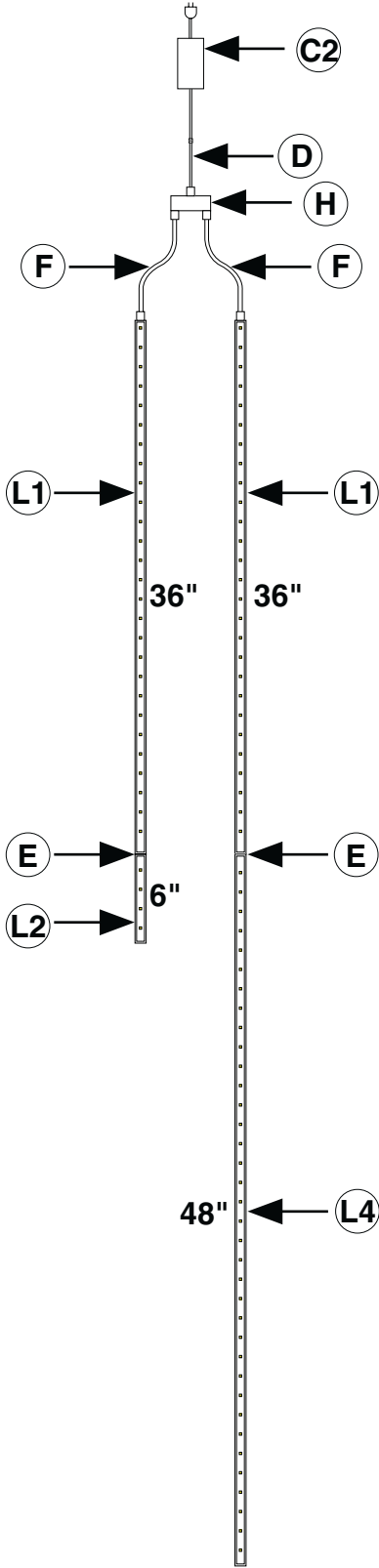

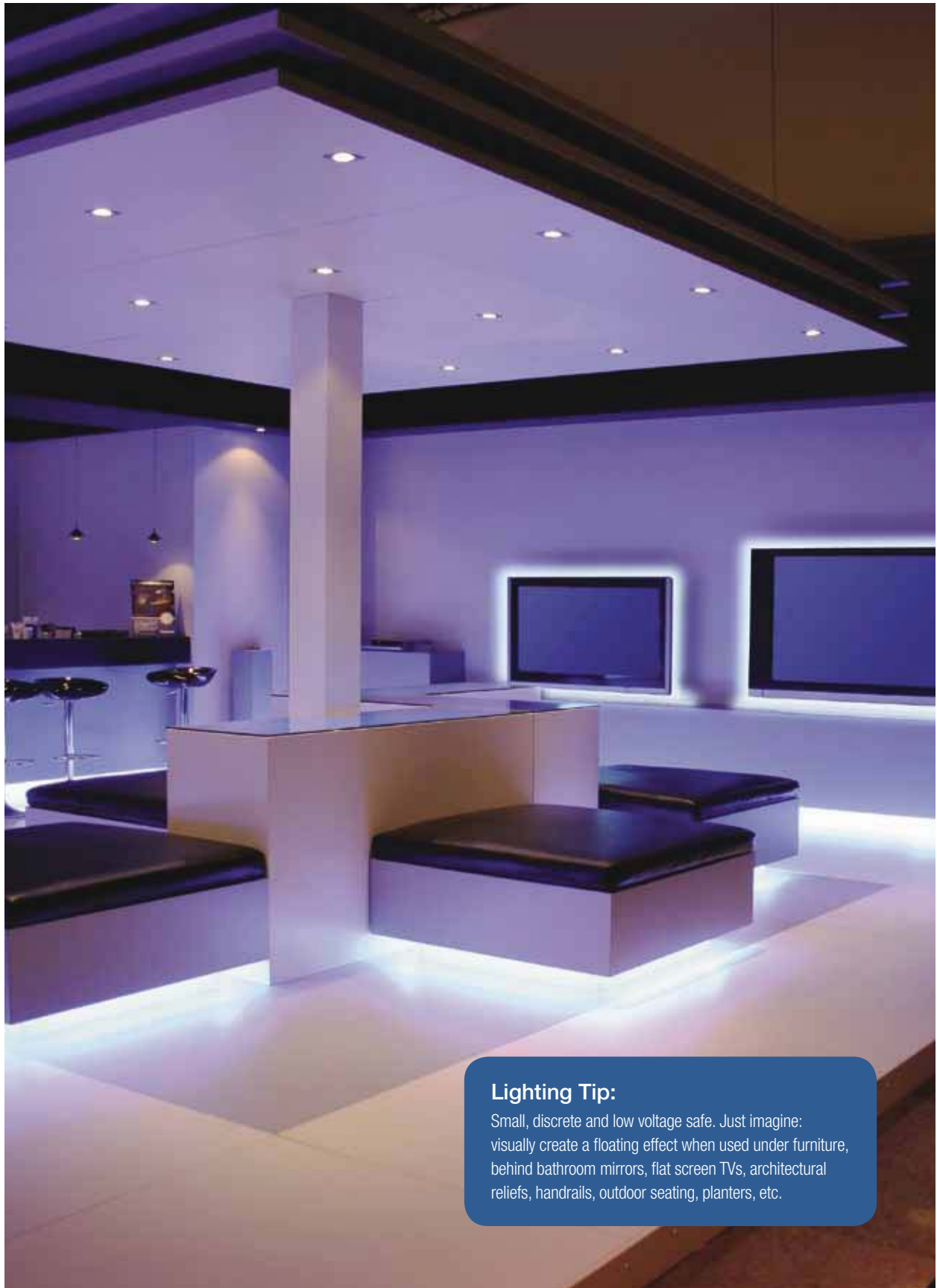

Lighting Tip:

Small, discrete and low voltage safe. Just imagine: visually create a floating effect when used under furniture, behind bathroom mirrors, flat screen TVs, architectural reliefs, handrails, outdoor seating, planters, etc.

LED Tapelight 3 Different Styles

Nora Lighting's LED Tapelight is available in three styles: Color Changing RGB, High Output and Standard. All Nora LED Tapelight is **separable every 12"** and can be easily disconnected and reconnected without soldering. In addition, it is also **field cuttable every 6 LEDs**. Sold in 16' rolls, 12", 6" and 4" segments, LED Tapelight comes standard with **pre-applied 3M™ Tape** for trouble-free mounting. As with all LED sources, there is **no UV light or infrared wavelengths**.



RGB LED Tapelight

- 40W per roll - 2.5W per foot
- 192 LEDs per roll - 12 LEDs per foot
- Several colors or automated changing of visual spectrum can be selected and programmed
- Red, Blue, and Green color in every LED diode combine to create up to 16 different colors
- 3 changeable brightness levels
- 120° Beam Angle



Creates up to 16 different colors to display singly or automatically transition.

High-Output LED Tapelight

- 270 Lumens per foot
- 64W per roll - 4W per foot
- 288 LEDs per roll - 18 LEDs per foot
- 270 Lumens per foot
- Single color Illumination
- Dimmable with Dimmable Power Supply
- 6 available colors: Blue, Green, Red, Yellow, Cool White (4200K), Warm White (3000K)
- 120° Beam Angle
- Title 24 Complaint



Blue

Green

Red

Yellow

Cool White

Warm White

LED Tapelight

- 65 Lumens per foot with 3000K CCT
- Single color Illumination
- 6 available colors: Blue, Green, Red, Yellow, Cool White (4200K), Warm White (3000K)
- Dimmable with Dimmable Power Supply
- Exceeds Title 24 high efficacy requirements



Blue

Green

Red

Yellow

Cool White

Warm White

ACCENT, UNDER CABINET, LINEAR, COVE LIGHTING

LED Tape Light

NEW!

LED Tape Light is a perfect solution for your LED linear lighting needs. This energy efficient and very low profile LED tape is great for use in many discreet locations. The flexible LED tape is designed to cast no shadows and boasts a desirable seamless glow. Our durable, silicone encapsulated tape, is cETLus Listed for Wet Location applications, and is IP65 rated. Each roll comes with (16) 12" sections linked together.

Features:

- 65 Lumens per foot with 3000K CCT
- 24 Watts Per Roll / 1.5 Watts Per Foot
- Separable every 12", easily disconnect and connected without soldering
- cETLus Wet Label listed
- Field cuttable every 4" or 6 LEDs
- Easy to install; pre-applied 3M™ tape or 15 acrylic mounting clips (included with 16' roll)
- Dimmable with Dimmable Power Supply
- 6 available colors: Blue, Green, Red, Yellow, Cool White (4200K), Warm White (3000K)
- Exceeds Title 24 high efficacy requirements
- No soldering or additional wiring is required
- No flicker or delay like compact fluorescents
- No UV light or infrared wavelengths

Construction: The silicone encapsulated tape can be cut every 4" or 6 LEDs at marked intervals. Cutting does not effect circuit (shrink wrap tube included for concealment). The tape light is also separable every 12", each connection has pre-applied shrink wrap around connections to ensure wet location listing. Simply slice the clear shrink wrap at each 12" connection, and separate male-female connectors. This eliminates soldering when using partial rolls.

Tape Light Kit: Complete kit for basic 16' installation. Includes: (1) 16' Tape Light Roll, (15) Clear Acrylic Clips, (1) 9" Power Line Interconnector, and (1) 24W LED Plug-In Driver.

Mounting: Each Tape Light roll comes with 15 clear acrylic clips and also comes with pre-applied 3M™ adhesive tape for simple installation. Plastic channel (NATL-420) also available, sold separately.

Driver: A wide variety of drivers are available from direct plug-ins, Class II, and Dimmable Class II Drivers. Drivers sold separately, see page 621.

Electrical:

Power: 24V DC Input / 1.5 Watts Per Foot
Light Source: 18 LEDs per foot
Operating Temperature: -25°C to 60°C (-13° F to 140° F)
Life Expectancy: 50,000 Hours
Maximum Run Length: 48'

Included with every Roll:

Each Tape Light Roll purchased includes a 9" power line connector [NATL-509], (15) clear acrylic clips, pre-applied 3M™ adhesive, and 16' tape consisting of 12" sections.

Listings:

cETLus Listed for Wet Location (not submersible)
 IP65 Rated
 Title 24 Compliant
 California Energy Commission Certified
 3 Year Limited Warranty

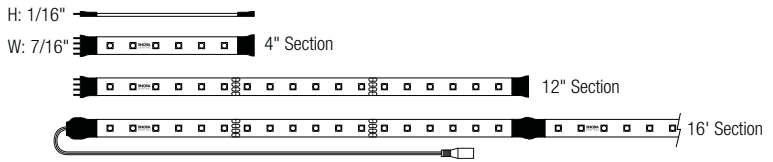

HOW TO SPECIFY LED TAPE LIGHT

CATALOG NUMBER	DESCRIPTION
NUTP1-16LED(color)	16' LED Tape Light Roll, consisting of (16) 12" sections
NUTP1-LED(color)/12	12" LED Tape Light Section, with male and female ends
NUTP1-LED(color)/4	4" LED Tape Light Section, with male and female ends
NUTP1-16LED30PS	16' 3000K LED Tape Light Kit, includes Plug-In Driver

Color: 3000K - Warm (30), 4200K - Cool (42), Blue (B), Green (G), Red (R), Yellow (Y)

ORDER EXAMPLE: NUTP1-LED42/4 = 4" LED Tape Light Section, 4200K



ACCENT, UNDER CABINET, LINEAR, COVE LIGHTING

LED Tape Light Accessories and Drivers



Shrink Wrap Tube
NATL-400 Pack of 5
Description: Used to seal connection made in the field. Necessary to maintain ETL Wet Listing. Pack of 3 shrink wrap tubes are included with every Tape Light roll.

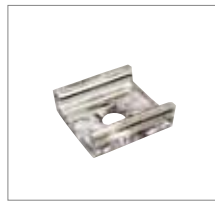

Clear Acrylic Mounting Clips
NATL-401 Pack of 15
Description: Used in conjunction with adhesive backing to attach Tape Light to a surface. Pack of 15 clear acrylic mounting clips are included with every Tape Light roll.



4' Plastic Channel
NATL-420B Black
NATL-420W White
Description: Used to mount Tape Light to various surfaces. Tape Light snaps into the channel. Field cuttable. UV protected.



End Cap
NATL-403
Description: Used to cover open end of Tape Light.



Power Line Interconnector
NATL-509 9" Cable
Description: To connect any Tape Light run to a driver. (1) NATL-509 is included with every Tape Light roll.



Power Line Interconnector with On/Off Switch
NATL-511 11" Cable
Description: To allow individual switching on any Tape Light run, and connect LED Tape Light run directly to LED Driver.



Interconnection Cables
NATL-202 2" Cable
NATL-206 6" Cable
NATL-218 18" Cable
NATL-236 36" Cable
NATL-272 72" Cable

Description: The interconnection cable allows easy linking of two Tape Lights sections. Cables are flexible and can be moved in any direction, or be joined together for custom lengths.

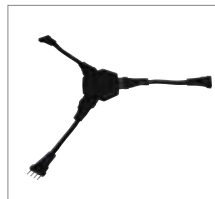

"Y" Splitter Cable
NATL-300
Description: Allows splitting the Tape Light from a run or driver, into two separate runs.



"X" Splitter Cable
NATL-301 11" Cable
Description: Allows splitting the Tape Light from a run or driver, into three separate runs



Class II LED Driver*
NATL-530HW 30W
NATL-560HW 60W
Voltage: 24V DC
Input Wire: 4" Input wire
Output Wire: 3-1/4" wire
Requires: NUSP-JBox for hard wiring.

Note: Convert to plug-in driver with NRA-6035



Class II LED Driver*
NATL-5100 100W
Voltage: 24V DC
Input Wire: 6" Cord and Plug
Output Wire: 3-1/4" Out Wire
Hardwiring: Cable can be cut to be hardwired, requires NUSP-JBox for hardwiring.



Dimmable Class II Remote Hardwire Magnetic Power Supply*
NMT-60/24C2 60W
NMT-96/24C2 96W
Voltage: 24V DC
Cable Length: 10 Foot incl. (30' Cable ordered separately)



Direct Plug-In Driver*
NATL-524 24W
NATL-545 45W
Voltage: 24V DC
Cable Length: 6 Feet



Power Line Connector
NALTL-10 10' Cable
NALTL-30 30' Cable
Description: To be used with NMT-60/24C2 and NMT-96/24C2 Class II LED Driver. NALTL-10 is included with NMT-60/24C2 and NMT-96/24C2.



Junction Box for Hard Wiring
NUSP-JBox
Description: To be used with NATL-530HW, NATL-560HW, or NATL-5100 Drivers. Capable of feeding two separate LED Drivers. Accepts Romex® or flex.



Flexible Extension Cord
NRA-125/6 6" Cable
NRA-125/12 12" Cable
NRA-125/18 18" Cable
NRA-125/72 72" Cable

Description: Used to extend length between NUSP-JBox and NATL-530HW or NATL-560HW. Can be joined together to create custom lengths.



Flexible Power Cord
NRA-6035W/6 6' Cable
NRA-6035W/10 10' Cable
Description: Used to convert NATL-530HW or NATL-560HW into a direct plug-in driver.

*Note: All drivers require NATL-509 or NATL-511 power line interconnector to connect to tape. * Specifications for Drivers on page 706

ACCENT, UNDER CABINET, LINEAR, COVE LIGHTING
LED Tape Light Sample Layout

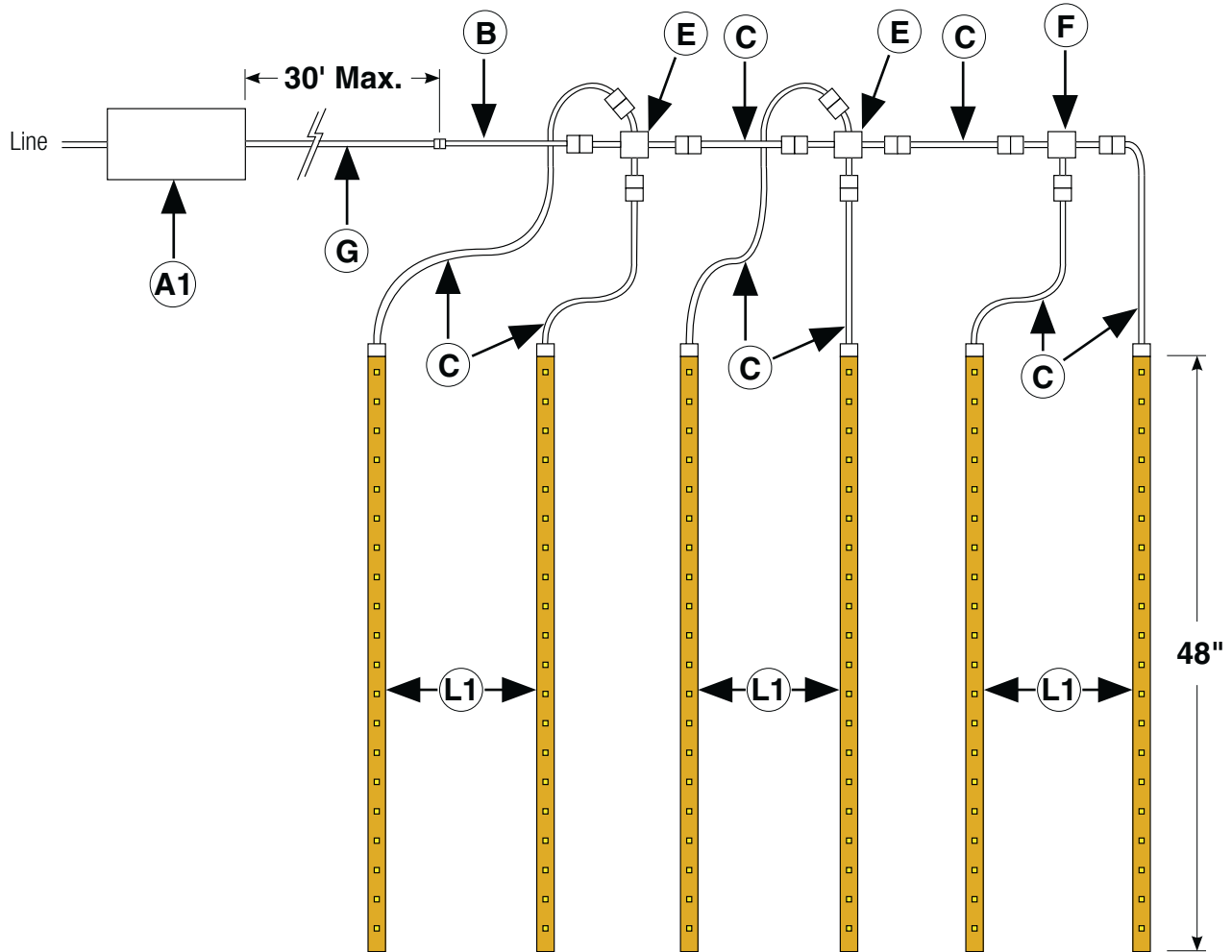

	DESCRIPTION	ITEM #
A1	60W Dimmable Magnetic Power Supply - Hardwire	NMT-60/24C2
B	9" Power Line Interconnector (one included with each Tape Light roll)	NATL-509
C	2" Interconnection Cable 6" Interconnection Cable 18" Interconnection Cable 36" Interconnection Cable 72" Interconnection Cable	NATL-202 NATL-206 NATL-218 NATL-236 NATL-272
E	"X" Splitter Cable (1 in & 3 out)	NATL-301
F	"Y" Splitter Cable (1 in & 2 out)	NATL-300
G	10' Power Line Connector (included with NMT-60/24C2) 30' Power Line Connector	NALTL-10 NALTL-30
L1	48" LED Tape Light Segment (Each NUTP1-16LED Roll contains (16) 12" detachable sections)	NUTP1-16LED(color)

ACCENT, UNDER CABINET, LINEAR, COVE LIGHTING LED Tape Light Sample Layout

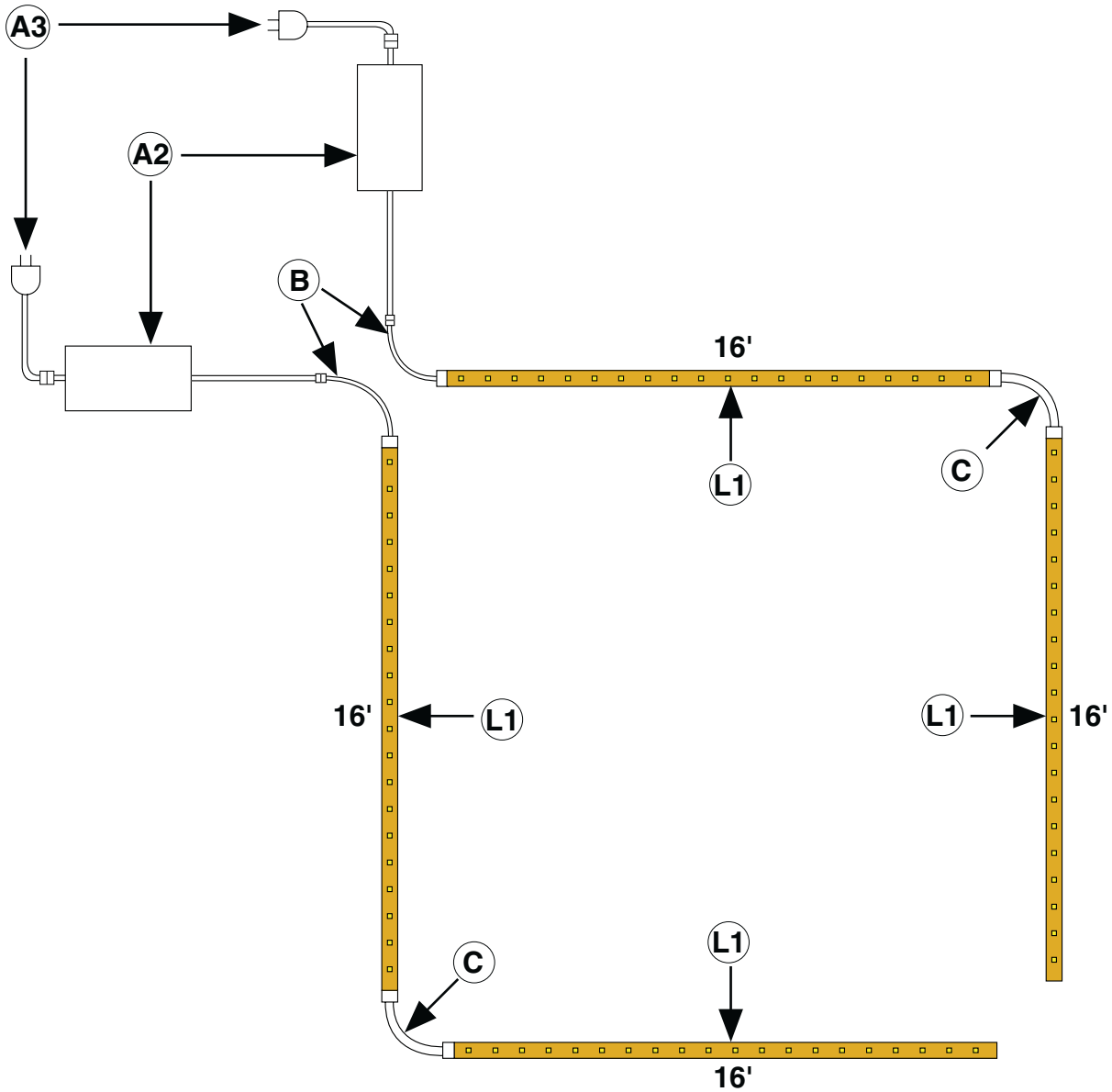

	DESCRIPTION	ITEM #
A2	60W Class II Hardwire LED Driver	NATL-560HW
A3	Flexible 6' Power Cord	NRA-6035W/6
B	9' Power Line Interconnector (one included with each Tape Light roll)	NATL-509
C	2' Interconnection Cable 6' Interconnection Cable 18' Interconnection Cable 36' Interconnection Cable 72' Interconnection Cable	NATL-202 NATL-206 NATL-218 NATL-236 NATL-272
L1	16' LED Tape Light Roll (Disconnect every 12" or can be cut every 4", contains (16) 12" segments)	NUTP1-16LED(color)



ACCENT, UNDER CABINET, LINEAR, COVE LIGHTING

RGB LED Tape Light (Color Changing)

RGB LED Tape can create up to 16 colors!
Program a single stationary color or multiple transitioning colors.



Each RGB LED run requires a controller and driver/power supply

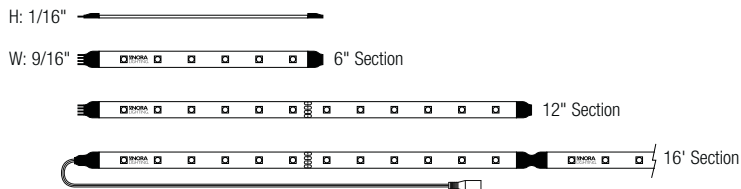
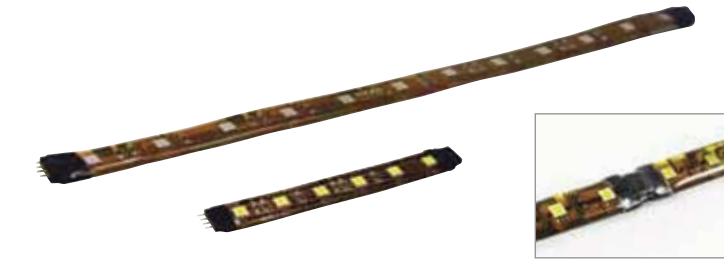

HOW TO SPECIFY RGB COLOR CHANGING LED TAPE LIGHT

CATALOG NUMBER	DESCRIPTION
NUTP3-16LEDRGB	16' LED Tape Light Roll, consisting of (16) 12" sections
NUTP3-LEDRGB/12	12" LED Tape Light Section, with male and female ends
NUTP3-LEDRGB/6	6" LED Tape Light Section, with male and female ends

ORDER EXAMPLE: NUTP3-16LEDRGB = 16' RGB LED Tape Light Roll

* Specifications for Drivers on page 706

RGB controller must be used between the Driver and RGB tape to accomplish RGB color changing.



Listings:
cETLus Listed for Wet Location (not submersible)
IP65 Rated
California Energy Commission
3 Year Limited Warranty

RGB LED Tape Light has the colors **Red**, **Green**, and **Blue** in every LED diode. Several colors of visual spectrum can be selected and programmed with a 120° viewing angle. A stationary color, automatic changing colors and brightness can be selected and changed at anytime with the press of a button. Very low profile RGB LED Tape Light is a great use in show exhibition lighting, architectural enhancements, bars, theaters, store fronts, or anywhere you need a punch of color. Controller needed to operate color variations. This flexible LED light source is a durable silicone encapsulated tape, cETLus Listed for Wet Locations applications and IP65 rated.

Features:

- Separable every 12" - easily disconnected and connected without soldering
- Field cuttable every 6" or 6 LEDs
- Shrink Wrap Tube at each Breakaway
- 40W per roll - 2.5W per foot
- Primary Colors: **Red**, **Green**, and **Blue**
- Several colors or automated changing of visual spectrum can be selected & programmed
- Synchronizable
- 3 changeable brightness levels with hand held remote
- 192 LEDs per roll - 12 LEDs per foot
- 120° Beam Angle
- Pre-applied 3M™ Tape for mounting
- No UV light or infrared wavelengths

Construction: The silicone encapsulated tape can be cut every 6 LEDs at marked intervals. Cutting does not effect circuit (shrink wrap tube included for concealment). RGB Tape Light is also separable every 12", each connection has pre-applied shrink wrap around connections to ensure wet location listing. Simply slice the clear shrink wrap at each electrical connection, and separate pieces. This eliminates soldering when using partial rolls.

Mounting: Each RGB Tape Light roll comes with 15 clear acrylic clips and also comes with pre-applied 3M™ adhesive tape for simple installation.

Driver: A wide variety of drivers are available from direct plug-ins, Class II, and hardwire power supplies are available. Drivers sold separately, see page 626.

Controller: Each run requires a controller, which can be linked together for color synchronization. The controller can be controlled locally or with an optional hand held remote.

Electrical:

Power: 24V DC Input / 2.5 Watts per Foot
Light Source: 12 LEDs per foot
Operating Temperature: -25°C to 60°C (-13° F to 140° F)
Life Expectancy: 50,000 Hours
Maximum Run Length: 32'

Included with every RGB Tape Light roll:

Each RGB Tape Light roll purchased includes a 12" power line connector [NARGB-709], (15) clear acrylic clips, pre-applied 3M™ adhesive, and 16' tape consisting of 12" sections.

Required to run RGB Tape Light:

RGB Tape Light, Power Line Interconnector, RGB Controller, and LED Driver.

ACCENT, UNDER CABINET, LINEAR, COVE LIGHTING

RGB LED Tape Light Accessories and Drivers



Shrink Wrap Tube

NATL-400 Pack of 5

Description: Used to seal connection made in the field. Necessary to maintain ETL Wet Listing. Pack of 3 shrink wrap tubes are included with every RGB Tape Light roll.



Clear Acrylic Mounting Clips

NATHR-685 Pack of 15

Description: Used in conjunction with adhesive backing to attach Tape Light to a surface. Pack of 15 clear acrylic mounting clips are included with every RGB Tape Light roll.



4' Aluminum Channel

NATHR-680 Aluminum

Description: Used to mount RGB Tape Light to various surfaces. RGB Tape Light snaps into the channel. Field cuttable..



End Cap

NATL-403

Description: Used to cover open end of RGB Tape Light.



Power Line Interconnector

NARGB-710 12" Cable

Description: To connect an RGB controller.
Note: (1) NARGB-710 is included with every RGB Tape Light roll. Use interconnection cables to increase length.



Interconnection Cables

- NARGB-702** 2" Cable
- NARGB-706** 6" Cable
- NARGB-718** 18" Cable
- NARGB-736** 36" Cable
- NARGB-772** 72" Cable

Description: The interconnection cable allows easy linking of 2 RGB Tape Lights sections. Cables are flexible and can be moved in any direction, or be joined together for custom lengths.

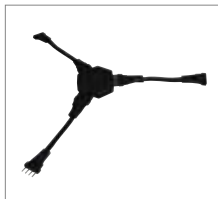

"Y" Splitter Cable

NARGB-700

Description: Allows splitting the RGB Tape Light from a run or driver, into two separate runs.



"X" Splitter Cable

NARGB-701

Description: Allows splitting the RGB Tape Light from a run or driver, into three separate runs.



Direct Plug-In Driver*

NATL-524 24W

NATL-545 45W

Voltage: 24V DC

Cable Length: 6 Feet



Class II LED Driver*

NATL-530HW 30W

NATL-560HW 60W

Voltage: 24V DC
Input Wire: 4" Input Wire
Output Wire: 3-1/4" Wire
Requires: NUSP-JBox for hard wiring.

Note: Convert to plug-in driver with NRA-6035



Class II LED Driver*

NATL-5100 100W

Voltage: 24V DC
Input Wire: 6' Cord and Plug
Output Wire: 3-1/4" Wire
Hardwiring: Cable can be cut to be hardwired, requires NUSP-JBox for hardwiring.



Class II Remote Hardwire Magnetic Power Supply*

NMT-60/24C2 60W

NMT-96/24C2 96W

Voltage: 24V DC
Cable Length: 10 Foot inc. (30' Cable ordered separately)

Note: RGB LED Tape cannot be dimmed. The controller with hand held remote allows 3 brightness levels.



Junction Box for Hard Wiring

NUSP-JBox

Description: To be used with NATL-530HW, NATL-560HW, or NATL-5100 Drivers. Capable of feeding two separate LED Drivers. Accepts Romex® or flex.



Flexible Extension Cord

NRA-125/6 6" Cable

NRA-125/12 12" Cable

NRA-125/18 18" Cable

NRA-125/72 72" Cable

Description: Used to extend length between NUSP-JBox and NATL-530HW or NATL-560HW. Can be joined together to create custom lengths.



Flexible Power Cord

NRA-6035W/6 6' Cable

NRA-6035W/10 10' Cable

Description: Used to convert NATL-530HW or NATL-560HW into a direct plug-in driver.



Power Line Connector

NALTL-10 10' Cable

NALTL-30 30' Cable

Description: To be used with NMT-60/24C2 and NMT-96/24C2 Class II LED Driver. NALTL-10 is included with NMT-60/24C2 and NMT-96/24C2.



RGB Controller

NARGB-760

Description: 360W Max. A controller is required for each RGB LED Tape Light run. It installs between the driver and the power line interconnector. The controller can be used to toggle between colors or changing modes.

Note: Requires the NARGB-710 power line interconnector to connect to RGB tape.



Hand Held Remote

NARGB-761

Description: For remote control of RGB Controller up to 22' away (must be in direct view line of RGB controller to work correctly). Used to program RGB Tape Light run to certain color configurations.

Key Selections: Brightness, Colors, Color Changing - Flash, Strobe, Fade and Smooth Fade, On/Off

*Note: Each RGB Tape Light run requires a driver, controller, power line interconnector and tape. * Specifications for Drivers on page 706
To accomplish the RGB color changing, you must use the RGB controller between the Driver and the RGB tape.

ACCENT, UNDER CABINET, LINEAR, COVE LIGHTING RGB LED Tape Light Sample Layout

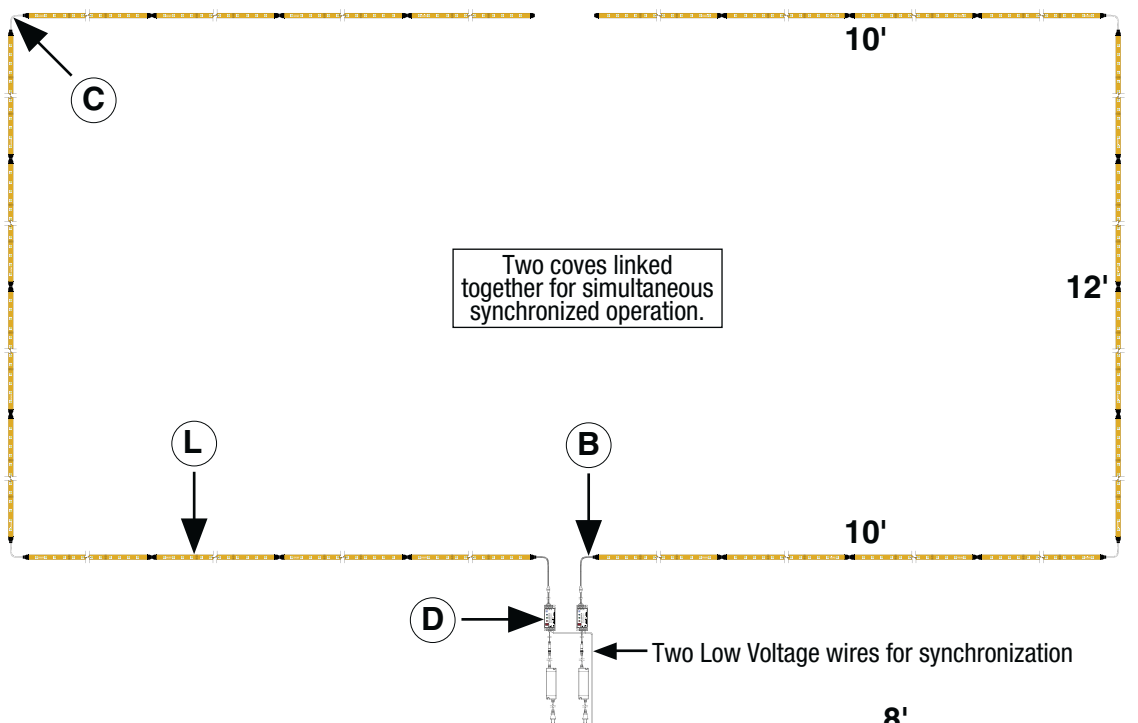
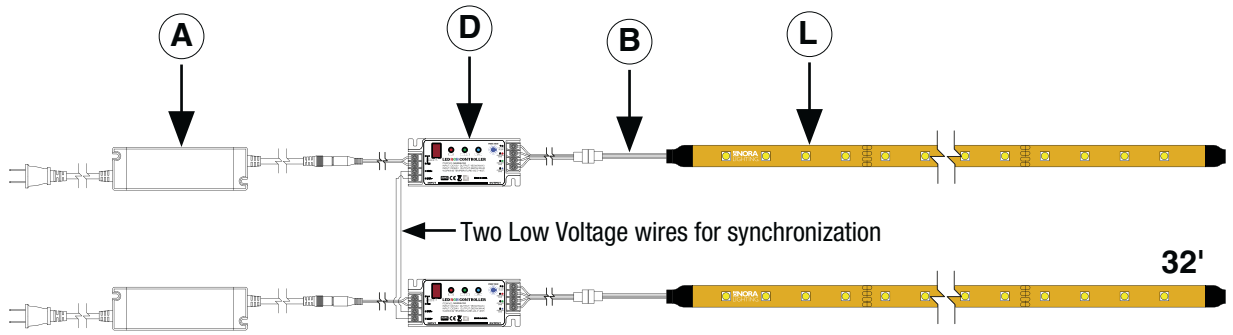

	DESCRIPTION	ITEM #
A	100W Class II LED Driver	NATL-5100
B	12" Power Line Interconnector (one included with each Tape Light roll)	NARGB-710
C	2" Interconnection Cable	NARGB-702
	6" Interconnection Cable	NARGB-706
	18" Interconnection Cable	NARGB-718
	36" Interconnection Cable	NARGB-736
	72" Interconnection Cable	NARGB-772
D	RGB Controller	NARGB-760
L	RGB LED Tape Light Roll (Disconnect every 12" or can be cut every 6", contains (16) 12" segments)	NUTP3-16LEDRGB

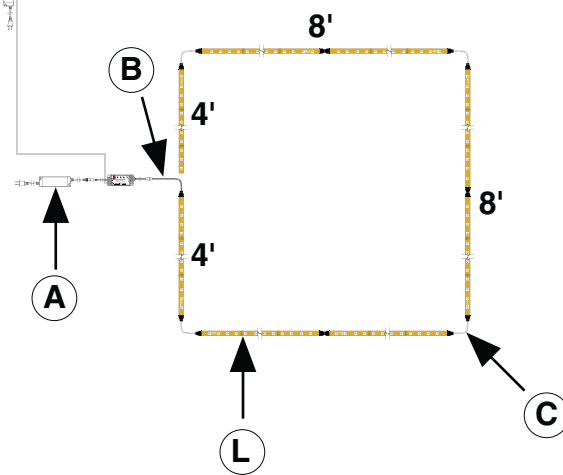

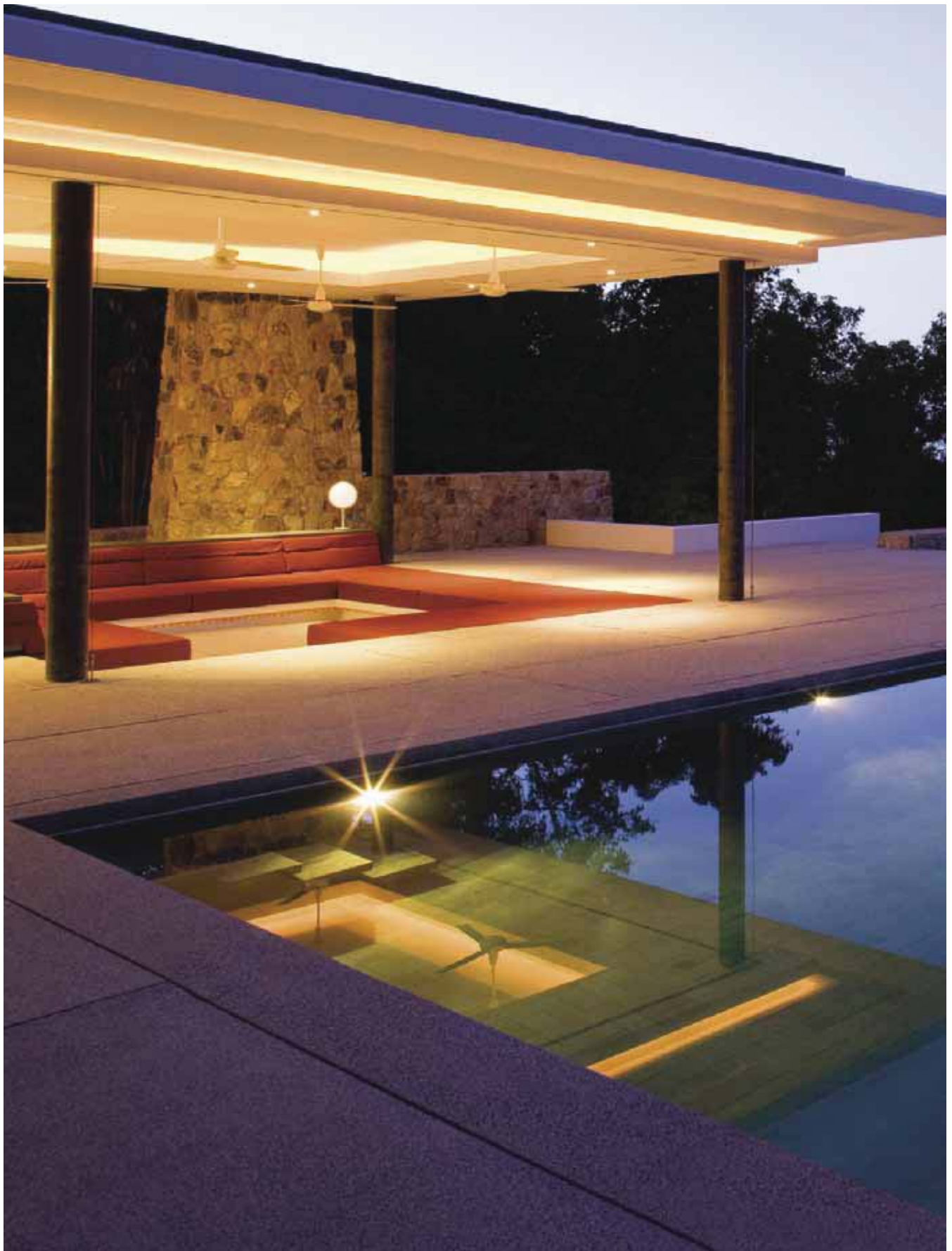

ACCENT, UNDER CABINET, LINEAR, COVE LIGHTING

High Output LED Tape Light

NEW!



270 Lumens Per Foot!

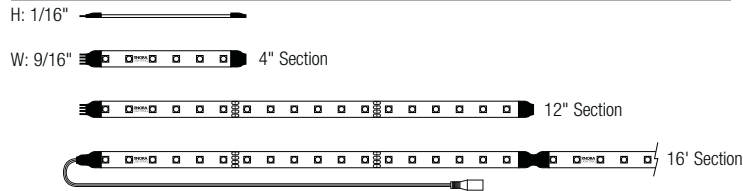

HOW TO SPECIFY HIGH OUTPUT LED TAPE LIGHT

CATALOG NUMBER	DESCRIPTION
NUTP2-16LED(color)	16' High Output LED Tape Light Roll, consisting of (16) 12" sections
NUTP2-LED(color)/12	12" High Output LED Tape Light Section, with male and female ends
NUTP2-LED(color)/4	4" High Output LED Tape Light Section, with male and female ends

Color: 3000K - Warm (30), 4200K - Cool (42), Blue (B), Green (G), Red (R), Yellow (Y)

ORDER EXAMPLE: NUTP2-LED42/4 = 4" High Output LED Tape Light Section, 4200K



High Output LED Tape Light has four times the light output of our standard tape, consumes only 4W per foot, and is a perfect solution for your LED linear lighting needs. Very low profile High Output LED Tape is great for use in cove lighting, architectural enhancements, under cabinet or many more discreet locations. This flexible LED light source is a durable silicone encapsulated tape, cETLus Listed for Wet Location applications and IP65 rated.

Features:

- Title 24 Compliant
- No soldering or additional wiring required
- Separable every 12" - easily disconnected and connected without soldering
- Field cuttable every 4" or 6 LEDs
- Dimmable with Dimmable Power Supply
- 64W per roll - 4W per foot
- 288 LEDs per roll - 18 LEDs per foot
- 270 Lumens per foot
- 120° Beam Angle
- Pre-applied 3M™ Tape for mounting
- No UV light or infrared wavelengths

Construction: The silicone encapsulated tape can be cut every 6 LEDs at marked 4" intervals. Cutting does not effect circuit (shrink wrap tube included for concealment). High Output Tape Light is separable every 12", each connection has pre-applied shrink wrap around connections to ensure wet location listing. Simply slice the clear shrink wrap at each 12" connection, and separate pieces. This eliminates soldering when using partial rolls.

Mounting: Each Tape Light roll comes with 15 clear acrylic clips and also comes with pre-applied 3M™ adhesive tape for simple installation.

Driver: A wide variety of drivers are available from direct plug-ins, Class II, and Hardwire Dimmable Class II Drivers. Drivers sold separately, see pages 630.

Electrical:

Power: 24V DC Input / 4 Watts Per Foot
Light Source: 18 High Output LEDs Per Foot
Operating Temperature: -25°C to 60°C (-13° F to 140° F)

Life Expectancy: 50,000 Hours
Maximum Run Length: 16'

Included with every High Output Tape Light Roll: Each Tape Light purchased includes a 12" power line connector [NAHO-609], (15) clear acrylic clips, pre-applied 3M™ adhesive, and 16' tape consisting of 12" sections.

Listings:

cETLus Listed for Wet Location (not submersible)
 IP65 Rated
 Title 24 Compliant
 California Energy Commission
 3 Year Limited Warranty

ACCENT, UNDER CABINET, LINEAR, COVE LIGHTING

High Output LED Tape Light Accessories and Drivers



Shrink Wrap Tube
NATL-400 Pack of 5
Description: Used to seal connection made in the field. Necessary to maintain ETL Wet Listing. Pack of 3 shrink wrap tubes are included with every Tape Light roll.



Clear Acrylic Mounting Clips
NATHR-685 Pack of 15
Description: Used in conjunction with adhesive backing to attach Tape Light to a surface. Pack of 15 clear acrylic mounting clips are included with every High Output Tape Light roll.



4' Aluminum Channel
NATHR-680 Aluminum
Description: Used to mount Tape Light to various surfaces. Tape Light snaps into the channel. Field cuttable. Recommended for most installations.



End Cap
NATL-403
Description: Used to cover open end of High Output Tape Light.



Power Line Interconnector
NAHO-609 12" Cable
Description: To connect any High Output Tape Light run to a driver. (1) NAHO-609 is included with every High Output Tape Light roll.



Power Line Interconnector with On/Off Switch
NAHO-611 11" Cable
Description: To allow individual switching on any High Output Tape Light run, and connect the LED tape light run to an LED driver.



Interconnection Cables
NAHO-602 2" Cable
NAHO-606 6" Cable
NAHO-618 18" Cable
NAHO-636 36" Cable
NAHO-672 72" Cable

Description: The interconnection cable allows easy linking of two High Output Tape Lights sections. Cables are flexible and can be moved in any direction, or be joined together for custom lengths.



"Y" Splitter Cable
NAHO-600
Description: Allows splitting the High Output Tape light from a run or driver, into two separate runs.

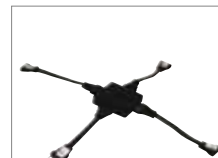

"X" Splitter Cable
NAHO-601
Description: Allows splitting High Output Tape Light from a run or driver, into three separate runs.



Class II LED Driver*
NATL-530HW 30W
NATL-560HW 60W
Voltage: 24V DC
Input Wire: 4" Input Wire
Output Wire: 3-1/4" Wire
Requires: NUSP-JBox for hard wiring

Note: Convert to plug-in driver with NRA-6035



Class II LED Driver*
NATL-5100 100W
Voltage: 24V DC
Input Wire: 6' Cord and Plug
Output Wire: 3-1/4" Wire
Hardwiring: Cable can be cut to be hardwired, requires NUSP-JBox for hardwiring.



Dimmable Class II Remote Hardwire Magnetic Power Supply*
NMT-60/24C2 60W
NMT-96/24C2 96W
Voltage: 24V DC
Cable Length: 10 Foot incl. (30' Cable ordered separately)



Direct Plug-In Driver*
NATL-524 24W
NATL-545 45W
Voltage: 24V DC
Cable Length: 6 Feet



Power Line Connector
NALTL-10 10' Cable
NALTL-30 30' Cable
Description: To be used with NMT-96/24C2 and NMT-60/24C2 Class II LED Driver. NALTL-10 is included with NMT-60/24C2 and NMT-96/24C2.



Junction Box for Hard Wiring
NUSP-JBox
Description: To be used with NATL-530HW, NATL-560HW, or NATL-5100 Drivers. Capable of feeding two separate LED Drivers. Accepts Romex® or flex.



Flexible Extension Cord
NRA-125/6 6" Cable
NRA-125/12 12" Cable
NRA-125/18 18" Cable
NRA-125/72 72" Cable

Description: Used to extend length between NUSP-JBox and NATL-530HW or NATL-560HW. Can be joined together to create custom lengths.



Flexible Power Cord
NRA-6035W/6 6' Cable
NRA-6035W/10 10' Cable
Description: Used to convert NATL-530HW or NATL-560HW into a direct plug-in driver.

*Note: All drivers require NAHO-609 OR NAHO-611 power line interconnector to connect to tape. * Specifications for Drivers on page 706

ACCENT, UNDER CABINET, LINEAR, COVE LIGHTING
High Output LED Tape Light Sample Layout

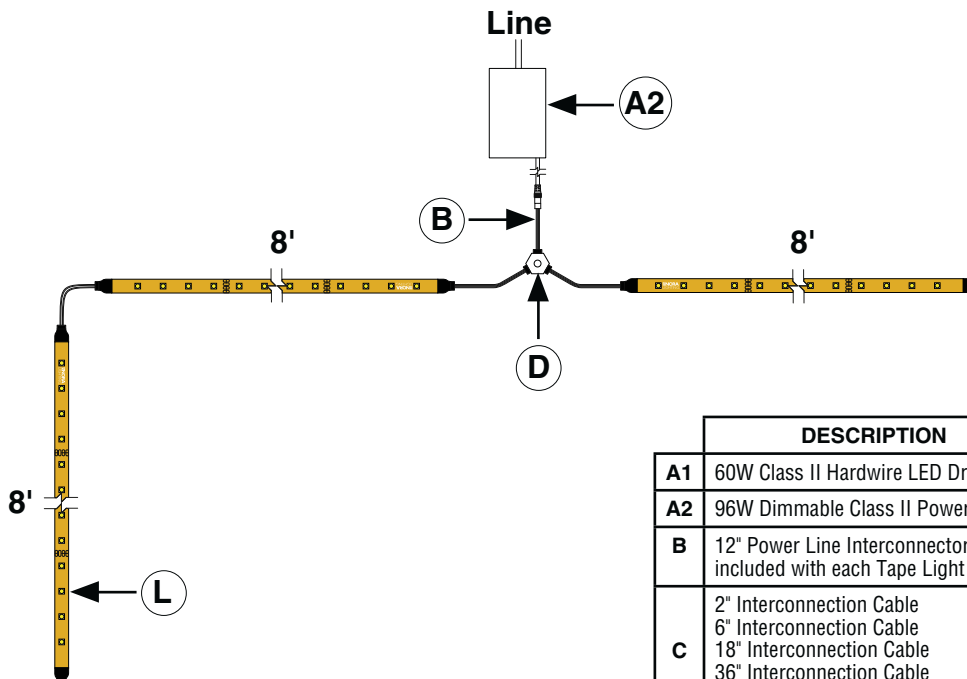
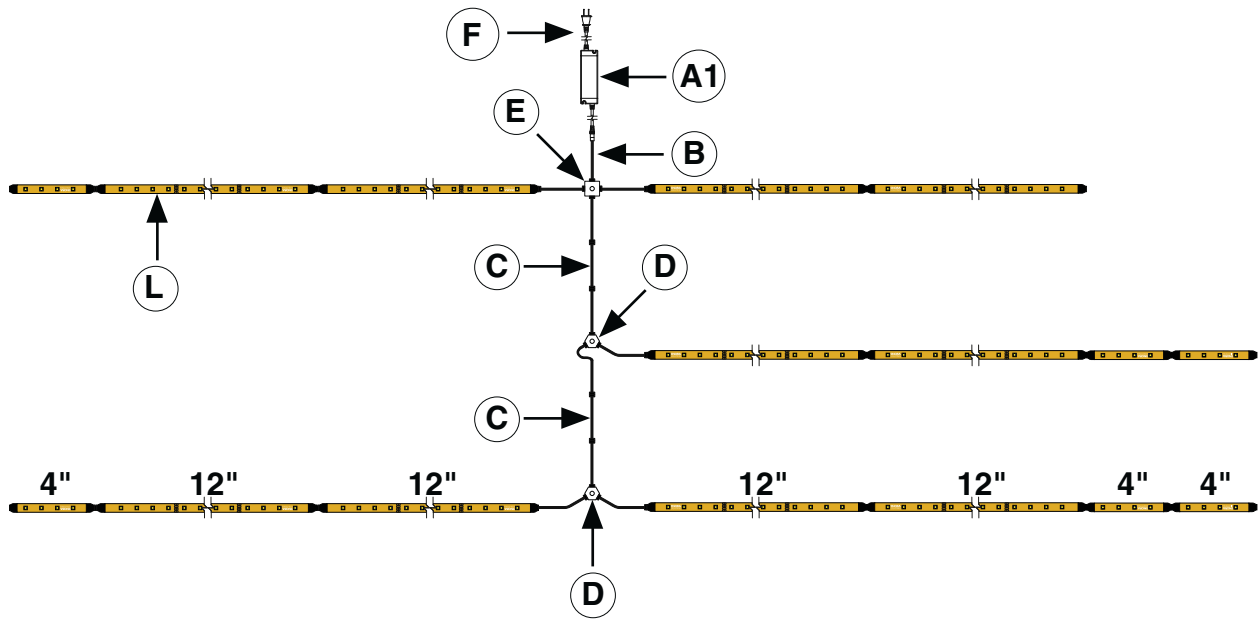

	DESCRIPTION	ITEM #
A1	60W Class II Hardwire LED Driver	NATL-560HW
A2	96W Dimmable Class II Power Supply	NMT-96/24C2
B	12" Power Line Interconnector (one included with each Tape Light roll)	NAHO-609
C	2" Interconnection Cable 6" Interconnection Cable 18" Interconnection Cable 36" Interconnection Cable 72" Interconnection Cable	NAHO-602 NAHO-606 NAHO-618 NAHO-636 NAHO-672
D	"Y" Splitter Cable	NAHO-600
E	"X" Splitter Cable	NAHO-601
F	Flexible 6' Power Cord	NRA-6035W/6
L	4" High Output LED Tape Light 12" High Output LED Tape Light 16' High Output LED Tape Light	NUTP2-LED(color)/4 NUTP2-LED(color)/12 NUTP2-16LED(color)

ACCENT, UNDER CABINET, LINEAR, COVE LIGHTING

Ultra Slim T5 Fluorescent

T5 Fluorescent slim, low profile under cabinet lighting fixtures ranging in length from 13-1/2" (34cm) to 47" (119cm) and 8 to 28 watts. Ideal for narrow spaces where bright even illumination is required.

Features:

- Ultra-slim (7/8" width) profile
- Cool, white T5 lamp included
- Solid state electronic ballast
- 6 sizes ranging 13-1/2" - 47"
- Daisy-chain up to 10 fixtures together
- Straight connections for long, shadow-free runs
- Power cord and straight connector included
- Flexible connectors in 6", 12", 18", and 72" lengths
- Each fixture includes On / Off switch
- Simple, instant plug-in electrical connection
- Installation packet includes clips for invisible or "U" bracket mounting
- Flicker-free start up
- High performance, cool operation
- Instant and easy installation
- cULus Listed

Housing: 0.09" injection molded white plastic construction

Mounting: Hardware provided for mounting fixture either to standard horizontal surface or to vertical wall surface

Electrical: Socket accepts bi-pin T5 fluorescent light source. Fixture contains recessed male connector for attachment to female receptacle from either 120V power cord or connector from other fixture. Fixtures can be hardwired with NUSP-JBox. Integral solid state ballast for efficient operation. Rocker switch on the side of the fixture allows for independent on / off control.

Note: 10 fixtures maximum may be connected together on single 120V power cord feed. Do not exceed 10 fixtures per feed.

Included with every fixture: 6' cord and plug, straight connector, (2) "U" Clips, (2) perpendicular clips, (2) invisible clips, screws, On/Off switch, and Cool White T5 lamp.

Listings:

cULus Listed for Dry Location
cULus Listed as Portable Fixture



actual size shown!



NRA-125 Series Connected



NRA-125 Connected



ULTRA SLIM T5 FLUORESCENT

CATALOG. NO.	LENGTH	LAMP	WATTAGE
NULS-8	13-1/2"	F8T5/CW 4100K (included)	8 Watt
NULS-13	22-1/2"	F13T5/CW 4100K (included)	13 Watt
NULS-18	25-1/8"	F18T5/CW 4100K (included)	18 Watt
NULS-21	35-1/2"	F21T5/CW 4100K (included)	21 Watt
NULS-24	37-1/4"	F24T5/CW 4100K (included)	24 Watt
NULS-28	47"	F28T5/CW 4100K (included)	28 Watt

ULTRA SLIM T5 FLUORESCENT ACCESSORIES

CATALOG. NO.	DESCRIPTION
NRA-125	13/16" Straight Connector, creates 1/2" between two fixtures
NRA-125/6	6" Flexible Connector
NRA-125/12	12" Flexible Connector
NRA-125/18	18" Flexible Connector
NRA-125/72	72" Flexible Connector
NRA-127	Mounting Hardware Package (included with each fixture)
NRA-143W	Right Angle Connector, White
NRA-6047	Mounting Clips, White
NUSP-JBox	J-Box for hard wiring, UL Listed includes male to male and male to female connector



ACCENT, UNDER CABINET, LINEAR, COVE LIGHTING
Ultra Slim T5 Fluorescent Sample Layout

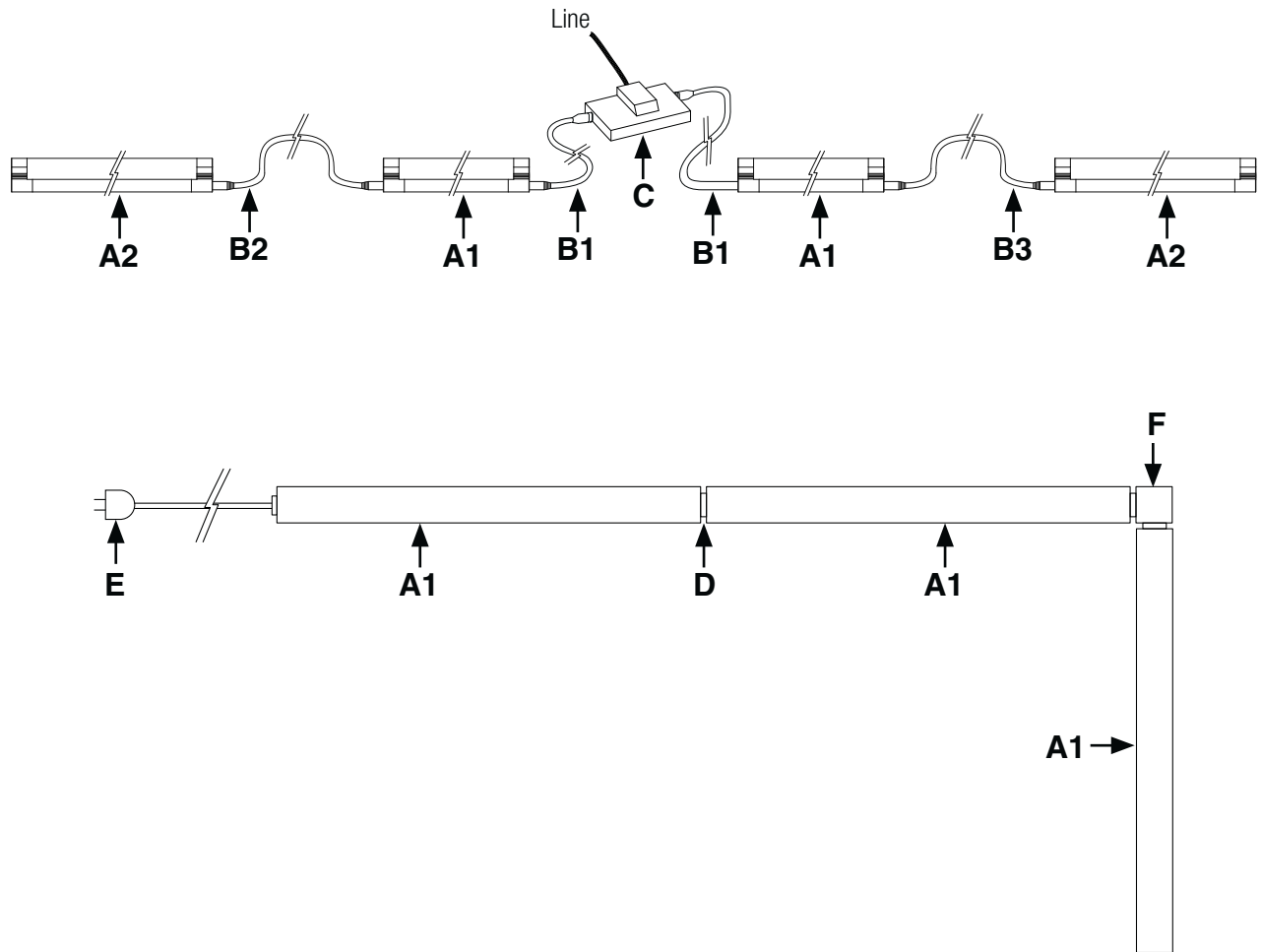

	DESCRIPTION	ITEM #
A1	21 Watt T5 Ultra Slim Fluorescent	NULS-21
A2	28 Watt T5 Ultra Slim Fluorescent	NULS-28
B1	6" Flexible Connector	NRA-125/6
B2	18" Flexible Connector	NRA-125/18
B3	72" Flexible Connector	NRA-125/72
C	Junction Box for Hardwiring	NUSP-JBox
D	Straight Connector (included with fixture)	NRA-125
E	6' Cord and Plug (included with fixture)	NRA-6035W/6
F	Right Angle Connector	NRA-143W

Notes:

1. Maximum of 10 fixture per run.
2. Each fixture has built-in on/off switch
3. Included hardware pack allows for invisible or "U" clip mounting

ACCENT, UNDER CABINET, LINEAR, COVE LIGHTING

Mini Inch Fluorescent

Lighting Tip: To light a back splash, mount to the rear of cabinet. To light the counter top more, mount toward the front of the cabinet. Use bronze fixtures on dark cabinets.

T5 Fluorescent under cabinet lighting fixtures ranging in lengths from 12" (32cm) to 42" (108cm) and 8 to 26 watts. Only 1" deep.

Features:

- Solid state FCC 18A compliant
- Post painted no exposed raw edges
- Die-formed housing of cold rolled steel
- Solid state electronic ballast
- 5 sizes ranging 12-1/4" - 42-1/2"
- One piece extruded diffuser with UV resistors
- Finished in baked white enamel, bronze, natural metal
- Knockouts provided on the top corner for on-off switch and outlet installation
- Knockouts provided at the side, back and rear for easy installation
- Keyhole mounting slots on the back
- Completely wired and ready for installation
- Suitable for individual or continuous rows
- Flicker-free start up
- High performance, cool operation
- Instant and easy installation
- UL and cUL Listed

Housing: Die-formed 0.040" cold rolled steel, 2-piece housing. Housing contains two 1/2" and 5/8" knockouts on bottom and side surfaces for easy access to wiring.

Mounting: Two (2) mounting screws provided for installation into wood surface via two keyhole slots located in the back of the fixture housing.

Electrical: Socket plate contains socket(s) to accept bi-pin T5 fluorescent light source (optional). Fixture is pre-wired for immediate hardwire connection to 120V power source. Integral Class-P, 120V electronic ballast for efficient operation. Includes Romex® connector

Listings:

cULus Listed
FCC Part 18A
Energy Star Rated

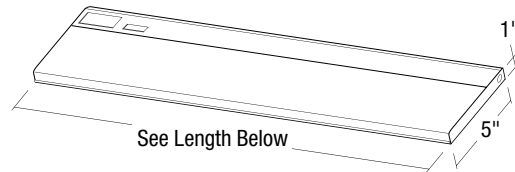

MINI INCH FLUORESCENT

CATALOG. NO.	LENGTH	LAMP(S)	FINISH
NU-12L	12-1/4"	(1) 8W T5 Cool White (included)	White
NU-12LBZ	12-1/4"	(1) 8W T5 Cool White (included)	Bronze
NU-12LN	12-1/4"	(1) 8W T5 Cool White (included)	Natural Metal
NU-21L	21-1/4"	(1) 13W T5 Cool White (included)	White
NU-21LBZ	21-1/4"	(1) 13W T5 Cool White (included)	Bronze
NU-21LN	21-1/4"	(1) 13W T5 Cool White (included)	Natural Metal
NU-24L	24-1/2"	(2) 8W T5 Cool White (included)	White
NU-24LBZ	24-1/2"	(2) 8W T5 Cool White (included)	Bronze
NU-24LN	24-1/2"	(2) 8W T5 Cool White (included)	Natural Metal
NU-32L	33-1/2"	(1) 8W T5 & (1) 13W T5 Cool White (included)	White
NU-32LBZ	33-1/2"	(1) 8W T5 & (1) 13W T5 Cool White (included)	Bronze
NU-32LN	33-1/2"	(1) 8W T5 & (1) 13W T5 Cool White (included)	Natural Metal
NU-42L	42-1/2"	(2) 13W T5 Cool White (included)	White
NU-42LBZ	42-1/2"	(2) 13W T5 Cool White (included)	Bronze
NU-42LN	42-1/2"	(2) 13W T5 Cool White (included)	Natural Metal

For factory installed rocker switch, add suffix "S" (for white unit only)

MINI INCH FLUORESCENT ACCESSORIES

CATALOG. NO.	DESCRIPTION	CATALOG. NO.	DESCRIPTION
NUL-12	Replacement Lens for NU-12	NUL-42	Replacement Lens for NU-42
NUL-21	Replacement Lens for NU-21	NUO-01	Grounded Convenience Outlet, 15A
NUL-24	Replacement Lens for NU-24	NUR-01	Rocker Switch
NUL-32	Replacement Lens for NU-32		



Lighting Tip:

Excellent source for bright even illumination in linear style closets.

ACCENT, UNDER CABINET, LINEAR, COVE LIGHTING

1-3/4" Fluorescent

NEW!

Now cUL Listed for general use

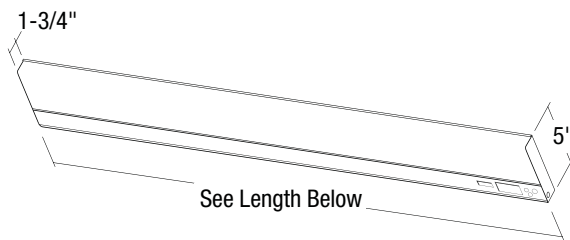

The 1-3/4 inch linear series has a low 1-3/4" profile and comes in five different lengths. cUL listed for general use this is ideal for closets, workshops, pantries and under cabinet applications.

Features:

- Economical
- Unobtrusive light source
- Energy efficient
- Easy to install
- Die-formed housing of cold rolled steel
- One piece white acrylic diffuser
- High gloss baked white enamel finish
- Knockouts provided on back, rear and sides for easy installation
- Knockouts provided for switch and convenience outlet
- Keyhole mounting slots provided on the back
- Completely wired and ready for installation
- Suitable for individual or continuous rows
- New electronic rapid start 120V ballast
- UL and cUL Listed for general use

Housing: Die-cast formed 0.040" rolled steel, 2-piece housing. Housing contains two 1/2", two 1/4", and five 1" knockouts for power feed. One of the 1" knockouts is located on bottom surface of housing for direct feed to back of fixture.

Mounting: Two (2) mounting screws provided for installation into wood surface via two keyhole slots located in the back of the fixture housing.

Electrical: Socket plate contains sockets to accept bi-pin T8 and T12 fluorescent light source (not included). Fixture is pre-wired for immediate hard wire connection to 120V power source. Integral Class-P, 120V Normal Power Factor ballast for efficient operation.

Listings:
cULus Listed



1-3/4" FLUORESCENT

CATALOG. NO.	LENGTH	BALLAST	LAMP
NU-1312EL	12-1/4"	Electronic	13W T8 (ordered separately)
NU-1518EL	18"	Electronic	15W T8 or 15W T12 (ordered separately)
NU-2024EL	24"	Electronic	17W T8 or 20W T12 (ordered separately)
NU-3036EL	36"	Electronic	25W T8 or 30W T12 (ordered separately)
NU-4048EL	48"	Electronic	32W T8 or 40W T12 (ordered separately)

1-3/4" FLUORESCENT ACCESSORIES

CATALOG. NO.	DESCRIPTION
NUL-1312	Replacement Lens for NU-1313EL
NUL-1518	Replacement Lens for NU-1518EL
NUL-2024	Replacement Lens for NU-2024EL
NUL-3036	Replacement Lens for NU-3036EL
NUL-4048	Replacement Lens for NU-4048EL
NUO-01	Grounded Convenience Outlet, 15A
NUR-01	Rocker Switch



ACCENT, UNDER CABINET, LINEAR, COVE LIGHTING

Line Voltage Halogen Under Cabinet

Nora Lighting offers this line voltage Halogen Under Cabinet family. These versatile performers feature a slim, 1-inch depth and have attractive finishes. Available in two or three-light configurations, these Mini Halogen light strips are perfect where higher levels of light in a small space are required. These products include a cord and plug as well as a two-position high/low switch. And, as an extra bonus, lamps are included!

Features:

- No transformer
- Efficient 20W G8 / JCD bulb - equivalent to 60W incandescent (included)
- Elliptical reflectors
- 2,000 hours lamp life
- Available as plug-in only
- Frosted lenses reduce glare
- Two-level switch; high, low
- Available for use with daisy-chained connectors (NRA-105 included)
- Choice of colors: Gold (G), Natural Metal (N), or White (W)
- UL and cUL Listed

Housing: Solid 0.025" steel backing for efficient heat dissipation. Steel 0.025" vacuum-metalized/painted face. Internal polished steel rectangular reflectors provide optimal light output. Beveled face and oval lens knockouts provide clean aesthetic design appearance.

Mounting: Four (4) mounting screws provided for installation into wood surface via two elongated keyhole slots located in the back of the fixture housing.

Electrical: Heavy-duty, long life ceramic bi-pin sockets 5-1/2" (14cm) on center for 20W G8 lamp source. Power switch provides two different light levels. Power cord terminates with standard, 2-prong polarized plug.

Listings:

UL and cUL Listed as Portable Lamp fixture

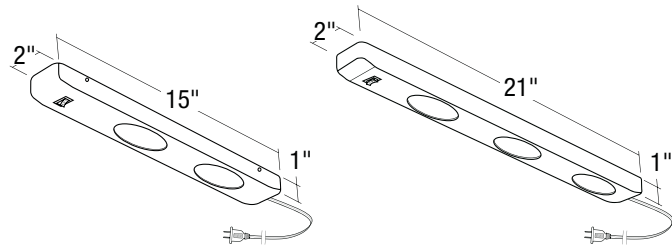

LINE VOLTAGE HALOGEN UNDER CABINET

CATALOG. NO.	LENGTH	LAMP	FINISH
NUL-315G	15"	2 x 20W G8 Halogen (included)	Gold
NUL-315N	15"	2 x 20W G8 Halogen (included)	Natural Metal
NUL-315W	15"	2 x 20W G8 Halogen (included)	White
NUL-321G	21"	3 x 20W G8 Halogen (included)	Gold
NUL-321N	21"	3 x 20W G8 Halogen (included)	Natural Metal
NUL-321W	21"	3 x 20W G8 Halogen (included)	White

LINE VOLTAGE HALOGEN UNDER CABINET ACCESSORIES

CATALOG. NO.	DESCRIPTION	CATALOG. NO.	DESCRIPTION
NRA-105/6B	6" Flexible Connector, Black	NRA-105/24B	24" Flexible Connector, Black
NRA-105/6W	6" Flexible Connector, White	NRA-105/24W	24" Flexible Connector, White
NRA-105/12B	12" Flexible Connector, Black	NRA-105B	End to End Connector, Black
NRA-105/12W	12" Flexible Connector, White	NRA-105W	End to End Connector, White



ACCENT, UNDER CABINET, LINEAR, COVE LIGHTING

Low Voltage Halogen Under Cabinet

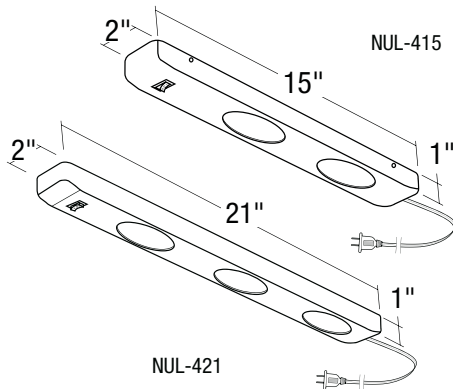

Nora Lighting offers this beautiful family of low voltage halogen undercabinets. The NUL-415 and 421 are a pleasure to look at with smooth profiles, rounded edges and beveled ends. Providing crisp white low voltage halogen light, the solid one-piece oval reflectors provide superior light performance, with the edges softened by high quality tempered frosted glass lenses. The metal is finished in traditional gold, natural metal or white.

Features:

- Plug-In installation
- Integral 12V Transformer
- 2,000 Hour Lamp Life
- Two-level switch; high, low
- Frosted lenses reduce glare
- Three High Quality Finishes
- Pre-Installed Hi/Lo Power Switch
- Reduced-Glare Frosted Lenses
- Choice of colors: Gold (G), Natural Metal (N), or White (W)
- UL and cUL Listed

Housing: Solid 0.025" steel backing for efficient heat dissipation. Steel 0.025" vacuum-metalized/painted face. Internal polished steel rectangular reflectors provide optimal light output. Beveled face and oval lens knockouts provide clean aesthetic design appearance.

Mounting: Four (4) mounting screws provided for installation into wood surface via two elongated keyhole slots located in the top of the fixture housing.

Transformer: Electronic solid state Class P, Thermally Protected Transformer.

Electrical: Heavy-duty, long life ceramic bi-pin sockets 5-1/2" (14cm) on center for 20W T3 lamp source. Power switch provides two different light levels. Power cord terminates at standard, 2-prong polarized plug; additionally, a single one-inch knockout in the back of the fixture housing allows user to hard wire the fixture to a 120V power source if desired.

Lamp: 20 Watt, 12 Volt, T3 G4 Base (included)

Listings:

UL and cUL Listed as Portable Lamp fixture

LOW VOLTAGE HALOGEN UNDER CABINET

CATALOG. NO.	LENGTH	LAMP	FINISH
NUL-415G	15"	2 x 20W T3 G4 Base (included)	Gold
NUL-415N	15"	2 x 20W T3 G4 Base (included)	Natural Metal
NUL-415W	15"	2 x 20W T3 G4 Base (included)	White
NUL-421G	21"	3 x 20W T3 G4 Base (included)	Gold
NUL-421N	21"	3 x 20W T3 G4 Base (included)	Natural Metal
NUL-421W	21"	3 x 20W T3 G4 Base (included)	White





ACCENT, UNDER CABINET, LINEAR, COVE LIGHTING

LED Puck Light



Nora Lighting introduces a new slim LED Puck Light system for accent, under cabinet, in cabinet, display cases, niche, furniture, jewelry cases, and other applications with limited space. These low-profile fixtures can be linked together to provide excellent and even illumination on all surfaces. The Nora LED Puck Light is one of the most energy efficient products in the market. Combined with ultra low-profile housing, Nora's LED Puck offers unique features and a great ease of installation. LED technology eliminates forward heat from the fixture, also no UV or infrared rays to harm artwork, retail displays or heat sensitive foods.

Features:

- Title 24 Compliant, energy efficient
- LEDs produce 70 lumens per watt (210 Lumens and 3 Watts per each unit)
- Available in single units or a three-puck kit
- Ten pucks can be daisy-chained on a single run
- 90' Maximum Distance
- Available in 3000K & 4200K
- Well suited for very small spaces: 1/2" deep with 2-3/4" diameter
- Easy installation using one screw
- 3", 6", 12", and 24" interconnectors included with each puck (can be linked together)
- Dimmable with Dimmable Power Supply
- RoHS compliant
- ETL and cETL listed for dry locations
- 30,000 hours of rated lamp life

LED PUCK LIGHT (12V SYSTEM)

CATALOG. NO.	WATTAGE	COLOR TEMPERATURE	FINISH
NMPK1-3LED30BZ	3W	3000K	Bronze
NMPK1-3LED30C	3W	3000K	Chrome
NMPK1-3LED30W	3W	3000K	White
NMPK1-3LED42BZ	3W	4200K	Bronze
NMPK1-3LED42C	3W	4200K	Chrome
NMPK1-3LED42W	3W	4200K	White

LED PUCK LIGHT KIT

CATALOG. NO.	PUCKS INCLUDED	COLOR TEMPERATURE	FINISH
NMPK2-3LED30BZ	3 LED Pucks (included)	3000K	Bronze
NMPK2-3LED30C	3 LED Pucks (included)	3000K	Chrome
NMPK2-3LED30W	3 LED Pucks (included)	3000K	White

Housing: Die-cast aluminum, round, available in 3 different colors with matching interconnectors: white and chrome (both with white), and bronze (with black).

Puck Light Kit: LED Puck Light Kit is a complete package ready from the box. Includes (3) 3000K LED Puck Lights, three sets of 3", 6", 12", & 24" interconnection cables, (1) 12" Power Line Interconnector with switch, (3) mounting clips and (1) 24W Direct Plug-In Driver.

Color Temperatures:

Warm White (3000K) or Cool White (4200K)

Finishes: Bronze (BZ), Chrome (C), or White (W)

Electrical:

- Voltage:** 12 Volt
- Input Watts:** 3W (1.2W per LED)
- Lumens at 4200K:** 210 lumens
- Efficacy at 4200K:** 70 lumens per watt
- Number of LEDs:** 3 per puck
- Maximum Distance:** 90' (10 LED Puck Lights max.)
- Estimated Life:** 30,000 hours

Listings:

ETL and cETL Listed for Dry Location
 RoHS Compliant
 Title 24 Compliant
 California Energy Commission
 3 Year Limited Warranty



ACCENT, UNDER CABINET, LINEAR, COVE LIGHTING

LED Puck Light Accessories and Drivers



Power Line Interconnector

NAPK-709B Black Cable

NAPK-709W White Cable

Length: 18"

Description: To connect a LED Puck Light run to a LED Driver

Note: Can be lengthened with interconnection cable



Power Line Interconnector with On/Off Switch

NAPK-711B Black Cable

NAPK-711W White Cable

Length: 12"

Description: To allow individual switching of any LED Puck Light run.



Interconnection Cables

NAPK-702 2" Cable

NAPK-703 3" Cable

NAPK-706 6" Cable

NAPK-712 12" Cable

NAPK-724 24" Cable

NAPK-736 36" Cable

NAPK-748 48" Cable

Cable Finish: Black (B) or White (W)

Description: Interconnection cables allow for easy linking of any two LED Puck Lights. Extend the length between pucks or to extend length of power line interconnector. Connections are male/female and can be joined together for custom lengths. (A 3", 6", 12" and 24" are included with each puck)



Splitter

NAPK-701B Black Splitter

NAPK-701W White Splitter

Description: To separate 3 LED Puck Light runs from a single driver or to split a run between puck lights.

Input: One

Output: Three



Dimmable Class II Remote Hardwire Magnetic Power Supply*

NMT-60/12C2 60W

Voltage: 12V DC

Cable Length: 10 Foot included (30' Cable ordered separately)

Maximum Load: 24 LED Puck Lights (10 LED Puck Lights maximum per run)



Power Line Connector

NAPK-10 10' Cable

NAPK-30 30' Cable

Description: To be used with NMT-60/12C2 Class II LED Driver. NAPK-10 is included with NMT-60/12C2.



Direct Plug-In Driver*

NAPK-524/12 24W

NAPK-550/12 50W

Voltage: 12V DC

Cable Length: 6 Feet



Class II LED Driver*

NAPK-530HW/12 30W

NAPK-560HW/12 60W

Voltage: 12V DC

Input Wire: 4" Input Wire

Output Wire: 3-1/4" Wire

Requires: NUSP-JBox for hard wiring

Note: Convert to plug-in driver with NRA-6035

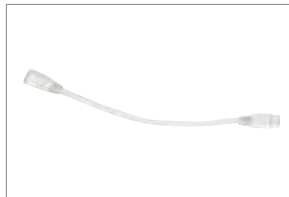

Flexible Extension Cord

NRA-125/6 6" Cable

NRA-125/12 12" Cable

NRA-125/18 18" Cable

NRA-125/72 72" Cable

Description: Used to extend length between NUSP-JBox and NAPK-530HW/12 or NAPK-560HW/12. Can be joined together to create custom lengths.



Flexible Power Cord

NRA-6035W/6 6' Cable

NRA-6035W/10 10' Cable

Description: Used to convert NAPK-530HW/12 or NAPK-560HW/12 into a direct plug-in driver.



Junction Box for Hard Wiring

NUSP-JBox

Description: To be used with NAPK-530HW/12 or NAPK-560HW/12 Drivers. Capable of feeding two separate LED Drivers. Accepts Romex® or flex.

*Note: All drivers require NAPK-709 or NAPK-711 power line interconnector to connect to puck. * Specifications for Drivers on page 706

ACCENT, UNDER CABINET, LINEAR, COVE LIGHTING LED Puck Light Sample Layout

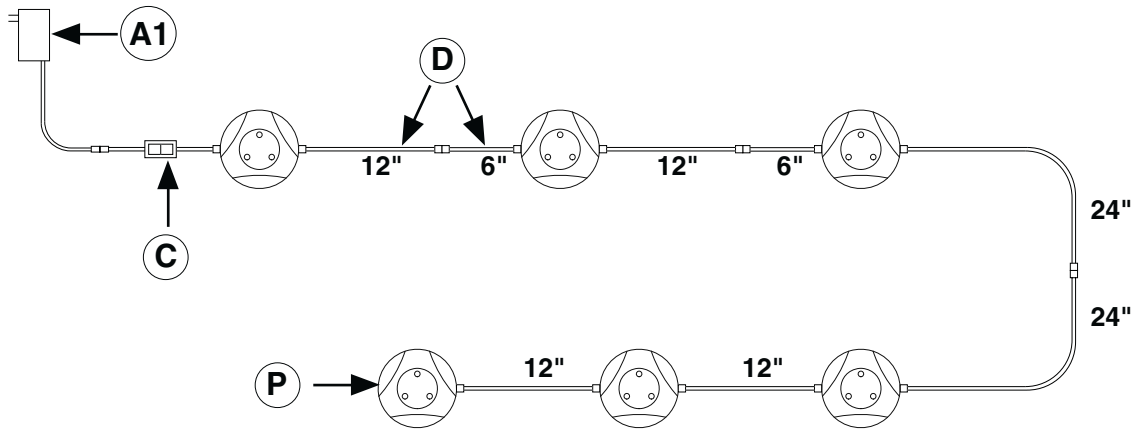

	DESCRIPTION	ITEM #
A1	24W Direct Plug-In Driver	NAPK-524/12
A2	60W Dmmable Class II Power Supply	NMT-60/12C2
B	18" Power Line Interconnector	NAPK-709
C	18" Power Line Interconnector with Switch	NAPK-711
D	2" Interconnection Cable	NAPK-702
	3" Interconnection Cable (included w/ ea. Puck)	NAPK-703
	6" Interconnection Cable (included w/ ea. Puck)	NAPK-706
	12" Interconnection Cable (included w/ ea. Puck)	NAPK-712
	24" Interconnection Cable (included w/ ea. Puck)	NAPK-724
	36" Interconnection Cable	NAPK-736
	48" Interconnection Cable	NAPK-748
E	Splitter	NAPK-701
P	LED Puck Light	NMPK1-3LED

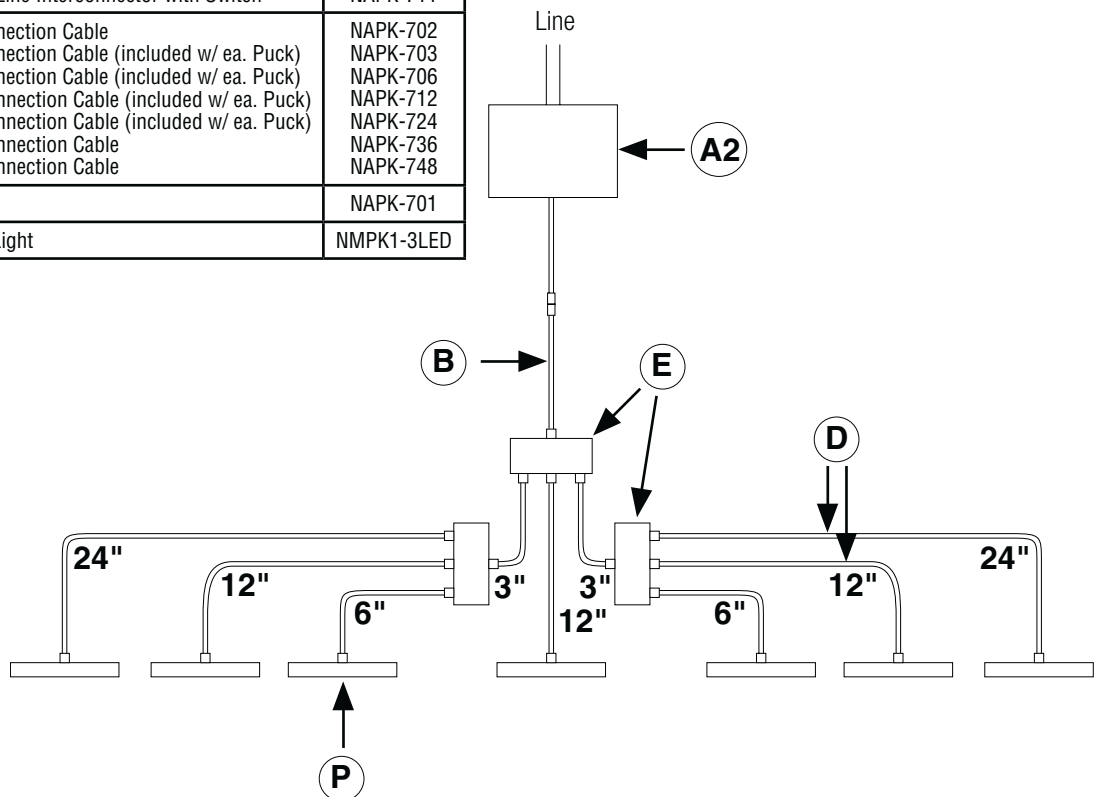



ACCENT, UNDER CABINET, LINEAR, COVE LIGHTING

Mini Low Voltage Xenon Puck Light

NOW IN
BRONZE



NM-127
Grooved



NOW IN
BRONZE



NM-128
Smooth

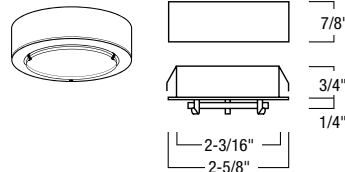
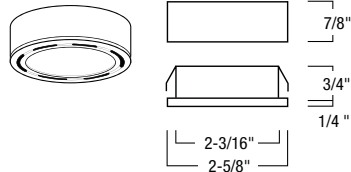

MINI LOW VOLTAGE XENON PUCK LIGHT

CATALOG. NO.	TRIM	LAMP (INCLUDED)	FINISH
NM-127	Grooved	20W Xenon T3 G4 Base max.	Black, Bronze, Chrome, Copper, Gold, Natural Metal, White
NM-128	Smooth	20W Xenon T3 G4 Base max.	Black, Bronze, Chrome, Copper, Gold, Natural Metal, White

Color and Optical Accessories ordered separately, see page 381
Transformers ordered separately, see pages 702-704



The Nora Lighting Mini Puck Light system provides state-of-the-art design with size, function and good looks in mind. The highly tooled construction of die-cast aluminum housing and tempered glass provides consistent quality and fine craftsmanship. Included with the fixture is the Xenon G4/JC Lamp, rated for 20 watts providing 350 initial lumens, and 72" lead wire. The Mini Puck Lights can be accessorized with various color filters, spread lenses, and transformers. All fixtures are UL and cUL Listed and the transformers are UL® recognized.

Features:

- Die-cast aluminum housing
- UV Tempered clear and frosted glass shield included
- High quality specular finish
- Recessed or Surface Mounted
- 72" Leads
- Dimmable

Mounting:

Housings and mounting screws are provided for recessed or surface applications.

Transformer:

12V Electronic, solid state low voltage transformer or magnetic transformer is required for operation. Approved for remote applications. Order transformer separately, see pages 702-704.

Dimming:

Dimmable with electronic low voltage dimmer with electronic low voltage transformer or magnetic low voltage dimmer with magnetic low voltage transformer.

Electrical:

Lamp socket with fiberglass insulated wiring is provided with strain relief installed into the housing's rear of G4 surface fixtures.

Lamp:

20 Watt, 12 Volt, T3 G4 Base (included) max.

Included with every fixture:

- Housing with matching finish for surface mounted applications
- 12V, T3 Xenon, 2800K, G4 Base Lamp
- 72" leads
- Clear and frosted UV glass lens

Finishes:

Black (B), Bronze (BZ), Chrome (C), Copper (CO), Gold (G), Natural Metal (N), and White (W).

Listing:

cULus Listed

ACCENT, UNDER CABINET, LINEAR, COVE LIGHTING

Mini Low Voltage Ultra-Slim Xenon Puck Light

The Nora Lighting Mini Puck Light system provides state-of-the-art design with size, function and good looks in mind. The highly tooled construction of die-cast aluminum housing and tempered glass provides consistent quality and fine craftsmanship. Included with the fixture is the Xenon G4/JC Lamp, rated for 10 watts providing 350 initial lumens, and 24" lead wire. The Mini Downlights can be accessorized with various color filters, spread lenses, and transformers. All fixtures are UL and cUL Listed and the transformers are UL® recognized.

Features:

- Die-cast aluminum body
- UV Tempered clear and frosted glass shield included
- High quality specular finish
- Recessed or Surface Mounted
- Ultra-Slim Profile
- Dimmable

Mounting:

Installs flush to cabinetry without the need to drill completely through the cabinet surface or can be surface mounted.

Transformer:

12V Electronic, solid state low voltage transformer or magnetic transformer is required for operation. Approved for remote applications. Order transformer separately, see pages 702-704.

Dimming:

Dimmable with electronic low voltage dimmer with electronic low voltage transformer or magnetic low voltage dimmer with magnetic low voltage transformer.

Electrical:

Lamp socket with fiberglass insulated wiring is provided with strain relief installed into the housing's rear of G4 surface fixtures.

Lamp:

10 Watt, 12 Volt, T3 G4 Base (included) max.

Included with every fixture:

- 12V, T3 Xenon, 2800K, G4 Base Lamp
- 24" leads
- Aluminum reflector inside die-cast housing
- Clear and frosted UV glass lens

Finishes:

Black (B), Chrome (C), Gold (G), and White (W).

Listing:

cULus Listed



NM-254

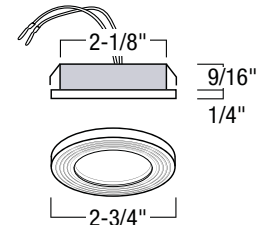

MINI LOW VOLTAGE ULTRA-SLIM XENON PUCK LIGHT

CATALOG. NO.	TRIM	LAMP (INCLUDED)	FINISH
NM-254	Ultra-Slim	10W Xenon T3 G4 Base max.	Black, Chrome, Gold, White

Color and Optical Accessories ordered separately, see page 381
Transformers ordered separately, see pages 702-704



ACCENT, UNDER CABINET, LINEAR, COVE LIGHTING

Mini Solution Xenon Puck Light Collection



The Nora Lighting Mini Puck Light Solution system provides state-of-the-art design with size, function and good looks in mind. The highly tooled construction of die-cast aluminum housing and tempered glass provides consistent quality and fine craftsmanship. The units may be recessed or surface mounted (housing supplied). Included with the fixture is the Xenon G4/JC Lamp, rated for 20 watts providing 350 initial lumens, and 24" lead wire. The Mini Puck Light Solutions can be accessorized with various color filters, spread lenses, and transformers. All fixtures are UL and cUL Listed and the transformers are UL® recognized.

Features:

- Die-cast aluminum body
- UV Tempered clear and frosted glass shield included
- High quality specular finish
- Can be recessed or surface mounted
- Blister pack
- Dimmable
- Available in four finishes
- 24" lead wire and connector

Mounting: Housings and mounting screws are provided for recessed or surface applications.

Transformer: 12V Electronic, solid state low voltage transformer or magnetic transformer is required for operation. Approved for remote applications. Order transformer separately, see pages 702-704.

Dimming:

Dimmable with electronic low voltage dimmer with electronic low voltage transformer or magnetic low voltage dimmer with magnetic low voltage transformer.

Electrical: Lamp socket with fiberglass insulated wiring is provided with strain relief installed into the housing's rear of G4 surface fixtures.

Lamp: 20 Watt, 12 Volt, T3 G4 Base (included) max.

Included with every fixture:

- Housing with matching finish for surface mounted applications
- 20W, 12V, T3 Xenon, 2800K, G4 Base Lamp
- 24" leads with connector
- Clear & frosted UV glass lens

Finishes:

Black (B), Chrome (C), Gold (G), and White (W)

Listing:

cULus Listed

MINI SOLUTION XENON PUCK LIGHT COLLECTION

CATALOG. NO.	TRIM	LAMP (INCLUDED)	FINISH
NM-240	Grooved	20W Xenon T3 G4 Base max.	Black, Chrome, Gold, White
NM-241	Smooth	20W Xenon T3 G4 Base max.	Black, Chrome, Gold, White

Color and Optical Accessories ordered separately, see page 381
Transformers ordered separately, see pages 702-704



ACCENT, UNDER CABINET, LINEAR, COVE LIGHTING

Mini Solution Xenon Decorative Puck Lights

Decorative "Puck" fixtures with shallow cone-shaped tinted and frosted glass face. Provide soft even illumination with visual comfort and interest.

Features:

- Die-cast aluminum body
- Tempered glass
- High quality specular finish
- Can be recessed or surface mounted
- Dimmable
- Six high quality finishes
- Blister pack
- 24" lead wire and connector

Mounting:

Housings and mounting screws are provided for recessed or surface applications.

Gemstone:

Available in three different glass gemstone finishes:

- White Diamond (NM-251)
- Blue Sapphire (NM-252)
- Green Emerald (NM-253).

Transformer:

12V Electronic, solid state low voltage transformer or magnetic transformer is required for operation. Approved for remote applications. Order transformer separately, see pages 702-704.

Dimming:

Dimmable with electronic low voltage dimmer with electronic low voltage transformer or magnetic low voltage dimmer with magnetic low voltage transformer.

Electrical:

Lamp socket with fiberglass insulated wiring is provided with strain relief installed into the housing's rear of G4 surface fixtures.

Lamp:

10 Watt, 12 Volt, T3 G4 Base (included) max.

Included with every fixture:

- Housing with matching finish for surface mounted applications
- 10W, 12V, T3 Xenon, 2800K, G4 Base Lamp
- 24" leads with connector
- Tempered glass
- Blister packaging

Finishes:

Black (B), Chrome (C), Copper (CO), Gold (G), Natural Metal (N), and White (W).

Listing:
cULus Listed



Available in 5 finishes and 3 glass colors!
Black, Chrome, Copper, Gold, Natural Metal and White finishes;
Diamond, Sapphire and Emerald glass

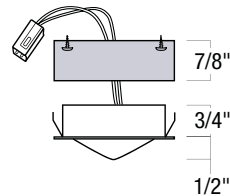
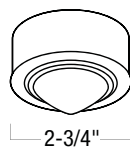

MINI SOLUTION XENON DECORATIVE PUCK LIGHTS

CATALOG. NO.	TRIM	LAMP (INCLUDED)	FINISH
NM-251	Diamond Gemstone	10W Xenon T3 G4 Base max.	Black, Chrome, Copper, Gold, Natural Metal, White
NM-252	Sapphire Gemstone	10W Xenon T3 G4 Base max.	Black, Chrome, Copper, Gold, Natural Metal, White
NM-253	Emerald Gemstone	10W Xenon T3 G4 Base max.	Black, Chrome, Copper, Gold, Natural Metal, White

Transformers ordered separately, see pages 702-704

ACCENT, UNDER CABINET, LINEAR, COVE LIGHTING

Mini Solution Xenon Decorative Puck Lights

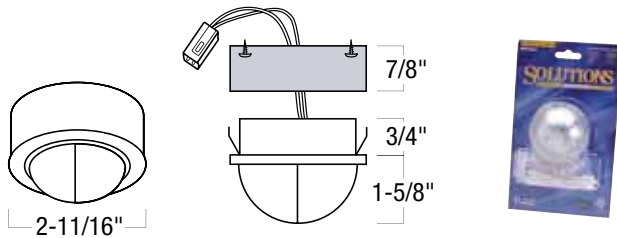

Decorative "Eye-Lid" puck light can be surface or recessed mounted. The "Eye-Lid" provides soft filtered wall wash light while hiding the source.

Features:

- Die-cast aluminum body
- Tempered glass
- Can be recessed or surface mounted
- Dimmable
- Six high quality finishes
- Blister pack
- 24" lead wire and connector

Mounting:

Housings and mounting screws are provided for recessed or surface applications.

Eyelid:

Solid die-cast shield with frosted glass

Transformer:

12V Electronic, solid state low voltage transformer or magnetic transformer is required for operation. Approved for remote applications. Order transformer separately, see pages 702-704.

Dimming:

Dimmable with electronic low voltage dimmer with electronic low voltage transformer or magnetic low voltage dimmer with magnetic low voltage transformer.

Electrical:

Lamp socket with fiberglass insulated wiring is provided with strain relief installed into the housing's rear of G4 surface fixtures.

Lamp:

10 Watt, 12 Volt, T3 G4 Base (included) max.

Included with every fixture:

- Housing with matching finish for surface mounted applications
- 10W, 12V, T3 Xenon, 2800K, G4 Base Lamp
- 24" leads with connector
- Tempered glass
- Blister packaging

Finishes:

Black (B), Chrome (C), Copper (CO), Gold (G), Natural Metal (N), and White (W).

Listing:

cULus Listed

MINI SOLUTION XENON DECORATIVE PUCK LIGHTS

CATALOG. NO.	TRIM	LAMP	FINISH
NM-250B	Eyelid	10W Xenon T3 G4 Base (included) max.	Black
NM-250C	Eyelid	10W Xenon T3 G4 Base (included) max.	Chrome
NM-250CO	Eyelid	10W Xenon T3 G4 Base (included) max.	Copper
NM-250G	Eyelid	10W Xenon T3 G4 Base (included) max.	Gold
NM-250N	Eyelid	10W Xenon T3 G4 Base (included) max.	Natural Metal
NM-250W	Eyelid	10W Xenon T3 G4 Base (included) max.	White

Transformers ordered separately, see pages 702-704



ACCENT, UNDER CABINET, LINEAR, COVE LIGHTING

Mini Low Voltage MR11/MR16 Adjustable Downlight

Thermally protected for Non-IC Ceiling Applications
1-3/4" and 2-5/16" Apertures

Nora Lighting offers the miniature recessed MR16 and MR11 series for applications where a wide range of lamps, colors and light-beam spreads are required to accomplish a specific task. The fixture, lamp and integral trim swivel to allow directional control of the light beam. The Mini Halogen Downlight can be used with various color filters and spread lenses. Designed for use with remote transformers. All fixtures are UL and cUL listed and the transformers are all UL® recognized.

Features:

- UV Tempered clear glass shield included
- High quality specular finish
- Dimmable
- Available in 7 finishes
- Adjustable up to 20 degrees
- Thermally protected
- ETL Listed for use in Non-IC ceilings

Mounting: Mini tower housing with thermal protector are required for fixtures, ordered separately.

NM-129 requires NH-120B housing (ordered separately)

NM-130 requires NH-121B housing (ordered separately)

Transformer: 12V Electronic, solid state low voltage transformer or magnetic transformer is required for operation. Approved for remote applications. Order transformer separately, see pages 702-704.

Dimming:

Dimmable with electronic low voltage dimmer with electronic low voltage transformer or magnetic low voltage dimmer with magnetic low voltage transformer.

Electrical: Lamp socket with fiberglass insulated wiring is provided for direct attachment to MR11 or MR16 lamps. 18" (46cm) wire lead included.

Lamp:

NM-129: 20W, 12V, MR16 max. (ordered separately)
NM-130: 20W, 12V, MR11 max. (ordered separately)

Finishes: Available in 7 finishes: Black (B), Bronze (BZ), Chrome (C), Copper (CO), Gold (G), Natural Metal (N), and White (W).

Listing:
ETL Listed



NOW IN BRONZE



NM-129 MR16



NM-130 MR11

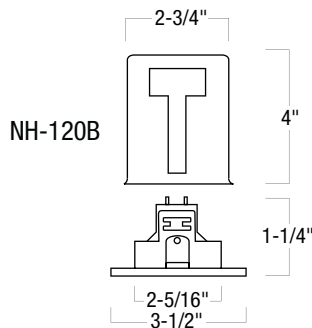
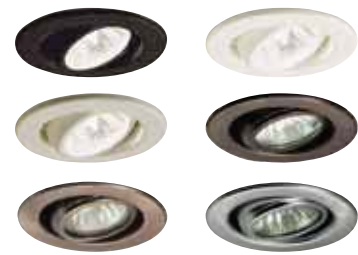

NH-120B

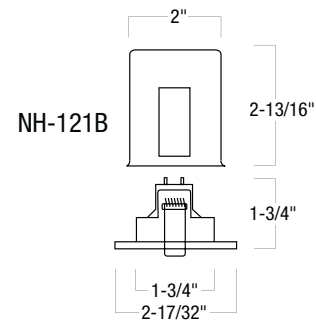

NH-121B

MINI LOW VOLTAGE MR11/MR16 DOWNLIGHT HOUSINGS

CATALOG. NO.	COMPATIBLE TRIM	FINISH	HEIGHT	WIDTH
NH-120B	NM-129 (MR16)	Black	4"	2-3/4"
NH-121B	NM-130 (MR11)	Black	2-13/16"	2"

MINI LOW VOLTAGE MR11/MR16 ADJUSTABLE TRIMS

CATALOG. NO.	TRIM	LAMP (NOT INCLUDED)	FINISH
NM-129	MR16 Surface Eyeball	20W MR16 max.	Black, Bronze, Chrome, Copper, Gold, Natural Metal, White
NM-130	MR11 Surface Eyeball	20W MR11 max.	Black, Bronze, Chrome, Copper, Gold, Natural Metal, White

Color and Optical Accessories ordered separately, see page 381
Transformers ordered separately, see pages 702-704

ACCENT, UNDER CABINET, LINEAR, COVE LIGHTING

Mini Solution MR11 Reflector Downlight

Thermally protected for Non-IC Ceiling Applications

1-3/8" Aperture



Small 1-3/8" aperture downlight has a deep set lamp for minimal glare. For use with remote transformers.

Features:

- Die-cast aluminum body
- UV Tempered clear glass shield included
- High quality specular finish
- Dimmable
- 3" Miniature housing included
- Blister pack
- Thermally protected
- ETL Listed for use in Non-IC ceilings

Mounting: Housings are included for recessed applications.

Transformer: 12V Electronic, solid state low voltage transformer or magnetic transformer is required for operation. Approved for remote applications. Order transformer separately, see pages 702-704.

Dimming:

Dimmable with electronic low voltage dimmer with electronic low voltage transformer or magnetic low voltage dimmer with magnetic low voltage transformer.

Electrical: MR11 lamp socket with fiberglass insulated wiring is provided with strain relief is installed into the housing rear. 24" wire lead with connector included.

Lamp:

20W, 12 Volt, MR11 max. (ordered separately)

Included with every fixture:

- 3" miniature housing
- 24" leads with connector
- Clear UV glass lens
- Blister packaging

Finishes: Black (B), Chrome (C), Gold (G), Natural Metal (N), and White (W)

Listing:

ETL Listed

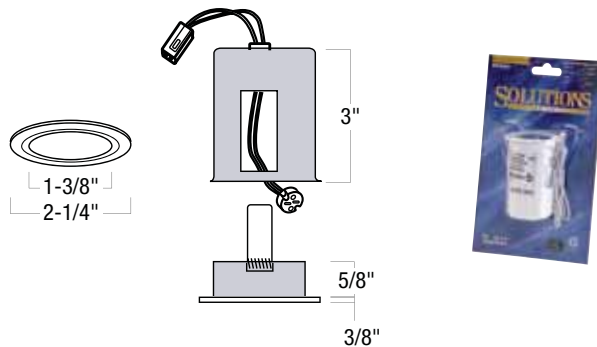

MINI SOLUTION MR11 REFLECTOR DOWNLIGHT

Housing included

CATALOG. NO.	LAMP	REFLECTOR FINISH	RING FINISH
NM-242B	20W MR11 (ordered separately) max.	Black	Black
NM-242C	20W MR11 (ordered separately) max.	Chrome	Chrome
NM-242G	20W MR11 (ordered separately) max.	Gold	Gold
NM-242N	20W MR11 (ordered separately) max.	Natural Metal	Natural Metal
NM-242W	20W MR11 (ordered separately) max.	White	White

Color and Optical Accessories ordered separately, see page 381
Transformers ordered separately, see pages 702-704



ACCENT, UNDER CABINET, LINEAR, COVE LIGHTING

Mini Solution MR11 Baffle Downlights

Thermally protected for Non-IC Ceiling Applications
1-3/4" Aperture

Small 1-3/4" baffled aperture downlight has excellent glare control. For use with remote transformers.

Features:

- Die-cast aluminum body
- UV Tempered clear glass shield included
- High quality die-cast baffle
- Dimmable
- Miniature housing included
- Blister pack
- 24" lead wire
- Thermally protected
- ETL approved for use in non-insulated ceilings

Mounting: Housings are included for recessed applications.

Transformer: 12V Electronic, solid state low voltage transformer or magnetic transformer is required for operation. Approved for remote applications. Order transformer separately, see pages 702-704.

Dimming:

Dimmable with electronic low voltage dimmer with electronic low voltage transformer or magnetic low voltage dimmer with magnetic low voltage transformer.

Electrical: Socket with fiberglass insulated wiring is provided with strain relief is installed into the housing rear. 24" wire lead included.

Lamp:

20W, 12 Volt, MR11 max (ordered separately)

Included with every fixture:

- 3" miniature housing with trim
- 24" leads
- Clear UV glass lens
- Blister packaging

Baffle Finishes:

Black (NM-243) or White (NM-244)

Ring Finishes:

Black (B), Chrome (C), Gold (G), and White (W)

Listing:

ETL Listed

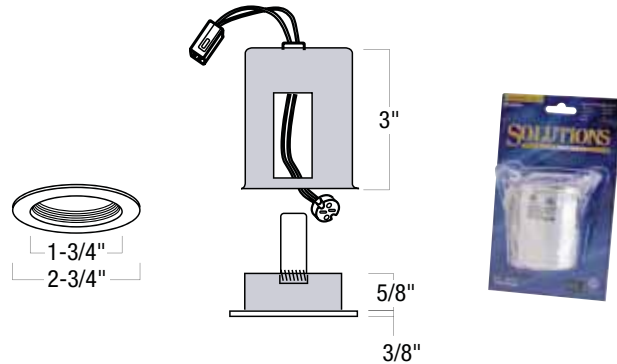

MINI SOLUTION MR11 BAFFLE DOWNLIGHTS

Housing included

CATALOG. NO.	LAMP	BAFFLE FINISH	RING FINISH
NM-243B	20W MR11 (ordered separately) max.	Black	Black
NM-243C	20W MR11 (ordered separately) max.	Black	Chrome
NM-243G	20W MR11 (ordered separately) max.	Black	Gold
NM-243W	20W MR11 (ordered separately) max.	Black	White
NM-244B	20W MR11 (ordered separately) max.	White	Black
NM-244C	20W MR11 (ordered separately) max.	White	Chrome
NM-244G	20W MR11 (ordered separately) max.	White	Gold
NM-244W	20W MR11 (ordered separately) max.	White	White

Color and Optical Accessories ordered separately, see page 381
Transformers ordered separately, see pages 702-704

ACCENT, UNDER CABINET, LINEAR, COVE LIGHTING

Mini Solution MR16 Baffle Downlights

Thermally protected for Non-IC Ceiling Applications

2-3/8" Aperture



NM-247
Black Baffle

NM-248
White Baffle

Small 2-3/8" baffled aperture with deep set lamp has minimal glare. Uses the popular MR16 lamp available in several beam spreads. For use with remote transformers.

Features:

- Die-cast aluminum body
- UV Tempered clear glass shield included
- High quality die-cast baffle
- Dimmable
- Miniature housing included
- Blister pack
- 24" lead wire
- Thermally protected
- ETL or cULus approved for use in non-insulated ceilings

Mounting: Housings are included for recessed applications.

Transformer: 12V Electronic, solid state low voltage transformer or magnetic transformer is required for operation. Approved for remote applications. Order transformer separately, see pages 702-704.

Dimming:

Dimmable with electronic low voltage dimmer with electronic low voltage transformer or magnetic low voltage dimmer with magnetic low voltage transformer.

Electrical: Socket with fiberglass insulated wiring is provided with strain relief is installed into the housing rear. 24" wire lead included.

Lamp:

20W, 12 Volt, MR16 max. (ordered separately)

Included with every fixture:

- 3" miniature housing with trim
- 24" leads with connector
- Clear UV glass lens
- Blister packaging

Baffle Finishes:

Black (NM-247) or White (NM-248)

Ring Finishes:

Black (B), Chrome (C), Gold (G), and White (W)

Listing:

NM-247: cULus Listed

NM-248: ETL Listed

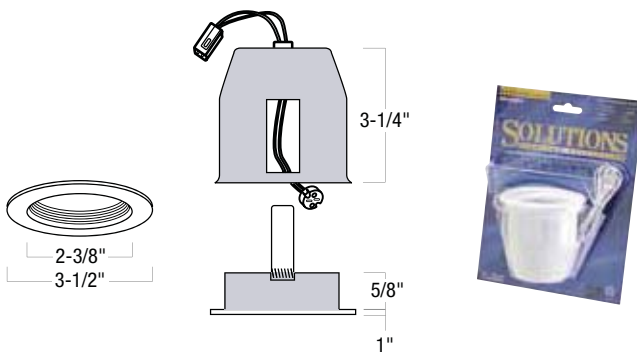

MINI SOLUTION MR16 BAFFLE DOWNLIGHTS

Housing included

CATALOG. NO.	LAMP	BAFFLE FINISH	RING FINISH
NM-247B	20W MR16 (ordered separately) max.	Black	Black
NM-247C	20W MR16 (ordered separately) max.	Black	Chrome
NM-247G	20W MR16 (ordered separately) max.	Black	Gold
NM-247W	20W MR16 (ordered separately) max.	Black	White
NM-248B	20W MR16 (ordered separately) max.	White	Black
NM-248C	20W MR16 (ordered separately) max.	White	Chrome
NM-248G	20W MR16 (ordered separately) max.	White	Gold
NM-248W	20W MR16 (ordered separately) max.	White	White

Color and Optical Accessories ordered separately, see page 381
Transformers ordered separately, see pages 702-704

ACCENT, UNDER CABINET, LINEAR, COVE LIGHTING

Mini Solution Adjustable MR11 Downlight

Thermally protected for Non-IC Ceiling Applications
1-13/16" and 2-1/16" Apertures

Small aperture adjustable downlights give direct, clean crisp halogen light where you want it. For use with remote transformers.

Features:

- Die-cast aluminum body
- UV Tempered clear glass shield included
- High quality specular finish
- Dimmable
- Miniature housing included
- Blister pack
- Available in four finishes
- 24" lead wire
- Adjustable up to 25°
- Thermally protected
- ETL approved for use in non-insulated ceilings

Mounting:

Housings are included for recessed applications.

Transformer:

12V Electronic, solid state low voltage transformer or magnetic transformer is required for operation. Approved for remote applications. Order transformer separately, see pages 702-704.

Dimming:

Dimmable with electronic low voltage dimmer with electronic low voltage transformer or magnetic low voltage dimmer with magnetic low voltage transformer.

Electrical:

Socket with fiberglass insulated wiring is provided with strain relief is installed into the housing rear. 24" wire lead included.

Lamp:

20W, 12 Volt, MR11 max. (ordered separately)

Included with every fixture:

- 3" miniature housing with trim
- 24" leads with connector
- Clear UV glass lens
- Blister packaging

Finishes:

Black (B), Chrome (C), Gold (G), and White (W).

Listing:

ETL Listed



NM-245
Gimbal



NM-246
Eyeball

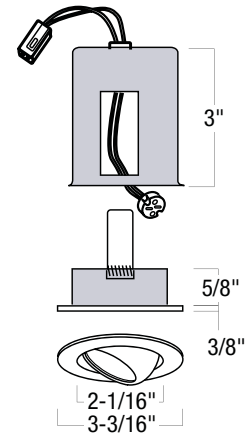
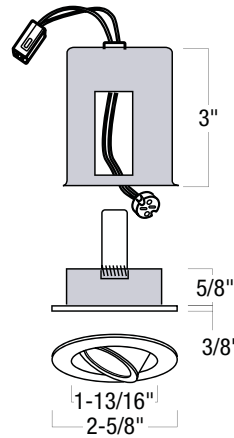

MINI SOLUTION ADJUSTABLE MR11 DOWNLIGHT

Housing included

CATALOG. NO.	TRIM	LAMP (NOT INCLUDED)	FINISH
NM-245	Gimbal	20W MR11 max.	Black, Chrome, Gold, White
NM-246	Eyeball	20W MR11 max.	Black, Chrome, Gold, White

Color and Optical Accessories ordered separately, see page 381
Transformers ordered separately, see pages 702-704



ACCENT, UNDER CABINET, LINEAR, COVE LIGHTING

Mini Solution Adjustable MR16 Downlight

Thermally protected for Non-IC Ceiling Applications
2-1/2" Aperture



Small 2-1/2" aperture adjustable fixtures offer 35° adjustment. Regressed MR16 provide crisp white halogen light. For use with remote transformers.

Features:

- Die-cast aluminum body
- UV Tempered clear glass shield included
- High quality specular finish
- Dimmable
- Miniature housing included
- Blister pack
- Available in four finishes
- 24" lead wire
- Adjustable up to 35°
- Thermally protected
- cULus approved for use in non-insulated ceilings

Mounting:

Housings are included for recessed applications.

Transformer:

12V Electronic, solid state low voltage transformer or magnetic transformer is required for operation. Approved for remote applications. Order transformer separately, see pages 702-704.

Dimming:

Dimmable with electronic low voltage dimmer with electronic low voltage transformer or magnetic low voltage dimmer with magnetic low voltage transformer.

Electrical:

Socket with fiberglass insulated wiring is provided with strain relief is installed into the housing rear. 24" wire lead included.

Lamp:

20W, 12 Volt, MR16 (ordered separately) max.

Included with every fixture:

- 3" miniature housing with trim
- 24" leads with connector
- Clear UV glass lens
- Blister packaging

Finishes:

Black (B), Chrome (C), Gold (G), and White (W).

Listing:

cULus Listed

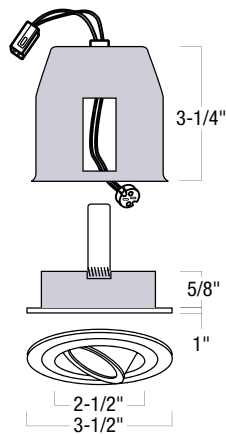

MINI SOLUTION ADJUSTABLE MR16 DOWNLIGHT
Housing included

CATALOG. NO.	TRIM	LAMP (NOT INCLUDED)	FINISH
NM-249	Gimbal	20W MR16 max.	Black, Chrome, Gold, White

Color and Optical Accessories ordered separately, see page 381
Transformers ordered separately, see pages 702-704



ACCENT, UNDER CABINET, LINEAR, COVE LIGHTING

Mini Solution Low Voltage Xenon Puck Light Kits

This three light puck kit may be recessed or surface mounted. Rated for use with one JC Bi-Pin G4 lamp. Included with the three puck light kit is a 60W electronic transformer with quick connectors and a 6' cord and plug.

Features:

- Die-cast aluminum body
- UV Tempered clear glass shield included
- High quality specular finish
- Can be recessed or surface mounted
- Available in four finishes
- Entire kit plugs together - no splicing required
- Blister pack
- 3 Mini Xenon trims with lamp included

Mounting: Housings and mounting screws are provided for recessed or surface applications.

Transformer: 12V 60W Electronic solid state low voltage transformer comes included with 6' cord and plug, and in-line switch. Transformer comes with 3 quick connectors to plug in directly to trims without any additional wiring. Replacement transformer may be ordered separately, see pages 702-704.

Electrical:

Lamp socket with fiberglass insulated wiring is provided with strain relief installed into the housing's rear of G4 surface fixtures.

Lamp:

20W, 12 Volt, T3 G4 Base max. (included)

Included with every kit:

- Housing with matching finish for surface mounted applications
- 20W, 12V, T3 Xenon, 2800K, G4 Base Lamp
- Quick connected trim and transformer
- 60W Electronic Transformer with 6' cord and plug, and in-line switch.

Finishes: Available in four finishes: Black (B), Chrome (C), Gold (G), and White (W)

Listing:

cULus Listed

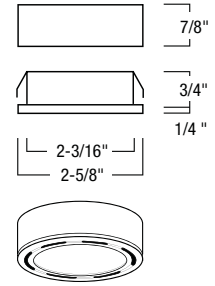

NMK-3240 Grooved

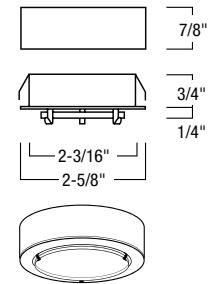

NMK-3241 Smooth

MINI SOLUTION LOW VOLTAGE XENON PUCK LIGHT KITS

CATALOG. NO.	TRIM	LAMP (INCLUDED)	FINISH
NMK-3240	Grooved	20W Xenon T3 G4 Base max.	Black, Chrome, Gold, White
NMK-3241	Smooth	20W Xenon T3 G4 Base max.	Black, Chrome, Gold, White

Color and Optical Accessories ordered separately, see page 381



ACCENT, UNDER CABINET, LINEAR, COVE LIGHTING

Mini Low Voltage Xenon Puck Light Kit



This three light puck kit may be recessed or surface mounted. Rated for use with one JC Bi-Pin G4 lamp. Included with the three puck light kit is a 60W electronic transformer with quick connectors and a 6' cord and plug.

Features:

- Die-cast aluminum body
- UV Tempered clear and frosted glass shield included
- High quality specular finish
- Recessed or surface applications
- Available in four finishes
- Entire kit plugs together - no splicing required
- 3 Mini Xenon trims with lamp included

Mounting:

Housings and mounting screws are provided for recessed or surface applications.

Transformer:

12V 60W Electronic solid state low voltage transformer comes included with 6' cord and plug, and in-line switch. Transformer comes hardwired with 3 quick connectors to plug in directly to trims without any additional wiring. Replacement transformer may be ordered separately, see pages 702-704.

Electrical:

Lamp socket with fiberglass insulated wiring is provided with strain relief installed into the housing's rear of G4 surface fixtures.

Lamp:

20W, 12 Volt, T3 G4 Base (included) max.

Included with every kit:

- Housing with matching finish for surface mounted applications
- 20W, 12V, T3 Xenon, 2800K, G4 Base Lamp
- Quick connected trim and transformer
- 60W Electronic Transformer with 6' cord and plug, and in-line switch

Finishes: Available in four finishes:

Black (B), Chrome (C), Gold (G), and White (W).

Listing:

cULus Listed

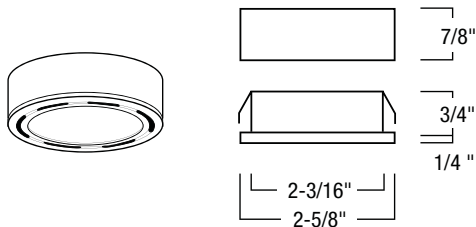

MINI LOW VOLTAGE XENON PUCK LIGHT KIT

CATALOG. NO.	TRIM	LAMP (INCLUDED)	FINISH
NM-126	Grooved	20W T3 Xenon max.	Black, Chrome, Gold, White

Color and Optical Accessories ordered separately, see page 381



ACCENT, UNDER CABINET, LINEAR, COVE LIGHTING

Puck and Mini Downlight Sample Layouts

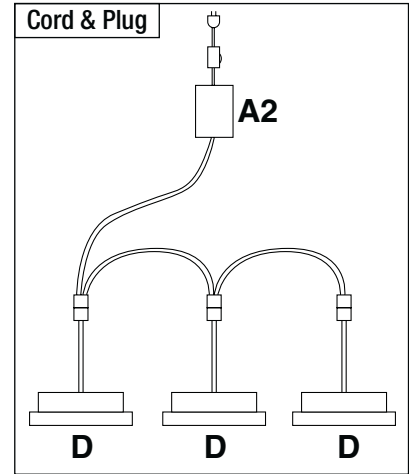
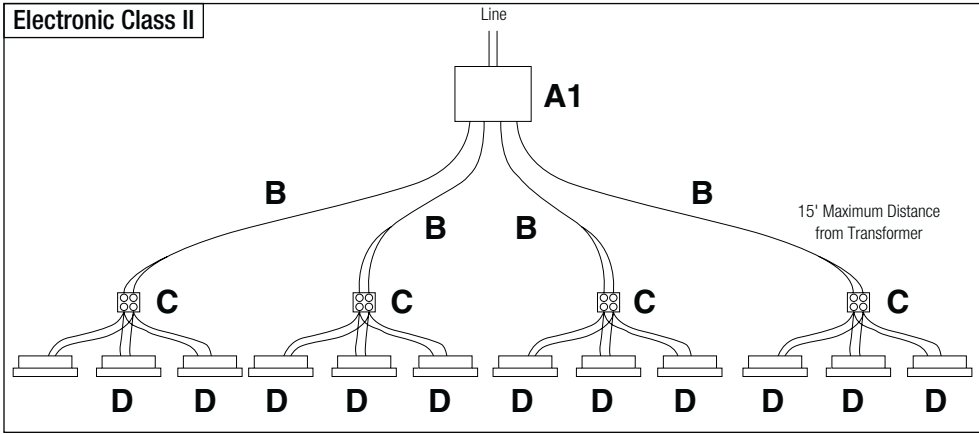

	DESCRIPTION	ITEM #
A1	360W Class II Electronic Transformer	NET-363/C2
A2	60W Electronic Cord & Plug Transformer (Black) 60W Electronic Cord & Plug Transformer (White)	NET-060WP NET-2060WP-W
A3	300W Class II Magnetic Transformer	NMT-300/C2
B	2-Wire Class II 5 Amp Wire	By Others
C	10 Amp Terminal Block	NDSA-2
D	Nora 20W Max. Puck Light or Mini Downlight	See Pages 643-653

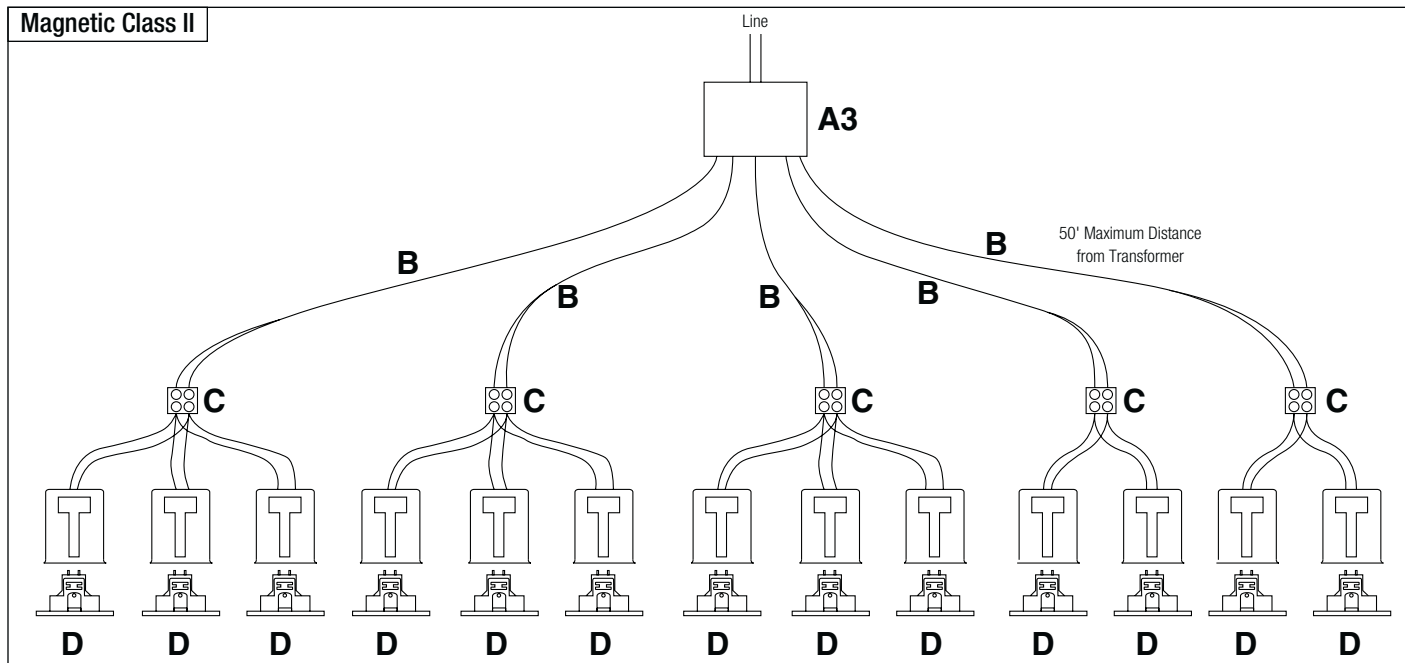

ACCENT, UNDER CABINET, LINEAR, COVE LIGHTING

Photometric and Voltage Information

COVE LIGHTING

Lamp (12V Xenon)	O.C. Lamp Spacing	Distance from Wall	Cove Height	Footcandles on Vertical Plane (Wall)				Footcandles on Horizontal Plane (Ceiling)			
				A	B	C	D	W	X	Y	Z
10W	3"	3"	6"	93	130	136	26	148	138	78	37
			9"	52	75	130	18	99	102	78	45
	3"	3"	12"	35	47	101	13	70	73	66	47
			6"	74	93	88	19	104	103	71	32
	4"	4"	6"	45	62	84	14	74	75	64	39
			9"	30	42	81	9	53	56	51	39
	4"	4"	12"	57	60	56	16	72	81	68	30
			6"	37	48	51	11	56	58	53	36
	5"	5"	6"	26	35	49	7	40	43	40	34
			9"								

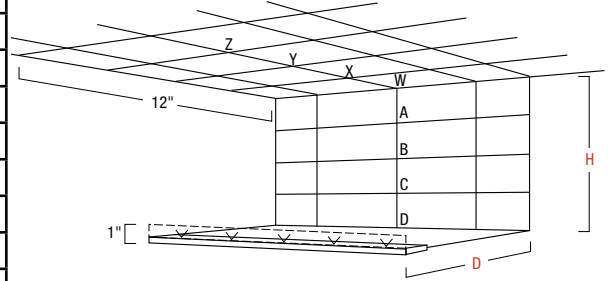

Note: Test conducted with 70% reflectance for ceiling and back wall

For 5W, 12V lamp: Use 0.43 multiplier
 For 10W, 24V lamp: Use 1.19 multiplier
 For 3W, 12V lamp: Use 0.19 multiplier
 For 5W, 24V lamp: Use 0.39 multiplier

UNDER CABINET LIGHTING

Lamp (12V)	Number of Fixtures	O.C. Lamp Spacing	Cabinet Height	Footcandles on Horizontal Plane							
				A	A1	B	B1	C	C1	D	D1
5W	8	3"	12"	19	12	32	20	74	44	29	18
5W	8	3"	18"	16	10	27	18	39	27	25	17
5W	8	3"	24"	13	9	21	15	23	9	19	14
10W	4	6"	12"	24	15	40	24	93	55	36	22
10W	4	6"	18"	19	3	34	22	49	34	31	21
10W	4	6"	24"	16	12	26	19	29	23	18	12

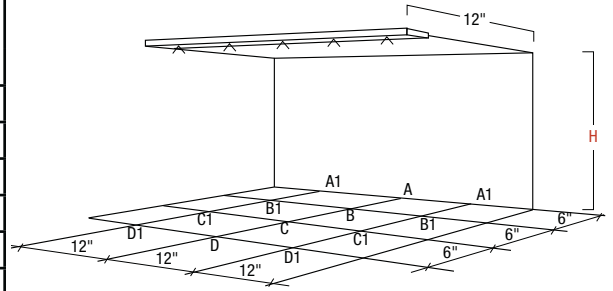

Note: Test conducted with 24" mounted 12" from wall

For 3W lamp: Multiply 5W results by 0.51
 For 5W lamp @ 4" O.C.: Use 0.76 multiplier
 For 5W lamp @ 6" O.C.: Use 0.50 multiplier
 For 10W lamp @ 4" O.C.: Use 1.49 multiplier
 For 10W lamp @ 8" O.C.: Use 0.91 multiplier

MAXIMUM RUN LENGTH (25A MAXIMUM LOAD)

Spacing	12V (300W)				24V (600W)			
	5W Xenon	10W Xenon	20W MR11	35W MR11	5W Xenon	10W Xenon	20W MR11	35W MR11
3"	14'	7'	3'-6"	2'	28'	14'	7'	4'
4"	18'-6"	9'	4'-6"	2'-6"	37'	18'	9'	5'
6"	27'-6"	14'	7'	4'	55'	28'	14'	8'
8"	37'	18'-6"	9'	5'	74'	37'	18'	10'

Note: Footage actually calculated using 23A load (276W at 12V; 552W at 24V) to prevent accidental breaker activation.

For comparison purposes ONLY. Actual run lengths may vary with transformer.

ACCENT, UNDER CABINET, LINEAR, COVE LIGHTING

Decolume Low Voltage Linear System

Festoon Strip Lighting LED, Xenon, and MR11 Sources

Nora Lighting's Decolume low-voltage lighting system provides limitless opportunities for creative architectural enhancements such as task and accent lighting. Designed for Commercial, Retail, Architectural, and Residential applications, designers and specifiers appreciate Decolume's versatility and simplicity of design. This miniaturized, flexible, linear lighting system has all the components necessary for exciting effects while allowing for easy installation. Decolume, which offers multiple light source options such as LED, incandescent, and xenon festoon, and MR11, truly lets you "Design with Light."

Features:

- Parallel wiring: loss of a lamp does not affect the rest of the strip (run)
- Snap-in lamp socket designed for ease of replacement
- Heavy duty vinyl insulator
- Injection molded socket enclosures, connectors, and components
- Easy and secure electrical connections
- Field cuttable
- UL Listed

Cable:

- Solid core 0.20" vinyl construction
- Dual 10G 30A stranded cable
- 300W Max 12V / 600W Max 24V
- 0.06" injection molded socket housings, regular, or custom spacing

Sockets:

- 0.03" stainless steel dual ended festoon socket
- Solid core triangular polycarbonate component housing stainless
- MR11 steel bi-pin socket sold separately, easily attached to festoon base.

Mounting: NDSC installs easily via mounting clips or channel (see accessories on page 660). Product may also be installed in pre-cut groove in building or architectural material surface. Note that 0.7" (17.54mm) is required for end power feed outer width.

Transformer: 12V or 24V Electronic, solid state low voltage transformer or magnetic transformer is required for operation. Order transformer separately, see pages 702-704.

Electrical:

Lamp Spacing: Preset or Custom

Input Voltage: 120V

Maximum Load: 25A 12V: 276W* 24V: 552W*

Maximum Distance for Single Run:

Obtained by calculating wattage per foot. Example:

10W 12V Xenon @ 4" o.c. = 30W/ft. divided into 276W* = 9.2' Max. single run

5W 24V Xenon @ 3" o.c. = 20W/ft. divided into 552W* = 27.6' Max. single run

* Actual wattage calculated at 23A to prevent accidental breaker activation.

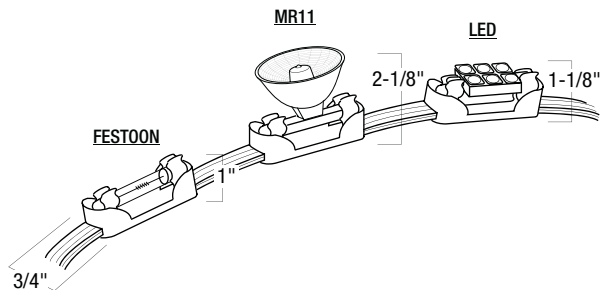

DECOLUME SYSTEM

CATALOG. NO.	SOCKET SPACING	SOCKET	COMPATIBLE LAMP
NDSC-BC	Blank Cable - No Sockets	Festoon	Festoon / LED / MR11*
NDSC-3	3"	Festoon	Festoon / LED / MR11*
NDSC-4	4"	Festoon	Festoon / LED / MR11*
NDSC-6	6"	Festoon	Festoon / LED / MR11*
NDSC-8	7-7/8"	Festoon	Festoon / LED / MR11*
NDSC-20	19-5/8"	Festoon	Festoon / LED / MR11*
NDSC-30	29-1/2"	Festoon	Festoon / LED / MR11*

* MR11 socket adapter sold separately

Accessories ordered separately, see page 660; Transformers ordered separately, see pages 702-704; Lamps ordered separately, see pages 755, 757.

Listings:

cULus Listed as Portable Lamp fixture
cULus Listed for Dry Location



ACCENT, UNDER CABINET, LINEAR, COVE LIGHTING

How To Specify Decolume System

Festoon Strip Lighting

DETERMINING WHAT YOU NEED:

- 1. Determine the lighting effect** desired such as architectural features (including cove lighting, cornices, columns), task lighting (including under cabinet or work stations) or accent lighting (such as display cases, furniture or wall units).
- 2. Determine the length** of the surface you wish to illuminate. Order sufficient lamped cable to accommodate corners. Cable is field cuttable.
- 3. Select the lamp spacing** to accomplish the light level desired. (3", 4", 6", etc.)
- 4. Select voltage.** Use 12V for shorter runs or 24V for longer runs.

- 5. Select the lamp type and wattage.** Multiply the lamp wattage by the number of lamps on your system to determine the total load. (Only use 12V lamps on a 12V system and 24V lamps on a 24V system)
- 6. Determine max. run lengths.**
12V System - divide total wattage by 276
24V System - divide total wattage by 552
Order terminal block and end cap for each run.
- 7. Select a transformer** based on the voltage, load, and the length of the runs. Transformers should be operated between 50% and 100% of the wattage load.
- 8. Select additional accessories** such as clips, connectors or additional sockets. Channel is required if mounting on combustible material.



ACCENT, UNDER CABINET, LINEAR, COVE LIGHTING

Decolume System Accessories

Festoon Strip Lighting



MR11 Lamp Socket

NDSA-1

For use with lensed MR11
(sold separately)



Mounting Clip

NDSA-3



Terminal Block

NDSA-2 Plastic, 10A Max.

NDSA-4 Porcelain, 10A Max.

NDSA-14 Porcelain, 30A Max.

NOTE: Specify NDSA-14 if not sure



Mounting Adhesive Pad

NDSA-10

Used to secure socket to various materials



End Cap

NDSA-7

To terminate a run



8' Decolume Channel

NDSA-11

Plastic channel is field cuttable



Reflector

NDSA-8

Polished reflector installs on socket.



8' Aluminum Channel

NDSA-12

Field cuttable

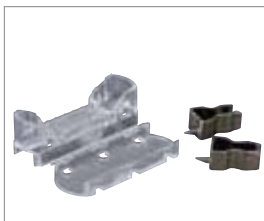

Two Piece Lamp Holder Kit

NDSK-LH



8' Aluminum Channel Diffuser

NDSA-13

Requires NDSA-12

Transformer Required - See Pages 702 - 704

ACCENT, UNDER CABINET, LINEAR, COVE LIGHTING

Decolume System Lamps

Festoon Strip Lighting



0.72W / 12V LED Festoon Lamps

NDSL-LED-0.72B	Blue
NDSL-LED-0.72G	Green
NDSL-LED-0.72R	Red
NDSL-LED-0.72W	Cool White
NDSL-LED-0.72WW	Warm White
NDSL-LED-0.72Y	Yellow



1.2W / 12V LED Festoon Lamps

NDSL-LED-1.2B	Blue
NDSL-LED-1.2G	Green
NDSL-LED-1.2R	Red
NDSL-LED-1.2W	Cool White
NDSL-LED-1.2WW	Warm White
NDSL-LED-1.2Y	Yellow



1W / 12V AC/DC LED Festoon Lamps

NDSL-LED-1W	Cool White
NDSL-LED-1WW	Warm White

- **Lamp Life:** 15,000 - 20,000 Hours
- **Color Rendering Index:** 80 CRI
- **Lumens:** 52-57 lm
- **2 Year Limited Warranty**



1W / 24V AC/DC LED Festoon Lamps

NDSL-LED-1W/24V	Cool White
NDSL-LED-1WW/24V	Warm White

- **Lamp Life:** 15,000 - 20,000 Hours
- **Color Rendering Index:** 80 CRI
- **Lumens:** 52-57 lm
- **2 Year Limited Warranty**



12 Volt MR11 Lamps

NDSL-20	20W N.Flood, Lensed
QU20MR11FTD	20W N.Flood
NDSL-35	35W Spot, Lensed
QU35MR11FTE	35W Spot
QU35MR11FTH	35W Flood
QU35MR11FTHL	35W Flood, Lensed



24 Volt MR11 Lamps

NDSL-20/24V	20W N.Flood, Lensed
QU20MR11FTC/24	20W N.Flood

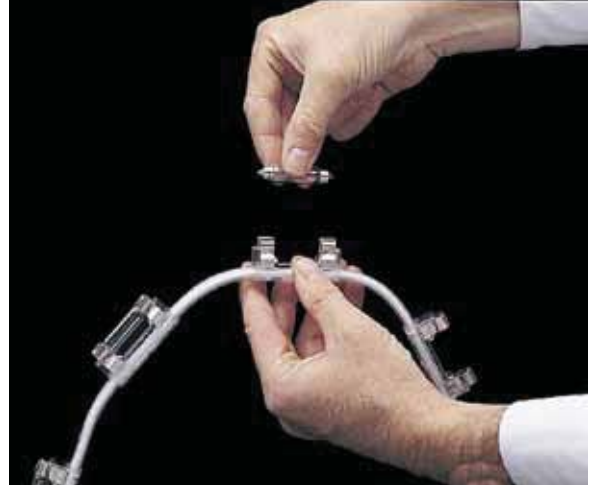

12V Incandescent Festoon Lamps

NDSL-5	5W
NDSL-5F	Frosted 5W
NDSL-10	10W



24V Incandescent Festoon Lamps

NDSL-3/24V	3W
NDSL-5/24V	5W
NDSL-5F/24V	Frosted 5W



12V Xenon Festoon Lamps

NDSL-5X	3W
NDSL-5XF	Frosted 3W
NDSL-10X	10W
NDSL-10XF	Frosted 10W



24V Xenon Festoon Lamps

NDSL-5X/24V	5W
NDSL-5XF/24V	Frosted 5W
NDSL-10X/24V	10W
NDSL-10XF/24V	Frosted 10W

For full description of lamp selection, see pages 755 - 757

ACCENT, UNDER CABINET, LINEAR, COVE LIGHTING

Decolume Sample Layout - 12 Volt System

Festoon Strip Lighting

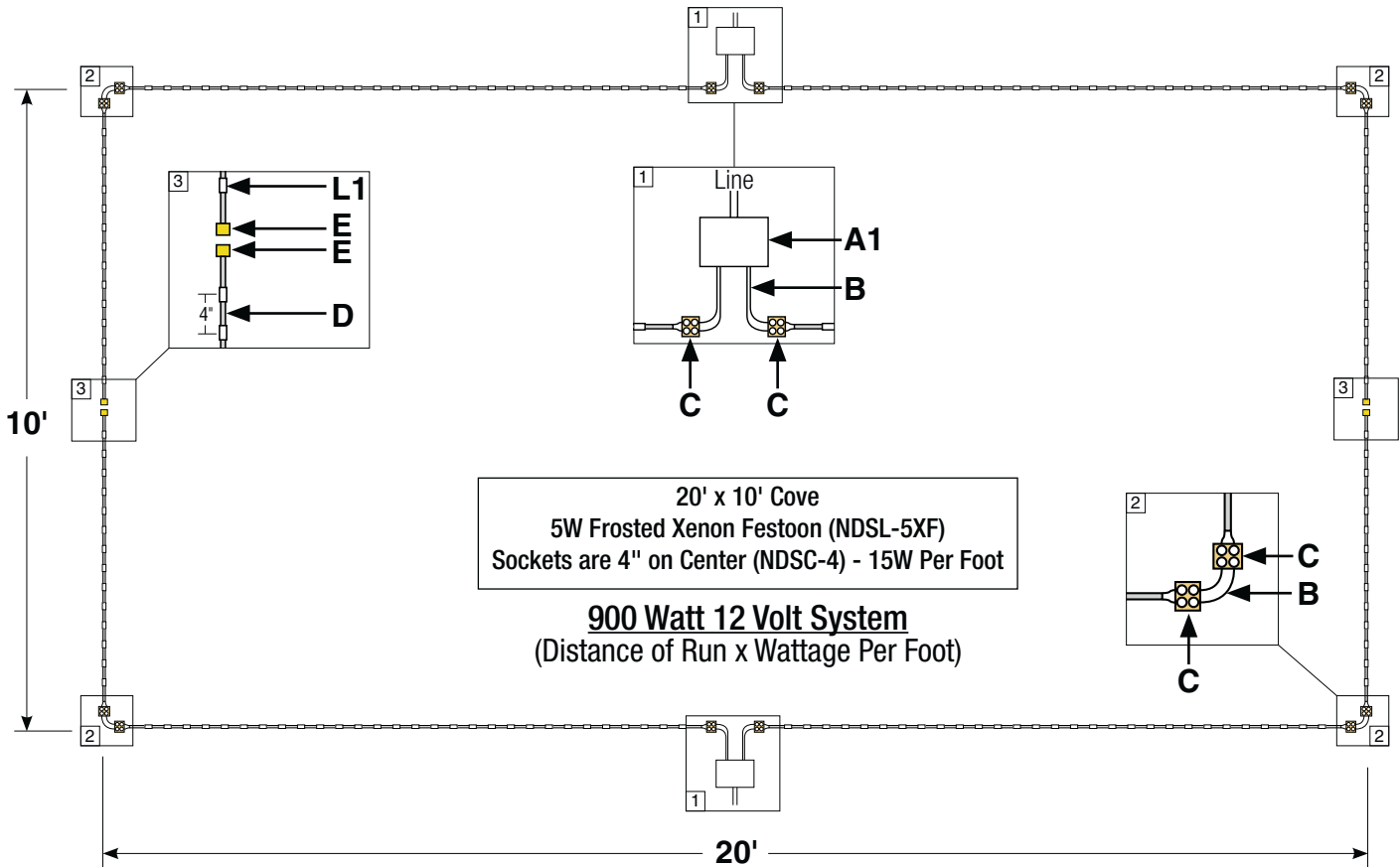

	DESCRIPTION	ITEM #
A1	600 Watt, 12 Volt Magnetic Transformer	NMT-600/12SP
A2	300 Watt, 12 Volt Magnetic Transformer	NMT-300/12SP
B	2-Wire 10 Gauge Wire	By Others
C	Terminal Block, 30 Amp	NDSA-14
D	Decolume Cable with Sockets 4" O.C.	NDSC-4
E	End Cap	NDSA-7
F	8' Decolume Aluminum Channel (cut to size)	NDSA-12
L1	5 Watt, 12 Volt, Xenon Festoon, Frosted	NDSL-5XF
L2	10 Watt, 12 Volt, Xenon Festoon, Frosted	NDSL-10XF

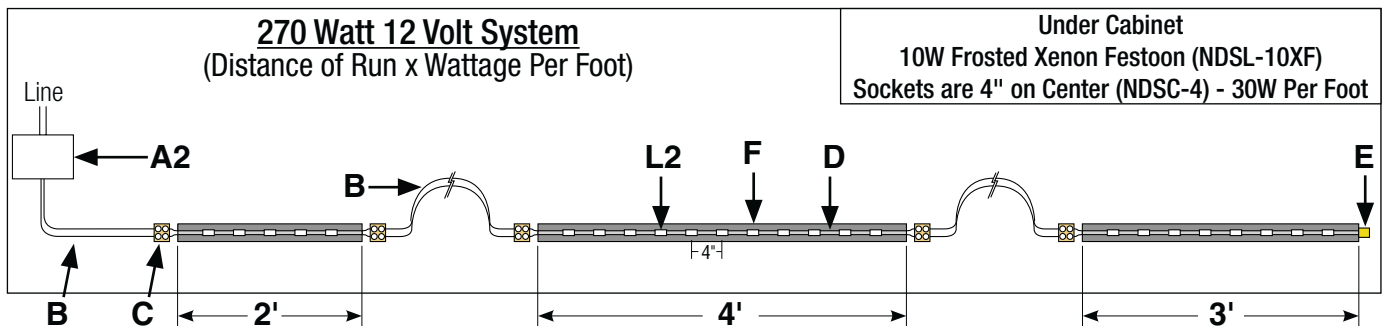

ACCENT, UNDER CABINET, LINEAR, COVE LIGHTING

Decolume Sample Layout - 24 Volt System

Festoon Strip Lighting

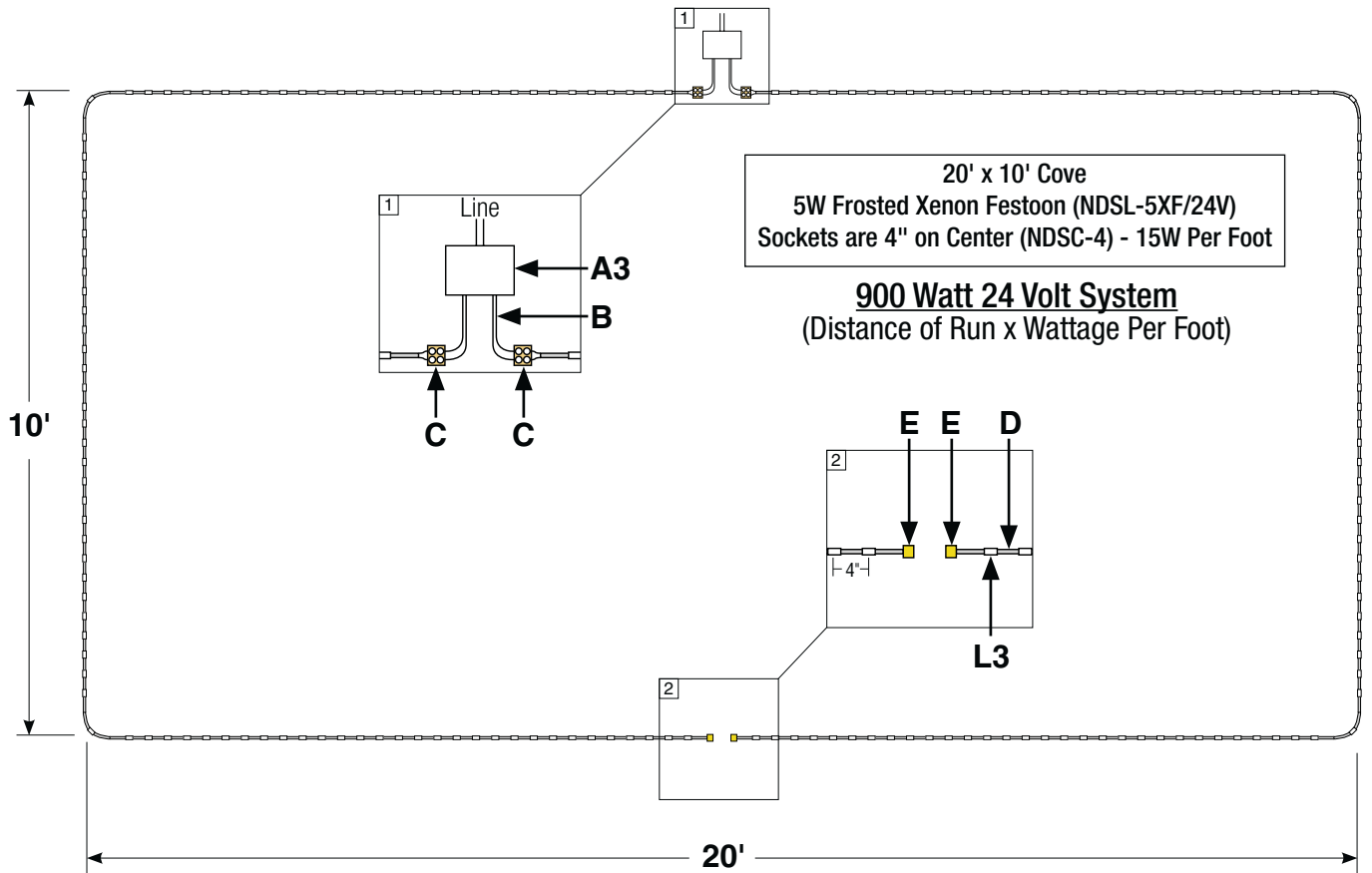

	DESCRIPTION	ITEM #
A3	1200 Watt, 24 Volt Magnetic Transformer	NMT-1200/24SP
B	2-Wire 10 Gauge Wire	By Others
C	Terminal Block, 30 Amp	NDSA-14
D	Decolume Cable with Sockets 4" O.C.	NDSC-4
E	End Cap	NDSA-7
L3	5 Watt, 24 Volt, Xenon Festoon, Frosted	NDSL-5XF/24V

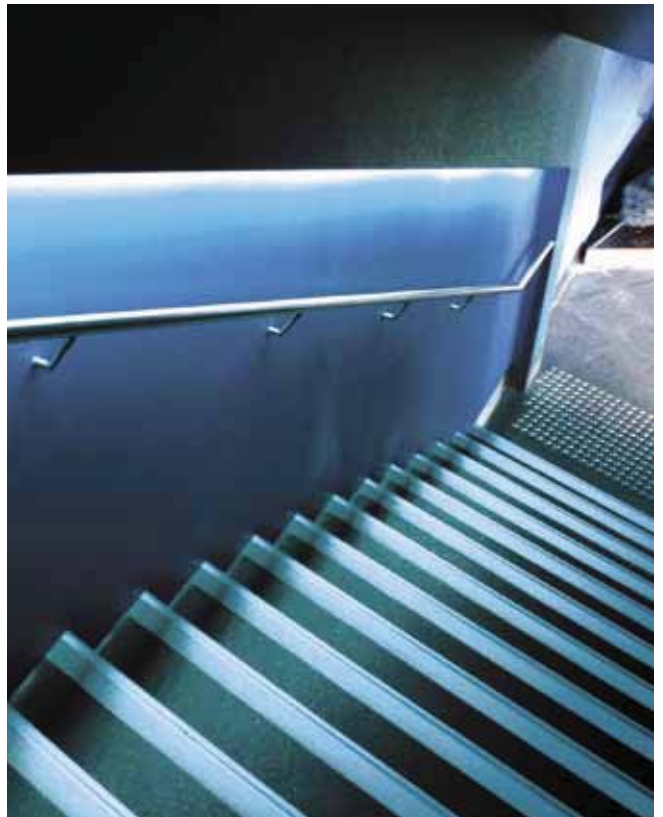

ACCENT, UNDER CABINET, LINEAR, COVE LIGHTING

Duralight™ LED System

UL Listed Rope Light

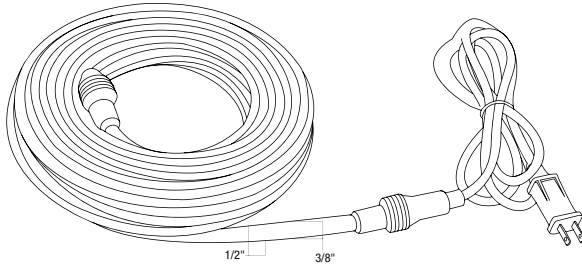
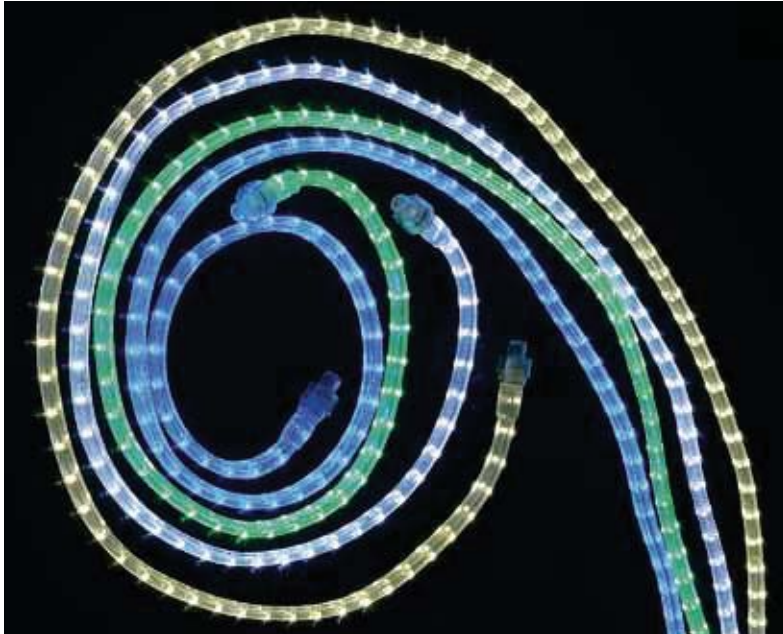

Nora LED Duralight™ provides a decorative element to a space as well as linear identification of architectural features or displays. LED Duralight™ is fully bendable, flame-resistant, has long lamp life and is made of heavy-duty, UV-rated clear vinyl. LED Duralight™ is an ideal lighting solution for edge illumination, back lighting, walkway, cove, or any difficult-to-light architectural element.

Features:

- Indoor / Outdoor
- Embedded LED lamps with 70,000 hour life
- Includes pre-installed male and female connectors, 5' cord and plug, threaded couplers, end cap and mounting clips
- Pre-cut lengths can easily be joined together up to a maximum of 150'
- UV stabilized
- Non-dimmable
- No driver required
- Constructed of solid core flexible vinyl (withstands 200 lbs. of pressure)
- UL and CSA Listed

Cable:

- Solid core vinyl construction
- Withstands 200 lbs. of pressure
- 3/8" thickness x 1/2" width
- UV rated
- Available in five colors

Mounting: NFL-4400 installs easily with mounting clips (NFL-405) or channel (NFL-509), see accessories. Product may also be installed in a pre-cut groove in building or architectural material surface.

Colors: Cool White (CW), Warm White (WW), Blue (B), Green (G), and Red (R).

Electrical:

Source: 0.8W per foot LED (CW, WW, B, G)
0.48W per foot LED (R)

Lamp Spacing: 1" (25mm) on center, fixed

Input Voltage: 120VAC

Fuse Rating: 5A, 125V (replaceable)

Operating Temperature: -4° F - 140° F

Maximum Load: 120 Watts

Maximum Length: 150' (45.72m)

Estimated Life: 25,000 hours

Power Cord Length: 5'

Listings:

UL Listed



DURALIGHT LED SYSTEM

CATALOG. NO.	LENGTH	AVAILABLE COLOR
NFL-4400/003	3'	Cool White (CW), Warm White (WW), Blue (B), Green (G)
NFL-4400/005	5'	Red (R)
NFL-4400/006	6'	Cool White (CW), Warm White (WW), Blue (B), Green (G)
NFL-4400/009	9'	Cool White (CW), Warm White (WW), Blue (B), Green (G)
NFL-4400/010	10'	Red (R)
NFL-4400/012	12'	Cool White (CW), Warm White (WW), Blue (B), Green (G)
NFL-4400/018	18'	Cool White (CW), Warm White (WW), Blue (B), Green (G)
NFL-4400/020	20'	Red (R)
NFL-4400/030	30'	Cool White (CW), Warm White (WW), Blue (B), Green (G)
NFL-4400/050	50'	Red (R)
NFL-4400/060	60'	Cool White (CW), Warm White (WW), Blue (B), Green (G)
NFL-4400/150	150'	Cool White (CW), Warm White (WW), Blue (B), Green (G), Red (R)

Accessories ordered separately, see pages 670-671

ACCENT, UNDER CABINET, LINEAR, COVE LIGHTING

Duralight™ 2-Wire Line Voltage System

UL Listed Rope Light

As a UL approved manufacturer, Nora Lighting offers a custom-cut or pre-packaged lengths of clear and colored two-wire, line voltage incandescent Duralight™. Custom-cut Duralight™ is available in 24" increments, and includes a pre-installed 5' power cord and end cap. Pre-packaged Duralight™ kits are available in various lengths from 2' to 150' and include pre-installed male and female connectors, a 5' power cord and end caps. Kits can be linked together to create a maximum length of 150'. Both custom-cut Duralight™ (5000 series) and pre-packaged Duralight™ (5500 series) are supplied with all necessary power components and do not require any assembly by the end user.

Features:

- Indoor / Outdoor
- Static, non-chasing only
- Weatherproof vinyl rope with embedded light sources
- UL Listed
- 25,000 hour life
- NFL-5000 includes pre-installed 5' power cord and end cap
- NFL-5500 includes pre-installed male and female connectors, end caps, 5' power cord, and mounting clips
- Easy, quick power cord electrical connection
- NOT field cuttable
- Dimmable
- Constructed of solid core flexible vinyl (withstands 200 lbs. of pressure)

Cable:

- Solid core vinyl construction
- 0.50 (13mm) outer diameter
- Withstands 200 lbs. pressure
- UV rated
- Available in four colors
- NFL-5000 Series comes in custom lengths from 2' to 150' in 24" increments (**not linkable**)
- NFL-5500 Series comes in pre-cut lengths: 2', 6', 10', 18', 30', 50', 150' (**not linkable**)

Mounting: NFL-5000 & NFL-5500 installs easily by mounting clips (NFL-505) or channel (NFL-509), see accessories. Product may also be installed in a pre-cut groove in building or architectural material surface.

Colors: Blue (B), Clear (C), Green (G), and Red (R).

Electrical:

Source: 5V/50MA lamp source (non-replaceable)
Lamp Spacing: 1" (25mm) on center, fixed
Input Voltage: 120V
Watts Per Foot: 5.5W
Operating Temperature: -4° F - 140° F
Maximum Load: 825VA
Maximum Length: 150' (45.72m)
Estimated Life: 25,000 hours
Power Cord Length: 5'

Listings:
 UL Listed



NFL-5000 Series
 Custom Cut - not Linkable



NFL-5500 Series
 Pre-Cut and Linkable

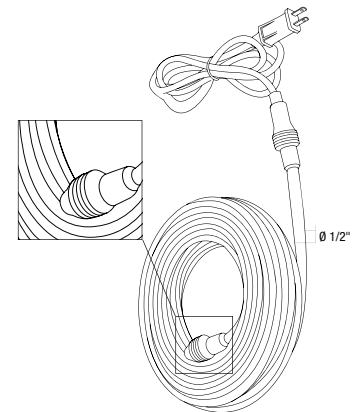
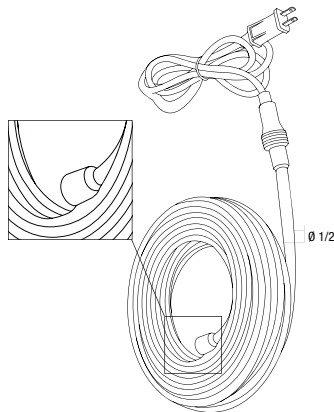

DURALIGHT 2-WIRE LINE VOLTAGE CUSTOM CUT SYSTEM

Custom cut to desired length and are **not linkable**

CATALOG. NO.	LENGTH	COLOR
NFL-5000	Custom Cut - 2' to 150' (24" increments)	Blue, Clear, Green, Red

Each custom-cut run incurs a termination assembly fee

DURALIGHT 2-WIRE LINE VOLTAGE PRE-CUT KITS

Linkable pre-cut lengths

CATALOG. NO.	LENGTH	AVAILABLE COLOR
NFL-5500/002	2' Kit	Blue (B), Clear (C), Green (G), Red (R)
NFL-5500/006	6' Kit	Blue (B), Clear (C), Green (G), Red (R)
NFL-5500/010	10' Kit	Blue (B), Clear (C), Green (G), Red (R)
NFL-5500/018	18' Kit	Blue (B), Clear (C), Green (G), Red (R)
NFL-5500/030	30' Kit	Blue (B), Clear (C), Green (G), Red (R)
NFL-5500/050	50' Kit	Blue (B), Clear (C), Green (G), Red (R)
NFL-5500/150	150' Kit	Blue (B), Clear (C), Green (G), Red (R)

Accessories ordered separately, see pages 670-671

ACCENT, UNDER CABINET, LINEAR, COVE LIGHTING

Duralight™ 2-Wire Low Voltage System

Rope Light

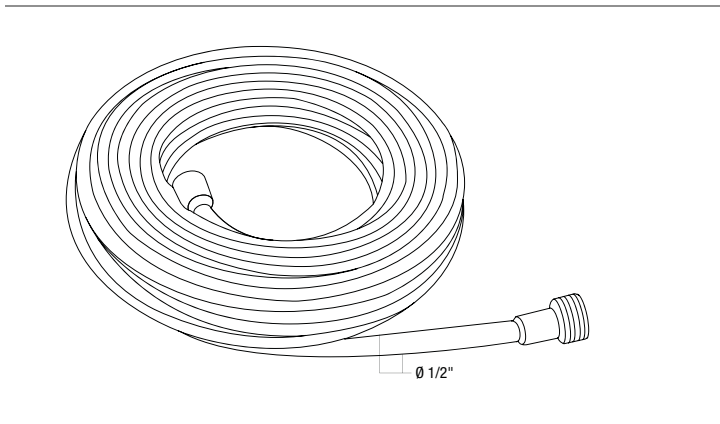
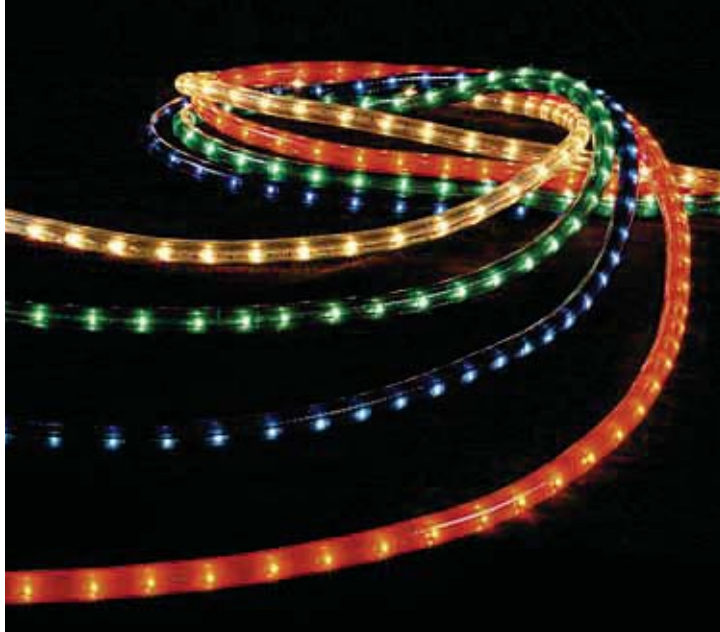

DURALIGHT 2-WIRE LOW VOLTAGE SYSTEM

CATALOG. NO.	LENGTH	COLOR
NFL-200	Ordered by the foot	Blue, Clear, Green, Red

Full roll (150') includes 5 sets of power cords, power connectors, splices, caps, and 30 mounting clips

Transformer is required and ordered separately, see pages 702-704

Accessories ordered separately, see pages 670-671

Low Voltage, "non-chasing" system is mainly used for accent and illumination. This product consists of an inner layer composed of multi-group subminiature lamps with identical specification arranged in a line; the outer layer is a PVC plastic tube. Its strong and formative core can be bent without breaking. Furthermore, this durable plastic is pressure resistant (every inch withstands 200 lbs. of pressure), waterproof, flame-retardant, and capable of operating in temperature range of -4° F to 140° F. Duralight™ is offered in 150' rolls and includes the necessary accessories to accomplish most mounting applications. Shorter lengths are also available.

Features:

- Indoor / Outdoor
- Choice of single, non-chasing colors
- Full roll (150') includes 5 sets of power cords, power connectors, splices, caps, and 30 mounting clips
- Low Voltage - 12 Volt
- Easy, quick power cord electrical connection
- Constructed of solid core flexible vinyl (withstands 200 lbs. of pressure)
- Weatherproof vinyl rope with embedded light sources

Cable:

- Solid core vinyl construction
- Withstands 200 lbs. of pressure
- 0.50 (13mm) outer diameter
- UV rated
- Available in four colors
- Cut Points: Every 6" on indicated cut mark

Mounting: NFL-200 installs easily via mounting clips or channel (see accessories). Product may also be installed in a pre-cut groove in building or architectural material surface. Note that 0.95" (24mm) is required for end power feed outer diameter. Product is waterproof; however, additional silicone sealant around the end cap and electrical connections is advisable in any outdoor location receiving direct precipitation or moisture.

Transformer: NFL-210 is required for each desired run. External Unit - 120V/60Hz Input; 12V Output; 65VA Max. Load. Affixed to cord and plug. UL Listed for NEC Class 2 installation requirements. Includes 6' incoming power cord and 6' outgoing cable to Duralight™. Note: Transformer is rated for dry location, indoor use only. For outdoor applications, use outdoor rated transformer by others.

Colors:

Blue (B), Clear (C), Green (G), and Red (R).

Electrical:

Source: 2V/140MA lamp source (non-replaceable)

Lamp Spacing: 1" (25mm) on center, fixed

Input Voltage: 12V

Operating Temperature: -4° F - 140° F

Maximum Load: 64.5VA

Maximum Length: 17'-6" (5.33M)

Estimated Life: 25,000 hours

ACCENT, UNDER CABINET, LINEAR, COVE LIGHTING

Duralight™ 3-Wire Line Voltage System Rope Light

Structural composition, weather and load resistance are characteristics common to all Duralight™ products. The three-wire chasing Duralight™ with multifunctional controller produces chasing, tracking, pulsating, and glimmering effects. A selection of colors are available making the decorated areas sparkle with color. The applications are unlimited with Duralight™ being offered in 150' rolls and includes all the necessary accessories to accomplish most mounting applications. Shorter lengths are also available.

Features:

- Indoor / Outdoor
- Chasing
- Available in single color or bi-color
- Line Voltage
- Full roll (150') includes 5 sets of power cords, power connectors, splices, caps, and 30 mounting clips
- Easy, quick power cord electrical connection
- Constructed of solid core flexible vinyl (withstands 200 lbs. of pressure)
- Weatherproof vinyl rope with embedded light sources

Cable:

- Solid core vinyl construction
- Withstands 200 lbs. of pressure
- 0.50 (13mm) outer diameter
- UV rated
- Available in four-color schemes
- Cut Points: **NFL-600:** Every 36" or every 36 lamps
NFL-700: Every 24" or every 24 lamps

Mounting: Installs easily via mounting clips or channel (see accessories). Product may also be installed in a pre-cut groove in building or architectural material surface. Note that 0.95" (24mm) is required for end power feed outer diameter. Product is waterproof; however, additional silicone sealant around the end cap and electrical connections is advisable in any outdoor location receiving direct precipitation or moisture. Controller is required with lighting system

Controller: Chase controllers divide electrical load and create various motion effects to include chasing, blinking, random oscillating patterns, and flashing to sound input. Sound activated controller includes a controller to change the microphone sensitivity to optimize desired effect.

Colors: Blue (B), Clear (C), Green (G), and Red (R).

Electrical:

Source: 6.5V/70MA lamp source (non-replaceable)
Lamp Spacing: **NFL-600:** 1" (25mm) on center, fixed
NFL-700: 3/4" (19mm) on center, fixed
Input Voltage: 120V
Operating Temperature: -4° F - 140° F
Maximum Load: 1,140VA
Maximum Length: 150' (45.72M)
Estimated Life: 25,000 hours
 Higher wattage is allowable on chase system as two circuits within chase controller divide load.

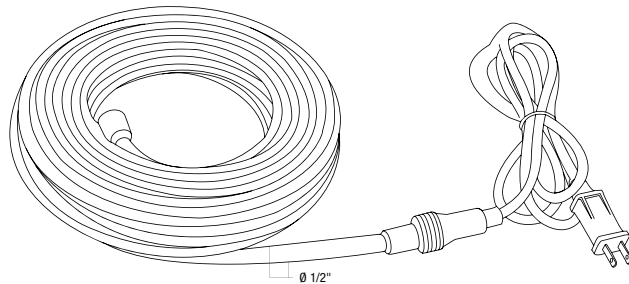
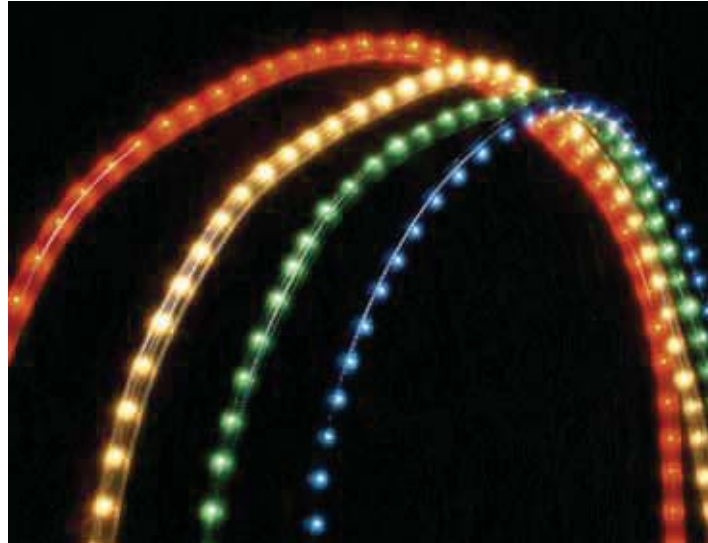

DURALIGHT 3-WIRE SINGLE COLOR LINE VOLTAGE

CATALOG. NO.	LENGTH	COLOR
NFL-600	Ordered by the foot	Blue, Clear, Green, Red

Full roll (150') includes 5 sets of power cords, power connectors, splices, caps, and 30 mounting clips
 Controllers and Accessories ordered separately, see pages 670-671

DURALIGHT 3-WIRE BI-COLOR LINE VOLTAGE

CATALOG. NO.	LENGTH	COLORS
NFL-700C/B	Ordered by the foot	Clear and Blue
NFL-700G/R	Ordered by the foot	Green and Red
NFL-700R/C	Ordered by the foot	Red and Clear

Full roll (150') includes 5 sets of power cords, power connectors, splices, caps, and 30 mounting clips
 Controllers and Accessories ordered separately, see pages 670-671

ACCENT, UNDER CABINET, LINEAR, COVE LIGHTING

Duralight™ Installation Tips

Rope Light



Use tie-straps (NFL-508) to secure DURALIGHT™ to wire.



On clean glass surface, use suction cup (NFL-510) mount and secure with tie-strap (NFL-508).



For design and forming: draw design on surface where DURALIGHT™ will be installed and use mounting clips (NFL-505) to secure DURALIGHT™ to surface.



For free form designs, use heavy wire to shape.



When straight line installation is needed, the channel (NFL-509) is required. Drill holes in channel and nail or screw channel onto surface.



If installing on glass, use double sided tape (NFL-511). When channel has been secured onto surface, press DURALIGHT™ into channel (NFL-509).



150' Duralight Kits

- NFL-200 2-wire Low Voltage Duralight
- NFL-600 3-wire Single Color Line Voltage Duralight
- NFL-700 3-wire Bi-Color Line Voltage Duralight

Kits include:

- 5 Power cords with power connectors
- 5 Splice connectors
- 5 Power connectors
- 30 Mounting clips
- 5 End caps

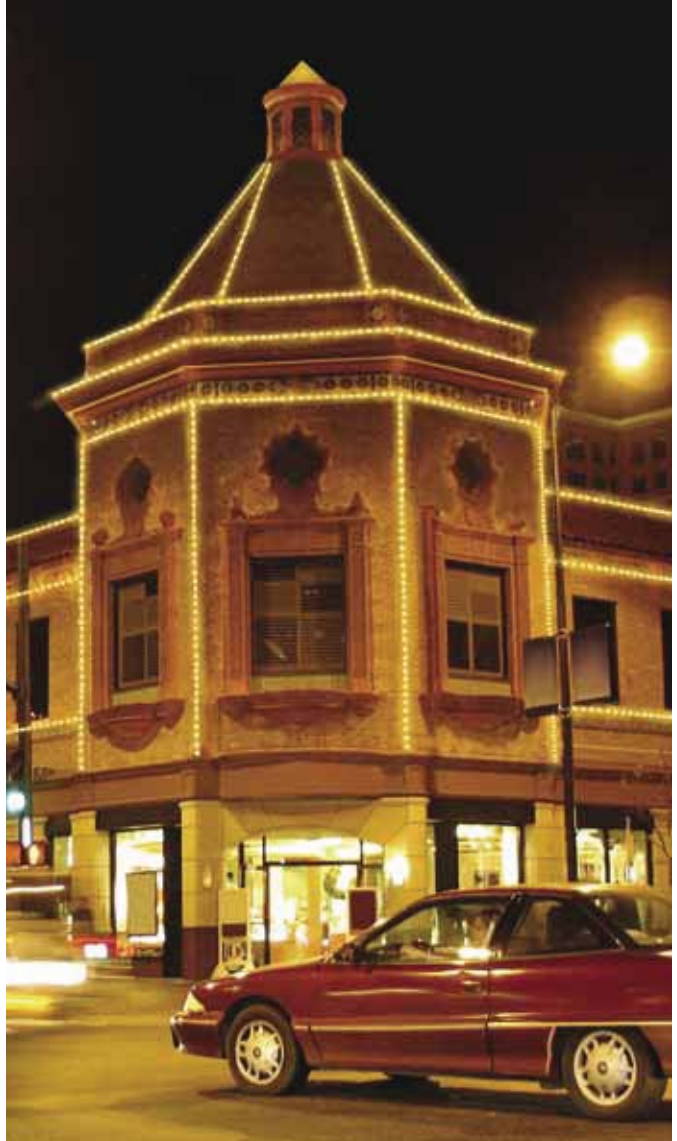

ACCENT, UNDER CABINET, LINEAR, COVE LIGHTING

Duralight™ Accessories

Rope Light

MOUNTING ACCESSORIES



LED Duralight Mounting Clip

NFL-405

Compatible: NFL-4400 Series

Description: Mounting clip created for mounting LED Duralight™ to a surface.



Mounting Clip

NFL-505

Compatible: NFL-200 Series
NFL-600 Series
NFL-700 Series
NFL-5000 Series
NFL-5500 Series

Description: Used to mount Duralight™ to surface.

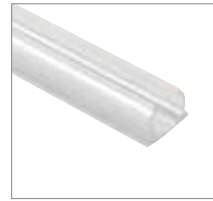

6' Channel

NFL-509

Compatible: All Duralight™
Description: 6' Channel used for precisely mounting Duralight™ in a linear run. Maybe nailed or screwed onto surface. Field Cuttable.

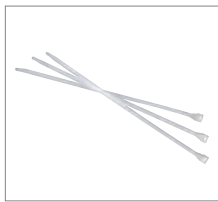

Tie Strap

NFL-508

Compatible: All Duralight™
Description: Used to secure Duralight™ to wire or suction cup (ordered separately).



Suction Cup Mount

NFL-510

Compatible: All Duralight™
Requires: NFL-508
Description: Used to mount Duralight™ to glass surface.

POWER CORDS, POWER CONNECTORS, AND EXTENSIONS



2-Wire Low Voltage Power Cord

NFL-201

Compatible: NFL-200 Series
Requires: NFL-202
Description: Used to connect 2-Wire Low Voltage Duralight™ to non-Nora transformer.



3-Wire Line Voltage Power Cord

NFL-601

Compatible: NFL-600 Series
NFL-700 Series
Requires: NFL-602
Description: Used to power 3-Wire Line Voltage Duralight™, includes Plug.



2-Wire Low Voltage Power Connector

NFL-202

Compatible: NFL-200 Series
Description: Used to connect Power Cord, Transformer, or Extension to Low Voltage Duralight™.



3-Wire Line Voltage Power Connector

NFL-602

Compatible: NFL-600 Series
NFL-700 Series
Description: Used to connect Power Cord or Extension to Line Voltage Duralight™.



2-Wire Low Voltage 2' Power Extension

NFL-214

Compatible: NFL-200 Series
Requires: NFL-202
Description: Used to extend Power Cord. Two or more can be combined to create custom lengths.



3-Wire Line Voltage 2' Power Extension

NFL-614

Compatible: NFL-200 Series
NFL-700 Series
Requires: NFL-602
Description: Used to extend Power Cord. Two or more can be combined to create custom lengths.



2-Wire Low Voltage 6' Power Extension

NFL-215

Compatible: NFL-200 Series
Requires: NFL-202
Description: Used to extend Power Cord. Two or more can be combined to create custom lengths.



3-Wire Line Voltage 6' Power Extension

NFL-615

Compatible: NFL-200 Series
NFL-700 Series
Requires: NFL-602
Description: Used to extend Power Cord. Two or more can be combined to create custom lengths.



2-Wire Low Voltage "Y" Connector

NFL-216

Compatible: NFL-200 Series
Requires: (2) NFL-202
Description: Used to split power into two separate Duralight™ runs.



3-Wire Low Voltage "Y" Connector

NFL-616

Compatible: NFL-600 Series
NFL-700 Series
Requires: (2) NFL-602
Description: Used to split power into two separate Duralight™ runs.

ACCENT, UNDER CABINET, LINEAR, COVE LIGHTING

Duralight™ Accessories

Rope Light

TRANSFORMER AND CONTROLLERS

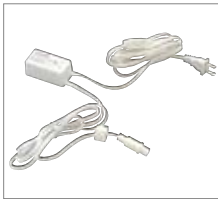

2-Wire Low Voltage Transformer

NFL-210

Compatible: NFL-200 Series
Requires: NFL-202
Rating: 12V/120V 65W
Maximum Distance: 20'
Power Cord Length: 6'
Dimmable: Yes



Running Light Controller

NFL-621

Compatible: NFL-600 Series
 NFL-700 Series
Function: Chasing or Tracing.



Running Light Controller

NFL-622

Compatible: NFL-600 Series
Function: Chasing, Full Light-up, and Auto Exchange (blinking).

CONNECTORS



2-Wire Low Voltage Invisible Splice Connector

NFL-206

Compatible: NFL-200 Series
Description: Used to connect two Low Voltage Duralights™ end to end.

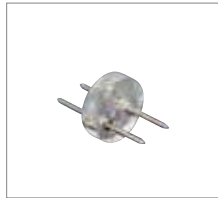

3-Wire Line Voltage Invisible Splice Connector

NFL-606

Compatible: NFL-600 Series
 NFL-700 Series
Description: Used to connect two 3-Wire Duralights™ cables end to end.



2-Wire Low Voltage Splice Connector

NFL-204

Compatible: NFL-200 Series
Description: Used to connect two Low Voltage Duralights™ cables straight.



3-Wire Line Voltage Splice Connector

NFL-604

Compatible: NFL-600 Series
 NFL-700 Series
Description: Used to connect two 3-Wire Duralights™ cables straight.



2-Wire Low Voltage 2' Connector

NFL-212

Compatible: NFL-200 Series
Requires: (2) NFL-202
Description: Used to connect two Low Voltage Duralights™ 2' apart.



3-Wire Line Voltage 2' Connector

NFL-612

Compatible: NFL-200 Series
 NFL-700 Series
Requires: (2) NFL-602
Description: Used to connect two Low Voltage Duralights™ 2' apart.



2-Wire Low Voltage 6' Connector

NFL-213

Compatible: NFL-200 Series
Requires: (2) NFL-202
Description: Used to connect two Low Voltage Duralights™ 6' apart.



3-Wire Line Voltage 6' Connector

NFL-613

Compatible: NFL-200 Series
 NFL-700 Series
Requires: (2) NFL-602
Description: Used to connect two Low Voltage Duralights™ 6' apart.



2-Wire Low Voltage "T" Connector

NFL-207

Compatible: NFL-200 Series
Description: Used to connect three Low Voltage Duralights™ in a "T" configuration.



3-Wire Line Voltage "T" Connector

NFL-607

Compatible: NFL-600 Series
 NFL-700 Series
Description: Used to connect three 3-Wire Duralights™ in a "T" configuration.

CUTTER AND END CAPS



Duralight™ Cutter

NFL-999

Compatible: All Duralight™
Description: Die-cast construction with tempered cutting blade, mechanically adjusts to accommodate various cord and cable thickness.



3-Wire End Cap

NFL-603

Compatible: NFL-600 Series
 NFL-700 Series
Description: Used to cover ends of Duralight™.



2-Wire End Cap

NFL-203

Compatible: NFL-200 Series
Description: Used to cover ends of Duralight™.



MINI TRACK

Introduction	675
Overview	676
Linear Lighting	678
Halogen Spotlights	679
Pendants	681
Accessories	682
Sample Layouts	684

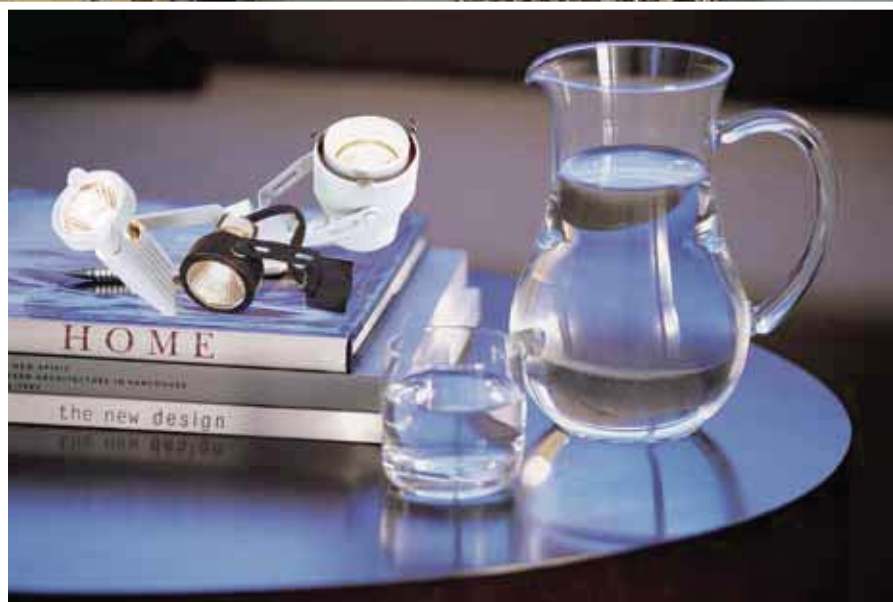

Nora Mini Track fixtures are smaller than a glass of water, but have the same sparkle and brilliance to create a refreshing effect.



The Nora Lighting family of Low Voltage Mini Track Lighting

Nora's Mini Track is a miniature track system powered by either 12 Volts or 24 Volts. The track can be ceiling mounted, used in case work, coves, undercabinet, displays, or any area where dramatic accent or linear lighting is required. A complete selection of remote transformers makes it easy to keep the system minimal while complying with today's energy conservation codes.

FEATURES

- Heavy Duty Polycarbonate Mini Track only measures 3/8" x 3/4" wide
- Solid 10 gauge conductors allow for 25 amp loads. Rated for a maximum of 300 Watts on a 12 Volt runs. Rated for 600 Watts on 24 Volt runs
- Mini Track sections can easily be field cut and are pre-drilled with mounting holes
- Each Mini Track includes (1) end cap, (1) end feed connector, and all mounting hardware
- Mini Track Fixtures and Linear Fixtures can easily be moved to meet changing lighting requirements
- Discrete fixtures for linear lighting are available in LED, Xenon, and incandescent sources
- Spotlights are available in six styles with MR11 and MR16 lamp sources
- Mini Track fixtures are constructed from the finest materials and finishes to complement any interior or architectural setting
- QuickJack Adapter allows for the use of over 100 glass and beaded pendants in addition to over 50 QuickJack fixtures
- Versatile Mini Track System has the ability to be powered by either remote transformers or surface mounted transformers
- cULus Listed
- LED Festoon Lamp for Linear Lighting **NEW!**
- Dimmable



Lighting Tip:

Nora's Low Voltage Mini Track System is an excellent choice in a place of traditional larger track lighting in smaller areas. Size the transformer to the load requirements to meet watts per square foot energy calculations.

Overview MINI TRACK



LINEAR ACCENT LIGHTING



NLMT-721 Maia™
3W-10W Xenon
Single Wedge Base p.678



NLMT-722 Maia II™
3W-10W Xenon
Double Wedge Base p.678



NLMT-731 Bella
3W-10W Xenon Rigid Loop p.678



NLMT-732 Bella II
3W-10W Xenon Festoon p.678
0.72W-1.2W LED Festoon p.678 **NEW!**

HALOGEN SPOTLIGHTS



NLMT-701 Caroli™ MR11
20W-35W MR11 12/24V p.679



NLMT-703 Caroli™ MR16
20W-50W MR16 12/24V p.679



NLMT-705 Capella™ MR11
20W-35W MR11 12/24V p.679



NLMT-706 Capella™ MR16
20W-50W MR16 12/24V p.679



NLMT-707 Electra™ MR11
20W-35W MR11 12/24V p.679



NLMT-709 Electra™ MR16
20W-50W MR16 12/24V p.679



NLMT-733 Piccolo
20W-35W MR11 12/24V p.680



NLMT-735 Cubino
20W-35W MR11 12/24V p.680



NLMT-736 Poquito
20W-35W MR11 12/24V p.680

PENDANT LIGHTING



NLMP-734 4' Polaris™
20W-50W JC 6.35 p.681
Glass ordered separately, see
pages 416-433



NLMP-738 8' Polaris™
20W-50W JC 6.35 p.681
Glass ordered separately, see
pages 416-433

MINI TRACK AND ACCESSORIES



Surface Mount Transformers
p.682



Remote Mount Transformers
p.683



Track and Accessories
p.682



Overview MINI TRACK QUICKJACK SYSTEM

LOW VOLTAGE QUICKJACK FIXTURES



NLMT-760 Mini Track QuickJack Adapter

NLMT-760 is needed for all NRS66 Series



NRS66-462 Ambra Pendant
Includes Glass
50W Bi-Pin p.506



NRS66-101 Argon Curve
50W MR16 p.484



NRS66-102 Argon Swivel
50W MR16 p.484

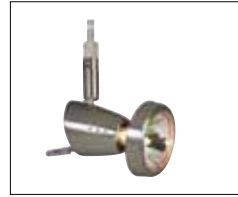

NRS66-103 Sienna w/Ring
50W MR16 p.484



NRS66-463 Petra Pendant
Includes Glass
50W Bi-Pin p.506

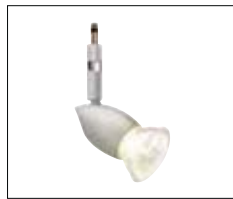

NRS66-104 Neat
50W MR16 p.484

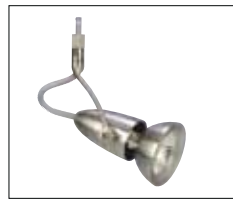

NRS66-105 Satellit Curve
50W MR16 p.485

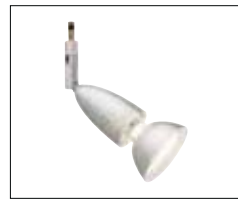

NRS66-106 Satellit Swivel
50W MR16 p.485



NRS66-107 Neon
50W MR16 p.485



NRS66-108 Lika
50W MR16 p.485

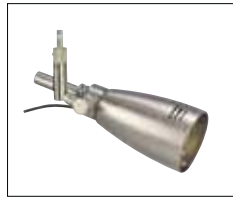

NRS66-109 Nica
50W MR16 p.487



NRS66-901 Penumbra
50W AR111 p.487



NRS66-902 Skyteam
50W AR111 p.488



NRS66-310 Fili Display
50W MR16 p.487



NRS66-302 Ives Gooseneck
50W MR16 p.487



NRS66-201PW Petra Curve
50W JC 6.35/MR16 p.488



NRS66-202PW Petra Swivel
50W JC 6.35/MR16 p.488



NRS66-203PW Melody
50W JC 6.35/MR16 p.488



NRS66-204 Swiftec
50W JC 6.35/MR16 p.489



NRS66-251 Kano Spot
50W MR16 p.489



NRS66-252 New Mirage
50W JC 6.35/MR16 p.489



NRS66-253 Lima
50W MR16 p.489



NRS66-457 8.5' Pendant
NRS66-458 20' Pendant
50W JC 6.35/MR16 p.509
Glass ordered separately, see pages 416-433

NLMT-760 is needed for all NRS66 Series

MINI TRACK

Linear Accent Lighting



Maia™ Single Wedge Base Lampholder with Polished Aluminum Reflector

NLMT-721 3W-10W

Lamp: 3W-10W 12/24V Xenon Wedge Base (not included)

Finish: Black (B), White (W)

Dimensions: Length: 2-5/8" Width: 3/4" Height: 5/8"

- Lamps sold separately - see page 756

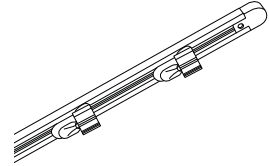

Maia II™ Double Wedge Base Lampholder with Polished Aluminum Reflector

NLMT-722 3W-10W

Lamp: 3W-10W 12/24V Xenon Wedge Base (not included)

Finish: Black (B), White (W)

Dimensions: Length: 2-5/8" Width: 3/4" Height: 5/8"

- Lamps sold separately - see page 756

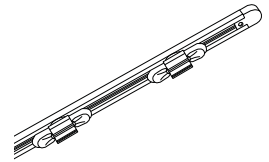

Bella Linear Rigid Loop Lampholder with Polished Aluminum Reflector

NLMT-731 3W-10W

Lamp: 3W-10W 12/24V Xenon Rigid Loop (not included)

Finish: Black (B), White (W)

Dimensions: Length: 2-1/8" Width: 1/2" Height: 7/8"

- Lamps sold separately - see page 756

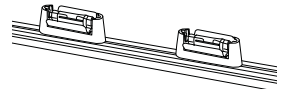

Bella II Linear Festoon Fixture with Polished Aluminum Reflector

NLMT-732 3W-10W

Lamp: 3W-10W 12/24V Xenon Festoon Base (not included)
3W-10W 12/24V Incandescent Festoon Base (not included)
 0.72W-1.2W LED Festoon Base (not included)

Finish: Black (B), White (W)

Dimensions: Length: 2-1/8" Width: 1/2" Height: 7/8"

- Lamps sold separately - see page 757

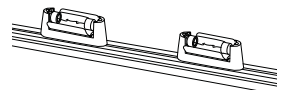



MINI TRACK Halogen Spotlights

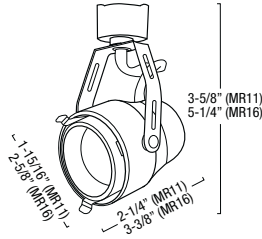

Caroli™ Studio Spot

NLMT-701	MR11	20W-35W
NLMT-703	MR16	20W-50W

Feature: Deep set lamp for excellent glare control
Lamp: 20W-35W MR11 12/24V (not included)
 20W-50W MR16 12/24V (not included)
Finish: Black (B), White (W)
Dimensions: Length: 2-1/4" Dia.: 1-15/16" Max Ext.: 3-5/8" (MR11)
 Length: 3-3/8" Dia.: 2-5/8" Max Ext.: 5-1/4" (MR16)

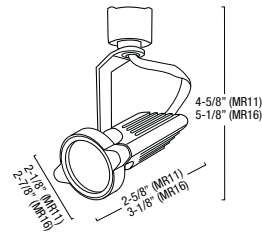

Capella™ Slantback

NLMT-705	MR11	20W-35W
NLMT-706	MR16	20W-50W

Feature: Die-cast aluminum construction (fixture body)
Lamp: 20W-35W MR11 12/24V (not included)
 20W-50W MR16 12/24V (not included)
Finish: Black (B), White (W)
Dimensions: Length: 2-5/8" Dia.: 2-1/8" Max Ext.: 4-5/8" (MR11)
 Length: 3-1/8" Dia.: 2-7/8" Max Ext.: 5-1/8" (MR16)

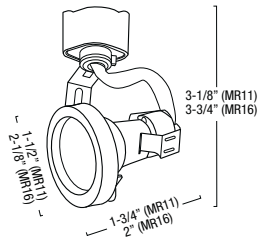

Electra™ Gimbal Ring

NLMT-707	MR11	20W-35W
NLMT-709	MR16	20W-50W

Lamp: 20W-35W MR11 12/24V (not included)
 20W-50W MR16 12/24V (not included)
Finish: Black (B), White (W)
Dimensions: Length: 1-3/4" Dia.: 1-1/2" Max Ext.: 3-1/8" (MR11)
 Length: 2" Dia.: 2-1/8" Max Ext.: 3-3/4" (MR16)



Lighting Tip:
 Nora's Mini Track System is an excellent linear solution. Use 24 Volt lamps and transformers for long runs up to 600 Watts. Sockets can easily be moved to meet changing applications.



MINI TRACK

Halogen Spotlights continued



Piccolo - Cylinder Mini Studio Spot

NLMT-733 20W-35W

Lamp: 20W-35W MR11 12/24V (not included)
Finish: Black (B), White (W)
Dimensions: Length: 2-1/4" Dia.: 1-5/8" Max Ext.: 4-1/4"

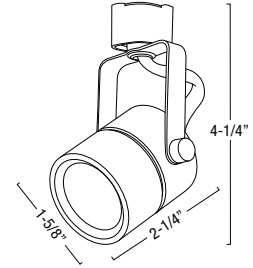

Cubino - Cube Mini Studio Spot

NLMT-735 20W-35W

Lamp: 20W-35W MR11 12/24V (not included)
Finish: Black (B), White (W)
Dimensions: Length: 2-1/4" Dia.: 1-5/8" Max Ext.: 4-1/4"

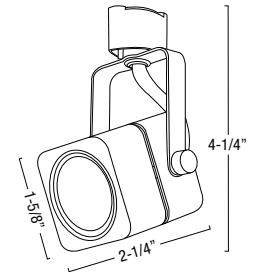

Poquito - Petite Octagon

NLMT-736 20W-35W

Lamp: 20W-35W Lensed MR11 12/24V (not included)
Finish: Black (B), White (W)
Dimensions: Length: 1-1/8" Dia.: 7/8" Max Ext.: 2-5/8"

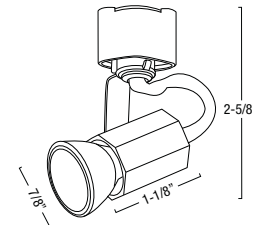

Lighting Tip:

Use Nora Mini Track System with after market LED MR11 and MR16s. Size transformer to load to meet watts per square foot requirements. The combination creates a miniature energy saving, long life lighting statement.



MINI TRACK Pendant Lighting



Polaris™ Mini Pendant Cord Adaptor

NLMP-734	4'	20W-50W
NLMP-738	8'	20W-50W

- Lamp:** 20W-50W JC 6.35 12/24V (not included)
Cord: Field adjustable up to any length
Finish: Black (B), White (W)
Dimensions: Length: 4' & 8'
Glass: Sold separately, see page 416-433
- Protective lamp shield included



Mini Track QuickJack Adapter

NLMT-760

- Feature:** Allows NRS66 Nora Rail fixtures and QuickJack pendants to be put on the Mini Track system, see pages 484-489, 506, 509 for available fixtures.
Finish: Black (B), White (W)
Dimensions: Length: 2-5/8" Dia.: 2-1/8" Max Ext.: 4-5/8" (MR11)
 Length: 3-1/8" Dia.: 2-7/8" Max Ext.: 5-1/8" (MR16)

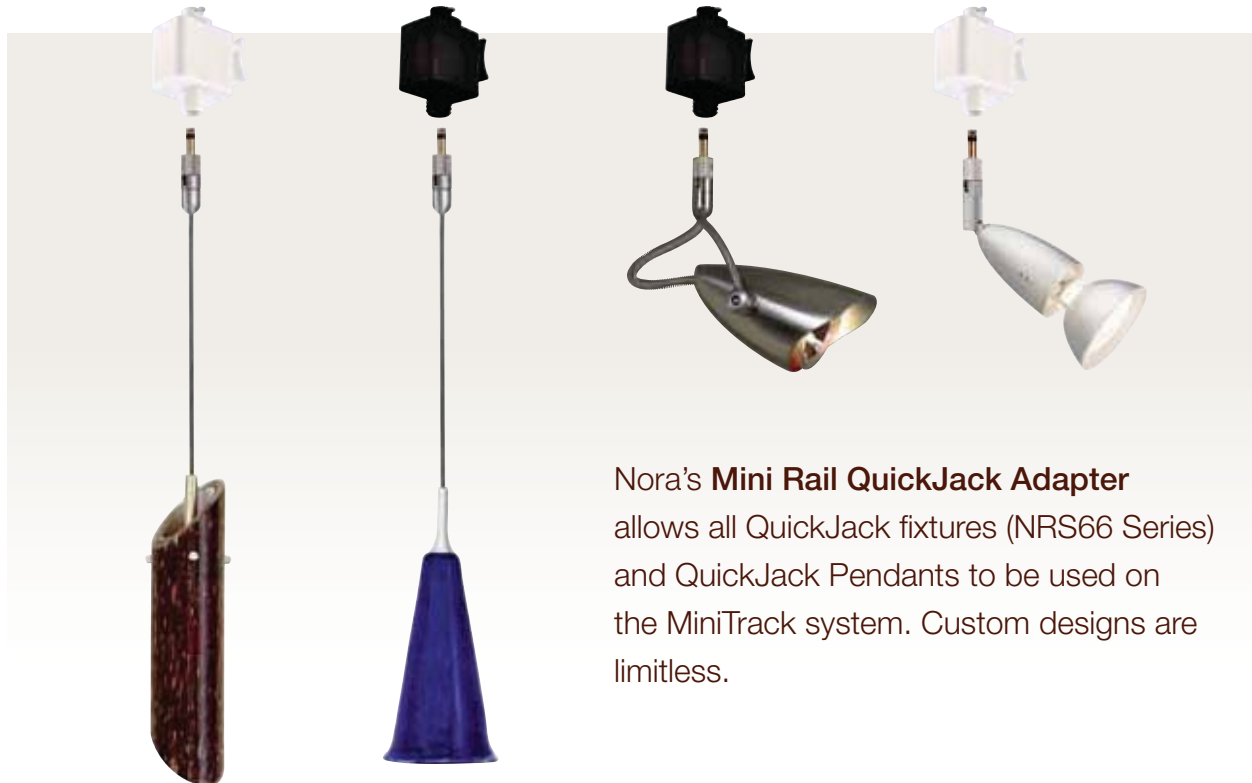

Nora's **Mini Rail QuickJack Adapter** allows all QuickJack fixtures (NRS66 Series) and QuickJack Pendants to be used on the MiniTrack system. Custom designs are limitless.

MINI TRACK Accessories



Low Voltage Mini Track

NLMT-702	2'
NLMT-704	4'
NLMT-708	8'

Finish: Black (B), White (W)

- Includes one end cap, end feed connector, and mounting hardware



End Cap

NLMT-718

Finish: Black (B), White (W)

- To end a run
- Adds 3/4" to length
- One included with each track section



End Feed Connector

NLMT-716

Finish: Black (B), White (W)

- To starting a run. Adds 1-7/8" to length
- Can be a power feed
- Can be used at end of run to power another run
- One included with each track section



Straight Connector

NLMT-710

Finish: Black (B), White (W)

- To connect two MiniTrack sections end to end
- Adds 3/4" to length



I-Connector

NLMT-712

Finish: Black (B), White (W)

- For connecting two sections. Adds 3-1/8" to length.



L-Connector

NLMT-713

Finish: Black (B), White (W)

- For connecting two sections at a 90° angle. Adds 1-7/8" to length.



Conduit End Feed Connector

NLMT-728

Finish: Black (B), White (W)

- To be mounted at the start of a run. Adds 2-5/8" to length
- Accepts standard 1/2" conduit
- Requires remote transformer
- Knockouts for rear or top feed



End Feed Connector with Canopy

NLMT-752

Finish: Black (B), White (W)

- 4-3/8" Width x 2-7/8" Length
- For starting a run
- Requires remote transformer
- Mounts over a single gang junction box



Monopoint Power Feeder

NLMT-719

Finish: Black (B), White (W)

- For use with single fixture and remote transformer
- Mounts directly over standard junction box
- 50W 12/24V max

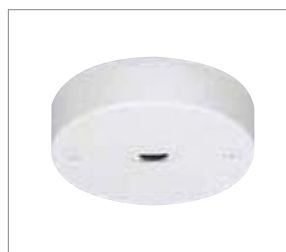

Monopoint with Integral Transformer

NLMT-747

Finish: Black (B), White (W)

- For use with single fixture
- Integral 12V, 50W electronic transformer allows use of single fixture
- Mounts directly over standard junction box
- 20W minimum load
- Dimmable with Electronic Low Voltage Dimmer

Lighting Tip: One System - Two Lighting Effects

Mini Track can be used for even illumination in a linear application and dramatic accent lighting utilizing spotlights on the same system.

MINI TRACK Accessories continued



Mini Track QuickJack Adapter

NLMT-760

Finish: Black (B), White (W)

- Allows NRS66 Nora Rail series to be put on the Mini Track, see pages 484-489, 506, 509
- cULus Listed



End Mount Electronic Transformer

NLMT-75 75W / 12V

Finish: Black (B), White (W)

- To be mounted at the start of a run. Adds 4-3/4" to length
- AC 120V input, AC 12V output
- 20 Watt Minimum Load
- Can be fed from rear or top
- 75W Electronic Transformer has short circuit and overload protection
- Dimmable with Electronic Low Voltage Dimmer
- cULus Listed



Canopy Electronic Mount Transformer

NLMT-150 150W / 12V

Finish: Black (B), White (W)

- To be mounted at the start of a run
- Mounts over standard junction box
- AC 120V input, AC 12V output
- 20 Watt Minimum Load
- 150W Electronic Transformer has short circuit and overload protection
- Dimmable with Electronic Low Voltage Dimmer
- cULus Listed



Remote Electronic Transformer

NET-1060 60W

NET-1075 75W

NET-1150 150W

- Approved for remote mounting up to 6'
- Short circuit & overload protection
- Dimmable
- See page 704-706 for complete selection of transformers



Remote Magnetic Transformer

NMT-150/12SP 150W 120/12V

Dimensions: 3-1/8" L x 2-7/8" W x 10" H

NMT-300/12SP 300W 120/12V

NMT-300/24SP 300W 120/24V

Dimensions: 4-1/4" L x 3-5/8" W x 10" H

NMT-600/12SP 600W 120/12V

NMT-600/24SP 600W 120/24V

Dimensions: 4-7/8" L x 4-1/4" W x 11-1/4" H

NMT-1200/12SP 1200W 120/12V

NMT-1200/24SP 1200W 120/24V

Dimensions: 7" L x 5" W x 12-1/2" H

- Remote mounting up to 40'
- Boost tap for longer runs
- High saturation magnetic core ensures quiet operation and allows dimming
- Individual breakers for overload protection
- Dimmable with magnetic low voltage dimmer
- See page 706 for transformer specifications



MR11/MR16 Lens Filters

NM-100B Blue Filter

NM-100Y Yellow Filter

NM-100G Green Filter

NM-100R Red Filter

NM-100F Frosted Len Filter

NM-100L Linear Spread Filter

NM-100S Spread Len Filter

- For MR11 add suffix "/MR11"
- For MR16 add suffix "/MR16"

MINI TRACK

Mini Track Sample Layouts

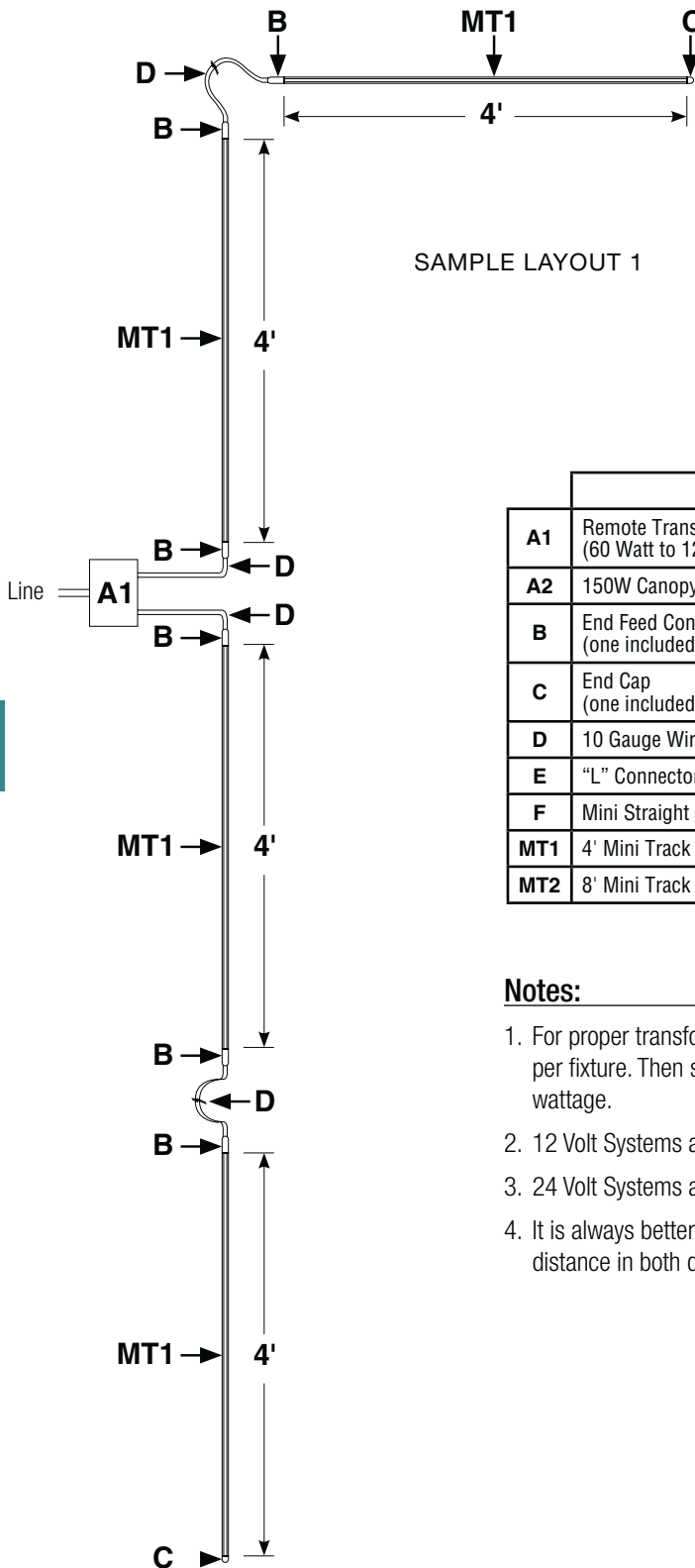

Possible layout for undercabinet application fed by remote transformer. Track can easily be cut in field for various cabinet widths.

	DESCRIPTION	ITEM #
A1	Remote Transformer (60 Watt to 1200 Watt)	See Pages 704-706 for 12V & 24V
A2	150W Canopy Mounted Electronic Transformer	NLMT-150
B	End Feed Connector (one included with each track)	NLMT-716
C	End Cap (one included with each track)	NLMT-718
D	10 Gauge Wire	By Others
E	"L" Connector	NLMT-713
F	Mini Straight Connector	NLMT-710
MT1	4' Mini Track (field cuttable)	NLMT-704
MT2	8' Mini Track (field cuttable)	NLMT-704

Notes:

1. For proper transformer size, multiply number of fixtures by wattage per fixture. Then select transformer rated for more than actual wattage.
2. 12 Volt Systems are limited to 300 Watts per run.
3. 24 Volt Systems are limited to 600 Watts per run.
4. It is always better to feed long runs in the center and go equal distance in both directions.

Mini Track Sample Layouts

Possible layout for ceiling application using an existing junction box.

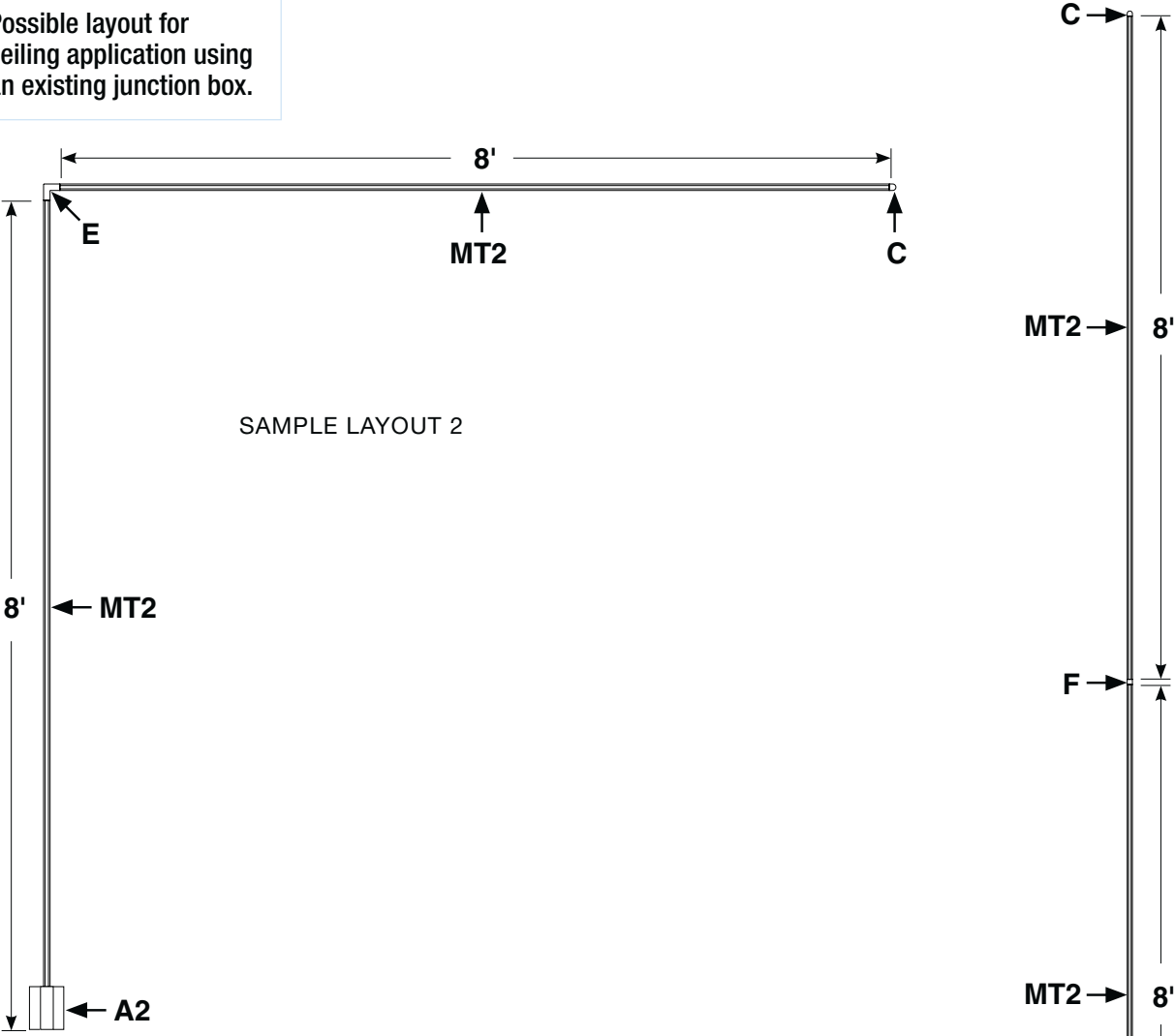

See Page 684 for Legend

Possible layout for a linear cover application using a remote transformer.
Hint: Use 24V transformer for longer runs and 600 watt capacity.

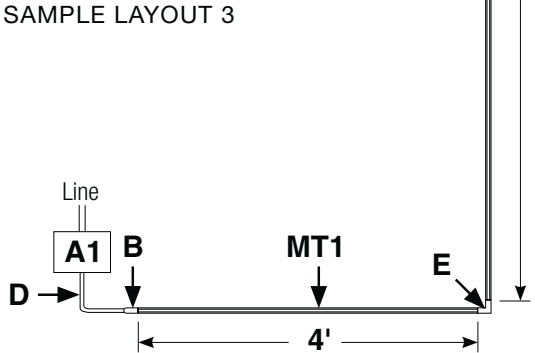

Daum
FRANCE

Daum
FRANCE



MINI RAIL

Introduction	689
Overview	690
Mini Rail Fixtures	692
Accessories	694
Sample Layouts	696



The Nora Lighting Mini Rail System



Nora's low voltage Mini Rail System combines design elegance with superior craftsmanship. This premier 25 Amp, 12V 300W or 24V 600W, cULus listed system can accommodate the smallest applications never before accomplished by conventional rail systems. With a circumference smaller than a dime, Nora Mini Rail is field bendable and cuttable. An assortment of solid brass MR11 and/or MR8 halogen fixtures (up to 35W each), complimented by a QuickJack attachment that will accept numerous MR16 fixtures from the Nora Rail and other compatible systems, thus offering a huge variety of flexibility and style. A 1W LED fixture available in 5 color light output options, provides the ultimate in technology and design. Available in 3 magnificent, jewelry-like finishes - Chrome, Matte Gold and Matte Nickel to match any decor. With vertical, horizontal, perpendicular and curved capabilities, this system provides the intimate lighting you have been looking for.

FEATURES

- Low voltage
- Miniature size
- Field bendable
- May be cut in the field
- Allows freestanding rails without additional support
- Mounts vertically or horizontally
- Available in Chrome (C), Matte Gold (MG), and Matte Nickel (MN) finishes
- 25 Amp capacity
- Rated for 12V, 300W or 24V, 600W
- Utilizes MR8 & MR11 lamps up to 35W. LED, Halogen, and Xelogen also available
- QuickJack system that provides an array of additional MR16 fixtures from other systems
- Assortment of pendant fixtures
- cULus listed

Lighting Tip:

Nora's Mini Rail can be an excellent solution to cabinet or display case lighting. Using the NMRS90-N14 Mini Rail Pass-Through sleeve it is possible to have a single rail without additional support to light a cabinet or display case. Mounted in a corner and remotely powered, this will provide flexible adjustment of fixtures on a single, visually beautiful finished rail. Mount in adjacent corners for dramatic cross illumination.

Overview NORA MINI RAIL

LOW VOLTAGE MINI RAIL FIXTURES



NMRS32-111 Wing
10W Max JC lamp p.692

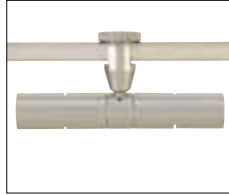

NMRS32-112 Twin Wing
10W Max ea. JC lamp p.692



NMRS32-121 Pivot
35W MR11 lamp p.692



NMRS32-122 Roller
35W MR11 lamp p.692



NMRS32-123 Cone
35W MR11 lamp p.693

LOW VOLTAGE MINI RAIL PENDANT FIXTURES



NMRS32-450 Pendant
35W Max JC 6.35 lamp p.693



NMRS32-524 Yoyo
35W Max JC 6.35 lamp p.693

LED MINI RAIL FIXTURE



NMRS37-331 Barrel
1W LED lamp p.693

LOW VOLTAGE QUICKJACK FIXTURES



NRS90-P32 Mini Rail QuickJack Adapter.
50W MR16 p.694

Needed for all NRS66 series to attach to Mini Rail



NRS66-101 Argon Curve
50W MR16 p.484



NRS66-102 Argon Swivel
50W MR16 p.484



NRS66-103 Sienna w/Ring
50W MR16 p.484



NRS66-104 Neat
50W MR16 p.484



NRS66-105 Satelit Curve
50W MR16 p.485



NRS66-106 Satelit Swivel
50W MR16 p.485

LOW VOLTAGE QUICKJACK FIXTURES



NRS66-107 Neon
50W MR16 p.485



NRS66-108 Lika
50W MR16 p.485



NRS66-109 Nica
50W MR16 p.487



NRS66-901 Penumbra
50W AR111 p.487



NRS66-902 Skyteam
50W AR111 p.488

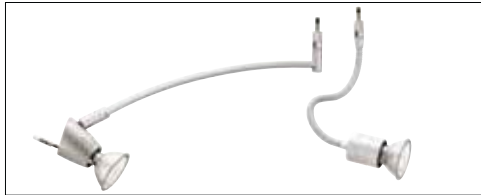

NRS66-310 Fili Display
50W MR16 p.487



NRS66-201PW Petra Curve
50W JC 6.35/MR16 p.488



NRS66-202PW Petra Swivel
50W JC 6.35/MR16 p.488



NRS66-203PW Melody
50W JC 6.35/MR16 p.488



NRS66-204 Swiftec
50W JC 6.35/MR16 p.489

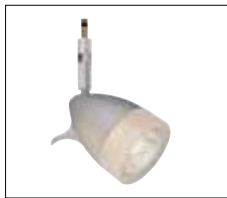

NRS66-251 Kano Spot
50W MR16 p.489



NRS66-252 New Mirage
50W JC 6.35/MR16 p.489



NRS66-253 Lima
50W MR16 p.489



NRS66-457 8.5' Pendant
50W JC 6.35/MR16 p.509



NRS66-458 20' Pendant
50W JC 6.35/MR16 p.509



NRS66-462 Ambra Pendant
50W Bi-Pin p.506



NRS66-463 Petra Pendant
50W Bi-Pin p.506

NORA MINI RAIL ACCESSORIES



Mini Rail Lengths
4' & 6' p.694



Power Feeds
p.694



Connectors and Supports
p.694



Transformers
p.695



Fixture Accessories
p.694

NORA MINI RAIL

Low Voltage Fixtures



Wing

NMRS32-111 10W Max

Lamp: 10W JC Lamp (included)

Finish: Chrome (C), Matte Gold (MG), Matte Nickel (MN)

Dimensions: Length: 2" Dia.: 5/8" Max Ext.: 1-1/4"

- Fixture rotates 345° horizontally
- Lamp shield can rotate 360° around lamp and be locked in place where needed
- UL & cUL Listed

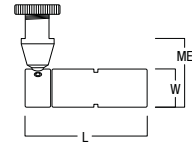

Twin Wing

NMRS32-112 10W Max each

Lamp: (2) 10W JC Lamp (included)

Finish: Chrome (C), Matte Gold (MG), Matte Nickel (MN)

Dimensions: Length: 3-5/8" Dia.: 5/8" Max Ext.: 1-1/4"

- Fixture rotates 345° horizontally
- Lamp shields can rotate 360° around lamp and be locked in place where needed
- UL & cUL Listed

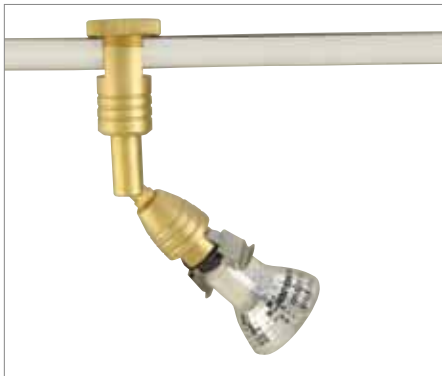
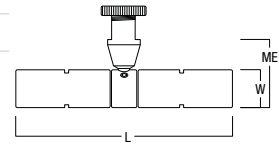

Pivot

NMRS32-121 35W Max

Lamp: 35W MR11 (included)

Finish: Chrome (C), Matte Gold (MG), Matte Nickel (MN)

Dimensions: Length: 1-9/16" Dia.: 9/16" Max Ext.: 2-5/8"

- Rotates 345° horizontal plane
- Adjustable from 0° - 90° vertical plane
- UL & cUL Listed

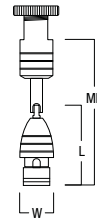

Roller

NMRS32-122 35W Max

Lamp: 35W MR11 (included)

Finish: Chrome (C), Matte Gold (MG), Matte Nickel (MN)

Dimensions: Length: 1-1/16" Dia.: 7/8" Max Ext.: 1-1/2"

- Rotates 345° horizontal plane
- Adjustable from 0° - 135° vertical plane
- UL & cUL Listed

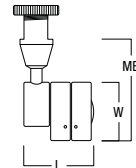

Lighting Tip:

Use after market LED MR11s for precise beam control and energy savings.

Lighting Tip:

For low ceiling applications, the Nora Mini Rail can be mounted as close as 3/4" from the ceiling. Bend the rail to follow an architectural form or detail. Power with a remote transformer sized to the actual load and meet energy code requirements.

NORA MINI RAIL Low Voltage Fixtures

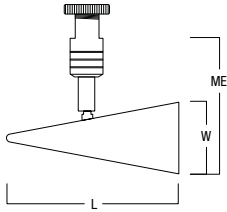

Cone

NMRS32-123 35W Max

Lamp: 35W MR11 (included)

Finish: Chrome (C), Matte Gold (MG), Matte Nickel (MN)

Dimensions: Length: 4-3/8" Dia.: 2-5/8" Max Ext.: 7-1/4"

- Rotates 345° horizontal plane
- Adjustable from 0° - 90° vertical plane
- UL & cUL Listed

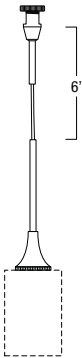

Pendant Assembly

NMRS32-450 35W Max

Lamp: 35W JC 6.35 Lamp (included)

Finish: Chrome (C), Matte Gold (MG), Matte Nickel (MN)

Dimensions: Length: 6'

- 6' (max) Cord length may be field cut
- UL & cUL Listed

Glass Sold Separately, see pages 416-433

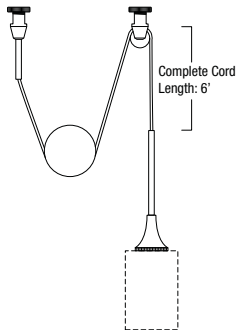

Yoyo Pendant Assembly

NMRS32-524 35W Max

Lamp: 35W JC 6.35 Lamp (included)

Finish: Chrome (C), Matte Gold (MG), Matte Nickel (MN)

Dimensions: Length: 6'

- 6' (max) Cord length may be field cut
- UL & cUL Listed

Glass Sold Separately, see pages 416-433

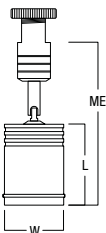

Barrel (LED)

NMRS37-331 1W

Lamp: 1W LED (included)

Finish: Chrome (C), Matte Gold (MG), Matte Nickel (MN)

LED Light Output: Blue (BU), Cool White (CW), Green (GR), Red (R), Warm White (WW)

Dimensions: Length: 1-1/4" Dia.: 1" Max Ext.: 2-11/16"

- Rotates 345° horizontal plane and adjustable from 0° - 90° vertical plane
- Built-in LED driver
- UL & cUL Listed



NORA MINI RAIL

Mini Rail Accessories



Mini Rail

NMRS90-P04 4' (1.2M)

NMRS90-P06 6' (2M)

Finish: Chrome (C), Matte Gold (MG),
Matte Nickel (MN)

Dimensions: Length: 4' & 6'

- End Caps included



Mini Rail End Caps

NMRS90-N01

Finish: Chrome (C), Matte Gold (MG),
Matte Nickel (MN)

- Sold individually



Mini Rail Live 17" Lead Power Feed

NMRS90-P13 17" Lead

Finish: Chrome (C), Matte Gold (MG),
Matte Nickel (MN)

- Provides power connection from Mini Rail to transformer.



Mini Rail Live Power Feed Through Shelf

NMRS90-P12 17" Lead

Finish: Chrome (C), Matte Gold (MG),
Matte Nickel (MN)

- Holds Mini Rail parallel to shelving
- Conducts power from transformer through shelving to Mini Rail.



Live Perpendicular Connector

NMRS90-P10

Finish: Chrome (C), Matte Gold (MG),
Matte Nickel (MN)

- Connects two Mini Rails perpendicular to each other
- Live connector disperses the same power to both rails



Live Universal Connector

NMRS90-P11

Finish: Chrome (C), Matte Gold (MG),
Matte Nickel (MN)

- Live connector of two rails



Mini Rail Pass-Through Sleeve

NMRS90-N14

Finish: Chrome (C), Matte Gold (MG),
Matte Nickel (MN)

- Allows Mini Rail to safely pass through wood shelving, etc., up to 1" thick
- In correct application, it can eliminate the need for some/all standoff supports.



Adjustable Slope/Straight Ceiling Standoff Connector

NMRS90-N74 4.3" - 5.4"

NMRS90-N75 6" - 8-3/4"

NMRS90-N76 8" - 13"

Finish: Chrome (C), Matte Gold (MG),
Matte Nickel (MN)



Adjustable Wall Standoff Connector

NMRS90-N16 7" - 12"

Finish: Chrome (C), Matte Gold (MG),
Matte Nickel (MN)

- Telescopic 7" - 12"
- Allow Mini Rail to be ran parallel to a vertical wall.



Mini Rail QuickJack Adapter

NMRS90-P32 2-1/4"

Finish: Chrome (C), Matte Gold (MG),
Matte Nickel (MN)

- Allows Nora Rail NRS66 series QuickJack fixtures (50W MR16) to be used on the Mini Rail System.

NORA MINI RAIL

Mini Rail Accessories



1" Standoff Connector

NMRS90-N51

Finish: Chrome (C), Matte Gold (MG),
Matte Nickel (MN)

- Screws into wood shelving or may be used for ceiling/wall mounting to suspend Mini Rail



Mini Rail Canopy (No transformer)

NMRS90-P14

Dimensions: OD: 5" Depth: 1-1/2"

- Requires power feed NMRS90-P12 OR NMRS90-P13
- May be used with 75W, 150W or 300W Electronic Transformers



Glass Shelf Support

NMRS90-N52

Finish: Chrome (C), Matte Gold (MG),
Matte Nickel (MN)

- Attaches to Mini Rail to provide support for adjustable glass/wood shelf



75W Electronic Transformer Canopy

NMRS90-P14/12 12V

NMRS90-P14/24 24V

Dimensions: OD: 5" Depth: 1-1/2"

- Requires power feed NMRS90-P12 OR NMRS90-P13
- Mounts permanently to outlet box
- UL & cUL listed



Suspension Tab From Shelves

NMRS90-N56 up to 1/4" Thick Shelf

NMRS90-N53 up to 1/2" Thick Shelf

NMRS90-N58 up to 5/16" Thick Shelf

Finish: Chrome (C), Matte Gold (MG),
Matte Nickel (MN)

- Allows Mini Rail to be suspended from a shelf
- Runs parallel to the shelf
- Includes plastic set screw for glass shelves



150W Electronic Transformer Canopy

NMRS90-P15/12 12V

NMRS90-P15/24 24V

Dimensions: OD: 5" Depth: 1-1/2"

- Requires power feed NMRS90-P12 OR NMRS90-P13
- Mounts permanently to outlet box
- UL & cUL listed



300W 12V Remote Round Electronic Transformer

NET-301/12Round 12V

Dimensions: OD: 3-11/16" Height: 1-3/8"

- Replacement transformer for NMRS90-P16
- Input: AC 120V, Output: AC 12V
- UL Recognized



300W Electronic Transformer Canopy

NMRS90-P16/12 12V

Dimensions: OD: 6-1/4" Depth: 2-1/2"

- Requires power feed NMRS90-P12 OR NMRS90-P13
- Mounts permanently to outlet box
- UL & cUL listed



Heat Sink for NET-301/12Round

NET-301/12RSink

Dimensions: OD: 4-7/8" Height: 1-1/2"

- Replacement Heat Sink for NMRS90-P16



Mini Rail Bending Device

NMRS90-N33

- Allows custom bending of rail in field

For complete selection of remote transformers, See Pages 704-706

NORA MINI RAIL

Mini Rail Sample Layouts

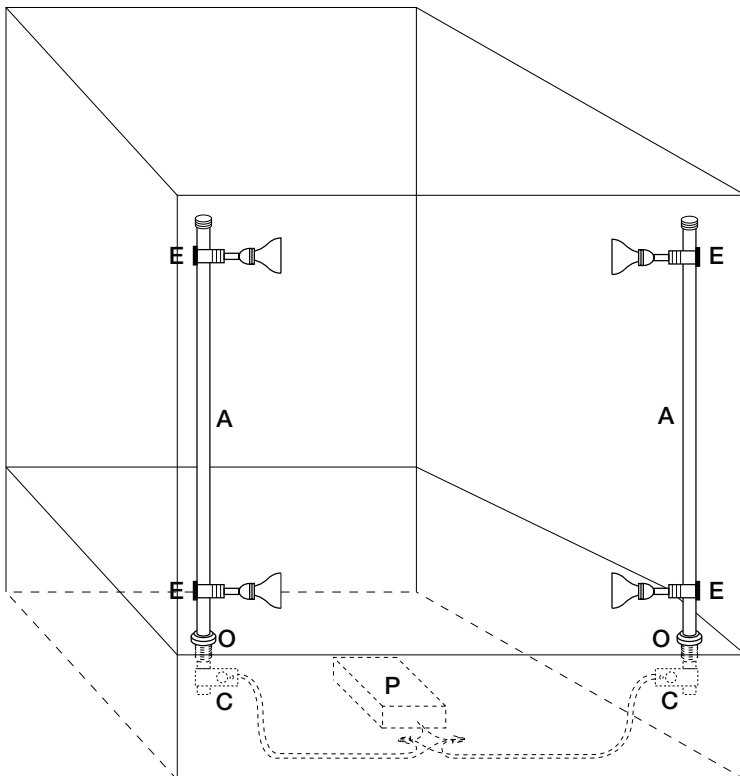

The application shown above was specified vertically. The chart and illustration below will assist in creating a similar specification.

	QTY.	DESCRIPTION	ITEM #
A	1	6' Mini Rail (cut into 2 sections)	NMRS90-P06
C	2	Live Power Feed	NMRS90-P13
E	4	Pivot Fixtures, Chrome	NMRS32-121
O	2	Surface Connector	NMRS90-N14
P	1	150W Electronic Transformer	NMRS32-123C

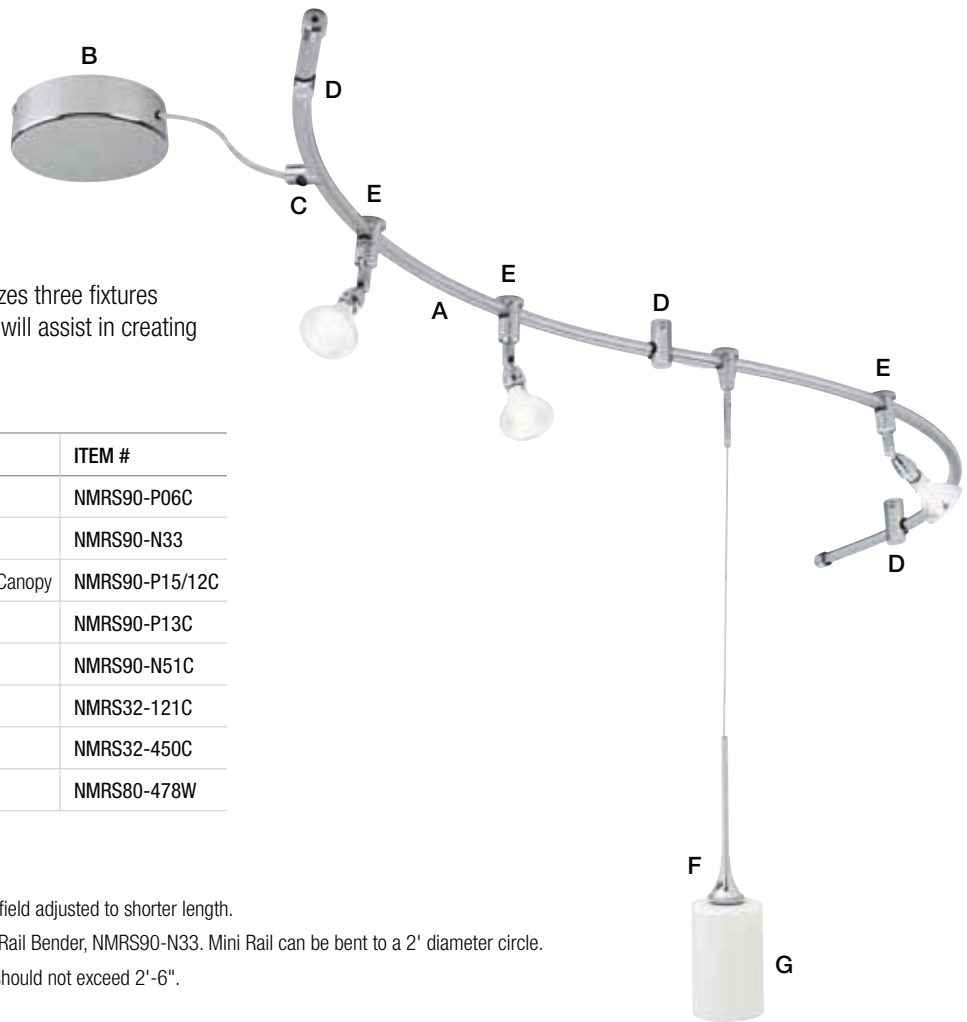

The application shown at right utilizes three fixtures and one pendant. The chart below will assist in creating a similar specification.

	QTY.	DESCRIPTION	ITEM #
A	1	6' Mini Rail, Chrome	NMRS90-P06C
(A)	1	Rail Bending Device	NMRS90-N33
B	1	150W Transformer, Chrome Canopy	NMRS90-P15/12C
C	1	Live Power Feed, Chrome	NMRS90-P13C
D	3	Suspension Tabs, Chrome	NMRS90-N51C
E	3	Pivot Fixtures, Chrome	NMRS32-121C
F	1	Pendant Fixture, Chrome	NMRS32-450C
G	1	Cassandra Glass, Frost White	NMRS80-478W

SPECIAL NOTES:

Pendant Cord Length: Maximum 6' can be field adjusted to shorter length.

Rail Bending: Only accomplished with Mini Rail Bender, NMRS90-N33. Mini Rail can be bent to a 2' diameter circle.

Rail Supports: Distance between supports should not exceed 2'-6".

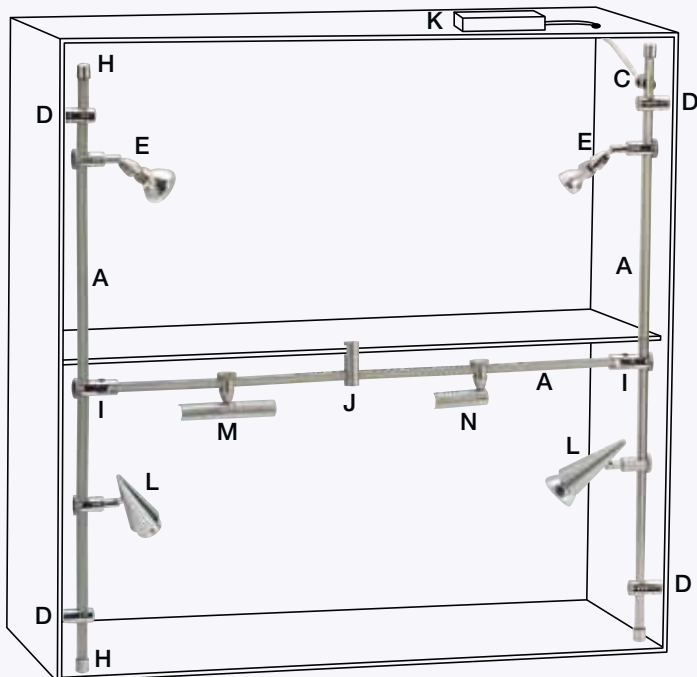

The application shown at left utilizes six fixtures. The chart below will assist in creating a similar specification.

	QTY.	DESCRIPTION	ITEM #
A	1	6' Mini Rail, Chrome (cut into 3 sections)	NMRS90-P06C
C	1	Live Power Feed, Chrome	NMRS90-P13C
D	4	Suspension Tabs, Chrome	NMRS90-N51C
E	2	Pivot Fixtures, Chrome	NMRS32-121C
H	2	Additional Endcaps, Chrome	NMRS90-N01C
I	2	Vertical Rail Connectors, Chrome	NMRS90-P10C
J	1	Suspension Tab for Shelf, Chrome	NMRS90-N58C
K	1	300W Electronic Transformer	NET-300SL
L	2	Cone Fixtures, Chrome	NMRS32-123C
M	1	Twin Wing Fixture, Chrome	NMRS32-112C
N	1	Wing Fixture, Chrome	NMRS32-111C

TRANSFORMERS & LED DRIVERS

- 699 Introduction
- 700 Overview
- 702 Class II Electronic & Magnetic Transformers
- 703 Economy Electronic Transformers
- 703 Premium Electronic Transformers
- 704 Enclosure Boxes for Electronic Transformers
- 704 Magnetic Transformers
- 705 Replacement Recessed Transformers
- 705 Replacement Electronic Ballast
- 706 Class II LED Drivers
- 706 Direct Plug-In LED Drivers
- 706 RGB Accessories
- 707 Class II LED Driver Accessories

Transformers and LED Drivers

Nora Lighting offers a complete line of transformers and LED drivers for replacement, remote, and remote enclosure applications. Electronic transformers and drivers offer solid state construction for silent operation while magnetic transformers and drivers offer dependable long life and are an excellent choice for commercial applications where 24/7 operation is required.

Class II Transformers

Class II transformers are designed for Class II wiring. Class II wiring can not exceed more than 5 amps (60 watts with 12 volt source) on a single run, therefore Class II listed transformers may not exceed 60 watt output. Class II transformers may not auto-reset due to a short or overload, they must shut down until the fault is corrected.

Nora offers Class II transformers in 60 watt electronic, 360 watt electronic, and 300 watt magnetic. The 360 watt and 300 watt consist of multiple 60 watt taps to meet Class II wiring requirements and are excellent for larger jobs and commercial applications. These transformers act as a distribution center for a Class II system.

Electronic Transformers

Nora offers electronic transformers in wattages from 60 to 360 watts. Additionally, the electronic transformers are available in Premium and Economy styles.

[Premium Electronic Transformers](#) are dimmable and have re-settable overload and short circuit protection. Once the overload or short has been corrected the premium transformer will re-set and operate again. Premium electronic transformers also include soft start which increases lamp life.

[Economy Electronic Transformers](#) are dimmable and have overload and short circuit protection. Unlike the premium transformers, these are not re-settable after an overload or short circuit and must be replaced after a short or overload.

Magnetic Transformers

Nora offers premium quality dimmable magnetic transformers in wattages from 150 to 1200. The magnetic transformers have re-settable breaker protection on both the primary and secondary sides. Additionally, all magnetic transformers have a boost tap to increase the voltage output for longer runs. The boost tap is necessary on long runs to get full designed lamp performance. Magnetic transformers are recommended for commercial applications or applications where the transformer must be remoted a far distance from the light run. Magnetic transformers have an inherent minimal amount of hum and this should be considered in the job application.

LED Drivers

Nora offers a complete selection of ETL or UL Listed electronic and magnetic drivers for Nora LED systems. Offered in 12V DC and 24V DC, Plug-In, Hardwire and Dimmable Hardwire. Nora offers flexibility for any commercial or residential application.



Overview TRANSFORMERS & DRIVERS

ELECTRONIC & MAGNETIC CLASS II TRANSFORMERS



60W Electronic Transformer
NET-060-BF Bottom Feed p.702
NET-060-LT End Feed p.702



60W Electronic Transformer
NET-1060 Blister Pack p.702
NET-2060 p.702



60W Electronic w/ Cord & Plug
NET-060WP Black p.702
NET-2060WP White p.702



360W Electronic Transformer
NET-363/C2 p.702



300W Magnetic Transformer
NMT-300/C2 p.702

ECONOMY ELECTRONIC TRANSFORMERS



60W & 75W Electronic Xfmr
NET-060 60W p.703
NET-075 75W p.703

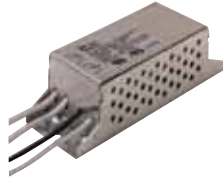

105W & 150W Electronic Xfmr
NET-105 105W p.703
NET-150 150W p.703



75W Electronic Transformer
NET-1075 Blister Pack p.703
NET-2075 p.703



75W Lighttech® Transformer
NET-075-BF 120V/12V p.703
NET-075-BF-277 277V/12V p.703
NET-075-LT 12V End Feed p.703
NET-075R/12 12V p.703
NET-075R/24 24V p.703

PREMIUM ELECTRONIC TRANSFORMERS



105W Electronic Transformer
NET-1105 Blister Pack p.703
NET-2105 p.703



150W Electronic Transformer
NET-1150 Blister Pack p.703
NET-2150 p.703



150W Lighttech® Transformer
NET-150R/12 12V Lighttech® p.703
NET-150R/24 24V Lighttech® p.703



300W Lighttech® Transformer
NET-300/SL 12V Slim Line p.703
NET-300/SL/24 24V Slim Line p.703
NET-300/24 24V p.704

ROUND ELECTRONIC XFMR



300W Remote Round Electronic Transformer
NET-301/12Round p.704

ENCLOSURE BOXES FOR ELECTRONIC TRANSFORMERS



Metal Enclosure Box for 60W or 75W Electronic Transformer
NETB-1 p.704



Metal Enclosure Box for 105W or 150W Electronic Transformer
NETB-2 p.704

MAGNETIC TRANSFORMERS



150W Magnetic Transformer
NMT-150/12SP 12V p.704



300W Magnetic Transformer
NMT-300/12SP 12V p.704
NMT-300/24SP 24V p.704



600W Magnetic Transformer
NMT-600/12SP 12V p.704
NMT-600/24SP 24V p.704



1200W Magnetic Transformer
NMT-1200/12SP 12V p.704
NMT-1200/24SP 24V p.704

CLASS II LED DRIVERS



Dimmable Magnetic LED Driver
NMT-60/12C2 12V 60W p.706
NMT-60/24C2 24V 60W p.706
NMT-96/24C2 24V 96W p.706



12V LED Driver
NAPK-530HW/12v 30W p.706
NAPK-560HW/12 60W p.706



24V LED Driver
NATL-530HW 30W p.706
NATL-560HW 60W p.706



24V LED Driver w/ Cord & Plug
NATL-5100 100W p.706

PLUG-IN LED DRIVERS



12V Direct Plug-In LED Driver
NAPK-724/12 24W p.706
NAPK-750/12 50W p.706



24V Direct Plug-In LED Driver
NATL-524 24W p.706
NATL-545 45W p.706

RGB ACCESSORIES



RGB Controller
NARGB-760 p.706



RGB Remote Control
NARGB-761 p.706

CLASS II LED DRIVERS ACCESSORIES



Power Line Connector
NAPK Series 12V p.707
NALTL Series 24V p.707



Junction Box for LED Driver
NUSP-JBox p.707

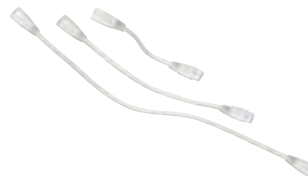

Extension Cord for LED Drivers
NRA-125 Series p.707



Power Cord for LED Drivers
NRA-6035W/6 6' p.707
NRA-6035W/10 10' p.707

REPLACEMENT RECESSED TRANSFORMERS



Magnetic Transformer
NRA-29/50W 50W p.705
NRA-29/75W 75W p.705



50W Transformer with Plate
NRA-6037 Magnetic p.705
NRA-6061 Electronic p.705

REPLACEMENT ELECTRONIC BALLAST



Ballast for Mini Inch Fluorescent
BAEBF008T5211FB 8W p.705
BAEBF013T5211FB 13W p.705
BAEBF901T5211FB 8W-13W p.705



Ballast for 1-3/4" Fluorescent
NLEB-1513 13W-15W p.705
NLEB-20 18W-20W p.705
NLEB-3040 25W-40W p.705

TRANSFORMERS AND DRIVERS

Class II Transformers



60W Lichtechnic® Electronic Class II Transformer
NET-060-LT End Feed, Bulk Pack
Input: AC 120V
Output: AC 12V
Wattage: 60W
Dimensions: W: 1-7/8" L: 3-1/8" H: 1-1/4"
Short Circuit and Overload Protection
 (Re-sets after short or overload has been fixed)
Dimmable with Electronic Low Voltage Dimmer
Listing: UL Recognized



60W Lichtechnic® Electronic Class II Transformer
NET-060-BF Bottom Feed, Bulk Pack
Input: AC 120V
Output: AC 12V
Wattage: 60W
Dimensions: W: 1-7/8" L: 3-1/8" H: 1-1/4"
Short Circuit and Overload Protection
 (Re-sets after short or overload has been fixed)
Dimmable with Electronic Low Voltage Dimmer
Listing: UL Recognized



60W Electronic Class II Transformer
NET-1060 Blister Pack
NET-2060 Individual Box
Input: AC 120V
Output: AC 12V
Wattage: 60W
Dimensions: W: 1-1/4" L: 3-1/4" H: 3/4"
Short Circuit and Overload Protection
 (Re-sets after short or overload has been fixed)
Dimmable with Electronic Low Voltage Dimmer
Listing: UL Recognized



60W Electronic Class II Transformer with Cord and Plug
NET-060WP Black
NET-2060WP-B Black
NET-2060WP-W White
Input: AC 120V
Output: AC 12V
Wattage: 60W
Dimensions: W: 1-1/4" L: 3-1/4" H: 3/4"
Short Circuit and Overload Protection
 (Re-sets after short or overload has been fixed)
Dimmable with Electronic Low Voltage Dimmer
Listing: UL Recognized
Includes: 6' Cord and Plug, 6' Low Voltage Leads, In-Line Switch, and 3 Quick Connectors
For use with: NM-126, NM-240, NM-241, NM-250, NM-251, NM-252, NM-253, NM-254



300W Magnetic Class II Transformer with 5 x 60W Breakers
NMT-300/C2
Input: AC 120V
Output: AC 12V
Wattage: 5 x 60W Breakers, each fused to 5A
Maximum Distance: 50'
Dimensions: W: 6-7/8" L: 6-3/8" H: 3"
Resists spikes, surges, and all other power irregularities
NEC Class II 5A Breaker Protection
Dimmable with Magnetic Low Voltage Dimmer
24 Hour Operation, direct sunlight capable
Listing: UL Listed



360W Electronic Class II Transformer with 6 x 60W Circuits
NET-363/C2
Input: AC 120V
Output: AC 12V
Wattage: 6 x 60W Circuits
Maximum Distance: 15'
Dimensions: W: 4-7/8" L: 8-3/8" H: 1-3/4"
Short Circuit and Overload Protection
 (Re-sets after short or overload has been fixed)
Dimmable with Electronic Low Voltage Dimmer
Knockouts provided for connection to pipe / flex conduit
Listing: UL Listed

TRANSFORMERS AND DRIVERS

Electronic Transformers



Economy Electronic Transformer

NET-060 65W
NET-075 75W

Input: AC 120V
Output: AC 12V
Dimensions: W: 1-7/8" L: 3-1/8" H: 1-1/4"
Short Circuit and Overload Protection (Not Resettable)
Listing: UL Recognized



75W Premium Lighttech® Electronic Transformer

NET-075-BF 120V/12V, Bottom Feed
NET-075-BF-277 277V/12V, Bottom Feed

Input: AC 120V
Output: AC 12V
Wattage: 75W
Dimensions: W: 1-7/8" L: 3-1/8" H: 1-1/4"
Resettable Short Circuit and Overload Protection
Listing: UL Recognized

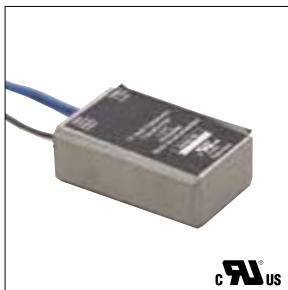

75W Premium Lighttech® Electronic Transformer

NET-075-LT 120V/12V, End Feed
NET-075R/12 120V/12V, End Feed
NET-075R/24 120V/12V, End Feed

Input: AC 120V
Output: AC 12V
Wattage: 75W
Dimensions: W: 1-7/8" L: 3-1/8" H: 1-1/4"
Resettable Short Circuit and Overload Protection
Listing: UL Recognized

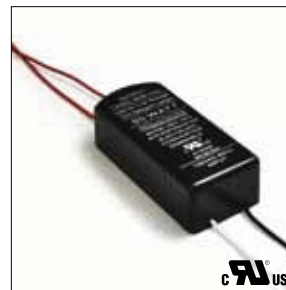

75W Premium Electronic Transformer

NET-1075 Blister Pack
NET-2075 Individual Box

Input: AC 120V
Output: AC 12V
Wattage: 75W
Dimensions: W: 6-7/8" L: 6-3/8" H: 3"
Resettable Short Circuit and Overload Protection
Listing: UL Recognized

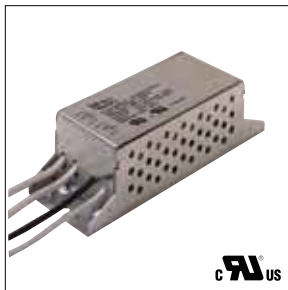

105W Economy Electronic Transformer

NET-105

Input: AC 120V
Output: AC 12V
Wattage: 105W
Dimensions: W: 1-3/4" L: 5-1/8" H: 1-7/16"
Short Circuit and Overload Protection (Not Resettable)
Listing: UL Recognized



105W Premium Electronic Transformer

NET-1105 Blister Pack
NET-2105 Individual Box

Input: AC 120V
Output: AC 12V
Wattage: 105W
Dimensions: W: 2-1/4" L: 4-3/8" H: 1-3/8"
Resettable Short Circuit and Overload Protection
Listing: UL Recognized

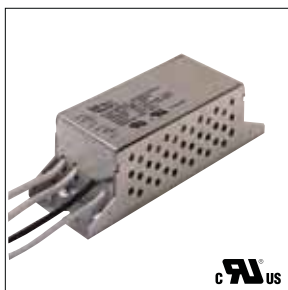

150W Economy Electronic Transformer

NET-150

Input: AC 120V
Output: AC 12V
Wattage: 150W
Dimensions: W: 1-3/4" L: 5-1/8" H: 1-7/16"
Short Circuit and Overload Protection (Not Resettable)
Listing: UL Recognized



150W Premium Electronic Transformer

NET-1150 Blister Pack
NET-2150 Individual Box

Input: AC 120V
Output: AC 12V
Wattage: 150W
Dimensions: W: 1-3/4" L: 4-1/4" H: 1-1/4"
Resettable Short Circuit and Overload Protection
Listing: UL Recognized



150W Premium Lighttech® Electronic Transformer

NET-150R/12 12V Output, Bulk Pack
NET-150R/24 24V Output, Bulk Pack

Input: AC 120V
Wattage: 150W
Dimensions: W: 2-1/4" L: 4-3/8" H: 1-3/8"
Resettable Short Circuit and Overload Protection
Listing: UL Recognized



300W Premium Lighttech® Electronic Slim Line Enclosed Transformer

NET-300/SL 12V Output
NET-300/SL/24 24V Output

Input: AC 120V
Wattage: 300W
Dimensions: W: 1-5/8" L: 9-3/8" H: 1-3/8"
Resettable Short Circuit and Overload Protection
Listing: UL Listed



All Electronic Transformers on this page are dimmable with Electronic Low Voltage Dimmer.

TRANSFORMERS AND DRIVERS

Electronic Transformers continued



**300W Premium Lightech®
Electronic Transformer**
NET-300/24 24V Output
Input: AC 120V
Output: AC 24V
Wattage: 300W
Dimensions: W: 1-1/2" L: 6" H: 1-1/8"
Resettable Short Circuit and Overload Protection
Listing: UL Recognized



**300W Premium Round Lightech®
Electronic Transformer**
NET-301/12Round 12V Output
Input: AC 120V
Output: AC 12V
Wattage: 300W
Dimensions: OD: 3-5/8" ID: 3/8" H: 1-3/8"
Resettable Short Circuit and Overload Protection
Listing: UL Recognized
Replacement Transformer for NMRS90-P16

All Electronic Transformers on this page are dimmable with Electronic Low Voltage Dimmer.

Metal Enclosures for Electronic Transformers



Metal Enclosure for Electronic Transformer
NETB-1
Knockouts allow for Line Voltage Input and Low Voltage Output
Dimensions: W: 2" L: 7" H: 2"
Listing: cULus Listed
For use with:
60W or 75W Electronic Transformers



Metal Enclosure for Electronic Transformer
NETB-2
Knockouts allow for Line Voltage Input and Low Voltage Output
Dimensions: W: 3-3/4" L: 6-5/8" H: 2-1/4"
Listing: cULus Listed
For use with:
105W or 150W Electronic Transformers

Magnetic Transformers



150W Magnetic Transformer
NMT-150/12SP 120V/12V, 150W
Breaker: (1) 20A Breaker
Maximum Distance: 50'
Dimensions: W: 2-7/8" L: 3-1/8" H: 10"
NEC Class I Breaker Protection
Short Circuit and Overload Protection
Boost Tap for Longer Runs
24 Hour Operation, Direct Sunlight Capable
Listing: UL Listed



300W Magnetic Transformer
NMT-300/12SP 120V/12V, 300W
NMT-300/24SP 120V/24V, 300W
Breaker:
NMT-300/12SP: (1) 25A Breaker
NMT-300/24SP: (1) 12.5A Breaker
Maximum Distance: 50'
Dimensions: W: 3-5/8" L: 4-1/4" H: 10"
NEC Class I Breaker Protection
Short Circuit and Overload Protection
Boost Tap for Longer Runs
24 Hour Operation, Direct Sunlight Capable
Listing: UL Listed



600W Magnetic Transformer
NMT-600/12SP 120V/12V, 2 x 300W
NMT-600/24SP 120V/24V, 1 x 600W
Breaker:
NMT-600/12SP: (2) 25A Breaker
NMT-600/24SP: (1) 25A Breaker
Maximum Distance: 50'
Dimensions: W: 4-1/4" L: 4-7/8" H: 11-1/4"
NEC Class I Breaker Protection
Short Circuit and Overload Protection
Boost Tap for Longer Runs
24 Hour Operation, Direct Sunlight Capable
Listing: UL Listed



1200W Magnetic Transformer
NMT-1200/12SP 120V/12V, 4 x 300W
NMT-1200/24SP 120V/24V, 2 x 600W
Breaker:
NMT-1200/12SP: (4) 25A Breaker
NMT-1200/24SP: (2) 25A Breaker
Maximum Distance: 50'
Dimensions: W: 5" L: 7" H: 12-1/2"
NEC Class I Breaker Protection
Short Circuit and Overload Protection
Boost Tap for Longer Runs
24 Hour Operation, Direct Sunlight Capable
Listing: UL Listed

All Magnetic Transformers on this page are dimmable with Magnetic Low Voltage Dimmer.

Replacement Recessed Transformers



Replacement Magnetic Transformer

NRA-29/50W 120V/12V 50W
NRA-29/75W 120V/12V 75W
NRA-29/277V 277V/12V 50W
NRA-29/75/277V 277V/12V 75W

Dimensions: W: 1-7/8" L: 2-1/4" H: 2-5/8"
Includes Thermal Protector
Listing: UL Recognized



Replacement Magnetic Transformer with Junction Box Cover

NRA-6037 120V/12V 50W

Dimensions: W: 2-5/8" L: 5-1/8" H: 3-3/8"

Includes Thermal Protector

Listing: UL Recognized

For use with: Low Voltage New Construction and Remodel Housings



Replacement Electronic Transformer with Junction Box Cover

NRA-6061 120V/12V 50W

Dimensions: W: 7/8" L: 5-1/8" H: 3-3/8"

Short Circuit and Overload Protection

Listing: UL Recognized

For use with: Low Voltage New Construction and Remodel Housings

Replacement Electronic Ballast



Replacement Electronic Ballast for Mini Inch Fluorescent Series

BAEBF008T5211FB 120V / 8W T5
BAEBF013T5211FB 120V / 13W T5
BAEBF901T5231FB 120V / 8W-13W T5

Input: 120VAC, 50/60Hz

Class P Thermally Protected

Dimensions:

BAEBF008T5211FB: W: 1-5/8" L: 4-1/4" H: 7/8"
 BAEBF013T5211FB: W: 1-3/4" L: 5-3/4" H: 7/8"
 BAEBF901T5231FB: W: 1-3/4" L: 5-3/4" H: 7/8"

For use with:

BAEBF008T5211FB: NU-12
 BAEBF013T5211FB: NU-21
 BAEBF901T5231FB: NU-24, NU-32, and NU-42

Listing: cULus Listed



Replacement Electronic Ballast for 1-3/4" Fluorescent Series

NLEB-1513 13W T8 or 15W T12
NLEB-20 18W T8 or 20W T12
NLEB-3040 25W-32W T8 or 30-40W T12

Input Voltage: 120VAC, 60Hz

Class P Thermally Protected. Rapid Start

Dimensions: W: 1-3/4" L: 6-3/8" H: 1-3/8"

For use with:

NLEB-1513: NU-1312EL, NU-1518EL
 NLEB-20: NU-2024EL
 NLEB-3040: NU-3036EL, NU-4048EL

Listing: cULus Listed

Replacement Recessed Electronic Ballast available on page 385

TRANSFORMERS AND DRIVERS

LED Drivers and RGB Accessories



Class II LED Plug-In Driver

NATL-5100 24 Volt / 100 Watts
Input: AC 100V-240V
Cord and Plug: 6' Cord and Plug
Cord Length: 3-1/4" Power Line Connector included
Dimensions: W: 2-5/8" L: 7-7/8" H: 1-3/8"
Hardwiring: Cable can be cut to be hardwired, requires NUSP-JBox for hardwiring
Note: Power line interconnector required for LED Lightbar or LED Tape Light
Non-Dimmable LED Driver
Listing: UL Recognized



RGB Controller

NARGB-760 For RGB Tape Light
Input: DC 24V
Input Wire: 12" included
Output Wire: 12" included
Dimensions: W: 2" L: 4-3/4" H: 1"
Functions: 16 different colors, 3 brightness levels, On/Off, 4 color patterns; (Flash, Strobe, Fade, Smooth)
Note: Capable of synchronizing multiple RGB controllers. RGB Remote control sold separately (NARGB-761). Power line interconnector required for LED RGB Tape Light.
Listing: RoHS Compliant



Direct Plug-In LED Driver

NAPK-724/12 12 Volt / 24 Watts
NAPK-750/12 12 Volt / 50 Watts
NATL-524 24 Volt / 24 Watts
NATL-545 24 Volt / 45 Watts
Input: AC 100V-240V
Cord Length: 6'
Dimensions: W: 1-3/4" L: 1-1/2" H: 3-3/4"
Note: Power line interconnector required for LED Lightbar, LED Tape Light, or LED Puck Light
Non-Dimmable LED Driver
Listing: cULus Listed



RGB Remote Control

NARGB-761 For RGB Controller
Maximum Distance: 22'
Dimensions: W: 1-7/8" L: 3-1/2" H: 1/4"
Functions: On/Off Buttons
 3 Brightness Levels
 Flash - 7 colors flashing
 Strobe - Red, Green, Blue strobe alternatively
 Fade - 7 colors fading in and out smoothly
 16 Different Color options



Class II Dimmable Hardwire LED Driver

NMT-60/12C2 12 Volt / 60 Watts
NMT-60/24C2 24 Volt / 60 Watts
NMT-96/24C2 24 Volt / 96 Watts
Input: AC 120V
Cord Length: 10' Power Line Connector included (30' Power Line Connector sold separately)
Dimensions: W: 2-1/2" L: 6-5/8" H: 2-3/8"
Dimmable with Magnetic Low Voltage Dimmer
Manual Reset Thermal Circuit - Secondary Side
Note: Power line interconnector required for LED Lightbar, LED Tape Light, or LED Puck Light
Listing: ETL Listed



Class II LED Driver

NAPK-530HW/12 12 Volt / 30 Watts
NAPK-560HW/12 12 Volt / 60 Watts
NATL-530HW 24 Volt / 30 Watts
NATL-560HW 24 Volt / 60 Watts
Input: AC 100V-240V
Input Wire: 4" Input Wire
Output Wire: 3-1/4" Power Line Connector included
Dimensions:
 NATL-530HW: L: 5-5/8" W: 1-3/4" H: 1-1/4"
 NATL-560HW: L: 6" W: 2-1/2" H: 2-1/4"
Requires: NUSP-JBox for hardwiring or NRA-6035 for direct plug-in
Note: Power line interconnector required for LED Lightbar, LED Tape Light, or LED Puck Light
Non-Dimmable LED Driver
Listing: UL Recognized

TRANSFORMERS AND DRIVERS

LED Driver Accessories



Junction Box for Class II LED Drivers

NUSP-JBox

Input: Accepts Romex® or flex

Output: Capable of feeding two separate LED Drivers.

To be used with:

NAPK-530HW/12: 30W 12V Class II LED Driver
 NAPK-560HW/12: 60W 12V Class II LED Driver
 NATL-530HW: 30W 24V Class II LED Driver
 NATL-560HW: 60W 24V Class II LED Driver
 NATL-5100: 100W 24V Class II LED Driver

Listing: UL Listed



Flexible Power Cord for LED Drivers

NRA-6035W/6

6' Power Cord

NRA-6035W/10

10' Power Cord

Feature: Allows LED Driver to be converted into a direct plug-in LED Driver. Can also be extended using NRA-125 Series.

To be used with:

NAPK-530HW/12: 30W 12V Class II LED Driver
 NAPK-560HW/12: 60W 12V Class II LED Driver
 NATL-530HW: 30W 24V Class II LED Driver
 NATL-560HW: 60W 24V Class II LED Driver

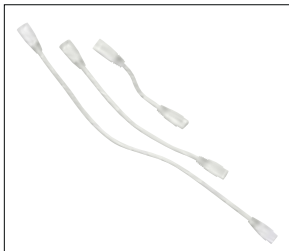

Extension Cord for LED Drivers

NRA-125/6

6" Cord

NRA-125/12

12" Cord

NRA-125/18

18" Cord

NRA-125/72

72" Cord

To be used with:

NAPK-530HW/12: 30W 12V Class II LED Driver
 NAPK-560HW/12: 60W 12V Class II LED Driver
 NATL-530HW: 30W 24V Class II LED Driver
 NATL-560HW: 60W 24V Class II LED Driver
 NRA-6035: 6' or 10' Power Cord

Used to extend length between NUSP-JBox and LED Hardwired Drivers

Can be joined together to create custom lengths



Power Line Connector

NAPK-10

12 Volt / 10' Cord

NAPK-30

12 Volt / 30' Cord

NALT-10

24 Volt / 10' Cord

NALT-30

24 Volt / 30' Cord

To be used with:

NMT-60/12C2: 12V Class II Dimmable LED Driver
 NMT-60/24C2: 24V Class II Dimmable LED Driver
 NMT-96/24C2: 24V Class II Dimmable LED Driver

Note: 10' Cord included with NMT-60/12C2, NMT-60/24C2, and NMT-96/24C2 drivers.



EXIT & EMERGENCY

Introduction	710
Overview	711
LED Exit Signs	714
Wet Location Exit Signs	722
Self-Illuminating Tritium Exit Sign	723
Steel LED Exit Sign	724
Steel Exit-Emergency Combination	724
Steel Emergency Light	724
Exit-Emergency Combinations	725
Emergency Lights	729
LED Mini Dual Head Emergency Light	730
Emergency Remote Heads	738
Exit and Emergency Accessories	740
Recessed Emergency Units	742

Exit & Emergency

Building lighting is generally thought of as a number of fixtures that allow occupants to live, move, and work in comfort and safety. Just as importantly, lighting must also help the same people safely and quickly leave a location, whether it is one individual, or a large group.

Situations differ...

They range from those that are simply leaving after a visit, to escaping a catastrophic event.

Environments differ...

The location can be an office building, a restaurant on a beach promenade, a sparsely visited storage area, or an oil rig in the middle of the ocean. The atmosphere can range from dry and hot to air conditioned and cool.

Solutions differ...

Nora Lighting offers fixtures ranging from simple incandescent emergency lights to efficient LED exit signs, some combined with high performance halogen emergency lights. Some have gaskets for salt spray and fog; some are self illuminating with no metal or electrical parts. Others have fine brush finished faces to complement architectural settings. Some hang from a wall or ceilings, others are recessed completely inside a ceiling.

One thing remains the same: all Nora signs and fixtures are designed to provide the safest possible egress regardless of the situation, location, or environment and are accessible for virtually any budget consideration.



LED EDGE-LIT EXITS

- Adjustable Face
- Recessed and Surface Mount
- AC, 2-Circuit, and Battery Backup
- Housings in Black, Aluminum, and White



LED DIE-CAST ALUMINUM EXITS

- Available in Self-Diagnostic
- Brushed Aluminum Face
- AC, 2-Circuit, and Battery Backup

SELF-LUMINOUS TRITIUM EXITS

- No Electricity Required
- 10, 15, or 20 Year Life

LED POLYCARBONATE EXITS

- Black and White Housings
- AC, 2-Circuit, and Battery Backup
- Universal - Double Face, Blank Plate
- Ceiling, Wall, or End Mounted
- Available for Wet, NEMA-4X locations



LED EXIT/EMERGENCY COMBINATIONS

- Available in 5 Styles
- Adjustable Head Position
- Wet Location



EMERGENCY LIGHTS

- Available in 14 Styles
- Surface and Recessed Mounted
- Remote Location Capability
- Die-Cast Aluminum and Polycarbonate Wet Location Units
- Outdoor and Indoor Remote Heads



NEW! STEEL BODY LED EXIT/EMERGENCY COMBINATIONS

- New York City Approved

COMPACT FLUORESCENT EMERGENCY PACKS

- Available as a complete integral unit or with remote test switch and indicator

Overview EXIT & EMERGENCY

LED EDGE-LIT EXIT SIGN



Adjustable LED Edge-Lit
NX-810-LED AC p.714
NX-811-LED 2-Circuit p.714
NX-812-LED Battery p.714
NEW! NX-822-LED NY Approved p.714



LED Edge-Lit Exit Sign
NX-506 LED AC p.715
NX-508-LED 2-Circuit p.715
NX-604-LED Battery p.715



Recessed Adjustable LED Edge-Lit
NX-813-LED AC p.716
NX-814-LED 2-Circuit p.716
NX-815-LED Battery p.716



Recessed LED Edge-Lit
NX-509-LED AC p.717
NX-510-LED 2-Circuit p.717
NX-608-LED Battery p.717

WALL MOUNT EDGE-LIT



Recessed Wall Mount Edge-Lit
NX-511-LED AC p.718
NX-609-LED Battery p.718



LED Die-Cast Exit Sign
NX-615-LED Self Diagnostic p.719
NX-505-LED AC p.720
NEW! NX-525-LED 2-Circuit p.720
NX-605-LED Battery p.720



Steel LED Exit Sign (NY Approved)
NX-550-LED Battery p.724



Universal LED Exit Sign
NX-503-LED AC p.721
NX-504-LED 2-Circuit p.721
NX-603-LED Battery p.721

LED WET LOCATION EXIT SIGN



LED Wet Location Exit Sign,
 Battery Backup, Green Letters
NX-607-LED/G p.722



LED Wet Location Exit Sign,
 Battery Backup, Red Letters
NX-607-LED/R p.722



Self Illuminating Tritium Exit
 Sign Green Letters
NX-606-TRI/G p.723



Self Illuminating Tritium Exit
 Sign Red Letters
NX-606-TRI/R p.723

WET LOCATION COMBO



LED Wet Location Exit/
 Emergency, Battery Backup
NEX-710-LED p.725



Steel LED Exit Sign w/ Adjustable
 Incandescent Heads (NY Approved)
NEX-750-LED/R2 2 Heads p.724
NEX-750-LED/R3 3 Heads p.724



LED Exit Sign with Adjustable
 Incandescent Heads
NEX-707-LED Square Head p.726
NEX-708-LED Round Head p.727



LED Exit Sign with Adjustable
 Halogen MR16 Heads
NEX-709-LED p.728

Overview EXIT & EMERGENCY *continued*

WET LABEL EMERGENCY LIGHT

NEW!

WET



Deco Xenon Emergency, with LED Sensor Option

NE-900 p.729

NEW!

WET



Emergency Fixture, Remote Capable, Wet Location Listed

NE-960 p.736

NEW!



Mini LED Dual Head, Beveled Emergency Light

NE-502-LED p.730

NEW!

WET



Mini LED Dual Head, Shown with NEG-50 Enclosure

NE-502-LED / NEG-50 p.730

EMERGENCY LIGHT



"Headless" Beveled Dual Integral Emergency Light

NE-806 p.731



Beveled Dual Head, Emergency Light

NE-803 p.732



Curved Dual Round Head, Emergency Light

NE-804 p.733



Beveled Dual MR16 Head, Emergency Light

NE-805 p.734

EMERGENCY LIGHT

NEW!



Steel Emergency Light (New York Approved)

NE-850/2 2 Heads p.724
NE-850/3 3 Heads p.724

EMERGENCY LIGHT WITH REMOTE CAPABILITY



Beveled Dual Square Head, Emergency Light, Remote Capable

NE-807 p.732



Beveled Dual Round Head, Emergency Light, Remote Capable

NE-808 p.733



Beveled Dual MR16 Head, Emergency Light, Remote Capable

NE-809 p.735

EMERGENCY REMOTE HEADS



Recessed Emergency Light, Beveled Face

NE-811 Square Head p.737
NE-812 Round Head p.737



Recessed Emergency Light, MR16 Halogen

NE-813 p.737

NEW!

WET



Single Head Remote

NE-831 Standard p.738
NE-931 UL Wet p.738

NEW!

WET



Double Head Remote

NE-832 Standard p.738
NE-932 UL Wet p.738



Single Remote

NE-837 Square p.738
NE-838 Round p.738
NE-839 MR16 p.738

EMERGENCY LOW VOLTAGE DOWNLIGHTS



6" Emergency New Construction
Low Voltage Housing
NL-601/EM p.742



4" Emergency New Construction
Low Voltage Housing
NL-401/EM p.742



3" Emergency New Construction
Low Voltage Housing
NL-301/EM p.742

LOW VOLTAGE EMERGENCY RETROFIT KIT



Low Voltage
Emergency Relay Unit
NELK-50 p.744



Low Voltage
Emergency Battery Units
NEBU Series p.744

LOW VOLTAGE EMERGENCY SELF CONTAINED KIT



6" Emergency New Construction
Low Voltage Kit
NEH-826 p.745



6" Emergency Remodel
Low Voltage Kit
NERH-826 p.745

6"-8" ARCHITECTURAL & COMMERCIAL COMPACT FLUORESCENT EMERGENCY HOUSINGS



6"-8" Horizontal Architectural
Emergency Frame-ins p.178



6"-8" Horizontal Commercial
Emergency Frame-ins p.179

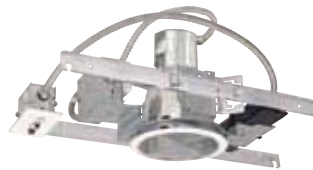

6"-8" Vertical Architectural
Emergency Frame-ins p.180



6"-8" Vertical Commercial
Emergency Frame-ins p.181

6" ECONOMY CFL EMERGENCY HOUSINGS



6" Economy Emergency Housing
with Internal Test Switch p.182



6" Economy Emergency Housing
with Remote Test Switch p.183

CFL EMERGENCY DOWNLIGHT RETROFIT KIT



Emergency Downlight Retrofit Kit
NEPK Series p.746



Test Switch, Indicator Assembly
NRA-123 p.746
NRA-123MAG p.746

EXIT AND EMERGENCY

LED Edge-Lit Exit Signs with Adjustable Housing (Field adjustable acrylic face for ceiling, wall, or sloped applications)

Ideal for architectural applications where aesthetic and minimal profile appearance is desired. The Edge-Lit series offers a small housing supporting a clear or mirrored acrylic face. LED sources within the housing cast a brilliant red or green illumination on letters embedded inside the acrylic face. Installation is versatile, with wall, ceiling, or side mount capability. AC-only, Emergency Circuit and 90 minute battery options are available.

Body:

- 12" Width x 10-5/8" Height x 1-5/8" Depth
- Extruded aluminum housing and acrylic panel

Housing:

- 2-Piece snap-together aluminum extrusion holding battery, LED source, PC board, and top of acrylic face.

Face:

- **6" Letters:** Available in either single or double faced. Acrylic face has rounded and finished edges for an attractive appearance. Red or Green 6" lettering inside face. Adhesive mounted chevrons are included. Face can be adjusted in the field 0° to 90° for wall, ceiling, or sloped applications.
- **8" Letters:** Available in either single or double faced. Acrylic face has rounded and finished edges for an attractive appearance. Red 8" lettering with 1" stroke. Adhesive mounted chevrons are included. Face can be adjusted in the field 0° to 90° for wall, ceiling, or sloped applications. New York Approved

Mounting:

- Wall, Side, or Ceiling
- Canopy and mounting hardware Included

Electrical:

Voltage

- 120V or 277V dual input

Power Consumption

- 3 watts normal / 5 watts emergency operation

Light Source

- LED strips

Emergency Circuit (NX-811-LED Only)

- 2nd Circuit for input from external EPS or other alternative emergency power source or generator.

Battery (NX-812-LED & NX-822-LED)

- Replaceable Ni-Cad battery (NEB-NICAD)
- 90 minute emergency operation

Testing

- High-charge / ready operation indicator light
- Test button

Circuitry Protection

- Isolated surge / short circuit protection
- Disconnect for deep discharge

Life Expectancy

- LED and PC circuitry are rated for approximately 25 years with no change in illumination level
- 5 year warranty on materials and workmanship

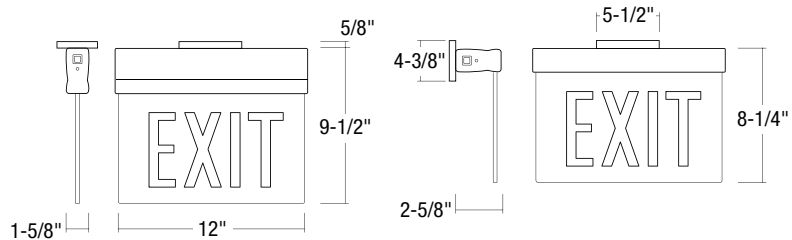

LED EDGE-LIT EXIT SIGN WITH ADJUSTABLE HOUSING

CATALOG. NO.	OPERATION	LETTER COLOR (ADD SUFFIX)	PANEL COLOR (ADD SUFFIX)	HOUSING COLOR (ADD SUFFIX)
NX-810-LED	AC Only	G - Green R - Red	1C - Single Face, Clear Acrylic	A - Natural Aluminum
			1M - Single Face, Mirrored Acrylic	B - Black
			2M - Double Face, Mirrored Acrylic	W - White
NX-811-LED	2-Circuit	G - Green R - Red	1C - Single Face, Clear Acrylic	A - Natural Aluminum
			1M - Single Face, Mirrored Acrylic	B - Black
			2M - Double Face, Mirrored Acrylic	W - White
NX-812-LED	Battery Backup	G - Green R - Red	1C - Single Face, Clear Acrylic	A - Natural Aluminum
			1M - Single Face, Mirrored Acrylic	B - Black
			2M - Double Face, Mirrored Acrylic	W - White
NX-822-LED New York Approved	Battery Backup	R - 8" Red	1C - Single Face, Clear Acrylic 1M - Single Face, Mirrored Acrylic 2M - Double Face, Mirrored Acrylic	A - Natural Aluminum B - Black W - White

Order Example:

NX-811-LEDR1MA - 2-Circuit, Red Letters, Single Face, Mirrored Acrylic, Natural Aluminum

Accessories Ordered Separately, see pages 740-741

Listings:

ETL Listed
CSA Listed
NEC
NFPA
State & Municipal



NORALIGHTING.

EXIT AND EMERGENCY LED Edge-Lit Exit Signs

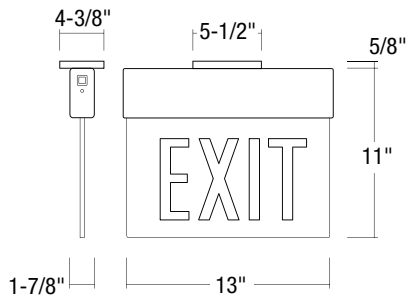

Ideal for architectural applications where aesthetic and minimal profile appearance is desired. The Edge-Lit series offers a small housing supporting a clear or mirrored acrylic face. LED sources within the housing cast a brilliant red or green illumination on letters embedded inside the acrylic face. AC-only, Emergency Circuit and 90 minute battery options are available.

Body:

- 13" Width x 11" Height x 1-7/8" Depth
- Extruded aluminum housing and acrylic panel

Housing:

- 2-Piece snap-together aluminum extrusion holding battery, LED source, PC board, and top of acrylic face.

Face:

- Available in either single or double faced. Acrylic face has rounded and finished edges for an attractive appearance. Red or Green 6" lettering inside face. Adhesive mounted chevrons are included.

Mounting:

- Ceiling Only
- Mounting Hardware Included

Electrical:

Voltage

- 120V or 277V dual input

Power Consumption

- 3 watts normal / 5 watts emergency operation

Light Source

- LED strips

Emergency Circuit (NX-508-LED Only)

- 2nd Circuit for input from external EPS or other alternative emergency power source or generator.

Battery (NX-604-LED Only)

- Replaceable Ni-Cad battery (NEB-NICAD)
- 90 minute emergency operation

Testing

- High-charge / ready operation indicator light
- Test button

Circuitry Protection

- Isolated surge / short circuit protection
- Disconnect for deep discharge

Life Expectancy

- LED and PC circuitry are rated for approximately 25 years with no change in illumination level
- 5 year warranty on materials and workmanship

RECESSED LED EDGE-LIT EXIT SIGN

CATALOG. NO.	OPERATION	LETTER COLOR (ADD SUFFIX)	PANEL COLOR (ADD SUFFIX)	HOUSING COLOR (ADD SUFFIX)
NX-506-LED	AC Only	G - Green	1C - Single Face, Clear Acrylic	A - Natural Aluminum
		R - Red	1M - Single Face, Mirrored Acrylic 2M - Double Face, Mirrored Acrylic	W - White
NX-508-LED	2-Circuit	G - Green	1C - Single Face, Clear Acrylic	A - Natural Aluminum
		R - Red	1M - Single Face, Mirrored Acrylic 2M - Double Face, Mirrored Acrylic	W - White
		G - Green R - Red	1C - Single Face, Clear Acrylic 1M - Single Face, Mirrored Acrylic 2M - Double Face, Mirrored Acrylic	A - Natural Aluminum W - White
NX-604-LED	Battery Backup	G - Green R - Red	1C - Single Face, Clear Acrylic 1M - Single Face, Mirrored Acrylic 2M - Double Face, Mirrored Acrylic	A - Natural Aluminum W - White

Order Example:

NX-506-LEDR1MA - AC Only, Red Letters, Single Face, Mirrored Acrylic, Natural Aluminum

Accessories Ordered Separately, see pages 740-741

Listings:

UL Listed
NEC
NFPA
State & Municipal



EXIT AND EMERGENCY

Recessed Adjustable LED Edge-Lit Exit Signs (Field adjustable acrylic face for ceiling, wall, or sloped applications)

Nora Lighting's new series of Recessed Edge-Lit fixtures represents a new direction for the Emergency and Exit product family. The wiring compartment and LED light sources are concealed within a galvanized steel housing that is completely recessed. Brilliant red or green sign illumination effects embedded within a clear or mirrored acrylic panel. Single or Double Face options are available with AC-Only, Emergency Circuit and 90 minute battery options are available.

Body:

- 12" Width x 8-1/4" Height x 1-1/4" Depth x 3/8" Panel Thickness
- Galvanized steel housing with die-cast cover plate and acrylic panel

Housing:

- Robust galvanized steel construction
- Brushed aluminum or white finish die-cast cover plate

Face:

- Edge-Lit Exit by Nora is available in either single or double face. Acrylic face has rounded and finished edge for attractive appearance. Red or green 6" lettering inside face with adhesive mounted chevrons included. Face can be adjusted in the field 0° to 90° for wall, ceiling, or sloped applications.

Mounting:

- Recessed Ceiling or Wall
- Adjustable bar hangers 24-1/2" maximum length
- Bar hangers are equipped with captive nails
- Bar hangers are adjustable vertically to compensate for varying ceiling heights
- Accepts maximum ceiling thickness of 1"

Electrical:

Voltage

- 120V or 277V dual input

Power Consumption

- 3 watts normal / 5 watts emergency operation

Light Source

- LED strips

Emergency Circuit (NX-814-LED Only)

- 2nd Circuit for input from external EPS or other alternative emergency power source or generator.

Battery (NX-815-LED Only)

- Replaceable Ni-Cad battery (NEB-NICAD)
- 90 minute emergency operation

Testing

- High-charge / ready operation indicator light
- Test button

Circuitry Protection

- Isolated surge / short circuit protection
- Disconnect for deep discharge

Life Expectancy

- LED and PC circuitry are rated for approximately 25 years with no change in illumination level
- 5 year warranty on materials and workmanship

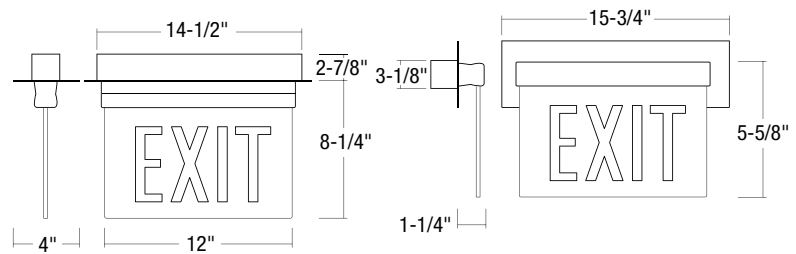

RECESSED ADJUSTABLE LED EDGE-LIT EXIT SIGN

CATALOG. NO.	OPERATION	LETTER COLOR (ADD SUFFIX)	PANEL COLOR (ADD SUFFIX)	HOUSING COLOR (ADD SUFFIX)
NX-813-LED	AC Only	G - Green R - Red	C - Single Face, Clear Acrylic	A - Natural Aluminum
			M - Single Face, Mirrored Acrylic	B - Black
			W - Single Face, White Acrylic	W - White
			2M - Double Face, Mirrored Acrylic	
NX-814-LED	2-Circuit	G - Green R - Red	C - Single Face, Clear Acrylic	A - Natural Aluminum
			M - Single Face, Mirrored Acrylic	B - Black
			W - Single Face, White Acrylic	W - White
			2M - Double Face, Mirrored Acrylic	
NX-815-LED	Battery Backup	G - Green R - Red	C - Single Face, Clear Acrylic	A - Natural Aluminum
			M - Single Face, Mirrored Acrylic	B - Black
			W - Single Face, White Acrylic	W - White
			2M - Double Face, Mirrored Acrylic	

Order Example:

NX-814-LEDRMA - 2-Circuit, Red Letters, Single Face, Mirrored Acrylic, Natural Aluminum

Accessories Ordered Separately, see pages 740-741

Listings:

ETL Listed
NEC
NFPA
State & Municipal



Recessed LED Edge-Lit Exit Signs

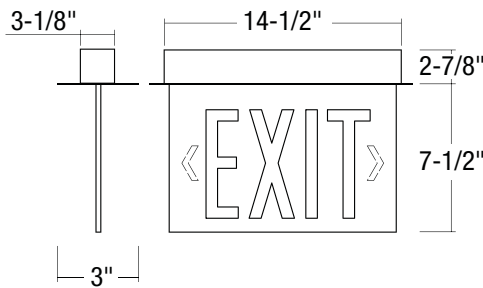

RECESSED LED EDGE-LIT EXIT SIGN

CATALOG. NO.	OPERATION	LETTER COLOR (ADD SUFFIX)	PANEL COLOR (ADD SUFFIX)	HOUSING COLOR (ADD SUFFIX)
NX-509-LED	AC Only	G - Green	1C - Single Face, Clear Acrylic	A - Natural Aluminum
		R - Red	1M - Single Face, Mirrored Acrylic 2M - Double Face, Mirrored Acrylic	W - White
NX-510-LED	2-Circuit	G - Green	1C - Single Face, Clear Acrylic	A - Natural Aluminum
		R - Red	1M - Single Face, Mirrored Acrylic 2M - Double Face, Mirrored Acrylic	W - White
NX-608-LED	Battery Backup	G - Green	1C - Single Face, Clear Acrylic	A - Natural Aluminum
		R - Red	1M - Single Face, Mirrored Acrylic 2M - Double Face, Mirrored Acrylic	W - White

Order Example:
NX-509-LED R1MA - AC Only, Red Letters, Single Face, Mirrored Acrylic, Natural Aluminum

Accessories Ordered Separately, see pages 740-741

Listings:

- UL Listed
- NEC
- NFPA
- State & Municipal



Nora Lighting's series of Recessed Edge-Lit fixtures represents a new direction for the Emergency and Exit product family. The wiring compartment and LED light sources are concealed within a sturdy galvanized steel housing that is completely recessed. Brilliant red or green sign illumination effects embedded within a clear or mirrored acrylic panel. Single or Double Face options are available with AC-Only, Emergency Circuit and 90 minute battery options are available.

Body:

- 14-1/2" Width x 7-1/2" Height x 3" Depth x 3/8" Panel Thickness
- Galvanized steel housing with die-cast cover plate and acrylic panel

Housing:

- Robust galvanized steel construction
- Brushed aluminum or white finish die-cast cover plate

Face:

- Edge-Lit Exit by Nora is available in either single or double face. Acrylic face has rounded and finished edge for attractive appearance. Red or green 6" lettering inside face with adhesive mounted chevrons included.

Mounting:

- Recessed Ceiling Only
- Adjustable bar hangers 24-1/2" maximum length
- Bar hangers are equipped with captive nails and slotted for T-Bar installations
- Bar hangers are adjustable vertically to compensate for varying ceiling heights
- Accepts maximum ceiling thickness of 1"

Electrical:

Voltage

- 120V or 277V dual input

Power Consumption

- 3 watts normal / 5 watts emergency operation

Light Source

- LED strips

Emergency Circuit (NX-510-LED Only)

- 2nd Circuit for input from external EPS or other alternative emergency power source or generator.

Battery (NX-608-LED Only)

- Replaceable Ni-Cad battery (NEB-NICAD)
- 90 minute emergency operation

Testing

- High-charge / ready operation indicator light
- Test button

Circuitry Protection

- Isolated surge / short circuit protection
- Disconnect for deep discharge

Life Expectancy

- LED and PC circuitry are rated for approximately 25 years with no change in illumination level
- 5 year warranty on materials and workmanship

EXIT AND EMERGENCY

Recessed Wall Mounted LED Edge-Lit Exit Signs

Nora Lighting's series of Recessed Edge-Lit fixtures represents a new direction for the Emergency and Exit product family. The wiring compartment and LED light sources are concealed within a robust galvanized steel housing that is completely recessed. Brilliant red or green sign illumination effects embedded within a clear or mirrored acrylic panel. Single or Double Face options are available with AC-Only, and 90 minute battery options are available.

Body:

- 13" Width x 9-1/8" Height x 1-5/8" Depth
- Galvanized steel housing with die-cast cover plate and acrylic panel

Housing:

- Robust galvanized steel construction
- Brushed aluminum finish die-cast cover plate

Face:

- Edge-Lit Exit by Nora is available in either single or double face. Acrylic face has rounded and finished edge for attractive appearance. Red or green 6" lettering inside face with adhesive mounted chevrons included.

Mounting:

- Wall Installation Only
- Adjustable bar hangers 24-1/2" maximum length
- Bar hangers are equipped with captive nails and slotted for T-Bar installation
- Bar hangers are adjustable vertically to compensate for varying ceiling heights
- Accepts maximum ceiling thickness of 1"

Electrical:

Voltage

- 120V or 277V dual input

Power Consumption

- 3 watts normal / 5 watts emergency operation

Light Source

- LED strips

Battery (NX-609-LED Only)

- Replaceable Ni-Cad battery (NEB-NICAD)
- 90 minute emergency operation

Testing

- High-charge / ready operation indicator light
- Test button

Circuitry Protection

- Isolated surge / short circuit protection
- Disconnect for deep discharge

Life Expectancy

- LED and PC circuitry are rated for approximately 25 years with no change in illumination level
- 5 year warranty on materials and workmanship

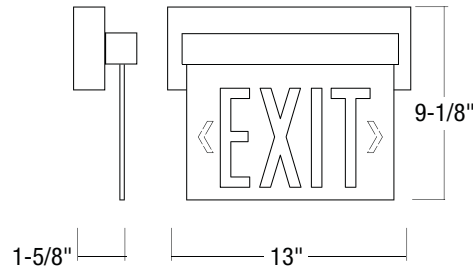

RECESSED WALL MOUNTED LED EDGE-LIT EXIT SIGN

CATALOG. NO.	OPERATION	LETTER COLOR (ADD SUFFIX)	PANEL COLOR (ADD SUFFIX)	HOUSING COLOR (ADD SUFFIX)
NX-511-LED	AC Only	G - Green R - Red	1C - Single Face, Clear Acrylic	A - Natural Aluminum
			1M - Single Face, Mirrored Acrylic	
			1W - Single Face, White Acrylic	
NX-609-LED	Battery Backup	G - Green R - Red	1C - Single Face, Clear Acrylic	A - Natural Aluminum
			1M - Single Face, Mirrored Acrylic	
			1W - Single Face, White Acrylic	

Order Example:

NX-609-LEDR1MA - Battery Backup, Red Letters, Single Face, Mirrored Acrylic, Natural Aluminum

Accessories Ordered Separately, see pages 740-741

Listings:

UL Listed
NEC
NFPA
State & Municipal



Self Diagnostic LED Die-Cast Architectural Exit Signs

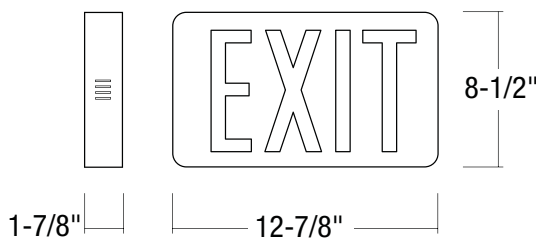

Ideal for architectural applications, Nora Lighting offers its low profile, die-cast aluminum LED exit sign with battery backup. Both die-cast faces are brushed to give a simple, yet elegant, effect. In the event of a power loss, the LED light sources will remain illuminated at their full light level for 90 minutes.

Body:

- 12-7/8" Width x 8-1/2" Height x 1-7/8" Depth
- Die-cast aluminum construction

Face:

- Available in either single or double faced
- 6" high text with color diffusion

Mounting:

- Wall, Side, or Ceiling
- Mounting Hardware and Canopy Included

Electrical:

Voltage

- 120V or 277V dual input

Power Consumption

- 2 Watts

Light Source

- Long Life LED sources

Battery

- Replaceable Ni-Cad battery (NEB-NICAD2)
- 90 minute emergency operation

Testing

- High-charge / ready operation indicator light
- Test button
- Automatic reset

Circuitry Protection

- Isolated surge / short circuit protection
- Disconnect for deep discharge

Life Expectancy

- LED and PC circuitry are rated for approximately 25 years with no change in illumination level

SELF DIAGNOSTIC LED DIE-CAST EXIT SIGNS

CATALOG. NO.	OPERATION	LETTER COLOR	FACE(S)	HOUSING COLOR
NX-615-LED/G	Battery Backup	Green	Single Face	Black
NX-615-LED/G/2F	Battery Backup	Green	Double Face	Black
NX-615-LED/R	Battery Backup	Red	Single Face	Black
NX-615-LED/R/2F	Battery Backup	Red	Double Face	Black

Accessories Ordered Separately, see pages 740-741

Self Diagnostic:

- Automatically monitors and tests to ensure proper operation
- Self tests 1 minute each month, 30 minutes every six months, and 90 minutes annually
- 5 year warranty on materials and workmanship

Listing:

- UL Listed
- NEC
- NFPA
- NFPA 101
- State & Municipal
- Suitable for Damp Location



EXIT AND EMERGENCY

LED Die-Cast Architectural Exit Signs

Ideal for architectural applications, Nora Lighting offers its low profile, die-cast aluminum LED exit sign in three different options. Both die-cast faces are burshed to give a simple, yet elegant, effect. In the event of a power loss, the LED light sources will remain illuminated at their full light level for 90 minutes. AC-only, Emergency Circuit and 90 minute battery options are available.

Body:

- 12-7/8" Width x 8-1/2" Height x 1-7/8" Depth
- Die-cast aluminum construction

Face:

- Available in either single or double faced
- Die-cast aluminum finish
- 6" high text with color diffusion

Mounting:

- Wall, Side, or Ceiling
- Mounting Hardware and Canopy Included

Electrical:

Voltage

- 120V or 277V dual input

Power Consumption

- 2 Watts

Light Source

- Long Life LED sources

Emergency Circuit (NX-525-LED Only)

- 2nd Circuit for input from external EPS or other alternative emergency power source or generator.

Battery (NX-605-LED Only)

- Replaceable Ni-Cad battery (NEB-NICAD2)
- 90 minute emergency operation

Testing

- High-charge / ready operation indicator light
- Test button
- Automatic reset

Circuitry Protection

- Isolated surge / short circuit protection
- Disconnect for deep discharge

Life Expectancy

- LED and PC circuitry are rated for approximately 25 years with no change in illumination level
- 5 year warranty on materials and workmanship

Listing:

UL Listed
 NEC
 NFPA
 State & Municipal
 Suitable for Damp Location

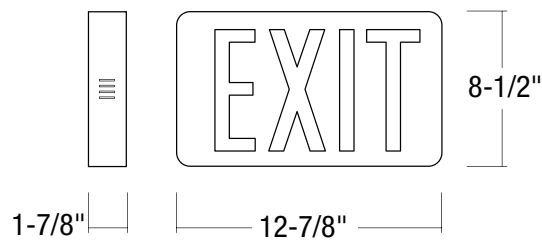

LED DIE-CAST EXIT SIGNS

CATALOG. NO.	OPERATION	LETTER COLOR	FACE(S)	HOUSING
NX-505-LED/G	AC Only	Green	Single Face	Black
NX-505-LED/GW	AC Only	Green	Single Face	White
NX-505-LED/G/2F	AC Only	Green	Double Face	Black
NX-505-LED/GW/2F	AC Only	Green	Double Face	White
NX-505-LED/R	AC Only	Red	Single Face	Black
NX-505-LED/RW	AC Only	Red	Single Face	White
NX-505-LED/R/2F	AC Only	Red	Double Face	Black
NX-505-LED/RW/2F	AC Only	Red	Double Face	White
NEW! NX-525-LED/G	2-Circuit	Green	Single/Double Face	Black
NEW! NX-525-LED/GW	2-Circuit	Green	Single/Double Face	White
NEW! NX-525-LED/R	2-Circuit	Red	Single/Double Face	Black
NEW! NX-525-LED/RW	2-Circuit	Red	Single/Double Face	White
NX-605-LED/G	Battery Backup	Green	Single Face	Black
NX-605-LED/GW	Battery Backup	Green	Single Face	White
NX-605-LED/G/2F	Battery Backup	Green	Double Face	Black
NX-605-LED/GW/2F	Battery Backup	Green	Double Face	White
NX-605-LED/R	Battery Backup	Red	Single Face	Black
NX-605-LED/RW	Battery Backup	Red	Single Face	White
NX-605-LED/R/2F	Battery Backup	Red	Double Face	Black
NX-605-LED/RW/2F	Battery Backup	Red	Double Face	White

Accessories Ordered Separately, see pages 740-741

EXIT AND EMERGENCY

Universal LED Exit Signs

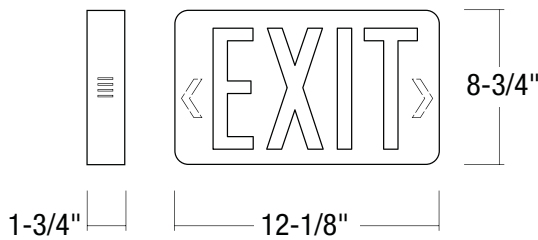

Nora Lighting's compact, low profile LED exit signs are as brilliant and visible as standard incandescent signs, yet use a fraction of the power. LED light sources require no maintenance for 25 years - saving greatly on maintenance and upkeep costs. Nora Lighting's LED exit signs are ideal for commercial and industrial standard non-emergency applications where low maintenance and operating costs are a must.

Body:

- 12-1/8" Width x 8-3/4" Height x 1-3/4" Depth
- Injection-molded thermoplastic housing

Face:

- Double faces are included. Blank face is also included if single face is desired
- 6" high text with color diffusion
- Replaceable knockout directional chevron

Mounting:

- Wall, Side, or Ceiling
- Mounting Hardware and Canopy Included

Electrical:

Voltage

- 120V or 277V dual input

Power Consumption

- 2 Watts

Light Source

- Long Life LED sources

Emergency Circuit (NX-504-LED Only)

- 2nd Circuit for input from external EPS or other alternative emergency power source or generator.

Battery (NX-603-LED Only)

- Replaceable Ni-Cad battery (NEB-NICAD2)
- 90 minute emergency operation

Testing

- High-charge / ready operation indicator light
- Test button
- Automatic reset

Circuitry Protection

- Isolated surge / short circuit protection
- Disconnect for deep discharge

Life Expectancy

- LED and PC circuitry are rated for approximately 25 years with no change in illumination level
- 5 year warranty on materials and workmanship

Listing:

UL Listed
 CSA (NX-503 & 603 red letters only)
 NEC
 NFPA
 State & Municipal
 Suitable for Damp Location



UNIVERSAL LED EXIT SIGNS

CATALOG. NO.	OPERATION	HOUSING COLOR	LETTER COLOR
NX-503-LED/BG	AC Only	Black Housing	Green Letters
NX-503-LED/BR	AC Only	Black Housing	Red Letters
NX-503-LED/G	AC Only	White Housing	Green Letters
NX-503-LED/GS	AC Only	White Housing	Green "SALIDA" Letters
NX-503-LED/R	AC Only	White Housing	Red Letters
NX-503-LED/RS	AC Only	White Housing	Red "SALIDA" Letters
NX-504-LED/BG	2-Circuit	Black Housing	Green Letters
NX-504-LED/BR	2-Circuit	Black Housing	Red Letters
NX-504-LED/G	2-Circuit	White Housing	Green Letters
NX-504-LED/GS	2-Circuit	White Housing	Green "SALIDA" Letters
NX-504-LED/R	2-Circuit	White Housing	Red Letters
NX-504-LED/RS	2-Circuit	White Housing	Red "SALIDA" Letters
NX-603-LED/BG	Battery Backup	Black Housing	Green Letters
NX-603-LED/BR	Battery Backup	Black Housing	Red Letters
NX-603-LED/G	Battery Backup	White Housing	Green Letters
NX-603-LED/GS	Battery Backup	White Housing	Green "SALIDA" Letters
NX-603-LED/R	Battery Backup	White Housing	Red Letters
NX-603-LED/RS	Battery Backup	White Housing	Red "SALIDA" Letters

Accessories Ordered Separately, see pages 740-741

EXIT AND EMERGENCY

LED Wet Location Exit Signs

For wet and corrosive environments, Nora offers the NX-607-LED exit sign approved for wet location environments. A heavy-duty gasket-protected housing completely seals all electrical components and connections from corrosive atmospheres, non-hazardous dust, water spray, splash, and regular hose-downs. Ideal for industrial or any other applications subject to wet or cold weather.

Body:

- 11" Width x 11" Height x 5" Depth
- High impact plastic

Face:

- Single face configuration only
- 6" high text with color diffusion
- Knockout directional chevrons

Mounting:

- Wall only
- Mounting Hardware Included

Electrical:

Voltage

- 120V or 277V dual input

Power Consumption

- 4.8 Watts

Light Source

- Long Life LED sources

Battery

- Replaceable Ni-Cad battery (NEB-NICAD)
- 90 minute emergency operation
- Internal solid state charging circuit

Testing

- High-charge / ready operation indicator light
- Waterproof rubber test button

Operating Temperature

- 32° - 104° Fahrenheit (0°-40° Celsius)

Life Expectancy

- LED and PC circuitry are rated for approximately 25 years with no change in illumination level. Ni-Cad battery requires standard maintenance

Listing:

UL Listed
 NEC
 NEMA-4X
 NFPA
 State & Municipal
 Suitable for Wet Location

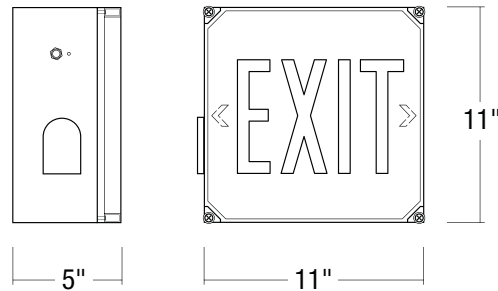

LED WET LOCATION EXIT SIGNS

CATALOG. NO.	OPERATION	LETTER COLOR	FACE	HOUSING COLOR
NX-607-LED/G	Battery Backup	Green	Single Face	White
NX-607-LED/R	Battery Backup	Red	Single Face	White

Accessories Ordered Separately, see pages 740-741



Self-Illuminating Tritium Exit Signs



For self-powered illumination applications, Nora proudly introduces the new NX-606-TRI that is powered completely by Tritium gas. The internal light tubes will last 10-20 years, similar to LED. Ideal for locations where running electrical lines is impractical and for industrial or hazardous environments such as oil rigs, mines, refineries, and many others. There are no conductive materials or electrical elements, so there is no danger of sparking within or outside the fixture housing.

Body:

- 12-3/4" Width x 9" Height x 1" Depth
- High impact, static-free ABS fire-retardant plastic construction

Face:

- Single face only
- 6" high text with prismatic diffusion
- Field-selected directional chevrons

Mounting:

- Wall, Side, or Ceiling
- Mounting Hardware Included

Illumination Source:

- Tritium enclosed in borosilicate glass internally coated with zinc sulfide phosphor. No electrical or metal components are used

Life Expectancy:

- Available from approximately 10 to 20 year of useable life. See table below for ordering info

Disposal:

- Field disposal is prohibited. Please return exhausted units to Nora Lighting

Listing:

UL Listed
 NRC
 OSHA
 Council of American Building Officials (BOCA), (ICBO, SBCC)
 NFPA
 City of Los Angeles
 State of California

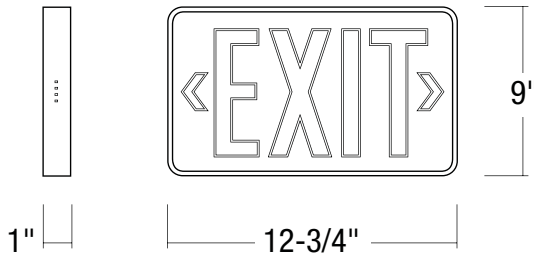

SELF-ILLUMINATING TRITIUM EXIT SIGNS

CATALOG. NO.	SOURCE	LETTER COLOR	FACE	HOUSING COLOR	LIFE EXPECTANCY
NX-606-TRI/G10	Tritium Gas	Green	Single Face	White	10 Years
NX-606-TRI/G15	Tritium Gas	Green	Single Face	White	15 Years
NX-606-TRI/G20	Tritium Gas	Green	Single Face	White	20 Years
NX-606-TRI/R10	Tritium Gas	Red	Single Face	White	10 Years
NX-606-TRI/R15	Tritium Gas	Red	Single Face	White	15 Years
NX-606-TRI/R20	Tritium Gas	Red	Single Face	White	20 Years

Accessories Ordered Separately, see pages 740-741



EXIT AND EMERGENCY

Steel LED Exit, LED Exit / Emergency, Emergency New York Approved

Nora's New 20 gauge steel body exit and emergency combination units are suitable for rugged applications and New York City approved.

Body:

- 20 Gauge Steel Construction

Housing:

- Low profile snap-together
- Snap-out knockouts for wiring

Face (NX-550-LED & NEX-750-LED):

- 8" High Letters with 1" stroke
- Snap-out chevrons
- New York Approved

Mounting:

- **NX-550-LED:** Universal (Wall, Side, or Ceiling)
- **NEX-750-LED:** Wall Mount
- **NE-850:** Wall Mount

Electrical:

Voltage

- 120V or 277V dual input
- Automatic solid state switching and charging

Light Source

- **NX-550-LED:** Long Life LEDs
- **NEX-750-LED:** Emergency fixture with 2 or 3 adjustable glare free light heads with positive positioning lock
- **NE-850:** Emergency fixture with 2 or 3 adjustable glare free light heads with positive positioning lock
- **2 Head Unit:** (2) 12 Watt T15 DC Lamps
- **3 Head Unit:** (3) 9 Watt T15 DC Lamps

Battery

- **NX-550-LED:** Ni-Cad 3.7 Watts @ 120V
- **NEX-750-LED:** Sealed Lead Acid 6V
- **NE-850:** Sealed Lead Acid 6V
- 90 minute emergency operation on fully charged battery

Testing

- High-charge / ready operation indicator light
- Test button

Circuitry Protection

- Solid state short circuit protection

Listing:

UL Listed
NFPA-101
Suitable for Damp Location
NY Approved



STEEL (NEW YORK APPROVED) LED EXIT AND EMERGENCY

CATALOG. NO.	OPERATION	LETTER COLOR	FACE	HOUSING COLOR	HEADS
NX-550-LEDU/R	Battery Backup	Red	Single/Double	White	N/A
NX-550-LEDU/RB	Battery Backup	Red	Single/Double	Black	N/A
NEX-750-LED/R2	Battery Backup	Red	Single/Double	White	(2) 12 Watt
NEX-750-LED/R3	Battery Backup	Red	Single/Double	White	(3) 9 Watt
NE-850/2	Battery Backup	N/A	N/A	White	(2) 12 Watt
NE-850/3	Battery Backup	N/A	N/A	White	(3) 9 Watt



LED Wet Location Exit / Emergency Combination



For wet and corrosive environments, Nora offers the NEX-710-LED emergency / exit sign approved for wet location environments. A heavy-duty gasket protected housing completely seals all electrical components and connections from corrosive atmospheres, non-hazardous dust, water spray, splash, and regular hose-downs. During normal operation, the exit sign operates on long life LED sources for brilliant, maintenance-free illumination. During emergency operation, the exit sign and dual incandescent heads operate 90 minutes under battery power. Ideal for industrial or any other applications subject to wet or cold weather.

Body:

- 11" Width x 16-3/4" Height x 5" Depth
- High-impact plastic construction

Face:

Exit

- Single face configuration only
- 6" high text with color diffusion
- Knockout directional chevrons

Emergency

- Two fully adjustable glare-free round heads for T5 light source

Mounting:

- Wall
- Mounting Hardware Included

Electrical:

Voltage

- 120V or 277V dual input

Power Consumption

- 4.8 Watts, normal operation
- 15 Watts, emergency operation

Light Source

- Exit: LED Light Sources
- Emergency: 2 x 6W T5 6V Wedge Base incandescent lamps

Battery

- Replaceable Lead-Calcium battery (NEB-6V-4.5)
- 90 minute emergency operation
- Internal solid state charging circuit

Testing

- High-charge / ready operation indicator light
- Waterproof rubber test button

Operating Temperature

- 32° - 104° Fahrenheit (0° - 40° Celsius)

Life Expectancy

- LED and PC circuitry are rated for approximately 25 years with no change in illumination level
- Emergency lamps and lead-calcium battery requires standard maintenance.

Listings:

UL Listed for Wet Location
 NEC
 NEMA-4X
 NFPA
 State & Municipal

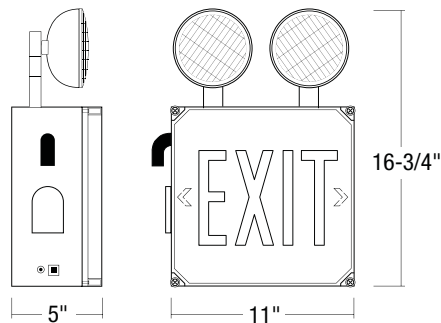

LED WET LOCATION EXIT / EMERGENCY COMBINATION

CATALOG. NO.	OPERATION	LETTER COLOR	FACE	HOUSING COLOR
NEX-710-LED/G	Battery Backup	Green	Single Face	White
NEX-710-LED/R	Battery Backup	Red	Single Face	White

Accessories Ordered Separately, see pages 740-741



EXIT AND EMERGENCY

LED Exit/Emergency w/Adjustable Incandescent Heads

NEX-707 Combination Dual Head Emergency / Exit fixture offers the ultimate in flexibility and options. During normal operation, the exit sign operates on long life LED sources for brilliant, maintenance-free illumination. During emergency operation, the exit sign and dual incandescent heads operate 90 minutes under battery power. The fixture can accept a second battery allowing two 5.4 watt remote heads to be installed within 15' of the main unit.

Body:

- 22-1/2" Max. Width x 14-1/2" Max. Height x 4-1/2" Depth
- Injection-molded dual housing with 1/2" replaceable knockouts for power conduit feed

Face:

Exit

- Double faces are included. Blank is also included if single face is desired
- 6" high text with color diffusion
- Knockout directional chevrons

Emergency

- Two adjustable arms with square heads complete with specular reflector and diffuser lens for T5 light source

Mounting:

- Wall, Side or Ceiling
- Canopy and mounting hardware Included

Electrical:

Voltage

- 120V or 277V dual input

Power Consumption

- 3.8 Watts, normal operation
- 15 Watts, emergency operation, with capacity for 10.8 additional watts if using remote fixtures and additional battery.

Light Source

- Exit: LED strip for normal operation
- Emergency: 2 x 6W T5 6V Wedge Base incandescent lamps

Battery

- 6V 4.5Amp Replaceable lead-calcium battery (NEB-6V-4.5) operates integral heads and exit LED sources. Additional battery can be added to operate two 6W remote fixtures (not included)
- 90 minute emergency operation
- Internal solid state charging circuit

Remote

- Accepts second battery, allowing (2) 5.4W remote heads to be installed within 15'

Testing

- High-charge / ready operation indicator light
- Test button

Circuitry Protection

- Isolated surge / short circuit protection

Life Expectancy

- LED and PC circuitry are rated for approximately 25 years with no change in illumination level
- Emergency lamps and lead-calcium battery requires standard maintenance.

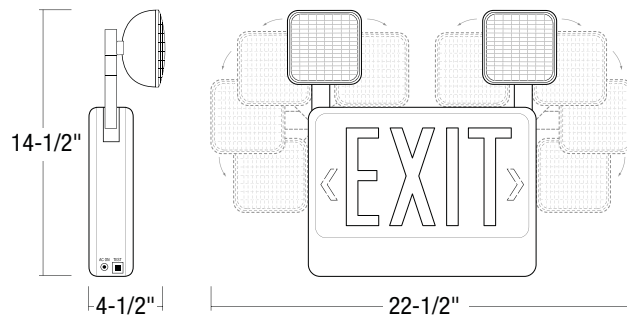

LED EXIT / EMERGENCY W/ ADJUSTABLE HEADS

CATALOG. NO.	OPERATION	LETTER COLOR	HOUSING COLOR
NEX-707-LED/G	Battery Backup	Green	White
NEX-707-LED/GB	Battery Backup	Green	Black
NEX-707-LED/GS	Battery Backup	Green "SALIDA"	White
NEX-707-LED/GBS	Battery Backup	Green "SALIDA"	Black
NEX-707-LED/R	Battery Backup	Red	White
NEX-707-LED/RB	Battery Backup	Red	Black
NEX-707-LED/RS	Battery Backup	Red "SALIDA"	White
NEX-707-LED/RBS	Battery Backup	Red "SALIDA"	Black

Accessories Ordered Separately, see pages 740-741

Listings:

UL Listed for Damp Location
 UL/CSA Listed (Red letters only)
 NEC
 NFPA
 State & Municipal



LED Exit/Emergency w/Adjustable Incandescent Heads

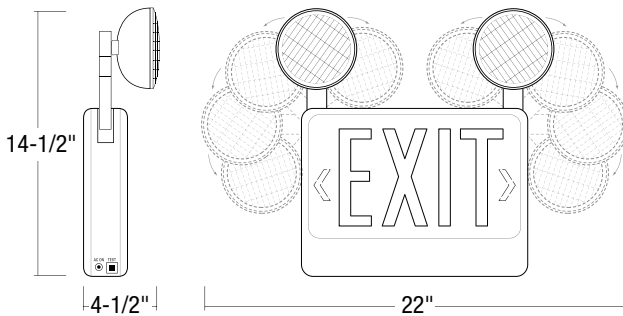

NEX-708 Combination Dual Head Emergency / Exit fixture offers the ultimate in flexibility and options. During normal operation, the exit sign operates on long life LED sources for brilliant, maintenance-free illumination. During emergency operation, the exit sign and dual incandescent heads operate 90 minutes under battery power. The fixture can accept a second battery allowing two 5.4 watt remote heads to be installed within 15' of the main unit.

Body:

- 22" Max. Width x 14-1/2" Max. Height x 4-1/2" Depth
- Injection-molded dual housing with 1/2" replaceable knockouts for power conduit feed

Face:

Exit

- Double faces are included. Blank is also included if single face is desired
- 6" high text with color diffusion
- Knockout directional chevrons

Emergency

- Two adjustable arms with round heads complete with specular reflector and diffuser lens for T5 light source

Mounting:

- Wall, Side or Ceiling
- Canopy and mounting hardware Included

Electrical:

Voltage

- 120V or 277V dual input

Power Consumption

- 3.8 Watts, normal operation
- 15 Watts, emergency operation, with capacity for 10.8 additional watts if using remote fixtures and additional battery.

Light Source

- Exit: LED strip for normal operation
- Emergency: 2 x 6W T5 6V Wedge Base incandescent lamps

Battery

- 6V 4.5Amp Replaceable lead-calcium battery (NEB-6V-4.5) operates integral heads and exit LED sources. Additional battery can be added to operate two 6W remote fixtures (not included)
- 90 minute emergency operation
- Internal solid state charging circuit

Remote

- Accepts second battery, allowing (2) 5.4W remote heads to be installed within 15'

Testing

- High-charge / ready operation indicator light
- Test button

Circuitry Protection

- Isolated surge / short circuit protection

Life Expectancy

- LED and PC circuitry are rated for approximately 25 years with no change in illumination level
- Emergency lamps and lead-calcium battery requires standard maintenance.

LED EXIT / EMERGENCY W/ ADJUSTABLE HEADS

CATALOG. NO.	OPERATION	LETTER COLOR	FACE	HOUSING COLOR
NEX-708-LED/G	Battery Backup	Green	Single Face	White
NEX-708-LED/GS	Battery Backup	Green "SALIDA"	Single Face	White
NEX-708-LED/R	Battery Backup	Red	Single Face	White
NEX-708-LED/RS	Battery Backup	Red "SALIDA"	Single Face	White

Accessories Ordered Separately, see pages 740-741

Listings:

UL Listed for Damp Location
 UL/CSA Listed (Red letters only)
 NEC
 NFPA
 State & Municipal



EXIT AND EMERGENCY

LED Exit / Emergency with Adjustable MR16 Heads

NEX-709 Combination Dual Head Emergency / Exit fixture offers the ultimate in flexibility and options. During normal operation, the exit sign operates on long life LED sources for brilliant, maintenance-free illumination. During emergency operation, the exit sign and dual MR16 halogen heads operate 90 minutes under battery power. The fixture can accept a second battery allowing two 5.4 watt remote heads to be installed within 15' of the main unit.

Body:

- 22-1/2" Max. Width x 14-1/2" Max. Height x 4-1/2" Depth
- Injection-molded dual housing with 1/2" replaceable knockouts for power conduit feed

Face:

Exit

- Double faces are included. Blank is also included if single face is desired
- 6" high text with color diffusion
- Knockout directional chevrons

Emergency

- Two adjustable arms with round heads holding self-protected, covered MR16 halogen lamps.

Mounting:

- Wall, Side or Ceiling
- Canopy and mounting hardware Included

Electrical:

Voltage

- 120V or 277V dual input

Power Consumption

- 3.8 Watts, normal operation
- 15 Watts, emergency operation, with capacity for 10.8 additional watts if using remote fixtures and additional battery.

Light Source

- Exit: LED strip for normal operation
- Emergency: 2 x 5W 6V MR16 Halogen Lamps

Battery

- 6V 4.5Amp Replaceable lead-calcium battery (NEB-6V-4.5) operates integral heads and exit LED sources. Additional battery can be added to operate two 5W remote fixtures (not included)
- 90 minute emergency operation
- Internal solid state charging circuit

Remote

- Accepts second battery, allowing (2) 5.4W remote heads to be installed within 15'

Testing

- High-charge / ready operation indicator light
- Test button

Circuitry Protection

- Isolated surge / short circuit protection

Life Expectancy

- LED and PC circuitry are rated for approximately 25 years with no change in illumination level
- Emergency lamps and lead-calcium battery requires standard maintenance.

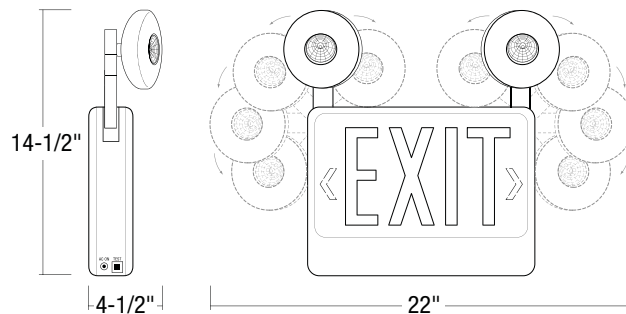

LED EXIT / EMERGENCY W/ ADJUSTABLE HEADS

CATALOG. NO.	OPERATION	LETTER COLOR	FACE(S)	HOUSING COLOR
NEX-709-LED/G	Battery Backup	Green	Single Face	White
NEX-709-LED/GS	Battery Backup	Green "SALIDA"	Single Face	White
NEX-709-LED/R	Battery Backup	Red	Single Face	White
NEX-709-LED/RS	Battery Backup	Red "SALIDA"	Single Face	White

Accessories Ordered Separately, see pages 740-741

Listings:

UL Listed for Damp Location
 UL/CSA Listed (Red letters only)
 NEC
 NFPA
 State & Municipal



EXIT AND EMERGENCY

Deco Xenon Emergency Light Wet Label

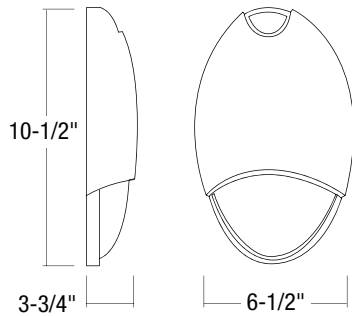

Decorative architectural outdoor design aluminum die-cast emergency light with battery backup. This self diagnostic low profile unit seals all electrical components from water spray, splash, and regular hose-downs. The sleek design blends seamlessly with any application and provides a contemporary alternative to typical "bug-eye" units. Ideal for retail stores, hotels, schools, restaurants, office buildings and many outdoor applications.

Features:

- Self diagnostic
- 90 minute battery backup
- Test switch and indicator light
- Dual Voltage 120V to 277V
- LED Photocell Option available

Body:

- 6-1/2" Width x 10-1/2" Height x 3-3/4" Depth
- Die-cast aluminum construction

Mounting:

- Wall
- Mounting Hardware Included

Electrical:

Voltage

- 120V or 277V dual input

Power Consumption

- 12 Watts

Light Source

- Emergency: 2 x 6W 6V Xenon lamps (included)
- Photocell: LED light source (optional)

Battery

- 6V 5Ah Replaceable Ni-Cad battery
- 90 minute emergency operation

Testing

- High-charge / ready operation indicator light
- Test button
- Automatic reset

Circuitry Protection

- Isolated surge / short circuit protection
- Disconnect for deep discharge

Life Expectancy

- LED and PC circuitry are rated for approximately 25 years with no change in illumination level

Self Diagnostic:

- Automatically monitors and tests to ensure proper operation
- Self tests 1 minute each month, 30 minutes every six months, and 90 minutes annually

LED Photocell Option:

- Optional LED photocell internally mounted that lights both clear lenses
- Dusk to dawn feature turns on at night and off during the day
- Available in Amber, Green, or White

Listing:

ETL and cETL Listed for Wet Location

DECO XENON EMERGENCY LIGHT

CATALOG. NO.	OPERATION	FINISH	LED COLOR
NE-900B	Battery Backup	Black	N/A
NE-900BSA	Battery Backup	Black	Amber
NE-900BSG	Battery Backup	Black	Green
NE-900BSW	Battery Backup	Black	White
NE-900BZ	Battery Backup	Bronze	N/A
NE-900BZSA	Battery Backup	Bronze	Amber
NE-900BZSG	Battery Backup	Bronze	Green
NE-900BZSW	Battery Backup	Bronze	White
NE-900S	Battery Backup	Silver	N/A
NE-900SSA	Battery Backup	Silver	Amber
NE-900SSG	Battery Backup	Silver	Green
NE-900SSW	Battery Backup	Silver	White
NE-900W	Battery Backup	White	N/A
NE-900WSA	Battery Backup	White	Amber
NE-900WSG	Battery Backup	White	Green
NE-900WSW	Battery Backup	White	White

For Cold Weather Option add suffix "CC"
Accessories Ordered Separately, see pages 740-741



EXIT AND EMERGENCY

LED Mini Dual Head Emergency Light

Nora's New LED adjustable dual head low profile emergency light produces 200 lumens of long life low energy LED light for egress lighting.

NE-502 Body:

- Injection molded thermoplastic ABS housing
- 13-5/8" Width x 4-1/8" Height x 3-1/8" Depth
- UL 94-5VA Flame Rating
- Snap-together design

NEG-50 Body:

- Weather-proof vandal resistant enclosure
- Polycarbonate cover - ABS back plate

Face:

- (2) Fully adjustable square shaped LED heads on beveled body

Mounting:

- Wall or Ceiling Mounted

Electrical:

Voltage

- 120V or 277V dual input
- Automatic solid state switching and charging

Light Source

- 2 x LED Heads provide 200 lumens at 4.68 watts
- 75 CRI
- 4410 CCT

Battery

- Lead-Acid (6V 2.5 Ah)
- 90 minute emergency operation
- 24 hour recharge after 90 minute discharge
- Low battery disconnection preventing deep discharge and damage to battery

Listing:

UL 94-5VA Flame Rating
Suitable for Wet Location with NEG-50
RoHS Compliant



NEW!

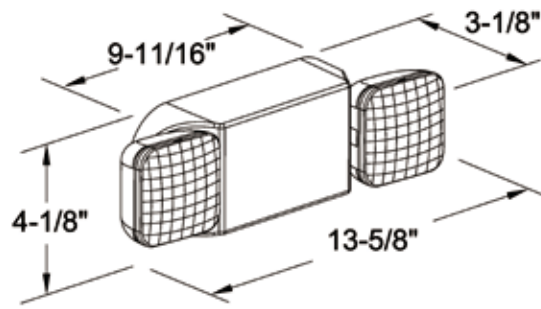

LED MINI DUAL HEAD EMERGENCY LIGHT

CATALOG. NO.	OPERATION	LIGHT SOURCE	FACE	HOUSING COLOR
NE-502	Battery Backup	2 x 2.34W LED	Beveled	White
NE-502B	Battery Backup	2 x 2.34W LED	Beveled	Black



NEG-50 shown with NE-502 installed

LED MINI DUAL HEAD ENCLOSURE

CATALOG. NO.	DESCRIPTION
NEG-50	Polycarbonate weather-proof vandal resistant enclosure with ABS back plate

For dimensions, see page 741

Xenon Emergency Light with Battery Backup

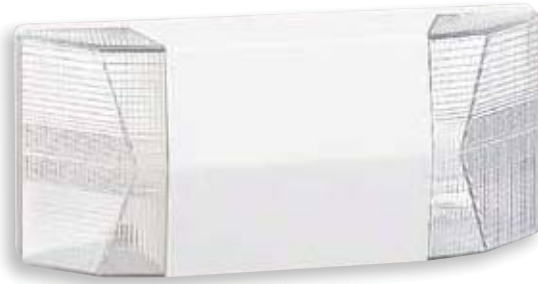

This dual integral low profile fixture offers the lowest profile of all Nora Emergency fixtures. The light sources are held within the body of the fixture, with both beveled side panels constructed of clear polycarbonate. These features make the NE-806 small enough for virtually any application, and eliminate the necessity of aiming and locking lamp heads.

Body:

- 11-13/16" Width x 5" Height x 2-11/16" Depth
- Injection-molded housing with access for ceiling or wall power supply

Face:

- Injection molded face with two clear polycarbonate covers on beveled surfaces.

Mounting:

- Wall or Ceiling
- Mounting Hardware Included

Electrical:

Voltage

- 120V or 277V dual input
- Automatic solid state switching and charging
- Automatic reset
- Quick wire connection - no extra hardware necessary

Light Source

- 2 x 6W DC T5 wedge base lamps (included)

Battery

- Replaceable, 6V, 4.5Ah lead-calcium (NEB-6V-4.5) maintenance free battery for backup operation during power loss
- 90 minute emergency operation on fully charged battery

Testing

- High-charge / ready operation indicator light
- Test button

Circuitry Protection

- Short circuit protection

Listing:

UL Listed
 CSA
 NFPA
 NEC
 State & Municipal
 Suitable for Damp Location

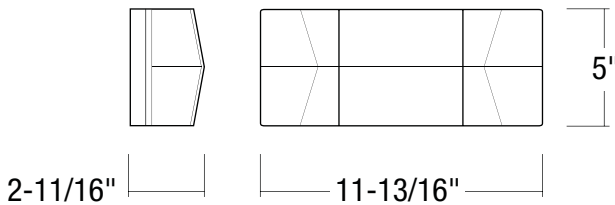

"HEADLESS" BEVELED DUAL INTEGRAL EMERGENCY LIGHT

CATALOG. NO.	OPERATION	LIGHT SOURCE	FACE	HOUSING COLOR
NE-806	Battery Backup	2 x 6W T5	Beveled	White

Accessories Ordered Separately, see pages 740-741



EXIT AND EMERGENCY

Incandescent Emergency Light Battery Backup & Remote Capability

This dual-head fixture provides a superior aiming and flexible appearance along with excellent performance. Dual lighting heads provide strong ambient light levels to assist in emergency egress during power failure. Internal solid state switching automatically activates fixture during power loss.

Body:

- 12-1/8" Width x 5-1/2" Height x 4" Depth
- Injection-molded housing with access for ceiling or wall power supply

Face:

- Injection molded face with two round lamp heads molded into sloped side surfaces of fixture. Each head is equipped with reflector and diffuser

Mounting:

- Wall or Ceiling
- Mounting Hardware Included

Electrical:

Voltage

- 120V or 277V dual input
- Automatic solid state switching and charging
- Quick wire connection - no extra hardware necessary

Light Source

- 2 x 6W DC T5 wedge base lamps (included)

Battery

- Replaceable, 6V, 4.5Ah lead-calcium (NEB-6V-4.5) maintenance free battery for backup operation during power loss
- 90 minute emergency operation on fully charged battery

Testing

- High-charge / ready operation indicator light
- Test button

Circuitry Protection

- Short circuit protection
- Disconnect for deep discharge

Listing:

UL Listed
CSA (NE-803 only)
NFPA
NEC
State & Municipal
Suitable for Damp Location

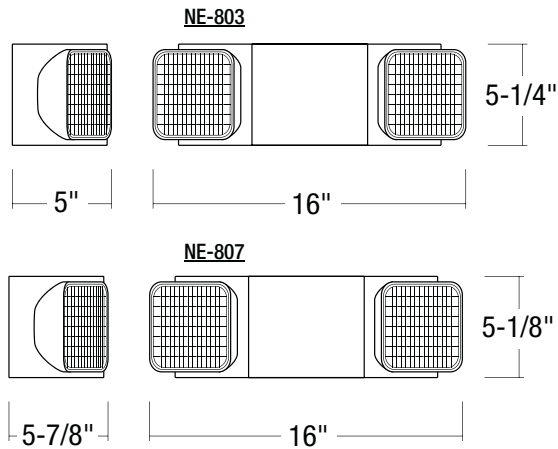

BEVELED DUAL HEAD EMERGENCY LIGHT

CATALOG. NO.	OPERATION	LIGHT SOURCE	FACE	HOUSING COLOR	REMOTE CAPABLE
NE-803	Battery Backup	2 x 6W T5	Beveled	White	No
NE-803B	Battery Backup	2 x 6W T5	Beveled	Black	No
NE-807	Battery Backup	2 x 6W T5	Beveled	White	Up to 2 x 6W

Accessories Ordered Separately, see pages 740-741

COMPATIBLE EMERGENCY REMOTE HEADS

Single Head NE-831 <small>WET NE-931 UL Wet</small>	Double Head NE-832 <small>WET NE-932 UL Wet</small>	Square Head NE-837	Round Head NE-838	MR16 Head NE-839

For complete description, see pages 738

Incandescent Emergency Light Battery Backup & Remote Capability



NE-804

NE-808

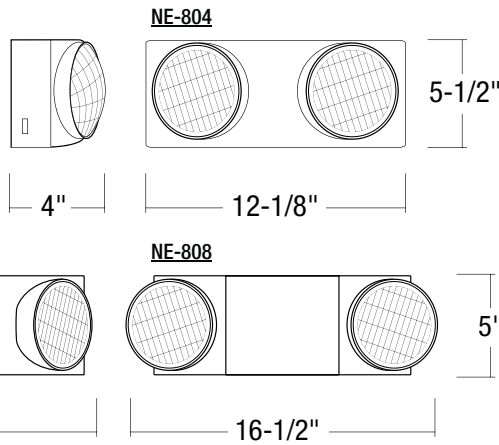

This dual-head fixture provides a compact, low profile appearance along with excellent performance. Dual lighting heads provide strong ambient light levels to assist in emergency egress during power failure. Internal solid state switching automatically activates fixture during power loss.

Body:

- Injection-molded housing with access for ceiling or wall power supply

Face:

- Injection molded face with two round lamp heads, each equipped with reflector and diffuser

Mounting:

- Wall or Ceiling
- Mounting Hardware Included

Electrical:

Voltage

- 120V or 277V dual input
- Automatic solid state switching and charging
- Quick wire connection - no extra hardware necessary

Light Source

- 2 x 6W DC T5 wedge base lamps (included)
- Emergency Light Fixtures: Two adjustable glare-free light heads with positive positioning lock
- Can operate 2 x 10W lamps if no remotes are connected (NE-808 only)

Battery

- NE-804: Replaceable, 6V, 4.5Ah lead-calcium (NEB-6V-4.5) maintenance free battery for backup operation during power loss
- NE-808: Replaceable, 6V, 7Ah lead-calcium maintenance free battery for backup operation during power loss
- 90 minute emergency operation on fully charged battery

Remote

- NE-808 may operate 2 x 6W remote heads at a maximum distance of 15 feet

Testing

- High-charge / ready operation indicator light
- Test button

Circuitry Protection

- Solid state short circuit protection
- Disconnect for deep discharge

Listing:

UL Listed
NFPA
NEC
State & Municipal
Suitable for Damp Location



BEVELED DUAL HEAD EMERGENCY LIGHT

CATALOG. NO.	OPERATION	LIGHT SOURCE	FACE	HOUSING COLOR	REMOTE CAPABLE
NE-804	Battery Backup	2 x 6W T5	Beveled	White	No
NE-804B	Battery Backup	2 x 6W T5	Beveled	Black	No
NE-808	Battery Backup	2 x 6W T5	Beveled	White	Up to 2 x 6W

Accessories Ordered Separately, see pages 740-741

COMPATIBLE EMERGENCY REMOTE HEADS

Single Head NE-831 WET NE-931 UL Wet	Double Head NE-832 WET NE-932 UL Wet	Square Head NE-837	Round Head NE-838	MR16 Head NE-839

For complete description, see pages 738

EXIT AND EMERGENCY

Halogen Emergency Light with Battery Backup

The beveled dual-head fixture offers superior aiming and flexibility in styling, with two round emergency light heads providing a strong source illumination for emergency egress. Dual MR16 sources replace the standard "head lamp" configuration. Internal solid state switching automatically activates fixture during power loss.

Body:

- 12-1/8" Width x 5-1/2" Height x 4" Depth
- Injection-molded housing with access for ceiling or wall power supply

Face:

- Beveled injection molded face with two round lamp heads molded into beveled surface of fixture. Each head holds a 5 watt covered MR16 lamp

Mounting:

- Wall or Ceiling
- Mounting Hardware Included

Electrical:

Voltage

- 120V or 277V dual input
- Automatic solid state switching and charging
- Quick wire connection - no extra hardware necessary

Light Source

- 2 x 5W MR16 lamps (included)

Battery

- Replaceable, 6V, 4.5Ah lead-calcium (NEB-6V-4.5) maintenance free battery for backup operation during power loss
- 90 minute emergency operation on fully charged battery

Testing

- High-charge / ready operation indicator light
- Test button

Circuitry Protection

- Short circuit protection
- Disconnect for deep discharge

Listing:

UL Listed
NFPA
NEC
State & Municipal
Suitable for Damp Location

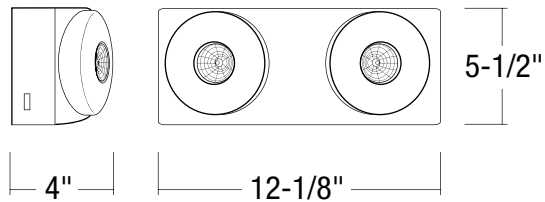

BEVELED DUAL HALOGEN HEAD EMERGENCY LIGHT

CATALOG. NO.	OPERATION	LIGHT SOURCE	FACE	HOUSING COLOR
NE-805	Battery Backup	2 x 5W MR16	Beveled	White
NE-805B	Battery Backup	2 x 5W MR16	Beveled	Black

Accessories Ordered Separately, see pages 740-741



Halogen Emergency Light with Remote Capability

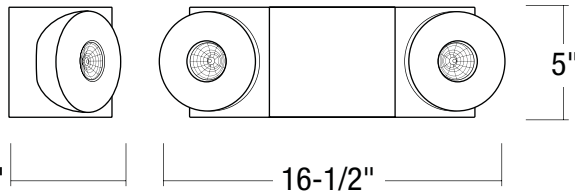

This dual-head fixture provides a compact, low profile appearance along with excellent performance. Dual lighting heads provide strong ambient light levels to assist in emergency egress during power failure. Internal solid state switching automatically activates fixture during power loss. Can also operate two remote heads for hard to reach areas requiring illumination.

Body:

- 16-1/2" Width x 5" Height x 5" Depth
- Injection-molded housing with access for ceiling or wall power supply

Face:

- Injection molded face with two round lamp heads. Each head holds a 5 watt covered MR16 lamp

Mounting:

- Wall or Ceiling
- Mounting Hardware Included

Electrical:

Voltage

- 120V or 277V dual input
- Automatic solid state switching and charging
- Quick wire connection - no extra hardware necessary

Light Source

- 2 x 5W MR16 halogen lamps (included)
- Can operate 2 x 10W lamps if no remotes are connected

Battery

- Replaceable, 6V, 7Ah lead-calcium maintenance free battery for backup operation during power loss
- 90 minute emergency operation on fully charged battery

Remote

- NE-809 may operate 2 x 6W remote heads at a maximum distance of 15 feet

Testing

- High-charge / ready operation indicator light
- Test button

Circuitry Protection

- Short circuit protection
- Disconnect for deep discharge

Listing:

UL Listed
 NFPA
 NEC
 State & Municipal
 Suitable for Damp Location



DUAL HEAD EMERGENCY LIGHT W/ REMOTE CAPABILITY

CATALOG. NO.	OPERATION	LIGHT SOURCE	FACE	HOUSING COLOR	REMOTE CAPABLE
NE-809	Battery Backup	2 x 5W MR16	Beveled	White	Up to 2 x 6W

Accessories Ordered Separately, see pages 740-741

COMPATIBLE EMERGENCY REMOTE HEADS

				
Single Head NE-831 <small>WET NE-931 UL Wet</small>	Double Head NE-832 <small>WET NE-932 UL Wet</small>	Square Head NE-837	Round Head NE-838	MR16 Head NE-839

For complete description, see page 738

EXIT AND EMERGENCY

Wet Location Emergency Light w/ Remote Capability

For wet and dirty areas, Nora offers the NE-960 Wet Location Emergency Light. A heavy-duty housing completely seals all electrical components and connections from water spray, splash, and corrosive atmospheres. During power outages the dual incandescent heads will operate for 90 minutes under battery power. Ideal for industrial applications, or any other subject to wet or cold weather.

Body:

- 11 1/2" Width x 13-1/2" Height x 5" Depth
- High-impact plastic construction

Face:

- Two fully adjustable glare-free round heads for T5 light source

Mounting:

- Wall
- Mounting Hardware Included

Electrical:

Voltage

- 120V or 277V dual input
- Automatic solid state switching and charging
- Quick wire connection - no extra hardware necessary

Light Source

- 2 x 6W DC T5 wedge base lamps (included)
- Emergency Light Fixtures: Two adjustable glare-free light heads with positive positioning lock
- Can operate 2 x 10W lamps if no remotes are connected

Battery

- Replaceable, 6V, 4.5Ah lead-calcium (NEB-6V-4.5) maintenance free battery for backup operation during power loss
- 90 minute emergency operation on fully charged battery
- Internal solid state charging circuit

Remote

- NE-960 may operate 2 x 6W remote heads at a maximum distance of 15 feet

Testing

- High-charge / ready operation indicator light
- Waterproof rubber test button

Operating Temperature

- 32° - 104° Fahrenheit (0° - 40° Celsius)

Circuitry Protection

- Short circuit protection
- Disconnect for deep discharge

Listing:

UL Listed for Wet Location
 NEC
 NEMA-4X
 NFPA
 State & Municipal

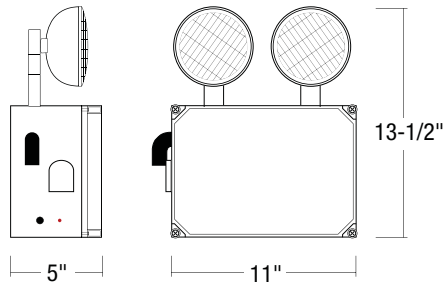

WET LOCATION EMERGENCY LIGHT W/REMOTE CAPABILITY

CATALOG. NO.	OPERATION	LIGHT SOURCE	HOUSING COLOR	REMOTE CAPABLE
NE-960	Battery Backup	2 x 6W T5	Grey	Up to 2 x 6W

Accessories Ordered Separately, see pages 740-741

COMPATIBLE EMERGENCY REMOTE HEADS

Single Head NE-831 <small>WET NE-931 UL Wet</small>	Double Head NE-832 <small>WET NE-932 UL Wet</small>	Square Head NE-837	Round Head NE-838	MR16 Head NE-839

For complete description, see page 738

Recessed Incandescent Emergency Light

NE-811

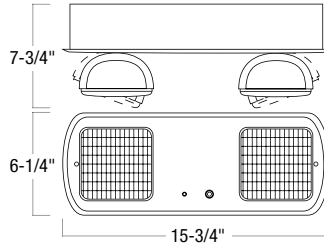

NE-812

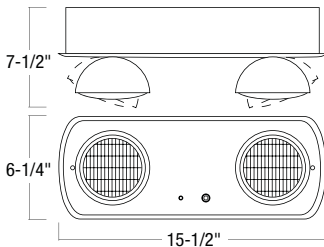

NE-813

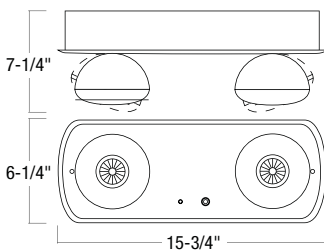

Recessed fixture combines the functionality of our high quality emergency fixtures with the low profile shape of a recessed unit. These versatile fixtures offers superior aiming and flexibility in styling, with new contemporary emergency light heads providing a strong source of illumination for emergency lighting.

Body:

- NE-811: 15-3/4" Width x 6-1/4" Height x 7-3/4" Depth
- NE-812: 15-1/2" Width x 6-1/4" Height x 7-1/2" Depth
- NE-813: 15-3/4" Width x 6-1/4" Height x 7-1/4" Depth
- 20 gauge steel housing

Face:

- Enamel-coated faceplate with beveled edges
- Fully adjustable thermoplastic heads. Each head is equipped with a polished reflector and clear polycarbonate diffuser.

Mounting:

- Universal brackets accept adjustable bar hangers (included) or flat bar hangers (ordered separately) slotted for T-Bar installations, or simple rigid steel conduit for tie-down to ceiling grids
- Recessed ceiling mount only (requires 3-3/4" ceiling clearance)

Electrical:

Voltage

- 120V or 277V dual input
- Automatic solid state switching and charging
- Automatic reset

Light Source

- NE-811: 2 x 10W T5 wedge base (included)
- NE-812: 2 x 10W T5 wedge base (included)
- NE-813: 2 x 10W MR16 lamp (included)

Battery

- Sealed maintenance free 6V, 12Ah lead-calcium battery for backup operation during power loss
- 90 minute emergency operation on fully charged battery

Testing

- High-charge / ready operation indicator light
- Test button

Circuitry Protection

- Short circuit protection
- Brown-out protection
- Disconnect for deep discharge

Listing:

UL Listed

RECESSED INCANDESCENT EMERGENCY LIGHT

CATALOG. NO.	OPERATION	LIGHT SOURCE	HEAD TYPE	HOUSING COLOR
NE-811	Battery Backup	2 x 10W T5	Square	White
NE-812	Battery Backup	2 x 10W T5	Round	White
NE-813	Battery Backup	2 x 10W MR16	Round	White

Accessories Ordered Separately, see pages 740-741



EXIT AND EMERGENCY

Emergency Remote Heads

Remote head fixtures provides a superior aiming and flexible appearance along with excellent performance. Dual lighting heads provide strong ambient light levels to assist in emergency egress during power failure. Internal solid state switching automatically activates fixture during power loss.

Body:

NE-831

- 4-7/8" Width x 7-1/8" Height x 7" Depth

NE-931

- 4-7/8" Width x 7-3/8" Height x 7-1/8" Depth

NE-832

- 12-1/2" Width x 6-1/8" Height x 7" Depth

NE-932

- 11-1/2" Width x 7" Height x 7-1/8" Depth

NE-837

- 4-5/8" Width x 4-5/16" Height x 5-3/16" Depth

NE-838

- 4-7/8" Width x 4-5/16" Height x 4-3/16" Depth

NE-839

- 4-7/8" Width x 4-5/16" Height x 4-3/16" Depth

Features:

- Fully adjustable, glare free light heads with positive positioning lock
- Reliable slide friction position hold
- Lamp included
- Efficient 6V operation
- Injection molded thermoplastic housing

Mounting:

- 5" canopy matching round mounting plate for 3" or 4" box standard
- Mounting Hardware Included

Electrical:

Voltage

- 6V or 12V Remote (6V lamp included)

Light Source

- 6V 6W T5 Wedge Base (included) or 6V 5W MR16 (included)

Remote

- Used with 6V or 12V remote output
- Lamp must be replaced for 12V operation

Listing:

UL 924 Compliant

UL Listed for Wet Location (NE-931, NE-932 only)



NE-831

NE-832

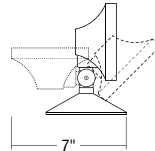
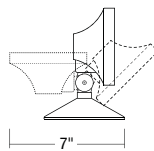
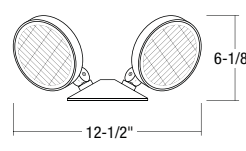
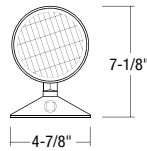

NE-931

NE-932

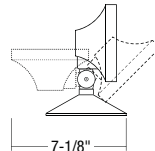
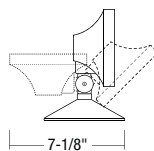
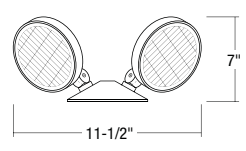
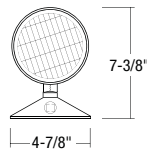

NE-837

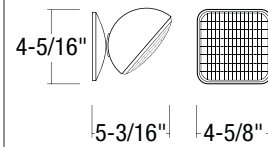

NE-838

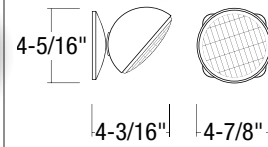

NE-839 MR16

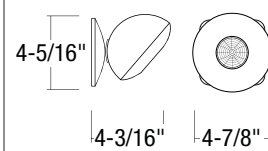

EMERGENCY REMOTE HEADS

CATALOG. NO.	VOLTAGE	HEAD(S)	LAMP(S)	CANOPY	HOUSING COLOR	UL LISTING
NE-831	6V or 12V	1	1 x 6W T5	Round	White	UL 924
NE-931	6V or 12V	1	1 x 6W T5	Round	Grey	UL Wet
NE-832	6V or 12V	2	2 x 6W T5	Round	White	UL 924
NE-932	6V or 12V	2	2 x 6W T5	Round	Grey	UL Wet
NE-837	6V or 12V	1	1 x 6W T5	Square	White	UL 924
NE-838	6V or 12V	1	1 x 6W T5	Square	White	UL 924
NE-839	6V or 12V	1	1 x 5W MR16	Square	White	UL 924

Emergency Head Photometric Data

5W DC T5 Lamp with Diffuser Lens

Use on NEX-700/2H, NEX-703-LED, NEX-704-LED, NEX-707-LED, NEX-708-LED, NE-800
NE-801, NE-803, NE-804, NE-807, NE-808, NE-831, NE-832, NE-837, NE-838, NE-931, NE-932

Lab: LM-63-1995 Test: 1101-5A Spacing Criteria: 0°-180° 0.3 90°-270° 0.6 Efficiency: 60.2%

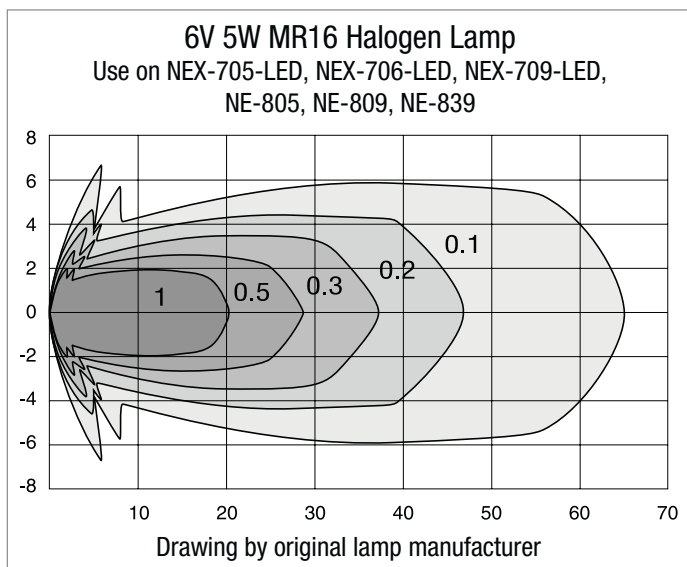
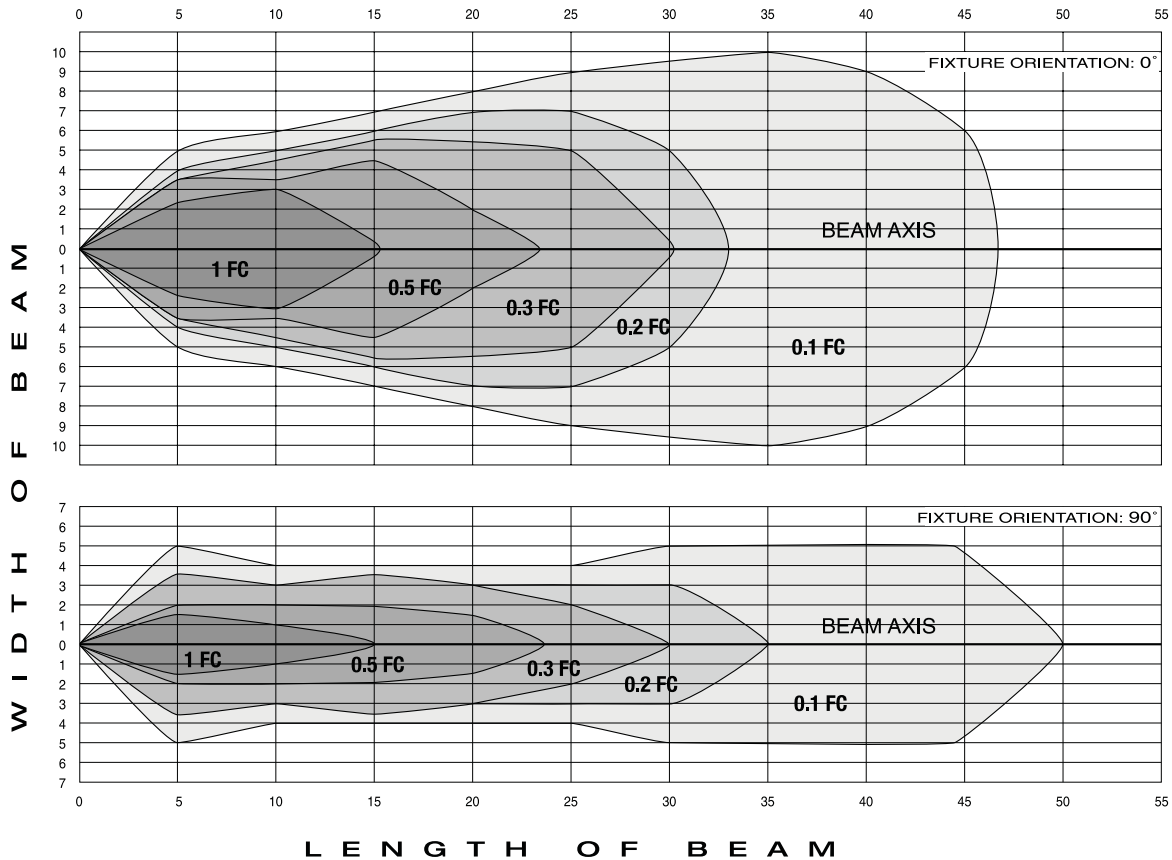

Note: As emergency heads on Nora fixtures are individually positioned, rotated, and aimed - each head should be regarded as a separate and independent fixture to itself. The following information is for each emergency head on a Nora fixture - not the entire fixture as a whole.

When using this information, or the .IES data file for dual head emergency fixtures, space each head 1'-2' apart (depending on the fixture), so in any layout there are pairs of emergency heads, with each pair representing one Nora dual-head fixture.

EXIT AND EMERGENCY

Exit & Emergency Accessories

Replacement NiCad Battery

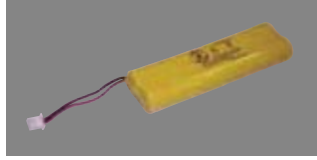

Catalog No. **Description**

NEB-NICAD Replacement Battery for LED Exit Signs, Rectangle 4.8V

- Compatible Exit Signs: NX-506-LED, NX-508-LED, NX-509-LED, NX-509-LED, NX-511-LED, NX-604-LED, NX-607-LED, NX-608-LED, NX-609-LED, NX-810-LED, NX-811-LED, NX-812-LED, NX-813-LED, NX-814-LED, NX-815-LED

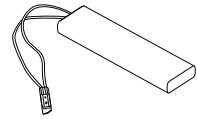

Replacement NiCad Battery

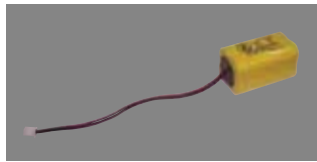

Catalog No. **Description**

NEB-NICAD2 Replacement Battery for LED Exit Signs, Square 4.8V

- Compatible Exit Signs: NX-505-LED, NX-603-LED, NX-605-LED, NX-615-LED

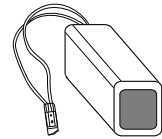

Replacement Lead Calcium Battery



Catalog No. **Description**

NEB-6V-4.5 Replacement/Additional Battery, 6 Volt, 4.5 Amp/Hour

- Compatible Emergency & Exit/Emergency Combination Units: NE-803, NE-804, NE-805, NE-806, NE-960, NEX-707, NEX-708, NEX-709, NEX-710-LED
- Can be used as an additional battery for remote capabilities



Replacement T5 Emergency Lamp



Catalog No. **Description**

6T5WB 6 Watt, 6 Volt, T5 Bulb, Wedge Base, for Emergency Units

- Compatible Emergency Units: NE-811, NE-812, NE-803, NE-804, NE-806, NE-807, NE-808, NE-831, NE-832, NE-837, NE-838, NE-931, NE-932, NE-960, NEX-707, NEX-708, NEX-710-LED



Replacement MR16 Emergency Lamp



Catalog No. **Description**

Q15MR16/6 5 Watt, 6 Volt, MR16 Halogen, GU5.3 Base, for Emergency Units

- Compatible Emergency Units: NE-839, NE-805, NE-809, NE-813, NEX-709



Replacement Chevrons



Catalog No. **Description**

NEXC-G Replacement Chevron for Edge-Lit Series, Green

NEXC-R Replacement Chevron for Edge-Lit Series, Red

- Set of 2 Chevrons
- Compatible Exit Signs: NX-506-LED, NX-508-LED, NX-509-LED, NX-510-LED, NX-511-LED, NX-604-LED, NX-608-LED, NX-609-LED, NX-810-LED, NX-811-LED, NX-812-LED, NX-813-LED, NX-814-LED, NX-815-LED



Exit & Emergency Accessories

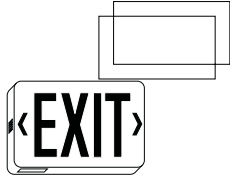

Catalog No.	Description
NEXL-G	Replacement Exit Face Plate with Green Letters and Lens
NEXL-R	Replacement Exit Face Plate with Red Letters and Lens

- White Thermoplastic Exit Face Plate
- Compatible Exit Signs: NX-503-LED, NX-504-LED, NX-603-LED

Replacement Face Plate and Lens

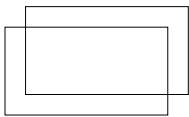

Catalog No.	Description
NEXL/G	Replacement Lens for Exit Signs, Green
NEXL/R	Replacement Lens for Exit Signs, Red

- Compatible Exit Signs: NX-503-LED, NX-504-LED, NX-505-LED, NX-525-LED, NX-603-LED, NX-605-LED, NX-615-LED

Replacement Lens



Catalog No.	Description
NEXL-BGS	Black Face Plate, Green SALIDA / EXIT Letters
NEXL-BRS	Black Face Plate, Red SALIDA / EXIT Letters
NEXL-GS	White Face Plate, Green SALIDA / EXIT Letters
NEXL-RS	White Face Plate, Red SALIDA / EXIT Letters

- Compatible Exit Signs: NX-503-LED, NX-504-LED, NX-603-LED
- Dual Spanish / English lettering
- 2-3/4" "SALIDA" text

Bilingual Exit Face Plate

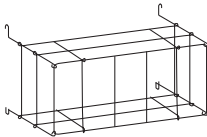

Catalog No.	Description
NEXS-M1	Metal Shield: 8" Height x 16" Width x 8" Depth
NEXS-M2	Metal Shield: 13" Height x 13" Width x 4" Depth
NEXS-M3	Metal Shield: 16" Height x 26" Width x 7" Depth

- Heavy duty construction

Protective Metal Shield

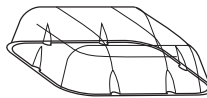

Catalog No.	Description
NEXS-P1	Polycarbonate Vandal / Environmental Resistant Shield 

- Heavy duty construction
- Gasket for Wet Location
- Width: 22" Height: 15" Depth: 8"

Protective Plastic Shield

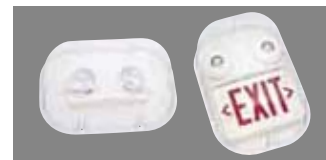

Catalog No.	Description
NEG-50	Polycarbonate Vandal / Environmental Resistant Shield 

- Heavy duty construction
- Gasket for Wet Location
- For use with LED Mini Dual Head Emergency Light (NE-502)
- Width: 15-3/8" Height: 7-3/4" Depth: 5-3/4"

Protective Plastic Shield



EXIT AND EMERGENCY

Emergency Low Voltage Downlight



NL-301AT/EM
3" 12V MR16 Emergency Housing, 50W



NL-401/EM
4" 12V MR16 Emergency Housing, 50W

Nora Lighting offers an added option to its family of 3-inch, 4-inch or 6-inch new construction low voltage downlights. Each Nora low voltage emergency fixture is supplied with an emergency fixture relay unit attached to the junction box. A remote location battery unit supplies power for up to four 50 watt emergency fixtures in the event of a power failure. The NEBU battery unit, with charging indicator light and test button switch, can be mounted out of sight in a storage closet, or any other accessible area. There is also the option to have separate emergency lights installed on the battery unit (battery unit ordered separately). In the event of a power failure, fixtures will remain illuminated for a minimum of 90 minutes, allowing for safe departure of the building's occupants. These high quality downlights are suitable for use in residential and commercial settings, as well as any public areas.



NL-601/EM
6" 12V MR16 Emergency Housing, 50W



NEBU Series
Emergency Battery Units

Emergency Low Voltage Downlight

Technical Data

Input Voltage: 120V or 277V, 60Hz
 Lamps Operated: 50W MR16, PAR36, or AR111
 Battery: 6V, 12Ah or 12V, 18Ah Sealed Lead-Calcium Battery
 Approvals: UL or ETL Listed
 Meets or exceeds UL, NEC, NFPA requirements for emergency lighting
 Emergency Operation: 90 minutes
 Required charging time: 24 hours (with battery completely drained)

Operation

Under normal operation, the fixture will operate from the standard transformer at full capacity. The fixture will automatically switch to emergency operation when the main power source is interrupted. Under emergency operation, the fixture draws its 12V power from the emergency battery. When normal power is restored, the fixture automatically returns to normal operation. If the fixture has been operating in emergency mode for 90 minutes or more, it will take 24 hours for the battery to completely recharge.

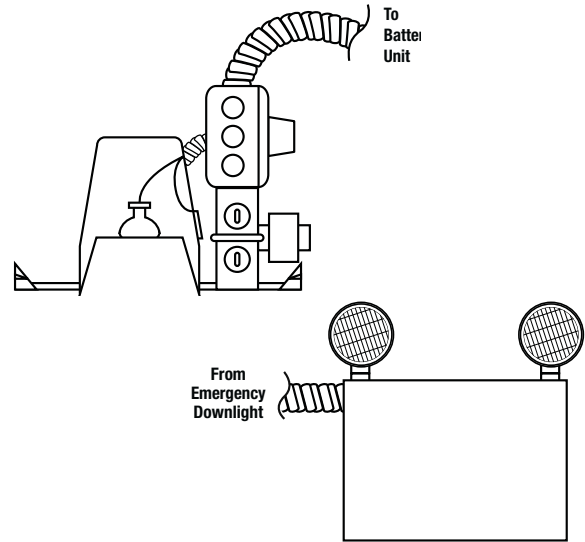

120V / 277V AC

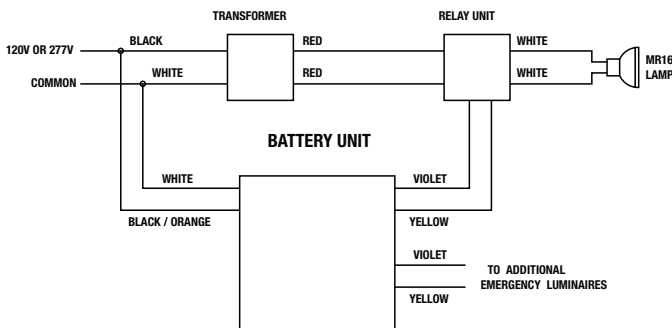

Wiring

The emergency relay unit is pre-wired into the junction box of the emergency fixture. The only open wires inside the junction box are those to be connected with a 277V or 120V electrical source (positive, neutral, and ground) and the violet and yellow wires to be connected with the violet and yellow wires inside the remote location battery unit (if using a power source circuit). The remaining open wires inside the battery unit should then be connected with a 277V or 120V electrical source (positive, neutral, and ground).

WIRING DISTANCE IN FEET (Maximum Voltage Drop 5%)					
Watts	#12 AWG	#10 AWG	#8 AWG	#6 AWG	#4 AWG
50W	42'	66'	106'	170'	275'
100W	21'	33'	53'	85'	138'

Note: For comparison purposed ONLY. Distances are measured from the battery unit to the furthest fixture.

How to Specify

To order a fixture with the emergency option, simply select the desired low voltage fixture, then add the suffix "/EM". **A remote location battery unit must also be ordered to power the fixture.** For example, if you need one 4", 277V low voltage fixture, you would specify one NL-401/50/277/EM and one NEBU-50. Use matrixes below to select housing and remote battery. See the Low Voltage Recessed Section (pages 221-251) for our wide variety of available trims.

PRODUCT MATRIX FOR LOW VOLTAGE HOUSING					
Catalog Number	Emergency	50W Max.	Airtight	120V	277V
NL-301AT/EM	X	X		X	
NL-401/EM	X	X		X	
NL-401AT/EM	X	X	X	X	
NL-401/50/277/EM	X	X			X
NL-601/EM	X	X		X	
NL-601/277V/EM	X	X			X

PRODUCT MATRIX FOR REMOTE BATTERY					
Battery Unit	Number of Emergency Fixtures				
	One	Two	Three	Four	Emergency Heads
NEBU-50	X				
NEBU-100		X			
NEBU-100/2H	X				X
NEBU-200				X	
NEBU-200/2H			X		X

EXIT AND EMERGENCY

Low Voltage Emergency Downlight Retrofit Kit

Emergency relay kit for use with existing low voltage lighting fixtures, already installed in the ceiling. Emergency relay system automatically switches low voltage fixture between emergency and normal power operation during power loss and restoration. The remote location battery unit operates up to four 50W low voltage lamps for a minimum of 90 minutes to allow safe egress during power outage. Upon restoration, the fixture returns to normal AC operation while the emergency battery unit returns to charging mode.

Application & How to Specify:

The NELK Kit can be used with most 3", 4", and 6" magnetic low voltage housings. The system can be customized to your application using our various emergency battery units (battery unit ordered separately).

Features:

- Trouble-free installation on most magnetic low voltage fixtures
- Powered by battery unit or 12V external emergency power source
- Maintenance Free Lead-Calcium Battery
- Integral indicator light and test switch on battery unit and optional emergency lights

Installation:

The NELK-50 relay unit is easily installed onto any fixture with a standard junction box knockout. One NELK-50 relay unit is required for each low voltage fixture selected to operate in emergency mode. The NEBU battery unit can be mounted out of sight in a storage closet, or any other accessible area.

Electrical:

Voltage

- 120V or 277V, 60Hz
- Automatic solid state switching and charging

Lamps Operated

- 50W MR16, PAR36, or AR111

Battery

- 6V, 12Ah or 12V, 18Ah Sealed Lead-Calcium

Testing

- High-charge / ready operation indicator light
- Test button

Operation:

- 90-minute emergency operation
- 24-hour charging time for completely depleted battery

Listing:

UL Listed
NFPA-LSC (Life Safety Code)
NEC / OSHA

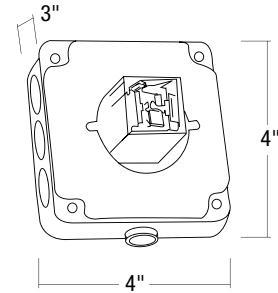

LOW VOLTAGE EMERGENCY RELAY UNIT

CATALOG. NO.	DESCRIPTION
NELK-50	Low Voltage Emergency Relay Unit (Required for each low voltage housing)

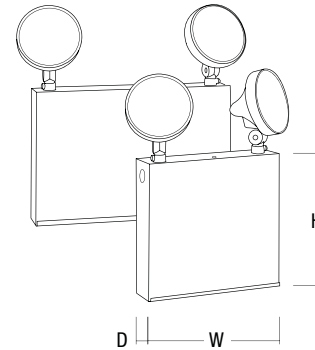

DIMENSIONS			
ITEM NO.	HEIGHT	WIDTH	DEPTH
NEBU-50	9-1/2"	14-3/8"	2-1/2"
NEBU-100	9-5/8"	14-1/2"	4"
NEBU-100/2H	15-5/8"	14-1/2"	4"
NEBU-200	9-1/2"	20"	4-1/4"
NEBU-200/2H	15-1/2"	20"	4-1/4"

LOW VOLTAGE EMERGENCY BATTERY UNITS

CATALOG. NO.	WATTAGE	# OF BATTERIES	# OF EMERGENCY HEADS
NEBU-50	50W	(2) 6V	None
NEBU-100	100W	(1) 12V	None
NEBU-100/2H	100W	(1) 12V	Two
NEBU-200	200W	(2) 12V	None
NEBU-200/2H	200W	(2) 12V	Two

Low Voltage Emergency Downlight

NEH-826

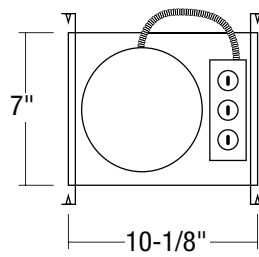
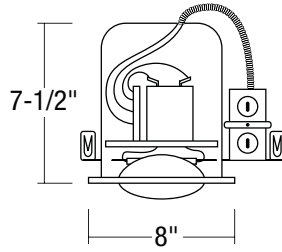

Nora's Self-Contained Recessed Emergency Downlight is a high-quality unit complete with recessed housing, battery, emergency unit, and attractive gimbal ring trim. In the event of a power failure, the low voltage emergency downlights provide a minimum of 90 minutes of illumination, allowing for safe departure of the building's occupants. These economical downlights are suitable for use in residential and commercial settings, as well as any public areas.

Features:

- Maintenance free lead-calcium battery
- 45° Adjustable gimbal ring with integrated indicator light and test switch
- Solid state transfer switching with brownout and short circuit protection
- Gimbal Trim and 15W PAR36 included

Installation:

Remodel

High tension tempered steel springs secure the remodel housings evenly to ceiling.

New Construction

Adjustable bar hangers with captive nails can be repositioned 90 degrees. Bar hangers are slotted for T-Bar installations.

NERH-826

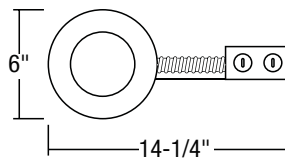
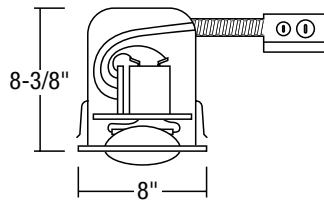

Electrical:

Voltage

- 120V or 277V, 60Hz

Lamps Operated

- 15W Sealed Beam PAR36 (included)

Battery

- 6V, 4Ah Sealed Lead-Calcium

Testing

- High-charge / ready operation indicator light
- Test button

Operation:

- 90-minute emergency operation
- 24-hour charging time for completely depleted battery

Gimbal Trim:

- Adjustable aiming up to 45 degrees
- Available in Black or White finish
- Metal trim available in Black, Chrome, Copper, Gold, or Natural Metal finish. Consult factory
- Integral test switch and AC-ON indicator are installed on the gimbal trim

Listing:

UL 924 Listed
 NEC / OSHA
 NYC MEA / BEC, Local Laws 16 & 41
 NFPA-LSC (Life Safety Code)

LOW VOLTAGE EMERGENCY DOWNLIGHTS

CATALOG. NO.	CONSTRUCTION	VOLTAGE	WATTAGE	TRIM COLOR
NEH-826B	New Construction	6 Volt	15W	Black
NEH-826W	New Construction	6 Volt	15W	White
NERH-826B	Remodel	6 Volt	15W	Black
NERH-826W	Remodel	6 Volt	15W	White

Metal trims are also available in Black, Chrome, Copper, Gold, or Natural Metal. Consult factory

EXIT AND EMERGENCY

Compact Fluorescent Emergency Downlight Retrofit Kit

Emergency ballast kit for use with existing compact fluorescent lighting fixtures, already installed in ceilings. Ballast circuitry automatically switches fluorescent fixture between emergency and normal power operation during power loss and restoration. Operates a fluorescent source at a reduced level for a minimum of 90 minutes to allow safe egress during power outage. Upon restoration, one or both lamps, depending on the host fixture type, return to normal AC operation while the emergency ballast returns to charging mode.

Application:

The NEPK Kit can be used with most 7 Watt through 42 Watt fluorescent lamps, including 4-Pin compact fluorescents.

Features:

- 7-year rated integral NiCad battery
- UL Listed for Dry Location
- Emergency illumination exceeds UL, NEC, and NFPA requirements
- Includes remote test switch and charge indicator light

Installation:

Mounting Center: 9"
Weight: 2-1/2 lbs.

Electrical:

Voltage

- 120V/277V

Total Power Consumption

- 3.5VA + lamp wattage

Operation:

- 200-1300 Initial Lumens (depending on lamp source used)
- 90-minute emergency operation
- 24-hour charging time for completely depleted battery

Battery:

- High Temperature Rated NiCad battery
- 7-year rated (10 years typical) life expectancy

Listing:

UL or cULus Listed (see chart)
NFPA-LSC (Life Safety Code)
NEC / OSHA
State and Local Municipal Codes

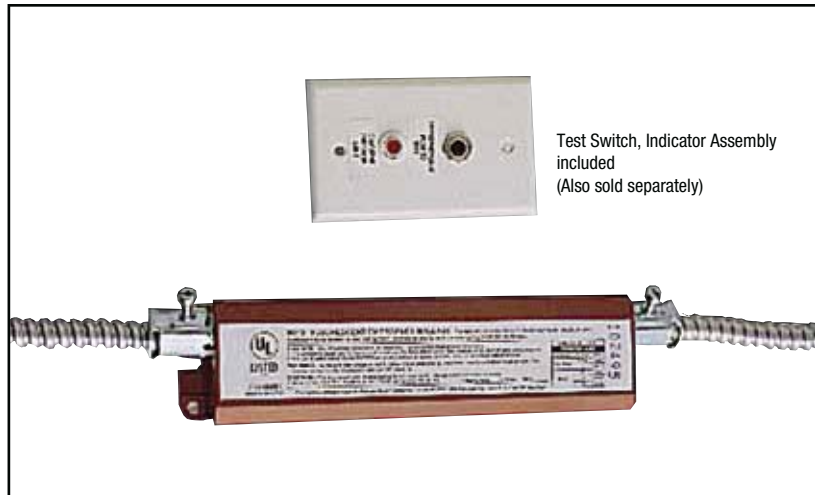

PRODUCT MATRIX										
Catalog Number	# Lamps		Wattage						Listing	
	Single	Double	7	9	13	18	26	32		42
2-Pin Magnetic:										
NEPK-13/I13A	•	•	•	•	•					cULus
NEPK-1826/I26A	•	•				•	•			cULus
4-Pin Electronic: single lamp only										
NEPK-1326E/I42A	•	•			•	•	•	•	•	UL
NEPK-I420A (1300 lumens)	•	•			•	•	•	•	•	cULus

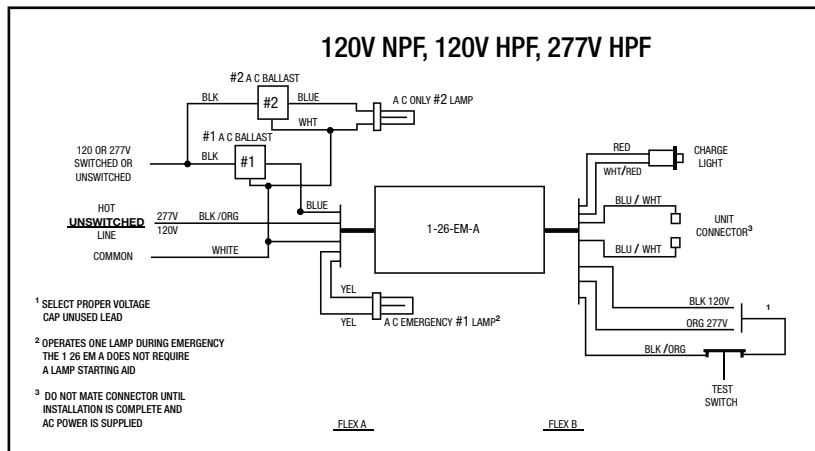

Example only - consult wiring diagrams included with emergency ballast

TEST SWITCH, INDICATOR ASSEMBLY

CATALOG. NO.	DESCRIPTION
NRA-123	Test Switch, Indicator Assembly (included with NEPK 4-Pin Electronic Series)
NRA-123MAG	Test Switch, Indicator Magnetic Assembly (included with NEPK 2-Pin Magnetic Series)



LAMPS

749 Overview

750 Compact Fluorescent Lamps

752 HID Metal Halide Lamps

753 Line Voltage Lamps

755 Low Voltage Lamps

Overview LAMPS

COMPACT FLUORESCENT LAMPS



Twin Tube
(2G11 Base) p.750

p.750

Twin Tube
(G23 Base) p.750

p.750

Twin Tube
(GX23 Base) p.750

p.750

Quad Tube
(G24Q Base) p.750

p.750

Triple Tube
(GX24Q Base) p.751

p.751

GU24
(GU24 Base) p.751

p.751

HID CERAMIC METAL HALIDE LAMPS

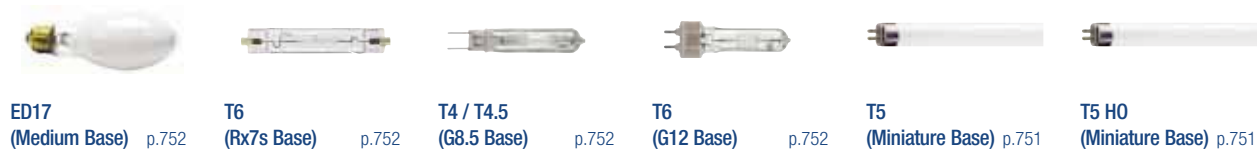

ED17

(Medium Base) p.752

T6

(Rx7s Base) p.752

T4 / T4.5

(G8.5 Base) p.752

T6

(G12 Base) p.752

T5

(Miniature Base) p.751

T5 H0

(Miniature Base) p.751



MR16

(GX10 Base) p.752

PAR20

(Medium Base) p.752

PAR30

(Medium Base) p.752

PAR38

(Medium Base) p.752

LINE VOLTAGE LAMPS



R20

(Medium Base) p.753

BR30/40

(Medium Base) p.753

T4

(DC Bayonet) p.753

T4 Halogen

(Bi-Pin G8 Base) p.753

T4 Halogen

(G9 Base) p.753

MR16

(GU10 Base) p.753

T3 Halogen

(RSC/R7s Base) p.753

PAR16

(Medium Base) p.754

PAR20

(Medium Base) p.754

PAR30

(Medium Base) p.754

PAR30L

(Medium Base) p.754

PAR38

(Medium Base) p.754

LOW VOLTAGE LAMPS

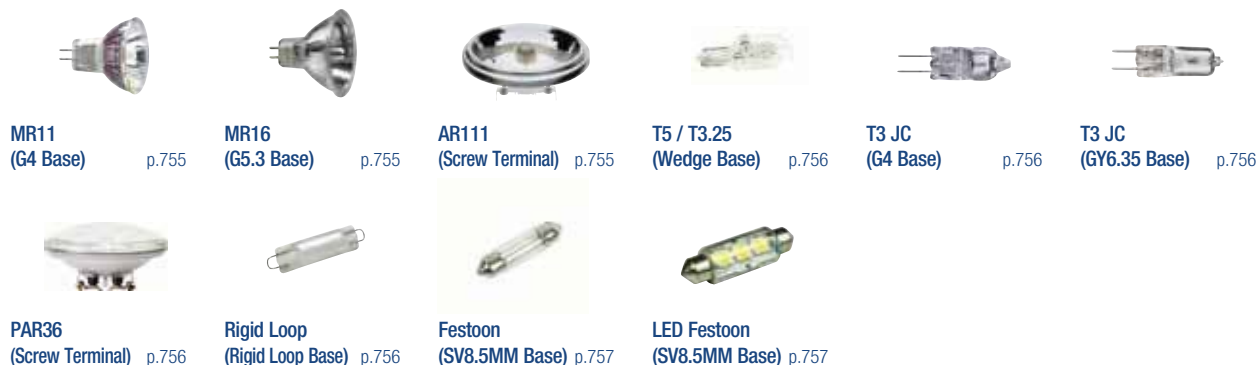

MR11

(G4 Base) p.755

MR16

(G5.3 Base) p.755

AR111

(Screw Terminal) p.755

T5 / T3.25

(Wedge Base) p.756

T3 JC

(G4 Base) p.756

T3 JC

(GY6.35 Base) p.756

PAR36

(Screw Terminal) p.756

Rigid Loop

(Rigid Loop Base) p.756

Festoon

(SV8.5MM Base) p.757

LED Festoon

(SV8.5MM Base) p.757

LAMPS

Compact Fluorescent Lamps



Catalog No.	Description
F18W/2G11/835	18 Watt CFL, 3500K CCT
F18W/2G11/841	18 Watt CFL, 4100K CCT
F27W/2G11/841	27 Watt CFL, 4100K CCT
F39W/2G11/835	39 Watt CFL, 3500K CCT
F39W/2G11/841	39 Watt CFL, 4100K CCT
F40W/2G11/835	40 Watt CFL, 3500K CCT
F40W/2G11/841	40 Watt CFL, 4100K CCT

- **Base:** 2G11, 4-Pin
- **Lamp Type:** Plug-In CFL



Catalog No.	Description
CFT5W/G23/827	5 Watt Twin Tube CFL, 2700K CCT
CFT5W/G23/841	5 Watt Twin Tube CFL, 4100K CCT
CFT7W/G23/827	7 Watt Twin Tube CFL, 2700K CCT
CFT7W/G23/841	7 Watt Twin Tube CFL, 4100K CCT
CFT9W/G23/827	9 Watt Twin Tube CFL, 2700K CCT
CFT9W/G23/841	9 Watt Twin Tube CFL, 4100K CCT
CFT13W/G23/827	13 Watt Twin Tube CFL, 2700K CCT
CFT13W/G23/835	13 Watt Twin Tube CFL, 3500K CCT
CFT13W/G23/841	13 Watt Twin Tube CFL, 4100K CCT

- **Base:** G23, 2-Pin
- **Lamp Type:** Twin Tube Plug-In CFL



Catalog No.	Description
CFQ13W/GX23/827	13 Watt Quad Tube CFL, 2700K CCT
CFQ13W/GX23/830	13 Watt Quad Tube CFL, 3000K CCT
CFQ13W/GX23/835	13 Watt Quad Tube CFL, 3500K CCT
CFQ13W/GX23/841	13 Watt Quad Tube CFL, 4100K CCT

- **Base:** GX23, 2-Pin
- **Lamp Type:** Twin Tube Plug-In CFL



Catalog No.	Description
CFQ13W/G24Q/827	13 Watt Quad Tube CFL, G24Q-1 Base, 2700K CCT
CFQ13W/G24Q/835	13 Watt Quad Tube CFL, G24Q-1 Base, 3500K CCT
CFQ13W/G24Q/841	13 Watt Quad Tube CFL, G24Q-1 Base, 4100K CCT
CFQ18W/G24Q/827	18 Watt Quad Tube CFL, G24Q-2 Base, 2700K CCT
CFQ18W/G24Q/830	18 Watt Quad Tube CFL, G24Q-2 Base, 3000K CCT
CFQ18W/G24Q/835	18 Watt Quad Tube CFL, G24Q-2 Base, 3500K CCT
CFQ18W/G24Q/841	18 Watt Quad Tube CFL, G24Q-2 Base, 4100K CCT
CFQ26W/G24Q/827	26 Watt Quad Tube CFL, G24Q-3 Base, 2700K CCT
CFQ26W/G24Q/830	26 Watt Quad Tube CFL, G24Q-3 Base, 3000K CCT
CFQ26W/G24Q/835	26 Watt Quad Tube CFL, G24Q-3 Base, 3500K CCT
CFQ26W/G24Q/841	26 Watt Quad Tube CFL, G24Q-3 Base, 4100K CCT

- **Base:** G24Q, 4-Pin
- **Lamp Type:** Quad Tube Plug-In CFL



Compact / Linear Fluorescent Lamps continued

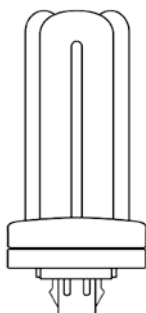

Catalog No.	Description
CFM13W/GX24Q/27	13 Watt Triple Tube CFL, GX24Q-1 Base, 2700K CCT
CFM13W/GX24Q/30	13 Watt Triple Tube CFL, GX24Q-1 Base, 3000K CCT
CFM13W/GX24Q/35	13 Watt Triple Tube CFL, GX24Q-1 Base, 3500K CCT
CFM13W/GX24Q/41	13 Watt Triple Tube CFL, GX24Q-1 Base, 4100K CCT
CFM18W/GX24Q/27	18 Watt Triple Tube CFL, GX24Q-2 Base, 2700K CCT
CFM18W/GX24Q/30	18 Watt Triple Tube CFL, GX24Q-2 Base, 3000K CCT
CFM18W/GX24Q/35	18 Watt Triple Tube CFL, GX24Q-2 Base, 3500K CCT
CFM18W/GX24Q/41	18 Watt Triple Tube CFL, GX24Q-2 Base, 4100K CCT
CFM26W/GX24Q/27	26 Watt Triple Tube CFL, GX24Q-3 Base, 2700K CCT
CFM26W/GX24Q/30	26 Watt Triple Tube CFL, GX24Q-3 Base, 3000K CCT
CFM26W/GX24Q/35	26 Watt Triple Tube CFL, GX24Q-3 Base, 3500K CCT
CFM26W/GX24Q/41	26 Watt Triple Tube CFL, GX24Q-3 Base, 4100K CCT
CFM32W/GX24Q/27	32 Watt Triple Tube CFL, GX24Q-3 Base, 2700K CCT
CFM32W/GX24Q/30	32 Watt Triple Tube CFL, GX24Q-3 Base, 3000K CCT
CFM32W/GX24Q/35	32 Watt Triple Tube CFL, GX24Q-3 Base, 3500K CCT
CFM32W/GX24Q/41	32 Watt Triple Tube CFL, GX24Q-3 Base, 4100K CCT
CFM42W/GX24Q/27	42 Watt Triple Tube CFL, GX24Q-4 Base, 2700K CCT
CFM42W/GX24Q/30	42 Watt Triple Tube CFL, GX24Q-4 Base, 3000K CCT
CFM42W/GX24Q/35	42 Watt Triple Tube CFL, GX24Q-4 Base, 3500K CCT
CFM42W/GX24Q/41	42 Watt Triple Tube CFL, GX24Q-4 Base, 4100K CCT

- **Base:** GX24Q, 4-Pin
- **Lamp Type:** Triple Tube Plug-In CFL



Catalog No.	Description
CFS13WGU24WW	13 Watt Self Ballasted Spiral GU24 CFL, Warm White
CFW15WGU24WW	15 Watt Self Ballasted R30 GU24 CFL, Warm White
CFS18WGU24WW	18 Watt Self Ballasted Spiral GU24 CFL, Warm White
CFS23WGU24WW	23 Watt Self Ballasted Spiral GU24 CFL, Warm White
CFS26WGU24WW	26 Watt Self Ballasted Spiral GU24 CFL, Warm White

- **Base:** GU24 Twist and Lock
- **Lamp Type:** Self Ballasted GU24 CFL



Catalog No.	Description
F8T5/CW	8 Watt T5 Linear Fluorescent Lamp, Cool White
F8T5/WW	8 Watt T5 Linear Fluorescent Lamp, Warm White
F13T5/CW	13 Watt T5 Linear Fluorescent Lamp, Cool White
F13T5/WW	13 Watt T5 Linear Fluorescent Lamp, Warm White
F18T5/3000	18 Watt T5 Linear Fluorescent Lamp, 3000K CCT
F18T5/CW	18 Watt T5 Linear Fluorescent Lamp, Cool White
F21T5/3000	21 Watt T5 Linear Fluorescent Lamp, 3000K CCT
F21T5/CW	21 Watt T5 Linear Fluorescent Lamp, Cool White
F24T5/3000	24 Watt T5 Linear Fluorescent Lamp, 3000K CCT
F24T5/CW	24 Watt T5 Linear Fluorescent Lamp, Cool White
F24T5H0/30	24 Watt T5 High Output Linear Fluorescent Lamp, 3000K CCT
F24T5H0/35	24 Watt T5 High Output Linear Fluorescent Lamp, 3500K CCT
F24T5H0/41	24 Watt T5 High Output Linear Fluorescent Lamp, 4100K CCT
F24T5H0/50	24 Watt T5 High Output Linear Fluorescent Lamp, 5000K CCT
F28T5/3000	28 Watt T5 Linear Fluorescent Lamp, 3000K CCT
F28T5/CW	28 Watt T5 Linear Fluorescent Lamp, Cool White
F39T5H0/30	39 Watt T5 High Output Linear Fluorescent Lamp, 3000K CCT
F39T5H0/35	39 Watt T5 High Output Linear Fluorescent Lamp, 3500K CCT
F39T5H0/41	39 Watt T5 High Output Linear Fluorescent Lamp, 4100K CCT
F39T5H0/50	39 Watt T5 High Output Linear Fluorescent Lamp, 5000K CCT
F54T5H0/30	54 Watt T5 High Output Linear Fluorescent Lamp, 3000K CCT
F54T5H0/35	54 Watt T5 High Output Linear Fluorescent Lamp, 3500K CCT
F54T5H0/41	54 Watt T5 High Output Linear Fluorescent Lamp, 4100K CCT
F54T5H0/50	54 Watt T5 High Output Linear Fluorescent Lamp, 5000K CCT

- **Base:** Miniature Bi-Pin (G5)
- **Lamp Type:** Linear Fluorescent Tube



LAMPS

HID Metal Halide Lamps

	<p>Catalog No. MP35/C/U/MED 32 Watt ED17, Coated Ceramic Metal Halide MP50/U/MED 50 Watt ED17, Clear Ceramic Metal Halide MP50/C/U/MED 50 Watt ED17, Coated Ceramic Metal Halide MP70/C/U/MED 70 Watt ED17, Coated Ceramic Metal Halide MP100/C/U/MED 100 Watt ED17, Coated Ceramic Metal Halide MP150/C/U/MED 150 Watt ED17, Coated Ceramic Metal Halide</p> <ul style="list-style-type: none"> • Base: Medium Screw Base • Lamp Type: HID - Ceramic Metal Halide 	
	<p>Catalog No. CMH70/TD/U/972 70 Watt T6, Double-Ended Ceramic Metal Halide</p> <ul style="list-style-type: none"> • Base: Rx7s • Lamp Type: Double-Ended HID - Ceramic Metal Halide 	
	<p>Catalog No. CMH20/TC/U/830 20 Watt T4, Single Ended Ceramic Metal Halide CMH36/TC/U/830 39 Watt T4.5, Single Ended Ceramic Metal Halide CMH70/TC/U/972 70 Watt T4.5, Single Ended Ceramic Metal Halide</p> <ul style="list-style-type: none"> • Base: G8.5 • Lamp Type: HID - Ceramic Metal Halide 	
	<p>Catalog No. CMH39/TU/U/830 20 Watt T6, Single Ended Ceramic Metal Halide CMH70/TU/U/830 39 Watt T6, Single Ended Ceramic Metal Halide</p> <ul style="list-style-type: none"> • Base: G12 • Lamp Type: HID - Ceramic Metal Halide 	
	<p>Catalog No. CMH20MR16/FL 20 Watt MR16, Ceramic Metal Halide, Floodlight CMH20MR16/SP 20 Watt MR16, Ceramic Metal Halide, Spotlight CMH39MR16/FL 39 Watt MR16, Ceramic Metal Halide, Floodlight CMH39MR16/SP 39 Watt MR16, Ceramic Metal Halide, Spotlight</p> <ul style="list-style-type: none"> • Base: GX10 Twist & Lock • Lamp Type: HID - Ceramic Metal Halide 	
	<p>Catalog No. CDM20PAR20/M/F 20 Watt PAR20, Ceramic Metal Halide, Floodlight CDM20PAR20/SP 20 Watt PAR20, Ceramic Metal Halide, Spotlight CDM35PAR20/M/F 39 Watt PAR20, Ceramic Metal Halide, Floodlight CDM35PAR20/M/S 39 Watt PAR20, Ceramic Metal Halide, Spotlight</p> <ul style="list-style-type: none"> • Base: Medium Screw Base • Lamp Type: HID - Ceramic Metal Halide 	
	<p>Catalog No. CDM35PAR30L/M/F 39 Watt PAR30L, Ceramic Metal Halide, Floodlight CDM35PAR30L/M/S 39 Watt PAR30L, Ceramic Metal Halide, Spotlight CDM70PAR30L/M/F 70 Watt PAR30L, Ceramic Metal Halide, Floodlight CDM70PAR30L/M/S 70 Watt PAR30L, Ceramic Metal Halide, Spotlight</p> <ul style="list-style-type: none"> • Base: Medium Screw Base • Lamp Type: HID - Ceramic Metal Halide 	
	<p>Catalog No. CDM70/PAR38/FL 70 Watt PAR38, Ceramic Metal Halide, Floodlight CDM70/PAR38/SP 70 Watt PAR38, Ceramic Metal Halide, Spotlight CDM100/PAR38/FL 100 Watt PAR38, Ceramic Metal Halide, Floodlight CDM100/PAR38/SP 100 Watt PAR38, Ceramic Metal Halide, Spotlight MP150PAR38/U/FL 150 Watt PAR38, Ceramic Metal Halide, Floodlight</p> <ul style="list-style-type: none"> • Base: Medium Screw Base • Lamp Type: HID - Ceramic Metal Halide 	

Line Voltage Lamps



Catalog No.	Description
50R20	50 Watt R20, Floodlight
65BR30	65 Watt BR30
150BR/FL	120 Watt BR40, Floodlight

- **Base:** Medium Screw Base
- **Lamp Type:** Incandescent - Reflector

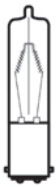

Catalog No.	Description
QR40WXENF/DCB	40 Watt T4, Double Contact Bayonet, Frosted
QR60WXEBF/DCB	60 Watt T4, Double Contact Bayonet, Frosted

- **Base:** Double Contact Bayonet
- **Lamp Type:** Halogen



Catalog No.	Description
T20JC/120	20 Watt T4 Halogen
T25JC/120	25 Watt T4, Halogen
T35JC/120	35 Watt T4, Halogen
T50JC/120	50 Watt T4, Halogen

- **Base:** Bi-Pin (G8)
- **Lamp Type:** Halogen

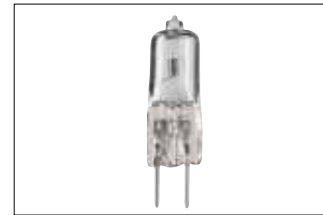

Catalog No.	Description
40G9	40 Watt T4, Halogen, Frosted
40G9F/O	40 Watt T4, Halogen, Frosted, Open Rated

- **Base:** G9
- **Lamp Type:** Halogen



Catalog No.	Description
20MR16/LINE/L10	20 Watt MR16, Halogen, Lensed
35MR16FMW/L10S	35 Watt MR16, Halogen, Lensed, Silver Back
50MR16/LINE/L10	50 Watt MR16, Halogen, Lensed, Floodlight
50MR16EXN/L10S	50 Watt MR16, Halogen, Lensed, Silver Back, Floodlight

- **Base:** GU10 Twist & Lock
- **Lamp Type:** Halogen - MR

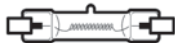

Catalog No.	Description
150R7S	150 Watt T3, Halogen, Frosted, MOL 4.68"
300RS7	300 Watt T3, Halogen, Frosted, MOL 4.68"
150T3Q	150 Watt T3, Halogen, MOL 3.13"

- **Base:** Recessed Single Contact (RSC or R7s)
- **Lamp Type:** Halogen - Double-Ended



LAMPS

Line Voltage Lamps continued



Catalog No.	Description
60PAR16/CAP/NFL	60 Watt PAR16, Halogen, Narrow Floodlight
60PAR16/CAP/NSP	60 Watt PAR16, Halogen, Narrow Spotlight
75PAR16/CAP/NFL	75 Watt PAR16, Halogen, Narrow Floodlight

- **Base:** Medium Screw Base
- **Lamp Type:** Halogen - PAR

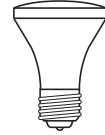

Catalog No.	Description
50PAR20/CAP/NFL	50 Watt PAR20, Halogen, Narrow Floodlight
50PAR20/CAP/NSP	50 Watt PAR20, Halogen, Narrow Spotlight

- **Base:** Medium Screw Base
- **Lamp Type:** Halogen - PAR



Catalog No.	Description
50PAR30/CAP/FL	50 Watt PAR30, Halogen, Floodlight
50PAR30/CAP/NSP	50 Watt PAR30, Halogen, Narrow Spotlight
50PAR30/CAP/WFL	50 Watt PAR30, Halogen, Wide Floodlight
75PAR30/CAP/FL	75 Watt PAR30, Halogen, Floodlight
75PAR30/CAP/SP	75 Watt PAR30, Halogen, Spotlight

- **Base:** Medium Screw Base
- **Lamp Type:** Halogen - PAR (Short Neck)

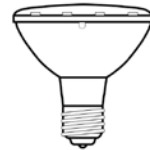

Catalog No.	Description
50PAR30/HAL/NFL	50 Watt PAR30L, Halogen, Narrow Floodlight
50PAR30L/H/WFL	50 Watt PAR30L, Halogen, Wide Floodlight

- **Base:** Medium Screw Base
- **Lamp Type:** Halogen - PAR (Long Neck)



Catalog No.	Description
45PAR38/HAL/FL	45 Watt PAR38, Halogen, Floodlight
60PAR/CAP/FL	60 Watt PAR38, Halogen, Floodlight
60PAR/HIR/FL	60 Watt PAR38, Halogen, Floodlight, Long Life
60PAR/HIR/FL40	60 Watt PAR38, Halogen, 40° Flood, Long Life
75PAR/CAP/SP	75 Watt PAR38, Halogen, Spotlight
75PAR/H/NFL	75 Watt PAR38, Halogen, Narrow Floodlight
90PAR/CAP/FL	90 Watt PAR38, Halogen, Floodlight
90PAR/H/NFL	90 Watt PAR38, Halogen, Narrow Floodlight
90PAR/HIR/FL	90 Watt PAR38, Halogen, Floodlight, Long Life
120PAR/HAL/FL	120 Watt PAR38, Halogen, Floodlight
150PAR/CAP/NFL	150 Watt PAR38, Halogen, Narrow Spotlight
150PAR/FL	150 Watt PAR38, Halogen, Floodlight

- **Base:** Medium Screw Base
- **Lamp Type:** Halogen - PAR



Low Voltage Lamps



Catalog No.	Description
NDSL-20	20 Watt, 12 Volt, MR11 Halogen, Lensed, Narrow Floodlight
NDSL-20/24V	20 Watt, 24 Volt, MR11 Halogen, Lensed, Narrow Floodlight
QU20MR11FTD	20 Watt, 12 Volt, MR11 Halogen, Narrow Floodlight
QU20MR11FTC/24	20 Watt, 24 Volt, MR11 Halogen, Narrow Floodlight
NDSL-35	35 Watt, 12 Volt, MR11 Halogen, Lensed, Spotlight
QU35MR11FTE	35 Watt, 12 Volt, MR11 Halogen, Spotlight
QU35MR11FTH	35 Watt, 12 Volt, MR11 Halogen, Floodlight
QU35MR11FTHL	35 Watt, 12 Volt, MR11 Halogen, Lensed, Floodlight

- **Base:** Bi-Pin (G4)
- **Lamp Type:** Halogen - MR



Catalog No.	Description
QI5MR16/6	5 Watt, 6 Volt, MR16 Halogen, For Emergency Units
L020HMR162PFGE	20 Watt, 12 Volt, Economy MR16, Lensed, Floodlight
QC20MR16BAB	20 Watt, 12 Volt, Premium MR16, Floodlight
QC20MR16ESX	20 Watt, 12 Volt, Premium MR16, Narrow Spotlight
QU20MR16BAB	20 Watt, 12 Volt, MR16, Floodlight
QU20MR16ESX	20 Watt, 12 Volt, MR16, Narrow Spotlight
L035HMR162PFGE	35 Watt, 12 Volt, Economy MR16, Lensed, Floodlight
QC35MR16FMW	35 Watt, 12 Volt, Premium MR16, Floodlight
QC35MR16FRA	35 Watt, 12 Volt, Premium MR16, Spotlight
QI35MR16FMV	35 Watt, 12 Volt, MR16 Halogen, Wide Floodlight
QU35MR16FMW	35 Watt, 12 Volt, MR16 Halogen, Floodlight
QU35MR16FMW/CS	35 Watt, 12 Volt, MR16, Lensed, Silver Back, Floodlight
QU35MR16FRB	35 Watt, 12 Volt, MR16 Halogen, Narrow Spotlight
QC50MR16EXN	50 Watt, 12 Volt, Premium MR16, Floodlight
QC50MR16EXT	50 Watt, 12 Volt, Premium MR16, Narrow Spotlight
QC50MR16EXZ	50 Watt, 12 Volt, Premium MR16, Narrow Floodlight
QC50MR16EFNV	50 Watt, 12 Volt, Premium MR16, Wide Floodlight
L050HMR162PFGE	50 Watt, 12 Volt, Economy MR16, Lensed, Floodlight
QU50MR16EXN/C	50 Watt, 12 Volt, MR16, Lensed, Floodlight
QU50MR16EXN/CS	50 Watt, 12 Volt, MR16, Lensed, Silver Back, Floodlight
QU50MR16EXT/C	50 Watt, 12 Volt, MR16, Lensed, Narrow Spotlight
QU50MR16EXZ/CS	50 Watt, 12 Volt, MR16, Lensed, Silver Back, Narrow Flood
QU50MR16EXN	50 Watt, 12 Volt, MR16, Floodlight
QU50MR16EXT	50 Watt, 12 Volt, MR16, Narrow Spotlight
QU50MR16EXZ	50 Watt, 12 Volt, MR16, Narrow Floodlight
QU65MR16FPA	65 Watt, 12 Volt, Premium MR16, Narrow Spotlight
QU65MR16FPC	65 Watt, 12 Volt, Premium MR16, Narrow Floodlight
QC71MR16EYC	71 Watt, 12 Volt, Premium MR16, Floodlight
QC71MR16EYF	71 Watt, 12 Volt, Premium MR16, Narrow Spotlight
QU75MR16EYC	75 Watt, 12 Volt, MR16 Halogen, Floodlight
QU75MR16EYF	75 Watt, 12 Volt, MR16 Halogen, Narrow Spotlight

- **Base:** Bi-Pin (G5.3)
- **Lamp Type:** Halogen - MR



Catalog No.	Description
QU50AR111FL	50 Watt, 12 Volt, AR111 Halogen, Floodlight
QU50AR111SP	50 Watt, 12 Volt, AR111 Halogen, Spotlight

- **Base:** G53 Screw Terminals
- **Lamp Type:** Halogen - AR



LAMPS

Low Voltage Lamps continued



Catalog No.	Description
6T5WB	6 Watt, 6 Volt, T5 Halogen, For Emergency Units
QI3WBX/12	3 Watt, 12 Volt, T3.25 Xenon, Clear
QI3WBX/24	3 Watt, 24 Volt, T3.25 Xenon, Clear
QI3WBXF/12	3 Watt, 12 Volt, T3.25 Xenon, Frosted
QI3WBXF/24	3 Watt, 24 Volt, T3.25 Xenon, Frosted
QI5WBX/12	5 Watt, 12 Volt, T3.25 Xenon, Clear
QI5WBX/24	5 Watt, 24 Volt, T3.25 Xenon, Clear
QI5WBXF/12	5 Watt, 12 Volt, T3.25 Xenon, Frosted
QI5WBXF/24	5 Watt, 24 Volt, T3.25 Xenon, Frosted
QI10WBX/12	10 Watt, 12 Volt, T3.25 Xenon, Clear
QI10WBX/24	10 Watt, 24 Volt, T3.25 Xenon, Clear
QI10WBXF/12	10 Watt, 12 Volt, T3.25 Xenon, Frosted
QI10WBXF/24	10 Watt, 24 Volt, T3.25 Xenon, Frosted
QI8WBX/12	18 Watt, 12 Volt, T3.25 Xenon, Clear

- **Base:** Wedge
- **Lamp Type:** Miniature - T Shape



Catalog No.	Description
QI10JC/12/G4	10 Watt, 12 Volt, T3 Halogen
QI10JC/12X	10 Watt, 12 Volt, T3 Xenon
QI20JC/12	20 Watt, 12 Volt, T3 Halogen
QI20JC/12X	20 Watt, 12 Volt, T3 Xenon

- **Base:** Bi-Pin (G4)
- **Lamp Type:** Miniature - T Shape

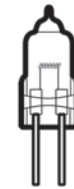

Catalog No.	Description
QI10JC/12	10 Watt, 12 Volt, T3 Halogen
QI35JC/12	35 Watt, 12 Volt, T3 Halogen
QI50JC/12	50 Watt, 12 Volt, T3 Halogen

- **Base:** Bi-Pin (GY6.35)
- **Lamp Type:** Halogen - Single Ended



Catalog No.	Description
35PAR36/WFL	35 Watt, 12 Volt, PAR36 Halogen, Wide Floodlight
36PAR36/CAP/WFL	35 Watt, 12 Volt, PAR36 Halogen, Wide Floodlight
50PAR36/FL	50 Watt, 12 Volt, PAR36 Halogen, Floodlight
50PAR36/NSP	50 Watt, 12 Volt, PAR36 Halogen, Narrow Spotlight

- **Base:** Screw Terminals
- **Lamp Type:** Sealed Beam - PAR



Catalog No.	Description
NDSL3XFRLB24V	3 Watt, 24 Volt, Rigid Loop, Frosted
NDSL3XRFB24V	3 Watt, 24 Volt, Rigid Loop, Clear
NDSL5XFRLB12V	5 Watt, 12 Volt, Rigid Loop, Frosted
NDSL5XFRLB24V	5 Watt, 24 Volt, Rigid Loop, Frosted
NDSL5XRFB12V	5 Watt, 12 Volt, Rigid Loop, Clear
NDSL5XRFB24V	5 Watt, 24 Volt, Rigid Loop, Clear
NDSL10XFRLB12V	10 Watt, 12 Volt, Rigid Loop, Frosted
NDSL10XFRLB24V	10 Watt, 24 Volt, Rigid Loop, Frosted
NDSL10XRFB12V	10 Watt, 12 Volt, Rigid Loop, Clear
NDSL10XRFB24V	10 Watt, 24 Volt, Rigid Loop, Clear

- **Base:** Rigid Loop
- **Lamp Type:** Miniature - T Shape



Low Voltage Lamps continued



Catalog No.	Description
NDSL-3/24V	3 Watt, 24 Volt, Incandescent Festoon
NDSL-5	5 Watt, 12 Volt, Incandescent Festoon
NDSL-5F	5 Watt, 12 Volt, Incandescent Festoon, Frosted
NDSL-5/24V	5 Watt, 24 Volt, Incandescent Festoon
NDSL-5F/24V	5 Watt, 24 Volt, Incandescent Festoon, Frosted
NDSL-5X	5 Watt, 12 Volt, Xenon Festoon
NDSL-5XF	5 Watt, 12 Volt, Xenon Festoon, Frosted
NDSL-5X/24V	5 Watt, 24 Volt, Xenon Festoon
NDSL-5XF/24V	5 Watt, 24 Volt, Xenon Festoon, Frosted
NDSL-10	10 Watt, 12 Volt, Incandescent Festoon
NDSL-10X	10 Watt, 12 Volt, Xenon Festoon
NDSL-10XF	10 Watt, 12 Volt, Xenon Festoon, Frosted
NDSL-10X/24V	10 Watt, 24 Volt, Xenon Festoon
NDSL-10XF/24V	10 Watt, 24 Volt, Xenon Festoon, Frosted

- **Base:** SV8.5MM
- **Lamp Type:** Miniature - Festoon

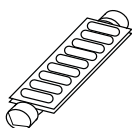

Catalog No.	Description
NDSL-LED-0.72B	0.72 Watt, 12 Volt, Blue LED Festoon
NDSL-LED-0.72G	0.72 Watt, 12 Volt, Green LED Festoon
NDSL-LED-0.72R	0.72 Watt, 12 Volt, Red LED Festoon
NDSL-LED-0.72W	0.72 Watt, 12 Volt, Cool White LED Festoon
NDSL-LED-0.72WW	0.72 Watt, 12 Volt, Warm White LED Festoon
NDSL-LED-0.72Y	0.72 Watt, 12 Volt, Yellow LED Festoon

- **Base:** SV8.5MM
- **Lamp Type:** Miniature - LED Festoon

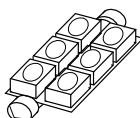

Catalog No.	Description
NDSL-LED-1.2B	1.2 Watt, 12 Volt, Blue LED Festoon
NDSL-LED-1.2G	1.2 Watt, 12 Volt, Green LED Festoon
NDSL-LED-1.2R	1.2 Watt, 12 Volt, Red LED Festoon
NDSL-LED-1.2W	1.2 Watt, 12 Volt, Cool White LED Festoon
NDSL-LED-1.2WW	1.2 Watt, 12 Volt, Warm White LED Festoon
NDSL-LED-1.2Y	1.2 Watt, 12 Volt, Yellow LED Festoon

- **Base:** SV8.5MM
- **Lamp Type:** Miniature - LED Festoon

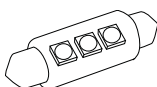

Catalog No.	Description
NDSL-LED-1W	1 Watt, 12 Volt, Cool White (3700K~4300K) LED Festoon
NDSL-LED-1WW	1 Watt, 12 Volt, Warm White (2800K~3200K) LED Festoon
NDSL-LED-1W/24V	1 Watt, 24 Volt, Cool White (3700K~4300K) LED Festoon
NDSL-LED-1WW/24V	1 Watt, 24 Volt, Warm White (2800K~3200K) LED Festoon

- **Base:** SV8.5MM
- **Lamp Type:** Miniature - LED Festoon
- **AC/DC**
- **Lamp Life:** 15,000 - 20,000 Hours
- **Color Rendering Index:** 80 CRI
- **Lumens:** 52-57 lm
- **2 Year Limited Warranty**

NEW!



INDEX

120PAR/HAL/FL	754	CFQ26W/G24Q/835	750	NAL-220	615	NDSL-10XF/24V	661, 757
150BR/FL	753	CFQ26W/G24Q/841	750	NAL-221	615	NDSL10XFRLB12V	756
150PAR/CAP/NFL	754	CFS13WGU24WW	167, 171, 175, 751	NAL-238	615	NDSL10XFRLB24V	756
150PAR/FL	754	CFS18WGU24WW	167, 171, 175, 751	NAL-245	615	NDSL10XRLB12V	756
150R7S	515, 753	CFS23WGU24WW	167, 171, 175, 751	NAL-250	615	NDSL10XRLB24V	756
150T3Q	753	CFS26WGU24WW	167, 171, 175, 751	NAL-258	615	NDSL-20	661, 755
20MR16/LINE/L10	753	CFT13W/G23/827	750	NALTL-10	615, 621, 626, 630, 707	NDSL-20/24V	661, 755
300R7S	515	CFT13W/G23/835	750	NALTL-30	615, 621, 626, 630, 707	NDSL-3/24V	661, 757
300RS7	753	CFT13W/G23/841	750	NAPK-10	640, 707	NDSL-35	661, 755
35MR16FMW/L10S	753	CFT5W/G23/827	750	NAPK-30	640, 707	NDSL3XFRLB24V	756
35PAR36/WF	756	CFT5W/G23/841	750	NAPK-524/12	640, 706	NDSL3XRLB24V	756
36PAR36/CAP/WFL	756	CFT7W/G23/827	750	NAPK-550/12	640, 706	NDSL-5	661, 757
40G9	515, 753	CFT7W/G23/841	750	NAPK-530HW/12	640, 706	NDSL-5/24V	661, 757
40G9F/O	515, 753	CFT9W/G23/827	750	NAPK-560HW/12	640, 706	NDSL-5F	661, 757
45PAR38/HAL/FL	754	CFT9W/G23/841	750	NAPK-701B	640	NDSL-5F/24V	661, 757
50MR16/L10S	601	CFW15WGU24WW	167, 171, 751	NAPK-701W	640	NDSL-5X	661, 757
50MR16/LINE/L10	753	CMH20/TC/U/830	752	NAPK-702	640	NDSL-5X/24V	661, 757
50MR16EXNL10	515	CMH20MR16/FL	515, 752	NAPK-703	640	NDSL-5XF	661, 757
50MR16EXNL10S	753	CMH20MR16/SP	752	NAPK-706	640	NDSL-5XF/24V	661, 757
50PAR20/CAP/NFL	754	CMH36/TC/U/830	752	NAPK-709B	640	NDSL5XFRLB12V	756
50PAR20/CAP/NSP	754	CMH39/TU/U/830	752	NAPK-709W	640	NDSL5XFRLB24V	756
50PAR30/CAP/FL	754	CMH39MR16/FL	752	NAPK-711B	640	NDSL5XRLB12V	756
50PAR30/CAP/NSP	754	CMH39MR16/SP	752	NAPK-711W	640	NDSL5XRLB24V	756
50PAR30/CAP/WFL	754	CMH70/TC/U/972	752	NAPK-712	640	NDSL-LED-0.72B	661, 757
50PAR30/HAL/NFL	754	CMH70/TD/U/972	752	NAPK-724	640	NDSL-LED-0.72G	661, 757
50PAR30L/H/WFL	754	CMH70/TU/U/830	752	NAPK-736	640	NDSL-LED-0.72R	661, 757
50PAR36/FL	756	F13T5/CW	751	NAPK-748	640	NDSL-LED-0.72W	661, 757
50PAR36/NSP	756	F13T5/WW	751	NARGB-700	626	NDSL-LED-0.72WW	661, 757
50R20	753	F18T5/3000	751	NARGB-701	626	NDSL-LED-0.72Y	661, 757
60PAR/CAP/FL	754	F18T5/CW	751	NARGB-702	626	NDSL-LED-1.2B	661, 757
60PAR/HIR/FL	754	F18W/2G11/835	750	NARGB-706	626	NDSL-LED-1.2G	661, 757
60PAR/HIR/FL40	754	F18W/2G11/841	750	NARGB-710	626	NDSL-LED-1.2R	661, 757
60PAR16/CAP/NFL	754	F21T5/3000	751	NARGB-718	626	NDSL-LED-1.2W	661, 757
60PAR16/CAP/NSP	754	F21T5/CW	751	NARGB-736	626	NDSL-LED-1.2WW	661, 757
65BR30	753	F24T5/3000	751	NARGB-760	626, 706	NDSL-LED-1.2Y	661, 757
6T5WB	740, 756	F24T5/CW	751	NARGB-761	626, 706	NDSL-LED-1W	661, 757
75PAR/CAP/SP	754	F24T5HO/30	751	NARGB-772	626	NDSL-LED-1W/24V	661, 757
75PAR/H/NFL	754	F24T5HO/35	751	NAT-380	603	NDSL-LED-1WW	661, 757
75PAR16/CAP/NFL	754	F24T5HO/41	751	NAT-381	603	NDSL-LED-1WW/24V	661, 757
75PAR30/CAP/FL	754	F24T5HO/50	751	NATHR-680	626, 630	NE-502	730
75PAR30/CAP/SP	754	F27W/2G11/841	750	NATHR-685	626, 630	NE-502/B	730
90PAR/CAP/FL	754	F28T5/3000	751	NATL-202	621	NE-803	732
90PAR/H/NFL	754	F28T5/CW	751	NATL-206	621	NE-803B	732
90PAR/HIR/FL	754	F39T5HO/30	751	NATL-218	621	NE-804	733
BAEBF008T5211FB	705	F39T5HO/35	751	NATL-236	621	NE-804B	733
BAEBF013T5211FB	705	F39T5HO/41	751	NATL-272	621	NE-805	734
BAEBF901T5231FB	705	F39T5HO/50	751	NATL-300	621	NE-805B	734
BAEBF908TQ43UAD	385	F39W/2G11/835	750	NATL-301	621	NE-806	731
BAEQF018TQ431AD	385	F39W/2G11/841	750	NATL-400	621, 626, 630	NE-807	732
BAEQF026TQ411UN	385	F40W/2G11/835	750	NATL-401	621	NE-808	733
CDM100/PAR38/FL	752	F40W/2G11/841	750	NATL-403	621, 626, 630	NE-809	735
CDM100/PAR38/SP	752	F54T5HO/30	751	NATL-420B	621	NE-811	737
CDM20PAR20/M/F	752	F54T5HO/35	751	NATL-420W	621	NE-812	737
CDM20PAR20/SP	752	F54T5HO/41	751	NATL-509	621	NE-813	737
CDM35PAR20/M/F	752	F54T5HO/50	751	NATL-5100	615, 621, 626, 630, 706	NE-831	738
CDM35PAR20/M/S	752	F8T5/CW	751	NATL-511	621	NE-832	738
CDM35PAR30L/M/F	752	F8T5/WW	751	NATL-524	615, 621, 626, 630, 706	NE-837	738
CDM35PAR30L/M/S	752	L020HMR162PFGE	755	NATL-530HW	615, 621, 626, 630, 706	NE-838	738
CDM70/PAR38/FL	752	L035HMR162PFGE	755	NATL-545	615, 621, 626, 630, 706	NE-839	738
CDM70/PAR38/SP	752	L050HMR162PFGE	755	NATL-560HW	615, 621, 626, 630, 706	NE-850/2	724
CDM70PAR30L/M/F	752	MP100/C/U/MED	752	NCE-830LBU1BN	450	NE-850/3	724
CDM70PAR30L/M/S	752	MP150/C/U/MED	752	NCE-830LBU3BN	450	NE-900B	729
CFM13W/GX24Q/27	751	MP150PAR38/L/FL	752	NCE-830LGR1BN	450	NE-900BSA	729
CFM13W/GX24Q/30	751	MP35/C/U/MED	752	NCE-830LGR3BN	450	NE-900BSG	729
CFM13W/GX24Q/35	751	MP50/C/U/MED	752	NCE-830LR1BN	450	NE-900BSW	729
CFM13W/GX24Q/41	751	MP50/U/MED	752	NCE-830LR3BN	450	NE-900BZ	729
CFM18W/GX24Q/27	751	MP70/C/U/MED	752	NCE-830LW1BN	450	NE-900BZSA	729
CFM18W/GX24Q/30	751	NA-100	602	NCE-830LW3BN	450	NE-900BZSG	729
CFM18W/GX24Q/35	751	NA-101B	602	NCL-309	446	NE-900BZSW	729
CFM18W/GX24Q/41	751	NA-200	602	NCL-310	446	NE-900S	729
CFM26W/GX24Q/27	751	NA-300	602	NCL-311	446	NE-900SSA	729
CFM26W/GX24Q/30	751	NA-301	602	NCL-312	446	NE-900SSG	729
CFM26W/GX24Q/35	751	NA-382	603	NDSA-1	660	NE-900SSW	729
CFM26W/GX24Q/41	751	NA-383	603	NDSA-10	660	NE-900W	729
CFM32W/GX24Q/27	751	NA-398	603	NDSA-11	660	NE-900WSA	729
CFM32W/GX24Q/30	751	NA-399	603	NDSA-12	660	NE-900WSG	729
CFM32W/GX24Q/35	751	NAHO-600	630	NDSA-13	660	NE-900WSW	729
CFM32W/GX24Q/41	751	NAHO-601	630	NDSA-14	660	NE-931	738
CFM42W/GX24Q/27	751	NAHO-602	630	NDSA-2	660	NE-932	738
CFM42W/GX24Q/30	751	NAHO-606	630	NDSA-3	660	NE-960	736
CFM42W/GX24Q/35	751	NAHO-609	630	NDSA-4	660	NEB-6V-4.5	740
CFM42W/GX24Q/41	751	NAHO-611	630	NDSA-7	660	NEB-NICAD	740
CFQ13W/G24Q/827	750	NAHO-618	630	NDSA-8	660	NEB-NICAD2	740
CFQ13W/G24Q/835	750	NAHO-636	630	NDSC-20	658	NEBU-100	744
CFQ13W/G24Q/841	750	NAHO-672	630	NDSC-3	658	NEBU-100/2H	744
CFQ13W/GX23/827	750	NAL-200	615	NDSC-30	658	NEBU-200	744
CFQ13W/GX23/830	750	NAL-201	615	NDSC-4	658	NEBU-200/2H	744
CFQ13W/GX23/835	750	NAL-202	615	NDSC-6	658	NEBU-50	744
CFQ13W/GX23/841	750	NAL-206	615	NDSC-8	658	NEG-50	730, 741
CFQ18W/G24Q/827	750	NAL-207	615	NDSC-BC	658	NEH-826B	745
CFQ18W/G24Q/830	750	NAL-207/72	615	NDSK-LH	660	NEH-826W	745
CFQ18W/G24Q/835	750	NAL-208	615	NDSL-10	661, 757	NELK-50	744
CFQ18W/G24Q/841	750	NAL-208/72	615	NDSL-10X	661, 757	NEPK-13/13A	746
CFQ26W/G24Q/827	750	NAL-212	615	NDSL-10X/24V	661, 757	NEPK-1326E/142A	746
CFQ26W/G24Q/830	750	NAL-218	615	NDSL-10XF	661, 757	NEPK-1826/126A	746

INDEX

NEPK-1420A	746	NFL-5000	666	NHFM-9100/ELQS	191	NHP8U-113EL	74
NERH-826B	745	NFL-505	670	NHFM-9150/EL	191	NHP8U-113EL/EM	178
NERH-826W	745	NFL-508	670	NHFM-935/EL	191	NHP8U-113EL/EMI	178
NET-060	703	NFL-509	670	NHFM-935/ELQS	191	NHP8U-118EL	74
NET-060-BF	702	NFL-510	670	NHFM-950/EL	191	NHP8U-118EL/EM	178
NET-060-LT	702	NFL-5500/002	666	NHFM-970/EL	191	NHP8U-118EL/EMI	178
NET-060WP	702	NFL-5500/006	666	NHFM-970/ELQS	191	NHP8U-12642EL	74
NET-075	703	NFL-5500/010	666	NHIC-17100DWQA	273	NHP8U-12642EL/EM	178
NET-075-BF	703	NFL-5500/018	666	NHIC-17QAT	274	NHP8U-12642EL/EMI	178
NET-075-BF-277	703	NFL-5500/030	666	NHIC-17QAT/FX	274	NHP8U-213EL	74
NET-075-LT	703	NFL-5500/050	666	NHIC-17QNBAT	274	NHP8U-213EL/EM	178
NET-075R/12	703	NFL-5500/150	666	NHIC-27QAT	276	NHP8U-213EL/EMI	178
NET-075R/24	703	NFL-600	668, 669	NHIC-350AT	331	NHP8U-218EL	74
NET-105	703	NFL-601	670	NHIC-4G24AT	172	NHP8U-218EL/EM	178
NET-1060	683, 702	NFL-602	670	NHIC-4LEDAT	54	NHP8U-218EL/EMI	178
NET-1075	683, 703	NFL-603	671	NHIC-501QAT	298	NHP8U-22642EL	74
NET-1105	703	NFL-604	671	NHIC-527QAT	302	NHP8U-22642EL/EM	178
NET-1150	683, 703	NFL-606	671	NHIC-5G24ATFL	168	NHP8U-22642EL/EMI	178
NET-150	703	NFL-607	671	NHIC-5LEDAT	50	NHP-926/13EL	134
NET-150R/12	703	NFL-612	671	NHIC-5LMRAT	61	NHP-926/18EL	134
NET-150R/24	703	NFL-613	671	NHIC-6G24ATFL	164	NHP-926/2642EL	134
NET-2060	702	NFL-614	670	NHIC-6LEDAT	46	NHPH-113SEL	138
NET-2060WP-B	702	NFL-615	670	NHIC-6LMRAT	60	NHPH-118SEL	138
NET-2060WP-W	702	NFL-616	670	NHIC-926/DWQAT	337	NHPH-213SEL	138
NET-2075	703	NFL-621	671	NHIC-926QAT	338	NHPH-218SEL	138
NET-2105	703	NFL-622	671	NHID-420	204	NHPH-226SEL	138
NET-2150	703	NFL-700	669	NHID-439	204	NHPH-2642SEL	138
NET-300/24	704	NFL-700C/B	668	NHID-470	204	NHPIC-113EL	90
NET-300/SL	703	NFL-700G/R	668	NHID-4GX10W	205	NHPIC-113EL/EM	179
NET-300/SL/24	703	NFL-700R/C	668	NHID-4P20W	205	NHPIC-118EL	90
NET-301/12Round	695, 704	NFL-999	671	NHID-4T415W	205	NHPIC-118EL/EM	179
NET-301/12RSink	695	NG-10	432	NHID-4T423W	205	NHPIC-13/2LEL	124
NET-363/C2	702	NG-50	432	NHID-4T432W	205	NHPIC-13/2LEL/EM	183
NETB-1	704	NG-66	432	NHID-4T615W	205	NHPIC-13/2LQ	124
NETB-2	704	NG-70	432	NHP-113EL	89	NHPIC-13EL	114
NEX-707-LED/G	726	NG-80	432	NHP-113EL/EM	179	NHPIC-13EL/EM	183
NEX-707-LED/GB	726	NG-90	432	NHP-113EL/EMI	179	NHPIC-13EL/EMI	182
NEX-707-LED/GBS	726	NGD-17	601	NHP-118EL	89	NHPIC-13ELAT	114
NEX-707-LED/GS	726	NH-120B	648	NHP-118EL/EM	179	NHPIC-13ELAT/EM	183
NEX-707-LED/R	726	NH-121B	648	NHP-118EL/EMI	179	NHPIC-13ELAT/EMI	182
NEX-707-LED/RB	726	NH-150	267	NHP-126EL	89	NHPIC-13MQ	114
NEX-707-LED/RBS	726	NH-26Q	278	NHP-126EL/EM	179	NHPIC-18EL	114
NEX-707-LED/RS	726	NH-26Q/FX	278	NHP-126EL/EMI	179	NHPIC-18EL/EM	183
NEX-708-LED/G	727	NH-26QNB	278	NHP-13/2LEL	125	NHPIC-18EL/EMI	182
NEX-708-LED/GS	727	NH-27Q	280	NHP-13/2LEL/EM	183	NHPIC-18ELAT	114
NEX-708-LED/R	727	NH-300	261	NHP-13/2LQ	125	NHPIC-18ELAT/EM	183
NEX-708-LED/RS	727	NH-350AT	332	NHP-13EL	116	NHPIC-18ELAT/EMI	182
NEX-709-LED/G	728	NH-501Q	300	NHP-13EL/EM	183	NHPIC-213EL	90
NEX-709-LED/GS	728	NH8PU-113EL	75	NHP-13EL/EMI	182	NHPIC-213EL/EM	179
NEX-709-LED/R	728	NH8PU-113EL/EM	179	NHP-13M	116	NHPIC-2642ELAT	113
NEX-709-LED/RS	728	NH8PU-113EL/EMI	179	NHP-18/2LEL	125	NHPIC-26ATE2	114
NEX-710-LED/G	725	NH8PU-118EL	75	NHP-18/2LEL/EM	183	NHPIC-26ATE2/EM	183
NEX-710-LED/R	725	NH8PU-118EL/EM	179	NHP-18EL	116	NHPIC-26ATE2/EMI	182
NEX-750-LED/R2	724	NH8PU-118EL/EMI	179	NHP-18EL/EM	183	NHPIC-26ELAT	114
NEX-750-LED/R3	724	NH8PU-12642EL	75	NHP-18EL/EMI	182	NHPIC-26ELAT/EM	183
NEXC-G	740	NH8PU-12642EL/EM	179	NHP-213EL	89	NHPIC-26ELAT/EMI	182
NEXC-R	740	NH8PU-12642EL/EMI	179	NHP-213EL/EM	179	NHPIC-413ATE2	152
NEXL/G	741	NH8PU-213EL	75	NHP-213EL/EMI	179	NHPIC-413ELAT	152
NEXL/R	741	NH8PU-213EL/EM	179	NHP-218EL	89	NHPIC-418ATE2	152
NEXL-BGS	741	NH8PU-213EL/EMI	179	NHP-218EL/EM	179	NHPIC-418ELAT	152
NEXL-BRS	741	NH8PU-218EL	75	NHP-218EL/EMI	179	NHPIC-426ATE2	152
NEXL-G	741	NH8PU-218EL/EM	179	NHP-226EL	89	NHPIC-426ELAT	152
NEXL-GS	741	NH8PU-218EL/EMI	179	NHP-226EL/EM	179	NHPIC-501QAT13	144
NEXL-R	741	NH8PU-22642EL	75	NHP-226EL/EMI	179	NHPIC-513ATE2	144
NEXL-RS	741	NH8PU-22642EL/EM	179	NHP-26/2LEL	125	NHPIC-513ELAT	144
NEXS-M1	741	NH8PU-22642EL/EMI	179	NHP-26/2LEL/EM	183	NHPIC-518ATE2	144
NEXS-M2	741	NH8PV-13EL	97	NHP-2642EL	116	NHPIC-518ELAT	144
NEXS-M3	741	NH8PV-18EL	97	NHP-2642EL/EM	183	NHPIC-526ATE2	144
NEXS-P1	741	NH8PV-2642EL	97	NHP-2642EL/EMI	182	NHPIC-526ELAT	144
NFL-200	667, 669	NH-926Q	340	NHP-2642EL/FB	116	NHPIC-926/13EAT	132
NFL-201	670	NHAV-6150	266	NHP-26EL	116	NHPIC-926/18EAT	132
NFL-202	670	NHAV-8300	260	NHP-26EL/EM	183	NHPIC-926/26EAT	132
NFL-203	671	NHFMG-7100/EL	197	NHP-26EL/EMI	182	NHPIC-926/32EAT	131
NFL-204	671	NHFMG-7100/ELQS	197	NHP-26EL/FB	116	NHPM-7100/EL	206
NFL-206	671	NHFMG-735/EL	197	NHP-501/13	146	NHPM-7100/ELQS	206
NFL-207	671	NHFMG-735/ELQS	197	NHP-501/13EL	146	NHPM-735/EL	206
NFL-210	671	NHFMG-750/EL	197	NHP-501/18EL	146	NHPM-735/ELQS	206
NFL-212	671	NHFMG-770/EL	197	NHP6-113EL	88	NHPM-750/EL	206
NFL-213	671	NHFMG-770/ELQS	197	NHP6-113EL/EM	178	NHPM-770/EL	206
NFL-214	670	NHFM-7100/EL	198	NHP6-113EL/EMI	178	NHPM-770/ELQS	206
NFL-215	670	NHFM-7100/ELQS	198	NHP6-118EL	88	NHPT-13EL	81
NFL-216	670	NHFM-735/EL	198	NHP6-118EL/EM	178	NHPT-13EL/EM	179
NFL-405	670	NHFM-735/ELQS	198	NHP6-118EL/EMI	178	NHPT-13EL/EMI	179
NFL-4400/003	665	NHFM-750/EL	198	NHP6-126EL	88	NHPT-18EL	81
NFL-4400/005	665	NHFM-770/EL	198	NHP6-126EL/EM	178	NHPT-18EL/EM	179
NFL-4400/006	665	NHFM-770/ELQS	198	NHP6-126EL/EMI	178	NHPT-18EL/EMI	179
NFL-4400/009	665	NHFMG-9100/EL	190	NHP6-213EL	88	NHPT-2642EL	81
NFL-4400/010	665	NHFMG-9100/ELQS	190	NHP6-213EL/EM	178	NHPT-2642EL/EM	179
NFL-4400/012	665	NHFM8-9150/EL	190	NHP6-213EL/EMI	178	NHPT-2642EL/EMI	179
NFL-4400/018	665	NHFM8-935/EL	190	NHP6-218EL	88	NHPT6-13EL	80
NFL-4400/020	665	NHFM8-935/ELQS	190	NHP6-218EL/EM	178	NHPT6-13EL/EM	178
NFL-4400/030	665	NHFM8-950/EL	190	NHP6-218EL/EMI	178	NHPT6-13EL/EMI	178
NFL-4400/050	665	NHFM8-970/EL	190	NHP6-226EL	88	NHPT6-18EL	80
NFL-4400/060	665	NHFM8-970/ELQS	190	NHP6-226EL/EM	178	NHPT6-18EL/EM	178
NFL-4400/150	665	NHFM-9100/EL	191	NHP6-226EL/EMI	178	NHPT6-18EL/EMI	178

INDEX

NHPT6-2642EL	80	NHRPH-218SEL	139	NL-3312NN	248, 334	NL-418BZ	238, 327
NHPT6-2642EL/EM	178	NHRPH-226SEL	139	NL-3312WW	248, 334	NL-418CO	238, 327
NHPT6-2642EL/EMI	178	NHRPH-2642SEL	139	NL-3318B	249, 335	NL-418N	238, 327
NHPV-13EL	103	NHRPIC-13EL	115	NL-3318BZ	249, 335	NL-418WB	238, 327
NHPV-13EL/EM	181	NHRPIC-13ELAT	115	NL-3318C	249, 335	NL-418WW	238, 327
NHPV-13EL/EMI	181	NHRPIC-13MQ	115	NL-3318CO	249, 335	NL-419C	238, 327
NHPV-18EL	103	NHRPIC-18EL	115	NL-3318G	249, 335	NL-419G	238, 327
NHPV-18EL/EM	181	NHRPIC-18ELAT	115	NL-3318N	249, 335	NL-420	240, 317, 328
NHPV-18EL/EMI	181	NHRPIC-26ATE2	115	NL-3318W	249, 335	NL-421	240, 317, 328
NHPV-2642EL	103	NHRPIC-26ELAT	115	NL-3325B	250, 335	NL-422B	240, 329
NHPV-2642EL/EM	181	NHRPIC-413ATE2	153	NL-3325BZ	250, 335	NL-422BZ	240, 329
NHPV-2642EL/EMI	181	NHRPIC-413ELAT	153	NL-3325C	250, 335	NL-422C	240, 329
NHPV-613EL	102	NHRPIC-418ATE2	153	NL-3325CO	250, 335	NL-422CO	240, 329
NHPV-613EL/EM	180	NHRPIC-418ELAT	153	NL-3325G	250, 335	NL-422G	240, 329
NHPV-613EL/EMI	180	NHRPIC-426ATE2	153	NL-3325N	250, 335	NL-422N	240, 329
NHPV-618EL	102	NHRPIC-426ELAT	153	NL-3325W	250, 335	NL-422W	240, 329
NHPV-618EL/EM	180	NHRPIC-504AT13	145	NL-3326B	250, 335	NL-423B	240, 329
NHPV-618EL/EMI	180	NHRPIC-513ATE2	145	NL-3326BZ	250, 335	NL-423BZ	240, 329
NHPV-62642EL	102	NHRPIC-513ELAT	145	NL-3326C	250, 335	NL-423C	240, 329
NHPV-62642EL/EM	180	NHRPIC-518ATE2	145	NL-3326CO	250, 335	NL-423CO	240, 329
NHPV-62642EL/EMI	180	NHRPIC-518ELAT	145	NL-3326G	250, 335	NL-423G	240, 329
NHPV-813EL	96	NHRPIC-526ATE2	145	NL-3326N	250, 335	NL-423N	240, 329
NHPV-813EL/EM	180	NHRPIC-526ELAT	145	NL-3326W	250, 335	NL-423W	240, 329
NHPV-813EL/EMI	180	NHRPIC-92613EAT	133	NL-3337CW	248, 334	NL-424B	241, 329
NHPV-818EL	96	NHRPIC-92618EAT	133	NL-3337GW	248, 334	NL-424BZ	241, 329
NHPV-818EL/EM	180	NHRPIC-92626EAT	133	NL-3345B	249, 334	NL-424C	241, 329
NHPV-818EL/EMI	180	NHRPM-7100/EL	207	NL-3345BZ	249, 334	NL-424CO	241, 329
NHPV-82642EL	96	NHRPM-7100/ELQS	207	NL-3345C	249, 334	NL-424G	241, 329
NHPV-82642EL/EM	180	NHRPM-735/EL	207	NL-3345CO	249, 334	NL-424N	241, 329
NHPV-82642EL/EMI	180	NHRPM-735/ELQS	207	NL-3345G	249, 334	NL-424W	241, 329
NHR-150	268	NHRPM-750/EL	207	NL-3345N	249, 334	NL-425B	241
NHR-26Q	279	NHRPM-770/EL	207	NL-3345W	249, 334	NL-425BZ	241
NHR-27Q	281	NHRPM-770/ELQS	207	NL-3348BB	249, 335	NL-425C	241
NHR-300	262	NHRPT6-13EL	82	NL-3348BW	249, 335	NL-425CO	241
NHR-354AT	333	NHRPT6-18EL	82	NL-3348WW	249, 335	NL-425G	241
NHR-504Q	301	NHRPT6-2642EL	82	NL-3365B	248	NL-425N	241
NHR-926Q	341	NHRPV-613EL	104	NL-3365BZ	248	NL-425W	241
NHRFM6-7100EL	199	NHRPV-618EL	104	NL-3365C	248	NL-426B	241
NHRFM6-7100ELQS	199	NHRPV-62642EL	104	NL-3365CO	248	NL-426BZ	241
NHRFM6-735EL	199	NHRPV-813EL	98	NL-3365G	248	NL-426C	241
NHRFM6-735ELQS	199	NHRPV-818EL	98	NL-3365N	248	NL-426CO	241
NHRFM6-750EL	199	NHRPV-82642EL	98	NL-3365W	248	NL-426G	241
NHRFM6-770EL	199	NL-301AT/1EL	246	NL-3366B	249	NL-426N	241
NHRFM6-770ELQS	199	NL-301AT/EM	743	NL-3366BZ	249	NL-426W	241
NHRFM6-9100EL	192	NL-301QAT	246	NL-3366C	249	NL-427W	241
NHRFM6-9100ELQS	192	NL-301QAT/20	246	NL-3366CO	249	NL-438B	329
NHRFM6-9150EL	192	NL-301QAT/37	246	NL-3366G	249	NL-438BZ	242
NHRFM6-935EL	192	NL-311G	249	NL-3366N	249	NL-438C	242, 329
NHRFM6-935ELQS	192	NL-317B	250	NL-3366W	249	NL-438N	242, 329
NHRFM6-950EL	192	NL-317C	250	NL-401/1EL/RFP	228	NL-438W	242, 329
NHRFM6-970EL	192	NL-317G	250	NL-401/277/RFP	228	NL-440	240, 328
NHRFM6-970ELQS	192	NL-317W	250	NL-401/2EL/RFP	228	NL-440B	240, 328
NHRIC-17QAT	275	NL-318B	250	NL-401/50/277/EM	743	NL-440BZ	240, 328
NHRIC-17QNBAT	275	NL-318C	250	NL-401/50/277V	230	NL-440C	240, 328
NHRIC-27QAT	277	NL-318G	250	NL-401/75	230	NL-440CO	240, 328
NHRIC-4G24AT	173	NL-318W	250	NL-401/75/1EL	230	NL-440G	240, 328
NHRIC-4LEDAT	55	NL-319G	251	NL-401/75/277V	230	NL-440N	240, 328
NHRIC-504QAT	299	NL-319W	251	NL-401/75/2EL	230	NL-441B	240
NHRIC-527QAT	303	NL-320B	250	NL-401/EM	743	NL-441BZ	240
NHRIC-5G24ATFL	169	NL-320G	250	NL-401/RFP	228	NL-441C	240
NHRIC-5LEDAT	51	NL-324BU	251	NL-401AT/1EL	230	NL-441CO	240
NHRIC-5LMRAT	61	NL-324P	251	NL-401AT/2EL	230	NL-441G	240
NHRIC-6G24ATFL	165	NL-324W	251	NL-401AT/EM	743	NL-441N	240
NHRIC-6LEDAT	47	NL-325BU	251	NL-401QAT	230	NL-441W	240
NHRIC-6LMRAT	60	NL-325P	251	NL-401QAT/20	230	NL-445	239, 328
NHRIC-926QAT	339	NL-325W	251	NL-401QAT/37	230	NL-445B	239, 328
NHRP-13/2LEL	126	NL-326BU	251	NL-401QAT/FX	230	NL-445BZ	239, 328
NHRP-13/2LQ	126	NL-326P	251	NL-402S	232	NL-445CO	239, 328
NHRP-13EL	117	NL-326W	251	NL-402S/1EL	232	NL-445N	239, 328
NHRP-13MQ	117	NL-327BU	251	NL-402S/20	232	NL-448	239, 328
NHRP-18/2LEL	126	NL-327P	251	NL-402S/37	232	NL-448BZ	239, 328
NHRP-18EL	117	NL-327W	251	NL-410	237, 326	NL-448CO	239, 328
NHRP-26/2LEL	126	NL-3310BB	248, 334	NL-410BZ	237, 326	NL-448N	239, 328
NHRP-2642EL	117	NL-3310BC	248, 334	NL-410CO	237, 326	NL-449	239, 328
NHRP-504/13	147	NL-3310BG	248, 334	NL-410N	237, 326	NL-450	239, 328
NHRP-504/13EL	147	NL-3310BW	248, 334	NL-410P	237, 326	NL-452	237, 326
NHRP-504/18EL	147	NL-3310BZBZ	248, 334	NL-411	237, 326	NL-453	237, 326
NHRP-926/13EL	135	NL-3310COCO	248, 334	NL-411B	237, 326	NL-453BZ	237, 326
NHRP-926/18EL	135	NL-3310NN	248, 334	NL-411BZ	237, 326	NL-461	242, 320, 330
NHRP-926/2642EL	135	NL-3310WB	248, 334	NL-411C	237, 326	NL-461C	242, 320, 330
NHRP6-113EL	91	NL-3310WBZ	248, 334	NL-411CO	237, 326	NL-462	242, 320, 330
NHRP6-118EL	91	NL-3310WC	248, 334	NL-411G	237, 326	NL-463BB	238, 327
NHRP6-126EL	91	NL-3310WG	248, 334	NL-411N	237, 326	NL-463BC	238, 327
NHRP6-213EL	91	NL-3310WW	248, 334	NL-411P	237, 326	NL-463BG	238, 327
NHRP6-218EL	91	NL-3312BB	248, 334	NL-412	237, 326	NL-463BN	238, 327
NHRP6-226EL	91	NL-3312BW	248, 334	NL-412G	237, 326	NL-463BW	238, 327
NHRP8U-113EL	76	NL-3312BZBZ	248, 334	NL-413	237, 326	NL-463BZ	238, 327
NHRP8U-118EL	76	NL-3312CBZ	248, 334	NL-413B	237, 326	NL-463CO	238, 327
NHRP8U-12642EL	76	NL-3312CC	248, 334	NL-414	237, 326	NL-463WB	238, 327
NHRP8U-213EL	76	NL-3312CG	248, 334	NL-414C	237, 326	NL-463WC	238, 327
NHRP8U-218EL	76	NL-3312COCO	248, 334	NL-414HZ	237, 326	NL-463WG	238, 327
NHRP8U-22642EL	76	NL-3312CW	248, 334	NL-416	237, 326	NL-463WW	238, 327
NHRPH-113SEL	139	NL-3312GG	248, 334	NL-417CW	238, 327	NL-465B	238, 327
NHRPH-118SEL	139	NL-3312GW	248, 334	NL-417GW	238, 327	NL-465BZ	238, 327
NHRPH-213SEL	139	NL-3312HZW	248, 334	NL-418BB	238, 327	NL-465C	238, 327

INDEX

NL-465CO	238, 327	NL-490B	239, 328	NL-671BZ	225, 357	NLR-304/1EL	247
NL-465G	238, 327	NL-490W	239, 328	NL-671C	225, 357	NLR-304Q	247
NL-465N	238, 327	NL-491B	239, 328	NL-671CO	225, 357	NLR-304Q/20	247
NL-465W	238, 327	NL-491N	239, 328	NL-671G	225, 357	NLR-304Q/37	247
NL-467BC	238	NL-491W	239, 328	NL-671N	225, 357	NLR-403S	233
NL-467BG	238	NL-495B	242, 320, 330	NL-671W	225, 357	NLR-403S/1EL	233
NL-467BN	238	NL-495B/PL	156, 161	NL-672B	225, 357	NLR-403S/20	233
NL-467BW	238	NL-495F	242, 320, 330	NL-672N	225, 357	NLR-403S/37	233
NL-467WW	238	NL-495F/PL	156, 161	NL-672W	225, 357	NLR-404/1EL/RFP	228
NL-468B	237, 326	NL-495P	242, 320, 330	NL-673B	225, 358	NLR-404/277/RFP	228
NL-468W	237, 326	NL-495P/PL	156, 161	NL-673C	225, 358	NLR-404/2EL/RFP	228
NL-469B	237, 327	NL-496B	242, 320, 330	NL-673G	225, 358	NLR-404/50/277V	231
NL-469BZ	237, 327	NL-496B/PL	156, 161	NL-673W	225, 358	NLR-404/75	231
NL-469C	237, 327	NL-496F	242, 320, 330	NL-675	285	NLR-404/75/1EL	231
NL-469CO	237, 327	NL-496F/PL	156, 161	NL-675B	224	NLR-404/75/277V	231
NL-469G	237, 327	NL-496P	242, 320, 330	NL-675W	224, 285	NLR-404/75/2EL	231
NL-469HZ	237, 327	NL-496P/PL	156, 161	NL-680B	226, 359	NLR-404/RFP	228
NL-469N	237, 327	NL-497B	242, 320, 330	NL-680BZ	226, 359	NLR-404AT/1EL	231
NL-469W	237, 327	NL-497B/PL	156, 161	NL-680C	226, 359	NLR-404AT/2EL	231
NL-470B	239	NL-497F	242, 320, 330	NL-680CO	226, 359	NLR-404QAT	231
NL-470BZ	239	NL-497F/PL	156, 161	NL-680G	226, 359	NLR-404QAT/20	231
NL-470C	239	NL-497P	242, 320, 330	NL-680N	226, 359	NLR-404QAT/37	231
NL-470CO	239	NL-497P/PL	156, 161	NL-680W	226, 359	NLR-405AT	234
NL-470G	239	NL-498B	241, 319, 330	NL-690B	227	NLR-405AT/20	234
NL-470N	239	NL-498BZ	241, 319, 330	NL-690W	227	NLR-405AT/37	234
NL-470W	239	NL-498C	241, 319, 330	NL-695B	227	NLR-604/1EL	223
NL-471W	228	NL-498CO	241, 319, 330	NL-695F	227	NLR-604/277/75Q	223
NL-4810BB	235, 324	NL-498G	241, 319, 330	NL-695P	227	NLR-604Q/277V	223
NL-4810BBZ	235, 324	NL-498N	241, 319, 330	NL-696B	227	NLR-604/2EL	223
NL-4810BCO	235, 324	NL-498W	241, 319, 330	NL-696F	227	NLR-604/75/1EL	223
NL-4810WC	235, 324	NL-601/1EL	222	NL-696P	227	NLR-604/75/2EL	223
NL-4810WG	235, 324	NL-601/277/75Q	222	NL-697B	227	NLR-604/75Q	223
NL-4810WN	235, 324	NL-601/277Q	222	NL-697F	227	NLR-604Q	223
NL-4810WW	235, 324	NL-601/277V/EM	743	NL-697P	227	NM-100/MR16	515
NL-4814BZBZ	235, 324	NL-601/2EL	222	NLEB-1513	705	NM-100B	381, 683
NL-4814BW	235, 324	NL-601/75/1EL	222	NLEB-20	705	NM-100B/MR16	601
NL-4814CB	235, 324	NL-601/75/2EL	222	NLEB-3040	705	NM-100C	381
NL-4814CC	235, 324	NL-601/75Q	222	NLEDC-561	61, 349	NM-100F	381, 683
NL-4814CG	235, 324	NL-601/EM	743	NLEDC-562	61, 349	NM-100F/MR16	601
NL-4814COCO	235, 324	NL-601Q	222	NLEDC-661	60, 348	NM-100G	381, 683
NL-4814CW	235, 324	NL-610W	224, 357	NLEDC-662	60, 348	NM-100G/MR16	601
NL-4814GW	235, 324	NL-611B	224, 357	NLEDR-561	61, 349	NM-100L	381, 683
NL-4814HZW	235, 324	NL-612	224, 357	NLEDR-562	61, 349	NM-100L/MR16	601
NL-4814NN	235, 324	NL-613	224, 357	NLEDR-661	60, 348	NM-100P	381
NL-4825B	236, 325	NL-613BZ	224, 357	NLEDR-662	60, 348	NM-100R	381, 683
NL-4825BZ	236, 325	NL-613CO	224, 357	NLIC-301AT/1EL	245	NM-100R/MR16	601
NL-4825C	236, 325	NL-614	224, 357	NLIC-301QAT	245	NM-100S	381, 683
NL-4825CO	236, 325	NL-616	224, 357	NLIC-301QAT/20	245	NM-100S/MR16	601
NL-4825G	236, 325	NL-618B	225, 358	NLIC-301QAT/37	245	NM-100Y	381, 683
NL-4825N	236, 325	NL-618BB	225, 358	NLIC-401/1EL/RFP	228	NM-100Y/MR16	601
NL-4825W	236, 325	NL-618W	225, 358	NLIC-401/277/RFP	228	NM-126	655
NL-4826B	236, 325	NL-619C	225, 358	NLIC-401/2EL/RFP	228	NM-127	643
NL-4826BZ	236, 325	NL-619G	225, 358	NLIC-401AT/1EL	229	NM-128	643
NL-4826C	236, 325	NL-620B	227, 359	NLIC-401AT/2EL	229	NM-129	648
NL-4826CO	236, 325	NL-620W	227, 359	NLIC-401AT/277V	229	NM-130	648
NL-4826G	236, 325	NL-628B	225, 358	NLIC-401QSAT	229	NM-240	645
NL-4826N	236, 325	NL-628W	225, 358	NLIC-401QSAT/20	229	NM-241	645
NL-4826W	236, 325	NL-640	227, 359	NLIC-401QSAT/37	229	NM-242B	649
NL-4827B	236, 325	NL-641	224	NLIC-401SAT/RFP	228	NM-242C	649
NL-4827BZ	236, 325	NL-641B	357	NLIC-601/1EL	221	NM-242G	649
NL-4827C	236, 325	NL-641W	224, 357	NLIC-601/2EL	221	NM-242N	649
NL-4827CO	236, 325	NL-642	224, 357	NLIC-601QAT	221	NM-242W	649
NL-4827G	236, 325	NL-643	224, 357	NLK-2600	356	NM-243B	650
NL-4827N	236, 325	NL-644	224, 357	NLK-2600EL	356	NM-243C	650
NL-4827W	236, 325	NL-645	227, 359	NLK-2636	356	NM-243G	650
NL-4840B	236, 325	NL-645B	227, 359	NLMP-734	443, 681	NM-243W	650
NL-4840BZ	236, 325	NL-645BZ	227, 359	NLMP-738	443, 681	NM-244B	650
NL-4840C	236, 325	NL-645CO	227, 359	NLMT-150	683	NM-244C	650
NL-4840CO	236, 325	NL-645N	227, 359	NLMT-701	679	NM-244G	650
NL-4840G	236, 325	NL-646	224, 357	NLMT-702	682	NM-244W	650
NL-4840N	236, 325	NL-648	226, 359	NLMT-703	679	NM-245	652
NL-4840W	236, 325	NL-649	226, 359	NLMT-704	682	NM-246	652
NL-4863BB	235, 324	NL-650	226, 359	NLMT-705	679	NM-247B	651
NL-4863BC	235, 324	NL-663B	226, 358	NLMT-706	679	NM-247C	651
NL-4863BG	235, 324	NL-663BZ	226, 358	NLMT-707	679	NM-247G	651
NL-4863BW	235, 324	NL-663C	226, 358	NLMT-708	682	NM-247W	651
NL-4863BZBZ	235, 324	NL-663CO	226, 358	NLMT-709	679	NM-248B	651
NL-4863COCO	235, 324	NL-663G	226, 358	NLMT-710	682	NM-248C	651
NL-4863NN	235, 324	NL-663N	226, 358	NLMT-712	682	NM-248G	651
NL-4863WW	235, 324	NL-663W	226, 358	NLMT-713	682	NM-248W	651
NL-4865B	235, 324	NL-663WW	226	NLMT-716	682	NM-249	653
NL-4865BZ	235, 324	NL-665	288	NLMT-718	682	NM-250B	647
NL-4865C	235, 324	NL-665B	226, 358	NLMT-719	682	NM-250C	647
NL-4865CO	235, 324	NL-665BZ	226, 288, 358	NLMT-721	678	NM-250CO	647
NL-4865G	235, 324	NL-665C	226, 288, 358	NLMT-722	678	NM-250G	647
NL-4865N	235, 324	NL-665CO	226, 288, 358	NLMT-728	682	NM-250N	647
NL-4865W	235, 324	NL-665G	226, 288, 358	NLMT-731	678	NM-250W	647
NL-486W	241, 320, 329	NL-665N	226, 288, 358	NLMT-732	678	NM-251	646
NL-4870B	236	NL-665W	226, 288, 358	NLMT-733	680	NM-252	646
NL-4870BZ	236	NL-670B	225, 289, 358	NLMT-735	680	NM-253	646
NL-4870C	236	NL-670BZ	225, 289, 358	NLMT-736	680	NM-254	644
NL-4870CO	236	NL-670CO	225, 289, 358	NLMT-747	682	NMK-3240	654
NL-4870G	236	NL-670N	225, 289, 358	NLMT-75	683	NMK-3241	654
NL-4870N	236	NL-670W	225, 289, 358	NLMT-752	682	NMOR-30	39
NL-4870W	236	NL-671B	225, 357	NLMT-760	443, 514, 681, 683	NMOR-501	39

INDEX

NMPK1-3LED30BZ	639	NMRL-L3E2650	397	NMRT-13445SS	398	NMRT-24652BW	395, 403
NMPK1-3LED30C	639	NMRL-L3M1650	397	NMRT-13445WW	398	NMRT-24652SS	395, 403
NMPK1-3LED30W	639	NMRL-L3M2650	397	NMRT-13463BW	398	NMRT-24652WW	395, 403
NMPK1-3LED42BZ	639	NMRS32-111	692	NMRT-13463SS	398	NMRT-24653BW	403
NMPK1-3LED42C	639	NMRS32-112	692	NMRT-13463WW	398	NMRT-24653SS	403
NMPK1-3LED42W	639	NMRS32-121	692	NMRT-13465BW	399	NMRT-24653WW	403
NMPK2-3LED30BZ	639	NMRS32-122	692	NMRT-13465SS	399	NMRT-24674BW	399
NMPK2-3LED30C	639	NMRS32-123	693	NMRT-13465WW	399	NMRT-24674SS	399
NMPK2-3LED30W	639	NMRS32-450	440, 693	NMRT-13470BW	399	NMRT-24674WW	399
NMR-30	39	NMRS32-524	440, 693	NMRT-13470SS	399	NMRT-L2418BW	398
NMRH-11E3020	394	NMRS37-331	693	NMRT-13470WW	399	NMRT-L2418SS	398
NMRH-11E3039	394	NMRS80-478	440	NMRT-13628BW	395, 403	NMRT-L2418WW	398
NMRH-11E3070	394	NMRS90-N01	694	NMRT-13628SS	395, 403	NMRT-L2445BW	398
NMRH-12E3020	394	NMRS90-N14	694	NMRT-13628WW	395, 403	NMRT-L2445SS	398
NMRH-12E3039	394	NMRS90-N16	694	NMRT-13652BW	395, 403	NMRT-L2445WW	398
NMRH-12E3070	394	NMRS90-N33	695	NMRT-13652SS	395, 403	NMRT-L2463BW	398
NMRH-13E3020	394	NMRS90-N51	695	NMRT-13652WW	395, 403	NMRT-L2463SS	398
NMRH-13E3039	394	NMRS90-N52	695	NMRT-13653BW	403	NMRT-L2463WW	398
NMRH-13E3070	394	NMRS90-N53	695	NMRT-13653SS	403	NMRT-L2465BW	399
NMRH-14E3020	394	NMRS90-N56	695	NMRT-13653WW	403	NMRT-L2465SS	399
NMRH-14E3039	394	NMRS90-N58	695	NMRT-13674BW	399	NMRT-L2465WW	399
NMRH-14E3070	394	NMRS90-N74	694	NMRT-13674SS	399	NMRT-L2470BW	399
NMRH-15E3020	394	NMRS90-N75	694	NMRT-13674WW	399	NMRT-L2470SS	399
NMRH-15E3039	394	NMRS90-N76	694	NMRT-14418BW	398	NMRT-L2470WW	399
NMRH-15E3070	394	NMRS90-P04	694	NMRT-14418SS	398	NMRT-L2628BW	395, 403
NMRH-24E3020	394	NMRS90-P06	694	NMRT-14418WW	398	NMRT-L2628SS	395, 403
NMRH-24E3039	394	NMRS90-P10	694	NMRT-14445BW	398	NMRT-L2628WW	395, 403
NMRH-24E3070	394	NMRS90-P11	694	NMRT-14445SS	398	NMRT-L2652BW	395, 403
NMRH-L2E3020	394	NMRS90-P12	694	NMRT-14445WW	398	NMRT-L2652SS	395, 403
NMRH-L2E3039	394	NMRS90-P13	694	NMRT-14463BW	398	NMRT-L2652WW	395, 403
NMRH-L2E3070	394	NMRS90-P14	695	NMRT-14463SS	398	NMRT-L2653BW	403
NMRH-L3E3020	394	NMRS90-P14/12	695	NMRT-14463WW	398	NMRT-L2653SS	403
NMRH-L3E3039	394	NMRS90-P14/24	695	NMRT-14465BW	399	NMRT-L2653WW	403
NMRH-L3E3070	394	NMRS90-P15/12	695	NMRT-14465SS	399	NMRT-L2674BW	399
NMRI-11N1075	402	NMRS90-P15/24	695	NMRT-14465WW	399	NMRT-L2674SS	399
NMRI-11N18150	402	NMRS90-P16/12	695	NMRT-14470BW	399	NMRT-L2674WW	399
NMRI-12N1075	402	NMRS90-P32	440, 514, 694	NMRT-14470SS	399	NMRT-L3418BW	398
NMRI-12N18150	402	NMRT-11418BW	398	NMRT-14470WW	399	NMRT-L3418SS	398
NMRI-13N1075	402	NMRT-11418SS	398	NMRT-14628BW	395, 403	NMRT-L3418WW	398
NMRI-13N18150	402	NMRT-11418WW	398	NMRT-14628SS	395, 403	NMRT-L3445BW	398
NMRI-14N1075	402	NMRT-11445BW	398	NMRT-14628WW	395, 403	NMRT-L3445SS	398
NMRI-14N18150	402	NMRT-11445SS	398	NMRT-14652BW	395, 403	NMRT-L3445WW	398
NMRI-15N1075	402	NMRT-11445WW	398	NMRT-14652SS	395, 403	NMRT-L3463BW	398
NMRI-15N18150	402	NMRT-11463BW	398	NMRT-14652WW	395, 403	NMRT-L3463SS	398
NMRI-24N1075	402	NMRT-11463SS	398	NMRT-14653BW	403	NMRT-L3463WW	398
NMRI-24N18150	402	NMRT-11463WW	398	NMRT-14653SS	403	NMRT-L3465BW	399
NMRI-L2N1075	402	NMRT-11465BW	399	NMRT-14653WW	403	NMRT-L3465SS	399
NMRI-L2N18150	402	NMRT-11465SS	399	NMRT-14674BW	399	NMRT-L3465WW	399
NMRI-L3N1075	402	NMRT-11465WW	399	NMRT-14674SS	399	NMRT-L3470BW	399
NMRI-L3N18150	402	NMRT-11470BW	399	NMRT-14674WW	399	NMRT-L3470SS	399
NMRL-11E1175	397	NMRT-11470SS	399	NMRT-15418BW	398	NMRT-L3470WW	399
NMRL-11E1650	397	NMRT-11470WW	399	NMRT-15418SS	398	NMRT-L3628BW	395, 403
NMRL-11E2175	397	NMRT-11628BW	395, 403	NMRT-15418WW	398	NMRT-L3628SS	395, 403
NMRL-11E2650	397	NMRT-11628SS	395, 403	NMRT-15445BW	398	NMRT-L3628WW	395, 403
NMRL-11M1650	397	NMRT-11628WW	395, 403	NMRT-15445SS	398	NMRT-L3652BW	395, 403
NMRL-11M2650	397	NMRT-11652BW	395, 403	NMRT-15445WW	398	NMRT-L3652SS	395, 403
NMRL-12E1175	397	NMRT-11652SS	395, 403	NMRT-15463BW	398	NMRT-L3652WW	395, 403
NMRL-12E1650	397	NMRT-11652WW	395, 403	NMRT-15463SS	398	NMRT-L3653BW	403
NMRL-12E2175	397	NMRT-11653BW	403	NMRT-15463WW	398	NMRT-L3653SS	403
NMRL-12E2650	397	NMRT-11653SS	403	NMRT-15465BW	399	NMRT-L3653WW	403
NMRL-12M1650	397	NMRT-11653WW	403	NMRT-15465SS	399	NMRT-L3674BW	399
NMRL-12M2650	397	NMRT-11674BW	399	NMRT-15465WW	399	NMRT-L3674SS	399
NMRL-13E1175	397	NMRT-11674SS	399	NMRT-15470BW	399	NMRT-L3674WW	399
NMRL-13E1650	397	NMRT-11674WW	399	NMRT-15470SS	399	NMS12175E1S1674	404
NMRL-13E2175	397	NMRT-12418BW	398	NMRT-15470WW	399	NMS13175E1S1674	404
NMRL-13E2650	397	NMRT-12418SS	398	NMRT-15628BW	395, 403	NMS14175E1S1674	405
NMRL-13M1650	397	NMRT-12418WW	398	NMRT-15628SS	395, 403	NMS15175E1S1674	405
NMRL-13M2650	397	NMRT-12445BW	398	NMRT-15628WW	395, 403	NMS16175E1S1674	405
NMRL-14E1475	397	NMRT-12445SS	398	NMRT-15652BW	395, 403	NMS22175E1S1674	405
NMRL-14E1650	397	NMRT-12445WW	398	NMRT-15652SS	395, 403	NMT-1200/12SP	683, 704
NMRL-14E2475	397	NMRT-12463BW	398	NMRT-15652WW	395, 403	NMT-1200/24SP	683, 704
NMRL-14E2650	397	NMRT-12463SS	398	NMRT-15653BW	403	NMT-150/12SP	683, 704
NMRL-14M1650	397	NMRT-12463WW	398	NMRT-15653SS	403	NMT-300/12SP	683, 704
NMRL-14M2650	397	NMRT-12465BW	399	NMRT-15653WW	403	NMT-300/24SP	683, 704
NMRL-15E1175	397	NMRT-12465SS	399	NMRT-15674BW	399	NMT-300/C2	702
NMRL-15E1650	397	NMRT-12465WW	399	NMRT-15674SS	399	NMT-60/12C2	640, 706
NMRL-15E2175	397	NMRT-12470BW	399	NMRT-15674WW	399	NMT-60/24C2	615, 621, 626, 630, 706
NMRL-15E2650	397	NMRT-12470SS	399	NMRT-24418BW	398	NMT-600/12SP	683, 704
NMRL-15M1650	397	NMRT-12470WW	399	NMRT-24418SS	398	NMT-600/24SP	683, 704
NMRL-15M2650	397	NMRT-12628BW	395, 403	NMRT-24418WW	398	NMT-96/24C2	615, 621, 626, 630, 706
NMRL-24E1175	397	NMRT-12628SS	395, 403	NMRT-24445BW	398	NOR-30	39
NMRL-24E1650	397	NMRT-12628WW	395, 403	NMRT-24445SS	398	NOR-401	39
NMRL-24E2175	397	NMRT-12652BW	395, 403	NMRT-24445WW	398	NP-22	121, 128, 137, 141, 292, 354
NMRL-24E2650	397	NMRT-12652SS	395, 403	NMRT-24463BW	398	NP-23	121, 129, 137, 141, 293, 355
NMRL-24M1650	397	NMRT-12652WW	395, 403	NMRT-24463SS	398	NP-24	122, 129, 137, 142, 294, 355
NMRL-24M2650	397	NMRT-12653BW	403	NMRT-24463WW	398	NP-24/PC	122, 294, 355
NMRL-L2E1175	397	NMRT-12653SS	403	NMRT-24465BW	399	NP-24PC	129, 142
NMRL-L2E1650	397	NMRT-12653WW	403	NMRT-24465SS	399	NP-322	292
NMRL-L2E2175	397	NMRT-12674BW	399	NMRT-24465WW	399	NP-323	294
NMRL-L2E2650	397	NMRT-12674SS	399	NMRT-24470BW	399	NP-324	295
NMRL-L2M1650	397	NMRT-12674WW	399	NMRT-24470SS	399	NP66-103	449, 483, 514
NMRL-L2M2650	397	NMRT-13418BW	398	NMRT-24470WW	399	NP66-203	449, 483, 514
NMRL-L3E1175	397	NMRT-13418SS	398	NMRT-24628BW	395, 403	NP66-203	449, 483, 514
NMRL-L3E1650	397	NMRT-13418WW	398	NMRT-24628SS	395, 403	NP66-203	449, 483, 514
NMRL-L3E2175	397	NMRT-13445BW	398	NMRT-24628WW	395, 403	NP66-203	449, 483, 514

INDEX

NPK-18EL	351	NRS19-204	477	NRS66-302	487	NRS90-N66	515
NPK-26EL	351	NRS19-450	438, 508	NRS66-310	487	NRS90-N70	512
NR-30	39	NRS19-456	438, 508	NRS66-457	439, 440, 443, 445, 483, 509	NRS90-N71	512
NR-3301	39	NRS19-460	505	NRS66-458	439, 440, 443, 445, 483, 509	NRS90-N72	512
NR-401	39	NRS19-462PW	452, 506	NRS66-462PW	452, 506	NRS90-N73	512
NR-401D	39	NRS19-463PW	452, 506	NRS66-463PW	452, 506	NRS90-N74	512
NR-401P	39	NRS19-464CL	453, 505	NRS66-562PW	452, 506	NRS90-N77	512
NR-501	39	NRS19-464FR	453, 505	NRS66-563PW	452, 506	NRS90-N89	512
NRA-10	383, 601	NRS19-464SF	453, 505	NRS66-901	487	NRS90-N91	512
NRA-105/12B	636	NRS19-465	438, 508	NRS66-902	488	NRS90-N91-M1	512
NRA-105/12W	636	NRS19-474	477	NRS70-601	422	NRS90-P01	513
NRA-105/24B	636	NRS19-501	476, 507	NRS70-602	422	NRS90-P02	513
NRA-105/24W	636	NRS19-551	439, 509	NRS70-603	422	NRS90-P03	513
NRA-105/6B	636	NRS19-562PW	452, 506	NRS70-604	422	NRS90-P04	510
NRA-105/6W	636	NRS19-563PW	452, 506	NRS70-605	422	NRS90-P06	510
NRA-105B	636	NRS21-102	503	NRS70-606	423	NRS90-P08	510
NRA-105W	636	NRS21-252	503	NRS70-607	423	NRS90-P10	511
NRA-106	39	NRS21-4104	500	NRS70-608	423	NRS90-P11	511
NRA-11	383	NRS21-8104	503	NRS80-204	431	NRS90-P12	445, 483, 514
NRA-123	385, 746	NRS29-4201	500	NRS80-401	421	NRS90-P13	511
NRA-123MAG	385, 746	NRS29-4202	501	NRS80-402	431	NRS90-P14	511
NRA-125	632	NRS29-4203	501	NRS80-403	431	NRS90-P15	511
NRA-125/12	615, 621, 626, 630, 632, 640, 707	NRS29-4204	501	NRS80-404	431	NRS90-P17	511
NRA-125/18	615, 621, 626, 630, 632, 640, 707	NRS29-4411	502	NRS80-405BU	453	NRS90-P30	512
NRA-125/6	615, 621, 626, 630, 632, 640, 707	NRS29-6451	502	NRS80-405GR	453	NRS90-P31	512
NRA-125/72	615, 621, 626, 630, 632, 640, 707	NRS29-6462	502	NRS80-4050	453	NRS90-P32	439, 483, 509, 514
NRA-126	379	NRS29-C204	500	NRS80-405R	453	NRS90-P33	514
NRA-127	632	NRS33-901	487	NRS80-405Y	453	NRS90-P34	514
NRA-130	385	NRS33-902	488	NRS80-406	428	NRS90-P35	514
NRA-132/24	599	NRS34-201	488	NRS80-407	428	NRS90-P37/1	511
NRA-132/48	599	NRS34-202	488	NRS80-408	428	NRS90-P37/10	511
NRA-132/72	599	NRS34-203	488	NRS80-411	421	NRS90-P37/12	511
NRA-132/96	599	NRS34-204	489	NRS80-451	426	NRS90-P37/14	511
NRA-136	515	NRS34-450	439, 509	NRS80-452	426	NRS90-P37/2.5	511
NRA-14	383	NRS34-456	439, 509	NRS80-453	425	NRS90-P37/5	511
NRA-14/5	383	NRS34-462PW	452, 506	NRS80-454	430	NRS90-P37/7.5	511
NRA-143W	632	NRS34-463PW	452, 506	NRS80-455	430	NRS90-P40	511
NRA-15	384	NRS34-551	439, 509	NRS80-456	430	NRS90-P47/12	514
NRA-151	384	NRS34-562PW	452, 506	NRS80-457	430	NRS90-P51	514
NRA-160	385	NRS34-563PW	452, 506	NRS80-458	432	NRS90-P56	444
NRA-203	382	NRS36-101	484	NRS80-459	432	NRS90-P80	511
NRA-21	384	NRS36-102	484	NRS80-461	430	NRS90-P81	512
NRA-212	60, 61, 348, 349	NRS36-103	484	NRS80-462	426	NRS90-P82	512
NRA-22	381	NRS36-104	484	NRS80-463	428	NRS90-P85	512
NRA-28	383	NRS36-105	485	NRS80-465	428	NRS90-P86	507, 512
NRA-29/277V	384, 705	NRS36-106	485	NRS80-466	425	NRS90-P87	511
NRA-29/50W	384, 705	NRS36-107	485	NRS80-467	425	NRS90-P88	511
NRA-29/75/277V	384, 705	NRS36-251	489	NRS80-468	429	NRS90-P89	511
NRA-29/75W	384, 705	NRS36-252	489	NRS80-469	429	NRS90-P90	511
NRA-34	383	NRS36-302	487	NRS80-470	426	NRS90-P91	511
NRA-34/10	356, 383	NRS36-310	487	NRS80-471	427	NRS90-P91-M1	511
NRA-36	383	NRS36-320	498	NRS80-472	424	NRS90-P99	511
NRA-37/10	356, 383	NRS45-201	497	NRS80-473	424	NRS90-R24-I	510
NRA-38	383	NRS45-301	451, 497	NRS80-474	431	NRS90-R24-0	510
NRA-60	383	NRS45-401	451, 497	NRS80-475	425	NRS90-R39-I	510
NRA-6035W/10	615, 621, 626, 630, 640, 707	NRS48-468	438, 508	NRS80-476	429	NRS90-R39-0	510
NRA-6035W/6	615, 621, 626, 630, 640, 707	NRS51-103	491	NRS80-477	427	NRS98-P58	444
NRA-6037	384, 705	NRS51-104	491	NRS80-480	416	NRS99-464CL	453, 505
NRA-6040	515	NRS51-105	491	NRS80-482	420	NRS99-464FR	453, 505
NRA-6047	632	NRS51-108	492	NRS80-483	421	NRS99-464SF	453, 505
NRA-6061	384, 705	NRS52-155	492	NRS80-484	420	NRS99-P45	444
NRA-82	599	NRS52-156	492	NRS80-485	417	NRS99-P45/12V	445
NRA-84	600	NRS52-157	492	NRS80-486	417	NRS99-P46	444
NRA-85	600	NRS54-220	491	NRS80-487	417	NRS99-P46/12V	445
NRA-86	381	NRS55-301	492	NRS80-490	419	NRS99-P47/12	483
NRE-820L	471	NRS56-220	491	NRS80-491	419	NRS99-P47/12V	445
NRS10-466	438, 508	NRS58-152/20	492	NRS80-492	419	NRS99-P51	445, 483
NRS11-101	473	NRS58-152/39	492	NRS80-493	418	NRS99-P55	444
NRS11-102	473	NRS58-153/39	493	NRS80-891	419	NS-12BZ	317
NRS11-103	473	NRS58-153/70	493	NRS80-892	419	NS-12CO	317
NRS11-104	473	NRS58-154	493	NRS80-893	418	NS-12N	317
NRS11-105	474	NRS59-158	493	NRS82-201	433	NS-12W	317
NRS11-106	474	NRS61-101	493	NRS82-202	433	NS-18	317
NRS11-107	474	NRS61-103	494	NRS82-203	433	NS-18B	317
NRS11-108	474	NRS61-104	494	NRS82-204	433	NS-18BZ	317
NRS11-112	475	NRS61-105	494	NRS90-C12-I	510	NS-18CO	317
NRS11-251	475	NRS61-108	494	NRS90-K633	499	NS-18N	317
NRS11-252	475	NRS61-110	495	NRS90-K833	499	NS-19C	317
NRS11-253	475	NRS61-253	495	NRS90-N01	515	NS-19G	317
NRS11-260	476	NRS66-101	484	NRS90-N02	513	NS-22B	160, 318
NRS11-302	478	NRS66-102	484	NRS90-N03	513	NS-22BZ	160, 318
NRS11-310	478	NRS66-103	484	NRS90-N04	513	NS-22C	160, 318
NRS11-320	498	NRS66-104	484	NRS90-N14	512	NS-22CO	160, 318
NRS17-301	498	NRS66-105	485	NRS90-N17	512	NS-22G	160, 318
NRS18-122	479	NRS66-106	485	NRS90-N18	512	NS-22N	160, 318
NRS18-123	479	NRS66-107	485	NRS90-N20	515, 602	NS-22W	160, 318
NRS18-128	479	NRS66-108	485	NRS90-N21	512	NS-23B	160, 318
NRS18-133	479	NRS66-109	487	NRS90-N22	512	NS-23BZ	160, 318
NRS18-138	480	NRS66-201	488	NRS90-N26	512	NS-23C	160, 318
NRS18-176	480	NRS66-202	488	NRS90-N27	512	NS-23CO	160, 318
NRS18-177	480	NRS66-203	488	NRS90-N31	515	NS-23G	160, 318
NRS18-178	480	NRS66-204	489	NRS90-N32	515	NS-23N	160, 318
NRS19-201	476	NRS66-251	489	NRS90-N33	515	NS-23W	160, 318
NRS19-202	477	NRS66-252	489	NRS90-N34	515	NS-24B	161, 318
NRS19-203	477	NRS66-253	489	NRS90-N35	515	NS-24BZ	161, 318

INDEX

NS-24C	161, 318	NS-4914CC	314	NSI-662W	373	NT-28B	286, 343
NS-24CO	161, 318	NS-4914CG	314	NSIC-401QAT	311	NT-28BZ	286, 343
NS-24G	161, 318	NS-4914COCO	314	NSL-401AT/10	322	NT-28CO	286, 343
NS-24N	161, 318	NS-4914CW	314	NSLIC-401AT/10	321	NT-28N	286, 343
NS-24W	161, 318	NS-4914GW	314	NSLR-404AT/10	323	NT-29C	286, 343
NS-25B	318	NS-4914HZW	314	NSP-109	375	NT-29G	286, 343
NS-25BZ	318	NS-4914NN	314	NSP-109/JB	375	NT-30	296
NS-25C	318	NS-4926B	315	NSP-1091	375	NT-301	594
NS-25CO	318	NS-4926BZ	315	NSP-1091/JB	375	NT-302	594
NS-25G	318	NS-4926C	315	NSP-1092	375	NT-303	594
NS-25N	318	NS-4926CO	315	NSP-1092/JB	375	NT-304	594
NS-25W	318	NS-4926G	315	NSR-404QAT	313	NT-304DC	601
NS-26B	319	NS-4926N	315	NSR-408/EL	159	NT-305	599
NS-26BZ	319	NS-4926W	315	NSR-408Q	159	NT-306	599
NS-26C	319	NS-4927B	315	NST-21	369	NT-307	597
NS-26CO	319	NS-4927BZ	315	NST-22	369	NT-308	600
NS-26G	319	NS-4927C	315	NST-23	369	NT-309	598
NS-26N	319	NS-4927CO	315	NT-22	121, 128, 137, 141, 210, 292, 344, 354	NT-30BZ	296
NS-26W	319	NS-4927G	315	NT-22B	121, 128, 137, 141, 210, 292, 344, 354	NT-30CO	296
NS-27B	319	NS-4927N	315	NT-22BZ	121, 128, 137, 141, 210, 292, 344, 354	NT-30D	297
NS-27BZ	319	NS-4927W	315	NT-22C	121, 128, 137, 141, 210, 292, 344, 354	NT-30DBZ	297
NS-27C	319	NS-4940B	314	NT-22CO	121, 128, 137, 141, 210, 292, 344, 354	NT-30DCO	297
NS-27CO	319	NS-4940BZ	314	NT-22G	121, 128, 137, 141, 210, 292, 344, 354	NT-30DN	297
NS-27G	319	NS-4940C	314	NT-22N	121, 128, 137, 141, 210, 292, 344, 354	NT-30N	296
NS-27N	319	NS-4940CO	314	NT-23	121, 129, 137, 141, 211, 293, 344, 355	NT-31	296
NS-27W	319	NS-4940G	314	NT-2302	595	NT-310	598
NS-38BZ	319	NS-4940O	314	NT-2303	595	NT-311	597
NS-38C	319	NS-4940W	314	NT-2304	595	NT-312	598
NS-38N	319	NS-50	160, 317	NT-2307	597	NT-313	598
NS-38W	319	NS-52	154, 174, 316	NT-2309	598	NT-314	598
NS-40	160, 316	NS-53	154, 174, 316	NT-2310	598	NT-315	598
NS-401QAT	312	NS-53BZ	154, 174, 316	NT-2311	597	NT-316	597
NS-406/EL	158	NS-57CW	316	NT-2312	598	NT-317	600
NS-406Q	158	NS-57GW	316	NT-2313	598	NT-318	600
NS-40A	316	NS-58	317	NT-2314	598	NT-319	598
NS-40BZBZ	160, 316	NS-76B	318	NT-2315	598	NT-32	296
NS-40C	160, 316	NS-76BZ	318	NT-2316	597	NT-320	598
NS-40CO	316	NS-76CO	318	NT-2318	600	NT-321	597
NS-40COCO	160	NS-76N	318	NT-2328	597	NT-322	599
NS-40G	160, 316	NS-76W	318	NT-2331	595	NT-323	599
NS-40N	160, 316	NSC-6500	380	NT-2348/10A	596	NT-324	599
NS-40P	316	NSC-6501	380	NT-2348/12A	596	NT-325	599
NS-41	160, 316	NSC-6502	380	NT-2348/14A	596	NT-326	599
NS-41A	316	NSC-6503	380	NT-2348/1A	596	NT-327	600
NS-41B	160, 316	NSC-6504	380	NT-2348/2.5A	596	NT-328	597
NS-41C	160, 316	NSC-6505	380	NT-2348/4.5A	596	NT-329	599
NS-41G	160, 316	NSC-6506	380	NT-2348/5A	596	NT-33	296
NS-41N	160, 316	NSC-6507	380	NT-2348/7.5A	596	NT-330	600
NS-41P	316	NSC-6508	380	NT-2352	597	NT-331	594
NS-42	160, 174, 316	NSC-6509	380	NT-2358/10A	596	NT-332	600
NS-4238BZ	161	NSC-6600	380	NT-2358/12A	596	NT-333	599
NS-4238C	161	NSC-6605	380	NT-2358/14A	596	NT-334	599
NS-4238N	161	NSC-6606	380	NT-2358/1A	596	NT-335	599
NS-4238W	161	NSC-6607	380	NT-2358/2.5A	596	NT-336	599
NS-42A	316	NSC-6608	380	NT-2358/4.5A	596	NT-337	598
NS-42G	160, 174, 316	NSC-6609	380	NT-2358/5A	596	NT-338	602
NS-43	160, 174, 316	NSC-6710	380	NT-2358/7.5A	596	NT-339	602
NS-43A	316	NSC-6711	380	NT-2358/1A	596	NT-33D	297
NS-43B	160, 174, 316	NSD-850EL	363	NT-2358/2.5A	596	NT-340	602
NS-44	160, 174, 316	NSD-870EL	363	NT-2358/4.5A	596	NT-341	602
NS-44A	316	NSH-8Q	367	NT-2358/5A	596	NT-342	602
NS-44C	160, 174, 316	NSHIC-8	366	NT-2358/7.5A	596	NT-343	602
NS-44HZ	160, 174, 316	NSHP-8/EL	365	NT-2358/10A	596	NT-344	602
NS-44N	160, 174, 316	NSHP-8/ELEM	365	NT-2358/12A	596	NT-345	602
NS-45	317	NSHP-82642EL	365	NT-2358/14A	596	NT-346	602
NS-45B	317	NSHP-82642ELEM	365	NT-2358/1A	596	NT-347	598
NS-45BZ	317	NSHP-8Q	365	NT-23B	121, 129, 137, 141, 211, 293, 344, 355	NT-348	597
NS-45CO	317	NSHP-8QEM	365	NT-23BZ	121, 129, 137, 141, 211, 293, 344, 355	NT-348/10A	596
NS-45N	317	NSHPIC-8	364	NT-23C	121, 129, 137, 141, 211, 293, 344, 355	NT-348/12A	596
NS-46	160, 174, 316	NSHPIC-8EL	364	NT-23CO	121, 129, 137, 141, 211, 293, 344, 355	NT-348/14A	596
NS-46A	316	NSI-125/JB	377	NT-23G	121, 129, 137, 141, 211, 293, 344, 355	NT-348/1A	596
NS-47	317	NSI-1251/JB	377	NT-23N	121, 129, 137, 141, 211, 293, 344, 355	NT-348/2.5A	596
NS-47B	317	NSI-1252/JB	377	NT-24	122, 129, 137, 142, 212, 295, 344, 355	NT-348/4.5A	596
NS-47BZ	317	NSI-140	377	NT-24B	122, 129, 137, 142, 212, 295, 344, 355	NT-348/5A	596
NS-47CO	317	NSI-1401	377	NT-24BZ	122, 129, 137, 142, 212, 295, 344, 355	NT-348/7.5A	596
NS-47N	317	NSI-1402	377	NT-24C	122, 129, 137, 142, 212, 295, 344, 355	NT-349	599
NS-48	317	NSI-161BN	376	NT-24CO	122, 129, 137, 142, 212, 295, 344, 355	NT-350	603
NS-48BZ	317	NSI-161P	376	NT-24G	122, 129, 137, 142, 212, 295, 344, 355	NT-351	602
NS-48CO	317	NSI-161W	376	NT-24N	122, 129, 137, 142, 212, 295, 344, 355	NT-352	597
NS-48N	317	NSI-162BN	376	NT-25	119, 137, 289, 343, 354	NT-355/20	599
NS-49	317	NSI-162P	376	NT-25B	119, 137, 289, 343, 354	NT-355/8	599
NS-4910BB	314	NSI-162W	376	NT-28	286, 343	NT-358/10A	596
NS-4910BBZ	314	NSI-601	374			NT-358/12A	596
NS-4910BCO	314	NSI-602	374			NT-358/14A	596
NS-4910WC	314	NSI-661BN	373			NT-358/1A	596
NS-4910WG	314	NSI-661P	373			NT-358/2.5A	596
NS-4910WN	314	NSI-661PC/BN	372			NT-358/4.5A	596
NS-4910WW	314	NSI-661PC/P	372			NT-358/5A	596
NS-4912BZ	314	NSI-661PC/W	372			NT-358/7.5A	596
NS-4912CO	314	NSI-661W	373			NT-360	601
NS-4912N	314	NSI-662BN	373			NT-361	601
NS-4912W	314	NSI-662P	373			NT-361X	601
NS-4914BW	314	NSI-662PC/BN	372			NT-362	381, 515, 601
NS-4914BZBZ	314	NSI-662PC/P	372			NT-363	602
NS-4914CB	314	NSI-662PC/W	372			NT-364	600

INDEX

NT-364C	600	NT-5025W	308	NTA-86	119, 210, 290, 354	NTH-111G24	553
NT-365	603	NT-5026B	309	NTA-86/2PL	127, 354	NTH-112	586
NT-366	598	NT-5026C	309	NTA-87	119, 210, 290, 354	NTH-113	588
NT-370	443, 514, 600	NT-5026CO	309	NTA-87/2PL	127, 354	NTH-115	585
NT-374	600	NT-5026G	309	NTA-88	119, 210, 290, 354	NTH-119	586
NT-374B	360, 384	NT-5026N	309	NTA-88/2PL	127, 354	NTH-120	588
NT-374W	360, 384	NT-5026W	309	NTA-88BZ	119, 210, 290, 354	NTH-121	588
NT-376	600	NT-5030BZ	306	NTA-88CO	119, 210, 290, 354	NTH-122	583
NT-376B	360, 384	NT-5030C	306	NTA-88N	119, 210, 290, 354	NTH-123	581
NT-376W	360, 384	NT-5030CO	306	NTA-89	119, 210, 290, 354	NTH-124	581
NT-40	297	NT-5030N	306	NTA-89/2PL	127, 354	NTH-125	581
NT-40D	297	NT-5030W	306	NTA-96	118, 208, 285, 352	NTH-126	582
NT-40N	297	NT-5045W	306	NTA-96/2PL	127, 352	NTH-127	582
NT-41	297	NT-5048B	306	NTA-96C	118, 208, 285, 352	NTH-128	582
NT-42	297	NT-5048N	306	NTA-96G	118, 208, 285, 352	NTH-129	582
NT-43	297	NT-5048W	306	NTA-97	118, 208, 285, 352	NTH-130	583
NT-43D	297	NT-5050B	150, 308	NTA-97/2PL	127, 352	NTH-131	589
NT-45	119, 141, 289, 353	NT-5050BZ	150, 308	NTA-97AHZ	118, 208, 285, 352	NTH-132	579
NT-46	119, 141, 289, 353	NT-5050CO	150, 308	NTA-97C	118, 208, 285, 352	NTH-133	579
NT-50	297	NT-5050N	150, 308	NTA-97C/2PL	127, 352	NTH-134	579
NT-5000BZ	170, 304	NT-5050W	150, 308	NTA-97CLI	118	NTH-135	579
NT-5000CO	170, 304	NT-5060B	305	NTA-97G	118, 208, 285, 352	NTH-136	580
NT-5000N	170, 304	NT-5060BZ	305	NTA-97HZ	118, 208, 285, 352	NTH-137	580
NT-5000W	170, 304	NT-5060CO	305	NTA-98	118, 208, 285, 352	NTH-138	585
NT-5001B	148, 170, 304	NT-5060N	305	NTA-98/2PL	127, 352	NTH-147	587
NT-5001BZ	148, 170, 304	NT-5060W	305	NTA-98B	118, 208, 285, 352	NTH-148	587
NT-5001CO	148, 170, 304	NT-5061B	306	NTA-98BZBZ	118, 208, 285, 352	NTH-149	584
NT-5001MW	148, 170, 304	NT-5061BZ	306	NTA-98COCO	118, 208, 285, 352	NTH-149G24	553
NT-5001N	148, 170, 304	NT-5061CO	306	NTA-98NN	118, 208, 285, 352	NTH-150	584
NT-5001W	148, 170, 304	NT-5061N	306	NTA-99	118, 208, 285, 352	NTH-151	585
NT-5002B	305	NT-5061W	306	NTA-99/2PL	127, 352	NTH-151	585
NT-5002BZ	305	NT-5070B	306	NTE-810L	531	NTH-160	441, 592
NT-5002C	305	NT-5070BZ	306	NTE-820L	531	NTH-161	441, 592
NT-5002CO	305	NT-5070CO	306	NTF-163	441, 592	NTH-162	441, 592
NT-5002G	305	NT-5070N	306	NTF-2642T	550	NTH-176	580
NT-5002HZ	305	NT-5070W	306	NTF-3218	551	NTH-177	580
NT-5002N	305	NT-5071B	305	NTF-3227	551	NTH-178	581
NT-5002W	305	NT-5071BZ	305	NTF-3239	551	NTH-613	576
NT-5010B	304	NT-5071CO	305	NTF-3240	551	NTH-614	576
NT-5010BZ	304	NT-5071N	305	NTF-4124	549	NTH-615	576
NT-5010CO	304	NT-5071W	305	NTF-4139	549	NTH-616	576
NT-5010N	304	NT-50B	297	NTF-4154	549	NTH-618	577
NT-5010W	304	NT-50BZ	297	NTF-4224	549	NTH-619	577
NT-5012B	170, 304	NT-50CO	297	NTF-4224-LENS	603	NTH-620	577
NT-5012BZ	170, 304	NT-50N	297	NTF-4239	549	NTH-621	577
NT-5012CO	170, 304	NT-51	289	NTF-4239-LENS	603	NTH-694	578
NT-5012N	170, 304	NT-51B	289	NTF-4254	549	NTH-695	578
NT-5012W	170, 304	NT-51BZ	289	NTF-4254-LENS	603	NTH-697	578
NT-5014B	171, 305	NT-51CO	289	NTFL-2642	603	NTH-150	590
NT-5014BZ	171, 305	NT-620B	297	NTFL-3218	603	NTH-151	590
NT-5014C	171, 305	NT-620C	297	NTFL-3227	603	NTH-151/2H	590
NT-5014CO	171, 305	NT-620G	297	NTFL-3229	603	NTH-156	590
NT-5014G	171, 305	NT-620W	297	NTFL-3240	603	NTH-156/2H	590
NT-5014HZ	305	NT-622B	292	NTFL-4124	603	NTH-156/4H	590
NT-5014N	171, 305	NT-622C	292	NTFL-4139	603	NTH-158	591
NT-5014W	171, 305	NT-622G	292	NTFL-4154	603	NTH-158/4H	591
NT-5020B	171, 304	NT-622W	292	NTG-4B/80	156, 161, 242, 319, 329, 382	NTH-172	591
NT-5020C	171, 304	NT-624B	295	NTG-4CF	156, 161, 242, 319, 329, 382	NTH-180	591
NT-5020G	171, 304	NT-624C	295	NTG-4FC	156, 161, 242, 319, 329, 382	NTH-181	591
NT-5020W	171, 304	NT-624G	295	NTG-4HC	156, 161, 242, 319, 329, 382	NTH-201	563
NT-5021B	171, 305	NT-641B	283	NTG-5B/80	151, 309, 382	NTH-201/75	563
NT-5021BZ	171, 305	NT-641CO	283	NTG-5CF	151, 309, 382	NTH-202	564
NT-5021C	171, 305	NT-641W	283	NTG-5FC	151, 309, 382	NTH-202/75	564
NT-5021CO	171, 305	NT-642	285	NTG-5HC	151, 309, 382	NTH-203	564
NT-5021G	171, 305	NT-643	285	NTG-6B/120	86, 94, 108, 120, 201, 212, 271, 296, 382	NTH-203/75	564
NT-5021HZ	305	NT-643C	285			NTH-205	565
NT-5021N	171, 305	NT-644	285	NTG-6B/80	86, 94, 108, 120, 201, 212, 271, 296, 382	NTH-207	565
NT-5021W	171, 305	NT-646	285			NTH-207/75	565
NT-5022B	307	NT-648B	289	NTG-6CF	86, 94, 108, 120, 201, 212, 271, 296, 382	NTH-208	566
NT-5022BZ	307	NT-648W	289			NTH-209	566
NT-5022C	307	NT-650	289	NTG-6FC	86, 94, 108, 120, 201, 212, 271, 296, 382	NTH-210	567
NT-5022CO	307	NTA-101	118, 208, 283, 352			NTH-211	567
NT-5022G	307	NTA-101/2PL	127, 352	NTG-6HC	86, 94, 108, 120, 201, 212, 271, 296, 382	NTH-212	568
NT-5022N	307	NTA-101BZ	118, 208, 283, 352			NTH-212/75	568
NT-5022W	307	NTA-101CO	118, 208, 283, 352	NTG-8B/167	79, 101, 195, 265, 382	NTH-213	568
NT-5023B	307	NTA-101N	208, 283, 352	NTG-8B/80	79, 101, 195, 265, 382	NTH-214	569
NT-5023BZ	307	NTA-101NN	118	NTG-8CF	79, 101, 195, 265, 382	NTH-214/75	569
NT-5023C	307	NTA-102	118, 208, 283, 352	NTG-8FC	79, 101, 195, 265, 382	NTH-215	569
NT-5023CO	307	NTA-102/2PL	127, 352	NTG-8HC	79, 101, 195, 265, 382	NTH-215/75	569
NT-5023G	307	NTA-103B	119, 210, 290, 353	NTH-101	587	NTH-216	589
NT-5023N	307	NTA-103B/2PL	127, 353	NTH-101G24	552	NTH-220	573
NT-5023W	307	NTA-103BZ	119, 210, 290, 353	NTH-102	588	NTH-2200/50	600
NT-5024B	308	NTA-103CO	119, 210, 290, 353	NTH-102G24	552	NTH-2200/75	600
NT-5024BZ	308	NTA-103N	119, 210, 290, 353	NTH-103	584	NTH-2201	563
NT-5024C	308	NTA-103W	119, 210, 290, 353	NTH-104	584	NTH-2202	564
NT-5024CO	308	NTA-103W/2PL	127, 353	NTH-104G24	552	NTH-2203	564
NT-5024G	308	NTA-638BZ	212, 296	NTH-105	589	NTH-2205	565
NT-5024N	308	NTA-638C	212, 296	NTH-105G24	553	NTH-2207	565
NT-5024W	308	NTA-638N	212, 296	NTH-106	589	NTH-2208	566
NT-5025B	308	NTA-638W	212, 296	NTH-106G24	553	NTH-2209	566
NT-5025BZ	308, 309	NTA-730B	283	NTH-107	586	NTH-221	570
NT-5025C	308	NTA-730B/PL	118, 166	NTH-108	586	NTH-2210	567
NT-5025CO	308	NTA-730W	283	NTH-109	585	NTH-2211	567
NT-5025G	308	NTA-730W/PL	118, 166	NTH-110	583	NTH-2212	568
NT-5025N	308			NTH-111	583	NTH-2213	568

INDEX

NTL-2214	569	NTM-323CO	294	NTM-54BZ	209, 287	NTR-5LED42PP	52
NTL-2215	569	NTM-323G	294	NTM-54CO	209, 287	NTR-5LED42PW	52
NTL-222	570	NTM-323N	294	NTM-54N	209, 287	NTR-5LED42WW	52
NTL-2220	573	NTM-323W	294	NTM-54W	209, 287	NTR-6LED30BW	48
NTL-225	572	NTM-324B	295	NTM-5517/50	546	NTR-6LED30PP	48
NTL-2250	572	NTM-324BZ	295	NTM-5517/70	546	NTR-6LED30PW	48
NTL-226	571	NTM-324C	295	NTM-55B	209, 287	NTR-6LED30WW	48
NTL-250	572	NTM-324CO	295	NTM-55BZ	209, 287	NTR-6LED42BW	48
NTL-262	557	NTM-324G	295	NTM-55CO	209, 287	NTR-6LED42PP	48
NTL-263	557	NTM-324N	295	NTM-55N	209, 287	NTR-6LED42PW	48
NTL-264	557	NTM-324W	295	NTM-55T4/20	534	NTR-6LED42WW	48
NTL-27A11/75	572	NTM-33	282	NTM-55T4/39	534	NTS-22	210, 291
NTL-27M84/75	556	NTM-34	282	NTM-55T6/39	534	NTS-22/2PL	128, 354
NTL-27M85/50	556	NTM-38	286, 343	NTM-55T6/70	534	NTS-22B	210, 291
NTL-27M86/50	556	NTM-39	286, 343	NTM-55W	209, 287	NTS-22B/2PL	128, 354
NTL-301	557	NTM-40	140, 282	NTM-5617/100	546	NTS-22BZ	210, 291
NTL-302	558	NTM-40/2R	140, 283	NTM-5617/50	546	NTS-22C	210, 291
NTL-303	558	NTM-40/OV	140, 282	NTM-5617/70	546	NTS-22C/2PL	128, 354
NTL-304	558	NTM-40B	140, 282	NTM-56B	209, 288	NTS-22CO	210, 291
NTL-304DC	558	NTM-40C	140, 282	NTM-56BG	209, 288	NTS-22G	210, 291
NTL-305	558	NTM-40G	140, 282	NTM-56C	209, 288	NTS-22N	210, 291
NTL-306	559	NTM-40N	140, 282	NTM-56G	209, 288	NTS-23	211, 293
NTL-307	559	NTM-41	140, 282	NTM-56W	209, 288	NTS-23/2PL	128, 355
NTL-309	442, 593	NTM-41/2R	140, 283	NTM-5717/100	547	NTS-23B	211, 293
NTL-310	442, 593	NTM-41/OV	140, 282	NTM-5717/50	547	NTS-23BZ	211, 293
NTL-311	442, 593	NTM-41BZ	140, 282	NTM-5717/70	547	NTS-23C	211, 293
NTL-312	442, 593	NTM-41C	140, 282	NTM-57B	209, 288	NTS-23C/2PL	128, 355
NTL-313	559	NTM-41CO	140, 282	NTM-57C	209, 288	NTS-23CO	211, 293
NTL-314	559	NTM-41G	140, 282	NTM-57G	209, 288	NTS-23G	211, 293
NTL-315	560	NTM-41N	140, 282	NTM-57W	209, 288	NTS-23N	211, 293
NTL-316	560	NTM-42	120, 128, 141, 210, 291, 354	NTM-58DE/70	547	NTS-24	211, 294
NTL-317	560	NTM-42BZ	120, 128, 141, 210, 291, 354	NTM-59T6/39	547	NTS-24/2PL	129, 355
NTL-318	560	NTM-42CO	120, 128, 141, 210, 291, 354	NTM-59T6/70	547	NTS-24B	211, 294
NTL-319	561	NTM-42N	120, 128, 141, 210, 291, 354	NTM-6038/70	544	NTS-24BZ	211, 294
NTL-320	561	NTM-42W	120, 128, 141, 210, 291, 354	NTM-6138/70	544	NTS-24C	211, 294
NTL-321	561	NTM-43	121, 128, 142, 211, 293, 355	NTM-615/45B	136, 342	NTS-24CO	211, 294
NTL-322	561	NTM-43BZ	121, 128, 142, 211, 293, 355	NTM-615/45W	136, 342	NTS-24G	211, 294
NTL-323	563	NTM-43CO	121, 128, 142, 211, 293, 355	NTM-615B	136, 342	NTS-24N	211, 294
NTM-17T4/20	535	NTM-43N	121, 128, 142, 211, 293, 355	NTM-615W	136, 342	NTS-25	212, 291
NTM-17T4/39	535	NTM-43W	121, 128, 142, 211, 293, 355	NTM-6220/35	538	NTS-25B	212, 291
NTM-17T4/70	535	NTM-46BZ	122, 129, 142, 211, 294, 355	NTM-6230/35	539	NTS-25BZ	212, 291
NTM-17T6/39	535	NTM-46CO	122, 129, 142, 211, 294, 355	NTM-6230/70	539	NTS-25C	212, 291
NTM-17T6/70	535	NTM-46M	122, 129, 142, 211, 294, 355	NTM-6238/70	539	NTS-25CO	212, 291
NTM-27P20/20	538	NTM-46N	122, 129, 142, 211, 294, 355	NTM-628B	288	NTS-25G	212, 291
NTM-27P20/39	538	NTM-46W	122, 129, 142, 211, 294, 355	NTM-628W	288	NTS-25N	212, 291
NTM-27P30/39	538	NTM-48	287	NTM-6320/35	540	NTS-26	212, 291
NTM-27P30/70	538	NTM-48BB	287	NTM-6330/20	540	NTS-26B	212, 291
NTM-27P38/70	538	NTM-49	287	NTM-6330/35	540	NTS-26BZ	212, 291
NTM-27T4/20	533	NTM-49BZ	287	NTM-6330/70	540	NTS-26C	212, 291
NTM-27T4/39	533	NTM-49CO	287	NTM-6338/70	540	NTS-26CO	212, 291
NTM-27T4/70	533	NTM-49N	287	NTM-6420/35	540	NTS-26G	212, 291
NTM-27T6/39	533	NTM-5038/100	544	NTM-6430/35	541	NTS-26N	212, 291
NTM-27T6/70	533	NTM-5038/70	544	NTM-6430/70	541	NTS-30	127, 208, 284, 353
NTM-27U30/20	533	NTM-50C	287	NTM-6438/70	541	NTS-30A	127, 208, 284, 353
NTM-27X15/20	537	NTM-50G	287	NTM-6617/70	546	NTS-30C	127, 208, 284, 353
NTM-27X35/20	537	NTM-5138/100	544	NTM-6630/35	539	NTS-30G	127, 208, 284, 353
NTM-27X45/20	537	NTM-5138/70	544	NTM-6630/70	539	NTS-31	127, 208, 284, 353
NTM-29BC	283	NTM-513B	148, 170, 304	NTM-6638/70	539	NTS-31A	127, 208, 284, 353
NTM-29BG	283	NTM-513W	148, 170, 304	NTM-713B/PL	166	NTS-31AHZ	127, 208, 284, 353
NTM-29BW	283	NTM-513WM	148, 170, 304	NTM-713BAL	283	NTS-31C	127, 208, 284, 353
NTM-29WC	283	NTM-5220/35	543	NTM-713W/PL	118, 166	NTS-31HZ	127, 208, 284, 353
NTM-29WG	283	NTM-5230/35	543	NTM-713WAL	283	NTS-31N	127, 208, 284, 353
NTM-29WW	283	NTM-5230/70	543	NTM-726B	290	NTS-32	127, 208, 284, 353
NTM-30	282	NTM-5238/100	543	NTM-726BZ	290	NTS-32B	127, 208, 284, 353
NTM-30/2R	282	NTM-5238/70	543	NTM-726CO	290	NTS-32BZ	127, 208, 284, 353
NTM-30/OV	282	NTM-526B	307	NTM-726N	290	NTS-32CO	127, 208, 284, 353
NTM-300B	296	NTM-526BZ	307	NTM-726W	290	NTS-32COCO	127, 208, 284, 353
NTM-300BZ	296	NTM-526CO	307	NTM-77T4/20	534	NTS-32G	127, 208, 284, 353
NTM-300CO	296	NTM-526N	307	NTM-77T4/39	534	NTS-32N	127, 208, 284, 353
NTM-300N	296	NTM-526W	307	NTM-77T4/70	534	NTS-33	127, 208, 284, 353
NTM-300W	296	NTM-52B	209, 286, 343	NTM-77T6/39	534	NTS-35B	141, 290
NTM-30B	282	NTM-52BZ	209, 286, 343	NTM-77T6/70	534	NTS-35C	141, 290
NTM-30C	282	NTM-52C	209, 286, 343	NTP-30	284	NTS-35G	141, 290
NTM-30CO	282	NTM-52CO	209, 286, 343	NTP-31	284	NTS-35W	141, 290
NTM-30G	282	NTM-52G	209, 286, 343	NTP-40	140, 284	NTS-40	140, 284
NTM-30N	282	NTM-52N	209, 286, 343	NTP-41	140, 284	NTS-40G	140, 284
NTM-31	282	NTM-52W	209, 286, 343	NTP-614/45B	136, 342	NTS-41	140, 284
NTM-31/2R	282	NTM-5320/35	541	NTP-614/45W	342	NTS-41C	140, 284
NTM-31/OV	282	NTM-5330/35	541	NTP-614B	136, 342	NTS-41HZ	140, 284
NTM-31B	282	NTM-5330/70	541	NTP-614W	136, 342	NTS-42	140, 284
NTM-31BZ	282	NTM-5338/100	542	NTP-615/45W	136	NTS-4222B	154
NTM-31C	282	NTM-5338/70	542	NTR-100	601	NTS-4222BZ	154
NTM-31G	282	NTM-53B	209, 286, 343	NTR-4LED30BW	56	NTS-4222C	154
NTM-31N	282	NTM-53BZ	209, 286, 343	NTR-4LED30PP	56	NTS-4222CO	154
NTM-32	282	NTM-53C	209, 286, 343	NTR-4LED30PW	56	NTS-4222G	154
NTM-322B	292	NTM-53CO	209, 286, 343	NTR-4LED30WW	56	NTS-4222N	154
NTM-322BZ	292	NTM-53G	209, 286, 343	NTR-4LED42BW	56	NTS-4222W	154
NTM-322C	292	NTM-53N	209, 286, 343	NTR-4LED42PP	56	NTS-4223B	154
NTM-322CO	292	NTM-53W	209, 286, 343	NTR-4LED42PW	56	NTS-4223BZ	154
NTM-322G	292	NTM-5420/35	542	NTR-4LED42WW	56	NTS-4223C	154
NTM-322N	292	NTM-5430/35	542	NTR-5LED30BW	52	NTS-4223CO	154
NTM-322W	292	NTM-5430/70	542	NTR-5LED30PP	52	NTS-4223G	154
NTM-323B	294	NTM-5438/100	542	NTR-5LED30PW	52	NTS-4223N	154
NTM-323BZ	294	NTM-5438/70	542	NTR-5LED30WW	52	NTS-4223W	154
NTM-323C	294	NTM-54B	209, 287	NTR-5LED42BW	52	NTS-4224B	155

INDEX

NTS-4224BZ	155	NTS-5222G	149	NTS-615G	136, 342	NTS-6246N	123
NTS-4224C	155	NTS-5222N	149	NTS-615W	136, 342	NTS-6246W	123
NTS-4224CO	155	NTS-5222W	149	NTS-6222	120	NTS-6247B	123
NTS-4224G	155	NTS-5223B	149	NTS-6222B	120	NTS-6247BZ	123
NTS-4224N	155	NTS-5223BZ	149	NTS-6222BZ	120	NTS-6247C	123
NTS-4224W	155	NTS-5223C	149	NTS-6222C	120	NTS-6247CO	123
NTS-4225B	155	NTS-5223CO	149	NTS-6222CO	120	NTS-6247G	123
NTS-4225BZ	155	NTS-5223G	149	NTS-6222G	120	NTS-6247N	123
NTS-4225C	155	NTS-5223N	149	NTS-6222N	120	NTS-6247W	123
NTS-4225CO	155	NTS-5223W	149	NTS-6223	121	NTS-630B	92
NTS-4225G	155	NTS-5224B	149	NTS-6223B	121	NTS-630BLI	92
NTS-4225N	155	NTS-5224BZ	149	NTS-6223BZ	121	NTS-630BLISF	92
NTS-4225W	155	NTS-5224C	149	NTS-6223C	121	NTS-630BLIWF	92
NTS-4226B	155	NTS-5224CO	149	NTS-6223CO	121	NTS-630W	92
NTS-4226BZ	155	NTS-5224G	149	NTS-6223G	121	NTS-630WLI	92
NTS-4226C	155	NTS-5224N	149	NTS-6223N	121	NTS-630WLISF	92
NTS-4226CO	155	NTS-5224W	149	NTS-6224	122	NTS-630WLIWF	92
NTS-4226G	155	NTS-5225B	150	NTS-6224B	122	NTS-631B	92
NTS-4226N	155	NTS-5225BZ	150	NTS-6224BZ	122	NTS-631C	92
NTS-4226W	155	NTS-5225C	150	NTS-6224C	122	NTS-631CLIWF	92
NTS-4227B	155	NTS-5225CO	150	NTS-6224CO	122	NTS-631CWF	92
NTS-4227BZ	155	NTS-5225G	150	NTS-6224G	122	NTS-631G	92
NTS-4227C	155	NTS-5225N	150	NTS-6224N	122	NTS-631LI	92
NTS-4227CO	155	NTS-5225W	150	NTS-6225	123	NTS-631LISF	92
NTS-4227G	155	NTS-5226B	150	NTS-6225B	123	NTS-631LIWF	92
NTS-4227N	155	NTS-5226BZ	150	NTS-6225BZ	123	NTS-631W	92
NTS-4227W	155	NTS-5226C	150	NTS-6225C	123	NTS-632B	94
NTS-4230BB	154, 174	NTS-5226CO	150	NTS-6225CO	123	NTS-632W	94
NTS-4230BW	154, 174	NTS-5226G	150	NTS-6225G	123	NTS-633CL	94
NTS-4230BZBZ	154, 174	NTS-5226N	150	NTS-6225N	123	NTS-633FL	94
NTS-4230COCO	154, 174	NTS-5226W	150	NTS-6226	123	NTS-634B	93
NTS-4230NN	154, 174	NTS-5230BZ	148, 170	NTS-6226B	123	NTS-634W	93
NTS-4230WW	154, 174	NTS-5230CO	148, 170	NTS-6226BZ	123	NTS-635B	94
NTS-4231BW	154, 174	NTS-5230N	148, 170	NTS-6226C	123	NTS-635W	94
NTS-4231CW	154, 174	NTS-5230W	148, 170	NTS-6226CO	123	NTS-636C	93
NTS-4231GW	154, 174	NTS-5231B	148, 171	NTS-6226G	123	NTS-636G	93
NTS-4231HZW	154, 174	NTS-5231BZ	148, 171	NTS-6226N	123	NTS-637C	92
NTS-4231WW	154, 174	NTS-5231C	148, 171	NTS-6230BB	166	NTS-637CLIWF	92
NTS-4238BZ	156	NTS-5231CO	148, 171	NTS-6230BW	166	NTS-637CWF	92
NTS-4238C	156	NTS-5231G	148, 171	NTS-6230BZBZ	166	NTS-637G	92
NTS-4238N	156	NTS-5231HZ	148, 171	NTS-6230BZW	166	NTS-637LI	92
NTS-4238W	156	NTS-5231N	148, 171	NTS-6230CC	166	NTS-637LISF	92
NTS-4255CW	154	NTS-5231W	148, 171	NTS-6230COCO	166	NTS-637LIWF	92
NTS-42B	140, 284	NTS-5238BZ	151	NTS-6230COW	166	NTS-637W	92
NTS-42CO	140, 284	NTS-5238C	151	NTS-6230CW	166	NTS-638C	94
NTS-42G	140, 284	NTS-5238N	151	NTS-6230GG	166	NTS-639DC	93
NTS-43	140, 284	NTS-5238W	151	NTS-6230GW	166	NTS-639LIDC	93
NTS-49B	288	NTS-5242B	148	NTS-6230HZW	166	NTS-639LISC	93
NTS-49C	288	NTS-5242BZ	148	NTS-6230NN	166	NTS-639LISFDC	93
NTS-49G	288	NTS-5242C	148	NTS-6230NW	166	NTS-639LISFSC	93
NTS-49W	288	NTS-5242CO	148	NTS-6230WW	166	NTS-639LIWFDC	93
NTS-5022B	307	NTS-5242G	148	NTS-6231BB	119, 166	NTS-639LIWFSC	93
NTS-5022BZ	307	NTS-5242N	148	NTS-6231BW	119, 166	NTS-639SC	93
NTS-5022C	307	NTS-5242W	148	NTS-6231BZBZ	119, 166	NTS-650B	84
NTS-5022CO	307	NTS-5243B	149	NTS-6231BZW	166	NTS-650BLI	84
NTS-5022G	307	NTS-5243BZ	149	NTS-6231CC	119, 166	NTS-650BLISF	84
NTS-5022N	307	NTS-5243C	149	NTS-6231COCO	119, 166	NTS-650BLIWF	84
NTS-5022W	307	NTS-5243CO	149	NTS-6231COW	166	NTS-650W	84
NTS-5023B	307	NTS-5243G	149	NTS-6231CW	119, 166	NTS-650WLI	84
NTS-5023BZ	307	NTS-5243N	149	NTS-6231GG	119, 166	NTS-650WLISF	84
NTS-5023C	307	NTS-5243W	149	NTS-6231GW	119, 166	NTS-650WLIWF	84
NTS-5023CO	307	NTS-5244B	149	NTS-6231HZW	119, 166	NTS-651B	84
NTS-5023G	307	NTS-5244BZ	149	NTS-6231NN	119, 166	NTS-651C	84
NTS-5023N	307	NTS-5244C	149	NTS-6231NW	166	NTS-651CLIWF	84
NTS-5023W	307	NTS-5244CO	149	NTS-6231WW	119, 166	NTS-651CWF	84
NTS-5024B	308	NTS-5244G	149	NTS-6238BZ	120	NTS-651G	84
NTS-5024BZ	308	NTS-5244N	149	NTS-6238C	120	NTS-651LI	84
NTS-5024C	308	NTS-5244W	149	NTS-6238N	120	NTS-651LISF	84
NTS-5024CO	308	NTS-5245B	150	NTS-6238W	120	NTS-651LIWF	84
NTS-5024G	308	NTS-5245BZ	150	NTS-6242B	120	NTS-651W	84
NTS-5024N	308	NTS-5245C	150	NTS-6242BZ	120	NTS-652B	86
NTS-5024W	308	NTS-5245CO	150	NTS-6242C	120	NTS-652W	86
NTS-5025B	308	NTS-5245G	150	NTS-6242CO	120	NTS-653CL	86
NTS-5025BZ	308, 309	NTS-5245N	150	NTS-6242G	120	NTS-653FL	86
NTS-5025C	308	NTS-5245W	150	NTS-6242N	120	NTS-654B	85
NTS-5025CO	308	NTS-5246B	150	NTS-6242W	120	NTS-654W	85
NTS-5025G	308	NTS-5246BZ	150	NTS-6244B	122	NTS-655B	86
NTS-5025N	308	NTS-5246C	150	NTS-6244BZ	122	NTS-655W	86
NTS-5025W	308	NTS-5246CO	150	NTS-6244C	122	NTS-656C	85
NTS-5026B	309	NTS-5246G	150	NTS-6244CO	122	NTS-657C	84
NTS-5026C	309	NTS-5246N	150	NTS-6244G	122	NTS-657CLIWF	84
NTS-5026CO	309	NTS-5246W	150	NTS-6244N	122	NTS-657CWF	84
NTS-5026G	309	NTS-5247B	151	NTS-6244W	122	NTS-657LI	84
NTS-5026N	309	NTS-5247BZ	151	NTS-6245B	121, 123	NTS-657LISF	84
NTS-5026W	309	NTS-5247C	151	NTS-6245BZ	121, 123	NTS-657LIWF	84
NTS-5038BZ	309	NTS-5247CO	151	NTS-6245C	121, 123	NTS-658C	86
NTS-5038C	309	NTS-5247G	151	NTS-6245CO	121, 123	NTS-659DC	85
NTS-5038N	309	NTS-5247N	151	NTS-6245G	121, 123	NTS-659LIDC	85
NTS-5038W	309	NTS-5247W	151	NTS-6245N	121, 123	NTS-659LISC	85
NTS-5049C	306	NTS-615/45B	136, 342	NTS-6245W	121, 123	NTS-659LISFDC	85
NTS-5049G	306	NTS-615/45C	136, 342	NTS-6246B	123	NTS-659LISFSC	85
NTS-5222B	149	NTS-615/45G	136, 342	NTS-6246BZ	123	NTS-659LIWFDC	85
NTS-5222BZ	149	NTS-615/45W	136, 342	NTS-6246C	123	NTS-659LIWFSC	85
NTS-5222C	149	NTS-615B	136, 342	NTS-6246CO	123	NTS-659SC	85
NTS-5222CO	149	NTS-615C	136, 342	NTS-6246G	123	NTS-662C	86

INDEX

NTS-663C	86	NTS-932CB	99, 194, 264	NUTP3-16LEDRGB	625	NX-822-LED	714
NTS-67C	140	NTS-932CW	99, 194, 264	NUTP3-LEDRGB/12	625	Q18WBX/12	756
NTS-67G	140	NTS-932GB	99, 194, 264	NUTP3-LEDRGB/6	625	QC20MR16BAB	755
NTS-714B	118, 285	NTS-932GW	99, 194, 264	NWC-11	456	QC20MR16ESX	755
NTS-714C	118, 285	NTS-932WLISF	99	NWC-12	456	QC35MR16FMW	755
NTS-714G	118, 285	NTS-932WLJWF	99	NWC-14	456	QC35MR16FRA	755
NTS-714W	118, 285	NTS-933C	100, 194, 264	NWC-19	456	QC50MR16EFNV	755
NTS-730B	106, 200, 270	NTS-933G	100, 194, 264	NWC-46	456	QC50MR16EXN	755
NTS-730BLI	106	NTS-933W	100, 194, 264	NWE-12	456	QC50MR16EXT	755
NTS-730BLISF	106	NTS-934C	99, 194, 264	NWE-19	456	QC50MR16EXZ	755
NTS-730BLJWF	106	NTS-934CLIWF	99	NWE-46	456	QC71MR16EYC	755
NTS-730W	106, 200, 270	NTS-934G	99, 194, 264	NWF-12	456	QC71MR16EYF	755
NTS-730WLI	106	NTS-934LISF	99	NWF-19	456	Q10JC/12	756
NTS-730WLISF	106	NTS-934LJWF	99	NWF-46	456	Q10JC/12/G4	756
NTS-730WLJWF	106	NTS-935FG	100, 195, 265	NWG-201	457	Q10JC/12X	756
NTS-731B	106, 200, 270	NTS-935G	100, 195, 265	NWO-11	457	Q10WBX/12	756
NTS-731C	106, 200, 270	NTS-935L	265	NWO-12	457	Q10WBX/24	756
NTS-731CLIWF	106	NTS-936CL	100, 195, 265	NWO-14	457	Q10WBXF/12	756
NTS-731CWF	106, 200, 270	NTS-936FL	100, 195, 265	NWO-19	457	Q10WBXF/24	756
NTS-731G	106, 200, 270	NTS-938C	101, 195, 265	NWO-46	457	Q120JC/12	756
NTS-731LI	106	NTS-939DC	100, 195, 264	NWS-12	457	Q120JC/12X	756
NTS-731LISF	106	NTS-939LISFDC	100	NWS-19	457	Q135JC/12	756
NTS-731LJWF	106	NTS-939LISFSC	100	NWS-46	457	QC35MR16FMV	755
NTS-731W	106, 200, 270	NTS-939LJWFDC	100	NWT-11	457	Q3WBX/12	756
NTS-732B	108, 201, 271	NTS-939LJWFSC	100	NWT-12	457	Q3WBX/24	756
NTS-732W	108, 201, 271	NTS-939SC	100, 194, 264	NWT-14	457	Q3WBXF/12	756
NTS-733CL	108, 201, 271	NU-12L	634	NWT-19	457	Q3WBXF/24	756
NTS-733FL	108, 201, 271	NU-12LBZ	634	NWT-46	457	Q50JC/12	756
NTS-734B	107, 200, 270	NU-12LN	634	NX-503-LED/BG	721	Q5MR16/6	740, 755
NTS-734W	107, 200, 270	NU-1312EL	635	NX-503-LED/BR	721	Q5WBX/12	756
NTS-735B	108, 201, 271	NU-1518EL	635	NX-503-LED/G	721	Q5WBX/24	756
NTS-735W	108, 201, 271	NU-2024EL	635	NX-503-LED/GS	721	Q5WBXF/12	756
NTS-736C	107, 200, 270	NU-21L	634	NX-503-LED/R	721	Q5WBXF/24	756
NTS-736G	107, 200, 270	NU-21LBZ	634	NX-503-LED/RS	721	QR40WXENF/DCB	753
NTS-737C	106, 200, 270	NU-21LN	634	NX-504-LED/BG	721	QR60WXEBF/DCB	753
NTS-737CLIWF	106	NU-24L	634	NX-504-LED/BR	721	QU20MR11FTC/24	661, 755
NTS-737CWF	106, 200, 270	NU-24LBZ	634	NX-504-LED/G	721	QU20MR11FTD	661, 755
NTS-737G	106, 200, 270	NU-24LN	634	NX-504-LED/GS	721	QU20MR16BAB	755
NTS-737LI	106	NU-3036EL	635	NX-504-LED/R	721	QU20MR16ESX	755
NTS-737LISF	106	NU-32L	634	NX-504-LED/RS	721	QU35MR11FTE	661, 755
NTS-737LJWF	106	NU-32LBZ	634	NX-505-LED/G	720	QU35MR11FTH	661, 755
NTS-738C	108, 201, 271	NU-32LN	634	NX-505-LED/G/2F	720	QU35MR11FTHL	661, 755
NTS-739DC	107, 200, 270	NU-4048EL	635	NX-505-LED/GW	720	QU35MR16FMW	755
NTS-739LIDC	107	NU-42L	634	NX-505-LED/GW/2F	720	QU35MR16FMW/CS	755
NTS-739LISC	107	NU-42LBZ	634	NX-505-LED/R	720	QU35MR16FRB	755
NTS-739LISFDC	107	NU-42LN	634	NX-505-LED/R/2F	720	QU50AR111FL	755
NTS-739LISFSC	107	NUL-12	634	NX-505-LED/RW	720	QU50AR111SP	755
NTS-739LJWFDC	107	NUL-1312	635	NX-505-LED/RW/2F	720	QU50MR16EXN	755
NTS-739LJWFSC	107	NUL-1518	635	NX-506-LED	715	QU50MR16EXN/C	755
NTS-739SC	107, 200, 270	NUL-2024	635	NX-508-LED	715	QU50MR16EXN/CS	601, 755
NTS-743W	108, 201, 271	NUL-21	634	NX-509-LED	717	QU50MR16EXT	755
NTS-871B	77	NUL-24	634	NX-510-LED	717	QU50MR16EXT/C	755
NTS-871C	77	NUL-3036	635	NX-511-LED	718	QU50MR16EXZ	755
NTS-871CLIWF	77	NUL-315G	636	NX-525-LED/G	720	QU50MR16EXZ/CS	755
NTS-871G	77	NUL-315N	636	NX-525-LED/G/2F	720	QU65MR16FPA	755
NTS-871LISF	77	NUL-315W	636	NX-525-LED/GW	720	QU65MR16FPC	755
NTS-871LJWF	77	NUL-32	634	NX-525-LED/R	720	QU75MR16EYC	755
NTS-871W	77	NUL-321G	636	NX-525-LED/RW	720	QU75MR16EYF	755
NTS-872BC	77	NUL-321N	636	NX-550-LEDU/R	724	T20JC/120	753
NTS-872BG	77	NUL-321W	636	NX-550-LEDU/RB	724	T25JC/120	753
NTS-872BLISF	77	NUL-4048	635	NX-603-LED/BG	721	T35JC/120	753
NTS-872BLJWF	77	NUL-415G	637	NX-603-LED/BR	721	T50JC/120	753
NTS-872WC	77	NUL-415N	637	NX-603-LED/G	721		
NTS-872WG	77	NUL-415W	637	NX-603-LED/GS	721		
NTS-872WLISF	77	NUL-42	634	NX-603-LED/R	721		
NTS-872WLJWF	77	NUL-421G	637	NX-603-LED/RS	721		
NTS-873C	78	NUL-421N	637	NX-604-LED	715		
NTS-873G	78	NUL-421W	637	NX-605-LED/G	720		
NTS-874C	77	NULB-12LED30	613	NX-605-LED/G/2F	720		
NTS-874CLIWF	77	NULB-12LED42	613	NX-605-LED/GW	720		
NTS-874G	77	NULB-24LED30	613	NX-605-LED/GW/2F	720		
NTS-874LISF	77	NULB-24LED42	613	NX-605-LED/R	720		
NTS-874LJWF	77	NULB-36LED30	613	NX-605-LED/R/2F	720		
NTS-875FG	78	NULB-36LED42	613	NX-605-LED/RW	720		
NTS-875G	78	NULB-48LED30	613	NX-605-LED/RW/2F	720		
NTS-875L	78	NULB-48LED42	613	NX-606-TRI/G10	723		
NTS-876CL	78	NULB-6LED30	613	NX-606-TRI/G15	723		
NTS-876FL	78	NULB-6LED42	613	NX-606-TRI/G20	723		
NTS-877CBG	78	NULS-13	632	NX-606-TRI/R10	723		
NTS-878C	79	NULS-18	632	NX-606-TRI/R15	723		
NTS-879DC	78	NULS-21	632	NX-606-TRI/R20	723		
NTS-879LISFDC	78	NULS-24	632	NX-607-LED/G	722		
NTS-879LISFSC	78	NULS-28	632	NX-607-LED/R	722		
NTS-879LJWFDC	78	NULS-8	632	NX-608-LED	717		
NTS-879LJWFSC	78	NUO-01	634, 635	NX-609-LED	718		
NTS-879SC	78	NUR-01	634, 635	NX-615-LED/G	719		
NTS-931B	99, 194, 264	NUSP-JBox	615, 621, 626, 630, 632, 640, 707	NX-615-LED/G/2F	719		
NTS-931C	99, 194, 264			NX-615-LED/R	719		
NTS-931CLIWF	99	NUTP1-16LED	620	NX-615-LED/R/2F	719		
NTS-931G	99, 194, 264	NUTP1-16LED30PS	620	NX-810-LED	714		
NTS-931LISF	99	NUTP1-LED/12	620	NX-811-LED	714		
NTS-931LJWF	99	NUTP1-LED/4	620	NX-812-LED	714		
NTS-931W	99, 194, 264	NUTP2-16LED	629	NX-813-LED	716		
NTS-932BLISF	99	NUTP2-LED/12	629	NX-814-LED	716		
NTS-932BLJWF	99	NUTP2-LED/4	629	NX-815-LED	716		

Nora Product Selection Guide

Product Family Color Codes

LED TRACK LED Track Fixtures

Pillar LED Track Fixtures

NTE 420, Series* - 100 Watt

Features: Up to 100 lumens per watt (lm/W)
 Color: 100% CRI
 Beam Spread: 20° (Narrow), 30° (Medium), 40° (Wide)
 Beam Spread: 12° (Narrow), 18° (Medium), 24° (Wide)
 Finish: Black, Silver, White
 Size: 100mm (4")
 Dimensions: 100mm (4") x 100mm (4")
 Availability: Free on-hand inventory

Over 75% energy savings when compared to incandescent!
 Integral LED Driver performs at the level of a 30W MR16

How to specify Pillar LED Track Fixtures

NTE-420	L	42	F	18	B	W
W420	100mm	42	18°	18	Black	W420
W420	100mm	42	30°	18	Black	W420
W420	100mm	42	40°	18	Black	W420

Mini Cylinder LED Track Fixtures

NTE 420, Series* - 50 Watt

Features: Up to 50 lumens per watt (lm/W)
 Color: 100% CRI
 Beam Spread: 20° (Narrow), 30° (Medium), 40° (Wide)
 Beam Spread: 12° (Narrow), 18° (Medium), 24° (Wide)
 Finish: Black, Silver, White
 Size: 50mm (2")
 Dimensions: 50mm (2") x 50mm (2")
 Availability: Free on-hand inventory

Over 75% energy savings when compared to incandescent!
 Integral LED Driver performs at the level of a 30W MR16

How to specify Mini Cylinder LED Track Fixtures

NTE-420	L	42	W	S	W
W420	50mm	42	18°	18	Black
W420	50mm	42	30°	18	Black
W420	50mm	42	40°	18	Black

TRAK | 531

Light Source Identification



LED



FLUORESCENT



HID
CERAMIC METAL HALIDE



LOW VOLTAGE



INCANDESCENT



RECESSED
LED, HID-CMH, CFL, Low Voltage, Incandescent, Step Light, Retrofit



MLS Multiple Lighting Systems
HID-CMH, Low Voltage, Incandescent



PENDANTS AND SCNCES
LED, Low Voltage, CFL, Incandescent



NORA RAIL - Line Voltage
LED, Low Voltage, HID-CMH, CFL, Incandescent



TRACK
LED, HID-CMH, CFL, Low Voltage, Incandescent



SPECIALTY LINEAR AND ACCENT
LED, CFL, Low Voltage, Incandescent



MINI TRACK - Low Voltage
LED, Xenon, Incandescent



MINI RAIL - Low Voltage
LED, Halogen Incandescent



TRANSFORMERS AND DRIVERS
Class II, Electronic, Magnetic



EXIT AND EMERGENCY
LED, Tritium, Incandescent



LAMPS
CFL, HID-CMH, Line Voltage, Low Voltage, LED



NORA LIGHTING, INC.
6505 Gayhart St.
Commerce, CA 90040
Tel: (800) 686-6672
Fax: (800) 500-9955
Email: nora@NoraLighting.com
NoraLighting.com

DOMESTIC FACILITIES:

Boston, MA
Charlotte, NC
Cincinnati, OH
Cleveland, OH
Dallas, TX
Hanover Park, IL
Los Angeles, CA
Louisville, KY
Nashville, TN
New York, NY
Philadelphia, PA
Syracuse, NY
Tampa, FL

INTERNATIONAL SALES:

6505 Gayhart St.
Commerce, CA 90040
Tel: (323) 767-2600
Fax: (323) 722-3677

The products shown in this catalog are covered by USA and International patents.
Specifications subject to change without notice.

© Copyright 2011 Nora Lighting, Inc. All rights reserved.

member

