



WPLED5
with junction box for conduit entry



WPLED10
with junction box for conduit entry



WPLED20
with surface mount
for recessed boxes



WPLED26
with junction box for conduit entry

SPECIFICATIONS

UL Listing:

Suitable for wet locations. Suitable for mounting within 4' of the ground. WPLED20 and WPLED26 Uplight UL listed for wet locations.

Finish:

White or bronze chip and fade resistant polyester powder coat finish

LED:

Multi-chip 5, 10 and 13 Watt high-output, long-life LEDs

Drivers:

5W Driver: Constant Current, Class 2, 100V-240V, 50/60 Hz, 1kv Surge Protection 350mA, 0.18 Amps., Power Factor: 43.7%

10W Driver: Constant Current, Class 2, 100V-240V, 50/60 Hz, 1kv Surge Protection 350mA, 0.3 Amps., Power Factor: 57.1%

13W Driver: Constant Current, Class 2, 100V-277V, 50/60 Hz, 4kv Surge Protection 720mA, 100-240VAC: 0.3-0.15 Amps 277VAC: 0.15 Amps., THD ≤ 20% Power Factor: 97.5%

20W Driver: Constant Current, Class 2, 100V-277V, 50/60 Hz, 4kv Surge Protection, 1000mA, 100-240VAC: 0.5 Amps 277VAC: 0.125 Amps., THD ≤ 10% Power Factor: 98.4%

26W Driver: Constant Current, Class 2, 100V-277V, 50/60 Hz, 6kv Surge Protection, 720mA, 100-277VAC: 0.4 Amps., THD ≤ 20%, Power Factor: 99.2%

California Title 24:

LPACK complies with California Title 24

Thermal Management:

Die-cast aluminum thermal management system for optimal heat dissipation



Cold Weather Starting:

Minimum starting temperature is -40°C (-40°F).

Green Technology:

Mercury and UV free, and are RoHS compliant.

Lumen Maintenance:

100,000-hour LED lifespan based on IES LM-80 results and TM-21 calculations*.

Housing:

Precision die-cast aluminum housing

IESNA LM-79 & LM-80 Testing:

RAB LED luminaires have been tested by an independent laboratory in accordance with IESNA LM-79 and LM-80, and have received the Department of Energy "Lighting Facts" label.

Color Uniformity:

RAB's range of CCT (Correlated Color Temperature) follows ANSI Specifications for the Chromaticity of Solid State Lighting (SSL) Products, ANSI C78.377-2011.

Color Stability:

RAB LED performance exceeds industry standards for chromatic stability.

Ambient Temperature:

WPLED5, WPLED10 and WPLED26: Suitable for use in 40°C (104°F) ambient temperatures. WPLED13 and WPLED20: Suitable for use in 50°C (122°F) ambient temperatures.

Brackets:

GOOSE1; GOOSE2; GOOSE3; GOOSE4; GOOSE5; ARM24; SWIVEL30; ARMSV24: See page 43 for bracket details.

Patents:

RAB LED Wallpacks are protected by U.S. patents and patents pending in U.S., Canada, China, Taiwan and Mexico.

*See TM-21 explanation on page 18.

Switch to LED Wallpacks For 80% Energy Savings.

PERFORMANCE COMPARISON

	 WPLED5	 WPLED10	 WPLED13	 WPLED20	 WPLED26
LED Watts / Input Watts	5W / 5.3W	10W / 13.2W	13W / 14.9W	20W / 21.7W	26W / 30W
Lumen Output	196	547	1064	1401	1816
Lumens Per Watt	37	41	71	65	61
Wallpack Equivalency	13W CFL / 60W Incan.	70W MH	100W MH	150W MH	175W MH
HID Replacement Range	13W CFL / 60W Incan.	35-100W	70-150W	100-175W	150-200W
Surge Protection	1000 Volts	1000 Volts	4000 Volts	4000 Volts	6000 Volts
Voltage	100-240	100-240	100-277	100-277	100-277
Max. Mounting Height	10 ft.	12 ft.	20 ft.	25 ft.	25 ft.
Mounting	Junction Box or Surface Plate	Junction Box or Surface Plate	Junction Box or Surface Plate	Junction Box or Surface Plate	Junction Box or Surface Plate

WPLED5 supplied with optional frosted lens.

CATALOG NUMBERS

Catalog # Bronze	Catalog # White	LED Watts	Color Temp	Mounting Height Range
WPLED5	WPLED5W	5	Cool (5000K)	5-10'
WPLED5Y	WPLED5YW	5	Warm (3000K)	5-10'
WPLED5N	WPLED5NW	5	Neutral (4000K)	5-10'
Surface Plate*				
WPLED10S	WPLED10SW	10	Cool (5000K)	8-12'
WPLED10SY	WPLED10SYW	10	Warm (3000K)	8-12'
Junction Box*				
WPLED10	WPLED10W	10	Cool (5000K)	8-12'
WPLED10Y	WPLED10YW	10	Warm (3000K)	8-12'
WPLED13	WPLED13W	13	Cool (5000K)	8-20'
WPLED13Y	WPLED13YW	13	Warm (3000K)	8-20'
WPLED13N	WPLED13NW	13	Neutral (4000K)	8-20'
WPLED20	WPLED20W	20	Cool (5000K)	10-20'
WPLED20Y	WPLED20YW	20	Warm (3000K)	10-20'
WPLED20N	WPLED20NW	20	Neutral (4000K)	10-20'
WPLED26	WPLED26W	26	Cool (5000K)	10-25'
WPLED26N	WPLED26NW	26	Neutral (4000K)	10-25'

*WPLED13, 20, 26 models include 2 Mounting options: Surface Plate for recessed Junction box and Junction Box. For Photocell option for WPLED20, 26 - add "PC" after color suffix. (Example: WPLED20/PC, WPLED26/PC).

ACCESSORIES

Catalog

WPLED26/E 120V-277V Standard Emergency Battery Backup

WPLED26/EC 120V-277V Cold Weather Emergency Battery Backup

BUY WITH CONFIDENCE



Fully Shielded Full Cutoff Optics



For use on LEED buildings to attain Light Pollution Reduction Credit



SUITABLE FOR WET LOCATIONS





WPLED2T78
with junction box for conduit entry



WPLED2T78FX
Flat wall mount with no arm



WPLED52FC
Full Cutoff (0°) with junction box for conduit entry

SPECIFICATIONS

UL Listing:
Suitable for wet locations.

Finish:
White or bronze chip and fade resistant polyester powder coat finish

LED:
WPLED52: Four multi-chip 13 Watt high-output long life LEDs

WPLED78: Six multi-chip 13 Watt high-output long life LEDs

Drivers:
WPLED52: Two drivers, Constant Current, Class 2, 100V-277V, 50/60 Hz, 6kv Surge Protection, 720mA, 100-277VAC: 0.4 Amps., THD ≤ 20%, Power Factor: 99.2%

WPLED78: Three drivers, Constant Current, Class 2, 100V-277V, 50/60 Hz, 6kv Surge Protection, 720mA, 100-277VAC: 0.4 Amps., THD ≤ 20%, Power Factor: 99.2%

Surge Protection: 6KV

California Title 24:
LPAK52 and LPAK78 complies with California Title 24

Thermal Management:
Superior heat sinking with external Air-Flow fins

Cold Weather Starting:
Minimum starting temperature is -40°C (-40°F).

Green Technology:
Mercury and UV free, and are RoHS compliant.

Lumen Maintenance:
100,000-hour LED lifespan based on IES LM-80 results and TM-21 calculations*.

Housing:
Die-cast aluminum housing, door frame, arm and wall bracket

Reflector:
Hydroformed aluminum designed for maximum efficiency

Gaskets:
High-temperature silicone

Mounting:
Die-cast aluminum wall bracket with (5) 1/2" conduit openings with plugs. Two-piece bracket with tether for ease of installation and wiring.

Arm:
Die-cast aluminum with wiring access plate

IESNA LM-79 & LM-80 Testing:
RAB LED luminaires have been tested by an independent laboratory in accordance with IESNA LM-79 and LM-80, and have received the Department of Energy "Lighting Facts" label.

Dark Sky Approved:
The International Dark Sky Association has approved the Full Cutoff (0°) and Cutoff (7.5°) versions of these products as a full cutoff, fully shielded luminaire.

Color Uniformity:
RAB's range of CCT (Correlated Color Temperature) follows ANSI for Specifications for the Chromaticity of Solid State Lighting (SSL) Products, ANSI C78.377-2011.

Color Stability:
RAB LED performance exceeds industry standards for chromatic stability.

Ambient Temperature:
WPLED52 and WPLED78: Suitable for use in 40°C (104°F) ambient temperatures.

Color Temperature (Nominal CCT):
WPLED52: Cool: 5000K; Neutral: 4000K
WPLED78: Cool: 5100K; Neutral: 4000K

Cutoff Options:
Full Cutoff (0°) - WPLED52 and WPLED78
Cutoff (7.5°) - WPLED52 family
Standard (15°) - WPLED52 family

Patents:
The WPLED52 and WPLED78 are protected by patents pending in the U.S., Canada, China, Taiwan and Mexico.

*See TM-21 explanation on page 18.

Say Goodbye to 250 & 400W HID Wallpacks

FEATURES

WPLED78
Type IV distribution (also known as a "Forward Throw") is especially suited for mounting on the sides of buildings and walls, and for illuminating the perimeter of parking areas.



WPLED52
Vertical Fins for Maximum Heat Dissipation



CATALOG NUMBERS

Catalog # Bronze	Catalog # White	Cutoff	LED Watts	Input Watts	Color Temp	Color Accuracy	Lumen Output	Lumens per Watt	Mounting Height Range	Voltage
WPLED52	WPLED52W	Standard (15°)	52	61	Cool (5000K)	67CRI	3884	64	20-35'	100-277V
WPLEDC52	WPLEDC52W	Cutoff (7.5°)	52	61	Cool (5000K)	67CRI	3888	64	20-35'	100-277V
WPLEDFC52	WPLEDFC52W	Full Cutoff (0°)	52	61	Cool (5000K)	67CRI	3890	64	20-35'	100-277V
WPLED52N	WPLED52NW	Standard (15°)	52	60	Neutral (4000K)	86CRI	2294	38	20-35'	100-277V
WPLEDC52N	WPLEDC52NW	Cutoff (7.5°)	52	60	Neutral (4000K)	86CRI	2297	38	20-35'	100-277V
WPLEDFC52N	WPLEDFC52NW	Full Cutoff (0°)	52	60	Neutral (4000K)	86CRI	2298	38	20-35'	100-277V
WPLED2T78	WPLED2T78W	Full Cutoff (0°)	78	90	Cool (5100K)	68CRI	5263	58	20-35'	100-277V
WPLED2T78N	WPLED2T78NW	Full Cutoff (0°)	78	91	Neutral (4000K)	87CRI	4284	47	20-35'	100-277V
WPLED3T78	WPLED3T78W	Full Cutoff (0°)	78	91	Cool (5100K)	68CRI	4959	55	20-35'	100-277V
WPLED3T78N	WPLED3T78NW	Full Cutoff (0°)	78	91	Neutral (4000K)	88CRI	3695	41	20-35'	100-277V
WPLED4T78	WPLED4T78W	Full Cutoff (0°)	78	91	Cool (5100K)	68CRI	5456	60	20-35'	100-277V
WPLED4T78N	WPLED4T78NW	Full Cutoff (0°)	78	91	Neutral (4000K)	88CRI	4287	47	20-35'	100-277V

For Swivel Photocell option for WPLED52 - add "/PCS" after color suffix (Example: WPLED52/PCS).

For Photocell option for WPLED78 - add "/PC" after color suffix (Example: WPLED4T78/PC).

For Swivel Photocell option for WPLED78 - add "/PCS" after color suffix (Example: WPLED4T78/PCS).

For Flat Wall Mount option for WPLED78 - add "FX" after color suffix (Example: WPLED2T78FX).

BUY WITH CONFIDENCE



Fully Shielded Full Cutoff Optics



For use on LEED buildings to attain Light Pollution Reduction Credit



SUITABLE FOR WET LOCATIONS



SPECIFICATIONS

UL Listing:

Suitable for wet locations.

Finish:

Bronze chip and fade resistant polyester powder coat finish

LED:

Multi-chip 10 and 13W high-output, long-life LED

Drivers:

10W Driver: Constant Current, Class 2, 100V-240V, 50/60 Hz, 1kv Surge Protection, 350mA, 0.3 Amps., Power Factor: 57.1%

13W Driver: Constant Current, Class 2, 100V-277V, 50/60 Hz, 4kv Surge Protection, 720mA, 100-240VAC: 0.3-0.15 Amps 277VAC: 0.15 Amps., THD ≤ 20% Power Factor: 97.5%

20W Driver: Constant Current, Class 2, 100V-277V, 50/60 Hz, 4kv Surge Protection, 1000mA, 100-240VAC: 0.5 Amps 277VAC: 0.125 Amps., THD ≤ 10% Power Factor: 98.4%

26W Driver: Constant Current, Class 2, 100V-277V, 50/60 Hz, 6kv Surge Protection, 720mA, 100-277VAC: .4 Amps., THD ≤ 20%, Power Factor: 99.2%

ALED52: Two 26W drivers. See 26W Driver for details.

ALED78: Three 26W drivers. See 26W Driver for details.

California Title 24:

ALED complies with California Title 24 building and electrical codes

Thermal Management:

Die-cast aluminum thermal management system for optimal heat dissipation

Cold Weather Starting:

Minimum starting temperature is -40°C (-40°F).

Green Technology:

Mercury and UV free, and are RoHS compliant.

Lumen Maintenance:

100,000-hour LED lifespan based on IES LM-80 results and TM-21 calculations*.

Gaskets:

High-temperature silicone

Housing:

Precision die-cast aluminum housing, lens frame and mounting plate

IESNA LM-79 & LM-80 Testing:

RAB LED luminaires have been tested by an independent laboratory in accordance with IESNA LM-79 and LM-80, and have received the Department of Energy "Lighting Facts" label.

Dark Sky Approved:

The International Dark Sky Association has approved all ALED products as full cutoff, fully shielded luminaires except for the ALED52 Standard (15°).

Color Uniformity:

RAB's range of CCT (Correlated Color Temperature) follows ANSI Specifications for the Chromaticity of Solid State Lighting (SSL) Products, ANSI C78.377-2011.

Color Stability:

RAB LED performance exceeds industry standards for chromatic stability.

Ambient Temperature:

ALED10, 26, 52 and 78: Suitable for use in 40°C (104°F) ambient temperatures.
ALED13 and ALED20: Suitable for use in 50°C (122°F) ambient temperatures.

Patents:

The ALED is protected by U.S. patent and patents pending in U.S., Canada, China, Taiwan and Mexico.

ALED Accessories:

Round Pole Adapter:

ALED 10, 13, 20 and 26W
Catalog#: RPA3L; RPA3.5L; RPA4L; RPA5L; RPA6L
ALED 52 and 78W
Catalog#: RPA3; RPA3.5; RPA4; RPA5 and RPA6

Pole Size for each Adapter:

RPA3; RPA3L = 3" Diameter Round Pole
RPA3.5; RPA3.5L = 3.5" Diameter Round Pole
RPA4; RPA4L = 4" Diameter Round Pole
RPA5; RPA5L = 5" Diameter Round Pole
RPA6; RPA6L = 6" Diameter Round Pole

Poles and Anchor Bolts:

Poles and Anchor Bolts sold separately. Visit rabweb.com for details.

*See TM-21 explanation on page 18.

Affordable, Energy-Saving, LED Area Lights

PERFORMANCE COMPARISON

	ALED10	ALED13	ALED20	ALED26	ALED52	ALED78
LED Watts / Input Watts	10W / 13.2W	13W / 14.9W	20W / 21.7W	26W / 30W	52W / 61W	78W / 91W
Delivered Lumens	547	1064	1401	1816	3884	4959*
Equivalent MH Area Light	35 Watts	50 Watts	50 Watts	70 Watts	150 Watts	250 Watts
Replacement Range	30-50W	35-70W	35-70W	42-100W	175-275W	200-400W
Weight	3.2 LB	3.3 LB	5.1 LB	6.5 LB	16.45 LB	32 LB
EPA	0.2	0.2	0.25	0.27	1.5	0.75

*Refers to lumen output of the ALED3T78. **Pole Configuration:** For Pole Configurations, go to rabweb.com.

SPECIFICATION-GRADE OPTICS

Type II: The Type II distribution is ideal for wide walkways, on ramps and entrance roadways, bike paths and other long and narrow lighting applications. Meant for lighting larger areas and usually located near the roadside, this type of lighting is commonly found on smaller side streets or jogging paths.

Type III: The Type III distribution is ideal for roadway, general parking, and other area lighting applications where a larger pool of lighting is required. It is intended to be located near the side of the area, allowing the light to project outward and fill the area.

Type IV: The Type IV distribution (also known as a "Forward Throw") is especially suited for mounting on the sides of buildings and walls, and for illuminating the perimeter of parking areas. It produces a semicircular distribution with essentially the same candlepower at lateral angles from 90° to 270°.

For assistance in choosing the distribution to match your application, please contact RAB Application Engineering by emailing applications@rabweb.com or calling 888 722-1000.

CATALOG NUMBERS

Catalog Number	LED Watts	Input Watts	Color Temp	IES Classification	BUG Rating	Color Accuracy	Lumen Output	Lumens per Watt	Mounting Height	Voltage
ALED10	10	13.2	Cool (5000K)	III	0 0 0	92CRI	547	41	10-15'	100-240V
ALED13	13	14.9	Cool (5000K)	III	1 0 0	66CRI	1064	71	10-20'	100-277V
ALED20	20	21.7	Cool (5000K)	III	1 0 0	70CRI	1401	65	10-25'	100-277V
ALED26	26	30.0	Cool (5000K)	IV	0 1 0	66CRI	1816	61	15-25'	100-277V
ALED52	52	61.0	Cool (5000K)	IV	0 1 1	67CRI	3884	64	20-35'	100-277V
ALEDC52	52	61.0	Cool (5000K)	III	0 1 1	67CRI	3888	64	20-35'	100-277V
ALED52C52	52	61.0	Cool (5000K)	III	0 1 1	67CRI	3890	64	20-35'	100-277V
ALED2T78	78	90.0	Cool (5100K)	II	1 0 1	68CRI	5263	58	20-35'	100-277V
ALED3T78	78	91.0	Cool (5100K)	III	1 0 1	68CRI	4959	55	20-35'	100-277V
ALED4T78	78	91.0	Cool (5100K)	IV	1 0 2	68CRI	5456	60	20-35'	100-277V

Values shown for cool temperature. Please visit rabweb.com for details on neutral and warm.

For Neutral White Light (4000K) - add "N" to Catalog Number (Example: ALED26N) for all wattages except ALED10. For Warm Light (3000K) - add "Y" to Catalog Number (Example: ALED26Y).

BUY WITH CONFIDENCE



Fully Shielded Full Cutoff Optics



For use on LEED buildings to attain Light Pollution Reduction Credit



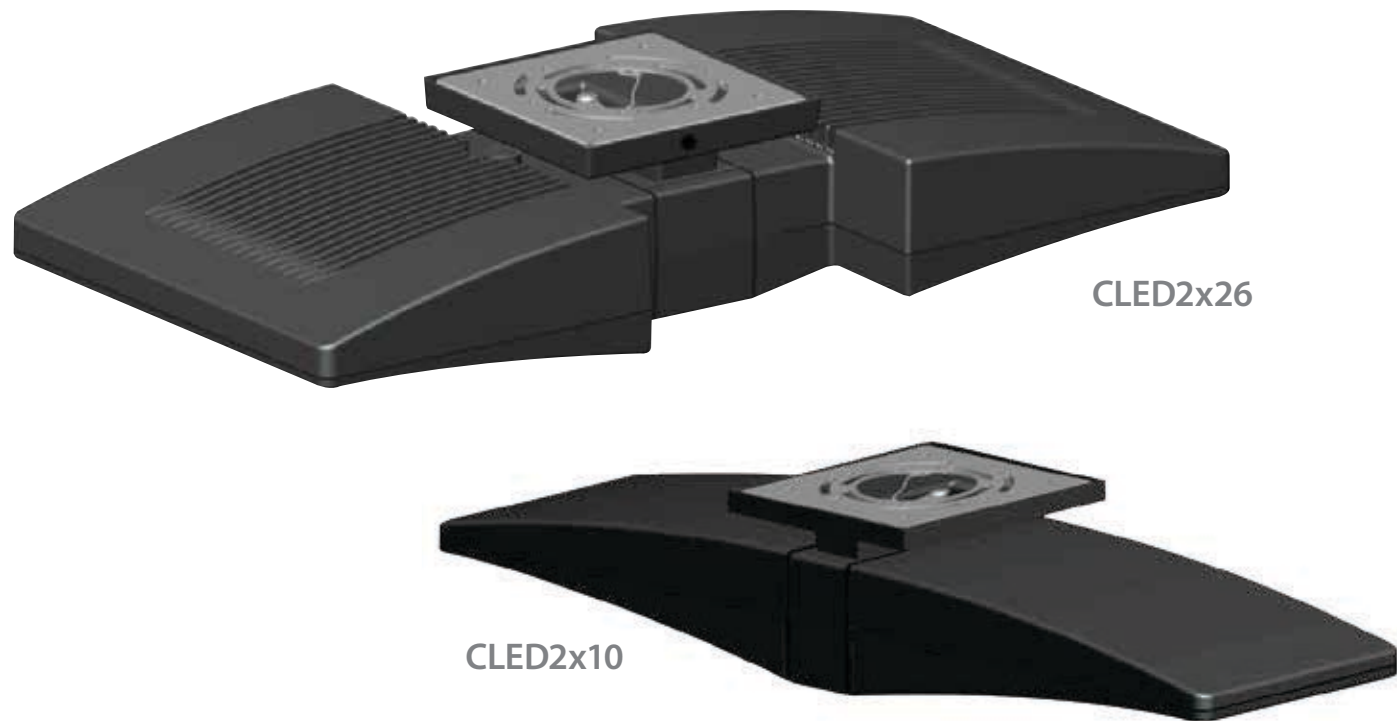

Replaces Inefficient Ceiling Fixtures and Reduces Operating and Maintenance Costs

PERFORMANCE COMPARISON

	CLED2x10	CLED2x13	CLED2x20	CLED2x26
LED Watts / Input Watts	20W / 25.7W	26W / 30.3W	40W / 43W	52W / 59.1W
Delivered Lumens	1045	2006	2746	3652
Equivalency	32W CFL	70W MH	100W MH	175W MH
Replacement Range	32-42W CFL up to 70W MH	70-100W MH	100-150W MH	100-250W MH
Mounting Height	8-15'	8-15'	8-15'	15-25'

SPECIFICATIONS

UL Listing:
UL listed for damp locations.

Finish:
White or bronze chip and fade resistant polyester powder coat finish

LED:
Multi-chip 10 and 13W high-output long-life LED

Drivers:
2x10W Driver: Constant Current, Class 2, 100V-240V, 50/60 Hz, 1kv Surge Protection, 350mA, 0.6 Amps., Power Factor: 57.1%

2x13W Driver: Constant Current, Class 2, 100V-277V, 50/60 Hz, 4kv Surge Protection, 720mA, 100-240VAC: 0.3-0.15 Amps 277VAC: 0.3 Amps., THD ≤ 20% Power Factor: 97.5%

2x20W Drivers: Constant Current, Class 2, 100V-277V, 50/60 Hz, 4kv Surge Protection, 1000mA, 100-240VAC: 0.5 Amps 277VAC: 0.25 Amps., THD ≤ 10% Power Factor: 98.4%

2x26W Drivers: Constant Current, Class 2, 100V-277V, 50/60 Hz, 6kv Surge Protection, 720mA, 100-277VAC: 0.8 Amps., THD ≤ 20%, Power Factor: 99.2%

California Title 24:
CLED complies with California Title 24 building and electrical codes.

Thermal Management:
Die-cast aluminum thermal management system for optimal heat dissipation

Cold Weather Starting:
Minimum starting temperature is -40°C (-40°F).

Green Technology:
Mercury and UV free, and are RoHS compliant.

Lumen Maintenance:
100,000-hour LED lifespan based on IES LM-80 results and TM-21 calculations*.

Gaskets:
High-temperature silicone

Housing:
Precision die-cast aluminum housing and lens framing

IESNA LM-79 & IESNA LM-80 Testing:
RAB LED luminaires have been tested by an independent laboratory in accordance with IESNA LM-79 and LM-80, and have received the Department of Energy "Lighting Facts" label.

Color Uniformity:
RAB's range of CCT (Correlated Color Temperature) follows ANSI Specifications for the Chromaticity of Solid State Lighting (SSL) Products, ANSI C78.377-2011.

Color Stability:
RAB LED performance exceeds industry standards for chromatic stability.

Ambient Temperature:
Suitable for use in 40°C (104°F) ambient temperatures.

Pendants:
Includes 6", 12" and 18" Pendant tubes with hang straight swivel. Can be joined for up to 36" length.

Patents:
RAB LED Ceiling fixtures are protected by patents pending in U.S., Canada, China, Taiwan and Mexico.

*See TM-21 explanation on page 18.

CATALOG NUMBERS

Catalog #	LED Watts	Input Watts	Color Temp	Lumen Output	Lumens per Watt	Mounting Height Range	Voltage
CLED2x10	2 x 10 (20W)	25.7	Cool (5000K)	1045	41	8'-15'	100-240V
CLED2x10W	2 x 10 (20W)	25.7	Cool (5000K)	1045	41	8'-15'	100-240V
CLED2x13	2 x 13 (26W)	30.3	Cool (5000K)	2006	66	8'-15'	100-277V
CLED2x13W	2 x 13 (26W)	30.3	Cool (5000K)	2006	66	8'-15'	100-277V
CLED2x20	2 x 20 (40W)	43.0	Cool (5000K)	2746	64	8'-15'	100-277V
CLED2x20W	2 x 20 (40W)	43.0	Cool (5000K)	2746	64	8'-15'	100-277V
CLED2x26	2 x 26 (52W)	59.1	Cool (5100K)	3652	62	15'-25'	100-277V
CLED2x26W	2 x 26 (52W)	59.1	Cool (5100K)	3652	62	15'-25'	100-277V

Values shown for cool temperature. Please visit rabweb.com for details on neutral and warm. For Warm light (3000K) add "Y" before color suffix (Example: CLED2x10YW) • For Neutral White Light (4000K) - add "N" before color suffix (Example: CLED2x26NW).

BUY WITH CONFIDENCE



Fully Shielded Full Cutoff Optics



For use on LEED buildings to attain Light Pollution Reduction Credit



PLED™ LED PENDANTS

PLED2x26

LPENDANT™ LED PENDANT

PLED2x20/UP

PAD4*
*For use with ALED luminaires

SPECIFICATIONS

UL Listing:
PLED2x20, 2x26, Uplight model UL listed for wet locations; PLED2x10, 2x13 Uplight UL listed for damp locations.

Finish:
White or bronze chip and fade resistant polyester powder coat finish

LED:
Multi-chip 10 and 13W high-output long-life LED

Drivers:
2x10W Driver: Constant Current, Class 2, 100V-240V, 50/60 Hz, 1kv Surge Protection, 350mA, 0.6 Amps., Power Factor: 57.1%

2x13W Driver: Constant Current, Class 2, 100V-277V, 50/60 Hz, 4kv Surge Protection, 720mA, 100-240VAC: 0.3-0.15 Amps 277VAC: 0.3 Amps., THD ≤ 20% Power Factor: 97.5%

2x20W Drivers: Constant Current, Class 2, 100V-277V, 50/60 Hz, 4kv Surge Protection, 1000mA, 100-240VAC: 0.5 Amps 277VAC: 0.25 Amps., THD ≤ 10% Power Factor: 98.4%

2x26W Drivers: Constant Current, Class 2, 100V-277V, 50/60 Hz, 6kv Surge Protection, 720mA, 100-277VAC: 0.8 Amps., THD ≤ 20%, Power Factor: 99.2%

California Title 24:
PLED complies with California Title 24 building and electrical codes.

Thermal Management:
Die-cast aluminum thermal management system for optimal heat dissipation

Cold Weather Starting:
Minimum starting temperature is -40°C (-40°F).

Green Technology:
Mercury and UV free, and are RoHS compliant.

Lumen Maintenance:
100,000-hour LED lifespan based on IES LM-80 results and TM-21 calculations*.

Gaskets:
High-temperature silicone

Housing:
Precision die-cast aluminum housing and lens framing

IESNA LM-79 & IESNA LM-80 Testing:
RAB LED luminaires have been tested by an independent laboratory in accordance with IESNA LM-79 and LM-80, and have received the Department of Energy "Lighting Facts" label.

Color Uniformity:
RAB's range of CCT (Correlated Color Temperature) follows ANSI Specifications for the Chromaticity of Solid State Lighting (SSL) Products, ANSI C78.377-2011.

Color Stability:
RAB LED performance exceeds industry standards for chromatic stability.

Ambient Temperature:
Suitable for use in 40°C (104°F) ambient temperatures.

Pendants:
Includes 6", 12" and 18" Pendant tubes with hang straight swivel. Can be joined for up to 36" length.

Patents:
RAB LED Pendant fixtures are protected by patents pending in U.S., Canada, China, Taiwan and Mexico.

*See TM-21 explanation on page 18.

Replaces Inefficient Ceiling Fixtures and Reduces Operating and Maintenance Costs

PERFORMANCE COMPARISON

	PLED2x10	PLED2x13	PLED2x20	PLED2x26
LED Watts / Input Watts	20W / 25.7W	26W / 30.3W	40W / 43W	52W / 59.1W
Delivered Lumens	1045	2006	2746	3652
Equivalency	32W CFL	70W MH	100W MH	175W MH
Replacement Range	32-42W CFL up to 70W MH	70-100W MH	100-150W MH	100-250W MH
Mounting Height	10-18'	10-18'	10-18'	10-18'

CATALOG NUMBERS

Catalog #	LED Watts	Input Watts	Color Temp	Lumen Output	Lumens per Watt	Mounting Height Range	Voltage
PLED2x10	2 x 10 (20W)	25.7	Cool (5000K)	1045	41	10'-18'	100-240V
PLED2x10W	2 x 10 (20W)	25.7	Cool (5000K)	1045	41	10'-18'	100-240V
PLED2x13	2 x 13 (26W)	30.3	Cool (5000K)	2006	68	10'-18'	100-277V
PLED2x13W	2 x 13 (26W)	30.3	Cool (5000K)	2006	68	10'-18'	100-277V
PLED2x20	2 x 20 (40W)	43.0	Cool (5000K)	2746	64	10'-18'	100-277V
PLED2x20W	2 x 20 (40W)	43.0	Cool (5000K)	2746	64	10'-18'	100-277V
PLED2x26	2 x 26 (52W)	59.1	Cool (5100K)	3652	62	15'-25'	100-277V
PLED2x26W	2 x 26 (52W)	59.1	Cool (5100K)	3652	62	15'-25'	100-277V

Values shown for cool temperature. Please visit rabweb.com for details on neutral and warm. For Warm light (3000K) add "Y" before color suffix (Example: PLED2x10YW) • For Neutral White Light (4000K) - add "N" before color suffix (Example: PLED2x26NW). For Uplight Pendant Fixtures, add suffix /UP after Catalog # (Example: PLED2x10/UP) • 10W and 13W suitable for damp locations in upright position.

Catalog #	Description	Thread	Color
PAD2	Pendant 2X Adaptor	½" NPS	Bronze
PAD2W	Pendant 2X Adaptor	½" NPS	White
PAD2-3/4	Pendant 2X Adaptor	¾" NPS	Bronze
PAD2W-3/4	Pendant 2X Adaptor	¾" NPS	White
PAD4	Pendant 4X Adaptor	½" NPS	Bronze
PAD4W	Pendant 4X Adaptor	½" NPS	White
PAD4-3/4	Pendant 4X Adaptor	¾" NPS	Bronze
PAD4W-3/4	Pendant 4X Adaptor	¾" NPS	White

All PAD2 and PAD4 Adaptors are to be used with ALED luminaires only. Pendant supplied by others.

BUY WITH CONFIDENCE



Fully Shielded Full Cutoff Optics



For use on LEED buildings to attain Light Pollution Reduction Credit





LFLED5
Flood and Spot
Options

HBLED10
Flood and Spot
Options

HSLED13
Tight Spot

SPECIFICATIONS

UL Listing:

Suitable for wet locations. Suitable for mounting within 4' of the ground.

Finish:

White, Bronze, Black or Verde Green chip and fade resistant polyester powder coat finish. LFLED5 also available in Brass designed for marine use.

LED:

LFLED5: Multi-chip 5W high-output, long-life LED

HBLED10: Multi-chip 10W high-output, long-life LED

HBLED13: Multi-chip 13W high-output, long-life LED

HSLED13: Multi-chip 13W high-output, long-life LED

Drivers:

5W Driver: Constant Current, Class 2, 50/60 Hz, 100 - 240VAC: 0.18 Amps., Power Factor: 43.7%

10W Driver: Constant Current, Class 2, 100V-240V, 50/60 Hz, 1kv Surge Protection, 350mA, 0.3 Amps., Power Factor: 57.1%

13W Driver: Constant Current, Class 2, 100V-277V, 50/60 Hz, 4kv Surge Protection, 720mA, 100-240VAC: 0.3-0.15 Amps 277VAC: 0.15 Amps., THD ≤ 20% Power Factor: 97.5%

California Title 24:

RAB LED Floodlights comply with California Title 24 building and electrical codes.

Thermal Management:

Die-cast aluminum thermal management system for optimal heat dissipation

Cold Weather Starting:

Minimum starting temperature is -40°C (-40°F).

Green Technology:

Mercury and UV free, and are RoHS compliant.

Lumen Maintenance:

100,000-hour LED lifespan based on IES LM-80 results and TM-21 calculations*.

Gaskets:

High-temperature silicone

Housing:

Precision die-cast aluminum housing, lens frame and mounting arm

IESNA LM-79 & LM-80 Testing:

RAB LED luminaires have been tested by an independent laboratory in accordance with IESNA LM-79 and LM-80, and have received the Department of Energy "Lighting Facts" label.

Color Uniformity:

RAB's range of CCT (Correlated Color Temperature) follows ANSI Specifications for the Chromaticity of Solid State Lighting (SSL) Products, ANSI C78.377-2011.

Color Stability:

RAB LED performance exceeds industry standards for chromatic stability.

Ambient Temperature:

Suitable for use in 40°C (104°F) ambient temperatures

Patents:

RAB LED Floodlight designs are protected by patents pending in U.S., Canada, China, and Taiwan.

*See TM-21 explanation on page 18.

Landscape Lighting That is Always Spot On...

FEATURES

LFLED5

- Microprismatic diffusion lens for smooth and even light distribution
- Available in five finishes
- Brass designed for marine environments
- Optional spot hood reflector available



HSLED13

- Spot lighting for over 40 feet away
- Perfect for flag lighting
- Available in four finishes



HBLED

- Comes with both spot and flood reflectors
- Available in 10 and 13 Watt
- Glare shield for effective light control
- Available in four finishes



Flag Lighting Tips

- Use at least 2, preferably 3 lights in a triangle so the flag is well lit no matter which direction the wind is blowing.
- Install fixtures away from the flag pole about 1/3 to 1/2 the height of the pole.

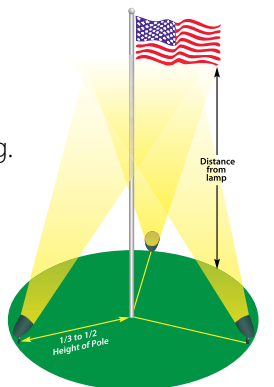

CATALOG NUMBERS

Catalog #	LED Watts	Input Watts	Color Temp	CRI	Lumens	Spot		Flood			
						Lumens per Watt	NEMA Type	Lumens	Lumens per Watt	NEMA Type	Voltage
LFLED5A	5	5.1	Cool (5000K)	68	250*	49*	3H x 3V*	299	59	4H x 4V	100-240V
LFLED5NA	5	5.1	Neutral (4000K)	90	148*	29*	3H x 3V*	208	41	4H x 4V	100-240V
LFLED5YA	5	5.1	Warm (3000K)	86	145*	28*	3H x 3V*	208	41	4H x 4V	100-240V
HBLED10A	10	13.3	Cool (5200K)	61	400	31	4H x 4V	338	25	5H x 5V	100-240V
HBLED10YA	10	13.2	Warm (3000K)	75	350	27	4H x 4V	297	23	5H x 5V	100-240V
HBLED13A	13	15.3	Cool (5000K)	69	820	54	4H x 4V	724	47	5H x 5V	100-277V
HBLED13NA	13	15.0	Neutral (4000K)	87	596	40	4H x 4V	505	34	5H x 5V	100-277V
HBLED13YA	13	15.2	Warm (3000K)	86	537	35	4H x 4V	461	30	5H x 5V	100-277V
HSLED13	13	15.2	Cool (5100K)	67	787	52	2H x 2V	----	---	----	100-277V
HSLED13N	13	15.2	Neutral (4000K)	84	570	37	2H x 2V	----	---	----	100-277V
HSLED13Y	13	15.2	Warm (3000K)	87	544	36	2H x 2V	----	---	----	100-277V

*With optional Spot Hood Reflector Kit

Finishes: For Black, White or Verde Green finish, add suffix B, W, or VG in place of Bronze (A)

Catalog number (Example: HSLED13YB).

LFLED5 - For Brass finish, add suffix BR at the end of the Catalog number (Example: LFLED5YBR).

ACCESSORIES FOR LFLED5

Catalog

LSLFLEDA Bronze Spot Reflector Kit

LSLFLEDB Black Spot Reflector Kit

LSLFLEDW White Spot Reflector Kit

LSLFLEDVG Verde Green Spot Reflector Kit

LSLFLEDBR Brass Spot Reflector Kit

BUY WITH CONFIDENCE



lighting
facts
LED Product Partner

UL US LISTED
SUITABLE FOR WET LOCATIONS



SPECIFICATIONS

UL Listing:

Suitable for wet locations. Suitable for mounting within 4' of the ground.

Finish:

White or bronze chip and fade resistant polyester powder coat finish

LED:

Multi-chip 6 and 13 Watt high-output long-life LED

Drivers:

13W Driver: Constant Current, Class 2, 100V-277V, 50/60 Hz, 6kv Surge Protection, 700mA, 100-277VAC: 0.4 Amps, THD ≤ 20% Power Factor: 99.2%

26W Driver: Constant Current, Class 2, 100V-277V, 50/60 Hz, 6kv Surge Protection, 720mA, 100-277VAC: 0.4 Amps., THD ≤ 20%, Power Factor: 99.2%

FFLED39: (1) 13W Driver plus (1) 26W Driver. See 13W (page 16) and 26W Driver details.

FFLED78: (3) 26W Drivers. See 26W Driver details.

California Title 24:

RAB LED Floodlights comply with California Title 24 building and electrical codes.

Thermal Management:

Superior heat sinking with external Air-Flow fins (Patent Pending)

Cold Weather Starting:

Minimum starting temperature is -40°C (-40°F).

Green Technology:

Mercury and UV free, and are RoHS compliant.

Lumen Maintenance:

100,000-hour LED lifespan based on IES LM-80 results and TM-21 calculations*.

Gaskets:

High-temperature silicone

Housing:

Precision die-cast aluminum housing and hood

IESNA LM-79 & LM-80 Testing:

RAB LED luminaires have been tested by an independent laboratory in accordance with IESNA LM-79 and LM-80, and have received the Department of Energy "Lighting Facts" label.

Color Uniformity:

RAB's range of CCT (Correlated Color Temperature) follows ANSI Specifications for the Chromaticity of Solid State Lighting (SSL) Products, ANSI C78.377-2011.

Color Stability:

RAB LED performance exceeds industry standards for chromatic stability.

Ambient Temperature:

Suitable for use in 40°C (104°F) ambient temperatures

Patents:

RAB LED Floodlight designs are protected by patents pending in U.S., Canada, China, and Taiwan.

*See TM-21 explanation on page 18.

Move Over HID... Meet the New Faces of Floodlights!

PERFORMANCE COMPARISON

	 FFLED18*	 FFLED39*	 FXLED78 (Trunnion Mount shown)
LED Watts / Input Watts	18W / 22.4W	38W / 45W	78W / 91W
Lumen Output	1624	2991	5927
Equivalency	70W MH	150W MH	250W MH
Replacement Range	35-150W MH	100-175W MH	150-320W MH
Mounting Height	Ground - 15'	Ground - 20'	Ground - 35'
Weight	4.8 lbs.	12.5 lbs.	24 lbs.

*It is recommended that the FFLED18 and FFLED39 be mounted with the RAB XC1 Heavy Duty Cover and the RAB VXC.

CATALOG NUMBERS

Catalog #	LED Watts	Input Watts	Color Temp	CRI	Lumen Output	Lumens per Watt	NEMA Type	Voltage
FFLED18	18	22.4	Cool (5100K)	70	1624	73	7H x 6V	100-277V
FFLED18N	18	22.3	Neutral (4000K)	83	1270	57	7H x 6V	100-277V
FFLED18Y	18	22.5	Warm (3000K)	85	1075	48	7H x 6V	100-277V
FFLED39	38	45.0	Cool (5100K)	68	2991	66	7H x 6V	100-277V
FFLED39N	38	45.0	Neutral (4000K)	86	2379	51	7H x 6V	100-277V
FFLED39Y	38	45.0	Warm (3000K)	87	2081	46	7H x 6V	100-277V
FXLED78T*	78	91.0	Cool (5100K)	67	5927	65	6H x 5V	100-277V
FXLED78TN	78	92.0	Neutral (4000K)	86	4645	51	6H x 5V	100-277V
FXLED78TY	78	90.0	Warm (3000K)	87	4037	45	6H x 5V	100-277V
FXLED78SF**	78	91.0	Cool (5100K)	67	5927	65	6H x 5V	100-277V
FXLED78SFN	78	92.0	Neutral (4000K)	86	4645	51	6H x 5V	100-277V
FXLED78SFY	78	90.0	Warm (3000K)	87	4037	45	6H x 5V	100-277V

*T designates Trunnion Mount. **SF designates Slipfitter Mount.

Finishes: For White finish, add suffix W at the end of the Catalog number (Example: FXLED78TYW).

For Photocell option for FFLED18, 39 - add "/PC, PC2" after color suffix (Example: FFLED18/PC, FFLED39/PC2)

For Swivel/Photocell option for FXLED78SF add "/PCS" after color suffix (Example: FXLED78SF/PCS).

ACCESSORIES

Catalog

FFLED18/E 120V-277V Standard Emergency Battery Backup

FFLED18/EC 120V-277V Cold Weather Emergency Battery Backup

GDFLED18W Wire Guard

GDFLED18P Shield

GDFLED39W Wire Guard

GDFLED39P Shield

GDFLED78W Wire Guard

GDFLED78P Shield

BUY WITH CONFIDENCE



SUITABLE FOR WET LOCATIONS

Solar LED

LED Fixtures for Solar Applications or other 10-30 Volt DC Systems

With RAB solar LED fixtures you'll get the same light output as older technology lighting sources with much less power drain.



PERFORMANCE COMPARISON

	 WPLED10DC	 WPLED13DC	 WPLED20DC	 WPLED26DC
LED Watts / Input Watts	10W / 13.2W	13W / 14.9W	20W / 21.7W	26W / 30W
Lumen Output	547	1064	1401	1816
Wallpack Equivalency	70W MH	100W MH	150W MH	175W MH
HID Replacement Range	35-100W	70-150W	100-175W	150-200W
Max. Mounting Height	12 ft.	20 ft.	25 ft.	25 ft.
Mounting	Junction Box or Surface Plate	Junction Box or Surface Plate	Junction Box or Surface Plate	Junction Box or Surface Plate

SPECIFICATIONS

<p>LED: Multi-chip 10 and 13 Watt high-output, long-life LEDs</p> <p>Electrical Input Specifications: 10W DC Driver: Max Watts: 10W; Input Volts: 10-30 VDC; Operating Amps: 1.3 - 0.4A</p>	<p>13W DC Driver: Max Watts: 15W; Input Volts: 10-30 VDC; Operating Amps: 1.5 - 0.5A</p> <p>20W DC Driver: Max Watts: 24W; Input Volts: 10-30 VDC; Operating Amps: 2.5 - 0.75A</p> <p>26W DC Driver: Max Watts: 30W; Input Volts: 10-30 VDC; Operating Amps: 3.0 - 1.0A</p>	<p>Lumen Maintenance: 100,000-hour LED lifespan based on IES LM-80 results and TM-21 calculations*.</p> <p>Cold Weather Starting: The minimum starting temperature is -30°C (-22°F).</p> <p><i>*See TM-21 explanation on page 18.</i></p>
--	--	---

CATALOG NUMBERS

Catalog # Bronze	Catalog # White	LED Watts	Color Temp	Mounting Height Range	Voltage
<i>Junction Box*</i> WPLED10DC	WPLED10DCW	10	Cool (5000K)	8-12'	10-30VDC
<i>Surface Plate*</i> WPLED10SDC	WPLED10SDCW	10	Cool (5000K)	8-12'	10-30VDC
WPLED13DC	WPLED13DCW	13	Cool (5000K)	8-20'	10-30VDC
WPLED20DC	WPLED20DCW	20	Cool (5000K)	10-20'	10-30VDC
WPLED26DC	WPLED26DCW	26	Cool (5000K)	10-25'	10-30VDC

Values shown for cool temperature. Please visit rabweb.com for details on neutral and warm. For Warm light (3000K) add "Y" before color suffix (Example: WPLED10DCYW) For Neutral White Light (4000K) add "N" before color suffix (Example: WPLED26DCNWX).

*WPLED13, 20, 26 models include 2 Mounting options: Surface Plate for recessed Junction box and Junction Box. For Photocell option for WPLED20, 26 - add "/PC" after color suffix (Example: WPLED20DC/PC, WPLED26DC/PC).

BUY WITH CONFIDENCE



For use on LEED buildings to attain Light Pollution Reduction Credit

Run Your Alternative Energy System With Optimum Efficiency.



PERFORMANCE COMPARISON

	 HBLED10DC	 HBLED13DC	 HSLED13DC	 FFLED18DC
LED Watts / Input Watts	10W / 13W	13W / 15W	13W / 15W	18W / 22W
Lumen Output	338 Flood / 400 Spot	724 Flood / 820 Spot	787	1624
Floodlight Equivalency	45W PAR	90W PAR	90W PAR	70W MH
Replacement Range	45-75W PAR	90-100W PAR	90-100W PAR	35-150W MH
Mounting Height	Ground - 15'	Ground - 15'	Ground - 15'	Ground - 15'
Weight	3.5 lbs.	3.5 lbs.	3.5 lbs.	4.8 lbs.

HBLED10DC and HBLED13DC come with a Flood and Spot Reflector. *It is recommended that the FFLED18DC be mounted with the RAB XC1 Heavy Duty Cover and the RAB VX1.

SPECIFICATIONS

<p>LED: Multi-chip 10, 13 and 18 Watt high-output, long-life LEDs</p> <p>Electrical Input Specifications: 10W DC Driver: Max Watts: 10W; Input Volts: 10-30 VDC; Operating Amps: 1.3 - 0.4A</p>	<p>13W DC Driver: Max Watts: 15W; Input Volts: 10-30 VDC; Operating Amps: 1.5 - 0.5A</p> <p>18W DC Driver: Max Watts: 30W; Input Volts: 10-30 VDC; Operating Amps: 3.0 - 1.0A</p>	<p>Lumen Maintenance: 100,000-hour LED lifespan based on IES LM-80 results and TM-21 calculations*.</p> <p>Cold Weather Starting: The minimum starting temperature is -30°C (-22°F).</p> <p><i>*See TM-21 explanation on page 18.</i></p>
--	---	---

CATALOG NUMBERS

Catalog #	LED Input		Color Temp	CRI	Spot		NEMA Type	Flood		NEMA Type	Voltage
	Watts	Watts			Lumens	per Watt		Lumens	per Watt		
HBLED10DCA	10	13.3	Cool (5200K)	61	400	31	4H x 4V	338	25	5H x 5V	10-30VDC
HBLED13DCA	13	15.3	Cool (5000K)	69	820	54	5H x 5V	724	47	5H x 5V	10-30VDC
HSLED13DCA	13	15.2	Cool (5100K)	52	787	52	2H x 2V	---	---	---	10-30VDC
FFLED18DC	18	22.4	Cool (5100K)	70	---	---	---	1624	73	7H x 6V	10-30VDC

Values shown for cool temperature. Please visit rabweb.com for details on neutral and warm. For Warm light (3000K) add "Y" before color suffix (Example: HBLED13DCYW) For Neutral White Light (4000K) add "N" before color suffix (Example: FFLED18DCNWX).

Finishes: HBLED - For Black, White or Verde Green finish, add suffix B, W, or VG in place of Bronze (A) Catalog number (Example: HBLED13DCB). FFLED - For White finish, add suffix W at the end of the Catalog number (Example: FFLED18DCW).

BUY WITH CONFIDENCE



LSTEALTH[®]

LED S E N S O R



WPLED20MS
(WPLED20 + SMS500)

STL1HBLED2x13W
(HBLED13 + STL110)

STL3FFLED18
(FFLED18 + STL360)

SPECIFICATIONS

UL Listing:
Suitable for wet locations.

Finish:
White or bronze chip and fade resistant polyester powder coat finish

Sensors:
SMS500: Switching Capacity: 5 Amps; 500W Incandescent @120V 250W Fluorescent; 120V AC 60HZ; Power Consumption 1W; Time Adjustment 5 Sec. to 15 Min; Surge Protection up to 3000V.

STL110: Switching Capacity: 8 Amps; 1000W Incandescent @120V 250W Fluorescent; 120V AC 60HZ; Power Consumption 1W; Time Adjustment 5 Sec. to 12 Min; Surge Protection up to 6000V.

STL200: Switching Capacity: 8 Amps; 1000W Incandescent @120V 250W Fluorescent; 120V AC 60HZ; Power Consumption 1W; Time Adjustment 5 Sec. to 12 Min; Surge Protection up to 6000V.

STL360: Switching Capacity: 8 Amps, 750 Watts LED @120 Volts 0.8pF Driver; 8 Amps, 500 Watts LED @120 Volts 0.5pF Driver; 120V AC 60HZ; Power Consumption 1W; Time Adjustment 5 Sec. to 12 Min; Surge Protection up to 6000V.

California Title 24:
RAB LSTEALTH comply with California Title 24 building and electrical codes.

Green Technology:
Mercury and UV free, and are RoHS compliant.

Lumen Maintenance:
100,000-hour LED lifespan based on IES LM-80 results and TM-21 calculations*.

Gaskets:
High-temperature silicone

Housing:
Precision die-cast aluminum housing, lens frame, mounting arm

IESNA LM-79 & LM-80 Testing:
RAB LED luminaires have been tested by an independent laboratory in accordance with IESNA LM-79 and LM-80, and have received the Department of Energy "Lighting Facts" label.

Color Uniformity:
RAB's range of CCT (Correlated Color Temperature) follows ANSI Specifications for the Chromaticity of Solid State Lighting (SSL) Products, ANSI C78.377-2011.

Color Stability:
RAB LED performance exceeds industry standards for chromatic stability.

Ambient Temperature:
Suitable for use in 40°C (104°F) ambient temperatures

Patents:
RAB LSTEALTH designs are protected by patents pending in U.S., Canada, China, and Taiwan.

*See TM-21 explanation on page 18.

The Sensor You Trust Now in LED!

LED and Best-in-Class Sensor Technology

SENSOR DETECTION PATTERNS



STEALTH Performance in a Cost-Effective Package
SMS500 - Small sensor. Full 180° coverage with universal swivel

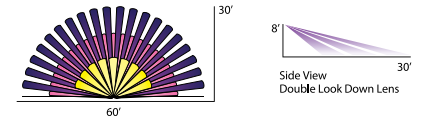

High Quality, Low Maintenance, No Callbacks

STL110 - 110° view, double look-down lens, reaches 70' wide and 50' out

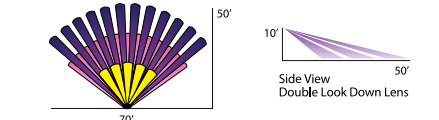

STL200 - 200° view, double look-down lens, reaches 100' wide and 30' out

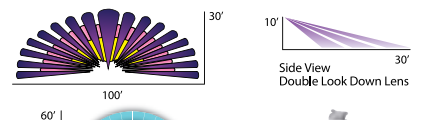

STL360 - Security-grade sensor has two detectors for 360° downward and 180° forward coverage.

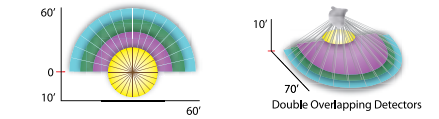

CATALOG NUMBERS

Wallpacks Catalog #	LED Watts	Input Watts	Color Temp	CRI	Lumen Output	Voltage
WPLED10MS	10	13	Cool (5000K)	92	547	120V
WPLED13MS	13	15	Cool (5000K)	66	1064	120V
WPLED20MS	20	22	Cool (5000K)	70	1401	120V
WPLED26MS	26	30	Cool (5000K)	66	1816	120V

Floodlights Catalog #	LED Watts	Input Watts	Color Temp	CRI	Spot			Flood			
					Lumens	Lumens per Watt	NEMA Type	Lumens	Lumens per Watt	NEMA Type	Voltage
STL1HBLED10	10	13.3	Cool (5200K)	61	400	30	4H x 4V	338	25	5H x 5V	120V
STL1HBLED2x10	20	26.6	Cool (5200K)	61	800	30	4H x 4V	676	25	5H x 5V	120V
STL2HBLED10	10	13.3	Cool (5200K)	61	400	30	4H x 4V	338	25	5H x 5V	120V
STL2HBLED2x10	20	26.6	Cool (5200K)	61	800	30	4H x 4V	676	25	5H x 5V	120V
STL3HBLED10	10	13.3	Cool (5200K)	61	400	30	4H x 4V	338	25	5H x 5V	120V
STL3HBLED2x10	20	26.6	Cool (5200K)	61	800	30	4H x 4V	676	25	5H x 5V	120V
STL1HBLED13	13	15.3	Cool (5000K)	69	820	54	4H x 4V	724	47	5H x 5V	120V
STL1HBLED2x13	26	30.6	Cool (5000K)	69	1640	54	4H x 4V	1448	47	5H x 5V	120V
STL2HBLED13	13	15.3	Cool (5000K)	69	820	54	4H x 4V	724	47	5H x 5V	120V
STL2HBLED2x13	26	30.6	Cool (5000K)	69	1640	54	4H x 4V	1448	47	5H x 5V	120V
STL3HBLED13	13	15.3	Cool (5000K)	69	820	54	4H x 4V	724	47	5H x 5V	120V
STL3HBLED2x13	26	30.6	Cool (5000K)	69	1640	54	4H x 4V	1448	47	5H x 5V	120V
FFLED18MS	18	22.4	Cool (5100K)	70	---	---	---	1624	73	7H x 6V	120V
STL3FFLED18	18	22.4	Cool (5100K)	70	---	---	---	1624	73	7H x 6V	120V

Values shown for cool temperature. Please visit rabweb.com for details on neutral and warm.

Finishes: For White finish, add suffix W at the end of the Catalog number (Example: STL3FFLED18W). For Warm light (3000K) add "Y" before color suffix (Example: STL1HBLED2x10YW). For Neutral White Light (4000K) add "N" before color suffix (Example: WPLED26MSNW).

ACCESSORIES Catalog # **GDFLED18W** Wire Guard **GDFLED18P** Shield

BUY WITH CONFIDENCE



Fully Shielded Full Cutoff Optics
*For Wallpacks Only



For use on LEED buildings to attain Light Pollution Reduction Credit
*For Wallpacks Only



SUITABLE FOR WET LOCATIONS





SPECIFICATIONS

UL Listing:

Suitable for wet locations. Suitable for mounting within 4' of the ground.

Finish:

White or bronze chip and fade resistant polyester powder coat finish

LED:

Multi-chip 5, 10 and 13W high-output long-life LEDs

Drivers:

5W Driver: Constant Current, Class 2, 100V-240V, 50/60 Hz, 1kv Surge Protection 350mA, 0.18 Amps., Power Factor: 43.7%

2x5W Driver: 0.36 Amps

10W Driver: Constant Current, Class 2, 100V-240V, 50/60 Hz, 1kv Surge Protection, 350mA, 0.3 Amps., Power Factor: 57.1%

2x10W Driver: 0.6 Amps

13W Driver: Constant Current, Class 2, 100V-277V, 50/60 Hz, 4kv Surge Protection, 720mA, 100-240VAC: 0.3-0.15 Amps 277VAC: 0.15 Amps., THD ≤ 20% Power Factor: 97.5%

2x13W Driver: 0.6 - 0.3 Amps, 277VAC: 0.3 Amps.

California Title 24:

RAB LED BLEDs comply with California Title 24 building and electrical codes.

Thermal Management:

Die-cast aluminum thermal management system for optimal heat dissipation

Cold Weather Starting:

Minimum starting temperature is -40°C (-40°F).

Green Technology:

Mercury and UV free, and are RoHS compliant.

Lumen Maintenance:

100,000-hour LED lifespan based on IES LM-80 results and TM-21 calculations*.

Gaskets:

High-temperature silicone

Housing:

Precision die-cast aluminum housing, lens frame

IESNA LM-79 & LM-80 Testing:

RAB LED luminaires have been tested by an independent laboratory in accordance with IESNA LM-79 and LM-80, and have received the Department of Energy "Lighting Facts" label.

Color Uniformity:

RAB's range of CCT (Correlated Color Temperature) follows ANSI Specifications for the Chromaticity of Solid State Lighting (SSL) Products, ANSI C78.377-2011.

Color Stability:

RAB LED performance exceeds industry standards for chromatic stability.

Ambient Temperature:

BLED5: Suitable for use in 40°C (104°F) ambient temperatures.

BLED10: Suitable for use in 40°C (104°F) ambient temperatures.

BLED13: Suitable for use in 50°C (122°F) ambient temperatures.

Bollard:

18", 36" and 42" lengths available for 5 Watt Bollard. 42" length for 10 and 13 Watt Bollards.

Patents:

RAB LED BLED designs are protected by U.S. patents and patents pending in U.S., Canada, China, Taiwan and Mexico.

*See TM-21 explanation on page 18.

Affordable LED Pathway Lighting

PURPOSE-BUILT LED LUMINAIRE

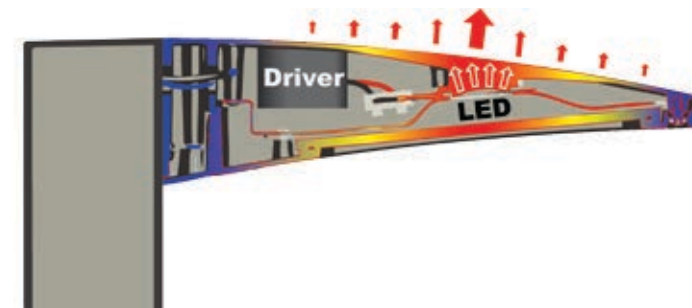

MOUNTING OPTIONS

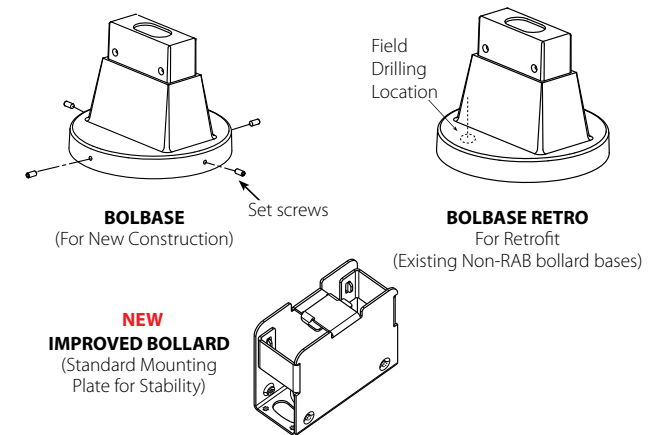

CATALOG NUMBERS

Catalog # Bronze	Catalog # White	LED Watts	Input Watts	Color Temp	Lumen Output	Lumens per Watt	Voltage
1 FIXTURE	1 FIXTURE						
BLED5-18*	BLED5-18W*	5	5.3	Cool (5000K)	196	37	100-240V
BLEDR5-18*	BLEDR5-18W*	5	5.2	Cool (5000K)	213	41	100-240V
2 FIXTURE	2 FIXTURE						
BLED2x5-18*	BLED2x5-18W*	5	10.6	Cool (5000K)	392	37	100-240V
BLEDR2x5-18*	BLEDR2x5-18W*	5	10.4	Cool (5000K)	426	41	100-240V

Values shown for cool temperature. Please visit rabweb.com for details on neutral and warm.

*Also Available in 36" and 42" Bollard lengths - Replace suffix 18 with 36 or 42 (Example: BLED5-36).

For Warm light (3000K) add "Y" before color suffix (Example: BLED5-18YW) • For Neutral White Light (4000K) - add "N" before color suffix (Example: BLED5-18NW).

1 FIXTURE	1 FIXTURE						
BLED10	BLED10W	10	13.2	Cool (5000K)	547	41	100-240V
BLED10Y	BLED10YW	10	13.2	Warm (3000K)	410	31	100-240V
2 FIXTURE	2 FIXTURE						
BLED2x10	BLED2x10W	20	26.4	Cool (5000K)	1094	41	100-240V
BLED2x10Y	BLED2x10YW	20	26.4	Warm (3000K)	820	31	100-240V
1 FIXTURE	1 FIXTURE						
BLED13	BLED13W	13	14.9	Cool (5000K)	1064	71	100-277V
BLED13Y	BLED13YW	13	14.9	Warm (3000K)	662	44	100-277V
2 FIXTURE	2 FIXTURE						
BLED2x13	BLED2x13W	26	29.8	Cool (5000K)	2128	71	100-277V
BLED2x13Y	BLED2x13YW	26	29.8	Warm (3000K)	1324	44	100-277V
1 FIXTURE	1 FIXTURE						
BLED20	BLED20W	20	21.7	Cool (5000K)	1401	65	100-277V
BLED20Y	BLED20YW	20	21.7	Warm (3000K)	662	44	100-277V
2 FIXTURE	2 FIXTURE						
BLED2x20	BLED2x20W	40	43.4	Cool (5000K)	2802	65	100-277V
BLED2x20Y	BLED2x20YW	40	43.4	Warm (3000K)	1970	45	100-277V

Please visit rabweb.com for details on neutral.

For Neutral White Light (4000K) - add "N" before color suffix (Example: BLED13NW).

BUY WITH CONFIDENCE



Fully Shielded
Full Cutoff Optics



For use on LEED
buildings to attain
Light Pollution
Reduction Credit



SUITABLE FOR WET LOCATIONS



VXBRLED13DG
VXBRLED26DG
NEW 26 Watts



VXLED13DG
VXLED26DG
NEW 26 Watts



VXBRLED13DG BLU

SPECIFICATIONS

UL Listing:

Suitable for wet locations. Suitable for mounting within 4' of the ground.

Finish:

Natural shot blasted aluminum

LED:

Multi-chip single 13W or 26W high-output long-life LED

13W Driver: Constant Current, 100V-277V, 50/60 Hz, 100-240VAC: 0.3-0.15 Amp, 277VAC: .15 Amps. THD ≤ 20% Power Factor: 97.5%

26W Driver: Constant Current, Class 2, 100V-277V, 50/60 Hz, 6kV Surge Protection, 720mA, 100-277VAC: 0.4 Amps., THD ≤ 20%, Power Factor: 99.2%

California Title 24:

RAB LED LVAPOR complies with California Title 24 codes.

Thermal Management (Patent Pending):

Die-cast LED housing designed for maximum heat dissipation

Cold Weather Starting:

Minimum starting temperature is -40°C (-40°F).

Green Technology:

Mercury and UV free, and are RoHS compliant.

Lumen Maintenance:

100,000-hour LED lifespan based on IES LM-80 results and TM-21 calculations*.

Gaskets:

High-temperature silicone

Housing:

Precision die-cast aluminum housing, lens frame

IESNA LM-79 & LM-80 Testing:

RAB LED luminaires have been tested by an independent laboratory in accordance with IESNA LM-79 and LM-80, and have received the Department of Energy "Lighting Facts" label.

Color Uniformity:

RAB's range of CCT (Correlated Color Temperature) follows ANSI Specifications for the Chromaticity of Solid State Lighting (SSL) Products, ANSI C78.377-2011.

Color Stability:

RAB LED performance exceeds industry standards for chromatic stability.

Ambient Temperature:

Suitable for use in 40°C (104°F) ambient temperatures.

Mounting:

(3) 1/2" NPS conduit entry points

Guard and Globe:

Shot blasted guard with frosted globe

Patents:

RAB LED Vaporproofs are protected by patents pending in U.S., Canada, China and Taiwan.

*See TM-21 explanation on page 18.

Traditional Look With Cutting-Edge Technology

TWO MOUNTING TYPES - TWO DIFFERENT APPLICATIONS



VXLED13DG
VXLED26DG
• Ceiling Mount
• Cool Light



VXLED13
VXLED26



VXBRLED13DG
VXBRLED26DG
• Wall Mount
• Cool Light



VXBRLED13
VXBRLED26



VXLED13DG BLU
• Ceiling Mount
• Blue Light

Designed For Beacon Applications

VXLED13DG, VXLED26DG, VXBRLED13DG and VXBRLED26DG must be customized with globes below

ACCESSORIES

Round Bottom Glass



Amber
GL100A



Blue
GL100B



Green
GL100G



Ruby
GL100R



Opal
GL100W



Clear
GL100HR



Prismatic
GL100PRS

Heat Resistant

Prismatic

Reflectors



Dome Reflector
RE200ST



Angle Reflector
RE200SA

Permaglobes, Unbreakable Polycarbonate



Amber
GL100PGA



Blue
GL100PGB



Green
GL100PGG



Ruby
GL100PGR



Opal
GL100PGW



Clear
GL100PG

NOTE: Replacement Frosted Globe: **GL100FR**

Die-Cast Guard



Die-Cast Aluminum Guard (Glass Globes Only)
GD100DG

Wire Guards



Wire Clamp Guard
GD100CLB



Flat Bottom Wire Guard (Polycarbonate Globes Only)
GD100BAR

CATALOG NUMBERS

Catalog Number	LED Watts	Input Watts	Color Temp	Lumen Output*	Lumens per Watt*	Voltage
VXLED13DG	13	15.1	Cool (5000K)	729	48	100-277V
VXBRLED13DG	13	15.1	Cool (5000K)	729	48	100-277V
VXLED26DG	26	30.0	Cool (5000K)	1955	66	100-277V
VXBRLED26DG	26	30.0	Cool (5000K)	1955	66	100-277V
VXLED13DG BLU	13	15.1	----	----	48	100-277V
VXBRLED13DG BLU	13	15.1	----	----	48	100-277V

*NOTE: These values pertain only to fixtures installed with standard frosted globe and will vary if installed with optional globes.

Values shown for cool temperature. Please visit rabweb.com for details on neutral and warm. For Warm light (3000K) add "Y" before color suffix (Example: VXLED13YDG) • For Neutral White Light (4000K) add "N" before color suffix (Example: VXLED13NDG).

BUY WITH CONFIDENCE





GOOSE4B 20" black gooseneck arm, 13W LED head and 15" Angled Cone Shade

GOOSE3B 30" black gooseneck arm, 13W LED head and 11" Straight Shade

GOOSE1B 24" black gooseneck arm, 13W LED head and 15" Angled Dome Shade

SPECIFICATIONS

UL Listing:

Suitable for wet locations. Suitable for mounting within 4' of the ground.

Finish:

Black or white chip and fade resistant polyester powder coat finish

LED:

Single multi-chip, 13 Watt high-output long-life LED

13W Driver: Constant Current, 100-277V, 50/60 Hz; 100-240VAC: 0.3-0.15 Amps, 277VAC: 0.15 Amps. THD ≤ 20% Power Factor: 97.5%

California Title 24:

RAB LED LGOOSE complies with California Title 24.

Thermal Management:

Custom heat sink assembly in thermal contact with die-cast aluminum housing for superior heat sinking

Cold Weather Starting:

Minimum starting temperature is -40°C (-40°F).

Green Technology:

Mercury and UV free, and are RoHS compliant.

Lumen Maintenance:

100,000-hour LED lifespan based on IES LM-80 results and TM-21 calculations*.

Gaskets:

High-temperature silicone

Housing:

Precision die-cast aluminum housing, lens frame and mounting plate

Mounting:

Heavy-duty mounting arm with "O" ring seal and stainless steel screw

Shades:

Angled Cone, Angled Dome or Straight Shade offered

IESNA LM-79 & LM-80 Testing:

RAB LED luminaires have been tested by an independent laboratory in accordance with IESNA LM-79 and LM-80, and have received the Department of Energy "Lighting Facts" label.

Color Uniformity:

RAB's range of CCT (Correlated Color Temperature) follows ANSI Specifications for the Chromaticity of Solid State Lighting (SSL) Products, ANSI C78.377-2011.

Color Stability:

RAB LED performance exceeds industry standards for chromatic stability.

Ambient Temperature:

Suitable for use in 40°C (104°F) ambient temperatures

Patents:

RAB LED Gooseneck design is protected by patents pending in U.S., Canada and China.

*See TM-21 explanation on page 18.

Main Street Just Got Brighter.. And Greener.

BUILD YOUR OWN FIXTURE

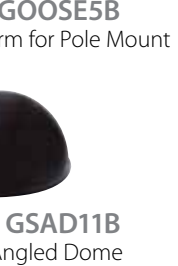

*All components are also available in white and unfinished.

CATALOG NUMBERS

Catalog # Black	Description	LED Watts	Input Watts	Color Temp	Lumen Output	Lumens per Watt	Voltage
GNLED13YB	13W LED Head	13	15.1	Warm (3000K)	556	36	100-277V
GNLED13NB	13W LED Head	13	15.1	Neutral (4000K)	643	43	100-277V

ACCESSORIES

Catalog #	Description	GOOSE3B	GOOSE4B	GOOSE5B	
GOOSE1B	Gooseneck 24" Arm	GOOSE3B	Gooseneck 30" Arm	GOOSE5B	Gooseneck 20" Arm - Pole Mount
GOOSE2B	Gooseneck 35" Arm	GOOSE4B	Gooseneck 20" Arm		
GSACB	15" Angled Cone Shade	GSAC11B	11" Angled Cone Shade		
GSADB	15" Angled Dome Shade	GSAD11B	11" Angled Dome Shade		
GSSTB	15" Straight Shade	GSST11B	11" Straight Shade		
LRFGNLEDB	Clear Lens and Reflector Kit w/Door Frame	LFGNLEDB	Frosted Lens and Door Frame Replacement		

Finishes: For White finish, add suffix W in place of B (Black) at the end of the Catalog number (Example: GNLED13YW). For Unfinished, add suffix U in place of B (Black) at the end of the Catalog number (Example: GOOSE1U).

BUY WITH CONFIDENCE





SPECIFICATIONS

UL Listing:

Suitable for wet locations. Suitable for mounting within 4' of the ground.

Finish:

White or bronze chip and fade resistant polyester powder coat finish

LED:

5W high output long life LED

5W Driver: Constant Current, Class 2, 100V-240V, 50/60 Hz, 1kv Surge Protection 350mA, 0.18 Amps., Power Factor: 43.7%

Thermal Management:

Integral cast aluminum mounting pad for optimum heat sinking to ensure cool operation with maximum LED life and light output

Cold Weather Starting:

Minimum starting temperature is -40°C (-40°F).

Green Technology:

Mercury and UV free, and are RoHS compliant.

Lumen Maintenance:

100,000-hour LED lifespan based on IES LM-80 results and TM-21 calculations*.

Housing:

Precision die-cast aluminum housing and mounting plate (Junction box not included).

Surge Protection:

1KV

IESNA LM-79 & LM-80 Testing:

RAB LED luminaires have been tested by an independent laboratory in accordance with IESNA LM-79 and 80, and have received the Department of Energy "Lighting Facts" label.

Ambient Temperature:

Suitable for use in 40°C (104°F) ambient temperatures.

Gaskets:

High-temperature silicone

Patents:

RAB LED STEP Lights are protected by U.S. patents and patents pending in Canada and China.

*See TM-21 explanation on page 18.

CATALOG NUMBERS

Catalog #	Description	LED Watts	Input Watts	Color Temp	Lumen Output	Lumens per Watt	Voltage
SLED5	Square Bronze	5	5.3	Cool (5000K)	196	37	100-240V
SLED5W	Square White	5	5.3	Cool (5000K)	196	37	100-240V
SLED5Y	Square Bronze	5	5.3	Warm (3000K)	128	24	100-240V
SLED5YW	Square White	5	5.3	Warm (3000K)	128	24	100-240V
SLEDR5	Round Bronze	5	5.2	Cool (5000K)	213	41	100-240V
SLEDR5W	Round White	5	5.2	Cool (5000K)	213	41	100-240V
SLEDR5Y	Round Bronze	5	5.2	Warm (3000K)	133	25	100-240V
SLEDR5YW	Round White	5	5.2	Warm (3000K)	133	25	100-240V

Please visit rabweb.com for details on neutral. For Neutral White Light - add "N" before color suffix (Example: SLED5NW).

Brackets



ARM24



ARMSV24



SWIVEL30



GOOSE1



GOOSE2



GOOSE4
for Wall Mount



GOOSE5
for Pole Mount



GOOSE3

SPECIFICATIONS

Gooseneck and Straight Arms:

Use to extend fixtures away from wall

Mounting:

Die-cast aluminum wall mounting plate. Fits over recessed junction box (not included) and mounts to wall. Mounts any fixture with 1/2" NPS threaded hole.

Weight capacity:

7lbs.

Construction:

All aluminum construction 1" diameter, 1/4" thick extension rod with 1/2" NPS threaded end with EZ locknut. Secures to wall mounting plate with (2) stainless steel set screws.*

Swivel Arm:

Directs light where you want it and adjusts 30° in both directions.

Finish:

Weather resistant polyester powder coat bronze or white.

*Mounting for all brackets except GOOSE4 and GOOSE5.

CATALOG NUMBERS

Catalog #	Description	Dimensions	Use With:
GOOSE1	Gooseneck Fixed Arm Bracket - Bronze	24-1/2" x 7-5/8"	WPLED20, WPLED26
GOOSE2	Gooseneck Fixed Arm Bracket - Bronze	35" x 7-5/8"	WPLED20, WPLED26
GOOSE3	Gooseneck Fixed Arm Bracket - Bronze	30" x 7-5/8"	WPLED20, WPLED26
GOOSE4	Gooseneck Fixed Arm Bracket - Bronze	20" x 7-5/8"	WPLED20, WPLED26
GOOSE5	Gooseneck Fixed Arm Bracket for Pole Mount - Bronze	20" x 7-5/8"	WPLED20, WPLED26
ARM24	Straight Arm Bracket - Bronze	24" x 1" Diameter Rod	WPLED10, WPLED13, WPLED20 and WPLED26
SWIVEL30	30' Swivel Bracket - Bronze	5" x 2-1/2" x 2-1/4"	WPLED10, WPLED13, WPLED20 and WPLED26
ARMSV24	Straight Arm Bracket with 30' Swivel - Bronze	26" Arm with 30' Swivel	WPLED10, WPLED13, WPLED20 and WPLED26

Finishes: For Black or White finish, add suffix B or W in place of Bronze Catalog number (Example: ARM24W). For Unfinished, add suffix U at the end of the Catalog number (Example: GOOSE1U).

Photometrics

Layout grid represents multiples of mounting height. Values shown in Footcandles.

Values shown are for cool light only. For neutral and warm, or to design your own custom lighting layout, visit rabweb.com, search for the product you are interested in, and use the EZ Layout tool.

In addition, our application engineers can help you create a custom lighting layout for your job. For Free.

WPLED5

5W LED Square Fixture at 8' Mounting Height

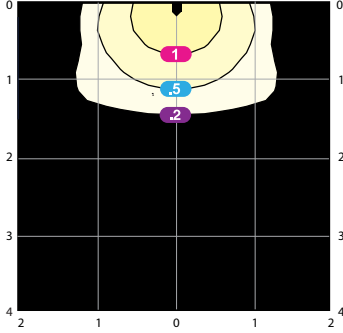

WPLEDR5

5W LED Round Fixture at 8' Mounting Height

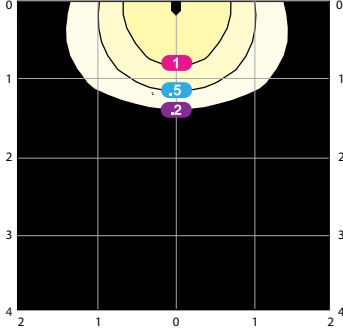

WPLED10

10W LED at 10' Mounting Height

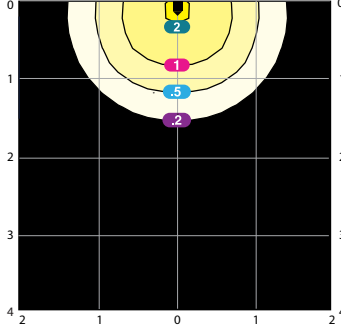

WPLED13

13W LED at 15' Mounting Height

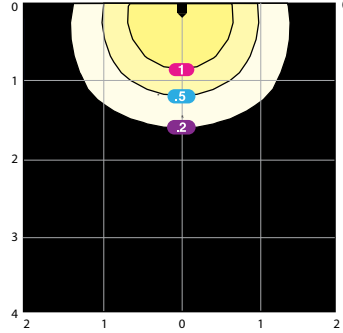

WPLED20

20W LED at 15' Mounting Height

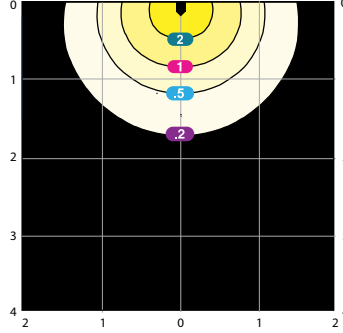

WPLED26

26W LED at 15' Mounting Height

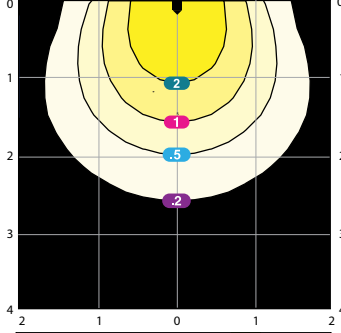

WPLED52

52W LED at 20' Mounting Height

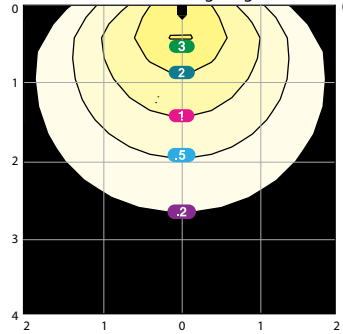

WPLED4T78 (Type IV)

78W LED at 20' Mounting Height

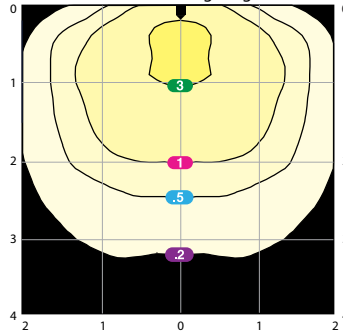

ALED10

10W LED at 10' Mounting Height

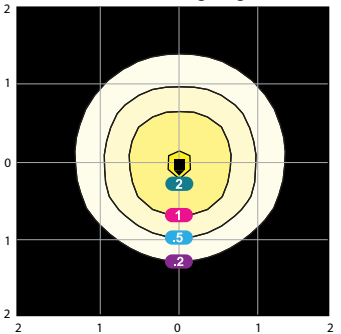

ALED13

13W LED at 15' Mounting Height

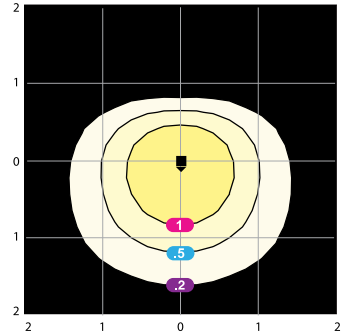

ALED20

20W LED at 20' Mounting Height

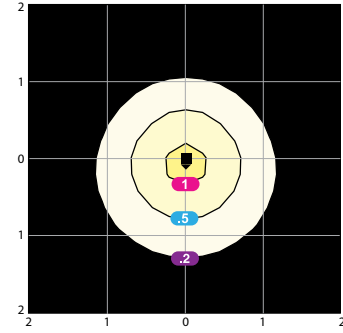

ALED26

26W LED at 20' Mounting Height

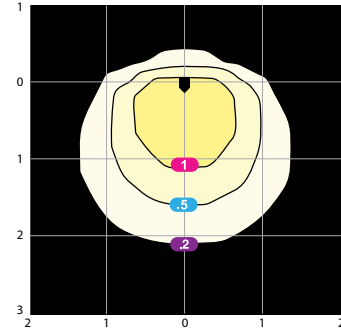

ALED52

52W LED at 30' Mounting Height

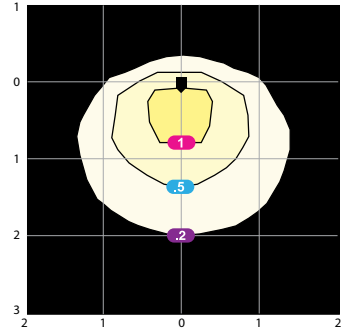

ALED2T78 (Type II)

78W LED at 20' Mounting Height

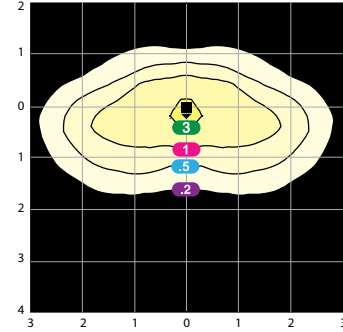

ALED3T78 (Type III)

78W LED at 20' Mounting Height

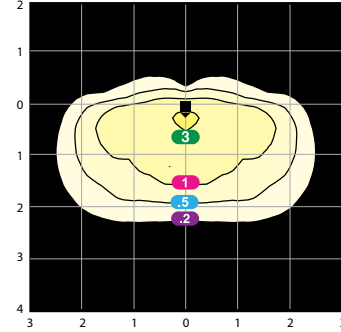

ALED4T78 (Type IV)

78W LED at 20' Mounting Height

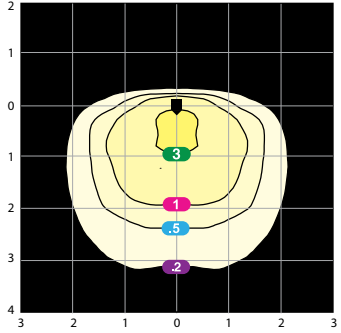

LFLED5Y (Flood)

5W LED at 8' Setback - 60° Above Horizon

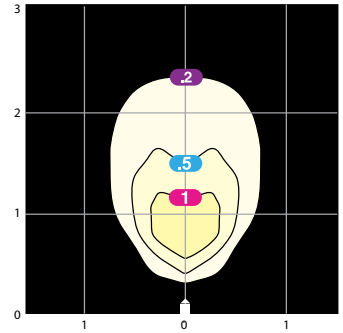

LFLED5Y (Spot)

5W LED at 8' Setback - 60° Above Horizon

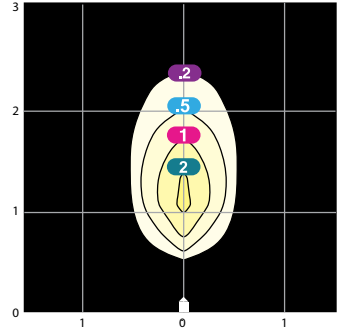

HBLED13 (Flood)

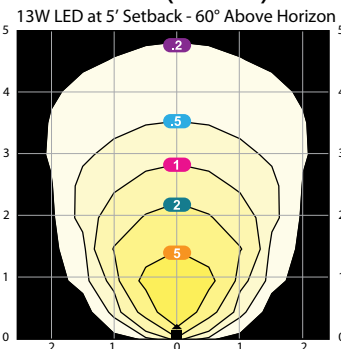

HBLED13 (Spot)

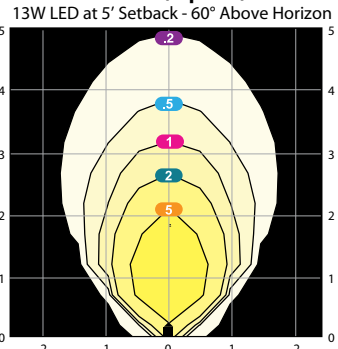

FFLED18

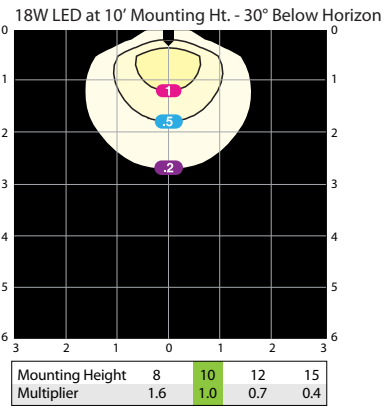

BLED2x20

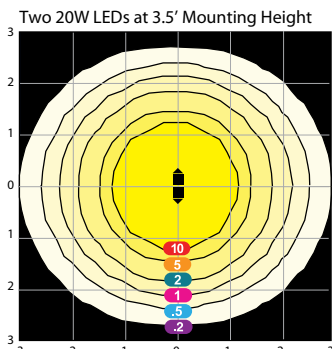

VXLED13DG

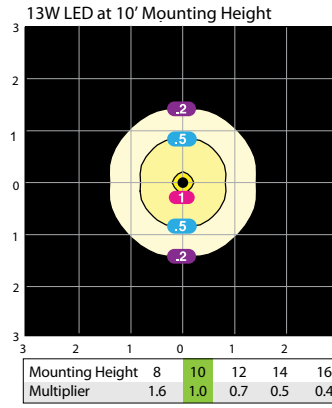

VXLED26DG

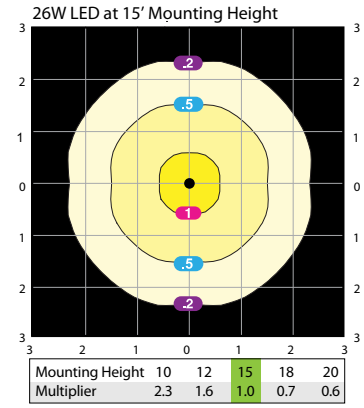

FFLED39

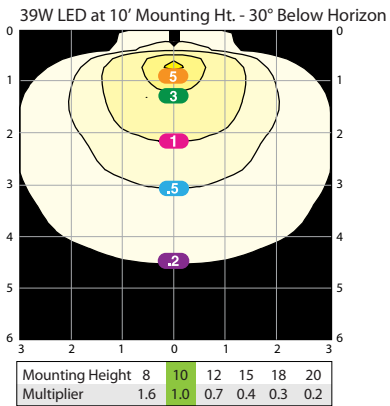

FXLED78

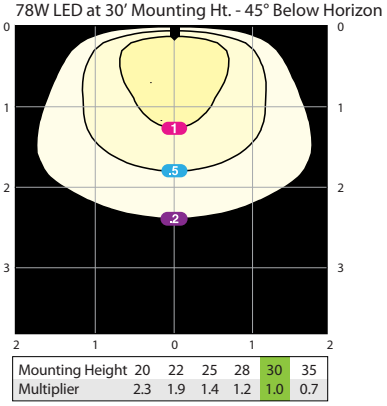

BLED5

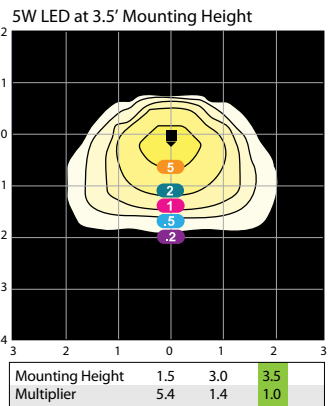

SLED5

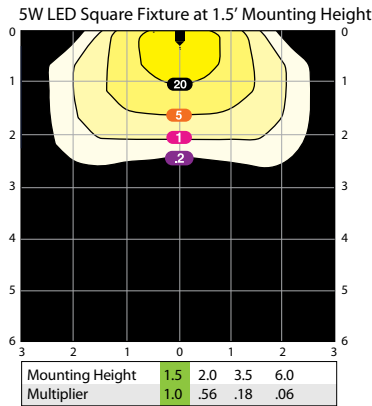

SLED5R

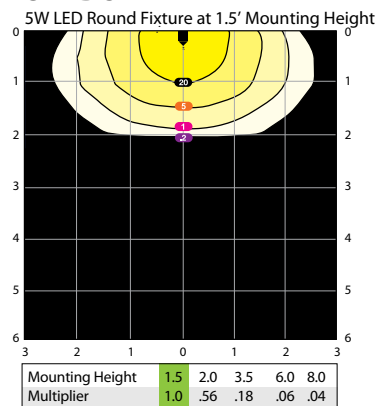

GNLED13B

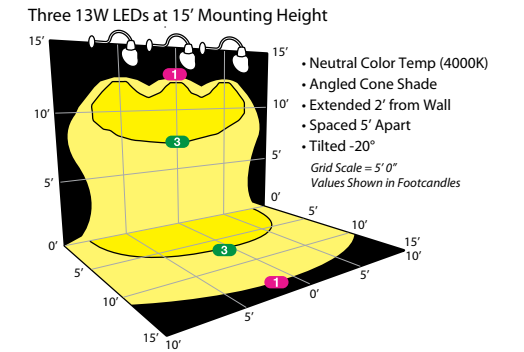

BLED2x5

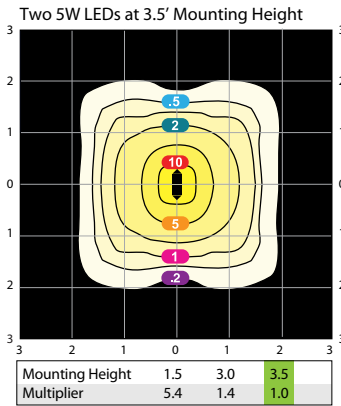

BLED10

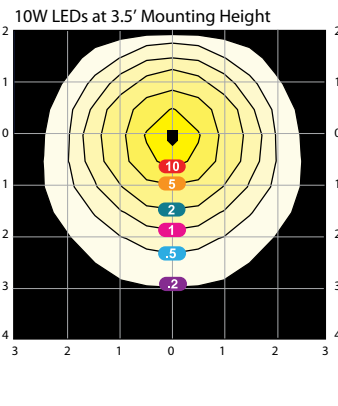

BLED2x10

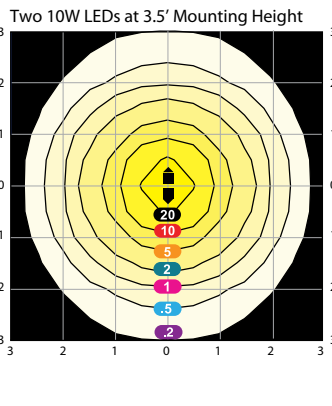

BLED13

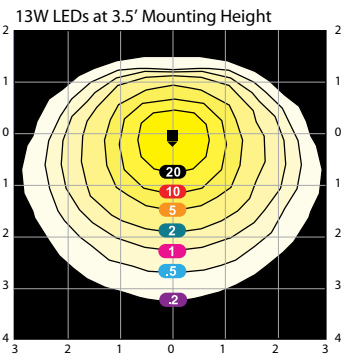

BLED2x13

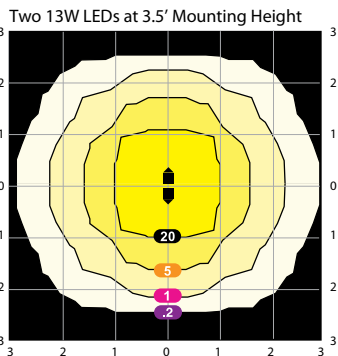

BLED20

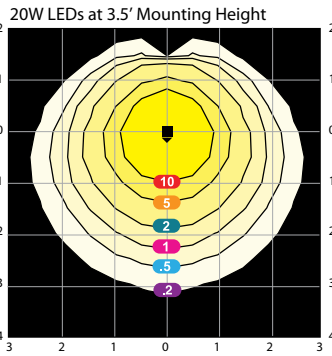

FLOODLIGHT FIELD & BEAM ANGLES

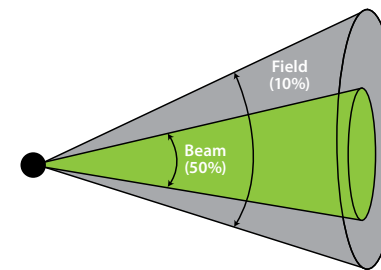

HBLED5 (Flood) - NEMA Type 5H x 5V

	Beam Angle (50%)	Field Angle (10%)
Horizontal	76°	96°
Vertical	76°	96°

HSLED13 - NEMA Type 2H x 2V

	Beam Angle (50%)	Field Angle (10%)
Horizontal	11°	24°
Vertical	12°	24°

HBLED5 (Spot) - NEMA Type 4H x 4V

	Beam Angle (50%)	Field Angle (10%)
Horizontal	29°	75°
Vertical	29°	75°

FFLED18 - NEMA Type 7H x 6V

	Beam Angle (50%)	Field Angle (10%)
Horizontal	102°	151°
Vertical	66°	108°

LFLED5 (Flood) - NEMA Type 4H x 4V

	Beam Angle (50%)	Field Angle (10%)
Horizontal	44°	65°
Vertical	44°	64°

HBLED13 (Flood) - NEMA Type 5H x 5V

	Beam Angle (50%)	Field Angle (10%)
Horizontal	65°	96°
Vertical	65°	96°

FFLED39 - NEMA Type 7H x 6V

	Beam Angle (50%)	Field Angle (10%)
Horizontal	136°	161°
Vertical	50°	100°

LFLED5 (Spot) - NEMA Type 3H x 3V

	Beam Angle (50%)	Field Angle (10%)
Horizontal	21°	40°
Vertical	20°	39°

HBLED13 (Spot) - NEMA Type 4H x 4V

	Beam Angle (50%)	Field Angle (10%)
Horizontal	26°	60°
Vertical	26°	60°

FXLED78 - NEMA Type 6H x 5V

	Beam Angle (50%)	Field Angle (10%)
Horizontal	96°	127°
Vertical	59°	94°

Percentages represent percentage of maximum beam candlepower.

Office Building Renovation Shines With RAB LED Lighting

A newly-renovated, professional office building in Jamestown, New York recently achieved the highest-quality, most energy-efficient exterior lighting possible when its old high pressure sodium fixtures were replaced with energy-efficient LED technology from RAB Lighting. According to Jody Peterson, owner of the property, "We went with 20 Watt LED fixtures mounted off the roof line on 24" arms with adjustable swivels to project lighting from the roof downward, as well as 5 Watt step lights for a wall wash effect to light the front of the building and the sidewalk. We also used 20 Watt double canopy LED fixtures underneath the cupolas to create a warm and well-lit entryway."

Bruce Hokanson, owner of Jamestown electrical contracting firm Hokanson Electric, praises the RAB fixtures' ease of installation. "The fixtures were all pre-wired, so they went in without any problems," he confirms. "The 20 Watt fixtures on the roof were great because their swivel allowed us to adjust them in a few different positions to find the ideal setting," he says.



Photos courtesy of Jon Elder

Peterson has been so pleased with the RAB LEDs that he's planning similar upgrades at a 5,400-square-foot food distribution center and a 20,000-square-foot medical center that he owns. "I would advise other building owners not to be afraid to spend the money to upgrade to LEDs," he says. "It's an investment you'll make once in a far superior product which will pay itself back every month, and the benefits will be very long-lasting."

"RAB's broad selection of high-quality, affordable LED fixtures makes it easy to upgrade to LED technology and enjoy long life and outstanding energy efficiency."

Matt Beebe, Branch Manager, Rexel Electrical Supplies, Jamestown



RAB LEDs Assure Self-Storage Facility of a Bright Future



Photo courtesy of Terry Crawley, Regional Sales Manager, RAB Lighting

Assured Self Storage, in Duncanville, Texas is one of 50,000 self-storage facilities in the U.S. "Like so many business owners and facility professionals, Assured did not want to play "Whack A Mole" with their lighting, constantly replacing lamps as they failed one or two at a time," explains RAB Regional Manager Terry Crawley. "They wanted a long-lasting light source that they could rely on to minimize maintenance

costs and concerns. Cutting their lighting energy bill by 80% is another big advantage!"

Impressed with RAB's WPLED20 solution, Christine Thurston, the facility's manager, installed 55 of the LED wallpack fixtures throughout their facilities in February 2011. "We love the lighting," Thurston confirms. "It gives a very inviting feeling and rich appearance to the property. In addition to the high quality of the light, our parent company, The Assured Group, loves the impact these fixtures have had on our energy bills and plans to use these lights in other facilities they build."

"In addition to the high quality of the light, our parent company loves the impact these fixtures have had on our energy bills and plans to use these lights in other facilities they build."

- Christine Thurston, Residential Manager of Assured Self Storage (Duncanville, TX)

RAB LED Shines on Thatcher McGhee's

The management team at Thatcher McGhee's Irish Pub & Eatery, in Pompton Plains, New Jersey, took great care with their lighting when they opened the restaurant's second branch. Thanks to RAB Lighting, the bright, warm, and welcoming ambiance that Thatcher McGhee's created for patrons is also environmentally friendly.

"Lighting sets the mood for everything," co-owner and long-time restaurateur Brendan Madden explained. Madden worked with Roland Zimmermann Electrical Contractor Inc. to review their options. "Shortly after RAB introduced its LED gooseneck lamps to the market," Jason Zimmermann said, "we decided to try a few to light the restaurant's front sign and we all agreed that they looked gorgeous at night. We then installed another six in the back and found that they successfully lit the entire area of the roof and looked great," he said.

"RAB's new LGOOSE LED fixtures offer restaurants like Thatcher McGhee's the perfect combination of vintage appeal and cutting-edge performance and efficiency," confirmed RAB CEO Ross Barna. "Featuring specially-engineered optics, a frosted glass lens, and a high Color Rendering index (CRI) of 86, the LGOOSE casts a smooth, natural, and uniform light with no glare, making it ideal

for illuminating and highlighting signage. Designed to match the architectural environment of the typical Main Street storefront," he added, "its three decorative shade options support the majority of outdoor retail and hospitality décors in one universal fixture design. At the same time," he continued, "the LGOOSE's 13 Watt LED technology delivers more than 80% energy

savings relative to an equivalent 75 Watt incandescent option and provides many years of maintenance-free light output without compromising quality of light."

"Lighting is huge in the restaurant business," Madden concluded, "and based on their quality, efficiency, long life, and cost, these RAB LEDs are the way to go."

"RAB's LGOOSE fixtures offer Thatcher McGhee's the old-style gooseneck charm consistent with the restaurant's theme and décor, but they're efficient and long-lasting too, which are important factors, because nobody wants to be changing bulbs 30+ feet up on a regular basis."

- Jason Zimmermann, Principal, Roland Zimmermann Electrical Contractor Inc. (Sloatsburg, NY)



Photo courtesy of David Gard

Affordable LED Lighting at Illinois School District



Reece Thome is the Energy Efficiency Manager for the school district in Hoffman Estates, Illinois, and is charged with evaluating building operations to conserve energy. Reece's energy cost analysis for the Conant High School unearthed the potential for substantial savings by upgrading existing 175 Metal Halide Wallpacks with new RAB LED LPACKs. The RAB LED fixtures not only offered a more affordable alternative to similar LED outdoor lighting, but also offered a substantial reduction in the school's energy consumption.

With \$5 million in budget cuts, Reece knew that the likelihood of getting budget approval for the project was slim. He conducted a cost analysis to demonstrate the return on investment (ROI). Additionally, Reece learned that many states across the country, including Illinois, are offering rebates or grants to schools and other facilities willing to install energy efficient "green products." Reece was excited to learn that these grants changed the lighting project from impossibility to a cost savings the school system felt was too

good to pass on. The grant allowed Conant to install the lights and pay only 10% of the cost of the system, with the rebates taking care of the other 90%. The program was approved by the school administration without hesitation.

"I knew there was an opportunity. My research showed that we could save \$5,000 a year and every month we were wasting money. In addition, I knew I had to act quickly since rebates usually do not last forever," said Reece.

Reece's LED success story should resonate with schools and commercial properties around the country. The RAB LPACK 20 has greatly improved the overall brightness in the canopy area welcoming students to Conant High School. The good news gets even better: many more states offer similar grants. To find a grant or rebate program in your area, go to www.rabweb.com/isave.

LEDs Save City \$46,000 a Year on Energy

Following an analysis of their lighting options in November 2010, Glen Cove officials agreed on an upgrade using highly-efficient LED technology from industry leader RAB Lighting. The 264 aesthetically-pleasing, bronze fixtures installed in December 2010 incorporate two 13 Watt LED light engines in a fully shielded, full cutoff design which ensures that light output is efficiently focused downward to highlight people and objects in the space. Tempered glass and double gasketing is able to withstand the extreme conditions associated with outdoor applications like parking garages, while the fixture's LED light engine is rated for 100,000 hours of life, which will help ensure long operation and significantly reduce maintenance costs for the city.



RAB Lighting's Nathan Drucker, Applications Engineering Manager for the Northvale, New Jersey-based lighting company, concurs that "RAB's CLED2X13 fixtures were indeed a great solution for the Glen Cove Parking Garage in terms of their optical design, outstanding energy efficiency, long life, and high lumen output. Based on the city's interest in lowering its energy consumption and costs, this fixture will reduce annual energy usage by over 240,000 kWh, delivering the city annual energy savings of more than \$46,000 and driving a project pay-back of only one year." Happily for the city, and on top of the attractive financial performance the RAB LED fixtures delivered all on their own, the project was also able to capitalize on a \$250 rebate per fixture extended by local utility Long Island Power Authority (LIPA), a financial incen-

tive which helped to offset the city's up-front project costs by over \$68,000. In terms of benefitting the environment, Glen Cove and LIPA spokespeople estimate that the lighting upgrade "will have the equivalent effect of eliminating over 307,661 pounds of CO2 from the air or avoiding the consumption of 15,840 gallons of gasoline by cars each year."

"Reduced cost to taxpayers, and decreased maintenance costs"



Student Housing Complex Roars Ahead with RAB LED

The Lion's Crossing student housing community—a 204-apartment complex located near Penn State University—was experiencing many issues with its outdoor area lighting when it agreed to undertake a lighting upgrade. "We had very dated-looking lights throughout the property," admits Stephanie Sherman, Property Manager. "The older, acorn-style fixtures we were using to light pathways sat on 8-foot-high black posts and had plastic covers, so they weren't very durable, and because they were fairly low to the ground, students started vandalizing them. All together, about half of our fixtures got vandalized and we had no way of replacing them because this style of fixture had been discontinued."

As Sherman and her team would find out, their upgrade, using 28 of RAB Lighting's "ALED20" fixture—a 20 Watt LED area light mounted on a 15' foot pole—ensured a host of benefits. "We like the sleek, unobtrusive design of RAB's fixtures and poles," she says. "The lights have great brightness and their slight bluish tint

makes the quality of the light softer than the harsh yellow lighting we had before. Also, the fixture heads point downward, so the light is well-directed, helping people to see where they're going. Finally," Sherman says, "they're much more durable, and now out of reach of our students, so they're less prone to vandalism."

"Response to the new lighting has been great," Sherman says. "The color and brightness are exceptional and we all feel a lot better knowing we can see where we're going. The new lighting also helps our courtesy officers conduct more effective rounds at night."

According to Whitehill's Edmonds, "RAB's LEDs were a great solution for Lion's Crossing." So much so that the team is planning to upgrade the lighting in the complex's breezeways and balconies in the coming year using RAB's LED ceiling lights and wall packs. Overall, says Sherman, "RAB provided a high-quality product at an affordable price. We're absolutely delighted with this system."



Photo courtesy of Simon Burns

RAB Lighting's LED Fixtures Are Helping Museum Achieve LEED Certification



Photos courtesy of Tory Taglio

When Don Aslett, author, business owner, CEO and the "King of Clean" created the Museum of Clean in Pocatello, Idaho, he looked toward RAB's energy-efficient LED fixtures to help him achieve the LEED-certified status he required. Because Don Aslett isn't just clean. He's green.

Don Aslett says the Museum and its grounds are in the final phases of becoming LEED certified, a recognized standard for measuring a building's sustainability by promoting environmentally-friendly design and construction practices. LED lighting fixtures reduce light pollution and will earn the Museum a light pollution reduction credit towards certification.

"The eco-friendliness and cost savings is great. I also really appreciate the aesthetics of RAB's luminaires."

- Don Aslett, Owner & CEO, Museum of Clean (Pocatello, ID)

Aslett's decision to use RAB Lighting's LED fixtures will also save him about \$20,000 in operating expenses over the next five years. "The eco-friendliness and cost savings is great," he says. "I also really appreciate the aesthetics of RAB's luminaires. They're modern-looking, clean, cutting-edge and beautiful. They make my museum look good, so they make me look good." The outdoor areas of the Museum property that

required lighting included a parking lot, a small park, walkways, the building perimeter, and a clock tower that's illuminated from the inside out. A wide variety of 84 RAB Lighting LED products, such as area lights, bollards, floodlights, wallpacks and motion sensors were installed.

"Museums now know they can lower their energy use and expenses by making some simple changes. One of the easiest ways to do this is by replacing metal halide fixtures with LED lighting," says Ross Barna, CEO of RAB Lighting, the Northvale, New Jersey-based leader in

outdoor LED lighting. "Many museums are now doing just that and have substantially reduced their energy bills. At RAB, we are dedicated to helping museums and other establishments achieve greater sustainability."

Aslett encourages everyone he meets, locals and tourists alike, to experience the Museum through personal visits, family field trips and corporate events. And besides, thanks in part to RAB Lighting, he enthused, "I have the most beautiful parking lot in town!"



WALLPACKS

35 - 150W HID / 26 - 42W CFL

SMALL SIZE



- Capacitor cradle removes heat
- Die-cast aluminum housing
- Photocell mounting hole
- Hinged door frame for easy relamping
- Silicone gasket
- White or bronze chip & fade resistant polyester powder coat finish
- Lamp supplied

3 Beam Patterns
To fit your job

Standard Cutoff Full Cutoff

Drilling template for easy wall box mounting

Quality tested

100%

UL LISTED
SUITABLE FOR WET LOCATIONS

Make the Switch to LED

Save energy
Save money

See LED pages 8-9 for details

Tallpack

Catalog #	White	Lamp Watts	Lamp Type	Lamp Base	Ballast	Input Watts	Lamp ANSI	Initial Lumens	Lamp Hours	Consider LED Replacement
HPS WPTS35	WPTS35W	35	ED17	Med	R-NPF 120V	46	S76	2,250	24,000	WPLED10
WPTS50	WPTS50W	50	ED17	Med	R-NPF 120V	62	S68	4,000	24,000	
WPTS70	WPTS70W	70	ED17	Med	R-NPF 120V	86	S62	6,300	24,000	

CFL

WPTF26	WPTF26W	26	GX24q-3	Triple	Electronic QT	29		1,800	12,000	WPLED10
WPTF28	WPTF28W	28	GX32d-3	Quad	NPF 120V	33		1,200	10,000	
WPTF32	WPTF32W	32	GX24q-3	Triple	Electronic QT	36		2,400	12,000	
WPTF42	WPTF42W	42	GX24q-4	Triple	Electronic QT	47		3,000	10,000	
WPTF42/ES	WPTF42/EWS	42	GX24q-4	Triple	Electronic QT	46		3,200	12,000	

Smart Tallpack

CFL WPTF28MS	WPTF28MSW	28	GX32d-3	Quad	NPF 120V	33		1,200	10,000	WPLED10MS
WPTF42MS	WPTF42MSW	42	GX24q-4	Triple	Electronic QT	47		3,000	10,000	

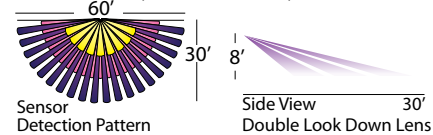

Die-cast with Glass

HPS WPTGSN70	WPTGSN70W	70	Med	ED17	R-NPF 120V	86	S62	6,300	24,000	WPLED10
WPTGSN70QT	WPTGSN70QW	70	Med	ED17	HX-HPF QT	91	S62	6,300	24,000	
WPTGSN100	WPTGSN100W	100	Med	ED17	R-NPF 120V	115	S54	9,500	24,000	
MH WPTGHN50	WPTGHN50W	50	Med	ED17	HX-NPF 120V	69	M110	3,400	10,000	WPLED10
WPTGHH50	WPTGHH50W	50	Med	ED17	HX-HPF QT	69	M110	3,400	10,000	
WPTGHH50QT	WPTGHH50QW	50	Med	ED17	HX-HPF QT	72	M110	3,400	10,000	
WPTGHN70	WPTGHN70W	70	Med	ED17	HX-NPF QT	94	M98	5,600	15,000	
WPTGHH70QT	WPTGHH70QW	70	Med	ED17	HX-HPF QT	90	M98	5,600	15,000	
WPTGHH100QT	WPTGHH100QW	100	Med	ED17	HX-HPF QT	129	M90	9,000	15,000	
WPTGHH100QT	WPTGHH100QW	100	Med	ED17	HX-HPF QT	129	M90	9,000	15,000	

For Photocell, add /PC after Catalog # (Example: WP2FCCH70QT/PC)



Patents: The design of the Tallpack is protected by U.S. Patent D569,029, Canada Patent D121,993, China Patent ZL200730149211.2 and Taiwan Patent D124,864.

WP1

HPS WP1SN35	WP1SN35W	35	Med	ED17	R-NPF 120V	46	S76	2,300	24,000	WPLED10
WP1SN50	WP1SN50W	50	Med	ED17	R-NPF 120V	62	S68	4,000	24,000	
WP1SN70	WP1SN70W	70	Med	ED17	R-NPF 120V	86	S62	6,300	24,000	
MH WP1H50	WP1H50W	50	Med	ED17	HX-NPF 120V	69	M110	3,400	10,000	WPLED10
WP1H70	WP1H70 W	70	Med	ED17	HX-NPF 120V	94	M98	5,600	15,000	
CFL WP1F26	WP1F26W	26	GX24q-3	Triple	Electronic QT	29		1,800	12,000	WPLED10
WP1F32	WP1F32W	32	GX24q-3	Triple	Electronic QT	36		2,400	12,000	
WP1F42	WP1F42W	42	GX24q-4	Triple	Electronic QT	46		3,200	12,000	
WP1F42/PC/ES	WP1F42/PC/ESW	42	GX24q-4	Triple	Electronic QT	46		3,200	12,000	

WP1G

HPS WP1GSN35	WP1GSN35W	35	Med	ED17	R-NPF 120V	46	S76	2,300	24,000	WPLED10
WP1GSN50	WP1GSN50W	50	Med	ED17	R-NPF 120V	62	S68	4,000	24,000	
WP1GSN70	WP1GSN70W	70	Med	ED17	R-NPF 120V	86	S62	6,300	24,000	
MH WP1GH50	WP1GH50W	50	Med	ED17	HX-NPF 120V	69	M110	3,400	10,000	WPLED10
WP1GH70	WP1GH70 W	70	Med	ED17	HX-NPF 120V	94	M98	5,600	15,000	
CFL WP1GF42	WP1GF42W	42	GX24q-4	Triple	Electronic QT	46		3,200	12,000	

WP1C

HPS WP1CSN35	WP1CSN35W	35	ED17	Med	R-NPF 120V	46	S76	2,300	24,000	WPLED10
WP1CSN50	WP1CSN50W	50	ED17	Med	R-NPF 120V	62	S68	4,000	24,000	
WP1CSN70	WP1CSN70W	70	ED17	Med	R-NPF 120V	86	S62	6,300	24,000	
MH WP1CH50	WP1CH50W	50	ED17	Med	HX-NPF 120V	69	M110	3,400	10,000	WPLED10
WP1CH70	WP1CH70W	70	ED17	Med	HX-NPF 120V	94	M98	5,600	15,000	
CFL WP1CF26	WP1CF26W	26	Triple	GX24q-3	Electronic QT	29		1,800	12,000	WPLED10
WP1CF32	WP1CF32W	32	Triple	GX24q-3	Electronic QT	36		2,400	12,000	
WP1CF42	WP1CF42W	42	Triple	GX24q-4	Electronic QT	46		3,200	12,000	
WP1CF42/PC/ES	WP1CF42/PC/ESW	42	Triple	GX24q-4	Electronic QT	46		3,200	12,000	

WP1FC

HPS WP1FCSN35	WP1FCSN35W	35	ED17	Med	R-NPF 120V	46	S76	2,300	24,000	WPLED13
WP1FCSN50	WP1FCSN50W	50	ED17	Med	R-NPF 120V	62	S68	4,000	24,000	
WP1FCSN70	WP1FCSN70W	70	ED17	Med	R-NPF 120V	86	S62	6,300	24,000	
MH WP1FCSN100	WP1FCSN100W	100	ED17	Med	R-NPF 120V	115	S54	9,500	24,000	WPLED26
WP1FCSN150	WP1FCSN150W	150	ED17	Med	R-NPF 120V	170	S55	16,000	24,000	
WP1FCSH150QT	WP1FCSH150QW	150	ED17	Med	HX-HPF QT	188	S55	16,000	24,000	
WP1FCH50QT	WP1FCH50QW	50	ED17	Med	HX-HPF QT	68	M110	3,400	10,000	
WP1FCH70QT	WP1FCH70QW	70	ED17	Med	HX-HPF QT	90	M98	5,600	15,000	
WP1FCH100QT	WP1FCH100QW	100	ED17	Med	HX-HPF QT	129	M90	9,000	15,000	
WP1FCH125PSQ	WP1FCH125PSQW	125	ED17	Med	HX-HPF QT	150	M150	12,000	15,000	
CFL WP1FCF26	WP1FCF26W	26	Triple	GX24q-3	Electronic QT	29		1,800	12,000	WPLED10
WP1FCF32	WP1FCF32W	32	Triple	GX24q-3	Electronic QT	36		2,400	12,000	
WP1FCF42	WP1FCF42W	42	Triple	GX24q-4	Electronic QT	46		3,200	12,000	

For Photocell, add /PC after Catalog # (Example: WP2FCCH70QT/PC)



Starting Temperature = 0°F, 28W = -20°F

Patents:

The design of the WP1FC is protected by U.S. Patent D561,377, Canada Patent 111930, China Patent ZL200530120058.1 and Taiwan Patent D126,172. The design of the WP1 is protected by U.S. Patent D440683 and similar patents pending in China, Taiwan and Canada.

ACCESSORIES

Wire Guard

Available for:

WPTG: GDWPTG

WP1G: GDWP1GW

WP1FC: GDWP1FCW



OPTIONS

Button Photocell - Add Suffix /PC (after Catalog #)

Swivel Photocell - Add Suffix /PCS (after Catalog #)

Available for: (Specify Wattage)

WP1

WP1G

WP1C

WP1FC



Single Fusing for 120 & 277V -

Add Suffix /F (after Catalog #)

Available for:

WP1

WP1G

WP1C

WP1FC

/ES catalog number products are ENERGY STAR qualified. Photocell included. See: www.energystar.gov



WALLPACKS

70 - 250W HID / 26 - 120W CFL

MID SIZE



Standard

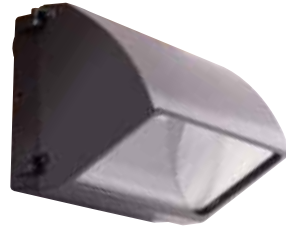

Cutoff



Full Cutoff

- Die-cast aluminum housing
- Photocell mounting hole
- Hinged door frame for easy relamping
- Tempered glass refractor
- Silicone gasket
- White or bronze chip & fade resistant polyester powder coat finish
- Lamp supplied

3 Beam Patterns

To fit your application



WP1C & WP1FC have a Capacitor cradle to remove heat from components

Quality tested



UL US LISTED
SUITABLE FOR WET LOCATIONS

Make the Switch to LED



See LED pages 8-11 for details

	Catalog # Bronze	White	Lamp Watts	Lamp Type	Lamp Base	Ballast	Input Watts	Lamp ANSI	Initial Lumens	Lamp Hours	Consider LED Replacement
WP2 Standard	HPS	WP2SH70	WP2SH70W	70	ED17	Med R-HPFSP 120V	86	S62	6,300	24,000	WPLED10
		WP2SH70QT	WP2SH70QTW	70	ED17	Med HX-HPF QT	91	S62	6,300	24,000	WPLED10
		WP2SN100	WP2SN100W	100	ED17	Med R-NPF 120V	115	S54	9,500	24,000	WPLED13
		WP2SH100	WP2SH100W	100	ED17	Med R-HPF 120V	115	S54	9,500	24,000	WPLED13
		WP2SH100QT	WP2SH100QTW	100	ED17	Med HX-HPF QT	115	S54	9,500	24,000	WPLED20
	MH	WP2SN150	WP2SN150W	150	ED17	Med R-HPFSP 120V	170	S55	16,000	24,000	WPLED20
		WP2SH150QT	WP2SH150QTW	150	ED17	Med HX-HPF QT	188	S55	16,000	24,000	WPLED20
		WP2H70	WP2H70W	PS 70	ED17	Med HX-NPF 120V	94	M98	5,600	15,000	WPLED10
		WP2H100QT	WP2H100QTW	PS 100	ED17	Med HX-HPF QT	129	M90	9,000	15,000	WPLED13
		WP2H125PSQ	WP2H125PSQW	PS 125	ED17/HBU	Med CWA-HPF QT	150	M150	12,000	15,000	WPLED20
	CFL	WP2H150PSQ	WP2H150PSQW	PS 150	ED17/U	Med CWA-HPF QT	190	M102	14,000	15,000	WPLED20
		WP2H150QT	WP2H150QTW	150	ED17	Med CWA-HPF QT	185	M107	12,500	10,000	WPLED20
		WP2F26	WP2F26W	26	Triple	GX24q-3 Electronic QT	29		1,800	12,000	WPLED10
		WP2F32	WP2F32W	32	Triple	GX24q-3 Electronic QT	36		2,400	12,000	WPLED10
		WP2F42	WP2F42W	42	Triple	GX24q-4 Electronic QT	46		3,200	12,000	WPLED10
WP2C Cutoff	HPS	WP2CSH70	WP2CSH70W	70	ED17	Med R-HPFSP 120V	86	S62	6,300	24,000	WPLED13
		WP2CSH70QT	WP2CSH70QTW	70	ED17	Med HX-HPF QT	91	S62	6,400	24,000	WPLED13
		WP2CSN100	WP2CSN100W	100	ED17	Med R-NPF 120V	115	S54	9,500	24,000	WPLED20
		WP2CSH100	WP2CSH100W	100	ED17	Med R-HPF 120V	115	S54	9,500	24,000	WPLED20
		WP2CSH100QT	WP2CSH100QTW	100	ED17	Med HX-HPF QT	115	S54	9,500	24,000	WPLED26
	MH	WP2CSH150QT	WP2CSH150QTW	150	ED17	Med HX-HPF QT	188	S55	16,000	24,000	WPLED26
		WP2CH70	WP2CH70W	PS 70	ED17	Med HX-NPF 120V	94	M98	5,600	15,000	WPLED13
		WP2CH100QT	WP2CH100QTW	PS 100	ED17	Med HX-HPF QT	129	M90	9,000	15,000	WPLED20
		WP2CH125PSQ	WP2CH125PSQW	PS 125	ED17/HBU	Med CWA-HPF QT	150	M150	12,000	15,000	WPLED20
		WP2CH150PSQ	WP2CH150PSQW	PS 150	ED17/U	Med CWA-HPF QT	185	M102	14,000	15,000	WPLED26
	CFL	WP2CH150QT	WP2CH150QTW	150	ED17	Med CWA-HPF QT	185	M107	12,500	15,000	WPLED26
		WP2CF26	WP2CF26W	26	Triple	GX24q-3 Electronic QT	29		1,800	12,000	WPLED10
		WP2CF32	WP2CF32W	32	Triple	GX24q-3 Electronic QT	36		2,400	12,000	WPLED10
		WP2CF42	WP2CF42W	42	Triple	GX24q-4 Electronic QT	46		3,200	12,000	WPLED10

For Photocell, add /PC after Catalog # (Example: WP2FCCH70QT/PC)



	Catalog # Bronze	White	Lamp Watts	Lamp Type	Lamp Base	Ballast	Input Watts	Lamp ANSI	Initial Lumens	Lamp Hours	Consider LED Replacement
WP2C Smart Pack with sensor	CFL WP2CF42MS	WP2CF42MSW	42	Triple	GX24q-4	Electronic QT	46	-----	3,200	12,000	WPLED10
	WP2F84MS	WP2F84MSW	84	2-42w Triple	GX24q-4	Electronic QT	92	-----	6,400	12,000	WPLED10
		120 volt only		120 volt only							
		Sensor Detection Pattern		Side View Double Look Down Lens							
WP2FC Full Cutoff	HPS	WP2FCSH70	WP2FCSH70W	70	ED17	Med R-HPF120V	86	S62	6,300	24,000	WPLED13
		WP2FCSH70QT	WP2FCSH70QTW	70	ED17	Med HX-HPF QT	91	S62	6,400	24,000	WPLED13
		WP2FCSN100	WP2FCSN100W	100	ED17	Med R-NPF 120V	115	S54	9,500	24,000	WPLED20
		WP2FCSH100	WP2FCSH100W	100	ED17	Med R-HPF 120V	115	S54	9,500	24,000	WPLED20
		WP2FCSH100QT	WP2FCSH100QTW	100	ED17	Med HX-HPF QT	115	S54	9,500	24,000	WPLED26
	MH	WP2FCSH150QT	WP2FCSH150QTW	150	ED17	Med HX-HPF QT	188	S55	16,000	24,000	WPLED26
		WP2FCH70QT	WP2FCH70QTW	PS 70	ED17	Med HX-NPF 120V	94	M98	5,600	15,000	WPLED13
		WP2FCH100QT	WP2FCH100QTW	PS 100	ED17	Med HX-HPF QT	129	M90	9,000	15,000	WPLED20
		WP2FCH125PSQ	WP2FCH125PSQW	PS 125	ED17/HBU	Med CWA-HPF QT	150	M150	12,000	15,000	WPLED26
		WP2FCH150PSQ	WP2FCH150PSQW	PS 150	ED17/U	Med CWA-HPF QT	185	M102	14,000	15,000	WPLED26
	CFL	WP2FCH150QT	WP2FCH150QTW	150	ED17	Med CWA-HPF QT	185	M107	12,500	15,000	WPLED26
		WP2FCF26	WP2FCF26W	26	Triple	GX24q-3 Electronic QT	29	S50	1,800	12,000	WPLED13
		WP2FCF32	WP2FCF32W	32	Triple	GX24q-3 Electronic QT	36	M136	2,400	12,000	WPLED13
		WP2FCF42	WP2FCF42W	42	Triple	GX24q-4 Electronic QT	46	M138	3,200	12,000	WPLED13

Patents: The design of the WP2FC Wallpack is protected by U.S. Patent D561,376, Canadian Patent 111944, China Patent ZL200530120059.6, and Taiwan Patent D126,173.

	Catalog # Bronze	White	Lamp Watts	Lamp Type	Lamp Base	Ballast	Input Watts	Lamp ANSI	Initial Lumens	Lamp Hours	Consider LED Replacement
WP3 Standard	HPS WP3SC250QT	WP3SC250QTW	250	ED28	Mogul	CWA HPF QT	295		28,500	24,000	WPLED52
	MH WP3H200PSQ	WP3H200PSQ W	200	T15	Mogul	CWA HPF QT	232		21,000	15,000	WPLED52
	WP3H250PSQ	WP3H250PSQ W	250	ED28	Mogul	CWA HPF QT	288		25,000	15,000	WPLED20
WP3C Cutoff	CFL WP3F120QT	WP3F120QTW	120	2G8-1	Hex	Electronic HPF	139	S50	9,000	20,000	WPLED20
	HPS WP3CSC250QT	WP3CSC250QTW	250	ED28	Mogul	CWA HPF QT	295	M136	28,500	24,000	WPLED52
	MH WP3CH200PSQ	WP3CH200PSQ W	200	T15	Mogul	CWA HPF QT	232	M138	21,000	15,000	WPLED52
WP3FC Full Cutoff	WP3CH250PSQ	WP3CH250PSQ W	250	ED28	Mogul	CWA HPF QT	288		25,000	15,000	WPLED13
	CFL WP3CF120QT	WP3CF120QTW	120	2G8-1	Hex	Electronic HPF	139		9,000	20,000	WPLED13
	HPS WP3FCSC250QT	WP3FCSC250QTW	250	ED28	Mogul	CWA HPF QT	295	S50	28,500	24,000	WPLED52
WP3FC Fully Shielded Full Cutoff Optics	MH WP3FCH200PSQ	WP3FCH200PSQ W	200	T15	Mogul	CWA HPF QT	232	M136	21,000	15,000	WPLED52
	WP3FCH250PSQ	WP3FCH250PSQ W	250	ED28	Mogul	CWA HPF QT	288		25,000	15,000	WPLED52

Patents: The design of the WP3FC Wallpack is protected by U.S. Patent D584,445, Canada Patent D127,159, Mexico Patent 28575, Taiwan Patent D130019 and China patent pending.

ACCESSORIES

Wire Guard

Available for:

- WP2: GDWP2W
- WP2FC: GDWP2FCW
- WP3: GDWP3W
- WP3C: GDWP3FC
- WP3FC: GDWP3FC



WP2 Retrofit Kit

Convert WP2 Standard to Cutoff: WP2CORK



CFL Battery Backup

Available for:

- WP2, WP2C & WP2FC
- 120V: /E1
- 277V: /E2



Emergency Battery Back Up:

Bodine "Coldpak" will operate the WP2 42watt CFL lamp for 90 minutes if power fails. Rated -20°C to +55°C. Battery is a maintenance free NiCad with 7-10 year life.

WALLPACKS

320 - 400W HID

LARGE SIZE



Standard



Cutoff



Full Cutoff

- Die-cast aluminum housing
- Photocell mounting hole
- Hinged door frame for easy relamping
- Tempered glass lens
- White or bronze chip & fade resistant polyester powder coat finish
- Silicone gasket
- Lamp supplied



3 Beam Patterns
To fit your application



Protective Packaging



Make the Switch to LED



Save energy
Save money

See LED pages 10-11 for details

WP4	Catalog # Bronze	White	Lamp Watts	Lamp Type	Lamp Base	Ballast	Input Watts	Lamp ANSI	Initial Lumens	Lamp Hours	Consider LED Replacement
Standard	HPS WP4SC400QT	WP4SC400QTW	400	ED18	Mogul	CWA HPF QT	464	S51	50,000	24,000	WPLED2T78
	MH WP4H320PSQ	WP4H320PSQW	320	ED28	Mogul	CWA HPF QT	368	M132	31,000	20,000	
	WP4H350PSQ	WP4H350PSQW	350	ED28	Mogul	CWA HPF QT	400	M131	35,000	20,000	
	WP4H400PSQ	WP4H400PSQW	400	ED28	Mogul	CWA HPF QT	450	M135	40,000	20,000	
Cutoff	HPS WP4CSC400QT	WP4CSC400QTW	400	ED18	Mogul	CWA HPF QT	464	S51	50,000	24,000	
	MH WP4CH320PSQ	WP4CH320PSQW	320	ED28	Mogul	CWA HPF QT	368	M132	31,000	20,000	
	WP4CH350PSQ	WP4CH350PSQW	350	ED28	Mogul	CWA HPF QT	400	M131	35,000	20,000	
	WP4CH400PSQ	WP4CH400PSQW	400	ED28	Mogul	CWA HPF QT	450	M135	40,000	20,000	
Full Cutoff	HPS WP4FCSC400QT	WP4FCSC400QTW	400	ED18	Mogul	CWA HPF QT	464	S51	50,000	24,000	
	MH WP4FCH320PSQ	WP4FCH320PSQW	320	ED28	Mogul	CWA HPF QT	368	M132	31,000	20,000	
	WP4FCH350PSQ	WP4FCH350PSQW	350	ED28	Mogul	CWA HPF QT	400	M131	35,000	20,000	
	WP4FCH400PSQ	WP4FCH400PSQW	400	ED28	Mogul	CWA HPF QT	450	M135	40,000	20,000	



Patents: The design of the WP4FC Wallpack is protected by U.S. Patent D583,977, Canada Patent D127,110, Mexico Patent 28574, Taiwan Patent D130,020 and China patent pending.

ACCESSORIES

Wire Guard
Available for:
WP4: GDWP3W
WP4C: GDWP3FC
WP4FC: GDWP3FC



OPTIONS

Button Photocell -
Add Suffix /PC (after Catalog #)
Swivel Photocell -
Add Suffix /PCS (after Catalog #)
Available for: (Specify Wattage)
WP4
WP4C



Single Fusing
for 120 & 277V
Add Suffix /F
(after Catalog #)
Available for:
WP4
WP4C

Double Fusing
for 208 & 240V
Add Suffix /FF
(after Catalog #)
Available for:
WP4
WP4C

Quartz Restrike
Add Suffix /QR
(after Catalog #)
Available for:
WP4
WP4C

Tamperproof
screws
Add Suffix /TP
(after Catalog #)
Available for:
WP4
WP4C

BARN LIGHTS

70 - 150W HID / 65W CFL

DUSK-TO-DAWN YARDLIGHT



Yard Blaster



Down Blaster



The "Shade"

- Photocell controlled
- Die-cast aluminum housing
- Hydroformed aluminum refractor
- One piece acrylic refractor on YLS
- Lamp supplied



Packed to arrive perfect



Yard Blaster ships in highly protective molded styrofoam packaging

Quality tested



Make the Switch to LED



Save energy
Save money

See LED pages 18-19 for details

Yard Blaster



Yard Blaster	Catalog # Bronze	White	Lamp Watts	Lamp Type	Lamp Base	Ballast	Input Watts	Lamp ANSI	Initial Lumens	Lamp Hours	Consider LED Replacement
HPS	YLS70	YLS70W	70	ED17	Medium	R-NPF 120V	86	S62	6,300	24,000	WPLED10
	MH YLH70	YLH70W	70	EDX17	Medium	NPF-HPF 120V	90	M98	5,600	15,000	WPLED13
	YLH100	YLH100W	100	EDX17	Medium	NPF-HPF 120V	135	M90	9,000	10,000	WPLED10
CFL	YLF65	YLF65W	65	Oct	Medium	NPF 120V			4,300	8,000	
HPS	YLS150	YLS150W	150	ED17	Medium	R-NPF 120V	170	S55	16,000	24,000	WPLED20
HPS	YDS70	YDS70W	70	ED17	Medium	R-NPF 120V	86		6,300	24,000	WPLED13
	YDS150	YDS150W	150	ED17	Medium	R-NPF 120V	170		16,000	24,000	WPLED26
	MH YDH70	YDH70W	70	EDX17	Medium	NPF-HPF 120V	90		5,600	15,000	WPLED13
YDH100	YDH100W	100	EDX17	Medium	NPF-HPF 120V	135		9,000	10,000	WPLED20	
CFL	YDF65	YDF65W	65	Oct	Medium	NPF 120V			4,300	8,000	WPLED13

The Shade



SHY
(Natural Aluminum)

Converts RAB Yard Blasters & similar "Barn Light" fixtures to Full Cutoff
Fits screw-on Barn Lights by: RAB • Lumark™
American • Heath®-Zenith • Regent/NCI
Electripak™ • Designer's Edge™

Fits clip-on Barn Lights by:
Hubbell • GE®



MOUNTING ARM

24" Curved Steel
(catalog # YARM24)
Available for:
Yard Blaster
Down Blaster



LIGHT DISTRIBUTION



Yard Blaster
Light Distribution



Down Blaster
Full Cutoff

45% more light
on the job!

FLOODLIGHTS

35 - 150W HID / 26 - 84 CFL

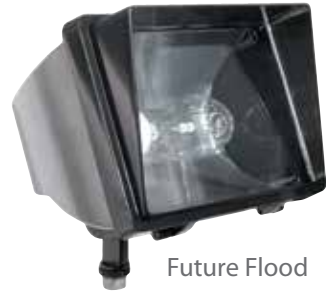

Future Flood



EZ Flood



EZ Flood with Visor

- Die-cast aluminum housing
- Hinged door frame for easy relamping
- Tempered glass lens
- White or bronze chip & fade resistant polyester powder coat finish
- Silicone gasket
- Lamp supplied



Built-in Glare Shield

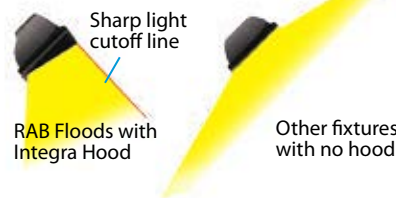

Variable Beam Spread

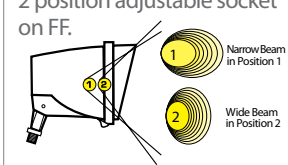

Make the Switch to LED



See LED pages 18-19 for details

	Catalog #	White	Lamp Watts	Lamp Type	Lamp Base	Ballast	Input Watts	Lamp ANSI	Initial Lumens	Lamp Hours	Consider LED Replacement		
Future Flood HPS	FF35	FF35W	35	ED17	Med	R-NPF 120V	46	S76	2,300	24,000	FFLED18		
	FF50	FF50W	50	ED17	Med	R-NPF 120V	62	S68	4,000	24,000			
	FF70	FF70W	70	ED17	Med	R-NPF 120V	86	S62	6,300	24,000			
	FF100	FF100W	100	ED17	Med	R-NPF 120V	115	S54	9,500	24,000			
	FF150	FF150W	150	ED17	Med	R-NPF 120V	170	S55	16,000	24,000			
	MH	FFH50	FFH50W	PS 50	ED17	Med	HX-NPF	72	M110	3,400		10,000	FFLED18
		FFH70	FFH70W	PS 70	ED17	Med	HX-NPF	94	M98	5,600		15,000	
	CFL	FF42QT	FF42QTW	42	Triple	Med	Electronic QT	46		3,200		12,000	FFLED18
		FF42QT/PC/ES	FF42QT/PC/ESW	42	Triple	Med	Electronic QT	46		3,200		12,000	

Patents: The design of the Future Flood is protected by U.S. Patent #D420458 and similar patents pending in China, Taiwan and Canada.

	Catalog #	White	Lamp Watts	Lamp Type	Lamp Base	Ballast	Input Watts	Lamp ANSI	Initial Lumens	Lamp Hours	Consider LED Replacement		
EZ Flood HPS	EZSH35	EZSH35W	35	ED17	Med	R-HPF 120V	46		2,300	24,000	FFLED18		
	EZSH50	EZSH50W	50	ED17	Med	R-HPF 120V	62		4,000	24,000			
	EZSH70	EZSH70W	70	ED17	Med	R-HPF 120V	86	S76	6,300	24,000			
	EZSH70QT	EZSH70QTW	70	ED17	Med	HX-HPF QT	91	S68	6,300	24,000			
	EZSH100	EZSH100W	100	ED17	Med	R-HPF 120V	115	S62	9,500	24,000			
	EZSH100QT	EZSH100QTW	100	ED17	Med	HX-HPF QT	130	S62	9,500	24,000			
	EZSH150	EZSH150W	150	ED17	Med	R-HPF 120V	170	S54	16,000	24,000			
	EZSH150QT	EZSH150QTW	150	ED17	Med	HX-HPF QT	188	S54	16,000	24,000			
	MH	EZHH50QT	EZHH50QTW	PS 50	ED17	Med	HX-HPF QT	72	S55	3,400		10,000	FFLED18
		EZHH70QT	EZHH70QTW	PS 70	ED17	Med	HX-HPF QT	90	S55	5,600		15,000	
CFL	EZFH26QT	EZFH26QTW	PS 26	GX24q-3	Triple	Electronic QT	29	M107	1,800	12,000	FFLED18		
	EZFH32QT	EZFH32QTW	32	GX24q-3	Triple	Electronic QT	36	M102	2,400	12,000			
	EZFH42QT	EZFH42QTW	42	GX24q-4	Triple	Electronic QT	46		3,200	12,000			
	EZFH84QT	EZFH84QTW	84	2-42w Triple	GX24q-4	Electronic QT	93		6,400	12,000			



Patents: The design of the EZ Flood is protected by patents and patents pending in the U.S., China and Taiwan

ACCESSORIES



/ES catalog number products are ENERGY STAR qualified. Photocell included. See: www.energystar.gov

LANDSCAPE FLOODS

50 - 150W

INCANDESCENT



HB101 Bell



HB101 Bullet



PAR20 Flood



Sleek 16

- Die-cast aluminum housing
- Heavy duty mounting arm
- 4 color choices of powder coat finishes that last
- EZ grip locknut



Easy Relamping

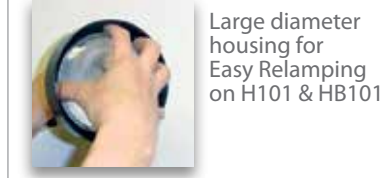

Large diameter housing for Easy Relamping on H101 & HB101

Large Silicone Gasket



Provides weatherproof protection around lamp & socket

Make the Switch to LED



See LED pages 16-17 for details

H System	Catalog #	Bronze	Black	White	Verde Green	Max. Lamp Watts	LF Floods	Catalog #	Bronze	Black	White	Verde Green	Max. Lamp Watts	Consider LED Replacement	
	PAR38	H101A	H101B	HB101W	HB101VG	150W		MR16 (low voltage)	LFM16A	LFM16B	LFM16W	LFM16VG	50W	LFLED5	
		HB101A	HB101B	HB101W	HB101VG	150W			PAR16	LFP16A	LFP16B	LFP16W	LFP16VG	60W	LFLED5
	PAR38							PAR16 PAR20 R Type	LF20A	LF20B	LF20W	LF20VG	75W	HBLED10	
									PAR20 PAR38	LFP38A	LFP38B	LFP38W	LFP38VG	150W	HBLED13
								PAR Floods	PAR38 (External gasket)	R90MA	R90MB	R90MW	R90MVG	150W	HBLED13
									PAR38 (Internal gasket)	R90A	R90B	R90W	R90VG	150W	HBLED13

ACCESSORIES for H101 & HB101



FLOODLIGHTS

50 - 1000W HID / 42 - 84W CFL

SPECIFICATION GRADE



Flex Flood



Flex Flood XL



Floodzilla



MegaFlood

- Die-cast aluminum housing
- Anodized aluminum reflector
- Tempered glass lens
- White or bronze chip & fade resistant polyester powder coat finish
- Silicone gasket
- Lamp supplied

Multiple mounting options



Make the Switch to **LED**



Save energy
Save money

See LED pages 8-11 for details

Catalog # Bronze	White	Lamp Watts	Lamp Type	Lamp Base	Ballast	EPA	Weight	Input Watts	Lamp ANSI	Initial Lumens	Lamp Hours	Consider LED Replacement
HPS FX70	FX70W	70	ED17	Med	R-HPF 120V	1.1	17	86	S62	6,300	24,000	FFLED18
FX70QT	FX70QTW	70	ED17	Med	HX-HPF QT	1.1	17	91	S62	6,300	24,000	
FX100	FX100W	100	ED17	Med	R-HPF 120V	1.1	19	115	S54	9,500	24,000	FFLED39
FX100QT	FX100QTW	100	ED17	Med	HX-HPF QT	1.1	19	130	S54	9,500	24,000	
FX150	FX150W	150	ED17	Med	R-HPF 120V	1.1	19	170	S55	16,000	24,000	FFLED39
FX150QT	FX150QTW	150	ED17	Med	HX-HPF QT	1.1	19	188	S55	16,000	24,000	
MH FXH50QT	FXH50QTW	PS 50	ED17	Med	HX-HPF QT	1.1	15	69	M110	3,400	10,000	FFLED18
FXH70QT	FXH70QTW	PS 70	ED17	Med	HX-HPF QT	1.1	16	91	M98	5,600	15,000	
FXH100QT	FXH100QTW	PS 100	ED17	Med	HX-HPF QT	1.1	17	129	M90	9,000	15,000	FFLED39
FXH125PSQ	FXH125PSQW	PS 125	ED17	Med	CWA-HPF QT	1.1	17	150	M150	12,000	15,000	
FXH150PSQ	FXH150PSQW	PS 150	ED17	Med	HX-HPF QT	1.1	17	185	M102	14,000	15,000	FFLED39
FXH150QT	FXH150QTW	150	ED17	Med	CWA-HPF QT	1.1	17	185	M107	12,500	10,000	
CFL FXF42QT	FXF42QTW	42	Triple	GX24q-4	Electronic HPF			46	*	3,200	12,000	FFLED18
FXF84QT	FXF84QTW	84	2-42W Triple	GX24q-4	Electronic HPF			92	*	6,400	12,000	

Mounting options: (catalog numbers above are for 1/2" Swivel Mount version)

Wall: add suffix "X" to Cat # (Example: FX70XQT) • Trunnion: add suffix "T" to Cat # (Example: FX70TQT)

Slipfitter: add suffix "SF" to Cat # (Example: FX70SFQT)

Catalog # Bronze	White	Lamp Watts	Lamp Type	Lamp Base	Ballast	EPA	Weight	Input Watts	Lamp ANSI	Initial Lumens	Lamp Hours	Consider LED Replacement
HPS FXL250XQT	FXL250XQTW	250	ED18	Mogul	CWA-HPF QT	2.0	34	295	S50	28,500	24,000	FXLED78
FXL400XQT	FXL400XQTW	400	ED18	Mogul	CWA-HPF QT	2.0	36	464	S51	50,000	24,000	
MH FXLH200XPSQ	FXLH200XPSQW	E 200	T15	Mogul	CWA-HPF QT	2.0	31	232	M136	19,000	15,000	FXLED78
FXLH250XPSQ	FXLH250XPSQW	E 250	ED28	Mogul	CWA-HPF QT	2.0	32	288	M138/M153	22,000	12,000	
FXLH320XPSQ	FXLH320XPSQW	E 320	ED28	Mogul	CWA-HPF QT	2.0	32	365	M132/M154	30,000	20,000	
FXLH350XPSQ	FXLH350XPSQW	E 350	ED28	Mogul	CWA-HPF QT	2.0	32	400	M131	33,000	20,000	
FXLH400XPSQ	FXLH400XPSQW	E 400	ED28	Mogul	CWA-HPF QT	2.0	32	450	M135/M155	40,000	20,000	

(catalog numbers above are for Wall Mount version)

Mounting options:

Trunnion: replace "X" with "T" in Cat # (Example: FXL250TQT) • Slipfitter: replace "X" with "SF" in Cat # (Example: FXL250SFQT)

Patents:

The design of the FlexFlood is protected by U.S. Patents D544125, D545472, D545471, D545987, China Patents ZL200530004904.3, ZL200530004905.8, ZL200530004903.9, ZL200530004906.2, ZL200530004902.4, Taiwan Patents D113250, D113248, and D113252.
The design of the FlexFlood XL is protected by U.S. Patents D552283, D550387, D549380 and D552282, Canada Patents D115522, D115602, D115147 and D115601, China Patents ZL200630133219.5, ZL200630133220.8, ZL200630014233.3 and ZL200630133222.7, Taiwan Patents D121517, D121171 and D120512 and Taiwan patents pending.

Catalog # Bronze	Lamp Watts	Lamp Type	Lamp Base	Ballast	EPA	Weight	Input Watts	Lamp ANSI	Initial Lumens	Lamp Hours	Consider LED Replacement
FLOODZILLA! HPS FZS250QT	250	ED18	Mogul	CWA-HPF QT	1.3	33	295	S50	28,500	24,000	FXLED78
FZS400QT	400	ED18	Mogul	CWA-HPF QT	1.3	35	464	S51	50,000	24,000	
MH FZH200PSQ	E 200	T15	Mogul	CWA-HPF QT	1.3	30	232	M136	19,000	15,000	FXLED78
FZH250PSQ	E 250	ED28	Mogul	CWA-HPF QT	1.3	31	288	M138	22,000	12,000	
FZH320PSQ	E 320	ED28	Mogul	CWA-HPF QT	1.3	31	368	M132	30,000	20,000	
FZH350PSQ	E 350	ED28	Mogul	CWA-HPF QT	1.3	31	400	M131	33,300	20,000	
FZH400PSQ	E 400	ED28	Mogul	CWA-HPF QT	1.3	31	450	M135	40,000	20,000	
MegaFlood HPS MEGS250QT	250	ED18	Mogul	CWA-HPF	2.0	33	295	S50	29,000	24,000	FXLED78
MEGS400QT	400	ED18	Mogul	CWA-HPF	2.0	36	464	S51	50,000	24,000	
MH MEGH200PSQ	E 200	ED28	Mogul	CWA-HPF QT	2.0	31	232	M136	19,000	15,000	FXLED78
MEGH250PSQ	E 250	ED28	Mogul	CWA-HPF QT	2.0	34	288	M138	22,000	12,000	
MEGH320PSQ	E 320	ED28	Mogul	CWA-HPF QT	2.0	34	368	M132	30,000	20,000	
MEGH350PSQ	E 350	ED28	Mogul	CWA-HPF QT	2.0	34	400	M131	33,300	20,000	
MEGH400PSQ	E 400	ED28	Mogul	CWA-HPF QT	2.0	34	450	M135	40,000	20,000	
Floodinator HPS FNS1000QT	1000	ED25	Mogul	CWA HPF QT	4.0	75	1100	S52	140,000	20,000	FXLED78
FNS1000/480	1000	ED25	Mogul	CWA HPF 480	4.0	75	1100	S52	140,000	20,000	
MH FNH1000QT	PS 1000	BT56	Mogul	CWA HPF QT	4.0	68	1080	M47	110,000	20,000	FXLED78
FNH1000/480	PS 1000	BT56	Mogul	CWA HPF 480	4.0	68	1080	M47	110,000	20,000	

Patents:

The design of Floodzilla is protected by U.S. Patents D547478 and D547477, Canada Patents D115521 and D115510, China Patents ZL200630133217.6 & ZL200630133221.2, Taiwan patents D121170 & D121172. The design of MegaFlood is protected by U.S. Patents D565772 and D570024, Canada Patents D121989 and D121991, China Patent ZL200730149208.0, Taiwan patent D127426 and patents pending in China and Taiwan. The design of Floodinator is protected by U.S. Patents D567980 and D572396, Canada Patents D121990 and D121998, China Patents ZL200730149207.6 & ZL200730149212.7 Taiwan patent D127687 and patents pending in Canada, Taiwan, China and Mexico.

BEAM CONTROL

MegaFlood & Floodinator Adjustable Reflector

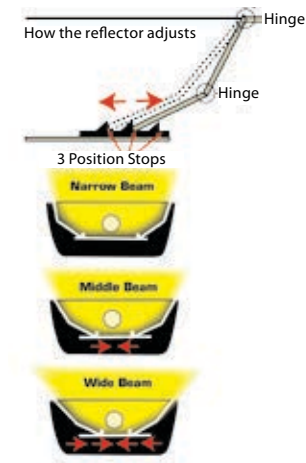

FX and FXL Variable Beam Spread

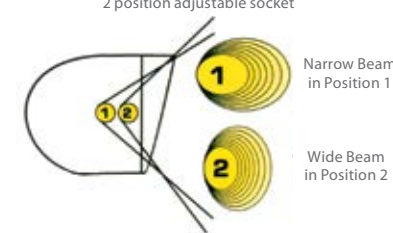

Integra Hood Glare Shield Flex Flood and Floodzilla have cut off beam control

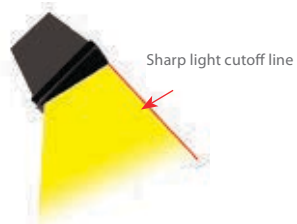

ACCESSORIES

Wire Guard

FlexFlood: GDFX
FlexFlood XL: GDFXL
Floodzilla: GDFZW
MegaFlood: GDMEGW
Floodinator: GDFN



Glare Hood

Floodzilla: FZH4 (4" length) FZH9 (9" length)
MegaFlood: MEGH4 (4" length) MEGH9 (9" length)
Floodinator: FNH6 (6" length) FNH12 (12" length)



Polycarbonate Shield

Floodzilla: GDFZP
MegaFlood: GDMEGP



FACTORY INSTALLED OPTIONS

	Button Photocell Add Suffix after Catalog Number 120V = /PC 208 - 277V = /PC2 480V = /PC4	Swivel Photocell Add Suffix after Catalog Number 120V = /PCS 208 - 277V = /PCS2 480V = /PCS4	Twist Lock Photocell Add Suffix after Catalog Number 120V = /PCT 208 - 277V = /PCT2 480V = /PCT4	Single Fusing for 120 & 277V Add Suffix /F after Catalog Number	Double Fusing for 208, 240 & 480V Add Suffix /FS after Catalog Number	Center Pin Torx® Tamperproof Screws Add Suffix /TP after Catalog Number
FlexFlood	•	•		•	•	•
FlexFlood XL	•	•		•	•	•
Floodzilla	•	•		•	•	•
MegaFlood	•	•		•	•	•
Floodinator		•		•	•	•

FLOODLIGHTS

QUARTZ FLOODS

75 - 1500W QUARTZ HALOGEN



Quality features

- Lamp packed with protective cushion for easy installation
- EZ Grip locknut

- Die-cast aluminum housing
- Tempered glass lens
- White or bronze chip & fade resistant polyester powder coat finish
- Integra Glare Shield*

* except for: QF300, QF500 & Qf1500



Designed for long lamp life

- Heat sinks for cooler operation = extended lamp and fixture life
- Gold plated socket contacts
- 250° Teflon coated socket wires



Make the Switch to LED

LED



Save energy
Save money

See LED pages 16-22 for details

Bullets

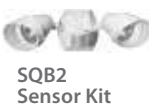

Bullets	Catalog # Bronze	White	Black	Verde Green	Lamp Watts	Lamp Type	Lamp Base	Initial Lumens	Lamp Hours	Replacement Lamp	Consider LED Replacement
QB1	QB1A	QB1W	QB1B	QB1VG	75	T-4	bi-pin (GY8.0)	1,500	1,500	LQ75-GY8	LFLED5
QB2 Twin Flood Kit	QB2A	QB2W	QB2B	QB2VG	75	T-4	bi-pin	1,500	1,500	LQ75-GY8	2-LFLED5
SQB1 Sensor Kit	SQB1A	SQB1W	SQB1B	SQB1VG	75	T-4	bi-pin	1,500	1,500	LQ75-GY8	WPLED10MS or STLHBLD10
	Kit contains: (1) QB1A (1) SMS500 (1) CU4A	Kit contains: (1) QB1W (1) SMS500 (1) CU4A	Kit contains: (1) QB1B (1) SMS500 (1) CU4A	Kit contains: (1) QB1VG (1) SMS500 (1) CU4A							
SQB2 Sensor Kit	SQB2A	SQB2W	SQB2B	SQB2VG	75	T-4	bi-pin	1,500	1,500	LQ75-GY8	WPLED20MS or STLHBLD10x2
	Kit contains: (1) QB2A (1) SMS500 (1) CU4A	Kit contains: (1) QB2W (1) SMS500 (1) CU4A	Kit contains: (1) QB2B (1) SMS500 (1) CU4A	Kit contains: (1) QB2VG (1) SMS500 (1) CU4							

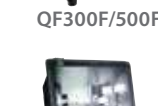
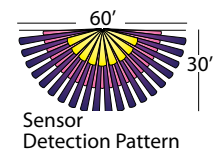

Catalog # Bronze	White	Lamp Watts	Lamp Type	Lamp Base	Initial Lumens	Lamp Hours	Replacement Lamp	Parts Lens	Consider LED Replacement
QF150F QF200F	QF150FW QF200FW	150 200	T3 T3	Double Ended Double Ended	2,800 3,600	2,000 2,000	LQ150 LQ200	LQ150F LQ200F	WPLED39
QF300F QF500F	QF300FW QF500FW	300 500	T3 T3	Double Ended Double Ended	6,100 11,000	2,000 2,000	LQ300 LQ500	LQ300F LQ500F	FXLED78
QF300 QF500	QF300W QF500W	300 500	T3 T3	Double Ended Double Ended	6,000 9,500	2,000 2,000	LQ300 LQ500		FXLED78
QF1500	n/a	1500	T3	Double Ended (Lamp not supplied)	33,000	2,000	n/a		

Worklights

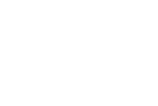

Catalog #	Color	Lamp Watts	Lamp Base	Initial Lumens	Lamp Hours	Replacement Lamp
QF150CL	Clamp: Black Fixture: Yellow	150	Double Ended RSC	2,800	2,000	LQ150
QF150P	Clamp: Black Fixture: Yellow	150	Double Ended RSC	2,800	2,000	LQ150
QF500P	Clamp: Black Fixture: Yellow	500	Double Ended RSC	10,500	2,000	LQ500
QF500T	Stand: Yellow Fixture: Black	500	Double Ended RSC	10,500	2,000	LQ500
QF2X500T	Stand: Yellow Fixture: Black	1000	Double Ended RSC	21,000	2,000	LQ500

ACCESSORIES

Chrome Plated Wire Guard (catalog # GDQF)
Available for: Quartz Curve 500



Chrome Plated Wire Guard (catalog # GDQF2)
Available for: Quartz Curve 200



AREA LIGHTS

WALL AND POLE MOUNTING

35 - 400W HID / 26 - 84W CFL



- Die-cast aluminum housing
- Custom hydroformed reflector
- Tempered glass lens
- Chip and fade resistant polyester powder coat finish
- Fins for heat dissipation
- Silicone O-ring gasket
- Stainless steel external hardware
- Lamp supplied



Size comparison

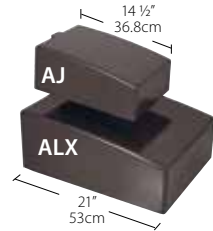

Pole Mounting

Mount 1-4 fixtures to a RAB pole



See pages 56-57 for more details

Make the Switch to LED



Save energy
Save money

See LED pages 12-13 for details



Pole Mount
Use at 10' - 15'
Mounting Height
Max EPA = 0.8

Catalog #	White	Lamp Watts	Lamp Type	Lamp Base	Ballast	Input Watts	Lamp ANSI	Initial Lumens	Lamp Hours	Consider LED Replacement
HPS AJSN35	AJSN35W	35	ED17	Med	R-NPF 120V	46	S76	2,300	24,000	ALED10
AJSN50	AJSN50W	50	ED17	Med	R-NPF 120V	62	S68	4,000	24,000	
AJSH70QT	AJSH70QTW	70	ED17	Med	HX-HPF QT	91	S62	6,400	24,000	ALED13
AJSH100QT	AJSH100QTW	100	ED17	Med	HX-HPF QT	115	S54	9,500	24,000	ALED26
AJSH150QT	AJSH150QTW	150	ED17	Med	HX-HPF QT	188	S55	16,000	24,000	ALED52
MH AJH50QT	AJH50QTW	50	PS ED17	Med	HX-HPF QT	69	M110	3,400	10,000	ALED13
AJH70QT	AJH70QTW	70	PS ED17	Med	HX-HPF QT	91	M98	5,600	15,000	ALED26
AJH100QT	AJH100QTW	100	PS ED17	Med	HX-HPF QT	129	M90	9,000	15,000	
AJH125PSQ	AJH125PSQW	125	PS ED17/HBU	Med	CWA-HPF QT	150	M150	12,000	15,000	ALED52
AJH150PSQ	AJH150PSQW	150	PS ED17	Med	CWA-HPF QT	185	M102	14,000	15,000	
AJH150QT	AJH150QTW	150	ED17	Med	CWA-HPF QT	185	M107	12,500	10,000	
CFL AJF26QT	AJF26QTW	26	Triple	GX24q-3	Electronic 26W	29	-----	1,800	12,000	ALED10
AJF32QT	AJF32QTW	32	Triple	GX24q-3	Electronic 32W	36	-----	2,400	12,000	
AJF42QT	AJF42QTW	42	Triple	GX24q-4	Electronic 42W	46	-----	3,200	12,000	ALED13
AJF52QT	AJF52QTW	52	Triple	GX24q-3	Electronic 52W	58	-----	3,600	12,000	
AJF64QT	AJF64QTW	64	Triple	GX24q-3	Electronic 64W	72	-----	4,800	12,000	ALED26
AJF84QT	AJF84QTW	84	Triple	GX24q-4	Electronic 84W	92	-----	6,400	12,000	



Pole Mount
Catalog #s above



Wall Mount
add suffix "X" to Catalog #
(Example: AJSN35X)



Flat Wall Mount
add suffix "FX" to Catalog #
(Example: AJSN35FX)



Patents: The design of the AJ Area Light is protected by U.S. Patents D579,140, D579,141, D591,445, Canada patents D127,031, D127,040, D127,045, China patents ZL200830143714.3, ZL200830143713.9, ZL200830143712.4, Mexico patents 27395, 28572, 28577 and Taiwan patents D129,808 and D131,622.



Pole Mount
Use at 15 - 25'
Mounting Height

Catalog #	Lamp Watts	Lamp Type	Lamp Base	Ballast	Input Watts	Lamp ANSI	Initial Lumens	Lamp Hours	Consider LED Replacement
HPS ALS250QT	250	ED18	Mogul	CWA-HPF	295	S50	29,000	24,000	ALED78
ALS400QT	400	ED18	Mogul	CWA-HPF	464	S51	50,000	24,000	
MH ALH200SFPSQ	200	ED28	Mogul	CWA HPF QT	232	M136	19,000	15,000	ALED78
ALH250SFPSQ	250	ED28	Mogul	CWA HPF QT	288	M138	22,000	12,000	
ALH320SFPSQ	320	ED28	Mogul	CWA HPF QT	368	M132	30,000	20,000	
ALH350SFPSQ	350	ED28	Mogul	CWA HPF QT	400	M131	33,300	20,000	
ALH400SFPSQ	400	ED28	Mogul	CWA HPF QT	450	M135	40,000	20,000	



Pole Mount
Catalog #s above
Max. EPA = 1.0



Wall Mount
add suffix "X" to Catalog #
(Example: ALS250XQT)



Slipfitter Mount
add suffix "SF" to Catalog #
(Example: ALS250SFQT)
Max. EPA = 2.0

U.S. patent D591,445, Canada D127,045, Mexico 28577 and patents pending in the U.S., China and Taiwan.



Pole Mount
Use at 15 - 25'
Mounting Height

Catalog #	Lamp Watts	Lamp Type	Lamp Base	Ballast	Input Watts	Lamp ANSI	Initial Lumens	Lamp Hours	Consider LED Replacement
HPS ALXS250QT	250	ED18	Mogul	CWA HPF QT	295	S50	29,000	24,000	ALED78
ALXS400QT	400	ED18	Mogul	CWA HPF QT	464	S51	50,000	24,000	
MH ALXH200PSQ	200	T15	Mogul	CWA HPF QT	232	M136	19,000	15,000	ALED78
ALXH250PSQ	250	ED28	Mogul	CWA HPF QT	288	M138	22,000	12,000	
ALXH320PSQ	320	ED28	Mogul	CWA HPF QT	368	M132	30,000	20,000	
ALXH350PSQ	350	ED28	Mogul	CWA HPF QT	400	M131	33,300	20,000	
ALXH400PSQ	400	ED28	Mogul	CWA HPF QT	450	M135	40,000	20,000	



Pole Mount
Catalog #s above



Wall Mount
add suffix "X" to Catalog #
(Example: ALXS250XQT)



Flat Wall Mount
add suffix "T" to Catalog #
(Example: ALXS250FXQT)



The design of the AL Area Light is protected by U.S. Patents D579140, D579141, D587839, Canada D127031, D127040, Taiwan D129808, Mexico 27395, 28396 and patents pending in China, Mexico and Taiwan.

ACCESSORIES

Chrome-Plated Wire Guard

AL:	Catalog#
AJ:	GDAJW
AL:	GDMEGW
ALX:	GDALXW



AJ shown with Wire Guard & House Side Shield

House Shield

AL:	Catalog#
AJ:	AJHS7
AL:	MEGH9
ALX:	ALXHS9



House Side Shield

Polycarbonate Shield

AL:	Catalog#
AL:	GDMEGP

FACTORY INSTALLED OPTIONS

Button Photocell

Swivel Photocell

AJ, AL, ALX

Add Suffix /PC or /PCS after Catalog Number (Specify Voltage)



Twistlock Photocell

Add Suffix /PCT after Catalog Number (Specify Voltage)

Single Fusing for 120 & 277V

Add Suffix /F after Catalog Number (Specify Voltage)

Double Fusing for 208 & 240V

Add Suffix /FF after Catalog Number (Specify Voltage)

480 Volt Ballast (consult factory) Add Suffix /480 after Catalog Number

FEATURES

ALX has a toolless removable ballast tray with quick disconnects



Hydroformed Reflector for superb photometric performance



POLES & BRACKETS

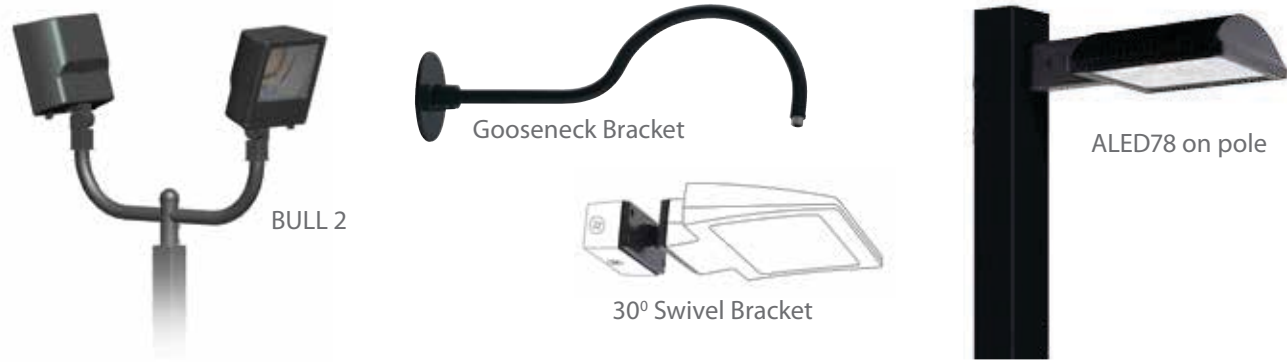

- Reinforced steel construction
- Polyester powder coat finish
- Poles have reinforced hand holes
- Galvanized anchor bolts & hardware
- 3/16" thick steel for slipfitters and wall brackets

Shipping Protection

RAB Poles are wrapped in heavy corrugated cardboard. Bases and ends have additional protection to prevent damage during shipment.

Shaft: 46,000 p.s.i. minimum yield
Base Plates: Slotted base plates 36,000 p.s.i.



Anchor Bolt Template included

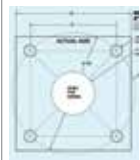

Quality tested



POLES

Catalog #	Shaft Size SQ(in)	Gauge	Pole Height (ft)	Hand Hole Dimensions	Anchor Bolt Dimensions	POLE CAPACITY Max. EPAs (sf) / Max. Weights (lb) ft. with 1.3 gust		
						70 MPH	80 MPH	100 MPH
Tenon Poles								
PS4-11-10WT	4	11	10	3" x 5"	3/4" x 17"x3"	27.6 / 690	21.1 / 530	13.1 / 330
PS4-11-15WT	4	11	15	3" x 5"	3/4" x 17"x3"	14.0 / 400	10.2 / 295	5.6 / 165
PS4-07-20WT	4	7	20	3" x 5"	3/4" x 30"x3"	16.2 / 390	11.8 / 285	6.3 / 150
PS4-11-20WT	4	11	20	3" x 5"	3/4" x 17"x3"	8.3 / 240	5.6 / 165	2.2 / 75
PS4-07-25WT	4	7	25	3" x 5"	3/4" x 30"x3"	10.7 / 245	7.2 / 165	2.9 / 65
PS4-11-25WT	4	11	25	3" x 5"	3/4" x 17"x3"	4.5 / 135	2.3 / 80	-
PS5-07-20WT	5	7	20	3" x 5"	1" x 36"x3"	28.2 / 670	20.9 / 495	11.8 / 280
PS5-07-25WT	5	7	25	3" x 5"	1" x 36"x3"	19.6 / 450	13.9 / 320	6.7 / 155
PS5-07-30WT	5	7	30	3" x 5"	1" x 36"x3"	12.1 / 300	7.8 / 195	2.4 / 60
PS5-11-20WT	5	11	20	3" x 5"	1" x 36"x3"	13.3 / 335	9.2 / 230	4.2 / 105
PS5-07-35WT	5	7	35	3" x 5"	1" x 36"x3"	7.2 / 180	3.7 / 95	-
PS5-11-25WT	5	11	25	3" x 5"	1" x 36"x3"	7.8 / 195	4.6 / 115	0.7 / 20
PS5-11-30WT	5	11	30	3" x 5"	1" x 36"x3"	3.7 / 95	1.2 / 30	-
Drilled Poles								
PS4-11-10D2	4	11	10	3" x 5"	3/4" x 17"x3"	27.6 / 690	21.1 / 530	13.1 / 330
PS4-11-15D2	4	11	15	3" x 5"	3/4" x 17"x3"	14.0 / 400	10.2 / 295	5.6 / 165
PS4-11-20D2	4	11	20	3" x 5"	3/4" x 17"x3"	8.3 / 240	5.6 / 165	2.2 / 75
PS4-11-25D2	4	11	25	3" x 5"	3/4" x 17"x3"	4.5 / 135	2.3 / 80	0.8 / 35
PS4-07-25D2	4	7	25	3" x 5"	3/4" x 30"x3"	10.7 / 245	7.2 / 165	2.9 / 65

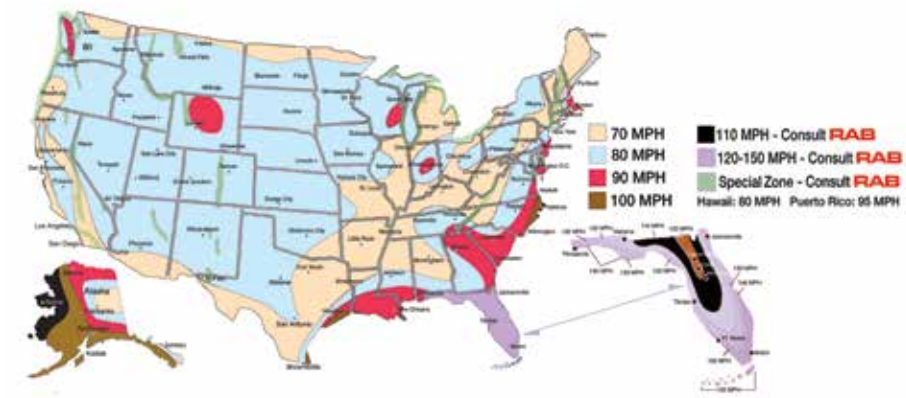

Specifications

Powder Coating: Polyester powder coating resists chipping and scratching. It's electrostatically applied and oven cured to powder manufacturer's specifications. Excellent color retention.

Hand Holes: Reinforced with steel cover. Powder coated hand hole covers. Finished interior to avoid hand scratches and cuts.

Shaft: 46,000 p.s.i. minimum yield

Base Plates: Slotted base plates 36,000 p.s.i.

BRACKETS

GOOSE1B Black
GOOSE1A Bronze
GOOSE1W White
Gooseneck Bracket

Mounts to: Wall
Accepts: 1/2" NPS thread
Max. Wt. Capacity: 7 lbs.



ARM24A Bronze
ARM24W White
Straight Arm Bracket

Mounts to: Wall
Accepts: 1/2" NPS thread
Max. Wt. Capacity: 7 lbs.



ARMSV24 Bronze
ARMSV24W White
30° Straight Arm w/ Swivel

Mounts to: Wall
Accepts: 1/2" NPS thread
Max. Wt. Capacity: 7 lbs.

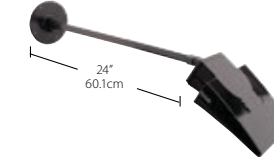

SWIVEL30 Bronze
SWIVEL30W White
30° Swivel Bracket

Mounts to: Wall
Accepts: 1/2" NPS thread
Max. Wt. Capacity: 7 lbs.



BAD4 BAD5 BAD6 Bronze
Pole Adapter

Mounts to: Steel Pole
Accepts: Slipfitter & Bullhorns
Max. Wt. Capacity: 7 lbs.
BAD4: Mounts to 4" square pole
BAD5: Mounts to 5" square pole
BAD6: Mounts to 6" square pole



BCAT2 Bronze
Cross Arm Bracket

Mounts to: BSF, BWALL9, BWC18 & BWT12
Accepts: 2 Trunnion Floods
Spacing: 28"
Max. Wt. Capacity: 52 lbs. / fixture
MAX. EPA: 5



BTW12 Galvanized Steel
Trunnion Wall Bracket

Mounts to: Wall
Accepts: Trunnion Floods
Spacing: 12"
Max. Wt. Capacity: 105 lbs.
Max. EPA: 5

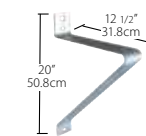

BWS7 Galvanized Steel
Slipfitter "S" Bracket

Mounts to: Wood Pole
Accepts: Slipfitter Floods
Spacing: 7"
Max. Wt. Capacity: 105 lbs.
Max. EPA: 5

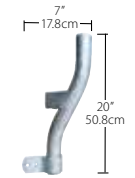

BSF Bronze
Slipfitter Bracket

Mounts to: 2 3/8" Tenon
Accepts: Trunnion Floods
Max. Wt.: 40 lbs.
Bracket EPA: .2

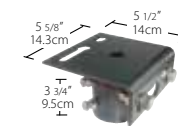

BWALL9 Bronze
Wall Bracket

Mounts to: Wall
Accepts: Trunnion Floods
Spacing: 9"
Max. Wt.: 40 lbs.
Max. EPA: .3



BWC18 Galvanized Steel
Curved Bracket for wood poles

Mounts to: Wood Pole
Accepts: Trunnion Floods
Spacing: 18"
Max. Wt.: 105 lbs.
Max. EPA: 5



BWC12 Galvanized Steel
Slipfitter Bracket for wood poles

Mounts to: Wood Pole
Accepts: Slipfitter Floods
Spacing: 12"
Max. Wt.: 105 lbs.
Max. EPA: 5



BULL2 Bronze
Bullhorn Bracket

Accepts: Slipfitter Floods
Max. Wt.: 100 lbs. each
Max. EPA: 5.0 each
Bracket EPA: 1.35

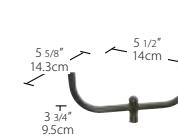

BULL2W Galvanized Steel
Slipfitter Bracket

Accepts: Slipfitter Floods
Max. Wt.: 100 lbs. each
Max. EPA: 5.0 each
Bracket EPA: 1.35



BULL3 Bronze
Bullhorn Bracket

Accepts: Slipfitter Floods
Max. Wt.: 90 lbs. each
Max. EPA: 4.0 each
Bracket EPA: 2.0

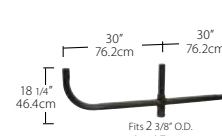

BULL4 Bronze
Curved Bracket for wood poles

Accepts: Slipfitter Floods
Max. Wt.: 77 lbs. each
Max. EPA: 2.5 each
Bracket EPA: 3.3

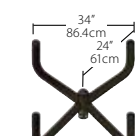

MAB Bronze
90° Slipfitter Bracket

MCB Bronze
90° Curved Slipfitter Bracket

Mounts to: Wall
Max. Wt. Capacity: 90 lbs.
Max. EPA: 4.0

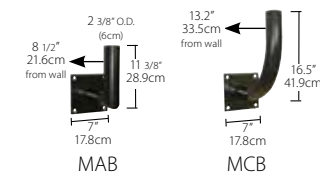

BGS Bronze
Surface Mount

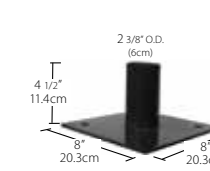

BGC Bronze
Slipfitter Concrete Mount

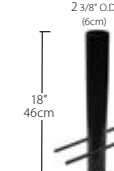

BTA4 Bronze
Tenon Adapter

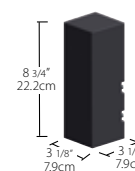

OUTDOOR SENSORS

SECURITY GRADE STEALTH SENSORS



STEALTH 360



STEALTH 200



STEALTH 110

- Quick test time
- Vandal-resistant color-matched lens
- 1000W switching capacity
- Protected manual override
- White or bronze finish
- 10-year warranty
- LED detection indicators



SUITABLE FOR WET LOCATIONS

Surge Protection

STEALTH MOV (metal oxide varistor) surge protection withstands 6000 Volts



Radio Frequency Immunity

STEALTH won't get fooled by RF signals



All Season Sensitivity

STEALTH Automatic Temperature Compensation operates flawlessly in both cold and hot weather. Other brands become too sensitive in cold and fail to turn on when it's hot.

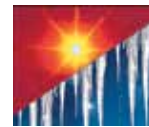

Make the Switch to LED



Save energy
Save money

See LED pp 22-23 for details

STEALTH[®] 360

Catalog # Bronze	White	Detection Pattern
STL360	STL360W	360°

- Security Grade sensor senses 180° out and 360° down. The most technically advanced sensor on the market!
- Universal CU4 EZ Plate included
- 1000 Watt switching capacity



CU4 EZ Plate



STEALTH 360X w/ X-10 transmitter

Catalog # Bronze	White	Detection Pattern
STL360X	STL360XW	360°

- Same features as STL360 plus...
- Plug-in chime module included
- House and unit code control knobs
- Controls lights, outlets, door chimes and other plug-in devices
- Up to 256 addresses for secure operation
- Interfaces with X-10, Leviton DHC and Lutron Radio RA

STEALTH[®] Kits 360

Catalog # Bronze	White	Detection Pattern
STL360H	STL360HW	360°
STL360HB	STL360HBW	360°

- Pre-assembled, pre-wired kits save installation time. The most technically advanced sensor flood kits!
- Die-cast aluminum floodlights
- Pre-wired, pre-assembled on CU4 Universal EZ Plate
- Accepts PAR-38 Lamps, 150 Watt maximum
- Lamps not supplied

Consider LED Replacement

STLFFLED18

STLFFLED18

STL360 DETECTION COVERAGE

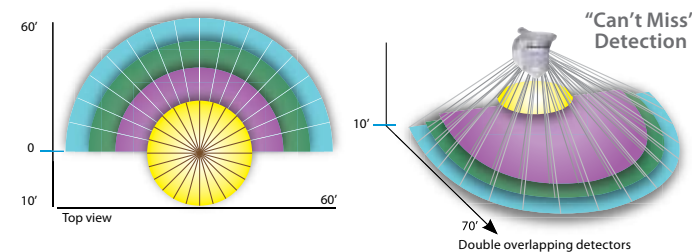

STL110 & 200 DETECTION PATTERNS

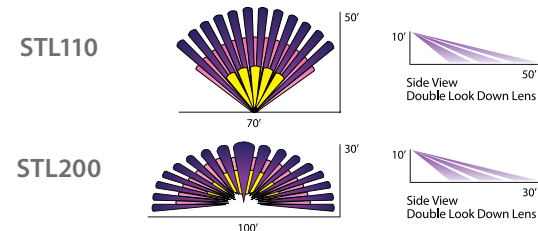

STEALTH[®]

Catalog # Bronze	White	Detection Pattern
STL110	STL110W	110°
STL200	STL200W	200°
STL12LV	n/a	110°



STEALTH 110



STEALTH 200



STEALTH 12V

- The "Pro's Choice" for reliability with hundreds of thousands of satisfied customers
- 100° detection
- LED detection and "on guard" indicator
- Pre-wired, pre-assembled on CU4 Universal EZ plate
- 6000 Volt surge protection
- 1000 Watt switching capacity

- 200° detection provides wide side-to-side coverage. Excellent for building perimeter protection.
- LED detection and "on guard" indicator
- Pre-wired and pre-assembled on CU4 Universal EZ plate
- Radio Frequency Immunity
- 6000 Volt surge protection
- 1000 Watt switching capacity

- 110° sensor for 12 Volt AC/DC systems.
- 96 Watt switching capacity
- Pre-wired, pre-assembled on CU4 Universal EZ Plate
- Great for low-voltage lighting
- Pre-wired and pre-assembled on CU4 Universal EZ plate

STEALTH[®] Kits

Completely Assembled And Pre-Wired For Quick Installation



STEALTH 110° Bell Flood Kit



STEALTH 110° Bullet Flood Kit



STEALTH 110° Economy Flood Kit



STEALTH 200° Bell Flood Kit



STEALTH 200° Bullet Flood Kit

Catalog # Bronze	White	Detection Pattern
STL110H	STL110HW	110°
STL110HB	STL110HBW	110°
STL110R	STL110RW	110°
STL200H	STL200HW	200°
STL200HB	STL200HBW	200°

- Pre-assembled, pre-wired kits save installation time.
- Die-cast aluminum floodlights
- Pre-wired, pre-assembled on CU4 Universal EZ Plate
- Accepts PAR-38 lamps, 150 Watt maximum
- Lamps not supplied

Consider LED Replacement

STL1HBLEDD2x13W

STL1HBLEDD2x13W

STL1HBLEDD2x13W

STL1HBLEDD2x13W

STL1HBLEDD2x13W

Patents: RAB sensor and fixture designs are protected under U.S. and international intellectual property laws.

OUTDOOR SENSORS



MINI SENSOR



TUFF DOME



GOTCHA



LUMINATOR

- Surge protection
- Quick test time
- Vandal resistant
- Color matched lens
- Protected manual override
- White or bronze finish

Quality tested



Floodlight kits come **Completely Assembled** And Pre-Wired For Quick Installation



Make the Switch to **LED**
Save energy
Save money
See LED pages 22-23 for details

Catalog #	Black	White	Detection Pattern
-----------	-------	-------	-------------------

Gotcha! Plus



GT500	GT500W	110°	<ul style="list-style-type: none"> • 110° view sensor with the features that professionals trust • 500W switching capacity @120V, Incandescent, 150W Fluorescent • 6000 Volt surge protection • Temperature compensation • Protected manual override with auto reset • 5 Year Warranty
-------	--------	------	--

Patents: The design of the Gotcha Sensor is protected by Canadian Patent 119244, China Patent ZL200730002266, and Taiwan Patents D123958.

Catalog #	Bronze	White	Detection Pattern
-----------	--------	-------	-------------------

Gotcha! Kit



GT500R	GT500RW	110°	<ul style="list-style-type: none"> • Gotcha Sensor with c2 weatherproof, corrosion-resistant polycarbonate floods • Molded gaskets • Corrosionproof universal cover plate • Suitable for wet locations • 500 Watt Incandescent switching capacity • Lights deactivate during daylight
--------	---------	------	---

Completely Assembled And Pre-Wired For Quick Installation

Consider LED Replacement
STLHBLEd2x13W

LUMINATOR



LS300	LS300W	110°	<ul style="list-style-type: none"> • 110° view sensor with corrosionproof, weatherproof, non-metallic case • 300 Watt switching capacity @120V • Manual override • 3000 Volt surge protection • Auto test logic • 3 Year Warranty
-------	--------	------	---

LUMINATOR Kit



Catalog #	Bronze	White	Detection Pattern
LU300	LU300W	110°	<ul style="list-style-type: none"> • 110° view sensor with corrosionproof, weatherproof, non-metallic case • 300 Watt switching capacity @120V • Manual override • 3000 Volt surge protection • Universal ball swivels for fully adjustable positioning • Auto test logic • 3 Year Warranty • Weatherproof & corrosionproof floods & mounting plate

Consider LED Replacement
STLHBLEd2x13W

Completely Assembled And Pre-Wired For Quick Installation

TUFF Dome™



STUFF500	STUFF500W	180°	<ul style="list-style-type: none"> • Vandalproof sensor with 180° detection provides wide side-to-side coverage. • LED detection and "on guard" indicator • Sensor adjusts up and down • Controls up to 500 Watts @120V, Incandescent, 100 Watts Fluorescent • Die-cast aluminum construction • Three 1/2" threaded holes for mounting lighting fixtures • Vandalproof polyethylene lens • 3000 Volt surge protection • Protected manual override with Auto Reset after 8 hours • 5 Year Warranty
----------	-----------	------	---

Mini Sensor™



SMS500	SMS500W	180°	<ul style="list-style-type: none"> • 180° detection pattern in our smallest sensor • 500 Watt switching capacity @120V, Incandescent, 100 Watts Fluorescent • Die-cast aluminum construction • 3000 Volt surge protection • Protected manual override with Auto Reset after 8 hours • 5 Year Warranty
--------	---------	------	---

Smart Box®



-----	SB500W	180°	<ul style="list-style-type: none"> • 180° view box mounted sensor fits single gang cast boxes • 500 Watt Incandescent switching capacity, 100 Watt Fluorescent • Easy-to-Read controls • 3000 Volt surge protection • Protected manual override with auto reset after 8 hours • Can be wired in parallel • Integral oversize wall plate included • 5 Year Warranty
-------	--------	------	--

SQB1 Light Kit®



SQB1A	SQB1W	180°	<ul style="list-style-type: none"> • 180° view Mini Sensor and 75 Watt Quartz Bullet flood • 500 Watt Incandescent switching capacity, 100 Watt Fluorescent • 3000 Volt surge protection • Protected manual override with auto reset after 8 hours • CU4 oversize wall plate included • 5 Year Warranty
-------	-------	------	---

WPLED20MS

SQB2 Light Kit®



SQB2A	SQB2W	180°	<ul style="list-style-type: none"> • 180° view Mini Sensor and (2) 75 Watt Quartz Bullet floods • 500 Watt Incandescent switching capacity, 100 Watt Fluorescent • Silicone O-ring gasket, thick tempered glass lens • 3000 Volt surge protection • Protected manual override with auto reset after 8 hours • CU4 oversize wall plate included • 5 Year Warranty
-------	-------	------	---

STLHBLEd2x13W

DETECTION PATTERNS

Gotcha & Luminator

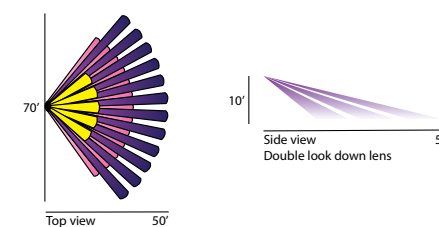

Tuff Dome, Mini Sensor & Smart Box

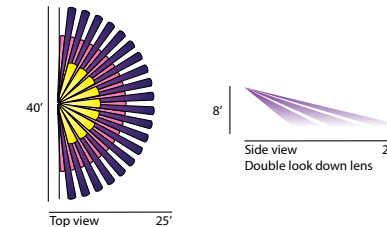

Patents: RAB sensor and fixture designs are protected under U.S. and international intellectual property laws.

OCCUPANCY SENSORS

INTERIOR LIGHT CONTROL



LOS2500



LOS1500



LOS1000

- LED detection indicators
- Can be wired in parallel
- Compatible with electronic ballasts
- 120 and 277 Volt models

Quality tested



LOS2500 has 3-detector 360° coverage



LOS1000 has time delay control



hidden under removable cover

Smart Switch® Occupancy	Catalog # White	Almond	Ivory	Detection Pattern	
	LOS800W/120	LOS800AL/120W	LOS800I/120W	180°	<ul style="list-style-type: none"> • Only hot and common wires required, no ground • 180° Occupancy sensor controls interior lights automatically • 800 Watts @120 Volts, 1200 Watts @277 Volts • Rated 6.7 Amps @120 Volts, 4.3 Amps @277 Volts • LED detection indicator • Fits decorator wall plates • 1000 sq. foot coverage area • Off / auto switch • Time delay control (8 seconds - 15 minutes) hidden under cover
	LOS800W/277	LOS800AL/277W	LOS800I/277W		



LOS800

Smart Switch® Vacancy	Catalog # White	Almond	Ivory	Detection Pattern	
	LVS800W/120	LVS800AL/120W	LVS800AL/120W	180°	<ul style="list-style-type: none"> • 180° sensor must be turned on manually but shuts off automatically • Only hot and common wires required, no ground • Meets California Title 24 standards • 800 Watts @120 Volts, 1200 Watts @277 Volts • Rated 6.7 Amps @120 Volts, 4.3 Amps @277 Volts • LED detection indicator • 1000 sq. foot coverage area • Tough, vandal resistant lens • Manual on / auto off • Time delay control (8 seconds - 15 minutes) hidden under cover
	LVS800W/277	LVS800AL/277W	LVS800AL/277W		



LVS800

Smart Switch® Occupancy	Catalog # White	Almond	Ivory	Detection Pattern	
	LOS1000W/120	n/a	LOS1000AL/120W	180°	<ul style="list-style-type: none"> • Hot, common and ground wires required • 180° Occupancy sensor controls interior lights automatically • 120 or 277 Volts • 1000 Watts @120 Volts, 1800 Watts @277 Volts • Rated 8 Amps, 1/6 horsepower • LED detection indicator • 1000 sq. foot coverage area • Tough, vandal resistant lens • Off / auto switch • Time delay control (8 seconds - 15 minutes) hidden under cover
	LOS1000W/277	n/a	LOS1000AL/277W		



LOS1000

Top view Detection Pattern for LOS800, LVS800 & LOS1000

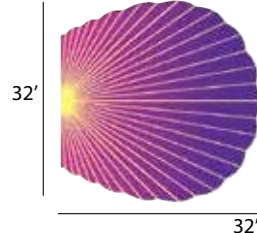

	Catalog # White	Detection Pattern	
Super Ceiling Sensor	LOS2500/120 LOS2500/277	360° Tritetection	<ul style="list-style-type: none"> • 360° Super ceiling sensor with triple overlapping coverage for superb sensitivity • 2000 Watts @120 Volts, 1500 Watts @277 Volts • 16 Amps @120 Volts, 5.4 Amps @277 Volt • LED detection indicator • Integral 16 Amp power pack • No extra wires to run or extra boxes to install • 2152 sq. foot coverage area @9' • Time delay control (10 seconds - 8 minutes) hidden under cover
Smart Switch® Ceiling	LOS1500/120 LOS1500/277	360°	<ul style="list-style-type: none"> • 360° View ceiling sensor with integral 20 Amp power pack • 2400 Watts @120 Volts, 4800 Watts @277 Volts • 20 Amps @120 volts, 20 Amps @ 277 Volt • 2000 sq. foot coverage area @9' • LED detection indicator • Manual override key • Time delay control (6 - 15 minutes) hidden under cover
Smart Switch® Hallway	LOS1500H/120 LOS1500H/277	180°	<ul style="list-style-type: none"> • Hallway version of the LOS1500 offers 16' x 60' hall pattern coverage • 2400 Watts @120 Volts, 4800 Watts @277 Volts • 20 Amps @120 Volts, 20 Amps @277 Volt • Covers 16' x 60' hallway pattern • LED detection indicator • Manual override key • Time delay control (6 - 15 minutes) hidden under cover

CEILING DETECTION PATTERNS

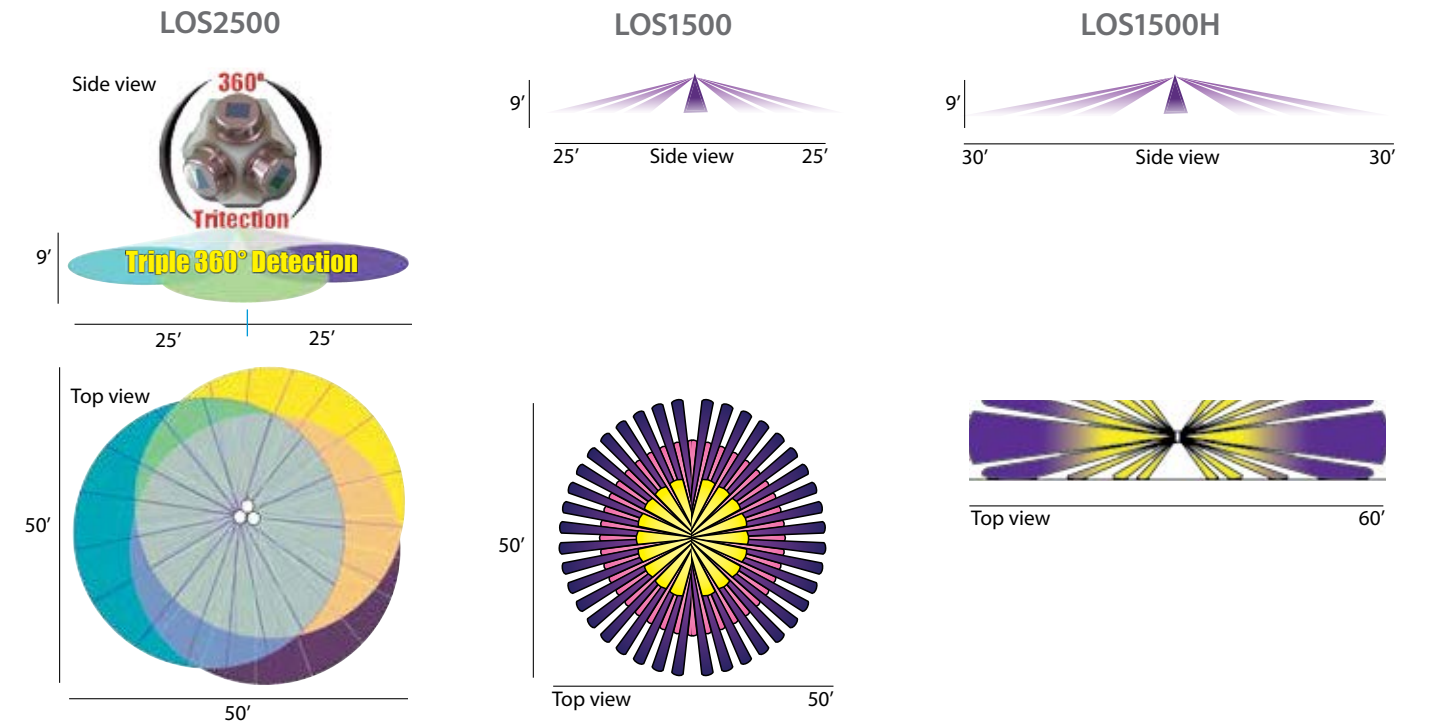

HIGH BAY - LOW BAY

LARGE SPACE INTERIOR LIGHTING



Low Bay Aluminum

High Bay Aluminum

Low Bay Prismatic

RBAY

- Heavy duty die-cast housing, wiring box & hook
- Spun semi-specular anodized aluminum
- Clear acrylic Lexalite Reflexor® prismatic refractor
- Safety chain included

- Easy leveling adjustment
- Open rated lamp supplied
- Rugged hook/loop with 3' cord for easy installation
- 7 position adjustable bracket on High Bays

Temporary HID



250W: BTH250GPSQ
400W: BTH400GPSQ
Great for construction sites!
Like the world's tallest office building.

RAB Lights the World Trade Tower



HIGH BAYS

250 Watt Pulse Start MH with Prismatic or Aluminum refractor - for use above 25 feet

	Catalog #	Starting Amps / Operating Amps				Lamp Type	Lamp Watts	Lamp Base	Ballast	Input Watts	Lamp ANSI	Initial Lumens	Lamp Hours
		120V	208V	240V	277V								
16" Prismatic	MH BHH250P16PSQ	1.4 / 2.5	.8 / 1.5	.7 / 1.3	.6 / 1.1	250	ED28	Mogul	CWA HPF QT	295	M153/0	23,800	15,000
16" Aluminum	MH BHH250A16PSQ	1.4 / 2.5	.8 / 1.5	.7 / 1.3	.6 / 1.1	250	ED28	Mogul	CWA HPF QT	295	M153/0	23,800	15,000
22" Prismatic	MH BHH250A22PSQ	1.4 / 2.5	.8 / 1.5	.7 / 1.3	.6 / 1.1	250	ED28	Mogul	CWA HPF QT	295	M153/0	23,800	15,000

400 Watt Pulse Start MH with Prismatic or Aluminum refractor - for use above 25 feet

22" Prismatic	MH BHH400P22PSQ	3.5 / 4.0	2.0 / 2.3	1.8 / 2.0	1.5 / 1.8	400	ED37	Mogul	CWA HPF QT	458	M155/0	41,000	20,000
16" Aluminum	MH BHH400A16PSQ	3.5 / 4.0	2.0 / 2.3	1.8 / 2.0	1.5 / 1.8	400	ED37	Mogul	CWA HPF QT	458	M155/0	41,000	20,000
22" Aluminum	MH BHH400A22PSQ	3.5 / 4.0	2.0 / 2.3	1.8 / 2.0	1.5 / 1.8	400	ED37	Mogul	CWA HPF QT	458	M155/0	41,000	20,000



LOW BAYS

250 Watt Pulse Start MH with Prismatic or Aluminum refractor - for use below 25 feet



	Catalog #	Starting Amps / Operating Amps				Lamp Type	Lamp Watts	Lamp Base	Ballast	Input Watts	Lamp ANSI	Initial Lumens	Lamp Hours
		120V	208V	240V	277V								
16" Prismatic	MH BLH250P16DLPSQ	1.4 / 2.5	.8 / 1.5	.7 / 1.3	.6 / 1.1	250	ED28	Mogul	CWA HPF QT	295	M153/0	23,800	15,000
16" Aluminum	MH BLH250AW16DLPSQ	1.4 / 2.5	.8 / 1.5	.7 / 1.3	.6 / 1.1	250	ED28	Mogul	CWA HPF QT	295	M153/0	23,800	15,000
22" Prismatic	MH BLH250AW22DLPSQ	1.4 / 2.5	.8 / 1.5	.7 / 1.3	.6 / 1.1	250	ED28	Mogul	CWA HPF QT	295	M153/0	23,800	15,000

400 Watt Pulse Start MH with Prismatic or Aluminum refractor - for use below 25 feet

22" Prismatic	MH BLH400P22DLPSQ	3.5 / 4.0	2.0 / 2.3	1.8 / 2.0	1.5 / 1.8	400	ED37	Mogul	CWA HPF QT	458	M155/0	41,000	20,000
16" Aluminum	MH BLH400AW16DLPSQ	3.5 / 4.0	2.0 / 2.3	1.8 / 2.0	1.5 / 1.8	400	ED37	Mogul	CWA HPF QT	458	M155/0	41,000	20,000
22" Aluminum	MH BLH400AW22DLPSQ	3.5 / 4.0	2.0 / 2.3	1.8 / 2.0	1.5 / 1.8	400	ED37	Mogul	CWA HPF QT	458	M155/0	41,000	20,000

Patents: The design of the RAB High and Low Bays is protected by U.S. Patents D582600 and D583980, Canadian Patent D125028 and D124992, China Patents ZL200830119857.0 and ZL200830119856.6, Taiwan patents pending.

RBAY HIGH BAY FLUORESCENT LIGHTING

Zstrong™

- Rigid Zstrong™ construction gives the RBAY a flex-free quality you can feel



Easy wiring

- Easy wiring and maintenance with hinged access panel and Quick Connector plug

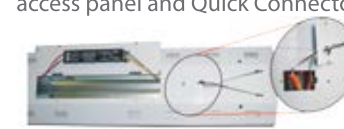

Strong-Box Pack

- Foam case packaging protects the RBAY so it arrives ready to install



RBAY 4 Energy efficient large space lighting - 4 lamp model for use below 25'

	Catalog #	Total Watts	Input Volts	Input Amps	Ballast Factor	Input Watts	Ballast Type	Lamp Base
T8	RB4T8 (T8 Fluorescent lamps)	4x32W	120-277V	.98 / .43	0.88	114	Instant Start HPF	Medium Bi Pin
T5HO	RB4T5 (T5HO Fluorescent lamps - not included)	4x54W	120-277V	2.0 / .85	1.00	241/236	Programmed Start HPF Rated for use with motion sensor	Miniature Bi Pin

RBAY6 Energy efficient large space lighting - 6 lamp model for use above

T8	RB6T8 (T8 Fluorescent lamps - not included)	6x32W	120-277V	1.49 / .65	0.88	173	Instant Start HPF	
T5HO	RB6T5 (T5HO Fluorescent lamps - not included)	6x54W	120-277V	3.0 / 1.28	1.00	362 / 354	Programmed Start HPF Rated for use with motion sensor	

Wire Guard



GDRB4PW (4 lamp model - wire guard w/ Prismatic Acrylic lens) LFRB4P (4 lamp model - hinged door w/ clear Acrylic lens)
GDRB6PW (6 lamp model - wire guard w/ Prismatic Acrylic lens) LFRB6P (6 lamp model - hinged door w/ clear Acrylic lens)

Note: On our RBAY product, the Lens and the Guard cannot be installed at the same time.

VANDALPROOF

FOR HIGH ABUSE LOCATIONS

35 - 150W HID / 7 - 96W CFL
75 - 100W Incandescent / 55 - 85W Induction



- Die formed heavy gauge steel reflectors
- Tough polycarbonate refractors
- Stainless steel hardware
- Both Vandalproof Center Pin Torx and slotted Phillips® head screws supplied

VAN5 Glare Stopper
Fully adjustable from total to zero light cutoff



Easier Installation
Conduit doesn't need to be bent



Make the Switch to LED



Save energy
Save money

See LED pages 14-15 for details



	Catalog # Bronze	White	Lamp Watts	Lamp Type	Lamp Base	Ballast	Input Watts	Lamp ANSI	Initial Lumens	Lamp Hours	Consider LED Replacement	
VAN1	CFL	VAN1F7	VAN1F7W	7	Twin	G23	NPF 120V	10	---	400	10,000	CLELED2x10
		VAN1F9	VAN1F9W	9	Quad	G23	NPF 120V	11	---	525	10,000	
		VAN1F13	VAN1F13W	13	Quad	GX23	NPF 120V	18	---	860	10,000	
		VAN1F14	VAN1F14W	14	Twin	G23	NPF 120V	20	---	800	10,000	
	Incand.	VAN1I	VAN1IW	75	A-19					1,210	750	CLELED2x10
VAN2	CFL	VAN2F9	VAN2F9W	9	Quad	G23	NPF 120V	11	---	525	10,000	CLELED2x10
		VAN2F26QT	VAN2F26QTW	26	Triple	GX24q-3	Electronic QT	29	---	1,800	12,000	
		VAN2F32QT	VAN2F32QTW	32	Triple	GX24q-3	Electronic QT	36	---	2,400	12,000	
	Incand.	VAN2I	VAN2IW	150	2-75W A-19					2,420	750	CLELED2x20
	VAN4	CFL	VAN4F26QT	VAN4F26QTW	26	Triple	GX24q-3	Electronic QT	29	---	1,800	12,000
VAN4F32QT			VAN4F32QTW	32	Triple	GX24q-3	Electronic QT	36	---	2,400	12,000	
VAN4F42QT			VAN4F42QTW	42	Triple	GX24q-4	Electronic QT	42	---	3,200	12,000	
VAN4F52QT			VAN4F52QTW	52	2-26W Triple	GX24q-3	Electronic QT	58	---	3,600	12,000	
Incand.		VAN4I	VAN4IW	75	A-19					1,210	750	CLELED2x10
VAN6	CFL	VAN6F13	VAN6F13W	13	Quad	GX23	NPF 120V	18	---	800	10,000	CLELED2x13
		VAN6F26	VAN6F26W	26	2-13W Twin	GX23	NPF 120V	36	---	1,650	12,000	
	HPS	VAN6S35	VAN6S35W	35	ED17	Med	R-NPF 120V	--	S76	2,250	24,000	CLELED2x13
		VAN6S50	VAN6S50W	50	ED17	Med	R-NPF 120V	--	S68	4,000	24,000	CLELED2x26

	Catalog # Bronze	White	Lamp Watts	Lamp Type	Lamp Base	Ballast	Input Watts	Lamp ANSI	Initial Lumens	Lamp Hours	Consider LED Replacement		
VAN3	CFL	VAN3F26QT	VAN3F26QTW	26	Triple	Med	Electronic QT	29	S76	1,800	12,000	CLELED2x13	
		VAN3F32QT	VAN3F32QTW	32	Triple	Med	Electronic QT	36	S68	2,400	12,000	CLELED2x20	
		VAN3F42QT	VAN3F42QTW	42	Triple	Med	Electronic QT	46	S62	3,200	12,000	CLELED2x26	
VAN3	HPS	VAN3S35	VAN3S35W	35	ED17	Med	R-NPF 120V	46		2,300	24,000	CLELED2x20	
		VAN3S50	VAN3S50W	50	ED17	Med	R-NPF 120V	62		4,000	24,000	CLELED2x26	
		VAN3S70	VAN3S70W	70	ED17	Med	R-NPF 120V	86		6,300	24,000		
VAN3	MH	VAN3HH50QT	VAN3HH50QTW	PS 50	ED17	Med	HX-HPF QT	69	M110	3,400	10,000	CLELED2x26	
		VAN3HH70QT	VAN3HH70QTW	PS 70	ED17	Med	HX-HPF QT	90	M98	5,600	15,000		
VAN5	CFL	VAN5F64QT	VAN5F64QTW	64	2x32W Triple	GX24q-3	Electronic QT	72		4,800	12,000	CLELED2x26	
		VAN5F84QT	VAN5F84QTW	84	2x42W Triple	GX24q-4	Electronic QT	92		6,400	12,000		
		VAN5F96QT	VAN5F96QTW	96	3x32W Triple	GX24q-3	Electronic QT	108		9,600	12,000		
VAN5	HPS	VAN5S100	VAN5S100W	100	ED17	Med	R-NPF 120V	115	S54	9,500	24,000	CLELED2x26	
		VAN5SH100QT	VAN5SH100QTW	100	ED17	Med	HX-HPF QT	115	S54	9,500	24,000		
		VAN5S150	VAN5S150W	150	ED17	Med	R-NPF 120V	170	S55	16,000	24,000		
		VAN5SH150QT	VAN5SH150QTW	150	ED17	Med	HX-HPF QT	188	S55	16,000	24,000		
	MH	VAN5HH100QT	VAN5HH100QTW	PS 100	ED17	Med	HX-HPF QT	129	M90	9,000	15,000	CLELED2x26	
VAN5HH125PSQ	VAN5HH125PSQW	PS 125	ED17	Med	CWA QT	150	M150	12,000	11,250				
VAN5HH150PSQ	VAN5HH150PSQW	PS 150	ED17	Med	CWA QT	190	M102	14,000	11,250				
		VAN5HH150QT	VAN5HH150QTW	150	ED17	Med	CWA-HPF QT	185	M107	12,500	10,000		
VAN11F	CFL	VAN11F26	VAN11F26W	26	2-13W Twin	GX23	NPF 120V	29		1,800	12,000	CLELED2x13	
		VAN11F52QT	VAN11F52QTW	52	2-26W Triple	GX24q-3	Electronic QT	58		3,600	12,000		CLELED2x26
VAN11F	Incand.	VAN11I	VAN11IW	60	A19	Med				890	750	CLELED2x10	
		VAN11I120	VAN11I120W	120	2-60W A-19	Med				1,780	750		CLELED2x13
VAN11S	HPS	VAN11S35	VAN11S35W	35	ED17	Med	R-NPF 120V	46	S76	2,250	24,000	CLELED2x13	
		VAN11S50	VAN11S50W	50	ED17	Med	R-NPF 120V	62	S68	4,000	24,000		CLELED2x26
		VAN11S70	VAN11S70W	70	ED17	Med	R-NPF 120V	86	S62	6,300	24,000		
VAN11S	MH	VAN11HH50QT	VAN11HH50QTW	PS 50	ED17	Med	HX-HPF QT	68	M110	3,400	10,000	CLELED2x26	
		VAN11HH70QT	VAN11HH70QTW	PS 70	ED17	Med	HX-HPF QT	90	M98	5,600	15,000		
VAN15F	CFL	VAN15F52QT	VAN15F52QTW	52	2-26W Triple	GX24q-3	Electronic QT			3,600	12,000	CLELED2x26	
		VAN15F64QT	VAN15F64QTW	64	2-32W Triple	GX24q-3	Electronic QT			4,800	12,000		
VAN15F	Incand.	VAN15I	VAN15IW	75	A19	Med				1,210	750	CLELED2x10	
		VAN15I150	VAN15I150W	150	2-75W A19	Med				2,420	750		CLELED2x20
VAN15S	HPS	VAN15S35	VAN15S35W	35	ED17	Med	R-NPF 120V	46	S76	2,250	24,000	CLELED2x13	
		VAN15S50	VAN15S50W	50	ED17	Med	R-NPF 120V	62	S68	4,000	24,000		CLELED2x26
		VAN15S70	VAN15S70W	70	ED17	Med	R-NPF 120V	86	S62	6,300	24,000		
		VAN15S100	VAN15S100W	100	ED17	Med	R-NPF 120V	115	S54	9,500	24,000		
			VAN15S150	VAN15S150W	150	ED17	Med	R-NPF 120V	170	S55	16,000	24,000	
VAN15S	MH	VAN15HH100QT	VAN15HH100QTW	PS 100	ED17	Med	HX-HPF QT	129	M90	9,000	15,000	CLELED2x26	
Garage Lighter	HPS	VANGS150QT	VANGS150QTW	150	ED17	Med	HX-HPF QT	188	S55	16,000	24,000		
Garage Lighter	MH	VANGH150QT	VANGH150QTW	150	ED17	Med	CWA-HPF QT	185	M107	12,500	10,000		
Garage Lighter	Induction	VANGQL55	VANGQL55W	55	ED17	Twist	Elec HPF 120V	55		3,500	100,000	CLELED2x26	
		VANGQL85	VANGQL85W	85	ED17	Twist	Elec HPF 120V	85		6,000	100,000		

OPTIONS

Button Photocell Add Suffix /PC after Catalog Number
Swivel Photocell Add Suffix /PCS after Catalog Number
 Available for: VAN3, VAN5, VAN11 & VAN15 HPS & MH Garage Lighter

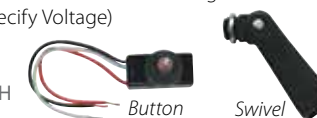

Mini Motion Sensor Add Suffix /MS after Catalog Number
 VAN3 (CFL 120V only)
 VAN5 (CFL 120V only)
 VAN11F26



Emergency Battery Back-Up
 VAN5 (CFL only) 120V: Add Suffix /E1 after Catalog Number
 277V: Add Suffix /E2 after Catalog Number
 Garage Lighter 120V: VANGF42QT/E1
 277V: VANGF42QT/E2

Torx Screwdriver VANDriver



LANDSCAPE

MIGHTY POSTS & COVERS



- Cleanly styled molded PVC cap
- Metal caps available for extra strength
- 1/2" threaded hole in cap
- Close-up plug included
- Set screw locks cap to post
- Rounded edges protect wires
- Internal seal provides weatherproof fit
- Sturdy "Ground Grabber" with teeth and ribs for maximum stability

Thick wall PVC posts & caps
Molded in Black, White and Verde Green



Your wire's not toast with Mighty Post

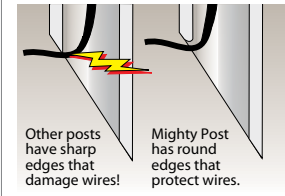

New in-use covers are Turtle tough!

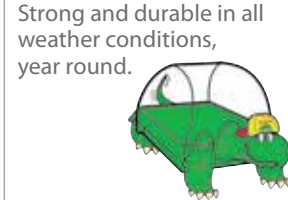

	Size	Catalog # Black	White	Verde Green
Mini Mighty Post	2" pipe 2 3/8" OD 17" long	MP17B	MP17W	MP17VG
Mighty Post	2 1/2" pipe 2 7/8" OD 19" long	MP19B	MP19W	MP19VG
Maxi-Mighty Post	2 1/2" pipe 2 7/8" OD 25" long	MP25B	MP25W	MP25VG

MIGHTY POST SELECTOR					
Pick the post that supports your fixture weight					
Fixture Series	Fixture Weight (lbs)	MP17	MP19	MPP19	MP25
Quartz Flood					
QF150	1	●	●	—	—
QB1	1	●	●	—	—
QF200	2	●	●	—	—
QF500/300	2	—	●	●	—
QF1500	8	—	●	●	●
Landscape					
LFM16/LFP16	1	●	●	●	—
H101/HB101	2	●	●	●	—
LF20	2	●	●	●	—
PLF	2	●	●	●	—
LL	3	●	●	●	—
LLD	4	—	●	●	●
HID Flood					
FF	8	—	●	●	●
EZ	17	—	●	●	●
FlexFlood	20	—	●	●	●
EZ or FX Tilted Back	20	—	—	●	●
LED Floods					
LFLED5	2	●	●	●	—
HSLED13	3	●	●	●	●
HBLED	3	●	●	●	●
FFLED18	5	●	●	●	●
FFLED39	13	—	●	●	●
FXLED78	24	—	●	●	●

Size	Catalog # Black	White	Verde Green	
2"	MCAP2B	MCAP2W	MCAP2VG	• PVC caps for replacement or making do-it-yourself Mighty Posts • MCAP2 fits 2" pipe with 2 3/8" O.D. • MCAP3 fits 2 1/2" pipe with 2 7/8" O.D. Fixtures with ground wires must be used
2 1/2"	MCAP3B	MCAP3W	MCAP3VG	

Size	Catalog # Black	White	Verde Green	Silver Gray	
2"	MMCAP2B	MMCAP2W	MMCAP2VG	• Die-cast aluminum caps for replacement or making Do-it-yourself Mighty Posts • MMCAP2 fits 2" pipe with 2 3/8" O.D. • MMCAP3 fits 2 1/2" pipe with 2 7/8" O.D. Has bare copper ground wire	
2 1/2"	MMCAP3B	MMCAP3W	MMCAP3VG		

Catalog # Black	White	Verde Green	Silver Gray	
TCB	TCW	TCVG	TCS	• In-use weatherproof cover protects in-use electrical devices in wet locations • Strong and durable in all weather conditions • Clear cover with colored back plate • Lockable latch-on cover • Fits all popular devices • Smooth-edged electrical cord slots protect wires
Lockable latch Fits all devices				

Catalog # Black	White	Verde Green	Silver Gray	
MPAB	MPAW	MPAVG	n/a	• Lets you install an in-use outlet or most other rectangular covers on a Mighty Post • Great for extra wiring room, mounting sensors or floodlights • Durable molded ABS • Cap and close-up plug included • Extends post height to keep outlets above plants and snow • Fits 2" (2 3/8" OD) pipe for a DIY post
Mighty Post Adapter				

Catalog # Black	White	Verde Green	Silver Gray	
TACB	TACW	TACVG	n/a	• Weatherproof cover with Mighty Post Adapter section for use with Mighty Post • Great for self-standing use in the yard • Durable molded ABS • Clear cover with colored back plate • Lockable latch on cover • Smooth edged electrical cord slots protect wires • Fits all popular devices • Cap and close up plug included • Fits 2" (2 3/8" OD) pipe for a DIY post
In-Use Cover + Post Adapter				

Catalog # Black	White	Verde Green	Silver Gray	
TPPB	TPPW	TPPVG	n/a	• Fits all popular devices 19" Mighty Post, Mighty Post Adapter & Turtle in-use cover all in one • Everything you need for a self-standing electrical outlet • Durable molded ABS • Clear cover with colored back plate • Lockable latch-on cover • Fits all popular devices • Smooth-edged electrical cord slots protect wires • Cap and close-up plug included
Turtle Power Post				

Catalog # Black	White	Verde Green	Silver Gray	
MPPB	MPPW	MPPVG	n/a	• Fits all popular devices 19" Mighty Post with Post Adapter and blank cover in place of the Turtle cover • Great for self-standing use in the yard • Durable molded ABS • Fits all popular devices
Mighty Post Plus				



LANDSCAPE

LAWN LIGHTS AND FLOODLIGHTS



4-Tier DomeTop



13W CFL Flood



HID Bullet with Visor

- Rugged, die-cast aluminum housing
- Durable powder coat finish
- Socket with all copper electrical parts
- Threaded, gasketed globes for durable weatherproofing and easy relamping



2 Level Light Cutoff



Wide light spread for wider walkways where maximum light is required

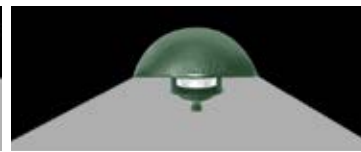

Full Cutoff for narrow walkways and glare free lighting in garden areas

Make the Switch to LED



Save energy
Save money

See LED pp 16-19 & 24-25 for details

LANDSCAPE LIGHTS

Four Tier 6" 6" diameter die-cast aluminum landscape lawn light - 100W maximum



	Catalog #	Black	Lamp Watts	Volts	Lamp Type	Lamp Base	Lamp Supplied	Initial Lumens	Lamp Hours	Minimum Starting Temp	Color Temp	Consider LED Replacement
Incand.	LL22VG	LL22B	100	120V	A-19	Med	No	1650	750	-2°C (32°F)	3500K	BLED10
CFL	LL22VG/F13	LL22B/F13	13	120V	Quad	GX23-2	Yes	860	10,000	-2°C (32°F)	3500K	

Four Tier Flare 10" diameter top tier, 6" diameter lower tier die-cast aluminum lawn light - 100W maximum



Incand.	LL23VG	LL23B	100	120V	A-19	Med	No	1650	750	-2°C (32°F)	3500K	BLED10
CFL	LL23VG/F13	LL23B/F13	13	120V	Quad	GX23-2	Yes	860	10,000	-2°C (32°F)	3500K	

Four Tier DomeTop



10" diameter top tier dome top landscape light - 100W maximum

Incand.	LLD4VG	LLD4B	75	120V	A-19	Med	No	1220	750	-2°C (32°F)	3500K	BLED10
CFL	LLD4VG/F13	LLD4B/F13	13	120V	Quad	GX23-2	Yes	860	10,000	-2°C (32°F)	3500K	

Three Tier 6" Rugged die-cast aluminum 6" diameter housings for 75W maximum landscape lights



Incand.	LL32VG	LL32B	75	120V	A-19	Med	No	1220	750	-2°C (32°F)	3500K	BLED10
CFL	LL32VG/F13	LL32B/F13	13	120V	Quad	GX23-2	Yes	860	10,000	-2°C (32°F)	3500K	

Three Tier Flare DomeTop



Catalog #	Black	Lamp Watts	Lamp Type	Lamp Base	Initial Lumens	Lamp Hours	Minimum Starting Temp	Color Temp
LL323VG	LL323B	75	A-19	Med	1220	750	-2°C (32°F)	3500K
LL323VG/F13	LL323B/F13	13	Quad	GX23-2	860	10,000	-2°C (32°F)	3500K

Three Tier DomeTop



Catalog #	Black	Lamp Watts	Lamp Type	Lamp Base	Initial Lumens	Lamp Hours	Minimum Starting Temp	Color Temp
LLD3VG	LLD3B	75	A-19	Med	1220	750	-2°C (32°F)	3500K
LLD3VG/F13	LLD3B/F13	13	Quad	GX23-2	860	10,000	-2°C (32°F)	3500K

CFL FLOODS

13 & 26 Watt Flood

Polycarbonate CFL floodlight supplied with 13 or 26 Watt twin tube lamps



NPF 120V
NPF 120V

Catalog #	Total Watts	# of Lamps	Lamp Watts	Lamp Base	Initial Lumens	Lamp Hours	Minimum Starting Temp	Color Temp
PLF13	13	1	13	GX23	900	10,000	0°F	2700K
PLF26	26	2	13	GX23	1800	10,000	0°F	2700K

39 Watt Flood

Polycarbonate CFL floodlight supplied with (3) 13 Watt twin tube lamps



NPF 120V

PLF39	39	3	13	GX23	2700	10,000	0°F	2700K
-------	----	---	----	------	------	--------	-----	-------

H SYSTEM FLOODS

HID Bullet w/ Hood

Bullet shape die-cast aluminum flood with hood for 70 & 100 Watt Metal Halide



Catalog #	Ballast	Input Watts	Lamp Watts	Lamp Type	Lamp Base	Starting Amps / Operating Amps	Lamp ANSI
HBHN70HA	HX-NPF 120V	94	70	PAR38	Med	2.8 / 2.2	M98
HBHH70HQTA	HX-HPF QT	94	70	PAR38	Med	.7 / .8 .4 / .5 .4 / .4 .3 / .4	M98
HBHH100HQTA	HX-HPF QT	129	100	PAR38	Med	1.0 / 1.2 .6 / .7 .5 / .6 .4 / .5	M90

HID Bullet w/ Visor

Bullet shape die-cast aluminum flood with visor for 70 & 100 Watt Metal Halide



HBHN70VA	HX-NPF 120V	94	70	PAR38	Med	2.8 / 2.2	M98
HBHH70VQTA	HX-HPF QT	94	70	PAR38	Med	.7 / .8 .4 / .5 .4 / .4 .3 / .4	M98
HBHH100VQTA	HX-HPF QT	129	100	PAR38	Med	1.0 / 1.2 .6 / .7 .5 / .6 .4 / .5	M90

HID Bell w/ Hood

Bell shape die-cast aluminum flood with hood for 70 & 100 Watt Metal Halide



H1HN70HA	HX-NPF 120V	94	70	PAR38		2.8 / 2.2	M98
H1HH70HQTA	HX-HPF QT	94	70	PAR38		.7 / .8 .4 / .5 .4 / .4 .3 / .4	M98
H1HH100HQTA	HX-HPF QT	129	100	PAR38		1.0 / 1.2 .6 / .7 .5 / .6 .4 / .5	M90

HID Bell w/ Visor

Bell shape die-cast aluminum flood with hood for 70 & 100 Watt Metal Halide



H1HN70VA	HX-NPF 120V	94	70	PAR38		2.8 / 2.2	M98
H1HH70VQTA	HX-HPF QT	94	70	PAR38		.7 / .8 .4 / .5 .4 / .4 .3 / .4	M98
H1HH100VQTA	HX-HPF QT	129	100	PAR38		1.0 / 1.2 .6 / .7 .5 / .6 .4 / .5	M90

NOTE:

For Black finish replace suffix "A" with "B" (Example: HBHN70HB)
For White finish replace suffix "A" with "W" (Example: HBHN70HW)
For Verde Green finish replace suffix "A" with "VG" (Example: HBHN70HVG)

VAPORPROOF

CEILING & WALL MOUNT LIGHTS

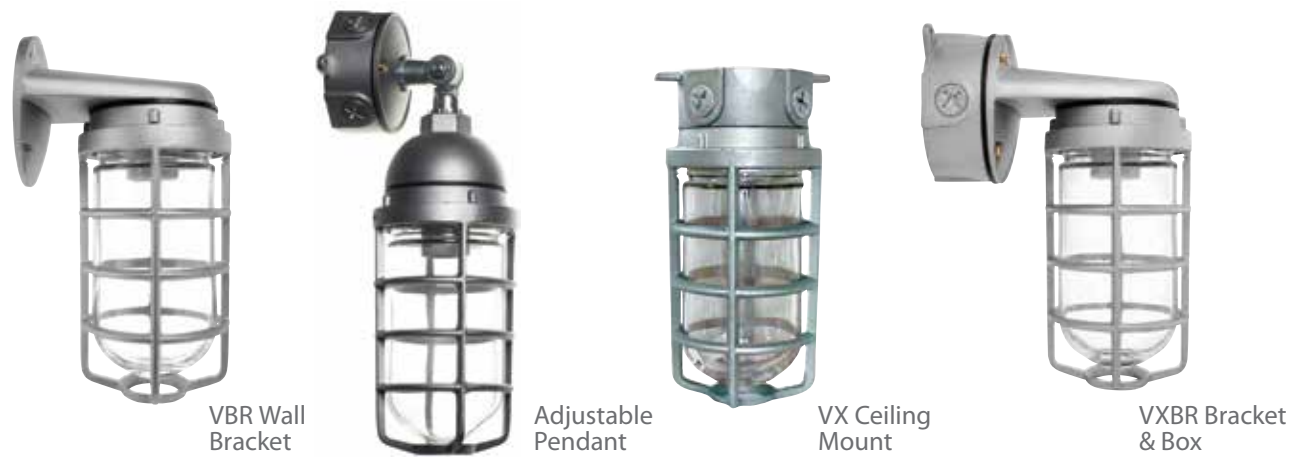

- Rugged, die-cast aluminum housing
- One piece die-cast aluminum guards
- Junction box with sturdy mounting lugs
- Clear, heat resistant glass globes
- Adapter plate included with VC fixtures
- High temperature silicone gaskets
- All stainless steel hardware

Quality tested



Make the Switch to **LED**



Save energy
Save money

See LED pp 26-27 for details

Wall Mount Die-cast aluminum construction with sturdy wall mounting bracket

VBR Bracket	Catalog # (Natural Finish)						Consider LED Replacement
	Clear Glass & Die-Cast Guard	Clear Glass & Wire Clamp Guard	Clear Glass Globe (No Guard)	Clear Permaglobe (No Guard)	White Permaglobe (No Guard)	Fixture Less Globe	
100 Series: Max Watts 150W Clear Glass 100W Colored Glass 75W Permaglobe	VBR100DG	VBR100G	VBR100	VBR100P	-----	VBR1	VXBRLED13DG
	VBR200DG	VBR200G	VBR200	VBR200P	-----	VBR2	VXBRLED13DG
200 Series: Max Watts 200W Clear Glass 150W Colored Glass 100W Permaglobe	VBR100DG	VBR100G	VBR100	VBR100P	-----	VBR1	VXBRLED13DG
	VBR200DG	VBR200G	VBR200	VBR200P	-----	VBR2	VXBRLED13DG

VXBR Bracket & Box Die-cast aluminum construction with built-in junction box and sturdy mounting lugs

100 Series: Max Watts 150W Clear Glass 100W Colored Glass 75W Permaglobe	VXBR100DG	VXBR100G	VXBR100	VXBR100P	-----	VXBR1	VXBRLED13DG
	VXBR200DG	VXBR200G	VXBR200	VXBR200P	-----	VXBR2	VXBRLED13DG
200 Series: Max Watts 300W Clear Glass 200W Colored Glass 100W Permaglobe	VXBR100DG	VXBR100G	VXBR100	VXBR100P	-----	VXBR1	VXBRLED13DG
	VXBR200DG	VXBR200G	VXBR200	VXBR200P	-----	VXBR2	VXBRLED13DG

Adjustable Pendant Universal swivel permits mounting at any angle—great for sloped ceilings!

100 Series: Max Watts 150W Clear Glass 100W Colored Glass 75W Permaglobe	VA100DG	VA100G	VA100	VA100P	-----	VA1	VXBRLED13DG
	VA200DG	VA200G	VA200	VA200P	-----	VA2	VXBRLED13DG
200 Series: Max Watts 300W Clear Glass 200W Colored Glass 100W Permaglobe	VA100DG	VA100G	VA100	VA100P	-----	VA1	VXBRLED13DG
	VA200DG	VA200G	VA200	VA200P	-----	VA2	VXBRLED13DG

Ceiling Mount Box mount, die-cast aluminum ceiling fixture with built-in junction box

VX 4" Box	Catalog # (Natural Finish)						Consider LED Replacement
	Clear Glass & Die-Cast Guard	Clear Glass & Wire Clamp Guard	Clear Glass Globe (No Guard)	Clear Permaglobe (No Guard)	White Permaglobe (No Guard)	Fixture Less Globe	
100 Series: Max Watts 150W Clear Glass 100W Colored Glass 75W Permaglobe	VX100DG	VX100G	VX100	VX100P	VX100PW	VX1	VXBRLED13DG
	VX200DG	VX200G	VX200	VX200P	VX200PW	VX2	VXBRLED13DG
200 Series: Max Watts 300W Clear Glass 200W Colored Glass 100W Permaglobe	VX100DG	VX100G	VX100	VX100P	VX100PW	VX1	VXBRLED13DG
	VX200DG	VX200G	VX200	VX200P	VX200PW	VX2	VXBRLED13DG

VP Pendant	Pendant mount, Die-cast aluminum construction with medium base socket						Consider LED Replacement
	Clear Glass & Die-Cast Guard	Clear Glass & Wire Clamp Guard	Clear Glass Globe (No Guard)	Clear Permaglobe (No Guard)	White Permaglobe (No Guard)	Fixture Less Globe	
100 Series: Max Watts 150W Clear Glass 100W Colored Glass 75W Permaglobe	VP100DG	VP100G	VP100	VP100P	VP100PW	VP1	VXBRLED13DG
	VP200DG	VP200G	VP200	VP200P	VP200PW	VP2	VXBRLED13DG
200 Series: Max Watts 300W Clear Glass 200W Colored Glass 100W Permaglobe	VP100DG	VP100G	VP100	VP100P	VP100PW	VP1	VXBRLED13DG
	VP200DG	VP200G	VP200	VP200P	VP200PW	VP2	VXBRLED13DG

VC Ceiling	Die-cast aluminum construction — mounts to existing surface or recessed 4" boxes						Consider LED Replacement
	Clear Glass & Die-Cast Guard	Clear Glass & Wire Clamp Guard	Clear Glass Globe (No Guard)	Clear Permaglobe (No Guard)	White Permaglobe (No Guard)	Fixture Less Globe	
100 Series: Max Watts 150W Clear Glass 100W Colored Glass 75W Permaglobe	VC100DG	VC100G	VC100	VC100P	VC100PW	VC1	VXBRLED13DG
	VC200DG	VC200G	VC200	VC200P	VC200PW	VC2	VXBRLED13DG
200 Series: Max Watts 300W Clear Glass 200W Colored Glass 100W Permaglobe	VC100DG	VC100G	VC100	VC100P	VC100PW	VC1	VXBRLED13DG
	VC200DG	VC200G	VC200	VC200P	VC200PW	VC2	VXBRLED13DG

VXL 3" Box	Die-cast aluminum construction with built-in 3" junction box and sturdy mounting lugs						Consider LED Replacement
	Clear Glass & Die-Cast Guard	Clear Glass & Wire Clamp Guard	Clear Glass Globe (No Guard)	Clear Permaglobe (No Guard)	White Permaglobe (No Guard)	Fixture Less Globe	
100 Series: Max Watts 150W Clear Glass 100W Colored Glass 75W Permaglobe	VXL100DG	VXL100G	VXL100	VXL100P	VXL100PW	VXL1	VXBRLED13DG
	VXL200DG	VXL200G	VXL200	VXL200P	VXL200PW	VXL2	VXBRLED13DG
200 Series: Max Watts 300W Clear Glass 200W Colored Glass 100W Permaglobe	VXL100DG	VXL100G	VXL100	VXL100P	VXL100PW	VXL1	VXBRLED13DG
	VXL200DG	VXL200G	VXL200	VXL200P	VXL200PW	VXL2	VXBRLED13DG

OPTIONS

13W Fluorescent, 120Volt: Available for: 100 Series only Lamp supplied - (add suffix)	add /F13	add /F13	add /F13	add /F13	add /F13	add /F13
22W Fluorescent, 120Volt: Available for: 200 Series only Lamp supplied - (add suffix)	add /F22	add /F22	add /F22	add /F22	add /F22	add /F22
3/4" tapped hubs: (add suffix)	add /-3/4	add /-3/4	add /-3/4	add /-3/4	add /-3/4	add /-3/4
Finish: (add suffix)	Silver Gray: add S	White: add W	Black: add B	add S	add S	add S

ACCESSORIES

Round Bottom Glass Globes



Permaglobes (Unbreakable Polycarbonate)



VAPORPROOF HID, CFL, GUARDS, REFLECTORS & GLOBES

CEILING & WALL MOUNT LIGHTS



- Rugged, die-cast aluminum housing
- One piece die-cast aluminum guards
- Junction box with sturdy mounting lugs
- Clear, heat-resistant glass globes
- Adapter plate included with VC fixtures
- High temperature silicone gaskets
- All stainless steel hardware



Quality tested



Make the Switch to LED



Save energy
Save money

See LED pp 26-27 for details

HID Ceiling

Catalog # Natural	Starting Amps / Operating Amps				Lamp Watts	Lamp Type	Lamp Base	Ballast	Input Watts	Lamp ANSI	Initial Lumens	Lamp Hours	Consider LED Replacement
	120V	208V	240V	277V									
HPS VX2SN35	1.4 / 0.8				35	ED17	Med	R-NPF 120V	46	S76	2,300	24,000	VXLED13DG
VX2SN50	1.8 / 1.2				50	ED17	Med	R-NPF 120V	62	S68	4,000	24,000	
VX2SH50DT	.5 / .6			.2 / .3	50	ED17	Med	HX-HPF DT	66	S68	4,000	24,000	
VX2SN70	2.3 / 1.7				70	ED17	Med	R-NPF 120V	86	S62	6,300	24,000	
VX2SH70QT	.6 / .8	4 / 5	4 / 3	3 / 4	70	ED17	Med	HX-HPF QT	91	S62	6,300	24,000	
VX2SH100QT	.9 / 1.1	6 / 6	5 / 6	4 / 5	100	ED17	Med	HX-HPF QT	130	S84	9,000	24,000	
MH VX2HN50	2.0 / 1.6				50	ED17	Med	HX-NPF 120V	68	M110	3,400	10,000	VXLED13DG
VX2HH50QT	.6 / .6	4 / 4	3 / 3	3 / 3	50	ED17	Med	HX-HPF QT	68	M110	3,750	10,000	
VX2HN70	2.8 / 2.2				70	ED17	Med	HX-HPF 120V	94	M98	5,000	15,000	
VX2HH70QT	.7 / .8	4 / 5	4 / 4	3 / 4	70	ED17	Med	HX-HPF QT	90	M98	5,000	15,000	
VX2HH100QT	1.0 / 1.2	6 / 7	5 / 6	4 / 5	100	ED17	Med	HX-HPF QT	129	M90	9,000	15,000	

HID Wall

HPS VXBR2SN35	1.4 / 0.8				35	ED17	Med	R-NPF 120V	46	S76	2,300	24,000	VXBRLED13DG
VXBR2SN50	1.8 / 1.2				50	ED17	Med	R-NPF 120V	62	S68	4,000	24,000	
VXBR2SH50DT	.5 / .6			.2 / .3	50	ED17	Med	HX-HPF DT	66	S68	4,000	24,000	
VXBR2SN70	2.3 / 1.7				70	ED17	Med	R-NPF 120V	86	S62	6,300	24,000	
VXBR2SH70QT	.6 / .8	4 / 5	4 / 3	3 / 4	70	ED17	Med	HX-HPF QT	91	S62	6,300	24,000	
VXBR2SH100QT	.9 / 1.1	6 / 6	5 / 6	4 / 5	100	ED17	Med	HX-HPF QT	130	S84	9,000	24,000	
MH VXBR2HN50	2.0 / 1.6				50	ED17	Med	HX-NPF 120V	68	M110	3,400	10,000	VXBRLED13DG
VXBR2HH50QT	.6 / .6	4 / 4	3 / 3	3 / 3	50	ED17	Med	HX-HPF QT	68	M110	3,750	10,000	
VXBR2HN70	2.8 / 2.2				70	ED17	Med	HX-HPF 120V	94	M98	5,000	15,000	
VXBR2HH70QT	.7 / .8	4 / 5	4 / 4	3 / 4	70	ED17	Med	HX-HPF QT	90	M98	5,000	15,000	
VXBR2HH100QT	1.0 / 1.2	6 / 7	5 / 6	4 / 5	100	ED17	Med	HX-HPF QT	129	M90	9,000	15,000	

CFL Ceiling

CFL VX1F13	0.1	0.1	0.1	.06	13	Quad	G24q-1	Elec HPF QT	16	-----	900	10,000
VX1F26	.30	.20	.13	.13	26	Triple	GX24q-3	Elec HPF QT	29	-----	1,800	12,000
VX2F32	.30	.20	.20	.13	32	Triple	GX24q-3	Elec HPF QT	36	-----	2,400	12,000
VX2F42	.40	.25	.20	.20	42	Triple	GX24q-4	Elec HPF QT	46	-----	3,200	12,000

CFL Wall



HID ceiling fixture for 35, 50,70 & 100 Watt HPS and 50,70 & 100 Watt Metal Halide

Catalog # Natural	Starting Amps / Operating Amps				Lamp Watts	Lamp Type	Lamp Base	Ballast	Input Watts	Lamp ANSI	Initial Lumens	Lamp Hours	Consider LED Replacement
	120V	208V	240V	277V									
CFL VXBR1F13	0.1	0.1	0.1	.06	13	Quad	G24q-1	Elec HPF QT	16	---	900	10,000	VXLED13DG
VXBR1F26	.30	.20	.13	.13	26	Triple	GX24q-3	Elec HPF QT	29	---	1,800	12,000	
VXBR2F32	.30	.20	.20	.13	32	Triple	GX24q-3	Elec HPF QT	36	---	2,400	12,000	
VXBR2F42	.40	.25	.20	.20	42	Triple	GX24q-4	Elec HPF QT	46	---	3,200	12,000	

add suffix "3/4" (Example: VX2SN35/3)

add suffix S (Example: VX2SN35S)
add suffix W (Example: VX2SN35W)
add suffix B (Example: VX2SN35B)

3/4" tapped hubs:
(add suffix)

Finish: (add suffix)
Silver Gray:
White:
Black:

add suffix "3/4" (Example: VX2SN35/3)

add suffix S (Example: VX2SN35S)
add suffix W (Example: VX2SN35W)
add suffix B (Example: VX2SN35B)

NOTE: Not for classified environments.



Vaporproof Guards & Reflectors

Die-Cast Guard



Catalog #	Series	Finish
GD100DG	100	Natural Aluminum
GD100DGS	100	Silver Gray
GD100DGB	100	Black
GD100DGW	100	White
GD200DG	200	Natural Aluminum
GD200DGS	200	Silver Gray
GD200DGB	200	Black
GD200DGW	200	White

Wire Clamp Guard



Catalog #	Series	Finish
GD100DCL	100	Natural Aluminum
GD100DCLS	100	Silver Gray
GD100DCLB	100	Black
GD100DCLW	100	White
GD200CLG	200	Natural Aluminum
GD200DCLS	200	Silver Gray
GD200DCLB	200	Black
GD200DCLW	200	White

Flat Bottom Wire Guard



GD100DBAR	100	Silver Gray
GD200BAR	200	Silver Gray

Dome Reflector



RV100ST	100	White
RV200ST	200	White

Angle Reflector



RV100A	100	White
RV200A	200	White

ACCESSORIES

Round Bottom Glass Globes



Permaglobes (Unbreakable Polycarbonate)



EXPLOSIONPROOF

INCANDESCENT FIXTURES



- EX & EB fixtures come complete with built-in junction box
- Cast aluminum construction
- Gray epoxy powder coat finish
- Heat and impact resistant prismatic glass globe
- Easy relamping with single thumb screw

Quality tested



For several years, RAB Explosionproof fixtures lit the Space Shuttle launch tower at the Kennedy Space Center.

EX Ceiling



Hub Size	# of Hubs	Catalog # w/Guard	Catalog # No Guard	Weight w/Guard		Weight w/o Guard	
				lb	kg	lb	kg
1/2"	4	EX124	EX12	12	5.4	11	5.0
1/2"	8	EX124T	EX12T	12	5.4	11	5.0
3/4"	4	EX124-3/4	EX12-3/4	15	6.8	14	6.4
3/4"	8	EX124T-3/4	EX12T-3/4	16	7.2	13	5.9

EB Bracket



1/2"	4	EB124	EB12	12	5.4	11	5.0
1/2"	8	EB124T	EB12T	12	5.4	11	5.0
3/4"	4	EB124-3/4	EB12-3/4	15	6.8	14	6.4
3/4"	8	EB124T-3/4	EB12T-3/4	16	7.2	13	5.9

EP Pendant



1/2"	1	EP124	EP12	12	5.4	11	5.0
3/4"	1	EP124-3/4	EP12-3/4	15	6.8	14	6.4



Location Class	Division	Groups	Operating Temp. code	Listed Max. Wattage		
				Without Reflector	w/Std. Dome Reflector	w/ 30° Dome Reflector
I	1&2	C&D	T3C	300	300	300
I	1&2	D Paint Spray	T4A	75	-	-
II	1&2	E&F	T3	200	150	200
II	1&2	E,F&G	T3C	100	-	150
III			T3C	100	100	150
I	1&2	C&D	T3C	300	300	300
I	1&2	D Paint Spray	T4A	75	-	-
II	1&2	E&F	T3	200	150	200
II	1&2	E,F&G	T3C	100	-	150
III			T3C	100	100	150
I	1&2	C&D	T3C	300	300	300
I	1&2	D Paint Spray	T4A	75	-	-
II	1&2	E&F	T3	200	150	200
II	1&2	E,F&G	T3C	100	-	150
III			T3C	100	100	150

ACCESSORIES

Standard Dome Reflector



Catalog #
RE200ST

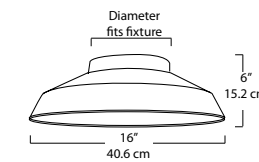

Angle Reflector



Catalog #
RE200A

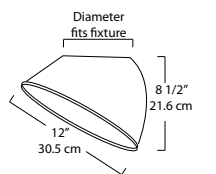

Junction Box



Catalog #
Cover Tap
1/2" NPT Side Hubs
3/4" NPT Side Hubs

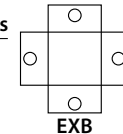

4 hole positions



Catalog #
Cover Tap
1/2" NPT Side Hubs
3/4" NPT Side Hubs

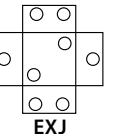

8 hole positions

PHOTOMETRICS

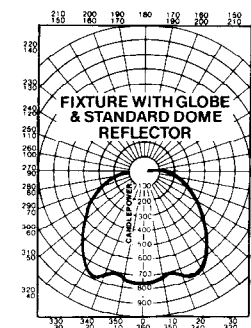
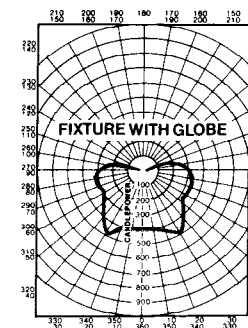

WEATHERPROOF

COVERS AND BOXES



Round Tuffy Cover

B3 Single Outlet Box

EZ-Plate

Rectangular Cover

Round Wiring Box



Close-Up Plug

EZ Plate Universal Mounting Plate

• Fits round, rectangular, octagonal, recessed & surface mount boxes

	Catalog #	Finish	# of Holes	Dimensions
	CU4A	Bronze	4	4 5/8" w x 4 3/4" h
	CU4B	Black	4	4 5/8" w x 4 3/4" h
	CU4	Silver Gray	4	4 5/8" w x 4 3/4" h
	CU4W	White	4	4 5/8" w x 4 3/4" h
	CU4VG	Verde Green	4	4 5/8" w x 4 3/4" h

Heavy Duty

• Die-cast aluminum for round wiring boxes

	Catalog #	Finish	Tap	Nominal Diameter
	X3C	Natural	Blank	3 1/2"
	XC	Natural	Blank	4 1/2"
	XC1	Natural	1/2" tap	4 1/2"
	XC2	Natural	3/4" tap	4 1/2"
	XC1A	Bronze	1/2" tap	4 1/2"
	XC1W	White	1/2" tap	4 1/2"

Die-cast Round

• Covers come with one or three 1/2" holes

	Catalog #	Finish	# of Holes	Dimensions
	C100A	Bronze	1	4 1/2"
	C100B	Black	1	4 1/2"
	C100	Silver Gray	1	4 1/2"
	C100W	White	1	4 1/2"
	C100VG	Verde Green	1	4 1/2"
	C103A	Bronze	3	4 1/2"
	C103B	Black	3	4 1/2"
	C103	Silver Gray	3	4 1/2"
	C103W	White	3	4 1/2"
	C103VG	Verde Green	3	4 1/2"

Round Tuffy Cover

• Four hole round polycarbonate cover with molded-in color

	Catalog #	Finish	# of Holes	Dimensions
	C4TB	Black	4	4 1/2"
	C4TW	White	4	4 1/2"

Turtle In-Use Cover

• Weatherproof cover protects in-use electrical devices in wet locations

	Catalog #	Finish	Size	Outlet Type
	TCS	Gray	3 5/8" w x 5 9/16" h	Single
	TCB	Black	3 5/8" w x 5 9/16" h	Single
	TC1W	White	3 5/8" w x 5 9/16" h	Single
	TCVG	Verde Green	3 5/8" w x 5 9/16" h	Single

Blank Rectangular Cover

• Stamped aluminum covers fit single (CR1) outlet boxes

	Catalog #	Finish	Size	Outlet Type
	CR1	Silver Gray	-	Single

Blank Square Cover

• Stamped aluminum covers fit double (CR2) outlet boxes

	Catalog #	Finish	Size	Outlet Type
	CR2	Silver Gray	-	Double

Close-Up Plugs

• Fits all RAB covers and boxes to provide a weatherproof seal to unused holes

	Catalog #	Finish	Size	Outlet Type
	R9	Natural	1/2"	-
	R9S	Silver Gray	1/2"	-
	R9B	Black	1/2"	-
	R9A	Bronze	1/2"	-
	R9W	White	1/2"	-
	R9VG	Verde Green	1/2"	-
	R10	Natural	3/4"	-
	R10S	Silver Gray	3/4"	-
	R10B	Black	3/4"	-
	R10A	Bronze	3/4"	-
	R10W	White	3/4"	-
	R10VG	Verde Green	3/4"	-
	R13	Natural	1"	-

Rectangular Tuffy Cover

• Three hole rectangular polycarbonate cover with molded-in color

	Catalog #	Finish	# of Holes	Dimensions
	R3TB	Black	1	2 7/8" w x 4 1/2" h
	R3TW	White	1	2 7/8" w x 4 1/2" h







Die-Cast Rectangular Covers

• One or Three hole rectangular die-cast aluminum cover

	Catalog #	Finish	# of Holes	Dimensions
	R14-1A	Bronze	1	2 7/8" w x 4 5/8" h
	R14-1B	Black	1	2 7/8" w x 4 5/8" h
	R14-1	Silver Gray	1	2 7/8" w x 4 5/8" h
	R14-1W	White	1	2 7/8" w x 4 5/8" h
	R14-1VG	Verde Green	1	2 7/8" w x 4 5/8" h
	R14-3A	Bronze	3	2 7/8" w x 4 5/8" h
	R14-3B	Black	3	2 7/8" w x 4 5/8" h
	R14-3	Silver Gray	3	2 7/8" w x 4 5/8" h
	R14-3W	White	3	2 7/8" w x 4 5/8" h
	R14-3VG	Verde Green	3	2 7/8" w x 4 5/8" h



Boxes and Slipfitters

• Die-cast aluminum wiring box with weatherproof gasket

	Catalog #	Finish	Hole Thread size	Nominal Diameter
	VXCA	Bronze	1/2"	4"
	VXCB	Black	1/2"	4"
	VXCW	White	1/2"	4"
	VXC	Natural	1/2"	4"
	VXCVG	Verde Green	1/2"	4"
	VXCA-3/4	Bronze	3/4"	4"
	VXCB-3/4	Black	3/4"	4"
	VXCW-3/4	White	3/4"	4"
	VXC-3/4	Natural	3/4"	4"
	VXCVG-3/4	Verde Green	3/4"	4"
	LRTC	Natural	1/2"	3"
	LRTC-3/4	Natural	3/4"	3"
	VXJ	Natural	1/2"	4"
	VXJ-3/4	Natural	3/4"	4"
	LRT4	Natural	1/2"	3"
	LRT4-3/4	Natural	3/4"	3"
	VXJ1	Natural	1/2"	4"
	VXJ1-3/4	Natural	1/2"	4"
	LRT5	Natural	1/2"	3"
	LRT5-3/4	Natural	1/2"	3"
	VXJ2	Natural	3/4"	4"
	VXJ2-3/4	Natural	3/4"	4"
	VX3A	Bronze	1/2"	4"
	VX3B	Black	1/2"	4"
	VX3W	White	1/2"	4"
	VX3	Natural	1/2"	4"
	VX3VG	Verde Green	1/2"	4"
	LRT3	Natural	1/2"	3"
	LRT3-3/4	Natural	1/2"	3"
	R15U	Natural	1/2"	3"

GFI Duplex Outlet Covers





• Ground fault interruptor for vertical or horizontal installation

	Catalog #	Finish	Size	Outlet Type
	GFI-V	Natural	2 7/8" w x 4 1/2" h	Single (Vertical)
	GFI-H	Natural	4 1/2" w x 2 7/8" h	Single (Horizontal)

Outlet Covers

• Heavy Die-cast covers with spring loaded lids keep water out

	Catalog #	Finish	Size	Outlet Type
	CO1	Silver Gray	4 1/2" w x 2 7/8" h	Single (Horizontal)

	Catalog #	Finish	Hole Tap size	# of Holes
	B3A	Bronze	1/2"	3
	B3B	Black	1/2"	3
	B3W	White	1/2"	3
	B3	Silver Gray	1/2"	3
	B3VG	Verde Green	1/2"	3
	B3-3/4	Silver Gray	3/4"	3
	B4A	Bronze	1/2"	4
	B4B	Black	1/2"	4
	B4W	White	1/2"	4
	B4	Silver Gray	1/2"	4
	B4VG	Verde Green	1/2"	4
	B4-3/4	Silver Gray	3/4"	4
	B5	Silver Gray	1/2"	5
	B5-3/4	Silver Gray	3/4"	5
	B5X	Silver Gray	1/2"	5
	B5X-3/4	Silver Gray	3/4"	5
	BD3	Silver Gray	1/2"	3
	BD3-3/4	Silver Gray	3/4"	3
	BD4	Silver Gray	1/2"	4
	BD4-3/4	Silver Gray	3/4"	4
	BD5	Silver Gray	1/2"	5
	BD5-3/4	Silver Gray	3/4"	5
	BD5X	Silver Gray	1/2"	5
	BD5X-3/4	Silver Gray	3/4"	5
	BD7	Silver Gray	1/2"	7
	BD7-3/4	Silver Gray	3/4"	7
	BD7X	Silver Gray	1/2"	7
	BD7X-3/4	Silver Gray	3/4"	7
	R7	Natural	1/2"	
	R7-3/4	Natural	3/4"	
	R5	Natural	1/2"	
	R5-3/4	Natural	3/4"	
	RT6	Natural	1/2"	9
	R3	Natural	1/2"	2

INDEX

Product Name	Category	Page #	Product Name	Category	Page #
AJ, AL & ALX	Area Lighting	68	LRT Series	Weatherproof	92
ALED	ALED	26	LSTEALTH	Sensors	38
Area Lighting HID	Area Lighting	68	LS & LU Series	Sensors - Outdoor	72
Area Lighting LED	ALED	26	LSTEP	LSTEP	46
Application Engineering	Tech Info	12	Luminator	Sensors - Outdoor	72
Ballast & Lamp Data	Ballast & Lamp Data	00	LVAPOR	LVAPOR	86
Barnlight	Wallpacks	56	MegaFlood	Floodlights	62
Bell Box (B3 box)	Weatherproof	92	Mighty Post	Landscape	82
Bollard LED	BLED	40	Mini Sensor	Sensors - Outdoor	72
Boxes (Weatherproof)	Weatherproof	92	Motion Activated Lighting	Sensors - Outdoor	72
Brackets	Brackets	47	Mounting Brackets LED	Brackets	47
Bullet Incandescent Floods	Floodlights	62	Mounting Brackets	Floodlights	62
Bullet Quartz Floods	Floodlights	62	MP Series Mounting Posts	Landscape	82
Bullhorns	Poles/Brackets	70	Occupancy Sensors	Sensors - Outdoor	72
C Series Covers	Weatherproof	92	Outdoor Sensors	Sensors - Outdoor	72
Ceiling LED Lights	CLED	28	Outlet Boxes	Weatherproof	92
Ceiling Sensors	Sensors - Occupancy	76	Pagoda Lawn Lights	Landscape	82
CFL Vaporproof	Vaporproof	86	Pendant LED	LPENDANT	30
CFL Wallpacks	Wallpacks	56	Permaglobes	Vaporproof	86
CU4	Weatherproof	92	Photometrics LED	Photometrics	48
Curve Quartz Floods	Floodlights	62	PLED	LPENDANT	30
Dome Top	Landscape	82	PLF Floods	Landscape	82
E Series	Explosionproof	91	Plugs	Weatherproof	92
Explosionproof Lighting	Explosionproof	91	Poles	Poles/Brackets	70
EZ Flood	Floodlights	62	Portables	Floodlights	62
EZ Plate	Weatherproof	92	Power Post	Landscape	82
FFLED	LFLOOD	32	Pulse Start MH Wallpacks	Wallpacks	56
FF Series	Floodlights	62	Pulse Start MH Floodlights	Floodlights	62
Flag Lighting	LFLOOD	32	QB & QF Series	Floodlights	62
Flex Flood	Floodlights	62	QF Worklights	Floodlights	62
Floodlight Field & Beam Angles	Photometrics	51	Quartz Floods	Floodlights	62
Floodlights LED	LFLOOD	32	R9 Series Plugs	Weatherproof	92
Floodzilla & Floodinator	Floodlights	62	R90	Floodlights	62
Full Cutoff Wallpacks	Wallpacks	56	R14	Weatherproof	92
Future Flood	Floodlights	62	RBay Series	High/Low Bays	78
FXLED	LFLOOD	32	RV Series Reflectors	Vaporproof	86
Garden Lights	Landscape	82	SB Series Smart Box	Sensors - Outdoor	72
Garage Lighter	Vandalproof	80	Sensors	Sensors - Outdoor	72
GD Series Guards	Vaporproof	86	Smart Switch	Sensors - Occupancy	76
GFI Covers	Weatherproof	92	Smart Tallpack	Wallpacks	56
GL Series Globes	Vaporproof	86	Solar LED	Solar LED	36
Gooseneck LED	LGOOSE	44	STEALTH	Sensors - Outdoor	72
Gotcha	Sensors - Outdoor	72	STEALTH LED	Sensors	38
H System Incandescent	Floodlights	62	Step Lights LED	LSTEP	46
H System HID	Landscape	82	STL360	Sensors - Outdoor	72
H101	Floodlights	62	Tallpack	Wallpacks	56
Hazardous Locations Lighting	Explosionproof	91	Tower Worklights	Floodlights	62
HBLEED	LFLOOD	32	Tuff Dome	Sensors - Occupancy	76
High Bay	High/Low Bays	78	Turtle Series	Landscape	82
High Bay Fluorescents	High/Low Bays	78	Universal Mounting Plate	Weatherproof	92
HSLED	LFLOOD	32	V Series	Vaporproof	86
Incandescent Floods	Floodlights	62	Vacancy Sensor	Sensors - Occupancy	76
Induction Vandalproof	Vandalproof	80	VAN Series	Vandalproof	80
In use cover	Landscape	82	Vaporproof HID & CFL	Vaporproof	86
Lawn Lights	Landscape	82	Vaporproof LED	LVAPOR	42
LED Area Lights	ALED	26	Vaporproof Globes	Vaporproof	86
LED Bollards	BLED	40	Vaporproof Guards	Vaporproof	86
LED Floodlights	LFLOOD	32	VX Series	Weatherproof	92
LED Vaporproof	LVAPOR	42	Wallpacks HID & CFL	Wallpacks	56
LED Wallpacks	LPACK	22	Wallpacks LED	LPACK	22
LFLED Flood	LFLOOD	32	Wall Switch Sensors	Sensors - Occupancy	76
LFLOOD	LFLOOD	32	Worklights	Floodlights	62
LGOOSE	LGOOSE	44	WP1,2,3,4 Series	Wallpacks	56
LL Series Garden Lights	Landscape	82	WPLED	LPACK	22
LPACK	LPACK	22	WPT Series (Tallpack)	Wallpacks	56
LOS & LV Series	Sensors - Occupancy	76	XC Series Covers	Weatherproof	92
Low Bay	High/Low Bays	78	YL Series Yard Light	Wallpacks	56
Low Voltage LED	Solar LED	36			

RAB is continually improving our products. Specifications may change without notice.
RAB products and materials are protected by U.S. and foreign patents, trademarks and copyrights, including those listed on various pages of this publication.