



WAC LIGHTING

2015 JUNE New Product

Table of Contents

LED Recessed	
Aether	1
Tesla New	3
Precision Multiples	11
Summit	13
<hr/>	
InvisiLED®	
Aluminum Channels for InvisiLED® New	14
<hr/>	
LED Track	
Exterminator W track New	15
Paloma W Track	19
W Track Current Limiter New	20
W Track Quick Connect™ Adapter New	21
Quick Connect™ Pendants and Fixtures	22
Exterminator H/L/J Track New	23
Summit H/L/J/Flexrail1™ Track	27
Precision H/L/J Track	29
H Track Current Limiter New	31
LED Track Luminaires	32
<hr/>	
LED Task	
Touch and Occupancy Control Kit	33
LED90 Edge Lit Button Light	34
Line™	35
Light Bars	37
<hr/>	
LED Exterior	
Endurance™	39
Tube	45
Scoop	49
Rubix	50
<hr/>	
LED Decorative	
Monterrey	53
Vector New	55
Glo	57
Disc New	58
<hr/>	
DweLED	59-80

3.5"

Fits in tight plenums

with complex HVAC ducts, sprinkler pipes and conduit runs

Aether™
3.5" Shallow
LED Downlight

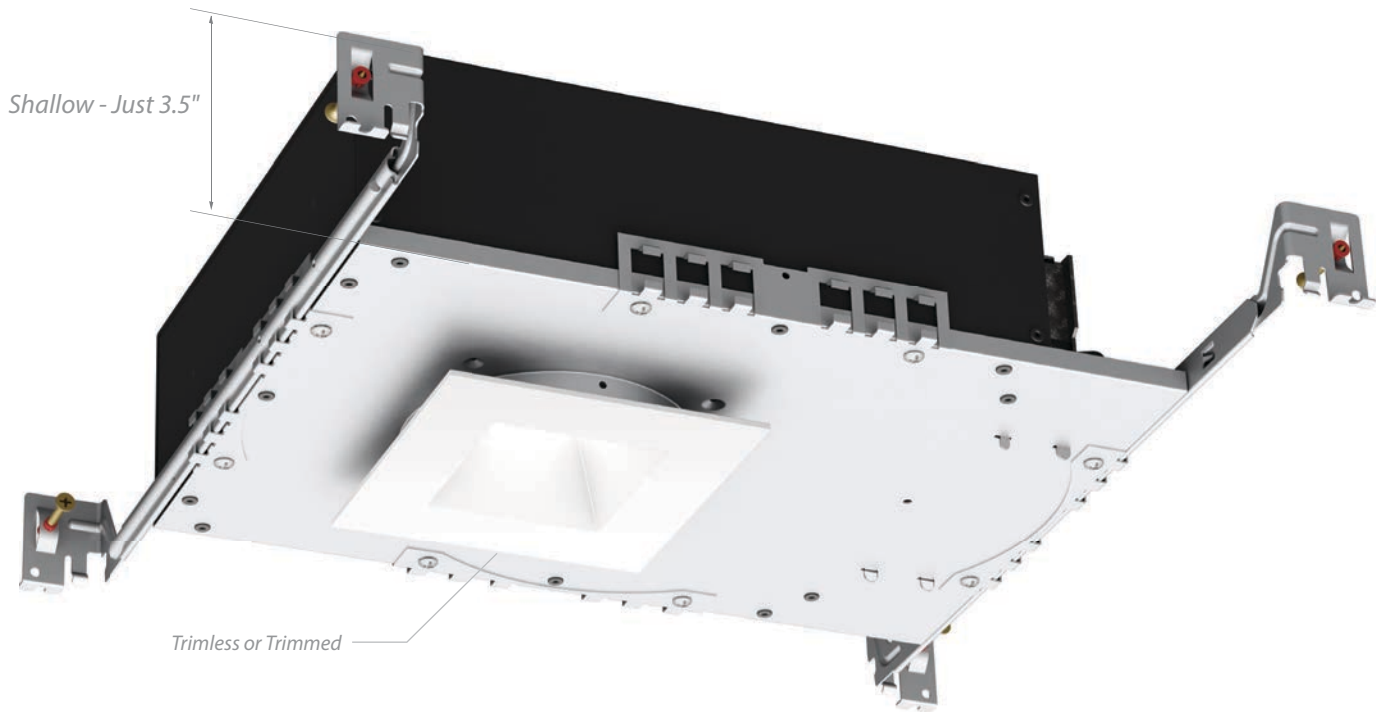

Aether™







3.5" Shallow LED Downlight

Power: 22.5W
Delivered Lumens: Up to 1375
Comparable to: 75W MR16
ELV Dimming: 100%-15% (120V Only)
0-10V Dimming: 100%-10%
Rated Life: 50,000 hours

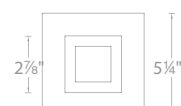

Designed to fit in tight plenum

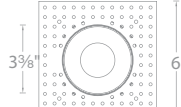
- Narrow IC Housing
- Energy Star® rated
- Wet location listed
- 3.5" trim aperture, 3.5" housing height
- 35° cut-off angle
- Universal input voltage (120V-220V-277V)
- Ceiling thickness: ½" - 1½"

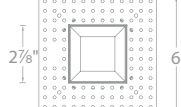
Trims (Order Housing Separately)

		HR-3LED-T120-WT Round
		HR-3LED-T720-WT Square
		HR-3LED-TL220-WT Round Trimless
		HR-3LED-TL820-WT Square Trimless

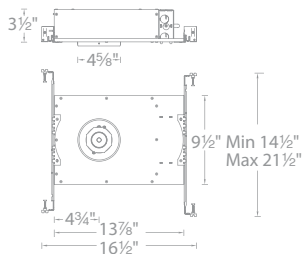
Housings

	Beam	Max CBCP	Max Lumen	Color Temp	CRI
 	HR-3LED-H20A New Construction Non-IC, Airtight				
	N 25°	4480	1375	927 2700K	90
 	HR-3LED-H20AC New Construction Non-IC, Airtight Chicago Plenum				
	F 40°	2555	1315	27 2700K	85
				930 3000K	90
				30 3000K	85
			35 3500K	85	
			40 4000K	85	

Example: **HR-3LED-H20A-F-930**

Tesla Pro 2" LED















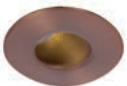

Delivered Lumens: Up to 1090
Comparable to: 50W MR16
Power: 14.5W
ELV Dimming: 100%-15% (120V Only)
0-10V Dimming: 100%-10%
Rated Life: 50,000 hours

High Output LED

- Wet and damp location listed
- Energy Star® rated
- CEC Title 24 Compliant (see website for list of models)
- 30° visual cutoff angle for glare control
- Adjustable fixtures are ideal for sloped ceiling applications
- Universal input voltage (120V-220V-277V)
- 2" aperture

Trims (Order Housing Separately)

Trims (Order Housing Separately)		Beam	Color Temp	CRI	Finish
		HR2LD-ET109P High Brightness Wet Location Listed Energy Star® 9° visual cutoff	N 30° F 55°		
		HR2LEDT109P Open Reflector Energy Star®	N 27° F 40°		
		HR2LEDT309P 0°- 30° Adjustable Energy Star®	N 27° F 40°		
		HR2LEDT409P 30°- 45° Adjustable Energy Star®	N 27° F 40°	827 2700K 85 927 2700K 90 830 3000K 85 930 3000K 90 835 3500K 85 840 4000K 85	BN Brushed Nickel CB Copper Bronze WT White
		HR2LEDT209P Shower Light Wet Location Listed Energy Star®	N 27°		
		HR2LEDT709P Open Reflector Energy Star®	N 30° F 45°		
		HR2LEDT509P 0°- 30° Adjustable Energy Star®	N 30° F 45°		

Example: **HR2LEDT109PF835BN**

Replacement Modules

Reflectors with different beam spreads and LED modules with different color temperature may be ordered separately

Reflectors

Narrow Flood **SL-REF-BL10-1-N**
 Flood **SL-REF-BL10-1-F**

LED

2700K 85 CRI **BXRC-27E1000-B-03**
 2700K 90 CRI **BXRC-27G1000-B-03**
 3000K 85 CRI **BXRC-30E1000-B-03**
 3000K 90 CRI **BXRC-30G1000-B-03**
 3500K 85 CRI **BXRC-35E1000-B-03**
 4000K 85 CRI **BXRC-40E1000-B-03**

Chicago Plenum

Chicago Plenum housings add extra building safety features that confine airflow in and out of the housing with elastomer gasket

Tesla Pro 2" Housing

Housings (Required)	Model	Input	Notes
<p><i>Adjustable New Construction</i></p>	<p>HR-2LED-H09D-ICA <i>IC-Rated, Airtight</i></p>	120V-277V	<p><i>Allows adjustment in any direction when used with adjustable trims</i></p>
<p><i>Remodel</i></p>	<p>HR-2LED-R09D-A <i>Non-IC, Airtight</i></p>	120V-277V	<p><i>Requires 3" of clearance from insulation on all sides</i></p> <p><i>Ceiling thickness: 1/2" - 1"</i></p> <p><i>Does not accommodate adjustments</i></p>
<p><i>Adjustable Remodel</i></p>	<p>HR-2LED-R14D <i>Non-IC</i></p>	120V-277V	<p>New Product</p> <p><i>Allows adjustment in any direction when used with adjustable trims</i></p> <p><i>Requires 3" of clearance from insulation on all sides</i></p> <p><i>Ceiling thickness: 1/2" - 5/8"</i></p>

















Tesla 2" LED



Delivered Lumens: Up to 730
Comparable to: 50W MR16
Power: 14.5W
ELV Dimming: 100%-15% (120V Only)
0-10V Dimming: 100%-10%
Rated Life: 90,000 hours

- Universal input voltage (120V-220V-277V)
- Wet and damp location listed
- 30° visual cutoff angle for glare control
- Adjustable fixtures are ideal for sloped ceiling applications
- 2" aperture

Trims (Order Housing Separately)

Trims (Order Housing Separately)		Beam	Color Temp	CRI	Finish
		HR-2LD-ET109 <i>Wet Location Listed</i> <i>Energy Star®</i> <i>9° visual cutoff</i>	S 16.5° N 30° F 53°		
		HR-2LED-T109 <i>Open Reflector</i>			
		HR-2LED-T309 <i>0°-30° Adjustable</i>	S 15° N 26° F 45°		
		HR-2LED-T409 <i>30°-45° Adjustable</i>	27 2700K 85 9W 3000K 90 W 3000K 85 35 3500K 85 C 4000K 85		BN Brushed Nickel CB Copper Bronze WT White
		HR-2LED-T209 <i>Shower Light</i> <i>Wet Location Listed</i>	N 26°		
		HR-2LED-T709 <i>Open Reflector</i>	S 15° N 26° F 45°		
		HR-2LED-T509 <i>0°-30° Adjustable</i>			

Example: **HR-2LD-ET109F-9W-BN**

Replacement Modules

Reflectors with different beam spreads and LED modules with different color temperature may be ordered separately

Reflectors

Spot	SL-REF-LUX10-S
Narrow Flood	SL-REF-LUX10-N
Flood	SL-REF-LUX10-F

LED

2700K	85 CRI	LXS8-PW27
3000K	90 CRI	LXS9-PW30
3000K	85 CRI	LXS8-PW30
3500K	85 CRI	LXS8-PW35
4000K	85 CRI	LXS8-PW40

Chicago Plenum

Chicago Plenum housings add extra building safety features that confine airflow in and out of the housing with elastomer gasket

Tesla 2" Housing

Housings (Required)	Model	Input	Notes
<p><i>Adjustable New Construction</i></p>	<p>HR-2LED-H09D-ICA <i>IC-Rated, Airtight</i></p>	120V-277V	<p><i>Allows adjustment in any direction when used with adjustable trims</i></p>
	<p>HR-2LED-H09D-ICAC <i>IC-Rated, Airtight Chicago Plenum</i></p>	120V-277V	<p><i>Ceiling thickness: 1/2"–3/4"</i></p>
<p><i>Remodel</i></p>	<p>HR-2LED-R09D-A <i>Non-IC, Airtight</i></p>	120V-277V	<p><i>Requires 3" of clearance from insulation on all sides</i></p> <p><i>Ceiling thickness: 1/2"–1"</i></p> <p><i>Does not accommodate adjustments</i></p>
<p><i>Adjustable Remodel</i></p>	<p>HR-2LED-R14D <i>Non-IC</i></p>	120V-277V	<p><i>Allows adjustment in any direction when used with adjustable trims</i></p> <p><i>Requires 3" of clearance from insulation on all sides</i></p> <p><i>Ceiling thickness: 1/2"–5/8"</i></p>



Tesla Pro 3.5" LED











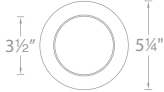
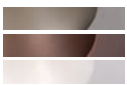





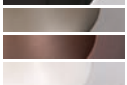

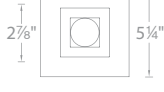
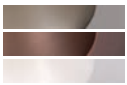

Power: 22W
Delivered Lumens: Up to 1460
Comparable to: 75W MR16
ELV Dimming: 100%-15% (120V Only)
0-10V Dimming: 100%-10%
Rated Life: 50,000 hours

High Output LED

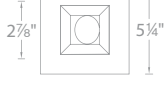

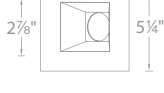

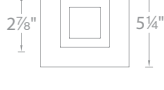

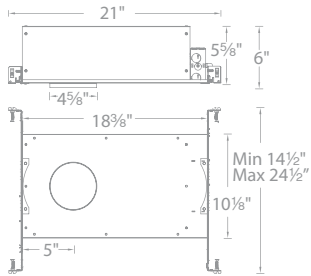

- Universal input voltage (120V-220V-277V)
- All Energy Star® rated
- Wet and Damp location listed
- 30° visual cutoff angle for glare control
- Adjustable fixtures are ideal for sloped ceiling applications
- 3.5" aperture

Trims (Order Housing Separately)

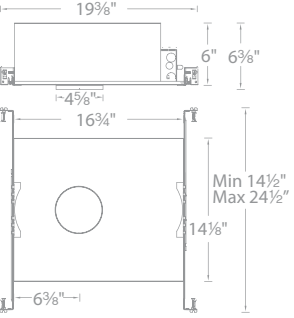
	Beam	Color Temp	CRI	Finish	Reflector/Trim
  <p>HR3LD-ET118P High Brightness Wet Location Listed Energy Star® 9° visual cutoff</p>	F 48°	827 2700K 85 927 2700K 90 830 3000K 85 930 3000K 90 835 3500K 85 840 4000K 85	BN Brushed Nickel CB Copper Bronze WT White		
  <p>HR3LEDT118P Downlight Energy Star®</p>	N 30° F 55°	827 2700K 85 927 2700K 90 830 3000K 85 930 3000K 90 835 3500K 85 840 4000K 85	HBN Haze/Brushed Nickel HCB Haze/Copper Bronze HWT Haze/White BBN Specular Black/Brushed Nickel BCB Specular Black/Copper Bronze BWT Specular Black/White BN Brushed Nickel CB Copper Bronze WT White		
  <p>HR3LEDT318P 0°- 30° Adjustable Energy Star®</p>	N 30° F 55°	827 2700K 85 927 2700K 90 830 3000K 85 930 3000K 90 835 3500K 85 840 4000K 85	BN Brushed Nickel CB Copper Bronze WT White		
  <p>HR3LEDT418P 30°- 45° Adjustable Energy Star®</p>	N 26° F 38°				
  <p>HR3LEDT218P Shower Light Wet Location Listed Energy Star®</p>	N 30°				
  <p>HR3LEDT718P Open Reflector Energy Star®</p>	N 30° F 52°	827 2700K 85 927 2700K 90 830 3000K 85 930 3000K 90 835 3500K 85 840 4000K 85	BN Brushed Nickel CB Copper Bronze WT White		
  <p>HR3LEDT518P 0°- 30° Adjustable Energy Star®</p>	N 30° F 52°				
  <p>HR3LEDT918P 30°- 45° Adjustable Energy Star®</p>	N 26° F 38°				
  <p>HR3LEDT818P Shower Light Wet Location Listed Energy Star®</p>	N 30°				

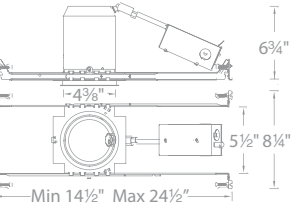
Example: **HR3LD-ET118PF930BN**

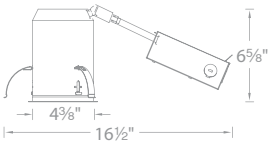
Tesla Pro 3.5" Housing

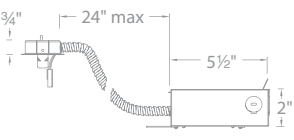
Housings (Required)	Model	Input	Notes
<p><i>Narrow New Construction</i></p>  	<p>HR-3LED-H18D1-ICA IC-Rated, Airtight</p>	120V-277V	Allows adjustment in one direction when used with adjustable trims
	<p>HR-3LED-H18D1-ICAC IC-Rated, Airtight Chicago Plenum</p>	120V-277V	Ceiling thickness: 1/2" - 3/4"
<p><i>Adjustable New Construction</i></p>  	<p>HR-3LED-H18D-ICA IC-Rated, Airtight</p>	120V-277V	<p>Allows adjustment in any direction when used with adjustable trims</p> <p>Ceiling thickness: 1/2" - 3/4"</p>
	<p>HR-3LED-H18D-ICAC IC-Rated, Airtight Chicago Plenum</p>	120V-277V	
	<p>HR-3LED-H18D-EMICA IC-Rated, Airtight Emergency Backup Battery</p>	120V	
	<p>HR-3LED-H18D-EMICAF IC-Rated, Airtight Emergency Backup Battery</p>	277V	
<p><i>New Construction</i></p>  	<p>HR-3LED-H18D-A Non-IC, Airtight</p>	120V-277V	<p>Requires 3" of clearance from insulation on all sides</p> <p>Ceiling thickness: 1/2" - 1"</p> <p>Does not accommodate adjustments</p>
<p><i>Remodel</i></p>  	<p>HR-3LED-R18D-A Non-IC, Airtight</p>	120V-277V	<p>Requires 3" of clearance from insulation on all sides</p> <p>Ceiling thickness: 1/2" - 1"</p> <p>Does not accommodate adjustments</p>
<p><i>Adjustable Remodel</i></p>  	<p>HR-3LED-R22D Non-IC</p>	120V-277V	<p>Allows adjustment in any direction when used with adjustable trims</p> <p>Requires 3" of clearance from insulation on all sides</p> <p>Ceiling thickness: 1/2" - 5/8"</p>

Replacement Modules

Reflectors with different beam spreads and LED modules with different color temperature may be ordered separately

Reflectors

Narrow Flood	SL-REF-BL10-1-N
Flood	SL-REF-BL10-1-F

LED

2700K	85 CRI	BXRC-27E1000-B-03
2700K	90 CRI	BXRC-27G1000-B-03
3000K	85 CRI	BXRC-30E1000-B-03
3000K	90 CRI	BXRC-30G1000-B-03
3500K	85 CRI	BXRC-35E1000-B-03
4000K	85 CRI	BXRC-40E1000-B-03

Chicago Plenum

Chicago Plenum housings add extra building safety features that confine airflow in and out of the housing with elastomer gasket











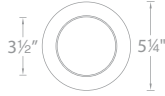







Tesla 3.5" LED



Power: 21.5W
Delivered Lumens: Up to 1070
Comparable to: 75W MR16
ELV Dimming: 100%-15% (120V Only)
0-10V Dimming: 100%-10%
Rated Life: 50,000 hours



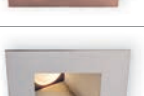



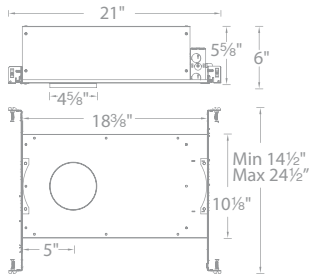

- Damp location listed (Shower Light is wet location listed)
- 30° visual cutoff angle for glare control
- Adjustable fixtures are ideal for sloped ceiling applications
- Universal driver (120V-220V-277V)

Trims (Order Housing Separately)

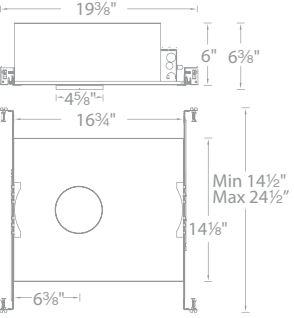
	Beam	Color Temp	CRI	Finish	Reflector/Trim
  <p>HR-3LED-ET118 Round Downlight Energy Star® 9° visual cutoff</p>	F 40°	27 2700K 85 9W 3000K 90 W 3000K 85 35 3500K 85 C 4000K 85		BN CB WT	Brushed Nickel/Brushed Nickel Copper Bronze/Copper Bronze White/White
  <p>HR-3LED-T118 Round Downlight</p>	S 15° N 28° F 50°	27 2700K 85 9W 3000K 90 W 3000K 85 35 3500K 85 C 4000K 85		HZ/BN HZ/CB HZ/WT SB/BN SB/CB SB/WT BN CB WT	Haze/Brushed Nickel Haze/Copper Bronze Haze/White Specular Black/Brushed Nickel Specular Black/Copper Bronze Specular Black/White Brushed Nickel/Brushed Nickel Copper Bronze/Copper Bronze White/White
  <p>HR-3LED-T318 Round 0°- 30° Adjustable</p>					
  <p>HR-3LED-T618 Round Pin Hole, 0°- 30° Adjustable</p>	S 15°				
  <p>HR-3LED-T418 Round 30°- 45° Adjustable</p>	S 15° N 28° F 41°				
  <p>HR-3LED-T218 Round Shower Light Wet Location Listed</p>	N 28°				
  <p>HR-3LED-T718 Square Downlight</p>	S 15° N 28° F 50°	27 2700K 85 9W 3000K 90 W 3000K 85 35 3500K 85 C 4000K 85		BN CB WT	Brushed Nickel/Brushed Nickel Copper Bronze/Copper Bronze White/White
  <p>HR-3LED-T818 Square Shower Light Wet Location Listed</p>	N 28°				
  <p>HR-3LED-T518 Square 0°- 30° Adjustable</p>	S 15° N 28° F 50°				
  <p>HR-3LED-T918 Square 30°- 45° Adjustable</p>					

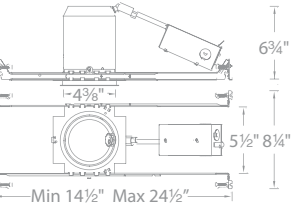
Example: **HR-3LED-T918F-W-CB**

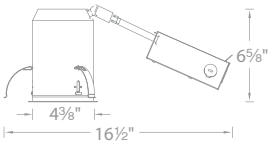
Tesla 3.5" Housing

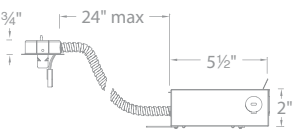
Housings (Required)	Model	Input	Notes
<p><i>Narrow New Construction</i></p>  	<p>HR-3LED-H18D1-ICA IC-Rated, Airtight</p>	120V-277V	Allows adjustment in one direction when used with adjustable trims
	<p>HR-3LED-H18D1-ICAC IC-Rated, Airtight Chicago Plenum</p>	120V-277V	Ceiling thickness: 1/2" - 3/4"
<p><i>Adjustable New Construction</i></p>  	<p>HR-3LED-H18D-ICA IC-Rated, Airtight</p>	120V-277V	Allows adjustment in any direction when used with adjustable trims Ceiling thickness: 1/2" - 3/4"
	<p>HR-3LED-H18D-ICAC IC-Rated, Airtight Chicago Plenum</p>	120V-277V	
	<p>HR-3LED-H18D-EMICA IC-Rated, Airtight Emergency Backup Battery</p>	120V	
<p>HR-3LED-H18D-EMICAF IC-Rated, Airtight Emergency Backup Battery</p>	277V		
<p><i>New Construction</i></p>  	<p>HR-3LED-H18D-A Non-IC, Airtight</p>	120V-277V	Requires 3" of clearance from insulation on all sides Ceiling thickness: 1/2" - 1" Does not accommodate adjustments
<p><i>Remodel</i></p>  	<p>HR-3LED-R18D-A Non-IC, Airtight</p>	120V-277V	Requires 3" of clearance from insulation on all sides Ceiling thickness: 1/2" - 1" Does not accommodate adjustments
<p><i>Adjustable Remodel</i></p>  	<p>HR-3LED-R22D Non-IC</p>	120V-277V	Allows adjustment in any direction when used with adjustable trims Requires 3" of clearance from insulation on all sides Ceiling thickness: 1/2" - 5/8"

Replacement Modules

Reflectors with different beam spreads and LED modules with different color temperature may be ordered separately

Reflectors

Spot	SL-REF-LUX10-S
Narrow Flood	SL-REF-LUX10-N
Flood	SL-REF-LUX10-F

LED

2700K	85 CRI	LXS8-PW27
3000K	90 CRI	LXS9-PW30
3000K	85 CRI	LXS8-PW30
3500K	85 CRI	LXS8-PW35
4000K	85 CRI	LXS8-PW40

Chicago Plenum

Chicago Plenum housings add extra building safety features that confine airflow in and out of the housing with elastomer gasket

Precision Multiples 4" LED with ELV or 0-10V dimming options



Black trim shown



Comparable to: 75W MR16
 Rated Life: 50,000 hours

Retractable Spot Lights

- ELV and 0-10V dimming options
- Black, white, or Invisible Trim™
- Energy Star® rated
- CEC Title 24 Compliant
- Fully retractable from housing
- 355° horizontal rotation and 180° vertical aiming
- Accepts 1 replacement lens

1 Light

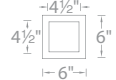
Trims

		MT-4LD116T Trim	WT White BK Black
		MT-4LD116TL-WT Invisible Trim™	

Example: **MT-4LD116T-WT**

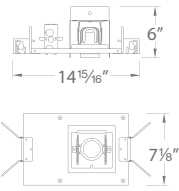

Housings

	Power	Max Lumens		Max CBCP		Beam	Color Temp	CRI	Interior
		20°	40°	20°	40°				
MT-4LD116N 0-10V dimming Non-IC, 120V-277V input	16.5W	1100	1080	5370	2390	S 20° F 40°	27 2700K 85	BK Black	
MT4LD116NE ELV dimming Non-IC, 120V input	16.5W	1005	990	4700	2115		927 2700K 90		
MT4LD111NE ELV dimming IC-Rated, 120V input	11.5W	890	885	3925	1820		30 3000K 85 930 3000K 90 35 3500K 85 40 4000K 85		

Example: **MT4LD111NE-F930-BK**

2 Lights

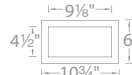
Trims

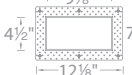
		MT-4LD216T Trim	WT White BK Black
		MT-4LD216TL-WT Invisible Trim™	

Example: **MT-4LD216T-WT**

Housings

	Power	Max Lumens		Max CBCP		Beam	Color Temp	CRI	Interior
		20°	40°	20°	40°				
MT-4LD216N 0-10V dimming Non-IC, 120V-277V input	33W	2200	2160	5370x2	2390x2	S 20° F 40°	27 2700K 85	BK Black	
MT4LD216NE ELV dimming Non-IC, 120V input	33W	2010	1980	4700x2	2115x2		927 2700K 90		
MT4LD211NE ELV dimming IC-Rated, 120V input	23W	1785	1765	3925x2	1820x2		30 3000K 85 930 3000K 90 35 3500K 85 40 4000K 85		

Example: **MT-4LD216N-S927-BK**



Replacement Lens

Amber	LENS-16-AMB	
Blue	LENS-16-BLU	
Green	LENS-16-GRN	
Red	LENS-16-RED	
Yellow	LENS-16-YEL	

UV Filter	LENS-16-UVF	
Frosted	LENS-16-FR	
Spread	LENS-16-SPR	
Beam Elongator	LENS-16-BEL	

3 Lights

Trims

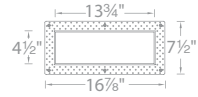
		MT-4LD316T Trim	WT White BK Black
		MT-4LD316TL-WT Invisible Trim™	

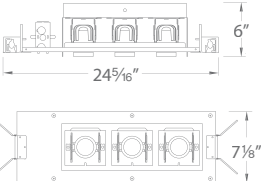

Example: MT-4LD316T-WT

Housings	Power	Max Lumens		Max CBCP		Beam	Color Temp	CRI	Interior
		20°	40°	20°	40°				
	MT-4LD316N 0-10V dimming Non-IC, 120V-277V input	49.5W	3300	3240	5370x3	2390x3	S 20° F 40°	27 2700K 85 927 2700K 90 30 3000K 85 930 3000K 90 35 3500K 85 40 4000K 85	BK Black
	MT4LD316NE ELV dimming Non-IC, 120V input	49.5W	3015	2970	4700x3	2115x3			
	MT4LD311NE ELV dimming IC-Rated, 120V input	34.5W	2680	2650	3925x3	1820x3			

Example: MT4LD311NE-S30-BK

4 Lights

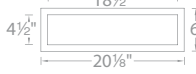
Trims

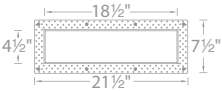
		MT-4LD416T Trim	WT White BK Black
		MT-4LD416TL-WT Invisible Trim™	

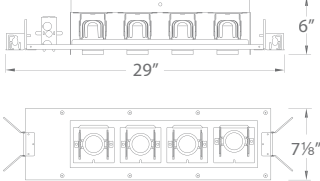

Example: MT-4LD416T-WT

Housings	Power	Max Lumens		Max CBCP		Beam	Color Temp	CRI	Interior
		20°	40°	20°	40°				
	MT-4LD416N 0-10V dimming Non-IC, 120V-277V input	66W	4400	4320	5370x4	2390x4	S 20° F 40°	27 2700K 85 927 2700K 90 30 3000K 85 930 3000K 90 35 3500K 85 40 4000K 85	BK Black
	MT4LD416NE ELV dimming Non-IC, 120V input	66W	4020	3960	4700x4	2115x4			
	MT4LD411NE ELV dimming IC-Rated, 120V input	46W	3570	3535	3925x4	1820x4			

Example: MT-4LD416N-S927-BK

4 Lights (2x2)

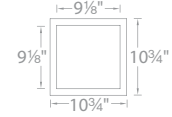
Trims

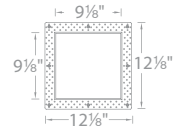
		MT-4LD226T Trim	WT White BK Black
		MT-4LD226TL-WT Invisible Trim™	

Example: MT-4LD226T-WT

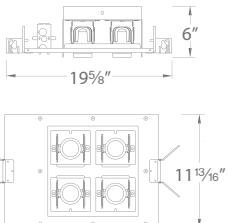
Housings	Power	Max Lumens		Max CBCP		Beam	Color Temp	CRI	Interior
		20°	40°	20°	40°				
	MT-4LD226N 0-10V dimming Non-IC, 120V-277V input	66W	4400	4320	5370x4	2390x4	S 20° F 40°	27 2700K 85 927 2700K 90 30 3000K 85 930 3000K 90 35 3500K 85 40 4000K 85	BK Black
	MT4LD226NE ELV dimming Non-IC, 120V input	66W	4020	3960	4700x4	2115x4			
	MT4LD221NE ELV dimming IC-Rated, 120V input	46W	3570	3535	3925x4	1820x4			

Example: MT4LD226NE-S930-BK



Summit™ 3.5" LED

Power: 17W
Delivered Lumens: 880
Comparable to: 50W MR16
ELV Dimming: 100%-10%
Input: 120V
Rated Life: 70,000 hours

Simple one size fits most

- ACLED non-IC downlight
- Configurable for both new construction and remodel
- Integral housing and trim
- Energy Star® rated
- Wet location listed
- 30° Visual cutoff angle for glare control
- Single proprietary lens for optimal light distribution
- Frosted lens for glare control
- 120VAC - no driver needed
- Ceiling thickness: 1/2" - 3/4"

Trims and Housing

	Beam	Color Temp	CRI
	50°	3000K	85
HR-3LED-17R-F30-WT Round Trim New Construction and Remodel Non-IC, Airtight			

Aluminum Channels for InvisiLED® Series

Aluminum Channel

LED-T-CH

5 feet

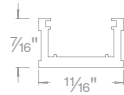

Includes a diffuser, two end caps, and five screws



Deep Aluminum Channel

LED-T-CH1

5 feet



Includes a diffuser, two end caps, and five screws



45° Angled Aluminum Channel

LED-T-CH2

5 feet

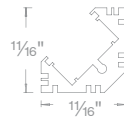

Includes a diffuser, two end caps, and five screws



New Product

LED-T-CL3-PT

2 pcs



Used to mount any aluminum channel
Includes 2 pieces, 4 screws



LED-T-CL2-PT

2 pcs

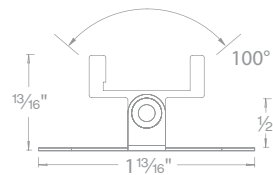

Used to mount any aluminum channel
Adjusts 50° from center either way
Includes 2 pieces, 4 screws



Compatible InvisiLED® Indoor Products



InvisiLED® Pro / Pro2
High Performance



InvisiLED® Classic 24V
White + four colors



InvisiLED® Palette / Daylight to Sunset
Color changing



New Product

52W Exterminator II W Track

Comparable: 70W HID
ELV Dimming: 100% - 1%
Rated Life: 80,000 hours

- Energy Star® rated
- Accommodates one lens accessory and one glare control accessory
- Reflectors and LED modules can be purchased separately for alternative beam angles and color temperatures
- 365° horizontal rotation and 180° vertical aiming

Track	Model	Max Lumens	Max CBCP	Color Temp	CRI	Finish
	WTK 120V WHK 277V 1052 52W	N 25° 4237 15970 F 55° 3910 1640	827 2700K 85 927 2700K 90 830 3000K 85 930 3000K 90 835 3500K 85 840 4000K 85	BK Black PT Platinum WT White		

Example: **WTK-1052N-930-WT**
 See Page 23 for H, L, J

LENS ACCESSORIES

Amber	LENS-25-AMB
Blue	LENS-25-BLU
Green	LENS-25-GRN
Red	LENS-25-RED
Yellow	LENS-25-YEL
UV Filter	LENS-25-UVF
Frosted	LENS-25-FR
Spread	LENS-25-SPR
Beam Elongating	LENS-25-BEL

REFLECTORS

25°	SL-REF-LUX1208-N
55°	SL-REF-LUX1208-F

GLARE CONTROL ACCESSORIES

Cross Louver	LENS-25-CRL
Snoot	LENS-25-SNOOT

LED MODULES

2700K	CRI 85	LHC1-2780-1208-W
2700K	CRI 90	LHC1-2790-1208-W
3000K	CRI 85	LHC1-3080-1208-W
3000K	CRI 90	LHC1-3090-1208-W
3500K	CRI 85	LHC1-3580-1208-W
4000K	CRI 85	LHC1-4080-1208-W



New Product

35W Exterminator II WTrack

Comparable: 50W HID
ELV Dimming: 100% - 5%
Rated Life: 60,000 hours

- Energy Star® rated
- CEC Title 24 Compliant
- Accommodates one lens accessory and one glare control accessory
- Reflectors and LED modules can be purchased separately for alternative beam angles and color temperatures
- 365° horizontal rotation and 180° vertical aiming

Track	Model	Max Lumens	Max CBCP	Color Temp	CRI	Finish
	WTK 120V WHK 277V 1035 35W	N 25° 2795 F 55° 2828	9748 3886	827 2700K 85	BK Black PT Platinum WT White	
				927 2700K 90		
				830 3000K 85		
				930 3000K 90		
				835 3500K 85		
				840 4000K 85		

Example: **WHK-1035F-830-BK**
 See Page 24 for H, L, J

LENS ACCESSORIES

Amber	LENS-20-AMB
Blue	LENS-20-BLU
Green	LENS-20-GRN
Red	LENS-20-RED
Yellow	LENS-20-YEL
UV Filter	LENS-20-UVF
Frosted	LENS-20-FR
Spread	LENS-20-SPR
Beam Elongating	LENS-20-BEL

REFLECTORS

25°	SL-REF-BL18-N
55°	SL-REF-BL18-F

GLARE CONTROL ACCESSORIES

Cross Louver	LENS-20-CRL
Snoot	LENS-20-SNOOT

LED MODULES

2700K	CRI 85	BXRC-27E4000-F-23
2700K	CRI 90	BXRC-27G4000-F-23
3000K	CRI 85	BXRC-30E4000-F-23
3000K	CRI 90	BXRC-30G4000-F-23
3500K	CRI 85	BXRC-35E4000-F-23
4000K	CRI 85	BXRC-40E4000-F-23



New Product

14W Exterminator II WTrack

Comparable: 20W HID
ELV Dimming: 100% - 1%
Rated Life: 100,000 hours

- Energy Star® rated
- CEC Title 24 Compliant
- Accommodates one lens accessory and one glare control accessory
- Reflectors and LED modules can be purchased separately for alternative beam angles and color temperatures
- 365° horizontal rotation and 180° vertical aiming

Track	Model	Max Lumens	Max CBCP	Color Temp	CRI	Finish
	WTK 120V 1014 14W	N 20° 965 F 40° 980	4585 2117	827 2700K 85	BK Black PT Platinum WT White	
				927 2700K 90		
				830 3000K 85		
				930 3000K 90		
				835 3500K 85		
				840 4000K 85		

Example: **WTK-1014N-927-WT**
 See Page 25 for H, L, J

LENS ACCESSORIES

Amber	LENS-11-AMB
Blue	LENS-11-BLU
Green	LENS-11-GRN
Red	LENS-11-RED
Yellow	LENS-11-YEL
UV Filter	LENS-11-UVF
Frosted	LENS-11-FR
Spread	LENS-11-SPR
Beam Elongating	LENS-11-BEL

REFLECTORS

20°	SL-REF-CXA1310-N
40°	SL-REF-CXA1310-F

GLARE CONTROL ACCESSORIES

Cross Louver	LENS-11-CRL
Snoot	LENS-11-SNOOT

LED MODULES

2700K	CRI 85	CXA1310-00J227H-W
2700K	CRI 90	CXA1310-0YG227H-W
3000K	CRI 85	CXA1310-00J430H-W
3000K	CRI 90	CXA1310-0YG430H-W
3500K	CRI 85	CXA1310-00J435H-W
4000K	CRI 85	CXA1310-0HK240H-W



Driver hidden inside
W track

23W Exterminator WTrack

Comparable: 39W HID
ELV Dimming: 100% - 10%
Rated Life: 60,000 hours

- Recessed Driver
- Energy Star® Rated
- Accommodates one lens accessory
- Reflectors and LED modules can be purchased separately for alternative beam angles and color temperatures
- 365° horizontal rotation and 180° vertical aiming

Track	Model	Max Lumens	Max CBCP	Color Temp	CRI	Finish
	WTK 120V WHK 277V	LED20 23W	S 20° 1450 6772 F 40° 1390 2928	27 2700K 85	BK Black PT Platinum WT White	
	927 2700K 90					
	30 3000K 85					
	930 3000K 90					
	35 3500K 85					
	40 4000K 85					

Example: **WTK-LED20F-30-PT**
 See Page 26 for H, L, J

LENS ACCESSORIES

Amber	LENS-16-AMB
Blue	LENS-16-BLU
Green	LENS-16-GRN
Red	LENS-16-RED
Yellow	LENS-16-YEL
UV Filter	LENS-16-UVF
Frosted	LENS-16-FR
Spread	LENS-16-SPR
Beam Elongating	LENS-16-BEL

REFLECTORS

20°	RF-S
40°	RF-F

LED MODULES

2700K CRI 85	BXRC-27E1000
2700K CRI 90	BXRC-27G1000
3000K CRI 85	BXRC-30E1000
3000K CRI 90	BXRC-30G1000
3500K CRI 85	BXRC-35E1000
4000K CRI 85	BXRC-40E1000

Driver hidden inside
W track

Twist to adjust beam angle



Use with a track cover for a seamless installation



8 foot W track cover: **W8-COV-WT**
Can be field-cut and painted



Paloma Adjustable Beam LED

Power: 24W
Delivered Lumens: Up to 1600
CBCP: Up to 7650
Comparable to: 20W HID
Rated Life: 50,000 hours

Museum-quality LED luminaire with adjustable beam angle

- Adjustable beam angle between 15° - 60°
- Die-cast aluminum construction
- 365° horizontal rotation and 180° vertical aiming
- Smooth and continuous ELV dimming for 120V

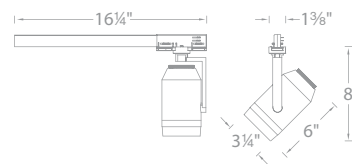

Track	Model	Color Temp	CRI	Max Lumens	Max CBCP	Finish
W Track	LED523	27 2700K	85	1340	6840	BK Black PT Platinum WT White
		927 2700K	90	1260	6515	
		30 3000K	85	1500	7595	
		930 3000K	90	1350	6635	
		35 3500K	85	1495	7280	
		40 4000K	85	1600	7650	

Example: **WTK-LED523-927-WT**

Adjustable Beam Angle

Adjustable between 15° - 60°

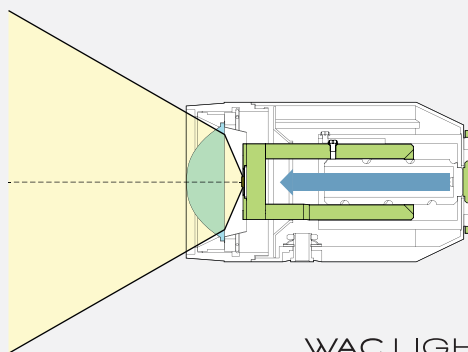
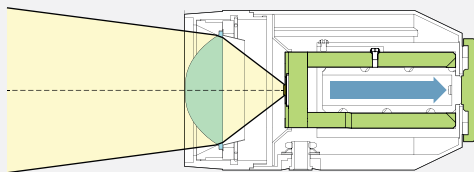

W Track Current Limiter

Now Available in 0.2A and 0.5A

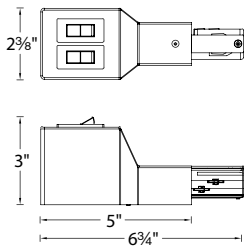

Surface Mount

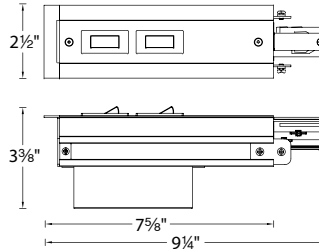



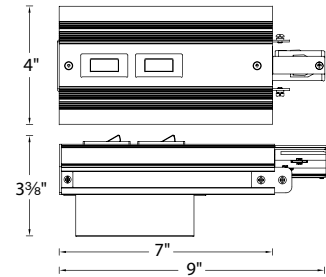



Recessed Flanged

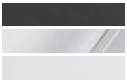







Recessed Flangeless

120V W Track

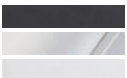
	Model	Rating	Circuit Breaker	Max Wattage	Finish
Single Live end (Left)	 WEDL Surface Mount	1/5A 1/2A 1A 2A 5A 7A 10A 12A	2 X 0.2Amp 2 X 0.5Amp 2 X 1 Amp 2 X 2.5Amp 2 X 5 Amp 2 X 7.5Amp 2 X 10Amp 2 X 12Amp	2 X 24W 2 X 60W 2 X 120W 2 X 300W 2 X 600W 2 X 900W 2 X 1200W 2 X 1440W	BK Black PT Platinum WT White 
	 WEDL-RT Recessed Flanged				
	 WEDL-RTL Recessed Flangeless				
Single Live end (Right)	 WEDR Surface Mount				
	 WEDR-RT Recessed Flanged				
	 WEDR-RTL Recessed Flangeless				

Example: **WEDL-1/5A-BK**

277V W Track

	Model	Rating	Circuit Breaker	Max Wattage	Finish
Single Live end (Left)	 WHEDL Surface Mount	1A 2A 5A 7A 10A 12A	2 X 1 Amp 2 X 2.5Amp 2 X 5 Amp 2 X 7.5Amp 2 X 10Amp 2 X 12Amp	2 X 277W 2 X 692W 2 X 1385W 2 X 2077W 2 X 2770W 2 X 3324W	BK Black PT Platinum WT White 
	 WHEDL-RT Recessed Flanged				
	 WHEDL-RTL Recessed Flangeless				
Single Live end (Right)	 WHEDR Surface Mount				
	 WHEDR-RT Recessed Flanged				
	 WHEDR-RTL Recessed Flangeless				

Example: **WHEDL-1A-BK**

W Track Quick Connect™ Adapter

New Product



Transformer hidden inside W track

The Quick Connect™ collection includes a wide array of pendants and fixtures with different mounting options.







The threaded male adapter makes inter-system compatibility a snap. Simply insert the metal fitting into the system adapter and hand tighten the collar.

Order one per Quick Connect™ fixture or pendant used.

Use with a track cover for a seamless installation

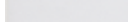

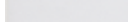
8 foot W track cover: **W8-COV-WT**
Can be field-cut and painted

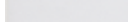
System Adapter	Specifications	Model	Finish									
W Track 120V 	<ul style="list-style-type: none"> • Recessed transformer within W track • Allows all Quick Connect™ elements to be used with the W track 120V systems • 1W minimum load transformer • Smooth and continuous ELV dimming 	EN-WQ50AR	<table border="0"> <tr> <td>BK</td> <td>Black</td> <td></td> </tr> <tr> <td>PT</td> <td>Platinum</td> <td></td> </tr> <tr> <td>WT</td> <td>White</td> <td></td> </tr> </table>	BK	Black		PT	Platinum		WT	White	
BK	Black											
PT	Platinum											
WT	White											

Example: **EN-WQ50AR-WT**

Quick Connect™ Pendants and Fixtures

Order one adapter per pendant or fixture used.



Quick Connect™ Fixtures





New Product

52W Exterminator II H/L/J Track

Comparable: 70W HID
ELV Dimming: 100% - 1%
Rated Life: 80,000 hours

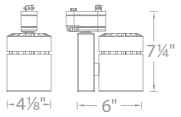
- Energy Star® rated
- Accommodates one lens accessory and one glare control accessory
- Reflectors and LED modules can be purchased separately for alternative beam angles and color temperatures
- 365° horizontal rotation and 180° vertical aiming

Track	Model	Max Lumens	Max CBCP	Color Temp	CRI	Finish
H H TRACK L L TRACK J J/J2 TRACK	 1052 52W	N 25° 4237 15970	F 55° 3910 4640	827 2700K 85	BN Brushed Nickel BK Black WT White	
				927 2700K 90		
		830 3000K 85				
		930 3000K 90				
		835 3500K 85				
		840 4000K 85				

Example: **L-1052F-840-WT**
 See Page 15 for W

LENS ACCESSORIES

Amber	LENS-25-AMB
Blue	LENS-25-BLU
Green	LENS-25-GRN
Red	LENS-25-RED
Yellow	LENS-25-YEL
UV Filter	LENS-25-UVF
Frosted	LENS-25-FR
Spread	LENS-25-SPR
Beam Elongating	LENS-25-BEL

REFLECTORS

25°	SL-REF-LUX1208-N
55°	SL-REF-LUX1208-F

GLARE CONTROL ACCESSORIES

Cross Louver	LENS-25-CRL
Snoot	LENS-25-SNOOT

LED MODULES

2700K	CRI 85	LHC1-2780-1208-W
2700K	CRI 90	LHC1-2790-1208-W
3000K	CRI 85	LHC1-3080-1208-W
3000K	CRI 90	LHC1-3090-1208-W
3500K	CRI 85	LHC1-3580-1208-W
4000K	CRI 85	LHC1-4080-1208-W



New Product

35W Exterminator II H/L/J Track

Comparable: 50W HID
ELV Dimming: 100% - 5%
Rated Life: 60,000 hours

- Energy Star® rated
- CEC Title 24 Compliant
- Accommodates one lens accessory and one glare control accessory
- Reflectors and LED modules can be purchased separately for alternative beam angles and color temperatures
- 365° horizontal rotation and 180° vertical aiming

Track	Model	Max Lumens	Max CBCP	Color Temp	CRI	Finish
H H TRACK L L TRACK J J/J2 TRACK	 1035 35W	N 25° 2795 F 55° 2828	9748 3886	827 2700K 85	BN Brushed Nickel BK Black WT White	
				927 2700K 90		
830 3000K 85						
930 3000K 90						
835 3500K 85						
840 4000K 85						

Example: **H-1035F-835-BK**
 See Page 16 for W

LENS ACCESSORIES

Amber	LENS-20-AMB
Blue	LENS-20-BLU
Green	LENS-20-GRN
Red	LENS-20-RED
Yellow	LENS-20-YEL
UV Filter	LENS-20-UVF
Frosted	LENS-20-FR
Spread	LENS-20-SPR
Beam Elongating	LENS-20-BEL

REFLECTORS

25°	SL-REF-BL18-N
55°	SL-REF-BL18-F

GLARE CONTROL ACCESSORIES

Cross Louver	LENS-20-CRL
Snoot	LENS-20-SNOOT

LED MODULES

2700K	CRI 85	BXRC-27E4000-F-23
2700K	CRI 90	BXRC-27G4000-F-23
3000K	CRI 85	BXRC-30E4000-F-23
3000K	CRI 90	BXRC-30G4000-F-23
3500K	CRI 85	BXRC-35E4000-F-23
4000K	CRI 85	BXRC-40E4000-F-23





New Product

14W Exterminator II H/L/J Track

Comparable: 20W HID
ELV Dimming: 100% - 1%
Rated Life: 100,000 hours

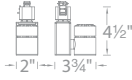
- Energy Star® rated
- CEC Title 24 Compliant
- Accommodates one lens accessory and one glare control accessory
- Reflectors and LED modules can be purchased separately for alternative beam angles and color temperatures
- 365° horizontal rotation and 180° vertical aiming

Track	Model	Max Lumens	Max CBCP	Color Temp	CRI	Finish
H H TRACK L L TRACK J J/J2 TRACK		1014 14W	N 20° 965 4585 F 40° 980 2117	827 2700K 85	BN Brushed Nickel BK Black WT White	
				927 2700K 90		
				830 3000K 85		
				930 3000K 90		
				835 3500K 85		
				840 4000K 85		

Example: **H-1014N-927-BN**
 See Page 17 for W

LENS ACCESSORIES

Amber	LENS-11-AMB
Blue	LENS-11-BLU
Green	LENS-11-GRN
Red	LENS-11-RED
Yellow	LENS-11-YEL
UV Filter	LENS-11-UVF
Frosted	LENS-11-FR
Spread	LENS-11-SPR
Beam Elongating	LENS-11-BEL

REFLECTORS

20°	SL-REF-CXA1310-N
40°	SL-REF-CXA1310-F

GLARE CONTROL ACCESSORIES

Cross Louver	LENS-11-CRL
Snoot	LENS-11-SNOOT

LED MODULES



2700K	CRI 85	CXA1310-00J227H-W
2700K	CRI 90	CXA1310-0YG227H-W
3000K	CRI 85	CXA1310-00J430H-W
3000K	CRI 90	CXA1310-0YG430H-W
3500K	CRI 85	CXA1310-00J435H-W
4000K	CRI 85	CXA1310-0HK240H-W



23W Exterminator H/L/J Track

Comparable: 39W HID
 ELV Dimming: 100% - 10%
 Rated Life: 60,000 hours

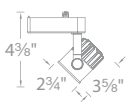
- Energy Star® Rated
- Accommodates one lens accessory
- Reflectors and LED modules can be purchased separately for alternative beam angles and color temperatures
- 365° horizontal rotation and 180° vertical aiming

Track	Model	Max Lumens	Max CBCP	Color Temp	CRI	Finish
H H TRACK L L TRACK J J/J2 TRACK	 LED20 23W	S 20° 1450 F 40° 1390	6772 2928	27 2700K 85	BN Brushed Nickel BK Black WT White	
				927 2700K 90		
				30 3000K 85		
				930 3000K 90		
				35 3500K 85		
				40 4000K 85		

Example: **H-LED20S-30-BN**
 See Page 18 for W

LENS ACCESSORIES

Amber	LENS-16-AMB
Blue	LENS-16-BLU
Green	LENS-16-GRN
Red	LENS-16-RED
Yellow	LENS-16-YEL
UV Filter	LENS-16-UVF
Frosted	LENS-16-FR
Spread	LENS-16-SPR
Beam Elongating	LENS-16-BEL

REFLECTORS

20°	RF-S
40°	RF-F

LED MODULES

2700K	CRI 85	BXRC-27E1000
2700K	CRI 90	BXRC-27G1000
3000K	CRI 85	BXRC-30E1000
3000K	CRI 90	BXRC-30G1000
3500K	CRI 85	BXRC-35E1000
4000K	CRI 85	BXRC-40E1000



LED207



LED201

Summit LED H/L/J Track

Power: 15W
Comparable: 50W MR16
CRI: 85
ELV Dimming: 100% - 10%
Input: 120V
Rated Life: 50,000 hours

Compact driverless LED track luminaire

- Energy Star® rated
- 120VAC - no driver needed
- Beamshift™ enables in-field change of beam angle (patent pending)
- Die-cast aluminum construction

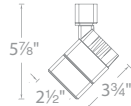
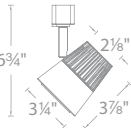
Track	Model	Color Temp	Beam*	Lumens	CBCP	Finish
H H TRACK L L TRACK J J/J2 TRACK	 LED207-30	3000K	25° 40°	540 660	1275 1030	BK Black WT White
	 LED201-30	3000K	25° 40°	540 660	1275 1030	BK Black WT White

Example: **H-LED207-30-WT**

*All Summit LED track luminaires come with Flood (40°) beam setting by default, which may be reconfigured to Narrow(25°) in field.

BeamShift™

All Summit series track luminaires come with BeamShift™, allowing in-field change of beam angle simply by changing the location of the lens

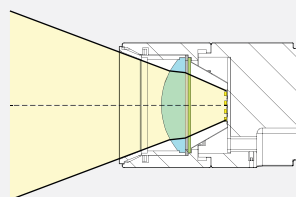

Flood Configuration
Lens located at the back

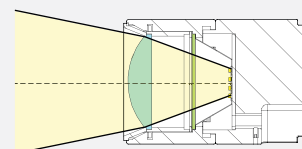

Spot Configuration
Lens located in the front



LED202



LED208

Summit LED H/L/J Track

Power: 15W
Comparable: 50W MR16
CRI: 85
ELV Dimming: 100% - 10%
Input: 120V
Rated Life: 50,000 hours

Compact driverless LED track luminaire

- Energy Star® rated
- 120VAC - no driver needed
- Beamshift™ enables in-field change of beam angle (patent pending)
- Die-cast aluminum construction

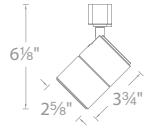
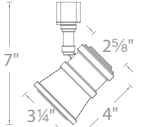
Track	Model	Color Temp	Beam*	Lumens	CBCP	Finish
H L J H TRACK L TRACK J/J2 TRACK	 LED202-30	3000K	25° 40°	540 660	1275 1030	BK Black WT White
	 LED208-30	3000K	25° 40°	540 660	1275 1030	AB Antique Bronze

Example: **H-LED202-30-BK**

* All Summit LED track luminaires come with Flood (40°) beam setting by default, which may be reconfigured to Narrow(25°) in field.

Replace the Halogen MR16

Summit series are the perfect replacement for the halogen MR16 as we offer

- Lower wattage with superior lumen output
- Over 10 times the rated life
- Less maintenance
- No projected heat
- Beamshift™ In-field changeable beam angle

Luminous Efficacy
At flood (40°) Beam angle

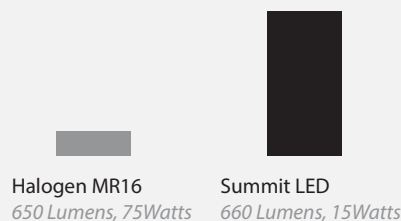

Rated Life

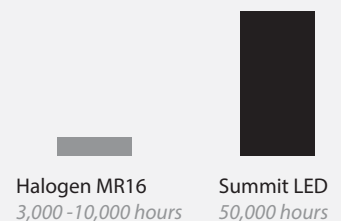



Precision LED H/L/JTrack

Power: 14.5W
Delivered Lumens: Up to 975
CBCP: Up to 4500
Comparable to: 65W MR16
ELV Dimming: 100%-10%
Rated Life: 70,000 hours

Compact single diode LED

- CEC Title24 Compliant
- Die-cast aluminum construction
- 365° horizontal rotation and 180° vertical aiming

Track	Model	Beam	Color Temp	CRI	Finish
H H TRACK L L TRACK J J/J2 TRACK	 LED160	S 20° F 40°	927 2700K	90	BK Black WT White
			27 2700K	85	
			930 3000K	90	
			30 3000K	85	
			35 3500K	85	
			40 4000K	85	

Example: **H-LED160S-927-BK**

Replacement Lenses

Amber	LENS-16-AMB	
Blue	LENS-16-BLU	
Green	LENS-16-GRN	
Red	LENS-16-RED	
Yellow	LENS-16-YEL	

UV Filter	LENS-16-UVF	
Frosted	LENS-16-FR	
Spread	LENS-16-SPR	
Beam Elongator	LENS-16-BEL	



LED202





LED208

Summit LED Flexrail1™ Track

Power: 15W
Comparable: 50W MR16
CRI: 85
ELV Dimming: 100% - 10%
Input: 120V
Rated Life: 50,000 hours

Compact driverless LED track luminaire

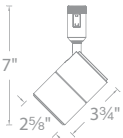
- Energy Star® rated
- 120VAC - no driver needed
- Beamshift™ enables in-field change of beam angle (patent pending)
- Die-cast aluminum construction

Track	Model	Color Temp	Beam*	Lumens	CBCP	Finish
HM1 FLEXRAIL1™ 	LED202-30	3000K	25° 40°	540 660	1275 1030	PT Platinum 
	LED208-30	3000K	25° 40°	540 660	1275 1030	DB Dark Bronze 

Example: **HM1-LED202-30-PT**

* All Summit LED track luminaires come with Flood (40°) beam setting by default, which may be reconfigured to Narrow(25°) in field.

BeamShift™

All Summit series track luminaires come with BeamShift™, allowing in-field change of beam angle simply by changing the location of the lens

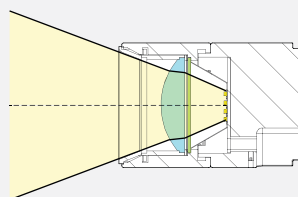

Flood Configuration
Lens located at the back

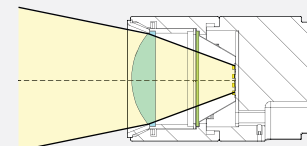

Spot Configuration
Lens located in the front

H Track Current Limiter

Now Available in 0.2A and 0.5A

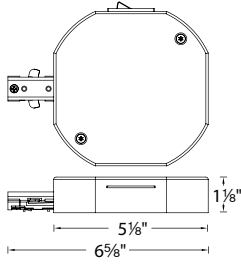

Single Live End

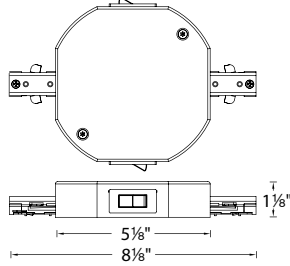

Double Live End

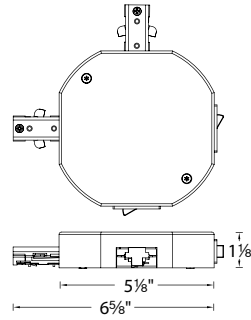



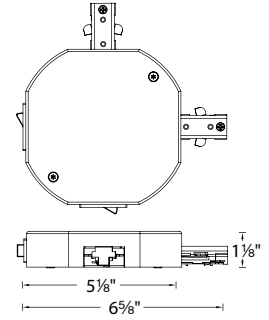

Double Live End(Left)



Double Live End(Right)

120V H Track

	Model	Circuit Breaker	Max Wattage	Finish
Single Live End 	THL-HLE-1/5A	0.2A	24W	BK Black BN Brushed Nickel DB Dark Bronze WT White 
	THL-HLE-1/2A	0.5A	60W	
	THL-HLE-1A	1A	120W	
	THL-HLE-2A	2.5A	300W	
	THL-HLE-5A	5A	600W	
	THL-HLE-7A	7.5A	900W	
	THL-HLE-10A	10A	1200W	
Double Live End 	THL-HI-1-1/5A	0.2A	24W	
	THL-HI-2-1/5A	0.2A per end	24W per end	
	THL-HI-1-1/2A	0.5A	60W	
	THL-HI-2-1/2A	0.5A per end	60W per end	
	THL-HI-1-1A	1A	120W	
	THL-HI-2-1A	1A per end	120W per end	
	THL-HI-1-2A	2.5A	300W	
	THL-HI-2-2A	2.5A per end	300W per end	
	THL-HI-1-5A	5A	600W	
	THL-HI-2-5A	5A per end	600W per end	
	THL-HI-1-7A	7.5A	900W	
	THL-HI-2-7A	7.5A per end	900W per end	
	THL-HI-1-10A	10A	1200W	
	THL-HI-2-10A	10A per end	1200W per end	
Double Live End (Left) 	THL-LEFT-1-1/5A	0.2A	24W	
	THL-LEFT-2-1/5A	0.2A per end	24W per end	
	THL-LEFT-1-1/2A	0.5A	60W	
	THL-LEFT-2-1/2A	0.5A per end	60W per end	
	THL-LEFT-1-1A	1A	120W	
	THL-LEFT-2-1A	1A per end	120W per end	
	THL-LEFT-1-2A	2.5A	300W	
	THL-LEFT-2-2A	2.5A per end	300W per end	
	THL-LEFT-1-5A	5A	600W	
	THL-LEFT-2-5A	5A per end	600W per end	
Double Live End (Right) 	THL-RIGHT-1-1/5A	0.2A	24W	
	THL-RIGHT-2-1/5A	0.2A per end	24W per end	
	THL-RIGHT-1-1/2A	0.5A	60W	
	THL-RIGHT-2-1/2A	0.5A per end	60W per end	
	THL-RIGHT-1-1A	1A	120W	
	THL-RIGHT-2-1A	1A per end	120W per end	
	THL-RIGHT-1-2A	2.5A	300W	
	THL-RIGHT-2-2A	2.5A per end	300W per end	
	THL-RIGHT-1-5A	5A	600W	
	THL-RIGHT-2-5A	5A per end	600W per end	
THL-RIGHT-1-7A	7.5A	900W		
THL-RIGHT-2-7A	7.5A per end	900W per end		
THL-RIGHT-1-10A	10A	1200W		
THL-RIGHT-2-10A	10A per end	1200W per end		

Example: **THL-LEFT-1-1/5A-WT**

LED Track Luminaires MR16 Replacement - Now with 1W-60W Transformer

Power: 8W
Lumens: 450
CBCP: 850
Color Temp: 3000K
CRI: 85
ELV Dimming: 100% - 10%
Input: 120V
Rated Life: 25,000 hours

- 1 W to 60 W load transformer
- Fixtures specifically designed to ensure proper lamp fit
- LED lamp included

System	Model	Finish
 HHT LHT JHT	164LED	BK WT <i>Black White</i>
 HHT LHT JHT	886LED	AB <i>Antique Bronze</i>
 HHT LHT JHT	874LED	AB <i>Antique Bronze</i>
 HHT LHT JHT	856LED	AB BK BN WT <i>Antique Bronze Black Brushed Nickel White</i>
 HHT LHT JHT	817LED	BK PT/BK PT/WT WT <i>Black Platinum/Black Platinum/White White</i>
 HHT LHT JHT	826LED	BK BN WT <i>Black Brushed Nickel White</i>
 HHT LHT JHT	816LED	BK BN WT <i>Black Brushed Nickel White</i>
 HHT LHT JHT	808LED	BK DB WT <i>Black Dark Bronze White</i>

System	Model	Finish
 HHT LHT JHT	160LED	BK WT <i>Black White</i>
 HHT LHT JHT	180LED	BK BN WT <i>Black Brushed Nickel White</i>
 HHT LHT JHT	809LED	BK BN WT <i>Black Brushed Nickel White</i>
 HHT LHT JHT	802LED	BK BN WT <i>Black Brushed Nickel White</i>
 HHT LHT JHT	846LED	BK WT <i>Black White</i>
 HHT LHT JHT	204LED	BK BN WT <i>Black Brushed Nickel White</i>
 HHT LHT JHT	801LED	BK WT <i>Black White</i>
 HHT LHT JHT	007LED	BK BN WT <i>Black Brushed Nickel White</i>

Example: HHT-808LED-DB

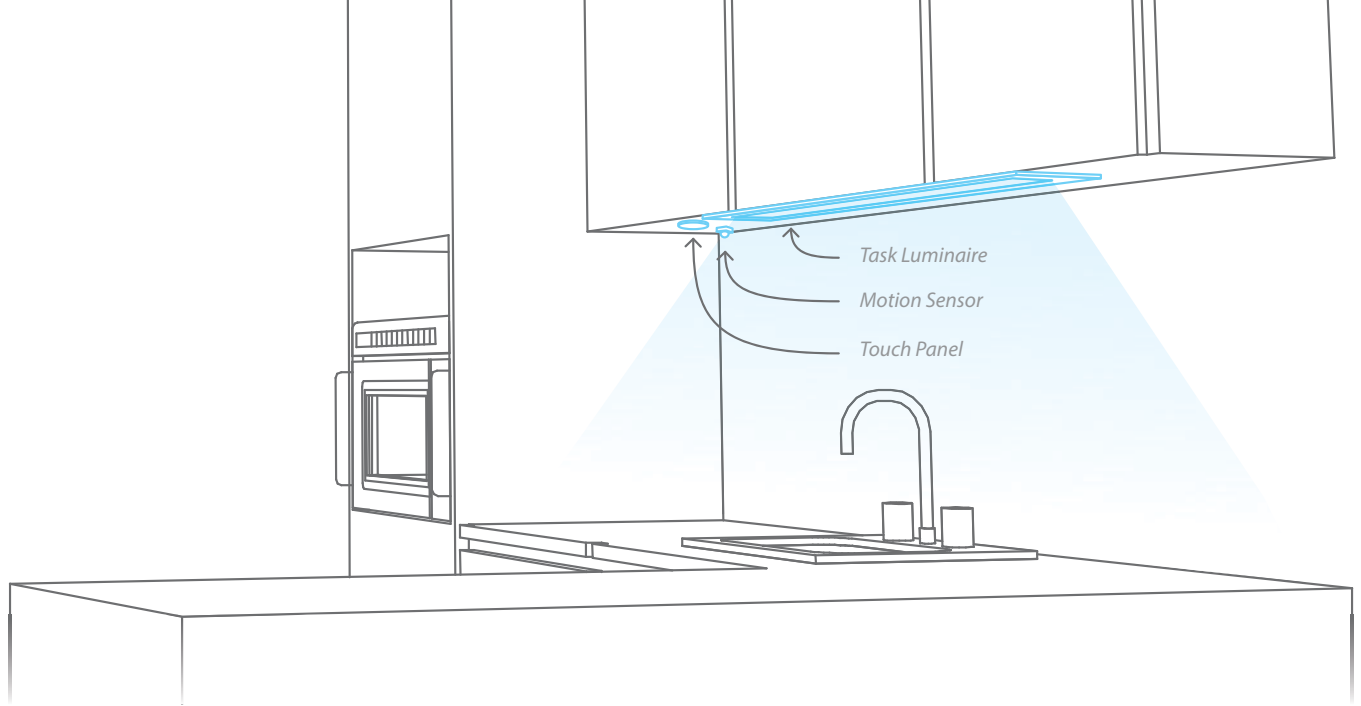

Touch and Occupancy Control Kit For Low Voltage Systems

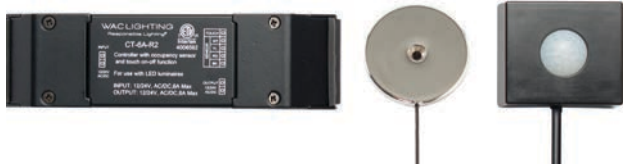
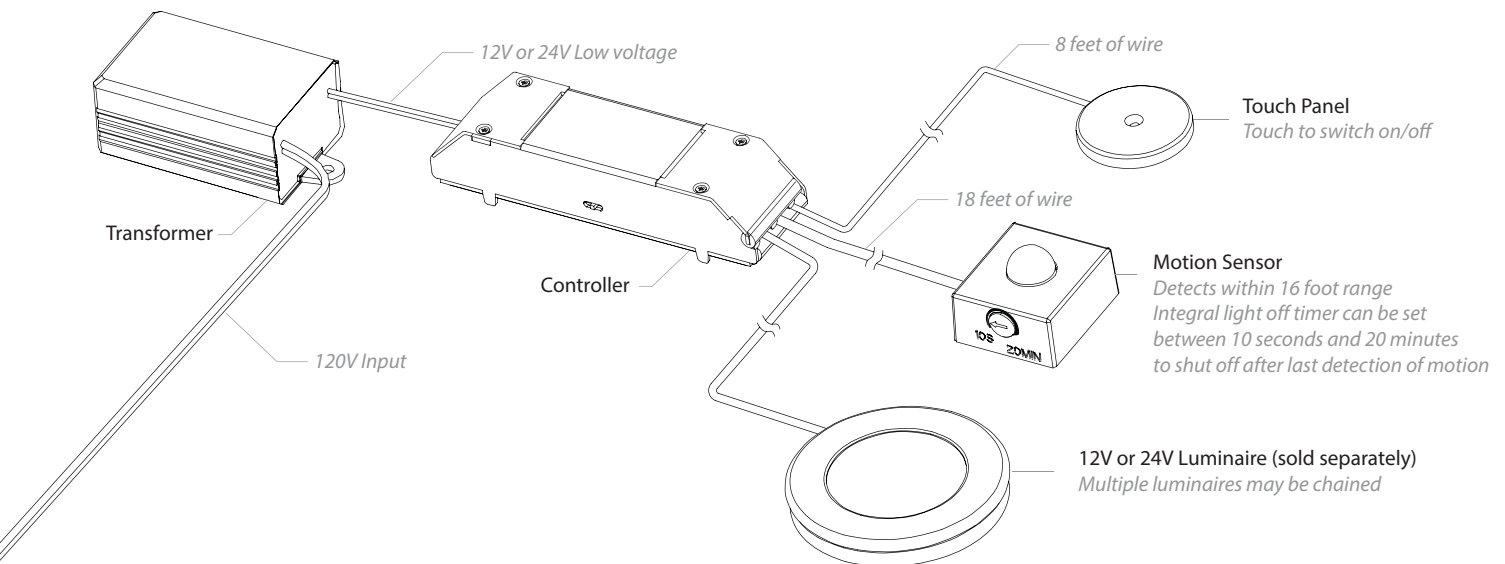

CT-6A-R2

Includes a Touch Panel, an Occupancy Sensor, and a Controller
AC/DC input at 12V(60W Max) or 24V(96W Max)
Connect on secondary side of driver/transformer

Three custom settings of lighting control

Touch and Sensor: Touch panel turns the luminaire on/off manually while the motion sensor turns it off when the space is vacant

Touch: Touch panel turns the luminaire on/off manually

Sensor: Motion sensor turns the luminaire on/off autonomously



Surface mounted

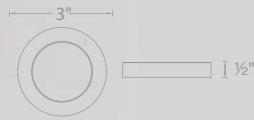

Recessed

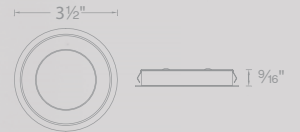

LED90 Edge Lit Button Light



Power: 24V, 5W
CRI: 90
ELV Dimming: 100% – 5%
Rated Life: 100,000 hours
Cutout: 3 1/4" for recessed applications

- Energy Star® rated
- CEC Title24 Compliant
- Can be surface mounted or recessed
- Super thin profile at 1/2"
- Edge-lit LEDs reduce glare and assure even light distribution
- Anti-microbial white paint

Model	Color Temp	Lumens	Finish
HR-LED90	27 2700K	200	BN <i>Brushed Nickel</i>
	30 3000K	200	BK <i>Black</i>
			WT <i>White</i>

Example: **HR-LED90-30-BN**
 Includes 6 foot lead wire

Class 2 enclosed electronic transformers (Required)

Model	Input	Output	Min Load	Max Fixture Run	L	W	H	
	120V	24V, 60W	1W	7	6 1/2"	1 5/8"	1 1/4"	<i>Fits through small openings</i>
	120V	24V, 96W	1W	10	6 1/2"	1 5/8"	1 1/4"	
	120V	24V, 60W	1W	7	2 3/4"	1 5/8"	1 3/4"	<i>Plug-in power supply with on/off switch and 6' detachable cord</i>

- Secondary wiring for Class 2 transformers does not require conduit sheathed cable or clamp wiring techniques
- Intrinsically safe, Class 2 transformers permit no greater than a 5 amp current to be drawn
- Non-metallic sheathed cable may be used for secondary wiring in walls and ceilings
- Power consumption may vary depending on the efficiency of the power supply being used



LINE™ 2.0 LED Undercabinet

Fixed Light Panel

- Energy Star® rated
- Diffused light source reduces glare, eliminates hard shadows
- Asymmetrical forward throw for optimal light distribution
- Anti-microbial paint (white only)
- Connections made at the center of each fixture

CRI: 90+
ELV Dimming: 100% – 10% (120V only)
Rated Life: 100,000 hours

	Length	Watt	Max Lumens	Max Fixture Run		Color Temp	Finish
				60 W	96 W		
	LN-LED06P	6.5W	265	6	11	27 2700K 30 3000K	AL Brushed Aluminum WT White
	LN-LED12P	10.5W	515	3	6		
	LN-LED18P	16W	875	2	4		
	LN-LED24P	20W	1160	2	3		
	LN-LED30P	23.5W	1345	1	2		

Example: **LN-LED18P-30-WT**

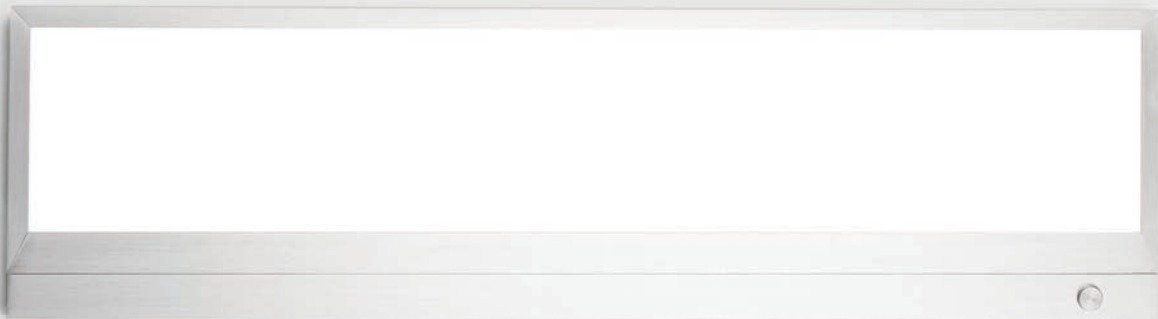

LINE™ LED Undercabinet

Detachable light panel for maintenance

- Energy Star® rated
- Diffused light source reduces glare, eliminates hard shadows
- Asymmetrical forward throw for optimal light distribution



CRI: 90+
ELV Dimming: 100% – 10% (120V only)
 100% / 50% high/low settings on board
Rated Life: 80,000 hours

	Length	Watt	Max Lumens	Max Fixture Run		Color Temp	Finish
				60 W	96 W		
	LN-LED06	7.0W	275	8	13	27 2700K 30 3000K	AL Brushed Aluminum
	LN-LED12	12.5W	600	4	7		
	LN-LED18	19.0W	955	3	5		
	LN-LED24	23.0W	1245	2	4		
	LN-LED30	26.0W	1345	2	3		

Example: **LN-LED18-27-AL**

"I" connector included with each luminaire





Class 2 Power Supply for LINE™ and LINE™ 2.0 (Required)

Type		Model	Output	Input	Dim	Dimensions
Remote		EN-2460-RB2-S EN-24100-RB2-S	60W (24V) 96W (24V)	120V	Yes	6½" × 1½" × 1¼"
Plug-In		EN-2460-P-AR-S EN-24100-P-AR-S	60W (24V) 96W (24V)	120V	Yes	2¾" × 1½" × 1¾" 4⅝" × 2" × 1⅝"





Control Accessory

Touch Panel and Motion Sensor		CT-6A-R2	Includes a Touch Panel, an Occupancy Sensor, and a Controller AC/DC input at 12V(60W Max) or 24V(96W Max) Connect on secondary side of driver/transformer			
-------------------------------	---	-----------------	---	--	--	--

Power Supply Accessories

Wiring Box with On/Off Switch option		TB-S		6¼" × 1⅝" × 1¼"	Use when spanning a large gap in a system layout without leaving exposed wiring (i.e. lighting kitchen cabinets on either side of a sink or window).	
Multiple Terminal Block		MTB-08	8 outputs	4⅞" × 1⅝" × ¾"	Easily wire multiple output connections for a neat installation without the use of open splices. One power supply input and 8 outputs. 5A capacity. Three mounting screws included.	
12' Extension Cable		SL-EXT-144		Wire: 144" Connector: 1⅝"	Use to extend the distance between power supply or wiring box (TB-S) to a LINE™ section.	
Wire Clip (10 Pack)		SL-WC-1		½" × ⅜"	Use to tack power cords or joiner cables neatly to a surface.	

Connection Accessories

Joiner Cables		SL-IC-06 SL-IC-12 SL-IC-24 SL-IC-36		6" 12" 24" 36"	Connects two sections of LINE™.	
Custom Cable Extenders		SL-IF		Ø3/8" × 3⅝"	Two female ends. Connects two joiner cables to create custom lengths.	
4-way "X" Connector		SL-X		Wires: 4" each Connectors: 1⅝" each	"X" connector has four male connectors and can be used to easily customize your design layout.	
3-way "Y" Connector		SL-Y		Wires: 4" each Connectors: 1⅝" each	"Y" connector has three male connectors and can be used to easily customize your design layout.	
"I" Connector		SL-I		Ø¼" × ⅞"	For end-to-end connection of LINE™ sections.	



New Brushed Aluminum Finish

Minimal space between luminaires

Shown: **BA-ACLED12-AL**

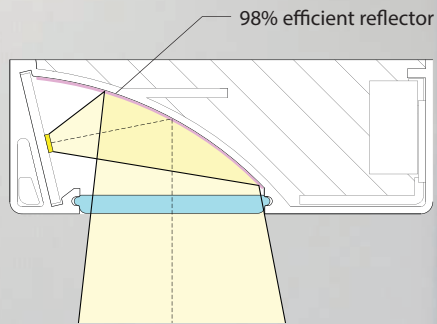

Uniform light

Using a 98% efficient reflector, light from the LED sources inside the housing diffuse inside the mixing chamber in order to create evenly distributed illumination. Energy Star® compliant.

- May be hard-wired with 120V power or used with a plug-in power cord
- Subsequent fixtures may be powered with an "I" Connector or Interconnect Cable carrying 120V
- May be individually switched and/or wired to a wall box switch/dimmer

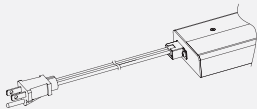

Power Cord

Model	WT	White	Length
BA-PC6	WT	White	6'
	BK	Black	

Supplies power in any application.

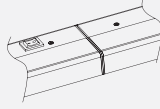

"I" Connector

Model	Max Fixture Run
BA-I-WT	6

Interconnection for seamless end to end transitions. Each light bar includes one.

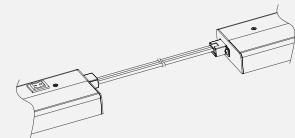

Interconnect Cable

Model	Length	Max Fixture Run	WT	White
BA-IC12	12"	4	WT	White
BA-IC24	24"	4		
BA-IC36	36"	3		
			BK	Black

Example: **BA-IC12-WT**

Links two light bars using a single power connection.

Endurance™

WAC LIGHTING

LED technology offers superior alternatives to conventional Halogen and HID sources. With factory sealed die-cast aluminum housings. Endurance™ provides lasting performance for years.

Patent pending design for a water and dust proof, IP66 rated luminaire. Thermal engineering for up to 100,000 hours of rated life, eliminating the need for maintenance once installed. Thoughtful details include a built-in level and factory sealed light engine.



Energy Star® Rated



Factory-Sealed Fixture Housing
Protects LEDs From
Environmental Factors



Dark Sky Friendly



IP66, WET

IP 66 Rated
Dust Tight, Waterproof



Motion and Photosensor Ready



LED Performs Efficiently
In Cold Weather With Added Lifespan



ETL & cETL Listed



Aluminum

Durable Die-Cast Aluminum



5 Year WAC Product Warranty

Flood	Fin		Hawk		
35W	19W	27W	35W	19W	27W
100W HID Equivalent 1945lm (3000K) 2070lm (5000K)	39W HID Equivalent 1390lm (3000K) 1460lm (5000K)	70W HID Equivalent 2075lm (3000K) 2135lm (5000K)	100W HID Equivalent 2750lm (3000K) 2825lm (5000K)	39W HID Equivalent 1345lm (3000K) 1435lm (5000K)	70W HID Equivalent 2050lm (3000K) 2095lm (5000K)
Architectural Bronze, White	Architectural Bronze, Graphite, White		Architectural Bronze, Graphite, White		

Sensors for Endurance™ Series

Motion Sensor
(120V)

MS-120-BZ Bronze
MS-120-GY Gray
MS-120-WT White

Photosensor
(120V)

PC-120-BZ Bronze
PC-120-GY Gray
PC-120-WT White

Endurance™ Flood



Heavy Duty 1/2" Threaded Mounting Arm

360° Horizontal Rotation
90° Vertical Aiming



CRI: 85
Rated Life: 60,000 hours

- IP66 and ETL & cETL Wet Location Listed
- Factory-Sealed LED Light Engine
- Energy Star® rated
- Die-Cast Aluminum Construction
- 120V Direct Wire - No Driver Needed
- Photo/Motion Sensor Sold Separately
- Smooth and Continuous ELV Dimming

1/2" Threaded Heavy Duty Mounting Arm

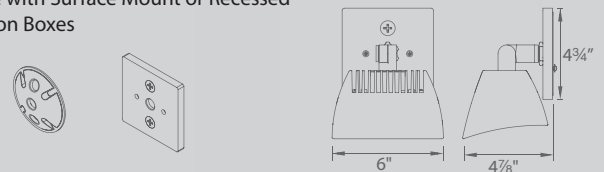
Also Includes Two Canopy Accessories for use with Surface Mount or Recessed Junction Boxes



		Power	Comparable	Max Delivered Lumens	Color Temp	Finish	
	WP-LED335	35W	100W HID	2070	30	aBZ	 Architectural Bronze
					50	aWT	

Example: **WP-LED335-30-aBZ**



Endurance™ Fin



Tempered Prismatic Glass
Reduces glare while optimizing light distribution

3 Outputs
2 Color Temperatures
1 Size

CRI: 85
Rated Life: 100,000 hours

- IP66 and ETL & cETL Wet Location Listed
- Factory-Sealed LED Light Engine
- Energy Star® and DLC rated
- Die-Cast Aluminum Construction
- 20° Forward Throw Illumination
- Built-in Level For Easy Adjustment
- Photo/Motion Sensor Sold Separately
- Universal Voltage Input (120V - 277V)
- Multi-Function Dimming: ELV (120V) or 0-10V

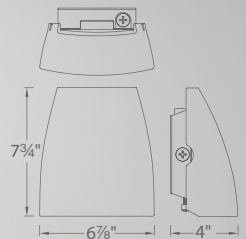

	Power	Comparable	Max Delivered Lumens	Color Temp	Finish	
	WP-LED119	19W	39W HID	1460	30 3000K 50 5000K	aBZ Architectural Bronze aGH Architectural Graphite aWT Architectural White
	WP-LED127	27W	70W HID	2135		
	WP-LED135	35W	100W HID	2825		

Example: **WP-LED119-30-aWT**



Endurance™ Hawk

Also Includes a Box Sleeve when used with existing Surface Mount Junction Boxes



Shown with the Box Sleeve over an existing Surface Mount Junction Box



Tempered Prismatic Glass
Reduces glare while optimizing light distribution

Mounts In Any Orientation

For Direct and Indirect Illumination

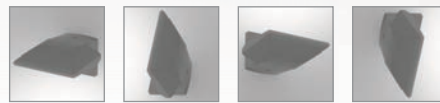



CRI: 85
Rated Life: 100,000 hours

- IP66 and ETL & cETL Wet Location Listed
- Factory-Sealed LED Light Engine
- Energy Star® and DLC rated
- Die-Cast Aluminum Construction
- 20° Forward Throw Illumination
- Photo/Motion Sensor Sold Separately
- Built-in Level For Easy Adjustment
- Universal Voltage Input (120V - 277V)
- Dimming: ELV (120V) or 0-10V

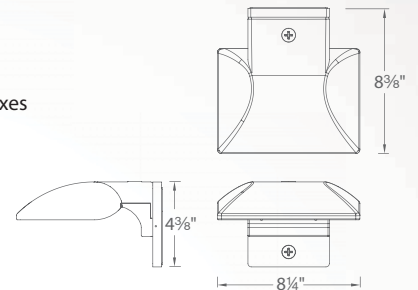
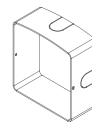
Also Includes a Box Sleeve when used with existing Surface Mount Junction Boxes



		Power	Comparable	Max Delivered Lumens	Color Temp	Finish	
	WP-LED219	19W	39W HID	1435	30 3000K	aBZ Architectural Bronze aGH Architectural Graphite aWT Architectural White	
	WP-LED227	27W	70W HID	2095	50 5000K		

Example: **WP-LED219-30-aBZ**



Tube Wall Mount

Color Temp: 3000K
CRI: 90
Rated Life: 70,000 hours

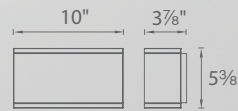

- IP65 Rated, ETL & cETL Wet Location Listed
- Energy Star® rated
- CEC Title 24 Compliant
- Mounts up or down
- Die-Cast Aluminum Construction
- Universal Voltage Input (120V - 277V)
- Dimming: ELV (120V only) or 0-10V (120V-277V)
- ADA Compliant

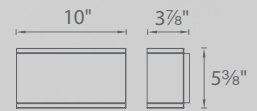

WS-W2609



WS-W2610

Distribution		Beam	Voltage	Watt	Lumens	Finish	
	Single Light	WS-W2609 Dark Sky Friendly Energy Star®	70°	120V - 277V	16W	825	AL Brushed Aluminum BK Black BZ Bronze GH Graphite WT White
	Double Light	WS-W2610	70°	120V - 277V	30W	1525	

Example: **WS-W2609-WT**



Tube Wall Mount

Color Temp: 3000K
CRI: 90
Rated Life: 70,000 hours

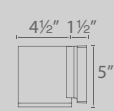

- IP65 Rated, ETL & cETL Wet Location Listed
- Energy Star® rated
- CEC Title 24 Compliant
- Mounts up or down
- Die-Cast Aluminum Construction
- Universal Voltage Input (120V - 277V)
- Dimming: ELV (120V only) or 0-10V (120V-277V)

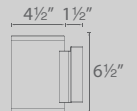

WS-W2605



WS-W2604

Distribution		Beam	Voltage	Watt	Lumens	Finish
 Single Light	WS-W2605 Dark Sky Friendly Energy Star®	33°	120V - 277V	16W	800	AL Brushed Aluminum BK Black BZ Bronze GH Graphite WT White
 Double Light	WS-W2604	33°	120V - 277V	30W	1750	

Example: **WS-W2604-BZ**



Tube Ceiling Mount

Color Temp: 3000K
CRI: 90
Rated Life: 70,000 hours

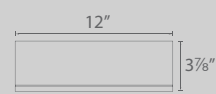

- IP65 Rated, ETL & cETL Wet Location Listed
- CEC Title 24 Compliant
- Wall or Ceiling Mount
- Die-Cast Aluminum Construction
- Universal Voltage Input (120V - 277V)
- Dimming: ELV (120V only) or 0-10V (120V-277V)

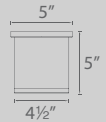

FM-W2612

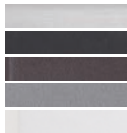

FM-W2605

	Distribution		Beam	Voltage	Watt	Lumens	Finish
	Down	FM-W2612	91°	120V - 277V	30W	1740	AL Brushed Aluminum BK Black BZ Bronze GH Graphite WT White
	Down	FM-W2605	33°	120V - 277V	16W	800	

Example: **FM-W2612-GH**



Tube Pendant Mount

Color Temp: 3000K
CRI: 90
Rated Life: 70,000 hours

- IP65 Rated, ETL & cETL Wet Location Listed
- CEC Title 24 Compliant
- Die-Cast Aluminum Construction
- Dimming: ELV (120V only) or 0-10V (120V-277V)
- Hang Straight Swivel
- Three 12" and one 6" down rods included

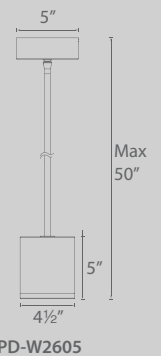

Distribution	Beam	Voltage	Watt	Lumens	Finish	
 Down	PD-W2605	33°	120V - 277V	16W	800	AL Brushed Aluminum
						BK Black
						BZ Bronze
						GH Graphite
						WT White

Example: **PD-W2605-BK**

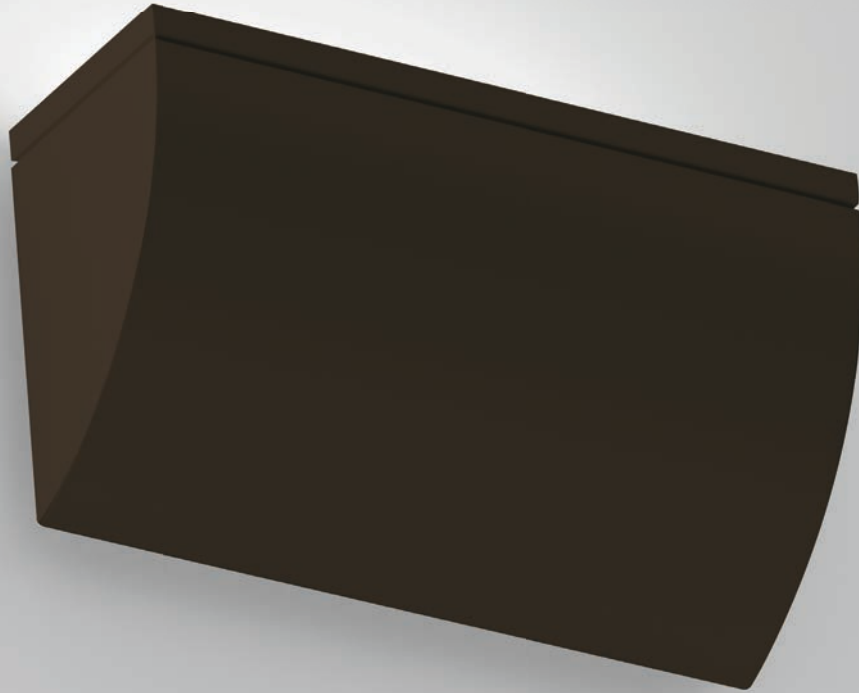

Scoop Wall Mount

Color Temp: 3000K
 CRI: 90
 Rated Life: 70,000 hours

- IP65 Rated, ETL & cETL Wet Location Listed
- Energy Star® rated
- CEC Title 24 Compliant
- Mounts Up or Down
- Die-Cast Aluminum Construction
- Universal Voltage Input (120V - 277V)
- Dimming: ELV (120V only) or 0-10V (120V-277V)
- ADA Compliant

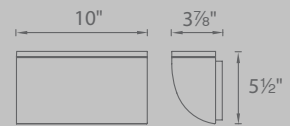

WS-W20506

Distribution	Beam	Voltage	Watt	Lumens	Finish
 Single Light	86°	120V - 277V	16W	805	AL Brushed Aluminum
					BK Black
					BZ Bronze
					GH Graphite
					WT White

Example: **WS-W20506-BZ**

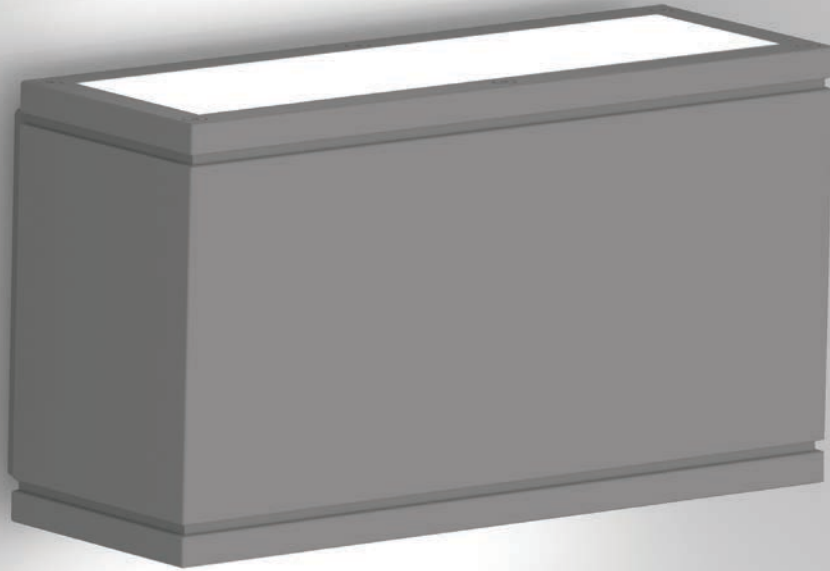

Rubix Wall Mount

Color Temp: 3000K
CRI: 90
Rated Life: 70,000 hours

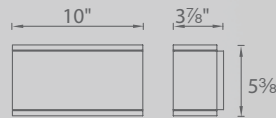

- IP65 Rated, ETL & cETL Wet Location Listed
- Energy Star® rated
- CEC Title 24 Compliant
- Mounts Up or Down
- Die-Cast Aluminum Construction
- Universal Voltage Input (120V - 277V)
- Dimming: ELV (120V only) or 0-10V (120V-277V)
- ADA Compliant

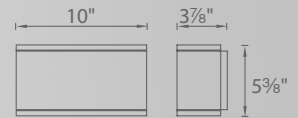

WS-W2509



WS-W2510

Distribution	Beam	Voltage	Watt	Lumens	Finish
 Single Light	WS-W2509 Dark Sky Friendly Energy Star®	86°	120V - 277V	16W	805
 Double Light	WS-W2510	86°	120V - 277V	30W	1385
					AL Brushed Aluminum BK Black BZ Bronze GH Graphite WT White



Example: **WS-W2510-GH**





Rubix Wall Mount

Color Temp: 3000K
CRI: 90
Rated Life: 70,000 hours

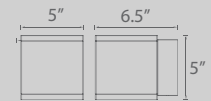
- IP65 Rated, ETL & cETL Wet Location Listed
- Energy Star® rated
- CEC Title 24 Compliant
- Mounts up or down
- Die-Cast Aluminum Construction
- Universal Voltage Input (120V - 277V)
- Dimming: ELV (120V only) or 0-10V (120V-277V)



WS-W2504, WS-W2505

Distribution		Beam	Voltage	Watt	Lumens	Finish
 Single Light	WS-W2504 Dark Sky Friendly Energy Star®	86°	120V - 277V	16W	750	AL Brushed Aluminum BK Black BZ Bronze GH Graphite WT White
 Double Light	WS-W2505	86°	120V - 277V	30W	1400	

Example: **WS-W2504-GH**





Rubix Ceiling Mount

Color Temp: 3000K
 CRI: 90
 Rated Life: 70,000 hours

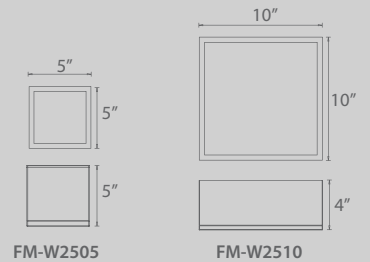
- IP65 Rated, ETL & cETL Wet Location Listed
- CEC Title 24 Compliant
- Wall or Ceiling Mount
- Die-Cast Aluminum Construction
- Universal Voltage Input (120V - 277V)
- Dimming: ELV (120V only) or 0-10V (120V-277V)



	Distribution		Beam	Voltage	Watt	Lumens	Finish
	Down	FM-W2505	86°	120V - 277V	16W	750	AL Brushed Aluminum BK Black BZ Bronze GH Graphite WT White
	Down	FM-W2510	95°	120V - 277V	30W	1875	

Example: **FM-W2510-WT**



Monterrey Fixed Rail

Color Temp: 3000K
CRI: 90
Rated Life: 60,000 hours

- Individually Adjustable Heads
- CEC Title 24 Compliant
- ETL & cETL Damp Location Listed
- Wall or Ceiling Mount
- Universal Voltage Input (120V - 277V)
- Driver located in J box with minimum inside dimension of 3½" x 3½" x 1½"
- Dimming: ELV (120V) or 0-10V

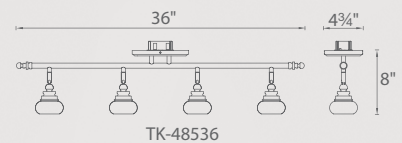



Antique Bronze

Antique Nickel

Burnished Brass

Polished Nickel

		Watt	LED Lumens	Delivered Lumens	Finish
	TK-48536	33W	1972	1905	AB <i>Antique Bronze</i> AN <i>Antique Nickel</i> BB <i>Burnished Brass</i> PN <i>Polished Nickel</i>



Example: **TK-48536-AB**



Vector Fixed Rail

Color Temp: 3000K
CRI: 90
Rated Life: 60,000 hours

- Energy Star® rated
- Individually Adjustable Heads
- ETL & cETL Damp Location Listed
- Wall or Ceiling Mount
- Aluminum Construction
- Universal Voltage Input (120V - 277V)
- Driver located in J box with minimum inside dimension of 3½" x 3½" x 1½"
- Dimming: ELV (120V) or 0-10V

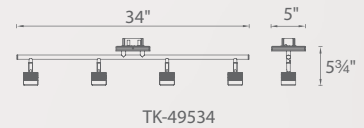

		Watt	LED Lumens	Delivered Lumens	Finish
	TK-49534	33W	1500	1465	BN <i>Brushed Nickel</i> BR <i>Brushed Brass</i> CH <i>Chrome</i>

Example: **TK-49534-CH**





New Product

Vector Monopoint

Color Temp: 3000K
CRI: 90
Rated Life: 60,000 hours

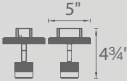
- Energy Star® rated
- Adjustable Head
- ETL & cETL Damp Location Listed
- Wall or Ceiling Mount
- Aluminum Construction
- Universal Voltage Input (120V - 277V)
- Driver located in J box
with minimum inside dimension of 3½" x 3½" x 1½"
- Dimming: ELV (120V) or 0-10V



		Watt	LED Lumens	Delivered Lumens	Finish
	MO-495	9W	441	438	BN <i>Brushed Nickel</i> BR <i>Brushed Brass</i> CH <i>Chrome</i>





Example: **MO-495-BR**

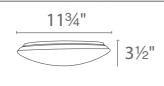
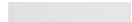

Glo LED Ceiling and Wall

CRI: 85
Dimming: 100% - 10%
Rated Life: 50,000 hours

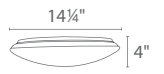
- Energy Star® rated
- ADA compliant for FM-211 and FM-214
- Wall or Ceiling Mount
- Opaque acrylic diffuser
- Multiple LED array for uniform illumination
- 120VAC - no driver needed
- Smooth and continuous ELV dimming

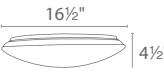
			Watt	Color Temp	LED Lumens	Delivered Lumens	Finish
		FM-211	15W	27 2700K 35 3500K	1355 1465	1015 1100	WT White 
		FM-214	24W	27 2700K 35 3500K	1915 2175	1435 1630	
		FM-216	33.5W	27 2700K 35 3500K	2815 3015	2110 2260	

Example: **FM-214-35-WT**



New Product

Disc LED Ceiling and Wall

Dimming: 100% - 10%
Rated Life: 50,000 hours



- Energy Star® rated
- Wet Location Listed
- CEC Title 24 Compliant
- ADA compliant
- Wall or Ceiling Mount
- Opaque acrylic diffuser
- Multiple LED array for uniform illumination
- 120VAC - no driver needed
- Smooth and continuous ELV dimming



Install over
a junction box

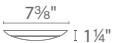

Retrofit over
a 5" or 6" recessed can

	Watt	Color Temp	CRI	LED Lumens	Delivered Lumens	Finish		
 7 3/8" x 1 1/4" FM-306	15W	930	3000K	90	1110	865	BN <i>Brushed nickel</i> BZ <i>Bronze</i> WT <i>White</i>	

Example: **FM-306-930-WT**

dweLED

by WAC Lighting

[dweL-E-D]

LED technology becomes accessible for decorative luminaires, with transitional styling and 2700K warm white light for even the most demanding applications.

dweLED decorative LED luminaires are designed to integrate within a variety of spaces ranging from multi-family residential to commercial and healthcare. Options include ADA compliance, ELV dimming, 277 volt power, wet location, and a variety of sizes and finishes.

The dweLED collection incorporates indoor and outdoor sconces, vanities, swing-arm reading lights, ceiling-mount lights, picture lights, and chandeliers, all engineered optimally for energy efficient LEDs.

Consult the factory to take advantage of our custom capabilities in large quantities.



LED Ceiling and Wall	
Slice	61
Dice	63
<hr/>	
LED Vanities and Sconces	
Ashton	65
Dunhill	67
Soho	69
Cube	71
Rondelle	73
<hr/>	
LED Outdoor	
Steampunk <small>New</small>	75
Arch	77
<hr/>	
LED Floor and Task	
Flip	79

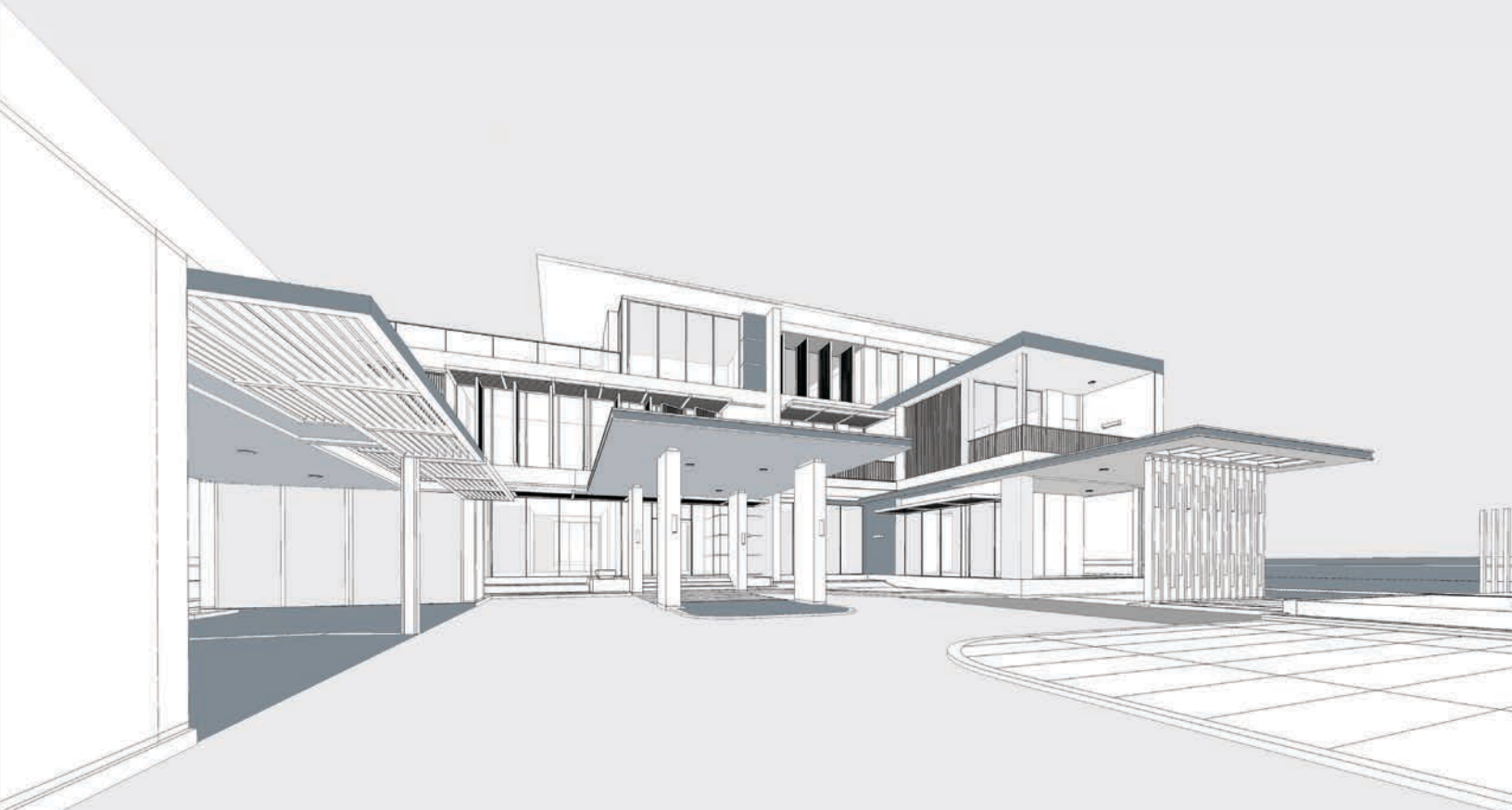



Slice LED Ceiling and Wall

CRI: 90
Dimming: 100% - 10%
Rated Life: 50,000 hours

- Etched $\frac{3}{4}$ " thick pressed glass diffuser with interior ceramic glaze
- Mount as a ceiling fixture or wall sconce
- ADA compliant when mounted on wall
- ETL & cETL damp location listed
- Smooth and continuous ELV dimming
- Also rated for installation in closets
- Transformer located in J box
- 277V available (special order)

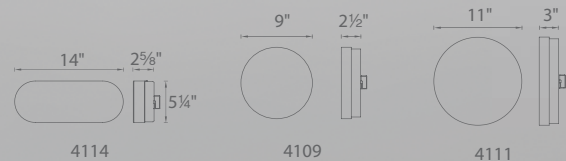



		Color Temp	Watt	LED Lumens	Delivered Lumens	Finish
	FM-4114-27	2700K	31W	1323	595	BN <i>Brushed Nickel</i>
	FM-4114-30	3000K	31W	1356	670	
	FM-4109-27	2700K	27W	1356	750	BN <i>Brushed Nickel</i> BZ <i>Bronze</i> CH <i>Chrome</i>
	FM-4109-30	3000K	27W	1392	770	
	FM-4111-27	2700K	31W	1593	915	
	FM-4111-30	3000K	31W	1635	940	

Example: **FM-4111-27-BZ**

For 277V special order, add an "F" before the color temperature: **FM-4111F-27-BZ**
 For alternate color temperature, special order adding -35: **FM-4111-35-BZ**





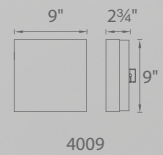
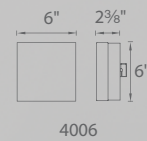
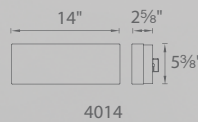

Dice LED Ceiling and Wall

CRI: 90
Dimming: 100% - 10%
Rated Life: 50,000 hours

- Etched $\frac{3}{4}$ " thick pressed glass diffuser with interior ceramic glaze
- Mount as a ceiling fixture or wall sconce
- ADA compliant when mounted on wall
- ETL & cETL damp location listed
- Smooth and continuous ELV dimming
- Also rated for installation in closets
- Transformer located in J box
- 277V available (special order)





		Color Temp	Watt	LED Lumens	Delivered Lumens	Finish	
	FM-4014-27	2700K	31W	1323	610	BN <i>Brushed Nickel</i>	
	FM-4014-30	3000K	31W	1356	640		
	FM-4006-27	2700K	17.5W	779	355	BN <i>Brushed Nickel</i> BZ <i>Bronze</i> CH <i>Chrome</i>	
	FM-4006-30	3000K	17.5W	800	365		
	FM-4009-27	2700K	27W	1341	885		
	FM-4009-30	3000K	27W	1376	910		

Example: **FM-4009-30-CH**

For 277V special order, add an "F" before the color temperature: **FM-4009F-30-CH**
For alternate color temperature, special order adding -35: **FM-4009-35-CH**

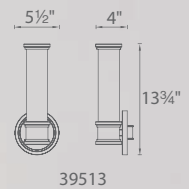

Ashton LED Vanities & Sconces

Color Temp: 2700K
CRI: 90
Dimming: 100% - 10%
Rated Life: 50,000 hours

- Etched opal glass
- Vertical or horizontal mount
- ETL & cETL Wet Location listed
- ADA compliant
- Smooth and continuous ELV dimming
- Transformer located in J box
- WS-39513 emits downlight as well as ambient light
- 277V available (special order)

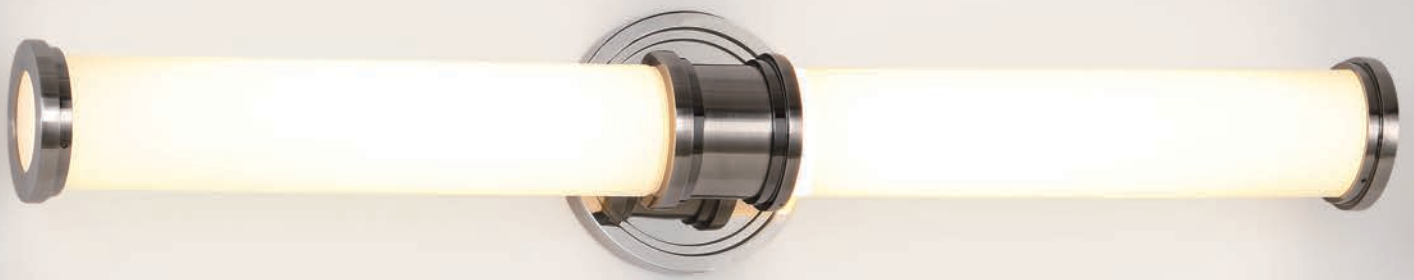

			Watt	LED Lumens	Delivered Lumens	Finish
	13"	WS-39513	25.5W	1093	770	AB <i>Antique Bronze</i> AN <i>Antique Nickel</i> BB <i>Burnished Brass</i> PN <i>Polished Nickel</i> 
	22"	WS-39522	30W	1373	990	
	28"	WS-39528	41W	1512	1320	

Example: **WS-39513-BB**

For 277V special order, add an "F" before the finish: **WS-39513F-BB**
 For alternate color temperature, special order adding -30 or -35: **WS-39513-35-BB**



Dunhill LED Vanities & Sconces

Color Temp: 2700K
CRI: 90
Dimming: 100% - 10%
Rated Life: 50,000 hours

- Etched opal glass
- Vertical or horizontal mount
- ETL & cETL damp location listed
- ADA compliant
- Conversion plate included
- Smooth and continuous ELV dimming
- Transformer located in J box
- 277V available (special order)

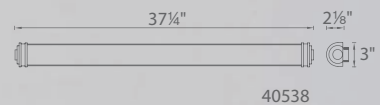
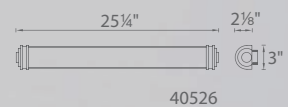



			Watt	LED Lumens	Delivered Lumens	Finish
	20"	WS-40520	27W	1125	770	AB <i>Antique Bronze</i> AN <i>Antique Nickel</i> BB <i>Burnished Brass</i> PN <i>Polished Nickel</i> 
	26"	WS-40526	33.5W	1551	935	
	38"	WS-40538	50W	2437	1330	

Example: **WS-40520-PN**

For 277V special order, add an "F" before the finish: **WS-40520F-PN**
 For alternate color temperature, special order adding -30 or -35: **WS-40520-30-PN**





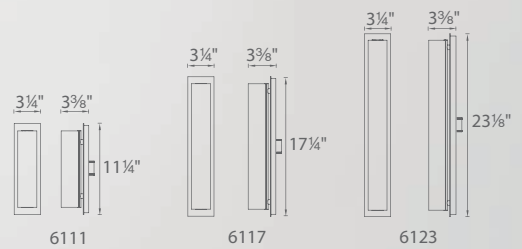

Soho LED Vanities & Sconces

Color Temp: 2700K
CRI: 90
Dimming: 100% - 10%
Rated Life: 50,000 hours

- Etched opal glass
- Vertical or horizontal mount
- ETL & cETL damp location listed
- ADA compliant
- Smooth and continuous ELV dimming
- Conversion plate for 4 inch Jbox included
- Transformer located in J box
- 277V available (special order)





			Watt	LED Lumens	Delivered Lumens	Finish
	11"	WS-6111	16W	700	520	
	17"	WS-6117	25W	1170	860	BN <i>Brushed Nickel</i> CH <i>Chrome</i> GL <i>Gold Plated</i> 
	23"	WS-6123	33.5W	1597	1245	

Example: **WS-6117-GL**

For 277V special order, add an "F" before the finish: **WS-6117F-GL**
 For alternate color temperature, special order adding -30 or -35: **WS-6117-30-GL**

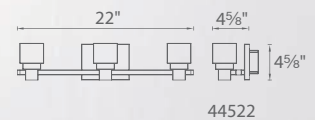

Kube LED Vanities & Sconces

Color Temp: 2700K
 CRI: 90
 Dimming: 100% - 10%
 Rated Life: 60,000 hours

- Each light also contains a powerful downlight
- ETL & cETL damp location listed
- ADA compliant for WS-44505
- Smooth and continuous ELV dimming
- Driver located in J box
 with minimum inside dimension of 3 1/2" x 3 1/2" x 1 1/2"
- 277V available for WS-44505 and WS-44512 (special order)
- WS-44522 has Universal Voltage Input (120V-277V)



		Watt	LED Lumens	Delivered Lumens	Finish
	1 Light WS-44505	18W	675	605	
	2 Lights WS-44512	32W	1554	1355	CH Chrome 
	3 Lights WS-44522 (120V-277V Input)	47.5W	2346	2210	

Example: **WS-44505-CH**

For 277V special order, add an "F" before the finish: **WS-44505F-CH**

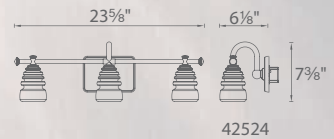
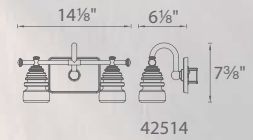
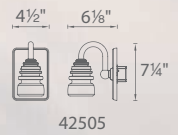





Rondelle LED Vanities & Sconces

Color Temp: 3000K
CRI: 90
Dimming: 100% - 10%
Rated Life: 60,000 hours

- ETL & cETL damp location listed
- Smooth and continuous ELV dimming
- Driver located in J box
- 277V available (special order)



			Watt	LED Lumens	Delivered Lumens	Finish
	1 Light	WS-42505	8.5W	230	220	
	2 Lights	WS-42514	16W	518	490	PN Polished Nickel 
	3 Lights	WS-42524	24.5W	865	805	

Example: **WS-42524-PN**

For 277V special order, add an "F" before the finish: **WS-42524F-PN**





Steampunk LED Outdoor

Color Temp: 3000K
 CRI: 90
 Dimming: 100% - 10%
 Rated Life: 80,000 hours

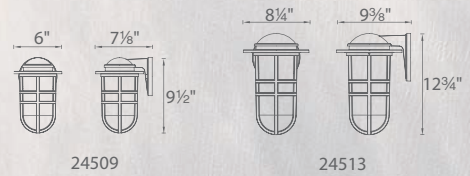
- Clear hammered seeded mouth blown glass
- ETL & cETL wet location listed, IP65 rated
- Die-cast Aluminum Construction
- Smooth and continuous ELV dimming
- 277V available (special order)



			Watt	LED Lumens	Delivered Lumens	Finish
	9"	WS-W24509	10W	624	365	BZ Bronze GH Graphite
	13"	WS-W24513	10W	657	440	

Example: **WS-W24513-BZ**

For 277V special order, add an "F" before the finish: **WS-W24513F-BZ**



Pivot hinge on canopy allows installation on sloped ceiling



New Product

Steampunk LED Outdoor Pendant

Color Temp: 3000K
CRI: 90
Dimming: 100% - 10%
Rated Life: 80,000 hours

- Clear hammered seeded mouth blown glass
- ETL & cETL wet location listed, IP65 rated
- Die-cast Aluminum Construction
- Smooth and continuous ELV dimming
- 277V available (special order)

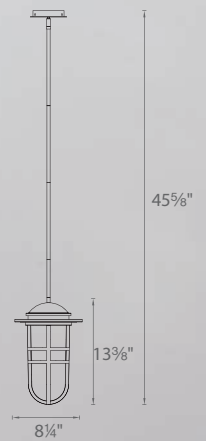

13"

PD-W24513

10W

750

470

BZ Bronze
GH Graphite



Example: **PD-W24513-GH**

For 277V special order, add an "F" before the finish: **PD-W24513F-GH**



Arch LED Outdoor

Color Temp: 3000K
CRI: 90
Dimming: 100% - 10%
Rated Life: 80,000 hours

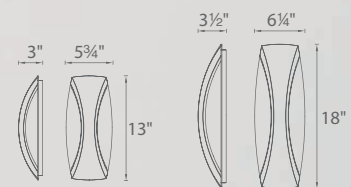

- Mounts vertical or horizontal
- ADA compliant
- Die-cast aluminum construction
- ETL & cETL wet location listed, IP65 rated
- Smooth and continuous ELV dimming
- 277V available (special order)



26513

26518

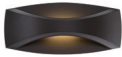

			Watt	LED Lumens	Delivered Lumens	Finish
	13"	WS-W26513	5W	154	120	BZ Bronze GH Graphite
	18"	WS-W26518	9.5W	398	225	

Example: **WS-W26518-BZ**

For 277V special order, add an "F" before the finish: **WS-W26518F-BZ**

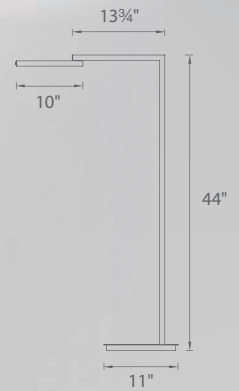

Flip LED Floor

Color Temp: 3000K

CRI: 85

Dimming: 100% - 10% (*Integral dimmer*)

Rated Life: 70,000 hours

- Fingertip touch dimmer
- Smooth arm swivel
- ETL & cETL damp location listed
- Driver located at the plug

	Watt	LED Lumens	Delivered Lumens	Finish
FL-1350	8W	490	430	BZ <i>Bronze</i> TT <i>Titanium</i>

Example: **FL-1350-BZ**



Flip LED Task

Color Temp: 3000K

CRI: 85

Dimming: 100% - 10% (Integral dimmer)

Rated Life: 70,000 hours

- Fingertip touch dimmer
- Smooth arm swivel
- ETL & cETL damp location listed
- Driver located at the plug

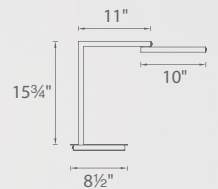

	Watt	LED Lumens	Delivered Lumens	Finish	
TL-1310	8W	490	430	BZ Bronze TT Titanium	

Example: **TL-1310-BZ**



WAC LIGHTING
Responsible Lighting®

wacighting.com 1-800-526-2588

WAC Lighting retains the right to modify the design of our products at any time as part of the company's continuous improvement program.
Please refer to our website for the latest product specifications. Copyright 2015