

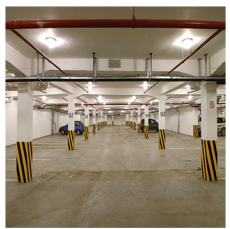

naturaled®

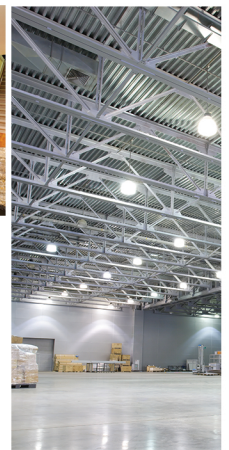

▶▶▶ LED Lamp & Fixture



Product Catalog
Edition VII

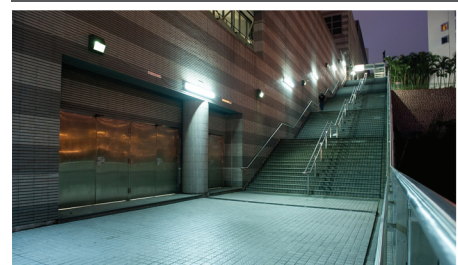

naturalLED®

Turning Light into Savings ▶▶▶



SB Area Light / Shoebox 75W, 110W, 180W, 240W

naturalLED® Area Light constructed with durable, die-cast aluminum housing and excellent thermal design. Our SB series is perfect for parking lots, streets, walkways, and streetscape, providing you with uniform and consistent color. A wide range of wattage selections equal to 150 watt to 1,000 watt HID fixtures, reducing maintenance and saving lamp & ballast replacement costs.

Our fixtures are DLC certified and IP65 rated with 3 types of mounting options available: Swivel Bracket, Slip Fitter, and 6" Extruded Arm. Compatible Integrated autonomous and photocell motion sensors are available as options to address your needs.



Key Features & Benefits

- ▶ DesignLights Consortium Certified
- ▶ IP65
- ▶ Uniform and consistent color
- ▶ Aluminum die cast housing
- ▶ Excellent thermal design
- ▶ CRI:70
- ▶ Universal Voltage 120-277V
- ▶ Operating Temp: -22°F~122°F
- ▶ 50,000 Hours rated average life
- ▶ 0-10V dimming
- ▶ Motion sensor compatible
- ▶ Photocell sensor compatible

Applications



- ▶ Parking Lot Lighting
- ▶ Street Lighting
- ▶ Site Lighting
- ▶ Streetscape Lighting
- ▶ Area Lighting

3 Color Choices



Qualifications



Item Code	Description	Color Temp	Wattage	Lumen Output	Equivalent Wattage	Voltage (V)	CRI	Beam Angle	Mount	Color			
7112	LED-FXSB75/3S/40K/DB-SF	4000K	75	5,898	250	120-277	70	Type 3	Slip Fitter	Bronze	●	●	●
7113	LED-FXSB75/3S/40K/DB-SB	4000K	75	5,898	250	120-277	70	Type 3	Swivel	Bronze	●	●	●
7114	LED-FXSB75/3S/40K/DB-EA6	4000K	75	5,898	250	120-277	70	Type 3	6" Arm	Bronze	●	●	●
7115	LED-FXSB75/3S/50K/DB-SF	5000K	75	5,898	250	120-277	70	Type 3	Slip Fitter	Bronze	●	●	●
7116	LED-FXSB75/3S/50K/DB-SB	5000K	75	5,898	250	120-277	70	Type 3	Swivel	Bronze	●	●	●
7117	LED-FXSB75/3S/50K/DB-EA6	5000K	75	5,898	250	120-277	70	Type 3	6" Arm	Bronze	●	●	●
7118	LED-FXSB110/3S/40K/DB-SF	4000K	110	8,574	250-400	120-277	70	Type 3	Slip Fitter	Bronze	●	●	●
7119	LED-FXSB110/3S/40K/DB-SB	4000K	110	8,574	250-400	120-277	70	Type 3	Swivel	Bronze	●	●	●
7120	LED-FXSB110/3S/40K/DB-EA6	4000K	110	8,574	250-400	120-277	70	Type 3	6" Arm	Bronze	●	●	●
7121	LED-FXSB110/3S/50K/DB-SF	5000K	110	8,574	250-400	120-277	70	Type 3	Slip Fitter	Bronze	●	●	●
7122	LED-FXSB110/3S/50K/DB-SB	5000K	110	8,574	250-400	120-277	70	Type 3	Swivel	Bronze	●	●	●
7123	LED-FXSB110/3S/50K/DB-EA6	5000K	110	8,574	250-400	120-277	70	Type 3	6" Arm	Bronze	●	●	●
7176	LED-FXSB110/3S/50K/BK-EA6	5000K	110	8,574	250-400	120-277	70	Type 3	6" Arm	Black	●	●	●
7169	LED-FXSB110/3S/50K/WH-EA6	5000K	110	8,574	250-400	120-277	70	Type 3	6" Arm	White	●	●	●
7192	LED-FXSB180/3S/40K/DB-SF	4000K	180	19,073	400-750	120-277	70	Type 3	Slip Fitter	Bronze	●	●	●
7193	LED-FXSB180/3S/40K/DB-SB	4000K	180	19,073	400-750	120-277	70	Type 3	Swivel	Bronze	●	●	●
7194	LED-FXSB180/3S/40K/DB-EA6	4000K	180	19,073	400-750	120-277	70	Type 3	6" Arm	Bronze	●	●	●
7195	LED-FXSB180/3S/50K/DB-SF	5000K	180	21,194	400-750	120-277	70	Type 3	Slip Fitter	Bronze	●	●	●
7196	LED-FXSB180/3S/50K/DB-SB	5000K	180	21,194	400-750	120-277	70	Type 3	Swivel	Bronze	●	●	●
7197	LED-FXSB180/3S/50K/DB-EA6	5000K	180	21,194	400-750	120-277	70	Type 3	6" Arm	Bronze	●	●	●
7400	LED-FXSB240/3S/40K/DB-SF	4000K	240	24,010	750-1000	120-277	70	Type 3	Slip Fitter	Bronze	●	●	●
7401	LED-FXSB240/3S/40K/DB-SB	4000K	240	24,010	750-1000	120-277	70	Type 3	Swivel	Bronze	●	●	●
7402	LED-FXSB240/3S/40K/DB-EA6	4000K	240	24,010	750-1000	120-277	70	Type 3	6" Arm	Bronze	●	●	●
7403	LED-FXSB240/3S/50K/DB-SF	5000K	240	25,638	750-1000	120-277	70	Type 3	Slip Fitter	Bronze	●	●	●
7404	LED-FXSB240/3S/50K/DB-SB	5000K	240	25,638	750-1000	120-277	70	Type 3	Swivel	Bronze	●	●	●
7405	LED-FXSB240/3S/50K/DB-EA6	5000K	240	25,638	750-1000	120-277	70	Type 3	6" Arm	Bronze	●	●	●

Accessories

P10024	MT-SF/DB	Slip Fitter (Bronze)
P10025	MT-SB/DB	Swivel Bracket (Bronze)
P10026	MT-EA6/DB	6" Arm (Bronze)
P10046	MT-4PA/DB	4" Round Pole Adaptor (Bronze)
P10047	MT-5PA/DB	5" Round Pole Adaptor (Bronze)
P10048	MT-6PA/DB	6" Round Pole Adaptor (Bronze)
P10049	MT-4PA/WH	4" Round Pole Adaptor (White)
P10050	MT-5PA/WH	5" Round Pole Adaptor (White)
P10051	MT-6PA/WH	6" Round Pole Adaptor (White)
P10043	SEN-LOD-500-SPD	Motion/Photocell 0-10V /100-277V Recommended for 8-20ft Height. Coverage: 2 x Height
P10045	SEN-LOD-500-SPC	Motion/Photocell 0-10V /100-277V Recommended for 15-30ft Height. Coverage: 3 x Height



SEN-LOD-500-SPC
Height: 15-30ft
(3-Times Height Coverage)





SEN-LOD-500-SPD
Height: 8-20 ft
(2-Times Height Coverage)

► Dimensions

	Wattage	A	B	C	Weight
	75	12.25-in	12.25-in	5.00-in	16.00-in
	Wattage	A	B	C	Weight
	110	16.50-in	16.50-in	7.00-in	25.00-in
	Wattage	A	B	C	Weight
	180	21.30-in	17.29-in	5.51-in	30.00-in
	Wattage	A	B	C	Weight
	240	21.30-in	20.72-in	5.51-in	37.00-in

► Mounting Dimensions

<p>Swivel Bracket</p>		a	b	c	d	e	f	g
		5.5-in	0.50-in	2.50-in	0.50-in	0.25-in	3.75-in	4.75-in
<p>Slip Fitter</p>		7.00-in	6.50-in	3.00-in	3.50-in	0.50-in	--	--
<p>6" Extruded arm</p>		8.75-in	4.00-in	4.50-in	2.50-in	4.00-in	2.00-in	2-M10

► Illuminance Distribution

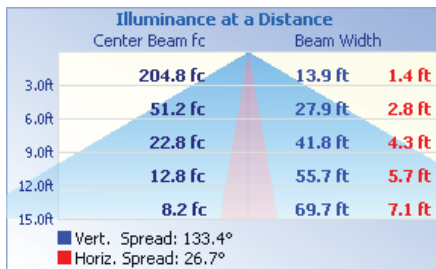
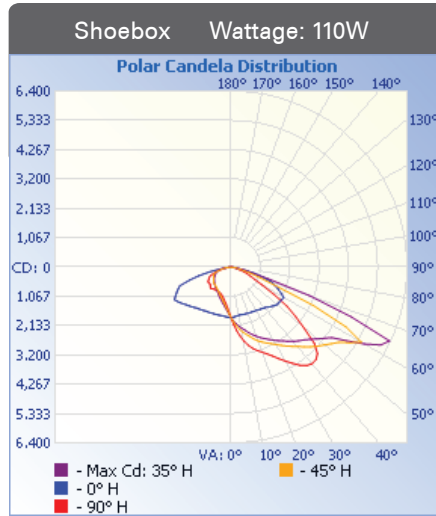
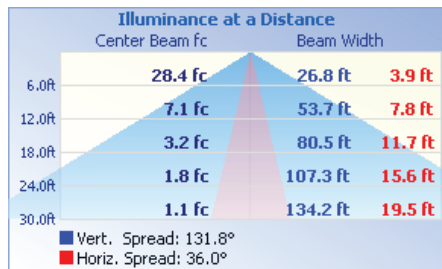
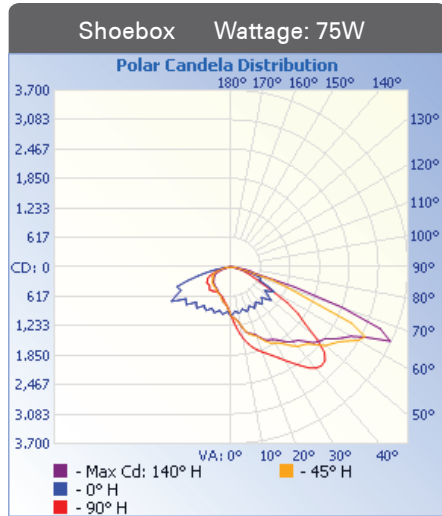

► Master Carton Package

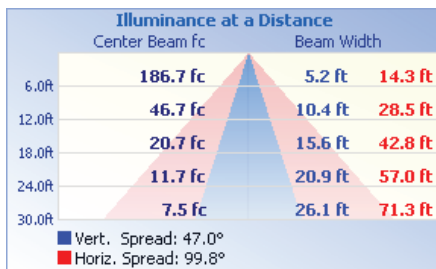
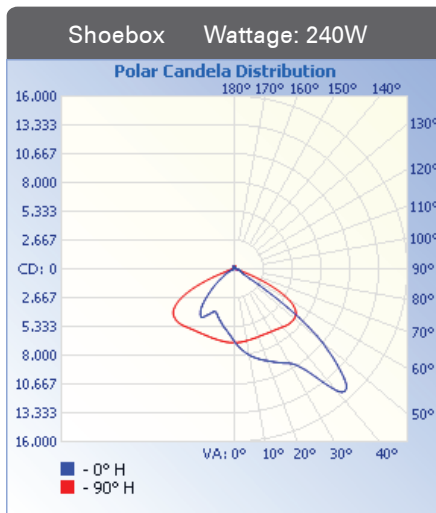
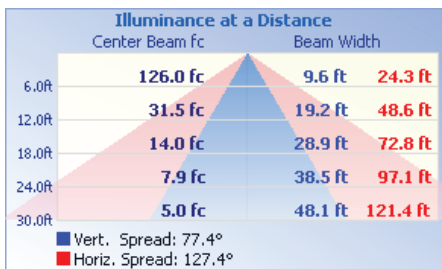
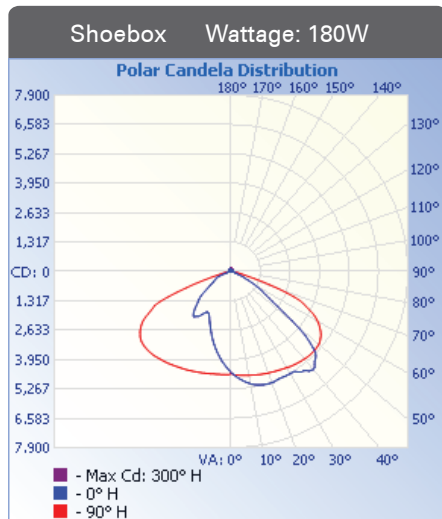
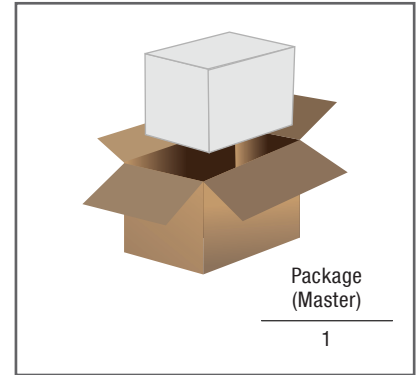

naturalLED®

Turning Light into Savings ▶▶▶

SWP Slim Wall Pack

15W, 29W, 50W

naturalLED® SWP is our slim, low-profile wall pack with smooth contemporary design. Well engineered high quality die-cast aluminum which delivers bright, crisp light.

Excellent thermal design ensures our SWP's performance over the life.

Installation made simple and easy with a hinged junction box. Our Slim-Wallpacks are available in 15 watt, 29 watt, and 50 watt with color options of White, Black and Bronze. Optional ½" knuckle mount or adjustable swivel bracket provide you the flexibility for your application.

SWP is ideal for landscape, wall/surface, low level pathway, apartment buildings, schools, multi-use facilities.

Key Features & Benefits

- ▶ DesignLights Consortium Certified
- ▶ Uniform and consistent color
- ▶ Aluminum die cast housing
- ▶ Excellent thermal design
- ▶ CRI:70
- ▶ Universal Voltage 120-277V
- ▶ Operating Temp: -22°F~122°F
- ▶ 50,000 Hours rated average life
- ▶ Photocell sensor compatible

Applications





- ▶ Security Lighting
- ▶ Pathway Lighting
- ▶ Perimeter Lighting
- ▶ Entryway Lighting

3 Color Choices



Qualifications



Item Code	Description	Color Temp	Wattage	Lumen Output	Depth	Equivalent Wattage	CRI	Finish	Rated Life				
7462	LED-FXSWP15/40K/BK	4000K	15	1,740	4-in	75W	70	Black	50,000	●	●	●	●
7463	LED-FXSWP15/50K/BK	5000K	15	1,797	4-in	75W	70	Black	50,000	●	●	●	●
7452	LED-FXSWP29/40K/BK	4000K	29	3,268	4-in	175W	70	Black	50,000	●	●	●	●
7453	LED-FXSWP29/50K/BK	5000K	29	3,329	4-in	175W	70	Black	50,000	●	●	●	●
7548	LED-FXSWP50/40K/BK	4000K	50	5,508	4-in	250W	70	Black	50,000		●	●	●
7549	LED-FXSWP50/50K/BK	5000K	50	5,856	4-in	250W	70	Black	50,000		●	●	●
7464	LED-FXSWP15/40K/WH	4000K	15	1,740	4-in	75W	70	White	50,000	●	●	●	●
7465	LED-FXSWP15/50K/WH	5000K	15	1,797	4-in	75W	70	White	50,000	●	●	●	●
7460	LED-FXSWP29/40K/WH	4000K	29	3,268	4-in	175W	70	White	50,000	●	●	●	●
7461	LED-FXSWP29/50K/WH	5000K	29	3,329	4-in	175W	70	White	50,000	●	●	●	●
7550	LED-FXSWP50/40K/WH	4000K	50	5,508	4-in	250W	70	White	50,000		●	●	●
7551	LED-FXSWP50/50K/WH	5000K	50	5,856	4-in	250W	70	White	50,000		●	●	●
7572	LED-FXSWP15/40K/DB	4000K	15	1,740	4-in	75W	70	Bronze	50,000	●	●	●	●
7573	LED-FXSWP15/50K/DB	5000K	15	1,797	4-in	75W	70	Bronze	50,000	●	●	●	●
7574	LED-FXSWP29/40K/DB	4000K	29	3,268	4-in	175W	70	Bronze	50,000	●	●	●	●
7575	LED-FXSWP29/50K/DB	5000K	29	3,329	4-in	175W	70	Bronze	50,000	●	●	●	●
7576	LED-FXSWP50/40K/DB	4000K	50	5,508	4-in	250W	70	Bronze	50,000		●	●	●
7577	LED-FXSWP50/50K/DB	5000K	50	5,856	4-in	250W	70	Bronze	50,000		●	●	●

Accessories

P10005	MT-SB-SWP/BK	Swivel Bracket Mount (Black)
P10006	MT-KNC-SWP/BK	Knuckle Mount (Black)
P10007	MT-SF-SWP/BK	Slip Fitter Mount (Black)
P10019	MT-SB-SWP/WH	Swivel Bracket Mount (White)
P10020	MT-KNC-SWP/WH	Knuckle Mount (White)
P10021	MT-SF-SWP/WH	Slip Fitter Mount (White)
P10074	MT-SB-SWP/DB	Swivel Bracket Mount (Bronze)
P10075	MT-KNC-SWP/DB	Knuckle Mount (Bronze)
P10076	MT-SF-SWP/DB	Slip Fitter Mount (Bronze)
P10036	SEN-PHO-BT-MT/MV	Nutton Photocell (120-277V)

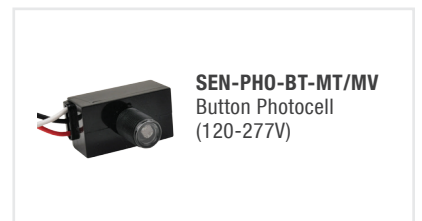

► Dimensions

15W 29W 50W		A	B	C	D	E
		5.25-in	6.30-in	7.87-in	4.00-in*	4.75-in

* Applies to ADA (Americans with Disabilities Act) Standard

► Mounting Dimensions

		a	b	c
<p>Knuckle mount</p>		4.21-in	4.65-in	4.21-in
<p>Slip Fitter</p>		7.04-in	2.95-in	3.25-in
<p>Swivel Bracket</p>		4.68-in	5.47-in	1.37-in

► Illuminance Distribution

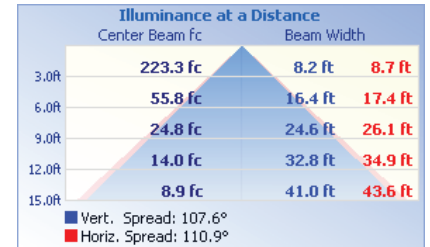
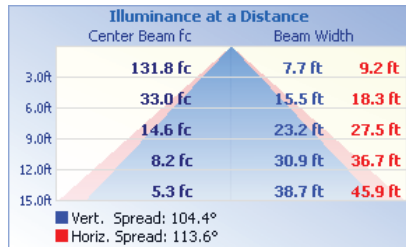
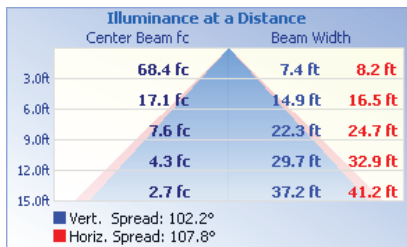
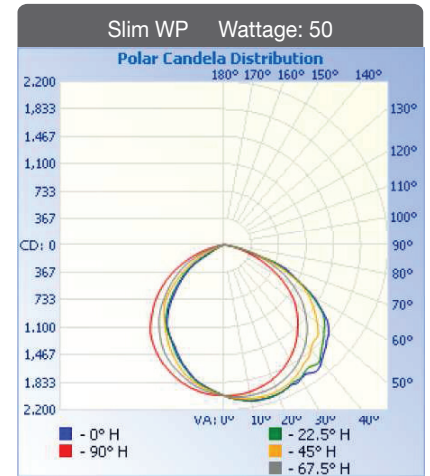
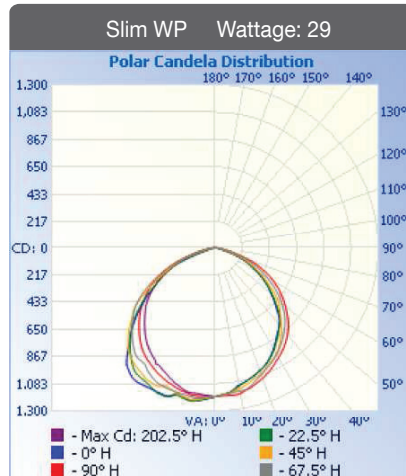
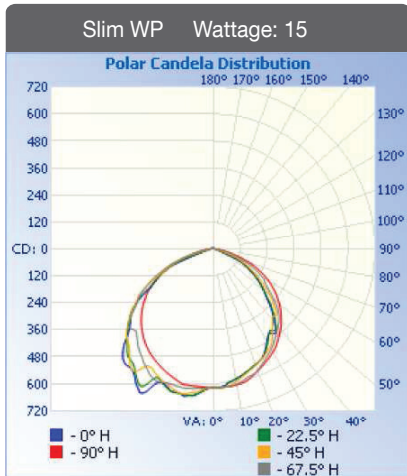

► Master Carton Package

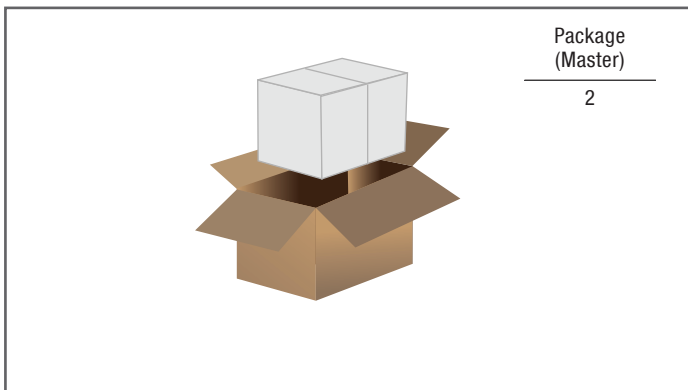



Turning Light into Savings ▶▶▶



TWP Traditional Wallpack

28W, 40W, 60W, 90W

naturaLED® TWP traditional wallpack comes in rugged cast-aluminum housing with excellent thermal design. DesignLights Consortium certified, our TWP product offers a popular but classic appearance for your needs.

Delivering it up to 9,000 lumens by replacing up to 400-watt metal halide luminaires, with energy saving up to 80%. The traditional shape maintains an aesthetic appearance and will replace any building's wall pack, or perimeter lighting.

Our TWP is ideal for outdoor applications such as carports, loading areas, driveways, parking area and pathways. Designed for wall mounting above four feet from ground.



Key Features & Benefits

- ▶ DesignLights Consortium Certified
- ▶ Long Life LED Chip
- ▶ Uniform and consistent color
- ▶ Excellent thermal design
- ▶ 15-30 foot height performance
- ▶ Shatter resistant glass
- ▶ Universal Voltage 120-277V
- ▶ Operating Temp: -22°F~122°F
- ▶ 50,000 Hours rated average life
- ▶ Photocell sensor compatible

Applications

- ▶ Area Lighting
- ▶ Security Lighting
- ▶ Pathway Lighting
- ▶ Perimeter Lighting
- ▶ Entryway Lighting

Color Choices























Bronze



Visor for Full Cutoff application Included
Require for DLC qualification

Qualifications



Item Code	Description	Color Temp	Wattage	Lumen Output	Equivalent Wattage	Voltage (V)	Rated Hours	Beam Type	Color	Cutoff Visor			
7466	LED-FXTWP28/40K/DB	4000K	28	3,000	175	120-277	50,000	F. Throw	Bronze	Included			
7467	LED-FXTWP28/50K/DB	5000K	28	3,000	175	120-277	50,000	F. Throw	Bronze	Included			
7086	LED-FXTWP40/40K/DB	4000K	40	3,076	175	120-277	50,000	F. Throw	Bronze	Included			
7087	LED-FXTWP40/50K/DB	5000K	40	3,076	175	120-277	50,000	F. Throw	Bronze	Included			
7088	LED-FXTWP60/40K/DB	4000K	60	4,612	250	120-277	50,000	F. Throw	Bronze	Included			
7089	LED-FXTWP60/50K/DB	5000K	60	4,612	250	120-277	50,000	F. Throw	Bronze	Included			
7138	LED-FXTWP90/40K/DB	4000K	90	5,896	400	120-277	50,000	F. Throw	Bronze	Included			
7139	LED-FXTWP90/50K/DB	5000K	90	5,896	400	120-277	50,000	F. Throw	Bronze	Included			

Accessories

P10036	SEN-PHO-BT-MT/MV	Button Photocell 120-277V
--------	------------------	---------------------------



► Dimensions

	Wattage	A	B	C	Weight (lbs)
	28	8.75-in	9.00-in	7.25-in	5.75
	40	14.50-in	7.50-in	9.00-in	9.50
	60	18.50-in	9.25-in	9.00-in	16.00
	90	18.50-in	9.25-in	9.00-in	18.60

► Illuminance Distribution

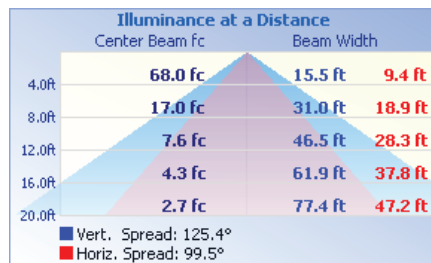
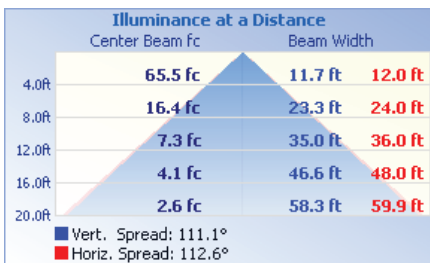
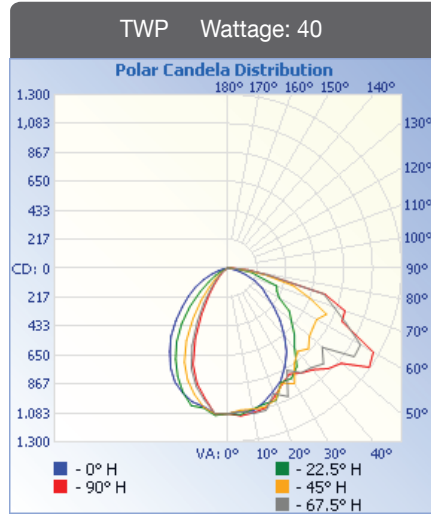
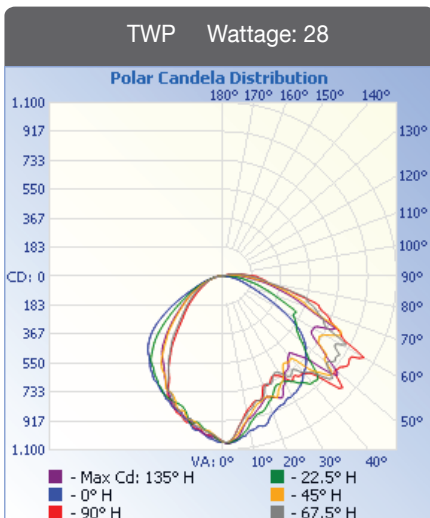

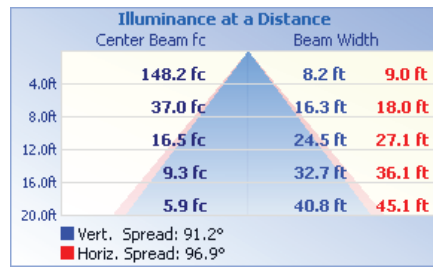
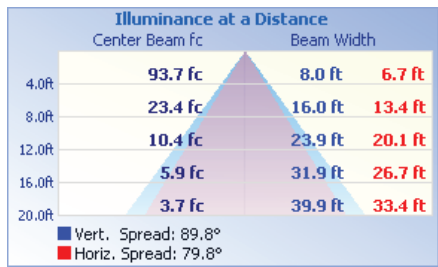
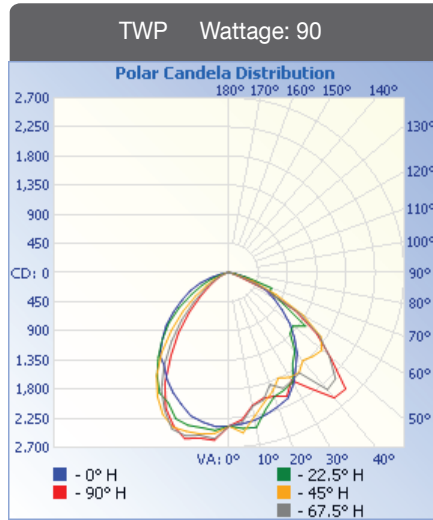
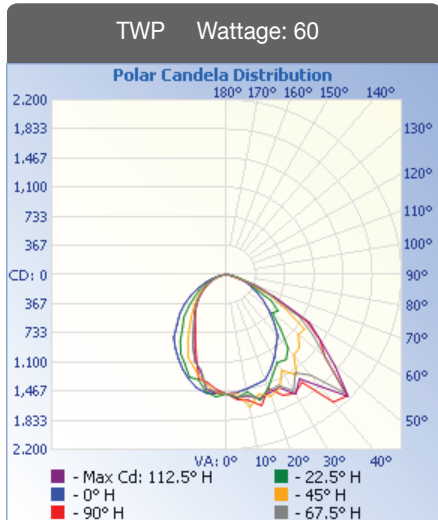

► Master Carton Package

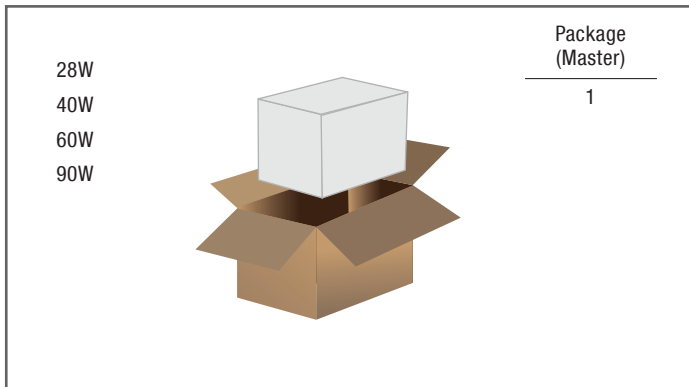

natural^{led}

Turning Light into Savings ▶▶▶



CWP Cutoff Wallpack

40W, 60W

naturalLED® CWP traditional wallpack comes in rugged cast-aluminum housing with excellent thermal design. DesignLights Consortium certified, our CWP product offers a popular but classic appearance with sleek angle design.

Delivering up to 5,000 lumens by replacing up to 250 watt metal halide luminaires, provides energy saving up to 72%. Our CWP is ideal for outdoor applications such as carports, loading areas, driveways, parking areas, and pathways. Designed for wall mounting above four feet from ground.



50,000
Rated
Life Hours

Key Features & Benefits

- ▶ DesignLights Consortium Certified
- ▶ Long Life LED Chips
- ▶ Uniform and consistent color
- ▶ Excellent thermal design
- ▶ 15-30 foot height performance
- ▶ Shatter-Resistent glass
- ▶ Universal Voltage 120-277V
- ▶ Operating Temp:- 22°F~122°F
- ▶ IP65 Rated
- ▶ 50,000 hrs rated average life
- ▶ Photocell sensor compatible

Applications

- ▶ Area Lighting
- ▶ Security Lighting
- ▶ Pathway Lighting
- ▶ Perimeter Lighting
- ▶ Entryway Lighting

Color Choices



Bronze

Qualifications



ORDERING INFORMATION

2

Item Code	Description	Color Temp	Wattage	Lumen Output	Equivalent Wattage	Voltage (V)	CRI	Rated Hours	Beam Type	Color	DLC	IP 65
7096	LED-FXCWP40/40K/DB	4000K	40	3,021	175	120-277	80	50,000	Cutoff	Bronze	●	●
7097	LED-FXCWP40/50K/DB	5000K	40	3,021	175	120-277	80	50,000	Cutoff	Bronze	●	●
7098	LED-FXCWP60/40K/DB	4000K	60	4,689	250	120-277	80	50,000	Cutoff	Bronze	●	●
7099	LED-FXCWP60/50K/DB	5000K	60	4,689	250	120-277	80	50,000	Cutoff	Bronze	●	●

Accessories

P10036	SEN-PHO-BT-MT/MV	Motion Sensor, 120-277V
--------	------------------	-------------------------

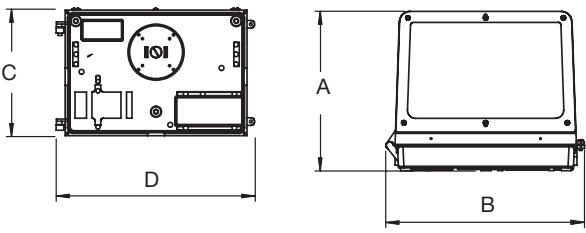

► Dimensions

	Wattage	A	B	C	D	Weight (lbs)
	40	11.50-in	14.50-in	9.00-in	14.50-in	10.36
	60	13.50-in	18.00-in	9.00-in	18.00-in	10.36

► Illuminance Distribution

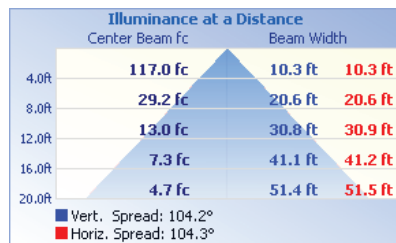
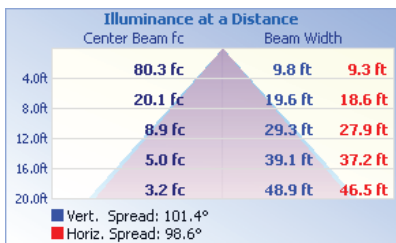
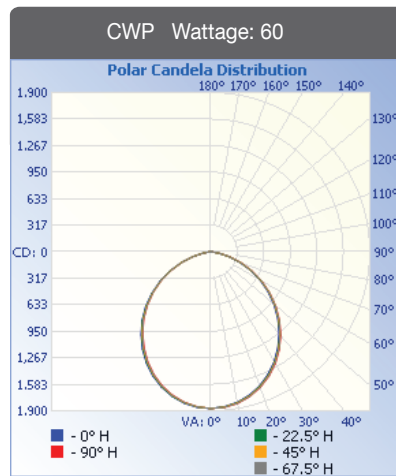
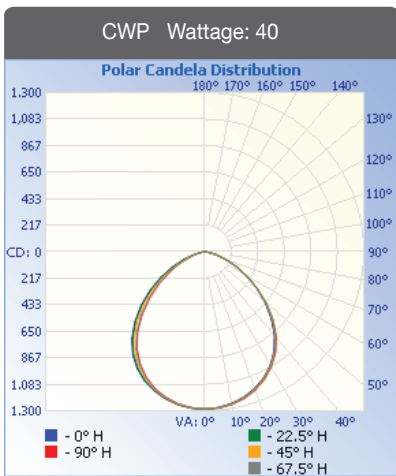

► Master Carton Package

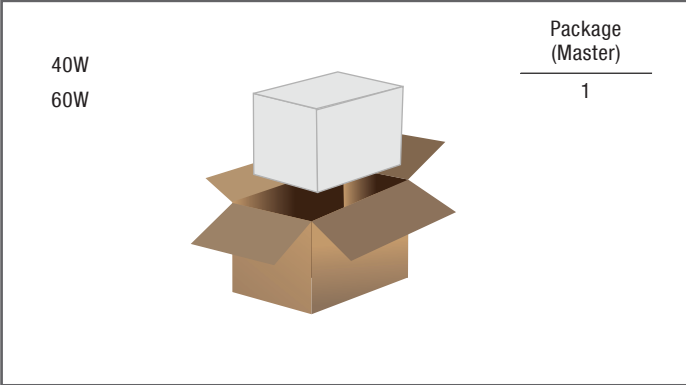



with 6 ft power cord whip

1/2" / 3/4" Stainless steel threaded nipple



FDL Floodlight 13W, 28W, 50W

naturalLED® floodlights provide a range of size and wattages to fit your needs. Our small flood lights create bright, security and spot lighting for a variety of applications such as perimeter, entryway, facades, landscapes, retail and residential complexes and architectural lighting.

Available in three power levels and flood beam distributions, to replace up to 250 watt. York-arm design can be adjustable to the angle best suit your needs.

Key Features & Benefits

- ▶ York-Style Arm
- ▶ High Powered LED Array
- ▶ Excellent thermal design
- ▶ Uniform and consistent color
- ▶ Aluminium die cast housing
- ▶ Operating Temp: -22°F~122°F
- ▶ 120-277V
- ▶ 50,000 hrs rated average life
- ▶ 6-foot whip power cord
- ▶ 1/2" stainless steel threaded nipple (Apply for 13W & 28W)
- ▶ 3/4" stainless steel threaded nipple (Apply for 50W)

Applications



- ▶ Security Lighting
- ▶ Architectural Lighting
- ▶ Perimeter Lighting
- ▶ Entryway/ Pathway Lighting

Color Choices



Qualifications



Item Code	Description	Color Temp	Wattage	Lumen Output	Equivalent Wattage	Voltage (V)	CRI	Beam Angle	Color	Rated Hours			
7513	LED-FXFDL13/40K/BK	4000K	13	1,301	75	120-277	72	Flood	Black	50,000	●	●	●
7514	LED-FXFDL13/50K/BK	5000K	13	1,319	75	120-277	72	Flood	Black	50,000	●	●	●
7544	LED-FXFDL13/40K/WH	4000K	13	1,301	75	120-277	72	Flood	White	50,000	●	●	●
7545	LED-FXFDL13/50K/WH	5000K	13	1,319	75	120-277	72	Flood	White	50,000	●	●	●
7515	LED-FXFDL28/40K/BK	4000K	28	3,010	175	120-277	72	Flood	Black	50,000	●	●	●
7516	LED-FXFDL28/50K/BK	5000K	28	3,084	175	120-277	72	Flood	Black	50,000	●	●	●
7546	LED-FXFDL28/40K/WH	4000K	28	3,010	175	120-277	72	Flood	White	50,000	●	●	●
7547	LED-FXFDL28/50K/WH	5000K	28	3,084	175	120-277	72	Flood	White	50,000	●	●	●
7517	LED-FXFDL50/40K/BK	4000K	50	5,621	250	120-277	72	Flood	Black	50,000		●	●
7518	LED-FXFDL50/50K/BK	5000K	50	5,741	250	120-277	72	Flood	Black	50,000		●	●
7558	LED-FXFDL50/40K/WH	4000K	50	5,621	250	120-277	72	Flood	White	50,000		●	●
7559	LED-FXFDL50/50K/WH	5000K	50	5,741	250	120-277	72	Flood	White	50,000		●	●

► Dimensions

	Wattage	A	B	C	D	Weight (lbs)
	13	4.20-in	3.80-in	4.50-in	3.40-in	1.89
	28	5.70-in	4.10-in	7.10-in	5.50-in	3.42
	50	6.80-in	5.40-in	8.80-in	7.30-in	6.66

► Illuminance Distribution

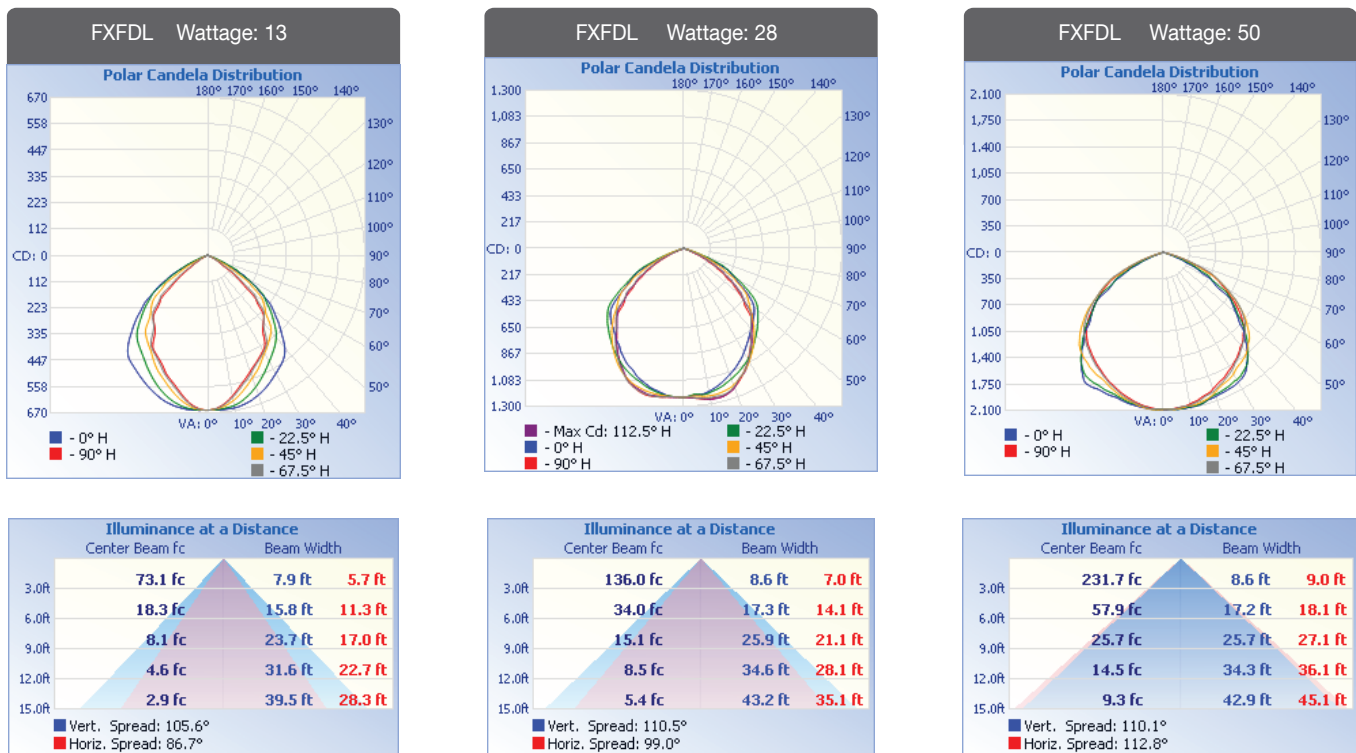

► Master Carton Package

13W

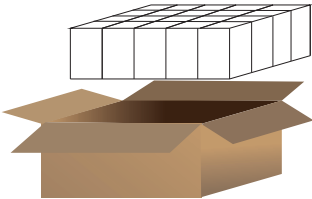

Package
(Master)

20

28W

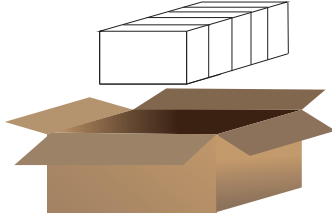

Package
(Master)

5

50W

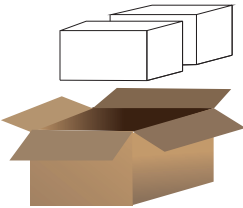

Package
(Master)

2



LED High Power Flood Light 240W

naturalLED[®] High Power Flood Light deliver the bright crisp light over its lifetime. Our High Power Flood Light comes with two beam types (30° and 60°). Ideal for parks, constructions, and sports field. Innovative modular system can generate over 110lm per watt. Most compact and efficient high power flood light.



Key Features & Benefits

- ▶ Glass with clear lens
- ▶ Instant Start/ Program Start
- ▶ Excellent color consistency
- ▶ No Flickering
- ▶ Aluminium die cast housing
- ▶ Noise-free design
- ▶ UL Listed
- ▶ Operating Temp: -22°F~122°F
- ▶ 120-277V
- ▶ 50,000 hrs rated average life
- ▶ Extended 9-foot power cable

Applications

- ▶ Light Towers
- ▶ Construction Lighting
- ▶ Landscape Lighting

Color Choices



Black





Qualifications



ORDERING INFORMATION

2

Item Code	Description	Color Temp	Wattage	Lumen Output	Equivalent Wattage	Voltage (V)	CRI	Beam Angle	Color	Rated Hours		
7445	LED-FXFDL240/50K30D/BK-YK	5000K	240	28,835	575-750W	120-277	80	30°	Black	50,000	•	•
7446	LED-FXFDL240/50K60D/BK-YK	5000K	240	28,977	575-750W	120-277	80	60°	Black	50,000	•	•

► Dimensions

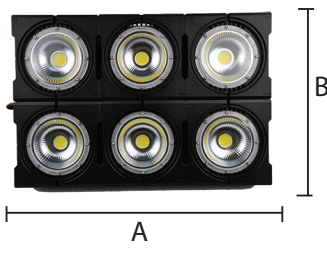
	Wattage	A	B			Weight (lbs)
	240	18.00-in	12.00-in			28.00

► Illuminance Distribution

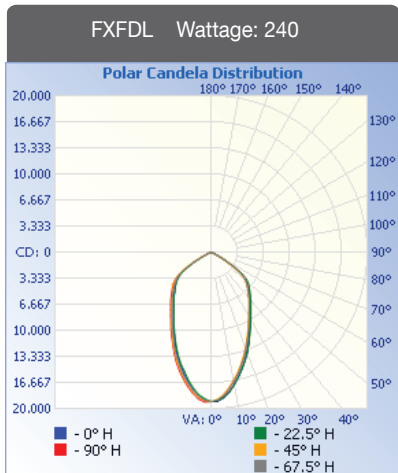

► Adjustable Arm

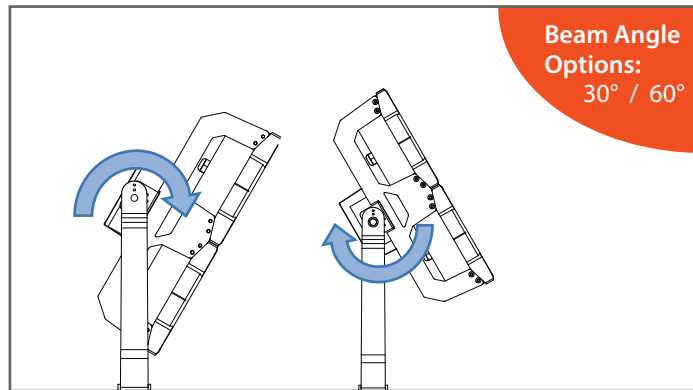

	Center Beam fc	Beam Width
10.0ft	191.0 fc	12.0 ft 12.3 ft
20.0ft	47.8 fc	24.0 ft 24.7 ft
30.0ft	21.2 fc	35.9 ft 37.0 ft
40.0ft	11.9 fc	47.9 ft 49.3 ft
50.0ft	7.6 fc	59.9 ft 61.7 ft

■ Vert. Spread: 61.8°
■ Horiz. Spread: 63.3°

▶ Master Carton Package

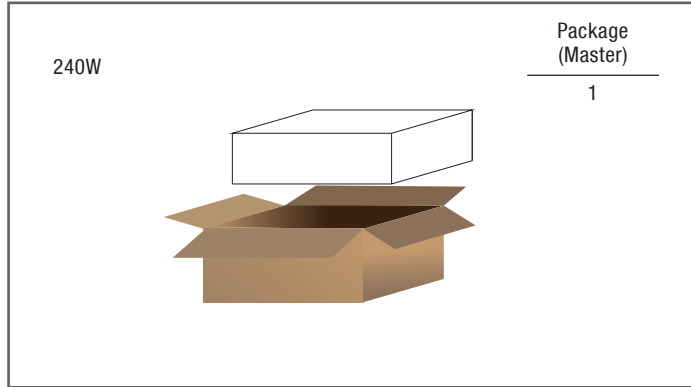

naturalLED®

Turning Light into Savings ▶▶▶



IP66
outdoor rated

FDL Floodlight

29W, 58W

naturalLED® outdoor lighting's classic floodlight provides energy efficient floodlighting solutions with a wide distribution. These powerful floodlights are available in two wattages, providing a versatile choice for applications such as facade, area and sign lighting.

Our FDL floodlights attach with knuckle mount providing a wide angle adjustable position from 30 to 90 degrees.



Wide angle adjustable
Knuckle mount with
indication of 30°, 60° or 90°



Key Features & Benefits

- ▶ Architectural & Spot Luminaires
- ▶ Long life LED chips
- ▶ Uniform and consistent color
- ▶ Excellent thermal design
- ▶ Power factor > 0.95
- ▶ CRI 70
- ▶ 120-277V
- ▶ 50,000 hrs rated average life
- ▶ Operating temp: -22°F~122°F
- ▶ 1/2" knuckle mount

Applications

- ▶ Area Lighting
- ▶ Spot Luminaires
- ▶ Architectural Lighting
- ▶ General Site Illumination
- ▶ Signage Lighting

Color Choices















Bronze

Qualifications



ORDERING INFORMATION

Item Code	Description	Color Temp	Wattage	Lumen Output	Equivalent Wattage	Voltage (V)	CRI	Rated Hours	Beam Angle	Color			
7179	LED-FXFDL29/40K/DB-KNC	4000K	29	3,336	175	120-277	70	50,000	Flood	Bronze			
7180	LED-FXFDL29/50K/DB-KNC	5000K	29	3,336	175	120-277	70	50,000	Flood	Bronze			
7181	LED-FXFDL58/40K/DB-KNC	4000K	58	6,735	250	120-277	70	50,000	Flood	Bronze			
7182	LED-FXFDL58/50K/DB-KNC	5000K	58	6,735	250	120-277	70	50,000	Flood	Bronze			

► Dimensions

	Wattage	A	B	C	D	E
	29 / 58	11.75-in	10.25-in	7.00-in	8.50-in	7.25-in
	F	G	H	I	J	K
	2.75-in	9.00-in	2.00-in	1.50-in	0.75-in	0.75-in

► Illuminance Distribution

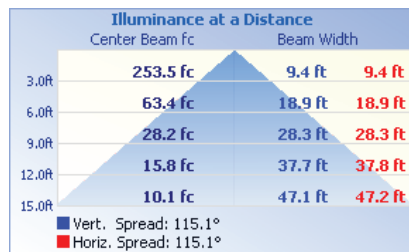
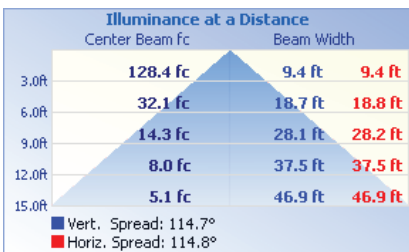
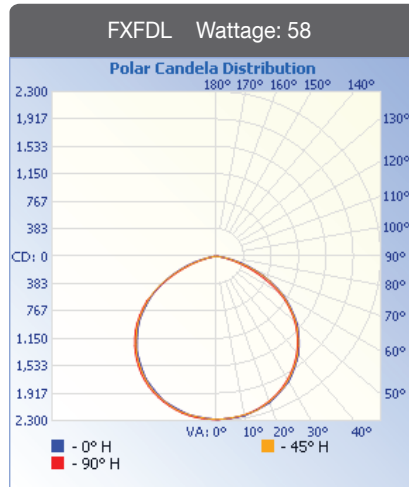
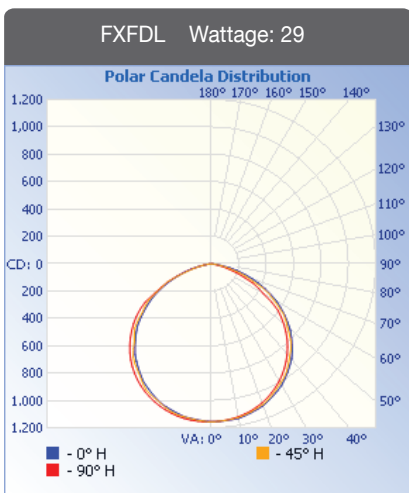

► Master Carton Package

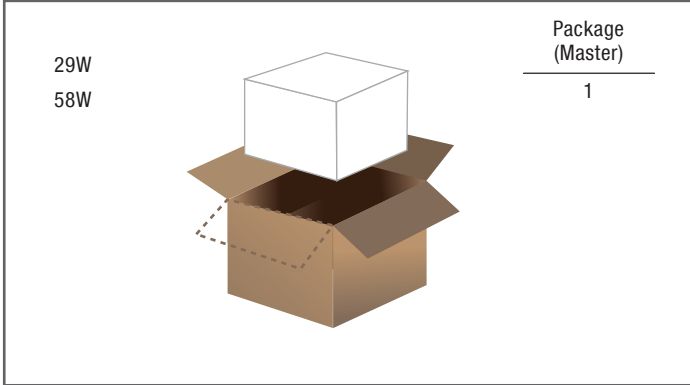



Security Barn, Wall Light

20W, 28W, 38W

naturalLED® security lighting provides you a wide range of wall mount or pole mount outdoor applications. An energy efficient alternative for the obsolete 100 watt mercury vapor exterior dusk-to-dawn barn lights with only 37 watt LED, saving more than 50% in energy savings.

With Die-Cast aluminum housing, our security lights are suitable for wet locations with the IP ratings of 65. Easy installation and maintenance free throughout the years of usage.

Key Features & Benefits

- ▶ Energy Star / DLC Compliant / Title 24
- ▶ IP65 Rating
- ▶ Uniform and consistent color
- ▶ Dusk to Dawn sensor included
- ▶ Excellent thermal design
- ▶ 15-30 foot height performance
- ▶ Universal Voltage 120-277V
- ▶ Operating Temp: -22°F~122°F
- ▶ Photocell Sensor included
- ▶ 50,000 hrs rated average life

Applications





















- ▶ Security Lighting
- ▶ Pathway Lighting
- ▶ Perimeter Lighting
- ▶ Area Lighting

Color Choices



Qualifications



Item Code	Description	Color Temp	Wattage	Lumen Output	Sensor	Equivalent Wattage	Voltage (V)	CRI	Rated Hours				
 7136	LED-FXSECW20/40K	4000K	20	1,446	Photocell	75	120-277	80	50,000				
7137	LED-FXSECW20/50K	5000K	20	1,489	Photocell	75	120-277	80	50,000				
 7190	LED-FXSECD28/40K	4000K	28	3,076	Photocell	100	120-277	72	50,000				
7191	LED-FXSECD28/50K	5000K	28	3,180	Photocell	100	120-277	72	50,000				
7477	LED-FXSECD38/40K	4000K	38	4,158	Photocell	150	120-277	72	50,000				
7478	LED-FXSECD38/50K	5000K	38	4,314	Photocell	150	120-277	72	50,000				
 7140	LED-FXSECD37/40K	4000K	37	2,753	Photocell	100	120-277	85	50,000				
7141	LED-FXSECD37/50K	5000K	37	2,989	Photocell	100	120-277	80	50,000				

ACCESSORIES

P10054	MT-DEA16	Dusk to Dawn 16" Extension Arm Pole
P10053	SEN-PHO-LK-MT/SRT	Twist-Lock Mount Shorting Cap

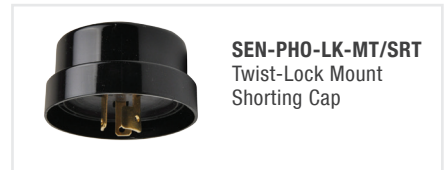

► Dimensions

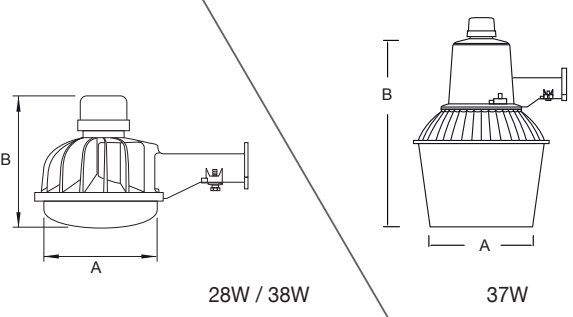
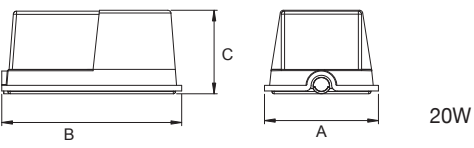
 <p>28W / 38W</p> <p>37W</p>	Wattage	A	B	C	Weight (lbs)
	Security 28W	6.70 -in	8.00-in	--	4.30
	Security 38W	6.70 -in	8.00-in	--	4.46
 <p>20W</p>	Barn 37W	9.65-in	18.50 -in	--	3.69
	Wall Light 20W	6.89 -in	11.00-in	5.16 -in	2.60

► Illuminance Distribution

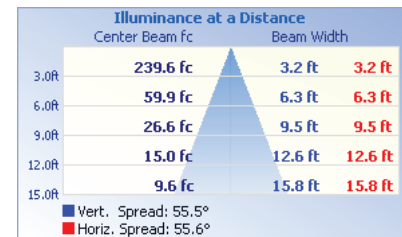
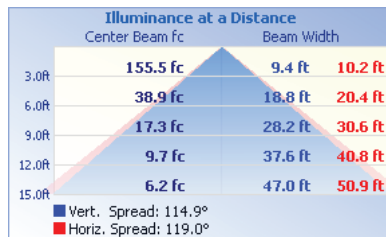
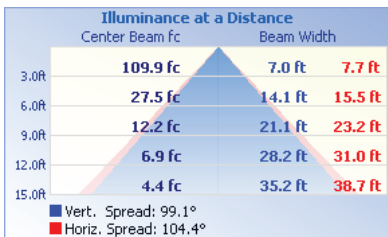
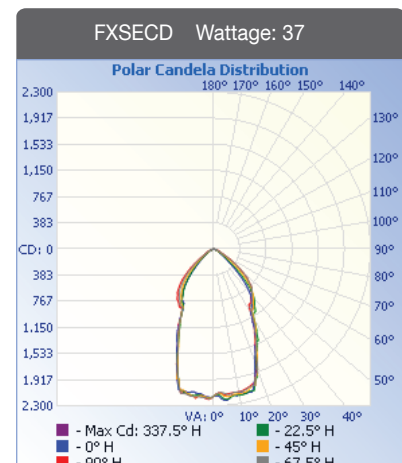
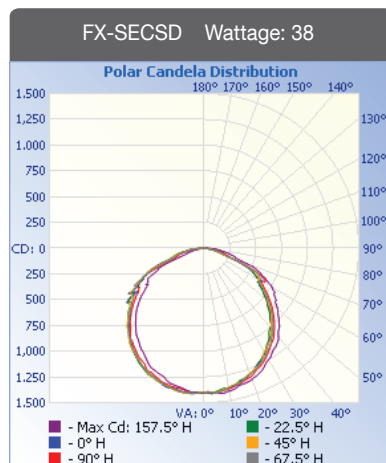
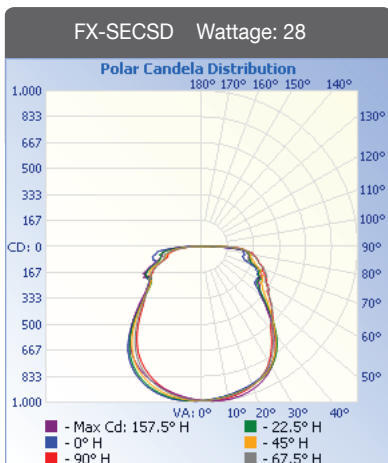

▶ Master Carton Package

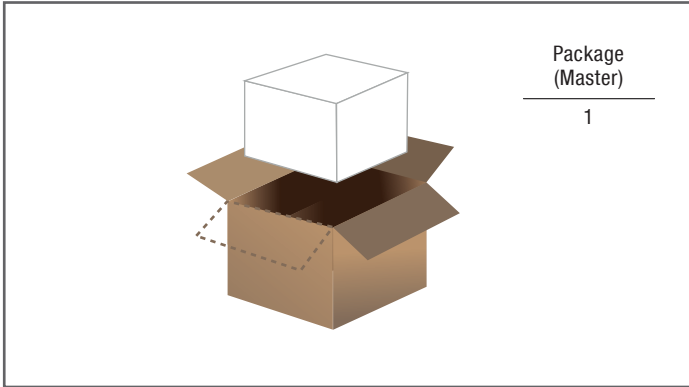



Turning Light into Savings ▶▶▶



BFS/BFD/SFD Wall Lights, Floodlights 10W, 20W

With a full array of Wall and Flood Lights, naturaLED has a wide selection of bullet floodlights (double head), bulkhead wall lights, and decorative wall sconces.

Our Floodlights and Wall Lights come in 10-watt and 20-watt to replace your existing incandescent up to 180-watt, saving up to 80% of energy. It is a great value energy efficient LED, using less energy and lasts up to 50,000 hours average life.

naturaLED® wall light are ideal lighting solution for security lights, residential and commercial, retail and any outdoor applications.



Key Features & Benefits

- ▶ UL Wet Locations
- ▶ Direct replacement and Instant On
- ▶ Up to 80% energy savings
- ▶ Contains no mercury or lead
- ▶ UL/cUL Listed
- ▶ Rated 50,000 hours average life
- ▶ 5 Years Limited Warranty
- ▶ Motion Sensor included

Applications

- ▶ Security Lighting
- ▶ Accent Lighting
- ▶ General Lighting
- ▶ Residential Lighting
- ▶ Restaurant Lighting
- ▶ Outdoor Lighting
- ▶ Wall Lighting

Color Choices



Qualifications



Item Code	Description	Color Temp	Wattage	Lumen Output	Equivalent Wattage	Beam Angle	Voltage	Color	Rated Hours	Sensor	
-----------	-------------	------------	---------	--------------	--------------------	------------	---------	-------	-------------	--------	--



Double Head Flood light with Motion Sensor

★ 7030	LED-FXBFD20/830/BK-SEN	3000K	20	1,400	180	70°	120-277	Black	50,000	•	•
★ 7031	LED-FXBFD20/850/BK-SEN	5000K	20	1,400	180	70°	120-277	Black	50,000	•	•
★ 7066	LED-FXBFD20/830/WH-SEN	3000K	20	1,400	180	70°	120-277	White	50,000	•	•
★ 7067	LED-FXBFD20/850/WH-SEN	5000K	20	1,400	180	70°	120-277	White	50,000	•	•



Double Head Flood light with Motion Sensor

★ 7032	LED-FXSFD20/830/WH-SEN	3000K	20	1,400	180	70°	120-277	White	50,000	•	•
★ 7033	LED-FXSFD20/850/WH-SEN	5000K	20	1,400	180	70°	120-277	White	50,000	•	•



Bulkhead Wall Light

★ 7024	LED-FXBWL10/830/BK	3000K	10	900	90	--	120-277	Black	50,000		•
★ 7025	LED-FXBWL10/850/BK	5000K	10	900	90	--	120-277	Black	50,000		•
★ 7062	LED-FXBWL10/830/WH	3000K	10	900	90	--	120-277	White	50,000		•



Decorative Wall Sconce

★ 7026	LED-FXDWS10/830/BK	3000K	10	700	90	--	120-277	Black	50,000		•
★ 7027	LED-FXDWS10/850/BK	5000K	10	700	90	--	120-277	Black	50,000		•
★ 7064	LED-FXDWS20/830/BK	3000K	20	1,400		--	120-277	Black	50,000		•
★ 7065	LED-FXDWS20/850/BK	5000K	20	1,400		--	120-277	Black	50,000		•

★ ETA September 2016

► Dimensions

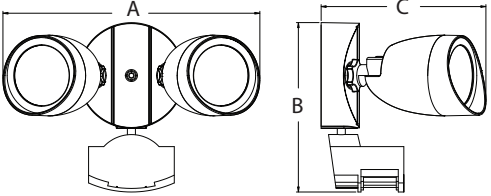
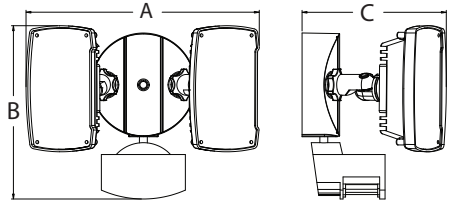
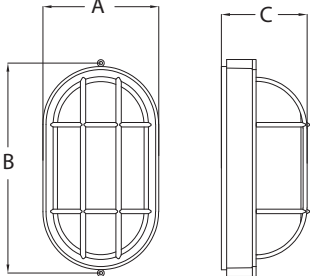
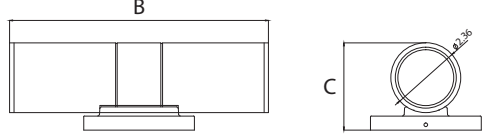
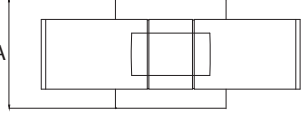
 <p>FXBFD</p>	Item	A	B	C	Weight (lbs)
 <p>FXSFD</p>	FXSFD	9.29-in	6.89-in	5.75-in	1.76
 <p>FXBWL</p>	FXBWL	7.08-in	11.25-in	5.55-in	3.53-lb
 <p>FXDWS 10W</p>	FXDWS 10W	5.00-in	6.70-in	3.15-in	1.54-lb
 <p>FXDWS 20W</p>	FXDWS 20W	5.00-in	11.69-in	3.54-in	2.43-lb

▶ Master Carton Package

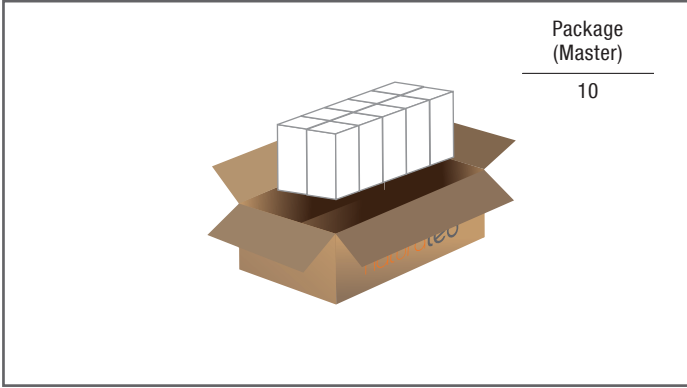

natural^{led}

Turning Light into Savings ▶▶▶



SCM Slim Canopy

45W, 70W

Our Slim canopy is DLC listed and UL listed for wet locations with a rating of IP65.

Aesthetically pleasing construction, low-profile design with die-cast aluminum housing, shatter-resistant polycarbonate prismatic lens. Dustproof, sealed structure, multiple 1/2" conduit entrances on side. The Canopy supports pendant mounting and direct surface ceiling mounting.

Ideal applications for parking garage, walkway and entrance lighting etc.



Key Features & Benefits

- ▶ DesignLights Consortium Certified
- ▶ Built-in Microwave Motion Sensor
- ▶ Default : Light dims at 30% when no motion is detected
- ▶ Long Life LED chips
- ▶ Uniform and consistent color
- ▶ Excellent thermal design
- ▶ Aluminum & glass
- ▶ Universal voltage 100-277V
- ▶ Working temperature : -22°F ~104°F
- ▶ 50,000 hrs rated average life

Applications



- ▶ Area Lighting
- ▶ Security Lighting
- ▶ Pathway Lighting
- ▶ Ceiling Lighting
- ▶ Parking Lighting

Color Choices



Qualifications



Item Code	Description	Color Temp	Wattage	Lumen Output	Equivalent Wattage	Voltage (V)	Beam Angle	CRI	Sensor			
7436	LED-FXSCM45/50K/BK	5000K	45	4,000	175W	120-277	140°	80		●	●	●
7438	LED-FXSCM70/50K/BK	5000K	70	5,900	250W	120-277	140°	80		●	●	●
7437	LED-FXSCM45/50K/WH	5000K	45	4,000	175W	120-277	140°	80		●	●	●
7439	LED-FXSCM70/50K/WH	5000K	70	5,900	250W	120-277	140°	80		●	●	●

Microwave Sensor Included

7560	LED-FXSCM45/50K/BK-SEN	5000K	45	4,000	175W	120-277	140°	80	●	●	●	●
7564	LED-FXSCM70/50K/BK-SEN	5000K	70	5,900	250W	120-277	140°	80	●	●	●	●
7561	LED-FXSCM45/50K/WH-SEN	5000K	45	4,000	175W	120-277	140°	80	●	●	●	●
7565	LED-FXSCM70/50K/WH-SEN	5000K	70	5,900	250W	120-277	140°	80	●	●	●	●

► Dimensions

	Item	A	B	C	D	Weight (lbs)
	45W / 70W	9.60-in	6.90-in	2.80-in	1.77-in	4.50

► Illuminance Distribution

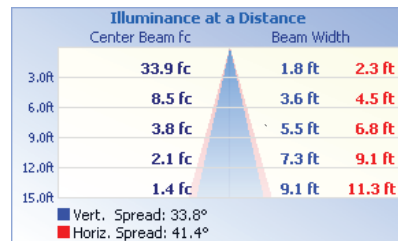
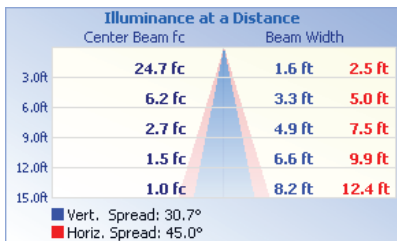
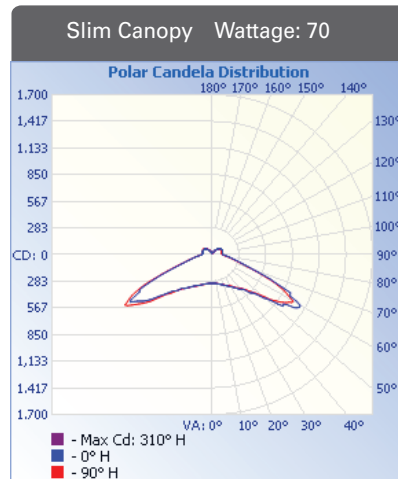
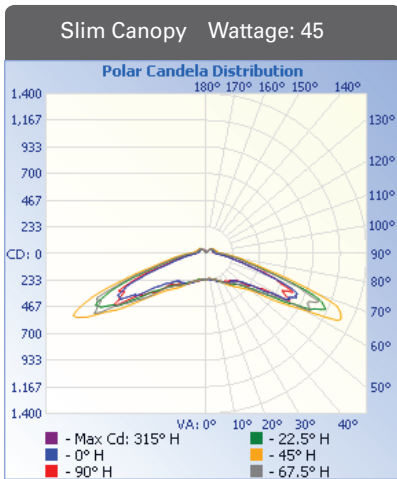

► Master Carton Package

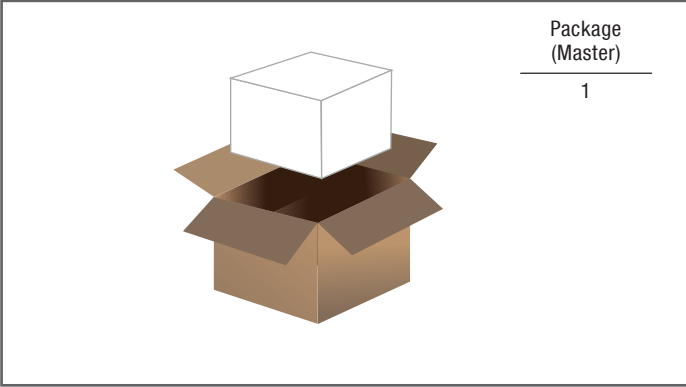



Turning Light into Savings ▶▶▶



Optical Lens
Precise Beam Control



CCM Canopy Ceiling Mount

40W, 60W

Our CCM series brings you our square shape surface mount with polycarbonate lens with excellent thermal design. Die cast aluminum housing, uniform and consistent color, DLC listed. CCM is ideal for any locations wall or ceiling mount.

CCM are used in damp locations such as canopies, covered walkways, entrance eaves, stairwells, parking, etc.

Key Features & Benefits

- ▶ DesignLights Consortium Certified
- ▶ Long Life LED Chips
- ▶ Uniform and consistent color
- ▶ Excellent thermal design
- ▶ 15-30 foot height performance
- ▶ Universal Voltage 120-277V
- ▶ Operating Temp: -22°F~122°F
- ▶ 50,000 hrs rated average life

Applications

- ▶ Area Lighting
- ▶ Security Lighting
- ▶ Pathway Lighting
- ▶ Perimeter Lighting
- ▶ Entryway Lighting
- ▶ Parking Garage

Color Choices





White Bronze

Qualifications



ORDERING INFORMATION

Item Code	Description	Color Temp	Wattage	Lumen Output	Equivalent Wattage	Voltage (V)	CRI	Beam Angle	Rated Hours	Color		
7166	LED-FXCCM40/40K/DB	4000K	40	3,429	175	120-277	82	140°	50,000	Bronze	•	•
7167	LED-FXCCM40/50K/DB	5000K	40	3,429	175	120-277	82	140°	50,000	Bronze	•	•
7538	LED-FXCCM40/40K/WH	4000K	40	3,429	175	120-277	82	140°	50,000	White	•	•
7539	LED-FXCCM40/50K/WH	5000K	40	3,429	175	120-277	82	140°	50,000	White	•	•
7084	LED-FXCCM60/40K/DB	4000K	60	5,258	250	120-277	81	140°	50,000	Bronze	•	•
7085	LED-FXCCM60/50K/DB	5000K	60	4,948	250	120-277	81	140°	50,000	Bronze	•	•
7536	LED-FXCCM60/40K/WH	4000K	60	4,948	250	120-277	81	140°	50,000	White	•	•
7537	LED-FXCCM60/50K/WH	5000K	60	4,948	250	120-277	81	140°	50,000	White	•	•

► Dimensions

	Wattage	A	B	C	Weight (lbs)
	40W	9.00-in	9.00-in	8.00-in	4.70
	60W	12.50-in	12.50-in	9.00-in	7.72

► Illuminance Distribution

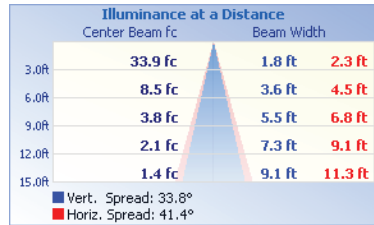
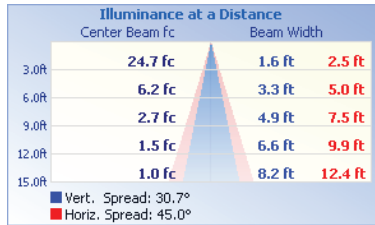
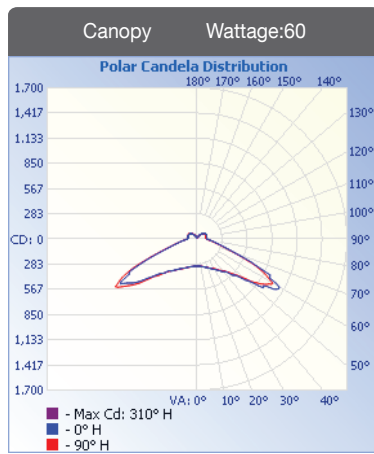
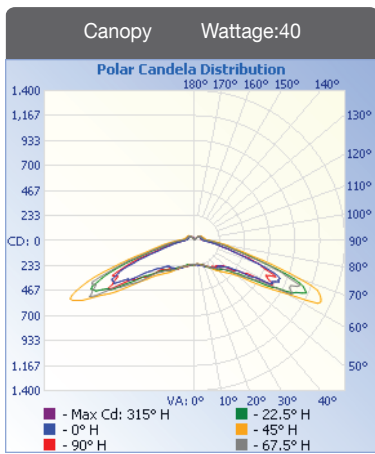

► Master Carton Package

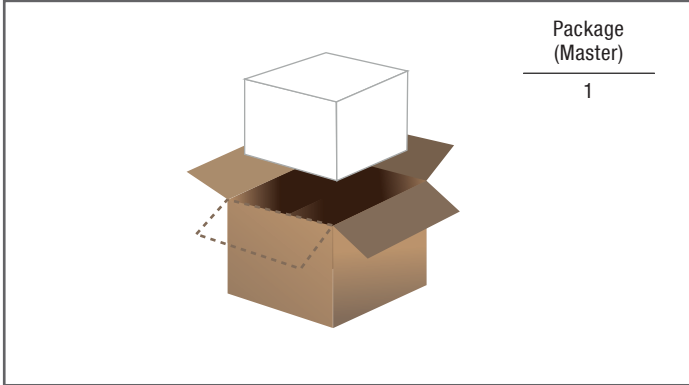

naturalLED®

Turning Light into Savings ▶▶▶



GSC Gas Station Canopy 45W, 75W, 100W, 150W

naturalLED® Gas Station Canopy (GSC) is designed to replace existing under canopy metal halide light fixtures in gas station canopies easily and cost effectively.

Our Gas Station Canopy LED provides advantages such as: longer life, lower energy consumption and better lighting characteristics, eliminated maintenance with 50,000+ hours of rated lamp life. Our fixtures are DLC certified and IP65 rated.



Key Features & Benefits

- ▶ Design Lights Consortium Certified
- ▶ Long Life LED Chips
- ▶ Uniform and consistent color
- ▶ Excellent thermal design
- ▶ Aluminum & Glass
- ▶ Universal Voltage 100-277V
- ▶ Working Temperature : -22°F ~ 130°F
- ▶ 50,000 hrs rated average life

Applications

- ▶ Gas Station Lighting











Color Choices



White

Qualifications



Item Code	Description	Color Temp	Wattage	Lumen Output	Equivalent Wattage	Voltage	Beam Angle	CRI	Rated Hours		
* 7440	LED-FXGSC45/50K/WH	5000K	45	5,400	250W	120-277V	115°	>80	50,000		
* 7441	LED-FXGSC75/50K/WH	5000K	75	9,000	320W	120-277V	115°	>80	50,000		
7553	LED-FXGSC100/50K/WH	5000K	100	12,000	400W	120-277V	115°	>80	50,000		
7555	LED-FXGSC150/50K/WH	5000K	150	18,052	400W	120-277V	115°	>80	50,000		

* ETA End of Aug 2016

► Dimensions

	Item	A	B	C	Weight (lbs)
	45W	12.70-in	1.90-in	10.00-in	15
	75W	12.70-in	1.90-in	10.00-in	15
	100W	18.70-in	1.57-in	9.25-in	24
	150W	18.70-in	1.57-in	9.25-in	24

► Illuminance Distribution

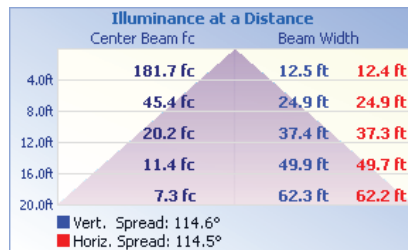
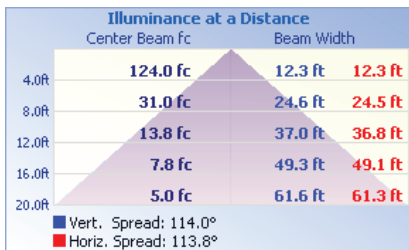
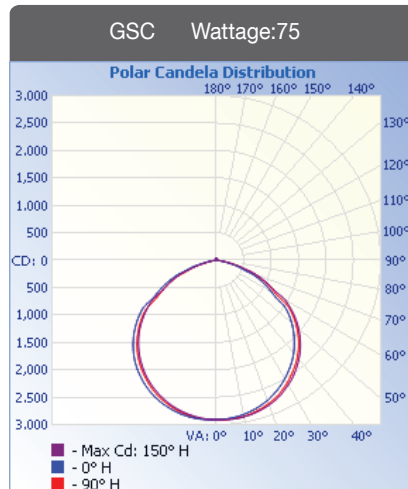
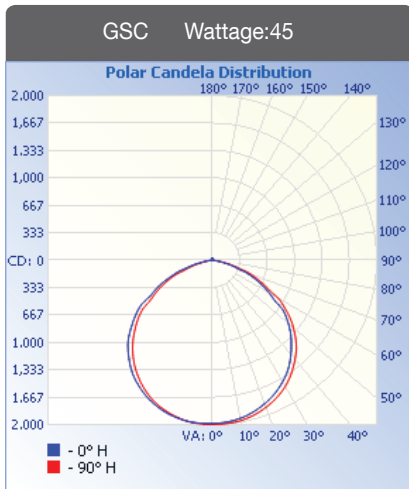

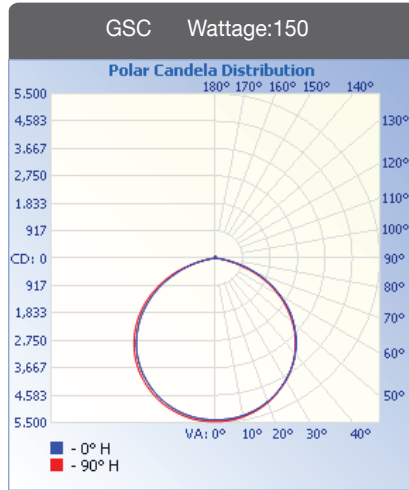
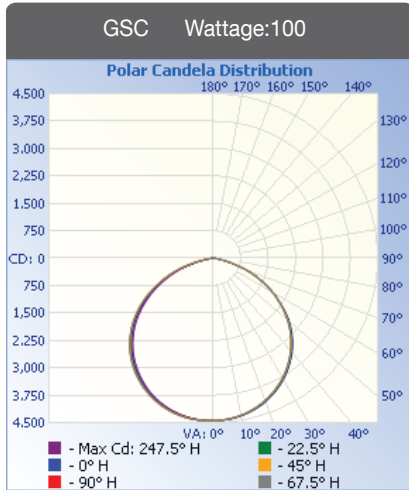

Illuminance at a Distance

	Center Beam fc	Beam Width
3.0R	494.4 fc	9.3 ft 9.3 ft
6.0R	123.6 fc	18.5 ft 18.6 ft
9.0R	54.9 fc	27.8 ft 27.9 ft
12.0R	30.9 fc	37.0 ft 37.2 ft
15.0R	19.8 fc	46.3 ft 46.5 ft

■ Vert. Spread: 114.1°
■ Horiz. Spread: 114.3°

Illuminance at a Distance

	Center Beam fc	Beam Width
4.0R	337.8 fc	12.4 ft 12.6 ft
8.0R	84.4 fc	24.8 ft 25.1 ft
12.0R	37.5 fc	37.2 ft 37.7 ft
16.0R	21.1 fc	49.6 ft 50.3 ft
20.0R	13.5 fc	62.0 ft 62.9 ft

■ Vert. Spread: 114.4°
■ Horiz. Spread: 115.1°

► Master Carton Package

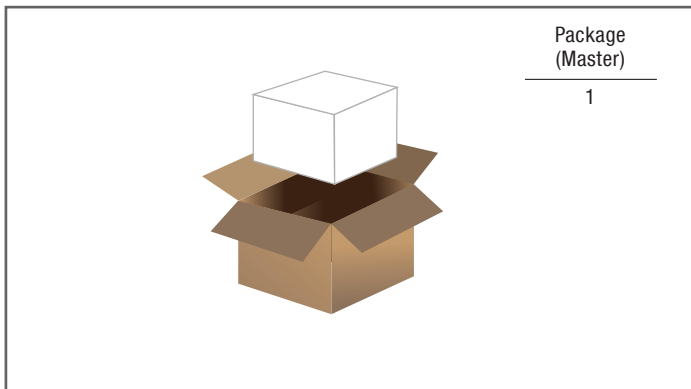

natural^{led}

Turning Light into Savings ▶▶▶



VT Vapor Tight Linear 29W, 58W

Our linear vapor tight is housed in polycarbonate silicon perimeter gasket with brackets for mounting. Engineered for powerful lighting, the IP65-rated LED Vapor Tight Linear Fixtures are designed to replace fluorescent strip fixtures and can be used in parking garage, corporate campus, education facility, storage facility, car washes, tunnels and stairwell lighting.

Using up to 65% less energy and operating for up to 50,000 average life hours, our fixtures comes with a 5-foot extend cable for easy installation.

Key Features & Benefits



- ▶ Designed for maximum operation in commercial environments and can operate in wide range of temperatures (-22°F to 122°F)
- ▶ 4-ft in length
- ▶ Uniform and consistent color
- ▶ Lighter weight housing for easy installation
- ▶ Wide Beam Angle: 153°
- ▶ 5VA Flammability Rating
- ▶ Plastic latches standard
- ▶ 50,000 Hours rated average life
- ▶ Built-in Microwave Motion Sensor
- ▶ Comes with 5-foot power cord whip

Applications

- ▶ Corporate Campus Lighting
- ▶ Education Facilities Lighting
- ▶ Healthcare Facilities Lighting
- ▶ Parking Structure
- ▶ Tunnels
- ▶ Car Washes
- ▶ Stairwell Lighting

Qualifications



Item Code	Description	Color Temp	Wattage	Lumen Output	Equivalent Wattage	Beam Angle	Voltage	Dimmable	Sensor			
7448	LED-FXVTL29/40K	4000K	29	3,238	108	153°	120-277	0-10V		●	●	●
7449	LED-FXVTL29/50K	5000K	29	3,434	108	153°	120-277	0-10V		●	●	●
7450	LED-FXVTL58/40K	4000K	58	6,424	216	153°	120-277	0-10V		●	●	●
7451	LED-FXVTL58/50K	5000K	58	7,010	216	153°	120-277	0-10V		●	●	●

Mircrowave Motion Sensor Included

★ 7582	LED-FXVTL29/40K-SEN	4000K	29	3,238	108	153°	120-277	0-10V	●	●	●	●
★ 7583	LED-FXVTL29/50K-SEN	5000K	29	3,434	108	153°	120-277	0-10V	●	●	●	●
★ 7584	LED-FXVTL58/40K-SEN	4000K	58	6,424	216	153°	120-277	0-10V	●	●	●	●
★ 7585	LED-FXVTL58/50K-SEN	5000K	58	7,010	216	153°	120-277	0-10V	●	●	●	●

★ ETA Aug 2016

► Dimensions

	Item	A	B	C	Weight (lbs)
	29W	49.84-in	4.84-in	2.95-in	4.75
	58W	49.84-in	4.84-in	2.95-in	5.42

► Illuminance Distribution

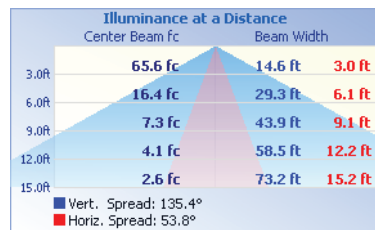
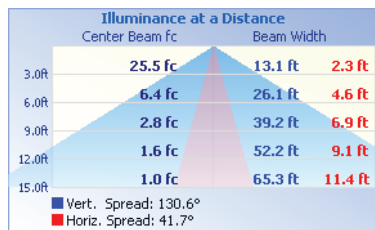
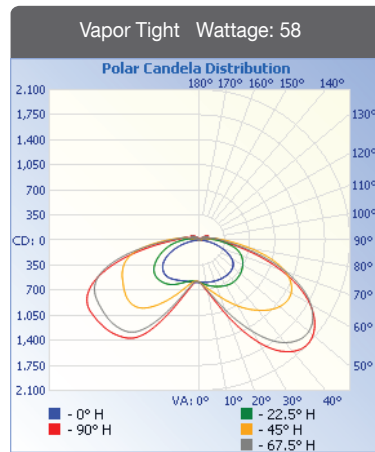
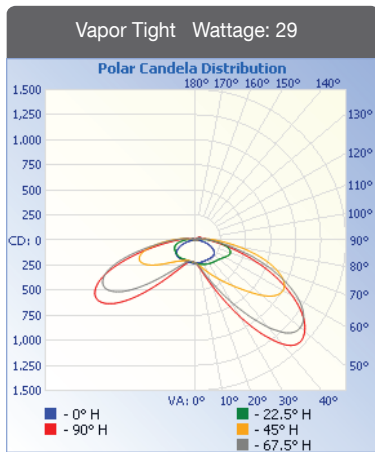

▶ Master Carton Package

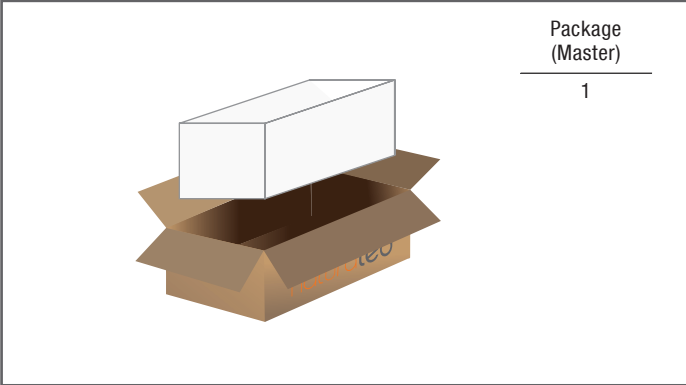



HB/LB

High / Low Bay

70W, 100W, 165W, 200W

naturalLED® offers a variety of High/Low Bay LED Fixtures. Available in 70 watt to 200 watt for producing the perfect lumen output for any application. These fixtures are an excellent replacement for high bays or low bays in applications such as warehouse, retail ceiling lighting and much more.

Our IP67 model is perfectly designed for industrial, retail and commercial interiors and exteriors. Optional compatible wireguards, motion sensors, and photocells are available with these fixtures.



Key Features & Benefits

- ▶ IP67*
- ▶ Uniform and consistent color
- ▶ Aluminum die-cast housing powder coated
- ▶ Excellent thermal design
- ▶ Type V
- ▶ 0-10V dimming
- ▶ Motion sensor available
- ▶ Universal Voltage: 120-277V
- ▶ Operating Temp: -40°F~130°F
- ▶ Extended 9-foot power cable
- ▶ 50,000 hrs rated average life
- ▶ Wireguard available as optional
- ▶ Anti-corrosion (IP67 feature)
- ▶ Shatterproof PC lens (IP67 feature)

Applications

- ▶ Warehouse Lighting
- ▶ Ceiling Lighting
- ▶ Retail Lighting
- ▶ Distribution Lighting
- ▶ Commercial Lighting



Color Choices



Qualifications



* IP67 applies only to 200W Highbay

Item Code	Description	Color Temp	Wattage	Lumen Output	Equivalent Wattage	Voltage (V)	Dimming	Beam Angle	Rated Hours	Color		
7475	LED-FXHB200/40K/IP67	4000K	200	19,000	400-575	120-277	0-10V	Type V	50,000	Silver	●	●
7476	LED-FXHB200/50K/IP67	5000K	200	20,000	400-575	120-277	0-10V	Type V	50,000	Silver	●	●
7125	LED-FXLB70/40K	4000K	70	6,650	175	120-277	0-10V	Type V	50,000	White	●	
7126	LED-FXLB70/50K	5000K	70	7,000	175	120-277	0-10V	Type V	50,000	White	●	
7128	LED-FXHB100/40K	4000K	100	10,100	250	120-277	0-10V	Type V	50,000	White	●	
7129	LED-FXHB100/50K	5000K	100	10,700	250	120-277	0-10V	Type V	50,000	White	●	
7131	LED-FXHB165/40K	4000K	165	13,900	400	120-277	0-10V	Type V	50,000	White	●	
7132	LED-FXHB165/50K	5000K	165	14,630	400	120-277	0-10V	Type V	50,000	White	●	
7170	LED-FXHB200/40K	4000K	200	20,000	400-575	120-277	0-10V	Type V	50,000	White	●	
7171	LED-FXHB200/50K	5000K	200	20,500	400-575	120-277	0-10V	Type V	50,000	White	●	

ACCESSORIES

Wireguard

P10027	WG-CBL18/WH	For indoor fixture only
--------	-------------	-------------------------

Motion Sensor for Indoor Application

► On/Off

P10038	SEN-LOS-501-SED	100-277V 2X D Lens
P10040	SEN-LOS-501-SEC	100-277V 3X C Lens

► Dimmable

P10042	SEN-LOD-500-SED	100-277V 2X D Lens
P10044	SEN-LOD-500-SEC	100-277V 3X C Lens

Motion Sensor for Outdoor Application

► On/Off

P10039	SEN-LOS-501-SPD	100-277V 2X D Lens
P10041	SEN-LOS-501-SPC	100-277V 3X C Lens

► Dimmable

P10043	SEN-LOD-500-SPD	100-277V 2X D Lens
P10045	SEN-LOD-500-SPC	100-277V 3X C Lens



SEN-LOD-SEC/SPC
Height: 15-30ft
(3-Times Height Coverage)

Available in IP66



SEN-LOD-SED/SPD
Height: 8-20 ft
(2-Times Height Coverage)

► Dimensions

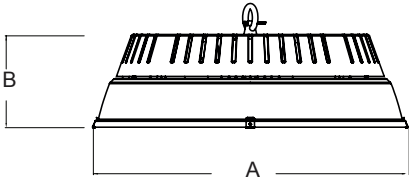
	Wattage	A	B	Weight (lbs)
	200W	17.80-in	9.80-in	15.00
	70W /100W	17.80-in	7.20-in	10.00
	165W / 200W	17.80-in	8.07-in	10.50

► Illuminance Distribution

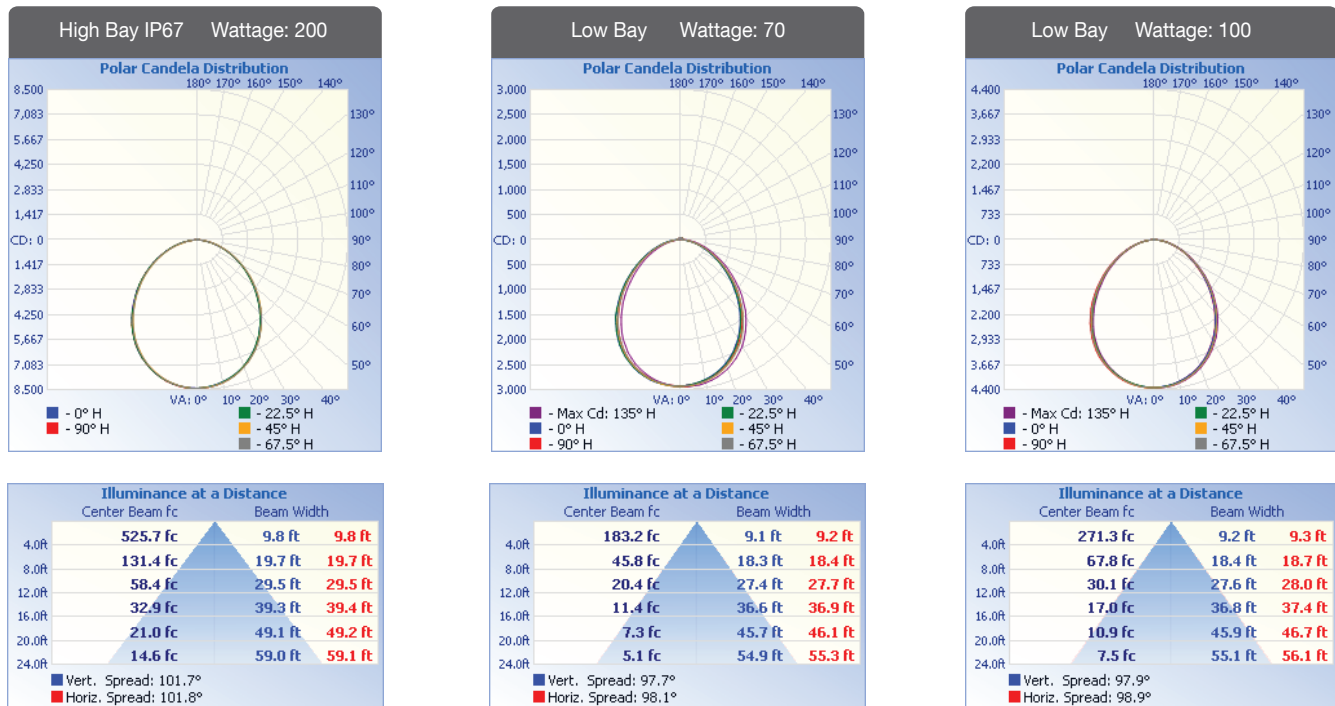

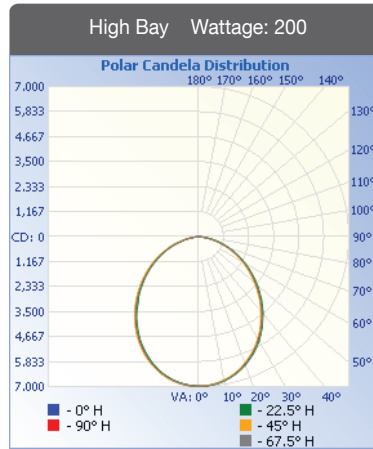
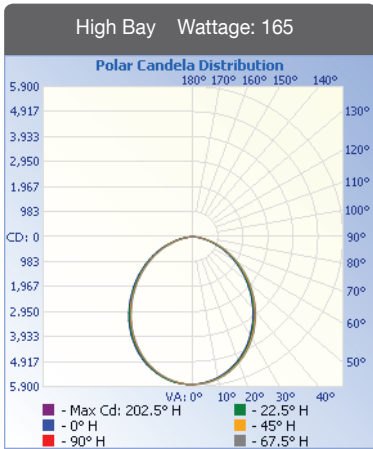

Illuminance at a Distance

	Center Beam fc	Beam Width
4.0ft	363.1 fc	9.5 ft 9.6 ft
8.0ft	90.8 fc	19.1 ft 19.1 ft
12.0ft	40.3 fc	28.6 ft 28.7 ft
16.0ft	22.7 fc	38.1 ft 38.3 ft
20.0ft	14.5 fc	47.7 ft 47.9 ft
24.0ft	10.1 fc	57.2 ft 57.4 ft

■ Vert. Spread: 100.0°
■ Horiz. Spread: 100.2°

Illuminance at a Distance

	Center Beam fc	Beam Width
4.0ft	436.2 fc	9.5 ft 9.6 ft
8.0ft	109.0 fc	19.0 ft 19.2 ft
12.0ft	48.5 fc	28.5 ft 28.8 ft
16.0ft	27.3 fc	38.0 ft 38.3 ft
20.0ft	17.4 fc	47.5 ft 47.9 ft
24.0ft	12.1 fc	57.0 ft 57.5 ft

■ Vert. Spread: 99.8°
■ Horiz. Spread: 100.3°

► Master Carton Package

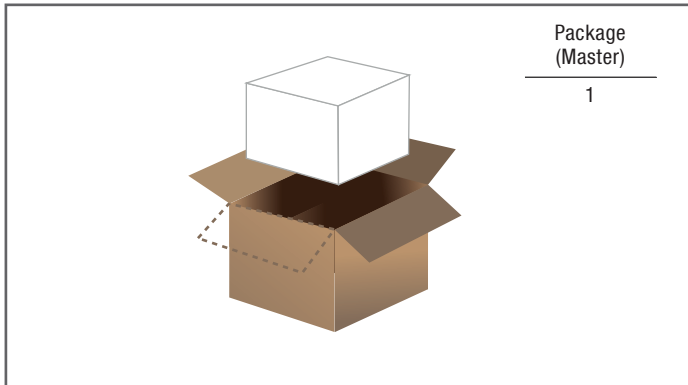

natural^{led}

Turning Light into Savings ▶▶▶



Compatible with
battery back up



TF 2'x2' / 2'x4' Troffer 38W, 50W, 76W

Our naturalLED Troffers are a perfect solution for grid ceiling needs. Our sizes are available in 2'x2' and 2'x4'. These light fixtures are designed for energy saving and easy installation. The integrated LED replacement uses 30% less power but produces the same original light as fluorescent troffers.

Our troffers are available in five different wattages comparable up to 130 watt fluorescent (4x32W T8 fluorescent tube) delivering up to 6,900 lumens with excellent uniformity and consistent color.

Key Features & Benefits

- ▶ Lightweight for easy installation
- ▶ Available in 2'x2' and 2'x4' configurations
- ▶ Uniform and consistent color
- ▶ Excellent thermal design
- ▶ Long life LED chips
- ▶ 0-10V dimming/ Dimming range of 5%-100%
- ▶ Powerfactor >0.9
- ▶ 120-277V
- ▶ 50,000 hrs rated average life

Applications

- ▶ Conference/ Meeting Rooms
- ▶ Factories/ Offices
- ▶ Schools/ Universities
- ▶ Hospitals
- ▶ Hotels



Color Choices



White

Qualifications



Item Code	Description	Color Temp	Wattage	Lumen Output	Equivalent Wattage	Voltage (V)	Dimming	Rated Hours	Size		
2'x2' Fixture											
7150	LED-FXTF38/2X2/835	3500K	38	3,545	60-70	120-277	0-10V	50,000	2'x2'	●	●
7151	LED-FXTF38/2X2/840	4000K	38	3,545	60-70	120-277	0-10V	50,000	2'x2'	●	●
7152	LED-FXTF38/2X2/850	5000K	38	3,545	60-70	120-277	0-10V	50,000	2'x2'	●	●

2'x4' Fixture											
7183	LED-FXTF50/2X4/835	3500K	50	4,953	90-100 (3 lamp fixture)	120-277	0-10V	50,000	2'x4'	●	●
7184	LED-FXTF50/2X4/840	4000K	50	4,953	90-100 (3 lamp fixture)	120-277	0-10V	50,000	2'x4'	●	●
7185	LED-FXTF50/2X4/850	5000K	50	4,953	90-100 (3 lamp fixture)	120-277	0-10V	50,000	2'x4'	●	●
7153	LED-FXTF76/2X4/835	3500K	76	6,903	120-130 (4 lamp fixture)	120-277	0-10V	50,000	2'x4'	●	●
7154	LED-FXTF76/2X4/840	4000K	76	6,903	120-130 (4 lamp fixture)	120-277	0-10V	50,000	2'x4'	●	●
7155	LED-FXTF76/2X4/850	5000K	76	6,903	120-130 (4 lamp fixture)	120-277	0-10V	50,000	2'x4'	●	●

► Dimensions

	Wattage	A	B	C	Weight (lbs)
	2'x2'	23.75-in	23.75-in	4.50-in	7.95
	2'x4'	48.00-in	23.75-in	4.50-in	9.95

► Illuminance Distribution

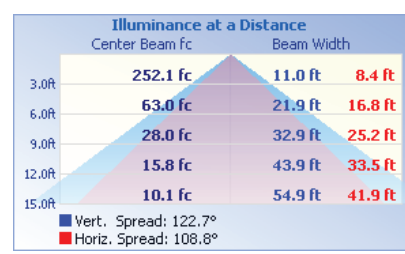
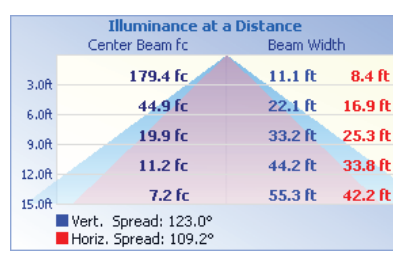
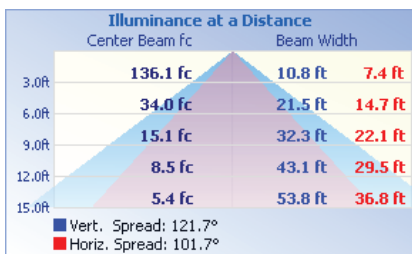
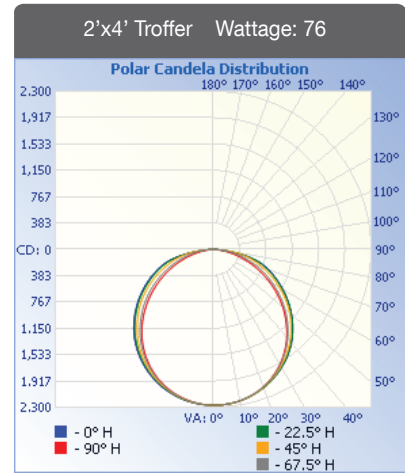
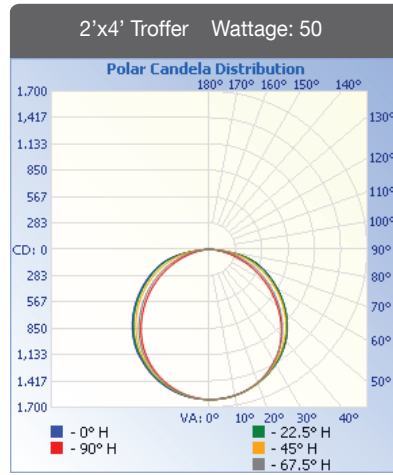
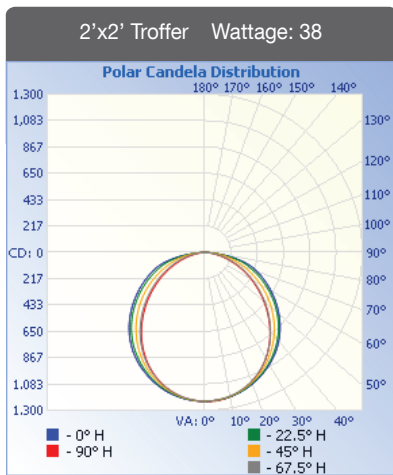

► Master Carton Package

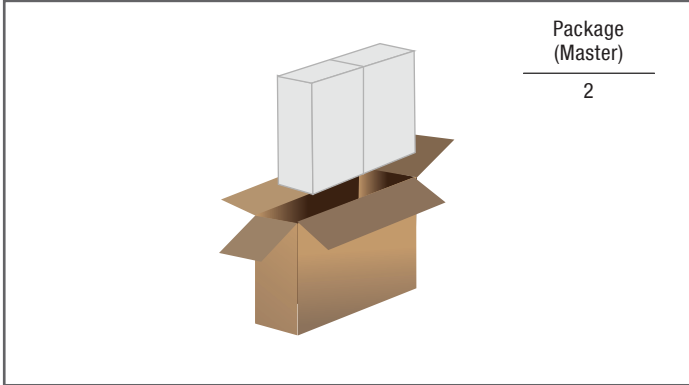



DAL Decorative Accent 23W

naturalLED® decorative accent design features clear-white acrylic diffusers with polished chrome frames. The dimmable, 50,000 rated life hours long-life 3000K and 4000K LEDs make this perfect for energy-saving applications and low-maintenance operation.

Available in different length of 1 feet and 2 feet offers flood illuminance lighting for your vanity design.



Key Features & Benefits

- ▶ Lightweight for easy installation
- ▶ Available in 1 feet and 2 feet configurations
- ▶ Uniform and consistent color
- ▶ Excellent thermal design
- ▶ Long life LED chips
- ▶ Dimmable
- ▶ 120V
- ▶ 50,000 hrs rated average life

Applications

- ▶ Bathroom Lighting
- ▶ Over Mirror Lighting
- ▶ Hotel Bathroom Lighting
- ▶ Furniture Top Lighting
- ▶ Make-up Mirror Lighting

Color Choices



White

Qualifications



ORDERING INFORMATION

Item Code	Description	Color Temp	Wattage	Lumen Output	Voltage (V)	Dimmable	Rated Hours	Length	
* 7018	LED-FXDAL23/12FR/830/NI	3000K	23	1,610	120	YES	50,000	12"	•
* 7019	LED-FXDAL23/12FR/840/NI	4000K	23	1,610	120	YES	50,000	12"	•
* 7020	LED-FXDAL23/24FR/830/NI	3000K	23	2,000	120	YES	50,000	24"	•
* 7021	LED-FXDAL23/24FR/840/NI	4000K	23	2,000	120	YES	50,000	24"	•

* ETA August 2016

► Dimensions

	Wattage	A	B	C	Weight (lbs)
	23W	12-in	9.45-in	3.86-in	2.42
	23W	24-in	4.98-in	4.11-in	2.60

► Illuminance Distribution

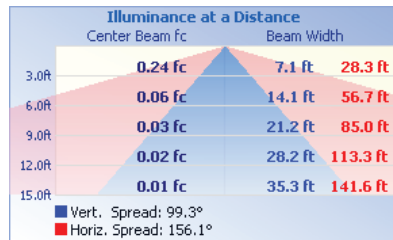
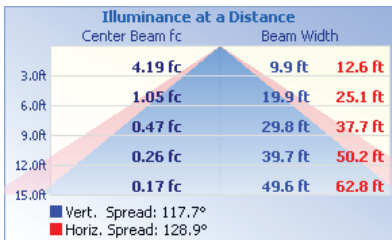
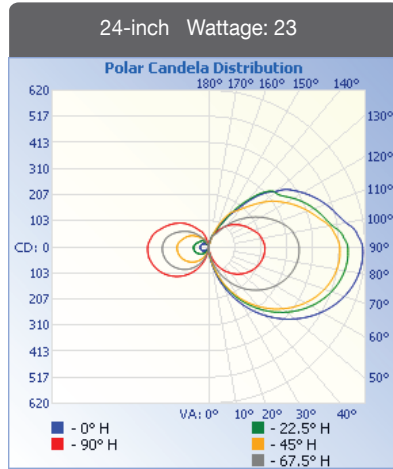
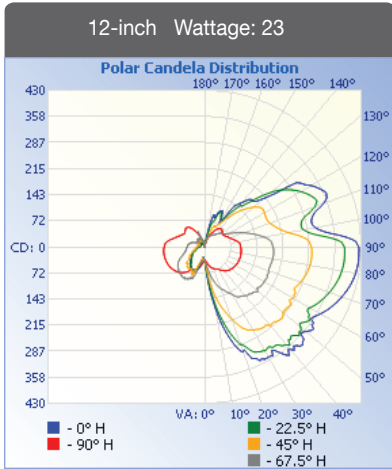

▶ Master Carton Package

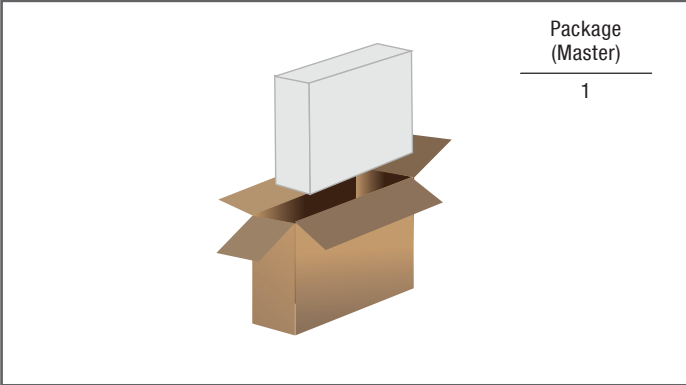

natural^{led}

Turning Light into Savings ▶▶▶



FMM Flush Mount Modern 18W, 22W, 26W

Our FMM series ceiling light is perfect for kitchens and open areas, hallways, bedrooms and any decorative lighting. Brighten your room with our energy efficient LED with our FMM ceiling. The design features low-profile body with nickel finish accents and a white acrylic diffuser.

Available in 3 sizes and replaces up to 200 watt incandescent bulbs.



Key Features & Benefits

- ▶ Easy Installation
- ▶ Energy Star Certified
- ▶ Uniform light distribution and consistent color
- ▶ Instant On
- ▶ Non-yellowing acrylic
- ▶ CRI: 80
- ▶ Dimmable
- ▶ 50,000 hrs rated average life

Applications

- ▶ Kitchen Lighting
- ▶ Decoration Lighting
- ▶ Hallway Lighting
- ▶ Bedroom Lighting

Color Choices



Nickel

Qualifications



ORDERING INFORMATION

Item Code	Description	Color Temp	Wattage	Lumen Output	Equivalent Wattage	Size	Voltage (V)	Rated Hours	Dimmable	
7430	LED12FMM-138L830-NI	3000K	18	1,380	120	12-inch	120	50,000	•	•
7431	LED12FMM-138L840-NI	4000K	18	1,380	120	12-inch	120	50,000	•	•
7433	LED14FMM-165L830-NI	3000K	22	1,652	150	14-inch	120	50,000	•	•
7434	LED14FMM-165L840-NI	4000K	22	1,652	150	14-inch	120	50,000	•	•
7533	LED16FMM-196L830-NI	3000K	26	1,960	200	16-inch	120	50,000	•	•
7534	LED16FMM-196L840-NI	4000K	26	1,960	200	16-inch	120	50,000	•	•

► Dimensions

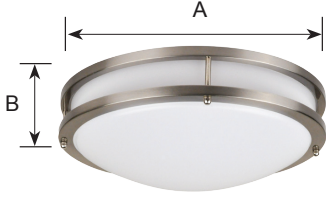
	Size	A	B	Weight (lbs)
	12-inch	12.00-in	3.35-in	1.96
	14-inch	14.00-in	3.74-in	2.49
	16-inch	16.00-in	4.33-in	3.01

► Illuminance Distribution

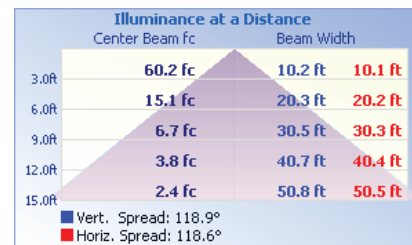
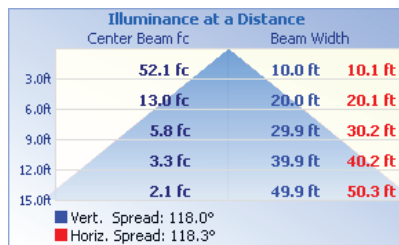
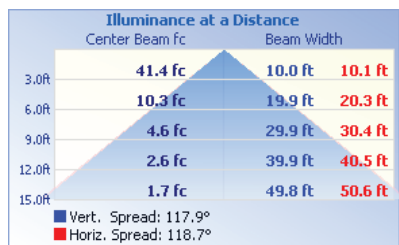
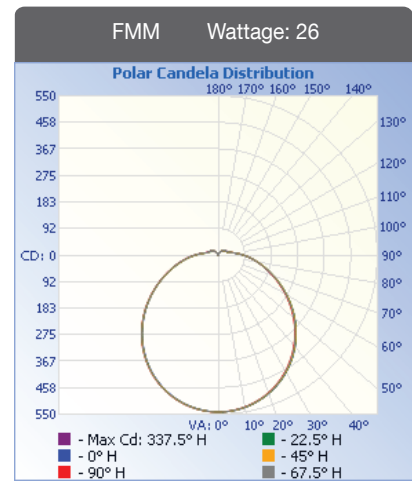
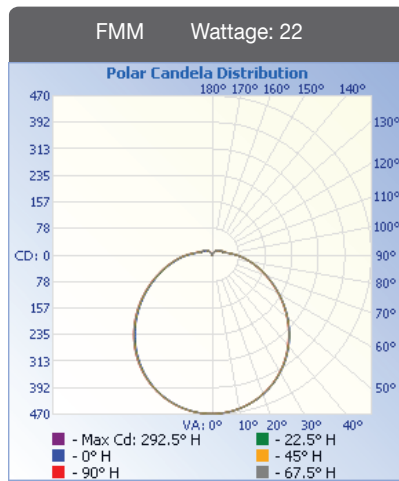
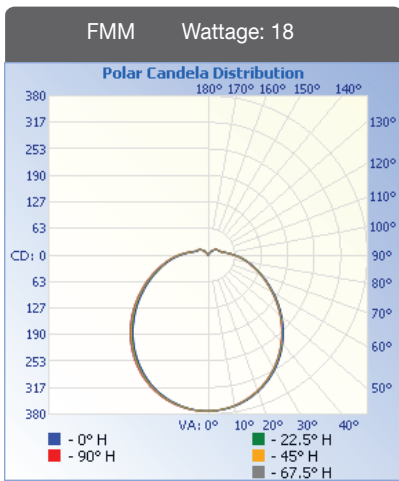

► Master Carton Package

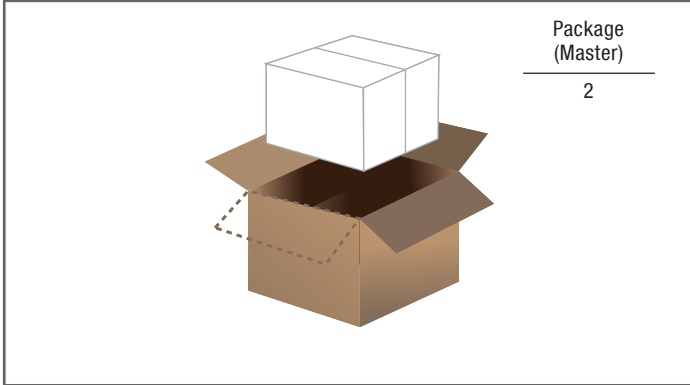

natural^{led}

Turning Light into Savings ▶▶▶



FMS Flush Mount Streamlined 14W, 22W

Featuring our new FMS flush mount Streamlined. Our LED flush mount saves much more than CFL or incandescent light. Our FMS is an excellent choice for a variety of spaces.

With a simple and clean design, our flush mount gives off an even light distribution.

Available in 11-inch and 15-inch, we also make it in two different colors to better fit your needs.



Key Features & Benefits

- ▶ Easy Installation
- ▶ Energy Star Certified
- ▶ Twist Lock Glass Lens or acrylic optional
- ▶ Uniform light distribution and consistent color
- ▶ Dimmable / Instant On
- ▶ Voltage: 120V
- ▶ 50,000 hrs rated average life

Applications

- ▶ Bathroom Lighting
- ▶ Kitchen Lighting
- ▶ Decoration Lighting
- ▶ Hallway Lighting
- ▶ Bedroom Lighting

Color Choices



Nickel Bronze

Qualifications



Item Code	Description	Color Temp	Wattage	Lumen Output	Equivalent Wattage	Size	Voltage (V)	CRI	Color	Rated Hours	Dimmable	
7418	LED11FMS-98L830-BZ	3000K	14	980	100	11-inch	120	84	Bronze	50,000	•	•
7419	LED11FMS-98L840-BZ	4000K	14	980	100	11-inch	120	84	Bronze	50,000	•	•
7421	LED15FMS-154L830-BZ	3000K	22	1,540	150	15-inch	120	82	Bronze	50,000	•	•
7422	LED15FMS-154L840-BZ	4000K	22	1,540	150	15-inch	120	82	Bronze	50,000	•	•
7424	LED11FMS-98L830-NI	3000K	14	980	100	11-inch	120	84	Nickel	50,000	•	•
7425	LED11FMS-98L840-NI	4000K	14	980	100	11-inch	120	84	Nickel	50,000	•	•
7427	LED15FMS-154L830-NI	3000K	22	1,540	150	15-inch	120	82	Nickel	50,000	•	•
7428	LED15FMS-154L840-NI	4000K	22	1,540	150	15-inch	120	82	Nickel	50,000	•	•

► Dimensions

	Size	A	B		Weight (lbs)
	11-inch	11.00-in	3.70-in	--	1.50
	15-inch	15.00-in	4.00-in	--	3.00

► Illuminance Distribution

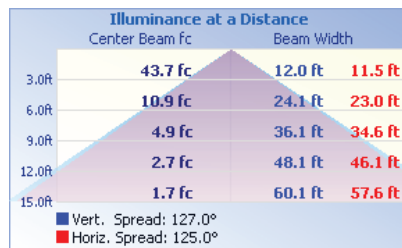
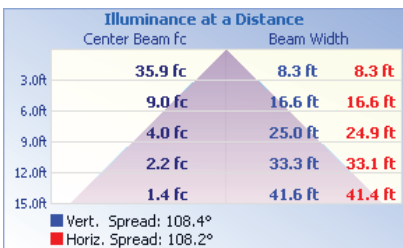
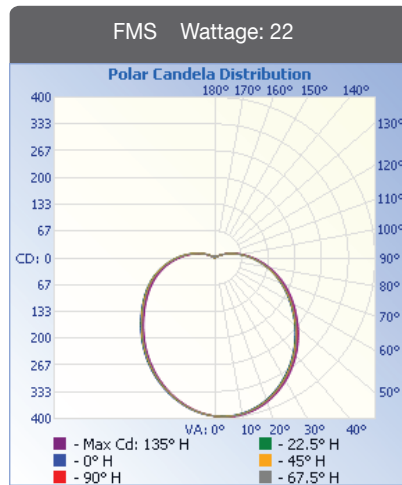
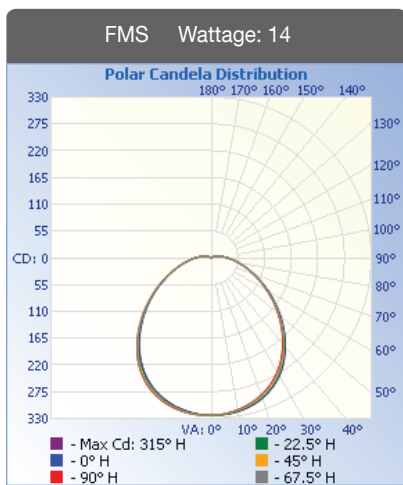

► Master Carton Package

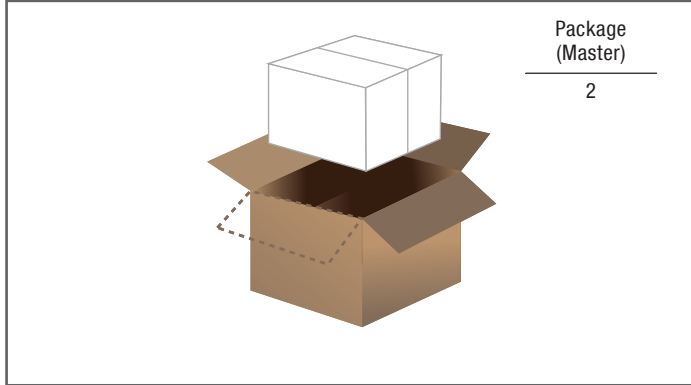



FMR Flush Mount Round 12W, 14W, 22W

Round LED Flush Mount from naturalLED features an acrylic diffuser with a sleek, compact design. This energy-efficient LED lighting solution over incandescent lighting will save you money on operating costs with energy savings up to 86%.

Our easy-latch secures diffuser to housing and makes for easy installation. Suitable for residential or commercial applications, mounting flush to ceiling or wall.



Key Features & Benefits

- ▶ Easy Installation
- ▶ Energy Star Certified
- ▶ Retrofit for CFL and incandescent Flush Mount
- ▶ Uniform light distribution and consistent color
- ▶ Dimmable
- ▶ Instant On
- ▶ Voltage: 120V
- ▶ 50,000 hrs rated average life

Applications

- ▶ Bathroom Lighting
- ▶ Kitchen Lighting
- ▶ Decoration Lighting
- ▶ Hallway Lighting
- ▶ Bedroom Lighting

Color Choices



Acrylic White

Easy Installation

Retrofit for CFL & incandescent Flush Mount



Qualifications



ORDERING INFORMATION

Item Code	Description	Color Temp	Wattage	Lumen Output	Equivalent Wattage	Size	Voltage (V)	CRI	Rated Hours	Dimmable	
★ 7058	LED8FMR-80L830	3000K	12	800	90	8-inch	120	83	35,000	•	•
★ 7059	LED8FMR-80L840	4000K	12	800	90	8-inch	120	83	35,000	•	•
7142	LED12FMR-110L830	3000K	14	1,143	100	12-inch	120	83	50,000	•	•
7143	LED12FMR-110L840	4000K	14	1,143	100	12-inch	120	83	50,000	•	•
7156	LED12FMR-110L850	5000K	14	1,143	100	12-inch	120	83	50,000	•	
7146	LED16FMR-160L830	3000K	22	1,672	150	16-inch	120	85	50,000	•	•
7147	LED16FMR-160L840	4000K	22	1,672	150	16-inch	120	85	50,000	•	•
7157	LED16FMR-160L850	5000K	22	1,672	150	16-inch	120	85	50,000	•	

★ ETA Aug 2016

► Dimensions

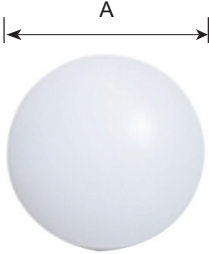
	Size	A			Weight (lbs)
	8-inch (12 Wattage)	8.00-in			1.00
	12-inch (14 Wattage)	12.00-in			1.10
	16-inch (22 Wattage)	16.00-in			1.90

► Illuminance Distribution

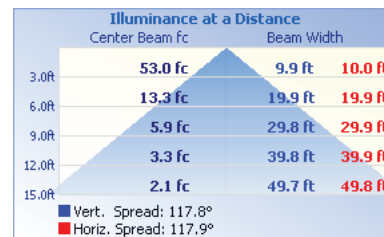
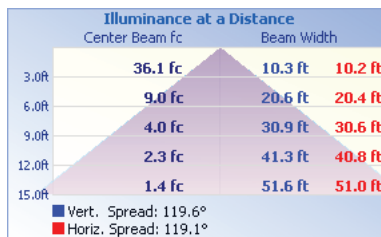
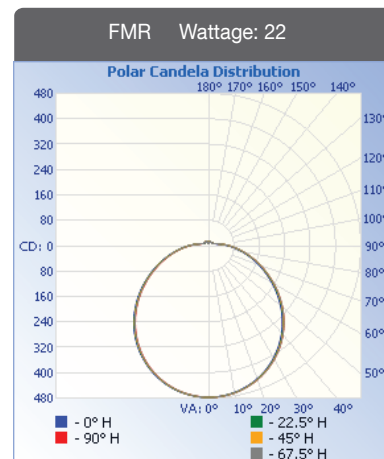
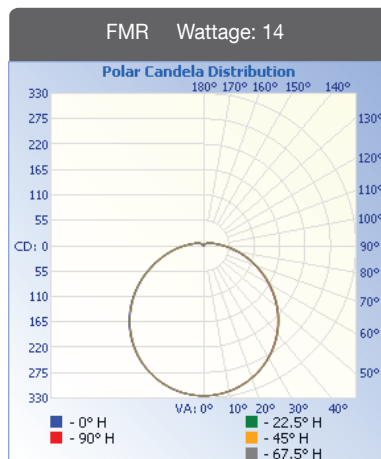

► Master Carton Package

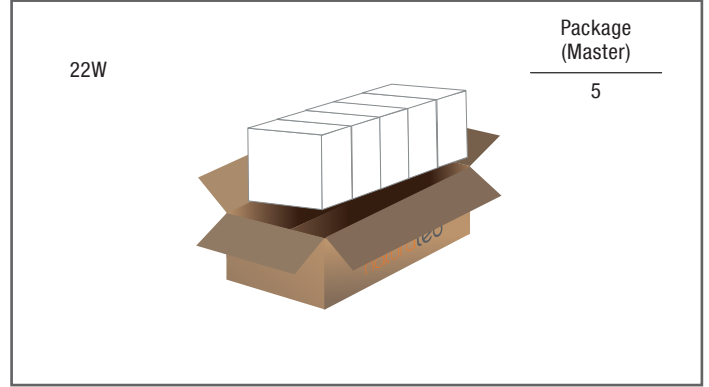
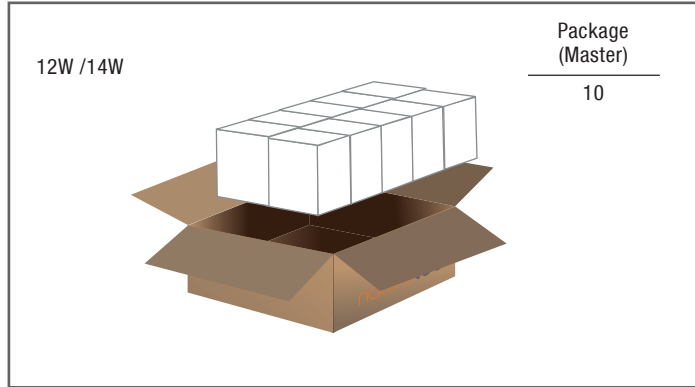



Turning Light into Savings ▶▶▶



FMC Flush Mount Compact 10W, 16W

Compact Flush Mount FMC is an excellent solution to replace traditional flush mount for smaller or limited space areas. naturaLED brings you our FMC series with easy installation that can be mounted to a 4-inch junction box and replacing 75 watt to 120 watt incandescent.

Installed latest DOB (Driver on Board) technology increase the performance reliability over its lifetime with the contemporary compact design. Perfect for both residential and commercial applications. Ideal for bathrooms, closets, smaller rooms, storage areas, hallways and stairways.

Key Features & Benefits

- ▶ Easy Installation
- ▶ Energy Star Certified
- ▶ Retrofit for CFL and incandescent Flush Mount
- ▶ Uniform light distribution and consistent color
- ▶ Dimmable
- ▶ Instant On
- ▶ Voltage: 120V
- ▶ Operating Temperature: -4°F~ 104°F
- ▶ 50,000 hrs rated average life

Applications

- ▶ Bathroom Lighting
- ▶ Kitchen Lighting
- ▶ Decoration Lighting
- ▶ Hallway Lighting
- ▶ Bedroom Lighting



Color Choices



White

Qualifications



Item Code	Description	Color Temp	Wattage	Lumen Output	Equivalent Wattage	Voltage (V)	CRI	Rated Hours	Dimmable		
7454	LED7FMC-70L830	3000K	10	700	75	120	83	50,000	•	•	•
7455	LED7FMC-70L840	4000K	10	700	75	120	83	50,000	•	•	•
7456	LED7FMC-70L850	5000K	10	700	75	120	83	50,000	•	•	•
★ 7055	LED7FMC-110L830	3000K	16	1,100	120	120	>80	35,000	•	•	•
★ 7056	LED7FMC-110L840	4000K	16	1,100	120	120	>80	35,000	•	•	•
★ 7057	LED7FMC-110L850	5000K	16	1,100	120	120	>80	35,000	•	•	•

★ ETA Aug 2016

► Dimensions

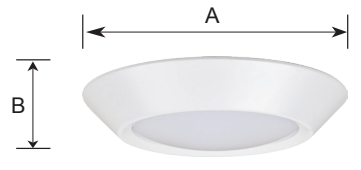
	Wattage	A	B		Weight (lbs)
	10W	7.00-in	1.75-in		1.10
	16W	7.25-in	1.25-in		0.7

► Illuminance Distribution

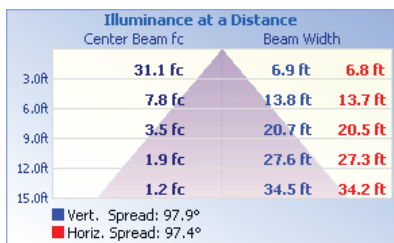
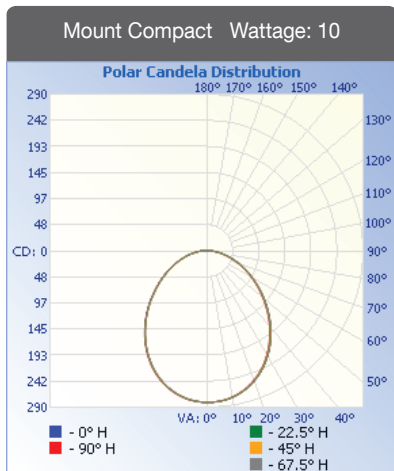

▶ Master Carton Package

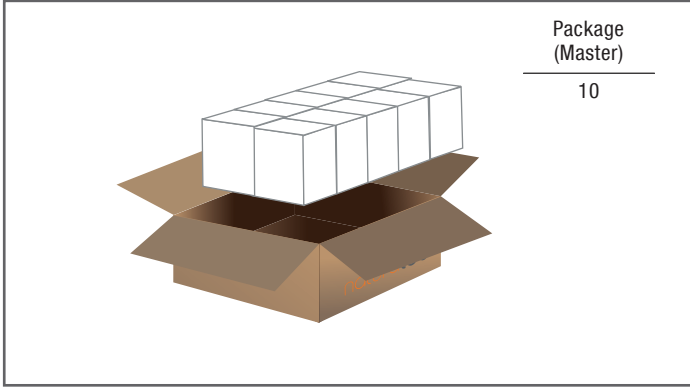

natural^{led}

Turning Light into Savings ▶▶▶



RL Retrofit Downlight (CRI90, CRI80) 9W, 13W

Our RL retrofit downlights are designed as energy-efficient lighting solution replacements for 50 watt and 90 watt incandescent lamps in the industry's most popular 4-inch and 5/6-inch recessed downlight fixtures.

Easy installation and certified Air-Tight, our retrofit recess cans are dimmable and come with built-in power connector. The torsion clips are adjustable to easily fit the recessed can at 5-inch or 6-inch.

Optional color trims in Bronze, Chrome, and Black are available.



Key Features & Benefits

- ▶ Easy Installation
- ▶ Energy Star Certified
- ▶ Certified Air-Tight per ASTM E283-04
- ▶ Meets CEC Standards
- ▶ CRI 80/ 90
- ▶ Voltage: 120V
- ▶ Retrofit 4"/ 5-6" standard recess can
- ▶ Dimmable/ Instant On
- ▶ 35,000/ 50,000 hours rated average life
- ▶ Built-in power connector with adjustable torsion clips

Applications

- ▶ Recessed Can Downlight
- ▶ Residential Lighting
- ▶ Retail Store Lighting
- ▶ School & University
- ▶ Restaurant Lighting

Color Choices (*Optional Trim)



Qualifications



NEW

Available accessories as optional:

1. Color Changing Trim



2. GU24 Base



Item Code	Description	Color Temp	Wattage	Lumen Output	Equivalent Wattage	Diameter	CRI	Rated Hours	Warranty (Years)	Dimmable	Air Tight	
7092	LED4RL-56L30K	3000K	9	560	50	4-in	80	35,000	3	•	•	•
7172	LED4RL-56L40K	4000K	9	560	50	4-in	80	35,000	3	•	•	•
7173	LED4RL-56L50K	5000K	9	560	50	4-in	80	35,000	3	•	•	•
7174	LED6RL-88L40K	4000K	13	880	85	5/6-in	80	35,000	3	•	•	•
7175	LED6RL-88L50K	5000K	13	880	85	5/6-in	80	35,000	3	•	•	•
7562	LED4RL-65L830	3000K	9	650	60	4-in	80	50,000	5	•	•	•
7566	LED4RL-65L840	4000K	9	650	60	4-in	80	50,000	5	•	•	•
7567	LED4RL-65L850	5000K	9	650	60	4-in	80	50,000	5	•	•	•
7563	LED6RL-98L830	3000K	13	980	90	5/6-in	80	50,000	5	•	•	•
7568	LED6RL-98L840	4000K	13	980	90	5/6-in	80	50,000	5	•	•	•
7569	LED6RL-98L850	5000K	13	980	90	5/6-in	80	50,000	5	•	•	•
7580	LED4RL-58L927	2700K	9	580	60	4-in	90	50,000	5	•	•	•
7578	LED4RL-58L930	3000K	9	580	60	4-in	90	50,000	5	•	•	•
7581	LED6RL-88L927	2700K	13	810	90	5/6-in	90	50,000	5	•	•	•
7579	LED6RL-88L930	3000K	13	810	90	5/6-in	90	50,000	5	•	•	•

Accessories

P10029	ADP-RLGU24-N	GU24 Socket Adaptor for LED Recessed Retrofit Kit
P10057	RT-4RL-BK	Recessed Trim: 4-in recessed light (Black)
P10060	RT-6RL-BK	Recessed Trim: 5/6-in recessed light (Black)
P10058	RT-4RL-CH	Recessed Trim: 4-in recessed light (Chrome)
P10061	RT-6RL-CH	Recessed Trim: 5/6-in recessed light (Chrome)
P10059	RT-4RL-BZ	Recessed Trim: 4-in recessed light (Bronze)
P10062	RT-6RL-BZ	Recessed Trim: 5/6-in recessed light (Bronze)

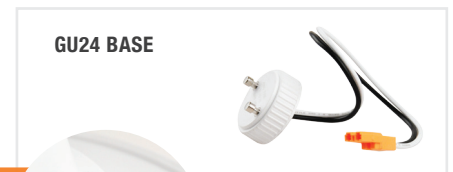
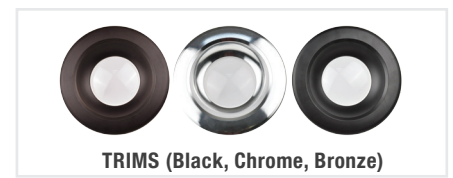

Adjustable Sizing
5" - 6" adjustable torsion clips to better fit the distance needed for installation.

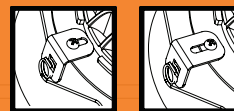

High CRI with LEDs



CRI80

CRI90

Color Rendering Index (CRI) describes how an object appears to the human eye based on ideal or natural light source. The CRI is an index, a measure, that tells something about how colors are represented by light coming from a certain light bulb, compared to how the colors are rendered with the light coming from a reference illuminant.

The CRI reports a unit less value, that can differ between 0 and 100. The value 100 means that there is no difference in color rendition between the light of the observed light bulb and the light of the reference illuminant. Lighting with a CRI of 85 to 90 is typically "excellent" at rendering colors of objects while CRI90 or greater are "superior".

► Dimensions

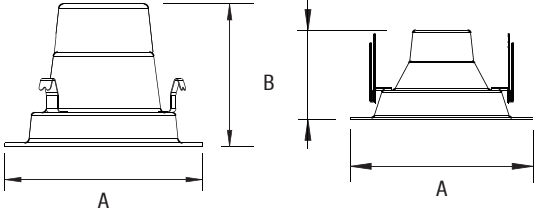
	Size	A	B	Weight (lbs)
	4-inch	5.00-in	3.50-in	0.60
	5/6-inch	7.50-in	3.80-in	0.90

► Illuminance Distribution

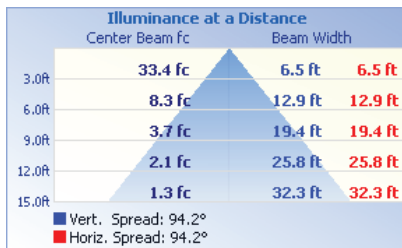
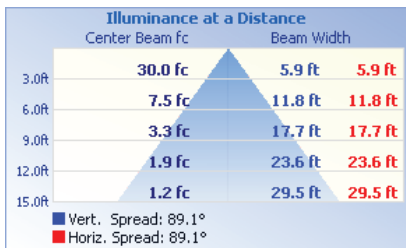
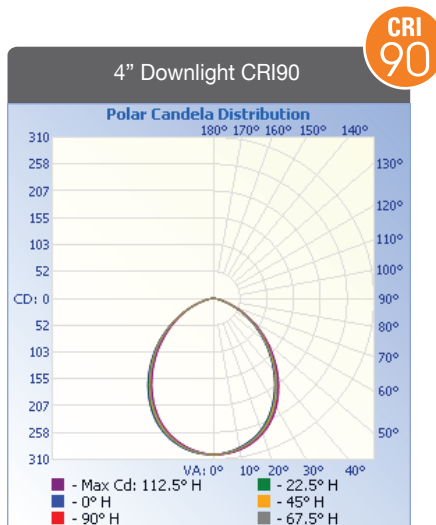
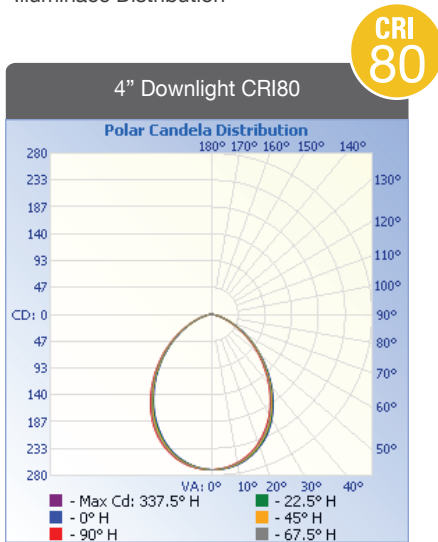

CRI 80

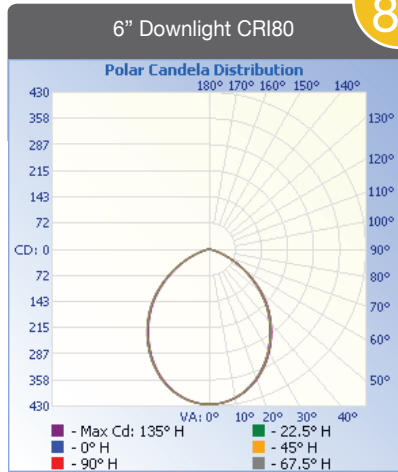

ILLUMINANCE AT A DISTANCE

	Center Beam fc	Beam Width	Beam Width
3.0ft	47.2 fc	6.4 ft	6.4 ft
6.0ft	11.8 fc	12.7 ft	12.8 ft
9.0ft	5.2 fc	19.1 ft	19.2 ft
12.0ft	2.9 fc	25.5 ft	25.5 ft
15.0ft	1.9 fc	31.8 ft	31.9 ft

Vert. Spread: 93.4°
Horiz. Spread: 93.6°

CRI 90

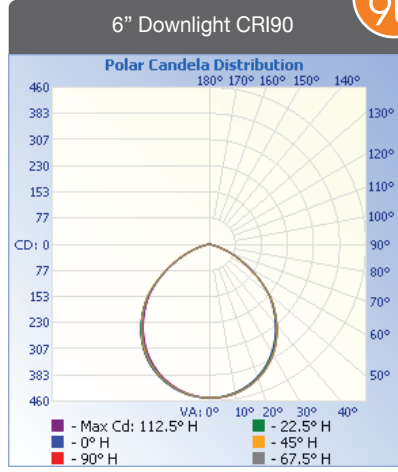

ILLUMINANCE AT A DISTANCE

	Center Beam fc	Beam Width	Beam Width
3.0ft	50.0 fc	7.3 ft	7.3 ft
6.0ft	12.5 fc	14.5 ft	14.5 ft
9.0ft	5.6 fc	21.8 ft	21.8 ft
12.0ft	3.1 fc	29.1 ft	29.1 ft
15.0ft	2.0 fc	36.4 ft	36.3 ft

Vert. Spread: 100.9°
Horiz. Spread: 100.9°

► Master Carton Package

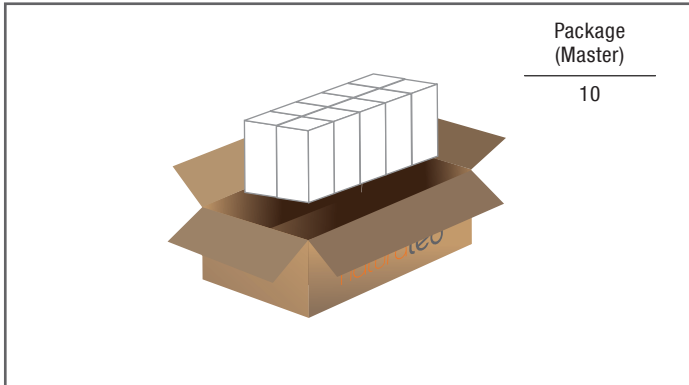

naturalLED®

Turning Light into Savings ▶▶▶



BR, R, A19, G DECORATIVE

5W, 6W, 7W, 9W, 12W, 16W

With a full array of A and BR lamps, naturalLED® offer various replacement for incandescent lamps. Direct replacement lamps for your decorative lighting, which is free of mercury and lead, UL listed and dimmability functions.

Our A19 comes in the choice of 6 watt, 9 watt, and 12 watt to replace your existing incandescent up to 75 watt, saving up to 84% of energy. It is a great value energy efficient lamp, using less energy and lasts up to 25,000 hours average life.

Our BR lamps available in standard medium base (E26), offering in 7 watt to 16 watt replacing up to 100 watt incandescent lamps. Our 14 watt BR30 and 16 watt BR40 are available for an excellent CRI90 meeting your lighting needs.

naturalLED® lamps are ideal lighting solution for track lights, display lights, hotel boutiques, residential, retail, museum lighting and any hospitality applications.



Key Features & Benefits

- ▶ Direct replacement and Instant On
- ▶ Up to 84% energy savings
- ▶ Contains no mercury or lead
- ▶ UL/cUL Listed
- ▶ Rated 15,000~25,000 hours average life
- ▶ 3 Years Limited Warranty

Applications

- ▶ Display Case Lighting
- ▶ Track Lighting
- ▶ Recessed Downlight
- ▶ Accent Lighting
- ▶ General Lighting
- ▶ Residential Lighting
- ▶ Restaurant Lighting

Color Choices



White

Qualifications



Item Code	Description	Bulbs	Color Temp	Wattage	Lumen Output	Equivalent Wattage	CRI	Voltage	Beam Angle	Rated Hours	Dimmable	
A19												
5946	LED6A19/48L/827	A19	2700K	6	450	40	>80	120V	Omni	25,000	•	•
5947	LED6A19/48L/840	A19	4000K	6	450	40	>80	120V	Omni	25,000	•	•
5948	LED6A19/48L/850	A19	5000K	6	450	40	>80	120V	Omni	25,000	•	•
5920	LED9A19/80L/827	A19	2700K	9	800	60	>80	120V	Omni	25,000	•	•
5921	LED9A19/80L/840	A19	4000K	9	800	60	>80	120V	Omni	25,000	•	•
5922	LED9A19/80L/850	A19	5000K	9	800	60	>80	120V	Omni	25,000	•	•
5860	LED12A19/110L/827	A19	2700K	12	1,100	75	>80	120V	Omni	25,000	•	•
5831	LED12A19/110L/840	A19	4000K	12	1,100	75	>80	120V	Omni	25,000	•	•
5832	LED12A19/110L/850	A19	5000K	12	1,100	75	>80	120V	Omni	25,000	•	•
A19-GU24												
5923	LED9A19/80L/GU24/827	A19	2700K	9	800	60	>80	120V	Omni	25,000	•	•
Candelabra / Globe												
5837	LED5CAB/32L/E12/27K	Candle	2700K	5	325	40	>80	120V	Candle	15,000	•	•
5838	LED5CAB/32L/E12/30K	Candle	3000K	5	325	40	>80	120V	Candle	15,000	•	•
5839	LED5CAB/32L/E12/50K	Candle	5000K	5	325	40	>80	120V	Candle	15,000	•	•
5814	LED6G25/45L/27K	G25	2700K	6	450	40	>80	120V	Flood	15,000	•	•
R / BR Lamps												
5834	LED8R20/50L/927	R20	2700K	8	500	50	>90	120V	R20	25,000	•	•
5835	LED9BR30/65L/927	BR30	2700K	9	650	65	>90	120V	BR30	25,000	•	•
5842	LED12BR30/90L/927	BR30	2700K	12	900	75	>90	120V	BR30	25,000	•	•
5836	LED15BR40/120L/927	BR40	2700K	15	1,200	90	>90	120V	BR40	25,000	•	•

► Dimensions

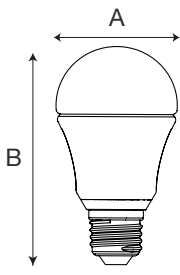
	Item	A	B		Weight (lbs)
	A19 (6-watt)	2.35-in	4.30-in	--	0.20
	A19 (9-watt)	2.35-in	4.60-in	--	0.30
	G25	3.10-in	4.70-in	--	0.30
	Candle	1.50-in	3.80-in	--	0.10

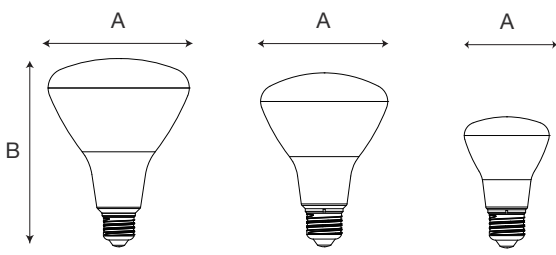
	Item	A	B		Weight (lbs)
	R20	2.50-in	3.80-in	--	0.14
	BR30	3.70-in	5.00-in	--	0.35
	BR40	4.50-in	6.40-in	--	0.57

► Master Carton Package

A19
G25
R20
BR30

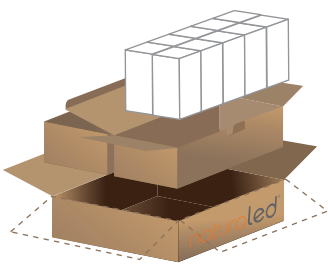

Package
(Master)
20

Candle

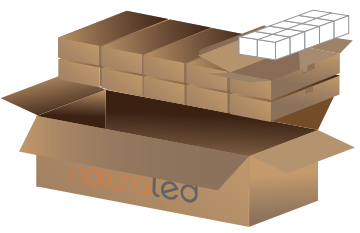

Package
(Master)
100

BR40

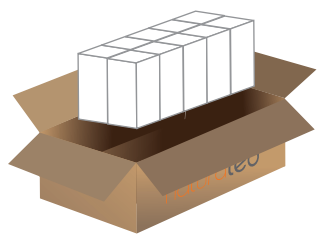

Package
(Master)
10

naturalLED®

Turning Light into Savings ▶▶▶



PAR / MR16 12 Volt / 120 Volt 7W, 9W, 13W

naturalLED® PAR and MR LED bulb provides a superior replacement for all incandescent PAR and MR lamp applications. An energy efficient integrated LED driver deliver the same lumen output equivalent with up to 85% energy savings. Our LEDs are direct replacement with energy star certification.

Perfect for display case lighting, track lighting, jewelry lighting and general lighting.



Key Features & Benefits

- ▶ Energy Star Certified
- ▶ Direct replacement and Instant On
- ▶ Up to 85% energy savings
- ▶ Contains no mercury or lead
- ▶ Noise-free design
- ▶ Beam Angle: 35°/40°
- ▶ UL/cUL Listed
- ▶ Voltage: 120V / 12V
- ▶ Rated 25,000 hours average life
- ▶ 3 Years Limited Warranty

Applications

- ▶ Display Case Lighting
- ▶ Track Lighting
- ▶ Recessed Downlight
- ▶ Accent Lighting
- ▶ General Lighting

Color Choices



White

Qualifications



Item Code	Description	Bulbs	Color Temp	Wattage	Lumen Output	Equivalent Wattage	CBCP	Base	Voltage	Beam Angle	Rated Hours	Dimmable	
PAR													
5924	LED8PAR20/50L/FL/930	PAR20	3000K	8	500	50	--	E26	120V	40°	25,000	•	•
5925	LED8PAR20/50L/FL/950	PAR20	5000K	8	500	50	--	E26	120V	40°	25,000	•	•
5926	LED10PAR30/80L/FL/930	PAR20	3000K	10	800	75	--	E26	120V	40°	25,000	•	•
5927	LED10PAR30/80L/FL/950	PAR30	5000K	10	800	75	--	E26	120V	40°	25,000	•	•
5928	LED10PAR30L/OD/80L/FL/930	PAR30L	3000K	10	800	75	--	E26	120V	40°	25,000	•	•
5929	LED10PAR30L/OD/80L/FL/950	PAR30L	5000K	10	800	75	--	E26	120V	40°	25,000	•	•
5930	LED15PAR38/OD/120L/FL/930	PAR38	3000K	15	1,100	90	--	E26	120V	40°	25,000	•	•
5931	LED15PAR38/OD/120L/FL/950	PAR38	5000K	15	1,200	90	--	E26	120V	40°	25,000	•	•
MR16													
5802	LED7MR16/40L/FL/30K	MR16	3000K	7	400	40	950	GU5.3	12V	40°	25,000		•
5864	LHO-7MR16/FL/30K	MR16	3000K	7	420	35	1,509	GU5.3	12V	35°	25,000	•	•
5849	LHO-7MR16/FL/50K	MR16	5000K	7	450	50	--	GU5.3	12V	35°	25,000	•	
5801	LED7MR16/45L/GU10/FL/30K	MR16	3000K	7	450	50	1,139	GU10	120V	40°	25,000		•
5821	LED7MR16/45L/GU10/FL/50K	MR16	5000K	7	450	50	--	GU10	120V	40°	25,000		

► Dimensions

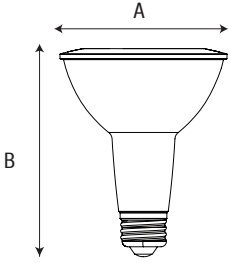
	Item	A	B		Weight (lbs)
	PAR20	2.50-in	3.50-in	--	0.23
	PAR30	3.70-in	3.70-in	--	0.41
	PAR30L	3.70-in	4.50-in	--	0.48
	PAR38	4.75-in	5.25-in	--	0.79

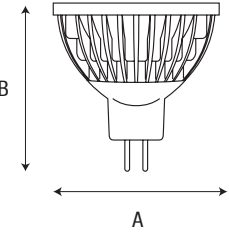
	Item	A	B		Weight (lbs)
	LED-7W	1.97-in	1.91-in	--	0.11
	LH0-7W	1.97-in	1.93-in	--	0.11
	GU10	1.97-in	2.13-in	--	0.11

► Master Carton Package

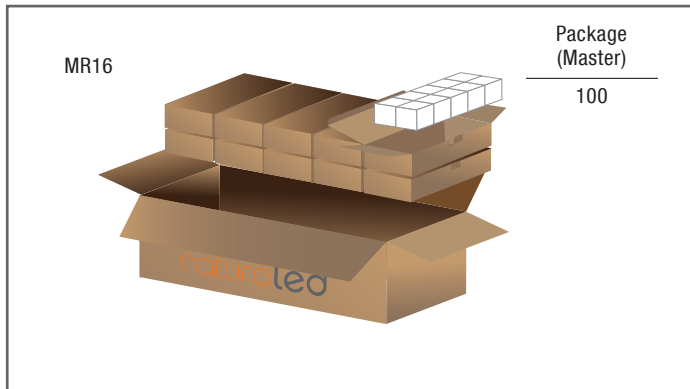
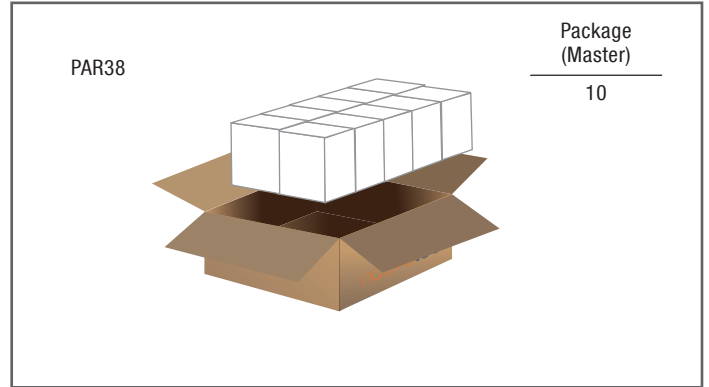
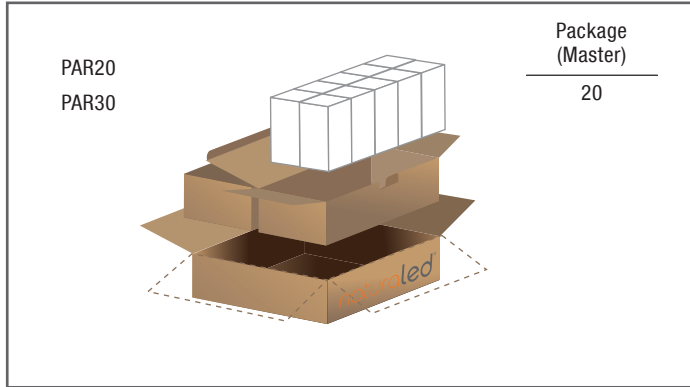



PL LED 4-Pin

Single Lamp Multi-Watt 5W-7W-9W

Instant Fit Plug-in

Our energy efficient PL LED 4-Pin Instant Fit, multi-watt lamp operates with a compact fluorescent electronic ballast. This lamp is a direct replacement for a 13W, 18W, or 26W 4-Pin PL/CFL lamp.

Available in a vertical or horizontal application with a 50,000 hour rated life. Our Instant Fit PL uses less energy, contains no mercury no UV or infrared radiation. The lamp wattage and lumens are adaptable to the ballast. With the same lamp you can replace up to three wattages with varied lumen output:

13W replacement uses 5W and has 550 lumens
 18W replacement uses 7W and has 650 lumens
 26W replacement uses 9W and has 800 lumens



Key Features & Benefits

- ▶ Instant Fit (Works with existing electronic ballast)
- ▶ Direct replacement for CFL: 13W, 18W, 26W
- ▶ Uniform light distribution and consistent color
- ▶ Universal socket for G24q (13W,18W, 26W)
- ▶ Instant On
- ▶ Rotatable Base for Horizontal lamp
- ▶ UL Type
- ▶ 50,000 hrs rated average life

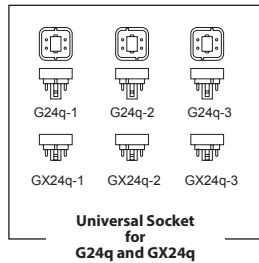

Applications

- ▶ Recessed Can Lighting
- ▶ Sconces
- ▶ Ceiling Fixtures

Color Choices



Acrylic White

Qualifications



Item Code	Description	Color Temp	Wattage	LED 5W Lumen Output (CFL 13W)	LED 7W Lumen Output (CFL 18W)	LED 9W Lumen Output (CFL 26W)	Beam Angle	CRI	Rated Hours	Rotatable
★ 5932	LED9PL/H/4P/935/IF	3500K	5	550	650	800	Horizontal	>90	50,000	•
★ 5933	LED9PL/H/4P/940/IF	4000K	5	550	650	800	Horizontal	>90	50,000	•
★ 5934	LED9PL/V/4P/935/IF	3500K	5	550	650	800	Vertical	>90	50,000	
★ 5935	LED9PL/V/4P/940/IF	4000K	5	550	650	800	Vertical	>90	50,000	

★ ETA Aug 2016

Lamp Replacement Chart

CFL	LED	Lumens
13W	5W	550
18W	7W	650
26W	9W	800

High CRI with LEDs



CRI80

CRI90

Color Rendering Index (CRI) describes how an object appears to the human eye based on ideal or natural light source. The CRI is an index, a measure, that tells something about how colors are represented by light coming from a certain light bulb, compared to how the colors are rendered with the light coming from a reference illuminant.

The CRI reports a unit less value, that can differ between 0 and 100. The value 100 means that there is no difference in color rendition between the light of the observed light bulb and the light of the reference illuminant. Lighting with a CRI of 85 to 90 is typically “excellent” at rendering colors of objects while CRI90 or greater are “superior”.

► Dimensions

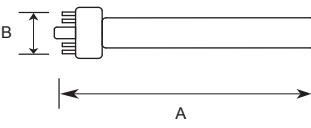
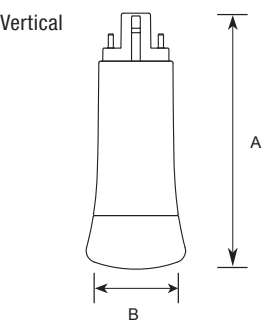
<p>Horizontal</p> 	<p>Vertical</p> 	Size	A	B		Weight (lbs)
		Horizontal	6.50-in	1.80-in		0.2
		Vertical	4.50-in	1.80-in		0.2

► Master Carton Package

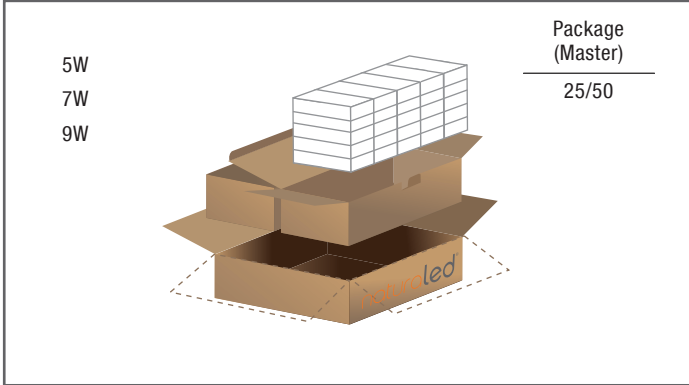

naturaLED®

Turning Light into Savings ▶▶▶



LED Corn Light Retrofit Lamp for HID

27W, 54W, 75W

Introducing our new naturaLED® retrofit for HID. Our LED Retrofit Lamp can replace existing HID and CFL lamps. Our fanless retrofit comes with an integrated driver three wattage options of 27W, 54W, and 75W replacing up to 400W HID lamps.

naturaLED® LED Corn Light features high lumen output and is omni directional. Perfect for industrial, commercial & residential applications.



Key Features & Benefits

- ▶ Integrated Ballast (By-Pass)
- ▶ Vertical or horizontal positions
- ▶ IP65
- ▶ For wet location
- ▶ Suitable for enclosed fixtures
- ▶ Contains no mercury or lead
- ▶ Noise-free design
- ▶ UL/cUL Listed
- ▶ UL Type
- ▶ Voltage: 120-277V
- ▶ Rated 50,000 hours average life
- ▶ 5 Years Limited Warranty

Applications

- ▶ High Bay Lamp
- ▶ Ceiling Lamp
- ▶ Garden Lamp
- ▶ Commercial Buildings
- ▶ Parking Garages
- ▶ Post Top

Color Choices



White

Qualifications



ORDERING INFORMATION

Item Code	Description	Color Temp	Wattage	Lumen Output	Equivalent Wattage	Base	Voltage	Beam Angle	Rated Hours	IP65	OLC
5944	LED27HID/EX39/300L/850	5000K	27	3,000	100W	EX39	120-277V	360°	50,000	•	•
5949	LED54HID/EX39/600L/850	5000K	54	6,000	250W	EX39	120-277V	360°	50,000	•	•
5950	LED75HID/EX39/800L/850	5000K	75	8,000	320W	EX39	120-277V	360°	50,000	•	•

► Dimensions

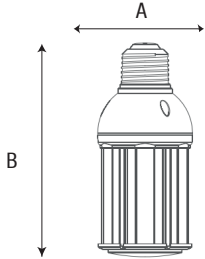
	Item	A	B		Weight (lbs)
	27W	3.54-in	7.87-in	--	1.75
	54W	3.54-in	11.00-in	--	2.00
	75W	3.75-in	12.00-in	--	2.60

► Illuminance Distribution

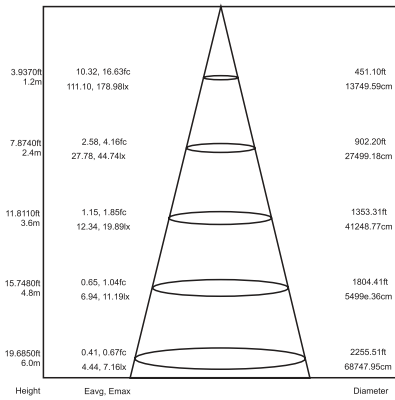

27W

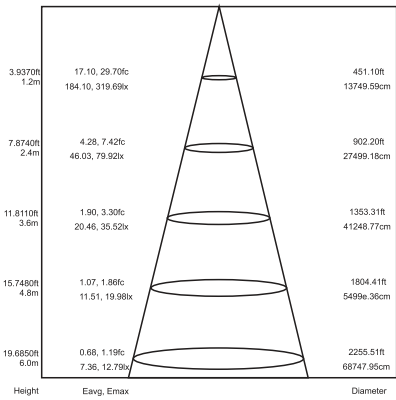

54W

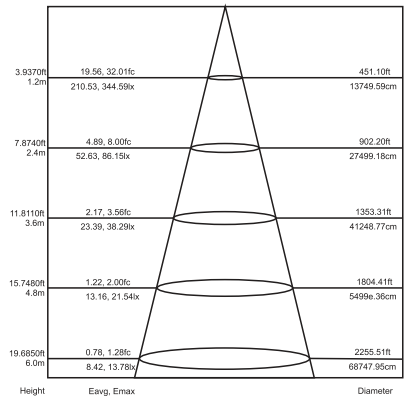

75W

► Master Carton Package

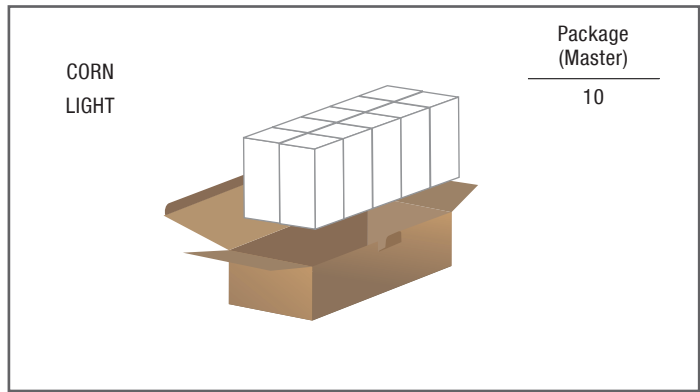



Turning Light into Savings ▶▶▶



JC/JCD Low/Line Voltage

1.6W, 3W

Ideal for use in applications where a halogen G4 12-Volt capsule and G9 120-Volt are used. Illuminate your walkway or accent your landscaping with our naturaLED® Low/Line Voltage Bi-Pin. Our Bi-Pin series produces white light and can replace your current 20 watt halogen G4/G9 capsule.

Rated for 25,000 life hours and should be used in 12 Volt and 120 Volt fixtures only.

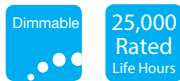

Key Features & Benefits

- ▶ Direct replacement and Instant On
- ▶ Up to 84% energy savings
- ▶ Contains no mercury or lead
- ▶ Voltage: 12V/120V
- ▶ Rated 25,000 hours average life
- ▶ 3 Years Limited Warranty

Applications

- ▶ Display Case Lighting
- ▶ Track Lighting
- ▶ Accent Lighting
- ▶ General Lighting
- ▶ Pendant lighting
- ▶ Desk light

Color Choices



Qualifications



ORDERING INFORMATION

Item Code	Description	Color Temp	Wattage	Lumen Output	Equivalent Wattage	Voltage	CRI	Base	Dimmable
5828	LHO-JC1.6T4G4/30K	3000K	1.6	140	20	12V	>80	G4	
5848	LHO-JC1.6T4G4/50K	5000K	1.6	160	20	12V	>80	G4	
5826	LHO-JCD3T4G9/30K	3000K	3	240	30	120V	>80	G9	•
5830	LHO-JCD3T4G9/50K	5000K	3	250	30	120V	>80	G9	•

► Dimensions

 <p>JCD-G9</p> <p>JC-G4</p>	<table border="1"> <thead> <tr> <th>Item</th> <th>A</th> <th>B</th> <th></th> <th>Weight (lbs)</th> </tr> </thead> <tbody> <tr> <td>JC-G4</td> <td>0.55-in</td> <td>1.60-in</td> <td>--</td> <td>0.02</td> </tr> <tr> <td>JCD-G9</td> <td>0.70-in</td> <td>1.80-in</td> <td>--</td> <td>0.04</td> </tr> <tr> <td></td> <td></td> <td></td> <td></td> <td></td> </tr> </tbody> </table>	Item	A	B		Weight (lbs)	JC-G4	0.55-in	1.60-in	--	0.02	JCD-G9	0.70-in	1.80-in	--	0.04									
Item	A	B		Weight (lbs)																					
JC-G4	0.55-in	1.60-in	--	0.02																					
JCD-G9	0.70-in	1.80-in	--	0.04																					

► Master Carton Package

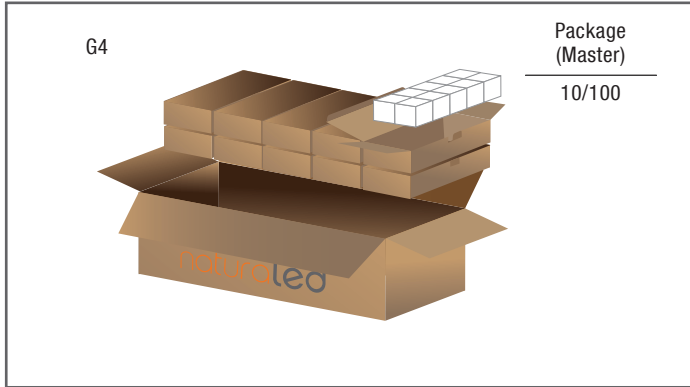

naturalLED®

Turning Light into Savings ▶▶▶



HO (R17d) Base

Single Base



50,000
Rated
Life Hours

BEAM
ANGLE
325°



Instant On



Single-Pin
Base



Medium
Bi-Pin Base



Non-Dimmable



50,000
Long
Life Hours



FL Ballast
Required

TUBE IF

Instant Fit T5/T8

10W, 11W, 15W, 17W, 38W, 42W

With naturalLED® Instant-Fit T5 and T8; it's the easiest way to upgrade your fluorescent fixture to an LED system.

Our Instant-Fit T5/T8 fits into an existing fluorescent system. Utilizes the existing electrical T5/T8 fluorescent ballast without re-wiring.

naturalLED Instant-Fit tubes come in variety of lamp lengths and lighting levels, it is the simplest LED upgrade for your fluorescent systems.

Key Features & Benefits

- ▶ Glass with frosted lens
- ▶ Compatible with Instant Start FL Electronic Ballast
- ▶ Excellent color consistency
- ▶ No Flickering
- ▶ Noise Free design
- ▶ UL/cUL Listed
- ▶ 50,000 hrs rated average life
- ▶ FL T5/T8 ballast required

Applications

- ▶ Conference Room
- ▶ Meeting Room
- ▶ Factory/ Office
- ▶ School & University
- ▶ Hospital
- ▶ Hotel

Color Choices



White

Qualifications



Item Code	Description	Color Temp	Wattage	Lumen Output	Equivalent Wattage	Length	Base	Beam Angle	Rated Hours	
5902	LED28T5/FR32/840/IF	4000K	28W	3,200	54	4-ft/ 48"	G5	325°	50,000	•
5903	LED28T5/FR32/850/IF	5000K	28W	3,200	54	4-ft/ 48"	G5	325°	50,000	•
5850	LED10T8/24FR11/835/IF	3500K	10W	1,150	17	2-ft/ 24"	Bi-Pin	325°	50,000	•
5851	LED10T8/24FR11/840/IF	4000K	10W	1,150	17	2-ft/ 24"	Bi-Pin	325°	50,000	•
5852	LED10T8/24FR11/850/IF	5000K	10W	1,150	17	2-ft/ 24"	Bi-Pin	325°	50,000	•
5891	LED11T8/36FR14/840/IF	4000K	11W	1,400	25	3-ft/ 36"	Bi-Pin	325°	50,000	
5892	LED11T8/36FR14/850/IF	5000K	11W	1,400	25	3-ft/ 36"	Bi-Pin	325°	50,000	
5914	LED15.5T8/FR18/840/IF	4000K	15.5W	1,800	32	4-ft/ 48"	Bi-Pin	325°	50,000	•
5915	LED15.5T8/FR18/850/IF	5000K	15.5W	1,800	32	4-ft/ 48"	Bi-Pin	325°	50,000	•
5916	LED18T8/FR22/840/IF	4000K	18W	2,200	32	4-ft/ 48"	Bi-Pin	325°	50,000	•
5917	LED18T8/FR22/850/IF	5000K	18W	2,200	32	4-ft/ 48"	Bi-Pin	325°	50,000	•
5887	LED38T8/96FR44/840/IF	4000K	38W	4,400	59	8-ft/ 96"	Single	325°	50,000	
5888	LED38T8/96FR44/850/IF	5000K	38W	4,400	59	8-ft/ 96"	Single	325°	50,000	
5897	LED42T8/96FR50/R17d/840/IF	4000K	42W	5,000	59	8-ft/ 96"	R17d	325°	50,000	
5898	LED42T8/96FR50/R17d/850/IF	5000K	42W	5,000	59	8-ft/ 96"	R17d	325°	50,000	

► Dimensions

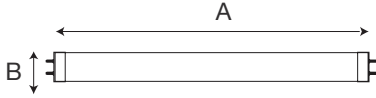
	Item	A	B		Weight (lbs)
	2-ft	1.00-in	24.00-in		0.25
	3-ft	1.00-in	36.00-in		0.35
	4-ft	1.00-in	48.00-in		0.50
	8-ft	1.00-in	96.00-in		1.00

► Illuminance Distribution

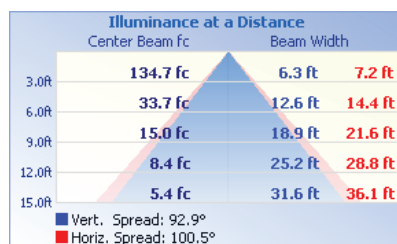
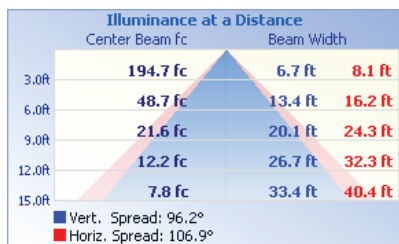
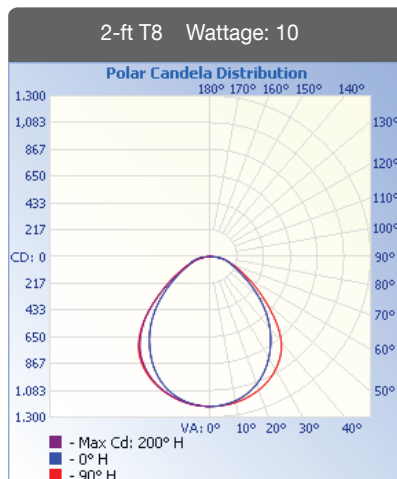
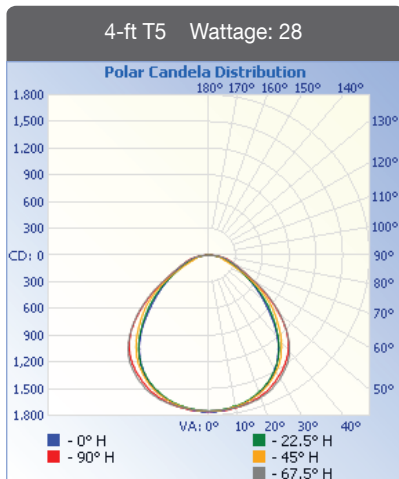

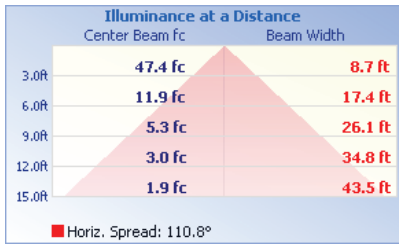
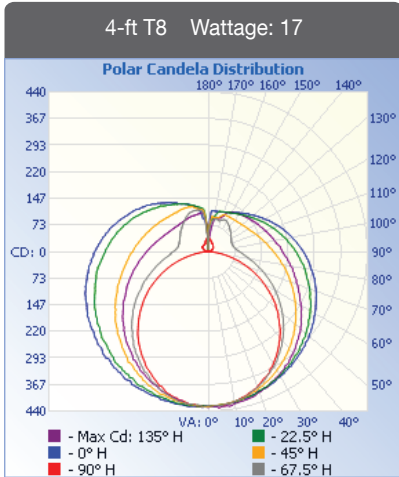

► Master Carton Package

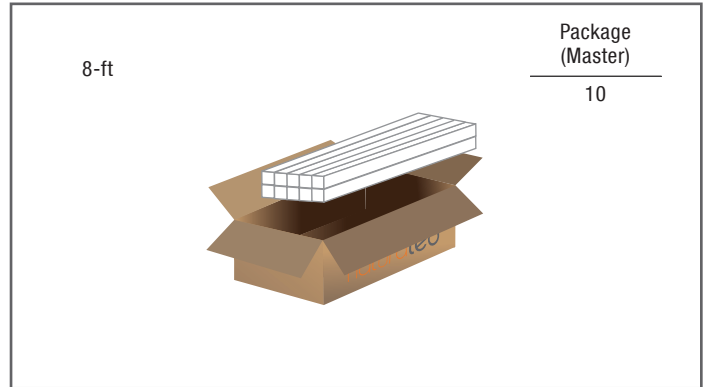
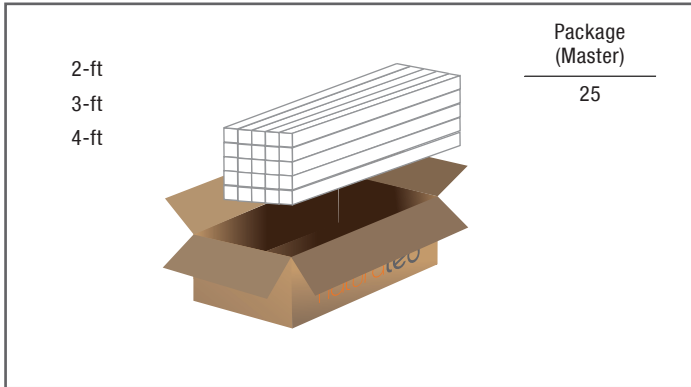



Turning Light into Savings ▶▶▶



TUBE AC120-277V 10W, 14W, 40W

Retrofit for T8 and T12 Fluorescent tubes.

Designed to be noise-free and non flickering, our tubes selection is 10 watt, 14 watt, and 40 watt replaces up to 59 watt T8 Fluorescent, saving up to 35% in energy.

Excellent in color consistency, our integrated driver design brings you the best retrofit solution.



Key Features & Benefits

- ▶ Retrofit for T8 & T12 Fluorescent Tube
- ▶ Excellent color consistency
- ▶ No flickering
- ▶ Noise-free design
- ▶ Universal Voltage 120-277V
- ▶ UL/cUL Listed
- ▶ 50,000 hrs rated average life

Applications

- ▶ Conference Room
- ▶ Meeting Room
- ▶ Factory/ Office
- ▶ School & University
- ▶ Hospital
- ▶ Hotel

Color Choices



White

Qualifications



ORDERING INFORMATION

Item Code	Description	Color Temp	Wattage	Lumen Output	Equivalent Wattage	Length	Base	CRI	Beam Angle	Rated Hours	
5778	LED10T8/24FR10/840	4000K	10	1,109	25	2-ft/ 24"	Bi-Pin	>80	120°	50,000	•
5774	LED10T8/24FR10/850	5000K	10	1,109	25	2-ft/ 24"	Bi-Pin	>80	120°	50,000	•
5779	LED10T8/36FR10/840	4000K	10	1,000	25	3-ft/ 36"	Bi-Pin	>80	120°	50,000	
5780	LED10T8/36FR10/850	5000K	10	1,050	25	3-ft/ 36"	Bi-Pin	>80	120°	50,000	
5817	LED14T8/FR17/840	4000K	14	1,700	32	4-ft/ 48"	Bi-Pin	>80	120°	50,000	•
5818	LED14T8/FR17/850	5000K	14	1,700	32	4-ft/ 48"	Bi-Pin	>80	120°	50,000	•
5811	LED40T8/96FR43/840	4000K	40	4,300	59	8-ft/ 96"	Single	>80	120°	50,000	
5812	LED40T8/96FR43/850	5000K	40	4,300	59	8-ft/ 96"	Single	>80	120°	50,000	

► Dimensions

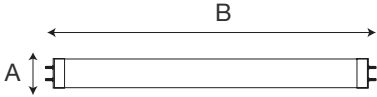
	Item	A	B		Weight (lbs)
	2-ft	1.00-in	24.00-in		0.50
	3-ft	1.00-in	36.00-in		0.50
	4-ft	1.00-in	48.00-in		0.80
	8-ft	1.00-in	96.00-in		1.50

► Master Carton Package

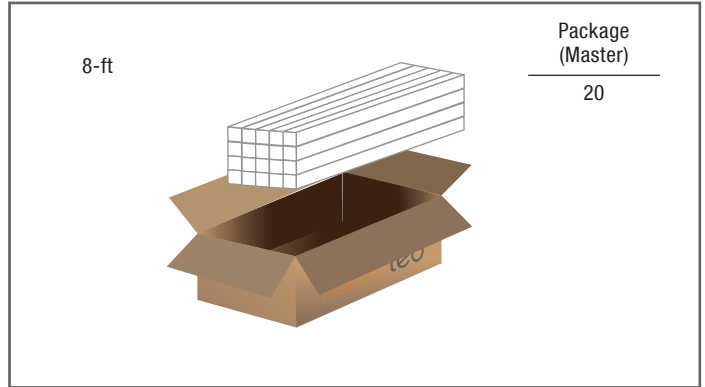
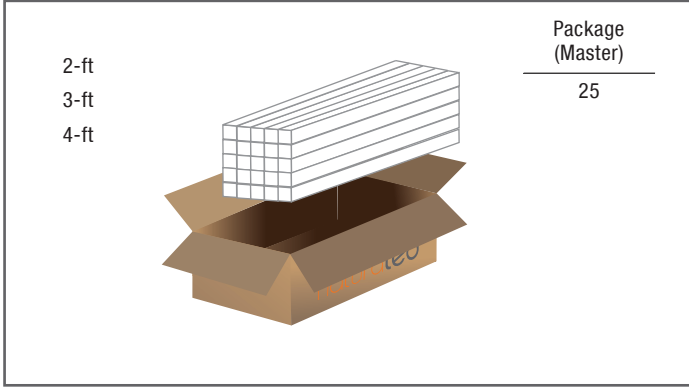

LED LAMP

▪ **MR16/MR11**

Inner/ Outer Carton: 10/100



▪ **PAR20/PAR30/PAR30L/R20/A19/G25/CANDELABRA**

Inner/ Outer Carton: 10/20

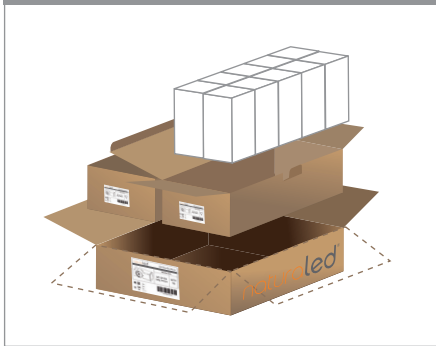

▪ **PAR38/R30/R40**

Outer Carton: 10



▪ **TUBE**

Outer Carton: 10 (5/Layer)

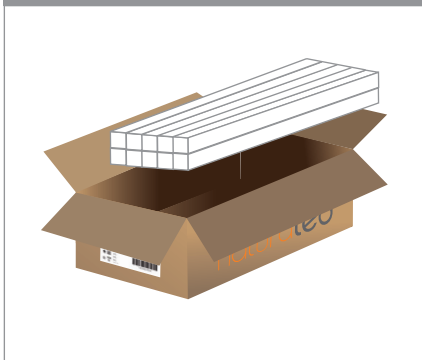

LED FIXTURE

▪ **4" DOWNLIGHT**

Inner/ Outer Carton: 10/20



▪ **6" DOWNLIGHT**

Outer Carton: 10

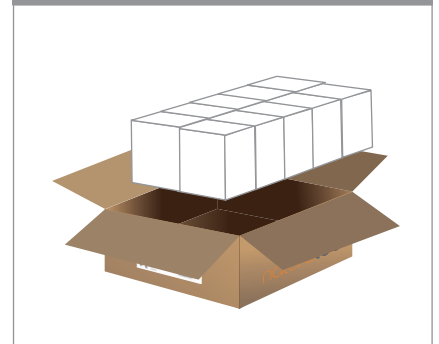

▪ **10.2W FLOODLIGHT**

Outer Carton: 50 (25/Layer)

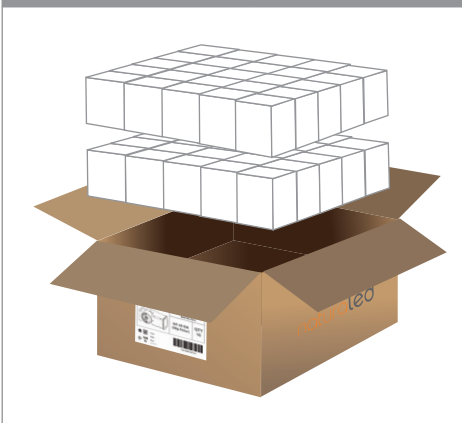

▪ **50W FLOODLIGHT**

Outer Carton: 2



▪ **CANOPY/PARKING GARAGE/SHOEBOX/WALL PACK/HI-BAY**

Outer Carton: 1

