

# Fluorescent

Lithonia manufactures the broadest and most innovative selection of fluorescent products in the industry for commercial, institutional and industrial applications.

Lithonia fluorescent fixtures incorporate the latest in energy-saving technology and design. This provides the assurance of high-quality, superior-performance products that meet your budget requirements. Every fixture is backed by Lithonia's industry-leading service, technical expertise and support.

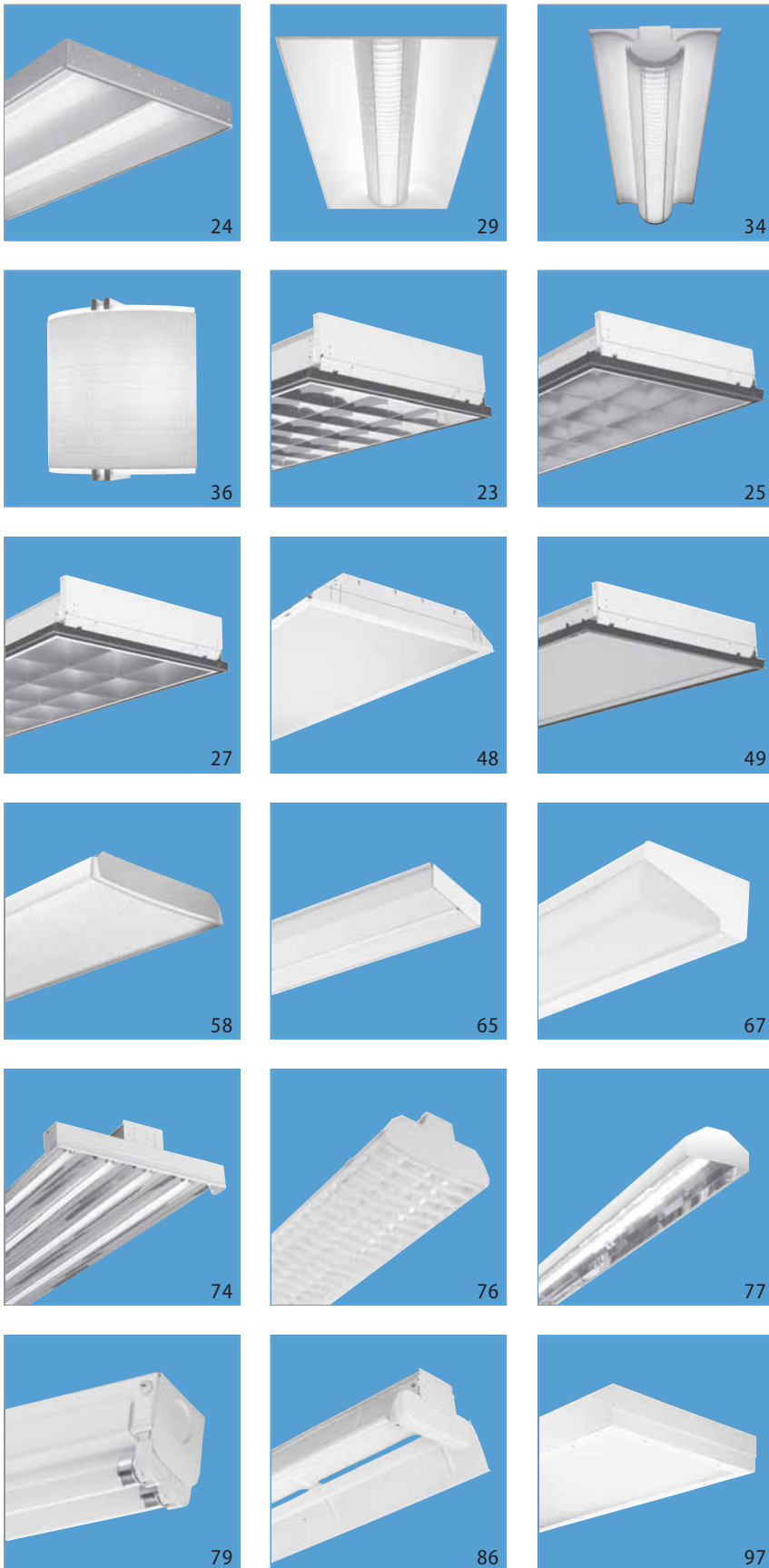



## CONTENTS

### Volumetric Lighting

RT5™ 22

### Architectural Lighting

Avante® Direct/Indirect Lighting 26  
 Linear Wallwash 37  
 Perimeter Systems 38

### Parabolics

Optimax® Light Control System 41  
 Paramax® Parabolic Troffers 43

### Lensed Troffers

Static Troffers 48, 51  
 Air-Handling Troffers 49

### Surface Commercials

Modular 52  
 Wraparounds 56  
 Undercabinet 64

### Wall Brackets

67

### Fluorescent High Bays

72

### Surface/Suspended

78

### Striplights

80

### Industrials

Shielded 86  
 Enclosed 91

### Cleanroom Lighting

94

### Rough Service

Surface 100  
 Recessed 103  
 Industrial 104

### Options and Accessories

106

# ENHANCE YOUR



## INTRODUCING RT5™ VOLUMETRIC RECESSED LIGHTING.

The new standard in fluorescent lighting. In a world dominated by parabolic fixtures, we saw the need for lighting that doesn't create an environment dominated by harsh overhead light or confining cave effect. The RT5™ Series is ideal for offices, schools, hospitals, retail and other workspaces.



### CREATES VISUAL HARMONY

RT5™ luminaires eliminate the glare and dark spots associated with parabolics, creating a comfortable environment to work in.

### IMPROVES OVERALL AESTHETICS

Thanks to its unique design, the RT5™ Series improves the aesthetics of any room by creating an unprecedented combination of volumetric lighting and a quiet ceiling. The fixture is pleasing to the eye, without drawing undue attention.

### REDUCES ENERGY CONSUMPTION

RT5™ volumetric lighting is good for the environment delivering up to 33% savings in energy over a standard 18-cell, three-lamp T8 parabolic.

# environment™

## VOLUMETRIC LIGHTING DONE WELL.

Advances in flat screen monitor technology and software afford the opportunity to allow controlled brightness at high angles. Brightness at these higher angles illuminates the entire volume of the space, eliminating harsh shadows, dark walls and cave effect arising from the sharp cutoff of the parabolic fixture. The controlled and gradual decrease in brightness delivered by RT5™ volumetric lighting enhances the environment without producing excessive light in the "glare zone."

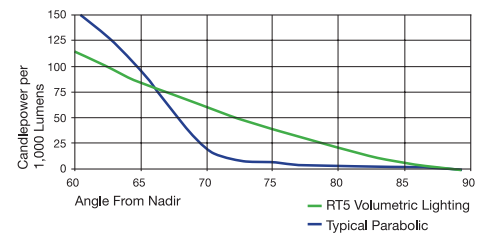

## A FEELING OF SPACIOUSNESS

The unique optical design of the RT5™ luminaire distributes light uniformly onto room and cubicle walls, from the bottom nearly to the top, eliminating the caving effect common with parabolics.

## QUIET PLEASE

With its recessed refractor, high-angle control, and balanced fixture-to-ceiling luminance ratio, the RT5™ Series produces a quiet ceiling that is not dominated by bright openings.

## GOODBYE GLARE

RT5™ fixtures produce volumetric light, while controlling light at high angles. This eliminates direct glare, as well as computer glare for the most widely used monitors and software today.



## Volumetric Recessed Lighting

# RT5™



### Intended Use

The RT5™ Series is designed for applications where comfort, aesthetics and energy savings are important. With volumetric lighting, this product is ideal for offices, schools, hospitals, retail and numerous other commercial applications.

### Features

Two-lamp RT5™ luminaire provides 33% energy savings when compared to a common three-lamp T8 system.

Low profile 3 1/8" depth makes the RT5™ fixture ideal for applications where plenum height is a factor.

Two-piece refractor system uses the combination of diffusing optical film and precisely extruded prisms to efficiently diffuse light.

Reflector includes micro-facets that echo the frequency of the prisms in the refractor, providing a quiet appearance in the ceiling.

Available in a number of ballast configurations including set light output or step level dimming. Step-dimming options (available on some units) allow the system to be switched to 50% power for compliance with common energy codes while illuminating both lamps.

Sloped endplates provide a balanced fixture-to-ceiling ratio while enhancing the perception of fixture height.

Ballast/lamp ballast efficacy of F28T5 is 100+ LPW.

Side-mounted ballast tray accessed by removing adjacent ceiling tile.

### Listings

UL Listed (standard). CSA Certified (see Options).

### Ordering Information

Series	Mounting	Wattage <sup>2</sup>	Ballast <sup>2</sup>	Lamp type <sup>3</sup>	Options
<b>2RT5</b> 2' wide	(blank) Grid	<b>14T5</b> 14W T5 (22")	<b>GEB95</b>	<b>LPM835P</b> Lamped with premium 3500°K lamp <sup>4</sup>	<b>PWS1836</b> 6' prewire, 3/8" diameter, 18-gauge, 3 wire <sup>6</sup>
<b>RT5</b> 1' wide	F Flange	<b>24T5HO</b> 24W T5HO (22")	<b>GEB95S</b>	<b>LPM830P</b> Lamped with premium 3000°K lamp <sup>4</sup>	<b>PWS1846</b> 6' prewire, 3/8" diameter, 18-gauge, 4 wire <sup>7</sup>
		<b>28T5</b> 28W T5 (46")	<b>GEB115</b>	<b>LPM841P</b> Lamped with premium 4100°K lamp <sup>4</sup>	<b>GLR</b> Fast blow fuse <sup>8</sup>
		<b>54T5HO</b> 54W T5HO (46")	<b>GEB115S</b>	<b>LP835</b> Lamped with premium 3500°K lamp <sup>5</sup>	<b>EL14</b> Emergency battery pack
			<b>GEB10PS</b>	<b>LP830</b> Lamped with premium 3000°K lamp <sup>5</sup>	<b>CSA</b> CSA Certified <sup>9</sup>
				<b>LP841</b> Lamped with premium 4100°K lamp <sup>5</sup>	

Example: **2RT5 28T5 MVOLT GEB95 LPM835P**

NOTES:

- 1 RT5™ 1x4 only. All other configurations are two-lamp.
- 2 Consult product availability for wattages and ballast types.
- 3 Lamp type required. All fixtures shipped with lamps installed.
- 4 F28T5 lamp type only.
- 5 F14T5, F24T5HO and F54T5HO lamp types only.
- 6 For use with standard, non step-dimming ballast.
- 7 For use with step-dimming ballast.
- 8 Specify voltage.
- 9 Consult factory for 347V.

Availability and Dimensions						
Series	Nominal size	Number of lamps	Lamp type	Ballast	Description	
2RT5	2'x4'	2	28T5	GEB95	Standard, set light output, .95BF	
			28T5	GEB95S	Standard, step dimming, .95BF	
			28T5	GEB115	High light, set light output, 1.15BF	
			28T5	GEB115S	High light, step dimming, 1.15BF	
			54T5HO	GEB10PS	Very high output, set light output, 1.0BF	
2RT5	2'x2'	2	14T5	GEB115	High light, set light output, 1.15BF	
			14T5	GEB115S	High light, step dimming, 1.15BF	
			24T5HO	GEB10PS	Very high output, set light output, 1.0BF	
RT5	1'x4'	1	28T5	GEB10PS	Standard, set light output, 1.0BF	
			2	28T5	GEB95	Standard, set light output, .95BF
				28T5	GEB95S	Standard, step dimming, .95BF
				54T5HO	GEB10PS	Very high output, set light output, 1.0BF

**Intended Use**

The surface-mount RT5™ Series is designed for applications where comfort, aesthetics and energy savings are important. With volumetric lighting, this product is ideal for offices, schools, hospitals, retail and numerous other commercial applications.

**Features**

Two-lamp RT5™ luminaire provides 33% energy savings when compared to a common three-lamp T8 system.

Low profile 3<sup>5</sup>/<sub>8</sub>" in depth.

Two-piece refractor system uses the combination of diffusing optical film and precisely extruded prisms to efficiently diffuse light.

Reflector includes micro-facets that echo the frequency of the prisms in the refractor, providing a quiet appearance in the ceiling.

Available in a number of ballast configurations including set light output or step level dimming. Step-dimming options (available on some units) allow the system to be switched to 50% power for compliance with common energy codes while illuminating both lamps.

Ballast/lamp efficacy of F28T5 is 100+ LPW.

**Listing**

UL Listed (standard). CSA Certified (see Options).

**RT5X**



**Ordering Information**

Example: **2RT5X 28T5 MVOLT GEB95 LPM835P**

Series	Wattage	Voltage	Ballast	Lamp type <sup>3</sup>	Options
<b>2RT5X</b> 2' wide	<b>14T5</b> 14W T5 (46") <b>24T5HO</b> 24W T5HO (46") <b>28T5</b> 28W T5 (46") <b>54T5HO</b> 54W T5HO (46")	<b>MVOLT</b> <b>347</b>	<b>GEB95</b> <b>GEB95S</b> <b>GEB115</b> <b>GEB115S</b> <b>GEB10PS</b>	<b>LPM835P</b> Lamped with premium 3500°K lamp <b>LPM830P</b> Lamped with premium 3000°K lamp <b>LPM841P</b> Lamped with premium 4100°K lamp <b>LP835</b> Lamped with premium 3500°K lamp <b>LP830</b> Lamped with premium 3000°K lamp <b>LP841</b> Lamped with premium 4100°K lamp	<b>GLR</b> Fast blow fuse <b>EL14</b> Emergency battery pack <b>CSA</b> CSA Certified

Availability and Dimensions					
Series	Nominal size	Number of lamps	Lamp type	Ballast	Description
2RT5X	2'x4'	2	28T5	GEB95	Standard, set light output, .95BF
			28T5	GEB95S	Standard, step dimming, .95BF
			28T5	GEB115	High light, set light output, 1.15BF
			28T5	GEB115S	High light, step dimming, 1.15BF
			54T5HO	GEB10PS	Very high output, set light output, 1.0BF
2RT5X	2'x2'	2	14T5	GEB115	High light, set light output, 1.15BF
			14T5	GEB115S	High light, step dimming, 1.15BF
			24T5HO	GEB10PS	Very high output, set light output, 1.0BF

*Avante*<sup>®</sup>  
Recessed Direct/Indirect Lighting

## Architectural Fluorescent



### Why Direct/Indirect?

The numerous lighting solutions available today allow the designer to choose the best fixtures based on the given architectural details of the space. Recessed direct/indirect is effective in spaces with low ceiling heights. Although originally developed for smaller private offices, anti-glare CRT screens, higher office partitions and improvements in information display have made recessed direct/indirect lighting effective in any open work area.

The high-angle light from the Avante<sup>®</sup> Series distributes light evenly throughout the space. This results in a lighter airy space with much less glare than any other recessed direct only system.



Surface / Sconces



AVSM



AVSP



AVSR

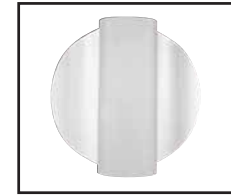

AVSC

Standard Diffusers



MDR



SBL



MDM



MDC

**Wide Range of Options**

The direct-through-the-diffuser light represents about 70% of the total light. The most popular diffuser is the round hole perforated metal diffuser backed with thin acrylic opal insert. This combination provides a pleasing balance between the brightness of the white reflectors and the surface of the diffuser. Acrylic lensed diffusers, straight blade louvers and slotted perforated patterns change the direct lighting effect and fixture's appearance.

Fixture brightness can be reduced by choosing the optional Aluminum Stepped Reflector. The diffuse aluminum surface breaks up light and results in less glare and more comfortable lighting.

**Color Accents**

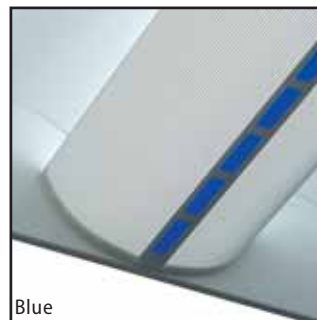

Blue

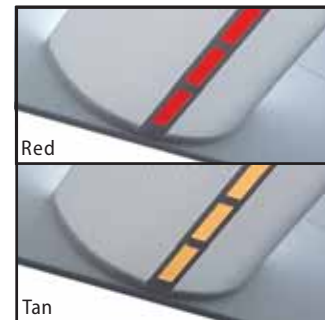

Red

Tan

**Light Distributions**



Symmetric



Asymmetric



SMD (Side Mounted Diffuser)



Recessed Direct/Indirect Lighting

# Avante®

2' X 2'



Ordering Information

<b>Series</b> <b>2AV</b> 2'wide, symmetric distribution	<b>Number of lamps</b> 1 2 3 Not included.
<b>Trim type</b> G Grid trim ST Screw slot	<b>Air function</b> (blank) Standard A Air supply/return

Intended Use

Originally developed for the small private office, Avante® 2x2 fixtures also are effective in corridors, libraries and food-service areas to enhance facial rendering and the feeling of space.

Features

Optimum mix of directional and diffuse reflected light for balanced illumination between task and proximate walls, enhanced visual comfort and minimized shadows.

Available in 2'x2' and 2'x4' symmetric distributions for general area lighting applications.

Choice of shielding options.

Matte-white polyester powder paint finished reflectors provide uniform light distribution. Optional diffuse aluminum stepped reflectors available.

Injection-molded plastic light traps prevent light leaks between shielding and end plates.

Compatible with screw slot and most 2-foot ceiling grids.

Covered by one or more of the following patents: 5,988,829; 399,586; 411,641; 413,402; 2,212,513; 87,513.

Listings

UL Listed (standard) and CSA Certified (standard; except for 347V – see Options). NOM Certified (see Options).

Example: 2AV G 2 CF40 MDR MVOLT GEB10RS

<b>Lamp type</b> 17 17W T8 (24") 14T5 14W T5 (22") 24T5HO 24W T5 (22") CF40 40W TTS (24") CF50 50W TTS (24")	<b>Light distribution</b> (blank) Symmetric distribution	<b>Options</b> GEB10IS T8 electronic ballast, ≤10% THD, instant start GEB10PS T5 electronic ballast, ≤10% THD, program start GEB10RS T8 electronic ballast, ≤10% THD, rapid start ALG Acrylic litter guard GLR Internal fast blow fuse <sup>1</sup> APB Air pattern control blades CSA CSA Certified (347 only) NOM NOM Certified
<b>Diffuser</b> MDR Metal diffuser, round holes SBL Straight blade louver, round holes MDM Metal diffuser, mini slots. ADP Acrylic diffuser, linear prismatic lens Others available; consult factory.	<b>Voltage</b> MVOLT 347 Others available; consult factory.	<b>Reflector options</b> ASR Aluminum stepped reflector See page 31 for others.

NOTES:  
1 Must specify 120 or 277 voltage.

	Ballast/Lamp Compatibility				
	17	14T5	24T5HO	CF40	CF50
GEB10IS					
GEB10PS	■		■		
GEB10RS				■	■

Accessories (Order separately)  
**DGA** Drywall ceiling adapter, unit installation. Use G trim plus DGA for support in plaster ceilings. (Add 22 for 2x2)

Dimensions are shown in inches (centimeters) unless otherwise noted.

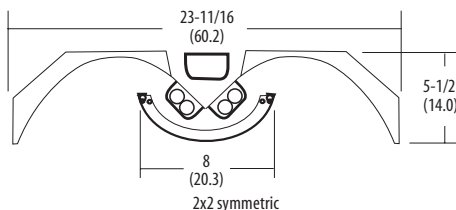

Availability and Dimensions				
Size	Series	Number of lamps	Lamp type	Height in.(cm)
2'x2'	2AV	1, 2, 3	14T5, 17, 24T5HO, CF40, CF50	5½ (14.0)

Recessed Direct/Indirect Lighting

Intended Use

An exceptional general lighting product that performs well in large spaces with high ceilings. Especially suitable for open office areas, public indoor space, libraries and airport waiting areas.

Features

The optimum mix of directional and diffuse reflected light combine for balanced illumination between task and proximate walls, enhanced visual comfort and minimized shadows.

Available in 2'x2' and 2'x4' symmetric distributions for general area lighting applications. End-to-end row mounting capability.

Choice of shielding options.

Matte-white polyester powder paint finished reflectors provide uniform light distribution. Optional diffuse aluminum stepped reflectors available.

Injection-molded plastic light traps prevent light leaks between shielding and end plates.

Compatible with screw slots and most 2-foot ceiling grids.

Covered by one or more of the following patents: 5,988,829; 399,586; 411,641; 413,402; 2,212,513; 87,513.

Listings

UL Listed (standard) and CSA Certified (standard; except for 347V – see Options). NOM Certified (see Options).

Avante®

2' X 4'

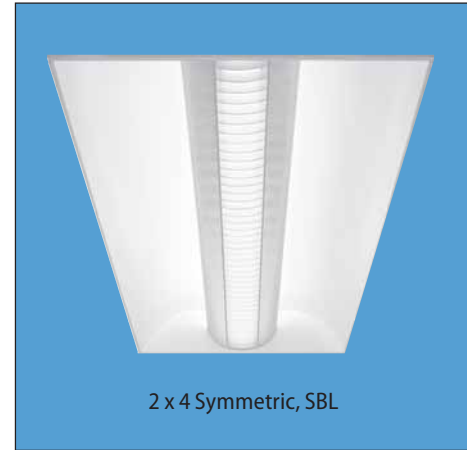

Ordering Information

Example: 2AV G 3 32 MDR MVOLT GEB10IS

<p><b>Series</b></p> <p>2AV 2'wide, symmetric distribution</p>	<p><b>Number of lamps</b></p> <p>1 2 3 Not included.</p>	<p><b>Lamp type</b></p> <p>32 32W T8 (48") 28T5 28W T5 (46") 54T5HO 54W T5 (46")</p>	<p><b>Light distribution</b></p> <p>(blank) Symmetric distribution</p>	<p><b>Options</b></p> <p><b>GEB10IS</b> T8 electronic ballast, ≤10% THD, instant start <b>GEB10PS</b> T5 electronic ballast, ≤10% THD, program start <b>GEB10RS</b> T8 electronic ballast, ≤10% THD, rapid start <b>ALG</b> Acrylic litter guard <b>GLR</b> Internal fast blow fuse<sup>1</sup> <b>APB</b> Air pattern control blades <b>CSA</b> CSA Certified (347 only) <b>NOM</b> NOM Certified</p> <p><b>Reflector options</b></p> <p><b>ASR</b> Aluminum stepped reflector</p> <p>See page 31 for others.</p>
<p><b>Trim type</b></p> <p><b>G</b> Grid trim <b>ST</b> Screw slot</p>	<p><b>Air function</b></p> <p>(blank) Standard <b>A</b> Air supply/return</p>	<p><b>Diffuser</b></p> <p><b>MDR</b> Metal diffuser, round holes <b>SBL</b> Straight blade louver, round holes <b>MDM</b> Metal diffuser, mini slots <b>ADP</b> Acrylic diffuser, linear prismatic lens</p> <p>Others available; consult factory.</p>	<p><b>Voltage</b></p> <p><b>MVOLT</b> <b>347</b></p> <p>Others available; consult factory.</p>	

NOTES:  
1 Must specify 120 or 277 voltage.

**lightquick<sup>XD</sup>**  
Express delivery products.  
See page 11 for details about LightQuick XD.

**Description**

2AV G 2 CF40 MDR MVOLT GEB10RS  
2AV G 3 32 MDR MVOLT 1/3 GEB10IS  
2AV G 3 32 MDR MVOLT GEB10IS  
2AV G 2 32 MDR MVOLT GEB10IS

Availability and Dimensions				
Size	Series	Number of lamps	Lamp type	Height in.(cm)
2'x4'	2AV	1,2,3	28T5, 32, 54T5HO	5½ (14.0)

	Ballast/Lamp Compatibility		
	32	28T5	54T5HO
GEB10IS	■		
GEB10PS		■	■
GEB10RS	■		

Accessories (Order separately)

**DGA** Drywall ceiling adapter, unit installation. Use G trim plus DGA for support in plaster ceilings. (Add 24 for 2x4)

Dimensions are shown in inches (centimeters) unless otherwise noted.

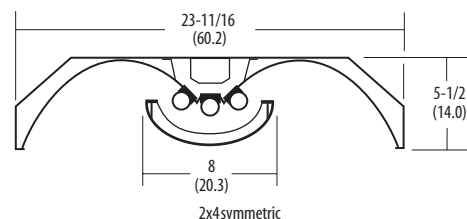

Recessed Direct/Indirect Lighting

# Avante®

## Side-Mount Diffuser

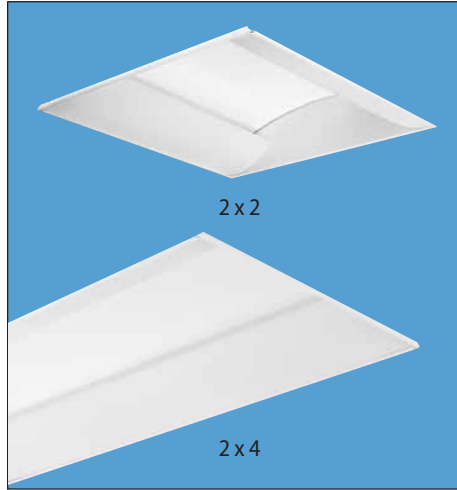

2 x 2

2 x 4

### Intended Use

Side-mounted diffuser, a recessed direct/indirect alternative with performance similar to symmetric Avante®. Especially suited for conference rooms, corridors and reception areas where soft, distinctive lighting is required.

### Features

The optimum mix of directional and diffuse reflected light combine for balanced illumination between task and proximate walls, enhanced visual comfort and minimized shadows.

Available in 2'x2' and 2'x4' with side-mounted diffusers.

Available with MDR and MDM shielding options.

Matte-white polyester powder paint finished reflectors provide uniform light distribution. Optional low-brightness diffuse aluminum stepped reflectors available.

Can be installed in continuous rows.

Injection-molded plastic light traps prevent light leaks between diffusers and end plates.

Covered by one or more of the following patents: 5,988,829; 399,586; 411,641; 413,402; 2,212,513; 87,513.

### Listings

UL Listed (standard). CSA Certified (standard; except for 347V – see Options). NOM Certified (see Options).

### Ordering Information

<b>Series</b> 2AV 2' wide	<b>Number of lamps</b> 2 4 Not included.
<b>Trim type</b> G Grid trim ST Screw slot	<b>Lamp type</b> 17 17W T8 (24") 32 32W T8 (48") 14T5 14W T5 (22") 28T5 28W T5 (46") 24T5HO 24W T5 (22") CF40 40W TT5 (24") <sup>2</sup> CF50 50W TT5 (24") <sup>2</sup> 54T5HO 54W T5 (46")

### Example: 2AV G 2 32 MDR SMD MVOLT GEB10RS

<b>Diffuser</b> MDR Metal diffuser, round holes MDM Metal diffuser, mini slots Others available; consult factory.	<b>Voltage</b> MVOLT 347 Others available; consult factory.
<b>Light distribution</b> SMD Side-mounted diffuser	

<b>Options</b>	
GEB10IS	T8 electronic ballast, ≤10% THD, instant start
GEB10PS	T5 electronic ballast, ≤10% THD, program start
GEB10RS	T8 electronic ballast, ≤10% THD, rapid start
ALG	Acrylic litter guard
GLR	Internal fast blow fuse <sup>1</sup>
CSA	CSA Certified (347 only)
NOM	NOM Certified
<b>Reflector options</b>	
ASR	Aluminum stepped reflector
See page 31 for others.	

Accessories (Order separately)

DGA\_ Drywall ceiling adapter, unit installation. Use G trim plus DGA for support in plaster ceilings. (Add 22 for 2x2, 24 for 2x4)

NOTES:

- 1 Must specify 120 or 277 voltage.
- 2 Two-lamp only.

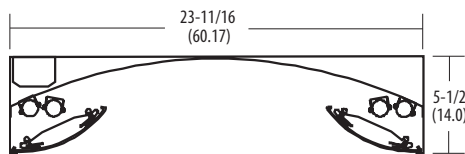

Dimensions are shown in inches (centimeters) unless otherwise noted.

### Ballast/Lamp Compatibility

	17	32	14T5	28T5	24T5HO	CF40	CF50	54T5HO
GEB10IS		■						
GEB10PS			■	■	■			■
GEB10RS		■				■	■	

### Availability and Dimensions

Nominal size	Series	Number of lamps	Lamp type	Height in.(cm)
2'x2' SMD	2AV	2, 4	14T5, 17, 24T5HO	5½ (14.0)
		2	CF40, CF50	5½ (14.0)
2'x4' SMD	2AV	2, 4	32, 28T5, 54T5HO	5½ (14.0)

## Recessed Avante® Availability Matrix

Options	AV 1x2	AV 1x2 ASY	AV 1x4	AV 1x4 ASY	2AV 2x2	2AV 2x2 SMD	2AV 2x4	2AV 2x4 SMD
<b>MDR</b> Metal diffuser round holes	■	■	■	■	■	■	■	■
<b>MDM</b> Metal diffuser mini-slots	■	■	■	■	■	■	■	■
<b>SBL</b> Straight blade louver	■		■		■	■	■	
<b>ADP</b> Acrylic diffuser prismatic					■		■	
<b>ASR</b> Aluminum stepped reflector	■	■	■	■	■	■	■	■
<b>APB</b> Air pattern control blades	■		■		■		■	
<b>ALG</b> Acrylic litter guard	■	■	■	■	■	■	■	■
<b>GLR</b> Internal fast blow fuse	■	■	■	■	■	■	■	■
<b>LP_</b> Lamped. Specify lamp type and color.	■	■	■	■	■	■	■	■
<b>EL</b> Emergency battery pack (nominal 300 lumens, see Life Safety section)	■ <sup>1</sup>	■ <sup>1</sup>	■ <sup>1</sup>	■ <sup>1</sup>	■ <sup>1</sup>	■ <sup>1</sup>	■ <sup>1</sup>	■ <sup>1</sup>
<b>EL55</b> Emergency battery pack for T5/T5HO (nominal 390-700 lumens, see Life Safety section)	■	■	■	■	■	■	■	■
<b>PWS1836</b> 6" prewire, 3/8" dia., 18-gauge, 3 wires	■	■	■	■	■	■	■	■
<b>LST</b> Labor-saving tandem	■	■	■	■	■	■	■	■
<b>NYC</b> New York City approved	■	■	■	■	■	■	■	■
<b>CP</b> Chicago plenum approved	■	■	■	■	■	■	■	■

Accessories for drywall ceiling mounting *		AV 1x2	AV 1x4	2AV 2x2	2AV 2x4
<b>DGA12</b> Drywall ceiling adapter		■			
<b>DGA14</b> Drywall ceiling adapter			■		
<b>DGA22</b> Drywall ceiling adapter				■	
<b>DGA24</b> Drywall ceiling adapter					■

\*Use G trim plus DGA accessory for fixture trim flange and fixture support in plaster or plasterboard ceilings.

**NOTES:**

1 Compact fluorescent and T8 only.

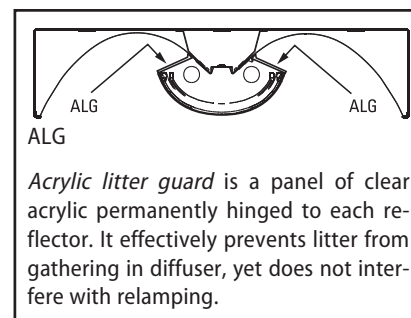

Recessed Direct/Indirect Lighting

# Avante®

1' X 2' and 1' X 4'  
Symmetric

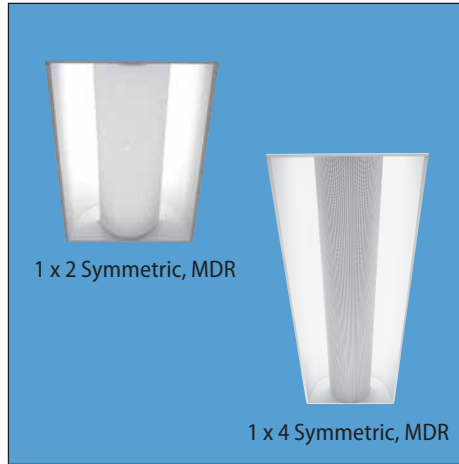

1 x 2 Symmetric, MDR

1 x 4 Symmetric, MDR

Intended Use

Symmetric 1'X4' Avante® fixtures provide general indoor lighting. When joined in continuous rows, they provide pleasant and efficient lighting for open office plans. Symmetric 1' X 2' fixtures often are used to light small areas.

Used in patterns, large public spaces illuminated with 1' wide symmetric Avante® fixtures are bright and attractive, yet with an unobtrusive ceiling.

Features

The optimum mix of directional and diffuse reflected light combine for balanced illumination between task and proximate walls, enhanced visual comfort and minimized shadows.

Available in 1'x 2' and 1'x 4' symmetric distributions for general area lighting applications. End-to-end row mounting capability.

Available with a variety of shielding options.

Matte-white polyester powder paint finished reflectors provide uniform light distribution. Optional diffuse aluminum stepped reflectors available.

Injection-molded plastic light traps prevent light leaks between shielding and end plates.

Covered by one or more of the following patents: 5,988,829; 399,586; 411,641; 413,402; 2,212,513; 87,513.

Listings

UL Listed (standard). CSA Certified (standard; except for 347V – see Options). NOM Certified (see Options).

Ordering Information

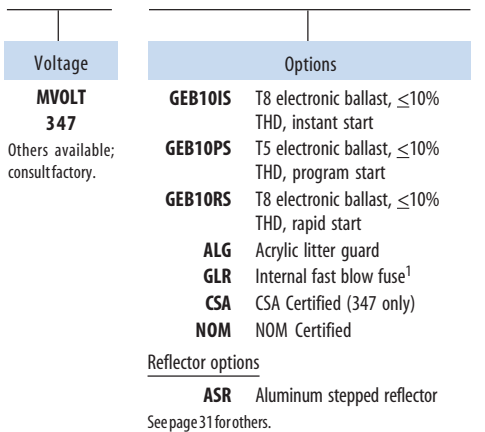
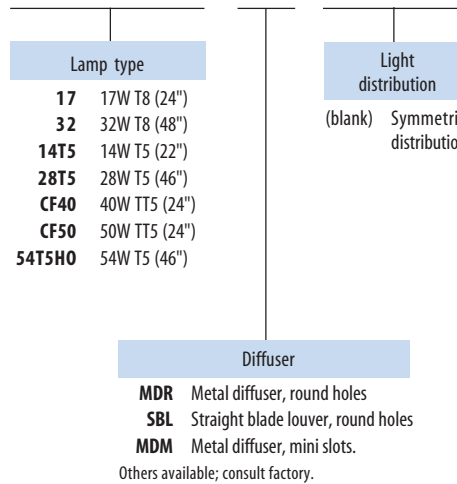
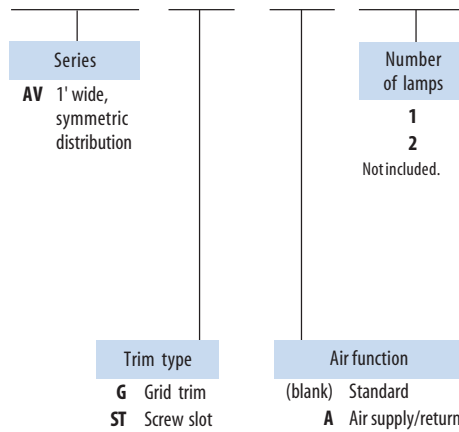

Example: AV G 2 32 MDR MVOLT GEB10RS

NOTES:  
1 Must specify 120 or 277 voltage.

Accessories (Order separately)

DGA\_ Drywall ceiling adapter, unit installation. Use G trim plus DGA for support in plaster ceilings. (Add 12 for 1x2, 14 for 1x4)

Dimensions are shown in inches (centimeters) unless otherwise noted.

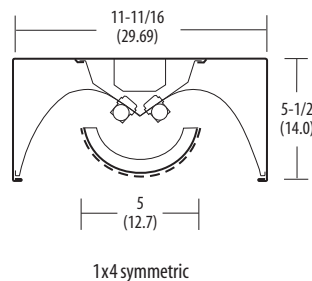

	Ballast/Lamp Compatibility						
	17	32	14T5	28T5	CF40	CF50	54T5HO
GEB10IS	■						
GEB10PS			■	■			■
GEB10RS		■			■	■	

Availability and Dimensions				
Size	Series	Number of lamps	Lamp type	Height in.(cm)
1'x2'	AV	1, 2	17, 14T5, CF40, CF50	5½ (14.0)
1'x4'	AV	1, 2	28T5, 32, 54T5HO	5½ (14.0)

Recessed Direct/Indirect Lighting

Intended Use

Asymmetric products deliver uniform vertical illumination. They produce excellent corridor lighting or accent lighting for retail applications in continuous rows.

Features

Optimum mix of directional and diffuse reflected light combine for balanced illumination between task and proximate walls, enhanced visual comfort and minimized shadows.

Asymmetric distribution available for dedicated wall washing or in combination with symmetric luminaires to maintain perimeter illumination.

Available with a variety of shielding options.

Matte-white polyester powder paint finished reflectors provide uniform light distribution. Optional diffuse aluminum stepped reflectors available.

Injection-molded plastic light traps prevent

light leaks between shielding and end plates.

Compatible with screw slot and most 2-foot ceiling grids.

Covered by one or more of the following patents: 5,988,829; 399,586; 411,641; 413,402; 2,212,513; 87,513.

Listings

UL Listed (standard). CSA Certified (standard; except for 347V – see Options). NOM Certified (see Options).

Avante®

1' X 2' and 1' X 4'  
Asymmetric

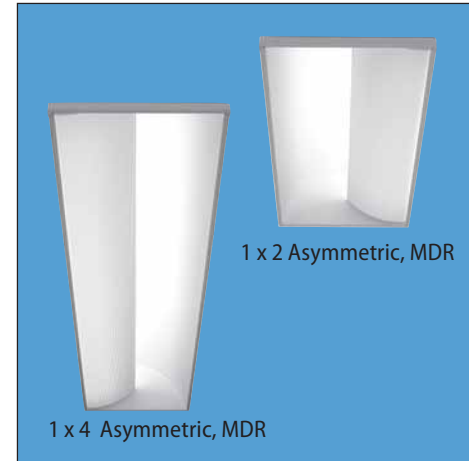

Ordering Information

Example: AV G 1 CF40 MDR ASY MVOLT GEB10RS

<b>Series</b> AV 1' wide asymmetric distribution	<b>Number of lamps</b> 1 2 <sup>2</sup> Not included.	<b>Lamp type</b> 17 17W T8 (24") 32 32W T8 (48") 14T5 14W T5 (22") 28T5 28W T5 (46") 24T5HO 24W T5 (22") CF40 40W TT5 (24") CF50 50W TT5 (24") 54T5HO 54W T5 (46")	<b>Light distribution</b> ASY Asymmetric distribution	<b>Voltage</b> MVOLT 347 Others available; consult factory.	<b>Options</b> GEB10IS T8 electronic ballast, ≤10% THD, instant start GEB10PS T5 electronic ballast, ≤10% THD, program start GEB10RS T8 electronic ballast, ≤10% THD, rapid start ALG Acrylic litter guard GLR Internal fast blow fuse <sup>3</sup> CSA CSA Certified (347 only) NOM NOM Certified
<b>Trim type</b> G Grid trim ST Screw slot	<b>Air function</b> (blank) Standard A Air supply/return <sup>1</sup>	<b>Diffuser</b> MDR Metal diffuser, round holes MDM Metal diffuser, mini slots. Others available; consult factory.	<b>Reflector options</b> ASR Aluminum stepped reflector See page 31 for others.		

NOTES:

- 1 Not available in AV 1x2 asymmetric.
- 2 2-lamp available only in AV 1x2 with 14T5, 17, or 24T5HO.
- 3 Must specify 120 or 277 voltage.

	Ballast/Lamp Compatibility							
	17	32	14T5	24T5HO	CF40	CF50	28T5	54T5HO
GEB10IS	■	■						
GEB10PS			■	■			■	■
GEB10RS	■	■			■	■		

Availability and Dimensions				
Size	Series	Number of lamps	Lamp type	Height in.(cm)
1'x2' ASY	AV	1, 2	14T5, 17, 24T5HO	5½ (14.0)
		1	CF40, CF50	5½ (14.0)
1'x4' ASY	AV	1, 2	32, 28T5, 54T5HO	5½ (14.0)

Accessories (Order separately)

DGA Drywall ceiling adapter, unit installation. Use G trim plus DGA for support in plaster ceilings. (Add 12 for 1x2, 14 for 1x4)

Dimensions are shown in inches (centimeters) unless otherwise noted.

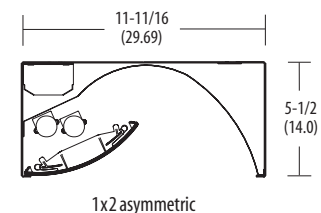

Direct/Indirect Lighting

# Avante®

## Surface/Suspended

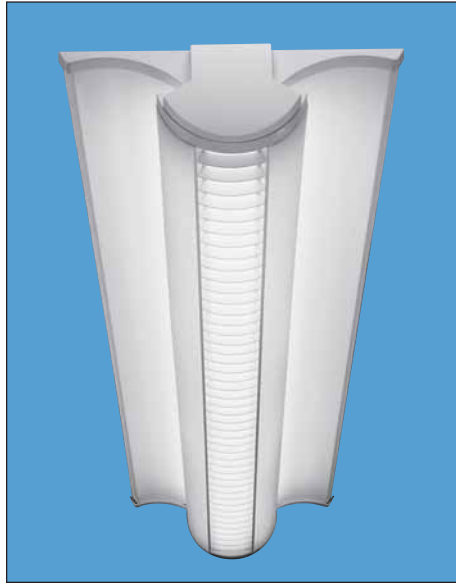

### Intended Use

1x2 – ideal for general or task lighting in alcoves, narrow corridors and small spaces. 1x4 – suitable for general area or task-specific lighting in both new construction and remodeling. Especially suited for conference rooms, reception areas, health care institutions, education facilities and offices.

### Features

Contemporary, low-profile construction, suitable for surface and suspended mounting, providing direct or semi-direct light distribution.

Rugged steel housing in 2', 4' or 8' field-joinable units for continuous rows.

Injection molded joiners with snap-on finished ends.

Available with popular Avante® 1x4 shieldings – MDR, MDM and SBL.

Reflectors finished with high-reflectance, matte-white polyester powder paint for uniform light distribution.

Reflector option includes painted white steel reflectors with or without semi-perforated option for uplight, or diffuse aluminum stepped reflector (ASR).

T5HO or T8 lamping configurations available.

### Listings

UL Listed (standard). CSA Certified (standard; except for 347V – see Options).

### Ordering Information

Example: **AVSM 2 32 MDR DLS MVOLT GEB10RS**

Series	Lamp type
<b>AVSM</b> 1' wide, 2' and 4' long	<b>17</b> 17W T8 (24") <b>32</b> 32W T8 (48")
<b>TAVSM</b> 1' wide, 8' long	<b>14T5</b> 14W T5 (22") <b>28T5</b> 28W T5 (46") <b>24T5HO</b> 24W T5 (22") <b>CF40</b> 40W TT5 (24") <b>CF50</b> 50W TT5 (24") <b>54T5HO</b> 54W T5 (46")

Number of loss lamps in cross section
1
2 <sup>1</sup>

Not included.

Diffuser	Voltage
<b>MDR</b> Metal diffuser, round holes <b>MDM</b> Metal diffuser, mini slots <b>SBL</b> Straight blade louver, round holes Others available; consult factory.	<b>MVOLT</b> <b>347</b> Others available; consult factory.

Light distribution
<b>ULR</b> Uplight, round hole, perforated band <sup>2</sup> <b>DLS</b> Downlight, solid

Options
<b>GEB10IS</b> T8 electronic ballast, ≤10% THD, instant start
<b>GEB10PS</b> T5 electronic ballast, ≤10% THD, program start
<b>GEB10RS</b> T8 electronic ballast, ≤10% THD, rapid start
<b>ALG</b> Acrylic litter guard
<b>GLR</b> Internal fast blow fuse <sup>3</sup>
<b>CSA</b> CSA Certified (347 only)

  

Reflector options
<b>ASR</b> Aluminum stepped reflector <sup>4</sup>

- NOTES:
- Available with straight-tube T5 or T8 lamps only.
  - For suspended mounting only.
  - Must specify 120 or 277 voltage.
  - Not available with ULR.

	Ballast/Lamp Compatibility						
	17	32	14T5	28T5	24T5HO	CF40	54T5HO
GEB10IS	■						
GEB10PS		■	■	■			■
GEB10RS	■	■				■	

Dimensions shown in inches (centimeters) unless otherwise noted.

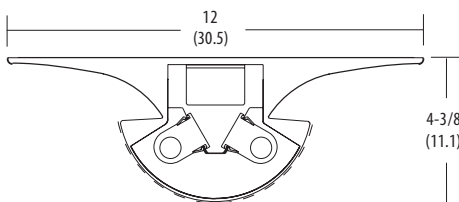

Availability and Dimensions				
Nominal size	Series	Number of lamps	Lamp type	Length
1'x2'	AVSM	1, 2	17, 14T5, 24T5HO	2'
		1	CF40, CF50	2'
1'x4'	AVSM	1, 2	32, 28T5, 54T5HO	4'
1'x8'	TAVSM	1, 2	32, 28T5, 54T5HO	8'

# Surface Avante® Availability Matrix

Options for AVSM		AVSM 1x2	AVSM 1x4	TAVSM 1x8
<b>GLR</b>	Internal fast blow fuse	■	■	■
<b>LP</b>	Lamped; specify lamp type and color	■	■	■
<b>EL</b>	Emergency battery pack (nominal 300 lumens, see Life Safety section)		■	■
<b>EL55</b>	Emergency battery pack for T5/T5HO (nominal 390-700 lumens, see Life Safety section)		■	■
<b>MDR</b>	Metal diffuser, round holes	■	■	■
<b>MDM</b>	Metal diffuser, mini-slots	■	■	■
<b>SBL</b>	Straight blade louver	■	■	■
<b>ALG</b>	Acrylic litter guard	■	■	■

Accessories for AVSM		AVSM 1x2	AVSM 1x4	AVSM 1x8
<b>AVAC</b>	For grid mounting, adjustable cables non-feed individual or row fixtures	■	■	■
<b>AVACF</b>	For grid mounting, adjustable cables feed individual fixtures (18ga SJT)	■	■	■
<b>AVACF_12AWG</b>	For grid mounting, adjustable cables feed row fixtures (12 ga SJT)	■	■	■
<b>AVAC_DWL</b>	For j-box or dry wall mounting, adjustable cables non-feed individual or row fixtures	■	■	■
<b>AVACF_DWL</b>	For j-box or dry wall mounting, adjustable cables feed individual fixtures (18 ga SJT)	■	■	■
<b>AVACF_DWL12AWG</b>	For j-box or dry wall mounting, adjustable cables feed row fixtures (12 ga SJT)	■	■	■
<b>SCY</b>	For j-box or dry wall mounting, stem mount non-feed or feed individual or row fixtures	■	■	■

Note: Fixtures supplied with 15/16"t-grid mounting hardware standard.

Lengths for AVSM accessories above (example: AVACF30)		AVSM 1x2	AVSM 1x4	AVSM 1x8
<b>_30</b>	3" to 30" below ceiling adjustable cable mounting	■	■	■
<b>_60</b>	30" to 60" below ceiling adjustable cable mounting	■	■	■
<b>_96</b>	60" to 96" below ceiling adjustable cable mounting	■	■	■
<b>_144</b>	96" to 144" below ceiling adjustable cable mounting	■	■	■
<b>SCY4</b>	4" below ceiling stem mounting	■	■	■

NOTES:  
1. Cannot be field installed.

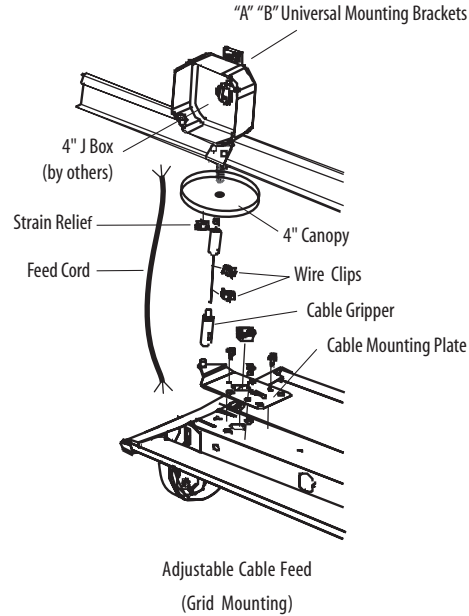
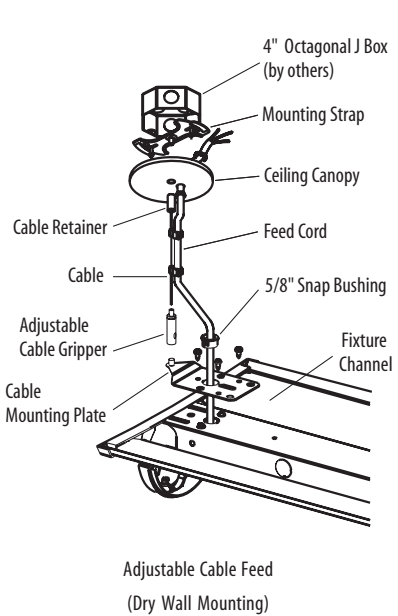
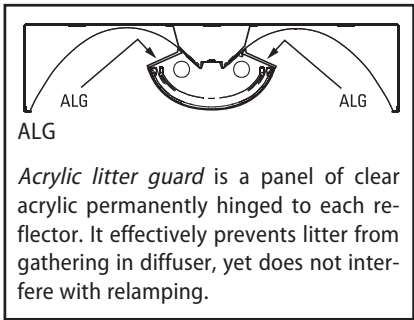



Architectural Lighting

# Avante®

Sconces

ADA

Features

Sconces include corridor and accent lighting in hospitality, educational, health care and circulation areas.

Listings

UL Listed (standard). CSA Certified or NOM Certified (see Options). All Avante® sconces are ADA compliant.

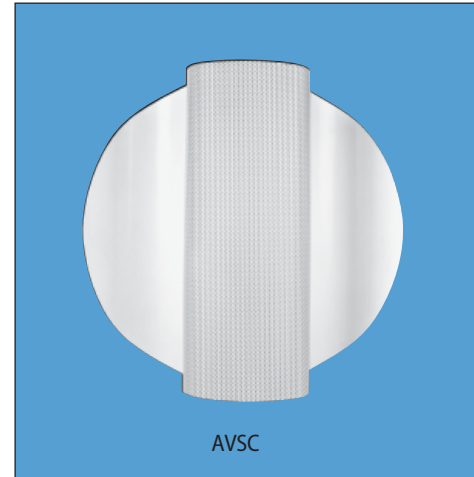

Ordering Information

Example: AVSP 2 13TT MDR 120

Model number	Number of lamps <sup>2</sup>	Lamp type	Diffuser	Voltage	Options <sup>4</sup>
AVSP Perforated shield <sup>1</sup>	1	13TT <sup>4</sup>	MDR Metal diffuser, round holes	120	ALB Anodized aluminum backplate <sup>4</sup>
AVSR Recessed perforated <sup>1</sup>	2 <sup>3</sup>	13DTT <sup>4</sup>	MDM Metal diffuser, mini slots	277	CSA CSA Certified
AVSC Cylinder	Not included.	CF18 <sup>5</sup>		347	NOM NOM Certified
		26DTT <sup>6</sup>		Others available; consult factory.	ADA Compliant.
		26TRT <sup>6</sup>			Reflector options
		32TRT <sup>6</sup>			ASR Aluminum stepped reflector <sup>7</sup>

Dimensions are shown in inches (centimeters) unless otherwise noted.

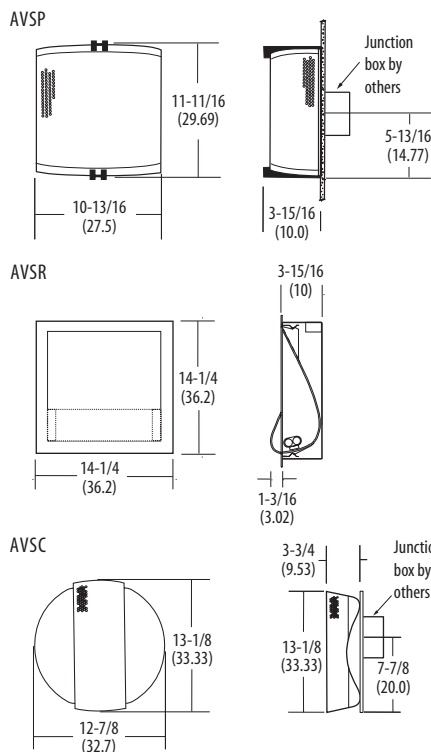

NOTES:

- 1 Dimming available.
- 2 Lamps not included.
- 3 Two-lamp available with AVSP models only.
- 4 Available with AVSP only.
- 5 Not available with AVSP.
- 6 Not available with AVSC.
- 7 Available with AVSC only.
- 8 1¼ (3.2) extension from wall.

Lamp Designations	
Type	Description
13TT	13W T4 twin-tube, 2-pin, GX23 base
13DTT	13W quad-tube, 4-pin electronic ballast, G24q-1 base
CF18	18W twin-tube T5
26DTT	26W quad-tube, 4-pin
26TRT	26W tri-tube, 4-pin
32TRT	32W tri-tube, 4-pin

Availability and Dimensions					
Model number	Number of lamps	Lamp type	Width in.(cm)	Depth in.(cm)	Length in.(cm)
AVSP	2	13TT, 13DTT, 26DTT	10 <sup>13</sup> / <sub>16</sub> (27.5)	3 <sup>15</sup> / <sub>16</sub> (10.0)	10 <sup>13</sup> / <sub>16</sub> (27.5)
AVSR <sup>8</sup>	1	CF18, 26DTT, 26TRT, 32TRT	14 <sup>3</sup> / <sub>4</sub> (37.5)	5 <sup>3</sup> / <sub>16</sub> (13.2)	14 <sup>3</sup> / <sub>4</sub> (37.5)
AVSC	1	CF18	12 <sup>7</sup> / <sub>8</sub> (32.7)	3 <sup>3</sup> / <sub>4</sub> (9.5)	13 <sup>1</sup> / <sub>8</sub> (33.3)

# Perceiva®

WW

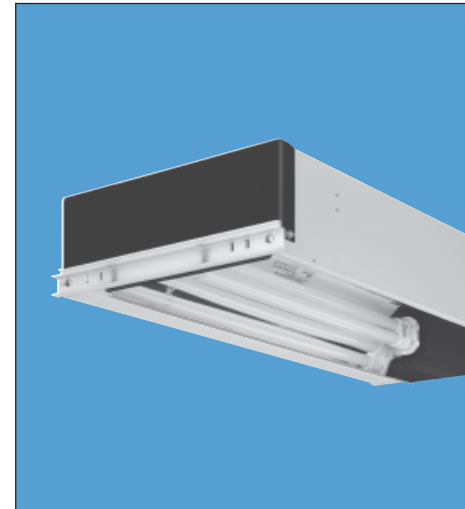

### Intended Use

Provides high performance, uniform, wall illumination. Highlights merchandise, artwork and signage.

### Features

Recessed fluorescent wallwash system provides energy-efficient accent lighting.

Provides maximum wall illumination with minimum brightness.

Eliminates hot spots, scalloping and shadows on vertical surfaces.

Highlights artwork, signage and merchandise.

High performance — 92% of light output illuminates wall. Asymmetric-throw reflector completely surrounds lamp cavity.

Choice of one or two T5 or T5HO lamps or compact lamp versions.

Ballast accessible from room side.

Reversible end trim accommodates both grid and screw-slot ceiling systems.

GF trim provides ceiling-tile support trims on long sides, grid trim on ends. Continuous row (grid trim only) or unit installation.

T-bar hold-down clips supplied standard. DGA accessory available to provide trim flange and fixture support in plaster or plasterboard ceilings. For use with G trim fixture.

### Listings

UL Listed (standard). CSA Certified (see Options).

Example: **WW G 2 32 120 IRLS GEB**

### Ordering Information

Series	Trim type	Number of lamps	Lamp type	Voltage	Reflector finish	Options
<b>WW</b> 12" wide For tandem double-length unit, add prefix <b>T</b> . Example: <b>TWW</b>	<b>G</b> Lay-in grid <sup>1</sup> <b>GF</b> Grid flanged <sup>2</sup> <b>ST</b> Screw slot	<b>1</b> <b>2</b> <sup>3</sup> Not included.	<b>17</b> 17W T8 (24") <b>32</b> 32W T8 (48") <b>14T5</b> 14W T5 (22") <b>24T5HO</b> 24W T5 (22") <b>CF40</b> 40W TT5 RS (24") <b>CF50</b> 50W TT5 RS (24") <b>28T5</b> 28W T5 (46") <b>54T5HO</b> 54W T5 (46")	<b>120</b> <b>277</b> <b>347</b> <b>MVOLT*</b> Others available; consult factory. *120-277V. Must specify GEB10IS.	<b>IRLS</b> Low iridescent specular silver <b>IRLD</b> Low iridescent diffuse silver	<b>GEB</b> Electronic ballast, ≤20% THD <b>GEB10IS</b> T8 electronic ballast, ≤10% THD, instant start <b>GEB10RS</b> T8 electronic ballast, ≤10% THD, rapid start <b>CSA</b> CSA Certified See pages 109 for others.

NOTES:

- 1 Use G trim plus DGA accessory for fixture-trim flange and fixture support in plaster or plasterboard ceilings.
- 2 Flanged sides, grid ends used in grid applications only.
- 3 2-lamp T5 and T5HO only.
- 4 Insert fixture width and length (in feet). Example: **DGA12**.

Accessories (Order separately)

**DGA** Flanged grid to drywall adapter, unit installation<sup>4</sup>

### Availability and Dimensions

Series	Nominal length	Lamps per cross section	Lamps per fixture	Lamp type	Height in.(cm)
WW	2'	1	1	17, CF40, CF50, 14T5, 24T5HO	4½ (11.4)
WW	4'	1	1	32, 28W T5, 54W T5HO	4½ (11.4)
TWW	4'	1	2	CF40, CF50	4½ (11.4)

Dimensions are shown in inches (centimeters) unless otherwise noted.

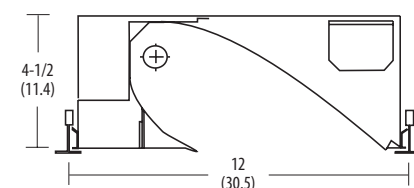

## Recessed Perimeter System

# RP



### Intended Use

Delivers wall illumination for continuous recessed perimeter lighting applications. Provides conformable corridor and effective accent lighting.

### Features

Continuous recessed wallwash lighting, available in any run length.

Full range of corner angles.

Choice of one or two lamps, staggered strip or butt strip electrical, optional internal reflector and a wide range of shielding for application flexibility.

Available in choice of air function.

Compatible with virtually all ceiling types.

Single-circuit, plug-in system standard. Facilitates

installation and prevents field miswiring. Two-circuit plug-in available.

Parabolic louvers are cantilevered from ceiling side of housing to allow for irregularities in wall surfaces.

Matches appearance of Paramax® family fixtures.

### Listings

UL Listed (standard). CSA Certified (see Options).

**IMPORTANT:** Specify a separate catalog number for each RP run length by designating both the *product information* and the *row takeoff information* below. Be sure measurements and corner conditions are specified on a continuous path around the proposed system.

### Ordering Information

Example: **RP 2 32 SE MVOLT GEB10IS SBL**

<b>Series</b> RP	<b>Channel options</b> (blank) None APB Air pattern control blade (with A) HRD Heat removal damper (with H)	<b>Lamps per cross section</b> 1 2 Not included.	<b>Electrical style</b> SE Staggered (SS) BE Butt (C)	<b>Voltage</b> MVOLT 347 Others available.	<b>Shielding<sup>1</sup></b> A12125 #12 pattern acrylic, .125" thick ACF Flat white acrylic PC1 1/2" X 1/2" X 1/2" louver PC2 1 1/2" X 1 1/2" X 1" louver PC3 3/4" X 3/4" X 1/2" louver SBL Straight blade louver, white PBL12 Parabolic louver <sup>2</sup>
<b>Air function<sup>1</sup></b> (blank) Static, no reveal B Static with reveal A Air supply/return with reveal H Heat-removal with reveal	<b>Lamp type</b> 17 17W T8 (24") 25 25W T8 (36") 32 32W T8 (48")	<b>Options<sup>1</sup></b> GLR Internal fast blow fusing GEB10IS T8 electronic ballast, ≤10% THD, instant start GEB10RS T8 electronic ballast, ≤10% THD, rapid start CSA CSA Certified	<b>Internal reflector</b> R		

### Row Takeoff Information

<b>Start condition</b> E End IC Inside corner OC Outside corner	<b>Corner angle<sup>2</sup></b> 90 90° 135 135°	<b>End condition</b> E End IC Inside corner OC Outside corner	<b>Corner angle<sup>2</sup></b> 90 90° 135 135°	<b>Row length</b> ____ (Specify feet and inches)
--	---	--	---	---

NOTES:  
1 Others available. Consult factory.  
2 Available only with IC or OC.

# NAT CNAT

### Intended Use

Recessed louvered (or lensed) architecturally styled products provide linear illumination for retail and other indoor applications.

### Features

Narrow 6", 8", 9" and 12" linear products for single or continuous-row applications. NAT models in 2', 3' and 4' lengths. CNAT models suitable for continuous-row applications in sizes up to 8'.

Up to 2" deep parabolic louver available in choice of louver finish. Other shielding types available.

Compatible with most ceiling types. See page 107.

### Listings

UL Listed (standard). CSA Certified or NOM Certified (see Options).

NAT – For single-unit applications

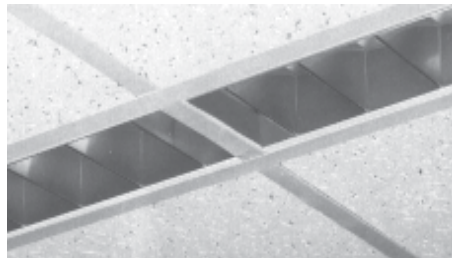

CNAT – For continuous-row applications

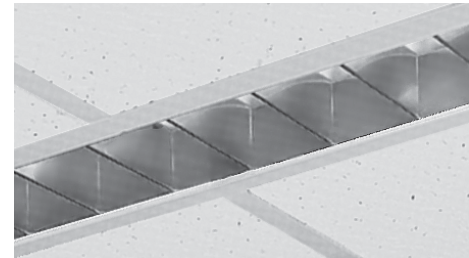

## Ordering Information

Example: **8NAT G 1 32 203LD MVOLT GEB10IS**

Series	Mounting	Number of lamps	Lamp type	Voltage	Options
<b>6NAT</b> 6" wide	<b>G</b> Lay-in grid	<b>1</b>	<b>17</b> 17W T8 (24")	<b>MVOLT</b>	<b>GEB10IS</b> T8 electronic ballast, ≤10% THD, instant start
<b>8NAT</b> 8" wide	<b>F</b> Flanged (see chart below)	<b>2</b>	<b>25</b> 25W T8 (36")	<b>347</b>	<b>GEB10RS</b> T8 electronic ballast, ≤10% THD, rapid start
<b>9NAT</b> 9" wide	<b>GF</b> Grid ends, flanged sides <sup>1</sup>	Not included.	<b>32</b> 32W T8 (48")	Others available; consult factory.	<b>CSA</b> CSA Certified
<b>NAT</b> 12" wide					<b>NOM</b> NOM Certified
<b>6CNAT</b> 6" wide					See page 109 for others.
<b>8CNAT</b> 8" wide					
<b>9CNAT</b> 9" wide					
<b>CNAT</b> 12" wide					

Louver depth	Louver blade spacing	Louver finish <sup>3</sup>	OR	Lay-in diffuser type
<b>15</b> 1.5" louver	<b>2</b> 2" center-to-center <sup>2</sup>	<b>LD</b> Low iridescent anodized semi-specular silver		<b>A12</b> #12 pattern acrylic
<b>20</b> 2" louver	<b>3</b> 3" center-to-center	<b>LS</b> Low iridescent anodized specular silver		<b>A19</b> #19 pattern acrylic, .156" thick

### NOTES:

- Available in NAT models only.
- 2" spacing available on 1.5" louver depth only.
- All lenses and louvers lift and shift.
- T (tandem) units use two louvers.

### Row Information For NAT, Flanged Mounting Only (Add suffix to catalog number)

- CRE** Trim for NAT continuous row end. Two required per row.
- CRM** Trim for NAT continuous row middle. Quantity per row is number of fixtures in row less two CRE.

### CNAT Accessories (Order separately)

- \_CNATGEP** One pair end plates for CNAT with G trim. End plate trim supports ceiling tile. Order one pair per row. Specify 6 (6"), 8 (8"), 9 (9") or leave blank for 12".
- \_CNATFEP** One pair end plates for CNAT with F trim. Order one pair per row. Specify 6 (6"), 8 (8"), 9 (9") or leave blank for 12".

### Availability and Dimensions

Series	Nominal length	Number of lamps	Lamp type	Number of cells		Height in.(cm)
				2" spacing	3" spacing	
NAT/CNAT	2' (Standard)	1, 2	17	12	8	6 (15.2)
	3' (Standard)	1, 2	25	18	12	6 (15.2)
	4' (Standard)	1, 2	32	24	16	6 (15.2)
TCNAT	6' (Tandem) <sup>4</sup>	1, 2	25	18x2 <sup>4</sup>	12x2 <sup>4</sup>	6 (15.2)
	8' (Tandem) <sup>4</sup>	1, 2	32	24x2 <sup>4</sup>	16x2 <sup>4</sup>	6 (15.2)

# Paramax® / Optimax®

Benchmark of Enduring Quality



The Paramax® Series, today's premier family of parabolic luminaires, offers a comprehensive selection of recessed and surface-mounted parabolics. A marriage of aesthetics and performance, Paramax® fixtures are the standard by which other parabolics are measured.

### Design Flexibility

The versatility of the Paramax® Series is further enhanced by a wide variety of optional configurations and companion luminaires, such as the RP architectural perimeter system and the NAT and CNAT narrow aperture series. Paramax® models are available for up to eight lamps with a choice of louver configurations, a full range of air functions and trim styles to fit virtually every type of ceiling system.

### Paramax® 2PM3N Luminaires

The Paramax® 2PM3N Series features innovative, state-of-the-art design that provides optimal performance with T8 lamps and electronic ballasts. The 2PM3N louver is engineered for maximum efficiency while maintaining excellent optical control and visual comfort. The housing is only 4½" deep, which allows installation in shallow plenums and features a superior paint finish, hemmed edges for ease of handling and integral T-bar retention.

### Optimax® Series Controls Glare

Optimax® fluorescent lighting system eliminates objectionable PC screen glare<sup>1</sup> caused by luminaire reflections. The key to Optimax® performance is the combination of an optimum shielding design that controls light at glare-producing angles and precise optical assemblies made of specially formulated, low iridescent, highly specular anodized aluminum.

As a result, Optimax® fixtures encourage productivity by eliminating the reflected luminaire screen glare that workers find uncomfortable.

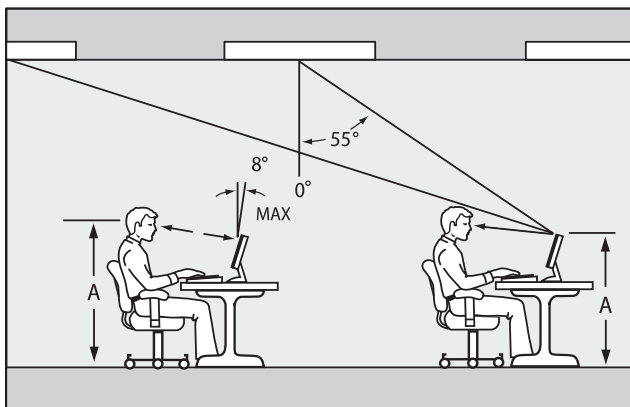

<sup>1</sup> The Optimax® Series effectively controls reflected glare in all workstations that meet ANSI/HFS Standard No. 100-1988 for operator and computer screen positions. All Optimax® fixtures meet criteria established by the lighting industry for fixture brightness in PC applications, including IES RP-1.

### Designing with Optimax® Luminaires

The Optimax® Series was created to provide appropriate lighting levels for large open office areas where PCs are used. Optimax® fixtures are available in a wide variety of sizes, air-handling functions, ceiling trim types and surface-mounted configurations that allow you to choose the appropriate luminaire for a specific application need. Small office areas and spaces that are adjacent to open areas are ideal for low-brightness Paramax® fixtures as a complement to Optimax® fixtures.

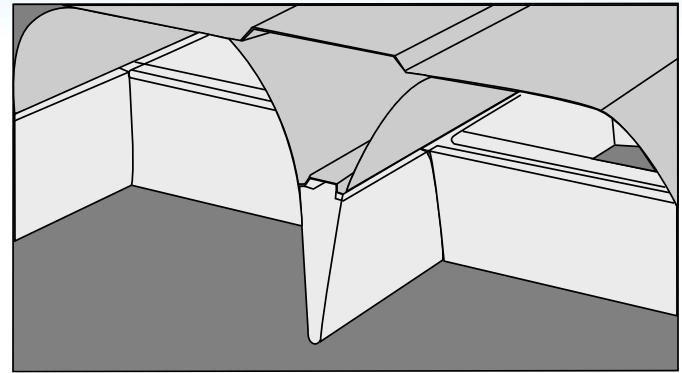

*Unique Louver Design* – Carefully formed louvers are shaped in a true tangential parabola for superior light control. Contoured housing (2'x4' and 20'x4' models) continues the parabolic shape of the louver to envelop the lamp in a fully reflective cavity. Precise fit between housing and louver eliminates light leaks, minimizes objectionable shadows and bright spots.

### Full Selection of Sizes

The Paramax® Series and the Optimax® Series feature a wide range of sizes and configurations. Standard models from 1'x2' wide through 4'x4' are offered, including 20"-wide versions for use in modular ceiling systems. Custom and metric sizes also can be specified, making Paramax® and Optimax® fixtures available for every type of commercial application.

	Available Sizes							
	PM4	2PM3N	PM3	PM2	HPM	PM3X	PMO	PMOX
1'x2'			■					
1'x4'			■		■	■	■	■
2'x2'	■	■		■		■	■	■
2'x4'	■	■		■		■	■	■
4'x4'			■			■		
20" x 4'			■				■	
Metric			■				■	

# PMO

Optimax®



### Intended Use

Full family of light-controlling parabolic luminaires designed to control screen glare in VDT open office environments.

### Features

Compound parabolic louver provides optimum light control.

Design optimized for use with T8 lamps and electronic ballasts.

Latest development in aluminum finishing minimizes louver iridescence. Ideal for use with triphosphor lamps.

Only listed lamp and cell configurations will provide Optimax® light control performance.

Hemmed sides and ends provide smooth edges for easy handling during installation.

Integral T-bar safety clips standard on most models.

Available in metric sizes. Consult Lithonia Lighting sales representative.

Surface-mounted versions also available. See page 52.

### Listing

UL Listed (standard). CSA Certified or NOM Certified (see Options).

## Ordering Information

Example: **2PMO G B 3 32 27LS MVOLT 1/3 GEB10IS**

Series	Air function	Lamp type	Number of cells	Louver finish	Voltage	Options
<b>PMO</b> 1' wide	<b>B</b> No air function	<b>17</b> 17W T8 (24")	<b>8</b>	<b>LS</b> Low-iridescent anodized specular silver	<b>MVOLT</b>	<b>1/3</b> One 3-lamp ballast
<b>2PMO</b> 2' wide	<b>A</b> Air supply/return	<b>U31</b> 31W T8 U (24")	<b>9</b>		<b>120</b>	<b>GEB</b> Electronic ballast, ≤20% THD
<b>20PMO</b> 20" wide	<b>H</b> Heat removal	<b>32</b> 32W T8 (48")	<b>12</b>	<b>LD</b> Low-iridescent anodized diffuse silver	<b>277</b>	<b>GEB10IS</b> T8 electronic ballast, ≤10% THD, instant start
	<b>D</b> Dual function supply/return/heat removal	<b>CF40</b> 40W TTS (24")	<b>18</b>		<b>347</b>	<b>GEB10RS</b> T8 electronic ballast, ≤10% THD, rapid start
			<b>27</b>			<b>CSA</b> CSA Certified
						<b>NOM</b> NOM Certified
						See page 109 for others.

Mounting trim	Number of lamps
<b>G</b> Grid	<b>1</b>
<b>F</b> Flanged	<b>2</b>
<b>MT</b> Modular fit-in	<b>3</b>
<b>ST</b> Screw slot	Not included.

Availability and Dimensions					
Nominal size	Series	Number of lamps	Lamp type	Number of cells	Height <sup>2</sup> in. (cm)
1'x4'	PMO	1	32	9 (1x9)	7¼ (18.4)
	PMO	2	32	9 (1x9)	7¼ (18.4)
2'x2'	2PMO	3	17, U31, CF40	12 (3x4)	6 (15.2)
	2PMO	2	17, U31, CF40	8 (2x4)	6 (15.2)
	2PMO	2	17, U31, CF40	12 (3x4)	6 ½ (16.5)
	20PMO(FP) <sup>1</sup>	2	17, U31, CF40	8 (2x4)	6 (15.2)
2'x4'	2PMO	3	32	27 (3x9)	6 (15.2)
	2PMO	2	32	27 (3x9)	6 11/16 (17)
	2PMO	2	32	18 (2x9)	6 (15.2)
	20PMO(FP) <sup>1</sup>	2	32	18 (2x9)	6 (15.2)
20" x 4'	20PMO	2	32	18 (2x9)	6 (15.2)

NOTES:

- 2FP2** and **4FP2** accessories available to fit 2' wide grid. Order separately.
- Some options increase fixture depth. Consult Lithonia Lighting sales representative if plenum depth is a factor.

Glare-Control System, 9" Aperture

# 9PMO

Optimax®

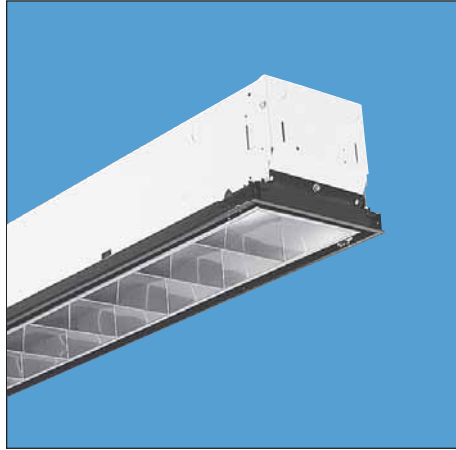

Intended Use

Ideal for corridors, stack lighting or wallwash in-door applications where superior glare control is important.

Features

Superior performance provided with a 9" aperture design.

Available in three distribution patterns, symmetric, asymmetric and bi-asymmetric, for efficient and precise illumination.

Asymmetric distribution provides uniform wall-wash for improved spatial brightness and visual brightness.

Symmetric distribution meets the industry's most rigorous standards for VDT lighting applications.

Bi-asymmetric distribution delivers high-angle light distribution on two vertical surfaces parallel to luminaire.

Complements design and style of other Optimax® and Paramax® products.

Listings

UL Listed (standard). CSA Certified or NOM Certified (see Options).

Ordering Information

Example: **9PMO G B 2 32 10LD ASY MVOLT GEB10IS**

<p><b>Series</b> 9PMO 9" wide</p>	<p><b>Air function</b> B No air function A Air supply/return</p>	<p><b>Number of cells</b> 10 1 row of 10</p>	<p><b>Louver finish</b> LS Low-iridescent anodized specular silver LD Low-iridescent anodized diffuse silver</p>	<p><b>Light distribution</b> (blank) Symmetric ASY Asymmetric BIAS Bi-asymmetric</p>	<p><b>Options</b> GEB10IS T8 electronic ballast, ≤10% THD, instant start GEB10RS T8 electronic ballast, ≤10% THD, rapid start CSA CSA Certified NOM NOM Certified See page 109 for others.</p>
<p><b>Mounting trim</b> G Lay-in grid F Flanged GF Grid trim ends and flange sides GF1 Grid trim ends, one grid side and one flange side</p>	<p><b>Number of lamps</b> 1 2 Not included.</p>	<p><b>Lamp type</b> 32 32W T8 (48")</p>	<p><b>Voltage</b> MVOLT 347 Others available.</p>		

Availability and Dimensions					
Nominal size	Series	Number of lamps	Lamp type	Number of cells	Height in.(cm)*
9"x4'	9PMO	1	32	10	7½ (19.1)
		2	32	10	7½ (19.1)

\*Consult factory for options to reduce overall fixture height.

Parabolic Troffers, 3" Louvers

# 2PM3N

Paramax®



**Intended Use**

High-performance parabolic luminaires for superior light control, visual comfort and light cut-off in open area indoor applications.

**Features**

- Contoured housing for superior light control.
- Design optimized for use with T8 lamps and electronic ballasts.
- Hemmed sides and ends provide smooth edges for easy handling during installation.
- Integral T-bar safety clips standard.
- Premium-grade aluminum louvers in choice of finishes, shipped in thermally sealed polyethylene wrapper.
- Mitered corners and interlocking construction assure precise parabolic shape.

Choice of cell configuration and lamping.

Compatible with most common ceiling types and air functions. For complete descriptions, see pages 107, 111.

**Listings**

UL Listed (standard). CSA Certified or NOM Certified (see Options).

Ordering Information

Example: **2PM3N G B 3 32 18LD MVOLT 1/3 GEB10IS**

<p><b>Series</b> 2PM3N 2' wide</p>	<p><b>Air function</b>  <b>B</b> No air function  <b>A</b> Air/supply/return  <b>H</b> Heat removal  <b>D</b> Dual function supply/return/heat removal</p>	<p><b>Lamp type</b>  <b>17</b> 17W T8 (24")  <b>U31</b> 31W T8 U (1<sup>5</sup>/<sub>8</sub>" leg)  <b>U316</b> 31W T8 U (6" leg)<sup>1</sup>  <b>32</b> 32W T8 (48")  <b>CF40</b> 40W TT5 (24")</p>	<p><b>Number of cells</b>  <b>6</b>  <b>9</b>  <b>12</b>  <b>16</b>  <b>18</b>  <b>24</b>  <b>32</b></p>	<p><b>Louver finish</b>  <b>LD</b> Low iridescent anodized diffuse silver  <b>LS</b> Low iridescent anodized specular silver</p>	<p><b>Options<sup>2</sup></b>  <b>1/3</b> One 3-lamp ballast  <b>1/4</b> One 4-lamp ballast  <b>GEB</b> Electronic ballast, ≤20% THD  <b>GEB10IS</b> T8 electronic ballast, ≤10% THD, instant start  <b>GEB10RS</b> T8 electronic ballast, ≤10% THD, rapid start  <b>CSA</b> CSA Certified  <b>NOM</b> NOM Certified</p> <p>See page 109 for others.</p>
<p><b>Mounting</b>  <b>G</b> Lay-in grid  <b>F</b> Flanged  <b>ST</b> Screw slot  <b>MT</b> Modular fit-in</p>	<p><b>Number of lamps</b>  <b>2</b>  <b>3</b>  <b>4</b>                  Not included.</p>	<p><b>Voltage</b>  <b>MVOLT</b>  <b>120</b>  <b>277</b>  <b>347</b></p> <p>Others available; consult factory.</p>			

Availability and Dimensions					
Nominal size	Series	Number of lamps	Lamp type	Number of cells <sup>3</sup> (rows x number in row)	Height <sup>2</sup> in. (cm)
2'x2'	2PM3N	2	17, U31, U316, CF40	<b>6</b> (2x3), <b>9</b> (3x3), <b>12</b> (4x3), <b>16</b> (4x4)	4½ (11.4)
		2	U316	6(2x3), 12(3x4)	4½ (11.4)
		3	17, U31, CF40	<b>9</b> (3x3), <b>16</b> (4x4)	4½ (11.4)
		3	17, CF40	12(3x4)	4½ (11.4)
2'x4'	2PM3N	4	17, CF40	<b>9</b> (3x3), <b>12</b> (4x3), <b>16</b> (4x4)	4½ (11.4)
		2	32	<b>12</b> (2x6), 16(2x8), 24(4x6)	4½ (11.4)
		3	32	<b>18</b> (3x6), 24(3x8)	4½ (11.4)
		4	32	12(2x6), 16(2x8), 18(3x6), 24(4x6), <b>32</b> (4x8)	4½ (11.4)

- NOTES:
- Not available on 3-lamp fixtures. Use U31.
  - Some options increase fixture depth. Consult Lithonia Lighting sales representative if plenum depth is a factor.
  - Popular cell configurations are shown in **bold** type.

**lightquick<sup>®</sup> XD**  
Express delivery products.

See page 11 for details about LightQuick XD.

**Description**

**2PM3N G B 3 32 18LD MVOLT GEB10IS**  
**2PM3N G B 2 U316 9LD MVOLT GEB10IS**  
**2PM3N G D 2 U316 9LD MVOLT GEB10IS ACS**  
**2PM3N G B 3 32 18LD MVOLT 1/3 GEB10IS**



Parabolic Troffers, 3" Louvers

# PM3

Paramax®

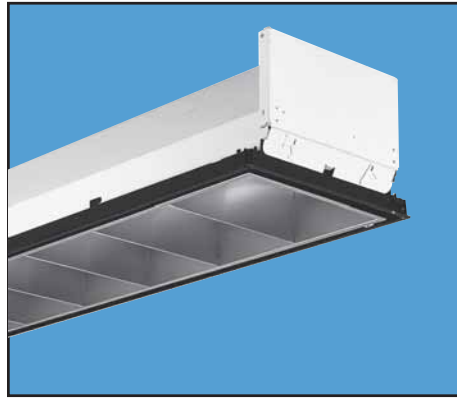

### Intended Use

High performance parabolic luminaires for superior light control, visual comfort and light cut-off in open area indoor applications.

### Features

Contoured housing for superior light control.

Design optimized for use with T8 lamps and electronic ballasts.

Hemmed sides and ends provide smooth edges for easy handling during installation.

Integral T-bar safety clips standard on most models.

Premium-grade aluminum louvers in choice of finishes, shipped in thermally sealed polyethylene wrapper.

Mitered corners and interlocking construction assure precise parabolic shape.

Choice of cell configuration and lamping.

Compatible with virtually all ceiling types and air functions. For complete descriptions, see pages 107, 111.

Surface-mounted versions also available. See page 53.

Metric sizes also available. Consult Lithonia Lighting sales representative.

### Listings

UL Listed (standard). CSA Certified or NOM Certified (see Options).

### Ordering Information

Example: **PM3 G B 2 32 8LD MVOLT GEB10IS**

Series	Air function	Lamp type	Number of cells	Louver finish	Voltage	Options
<b>PM3</b> 1' wide	<b>B</b> No air function	<b>17</b> 17W T8 (24")	<b>3</b>	<b>LD</b> Low iridescent anodized diffuse silver	<b>MVOLT</b>	<b>1/3</b> One 3-lamp ballast
<b>20PM3</b> 20" wide	<b>A</b> Air supply/return	<b>U31</b> 31W T8 U (1 1/8" leg)	<b>4</b>		<b>120</b>	<b>1/4</b> One 4-lamp ballast
<b>4PM3</b> 4' wide	<b>H</b> Heat removal	<b>U316</b> 31W T8 U (6" leg)	<b>6</b>	<b>LS</b> Low iridescent anodized specular silver	<b>277</b>	<b>GEB</b> Electronic ballast, ≤20% THD
	<b>D</b> Dual function supply/return/heat removal	<b>32</b> 32W T8 (48")	<b>8</b>		<b>347</b>	<b>GEB10IS</b> T8 electronic ballast, ≤10% THD, instant start
		<b>CF40</b> 40W TT5 (24")	<b>9</b>		Others available.	<b>GEB10RS</b> T8 electronic ballast, ≤10% THD, rapid start
			<b>12</b>			<b>CSA</b> CSA Certified
			<b>16</b>			<b>NOM</b> NOM Certified
			<b>18</b>			See page 109 for others.
			<b>24</b>			
			<b>36</b>			
			<b>64</b>			
Mounting	Number of lamps					
<b>G</b> Lay-in grid	<b>1</b>					
<b>F</b> Flanged	<b>2</b>					
<b>MT</b> Modular fit-in	<b>3</b>					
	<b>4</b>					
	<b>6</b>					
	<b>8</b>					
	Not included.					

NOTES:

- 1 Popular cell configurations are shown in **bold** type.
- 2 Some options increase fixture depth. Consult Lithonia Lighting sales representative if plenum depth is a factor.

Availability and Dimensions					
Nominal size	Series	Number of lamps	Lamp type	Number of cells <sup>1</sup> (rows x number in row)	Height <sup>2</sup> in. (cm)
1'x2'	PM3	1, 2	17, U31, CF40	3(1x3), <b>4(1x4)</b> , 6(2x3), 8(2x4)	7 1/4 (18.4)
		1	U316	3(1x3), <b>4(1x4)</b> , 6(2x3), 8(2x4)	7 1/4 (18.4)
1'x4'	PM3	1, 2, 3	32	6(1x6), <b>8(1x8)</b> , <b>9(1x9)</b>	7 1/4 (18.4)
		2	32	12(2x6), <b>16(2x8)</b>	7 1/4 (18.4)
20"x4'	20PM3	2	32	<b>12(2x6)</b> , 16(2x8), 18(3x6), 24(3x8)	5 15/16 (15.1)
		3	32	<b>18(3x6)</b> , <b>24(3x8)</b>	5 15/16 (15.1)
4'x4'	4PM3	4	32	<b>12(2x6)</b> , 16(2x8), 18(3x6), 24(3x8)	5 15/16 (15.1)
		6	32	<b>36(6x6)</b> , <b>64(8x8)</b>	6 1/2 (16.5)
		8	32	<b>36(6x6)</b> , <b>64(8x8)</b>	6 1/2 (16.5)

Parabolic Troffers, 4" Louvers

# PM4

Paramax®



**Intended Use**

Deep-cell parabolic luminaires for use in open-area indoor applications and electronic offices where optical control, visual comfort and light cut-off are important.

**Features**

4"-deep, premium-grade aluminum louvers in choice of finishes, shipped in thermally sealed polyethylene wrapper.

Design optimized for use with T8 lamps and electronic ballasts.

Hemmed sides and ends provide smooth edges for easy handling during installation.

Integral T-bar safety clips standard.

Mitered louver corners and interlocking construction assure precise parabolic shape.

Choice of cell configuration and lampping.

Compatible with virtually all ceiling types and air functions. For complete descriptions, see pages 107, 111.

**Listings**

UL Listed (standard). CSA Certified or NOM Certified (see Options).

**Ordering Information**

Example: **2PM4 G B 3 32 18LD MVOLT 1/3 GEB10IS**

<b>Series</b> 2PM4 2' wide	<b>Air function</b> B No air function A Air supply/return H Heat removal D Dual function supply/return/removal	<b>Lamp type</b> 17 17W T8 (24") U31 31W T8 U (1 5/8" leg) U316 31W T8 U (6" leg) <sup>1</sup> 32 32W T8 (48") CF40 40W T85 (24")	<b>Number of cells</b> 6 9 12 16 18 24 32	<b>Louver finish</b> LD Low-iridescent anodized diffuse silver LS Low-iridescent anodized specular silver	<b>Voltage</b> MVOLT 120 277 347 Others available; consult factory.	<b>Options</b> 1/3 One 3-lamp ballast 1/4 One 4-lamp ballast GEB Electronic ballast, ≤20% THD GEB10IS T8 electronic ballast, ≤10% THD, instant start GEB10RS T8 electronic ballast, ≤10% THD, rapid start CSA CSA Certified NOM NOM Certified See page 109 for others.
<b>Mounting</b> G Lay-in grid F Flanged MT Modular fit-in ST Screw slot	<b>Number of lamps</b> 2 3 4 Not included.					

Availability and Dimensions					
Nominal size	Series	Number of lamps	Lamp type	Number of cells <sup>2</sup> (rows x number in row)	Height <sup>3</sup> in. (cm)
2'x2'	2PM4	2	U316	6(2x3), <b>9</b> (3x3), 12(3x4), <b>16</b> (4x4)	6 (15.2)
		2	17, U31, CF40	6(2x3), <b>9</b> (3x3), 12(4x3), <b>16</b> (4x4)	6 (15.2)
		3	17, U31, CF40	<b>9</b> (3x3), 12(3x4), 16(4x4)	6 (15.2)
		4	17, CF40	6(2x3), 9(3x3), 12(4x3), <b>16</b> (4x4)	6 (15.2)
2'x4'	2PM4	2	32	<b>12</b> (2x6), 16(2x8), 18(3x6), 24(4x6), 32(4x8)	6 (15.2)
		3	32	<b>18</b> (3x6), <b>24</b> (3x8), 32(4x8)	6 (15.2)
		4	32	12(2x6), 16(2x8), 18(3x6), 24(4x6), <b>32</b> (4x8)	6 (15.2)

NOTES:

- 1 Not available on 3-lamp fixtures. Use U31.
- 2 Popular cell configurations are shown in bold type.
- 3 Some options increase fixture depth. Consult Lithonia Lighting sales representative if plenum depth is a factor.

Parabolic Troffers, 2" Louvers

# PM2

Paramax®



### Intended Use

Louvered parabolic luminaires for optical control in general office environments and open indoor spaces.

### Features

Contoured housing for superior light control.

Design optimized for use with T8 lamps and electronic ballasts.

Hemmed sides and ends provide smooth edges for easy handling during installation.

Integral T-bar safety clips standard.

2" deep premium-grade aluminum louvers shipped in thermally sealed polyethylene wrapper.

Mitered louver corners and interlocking construction assure precise parabolic shape.

Choice of cell configuration and lampping.

Compatible with virtually all ceiling types and air functions. For complete descriptions, see pages 107, 111.

### Listings

UL Listed (standard). CSA Certified or NOM Certified (see Options).

## Ordering Information

Example: **2PM2 G B 3 32 18LD MVOLT GEB10IS**

Series	Air function	Number of lamps	Lamp type	Number of cells	Louver finish	Options
<b>2PM2</b> 2' wide	<b>B</b> No air function	<b>2</b>	<b>17</b> 17W T8 (24")	<b>6</b>	<b>LD</b> Low iridescent anodized diffuse silver	<b>1/3</b> One 3-lamp ballast
	<b>A</b> Air supply/return	<b>3</b>	<b>U31</b> 31W T8 U (1 <sup>5</sup> / <sub>8</sub> " leg)	<b>9</b>		<b>1/4</b> One 4-lamp ballast
	<b>H</b> Heat removal	<b>4</b> Not included.	<b>U316</b> 31W T8 U (6" leg) <sup>1</sup>	<b>12</b>	<b>LS</b> Low iridescent anodized specular silver	<b>GEB</b> Electronic ballast, ≤20% THD
	<b>D</b> Dual function supply/return, removal		<b>32</b> 32W T8 (48")	<b>16</b>		<b>GEB10IS</b> T8 electronic ballast, ≤10% THD, instant start
			<b>CF40</b> 40W TFS (24")	<b>18</b>		<b>GEB10RS</b> T8 electronic ballast, ≤10% THD, rapid start
				<b>24</b>		<b>CSA</b> CSA Certified
				<b>32</b>		<b>NOM</b> NOM Certified
						See page 109 for others.
<b>Mounting</b>					<b>Voltage</b>	
<b>G</b> Lay-in grid					<b>MVOLT</b>	
<b>F</b> Flanged					<b>120</b>	
<b>MT</b> Modular fit-in					<b>277</b>	
<b>ST</b> Screw slot					<b>347</b>	
					Others available; consult factory.	

NOTES:

- 1 Not available on 3-lamp fixtures. Use U31.
- 2 Popular cell configurations are shown in **bold** type.
- 3 Some options increase fixture depth. Consult Lithonia Lighting sales representative if plenum depth is a factor.

Availability and Dimensions				
Nominal size	Number of lamps	Lamp type	Number of cells <sup>2</sup> (rows x number in row)	Height <sup>3</sup> in. (cm)
2'x2'	2	U316	6(2x3), <b>9</b> (3x3), 12(3x4), <b>16</b> (4x4)	4½(11.4)
	2	17, U31, CF40	6(2x3), <b>9</b> (3x3), 12(4x3), <b>16</b> (4x4)	4½(11.4)
	3	17, U31, CF40	<b>9</b> (3x3), 12(3x4), 16(4x4)	4½(11.4)
	4	17, CF40	6(2x3), 9(3x3), 12(4x3), <b>16</b> (4x4)	4½(11.4)
2'x4'	2	32	<b>12</b> (2x6), 16(2x8), 18(3x6), <b>24</b> (4x6), 32(4x8)	4½(11.4)
	3	32	<b>18</b> (3x6), <b>24</b> (3x8), 32(4x8)	4½(11.4)
	4	32	12(2x6), 16(2x8), 18(3x6), <b>24</b> (4x6), <b>32</b> (4x8)	4½(11.4)

## Parabolic Troffers, High-Performance 1'x4'

### Intended Use

High performance parabolic troffer for office lighting systems in VDT applications.

### Features

High-efficiency 1'x4' Paramax® fixtures.

Lamps stacked vertically for uniform louver brightness in multi-level switching applications.

Design optimized for use with T8 lamps and electronic ballasts.

Hemmed sides and ends provide smooth edges for easy handling during installation.

Integral T-bar safety clips standard.

Choice of louver finish and air function.

Compatible with virtually all ceiling types. See page 107.

Available in surface-mount and metric-size versions. Consult Lithonia Lighting sales representative.

### Listings

UL Listed (standard). CSA Certified or NOM Certified (see Options).

# HPM3

Paramax®



### Ordering Information

Example: **HPM3 G B 2 32 8LD MVOLT GEB10IS**

Series	Air function	Number of lamps	Lamp type	Number of cells	Louver finish	Options
<b>HPM3</b> 1' wide	<b>B</b> No air function <b>A</b> Air supply/return <b>H</b> Heat removal <b>D</b> Dual function supply/return heat removal	<b>2</b> Not included.	<b>32</b> 32W T8 (48")	<b>6</b> <b>8</b> <b>9</b>	<b>LD</b> Low iridescent anodized diffuse silver <b>LS</b> Low iridescent anodized specular silver	<b>1/3</b> One 3-lamp ballast <b>1/4</b> One 4-lamp ballast <b>GEB10IS</b> T8 electronic ballast, ≤10% THD, instant start <b>GEB10RS</b> T8 electronic ballast, ≤10% THD, rapid start <b>CSA</b> CSA Certified <b>NOM</b> NOM Certified See pages 109 for others.
	<b>Trim type</b>				<b>Voltage</b>	
	<b>G</b> Lay-in grid <b>F</b> Flanged <b>MT</b> Modular fit-in				<b>MVOLT</b> <b>120</b> <b>277</b> <b>347</b> Others available; consult factory.	

Availability and Dimensions					
Nominal size	Series	Number of lamps	Lamp type	Number of cells <sup>1</sup> (rows x number in row)	Height in. (cm)
1'x4'	HPM3	2	32	6(1x6), <b>8(1x8)</b> , <b>9(1x9)</b>	7¼ (18.4)

#### NOTES:

1 Popular cell configurations are shown in **bold** type.

## Lensed Troffers

# SP8

Static



### Intended Use

Specification premium, high performance, static T8 luminaires provide general illumination for recessed indoor applications; ideal for restricted plenum spaces.

### Features

Innovative low-profile design optimized around T8 lamps, low-profile electronic ballasts and T8 compact sockets.

Hemmed sides provide smooth edges for easy handling during installation.

Standard steel door frame features precise flush-mitered corners.

Unique door frame design delivers a premium extruded appearance.

Housing and door frame interface provides a superior mechanical light seal without the use of foam gasketing.

Standard latch provides spring action. Door latches and hinges from either side.

Improved performance – higher fixture efficiency and reduced lamp image.

Integral T-bar safety clips are standard; no need to install separate clips.

Aluminum door frames available, flush or regressed.

Compatible with virtually all ceiling types. Field trim modification kits also available. See page 107.

U.S. patents – 6,210,025; 6,231,213; 6,213,625; 2,288,471.

### Listings

UL Listed (standard). CSA Certified or NOM Certified (see Options).

## Ordering Information

Example: **2SP8 G 3 32 A12 MVOLT 1/3 GEB10IS**

Series	Number of lamps	Frame type	Voltage	Options
SP8 1' wide	1 <sup>1</sup>	(blank) Flush steel, white	<b>MVOLT</b>	<b>1/3</b> One 3-lamp ballast
2SP8 2' wide	2	<b>FN</b> Flush aluminum, natural	<b>120</b>	<b>1/4</b> One 4-lamp ballast
	3	<b>FM</b> Flush aluminum, matte black	<b>277</b>	<b>GEB</b> Electronic ballast, ≤20% THD
	4 <sup>2</sup>	<b>FW</b> Flush aluminum, white	<b>347</b>	<b>GEB10IS</b> T8 electronic ballast, ≤10% THD, instant start
	6 <sup>2</sup>	<b>RN</b> Regressed aluminum, natural	Others available.	<b>GEB10RS</b> T8 electronic ballast, ≤10% THD, rapid start
	Not included.	<b>RM</b> Regressed aluminum, matte black		<b>CSA</b> CSA Certified
		<b>RW</b> Regressed aluminum, white		<b>NOM</b> NOM Certified
				See pages 106, 109 for others.
Trim type	Lamp type	Diffuser type		
<b>G</b> Grid	<b>17</b> 17W T8 (24")	<b>A12</b> #12 pattern acrylic <sup>4</sup>		
<b>F</b> Flanged	<b>U31</b> 31W T8 U (1 <sup>5</sup> / <sub>8</sub> " leg)	<b>A12125</b> #12 pattern acrylic, .125" thick		
<b>MT</b> Modular fit-in	<b>U316</b> 31W T8 U (6" leg) <sup>3</sup>	<b>RA125</b> #12 pattern acrylic, .125" thick (reverse apex)		
	<b>32</b> 32W T8 (48")	<b>A19</b> #19 pattern acrylic, .156" thick		
	<b>CF40</b> 40W TT5 (24")	<b>K20</b> #20 pattern acrylic, .140" thick		
		<b>84Y</b> Holophane 8224 with overlay		
		<b>PC15</b> 1/2"x1/2"x1/2" plastic cube louver, silver		
		<b>PC25</b> 1 1/2"x1 1/2"x1" plastic cube louver, silver with flange		
		<b>PC35</b> 3/4"x3/4"x1/2" plastic cube louver, silver		

NOTES:

- 1-lamp model available in 1'x4' only.
- 4- and 6-lamp models available with 17W and 32W straight tubes only.
- Not available on 3-lamp fixtures. Use U31.
- Standard A12 diffuser has reverse apex technology.

### Availability and Dimensions

Nominal size	Series	Number of Lamps	Lamp type	Height in.(cm)
1'x4'	SP8	1,2,3	32	4 1/2 (11.4)
2'x2'	2SP8	2	17,U31, U316, CF40	3 11/16 (9.3)
		3	17, U31, CF40	3 11/16 (9.3)
		4	17	3 11/16 (9.3)
2'x4'	2SP8	2, 3, 4, 6	32	3 11/16 (9.3)

**SP**

*Air-Handling*

**Intended Use**

Complete selection of specification premium air-handling luminaires recommended for all general illumination recessed applications.

**Features**

Fully gasketed door frame with spring-action latches.

Full black reveal has floating door appearance.

Aluminum door frames available; flush or regressed. Air-flow control available with optional heat removal dampers and air pattern control blades.

Integral T-bar safety clips are standard on 1'x4', 2'x2' and 2'x4' fixtures. No need to install separate clips.

Compatible with virtually all ceiling types. See page 107. Field trim modification kits also available.

Some fixtures available in metric sizes. Contact Lithonia Lighting sales representative.

**Listings**

Listings – UL Listed (standard), CSA Certified or NOM Certified (see Options).

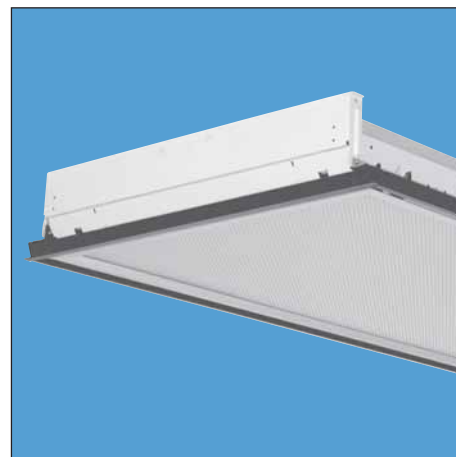

**Ordering Information**

Example: **2SP G A 3 32 A12 MVOLT 1/3 GEB10IS**

Series	Air function	Lamp type	Frame type	Voltage	Options
<b>SP</b> 1' wide <b>2SP</b> 2' wide <b>4SP</b> 4' wide <sup>1</sup>	<b>B</b> No air function, with reveal <b>A</b> Air supply/return <b>H</b> Heat removal <b>D</b> Dual function supply/return/heat removal	<b>17</b> 17W T8 (24") <b>U31</b> 31W T8 U (1 1/8" leg) <b>U316</b> 31W T8 U (6" leg) <sup>4</sup> <b>32</b> 32W T8 (48") <b>CF40</b> 40W TTS (24")	(blank) Flush steel, white <b>FN</b> Flush aluminum, natural <b>FM</b> Flush aluminum, matte black <b>FW</b> Flush aluminum, white <b>RN</b> Regressed aluminum, natural <b>RM</b> Regressed aluminum, matte black <b>RW</b> Regressed aluminum, white	<b>MVOLT</b> <b>120</b> <b>277</b> <b>347</b> Others available.	<b>1/3</b> One 3-lamp ballast <b>1/4</b> One 4-lamp ballast <b>GEB</b> Electronic ballast, ≤20% THD <b>GEB10IS</b> T8 electronic ballast, ≤10% THD, instant start <b>GEB10RS</b> T8 electronic ballast, ≤10% THD, rapid start <b>CSA</b> CSA Certified <b>NOM</b> NOM Certified See pages 106, 109 for others.
Trim type	Number of lamps	Diffuser type <sup>5</sup>			
<b>G</b> Grid <b>F</b> Flanged <b>MT</b> Modular fit-in <b>ST</b> Screw slot <sup>1,2</sup>	<b>1</b> <sup>3</sup> <b>2</b> <b>3</b> <b>4</b> <b>6</b> <b>8</b> Not included.	<b>A12</b> #12 pattern acrylic <b>A12125</b> #12 pattern acrylic, .125" thick <b>A19</b> #19 pattern acrylic, .156" thick <b>K20</b> #20 pattern acrylic, .140" thick <b>84Y</b> Holophane 8224 with overlay			

Availability and Dimensions				
Nominal size	Series	Number of lamps	Lamp type	Height <sup>7</sup> in. (cm)
1'x4'	SP AIR	1, 2, 3	32	7 1/4 (18.4)
2'x2'	2SP AIR	2	17, U31, U316, CF40	4 1/2 (11.4)
		3	17, U31, CF40	4 1/2 (11.4)
		4	17, CF40	4 1/2 (11.4)
2'x4'	2SP AIR	2, 3, 4	32	4 1/2 (11.4)
4'x4'	4SP AIR <sup>4,6</sup>	4, 6, 8	32	5 (12.7)

- NOTES:
- 1 Not available with flush steel door.
  - 2 Consult factory for fixture depth.
  - 3 1-lamp model available in 1'x4' only.
  - 4 Not available on 3-lamp fixtures. Use U31.
  - 5 Center mullion standard on 4SP AIR. 4'x4' lens optional.
  - 6 Integral T-bar clips not available. Use LATIC option.
  - 7 Some options increase fixture depth. Consult Lithonia Lighting sales representative if plenum depth is a factor.

## Specification Premium Troffers

# SP

## Small-Cell Louvers Air-Handling

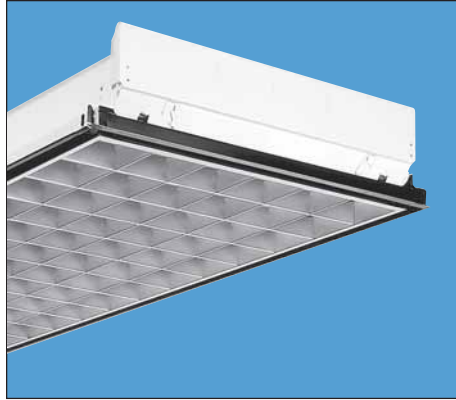

### Intended Use

Specification premium air-handling luminaires recommended for all general illumination indoor applications.

### Features

Premium-grade troffer with architectural small-cell aluminum louvers.

Choice of 1.5" and .75" deep cells.

Louver available in choice of low iridescent silver or low iridescent diffuse anodized finish.

Full black reveal and floating louver when air function is specified.

Integral T-bar clips standard on 1'x4', 2'x2' and 2'x4' fixtures. Eliminates the need to install separate clips.

Spring action latches standard.

Some fixtures available in metric sizes. Contact Lithonia Lighting sales representative.

### Listings

UL Listed (standard). CSA Certified or NOM Certified (see Options).

## Ordering Information

Example: **2SP G D 3 32 10515LD MVOLT 1/3 GEB10IS**

Series	Air function <sup>1</sup>	Number of lamps	Louver type	Louver finish	Options
SP 1' wide	(blank) Static, no reveal	1 <sup>2</sup>	1'X4' 1315 13 cells, 1.5" deep	LD Low iridescent anodized diffuse silver	1/3 One 3-lamp ballast
2SP 2' wide	B No air function (with reveal)	2	2615 26 cells, 1.5" deep	LS Low iridescent anodized specular silver	1/4 One 4-lamp ballast
	A Air supply/return	3	3915 39 cells, 1.5" deep		GEB Electronic ballast, ≤20% THD
	H Heat removal	4	4515 45 cells, 1.5" deep		GEB10IS T8 electronic ballast, ≤10% THD, instant start
	D Dual function supply/ return/ heat removal	6 Not included.	18675 186 cells, .75" deep		GEB10RS T8 electronic ballast, ≤10% THD, rapid start
			2'X2' 3615 36 cells, 1.5" deep		CSA CSA Certified
			4915 49 cells, 1.5" deep		NOM NOM Certified
			16975 169 cells, .75" deep		See pages 106,109 for others.
			2'X4' 7815 78 cells, 1.5" deep		
			10515 105 cells, 1.5" deep		
			37775 377 cells, .75" deep		
Trim type		Lamp type		Voltage	
G Grid		17 17W T8 (24")		MVOLT	
F Flanged		U31 31W T8 U (1 <sup>1/2</sup> " leg)		120	
MT Modular fit-in		U316 31W T8 U (6" leg) <sup>3</sup>		277	
		32 32W T8 (48")		347	
		CF40 40W TTS (24")		Others available.	

### NOTES:

- Some options increase fixture depth. Consult Lithonia Lighting sales representative if plenum depth is a factor.
- 1-lamp model available in 1'x4' only.
- Not available on 3-lamp fixtures. Use U31.

### Availability and Dimensions

Nominal size	Series	Number of lamps	Lamp type	Height <sup>1</sup> in.(cm)
1'x4'	SP AIR	1, 2, 3	32	7¼ (18.4)
		2	17, U31, U316, CF40	4½ (11.4)
2'x2'	2SP AIR	3	17, U31, CF40	4½ (11.4)
		4	17, CF40	4½ (11.4)
2'x4'	2SP AIR	2, 3, 4, 6	32	4½ (11.4)

# GT8

Static

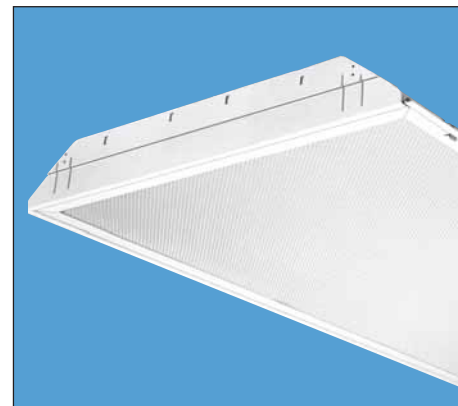

### Intended Use

Low-profile, static T8 luminaire provides general illumination for recessed indoor applications. Ideal for restricted plenums.

### Features

Innovative low-profile design optimized around T8 lamps and low-profile electronic ballasts.

Hemmed sides provide smooth edges for easy handling during installation.

Standard steel door frame features precise flush mitered corners. Unique design delivers a premium extruded appearance.

Housing and door frame interface provides a superior mechanical light seal without the use of foam gasketing.

Standard latch provides spring action. Door latches and hinges from either side.

Improved performance – higher fixture efficiency.

Integral T-bar safety clips are standard – no need to install separate clips.

Aluminum door frames available, flush or regressed.

Compatible with most ceiling types. Field trim modification kits also available. See page 107.

U.S. patents – 6,210,025; 6,231,213; 6,213,625; 2,288,471.

### Listings

UL Listed (standard). CSA Certified or NOM Certified (see Options).

### Ordering Information

Example: **2GT8 4 32 A12 MVOLT 1/4 GEB10IS**

Series	Number of lamps	Frame type	Voltage	Options
<b>GT8</b> 1' wide	<b>1</b> <sup>1</sup>	(blank) Flush steel, white	<b>MVOLT</b>	<b>1/3</b> One 3-lamp ballast
<b>2GT8</b> 2' wide	<b>2</b>	<b>FN</b> Flush aluminum, natural	<b>120</b>	<b>1/4</b> One 4-lamp ballast
	<b>3</b>	<b>FM</b> Flush aluminum, matte black	<b>277</b>	<b>GEB</b> Electronic ballast, ≤20% THD
	<b>4</b> <sup>2</sup>	<b>FW</b> Flush aluminum, white	<b>347</b>	<b>GEB10IS</b> T8 electronic ballast, ≤10% THD, instant start
	Not included.	<b>RN</b> Regressed aluminum, natural	Others available.	<b>GEB10RS</b> T8 electronic ballast, ≤10% THD, rapid start
		<b>RM</b> Regressed aluminum, matte black		<b>CSA</b> CSA Certified
		<b>RW</b> Regressed aluminum, white		<b>NOM</b> NOM Certified
				See pages 106, 109 for others.
Trim type	Lamp type	Diffuser type		
(blank) Grid	<b>17</b> 17W T8 (24")	<b>A12</b> #12 pattern acrylic		
<b>F</b> Flanged	<b>U31</b> 31W T8 U (1 <sup>5</sup> / <sub>8</sub> " leg)	<b>A12125</b> #12 pattern acrylic, .125" thick		
	<b>U316</b> 31W T8 U (6" leg) <sup>3</sup>	<b>A19</b> #19 pattern acrylic, .156" thick		
	<b>32</b> 32W T8 (48")	<b>A15</b> #15 pattern acrylic, .200" thick		
	<b>CF40</b> 40W TT5 (24") <sup>3</sup>	<b>K20</b> #20 pattern acrylic, .140" thick		
		<b>84Y</b> Holophane 8224 with overlay		
		<b>PC15</b> 1/2"x1/2"x1/2" plastic cube louver, silver		
		<b>PC25</b> 1 1/2"x1 1/2"x1" plastic cube louver, silver with flange <sup>4</sup>		
		<b>PC35</b> 3/4"x3/4"x1/2" plastic cube louver, silver		

NOTES:  
 1 1-lamp model available in 1' x 4' only.  
 2 4-lamp models available with 17W or 32W straight tube lamps only.  
 3 Not available on 3-lamp fixtures. Use U31.  
 4 Available with flush door frames only. Some 2x2 lamp and electrical combinations not available with PC2 louvers. Consult factory.

Availability and Dimensions				
Nominal size	Series	Number of lamps	Lamp type	Height in. (cm)
1'x4'	GT8	1, 2, 3	32	4 1/2 (11.4)
2'x2'	2GT8	2	17, U31, U316, CF40	3 3/16 (8.0)
		3	17, U31	3 3/16 (8.0)
		4	17	3 3/16 (8.0)
2'x4'	2GT8	2, 3, 4	32	3 3/16 (8.0)

**lightquick<sup>®</sup> XD**  
 Express delivery products.  
 See page 11 for details about LightQuick XD.

---

*Description*

**2GT8 2 U316 A12 MVOLT GEB10IS**  
**2GT8 3 32 A12 MVOLT 1/3 GEB10IS**  
**2GT8 4 32 A12 MVOLT 1/4 GEB10IS**



Surface-Mounted Optimax®

# PMOX

Optimax®

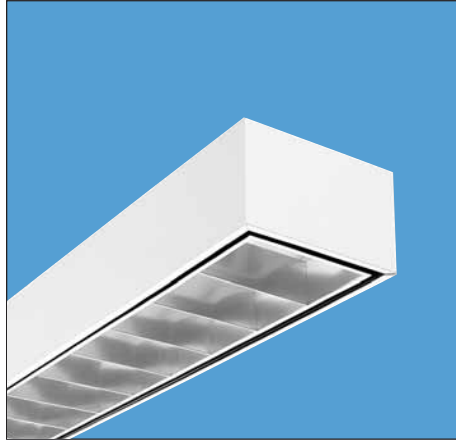

**Intended Use**

Surface-mounted parabolic luminaires designed to control screen glare in VDT open office environments.

**Features**

- Optimax® light-controlling optical assembly.
- Surface or stem-mounting. A perfect companion to Optimax® recessed luminaires.
- Floating louver appearance with full black reveal.
- Standard exterior finish is gloss white.
- Provides optimum light control to eliminate objectionable glare on VDT screens caused by reflections from overhead lighting.
- Full top cover available.

**Listings**

UL Listed (standard). CSA Certified or NOM Certified (see Options).

Ordering Information

Example: **2PMOX 3 32 27LS MVOLT GEB10IS**

Series	Number of lamps	Lamp type	Number of cells	Louver finish	Voltage	Options
<b>PMOX</b> 1' wide	1 2 3 Not included.	<b>17</b> 17W T8 (24")	<b>8</b> 2 rows of 4 (2'x2')	<b>LD</b> Low iridescent anodized diffuse silver	<b>MVOLT</b>	<b>1/3</b> One 3-lamp ballast
<b>2PMOX</b> 2' wide		<b>U31</b> 31W T8 U (1½" leg)	<b>9</b> 1 row of 9 (1'x4')		<b>120</b>	<b>GEB</b> Electronic ballast, ≤20% THD
		<b>32</b> 32W T8 (48")	<b>12</b> 3 rows of 4 (2'x2')	<b>LS</b> Low iridescent anodized specular silver	<b>277</b>	<b>GEB10IS</b> T8 electronic ballast, ≤10% THD, instant start
	<b>CF40</b> 40W T15 (24")	<b>18</b> 2 rows of 9 (20"x4')	<b>347</b>		Others available; consult factory.	<b>GEB10RS</b> T8 electronic ballast, ≤10% THD, rapid start
			<b>27</b> 3 rows of 9 (2'x4')			<b>CSA</b> CSA Certified <b>NOM</b> NOM Certified See page 112 for others.

Availability and Dimensions					
Nominal size	Series	Number of lamps	Lamp type	Number of cells (rows x number in row)	Height in.(cm)
1'x4'	PMOX	1	32	9 (1x9)	7¼ (18.4)
	PMOX	2	32	9 (1x9)	7¼ (18.4)
	TPMOX	1	(2)CF40	9 (1x9)	7¼ (18.4)
2'x2'	2PMOX	3	17, U31, CF40	12 (3x4)	6⅞ (15.6)
	2PMOX	2	17, U31, CF40	8 (2x4)	6⅞ (15.6)
	2PMOX	2	17, U31, CF40	12 (3x4)	6⅞ (15.6)
2'x4'	2PMOX	3	32	27 (3x9)	6⅞ (15.6)
	2PMOX	2	32	18 (2x9)	6⅞ (15.6)
	2PMOX	2	32	27 (3x9)	6⅞ (15.6)

# PM3X

Paramax®

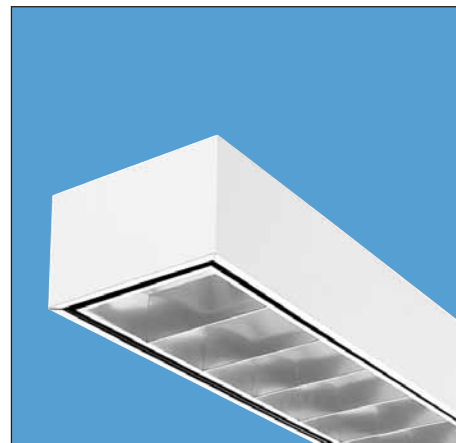

### Intended Use

High-performance surface-mounted parabolic luminaires for superior light control, visual comfort and light cutoff in open area indoor applications.

### Features

Sturdy steel housing with Paramax® 3" premium-grade aluminum louver.

For surface or stem mounting. A perfect companion to Paramax® recessed luminaires.

Choice of size, lamping, cell configuration and louver finish.

Floating louver appearance with full black reveal.

Standard exterior finish is gloss white. Full top cover available.

### Listings

UL Listed (standard). CSA Certified or NOM Certified (see Options).

### Ordering Information

Example: **2PM3X 3 32 18LD MVOLT 1/3 GEB10IS**

Series	Number of lamps	Lamp type	Number of cells	Louver finish	Voltage	Options
<b>PM3X</b> 1' wide	<b>1</b>	<b>17</b> 17W T8 (24")	<b>3</b>	<b>LD</b> Low iridescent anodized semi-specular silver	<b>MVOLT</b>	<b>1/3</b> One 3-lamp ballast
<b>2PM3X</b> 2' wide	<b>2</b>	<b>U31</b> 31W T8 U (1½" leg)	<b>4</b>	<b>LS</b> Low iridescent anodized specular silver	<b>120</b>	<b>1/4</b> One 4-lamp ballast
<b>HPM3X</b> 1' wide	<b>3</b>	<b>U316</b> 31W T8 U (6" leg)	<b>6</b>		<b>277</b>	<b>GEB</b> Electronic ballast, ≤20% THD
<b>4PM3X</b> 4' wide	<b>4</b>	<b>32</b> 32W T8 (48")	<b>8</b>		<b>347</b>	<b>GEB10IS</b> T8 electronic ballast, ≤10% THD, instant start
See page 47 for HPM3 Series.	<b>6</b>	<b>CF40</b> 40W TT5 (24")	<b>9</b>		Others available; consult factory.	<b>GEB10RS</b> T8 electronic ballast, ≤10% THD, rapid start
	<b>8</b>		<b>12</b>			<b>CSA</b> CSA Certified
	Not included.		<b>16</b>			<b>NOM</b> NOM Certified
			<b>18</b>			See page 112 for others.
			<b>24</b>			
			<b>32</b>			
			<b>36</b>			
			<b>64</b>			

Availability and Dimensions					
Nominal size	Series	Number of lamps	Lamp type	Number of cells <sup>1</sup> (rows x number in row)	Height <sup>2</sup> in.(cm)
1'x4'	PM3X	1, 2, 3	32	6(1x6), <b>8</b> (1x8), <b>9</b> (1x9)	7 <sup>1</sup> / <sub>16</sub> (17.9)
		2	32	12(2x6), <b>16</b> (2x8)	7 <sup>1</sup> / <sub>16</sub> (17.9)
2'x2'	2PM3X	2	U316	6(2x3), <b>9</b> (3x3), 12(3x4), <b>16</b> (4x4)	6 <sup>1</sup> / <sub>8</sub> (15.6)
		2	17, U31, CF40	6(2x3), <b>9</b> (3x3), 12(4x3), <b>16</b> (4x4)	6 <sup>1</sup> / <sub>8</sub> (15.6)
		3	17, U31, CF40	<b>9</b> (3x3), 12(3x4), 16(4x4)	6 <sup>1</sup> / <sub>8</sub> (15.6)
		4	17, CF40	9(3x3), 12(4x3), <b>16</b> (4x4)	6 <sup>1</sup> / <sub>8</sub> (15.6)
2'x4'	2PM3X	2	32	<b>12</b> (2x6), 16(2x8), 18(3x6), 24(4x6), 32(4x8)	6 <sup>1</sup> / <sub>8</sub> (15.6)
		3	32	<b>18</b> (3x6), <b>24</b> (3x8), 32(4x8)	6 <sup>1</sup> / <sub>8</sub> (15.6)
		4	32	12(2x6), 16(2x8), 18(3x6), 24(4x6), <b>32</b> (4x8)	6 <sup>1</sup> / <sub>8</sub> (15.6)
4'x4'	4PM3X	6	32	<b>36</b> (6x6), 64(8x8)	6 <sup>1</sup> / <sub>2</sub> (16.5)
		8	32	36(6x6), <b>64</b> (8x8)	6 <sup>1</sup> / <sub>2</sub> (16.5)

NOTES:

- 1 Popular cell configurations are shown in **bold** type.
- 2 Some options increase fixture depth. Consult Lithonia Lighting sales representative if depth is a factor.

## Modular Commercials

# M

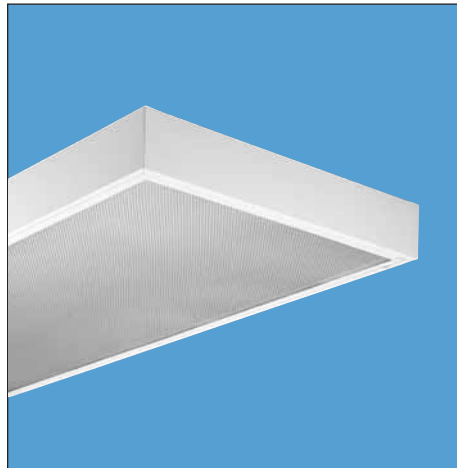

### Intended Use

Surface or stem-mounted lensed fixture for general illumination in commercial offices and retail indoor applications.

### Features

Die-formed, cold-rolled steel housing finished with baked white enamel.

Standard door is fully gasketed flush steel with sturdy tee hinges and opposing, rotary-action cam latches.

Spring-loaded latches optional.

Aluminum doors available, flush or regressed with choice of finish.

For surface or stem mounting, unit or row installation.

*For unit mounting on stems:* Minimum of two mounting stems required on 1'x4' models (four

required on 3-lamp models). Four stems required on 2'x4' models.

*For row mounting on stems:* Use half the number of stems required for unit mounting except on last fixture in row. Example: on 2'x4' two-lamp and four-lamp fixtures, use two stems per fixture plus two per row.

### Listings

UL Listed (standard) and CSA Certified (standard; except for 347V – see Options). NOM Certified (see Options).

### Ordering Information

Example: **2M 2 32 RW A19 MVOLT GEB10IS**

Series	Lamp type
<b>M</b> 1' wide	<b>17</b> 17W T8 (24")
<b>2M</b> 2' wide	<b>U31</b> 31W T8 U (1 <sup>5</sup> / <sub>8</sub> " leg)
<b>4M</b> 4' wide	<b>U316</b> 31W T8 U (6" leg) <sup>2</sup>
	<b>32</b> 32W T8 (48")
	<b>CF40</b> 40W TTS (24")

Number of lamps
1
2
3 <sup>1</sup>
4
6
8
Not included.

Frame type
(blank) Flush steel, white
<b>FN</b> Flush aluminum, natural
<b>FM</b> Flush aluminum, matte black
<b>FW</b> Flush aluminum, white
<b>RN</b> Regressed aluminum, natural
<b>RM</b> Regressed aluminum, matte black
<b>RW</b> Regressed aluminum, white

Diffuser type
<b>A12</b> #12 pattern acrylic
<b>A12125</b> #12 pattern acrylic, .125" thick
<b>A19</b> #19 pattern acrylic, .156" thick
<b>PC15</b> ½"x½"x½" plastic cube louver, silver

Center mullion standard on 4'x4' models.

Voltage
<b>MVOLT</b>
<b>120</b>
<b>277</b>
<b>347</b>
Others available.

Options
<b>1/3</b> One 3-lamp ballast
<b>1/4</b> One 4-lamp ballast
<b>GEB</b> Electronic ballast, ≤20% THD
<b>GEB10IS</b> T8 electronic ballast, ≤10% THD, instant start
<b>GEB10RS</b> T8 electronic ballast, ≤10% THD, rapid start
<b>CSA</b> CSA Certified (347V only)
<b>NOM</b> NOM Certified

See page 112 for others.

NOTES:

- 1 Stem mounting is not recommended for 3-lamp 2x4 models.
- 2 6" leg spacing standard on 2-lamp models. Not available on 3-lamp models; specify U31.

Availability and Dimensions						
Nominal size	Series	Number of lamps	Lamp type	Width in.(cm)	Depth in.(cm)	Length in.(cm)
1'x4'	M	1, 2, 3	32	12 (30.5)	3¾ (9.5)	48 (121.9)
			U316			
2'x2'	2M	2, 3, 4	17, U31, CF40	24 (61.0)	3¾ (9.5)	24 (61.0)
			17, CF40			
2'x4'	2M	2, 3, 4	32	24 (61.0)	3¾ (9.5)	48 (121.9)
4'x4'	4M	4, 6, 8	32	48 (121.9)	3¾ (9.5)	48 (121.9)

**EC**

**Intended Use**

Use for direct lighting in applications such as schools or all-purpose facilities.

**Features**

- Fits standard 4'x4' inverted tee grid opening.
- Uses standard 2'x4' ceiling tiles – no cutting required.
- High-gloss, baked white enamel finish.
- Extruded acrylic prismatic diffuser.
- For unit or row installation.

**Listings**

UL Listed (standard). CSA Certified or NOM Certified (see Options).

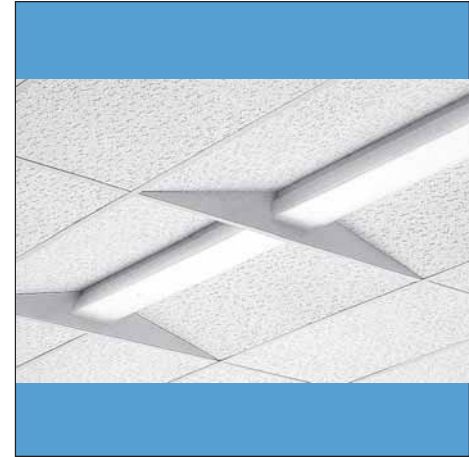

Example: **EC 2 32 MVOLT GEB10IS**

**Ordering Information**

<p><b>Series</b></p> <p><b>EC</b></p> <p>For tandem double-length unit, add prefix T. Example: <b>TEC</b>.</p>	<p><b>Number of lamps</b></p> <p><b>1</b> <b>2</b></p> <p>Not included.</p>	<p><b>Lamp type</b></p> <p><b>32</b> 32W T8 (48")</p>	<p><b>Diffuser type</b></p> <p>(blank) Acrylic prismatic</p>	<p><b>Voltage</b></p> <p><b>MVOLT</b> <b>347</b></p>	<p><b>Options</b></p> <p><b>1/4</b> One 4-lamp ballast</p> <p><b>GEB10IS</b> T8 electronic ballast, ≤10% THD, instant start</p> <p><b>GEB10PS</b> T8 electronic ballast, ≤10% THD, rapid start</p> <p><b>CSA</b> CSA Certified</p> <p><b>NOM</b> NOM Certified</p>
--	---	---	--	--	--

**Availability and Dimensions**

Nominal length	Series	Lamps per cross section	Lamps per fixture	Length in.(cm)	Height in.(cm)
4'	EC	1	1	48 (121.9)	6 (15.2)
		2	2	48 (121.9)	6 (15.2)
8'	TEC	1	2	96 (243.8)	6 (15.2)
		2	4	96 (243.8)	6 (15.2)

## Architectural Wraparounds

# AW

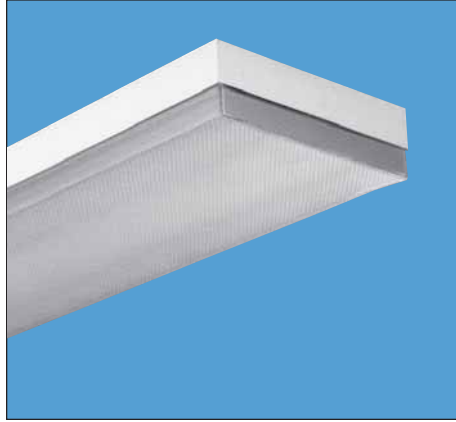

### Intended Use

For surface or suspended applications that require a low-profile architectural appearance. Provides high vertical and horizontal illumination for walkways, corridors, offices and retail applications.

### Features

Flat-bottom acrylic prismatic diffuser with sonic-welded, injection-molded, luminous ends.

Diffuser held by four torsion springs. Hinges or latches from either side for easy cleaning and service.

Choice of width — models available with 2, 3 or 4 lamps. For 5¼" width, see companion CA Series.

Optional high-impact-resistant acrylic (AR) diffuser includes 50% DR additive for strength.

Two 4-foot diffusers provided on tandem models.

White housing standard, black and special colors optional.

For surface or stem mounting, unit or row installation. Order two hangers for 2-lamp and 4-lamp models, four hangers for 3-lamp models.

### Listings

UL Listed (standard). CSA Certified or NOM Certified (see Options).

### Ordering Information

Series
<b>AW</b> Standard width
<b>2AW</b> 2 lamps in wide housing
For tandem double-length unit, add prefix <b>T</b> . Example: <b>TAW</b>

Number of lamps
<b>2</b>
<b>3</b>
<b>4</b>
Not included.

Lamp type
<b>32</b> 32W T8 (48")

Diffuser type
(blank) Prismatic
<b>AR</b> High-impact prismatic

Voltage
<b>MVOLT</b>
<b>347</b>

Options
<b>1/3</b> One 3-lamp ballast
<b>1/4</b> One 4-lamp ballast
<b>GEB10IS</b> T8 electronic ballast, ≤10% THD, instant start
<b>GEB10RS</b> T8 electronic ballast, ≤10% THD, rapid start
<b>CSA</b> CSA Certified
<b>NOM</b> NOM Certified

See page 112 for others.

Example: **AW 2 32 AR MVOLT GEB10IS**

Availability and Dimensions						
Series	Lamps per cross section	Lamps per fixture	Lamp length in.	Width in.(cm)	Depth in.(cm)	Length in.(cm)
AW	2	2	48	11¼ (28.6)	3⅝(8.4)	48 (121.9)
	3	3	48	16¾ (42.5)	3⅝(8.4)	48 (121.9)
	4	4	48	16¾ (42.5)	3⅝(8.4)	48 (121.9)
2AW	2	2	48	16¾ (42.5)	3⅝(8.4)	48 (121.9)
TAW	2	4	48	11¼ (28.6)	3⅝(7.9)	96 (243.8)
	3	6	48	16¾ (42.5)	3⅝(7.9)	96 (243.8)
	4	8	48	16¾ (42.5)	3⅝(7.9)	96 (243.8)
T2AW	2	4	48	16¾ (42.5)	3⅝(7.9)	96 (243.8)

## Corridor Acrylic Wraparounds

# CA

### Intended Use

For applications where a narrow-profile architectural appearance is desired. Ideal for areas such as corridors or stairwells where size is critical.

### Listings

UL Listed (standard). CSA Certified or NOM Certified (see Options).

### Features

Companion to AW Series, but only 5¼" wide.

Choice of flat-bottom diffusers — prismatic acrylic or matte white opal acrylic. Both available in high-impact versions.

Diffuser held by four torsion springs. Hinges open from either side for easy cleaning and service.

Slim, low-profile housing for ceiling or wall mounting.

White housing standard. Black and special colors optional.

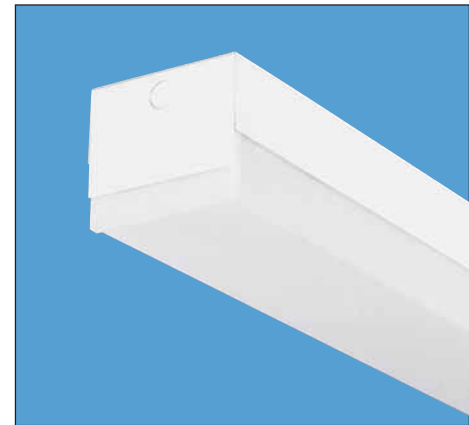

## Ordering Information

Example: **CA 1 32 ACW MVOLT GEB10IS**

Series	Number of lamps	Lamp type	Diffuser type	Voltage	Options
<b>CA</b>	<b>1</b>	<b>17</b> 17W T8 (24")	(blank) Prismatic	<b>120</b>	<b>1/4</b> One 4-lamp ballast
For tandem double-length unit, add prefix <b>T</b> . Example: <b>TCA</b>	<b>2</b>	<b>20</b> 20W T12 (24")	<b>AR</b> High-impact prismatic	<b>277</b>	<b>GEB10IS</b> T8 electronic ballast, ≤10% THD, instant start
	Not included.	<b>25</b> 25W T8 (36")	<b>ACW</b> Matte white	<b>MVOLT</b>	<b>GEB10RS</b> T8 electronic ballast, ≤10% THD, rapid start
		<b>30</b> 30W T12 (36")	<b>AWR</b> High-impact matte white	<b>347</b>	<b>CSA</b> CSA Certified
		<b>32</b> 32W T8 (48")			<b>NOM</b> NOM Certified
					See page 112 for others.

### Availability and Dimensions

Series	Lamps per cross section	Lamps per fixture	Lamp length in.	Width in.(cm)	Depth in.(cm)	Length in.(cm)
CA	1	1	24	5¼ (13.3)	4 <sup>5</sup> / <sub>8</sub> (11.8)	24½ (62.2)
	2	2	24	5¼ (13.3)	4 <sup>5</sup> / <sub>8</sub> (11.8)	24½ (62.2)
CA	1	1	36	5¼ (13.3)	4 <sup>5</sup> / <sub>8</sub> (11.8)	36½ (92.7)
	2	2	36	5¼ (13.3)	4 <sup>5</sup> / <sub>8</sub> (11.8)	36½ (92.7)
CA	1	1	48	5¼ (13.3)	4 <sup>5</sup> / <sub>8</sub> (11.8)	48½ (123.2)
	2	2	48	5¼ (13.3)	4 <sup>5</sup> / <sub>8</sub> (11.8)	48½ (123.2)
TCA	1	2	48	5¼ (13.3)	4 <sup>5</sup> / <sub>8</sub> (11.8)	97 (246.4)
	2	4	48	5¼ (13.3)	4 <sup>5</sup> / <sub>8</sub> (11.8)	97 (246.4)

## Low-Profile Wraparounds

# LB

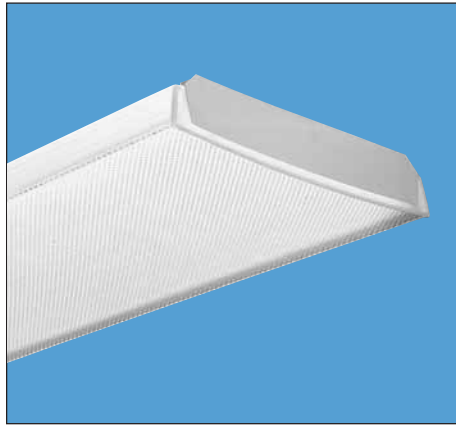

### Ordering Information

Series	Number of lamps
<b>LB</b> Standard width	<b>2</b>
<b>2LB</b> 2 lamps in wide housing	<b>3</b>
	<b>4</b>

Fortandem double-length unit, add prefix **T**. Example: **TLB**  
Not included.

### Intended Use

For applications requiring a clean, decorative appearance. Provides high vertical illumination and brightness control.

### Features

Acrylic prismatic diffuser with sonic-welded, injection-molded, luminous ends. Matches CB Series in appearance.

White enamel end plates – optional appliques available for field installation.

Linear side prisms control brightness; pyramidal bottom prisms minimize lamp image.

Continuous, interlocking-diffuser support prevents accidental opening, simplifies cleaning and service.

For surface or stem mounting, unit or row installation. Snap-in aligners permit row mounting without tools.

Minimum two hangers required. For row installation, one hanger per fixture plus one per row required. Four single-stem hangers required for 3-lamp versions.

### Listings

UL Listed (standard) and CSA Certified (standard; except for 347V – see Options). NOM Certified (see Options).

Lamp type	Voltage
<b>17</b> 17W T8 (24")	<b>MVOLT</b>
<b>20</b> 20W T12 (24")	<b>120</b>
<b>32</b> 32W T8 (48")	<b>277</b>
	<b>347</b>

### Example: LB 2 32 MVOLT GEB10IS

Options
<b>1/3</b> One 3-lamp ballast
<b>1/4</b> One 4-lamp ballast
<b>GEB10IS</b> T8 electronic ballast, ≤10% THD, instant start
<b>GEB10RS</b> T8 electronic ballast, ≤10% THD, rapid start
<b>CSA</b> CSA Certified (347V only)
<b>NOM</b> NOM Certified

See page 112 for others.

Accessories (Order separately)

Order one pair per fixture or row

- LB2W\*** Walnut end plate appliques for narrow body, one pair.
- LB4W\*** Walnut end plate appliques for wide body, one pair.

\* For teak appliques, substitute **T** for **W** in catalog number. Example: **LB2T**.

Availability and Dimensions						
Series	Lamps per cross section	Lamps per fixture	Lamp length in.	Width in. (cm)	Depth in. (cm)	Length in. (cm)
LB	2	2	24	10 (25.4)	3 (7.6)	24 (61.0)
	4	4	24	15 <sup>3</sup> / <sub>8</sub> (39.1)	3 (7.6)	24 (61.0)
LB	2	2	48	10 (25.4)	3 (7.6)	48 (121.9)
	3	3	48	15 <sup>3</sup> / <sub>8</sub> (39.1)	3 (7.6)	48 (121.9)
2LB	4	4	48	15 <sup>3</sup> / <sub>8</sub> (39.1)	3 (7.6)	48 (121.9)
	2	2	48	15 <sup>3</sup> / <sub>8</sub> (39.1)	3 (7.6)	48 (121.9)
TLB	2	4	48	10 (25.4)	3 (7.6)	96 (243.8)
	3	6	48	15 <sup>3</sup> / <sub>8</sub> (39.1)	3 (7.6)	96 (243.8)
T2LB	4	8	48	15 <sup>3</sup> / <sub>8</sub> (39.1)	3 (7.6)	96 (243.8)
	2	4	48	15 <sup>3</sup> / <sub>8</sub> (39.1)	3 (7.6)	96 (243.8)

**lightquick<sup>®</sup> XD**  
Express delivery products.  
See page 11 for details about LightQuick XD.

**Description**

**LB 4 32 MVOLT 1/4 GEB10IS**

**LB 2 32 MVOLT GEB10IS**

**CB**

**Intended Use**

For applications requiring a narrow profile and decorative appearance. Ideal for corridors or spaces where medium light levels in a compact design are preferred.

**Features**

Acrylic prismatic diffuser with sonic-welded, injection-molded, luminous ends. Matches LB Series in appearance.

White enamel end plates.

Linear side prisms control brightness, pyramidal bottom prisms minimize lamp image.

Continuous, interlocking-diffuser support prevents accidental opening, simplifies cleaning and service.

For surface or stem mounting, unit or row installation. Snap-in couplers permit row mounting without tools.

Minimum two hangers required. For row installation, one hanger per fixture plus one per row required.

**Listings**

UL Listed (standard). CSA Certified (see Options).

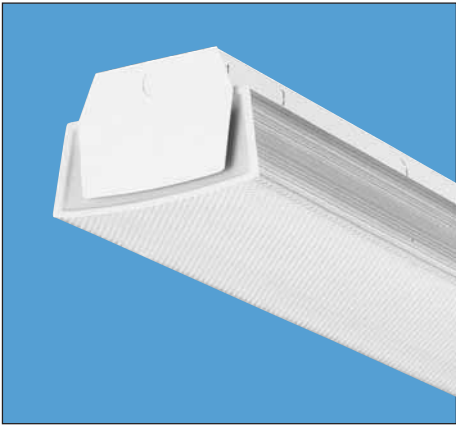

Example: **CB 1 32 MVOLT GEB10IS**

**Ordering Information**

Series	Number of lamps	Lamp type	Voltage	Options
<b>CB</b> <small>For tandem double-length unit, add prefix T. Example: TCB</small>	<b>1</b> <b>2</b> <small>Not included.</small>	<b>17</b> 17W T8 (24") <b>20</b> 20W T12 (48") <b>32</b> 32W T8 (48")	<b>MVOLT</b> <b>120</b> <b>277</b> <b>347</b>	<b>1/4</b> One 4-lamp ballast <b>GEB10IS</b> T8 electronic ballast, ≤10% THD, instant start <b>GEB10PS</b> T8 electronic ballast, ≤10% THD, rapid start <b>CSA</b> CSA Certified <small>See page 112 for others.</small>

Availability and Dimensions						
Series	Lamps per cross section	Lamps per fixture	Lamp length in.	Width in. (cm)	Depth in. (cm)	Length in. (cm)
CB	1,2	1,2	24	7 (17.8)	4½ (11.4)	24 (61.0)
			48	7 (17.8)	4½ (11.4)	48 (121.9)
TCB	1,2	2,4	48	7 (17.8)	4½ (11.4)	96 (243.8)



## Square-Basket Wraparounds

# SB

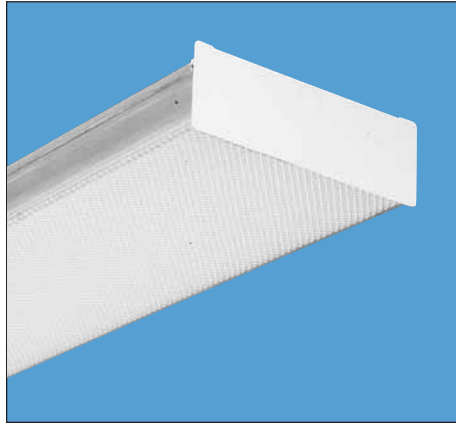

### Intended Use

For applications that require the clean appearance of a flat-bottom diffuser. Provides high light levels for storage rooms, offices or retail applications.

### Features

Flat-bottom acrylic prismatic diffuser. Matches CS Series in appearance.

Full-depth, white enamel end plates.

Linear side prisms control brightness, pyramidal bottom prisms minimize lamp image.

Diffuser hinges open from either side for easy cleaning and service.

For surface or stem mounting (4-foot models only), unit or row installation.

Minimum two single-stem hangers required. For row installation, one hanger per fixture plus one per row required.

### Listings

UL Listed (standard) and CSA Certified (standard; except for 347V – see Options). NOM Certified (see Options).

### Ordering Information

Series	Number of lamps
<b>SB</b> Standard width	<b>2</b>
<b>2SB</b> 2 lamps in wide housing	<b>4</b>
	Not included.

Lamp type	Voltage
<b>17</b> 17W T8 (24")	<b>MVOLT</b>
<b>20</b> 20W T12 (24")	<b>120</b>
<b>32</b> 32W T8 (48")	<b>277</b>
	<b>347</b>

### Example: SB 2 32 MVOLT GEB10IS

Options	
<b>1/3</b>	One 3-lamp ballast
<b>1/4</b>	One 4-lamp ballast
<b>GEB10IS</b>	T8 electronic ballast, ≤10% THD, instant start
<b>GEB10RS</b>	T8 electronic ballast, ≤10% THD, rapid start
<b>CSA</b>	CSA Certified (347V only)
<b>NOM</b>	NOM Certified

See page 112 for others.

**lightquick<sup>®</sup> XD**

*Express delivery products.*

See page 11 for details about LightQuick XD.

#### Description

**SB 4 32 MVOLT 1/4 GEB10IS**

**SB 2 32 MVOLT GEB10IS**

### Availability and Dimensions

Series	Lamps per cross section	Lamps per fixture	Lamp length in.	Width in. (cm)	Depth in. (cm)	Length in. (cm)
SB	2	2	24	8 <sup>1</sup> / <sub>3</sub> (21.2)	2 <sup>7</sup> / <sub>8</sub> (6.0)	24 (61.0)
	2	2	48	8 <sup>1</sup> / <sub>3</sub> (21.2)	2 <sup>7</sup> / <sub>8</sub> (6.0)	48 (121.9)
	4	4	48	13 <sup>3</sup> / <sub>4</sub> (34.9)	2 <sup>7</sup> / <sub>8</sub> (6.0)	48 (121.9)
2SB	2	2	48	13 <sup>3</sup> / <sub>4</sub> (34.9)	2 <sup>7</sup> / <sub>8</sub> (6.0)	48 (121.9)

## Corridor Square-Basket Wraparounds

### Intended Use

For applications that require a narrow-profile design with flat-bottom diffuser. Provides medium light levels in a compact fixture.

### Features

Contemporary style with flat-bottom acrylic prismatic diffuser. Matches SB Series in appearance.

Linear side prisms control brightness. Pyramidal bottom prisms minimize lamp image.

Diffuser hinges open from either side for easy cleaning and service.

Two 4-foot diffusers provided on 8-foot units.

For surface or stem mounting, unit or row installation.

Minimum two hangers required. For row installation, one hanger per fixture plus one per row required.

Suitable for wall mounting with diffuser mounting clips (included with fixture).

### Listings

UL Listed (standard). CSA Certified (see Options).

# CS

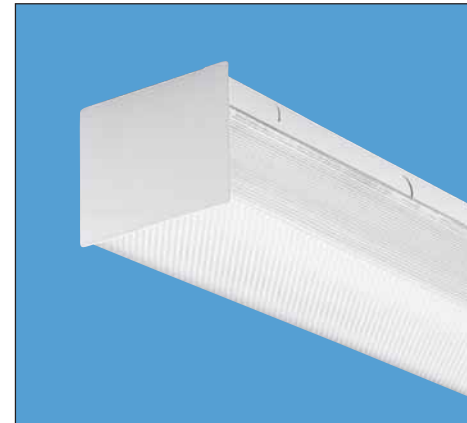

Example: **CS 1 32 MVOLT GEB10IS**

### Ordering Information

Series	Number of lamps	Lamp type	Voltage	Options
<b>CS</b>	<b>1</b>	<b>17</b> 17W T8 (24")	<b>MVOLT</b>	<b>1/4</b> One 4-lamp ballast
For tandem double-length unit, add prefix T. Example: <b>TCS</b>	<b>2</b> Not included.	<b>20</b> 20W T12 (24")	<b>120</b>	<b>GEB10IS</b> T8 electronic ballast, ≤10% THD, instant start
		<b>32</b> 32W T8 (48")	<b>277</b>	<b>GEB10RS</b> T8 electronic ballast, ≤10% THD, rapid start
			<b>347</b>	<b>CSA</b> CSA Certified

See page 112 for others.

### Availability and Dimensions

Series	Lamps per cross section	Lamps per fixture	Lamp length in.	Width in. (cm)	Depth in. (cm)	Length in. (cm)
CS	1	1	24	5 <sup>13</sup> / <sub>16</sub> (14.8)	4½ (11.4)	24 (61.0)
	2	2	24	5 <sup>13</sup> / <sub>16</sub> (14.8)	4½ (11.4)	24 (61.0)
	1	1	48	5 <sup>13</sup> / <sub>16</sub> (14.8)	4½ (11.4)	48 (121.9)
	2	2	48	5 <sup>13</sup> / <sub>16</sub> (14.8)	4½ (11.4)	48 (121.9)
TCS	1	2	48	5 <sup>13</sup> / <sub>16</sub> (14.8)	4½ (11.4)	96 (243.8)
	2	4	48	5 <sup>13</sup> / <sub>16</sub> (14.8)	4½ (11.4)	96 (243.8)

## Specification Premium Wraparounds

# CLM

*Classmate™*



### Intended Use

For applications where brightness and vertical illumination are beneficial. Ideal for schools and other applications that require high light levels.

### Features

High-impact, vandal-resistant acrylic diffuser with white, sonic-welded, injection-molded ends standard.

Optional Holophane® injection-molded acrylic Controlens® wraparound shielding bonded to opaque acrylic end caps.

Shielding is secured by spring-loaded metal latches — hinges open from either side for easy cleaning and service.

For surface or stem mounting, unit or row installation.

Unit installation requires two single-stem hangers

or one double-stem hanger on 4-foot units. Row installation requires one hanger per fixture plus one per row.

Ballast cover secured by quarter-turn fastener — no tools required to access electrical chamber.

Rotary, anti-vibration lampholders standard.

### Listings

UL Listed (standard). CSA Certified or NOM Certified (see Options).

### Ordering Information

Series
<b>CLM</b>
For tandem double-length unit, add prefix T. Example: <b>TCLM</b>

Number of lamps
<b>1</b>
<b>2</b>
<b>3</b>
Not included.

Lamp type
<b>32</b> 32W T8 (48")

Diffuser type <sup>1</sup>
(blank) High-impact acrylic
<b>IM</b> Holophane#7100 injection-molded acrylic

Voltage
<b>MVOLT</b>
<b>347</b>

Options
<b>1/3</b> One 3-lamp ballast
<b>1/4</b> One 4-lamp ballast
<b>GEB10IS</b> T8 electronic ballast, ≤10% THD, instant start
<b>GEB10RS</b> T8 electronic ballast, ≤10% THD, rapid start
<b>CSA</b> CSA Certified
<b>NOM</b> NOM Certified
See page 112 for others.

Example: **CLM 2 32 MVOLT GEB10IS**

NOTES:  
1 Diffusers shipped separately.

### Availability and Dimensions

Series	Lamps per cross section	Lamps per fixture	Lamp length in.	Width in. (cm)	Depth in. (cm)	Length in. (cm)
CLM	1	1	48	8 <sup>9</sup> / <sub>16</sub> (21.7)	4 <sup>3</sup> / <sub>8</sub> (11.1)	48 (121.8)
	2	2	48	8 <sup>9</sup> / <sub>16</sub> (21.7)	4 <sup>3</sup> / <sub>8</sub> (11.1)	48 (121.8)
	3	3	48	8 <sup>9</sup> / <sub>16</sub> (21.7)	4 <sup>3</sup> / <sub>8</sub> (11.1)	48 (121.8)
TCLM	1	2	48	8 <sup>9</sup> / <sub>16</sub> (21.7)	4 <sup>3</sup> / <sub>8</sub> (11.1)	96 (243.6)
	2	4	48	8 <sup>9</sup> / <sub>16</sub> (21.7)	4 <sup>3</sup> / <sub>8</sub> (11.1)	96 (243.6)
	3	6	48	8 <sup>9</sup> / <sub>16</sub> (21.7)	4 <sup>3</sup> / <sub>8</sub> (11.1)	96 (243.6)

## Injection-Molded Wraparounds

# VC

### Intended Use

For surface-mount applications that require optimum optical control with low brightness. Ideal for public areas such as schools, airports, libraries, retail stores and offices.

### Features

Injection-molded, flat-bottom acrylic prismatic diffuser provides optimum controlled, low brightness illumination.

Linear side prisms control brightness. Pyramidal bottom prisms minimize lamp image.

Concealed hinge or latch system permits diffuser to be hinged from either side.

Design minimizes ceiling shadows and sharp contrasts.

For surface or stem mounting, individual or row installation. For row installation, one hanger per fixture plus one per row required.

End plates shipped as accessory, one pair required for individual or end of row mount.

Decorative end plates are required for individual mount or one pair for each row of fixtures.

### Listings

UL Listed (standard). CSA Certified or NOM Certified (see Options).

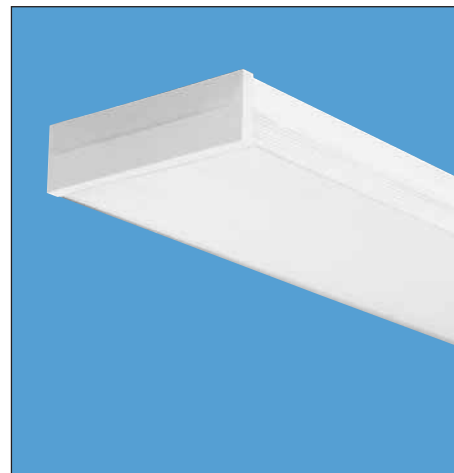

### Ordering Information

Example: **VC 2 32 MVOLT GEB10IS VC2WH**

Series	Number of lamps	Lamp type	Voltage	Options	End plates
<b>VC</b> Standard width	<b>2</b>	<b>32</b> 32W T8 (48")	<b>MVOLT</b>	<b>1/4</b> One 4-lamp ballast	(blank) No end plates (for continuous runs)
<b>2VC</b> 2 lamps in wide housing	<b>4</b> Not included.		<b>347</b>	<b>GEB10IS</b> T8 electronic ballast, ≤10% THD, instant start	<b>VC2WH</b> Two end plates, standard width, white (for individual fixture or end of row)
For tandem double-length unit, add prefix <b>T</b> . Example: <b>TVC</b>				<b>GEB10RS</b> T8 electronic ballast, ≤10% THD, rapid start	<b>VC4WH</b> Two end plates, wide width, white (for individual fixture or end of row)
				<b>CSA</b> CSA Certified	
				<b>NOM</b> NOM Certified	
				See page 112 for others.	

### Availability and Dimensions

Series	Lamps per cross section	Lamps per fixture	Width in.(cm)	Depth in.(cm)	Length in.(cm)
VC	2	2	10¾ (27.3)	3¼ (8.3)	48 (121.9)
	4	4	15¾ (40.0)	3¼ (8.3)	48 (121.9)
2VC	2	2	15¾ (40.0)	3¼ (8.3)	48 (121.9)
	4	4	10¾ (27.3)	3¼ (8.3)	96 (243.8)
TVC	2	8	15¾ (40.0)	3¼ (8.3)	96 (243.8)
	4	4	15¾ (40.0)	3¼ (8.3)	96 (243.8)

## Solid-Front Undercabinet Lights

# N2S

*Finesse*®

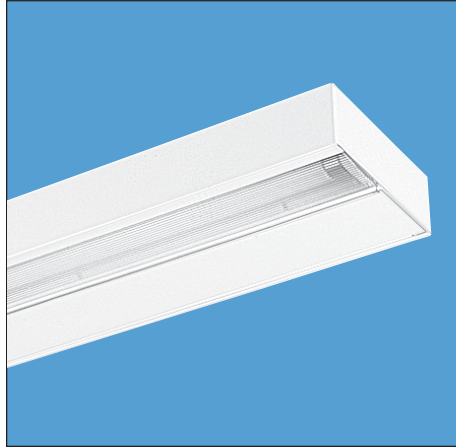

### Intended Use

For undercabinet applications that require additional shielding from direct glare. Ideal for offices, hospitals, laboratories and kitchens.

### Features

Trim, 1<sup>5</sup>/<sub>8</sub>" low-profile design with a smooth show surface, free of knockouts.

Paint after fabrication, gloss-white enamel finish on all metal parts.

Solid-front housing eliminates direct glare.

Snap-in, positive lens retention.

Proprietary, shatter-resistant diffuser provides optimum uniformity of light distribution.

Utilizes T8 lamp technology for energy efficiency and maximum visual clarity.

Separate, hingeable service tray for easy

installation and maintenance — no tools required for relamping.

Limited lifetime warranty.

### Listings

UL Listed (standard). CSA Certified or NOM Certified (see Options).

### Ordering Information

Series	Lamp type	Voltage	Options
<b>N2S</b>	<b>13T8PH</b> 13W T8 preheat (12") <sup>1</sup> <b>15T8PH</b> 15W T8 preheat (18") <sup>1</sup> <b>15T8</b> 15W T8 trigger start HPF (18") <sup>1</sup> <b>17</b> 17W T8 (24") <sup>1</sup> <b>25</b> 25W T8 (36") <b>32</b> 32W T8 (48") <b>60T8</b> 40W T8 (60") Not included.	<b>MVOLT</b> <b>120</b> <b>277</b> <b>347</b> Others available.	<b>GEB10IS</b> T8 electronic ballast, instant start <b>GEB10RS</b> T8 electronic ballast, rapid start <b>GLR</b> Internal fast blow fuse <sup>2</sup> <b>GMF</b> Internal slow-blow fuse <sup>2</sup> <b>CSW</b> 6-foot, 3-wire grounded cordset, right end <sup>3,4,5</sup> <b>CSWL</b> 6-foot, 3-wire grounded cordset, left end <sup>3,4,5</sup> <b>CSWC</b> 6-foot, 3-wire grounded cordset, back center <sup>3,4,5</sup> <b>CO</b> Convenience outlet, bottom right <sup>3,6</sup> <b>COL</b> Convenience outlet, bottom left <sup>3,6</sup> <b>SWR</b> Rocker switch, bottom right <sup>3</sup> <b>SWRL</b> Rocker switch, bottom left <sup>3</sup> <b>SWRC</b> Rocker switch, bottom center <sup>3,7</sup> <b>CSA</b> CSA Certified <b>NOM</b> NOM Certified

**NOTES:**

- 1 Not available with SWRC or RIF1 options.
- 2 Must specify voltage.
- 3 Available with 120V ballast only.
- 4 Not available with CO/COL convenience outlet options.
- 5 Cordset must always be specified for installation on same end of fixture as switch location.
- 6 Not available with CSW/CSWL/CSWC cordset options.
- 7 Not available on 12", 18" or 24" units.

### Example: N2S 32 MVOLT GEB10IS



### Availability and Dimensions

Nominal length	Lamp type	Width in. (cm)	Depth in. (cm)	Length in. (cm)
1'	13T8PH	5½ (14.0)	1 <sup>5</sup> / <sub>8</sub> (4.1)	12 <sup>7</sup> / <sub>8</sub> (30.8)
1½'	15T8PH, 15T8	5½ (14.0)	1 <sup>5</sup> / <sub>8</sub> (4.1)	18 <sup>1</sup> / <sub>8</sub> (46.0)
2'	17	5½ (14.0)	1 <sup>5</sup> / <sub>8</sub> (4.1)	24 <sup>1</sup> / <sub>8</sub> (61.3)
3'	25	5½ (14.0)	1 <sup>5</sup> / <sub>8</sub> (4.1)	36 <sup>1</sup> / <sub>8</sub> (91.8)
4'	32	5½ (14.0)	1 <sup>5</sup> / <sub>8</sub> (4.1)	48 <sup>1</sup> / <sub>8</sub> (122.2)
5'	60T8	5½ (14.0)	1 <sup>5</sup> / <sub>8</sub> (4.1)	60 (152.4)

## All-Purpose Undercabinet Lights

# 2UC



Example: **2UC 30 AR 120 HPF**

### Intended Use

For undercabinet or display lighting where a compact luminaire design is required. Provides medium light levels.

### Features

All-purpose profile. Available in four lengths. T8 or T12 lamp source.

Fastener-free show surface.

Separate, hingeable service tray for easy installation and maintenance — no tools required for relamping.

Flanged, shatter-resistant, milk-white diffuser.

Gloss-white enamel finish.

### Listings

UL Listed (standard). CSA Certified (see Options).

### Ordering Information

Series	Lamp type	Diffuser	Voltage	Ballast options	Options
<b>2UC</b>	<b>15</b> 15W T12 (18")	(blank) Standard white	<b>MVOLT</b>	<b>HPF</b> High power factor	<b>SWR</b> Rocker switch, installed <sup>1</sup>
	<b>17</b> 17W T8 (24")	<b>AR</b> High-impact white	<b>120</b>	<b>LPF</b> Low power factor	<b>GLR</b> Internal fast blow fuse <sup>2</sup>
	<b>20</b> 20W T12 (24")	<b>OP</b> Opaque front, clear acrylic bottom	<b>277</b>	<b>GEB10IS</b> T8 electronic ballast, instant start	<b>CSW</b> 6' cordset, white <sup>1</sup>
	<b>25</b> 25W T8 (36")		<b>347</b>	<b>GEB10RS</b> T8 electronic ballast, rapid start	<b>CO</b> Grounded convenience outlet <sup>1</sup>
	<b>30</b> 30W T12 (36")		Others available.		<b>RIF1</b> Radio interference filter (one per fixture)
	<b>32</b> 32W T8 (48")	Not included.			<b>CSA</b> CSA Certified

Availability and Dimensions				
Nominal length	Lamp type	Width in. (cm)	Depth in. (cm)	Length in. (cm)
1½'	15	5¼ (13.3)	1 <sup>13</sup> / <sub>16</sub> (4.6)	18¼ (46.4)
2'	17, 20	5¼ (13.3)	1 <sup>13</sup> / <sub>16</sub> (4.6)	24¼ (61.6)
3'	25, 30	5¼ (13.3)	1 <sup>13</sup> / <sub>16</sub> (4.6)	36¼ (92.1)
4'	32	5¼ (13.3)	1 <sup>13</sup> / <sub>16</sub> (4.6)	48¼ (122.6)

NOTES:  
 1 120V only.  
 2 Must specify voltage



## Low-Profile Undercabinet Lights

# UC

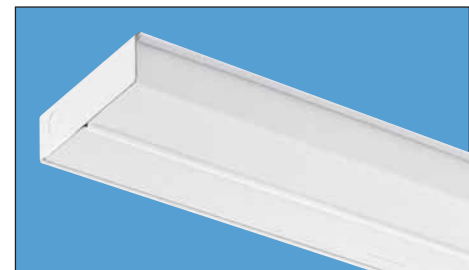

Example: **UC 33 OP 120 CSW**

### Intended Use

Use under cabinets in school, display or residential applications. Delivers medium light levels in a compact design.

### Features

Trim, low-profile design. Available in five lengths. T5 lamp source.

Separate, hingeable service tray for easy installation and maintenance — no tools required for relamping.

Factory-installed starters on all preheat models.

Romex conduit connector provided with each fixture.

Snap-fit, shatter-resistant, milk-white acrylic diffuser design with 15% DR.

### Listings

UL Listed (standard). CSA Certified (see Options).

### Ordering Information

Series	Lamp type <sup>1</sup>	Diffuser	Voltage	Options
<b>UC</b>	<b>12</b> One 8W T5 (12")	(blank) White	<b>120</b>	<b>GLR</b> Internal fast blow fuse
	<b>21</b> One 13W T5 (21")	<b>OP</b> Opaque front, clear acrylic bottom	<b>277</b>	<b>CSW</b> 6' cordset <sup>2</sup>
	<b>24</b> Two 8W T5 (24")		Others available.	<b>LPWW</b> Warm white 3000°K T5 lamp(s), installed
	<b>33</b> One 8W T5 and one 13W T5 (33")			<b>CO</b> Grounded convenience outlet <sup>2</sup>
	<b>42</b> Two 13W T5 (42")	Not included.		<b>SWR</b> Rocker switch, installed <sup>2</sup>
				<b>CSA</b> CSA Certified

Availability and Dimensions				
Nominal length	Lamp type	Width in. (cm)	Depth in. (cm)	Length in. (cm)
1'	8	5 (12.7)	1 <sup>3</sup> / <sub>16</sub> (3.0)	12 <sup>3</sup> / <sub>8</sub> (31.4)
1¾'	13	5 (12.7)	1 <sup>3</sup> / <sub>16</sub> (3.0)	21 <sup>3</sup> / <sub>8</sub> (52.2)
2'	8 (2)	5 (12.7)	1 <sup>3</sup> / <sub>16</sub> (3.0)	24½ (62.3)
2¾'	8, 13	5 (12.7)	1 <sup>3</sup> / <sub>16</sub> (3.0)	33½ (85.1)
3½'	13 (2)	5 (12.7)	1 <sup>3</sup> / <sub>16</sub> (3.0)	42½ (108.0)

NOTES:  
 1 For instant-on ballast, add E after fixture length. Example: UC33EOP120CSW  
 2 120V only.



## All-Purpose Undercabinet Lights

# UC8



### Intended Use

For undercabinet or display lighting where a compact luminaire design is required.

### Features

Low profile design with on/off switch. Available in four lengths. All mounting hardware included. Rugged powder coated steel housing. Separate, hingeable service tray for easy installation and maintenance. Milk white acrylic diffuser provides soft widespread illumination with zip-lock for easy lamp replacement and superior retention.

T8 electronic ballast (120V, 60Hz) as standard.

Approved for residential use, ensures no flickering and quiet operation without interfering with home electronics.

Utilizes T8 lamps for energy efficiency, superior color rendering and long life. Not included.

### Listings

Standard fixtures are UL Listed to US and Canadian safety standards.

### Ordering Information

Series	Lamp number & type <sup>1</sup>
<b>UC8</b>	<b>15</b> 15W T8 (18")
	<b>24</b> 17W T8 (24")
	<b>36</b> 25W T8 (36")
	<b>48</b> 32W T8 (48")

Voltage
<b>120</b> Standard 120V electronic T8 ballast

Switch
<b>SWR</b> Standard on/off switch

Options
Consultfactory.

Example: **UC8 15 120 SWR**

### Availability and Dimensions

Nominal length	Model number	Number of lamps <sup>1</sup>	Length in. (cm)	Width in. (cm)	Depth in. (cm)
18"	UC8 15 120 SWR	(1) 15W T8	18 5/16 (46.5)	4 (10.2)	1 3/8 (3.5)
24"	UC8 17 120 SWR	(1) 17W T8	24 5/16 (61.8)	4 (10.2)	1 3/8 (3.5)
36"	UC8 25 120 SWR	(1) 25W T8	36 5/16 (92.2)	4 (10.2)	1 3/8 (3.5)
48"	UC8 32 120 SWR	(1) 32W T8	48 5/16 (122.7)	4 (10.2)	1 3/8 (3.5)

#### NOTES:

<sup>1</sup> Lamps not included.

## Twin Task Lights

# TTL

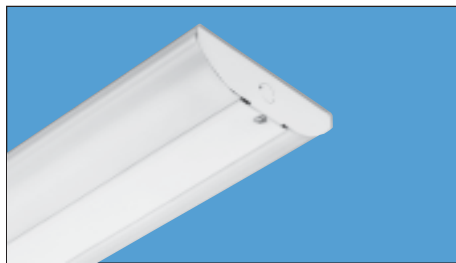

### Intended Use

Task lighting for under cabinets where a compact luminaire design is required.

### Features

Low profile design with on/off switch. Available in two lengths. All mounting hardware included. Rugged powder coated steel housing. Milk white acrylic diffusers provide soft widespread illumination with zip-lock for easy lamp replacement and superior retention.

T5 electronic ballast (120V, 60Hz) as standard. Approved for residential use, ensures no flickering and quiet operation without interfering with home electronics.

Utilizes T5 lamps for energy efficiency, superior color rendering and long life. Not included.

### Listings

UL Listed to US and Canadian safety standards.

### Ordering Information

Series	Lamp number & type <sup>1</sup>
<b>TTL</b>	<b>2 8W</b> 8W T5 (12 1/2")
	<b>2 13W</b> 17W T5 (21 1/2")

Voltage
<b>120</b> Standard 120V electronic T8 ballast

Options
Consultfactory.

Example: **TTL 2 8W 120**

### Availability and Dimensions

Nominal length	Model number	Number of lamps <sup>1</sup>	Width in. (cm)	Depth in. (cm)	Length in. (cm)
12"	TTL 2 8W 120	(1) 8W T5	4 5/8 (11.7)	1 1/2 (3.2)	12 1/2 (31.8)
21"	TTL 2 13W 120	(1) 13W T5	4 5/8 (11.7)	1 1/2 (3.2)	21 1/2 (54.6)

#### NOTES:

<sup>1</sup> Lamps not included.

Commercial Wall Brackets

**WP**

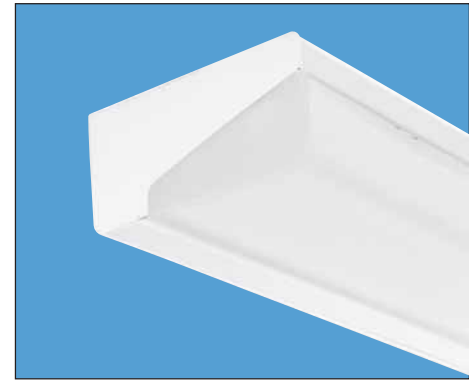

Example: **WP 2 32 MVOLT GEB10IS**

Intended Use

For applications that require a contemporary, low-profile appearance. Ideal for stairwells, restrooms, patient care lobbies or corridors.

Features

Available in 2', 3' or 4' length with one or two lamps in cross-section.

All fabricated components of 20-gauge CRS. All metal parts finished with electrostatically deposited, thermally set polyester powder paint after fabrication.

Proprietary, snap-in diffuser of tinted 50% DR acrylic with prismatic pattern.

Direct or direct/indirect distribution available.

Detachable, hinged electrical service tray for easy installation and maintenance. No tools required for relamping.

Fluorescent and incandescent night-light capabilities.

Through-wire/row-mount capabilities.

Standard finish post-paint, gloss-white enamel on all metal parts. Architectural black, 40% gloss post-paint available as an option.

Listings

UL Listed (standard). CSA Certified (see Options).

Ordering Information

Series	Number of lamps	Lamp type	Shielding type <sup>1</sup>	Voltage
<b>WP</b>	<b>1</b>	<b>17</b> 17W T8 (24")	(blank) #12 pattern inverted, .125" thick acrylic, uplight	<b>MVOLT</b> <b>347</b>
		<b>20</b> 20W T12 (24")		
	<b>2</b>	<b>25</b> 25W T8 (36")	<b>ACF125</b> Matte white flat acrylic, .125" thick, uplight <sup>2</sup>	
	Not included.	<b>30</b> 30W T12 (36")	<b>PCL12125V</b> #12 pattern inverted, .125" thick polycarbonate, uplight <sup>2</sup>	
		<b>32</b> 32W T8 (48")		

Options
<b>S1</b> Left-mounted on/off pull-switch (all lamps) <sup>3,4</sup>
<b>S2</b> Left-mounted on/off pull-switch for downlight, remote uplight switching <sup>3,5,6</sup>
<b>S4</b> Left-mounted 4-position pull-switch (front only, rear only, all on, all off) <sup>3,4,5,6</sup>
<b>BF</b> Internal baffle to divide uplight and downlight <sup>2</sup>
<b>SWR</b> Rocker switch, bottom right <sup>3,4</sup>
<b>CO</b> Grounded convenience outlet, right-mounted <sup>4</sup>
<b>MB</b> Architectural matte black finish
<b>RIF1</b> Radio interference filter (one per fixture)
<b>GEB10IS</b> T8 electronic ballast, ≤10% THD, instant start
<b>GEB10PS</b> T8 electronic ballast, ≤10% THD, rapid start
<b>2/1</b> Two 1-lamp ballasts
<b>TPS</b> Tamperproof screw
<b>DO</b> Downlight only; solid-top metal housing
<b>CSA</b> CSA Certified

NOTES:

- 1 Supplied with standard high-impact acrylic lower diffuser.
- 2 Not available with **DO** option.
- 3 120V.
- 4 Specify 120/277 voltage.
- 5 Requires **BF** option.
- 6 Requires **2/1** option for 2-lamp fixtures.

Accessories (Order separately)

- U4220** Hex-base driver bit, Torx TX20, for tamper-resistant screws with center pin

Availability and Dimensions					
Series	Number of lamps	Lamp type	Width in. (cm)	Depth in. (cm)	Length in. (cm)
WP	1, 2	17, 20	7 3/8 (18.7)	3 1/4 (8.26)	24 7/16 (62.1)
		25, 30	7 3/8 (18.7)	3 1/4 (8.26)	36 7/16 (92.6)
		32	7 3/8 (18.7)	3 1/4 (8.26)	48 7/16 (123.0)



All-Purpose Wall Brackets

# WC

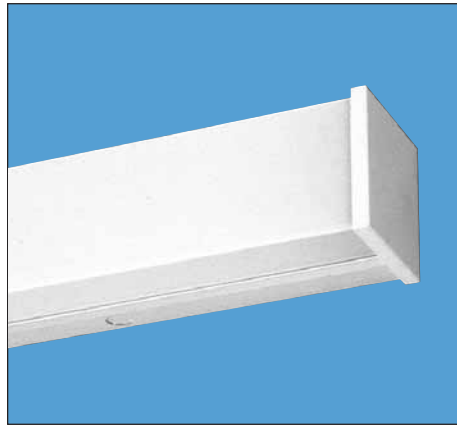

Intended Use

For multi-purpose areas such as corridors, utility rooms and lavatories where high vertical illumination is required.

Features

Available in 2', 3' and 4' models.  
 Suitable for wall or ceiling mounting.  
 Can be mounted vertically or horizontally. For individual mounting.  
 Steel housing with opal acrylic diffuser standard. Clear, prismatic #12 pattern acrylic lens and front metal fascia available.  
 Easy-maintenance design. Standard endcaps are spring-loaded for easy diffuser removal – no tools required.

Listings

UL Listed (standard). CSA Certified or NOM Certified (see Options).

Ordering Information

Example: **WC 2 32 MVOLT GEB10IS**

Series	Number of lamps	Lamp type
<b>WC</b>	<b>1</b>	<b>17</b> 17W T8 (24")
	<b>2</b>	<b>20</b> 20W T12 (24")
	Not included.	<b>25</b> 25W T8 (36")
		<b>30</b> 30W T12 (36")
		<b>32</b> 32W T8 (48")

Diffuser type
(blank) Matte white opal acrylic
<b>A12</b> #12 pattern acrylic
<b>FAC</b> Matte white opal acrylic with front metal fascia
<b>FA12</b> #12 pattern acrylic with front metal fascia

Voltage
<b>MVOLT</b>
<b>347</b>

Options
<b>GEB10IS</b> T8 electronic ballast, ≤10% THD, instant start
<b>GEB10PS</b> T8 electronic ballast, ≤10% THD, rapid start
<b>S1</b> On/off pull-switch (all lamps), lower left <sup>1,2</sup>
<b>CO</b> Grounded convenience outlet, lower right <sup>1,2</sup>
<b>MB</b> Architectural matte black finish
<b>CSA</b> CSA Certified
<b>NOM</b> NOM Certified

NOTES:  
 1 120V only.  
 2 Specify 120/277V.

Availability and Dimensions					
Series	Number of lamps	Lamp type	Width in. (cm)	Depth in. (cm)	Length in. (cm)
WC	1, 2	17, 20	4½ (11.7)	4½ (11.7)	24 (61.0)
		25, 30	4½ (11.7)	4½ (11.7)	36 (91.4)
		32	4½ (11.7)	4½ (11.7)	48 (121.9)

# WS

### Intended Use

For applications where direct distribution is preferred in a simple, unobtrusive design.

### Features

Trim, contemporary design fits any wall-mount application. Steel housing with high-gloss white enamel PAF finish standard.

Available in 2', 3' and 4' models.

Welded 20-gauge steel construction.

Designed for easy installation and maintenance.

### Listings

UL Listed (standard). CSA Certified or NOM Certified (see Options).

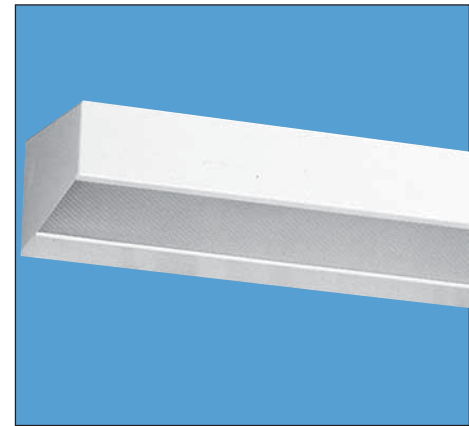

Example: **WS 2 32 A12 MVOLT GEB10IS**

### Ordering Information

Series	Number of lamps	Lamp type	Diffuser type	Voltage	Options
<b>WS</b>	1 2 Not included.	<b>17</b> 17W T8 (24") <b>25</b> 25W T8 (36") <b>32</b> 32W T8 (48")	<b>A12</b> #12 pattern acrylic <b>A12125</b> #12 pattern acrylic, .125" thick <b>A19</b> #19 pattern acrylic, .156" thick	<b>MVOLT</b> <b>347</b>	<b>1/3</b> One 3-lamp ballast <b>1/4</b> One 4-lamp ballast <b>GEB10IS</b> T8 electronic ballast, instant start <b>GEB10RS</b> T8 electronic ballast, rapid start <b>S1</b> On/off pull-switch (all lamps), lower left <sup>1</sup> <b>CO</b> Grounded convenience outlet, lower right <sup>1</sup> <b>SWR</b> Rocker switch installed <sup>1</sup> <b>CSA</b> CSA Certified <b>NOM</b> NOM Certified

### Availability and Dimensions

Series	Nominal length	Number of lamps	Lamp type	Width in. (cm)	Depth in. (cm)	Length in. (cm)
WS	2'	1, 2	17, 20	6 <sup>7</sup> / <sub>8</sub> (17.5)	3 <sup>1</sup> / <sub>2</sub> (8.9)	25 (63.5)
	3'	1, 2	25, 30	6 <sup>7</sup> / <sub>8</sub> (17.5)	3 <sup>1</sup> / <sub>2</sub> (8.9)	37 (94.0)
	4'	1, 2	32, 40	6 <sup>7</sup> / <sub>8</sub> (17.5)	3 <sup>1</sup> / <sub>2</sub> (8.9)	49 (124.5)

NOTES:

1 120V only.

## Contemporary Wall Brackets

# W

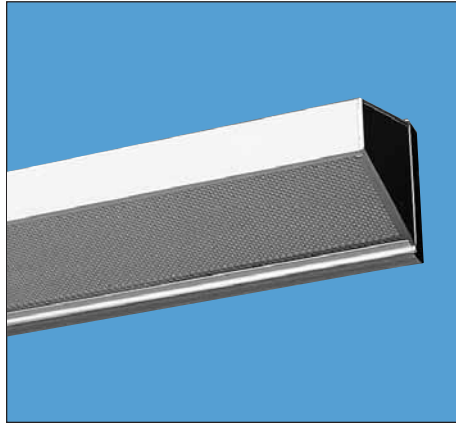

### Intended Use

For applications where a sleek, brushed aluminum fixture body in a direct lighting pattern will enhance the space.

### Features

One-piece, brushed aluminum housing assembly.

Injection-molded end plates standard with woodgrain vinyl finish.

Lens housing secured to channel assembly by spring-loaded latches.

Acrylic diffusers standard (prismatic lower .125", matte white upper panel .187").

Grounded convenience outlet available on 120V unit.

Standard configuration – Uplight and downlight, optional downlight only available with DO option.

Uplight and downlight distribution options available.

### Listings

UL Listed (standard). CSA Certified or NOM Certified (see Options).

### Ordering Information

Series	Number of lamps	Lamp type
<b>W</b>	<b>1</b>	<b>U16</b> 16W T8 U (12") <sup>1</sup>
	<b>2</b>	<b>17</b> 17W T8 (24")
	Not included.	<b>CF18</b> 18W TT5 RS (12")
		<b>20</b> 20W T12 (24")
		<b>25</b> 25W T8 (36")
		<b>30</b> 30W T12 (36")
		<b>32</b> 32W T8 (48")

#### NOTES:

- 1 One lamp only.
- 2 120V only.

Diffuser type	Voltage
(blank) #12 pattern diffuser, .187" thick, upper lens	<b>MVOLT</b>
<b>A12U</b> #12 pattern diffuser, .125" thick, upper lens	<b>347</b>
<b>A19</b> #19 pattern diffuser, .156" thick	
<b>ACF</b> Flat acrylic matte white diffuser, .125" thick	

### Example: W 2 32 MVOLT GEB10IS

Options
<b>GEB10IS</b> T8 electronic ballast, instant start
<b>GEB10RS</b> T8 electronic ballast, rapid start
<b>A12U</b> #12 pattern diffuser, .125" thick, upper lens
<b>DO</b> Downlight only
<b>S1</b> On/off pull-switch (all lamps) <sup>2</sup>
<b>BF</b> Baffle to divide uplight and downlight
<b>N</b> Night-light, unswitched, 7W C7 lamp (included), top left
<b>NS</b> Night-light with push-switch, 7W C7 (included), top left
<b>CO</b> Grounded convenience outlet <sup>2</sup>
<b>AE</b> Brushed aluminum end cap appliques
<b>MB</b> Matte black finish
<b>MW</b> Matte white finish
<b>CSA</b> CSA Certified
<b>NOM</b> NOM Certified

### Availability and Dimensions

Series	Nominal length	Number of lamps	Lamp type	Width in. (cm)	Depth in. (cm)	Length in. (cm)
W	1'	1	U16	7 <sup>1</sup> / <sub>32</sub> (17.9)	5 <sup>1</sup> / <sub>8</sub> (13.0)	13 <sup>3</sup> / <sub>8</sub> (34.6)
	1'	1, 2	CF18	7 <sup>1</sup> / <sub>32</sub> (17.9)	5 <sup>1</sup> / <sub>8</sub> (13.0)	13 <sup>3</sup> / <sub>8</sub> (34.6)
	2'	1, 2	17, 20	7 <sup>1</sup> / <sub>32</sub> (17.9)	5 <sup>1</sup> / <sub>8</sub> (13.0)	24 <sup>3</sup> / <sub>8</sub> (61.9)
	3'	1, 2	25, 30	7 <sup>1</sup> / <sub>32</sub> (17.9)	5 <sup>1</sup> / <sub>8</sub> (13.0)	36 <sup>3</sup> / <sub>8</sub> (92.4)
	4'	1, 2	32	7 <sup>1</sup> / <sub>32</sub> (17.9)	5 <sup>1</sup> / <sub>8</sub> (13.0)	48 <sup>3</sup> / <sub>8</sub> (122.9)

## Commercial and Medical Wall Brackets

### Intended Use

For applications where a controllable direct or indirect component is desired. Ideal for corridors, dressing rooms, hospitals or other patient-care facilities.

### Features

Available in 2', 3' and 4' models.

Die-cast aluminum ends and matching aluminum door. Woodgrain vinyl finish standard.

Door locks open for easy relamping.

Heavy-gauge steel housing and wireway assembly.

Internal baffle for uplight and/or downlight, four-position pull-switch and grounded convenience outlet are standard on WM, optional on WB.

WM available in 120V only. Pull-switches and convenience outlets available on 120V only.

### Listings

UL Listed (standard). CSA Certified or NOM Certified (see Options).

# WB WM

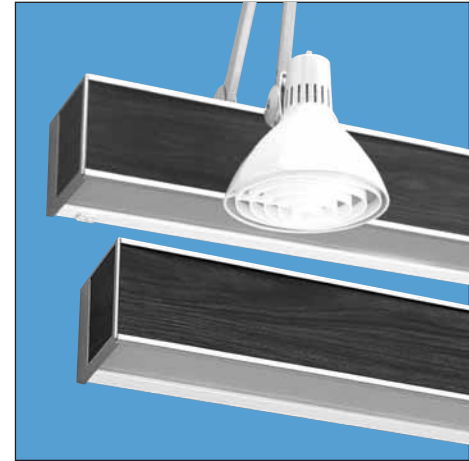

Example: **WB 2 32 A12 MVOLT GEB10IS**

### Ordering Information

Series	Number of lamps <sup>1</sup>	Lamp type	Shielding type	Voltage	Options
<b>WB</b> Commercial		<b>17</b> 17W T8 (24")	<b>A12</b> #12 pattern acrylic (uplight and downlight)	<b>MVOLT</b>	<b>1/3</b> One 3-lamp ballast
<b>WM</b> Medical	1	<b>20</b> 20W T12 (24")	<b>A12L</b> #12 pattern acrylic (downlight only) – WB only	<b>347</b>	<b>1/4</b> One 4-lamp ballast
	2	<b>25</b> 25W T8 (36")	<b>A12U</b> #12 pattern acrylic (uplight only)	Not included.	<b>GEB10IS</b> T8 electronic ballast, instant start
	3	<b>30</b> 30W T12 (36")	<b>3EA</b> KSH 3-E asymmetric lens (no direct light away from wall)		<b>GEB10RS</b> T8 electronic ballast, rapid start
	4	<b>32</b> 32W T8 (48")			<b>S1</b> On/off pull-switch (all lamps). WB only <sup>2</sup>
	Not included.				<b>S2</b> On/off pull-switch for downlight; remote uplight switching <sup>2,3,4</sup>
					<b>BF</b> Baffle to divide uplight and downlight <sup>5</sup>
					<b>CO</b> Grounded convenience outlet <sup>2,5</sup>
					<b>N</b> Night light, unswitched, top left. 7W C7 lamp (included) <sup>2</sup>
					<b>NS</b> Nightlight with push-switch, top left. 7W C7 lamp (included) <sup>2</sup>
					<b>XB</b> Mounting bracket and power supply for examination light; WM only <sup>2</sup>
					<b>IV</b> IV arm assembly, right-end mounting. WM only
					<b>WH</b> White finish
					<b>CSA</b> CSA Certified
					<b>NOM</b> NOM Certified

#### NOTES:

- 1 Three-lamp models are standard with two lamps bottom, one top. Order **Y** option for one bottom, two top. Example: WB 3Y32A12 120.
- 2 120V only.
- 3 Requires **BF** option.
- 4 Requires **2/1** option for 2-lamp fixtures.
- 5 Standard on WM, not available in Canada.

### Availability and Dimensions

Series	Nominal length	Number of lamps	Lamp type	Width in. (cm)	Depth in. (cm)	Length in. (cm)
WB	2'	1, 2, 3, 3Y, 4	17, 20	6 ¾ (17.1)	5 ½ (14.0)	24 ¼ (61.6)
WB	3'	1, 2, 3, 3Y, 4	25, 30	6 ¾ (17.1)	5 ½ (14.0)	36 ¼ (92.1)
WM	3'	2, 3, 3Y, 4	25, 30	6 ¾ (17.1)	5 ½ (14.0)	36 ¼ (92.1)
WB	4'	1, 2, 3, 3Y, 4	32	6 ¾ (17.1)	5 ½ (14.0)	48 ¼ (122.6)
WM	4'	2, 3, 3Y, 4	32	6 ¾ (17.1)	5 ½ (14.0)	48 ¼ (122.6)

### Accessories for WM

(Order separately)

- XL** Examination light. Light gray finish standard. Uses one medium-base A lamp, 100W maximum. Must order **XB** option for mounting bracket and power supply outlet.<sup>2</sup>
- XL** XL with louver.

Fluorescent High Bay

# Fluorescent High Bays

Lithonia Lighting is the leader in T5HO fluorescent high bays as a one-for-one alternative for HID lighting systems. Lithonia offers a wide variety of lighting systems to meet individual tasks. The Lithonia high bay offering provides both reliability and performance.

Specific fixtures include Cool Running™ Technology for peace-of-mind operation in even the most demanding applications.



Energy Savings

Fluorescent systems provide up to 50% savings when compared to existing 400-watt metal halide systems. Depending on your choice of lamp type, fluorescent is the right choice for comparable perceived light while providing significant energy savings.

Lighted Space

The fluorescent systems provide a number of benefits when compared to common high bay products. Fluorescent improves uniformity in the space thus eliminating the scallops or poor uniformity commonly associated with other systems.

Maintained Illumination

Fluorescent provides improved illumination in the space by providing the right amount of light at initial installation and carries on until the rated end of life. Typical fluorescent lamps lose only 10% of the rated lamp lumens throughout the life of the lamp while metal halide can lose up to 50% from initial rated lumens.

Improved Color

Fluorescent systems are rated at 70+ or 80+ CRI compared to common metal halide sources at 62. This improvement in color provides a better lighted space, cleaner environment and the perception of higher light levels.

Other Common Benefits

Sound Rating – Fluorescent systems are A sound rated thus providing a quieter environment for employees and/or customers.

Low profile – Fluorescent high bays are much lower profile thus reducing the likelihood of accidental damage caused by forklifts or other machinery.

Low Mercury – Even with more lamps the combined total of fluorescent lamps have half the mercury content of metal halide lamps.

Lithonia Lighting offers a wide offering of fluorescent high bay products to meet any application need.



Fluorescent High Bay



Intended Use

The I-BEAM™ Series is the workhorse of the high bay series of products. The I-BEAM™ fixture is the first fluorescent high bay to include T5HO Cool Running™ Technology with a 5-year ballast warranty and is UL Listed up to 55° C applications. The I-BEAM™ Series is ideal for applications such as manufacturing or warehousing where elevated ambient temperatures are common.

Features

Standard with unique high temperature T5HO system technology for applications up to 55° C. Five-year ballast warranty. Available with narrow (aisle) or high mounting heights or wide (general or lower mounting heights) distribution. 4 or 6-lamp configuration with T5HO or T8 lamps. Recommended mounting 16'-40'.

I-BEAM™



Intended Use

The SPEC-BEAM™ Series couples high performance in a rugged-construction, full-body design to provide reliable performance in any application. SPEC-BEAM™ fixtures feature Cool Running™ Technology and 5-year ballast warranty for T5HO with a UL listing for 55° C. Applications include warehousing, industrial, commercial, retail and manufacturing.

Features

Cool Running™ Technology with T5HO system with five-year ballast warranty will be available soon. Single- or two-point mounting. Open optical or shielding. A variety of photometric distributions to meet any application need. Available in 2, 3, 4, or 6-lamp operation. Recommended mounting from 16'-40'.

SPEC-BEAM™



Intended Use

The distinctive appearance of the MS5HB fixture only is matched by the reliable performance it provides. This series includes cross blades for additional shielding of the lamps. Ideal for climate-controlled spaces in medium to low mounting heights where shielding of the lamps is important such as assembly lines, retail or aisles.

Features

Linear design provides improved uniformity in space. T5HO or T8 lamp types in 2 or 3-lamp cross section. Wide or narrow distribution. Cross blades for lamp shielding. Mounting styles include aircraft cable, tong or chain. Recommended mounting 14'-30'.

MS5HB/MS8

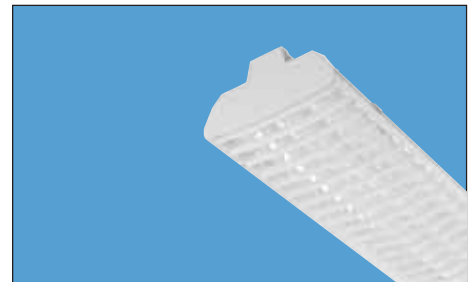

Intended Use

Designed to deliver peak optical performance with maximum efficiency and beam control in industrial, commercial and insitutional applications. Using high performance optics can reduce the number of fixtures required and maximize energy savings. Ideal for high ambient operation with Cool Running™ Technology and 5-year ballast warranty.

Features

Available in 8', 12' or 16' lengths with 1-lamp cross section. Focused beam for high performance. Suspended mounting. Recommended mounting heights 18'-50'.

FAL



Intended Use

The MS5 Series is the right choice for applications requiring high light levels at lower mounting heights in a compact fixture design. The MS5 fixture is ideal for applications requiring shielding such as assembly lines, retail offices, corridors, aisles or libraries. Suggested use in climate-controlled spaces.

Features

Compact design makes this product unobtrusive yet provides high light levels in a 1 or 2-lamp cross section. T5 or T5HO lamp types. Cross blade louver provides excellent shielding. Very low profile. Recommended mounting 8'-16'.

MS5

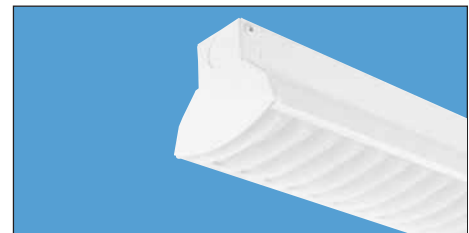

## Fluorescent High Bay

# I-BEAM™



### Intended Use

The I-BEAM™ Series is the ideal one-for-one replacement of common metal halide high bay systems. Applications include manufacturing, warehousing, commercial facilities and retail. I-BEAM™ fixtures perform best at mounting heights from 15'-40'.

### Features

The I-BEAM™ Series includes patented T5HO Cool Running™ Technology for elevated ambient operation up to 55° C.

Five-year ballast warranty on T5HO or T8 ballast.

Tall end caps protect optical system during shipment and installation.

Available in 4 or 6-lamp configuration.

Optics available with or without uplight.

Narrow distribution (ND) ideal for aisle or higher mounting heights. Reflector includes precision-formed segmented optics utilizing Alanod MIRO® 4 specular.

Wide distribution is achieved with high reflectance white paint. Ideal for general or open areas.

Sockets include rotating collars and enclosed contacts.

### Listings

UL Listed to US and Canadian safety standards. NOM Certified (see Options).

### Ordering Information

Example: **IB 454L**

Series	Number of lamps/wattage	Distribution	Voltage	Ballast	Ballast configuration	Options
<b>IB I-BEAM™</b>	<u>Lamps Installed<sup>1</sup></u>	(blank) Narrow distribution with uplight	(blank) MVOLT <sup>2</sup>	<u>T5HO</u>	(blank) Standard configuration <sup>4</sup>	<b>EL14</b> Emergency battery pack <sup>6</sup>
	<b>454L</b> 4-lamp, 54W T5HO	<b>NDS</b> Narrow distribution with no uplight	<b>120</b> 120 volt	(blank) Program start 1.0 BF	<b>2/3</b> Two three-lamp ballasts	<b>MSI</b> Occupancy-sensor prewired <sup>7</sup>
	<b>654L</b> 6-lamp, 54W T5HO	<b>WD</b> Wide with uplight	<b>277</b> 277 volt	<u>T8</u>	<b>2/2</b> Two two-lamp ballasts	<b>OCS</b> OCS OnePass® installed <sup>8</sup>
	<b>432L</b> 4-lamp, 32W T8	<b>WDS</b> Wide distribution, no uplight	<b>347</b> 347 volt	(blank) Instant start 1.2 BF		<b>FSP</b> Integral side panels
	<b>632L</b> 6-lamp, 32W T8		<b>480</b> 480 volt <sup>3</sup>	<b>GEB10IS</b> Instant start 0.88 BF		<b>NOM</b> NOM Certified
	<u>Unlamped</u>			<b>GEB10RS</b> Rapid start		<b>PMP</b> Pendant monopoint <sup>9</sup>
	<b>432</b> 4-lamp, 32W T8					
	<b>632</b> 6-lamp, 32W T8					

Lamps installed	
<u>T5HO</u>	
(blank)	F54T5HO/841
<b>LP835</b>	F54T5HO/835
<b>LP830</b>	F54T5HO/830
<b>LP850</b>	F54T5HO/850
<u>T5HO Amalgam<sup>5</sup></u>	
<b>LP830A</b>	F54T5HO/830
<b>LP835A</b>	F54T5HO/835
<b>LP841A</b>	F54T5HO/841
<u>T8</u>	
(blank)	F32T8/741
<b>LP735</b>	F32T8/735
<b>LP730</b>	F32T8/730

### Accessories (Order separately)

- IBAC120** Aircraft cable 10' Y hanger (one pair)
- IBAC240** Aircraft cable 20' Y hanger (one pair)
- WGIBZ** Wireguard, zinc-coated
- HC36** Chain hanger, 36"
- IBHMP** Hook monopoint
- IBPMP** Pendant monopoint<sup>9</sup>

### NOTES:

- 1 Lamps installed are F54T5HO/841 for T5HO and F32T8/741 for T8.
- 2 120-277 volt. Available on T5HO and T8. 0.88 BF only.
- 3 For use with T5HO only. Consult factory for use with T8.
- 4 See ballast configuration chart.
- 5 Not for use with motion sensors or EL14.
- 6 UL Listed for 55°C. Output in emergency mode varies with ambient temperature (approx. 944 lumens at 25°C and 911 lumens at 45°C). Single-lamp operation only. Not available with HVOLT.
- 7 Use of rapid start ballast recommended to avoid shortened lamp life.
- 8 Specify voltage. 120 or 277V only.
- 9 Fixture must be ordered with PMP for channel modification. Splice box ships separately.

Ballast Configuration Chart		
Lamp type	4-lamp	6-lamp
T5HO	(1) 4-lamp ballast	(1) 4-lamp and (1) 2-lamp ballast
T8 (.88)	(1) 4-lamp ballast	(1) 4-lamp and (1) 2-lamp ballast
T8 (1.2)	(2) 2-lamp ballasts	(2) 3-lamp ballasts

www.lithonia.com, keyword: I-BEAM

Intended Use

Ideal for one replacement for HID high bay luminaires. Provides large area lighting in a variety of photometric distributions for warehouse, industrial, commercial, retail and manufacturing areas.

Features

Patented T5HO Cool Running™ Technology UL Listed operation up to 55° C with 5-year ballast warranty will soon be available.

Four optical systems that can be tailored to meet specific application needs. All reflectors systems include 95% reflective specular Alanod MIRO® 4. Reflector warranted for 25 years.

Focus – Precision control narrow distribution for maximum punch in tight spaces.

Narrow – Standard distribution for narrow distribution in narrow aisles or higher mounting heights.

Medium – Ideal for wide aisle or medium mounting heights. High reflectance specular.

Wide – The best choice for medium mounting heights in general or open spaces at medium to low mounting heights.

Reflector choices include upright or direct. No upright options include 2-3% upright for heat management venting.

Suitable for single monopoint or two-point fixture mounting, chain, cable or monopoint hangers.

Lamp shielding option is available with hinge and rotary cam latches for easy access to optical system. Lenses are held in place with lens clips.

Option fixture housing with aluminum construction.

Listings

UL Listed to US and Canadian safety standards.

SPEC-BEAM™



SPEC-BEAM™ SPECIFICATION GRADE HIGH-BAY



Ordering Information

Example: FSB 654L

Series	Photometric distribution	Lamp shielding <sup>4</sup>	Ballast configuration	Lamps installed	Options
<b>FSB</b> SPEC-BEAM™	(blank) Narrow distribution with upright $0.9 \leq SC < 1.2$ <b>NDS</b> Narrow distribution no upright $0.9 \leq SC < 1.2^2$ <b>KD</b> Medium distribution with upright $1.2 \leq SC \leq 1.4$ <b>KDS</b> Medium distribution no upright $1.2 \leq SC \leq 1.4^2$	(blank) No shielding <b>A12</b> Pattern 12 acrylic <sup>5</sup> <b>ACL</b> Clear acrylic, 0.125" <b>PCL125</b> Clear polycarbonate, 0.125"	(blank) Standard configuration (see chart) <b>2/3</b> (2) 3-lamp ballast <b>2/2</b> (2) 2-lamp ballast	<b>T5HO</b> (blank) F54T5HO/841 <b>LP830</b> F54T5HO/830 <b>LP835</b> F54T5HO/835 <b>LP850</b> F54T5HO/850 <b>T5HO Amalgam</b> <b>LP830A</b> F54T5HO/830 <b>LP835A</b> F54T5HO/835 <b>LP841A</b> F54T5HO/841	<b>EL14</b> Emergency battery pack (1400 Lumens) <sup>8</sup> <b>GLR</b> Internal fast blow fusing <sup>9</sup> <b>OC5</b> OnePass® Installed <sup>9</sup> <b>MSIA</b> Occupancy sensor prewired aisle wedge <sup>9</sup> <b>MSI360</b> Occupancy sensor prewired 360° area for 25" <sup>9</sup> <b>AL</b> Aluminum construction, PAF <b>PAF</b> Powder coat after fabrication <b>WGI</b> Wireguard, 11 gauge, PAF <b>OUTCTR</b> Wiring leads through center of fixture (For use with monopoint hanger when using hanger as a wiring connection point)
<b>Number of lamps/wattage</b>	<b>SD</b> Spread distribution with upright $1.4 < SC \leq 1.8$	<b>Voltage</b>	<b>Ballast type</b>	<b>T8</b>	
<b>Lamps installed<sup>1</sup></b>	<b>SDS</b> Spread distribution no upright $1.4 < SC \leq 1.8^2$ <b>WD</b> Wide distribution with upright $1.8 < SC^3$ <b>WDS</b> Wide distribution no upright $1.8 < SC^2$ <b>TD</b> Focus distribution with upright $SC < 0.9^3$ <b>TDS</b> Focus distribution no upright $SC < 0.9^3$	(blank) MVOLT <sup>6</sup> <b>120</b> 120 volt <b>277</b> 277 volt <b>347</b> 347 volt <b>480</b> 480 volt <sup>7</sup>	<b>T5HO</b> (blank) Program start, 1.0 BF <b>T8</b> (blank) Instant start, 1.2 BF <b>GEB10IS</b> Instant start, 0.88 BF	(blank) F32T8/741 <b>LP730</b> F32T8/730 <b>LP735</b> F32T8/735	
<b>Unlamped</b>	<b>Accessories</b> (Order as separate catalog number)		<b>NOTES:</b>		
<b>232</b> 2-lamp, 32W T8 <b>332</b> 3-lamp, 32W T8 <b>432</b> 4-lamp, 32W T8 <b>632</b> 6-lamp, 32W T8	<b>FSBAC120</b> Aircraft cable 10' Y hanger (one pair) <b>FSBAC240</b> Aircraft cable 20' Y hanger (one pair) <b>HSD36</b> Chain hanger, 36" <b>THSD</b> Monopoint hanger w/ top opening <b>THSDHB</b> Monopoint hanger w/ 3/4" hub <b>THSDSK</b> Side covers for Monopoint hanger (For use with Monopoint hanger when using hanger as a wiring connection point)		1 Lamps installed are F54T5HO/841 for T5HO or F32T8/741 for T8. All T5HO fixtures ship lamped. 2 No upright reflectors options incorporate heat managing venting above the fixture that produce 2-3% upright. 3 T5HO lamps only. 4 Lamp shielding is provided in door frame. 5 A12 not available with WD and WDS distribution. 6 120-277 volt. 7 For use with T5HO. Consult factory for T8. 8 UL Listed for 40°C only. Consult factory for 6-lamp fixtures. 9 Specify voltage.		

Availability and Dimensions				
Nominal size	Series	Number of lamps	Lamp type	Height
12"x4"	FSB 2	2	32, 54T5HO	4.7"
	FSB 3	3	32, 54T5HO	4.7"
16"x4"	FSB 4	4	32, 54T5HO	4.7"
24"x4"	FSB 6	6	32, 54T5HO	4.7"

Standard Ballast Configuration Chart				
Lamp type	2-lamp	3-lamp	4-lamp	6-lamp
T5HO	(1) 2-lamp ballast	(1) 3-lamp ballast	(1) 4-lamp ballast	(1) 4-lamp ballast and (1) 2-lamp ballast
T8 (0.88)	(1) 2-lamp ballast	(1) 3-lamp ballast	(1) 4-lamp ballast	(1) 4-lamp ballast and (1) 2-lamp ballast
T8 (1.2)	(1) 2-lamp ballast	(1) 3-lamp ballast	(2) 2-lamp ballasts	(2) 3-lamp ballasts



## Fluorescent High Bay

# MS5HB/ MS8

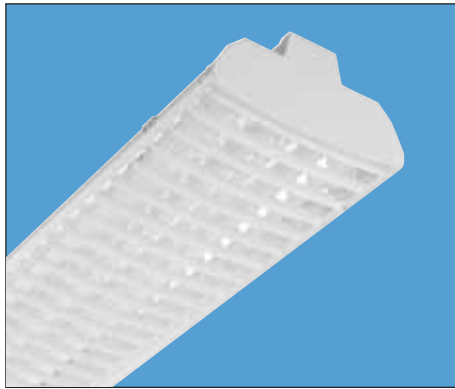

### Intended Use

Intended for use in retail stores, warehouses and manufacturing applications where high lumen package in a compact fixture design is required. Ideal for mounting heights up to 35 feet in controlled ambient facilities. Recommended for climate control spaces.

### Features

Available in 2 or 3-lamp cross-section.

White straight blade louver assembly provides shielding and reduces brightness. Louver assembly is hinged and latched for easy servicing.

20-gauge housing/reflector provides rugged construction.

Narrow distribution for aisle applications or wide distribution for general areas, direct or upright versions available.

Sockets feature rotating collars and enclosed contacts.

For individual or row mounting, a variety of hanging methods such as tong hangers, aircraft cable or stems available.

### Listings

UL Listed (standard). CSA Certified (see Options).

## Ordering Information

Example: **TMS5HB 3 54T5HO SBL ND MVOLT 1/41/2 GEB10PS**

Series	Lamp type	Distribution	Voltage	Ballast type	Options
<b>MS5HB</b> T5 low-profile direct/indirect	<b>32</b> 32WT8 (48")	<b>ND</b> Narrow	<b>MVOLT</b>	<b>GEB10PS</b> T5 electronic ballast, program start	<b>GLR</b> Internal fast blow fuse <sup>3</sup>
<b>MS5HBST</b> T5 low-profile solid top <sup>1</sup>	<b>54T5HO</b> 54W T5HO (46")	<b>WD</b> Wide	<b>347</b>	<b>GEB10IS</b> T8 electronic ballast, instant start	<b>GMF</b> Internal slow blow fuse <sup>3</sup>
<b>MS8</b> T8 low-profile direct/indirect			<b>480</b>		<b>EL55</b> T5 emergency battery pack (nominal 1250 lumens)
<b>MS8ST</b> T8 low-profile solid top					<b>CSA</b> CSA Certified

Number of lamps	Configuration	Ballast configuration
<b>2</b>	(blank) No louver	(blank) All 2-lamp ballasts <sup>2</sup>
<b>3</b>	<b>SBL</b> White straight blade louver assembly	<b>1/3</b> One 3-lamp ballast
Not included		<b>1/4</b> One 4-lamp ballast
		<b>1/41/2</b> One 4-lamp ballast and one 2-lamp ballast
		<b>2/3</b> Two 3-lamp ballasts

### NOTES:

- Available in 2 lamp only.
- Odd lamp configurations will include a lamp ballast.
- Specify voltage.

### Accessories (Order separately)

- MSHBAC** Adjustable aircraft cable support (non-feed), (specify length as **36**, **72** or **120** inches).
- MSHBACF** Aircraft cable feed and support, (specify length as **36**, **72** or **120** inches).
- THMS5HB** Tong hanger.
- SQ** Swivel stem hanger (specify length in 2" increments).
- HC36** Chain hanger – 36".
- WGMS5HB2** 4' wire guard for MS5HB, zinc coated. (Two required for 8' lengths)
- WGMS8Z** 4' wire guard for MS8, zinc coated. (Two required for 8' lengths)

### Availability and Dimensions

Series	Lamps per cross-section	Lamps per fixture	Lamp type	Width in.	Depth in.	Length in.
MS5HB	2, 3	2, 3	54T5HO	9¾	4¼	46 <sup>1</sup> / <sub>16</sub>
TMS5HB	2, 3	4, 6	54T5HO	9¾	4¼	92 <sup>1</sup> / <sub>8</sub>
MS5HBST	2	2	54T5HO	9¾	4¼	46 <sup>1</sup> / <sub>16</sub>
TMS5HBST	2	4	54T5HO	9¾	4¼	92 <sup>1</sup> / <sub>8</sub>
MS8	2, 3	2, 3	32	9¾	4¼	48
TMS8	2, 3	4, 6	32	9¾	4¼	96

Intended Use

FAL luminaires are designed to deliver peak optical performance with maximum efficiency and beam control in industrial, commercial, and institutional applications with mounting height up to 50'. Using high performance optics can reduce the number of fixtures required and maximize energy savings.

Features

Patented T5HO Cool Running™ Technology for elevated ambient operation up to 55°C will soon be available. Available in three lengths: 8', 12' and 16'. 12' assembly includes a 4' and 8' section, 16' assemblies include two 8' assemblies. Fixtures are joined together in the field with rigid internal brackets using 8 screws. All assemblies require only two support points. See accessories below.

Reflector is precision-formed, high-performance, 95% total reflectance, and segmented optics utilizing Alanod MIRO® 4 specular aluminum. Warranted for 25 years.

One lamp cross section with focused beam.

For suspension by chain or cable.

Tool-less ballast and wiring access.

Internal occupancy sensors standard. T8 fixtures that are specified with internal sensors are 6" longer.

Secured with rotary locking lamp sockets to minimize disconnection from vibration or incidental contact.

Listings

UL Listed to US and Canadian safety standards.

FAL



Ordering Information

Example: FAL 54L

Series	Wattage/lamps	Distribution	Voltage	Ballast type	Ballast configuration	Options
<b>FAL</b> Aisle lighter, 8'	<u>Lamps installed</u> <sup>1</sup>	(blank) Focus distribution	(blank) MVOLT <sup>2</sup>	<b>T5HO</b>	(blank) Standard configuration (see chart)	<b>EL14</b> Emergency battery pack (1400 lumens) <sup>4</sup>
<b>FAL12</b> Aisle lighter, 12'	<b>54L</b> 54WT5HO	no uplight, SC < 0.9	<b>347</b> 347 volt	(blank) Program start, 1.0 BF	<b>1/4</b> One 4-lamp ballast	<b>GLR</b> Internal fast blow fuse <sup>5</sup>
<b>FAL16</b> Aisle lighter, 16'	<b>32L</b> 32W T8		<b>480</b> 480 volt <sup>3</sup>	<b>T8</b>	<b>2/2</b> Two 2-lamp ballasts	<b>OCS</b> OCS OnePass® installed <sup>5</sup>
	<u>Unlamped</u>			(blank) Instant start, 1.2 BF		<b>MSIA</b> Occupancy sensor prewired aisle wedge <sup>5</sup>
	<b>54</b> 54W T5HO			<b>GEB10IS</b> Instant start, 0.88 BF		<b>PAF</b> Powder coat after fabrication
	<b>32</b> 32W T8					<b>WGI</b> Wireguard, 11 gauge, PAF

Lamps installed	
<b>T5HO</b>	
(blank)	F54T5HO/841
<b>LP830</b>	F54T5HO/830
<b>LP835</b>	F54T5HO/835
<b>LP850</b>	F54T5HO/850
<b>T5HO Amalgam</b>	
<b>LP841A</b>	F54T5HO/841
<b>LP830A</b>	F54T5HO/830
<b>LP835A</b>	F54T5HO/835
<b>T8</b>	
(blank)	F32T8/741
<b>LP730</b>	F32T8/730
<b>LP735</b>	F32T8/735

NOTES:

- Lamps installed are F54T5HO/841 for T5HO or F32T8/741 for T8.
- 120-277 volt.
- For use with T5HO. Consult factory for use with T8.
- UL Listed for 40° Ambient.
- Specify voltage.
- Not for use with sensors.

Accessories (Order as separate catalog number)

<b>FSBAC120</b>	Aircraft cable 10' Y hanger (one pair)
<b>FSBAC240</b>	Aircraft cable 20' Y hanger (one pair)
<b>HSD36</b>	Chain hanger, 36"
<b>WGFAL</b>	Wireguard, 43" <sup>6</sup>

Availability and Dimensions

Nominal size	Series	Fixture configuration	Number of lamps
7.2"x8'	FAL	8' section	2
7.2"x12'	FAL 12	4' + 8' section	3
7.2"x16'	FAL 16	(2) 8' sections	4

Standard Ballast Configuration Chart

Lamp type	8'	12'	16'
T5HO	(1) 2-lamp ballast	(1) 3-lamp ballast	(1) 4-lamp ballast
T8 (0.88)	(1) 2-lamp ballast	(1) 3-lamp ballast	(1) 4-lamp ballast
T8 (1.2)	(1) 2-lamp ballast	(1) 3-lamp ballast	(2) 2-lamp ballasts

## Low-Profile T5 Direct

# MS5



### Ordering Information

Series	Lamp type
<b>MS5</b> For tandem double-length unit, add prefix 'L'. Example: <b>TMS5</b>	<b>14T5</b> 14W T5 (22") <b>21T5</b> 21W T5 (34") <b>24T5HO</b> 24W T5HO (22") <b>28T5</b> 28W T5 (46") <b>39T5HO</b> 39W T5HO (34") <b>54T5HO</b> 54W T5HO (46")
Number of lamps 1 2 Not included.	

**NOTES:**

- 1 Only available on 28W and 54W.
- 2 Finish and reflector type not applicable.
- 3 Available with 54T5HO lamp type only.
- 4 Specify voltage.
- 5 Not available in Canada.
- 6 Not for use in combination with reflector.
- 7 Available with 3', 4' and 8' lengths only.
- 8 120-277V only for power feed.
- 9 Standard wire size for power feed is 18 gauge. For 12 gauge add **12AWG** to the end of catalog number. Consult factory for length of runs and required wire size.
- 10 Based on SMR reflector.

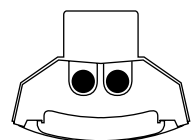

MS5 SBL

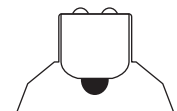

MS5 SMR

### Intended Use

Use in surface or suspended applications such as retail, manufacturing or renovation that require high light levels in a compact luminaire design.

### Features

Compact, low-profile design. High fixture performance.

Extended-height end caps for socket support. Full end cap available.

High-gloss baked white enamel or galvanized finish.

Choice of 1 or 2 lamps in 2', 3', 4' or 8' lengths.

Available reflectors include white, specular or galvanized finishes in solid or perforated styles.

White straight blade louver available for applications requiring additional shielding and cutoff.

Aircraft cable mounting hardware available.

### Listings

UL Listed (standard). CSA Certified (see Options).

### Example: MS5 1 54T5HO SMR MVOLT GEB10PS

Configuration	Finish	Voltage	Options
(blank) No reflector <b>ASMR</b> Asymmetric reflector <b>SMR</b> Symmetric reflector <b>SBL</b> White straight blade louver assembly (solid, white reflectors included) <sup>1,2</sup>	(blank) White <b>SAR95</b> Specular aluminum reflector-MIRO® (white channel) <b>GALV</b> Galvanized	<b>MVOLT</b> <b>347<sup>3</sup></b>	<b>GEB10PS</b> Electronic ballast, program start <b>GLR</b> Internal fast blow fuse <sup>4</sup> <b>GMF</b> Internal slow blow fuse <sup>4</sup> <b>EL55</b> Emergency battery pack (nominal 390-700 lumens) <sup>1,4,5</sup> <b>CSA</b> CSA Certified See page 113 for others.
Reflector style (blank) Solid <b>PERF</b> Perforated			

### Accessories

(Order separately)

- WGM55Z** Wireguard, 4', zinc<sup>6</sup>
- THMS5** Tong hanger (1 pair)
- MSSEP** Full depth end plate for standard reflector (1 pair)
- MSSEP SBL** Full depth end plate for louvered reflector (1 pair)
- 1B** Ceiling spacer (adjusts 1-1/2" to 2-1/2" from ceiling)
- SQ** Swivel stem hanger (specify length in 2" increments)
- MSSACF** Adjustable aircraft cable system with power feed (specify length as **36**, **72** or **108** inches)<sup>7,8,9</sup>
- MSSAC** Adjustable aircraft cable system (specify **36**, **72** or **108** inches)<sup>9</sup>

### Availability and Dimensions<sup>10</sup>

Nominal length	Series	Lamps per cross section	Lamps per fixture	Lamp type	Width in. (cm)	Depth in. (cm)	Length in. (cm)
2'	MS5	1, 2	1, 2	14T5, 24T5HO	4¾ (12.1)	2 <sup>13</sup> / <sub>16</sub> (7.1)	22 <sup>7</sup> / <sub>16</sub> (56.9)
3'	MS5	1, 2	1, 2	21T5, 39T5HO	4¾ (12.1)	2 <sup>13</sup> / <sub>16</sub> (7.1)	34¼ (87)
4'	MS5	1, 2	1, 2	28T5, 54T5HO	4¾ (12.1)	2 <sup>13</sup> / <sub>16</sub> (7.1)	46 <sup>1</sup> / <sub>16</sub> (116.9)
8'	MS5	1, 2	2, 4	28T5, 54T5HO	4¾ (12.1)	2 <sup>13</sup> / <sub>16</sub> (7.1)	92 <sup>1</sup> / <sub>16</sub> (233.7)

# MS5

### Intended Use

Use for coves, displays or any application requiring a low-profile luminaire that provides high light levels. Ideal for commercial, retail or manufacturing.

### Features

Compact, low-profile design. High fixture performance.

Available in standard or staggered channels. Staggered design includes 4" stagger for uninterrupted continuous illumination.

Extended-height end caps for socket support.

High-gloss baked white enamel or galvanized finish. Heavy-duty 20-gauge channel.

Choice of 1 or 2 lamps in 2', 3', 4' or 8' lengths.

### Listings

UL Listed (standard). CSA Certified (see Options).

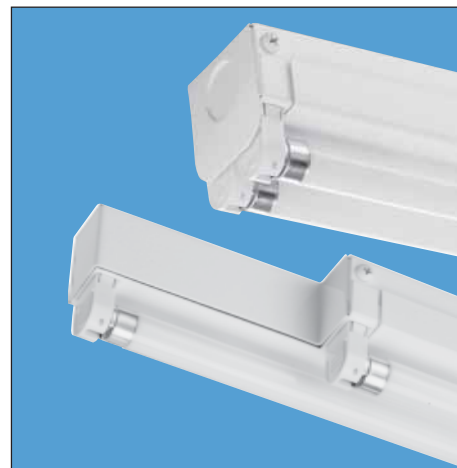

### Ordering Information

Example: **MS5 1 54T5HO MVOLT GEB10PS**

Series	Number of lamps	Lamp type	Voltage	Options
<b>MS5</b> Standard channel	<b>1</b>	<b>14T5</b> 14W T5 (22")	<b>MVOLT</b>	<b>GEB10PS</b> Electronic ballast, program start
<b>MS5SS</b> Staggered channel	<b>2</b> Not included.	<b>21T5</b> 21W T5 (34")	<b>347<sup>2</sup></b>	<b>GLR</b> Internal fast blow fuse <sup>3</sup>
		<b>24T5HO</b> 24W T5HO (22")		<b>GMF</b> Internal slow blow fuse <sup>3</sup>
		<b>28T5</b> 28W T5 (46")		<b>EL55</b> Emergency battery pack (nominal 390-700 lumens) <sup>3,4</sup>
		<b>39T5HO</b> 39W T5HO (34")		<b>CSA</b> CSA Certified
		<b>54T5HO</b> 54W T5HO (46")		See page 113 for others.

For tandem double-length unit, add prefix **T**.<sup>1</sup> Example: **TMS5**

**NOTES:**

- 1 Only available on 28W and 54W.
- 2 Available with 54T5HO lamp type only.
- 3 Specify voltage.
- 4 Not available in Canada.
- 5 For other lengths, replace 48 with correct length required; nominal 2' = 24, 3' = 36. Two reflectors required for 8' lengths.

Accessories (Order separately)

- WGMSSZ** Wireguard, 4', zinc
- THMSS** Tong hanger (1 pair)
- 1B** Ceiling spacer (adjusts 1-1/2" to 2-1/2" from ceiling)
- SQ** Swivel stem hanger (specify length in 2" increments)
- MS5SSASR 2 48** Asymmetric reflector for staggered, 4', two-lamp configuration<sup>1,5</sup>
- MS5SSASR 1 48** Asymmetric reflector for staggered, 4', one-lamp configuration<sup>5</sup>

Availability and Dimensions							
Nominal length	Series	Lamps per cross section	Lamps per fixture	Lamp type	Width in. (cm)	Depth in. (cm)	Length in. (cm)
2'	MS5SS	1, 2	1, 2	14T5, 24T5HO	2 (5.1)	2 1/4 (5.7)	22 1/2 (57.1), 26 1/2 (67.3)
	MSS	1, 2	1, 2	14T5, 24T5HO	2 (5.1)	2 1/4 (5.7)	22 7/16 (56.9)
3'	MS5SS	1, 2	1, 2	21T5, 39T5HO	2 (5.1)	2 1/4 (5.7)	34 1/4 (87), 38 1/4 (97.1)
	MSS	1, 2	1, 2	21T5, 39T5HO	2 (5.1)	2 1/4 (5.7)	34 1/4 (87)
4'	MS5SS	1, 2	1, 2	28T5, 54T5HO	2 (5.1)	2 1/4 (5.7)	46 1/16 (117), 50 1/16 (127.2)
	MSS	1, 2	1, 2	28T5, 54T5HO	2 (5.1)	2 1/4 (5.7)	46 1/16 (117)
8'	MS5SS	1, 2	1, 2	28T5, 54T5HO	2 (5.1)	2 1/4 (5.7)	88 1/16 (223.7), 96 1/16 (243.8)
	MSS	1, 2	2, 4	28T5, 54T5HO	2 (5.1)	2 1/4 (5.7)	92 1/16 (233.7)

## Standard Striplights

# S

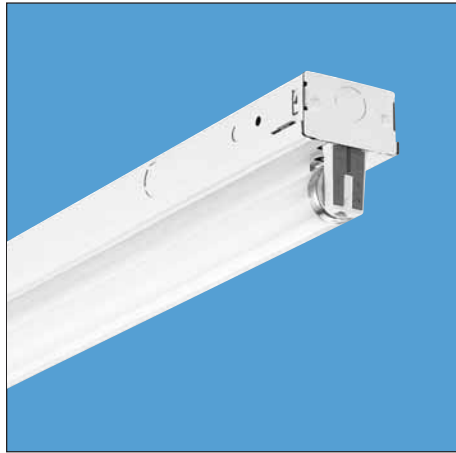

### Intended Use

For applications that require medium illumination levels and narrow construction. Suitable for general or task lighting.

### Features

Slim channel for easy handling in unit or row, ceiling or wall-mount applications.

High-gloss, baked enamel finish.

Combination end plate/channel connector furnished.

White or specular reflectors available.

Channel cover retained by quarter-turn fastener.

### Listings

UL Listed (standard) and CSA Certified (standard; except for 347V – see Options). NOM Certified (see Options).

## Ordering Information

Example: **S 1 32 MVOLT GEB10IS**

Series
<b>S</b>

Fortandem double-length unit, add prefix T.<sup>1</sup> Example: **TS**

Number of lamps
<b>1</b>

Not included.

Lamp type
<b>15</b> 15W T12 (18")
<b>15PH</b> 15W T12 (18")
<b>17</b> 17W T8 (24")
<b>20</b> 20W T12 (24")
<b>20PH</b> 20W T12 (24")
<b>25</b> 25W T8 (36")
<b>30</b> 30W T12 (36")
<b>30PH</b> 30W T12 (36")
<b>32</b> 32W T8 (48")

Voltage
<b>MVOLT</b>
<b>120</b>
<b>277</b>
<b>347</b>

Ballast options
<b>LPF</b> Low power factor (for 15W, 20W, 30W only)
<b>HPF</b> High power factor (for 15W, 20W, 30W only)
<b>GEB10IS</b> T8 electronic ballast, instant start
<b>GEB10RS</b> T8 electronic ballast, rapid start

Options
<b>CSA</b> CSA Certified (347V only)
<b>NOM</b> NOM Certified

See page 113 for others.

### NOTES:

- Order two 36" reflectors for 72" fixtures and two 48" reflectors for 96" fixtures.
- Maximum depth to center of lamps.

### Reflector Accessories (Order separately)

Reflector type	Length	Finish
<b>SASR</b> Asymmetric	<b>24</b> 24" nominal	(blank) White
<b>SSMR</b> Symmetric	<b>36</b> 36" nominal <sup>1</sup>	<b>SSR</b> Specular silver, steel
	<b>48</b> 48" nominal <sup>1</sup>	

### Availability and Dimensions

Nominal length	Series	Lamps per cross section	Lamps per fixture	Lamp type	Width in. (cm)	Depth <sup>2</sup> in. (cm)	Length in. (cm)
1½'	S	1	1	15, 15PH	2¾ (7.0)	2¾ (7.0)	18 (45.7)
2'	S	1	1	17, 20, 20PH	2¾ (7.0)	2¾ (7.0)	24 (61.0)
3'	S	1	1	25, 30	2¾ (7.0)	2¾ (7.0)	36 (91.4)
4'	S	1	1	32	2¾ (7.0)	2¾ (7.0)	48 (121.9)
6'	TS	1	2	25, 30	2¾ (7.0)	2¾ (7.0)	72 (182.9)
8'	TS	1	2	32	2¾ (7.0)	2¾ (7.0)	96 (243.8)

**lightquick<sup>®</sup> XD**  
Express delivery products.  
See page 11 for details about LightQuick XD.

---

*Description*

**S 1 32 MVOLT GEB10IS**

www.lithonia.com, keyword: S

## General-Purpose Channels



### Intended Use

For applications that require low to medium illumination levels. Suitable for general purpose applications.

### Listings

UL Listed (standard) and CSA Certified (standard; except for 347V – see Options). NOM Certified (see Options).

### Features

Steel channel (standard) with high-gloss, baked enamel finish.

Optional aluminum channel available – features corrosion-resistant fasteners for use in damp and harsh locations.

Combination end plates/channel connector furnished for either unit-mounted or continuous-row application.

White or specular reflectors available.

Channel cover retained by quarter-turn fastener.

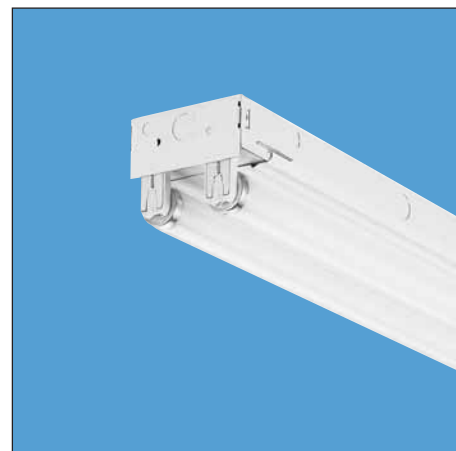

## Ordering Information

Example: **C 2 32 MVOLT GEB10IS**

Series	Number of lamps <sup>1</sup>	Lamp type	Voltage
<b>C</b>	<b>1</b>	<b>17</b> 17W T8 (24")	<b>MVOLT</b>
For optional aluminum channel, add suffix <b>AL</b> to catalog number. Example C2 96 120 <b>AL</b> . See Options.	<b>2</b> Not included.	<b>20</b> 20W T12 (24")	<b>120</b>
For tandem double-length unit, add prefix <b>T</b> . <sup>1</sup> Example: <b>TC</b>		<b>24HO</b> 35W T12 800mA (24") <sup>2</sup>	<b>277</b>
		<b>25</b> 25W T8 (36")	<b>347</b>
		<b>30</b> 30W T12 (36")	
		<b>32</b> 32W T8 (48")	
		<b>36HO</b> 45W T12 800mA (36") <sup>2</sup>	
		<b>48</b> 39W T12 slimline (48")	
		<b>48HO</b> 60W T12 800mA (48") <sup>2</sup>	
		<b>72</b> 55W slimline (72")	
		<b>72HO</b> 85W T12 800mA (72") <sup>2</sup>	
		<b>96HO</b> 110W T12 800mA (96") <sup>2</sup>	
		<b>96T8</b> 59W T8 slimline (96")	
		<b>96T8HO</b> 86W T8 380mA (96") <sup>2</sup>	

Ballast options	Options
<b>1/4</b> One 4-lamp ballast	<b>AL</b> Aluminum body
<b>GEB10IS</b> T8 electronic ballast, instant start	<b>CSA</b> CSA Certified (347V only)
<b>GEB10RS</b> T8 electronic ballast, rapid start	<b>NOM</b> NOM Certified
<b>LPF</b> Low power factor (for 20W or 30W only)	See page 113 for others.
<b>HPF</b> High power factor (for 20W or 30W only)	

### NOTES:

- Tandem CF lamp types available in one-lamp only.
- HO models available with aluminum channel only or steel channel with electronic ballast.
- Order two 36" reflectors for 72" fixtures and two 48" reflectors for 96" fixtures.
- Maximum depth to center of lamps.

### Reflector Accessories (Order separately)

Reflector type	Length	Finish
<b>CASR</b> Asymmetric	<b>24</b> 24" nominal	(blank) White
<b>CSMR</b> Symmetric	<b>36</b> 36" nominal <sup>3</sup>	<b>SSR</b> Specular silver, steel
	<b>48</b> 48" nominal <sup>3</sup>	

### Availability and Dimensions

Nominal length	Series	Lamps per cross section	Lamps per fixture	Lamp type	Width in. (cm)	Depth <sup>4</sup> in. (cm)	Length in. (cm)
2'	C/C AL	1, 2	1, 2	17, 20	4 <sup>3</sup> / <sub>16</sub> (10.6)	2 <sup>15</sup> / <sub>16</sub> (7.5)	24 (61.0)
	C AL	1, 2	1, 2	24HO	4 <sup>3</sup> / <sub>16</sub> (10.6)	3 <sup>15</sup> / <sub>16</sub> (9.6)	24 (61.0)
3'	C/C AL	1, 2	1, 2	25, 30	4 <sup>3</sup> / <sub>16</sub> (10.6)	2 <sup>15</sup> / <sub>16</sub> (7.5)	36 (91.4)
	TC AL	1, 2	1, 2	36HO	4 <sup>3</sup> / <sub>16</sub> (10.6)	3 <sup>13</sup> / <sub>16</sub> (9.6)	36 (91.4)
4'	C/C AL	1, 2	1, 2	32, 48	4 <sup>3</sup> / <sub>16</sub> (10.6)	2 <sup>15</sup> / <sub>16</sub> (7.5)	48 (121.9)
	C AL	1, 2	1, 2	48HO	4 <sup>3</sup> / <sub>16</sub> (10.6)	3 <sup>13</sup> / <sub>16</sub> (9.6)	48 (121.9)
6'	TC/TC AL	1	2	25, 30	4 <sup>3</sup> / <sub>16</sub> (10.6)	2 <sup>15</sup> / <sub>16</sub> (7.5)	72 (182.9)
	TC/TC AL	2	4	25, 30	4 <sup>3</sup> / <sub>16</sub> (10.6)	2 <sup>15</sup> / <sub>16</sub> (7.5)	72 (182.9)
	C/C AL	1, 2	1, 2	72	4 <sup>3</sup> / <sub>16</sub> (10.6)	2 <sup>15</sup> / <sub>16</sub> (7.5)	72 (182.9)
	C AL	1, 2	1, 2	72HO	4 <sup>3</sup> / <sub>16</sub> (10.6)	3 <sup>13</sup> / <sub>16</sub> (9.6)	72 (182.9)
8'	TC/TC AL	1	2	32	4 <sup>3</sup> / <sub>16</sub> (10.6)	2 <sup>15</sup> / <sub>16</sub> (7.5)	96 (243.8)
	TC/TC AL	2	4	32	4 <sup>3</sup> / <sub>16</sub> (10.6)	2 <sup>15</sup> / <sub>16</sub> (7.5)	96 (243.8)
	C/C AL	1, 2	1, 2	96T8, 96T8HO	4 <sup>3</sup> / <sub>16</sub> (10.6)	2 <sup>15</sup> / <sub>16</sub> (7.5)	96 (243.8)
	C AL	1, 2	1, 2	96HO	4 <sup>3</sup> / <sub>16</sub> (10.6)	3 <sup>13</sup> / <sub>16</sub> (9.6)	96 (243.8)

**lightquick<sup>®</sup> XD**  
Express delivery products.

See page 11 for details about LightQuick XD.

---

*Description*

**C 2 32 MVOLT GEB10IS**

Heavy-Duty Channels

# UNS/UND/ UN



Intended Use

Use for applications requiring high illumination in medium to high mounting heights and a rugged, heavy-duty strip design.

Features

Heavy-duty formed channel with high-gloss, baked enamel finish.

Lampholders secured by screwed-on end plates.

Channel connector furnished for continuous mounting.

Symmetric or asymmetric reflectors available.

Listings

UL Listed (standard) and CSA Certified (standard; except for 347V – see Options). NOM Certified (see Options).

Ordering Information

Example: **UND 2 96HO 120 ES CW20**

Series	Description
<b>UNS</b>	1 or 2 lamps, T12 and T8 rapid start and slimline, standard width
<b>UND</b>	1 or 2 lamps, T12 HO or VHO, standard width
<b>UN</b>	3 or 4 lamps, T12 and T8, wide channel
<b>2UN</b>	2 lamps, T12 and T8, wide channel

Number of lamps
1
2
3
4

Lamp type	Description
<b>17</b>	17W T8 (24")
<b>20</b>	20W T12 (24")
<b>24</b>	24W T12 slimline (24")
<b>24HO</b>	35W T12 800mA (24")
<b>25</b>	25W T8 (36")
<b>30</b>	30W T12 (36")
<b>32</b>	32W T8 (48")
<b>36</b>	36W T12 slimline (36")
<b>36HO</b>	45W T12 800mA (36")
<b>48</b>	38W T12 slimline (48")
<b>48HO</b>	60W T12 800mA (48")
<b>48VHO</b>	110W T12 1500mA (48")
<b>72</b>	55W T12 slimline (72")
<b>72HO</b>	85W T12 800mA (72")
<b>96T8</b>	96W T8 slimline (96")
<b>96T8HO</b>	96W T8 T8HO (96")
<b>96HO</b>	110W T12 800m A (96")
<b>96VHO</b>	210W T12 1500m A (96")

Voltage
<b>MVOLT</b>
<b>120</b>
<b>277</b>
<b>347</b>

Options
<b>1/3</b> One 3-lamp ballast
<b>1/4</b> One 4-lamp ballast
<b>ES</b> T12 energy-saving ballast
<b>CW20</b> Cold temperature ballast
<b>GEB10IS</b> T8 electronic ballast, instant start
<b>GEB10RS</b> T8 electronic ballast, rapid start
<b>CSA</b> CSA Certified (347V only)
<b>NOM</b> NOM Certified

See page 113 for others.

Availability and Dimensions						
Series	Lamps per cross section	Lamps per fixture	Lamp type	Width in. (cm)	Depth <sup>1</sup> in. (cm)	Length in. (cm)
UNS	1,2	1,2	17, 20, 24	4 <sup>3</sup> / <sub>8</sub> (11.1)	3 (7.6)	24 (69.9)
UND	1,2	1,2	24HO	4 <sup>3</sup> / <sub>8</sub> (11.1)	3 <sup>11</sup> / <sub>16</sub> (9.3)	24(69.9)
UN	3,4	3,4	17, 20, 24	4 <sup>3</sup> / <sub>8</sub> (11.1)	3 <sup>3</sup> / <sub>4</sub> (9.5)	24 (69.9)
UNS	1,2	1,2	25, 30, 36	4 <sup>3</sup> / <sub>8</sub> (11.1)	3 (7.6)	36 (91.4)
UND	1,2	1,2	36HO	4 <sup>3</sup> / <sub>8</sub> (11.1)	3 <sup>11</sup> / <sub>16</sub> (9.3)	36 (91.4)
UN	3,4	3,4	25, 36, 36HO	4 <sup>3</sup> / <sub>8</sub> (11.1)	3 <sup>3</sup> / <sub>4</sub> (9.5)	36 (91.4)
UNS	1,2	1,2	32, 48	4 <sup>3</sup> / <sub>8</sub> (11.1)	3 (7.6)	48 (121.9)
UND	1,2	1,2	48HO, 48VHO	4 <sup>3</sup> / <sub>8</sub> (11.1)	3 <sup>11</sup> / <sub>16</sub> (9.3)	48 (121.9)
UN	3,4	3,4	32, 48, 48HO	9 (22.9)	3 <sup>3</sup> / <sub>4</sub> (9.5)	48 (121.9)
2UN	2	2	32, 48, 48HO	9 (22.9)	3 <sup>3</sup> / <sub>4</sub> (9.5)	48 (121.9)
UNS	1,2	1,2	72	4 <sup>3</sup> / <sub>8</sub> (11.1)	3 (7.6)	72 (182.9)
UND	1,2	1,2	72HO	4 <sup>3</sup> / <sub>8</sub> (11.1)	3 <sup>11</sup> / <sub>16</sub> (9.3)	72 (182.9)
UN	3,4	3,4	72,72HO	9 (22.9)	3 <sup>3</sup> / <sub>4</sub> (9.5)	72 (182.9)
UNS	1,2	1,2	96T8HO	4 <sup>3</sup> / <sub>8</sub> (11.1)	3 (7.6)	96 (243.8)
UND	1,2	1,2	96HO, 96VHO <sup>1</sup>	4 <sup>3</sup> / <sub>8</sub> (11.1)	3 <sup>11</sup> / <sub>16</sub> (9.3)	96 (243.8)
UN	3,4	3,4	96HO, 96T8, 96T8HO	9 (22.9)	3 <sup>3</sup> / <sub>4</sub> (9.5)	96 (243.8)
2UN	2	2	96HO, 96T8, 96T8HO, 96VHO <sup>1</sup>	4 <sup>3</sup> / <sub>8</sub> (11.1)	3 <sup>3</sup> / <sub>4</sub> (9.5)	96 (243.8)
TUN	1,2	2,4	32	9 (22.9)	3 <sup>3</sup> / <sub>4</sub> (9.5)	96 (243.8)
TUN	3,4	6,8	32	9 (22.9)	3 <sup>3</sup> / <sub>4</sub> (9.5)	96 (243.8)
T2UN	2	4	32	9 (22.9)	3 <sup>3</sup> / <sub>4</sub> (9.5)	96 (243.8)
TUNS	1,2	2,4	96T8HO	4 <sup>3</sup> / <sub>8</sub> (11.1)	3 (7.6)	192 (487.7)
TUND	1,2	2,4	96HO, 96VHO <sup>1</sup>	4 <sup>3</sup> / <sub>8</sub> (11.1)	3 <sup>11</sup> / <sub>16</sub> (9.3)	192 (487.7)
UN	3,4	3,4	96HO, 96T8, 96T8HO	9 (22.9)	3 <sup>3</sup> / <sub>4</sub> (9.5)	192 (487.7)
T2UN	2	4	96HO, 96T8, 96T8HO, 96VHO <sup>1</sup>	9 (22.9)	3 <sup>3</sup> / <sub>4</sub> (9.5)	192 (487.7)

NOTES:

1 Fixture depth is 4 1/8" (10.5 cm).

Recessed Row Systems

# RR/CRR/ CRRS



Intended Use

Recessed open (or lensed) row system provides linear illumination for retail and other applications. On CRRS models, lamps are visible from street to attract attention to retail operations.

Features

Channel rests on standard 12" center-to-center T-bar components. T-bar support required along length of fixture or row and across ends.

T-bar clips secure channel to ceiling system.

Bi-pin, slimline or 800mA lamps.

RR units shipped assembled in 2', 3', 4', 6' and 8' lengths for easy installation. End plates included and assembled on fixture.

CRR units provide a continuous row of illumination without interruption by end plates and cross tees.

In row wiring, connection is made through continuous channel. Access to ballast is through channel cover (retained by quarter-turn fasteners).

High-gloss, baked white enamel, die-embossed reflector.

CRRS units feature shallow continuous reflector design that drops lamp center even with ceiling plane.

Listings

UL Listed (standard). CSA Certified (see Options).

Ordering Information

Series	Number of lamps	Lamp type	Diffuser type	Voltage	Options
<b>RR</b> Recessed row	<b>1</b>	<b>17</b> 17W T8 (24")	(blank) Open channel	<b>MVOLT</b>	<b>1/4</b> One 4-lamp ballast
<b>CRR</b> Continuous recessed row	<b>2</b>	<b>20</b> 20W T12 (24")	<b>A12</b> #12 pattern acrylic diffuser (RR and CRR only)	<b>347</b>	<b>GEB</b> Electronic ballast, ≤20% THD (F96 T8 only) <sup>3</sup>
<b>CRRS</b> Continuous recessed row, shallow	<b>3<sup>1</sup></b>	<b>24HO</b> 35W 800mA (24")			<b>GEB10IS</b> T8 electronic ballast, ≤10% THD, instant start
	Not included.	<b>25</b> 25W T8 (36")			<b>GEB10PS</b> T8 electronic ballast, ≤10% THD, rapid start
		<b>30</b> 30W T12 (36")			<b>CSA</b> CSA Certified
		<b>32</b> 32W T8 (48")			See page 113 for others.
		<b>36HO</b> 45W 800mA (36")			
		<b>48</b> 38W slimline (48")			
		<b>48HO</b> 60W 800mA (48")			
		<b>72</b> 55W slimline (72")			
		<b>72HO</b> 85W 800mA (72")			
		<b>96HO</b> 110W 800mA (96")			
		<b>96T8</b> 59W T8 slimline (96")			

For tandem double-length unit, add prefix T. Example: **TCRR**.

Example: CRR 2 96T8 MVOLT GEB

Availability and Dimensions						
Nominal length	Series	Lamps per cross section	Lamps per fixture	Lamp type	Depth in.(cm)	Length in.(cm)
2'	RR/CRR	1, 2, 3 <sup>1</sup>	1, 2, 3	17, 20	5 <sup>13</sup> / <sub>16</sub> (14.8)	24 (61.0)
	RR/CRR	1, 2	1, 2	24HO	6 <sup>1</sup> / <sub>8</sub> (15.6)	24 (61.0)
	CRRS	1, 2	1, 2	24HO	5 <sup>13</sup> / <sub>16</sub> (14.8)	24 (61.0)
3'	RR/CRR	1, 2, 3 <sup>1</sup>	1, 2, 3	25, 30	5 <sup>13</sup> / <sub>16</sub> (14.8)	36 (91.4)
	RR/CRR	1, 2	1, 2	36HO	6 <sup>1</sup> / <sub>8</sub> (15.6)	36 (91.4)
	CRRS	1, 2	1, 2	36HO	5 <sup>13</sup> / <sub>16</sub> (14.8)	36 (91.4)
4'	RR/CRR	1, 2, 3 <sup>1</sup>	1, 2, 3	32, 48	5 <sup>13</sup> / <sub>16</sub> (14.8)	48 (121.9)
	RR/CRR	1, 2	1, 2	48HO	6 <sup>1</sup> / <sub>8</sub> (15.6)	48 (121.9)
	CRRS	1, 2	1, 2	48HO	5 <sup>13</sup> / <sub>16</sub> (14.8)	48 (121.9)
6'	TRR/TCRR	1, 2, 3 <sup>1</sup>	2, 4, 6	25, 30	5 <sup>13</sup> / <sub>16</sub> (14.8)	72 (182.9)
	RR/CRR	1, 2	1, 2	72	5 <sup>13</sup> / <sub>16</sub> (14.8)	72 (182.9)
	RR/CRR	1, 2	1, 2	72HO	6 <sup>1</sup> / <sub>8</sub> (15.6)	72 (182.9)
	CRRS	1, 2	1, 2	72HO	5 <sup>13</sup> / <sub>16</sub> (14.8)	72 (182.9)
8'	TRR/TCRR	1, 2, 3 <sup>1</sup>	2, 4, 6	32	5 <sup>13</sup> / <sub>16</sub> (14.8)	96 (243.8)
	RR/CRR	1, 2	1, 2	96T8	5 <sup>13</sup> / <sub>16</sub> (14.8)	96 (243.8)
	RR/CRR	1, 2	1, 2	96HO	6 <sup>1</sup> / <sub>8</sub> (15.6)	96 (243.8)
	CRRS	1, 2	1, 2	96HO	5 <sup>13</sup> / <sub>16</sub> (14.8)	96 (243.8)
16'	TRR/TCRR	1, 2	2, 4	96T8	5 <sup>13</sup> / <sub>16</sub> (14.8)	192 (487.7) <sup>2</sup>
	TRR/TCRR	1, 2	2, 4	96HO	6 <sup>1</sup> / <sub>8</sub> (15.6)	192 (487.7) <sup>2</sup>
	TCRRS	1, 2	2, 4	96HO	5 <sup>13</sup> / <sub>16</sub> (14.8)	192 (487.7) <sup>2</sup>

Accessories (Order separately)

**CRREP** End plates flanged to support ceiling tile (pair). Order one pair per row. Required on all CRR and CRRS installations.

NOTES:

- 3-lamp models are T8 only.
- Fixture is shipped in two 96" cartons, tandem-wired using quick-connect plugs (installed).
- Specify voltage.



Side-Mounted Strips

# SM

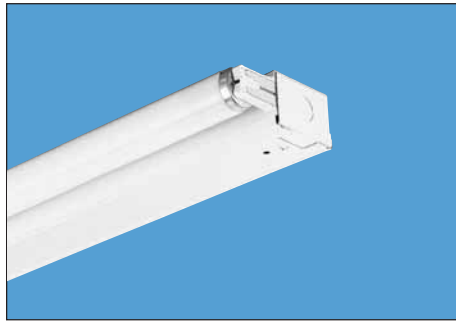

Intended Use

Ideal for displays or any application with limited space.

Features

Low-profile body and side-mounted lamps permit installation in shallow spaces and provide good illumination.

High-gloss, baked enamel finish.

Channel cover secured by quarter-turn fasteners for easy access.

Listings

UL Listed (standard) and CSA Certified (standard; except for 347V – see Options). NOM Certified (see Options).

Ordering Information

Example: **SM 2 32 MVOLT ES**

Series	Number of lamps	Lamp type	Voltage	Ballast options	Options
<b>SM</b> For tandem double-length unit, add prefix T. Example: <b>TSM</b>	<b>1</b> <b>2</b> <b>2L<sup>1</sup></b> <b>3</b> Not included.	<b>15</b> 15W T12 (18") <b>15PH</b> 15W T12 preheat (18") <b>17</b> 17W T8 (24") <b>20</b> 20W T12 (24") <b>20PH</b> 20W T12 preheat (24") <b>25</b> 25W T8 (36") <b>30</b> 30W T12 (36") <b>30PH</b> 30W T12 preheat (36") <b>32</b> 32W T8 (48")	<b>MVOLT</b> <b>347</b>	<b>LPF</b> Low power factor (for 15W, 20W, 30W) <b>HPF</b> High power factor (for 15W, 20W, 30W) <b>ES</b> Energy-saving ballast	<b>1/3</b> One 3-lamp ballast <b>1/4</b> One 4-lamp ballast <b>GEB10IS</b> T8 electronic ballast, instant start <b>GEB10RS</b> T8 electronic ballast, rapid start <b>CSA</b> CSA Certified (347V only) <b>NOM</b> NOM Certified See page 113 for others.

NOTES:

- 1 L lamp configuration, see below.
- 2 Maximum depth to center of lamps.

Lamp Configurations

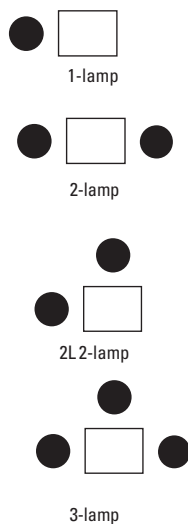

Availability and Dimensions

Nominal length	Series	Lamps per cross section	Lamps per fixture	Lamp type	Width in. (cm)	Depth <sup>2</sup> in. (cm)	Length in. (cm)
1½'	SM	1	1	15, 15PH	4½ (11.4)	1 11/16 (4.3)	18 (45.7)
		2	2	15, 15PH	6¼ (15.9)	1 11/16 (4.3)	18 (45.7)
		2L	2	15, 15PH	4½ (11.4)	3 (7.6)	18 (45.7)
2'	SM	1	1	17, 20, 20PH	4½ (11.4)	1 11/16 (4.3)	24 (61.0)
		2	2	17, 20, 20PH	6¼ (15.9)	1 11/16 (4.3)	24 (61.0)
		2L	2	17, 20, 20PH	4½ (11.4)	3 (7.6)	24 (61.0)
3'	SM	3	3	25, 30, 30PH	6¼ (15.9)	3 (7.6)	36 (91.4)
		1	1	25, 30, 30PH	4½ (11.4)	1 11/16 (4.3)	36 (91.4)
		2	2	25, 30, 30PH	6¼ (15.9)	1 11/16 (4.3)	36 (91.4)
		2L	2	25, 30, 30PH	4½ (11.4)	3 (7.6)	36 (91.4)
		3	3	25, 30, 30PH	6¼ (15.9)	3 (7.6)	36 (91.4)
4'	SM	1	1	32	4½ (11.4)	1 11/16 (4.3)	48 (121.9)
		2	2	32	6¼ (15.9)	1 11/16 (4.3)	48 (121.9)
		2L	2	32	4½ (11.4)	3 (7.6)	48 (121.9)
		3	3	32	6¼ (15.9)	3 (7.6)	48 (121.9)
8'	TSM	1	2	32	4½ (11.4)	1 11/16 (4.3)	96 (243.8)
		2	4	32	6¼ (15.9)	1 11/16 (4.3)	96 (243.8)
		2L	4	32	4½ (11.4)	3 (7.6)	96 (243.8)
		3	6	32	6¼ (15.9)	3 (7.6)	96 (243.8)

## Staggered Striplights / Telescoping Staggered Striplights

### Intended Use

Use for applications requiring uninterrupted illumination levels such as covers or displays.

### Features

Channel is offset at both ends to accept adjoining fixtures in row applications.

Channel connectors furnished.

Lamps in adjacent fixtures overlap 4" to provide a continuous illumination.

High-gloss, baked-enamel finish.

Telescoping version provides even continuous environment without shadows.

Optional aluminum fixtures feature corrosion-resistant fasteners for use in damp and harsh locations.

### Listings

UL Listed (standard). CSA Certified or NOM Certified (see Options).

# SS/SST

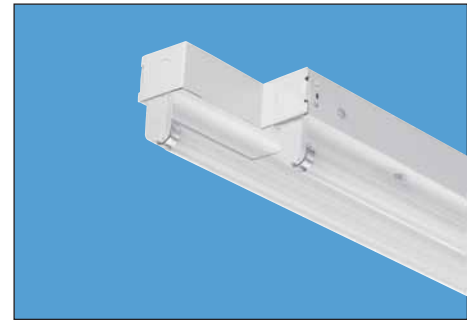

Example: **SS 2 32 MVOLT GEB10IS**

### Ordering Information

Series	Number of lamps	Lamp type	Voltage	Options
<b>SS</b> Standard	<b>1</b>	<b>17</b> 17W T8 (24")	<b>347</b>	<b>1/4</b> One 4-lamp ballast
<b>SST</b> Telescoping	<b>2</b>	<b>25</b> 25W T8 (36")	<b>MVOLT</b>	<b>GEB10IS</b> T8 electronic ballast, instant start
For optional aluminum channel, add suffix <b>AL</b> to catalog number. Example: SS296120AL		<b>32</b> 32W T8 (48")	Others available.	<b>GEB10RS</b> T8 electronic ballast, rapid start
For tandem-wired double length unit, add prefix <b>T</b> . Example: <b>TSS</b>		<b>96HO</b> 110W T12 800mA (96")		<b>AL</b> Aluminum
	Not included.	<b>96T8</b> 59W T8 (96")		<b>CSA</b> CSA Certified
		<b>96T8HO</b> 86W T8 380mA (96")		<b>NOM</b> NOM Certified

See page 113 for others.

NOTES:  
1 Maximum depth to center of lamps.

### Availability and Dimensions

Nominal length	Series	Lamps per cross section	Lamps per fixture	Lamp type	Width in. (cm)	Depth <sup>1</sup> in. (cm)	Length in. (cm)
2'	SS/ SS AL	1	1	17	4 <sup>7</sup> / <sub>16</sub> (10.6)	2 <sup>5</sup> / <sub>16</sub> (7.5)	24 (61.0)
	SS/ SS AL	2	2	17	4 <sup>3</sup> / <sub>16</sub> (10.6)	2 <sup>5</sup> / <sub>16</sub> (7.5)	28 (71.1)
	SST	2	2	17, 20	4 <sup>3</sup> / <sub>4</sub> (11.1)	2 <sup>5</sup> / <sub>16</sub> (7.5)	28 (71.1)
3'	SS/ SS AL	1	1	25	4 <sup>7</sup> / <sub>16</sub> (10.6)	2 <sup>5</sup> / <sub>16</sub> (7.5)	36 (91.4)
	SS/ SS AL	2	2	25	4 <sup>7</sup> / <sub>16</sub> (10.6)	2 <sup>5</sup> / <sub>16</sub> (7.5)	40 (101.6)
	SST	2	2	25, 30	4 <sup>3</sup> / <sub>4</sub> (11.1)	2 <sup>5</sup> / <sub>16</sub> (7.5)	40 (101.6)
4'	SS/ SS AL	1	1	32	4 <sup>7</sup> / <sub>16</sub> (10.6)	2 <sup>5</sup> / <sub>16</sub> (7.5)	48 (121.9)
	SS/ SS AL	2	2	32	4 <sup>3</sup> / <sub>16</sub> (10.6)	2 <sup>5</sup> / <sub>16</sub> (7.5)	52 (132.1)
	SST	2	2	32	4 <sup>3</sup> / <sub>4</sub> (11.1)	2 <sup>5</sup> / <sub>16</sub> (7.5)	52 (132.1)
8'	TSS/ TSS AL	1	2	32	4 <sup>7</sup> / <sub>16</sub> (10.6)	2 <sup>5</sup> / <sub>16</sub> (7.5)	92 (233.7)
	TSS/ TSS AL	2	4	32	4 <sup>7</sup> / <sub>16</sub> (10.6)	2 <sup>5</sup> / <sub>16</sub> (7.5)	100 (254.0)
	SS/ SS AL	1	1	96T8HO, 96T8	4 <sup>7</sup> / <sub>16</sub> (10.6)	2 <sup>5</sup> / <sub>16</sub> (7.5)	96 (243.8)
	SS/ SS AL	2	2	96T8HO, 96T8	4 <sup>7</sup> / <sub>16</sub> (10.6)	2 <sup>5</sup> / <sub>16</sub> (7.5)	100 (254.0)
	SS/ SS AL	1	1	96HO	4 <sup>7</sup> / <sub>16</sub> (10.6)	3 <sup>3</sup> / <sub>16</sub> (9.7)	96 (243.8)
	SS/ SS AL	2	2	96HO	4 <sup>7</sup> / <sub>16</sub> (10.6)	3 <sup>3</sup> / <sub>16</sub> (9.7)	100 (254.0)

## Heavy-Duty Turret Industrials

# AF

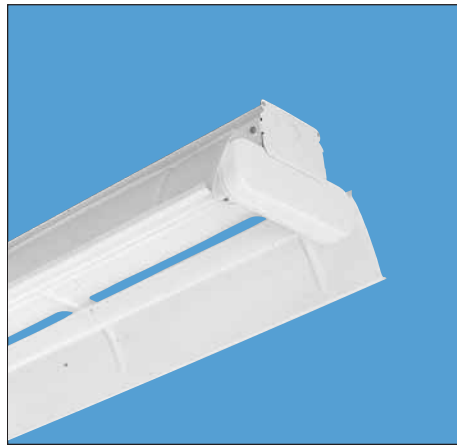

### Intended Use

For mounting heights up to 25' that require high light levels. Ideal for medium to heavy-duty manufacturing areas, warehousing, storage or task lighting.

### Features

Solid-top, 10% uplight or 20% uplight reflector is die-embossed, constructed of heavy-gauge cold rolled steel and painted after fabrication. Baked white enamel finish standard, porcelain available. Pressure-lock lampholders enclosed in a snap-in turret housing.

Available in 4' or 8' tandem wired lengths. Full depth end plates available (order separately, one per fixture or row). Accepts plug-in option for 1, 2 or 3 primary circuits.

Ballast – Thermally protected, resetting, Class P, HPF, non-PCB, UL Listed, CSA Certified ballast standard. Sound rating depends on lamp/ballast combination.

Wiring & Electrical – AWM, TFN and THHN wire used throughout, rated for required temperatures.

Mounting – For unit or row installations, surface or suspended mounting.

### Listings

UL Listed (standard) and CSA Certified (standard; except for 347V – see Options). NOM Certified (see Options).

### Ordering Information

Example: **AF 2 32 MVOLT GEB10IS**

Series
<b>AF</b> 20% uplight
<b>AF10</b> 10% uplight
<b>AFST</b> Solid reflector

For tandem double-length unit, add prefix T. Example: **TAF**

Number of lamps
<b>1</b>
<b>2</b>
<b>3</b>
<b>4</b>

Not included.

Lamp type
<b>32</b> 32W T8 (48")
<b>48</b> 38W Slimline (48")
<b>48HO</b> 60W 800mA (48")
<b>48T8HO</b> 44W T8 (48")
<b>48PG</b> 110W 1500mA (48")
<b>96HO</b> 110W 800mA (96")
<b>96PG</b> 215W 1500mA (96")
<b>96T8</b> 59W T8 Slimline (96")
<b>96T8HO</b> 86W T8 380mA (96")

Voltage
<b>MVOLT</b>
<b>347</b>

Options/Accessories <sup>1</sup>
<b>1/3</b> One 3-lamp ballast
<b>1/4</b> One 4-lamp ballast
<b>GEB</b> Electronic ballast (F96T8 + F96T8110)
<b>GEB10IS</b> T8 electronic ballast, instant start
<b>GEB10RS</b> T8 electronic ballast, rapid start
<b>PO</b> White porcelain reflector finish
<b>ACEP</b> Full-depth end plates (1 pair) <sup>1</sup>
<b>DLAF ME</b> 30°x30° metal eggcrate louver, 48" long <sup>1</sup>
<b>DLAF A12</b> Framed acrylic prismatic lens, #12 <sup>1</sup>
<b>CSA</b> CSA Certified (347V only)
<b>NOM</b> NOM Certified

See page 113 for others.

#### NOTES:

- Order accessories as separate catalog numbers.
- For detailed mounting information, consult the product specification sheets.
- PG fixture not available with 4 lamps.

Availability and Dimensions						
Series	Lamps per cross section	Lamps per fixture	Lamp type	Width <sup>2</sup> in. (cm)	Depth <sup>2</sup> in. (cm)	Length <sup>2</sup> in. (cm)
AF, AF10, AFST	1, 2, 3, 4	1, 2, 3, 4	32	13 <sup>3</sup> / <sub>8</sub> (33.4)	6 <sup>5</sup> / <sub>8</sub> (15.8)	49 <sup>13</sup> / <sub>16</sub> (126.5)
AF, AF10, AFST	2, 3, 4	2, 3, 4	48, 48HO	13 <sup>3</sup> / <sub>8</sub> (33.4)	6 <sup>5</sup> / <sub>8</sub> (15.8)	48 (121.9)
			48PG <sup>3</sup> , 48HO	13 <sup>3</sup> / <sub>8</sub> (33.4)	6 <sup>5</sup> / <sub>8</sub> (15.8)	48 (121.9)
TAF, TAF10, TAFST	1, 2, 3, 4	2, 4, 6, 8	32	13 <sup>3</sup> / <sub>8</sub> (33.4)	6 <sup>5</sup> / <sub>8</sub> (15.8)	99 <sup>19</sup> / <sub>32</sub> (253.2)
			48, 48HO, 48PG <sup>3</sup>	13 <sup>3</sup> / <sub>8</sub> (33.4)	6 <sup>5</sup> / <sub>8</sub> (15.8)	96 (243.8)
AF, AF10, AFST	1, 2, 3, 4	1, 2, 3, 4	96T8, 96HO	13 <sup>3</sup> / <sub>8</sub> (33.4)	6 <sup>5</sup> / <sub>8</sub> (15.8)	96 (243.8)
			96T8HO, 96PG <sup>3</sup>	13 <sup>3</sup> / <sub>8</sub> (33.4)	6 <sup>5</sup> / <sub>8</sub> (15.8)	96 (243.8)

# AFP

### Intended Use

For mounting heights up to 25' that require high light levels. Ideal for medium to heavy-duty areas, manufacturing, warehousing, storage or task lighting.

### Features

Solid-top or 10% uplight reflector is die-embossed, constructed of heavy-gauge cold rolled steel and painted after fabrication. Baked white enamel finish standard, porcelain available. Pressure-lock lampholders enclosed in a snap-in turret housing.

Available in 4' or 8' tandem wired lengths. Full depth end plates available (order separately, one per fixture or row). Accepts plug-in option for 1, 2 or 3 primary circuits.

Ballast – Thermally-protected, resetting, Class P, HPF, non-PCB, UL Listed, CSA Certified ballast standard. Sound rating depends on lamp/ballast combination.

Wiring & Electrical – AWM, TFN and THHN wire used throughout, rated for required temperatures.

Mounting – For unit or row installations, surface or suspended mounting.

### Listings

UL Listed (standard) and CSA Certified (standard; except for 347V – see Options). NOM Certified (see Options).

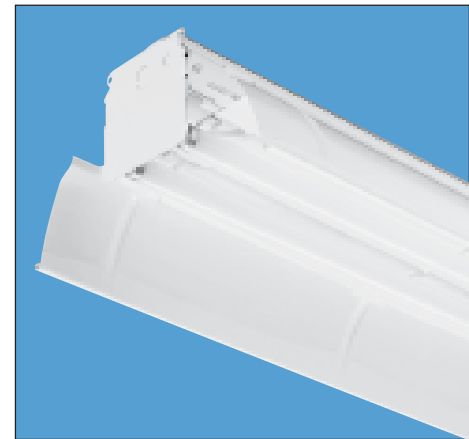

Example: **AFP 2 32 MVOLT GEB10IS**

### Ordering Information

Series	Number of lamps	Lamp type	Voltage	Options/Accessories <sup>1</sup>
<b>AFP</b> 10% uplight	<b>1</b>	<b>28T5</b> 28W T5 (46")	<b>MVOLT</b>	<b>1/3</b> One 3-lamp ballast
<b>AFPST</b> Solid reflector	<b>2</b>	<b>32</b> 32W T8 (48")	<b>347</b>	<b>1/4</b> One 4-lamp ballast
For tandem double-length unit, add prefix <b>T</b> . Example: <b>TAF</b>	<b>3</b> Not included.	<b>54T5HO</b> 54W T5HO (46")		<b>GEB10IS</b> T8 electronic ballast, instant start
				<b>GEB10RS</b> T8 electronic ballast, rapid start
				<b>GEB10PS</b> T5 electronic ballast, program start
				<b>ACEP</b> Full-depth endplates (1 pair) <sup>1</sup>
				<b>DLAF ME</b> 30°x30° metal eggcrate louver, 48" long <sup>1</sup>
				<b>DLAF A12</b> Framed acrylic prismatic lens, #12 pattern, 48" long <sup>1</sup>
				<b>PO</b> White porcelain reflector finish
				<b>CSA</b> CSA Certified (347V only)
				<b>NOM</b> NOM Certified

See page 113 for others.

Availability and Dimensions						
Series	Lamps per cross section	Lamps per fixture	Lamp type	Width <sup>2</sup> in. (cm)	Depth <sup>2</sup> in. (cm)	Length <sup>2</sup> in. (cm)
AFP, AFPST	1, 2, 3	1, 2, 3	28T5, 32, 54T5HO	13 <sup>3</sup> / <sub>8</sub> (33.4)	6 <sup>5</sup> / <sub>8</sub> (15.8)	49 <sup>13</sup> / <sub>16</sub> (126.5)
TAFP, TAFPST	1, 2, 3	2, 4, 6	28T5, 32, 54T5HO	13 <sup>3</sup> / <sub>8</sub> (33.4)	6 <sup>5</sup> / <sub>8</sub> (15.8)	99 <sup>19</sup> / <sub>32</sub> (253.2)

NOTES:

- 1 Order accessories as separate catalog numbers.
- 2 For detailed mounting information, consult the product specification sheets.

## General-Purpose Industrials

# EJS/EJD/EJ



### Intended Use

For mounting heights up to 20' requiring low to medium light levels. Ideal for light-duty task lighting, aisles, warehousing, storage and retail.

### Features

Solid top reflector or uplight is available. Premium-gauge channel features gripper-back design for strength and rigidity. Extra-wide channel and reflector on 3 and 4 light fixtures. Sturdy combination reflector and channel cover secured by quarter-turn latch for easy access to wire-way.

Screw-on endplates. Available in tandem wiring lengths. Accepts plug-in options for 1, 2 or 3 primary circuits. High-gloss, baked enamel finish reflector painted after fabrication. (Optional finishes available.)

Ballast – Thermally protected, resetting, Class P, HPF, non-PCB, UL Listed, CSA Certified ballast is standard. Sound rating depends on lamp/ballast combination.

Wiring & Electrical – AWM, TFN or THHN wire used throughout, rated for required temperatures.

Mounting – For unit or row installations, surface or suspended mounting.

### Listings

UL Listed (standard) and CSA Certified (standard; except for 347V – see Options). NOM Certified (see Options).

## Ordering Information

Example: **EJ 2 32 MVOLT GEB10IS**

Series		Number of lamps		Lamp type		Options / Accessories	
<b>EJS</b>	1 or 2 lamps, solid top, T12 and T8, rapid start and slimline, standard width	<b>1</b>		<b>17</b>	17W T8 (24")	<b>1/3</b>	One 3-lamp ballast
<b>EJSA</b>	1 or 2 lamps, uplight, T12 and T8, rapid start and slimline, standard width	<b>2</b>		<b>20</b>	20W T12(24")	<b>1/4</b>	One 4-lamp ballast
<b>EJD</b>	1 or 2 lamps, solid top, T12 HO and VHO, rapid start and slimline, standard width	<b>3</b>		<b>24</b>	24W T12 slimline (24")	<b>ES</b>	T12 energy-saving ballast
<b>EJDA</b>	1 or 2 lamps, uplight, T12 HO and VHO, rapid start and slimline, standard width	<b>4</b>		<b>24HO</b>	35W T12 800mA (24")	<b>CW</b>	Cold temperature ballast (T12HO only)
<b>EJ</b>	3 or 4 lamps, solid top, T12 and T8, wide channel	Not included.		<b>25</b>	25W T8 (36")	<b>GEB</b>	T8 electronic ballast, ≤20% THD, instant start
<b>EJA</b>	3 or 4 lamps, uplight, T12 and T8, wide channel			<b>30</b>	30W T12 (36")	<b>GEB10IS</b>	T8 electronic ballast, ≤10% THD, instant start
<b>2EJ</b>	2 lamps, solid top, T12 and T8, wide channel			<b>32</b>	32W T8 (48")	<b>GEB10RS</b>	T8 electronic ballast, ≤10% THD, rapid start
<b>2EJA</b>	2 lamps, uplight, T12 and T8, wide channel			<b>36</b>	36W T12 slimline (36")	<b>CSA</b>	CSA Certified (347V only)
				<b>36HO</b>	45W 800mA (36")	<b>NOM</b>	NOM Certified
				<b>48</b>	38W T12 slimline (48")	See page 113 for others.	
				<b>48HO</b>	60W T12 800mA (48")		
				<b>48VHO</b>	110W T12 1500mA (48")		
				<b>54T5HO</b>	54W T5 HO (46")		
				<b>72</b>	55W T12 slimline (72")		
				<b>72HO</b>	85W T12 800mA (72")		
				<b>96T8</b>	96W T8 slimline (96")		
				<b>96T8HO</b>	86W T8 T8HO (96")		
				<b>96HO</b>	110W T12 800mA (96")		
				<b>96VHO</b>	215W T12 1500mA (96")		

Availability and Dimensions						
Series	Lamps per cross section	Lamps per fixture	Lamp type	Width <sup>1</sup> in. (cm)	Depth <sup>1</sup> in. (cm)	Length <sup>1</sup> in. (cm)
EJS, EJSA	1, 2	1, 2	17, 20, 24	12 (30.5)	4 1/4 (10.8)	24 (69.9)
EJD, EJDA	1, 2	1, 2	24HO	12 (30.5)	4 15/16 (12.5)	24 (69.9)
EJ	3, 4	3, 4	17, 20, 24	12 (30.5)	5 1/4 (13.3)	24 (69.9)
EJS, EJSA	1, 2	1, 2	25, 36, 36	12 (30.5)	4 1/4 (10.8)	36 (91.4)
EJD, EJDA	1, 2	1, 2	36HO	12 (30.5)	4 15/16 (12.5)	36 (91.4)
EJ	3, 4	3, 4	25, 36, 36HO	12 (30.5)	5 1/4 (13.3)	36 (91.4)
EJS, EJSA	1, 2	1, 2	32, 40, 48, 48T8HO, 54T5HO	12 (30.5)	4 1/4 (10.8)	48 (121.9)
EJD, EJDA	1, 2	1, 2	48HO, 48VHO <sup>1</sup>	12 (30.5)	4 15/16 (12.5)	48 (121.9)
EJ	3, 4	3, 4	32, 48, 48HO	16 (40.6)	5 1/4 (13.3)	48 (121.9)
2EJ	2	2	32, 48, 48HO	16 (40.6)	5 1/4 (13.3)	48 (121.9)
EJS, EJSA	1, 2	1, 2	72, 72T8HO	12 (30.5)	4 1/4 (10.8)	72 (182.9)
EJD, EJDA	1, 2	1, 2	72HO	12 (30.5)	4 15/16 (12.5)	72 (182.9)
EJ	3, 4	3, 4	72, 72HO	16 (40.6)	5 1/4 (13.3)	72 (182.9)
EJS, EJSA	1, 2	1, 2	96HOT8	12 (30.5)	4 1/4 (10.8)	96 (243.8)
EJD/EJDA	1, 2	1, 2	96HO, 96VHO <sup>1</sup>	12 (30.5)	4 15/16 (12.5)	96 (243.8)
EJ	3, 4	3, 4	96HO, 96T8VHO, 96T8VHO	16 (40.6)	5 1/4 (13.3)	96 (243.8)
2EJ	2	2	96HO, 96T8VHO, 96T8VHO, 96VHO <sup>1</sup>	12 (30.5)	5 1/4 (13.3)	96 (243.8)
TEJ	1, 2	2, 4	32	16 (40.6)	5 1/4 (13.3)	96 (243.8)
TEJ	3, 4	6, 8	32	16 (40.6)	5 1/4 (13.3)	96 (243.8)
T2EJ	2	4	32	16 (40.6)	5 1/4 (13.3)	96 (243.8)
TEJS, TEJSA	1, 2	2, 4	96T8, 96T8HO	12 (30.5)	4 1/4 (10.8)	192 (487.7)
TEJD/TEJDS	1, 2	2, 4	96HO, 96VHO <sup>1</sup>	12 (30.5)	4 15/16 (12.5)	192 (487.7)
EJ	3, 4	3, 4	96HO, 96T8, 96T8VHO	16 (40.6)	5 1/4 (13.3)	192 (487.7)
T2EJ	2	4	96HO, 96T8, 96T8HO, 96VHO <sup>1</sup>	16 (40.6)	5 1/4 (13.3)	192 (487.7)

Voltage	
MVOLT	
120	
277	
347	

NOTES:  
1 Fixtures not available with 4 lamps.

**lightquick<sup>®</sup> XD**  
Express delivery products.  
See page 11 for details about LightQuick XD.

Description
<b>EJD 2 96HO 120 ES CW20</b>



**Intended Use**

For mounting heights up to 16' requiring low to medium light levels. Ideal for light-duty areas, utility, storage rooms or retail.

**Features**

Solid top reflector or 8% upright is available. Sturdy combination reflector and channel cover secured by captive quarter-turn latch for easy access to wireway. Combination endplate/channel connector supplied with each fixture. High-gloss backed white enamel finish. Reflector is painted after fabrication. Available in tandem wired lengths. Accepts plug-ins for 1, 2 or 3 primary circuits.

Ballast – Thermally-protected, resetting, Class P, HPF, non-PCB, UL Listed, CSA Certified ballast is

standard. Sound rating depends on lamp/ballast combination.

Wiring & Electrical – AWM, TFN or THHN wire used throughout, rated for required temperatures.

Mounting – For unit or row installations, surface or suspended mounting.

**Listings**

UL Listed (standard) and CSA Certified (standard; except for 347V – see Options). NOM Certified (see Options).

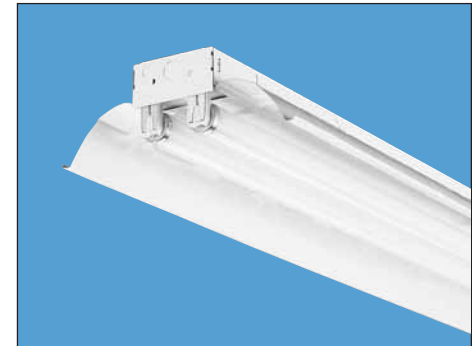

**Ordering Information**

Example: **L 2 32 MVOLT GEB10IS**

Series	Number of lamps	Lamp type	Voltage	Options/accessories
<b>L</b> Solid reflector	<b>1</b>	<b>17</b> 17W T8 (24")	<b>MVOLT</b>	<b>1/4</b> One 4-lamp ballast
<b>LA</b> 8% upright	<b>2</b>	<b>20</b> 20W T12 (24") <sup>1</sup>	<b>347</b>	<b>GEB10IS</b> T8 electronic ballast, instant start
For tandem double-length unit, add prefix T. Example: <b>TL</b>	Not included.	<b>32</b> 32W T8 (48")		<b>GEB10RS</b> T8 electronic ballast, rapid start
		<b>48</b> 38W slimline (48")		<b>CSA</b> CSA Certified (347V only)
		<b>48T8HO</b> 44W T8 (48")		<b>NOM</b> NOM Certified
		<b>96T8</b> 59W T8 slimline (96")		See page 113 for others.
		<b>96T8HO</b> 86W T8 380mA (96")		

**NOTES:**

- 1 Specify ballast option HPF or LPF for 20W.
- 2 For detailed mounting information consult the product specification sheets.

**Availability and Dimensions**

Series	Lamps per cross section	Lamps per fixture	Lamp type	Width <sup>2</sup> in.(cm)	Depth <sup>2</sup> in.(cm)	Length <sup>2</sup> in.(cm)
L, LA	1	1	17, 20 <sup>1</sup>	12 (30.5)	4 (10.2)	24 (61.0)
	2	2	17, 20 <sup>1</sup>	12 (30.5)	4 (10.2)	24 (61.0)
L, LA	1	1	32, 48	12 (30.5)	4 (10.2)	48 (121.9)
	2	2	32, 48, 48T8HO	12 (30.5)	4 (10.2)	48 (121.9)
TL, TLA	1	2	32, 48, 48T8HO	12 (30.5)	4 (10.2)	96 (243.8)
	2	4	32, 48	12 (30.5)	4 (10.2)	96 (243.8)
L, LA	1	1	96T8, 96T8HO	12 (30.5)	4 (10.2)	96 (243.8)
	2	2	96T8, 96T8HO	12 (30.5)	4 (10.2)	96 (243.8)

Heavy-Duty Parabolic Industrials

PV

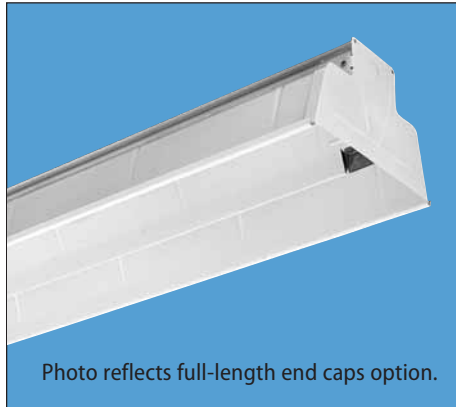

Photo reflects full-length end caps option.

Intended Use

For mounting heights up to 25' requiring low to high light levels and excellent glare control. Ideal for manufacturing assembly lines, inspection areas and warehousing.

Features

Heavy-duty formed channel with parabolic, deep die-embossed reflector with high-gloss baked enamel finish. Porcelain finish optional.

Center "V" provides 30° crosswise shielding to minimize glare. 20% uplift standard.

Full-depth endplates required. Order separately, one pair per fixture or row.

Reflector aligners and channel connector furnished for continuous-row mounting.

Spring-loaded sockets securely hold lamps in rough-duty applications.

Ballast – Thermally protected, resetting, Class P, HPF, non-PCB, UL Listed, CSA Certified ballast is standard. Sound rating depends on lamp/ballast combination.

Wiring & Electrical – AWM, TFN or THHN wire used throughout, rated for required temperatures.

Mounting – For unit or row installations, surface or suspended mounting. Order endplates separately, one per fixture or row.

Listings

UL Listed (standard). CSA Certified or NOM Certified (see Options). Suitable for damp locations.

Ordering Information

Series	Number of lamps
<b>PV</b>	<b>2</b>
Fortandem double-length unit, add prefix <b>T</b> . Example: <b>TPV</b>	Not included.

Lamp type	Voltage
<b>28T5</b> 28W T5 (46")	<b>MVOLT</b>
<b>32</b> 32W T8 (48")	<b>347</b>
<b>48</b> 38W Slimline (48")	
<b>48HO</b> 60W 800mA (48")	
<b>48T8HO</b> 44W T8 (48")	
<b>48PG</b> 110W 1500mA (48")	
<b>54T5HO</b> 54W T5 HO (46")	
<b>96HO</b> 110W 800mA (96")	
<b>96PG</b> 215W 1500mA (96")	
<b>96T8</b> 59W T8 Slimline (96")	
<b>96T8HO</b> 86W T8 380mA (96")	

Example: **PV 2 32 MVOLT GEB10IS**

Options/Accessories <sup>1</sup>
<b>GEB</b> Electronic ballast (F96T8 or F96T8HO only)
<b>GEB10IS</b> T8 electronic ballast, instant start
<b>GEB10RS</b> T8 electronic ballast, rapid start
<b>GEB10PS</b> T5 electronic ballast, program start
<b>PO</b> White porcelain reflector finish
<b>PCEP</b> Full-depth end plates (1 pair) required. Use one pair per fixture for single unit installations or one pair per row. <sup>1</sup>
<b>CSA</b> CSA Certified
<b>NOM</b> NOM Certified

See page 113 for others.

NOTES:

- Order accessories as separate catalog numbers.
- For detailed mounting information consult the product specification sheets.

Availability and Dimensions

Series	Lamps per cross section	Lamps per fixture	Lamp type	Width <sup>2</sup> in. (cm)	Depth <sup>2</sup> in. (cm)	Length <sup>2</sup> in. (cm)
PV		2	28T5, 32, 54T5HO	13 <sup>3</sup> / <sub>8</sub> (33.4)	6 <sup>5</sup> / <sub>8</sub> (15.8)	49 <sup>13</sup> / <sub>16</sub> (126.5)
TPV	2	4	28T5, 32, 54T5HO	13 <sup>3</sup> / <sub>8</sub> (33.4)	6 <sup>5</sup> / <sub>8</sub> (15.8)	99 <sup>19</sup> / <sub>32</sub> (253.2)
PV	2	2	48, 48HO, 48T8HO, 48PG	13 <sup>3</sup> / <sub>8</sub> (33.4)	6 <sup>5</sup> / <sub>8</sub> (15.8)	48 (121.9)
TPV	2	4	28T5, 48, 48HO, 48T8HO, 48PG, 54T5HO	13 <sup>3</sup> / <sub>8</sub> (33.4)	6 <sup>5</sup> / <sub>8</sub> (15.8)	96 (243.8)
PV	2	2	96, 96HO, 96PG, 96T8, 96T8HO	13 <sup>3</sup> / <sub>8</sub> (33.4)	6 <sup>5</sup> / <sub>8</sub> (15.8)	96 (243.8)

## Enclosed Fiberglass Housing

# DM DMW



Example: **DM 2 32 MVOLT GEB10IS**

### Intended Use

For low to medium mounting heights and harsh environments where dust, dirt, humidity or moisture is present. Ideal for canopies, shipping docks, refrigerated areas, food processing and other non-hazardous environments.

### Features

Impact-resistant, UV-stabilized, reinforced polyester fiberglass housing. Shatter-resistant 15% DR acrylic diffuser standard, high impact 50% DR available. Poured-in gasketing provides a continuous seal between housing and diffuser. Captive, corrosion-resistant, cam-action latches secure the diffuser. Stainless steel (STSL) latches also are available.

Ballast – Thermally protected, resetting, Class P, HPF, non-PCB, UL Listed, CSA Certified ballast is standard. Sound rating depends on lamp/ballast combination.

Wiring and Electrical – AWM, TFN or THHN wire used throughout, rated for required temperatures.

Mounting – For unit or row installations, surface (ceiling or wall) or suspended mounting.

### Listings

120V, 277V and MVOLT are UL Listed and CSA Certified (standard). See Options for 347V and NOM Certified. DM is damp location, DMW is wet location listed for covered ceiling applications.

## Ordering Information

Series	Number of lamps	Lamp type	Diffuser type	Voltage	Options/Accessories <sup>3,4</sup>
<b>DM</b> Damp location	<b>1</b>	<b>32</b> 32W T8 (48")	(blank) Acrylic, 15% DR	<b>MVOLT</b>	<b>1/3</b> One 3-lamp ballast
<b>DMW</b> Wet location		<b>48</b> 38W slimline (48") <sup>2</sup>	<b>AR</b> High-impact acrylic, 50% DR	<b>120</b>	<b>1/4</b> One 4-lamp ballast
Fortandem double-length unit, add prefix T. Example: <b>TDM</b>		<b>60W</b> 800mA (48") <sup>2</sup>	<b>DP</b> Deep acrylic, 15% DR <sup>3</sup>	<b>277</b>	<b>GEB10IS</b> T8 electronic ballast, instant start
	<b>3</b> <sup>1</sup>	<b>96HO</b> 110W 800mA (96") <sup>2</sup>	<b>ARDP</b> Deep high-impact acrylic, 50% DR <sup>3</sup>	<b>347</b>	<b>GEB10RS</b> T8 electronic ballast, rapid start
	Not included.	<b>96T8</b> 59W T8 slimline (96")			<b>BCD</b> Mounting bracket to chainhang DM/DMW (2 per package, excludes chain) <sup>4</sup>
		<b>96T8HO</b> 86W T8 380mA (96")			<b>HC</b> Wire hook and 36" chain set (2 per package) <sup>4</sup>
					<b>WLF</b> Field-installable wet location fittings to stem-hang DMW on ½" rigid conduit (2 per package). For factory-installed fittings on top, order WLF as an option.
					<b>CSA</b> CSA Certified (347V only)
					<b>NOM</b> NOM Certified

See page 113 for others.

Availability and Dimensions						
Series	Lamps per cross section	Lamps per fixture	Lamp type	Width in. (cm)	Depth in. (cm)	Length in. (cm)
DM, DMW	1, 2, 3 <sup>1</sup>	1, 2, 3	32	7 <sup>5</sup> / <sub>8</sub> (18.4)	4 <sup>3</sup> / <sub>4</sub> (9.5)	50 (127.0)
DM, DMW	1, 2	1, 2	48, 48HO, 48T8HO	7 <sup>5</sup> / <sub>8</sub> (18.4)	5 <sup>5</sup> / <sub>8</sub> (13.3)	50 (127.0)
DM, DMW (DP or ARDP)	1, 2, 3 <sup>1</sup>	1, 2, 3	32	7 <sup>5</sup> / <sub>8</sub> (18.4)	5 <sup>5</sup> / <sub>8</sub> (13.3)	50 (127.0)
TDM, TDMW	1, 2	2, 4	32, 48, 48HO, 48T8HO	7 <sup>5</sup> / <sub>8</sub> (18.4)	5 <sup>5</sup> / <sub>8</sub> (13.3)	98 (248.9)
DM, DMW	1, 2	1, 2	96HO, 96T8, 96T8HO	7 <sup>5</sup> / <sub>8</sub> (18.4)	5 <sup>5</sup> / <sub>8</sub> (13.3)	98 (248.9)

### NOTES:

- 3-lamp models only available with T8 lamp source.
- Specify voltage.
- Deep lens is standard on 4' slimline, HO (800mA) and 8' fixtures. To match deep appearance on 4' rapid start, order **DP** or **ARDP** option.
- Order accessories as separate catalog number.

**lightquick<sup>®</sup> XD**  
Express delivery products.

See page 11 for details about LightQuick XD.

Description

**DMW 2 32 MVOLT GEB10IS**



Enclosed Steel Housing

# DMS DMSW

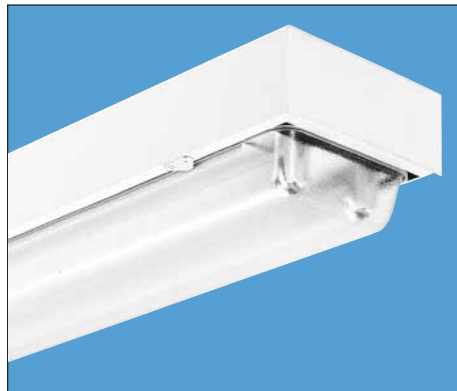

Intended Use

For low to medium mounting heights and harsh environments where dust, dirt, humidity or moisture is present. Ideal for canopies, shipping docks, refrigerated areas, food processing and other non-hazardous environments.

Features

Fully gasketed, totally enclosed fixture is available in heavy-duty steel or aluminum housing (AL option) with a baked white enamel finish. A shatter-resistant 15% DR acrylic diffuser (50% DR available) is secured by captive, corrosion-resistant pivot latches.

Ballast – Thermally protected, resetting, Class P, HPPF, non-PCB, UL Listed, CSA Certified ballast is standard. Sound rating depends on lamp/ballast combination.

Wiring and Electrical – AWM, TFN or THHN wire used throughout, rated for required temperatures.

Mounting – For unit or row installations, surface or suspended mounting. Wet location DMSW available for covered ceiling mount only.

Listings

UL Listed (standard). CSA Certified or NOM Certified (see Options). Suitable for damp locations. DMSW is listed for wet locations covered ceiling applications.

Ordering Information

Example: **DMS 2 32 MVOLT GEB10IS**

Series	Number of lamps	Lamp type	Diffuser type	Voltage	Options/accessories
<b>DMS</b> Damp location	1 2 3 <sup>1</sup> Not included.	<b>32</b> 32W T8 (48")	(blank) Acrylic, 15% DR	<b>MVOLT</b> <b>347</b>	<b>GEB10IS</b> T8 electronic ballast, instant start <b>GEB10RS</b> T8 electronic ballast, rapid start <b>AL</b> Aluminum housing <b>WLF</b> Field-installable wet location fittings to stem-hang DMS on 1/2" rigid conduit (2 per package). For factory-installed fittings on top, order WLF as an option. <b>CSA</b> CSA Certified <b>NOM</b> NOM Certified See page 113 for others.
<b>DMSW</b> Wet location		<b>48</b> 38W slimline (48")	<b>AR</b> High-impact acrylic, 50% DR		
For tandem double-length unit, add prefix T. Example: <b>TDMS</b>		<b>48HO</b> 60W 800mA (48")	<b>DP</b> Deep acrylic, 15% DR <sup>2</sup>		
		<b>48T8HO</b> 44W T8 (48")	<b>ARDP</b> High-impact deep acrylic, 50 DR <sup>2</sup>		
		<b>96HO</b> 110W 800mA (96")			
		<b>96T8</b> 59W T8 slimline (96")			
		<b>96T8HO</b> 86W T8 380mA (96")			

NOTES:

- 1 3-lamp models only available with T8 lamp source.
- 2 Deep lens is standard on 4' slimline, HO (800mA) and 8' fixtures. To match deep appearance on 4' rapid start, order **DP** or **ARDP** option.

Availability and Dimensions						
Series	Lamps per cross section	Lamps per fixture	Lamp type	Width in. (cm)	Depth in. (cm)	Length in. (cm)
DMS, DMSW	1, 2, 3 <sup>1</sup>	1, 2, 3	32, 48, 48HO, 48T8HO	8 <sup>5</sup> / <sub>8</sub> (20.9)	5 <sup>1</sup> / <sub>4</sub> (13.3) 6 <sup>1</sup> / <sub>8</sub> (15.3)	50 <sup>5</sup> / <sub>16</sub> (129.4) 50 <sup>5</sup> / <sub>16</sub> (129.4)
DMS, DMSW (DP or ARDP)	1, 2, 3 <sup>1</sup>	1, 2, 3	32, 48, 48HO, 48T8HO	8 <sup>5</sup> / <sub>8</sub> (20.9)	6 <sup>1</sup> / <sub>8</sub> (15.3)	50 <sup>5</sup> / <sub>16</sub> (129.4)
TDMS, TDMSW	1, 2, 3 <sup>1</sup>	2, 4, 6	32, 48, 48HO, 48T8HO	8 <sup>5</sup> / <sub>8</sub> (20.9)	6 <sup>1</sup> / <sub>8</sub> (15.3)	98 <sup>5</sup> / <sub>16</sub> (251.3)
DMS, DMSW	1, 2	1, 2	96HO, 96T8, 96T8HO	8 <sup>5</sup> / <sub>8</sub> (20.9)	6 <sup>1</sup> / <sub>8</sub> (15.3)	98 <sup>5</sup> / <sub>16</sub> (251.3)

# EIS EFS

Tough Task™

### Intended Use

Intended for demanding areas such as dust or hosedown (EIS) and food processing (EFS) applications. Applications include EIS – docks, marine environments, heavy industrials and other non-hazardous environments; EFS – food/beverage processing, cosmetics and pharmaceuticals.

### Features

Fully gasketed, totally enclosed fixture formed of heavy-duty aluminum construction. Fully seam-welded construction. A wide variety of finishes available.

Clear prismatic, injection-molded high strength acrylic diffuser (polycarbonate optional). Diffuser retained to housing with stainless steel fasteners.

Available in standard (2- or 3-lamp) or narrow (1 lamp) channel with your choice of T5 or T8 lamps.

For unit or row installation, surface (ceiling or wall) or suspended.

### Listing

UL Listed to US and Canadian safety standards. See Options for 347V.

EIS – IP65 rated for protection against the ingress of water and contaminants.

EFS – IP65 rated for the protection against the ingress of water and contaminants. Complies with FDA/USDA guidelines and is Food Zone Non-Contact certified.

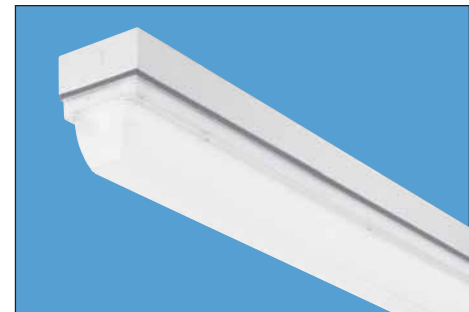
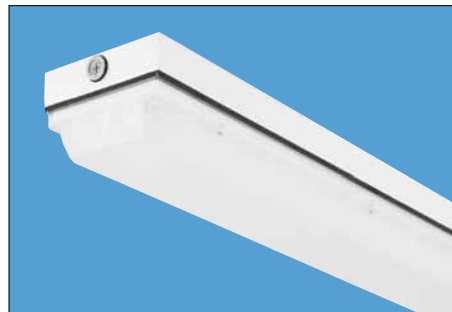

### Ordering Information

Example: **EIS 2 32 MVOLT GEB10IS**

Series	Lamps <sup>1</sup>	Wattage	Diffuser type	Voltage	Options
<b>EIS</b> Enclosed industrial (wide)	<b>1</b> <b>2</b>	<b>28T5</b> 28W T5 (46") <b>32</b> 32W T8 (48")	(blank) Prismatic acrylic	<b>MVOLT</b>	<b>1/3</b> One 3-lamp ballast (T8 only)
<b>EISC</b> Enclosed industrial (narrow)	<b>3</b> Not included.	<b>48HO</b> 60W 800mA T12 (48")	<b>PCL</b> Prismatic polycarbonate <sup>3</sup>	<b>347</b>	<b>GEB10IS</b> T8 electronic ballast, instant start <b>GEB10PS</b> T5 electronic ballast, program start <b>GEB10RS</b> T8 electronic ballast, rapid start
<b>EFS</b> Enclosed food service (wide)		<b>54T5HO</b> 54W T5HO (46") <sup>2</sup>			<b>CW20</b> T12 cold-weather ballast, -20°F starting <b>ELDW</b> Emergency lighting wet location (nominal 300 lumens) <sup>4</sup>
<b>EFSC</b> Enclosed food service (narrow)					<b>EL14DW</b> Emergency lighting wet location (nominal 1400 lumens) <sup>4</sup> <b>GLR</b> Internal fast blow fuse <b>RIF1</b> Radio interference filter, one per fixture <sup>5</sup> <b>STSW</b> Stainless steel housing, white <b>STS</b> Stainless steel housing, natural <b>CSA</b> Listed and labeled to comply with Canadian standards (347V only)

Availability and Dimensions					
Series	Lamps per fixture	Lamp type	Width in. (cm)	Depth in. (cm)	Length in. (cm)
EIS	3	28T5, 32, 48HO	9¾ (24.8)	6 (15.2)	4 (10.2)
	2	54T5HO	9¾ (24.8)	6 (15.2)	4 (10.2)
EFS	3	28T5, 32, 48HO	9¾ (24.8)	6 (15.2)	4 (10.2)
	2	54T5HO	9¾ (24.8)	6 (15.2)	4 (10.2)
EISC	1	28T5, 32, 54T5HO	5⅞ (14.9)	6¾ (17.1)	4 (10.2)
EFSC	1	28T5, 32, 54T5HO	5⅞ (14.9)	6¾ (17.1)	4 (10.2)

Accessories (Order separately)

**WLF** Wet location fittings (1 pair, not installed)

#### NOTES:

- Reference availability chart below.
- Must be specified with ACNS90 ballast.
- Not available with EFS or EFSC.
- Luminaires ordered with **DW** option; (Example: **EL5DW**), will bear the UL emergency lighting equipment label for damp or wet locations. Available only with T8 lamp types.
- For one filter per ballast, specify RIF2.

## High Pressure Hosedown Fixtures

# EFT

*Tough Task™*



### Ordering Information

Series	Number of lamps
<b>EFT</b>	<b>2</b>
	Not included.

Wattage
<b>32</b> 32W T8 (48")
<b>48HO</b> 60W 800mA (48")
<b>48T8HO</b> 44W T8 (48")
<b>96HO</b> 110W 800mA (96")
<b>96T8HO</b> 86W T8 380mA (96")

Voltage
<b>MVOLT</b>
<b>120</b>
<b>277</b>
<b>347</b>
<small>*120-277V. Must specify GEB10IS.</small>

Options
<i>Shipped installed in fixture</i>
<b>CW20</b> Cold weather ballast -20°F <sup>1</sup>
<b>GEB10IS</b> T8 electronic ballast, instant-start
<b>GEB10RS</b> T8 electronic ballast, rapid-start
<b>ELDW</b> Emergency lighting wet location, 300 lumens
<b>EL14DW</b> Emergency lighting wet location, 1400 lumens
<b>GLR</b> Internal fast blow fuse
<b>CS88</b> Brad Harrison 16/3 cord and plug set 5'
<b>CSA</b> Listed and labeled to comply with Canadian safety standards (347V only)

### Intended Use

For low to medium mounting heights in demanding applications including hosedown and food processing areas requiring ease of cleanability, compliance to FDA/USDA requirements and NSF splash-zone certification. Applications include meat/poultry/beverage processing, cosmetics and pharmaceuticals.

### Features

Totally enclosed fixture with tubular acrylic, high-impact lens surrounding an aluminum channel. Channel is finished with a high-gloss, baked white polymeric powder.

Stainless steel end caps with silicone o-ring closed cell gaskets close off fixture ends.

High-impact, clear DR acrylic lens; .125" nominal thickness.

Two 7" stainless steel aircraft cables and s-hooks included.

Fixture supplied with 5' power cord.

4' and 8' lengths available.

### Listings

UL Listed to US and Canadian safety standards, maximum 40° C ambient temperature. See Options for 347V. IP65 rated for protection against ingress of water and contaminants. NSF International certified splash-zone and meets FDA/USDA guidelines (standard).

### Example: EFT 2 32 MVOLT GEB10IS

NOTES:  
1 T12HO only.

Availability and Dimensions					
Series	Number of lamps	Lamp type	Width in. (cm)	Depth in. (cm)	Length in. (cm)
EFT	2	32, 48HO, 48T8HO	6½ (16.5)	7¼ (18.4)	50 (127.0)
EFT	2	96HO, 96T8HO	6½ (16.5)	7¼ (18.4)	98 (248.9)

# WRT

### Intended Use

General illumination for indoor and outdoor, covered-ceiling locations. Ideal for showers locker rooms, recreational facilities, kitchens and other applications calling for a wet location listing.

### Listings

UL Listed (standard) and CSA Certified (standard; except for 347V – see Options). NOM Certified (see Options). UL Listed for wet locations for covered-ceiling applications.

### Features

Code gauge steel housing. All metal parts are finished with electrostatically deposited, thermally set polyester powder paint after fabrication.

Available for grid or flange ceiling types.

Closed-cell neoprene gasketing between the lens, door frame, housing and mounting surface.

Extruded aluminum door frame features mitered corners.

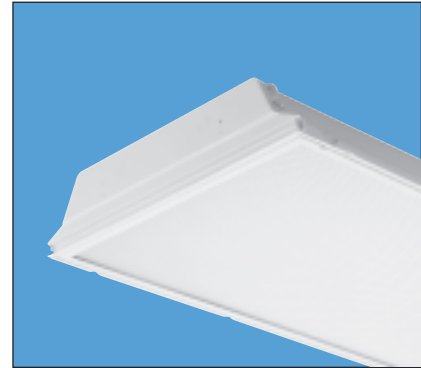

### Ordering Information

Example: **2WRT G 2 32 A12125 MVOLT GEB10IS**

Series	Trim type	Lamps	Lamp type	Door frame	Diffuser type <sup>3</sup>	Voltage	Options
<b>2WRT</b> 2' wide	<b>G</b> Lay-in grid trim	<b>1</b>	<b>17</b> 17W T8 (24")	(blank) Flush aluminum, white	<b>A12125</b> #12 pattern acrylic, .125" thick	<b>MVOLT</b> <b>347</b>	<b>1/3</b> One 3-lamp ballast
<b>WRT</b> 1' wide		<b>2</b>	<b>20</b> 20W T8 T12 (24") <sup>1</sup>	<b>FN</b> Flush aluminum, natural			<b>A15</b> #15 pattern acrylic, .2" thick
	<b>F</b> Overlapping flange trim	<b>3</b>	<b>U31</b> 31W T8 U-lamp (24")	<b>FM</b> Flush aluminum, black <sup>2</sup>	<b>A19</b> #19 pattern acrylic, .156" thick		<b>GEB10IS</b> T8 electronic ballast, instant start
		<b>4</b>	<b>U316</b> 31W T8 U-lamp (24", 6" leg spacing)				<b>GEB10RS</b> T8 electronic ballast, rapid start
		<b>6</b>	<b>32</b> 32W T8 (48")				<b>CSA</b> CSA Certified (347V only)
			Not included.	<b>CF40</b> 40W CF lamp (35") <sup>1</sup>			

Availability and Dimensions				
Nominal size	Series	Number of lamps	Lamp type	Height in. (cm)
1'x4'	WRT	1, 2, 3	32	4 1/2 (11.4)
		2	17, 20, U31	3 11/16 (9.3)
2'x2'	2WRT	2	U316, CF40	3 11/16 (9.3)
		3	17, 20, U31, CF40	3 11/16 (9.3)
		4	17, 20	3 11/16 (9.3)
2'x4'	2WRT	2, 3, 4, 6	32	3 11/16 (9.3)

NOTES:

- Specify 120 or 277 volt
- Not available with 4-lamp fixture.
- Add suffix V for internal prisms. Example: A12125V.

Troffers

# SRT

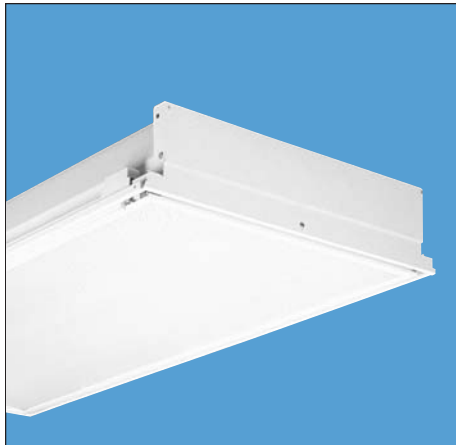

### Intended Use

Suitable for use in contamination-controlled environments ISO7 (Class 10,000) and ISO8 (Class 100,000) applications.

### Features

Code-gauge steel housing is completely sealed with silicone caulk. Aluminum mitered-corner door frame features sealed cam latches and neoprene gasketing between door and housing.

Metal parts are finished after fabrication with electrostatically deposited, thermally set polyester paint.

Meets requirements for hosedowns up to 100 psi (see Options).

Suitable for use in 1", 1-1/2" and 2" wide T-bars, or with overlapping flange and swing-out hangers for use in dry or plaster ceilings.

### Listings

UL Listed (standard). CSA Certified or NOM Certified (see Options). C-UL Listed for wet locations and covered-ceiling installations.

## Ordering Information

Example: **2SRT G 3 32 FW A12125V MVOLT 1/3 GEB10IS**

Series	Number of lamps	Lamp type	Frame type	Diffuser type <sup>3</sup>	Voltage	Options/Accessories
<b>SRT</b> 1' wide	<b>1</b> <b>2</b> <b>3</b> <b>4</b> <b>6</b> Not included.	<b>17</b> 17W T8 (24")	<b>FW</b> Aluminum inset, white	<b>A12125V</b> #12 pattern acrylic, .125" thick, inverted	<b>MVOLT</b>	<b>1/3</b> One 3-lamp ballast
<b>2SRT</b> 2' wide		<b>U31</b> 31W T8-U (24", 1 5/8" leg spacing)	<b>FN</b> Aluminum inset, natural	<b>PCL12125V</b> #12 pattern polycarbonate, .125" thick, inverted	<b>120</b>	<b>1/4</b> One 4-lamp ballast
For CF lamps in tandem, add prefix <b>T</b> . Example:		<b>U316</b> 31W T8-U (24", 6" leg spacing)		<b>SYA</b> PSI symmetric/asymmetric acrylic	<b>277</b>	<b>GEB10IS</b> T8 electronic ballast, instant start
		<b>32</b> 32W T8 (48")		<b>SYAR</b> PSI symmetric/asymmetric acrylic with radio filter grid <sup>4</sup>	<b>347</b>	<b>GEB10RS</b> T8 electronic ballast, rapid start
		<b>CF50</b> 50W T5 (24") <sup>2</sup>				<b>ABC</b> Triple neoprene gasketing (frame, lens and housing).
		<b>CF55</b> 55W T5 (24") <sup>2</sup>				<b>LG</b> Additional lens gasketing, neoprene.
<b>Trim type</b>		<b>54</b> 54W T5 (48")				<b>LPD</b> Suitable for low-pressure hosedown, up to 100 psi. <sup>5</sup>
<b>G</b> Grid, 1"-1 1/2" wide tee						<b>CSA</b> CSA Certified
<b>G20</b> Grid, 2" wide tee <sup>1</sup>						<b>NOM</b> NOM Certified
<b>F</b> Overlapping flange						<b>BDP</b> In-fixture ballast disconnect plug.

See page 109 for others.

NOTES:

- Not available for 1x2 and 1x4.
- Maximum number of lamps is four. Maximum for tandem lamp is six. 2x4 configuration only.
- Only pattern #12 shielding will ship inverted standard and is indicated by a V. Example:
- Not available with lens gasketing.
- Requires minimum .125" thick lens and gasketing.
- Flanged fixture height is 5 3/4" (14.61).
- Flanged fixture height is 5" (12.70).

Availability and Dimensions (SRT, SRH, SSH)						
Nominal size	Series	Number of lamps	Lamp type	SRT depth in. (cm)	SRH depth in. (cm)	SSH depth in. (cm)
1'x2'	SRT, SRH, SSH	1, 2, 3	17	4 7/8 (12.38) <sup>6</sup>	4 5/8 (11.75) <sup>7</sup>	4 1/2 (11.4)
		1, 2	U31	4 7/8 (12.38) <sup>6</sup>	4 5/8 (11.75) <sup>7</sup>	4 1/2 (11.4)
1'x4'	SRT, SRH, SSH	1, 2, 3	32	4 7/8 (12.38) <sup>6</sup>	4 5/8 (11.75) <sup>7</sup>	4 1/2 (11.4)
		1, 2, 3, 4	17	4 7/8 (12.38) <sup>6</sup>	4 5/8 (11.75) <sup>7</sup>	4 1/2 (11.4)
2'x2'	2SRT, 2SRH	1, 2, 3	U31	4 7/8 (12.38) <sup>6</sup>	4 5/8 (11.75) <sup>7</sup>	4 1/2 (11.4)
		1, 2	U316	4 7/8 (12.38) <sup>6</sup>	4 5/8 (11.75) <sup>7</sup>	4 1/2 (11.4)
2'x4'	2SSH	2, 3, 4, 6	32	4 7/8 (12.38) <sup>6</sup>	4 5/8 (11.75) <sup>7</sup>	4 1/2 (11.4)
		2, 3	CF50, CF55	4 7/8 (12.38) <sup>6</sup>	4 5/8 (11.75) <sup>7</sup>	4 1/2 (11.4)
		2, 3, 4	54	4 7/8 (12.38) <sup>6</sup>	4 5/8 (11.75) <sup>7</sup>	4 1/2 (11.4)

## Intended Use

Suitable for use in contamination-controlled environments ISO5 (Class 100) and ISO6 (Class 1,000) applications, such as electronic assembly, pharmaceutical processing, semiconductor manufacturing, chemical labs and the medical industry.

## Features

Completely sealed, one-piece housing is fabricated from 20-gauge cold-rolled steel. Seams sealed with silicone caulk.

Full door frame is one-piece, 18-gauge CRS featuring triple closed-cell, cross-linked neoprene gasketing between the door, lens and housing. Optional four-piece inset door also available for grid mounted fixtures.

Full 2'x4' door frame secured to housing by 10 stainless steel captive screws, inset door features four screws.

Optional stainless steel and aluminum housings and door frames available.

Metal parts finished with electrostatically deposited, thermally set polyester powder paint after fabrication.

Meets requirements for hosedowns up to 200 psi (see Options).

Suitable for use in 1", 1-1/2" and 2" wide T-grids, or with overlapping flange and swing-out hangers for use in dry or plaster ceilings.

## Listings

UL Listed (standard). CSA Certified or NOM Certified (see Options). UL Listed for wet locations, covered-ceiling installations.

SRH



## Ordering Information

Example: 2SRH G 4 32 FSF A12156V MVOLT GEB10IS

Series	Number of lamps	Lamp type	Frame type	Voltage	Options/accessories
<b>SRH</b> 1' wide	<b>1</b>	<b>17</b> 17W T8 (24")	<b>FSF</b> Steel full, white	<b>MVOLT</b>	<b>1/3</b> One 3-lamp ballast
<b>2SRH</b> 2' wide	<b>2</b>	<b>U31</b> 31W T8-U (24", 1 5/8" leg spacing)	<b>FSSF</b> Stainless full, natural	<b>347</b>	<b>1/4</b> One 4-lamp ballast
For CF lamps in tandem, add prefix . Example	<b>3</b>	<b>U316</b> 31W T8-U (24", 6" leg spacing)	<b>FSSFW</b> Stainless full, white		<b>GEB10IS</b> T8 electronic ballast, instant start
	<b>4</b>	<b>32</b> 32W T8 (48")	<b>FWF</b> Aluminum full, white		<b>GEB10RS</b> T8 electronic ballast, rapid start
	<b>6</b>	<b>48HO</b> 60W 800mA (48") <sup>2</sup>	<b>FW</b> Aluminum inset, white <sup>3</sup>		<b>AL</b> Painted aluminum housing, white
	Not included.		<b>FN</b> Aluminum inset, natural <sup>3</sup>		<b>HPD</b> Suitable for high pressure hose-down up to 200 psi <sup>5</sup>
			<b>FSS</b> Stainless inset, natural <sup>3</sup>		<b>STSW</b> Stainless steel housing, white
			<b>FSSW</b> Stainless inset, white <sup>3</sup>		<b>CSA</b> CSA Certified
					<b>NOM</b> NOM Certified
					See page 109 for others.
Trim type			Diffuser type <sup>4</sup>		
<b>G</b> Grid, 1" to 1 1/2" wide tees			<b>A12125V</b> #12 pattern acrylic, .125" thick, inverted		
<b>F</b> Overlapping flanged			<b>A12156V</b> #12 pattern acrylic, .156" thick, inverted		
<b>G20</b> Grid, 2" wide tee <sup>1</sup>			<b>PCL12125V</b> #12 pattern polycarbonate, .125" thick, inverted		
			<b>SYA</b> PSI symmetric/asymmetric acrylic		
			<b>SYAR</b> PSI symmetric asymmetric acrylic with radio filter grid		

## NOTES:

- 1 Not available for 1x2 and 1x4.
- 2 Maximum 2-lamp availability.
- 3 For use with grid-mounted fixtures only.
- 4 Only pattern #12 shielding will ship inverted standard and is indicated by a V. Example:
- 5 Must specify lens thickness of at least .156".

Surface-Mount

# SSH



**Intended Use**

Suitable for use in contamination-controlled environments ISO5 (Class 100) and ISO6 (Class 1,000) applications, such as electronic assembly, pharmaceutical processing, semiconductor manufacturing, chemical labs and the medical industry.

**Features**

Surface models feature seam-welded housing. Completely-sealed, one-piece housing is fabricated from 20-gauge cold-rolled steel.

Full door frame is one-piece, 18-gauge CRS featuring triple closed-cell, cross-linked neoprene gasketing between the door, lens and housing. Optional four-piece inset door also available.

Full 2'x4' door frame secured to housing by 10 stainless steel captive screws, while inset door features four screws.

Optional stainless steel and aluminum housings and door frames available.

Metal parts finished with electrostatically deposited, thermally set polyester powder paint after fabrication.

Meets requirements for hosedowns up to 200 psi (see Options).

**Listings**

UL Listed (standard). CSA Certified or NOM Certified (see Options). UL Listed for wet locations and covered-ceiling installations. Optional FDA, food processing areas available.

Ordering Information

Example: **2SSH 3 32 FW A12125V MVOLT 1/3 GEB10IS**

Series	Lamp type	Diffuser type <sup>1</sup>	Voltage	Options/accessories
<b>SSH</b> 1'wide <b>2SSH</b> 2' wide For (Clamps in tandem, add prefix . Example	<b>17</b> 17W T8 (24") <b>U31</b> 31W T8-U (24", 1 <sup>5</sup> / <sub>8</sub> " leg spacing) <b>U316</b> 31W T8-U (24", 6" leg spacing) <b>32</b> 32W T8 (48")	<b>A12125V</b> #12 pattern acrylic, .125" thick, inverted <b>A12156V</b> #12 pattern acrylic, .156" thick, inverted <b>PCL12125V</b> #12 pattern polycarbonate, .125" thick, inverted <b>SYA</b> PSI symmetric/asymmetric acrylic <b>SYAR</b> PSI symmetric/asymmetric acrylic with radio filter grid	<b>MVOLT</b> <b>347</b> Others available.	<b>1/3</b> One 3-lamp ballast <b>1/4</b> One 4-lamp ballast <b>GEB10IS</b> T8 electronic ballast, instant start <b>GEB10RS</b> T8 electronic ballast, rapid start <b>AL</b> Painted aluminum housing, white <b>HPD</b> Suitable for high pressure hose-down up to 200 psi <sup>2</sup> <b>STS</b> Stainless steel housing, natural <b>STSW</b> Stainless steel housing, white <b>CSA</b> CSA Certified <b>NOM</b> NOM Certified
	<b>Number of lamps</b> <b>1</b> <b>2</b> <b>3</b> <b>4</b> <b>6</b> Not included.	<b>Frame type</b> <b>FSF</b> Steel full, white <b>FSSF</b> Stainless full, natural <b>FSSF</b> Stainless full, white <b>FWF</b> Aluminum full, white <b>FW</b> Aluminum inset, white <b>FN</b> Aluminum inset, natural <b>FSS</b> Stainless inset, natural <b>FSSW</b> Stainless inset, white		See page 112 for others.

NOTES:  
 1 Only pattern #12 shielding will ship inverted standard and is indicated by a V. Example:  
 2 Must specify lens thickness of at least .156".

Teardrop Fixtures

**STP**

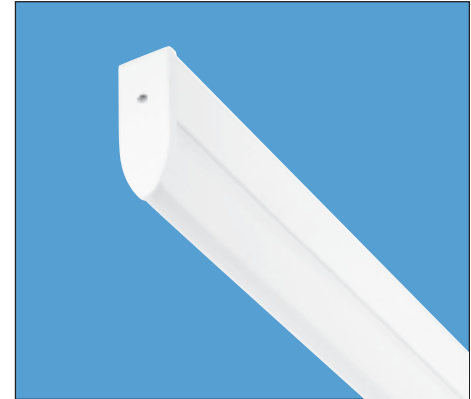

Intended Use

Suitable for use in ISO4 (Class 10) and ISO5 (Class 100) cleanroom applications.

Features

Die-formed 20-gauge cold rolled steel or extruded aluminum channel. Stainless steel or formed aluminum housings available. Finish (standard) – White polyester powder paint, other finishes available (see Options).

Diffuser is one piece, extruded, white acrylic with internal linear prisms for optimum light control. Smooth external surface for undisturbed airflow. Clear available.

For surface mounting to 2" T-bar. Suitable for individual or row mounting.

STP – End caps not included, order as an accessory.

Listings

UL Listed to US and Canadian safety standards. See Options for 347V. Tested in compliance with the International Organization for Standardization (ISO) Worldwide Contamination Classification.

Ordering Information

Series <b>STP</b> <small>Fortandem double-length unit, add prefix T. Example: <b>TSTP</b></small>	Number of lamps <b>1</b> <small>Not included.</small>	Lamp type <b>32</b> 32W T8 (48")	Diffuser (blank) White acrylic <b>ACR</b> Clear acrylic	Voltage <b>MVOLT</b> <b>347</b> <small>Others available.</small>
---	---	-------------------------------------	---	---

Example: **STP 1 32 MVOLT GEB10IS**

Options	
<b>GEB10IS</b>	Electronic ballast for T8 < 10% THD, Instant start
<b>GLR</b>	Internal fast blow fuse
<b>GMF</b>	Internal slow-blow fuse
<b>RIF</b>	Radio interference filter (one per fixture)
<b>STSW</b>	Stainless steel housing, white
<b>AL</b>	Aluminum housing, white
<b>CSA</b>	Listed and labeled to comply with Canadian standards (347V only)

Accessories (Order separately)

- STPEP** Pair of cold rolled steel end caps, white
- STPEPAL** Pair of aluminum end caps, white
- STPEPSTW** Pair of stainless steel end caps, white

Availability and Dimensions

Series	Lamps per fixture	Lamp type	Width in. (cm)	Depth in. (cm)	Length in. (cm)
STP	1	32, 40	2 (5.1)	6 (15.2)	48 (121.9)
TSTP	2	32, 40	2 (5.1)	6 (15.2)	96 (243.8)



Surface Enclosed

# VSL VSLC



Intended Use

For areas that require higher levels of protection from physical assault or environmental elements, while providing proper illumination for safety and security.

Features

**Housing** – Heavy-duty 16-gauge cold-rolled steel, one-piece housing for durability and security.

**Ballast Cover** – Ballast and lampholders are installed to wireway cover to provide easy installation and service. Wireway cover safety chains included.

**Socket** – Medium bi-pin, highly heat resistant, with internal locking collar for positive lamp retention and resistance to impact and vibration.

**Finish** – Five-stage, iron-phosphate pretreatment ensures superior paint adhesion and rust resistance. Painted parts finished with high-gloss, baked white enamel.

**Lens** – Clear prismatic, injection-molded and UV-stabilized polycarbonate lens (.130" thick) that completely encloses face and all sides of housing. No exposed metal surfaces. Optional lens (SCE) features easily removable molded-in lens membrane centered over end plate knock-outs for surface conduit and wiring access. Includes gaskets (one pair, not installed). Lens is secured to housing with tamper-resistant Torx® T-20 screws with center reject pin (included).

**Gasket** – One-piece, closed cell neoprene pad mounting gasket is factory installed to help seal against moisture, dust and insects.

**Ballast** – GEB10IS ballast for T8 lamps is electronic with 0°F starting temperature.

Listings

UL Listed to US and Canadian safety standards. CSA Certified (see Options). UL Listed for 25°C ambient and wet locations in covered-ceiling applications.

Ordering Information

Series	Number of lamps	Lamp type
VSL 9 1/4" wide	2	17 17W T8 (24")
	3 <sup>1,2</sup>	32 32W T8 (48") <sup>3</sup>
Not included.		
VSLC 5 3/8" wide	1	17 17W T8 (24")
		32 32W T8 (48")

Lens type	Voltage
(blank) Solid-end lens	347
SCE Surface conduit entry lens <sup>3</sup>	MVOLT

Example: VSL 2 32 MVOLT GEB10IS

Options
DL Damp location
ELDW Emergency battery pack (300 lumens) <sup>2,4</sup>
GEB10IS Instant start electronic ballast
GEB10RS Rapid start electronic ballast
GLR Internal fast-blow fusing <sup>5</sup>
RIF1 Radio interference filter, one per fixture
CSA CSA Certified

NOTES:

- 3-lamp model available in 32W T8 only.
- Available in 4-foot fixtures only.
- Provided with one pair of surface conduit gaskets.
- Luminaires ordered with ELDW option (Example: ELSDW) will bear UL Emergency Lighting Equipment label for damp or wet location, depending on fixture.
- Specify voltage.

Accessories (Order separately)

- RK1 T20BIT Torx TX20 hex-base driver bit for tamper-resistant screws with center reject pin.
- RK1 T20DRV Torx TX20 screwdriver for tamper-resistant screws with center reject pin.
- SCG Surface conduit gasket (one pair, not installed)

Availability and Dimensions					
Series	Lamps per fixture	Lamp type	Width in. (cm)	Depth in. (cm)	Length in. (cm)
VSL	2	17	9 1/4" (23.5)	3 3/8" (8.6)	25 3/8" (64.5)
	2	32	9 1/4" (23.5)	3 3/8" (8.6)	49 3/8" (125.4)
	3	32	9 1/4" (23.5)	3 3/8" (8.6)	49 3/8" (125.4)
VSLC	1	17	5 3/8" (13.7)	4 1/2" (11.4)	25 3/4" (65.4)
	1	32	5 3/8" (13.7)	4 1/2" (11.4)	49 3/4" (126.4)

## Wraparounds/Corridor Wraparounds

### Intended Use

General illumination for rough service (vandal-resistant) applications. Designed for use in corridors, entryways, meeting rooms, classrooms, locker rooms and more.

### Features

**Housing** – One-piece, 16-gauge cold-rolled steel housing is die-formed and welded together with reinforcing members for strength. Aluminum and white stainless steel housings available (see Options).

**Finish** – All metal parts are post-painted in white polyester powder coat for smooth, finished edges and corrosion resistance.

**Lens** – UV-stabilized polycarbonate lens is extruded A12 prismatic pattern with internal linear side prisms, .130" thick polycarbonate (standard). Secured to housing with stainless steel Torx® T-20 tamper-resistant screws (included).

**Ballast Cover** – Ballast and lampholders are

secured to channel cover or to channel to provide easy installation and service.

**Socket** – Medium bi-pin, highly heat resistant, with internal locking collar for positive lamp retention and resistance to impact and vibration.

**Ballast** – GEB10 IS ballast for T8 lamps is electronic with 0°F starting temperature.

### Listings

UL Listed (standard). CSA Certified (see Options). UL Listed for 25°C ambient and damp locations.

# VW VWC

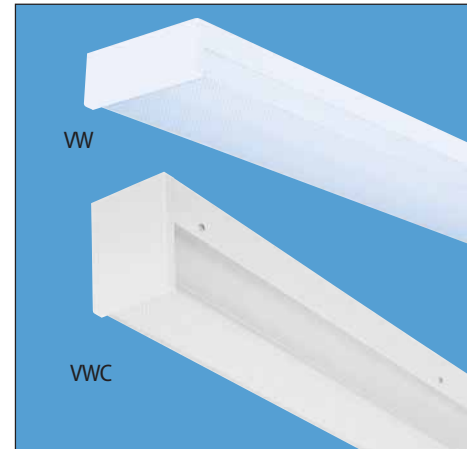

### Ordering Information

Series	Number of lamps	Lamp type	Lens type	Voltage
<b>VW</b>	2 or 3 lamps in 8 <sup>3</sup> / <sub>8</sub> " housing	<b>17</b> 17W T8 (24")	(blank) Polycarbonate, .130" thick	<b>347 MVOLT</b>
	or 4 lamps in 13 <sup>1</sup> / <sub>4</sub> " housing	<b>32</b> 32W T8 (48")	<b>ACR</b> High-impact acrylic, 50% DR	
			<b>PCL156</b> Polycarbonate, .156" thick	
<b>2VW</b>	2 lamps in 13 <sup>1</sup> / <sub>4</sub> " housing			
<b>VWC</b>	4 <sup>1</sup> / <sub>2</sub> " housing			

Example: **VW 2 32 MVOLT GEB10IS**

Options	
<b>AL</b>	Aluminum housing
<b>ELDW</b>	Emergency lighting (300 lumens) <sup>1</sup>
<b>GEB10IS</b>	Electronic ballast, instant start
<b>GEB10RS</b>	Electronic ballast, rapid start
<b>GLR</b>	Internal fast-blow fusing <sup>2</sup>
<b>RIF1</b>	Radio interference filter, one per fixture
<b>STSW</b>	Stainless steel housing, white
<b>CSA</b>	CSA Certified

#### NOTES:

- Luminaires ordered with ELDW option (Example ELSDW) will bear the UL Emergency Lighting Equipment label for damp or wet locations, depending on the fixture.
- Specify voltage.

#### Accessories (Order separately)

- RK1 T20BIT** Torx TX20 hex-base driver bit for tamper-resistant screws with center reject pin.
- RK1 T20DRV** Torx TX20 screwdriver for tamper-resistant screws with center reject pin.

Availability and Dimensions					
Series	Lamps per fixture	Lamp type	Width in. (cm)	Depth in. (cm)	Length in. (cm)
VW	2	32	8% (21.3)	3 <sup>1</sup> / <sub>4</sub> (8.3)	49 (124.5)
	3	32	8% (21.3)	5 (12.7)	49 (124.5)
	4	32	13 <sup>1</sup> / <sub>4</sub> (33.7)	3% (8.6)	49 (124.5)
2VW	2	32	13 <sup>1</sup> / <sub>4</sub> (33.7)	3% (8.6)	49 (124.5)
VWC	1,2	17	4 <sup>1</sup> / <sub>2</sub> (10.8)	5 <sup>1</sup> / <sub>4</sub> (13.3)	25% (64.5)
	1,2	32	4 <sup>1</sup> / <sub>2</sub> (10.8)	5 <sup>1</sup> / <sub>4</sub> (13.3)	49% (125.4)

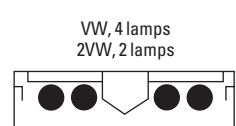
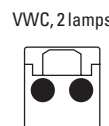
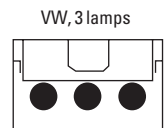
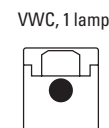
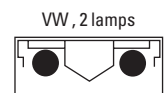

Modular Commercials

# VRS

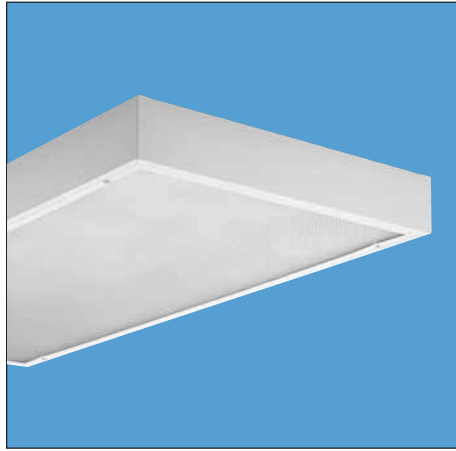

**Intended Use**

General illumination for rough service (vandal-resistant) applications. Ideal for areas where safety and security are a concern.

**Features**

**Housing** – Clean design includes overlap mitered housing and door frame corners. Formed from cold-rolled steel. Housing corners spot-welded for strength.

**Door** – Flush steel door frame secured by four stainless steel tamper-resistant Torx® T-20 with center pin screws, two per side. Three tamper-resistant screws per side available. (Specify TP6 option).

**Finish** – Painted parts finished with high gloss, baked white enamel. Five-stage iron-phosphate

pretreatment ensures superior paint adhesion and rust resistance.

**Lens** – Variety of shielding available including VL, durable .250" polycarbonate sheet laminated to .125" A12 pattern acrylic overlay. Impact-resistant acrylic or prismatic polycarbonate also available.

**Ballast** – Thermally-protected, resetting, Class P, HPF, non-PCB, UL Listed, CSA Certified ballast is standard.

**Listings**

UL Listed (standard). CSA Certified (see Options). UL Listed for 25°C ambient and damp locations.

Ordering Information

Example: **VRS 2 32 AR12 MVOLT GEB10IS**

Series	Number of lamps	Lamp type	Lens type	Voltage	Options
<b>VRS</b> 1' wide	<b>1</b>	<b>17</b> 17W T8 (24")	<b>AR12</b> #12 pattern, high-impact acrylic, .140" thick	<b>347</b>	<b>GEB10IS</b> Electronic ballast, instant start
<b>2VRS</b> 2' wide	<b>2</b>	<b>U31</b> 31W T8-U (1 $\frac{5}{8}$ " leg)	<b>VL</b> Polycarbonate lens laminated to #12 pattern acrylic overlay, .375" thick	<b>MVOLT</b>	<b>GEB10RS</b> Electronic ballast, rapid start
	<b>3</b>	<b>U316</b> 31W T8-U (6" leg) <sup>1</sup>			<b>CSA</b> CSA Certified
	<b>4</b>	<b>32</b> 32W T8 (48")			For other options and accessories, see below and page 112.
	<b>6</b>				

NOTES:  
 1 Not available on 3-lamp fixtures. Use U31.

Accessories	(Order separately)
<b>RK1 T20BIT</b>	Torx TX20 hex-base driver bit for tamper-resistant screws with center reject pin.
<b>RK1 T20DRV</b>	Torx TX20 screwdriver for tamper-resistant screws with center reject pin.

Availability and Dimensions						
Nominal size	Series	Number of lamps	Lamp type	Width in. (cm)	Depth in. (cm)	Length in. (cm)
1'x4'	VRS	1, 2, 3	32	12 (30.5)	3 $\frac{3}{4}$ (9.5)	48 (121.9)
2'x2'	2VRS	2, 3	17, U31, U316	24 (61.0)	3 $\frac{3}{4}$ (9.5)	24 (61.0)
		1, 2	17, U31, U316	24 (61.0)	3 $\frac{3}{4}$ (9.5)	24 (61.0)
2'x4'	2VRS	2, 3, 4, 6	32	24 (61.0)	3 $\frac{3}{4}$ (9.5)	48 (121.9)

Recessed Troffers

# VRT

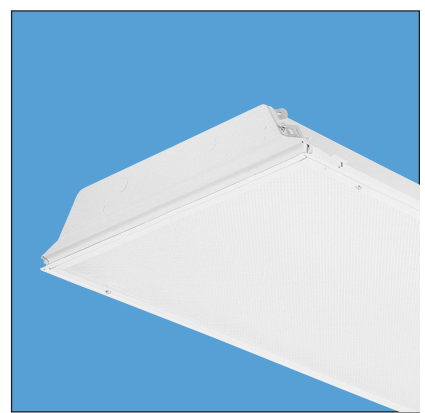

### Intended Use

General illumination for rough service (vandal-resistant) applications. Ideal for areas that require higher levels of protection from physical assault, while providing proper illumination for safety or security.

### Features

Housing – Steel door frame features overlap mitered corners. Formed from cold-rolled steel and secured by stainless steel tamper-resistant Torx® T-20 screws, two per side standard (four included). Ceiling trims available to fit most recessed applications.

Finish – Painted parts finished with high-gloss, baked white enamel. Five-stage iron-phosphate pretreatment ensures superior paint adhesion

and rust resistance.

Lens – Variety of shielding available including VL, durable .250" polycarbonate sheet laminated to .125" A12 pattern acrylic overlay. Impact-resistant acrylic or prismatic polycarbonate also available.

Ballast – Thermally-protected, resetting, Class P, HPF, non-PCB, UL Listed, CSA Certified ballast is standard.

### Listings

UL Listed (standard). CSA Certified or NOM Certified (see Options). UL Listed for 25°C ambient and damp locations. For non-tamper-resistant, standard wet location fixture, see WRT fluorescent troffer on page 95.

### Ordering Information

Example: **2VRT G 4 32 AR12 MVOLT 1/4 GEB10IS**

Series	Trim type <sup>1</sup>	Number of lamps	Lamp type	Diffuser type	Voltage	Options
<b>VRT</b> 1' wide <b>2VRT</b> 2' wide	<b>G</b> Lay-in grid <b>F</b> Overlapping flange <b>MT</b> Modular fit-in	1 2 3 4 6 Not included.	<b>17</b> 17W T8 (24") <b>U31</b> 31W T8-U (24") <b>U316</b> 31W T8-U (6" leg) <sup>2</sup> <b>32</b> 32W T8 (48") <b>CF40</b> 40W T5 lamp (24")	<b>AR12</b> #12 pattern, high-impact acrylic, .140" thick <b>ARF12</b> #12 pattern, high-impact acrylic with RF grid, .140" <b>PCL12187 VL</b> #12 pattern polycarbonate, .187" .250" clear polycarbonate lens laminated to A12 pattern acrylic overlay, .125" acrylic	<b>347</b> <b>MVOLT</b>	<b>GEB10IS</b> Electronic ballast, instant start <b>GEB10RS</b> Electronic ballast, rapid start <b>CSA</b> CSA Certified <b>NOM</b> NOM Certified For other options and accessories, see below and pages 106,109.

NOTES:  
1 Consult factory for screw slot and ST trim.  
2 Not available on 3-lamp fixtures.

Accessories	(Order separately)
<b>RK1 T20BIT</b>	Torx TX20 hex-base driver bit for tamper-resistant screws with center reject pin.
<b>RK1 T20DRV</b>	Torx TX20 screwdriver for tamper-resistant screws with center reject pin.

Availability and Dimensions				
Nominal size	Series	Number of lamps	Lamp type	Depth in. (cm)
1'x4'	VRT	1, 2, 3	32	4 1/2 (11.4)
		2	17,20,U31,U316,CF40	3 11/16 (9.3)
		3	17, 20	3 11/16 (9.3)
2'x2'	2VRT	3	U31	3 11/16 (9.3)
		4	17, 20	3 11/16 (9.3)
		4	CF40	3 11/16 (9.3)
2'x4'	2VRT	2, 3, 4, 6	32	3 11/16 (9.3)

Industrials

# VRI

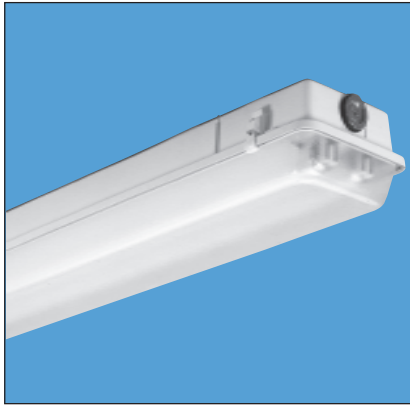

**Intended Use**

General illumination for rough service (vandal-resistant) applications. Ideal for tunnels, canopies, shipping docks, refrigerated areas, food processing, or any non-hazardous environment that requires a wet location listing.

**Features**

**Housing** – Impact-resistant, UV-resistant, fiber-glass-reinforced polyester housing with cold rolled steel enclosed wireway.

**Lens** – High-impact acrylic diffuser standard. Secured to fully-gasketed housing by captive, tamper-resistant cam-action latches.

For non-tamper-resistant fixture, see DMW fluorescent industrial, page 91.

**Latches** – Six tamper-resistant latches per 4' unit, ten per 8' unit.

**Finish** – Painted parts finished with high-gloss, baked white enamel. Five-stage iron-phosphate

pretreatment ensures superior paint adhesion and rust resistance.

**Installation** – Suitable for surface, chain or stem mounting.

**Ballast** – Thermally-protected, Class P, HPF electronic ballast standard.

**Listings**

UL Listed (standard). CSA Certified (see Options). UL Listed for 25°C ambient and wet locations covered-ceiling installations.

**Ordering Information**

Example: **VRI 2 32 MVOLT GEB10IS**

Series	Number of lamps	Lamp type	Lens type <sup>2</sup>	Voltage	Options
<b>VRI</b>	<b>1</b>	<b>28</b> 28W T5 (46") <sup>4</sup>	(blank) High-impact acrylic, 50% DR	<b>347</b>	<b>GEB10IS</b> T8 electronic ballast, instant start
For tandem double length unit, add prefix T. Example: <b>TVRI</b>	<b>2</b>	<b>54</b> 54W TSHO (46") <sup>4</sup>	<b>DP</b> High-impact deep acrylic, 50% DR <sup>2</sup>	<b>MVOLT</b>	<b>GEB10RS</b> T8 electronic ballast, rapid start
	<b>3</b> <sup>1</sup>	<b>32</b> 32W T8 (48")	<b>PCL</b> Polycarbonate <sup>3,5</sup>		<b>CSA</b> CSA Certified
	Not included.	<b>48</b> 38W Slimline (48")			For other options and accessories, see below and page 113.
		<b>48HO</b> 60W 800 mA (48")			
		<b>96HO</b> 110W 800mA (96")			
		<b>96T8</b> 59W T8 Slimline (96")			
		<b>96T8HO</b> 86W T8 380mA (96")			

NOTES:

- 1 32WT8 only.
- 2 Deep lens is standard on 4' slimline, HO (800mA) and 8' fixtures. To match appearance on 4' rapid start, order DP option.
- 3 Standard depth lens provided.
- 4 2-lamp maximum.
- 5 PCL only available with T5 and 32WT8 fixtures.

Accessories (Order separately)

- RK1 T20BIT** Torx TX20 hex-base driver bit for tamper-resistant screws with center reject pin.
- RK1 T20DRV** Torx TX20 screwdriver for tamper-resistant screws with center reject pin.

Availability and Dimensions

Series	Lamps per cross section	Lamps per fixture	Lamp type	Width in. (cm)	Depth in. (cm)	Length in. (cm)
VRI	1, 2, 3 <sup>1</sup>	1, 2, 3	32	7½ (19.4)	4¼ (12.1)	50 (127.0)
VRI (ARDP option)	1, 2, 3 <sup>1</sup>	1, 2, 3	32	7½ (19.4)	5½ (14.3)	50 (127.0)
TVRI	1, 2	2, 4	32, 48, 48HO	7½ (19.4)	5½ (14.3)	98 (248.9)
VRI	1, 2	1, 2	96HO, 96T8, 96T8HO	7½ (19.4)	5½ (14.3)	98 (248.9)
VRI	2	2	28	7½ (19.4)	5½ (14.3)	98 (248.9)
VRI	2	2	54	7½ (19.4)	5½ (14.3)	98 (248.9)

Corner and Surface Mount

VDC  
VDS

Intended Use

General illumination for rough service (vandal resistant) applications. Designed for indoor and outdoor applications like corridors, walkways, pedestrian tunnels, canopies and drive-through areas.

Features

Housing – Heavy-duty, 16-gauge cold-rolled steel, one-piece housing for corner-mounted (VDC) or surface-mounted (VDS) applications. Housing and reinforcing members welded together for strength. Optional stainless steel or aluminum housings available.

Finish – All metal parts are post-painted in white polyester powder coat for smooth, finished edges and corrosion resistance.

Lens – Clear, internally frosted, UV-stabilized, injection-molded polycarbonate lens standard. Smooth exterior for easy maintenance. Lens gasketed against moisture and contaminants and secured to housing with six stainless steel Torx®

T-20 tamper-resistant screws (included).

Ballast cover – Ballast and lampholders are secured to channel cover to provide easy installation and maintenance. Channel-cover safety chains included.

Ballast – Class P, HPF ballast is UL Listed. Ballast for 32W is standard GEB10IS with a 0°F starting temperature.

Listings

UL Listed (standard). CSA Certified (see Options). UL Listed for 25°C ambient and damp locations (wet locations in covered ceiling applications only).

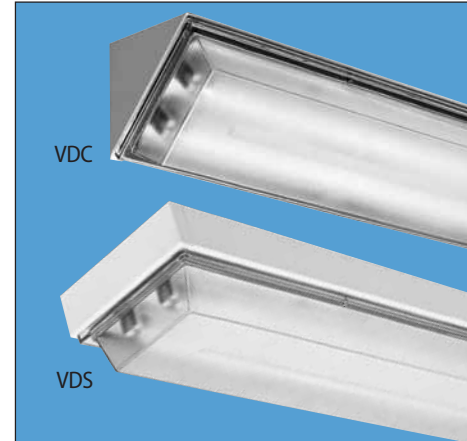

Ordering Information

Example: VDC 2 32 MVOLT GEB10IS

Series	Number of lamps	Lamp type	Lens type	Voltage	Options
VDC Corner-mount	1	32 32W T8 (48")	(blank) Clear polycarbonate	347	AL Aluminum housing, white
VDS Surface-mount	2	48HO 60W 800mA(48")	PCLW White polycarbonate	MVOLT	CW Cold-weather ballast <sup>1,2</sup>
	Not included.				CW20 Cold-weather ballast, -20°F starting <sup>3,4</sup>
					ELDW Emergency lighting (300 lumens) <sup>5,6</sup>
					EL5DW Emergency lighting (500 lumens) <sup>5,7</sup>
					EL6DW Emergency lighting (600 lumens) <sup>5,7</sup>
					EL14DW Emergency lighting (1400 lumen) <sup>7</sup>
					GEB10IS Electronic ballast, instant start
					GEB10RS Electronic ballast, rapid start
					GLR Internal fast-blow fusing <sup>8</sup>
					RIF1 Radio interference filter, one per fixture
					STS Stainless steel housing, natural
					SSTW Stainless steel housing, white
					WL Wet location (covered ceiling only) <sup>1</sup>
					CSA CSA Certified

NOTES:

- 1 Not available with EL option.
- 2 Not recommended for use in ambient temperatures exceeding 40°F.
- 3 Not available with 48HO 347V.
- 4 Must be specified with 48HO for cold weather.
- 5 Will default to 300 or 600 lumens depending on lamp type (32-300, 48HO-600).
- 6 Luminaires ordered with DW option (Example: EL5DW) will bear UL Emergency Lighting Equipment label for damp or wet locations, depending on fixture.
- 7 Not available with 48HO.
- 8 Specify voltage.

Availability and Dimensions

Series	Lamps per fixture	Lamp type	Width in. (cm)	Depth in. (cm)	Length in. (cm)
VDC	1, 2	32, 48HO	7½" (19.1)	6⅛" (15.5)	50 ⅙" (127.2)
VDS	1, 2	32, 48HO	7¾" (19.2)	4½" (11.5)	50 ⅙" (128.5)

Accessories (Order separately)

- RK1 T20BIT** Torx TX20 hex-base driver bit for tamper-resistant screws with center reject pin.
- RK1 T20DRV** Torx TX20 screwdriver for tamper-resistant screws with center reject pin.

## Door Frames and Diffusers



### Troffer Options

Listed below are the door frames and shielding media available for Lithonia static and air-handling troffers. The matrix shows the availability for each option within specific troffer families.

Other diffusers in addition to those listed below are available. Contact your Lithonia Lighting sales representative.

- Option available on **all models**.
- Option available on **most models**; consult factory for exceptions.

### Availability Matrix

	See page	Option Designation	GT8	SP8	SP	SP AIR	VRT
<b>DOOR FRAMES</b> Flush steel door standard unless otherwise noted. To order door frames below, add designation after lamps in catalog number.							
Regressed natural anodized aluminum	107	<b>RN</b>	■	■	■	■	
Regressed aluminum, white finish	107	<b>RW</b>	■	■	■	■	
Regressed aluminum, matte black finish	107	<b>RM</b>	■	■	■	■	
Flush natural anodized aluminum	107	<b>FN</b>	■	■	■	■	■
Flush aluminum, white finish	107	<b>FW</b>	■	■	■	■	■
Flush aluminum, matte black finish	107	<b>FM</b>	■	■	■	■	■
<b>LENSES AND LOUVERS</b>							
#12 pattern acrylic	108	<b>A12</b>	■	■	■	■	
#12 pattern acrylic, .125" thick	108	<b>A12125</b>	■	■	■	■	
#12 pattern acrylic, reverse apex, .125" thick <sup>2</sup>	108	<b>RA125</b>		■			
#19 pattern acrylic, .156" thick	108	<b>A19</b>	■	■	■	■	
Low-brightness acrylic school lens	108	<b>ASL</b>	■	■	■	■	
Injection-molded acrylic, .140"-.150" thick		<b>IM</b>	■	■	■	□	
Vandal-resistant acrylic lens, .375" thick		<b>VL</b>	■	■	■	□	
Radio frequency shielding (A12; others available)	108	<b>ARF12</b>	■	■	■	□	
Dropped dish, matte white acrylic		<b>AC</b>	■	■	■		
White aluminum eggcrate ½" x ½" x ½"		<b>ALE</b>	■	■	■	□	
White plastic eggcrate, ½" x ½" x ½"		<b>PL</b>	■	■	■		
Parabolic plastic-cube, ½" x ½" x ½" <sup>1</sup>	108	<b>PC1</b>	■	■	■	□	
Parabolic plastic-cube, 1½" x 1½" x 1" <sup>1</sup>	108	<b>PC2</b>	■	■	■	□	
Parabolic plastic-cube, ¾" x ¾" x ½" <sup>1</sup>	108	<b>PC3</b>	■	■	■	□	
Parabolic plastic hex-cell, ½" deep <sup>1</sup>		<b>PX</b>	■	■	■		
<b>REFLECTIVE SURFACES</b>							
95% reflective silver	108	<b>SSR</b>	□	■	■	■	

**NOTES:**

1 Add suffix **S** for silver or **G** for gold. Example: **PC1G**. For acrylic, add **A**. Example: **PC1SA**.

2 Pattern acrylic, reverse apex, .125" thick.

**Regressed Aluminum**

- RN** – Natural anodized
- RM** – Matte black
- RW** – White



Regressed aluminum, white finish

**Flush Aluminum**

- FN** – Natural anodized
- FM** – Matte black
- FW** – White



Flush aluminum, white finish

**Flush Steel**

- White (standard)
- FSM** – Matte black (optional on some models)



Flush steel, white finish

**Ceiling Compatibility**

**Paramax® and Optimax®**

Type of Ceiling	Appropriate Trim Type			
	G	F	MT	ST
Exposed grid tee	■			
Concealed grid tee	■			■
Concealed Z spline		■	■	
Metal pan <sup>1</sup>			■	
Screw slot <sup>1</sup>				■
Plaster or plasterboard		■		

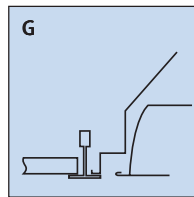

LAY-IN TRIM  
Exposed grid tee

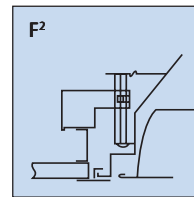

OVERLAPPING FLANGED TRIM  
with swing-gate hangers

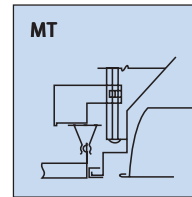

MODULAR FIT-IN TRIM with  
swing-gate hangers

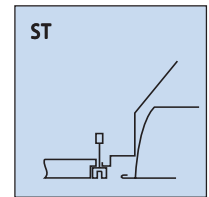

SCREW SLOT TRIM, louver  
flush to ceiling

**SP, SP8, GT8 and VRT**

Type of Ceiling	Appropriate Trim Type		
	G	F	MT
Exposed grid tee	■		
Concealed grid tee	■		
Concealed Z spline		■	■
Metal pan <sup>1</sup>		■	■
Screw slot <sup>1</sup>	■		
Plaster or plasterboard		■	

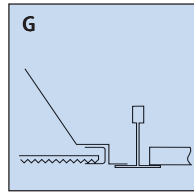

LAY-IN TRIM  
Exposed or concealed grid tee

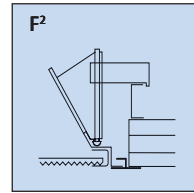

OVERLAPPING FLANGED TRIM  
with swing-gate hangers

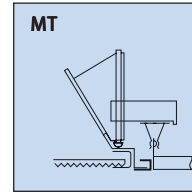

MODULAR FIT-IN TRIM with  
swing-gate hangers

**Plaster Frames**

Plaster frames provide a clean, square edge for wet plaster ceiling openings. Order **F trim** factory installed on fixture, then order appropriate size plaster frame option for each fixture to be installed. (Not required for drywall ceilings.)

Catalog No.	(Order separately)
<b>PF4</b>	Pair of sides for 4' long
<b>PF2</b>	Pair of sides for 2' long
<b>PFE</b>	Pair of ends for 1'x4'
<b>2PFE</b>	Pair of ends for 2' wide
<b>20PFE</b>	Pair of ends for 20" wide

**Filler Pans**

Accessory filler pans to finish out ceiling grids. Side filler pans typically are used when 20"-wide fixtures are installed in 2'-wide grid systems. End filler pans are used to install 4' units into 5' grid systems.

Catalog No.	(Order separately)
<b>2FP2</b>	Side filler pans (pair), white, 2" wide, 2' long.
<b>2FP6</b>	End filler pans (pair), white, 6" wide, 2' long.
<b>4FP2</b>	Side filler pans (pair), white, 2" wide, 4' long.
<b>20FP6</b>	Side filler pans (pair), white, 6" wide, 20" long.

**Drywall Grid Adapter**

Drywall grid adapters (**DGA**) are used to install grid trimmed troffers in plasterboard or other hard ceilings. Order DGA accessories separately. Compatible with all lay-in troffers. Order using DGA plus nominal fixture size. Example: **DGA24**.

**Metric Availability**

Metric versions of some recessed fluorescent fixtures are available. Consult your Lithonia Lighting sales representative.

**NOTES:**

- 1 Consult factory prior to order.
- 2 Requires CRE and CRM trim options for continuous row mounting.



Optional Lenses

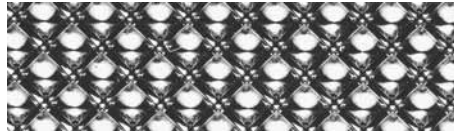

**A12\***

- Standard Lithonia shielding
- Extruded, clear 100% acrylic
- 3/16" female prisms
- Nominal .095" thick (.125", .156" and .187" optional)

Example: **2GT8 4 32 A12 MVOLT 1/4 GEB10IS**

Add suffix **T** for tinted.

\* Reverse apex prism design used on SP8 only. (for .125", specify RA125)

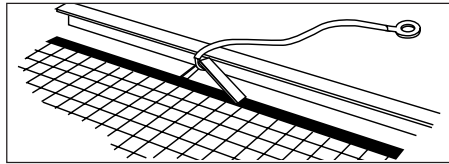

**Radio frequency shielding**

- For hospitals, TV stations or wherever sensitive electronic equipment is in use
- Choice of patterns and thicknesses
- Not available in fixtures with lens gasketing



**PC1**

- Injection-molded parabolic polystyrene plastic louver
- 1/2" x 1/2" x 1/2" square cell, 45° shielding
- Specify choice of specular gold (**G**) or specular silver (**S**)

Example: **2SP8 G 3 32 PC1S MVOLT 1/3 GEB10IS**

Add suffix **A** for acrylic.



**Small-Cell**

- Small-cell aluminum parabolic louvers for SP AIR and SP8
- Choice of cell size and 1/2" or 3/4" depth
- Specify number of cells, plus louver depth (15 for 1.5" and 75 for .75") and finish. For 78 cells, 1.5" deep, specular finish:

Example: **2SP G B 3 32 7815LS MVOLT 1/3 GEB10IS.**

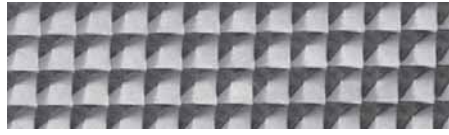

**A19**

- High VCP — very low brightness in direct glare zone
- 3/16" square-base male conical prisms
- High efficiency
- Minimizes lamp image
- Nominal .156" thick (.187" optional)

Example: **2SP8 G 3 32 A19 MVOLT 1/3 GEB10IS**

Add suffix **T** for tinted.

To order any lens with optional thickness, add thickness to designation.

Example: **2SP8 G 3 32 A12125 MVOLT GEB10IS**



**ASL**

- Acrylic school lens, developed for lighting applications where brightness control is critical (schools, libraries, etc.)
- Extruded, clear 100% acrylic
- Nominal .156" thick (.187" optional)

Example: **2SP8 G 3 32 ASL MVOLT 1/3 GEB10IS**

Add suffix **T** for tinted.

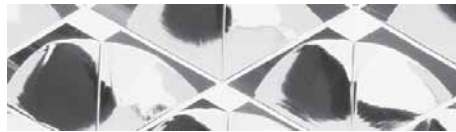

**PC2**

- Injection-molded parabolic polystyrene plastic louver
- 1 1/2" x 1 1/2" x 1" square cell, 35° shielding
- Specify choice of specular gold (**G**) or specular silver (**S**)

Example: **2SP8 G 3 32 PC2S MVOLT 1/3 GEB10IS**

Add suffix **A** for acrylic.



**PC3**

- Injection-molded parabolic polystyrene plastic louver
- 3/4" x 3/4" x 1/2" square cell
- Specify choice of specular gold (**G**) or specular silver (**S**)

Example: **2SP8 G 3 32 PC3S MVOLT 1/3 GEB10IS**

Add suffix **A** for acrylic.

**Reflective Surface**

**SSR**

95% minimum-reflectance silver inserts. 10-year warranty by material manufacturer. See pages 112-113 for availability.

Additional lenses and louvers available. Consult factory or Lithonia Lighting sales representative.

## Electrical, Wiring and Miscellaneous Options

### Troffer Options

Listed below are major electrical wiring and other options available for Lithonia Lighting static and air-handling troffers. The matrix shows the availability of each option within specific troffer families.

Certain combinations of options are incompatible in the same fixture. Consult factory for details.

- Option available on **all models**.
- Option available on **most models**; consult factory for exceptions.



Availability Matrix

	See page	Option Designation	GT8	SP8	SP	SRT SRH	SP AIR	VRT	PM2 PM4	PMO PM3 HPM3	2PM3N	NAT CNAT	AV	WW
<b>ELECTRICAL</b>			To order, add designation as a suffix to fixture catalog number, unless otherwise noted.											
Ballast options	115	—	■	■	■	■	■	■	■	■	■	■	■	■
Dimming ballasts	—	—	□	□	■	□	□	□	□	□	□	□	□	□
Multi-volt ballasts (120-277V) <sup>1</sup>	—	<b>MVOLT</b>	■	■	■	■	■	■	■	■	■	■	■	□
Emergency lighting <sup>2</sup>	116	<b>EL/EL14</b>	■	■	■	□	■	■	■	■	■	■	■	□
Fusing	115	<b>GLR/GMF</b>	■	■	■	■	■	■	■	■	■	■	■	■
Radio interference filter	116	<b>RIF</b>	■	■	■	■	■	■	■	■	■	■	■	■
Labeled for fire-rated ceiling	115	<b>FR</b>	■	■	■	■	■	■	■	■	■	■	■	■
<b>WIRING</b>			To order, add designation as a suffix to fixture catalog number, unless otherwise noted.											
Prewiring	115	<b>PW_</b>	■	■	■	■	■	■	■	■	■	■	■	■
Labor-saving tandem	110	<b>LST</b>	■	■	■	■	■	■	■	■	■	■	■	□
Reloc <sup>®</sup> wiring systems	682	—	■	■	■	■	■	■	■	■	■	■	■	■
<b>MISCELLANEOUS</b>			To order, add designation as a suffix to fixture catalog number, unless otherwise noted.											
2 channel covers installed	—	<b>2R</b>	■	■	■	□	■	■	■	■	■	■	■	■
Tamper-resistant door <sup>3, 6</sup>	116	<b>TPS/TP4</b>	■	■	■	□	■	■	■	■	■	■	■	■
Additional lens gasketing	—	<b>LG</b>	□	□	□	□	■	■	■	■	■	■	■	■
T-bar safety clips (snap-on) <sup>4</sup>	115	<b>HTC</b>	■	■	■	■	■	■	■	■	■	■	■	■
T-bar safety clips (screw-on) <sup>4</sup>	115	<b>LATC</b>	■	■	■	□	■	■	■	■	■	■	■	■
Air-pattern control blades	111	<b>APB</b>	■	■	■	■	■	■	■	■	■	■	■	■
Heat-removal dampers	111	<b>HRD</b>	■	■	■	■	■	■	■	■	■	■	■	■
Air closure strips	111	<b>ACS</b>	■	■	■	■	■	■	■	■	■	■	■	■
Lamps furnished and installed	116	—	■	■	■	■	■	■	■	■	■	■	■	■
Job pack <sup>5</sup>	116	<b>JP</b>	■	■	■	■	■	■	■	■	■	■	■	□

**NOTES:**

- 1 Consult factory for availability.
- 2 Addition of emergency battery pack options may increase overall fixture depth. Consult factory.
- 3 **TPS** = one tamperproof screw per latch, **TP4** = 4 tamperproof screws (2 on latch side, 2 on hinge side).
- 4 Integral T-bar safety clips are standard for most models of GT8, SP8, SP, 2pm2, 2pm4, 2PM3N and 2PM0 fixture families. Also available on 1x4 PM3, PMO and HPM3 fixtures. Consult factory for specific exceptions.
- 5 Palletized and stretch-wrapped without individual cartons. Available for **G** (grid) and **MT** (modular) trims only.
- 6 VRT standard with 4 tamperproof screws.

## Labor-Saving Tandem Option

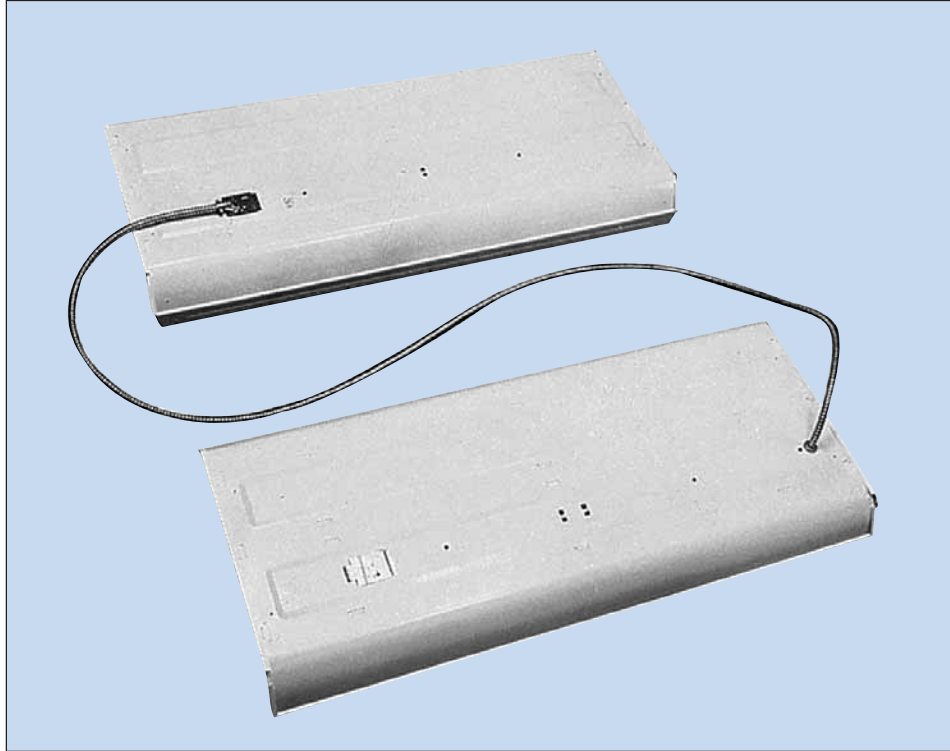

REDUCES THE NUMBER OF BALLASTS REQUIRED FOR FLUORESCENT TROFFERS.

- Simple, snap-together design.
- Uses *half* the connections.
- Uses *half* the wiring and components.
- Available on all sizes and types of Lithonia troffers with access plates.
- Wiring connections for both fixtures located at one access plate.
- Interconnection cable is fully prewired and pre-assembled.
- Polarized nylon plugs ensure positive connections, prevent miswiring.
- Identified ballast leads simplify multi-level switching.

Simply wire in the Master unit using hardwiring, prewiring or Reloc® wiring.

Then snap-connect the Satellite unit to the Master unit. Installation is complete.

### Ordering Information

Example: **2SP8 G 3 32 A12 MVOLT GEB10IS LST11**

1. Select desired troffer model.
2. Add one of the following as a suffix to standard Lithonia Lighting catalog number:
  - LST** 9' cable (standard cable length)
  - LST7** 7' cable
  - LST11** 11' cable

(Consult factory for other lengths.)

NOTE: Order fixtures in pairs. Factory will supply correct number of Master and Satellite units.

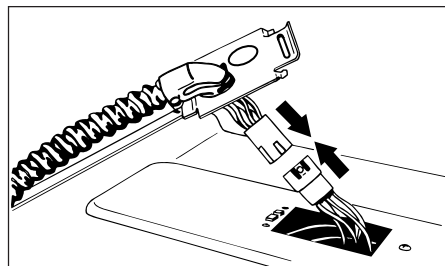

Join nylon connector

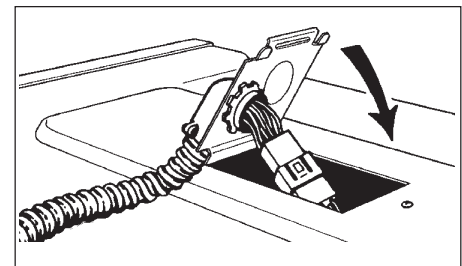

Close access plate

LST saves up to 40% of installation labor and wiring costs.

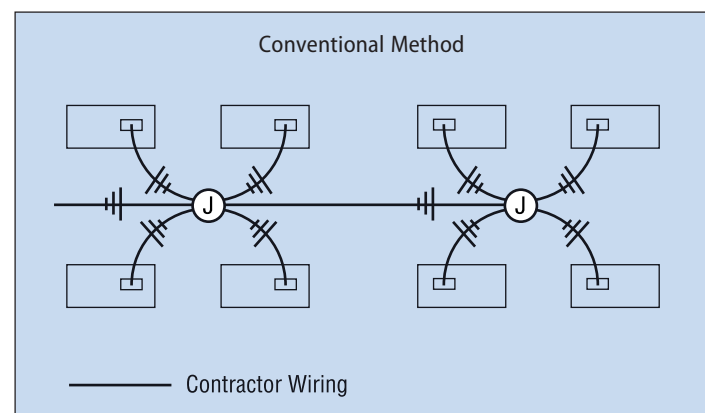
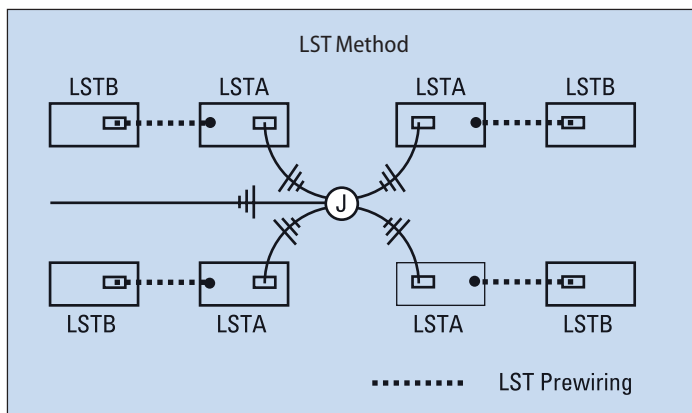

## Air-Handling Options

Lithonia Lighting manufactures a complete line of troffers designed to provide any level of air-handling capability, from simple heat removal to a combination of all air functions. Compatible with a full range of air equipment by major man-

ufacturers, these fixtures comprise the most complete and comprehensive family of air-handling troffers available.

Ductwork, including air boots, supplied by others.

Best choice for...

- Dependable performance
- Application flexibility
- Air-equipment compatibility

### Complete Air-Handling Capability

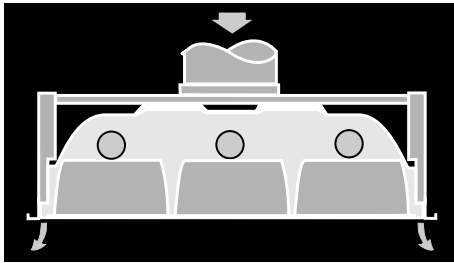

A – Air Supply

Air is supplied to occupied space through slots in side rails. Air diffusers connected to slots provide cooled or heated air to the space. Optional air-pattern control blades control airflow. Available on SP AIR, Paramax® and Optimax®.

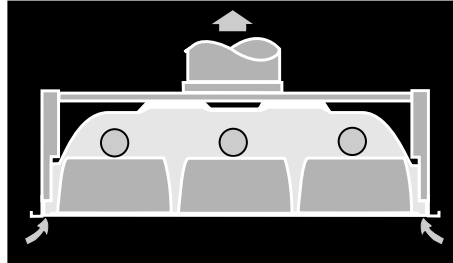

A – Air Return

Air is removed from occupied space through slots in side rails. Air is returned to plenum or to air diffusers connected to slots. Available on SP AIR, Paramax® and Optimax®.

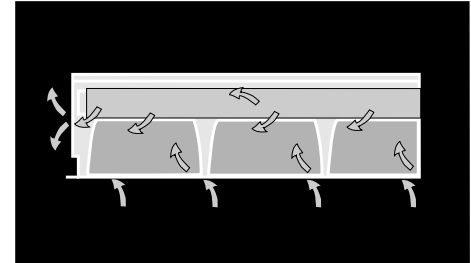

H – Heat Removal

Room air and fixture heat are removed through slots in the top or end of fixture housing. Slots in top are louvered to minimize entry of plenum contaminants into lamp cavity. Optional dampers available to control air flow. Available on SP AIR, Paramax® and Optimax®.

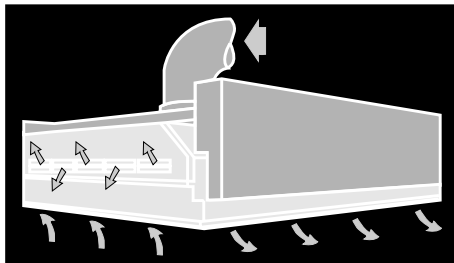

D – All Air Functions

Full-function air-handling capability. Dual-function air supply and/or return through side rails and heat removal through lamp cavity. Available on SP AIR, Paramax® and Optimax®.

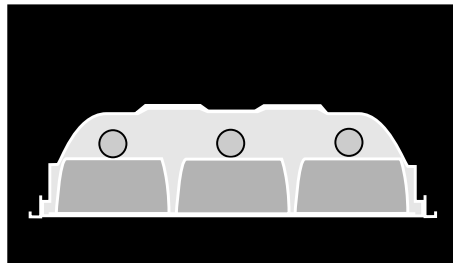

B – No Air Functions

Static troffer that provides no air functions, but matches other models in appearance for continuity of design. Available on SP AIR, Paramax® and Optimax®.

### Air Control Options

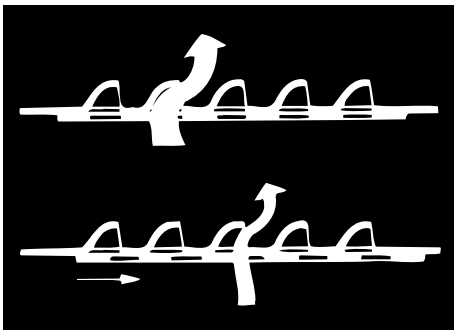

HRD – Heat-Removal Dampers

Designed to adjust or close off airflow through louvered slots on heat-removal models. Accessible from below. Design varies by fixture.

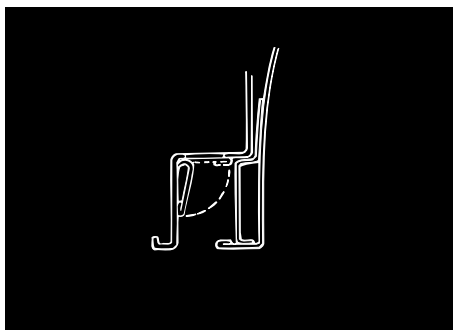

APB – Air-Pattern Control Blades

Designed to adjust or direct airflow on air supply/return models. Adjusts without tools from fully open to fully closed. Accessible from below.

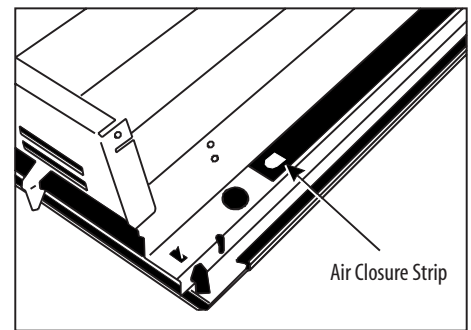

ACS – Air Closure Strips

Designed to convert fixture from air-handling to static in the field (no tools required). Not accessible from below.

## Electrical, Hanging and Miscellaneous Options



### Availability

Listed below are the major electrical and other options available for Lithonia Lighting commercial fixtures. The matrix shows the availability of each option within specific fixture families.

Additional options and accessories are available. Contact your Lithonia Lighting sales representative for information.

- Option available on **all models**.
- Option available on **most models**; consult factory for exceptions.

### Commercial Fixtures

	Option Designation	PMOX PM3X	M VRS	SSH	AW	CA	SB	LB CB	CS	CLM	VC
<b>ELECTRICAL</b>											
Energy-saving systems	ES	■	□	□	■	□	□	■	■	■	■
Ballast options (page 115)	—	□	□	□	□	□	□	□	□	□	□
Dimming ballasts	—	□	□	□	□	□	□	■	■	□	□
Multivolt ballast (120-277V range) <sup>1</sup>	MVOLT	□	□	□	□	□	□	□	□	□	□
Emergency lighting <sup>2</sup>	EL, EL14	■	■	□	■	■	□	■	■	□	■
Fusing	GLR/GMF	■	■	■	■	■	■	■	■	■	■
Radio interference filter (page 116)	RIF	■	■	□	■	□	■	■	■	□	■
<b>HANGING DEVICES</b>											
Swivel-stem hanger (page 117)	SQ_	□			□	■		■	■	■	■
Double-stem hanger (page 117)	DSH24			□	□		□	□		□	
Ceiling spacer (page 117)	1B	□			□	■		■	■	■	■
Hooker® hanger (page 117)	HRC/HRC1							■			
Single stem rod	SQRH_										
<b>MISCELLANEOUS</b>											
95% reflective silver (page 108)	SSR	□	□					□			
Tamper-resistant (page 116)	TPS		□	■							
Spring-loaded latch (page 116)	SLL	□	□								

NOTES:

- 1 Consult factory for availability.
- 2 For CSA emergency lighting, add prefix B50C.

Order hanging devices as accessories, using separate catalog numbers. Order options by adding suffix to catalog number, unless otherwise noted.

### Metric Availability

Metric versions of some surface fluorescent fixtures are available. Consult your Lithonia Lighting sales representative.

## Electrical, Hanging and Miscellaneous Options

### Availability

Listed are the major electrical and other options available for Lithonia Lighting strip and industrial fixtures. The matrix shows the availability of each option within specific families.

Additional options and accessories are available. Contact your Lithonia Lighting sales representative for information.

- Option available on **all models**.
- Option available on **most models**; consult factory for exceptions.

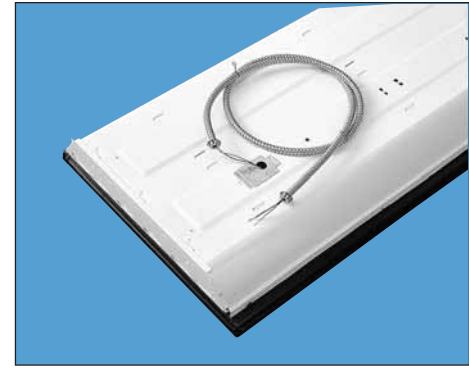

### Strips and Industrials

Designation	SM	SS SST	AF AFP	PV	EJS EJD	L LA	DMW VRI	DMS DMSW	DM	RR CRR CRRS	IB	HB5 HBB	MS8 MS5HB	MS5 MS5SS	S	C	UNS UND
<b>ELECTRICAL</b>																	
Plug-in (page 114)	<b>PLR_G/PLF_G</b>	■	■	■	■	■				■			□	□	■	■	■
Tandem quick-connect (page 114)	<b>TWP</b>	□	□	■	□	□				■					□	□	■
Emergency lighting (page 116) <sup>1</sup>	<b>EL, EL14</b>	□	□	■	■	■	■	■	■	■	□	■	□	□	□	■	■
Fusing (page 115)	<b>GLR/GMF</b>	■	■	■	■	■	■	■	■	■	■	■	■	■	■	■	■
Radio interference filter (page 116)	<b>RIF</b>	■	■	■	■	■	■	■	■	■	■	■	■	■	■	■	■
Cordset, 120V (U-ground plug) (page 116)	<b>CS1</b>	■	■	■	■	■					□	□	□		■	■	■
Cordset, 120V (twist-lock grounded plug) (page 116)	<b>CS3</b>	■	■	■	■	■					□	□	□		■	■	■
Cordset, 277V (U-ground plug) (page 116)	<b>CS7</b>	■	■	■	■	■					□	□	□		■	■	■
Cordset, 277V (twist-lock grounded plug) (page 116)	<b>CS11</b>	■	■	■	■	■					□	□	□		■	■	■
<b>HANGING DEVICES</b>																	
Tong (slide clamp) hanger (page 117)	<b>THUN</b>			■	■	□											□
	<b>TH2UN</b>					□											□
Hooker® hanger (page 117)	<b>THC</b>		□				■										■
	<b>HR_</b>			■	■	□	□										□
Swivel-stem hanger (page 117)	<b>SQ_</b>	□	□	■	■	■	■	□	□	□			■	■	■	■	■
Double-stem hanger (page 117) <sup>2</sup>	<b>DSH24</b>		□	□	□	□	□								□	□	□
Ceiling spacer (page 117)	<b>1B</b>	□	□	■	■	□	□						■	■	■	■	■
Chain hanger (page 117)	<b>HC36</b>		□	■	■	□	■	□	□		■		■		■	■	□
<b>MISCELLANEOUS</b>																	
95% reflective silver (page 108)	<b>SSR</b>			■		■				■							□
Wireguards (page 117)	<b>WG_</b>		■	■	□	■	■				■	■	■		■	■	■
Aluminum housing	<b>AL</b>		■					■									■

#### NOTES:

- 1 For CSA emergency lighting, add prefix B50C. See page XX.
- 2 Available on most 4' fixtures. Consult factory.

Order hanging devices and wireguard accessories as separate catalog numbers. Order options by adding suffix to catalog number, unless otherwise noted.

## PLF – Advanced 3-Circuit Plug-In

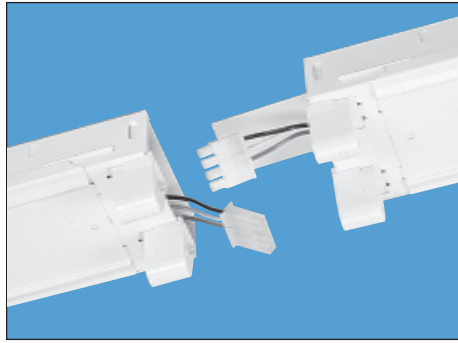

Advanced plug-in system with three-circuit capability. Available on industrial and strip products and a variety of architectural products mounted in continuous rows. 1, 2, 3 and 4-lamp fixtures. PLF22 (2-circuit) and PLF33 (3-circuit) crossover harness switches hot circuit serving next fixture in row. Reduces fixture types on job for alternating circuit applications (see example below.)

Easy one-step installation, saves up to 35% on labor costs. Expanded switching flexibility helps

save energy. Rows can be 50% longer with two-circuit systems. Polarized, lock-together nylon connectors prevent miswiring in the field. #12 THHN conductor, rated 600V, 90°C. White neutral wire included. Grounding accomplished by fixture in-row connectors.

CSA Certified systems available with up to 2 circuits. **G** ground required.

### Ordering Information

**Example: UND 2 96HO 120 ES PLF3C**

Series	Number of "hot" wires	Branch circuits	Ground
<b>PLF</b>	(blank) Not required for 22 or 33	(Circuits to which ballasts are connected)	(blank) No ground in PLF
<b>PLF22</b>	<b>1</b> Black	(blank) Not required for 22 or 33	<b>G</b> Ground. Maximum 2 circuits.
<b>PLF33</b>	<b>2</b> Black and red	<b>A</b> Black wire	
	<b>3</b> Black, red and blue <sup>1</sup>	<b>B</b> Red wire	
		<b>C</b> Blue wire <sup>1</sup>	
		<b>AB</b> Outboard lamps to black, inboard to red	
		<b>AC</b> Outboard lamps to black, inboard to blue <sup>1</sup>	

NOTES:  
1 Ground not available.

### Typical Applications

- Multiple circuit and single circuit for longer continuous rows
- Multiple circuit with alternating fixtures on separate circuits, 2-circuit (PLF 22) and 3-circuit (PLF 33)
- Multiple circuit with night-lights located along row as desired

PLF 3 C	PLF 3 C	PLF 3 C	PLF 3 C	PLF 2 B	PLF 2 B	PLF 2 B	PLF 2 B	PLF 1	PLF 1	PLF 1
(All PLF 22)										
Circuit A	Circuit B	Circuit A	Circuit B	Circuit A	Circuit B	Circuit A	Circuit B	Circuit A	Circuit B	Circuit A
(All PLF 33)										
Circuit A	Circuit B	Circuit C	Circuit A	Circuit B	Circuit C	Circuit A	Circuit B	Circuit C	Circuit A	Circuit B
PLF 3 A	PLF 3 A	PLF 3 A	PLF 3 C	PLF 3 B	PLF 3 B	PLF 3 B	PLF 3 C	PLF 3 A	PLF 3 A	PLF 3 A

## Tandem Quick-Connect Plug-In

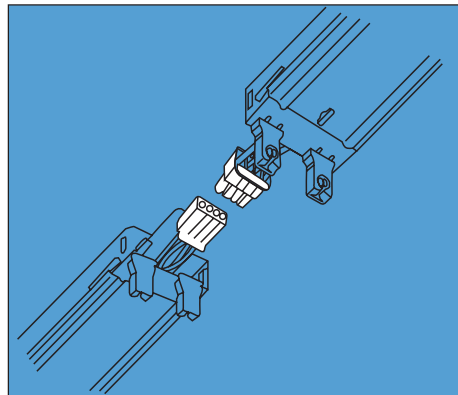

Fully prewired secondary wiring for continuous row, strip and industrial applications. Simply install two channel sections and connect plugs.

One worker can install – more efficient than a two-worker installation of one 16-foot length. Lock-together nylon plugs are polarized to prevent miswiring.

Available on all tandem-wired (T) strip, industrial fixtures and a variety of architectural row-mounted products.

**TWP** and **TILWP** available. Consult factory.

## Industrial Strip Options

### PW – Prewiring Option

(Troffers only)

Complete range of prewired whips for every installation requirement.

- Factory-installed flexible cable, wired into fixture through access plate.
- $\frac{3}{8}$ " cable with snap-in connectors standard.  $\frac{1}{2}$ " cable optional.
- Choice of wire gauge.
- Up to five wires, including one neutral (white) and one ground (green) – permits multi-level switching.
- Ready to connect to J-box.

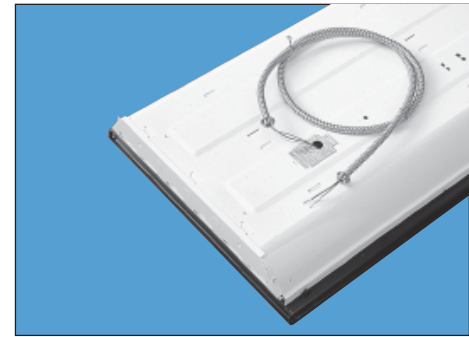

Develop 6- or 7-digit suffix as explained below. Add suffix to fixture catalog number.

### Ordering Information

Example: **2GT8 3 32 A12 MVOLT 1/3 GEB10IS PWS1836**

( $\frac{3}{8}$ " flex cable with three No. 18 AWG leads B, W, GR, cable 6' long.)

Family	Cable	Wire gauge	Number of wires	Cable length
<b>PW</b> Prewire	(blank) $\frac{1}{2}$ " dia. S $\frac{3}{8}$ " dia.	12 14 18	3 1 circuit 4 2 circuits 5 3 circuits	6 6 feet

### T-Bar Safety Clips

Screw-on Clips (Troffers only)

**LATC** Hold-down clips to secure troffer to T-bar. Field installed. Attach by screwing to fixture end plates. Four furnished per fixture.

Example: **2PM4 G B 3 32 18LD 120 GEB LATC**

NOTE: Safety clips may be used on fixtures with integral T-bar clips if additional means of attachment are required.

Snap-on Clips (Troffers, RR, CRR)

**HTC** Hold-down clips to secure troffer to T-bar. Four furnished per fixture.

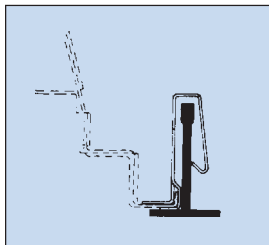

### Ballast Options

- CW** Cold-weather ballast; 0°F starting for RS slimline lamps and some T8 lamps
- CW20** Cold-weather ballast; -20°F starting for HO and PG lamps.
- GEB10IS** Electronic ballast, instant start maximum 10% THD. (32T8 only, other wattage may vary by lamp or wattage type. MVOLT standard. Factory choice; see page 708 for specification and ordering information.
- GEB10PS** Electronic ballast, program start maximum 10% THD. Factory choice; see page 708 for specification and ordering information.
- GEB10RS** Electronic ballast, rapid start, maximum 10% THD. Factory choice; see page 708 for specification and ordering information.
- GEBH** Electronic ballast, instant start with 1.20 (nominal) ballast factor. Factory choice; see page 708 for specification and ordering information.

Example: **C 2 32 MVOLT GEB10IS**

### Fusing

One per ballast furnished. Fusing not recommended for use with 277V magnetic dimming ballasts.

Internal Fusing

- BKTK** Internal fast-blow fuse. For use in 347V fixtures.
- GLR** Internal fast-blow fuse.
- GMF** Internal slow-blow fuse.

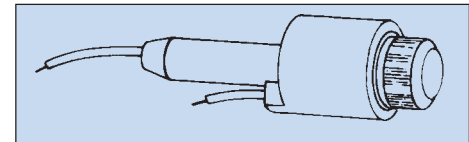

External Fusing

(Strips and open industrials only)

- GLRX** External fast-blow fuse.
- GMFX** External slow-blow fuse.



### Construction for Fire-Rated Ceilings

(Troffers only)

**FR** Lithonia fluorescent troffers are UL Listed and are compatible with UL fire-rated ceiling assemblies. Upon request for the FR option, the FR label is applied to the back of the housing. Label states: *This troffer is specially designed to be installed in fire-rated or insulated ceilings.*

Example: **2GT8 4 32 A12 MVOLT 1/4 GEB10IS FR**

NOTE: Not applicable for CSA or NOM listings. Some dimming and some compact lamp troffers may require electronic ballasts.



## Miscellaneous Options

### Tamper-Resistant Doors

Tamper-resistant Torx head T20H (with pin) screws to secure door to housing.

- TPS** Torx head T20H screws – 1 per latch
- TP4** Torx head T20H screws – 2 latch side/ 2 hinge side

Example: **2SP G 3 40 A12 120 ES TPS**

Note: Four Torx head T20H screws are standard on VRS and VRT Series.

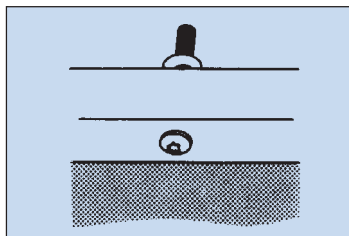

### Spring Latches (Troffers and M Series only)

- SLL** Spring-loaded latch option
- SAL** Spring-action latch option for 2GT8 only.

Example: **2M 4 40 FW A12 120 ES SLL**

### Lamps Furnished and Installed (Troffers only)

- LPESCW** Energy-saving cool white
- LPESWW** Energy-saving warm white
- LP730** Min. 70 CRI & 3000K color temp.
- LP735** Min. 70 CRI & 3500K color temp.
- LP741** Min. 70 CRI & 4100K color temp.
- LP830** Min. 80 CRI & 3000K color temp.
- LP835** Min. 80 CRI & 3500K color temp.
- LP841** Min. 80 CRI & 4100K color temp.

Example: **2SP8 G 3 32 A12 120 GEB LP735**

### Radio Interference Filters

- RIF** Inductive capacitor circuit designed to minimize interference from feedback into line. 120V or 277V, 50Hz or 60Hz. Order either one per fixture (RIF1) or one per ballast (RIF2).

Example: **2SP8 G 3 32 A12 277 GEB RIF1**

- EIS** Inductive capacitor circuit designed to minimize interference from feedback into line. Meets MIL-STD 461A/462/463. Order either one per fixture (EIS1) or one per ballast (EIS2).

Example: **2SP8 G 3 32 A12 120 GEB EIS2**

### Cordsets

Grounded, three-wire cordsets (black) are 6' long, 18-gauge, with SJT insulation. Prewired to fixture. Others available; consult sales representative.

- CS1** 120V, U-ground plug (NEMA 5-15P)
- CS3** 120V, twist-lock plug (NEMA L5-15P)
- CS7** 277V, U-ground plug (NEMA 7-15P)
- CS11** 277V, twist-lock plug (NEMA L7-15P)
- CS24** 347V, twist-lock plug (NEMA L24-20P)

Example: **AF 2 96 277 CS7**

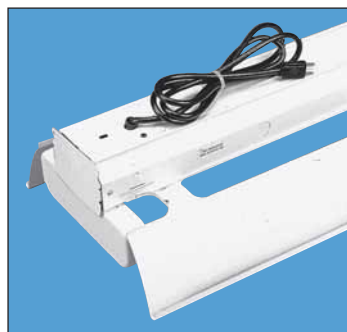

### Emergency Battery Packs

Factory-installed Lithonia Emergency Systems battery pack available for most fluorescent fixtures. See Emergency Systems section for lamp and ballast compatibility. Addition of an emergency option may increase fixture depth in some 2'x2' troffers. Consult factory.

- | <i>UL Listed</i> | <i>CSA Certified</i> |   |
|------------------|----------------------|---|
| <b>EL</b>        | <b>B100C</b>         | Fixture equipped for one-lamp emergency operation of 4' lamps. (PS300 installed)  |
| <b>EL5</b>       | <b>B90C</b>          | Fixture equipped for one-lamp emergency operation of 4' lamps. (PS500 installed)  |
| <b>EL6</b>       | <b>B70C</b>          | Fixture equipped for one-lamp or two-lamp emergency operation of 4' lamps and one-lamp emergency operation of 8' lamps. (PS600 installed) |
| <b>EL14</b>      | <b>B50C</b>          | Fixture equipped for one-lamp or two-lamp emergency operation of 4' lamps and one-lamp operation of 8' lamps. (PS1400 installed)          |
| <b>EM</b>        | <b>CEM</b>           | Inverter only option. Fixture labeled for emergency use, no integral ballast.   |

Add suffix **DW** to catalog number to specify damp/wet listing. UL Listed only. Example: **EL6DW**

### Packaging

**JP – Job Pack** Consult factory for availability.

Job-site load of fixtures on pallets, wrapped without individual cartons. Secured to pallet.

- No carton disposal.
- Faster and easier to unload.
- Superior protection – reduces handling damage.
- Paramax® and other Lithonia troffers G grid and MT modular trim only, packed with end protectors, secured to pallet by heavy-duty plastic.
- Industrials and strips protected by heavy-duty corrugated sheet and secured to pallet. Reflectors packed separately.

Add suffix **JP** to fixture catalog number. Factory will determine number of fixtures per pallet.

Example: **2GT8 4 32 A12 120 GEB JP**



Miscellaneous Options

Wireguards (Order separately)

14-gauge baked white enamel, 4' long. Order two for 8' fixtures.

For use with: Catalog number:

UN (with UNASR48 reflector)	<b>WGUNASR</b>
2UN (9" wide)	<b>WG2UN</b>
UNS/UND	<b>WGCUN</b>
C (with CASR48 reflector)	<b>WGCASR</b>
C (with CSMR48 reflector)	<b>WGCSMR</b>
S (with SASR48 reflector)	<b>WGSASR</b>
S (with SSMR48 reflector)	<b>WGSMSR</b>
S (without reflector)	<b>WGS</b>
AF, PV	<b>WGAFPV</b>
EJ (12" wide)	<b>WGJ</b>
2EJ (16" wide)	<b>WG2EJ</b>
L	<b>WGL</b>

For optional 11-gauge construction, add suffix 11 to catalog number. Example: **WGSASR11**

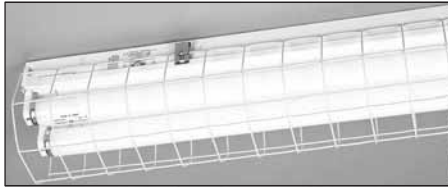

Swivel-Stem Hangers (Order separately)

- SQ** Complete assembly with stem up to 48" (consult factory for longer lengths). Specify stem length in 2" increments and adjust as needed. 5/8" O.D. stem. Swivels 30° from vertical in any direction. Example: **SQ24**
- HDSQ** Complete heavy-duty assembly. Specify length in 2" increments and adjust as needed, swivels 45° from vertical. Example: **HDSQ36**
- ST** Pipe stem only. Specify length up to 60". Example: **ST18**
- Q** Canopy, offset bar and parts only.
- ST\_TBE** Pipe stem only, threaded both ends. Coupler included. Specify length from 6" to 60". Example: **ST48TBE**.

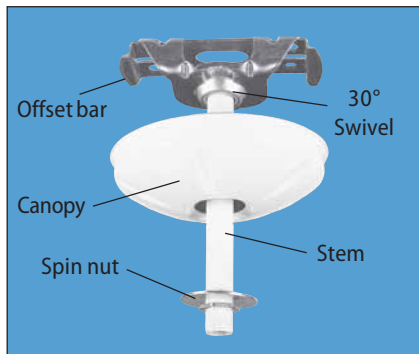

Ceiling Spacer (Order separately)

- 1B** Hanger spaces fixtures 1½" to 2½" from ceiling. For unit mounting, order two per fixture; for row mounting, order one per fixture plus one per row. Standard pack: 2, 20, 100.



Chain Hangers (Order separately)

- HC** Wire hook and 36" chain set, option or accessory. One pair per fixture furnished. Not compatible with fixtures over 5" wide.

Example: **UN 2 32 120 HC** or **HC36** (accessory)



Tong Hangers (Order separately)

Order by channel width. For unit or row mounting, order two per fixture. All tong (slide clamp) hangers are suitable for use with 3/8" or smaller mounting rods. Rods smaller than 3/8" diameter require use of appropriate washers (supplied by others). Standard pack: 2, 100.

- THUN** Hanger for 5" channel
- TH2UN** Hanger for 9" channel
- THC** Hanger for 4¾" channel
- THK** Hanger for 4¾" channel
- THSR** Hanger for 5" channel (uses carriage bolt mounting rod)

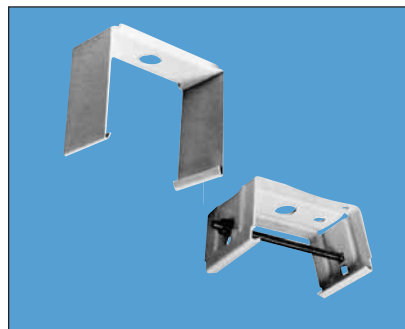

Double-Stem Hangers (Order separately)

- DSH24** Complete assembly with double canopy and two 24" stems on 10" centers. For most 4' fixtures. Other stem lengths available.



Hooker® Hangers (Order separately)

Patented, no-tools system for easy mounting to grid tee ceilings. For use with inverted tee exposed grid ceilings, nominal 1" wide.

- Hooks anywhere on grid – main tee, cross tee or intersection.
- Die-formed from heavy-gauge steel.
- Fixture can be mounted parallel or perpendicular to grid, flush to ceiling or 1½" below tee.

Two required per fixture. Standard pack: 10, 48.

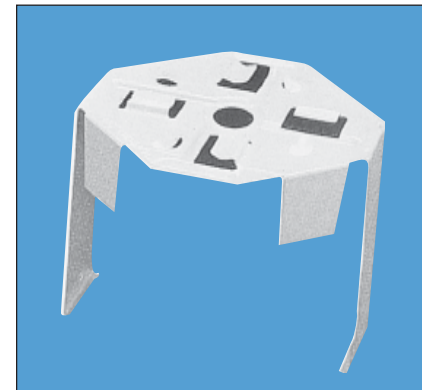

**lightquick<sup>®</sup> XD**  
Express delivery products.

See page 11 for details about LightQuick XD.

Description

- WGL**
- WGCUN**
- HC36**

Number	Type of mounting	For use with
<b>HRC</b>	Flush to ceiling	CB, L, C and ALC fixtures with 4¾" wide and 2¼" deep channels.
<b>HRC1</b>	Spaced 1½" from ceiling	
<b>HRUN</b>	Flush to ceiling	PV, AF fixtures with 5" channels
<b>HRUN1</b>	Spaced 1½" from ceiling	
<b>HRUNS1</b>	Spaced 1½" from ceiling	UN, S, EJS

HOOKER® Hanger, Pat. No. 3,589,660