



JUNO[®]

Residential Recessed Lighting

Brilliant lighting for every room of the home

[®]
JUNO LIGHTING GROUP
by Schneider Electric



Table of Contents	Page	Page
Juno Offering Residential Recessed	2 - 5	Step Lights 120 - 137
Lighting for Our Environment	6 - 7	• LED 120
Lighting Like A Pro	8 - 21	• CFL 132
Lighting Techniques	22 - 29	• Incandescent 136
Downlights 30 - 105		Photometrics 138 - 160
• LED 30		Accessories 161
• CFL 64		Index 162
• Incandescent 78		
Slope Ceiling Downlights 106 - 119		
• LED 106		
• CFL 112		
• Incandescent 116		

Juno Recessed Lighting

Advanced illumination for the discerning homeowner

Welcome to the world of Juno Recessed Lighting. A brilliant world where lighting is effective and efficient ... blending seamlessly with every décor ... perfectly illuminating every room of the house.

Juno offers the largest selection of high-quality recessed fixtures, incorporating industry leading performance, features and efficiency. Flat or sloped ceilings; ambient, task or accent lighting; niches or open spaces; Juno has a solution for every conceivable application.

Juno recessed fixtures are the favorite of contractors, architects, and lighting designers because they offer feature-rich installation, integrate quietly into ceilings, and present artwork, textures and architectural features at their dramatic best. They set the mood, expand space, and create stunning effects ... all the while allowing you to navigate easily throughout the interior of your home.

So whether you want your lighting to make a bold statement, provide practical illumination, or both, you need to look no further than Juno's superb line of recessed lighting products.



The best and the brightest

Every Juno recessed fixture is designed and engineered in the United States to exacting quality standards, employing only the finest materials and manufacturing processes. A full range of trims, optics, and light sources ensures that you will be able to create the exact lighting effect you desire with the economy and efficiency you demand.

In addition to its exceptional recessed fixtures, Juno offers an extensive range of track systems, decorative pendants, and linear lighting solutions. By taking advantage of this diverse fixture collection, you can employ layers of light to create any mood or suit any illumination requirement throughout your home.

Since 1976, we have been providing the lighting industry with innovative products and unsurpassed service and support. When you choose Juno fixtures for your home, rest assured you are choosing the best and brightest.



Housing Offering

Juno Downlights are a complete line of LED, compact fluorescent, low-voltage, and incandescent recessed luminaires for both flat and sloped ceilings. They provide high-quality illumination for all your applications, including general, task, accent, wall-wash, and step lighting. New construction and remodel housings are available in 2", 3", 4", 5", and 6" sizes for insulated and non-insulated ceilings.



Air-Loc®

Juno IC housings are Air-Loc rated and designed to minimize air leak paths. Air-Loc rated housings are tested in accordance with ASTM E283 and certified by an independent laboratory to be in compliance with the minimum air-leakage standards as set in the International Energy Conservation Code, as well as several state energy codes, including Washington State. Significant cost savings are realized as summarized in the chart below:



	Standard IC	Juno Air-Loc IC	Juno Air-Loc IC w/Air-Loc Trim or Gasket
Areas of Leak Path	2.8 sq. inches	2.46 sq. inches	< .1 sq. inch
Air Leakage	5 cu. ft./min. 2.6 million cu. ft./year	2.6 cu. ft./min. 1.4 million cu. ft./year	0
Energy Loss	.86 million BTUs/year	.45 million BTUs/year	0
Annual Energy Savings (VS. STANDARD IC)		\$3.53 per fixture	\$7.34 per fixture

* Based on 10 cents per KWH



Real Nail 3® Bar Hanger

The Juno originated, Real Nail bar hanger has set the industry standard for ease of installation for over 35 years. This 3rd generation design features an improved range of benefits:

- Proprietary bugle-head, ring shank nail for positive installation and simple claw hammer removal when repositioning housings
- Integral T-bar clip for secure installation in suspended ceilings
- Patented break-away bars for tight joist spacings
- Curved foot facilitates alignment with joist bottom

Regulatory Listings & Standards - Catalog Icons



- ENERGY STAR® Qualified products



- Juno's sealed recessed IC housings meet IECC Air-Loc® Code requirements per ASTM E283 for minimum leakage with IC housing



- Juno Downlights meet the high efficacy requirements of California Title 24-2008



- UL and C-UL Listed for Wet Location when used with outdoor rated lamps or when used with lensed trims



- Many Juno Step Lights are ADA Compliant
- LED fixtures are RoHS Compliant

Aesthetically Superior Trims

Juno's downlight trim offering is unparalleled in the industry; choose from 3", 4", 5" and 6" baffle, cone, wall wash, and lensed trims in an array of finishes and styles.



Clear Cone

Specular finish produces a neutral appearance with exceptionally low brightness.



Haze Cone

Uniform satin finish has a soft luminous appearance and hides dust and fingerprints. Blends with white ceilings and coordinates well with cooler interior finishes, light hardwoods and metallic accents such as satin nickel and stainless steel.



Wheat Haze Cone

Offers a rich trim appearance, and adds subtle warmth to an interior. Coordinates well with warmer tone interior finishes, hardwoods and metallic accents such as satin brass and oil-rubbed bronze.



Gold Cone

Specular finish with a pale gold tint slightly warms lamp color temperature and provides decorative aperture appearance.



Black Cone

Specular black finish produces lowest possible brightness and maximum source concealment.



Black Baffle

Sharply defined concentric ridges reduce trim brightness and create a pleasing architectural appearance.



White Baffle

Brighter appearance when illuminated, but blends with white ceiling when off.

Styles

Baffle



Cone



Adjustable



Wall Wash



Decorative



Lensed



Trim Ring Finishes

- ABZ** - Classic Aged Bronze
- BL** - Black
- GP** - Graphite
- PW** - Plastic White (Polycarbonate material shower trim)
- SC** - Satin Chrome
- SL** - Silver
- WH** - White





Energy efficiency ... it just makes \$ense

Today, we live in an environment where the specter of global warming threatens our eco-system and our very way of life. That's why Juno recessed fixtures are designed first-and-foremost for optimal energy efficiency. Efficient lighting requires less electrical power, which in turn, contributes to a cleaner, more sustainable habitat for all living things.

Juno leads the way in efficiency with ENERGY STAR® Qualified LED fixtures that consume as little as 15% of the energy of conventional lighting. Our CFL fixtures also offer outstanding efficiency but in a very affordable package. Even our halogen units provide substantial energy savings compared to standard incandescent lamps. Energy efficiency ... it just makes sense. Our most efficient fixtures can help reduce your electric bill thanks to energy-saving light sources and unique construction features such as our Air-loc® housings. And when you install energy efficient lighting products, you may find that you qualify for valuable rebates from your local utility company.

Saving energy. It makes sense for our planet ... and your pocketbook.

D See pages 30, 106, and 120 for the latest energy efficient LED fixtures.

The background of the page is a photograph of a large, two-story stone house with a dark, gabled roof. The house is set on a lush green lawn under a bright blue sky with scattered white clouds. The house features a prominent arched window on the ground floor and a large multi-paned window on the second floor. The overall scene is bright and sunny.

Juno leads the way in efficiency with ENERGY STAR® Qualified LED fixtures that consume as little as 15% of the energy of conventional lighting.



Lighting your home like a pro

Light is an invisible element that has a tremendous influence on your quality of life. Nowhere is this influence greater than in the interior of your home. How you illuminate it has everything to do with the look, feel and quality of your environment. Lighting professionals understand this and deftly use lighting to create mood and ambiance in addition to general illumination. For the homeowner, knowledge of a few lighting basics can go a long way toward achieving professional results.

Know your space

Before selecting your lighting, you need a clear idea about what you want the lighting to do. Think about how you use each room, its architectural features, and the furniture layout. Consider the carpeting, fabrics, and colors; paintings, collectibles, and other forms of art. There are lighting techniques tailored to every situation, and the first step is to understand your needs.

D Use warm color temperatures in your home such as 2700K or 3000K.



What you can control

There are three major aspects of lighting that you can control. First, there's the amount of light produced by your fixtures, measured in lumen output and footcandles. Next is the distribution of light, i.e. where the light is going. Finally, there's the quality of light, which refers to whether the light is warm, cool, or somewhere in between. By taking control of these elements, you can create the ideal lighting scheme for every interior space.

Lighting in layers

Layering is the concept of incorporating different types of lighting into a specific space to satisfy multiple illumination requirements. For instance, a dining room can have linear fixtures in coves to expand space or establish a mood, or fixtures can be incorporated into casework to add sparkle to glassware. Recessed downlights positioned above tables and serving areas can be dimmed for a romantic dinner or used at full intensity when doing homework or paying the bills. Chandeliers, pendants, and sconces can provide general illumination or produce a lateral lighting element that fills in shadows on walls and on people's faces.

With multiple lighting layers, you will always have just the right light for your specific purpose. And by balancing all the layers at your disposal, you can create just the right atmosphere for any occasion.



Kitchen*



Downlighting (General)

Fills the room with light, allowing you to move through your space. Downlights can also be centered over islands and leading edges of countertops for task illumination.

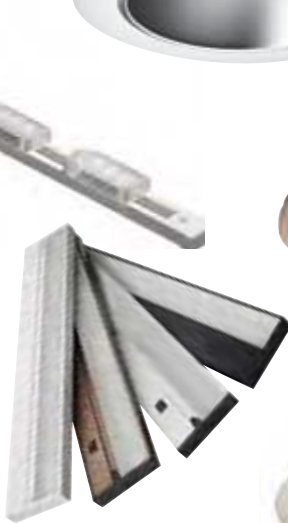

Undercabinet (Task)

Illuminate countertops, backsplashes and other work surfaces with undercabinet fixtures. Cool, bright-white light is ideal for cooking chores such as cutting, slicing, and dicing. Modular, linear fixtures are ideal for long surface lengths, while “solo” fixtures put light exactly where needed.



Accent/Mood Lighting

Highlight decorative cabinet detail, artwork or architectural features with adjustable downlights or mini-downlights. Set the mood by lighting cabinet interiors with linear lighting or mini-downlights, and the space between cabinets and ceiling with linear lighting. Lighting controls can provide selective dimming to create the perfect effect.



Pendants/Decorative

Add a decorative touch and general illumination over islands and tabletops. Translucent pendant shades also provide a lateral lighting element that fills shadows and contributes to the overall mood.

D Juno’s complete line of linear lighting fixtures are ideal for task, cove, up-lighting and undercabinet lighting. All offer a comprehensive selection of finishes, lengths and lamp options, including the latest energy efficient LED technology. See our website for product details – www.junolightinggroup.com

*For comprehensive lighting techniques, see pages 22-29.



Dining Room*



Downlighting (General)

Provide general illumination with downlighting; position fixtures in the general navigating area to fill the room with light. Light vertical surfaces such as walls, draperies, or screens with recessed adjustables or wall washers to add visual interest and showcase artwork or architectural details.



Accent/Mood Lighting

Supplement the light from pendants and chandeliers while enhancing the richness of natural woods and highlighting centerpieces and place settings. Lighting wall-mounted artwork with recessed adjustable fixtures also adds to the dramatic appeal of the room. Incorporate linear lighting in coves, mini-downlights or solo undercabinet lighting into china cabinets to produce sparkle and spaciousness.



Pendants/Decorative

Make a bold statement with decorative pendants that set the tone for your dining room. Position pendants above tables or serving areas, and arrange them in clusters for a creative splash. Pendants with translucent shades give off a soft, warm glow that also provides a lateral lighting component to fill distracting shadows.

D To create an inviting environment for your guests, consider Juno's exclusive WarmDim® LED fixtures along with Aculux® precision luminaires to highlight place settings and create sparkle.

*For comprehensive lighting techniques, see pages 22-29.

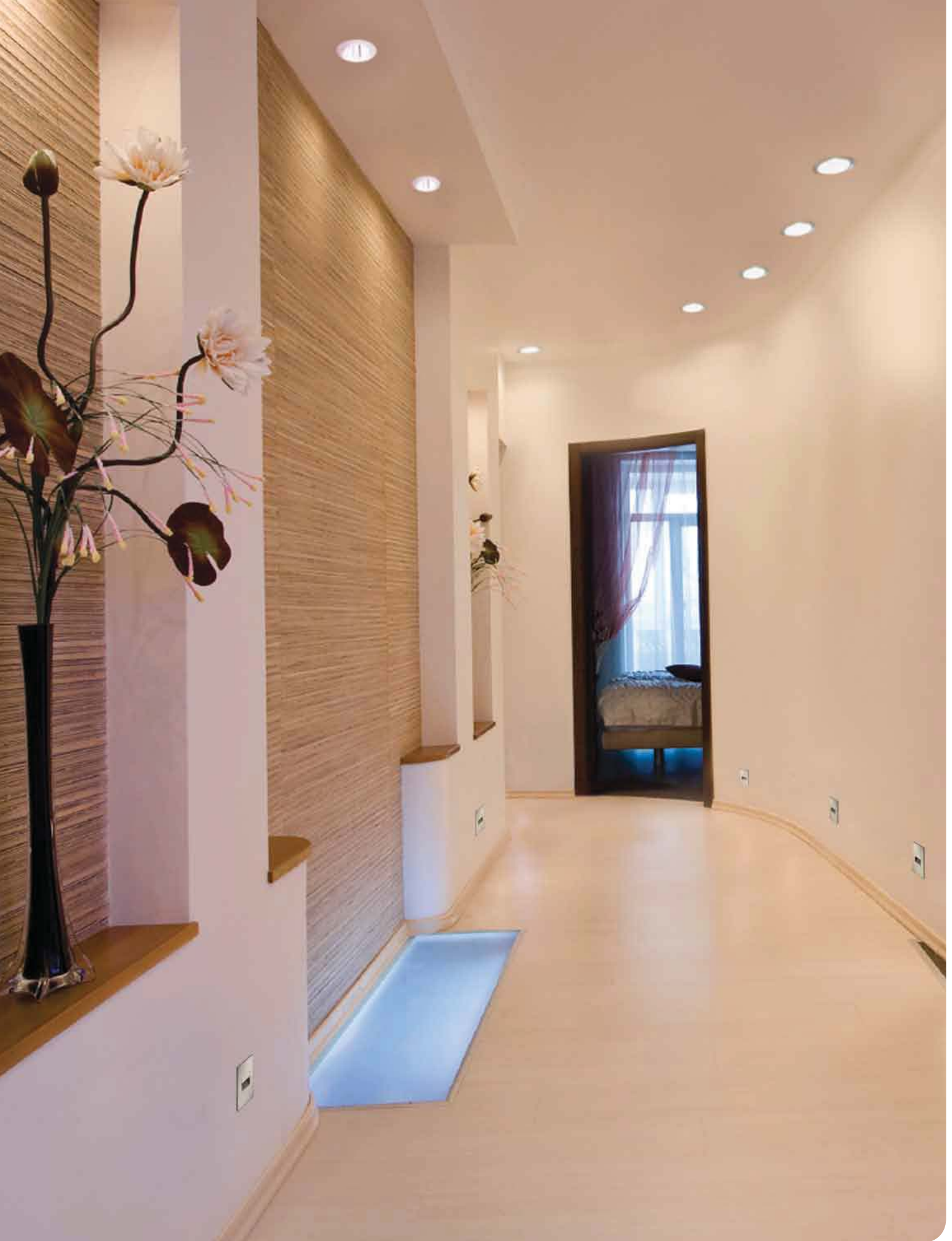

Hallway & Step Lights*



Downlighting (General)

Provide general and navigational lighting with recessed downlights. Combine fixture placement with the appropriate lamp output to create uniform lighting or pools of light that add visual interest and make the hallway appear larger.



Step Lights, Night Lights

Illuminate hallways, pathways, or stairs to provide safe navigation and add a sense of visual direction and destination.



Accent

Highlight artwork with adjustable accent lighting. Create a dramatic focal point with brightly lit objects at the end of hallways. Use mini recessed fixtures to illuminate niches and nooks.

Grazing

Introduces shadow and contrast to lend a dimensional appearance to brick, stone, stucco or textured material.



Wall Washing

Uniform illumination on walls makes hallways feel wider and brighter. Recessed wall wash fixtures provide ceiling to floor lighting, eliminating scallop patterns that can cause a cave-like effect.

D Evenly spaced hallway downlights and step lights provide a sense of visual direction and destination.

*For comprehensive lighting techniques, see pages 22-29.



Bathroom*



Downlighting (General)

For a large bathroom, use multiple downlight fixtures spaced throughout the room for general lighting. Downlights mounted over the sink or vanity brighten horizontal surfaces and provide illumination for grooming or applying makeup. Soft, flat light from wall-mounted fixtures fills-in facial shadows when using mirrors.



Accent

Selectively illuminating artwork and architectural elements can make the bathroom environment more interesting and intimate.



Shower Light

Lensed downlight fixtures approved for wet locations may be mounted in showers and above baths and whirlpools.

D Proper downlight placement combined with soft, flat light from wall-mounted fixtures fills-in facial shadows when using mirrors.

*For comprehensive lighting techniques, see pages 22-29.



Living Room*



Downlighting (General)

Provide illumination for the most dramatic room of the home. In addition to general lighting, downlights can be used to wash the walls with light, creating a brighter, more spacious environment. And Downlights can be positioned to graze the surfaces of brick, stone, or stucco to accentuate textures and add contrast.



Accent, Cove

Emphasizing focal points adds visual interest. Use narrow-beam downlights with higher light-output and adjustable trim to dramatize artwork, end tables and collectibles. Establish a mood with downlighting or linear lighting by illuminating architectural features such as columns, niches, and coves. Add miniature fixtures to built-in casework to add sparkle and further expand interior spaces.

Downlights can provide general lighting or create dramatic effects whether ceilings are flat or sloped.

*For comprehensive lighting techniques, see pages 22-29.



Precision Lighting

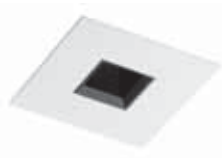

Aculux® ... the ultimate expression of recessed lighting perfection

The Aculux line of precision recessed luminaires offers elegance, style, and performance. These superb fixtures are designed to provide highly efficient illumination while producing dramatic, space-enhancing lighting effects.

Featuring precision gearing and adjustments, Aculux can put light precisely where you want it, whether you are highlighting a painting, sculpture, or tabletop ... or illuminating an entire room. And Aculux incorporates a unique adjustable platform that permits perfect fixture-to-fixture alignment. No other downlights can match the degree of precision adjustments offered by Aculux.

Aculux apertures may be either round or square and are available in sizes from 7" all the way down to stylish pinholes. Trim options range from nearly invisible tapered flanges to flush-mount designs that literally disappear into the ceiling. A spectacular collection of reflectors includes colors and finishes to complement any décor. Whether your look is contemporary or traditional, Aculux delivers stunning results quite distinct from standard recessed fixtures.

Aculux luminaires are designed for a wide range of light sources including ultra-efficient LEDs that offer unprecedented energy savings and service life. These supremely versatile fixtures excel at general, task, accent and wall wash lighting for today's leading homes and are an ideal complement to Juno's comprehensive recessed lighting collection.

Aculux adjustable luminaires complement Juno downlights adding dramatic visual appeal to any room. To learn more about the precision fixtures offered in the Aculux brand, visit www.junolightinggroup.com

Lighting Techniques & Planning Tips

General Lighting

General lighting sets the basic ambient illumination level of a space. It is important for circulation and functionality.

Uniform Downlighting

Uniform illumination provides a layer of ambient light typically used to provide general lighting on horizontal surfaces. It is important to note that, while useful, uniform illumination typically has the least visual impact on a space. Uniform illumination can be accomplished using the following techniques.

8' - 10' Ceilings

Use wide distribution LED or frosted PAR lamp downlights with a baffle or a cone, spaced approximately the same distance on center as the ceiling height. As an alternate, A-lamp/CFL multipliers will provide somewhat more diffuse/uniform illumination. Use Juno's 600 lumen LED downlights for the ultimate energy efficient option.

10' and Higher Ceilings

Medium and narrow spread LEDs or PAR lamps in downlights using a baffle or a cone provide more concentrated light beams and are effective for uniform illumination from higher ceilings. For higher ceilings, narrower beam spreads are required. Use Juno's 900 lumen LED downlights with a medium or narrow optic for the ultimate energy efficient option.

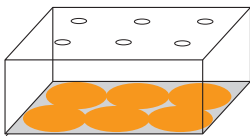

Non-Uniform Downlighting

Non-uniform downlighting provides the appearance of pools of light and can provide a more interesting visual appearance. Non-uniform illumination is generally accomplished with narrow PAR or MR16 lamps, or Juno's G3 LED downlights with the narrow optic spaced far enough apart so their beams do not overlap. Spacing is a function of the chosen lamp's beam spread and desired effect.

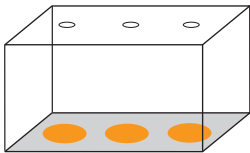

Task Lighting - Ceiling Techniques

Supplemental illumination is essential for performing tasks accurately, efficiently, and safely.

Task Lighting

Placement of recessed downlights to facilitate tasks is critical. For counter or work surface tasks, recessed fixtures should be placed between the cabinet face and the front edge of the counter. This position avoids casting of shadows and minimizes veiling reflections. Medium beam lamps will light inside of cabinets and also highlight cabinet detail, providing light on the vertical surface.

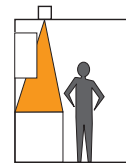

Correct



Incorrect

When lighting paper-handling tasks, adjustable downlights should be placed on each side of the task to minimize glare and veiling reflections.

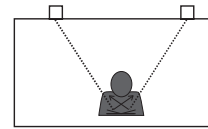

Correct

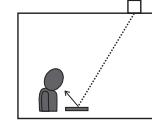

Incorrect

When lighting tasks in front of people, such as on a tabletop, it is important to locate downlights in front of the person so as not to cast unnatural/unpleasant shadows. For grooming at a vanity or mirror, provide fill lighting from a diffuse source, such as a wall sconce. Accent hardware and countertops with recessed narrow beams.

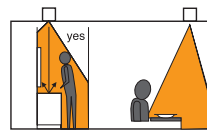

Correct

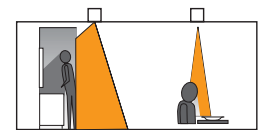

Incorrect

Application Tips

Downlight fixtures are assigned a value called spacing criteria (SC). The SC is typically a number from .5 to 1.5 and can be found on Juno product specification sheets. It indicates how close together fixtures need to be spaced in relation to the mounting height from the ceiling to the workplane or floor to achieve overlapping beams for uniform illumination. For example, if the SC of a fixture is equal to 1, you would space the fixtures a maximum of 1x mounting height for even illumination. (The mounting height can be the floor or table top 2'- 6" above the floor.) For higher levels of illumination, fixtures can be spaced closer together.

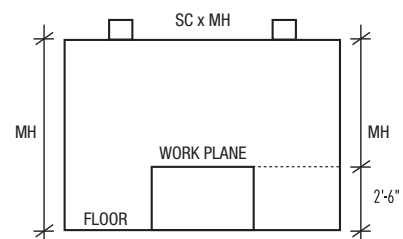

Task Lighting - Undercabinet and Indirect Linear Techniques

Juno Undercabinet luminaires place bright lighting on work surfaces by utilizing a light source located close to the task. This placement is ideal since general lighting is often blocked by a person's shadow or a shadow from upper cabinets. Undercabinet lighting provides the increased light levels required to accurately, quickly, and safely perform tasks.

Recommended Illuminance Levels

Twenty to fifty footcandles are generally adequate to perform kitchen undercabinet tasks such as food preparation or paying bills. More detailed tasks such as sewing or craftwork require 50-150 footcandles. Tasks that are very small, have intricate detail, or involve very dark surfaces may require even higher illumination levels. With the advent of dimmable halogen, xenon and LED undercabinet lighting, what was once strictly task lighting is now also used as accent lighting for granite, hardware, tile, backsplashes, and other fine finishes to provide an element of sparkle and vitality.

Accent Lighting

Cabinets and shelves create dark cavities that can detract from the aesthetics of a room. By illuminating these cavities, Juno Undercabinet fixtures create visual interest and a sense of spaciousness and, in addition, can highlight objects of interest. Juno Mini Downlights, Solo-Task and Trac 12™ linear fixtures are ideal for accent lighting applications.

Recommended Illuminance Levels: Accent lighting usually requires 20 footcandles or less.

Indirect Cove Lighting

Indirect lighting above cabinets or in architectural coves can increase the sense of spaciousness and add drama and pleasing warmth to an interior. Juno Trac 12™ linear lighting is ideal for cove lighting applications.

Recommended Illuminance Levels: Cove lighting usually requires 20 footcandles or less.

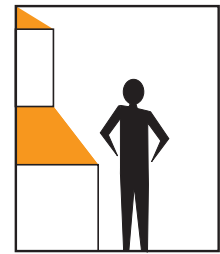

Correct

Special Design Considerations

Dark Interior Finishes

The amount of perceived light from undercabinet, accent, and cove lighting will vary greatly depending on the reflectance of surrounding surfaces. A dark countertop and backsplash will absorb light from undercabinet fixtures and diminish its apparent brightness. Likewise, indirectly illuminating a dark wood-paneled ceiling from an architectural cove will be much less dramatic than illuminating a white ceiling. Providing increased levels of illumination can partially offset light absorption by dark surfaces.

High Ambient Light Levels

The apparent brightness of a lighted countertop, cabinet interior, or cove will also vary depending on the amount of general room illumination. If the general ambient lighting is 30 footcandles, then a cabinet interior illuminated to only 20 footcandles will not appear illuminated. Conversely, in a darkened room, 20 footcandles will appear brilliant. A minimum 3:1 ratio between the focus area and background is recommended to have visual impact. A 5:1 ratio makes the focus area appear twice as bright.

Age

As age increases, so does our need for light. A typical 65-year-old needs five times more light than a teenager to experience equal visual acuity.

Shiny Work Surfaces

For high-gloss countertops and backsplashes, place the fixture at the front edge of the cabinet to minimize glare reflecting into the eyes of someone working at the counter. Keep in mind that shiny dark surfaces act like a mirror and will reflect any source of light that is placed above them. How the reflected image of one fixture appears vs. another is subjective.

Cove Lighting

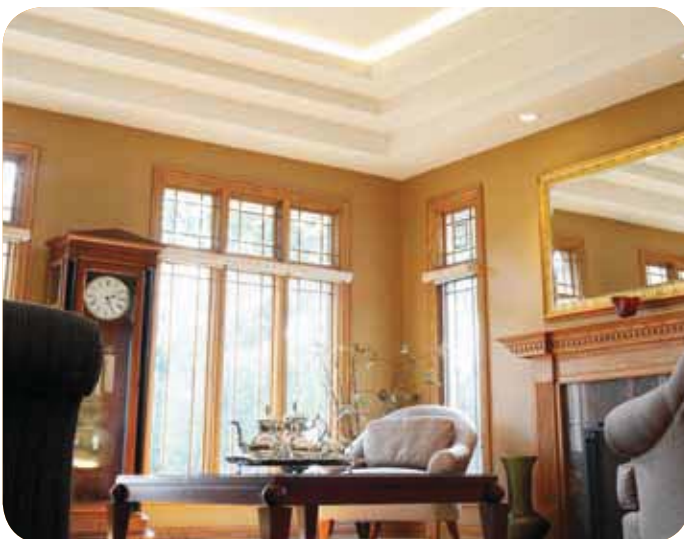

Undercabinet Lighting



Accent Lighting

Accent lighting creates high contrast on objects of interest such as sculptures, paintings, collectibles and architectural details. For noticeable visual impact, accent lighting should be at least three times as bright as the surrounding area. More dramatic accent lighting requires contrast ratios of 5:1 or greater. Smaller objects such as figurines or gem stones will benefit from even higher ratios of up to 20:1.

Accent lighting of flat artwork

Flat art is ideally illuminated by a light source striking its surface at a 30° angle. This eliminates reflected glare from vertical glass and prevents casting a shadow of the viewer onto the artwork. To determine the correct distance from wall to fixture you can use the formula listed below or the quick reference chart on the right.

Formula to calculate luminaire distance from the wall for a 30° aiming angle where H = Distance from the ceiling to the aiming point and D = Distance from the wall to the center of the luminaire. (The aiming point is generally located at 1/3 down from the top of the picture or object.)

$$D = H \times .6$$

Example: $D = 4.5' \times .6 = 2.7'$ or approximately 2'-8"

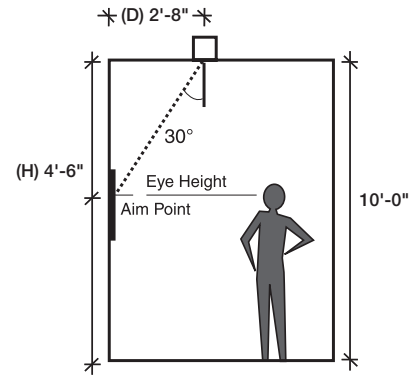

If the formula places the fixture on a beam or mechanical obstruction, move the fixture closer, **not** farther back.

Accent lighting of three dimensional objects

"Key and fill" is an effective technique for accentuating the three-dimensional character of an object. This technique uses key and fill lighting from two sides of the object. Key lighting is a "hard" accent light used to create shadows and highlight an object's form and texture. Fill lighting is a softer light directed from the opposite side of the object to soften the shadows, making the object appear more natural. Other techniques can also be applied to further accentuate unique features, such as silhouetting an object from behind with a wall wash.

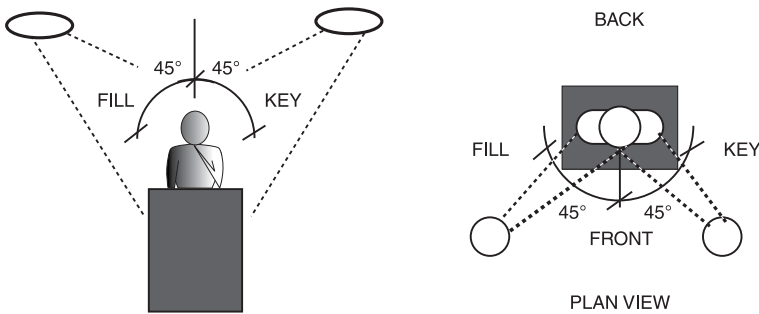

Accent Lighting Fixture/Lamp Choices:

12-volt MR16 adjustables are the fixture of choice for accent lighting due to their small aperture; intense beam spreads; and available range of light control and color correction accessories — see pages 82-84 for low-voltage MR16 housings and trims.

PAR36 adjustables are ideal for longer throw distances up to 30', where tightly controlled pinspots of light are required.

PAR lamp adjustables provide less costly accent lighting and are well suited for illuminating larger objects or areas such as fireplaces, coffee tables, large art or murals, potted trees, etc — see the TC46 housing on page 85.

Wall Lighting

The illumination of vertical surfaces can impact the perception of a space more than any other type of lighting. Light reflecting off of walls creates a bright, spacious feel and adds visual interest.

Wall Washing

Wall washing provides even, diffuse illumination of vertical surfaces such as walls, large paintings, wall hangings, bookcases and shelving, cabinet fronts (glass not recommended), or stairwells. The desired effect is that of an even blanket or "wash" of light without hot spots or scallops. The diffuse nature of wall wash illumination has the effect of flattening out textured surfaces.

Wall wash luminaires are usually spaced equal to the set back distance from the wall. Closer spacing leads to higher light levels with better uniformity. There are three fixture types that are most commonly used to achieve uniform wall washing:

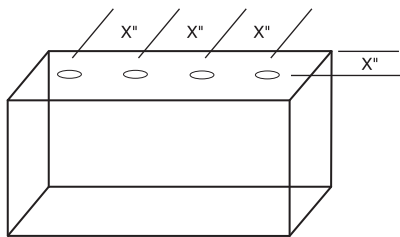

Scoop Wall Wash Trims

These are the most economical type of wall washer. The combination of a directional reflector and a light "scoop" direct light toward the wall. Most residential scoop wall washers utilize A-lamps or LEDs. Scoop wall wash trims are generally spaced 20" - 30" from the wall and 20" - 30" apart.



Lensed PAR/MR Wall Washers (Aculux® only)

These utilize an internal kicker reflector and a special spread lens to more efficiently put light on the wall. Lensed wall washers produce a soft, slightly vertical pattern that can be used singularly or in multiples. MR16 lensed wall washers are generally spaced 12" - 18" from the wall and 12" - 18" apart. PAR lamp, lensed wall washers are generally spaced 2' from the wall and 2' apart. Consult specification sheets for specific information on spacing and light levels.



A-lamp/CFL Downlight/Wall Washers (Aculux® only)

These open multiplier fixtures with an integral "kicker" reflector combine downlighting and scallop-free wall washing into a single luminaire. Reflector configurations are available to light a single wall, opposite walls (such as in a corridor), or a corner. These luminaires are almost always used in multiples, and offer the appearance of standard multiplier downlights. Open/downlight wall wash trims are generally spaced 24" - 36" from the wall and 24" - 36" apart.



Single



180° Double



180° Corner

Grazing

By placing downlights 6" - 12" on center from a wall, a grazing effect can be achieved on textured surfaces such as brick, stone or stucco. PAR or narrow flood LEDs are a good source to use for grazing. (**Note:** Grazing on smooth surfaces is not recommended as it will magnify any surface imperfections).

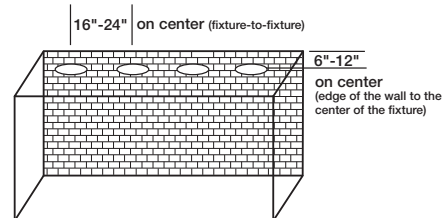

Light Scallops

Light scallops can be an intentional or unintentional effect of a downlighting plan. A row of downlights close to the wall will cause light scallops, which can add visual interest to a space. The more diffuse the light source and trim, the softer the scallop. For example an R/BR-lamp mounted in a white baffle trim will barely create any scallop; a PAR lamp in a deep-black baffle trim will cause a crisp scallop. The most defined scallop effect is accomplished with an A-Lamp or CFL multiplier. You should also be mindful of the vertical location of the center of scallops relative to architectural features such as cabinet frames, doorways, windows, etc. The best scallop effect should be symmetrical and requires careful measurement and planning.

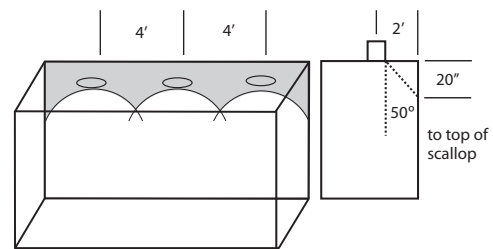

Well placed Light Scallops using 6" downlights

Scallop height will vary with setback, trim, and lamp combination. The lower the ceiling, the higher the scallop tips should be, e.g. on an 8' ceiling, the scallop peaks should be approximately 9" - 15" from the ceiling.

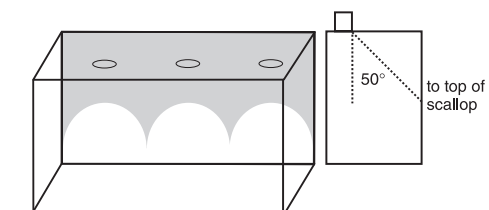

Scallops placed too low on wall will cause a "cave effect"

Pendant Lighting (Kitchen Island)

Hanging pendants with glass or fabric shades are functional, beautiful pieces of art that provide surface mood lighting. An odd number of pendants is usually desirable for symmetrical spacing. The “middle” pendant should be placed in the center of the kitchen island, and each subsequent pendant should be spaced 18" to 24" on center for smaller sizes or up to 30" on center for larger sizes. The recommended mounting height, measured from the bottom of the pendant shade to the top of the surface (countertop/tabletop), is typically 29" to 33". Avoid placing the pendants directly over the edge of the counter; 12" to 14" from each edge is recommended.

Note: The greater the bottom diameter (aperture) of the pendant, the lower it should be mounted to avoid glare and visual exposure to the lamp. Pendant height also will vary depending on the height of the individuals living in the space.

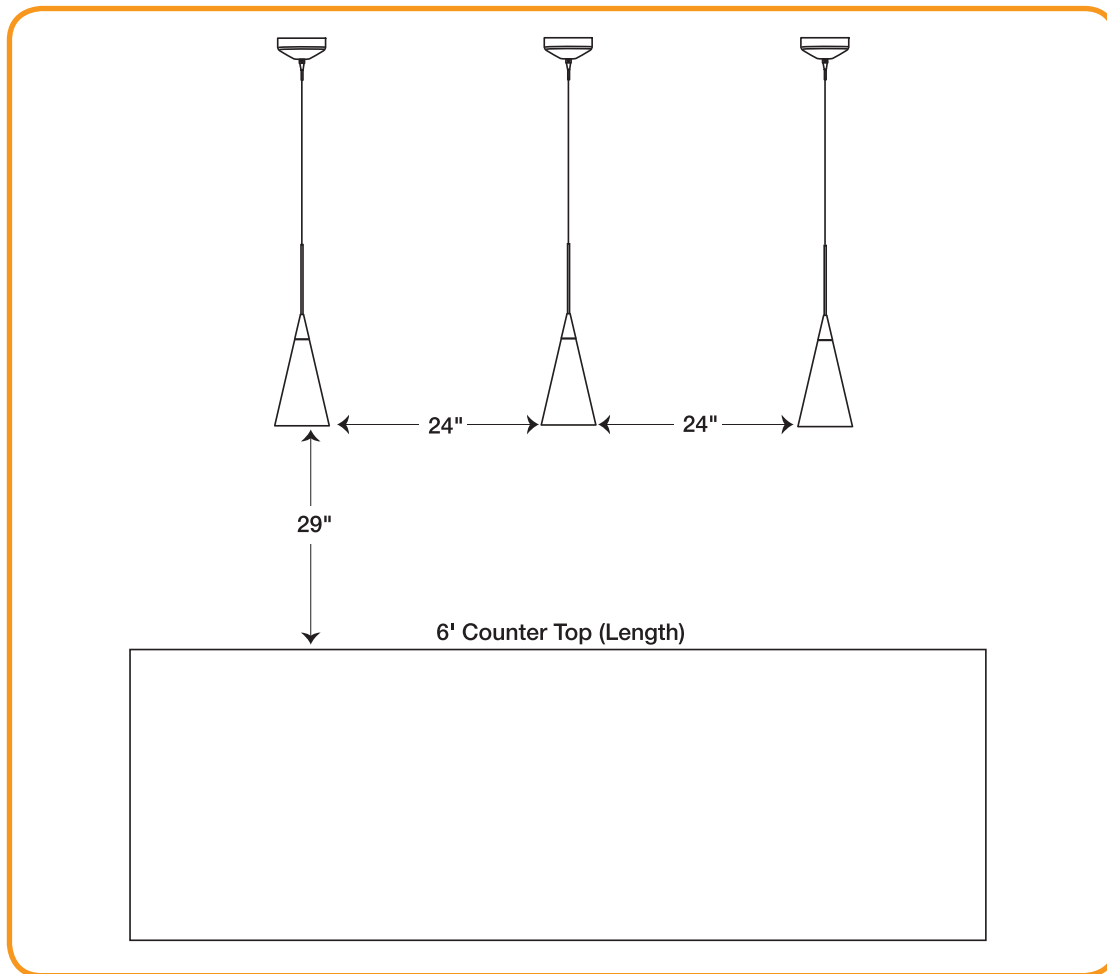



Lamp and Trim Selection

Juno recessed housings are designed to accept a variety of different lamp types and trims. Each lamp type has unique performance characteristics and each trim has a different function and/or appearance. The following information will help you select the best lamp type and trim for your application.

Lamp Types

Lamps for recessed lighting can be categorized into directional and diffuse. Directional lamps contain integral reflectors to direct and control the light. Diffuse lamps produce omni-directional light and are used in conjunction with trims that have reflectors to control their distribution.

Directional Lamps

LED (Dedicated)

LED light sources can be integral to the fixture or a screw-in retrofit. Light output and color consistency have improved dramatically since LEDs were first introduced, and today they represent the state of the art in residential lighting. LEDs are more easily dimmed than CFLs, have a 50,000-hour rated life, and produce minimal UV with virtually no projected heat. Although more expensive than conventional light sources, LEDs are very energy efficient and especially useful for inaccessible locations or where long lamp-life lighting applications are desirable, such as kitchens, tall ceilings, etc. Optimal performance results from integrating the LED package into the housing design so that internal heat is well dissipated and the optics are customized for the LED light engine. This approach is superior to the "one size fits all" nature of screw-in retrofit LEDs. Juno dedicated LED housings typically offer 50,000-hour rated service life.

Incandescent R and BR lamps

R (reflector) and BR (bulge reflector) lamps are made of "soft glass" with an integral funnel shaped reflector. These lamps are available in several sizes and wattages in both spot and flood patterns and are the most economical type of directional lamp. R/BR Flood lamps produce a pleasant, warm, diffuse light well suited for general ambient illumination and subtle directional lighting. Like the incandescent A-lamp, R and BR lamps are subject to increasing legislative regulations on energy consumption. Typical rated life: 2,000 hours.

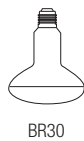

BR30

Halogen PAR lamps

Parabolic Aluminized Reflector (PAR) lamps are similar to R lamps, but have a more controlled lens/reflector optical system. Clearly recognizable by their thicker pressed glass construction, these halogen sources produce whiter, more concentrated beams of light. Available in a wide variety of sizes, wattages, and beam spreads, PAR lamps are well suited for higher-level ambient lighting, task lighting, and accent lighting. Typical rated life: 2,000 hours.



PAR30L

MR16 & PAR36 low-voltage lamps

These halogen sources have smaller "point-source" filaments that are accurately aligned in integral computer designed reflectors. This combination produces precisely controlled beams of light in a tremendous variety of beam patterns and intensities. Low-voltage lamps are used in special fixtures that contain a step-down 12-volt transformer. They are best used to precisely highlight artwork, sculpture, and architectural details and to create other dramatic effects. Typical rated life: MR16-5,000 hours, PAR36-2,000 hours.



MR16



PAR36

Diffuse Lamps

Incandescent A-Lamps

Also known as general service lamps, A-lamps provide a soft, warm, uniform ambient illumination. They are ideally suited for use in downlight and wall wash trims that contain integral reflectors. Incandescent A-lamps are the most economical, often costing less than a dollar each. White coated A-lamps are preferable to the generic inside frost types. Typical rated life: 750 hours.



A-Lamp

Halogen A-line Lamps

Similar in appearance to incandescent A lamps, halogen A-line lamps incorporate a halogen capsule inside as opposed to a standard bare filament. Like all halogen sources, they are typically whiter, brighter, and last longer than standard incandescent lamps. As energy regulations become more restrictive, these could replace standard incandescent A lamps, since they are about one third more energy efficient.



BT15

Compact Fluorescent Lamps (Dedicated)

Compact Fluorescent Lamps (CFL) are similar in size and light output to A-lamps, but produce 3-5 times more light per watt consumed. This energy savings, combined with a significantly longer rated life, makes them ideal for ambient lighting in rooms such as kitchens which experience long burning hours. CFLs are used in special recessed housings with integral ballasts that regulate the starting and operating current. CFLs are more difficult and costly to dim and do not create the characteristic intimate feeling associated with dimmed incandescent or halogen lamps. Typical rated life: 10,000 hours.



Color Temperature

Lamps have different color characteristics that can affect the appearance and feel of a space. The color that a lamp produces is expressed as its Color Temperature, in degrees Kelvin (K). Like an iron in a fire, the higher the temperature, the cooler the color of the light. Standard incandescent lamps have a 2700° K color that is warm and familiar... something you might associate with a table lamp or chandelier. Halogen lamps have a whiter, crisper 3000° K color. Halogen lamps are also more efficient than standard incandescent lamps, producing up to 50% more light per watt of energy consumed. Both standard incandescent and halogen lamps can be dimmed to create a warmer, more intimate atmosphere. (Placing incandescent or halogen lamps on dimmers also will considerably extend their service life.)

Lamp and Trim Selection, continued

Trim Styles

Recessed trims are available in a variety of basic aperture styles described below. The correct aperture style for a given application is partially dependent on personal preference.

Baffles

Baffles are the most popular of all residential recessed trims. They are deeply grooved to absorb extraneous light and create a crisp architectural appearance. They are economical, easy to maintain, and available in black or white. Black baffles have low aperture brightness. White baffles blend with the ceiling to eliminate the appearance of dark holes and serve to soften light scallops on adjacent walls.



Cones

Cones produce a low brightness aperture with a choice of polished clear, gold, black, haze, wheat haze or pewter. Clear and gloss white cones are the least conspicuous, gold provides a warm accent to a room, and black serves to more fully obscure the lamp and lamp image. Haze has a softer, cool appearance, depending on the light source, that blends with white ceilings. Wheat haze has a soft, warm appearance that coordinates with warmer-tone interior finishes.



Multipliers

Multipliers are similar in appearance to cones but are designed to control the omni-directional light from diffuse A-lamps and CFLs. They are available in white, clear, gold, haze and wheat haze finishes.



Lensed

Lensed apertures are designed to provide a very diffuse light quality and to protect the lamp. They are particularly useful in wet locations such as bathrooms and eave lighting, as well as closets and pantries.



Luminous

Luminous trims combine the diffuse quality of a lensed trim but with an open downlight component. Luminous trims provide efficient downlighting while producing a pleasing, soft glow of light on the ceiling and upper part of walls.



Adjustables

Several types of adjustable trims are available for accent and perimeter lighting. Eyeball style trims are the most economical. Gimbal rings and recessed adjustables provide excellent adjustability while concealing the light source.



Wall Washers

A variety of wall wash trims are designed to provide even ceiling to floor illumination of vertical surfaces without light scallops. The scoop wall wash is the most economical. Lensed PAR lamp wall washers put more light on the wall and multipliers with cut-out "kicker" reflectors provide a combination of efficient downlighting and wall wash illumination.



What trim size is right for the application?

This is a commonly asked question that does not have a single answer. Generally, smaller aperture trims are less conspicuous and therefore considered more architecturally desirable. Six-inch trims are still the mainstay for general residential downlight and wall wash illumination, due to their ability to accommodate a wide range of lamps, wattages, and efficient optics. Five-inch trims have become popular for task lighting, and even general lighting in smaller scale settings. Four-inch trims are useful for task and accent lighting with short throw distances and/or lower light level requirements, such as over a bar or counter. They have also become the choice for inconspicuous yet powerful precision accent lighting. Juno's unique three-inch trims find use in close proximity downlighting in niches and casework. Juno's one-inch LED mini-downlights and gimbals are also ideal for these types of applications. With the advent of LEDs, smaller apertures can now provide lumen output previously achieved in only larger sizes.



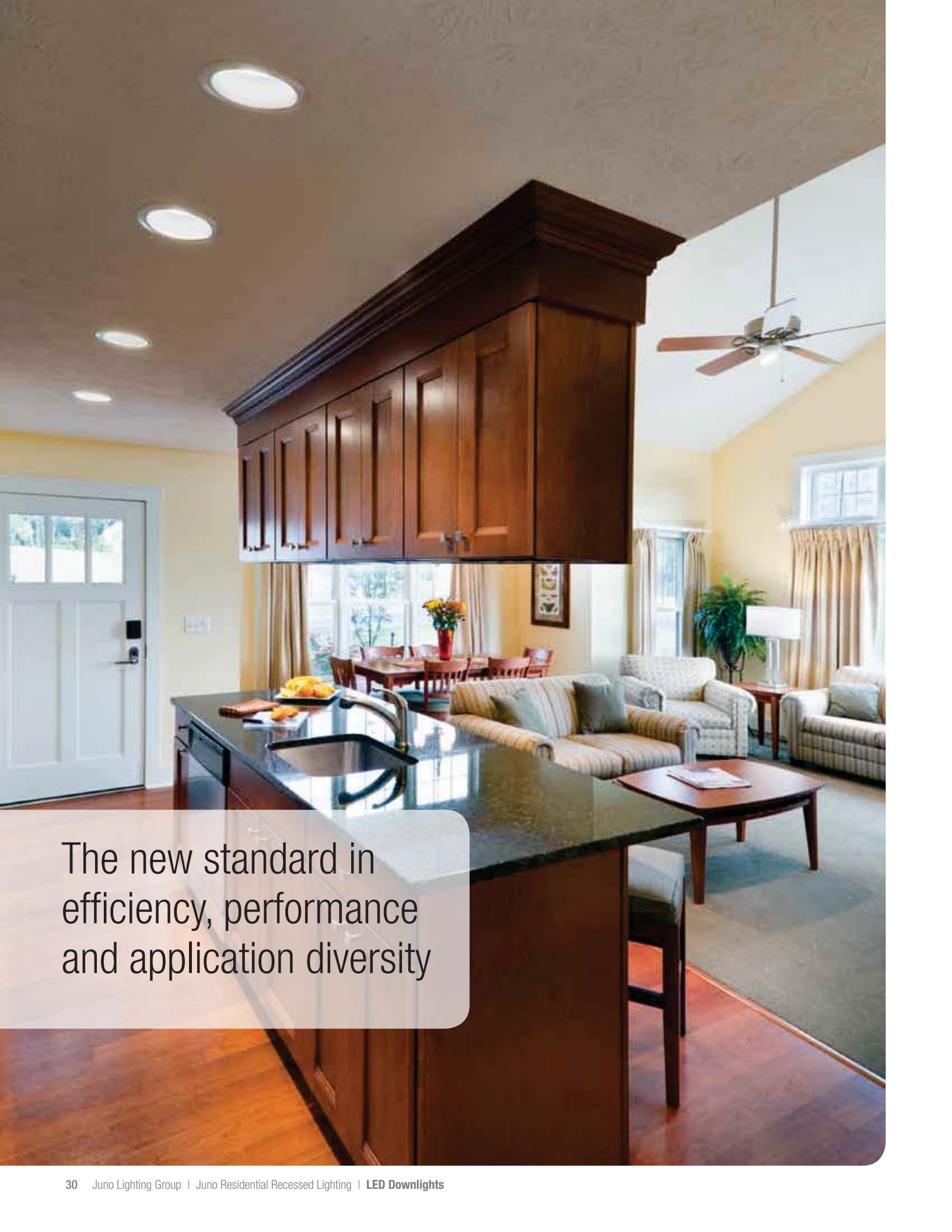

The new standard in efficiency, performance and application diversity

LED Downlights

Juno LED downlights are setting new standards for efficiency, performance and application diversity.

Since their inception, Juno LED Downlights have been an unqualified success, offering unprecedented energy savings, superior quality, brilliant white light, and exceptional service life. The Juno LED product family has taken another step forward with a host of LED fixtures; Generation 3 downlights, slope and super-slope downlights, mini downlights, and mini gimbals, as well as Retrofit LED modules available in a downlight and eyeball version.

No matter what your application, you'll find that Juno LED Downlights have advanced the art and science of illumination to the next plateau, with a range of fixtures that are engineered in the USA by our highly regarded design team.

Juno LED Advantages

- LEDs use as little as 15% of the energy of conventional lighting
- Expected service life of 50,000 hours
- 25-times the life expectancy of incandescent
- Typically offer 11-years or more of maintenance-free operation
- LEDs contain no toxic lead, mercury, or PCBs
- Available with exclusive Juno WarmDim[®] technology
- 1", 4", 5", 6" aperture options
- 600 or 900 lumens can be used in IC or TC applications
- 2700K, 3000K, 3500K, or 4100K color temperature options
- Available with standard Juno trims



LED housings ... the energy-efficient advantage



ENERGY STAR®

Most Juno LED Downlights are listed as ENERGY STAR Qualified to luminaire V1.1 requirements. ENERGY STAR is a government sponsored program that establishes criteria and testing requirements to ensure energy efficient luminaires meet consistent performance standards. Many local utilities offer builder and homeowner rebates for installing ENERGY STAR Qualified products.



T24

Juno LED Downlights are certified to meet the high efficacy requirements of California Title 24-2008.



Air-Loc®

Juno IC LED housings are Air-Loc rated and designed to minimize air leak paths. Air-Loc rated housings are tested in accordance with ASTM E283 and certified by an independent laboratory to be in compliance with the minimum air-leakage standards as set in the International Energy Conservation Code, as well as several state energy codes, including Washington State.

The industry's most comprehensive LED downlight offering



Housings

Juno offers the most comprehensive LED lineup in the industry, including downlights for standard and slope ceilings; new construction, remodel, and retrofit; plus adjustable eyeballs, minis, and gimbals. Generation 3 LED downlights are available with IC or TC rated housings with light output up to 900 lumens. And they are all designed and engineered in the USA to the very highest standards.

Color Temperature Offering

Select from a large range of color temperatures to suit any application: 2700K, 3000K, 3500K and 4100K.

Trims

Juno LED downlights are as beautiful as they are efficient. The extensive trim options include baffle, cone, decorative, lensed, and wall wash in a wide variety of handsome colors and finishes. The trim collection is compatible with both 600- and 900-lumen housings.



Juno LED Downlight Index

	4", 5", 6" 600 Lumen, WarmDim® LED Dimming Captures all the warmth and ambiance previously achieved only with incandescent dimming. See WarmDim Retrofits on pages 58-60.	36 - 41
	4", 5", 6" 600 Lumen, IC New Construction and Remodel Low wattage operation for task and accent illumination; accepts downlight, wall wash or lensed trims.	42 - 53
	5" and 6" 900 Lumen, IC New Construction and Remodel Low wattage housings for use where higher levels of illumination are desired; accepts downlight, wall wash, or lensed trims.	50, 54
	6" 600 and 900 Lumen, Retrofit Downlight Trim Module Quickly and economically upgrades standard recessed downlight housings to efficient LED illumination. Also available in WarmDim® LED Technology.	56-58
	6" 600 and 900 Lumen, Retrofit Eyeball Trim Module Quickly and economically upgrades standard recessed housings to efficient LED illumination; for applications requiring adjustability. Also available in WarmDim® LED Technology.	56, 60
	Mini Downlight and Gimbal An ideal solution for illuminating niches, bookcases, soffits, and other confined areas. The gimbal provides fully adjustable illumination for confined spaces.	62 -63



Standard LED dimming

Juno WarmDim dimming

WarmDim[®] LED Dimming 4", 5" and 6", 600 Lumen LED Downlights



Juno technology breakthrough brings warmth to LED dimming

Juno Generation 3 LED Downlights with the exclusive patent pending WarmDim feature bring atmosphere and romance to LED lighting. Juno WarmDim downlights incorporate a proprietary, micro-processor controlled light engine that warms the LED color temperature while dimming to capture all the warmth and ambiance previously achieved only with incandescent dimming. Now you can match the mood to every occasion while still experiencing the operating efficiencies of LED lighting. It's a Juno first ... a Juno exclusive for recessed downlights.

Like all the downlights in the Juno Generation 3 family, the WarmDim version raises the bar for LED efficiency, producing over 600 lumens of high-quality light while using just 14 watts. They are offered in new construction and remodel housing styles and are approved for use in both insulated and non-insulated ceilings. They include push-in electrical connectors and all the easy-installation features you have come to expect from Juno.



6" WarmDim LED housing shown.

- A. WarmDim® LED light engine:** Proprietary WarmDim technology features micro-processor controlled dimming that replicates the warmth of incandescent dimming. Generation 3 LED array produces 600 lumens from just 14 watts. LEDs are binned to exceed ENERGY STAR® requirements, providing superior fixture-to-fixture color uniformity. Offered in 3000K LED CCT with 83 CRI typical at full lumen output.
- B. LED driver:** Dedicated 120V LED driver supports WarmDim forward phase dimming using readily available incandescent, magnetic low-voltage, and electronic low-voltage dimmers.
- C. Effective thermal management:** The LED light engine is integrated into a one piece, high-purity aluminum, thermally conductive housing that provides uninterrupted heat transfer. This efficient thermal management system assures that at the end of their 50,000-hour service life, the LEDs can be expected to produce 70% of their initial light output with no perceptible color change.
- D. Versatile installation:** The low-profile housing fits easily within 2 x 6 ceiling joists, facilitating installation in shallow applications. New construction housings are supplied with the Juno Real Nail 3® bar hanger system. For suspended ceilings, the integral T-bar notch can be used to secure the housing onto the ceiling grid – no accessory clips required. See page 43 for a full description on the Real Nail® 3 bar hangers.

E. Efficient, low-glare optics: The reflector and high-transmission diffusing lens are computer optimized for each aperture size, producing an optic system that provides uniform light distribution and reduced glare. The lens conceals the LED light source, yielding an aesthetic similar to deeply regressed PAR lamps. For the 5" and 6" downlights, wide-flood beam pattern is standard; a medium-flood pattern is also available and can be changed easily via the convenient twist-and-lock accessory feature.

F. Extensive trim collection: WarmDim LED recessed housings are compatible with a broad selection of existing Juno 4", 5" and 6" open and lensed trims. For wall wash applications, a dedicated LED scoop trim is also available for 5" and 6" housings.

Unlike traditional LED dimming, Juno WarmDim® warms as it dims, emulating incandescent dimming.

Traditional LED Dimming

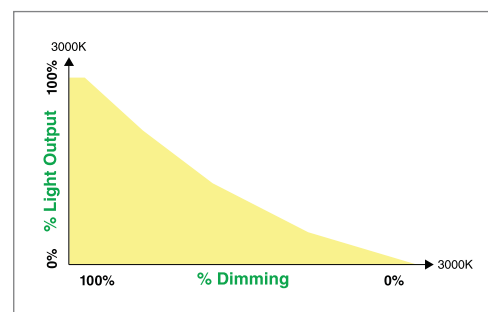

Juno WarmDim® Dimming

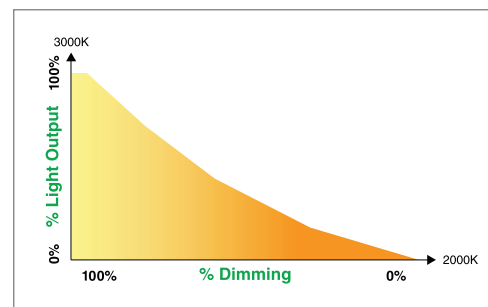

4" IC-Rated 600 Lumen WarmDim[®] LED Downlights

Juno's exclusive WarmDim technology brings the warmth and atmosphere of incandescent dimming to the world of LED downlighting. The smaller 4" aperture size blends inconspicuously into the ceiling.



4" WarmDim[®] IC1LWDG3 Series



(New Construction Shown)



Dedicated 4" WarmDim LED new construction or remodel housings with integral light engine and dimmable driver. 14W nominal dedicated 120V driver with forward phase and ELV dimming. Shallow housing allows for fit into a 2x6 construction. IC housing is designed for use with IC or Non-IC construction. Wide flood optic provided as standard.

New Construction

12¼" L x 6¾" W x 6" H
Ceiling cutout: 4½"

Remodel

14⅝" L x 4¾" W x 4⅜" H
Ceiling cutout: 4⅝"

Qualified Dimmers

Compatible with incandescent, magnetic low voltage or electronic low voltage wall box dimmers.

Refer to catalog # on www.junolightinggroup.com for the specific list of Juno Lighting Group qualified dimmer model numbers on the specification sheet.

Example: IC1RLWDG3-3K-1

Housing	Color Temp.	Input Voltage
IC1LWDG3 (New Construction)	3K 3000K	1 Dedicated 120V Only,
IC1RLWDG3 (Remodel)		(forward phase and ELV dimming)

4" LED Downlight Trims

The trims shown here may be used with any 4" IC-Rated 600 Lumen WarmDim[®] LED housings shown on page 36.

Downlights	Decorative	Lensed	
 <p>Pinhole with Integral Shield 13-WH White 2" Aperture</p>	 <p>Beveled Cylinder 4103FROST-WH 4103FROST-SC 3" Aperture</p>	 <p>Drop Opal 11-WH</p>	 <p>Beveled Dome - Lensed 4101-ABZ 4101-SC 4101-WH</p>
 <p>Baffle 14B-WH Black 14B-SC Black 14B-ABZ Black 14B-BL Black 14W-WH White 3 3/8" Aperture</p>	 <p>Beveled Cone 4104HZ-SC Haze 4104WHZ-ABZ Wheat Haze 3 3/8" Aperture</p>	 <p>Frosted Lens with Clear Center 12W-WH 12W-SC 12W-ABZ</p>	 <p>Beveled Lens 4102-ABZ 4102-SC 4102-WH</p>
 <p>Cone 17C-WH Clear Alzak[®] 17G-WH Gold Alzak[®] 17B-WH Black Alzak[®] 17PT-SC Pewter Alzak[®] 17W-WH Gloss White 17HZ-WH Haze 17WHZ-WH Wheat Haze 17WHZ-ABZ Wheat Haze 3 3/8" Aperture</p>	 <p>Glass Cylinder 4150MESH-SC 2 5/8" Aperture</p>	<p>Trim Ring Finishes ABZ: Classic Aged Bronze WH: White SC: Satin Chrome BL: Black</p>	

ENERGY STAR[®] Qualification and T24 certification is dependent on trim finish.

5" IC-Rated 600 WarmDim[®] LED Downlights

Juno 5" WarmDim LED downlights warm as they dim, emulating the romantic mood of incandescent dimming. Ultra-efficient LED illumination saves energy and offers a remarkable rated service life of 50,000 hours.



5" WarmDim[®] IC20LWDG3 Series



(New Construction Shown)



Dedicated 5" WarmDim LED new construction or remodel housings with integral light engine and dimmable driver. 14W nominal dedicated 120V driver with forward phase and ELV dimming. Shallow housing allows for fit into a 2x6 construction. IC housing is designed for use with IC or Non-IC construction. Wide flood optic provided as standard.

New Construction	Remodel
15¼" L x 9⅞" W x 4⅞" H	13½" L x 5⅞" W x 4⅞" H
Ceiling cutout: 5⅝"	Ceiling cutout: 5½"

Example: IC20RLWDG3-3K-1

Housing	Color Temp.	Input Voltage
IC20LWDG3 (New Construction)	3K 3000K	1 Dedicated 120V Only, (forward phase and ELV dimming)
IC20RLWDG3 (Remodel)		











Qualified Dimmers

Compatible with incandescent, magnetic low voltage or electronic low voltage wall box dimmers.

Refer to catalog # on www.junolightinggroup.com for the specific list of Juno Lighting Group qualified dimmer model numbers on the specification sheet.

5" LED Downlight Trims

The trims shown here may be used with any 5" IC-Rated 600 Lumen LED WarmDim[®] housings shown on page 38.

Downlights	Wall Wash	Lensed	
 <p>Downlight Baffle† 205W-WH White 205B-WH Black 205B-SC Black 205B-ABZ Black 4 3/8" Aperture</p> 	 <p>Wall Wash 213G3W-WH White 213G3B-WH Black</p>	 <p>Flat Glass Shower Trim* 210N-ABZ 210N-SC 210N-WH</p> 	 <p>White Baffle, Regressed Frosted Dome Lens* 2130W-WH 2130B-WH</p> 
 <p>Downlight Cone† 204C-WH Clear Alzak[®] 204G-WH Gold Alzak[®] 204B-WH Black Alzak[®] 204PT-SC Pewter Alzak[®] 204W-WH Gloss White 204HZ-WH Haze 204WHZ-WH Wheat Haze 204WHZ-ABZ Wheat Haze 4 3/8" Aperture</p> 		 <p>Frosted Lens with Clear Center* 212N-ABZ 212N-SC 212N-WH</p> 	 <p>Beveled Frame, Frosted Dome Lens* 5101-ABZ 5101-SC 5101-WH</p> 
<p>Trim Ring Finishes ABZ: Classic Aged Bronze SC: Satin Chrome WH: White</p>	<p>Accessories</p>  <p>Catalog Number LEDOPTICG3-M SMPLT-5</p>	<p>Description Medium Flood Optic (50° beam) Galvanized steel plate for locating remodel style housings in new construction. Screw/nail holes for full coverage between 16" & 24".</p>	

ENERGY STAR[®] Qualification and T24 certification is dependent on trim finish.
See housing spec sheet on www.junolightinggroup.com for specific information for each trim.

* Do not use reflector shipped with trim for LED housing. Discard or recycle reflector.
† See accessory page 161 for additional trim ring finishes, order separately.

6" IC-Rated 600 Lumen WarmDim[®] LED Downlights

Juno's exclusive WarmDim LED downlights replicate the effect of incandescent dimming, offering a warm, natural glow as light levels are reduced. The 6" housings feature the largest selection of trims and accessories.



6" WarmDim[®] IC22LWDG3 Series



(New Construction Shown)



Dedicated 6" WarmDim LED new construction or remodel housings with integral light engine and dimmable driver. 14W nominal dedicated 120V driver with forward phase and ELV dimming. Shallow housing allows for fit into a 2x6 construction. IC housing is designed for use with IC or Non-IC construction. Wide flood optic provided as standard.

New Construction	Remodel
15 1/4" L x 9 1/8" W x 4 7/8" H	14 1/2" L x 7 1/4" W x 5 1/8" H
Ceiling cutout: 6 3/4"	Ceiling cutout: 6 3/4"

Qualified Dimmers

Compatible with incandescent, magnetic low voltage or electronic low voltage wall box dimmers.

Refer to catalog # on www.junolightinggroup.com for the specific list of Juno Lighting Group qualified dimmer model numbers on the specification sheet.

Example: IC22RLWDG3-3K-1

Housing	Color Temp.	Input Voltage
IC22LWDG3 (New Construction)	3K 3000K	1 Dedicated 120V Only, (forward phase and ELV dimming)
IC22RLWDG3 (Remodel)		

Also see WarmDim[®] Retrofit LED Downlight and Eyeball Trim Modules on pages 58-60.

6" LED Downlight Trims

The trims shown here may be used with any 6" IC-Rated 600 Lumen LED WarmDim[®] housings shown on page 40.

Downlights



Downlight Baffle†
24W-WH White
24B-WH Black
24B-SC Black
24B-ABZ Black
24B-BL Black
5¾" Aperture



Downlight Cone†
27C-WH Clear Alzak[®]
27G-WH Gold Alzak[®]
27B-WH Black Alzak[®]
27PT-SC Pewter Alzak[®]
27W-WH Gloss White
27HZ-WH Haze
27WHZ-WH Wheat Haze
27WHZ-ABZ Wheat Haze
5¾" Aperture



Decorative



Octagonal
9024W-WH
5¾" Aperture

Decorative, cont.



Luminous Disc (Frosted)
9324-SC
3¼" Aperture



Metal Band
9524-SC
5¾" Aperture



Luminous Collar (Frosted)
9702
6¾" Aperture

Wall Wash



Wall Wash
262G3W-WH White
262G3B-WH Black

Lensed



Albalite
20-PW Shower/
Closet Light
20-WH



Drop Opal
21-PW Shower/
Closet Light
21-WH



Fresnel
22-WH

Lensed, cont.



Frosted Lens*
239-WH



Frosted Lens with Clear Center
242-ABZ
242-SC
242-WH



Decorative Swirled Etched Opal Glass*
243-WH



White Baffle, Regressed Frosted Dome Lens*
2330W-WH
2330B-WH



Beveled Frame, Frosted Dome Lens*
6101-ABZ
6101-SC
6101-WH



Trim Ring Finishes

ABZ: Classic Aged Bronze **SC:** Satin Chrome
WH: White **BL:** Black
PW: Plastic White (Polycarbonate material shower trim)

Accessories



Catalog Number **Description**
LEDOPTICG3-M Medium Flood Optic (50° beam)

ENERGY STAR[®] Qualification and T24 certification is dependent on trim finish.
See housing spec sheet on www.junolightinggroup.com for specific information for each trim.

* Do not use reflector shipped with trim for LED housing. Discard or recycle reflector.

† See accessory page 161 for additional trim ring finishes, order separately.



Generation 3 4" IC-Rated 600 Lumen LED Downlights



Ultra-efficient LED lighting with extra style and flair

The smaller aperture of the 4-inch, Juno Generation 3 LED downlight offers the “designer-look” that perfectly complements many of today’s upscale residential interiors. These ultra-efficient fixtures produce 600 lumens of brilliant white light, while requiring just 10.5-watts input to deliver over 60 lumens per watt. Offered in new construction or remodel housing styles, they are approved for use in both insulated and non-insulated ceilings. They include push-in electrical connectors and all the easy-installation features Juno is famous for.



- A. Generation 3 LED light engine:** Advanced LED technology produces 600 lumens from just 10.5-watts input. LEDs are binned to exceed ENERGY STAR® requirements and provide superior fixture-to-fixture color uniformity. Color temperatures of 2700K, 3000K, 3500K, and 4100K are available; 83 CRI typical.
- B. Superior thermal management:** Double wall, shallow construction. LED array is attached to high-purity aluminum, thermally conductive inner housing and heat sink, which provides superior heat transfer to ensure long life of LEDs. At the end of their 50,000 hour rated life, the LEDs can be expected to produce 70% of their initial light output with no perceptible changes in color.
- C. Low-glare, high-efficiency optics:** The reflector and high-transmission diffusing lens are optimized for the smaller 4" aperture, resulting in an optic system that provides uniform light distribution and reduced glare. The lens also serves to conceal the LED light source, producing an aesthetic similar to a deeply regressed PAR20 lamp.
- D. LED driver options:** Specify either dedicated 120-volt driver with forward and reverse phase dimming or universal voltage driver (120-277V) with 0-10V dimming.
- E. Extensive trim selection:** The 4", Generation 3 LED recessed housing is compatible with a wide range of existing Juno open and lensed trims.

F. Real Nail® 3 Bar Hangers
The industry's best engineered mounting system ...

Juno housings originated the Real Nail bar hanger system that set the standard for quality and ease of installation

Patented Real Nail® 3 Hangers

Permit quick housing placement anywhere within 24" O.C. joists or suspended ceilings.

Captive Bugle Head Nail

Quickly secures housing in place. The nail is easily removable for quick housing repositioning/relocation without changing the bar hanger or nail.

Bar Hanger Locking

Secures bar hanger adjustments with the oversized locking screw or the quick-lock screwdriver slot feature.

Patented Break-Away Design

Score lines on the bar hangers provide a clean and fast break to fit the housing in tight applications.

T-Bar Mounting

Integral T-bar mounting feature secures the housing to suspended ceilings; no additional parts required.

Locking System

Quick-Loc slot and oversized set screw lock fixture in position.



4" IC-Rated 600 Lumen Generation 3 LED Downlights

The smaller aperture of the 4", Generation 3 downlight offers the "designer look," while advanced LED technology from Juno maximizes energy savings. The extensive trim offering complements a wide range of interior styles.

4" New Construction



IC1LEDG3 Series
Dedicated 4" LED new construction housing with integral light engine and choice of dimmable drivers: 10.5W nominal dedicated 120 volt driver with forward phase and ELV dimming or 12W nominal universal 120V-277V driver with 0-10V dimming. Shallow housing construction allows for fit in 2 x 6 construction. IC housing designed for use with IC or non-IC construction. Wide flood optic provided as standard.

1 1/4" L x 6 3/4" W x 6" H
Ceiling cutout: 4 1/2"

Example: IC1LEDG3-27K-1

Housing	Color Temp.	Input Voltage
IC1LEDG3	27K 2700K	1 Dedicated 120V Only, (forward phase and ELV dimming)
	3K 3000K	
	35K 3500K	U Universal Voltage 120-277V, (0-10V dimming)
	41K 4100K	

4" Remodel



Shown with dedicated 120 volt driver.



IC1RLEDG3 Series
Dedicated 4" LED remodel housing with integral light engine and choice of dimmable drivers: 10.5W nominal dedicated 120 volt driver with forward phase and ELV dimming or 12W nominal universal 120V-277V driver with 0-10V dimming. Shallow housing construction allows for fit in 2 x 6 construction. Air-Loc® gasket kit supplied with housing. IC housing designed for use with IC or non-IC construction. Wide flood optic provided as standard.

1 1/4" L x 4 3/4" W x 4 3/8" H
Ceiling cutout: 4 3/8"

Example: IC1RLEDG3-27K-1

Housing	Color Temp.	Input Voltage
IC1RLEDG3	27K 2700K	1 Dedicated 120V Only, (forward phase and ELV dimming)
	3K 3000K	
	35K 3500K	U Universal Voltage 120-277V, (0-10V dimming)
	41K 4100K	



Qualified Dimmers

Dedicated 120-volt fixtures (-1): Compatible with incandescent, magnetic low voltage or electronic low voltage wall box dimmers.

Universal voltage fixtures (-U): Compatible with 0-10V wall box dimmers.

Refer to catalog # on www.junolightinggroup.com for the specific list of Juno Lighting Group qualified dimmer model numbers on the specification sheet.

600 lumen



4" LED Downlight Trims

The trims shown here may be used with any 4" IC-Rated 600 Lumen Generation 3 LED housings shown on page 44.

Downlights	Decorative	Lensed	
 <p>Pinhole with Integral Shield 13-WH 2" Aperture</p>	 <p>Beveled Cylinder 4103FROST-WH 4103FROST-SC 3" Aperture</p>	 <p>Drop Opal 11-WH</p>	 <p>Beveled Dome - Lensed 4101-ABZ 4101-SC 4101-WH</p>
 <p>Baffle 14B-WH Black 14B-SC Black 14B-ABZ Black 14B-BL Black 14W-WH White 3 3/8" Aperture</p>	 <p>Beveled Cone 4104HZ-SC Haze 4104WHZ-ABZ Wheat Haze 3 3/8" Aperture</p>	 <p>Frosted Lens with Clear Center 12W-WH 12W-SC 12W-ABZ</p>	 <p>Beveled Lens 4102-ABZ 4102-SC 4102-WH</p>
 <p>Cone 17C-WH Clear Alzak® 17G-WH Gold Alzak® 17B-WH Black Alzak® 17PT-SC Pewter Alzak® 17W-WH Gloss White 17HZ-WH Haze 17WHZ-WH Wheat Haze 17WHZ-ABZ Wheat Haze 3 3/8" Aperture</p>	 <p>Glass Cylinder 4150MESH-SC 2 3/8" Aperture</p>	<p>Trim Ring Finishes ABZ: Classic Aged Bronze SC: Satin Chrome WH: White BL: Black</p>	

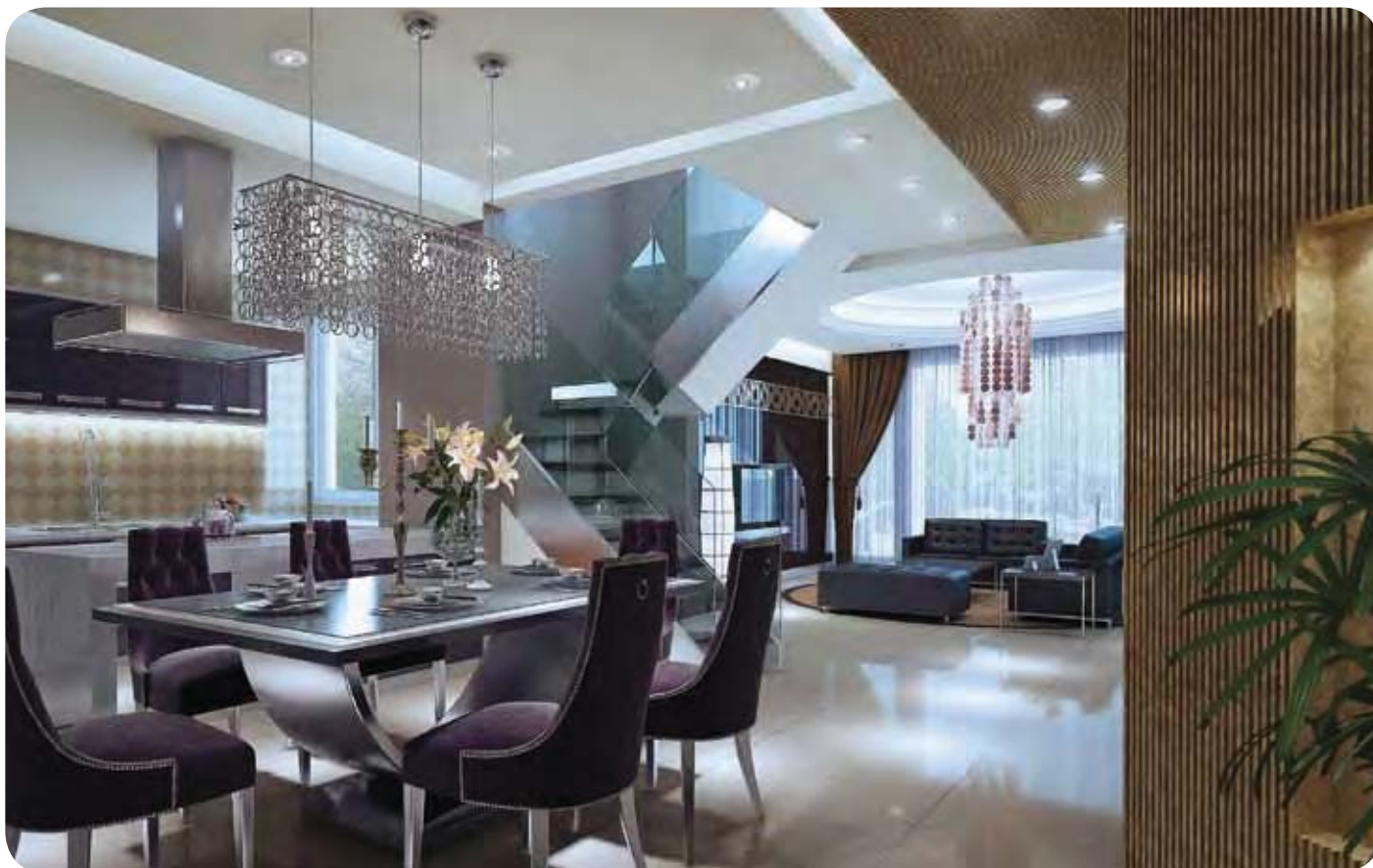

Generation 3 5" and 6" IC-Rated 600 & 900 Lumen LED Downlights



Offering ultra-efficient, high-performance illumination for residential interiors

With the latest generation of LED downlights, Juno offers greater efficiency, higher performance, and more sophisticated optics than ever before. For the Generation 3 LED line, Juno has reduced the energy consumption of its 600-lumen, IC-Rated downlight by over 25% and offers a 900-lumen IC-Rated downlight that consumes just 14.6 watts.

Juno Generation 3, IC-Rated, 600- and 900-lumen LED downlights provide superior illumination for both standard and high ceiling applications. Designed for either new construction or remodel applications, they are approved for use in both insulated and non-insulated ceilings. They include push-in electrical connectors and all the easy-installation features Juno is famous for.

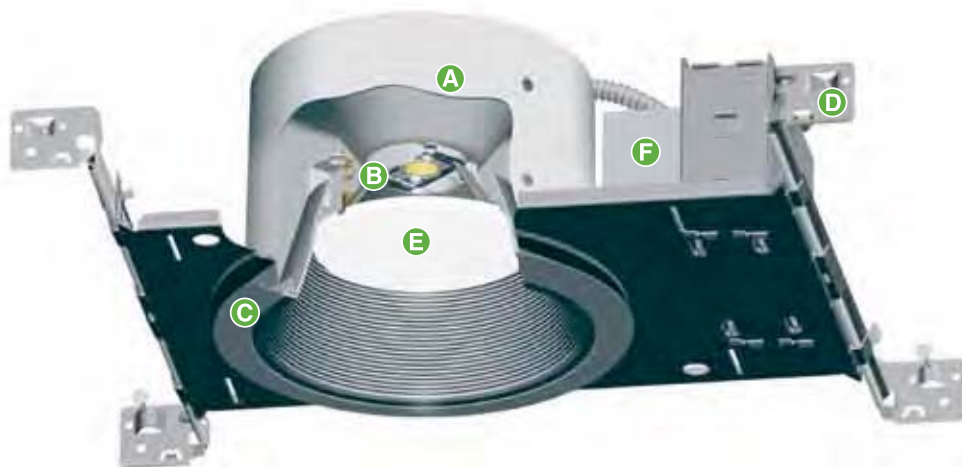

A. Advanced thermal management: Single piece, thermally conductive aluminum housing is secured to the plaster frame and draws heat away from the LEDs through the continuous metal construction to ensure long life of the LEDs. At the end of their 50,000 hour rated life, the LEDs can be expected to produce 70% of their initial light output with no perceptible changes in color.

B. Generation 3 LED light engine: The light engine features the latest in high-performance LED arrays. The 600-lumen fixture uses just 10.5 watts input; the 900-lumen fixture just 14.6 watts. LEDs are binned to exceed ENERGY STAR® requirements and provide superior fixture-to-fixture color uniformity. Available color temperatures are 2700K, 3000K, 3500K, and 4100K with 83 CRI typical.

C. Extensive trim options: Generation 3 LED recessed housings are compatible with a broad selection of existing Juno 5" and 6" open and lensed trims. A dedicated LED scoop trim is also available for wall wash applications.

D. Easy installation: Lower-profile housing permits easy installation in a wide range of applications and fits nicely within shallow, 2 x 6 ceiling joist. New-construction housings are supplied with the Juno Real Nail 3® bar hanger system. For suspended ceilings, the integral T-bar notch can be used to secure the housing onto the ceiling grid – no accessory clips required. See page 43 for a full description of the Real Nail® 3 bar hangers.

E. High-efficiency, low-brightness optics: The computer-optimized reflector features a high-reflectance white finish that together with a high-transmission diffusing lens produces uniform aperture luminance while concealing the LED light source. From below, it looks like an incandescent fixture with a deeply regressed PAR30 lamp. Alternate optics are available for all 5" and 6" Generation 3 fixtures. Wide-flood beam pattern is standard; medium-flood, narrow-flood and spot are also available. Reflector styles can be changed easily via the convenient twist and lock accessory feature.

F. LED driver options: Specify either dedicated 120-volt driver with forward and reverse phase dimming or universal voltage driver (120-277V) with 0-10V dimming.

Beam Patterns

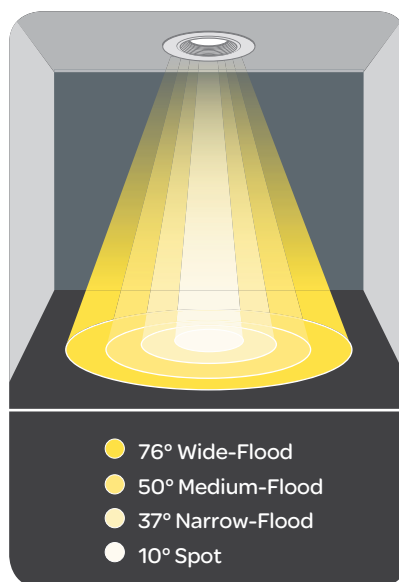

- 76° Wide-Flood
- 50° Medium-Flood
- 37° Narrow-Flood
- 10° Spot

Juno Generation 3, 5" and 6", IC-Rated, 600 & 900 Lumen LED Downlights are available in four optics. Wide-flood beam pattern is standard; medium-flood, narrow-flood and spot are also available. Reflector styles can be changed easily via the convenient twist and lock accessory feature.





5" IC-Rated 600 Lumen Generation 3 LED Downlights

This 5", Generation 3 LED downlight is over 25% more energy efficient than its predecessor, requiring just 10.5 watts to produce 600 brilliant lumens. Available for both new construction and remodel applications.

5" New Construction



Shown with universal voltage driver.



IC20LEDG3 Series

Dedicated 5" LED new construction housing with integral light engine and choice of dimmable drivers: 10.5W nominal dedicated 120 volt driver with forward phase and ELV dimming or 12W nominal universal 120V-277V driver with 0-10V dimming. Shallow housing allows for fit in 2 x 6 construction. Air-Loc® fully sealed housing does not require separate gasket. IC housing designed for use in IC or non-IC construction. Wide flood optic provided as standard.

15¼" L x 9⅞" W x 4⅞" H
Ceiling cutout: 5⅞"

Example: IC20LEDG3-27K-1

Housing	Color Temp.	Input Voltage
IC20LEDG3	27K 2700K	1 Dedicated 120V Only, (forward phase and ELV dimming)
	3K 3000K	
	35K 3500K	U Universal Voltage 120-277V, (0-10V dimming)
	41K 4100K	

5" Remodel



Shown with dedicated 120 volt driver.



IC20RLEDG3 Series

Dedicated 5" LED remodel housing with integral light engine and choice of dimmable drivers: 10.5W nominal dedicated 120 volt driver with forward phase and ELV dimming or 12W nominal universal 120V-277V driver with 0-10V dimming. Shallow housing construction allows for fit in 2 x 6 construction. Air-Loc gasket kit supplied with housing. IC housing designed for use with IC or non-IC construction. Wide flood optic provided as standard.

13½" L x 5⅞" W x 4⅞" H
Ceiling cutout: 5½"

Example: IC20RLEDG3-27K-1

Housing	Color Temp.	Input Voltage
IC20RLEDG3	27K 2700K	1 Dedicated 120V Only, (forward phase and ELV dimming)
	3K 3000K	
	35K 3500K	U Universal Voltage 120-277V, (0-10V dimming)
	41K 4100K	



Qualified Dimmers

Dedicated 120-volt fixtures (-1): Compatible with incandescent, magnetic low voltage or electronic low voltage wall box dimmers.

Universal voltage fixtures (-U): Compatible with 0-10V wall box dimmers.

Refer to catalog # on www.junolightinggroup.com for the specific list of Juno Lighting Group qualified dimmer model numbers on the specification sheet.

5" LED Downlight Trims

The trims shown here may be used with any 5" IC-Rated 600 Lumen LED housings shown on page 48.

Downlights	Wall Wash	Lensed											
 <p>Downlight Baffle† 205W-WH White 205B-WH Black 205B-SC Black 205B-ABZ Black 4 5/8" Aperture</p> 	 <p>Wall Wash 213G3W-WH White 213G3B-WH Black</p>	 <p>Flat Glass Shower Trim* 210N-ABZ 210N-SC 210N-WH</p> 	 <p>White Baffle, Regressed Frosted Dome Lens* 2130W-WH White 2130B-WH Black</p> 										
 <p>Downlight Cone† 204C-WH Clear Alzak® 204G-WH Gold Alzak® 204B-WH Black Alzak® 204PT-SC Pewter Alzak® 204W-WH Gloss White 204HZ-WH Haze 204WHZ-WH Wheat Haze 204WHZ-ABZ Wheat Haze 4 5/8" Aperture</p> 		 <p>Frosted Lens with Clear Center* 212N-ABZ 212N-SC 212N-WH</p> 	 <p>Beveled Frame, Frosted Dome Lens* 5101-ABZ 5101-SC 5101-WH</p> 										
<p>Trim Ring Finishes ABZ: Classic Aged Bronze SC: Satin Chrome WH: White</p>	<p>Accessories</p>  <table border="1"> <thead> <tr> <th>Catalog Number</th> <th>Description</th> </tr> </thead> <tbody> <tr> <td>LEDOPTICG3-M</td> <td>Medium Flood Optic (50° beam)</td> </tr> <tr> <td>LEDOPTICG3-N</td> <td>Narrow Flood Optic (37° beam)</td> </tr> <tr> <td>LEDOPTICG3-S</td> <td>Spot Optic (10° beam)</td> </tr> <tr> <td>SMPLT-5</td> <td>Galvanized steel plate for locating remodel style housings in new construction. Screw/nail holes for full coverage between 16" & 24".</td> </tr> </tbody> </table>	Catalog Number	Description	LEDOPTICG3-M	Medium Flood Optic (50° beam)	LEDOPTICG3-N	Narrow Flood Optic (37° beam)	LEDOPTICG3-S	Spot Optic (10° beam)	SMPLT-5	Galvanized steel plate for locating remodel style housings in new construction. Screw/nail holes for full coverage between 16" & 24".		
Catalog Number	Description												
LEDOPTICG3-M	Medium Flood Optic (50° beam)												
LEDOPTICG3-N	Narrow Flood Optic (37° beam)												
LEDOPTICG3-S	Spot Optic (10° beam)												
SMPLT-5	Galvanized steel plate for locating remodel style housings in new construction. Screw/nail holes for full coverage between 16" & 24".												

ENERGY STAR® Qualification and T24 certification is dependent on trim finish and LED color temperature. See housing spec sheet on www.junolightinggroup.com for specific information for each trim.

* Do not use reflector shipped with trim for LED housing. Discard or recycle reflector.
† See accessory page 161 for additional trim ring finishes, order separately.



5" IC-Rated 900 Lumen Generation 3 LED Downlights

The 900 lumen output of this 5", Generation 3 LED downlight is ideal for high ceiling applications. Consuming just 14.6 watts, it offers energy-saving efficacy of over 60 lumens per watt.

5" New Construction



Shown with universal voltage driver.



IC920LEDG3 Series

Dedicated 5" LED new construction housing with integral light engine and choice of dimmable drivers: 14.6W nominal dedicated 120 volt driver with forward phase and ELV dimming or 15.8W nominal universal 120V-277V driver with 0-10V dimming. Shallow housing allows for fit in 2 x 6 construction. Air-Loc fully sealed housing does not require separate gasket. IC housing designed for use in IC or non-IC construction. Wide flood optic provided as standard.

15¼" L x 9⅞" W x 4⅞" H
Ceiling cutout: 5⅞"

Example: IC920LEDG3-27K-1

Housing	Color Temp.	Input Voltage
IC920LEDG3	27K 2700K	1 Dedicated 120V Only, (forward phase and ELV dimming)
	3K 3000K	
	35K 3500K	U Universal Voltage 120-277V, (0-10V dimming)
	41K 4100K	

5" Remodel



Shown with dedicated 120 volt driver.



IC920RLEDG3 Series

Dedicated 5" LED remodel housing with integral light engine and choice of dimmable drivers: 14.6W nominal dedicated 120 volt driver with forward phase and ELV dimming or 15.8W nominal universal 120V-277V driver with 0-10V dimming. Shallow housing construction allows for fit in 2 x 6 construction. Air-Loc gasket kit supplied with housing. IC housing designed for use with IC or non-IC construction. Wide flood optic provided as standard.

13½" L x 5⅞" W x 4⅞" H
Ceiling cutout: 5½"

Example: IC920RLEDG3-27K-1

Housing	Color Temp.	Input Voltage
IC920RLEDG3	27K 2700K	1 Dedicated 120V Only, (forward phase and ELV dimming)
	3K 3000K	
	35K 3500K	U Universal Voltage 120-277V, (0-10V dimming)
	41K 4100K	



Qualified Dimmers

Dedicated 120-volt fixtures (-1): Compatible with incandescent, magnetic low voltage or electronic low voltage wall box dimmers.

Universal voltage fixtures (-U): Compatible with 0-10V wall box dimmers.

Refer to catalog # on www.junolightinggroup.com for the specific list of Juno Lighting Group qualified dimmer model numbers on the specification sheet.

900 lumen

5" LED Downlight Trims

The trims shown here may be used with any 5" IC-Rated 900 Lumen LED housings shown on page 50.

Downlights	Wall Wash	Lensed											
 <p>Downlight Baffle† 205W-WH White 205B-WH Black 205B-SC Black 205B-ABZ Black 4 1/2" Aperture</p> 	 <p>Wall Wash 213G3W-WH White 213G3B-WH Black</p>	 <p>Flat Glass Shower Trim* 210N-ABZ 210N-SC 210N-WH</p> 	 <p>White Baffle, Regressed Frosted Dome Lens* 2130W-WH White 2130B-WH Black</p> 										
 <p>Downlight Cone† 204C-WH Clear Alzak[®] 204G-WH Gold Alzak[®] 204B-WH Black Alzak[®] 204PT-SC Pewter Alzak[®] 204W-WH Gloss White 204HZ-WH Haze 204WHZ-WH Wheat Haze 204WHZ-ABZ Wheat Haze 4 1/2" Aperture</p> 		 <p>Frosted Lens with Clear Center* 212N-ABZ 212N-SC 212N-WH</p> 	 <p>Beveled Frame, Frosted Dome Lens* 5101-ABZ 5101-SC 5101-WH</p> 										
<p>Trim Ring Finishes ABZ: Classic Aged Bronze SC: Satin Chrome WH: White</p>	<p>Accessories</p>  <table border="1"> <thead> <tr> <th>Catalog Number</th> <th>Description</th> </tr> </thead> <tbody> <tr> <td>LEDOPTICG3-M</td> <td>Medium Flood Optic (50° beam)</td> </tr> <tr> <td>LEDOPTICG3-N</td> <td>Narrow Flood Optic (37° beam)</td> </tr> <tr> <td>LEDOPTICG3-S</td> <td>Spot Optic (10° beam)</td> </tr> <tr> <td>SMPLT-5</td> <td>Galvanized steel plate for locating remodel style housings in new construction. Screw/nail holes for full coverage between 16" & 24".</td> </tr> </tbody> </table>	Catalog Number	Description	LEDOPTICG3-M	Medium Flood Optic (50° beam)	LEDOPTICG3-N	Narrow Flood Optic (37° beam)	LEDOPTICG3-S	Spot Optic (10° beam)	SMPLT-5	Galvanized steel plate for locating remodel style housings in new construction. Screw/nail holes for full coverage between 16" & 24".		
Catalog Number	Description												
LEDOPTICG3-M	Medium Flood Optic (50° beam)												
LEDOPTICG3-N	Narrow Flood Optic (37° beam)												
LEDOPTICG3-S	Spot Optic (10° beam)												
SMPLT-5	Galvanized steel plate for locating remodel style housings in new construction. Screw/nail holes for full coverage between 16" & 24".												

ENERGY STAR[®] Qualification and T24 certification is dependent on trim finish and LED color temperature. See housing spec sheet on www.junolightinggroup.com for specific information for each trim.

* Do not use reflector shipped with trim for LED housing. Discard or recycle reflector.

† See accessory page 161 for additional trim ring finishes, order separately.



6" IC-Rated 600 Lumen Generation 3 LED Downlights

The 6", Generation 3 LED downlights feature the most extensive collection of trims and accessories.

6" New Construction



Shown with universal voltage driver.



IC22LEDG3 Series

Dedicated 6" LED new construction housing with integral light engine and choice of dimmable drivers: 10.5W nominal dedicated 120 volt driver with forward phase and ELV dimming or 12W nominal universal 120V-277V driver with 0-10V dimming. Shallow housing allows for fit in 2 x 6 construction. Air-Loc® fully sealed housing does not require separate gasket. IC housing designed for use in IC or non-IC construction. Wide flood optic provided as standard.

15¼" L x 9½" W x 4⅞" H
Ceiling cutout: 6¾"

Example: IC22LEDG3-27K-1

Housing	Color Temp.	Input Voltage
IC22LEDG3	27K 2700K	1 Dedicated 120V Only, (forward phase and ELV dimming)
	3K 3000K	
	35K 3500K	U Universal Voltage 120-277V, (0-10V dimming)
	41K 4100K	

6" Remodel



Shown with dedicated 120 volt driver.



IC22RLEDG3 Series

Dedicated 6" LED remodel housing with integral light engine and choice of 10.5W nominal dedicated 120 volt driver with forward phase and ELV dimming or 12W nominal universal 120V-277V driver with 0-10V dimming. Shallow housing construction allows for fit in 2 x 6 construction. Air-Loc® gasket kit supplied with housing. IC housing designed for use with IC or non-IC construction. Wide flood optic provided as standard.

14½" L x 7¼" W x 5⅞" H
Ceiling cutout: 6¾"

Example: IC22RLEDG3-27K-1

Housing	Color Temp.	Input Voltage
IC22RLEDG3	27K 2700K	1 Dedicated 120V Only, (forward phase and ELV dimming)
	3K 3000K	
	35K 3500K	U Universal Voltage 120-277V, (0-10V dimming)
	41K 4100K	



Qualified Dimmers

Dedicated 120-volt fixtures (-1): Compatible with incandescent, magnetic low voltage or electronic low voltage wall box dimmers.

Universal voltage fixtures (-U): Compatible with 0-10V wall box dimmers.

Refer to catalog # on www.junolightinggroup.com for the specific list of Juno Lighting Group qualified dimmer model numbers on the specification sheet.

600 lumen



6" LED Downlight Trims

The trims shown here may be used with any 6" IC-Rated 600 Lumen LED housings shown on page 52.

Downlights



Downlight Baffle†
24W-WH White
24B-WH Black
24B-SC Black
24B-ABZ Black
24B-BL Black
5¾" Aperture



Downlight Cone†
27C-WH Clear Alzak®
27G-WH Gold Alzak®
27B-WH Black Alzak®
27PT-SC Pewter Alzak®
27W-WH Gloss White
27HZ-WH Haze
27WHZ-WH Wheat Haze
27WHZ-ABZ Wheat Haze
5¾" Aperture



Decorative



Octagonal
9024W-WH
5¾" Aperture

Decorative, cont.



Luminous Disc (Frosted)
9324-SC
3¾" Aperture



Metal Band
9524-SC
5¾" Aperture



Luminous Collar (Frosted)
9702
6¾" Aperture

Wall Wash



Wall Wash
262G3W-WH White
262G3B-WH Black

Lensed



Albalite
20-PW Shower/
Closet Light
20-WH



Drop Opal
21-PW Shower/
Closet Light
21-WH



Fresnel
22-WH



Lensed, cont.



Frosted Lens*
239-WH



Frosted Lens with Clear Center
242-ABZ
242-SC
242-WH



Decorative Swirled Etched Opal Glass*
243-WH



White Baffle, Regressed Frosted Dome Lens*
2330W-WH White
2330B-WH Black



Beveled Frame, Frosted Dome Lens*
6101-ABZ
6101-SC
6101-WH



Trim Ring Finishes

ABZ: Classic Aged Bronze **SC:** Satin Chrome
WH: White **BL:** Black
PW: Plastic White (Polycarbonate material shower trim)

Accessories



Catalog Number	Description
LEDOPTICG3-M	Medium Flood Optic (50° beam)
LEDOPTICG3-N	Narrow Flood Optic (37° beam)
LEDOPTICG3-S	Spot Optic (10° beam)

ENERGY STAR® Qualification and T24 certification is dependent on trim finish and LED color temperature. See housing spec sheet on www.junolightinggroup.com for specific information for each trim.

* Do not use reflector shipped with trim for LED housing. Discard or recycle reflector.

† See accessory page 161 for additional trim ring finishes, order separately.



6" IC-Rated 900 Lumen Generation 3 LED Downlights

The 900 lumen output of this 6", Generation 3 LED downlight is ideally suited for illuminating dramatic spaces with high ceilings. Compatible with a broad selection of existing Juno 6" open and lensed trims, and available with a dedicated LED scoop trim for wall washing.

6" New Construction



Shown with universal voltage driver.



IC922LEDG3 Series

Dedicated 6" LED new construction housing with integral light engine and choice of dimmable drivers: 14.6W nominal dedicated 120 volt driver with forward phase and ELV dimming or 15.8W nominal universal 120V-277V driver with 0-10V dimming. Shallow housing allows for fit in 2 x 6 construction. Air-Loc® fully sealed housing does not require separate gasket. IC housing designed for use in IC or non-IC construction. Wide flood optic provided as standard. Wide flood optic provided as standard.

15¼" L x 9¼" W x 5½" H
Ceiling cutout: 6¼"

Example: IC922LEDG3-27K-1

Housing	Color Temp.	Input Voltage
IC922LEDG3	27K 2700K	1 Dedicated 120V Only, (forward phase and ELV dimming)
	3K 3000K	
	35K 3500K	U Universal Voltage 120-277V, (0-10V dimming)
	41K 4100K	

6" Remodel



Shown with dedicated 120 volt driver.



IC922RLEDG3 Series

Dedicated 6" LED remodel housing with integral light engine and choice of dimmable drivers: 14.6W nominal dedicated 120 volt driver with forward phase and ELV dimming or 15.8W nominal universal 120V-277V driver with 0-10V dimming. Shallow housing allows for fit in 2 x 6 construction. Air-Loc® gasket kit supplied with housing. IC housing designed for use with IC or non-IC construction. Wide flood optic provided as standard. Wide flood optic provided as standard.

14½" L x 7¼" W x 5½" H
Ceiling cutout: 6¼"

Example: IC922RLEDG3-27K-1

Housing	Color Temp.	Input Voltage
IC922RLEDG3	27K 2700K	1 Dedicated 120V Only, (forward phase and ELV dimming)
	3K 3000K	
	35K 3500K	U Universal Voltage 120-277V, (0-10V dimming)
	41K 4100K	



Qualified Dimmers

Dedicated 120-volt fixtures (-1): Compatible with incandescent, magnetic low voltage or electronic low voltage wall box dimmers.

Universal voltage fixtures (-U): Compatible with 0-10V wall box dimmers.



























Refer to catalog # on www.junolightinggroup.com for the specific list of Juno Lighting Group qualified dimmer model numbers on the specification sheet.

900 lumen



6" LED Downlight Trims

The trims shown here may be used with any 6" IC-Rated 900 Lumen LED housings shown on page 54.

Downlights	Decorative, cont.	Lensed	Lensed, cont.	
 <p>Downlight Baffle† 24W-WH White 24B-WH Black 24B-SC Black 24B-ABZ Black 24B-BL Black 5 3/4" Aperture</p> 	 <p>Luminous Disc (Frosted) 9324-SC 3 1/4" Aperture</p>	 <p>Albalite 20-PW Shower/ Closet Light 20-WH</p> 	 <p>Frosted Lens* 239-WH</p> 	 <p>White Baffle, Regressed Frosted Dome Lens* 2330W-WH White 2330B-WH Black</p> 
 <p>Downlight Cone† 27C-WH Clear Alzak® 27G-WH Gold Alzak® 27B-WH Black Alzak® 27PT-SC Pewter Alzak® 27W-WH Gloss White 27HZ-WH Haze 27WHZ-WH Wheat Haze 27WHZ-ABZ Wheat Haze 5 3/4" Aperture</p> 	 <p>Metal Band 9524-SC 5 7/8" Aperture</p>	 <p>Drop Opal 21-PW Shower/ Closet Light 21-WH</p> 	 <p>Frosted Lens with Clear Center 242-ABZ 242-SC 242-WH</p> 	 <p>Beveled Frame, Frosted Dome Lens* 6101-ABZ 6101-SC 6101-WH</p> 
	 <p>Luminous Collar (Frosted) 9702 6 3/8" Aperture</p>	 <p>Fresnel 22-WH</p> 	 <p>Decorative Swirled Etched Opal Glass* 243-WH</p> 	
<p>Decorative</p>  <p>Octagonal 9024W-WH 5 3/4" Aperture</p>	<p>Wall Wash</p>  <p>Wall Wash 262G3W-WH White 262G3B-WH Black</p>			
<p>Trim Ring Finishes</p> <p>ABZ: Classic Aged Bronze SC: Satin Chrome WH: White BL: Black PW: Plastic White (Polycarbonate material shower trim)</p>		<p>Accessories</p>  <p>LEDOPTICG3-M Medium Flood Optic (50° beam) LEDOPTICG3-N Narrow Flood Optic (37° beam) LEDOPTICG3-S Spot Optic (10° beam)</p>		
<p>ENERGY STAR® Qualification and T24 certification is dependent on trim finish and LED color temperature. See housing spec sheet on www.junolightinggroup.com for specific information for each trim.</p> <p>* Do not use reflector shipped with trim for LED housing. Discard or recycle reflector. † See accessory page 161 for additional trim ring finishes, order separately.</p>				

Retrofit LED Trim Modules



Ultra-efficient, super-easy, very affordable

With Juno Retrofit LED Trim Modules, standard 6" recessed housings can be quickly and conveniently upgraded to efficient LED illumination. These economical LED trims are available in 600 or 900 lumen modules and the patent pending WarmDim® technology is offered with the 600 lumen LED trim modules. The J6RL series provides up to 900 lumens of brilliant illumination that is equivalent to the output of a 75W PAR30 ... but requiring just 15.4 watts input. ENERGY STAR® Qualified. Dimmable with most incandescent, magnetic low-voltage, and electronic low-voltage dimmers.

A. All-In-One Design:

Downlight:

LEDs, driver and trim are contained in a single unit. Includes a whip adapter with screw base and quick-connect plug for easy retrofit in 6" housings equipped with a medium-base socket. Or the unit can be installed directly into a dedicated Juno quick-connect housing. Retrofit compatible with Juno 6" standard and shallow housings as well as with other manufacturers' housings*. Module is wet location listed and designed for use in IC or non-IC, new-construction or remodel housings*.

Eyeball:

All-in-one trim, driver, and adjustable eyeball are designed as a single unit for installation into retrofit, new construction, or remodel applications. Rotates 358 degrees with vertical adjustment of 30 degrees. For use with IC or non-IC, 6" housings. Compatible with Juno 6" standard and shallow housings as well as those of other manufacturers*.

B. LED Light Engine: The LED array is integrated with a one-piece, high-purity aluminum, thermally conductive trim to provide uninterrupted heat transfer. Ensures long life of the LEDs even when used in housings covered with insulation. At the end of their 50,000 hour rated life, the LEDs can be expected to produce 70% of their initial light output with no perceptible changes in color.

C. Efficient Thermal Management: The LED array is integrated with a one-piece, high-purity aluminum, thermally conductive trim to provide uninterrupted heat transfer. Ensures long life of the LEDs even when used in housings covered with insulation. At the end of their 50,000 hour rated life, the LEDs can be expected to produce 70% of their initial light output with no perceptible changes in color.

D. Easy Installation: Whip adapter with screw base and quick-connect plug screws into 6" housings equipped with medium-base sockets. It's nearly as easy as installing a conventional lamp. Or for California Title 24 compliance, Retrofit LED Modules can be installed into dedicated Juno new-construction or remodel housings with hard-wired quick connects. Torsion springs secure trim into housing.

E. High-Efficiency, Low-Glare Optics:

Downlight:

A computer-optimized reflector and deeply regressed high-transmission diffusing lens provide uniform light distribution and effective glare control, while concealing the LED light source from view.

Eyeball:

A computer-optimized reflector and high-transmission diffusing lens create an efficient, aesthetically pleasing optic system that provides uniform light distribution while reducing glare and masking the LED source. Wide-flood beam pattern is standard; medium-flood, narrow-flood, and spot also available. Reflector styles can be changed easily via the convenient twist-and-lock accessory feature. See page 60 for optic options.

F. Aesthetic Trim:

Downlight:

The Retrofit LED Downlight Trim Module ships complete with either a baffle or cone insert that mimics the aesthetics of Juno's most popular trims. These interchangeable trim inserts can be easily changed in the field to customize the look of the product.

Eyeball:

An attractive addition to any décor, the aluminum, adjustable eyeball trim module follows traditional Juno styling and is finished in lustrous white.

G. Dimmable LED Driver: State of the art 120V LED forward phase driver is dimmable using most incandescent, magnetic low-voltage, and electronic low-voltage dimmers.

H. Juno Retrofit LED Trim Modules with quick-connect housings comply with Title 24 requirements

Juno Retrofit LED Trim Modules can be installed in dedicated, 6" Juno new-construction or remodel housings via hard-wired quick connects. When installed in this configuration, these units offer full California Title 24 compliance.



Supplied whip adapter with screw base and quick-connect plug permits quick installation in 6" housings equipped with medium-base sockets.

* See spec sheet for housing compatibility.

Retrofit LED Downlight Trim Module

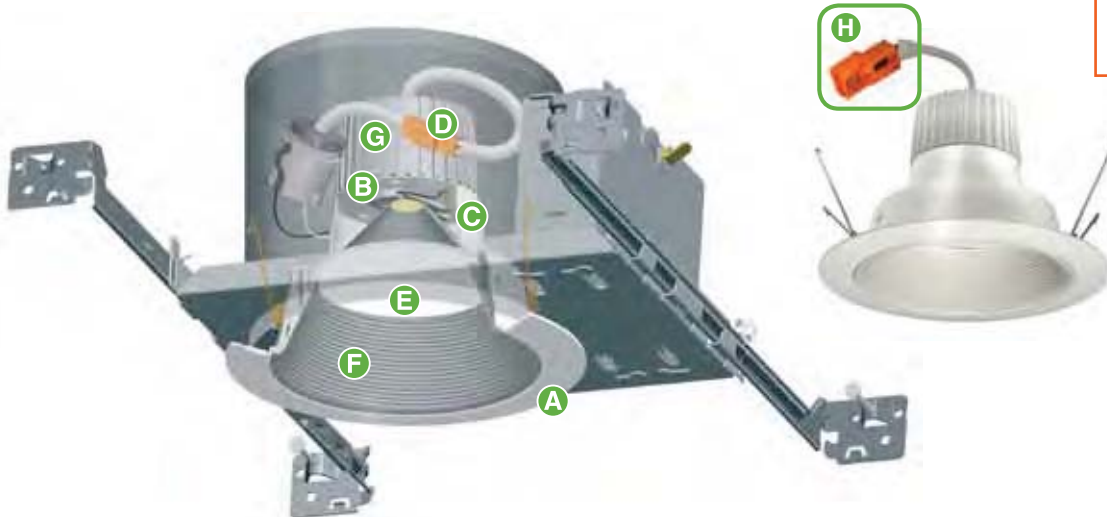

WarmDim[®]
Bringing Warmth to LED Dimming™

Available in 600 lumen
Trim Module.

Juno Retrofit LED Downlight Trim Modules are available in a selection of finishes designed to complement a wide range of décors.



White Baffle



Black Baffle



Clear Cone



White Cone



Haze Cone



Wheat Haze Cone

Retrofit LED Eyeball Trim Module

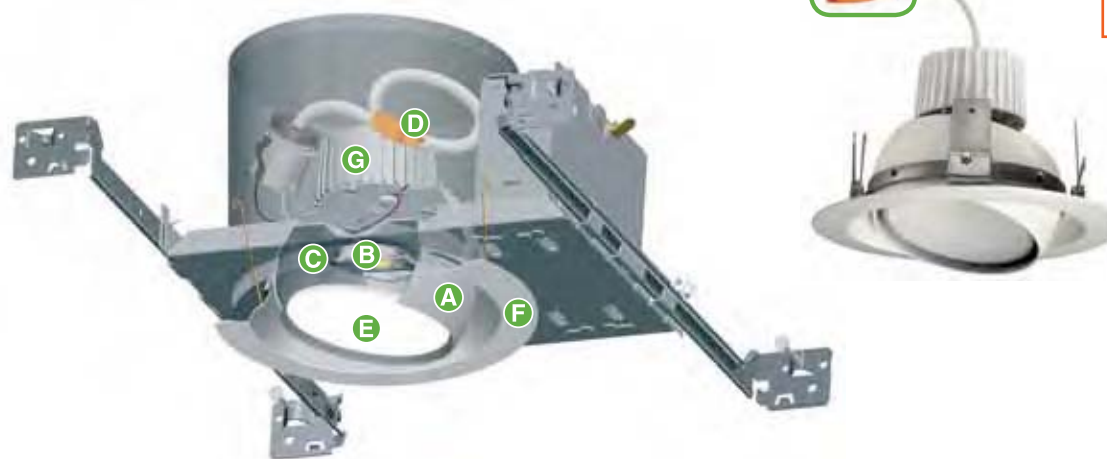

WarmDim[®]
Bringing Warmth to LED Dimming™

Available in 600 lumen
Trim Module.

Retrofit LED Eyeball Trim Modules are available in four optics:

Wide-flood beam pattern is standard; medium-flood, narrow-flood and spot optics are also available. Reflector styles can be changed easily via the convenient twist-and-lock accessory feature.





Retrofit LED Downlight Trim Module

Quick, easy, and affordable ... these retrofit LED modules upgrade standard 6" recessed housings to energy-efficient LED illumination. Medium-base socket, screw-in whip adapter included.

6" Retrofit 600 and 900 Lumen Downlight Trim Module



J6RLG3

All-in-one 6" LED Retrofit Downlight Trim available with choice of integral 600 Lumen 10.5W nominal or 900 Lumen 15.4W nominal light engine and dedicated 120V driver, dimmable with use of most incandescent, magnetic and electronic low voltage wall box dimmers. Designed for use in IC or non-IC construction. White trim flange is standard.



Medium-based socket whip adapter included with trim.

Example: J6RLG3-27K-6-WWH

Retrofit Downlight Trim	Color Temp.	Lumen Package	Trim Style
J6RLG3	27K 2700K	6 600 Lumen	WWH White Baffle
	3K 3000K	9 900 Lumen	BWH Black Baffle
	35K 3500K		CLW Clear Cone
	41K 4100K		WHW White Cone
			HZW Haze Cone
			WZW Wheat Haze Cone

Trim Inserts

Downlights



White Baffle
J6RLTRIM-WWH
White Baffle



White Cone
J6RLTRIM-WHW
White Cone



Black Cone
J6RLTRIM-BWH
Black Baffle



Haze Cone
J6RLTRIM-HZW
Haze Cone



Clear Cone
J6RLTRIM-CLW
Clear Cone



Wheat Haze Cone
J6RLTRIM-WZW
Wheat Haze Cone

5 1/8" Aperture

Interchangeable trim inserts can be easily changed in the field to customize the look of the trim module.

ENERGY STAR® Qualification and T24 certification is dependent on trim finish and LED color temperature.

See housing spec sheet on www.junolighting-group.com for specific information for each trim.

6" Retrofit 600 Lumen WarmDim® LED Downlight Trim Module



J6RLWDG3

All-in-one 6" WarmDim® LED Retrofit Downlight trim with integral 600 lumen 14W nominal light engine and dedicated 120V driver, dimmable with use of most incandescent, magnetic and electronic low voltage wall box dimmers. Designed for use in IC or non-IC construction. White trim flange is standard.



Medium-based socket whip adapter included with trim.



Example: J6RLWDG3-3K-6-WWH

Retrofit Downlight Trim	Color Temp.	Lumen Package	Trim Style
J6RLWDG3	3K 3000K	6 600 Lumen	WWH White Baffle
			BWH Black Baffle
			CLW Clear Cone
			WHW White Cone
			HZW Haze Cone
			WZW Wheat Haze Cone



Juno Dedicated LED Housings



Fixture Style: IC23-LEDT24
Description: 6" IC New Construction



Fixture Style: IC23R-LEDT24
Description: 6" IC Remodel



Accessories

V6RL-TRB



Torsion receiver bracket kit to install Juno Retrofit LED Trim Modules into housings that do not have torsion receiver brackets

Compatible Housings

The J6RL Series Retrofit LED Downlight Trim Modules are compatible with most 6" recessed housings measuring at least 5-1/4" high with an inside diameter between 6" and 6-3/4". Removal of the housing socket plate or socket mounting bracket may be required in order for the trim to fit properly. Compatible housings include, but not limited to:

- Juno® housings:** IC2 and TC2 Series, IC22 Series, IC23 Series, IC21 Series
- VuLite® housings:** V6IC and V6TC Series
- Halo® housings:** H7 Series
- Thomas® Lighting housings:** PS1 and PS3 Series
- Capri housings:** QL1 Series
- Lithonia Lighting® housings:** L7X and LC6 Series

Qualified Dimmers - 120V

Compatible with incandescent, magnetic low voltage or electronic low voltage wall box dimmer.

Refer to catalog # on www.junolightinggroup.com for the specific list of Juno Lighting Group qualified dimmer model numbers on the specification sheet.



Retrofit LED Eyeball Trim Module

This retrofit LED eyeball installs easily into existing 6" recessed housings and provides 358-degrees rotation and up to 30-degrees vertical adjustment. Medium-base socket, screw-in whip adapter included.

6" Retrofit 600 and 900 Lumen Eyeball Trim Module



J6RLEG3

All-in-one 6" LED Retrofit Eyeball Trim available with choice of integral 600 Lumen 10.5W nominal or 900 Lumen 15.4W nominal light engine and dedicated 120V driver, dimmable with use of most incandescent, magnetic and electronic low voltage wall box dimmers. Designed for use in IC or non-IC construction. Wide flood optic provided as standard.



Medium-based socket whip adapter included with trim.

Example: J6RLEG3-27K-6-WH

Retrofit Eyeball Trim	Color Temp.	Lumen Package	Trim Style
J6RLEG3	27K 2700K	6 600 Lumen	WH White
	3K 3000K	9 900 Lumen	
	35K 3500K		
	41K 4100K		

Compatible Housings

The J6RLE Series Retrofit LED Eyeball Trim Modules are compatible with most 6" recessed housings measuring at least 5-1/4" high with an inside diameter between 6" and 6-3/4". Removal of the housing socket plate or socket mounting bracket may be required in order for the trim to fit properly. Compatible housings include, but not limited to:

- Juno® housings:** IC2 and TC2 Series, IC22 Series, IC23 Series, IC21 Series
- VuLite® housings:** V6IC and V6TC Series
- Halo® housings:** H7 Series
- Thomas® Lighting housings:** PS1 and PS3 Series
- Capri housings:** QL1 Series
- Lithonia Lighting® housings:** L7X and LC6 Series

6" Retrofit 600 Lumen WarmDim® LED Eyeball Trim Module



J6RLEWDG3

All-in-one 6" WarmDim® LED Retrofit Eyeball trim with integral 600 lumen 14W nominal light engine and dedicated 120V driver, dimmable with use of most incandescent, magnetic and electronic low voltage wall box dimmers. Designed for use in IC or non-IC construction. Wide flood optic is standard.



Medium-based socket whip adapter included with trim.



Example: J6RLEWDG3-3K-6-WH

Retrofit Eyeball Trim	Color Temp.	Lumen Package	Trim Style
J6RLEWDG3	3K 3000K	6 600 Lumen	WH White

Juno Dedicated LED Housings



Fixture Style: IC23-LEDT24
Description: 6" IC New Construction



Fixture Style: IC23R-LEDT24
Description: 6" IC Remodel



Accessories



- LEDOPTICG3-M**
- LEDOPTICG3-N**
- LEDOPTICG3-S**

Medium Flood Optic (50° beam)
Narrow Flood Optic (37° beam)
Spot Optic (10° beam)

Note: For best performance use LEDOPTICG3-M with WarmDim® Eyeball Trim Module.



V6RL-TRB

Torsion receiver bracket kit to install Juno Retrofit LED Trim Modules into housings that do not have torsion receiver brackets

Qualified Dimmers - 120V

Compatible with incandescent, magnetic low voltage or electronic low voltage wall box dimmer.

Refer to catalog # on www.junolightinggroup.com for the specific list of Juno Lighting Group qualified dimmer model numbers on the specification sheet.

Note: ENERGY STAR® Qualification and T24 certification is dependent on LED color temperature. See housing specification sheet on www.junolightinggroup.com for specific information.





Mini LED Downlight/Gimbal

Big-time illumination for small spaces

Ideal for niches, bookcases, soffits, cabinetry and so much more, Juno Mini LED Downlights and Gimbals open-up a multitude of task and accent lighting possibilities, especially when installation space is at a premium. Using less than 5-watts input, these versatile little recessed luminaires are the most energy-efficient solution for providing the desired look and just the right amount of light in confined areas.

A. Ultra-compact design

Compared to most recessed luminaires, these fixtures are diminutive. With a trim diameter of just 2-1/4" and an overall height of just 2-7/8", the Mini LED Downlight can be recessed into extra-small spaces. The Mini LED Gimbal is similar in size with a 2-5/8" trim diameter and 3-1/4" fixture height. The Mini LED Gimbal features 30° vertical aiming and 360° rotation adjustment, so that light can be aimed as needed. Both styles are offered in classic Juno white and black painted finishes, as well as premium satin nickel or bronze plated finishes.

B. Super-efficient LED light engine

Common light engine to Juno's Trac 12™ LED mini-cylinder spotlights using Luxeon® Rebel LEDs. Color temperatures of 2700K, 3000K, 3500K, and 4100K are available, and color rendering is excellent with CRI of 85 typical. Service life is a remarkable 50,000 hours at 70% lumen maintenance.

C. LED driver and transformer options

The onboard LED driver operates at 5 watts input and 12-volts AC and requires a Class 2, 120V to 12V electronic or magnetic, remote transformer to complete the system. Juno's TL602E electronic transformer and TL576 magnetic transformer both with 60W maximum, were designed specifically for use with these fixtures and are dimmable.

D. Versatile optics

The optical system is designed for maximum versatility in a wide range of accent and task lighting situations. A choice of three optics is available: spot (16°), narrow flood (24°), or flood (35°).

E. Easy installation

The cutout dimensions of 2" for the Mini LED Downlight and 2-3/8" for the Mini LED Gimbal correspond to common hole-saw sizes. Both fixture styles are held in place with easy-to-use "mouse-trap" springs. Installation is fast, simple, and secure into mounting surfaces 1/8" to 1" thick.

F. Simplified wiring

Removable cover plate provides quick access to wiring compartment. Terminal blocks facilitate simple wiring with commonly available low voltage cable (Type CL2 or NEC Equivalent, 18-12 AWG) for one fixture, or for daisy chaining multiple fixtures.

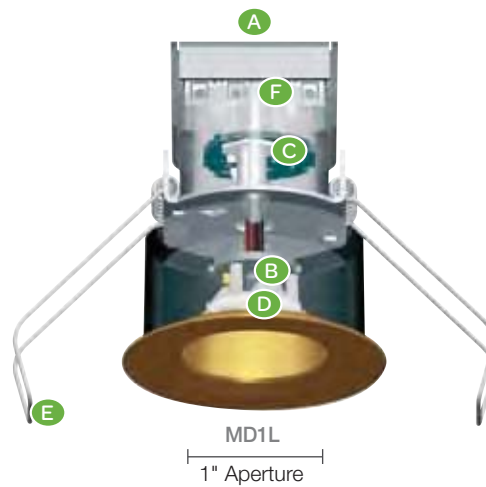

IC-Rated Mini LED Downlight and Mini LED Gimbal

Ideal for niches, bookcases, soffits, displays, elevators and so much more, Juno Mini LED Downlights and Gimbals open-up a multitude of task and accent lighting possibilities.

Mini LED Downlights



2 1/4" W x 2 7/8" H, fixture springs expand to 6" W.
Surface cutout: 2"
Aperture: 1"

Example: MD1L41K-NFL-SN

Housing	Color Temp.	Optic	Finish
MD1L	27K 2700K	SP Spot	WH White
 MD1LW (Outdoor & Wet Location Approved)	3K 3000K	NFL Narrow Flood	BL Black
	35K 3500K	FL Flood	SN Satin Nickel
	41K 4100K		BZ Bronze

Finish Options:

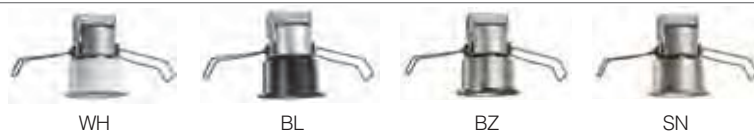

Mini LED Gimbals



2 5/8" W x 3 1/4" H, fixture springs expand to 6" W.
Surface cutout: 2 3/4"
Aperture: 1 1/4"

Example: MG1L41K-NFL-SN

Housing	Color Temp.	Optic	Finish
MG1L	27K 2700K	SP Spot	WH White
	3K 3000K	NFL Narrow Flood	BL Black
	35K 3500K	FL Flood	SN Satin Nickel
	41K 4100K		BZ Bronze

Finish Options:



TL602E and TL576 Transformers



Check specification sheet on www.junolightinggroup.com for a partial list of compatible dimmers. Contact Juno Lighting Group Technical Services for other dimmer model qualifications.

Performance Notes: TL602E should be located no more than 4' from first fixture in run. With TL602E fully loaded, run lengths longer than 18' with 12 AWG are not recommended due to voltage drop. To avoid excessive drop in light output, make sure the fixture voltage at the last fixture is at least 10 volts. For longer runs or remote mount transformer installation, use magnetic transformer TL576.

Ordering Options

Example: TL602E-60-WH-CP6

Electronic		
Catalog No.	Finish	Description
TL602E-10-WH	White	10W 12V AC Electronic Driver/Transformer
TL602E-25-WH	White	25W 12V AC Electronic Driver/Transformer
TL602E-60-WH	White	60W 12V AC Electronic Driver/Transformer
Suffix No.	Description	
-CP6	6ft. Cord & Plug, factory installed	

(Add as suffix to catalog number)

Example: TL576-60-BL

Magnetic		
Catalog No.	Finish	Description
TL576-10-BL	Black	10W 12V AC Magnetic Transformer
TL576-25-BL	Black	25W 12V AC Magnetic Transformer
TL576-60-BL	Black	60W 12V AC Magnetic Transformer

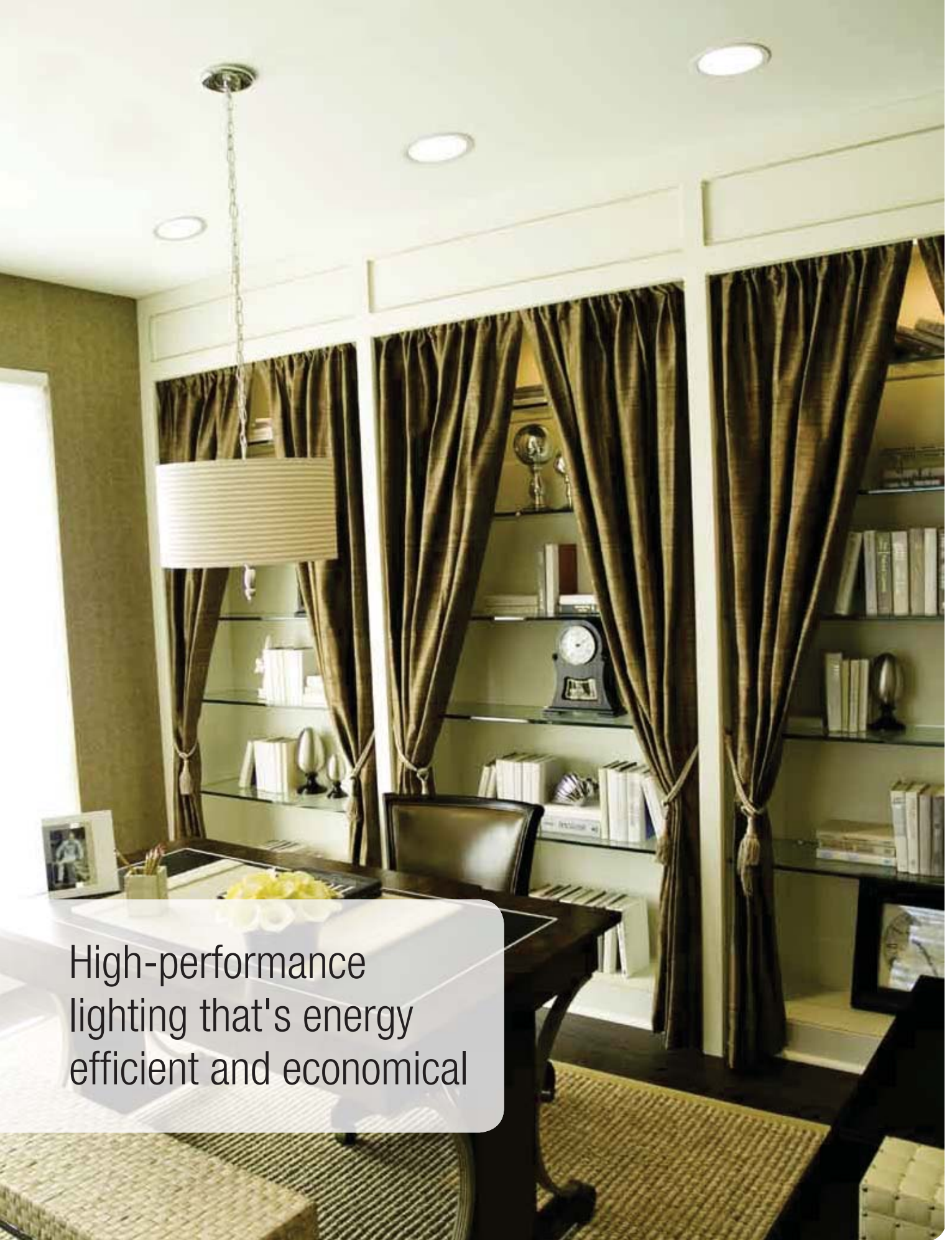

High-performance lighting that's energy efficient and economical

CFL Downlights

Juno universal Compact Fluorescent (CFL) downlights provide significant energy savings compared to incandescent lighting. They offer diffuse general lighting and are ideal in areas of the home that experience longer hours of illumination and do not require dimming, such as kitchens, home offices, laundry rooms, and hobby or fitness areas.

Juno CFL downlights integrate state-of-the-art electronic ballasts into high-quality recessed housings to optimize operation with pin-based CFL amalgam lamps, thereby maximizing light output, brightness control, and longevity. Premium electronic ballasts provide flicker-free instant start without the characteristic hum of older generation magnetic ballasts.

Juno CFL Advantages

- 3- to 4-times more energy efficient than halogen lighting
- 10-times longer service life than halogen lighting
- Far less heat generation than halogen
- Rapid start electronic ballast for flicker-free operation
- High color rendering



CFL Downlights

Engineered for lighting performance and energy efficiency

A. Housings

Energy efficient CFL housings are available in 4", 5", and 6" sizes with wattages ranging from 13W to 42W.

B. Electronic Ballast

Rapid start electronic ballast is mounted between J-box and housing for ease of maintenance.

C. Trims

A wide variety of trim styles, including lensed, baffle, cone, and decorative are available in an array of attractive finishes. Selected trims feature specially designed reflectors optimized for CFL lamps.

D. CFL Pin Lamps

Pin-based CFLs are as much as 80% more energy efficient than incandescent lighting and last up to 10-times longer.

E. Real Nail® 3 Bar Hangers

The industry's best engineered mounting system ...

Juno housings originated the Real Nail bar hanger system that set the standard for quality and ease of installation

Patented Real Nail® 3 Hangers

Permit quick housing placement anywhere within 24" O.C. joists or suspended ceilings.

Captive Bugle Head Nail

Quickly secures housing in place. The nail is easily removable for quick housing repositioning/relocation without changing the bar hanger or nail.

Bar Hanger Locking

Secures bar hanger adjustments with the oversized locking screw or the quick-lock screwdriver slot feature.

Illustrated here is the Juno ICPL626E with 2330W-WH housing

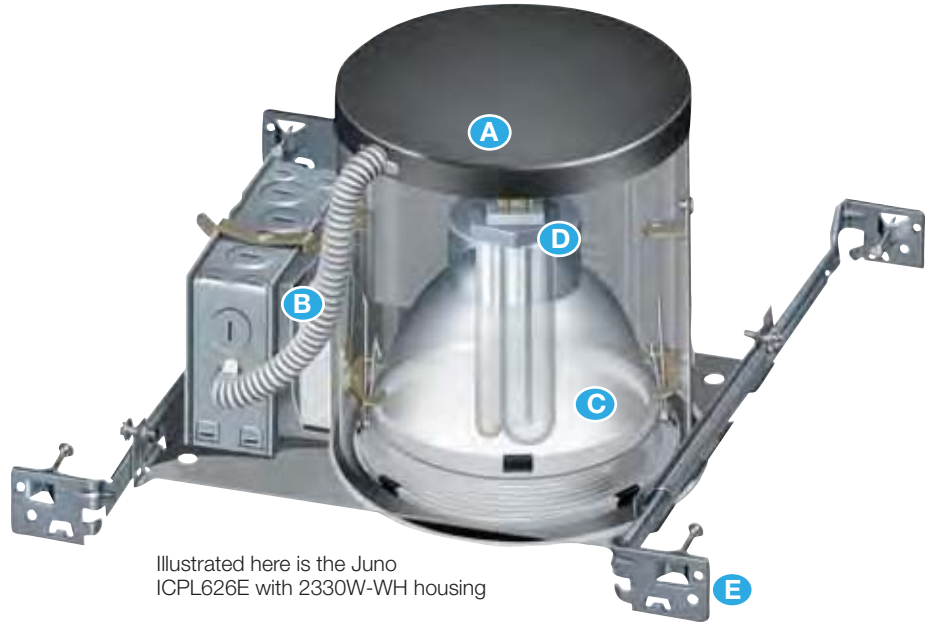

Patented Break-Away Design

Score lines on the bar hangers provide a clean and fast break to fit the housing in tight applications.

T-Bar Mounting

Integral T-bar mounting feature secures the housing to suspended ceilings; no additional parts required.

Locking System

Quick-Loc slot and oversized set screw lock fixture in position.



The industry's most comprehensive line of CFL downlights

Housings

Juno's extensive line of CFL downlights are designed and engineered in the USA to the highest standards. They provide an energy-efficient, yet economical solution for task and general lighting in kitchens, studies, laundry areas, hobby or fitness rooms, and many other parts of the home.

Juno CFL downlights are available with new construction or remodel housings and with 4", 5", or 6" aperture sizes. State of the art electronic ballasts provide rapid starting and flicker-free operation without the annoying hum associated with older magnetic ballasts. Compared to incandescent lighting, Juno CFLs are up to 80% more efficient and last as much as 10-times longer.

Trims

Juno CFL downlights feature many reflector designs optimized specially for CFL lamps, ensuring best-in-class lighting performance. A wide variety of trims are available to complement any interior décor. Three of our most popular trim designs are shown below.

Performance



2330

The 2330 trim features an innovative optical system where optimum lamp placement, reflector design, and diffusing glass lens combine to produce illumination levels and light uniformity far superior to incandescent fixtures with open baffle trim.

Contemporary Bevel



5101

The 5101/6101 trim possesses the same qualities as the Performance trim but with an attractive, contemporary touch.

Traditional



239

The 239 trim features a specially designed, glass diffusing lens, which conceals the CFL lamp image and provides uniform luminance on the lens without hot spots.



Juno CFL downlights provide best-in-class lighting performance and energy efficiency

CFL downlights ... the energy efficient advantage



Juno downlights meet the high efficacy requirements of California Title 24-2008.

CFL vs. Incandescent Energy Usage Chart

This chart compares CFL energy requirements to equivalent incandescent lighting. CFLs consume approximately 60% to 80% less energy than incandescent, equating to substantial savings.

Example: Six 26W CFLs operated 6 hours per day, 5 days a week, provide illumination equal to six 100W incandescent lamps, yielding an annual savings of \$69.00.*

CFL Lamp	Incandescent Equivalent
13W	40-60 watts
18W	60-75 watts
26W	75-100 watts
32W	100 watts
42W	100-150 watts

Juno CFL Downlights vs. Retrofit CFLs

Most self-ballasted screw-in retrofit lamps are not designed or tested to operate in recessed fixtures. As a result, they typically operate too hot in this application, causing significant reductions in light output and lamp life. Juno's ballasted CFL housings are optimized for operation with pin-based CFLs to achieve maximum light output, brightness control and longevity, while minimizing the cost of replacement lamps.

* Based on national average of \$0.10/KWh and typical data regarding lamp lumen depreciation and lamp/ballast watts.

Juno CFL Downlight Index



4" Vertical CFL ICPL and PL New Construction and Remodel

70 - 71

Small aperture provides a stylish, designer look that disappears unobtrusively into the ceiling.



5" Vertical CFL ICPL and PL New Construction and Remodel

72 - 73

Housings for both insulated and non-insulated ceilings.



6" Vertical CFL ICPL and PL New Construction and Remodel (High Wattage)

74 - 75

26W, 32W, or 42W housings for higher ceiling applications or wherever greater light output is required.



6" Vertical CFL ICPL and PL New Construction and Remodel

76 - 77

13W and 18W housings for standard installations.



4" Vertical Compact Fluorescent Downlights

The stylishly small 4" aperture of this Juno CFL downlight makes it an excellent illumination choice for many of today's contemporary interiors.

4" New Construction or Remodel

13 Watt CFL Housings



ICPL Fluorescent Housing
Air-Loc® CFL housing may be covered with insulation. Easy access ballast.

ICPL413E 120V HPF
Electronic Ballast

18½" L x 9½" W x 7¼" H
Ceiling cutout: 4½"
One 13W Triple Tube
(4-pin) CFL*



ICPL Fluorescent Remodel Housing
Air-Loc® CFL Remodel housing may be covered with insulation. Easy access ballast.

ICPL413RE 120V HPF
Electronic Ballast

12" L x 4¾" W x 6¼" H
Ceiling cutout: 4¾"
One 13W Triple Tube
(4-pin) CFL*

18 Watt CFL Housings



ICPL Fluorescent Housing
Air-Loc® CFL housing may be covered with insulation. Easy access ballast.

ICPL418E 120V HPF
Electronic Ballast

18½" L x 9½" W x 7¼" H
Ceiling cutout: 4½"
One 18W Triple Tube
(4-pin) CFL*



ICPL Fluorescent Remodel Housing
Air-Loc® CFL Remodel housing may be covered with insulation.

ICPL418RE 120V HPF
Electronic Ballast

12" L x 4¾" W x 6¼" H
Ceiling cutout: 4¾"
One 18W Triple Tube
(4-pin) CFL*



PL Fluorescent Housing
Energy-efficient CFL housing. Requires 3" spacing from insulation.

PL413EU 120V thru 277V HPF
Electronic Ballast

11⅞" L x 6¾" W x 6⅞" H
Ceiling cutout: 4½"
One 13W Triple Tube (4-pin) CFL*



PL Fluorescent Housing
Energy-efficient CFL housing. Requires 3" spacing from insulation.

PL418EU 120V thru 277V HPF
Electronic Ballast

11⅞" L x 6¾" W x 6⅞" H
Ceiling cutout: 4½"
One 18W Triple Tube (4-pin) CFL*

Note: In Canada when insulation is present, Type IC fixtures must be used.

* Lamp not included.



4" 13/18/26 Watt CFL Trims

The trims shown here may be used with any 4" CFL housing shown on page 70 and 71.

26 Watt CFL Housings



**HPF/NPF
ICPL Fluorescent Housing**
Air-Loc® CFL housing may be covered with insulation.
Easy access ballast.

ICPL426E 120V HPF Electronic Ballast
ICPL426EN 120V NPF Electronic Ballast
ICPL426EN-DB120 ICPL426E with 120V NPF
Dimmable Ballast – T24 compliant

18½" L x 9½" W x 7¼" H
Ceiling cutout: 4½"
One 26W Triple Tube
(4-pin) CFL*



PL Fluorescent Housing
Energy-efficient CFL housing.
Requires 3" spacing from
insulation.

PL426EU 120V thru 277V
HPF Electronic Ballast

11⅞" L x 6¾" W x 6⅞" H
Ceiling cutout: 4½"
One 26W Triple Tube
(4-pin) CFL*



**PL Fluorescent
Remodel Housing**
Energy-efficient CFL
housing. Requires 3"
spacing from insulation.

PL426RE 120V thru
277V HPF Electronic
Ballast

12" L x 4¾" W x 6¼" H
Ceiling cutout: 4¾"
One 26W Triple Tube
(4-pin) CFL*

Downlights



**Pinhole with
Integral Shield
13-WH**
2" Aperture



Baffle
14W-WH White
14B-WH Black
14B-SC Black
14B-ABZ Black
14B-BL Black
3⅝" Aperture



Cone
17CLI-WH Clear Low
Iridescent Alzak®
17G-WH Gold Alzak®
17B-WH Black Alzak®
17PT-SC Pewter Alzak®
17W-WH Gloss White
17HZ-WH Haze
17WHZ-WH Wheat Haze
17WHZ-ABZ Wheat Haze
3⅝" Aperture



Baffle
Optimized for CFL
140B-WH Black
140W-WH White
3⅝" Aperture

Downlights, cont.



Cone
Optimized for CFL
170CLI-WH Clear Low
Iridescent Alzak®
170HZ-WH Haze
170WHZ-WH Wheat Haze
3⅝" Aperture



Decorative
Beveled Cylinder
4103FROST-WH
4103FROST-SC
3" Aperture



Beveled Cone
4104HZ-SC
4104WHZ-ABZ
3⅝" Aperture



Glass Cylinder
4150MESH-SC
2⅝" Aperture

Lensed



**Drop Opal
11-WH**
(Not for use with
ICPL413RE or
ICPL418RE)



**Frosted Lens
with Clear
Center**
12W-WH
12W-SC
12W-ABZ



**Beveled Frame,
Frosted Dome
Lens**
4101-WH
4101-SC
4101-ABZ



Beveled Lens
4102-WH
4102-SC
4102-ABZ

Trim Ring Finishes

ABZ: Classic Aged Bronze
WH: White

SC: Satin Chrome
BL: Black



5" Vertical Compact Fluorescent Downlights

Juno 5" CFL downlights are available with housings for both insulated and non-insulated ceilings and offer up to 80% greater energy efficiency than comparable incandescent fixtures.

5" New Construction or Remodel

13 Watt CFL Housings



ICPL Fluorescent Housing
Air-Loc® CFL housing may be covered with insulation. Easy access ballast.

ICPL Fluorescent Remodel Housing
Air-Loc® CFL remodel housing may be covered with insulation.

ICPL513E 120V HPF Electronic Ballast

16¹/₈" L x 9¹/₈" W x 7¹/₂" H
Ceiling cutout: 5¹/₂"
One 13W Triple Tube or Quad (4-pin) CFL*

ICPL513RE 120V HPF Electronic Ballast

12¹/₂" L x 5⁷/₈" W x 7¹/₂" H
Ceiling cutout: 5¹/₂"
One 13W Triple Tube or Quad (4-pin) CFL*

18 Watt CFL Housings



ICPL Fluorescent Housing
Air-Loc® CFL housing may be covered with insulation. Easy access ballast.

ICPL Fluorescent Remodel Housing
Air-Loc® CFL remodel housing may be covered with insulation.

ICPL518E 120V HPF Electronic Ballast

16¹/₈" L x 9¹/₈" W x 7¹/₂" H
Ceiling cutout: 5¹/₂"
One 18W Triple Tube (4-pin) CFL*

ICPL518RE 120V HPF Electronic Ballast

12¹/₂" L x 5⁷/₈" W x 7¹/₂" H
Ceiling cutout: 5¹/₂"
One 18W Triple Tube (4-pin) CFL*

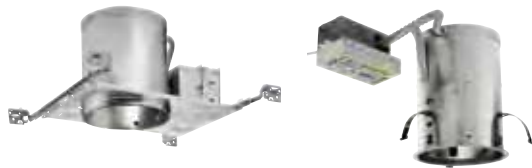

PL Fluorescent Housing
Energy-efficient, CFL housing. Requires 3" spacing from insulation.

PL Fluorescent Remodel Housing
Energy-efficient, CFL housing. Requires 3" spacing from insulation.

PL513EU 120V thru 277V HPF Electronic Ballast

11¹/₈" L x 6³/₄" W x 7¹/₂" H
Ceiling cutout: 5¹/₂"
One 13W Triple Tube or Quad (4-pin) CFL*

PL513RE 120V thru 277V HPF Electronic Ballast

12¹/₂" L x 5⁷/₈" W x 7¹/₂" H
Ceiling cutout: 5¹/₂"
One 13W Triple Tube or Quad (4-pin) CFL*

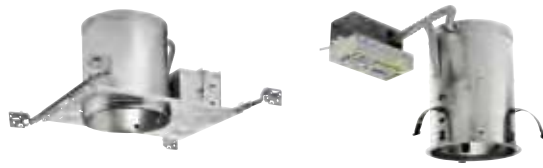

PL Fluorescent Housing
Ballast. Energy-efficient, CFL housing. Requires 3" spacing from insulation.

PL Fluorescent Remodel Housing
Energy-efficient, CFL housing. Requires 3" spacing from insulation.

PL518EU 120V thru 277V HPF Electronic

11¹/₈" L x 6³/₄" W x 7¹/₂" H
Ceiling cutout: 5¹/₂"
One 18W Triple Tube (4-pin) CFL*

PL518RE 120V thru 277V HPF Electronic Ballast.

12¹/₂" L x 5⁷/₈" W x 7¹/₂" H
Ceiling cutout: 5¹/₂"
One 18W Triple Tube (4-pin) CFL*

Note: In Canada when insulation is present, Type IC fixtures must be used.
* Lamp not included.



5" 13/18/26 Watt CFL Trims

The trims shown here may be used with any 5" CFL housing shown on page 72 and 73.

26 Watt CFL Housings



**HPF/NPF
ICPL Fluorescent Housings**
Air-Loc® CFL housing may be covered with insulation. Easy access ballast.

ICPL526E 120V HPF
Electronic Ballast

ICPL526EN 120V NPF
Electronic Ballast

ICPL526E-DB120
ICPL526E with 120V HPF
Dimmable Ballast –
T24 compliant

ICPL526EN-DB120
ICPL526E with 120V NPF
Dimmable Ballast –
T24 compliant

16 $\frac{1}{8}$ " L x 9 $\frac{1}{8}$ " W x 7 $\frac{1}{2}$ " H
Ceiling cutout: 5 $\frac{1}{2}$ "
One 26W Triple Tube
(4-pin) CFL*



PL Fluorescent Housing
Energy-efficient, CFL
housing. Requires 3"
spacing from insulation.

PL526EU 120V thru 277V
HPF Electronic Ballast

11 $\frac{1}{8}$ " L x 6 $\frac{3}{4}$ " W x 7 $\frac{1}{2}$ " H
Ceiling cutout: 5 $\frac{1}{2}$ "
One 26W Triple Tube
(4-pin) CFL*



**HPF/NPF
ICPL Fluorescent Remodel
Housing.** Air-Loc® vertical CFL
remodel housing for remodel
applications.

ICPL526RE 120V HPF
Electronic Ballast

ICPL526REN 120V NPF
Electronic Ballast

ICPL526REN-DB120
ICPL526REN with 120V NPF
Dimmable Ballast –
T24 compliant

12 $\frac{1}{2}$ " L x 5 $\frac{7}{8}$ " W x 7 $\frac{1}{2}$ " H
Ceiling cutout: 5 $\frac{1}{2}$ "
One 26W Triple Tube
(4-pin) CFL*



PL Fluorescent Remodel
Energy-efficient, CFL
housing. Requires 3"
spacing from insulation.

PL526RE 120V thru 277V
HPF Electronic Ballast

12 $\frac{1}{2}$ " L x 5 $\frac{7}{8}$ " W x 7 $\frac{1}{2}$ " H
Ceiling cutout: 5 $\frac{1}{2}$ "
One 26W Triple Tube
(4-pin) CFL*

Downlights



Baffle
215W-WH White
215B-WH White
4 $\frac{3}{8}$ " Aperture



Reflector
216C-WH Clear Alzak®
216HZ-WH Haze
216W-WH Gloss White
216G-WH Gold Alzak®
216WHZ-WH Wheat
Haze
4 $\frac{3}{8}$ " Aperture



Reflector with Baffle*
218W-WH White
218B-WH Black
4 $\frac{3}{8}$ " Aperture



Reflector*
219C-WH Clear Low
Iridescent Alzak®
219HZ-WH Haze
219HZ-SC Haze
219WHZ-WH Wheat Haze
219WHZ-ABZ Wheat Haze
4 $\frac{3}{8}$ " Aperture

Lensed



**Flat Glass
Shower Trim**
210N-ABZ
210N-SC
210N-WH



**Baffle, Regressed
Frosted Dome
Lens with
Reflector**
2130W-WH White
2130B-WH Black



**Beveled Frame,
Frosted Dome
Lens with
Reflector**
5101-ABZ
5101-SC
5101-WH

Accessories

ALG5: Energy Conserving Gasket for 5" New Construction Air-Loc® IC Housings

ALG5R: Energy Conserving Gasket Kit for 5" Air-Loc® IC Remodel Housings

SMPLT-5: Galvanized steel plate for locating remodel style housings in new construction. Screw/nail holes for full coverage between 16" & 24" joists.

Trim Ring Finishes

ABZ: Classic Aged Bronze **SC:** Satin Chrome **WH:** White

* 218 & 219 optimized for 26W Triples & 13W Quads.



6" Vertical Compact Fluorescent Downlights (High Wattage)

Juno 6" high-wattage CFL downlights are the energy-efficient choice for higher ceiling applications and anywhere in the home where higher levels of illumination are desired.

6" New Construction or Remodel

26 Watt CFL Housings



HPF/NPF ICPL Fluorescent Housing, Air-Loc® CFL housing may be covered with insulation. Easy access ballast.

ICPL626E 120V HPF Electronic Ballast

ICPL626EN 120V NPF Electronic Ballast

ICPL626E-DB120 ICPL626E with 120V HPF dimmable ballast – T24 compliant

ICPL626EN-DB120 ICPL626EN with 120V NPF dimmable ballast – T24 compliant

16¹/₈" L x 9¹/₈" W x 7¹/₂" H
Ceiling cutout: 6³/₈"
One 26W Triple Tube (4-pin) CFL*

HPF/NPF ICPL Fluorescent Remodel Housing, Air-Loc® vertical CFL remodel housing for remodel applications.

ICPL626RE 120V HPF Electronic Ballast

ICPL626REN 120V NPF Electronic Ballast

ICPL626RE-DB120 ICPL626REN with 120V NPF dimmable ballast – T24 compliant

13³/₄" L x 7⁵/₁₆" W x 7¹/₂" H
Ceiling cutout: 6³/₄"
One 26W Triple Tube (4-pin) CFL*

32 Watt CFL Housings



ICPL Fluorescent Housing, Air-Loc® CFL double wall housing does not require separate gasket. Housing may be covered with insulation.

ICPL632E 120V HPF Electronic Ballast

ICPL632E-DB120 ICPL632E with 120V HPF Dimmable Ballast – T24 compliant

ICPL632EN-DB120 ICPL632EN with 120V NPF Dimmable Ballast – T24 compliant

16¹/₈" L x 9¹/₈" W x 7¹/₂" H
Ceiling cutout: 6³/₈"
One 26/32W Triple Tube (4-pin) CFL*

42 Watt CFL Housings



PL Fluorescent Housing Energy-efficient, CFL housing. Requires 3" spacing from insulation.

PL642EU Easy access 120V thru 277V HPF Electronic Ballast

16¹/₈" L x 7³/₄" W x 7¹/₄" H
Ceiling cutout: 6⁷/₈"
One 26/32/42W Triple Tube (4-pin) CFL*



PL Fluorescent Remodel Housing Energy-efficient, CFL housing. Requires 3" spacing from insulation.

PL642RE 120V thru 277V HPF Electronic Ballast

13³/₄" L x 7⁵/₁₆" W x 7¹/₄" H
Ceiling cutout: 6³/₄"
One 26/32/42W Triple Tube (4-pin) CFL*















Note: In Canada when insulation is present, Type IC fixtures must be used.

* Lamp not included.



6" High Wattage CFL Trims

The trims shown here may be used with any 6" CFL housing shown on page 74.

Downlights	Wall Wash	Lensed	Decorative
 Ultra-Trim Baffle 28W-WH White 28B-WH White 5 7/8" Aperture	 Reflector 2320C-WH Clear Low Iridescent Alzak [®] 2320HZ-WH Haze 2320HZ-SC Haze 2320WHZ-WH Wheat Haze 2320WHZ-ABZ Wheat Haze - Optimized for 32W ICPL632E 6" Aperture	 Albalite Lens with Reflector 220-PW Shower/ Closet Light 220-WH 26W Max	 Baffle, Regressed Frosted Dome Lens with Reflector 2330W-WH White 2330B-WH Black
 Ultra-Trim Cone 29C-WH Clear 29W-WH White 5 7/8" Aperture	 Scoop 261W-WH White 261B-WH Black 26W Max	 Drop Opal with Reflector 241-PW Shower/ Closet Light 241-WH 26W Max	 Frosted Flat Lens with Reflector 239-WH
 Reflector with Black Baffle 233C-WH Clear Alzak [®] 5 7/8" Aperture	 Decorative Swirled Etched Opal Glass* 243-WH	 Drop Opal with Reflector 271-PW Shower/ Closet Light ICPL626E: 26W ICPL632E/PL642: 32W	 Beveled Frame, Frosted Dome Lens with Reflector 6101-ABZ 6101-SC 6101-WH
 Reflector* 232C-WH Clear Alzak [®] 232HZ-WH Haze 232W-WH Gloss White 232G-WH Gold Alzak [®] 232WHZ-WH Wheat Haze 5 7/8" Aperture	 Fluted Drop Opal† 9900-WH	 Frosted Lens with Clear Center 242-ABZ 242-SC 242-WH	
Accessories ALG6: Energy Conserving Gasket for 6" Air-Loc [®] IC New Construction Housings ALG6R: Energy Conserving Gasket Kit for 6" Air-Loc [®] IC Remodel Housings	Trim Ring Finishes ABZ: Classic Aged Bronze SC: Satin Chrome PW: Plastic White WH: White (Polycarbonate material shower trim)		
† See accessory page 161 for additional trim ring finishes, order separately. * Specify General Electric or Osram Sylvania lamps only.			



6" Vertical Compact Fluorescent Downlights

Juno 6" CFL downlights are available with housings for both insulated and non-insulated ceilings and offer the largest selection of trim and optics packages.

6" New Construction or Remodel

13 Watt CFL Housings



ICPL Fluorescent Housing
Air-Loc® CFL housing may be covered with insulation. Easy access ballast.

ICPL613E 120V HPF Electronic Ballast

16¹/₈" L x 9¹/₈" W x 7¹/₂" H
Ceiling cutout: 6³/₈"
One 13W Triple Tube or Quad (4-pin) CFL*

18 Watt CFL Housings



ICPL Fluorescent Housing
Air-Loc® CFL housing may be covered with insulation. Easy access ballast.

ICPL618E 120V HPF Electronic Ballast

16¹/₈" L x 9¹/₈" W x 7¹/₂" H
Ceiling cutout: 6³/₈"
One 18W Triple Tube (4-pin) CFL*



ICPL Fluorescent Remodel Housing
Air-Loc® CFL housing may be covered with insulation.

ICPL618RE 120V HPF Electronic Ballast

13³/₄" L x 7¹⁵/₁₆" W x 7¹/₄" H
Ceiling cutout: 6³/₈"
One 18W Triple Tube (4-pin) CFL*



PL Fluorescent Housing
Energy-efficient CFL housing. Requires 3" spacing from insulation.

PL613EU Easy access 120V thru 277V HPF Electronic Ballast

16¹/₈" L x 7³/₄" W x 7¹/₄" H
Ceiling cutout: 6³/₈"
One 13W Triple Tube or Quad (4-pin) CFL*



PL Fluorescent Remodel Housing
Energy-efficient CFL remodel housing. Requires 3" spacing from insulation.

PL613RE Easy access 120V thru 277V HPF Electronic Ballast

13³/₄" L x 7⁷/₁₆" W x 7¹/₄" H
Ceiling cutout: 6³/₈"
One 13W Triple Tube or Quad (4-pin) CFL*

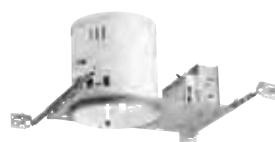

PL Fluorescent Housing
Energy-efficient CFL housing. Requires 3" spacing from insulation.

PL618EU 120V thru 277V HPF Electronic Ballast

16¹/₈" L x 7³/₄" W x 7¹/₄" H
Ceiling cutout: 6³/₈"
One 18W Triple Tube (4-pin) CFL*



PL Fluorescent Remodel Housing
Energy-efficient CFL housing. Requires 3" spacing from insulation.

PL618RE Easy access 120V thru 277V HPF Electronic Ballast













13³/₄" L x 7⁷/₁₆" W x 7¹/₄" H
Ceiling cutout: 6³/₈"
One 18W Triple Tube (4-pin) CFL*

Note: In Canada when insulation is present, Type IC fixtures must be used.
* Lamp not included.



6" 13/18 Watt CFL Trims

The trims shown here may be used with any 6" CFL housing shown on page 76.

Downlights	Wall Wash	Lensed	
 <p>Ultra-Trim Baffle 28W-WH White 28B-WH Black 5 7/8" Aperture</p>	 <p>Scoop 261W-WH White 261B-WH Black</p>	 <p>Albalite Lens with Reflector 240-PW Shower/ Closet Light 240-WH</p>	 <p>Baffle, Regressed Frosted Dome Lens with Reflector 2330W-WH White 2330B-WH Black</p>
 <p>Ultra-Trim Cone 29C-WH Clear 29W-WH White 5 7/8" Aperture</p>	<p>Decorative</p>  <p>Decorative Swirled Etched Opal Glass* 243-WH</p>	 <p>Drop Opal with Reflector 241-PW Shower/ Closet Light 241-WH</p>	 <p>Frosted Flat Lens with Reflector 239-WH</p>
 <p>Reflector with Black Baffle 233C-WH Clear Alzak® 5 7/8" Aperture</p>	 <p>Fluted Drop Opal† 9900-WH</p>	 <p>Drop Opal with Reflector 271-PW Shower/ Closet Light</p>	 <p>Beveled Frame, Frosted Dome Lens with Reflector 6101-ABZ 6101-SC 6101-WH</p>
 <p>Reflector* 232C-WH Clear Alzak® 232HZ-WH Haze 232W-WH Gloss White 232G-WH Gold Alzak® 232WHZ-WH Wheat Haze 5 7/8" Aperture</p>			

Wet Location (Umbrella icon) and **Air-LOC** (Air-LOC icon) labels are present next to several trim options.

Accessories

ALG6: Energy Conserving Gasket for 6" New Construction Air-Loc® IC Housings

ALG6R: Energy Conserving Gasket Kit for 6" Air-Loc® IC Remodel Housings

Trim Ring Finishes

ABZ: Classic Aged Bronze

SC: Satin Chrome

PW: Plastic White

WH: White

(Polycarbonate material shower trim)

† See accessory page 161 for additional trim ring finishes, order separately.

* Specify General Electric or Osram Sylvania lamps only.

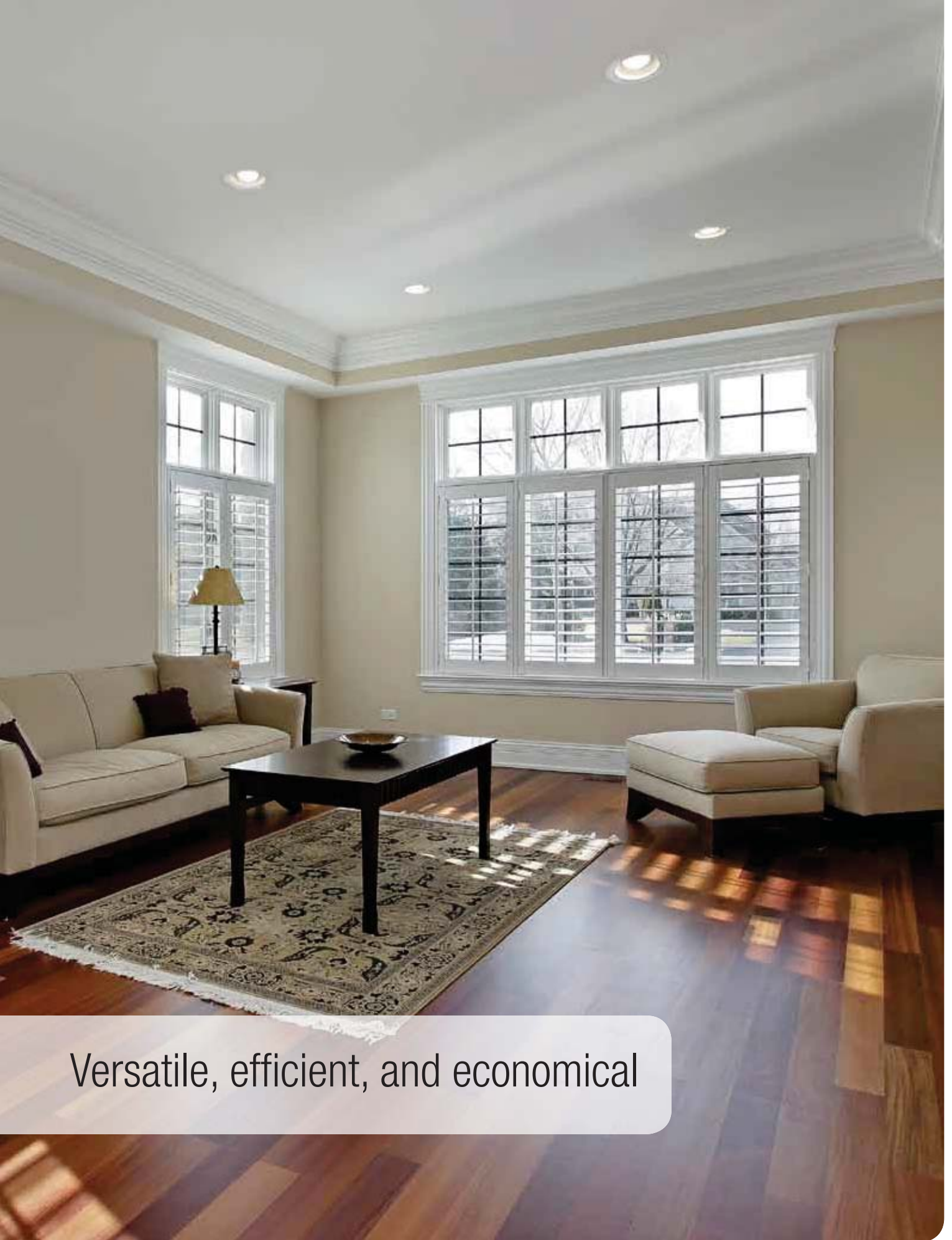

Versatile, efficient, and economical

Incandescent Downlights

Juno's incandescent downlights are the industry's most comprehensive and versatile line. No matter what your application, you are certain to find the perfect solution with Juno... from new construction to remodel housings... from 3" miniature downlights to 6" downlights for general illumination... from white baffle trims to stunning satin-chrome trims. Whether it's general downlighting, task, wall washing, or accent lighting, Juno recessed incandescent fixtures will meet your every illumination need.

Juno incandescent downlights are designed and engineered in the USA for economy, efficiency, and ease of installation. Juno innovations such as IC housings that can be directly covered with insulation and sealed Air-Loc[®] housings offer substantial gains in energy efficiency. And Juno's Real Nail[®] 3 bar hanger system leads the way in installation simplicity.

Juno Incandescent Downlight Advantages

- The industry's most comprehensive downlight line
- Aperture sizes of 3", 4", 5", and 6"
- Housings for either insulated or non-insulated ceilings
- Large selection of efficient, long-life halogen fixtures
- Extensive selection of high-quality reflector and trim finishes
- Easy installation with the Real Nail[®] 3 bar hanger system



Juno incandescent downlights

Versatile, practical, and economical pretty well describes Juno's lineup of incandescent downlights. They're versatile in the wide selection of housing and trim styles and sizes ... practical in the design and installation features such as the patented Real Nail® 3 bar hanger system ... and economical in initial installed costs and energy efficiency.

Juno incandescent downlights are available in a wide variety of low-voltage and line-voltage models, new construction and remodel housings, and four aperture sizes for insulated or non-insulated installations.

Juno Incandescent Downlight Index

	<p>4" MR16 and 6" MR16/PAR36 Universals Low-voltage operation for task and accent illumination; accepts downlight or adjustable trims.</p>	82-85
	<p>3" Mini and 4" R/PAR20 Universals Small aperture offers clean ceiling appearance; Mini is ideal for accent lighting in confined spaces.</p>	86-89
	<p>5" Universals Provides smaller aperture appearance and can be used with R or PAR lamps; accepts downlight, wall wash, lensed or adjustable trims.</p>	90-91
	<p>5" Shallow Universals Can be used in applications where vertical space is limited; accepts downlight, lensed or adjustable trims.</p>	92-93
	<p>6" Deluxe Universals, High Wattage Offers the greatest trim and wattage selection and optimum lamp position; accepts downlight, wall wash, lensed, decorative or adjustable trims.</p>	94-97
	<p>6" Standard Universals Offers basic trim selection with certain wattage and lamp position restrictions; accepts downlight, lensed or adjustable trims.</p>	98-99
	<p>6" Standard Universals with Floating Socket Optimized for quick attachment to enclosed and adjustable style trims; accepts downlight, wall wash, or adjustable trims.</p>	100-101
	<p>6" Shallow Universals Ideal solution for 2 x 6 construction or when installation space is limited; accepts downlight, lensed or adjustable trims.</p>	102-103
	<p>8" and 10" Squares Features large opal or prismatic lens and higher lamp wattages to produce bright, diffuse and shadow-free illumination.</p>	104-105



4" MR16 Universals

Juno's 4" low-voltage series offers a wide variety of housings and trims utilizing 12-volt, MR16 lamps. These lamps provide excellent beam control and superior color rendering for accent, task, wall washing, or downlight applications.

4" MR16 Universals



AIR-LOC



IC Housing

50 Watt Energy-efficient, Air-Loc® double wall housing. May be covered with insulation. No separate gasket required. Housing includes 50VA 12V, thermally protected magnetic transformer.

IC44N with Real Nail® 3 bar hangers

IC44S with deep plaster lip. Smaller footprint bar hangers (Real Nail® 2)

IC44W with push-in electrical connectors and Real Nail® 3 bar hangers

50W MR16

18½" L x 9⅛" W x 7⅝" H*

Ceiling cutout: 4½"

*8⅜" - IC44S

TC Housing

50 Watt housing includes 50VA 12V, thermally protected magnetic transformer. Requires 3" spacing from insulation.

TC44N with Real Nail® 3 bar hangers

TC44V with 277V magnetic transformer and Real Nail® 3 bar hangers

TC44S with smaller footprint bar hangers (Real Nail® 2)

50W MR16

12⅞" L x 6¼" W x 5⅝" H

Ceiling cutout: 4½"



TC Remodel Housing

50 Watt housing includes 50VA 12V, thermally protected magnetic transformer and mounting tray. Requires 3" spacing from insulation. Transformer tray and housing may be installed from below through a 4⅞" hole.

TC44R Remodel Housing

50W MR16

10½" L x 4¼" W x 5¼" H

Ceiling cutout: 4⅞"



TC Housing

75 Watt housing includes 75VA 12V, thermally protected magnetic transformer. Requires 3" spacing from insulation.

TC47 with Real Nail® 3 bar hangers

TC47V with 277V magnetic transformer and Real Nail® 3 bar hangers

75W MR16

12¾" L x 6¼" W x 6" H

Ceiling cutout: 4½"

Note: In Canada when insulation is present, Type IC fixtures must be used.
Use dimmers specifically designed for low voltage magnetic transformers.



4" MR16 Universal Trims

The trims shown here may be used with any 4" MR16 Universal housing on page 82.

Downlight Trims



Deep Cone
 442B-WH Black Alzak®
 442C-WH Clear Alzak®
 442G-WH Gold Alzak®
 442HZ-WH Haze
 442WHZ-WH Wheat Haze
 50W MR16
 3 3/8" Aperture



Pinhole with Baffle
 443B-WH Pinhole w/
 Black Baffle
 IC/TC44: 50W MR16;
 TC47: 75W MR16
 1 1/4" Aperture

Adjustables



**Baffle - Downlight/
 Adjustable**
 444W-WH White
 444B-WH Black
 444B-ABZ Black
 444B-SC Black
 444B-BL Black
 30° vertical adjustment
 IC/TC44: 50W MR16;
 TC47: 75W MR16
 3 3/8" Aperture



**Cone - Downlight/
 Adjustable**
 447B-WH Black Alzak®
 447C-WH Clear Alzak®
 447G-WH Gold Alzak®
 447HZ-WH Haze
 447PT-SC Pewter Alzak®
 447WHZ-ABZ Wheat Haze
 447WHZ-WH Wheat Haze
 35° vertical adjustment
 IC/TC44: 50W MR16;
 TC47: 75W MR16
 3 3/8" Aperture



Flush Gimbal Ring
 440-ABZ
 440-BL
 440-SC
 440-WH
 40° vertical adjustment
 50W MR16
 Uses 2" light control
 lenses-consult factory.

Adjustables, cont.



Eyeball w/Black Baffle
 448-WH
 35° vertical adjustment
 IC/TC44: 50W MR16;
 TC47: 75W MR16



**AVIO™ Square
 Gimbal Ring**
 XR16101BL
 XR16101GP
 XR16101SL
 XR16101WH
 45° vertical adjustment
 IC/TC44: 50W MR16
 TC47: 75W MR16



Adjustable Slot Aperture
 445-WH
 45° vertical adjustment
 IC/TC44: 50W MR16;
 TC47: 75W MR16
 1 1/2" x 2 1/8" Slot Aperture



Aiming Elbow
 449-ABZ
 449-BL
 449-SC
 449-WH
 75° vertical adjustment
 50W MR16

Lensed



**Downlight/
 Adjustable
 Shower Trim**
 441W-ABZ
 441W-SC
 441W-WH
 35° vertical adjustment
 50W MR16



Wall Wash



Adjustable Scoop
 446-WH
 45° vertical adjustment
 IC/TC44: 50W MR16;
 TC47: 75W MR16

More trim selection on the next page →

Accessories



Light Accessories, see page 161

4TSA

Torsion Spring Adapter for use in TC44, IC44N and TC47

SMPLT-4

Galvanized steel plate for locating remodel style housings in new construction. Screw/nail holes for full coverage between 16" and 24" joists. For use with TC44R.

Trim Ring Finishes

ABZ: Classic Aged Bronze
SC: Satin Chrome
WH: White
BL: Black

4" Deco Trims Series - MR16

The 4" Deco trim makes a definitive contemporary statement and adds a designer touch to your Juno low-voltage lighting layout. The trims listed below are for use with 50-watt housings located on preceding page 82.



4" Deco Trims Series - For MR16 Housing IC44 / TC44 / TC47 (See housings on page 82.)

Decorative Downlights



Beveled Lensed
 4402-ABZ
 4402-SC
 4402-WH
 30° vertical adjustment
 50W MR16



Beveled Dome Lensed
 4401-ABZ
 4401-SC
 4401-WH
 50W MR16



Frosted Glass
 4481CLEAR
 50W MR16



Solid Glass Collar
 4480FROST
 50W MR16
 2 5/8" Aperture



Beveled Cone
 4404HZ-SC Haze
 4404WHZ-ABZ Wheat
 Haze
 30° vertical adjustment
 50W MR16
 3 5/8" Aperture



Beveled Cylinder
 4403FROST-SC
 Frost Glass
 4403FROST-WH
 Frost Glass
 30° vertical adjustment
 50W MR16
 3" Aperture



Mesh Glass Cylinder
 4450MESH-SC
 50W MR16
 2 5/8" Aperture

Accessories



Light Accessories, see page 161

4TSA

Torsion Spring Adapter for use in TC44, IC44N and TC47

Trim Ring Finishes

ABZ: Classic Aged Bronze
SC: Satin Chrome
WH: White

6" MR16/PAR36 Universals

Juno offers 6" low-voltage housings and trims to coordinate with the popular Juno 6" line-voltage downlights. Choose from MR16 or PAR36 light sources.

6" Low Voltage Universal Housings



MR16 TC Housing

Housing includes 75VA 12V, thermally protected magnetic transformer and adjustable bar hangers. Requires 3" spacing from insulation.

TC45 with Real Nail® 3 bar hangers

50W or 75W MR16
13½" L x 7½" W x 7¼" H
Ceiling cutout: 6⅞"



PAR36 TC Housing

Housing includes 50VA 12V, thermally protected magnetic transformer and adjustable bar hangers. Requires 3" spacing from insulation.

TC46 with Real Nail® 3 bar hangers

50W PAR36
13½" L x 7½" W x 7¼" H
Ceiling cutout: 6½"

Note: In Canada when insulation is present, Type IC fixtures must be used.

6" MR16 Trims / 6" PAR36 Trims

Adjustables — 6" MR16 Trims



Baffle - Downlight/ Adjustable

454B-WH Black
35° vertical adjustment
75W MR16
3½" Aperture



Cone - Downlight/ Adjustable

457C-WH Clear Alzak®
35° vertical adjustment
75W MR16
3½" Aperture



Cylinder Spotlight in Baffle

458W-WH White
50° vertical adjustment
50W MR16
5¾" Aperture

Adjustables - 6" PAR36 Trims



Baffle - Downlight/ Adjustable

464W-WH White
464B-WH Black
35° vertical adjustment,
358° rotation
50W PAR36
5¾" Aperture



Cone - Downlight/ Adjustable†

467C-WH Clear Alzak®
35° vertical adjustment,
358° rotation
50W PAR36
5¾" Aperture

Accessory

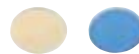

For MR16 Light Accessories,
see page 161

Trim Ring Finishes

ABZ: Classic Aged Bronze
SC: Satin Chrome
WH: White
BL: Black

† See accessory page 161 for additional trim ring finishes, order separately.



3" Mini Universals

Mini halogen downlights are ideal for illuminating small niches and casework.

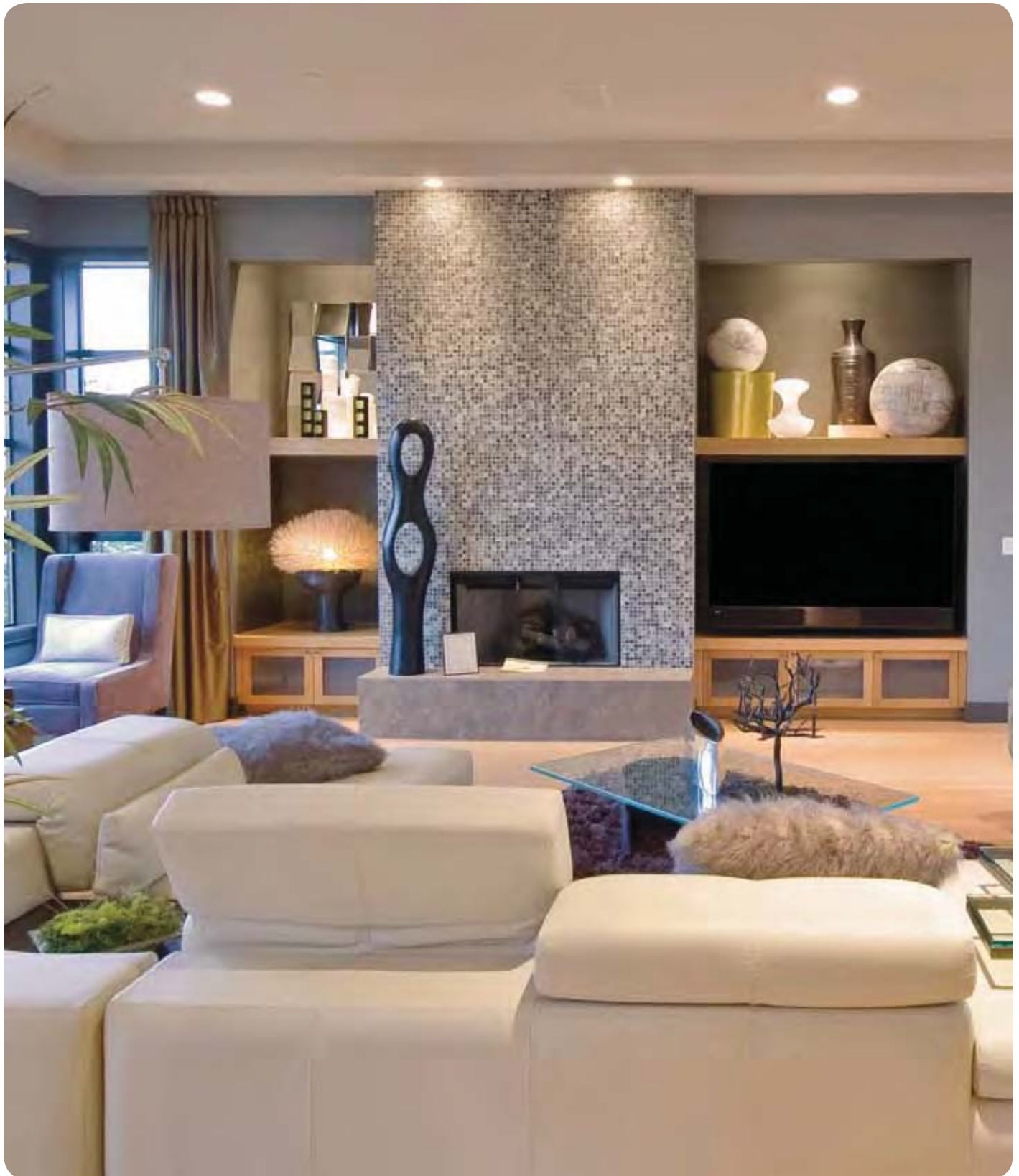

3" Mini-Downlight Housings with Trims



3" Mini-round TC Housing and Trim

Shipped complete with trims as listed.

Requires 3" spacing from insulation.

TC18-184W-WH White Baffle

TC18-184B-WH Black Baffle

60W PAR16

7⁷/₈" L x 3³/₈" W x 6¹/₄" H

Ceiling cutout: 3³/₄"

2¹/₂" Aperture



3" Mini-square TC Housing and Trim

Shipped complete with trims as listed.

Requires 3" spacing from insulation.

TC19-194B-WH Black Baffle

60W PAR16

7⁷/₈" L x 3³/₈" W x 6¹/₄" H

Ceiling cutout: 3³/₄" sq.

2¹/₂" Aperture

Note: In Canada when insulation is present, Type IC fixtures must be used.

Features

- Shallow housing easily fits into casework and other tight spaces
- PAR16 halogen lamp produces focused accent lighting from a miniature 2-1/2" aperture
- Easy to use Real Nail® 3 bar hangers are pre-installed
- Unique plaster frame design facilitates new construction or remodel installation
- TC18 and TC19 series fixtures are shipped complete with housing, trim, and bar hangers

 For an even smaller downlight with an energy-efficient LED light source, see page 62 for Juno Mini LED Downlights and Gimbals.



4" R/PAR20 Universals

These small aperture downlights utilize the popular PAR20 and R20 light sources. They are an excellent choice for lower installation-height applications such as soffits, casework and niches, as well as in settings with shorter beam-throw distances or lower light-level requirements.

4" R/PAR Housings



IC Housing
Energy-efficient, Air-Loc® housing can be covered with insulation. Air-Loc rated in combination with all trims without use of gasket or caulking.

IC1 with Real Nail® 3 bar hangers
IC1S with smaller footprint bar hanger (Real Nail® 2)
IC1W with push-in electrical connectors and Real Nail® 3 bar hangers
12¼" L x 6¾" W x 6" H

IC1P Slightly larger IC housing for use with model 10 trim and GU10-WHIP.

16⅞" L x 9⅞" W x 7½" H
Ceiling cutout: 4½"



TC Housing
Requires 3" spacing from insulation.

TC1 with Real Nail® 3 bar hangers
TC1S with smaller footprint bar hanger (Real Nail® 2)

12⅞" L x 6¾" W x 5⅜" H
Ceiling cutout: 4½"



TC Remodel Housing
Requires 3" spacing from insulation. Installs from below ceiling.

TC1R Remodel Housing

11½" L x 4¾" W x 5¼" H
Ceiling cutout: 4⅞"



Housing Accessories

4TSA: Torsion Spring Adapter for use in TC44, IC44N, IC1, TC1 and TC47

T599: 1" socket extension for use with trims 12 and 4180FROST

GU10-WHIP: For use in IC1P, TC1, and TC1R housings with trims 10 (page 89) and 440, 445, 446, and 448 (page 83, 50W 120V MR16). For use in IC1 housing with trims 440 & 448 only.



SMPLT-4: Galvanized steel plate for locating remodel style housings in new construction. Screw/nail holes for full coverage between 16" and 24" joists. For use with TC1R.

Note: In Canada when insulation is present, Type IC fixtures must be used.

The trims shown here may be used with any 4" R/PAR20 Universal housing on page 88.

4" Line Voltage Trims

Downlights



Pinhole with Integral Shield
13-WH
 IC1: 30W R20, 35W PAR20
 IC1P/TC: 50W PAR/R20
 IC1P: 40W K19
 2" Aperture



Baffle
14W-WH White
14B-BL Black
14B-WH Black
14B-ABZ Black
14B-SC Black
 IC1: 50W PAR20
 (Requires T599
 Socket Extender),
 50W R20
 IC1P/TC1/TC1R: 50W
 PAR/R20
 3 3/8" Aperture



PAR20/R20 Cone
17B-WH Black Alzak®
17C-WH Clear Alzak®
17G-WH Gold Alzak®
17HZ-WH Haze
17PT-SC Pewter Alzak®
17W-WH Gloss White
17WHZ-ABZ Wheat Haze
17WHZ-WH Wheat Haze
 IC1/IC1P/TC1/TC1R:
 50W PAR/R20
 IC1P: 60W K19
 3 3/8" Aperture

Adjustables



Gimbal Ring
10-ABZ
10-BL
10-SC
10-WH
 IC1P/TC: 50W PAR20;
 75W ES20 (120V GU10)
 Adjustment: PAR20=25°,
 ES20=35°



Mini Eyeball PAR16
18-SC
18-WH
 40W R16
 60W PAR16
 Adjustment: 35° vertical



Mini Eyeball
19-WH
 IC-25W R14; TC-40W R14,
 40W R16
 (Intermediate screw base
 lamp)
 Adjustment: 35° vertical

Wall Wash



Scoop
16-WH
 IC-25W R14; TC-40W R14,
 40W R16
 (Intermediate screw base
 lamp) Adjustment: 35°
 vertical

Lensed



Frosted Lens with Clear Center
12W-ABZ
12W-SC
12W-WH
 IC1: 30W R20,
 50W PAR20 with 1"
 socket extender #T599
 IC1P/TC: 50W PAR/R20
 IC1P: 40W K19



Drop Opal
11-WH
 IC1: 30W R20,
 35W PAR20
 IC1P: 30W R20,
 50W PAR20, 40W K19
 TC: 50W PAR/R20



4" Line Voltage Deco Trims



Beveled Lensed
4102-ABZ
4102-SC
4102-WH
 IC1: 50W PAR20, 30W R20
 IC1P/TC: 50W PAR/R20



Beveled Dome Lensed
4101-ABZ
4101-SC
4101-WH
 IC1: 50W PAR20, 30W R20
 IC1P/TC: 50W PAR/R20



Frosted Glass
4181CLEAR
 IC1: 50W PAR20,
 30W R20
 IC1P/TC: 50W PAR/R20



Solid Glass Collar
4180FROST
 IC1: 50W PAR20,
 30W R20 w/ 1" socket
 extender #T599
 IC1P/TC: 50W PAR/R20
 2 5/8" Aperture



Beveled Cone
4104HZ-SC Haze
4104WHZ-ABZ Wheat
 Haze
 50W MR16
 3 3/8" Aperture



Beveled Cylinder
4103FROST-SC
 Frost Glass
4103FROST-WH
 Frost Glass
 50W MR16
 3" Aperture



Mesh Glass Cylinder
4150MESH-SC
 IC1: 50W PAR20, 30W R20
 IC1P/TC: 50W PAR/R20
 2 5/8" Aperture

Trim Ring Finishes

ABZ: Classic Aged Bronze
SC: Satin Chrome
WH: White
BL: Black



5" Universals

Juno offers a wide selection of 5" housings and trims that accommodates many of the same lamps and wattage ratings as the popular 6" series. The reduced size aperture provides a pleasing, smaller scale that compliments many settings.

5" Universal Housings



IC Housing
Energy-efficient, Air-Loc® housing can be covered with insulation.

- IC20** with Real Nail® 3 bar hangers
- IC20S** with smaller footprint bar hanger (Real Nail® 2)
- IC20W** with push-in electrical connectors
- IC20N** with no socket plate (trim 208, 210, 215, 216 and 529 only)
- IC20NW** with push-in electrical connector & no socket plate (trims 208, 210, 215, 216 and 529 only)

11½" L x 6¾" W x 7½" H
Ceiling cutout: 5½"

Note: In Canada when insulation is present, Type IC fixtures must be used.



IC Remodel Housing
Energy-efficient, Air-Loc® housing can be covered with insulation. Installs from below ceiling.

IC20R Remodel Housing

12½" L x 5¾" W x 7½" H
Ceiling cutout: 5½"

5" Universal Trims

Downlights



BR30/PAR30 Baffle†
205W-WH White
205B-WH Black
205B-ABZ Black
205B-SC Black
IC: 50W PAR30
TC: 75W PAR30, 65W BR30
4¾" Aperture



Deep Baffle†
For TC Housings Only
203W-WH White
203B-WH Black
TC: 75W PAR30, 65W BR30
4¾" Aperture



BR30/PAR30 Cone†
204B-WH Black Alzak®
204C-WH Clear Alzak®
204G-WH Gold Alzak®
204HZ-WH Haze
204PT-SC Pewter Alzak®
204W-WH White
204WHZ-ABZ Wheat Haze
204WHZ-WH Wheat Haze
IC20: 50W PAR30
TC20: 75W PAR30, 75W PAR30L, 65W BR30
4¾" Aperture



Open Frame
201N-WH
65W BR30
4" Aperture



PAR/R20 Cone†
207B-WH Black Alzak®
207C-WH Clear Alzak®
207G-WH Gold Alzak®
207HZ-WH Haze
207W-WH Gloss White
207WHZ-WH Wheat Haze
50W PAR/R20
4¾" Aperture



Deep Cone†
206B-WH Black Alzak®
206C-WH Clear Alzak®
206G-WH Gold Alzak®
206HZ-WH Haze
206PT-SC Pewter Alzak®
206WHZ-ABZ Wheat Haze
206WHZ-WH Wheat Haze
IC: 50W PAR30
TC: 75W PAR30, 65W BR30
4½" Aperture



BR30/PAR30 Enclosed Baffle*
(Wet Location w/Outdoor Lamps)
215W-WH White
215B-WH Black
IC20: 65W BR30, 75W PAR30L, 75W PAR30, w/Socket Extender
IC20N: 65W BR30
TC: 75W PAR30L, 75W PAR30, w/Socket Extender, 85W BR30, 60W A19
4¾" Aperture



BR30/PAR30 Enclosed Cone*
(Wet Location w/Outdoor Lamps)
216C-WH Clear Alzak®
216G-WH Gold Alzak®
216HZ-WH Haze
216W-WH Gloss White
216WHZ-WH Wheat Haze
IC20: 65W BR30, 75W PAR30L, 75W PAR30, w/Socket Extender
IC20N: 65W BR30
TC: 75W PAR30L, 75W PAR30, w/Socket Extender, 85W BR30, 60W A19 (Clear and Gold Cone), 40W A19 (White Cone)
4¾" Aperture



* Wet location approved when used with outdoor rated lamps.

† See accessory page 161 for additional trim ring finishes, order separately.



TC Housing

Requires 3" spacing from insulation.

TC20S with smaller footprint bar hanger (Real Nail® 2)
TC20 with Real Nail® 3 bar hangers

11½" L x 6¼" W x 7½" H
 Ceiling cutout: 5½"



TC Remodel Housing

Requires 3" spacing from insulation. Installs from below ceiling.

TC20R Remodel Housing

12½" L x 5⅞" W x 7½" H
 Ceiling cutout: 5½"



Note: In Canada when insulation is present, Type IC fixtures must be used.

Adjustables



Eyeball with Baffle

208NW-WH White
208NB-WH Black
 35° vertical adjustment,
 358° rotation
 50W PAR/R20



Gimbal Ring in Baffle

688W-WH White
688B-WH Black
 30° vertical adjustment,
 358° rotation
 IC: 50W PAR30;
 TC: 75W PAR30



PAR30 Eyeball

529-ABZ
529-SC
529-WH
 30° vertical adjustment,
 358° rotation
 75W PAR30



Gimbal Ring with Flat Trim

209N-WH
 30° vertical adjustment,
 358° rotation
 75W PAR30



Gimbal Ring in Cone

689C-WH Clear Alzak®
689G-WH Gold Alzak®
689HZ-WH Haze
689WHZ-WH Wheat Haze
689WHZ-ABZ Wheat Haze
 30° vertical adjustment,
 358° rotation
 IC: 50W PAR30; TC: 75W PAR30

Lensed



Dome Shower Trim

211-PW
 40W A19



Flat Glass Shower Trim

210N-ABZ
210N-SC
210N-WH
 IC20: 40W A19,
 IC20N: 35W PAR30L
 TC20: 90W A19



Frosted Lens with Clear Center

212N-ABZ
212N-SC
212N-WH
 IC: 50W PAR30,
 40W A15
 TC: 75W PAR30,
 60W A15



Accessories

ALG5: Energy Conserving Gasket for 5" New Construction Air-Loc® IC Housing

ALG5R: Energy Conserving Gasket Kit for 5" Remodel Air-Loc® IC Housing

SMPLT-5: Galvanized steel plate for locating remodel style housings in new construction. Screw/nail holes for full coverage between 16" & 24" joists for use with IC20R and TC20R.

Trim Ring Finishes

ABZ: Classic Aged Bronze

WH: White

SC: Satin Chrome

BL: Black

PW: Plastic White (Polycarbonate material shower trim)



5" Shallow Universals

These downlights are designed for applications where vertical installation space is limited and are offered with a selection of popular downlight, adjustable, or lensed trims. Both new construction and remodel housings fit comfortably within 2 x 6 ceiling joists, and IC-rated housings can be covered with insulation.



5" Shallow Universal Housings



IC Housing
5" IC Shallow New Construction Housing

IC25 with Real Nail® 3 bar hangers
IC25S with smaller footprint bar hanger (Real Nail® 2)
IC25W with push-in electrical connectors and Real Nail® 3 bar hangers

11 $\frac{1}{8}$ " L x 6 $\frac{3}{4}$ " W x 5 $\frac{1}{4}$ " H
 Ceiling cutout: 5 $\frac{1}{2}$ "



IC Remodel Housing
5" IC Shallow Remodel Housing

IC25R Remodel Housing

12 $\frac{1}{2}$ " L x 5 $\frac{7}{8}$ " W x 5 $\frac{3}{4}$ " H
 Ceiling cutout: 5 $\frac{1}{2}$ "

5" Shallow Universal Trims

Downlights



Shallow Baffle
 (Wet Location w/ outdoor lamps)
275W-WH White
275B-WH Black
 50W BR30,
 50W PAR30, 50W PAR30L
 4 $\frac{3}{8}$ " Aperture



Shallow Cone**
276B-WH Black Alzak®
276W-WH Gloss White
276C-WH Clear Alzak®
276HZ-WH Haze
276WHZ-WH Wheat Haze
 50W BR30,
 50W PAR30, 50W PAR30L
 4 $\frac{3}{8}$ " Aperture



Lensed



Frosted Lens with Clear Center
212N-ABZ
212N-SC
212N-WH
 35W PAR30



Adjustable



Eyeball with Baffle
208W-WH White
208B-WH Black
 50W PAR20, R20
 35° vertical adjustment,
 358° rotation



PAR30 Eyeball
529-ABZ
529-SC
529-WH
 50W PAR30
 30° vertical adjustment,
 358° rotation

Adjustable, cont.



Gimbal Ring with Flat Trim
209N-WH White
 35W PAR30
 30° vertical adjustment,
 358° rotation



Gimbal Ring in Baffle
688W-WH White
688B-WH Black
 35W PAR30
 30° vertical adjustment,
 358° rotation



Gimbal Ring in Cone
689C-WH Clear Alzak®
689G-WH Gold Alzak®
689HZ-WH Haze
689WHZ-WH Wheat Haze
689WHZ-ABZ Wheat Haze
 35W PAR30
 30° vertical adjustment,
 358° rotation

Trim Ring Finishes

ABZ: Classic Aged Bronze
SC: Satin Chrome
WH: White



6" Deluxe Universal Line-Voltage Series

Juno 6" Universal downlights support the use of higher wattage lamps and the widest selection of trims. They feature deep lamp shielding for maximum brightness control. The IC2 model has a deluxe double-wall housing that provides optimal performance when covered with insulation.



6" Deluxe Universal Housings



IC Housing
Energy-efficient, Air-Loc® double wall housing can be covered with insulation.

IC2 with Real Nail® 3 bar hangers
IC2W with push-in electrical connectors and Real Nail® 3 bar hangers

17 $\frac{1}{8}$ " L x 9 $\frac{1}{8}$ " W x 7 $\frac{1}{2}$ " H
Ceiling cutout: 6 $\frac{1}{8}$ "



TC Housing
Requires 3" spacing from insulation.

TC2 with Real Nail® 3 bar hangers
TC2S with smaller footprint bar hanger (Real Nail® 2)
TC2W with push-in electrical connectors and Real Nail® 3 bar hangers

13 $\frac{1}{8}$ " L x 7 $\frac{1}{2}$ " W x 7 $\frac{1}{2}$ " H
Ceiling cutout: 6 $\frac{1}{8}$ "

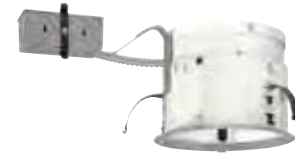

TC Remodel Housing
Requires 3" spacing from insulation. Installs from below ceiling.

TC2R Remodel Housing

13 $\frac{3}{4}$ " L x 7 $\frac{1}{8}$ " W x 5 $\frac{1}{4}$ " min H;
7 $\frac{1}{4}$ " max H
Ceiling cutout: 6 $\frac{3}{4}$ "

Note: In Canada when insulation is present, Type IC fixtures must be used.

6" Deluxe Universal Trims

Downlights



Tapered Baffle*†
24W-WH White
24B-BL Black
24B-WH Black
24B-ABZ Black
24B-SC Black
75W PAR30L,
65W BR30
5 $\frac{1}{4}$ " Aperture



Straight Baffle†
25W-WH White
25B-WH Black
25B-BL Black
25B-SC Black
IC: 85W BR40, 90W PAR38
TC: 150W PAR38, 120W
BR40
5 $\frac{1}{4}$ " Aperture



PAR30 Deep Cone†
257B-WH Black Alzak®
257C-WH Clear Alzak®
257G-WH Gold Alzak®
257HZ-WH Haze
257WHZ-WH Wheat Haze
75W PAR30, 100W PAR38
5 $\frac{1}{8}$ " Aperture



BR30 Open Frame
250-ABZ
250-SC
250-WH
65W BR30
4" Aperture



Pinhole with Baffle
23B-WH Black
50W R/PAR20
3 $\frac{3}{8}$ " Aperture



PAR30 Deep Baffle†
254W-WH White
254B-WH Black
75W PAR30, 100W PAR38
5 $\frac{1}{8}$ " Aperture



BR40/R40 Open Frame
251-WH
IC: 100W BR40
TC: 120W BR40, 250W R40
Heat Lamp
5 $\frac{1}{8}$ " Aperture

More trim selection on the next page →



Straight Cone†
26B-WH Black Alzak®
26C-WH Clear Alzak®
26G-WH Gold Alzak®
26HZ-WH Haze
26PT-SC Pewter Alzak®
26W-WH Gloss White
26WHZ-WH Wheat Haze
IC: 90W PAR38, 85W BR40
TC: 150W PAR38,
120W BR40
5 $\frac{1}{4}$ " Aperture



Tapered Cone*†
27B-WH Black Alzak®
27C-WH Clear Alzak®
27G-WH Gold Alzak®
27HZ-WH Haze
27PT-SC Pewter Alzak®
27W-WH Gloss White
27WHZ-ABZ Wheat Haze
27WHZ-WH Wheat Haze
75W PAR30L, 65W BR30
5 $\frac{1}{8}$ " Aperture

Accessories

ALG6: Energy Conserving Gasket for
6" New Construction Air-Loc® IC Housings

* Trim may be used with TC2R housing adjusted in lowest (5 $\frac{1}{4}$ ") height position.

† See accessory page 161 for additional trim ring finishes, order separately.

Trim Ring Finishes

ABZ: Classic Aged Bronze
SC: Satin Chrome
WH: White
BL: Black

6" Deluxe Universal Line-Voltage Series, cont.

6" Deluxe Universal Trims Trims listed below are for use with housings located on the preceding page 95.

Downlights



Ultra-Trim Baffle
(Wet Location w/
Outdoor Lamps)
28W-WH White
28B-WH Black
IC: 75W A19, 100W
PAR38, 75W PAR30/
30L, 85W BR30,
120W BR40
TC: 100W A19, 150W
A21, 150W PAR38,
75W PAR30/30L, 85W
BR30, 120W BR40
5 7/8" Aperture



**Economy A-Lamp
Reflector with Baffle**
230CW-WH Clear w/
White Baffle
230CB-WH Clear w/
Black Baffle
100W A19
5 1/2" Aperture



**A-Lamp Reflector with
Black Baffle**
233C-WH Clear Alzak®
IC: 75W A19
TC: 100W A19, 150W A21
5 7/8" Aperture



Ultra-Trim Cone
(Wet Location w/
Outdoor Lamps)
29C-WH Deep - Clear
29W-WH Deep - White
IC: 100W A19, 100W
PAR38, 75W
PAR30/30L, 85W BR30,
120W BR40
TC: 100W A19, 150W
A21, 150W PAR38,
75W PAR30/30L, 85W
BR30, 120W BR40
5 7/8" Aperture



Shallow Baffle*†
244W-WH White
244B-WH Black
75W PAR30/30L,
65W BR30
5 3/4" Aperture



Shallow Cone†
247C-WH Clear Alzak®
247G-WH Gold Alzak®
247B-WH Black Alzak®
247HZ-WH Haze
247WHZ-WH Wheat Haze
75W PAR30/30L, 65W
BR30
5 3/4" Aperture



A-Lamp Reflector
232C-WH Clear Alzak®
232HZ-WH Haze
232G-WH Gold Alzak®
232W-WH Gloss White
232WHZ-WH Wheat
Haze
IC2/TC2: 150W A21,
100W A19
IC2: 75W A19 (White
Finish Only)
TC2: 100W A19 (White
Finish Only)
5 7/8" Aperture

Adjustables



**Low Voltage Cylinder
Spotlight in Baffle*****
427W-WH White Cylinder
with White Baffle
45° vertical adjustment,
358° rotation
50W MR16



**R/PAR20 Regressed
Eyeball***
228-WH White
50W R/PAR20

**R/PAR20 Regressed
Eyeball in Baffle***
248W-WH White
50W R/PAR20



**PAR/BR30 Regressed
Eyeball***
229-ABZ
229-BL
229-SC
229-WH
75W PAR30L, 65W BR30

**PAR/BR30 Regressed
Eyeball in Baffle***
249W-WH White Baffle
249B-WH Black Baffle
75W PAR30L, 65W BR30



**Cylinder Spotlight in
Baffle***
226B-WH Black Cylinder
in Black Baffle
226W-WH White Cylinder
in White Baffle
60W PAR16



**PAR30 Adjustable
Tapered Baffle*†**
264W-WH White
264B-WH Black
75W PAR30
5 3/4" Aperture



**Low Voltage Pinhole
with Baffle****
424B-WH Black
30° vertical adjustment,
358° rotation
IC: 35W MR16;
TC: 50W MR16
3 1/2" Aperture



**PAR30 Adjustable
Tapered Cone*†**
267B-WH Black Alzak®
267C-WH Clear Alzak®
267G-WH Gold Alzak®
267HZ-WH Haze
267WHZ-WH Wheat Haze
75W PAR30
4" Aperture



Gimbal Ring in Baffle
224W-WH White
224B-WH Black
IC: 75W PAR38/Medium
Side Prong
TC: 150W PAR38/Medium
Side Prong
5 3/4" Aperture



**AVIO™ Square Gimbal
Ring**
XR30101BL
XR30101GP
XR30101SL
XR30101WH
IC/TC2/TC2R: 75W PAR30

Wall Wash



Scoop
261W-WH White Baffle
261B-WH Black Baffle
IC: 40W A19
TC: 75W A19

Lensed



Albalite
20-PW Shower/
Closet Light
20-WH
IC: 40W A19;
TC: 75W A19



**Albalite with
Reflector**
240-PW Shower/
Closet Light
240-WH
IC: 60W A19; TC:
100W A19





Lensed, cont.



Drop Opal*
21-PW Shower/
Closet Light
21-WH
IC: 40W A19;
TC: 75W A19



Drop Opal with Reflector*
241-PW Shower/
Closet Light
241-WH
IC: 60W A19;
TC: 100W A19



Frosted Lens with Clear Center Shower Trim
242-ABZ
242-SC
242-WH
IC: 75W PAR38,
60W PAR38 IR
TC: 120W PAR38



Fresnel
22-WH
IC: 40W A19;
TC: 75W A19



Frosted Lens with Reflector
239-WH
IC2: 40W A19,
35W PAR30L
TC2: 100W A19
TC2R: 75W A19



Decorative



Metal Band*
9524-SC
65W BR30
6½" Ring
5½" Aperture



Luminous Disc (Frosted)*
9324-SC
65W BR30
3¼" Aperture



Fluted Drop Opal*†
9900-WH
IC: 60W A19
TC: 75W A19



Octagonal*
9024W-WH White
65W BR30
5¼" Aperture



Luminous Collar (Frosted)*
9702
65W BR30
6¾" Aperture



Decorative Swirled Etched Opal Glass
243-WH
IC: 60W A19;
TC: 100W A19



Trim Ring Finishes

ABZ: Classic Aged Bronze
SC: Satin Chrome
WH: White
BL: Black

* Trim may be used with TC2R housing adjusted in lowest (5¼") height position.
** Supplied with magnetic transformer.
*** Use dimmers specifically designed for low voltage magnetic transformers.
† See accessory page 161 for additional trim ring finishes, order separately.





6" Standard Universals

Standard Universal downlights are offered with basic trim options but include all the installation and performance features Juno is known for.

6" Standard Universal Housings



Economy IC Housing
Energy-efficient, Air-Loc® housing can be covered with insulation.

- IC22** with Real Nail® 3 bar hangers
- IC22S** with smaller footprint bar hanger (Real Nail® 2)
- IC22W** with Real Nail® 3 bar hangers and quick electrical connectors.

13 1/8" L x 7 1/2" W x 7 1/8" H
Ceiling cutout: 6 3/4"



Economy IC Remodel Housing
Energy-efficient, Air-Loc® housing can be covered with insulation. Installs from below ceiling with clips provided.

IC22R Remodel Housing
13 3/4" L x 7 7/16" W x 7 1/8" H
Ceiling cutout: 6 3/4"

6" Standard Universal Trims

BR/PAR Downlights



Tapered Cone†
27B-WH Black Alzak®
27C-WH Clear Alzak®
27G-WH Gold Alzak®
27HZ-WH Haze
27PT-SC Pewter Alzak®
27W-WH Gloss White
27WHZ-ABZ Wheat Haze
27WHZ-WH Wheat Haze
 50W PAR30, 65W BR30,
 75W PAR30L
 5 3/4" Aperture



Tapered Baffle†
24W-WH White
24B-WH Black
24B-ABZ Black
24B-BL Black
24B-SC Black
 75W PAR30L,
 50W PAR30, 65W BR30
 5 3/4" Aperture



Shallow Baffle† 
244W-WH White
244B-WH Black
 60W PAR30, 65W BR30,
 75W PAR30L
 5 3/4" Aperture



Straight Baffle†
25W-WH White
25B-BL Black
25B-ABZ Black
25B-WH Black
25B-SC Black
 50W PAR30, 65W BR30



Ultra-Trim Cone - Fully Enclosed* 
 (Wet Location w/
 Outdoor Lamps)
29C-WH Clear Cone
29W-WH White Cone
 60W A19, 65W BR30,
 75W PAR30/30L,
 90W PAR38/BR40
 5 3/4" Aperture



BR30 Open Frame
250-ABZ
250-SC
250-WH
 65W BR30
 4" Aperture



Shallow Cone† 
247B-WH Black Alzak®
247C-WH Clear Alzak®
247G-WH Gold Alzak®
247HZ-WH Haze
247WHZ-WH Wheat Haze
 75W PAR30L, 65W BR30,
 75W PAR30
 5 3/4" Aperture



BR30 Regressed Open Frame
252-WH
 65W BR30
 4" Aperture



Ultra-Trim Baffle - Fully Enclosed* 
 (Wet Location w/
 Outdoor Lamps)
28W-WH White
28B-WH Black
 60W A19, 65W BR30,
 75W PAR30/30L,
 90W PAR38/BR40
 5 3/4" Aperture

Adjustables



Cylinder Spotlight in Baffle
226W-WH White
 Cylinder
 in White Baffle
226B-WH Black
 Cylinder
 in Black Baffle
 60W PAR16

Adjustables, cont.



R/PAR20 Regressed Eyeball
228-WH
 50W R/PAR20

R/PAR20 Regressed Eyeball in Baffle
248W-WH White
 50W R/PAR20



PAR/BR30 Regressed Eyeball
229-ABZ
229-BL
229-SC
229-WH
 75W PAR30L, 65W BR30

PAR/BR30 Regressed Eyeball in Baffle
249W-WH White
249B-WH Black
 75W PAR30L, 65W BR30



Adjustables, cont.



PAR30 Adjustable Tapered Baffle†
264W-WH White
264B-WH Black
50W PAR30
5¼" Aperture



PAR30 Adjustable Tapered Cone†
267B-WH Black Alzak®
267C-WH Clear Alzak®
267G-WH Gold Alzak®
267HZ-WH Haze
267WHZ-WH Wheat Haze
50W PAR30
4" Aperture



AVIO™ Square Gimbal Ring
XR30101BL
XR30101GP
XR30101SL
XR30101WH
75W PAR30



A-Lamp Reflector
231C-WH Clear Alzak®
231G-WH Gold Alzak®
231W-WH Gloss White
60W A19
5¼" Aperture

BR/PAR Decorative



Luminous Disc (Frosted)
9324-SC
65W BR30, 50W PAR30
3¼" Aperture



Luminous Collar (Frosted)*
9702
65W BR30, 50W PAR30, 75W PAR30L
6¾" Aperture

BR/PAR Decorative, cont.



Metal Band
9524-SC
65W BR30, 50W PAR30, 75W PAR30L
6½" Ring
5¾" Aperture

A-Lamp Downlights



Octagonal
9024W-WH
65W BR30, 50W PAR30
5¼" Aperture

Lensed



Frosted Lens with Reflector
239-WH
40W A19, 35W PAR30L



Lensed, cont.



Frosted Lens with Clear Center
242-ABZ
242-SC
242-WH
45W PAR38



Drop Opal with Reflector Shower Trim
241-PW Shower/Closet Light
241-WH
40W A19



Accessories

ALG6: Energy Conserving Gasket for 6" New Construction Air-Loc® Housings

ALG6R: Energy Conserving Gasket Kit for 6" Remodel Air-Loc® IC Housing

* Wet location approved when used with outdoor rated lamps.

† See accessory page 161 for additional trim ring finishes, order separately.

Trim Ring Finishes

ABZ: Classic Aged Bronze

SC: Satin Chrome

PW: Plastic White (Polycarbonate material shower trim)

WH: White

BL: Black



6" Standard Universals with Floating Socket

Standard Universal downlights with floating sockets are optimized for the quickest possible attachment to enclosed and adjustable style trims.

6" Standard Universal Housings (Floating Socket)



Economy IC Housing

Energy-efficient, Air-Loc® housing with floating socket.

IC23 with Real Nail® 3 bar hangers

IC23W with Real Nail® 3 bar hangers and push-in electrical connectors.

13 1/8" L x 7 1/2" W x 7 1/8" H

Ceiling cutout: 6 3/8"

6" Standard Universal Trims

BR/PAR Downlights



Ultra-Trim Baffle - Fully Enclosed*

(Wet Location w/ Outdoor Lamps)

28W-WH White
28B-WH Black
60W A19, 65W BR30, 75W PAR30/30L, 90W PAR38/BR40
5 3/4" Aperture



Shallow Baffle

244W-WH White
244B-WH Black
60W PAR30, 65W BR30, 75W PAR30L
5 3/4" Aperture



Shallow Cone†

247B-WH Black Alzak®
247C-WH Clear Alzak®
247G-WH Gold Alzak®
247HZ-WH Haze
247WHZ-WH Wheat Haze
75W PAR30L, 65W BR30, 75W PAR30
5 3/4" Aperture



PAR30 Adjustable Tapered Cone†

267B-WH Black Alzak®
267C-WH Clear Alzak®
267G-WH Gold Alzak®
267HZ-WH Haze
267WHZ-WH Wheat Haze
50W PAR30
4" Aperture



PAR/BR30 Regressed Eyeball

229-ABZ
229-BL
229-SC
229-WH
75W PAR30L, 65W BR30

PAR/BR30 Regressed Eyeball in Baffle

249W-WH White
249B-WH Black
75W PAR30L, 65W BR30



Ultra-Trim Cone - Fully Enclosed*

(Wet Location w/ Outdoor Lamps)

29C-WH Clear
29W-WH White
60W A19, 65W BR30, 75W PAR30/30L, 90W PAR38/BR40
5 3/4" Aperture



BR30 Open Frame

250-ABZ
250-SC
250-WH
65W BR30
4" Aperture

BR/PAR Adjustables



Cylinder Spotlight in Baffle

226W-WH White
Cylinder in White Baffle
226B-WH Black
Cylinder in Black Baffle
60W PAR16



PAR30 Adjustable Tapered Baffle†

264W-WH White
264B-WH Black
50W PAR30
5 3/4" Aperture



R/PAR20 Regressed Eyeball

228-WH
50W R20/PAR20

R/PAR20 Regressed Eyeball in Baffle

248W-WH White
50W R20/PAR20



A-Lamp Downlights



A-Lamp Reflector
 232C-WH Clear Alzak®
 232G-WH Gold Alzak®
 232HZ-WH Haze
 232W-WH Gloss White
 232WHZ-WH Wheat
 Haze
 60W A19
 5½" Aperture



A-Lamp Reflector with Black Baffle
 233C-WH Clear Alzak®
 40W A19
 5½" Aperture



Economy A-Lamp Reflector with Black Baffle (IC23 Series only)
 230CW-WH Clear w/ White Baffle
 230CB-WH Clear w/ Black Baffle
 40W A19
 5½" Aperture

Wall Wash



Scoop
 261W-WH White Baffle
 261B-WH Black Baffle
 40W A19

Lensed



Drop Opal with Reflector Shower Trim
 241-PW Shower/ Closet Light
 241-WH
 40W A19



Frosted Lens with Reflector
 239-WH
 40W A19,
 35W PAR30L



Accessories

ALG6: Energy Conserving Gasket for 6" New Construction Air-Loc® IC Housings

* Wet location approved when used with outdoor rated lamps.

† See accessory page 161 for additional trim ring finishes, order separately.

Trim Ring Finishes

ABZ: Classic Aged Bronze

SC: Satin Chrome

PW: Plastic White (Polycarbonate material shower trim)

WH: White

BL: Black



6" Shallow Universals

Shallow universal housings are the ideal solution where vertical installation space is limited. The overall housing height is only 5-3/4", permitting these fixtures to fit comfortably within 2 x 6 ceiling joists. Housings are available for new construction or remodeling, can be completely covered with insulation, and used with a variety of downlight, adjustable, or lensed trims.



6" Shallow Universal Housings



IC Housing
Energy-efficient, Air-Loc® housing can be covered with insulation.

IC21 with Real Nail® 3 bar hangers

13¼" L x 7½" W x 5¼" H
Ceiling cutout: 6⅞"



IC Remodel Housing
Energy-efficient, Air-Loc® housing can be covered with insulation. Installs from below ceiling.

IC21R Remodel Housing

13¼" L x 7⅞" W x 5¼" H
Ceiling cutout: 6⅞"

6" Shallow Universal Trims

Downlights



Air-Loc

Shallow Baffle†
244W-WH White
244B-WH Black
50W PAR30, 75W PAR30L
65W BR30
5¼" Aperture



Air-Loc

Shallow Cone†
247B-WH Black Alzak®
247C-WH Clear Alzak®
247G-WH Gold Alzak®
247HZ-WH Haze
247WHZ-WH Wheat Haze
75W PAR30, 75W PAR30L,
65W BR30
5¼" Aperture



BR30 Open Frame
250-ABZ
250-SC
250-WH
65W BR30
4" Aperture

Adjustables



R/PAR20 Regressed Eyeball
228-WH
50W R/PAR20

R/PAR20 Eyeball in Baffle
248W-WH White
50W R/PAR20



PAR/BR30 Regressed Eyeball
229-ABZ
229-BL
229-SC
229-WH
75W PAR30L, 65W BR30

PAR/BR30 Regressed Eyeball in Baffle
249W-WH White
249B-WH Black
75W PAR30L, 65W BR30



AVIO™ Square Gimbal Ring
XR30101BL
XR30101GP
XR30101SL
XR30101WH
75W PAR30

Lensed



Drop Opal with Reflector
241-PW Shower/
Closet Light
241-WH
40W A19



Accessories

ALG6: Energy Conserving Gasket for 6" New Construction Air-Loc® IC Housing

ALG6R: Energy Conserving Gasket Kit for 6" Remodel Air-Loc® Remodel Housing

† See accessory page 161 for additional trim ring finishes, order separately.

Trim Ring Finishes

ABZ: Classic Aged Bronze

SC: Satin Chrome

PW: Plastic White (Polycarbonate material shower trim)

WH: White

BL: Black

Juno®

Squares

These downlights feature square apertures with large opal or prismatic lenses. They use higher-wattage lamps to produce bright, diffuse and shadow-free illumination.



Square Housings

8" Square



IC Housing

Energy-efficient, double wall housing.
Can be covered with insulation.

IC6 with Real Nail[®] 3 bar hangers

17 $\frac{3}{8}$ " L x 9 $\frac{1}{2}$ " W x 7" H
Ceiling cutout: 8 $\frac{5}{8}$ " sq.



TC Housing

Requires 3" spacing from insulation.

TC6 with Real Nail[®] 3 bar hangers

17 $\frac{3}{8}$ " L x 9 $\frac{1}{2}$ " W x 5" H
Ceiling cutout: 8 $\frac{5}{8}$ " sq.

Square Trims

8" Square Trim



Crystal Diffuser 60-WH

IC: 60W A19
TC: 100W A19
Aperture: 9 $\frac{1}{2}$ " sq.

10" Square



IC Housing

Energy-efficient, double wall housing.
Can be covered with insulation.

IC7 with Real Nail[®] 3 bar hangers

20 $\frac{3}{8}$ " L x 11 $\frac{1}{16}$ " W x 7" H
Ceiling cutout: 10 $\frac{1}{2}$ " sq.



TC Housing

Requires 3" spacing from insulation.

TC7 with Real Nail[®] 3 bar hangers

20 $\frac{3}{8}$ " L x 11 $\frac{1}{16}$ " W x 5 $\frac{1}{2}$ " H
Ceiling cutout: 10 $\frac{1}{2}$ " sq.

10" Square Trims



Crystal Diffuser 70-WH

IC: 100W A19
TC: 150W A21/100W A19
Aperture: 11 $\frac{1}{8}$ " sq.



Drop Opal 71-WH

IC: 100W A19
TC: 150W A21/100W A19
Aperture: 11 $\frac{1}{8}$ " sq.

Note: In Canada when insulation is present, Type IC fixtures must be used.



High-performance
lighting with efficiency
and style

Slope Ceiling LED Downlights

For the first time, a recessed LED downlight has been specifically designed for sloped ceilings. Juno's Slope and Super-Slope LED housings cover pitch ranges of 2/12 to 12/12 (9° to 45°) and deliver up to 900 high-performance lumens with efficiency and style.

Now you can have the efficiency, performance, and longevity of LED illumination in today's most avant-garde interiors. Juno's 6", sloped ceiling LED housings are IC rated and can be used in either insulated or non-insulated, new construction applications.

Juno Slope Ceiling LED Downlight Advantages

- Covers standard and super slope applications ranging from pitch of 2/12 to 12/12
- Delivers up to 900 brilliant LED lumens from just 15 super-efficient watts
- Service life is rated at a remarkable 50,000 hours
- Available with color temperatures of 2700K, 3000K, 3500K, and 4100K
- Excellent Color Rendering Index of 83 typical
- LEDs contain no toxic lead, mercury, or PCBs
- Extensive selection of cone, baffle, and lensed trims that blend seamlessly with sloped ceilings
- Dimmable driver options include forward and reverse phase dimming and universal voltage driver (120-277V) with 0-10V dimming
- Patent pending design



Generation 3 6" IC-Rated LED Downlights for Slope and Super Slope Ceilings

Delivering 900 high-performance lumens with efficiency and style

Juno's Slope and Super Slope LED housings are the industry's first recessed LED luminaires designed specifically for slope ceiling applications. Juno's Slope ceiling LED offering includes 6" new construction housings for both standard and super slope applications covering a pitch range of 2/12 to 12/12. Juno's Slope and Super Slope LED housings can be used in insulated and non-insulated ceilings, and include all the quality and engineering prowess Juno is famous for.

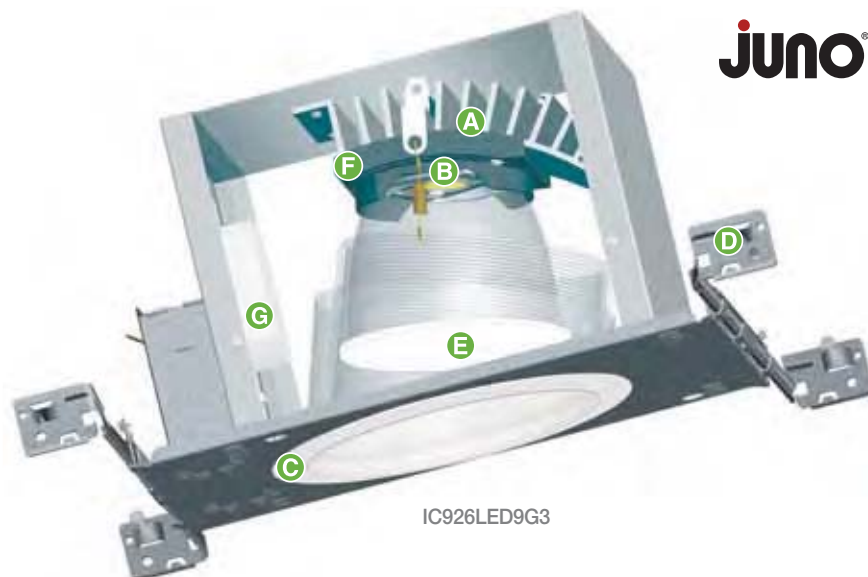

A. Advanced thermal management: Juno Slope and Super Slope LED Downlights achieve superior thermal management by integrating an extruded aluminum heat sink and a cast aluminum slider plate directly with the fixture housing. Advanced thermal-management technology permits the LEDs to easily attain their remarkable rated service life of 50,000 hours at 70% lumen maintenance ... even when covered with insulation.

B. High-output LED light engine: The light engine features the latest in high-performance LED arrays. Fixture output of over 900 lumens requires just 14.6 watts nominal – a mere fraction of the energy needed by conventional light sources. LEDs are binned to exceed ENERGY STAR® requirements and provide superior fixture-to-fixture color uniformity. With available color temperatures of 2700K, 3000K, 3500K and 4100K, and a typical CRI of 83, these fixtures are well-suited to a broad range of applications.



C. Aesthetic trim options: Juno LED slope ceiling housings are compatible with a selection of existing Juno 6" slope ceiling cone, baffle and lensed trims. Juno's downlight trims feature shadow-free, knife edge trim rings that blend unobtrusively with sloped ceilings and are removable for painting if desired.

D. Easy installation: Installs easily in either insulated or non-insulated, new-construction applications. Standard Slope fixtures accommodate ceilings with 2/12 to 6/12 pitch (9° to 27°). Super-Slope fixtures are designed for 7/12 to 12/12 pitch (30° to 45°). The housings are supplied with the Juno Real Nail® 3 bar hanger system, which includes captive bugle-headed nails to secure the fixture in wood joist construction or integral T-bar clips for suspended ceiling installation.

E. High-efficiency optics: A computer-optimized reflector combined with a high-transmission diffusing lens conceals the LEDs and produces uniform aperture luminance. The PAR38 size reflector developed specifically for the slope LED provides optimum performance and obscures view into the housing through all pitch ranges.

F. Adjustable Slider Plate: The adjustable slider plate allows the LEDs and reflector to be positioned perpendicular to the floor through the entire pitch range and includes 1/4" adjustment indicators for consistent fixture-to-fixture alignment.

G. Dimmable LED driver: Specify either dedicated 120-volt driver with forward and reverse phase dimming or universal voltage driver (120-277V) with 0-10V dimming.

Both the Juno Slope and Super Slope LED Downlights are a perfect complement to existing Juno downlights, offering a similar below-the-ceiling aesthetic.



6" IC-Rated 900 Lumen Generation 3 Slope Ceiling LED Downlights

6" new construction housings for use in standard slope applications with 2/12 to 6/12 pitch (9° to 27°).

6" Slope New Construction



Air-Loc Dedicated 6" Slope Ceiling LED new construction housing with integral light engine and choice of dimmable drivers:

14.6W nominal dedicated 120-volt driver with forward phase and ELV dimming or 15.8W nominal universal 120V-277V driver with 0-10V dimming. Air-Loc fully sealed housing does not require separate gasket. IC housing designed for use in IC or non-IC construction.

16¹/₈" L x 9¹/₈" W x 7⁵/₈" H
Ceiling cutout: 7¹/₂" x 6¹/₁₆"

Example: IC926LED9G3-27K-1

Housing	Color Temp.	Input Voltage
IC926LED9G3	27K 2700K	1 Dedicated 120V Only, (forward phase and ELV dimming)
	3K 3000K	
	35K 3500K	U Universal Voltage 120-277V, (0-10V dimming)
	41K 4100K	

Qualified Dimmers

Dedicated 120-volt fixtures (-1): Compatible with incandescent, magnetic low voltage or electronic low voltage wall box dimmers.

Universal voltage fixtures (-U): Compatible with 0-10V wall box dimmers.

Refer to catalog # on www.junolightinggroup.com for the specific list of Juno Lighting Group qualified dimmer model numbers on the specification sheet.

6" Slope LED Trims

Downlights



IMPROVED DESIGN

Downlight Baffle*

- 614B-WH Black
- 614B-SC Black
- 614B-ABZ Black
- 614B-BL Black
- 614W-WH White



Downlight Cone

- 620C-WH Clear Alzak®
- 620B-WH Black Alzak®
- 620HZ-WH Haze
- 620HZ-SC Haze
- 620W-WH White
- 620WHZ-WH Wheat Haze
- 620WHZ-ABZ Wheat Haze

Trim Ring Finishes

- ABZ:** Classic Aged Bronze
- SC:** Satin Chrome
- WH:** White
- BL:** Black

* Patent pending one piece design eliminates the unsightly seam on the long side of the baffle.

Lensed



Baffle, Regressed Frosted Dome Lens

- 6330W-WH White



6" IC-Rated 900 Lumen Generation 3 Super Slope Ceiling LED Downlights

6" new construction housings for use in super slope applications with 7/12 to 12/12 pitch (30° to 45°).

6" Super Slope New Construction



Air-Loc Dedicated 6" Super Slope Ceiling LED new construction housing with integral light engine and choice of dimmable drivers:

14.6W nominal dedicated 120 volt driver with forward phase and ELV dimming or 15.8W nominal universal 120V-277V driver with 0-10V dimming. Air-Loc fully sealed housing does not require separate gasket. IC housing designed for use in IC or non-IC construction.

18½" L x 9⅞" W x 7⅞" H
Ceiling cutout: 8⅞" x 6⅞"

Example: IC928LED9G3-27K-1

Housing	Color Temp.	Input Voltage
IC928LED9G3	27K 2700K	1 Dedicated 120V Only, (forward phase and ELV dimming)
	3K 3000K	
	35K 3500K	U Universal Voltage 120-277V, (0-10V dimming)
	41K 4100K	

Qualified Dimmers

Dedicated 120-volt fixtures (-1): Compatible with incandescent, magnetic low voltage or electronic low voltage wall box dimmers.

Universal voltage fixtures (-U): Compatible with 0-10V wall box dimmers.

Refer to catalog # on www.junolightinggroup.com for the specific list of Juno Lighting Group qualified dimmer model numbers on the specification sheet.

6" Super Slope LED Trims

Downlights



Downlight Baffle
604B-WH Black
604B-SC Black
604B-ABZ Black
604B-BL Black
604W-WH White



Downlight Cone
602C-WH Clear Alzak®
602B-WH Black Alzak®
602HZ-WH Haze
602HZ-SC Haze
602W-WH White
602WHZ-WH Wheat Haze
602WHZ-ABZ Wheat Haze

Lensed



Baffle, Regressed Frosted Dome Lens
6033W-WH White



Trim Ring Finishes

ABZ: Classic Aged Bronze
WH: White

SC: Satin Chrome
BL: Black

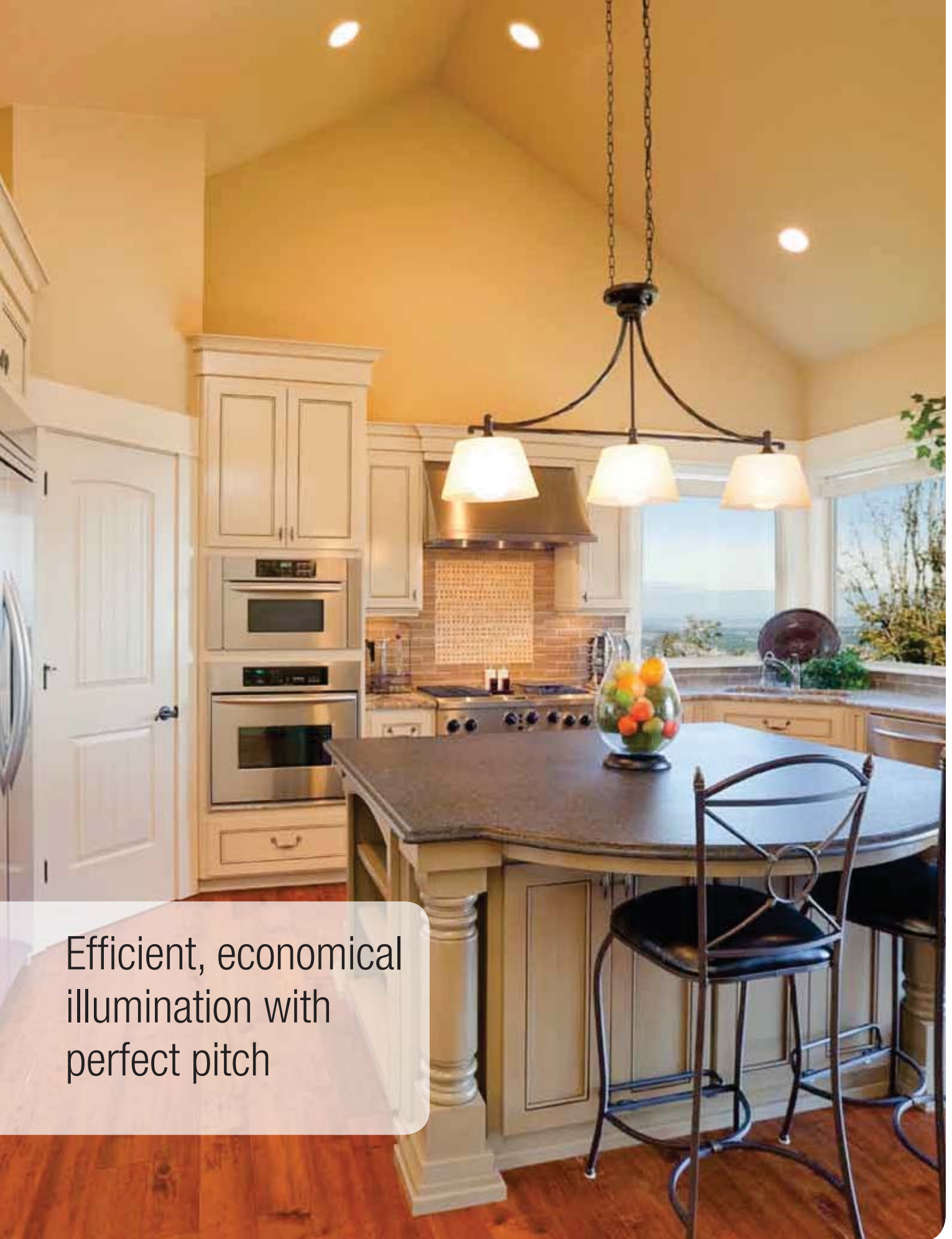

Efficient, economical illumination with perfect pitch

Slope Ceiling Compact Fluorescent Downlights

Juno Slope Ceiling CFL downlights bring an energy-efficient, economical solution to illuminating today's contemporary interiors. They cover pitch ranges from 2/12 to 12/12 and focus high-quality light perpendicular to the floor.

Juno Slope Ceiling CFL downlights feature state of the art electronic ballasts that provide rapid starting and flicker-free operation without the annoying hum associated with older magnetic ballasts. And compared to incandescent lighting, CFLs are up to 80% more efficient and last as much as 10-times longer.

Juno Slope Ceiling CFL Downlight Advantages

- Covers standard and super slope applications ranging from pitch of 2/12 to 12/12
- Permits lamp to remain perpendicular to the floor throughout entire pitch range
- 3- to 4-times more energy efficient than halogen lighting
- 10-times longer service life than halogen lighting
- Far less heat generation than halogen
- Rapid start electronic ballasts for flicker-free operation
- High color rendering



6" Slope Ceiling Compact Fluorescent Downlights

A. Electronic Ballast

Rapid start electronic ballast is mounted on J-box cover inside the housing for ease of maintenance.

B. Double Wall Housing

Housing provides Air-Loc® seal without requiring a separate gasket.

C. Upper Reflector

Reflector finish is optimized for CFLs to maximize fixture efficiency. Snap-on paint shield protects reflector during installation.

D. Adjustable Socket Plate

Adjustable socket plate permits lamp to remain perpendicular to floor through entire pitch range and includes 1/4" adjustment indicators for consistent fixture-to-fixture alignment.

E. Socket

Threaded barrel socket with positive stop facilitates easy removal and installation of the upper reflector.

F. Knife Edge Metal Trim Ring and Angle-Cut Baffle

Juno's knife-edge trim ring eliminates shadow lines at the ceiling and is removable for painting if desired. Baffle grooves remain parallel to the floor, assuring proper optics.

G. Real Nail® 3 Bar Hangers

The industry's best engineered mounting system ...

Juno housings originated the Real Nail bar hanger system that set the standard for quality and ease of installation

Patented Real Nail® 3 Hangers

Permit quick housing placement anywhere within 24" O.C. joists or suspended ceilings.

Captive Bugle Head Nail

Quickly secures housing in place. The nail is easily removable for quick housing repositioning/relocation without changing the bar hanger or nail.

Bar Hanger Locking

Secures bar hanger adjustments with the oversized locking screw or the quick-lock screwdriver slot feature.

Where form and function meet

Building on Juno's patented slope-ceiling downlight design, the CFL offering includes new construction and remodel housings for both standard and super slope applications ranging in pitch from 2/12 to 12/12. The housings feature Air-Loc® construction, efficient electronic ballasts, and an integral upper reflector that works in conjunction with slope baffle and cone trims to achieve maximum light output.

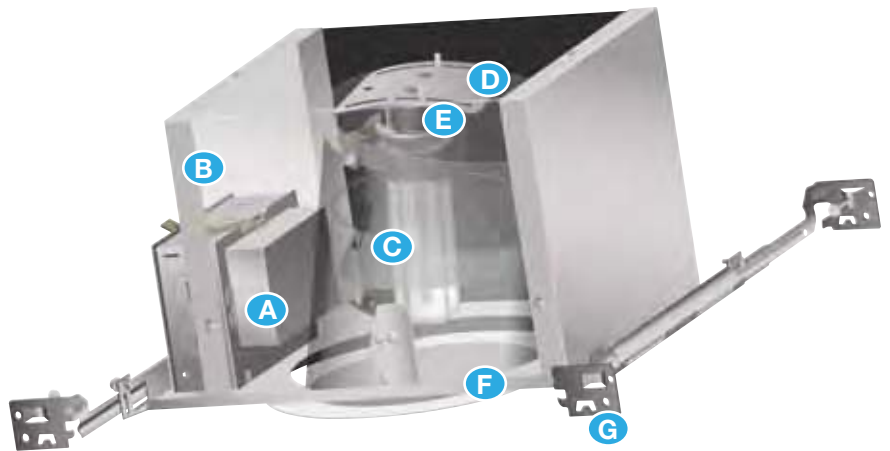

Illustrated here is the Juno ICPL926-42 housing with a 614W-WH trim.

Patented Break-Away Design

Score lines on the bar hangers provide a clean and fast break to fit the housing in tight applications.

T-Bar Mounting

Integral T-bar mounting feature secures the housing to suspended ceilings; no additional parts required.

Locking System

Quick-Loc slot and oversized set screw lock fixture in position.

6" CFL Standard Slope 2/12 to 6/12 Pitch (9° to 27°)



AIR-LOC
T24

New Construction Housing
Air-Loc® CFL double wall housing does not require separate gasket. Housings may be covered with insulation.

ICPL926-42 120V HPF Electronic Ballast
ICPL926-42-DB120
ICPL926-42 with 120V HPF Dimmable Ballast – T24 compliant

16½" L x 9½" W x 7⅞" H
Ceiling cutout: 7½" x 6⅞" Oval

One 26W, 32W or 42W triple tube (4-pin) CFL*



AIR-LOC
T24

Remodel Housings
Air-Loc® CFL remodel housing does not require separate gasket. Housings may be covered with insulation.

ICPL926R-32 120V HPF Electronic Ballast
ICPL926R-32N-DB120
ICPL926R-32 with 120V NPF Dimmable Ballast – T24 compliant

14" L x 6⅞" W x 7⅞" H
Ceiling cutout: 6½" x 6⅞" Oval

One 26W or 32W triple tube (4-pin) CFL*

6" CFL Super Slope 7/12 to 12/12 Pitch (30° to 45°)

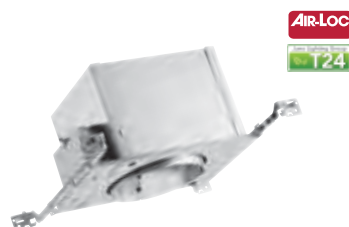

AIR-LOC
T24

New Construction Housing
Air-Loc® CFL double wall housing does not require separate gasket. Housings may be covered with insulation.

ICPL928-42 120V HPF Electronic Ballast
ICPL928-42-DB120
ICPL928-42 with 120V HPF Dimmable Ballast – T24 compliant

18½" L x 9½" W x 7⅞" H
Ceiling cutout: 8⅞" x 6⅞" Oval

One 26W, 32W or 42W triple tube (4-pin) CFL*



AIR-LOC
T24

Remodel Housing
Air-Loc® CFL remodel housing does not require separate gasket. Housings may be covered with insulation.

ICPL928R-32 120V HPF Electronic Ballast
ICPL928R-32N-DB120
ICPL928R-32 with 120V NPF Dimmable Ballast – T24 compliant

13¾" L x 7⅞" W x 7⅞" H
Ceiling cutout: 6⅞" x 8¼" Oval

One 26W for 32W triple tube (4-pin) CFL*

* Lamp not included

** Patent pending one piece design eliminates the unsightly seam on the long side of the baffle.

6" Standard Slope Trims

Downlights



IMPROVED DESIGN



Baffle**
614W-WH White
614B-WH Black
614B-BL Black
614B-ABZ Black
614B-SC Black
ICPL926-42: 42W Max
ICPL926R-32: 32W Max

Cone
612C-WH Clear Alzak®
612G-WH Gold Alzak®
612B-WH Black Alzak®
612HZ-WH Haze
612HZ-SC Haze
612W-WH White
612WHZ-ABZ Wheat Haze
612WHZ-WH Wheat Haze
ICPL926-42: 42W Max
ICPL926R-32: 32W Max

Lensed



Baffle, Regressed Frosted Dome Lens
6330W-WH White
ICPL926-42: 32W Max
ICPL926R-32: 26W Max

Trim Ring Finishes

ABZ: Classic Aged Bronze
SC: Satin Chrome
WH: White
BL: Black

6" Super Slope Trims

Downlights



Baffle
604W-WH White
604B-WH Black
604B-BL Black
604B-ABZ Black
604B-SC Black
ICPL928-42: 42W Max
ICPL928R-32: 32W Max

Cone
602C-WH Clear Alzak®
602G-WH Gold Alzak®
602B-WH Black Alzak®
602HZ-WH Haze
602HZ-SC Haze
602W-WH White
602WHZ-ABZ Wheat Haze
602WHZ-WH Wheat Haze
ICPL928-42: 42W Max
ICPL928R-32: 32W Max

Lensed



Baffle, Regressed Frosted Dome Lens
6033W-WH White
ICPL928-42: 32W Max
ICPL928R-32: 26W Max

Trim Ring Finishes

ABZ: Classic Aged Bronze
SC: Satin Chrome
WH: White
BL: Black

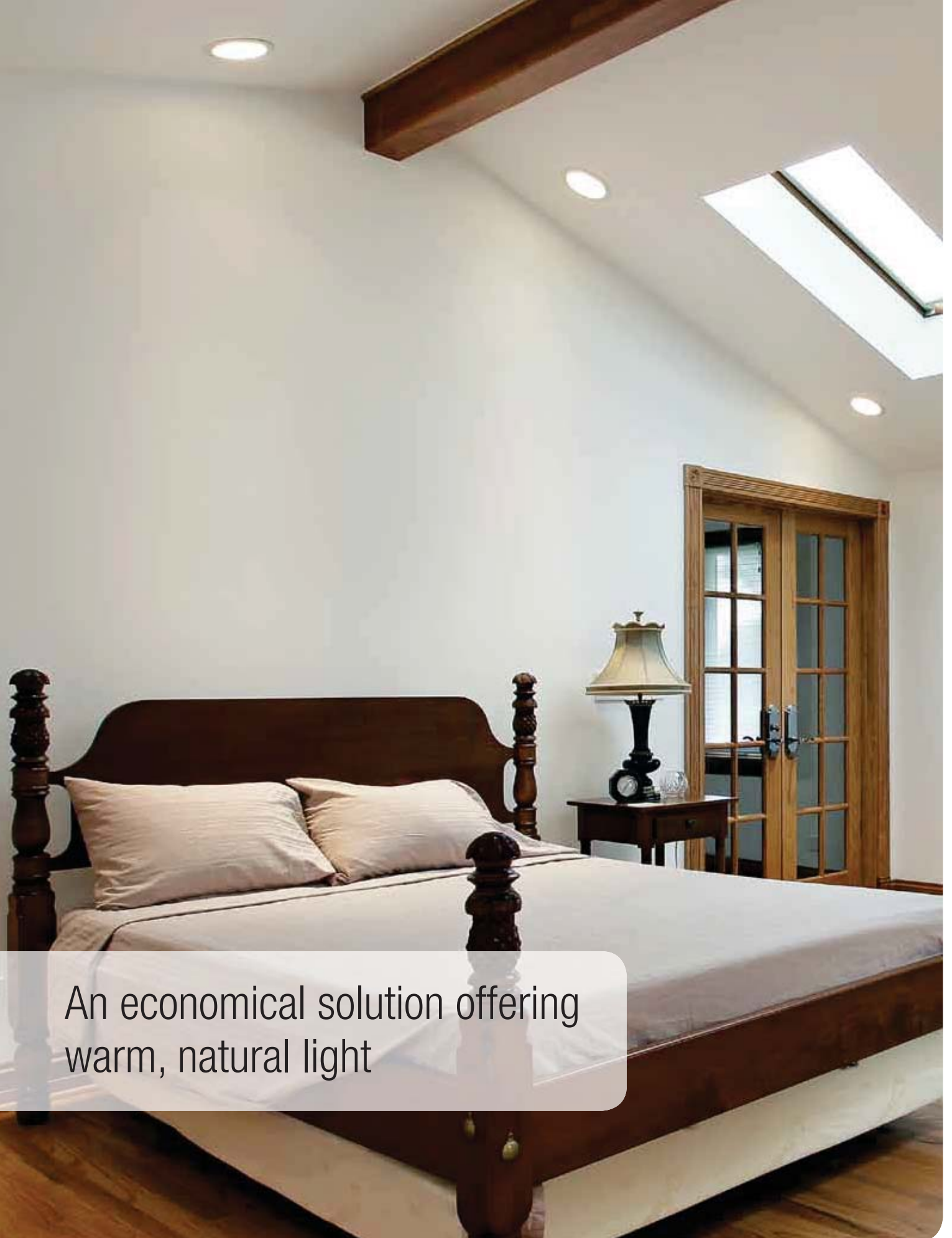

An economical solution offering warm, natural light

Slope Ceiling Incandescent Downlights

Juno's patented incandescent downlight housings for sloped ceiling applications cover the full pitch range from 2/12 for standard slopes up to 12/12 for super slopes. The housings are available in new construction or remodel versions for both insulated and non-insulated ceilings. The lamp socket is adjustable, enabling the light beam to be kept perpendicular to the floor. Downlight, adjustable, and lensed trims are available with a wide variety of baffles and reflector cones.

Economical incandescent lamps produce warm, natural illumination. Juno offers a broad selection of lamp types and wattages, assuring that you'll have just the right amount of light for your interior space.

Juno Slope Ceiling Incandescent Downlight Advantages

- Covers standard and super slope applications ranging from pitch of 2/12 to 12/12
- Adjustable socket enables light beam to be aimed perpendicular to the floor
- Angle-cut baffle assures that grooves remain parallel to the floor for proper optic performance
- Oblique angle of shovel-cut housing holds the trim flush with the ceiling





6" Incandescent Sloped Ceiling Downlights

Juno's patented Slope Ceiling Downlights direct light straight down, providing proper light distribution from a sloped surface.

6" Standard Slope Housings – 2/12 to 6/12 Pitch (9° to 27°)



IC Housing

Energy-efficient, Air-Loc® double wall housing can be covered with insulation. Fits 2 x 8 construction.

IC926 with Real Nail® 3 bar hangers
IC926W with push-in electrical connectors and Real Nail® 3 bar hangers

16½" L x 9½" W x 7⅝" H
Ceiling opening: 7½" x 6⅞" oval



TC Housing

Requires 3" spacing from insulation. For 2 x 8 or 2 x 10 construction. Adjustable fixture height: 7½" to 9"

TC926 with Real Nail® 3 bar hangers

16½" L x 9½" W
Ceiling opening: 7½" x 6⅞" oval



TC Remodel Housing

Requires 3" spacing from insulation. For 2 x 8 or 2 x 10 construction. Adjustable fixture height: 7½" to 9"

TC926R Remodel Housing

14" L x 6⅞" W
Ceiling opening: 6½" x 6⅞" oval

Note: In Canada when insulation is present, Type IC fixtures must be used.

6" Standard Slope Trims

Downlights



IMPROVED DESIGN

Downlight Baffle*

614W-WH White
614B-WH Black
614B-ABZ Black
614B-BL Black
614B-SC Black
IC: 90W PAR38;
TC: 150W PAR38



Reflector Cone

612B-WH Black Alzak®
612C-WH Clear Alzak®
612G-WH Gold Alzak®
612HZ-SC Haze
612HZ-WH Haze
612W-WH White
612WHZ-ABZ Wheat Haze
612WHZ-WH Wheat Haze
IC: 75W PAR30,
90W PAR38, 65W BR30
TC: 75W PAR30,
150W PAR38, 85W BR30

Adjustables



Cylinder Spotlight in Baffle

616W-WH White
616B-WH Black
60W PAR16
45° vertical adjustment,
358° rotation



Low Voltage Cylinder Spotlight in Baffle

617W-WH White
45° vertical adjustment,
358° rotation
IC: 35W MR16;
TC: 50W MR16
Supplied with magnetic transformer. Use dimmers specifically designed for low voltage magnetic transformers.

Lensed



Eyeball in Baffle

619W-WH White
619B-WH Black
35° vertical adjustment,
358° rotation
IC/TC: 85W BR30



Lensed Shower Trim

Flat Diffuser
610W-WH White
610B-WH Black
IC: 50W PAR30
TC: 75W A19,
75W PAR30



Accessories

ALG926: Energy Conserving Gasket Kit for Air-Loc® IC926 housing.

Trim Ring Finishes

ABZ: Classic Aged Bronze
SC: Satin Chrome
WH: White
BL: Black

* Patent pending one piece design eliminates the unsightly seam on the long side of the baffle.

U.S Patent No. 4,729,08. Canadian Patent No. 1264158.

6" Incandescent Super Sloped Ceiling Downlights

Juno's patented Super Slope Ceiling Downlights are available in new construction or remodel versions for both insulated and non-insulated ceilings.

6" Super Slope Housings – 7/12 to 12/12 Pitch (30° to 45°)



AIR-LOC

IC Housing

Energy-efficient, Air-Loc® double wall housing can be covered with insulation. Fits 2 x 8 construction.

IC928 with Real Nail® 3 bar hangers
IC928W with push-in electrical connectors and Real Nail® 3 bar hangers

18½" L x 9⅝" W x 7⅝" H
 Ceiling opening: 6⅞" x 8⅞" oval



TC Housing

Requires 3" spacing from insulation. For 2 x 8 or 2 x 10 construction. Adjustable fixture height: 7½" to 9⅞"

TC928 with Real Nail® 3 bar hangers

18½" L x 9⅞" W
 Ceiling opening: 6⅞" x 8⅞" oval



TC Remodel Housing

Requires 3" spacing from insulation. For 2 x 8 or 2 x 10 construction. Adjustable fixture height: 7⅝" to 9"

TC928R Remodel Housing

14" L x 7⅝" W
 Ceiling opening: 6⅞" x 8⅞" oval

Note: In Canada when insulation is present, Type IC fixtures must be used.

6" Super Slope Trims

Downlights



Downlight Baffle

604W-WH White
604B-WH Black
604B-ABZ Black
604B-BL Black
604B-SC Black
 IC: 90W PAR38;
 TC: 150W PAR38
 For superior baffling, use 75W PAR30



Reflector Cone

602B-WH Black Alzak®
602C-WH Clear Alzak®
602G-WH Gold Alzak®
602HZ-SC Haze
602HZ-WH Haze
602W-WH White
602WHZ-ABZ Wheat Haze
602WHZ-WH Wheat Haze
 IC: 75W PAR30, 90W PAR38, 85W BR30
 TC: 75W PAR30, 150W PAR38, 85W BR30

Adjustables



Cylinder Spotlight in Baffle

606W-WH White
606B-WH Black
 60W PAR16
 45° vertical adjustment,
 358° rotation

Accessories

ALG928: Energy Conserving Gasket Kit for Air-Loc® IC928 Housing

Lensed



Lensed Shower Trim

Flat Diffuser
603W-WH White
603B-WH Black
 IC: 50W PAR30
 TC: 75W A19, 75W PAR30



Trim Ring Finishes

ABZ: Classic Aged Bronze
SC: Satin Chrome
WH: White
BL: Black

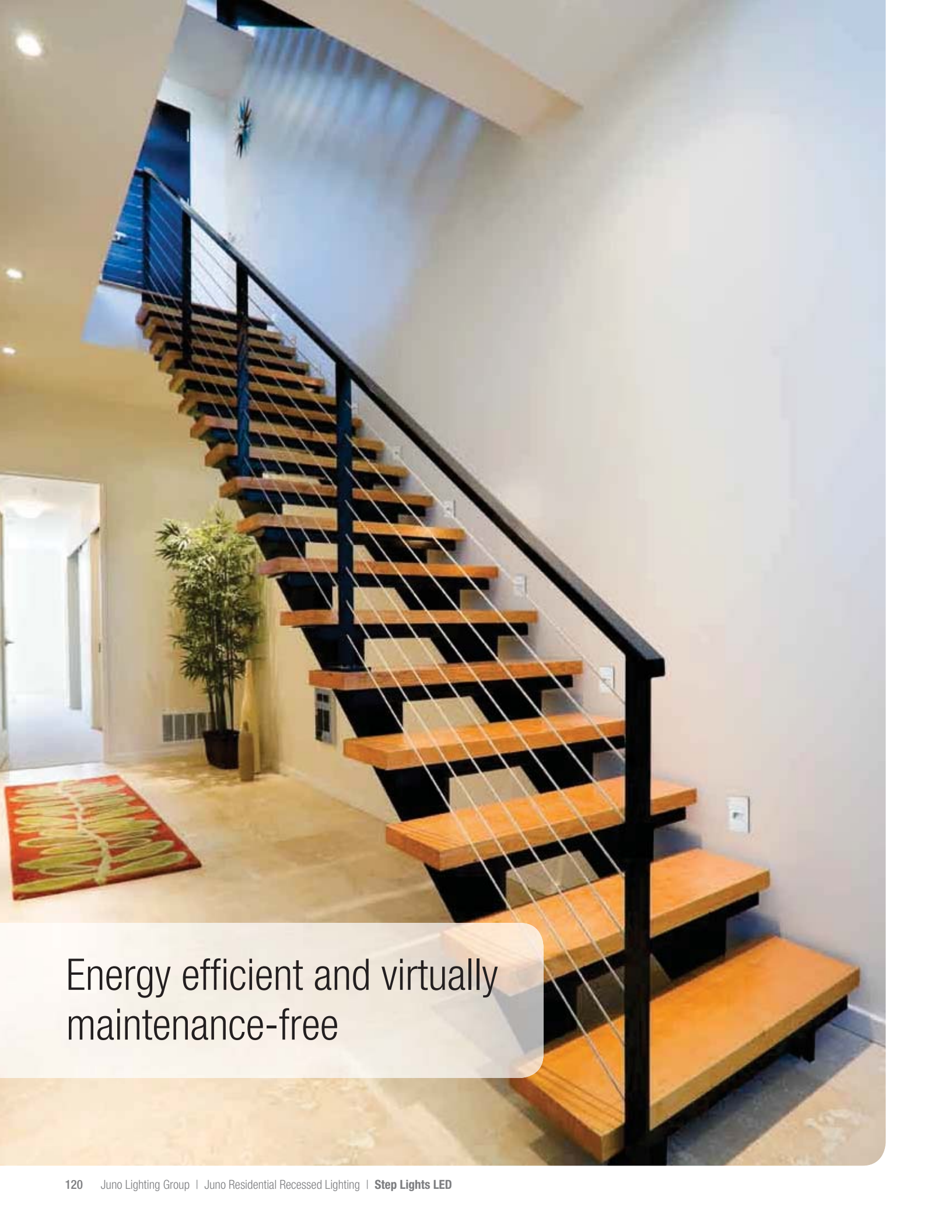

Energy efficient and virtually maintenance-free

LED Step Lights . . .

the all around performers

Juno LED Step Lights are an energy efficient, virtually maintenance-free solution for indoor and outdoor, low-level lighting. They produce high-quality light with minimal power consumption, are rated to last a remarkable 50,000 hours, and are backed by a limited 5-year warranty. LEDs contain no toxic lead or mercury and produce no harmful ultraviolet or infrared wavelengths, making them the ideal eco-friendly solution.

**Up to 85% more energy
efficient than incandescent;
50,000-hour rated service life**



Mini LED Step Lights

Low-level lighting ... high style

For such a small fixture, Juno Mini LED Step Lights make a major statement. These architectural grade fixtures are about the size of a standard switch plate. With an approximate aperture size of one-inch square, they offer a unique, high-style appearance that blends seamlessly into its environment. An array of beautiful finishes completes the package. With their trendsetting design, extraordinary energy efficiency and long service life, Juno Mini LED Step Lights represent the new standard in upscale low-level lighting.

 Fashion forward low-level lighting

The supremely versatile step light

This little light goes a long way. The unique, compact, modular construction of the Mini LED Step Light provides solutions for a diverse number of applications. The IC-Rated, all-in-one design includes the 3-watt LED light engine, 120-volt dimmable driver, optic, and decorative face plate that all mount directly to a standard 2" x 4" junction box. Choose from four distinct optic designs and a selection of high-quality finishes.

Shown in actual size



Cutoff - Vertical Orientation

Cutoff - Horizontal Orientation

Delivering modular flexibility for vertical and horizontal installations

Juno Mini LED Step Lights can be mounted in the wall either vertically or horizontally (shipped from the factory in the vertical position). Fixture orientation can be easily changed by simply removing the optic, rotating the mounting plate and re-installing in the horizontal orientation. The face plate easily attaches to the back plate with a single set screw. Juno Mini LED Step Lights provide unsurpassed flexibility for virtually any installation.



Optic Options

Adaptable to your specific needs

Four striking optic designs satisfy a variety of illumination and aesthetic requirements. Each optic creates a one-of-a-kind lighting effect, ranging from a subtle pool of accent lighting to a wide distribution ideally suited for steps and pathways. Juno Mini LED Step Lights are adaptable to a wide variety of low-level lighting applications.

Marker

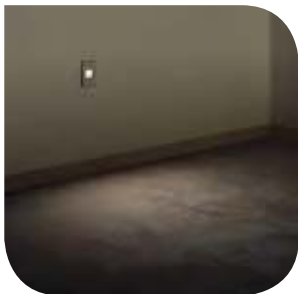

The opal lens produces an attractive glow ideal for marking corridors or pathways.

Hood

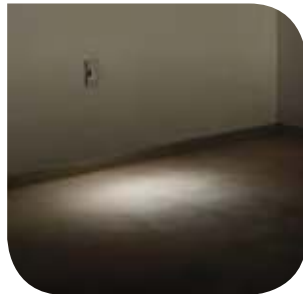

Casts a pleasant pool of light at floor level while eliminating glare - ideal for theatre or auditorium lighting.

Cutoff



Balances low glare with a wide light pattern for steps and pathway lighting.

Louver

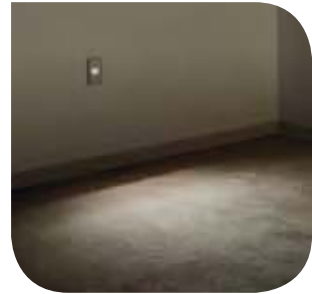

Integral louver provides superior shielding, making it an excellent choice for step lighting and other low level applications.

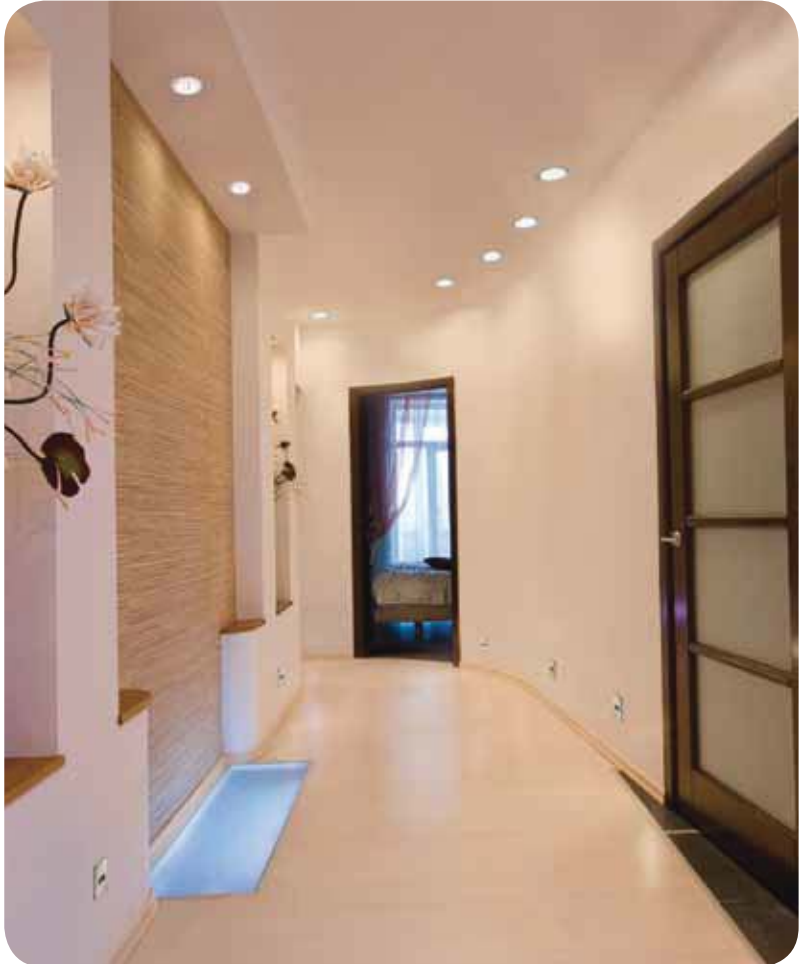



Outdoor/Wet Location Mini LED Step Lights

IP65



Specially designed to resist the elements

Constructed of high-quality, die-cast aluminum, the LMSW Series of Outdoor/Wet Location Mini IC-Rated LED Step Lights provides long lasting performance in virtually any wet location.

Designed to mount directly in standard 2"x4" (2-1/8" minimum depth) or 4"x4" (1-1/2" minimum depth) junction boxes.



- A. Gasket** protects the junction box from intrusion of water and contaminants.
- B. Light Engine Driver** features a diffused lens (not shown) that protects the LED against water infiltration. Accepts 120V input and is dimmable with reverse phase electronic low-voltage dimmers.
- C. O-rings** prevent water seepage around the screws.
- D. Drain Slot** guides water away from the fixture without compromising aesthetics.
- E. Decorative Faceplate with Corrosion-Resistant Finish** preserves the appearance for years of use. Field adjustable in horizontal or vertical orientation.
- F. Four optic choices are available.**

Finishes

Juno IC-Rated Mini LED Step Lights are available for both indoor and outdoor applications. High-quality indoor finishes include plated bronze and satin nickel; outdoor/wet location units are finished with corrosion-resistant textured bronze or silver for superior durability. All fixtures are also available in white or black.

Indoor (LMS) finishes

Shown in vertical orientation



Black,
Textured

White,
Textured

Satin Nickel,
Plated

Bronze,
Plated

Dimensions:

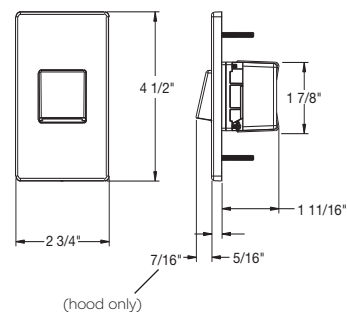

LMS - Indoor

(Shown in vertical orientation)

IP65



Outdoor/Wet Location (LMSW) finishes

Shown in horizontal orientation



Black,
Textured

White,
Textured

Silver,
Textured

Bronze,
Textured

Dimensions:

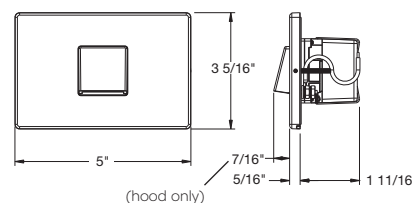

LMSW - Wet Location

(Shown in vertical orientation)

Ordering Information

Example: LMS-3K-C-BL, LMSW-41K-L-SR

Catalog No.	Color Temperature	Optics	Finishes
LMS - Indoor	3K - 3000K	C - Cutoff	Indoor: BL - Black, Textured WH - White, Textured SN - Satin Nickel, Plated BZ - Bronze, Plated Wet Location: BL - Black, Textured WH - White, Textured SR - Silver, Textured BZ - Bronze, Textured
LMSW - Outdoor/Wet Location	41K - 4100K	L - Louver	
		H - Hood	
		M - Marker	





Step-up to Juno Performance LED Step Lights

The outdoor-rated Juno Performance LED Step Lights are the perfect combination of aesthetic fixture design and optimum illumination performance. These architectural-grade fixtures feature sleek, low-profile trims, attractively finished in corrosion-resistant, textured paint. Trims and matching hardware are available in black, white, silver, and bronze.

IP65



 Energy efficient, long service life and eco-friendly

Features

- Unique all-in-one power module mounts directly to the cast aluminum trim and includes the LED light engine and 120-volt, non-dimming driver.
- Low-profile trim and baffle-steps produce wide illumination patterns and minimize glare.
- LEDs are concealed from direct view with a matte-textured diffuser.
- Fixture produces up to 300 lumens with nominal 13-watt power consumption.
- 3000K or 4100K color temperature available.
- May be used as a retrofit for existing Juno PL115 outdoor-rated step light installations.

Finishes



Black



White



Silver



Bronze

Ordering Information

Order housing and power module trim separately.

Example: IC115LEDHSG
Back Housing
IC115LEDHSG



Example: 838LED-13-41K-BL			
Power Module Trim	Wattage	Color Temperature	Finish
838LED –	13 - 13W	3K - 3000K 41K- 4100K	BL Black Textured WH White Textured SR Silver Textured BZ Bronze Textured



Trim Size: 9³/₄" L x 3⁵/₈" H

Dimensions:

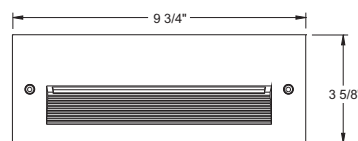
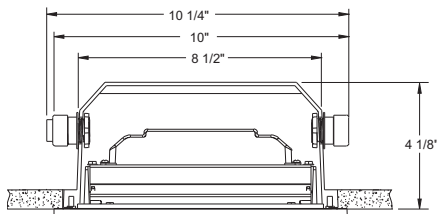

Wall Cutout: 9" x 3"



Indoor and Outdoor Rated LED Step Lights

Juno's LED step lights provide an energy-efficient solution for low-level lighting in indoor or outdoor applications. Consuming just 6-watts of power, these LED step lights use far less energy than the comparable incandescent and fluorescent versions and are compatible with standard trims.



Indoor-Rated LED Step/Night Light

The indoor LED Step/Night Light is rated for use in wall- or ceiling-mount, indoor drywall applications. Two trims are available: one featuring a diffuse-glass lens for even light distribution; the other with louvers that reduce glare and provide a softer lighting effect.

- Dedicated LED housing ships complete with LED light engine and 120-volt, non-dimming driver
- Recessed housing is IC-Rated and can be completely covered with insulation
- Real Nail® 3 bar hanger system provides quick and easy installation
- 3000K or 4100K color temperature available

Ordering Information

Order housing and trim separately.

Example: IC113LED-3K

Housing	Color Temperature
IC113LED	3K - 3000K 41K - 4100K



Example: 840-WH

Trim Description

104-WH - Diffuse Glass Lens, White Trim



840-WH - Angled Louvers, White Trim



Trim Size: 9¹/₁₆" L x 4⁷/₁₆" H

Dimensions:

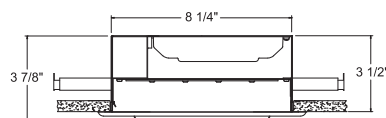
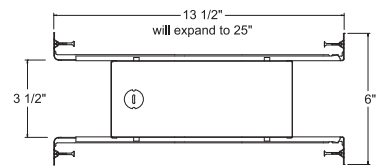

Wall Cutout: 8³/₄" x 3³/₄"



Outdoor Rated LED Step Light

The Outdoor LED Step Light is rated for use in outdoor and indoor wall-mount applications, including concrete pour, brick masonry, or drywall. Trims are cast aluminum and are offered in opal lens, grill and louver designs.

- Die-cast aluminum housing is IC rated and gasketed for wet locations
- Back housing ships separately from power module for rough-in purposes
- Power module assembly with LED light engine and 120-volt, non-dimming driver is mounted directly to metal tray for ease of installation into housing
- 3000K or 4100K color temperature available

Ordering Information

Order housing, power module and trim separately.

Example: IC115LEDHSG		Example: IC115LEDPM-3K		Example: 835-WH	
Back Housing		Power Module	Color Temperature	Trim/Description	
IC115LEDHSG		IC115LEDPM	3K - 3000K 41K - 4100K	835-WH - Full Opal Lens - White 835-BL - Full Opal Lens - Black	
				836-WH - Opal Lens with Grill - White 836-BL - Opal Lens with Grill - Black	
				837-WH - Opal Lens with Angled Louvers - White 837-BL - Opal Lens with Angled Louvers - Black	
				Trim Size: 9 3/4" L x 3 5/8" H	

Dimensions:

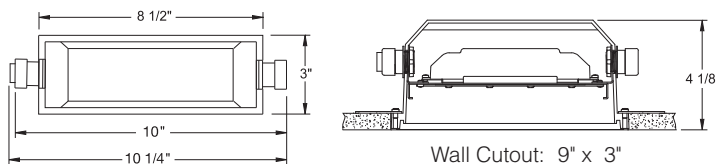



Offering CFL efficiency
and economy

CFL Step Lights

energy efficient and economical

Juno CFL Step Lights integrate the economy and energy efficiency of compact fluorescent lamps into a high-quality step light fixture. Approved for both indoor and outdoor applications, this step-light series offers two trims for indoor use; three trims for outdoors. The rugged outdoor units feature a die-cast aluminum back housing that is gasketed for wet locations and rated for concrete pour, brick masonry, or drywall applications.

 Up to 4-times more efficient than incandescent lighting



Indoor Rated CFL Step/Night Light



The Indoor CFL Step/Night Light is rated for use in indoor, wall- or ceiling-mount drywall applications. Trim offering includes diffuse-glass lens and louver designs.

- 7-watt or 9-watt, 2-pin CFL lamp mounts horizontally in fixture
- Includes 120-volt, non-dimming ballast
- Recessed housing is IC rated and can be completely covered with insulation
- Real Nail® 3 bar hanger system provides quick and easy installation

Ordering Information

Order housing and trim separately.

Example: ICPL813

Housing

ICPL813



Example: 104-WH

Trim Description

104-WH - Diffuse Glass Lens, White Trim



840-WH - Angled Louvers, White Trim



Trim Size: 9⁹/₁₆" L x 4⁷/₈" H

Dimensions:

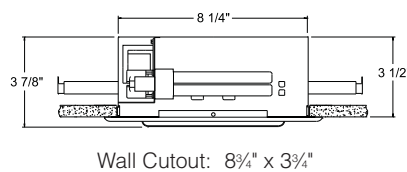
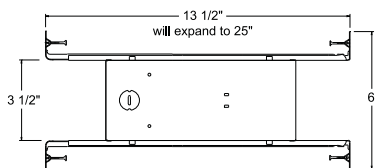

Trim Finishes: **WH:** White

Outdoor Rated CFL Step Light



The Outdoor CFL Step Light is rated for use in concrete pour applications or non-insulated areas. Trims are cast aluminum and offered in opal lens grill and louver designs.

- 7W or 9W 2-pin CFL lamp mounts horizontally in fixture
- Includes 120-volt, non-dimming ballast
- Die-cast aluminum housing is gasketed for wet locations

Ordering Information

Order housing and trim separately.

Example: PL115

Housing

PL115



Example: 835-WH

Trim/Description

835-WH - Full Opal Lens - White

835-BL - Full Opal Lens - Black

836-WH - Opal Lens with Grill - White

836-BL - Opal Lens with Grill - Black

837-WH - Opal Lens with Angled Louvers - White

837-BL - Opal Lens with Angled Louvers - Black



Trim Size: 9 1/4" L x 3 5/8" H

Dimensions:

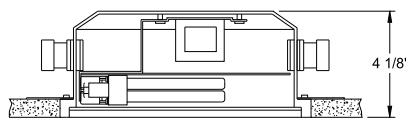
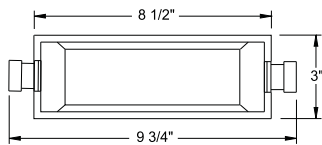

Wall Cutout: 8 1/2" x 3"

Trim Finishes: **WH:** White, **BL:** Black



Incandescent Step Lights

Juno incandescent step lights are a cost-effective option for low-level, indoor lighting applications. With two trims available — one featuring a diffuse lens for even light distribution and another with louvers to provide a softer effect with reduced glare — these step lights suit a variety of needs. These fixtures can be used in either insulated or non-insulated areas and incorporate the Real Nail® 3 bar hanger system for fast, easy installation.

 **The cost-effective
step lighting solution**

Night Lights/Step Lights

The Indoor Incandescent Step/Night Light is rated for use in indoor wall- or ceiling-mount drywall applications. Trim offering includes diffuse glass lens and louver designs.

- Provided with medium base porcelain socket
- Recessed housing is IC rated and can be completely covered with insulation
- Rated for 25W A19 lamp in insulated IC applications, or 40W A19 lamp in Non-IC applications
- Real Nail® 3 Bar Hangers for quick housing placement

Ordering Information

Order housing and trim separately.

Night/Step Light Housings

Example: ICTC113

Housing

ICTC113



Incandescent Housing
Can be covered with insulation.
IC: 25W A19
TC: 40W A19
8 1/4" L x 3 1/2" W x 3 1/2" D

Wall cutout: 8 3/4" x 3 3/4"

Example: 104-WH

Trim/Description

104-WH Diffuse Glass Lens



840-WH Angled Louvers



Trim Finishes: **WH:** White
Trim Size: 9 9/16" L x 4 7/8" H

Dimensions:

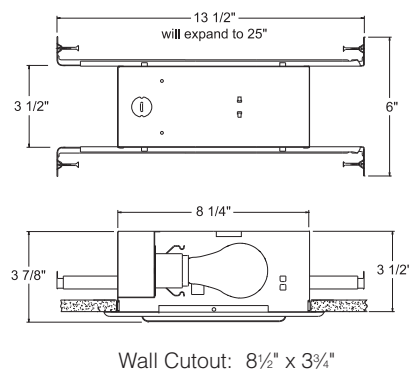

Night Light Kits

Example: ICTC113-840WH

Housing

ICTC113



Incandescent Night Light Kit
ICTC113-840WH
Complete unit with white louvered steel trim.
Housing can be covered with insulation.
IC: 25W A19
TC: 40W A19
Housing: 8 1/4" L x 3 1/2" W x 3 1/2" D

Wall cutout: 8 3/4" x 3 3/4"

Trim Finishes: **WH:** White
Trim Size: 9 9/16" L x 4 7/8" H

Photometric Data

The tables on the following pages provide illumination levels (FC) and beam size (in feet) for lamps of various wattages and beam patterns. Data is given for lamps aimed at both horizontal and vertical surfaces.

Maximum candlepower and rated life is also indicated for each lamp. Lamp performance is based on bare lamp photometrics provided by lamp manufacturers. Additional information may be obtained from Juno.

Photometrics Data Index	Page
WarmDim [®] 4" 600 Lumen LED Downlights	147
WarmDim [®] 5" 600 Lumen LED Downlights	148
WarmDim [®] 6" 600 Lumen LED Downlights	149
.....	
4" 600 Lumen LED Downlights	150
5" 600 Lumen LED Downlights	151
6" 600 Lumen LED Downlights	152
.....	
5" 900 Lumen LED Downlights	153
6" 900 Lumen LED Downlights	154
.....	
LED Optics (5" and 6" Downlights and Retrofit Eyeball)	155
.....	
6" 600 Lumen LED Wall Wash	156
.....	
Juno [®] Retrofit LED Downlight	157
.....	
Juno [®] Retrofit LED Eyeball	158
.....	
6" Slope Ceiling LED Downlights	159
.....	
2" Mini LED Downlights	160
.....	

Photometric Data



For Horizontal Aiming Angles

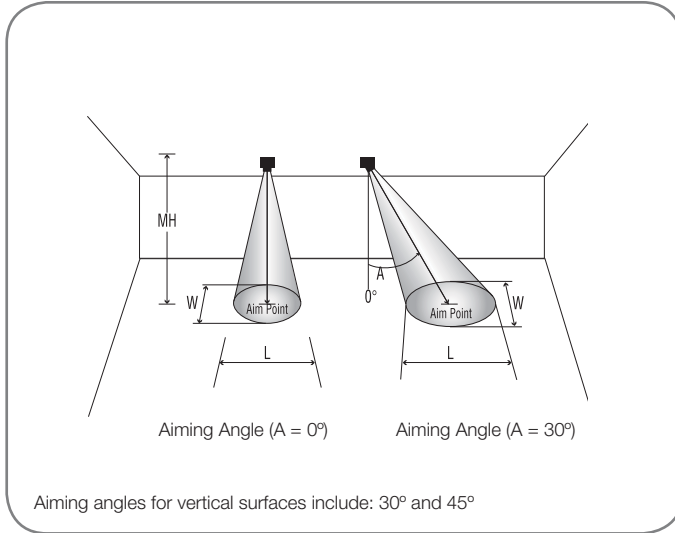

For Vertical Aiming Angles

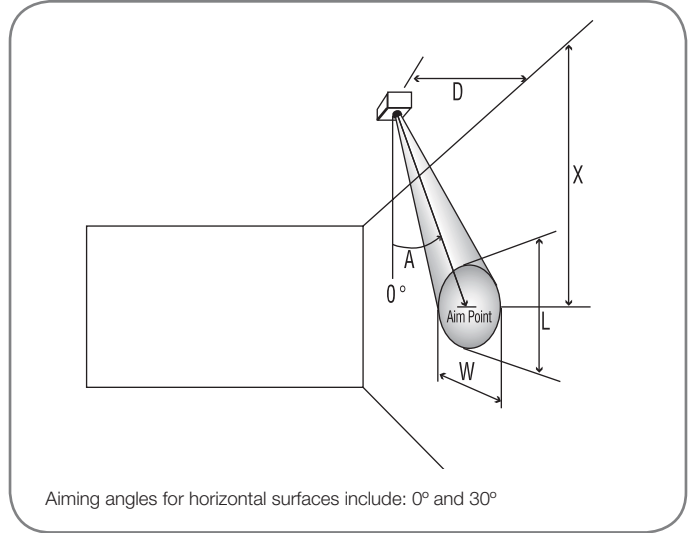

- CBCP** - Center Beam Candle Power
- A** - Aiming angle of fixture/lamp, measured from 0°
- MH** - Vertical distance from the fixture/lamp to the horizontal surface
- FC** - Footcandles at beam center (aim point)
- L** - Length of beam
- W** - Width of beam
- D** - Distance from fixture/lamp to wall
- X** - Aiming angle of fixture/lamp, measured from 0°

General Lighting

Light intensity is measured by footcandles (fc). As an example, moonlight on a clear night measures roughly 4 footcandles. The following are recommended illumination levels for various rooms and activities in the home.

Low Illumination 5 to 24 fc

Circulation lighting	Shower Stall
Closet	Halls/Corridors
Entry Way	General Lighting

Medium Illumination 25 to 35 fc

Cooking Surface Lighting	Grooming
Dining Room Chandelier	Laundry/Ironing
Dining Room Spotlight	Recreation

High Illumination over 35 fc

Accent Lighting	Hobby Areas
Kitchen Counter/Sink	Desk
Game Table	Reading/Sewing

				Horizontal Surface									Vertical Surface																	
				0 degrees			30 degrees			30 degrees			45 degrees			60 degrees														
Fixture	Beam Type	Beam Spread	Rated Life	CBPC	MH	FC	L	W	FC	L	W	D	FC	X	L	W	FC	X	L	W	D	FC	X	L	W					
39W PAR20 Halogen IR* (Osram/Sylvania)	SP	10°	3000	4000	6	111	1.0	1.0	72	1.4	1.2	2	125	3.5	1.4	0.7	354	2.0	0.7	0.5	3	289	1.7	0.7	0.6					
					8	63	1.4	1.4	41	1.9	1.6	3	56	5.2	2.1	1.0	157	3.0	1.1	0.7	4	162	2.3	0.9	0.8					
					10	40	1.7	1.7	26	2.3	2.0	4	31	6.9	2.9	1.4	88	4.0	1.4	1.0	5	104	2.9	1.2	1.0					
					12	28	2.1	2.1	18	2.8	2.4	5	20	8.7	3.6	1.7	57	5.0	1.8	1.2	6	72	3.5	1.4	1.2					
	FL	30°	3000	1100	6	20	2.4	2.4	13	3.3	2.8	6	14	10.4	4.3	2.1	39	6.0	2.1	1.5	7	53	4.0	1.6	1.4					
					4	69	2.1	2.1	45	2.9	2.5	2	34	3.5	5.5	2.1	97	2.0	2.3	1.5	3	79	1.7	2.2	1.9					
					5	44	2.7	2.7	29	3.7	3.1	3	15	5.2	8.2	3.2	43	3.0	3.5	2.3	4	45	2.3	2.9	2.5					
					6	31	3.2	3.2	20	4.4	3.7	4	9	6.9	10.9	4.3	24	4.0	4.6	3.0	5	29	2.9	3.7	3.1					
	NFL	30°	3000	1100	7	22	3.8	3.8	15	5.1	4.3	5	6	8.7	13.7	5.4	16	5.0	5.8	3.8	6	20	3.5	4.4	3.7					
					8	17	4.3	4.3	11	5.9	5.0	6	4	10.4	16.4	6.4	11	6.0	6.9	4.5	7	15	4.0	5.1	4.3					
					45W PAR16 Halogen	NSP	10°	2000	5000	6	139	1.0	1.0	90	1.4	1.2	2	156	3.5	1.4	0.7	442	2.0	0.7	0.5	6	90	3.5	0.9	0.8
										8	78	1.4	1.4	51	1.9	1.6	3	69	5.2	2.1	1.0	196	3.0	1.1	0.7	9	40	5.2	1.4	1.2
10	50	1.7	1.7	32						2.3	2.0	4	39	6.9	2.9	1.4	110	4.0	1.4	1.0	12	23	6.9	1.9	1.6					
12	35	2.1	2.1	23						2.8	2.4	5	25	8.7	3.6	1.7	71	5.0	1.8	1.2	15	14	8.7	2.3	2.0					
NFL	27°	2000	1400	14		26	2.4	2.4	17	3.3	2.8	6	17	10.4	4.3	2.1	49	6.0	2.1	1.5	18	10	10.4	2.8	2.4					
				3		156	1.4	1.4	101	2.0	1.7	1	175	1.7	2.3	1.0	495	1.0	1.0	0.7	4	57	2.3	1.3	1.1					
				5		56	2.4	2.4	36	3.3	2.8	2	44	3.5	4.6	1.9	124	2.0	2.0	1.4	6	25	3.5	2.6	2.2					
				7		29	3.4	3.4	19	4.6	3.9	3	19	5.2	7.0	2.9	55	3.0	3.1	2.0	8	14	4.6	3.9	3.3					
NFL	27°	2000	1400	9		17	4.3	4.3	11	5.9	5.0	4	11	6.9	9.3	3.8	31	4.0	4.1	2.7	10	9	5.8	5.2	4.4					
				11		12	5.3	5.3	8	7.2	6.1	5	7	8.7	11.6	4.8	20	5.0	5.1	3.4	12	6	6.9	6.5	5.5					
				60W PAR16 Halogen		NSP	10°	2000	5400	6	150	1.0	1.0	97	1.4	1.2	2	169	3.5	1.4	0.7	447	2.0	0.7	0.5	6	97	3.5	0.5	0.4
										8	84	1.4	1.4	55	1.9	1.6	3	75	5.2	2.1	1.0	212	3.0	1.1	0.7	7	72	4.0	0.7	0.6
10	54	1.7	1.7		35					2.3	2.0	4	42	6.9	2.9	1.4	119	4.0	1.4	1.0	8	55	4.6	0.9	0.8					
12	38	2.1	2.1		24					2.8	2.4	5	27	8.7	3.6	1.7	76	5.0	1.8	1.2	9	43	5.2	1.2	1.0					
NFL	30°	2000	1550		14	28	2.4	2.4	18	3.3	2.8	6	19	10.4	4.3	2.1	53	6.0	2.1	1.5	10	35	5.8	1.4	1.2					
					4	97	2.1	2.1	63	2.9	2.5	2	48	3.5	5.5	2.1	137	2.0	2.3	1.5	2	252	1.2	1.5	1.2					
					6	43	3.2	3.2	28	4.4	3.7	3	22	5.2	8.2	3.2	61	3.0	3.5	2.3	3	112	1.7	2.2	1.9					
					8	24	4.3	4.3	16	5.9	5.0	4	12	6.9	10.9	4.3	34	4.0	4.6	3.0	4	63	2.3	2.9	2.5					
NFL	30°	2000	1550		10	16	5.4	5.4	10	7.3	6.2	5	8	8.7	13.7	5.4	22	5.0	5.8	3.8	5	40	2.9	3.7	3.1					
					12	11	6.4	6.4	7	8.8	7.4	6	5	10.4	16.4	6.4	15	6.0	6.9	4.5	6	28	3.5	4.4	3.7					
					75W PAR16 Halogen	NSP	10°	2000	7500	6	208	1.0	1.0	135	1.4	1.2	2	234	3.5	1.4	0.7	663	2.0	0.7	0.5	6	135	3.5	1.4	1.2
										8	117	1.4	1.4	76	1.9	1.6	3	104	5.2	2.1	1.0	295	3.0	1.1	0.7	7	99	4.0	1.6	1.4
10	75	1.7	1.7	49						2.3	2.0	4	59	6.9	2.9	1.4	166	4.0	1.4	1.0	8	76	4.6	1.9	1.6					
12	52	2.1	2.1	34						2.8	2.4	5	38	8.7	3.6	1.7	106	5.0	1.8	1.2	9	60	5.2	2.1	1.8					
NFL	30°	2000	1900	14		38	2.4	2.4	25	3.3	2.8	6	26	10.4	4.3	2.1	74	6.0	2.1	1.5	10	49	5.8	2.3	2.0					
				4		119	2.1	2.1	77	2.9	2.5	2	59	3.5	5.5	2.1	168	2.0	2.3	1.5	2	309	1.2	1.5	1.2					
				6		53	3.2	3.2	34	4.4	3.7	3	26	5.2	8.2	3.2	75	3.0	3.5	2.3	3	137	1.7	2.2	1.9					
				8		30	4.3	4.3	19	5.9	5.0	4	15	6.9	10.9	4.3	42	4.0	4.6	3.0	4	77	2.3	2.9	2.5					
NFL	30°	2000	1900	10		19	5.4	5.4	12	7.3	6.2	5	10	8.7	13.7	5.4	27	5.0	5.8	3.8	5	49	2.9	3.7	3.1					
				12		13	6.4	6.4	9	8.8	7.4	6	7	10.4	16.4	6.4	19	6.0	6.9	4.5	6	34	3.5	4.4	3.7					

The beam spread in degrees and the beam "L" and "W" in the tables are computed at 50% of centerbeam candlepower and represent areas of "effective illumination".

* Replaces higher wattage standard halogen lamp which is no longer manufactured as of July 2012 in compliance with 2007 Energy Independence and Security Act.
 Note: Data shown is for a specific lamp from a specific lamp manufacturer. Wattage, CBPC & life on the newer IR PAR style lamps varies.
 Consult lamp manufacturer literature for complete information.

Bare Lamp - Halogen, continued



		Horizontal Surface				Vertical Surface																							
Fixture	Beam Type	Beam Spread	Rated Life	CBCP	0 degrees				30 degrees				45 degrees				60 degrees												
					MH	FC	L	W	FC	L	W	D	FC	X	L	W	D	FC	X	L	W								
39W PAR30 Halogen* (Osram/Sylvania)	SP	10°	3000	5800	6	161	1.0	1.0	105	1.4	1.2	3	81	5.2	2.1	1.0	228	3.0	1.1	0.7	6	105	3.5	1.4	1.2				
					8	91	1.4	1.4	59	1.9	1.6	4	45	6.9	2.9	1.4	128	4.0	1.4	1.0	7	77	4.0	1.6	1.4				
					10	58	1.7	1.7	38	2.3	2.0	5	29	8.7	3.6	1.7	82	5.0	1.8	1.2	8	59	4.6	1.9	1.6				
					12	40	2.1	2.1	26	2.8	2.4	6	20	10.4	4.3	2.1	57	6.0	2.1	1.5	9	47	5.2	2.1	1.8				
					14	30	2.4	2.4	19	3.3	2.8	7	15	12.1	5.0	2.4	42	7.0	2.5	1.7	10	38	5.8	2.3	2.0				
	NFL	25°	3000	1600	4	100	1.8	1.8	65	2.4	2.0	2	50	3.5	4.2	1.8	141	2.0	1.9	1.3	4	65	2.3	2.4	2.0				
					6	44	2.7	2.7	29	3.6	3.1	3	22	5.2	6.2	2.7	63	3.0	2.8	1.9	5	42	2.9	3.0	2.6				
					8	25	3.5	3.5	16	4.8	4.1	4	13	6.9	8.3	3.5	35	4.0	3.7	2.5	6	29	3.5	3.6	3.1				
					10	16	4.4	4.4	17	6.0	5.1	5	8	8.7	10.4	4.4	23	5.0	4.7	3.1	7	21	4.0	4.2	3.6				
					12	11	5.3	5.3	7	7.2	6.1	6	6	10.4	12.5	5.3	16	6.0	5.6	3.8	8	16	4.6	4.8	4.1				
					WFL	50°	3000	600	3	67	2.8	2.8	43	4.0	3.2	1	75	1.7	10.7	1.9	212	1.0	2.4	1.3	2	97	1.2	2.7	2.2
									5	24	4.7	4.7	16	6.7	5.4	2	19	3.5	21.5	3.7	53	2.0	4.8	2.6	3	43	1.7	4.0	3.2
									7	12	6.5	6.5	8	9.4	7.5	3	8	5.2	**	5.6	24	3.0	7.2	4.0	4	24	2.3	5.4	4.3
									9	7	8.4	8.4	5	12.1	9.7	4	5	6.9	**	7.5	13	4.0	9.5	5.3	5	16	2.9	6.7	5.4
									11	5	10.3	10.3	3	14.7	11.8	5	3	8.7	**	9.3	8	5.0	11.9	6.6	6	11	3.5	8.0	6.5
					50W PAR30 Halogen IR* (Philips)	SP	10°	4200	12300	6	342	1.0	1.0	222	1.4	1.2	3	171	5.2	2.1	1.0	483	3.0	1.1	0.7	7	163	4.0	1.6
8	192	1.4	1.4	125						1.9	1.6	4	96	6.9	2.9	1.4	272	4.0	1.4	1.0	8	125	4.6	1.9	1.6				
10	123	1.7	1.7	80						2.3	2.0	5	62	8.7	3.6	1.7	174	5.0	1.8	1.2	9	99	5.2	2.1	1.8				
12	85	2.1	2.1	55						2.8	2.4	6	43	10.4	4.3	2.1	121	6.0	2.1	1.5	10	80	5.8	2.3	2.0				
14	63	2.4	2.4	41						3.3	2.8	7	31	12.1	5.0	2.4	89	7.0	2.5	1.7	11	66	6.4	2.6	2.2				
FL	25°	4200	3850	4		241	1.8	1.8	156	2.4	2.0	2	120	3.5	4.2	1.8	340	2.0	1.9	1.3	3	278	1.7	1.8	1.5				
				6		107	2.7	2.7	69	3.6	3.1	3	53	5.2	6.2	2.7	151	3.0	2.8	1.9	4	156	2.3	2.4	2.0				
				8		60	3.5	3.5	39	4.8	4.1	4	30	6.9	8.3	3.5	85	4.0	3.7	2.5	5	100	2.9	3.0	2.6				
				10		39	4.4	4.4	25	6.0	5.1	5	19	8.7	10.4	4.4	54	5.0	4.7	3.1	6	69	3.5	3.6	3.1				
				12		20	6.2	6.2	13	8.4	7.2	6	13	10.4	12.5	5.3	38	6.0	5.6	3.8	7	51	4.0	4.2	3.6				
				WFL		40°	4200	1420	4	89	2.9	2.9	58	4.1	3.4	1	178	1.7	4.8	1.5	502	1.0	1.7	1.0	2	231	1.2	2.0	1.7
									6	39	4.4	4.4	26	6.1	5.0	2	44	3.5	9.7	2.9	126	2.0	3.4	2.1	3	102	1.7	3.0	2.7
									8	22	5.8	5.8	14	8.1	6.7	3	20	5.2	14.5	4.4	56	3.0	5.0	3.1	4	58	2.3	4.1	3.4
10	14	7.3	7.3		9				10.2	8.4	4	11	6.9	19.3	5.8	31	4.0	6.7	4.1	5	37	2.9	5.1	4.2					
					12	10	8.7	8.7	6	12.2	10.1	5	7	8.7	24.2	7.3	20	5.0	8.4	5.1	6	26	3.5	6.1	5.0				

The beam spread in degrees and the beam "L" and "W" in the tables are computed at 50% of centerbeam candlepower and represent areas of "effective illumination".

* Replaces higher wattage standard halogen lamp which is no longer manufactured as of July 2012 in compliance with 2007 Energy Independence and Security Act.
 Note: Data shown is for a specific lamp from a specific lamp manufacturer. Wattage, CBCP & life on the newer IR PAR style lamps varies.
 Consult lamp manufacturer literature for complete information.

** Due to steep aiming angle, length of beam extends beyond 25'. Each angle listed is measured from 0° vertical.

Bare Lamp - Halogen and Incandescent, continued



		Horizontal Surface					Vertical Surface																		
Fixture	Beam Type	Beam Spread	Rated Life	CBCP	0 degrees					30 degrees					45 degrees					60 degrees					
					MH	FC	L	W	FC	L	W	D	FC	X	L	W	FC	X	L	W	D	FC	X	L	W
20W MR11 Halogen 	SP	15°	3500	1760	4	110	1.1	1.1	71	1.4	1.2	2	55	3.5	2.2	1.1	156	2.0	1.1	0.7	4	71	2.3	0.7	0.6
					6	49	1.6	1.6	32	2.1	1.8	3	24	5.2	3.3	1.6	69	3.0	1.6	1.1	5	46	2.9	1.1	0.9
					8	28	2.1	2.1	18	2.8	2.4	4	14	6.9	4.4	2.1	39	4.0	2.1	1.5	6	32	3.5	1.4	1.2
					10	18	2.6	2.6	11	3.5	3.0	5	9	8.7	5.6	2.6	25	5.0	2.7	1.9	7	23	4.0	1.8	1.5
					12	12	3.2	3.2	8	4.2	3.6	6	6	10.4	6.7	3.2	17	6.0	3.2	2.2	8	18	4.6	2.1	1.8
	FL	30°	3500	600	2	150	1.1	1.1	97	1.5	1.2	1	75	1.7	2.7	1.1	212	1.0	1.2	0.8	2	97	1.2	0.7	0.6
					4	38	2.1	2.1	24	2.9	2.5	2	19	3.5	5.5	2.1	53	2.0	2.3	1.5	3	43	1.7	1.5	1.2
					6	17	3.2	3.2	11	4.4	3.7	3	8	5.2	8.2	3.2	24	3.0	3.5	2.3	4	24	2.3	2.2	1.9
					8	9	4.3	4.3	6	5.9	5.0	4	5	6.9	10.9	4.3	13	4.0	4.6	3.0	5	16	2.9	2.9	2.5
					10	6	5.4	5.4	4	7.3	6.2	5	3	8.7	13.7	5.4	8	5.0	5.8	3.8	6	11	3.5	3.7	3.1
35W MR11 Halogen 	SP	20°	3500	3000	4	188	1.4	1.4	122	1.9	1.6	2	94	3.5	3.1	1.4	265	2.0	1.5	1.0	4	122	2.3	1.0	0.8
					6	83	2.1	2.1	54	2.9	2.4	3	42	5.2	4.7	2.1	118	3.0	2.2	1.5	5	78	2.9	1.4	1.2
					8	47	2.8	2.8	30	3.8	3.3	4	23	6.9	6.2	2.8	66	4.0	2.9	2.0	6	54	3.5	1.9	1.6
					10	30	3.5	3.5	19	4.8	4.1	5	15	8.7	7.8	3.5	42	5.0	3.6	2.5	7	40	4.0	2.4	2.0
					12	21	4.2	4.2	14	5.7	4.9	6	10	10.4	9.3	4.2	29	6.0	4.4	3.0	8	30	4.6	2.9	2.4
	FL	30°	3500	1300	2	325	1.1	1.1	211	1.5	1.2	1	163	1.7	2.7	1.1	460	1.0	1.2	0.8	2	211	1.2	0.7	0.6
					4	81	2.1	2.1	53	2.9	2.5	2	41	3.5	5.5	2.1	115	2.0	2.3	1.5	3	94	1.7	1.5	1.2
					6	36	3.2	3.2	23	4.4	3.7	3	18	5.2	8.2	3.2	51	3.0	3.5	2.3	4	53	2.3	2.2	1.9
					8	20	4.3	4.3	13	5.9	5.0	4	10	6.9	10.9	4.3	29	4.0	4.6	3.0	5	34	2.9	2.9	2.5
					10	13	5.4	5.4	8	7.3	6.2	5	7	8.7	13.7	5.4	18	5.0	5.8	3.8	6	23	3.5	3.7	3.1
65W BR30 Incandescent 	SP	27°	2000	1680	2	420	1.0	1.0	273	1.3	1.1	2	53	3.5	4.6	1.9	148	2.0	2.0	1.4	3	121	1.7	2.0	1.7
					4	105	1.9	1.9	68	2.6	2.2	3	23	5.2	7.0	2.9	66	3.0	3.1	2.0	4	68	2.3	2.6	2.2
					6	47	2.9	2.9	30	3.9	3.3	4	13	6.9	9.3	3.8	37	4.0	4.1	2.7	5	44	2.9	3.3	2.8
					8	26	3.8	3.8	17	5.2	4.4	5	8	8.7	11.6	4.8	24	5.0	5.1	3.4	6	30	3.5	3.9	3.3
					10	17	4.8	4.8	11	6.5	5.5	6	6	10.4	13.9	5.8	16	6.0	6.1	4.1	7	22	4.0	4.6	3.9
	FL	60°	2000	510	2	128	2.3	2.3	83	3.5	2.7	1	64	1.7	** 2.3	180	1.0	3.5	1.6	1	331	0.6	1.7	1.3	
					3	57	3.5	3.5	37	5.2	4.0	2	16	3.5	** 4.6	45	2.0	6.9	3.3	2	83	1.2	3.5	2.7	
					4	32	4.6	4.6	21	6.9	5.3	3	7	5.2	** 6.9	20	3.0	10.4	4.9	3	37	1.7	5.2	4.0	
					5	20	5.8	5.8	13	8.7	6.7	4	4	6.9	** 9.2	11	4.0	13.9	6.5	4	21	2.3	6.9	5.3	
					6	14	6.9	6.9	9	10.4	8.0	5	3	8.7	** 11.5	7	5.0	17.3	8.2	5	13	2.9	8.7	6.7	
120W BR40 Incandescent 	SP	20°	2000	6690	6	186	2.1	2.1	121	2.9	2.4	3	93	5.2	4.7	2.1	263	3.0	2.2	1.5	5	174	2.9	2.4	2.0
					8	105	2.8	2.8	68	3.8	3.3	4	52	6.9	6.2	2.8	148	4.0	2.9	2.0	6	121	3.5	2.9	2.4
					10	67	3.5	3.5	43	4.8	4.1	5	33	8.7	7.8	3.5	95	5.0	3.6	2.5	7	89	4.0	3.3	2.9
					12	46	4.2	4.2	30	5.7	4.9	6	23	10.4	9.3	4.2	66	6.0	4.4	3.0	8	68	4.6	3.8	3.3
					14	34	4.9	4.9	22	6.7	5.7	7	17	12.1	10.9	4.9	48	7.0	5.1	3.5	9	54	5.2	4.3	3.7
	FL	53°	2000	1430	4	89	4.0	4.0	58	5.8	4.6	2	45	3.5	** 4.0	126	2.0	5.3	2.8	3	103	1.7	4.3	3.5	
					6	40	6.0	6.0	26	8.7	6.9	3	20	5.2	** 6.0	56	3.0	8.0	4.2	4	58	2.3	5.8	4.6	
					8	22	8.0	8.0	15	11.6	9.2	4	11	6.9	** 8.0	32	4.0	10.6	5.6	5	37	2.9	7.2	5.8	
					10	14	10.0	10.0	9	14.5	11.5	5	7	8.7	** 10.0	20	5.0	13.3	7.1	6	26	3.5	8.7	6.9	
					12	10	12.0	12.0	6	17.4	13.8	6	5	10.4	** 12.0	14	6.0	15.9	8.5	7	19	4.0	10.1	8.1	

The beam spread in degrees and the beam "L" and "W" in the tables are computed at 50% of centerbeam candlepower and represent areas of "effective illumination".
 ** Due to steep aiming angle, length of beam extends beyond 25'. Each angle listed is measured from 0° vertical.

		Horizontal Surface					Vertical Surface										
Fixture	Beam Type	Beam Spread	Rated Life	CBCP	0 degrees			30 degrees			45 degrees			60 degrees			
					MH	FC	L W	FC	L W	D	FC	X L W	FC	X L W	D	FC	X L W
35W MR16 Halogen	NSP	10°	4000	9100													
					6	253	1.0 1.0	164	1.4 1.2	3	126	5.2 2.1 1.0	357	3.0 1.1 0.7	6	164	3.5 0.7 0.6
					8	142	1.4 1.4	92	1.9 1.6	4	71	6.9 2.9 1.4	201	4.0 1.4 1.0	7	121	4.0 0.9 0.8
					10	91	1.7 1.7	59	2.3 2.0	5	46	8.7 3.6 1.7	129	5.0 1.8 1.2	8	92	4.6 1.2 1.0
		NFL	25°	4000	2000												
	4					125	1.8 1.8	81	2.4 2.0	2	63	3.5 4.2 1.8	177	2.0 1.9 1.3	4	81	2.3 1.2 1.0
	6					56	2.7 2.7	36	3.6 3.1	3	28	5.2 6.2 2.7	79	3.0 2.8 1.9	5	52	2.9 1.8 1.5
	8					31	3.5 3.5	20	4.8 4.1	4	16	6.9 8.3 3.5	44	4.0 3.7 2.5	6	36	3.5 2.4 2.0
		FL	35°	4000	1500												
	4					94	2.5 2.5	61	3.5 2.9	2	47	3.5 7.2 2.5	133	2.0 2.8 1.8	4	61	2.3 1.7 1.5
	6					42	3.8 3.8	27	5.2 4.4	3	21	5.2 10.8 3.8	59	3.0 4.2 2.7	5	39	2.9 2.6 2.2
	8					23	5.0 5.0	15	7.0 5.8	4	12	6.9 14.4 5.0	33	4.0 5.6 3.6	6	27	3.5 3.5 2.9
	WFL	60°	4000	650													
2					163	2.3 2.3	106	3.5 2.7	1	81	1.7 ** 2.3	230	1.0 3.5 1.6	2	106	1.2 1.7 1.3	
4					41	4.6 4.6	26	6.9 5.3	2	20	3.5 ** 4.6	57	2.0 6.9 3.3	3	47	1.7 3.5 2.7	
6					18	6.9 6.9	12	10.4 8.0	3	9	5.2 ** 6.9	26	3.0 10.4 4.9	4	26	2.3 5.2 4.0	
37W MR16 Halogen IR Lensed	NSP	10°	5000	12500													
					6	347	1.0 1.0	226	1.4 1.2	3	174	5.2 2.1 1.0	491	3.0 1.1 0.7	6	226	3.5 0.7 0.6
					8	195	1.4 1.4	127	1.9 1.6	4	98	6.9 2.9 1.4	276	4.0 1.4 1.0	7	166	4.0 0.9 0.8
					10	125	1.7 1.7	81	2.3 2.0	5	63	8.7 3.6 1.7	177	5.0 1.8 1.2	8	127	4.6 1.2 1.0
		NFL	25°	5000	4400												
	4					275	1.8 1.8	179	2.4 2.0	2	138	3.5 4.2 1.8	389	2.0 1.9 1.3	4	179	2.3 1.2 1.0
	6					122	2.7 2.7	79	3.6 3.1	3	61	5.2 6.2 2.7	173	3.0 2.8 1.9	5	114	2.9 1.8 1.5
	8					69	3.5 3.5	45	4.8 4.1	4	34	6.9 8.3 3.5	97	4.0 3.7 2.5	6	79	3.5 2.4 2.0
		FL	35°	5000	2200												
	3					244	1.9 1.9	159	2.6 2.2	2	69	3.5 7.2 2.5	194	2.0 2.8 1.8	3	159	1.7 1.7 1.5
	4					138	2.5 2.5	89	3.5 2.9	3	31	5.2 10.8 3.8	86	3.0 4.2 2.7	4	89	2.3 2.6 2.2
	6					61	3.8 3.8	40	5.2 4.4	4	17	6.9 14.4 5.0	49	4.0 5.6 3.6	5	57	2.9 3.5 2.9
	WFL	60°	5000	1100													
2					275	2.3 2.3	179	3.5 2.7	1	138	1.7 ** 2.3	389	1.0 3.5 1.6	2	179	1.2 1.7 1.3	
4					69	4.6 4.6	45	6.9 5.3	2	34	3.5 ** 4.6	97	2.0 6.9 3.3	3	79	1.7 3.5 2.7	
6					31	6.9 6.9	20	10.4 8.0	3	15	5.2 ** 6.9	43	3.0 10.4 4.9	4	45	2.3 5.2 4.0	
20W MR16 Halogen	VNSP	7°	3000	7400													
					6	206	0.7 0.7	134	1.0 0.8	3	103	5.2 1.5 0.7	291	3.0 0.7 0.5	6	134	3.5 1.0 0.8
					9	91	1.1 1.1	59	1.5 1.3	4	58	6.9 2.0 1.0	164	4.0 1.0 0.7	7	98	4.0 1.1 1.0
					12	51	1.5 1.5	33	2.0 1.7	5	37	8.7 2.5 1.2	105	5.0 1.2 0.9	8	75	4.6 1.3 1.1
		NSP	15°	5000	3750												
	4					234	1.1 1.1	152	1.4 1.2	2	117	3.5 2.2 1.1	331	2.0 1.1 0.7	4	152	2.3 1.4 1.2
	6					104	1.6 1.6	68	2.1 1.8	3	52	5.2 3.3 1.6	147	3.0 1.6 1.1	5	97	2.9 1.8 1.5
	8					59	2.1 2.1	38	2.8 2.4	4	29	6.9 4.4 2.1	83	4.0 2.1 1.5	6	68	3.5 2.1 1.8
	10					38	2.6 2.6	24	3.5 3.0	5	19	8.7 5.6 2.6	53	5.0 2.7 1.9	7	50	4.0 2.5 2.1
	12					26	3.2 3.2	17	4.2 3.6	6	13	10.4 6.7 3.2	37	6.0 3.2 2.2	8	38	4.6 2.8 2.4

The beam spread in degrees and the beam "L" and "W" in the tables are computed at 50% of centerbeam candlepower and represent areas of "effective illumination".
 ** Due to steep aiming angle, length of beam extends beyond 25'. Each angle listed is measured from 0° vertical.

Bare Lamp - Halogen, continued



Fixture	Beam Type	Beam Spread	Rated Life	CBCP	Horizontal Surface						Vertical Surface														
					0 degrees			30 degrees			30 degrees				45 degrees			60 degrees							
					MH	FC	L W	FC	L	W	D	FC	X	L	W	FC	X	L	W	D	FC	X	L	W	
42W MR16 Halogen	VNSP	9°	3500	12300																					
					8	192	1.3	1.3	125	1.7	1.5	4	96	6.9	2.6	1.3	272	4.0	1.3	0.9	7	163	4.0	1.5	1.3
					10	123	1.6	1.6	80	2.1	1.8	5	62	8.7	3.2	1.6	174	5.0	1.6	1.1	8	125	4.6	1.7	1.5
					12	85	1.9	1.9	55	2.5	2.2	6	43	10.4	3.8	1.9	121	6.0	1.9	1.3	9	99	5.2	1.9	1.6
					14	63	2.2	2.2	41	2.9	2.5	7	31	12.1	4.5	2.2	89	7.0	2.2	1.6	10	80	5.8	2.1	1.8
16	48	2.5	2.5	31	3.4	2.9	8	24	13.9	5.1	2.5	68	8.0	2.5	1.8	11	66	6.4	2.3	2.0					
50W MR16 Halogen	NSP	10°	6000	9100																					
					6	253	1.6	1.6	164	2.1	1.8	3	126	5.2	3.3	1.6	357	3.0	1.6	1.1	6	164	3.5	1.1	0.9
					8	142	2.1	2.1	92	2.8	2.4	4	71	6.9	4.4	2.1	201	4.0	2.1	1.5	7	121	4.0	1.4	1.2
					10	91	2.6	2.6	59	3.5	3.0	5	46	8.7	5.6	2.6	129	5.0	2.7	1.9	8	92	4.6	1.8	1.5
					12	63	3.2	3.2	41	4.2	3.6	6	32	10.4	6.7	3.2	89	6.0	3.2	2.2	9	73	5.2	2.1	1.8
14	46	3.7	3.7	30	4.9	4.3	7	23	12.1	7.8	3.7	66	7.0	3.8	2.6	10	59	5.8	2.5	2.1					
NFL	25°	6000	3200																						
				4	200	1.8	1.8	130	2.4	2.0	2	100	3.5	4.2	1.8	285	2.0	1.9	1.3	4	130	2.3	1.2	1.0	
				6	89	2.7	2.7	58	3.6	3.1	3	44	5.2	6.2	2.7	126	3.0	2.8	1.9	5	83	2.9	1.8	1.5	
				8	50	3.5	3.5	32	4.8	4.1	4	25	6.9	8.3	3.5	71	4.0	3.7	2.5	6	58	3.5	2.4	2.0	
				10	32	4.4	4.4	21	6.0	5.1	5	16	8.7	10.4	4.4	45	5.0	4.7	3.1	7	42	4.0	3.0	2.6	
12	22	5.3	5.3	14	7.2	6.1	6	11	10.4	12.5	5.3	31	6.0	5.6	3.8	8	32	4.6	3.6	3.1					
FL	40°	6000	1700																						
				3	189	2.2	2.2	123	3.0	2.5	2	53	3.5	9.7	2.9	150	2.0	3.4	2.1	3	123	1.7	2.0	1.7	
				4	106	2.9	2.9	69	4.1	3.4	3	24	5.2	14.5	4.4	67	3.0	5.0	3.1	4	69	2.3	3.0	2.5	
				6	47	4.4	4.4	31	6.1	5.0	4	13	6.9	19.3	5.8	38	4.0	6.7	4.1	5	44	2.9	4.1	3.4	
				8	27	5.8	5.8	17	8.1	6.7	5	9	8.7	24.2	7.3	24	5.0	8.4	5.1	6	31	3.5	5.1	4.2	
10	17	7.3	7.3	11	10.2	8.4	6	6	10.4	**	8.7	17	6.0	10.1	6.2	7	23	4.0	6.1	5.0					
WFL	55°	6000	900																						
				2	225	2.1	2.1	146	3.1	2.4	1	113	1.7	22.3	2.1	318	1.0	2.9	1.5	2	146	1.2	1.5	1.2	
				3	100	3.1	3.1	65	4.6	3.6	2	28	3.5	**	4.2	80	2.0	5.7	2.9	3	65	1.7	3.1	2.4	
				4	56	4.2	4.2	37	6.1	4.8	3	13	5.2	**	6.2	35	3.0	8.6	4.4	4	37	2.3	4.6	3.6	
				6	25	6.2	6.2	16	9.2	7.2	4	7	6.9	**	8.3	20	4.0	11.4	5.9	5	23	2.9	6.1	4.8	
8	14	8.3	8.3	9	12.2	9.6	5	5	8.7	**	10.4	13	5.0	14.3	7.4	6	16	3.5	7.6	6.0					
50W MR16 Halogen IR Lensed	SP	10°	5000	15000																					
					6	417	1.0	1.0	271	1.4	1.2	3	208	5.2	2.1	1.0	589	3.0	1.1	0.7	6	271	3.5	0.7	0.6
					8	234	1.4	1.4	152	1.9	1.6	4	117	6.9	2.9	1.4	331	4.0	1.4	1.0	7	199	4.0	0.9	0.8
					10	150	1.7	1.7	97	2.3	2.0	5	75	8.7	3.6	1.7	212	5.0	1.8	1.2	8	152	4.6	1.2	1.0
					12	104	2.1	2.1	68	2.8	2.4	6	52	10.4	4.3	2.1	147	6.0	2.1	1.5	9	120	5.2	1.4	1.2
14	77	2.4	2.4	50	3.3	2.8	7	38	12.1	5.0	2.4	108	7.0	2.5	1.7	10	97	5.8	1.6	1.4					
NFL	25°	5000	5700																						
				4	356	1.8	1.8	231	2.4	2.0	2	178	3.5	4.2	1.8	504	2.0	1.9	1.3	4	231	2.3	1.2	1.0	
				6	158	2.7	2.7	103	3.6	3.1	3	79	5.2	6.2	2.7	224	3.0	2.8	1.9	5	148	2.9	1.8	1.5	
				8	89	3.5	3.5	58	4.8	4.1	4	45	6.9	8.3	3.5	126	4.0	3.7	2.5	6	103	3.5	2.4	2.0	
				10	57	4.4	4.4	37	6.0	5.1	5	29	8.7	10.4	4.4	81	5.0	4.7	3.1	7	76	4.0	3.0	2.6	
12	40	5.3	5.3	26	7.2	6.1	6	20	10.4	12.5	5.3	56	6.0	5.6	3.8	8	58	4.6	3.6	3.1					
FL	35°	5000	2850																						
				3	317	1.9	1.9	206	2.6	2.2	2	89	3.5	7.2	2.5	252	2.0	2.8	1.8	3	206	1.7	1.7	1.5	
				4	178	2.5	2.5	116	3.5	2.9	3	40	5.2	10.8	3.8	112	3.0	4.2	2.7	4	116	2.3	2.6	2.2	
				6	79	3.8	3.8	51	5.2	4.4	4	22	6.9	14.4	5.0	63	4.0	5.6	3.6	5	74	2.9	3.5	2.9	
				8	45	5.0	5.0	29	7.0	5.8	5	14	8.7	18.0	6.3	40	5.0	7.0	4.5	6	51	3.5	4.3	3.6	
10	29	6.3	6.3	19	8.7	7.3	6	10	10.4	21.6	7.6	28	6.0	8.4	5.4	7	38	4.0	5.2	4.4					
WFL	60°	5000	1430																						
				2	358	2.3	2.3	232	3.5	2.7	1	179	1.7	**	2.3	506	1.0	3.5	1.6	2	232	1.2	1.7	1.3	
				3	159	3.5	3.5	103	5.2	4.0	2	45	3.5	**	4.6	126	2.0	6.9	3.3	3	103	1.7	3.5	2.7	
				4	89	4.6	4.6	58	6.9	5.3	3	20	5.2	**	6.9	56	3.0	10.4	4.9	4	58	2.3	5.2	4.0	
				6	40	6.9	6.9	26	10.4	8.0	4	11	6.9	**	9.2	32	4.0	13.9	6.5	5	37	2.9	6.9	5.3	
8	22	9.2	9.2	15	13.9	10.7	5	7	8.7	**	11.5	20	5.0	17.3	8.2	6	26	3.5	8.7	6.7					

The beam spread in degrees and the beam "L" and "W" in the tables are computed at 50% of centerbeam candlepower and represent areas of "effective illumination".
 ** Due to steep aiming angle, length of beam extends beyond 25'. Each angle listed is measured from 0° vertical.

		Horizontal Surface					Vertical Surface																																																																																																																				
				0 degrees			30 degrees			30 degrees				45 degrees				60 degrees																																																																																																									
Fixture	Beam Type	Beam Spread	Rated Life	CBCP	MH	FC	L	W	FC	L	W	D	FC	X	L	W	FC	X	L	W	D	FC	X	L	W																																																																																																		
71W MR16 Halogen	SP	15°	4000	11500	6	319	1.6	1.6	207	2.1	1.8	3	160	5.2	3.3	1.6	452	3.0	1.6	1.1	6	207	3.5	1.1	0.9	8	180	2.1	2.1	117	2.8	2.4	4	90	6.9	4.4	2.1	254	4.0	2.1	1.5	7	152	4.0	1.4	1.2	10	115	2.6	2.6	75	3.5	3.0	5	58	8.7	5.6	2.6	163	5.0	2.7	1.9	8	117	4.6	1.8	1.5	12	80	3.2	3.2	52	4.2	3.6	6	40	10.4	6.7	3.2	113	6.0	3.2	2.2	9	92	5.2	2.1	1.8	14	59	3.7	3.7	38	4.9	4.3	7	29	12.1	7.8	3.7	83	7.0	3.8	2.6	10	75	5.8	2.5	2.1														
					NFL	25°	4000	5500	4	344	1.8	1.8	223	2.4	2.0	2	172	3.5	4.2	1.8	486	2.0	1.9	1.3	4	223	2.3	1.2	1.0	6	153	2.7	2.7	99	3.6	3.1	3	76	5.2	6.2	2.7	216	3.0	2.8	1.9	5	143	2.9	1.8	1.5	8	86	3.5	3.5	56	4.8	4.1	4	43	6.9	8.3	3.5	122	4.0	3.7	2.5	6	99	3.5	2.4	2.0	10	55	4.4	4.4	36	6.0	5.1	5	28	8.7	10.4	4.4	78	5.0	4.7	3.1	7	73	4.0	3.0	2.6	12	38	5.3	5.3	25	7.2	6.1	6	19	10.4	12.5	5.3	54	6.0	5.6	3.8	8	56	4.6	3.6	3.1										
									FL	40°	4000	2200	3	244	2.2	2.2	159	3.0	2.5	2	69	3.5	9.7	2.9	194	2.0	3.4	2.1	3	159	1.7	2.0	1.7	4	138	2.9	2.9	89	4.1	3.4	3	31	5.2	14.5	4.4	86	3.0	5.0	3.1	4	89	2.3	3.0	2.5	6	61	4.4	4.4	40	6.1	5.0	4	17	6.9	19.3	5.8	49	4.0	6.7	4.1	5	57	2.9	4.1	3.4	8	34	5.8	5.8	22	8.1	6.7	5	11	8.7	24.2	7.3	31	5.0	8.4	5.1	6	40	3.5	5.1	4.2	10	22	7.3	7.3	14	10.2	8.4	6	8	10.4	**	8.7	22	6.0	10.1	6.2	7	29	4.0	6.1	5.0						
													35W PAR36 Halogen	VNSP	5°	4000	25000	8	391	0.7	0.7	254	0.9	0.8	4	195	6.9	1.4	0.7	552	4.0	0.7	0.5	6	451	3.5	0.5	0.4	10	250	0.9	0.9	162	1.2	1.0	5	125	8.7	1.8	0.9	354	5.0	0.9	0.6	8	254	4.6	0.6	0.5	12	174	1.0	1.0	113	1.4	1.2	6	87	10.4	2.1	1.0	246	6.0	1.0	0.7	10	162	5.8	0.7	0.6	14	128	1.2	1.2	83	1.6	1.4	7	64	12.1	2.5	1.2	180	7.0	1.2	0.9	12	113	6.9	0.8	0.7	16	98	1.4	1.4	63	1.9	1.6	8	49	13.9	2.8	1.4	138	8.0	1.4	1.0	14	83	1.1	0.9	0.8	
																		NSP	8°	4000	8000	6	222	0.8	0.8	144	1.1	1.0	2	250	3.5	1.1	0.6	707	2.0	0.6	0.4	4	325	2.3	0.4	0.3	8	125	1.1	1.1	81	1.5	1.3	3	111	5.2	1.7	0.8	314	3.0	0.8	0.6	5	208	2.9	0.6	0.5	10	80	1.4	1.4	52	1.9	1.6	4	63	6.9	2.3	1.1	177	4.0	1.1	0.8	6	144	3.5	0.7	0.6	12	56	1.7	1.7	36	2.2	1.9	5	40	8.7	2.8	1.4	113	5.0	1.4	1.0	7	106	4.0	0.9	0.8	14	41	2.0	2.0	27	2.6	2.3	6	28	10.4	3.4	1.7	79	6.0	1.7	1.2	8	81
	FL	30°	4000	900																		4	56	2.1	2.1	37	2.9	2.5	1	113	1.7	2.7	1.1	318	1.0	1.2	0.8	2	146	1.2	0.7	0.6	6	25	3.2	3.2	16	4.4	3.7	2	28	3.5	5.5	2.1	80	2.0	2.3	1.5	3	65	1.7	1.5	1.2	8	14	4.3	4.3	9	5.9	5.0	3	13	5.2	8.2	3.2	35	3.0	3.5	2.3	4	37	2.3	2.2	1.9	10	9	5.4	5.4	6	7.3	6.2	4	7	6.9	10.9	4.3	20	4.0	4.6	3.0	5	23	2.9	2.9	2.5	12	6	6.4	6.4	4	8.8	7.4	5	5	8.7	13.7	5.4	13	5.0	5.8	3.8	6	16
					50W PAR36 Halogen	VNSP	5°	4000														39000	8	609	0.7	0.7	396	0.9	0.8	4	305	6.9	1.4	0.7	862	4.0	0.7	0.5	6	704	3.5	0.5	0.4	10	390	0.9	0.9	253	1.2	1.0	5	195	8.7	1.8	0.9	552	5.0	0.9	0.6	8	396	4.6	0.6	0.5	12	271	1.0	1.0	176	1.4	1.2	6	135	10.4	2.1	1.0	383	6.0	1.0	0.7	10	253	5.8	0.7	0.6	14	199	1.2	1.2	129	1.6	1.4	7	99	12.1	2.5	1.2	281	7.0	1.2	0.9	12	176	6.9	0.8	0.7	16	152	1.4	1.4	99	1.9	1.6	8	76	13.9	2.8	1.4	215	8.0	1.4	1.0	14
									NSP	8°	4000	10000											6	278	0.8	0.8	180	1.1	1.0	2	313	3.5	1.1	0.6	884	2.0	0.6	0.4	4	406	2.3	0.4	0.3	8	156	1.1	1.1	101	1.5	1.3	3	139	5.2	1.7	0.8	393	3.0	0.8	0.6	5	260	2.9	0.6	0.5	10	100	1.4	1.4	65	1.9	1.6	4	78	6.9	2.3	1.1	221	4.0	1.1	0.8	6	180	3.5	0.7	0.6	12	69	1.7	1.7	45	2.2	1.9	5	50	8.7	2.8	1.4	141	5.0	1.4	1.0	7	133	4.0	0.9	0.8	14	51	2.0	2.0	33	2.6	2.3	6	35	10.4	3.4	1.7	98	6.0	1.7	1.2	8
														FL	30°	4000	1300						4	81	2.1	2.1	53	2.9	2.5	1	163	1.7	2.7	1.1	460	1.0	1.2	0.8	2	211	1.2	0.7	0.6	6	36	3.2	3.2	23	4.4	3.7	2	41	3.5	5.5	2.1	115	2.0	2.3	1.5	3	94	1.7	1.5	1.2	8	20	4.3	4.3	13	5.9	5.0	3	18	5.2	8.2	3.2	51	3.0	3.5	2.3	4	53	2.3	2.2	1.9	10	13	5.4	5.4	8	7.3	6.2	4	10	6.9	10.9	4.3	29	4.0	4.6	3.0	5	34	2.9	2.9	2.5	12	9	6.4	6.4	6	8.8	7.4	5	7	8.7	13.7	5.4	18	5.0	5.8	3.8	6

The beam spread in degrees and the beam "L" and "W" in the tables are computed at 50% of centerbeam candlepower and represent areas of "effective illumination".
 ** Due to steep aiming angle, length of beam extends beyond 25'. Each angle listed is measured from 0° vertical.

4" 600 Lumen WarmDim® LED Downlights Juno®

White Baffle – IC1LWDG3-3K and IC1RLWDG3-3K with 14W-WH

Photometric Report

Test Report #: LTL27634

Catalog No: IC1LWDG3-3K-1
with 14W-WH Trim

Luminaire Spacing Criterion: 0.85

Luminaire LPW: 43.1

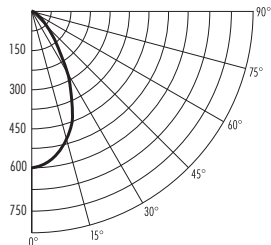

Candlepower Distribution

(Candelas)

Degrees Vertical	0°
0	601
5	589
15	500
25	355
35	204
45	82
55	32
65	13
75	8
85	2
90	0

Average Initial Footcandles

Multiple Units (Square Array, 60' x 60' room)

Ceiling 80% Wall 50% Floor 20%

Spacing	RCR1	RCR3	RCR5
4.0'	41	35	30
5.0'	26	22	19
6.0'	18	15	13
7.0'	15	12	11
8.0'	12	10	8
9.0'	9	8	6
10.0'	7	6	5

Zonal Lumen Summary

Zone	Lumens	%Lamp	%Fixture
0 - 30°	357	N/A	59.2
0 - 40°	483	N/A	80.2
0 - 60°	578	N/A	95.9
0 - 90°	602	N/A	100.0

Initial Footcandles

(One Unit, 14.0W, 57.1° Beam)

Distance to Illuminated Plane (Ft.)	Footcandles Beam Center	Beam Diameter
4	37.6	4.4'
6	16.7	6.5'
8	9.4	8.7'
10	6.0	10.9'

Luminance (Average cd/m²)

Degrees	Average Luminance
45	18730
55	8874
65	5032
75	4932
85	4487

Haze Cone – IC1LWDG3-3K and IC1RLWDG3-3K with 17HZ-WH

Photometric Report

Test Report #: PT02120103R

Catalog No: IC1LWDG3-3K
with 17HZ-WH Trim

Luminaire Spacing Criterion: 0.82

Luminaire LPW: 43

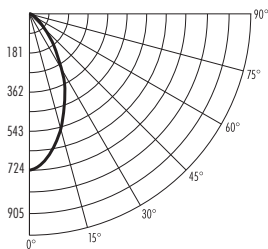

Candlepower Distribution

(Candelas)

Degrees Vertical	0°
0	724
5	701
15	579
25	395
35	187
45	61
55	19
65	3
75	0
85	0
90	0

Average Initial Footcandles

Multiple Units (Square Array, 60' x 60' room)

Ceiling 80% Wall 50% Floor 20%

Spacing	RCR1	RCR3	RCR5
4.0'	41	38	34
5.0'	26	24	22
6.0'	18	17	15
7.0'	15	14	12
8.0'	12	11	10
9.0'	9	8	7
10.0'	7	6	5

Zonal Lumen Summary

Zone	Lumens	%Lamp	%Fixture
0 - 30°	406	N/A	67.9
0 - 40°	525	N/A	87.9
0 - 60°	594	N/A	99.4
0 - 90°	598	N/A	100.0

Initial Footcandles

(One Unit, 14.0W, 53.2° Beam)

Distance to Illuminated Plane (Ft.)	Footcandles Beam Center	Beam Diameter
4	45.3	4.0'
6	20.1	6.0'
8	11.3	8.0'
10	7.2	10.0'

Luminance (Average cd/m²)

Degrees	Average Luminance
45	13873
55	5286
65	1266
75	0
85	0

Fixtures tested to IES recommended standard for solid state lighting per LM-79-08. Photometric performance on a single unit represents a baseline of performance for the fixture. Results may vary in the field.

White Baffle – IC20LWDG3-3K and IC20RLWDG3-3K with 205W-WH

Photometric Report

Test Report #: LTL27633
 Catalog No: IC20LWDG3-3K-1
 with 205W-WH Trim and
 standard wide flood optic
 Luminaire Spacing Criterion: 1.10
 Luminaire LPW: 43.3

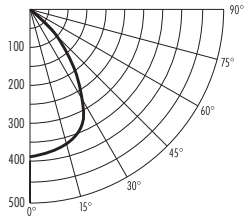

Candlepower Distribution

(Candelas)

Degrees Vertical	0°
0	389
5	388
15	373
25	323
35	218
45	104
55	55
65	31
75	19
85	5
90	0

Average Initial Footcandles

Multiple Units (Square Array, 60' x 60' room)
 Ceiling 80% Wall 50% Floor 20%

Spacing	RCR1	RCR3	RCR5
4.0'	41	34	28
5.0'	26	22	18
6.0'	18	15	12
7.0'	15	12	10
8.0'	12	10	8
9.0'	9	7	6
10.0'	7	5	4

Initial Footcandles

(One Unit, 14.1W , 73.5° Beam)

Distance to Illuminated Plane (Ft.)	Footcandles Beam Center	Beam Diameter
4	24.3	6.0'
6	10.8	9.0'
8	6.1	11.9'
10	3.9	14.9'

Luminance (Average cd/m²)

Degrees	Average Luminance
45	14360
55	9327
65	7155
75	7058
85	5073

Zonal Lumen Summary

Zone	Lumens	%Lamp	%Fixture
0 - 30°	289	N/A	47.3
0 - 40°	424	N/A	69.3
0 - 60°	556	N/A	90.9
0 - 90°	612	N/A	100.0

Haze Cone – IC20LWDG3-3K and IC20RLWDG3-3K with 204HZ-WH

Photometric Report

Test Report #: PT01121704R
 Catalog No: IC20LWDG3-3K
 with 204HZ-WH Trim and
 standard wide flood optic
 Luminaire Spacing Criterion: 1.14
 Luminaire LPW: 47

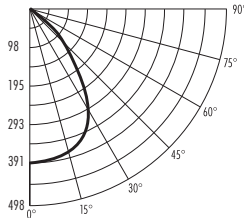

Candlepower Distribution

(Candelas)

Degrees Vertical	0°
0	391
5	391
15	380
25	334
35	233
45	122
55	68
65	37
75	15
85	0
90	0

Average Initial Footcandles

Multiple Units (Square Array, 60' x 60' room)
 Ceiling 80% Wall 50% Floor 20%

Spacing	RCR1	RCR3	RCR5
4.0'	45	39	34
5.0'	29	25	22
6.0'	20	17	15
7.0'	16	14	12
8.0'	13	11	10
9.0'	10	9	7
10.0'	7	6	6

Initial Footcandles

(One Unit, 14.0W , 76.2° Beam)

Distance to Illuminated Plane (Ft.)	Footcandles Beam Center	Beam Diameter
4	24.4	6.3'
6	10.9	9.4'
8	6.1	12.5'
10	3.9	15.7'

Luminance (Average cd/m²)

Degrees	Average Luminance
45	13637
55	9286
65	6954
75	4613
85	0

Zonal Lumen Summary

Zone	Lumens	%Lamp	%Fixture
0 - 30°	296	N/A	45.2
0 - 40°	441	N/A	67.3
0 - 60°	600	N/A	91.6
0 - 90°	655	N/A	100.0

Fixtures tested to IES recommended standard for solid state lighting per LM-79-08. Photometric performance on a single unit represents a baseline of performance for the fixture. Results may vary in the field.

6" 600 Lumen WarmDim® LED Downlights **Juno**

White Baffle – IC22LWDG3-3K and IC22RLWDG3-3K with 24W-WH

Photometric Report

Test Report #: LTL28095

Catalog No: IC22LWDG3-3K-1

with 24W-WH Trim and standard wide flood optic

Luminaire Spacing Criterion: 1.16

Luminaire LPW: 47

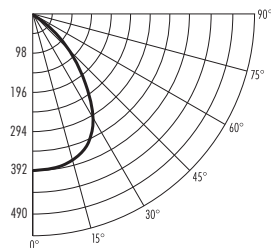

Candlepower Distribution

Degrees Vertical		0°
0	392	
5	390	
15	371	
25	335	
35	258	
45	127	
55	56	
65	27	
75	16	
85	4	
90	0	

Average Initial Footcandles

Multiple Units (Square Array, 60' x 60' room)
Ceiling 80% Wall 50% Floor 20%

Spacing	RCR1	RCR3	RCR5
4.0'	44	36	30
5.0'	28	23	19
6.0'	20	16	13
7.0'	16	13	11
8.0'	13	10	8
9.0'	10	8	6
10.0'	7	6	5

Zonal Lumen Summary

Zone	Lumens	%Lamp	%Fixture
0 - 30°	295	N/A	45.1
0 - 40°	453	N/A	69.3
0 - 60°	604	N/A	92.4
0 - 90°	653	N/A	100.0

Initial Footcandles

(One Unit, 14.0W, 79.5° Beam)

Distance to Illuminated Plane (Ft.)	Footcandles Beam Center	Beam Diameter
4	24.5	6.7'
6	10.9	10.0'
8	6.1	13.3'
10	3.9	16.6'

Luminance (Average cd/m²)

Degrees	Average Luminance
45	10693
55	5779
65	3858
75	3744
85	2924

Haze Cone – IC22LWDG3-3K and IC22RLWDG3-3K with 27HZ-WH

Photometric Report

Test Report #: PT01121404R

Catalog No: IC22LWDG3-3K

with 27HZ-WH Trim and standard wide flood optic

Luminaire Spacing Criterion: 0.98

Luminaire LPW: 48

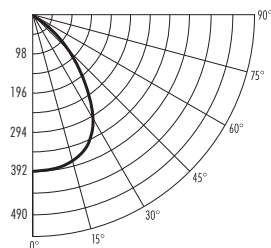

Candlepower Distribution

Degrees Vertical		0°
0	554	
5	536	
15	465	
25	390	
35	279	
45	125	
55	38	
65	7	
75	0	
85	0	
90	0	

Average Initial Footcandles

Multiple Units (Square Array, 60' x 60' room)
Ceiling 80% Wall 50% Floor 20%

Spacing	RCR1	RCR3	RCR5
4.0'	46	42	37
5.0'	30	27	24
6.0'	21	19	17
7.0'	17	15	13
8.0'	13	12	11
9.0'	10	9	8
10.0'	7	7	6

Zonal Lumen Summary

Zone	Lumens	%Lamp	%Fixture
0 - 30°	360	N/A	53.2
0 - 40°	531	N/A	78.6
0 - 60°	668	N/A	98.8
0 - 90°	676	N/A	100.0

Initial Footcandles

(One Unit, 14.0W, 69.8° Beam)

Distance to Illuminated Plane (Ft.)	Footcandles Beam Center	Beam Diameter
4	34.6	5.6'
6	15.4	8.4'
8	8.7	11.2'
10	5.5	14.0'

Luminance (Average cd/m²)

Degrees	Average Luminance
45	9666
55	3675
65	907
75	0
85	0

Fixtures tested to IES recommended standard for solid state lighting per LM-79-08. Photometric performance on a single unit represents a baseline of performance for the fixture. Results may vary in the field.

White Baffle - IC1LEDG3-35K and IC1RLEDG3-35K with 14W-WH

Photometric Report

Test Report #: LTL26325R

Catalog No: IC1LEDG3-35K-1
with 14W-WH Trim

Luminaire Spacing Criterion: 0.70

Luminaire LPW: 66

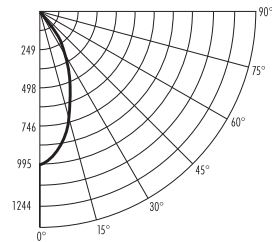

Candlepower Distribution

Candelas	
Degrees Vertical	0°
0	995
5	960
15	713
25	410
35	189
45	63
55	26
65	12
75	7
85	0
90	0

Multiplier: 27K - 0.90
3K - 0.97
41K - 1.04

Average Initial Footcandles

Multiple Units (Square Array, 60' x 60' room)
Ceiling 80% Wall 50% Floor 20%

Spacing	RCR1	RCR3	RCR5
4.0'	47	40	34
5.0'	30	25	22
6.0'	21	18	15
7.0'	17	14	12
8.0'	13	11	10
9.0'	10	9	7
10.0'	8	6	5

Zonal Lumen Summary

Zone	Lumens	%Lamp	%Fixture
0 - 30°	473	N/A	68.8
0 - 40°	592	N/A	86.0
0 - 60°	667	N/A	96.9
0 - 90°	689	N/A	100.0

Initial Footcandles

(One Unit, 10.4W, 43.8° Beam)

Distance to Illuminated Plane (Ft.)	Footcandles Beam Center	Beam Diameter
4	62.2	3.2'
6	27.6	4.8'
8	15.5	6.4'
10	10.0	8.0'

Luminance (Average cd/m²)

Degrees	Average Luminance
45	14372
55	7246
65	4416
75	4605
85	0

Haze Cone - IC1LEDG3-35K and IC1RLEDG3-35K with 17HZ-WH

Photometric Report

Test Report #: LTL26326R

Catalog No: IC1LEDG3-35K-1
with 17HZ-WH Trim

Luminaire Spacing Criterion: 0.70

Luminaire LPW: 67

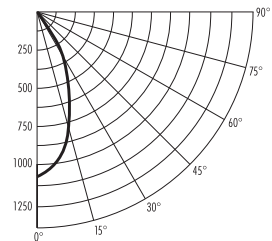

Candlepower Distribution

Candelas	
Degrees Vertical	0°
0	1055
5	1016
15	750
25	436
35	182
45	61
55	21
65	5
75	1
85	0
90	0

Multiplier: 27K - 0.90
3K - 0.97
41K - 1.04

Average Initial Footcandles

Multiple Units (Square Array, 60' x 60' room)
Ceiling 80% Wall 50% Floor 20%

Spacing	RCR1	RCR3	RCR5
4.0'	47	40	34
5.0'	30	25	22
6.0'	21	18	15
7.0'	17	14	12
8.0'	13	11	10
9.0'	10	9	7
10.0'	8	6	5

Zonal Lumen Summary

Zone	Lumens	%Lamp	%Fixture
0 - 30°	500	N/A	72.4
0 - 40°	616	N/A	89.3
0 - 60°	685	N/A	99.2
0 - 90°	690	N/A	100.0

Initial Footcandles

(One Unit, 10.4W, 43.8° Beam)

Distance to Illuminated Plane (Ft.)	Footcandles Beam Center	Beam Diameter
4	65.9	3.2'
6	29.3	4.8'
8	16.5	6.4'
10	10.6	8.1'

Luminance (Average cd/m²)

Degrees	Average Luminance
45	13773
55	5906
65	1744
75	364
85	0

Fixtures tested to IES recommended standard for solid state lighting per LM-79-08. Photometric performance on a single unit represents a baseline of performance for the fixture. Results may vary in the field.

5" 600 Lumen LED Downlights



White Baffle - IC20LEDG3-35K and IC20RLEDG3-35K with 205W-WH

Photometric Report

Test Report #: LTL25982

Catalog No: IC20LEDG3-35K
with 205W-WH Trim and
standard wide flood optic

Luminaire Spacing Criterion: 1.10

Luminaire LPW: 60.3

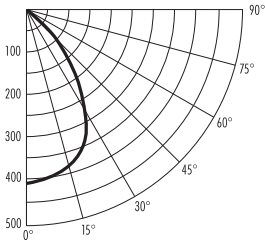

Candlepower Distribution

(Candelas)	
Degrees Vertical	0°
0	408
5	406
15	389
25	337
35	228
45	108
55	58
65	32
75	19
85	5
90	0

Multiplier: 27K - 0.90
3K - 0.97
41K - 1.04

Average Initial Footcandles

Multiple Units (Square Array, 60' x 60' room)

Ceiling 80% Wall 50% Floor 20%				
Spacing	RCR1	RCR3	RCR5	
4.0'	44	37	31	
5.0'	28	23	20	
6.0'	19	16	14	
7.0'	16	13	11	
8.0'	12	10	9	
9.0'	10	8	7	
10.0'	7	6	5	

Zonal Lumen Summary

Zone	Lumens	%Lamp	%Fixture
0 - 30°	302	N/A	47.3
0 - 40°	442	N/A	69.5
0 - 60°	580	N/A	91.1
0 - 90°	637	N/A	100.0

Initial Footcandles

(One Unit, 10.6W, 73.4° Beam)

Distance to Illuminated Plane (Ft.)	Footcandles Beam Center	Beam Diameter
4	25.5	6.0'
6	11.3	8.9'
8	6.4	11.9'
10	4.1	14.9'

Luminance (Average cd/m²)

Degrees	Average Luminance
45	15700
55	10350
65	7793
75	7525
85	5385

Haze Cone - IC20LEDG3-35K and IC20RLEDG3-35K with 204HZ-WH

Photometric Report

Test Report #: LTL25980R

Catalog No: IC20LEDG3-35K
with 204HZ-WH Trim and
standard wide flood optic

Luminaire Spacing Criterion: 1.18

Luminaire LPW: 64

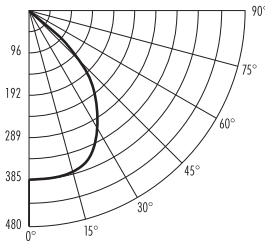

Candlepower Distribution

(Candelas)	
Degrees Vertical	0°
0	385
5	385
15	378
25	343
35	251
45	132
55	74
65	38
75	14
85	0
90	0

Multiplier: 27K - 0.90
3K - 0.97
41K - 1.04

Average Initial Footcandles

Multiple Units (Square Array, 60' x 60' room)

Ceiling 80% Wall 50% Floor 20%				
Spacing	RCR1	RCR3	RCR5	
4.0'	47	39	34	
5.0'	30	25	21	
6.0'	21	17	15	
7.0'	17	14	12	
8.0'	13	11	10	
9.0'	10	9	7	
10.0'	7	6	5	

Zonal Lumen Summary

Zone	Lumens	%Lamp	%Fixture
0 - 30°	300	N/A	44.2
0 - 40°	455	N/A	67.0
0 - 60°	625	N/A	92.0
0 - 90°	679	N/A	100.0

Initial Footcandles

(One Unit, 10.6W, 78.2° Beam)

Distance to Illuminated Plane (Ft.)	Footcandles Beam Center	Beam Diameter
4	24.1	6.5'
6	10.7	9.8'
8	6.0	13.0'
10	3.9	16.3'

Luminance (Average cd/m²)

Degrees	Average Luminance
45	18178
55	12510
65	8828
75	5137
85	0

Fixtures tested to IES recommended standard for solid state lighting per LM-79-08. Photometric performance on a single unit represents a baseline of performance for the fixture. Results may vary in the field.

White Baffle - IC22LEDG3-35K and IC22RLEDG3-35K with 24W-WH

Photometric Report

Test Report #: LTL25974R

Catalog No: IC22LEDG3-35K with 24W-WH Trim and standard wide flood optic

Luminaire Spacing Criterion: 1.16

Luminaire LPW: 64

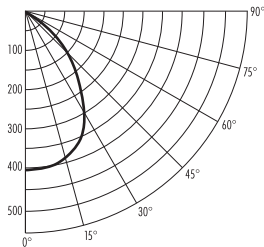

Candlepower Distribution

(Candelas)

Degrees Vertical	0°
0	404
5	401
15	379
25	337
35	261
45	139
55	61
65	28
75	16
85	4
90	0

Multiplier: 27K - 0.90
3K - 0.97
41K - 1.04

Average Initial Footcandles

Multiple Units (Square Array, 60' x 60' room)

Ceiling 80% Wall 50% Floor 20%

Spacing	RCR1	RCR3	RCR5
4.0'	46	39	33
5.0'	30	25	21
6.0'	21	17	15
7.0'	17	14	12
8.0'	13	11	9
9.0'	10	8	7
10.0'	7	6	5

Zonal Lumen Summary

Zone	Lumens	%Lamp	%Fixture
0 - 30°	300	N/A	44.4
0 - 40°	461	N/A	68.2
0 - 60°	625	N/A	92.5
0 - 90°	675	N/A	100.0

Initial Footcandles

(One Unit, 10.6W , 79.8° Beam)

Distance to Illuminated Plane (Ft.)	Footcandles Center	Beam Diameter
4	25.3	6.7'
6	11.2	10.0'
8	6.3	13.4'
10	4.0	16.7'

Luminance (Average cd/m²)

Degrees	Average Luminance
45	11731
55	6304
65	4019
75	3756
85	2961

Haze Cone - IC22LEDG3-35K and IC22RLEDG3-35K with 27HZ-WH

Photometric Report

Test Report #: LTL25976R

Catalog No: IC22LEDG3-35K with 27HZ-WH Trim and standard wide flood optic

Luminaire Spacing Criterion: 1.02

Luminaire LPW: 66

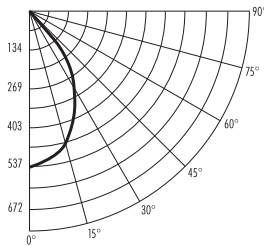

Candlepower Distribution

(Candelas)

Degrees Vertical	0°
0	537
5	525
15	462
25	389
35	288
45	144
55	47
65	10
75	0
85	0
90	0

Multiplier: 27K - 0.90
3K - 0.97
41K - 1.04

Average Initial Footcandles

Multiple Units (Square Array, 60' x 60' room)

Ceiling 80% Wall 50% Floor 20%

Spacing	RCR1	RCR3	RCR5
4.0'	48	40	35
5.0'	31	26	22
6.0'	21	18	15
7.0'	17	15	12
8.0'	14	11	10
9.0'	10	9	8
10.0'	8	6	6

Zonal Lumen Summary

Zone	Lumens	%Lamp	%Fixture
0 - 30°	357	N/A	51.0
0 - 40°	535	N/A	76.3
0 - 60°	691	N/A	98.5
0 - 90°	701	N/A	100.0

Initial Footcandles

(One Unit, 10.6W , 72.9° Beam)

Distance to Illuminated Plane (Ft.)	Footcandles Center	Beam Diameter
4	33.6	5.9'
6	14.9	8.9'
8	8.4	11.8'
10	5.4	14.8'

Luminance (Average cd/m²)

Degrees	Average Luminance
45	12141
55	4897
65	1366
75	0
85	0

Fixtures tested to IES recommended standard for solid state lighting per LM-79-08. Photometric performance on a single unit represents a baseline of performance for the fixture. Results may vary in the field.

5" 900 Lumen LED Downlights



White Baffle - IC920LEDG3-35K and IC920RLEDG3-35K with 205W-WH

Photometric Report

Test Report #: LTL25985R

Catalog No: IC920LEDG3-35K with 205W-WH Trim and standard wide flood optic

Luminaire Spacing Criterion: 1.10

Luminaire LPW: 56

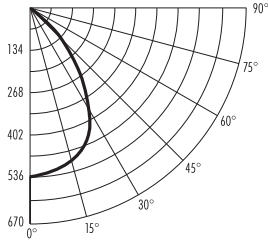

Candlepower Distribution

(Candelas)

Degrees Vertical	0°
0	536
5	534
15	511
25	441
35	299
45	142
55	76
65	42
75	25
85	6
90	0

Multiplier: 27K - 0.90
3K - 0.97
41K - 1.04

Average Initial Footcandles

Multiple Units (Square Array, 60' x 60' room)

Ceiling 80% Wall 50% Floor 20%

Spacing	RCR1	RCR3	RCR5
4.0'	57	48	41
5.0'	37	31	26
6.0'	26	21	18
7.0'	21	17	15
8.0'	16	14	12
9.0'	13	10	9
10.0'	9	8	7

Zonal Lumen Summary

Zone	Lumens	%Lamp	%Fixture
0 - 30°	396	N/A	47.3
0 - 40°	580	N/A	69.4
0 - 60°	761	N/A	91.1
0 - 90°	835	N/A	100.0

Initial Footcandles

(One Unit, 14.9W, 73.3° Beam)

Distance to Illuminated Plane (Ft.)	Footcandles Center	Beam Diameter
4	33.5	6.0'
6	14.9	8.9'
8	8.4	11.9'
10	5.4	14.9'

Luminance (Average cd/m²)

Degrees	Average Luminance
45	20608
55	13605
65	10197
75	9807
85	6956

Haze Cone - IC920LEDG3-35K and IC920RLEDG3-35K with 204HZ-WH

Photometric Report

Test Report #: LTL25983R

Catalog No: IC920LEDG3-35K with 204HZ-WH Trim and standard wide flood optic

Luminaire Spacing Criterion: 1.18

Luminaire LPW: 58

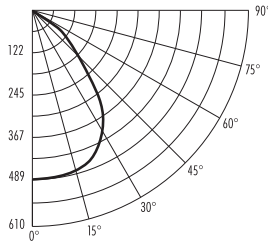

Candlepower Distribution

(Candelas)

Degrees Vertical	0°
0	488
5	489
15	480
25	434
35	317
45	167
55	93
65	49
75	17
85	0
90	0

Multiplier: 27K - 0.90
3K - 0.97
41K - 1.04

Average Initial Footcandles

Multiple Units (Square Array, 60' x 60' room)

Ceiling 80% Wall 50% Floor 20%

Spacing	RCR1	RCR3	RCR5
4.0'	59	49	42
5.0'	38	32	27
6.0'	26	22	19
7.0'	21	18	15
8.0'	17	14	12
9.0'	13	11	9
10.0'	9	8	7

Zonal Lumen Summary

Zone	Lumens	%Lamp	%Fixture
0 - 30°	380	N/A	44.2
0 - 40°	576	N/A	67.0
0 - 60°	791	N/A	92.0
0 - 90°	860	N/A	100.0

Initial Footcandles

(One Unit, 14.9W, 78.1° Beam)

Distance to Illuminated Plane (Ft.)	Footcandles Center	Beam Diameter
4	30.5	6.5'
6	13.6	9.7'
8	7.6	13.0'
10	4.9	16.2'

Luminance (Average cd/m²)

Degrees	Average Luminance
45	23005
55	15831
65	11180
75	6480
85	0

Fixtures tested to IES recommended standard for solid state lighting per LM-79-08. Photometric performance on a single unit represents a baseline of performance for the fixture. Results may vary in the field.

White Baffle - IC922LEDG3-35K and IC922RLEDG3-35K with 24W-WH

Photometric Report

Test Report #: LTL25977R
 Catalog No: IC922LEDG3-35K
 with 24W-WH Trim and
 standard wide flood optic
 Luminaire Spacing Criterion: 1.16
 Luminaire LPW: 60

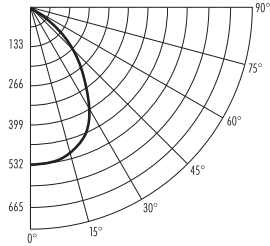

Candlepower Distribution

(Candelas)	
Degrees Vertical	0°
0	531
5	528
15	500
25	444
35	344
45	183
55	80
65	38
75	21
85	6
90	0

Multiplier: 27K - 0.90
 3K - 0.97
 41K - 1.04

Average Initial Footcandles

Multiple Units (Square Array, 60' x 60' room)
 Ceiling 80% Wall 50% Floor 20%

Spacing	RCR1	RCR3	RCR5
4.0'	61	51	44
5.0'	39	33	28
6.0'	27	23	20
7.0'	22	18	16
8.0'	17	15	12
9.0'	13	11	10
10.0'	10	8	7

Zonal Lumen Summary

Zone	Lumens	%Lamp	%Fixture
0 - 30°	395	N/A	44.4
0 - 40°	607	N/A	68.2
0 - 60°	823	N/A	92.5
0 - 90°	890	N/A	100.0

Initial Footcandles

(One Unit, 14.9W, 79.8° Beam)

Distance to Illuminated Plane (Ft.)	Beam Center	Beam Diameter
4	24.3	6.0'
6	10.8	9.0'
8	6.1	11.9'
10	3.9	14.7'

Luminance (Average cd/m²)

Degrees	Average Luminance
45	15442
55	8313
65	5305
75	4933
85	4091

Haze Cone - IC922LEDG3-35K and IC922RLEDG3-35K with 27HZ-WH

Photometric Report

Test Report #: LTL25979R
 Catalog No: IC922LEDG3-35K
 with 27HZ-WH Trim and
 standard wide flood optic
 Luminaire Spacing Criterion: 1.02
 Luminaire LPW: 61

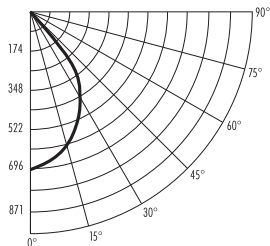

Candlepower Distribution

(Candelas)	
Degrees Vertical	0°
0	696
5	681
15	600
25	504
35	374
45	186
55	61
65	13
75	0
85	0
90	0

Multiplier: 27K - 0.90
 3K - 0.97
 41K - 1.04

Average Initial Footcandles

Multiple Units (Square Array, 60' x 60' room)
 Ceiling 80% Wall 50% Floor 20%

Spacing	RCR1	RCR3	RCR5
4.0'	63	52	45
5.0'	40	33	29
6.0'	28	23	20
7.0'	23	19	16
8.0'	18	15	13
9.0'	14	11	10
10.0'	10	8	7

Zonal Lumen Summary

Zone	Lumens	%Lamp	%Fixture
0 - 30°	464	N/A	50.9
0 - 40°	694	N/A	76.3
0 - 60°	896	N/A	98.5
0 - 90°	910	N/A	100.0

Initial Footcandles

(One Unit, 14.9W, 72.8° Beam)

Distance to Illuminated Plane (Ft.)	Footcandles Beam Center	Beam Diameter
4	43.5	5.9'
6	19.3	8.8'
8	10.9	11.8'
10	7.0	14.7'

Luminance (Average cd/m²)

Degrees	Average Luminance
45	15711
55	6392
65	1788
75	0
85	0

Fixtures tested to IES recommended standard for solid state lighting per LM-79-08. Photometric performance on a single unit represents a baseline of performance for the fixture. Results may vary in the field.

Juno Generation G3 LED Optic Reflector Accessories



For use with: IC20/IC20RLED Series; IC22/IC22RLED Series; IC920/IC920RLED Series; IC922/IC922RLED Series and J6RLEG3 Series

Medium Flood

(Ships as accessory)

Photometric Report

Test Report #: PT11111804R

Catalog No: IC22LEDG3-35K with 24W-WH Trim and LEDOPTICG3-M medium flood optic

Luminaire Spacing Criterion: 0.76

Luminaire LPW: 65

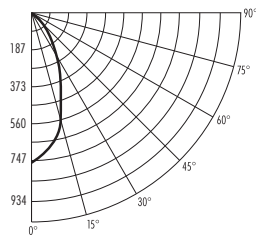

Candlepower Distribution

(Candelas)

Degrees Vertical	0°
0	747
5	712
15	552
25	380
35	226
45	87
55	36
65	21
75	12
85	3
90	0

Multiplier: 27K - 0.90
3K - 0.97
41K - 1.04

Average Initial Footcandles

Multiple Units (Square Array, 60' x 60' room)

Ceiling 80% Wall 50% Floor 20%

Spacing	RCR1	RCR3	RCR5
4.0'	46	39	33
5.0'	30	25	21
6.0'	21	17	15
7.0'	17	14	12
8.0'	13	11	9
9.0'	10	9	7
10.0'	7	6	5

Zonal Lumen Summary

Zone	Lumens	%Lamp	%Fixture
0 - 30°	395	N/A	58.2
0 - 40°	536	N/A	79.0
0 - 60°	641	N/A	94.4
0 - 90°	679	N/A	100.0

Initial Footcandles

(One Unit, 10.4W, 50.8° Beam)

Distance to Illuminated Plane (Ft.)	Footcandles Beam Center	Beam Diameter
4	46.7	3.8'
6	20.8	5.7'
8	11.7	7.6'
10	7.5	9.5'

Luminance (Average cd/m²)

Degrees	Average Luminance
45	6754
55	3428
65	2659
75	2605
85	1934

Narrow Flood

(Ships as accessory)

Photometric Report

Test Report #: PT11112102R

Catalog No: IC22LEDG3-35K with 24W-WH Trim and LEDOPTICG3-N narrow flood optic

Luminaire Spacing Criterion: 0.60

Luminaire LPW: 68

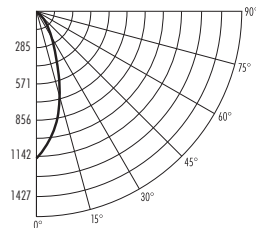

Candlepower Distribution

(Candelas)

Degrees Vertical	0°
0	1142
5	1063
15	699
25	366
35	237
45	43
55	23
65	16
75	11
85	2
90	0

Multiplier: 27K - 0.90
3K - 0.97
41K - 1.04

Average Initial Footcandles

Multiple Units (Square Array, 60' x 60' room)

Ceiling 80% Wall 50% Floor 20%

Spacing	RCR1	RCR3	RCR5
4.0'	48	41	36
5.0'	31	26	23
6.0'	21	18	16
7.0'	17	15	13
8.0'	14	12	10
9.0'	11	9	8
10.0'	8	7	6

Zonal Lumen Summary

Zone	Lumens	%Lamp	%Fixture
0 - 30°	466	N/A	66.3
0 - 40°	605	N/A	86.2
0 - 60°	672	N/A	95.6
0 - 90°	702	N/A	100.0

Initial Footcandles

(One Unit, 10.4W, 36.5° Beam)

Distance to Illuminated Plane (Ft.)	Footcandles Beam Center	Beam Diameter
4	71.4	2.6'
6	31.7	4.0'
8	17.8	5.3'
10	11.4	6.6'

Luminance (Average cd/m²)

Degrees	Average Luminance
45	3337
55	2155
65	2127
75	2388
85	1289

Spot

(Ships as accessory)

Photometric Report

Test Report #: PT11111805R

Catalog No: IC22LEDG3-35K with 24W-WH Trim and LEDOPTICG3-S spot optic

Luminaire Spacing Criterion: 0.20

Luminaire LPW: 63

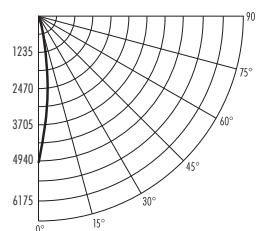

Candlepower Distribution

(Candelas)

Degrees Vertical	0°
0	4940
5	2559
15	604
25	205
35	96
45	54
55	35
65	22
75	7
85	0
90	0

Multiplier: 27K - 0.90
3K - 0.97
41K - 1.04

Average Initial Footcandles

Multiple Units (Square Array, 60' x 60' room)

Ceiling 80% Wall 50% Floor 20%

Spacing	RCR1	RCR3	RCR5
4.0'	45	40	36
5.0'	29	25	23
6.0'	20	18	16
7.0'	16	14	13
8.0'	13	11	10
9.0'	10	9	8
10.0'	7	6	6

Zonal Lumen Summary

Zone	Lumens	%Lamp	%Fixture
0 - 30°	489	N/A	74.7
0 - 40°	551	N/A	84.2
0 - 60°	625	N/A	95.5
0 - 90°	655	N/A	100.0

Initial Footcandles

(One Unit, 10.4W, 10.5° Beam)

Distance to Illuminated Plane (Ft.)	Footcandles Beam Center	Beam Diameter
4	308.8	0.7'
6	137.2	1.1'
8	77.2	1.5'
10	49.4	1.8'

Luminance (Average cd/m²)

Degrees	Average Luminance
45	4211
55	3330
65	2792
75	1520
85	0

Fixtures tested to IES recommended standard for solid state lighting per LM-79-08. Photometric performance on a single unit represents a baseline of performance for the fixture. Results may vary in the field.

For IC922G3 Series, use 1.336 multiplier.



6" 600 Lumen LED Wall Wash

LED Wall Wash – IC22LEDG3-35K with 262G3W-WH

Photometric Report

Test Report #: PT10111901
 Catalog No: IC22LEDG3-35K
 with 262G3W-WH Trim
 Luminaire Spacing Criterion @ 90°: 1.03
 Luminaire LPW: 6" IC LEDG3
 Downlight, Scoop Type Wall
 Wash Trim

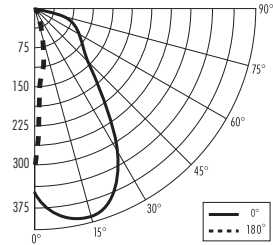

Candlepower Distribution

(Candelas)

Degrees	0°	180°
Vertical	Wall Wash	Downlight
0	319	319
5	358	221
10	368	123
15	369	79
20	360	60
25	344	46
30	315	36
35	265	27
40	196	22
45	136	20
50	102	20
55	83	18
60	71	15
65	63	11
70	58	6
75	45	0
80	29	0
85	17	0
90	0	0

Multiplier: 27K - 0.90, 3K - 0.97, 41K - 1.04

Zonal Lumen Summary

Zone	Lumens	%Lamp	%Fixture
0 - 30°	193	N/A	44.4
0 - 40°	286	N/A	66.0
0 - 60°	381	N/A	87.9
0 - 90°	433	N/A	100.0
90 - 180°	0	N/A	0
0 - 180°	433	N/A	100.0

Luminance (Average cd/m²)

Degrees	Average 180° Downlight Luminance
45	1569
55	1728
65	1393
75	0
85	0

Footcandles on Wall from Multiple Fixtures

Fixture Distance to Wall	2'						3'					
	2'			3'			3'			4'		
Fixture Centers (spacing)	2'			3'			3'			4'		
1'	17	16	17	14	8	14	7	6	7	6	4	6
2'	19	18	19	15	10	15	8	7	8	6	5	6
3'	20	20	20	15	12	15	9	8	9	7	5	7
4'	17	17	17	11	11	11	9	9	9	7	6	7
5'	12	12	12	8	8	8	9	9	9	7	7	7
6'	9	9	9	6	6	6	8	8	8	6	6	6
7'	7	7	7	5	5	5	6	6	6	5	5	5
8'	6	6	6	4	4	4	5	5	5	4	4	4
9'	4	5	4	3	3	3	4	4	4	3	3	3

* For 262G3B-WH trim, use 0.90 multiplier.

* Note: Multipliers are provided for estimating purposes only. Use IES photometric files for precise photometric information.

6" Retrofit LED Downlight Trim



White Baffle - J6RLG3-27K-6-WWH, 600 Lumen

Photometric Report

Test Report #: PT12110101R
 Catalog No: J6RLG3-27K-6-WWH
 with White Baffle Trim Insert
 Luminaire Spacing Criterion: 1.14
 Luminaire LPW: 58

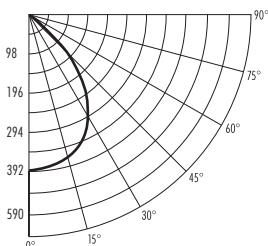

Candlepower Distribution

Degrees Vertical	0°
0	392
5	388
15	367
25	329
35	243
45	105
55	48
65	26
75	11
85	1
90	0

Multiplier: 3K - 1.02
 35K - 1.03
 41K - 1.04

Average Initial Footcandles

Multiple Units (Square Array, 60" x 60" room)
 Ceiling 80% Wall 50% Floor 20%

Spacing	RCR1	RCR3	RCR5
4.0'	41	34	29
5.0'	26	22	18
6.0'	18	15	13
7.0'	15	12	10
8.0'	12	10	8
9.0'	9	7	6
10.0'	7	5	5

Zonal Lumen Summary

Zone	Lumens	%Lamp	%Fixture
0 - 30°	291	N/A	47.6
0 - 40°	439	N/A	72.0
0 - 60°	570	N/A	93.4
0 - 90°	610	N/A	100.0

Initial Footcandles

(One Unit, 10.5W , 76.6° Beam)

Distance to Illuminated Plane (Ft.)	Footcandles Beam Center	Beam Diameter
4	24.5	6.3'
6	10.9	9.5'
8	6.1	12.6'
10	3.9	15.8'

Luminance (Average cd/m²)

Degrees	Average Luminance
45	8104
55	4604
65	3323
75	2388
85	645

White Baffle - J6RLG3-27K-9-WWH, 900 Lumen

Photometric Report

Test Report #: PT12110101R
 Catalog No: J6RLG3-27K-9-WWH
 with White Baffle Trim
 Luminaire Spacing Criterion: 1.14
 Luminaire LPW: 56

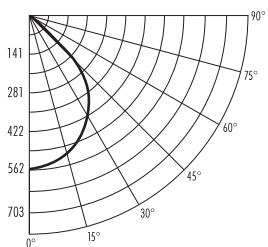

Candlepower Distribution

Degrees Vertical	0°
0	562
5	556
15	527
25	473
35	349
45	150
55	69
65	37
75	16
85	1
90	0

Multiplier: 3K - 1.07
 35K - 1.08
 41K - 1.09

Average Initial Footcandles

Multiple Units (Square Array, 60" x 60" room)
 Ceiling 80% Wall 50% Floor 20%

Spacing	RCR1	RCR3	RCR5
4.0'	59	49	41
5.0'	38	31	26
6.0'	26	22	18
7.0'	21	18	15
8.0'	17	14	12
9.0'	13	11	9
10.0'	9	8	7

Zonal Lumen Summary

Zone	Lumens	%Lamp	%Fixture
0 - 30°	417	N/A	47.6
0 - 40°	630	N/A	72.0
0 - 60°	817	N/A	93.4
0 - 90°	875	N/A	100.0

Initial Footcandles

(One Unit, 15.7W , 76.6° Beam)

Distance to Illuminated Plane (Ft.)	Footcandles Beam Center	Beam Diameter
4	35.1	6.3'
6	15.6	9.5'
8	8.8	12.6'
10	5.6	15.8'

Luminance (Average cd/m²)

Degrees	Average Luminance
45	11629
55	6606
65	4769
75	3426
85	925

White Baffle - J6RLWDG3-3K-6-WWH, WarmDim® 600 Lumen

Photometric Report

Test Report #: PT09122404R
 Catalog No: J6RLWDG3-3K-6-WWH
 with White Baffle Trim
 Luminaire Spacing Criterion: 1.14
 Luminaire LPW: 43

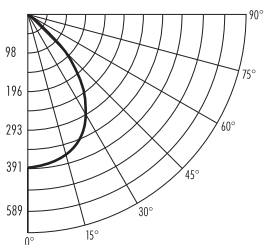

Candlepower Distribution

Degrees Vertical	0°
0	391
5	388
15	365
25	324
35	235
45	107
55	49
65	25
75	11
85	2
90	0

Average Initial Footcandles

Multiple Units (Square Array, 60" x 60" room)
 Ceiling 80% Wall 50% Floor 20%

Spacing	RCR1	RCR3	RCR5
4.0'	26	22	18
5.0'	17	14	12
6.0'	12	10	8
7.0'	10	8	7
8.0'	8	6	5
9.0'	6	5	4
10.0'	4	3	3

Zonal Lumen Summary

Zone	Lumens	%Lamp	%Fixture
0 - 30°	287	N/A	47.6
0 - 40°	432	N/A	71.5
0 - 60°	563	N/A	93.2
0 - 90°	604	N/A	100.0

Initial Footcandles

(One Unit, 14.0W , 75.9° Beam)

Distance to Illuminated Plane (Ft.)	Footcandles Beam Center	Beam Diameter
4	24.4	6.2'
6	10.9	9.4'
8	6.1	12.5'
10	3.9	15.6'

Luminance (Average cd/m²)

Degrees	Average Luminance
45	8302
55	4643
65	3294
75	2338
85	1389

Fixtures tested to IES recommended standard for solid state lighting per LM-79-08. Photometric performance on a single unit represents a baseline of performance for the fixture. Results may vary in the field.

Standard Wide-Flood Optic - J6RLEG3-27K-6-WH

Photometric Report

Test Report #: PT01121201R
 Catalog No: J6RLEG3-27K-6-WH*
 with standard wide-flood optic
 Luminaire Spacing Criterion: 1.14
 Luminaire LPW: 60

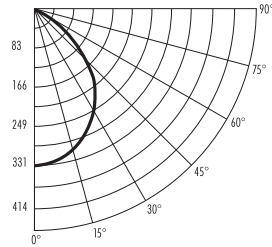

Candlepower Distribution

(Candelas)

Degrees Vertical	0°
0	331
5	328
15	309
25	273
35	216
45	145
55	85
65	43
75	16
85	0
90	0

Multiplier: 3K - 1.02
 35K - 1.03
 41K - 1.04

Average Initial Footcandles

Multiple Units (Square Array, 60" x 60" room)
 Ceiling 80% Wall 50% Floor 20%

Spacing	RCR1	RCR3	RCR5
4.0'	42	34	28
5.0'	27	22	18
6.0'	19	15	12
7.0'	15	12	10
8.0'	12	10	8
9.0'	9	7	6
10.0'	7	5	4

Initial Footcandles

(One Unit, 10.5W, 84.3" Beam)

Distance to Footcandles Illuminated Plane (Ft.)	Beam Center	Beam Diameter
4	20.7	7.2'
6	9.2	10.9'
8	5.2	14.5'
10	3.3	18.1'

Luminance (Average cd/m²)

Degrees	Average Luminance
45	22414
55	16135
65	11223
75	6705
85	0

Zonal Lumen Summary

Zone	Lumens	%Lamp	%Fixture
0 - 30°	243	N/A	38.6
0 - 40°	378	N/A	59.9
0 - 60°	567	N/A	90.0
0 - 90°	630	N/A	100.0

*900 Lumen Multiplier: 1.477

Narrow-Flood Optic - J6RLEG3-27K-6-WH

Photometric Report

Test Report #: PT01121203R
 Catalog No: J6RLEG3-27K-6-WH*
 with LEDOPTICG3-N narrow-flood optic
 Luminaire Spacing Criterion: 0.58
 Luminaire LPW: 61

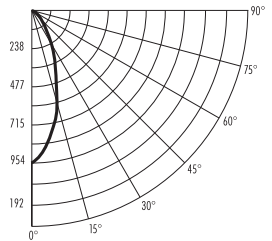

Candlepower Distribution

(Candelas)

Degrees Vertical	0°
0	954
5	887
15	558
25	294
35	197
45	112
55	33
65	12
75	4
85	0
90	0

Multiplier: 3K - 1.02
 35K - 1.03
 41K - 1.04

Average Initial Footcandles

Multiple Units (Square Array, 60" x 60" room)
 Ceiling 80% Wall 50% Floor 20%

Spacing	RCR1	RCR3	RCR5
4.0'	44	37	32
5.0'	28	24	20
6.0'	19	16	14
7.0'	16	13	11
8.0'	12	10	9
9.0'	10	8	7
10.0'	7	6	5

Initial Footcandles

(One Unit, 10.5W, 35.4" Beam)

Distance to Footcandles Illuminated Plane (Ft.)	Beam Center	Beam Diameter
4	59.6	2.6'
6	26.5	3.8'
8	14.9	5.1'
10	9.5	6.4'

Luminance (Average cd/m²)

Degrees	Average Luminance
45	17342
55	6253
65	3011
75	1788
85	0

Zonal Lumen Summary

Zone	Lumens	%Lamp	%Fixture
0 - 30°	376	N/A	59.3
0 - 40°	499	N/A	78.7
0 - 60°	618	N/A	97.3
0 - 90°	635	N/A	100.0

*900 Lumen Multiplier: 1.477

Fixtures tested to IES recommended standard for solid state lighting per LM-79-08. Photometric performance on a single unit represents a baseline of performance for the fixture. Results may vary in the field.

Lamp	Beam Type	Beam Spread °	Rated Life	CBCP	Horizontal Surface		Vertical Surface	
					0 degrees		30 degrees	
					MH	FC L W	FC L W	D FC X L W
J6RLEG3-27K-6-WH with LEDOPTICG3-M Medium-Flood Optic	MFL	50°	50000	694	3	77 2.8 2.8	50 4.0 3.2	1 87 1.7 10.7 1.9
					4	43 3.7 3.7	28 5.4 4.3	2 22 3.5 21.5 3.7
					5	28 4.7 4.7	18 6.7 5.4	3 10 5.2 *** 5.6
					6	19 5.6 5.6	13 8.0 6.5	4 5 6.9 *** 7.5
					7	14 6.5 6.5	9 9.4 7.5	5 3 8.7 *** 9.3
J6RLEG3-27K-6-WH with LEDOPTICG3-N Narrow-Flood Optic	NFL	35°	50000	954	3	106 1.9 1.9	69 2.6 2.2	1 119 1.7 3.6 1.3
					4	60 2.5 2.5	39 3.5 2.9	2 30 3.5 7.2 2.5
					5	38 3.2 3.2	25 4.3 3.6	3 13 5.2 10.8 3.8
					6	27 3.8 3.8	17 5.2 4.4	4 7 6.9 14.4 5.0
					7	19 4.4 4.4	13 6.1 5.1	5 5 8.7 18.0 6.3
J6RLEG3-27K-6-WH with LEDOPTICG3-S Spot Optic	SP	10°	50000	4123	4	258 0.7 0.7	167 0.9 0.8	2 129 3.5 1.4 0.7
					5	165 0.9 0.9	107 1.2 1.0	3 57 5.2 2.1 1.0
					6	115 1.0 1.0	74 1.4 1.2	4 32 6.9 2.9 1.4
					7	84 1.2 1.2	55 1.6 1.4	5 21 8.7 3.6 1.7
					8	64 1.4 1.4	42 1.9 1.6	6 14 10.4 4.3 2.1

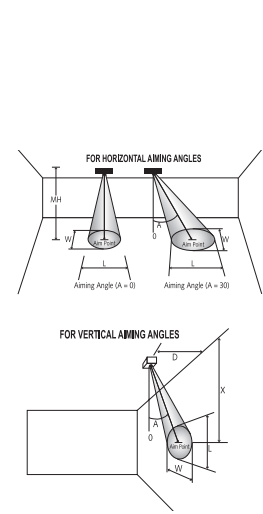

CBCP • Centerbeam candlepower **FC** • Footcandles at beam center (aim point)
 In vertical aiming applications, aim point (X) is determined by dividing distance from the wall (D) by the tangent of the desired aim angle (A) (0.5774 for 30°).

For 3000K fixtures, use 1.02 multiplier; for 3500K fixtures, use 1.03 multiplier; for 4100K fixtures, use 1.04 multiplier.

*** Due to steep aiming angle, length of beam extends beyond 25'.

6" 900 Lumen Slope/Super Slope Ceiling



Standard Slope - IC926LED9G3-35K with 614W-WH

Photometric Report

Test Report #: PT06120501R

Catalog No: IC926LED9G3-35K-1 with 614W-WH Trim

Luminaire Spacing Criterion: 1.46

Luminaire LPW: 64

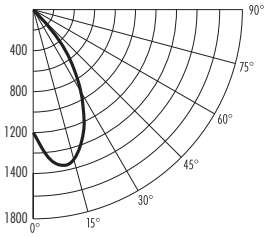

Candlepower Distribution

(Candelas)	
Degrees Vertical	0°
0	1090
5	1042
10	956
15	847
20	716
25	585
30	453
35	328
40	204
45	115
50	65
55	39
60	26
65	19
70	13
75	9
80	6
85	2
90	0

Average Initial Footcandles

Multiple Units (Square Array, 60' x 60' room)

Ceiling 80% Wall 50% Floor 20%

Spacing	RCR1	RCR3	RCR5
4.0'	67	56	49
5.0'	43	36	31
6.0'	30	25	22
7.0'	24	20	17
8.0'	19	16	14
9.0'	15	12	11
10.0'	11	9	8

Zonal Lumen Summary

Zone	Lumens	%Lamp	%Fixture
0 - 30°	611	50.9	62.8
0 - 40°	816	68.0	84.0
0 - 60°	941	78.4	96.8
0 - 90°	972	81.0	100.0

Initial Footcandles

(One Unit, 15.1W, 52.9° Beam)

Distance to Footcandles Illuminated Plane (Ft.)	Beam Center	Beam Diameter
6	30.3	6.0'
8	17.0	8.0'
10	10.9	10.0'
12	7.6	11.9'
14	5.6	13.9'
16	4.3	15.9'
18	3.4	17.9'
20	2.7	19.9'

Luminance (Average cd/m²)

Degrees	Average Luminance
45	39064
55	12510
65	5023
75	1963
85	1756

Super Slope - IC928LED9G3-35K with 604W-WH

Photometric Report

Test Report #: PT06120601R

Catalog No: IC928LED9G3-35K-1 with 604W-WH Trim

Luminaire Spacing Criterion: 2.54

Luminaire LPW: 64

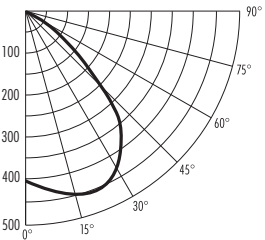

Candlepower Distribution

(Candelas)	
Degrees Vertical	0°
0	403
5	419
10	443
15	464
20	473
25	467
30	444
35	397
40	330
45	259
50	176
55	101
60	56
65	31
70	17
75	10
80	7
85	3
90	0

Average Initial Footcandles

Multiple Units (Square Array, 60' x 60' room)

Ceiling 80% Wall 50% Floor 20%

Spacing	RCR1	RCR3	RCR5
4.0'	66	54	44
5.0'	42	34	28
6.0'	29	24	19
7.0'	24	19	16
8.0'	19	15	12
9.0'	14	12	10
10.0'	11	9	7

Zonal Lumen Summary

Zone	Lumens	%Lamp	%Fixture
0 - 30°	388	32.3	39.8
0 - 40°	637	53.1	65.5
0 - 60°	928	77.4	95.4
0 - 90°	973	81.1	100.0

Initial Footcandles

(One Unit, 15.1W, 52.9° Beam)

Distance to Footcandles Illuminated Plane (Ft.)	Beam Center	Beam Diameter
6	11.2	12.6'
8	6.3	16.7'
10	4.0	20.9'
12	2.8	25.1'
14	2.1	29.3'
16	1.6	33.5'
18	1.2	37.7'
20	1.0	41.9'

Luminance (Average cd/m²)

Degrees	Average Luminance
45	118023
55	63151
65	20254
75	5545
85	2338

Fixtures tested to IES recommended standard for solid state lighting per LM-79-08. Photometric performance on a single unit represents a baseline of performance for the fixture. Results may vary in the field.

SPOT - MD1L35K-SP-WH

Photometric Report

Test Report #: PT10102802
 Catalog No: MD1L35K-SP-WH
 Luminaire Spacing Criterion: 0.28
 Luminaire LPW: 38.6

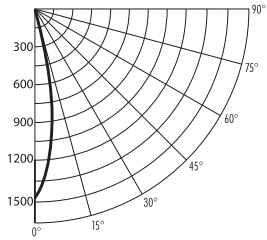

Candlepower Distribution

Candelas	
Degrees Vertical	0°
0	1453
5	1086
15	211
25	52
35	11
45	4
55	0
65	0
75	0
85	0
90	0

Multiplier: 27K - 0.92
 3K - 0.96
 41K - 1.06

Average Initial Footcandles

Multiple Units (Square Array, 60' x 60' room)
 Ceiling 80% Wall 50% Floor 20%

Spacing	RCR1	RCR3	RCR5
4.0'	14	13	12
5.0'	9	8	7
6.0'	6	6	5
7.0'	5	5	4
8.0'	4	4	3
9.0'	3	3	3
10.0'	2	2	2

Initial Footcandles

(One Unit, 5W, 15.7° Beam)

Distance to Illuminated Plane (Ft.)	Footcandles Center	Beam Diameter
4	90.8	1.1'
6	40.4	1.7'
8	22.7	2.2'
10	14.5	2.8'

Luminance (Average cd/m²)

Degrees	Average Luminance
45	6377
55	0
65	0
75	0
85	0

Narrow Flood - MD1L35K-NFL-WH

Photometric Report

Test Report #: LTL21544
 Catalog No: MD1L35K-NFL-WH
 Luminaire Spacing Criterion: 0.40
 Luminaire LPW: 38.2

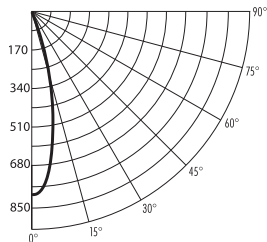

Candlepower Distribution

Candelas	
Degrees Vertical	0°
0	803
5	701
15	277
25	74
35	19
45	5
55	2
65	0
75	0
85	0
90	0

Multiplier: 27K - 0.92
 3K - 0.96
 41K - 1.06

Average Initial Footcandles

Multiple Units (Square Array, 60' x 60' room)
 Ceiling 80% Wall 50% Floor 20%

Spacing	RCR1	RCR3	RCR5
4.0'	13	12	11
5.0'	9	8	7
6.0'	6	5	5
7.0'	5	4	4
8.0'	4	4	3
9.0'	3	3	2
10.0'	2	2	2

Initial Footcandles

(One Unit, 5W, 23.6° Beam)

Distance to Illuminated Plane (Ft.)	Footcandles Center	Beam Diameter
4	50.2	1.7'
6	22.3	2.5'
8	12.5	3.3'
10	8.0	4.2'

Luminance (Average cd/m²)

Degrees	Average Luminance
45	6171
55	3215
65	0
75	0
85	0

Flood - MD1L35K-FL-WH

Photometric Report

Test Report #: PT10102803
 Catalog No: MD1L35K-FL-WH
 Luminaire Spacing Criterion: 0.56
 Luminaire LPW: 37.2

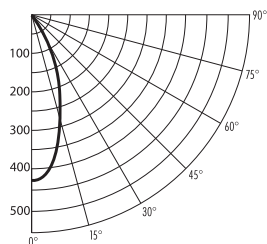

Candlepower Distribution

Candelas	
Degrees Vertical	0°
0	424
5	403
15	240
25	104
35	28
45	9
55	4
65	2
75	0
85	0
90	0

Multiplier: 27K - 0.92
 3K - 0.96
 41K - 1.06

Average Initial Footcandles

Multiple Units (Square Array, 60' x 60' room)
 Ceiling 80% Wall 50% Floor 20%

Spacing	RCR1	RCR3	RCR5
4.0'	13	12	11
5.0'	8	8	7
6.0'	6	5	5
7.0'	5	4	4
8.0'	4	3	3
9.0'	3	3	2
10.0'	2	2	2

Initial Footcandles

(One Unit, 5W, 34.9° Beam)

Distance to Illuminated Plane (Ft.)	Footcandles Center	Beam Diameter
4	26.5	2.5'
6	11.8	3.8'
8	6.6	5.0'
10	4.2	6.3'

Luminance (Average cd/m²)

Degrees	Average Luminance
45	16739
55	7738
65	7000
75	0
85	0

Fixtures tested to IES recommended standard for solid state lighting per LM-79-08. Photometric performance on a single unit at 12VAC in a 25°C ambient represents a baseline of performance for the fixture. Results may vary in the field and when multiple fixtures are used in a system.







Mini LED Gimbal performance data available at www.junolightinggroup.com.

Light Control Lenses: 1-3/4" Diameter



Customizes the visual effect with a complete range of optical accessories offered with the 4" Low Voltage downlights, see page 82.

-  **Prismatic Spread Lens**
T557 Coarse prism lens enlarges beam size. Especially useful with narrow flood lamps.
-  **Linear Spread Lens**
T559 Elongates beam into a wide oval pattern
-  **Diffusion Lens**
T5520 Frosted lens softens the beam and lightly diffuses the pattern
-  **Uniformity Lens**
T5521 Fine prismatic lens eliminates striations without altering size of beam
-  **UV Filter**
T5522 Optivex™ museum quality filter blocks UV transmission below 400nm
-  **Color Correction Filters**
T5516 Daylight Blue cools color temperature to 4250° K
-  **T5518** Cosmetic Peach warms color temperature to 2700° K

Dichroic Color Filters

-  **T5501** Red
-  **T5503** Medium Green
-  **T5504** Medium Blue
-  **T5505** Yellow
-  **T5506** Magenta
-  **T5511** Blue Green (Cyan)

Non-Dichroic Color Filters

-  **T551** Medium Pink
-  **T553** Medium Blue
-  **T555** Medium Amber

Hexagonal Cell Louver

-  **T5559BL** Provides 45° lamp shielding

LED Optics

For use with: IC20/IC20RLED Series; IC22/IC22RLED Series; IC920/IC920RLED Series; IC922/IC922RLED Series, J6RLEG3 and J6RLEWDG3* Series

- LEDOPTICG3-M** Medium Flood Optic (50° beam)
- LEDOPTICG3-N** Narrow Flood Optic (37° beam)
- LEDOPTICG3-S** Spot Optic (10° beam)

*Note: For best performance use medium flood optic with WarmDim® Eyeball Trim Module (J6RLEWDG3 Series).

Air-Loc® Conversion Gasket

Converts the housing and trim to a more energy efficient source by stopping air-leakage.





- | | |
|---|---|
| ALG5 5" Energy Conserving Gasket for Air-Loc® IC Housings | ALG6R 6" Energy Conserving Gasket for Air-Loc® IC Remodel Housings |
| ALG5R 5" Energy Conserving Gasket Kit for Air-Loc® IC Remodel Housings | ALG926 Air-Loc® Energy Conserving Gasket for IC926 Slope Ceiling |
| ALG6 6" Energy Conserving Gasket for Air-Loc® IC Housings | ALG928 Air-Loc® Energy Conserving Gasket for IC928 Super Slope Ceiling |

Color Trim Ring Options

Many 5" and 6" Juno trim rings colors can be changed to update or modify your room.



5" Trim Ring Colors:

For use with trims: 203, 204, 205, 206 & 207

-  **TR5-ABZ** Classic Aged Bronze
-  **TR5-BL** Black
-  **TR5-SC** Satin Chrome
-  **TR5-WH** White

6" Trim Ring Colors:

For use with trims: 24, 25, 26, 27, 244, 247, 254, 257, 264, 467 and 9900

-  **TR6-ABZ** Classic Aged Bronze
-  **TR6-BL** Black
-  **TR6-SC** Satin Chrome
-  **TR6-WH** White

Mounting Accessories and Hardware

- SMPLT-4** 4" galvanized steel plate for locating remodel style housings in new construction. Screw/nail holes for full coverage between 16" and 24" joists. For use with TC44R and TC1R.
- SMPLT-5** 5" galvanized steel plate for locating remodel style housings in new construction. Screw/nail holes for full coverage between 16" & 24" joists for use with IC20RLWDG3, IC20RLEDG3, IC920RLEDG3, IC20R and TC20R.
- T599** 1" socket extension for use with trims 12 and 4180FROST or 14 trim when using a GE PAR20 in an IC1 housing.
- 4TSA** Torsion Spring Adapter for use in TC44, IC44N, IC1, TC1 and TC47.
- GU10-WHIP** For use with IC1P, TC1 and 440, 445, 446, and 448. (pages 83, 88 and 89, 50W 120V MR16). For use in IC1 housing with trims 440 and 448 only.



Additional recessed lighting solutions literature can be downloaded from www.junolightinggroup.com/literature



Juno Undercabinet



Juno Undercabinet Solo-Task Lighting

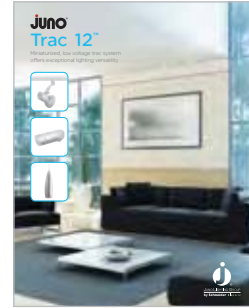

Juno Trac 12



Juno Step Lights



Juno LED Pendants



Juno LED Mini Pendants



Juno Trac Lighting

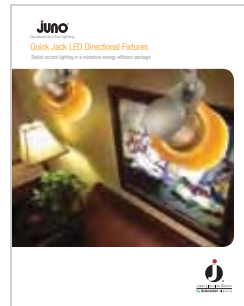

Juno Quick Jack LED



Aculux Recessed Precision Luminaires

Juno

Recessed and Trac Lighting

indy

Architectural Recessed Lighting

AccuLite

Commercial and Industrial Lighting

AcuLux

Precision Recessed Lighting

Navilite

Exit and Emergency Lighting

DanaLite

Architectural Linear Lighting



Juno Lighting Group

1300 South Wolf Road
Des Plaines, IL 60018

Ph: 847.827.9880

www.junolightinggroup.com

Regional Offices & Warehouses

California

Illinois

Indiana

Pennsylvania

Texas

Ontario, CN

For additional information about our currently stocked products or to place an order, please contact your local Viking Electric Supply sales representative.

VE Viking Electric Supply

www.vikingelectric.com

©2013 JUNO LIGHTING, LLC. The marks appearing in this catalog are registered trademarks of Juno Lighting, LLC unless otherwise noted. Products shown in this brochure are covered by U.S. and international patents and patents pending. Specifications subject to change without notice. Other marks used herein, including Halo, Thomas, Capri, Lithonia, Luxeon, Alzak are recognized trademarks of their respective companies. Photography: Cover and page 68 provided by Douglas A. Salin Photography.