







# SPECIAL PURPOSE ELECTRICAL FASTENERS

## WIRE SCREW ON CONNECTOR KIT



- 120 pc. Color Coded Screw On Wire Connectors
- Cover most common construction wire ranges
- Deep Skirt Entry provides protector from flash-over and shorts
- Sure Grip Ribs
- Connectors meet UL-CSA Standards

|  |  |   |  |  |  |
|--|--|---|--|--|--|
| <b>40 pcs.</b><br>MWNG2216<br><br>Joins No. 22-16 AWG<br>Min. 1 No. 20<br>+ 1 No. 22<br>Max. 2 No. 16 | <b>30 pcs.</b><br>MWNB2214<br><br>Joins No. 22-14 AWG<br>Min. 3 No. 22<br>Max. 3 No. 16 | <b>20 pcs.</b><br>MWNO2214<br><br>Joins No. 22-14 AWG<br>Min. 3 No. 22<br>Max. 3 No. 16<br>+ 1 No. 18 | <b>15 pcs.</b><br>MWNY1812<br><br>Joins No. 18-12 AWG<br>Min. 1 No. 14<br>+ 1 No. 18<br>Max. 2 No. 14<br>+ 3 No. 16 | <b>10 pcs.</b><br>MWNR1810<br><br>Joins No. 18-10 AWG<br>Min. 1 No. 12<br>+ 2 No. 18<br>Max. 3 No. 10 | <b>5 pcs.</b><br>MWNWG148<br><br>Joins No. 14-8 AWG<br>Min. 3 No. 12<br>Max. 4 No. 10 |
|--|--|---|--|--|--|

| PART# | UPC#  | QTY/<br>PCS | COLOR     | JOINS                                   | WT. PER<br>PKG. | STD. PKG. | SUGGESTED TRADE<br>LIST PRICE PER |
|-------|-------|-------------|-----------|---|-----------------|-----------|-----------------------------------|
| MWNK1 | 39415 | 40          | Gray      | 22-16 AWG / Min 1#20+#22 Max 2#16       | .60             | 1         | 57.90/ea kit                      |
|       |       | 30          | Blue      | 22-14 AWG / Min 3#22 Max 3#16+1#18      |                 |           |                                   |
|       |       | 20          | Orange    | 22-14 AWG / Min 3#22 Max 3#16+1#18      |                 |           |                                   |
|       |       | 15          | Yellow    | 18-12 AWG / Min 1#14+1#18 Max 2#14+1#18 |                 |           |                                   |
|       |       | 10          | Red       | 18-12 AWG / Min 1#12+2#18 Max 3#10      |                 |           |                                   |
|       |       | 5           | Gray Wing | 14-18 AWG / Min 3#12 Max 4#10           |                 |           |                                   |

## WIRE SCREW ON CONNECTORS



- Color Coded Screw On Connectors.
- Sure Grip Ribs improves grasp ability.
- Swept-Back Wings allowing increased torque strength.
- Square Wire Spring provides more secure gripping on conductors.
- Deep Skirt Entry provides protection from flash-over and shorts.
- MWNWGR1410 is a grounding connector which allows quick grounding while providing all the features of standard wing connectors.
- Color Coded Green for quick identification.
- Connectors meet UL-CSA Standards.

| PART#     | UPC#  | COLOR       | JOINS                                   | WT. PER<br>PKG. | STD. PKG. | SUGGESTED TRADE<br>LIST PRICE PER |
|-----------|-------|-------------|---|-----------------|-----------|-----------------------------------|
| MWNG2216  | 39411 | Gray        | 22-16 AWG / Min 1#20+#22 Max 2#16       | .13             | 100       | 9.74/c                            |
| MWNB2214  | 39409 | Blue        | 22-14 AWG / Min 3#22 Max 3#16+1#18      | .19             | 100       | 10.62/c                           |
| MWNO2214  | 39407 | Orange      | 22-14 AWG / Min 3#22 Max 3#16+1#18      | .19             | 100       | 12.43/c                           |
| MWNY1812  | 39405 | Yellow      | 18-12 AWG / Min 1#14+1#18 Max 2#14+1#18 | .47             | 100       | 13.68/c                           |
| MWNR1810  | 39403 | Red         | 18-10 AWG / Min 1#12+2#18 Max 3#10      | .85             | 100       | 18.22/c                           |
| MWNWG148  | 39401 | Gray Wing   | 14-8 AWG / Min 3#12 Max 4#10            | .64             | 50        | 13.30/c                           |
| MWNWY1812 | 39431 | Yellow Wing | 18-12 AWG / Min 2#18 Max 3#12           | .45             | 100       | 18.31/c                           |
| MWNWT2212 | 39429 | Tan Wing    | 22-12 AWG / Min 3#22 Max 4#12           | .48             | 100       | 20.91/c                           |
| MWNWR1810 | 39427 | Red Wing    | 18-10 AWG / Min 3#16 Max 5#12           | .85             | 100       | 21.48/c                           |

# SPECIAL PURPOSE ELECTRICAL FASTENERS

METALLICS IS THE ONLY FASTENER SUPPLIER TO AMERICA'S DISTRIBUTORS TO MANUFACTURE ITS OWN GROUNDING SCREWS

MADE IN USA



Manufactured by Avanti Screw, Inc., A Metallics Affiliate



## GROUNDING SCREWS

ROUND HEAD WASHER "COMBO" SLOTTED/PHILLIPS  
STEEL GREEN ZINC



| PART#   | BOX UPC# | JAR UPC# | DIAMETER | LENGTH | WT. PER PKG. | STD. PKG./MSTR. SLEEVE | SUGGESTED TRADE LIST PRICE PER |
|---------|----------|----------|----------|--------|--------------|------------------------|--------------------------------|
| GS20    | 16105    |          | 10-32    | 3/8    | .58          | 100                    | 9.14/c                         |
| JGS20   |          | 82643    | 10-32    | 3/8    | .54          | 100                    | 9.14/c                         |
| GS20500 |          | 82005    | 10-32    | 3/8    | 2.75         | 500                    | 7.76/c                         |

OTHER SIZES AND QUANTITIES AVAILABLE BY REQUEST



## GROUNDING SCREWS

HEX WASHER "COMBO" SLOTTED/PHILLIPS  
DOG POINT - STEEL GREEN ZINC



| PART#    | BOX UPC# | JAR UPC# | DIAMETER | LENGTH      | WT. PER PKG. | STD. PKG./MSTR. SLEEVE | SUGGESTED TRADE LIST PRICE PER |
|----------|----------|----------|----------|-------------|--------------|------------------------|--------------------------------|
| GSH19*   | 82086    |          | 8-32     | 5/16 Type F | .36          | 100                    | 18.59/c                        |
| JGSH19*  |          | 82079    | 8-32     | 5/16 Type F | .35          | 100                    | 13.59/c                        |
| GSH24*   | 82087    |          | 10-32    | 3/8 Type F  | .55          | 100                    | 17.72/c                        |
| JGSH24*  |          | 82092    | 10-32    | 3/8 Type F  | .57          | 100                    | 17.72/c                        |
| GSH20    | 16110    |          | 10-32    | 3/8         | .57          | 100                    | 8.40/c                         |
| JGSH20   |          | 82080    | 10-32    | 3/8         | .51          | 100                    | 8.40/c                         |
| GSH20500 |          | 82010    | 10-32    | 3/8         | 2.45         | 500                    | 7.14/c                         |
| GSH205M  | 82103    |          | 10-32    | 3/8         | 22.85        | 5000                   | 66.92/m                        |
| GSH208M  | 82104    |          | 10-32    | 3/8         | 37.20        | 8000                   | 43.75/m                        |

\*SLOTTED ONLY, DENOTES A PRODUCT NOT MANUFACTURED IN THE USA

OTHER SIZES AND QUANTITIES AVAILABLE BY REQUEST



## GROUNDING SCREWS

HEX WASHER "COMBO" SLOTTED/PHILLIPS  
TYPE 23 THREAD CUTTING  
STEEL GREEN ZINC

MADE IN USA



Manufactured by Avanti Screw, Inc., A Metallics Affiliate



| PART#     | BOX UPC# | JAR UPC# | DIAMETER | LENGTH | WT. PER PKG. | STD. PKG./MSTR. SLEEVE | SUGGESTED TRADE LIST PRICE PER |
|-----------|----------|----------|----------|--------|--------------|------------------------|--------------------------------|
| JGSH15*   |          | 39496    | 8-32     | 1/4    | .30          | 100                    | 24.75/c                        |
| GSH1510M* | 82101    |          | 8-32     | 1/4    | 26.74        | 10000                  | 108.64/m                       |
| GSH23     | 16115    |          | 10-32    | 3/8    | .51          | 100                    | 9.39/c                         |
| JGSH23    |          | 82091    | 10-32    | 3/8    | .54          | 100                    | 9.39/c                         |
| GSH23500  |          | 82015    | 10-32    | 3/8    | 2.55         | 500                    | 7.97/c                         |

\*SLOTTED ONLY, DENOTES A PRODUCT NOT MANUFACTURED IN THE USA

OTHER SIZES AND QUANTITIES AVAILABLE BY REQUEST



## GROUNDING SCREWS

"QUADRIVE" HEX WASHER, SLOTTED, PHILLIPS  
AND SQUARE DRIVE DOG POINT  
STEEL GREEN ZINC

MADE IN USA



Manufactured by Avanti Screw, Inc., A Metallics Affiliate

Four drives in one head



| PART#    | BOX UPC# | JAR UPC# | DIAMETER | LENGTH | WT. PER PKG. | STD. PKG./MSTR. SLEEVE | SUGGESTED TRADE LIST PRICE PER |
|----------|----------|----------|----------|--------|--------------|------------------------|--------------------------------|
| GSH21    | 16111    |          | 10-32    | 3/8    | .65          | 100                    | 9.37/c                         |
| JGSH21   |          | 82081    | 10-32    | 3/8    | .63          | 100                    | 9.37/c                         |
| GSH21500 |          | 82011    | 10-32    | 3/8    | 2.99         | 500                    | 7.97/c                         |
| GSH21M   | 82085    |          | 10-32    | 3/8    | 5.14         | 1000                   | 79.65/m                        |

OTHER SIZES AND QUANTITIES AVAILABLE BY REQUEST

Introduced in 1999

# SPECIAL PURPOSE ELECTRICAL FASTENERS



## GROUNDING SCREWS

"QUADRIVE" HEX WASHER, SLOTTED, PHILLIPS AND SQUARE DRIVE - TYPE 23 THREAD CUTTING STEEL GREEN ZINC



Four drives in one head

- Hex
- Slotted
- Phillips
- Square Drive

Introduced in 1999

| PART#    | BOX<br>UPC# | JAR<br>UPC# | DIAMETER | LENGTH | WT. PER<br>PKG. | STD. PKG./<br>MSTR. SLEEVE | SUGGESTED TRADE<br>LIST PRICE PER |
|----------|-------------|-------------|----------|--------|-----------------|----------------------------|-----------------------------------|
| GSH22    | 16112       |             | 10-32    | 3/8    | .53             | 100                        | 9.37/c                            |
| JGSH22   |             | 82090       | 10-32    | 3/8    | .57             | 100                        | 9.37/c                            |
| GSH22500 |             | 82012       | 10-32    | 3/8    | 2.97            | 500                        | 7.97/c                            |

OTHER SIZES AND QUANTITIES AVAILABLE BY REQUEST



## GROUNDING CLIPS

STEEL GREEN ZINC

Designed To Fit #10-#12-#14  
Copper or Aluminum Wire

| PART#   | BOX<br>UPC# | UPC<br>NO. | WT. PER<br>PKG. | STD. PKG./<br>MSTR. SLEEVE | SUGGESTED TRADE<br>LIST PRICE PER |
|---------|-------------|------------|-----------------|----------------------------|-----------------------------------|
| CG20    | 16100       |            | .42             | 100                        | 21.95/c                           |
| JCG20   |             | 82649      | .40             | 100                        | 21.95/c                           |
| CG20500 |             | 83100      | 1.89            | 500                        | 17.10/c                           |

OTHER SIZES AND QUANTITIES AVAILABLE BY REQUEST

7 inch

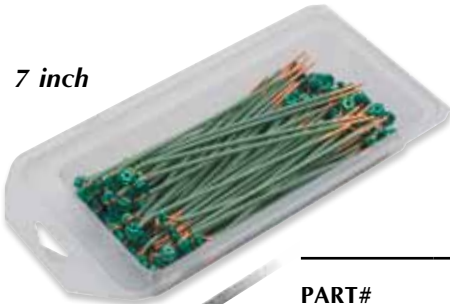

## GROUNDING PIGTAILS

WITH HEX WASHER "COMBO" SLOTTED  
PHILLIPS DOG POINT  
STEEL GREEN ZINC

Grounding Screw Attached



| PART#                              | UPC#  | SIZE     | WT. PER<br>PKG. | STD. PKG./<br>MSTR. SLEEVE | SUGGESTED TRADE<br>LIST PRICE PER |
|------------------------------------|-------|----------|-----------------|----------------------------|-----------------------------------|
| <b>SOLID COPPER INSULATED WIRE</b> |       |          |                 |                            |                                   |
| PT30                               | 16000 | #14 Wire | 1.41            | 100 box                    | 47.90/c                           |
| PT30M                              | 16013 | #14 Wire | 15.10           | 1000 box                   | 416.85/m                          |
| PT40                               | 16005 | #12 Wire | 1.88            | 100 box                    | 53.68/c                           |
| PT40K                              | 10679 | #12 Wire | 4.77            | 250 jar                    | 50.68/c                           |
| PT40J                              | 16039 | #12 Wire | 1.94            | 100 jar                    | 53.68/c                           |
| PT40BULK                           | 16017 | #12 Wire | 19.60           | 1000 box                   | 474.75/m                          |
| PT50                               | 16041 | #12 Wire | 1.96            | 100 box                    | 92.73/c                           |

The PT50 Stripped/#10 Fork.

OTHER SIZES AND QUANTITIES AVAILABLE BY REQUEST

- Phillips
- Hex

Helpful Hints From Metallics: **GOT FASTENERS?**  
Did You forget to ask?

# SPECIAL PURPOSE ELECTRICAL FASTENERS

7 inch



## GROUNDING PIGTAILS

WITH HEX WASHER "COMBO"  
SLOTTED/PHILLIPS DOG POINT  
STEEL GREEN ZINC

Grounding Screw Attached



| PART#   | UPC#  | SIZE     | WT. PER PKG. | STD. PKG./MSTR. SLEEVE | SUGGESTED TRADE LIST PRICE PER |
|---|-------|----------|--------------|------------------------|--------------------------------|
| <b>STRANDED COPPER INSULATED WIRE (with fork and ring terminal)</b> |       |          |              |                        |                                |
| PTS30   | 16001 | #14 Wire | 1.41         | 50 box                 | 98.38/c                        |
| PTS30C  | 16032 | #14 Wire | 2.26         | 100 box                | 96.90/c                        |
| PTS40   | 16006 | #12 Wire | 1.88         | 50 box                 | 133.98/c                       |
| PTS40C  | 16033 | #12 Wire | 2.82         | 100 box                | 130.00/c                       |

OTHER SIZES AND QUANTITIES AVAILABLE BY REQUEST

7 inch



## GROUNDING PIGTAILS

WITH HEX WASHER "COMBO"  
SLOTTED/PHILLIPS DOG POINT  
STEEL GREEN ZINC

Grounding Screw Attached



| PART#  | UPC#  | SIZE     | WT. PER PKG. | STD. PKG./MSTR. SLEEVE | SUGGESTED TRADE LIST PRICE PER |
|--|-------|----------|--------------|------------------------|--------------------------------|
| <b>BARE SOLID COPPER WIRE IN A PLASTIC BOX</b> |       |          |              |                        |                                |
| PT30B  | 16015 | #14 Wire | 1.42         | 100 box                | 44.65/c                        |
| PT40B  | 16010 | #12 Wire | 1.87         | 100 box                | 53.07/c                        |

OTHER SIZES AND QUANTITIES AVAILABLE BY REQUEST

7 inch



## GROUNDING PIGTAILS

WITH "QUADRIVE" HEX WASHER, SLOTTED,  
PHILLIPS, SQUARE DRIVE, DOG POINT  
STEEL GREEN ZINC

Grounding Screw Attached

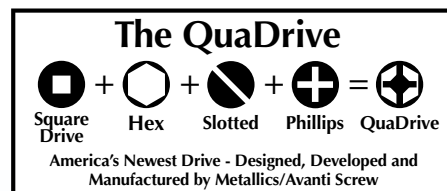

Screws  
Manufactured by  
Avanti Screw, Inc.,  
A Metalics Affiliate  
Assembled in  
USA

| PART#                              | UPC#  | SIZE     | WT. PER PKG. | STD. PKG./MSTR. SLEEVE | SUGGESTED TRADE LIST PRICE PER |
|------------------------------------|-------|----------|--------------|------------------------|--------------------------------|
| <b>SOLID COPPER INSULATED WIRE</b> |       |          |              |                        |                                |
| PT35                               | 16021 | #14 Wire | 1.62         | 100 box                | 47.90/c                        |
| PT45                               | 16026 | #12 Wire | 2.06         | 100 box                | 53.68/c                        |
| PT45M                              | 16028 | #12 Wire | 19.40        | 100 box                | 531.59/c                       |

OTHER SIZES AND QUANTITIES AVAILABLE BY REQUEST

# SPECIAL PURPOSE ELECTRICAL FASTENERS

8 inch



 Phillips

## 8" GROUNDING PIGTAILS

- #12 Solid Copper Wire with Grounding Screw attached.
- 10-32 x 3/8 Hex Head Phillips/Slotted Dog Point Steel Green Zinc.

MADE IN USA



Wire Only

| PART#    | UPC#  | LENGTH | SCREW DIAMETER | SCREW LENGTH | WT. PER PKG. | STD. PKG./MSTR. SLEEVE | SUGGESTED TRADE LIST PRICE PER |
|----------|-------|--------|----------------|--------------|--------------|------------------------|--------------------------------|
| PT408    | 16008 | 8      | 10-32          | 3/8          | 2.30         | 100                    | 68.48/c                        |
| PT408FS* | 16158 | 8      | 10-32          | 3/8          | 1.88         | 100                    | 73.93/c                        |

\*PT408FS With Female Spade End.

\*Denotes product not made in USA

## GROUNDING PIGTAILS

WITH HEX WASHER "COMBO"  
SLOTTED/PHILLIPS DOG POINT  
STEEL GREEN ZINC

Grounding Screw Attached

Wire

MADE IN USA



Assembled in USA

10 INCH

 Hex

 Phillips

| PART#                              | UPC#  | SIZE     | WT. PER PKG. | STD. PKG. | SUGGESTED TRADE LIST PRICE PER |
|------------------------------------|-------|----------|--------------|-----------|--------------------------------|
| <b>SOLID COPPER INSULATED WIRE</b> |       |          |              |           |                                |
| PT4010                             | 16007 | #12 Wire | .62          | 25 bag    | 61.88/c                        |
| PT4010V                            | 16092 | #12 Wire | 12.63        | 500 box   | 55.66/c                        |

OTHER SIZES AND QUANTITIES AVAILABLE BY REQUEST

## GROUNDING PIGTAILS

WITH "QUADRIVE" HEX WASHER, SLOTTED/PHILLIPS,  
SQUARE DRIVE DOG POINT  
STEEL GREEN ZINC

Grounding Screw Attached

Wire

MADE IN USA





Screws

Manufactured by Avanti Screw, Inc., A Metallics Affiliate

Assembled in USA

**The QuaDrive**

  
Square Drive

  
Hex

  
Slotted

  
Phillips

  
QuaDrive

America's Newest Drive - Designed, Developed and Manufactured by Metallics/Avanti Screw

| PART#                              | UPC#  | SIZE     | WT. PER PKG. | STD. PKG. | SUGGESTED TRADE LIST PRICE PER |
|------------------------------------|-------|----------|--------------|-----------|--------------------------------|
| <b>SOLID COPPER INSULATED WIRE</b> |       |          |              |           |                                |
| PT4012                             | 16012 | #12 Wire | .72          | 25 bag    | 65.68/c                        |
| PT4012V                            | 16094 | #12 Wire | 15.50        | 500 box   | 62.32/c                        |

OTHER SIZES AND QUANTITIES AVAILABLE BY REQUEST

# SPECIAL PURPOSE ELECTRICAL FASTENERS



## THREE-IN-ONE TAP THREAD CLEANING TOOL

| PART#  | UPC#  | SIZES             | WT. PER PKG. | STD. PKG. | SUGGESTED TRADE LIST PRICE PER |
|--------|-------|-------------------|--------------|-----------|--------------------------------|
| 681032 | 16345 | 6-32, 8-32, 10-32 | .21          | 1         | 31.61/ea                       |



## GRAY CONICAL PLASTIC WALL ANCHOR KITS

A special use wall anchor kit for hanging raceway. The 10 x 1 flat head phillips sms zinc plated fits flush with metal and will not damage wire

MASTER  
CARTONS  
CONTAIN:  
25 KITS  
18 JARS



| PART#                                  | UPC#      | SIZE | SIZE   | ITEM                      | WT. PER PKG. | QTY. | SUGGESTED TRADE LIST PRICE PER |
|--|-----------|------|--------|---------------------------|--------------|------|--------------------------------|
| <b>ANCHOR KIT DESIGNED FOR RACEWAY</b> |           |      |        |                           |              |      |                                |
| WAK23F                                 | 39182/kit | 1/4  | 1/4    | Gray Ribbed Anchors       | .80          | 100  | 14.44/ea kit                   |
| WAKJ23F                                | 20745/jar |      | 10 x 1 | Flat Head Phillips Screws | .80          | 100  |                                |
|  |           |      | 1/4    | Masonry Drill             |              | 1    |                                |

OTHER SIZES AND QUANTITIES AVAILABLE BY REQUEST



## PAN HEAD TRI-DRIVE TELECOM CABINET SCREWS

STEEL ZINC • BLACK OXIDE

For use in Telecom Cabinets, Relay Racks and Patch Panels

MADE IN USA



Manufactured by  
Avanti Screw, Inc.,  
A Metallics Affiliate

| PART#              | UPC#  | DIAMETER | LENGTH | WT. PER PKG. | STD. PKG./MSTR. SLEEVE | SUGGESTED TRADE LIST PRICE PER |
|--------------------|-------|----------|--------|--------------|------------------------|--------------------------------|
| <b>STEEL ZINC</b>  |       |          |        |              |                        |                                |
| JTEL1032           | 84440 | 10-32    | 5/8    | .64          | 100/500                | 122.33/c                       |
| JTEL103234         | 84442 | 10-32    | 3/4    | .74          | 100/500                | 19.54/c                        |
| JTEL1224           | 84445 | 12-24    | 5/8    | .48          | 50/250                 | 19.54/c                        |
| JTEL1228           | 84450 | 12-28    | 5/8    | .48          | 50/250                 | 19.54/c                        |
| <b>BLACK OXIDE</b> |       |          |        |              |                        |                                |
| TEL1024BLK         | 39250 | 10-24    | 5/8    | .31          | 50                     | 59.47/c                        |
| JTEL1024BLK        | 84444 | 10-24    | 5/8    | .62          | 100/500                | 59.47/c                        |
| TEL1032BLK         | 39260 | 10-32    | 5/8    | .33          | 50                     | 59.47/c                        |
| JTEL1032BLK        | 84441 | 10-32    | 5/8    | .64          | 100/500                | 59.47/c                        |
| TEL1032BLKV        | 39262 | 10-32    | 5/8    | 3.06         | 500                    | 59.47/c                        |
| TEL1224BLK         | 39097 | 12-24    | 5/8    | .48          | 50                     | 11.74/c                        |
| JTEL1224BLK        | 84446 | 12-24    | 5/8    | .85          | 100                    | 23.48/c                        |
| TEL1224BLKV        | 39099 | 12-24    | 5/8    | 4.08         | 500                    | 23.48/c                        |

OTHER SIZES AND QUANTITIES AVAILABLE BY REQUEST

# SPECIAL PURPOSE ELECTRICAL FASTENERS

## CAGE NUTS

STEEL BLACK PHOSPHATE

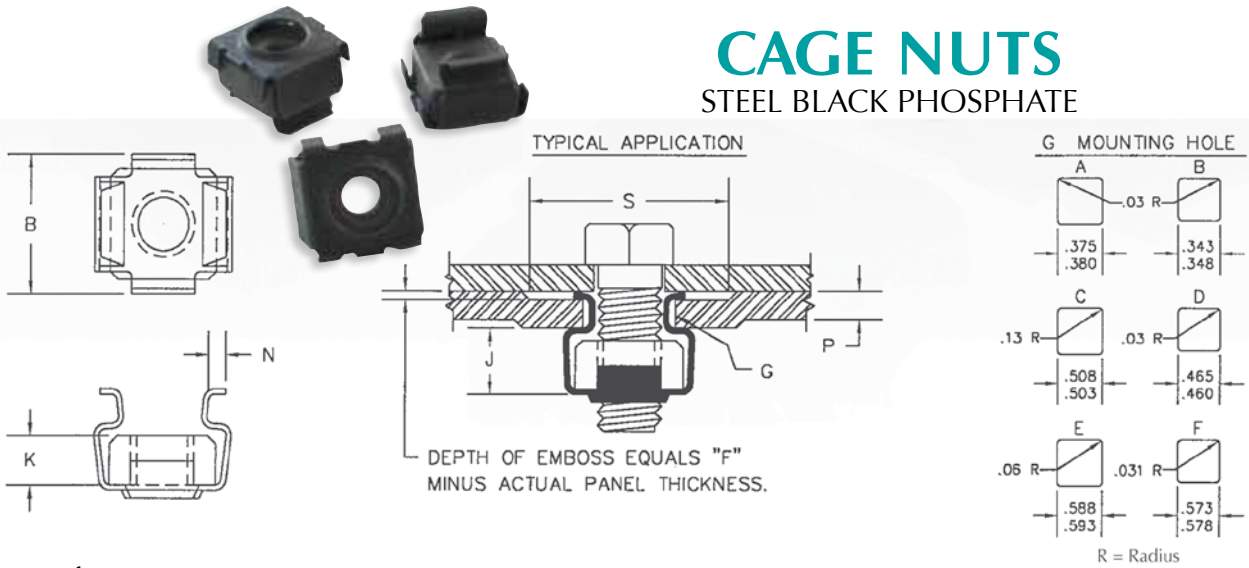

(Spec. Info)

| PART#    | SCREW SIZE | PANEL RANGE P | F   | S     | MNTG. HOLE G | B    | J    | N   | K     |
|----------|------------|---------------|-----|-------|--------------|------|------|-----|-------|
| CNN1024  | 10-24      | .025 - .063   | 0.1 | 0.531 | A or B       | 0.52 | 0.06 | 0.6 | 0.156 |
| CNN1032  | 10-32      | .025 - .063   | 0.1 | 0.531 | A or B       | 0.52 | 0.06 | 0.6 | 0.156 |
| CNN1032M | 10-32      | .025 - .063   | 0.1 | 0.531 | A or B       | 0.52 | 0.06 | 0.6 | 0.156 |
| CNN1224  | 12-24      | .025 - .063   | 0.1 | 0.531 | A or B       | 0.52 | 0.06 | 0.6 | 0.156 |

| PART#    | UPC#  | CAGE NUT SIZE | PANEL RANGE | MOUNTING HOLE          | COATING         | WT. PER PKG. | STD. PKG./MSTR. SLEEVE | SUGGESTED TRADE LIST PRICE PER |
|----------|-------|---------------|-------------|------------------------|-----------------|--------------|------------------------|--------------------------------|
| CNN1024  | 30030 | 10-24         | .025-.063   | .343-.348 or .375-.380 | Black Phosphate | .63          | 50                     | 37.35/c                        |
| CNN1032  | 30025 | 10-32         | .025-.063   | .343-.348 or .375-.380 | Black Phosphate | .54          | 50                     | 34.25/c                        |
| CNN1032M | 85592 | 10-32         | .025-.063   | .343-.348 or .375-.380 | Black Phosphate | 11.26        | 1000                   | 649.32/m                       |
| CNN1224  | 30035 | 12-24         | .025-.063   | .343-.348 or .375-.380 | Black Phosphate | .60          | 50                     | 41.83/c                        |

OTHER SIZES AND QUANTITIES AVAILABLE BY REQUEST  
SOME SIZES AVAILABLE IN STAINLESS STEEL

## CAGE NUT KITS

STEEL BLACK PHOSPHATE

For use in telecom cabinets, relay racks and patch panels



| PART#    | UPC#  | CAGE NUT SIZE | PANEL RANGE | MOUNTING HOLE          | SCREW DIAMETER | SCREW LENGTH | WT. PER PKG. | STD. PKG./MSTR. SLEEVE | SUGGESTED TRADE LIST PRICE PER |
|----------|-------|---------------|-------------|------------------------|----------------|--------------|--------------|------------------------|--------------------------------|
| CNN1024K | 85585 | 10-24         | .025-.063   | .343-.348 or .375-.380 | 10-24          | 5/8          | .96          | 50                     | 58.33/ea kit                   |
| CNN1032K | 85590 | 10-32         | .025-.063   | .343-.348 or .375-.380 | 10-32          | 5/8          | .80          | 50                     | 55.81/ea kit                   |
| CNN1224K | 85595 | 12-24         | .025-.063   | .343-.348 or .375-.380 | 12-24          | 5/8          | .96          | 50                     | 63.71/ea kit                   |

OTHER SIZES AND QUANTITIES AVAILABLE BY REQUEST

# SPECIAL PURPOSE ELECTRICAL FASTENERS



## QUICK FIX GB® SPACERS

POLYETHYLENE

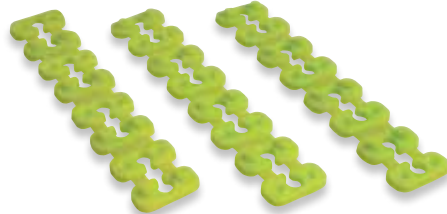
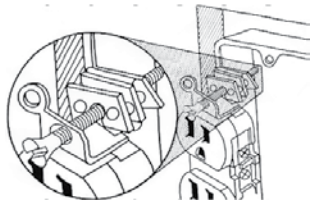

- Stackable spacers for wiring devices
- Fill gaps and bring devices flush with surface
- Supports devices securely to wallbox
- Prevents broken faceplates
- Green color disassociates any notion of an earth-ground connection

| PART#  | UPC#  | WT. PER PKG. | STD. PKG. | SUGGESTED TRADE LIST PRICE PER |
|--------|-------|--------------|-----------|--------------------------------|
| SLSP50 | 71666 | .38          | 50        | 60.00/c                        |



## WIRE TERMINAL KIT

Contains 240 of the most Common Vinyl Insulated Wire Terminals, Plus Crimping Tool in a Plastic Case.

| PART#   | UPC#           | SIZE     | ITEM   | WT. PER PKG. | STD. PKG. | SUGGESTED TRADE LIST PRICE PER |
|---------|----------------|----------|--|--------------|-----------|--------------------------------|
| MWTK1   | 39450          | 22-10 ga | Wire Terminal Crimper                            | 1.60         | 1         | 125.47 /ea kit                 |
|         |                | #22-#18  | Butt Connector                                   |              | 20        |                                |
|         |                | #16-#14  | Butt Connector                                   |              | 20        |                                |
|         |                | #12-#10  | Butt Connector                                   |              | 20        |                                |
|         |                | #12-#10  | Ring Connector #8 Stud                           |              | 10        |                                |
|         |                | #12-#10  | Ring Connector #10 Stud                          |              | 10        |                                |
|         |                | #12-#10  | Ring Connector <sup>5</sup> / <sub>16</sub> Stud |              | 10        |                                |
|         |                | #12-#10  | Ring Connector <sup>3</sup> / <sub>8</sub> Stud  |              | 10        |                                |
|         |                | #16-#14  | Ring Connector #6 Stud                           |              | 10        |                                |
|         |                | #16-#14  | Ring Connector #10 Stud                          |              | 10        |                                |
|         |                | #22-#18  | Ring Connector #6 Stud                           |              | 10        |                                |
|         |                | #22-#18  | Ring Connector #10 Stud                          |              | 10        |                                |
|         |                | #12-#10  | Spade Connector #6 Stud                          |              | 10        |                                |
|         |                | #12-#10  | Spade Connector #10 Stud                         |              | 10        |                                |
|         |                | #16-#14  | Spade Connector #6 Stud                          |              | 10        |                                |
|         |                | #16-#14  | Spade Connector #10 Stud                         |              | 10        |                                |
|         |                | #22-#18  | Spade Connector #6 Stud                          |              | 10        |                                |
|         |                | #22-#18  | Spade Connector #10 Stud                         |              | 10        |                                |
|         |                | #16-#14  | 250 QDC Male                                     |              | 10        |                                |
|         |                | #16-#14  | 250 QDC Female                                   |              | 10        |                                |
| #22-#18 | 250 QDC Male   | 10       |  |              |           |                                |
| #22-#18 | 250 QDC Female | 10       |  |              |           |                                |

OTHER SIZES, MATERIALS AND QUANTITIES AVAILABLE BY REQUEST

*If you can't find the fastener you are looking for, call and experience the Metallics difference.*

**?<sup>s</sup> Call Us.**  
**1-800-243-8272**



# SPECIAL PURPOSE ELECTRICAL FASTENERS

## WIRE TERMINALS

The most commonly Vinyl Insulated Terminals...  
Rings, Spades, Disconnects, and Butt Connectors.



| PART#      | UPC#  | SIZE     | ITEM   | WT. PER PKG. | STD. PKG. | SUGGESTED TRADE LIST PRICE PER |
|------------|-------|----------|--|--------------|-----------|--------------------------------|
| MWTC1      | 39452 | 22-10 ga | Wire Terminal Crimper                            | .40          | 1         | 24.19/ea                       |
| MWBC2218   | 39458 | #22-#18  | Butt Connector                                   | .24          | 100       | 21.26/c                        |
| MWBC1614   | 39461 | #16-#14  | Butt Connector                                   | .32          | 100       | 24.04/c                        |
| MWBC1210   | 39464 | #12-#10  | Butt Connector                                   | .56          | 100       | 31.96/c                        |
| MWRC12108  | 40113 | #12-#10  | Ring Connector #8 Stud                           | .43          | 100       | 34.36/c                        |
| MWRC121010 | 40114 | #12-#10  | Ring Connector #10 Stud                          | .42          | 100       | 31.92/c                        |
| MWRC121056 | 40116 | #12-#10  | Ring Connector <sup>5</sup> / <sub>16</sub> Stud | .53          | 100       | 42.56/c                        |
| MWRC121038 | 40117 | #12-#10  | Ring Connector <sup>3</sup> / <sub>8</sub> Stud  | .53          | 100       | 47.53/c                        |
| MWRC16146  | 40106 | #16-#14  | Ring Connector #6 Stud                           | .24          | 100       | 24.24/c                        |
| MWRC161410 | 40108 | #16-#14  | Ring Connector #10 Stud                          | .24          | 100       | 24.82/c                        |
| MWRC22186  | 40100 | #22-#18  | Ring Connector #6 Stud                           | .15          | 100       | 21.06/c                        |
| MWRC221810 | 40102 | #22-#18  | Ring Connector #10 Stud                          | .42          | 100       | 31.92/c                        |
| MWSC12106  | 40134 | #12-#10  | Spade Connector #6 Stud                          | .42          | 100       | 30.07/c                        |
| MWSC121010 | 40136 | #12-#10  | Spade Connector #10 Stud                         | .42          | 100       | 30.07/c                        |
| MWSC16146  | 40128 | #16-#14  | Spade Connector #6 Stud                          | .26          | 100       | 27.16/c                        |
| MWSC161410 | 40130 | #16-#14  | Spade Connector #10 Stud                         | .25          | 100       | 27.16/c                        |
| MWSC22186  | 40122 | #22-#18  | Spade Connector #6 Stud                          | .20          | 100       | 24.94/c                        |
| MWSC221810 | 40124 | #22-#18  | Spade Connector #10 Stud                         | .20          | 100       | 24.94/c                        |
| MQDC1614M  | 39470 | #16-#14  | 250QDC Male                                      | .25          | 100       | 26.71/c                        |
| MQDC1614F  | 39483 | #16-#14  | 250QDC Female                                    | .18          | 100       | 25.64/c                        |
| MQDC2218M  | 39469 | #22-#18  | 250QDC Male                                      | .22          | 100       | 26.71/c                        |
| MQDC2218F  | 39481 | #22-#18  | 250QDC Female                                    | .16          | 100       | 25.64/c                        |

OTHER SIZES AND QUANTITIES AVAILABLE BY REQUEST

Our persistence and determination to ship the same day and maintain the highest fill rate in America among fastener suppliers to the distributor market is not by accident. In all our management offices, this quotation is displayed:

*Nothing in the world can take the place of persistence. Talent will not; nothing is more common than unsuccessful men with talent. Genius will not; unrewarded genius is almost a proverb. Education will not; the world is full of educated derelicts. Persistence and determination alone are omnipotent.*

— Calvin Coolidge

***The secret is out: "Our motivation starts at the top."***

# SPECIAL PURPOSE ELECTRICAL FASTENERS

## OVAL HEAD SLOTTED WALL PLATE SCREWS

STEEL ZINC • 18-8 STAINLESS

Plated and painted. Packaged in visual plastic hanging box



| PART#                 | UPC#  | SIZE | LENGTH | COLOR           | WT. PER PKG. | STD. PKG. MSTR. SLEEVE | SUGGESTED TRADE LIST PRICE PER |
|-----------------------|-------|------|--------|-----------------|--------------|------------------------|--------------------------------|
| <b>STEEL ZINC</b>     |       |      |        |                 |              |                        |                                |
| SP382                 | 10323 | 6-32 | 7/32   | Brown           | .21          | 100/500                | 19.99/c                        |
| SP380                 | 10321 | 6-32 | 7/32   | Ivory           | .21          | 100/500                | 19.99/c                        |
| SP379                 | 10320 | 6-32 | 7/32   | White           | .21          | 100/500                | 19.99/c                        |
| SP175                 | 16306 | 6-32 | 1/2    | Antique Copper  | .27          | 100/500                | 5.10/c                         |
| SP176                 | 16305 | 6-32 | 1/2    | Brass Plate     | .26          | 100/500                | 11.52/c                        |
| SP177                 | 16310 | 6-32 | 1/2    | Nickel Plate    | .29          | 100/500                | 10.72/c                        |
| SP178                 | 16315 | 6-32 | 1/2    | Antique Black   | .26          | 100/500                | 9.89/c                         |
| SP178B                | 16316 | 6-32 | 1/2    | Antique Black   | 2.07         | 1000                   | 75.54/m                        |
| SP179                 | 16320 | 6-32 | 1/2    | White           | .28          | 100/500                | 9.89/c                         |
| SP180                 | 16325 | 6-32 | 1/2    | Ivory           | .29          | 100/500                | 9.89/c                         |
| SP173                 | 16300 | 6-32 | 1/2    | Almond          | .30          | 100/500                | 9.89/c                         |
| SP181                 | 16330 | 6-32 | 1/2    | Gray            | .28          | 100/500                | 7.86/c                         |
| SP182                 | 16335 | 6-32 | 3/4    | Brown           | .28          | 100/500                | 4.51/c                         |
| SP190                 | 16303 | 6-32 | 3/4    | White           | .35          | 100/500                | 12.33/c                        |
| SP191                 | 16304 | 6-32 | 3/4    | Ivory           | .36          | 100/500                | 12.33/c                        |
| SP279                 | 16301 | 6-32 | 1      | White           | .43          | 100/500                | 12.66/c                        |
| SP280                 | 16302 | 6-32 | 1      | Ivory           | .43          | 100/500                | 12.66/c                        |
| SP184                 | 16338 | 6-32 | 1      | Black           | .43          | 100/500                | 12.66/c                        |
| SP281                 | 16411 | 6-32 | 2      | Ivory           | .72          | 100/500                | 15.52/c                        |
| SP282                 | 16412 | 6-32 | 2      | White           | .72          | 100/500                | 15.52/c                        |
| <b>18-8 STAINLESS</b> |       |      |        |                 |              |                        |                                |
| SP170                 | 16406 | 6-32 | 1/2    | Stainless Steel | .29          | 100/500                | 12.63/c                        |
| SP283                 | 16413 | 6-32 | 1      | Stainless Steel | .40          | 100/500                | 16.66/c                        |
| SP172                 | 16307 | 6-32 | 1 1/4  | Stainless Steel | .44          | 100/500                | 20.79/c                        |
| SP284                 | 16312 | 6-32 | 1 1/2  | Stainless Steel | .49          | 100/500                | 16.42/c                        |

OTHER SIZES AND QUANTITIES AVAILABLE BY REQUEST

## SWITCH PLATE SCREW KITS

A convenient assortment of switch plate screws in the most popular colors and finishes plated and painted

### 275 PIECE RENOVATION KIT SPK100 CONTAINS:

50 6-32 x 1/2 Black, 50 Nickel, 50 Almond, 50 Ivory, 50 White  
25 6-32 x 1 1/4 Flat Head Slot Switch Plate Screw, Zinc Plated

### 500 PIECE NEW CONSTRUCTION SPK101 CONTAINS:

100 each 6-32 x 1/2 Ivory, White, Stainless  
75 each 6-32 x 1 Ivory, White  
50 6-32 x 1 1/4 Flat Head Slot Switch Plate Screw, Zinc Plated

### 600 PIECE NEW CONSTRUCTION SPK102 CONTAINS:

100 each 6-32 x 7/32, 6-32 x 1/2, 6-32 x 3/4, 6-32 x 1, 6-32 x 1 1/4, 6-32 x 2 Ivory, White, Stainless  
75 each 6-32 x 1 Ivory, White  
50 6-32 x 1 1/4 Flat Head Slot Switch Plate Screw, Zinc Plated



MASTER  
CARTONS  
CONTAIN:  
25 KITS  
18 JARS

| PART#                   | UPC#  | DIAMETER | LENGTH                      | STYLE     | WT. PER PKG. | SUGGESTED TRADE LIST PRICE PER |  |
|-------------------------|-------|----------|-----------------------------|-----------|--------------|--------------------------------|--|
| SPK100                  | 16400 | 6-32     | 1/2, 1 1/4                  | Oval Head | 1.84         | 24.73/ea kit                   |  |
| <b>RENOVATION</b>       |       |          |                             |           |              |                                |  |
| SPK101                  | 16401 | 6-32     | 1/2, 1, 1 1/4               | Oval Head | 1.60         | 47.01/ea kit                   |  |
| <b>NEW CONSTRUCTION</b> |       |          |                             |           |              |                                |  |
| SPK102                  | 16402 | 6-32     | 7/32, 1/2, 3/4, 1, 1 1/4, 2 | Oval Head | 1.89         | 28.20/ea kit                   |  |
| <b>NEW CONSTRUCTION</b> |       |          |                             |           |              |                                |  |

OTHER SIZES AND QUANTITIES AVAILABLE BY REQUEST

# SPECIAL PURPOSE ELECTRICAL FASTENERS



## OVAL/FLAT HEAD SLOTTED NYLON SWITCH PLATE SCREWS

| PART#  | UPC#  | DIAMETER | LENGTH | WT.<br>PER PKG. | STD. PKG./<br>MSTR SLEEVE | SUGGESTED TRADE<br>LIST PRICE PER |
|--------|-------|----------|--------|-----------------|---------------------------|-----------------------------------|
| SPN300 | 16350 | 6-32     | 1/2    | .11             | 100/500                   | 10.82/c                           |
| JFMN68 | 74568 | 6-32     | 1 1/4  | .12             | 100/500                   | 36.12/c                           |

OTHER SIZES AND QUANTITIES AVAILABLE BY REQUEST



## UNDERCUT OVAL HEAD SLOTTED DECORATIVE SWITCH PLATE SCREWS

STEEL ZINC • PAINTED

For wall plates not accepting standard 1/2" switch plate screws

| PART#  | UPC#  | SIZE | LENGTH | COLOR  | WT.<br>PER PKG. | STD. PKG./<br>MSTR SLEEVE | SUGGESTED TRADE<br>LIST PRICE PER |
|--------|-------|------|--------|--------|-----------------|---------------------------|-----------------------------------|
| SPD379 | 16321 | 6-32 | 1/4    | White  | .14             | 50                        | 8.56/c                            |
| SPD380 | 16326 | 6-32 | 1/4    | Ivory  | .14             | 50                        | 8.56/c                            |
| SPD382 | 16336 | 6-32 | 1/4    | Almond | .14             | 50                        | 9.02/c                            |
| SPD383 | 16341 | 6-32 | 1/4    | Gray   | .14             | 50                        | 9.02/c                            |
| SPD381 | 16327 | 6-32 | 1/4    | Brown  | .14             | 50                        | 20.16/c                           |
| SPD384 | 16342 | 6-32 | 1      | White  | .25             | 50                        | 11.20/c                           |
| SPD385 | 16343 | 6-32 | 1      | Ivory  | .26             | 50                        | 11.20/c                           |

OTHER SIZES AND QUANTITIES AVAILABLE BY REQUEST

## UNDERCUT OVAL HEAD SLOTTED DECORATIVE SWITCH PLATE SCREW KIT

STEEL ZINC • PAINTED



A convenient assortment of popular colors for wall plates not accepting standard 1/2" switch plate screws

**250 PIECE SPDK200 KIT CONTAINS:**

6-32 x 1/4 - 50 White, 50 Ivory, 50 Almond, 50 Gray  
**PLUS** 6-32 x 1 - 25 White, 25 Ivory

| PART#   | UPC#  | DIAMETER | LENGTH  | STYLE   | WT.<br>PER PKG. | STD. PKG./<br>MSTR SLEEVE | SUGGESTED TRADE<br>LIST PRICE PER |
|---------|-------|----------|---------|---|-----------------|---------------------------|-----------------------------------|
| SPDK200 | 16405 | 6-32     | 1/4 & 1 | Assorted Steel Slotted, Undercut, Oval Head Switch Plate Screws | .68             | 1/25 kits                 | 25.50/ea kit                      |

OTHER SIZES AND QUANTITIES AVAILABLE BY REQUEST



## TAMPER-RESIST SPANNER OVAL HEAD SWITCH PLATE SCREWS

18-8 STAINLESS



Spanner

| PART#   | UPC#  | DIAMETER | LENGTH | WT. PER<br>PKG. | STD. PKG./<br>MSTR. SLEEVE | SUGGESTED TRADE<br>LIST PRICE PER |
|---------|-------|----------|--------|-----------------|----------------------------|-----------------------------------|
| SPT201  | 10279 | 6-32     | 1/4    | .17             | 50                         | 210.17/c                          |
| SPT200  | 16355 | 6-32     | 1/2    | .19             | 50                         | 87.83/c                           |
| SPT300  | 10270 | 6-32     | 1      | .27             | 50                         | 89.91/c                           |
| SPT400  | 10275 | 6-32     | 1 1/2  | .35             | 50                         | 121.65/c                          |
| SPT812  | 16362 | 8-32     | 1 1/4  | .68             | 50                         | 242.54/c                          |
| SPT820* | 16367 | 10-24    | 3/4    | .64             | 100                        | 129.33/c                          |

\*PAN HEAD.

COMES COMPLETE WITH 00SP6B SPANNER INSERT DRIVER. OTHER SIZES AND QUANTITIES AVAILABLE BY REQUEST

# SPECIAL PURPOSE ELECTRICAL FASTENERS

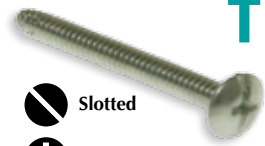

## TRUSS HEAD COMBO RECEPTACLE AND WIRING DEVICE SCREWS

SLOTTED/PHILLIPS  
HARDENED TYPE F - STEEL ZINC

| PART# | UPC#  | DIAMETER | LENGTH | WT. PER PKG. | STD. PKG./MSTR. SLEEVE | SUGGESTED TRADE LIST PRICE PER |
|-------|-------|----------|--------|--------------|------------------------|--------------------------------|
| TM80  | 43138 | 6-32     | 1/2    | .26          | 100                    | 6.76/c                         |
| TM81  | 43141 | 6-32     | 3/4    | .37          | 100                    | 6.06/c                         |
| JTM81 | 84781 | 6-32     | 3/4    | .36          | 100                    | 6.98/c                         |
| TM63  | 43144 | 6-32     | 1      | .44          | 100                    | 7.05/c                         |
| JTM63 | 84763 | 6-32     | 1      | .42          | 100                    | 7.05/c                         |
| TM63M | 43152 | 6-32     | 1      | 3.86         | 1000                   | 60.00/m                        |
| TM68  | 43147 | 6-32     | 1 1/4  | .52          | 100                    | 9.16/c                         |
| TM82  | 43150 | 6-32     | 1 1/2  | .62          | 100                    | 8.66/c                         |
| JTM82 | 84782 | 6-32     | 1 1/2  | .58          | 100                    | 9.95/c                         |
| TM83  | 43153 | 6-32     | 2      | .79          | 100                    | 12.83/c                        |
| JTM83 | 84783 | 6-32     | 2      | .74          | 100                    | 12.83/c                        |

OTHER SIZES AND QUANTITIES AVAILABLE BY REQUEST. JAR PACKAGING ALSO AVAILABLE

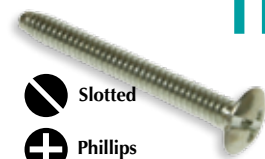

## TRUSS HEAD COMBO RECEPTACLE AND WIRING DEVICE SCREWS

SLOTTED/PHILLIPS  
LEAD POINT - STEEL ZINC

MADE IN USA



Manufactured by  
Avanti Screw, Inc.,  
A Metallics Affiliate

| PART#    | UPC#  | SIZE | SIZE  | WT. PER PKG. | STD. PKG./MSTR. SLEEVE | SUGGESTED TRADE LIST PRICE PER |
|----------|-------|------|-------|--------------|------------------------|--------------------------------|
| TM80LP   | 43154 | 6-32 | 1/2   | .28          | 100                    | 6.11/c                         |
| TM81LP   | 43155 | 6-32 | 3/4   | .38          | 100                    | 6.25/c                         |
| TM81LP4M | 41801 | 6-32 | 3/4   | 12.16        | 4000                   | 46.25/m                        |
| TM81LPB  | 41781 | 6-32 | 3/4   | 34.20        | 9000                   | 44.86/m                        |
| TM63LP   | 43156 | 6-32 | 1     | .44          | 100                    | 6.29/c                         |
| TM68LP   | 43157 | 6-32 | 1 1/4 | .52          | 100                    | 8.23/c                         |
| TM82LP   | 43158 | 6-32 | 1 1/2 | .59          | 100                    | 8.95/c                         |
| TM83LP   | 43159 | 6-32 | 2     | .72          | 100                    | 11.54/c                        |

OTHER SIZES AND QUANTITIES AVAILABLE BY REQUEST. JAR PACKAGING ALSO AVAILABLE

An American Made Alternative To the Blue Concrete Screw – See Page 138.



### QUADRIVE CONCRETE SCREW ANCHORS

- ← Large fillet under head to fit 3/16" and 1/4" holes provides greater driving strength
- ← Fluted, interrupted threads aid tapping into masonry products
- ← Hilo threads for faster application
- ← Silver color to match conduit, strap and concrete

STOP THE SNAPPING

**The QuaDrive**



Square Drive + Hex + Slotted + Phillips = QuaDrive  
America's Newest Drive – Designed, Developed and Manufactured Only By Metallics/Avanti Screw

MADE IN USA  
Made by Avanti Screw, Inc., A Metallics Affiliate

We will be glad to send a sample bag of 10 pieces to our Distributors for their customer trials. **Please specify size!**

**Metallics Inc. • 800-243-8272 • sales@metallics.us**

# SPECIAL PURPOSE ELECTRICAL FASTENERS

## INSULATING FOAM GASKETS



- Energy saving gaskets prevent heat and cold loss through outlets and switches located on outside walls.
- Constructed of UL Rated, close-cell polyethylene insulating foam.
- Available in three different designs: Toggle Switch, Duplex Receptacle & GFI or Decora



| PART#   | UPC#  | ITEM              | WT. PER EACH | STD. PKG. | SUGGESTED TRADE LIST PRICE PER |
|---------|-------|-------------------|--------------|-----------|--------------------------------|
| WGT25   | 71651 | Toggle Switch     | .14          | 25        | 32.84/c                        |
| WGR25   | 71652 | Duplex Receptacle | .14          | 25        | 32.84/c                        |
| WGD25   | 71653 | GFI/Decora        | .14          | 25        | 32.84/c                        |
| WGT100  | 71654 | Toggle Switch     | .48          | 100       | 29.45/c                        |
| WGR100  | 71655 | Duplex Receptacle | .48          | 100       | 29.40/c                        |
| WGD100  | 71656 | GFI/Decora        | .48          | 100       | 29.40/c                        |
| WGC100* | 71657 | Combo Pack        | .48          | 100       | 29.40/c                        |

\*CONTAINS: 30 TOGGLE, 30 DUPLEX, 40 DECORA  
OTHER SIZES AND QUANTITIES AVAILABLE BY REQUEST



## CONDUIT DRIVE STRAPS

STEEL ZINC ROUND TYPE



| PART#   | UPC#  | SIZE EMT  | SIZE PIPE & FLEX. COND. | SIZE OVERALL LENGTH | WT. PER PKG. | STD. PKG. | SUGGESTED TRADE LIST PRICE PER |
|---|-------|-----------|-------------------------|---------------------|--------------|-----------|--------------------------------|
| For use in metal and plastic conduit and tubing |       |           |                         |                     |              |           |                                |
| CDS1  | 21200 | 3/8 - 1/2 | 3/8                     | 2                   | 1.93         | 100       | 27.60/c                        |
| CDS2  | 21205 | 3/4       | 1/2                     | 2 1/4               | 2.23         | 100       | 31.33/c                        |
| CDS3  | 21210 | 1         | 3/4                     | 2 1/4               | 2.37         | 100       | 35.71/c                        |

OTHER SIZES AND QUANTITIES AVAILABLE BY REQUEST



## CONDUIT DRIVE STRAPS

STEEL COPPER PLATED ROUND TYPE



| PART#   | UPC#  | SIZE COPPER TUBE | SIZE COPPER PIPE | SIZE OVERALL LENGTH | WT. PER PKG. | STD. PKG. | SUGGESTED TRADE LIST PRICE PER |
|---|-------|------------------|------------------|---------------------|--------------|-----------|--------------------------------|
| For use in areas requiring copper pipe and tubing |       |                  |                  |                     |              |           |                                |
| CDS5  | 21300 | 1/2              | 3/8 - 1/2        | 2                   | 1.87         | 100       | 25.53/c                        |
| CDS6  | 21305 | 3/4              | 3/4              | 2 1/4               | 2.50         | 100       | 27.38/c                        |

OTHER SIZES AND QUANTITIES AVAILABLE BY REQUEST

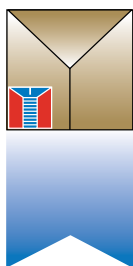

## METALLICS

AMERICA'S SOURCE FOR PREMIER AND INNOVATIVE FASTENERS & ANCHORS

# SPECIAL PURPOSE ELECTRICAL FASTENERS



## CONDUIT DRIVE STRAPS

STAMPED GALVANIZED



| PART# | UPC#  | SIZE<br>COPPER PIPE | SIZE | WT. PER<br>PKG. | STD. PKG. | SUGGESTED TRADE<br>LIST PRICE PER |
|-------|-------|---------------------|------|-----------------|-----------|-----------------------------------|
| SDS10 | 21215 | 3/8-1/2             | 3/8  | 1.70            | 100       | 23.96/c                           |
| SDS20 | 21220 | 3/4                 | 1/2  | 2.13            | 100       | 27.20/c                           |
| SDS30 | 21225 | 1                   | 3/4  | 2.29            | 100       | 29.04/c                           |

OTHER SIZES AND QUANTITIES AVAILABLE BY REQUEST



## PLUMBERS TAPE PERFORATED

STEEL GALVANIZED

| PART# | UPC#  | GAUGE | WIDTH | WT. PER<br>PKG. | STD. PKG.               | SUGGESTED TRADE<br>LIST PRICE PER |
|-------|-------|-------|-------|-----------------|-------------------------|-----------------------------------|
| HR750 | 22550 | 20    | 3/4   | 7.80            | 10 rolls of 10'/per pkg | 42.65/ea                          |
| HR770 | 22553 | 24    | 3/4   | 4.31            | 10 rolls of 10'/per pkg | 41.72/ea                          |

COPPER AVAILABLE UPON REQUEST

OTHER SIZES AND QUANTITIES AVAILABLE BY REQUEST

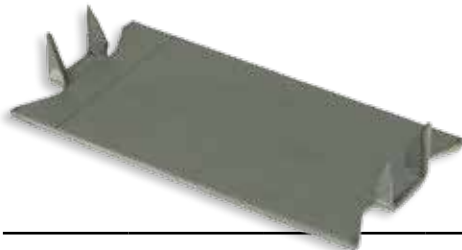

## NAIL PLATES

STEEL

For Romex, BX, UF, S.E.V. and other Cables



| PART#   | UPC#  | LENGTH | WIDTH | GAUGE | WT. PER<br>PKG. | STD. PKG. | SUGGESTED TRADE<br>LIST PRICE PER |
|---------|-------|--------|-------|-------|-----------------|-----------|-----------------------------------|
| *NP400  | 16500 | 2 3/4  | 1 1/2 | 16    | 6.23            | 100       | 25.42/c                           |
| *NP400B | 16515 | 2 3/4  | 1 1/2 | 16    | 33.90           | 500       | 24.66/c                           |
| *NP401  | 16517 | 3      | 1 1/2 | 18    | 15.00           | 250       | 18.90/c                           |
| *NP660  | 16599 | 5      | 1 1/2 | 16    | 7.00            | 100       | 37.70/c                           |
| *NP600  | 16503 | 5      | 1 1/2 | 20    | 7.69            | 100       | 37.69/c                           |
| *NP800  | 16504 | 5      | 3     | 16    | 24.25           | 100       | 65.16/c                           |

\*DIMENSIONS ON ALL NAIL PLATES/STRAPS ARE APPROXIMATE

OTHER SIZES, GAUGES AND QUANTITIES AVAILABLE BY REQUEST



NPL12



NP580

## PLATE STRAPS

STEEL



| PART#   | UPC#  | WIDTH | LENGTH | HOLE | GAUGE | WT. PER<br>PKG. | STD. PKG. | SUGGESTED TRADE<br>LIST PRICE PER |
|---------|-------|-------|--------|------|-------|-----------------|-----------|-----------------------------------|
| *NS1812 | 22548 | 1 1/2 | 18     | 8    | 12    | 16.15           | 25        | 186.56/c                          |
| *NS1816 | 22549 | 1 1/2 | 18     | 8    | 16    | 45.45           | 100       | 139.00/c                          |
| *NPL12  | 12194 | 1 1/2 | 12     | 8    | 18    | 24.19           | 50        | 137.34/c                          |
| *NS2412 | 22565 | 1 1/2 | 24     | 8    | 12    | 21.00           | 25        | 245.04/c                          |
| *NS2416 | 22567 | 1 1/2 | 24     | 8    | 16    | 27.00           | 50        | 222.60/c                          |
| *NS2418 | 22568 | 1 1/2 | 24     | 8    | 18    | 21.00           | 50        | 198.68/c                          |
| *NP580  | 16520 | 5     | 8      | 5    | 16    | 32.00           | 50        | 377.80/c                          |
| *NPL188 | 16480 | 5     | 18     | 5    | 16    | 39.19           | 25        | 756.88/c                          |

OTHER SIZES, GAUGES, AND QUANTITIES AVAILABLE BY REQUEST. \*DIMENSIONS ON ALL NAIL PLATES/STRAPS ARE APPROXIMATE



# SPECIAL PURPOSE ELECTRICAL FASTENERS



SB300

## BOX SUPPORTS

STEEL  
ELECTRO-GALVANIZED



SBL300

2 1/2"

| PART#  | UPC#  | WT. PER PKG. | STD. PKG.                  | SUGGESTED TRADE LIST PRICE PER |
|--------|-------|--------------|----------------------------|--------------------------------|
| SB300  | 16200 | 5.29         | 100 pairs/200 pieces total | 64.33/c                        |
| SBL300 | 15577 | 6.00         | 100 pairs/200 pieces total | 301.88/c                       |

OTHER SIZES AND QUANTITIES AVAILABLE BY REQUEST



100KOS

Size Is Stamped On Seal

## KNOCK-OUT SEALS

STEEL ZINC

The ultimate in high quality safety

3-Piece Quick-Seal to plug holes in panel boxes



150KOSG



| PART#  | UPC#  | SIZE  | PC. K/O SEAL | WT. PER PKG. | STD. PKG. | SUGGESTED TRADE LIST PRICE PER |
|--------|-------|-------|--------------|--------------|-----------|--------------------------------|
| 50KOS  | 41301 | 1/2   | 3            | .25          | 10        | 199.40/c                       |
| 75KOS  | 41302 | 3/4   | 3            | .33          | 10        | 268.20/c                       |
| 100KOS | 41303 | 1     | 3            | .47          | 10        | 272.40/c                       |
| 125KOS | 41304 | 1 1/4 | 3            | .74          | 10        | 294.00/c                       |
| 150KOS | 41306 | 1 1/2 | 3            | .95          | 10        | 372.00/c                       |
| 200KOS | 41307 | 2     | 3            | 1.38         | 10        | 514.90/c                       |
| 250KOS | 41308 | 2 1/2 | 3            | 2.10         | 10        | 891.00/c                       |
| 300KOS | 41309 | 3     | 3            | 1.50         | 5         | 1133.40/c                      |
| 350KOS | 41311 | 3 1/2 | 3            | 1.93         | 5         | 1599.20/c                      |
| 400KOS | 41312 | 4     | 3            | 2.74         | 5         | 1833.40/c                      |

### GASKETED

|         |       |       |   |      |    |           |
|---------|-------|-------|---|------|----|-----------|
| 50KOSG  | 41650 | 1/2   | 4 | .30  | 10 | 259.30/c  |
| 75KOSG  | 41651 | 3/4   | 4 | .36  | 10 | 366.80/c  |
| 100KOSG | 41652 | 1     | 4 | .45  | 10 | 396.40/c  |
| 125KOSG | 41653 | 1 1/4 | 4 | .78  | 10 | 444.40/c  |
| 150KOSG | 41654 | 1 1/2 | 4 | 1.02 | 10 | 505.60/c  |
| 200KOSG | 41655 | 2     | 4 | 1.62 | 10 | 738.60/c  |
| 250KOSG | 41658 | 2 1/2 | 4 | 2.10 | 10 | 1251.90/c |
| 300KOSG | 41660 | 3     | 4 | 1.74 | 5  | 1600.40/c |
| 400KOSG | 41317 | 4     | 4 | 2.94 | 5  | 2025.40/c |

OTHER SIZES AND QUANTITIES AVAILABLE BY REQUEST



## GALVANIZED NAIL-ON DRIVE RINGS

STEEL ZINC

| PART#  | UPC#  | EYE SIZE | WT. PER PKG. | STD. PKG. | SUGGESTED TRADE LIST PRICE PER |
|--------|-------|----------|--------------|-----------|--------------------------------|
| MDR12  | 81549 | 1/2      | .14          | 10        | 34.50/c                        |
| MDR58  | 81551 | 5/8      | .14          | 10        | 43.50/c                        |
| MDR78  | 81553 | 7/8      | .53          | 10        | 78.00/c                        |
| MDR114 | 81555 | 1 1/4    | .78          | 10        | 103.70/c                       |

OTHER SIZES AND QUANTITIES AVAILABLE BY REQUEST

# SPECIAL PURPOSE ELECTRICAL FASTENERS



MBR125

## BRIDLE RINGS

STEEL ZINC



MBR150WS

| PART#                       | UPC#  | EYE SIZE | THREAD SIZE | WT. PER PKG. | STD. PKG. | SUGGESTED TRADE LIST PRICE PER |
|-----------------------------|-------|----------|-------------|--------------|-----------|--------------------------------|
| <b>MACHINE SCREW THREAD</b> |       |          |             |              |           |                                |
| MBR125                      | 81557 | 1¼       | ¼ -20       | .72          | 10        | 173.30/c                       |
| MBR150                      | 81559 | 1½       | ¼ -20       | .81          | 10        | 173.30/c                       |
| MBR200                      | 81561 | 2        | ¼ -20       | .97          | 10        | 173.30/c                       |
| <b>WOOD SCREW THREAD</b>    |       |          |             |              |           |                                |
| MBR100WS                    | 81560 | 1        | .230        | .58          | 10        | 86.50/c                        |
| MBR150WS                    | 81563 | 1½       | .230        | .79          | 10        | 251.20/c                       |
| MBR200WS                    | 81565 | 2        | .230        | .98          | 10        | 251.20/c                       |

OTHER SIZES AND QUANTITIES AVAILABLE BY REQUEST

## CONTRACTOR NAIL APRON

- Natural Canvas with 2 Large Pockets
- Large Pockets for Tools or Fasteners
- One Small Pocket for Pen or Pencil



| PART# | UPC#  | POCKETS | WT. PER PKG. | STD. PKG. | SUGGESTED TRADE LIST PRICE PER |
|-------|-------|---------|--------------|-----------|--------------------------------|
| NAP1  | 71740 | 2       | .22          | 1         | 8.05/ea                        |

OTHER SIZES AND QUANTITIES AVAILABLE BY REQUEST



MN20D50

## BRIGHT COMMON NAILS

STEEL

20D and 30D packaged in 50 lb. cartons



MN30D50

| PART#   | UPC#  | SIZE | WT. PER PKG. | STD. PKG. | SUGGESTED TRADE LIST PRICE PER |
|---------|-------|------|--------------|-----------|--------------------------------|
| MN20D50 | 21320 | 20D  | 50.00        | 1100      | 162.40/c                       |
| MN30D50 | 21330 | 30D  | 50.00        | 1450      | 181.89/c                       |



## BRIGHT COMMON NAILS

STEEL

For all types of rough-in wood construction

| PART# | UPC#  | SIZE | WT. PER PKG. | APPROX. COUNT | STD. PKG. | SUGGESTED TRADE LIST PRICE PER |
|-------|-------|------|--------------|---------------|-----------|--------------------------------|
| MN8C  | 21226 | 8D   | 2.63         | 220           | 1 Jar     | 9.81/ea                        |
| MN10C | 21227 | 10D  | 2.63         | 170           | 1 Jar     | 9.81/ea                        |
| MN12C | 21340 | 12D  | 2.53         | 158           | 1 Jar     | 4.73/ea                        |
| MN16C | 21228 | 16D  | 2.64         | 115           | 1 Jar     | 9.81/ea                        |

OTHER SIZES AND QUANTITIES AVAILABLE BY REQUEST



# SPECIAL PURPOSE ELECTRICAL FASTENERS

## BRIGHT FINISH NAILS

STEEL

*For interior and exterior wood finishes*



| PART# | UPC#  | SIZE | WT. PER PKG. | APPROX. COUNT | STD. PKG. | SUGGESTED TRADE LIST PRICE PER |
|-------|-------|------|--------------|---------------|-----------|--------------------------------|
| MN4F  | 21229 | 4D   | 2.61         | 1350          | 1 Jar     | 11.92/ea                       |
| MN6F  | 21230 | 6D   | 2.62         | 1390          | 1 Jar     | 10.82/ea                       |

OTHER SIZES AND QUANTITIES AVAILABLE BY REQUEST

## HOT GALVANIZED BOX NAILS

STEEL

*For exterior areas affected by water and humidity*



| PART#  | UPC#  | SIZE | WT. PER PKG. | APPROX. COUNT | STD. PKG. | SUGGESTED TRADE LIST PRICE PER |
|--------|-------|------|--------------|---------------|-----------|--------------------------------|
| MN6HG  | 21231 | 6D   | 2.62         | 450           | 1 Jar     | 12.70/ea                       |
| MN8HG  | 21232 | 8D   | 2.63         | 290           | 1 Jar     | 12.70/ea                       |
| MN10HG | 21233 | 10D  | 2.66         | 190           | 1 Jar     | 12.45/ea                       |
| MN16HG | 21234 | 16D  | 2.64         | 135           | 1 Jar     | 12.70/ea                       |

OTHER SIZES AND QUANTITIES AVAILABLE BY REQUEST

## GALVANIZED ROOFING BOX NAILS

STEEL



| PART#      | UPC#  | SIZE | WT. PER PKG. | APPROX. COUNT | STD. PKG.  | SUGGESTED TRADE LIST PRICE PER |
|------------|-------|------|--------------|---------------|------------|--------------------------------|
| MN112HGJST | 21253 | 1½   | 50.00        | 6250          | 50 lb box  | 213.89/ea                      |
| MN112R     | 21247 | 1½   | 5.32         | 970           | 5 lb box   | 14.70/ea                       |
| MN112R25   | 21248 | 1½   | 2.66         | 485           | 2.5 lb box | 9.85/ea                        |

OTHER SIZES AND QUANTITIES AVAILABLE BY REQUEST

## COATED SINKER NAILS

STEEL

*For all types of rough-in wood construction*



Coating allows faster penetration

| PART#    | JAR UPC# | SIZE | WT. PER PKG. | APPROX. COUNT | STD. PKG.  | SUGGESTED TRADE LIST PRICE PER |
|----------|----------|------|--------------|---------------|------------|--------------------------------|
| MN8S     | 21235    | 8D   | 2.63         | 340           | 1 Jar      | 9.69/ea                        |
| MN10S    | 21236    | 10D  | 2.57         | 240           | 1 Jar      | 10.23/ea                       |
| MN16S    | 21237    | 16D  | 2.67         | 140           | 1 Jar      | 9.48/ea                        |
| MN16S50B | 21297    | 16D  | 50.00        | 2600          | 50 lb Box  | 226.42/ea                      |
| MN16SP   | 21285    | 16D  | 10.00        | 520           | 10 lb Pail | 51.34/ea                       |

OTHER SIZES AND QUANTITIES AVAILABLE BY REQUEST

## BRIGHT DUPLEX NAILS

STEEL

*For temporary wood structure/Double head allows for ease of extraction and disassembly*



| PART#  | JAR UPC# | SIZE | WT. PER PKG. | APPROX. COUNT | STD. PKG. | SUGGESTED TRADE LIST PRICE PER |
|--------|----------|------|--------------|---------------|-----------|--------------------------------|
| MN8DP  | 21238    | 8D   | 2.61         | 200           | 1 Jar     | 10.94/ea                       |
| MN16DP | 21239    | 16D  | 2.63         | 105           | 1 Jar     | 10.94/ea                       |

OTHER SIZES AND QUANTITIES AVAILABLE UPON REQUEST

# SPECIAL PURPOSE ELECTRICAL FASTENERS



## BRIGHT JOIST HANGER NAILS

STEEL

For all types of light brackets, straps in wood joists

| PART#  | JAR<br>UPC# | SIZE      | WT.<br>PER PKG. | APPROX.<br>COUNT | STD. PKG. | SUGGESTED TRADE<br>LIST PRICE PER |
|--------|-------------|-----------|-----------------|------------------|-----------|-----------------------------------|
| MN114J | 21240       | 1¼ - 9 GA | 2.59            | 360              | 1 Jar     | 10.75/ea                          |
| MN112J | 21241       | 1½ - 9 GA | 2.60            | 300              | 1 Jar     | 10.94/ea                          |

OTHER SIZES AND QUANTITIES AVAILABLE UPON REQUEST



## HEAT TEMPERED FLUTED MASONRY NAILS

STEEL

Nails designed to penetrate concrete and other masonry products

| PART#   | JAR<br>UPC# | SIZE | WT.<br>PER PKG. | APPROX.<br>COUNT | STD. PKG. | SUGGESTED TRADE<br>LIST PRICE PER |
|---------|-------------|------|-----------------|------------------|-----------|-----------------------------------|
| MN1TM   | 21242       | 1    | 2.60            | 370              | 1 Jar     | 12.98/ea                          |
| MN112TM | 21243       | 1½   | 2.55            | 225              | 1 Jar     | 12.98/ea                          |
| MN2TM   | 21244       | 2    | 2.64            | 180              | 1 Jar     | 13.10/ea                          |
| MN212TM | 21245       | 2½   | 2.63            | 168              | 1 Jar     | 13.14/ea                          |
| MN3TM   | 21246       | 3    | 2.62            | 135              | 1 Jar     | 13.71/ea                          |

OTHER SIZES AND QUANTITIES AVAILABLE UPON REQUEST



## EZ STAPLES

Easy to handle, get into tight spaces and reduce drops



EZSTPL1C



EZSTPL5C



EZSTPL2M



EZ-POUR LIDS!

| PART#    | UPC#  | SIZE  | WT. PER<br>PKG. | STD. PKG. | SUGGESTED TRADE<br>LIST PRICE PER |
|----------|-------|-------|-----------------|-----------|-----------------------------------|
| EZSTPL1C | 85245 | ½ x 1 | .59             | 100 jar   | 15.52/c                           |
| EZSTPL5C | 85250 | ½ x 1 | 2.76            | 500 pail  | 74.93/c                           |
| EZSTPL2M | 85255 | ½ x 1 | 11.12           | 2000 pail | 282.07/c                          |

OTHER SIZES AND QUANTITIES AVAILABLE UPON REQUEST

## FOLD OVER STRAPS

ALUMINUM



MSC25  
1" Wide

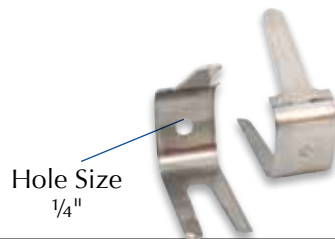

Hole Size  
¼"

MSC35  
1⅜" Wide



MSC40  
1½" Wide

| PART# | UPC#  | DESCRIPTION                                  | WT. PER<br>PKG. | STD. PKG. | SUGGESTED TRADE<br>LIST PRICE PER |
|-------|-------|--|-----------------|-----------|-----------------------------------|
| MSC25 | 53381 | Aluminum ¼" Hole Size - Strap Cable Size 2/3 | 1.7             | 50        | 81.32/c                           |
| MSC35 | 53382 | Aluminum ¼" Hole Size - Strap Cable Size 2/0 | 1.5             | 25        | 114.36/c                          |
| MSC40 | 53383 | Aluminum ¼" Hole Size - Strap Cable Size 4/0 | 1.5             | 25        | 114.36/c                          |

# SPECIAL PURPOSE ELECTRICAL FASTENERS

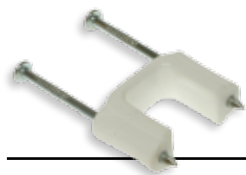

## STACKING STAPLES

PLASTIC



| PART#    | UPC#  | CABLE SIZE   | WT. PER PKG. | STD. PKG. | SUGGESTED TRADE LIST PRICE PER |
|----------|-------|--|--------------|-----------|--------------------------------|
| SCT6215  | 21755 | For stacking two 2-wire #14 or #12 NM cable                        | .39          | 50        | 12.94/c                        |
| SCT6215C | 21785 | For stacking two 2-wire #14 or #12 NM cable                        | .87          | 100       | 12.19/c                        |
| SCT6215V | 21786 | For stacking two 2-wire #14 or #12 NM cable                        | 4.06         | 500       | 12.22/c                        |
| SCT6315  | 21760 | For stacking three 2-wire or a 2-wire & 3-wire #14 or #12 NM cable | .46          | 50        | 15.08/c                        |
| SCT6315C | 21783 | For stacking three 2-wire or a 2-wire & 3-wire #14 or #12 NM cable | .99          | 100       | 14.38/c                        |
| SCT6315V | 21784 | For stacking three 2-wire or a 2-wire & 3-wire #14 or #12 NM cable | 4.42         | 500       | 14.38/c                        |
| SCT6415  | 21765 | For stacking two 3-wire or four 2-wire #14 or #12 NM cable         | .46          | 50        | 17.96/c                        |
| SCT6415C | 21788 | For stacking two 3-wire or four 2-wire #14 or #12 NM cable         | 1.08         | 100       | 17.50/c                        |
| SCT6415V | 21787 | For stacking two 3-wire or four 2-wire #14 or #12 NM cable         | 4.85         | 500       | 17.50/c                        |

OTHER SIZES AND QUANTITIES AVAILABLE BY REQUEST



## SERVICE ENTRANCE STAPLES

PLASTIC



| PART#   | UPC#  | CABLE SIZE   | COLOR | WT. PER PKG. | STD. PKG. | SUGGESTED TRADE LIST PRICE PER |
|---------|-------|--------------|-------|--------------|-----------|--------------------------------|
| SES4115 | 21770 | #6 type SER  | Gray  | .63          | 50        | 43.72/c                        |
| SES4215 | 21771 | #6 type SEU  | Gray  | .60          | 50        | 43.72/c                        |
| SES4312 | 21775 | #2 type SER  | Gray  | .45          | 25        | 53.60/c                        |
| SES4412 | 21776 | #2 type SEU  | Gray  | .33          | 25        | 49.60/c                        |
| SES4512 | 21781 | 4/0 type SEU | Gray  | .51          | 25        | 73.56/c                        |
| SES4612 | 21780 | 4/0 type SER | Gray  | .67          | 25        | 73.56/c                        |

OTHER SIZES AND QUANTITIES AVAILABLE BY REQUEST

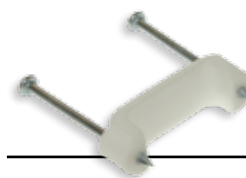

## CABLE STAPLES

PLASTIC



| PART#  | UPC#  | CABLE SIZE   | WT. PER PKG. | STD. PKG. | SUGGESTED TRADE LIST PRICE PER |
|--------|-------|--|--------------|-----------|--------------------------------|
| PCS125 | 21790 | 2 & 3 wire NM cable up to #12<br>2-wire UF cable up to #12 & other cable up to 1/2" wide | .45          | 100       | 7.15/c                         |
| PCS345 | 21795 | 2-wire NM & UF cable up to #8<br>3-wire UF Cable up to #12 & other cable up to 3/4" wide | .47          | 100       | 7.86/c                         |

OTHER SIZES AND QUANTITIES AVAILABLE BY REQUEST

# SPECIAL PURPOSE ELECTRICAL FASTENERS



## CO-AXIAL STAPLES

PLASTIC



| PART#   | UPC#  | WIDTH | WT. PER PKG. | STD. PKG. | SUGGESTED TRADE LIST PRICE PER |
|---------|-------|-------|--------------|-----------|--------------------------------|
| CAS5051 | 21800 | 1/4   | .21          | 100       | 6.28/c                         |

OTHER SIZES AND QUANTITIES AVAILABLE BY REQUEST

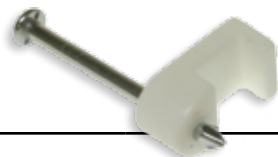

## SMALL WIRE STAPLES

PLASTIC



| PART#   | UPC#  | CABLE SIZE | WT. PER PKG. | STD. PKG. | SUGGESTED TRADE LIST PRICE PER |
|---------|-------|------------|--------------|-----------|--------------------------------|
| SPS5151 | 21810 | 1/4 x 1/8  | .20          | 100       | 6.28/c                         |

OTHER SIZES AND QUANTITIES AVAILABLE BY REQUEST

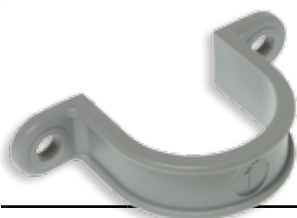

## PVC CONDUIT STRAPS

FOR PVC ELECTRICAL CONDUIT



| PART#  | UPC#  | CONDUIT SIZE | COLOR | WT. PER PKG. | STD. PKG. | SUGGESTED TRADE LIST PRICE PER |
|--------|-------|--------------|-------|--------------|-----------|--------------------------------|
| PCS212 | 21815 | 1/2          | Gray  | .66          | 100       | 22.77/c                        |
| PCS234 | 21816 | 3/4          | Gray  | .79          | 100       | 26.82/c                        |
| PCS244 | 21817 | 1            | Gray  | 1.05         | 100       | 37.49/c                        |
| PCS254 | 21818 | 1 1/4        | Gray  | .73          | 50        | 43.72/c                        |
| PCS264 | 21819 | 1 1/2        | Gray  | .95          | 50        | 47.78/c                        |
| PCS274 | 21821 | 2            | Gray  | 1.40         | 50        | 62.48/c                        |
| PCS284 | 21823 | 2 1/2        | Gray  | .29          | 5         | 125.60/c                       |
| PCS294 | 21825 | 3            | Gray  | .34          | 5         | 171.40/c                       |
| PCS204 | 21829 | 4            | Gray  | .44          | 5         | 331.80/c                       |

OTHER SIZES AND QUANTITIES AVAILABLE BY REQUEST



## CONDUIT LOCK NUTS

STEEL ZINC

| PART#   | UPC#  | CONDUIT SIZE | WT. PER PKG. | STD. PKG. | SUGGESTED TRADE LIST PRICE PER |
|---------|-------|--------------|--------------|-----------|--------------------------------|
| SFLN50  | 13575 | 1/2          | .92          | 100       | 14.43/c                        |
| SFLN75  | 13576 | 3/4          | 1.65         | 100       | 19.73/c                        |
| SFLN100 | 13577 | 1            | 2.80         | 100       | 29.18/c                        |
| SFLN125 | 13578 | 1 1/4        | 2.01         | 50        | 40.96/c                        |
| SFLN150 | 13579 | 1 1/2        | 2.49         | 50        | 48.70/c                        |
| SFLN200 | 13581 | 2            | 4.50         | 50        | 66.26/c                        |
| SFLN250 | 13583 | 2 1/2        | 3.05         | 25        | 183.96/c                       |
| SFLN300 | 13585 | 3            | 4.35         | 25        | 236.84/c                       |
| SFLN400 | 13589 | 4            | 1.49         | 20        | 349.05/c                       |

OTHER SIZES AND QUANTITIES AVAILABLE BY REQUEST



# SPECIAL PURPOSE ELECTRICAL FASTENERS



## NON-INSULATED CABLE STAPLES

302 STAINLESS

| PART#     | UPC#  | DIMENSIONS       | WT. PER PKG. | STD. PKG./MSTR SLEEVE | SUGGESTED TRADE LIST PRICE PER |
|-----------|-------|------------------|--------------|-----------------------|--------------------------------|
| JCST40SS  | 20984 | 1 L x 1/2 W      | .61          | 100 jar               | 22.00/c                        |
| FST40SS   | 20985 | 1 L x 1/2 W      | 2.89         | 500 box               | 19.80/c                        |
| KST40SS   | 20986 | 1 L x 1/2 W      | 28.90        | 5,000 box             | 17.83/c                        |
| JCST100SS | 20987 | 1 1/4 L x 9/16 W | .62          | 100 jar               | 29.28/c                        |
| FST100SS  | 20988 | 1 1/4 L x 9/16 W | 2.96         | 500 box               | 26.35/c                        |
| KST100SS  | 20989 | 1 1/4 L x 9/16 W | 29.60        | 5,000 box             | 23.73/c                        |

## NON-INSULATED CABLE STAPLES

C = 100 PCS PER BOX  
F = 500 PCS PER JAR  
P = 5,000 PCS PER PAIL



EXAMPLE: CST40 = 100 PCS FST40 = 500 PCS PST40 = 5,000 PCS

| PART#  | UPC#  | USE                                 | LENGTH | WIDTH  | WT. PER PKG.              | STD. PKG./MSTR. SLEEVE | SUGGESTED TRADE LIST PRICE PER |
|--|-------|-------------------------------------|--------|--------|---------------------------|------------------------|--------------------------------|
| CST40  | 21000 | N.M.C. 2 Romex #12 & #14            | 1      | 1/2    | .60                       | 100/box                | 3.74/c                         |
| JCST40   | 84970 |                                     |        |        | .61                       | 100/jar                | 3.74/c                         |
| FST40  | 21005 |                                     |        |        | 2.89                      | 500/jar                | 3.46/c                         |
| PST40  | 21007 |                                     |        |        | 26.95                     | 5000/pail              | 32.86/c                        |
| CST100   | 21010 | N.M.C. & Armored #14, #12, #10 w/gr | 1 1/4  | 9/16   | .73                       | 100/box                | 4.22/c                         |
| JCST100  | 84980 |                                     |        |        | .62                       | 100/jar                | 4.22/c                         |
| FST100   | 21015 |                                     |        |        | 3.88                      | 500/jar                | 3.85/c                         |
| PST100   | 21017 |                                     |        |        | 35.90                     | 5000/pail              | 36.75/c                        |
| <b>N.M.C. - to be used on non-metallic cable</b> |       |                                     |        |        |                           |                        |                                |
| CST300   | 21020 | Service Entrance SEU3 #6            | 1 5/16 | 3/4    | 1.18                      | 100/box                | 7.80/c                         |
| FST300   | 21022 |                                     |        |        | 6.26                      | 500/jar                | 7.00/c                         |
| CST350   | 21025 | Service Entrance SEU2 #6            | 1 1/2  | 1 1/16 | 1.31                      | 100/box                | 9.72/c                         |
| FST350   | 21027 |                                     |        |        | For 2 #3 Full 10 Ga. Wire | 6.41                   | 500/jar                        |
| M151   | 23565 | 4/0 SER Cable Steel                 | 2 1/2  | 1 7/8  | 3.81                      | 100                    | 10.58/c                        |

OTHER SIZES AND QUANTITIES AVAILABLE BY REQUEST

CST40I



## INSULATED CABLE STAPLES

STEEL/PLASTIC

For better cable protection!



| PART#    | UPC#  | WIRE SIZE     | SIZE         | WT. PER PKG. | STD. PKG./MSTR. SLEEVE | SUGGESTED TRADE LIST PRICE PER |
|----------|-------|---------------|--------------|--------------|------------------------|--------------------------------|
| CST40I   | 21030 | #12, #14      | 1 x 1/2      | .59          | 100 box                | 5.86/c                         |
| JCST40I  | 85374 | #12, #14      | 1 x 1/2      | .54          | 100 jar                | 5.86/c                         |
| CST100I  | 21018 | #10, #12, #14 | 1 1/4 x 9/16 | .71          | 100 box                | 5.70/c                         |
| JCST100I | 85378 | #10, #12, #14 | 1 1/4 x 9/16 | .71          | 100 jar                | 5.70/c                         |
| CST350P  | 21093 | #10, #12, #14 | 1 1/4 x 9/16 | 27.25        | 2000 pail              | 92.55/m                        |
| CST100P  | 29006 | #10, #12, #14 | 1 1/4 x 9/16 | 13.35        | 1500 pail              | 70.63/m                        |
| FST100I  | 21019 | #10, #12, #14 | 1 1/4 x 9/16 | 3.50         | 250 jar                | 5.60/c                         |
| PST100I  | 21021 | #10, #12, #14 | 1 1/4 x 9/16 | 37.00        | 5000 pail              | 52.32/m                        |
| FST40I   | 21035 | #10, #12, #14 | 1 x 1/2      | 2.74         | 500 jar                | 6.12/c                         |
| PST40I   | 21040 | #10, #12, #14 | 1 x 1/2      | 28.98        | 5000 pail              | 47.57/m                        |

OTHER SIZES AND QUANTITIES AVAILABLE BY REQUEST

# SPECIAL PURPOSE ELECTRICAL FASTENERS

## RAFTER AND TRUSS STAPLES

PLASTIC



- Save time and frustration by fastening cable from the front of the rafters and trusses
- Increase productivity
- Made for hard to reach places such as rafters and floor joists
- Eliminates damage to wire jacket
- Reduces bent over nails



| PART# | UPC#  | SIZE | WT. PER PKG. | STD. PKG. | SUGGESTED TRADE LIST PRICE PER |
|-------|-------|------|--------------|-----------|--------------------------------|
| RJS1  | 21910 | 1/2  | 1.14         | 100       | 57.62/c                        |
| RJS2  | 21912 | 1/2  | 6.55         | 500       | 55.29/c                        |

OTHER SIZES AND QUANTITIES AVAILABLE BY REQUEST

## WHITE INSULATED TWO NAIL STAPLES

PLASTIC

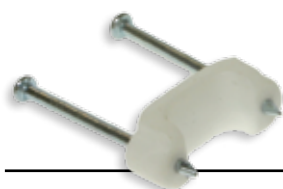

| PART#   | UPC#  | SIZE | WT. PER PKG. | STD. PKG. | SUGGESTED TRADE LIST PRICE PER |
|---|-------|------|--------------|-----------|--------------------------------|
| CS50  | 21914 | 1/2  | .45          | 100       | 11.27/c                        |
| CS50V   | 21917 | 1/2  | 2.25         | 500       | 3.49/c                         |
| CS50P   | 21916 | 1/2  | 9.98         | 2000      | 74.66/m                        |
| CS75  | 21918 | 3/4  | .48          | 100       | 11.44/c                        |
| CS75P   | 21920 | 3/4  | 8.05         | 1500      | 82.77/m                        |
| 1/2 secures 14-2 or 12-2 with ground non-metallic cable and other non-metallic cable 1/2 wide |       |      |              |           |                                |
| 3/4 secures 12-3 or 10-3 with ground non-metallic cable and other non-metallic cable 3/4 wide |       |      |              |           |                                |

OTHER SIZES AND QUANTITIES AVAILABLE BY REQUEST

## BLACK INSULATED TWO NAIL STAPLES

PLASTIC



| PART#   | UPC#  | SIZE | WT. PER PKG. | STD. PKG. | SUGGESTED TRADE LIST PRICE PER |
|---|-------|------|--------------|-----------|--------------------------------|
| CCS50   | 21926 | 1/2  | .44          | 100       | 8.64/c                         |
| CCS50P  | 21928 | 1/2  | 9.81         | 2000      | 56.50/m                        |
| CCS75   | 21930 | 3/4  | .49          | 100       | 9.57/c                         |
| CCS75P  | 21932 | 3/4  | 7.35         | 1500      | 66.61/m                        |
| 1/2 secures 14-2 or 12-2 with ground non-metallic cable and other non-metallic cable 1/2 wide |       |      |              |           |                                |
| 3/4 secures 12-3 or 10-3 with ground non-metallic cable and other non-metallic cable 3/4 wide |       |      |              |           |                                |

OTHER SIZES AND QUANTITIES AVAILABLE BY REQUEST

## DATA COMM. STAPLES .190 DIAMETER

PLASTIC



| PART# | UPC#  | SIZE | WT. PER PKG. | STD. PKG. | SUGGESTED TRADE LIST PRICE PER |
|-------|-------|------|--------------|-----------|--------------------------------|
| DCS1  | 21938 | .190 | .23          | 100       | 10.37/c                        |
| DCS1V | 21939 | .190 | 1.15         | 500       | 8.13/c                         |

OTHER SIZES AND QUANTITIES AVAILABLE BY REQUEST

# SPECIAL PURPOSE ELECTRICAL FASTENERS

## INSULATED STAPLES

FOR LOW VOLTAGE WIRING

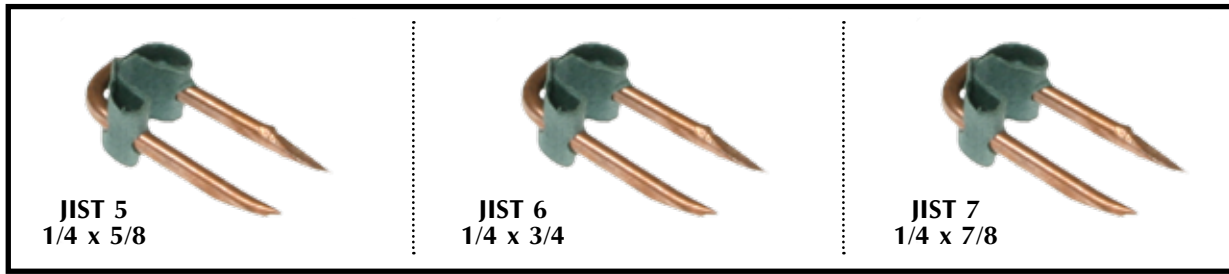

| PART# | UPC#  | SIZE | WIDTH | LENGTH OF LEGS | WT. PER PKG. | STD. PKG./MSTR. SLEEVE | SUGGESTED TRADE LIST PRICE PER |
|-------|-------|------|-------|----------------|--------------|------------------------|--------------------------------|
| JIST5 | 81018 | #5   | 1/4   | 5/8            | .22          | 100/500                | 4.79/c                         |
| JIST6 | 81019 | #6   | 1/4   | 3/4            | .24          | 100/500                | 4.22/c                         |
| JIST7 | 81020 | #7   | 1/4   | 7/8            | .25          | 100/500                | 5.57/c                         |

OTHER SIZES AND QUANTITIES AVAILABLE BY REQUEST



## CEILING COVER PLATES ADJUSTABLE

ADJUSTS TO FIT 3" OR 4" OUTLET BOXES

Includes plate, adjustable strap and flat head slotted machine screw.

White color to suit most applications.

| PART# | UPC#  | BOX SIZES | CANOPY SIZE | WT. PER PKG. | STD. PKG. | SUGGESTED TRADE LIST PRICE PER |
|-------|-------|-----------|-------------|--------------|-----------|--------------------------------|
| CP1A  | 41300 | 3 & 4     | 5 1/4       | .12          | 10        | 501.30/c                       |

OTHER SIZES AND QUANTITIES AVAILABLE BY REQUEST



## CEILING COVER PLATES STANDARD

ATTACHES DIRECTLY TO CEILING OUTLET BOXES

Holes predrilled. Flat head slotted machine screws included.

White color to suit most applications.

| PART# | UPC#  | BOX SIZES | CANOPY SIZE | WT. | STD. PKG. | SUGGESTED TRADE LIST PRICE PER |
|-------|-------|-----------|-------------|-----|-----------|--------------------------------|
| CP3S  | 41305 | 3         | 5 1/4       | .18 | 10        | 410.90/c                       |
| CP4S  | 41310 | 4         | 5 1/4       | .15 | 10        | 410.90/c                       |

OTHER SIZES AND QUANTITIES AVAILABLE BY REQUEST

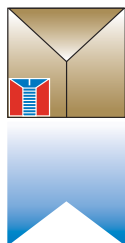

**Metallics & Avanti Screw, Inc.**  
**Where Manufacturing Quality is Job One!**