

Industrial Grade

Extra Heavy-Duty Specification Grade Toggle and Locking Switches

Leviton's Industrial Grade AC toggle switches for extra heavy-duty applications represent top-of-the-line quality and peak performance. Leviton uses the finest materials available and the highest production standards to produce industrial switches of unmatched versatility and reliability.

Specifications and Features

- Top-of-the-line industrial quality
- Heavy gauge copper alloy one-piece arm for top performance
- Large silver cadmium-oxide contacts for long life, prevent sticking, welding and excessive pitting
- Color-coded covers: 15 Amp-Blue; 20 Amp-Red; 30 Amp-Green
- Fully enclosed switch mechanism in rugged housing for strength, tracking and arc resistance
- Brass combination-head terminal screws on Extra Heavy-Duty devices, steel combination head terminal screws on other devices
- Self-grounding clip (self-grounding when used with a grounded metal wallbox)
- Wire lead switches for fast and easy installation
- Backed by a Limited Ten-Year Warranty

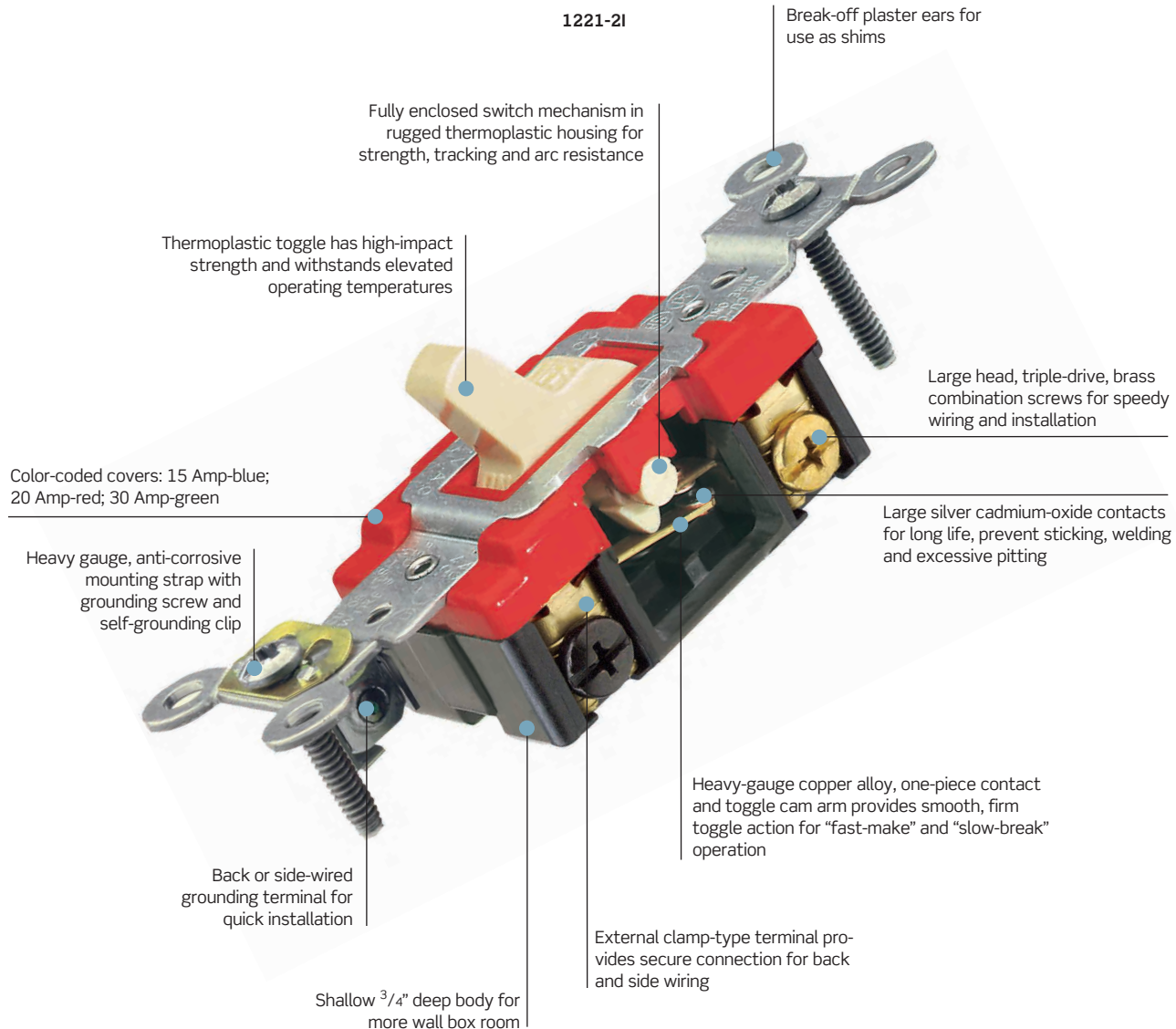

Industrial Grade

Maintained and Momentary Contact Extra Heavy-Duty Specification Grade Toggle Switches

Specifications and Features

- Positive switching action with center-off position
- Large silver cadmium-oxide contacts for long life, prevent sticking, welding and excessive pitting
- Clamp-type terminals accept up to #10 CU wire
- Full rated current capacity on fluorescent, tungsten and resistive loads; motor load capacity up to 80% switch current rating
- Backed by a Limited Ten-Year Warranty

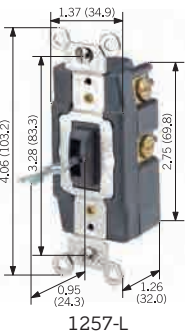
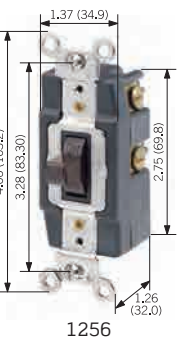
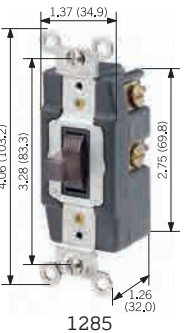
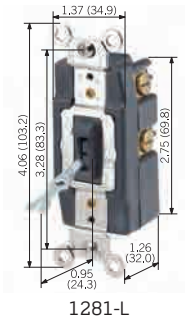

BACK AND SIDE WIRED - MAINTAINED CONTACT U S

Description	Color	Cat No.		
		120/277VAC		
Rating		15A	20A	30A
Single Pole, Double Throw, Center Off	White	1281-W	1285-W	—
	Ivory	1281-I	1285-I	1287-I
	Grey	—	1285-GY	—
	Brown	1281	1285	1287
	Red	—	1285-R	—
Single Pole, Double Throw, Locking†	Black	1281-L	1285-L	1287-L
Single Pole, Double Throw, Center Off	White	1282-W	1286-W	1288-W
	Ivory	1282-I	1286-I	1288-I
	Brown	1282	1286	1288
Double Pole, Double Throw, Locking†	Ivory	—	—	1288-LI
	Black	—	—	1288-L

†Key for Locking Switch: Cat. No. 55500-PRT.

BACK AND SIDE WIRED - MOMENTARY CONTACT U S

Description	Color	Cat No.		
		120/277VAC		
Rating		15A	20A	30A
Single Pole, Double Throw, Center Off	White	1256-W	—	—
	Ivory	1256-I	1257-I	—
	Grey	1256-GY	—	—
	Brown	1256	1257	1260*
	Red	—	1257-R	—
Single Pole, Double Throw, Center Off, Locking†	Ivory	—	1257-LI	—
Single Pole, Double Throw, Center Off	Brown	—	1257-L	—
	Brown	—	—	1262*

†Key for Locking Switch: Cat. No. 55500-PRT.
CSA Certified except where indicated by*.

TESTING AND CODE COMPLIANCE

- Meets all NEMA WD 1 & 6, and ANSI requirements
- Meets Federal Specification WS-896
- UL Listed (File #E-7458)
- CSA Certified (File #152105)
- NOM Certified (#057)

MATERIAL CHARACTERISTICS

- Environmental: Flammability, Rated V2
- Operating Temperature: -40°C to 65°C

ELECTRICAL

- Dielectric Voltage: Withstands 1500V for 1 min.
- Overload UL 20 Test: 100 cycles of overload at 4.8 times rated current
- Temp. Rise: 30° C max at full rated current
- Endurance: UL 20/Fed Spec 50,000 cycles min., tungsten filament lamp load (Fed.Spec.) WS896E, SP, DP, 3-Way, 4-Way, Pilot Light, Illum., Key Lock

MECHANICAL

- Terminal I.D.: Brass-Hot, Black-Hot, White Neutral, Green Grounding
- Terminal Accom.: #14-#10 AWG back wired; #14-#12 AWG side wired
- Product I.D.: Ratings are permanently stamped on device strap
- Torque Range: 12-14 inch pounds

HORSEPOWER

- 15A — 1/2 @ 120V, 2 @ 240V 12 AMP Max
- 20A — 1 @ 120V, 2 @ 240V 16 AMP Max
- 30A — 2 @ 120V, 2 @ 240V 24 AMP Max

DIMENSIONS

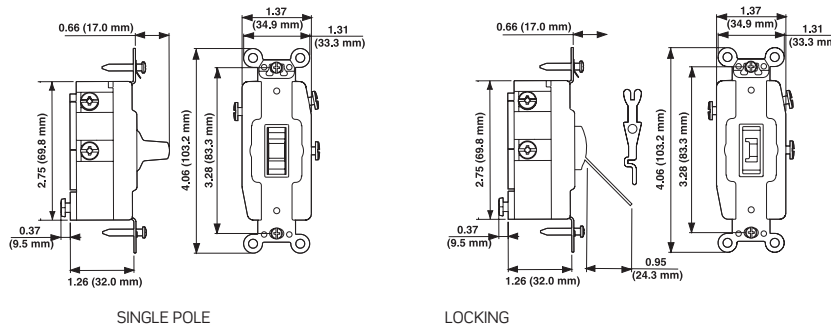

Pilot Light and Lighted Handle Extra Heavy-Duty Specification Grade Toggle Switches

Specifications and Features

- Pilot light and lighted handle switches provide top performance in punishing industrial applications
- Lighted handle illuminated when load is OFF. Pilot light toggle illuminated when load is ON
- 120 and 277V versions in single pole and 3-Way
- Fully enclosed switch mechanism in rugged housing for strength, track and arc resistance
- Self-grounding clip (self-grounding when used with a grounded metal wallbox)
- Backed by a Limited Ten-Year Warranty

BACK AND SIDE WIRED - PILOT LIGHT U S

Description	Colors	Cat No.			
Rating		15A - 120V	20A - 120V	20A - 277V	30A - 120V
Single Pole	Clear	1201-PLC	1221-PLC	1221-7PC	3031-PLC
	Red	1201-PLR	1221-PLR	1221-7PR	3031-PLR
	Green	1201-PLG	1221-PLG	-	-
Double Pole	Clear	-	1222-PLC	-	3032-PLC
	Red	1202-PLR	1222-PLR	1222-7PR	3032-PLR
	Green	-	1222-PLG	-	-
3-Way	Clear	1203-PLC	1223-PLC	-	-
	Red	1203-PLR	1223-PLR	1223-7PR	-
	Green	1203-PLG	1223-PLG	-	-

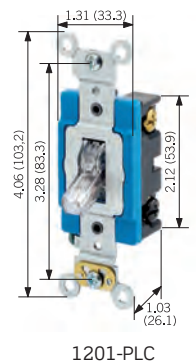

Industrial Grade

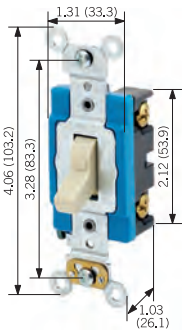

1201-LHI

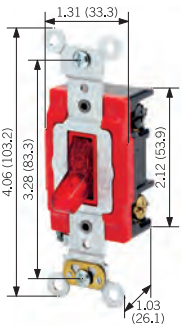

1222-PLR

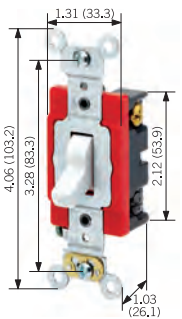

1223-LHW

BACK AND SIDE WIRED - LIGHTED HANDLE U S

Description	Color	Cat No.			
Rating		15A - 120V	20A - 120V	20A - 277V	30A - 120V
Single Pole	Clear	1201-LHC	1221-LHC	1221-7LC	—
	White	1201-LHW	1221-LHW	1221-7LW	—
	Ivory	1201-LHI	1221-LHI	1221-7LI	3031-LHI
3-Way	Clear	1203-LHC	1223-LHC	1223-7LC	
	White	1203-LHW	1223-LHW	1223-7LW	
	Ivory	1203-LHI	1223-LHI	1223-7LI	

TESTING AND CODE COMPLIANCE

- Meets all NEMA WD 1 & 6, and ANSI requirements
- Meets Federal Specification WS-896
- UL Listed (File #E-7458)
- CSA Certified (File #152105)
- NOM Certified (#057)

MATERIAL CHARACTERISTICS

- Environmental: Flammability, Rated V2
- Operating Temperature: -40°C to 65°C

ELECTRICAL

- Dielectric Voltage: Withstands 1500V for 1 min.
- Overload UL 20 Test: 100 cycles of overload at 4.8 times rated current
- Temp. Rise: 30° C max at full rated current
- Endurance: UL 20/Fed Spec 50,000 cycles min., tungsten filament lamp load (Fed.Spec.) WS896E, SP, DP, 3-Way, 4-Way, Pilot Light, Illum., Key Lock

MECHANICAL

- Terminal I.D.: Brass-Hot, Black-Hot, White-Neutral, Green-Grounding
- Terminal Accom.: #14-#10 AWG back wired; #14-#12 AWG side wired
- Product I.D.: Ratings are permanently stamped on device strap
- Torque Range: 12-14 inch pounds

HORSEPOWER

- 15A — 1/2 @ 120V, 2 @ 240V 12 AMP Max
- 20A — 1 @ 120V, 2 @ 240V 16 AMP Max
- 30A — 2 @ 120V, 2 @ 240V 24 AMP Max

DIMENSIONS

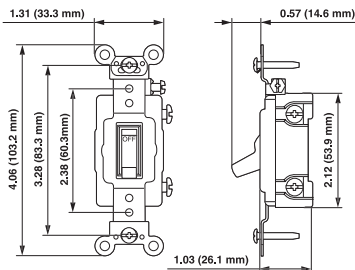

SINGLE POLE

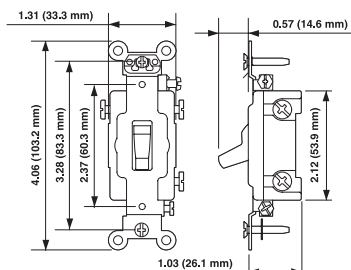

3-WAY