

A

Wire Termination



Wire-Nut® Wire Connectors

- Five color-coded models cover a full range of wire sizes from 22 - 8 AWG
- Fixed, square-wire spring creates its own threads – maintains a secure positive grip that will not relax over time
- No pre-twisting required – positive grip design provides fast, easy installation
- Deep, wide skirt helps protect against flash-over and turned-back strands for maximum dielectric protection
- Reusable for easy circuit changes and additions
- Tough, UL94V-2 flame-retardant shell rated at 105°C (221°F)
- UL Listed to 486C and CSA certified to C22.2 #188; comply with Federal Specification W-S-610E
- Classified in accordance with IEC Publications 998-2 and 998-2-4



Dimensions (Inches/mm)

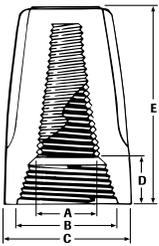

| Model | A | B | C | D | E |
|-------|--------------|------------|-------------|--------------|--------------|
| 71B® | 11/64 4.5 | 1/4 6.5 | 21/64 8 | 11/64 4.5 | 37/64 15 |
| 72B® | 11/64 4.5 | 5/16 8 | 25/64 10 | 3/16 5 | 45/64 18 |
| 73B® | 11/64 4.5 | 11/32 9 | 7/16 11 | 11/32 9 | 55/64 22 |
| 74B® | 17/64 7 | 7/16 11 | 35/64 14 | 5/16 8 | 61/64 24 |
| 76B® | 9/32 7 | 1/2 13 | 19/32 15 | 3/8 10 | 1-1/16 27 |

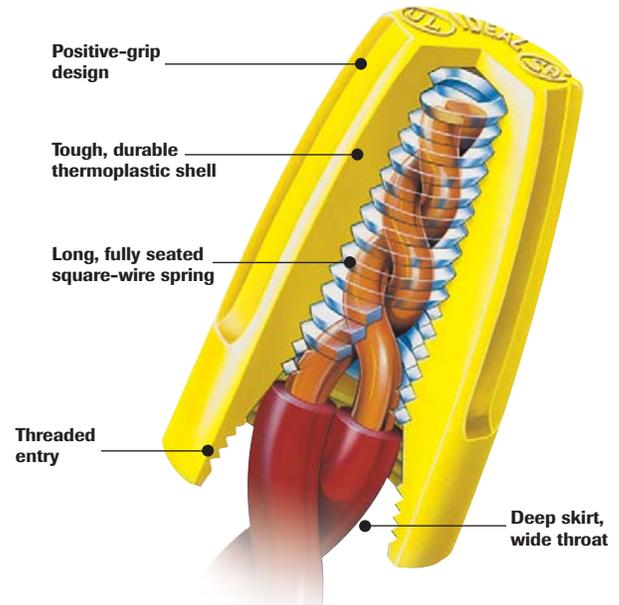

| Model | Color | Wire Combination Range | Wire Combination Range (mm) | Quantity | Cat. No. |
|-------|--------|---|---|----------------------------------|----------------|
| 71B® | Gray | 300V 22 to 16 AWG Min. 2 #22 – Max. 2 #16 | 300V ,34mm ² to 1,5mm ² Min. 2-,34mm ² Max. 3-1,5mm ² | Box of 100 | 30-071 |
| | | | | Carton of 1,000 | 30-171 |
| | | | | Keg of 25,000 (loose pack) | 30-271 |
| | | | | Barrel of 150,000 | 30-871 |
| 72B® | Blue | 300V 22 to 14 AWG Min. 2 #22 – Max. 3 #16 | 300V ,34mm ² to 2,5mm ² Min. 2-,34mm ² Max. 3-1,5mm ² | Box of 100 | 30-072 |
| | | | | Carton of 1,000 | 30-172 |
| | | | | Keg of 10,000 (loose pack) | 30-272 |
| | | | | Barrel of 85,000 | 30-872 |
| 73B® | Orange | 600V* 22 to 14 AWG Min. 1 #18 & 1 #20 Max. 4 #16 & 1 #20 | 600V* ,34mm ² to 2,5mm ² Min. 1-,75mm ² w/1-,50mm ² Max. 4-1,5mm ² w/1-,50mm ² | Box of 100 | 30-073 |
| | | | | Jar of 300 | 30-073J |
| | | | | Carton of 1,000 | 30-173 |
| | | | | Keg of 10,000 (20 bags, 500 ea.) | 30-273 |
| 74B® | Yellow | 600V* 18 to 12 AWG Min. 2 #18 Max. 4 #14 & 1 #18 | 600V* ,75mm ² to 4,0mm ² Min. 2-,75mm ² Max. 4-2,5mm ² w/1-,75mm ² | Keg of 10,000 (loose pack) | 30-673 |
| | | | | Barrel of 50,000 | 30-873 |
| | | | | Box of 100 | 30-074 |
| | | | | Jar of 175 | 30-074J |
| 76B® | Red | 600V* 18 to 10 AWG Min. 2 #14 Max. 2 #10 & 2 #12 | 600V* ,75mm ² to 6,0mm ² Min. 2-2,5mm ² Max. 2-6,0mm ² w/2-4,0mm ² | Carton of 1,000 | 30-174 |
| | | | | Keg of 5,000 (10 bags, 500 ea.) | 30-274 |
| | | | | Keg of 10,000 (loose pack) | 30-674 |
| | | | | Barrel of 35,000 | 30-874 |
| | | | | Box of 100 | 30-076 |
| | | | | Carton of 1,000 | 30-176 |
| | | | | Keg of 5,000 (20 bags, 250 ea.) | 30-276 |
| | | | | Barrel of 15,000 | 30-876 |

*1,000V maximum in fixtures and signs

High Temperature Wire-Nut® Wire Connectors

All of the Wire-Nut® Wire Connector features plus:

- Black, thermoplastic shell specially designed to withstand the extreme heat build-up commonly found in high-wattage light fixtures and signs. UL Listed to 150°C (302°F)
- Four models to cover wire ranges from 22 through 12 AWG



| Model | Color | Wire Combination Range | Wire Combination Range (mm) | Quantity | Cat. No. |
|-------|-------|---|--|----------------------------|---------------|
| 71B® | Black | 300V 22 to 16 AWG Min. 2 #22 Str Max. 2 #16 | 300V ,34mm² to 1,5mm² Min. 2-,34mm² Max. 2-,1,5mm² | Carton of 1,000 | 30-151 |
| | | | | Keg of 25,000 (loose pack) | 30-251 |
| 72B® | Black | 300V 22 to 14 AWG Min. 2 #22 Max. 3 #16 | 300V ,34mm² to 2,5mm² Min. 2-,34mm² Max. 3-,1,5mm² | Carton of 1,000 | 30-152 |
| | | | | Keg of 10,000 (loose pack) | 30-252 |
| 73B® | Black | 600V* 22 to 14 AWG Min. 1 #18 w/1 #20 Max. 4 #16 & 1 #20 | 600V* ,34mm² to 2,5mm² Min. 1-,75mm² w/1-,50mm² Max. 4-,1,5mm² w/1-,50mm² | Carton of 1,000 | 30-153 |
| | | | | Keg of 10,000 (loose pack) | 30-253 |
| 59B™ | Black | 600V* 22 to 12 AWG Min. 2 #20 Max. 3 #14 | 600V* ,34mm² to 4,0mm² Min. 2-,5mm² Max. 3-,2,5mm² | Box of 100 | 30-059 |
| | | | | Carton of 1,000 | 30-159 |
| | | | | Keg of 5,000 (loose pack) | 30-259 |

*1,000V maximum in fixtures and signs



Dimensions (Inches/mm)

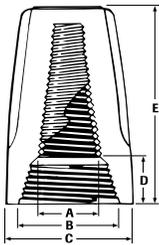

| Model | A | B | C | D | E |
|-------|-------|-------|-------|-------|--------|
| 71B® | 5/32 | 1/4 | 21/64 | 13/64 | 37/64 |
| Black | 4 | 6.5 | 8 | 5 | 15 |
| 72B® | 13/64 | 5/16 | 25/64 | 15/64 | 45/64 |
| Black | 5 | 8 | 10 | 6 | 18 |
| 73B® | 13/64 | 23/64 | 7/16 | 3/8 | 55/64 |
| Black | 5 | 9 | 11 | 9.5 | 22 |
| 59B™ | 13/64 | 13/32 | 31/64 | 37/64 | 1-1/16 |
| Black | 5 | 10 | 12 | 14.5 | 27 |

Wing-Nut® Wire Connectors

- Three color-coded models cover a full range of wire sizes from 18 through 6 AWG
- Specially designed contoured wings provide a secure grip for extra leverage on maximum wire combinations
- Live-action spring expands to accept wire shape and size with no pre-twisting required
- Square-wire spring threads directly onto conductors for fast, secure connections
- Deep skirt helps protect against flash-over and turned-back strands for maximum dielectric protection
- Easily removed for repeat usage on same size or larger wire combinations
- Tough, UL 94V-2 flame-retardant shell rated at 105°C (221°F)
- UL Listed to 486C and CSA Certified to C22.2 #188; comply with Federal Specification W-S-610E
- Classified in accordance with IEC Publications 998-2 and 998-2-4



Wire Connectors

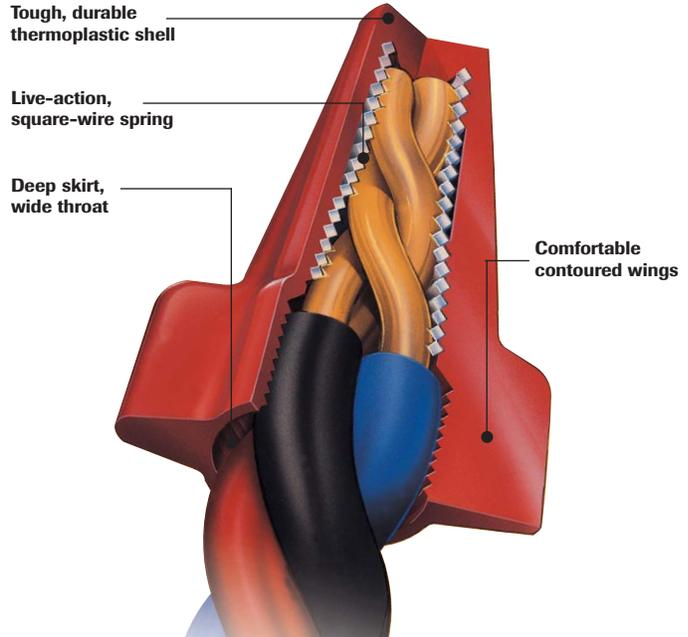

Dimensions (Inches/mm)

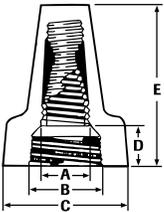

| Model | A | B | C | D | E |
|-------|--------------|---------------|--------------|---------------|-----------------|
| 451° | 15/64 6 | 11/32 9 | 11/16 18 | 5/16 8 | 1-1/64 26 |
| 452° | 21/64 8.5 | 15/32 12 | 15/16 24 | 5/16 8 | 1-15/64 31.5 |
| 454° | 7/16 11 | 5/8 16 | 1-3/16 30 | 13/32 10.5 | 1-15/32 37.5 |
| 92° | 21/64 8.5 | 13/32 10.5 | 29/32 23 | 9/32 10 | 1-5/32 30 |

| Model | Color | Wire Combination Range | Wire Combination Range (mm) | Quantity | Cat. No. |
|-------|--------|--|--|---------------------------------|----------------|
| 451° | Yellow | 600V* 18 thru 10 AWG Min. 2 #18 Max. 3 #12 | 600V* ,75mm ² to 6,0mm ² Min. 2-,75mm ² Max. 3-4,0mm ² | Box of 100 | 30-451 |
| | | | | Jar of 225 | 30-451J |
| | | | | Jar of 500 | 30-651J |
| | | | | Carton of 1,000 | 30-551 |
| | | | | Keg of 5,000 (10 bags, 500 ea.) | 30-651 |
| 452° | Red | 600V* 18 thru 8 AWG Min. 2 #18 Max. 4 #10 | 600V* ,75mm ² to 10,0mm ² Min. 2-,75mm ² Max. 4-6,0mm ² | Barrel of 35,000 | 30-851 |
| | | | | Box of 100 | 30-452 |
| | | | | Jar of 300 | 30-452J |
| | | | | Jar of 500 | 30-652J |
| | | | | Carton of 1,000 | 30-552 |
| 454° | Blue | 600V* 14 thru 6 AWG Min. 3 #12 Max. 1 #6 & 2 #8 | 600V* 2,5mm ² to 16,0mm ² Min. 3-4,0mm ² Max. 2-16,0mm ² w/1-4,0mm ² | Keg of 5,000 (10 bags, 500 ea.) | 30-652 |
| | | | | Barrel of 25,000 | 30-852 |
| | | | | Box of 50 | 30-454 |
| | | | | Keg of 2,500 (25 bags, 100 ea.) | 30-654 |

*1,000V maximum in fixtures and signs

| Model | Wire Combinations |
|------------|---|
| 451 Yellow | Min 2 #18 ————— Max 3 #12 |
| 452 Red | Min 2 #18 ————— Max 4 #10 ————— Max 1 #6 & 2 #8 |
| 454 Blue | Min 3 #12 ————— Max 1 #6 & 2 #8 |



Greenie® Grounding Connector

- Designed for making ground connections and bonding non-metallic sheathed cable
- Contoured wings for maximum leverage
- Live-action, square-wire spring provides superior grounding connections
- Tough, UL 94V-2 flame-retardant shell
- UL Listed to 467 and CSA Certified to C22.2 #188; complies with Federal Specification W-S-610E

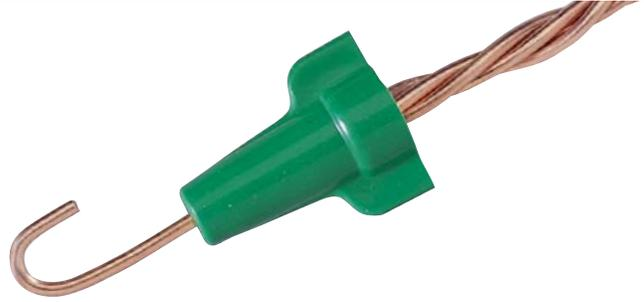

| Model | Wire Combination Range | Wire Combination Range (mm) | Quantity | Cat. No. |
|-------|--|---|---------------------------------|----------------|
| 92® | 14 thru 10 AWG Min. 2 #14 Max. 3 #12 & 1 #14 | 2,5mm ² to 6,0mm ² Min. 2-2,5mm ² Max. 3-4,0mm ² w/1-2,5mm ² | Box of 100 | 30-092 |
| | | | Jar of 150 | 30-092J |
| | | | Carton of 1,000 | 30-192 |
| | | | Keg of 5,000 (10 bags, 500 ea.) | 30-292 |



Greenie® Grounding Connector fully meets the intent of the N.E.C. and specifically aids in compliance with the following:

ARTICLE 250: GROUNDING

- 250-146 Connecting Receptacle Grounding Terminal to Box
- 250-148 Continuity and Attachment of Equipment Grounding Conductors to Boxes
 - (B) Grounding continuity
 - (D) Nonmetallic boxes

Twister® Wire Connectors

- Exceptional wire-range capacity – three models handle wire combinations from as small as 22 AWG to as large as 6 AWG
- Ribbed cap provides a secure grip and fast fingertip starts
- Swept wings offer extra leverage and less effort for large wire combinations
- Hexagonal shape accommodates standard nutdriver for tool installation
- Live-action, square-wire spring locks onto wire for safe, secure connections
- Deep skirt helps protect against flash-over and turned-back strands for maximum dielectric protection
- Tough, UL 94V-2 flame-retardant shell rated at 105°C (221°F)
- UL Listed to 486C and CSA Certified to C22.2 #188; comply with Federal Specification W-S-610E
- Classified in accordance with IEC Publications 998-2 and 998-2-4

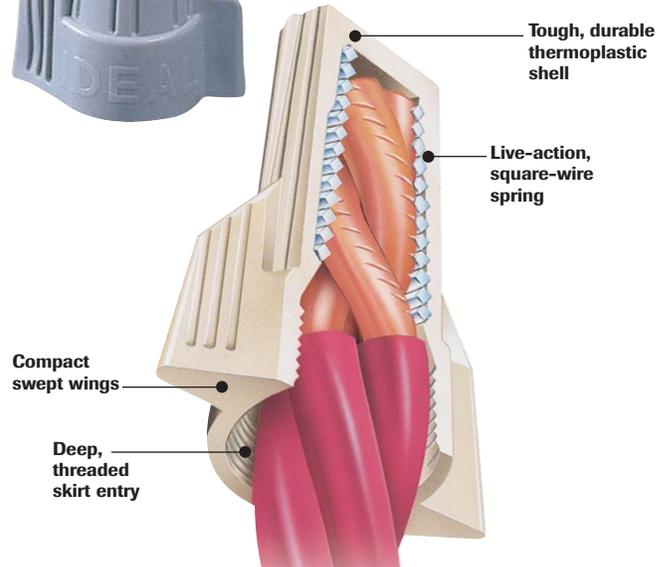
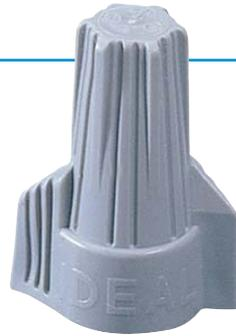

| Model | Color | Wire Combination Range | Wire Combination Range (mm) | Quantity | Cat. No. |
|-------|----------|---|--|---------------------------------|----------------|
| 340° | Lt. Blue | 600V* 22 thru 10 AWG Min. 2 #22 Max. 3 #12 | 600V* ,34mm ² to 4,0mm ² Min. 2-,34mm ² Max. 3-4,0mm ² | Box of 100 | 30-340 |
| | | | | Bag of 500 | 30-640 |
| | | | | Jar of 500 | 30-640J |
| | | | | Barrel of 35,000 | 30-840 |
| 341° | Tan | 600V* 22 thru 8 AWG Min. 3 #22 Max. 3 #10 | 600V* ,34mm ² to 10,0mm ² Min. 3-,34mm ² Max. 3-6,0mm ² | Box of 50 | 30-141 |
| | | | | Box of 100 | 30-341 |
| | | | | Jar of 400 | 30-441J |
| | | | | Jar of 750 | 30-341J |
| | | | | Carton of 1,000 | 30-541 |
| | | | | Keg of 5,000 (10 bags, 500 ea.) | 30-641 |
| | | | | Barrel of 25,000 | 30-841 |
| 342° | Gray | 600V* 18 thru 8 AWG Min. 3 #14 Max. 2 #8 w/2 #12 | 600V* ,75mm ² to 10,0mm ² Min. 3-2,5mm ² Max. 2-10,0mm ² w/2-4,0mm ² | Box of 25 | 30-142 |
| | | | | Box of 50 | 30-342 |
| | | | | Keg of 2,500 (10 bags, 250 ea.) | 30-642 |

*1,000V maximum in fixtures and signs



| Combination | 2#22 | 3#22 | 3#14 | 3 #12 | 3#10 | 2#12 w/2#8 |
|--------------|---------------------------------------|-----------------------------|-------------------------------|-------------------------------|--------------------------------|-----------------------------|
| Cir Mil Area | 1,280 (.65mm ²) | 1,920 (.97mm ²) | 12,330 (6.24mm ²) | 19,590 (9.93mm ²) | 31,140 (15.78mm ²) | 46,080 (23mm ²) |
| 340° | [Diagram showing wire range for 340°] | | | | | |
| 341° | [Diagram showing wire range for 341°] | | | | | |
| 342° | [Diagram showing wire range for 342°] | | | | | |

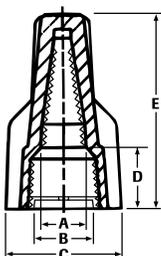

Dimensions (Inches/mm)

| Model | A | B | C | D | E |
|------------------|-------------|---------------|---------------|---------------|---------------|
| 340° Lt. Blue | 5/16 7.8 | 3/8 9.5 | 39/64 15.2 | 27/64 10.6 | 63/64 24.9 |
| 341° Tan | 17/64 7 | 29/64 11.5 | 23/32 18 | 23/64 9 | 1-1/8 28.5 |
| 342° Gray | 3/8 9.5 | 9/16 20 | 1.0 25.5 | 13/32 10.5 | 1-19/64 33 |

Twister[®] PRO Wire Connector

- SureGrip™ overmolding provides better grip for improved leverage and more torque
- Comfortable swept wings designed to help reduce hand fatigue
- Expanding square-wire spring provides a secure connection every time
- Better grip and more leverage for faster connections with less effort



Molded vertical grooves provide maximum grip

Patented swept-wing SureGrip™ design

Exceptional wire range and capacity
 - Min. 2 #18
 - Max. 4 #10



Wire Connectors

| Model | Color | Wire Combination Range | Wire Combination Range (mm) | Quantity | Cat. No. |
|-------|--|--|--|------------|----------|
| 344 | Red/Gray  | 600V* 22 to 8 AWG Min. 2 #18 Max. 4 #10 | 600V* ,34mm ² to 10,0mm ² Min. 2-,75mm ² Max. 4-6,0mm ² | Tube of 25 | 30-144J |
| | | | | Jar of 250 | 30-244J |
| | | | | Jar of 500 | 30-644J |

*1,000V maximum in fixtures and signs



| Combination | Min. 2 #18 | 4 #14 | 5 #12 | Max. 4 #10 |
|------------------|--|-------|-------|------------|
| 344 [®] | [Progressive bar showing compatibility with wire combinations] | | | |

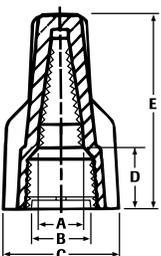

Dimensions (Inches/mm)

| Model | A | B | C | D | E |
|-----------------|--------------|-------------|---------------|--------------|---------------|
| 344 Red/Gray | 11/32 8.8 | 1/2 12.7 | 15/16 23.5 | 7/16 10.7 | 1-1/4 31.8 |

WeatherProof™ and UnderGround™ Wire Connectors

- Silicone-based sealant protects against moisture and corrosion
- Easy to apply, pre-filled twist-on wire connectors
- UL Listed to 486D for use in damp/wet locations or direct burial
- Handles wire sizes from #20 to #6 copper conductors

WeatherProof™ – suitable for interior and exterior electrical connections exposed to rain or damp conditions.

UnderGround™ – suitable for use in a wide variety of direct burial and wet location electrical connections.

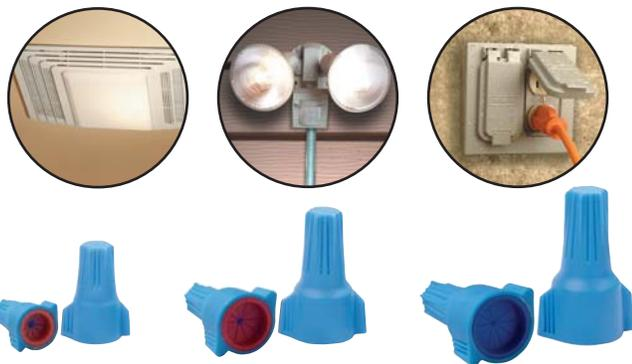

WeatherProof™ Wire Connectors

| Model | Color | Wire Combination Range | Wire Combination Range (mm) | Quantity | Cat. No. |
|-------|---------------|---|--|-----------------------|---------------|
| 61 | Blue/Orange | 600V* 22 to 14 AWG Min. 2 #20 Max. 2 #14 | 600V* ,34mm ² to 4,0mm ² Min. 2-,5mm ² Max. 2-2,5mm ² | Card of 6 | 30-061 |
| | | | | Card of 25 | 30-161 |
| | | | | Box of 100 | 30-261 |
| | | | | Box of 1,000 | 30-361 |
| 62 | Blue/Red | 600V* 18 to 8 AWG Min. 2 #18 Max. 3 #10 | 600V* ,75mm ² to 10,0mm ² Min. 2-,75mm ² Max. 3-6,0mm ² | Card of 5 | 30-062 |
| | | | | Card of 20 | 30-162 |
| | | | | Box of 100 | 30-262 |
| | | | | Box of 1,000 | 30-362 |
| 63 | Blue/Dr. Blue | 600V* 16 to 6 AWG Min. 3 #14 Max. 2 #8 & 1 #10 | 600V* 1,5mm ² to 16,0mm ² Min. 3-2,5mm ² Max. 2-10,0mm ² w/1-6,0mm ² | Card of 3 | 30-063 |
| | | | | Card of 15 | 30-163 |
| | | | | Box of 100 | 30-263 |
| | | | | Box of 1,000 (yellow) | 30-363 |

UnderGround™ Wire Connectors

| Model | Color | Wire Combination Range | Wire Combination Range (mm) | Quantity | Cat. No. |
|-------|---------------|---|--|-----------------------|----------------|
| 60 | Blue/Blue | 600V* 20 to 10 AWG Min. 2 #20 Max. 1 #10 & 2 #12 | 600V* ,5mm ² to 6,0mm ² Min. 2-,5mm ² Max. 1-6,0mm ² w/2-4,0mm ² | Card of 2 | 30-060 |
| | | | | Card of 10 | 30-760 |
| | Yellow | | | Box of 100 | 30-260 |
| | | | | Box of 1,000 | 30-360 |
| 64 | Blue/Dk. Blue | 600V* 18 to 8 AWG Min. 2 #18 Max. 3 #10 | 600V* ,75mm ² to 10,0mm ² Min. 2-,75mm ² Max. 3-6,0mm ² | Box of 1,000 (yellow) | 30-360Y |
| | | | | Card of 2 | 30-064 |
| | Yellow | | | Card of 10 | 30-764 |
| | | | | Box of 50 | 30-264 |
| | | Box of 1,000 | 30-364 | | |
| | | | Box of 25 (yellow) | 30-164Y | |

*1,000V maximum in fixtures and signs

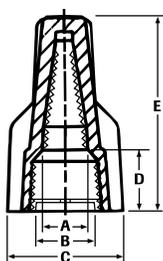

Dimensions (Inches/mm)

| Model | A | B | C | D | E |
|-------|------------|--------------|---------------|--------------|----------------|
| 61 | 3/16 (4,8) | 5/16 (7,9) | 21/32 (16,7) | 13/32 (10,3) | 29/32 (23,0) |
| 62 | 9/32 (7,1) | 1/2 (12,7) | 15/16 (23,8) | 19/32 (15,1) | 1-11/32 (34,1) |
| 63 | 3/8 (9,5) | 19/32 (15,1) | 1-1/16 (27,0) | 23/32 (18,3) | 1-19/32(40,5) |
| 60 | 9/32 (7,1) | 17/32 (13,5) | 41/64 (16,2) | 55/64 (22,0) | 1-21/32 (42,0) |
| 64 | 9/32 (7,1) | 19/32 (15,1) | 29/32 (23,0) | 1-1/8 (28,6) | 2-1/32 (51,6) |



WARNING:

1. One time use only. Do not reuse.
2. Wiring must comply with all applicable electrical codes.
3. For use on copper wire only. Do not use on aluminum wire.
4. Not for use in continuous submersion applications.

Twister® Al/Cu Wire Connector

- Only aluminum-to-copper twist-on connector specifically designed to guarantee a secure connection while preventing aluminum corrosion
- Specially formulated corrosion-resistant compound cuts and penetrates corrosion build-up on aluminum conductors for increased conductivity and cooler connections
- Compact, one-piece design features ribbed cap, swept wings and hexagonal head for easy installation by hand or with standard nutdriver
- Live-action, square-wire spring expands and contracts with aluminum wire
- Deep skirt provides maximum dielectric strength
- Tough, UL 94V-2 flame-retardant shell rated at 105°C (221°F)
- Complies with N.E.C. Section #110-14(b) for aluminum-to-copper connections; UL Listed to 486C and CSA Certified to C22.2 #188; complies with Federal Specification W-S-610E
- UL Listed to 467 for grounding and bonding

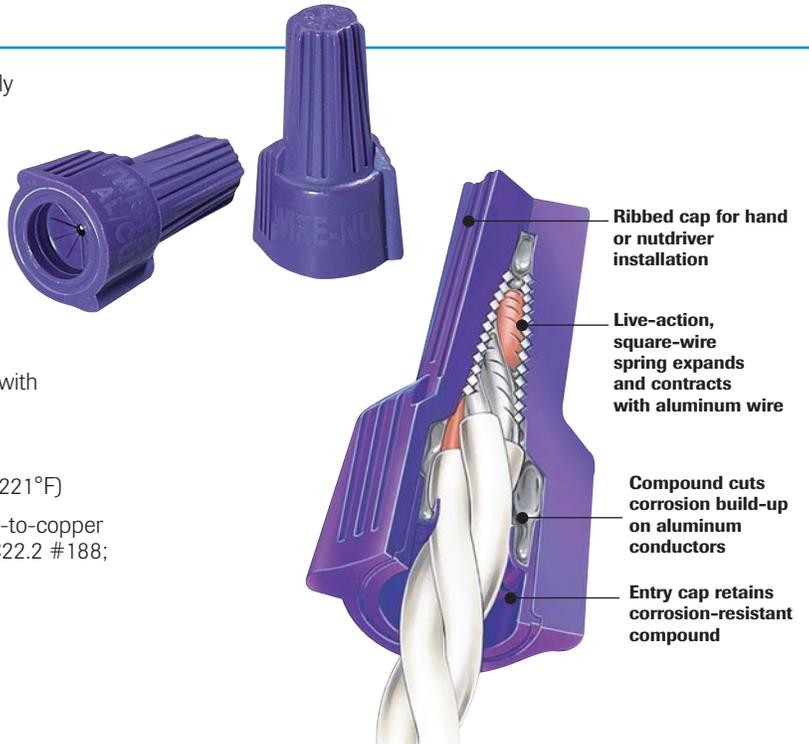

| Model | Color | Wire Combinations | Quantity | Cat. No. |
|---|-----------------|--------------------------------------|------------|----------|
| 65 | Purple | 1 #10 Al solid w/1 or 2 #10 Cu solid | Card of 2 | 30-065 |
| | | 1 #10 Al w/1 or 2 #12 Cu | | |
| | | 2 #10 Al solid w/1 #12 Cu | Card of 10 | 30-765 |
| | | 1 #10 Al w/1 or 2 #14 Cu | | |
| | | 2 #10 Al solid w/1 #14 Cu | Card of 25 | 30-165 |
| | | 2 #12 Al solid w/1 #10 Cu | | |
| 1 #12 Al solid w/1 or 2 #10 Cu | Box of 100 | 30-265 | | |
| 1 #12 Al stranded w/1 or 2 #10 Cu solid | | | | |
| 1 #12 Al w/1 or 2 #12 Cu | | | | |
| 2 #12 Al solid w/1 #12 Cu | | | | |
| 1 #12 Al w/1 or 2 #14 Cu | | | | |
| 2 #12 Al solid w/1 #14 Cu | | | | |
| 1 #10 Al w/1 or 2 #18 Cu | | | | |
| 2 #10 Al solid w/1 #18 Cu | | | | |
| 1 #12 Al w/1 or 2 #16 Cu | | | | |
| 2 #12 Al solid w/1 #16 Cu | | | | |
| 1 #10 Al w/1 or 2 #16 Cu | Carton of 1,000 | 30-365 | | |
| 2 #10 Al solid w/1 #16 Cu | | | | |
| 1 #12 Al w/1 or 2 #18 Cu | | | | |
| 2 #12 Al solid w/1 #18 Cu | | | | |

600V maximum building wire; 1,000V signs or lighting fixtures



Wire Connector also listed as grounding equipment

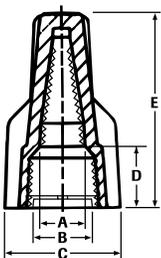

Dimensions (Inches mm)

| Model | A | B | C | D | E |
|-------|----------------------|-------------------------|-----------------------|-----------------------|-------------------------|
| 65 | $\frac{17}{64}$ 7 | $\frac{13}{32}$ 10.5 | $\frac{13}{16}$ 21 | $\frac{35}{64}$ 14 | $\frac{1-11}{32}$ 34 |

WARNING:

1. One time use only. Do not reuse connector.
2. Do not use on aluminum to aluminum wire combinations.
3. Wiring must comply with all applicable electrical codes.
4. Contact IDEAL for complete wire combination listing.

Wire-Nut® Wire Connector Sockets

- Speeds installation of Wire-Nut® Wire Connectors
- Fit any pneumatic or electric tool with a 1/4 in. chuck or drive socket



| For Connector Model | Cat. No. |
|-------------------------------------|---------------|
| 71B®, 71B® Black, 72B® & 72B® Black | 30-903 |
| 73B® & 73B® Black | 30-904 |
| 59B™ | 30-905 |
| 74B®, 76B® & 59B™ | 30-906 |

Wire-Nut® Wire Connector Wrench

- Speeds installation of Wire-Nut® Wire Connectors
- Excellent leverage helps reduce fatigue



| For Connector Model | Cat. No. |
|---------------------|--------------|
| 73B®, 74B® & 76B® | H-632 |

Spin-Twist® Wire Connector Socket

- Speeds installation of IDEAL and BUCHANAN Wire Connectors
- For use with electric corded or cordless drill drivers
- 1/4 in. chuck fits most drills or drive sockets



| For Connector Model | Cat. No. |
|---|---------------|
| Wire-Nut®, Wing-Nut®, Twister®, B-CAP® and WingTwist™ | 30-902 |

Twist-a-Nut™ 7-in-1 Screwdriver

- Facilitate installation of connectors
- Universal Wire-Nut® Wrench in handle
- Accepts most twist-on connectors



| Description | Cat. No. |
|---------------------|---------------|
| 7-in-1 Twist-a-Nut™ | 35-908 |

Wire-Nut® Wire Connector Wrench/Screwdriver Combo

- Speeds installation of Wire-Nut® Wire Connectors
- Slotted-tip screwdriver with convenient connector-wrench socket in end of insulated handle

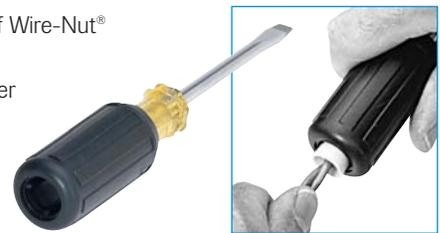

| For Connector Model | Type | Cat. No. |
|---------------------|--------------------------------|---------------|
| 74B® & 76B® | Mechanic – 1/4 in. x 4 in. | 30-331 |
| 74B® & 76B® | Electrician – 3/16 in. x 6 in. | 30-333 |

Nutmaster® Nutdrivers

- Speeds installation of Twister® Wire Connectors
- Nickel/chrome plated to resist rust and corrosion
- Cushioned rubber grip

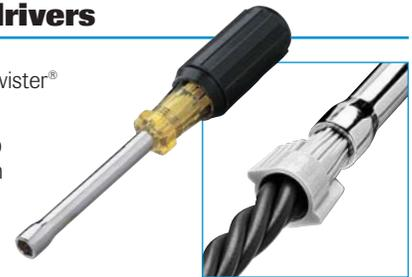

| For Connector Model | Cat. No. |
|---------------------|---------------|
| 341® | 35-292 |
| 342® | 35-295 |

Ratch Wrench

- Speeds installation of B-CAP® Wire Connectors
- Either end accepts 1/4-in. drive for tight-spot wire splicing



| For Connector Model | Cat. No. |
|---------------------|-------------|
| B1, B2 & B4 | BR-5 |

High-Speed Wire Connector Chuck

- Cordless screwdriver adapter for installing B-CAP® Wire Connectors



| For Connector Model | Cat. No. |
|---------------------|--------------|
| B1, B2 & B4 | HSC-1 |

Wire Termination

powerplug Luminaire Disconnect

- The first push-in disconnect to meet the new NEC and CEC code changes for non-residential fluorescent luminaires
- Perfect for OEM or retrofit lighting applications
- Meets UL and CSA finger-probe safety requirements
- Allows safe disconnect of hot and neutral ballast wiring

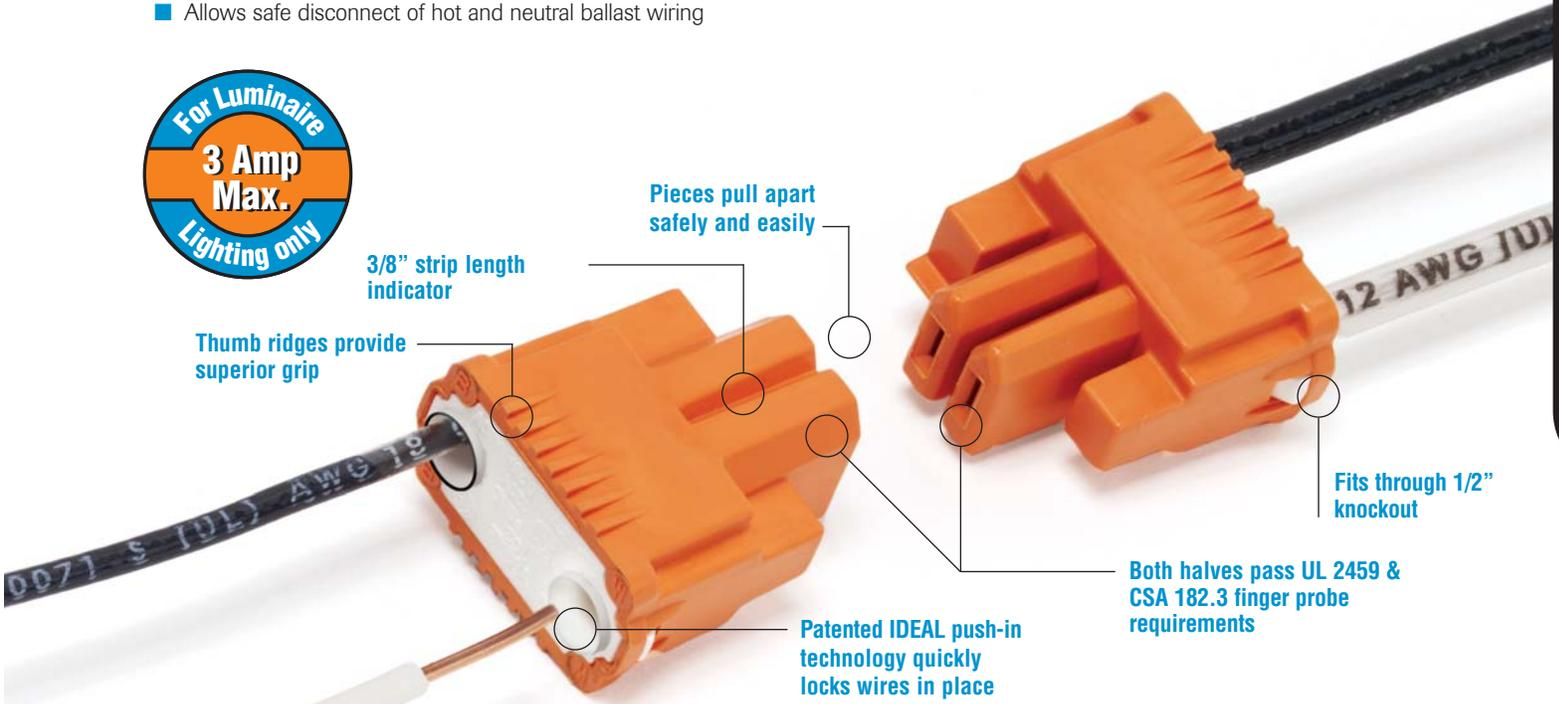
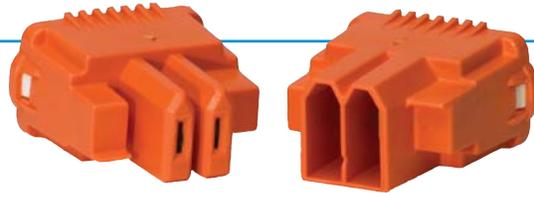

Both halves pass UL 2459 & CSA 182.3 finger probe requirements

Wire Connectors

| | | | |
|----------------------------|---------------|-------------------------|--|
| Materials | | Wire Range | |
| Housings: | Nylon | Solid | 12 AWG – 18 AWG |
| Contacts: | Copper Alloy | Stranded | 12 AWG – 14 AWG (19 strand or less) |
| Ratings | | Stranded (Tin-Bonded) | 12 AWG (19 strand or less) 14 AWG (19 strand or less) 16 AWG (26 strand or less) 18 AWG (16 strand or less) |
| Temperature: | 105°C (221°F) | Agency Approvals | |
| Flammability: | UL 94V-0 | UL 2459 | CSA 182.3 RoHS Compliant |
| Current Interruption: | 10 Cycles | Physical | |
| Max. Current Rating | | Strip Length: | 3/8" ± 1/16" |
| 120V | 3 Amps | Number of Circuits: | 2 (3 circuit coming soon) |
| 277V | 1.3 Amps | Color: | Orange and White |
| 347V | 1 Amps | Mating/Unmating Force: | 3-8 Pounds |
| 480V | 0.75 Amps | Patents Pending | |
| 600V | 0.60 Amps | | |

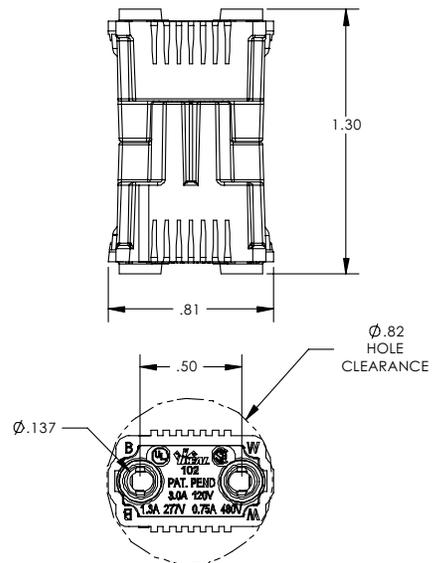

Listed Luminaire Disconnect 3HME

| Model | Color | Wire Combination Range | Wire Combination Range (mm) | Quantity | Cat. No. |
|-------|--------|-------------------------|--|--------------|----------|
| 102 | Orange | 600V* 18 thru 12 AWG | 600V* ,75mm ² to 24,0mm ² | Card of 25 | 30-372 |
| | | | | Jar of 75 | 30-382J |
| | | | | Jar of 150 | 30-352J |
| | | | | Box of 1,000 | 30-102 |

*1,000V maximum in fixtures and signs

In-Sure™ Push-In Wire Connectors

- No-twist connection reduces repetitive motion fatigue
 - Low insertion force for fast and easy connections
 - Compact size makes installation easy
 - Clear shell gives visual verification of connection
 - UL Listed to 486C and CSA Certified to C22.2 #188
 - UL 467 Listed for grounding and bonding applications
- Accepts the following copper wire sizes
 - **Solid**
#20 - #12 solid
 - **Stranded**
#16 - #14 (19 strand or less)
#18 (7 strand or less)
 - **Stranded (Tin Bonded)**
#14 - #12 (19 strand or less)
#16 (26 strand or less)
#18 (16 strand or less)

Wire Connectors



| Model | Color | Ports | Length | | Width | | Height | | Quantity | Cat. No. |
|-------|--------|-----------|--------|-------|-------|-------|--------|-------|--------------|----------------|
| | | | In. | mm | In. | mm | In. | mm | | |
| 84 | Red | 2 | .355 | 9.02 | .434 | 11.02 | .729 | 18.52 | Box of 100 | 30-084 |
| | | | | | | | | | Jar of 300 | 30-084J |
| | | | | | | | | | Box of 1,000 | 30-184 |
| | | | | | | | | | Box of 5,000 | 30-684 |
| 85 | Orange | 3 | .355 | 9.02 | .591 | 15.01 | .729 | 18.52 | Box of 100 | 30-085 |
| | | | | | | | | | Jar of 250 | 30-085J |
| | | | | | | | | | Box of 1,000 | 30-185 |
| | | | | | | | | | Box of 5,000 | 30-685 |
| 86 | Yellow | 4 | .355 | 9.02 | .748 | 18.99 | .729 | 18.52 | Box of 100 | 30-086 |
| | | | | | | | | | Jar of 200 | 30-086J |
| | | | | | | | | | Box of 1,000 | 30-186 |
| | | | | | | | | | Box of 4,000 | 30-686 |
| 87 | Gray | 5 | .355 | 9.02 | .907 | 23.03 | .729 | 18.52 | Box of 50 | 30-087 |
| | | | | | | | | | Jar of 150 | 30-087J |
| | | | | | | | | | Box of 1,000 | 30-187 |
| | | | | | | | | | Box of 5,000 | 30-687 |
| 88 | Blue | 6 Stacked | .607 | 15.42 | .603 | 15.32 | .729 | 18.52 | Box of 50 | 30-088 |
| | | | | | | | | | Jar of 100 | 30-088J |
| | | | | | | | | | Box of 1,000 | 30-188 |
| | | | | | | | | | Box of 5,000 | 30-688 |
| 90 | Black | 8 | .355 | 9.02 | 1.38 | 35.03 | .717 | 18.21 | Box of 50 | 30-090 |
| | | | | | | | | | Jar of 100 | 30-090J |
| | | | | | | | | | Box of 1,000 | 30-190 |
| | | | | | | | | | Box of 2,000 | 30-690 |

Installation as easy as 1-2-3...

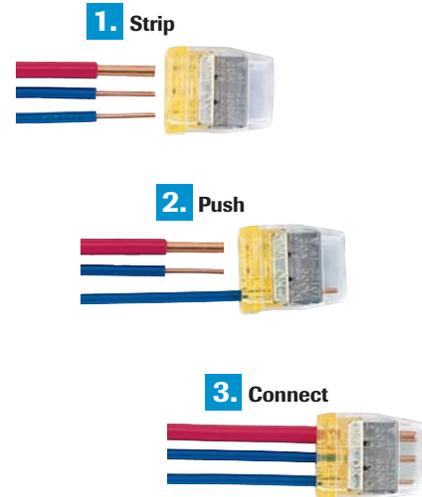

COPPER TO COPPER ONLY. Do not use on aluminum.
 Temperature rating: 105°C (221°F) maximum
 600V maximum building wire, 1000V maximum signs or lighting fixtures



Term-a-Nut® Pigtail Wire Connectors

- Ultra-flexible 6-in. lead allows for easy positioning in outlet box – reduces stress on device, wires and connection
- Wide range of wire combinations – #18 through #12 solid or stranded conductors
- Brass adapter for strong, conductive transition from spring to lead wire
- Brass-alloy terminals with locking tabs for fast, efficient device connection
- UL 486A and UL 486C Listed and tested to CSA standard C22.2 #65 and C22.2 #188
- Wire Range: Red/Green Shell – Min. 2 #18 w/1 #14, Max. 4 #12

| Shell Color | Wire Color | Terminal End | Quantity | Cat. No. |
|-------------|-------------------|--------------|----------|----------|
| Red | White | #10 fork | 25 | 30-3170 |
| Red | White | #10 fork | 10 | 30-3370 |
| Red | Black | #10 fork | 25 | 30-3171 |
| Red | Black | #10 fork | 10 | 30-3371 |
| Red | White | Stripped end | 25 | 30-3172 |
| Red | Black | Stripped end | 25 | 30-3173 |
| Green | Green | #10 fork | 25 | 30-3180 |
| Green | Green | #10 fork | 10 | 30-3380 |
| MultiPak* | White/Black/Green | #10 fork | 9 | 30-3181 |

*Includes 3 red shells w/white wire, 3 red shells w/black wire, and 3 green shells w/green wire.



Cu/Cu
Only



Wire Connectors

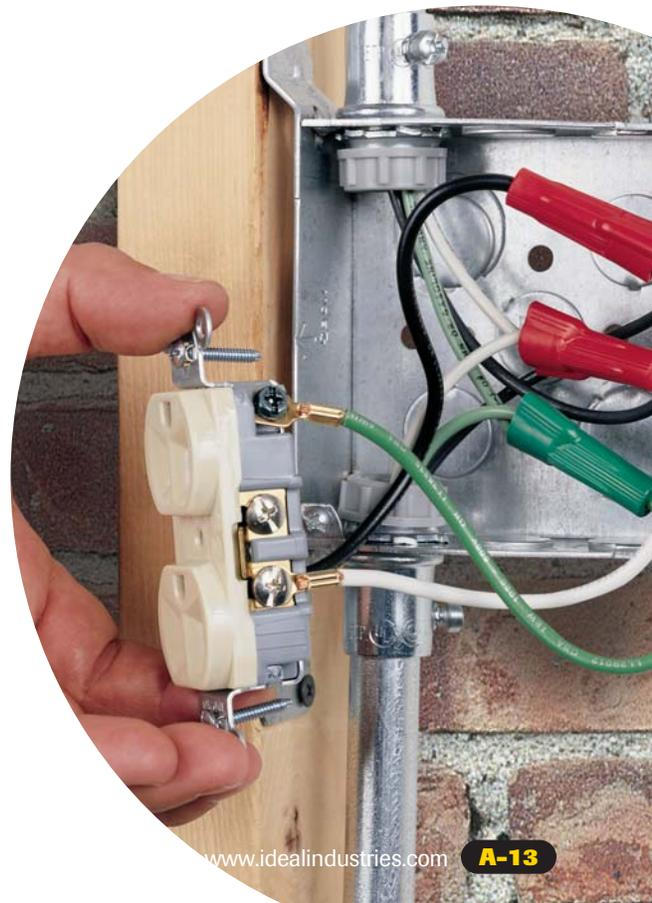
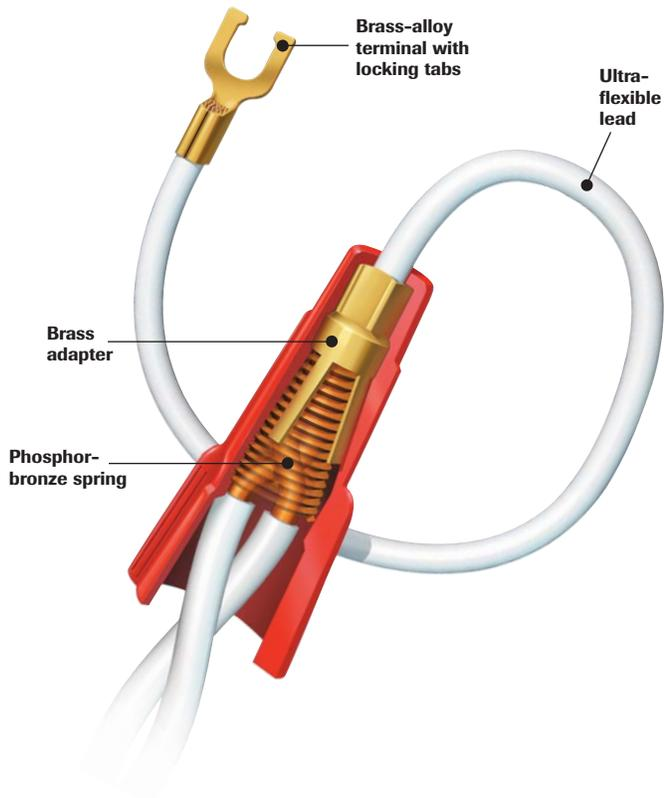

Grounding Connectors

- Term-a-Nut® grounding connectors address specific requirements for grounding to steel outlet boxes and wiring multiple devices
- UL Listed to UL486C and UL467 (grounding and bonding)



Term-a-Nut® Grounding Connector

Connects multiple grounding conductors to a device.

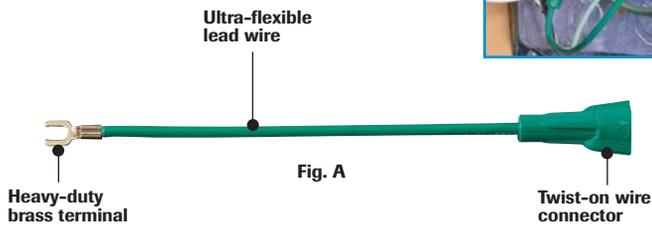

Term-a-Nut® Grounding Connector

Bonds the box to the grounding conductors.

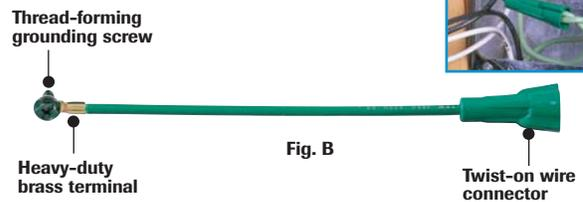

Term-a-Nut® Grounding Connector

Connects grounding conductors to a device's grounding screw, connects grounding conductors to the mounting box and bonds the device to the box.

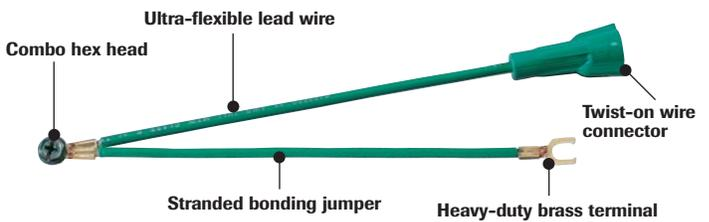

| Term-a-Nut® Grounding Connectors | Quantity | Cat. No. | Fig. |
|--|------------|----------------|------|
| Term-a-Nut® Grounding Connector, 12 AWG stranded, 6 in. tail w/#10 fork | Bag of 10 | 30-3380 | A |
| Term-a-Nut® Grounding Connector, 12 AWG stranded, 6 in. tail w/#10 fork | Bag of 25 | 30-3180 | A |
| Term-a-Nut® Grounding Connector, 12 AWG stranded, 6 in. tail w/#10 fork | Box of 100 | 30-3280 | A |
| Term-a-Nut® Grounding Connector, 12 AWG stranded, 6 in. tail w/#10 fork | Box of 250 | 30-3680 | A |
| Term-a-Nut® Grounding Connector, 12 AWG stranded w/#10 ring & ground screw | Bag of 25 | 30-3182 | B |
| Term-a-Nut® Grounding Connector, 12 AWG stranded w/#10 ring & ground screw and 6 in. jumper w/#10 fork | Bag of 10 | 30-3386 | C |

Grounding Accessories

- Solid and stranded pigtail lead wires are convenient for stranded device grounding applications
- Grounding screws offer a unique thread-forming feature, plus combination hex, Phillips, slotted and Robertson tip

Grounding Tails - Stranded Wire

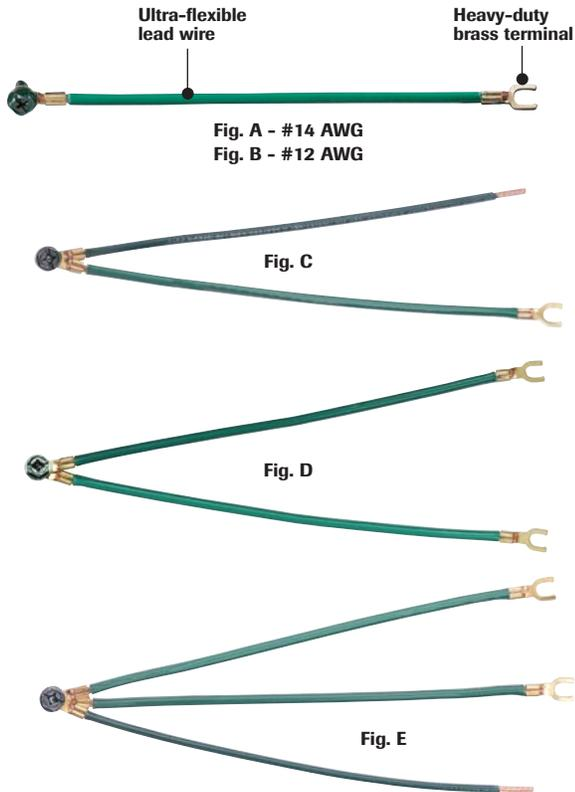

| Stranded Wire Grounding Tails | Quantity | Cat. No. | Fig. |
|--|---------------|----------------|------|
| 14 AWG stranded 7-3/4 in. tail w/#10 fork & 10 ring and ground screw | Bag of 25 | 30-3183 | A |
| 12 AWG stranded, 7-3/4 in. tail w/#10 fork & 10 ring and ground screw | Bag of 25 | 30-3184 | B |
| 12 AWG stranded, 7-3/4 in. tail w/#10 fork & 10 ring and ground screw | Bundle of 100 | 30-3284 | B |
| 12 AWG stranded, 2-wire tail joined w/#10 ring and ground screw, one stripped-end tail and one 10 fork tail | Bag of 25 | 30-3287 | C |
| 12 AWG stranded, 2-wire tail joined w/#10 ring and ground screw and two #10 fork tails | Bag of 25 | 30-3288 | D |
| 12 AWG stranded, 3-wire tail joined w/#10 ring and ground screw, one stripped-end tail and two 10 fork tails | Bag of 25 | 30-3289 | E |

Grounding Tails - Solid Wire

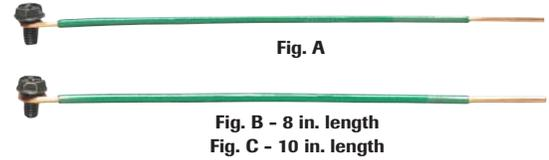

| Solid Wire Grounding Tails | Quantity | Cat. No. | Fig. |
|--|--------------|----------------|------|
| 14 AWG solid, 8 in. tail w/loop & ground screw and stripped end | Box of 50 | 30-3390 | A |
| 12 AWG solid, 8 in. tail w/loop & ground screw and stripped end | Box of 50 | 30-3392 | B |
| 12 AWG solid, 8 in. tail w/loop & ground screw and stripped end | Bundle of 50 | 30-3496 | B |
| 12 AWG solid, 10 in. tail w/loop & ground screw and stripped end | Bundle of 50 | 30-3394 | C |

Grounding Accessories

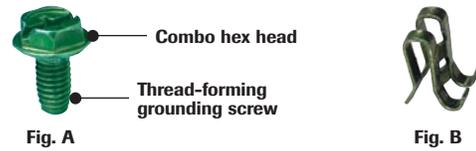

| Miscellaneous Grounding Products | Quantity | Cat. No. | Fig. |
|--|-------------|----------------|------|
| Ground Screw, thread-forming, combination hex, Phillips, slotted and Robertson-tip | Pack of 50 | 30-3194 | A |
| Ground Screw, thread-forming, combination hex, Phillips, slotted and Robertson-tip | Bag of 100 | 30-3294 | A |
| Grounding clip – accepts 10, 12 or 14 AWG wire | Pack of 100 | 30-3395 | B |

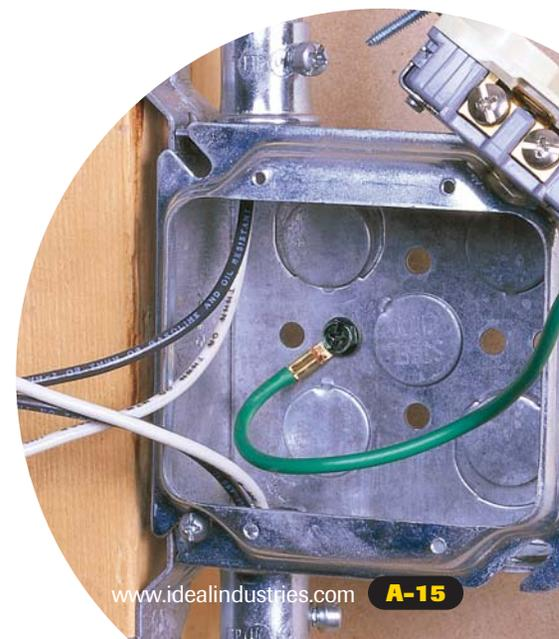

Term-a-Nut® Terminal Wire Connectors

- No tools required – installs quickly without crimping – easily removed for quick changes
- Use with single or multiple wires – solid and/or stranded 22 to 12 AWG
- Highly conductive brass terminal and phosphor-bronze spring for maximum conductivity and smooth performance
- Tough, UL 94V-2 flame-retardant shell rated at 105°C (221°F)
- UL 486A and UL 486C Listed and tested to CSA C22.2 #65 and C22.2 #188

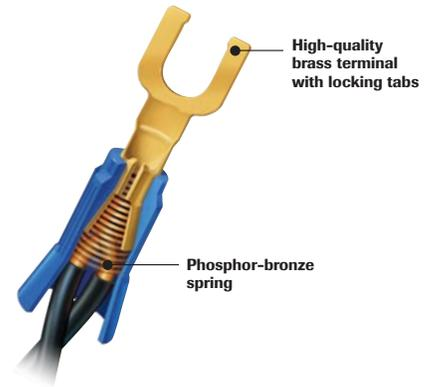

| Terminal Configurations | Qty./Clamshell | Cat. No. |
|-------------------------|----------------|----------------|
| #10 fork | 25 | 30-3004 |
| #8 fork | 25 | 30-3014 |
| .250 in. disconnect | 25 | 30-3006 |
| #10 ring | 25 | 30-3012 |
| #8 ring | 25 | 30-3010 |
| Assortment | 40/kit* | 30-3901 |

*Kit contains 8 each: 30-3004, 30-3014, 30-3006, 30-3012 and 30-3010.



Crimp Terminals-Rings, Forks, Disconnects and Splices

- Butted seam-construction prevents splitting under maximum pressure
- Internal barrel serrations grip wires tightly to resist pull-out and reduce electrical resistance
- Tin-plated brass construction for corrosion resistance
- Shouldered barrel insulation quickly positions terminal for proper crimping
- Expanded insulation entry accommodates a wide variety of insulation diameters and provides additional insulation support
- Color-coded insulation and wire range stamped on terminal for easy identification

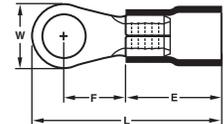

Vinyl Insulated Ring Terminals

| Wire Range (AWG) | Wire Range (mm ²) | Stud Size (Inches) | Stud Size (mm) | Max. Wire Ins. Dia. (Inches) | Max. Wire Ins. Dia. (mm) | Dimensions (Inches) | | | | Dimensions (mm) | | | | Ctn. Qty. | Cat. No. | Ctn. Qty. | Cat. No. |
|------------------|-------------------------------|--------------------|----------------|------------------------------|--------------------------|---------------------|------|------|------|-----------------|------|------|------|-----------|----------------|-----------|----------------|
| | | | | | | L | W | E | F | L | W | E | F | | | | |
| 22 – 18 | 0.5 – 1.0 | 6 | 3.7 | .157 | 4.0 | .764 | .260 | .394 | .248 | 19.4 | 6.6 | 10.0 | 6.3 | 25 | 83-2121 | — | — |
| | | 8 | 4.3 | | | .819 | .315 | .394 | .276 | 20.8 | 8.0 | 10.0 | 7.0 | 25 | 83-2131 | — | — |
| | | 10 | 5.3 | | | .819 | .315 | .394 | .276 | 20.8 | 8.0 | 10.0 | 7.0 | 25 | 83-2141 | — | — |
| | | 1/4 | 6.4 | | | 1.055 | .457 | .394 | .433 | 26.8 | 11.6 | 10.0 | 11.0 | 25 | 83-2151 | — | — |
| 16 – 14 | 1.5 – 2.5 | 6 | 3.7 | .177 | 4.5 | .764 | .260 | .394 | .248 | 19.4 | 6.6 | 10.0 | 6.3 | 25 | 83-2221 | — | — |
| | | 8 | 4.3 | | | .858 | .335 | .394 | .307 | 21.8 | 8.5 | 10.0 | 7.8 | 25 | 83-2231 | — | — |
| | | 10 | 5.3 | | | .858 | .374 | .394 | .287 | 21.8 | 9.5 | 10.0 | 7.3 | 25 | 83-2241 | 1,000 | 84-2241 |
| | | 1/4 | 6.4 | | | 1.055 | .472 | .394 | .433 | 26.8 | 12.0 | 10.0 | 11.0 | 25 | 83-2251 | — | — |
| 12 – 10 | 4.0 – 6.0 | 8 | 4.3 | .248 | 6.3 | 1.047 | .374 | .512 | .358 | 26.6 | 9.5 | 13.0 | 9.1 | 25 | 83-2331 | — | — |
| | | 10 | 5.3 | | | 1.047 | .374 | .512 | .358 | 26.6 | 9.5 | 13.0 | 9.1 | 25 | 83-2341 | 1,000 | 84-2341 |
| | | 1/4 | 6.4 | | | 1.167 | .472 | .512 | .413 | 29.5 | 12.0 | 13.0 | 10.5 | 25 | 83-2351 | — | — |
| | | 5/16 | 8.4 | | | 1.339 | .591 | .512 | .531 | 34.0 | 15.0 | 13.0 | 13.5 | 25 | 83-2361 | — | — |
| | | 3/8 | 10.5 | | | 1.339 | .591 | .512 | .531 | 34.0 | 15.0 | 13.0 | 13.5 | 25 | 83-2371 | — | — |

75° C/600 Volts max.



Wire Termination

Non-Insulated Ring Terminals

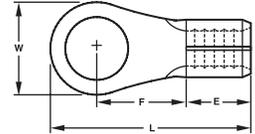

| Wire Range (AWG) | Wire Range (mm ²) | Stud Size (Inches) | Stud Size (mm) | Dimensions (Inches)* | | | | Dimensions (mm)** | | | | Ctn. Qty. | Cat. No. | Ctn. Qty. | Cat. No. |
|------------------|-------------------------------|--------------------|----------------|----------------------|------|------|------|-------------------|------|------|------|-----------|----------------|-----------|----------------|
| | | | | L | W | E | F | L | W | E | F | | | | |
| 22 - 18 | 0.5 - 1.0 | 8 10 | 4.3 5.3 | .622 | .315 | .189 | .276 | 15.8 | 8.0 | 4.8 | 7.0 | 25 | 83-0131 | — | — |
| | | | | .622 | .315 | .189 | .276 | 15.8 | 8.0 | 4.8 | 7.0 | 25 | 83-0141 | — | — |
| 16 - 14 | 1.5 - 2.5 | 6 | 3.7 | .567 | .260 | .189 | .248 | 14.4 | 6.6 | 4.8 | 6.3 | 25 | 83-0221 | — | — |
| | | 8 | 4.3 | .661 | .335 | .189 | .307 | 16.8 | 8.5 | 4.8 | 7.8 | 25 | 83-0231 | — | — |
| | | 10 | 5.3 | .661 | .374 | .189 | .287 | 16.8 | 9.5 | 4.8 | 7.3 | 25 | 83-0241 | 1,000 | 84-0241 |
| 12 - 10 | 4.0 - 6.0 | 8 | 4.3 | .772 | .374 | .236 | .358 | 19.6 | 9.5 | 6.0 | 9.1 | 25 | 83-0331 | — | — |
| | | 10 | 5.3 | .772 | .374 | .236 | .358 | 19.6 | 9.5 | 6.0 | 9.1 | 25 | 83-0341 | 1,000 | 84-0341 |
| | | 1/4 | 6.4 | .886 | .472 | .236 | .413 | 22.5 | 12.0 | 6.0 | 10.5 | 25 | 83-0351 | — | — |
| 8 | 8.0 | 10 | 5.3 | .937 | .472 | .337 | .366 | 23.8 | 12.0 | 8.5 | 9.3 | 25 | 83-0421 | — | — |
| | | 1/4 | 6.4 | .937 | .472 | .337 | .366 | 23.8 | 12.0 | 8.5 | 9.3 | 25 | 83-0431 | — | — |
| | | 5/16 | 8.4 | 1.161 | .591 | .337 | .543 | 29.8 | 15.0 | 8.5 | 13.8 | 25 | 83-0441 | — | — |
| | | 3/8 | 10.5 | 1.161 | .591 | .337 | .543 | 29.8 | 15.0 | 8.5 | 13.8 | 25 | 83-0451 | — | — |
| 6 | 14.0 | 10 | 5.3 | 1.173 | .472 | .413 | .524 | 29.8 | 12.0 | 10.5 | 13.3 | 20 | 83-0511 | — | — |
| | | 1/4 | 6.4 | 1.173 | .472 | .413 | .524 | 29.8 | 12.0 | 10.5 | 13.3 | 20 | 83-0521 | — | — |
| | | 5/16 | 8.4 | 1.280 | .630 | .413 | .559 | 32.5 | 16.0 | 10.5 | 14.2 | 20 | 83-0531 | — | — |
| | | 3/8 | 10.5 | 1.280 | .630 | .413 | .559 | 32.5 | 16.0 | 10.5 | 14.2 | 20 | 83-0541 | — | — |
| 4 | 22.0 | 1/4 | 6.4 | 1.319 | .650 | .472 | .531 | 33.5 | 16.5 | 12.0 | 13.5 | 20 | 83-0611 | — | — |
| | | 5/16 | 8.4 | 1.319 | .650 | .472 | .531 | 33.5 | 16.5 | 12.0 | 13.5 | 20 | 83-0621 | — | — |
| | | 3/8 | 10.5 | 1.319 | .650 | .472 | .531 | 33.5 | 16.5 | 12.0 | 13.5 | 20 | 83-0631 | — | — |

105°C/600 Volts max.

*Plus or minus .020 in.

**Plus or minus .50 in.

Listed 774A Cu Only Pressure Wire Connector

Vinyl Insulated Spade Terminals

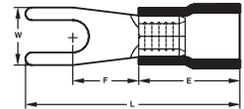

| Wire Range (AWG) | Wire Range (mm ²) | Stud Size (Inches) | Stud Size (mm) | Max. Wire Ins. Dia. (Inches) | Max. Wire Ins. Dia. (mm) | Dimensions (Inches) | | | | Dimensions (mm) | | | | Ctn. Qty. | Cat. No. | Ctn. Qty. | Cat. No. |
|------------------|-------------------------------|--------------------|----------------|------------------------------|--------------------------|---------------------|------|------|------|-----------------|------|------|------|-----------|----------------|-----------|----------------|
| | | | | | | L | W | E | F | L | W | E | F | | | | |
| 22 - 18 | 0.5 - 1.0 | 6 | 3.7 | .157 | 4.0 | .827 | .252 | .394 | .256 | 21.0 | 6.4 | 10.0 | 6.5 | 25 | 83-7111 | 1,000 | 84-7111 |
| | | 8 | 4.3 | | | .827 | .283 | .394 | .256 | 21.0 | 7.2 | 10.0 | 6.5 | 25 | 83-7121 | — | — |
| | | 10 | 5.3 | | | .827 | .374 | .394 | .256 | 21.0 | 9.5 | 10.0 | 6.5 | 25 | 83-7131 | — | — |
| 16 - 14 | 1.5 - 2.5 | 6 | 3.7 | .177 | 4.5 | .827 | .236 | .394 | .256 | 21.0 | 6.0 | 10.0 | 6.5 | 25 | 83-7151 | — | — |
| | | 8 | 4.3 | | | .827 | .283 | .394 | .256 | 21.0 | 7.2 | 10.0 | 6.5 | 25 | 83-7161 | 1,000 | 84-7161 |
| | | 10 | 5.3 | | | .827 | .366 | .394 | .256 | 21.0 | 9.3 | 10.0 | 6.5 | 25 | 83-7171 | 1,000 | 84-7171 |
| 12 - 10 | 4.0 - 6.0 | 6 | 3.7 | .248 | 6.3 | 1.004 | .327 | .512 | .276 | 25.5 | 8.3 | 13.0 | 7.0 | 25 | 83-7201 | — | — |
| | | 8 | 4.3 | | | 1.004 | .283 | .512 | .357 | 25.5 | 9.0 | 13.0 | 7.0 | 25 | 83-7211 | — | — |
| | | 10 | 5.3 | | | 1.004 | .283 | .512 | .354 | 25.5 | 9.0 | 13.0 | 7.0 | 25 | 83-7221 | 500 | 84-7221 |
| | | 1/4 | 6.4 | | | 1.240 | .472 | .512 | .472 | 31.5 | 12.0 | 13.0 | 12.0 | 25 | 83-7231 | — | — |

75° C/600 Volts max.

Listed 774A Cu Only Pressure Wire Connector

Crimp Tools



#30-518 Tool w/die
#30-519 Replacement die



#83-005



#88-843

Insulated and Non-Insulated Terminals, Splices and Disconnects (#22 - #10 AWG) are UL Listed when used with IDEAL Crimp Tool #30-518 (Replacement Die #30-519).
Non-Insulated Ring Terminals (#8 - #4 AWG) are UL Listed when used with IDEAL Crimp Tool #83-005 or #88-843.
Non-Insulated Disconnects, Splices and Vinyl Insulated Parallel Splices (#22 - #10 AWG) are not UL Listed; recommended IDEAL Crimp Tool #30-518.
Non-Insulated Splices (#8 - #4 AWG) are not UL Listed, recommended IDEAL Crimp Tool #83-005 or #88-843.

Vinyl Insulated Snap Spade Terminals



| Wire Range (AWG) | Wire Range (mm ²) | Stud Size (Inches) | Stud Size (mm) | Max. Wire Ins. Dia. (Inches) | Max. Wire Ins. Dia. (mm) | Dimensions (Inches) | | | | Dimensions (mm) | | | | Ctn. Qty. | Cat. No. |
|------------------|-------------------------------|--------------------|----------------|------------------------------|--------------------------|---------------------|------|------|------|-----------------|------|------|------|-----------|-------------------------------|
| | | | | | | L | W | E | F | L | W | E | F | | |
| 22 - 18 | 0.5 - 1.0 | 6 | 3.7 | .134 | 4.0 | .827 | .252 | .394 | .256 | 21.0 | 6.4 | 10.0 | 6.5 | 25 | 83-7011 83-7021 83-7031 |
| | | 8 | 4.3 | | | .827 | .283 | .394 | .256 | 21.0 | 7.2 | 10.0 | 6.5 | | |
| | | 10 | 5.3 | | | .827 | .319 | .394 | .256 | 21.0 | 8.1 | 10.0 | 6.5 | | |
| 16 - 14 | 1.5 - 2.5 | 6 | 3.7 | .161 | 4.5 | .827 | .236 | .394 | .256 | 21.0 | 6.0 | 10.0 | 6.5 | 25 | 83-7051 83-7061 83-7071 |
| | | 8 | 4.3 | | | .827 | .319 | .394 | .256 | 21.0 | 8.1 | 10.0 | 6.5 | | |
| | | 10 | 5.3 | | | .827 | .319 | .394 | .256 | 21.0 | 8.1 | 10.0 | 6.5 | | |
| 12 - 10 | 4.0 - 6.0 | 8 | 4.3 | .248 | 6.3 | .992 | .327 | .512 | .276 | 25.2 | 8.3 | 13.0 | 7.0 | 25 | 83-7081 83-7091 83-7101 |
| | | 10 | 5.3 | | | .992 | .354 | .512 | .276 | 25.2 | 9.0 | 13.0 | 7.0 | | |
| | | 1/4 | 6.4 | | | 1.240 | .472 | .512 | .472 | 31.5 | 12.0 | 13.0 | 12.0 | | |

75° C/600 Volts max.

Listed 774A Cu Only Pressure Wire Connector

Non-Insulated Spade Terminals

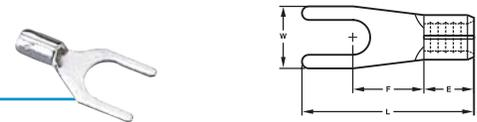

| Wire Range (AWG) | Wire Range (mm ²) | Stud Size (Inches) | Stud Size (mm) | Dimensions (Inches) | | | | Dimensions (mm) | | | | Ctn. Qty. | Cat. No. | Ctn. Qty. | Cat. No. |
|------------------|-------------------------------|--------------------|----------------|---------------------|------|------|------|-----------------|------|-----|------|-----------|-------------------------------|-----------|----------|
| | | | | L | W | E | F | L | W | E | F | | | | |
| 22 - 18 | 0.5 - 1.0 | 6 | 3.7 | .630 | .252 | .189 | .256 | 16.0 | 6.4 | 4.8 | 6.5 | 25 | 83-6111 83-6121 83-6131 | — | — |
| | | 8 | 4.3 | .630 | .283 | .189 | .256 | 16.0 | 7.2 | 4.8 | 6.5 | 25 | | | |
| | | 10 | 5.3 | .630 | .319 | .189 | .256 | 16.0 | 8.1 | 4.8 | 6.5 | 25 | | | |
| 16 - 14 | 1.5 - 2.5 | 8 | 4.3 | .630 | .283 | .189 | .256 | 16.0 | 7.2 | 4.8 | 6.5 | 25 | 83-6161 83-6171 | — | — |
| | | 10 | 5.3 | .630 | .366 | .189 | .256 | 16.0 | 9.3 | 4.8 | 6.5 | 25 | | | |
| 12 - 10 | 4.0 - 6.0 | 8 | 4.3 | .728 | .354 | .236 | .276 | 18.5 | 9.0 | 6.0 | 7.0 | 25 | 83-6211 83-6221 83-6231 | — | — |
| | | 10 | 5.3 | .728 | .354 | .236 | .276 | 18.5 | 9.0 | 6.0 | 7.0 | 25 | | | |
| | | 1/4 | 6.4 | .965 | .472 | .236 | .472 | 24.5 | 12.0 | 6.0 | 12.0 | 25 | | | |

105° C/600 Volts max.

Listed 774A Cu Only Pressure Wire Connector

Vinyl Insulated Multi-Stack Disconnects



| Wire Range (AWG) | Wire Range (mm ²) | Tab Size (Inches) | Tab Size (mm) | Max. Wire Ins. Dia. (Inches) | Max. Wire Ins. Dia. (mm) | Dimensions (Inches) | | | | | | Dimensions (mm) | | | | | | Ctn. Qty. | Cat. No. |
|------------------|-------------------------------|-------------------|---------------|------------------------------|--------------------------|---------------------|------|------|------|------|------|-----------------|------|-----|-----|------|-----|-----------|----------|
| | | | | | | L | B | W | F | W1 | F1 | L | B | W | F | W1 | F1 | | |
| 22 - 18 | 0.5 - 1.0 | .250 x .032 | 6.35 x 0.8 | .150 | 3.8 | .886 | .413 | .260 | .315 | .250 | .323 | 22.5 | 10.5 | 6.6 | 8.0 | 6.35 | 8.2 | 25 | 83-9611 |
| 16 - 14 | 1.5 - 2.5 | .250 x .032 | 6.35 x 0.8 | .185 | 4.7 | .886 | .413 | .260 | .315 | .250 | .323 | 22.5 | 10.5 | 6.6 | 8.0 | 6.35 | 8.2 | 25 | 83-9621 |
| 12 - 10 | 4.0 - 6.0 | .250 x .032 | 6.35 x 0.8 | .244 | 6.2 | .945 | .512 | .260 | .315 | .250 | .323 | 22.5 | 13.0 | 6.6 | 8.0 | 6.35 | 8.2 | 25 | 83-9631 |

75° C/300 Volts max.

Listed 774A Cu Only Pressure Wire Connector

Vinyl Insulated Female Disconnects



| Wire Range (AWG) | Wire Range (mm ²) | Tab Size (Inches) | Tab Size (mm) | Max. Wire Ins. Dia. (Inches) | Max. Wire Ins. Dia. (mm) | Dimensions (Inches) | | | | Dimensions (mm) | | | | Ctn. Qty. | Cat. No. | Ctn. Qty. | Cat. No. |
|------------------|-------------------------------|-------------------|---------------|------------------------------|--------------------------|---------------------|------|------|------|-----------------|------|-----|-----|-----------|----------------|-----------|----------------|
| | | | | | | L | B | W | F | L | B | W | L | | | | |
| 22 - 18 | 0.5 - 1.0 | .110 x .020 | 2.8 x 0.5 | .150 | 3.8 | .728 | .413 | .126 | .256 | 18.5 | 10.5 | 3.2 | 6.5 | 25 | 83-9511 | — | — |
| 16 - 14 | 1.5 - 2.5 | .110 x .020 | 2.8 x 0.5 | .185 | 4.7 | .748 | .413 | .126 | .256 | 19.0 | 10.5 | 3.2 | 6.5 | 25 | 83-9521 | — | — |
| 22 - 18 | 0.5 - 1.0 | .187 x .020 | 4.75 x 0.5 | .150 | 3.8 | .764 | .413 | .197 | .252 | 19.4 | 10.5 | 5.0 | 6.4 | 25 | 83-9541 | — | — |
| 16 - 14 | 1.5 - 2.5 | .187 x .020 | 4.75 x 0.5 | .185 | 4.7 | .764 | .413 | .197 | .252 | 19.4 | 10.5 | 5.0 | 6.4 | 25 | 83-9551 | — | — |
| 22 - 18 | 0.5 - 1.0 | .250 x .032 | 6.35 x 0.8 | .150 | 3.8 | .819 | .413 | .260 | .287 | 20.8 | 10.5 | 6.6 | 7.3 | 25 | 83-9571 | — | — |
| 16 - 14 | 1.5 - 2.5 | .250 x .032 | 6.35 x 0.8 | .185 | 4.7 | .819 | .413 | .260 | .287 | 20.8 | 10.5 | 6.6 | 7.3 | 25 | 83-9581 | 500 | 84-9581 |
| 14 - 12 | 2.5 - 4.0 | .250 x .032 | 6.35 x 0.8 | .244 | 6.2 | .917 | .512 | .260 | .287 | 23.3 | 13.0 | 6.6 | 7.3 | 25 | 83-9591 | — | — |
| 12 - 10 | 4.0 - 6.0 | .250 x .032 | 6.35 x 0.8 | .244 | 6.2 | .917 | .512 | .260 | .287 | 23.3 | 13.0 | 6.6 | 7.3 | 25 | 83-9601 | — | — |

75° C/300 Volts max.

Listed 774A Cu Only Pressure Wire Connector

Vinyl Insulated Male Disconnects

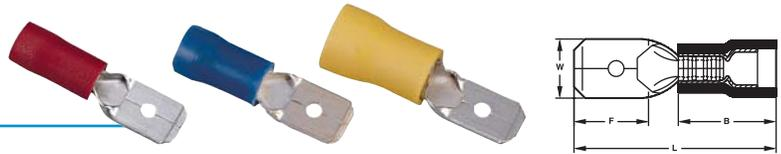

| Wire Range (AWG) | Wire Range (mm ²) | Tab Size (Inches) | Tab Size (mm) | Max. Wire Ins. Dia. (Inches) | Max. Wire Ins. Dia. (mm) | Dimensions (Inches) | | | | Dimensions (mm) | | | | Ctn. Qty. | Cat. No. |
|------------------|-------------------------------|-------------------|---------------|------------------------------|--------------------------|---------------------|------|------|------|-----------------|------|------|-----|-----------|----------------|
| | | | | | | L | B | W | F | L | B | W | F | | |
| 22 - 18 | 0.5 - 1.0 | .250 x .032 | 6.35 x 0.8 | .150 | 3.8 | .858 | .413 | .250 | .303 | 21.8 | 10.5 | 6.35 | 7.7 | 25 | 83-9971 |
| 16 - 14 | 1.5 - 2.5 | .250 x .032 | 6.35 x 0.8 | .185 | 4.7 | .858 | .413 | .250 | .303 | 21.8 | 10.5 | 6.35 | 7.7 | 25 | 83-9981 |
| 12 - 10 | 4.0 - 6.0 | .250 x .032 | 6.35 x 0.8 | .244 | 6.2 | .945 | .512 | .250 | .303 | 24.0 | 13.0 | 6.35 | 7.7 | 25 | 83-9991 |

75° C/300 Volts max.

Listed 774A Cu Only Pressure Wire Connector

Non-Insulated Female Disconnects

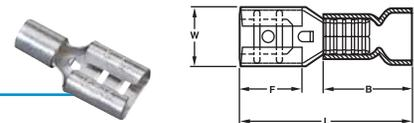

| Wire Range (AWG) | Wire Range (mm ²) | Tab Size (Inches) | Tab Size (mm) | Dimensions (Inches) | | | | Dimensions (mm) | | | | Ctn. Qty. | Cat. No. |
|------------------|-------------------------------|-------------------|---------------|---------------------|------|------|------|-----------------|-----|-----|-----|-----------|----------------|
| | | | | L | B | W | F | L | B | W | F | | |
| 22 - 18 | 0.5 - 1.0 | .110 x .020 | 2.8 x 0.5 | .630 | .189 | .126 | .256 | 16.0 | 4.8 | 3.2 | 6.5 | 25 | 83-9411 |
| 16 - 14 | 1.5 - 2.5 | .110 x .020 | 2.8 x 0.5 | .630 | .189 | .126 | .256 | 16.0 | 4.8 | 3.2 | 6.5 | 25 | 83-9421 |
| 22 - 18 | 0.5 - 1.25 | .187 x .020 | 4.75 x 0.5 | .630 | .189 | .197 | .252 | 16.0 | 4.8 | 5.0 | 6.4 | 25 | 83-9441 |
| 16 - 14 | 1.5 - 2.5 | .187 x .020 | 4.75 x 0.5 | .630 | .189 | .197 | .252 | 16.0 | 4.8 | 5.0 | 6.4 | 25 | 83-9451 |
| 22 - 18 | 0.5 - 1.25 | .250 x .032 | 6.35 x 0.8 | .630 | .189 | .260 | .287 | 16.0 | 4.8 | 6.6 | 7.3 | 25 | 83-9471 |
| 16 - 14 | 1.5 - 2.5 | .250 x .032 | 6.35 x 0.8 | .630 | .189 | .260 | .287 | 16.0 | 4.8 | 6.6 | 7.3 | 25 | 83-9481 |
| 12 - 10 | 4.0 - 6.0 | .250 x .032 | 6.35 x 0.8 | .728 | .236 | .260 | .287 | 18.5 | 6.0 | 6.6 | 7.3 | 25 | 83-9501 |

105° C/300 Volts max.

Nylon Fully-Insulated Female Disconnects



| Wire Range (AWG) | Wire Range (mm ²) | Tab Size (Inches) | Tab Size (mm) | Max. Wire Ins. Dia. (Inches) | Max. Wire Ins. Dia. (mm) | Dimensions (Inches) | | | | Dimensions (mm) | | | | Ctn. Qty. | Cat. No. | Ctn. Qty. | Cat. No. |
|------------------|-------------------------------|-------------------|---------------|------------------------------|--------------------------|---------------------|------|------|------|-----------------|------|-----|-----|-----------|----------------|-----------|----------------|
| | | | | | | L | B | W | F | L | B | W | L | | | | |
| 22 - 18 | 0.5 - 1.0 | .250 x .032 | 6.35 x 0.8 | .150 | 3.8 | .866 | .433 | .260 | .287 | 22.0 | 11.0 | 6.6 | 7.3 | 25 | 83-9771 | — | — |
| 16 - 14 | 1.5 - 2.5 | .250 x .032 | 6.35 x 0.8 | .185 | 4.7 | .866 | .433 | .260 | .287 | 22.0 | 11.0 | 6.6 | 7.3 | 25 | 83-9781 | 1,000 | 84-9781 |
| 12 - 10 | 4.0 - 6.0 | .250 x .032 | 6.35 x 0.8 | .244 | 6.2 | .945 | .512 | .260 | .287 | 24.0 | 13.0 | 6.6 | 7.3 | 25 | 83-9791 | 500 | 84-9791 |

105° C/300 Volts max.

Listed 774A **Cu Only** Pressure Wire Connector

Nylon Fully-Insulated Male Disconnects



| Wire Range (AWG) | Wire Range (mm ²) | Tab Size (Inches) | Tab Size (mm) | Max. Wire Ins. Dia. (Inches) | Max. Wire Ins. Dia. (mm) | Dimensions (Inches) | | | | Dimensions (mm) | | | | Ctn. Qty. | Cat. No. |
|------------------|-------------------------------|-------------------|---------------|------------------------------|--------------------------|---------------------|------|------|------|-----------------|------|------|-----|-----------|----------------|
| | | | | | | L | B | W | F | L | B | W | F | | |
| 22 - 18 | 0.5 - 1.0 | .250 x .032 | 6.35 x 0.8 | .150 | 3.8 | .906 | .433 | .250 | .303 | 23.0 | 11.0 | 6.35 | 7.7 | 25 | 83-9911 |
| 16 - 14 | 1.5 - 2.5 | .250 x .032 | 6.35 x 0.8 | .185 | 4.7 | .945 | .433 | .250 | .303 | 24.0 | 11.0 | 6.35 | 7.7 | 25 | 83-9921 |
| 12 - 10 | 4.0 - 6.0 | .250 x .032 | 6.35 x 0.8 | .244 | 6.2 | .984 | .512 | .250 | .303 | 25.0 | 13.0 | 6.35 | 7.7 | 25 | 83-9931 |

105° C/300 Volts max.

Listed 774A **Cu Only** Pressure Wire Connector

Vinyl Insulated Bullet Disconnects



| Wire Range (AWG) | Wire Range (mm ²) | Max. Wire Ins. Dia. (Inches) | Max. Wire Ins. Dia. (mm) | Dimensions (Inches) | | | | Dimensions (mm) | | | | Ctn. Qty. | Cat. No. |
|------------------|-------------------------------|------------------------------|--------------------------|---------------------|------|------|------|-----------------|------|-----|-----|-----------|----------------|
| | | | | L | B | W | F | L | B | W | F | | |
| 22 - 18 | 0.5 - 1.0 | .150 | 3.8 | .846 | .413 | .157 | .335 | 21.5 | 10.5 | 4.0 | 8.5 | 25 | 83-8001 |
| 16 - 14 | 1.5 - 2.5 | .185 | 4.7 | .846 | .413 | .157 | .335 | 21.5 | 10.5 | 4.0 | 8.5 | 25 | 83-8011 |

75° C/300 Volts max.

Listed 774A **Cu Only** Pressure Wire Connector

Vinyl Fully-Insulated Receptacle Disconnects



| Wire Range (AWG) | Wire Range (mm ²) | Max. Wire Ins. Dia. (Inches) | Max. Wire Ins. Dia. (mm) | Dimensions (Inches) | | | | Dimensions (mm) | | | | Ctn. Qty. | Cat. No. |
|------------------|-------------------------------|------------------------------|--------------------------|---------------------|------|------|------|-----------------|------|-----|-----|-----------|----------------|
| | | | | L | B | W | F | L | B | W | F | | |
| 22 - 18 | 0.5 - 1.0 | .150 | 3.8 | .917 | .413 | .153 | .287 | 23.3 | 10.5 | 3.9 | 7.3 | 25 | 83-8101 |
| 16 - 14 | 1.5 - 2.5 | .185 | 4.7 | .917 | .413 | .153 | .287 | 23.3 | 10.5 | 3.9 | 7.3 | 25 | 83-8111 |

75° C/300 Volts max.

Listed 774A **Cu Only** Pressure Wire Connector

Non-Insulated Flag Female Disconnect

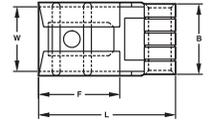

| Wire Range (AWG) | Wire Range (mm ²) | Tab Size (Inches) | Tab Size (mm) | Dimensions (Inches) | | | | Dimensions (mm) | | | | Ctn. Qty. | Cat. No. |
|------------------|-------------------------------|-------------------|---------------|---------------------|------|------|------|-----------------|-----|-----|-----|-----------|----------------|
| | | | | L | B | W | F | L | B | W | F | | |
| 16 – 14 | 1.5 – 2.5 | .250 x .032 | 6.35 x 0.8 | .551 | .291 | .260 | .299 | 14.0 | 7.4 | 6.6 | 7.6 | 25 | 83-9401 |

105° C/300 Volts max.

Disconnect Adapter – Male to Female (2-1)

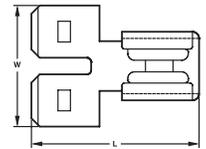

| Tab Size (Inches) | Tab Size (mm ²) | Dimensions (Inches) | | Dimensions (mm) | | Ctn. Qty. | Cat. No. |
|-------------------|-----------------------------|---------------------|------|-----------------|-----|-----------|----------------|
| | | L | W | L | W | | |
| .250 x .032 | 6.35 x 0.8 | .551 | .260 | 14.0 | 6.6 | 25 | 83-9801 |

105° C/300 Volts max.

Non-Insulated Butt Splices

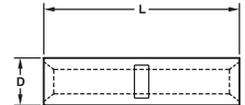

| Wire Range (AWG) | Wire Range (mm ²) | Dimensions (Inches) | | Dimensions (mm) | | Ctn. Qty. | Cat. No. | Ctn. Qty. | Cat. No. |
|------------------|-------------------------------|---------------------|------|-----------------|------|-----------|----------------|-----------|----------------|
| | | L | D | L | D | | | | |
| 22 – 18 | 0.5 – 1.0 | .591 | .130 | 15.0 | 3.3 | 25 | 83-9001 | — | — |
| 16 – 14 | 1.5 – 2.5 | .591 | .154 | 15.0 | 3.9 | 25 | 83-9011 | — | — |
| 12 – 10 | 4.0 – 6.0 | .591 | .213 | 15.0 | 5.4 | 25 | 83-9021 | 500 | 84-9021 |
| 8 | 8.0 | .827 | .276 | 21.0 | 7.0 | 25 | 83-9031 | 250 | 84-9031 |
| 6 | 14.0 | 1.024 | .350 | 26.0 | 8.9 | 20 | 83-9041 | — | — |
| 4 | 22.0 | 1.142 | .445 | 29.0 | 11.3 | 20 | 83-9051 | — | — |

105° C/600 Volts max.

Non-Insulated Parallel Splices

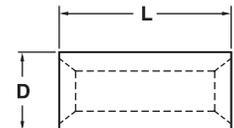

| Wire Range (AWG) | Wire Range (mm ²) | Dimensions (Inches) | | Dimensions (mm) | | Ctn. Qty. | Cat. No. | Ctn. Qty. | Cat. No. |
|------------------|-------------------------------|---------------------|------|-----------------|-----|-----------|----------------|-----------|----------------|
| | | L | D | L | D | | | | |
| 22 – 18 | 0.5 – 1.0 | .315 | .130 | 8.0 | 3.3 | 25 | 83-9071 | — | — |
| 16 – 14 | 1.5 – 2.5 | .315 | .154 | 8.0 | 3.9 | 25 | 83-9081 | 1,000 | 84-9081 |
| 12 – 10 | 4.0 – 6.0 | .335 | .213 | 8.5 | 5.4 | 25 | 83-9091 | — | — |

105° C/600 Volts max.

Vinyl Insulated Butt Splices



| Wire Range (AWG) | Wire Range (mm ²) | Max. Wire Ins. Dia. (Inches) | Max. Wire Ins. Dia. (Inches) | Dimensions (Inches) | | Dimensions (mm) | | Ctn. Qty. | Cat. No. | Ctn. Qty. | Cat. No. |
|------------------|-------------------------------|------------------------------|------------------------------|---------------------|------|-----------------|-----|-----------|----------------|-----------|----------------|
| | | | | L | D | L | D | | | | |
| 22 – 18 | 0.5 – 1.25 | .157 | 4.0 | .986 | .067 | 24.6 | 1.7 | 25 | 83-9281 | 1,000 | 84-9281 |
| 16 – 14 | 1.5 – 2.5 | .177 | 4.5 | .986 | .091 | 24.6 | 2.3 | 25 | 83-9291 | 1,000 | 84-9291 |
| 12 – 10 | 4.0 – 6.0 | .248 | 6.3 | 1.043 | .134 | 26.5 | 3.4 | 25 | 83-9301 | 500 | 84-9301 |

75° C/600 Volts max.

Listed 774A **Cu Only** Pressure Wire Connector

Vinyl Insulated Parallel Splices



| Wire Range (AWG) | Wire Range (mm ²) | Max. Wire Ins. Dia. (Inches) | Max. Wire Ins. Dia. (mm) | Dimensions (Inches) | | Dimensions (mm) | | Ctn. Qty. | Cat. No. |
|------------------|-------------------------------|------------------------------|--------------------------|---------------------|------|-----------------|-----|-----------|----------------|
| | | | | L | W | L | W | | |
| 22 – 18 | 0.5 – 1.0 | .157 | 4.0 | .512 | .067 | 13.0 | 1.7 | 25 | 83-9351 |
| 16 – 14 | 1.5 – 2.5 | .177 | 4.5 | .512 | .091 | 13.0 | 2.3 | 25 | 83-9361 |
| 12 – 10 | 4.0 – 6.0 | .248 | 6.3 | .591 | .134 | 15.0 | 3.4 | 25 | 83-9371 |

75° C/600 Volts max.

Tap Splice Connectors



| Wire Range (AWG) | Wire Range (mm ²) | Color | Dimensions (Inches) | | Dimensions (mm) | | Ctn. Qty. | Cat. No. |
|------------------|-------------------------------|--------|---------------------|------|-----------------|------|-----------|----------------|
| | | | L | W | L | W | | |
| 22 – 18 | 0.5 – 1.0 | Red | 1.063 | .787 | 27.0 | 20.0 | 25 | 83-3261 |
| 16 – 14 | 1.5 – 2.5 | Blue | 1.063 | .787 | 27.0 | 20.0 | 25 | 83-3271 |
| 12 – 10 | 4.0 – 6.0 | Yellow | 1.358 | .807 | 34.5 | 20.5 | 25 | 83-3281 |

105° C/600 Volts max.

Terminal Strips

- Heavy-duty, corrosion-resistant screws, surface plates and optional hardware
- Accessory hardware provides a variety of termination options
- Available cover helps prevent contact with live terminals

89-200 Series Terminal Strips 30A/600V* UL/CSA

- .562 in. (14.28mm) center spacing
- Accepts wire sizes from 22 through 10 AWG Cu
- #8-32 phillslot, zinc-plated steel terminal screws (Recommended torque: 16 in. - lb.)

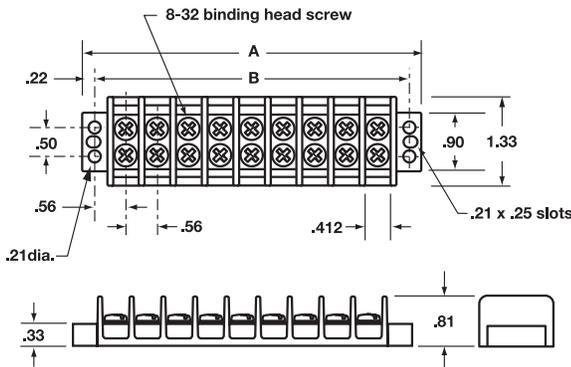

| No. of Poles | Dimensions (Inches) | | Cat. No. |
|--------------|---------------------|------|---------------|
| | A | B | |
| 2 | 2.13 | 1.69 | 89-202 |
| 3 | 2.69 | 2.25 | 89-203 |
| 4 | 3.25 | 2.81 | 89-204 |
| 6 | 4.37 | 3.94 | 89-206 |
| 8 | 5.50 | 5.06 | 89-208 |
| 10 | 6.62 | 6.19 | 89-210 |
| 12 | 7.75 | 7.31 | 89-212 |

*Max. electrical rating 30A/250V when used with optional quick-connects.



- Rugged polyester thermoplastic base (UL Rated 94V-O)
- Operating temperature rated from 130°C (260°F) to -40°C (-40°F)
- UL Recognized (E62622) and CSA Certified (LR15364)

89-300 Series Terminal Strips 15A/250V** UL, 15A/150V** CSA

- .375 in. (9.52mm) center spacing
- Accepts wire sizes from 22 through 14 AWG Cu
- #6-32 phillslot, zinc-plated steel terminal screws (Recommended torque: 9 in. - lb.)

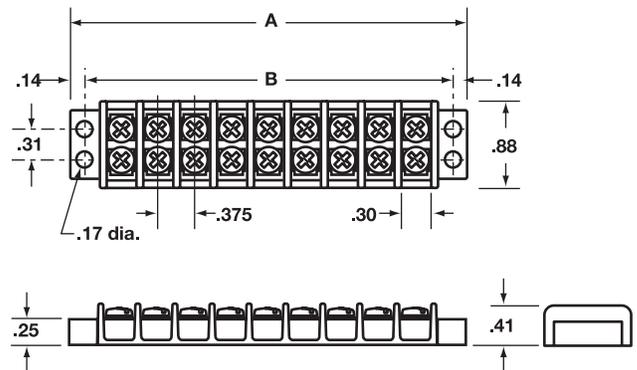

| No. of Poles | Dimensions (Inches) | | Cat. No. |
|--------------|---------------------|------|---------------|
| | A | B | |
| 2 | 1.40 | 1.12 | 89-302 |
| 4 | 2.16 | 1.88 | 89-304 |
| 6 | 2.90 | 2.62 | 89-306 |
| 8 | 3.66 | 3.38 | 89-308 |
| 10 | 4.40 | 4.12 | 89-310 |
| 12 | 5.16 | 4.88 | 89-312 |

**Max. electrical rating 15A/125V when used with optional quick-connects.



89-400 Series Terminal Strips 20A/250V UL/CSA

- .437 in. (11.10mm) center spacing
- Accepts wire sizes from 22 through 12 AWG Cu
- #6-32 phillslot, zinc-plated steel terminal screws (Recommended torque: 9 in. - lb.)

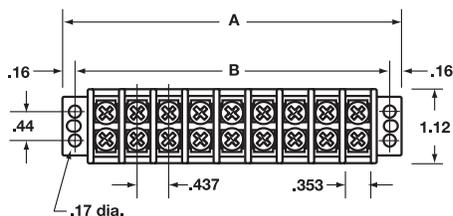

| No. of Poles | Dimensions (Inches) | | Cat. No. |
|--------------|---------------------|------|----------|
| | A | B | |
| 2 | 1.63 | 1.31 | 89-402 |
| 4 | 2.51 | 2.18 | 89-404 |
| 6 | 3.38 | 3.06 | 89-406 |
| 8 | 4.25 | 3.93 | 89-408 |
| 10 | 5.13 | 4.81 | 89-410 |
| 12 | 6.00 | 5.68 | 89-412 |



89-500 Series Terminal Strips 60A/600V* UL/CSA

- Available in standard or shorting-block style
- .625 in. (15.88mm) center spacing
- Accepts wire sizes from 22 through 6 AWG Cu
- #10-32 slotted, nickel plated brass terminal screws (Recommended torque: 20 in. - lb.)

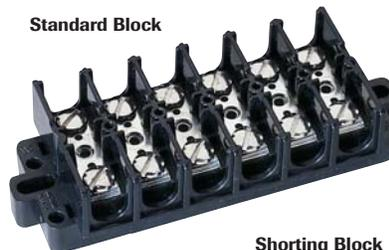

Shorting Block

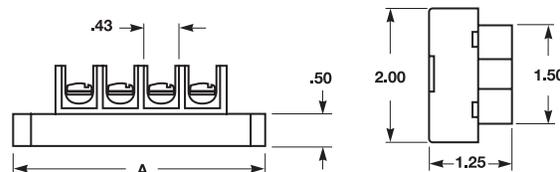
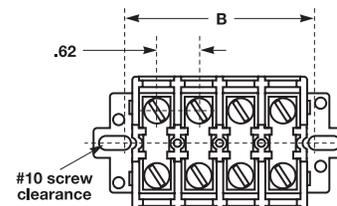

| No. of Poles | Dimensions (Inches) | | Standard Block Cat. No. | Shorting Block Cat. No. |
|--------------|---------------------|------|-------------------------|-------------------------|
| | A | B | | |
| 4 | 3.75 | 2.87 | 89-504 | 89-505 |
| 6 | 5.00 | 4.12 | 89-506 | 89-507 |
| 8 | 6.25 | 5.37 | 89-508 | 89-509 |
| 12 | 8.75 | 7.87 | 89-512 | 89-513 |

*Max. electrical rating 60A/600V achieved only when used with #6 AWG copper wire crimped to ring terminal.



Covers

- Helps prevent contact with live terminals



| No. of Circuits | For Use With Terminal Strip Series | | | |
|-----------------|------------------------------------|-----------------------------|-----------------------------|-----------------------------|
| | 89-200 Clear Cat. No. | 89-300 Clear Cat. No. | 89-400 Clear Cat. No. | 89-500 Clear Cat. No. |
| 2 | 89-233 | 89-334 | 89-434 | — |
| 3 | 89-234 | — | — | — |
| 4 | 89-235 | 89-335 | 89-435 | 89-514 |
| 6 | 89-236 | 89-336 | 89-436 | 89-516 |
| 8 | 89-237 | 89-337 | 89-437 | 89-518 |
| 10 | 89-238 | 89-338 | 89-438 | — |
| 12 | 89-239 | 89-339 | 89-439 | 89-520 |

Quick Connects

- Allows fast, flexible circuit changes

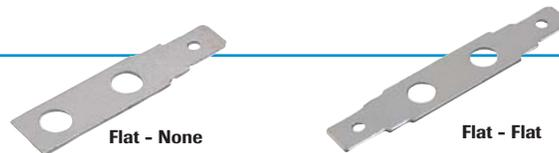

| For Use With | | Qty | Flat - None Cat. No. | Flat - Flat Cat. No. |
|-----------------------|-------------------|---------|-------------------------|-------------------------|
| Terminal Strip Series | Tab Size (Inches) | | | |
| 89-300 | .187 x .020 | 10 pcs. | 89-314 | 89-317 |
| 89-200 & 89-400 | .250 x .031 | 10 pcs. | 89-414 | 89-417 |

Jumpers

- Provides easy connection of multiple circuits

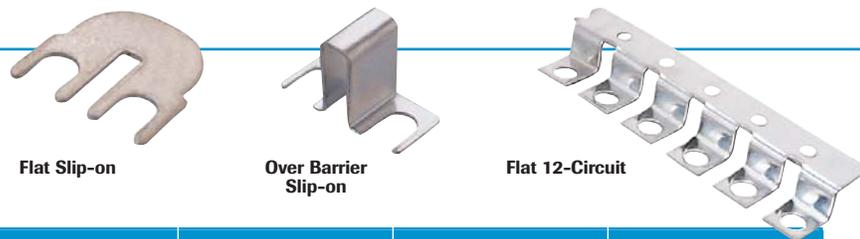

| For Use With | Center Spacing (Inches) | Qty. | Flat Slip-on Cat. No. | Over Barrier Slip-on Cat. No. | Flat 12-Circuit Cat. No. |
|-----------------------|-------------------------|----------|--------------------------|----------------------------------|-----------------------------|
| Terminal Strip Series | | | | | |
| 89-200 | .562 | 10 pcs. | 89-229 | 89-224 | — |
| | | 100 pcs. | 89-230 | — | — |
| 89-300 | .375 | 10 pcs. | 89-323 | 89-324 | — |
| | | 100 pcs. | 89-330 | — | — |
| 89-400 | .437 | 10 pcs. | 89-423 | 89-424 | — |
| | | 100 pcs. | 89-430 | — | — |
| 89-500 | .625 | 2 pcs. | — | — | 89-525 |

Barrier Strips

- Recessed screws and tubular contacts provide added safety and help prevent short circuits
- Tubular contacts connect stripped, un-terminated solid or stranded wire directly to each contact
- Integrated wire protectors prevent twisting and breakage of stranded wire during connection
- Modular 12-circuit design can be cut into smaller sections, or stacked end-to-end
- Rugged nylon construction, UL 94V2
- Operating temperature rated to 105°C (221°F)

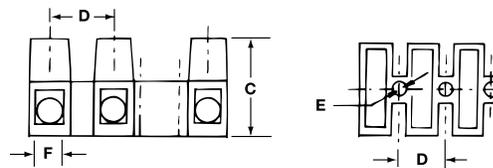
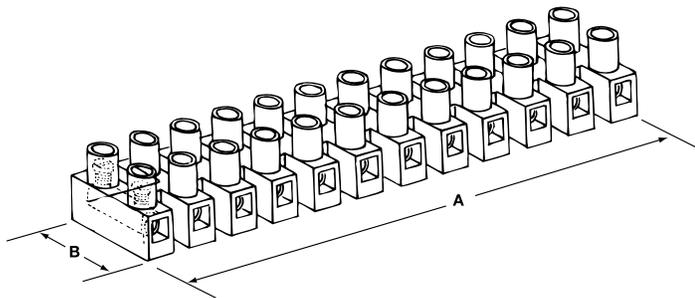

Barrier Strips

| Electrical Ratings | Wire Range (AWG) | No. of Circuits | Torque in.-lb. | Model No. | Dimensions (Inches) | | | | | | Dimensions (mm) | | | | | | Cat. No. |
|--------------------|------------------|-----------------|----------------|-----------|---------------------|-------|-------|-------|-------|-------|-----------------|------|------|------|-----|-----|---------------|
| | | | | | A | B | C | D | E | F* | A | B | C | D | E | F** | |
| 20A/600V UL | 22 - 12 | 12 | 3.5 | PA8DS | 3.787 | 0.669 | 0.570 | 0.315 | 0.114 | 0.110 | 96.2 | 17.0 | 14.5 | 8.0 | 2.9 | 2.8 | 89-608 |
| 10A/400V CSA | 20 - 18 | | | | | | | | | | | | | | | | |
| 30A/600V UL | 22 - 10 | 12 | 4.4 | PA10DS | 4.626 | 0.795 | 0.670 | 0.394 | 0.142 | 0.134 | 117.0 | 20.2 | 17.0 | 10.0 | 3.6 | 3.4 | 89-610 |
| 20A/400V CSA | 18 - 14 | | | | | | | | | | | | | | | | |
| 35A/600V UL/CUL | 22 - 10 | 12 | 7.0 | PA12DS | 5.540 | 0.937 | 0.748 | 0.472 | 0.154 | 0.154 | 140.7 | 23.8 | 19.0 | 12.0 | 3.9 | 3.9 | 89-612 |
| 50A/600V UL/CUL | 20 - 8 | 12 | 12.0 | PA14DS | 6.220 | 1.008 | 0.992 | 0.531 | 0.173 | 0.189 | 158.0 | 25.6 | 25.2 | 13.5 | 4.4 | 4.8 | 89-614 |

*Plus or minus .004 in.

**Plus or minus 0.1mm



Crimp Connectors



- Designed for making fast, permanent, pressure-type connections
- Long, zinc-plated steel sleeves maximize contact area with conductors
- Will not vibrate loose when securely crimped
- Steel crimp connectors are UL Listed to 486C and CSA Certified to C22.2 #188; comply with Federal Specification W-S-610E.

Steel Crimp Connectors

| Model | Wire Combination Range | Quantity | Cat. No. |
|-------|--|-----------------|---------------|
| 410 | 600V 18 thru 10 AWG Min. 1 #14 & 1 #18 Max. 2 #10 & 2 #14 | Box of 100 | 30-410 |
| | | Carton of 1,000 | 30-510 |
| | | Keg of 10,000 | 30-610 |
| 411 | 600V 18 thru 8 AWG Min. 3 #12 Max. 4 #10 | Box of 40 | 30-401 |
| | | Box of 50 | 30-411 |
| | | Carton of 1,000 | 30-511 |
| 412 | 600V 18 thru 4 AWG Min. 1 #14 & 1 #16 Max. 2 #8 & 1 #6 | Box of 20 | 30-402 |
| | | Box of 50 | 30-412 |
| | | Carton of 1,000 | 30-512 |

Dimensions (Inches)

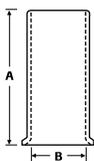

| Model | A | B |
|-----------|-------|-------|
| 410 Steel | 3/8 | 13/64 |
| 411 Steel | 5/8 | 1/4 |
| 412 Steel | 51/64 | 19/64 |



IDEAL hand tools U.L. listed for Model 410, 411, 412.
Crimps: 30-420, 30-425, 30-429, 30-430.

Wrap-Cap® Insulators

- Provide high dielectric and physical protection for UL Listed, non-insulated pressure-type wire connectors
- Cap and loop design eliminates need for tape
- Unique design completely covers splice — insulates both around and between wires
- Reusable and easy to install
- UL Listed and CSA Certified for 600V maximum building wiring (1,000V maximum for fixtures and signs); temperature rated at 75°C (167°F) maximum



| Model | Description | Quantity | Cat. No. |
|-------|---------------------------------------|-----------------|---------------|
| 415 | Insulator for Model 410 sleeves | Box of 20 | 30-405 |
| | | Box of 100 | 30-415 |
| | | Carton of 1,000 | 30-515 |
| | | Keg of 10,000 | 30-615 |
| 417 | Insulator for Model 411 & 412 sleeves | Box of 10 | 30-407 |
| | | Box of 50 | 30-417 |
| | | Carton of 1,000 | 30-517 |

Dimensions (Inches)

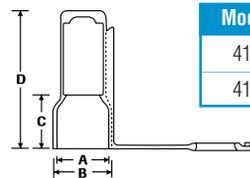

| Model | A | B | C | D |
|-------|-------|-----|-------|---------|
| 415 | 1/2 | 5/8 | 23/32 | 1-13/64 |
| 417 | 11/16 | 3/4 | 3/4 | 1-25/32 |



Pre-Insulated Crimp Connectors

- Three models cover a wide range of wire combinations from 22 AWG stranded through 8 AWG stranded
- Compact design fits easily into tight locations
- Flared skirt protects against turned-back strands
- Beveled opening eases wire entry
- UL Listed and CSA Certified for 600V maximum building wiring (1,000V maximum for fixtures and signs); temperature rated at 105°C (221°F) maximum



| Model | Wire Combination Range | Quantity | Cat. No. |
|-------|---|----------|---------------|
| 48 | 600V* Min. 2 #22 Max. 1 #14 w/2 #18 | 1,000 | 30-245 |
| | | 10,000 | 30-645 |
| 49 | 600V* Min. 1 #22 w/1 #18 Max. 1 #12 w/1 #16 | 1,000 | 30-249 |
| | | 10,000 | 30-649 |
| NC-8 | 600V* Min. 4 #w16 Max. 1 #12 w/4 #14 | 1,000 | 30-148 |
| | | 5,000 | 30-648 |

*1,000V maximum in fixtures and signs



Set-Screw Wire Connectors



- Eliminates need for restripping wire each time connection is disturbed
- Solid brass sleeves in three sizes handle 18 through 12 AWG wires
- Set-screw easily and securely applies maximum compression to conductors to ensure a vibration-resistant splice
- Permits fast visual inspection of splice
- Tough, flame-retardant shell rated at 150°C (302°F)
- UL Listed to 486C and CSA Certified to C22.2 #188 ; comply with Federal Specification W-S-610E

| Model | Wire Combination Range | Quantity | Cat. No. |
|-------|--|-----------------|---------------|
| 10 | 300V 22 thru 16 AWG Min. 1 #20 w/1 #22 Max. 2 #14 w/1 #16 | Box of 100 | 30-210 |
| | | Carton of 1,000 | 30-310 |
| 11 | 600V 22 thru 14 AWG Min. 1 #14 w/1 #20 Max. 3 #14 w/2 #18 | Box of 100 | 30-211 |
| | | Carton of 1,000 | 30-311 |
| 22 | 600V 20 thru 10 AWG Min. 1 #16 w/3 #18 Max. 2 #10 w/1 #12 | Box of 100 | 30-222 |
| | | Carton of 1,000 | 30-322 |

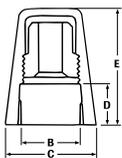

Dimensions (Inches)

| Model | Insert | | Shell | | | |
|-------|--------|------|-------|-------|--------|--|
| | A | B | C | D | E | |
| 10 | 1/8 | 5/16 | 1/2 | 19/64 | 45/64 | |
| 11 | 3/16 | 3/8 | 33/64 | 13/32 | 63/64 | |
| 22 | 1/4 | 1/2 | 11/16 | 13/32 | 1-1/64 | |



Set-Screw Holder

- Convenient tool for holding and tightening set-screw connectors
- Accepts IDEAL Models 11 and 22 set-screw connectors



| For Connector Models | Cat. No. |
|----------------------|---------------|
| 11 & 22 | K-2422 |

Noalox® Anti-Oxidant



- Anti-oxidant and anti-seizing compound improves efficiency and service life of aluminum electrical applications
- Suspended zinc particles penetrate and cut aluminum oxide
- Provides additional inner-strand and inner-conductor current paths for improved conductivity and cooler connections
- Carrier material excludes air to prevent further oxidation
- For use with all types of pressure-type wire connectors including screw-on, tap, service entrance and split-bolt
- Reduces galling and seizing on aluminum conduit joints – promotes good ground continuity

| Description | Cat. No. |
|----------------------|---------------|
| 1/2-oz. Tube | 30-024 |
| 4-oz. Squeeze bottle | 30-026 |
| 8-oz. Squeeze bottle | 30-030 |
| 8-oz. Brush cap | 30-031 |
| 1-gal. Bucket | 30-032 |
| 5-gal. Bucket | 30-040 |



Powr-Connect™ Mechanical Lugs

- Chamfered entry for faster, more reliable connections
- Uniform plating resists corrosion, reduces contact resistance and provides maximum conductivity
- UL Listed at 600V – acceptable for use through 2,000V
- Can be used through 8,000V if installed in accordance with National Electric Code Section 310-6 (UL Green Book)
- UL Listed to 486B for dual-rated connectors – UL Listed to 486A for copper connectors
- Meets ANSI C119.4 requirements

Dual-Rated (Al/Cu) Single-Barrel Connectors

- Electro tin-plated, high-strength aluminum alloy construction
- UL Listed to 486B (AL9CU)

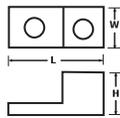
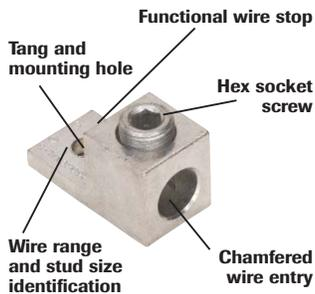
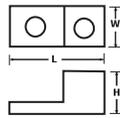
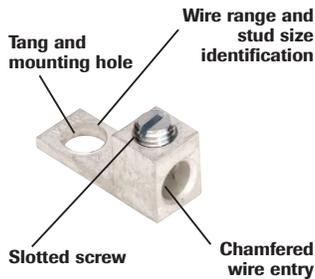

| Model | Wire Range | Dimensions (Inches) | | | Stud Size (In.) | Cat. No. |
|---|-------------------|---------------------|-------|--------|-----------------|----------|
| | | L | W | H | | |
| LA-50-1 | 6 – 14 AWG | 1-1/16 | 3/8 | 1/2 | 1/4 | 87-002 |
| Narrow type – special mounting requirements | | | | | | |
| LA-2 | 2 – 14 AWG | 1-5/32 | 1/2 | 9/16 | 1/4 | 87-005 |
| LA-1/0 | 1/0 – 14 AWG | 1-15/32 | 5/8 | 25/32 | 1/4 | 87-007 |
| LA-1/0* | 1/0 – 14 AWG | 1-15/32 | 5/8 | 25/32 | 3/8 | 87-008 |
| LA-2/0 | 2/0 – 14 AWG | 1-15/32 | 5/8 | 25/32 | 1/4 | 87-009 |
| LA-2/0* | 2/0 – 14 AWG | 1-15/32 | 5/8 | 23/32 | 3/5 | 87-010 |
| LA-250 | 250 KCMIL – 6 AWG | 2 | 1 | 1-1/8 | 5/16 | 87-011 |
| LA-250* | 250 KCMIL – 6 AWG | 2 | 1 | 1-1/8 | 3/8 | 87-012 |
| LA-350 | 350 KCMIL – 6 AWG | 2-1/4 | 1-1/8 | 1-1/4 | 3/8 | 87-015 |
| LA-350* | 350 KCMIL – 6 AWG | 2-1/4 | 1-1/8 | 1-1/4 | 1/2 | 87-016 |
| LA-500 | 500 KCMIL – 4 AWG | 2-13/16 | 1-1/4 | 1-9/16 | 3/8 | 87-017 |
| LA-500* | 500 KCMIL – 4 AWG | 2-13/16 | 1-1/2 | 1-9/16 | 1/2 | 87-018 |

*Larger mounting hole



Dual-Rated (Al/Cu) Two-Barrel Connectors

- Electro tin-plated, high-strength aluminum alloy construction
- UL 486B Listed AL9CU

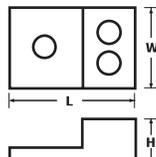
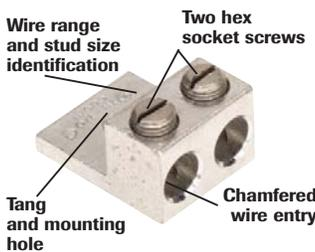

| Model | Wire Range | Dimensions (Inches) | | | Stud Size (In.) | Cat. No. |
|----------|-----------------------|---------------------|---------|--------|-----------------|----------|
| | | L | W | H | | |
| L2A1-1/0 | 1/0 – 14 AWG (2) | 1-15/32 | 1-1/8 | 25/32 | 1/4 | 87-040 |
| L2A1-2/0 | 2/0 – 14 AWG (2) | 1-15/32 | 1-1/4 | 25/32 | 1/4 | 87-042 |
| L2A1-250 | 250 KCMIL – 6 AWG (2) | 2-9/16 | 1-5/8 | 1-3/16 | 3/8 | 87-044 |
| L2A1-350 | 350 KCMIL – 6 AWG (2) | 2-7/8 | 1-15/16 | 1-1/4 | 1/2 | 87-046 |
| L2A1-600 | 600 KCMIL – 2 AWG (2) | 3-3/16 | 2-13/32 | 1-9/16 | 1/2 | 87-048 |



Dual-Rated (Al/Cu) Panel-Board Connectors

- Electro tin-plated, high-strength aluminum alloy construction
- UL Listed to 486B (AL9CU)

Mechanical Lugs

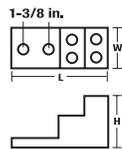
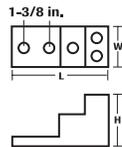
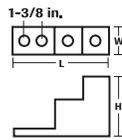
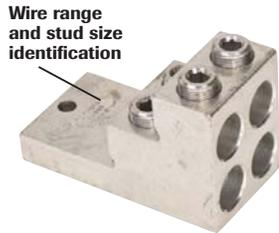
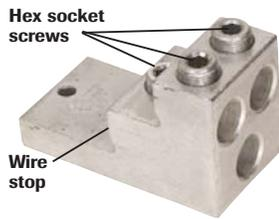
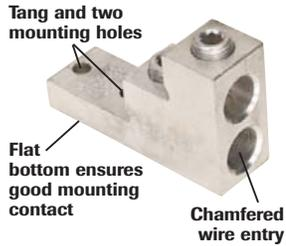

| Model | Wire Range | Dimensions (Inches) | | | Stud Size (In.) | Cat. No. |
|---------|---------------------|---------------------|---------|---|-----------------|---------------|
| | | L | W | H | | |
| PV2-600 | 600 KCMIL – 2 AWG | 4-29/32 | 1-1/2 | 3 | 3/8 | 87-126 |
| PV2-750 | 750 KCMIL – 1/0 AWG | 4-29/32 | 1-9/16 | 3 | 3/8 | 87-129 |
| PV3-600 | 600 KCMIL – 2 AWG | 4-29/32 | 2-1/2 | 3 | 3/8 | 87-132 |
| PV3-750 | 750 KCMIL – 1/0 AWG | 4-29/32 | 2-27/32 | 3 | 3/8 | 87-135 |
| PV4-600 | 600 KCMIL – 2 AWG | 4-29/32 | 2-1/2 | 3 | 3/8 | 87-138 |
| PV4-750 | 750 KCMIL – 3/0 AWG | 4-29/32 | 2-27/32 | 3 | 3/8 | 87-141 |



Dual-Rated (Al/Cu) Splicer Reducers

- Electro tin-plated, high-strength aluminum alloy construction
- UL Listed to 486B (AL9CU)

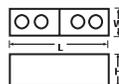
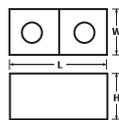
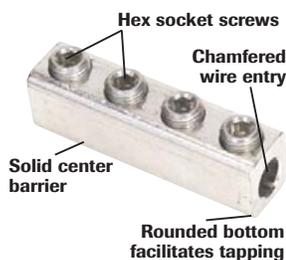
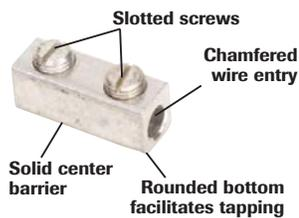

| Model | Wire Range | Dimensions (Inches) | | | Stud Size (In.) | Cat. No. |
|---------|-------------------|---------------------|-----|-------|-----------------|---------------|
| | | L | W | H | | |
| SR-2* | 2 – 14 AWG | 1-3/8 | 1/2 | 9/16 | 5/8 | 87-143 |
| SR-1/0* | 1/0 – 14 AWG | 1-29/32 | 3/4 | 3/4 | 7/8 | 87-144 |
| SR-250 | 250 KCMIL – 6 AWG | 3-15/16 | 1 | 1-1/8 | 1-15/16 | 87-145 |

*Slotted screws



Powr-Connect™ Tap Connectors

Dual-Rated (Al/Cu) Parallel-Tap Connectors with Covers

- Electro tin-plated, high-strength aluminum alloy construction
- UL Listed to 486B (AL9CU) – 105°C, 600V max.

Insulating cover reduces installation cost

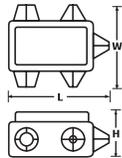
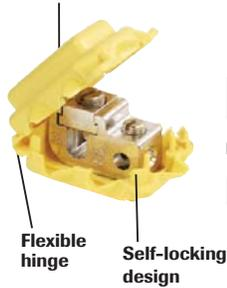

| Model | Wire Range | | Strip Length (In.) | Dimensions (Inches) | | | Cat. No. |
|---------|---------------------|-------------------|--------------------|---------------------|---------|--------|---------------|
| | Main | Tap | | L | W | H | |
| GP-2C | 2 – 12 AWG | 4 – 14 AWG | 5/8 | 2-7/32 | 1-29/32 | 1-7/64 | 87-180 |
| GP-1/0C | 1/0 – 2 AWG | 1/0 – 14 AWG | 3/4 | 2-5/8 | 2-5/32 | 1-1/4 | 87-182 |
| GP-250C | 250 KCMIL – 1/0 AWG | 250 KCMIL – 6 AWG | 1-1/16 | 3-7/16 | 2-7/8 | 1-5/8 | 87-186 |
| GP-350C | 350 KCMIL – 4/0 AWG | 350 KCMIL – 6 AWG | 1-1/4 | 3-3/4 | 3-3/16 | 1-3/4 | 87-190 |
| GP-500C | 500 – 350 KCMIL | 500 KCMIL – 2 AWG | 1-3/8 | 4-3/8 | 3-5/16 | 2-3/32 | 87-194 |



Dual-Rated (Al/Cu) Parallel-Tap Connectors without Covers

- Electro tin-plated, high-strength aluminum alloy construction
- UL Listed to 486B (AL9CU)

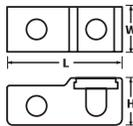

| Model | Wire Range | | Strip Length (In.) | Dimensions (Inches) | | | Cat. No. |
|--------|---------------------|-------------------|--------------------|---------------------|--------|--------|---------------|
| | Main | Tap | | L | W | H | |
| GP-2 | 2 – 12 AWG | 4 – 14 AWG | 5/8 | 1-25/64 | 5/8 | 7/8 | 87-150 |
| GP-1/0 | 1/0 – 2 AWG | 1/0 – 14 AWG | 3/4 | 1-3/4 | 3/4 | 1 | 87-152 |
| GP-250 | 250 KCMIL – 1/0 AWG | 250 KCMIL – 6 AWG | 1-1/16 | 2-9/32 | 1-1/16 | 1-5/16 | 87-156 |



Insulating Covers for Parallel-Tap Connectors

- 600V maximum
- 105°C maximum temperature

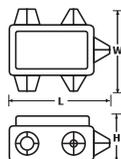
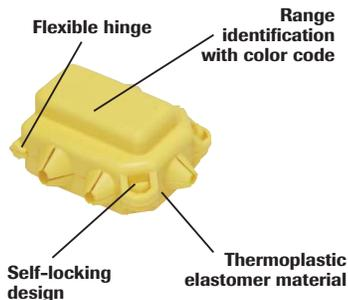

| Model | For Use With: | Color | Dimensions (Inches) | | | Cat. No. |
|---------|---------------|--------|---------------------|---------|--------|---------------|
| | | | L | W | H | |
| GIC-2 | 87-150 | Yellow | 2-7/32 | 1-29/32 | 1-7/64 | 87-370 |
| GIC-1/0 | 87-152 | Gray | 2-5/8 | 2-5/32 | 1-1/4 | 87-372 |
| GIC-250 | 87-150 | Red | 3-7/16 | 2-7/8 | 1-5/8 | 87-374 |



Powr-Connect™ Grounding Connectors

- Designed to maintain proper contact and alignment between ground and wire rod

- Brass or plated screws for corrosion resistance
- High-strength copper alloy construction

Type K Split Bolts for Copper Connections

- High-strength copper alloy construction (nut, bolt and body)
- UL 486A Listed

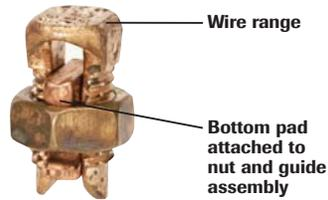

| Model | Range for Equal Run & Tap | Min. Tap with Max. Run | Cat. No. |
|-------|---------------------------|------------------------|---------------|
| | | | |
| K-8 | 8 str. – 10 str. | 14 str. | 87-651 |
| K-6 | 6 sol. – 8 str. | 14 str. | 87-652 |
| K-4 | 4 sol. – 8 str. | 14 str. | 87-653 |
| K-3 | 2 sol. – 6 str. | 14 str. | 87-654 |
| K-2 | 2 str. – 6 str. | 14 str. | 87-655 |
| K-1/0 | 1/0 str. – 4 str. | 14 str. | 87-656 |
| K-2/0 | 2/0 str. – 2 str. | 14 str. | 87-657 |
| K-3/0 | 3/0 str. – 1 str. | 8 sol. | 87-658 |

Dual-Rated (Al/Cu) Type AS Split Bolts

- UL 486B Listed AL9CU

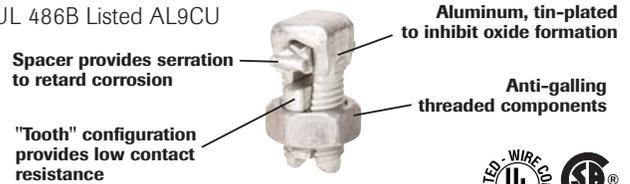

| Model | Wire Range | | | | Cat. No. |
|--------|------------|-----------|----------|---------|---------------|
| | Run | | Tap | | |
| | Max. | Min. | Max. | Min. | |
| AS-6 | 6 str. | 10 sol. | 6 str. | 10 sol. | 87-681 |
| AS-4 | 4 str. | 8 sol. | 4 str. | 10 sol. | 87-682 |
| AS-2 | 2 str. | 6 sol. | 2 str. | 8 str. | 87-683 |
| AS-1/0 | 1/0 str. | 2 compact | 1/0 str. | 8 sol. | 87-685 |
| AS-2/0 | 2/0 str. | 2 compact | 2/0 str. | 8 str. | 87-686 |
| AS-4/0 | 4/0 str. | 2 compact | 4/0 str. | 6 str. | 87-687 |

Heavy-Duty Clamps

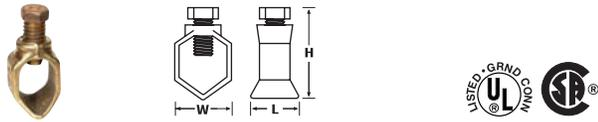

| Model | Rod Dia. (In.) | Wire Range | Dimensions (Inches) | | | Cat. No. |
|-------|----------------|------------|---------------------|-----|---|---------------|
| | | | H | W | L | |
| WB58 | 5/8 | 1/0 – 8 | 2-1/8 | 7/8 | 1 | 87-958 |

High-Strength Ground Clamps

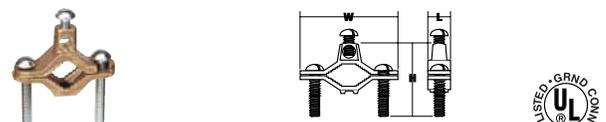

| Model | Pipe Size (In.) | Wire Range | Dimensions (Inches) | | | Cat. No. |
|-------|-----------------|------------|---------------------|-------|-----|---------------|
| | | | H | W | L | |
| J | 1/2 – 1 | 2 – 10 | 2-3/4 | 2-3/8 | 3/4 | 87-563 |
| J2 | 1-1/4 – 2 | 2 – 10 | 3-3/4 | 3-5/8 | 7/8 | 87-564 |

Dual-Rated (Al/Cu) Street-Light Connector Kit with Cover

- UL 486A Listed (Lug only)



| Model | Wire Range | No. of Cond. | Dimensions (Inches) | | | Cat. No. |
|---------|--------------|--------------|---------------------|--------|--------|---------------|
| | | | L | W | H | |
| SLK-1/0 | 1/0 – 14 AWG | 3 | 2 | 1-3/16 | 2-3/16 | 88-100 |

Powr-Connect™ Mechanical Solderless Lugs

Single-Hole Solderless Lugs for Copper Conductors (Offset)

- Electrolytic copper construction
- UL 486A listed



Wire range and stud size identification

Slotted screw

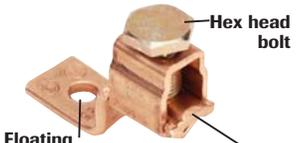
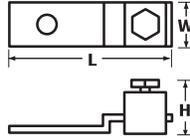

Hex head bolt

Floating offset tang

Barrel collar ensures positive contact

| Model | Wire Range | Stud Size (In.) | Dimensions (Inches) | | | Cat. No. |
|--------|-------------|-----------------|---------------------|------|---------|----------|
| | | | L | W | H | |
| CF-25* | 10 – 14 AWG | #8 | 1 | 5/16 | 3/8 | 87-700 |
| CF-35 | 6 – 14 AWG | 3/16 | 1-3/32 | 3/8 | 3/4 | 87-701 |
| CF-70 | 4 – 14 AWG | 1/4 | 1-5/16 | 1/2 | 13/16 | 87-702 |
| CF-90 | 2 – 8 AWG | 1/4 | 1-15/32 | 1/2 | 1 | 87-703 |
| CF-125 | 1/0 – 2 AWG | 1/4 | 1-13/16 | 5/8 | 1-11/32 | 87-704 |
| CF-225 | 4/0 – 2 AWG | 5/16 | 2-5/8 | 1 | 1-13/16 | 87-706 |

*Not CSA Certified



Single-Hole Solderless Lugs for Copper Conductors

- Electrolytic copper construction
- UL 486A Listed



Slotted screw

Tang staked to collar

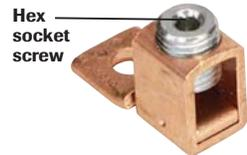
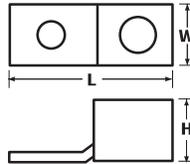

Hex socket screw

| Model | Wire Range | Stud Size (In.) | Dimensions (Inches) | | | Cat. No. |
|-------|--------------|-----------------|---------------------|-----|-----|----------|
| | | | L | W | H | |
| FT-65 | 6 – 14 AWG | 3/16 | 1 | 3/8 | 3/4 | 87-736 |
| FT-90 | 1/0 – 14 AWG | 1/4 | 1-17/64 | 5/8 | 1 | 87-738 |



Dual-Rated (Al/Cu) Collar Connectors

Slotted wire screw



10-32 tapped mounting hole with 0.229 in. square boss for bottom mounting to electrical devices or bus bars

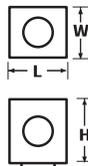

| Model | Wire Range | Dimensions (Inches) | | | Cat. No. |
|---------|--------------|---------------------|-------|-------|----------|
| | | L | W | H | |
| CA-60** | 2 – 14 AWG | 9/16 | 15/32 | 15/32 | 87-583 |
| CA-110* | 1/0 – 14 AWG | 19/32 | 17/32 | 5/8 | 87-585 |

*Successfully tested to AL9CU
**Successfully tested to AL7CU





Our **wedge-edge** expanding spring is specially designed for faster pull-up and quick connections. It also accommodates a wide range of wire gauges.



The **Buchanan C-24** Crimp Tool has an iron-clad reputation that's up to every job, every time. A patented four-way crimp ensures reliable connections, while the spring-loaded, cam-actuated design fits a wide range of connectors.



The comprehensive line of **Buchanan** sectional terminal blocks offers a wide range of block configurations, mounting options and contact styles accommodating wire sizes from 30 AWG to 250 MCM.



The **B2 B-CAP**® Wire Connector is the universal connector that accepts the widest range of wire combinations. Plus, the Classic Fin™ ergonomic design fits easily in tight electrical boxes.

(2) #18 stranded

(1) #14 solid

(1) #18 stranded
(2) #14 solid

(1) #14 solid
(2) #12 stranded

(2) #10 stranded

(3) #12 solid
(2) #14 solid

(5) #12 solid

B-CAP® Wire Connectors

- Three color-coded models cover a full range of wire sizes from 22 AWG through 6 AWG
- Classic Fin™ design provides secure grip for extra leverage on maximum wire combinations
- Live-action spring expands to accept wire shape and size – no pre-twisting required
- Square-wire spring threads directly onto conductors for fast, secure connections
- Deep skirt protects against flash-over and turned-back strands for maximum dielectric protection
- Easily removed for repeat usage on same size or larger wire combinations
- Tough, UL 94V-2 flame-retardant shell rated at 105°C (221°F)
- Green-B® designed for making ground connections and bonding non-metallic sheathed cable
- UL 486C Listed (Green-B® UL 467 Listed) and CSA 22.2 #188 Certified; comply with Federal Specification -S-610E



Twist-on Wire Connectors

Dimensions (Inches / mm)

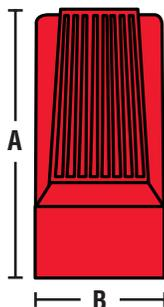

| Model | A | B |
|-------|--------------------------|-----------------------|
| B1 | $\frac{31}{32}$ 24.5 | $\frac{15}{32}$ 12 |
| B2 | $\frac{1-5}{32}$ 29.5 | $\frac{9}{16}$ 14 |
| B4 | $\frac{1-1}{2}$ 38 | $\frac{3}{4}$ 19 |
| BGR | $\frac{1-5}{32}$ 29.5 | $\frac{9}{16}$ 14 |

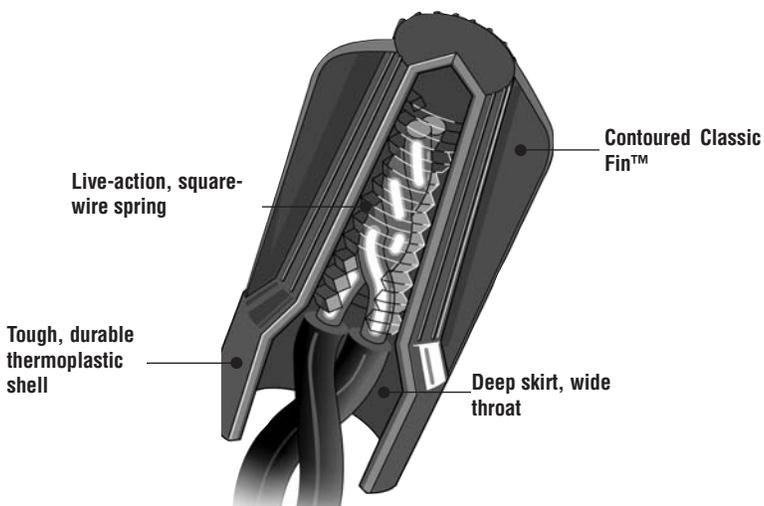

| Model | Color | Wire Combination Range (Inches) | Wire Combination Range (mm) | Quantity / Package | Cat. No. |
|-------|-----------|---|---|-----------------------------------|-----------------|
| B1 | Yellow | 600V* 22 to 10 AWG Min. 2 #18 Max. 3 #12 | 600V* ,34mm ² to 6,0mm ² Min. 2-,75mm ² Max. 3-4,0mm ² | 100 / Box | B1-1 |
| | | | | 250 / Jar | B1-250JR |
| | | | | 500 / Jar | B1-500JR |
| | | | | 2,500 / Bucket (5 bags, 500 ea.) | B1-25 |
| | | | | 10,000 / Keg (20 bags, 500 ea.) | B1-B |
| | | | | Barrel of 25,000 | B1-SK |
| B2 | Red | 600V* 22 to 8 AWG Min. 2 #18 Max. 5 #12 | 600V* ,34mm ² to 10,0mm ² Min. 2-,75mm ² Max. 5-4,0mm ² | 100 / Box | B2-1 |
| | | | | 350 / Jar | B2-350JR |
| | | | | 500 / Jar | B2-500JR |
| | | | | 2,500 / Bucket (5 bags, 500 ea.) | B2-25 |
| | | | | 10,000 / Keg (20 bags, 500 ea.) | B2-B |
| | | | | Barrel of 25,000 | B2-SK |
| B4 | Blue-Gray | 600V* 14 to 6 AWG Min. 2 #12 Max. 2 #6 | 600V* 2,5mm ² to 16,0mm ² Min. 2-4,0mm ² Max. 2-16,0mm ² | 50 / Box | B4-1 |
| | | | | 1,000 / Bucket (4 bags, 250 ea.) | B4-25 |
| | | | | 2,500 / Keg (10 bags, 250 ea.) | B4-B |
| | | | | 50 / Box | BGR-1 |
| BGR | Green | 14 to 10 AWG Min. 2 #14 Max. 5 #12 | 2,5mm ² to 6,0mm ² Min. 2-2,5mm ² Max. 5-4,0mm ² | 2,500 / Bucket (10 bags, 250 ea.) | BGR-25 |
| | | | | 5,000 / Keg (20 bags, 250 ea.) | BGR-B |

*1,000V maximum in fixtures and signs



WireTwist™ Wire Connectors

- Five color-coded models cover common construction wire ranges
- Ribbed cap provides positive grip for fast, easy installation
- Fixed, square-wire spring threads itself creating a secure pressure grip
- Deep, wide-throated skirt protects against flash-over and turned-back strands for maximum dielectric protection
- Tough, UL 94V-2 flame-retardant shell rated at 105°C (221°F)
- UL 486C Listed and CSA 22.2 #188 Certified



Dimensions (Inches / mm)

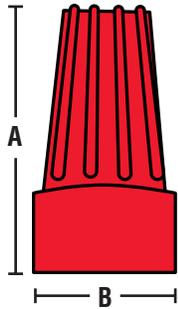

| Model | A | B |
|-------|------------------------|-----------------------|
| WT1 | $\frac{37}{64}$ 15 | $\frac{21}{64}$ 8 |
| WT2 | $\frac{45}{64}$ 18 | $\frac{25}{64}$ 10 |
| WT3 | $\frac{55}{64}$ 22 | $\frac{7}{16}$ 11 |
| WT4 | $\frac{61}{64}$ 24 | $\frac{35}{64}$ 14 |
| WT6 | $\frac{1-1}{16}$ 27 | $\frac{21}{32}$ 17 |

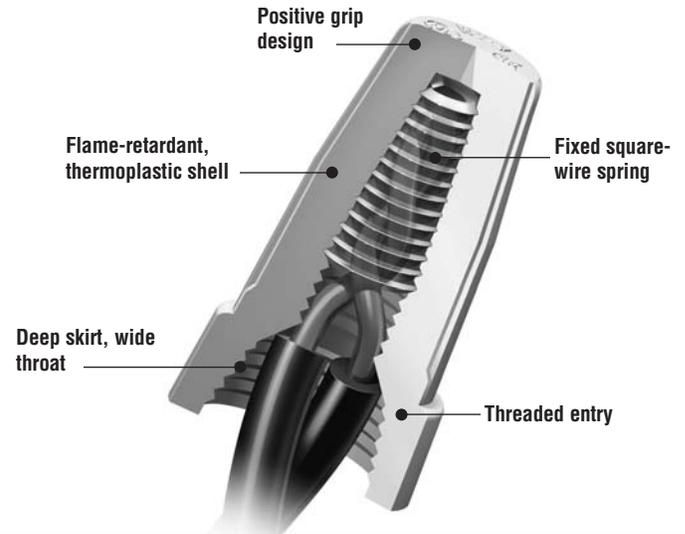

Twist-on Wire Connectors

| Model | Color | Wire Combination Range (Inches) | Wire Combination Range (mm) | Quantity / Package | BUCHANAN Cat. No. | IDEAL Cat. No. |
|-------|--------|---|--|--------------------|-------------------|----------------|
| WT1 | Gray | 300V 22 to 14 AWG Min. 3 #22 Max. 2 #16 | 300V ,34mm ² to 2,5mm ² Min. 3-,34mm ² Max. 2-1,5mm ² | 100 / Box | WT1-1 | 30-WT1C |
| | | | | 500 / Bag | WT1-B | 30-WT1B |
| | | | | 50,000 / Barrel | — | 30-891 |
| WT2 | Blue | 300V 22 to 14 AWG Min. 3 #20 Max. 3 #16 | 300V ,34mm ² to 2,5mm ² Min. 3-,50mm ² Max. 3-1,5mm ² | 100 / Box | WT2-1 | 30-WT2C |
| | | | | 500 / Bag | WT2-B | 30-WT2B |
| | | | | 50,000 / Barrel | — | 30-892 |
| WT3 | Orange | 600V* 22 to 14 AWG Min. 2 #18 Max. 2 #14 | 600V* ,34mm ² to 2,5mm ² Min. 2-,75mm ² Max. 2-2,5mm ² | 100 / Box | WT3-1 | 30-WT3C |
| | | | | 500 / Bag | WT3-B | 30-WT3B |
| | | | | 50,000 / Barrel | — | 30-893 |
| WT4 | Yellow | 600V* 22 to 10 AWG Min. 3 #20 Max. 2 #12 | 600V* ,75mm ² to 6,0mm ² Min. 3-,50mm ² Max. 2-4,0mm ² | 100 / Box | WT4-1 | 30-WT4C |
| | | | | 500 / Bag | WT4-B | 30-WT4B |
| | | | | 30,000 / Barrel | — | 30-894 |
| WT6 | Red | 600V* 20 to 8 AWG Min. 2 #14 Max. 4 #12 | 600V* ,50mm ² to 10,0mm ² Min. 2-2,5mm ² Max. 4-4,0mm ² | 100 / Box | WT6-1 | 30-WT6C |
| | | | | 250 / Bag | WT6-B | 30-WT6B |
| | | | | 20,000 / Barrel | — | 30-896 |

*1,000V maximum in fixtures and signs

**Includes 5 each of WT1, WT2, WT3, WT4 and WT6 WireTwist™ Wire Connectors



WingTwist™ Wire Connectors

- Four color-coded models cover common construction wire ranges; green model designed for ground connections
- Unique contoured wing design acts as built-in wrench providing maximum torque with minimum effort
- Fixed, square-wire spring threads itself creating secure pressure grip
- Deep, wide-throated skirt protects against flash-over and turned-back strands for maximum dielectric protection
- Tough, UL 94V-2 flame retardant shell rated at 105°C (221°F)
- UL 486C Listed (WGR UL 467 Listed) and CSA C22.2 #188 Certified



Tough, flame-retardant shell

Fixed square-wire spring

Deep, wide skirt

Built-in contoured wings

Dimensions (Inches/mm)

| Model | A | B |
|-------|-----------------------|----------------------|
| WT51 | $\frac{1-1/32}{26}$ | $\frac{23/32}{18}$ |
| WT52 | $\frac{1-1/4}{32}$ | $\frac{29/32}{23}$ |
| WT53 | $\frac{1-5/16}{33}$ | $\frac{1}{25}$ |
| WT54 | $\frac{1-9/16}{40}$ | $\frac{1-15/64}{31}$ |
| WGR | $\frac{1-5/32}{29.5}$ | $\frac{7/8}{22}$ |

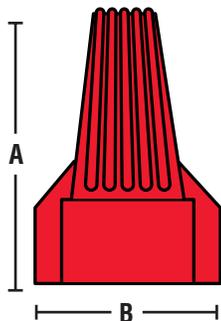

Twist-on Wire Connectors

| Model | Color | Wire Combination Range (Inches) | Wire Combination Range (mm) | Quantity / Package | BUCHANAN Cat. No. | IDEAL Cat. No. |
|-------|--------------|---|---|-------------------------|-------------------|-----------------|
| WT51 | Yellow | 600V* 18 to 10 AWG Min. 2 #18 Max. 3 #12 | 600V* ,75mm ² to 6,0mm ² Min. 2-,75mm ² Max. 3-4,0mm ² | 100 / Box | WT51-1 | 30-WT51C |
| | | | | 500 / Bag | WT51-B | 30-WT51B |
| | | | | 500 / Jar | WT51-500JR | 30-WT51J |
| | | | | 25,000 / Barrel | WT51-SK | 30-886 |
| WT41 | Tan | 600V* 22 to 10 AWG Min. 2 #20 Max. 3 #10 Solid | 600V* ,34mm ² to 6,0mm ² Min. 2-0,5mm ² Max. 3-6,0mm ² | 100 / Box | WT41-1 | 30-WT41C |
| | | | | 500 / Bag | WT41-B | 30-WT41B |
| | | | | 500 / Jar | WT41-500JR | 30-WT41J |
| | | | | 25,000 / Barrel | WT41-SK | 30-885 |
| WT52 | Red | 600V* 18 to 10 AWG Min. 2 #14 Max. 5 #12 | 600V* ,75mm ² to 6,0mm ² Min. 2-2,5mm ² Max. 5-4,0mm ² | 100 / Box | WT52-1 | 30-WT52C |
| | | | | 500 / Bag | WT52-B | 30-WT52B |
| | | | | 500 / Jar | WT52-500JR | 30-WT52J |
| | | | | 25,000 / Barrel | WT52-SK | 30-887 |
| WT54 | Blue | 600V* 14 to 6 AWG Min. 3 #12 Max. 2 #6 | 600V* 2,5mm ² to 16,0mm ² Min. 3-4,0mm ² Max. 2-16,0mm ² | 50 / Box | WT54-1 | 30-WT54C |
| | | | | 100 / Bag | WT54-B | 30-WT54B |
| WGR | Green | 14 to 10 AWG Min. 2 #14 Max. 5 #12 | 2,5mm ² to 6,0mm ² Min. 2-2,5mm ² Max. 5-4,0mm ² | 50 / Box | WGR-1 | 30-WGRC |
| | | | | 250 / Bag | WGR-B | 30-WGRB |
| | | | | 500 / Jar | WGR-500JR | 30-WGRJ |
| | | | | 25,000 / Barrel | WGR-SK | 30-890 |
| WT5 | Assortment** | See WT51 & WT52 above | See WT51 & WT52 above | (75 Yellow, 75 Red)/Jar | WT5152JR | — |

*1,000V maximum in fixtures and signs

**Includes 75 each of WT51 and WT52 WingTwist™ Wire Connectors

Splice Cap Crimp Connectors

- Designed for making fast, permanent, pressure-type connections
- Solid copper sleeves require less crimping pressure
- Resist corrosion in harsh environments
- Tin-plated steel sleeves also available
- UL 486C Listed and CSA C22.2 #188 Certified; comply with Federal Specification W-S-61D



| Description | Wire Combination Range (Inches) | Quantity / Package | Cat. No. |
|------------------------|---|--------------------|---------------|
| Copper Crimp Connector | 600V* 18 to 10 AWG Min. 2 #18 Max. 4 #12 | 100 / Box | 2006S |
| | | 1,000 / Bag | 2006SB |
| Copper Crimp Connector | 600V* 14 to 4 AWG Min. 2 #10 Max. 2 #6 | 50 / Box | 2011S |
| | | 500 / Bag | 2011SB |

*1,000V maximum in fixtures and signs



Four-Way Crimp Tool

- Patented design ensures even compression and reliable connectors
- Spring-loaded, cam-actuated plungers
- Fingertip adjustment for different connector sizes



| Description | Cat. No. |
|---------------------|-------------|
| Four-Way Crimp Tool | C-24 |

Splice Cap Insulators

- Convenient, safe and fast installation
- Snap-on nylon construction
- Rated at 105°C (221°F) – 600V (1,000V maximum in fixtures and signs)

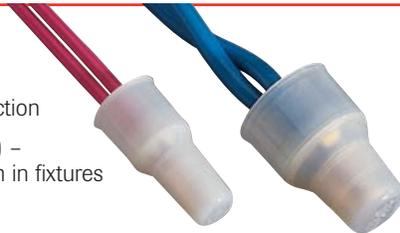

| For Connector Model | Quantity / Package | Cat. No. |
|---------------------|--------------------|--------------|
| 2006S & 2008S | 100 / Box | 2007 |
| | 1,000 / Bag | 2007B |
| 2011S | 50 / Box | 2014 |
| | 500 / Bag | 2014B |

Termend® Lugs

- Convenient, safe and fast installation
- One size fits 16 AWG through 8 AWG solid or stranded wire
- Available in ring, spade and locking spade



| Tongue Type | Stud Size | Quantity / Package | Cat. No. |
|---------------|-----------|--------------------|-----------------|
| Ring | 10 | 50 / Box | 16-8-10 |
| Ring | 1/4 | 50 / Box | 16-8-1/4 |
| Spade | 10 | 50 / Box | 16-8-10S |
| Locking Spade | 10 | 50 / Box | 16-8-10L |

B-TAP® Insulation-Piercing Tap Connectors

- Eliminates split bolts and tape
- Easy two-minute installation requires only box/socket wrench
- Installs on energized systems eliminating costly power shutdowns
- Self-sealing, grease-filled end-cap ensures safe, weather-tight connection
- Unique turbo spacer keeps connector wide open for quick and easy installation
- Torque-regulating nut breaks off when proper tension is reached
- Full-line is 600V dual-rated, 194°F (90°C)



B-Tap® Wire Range Chart

| Cat. No. | | Wire Size | | | | | | | | | | | | | | | | | | |
|------------|-----------------|-----------|----|----|---|---|---|---|---|---|-----|-----|-----|-----|-----|-----|-----|-----|-----|-----|
| | | 14 | 12 | 10 | 8 | 6 | 4 | 3 | 2 | 1 | 1/0 | 2/0 | 3/0 | 4/0 | 250 | 300 | 350 | 400 | 500 | 750 |
| BTC1/0-10 | Main: 1/0 - 8 | | | | | | | | | | | | | | | | | | | |
| | Tap: 2 - 10 | | | | | | | | | | | | | | | | | | | |
| BTC2/0-14 | Main: 2/0 - 4 | | | | | | | | | | | | | | | | | | | |
| | Tap: 10 - 14 | | | | | | | | | | | | | | | | | | | |
| BTC4/0-4 | Main: 4/0 - 2 | | | | | | | | | | | | | | | | | | | |
| | Tap: 4/0 - 4 | | | | | | | | | | | | | | | | | | | |
| BTC4/0-10 | Main: 4/0 - 3 | | | | | | | | | | | | | | | | | | | |
| | Tap: 2 - 10 | | | | | | | | | | | | | | | | | | | |
| BTC4/0-6 | Main: 4/0 - 2 | | | | | | | | | | | | | | | | | | | |
| | Tap: 2/0 - 6 | | | | | | | | | | | | | | | | | | | |
| BTC250-4 | Main: 250 - 1 | | | | | | | | | | | | | | | | | | | |
| | Tap: 4/0 - 4 | | | | | | | | | | | | | | | | | | | |
| BTC350-1/0 | Main: 350 - 1/0 | | | | | | | | | | | | | | | | | | | |
| | Tap: 350 - 1/0 | | | | | | | | | | | | | | | | | | | |
| BTC500-4 | Main: 500 - 2/0 | | | | | | | | | | | | | | | | | | | |
| | Tap: 4/0 - 4 | | | | | | | | | | | | | | | | | | | |
| BTC500-1/0 | Main: 500 - 4/0 | | | | | | | | | | | | | | | | | | | |
| | Tap: 350 - 1/0 | | | | | | | | | | | | | | | | | | | |
| BTC500-14 | Main: 750 - 3/0 | | | | | | | | | | | | | | | | | | | |
| | Tap: 10 - 14 | | | | | | | | | | | | | | | | | | | |
| BTC750-250 | Main: 750 - 250 | | | | | | | | | | | | | | | | | | | |
| | Tap: 500 - 250 | | | | | | | | | | | | | | | | | | | |

Main —
Tap —

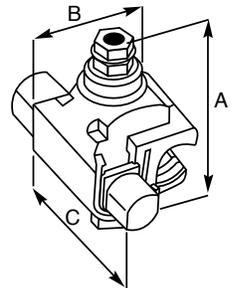

| Conductor Range | | Voltage Rating | Dimensions (Inches) | | | Socket Size (Inches) | Torque (In. Lbs.) | No. of Bolts | Cat. No. |
|-----------------|--------------------|----------------|---------------------|-----|------|----------------------|-------------------|--------------|-------------------|
| Run | Tap | | A | B | C | | | | |
| 1/0-8 | 2-10 ¹ | 600V | 3.1 | 1.8 | 2.2 | 1/2 | 80 | 1 | BTC1/0-10 |
| 2/0-4 | 10-14 ² | 600V | 3.1 | 1.8 | 2.2 | 1/2 | 80 | 1 | BTC2/0-14 |
| 4/0-2 | 4/0-4 | 600V | 4.4 | 2.4 | 3.2 | 1/2 | 160 | 1 | BTC4/0-4 |
| 4/0-3 | 2-10 ³ | 600V | 3.1 | 1.8 | 2.2 | 1/2 | 125 | 1 | BTC4/0-10 |
| 4/0-2 | 2/0-6 | 600V | 3.5 | 2.2 | 2.5 | 1/2 | 160 | 1 | BTC4/0-6 |
| 250-1 | 4/0-4 | 600V | 3.5 | 2.2 | 2.5 | 1/2 | 160 | 1 | BTC250-4 |
| 350-1/0 | 350-1/0 | 600V | 4.5 | 3 | 3.9 | 5/8 | 330 | 2 | BTC350-1/0 |
| 500-2/0 | 4/0-4 | 600V | 4.5 | 3 | 3.9 | 5/8 | 330 | 2 | BTC500-4 |
| 500-4/0 | 350-1/0 | 600V | 4.5 | 3 | 3.9 | 5/8 | 330 | 2 | BTC500-1/0 |
| 750-3/0 | 10-14 ⁴ | 600V | 3.7 | 2.5 | 2.2 | 1/2 | 80 | 1 | BTC500-14 |
| 750-250 | 500-250 | 600V | 4.7 | 3.4 | 4.75 | 5/8 | 330 | 2 | BTC750-250 |
| Assortment* | | | | | | | | | BTCA-2 |

* Includes BTC 1/0-10, BTC 2/0-14, BTC 4/0-2, BTC 4/0-10, BTC 4/0-6, BTC 250-4, BTC 350-1/0, BTC 500-4 & BTC 500-1/0

¹ Tap #2 - #10 Cu solid/stranded; #2 - #10 Al stranded

² Tap #10 - #14 Cu solid/stranded; #10 - #14 Al stranded

³ Tap #2 - #10 Cu solid/stranded; #2 - #8 Al stranded

⁴ Tap #10 - #14 Cu solid/stranded; #10 - #12 Al stranded



Waterproof Breakaway Steeltight Connector & Splice Insulating Kits

- Safe and easy installation in five minutes or less
- No special equipment necessary – requires only a knife, wire stripper and crimp tool
- Unique wire entry port, cut-off design accommodates industry’s widest range of insulation diameters
- Fewer parts than competitive brands for better waterproof protection
- Built-in break-away design eliminates de-energization of complete circuits
- Safely separates upon impact without breaking wires – eliminates potential danger and electrical shock (breakaway models)
- Unique 2-in-1 one-piece crimp barrel accommodates industry’s widest range of conductors (breakaway models)
- Spring-loaded contacts compensate for thermal expansion to maintain integrity of waterproof connection (breakaway models)



Streetlight Kits

Application Guide

Examples of Several Kit Configurations

For Poles with Transformer Bases, Standard Bases and Junction Boxes

Underground Feed Phase to Phase

Configurations

- D65 dual in-line for phases and two 84 or 84S kits for taps
- Two 82 or 82S Y-Tap Kits for phases and taps
- Two BTS4 B-CAP® Twist & Seal Wire Connectors

Comments

Recommended
Cost-effective
Non-breakaway, small gauge (8 AWG and above).
See Wire Connector section.

Underground Feed Phase to Neutral

Configurations

- D65PN dual in-line for phase and neutral and Two 84 or 84S kits for tap
- One 82 or 82S Y-Tap Kit for phase and tap and one 83 or 83S Y-Tap Kit for neutral and tap
- Two BTS4 B-CAP® Twist and Seal Wire Connectors

Comments

Recommended configuration
Cost-effective
Non-breakaway, small gauge (8 AWG and above).
See Wire Connector section.

For Lights Mounted to Utility Poles, etc...

Overhead Feed

- Two B-Tap® Insulation Piercing Connectors for phase and/or tap (for insulated conductors only)

Recommended configuration, see B-Tap® Insulation Piercing Connectors in this catalog.

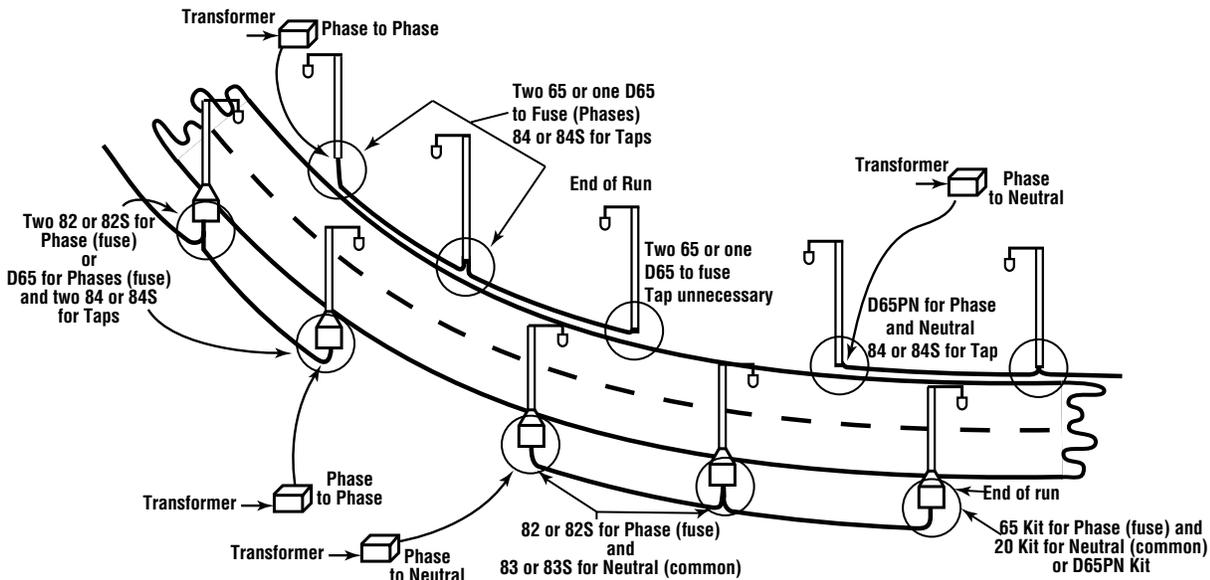

Ordering Information

Use the following chart and table to determine the correct part number by choosing model, line side, and load side ordering codes from the shaded columns. See example below, right (Page A-45).

Breakaway In-Line Kits



MODEL

| Application | Electrical Rating | Ordering Code |
|--|---|---------------|
| In-Line Neutral Non-Fused Breakaway | 30 Amp 600 Volt | 20 – |
| In-Line Phase Fused Breakaway | 1/10-30 Amp 600 Volt | 65 – |
| Dual In-Line Phase Fused Breakaway | 1/10-30 Amp 600 Volt | D65 – |
| Dual In-Line Phase & Neutral Fused Breakaway | 1/10-30 Amp Phase 30 Amp Neutral 600 Volt | D65PN – |

Breakaway Y-Tap Kits

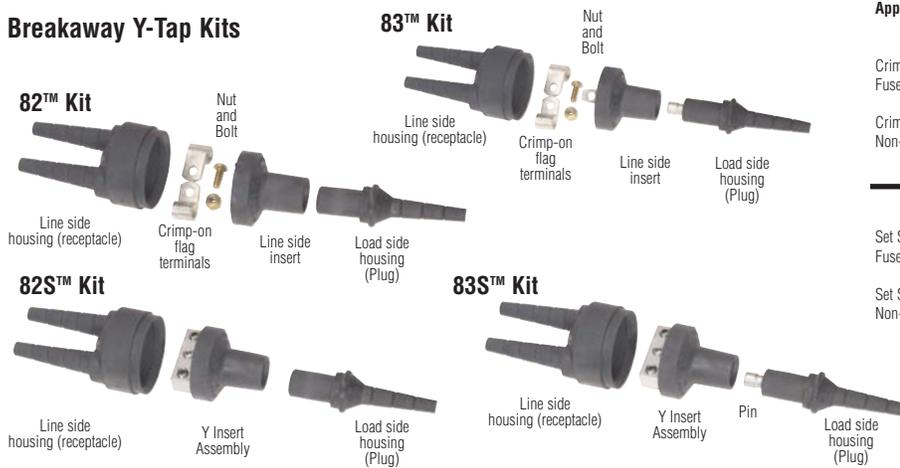

| Application | Electrical Rating | Ordering Code |
|---------------------------------------|---|---------------|
| Crimped Phase Fused Tap & Run | 1/10-30 Amp 600 Volt | 82 – |
| Crimp Neutral Non-Fused Tap & Run | 125 Amp Line 30 Amp Load 600 Volt | 83 – |
| Set Screw Phase Fused Tap & Run | 1/10-30 Amp 600 Volt | 82S – |
| Set Screw Neutral Non-Fused Tap & Run | 70 Amp Line 30 Amp Load 600 Volt | 83S – |

Y-Splice Kits



| Application | Electrical Rating | Ordering Code |
|----------------------------|---------------------|---------------|
| Crimp Splice Tap & Run | 150 Amp 600 Volt | 84 – |
| Set Screw Splice Tap & Run | 70 Amp 600 Volt | 84S – |

| Excerpts of the 1996 NEC Tables 5 & 5A Dimensions of Insulated Conductors and Fixture Wires | | | | | | | | | |
|--|--|-----------|-------|-----------|-------------|-------------|--|-------|-------|
| Size (AWG) | Approx. Diameter in Inches for Insulation Types: | | | | | | Approx. Diameter in Inches for Compact AL with Insulation Types: | | |
| | RH | RHW-2,RHW | TW | THW,THW-2 | THWN,THWN-2 | XHHW,XHHW-2 | THW,THHW | THHN | XHHW |
| 14 | 0.163 | 0.193 | 0.133 | 0.163 | 0.111 | 0.133 | – | – | – |
| 12 | 0.182 | 0.212 | 0.152 | 0.182 | 0.130 | 0.152 | – | – | – |
| 10 | 0.236 | 0.236 | 0.176 | 0.206 | 0.164 | 0.176 | – | – | – |
| 8 | 0.326 | 0.326 | 0.236 | 0.266 | 0.216 | 0.236 | 0.255 | – | 0.224 |
| 6 | 0.364 | 0.364 | 0.304 | 0.304 | 0.254 | 0.274 | 0.290 | 0.240 | 0.260 |
| 4 | 0.412 | 0.412 | 0.352 | 0.352 | 0.324 | 0.322 | 0.335 | 0.305 | 0.305 |
| 3 | 0.440 | 0.440 | 0.380 | 0.380 | 0.352 | 0.350 | – | – | – |
| 2 | 0.472 | 0.472 | 0.412 | 0.412 | 0.384 | 0.382 | 0.390 | 0.360 | 0.360 |
| 1 | 0.582 | 0.582 | 0.492 | 0.492 | 0.446 | 0.442 | 0.465 | 0.415 | 0.415 |
| 1/0 | 0.622 | 0.622 | 0.532 | 0.532 | 0.486 | 0.482 | 0.500 | 0.450 | 0.450 |

National Electric Code®, Copyright © 1996, National Fire Protection Association, Quincy MA 02269

Streetlight Kits

Wire Termination

| LINE SIDE | | | |
|------------------------------------|--------------------------------|----------------|--------------------------|
| Insulation Diameter Range (Inches) | Stranded* Conductor Size (AWG) | Type | Ordering Code (CHOOSE 1) |
| .120-.430 | 12-6 | Copper Crimp | U - |
| | 12-6 | Aluminum Crimp | UA - |
| | 4 or 2 | Copper Crimp | LC - |
| | 4 or 2 | Aluminum Crimp | LA - |

| LOAD SIDE | | | | |
|------------------------------------|----------------------------------|--------------------------------|----------------|--------------------------|
| Insulation Diameter Range (Inches) | Equivalent Conductor (See Table) | Stranded* Conductor Size (AWG) | Type | Ordering Code (CHOOSE 1) |
| .120-.430 | 1 | 12-6 | Copper Crimp | U |
| | | 12-6 | Aluminum Crimp | UA |
| | | 4 or 2 | Copper Crimp | LC |
| | | 4 or 2 | Aluminum Crimp | LA |

NOTE: It is not necessary to use the load side ordering code if it is the same as the line side code, i.e., a 65U-U is ordered as a 65U.

| Insulation Diameter Range (Inches) | Ordering Code (CHOOSE 1) | Stranded* Conductor Size (AWG) | Type | Ordering Code (CHOOSE 1) | Insulation Diameter Range (Inches) | Equivalent Conductor (See Table) | Stranded* Conductor Size (AWG) | Type | Ordering Code (CHOOSE 1) |
|------------------------------------|--------------------------|--------------------------------|---|--------------------------|------------------------------------|----------------------------------|--------------------------------|----------------|--------------------------|
| .155-.430 | ADB | 10 | Copper Crimp | 6 - | .120-.430 | 1 | 12-6 | Copper Crimp | C |
| | | 8 | Copper Crimp | 4 - | | | 12-6 | Aluminum Crimp | A |
| | | 6 | Copper Crimp | 3 - | | | 4 or 2 | Copper Crimp | LC |
| | | 4 | Copper Crimp | 2 - | | | | 4 or 2 | Aluminum Crimp |
| .420-.785 | EAFB | 2 | Copper Crimp | 1 - | .120-.430 | 1 | 12-6 | Aluminum Crimp | A |
| | | 1 | Copper Crimp | 0 - | | | 4 or 2 | Copper Crimp | LC |
| | | 1/0 | Copper Crimp | 10 - | | | 4 or 2 | Aluminum Crimp | LA |
| | | 10 | Copper Crimp | 6 - | | | | | |
| .155-.430 | ADB | 10 | Terminal Block with Set Screws Copper or Alum. Conductors | 1 - | .120-.430 | 1 | 12-6 | Copper Crimp | C |
| | | 8 | | 1 - | | | 12-6 | Aluminum Crimp | A |
| | | 6 | | 1 - | | | 4 or 2 | Copper Crimp | LC |
| | | 4 | | 1 - | | | 4 or 2 | Aluminum Crimp | LA |
| .420-.785 | EAFB | 2 | Copper or Alum. Conductors | 1 - | .120-.430 | 1 | 12-6 | Aluminum Crimp | A |
| | | 1 | Copper or Alum. Conductors | 10 - | | | 4 or 2 | Copper Crimp | LC |
| | | 1/0 | Copper or Alum. Conductors | 10 - | | | 4 or 2 | Aluminum Crimp | LA |
| | | 10 | Copper or Alum. Conductors | 10 - | | | | | |

| Insulation Diameter Range (Inches) | Ordering Code (CHOOSE 1) | Stranded* Conductor Size (AWG) | Type | Ordering Code (CHOOSE 1) | Insulation Diameter Range (Inches) | Equivalent Conductor (See Table) | Conductor Size (AWG) | Type | Ordering Code (CHOOSE 1) |
|------------------------------------|--------------------------|--------------------------------|---|--------------------------|------------------------------------|----------------------------------|----------------------|--|--------------------------|
| .155-.430 | ADB | 10 | Copper Crimp | 6 - | .120-.430 | 1 | 10 | Copper Crimp | 6 |
| | | 8 | Copper Crimp | 4 - | | | 8 | Copper Crimp | 4 |
| | | 6 | Copper Crimp | 3 - | | | 6 | Copper Crimp | 3 |
| | | 4 | Copper Crimp | 2 - | | | 4 | Copper Crimp | 2 |
| .420-.785 | EAFB | 2 | Copper Crimp | 1 - | .120-.430 | 1 | 2 | Copper Crimp | 1 |
| | | 1 | Copper Crimp | 0 - | | | 1 | Copper Crimp | 0 |
| | | 1/0 | Copper Crimp | 10 - | | | | | |
| | | 10 | Copper Crimp | 6 - | | | | | |
| .155-.430 | ADB | 10 | Terminal Block with Set Screws Copper or Alum. Conductors | 1 - | .120-.430 | 1 | 10-2 | Terminal Block Copper or Aluminum Conductors | N/A |
| | | 8 | | 1 - | | | | | |
| | | 6 | | 1 - | | | | | |
| | | 4 | | 1 - | | | | | |
| .420-.785 | EAFB | 2 | Copper or Alum. Conductors | 1 - | .120-.430 | 1 | 10-2 | Terminal Block Copper or Aluminum Conductors | N/A |
| | | 1 | Copper or Alum. Conductors | 10 - | | | | | |
| | | 1/0 | Copper or Alum. Conductors | 10 - | | | | | |
| | | 10 | Copper or Alum. Conductors | 10 - | | | | | |



LR32565

NOTE:
Fused kits require a 13/32" x 1 1/2" fuse. **DO NOT USE GLASS OR INDICATING TYPES.**
Waterproof or direct burial wire is recommended. **THHN is NOT recommended.**

* For solid wire: 14-4 AWG, use codes U, UA, C, or A. 2 AWG, use codes LC or LA.

Example:

A Y-Tap Kit with set screws for a 2 AWG phase line side conductor with a diameter of .472" and a 10 AWG copper load side conductor is ordered as an 82S-EAFB1-C.

Terminal Blocks

BUCHANAN CONSTRUCTION PRODUCTS, INC. offers the industry's most comprehensive and accommodating line of terminal blocks. BUCHANAN terminal blocks make wiring jobs simpler and allow easy ready hook-up of wires from different components or areas throughout a structure.

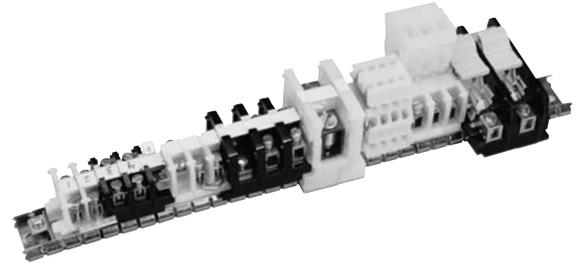

- Wide range of configurations to solve virtually any wiring need
- Wide wire ranges – 30 AWG to 250 KCMIL (MCM)
- Easy installation – connect and disconnect quickly making them perfect for maintenance and troubleshooting applications
- Versatile, accommodating sectional design
- Three housing options to meet your specific applications – nylon, phenolic and polyester
- Wide selection of contact types
- Full line of accessories for easy customization

100 Series - Miniature (High Density)

These miniature terminal blocks fit on a much smaller channel to save valuable panel space or can be surface mounted directly to the panel. Miniature blocks accept wire as large as 12 AWG.

- No wire crimping required – clamp contacts hold wire from 30 AWG to 12 AWG better than crimp-on terminals
- Saves installation time and cost – tubular clamp contacts supplied with captive screws backed out
- Nylon housing for rugged applications
- Positive stop prevents wire from being inserted too far and prevents screw from being tightened on insulation; easy access contact provides safe, reliable and cost-effective connection
- Quick installation and change – additional sections may be added or removed without removing channel mounting screw
- Matte-finish area for marking directly on block



| Catalog Number - 100 Series | 125 | 115 | End Section | |
|-----------------------------|--------------------------|-------------------------------|--------------------------|-------------------------------|
| | | | 130 | 120 |
| Mounting Style | Direct Mount (Flat Base) | Channel Mount (Dovetail Base) | Direct Mount (Flat Base) | Channel Mount (Dovetail Base) |

WIRE RANGE: Solid or Stranded

Tubular Clamp

1 #12 AWG, 1 #14 AWG, 1 to 3 #16 AWG, 1 to 5 #18 AWG, 1 to 6 #20 AWG, 1 to 7 #22 AWG

Terminal Block Specifications

| 100 Series | 125 | 115 |
|-----------------------------------|---------------|-----|
| Housing Material | Nylon | |
| Maximum Service Temperature | 125°C (257°F) | |
| Flammability | UL94V2 | |
| Wire Strip Length (in.) | 5/16 | |
| Torque (lbs.) | 6-9 | |
| UL Rating | 28A @ 300V | |
| Wire Range (AWG) Solid & Stranded | 30-12 | |
| Pitch (in.) | 0.25 | |
| Terminals per foot | 48 | |

Miniature - Single Tier HIGH DENSITY

Flat Base

$$C = .29 + (.25 \times N)$$

$$L = .51 + (.25 \times N)$$

On Miniature #12 Channel:

$$CCH = 1.00 + (.25 \times A)$$

$$LCH = 1.35 + (.25 \times A)$$

A = N when N is even

A = N + 1 when N is odd

N = Number of Miniature Sections

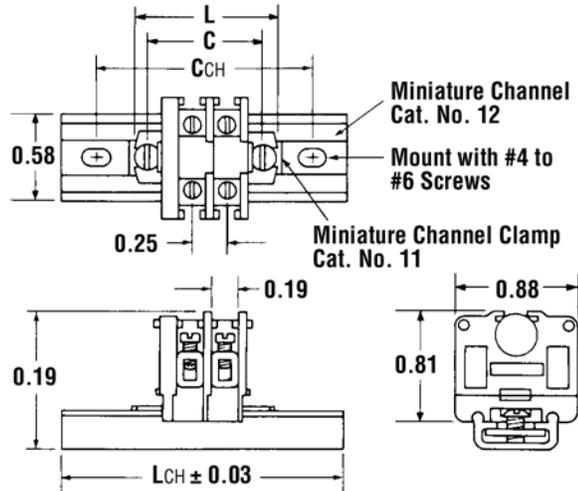

Dovetail Base

$$C = .35 + (.25 \times N)$$

$$L = .50 + (.25 \times N)$$

On Standard #60 Channel:

$$CCH = 2.00 + (.25 \times A)$$

$$LCH = 2.75 + (.25 \times A)$$

N = Number of Single Tier Sections

On Miniature #12 Channel:

$$CCH = 1.00 + (.25 \times A)$$

$$LCH = 1.35 + (.25 \times A)$$

A = N when N is even

A = N + 1 when N is odd

N = Number of Miniature Sections

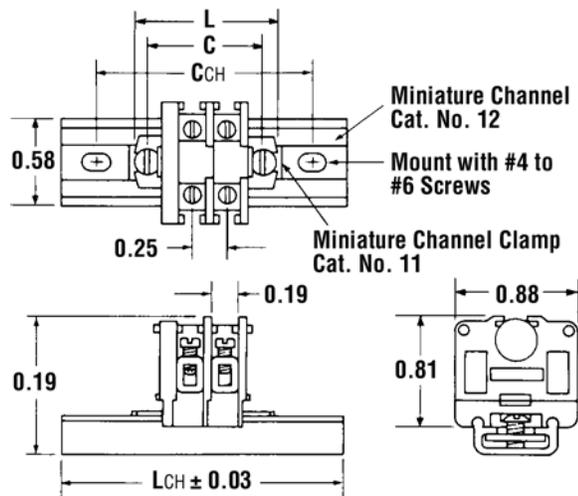

900 Series Medium Duty

This family of polyester blocks is ideal for high temperature applications. The rugged material withstands temperatures up to 302°F (150°C)

- Three contact styles cover broad wire range – accept single wire or combinations from 22 AWG to 8 AWG solid or stranded
- Rated at 15A to 50A per circuit
- Flat base models mount directly to surfaces; dovetail base models mount on stranded channel
- Only one end section needed per block assembly
- Readily identifiable circuits - write directly on matte surface of block
- Sections snap-fit with Heavy Duty, Intermediate Heavy Duty and Fuse blocks



Specifications

Center-to-Center Spacing: .375 in.

Voltage Rating: 600 Volt max., Current: 50 Amp max.

Ampacity: #8 - #22 AWG

| Catalog Number | 921 | 0921 | 924 | 0924 | 925 | 0925 | 930 | 0930 |
|-------------------------|--------------------------|-------------------------------|--------------------------|-------------------------------|--------------------------|-------------------------------|----------------------------|-----------------------------|
| Mounting Style | Direct Mount (Flat Base) | Channel Mount (Dovetail Base) | Direct Mount (Flat Base) | Channel Mount (Dovetail Base) | Direct Mount (Flat Base) | Channel Mount (Dovetail Base) | End Section (Direct Mount) | End Section (Channel Mount) |
| Ampacity | 15A | | 50A | | 30A | | — | — |
| Contact Type | Strap Screw | | Tubular Screw | | Tubular Clamp | | — | — |
| Screw Type | 6-32 Combo Head | | 10-32 Combo Head | | 10-32 Combo Head | | — | — |
| Screw Torque | 12 in./lbs. | | 8 in./lbs. | | 8 in./lbs. | | — | — |
| Wire Range (AWG) | #14 to #22 | | #8 to #22 | | #10 to #22 | | — | — |

| | |
|------------------------------------|---------------------------|
| Housing Material | Polyester (gray) |
| Contact Material | Copper Alloy, Zinc Plated |
| Screw Material | Steel, Zinc Plated |
| Maximum Service Temperature | 150°C (302°F) |
| Flammability | UL94V-0 Rated |



WIRE RANGE: Solid or Stranded

Strap Screw

1 #22 to 1 #14 AWG

Tubular Screw

1 #8 AWG, 1 #10 AWG, 1 to 3 #12 AWG, 1 to 4 #14 AWG, 1 to 4 #16 AWG, 1 to 5 #18 AWG, 1 to 10 #22 AWG

Tubular Clamp

1 #10 AWG, 1 or 2 #12 AWG, 1 to 3 #14 AWG, 1 to 4 #16 AWG, 1 to 5 #18 AWG, 1 to 10 #22 AWG

Terminal Blocks

900 Series

Strap Screw

Direct Mount (Flat Base)

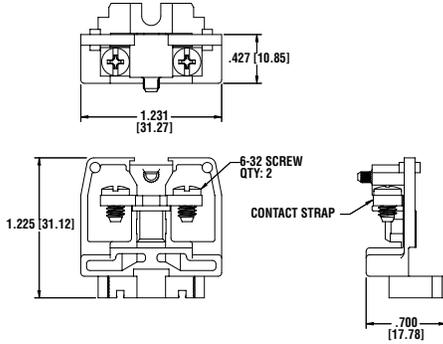

Channel Mount (Dovetail Base)

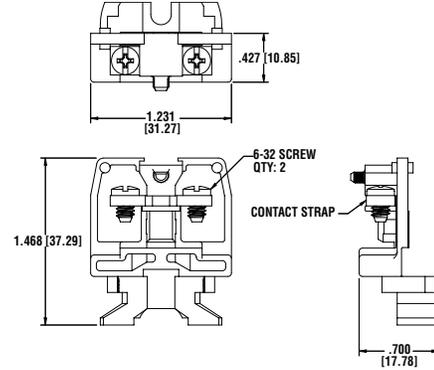

Tubular Screw/Tubular Clamp

Direct Mount (Flat Base)

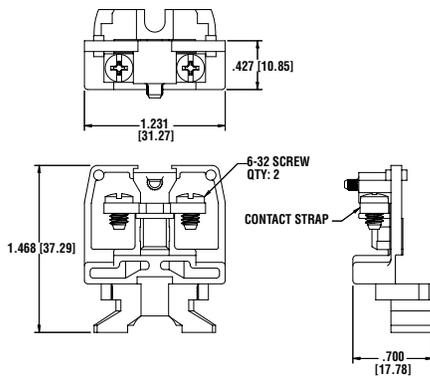

Channel Mount (Dovetail Base)

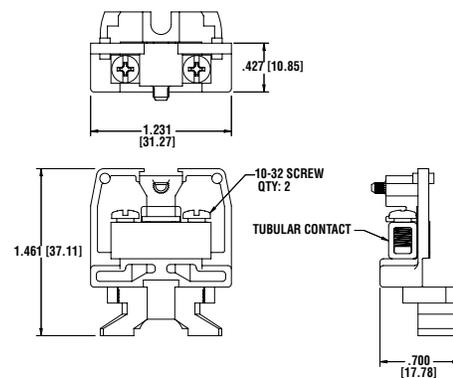

End Section

Direct Mount (Flat Base)

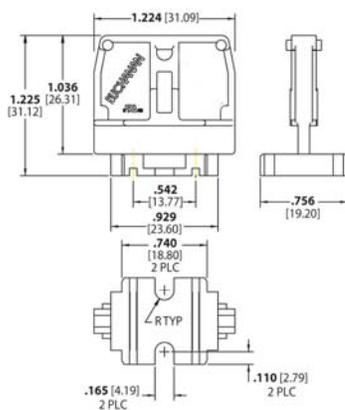

Channel Mount (Dovetail Base)

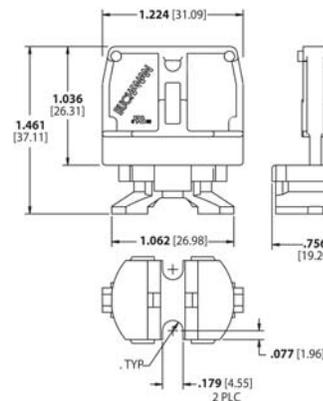

200 Series - Nylon HEAVY DUTY

This compact design, heavy-duty line accepts single wire or combinations up to 4 AWG, solid or stranded.; 600V UL and NEMA rating.

- 138 circuits per 6 foot length
- Three contact styles conservatively rated from 35A to 85A per circuit
- Two-way flat-base models surface mount directly to the panel or snap-on miniature channel; dovetail base models mount on standard channel
- Only one end section needed per block assembly
- Readily identifiable circuits – mark directly on painted surface of block sections or use removable marking tape
- Nylon housing for more rugged applications
- Sections snap-fit with Phenolic Heavy Duty, Intermediate Heavy Duty and Fuse blocks

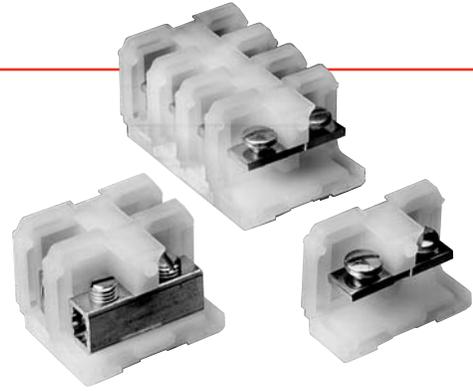

Specifications

Center-to-Center Spacing: .50 in. CL: 24 circuits per foot.

Voltage Rating: Blocks meet 600V creepage and clearance requirements of NEMA, UL and CSA for general industrial control equipment and panelboards. Withstand voltages greatly in excess of IEEE switchgear standards for 750V.

Ampacity: For a single 4 AWG wire, the maximum amperage recommended is 85A.



| Catalog Number | 241 | 0241 | 242 | 0242 | 243 | 0243 | 250 | 0250 |
|--------------------------|----------------------------|-------------------------------|--------------------------|-------------------------------|--------------------------|-------------------------------|----------------------------|-----------------------------|
| Mounting Style | Direct Mount (Flat Base) | Channel Mount (Dovetail Base) | Direct Mount (Flat Base) | Channel Mount (Dovetail Base) | Direct Mount (Flat Base) | Channel Mount (Dovetail Base) | End-Section (Direct Mount) | End-Section (Channel Mount) |
| Ampacity | 35A | | 85A | | 65A | | — | — |
| Contact Type | Strap Screw | | Tubular Screw | | Tubular Clamp | | — | — |
| Screw Type | 10-32 Slotted Binding Head | | 1/4-28 Slotted Headless | | 1/4-28 Slotted Headless | | — | — |
| Wire Range (AWG) | #22 to #10 | | #18 to #4 | | #18 to #6 | | — | — |
| Wire Strip Length | — | | 1/2 in. | | 1/2 in. | | — | — |

| | |
|---|--|
| Housing Material | Nylon, Type 6/6 unfilled |
| Contact Material | Copper / Copper Alloy |
| Screw Material | Steel Plated |
| Maximum Service Temperature | 125°C (257°F) |
| Breakdown Voltage AC, 60Hz | 7000V |
| Dielectric Strength (RH40% at sea level) | 470-385 V/mil thickness (per ASTM D149) |
| UL High Voltage Arc Testing (in./min.) | 0.1 - .35 |
| Water Absorption (24 hrs. % weight gain) | 1.5% |
| Flammability | 94V-2 (per UL94) |
| Chemical Resistance | Resistant to aromatic hydrocarbons, strong alkalis |
| Radiation Resistance (ergs g⁻¹ C) | 8 x 10 ⁷ |

WIRE RANGE: Solid or Stranded

Strap Screw

1 #22 to 1 #10 AWG

Tubular Screw

1 #4 AWG, 1 #6 AWG, 1 or 2 #8 AWG, 1 to 4 #10 AWG, 1 to 5 #12 AWG, 1 to 6 #14 AWG, 1 to 6 #16 AWG, 1 to 8 #18 AWG

Tubular Clamp

1 #6 AWG, 1 or 2 #8 AWG, 1 to 3 #10 AWG, 1 to 4 #12 AWG, 1 to 4 #14 AWG, 1 to 6 #16 AWG, 1 to 8 #18 AWG



LR25557



E63810

200 Series - Nylon HEAVY DUTY

Flat Base (Direct Mount)

$$C = .56 + (.50 \times N)$$

$$L = .78 + (.50 \times N)$$

N = Number of circuits

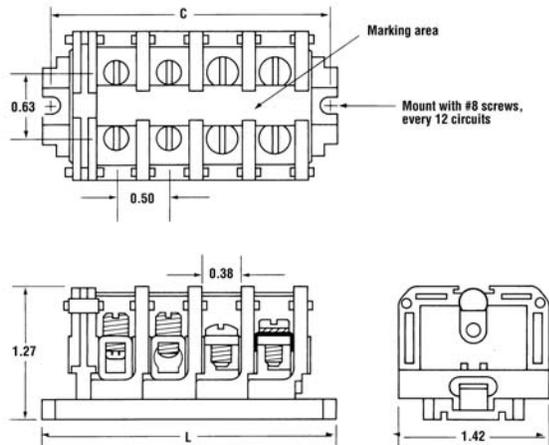

Flat Base Mounted on #12 Miniature Channel

$$LCH = 1.85 + (.50 \times N)$$

$$CCH = 1.50 + (.50 \times N)$$

N = Number of Circuits

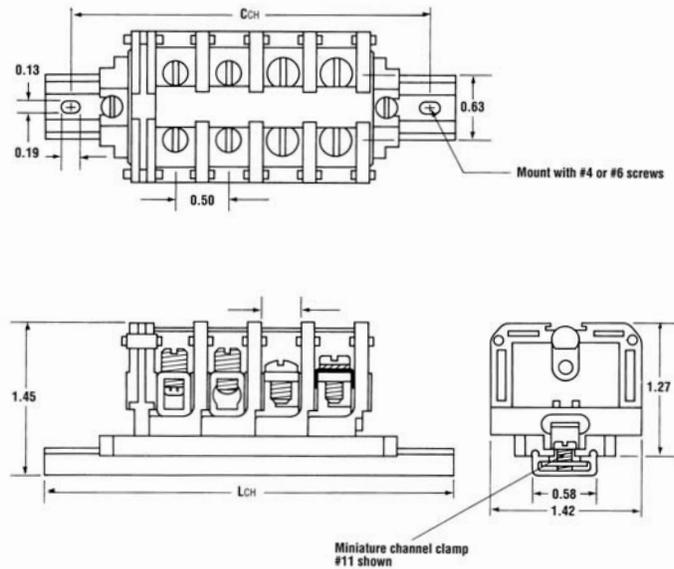

Dovetail Base Mounted on Standard #60 Channel

$$LCH = .303 + (.50 \times N)$$

$$CCH = 2.28 + (.50 \times N)$$

N = Number of circuits

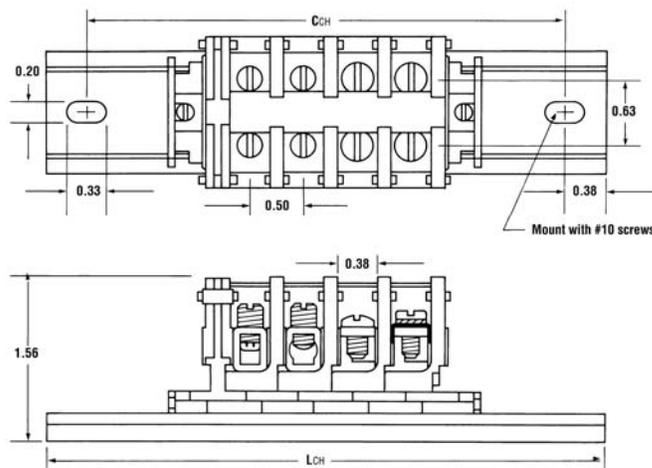
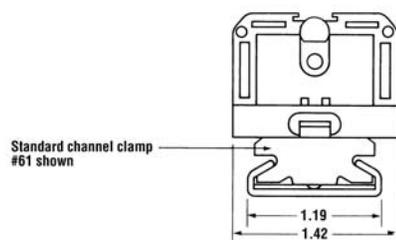

200 Series - Phenolic HEAVY DUTY

The family of phenolic heavy duty blocks is ideal for high temperature, high current applications. The rugged material withstands temperatures up to 302°F (150°C).

- Sturdy block accepts single wire or combinations up to 4 AWG solid or stranded
- 122 circuits per 6 foot length
- Three contact styles conservatively rated to 35A to 85A
- Only one end section needed per block assembly
- Readily identifiable circuits – mark directly on painted marking surface or use removable marking strip
- Sections snap-fit with Nylon Heavy Duty, Intermediate Heavy Duty and Fuse Blocks



Specifications

Center-to-Center Spacing: .56 in. CL: 20 circuits per foot.

Voltage Rating: Blocks meet 600V creepage and clearance requirements of NEMA, UL and CSA for general industrial control equipment and panelboards. Withstand voltages greatly in excess of IEEE switchgear standards for 750V.

Ampacity: For a single 4 AWG wire, the maximum amperage recommended is 85A.



| Catalog Number | 221 | 0221 | 222 | 0222 | 223 | 0223 | 230 | 0230 |
|--------------------------|----------------------------|-------------------------------|--------------------------|-------------------------------|--------------------------|-------------------------------|----------------------------|-----------------------------|
| Mounting Style | Direct Mount (Flat Base) | Channel Mount (Dovetail Base) | Direct Mount (Flat Base) | Channel Mount (Dovetail Base) | Direct Mount (Flat Base) | Channel Mount (Dovetail Base) | End-Section (Direct Mount) | End-Section (Channel Mount) |
| Ampacity | 35A | | 85A | | 65A | | — | — |
| Contact Type | Strap Screw | | Tubular Screw | | Tubular Clamp | | — | — |
| Screw Type | 10-32 Slotted Binding Head | | 1/4-28 Slotted Headless | | 1/4-28 Slotted Headless | | — | — |
| Wire Range (AWG) | #22 to #10 | | #18 to #4 | | #18 to #6 | | — | — |
| Wire Strip Length | — | | 1/2 in. | | 1/2 in. | | — | — |

| | |
|---|---|
| Housing Material | Phenolic, Filled, Flame retardant |
| Contact Material | Copper / Copper Alloy |
| Screw Material | Steel Plated |
| Maximum Service Temperature | 150°C (302°F) |
| Breakdown Voltage AC, 60Hz | 7000V |
| Dielectric Strength (RH40% at sea level) | 300V/mil thickness (per ASTM D149) |
| UL High Voltage Arc Testing (in./min.) | .49 - .59 |
| Water Absorption (24 hrs. % weight gain) | 45% (per ASTM D570) |
| Flammability | 94V-1 (per UL94) |
| Chemical Resistance | Resistant to acids, alkalies, aliphatic hydrocarbons and ketones (per ASTM D5343) |
| Radiation Resistance (ergs g⁻¹ C) | 2.7 x 10 ⁶ min. |

WIRE RANGE: Solid or Stranded

Strap Screw

1 #18 to 1 #8 AWG

Tubular Screw

1 #4 AWG, 1 #6 AWG, 1 or 2 #8 AWG, 1 to 4 #10 AWG, 1 to 5 #12 AWG, 1 to 6 #14 AWG, 1 or 6 #16 AWG, 1 to 8 #18 AWG

Tubular Clamp

1 #6 AWG, 1 or 2 #8 AWG, 1 to 3 #10 AWG, 1 to 4 #12 AWG, 1 to 4 #14 AWG, 1 to 6 #16 AWG, 1 to 8 #18 AWG



LR25557



E63810

200 Series - Phenolic HEAVY DUTY

Flat Base (Direct Mount)

$$C = .59 + (.57 \times N)$$

$$L = .81 + (.57 \times N)$$

N = Number of circuits

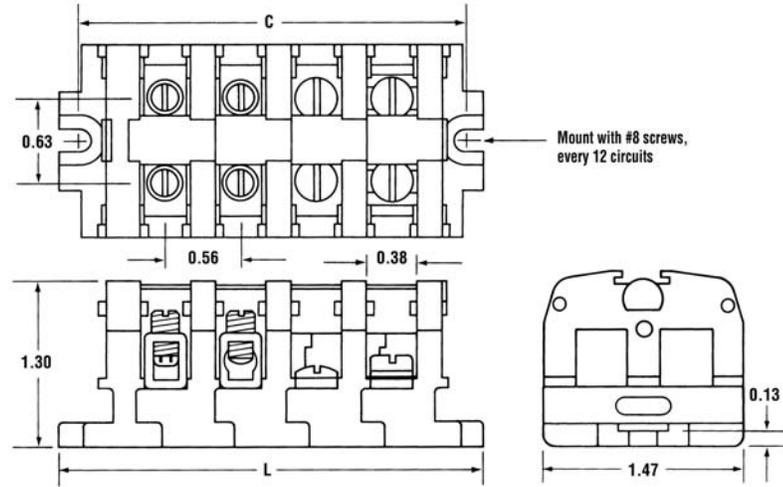

Dovetail Base Mounted on Standard #60 Channel

$$C_{CH} = 2.31 + (.57 \times N)$$

$$L_{CH} = 3.06 + (.57 \times N)$$

N = Number of circuits

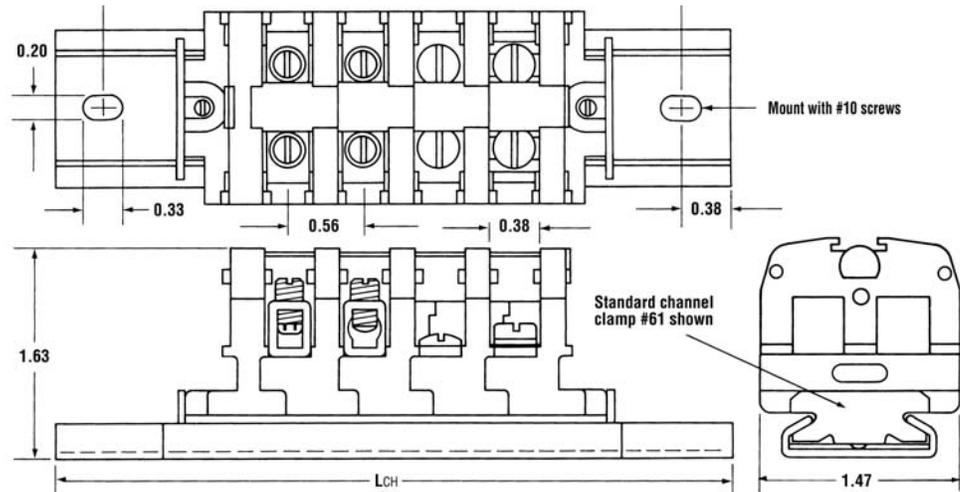

Nylon INTERMEDIATE HEAVY DUTY

The 800 Series line of 600V blocks is conservatively rated up to 150A for a single 1/0 AWG copper wire.

- Exceptionally compact block accepts single wire or combinations up to 1/0 AWG
- 92 circuits per 6 foot length
- Tubular screw contact style accepts AWG sizes from 12 to 1/0, solid or stranded
- Two-way mounting base fits standard channel or mounts directly to flat surfaces
- Only one end section needed per block assembly
- Readily identifiable circuits – write directly on painted marking surface or use removable vinyl marking strip
- Nylon housing for rugged applications, 7/16 -20 slotted headless screws
- Snap-fit with Heavy-Duty Nylon and Phenolic and Fuse Blocks

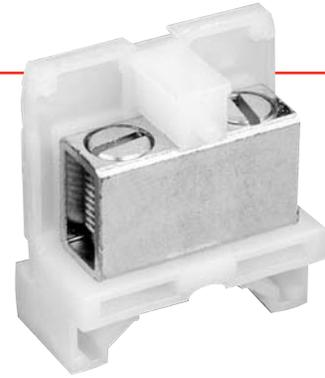

Specifications

Center-to-Center Spacing: .75 in. CL: 16 circuits per foot.

Voltage Rating: Blocks meet 600V creepage and clearance requirements of NEMA, UL and CSA standards for general industrial control equipment and panelboards. Withstand voltages greatly in excess of IEEE switchgear standards for 750V.

Ampacity: For a single 1/0 AWG copper wire, the maximum amperage recommended is 150A.

| Catalog Number | 824 | 830 |
|-------------------|--------------------------|-------------|
| Mounting Style | Two-Way Mounting Base | End Section |
| Ampacity | 150A | — |
| Contact Type | Tubular Screw | — |
| Screw Type | 7/16-20 Slotted Headless | — |
| Wire Range (AWG) | 12 to 1/0 | — |
| Wire Strip Length | 11/16 in. | — |

| | |
|---|--|
| Housing Material | Nylon, Type 6/6 Unfilled |
| Contact Material | Copper |
| Screw Material | Steel, Zinc-Plated |
| Maximum Service Temperature | 125°C (257°F) |
| Breakdown Voltage AC, 60Hz | 8800V |
| Dielectric Strength (RH40% at sea level) | 470-385V/mil thickness (per ASTM D149) |
| UL High Voltage Arc Testing (in./min.) | .01 - .35 |
| Water Absorption (24 hrs. % weight gain) | 1.5% |
| Flammability | 94V-2 |
| Chemical Resistance | Resistant to aromatic hydrocarbons, strong alkalis |
| Radiation Resistance (ergs g ⁻¹ C) | 8 x 10 ⁷ |

WIRE RANGE: Solid or Stranded

Tubular Screw

1 #1/0 AWG, 1 #1 AWG, 1 #2 AWG, 1 or 2 #4 AWG, 1 to 3 #6 AWG, , 2, 3 or 5 #8 AWG, 1 to 6 #10 AWG, 1 to 7 #12 AWG



LR25557 E63810

Phenolic HEAVY DUTY

Flat Base (Direct Mount)

$$C = .59 + (.75 \times N)$$

$$L = .81 + (.75 \times N)$$

N = Number of circuits

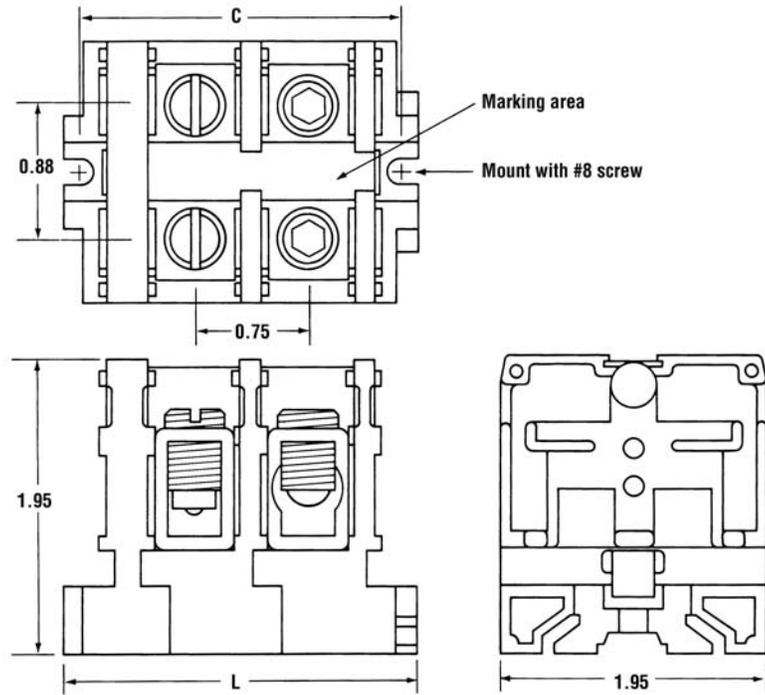

Dovetail Base Mounted on Standard #60 Channel

$$CCH = 2.31 + (.75 \times N)$$

$$LCH = 3.06 + (.75 \times N)$$

N = Number of circuits

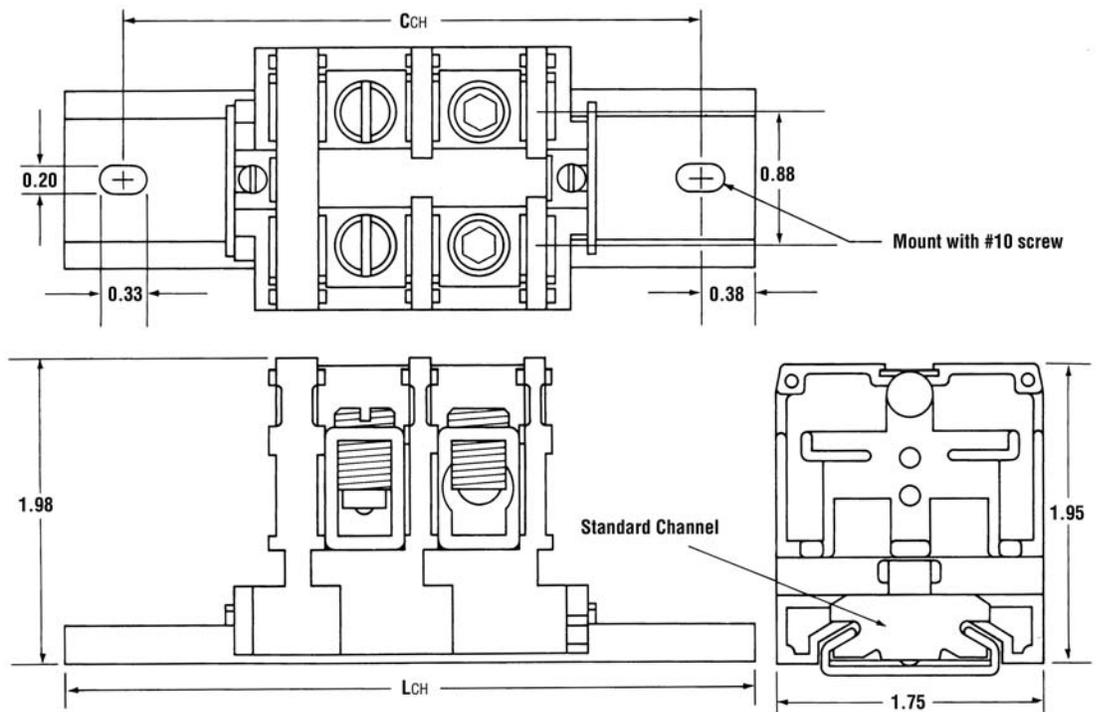

Phenolic ULTRA HEAVY DUTY - 250 KCMIL (MCM)

This Ultra Heavy Duty line is rated up to 255 amps with a single 250 KCMIL conductor.

- Compact block accepts wire sizes up to 2/0 or 250 KCMIL (MCM)
- 57 circuits per 6 foot length
- Tubular screw contact style for maximum electrical rating
- Block mounts directly on flat surface or standard channel
- Only one end section needed per block assembly
- Readily identifiable circuits – write directly on painted marking area or use removable vinyl marking strip
- Hex socket screws allow maximum torque when using large wire sizes
- High current capacity snap-fit sectional blocks do not snap-fit with other block styles

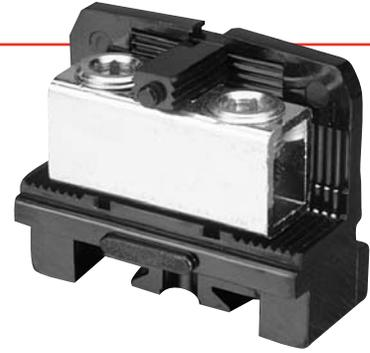

Specifications

Center-to-Center Spacing: 1.19 in. CL: 9 circuits per foot.

Voltage Rating: Blocks meet 600V creepage and clearance requirements of NEMA, UL and CSA for general industrial control equipment and panelboards. Withstand voltages greatly in excess of IEEE switchgear standards for 750V.

Ampacity: For a single 250 KCMIL wire, the maximum amperage recommended is 255A.

| Catalog Number | 426 | 427 | 430 |
|-------------------|-----------------------|-----------------------|-------------|
| Mounting Style | Two-Way Mounting Base | Two-Way Mounting Base | End-Section |
| Ampacity | 175A | 255A | — |
| Contact Type | Tubular Screw | Tubular Screw | — |
| Screw Type | 1/2-30 Hex Socket | 3/4-16 Hex Socket | — |
| Wire Range (AWG) | #12-2/0 | #6-250 KCMIL/MCM | — |
| Wire Strip Length | 1 in. | 1 in. | — |

| | |
|---|---|
| Housing Material | Phenolic, Filled, Flame retardant |
| Contact Material | Copper |
| Screw Material | Steel Plated |
| Maximum Service Temperature | 150°C (302°F) |
| Breakdown Voltage AC, 60Hz | 10000V |
| Dielectric Strength (RH40% at sea level) | 300V/mil thickness (per ASTM D149) |
| UL High Voltage Arc Testing (in./min.) | .49 - .58 |
| Water Absorption (24 hrs. % weight gain) | 0.45% (per ASTM D570) |
| Flammability | 94V-1 (per UL94) |
| Chemical Resistance | Resistant to acids, alkalis and aliphatic, hydrocarbons and ketones (per ASTM D543) |
| Radiation Resistance (ergs g ⁻¹ C) | 2.7 x 10 ⁶ min. |

WIRE RANGE: Solid or Stranded

Tubular Screw

1 #2/0 AWG, 1 #1/0 AWG, 1 #1 AWG, 1 or 2 #2 AWG, 1 to 3 #4 AWG, 1 to 3 #6 AWG, 1 to 4 #8 AWG, 1 to 6 #10 AWG, 2 to 8 #12 AWG

Tubular Screw

1 #250 KCMIL, 1 #4/0 AWG, 1 #3/0 AWG, 1 or 2 #2/0 AWG, 1 or 2 #1/0 AWG, 1 or 2 #1 AWG, 1 to 3 #2 AWG, 1 to 4 #4 AWG, 1 to 5 #6 AWG



LR25557



E63810

Phenolic HEAVY DUTY

Flat Base Mounted on Standard #60 Channel

$$C = 1.19 + (1.19 \times N)$$

$$L = 1.40 + (1.19 \times N)$$

$$CCH = 2.90 + (2.90 \times N)$$

$$LCH = 3.65 + (3.65 \times N)$$

N = Number of circuits

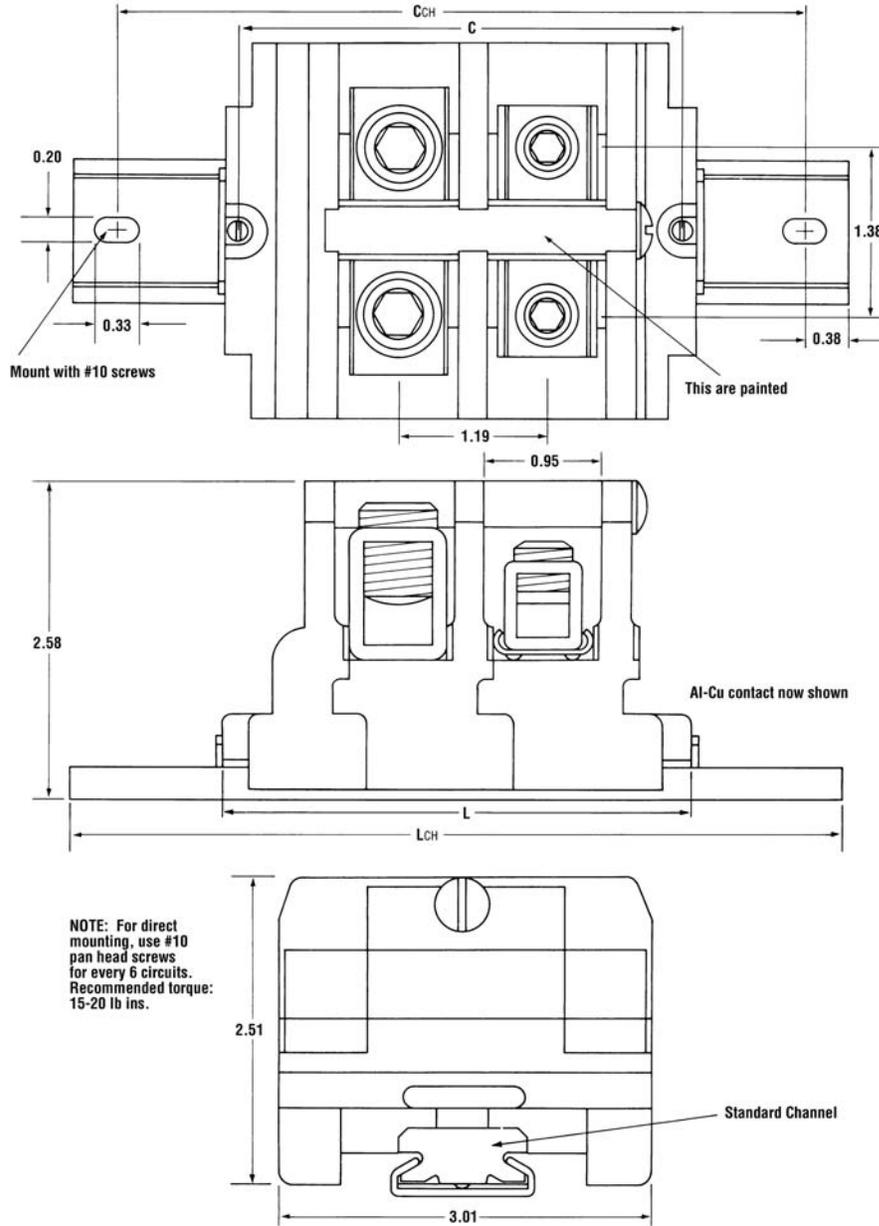

Terminal Blocks

Nylon Fuse Blocks

- Provide in-line circuit protection for any circuit or group of circuits
- Three contact styles for terminated or unterminated wire are conservatively rated to 30A
- Remove, check and replace fuses safely and quickly
- Switch-action fuse blocks open circuits before fuse can be removed or installed
- Good circuit density when mounted adjacently – 91 circuits per 6 foot length
- Nylon housing for more rugged applications
- Dovetail base mounts on standard channel; can also be mounted on flat surfaces
- Only one end section needed per block assembly
- Open or close several circuits simultaneously – holes in puller handles allow use of nylon “ganging” rods
- Readily identifiable circuits – mark directly on white, matte-surface puller assembly, marking tab on block or use removable marking tape
- Sections snap-fit with Heavy Duty and Intermediate Heavy Duty Blocks

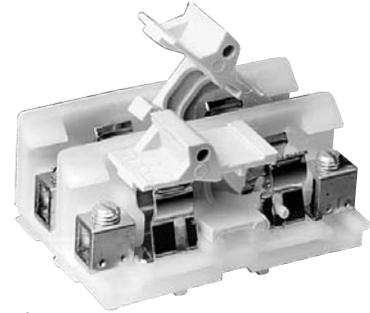

Specifications

Center-to-Center Spacing: .75 in. CL: 16 circuits per foot.

Voltage Rating: Blocks meet 600V creepage and clearance requirements of NEMA, UL and CSA for general industrial control equipment and panelboards. Withstand voltages greatly in excess of IEEE switchgear standards for 750V.

Ampacity: Fuse blocks, 30A

Fuse Size: Any 13/32 in. x 1-1/2 in. ferrule-type cartridge fuse up to 30A, indicating, which meets Mil. Spec. F-15160 is recommended.



| Catalog Number | 0311 | 0318 | 0312 | 0380 |
|-------------------|-------------------------------|-------------------------------|-------------------------------|-------------|
| Mounting Style | Channel Mount (Dovetail Base) | Channel Mount (Dovetail Base) | Channel Mount (Dovetail Base) | End-Section |
| Ampacity | 30A | 30A | 30A | — |
| Contact Type | Strap Screw | Strap Clamp | Tubular Screw | — |
| Screw Type | 10-32 Binding Head | 8-32 Pan Head w/Clamp | 1/4-28 Set Screw | — |
| Wire Range (AWG) | #22 to #8 | #18 to #8 | #18 - #8 | — |
| Wire Strip Length | — | 1/2 in. | 1/2 in. | — |

| | |
|---|---|
| Housing Material | Nylon |
| Contact Material | Aluminum Alloy |
| Screw Material | Steel Plated |
| Maximum Service Temperature | 125°C (257°F) |
| Breakdown Voltage AC, 60Hz | 7400V |
| Dielectric Strength (RH40% at sea level) | 470-385V/mil thickness (per ASTM D149) |
| UL High Voltage Arc Testing (in./min.) | .01 - .35 |
| Water Absorption (24 hrs. % weight gain) | 1.5% (per ASTM D570) |
| Flammability | 94V-2 (per UL94) |
| Chemical Resistance | Resistance to aromatic hydrocarbons, strong alkalis |
| Radiation Resistance (ergs g ⁻¹ C) | 8 x 10 ⁷ |

WIRE RANGE: Solid or Stranded

Tubular Screw

1 #1/0 AWG, 1 #1 AWG, 1 #2 AWG, 1 or 2 #4 AWG, 1 to 3 #6 AWG, , 2, 3 or 5 #8 AWG, 1 to 6 #10 AWG, 1 to 7 #12 AWG



Nylon Fuse Blocks

Dovetail Base Mounted on Standard #60 Channel (may also be mounted direct)

$$C = .56 + (.75 \times N)$$

$$L = .78 + (.75 \times N)$$

$$CCH = 2.28 + (.75 \times N)$$

$$LCH = 3.03 + (.75 \times N)$$

N = Number of circuits

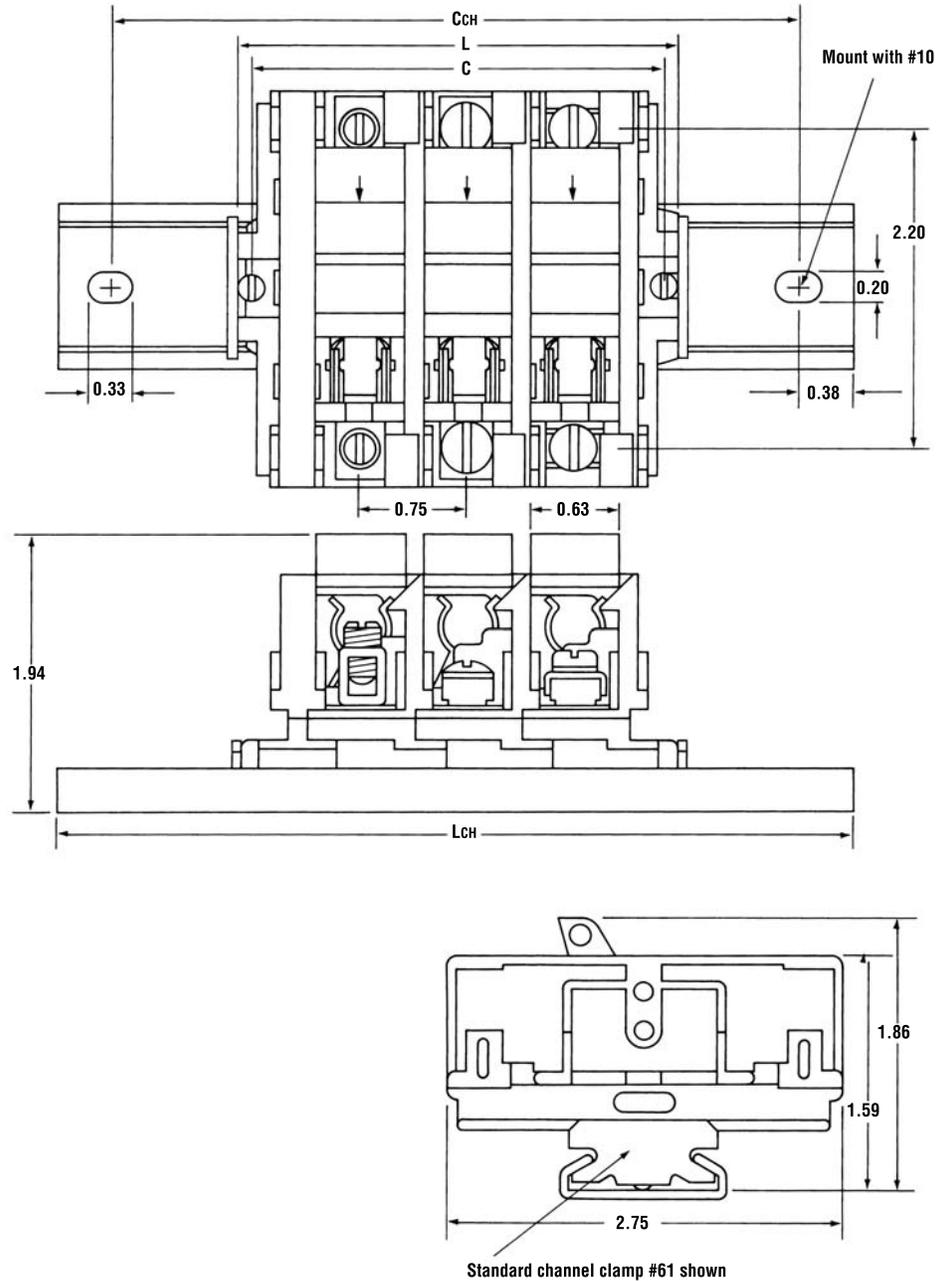

Phenolic Fuse Blocks

- Provide in-line circuit protection for any circuit or group of circuits
- Three contact styles for terminated or unterminated wire are conservatively rated to 30A
- Remove, check and replace fuses safely and quickly – switch-action fuse blocks open circuits before fuse can be removed or installed
- Good circuit density when mounted adjacently – 91 circuits per 6 foot length
- Use in high temperature applications – phenolic housing withstands temperatures up to 302°F (150°C)
- Flat base models for surface mounting, dovetail base models for standard channel
- Only one end section needed per block assembly
- Open or close several circuits simultaneously – holes in puller handles allow use of nylon “ganging” rods
- Readily identifiable circuits – mark directly on white, matte-surface puller assembly, marking tab on block or use removable marking tape
- Sections snap-fit with Heavy Duty and Intermediate Heavy Duty Blocks

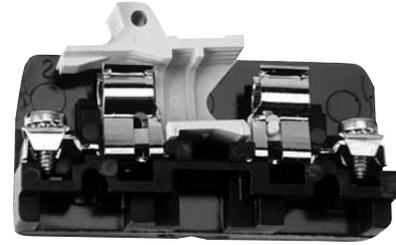

Specifications

Center-to-Center Spacing: .75 in. CL: 16 circuits per foot.

Voltage Rating: Blocks meet 600V creepage and clearance requirements of NEMA, UL and CSA for general industrial control equipment and panelboards. Withstand voltages greatly in excess of IEEE switchgear standards for 750V.

Ampacity: Fuse blocks, 30A

Fuse Size: Any 13/32 in. x 1-1/2 in. ferrule-type cartridge fuse up to 30A, indicating or non-indicating, which meets MIL. Spec. F-15160 is recommended.

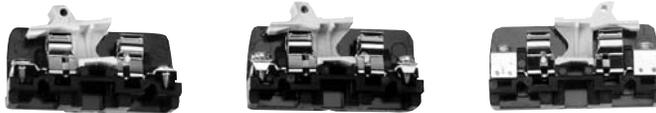

| Catalog Number | 351 | 0351 | 358 | 0358 | 352 | 0352 | 330 | 0330 |
|--------------------------|--------------------------|-------------------------------|--------------------------|-------------------------------|--------------------------|-------------------------------|----------------------------|----------------------------|
| Mounting Style | Direct Mount (Flat Base) | Channel Mount (Dovetail Base) | Direct Mount (Flat Base) | Channel Mount (Dovetail Base) | Direct Mount (Flat Base) | Channel Mount (Dovetail Base) | End-Section (Direct Mount) | End-Section (ChannelMount) |
| Ampacity | 30A | | 30A | | 30A | | — | — |
| Contact Type | Strap Screw | | Strap Clamp | | Tubular Screw | | — | — |
| Screw Type | 10-32 Binding Head | | 8-32 Pan Head w/Clamp | | 1/4-28 Set Screw | | — | — |
| Wire Range (AWG) | #22 to #8 | | #18 to #8 | | #18 - #8 | | — | — |
| Wire Strip Length | — | | 1/2 in. | | 1/2 in. | | — | — |

| | |
|---|---|
| Housing Material | Phenolic, Filled, Flame retardant |
| Contact Material | Copper alloy |
| Screw Material | Steel Plated |
| Maximum Service Temperature | 150°C (302°F) |
| Breakdown Voltage AC, 60Hz | 8400V |
| Dielectric Strength (RH40% at sea level) | 300V/mil thickness (per ASTM D149) |
| UL High Voltage Arc Testing (in./min.) | .49 - .58 |
| Water Absorption (24 hrs. % weight gain) | 0.45% (per ASTM D570) |
| Flammability | 94V-1 (per UL94) |
| Chemical Resistance | Resistance to acids, alkalis and aliphatic hydrocarbons and ketones (per ASTM D543) |
| Radiation Resistance (ergs g⁻¹ C) | 2.7 x 10 ⁷ min. |

WIRE RANGE: Solid or Stranded

Tubular Screw, Cat. No. 362 and 0362

1 #4 AWG, 1 #6 AWG, 1 or 2 #8 AWG, 1 to 4 #10 AWG, 1 to 5 #12 AWG, 1 to 6 #14 AWG, 1 to 6 #16 AWG, 1 to 8 #18 AWG



LR25557



E63810

Phenolic Fuse Blocks

Flat Base (Direct Mount)

$$C = .59 + (.75 \times N)$$

$$L = .81 + (.75 \times N)$$

N = Number of circuits

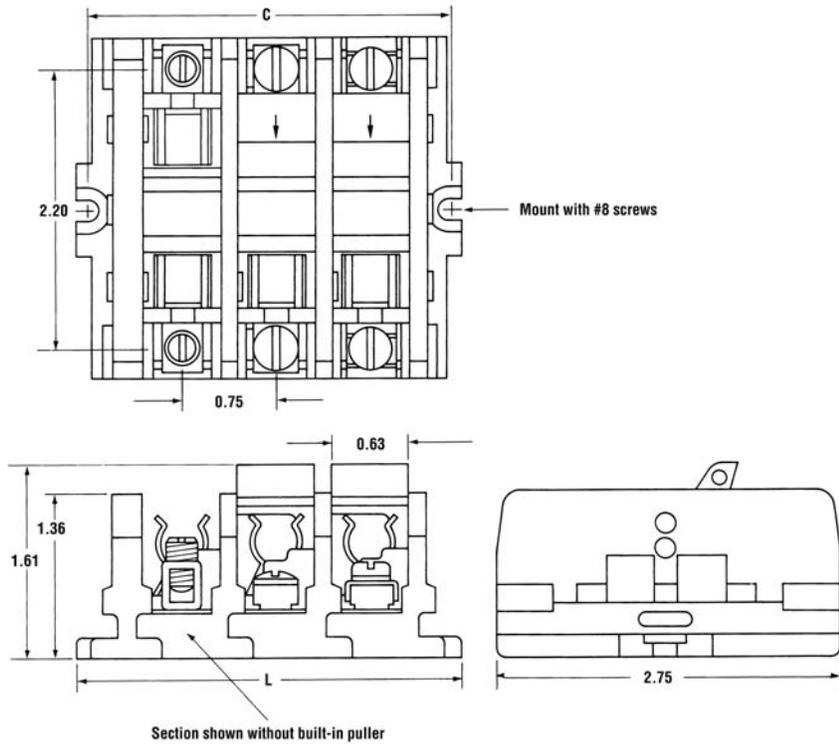

Dovetail Base Mounted on Standard #60 Channel

$$CCH = 2.31 + (.76 \times N)$$

$$LCH = 3.06 + (.76 \times N)$$

N = Number of circuits

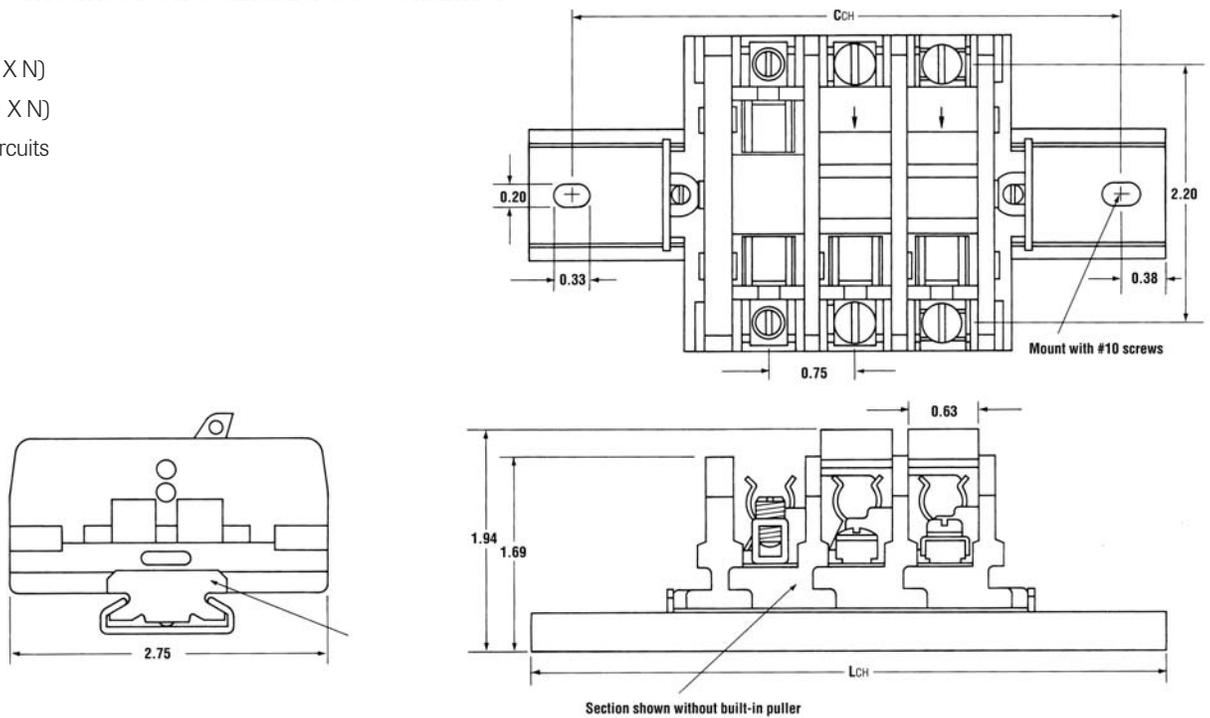

Phenolic One Piece

Traditional standard in the heavy industrial, rail transport, utility and traffic control industries. The rugged, one-piece construction finds wide application in dirty and fibration-prone environments.

- Two, four, six, eight and twelve circuit models
- Strap screw contacts accept wire 8 AWG and smaller and are rated to 50 Amps
- Dovetail base mounts on standard size channel
- Pilot point screws with strap screw contacts speed installation time
- Easily identifiable circuits with use of plain white marking strip
- No assembly required - each block is a single, easily installed unit

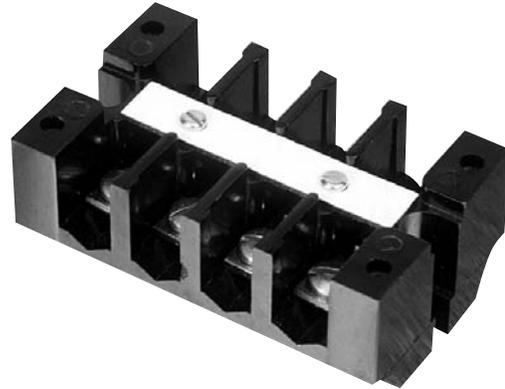

Specifications

Center-to-Center Spacing: .63 in. CL

Voltage Rating: Blocks meet 600V creepage and clearance requirements of NEMA, UL and CSA for general industrial control equipment and panelboards. Withstand voltages greatly in excess of IEEE switchgear standards for 750V.

Ampacity: For a single 8 AWG wire, the maximum amperage recommended is 50A.

| Catalog Number | B102 | B104 | B106 | B108 | B112 |
|---------------------------|-----------------------|-----------------------|-----------------------|-----------------------|-----------------------|
| Mounting Style | Two-Way Mounting Base | Two-Way Mounting Base | Two-Way Mounting Base | Two-Way Mounting Base | Two-Way Mounting Base |
| Number of Circuits | 2 | 4 | 6 | 8 | 12 |
| Ampacity | 50A | 50A | 50A | 50A | 50A |
| Contact Type | Strap Screw (Steel) | Strap Screw (Steel) | Strap Screw (Steel) | Strap Screw (Steel) | Strap Screw (Steel) |
| Screw Type | 10-32 Binding Head | 10-32 Binding Head | 10-32 Binding Head | 10-32 Binding Head | 10-32 Binding Head |
| Wire Range (AWG) | #18 to #8 | #18 to #8 | #18 to #8 | #18 to #8 | #18 to #8 |

| | |
|---|--|
| Housing Material | Phenolic, Filled, Flame retardant |
| Contact Material | Copper / Copper Alloy |
| Screw Material | Steel Plated |
| Maximum Service Temperature | 150°C (302°F) |
| Dielectric Strength (RH40% at sea level) | 300V/mil thickness (per ASTM D149) |
| UL High Voltage Arc Testing (in./min.) | .49 - .58 |
| Water Absorption (24 hrs. % weight gain) | 0.45% (per ASTM D570) |
| Flammability | 94V-1 (per UL94) |
| Chemical Resistance | Resistance to acids, alkalies and aliphatic hydrocarbons and ketones (per ASTM D543) |
| Radiation Resistance (ergs g⁻¹ C) | 2.7 x 10 ⁷ min. |

WIRE RANGE: Solid or Stranded
Strap Screw
1 #18 AWG through 1 #8 AWG

Dimensions

| No. of Circuits | C | L |
|-----------------|------|------|
| 2 | 1.63 | 2.0 |
| 4 | 2.88 | 3.25 |
| 6 | 4.13 | 4.50 |
| 8 | 5.38 | 5.75 |
| 12 | 7.88 | 8.25 |



Phenolic One Piece

Dovetail Base Mounted on Standard #60 Channel Strap Screw (Steel)

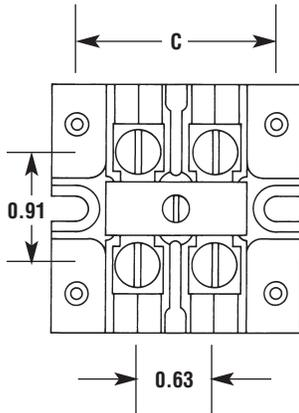

| No. of Circuits | C | L |
|-----------------|------|------|
| 2 | 1.63 | 2.0 |
| 4 | 2.88 | 3.25 |
| 6 | 4.13 | 4.50 |
| 8 | 5.38 | 5.75 |
| 12 | 7.88 | 8.25 |

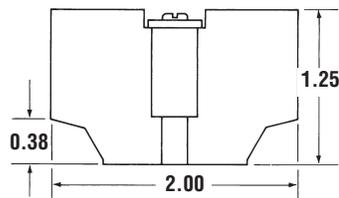
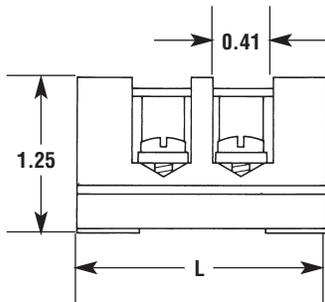

Mounting Channels



| Mounting Channels | Length | Cat. No. | For use with: |
|--------------------------------|----------------|------------------------|--|
| Miniature Channel | 3 ft. | 12 | Heavy Duty (200 Series) |
| Steel Channel | 6 ft. 3 ft. | 60 63 | Medium Duty (900 Series) Heavy Duty (200 Series) Intermediate Heavy Duty (800 Series) Ultra Heavy Duty (400 Series) Fuse Blocks (300 Series) |
| Steel Channel (Breakaway) | 3 ft. | 60B36 | Medium Duty (900 Series) Heavy Duty (200 Series) Intermediate Heavy Duty (800 Series) Ultra Heavy Duty (400 Series) Fuse Blocks (300 Series) |
| Aluminum Channel (Pre-punched) | 6 ft. 3 ft. | 64 67 | Medium Duty (900 Series) Heavy Duty (200 Series) Intermediate Heavy Duty (800 Series) Ultra Heavy Duty (400 Series) Fuse Blocks (300 Series) |

Channel Clamps

| Channel Clamps | Cat. No. | For use with: |
|-----------------|-----------|---|
| Miniature Clamp | 11 | High Density Miniature (100 Series) Heavy Duty (200 Series) |
| Snap-in Clamp | 62 | High Density Miniature (100 Series) Medium Duty (900 Series) Heavy Duty (200 Series) Intermediate Heavy Duty (800 Series) Ultra Heavy Duty (400 Series) Fuse Blocks (300 Series) |
| Universal Clamp | 68 | High Density Miniature (100 Series) Medium Duty (900 Series) Heavy Duty (200 Series) Intermediate Heavy Duty (800 Series) Ultra Heavy Duty (400 Series) Fuse Blocks (300 Series) |
| Universal Clamp | 61 | High Density Miniature (100 Series) Medium Duty (900 Series) Heavy Duty (200 Series) Intermediate Heavy Duty (800 Series) Ultra Heavy Duty (400 Series) Fuse Blocks (300 Series) |



Accessories

Covers



| Description | Cat. No. | Available for: |
|----------------|----------|---|
| Terminal Block | 13 | High Density Miniature (100 Series) |
| | 23 | Heavy Duty (200 Series) Heavy Duty-Phenolic (200 Series) |
| | 71 | Medium Duty (900 Series) |

Jumpers

Jumper for Tubular Contacts



Jumper for Strap Screw



Snap-apart Jumper



| Description | Cat. No. | Available for: |
|------------------------------|----------|----------------------------------|
| Jumpers for Tubular Contacts | 41 | Heavy Duty-Phenolic (200 Series) |
| | 42 | Heavy Duty (200 Series) |
| | 43 | Heavy Duty-Phenolic (200 Series) |
| | 70 | Medium Duty (900 Series) |
| | 73 | Medium Duty (900 Series) |

