

## Rigid/Aluminum Conduit Bodies, Gaskets and Covers

### Conduit Bodies, Covers and Gaskets

#### Applications

- Junction for branch conduits — “A” Series bodies for Rigid and IMC conduit maintain a weather resistant conduit system when used with covers and gaskets
- “B” Series bodies for thin wall conduit (EMT) saves cost of connector and labor in indoor applications
- Spacious, accessible wiring chamber provides a convenient location to pull conductors and make splices
- Aluminum conduit bodies can be used with steel rigid conduit — NEC 346-1, and Steel EMT, NEC 348-1

#### Features/Benefits

- Copper-free\* aluminum provides increased corrosion resistance
- Precision cast and machined surfaces permit safer wire pulling
- Clean cover edges provide good gasket sealing
- Precision NPT threaded and set screw hubs allow trouble-free field installation for rigid, IMC or EMT conduit
- Retained deep slotted stainless steel cover screws for faster installation
- Clear UL, CSA and cubic content markings speed approval by inspectors

#### Standard Finish

- Conduit bodies and die cast covers: powder coated
- Stamped covers: Natural

#### Standard Materials

- Conduit Bodies: Die cast aluminum alloy A360 with less than .004 copper content (copper-free)
- Covers: (CV Series) Die cast aluminum alloy A360 with less than .004 copper content (copper-free), and stainless steel screws
- Covers: (SCV Series) Stamped aluminum alloy with less than .004 copper content (copper-free), and stainless steel screws
- Gaskets: (GKN Series) Neoprene
- Gaskets: (GKV Series) Composition

#### Compliances

- UL Listed
- CSA Certified
- Federal Spec. W-C-586
- NEC Article 370-28

#### Sample Specifications

- Conduit bodies shall be die cast copper-free\* aluminum alloy A360. All conduit stops shall be free of rough edges. Conduit bodies shall be finished with powder coated paint. Conduit bodies shall be Red•Dot® Catalog No. \_\_\_\_\_

\*Less than .004 copper content

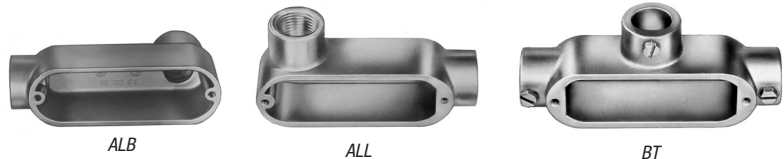

### Conduit Bodies, Covers and Gaskets — A Series

#### C Style

- Fittings, covers and gaskets are interchangeable with those produced by other leading manufacturers.
- Finish: Powder coated urethane.

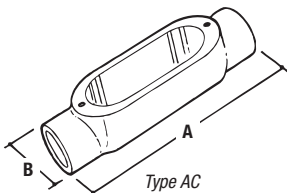

CAT. NO.	TRADE SIZE	A	B	STD. CTN.
AC-1-RD	1/2"	3/8	1 21/64	50
AC-2-RD	3/4"	4 5/8	1 17/32	50
AC-3	1"	5 5/8	1 3/4	25
AC-4-RD	1 1/4"	7 1/4	2 1/2	10
AC-5	1 1/2"	7 1/4	2 5/8	10
AC-6-RD	2"	9 1/2	3 1/2	5
AC-7*	2 1/2"	12 1/4	4 1/2	1
AC-8*	3"	12 1/4	4 1/2	1
AC-9*	3 1/2"	15	5 1/2	1
AC-10-RD*	4"	15	5 1/2	1

CAT. NO.	HUB SIZE	STD. CTN.
<b>D-PAK™ *</b>		
DAC-1-CG	1/2"	12
DAC-2-CG	3/4"	15
DAC-3-CG	1"	8
DAC-4-CG	1 1/4"	6
DAC-5-CG	1 1/2"	5
DAC-6-CG	2"	2
DAC-7-CG	2 1/2"	2
DAC-8-CG	3"	2
DAC-9-CG	3 1/2"	2
DAC-10-CG	4"	2

\* Shipped with cover. Price includes cost of cover and body. UL File No. E-28688.



## Rigid/Aluminum Conduit Bodies, Gaskets and Covers

### Conduit Bodies, Covers and Gaskets — A Series (continued)

#### LB Style

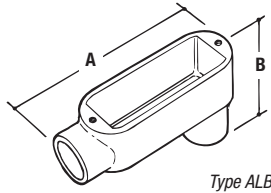

CAT. NO.	TRADE SIZE	A	B	STD. CTN.
ALB-1	½"	3⅞	2⅞	50
ALB-2	¾"	4⅞	2⅞	50
ALB-3	1"	5⅞	2¾	25
ALB-4	1¼"	7¼	3⅞	10
ALB-5	1½"	7¼	3⅞	10
ALB-6	2"	9½	4½	5
ALB-7*	2½"	12¼	5½	1
ALB-8*	3"	12¼	5⅞	1
ALB-9*	3½"	15	6⅞	1
ALB-10*	4"	15	6⅞	1

CAT. NO.	HUB SIZE	STD. CTN.
<b>D-PAK® *</b>		
DALB-1-CG	½"	25
DALB-2-CG	¾"	16
DALB-3-CG	1"	6
DALB-4-CG	1¼"	5
DALB-5-C	1½"	5
DALB-6-CG	2"	2
DALB-7-CG	2½"	2
DALB-8-CG	3"	2
DALB-9-CG	3½"	2
DALB-10-CG	4"	2

\* Shipped with cover. Price includes cost of cover and body.

UL File No. E-28688.

#### LL Style

- Die cast copper-free aluminum construction.
- Provide access for pulling, splicing and maintenance.
- For rigid conduit/IMC applications.
- UL Listed.

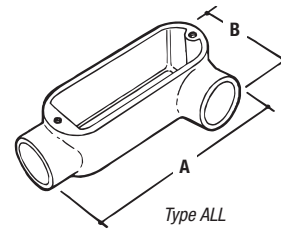

CAT. NO.	TRADE SIZE	A	B	STD. CTN.
ALL-1	½"	3⅞	2	50
ALL-2	¾"	4⅞	2⅞	50
ALL-3	1"	5⅞	2½	25
ALL-4	1¼"	7¼	3⅞	10
ALL-5	1½"	7¼	3⅞	10
ALL-6	2"	9½	3⅞	5
ALL-7*	2½"	12¼	5½	1
ALL-8*	3"	12¼	5½	1
ALL-9*	3½"	15	6⅞	1
ALL-10*	4"	15	6⅞	1

CAT. NO.	HUB SIZE	STD. CTN.
<b>D-PAK™ *</b>		
DALL-1-CG	½"	12
DALL-2-CG	¾"	15
DALL-3-CG	1"	5
DALL-4-CG	1¼"	4
DALL-5-CG	1½"	5
DALL-6-CG	2"	2
DALL-7-CG	2½"	2
DALL-8-CG	3"	2
DALL-9-CG	3½"	2
DALL-10-CG	4"	2

\* Shipped with cover. Price includes cost of cover and body.

UL File No. E-28688.

Red•Dot® Weatherproof Boxes and Covers

### Conduit Bodies, Covers and Gaskets — A Series (continued)

#### LR Style

- Die cast copper-free aluminum construction
- Provide access for pulling, splicing and maintenance
- For rigid conduit/IMC applications
- Fittings, covers and gaskets are interchangeable with those produced by other leading manufacturers
- Finish: Powder coated urethane

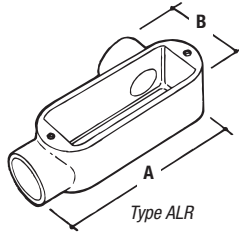

CAT. NO.	TRADE SIZE	A	B	STD. CTN.
ALR-1	1/2"	3/8"	2	50
ALR-2	3/4"	4 5/8"	2 1/16"	50
ALR-3	1"	5 3/8"	2 1/2"	25
ALR-4	1 1/4"	7 1/4"	3 3/8"	10
ALR-5	1 1/2"	7 3/4"	3 3/8"	10
ALR-6	2"	9 1/2"	3 15/16"	5
ALR-7*	2 1/2"	12 1/4"	5 1/2"	1
ALR-8*	3"	12 1/4"	5 1/2"	1
ALR-9*	3 1/2"	15	6 1/2"	1
ALR-10*	4"	15	6 1/2"	1

\* Threaded shipped with cover. Price includes cost of cover and body.

UL® File No. E-28688.

CAT. NO.	HUB SIZE	STD. CTN.
<b>D-PAK® *</b>		
DALR-1-CG	1/2"	12
DALR-2-CG	3/4"	15
DALR-3-CG	1"	5
DALR-4-CG	1 1/4"	4
DALR-5-CG	1 1/2"	4
DALR-6-CG	2"	2
DALR-7-CG	2 1/2"	2
DALR-8-CG	3"	2
DALR-9-CG	3 1/2"	2
DALR-10-CG	4"	2

UL® Listed.

#### LRL Style

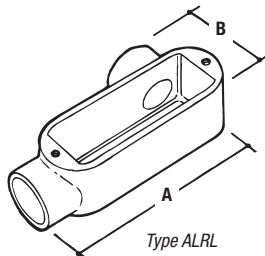

CAT. NO.	TRADE SIZE	A	B	STD. CTN.
ALRL-1	1/2"	3/8"	2	50
ALRL-2	3/4"	4 5/8"	2 1/16"	50
ALRL-3	1"	5 3/8"	2 1/2"	25
ALRL-4	1 1/4"	7 1/4"	3 3/8"	10
ALRL-5	1 1/2"	7 3/4"	3 3/8"	10
ALRL-6	2"	9 1/2"	3 15/16"	5

Shipped with cover. Price includes cost of cover and body.

UL® File No. E-28688.

#### T Style

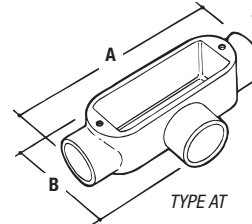

CAT. NO.	TRADE SIZE	A	B	STD. CTN.
AT-1	1/2"	3/8"	2 1/16"	50
AT-2	3/4"	4 5/8"	2 1/16"	50
AT-3	1"	5 3/8"	2 5/8"	25
AT-4	1 1/4"	7 1/4"	3 17/32"	10
AT-5	1 1/2"	7 1/4"	3 17/32"	10
AT-6	2"	9 1/2"	4	5
AT-7*	2 1/2"	12 1/4"	5 25/32"	1
AT-8*	3"	12 1/4"	5 25/32"	1
AT-9*	3 1/2"	15	6 13/16"	1
AT-10*	4"	15	6 13/16"	1

CAT. NO.	HUB SIZE	STD. CTN.
<b>D-PAK® *</b>		
DAT-1-CG	1/2"	12
DAT-2-CG	3/4"	14
DAT-3-CG	1"	5
DAT-4-CG	1 1/4"	5
DAT-5-CG	1 1/2"	5
DAT-6-CG	2"	2
DAT-7-CG	2 1/2"	2
DAT-8-CG	3"	2
DAT-9-CG	3 1/2"	2
DAT-10-CG	4"	2

\* Shipped with cover. Price includes cost of cover and body.

UL® File No. E-28688.

#### Dead End

- Retained stainless steel cover screws
- Cubic capacity UL and CSA clearly shown
- Smooth throats for easy wire pulling
- Ultra-high pressure die cast copper-free aluminum
- UL Listed, CSA Certified



CAT. NO.	HUB SIZE
AE-1	1/2"
AE-2	3/4"

## Rigid/Aluminum Conduit Bodies, Gaskets and Covers

### Aluminum Conduit Bodies, Covers and Gaskets — B Series

#### C Style

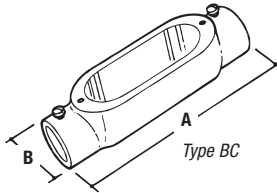

CAT. NO.	TRADE SIZE	A	B	STD. CTN.
BC-1-RD	½"	3⅞	1⅞	50
BC-2-RD	¾"	4⅞	1⅞	50
BC-3	1"	5⅞	1⅞	25
BC-4	1½"	7⅞	2⅞	10
BC-5	1½"	7⅞	2⅞	10
BC-6	2"	9⅞	3⅞	5

UL® File No. E-28688.

#### LB Style

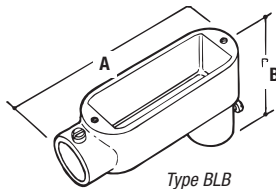

CAT. NO.	TRADE SIZE	A	B	STD. CTN.
BLB-1	½"	3⅞	2⅞	50
BLB-2	¾"	4⅞	2⅞	50
BLB-3	1"	5⅞	2⅞	25
BLB-4	1½"	7⅞	3⅞	10
BLB-5	1½"	7⅞	3⅞	10
BLB-6	2"	9⅞	4⅞	5
BLB-7*	2½"	12⅞	5⅞	1
BLB-8*	3"	12⅞	5⅞	1
BLB-9*	3½"	15	6⅞	1
BLB-10*	4"	15	6⅞	1

#### D-PAK® \*

CAT. NO.	TRADE SIZE	STD. CTN.
DBLB-1-C*	½"	25
DBLB-2-C*	¾"	16
DBLB-3-C*	1"	6

\* Threaded Hubs shipped with cover.

Price includes cost of cover and body.

UL® File No. E-28688.

#### LL Style

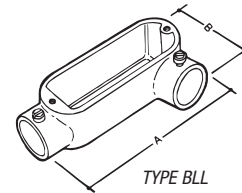

CAT. NO.	TRADE SIZE	A	B	STD. CTN.
BLL-1	½"	3⅞	2	50
BLL-2	¾"	4⅞	2⅞	50
BLL-3	1"	5⅞	2⅞	25

UL® File No. E-28688

#### LR Style

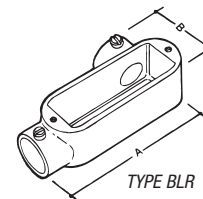

CAT. NO.	TRADE SIZE	A	B	STD. CTN.
BLR-1	½"	3⅞	2	50
BLR-2	¾"	4⅞	2⅞	50
BLR-3	1"	5⅞	2⅞	25

UL® File No. E-28688

#### LRL Style

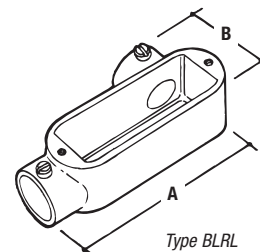

CAT. NO.	TRADE SIZE	A	B	STD. CTN.
BLRL-1	½"	3⅞	2	50
BLRL-2	¾"	4⅞	2⅞	50
BLRL-3	1"	5⅞	2⅞	25
BLRL-4	1½"	7⅞	3⅞	10
BLRL-5	1½"	7⅞	3⅞	10
BLRL-6	2"	9⅞	3⅞	5

Shipped with cover.

Price includes cost of cover and body.

UL® File No. E-28688.

Red•Dot® Weatherproof Boxes and Covers

## Rigid/Aluminum Conduit Bodies, Gaskets and Covers

### Aluminum Conduit Bodies, Covers and Gaskets — B Series (continued)

#### T Style

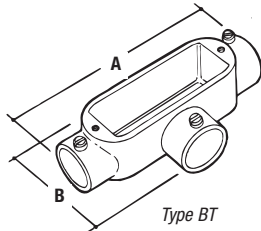

CAT. NO.	TRADE SIZE	A	B	STD. CTN.
BT-1	½"	3¾"	2⅞"	50
BT-2	¾"	4¾"	2⅞"	50
BT-3	1"	5¾"	2¾"	25
BT-4	1½"	7¼"	3⅞"	10
BT-5	1½"	7¼"	3⅞"	10
BT-6	2"	9½"	4"	5
BT-7*	2½"	12¼"	5⅞"	1
BT-8*	3"	12¼"	5⅞"	1
BT-9*	3½"	15"	6⅞"	1
BT-10*	4"	15"	6⅞"	1

\* Threaded Hubs shipped with cover.

Price includes cost of cover and body.

UL® File No. E-28688.

### Aluminum Covers with Stainless Steel Screws

- SCV = Stamped aluminum
- CV = Die cast aluminum
- Steel zinc plated screws



CAT. NO.	CONDUIT SIZE	STD. CTN.
CV-1	½"	250
CV-2	¾"	250
CV-3	1"	250
CV-4	1¼"-1½"	50
CV-5	2"	25
CV-6	2½"-3"	5
CV-7	3½"-4"	5
SCV-1	½"	250
SCV-2	¾"	250
SCV-3	1"	250
SCV-4	1¼"-1½"	250
SCV-5	2"	100

UL® File No. E-28688.

### Gaskets — Composition



Fiber Gasket

CAT. NO.	CONDUIT SIZE	STD. CTN.
GKV-1	½"	100
GKV-2	¾"	50
GKV-3	1"	25
GKV-4	1¼"-1½"	25
GKV-5	2"	25
GKV-6	2½"-3"	5
GKV-7	3½"-4"	5

### Gaskets — Neoprene

- Fiber or neoprene material



Neoprene Gasket

CAT. NO.	CONDUIT SIZE	STD. CTN.
GKN-1	½"	100
GKN-2	¾"	50
GKN-3	1"	25
GKN-4	1¼"-1½"	25
GKN-5	2"	25
GKN-6	2½"-3"	5
GKN-7	3½"-4"	5

## Rigid/Aluminum Conduit Bodies, Gaskets and Covers

### C, E and T

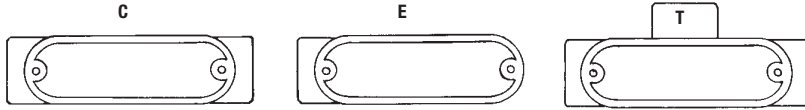

SIZE	A	B	C	D	E	F	G	CI
1/2"	3 3/8	4 3/8	1 1/8	1 3/8	2 13/32	2 1/16	1 3/16	4.3
3/4"	4 3/8	5 3/8	1 1/2	1 3/8	2 29/32	2 1/32	1 5/16	7.3
1"	5 3/8	5 15/16	1 3/4	1 3/8	3 1/2	2 3/8	1	11.8
1 1/4"	7 1/4	7 7/8	2 1/2	2 1/2	4 3/16	3 17/32	1 3/8	32.0
1 1/2"	7 1/4	7 7/8	2 1/2	2 1/2	4 3/16	3 17/32	1 1/2	32.0
2"	9 1/2	10 1/16	3 3/8	3 3/16	5 5/32	4	10	69.5
2 1/2"	12 1/4	13	4 1/2	4 1/2	6 7/8	5 25/32	2 1/16	190.0
3"	12 1/4	13	4 1/2	4 1/2	6 7/8	5 25/32	2 1/16	190.0
3 1/2"	15	16 3/16	5 1/2	5 1/16	8 1/16	6 1/16	3	366.0
4"	15	16 3/16	5 1/2	5 1/16	8 1/16	6 1/16	3	366.0

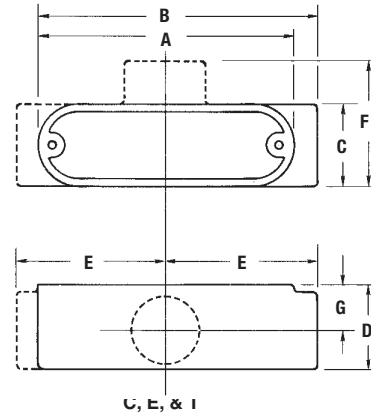

### LL, LR and LRL

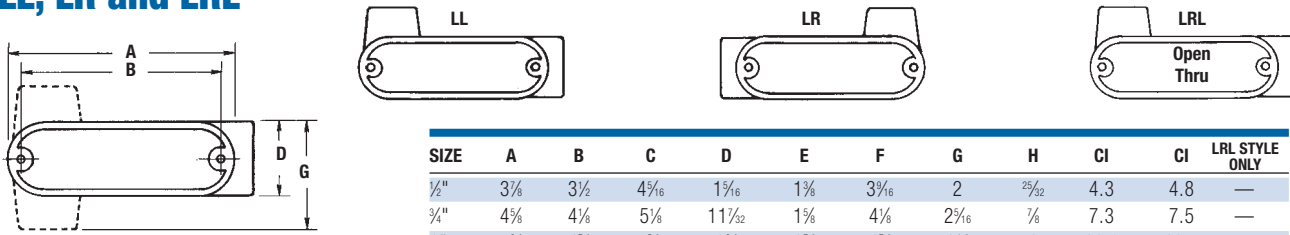

SIZE	A	B	C	D	E	F	G	H	CI	CI	LRL STYLE ONLY
1/2"	3 3/8	3 1/2	4 3/16	1 1/16	1 3/8	3 3/16	2	2 5/32	4.3	4.8	—
3/4"	4 3/8	4 3/8	5 3/8	1 11/32	1 3/8	4 3/8	2 1/16	7/8	7.3	7.5	—
1"	5 3/8	4 3/8	5 5/16	1 1/4	1 3/8	4 3/8	2 1/2	1	11.8	12.5	—
1 1/4"	7 1/4	6 1/2	7 7/8	2 1/2	2 3/4	6 3/16	3 3/8	1 1/2	32.0	36.5	—
1 1/2"	7 1/4	6 1/2	7 7/8	2 1/2	2 3/4	6 3/16	3 3/8	1 1/2	32.0	36.5	—
2"	9 1/2	8 9/16	10 1/16	3 3/8	3 3/16	8 3/16	3 15/16	1 15/16	69.5	73.8	—
2 1/2"	12 1/4	11 1/4	13	4 1/2	4 1/2	10 1/4	5 1/2	2 1/8	190.0	—	—
3"	12 1/4	11 1/4	13	4 1/2	4 1/2	10 1/4	5 1/2	2 1/8	190.0	—	—
3 1/2"	15	14 3/16	16 1/4	5 1/2	5 1/2	12 1/4	6 1/2	3	366.0	—	—
4"	15	14 3/16	16 1/4	5 1/2	5 1/2	12 1/4	6 1/2	3	366.0	—	—

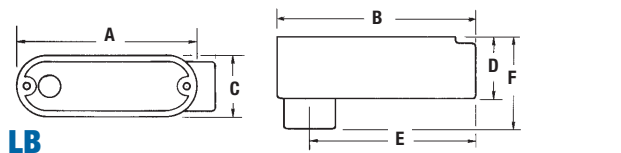

SIZE	A	B	C	D	E	F	CI
1/2"	3 3/8	4 3/32	1 3/16	1 1/16	3 1/2	2 1/16	4.3
3/4"	4 3/8	5 3/8	1 11/32	1 3/8	4 3/4	2 1/16	7.3
1"	5 3/8	5 15/16	1 3/4	1 3/8	4 15/16	2 3/4	11.8
1 1/4"	7 1/4	7 7/8	2 1/2	2 1/2	6 1/2	3 3/16	32.0
1 1/2"	7 1/4	7 7/8	2 1/2	2 1/2	6 3/16	3 13/16	32.0
2"	9 1/2	9 13/16	3 3/8	3 3/16	8	4 1/2	69.5
2 1/2"	12 1/4	13	4 1/2	3 3/8	10 27/32	5 1/4	190.0
3"	12 1/4	13	4 1/2	4 1/2	10 1/2	5 1/2	190.0
3 1/2"	15	16 3/16	5 1/2	5 1/16	13 1/2	6 15/16	366.0
4"	15	16 3/16	5 1/2	5 1/16	13 1/2	6 15/16	366.0

### Conduit Body Wiring Table\* — Style of Fitting

TRADE SIZE	LB	C	T	LL, LR, LRL
3/4"	#6	#6	#6	#6
1"	#4	#4	#4	#4
1 1/4"	#2	#2	#2	#2
1 1/2"	1/0	1/0	#1	1/0
2"	4/0	2/0	1/0	4/0
2 1/2"	300 MCM	250 MCM	2/0	300 MCM
3"	400 MCM	250 MCM	2/0	500 MCM
3 1/2"	500 MCM	350 MCM	250 MCM	500 MCM
4"	500 MCM	350 MCM	250 MCM	500 MCM

\*The Maximum number and size of wire that can be safely pulled is based on three type XHHW wires or equal.

Red-Dot® Weatherproof Boxes and Covers