

### Standards and Certifications

#### UL Listings

All Eaton Type BR loadcenters are listed under UL File E52977 except the 2–8 circuit loadcenters, up through and including 125 A, which are listed under UL File E8741.



### Catalog Number Selection

#### Single- and Three-Phase Through 600 A

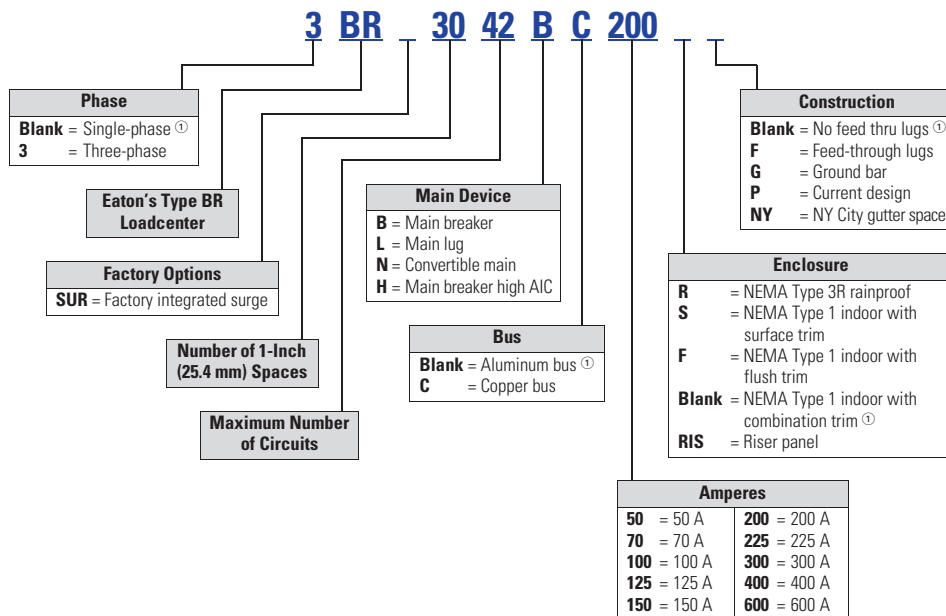

#### Note

① No character space used.

# 1.2

## Loadcenters and Circuit Breakers

### Type BR Loadcenters and Circuit Breakers

1

#### Product Selection

##### Single-Phase—Main Circuit Breaker Loadcenters—10/25 kAIC

BR4040B200



##### Single-Phase Three-Wire—120/240 Vac—Insulated/Bondable Split Neutral

Main Breaker Type	Main Ampere Rating	Maximum Number 1-Inch (25.4 mm)		Enclosure Type	Box Size	Wire Size Range Cu/Al 60 °C or 75 °C for Main Breaker	Loadcenter Catalog Number with Combination <sup>①</sup> or NEMA Type 3R Cover
		Spaces	Circuits				
BR 10 kAIC	100	8	16	Indoor	B1	#4–1/0 <sup>②</sup>	BR816B100
		10	20	Indoor	A1		BR1020B100S11
		10	20	Indoor	A1		BR1020B100F11
		10	20	Outdoor	B2R		BR1020B100RF <sup>③④</sup>
		12	12	Indoor	B2		BR1212B100
		12	20	Indoor	B2		BR1220B100
		12	24	Outdoor	B2R		BR1224B100R <sup>④</sup>
		16	16	Indoor	C1		BR1616B100
		16	20	Indoor	C1		BR1620B100
	16	24	Outdoor	C1R	BR1624B100R <sup>④</sup>		
	20	24	Outdoor	C3R	BR2024B100R <sup>④</sup>		
	20	20	Indoor	C2	BR2020B100		
	16	24	Indoor	C1	BR1624B100		
	30	30	Indoor	D1	BR3030B100		
	125	16	24	Indoor	C1	#4–2/0	BR1624B125
	20	24	Indoor	C1	BR2024B125		
	20	24	Outdoor	C3R	BR2024B125R <sup>④</sup>		
	30	30	Indoor	D1	BR3030B125		
BRH <sup>⑤</sup> 22 kAIC	100	20	24	Indoor	C2	#4–1/0	BR2024H100 <sup>⑤</sup>
CSR <sup>⑥</sup> 25 kAIC	150	8	16	Outdoor	C3R	#2–300 kcmil	BR816B150RF <sup>③④⑦</sup>
		16	30	Indoor	C4		BR1630B150
		20	30	Indoor	C4		BR2030B150
		20	30	Outdoor	D1R		BR2030B150R <sup>④</sup>
		20	40	Indoor	D1		BR2040B150
		20	40	Outdoor	D1R		BR2040B150R <sup>④</sup>
		24	30	Indoor	G1		BR2430B150
		30	30	Outdoor	G1R		BR3030B150R <sup>④</sup>
		30	30	Indoor	G1		BR3030B150
	30	40	Indoor	G1	BR3040B150		
	200	4	8	Outdoor	8R	#2–300 kcmil	BR48B200RF <sup>③⑦⑧</sup>
	8	16	Outdoor	C3R	BR816B200RF <sup>③④</sup>		
	16	32	Indoor	C4	BR1632B200		
	20	40	Outdoor	D1R	BR2040B200R <sup>④</sup>		
	20	40	Indoor	D1	BR2040B200		
	24	40	Indoor	G1	BR2440B200		
	30	40	Outdoor	G1R	BR3040B200R <sup>④</sup>		
	30	40	Indoor	G1	BR3040B200 <sup>⑨</sup>		
40	40	Outdoor	L1R	BR4040B200R <sup>④</sup>			
40	40	Indoor	L1	BR4040B200			
40	50	Indoor	L1	BR4050B200			
60	120	Indoor	L3	BR60120B200			
60	120	Outdoor	L3R	BR60120B200R			
225	42	42	Indoor	L2	#1–250 kcmil	BR4242B225	
42	42	Outdoor	L2R	BR4242B225R <sup>④</sup>			

#### Notes

- ① Combination style covers may be used in surface or flush applications.
- ② Wire range size for BR1020B100SP is #6–#1 Cu/Al.
- ③ Includes through-feed lugs for both phase and neutral conductors.
- ④ Rainproof panels are furnished with hub closure plates. For rainproof hubs, refer to **Page V1-T1-66**.
- ⑤ 22 kAIC series combination rating is obtained when Types BD, BR, BQ, BQC and GFCB 10 kAIC branch breakers are used in series with Type BRH main breaker.
- ⑥ 25 kAIC series combination rating is obtained when Types BD, BR, BQ, BQC and GFCB 10 kAIC branch circuit breakers are used in series with Type CSR main breaker.
- ⑦ Supplied with adapter plate to use DS Group1 hubs on **Page V1-T1-66**. If 2.50-inch (63.5 mm) hub is needed, remove adapter and use ARP00007CH25 hub.
- ⑧ Neutral is bonded—suitable for service entrance only—cannot be converted for sub-feed application.
- ⑨ Add G to the end of the catalog number for factory-installed GBK2120 ground bar.

All main circuit breaker loadcenters are listed for use as service entrance equipment and are shipped with neutral bonding strap preattached. The maximum rating of the panel is the main circuit breaker rating when used as service entrance equipment. Ground bar kits priced separately. See **Page V1-T1-66**.

### Main Circuit Breaker Loadcenters—10/22 kAIC

B4242DFN



### Single-Phase Three-Wire—120/240 Vac—Insulated/Bondable Split Neutral

Main Breaker Type	Main Ampere Rating	Maximum Number 1-Inch (25.4 mm)		Enclosure Type	Box Size	Wire Size Range Cu/Al 60 °C or 75 °C for Main Breaker	Commercial Loadcenter Catalog Number <sup>①②③</sup>	
		Spaces	Circuits				With Flush or NEMA Type 3R Cover	With Surface Cover
DK <sup>④</sup>	300	42	42	Indoor	24	(2) #3/0–250 kcmil	<b>BR4242B300F</b>	<b>BR4242B300S</b>
	400	42	42	Indoor	24	(2) #3/0–250 kcmil	<b>BR4242B400F</b>	<b>BR4242B400S</b>
		42	42	Outdoor	47	(2) #3/0–250 kcmil	<b>BR4242B400R</b> <sup>⑤</sup>	—
HLD <sup>⑥</sup>	600	42	42	Indoor	24	(2) #3/0–500 kcmil	—	<b>BR4242B600S</b>

#### Notes

- ① Ground bar kits priced separately. See **Page V1-T1-66**.
- ② The maximum rating of the panel is the main circuit breaker rating when used as service entrance equipment.
- ③ Door lock and key included with loadcenter.
- ④ Type DK main circuit breaker is rated 65 kAIC at 240 Vac and allows a 22 kAIC series rating on the panel when Types BR, BD and BJ branch circuit breakers are used.
- ⑤ Rainproof panels are furnished with hub closure plates. For rainproof hubs, refer to **Page V1-T1-66**.
- ⑥ Type HLD main circuit breaker is rated 65 kAIC at 240 Vac. Type HLD circuit breaker **is not** series rated with Types BR, BD and BJ branch circuit breakers.

Box sizes **Pages V1-T1-67** through **V1-T1-70**.

Please contact the Lincoln Flex Center for any configurations not listed.

# 1.2

## Loadcenters and Circuit Breakers

### Type BR Loadcenters and Circuit Breakers

1

#### Single-Phase—Main Lug Loadcenters

#### Single-Phase Three-Wire—120/240 Vac—Insulated/Bondable Split Neutral

Main Ampere Rating	Maximum Number 1-Inch (25.4 mm)		Enclosure Type	Trim Type	Box Size	Wire Size Range Cu/Al 60 °C or 75 °C for Main Lugs	Loadcenter Catalog Number					
	Spaces	Circuits										
70	Surface	Outdoor	Indoor	Surface (no door)	5	#8-#2	BR24L70SP <sup>①②</sup>					
			Indoor	Surface (no door)	5		BR24L70SGP <sup>②③</sup>					
	Outdoor	—	5R	BR24L70RP <sup>①②④</sup>								
	Indoor	Flush (no door)	5	BR24L70FP <sup>①②</sup>								
	Indoor	Flush (no door)	5	BR24L70FGP <sup>②⑤</sup>								
125	Flush	Outdoor	Indoor	Surface (no door)	6	#14-1/0	BR24L125SP <sup>①②</sup>					
			Outdoor	—	6R		BR24L125RP <sup>①②④</sup>					
			Outdoor	—	6R		BR24L125RSEP <sup>②⑦⑧</sup>					
			Outdoor	—	6R		BR24L125RSE2P <sup>②⑥⑦</sup>					
			Indoor	Flush (no door)	6		BR24L125FP <sup>①②</sup>					
	Surface (No Door)	Indoor	Surface (no door)	Indoor	Surface (no door)	7	#14-1/0	BR48L125SP <sup>①⑨</sup>				
				Indoor	Surface (no door)	7		BR48L125SGP <sup>③⑨</sup>				
				Outdoor	—	7R		BR48L125RP <sup>①④⑨</sup>				
				Indoor	Flush (no door)	7		BR48L125FP <sup>①⑨</sup>				
				Indoor	Flush (with door)	7		BR48L125FDP <sup>①⑨</sup>				
				Indoor	Flush (no door)	7		BR48L125FGP <sup>③⑨</sup>				
				Flush (No Door)	Indoor	Surface (with door)		Indoor	Surface (with door)	7	#14-#1	BR612L125SP <sup>①⑩</sup>
								Indoor	Surface (no door)	7		BR612L125SGP <sup>⑩⑪</sup>
								Indoor	Surface (with door)	7		BR612L125SDP <sup>①⑩</sup>
								Indoor	Surface (with door)	7		BR612L125SDGP <sup>⑩⑪</sup>
	Outdoor	—	7R				BR612L125RP <sup>①④⑩</sup>					
	Outdoor	Indoor	Flush (no door)	Indoor	Flush (no door)	7	#14-#1	BR612L125FP <sup>①⑩</sup>				
				Indoor	Flush (no door)	7		BR612L125FGP <sup>⑤⑩⑪</sup>				
				Indoor	Flush (with door)	7		BR612L125FDP <sup>⑩</sup>				
				Indoor	Flush (with door)	7		BR612L125FDGP <sup>⑤⑩⑪</sup>				
Indoor				Surface (no door)	Indoor	Surface (no door)		7	#14-#1	BR816L125SP <sup>①⑩</sup>		
					Indoor	Surface (no door)		7		BR816L125SGP <sup>⑩⑫</sup>		
					Indoor	Surface (with door)		7		BR816L125SDP <sup>①⑩</sup>		
					Indoor	Surface (with door)		7		BR816L125SDGP <sup>⑩⑫</sup>		
					Outdoor	—		7R		BR816L125RP <sup>①④⑩</sup>		
					Indoor	Flush (no door)		7		BR816L125FP <sup>①⑩</sup>		
	Indoor	Flush (no door)	7		BR816L125FGP <sup>⑤⑩⑫</sup>							
	Indoor	Flush (with door)	7		BR816L125FDP <sup>①⑩</sup>							
Indoor	Flush (with door)	7	BR816L125FDGP <sup>⑤⑩⑫</sup>									



#### Notes

- ① Ground bar kits priced separately. See **Page V1-T1-66**.
  - For 2/4 circuit loadcenters, use GBK5 or GBK520 ground bar.
  - For 4/8, 6/12 and 8/16 circuit loadcenters, use GBK10 ground bar.
  - Ground bars mount to the left side wall of the enclosure for the 4/8, 6/12 and 8/16 circuit loadcenters.
- ② Suitable for use as service equipment when not more than two service disconnecting mains are provided or when not used as a lighting and appliance panelboard (see Article 408.34 of the NEC).
- ③ Ground bar GBK5 is installed.
- ④ Rainproof panels are furnished with hub closure plates. For rainproof hubs, refer to **Page V1-T1-66**.
- ⑤ CSA and UL approved.
- ⑥ Neutral/ground holes (6) #14-6 and (3) #14-2/0 AWG Cu/Al.
- ⑦ For use as service entrance applications only.
- ⑧ Neutral/ground holes (6) #14-6 and (3) #14-1/0 AWG Cu/Al.
- ⑨ Suitable for use as service equipment when not more than two service disconnecting mains are provided or when not more than six service disconnecting mains are provided and when not used as a lighting and appliance panelboard (see Article 408.34 of the NEC).
- ⑩ Suitable for use as service equipment when a main breaker is used or when not more than six service disconnecting mains are provided and when not used as a lighting and appliance panelboard (see Article 408.34 of the NEC).
- ⑪ Ground bar GBK10 is installed.
- ⑫ Ground bar GBK14 is installed.

Box sizes **Pages V1-T1-67** through **V1-T1-70**.

### Single-Phase—Main Lug Loadcenters

#### Single-Phase Three-Wire—120/240 Vac—Insulated/Bondable Split Neutral, continued

Main Ampere Rating	Maximum Number 1-Inch (25.4 mm)		Enclosure Type	Box Size	Wire Size Range Cu/Al 60 °C or 75 °C for Main Lugs	Loadcenter Catalog Number with Combination or NEMA Type 3R Cover <sup>①</sup>			
	Spaces	Circuits							
BR1224L125 	125	12	12	Indoor	#6–2/0	BR1212L125 <sup>②③④⑤</sup>			
		12	24	Indoor		B1	BR1224L125 <sup>②④⑤</sup>		
		12	24	Indoor		B1	BR1224L125G <sup>②④⑤</sup>		
		12	24	Indoor		B1	BR1224L125DG <sup>②④⑤⑥</sup>		
		12	24	Outdoor		B1R	BR1224L125R <sup>②⑤⑦</sup>		
		16	16	Indoor		B2	BR1616L125 <sup>②④⑤</sup>		
		16	24	Indoor		B2	BR1624L125 <sup>②④</sup>		
		16	24	Indoor		B2	BR1624L125G <sup>②④</sup>		
		16	24	Outdoor		B2R	BR1624L125R <sup>②⑦</sup>		
		20	20	Indoor		C1	BR2020L125 <sup>②④⑤</sup>		
		20	24	Indoor		C1	BR2024L125 <sup>②④</sup>		
		20	24	Indoor		C1	BR2024L125G <sup>②④⑥</sup>		
		20	24	Outdoor		C1R	BR2024L125R <sup>②⑦</sup>		
		24	24	Indoor		C2	BR2424L125 <sup>②④</sup>		
		24	24	Indoor		C2	BR2424L125G <sup>②④⑥</sup>		
		30	42	Indoor		D1	BR3042L125 <sup>②④</sup>		
150	16	30	Indoor	C2	#1–300 kcmil	BR1630L150 <sup>④⑨</sup>			
	20	30	Indoor	C2		BR2030L150 <sup>④⑨</sup>			
BR1224L200 	200	8	16	Outdoor	#1–300 kcmil	BR816L200RF <sup>⑤⑦⑩</sup>			
		12	24	Indoor		B2	BR1224L200 <sup>④⑤⑨</sup>		
		12	24	Outdoor		B2R	BR1224L200R <sup>⑤⑦⑨</sup>		
		20	40	Indoor		C2	BR2040L200 <sup>④⑨</sup>		
		20	40	Indoor		C2	BR2040L200G <sup>④⑥⑨</sup>		
		20	40	Outdoor		C3R	BR2040L200R <sup>⑦⑨</sup>		
		24	40	Indoor		C4	BR2440L200 <sup>④⑨</sup>		
		30	40	Indoor		D1	BR3040L200 <sup>④⑨</sup>		
		30	40	Indoor		D1	BR3040L200G <sup>④⑥⑨</sup>		
		30	40	Outdoor		D1R	BR3040L200R <sup>⑦⑨</sup>		
		40	40	Indoor		G1	BR4040L200 <sup>④⑨</sup>		
		40	40	Indoor		G1	BR4040L200G <sup>④⑥</sup>		
		40	40	Outdoor		G1R	BR4040L200R <sup>⑦⑨</sup>		
		60	120	Indoor		L3	BR60120L200 <sup>⑩</sup>		
		225	42	42		Indoor	L1	#1–300 kcmil	BR4242L225 <sup>④</sup>
			42	42		Outdoor	L1R		BR4242L225R <sup>⑦</sup>

#### Notes

- ① Ground bar kits priced separately unless otherwise noted. See **Page V1-T1-66**.
- ② Has notch for BREQS125 hold-down kit.
- ③ Single, movable neutral is provided.
- ④ Combination cover style.
- ⑤ Suitable for use as service equipment when not more than six main disconnecting means are provided and when not used as a lighting and appliance panelboard (see Article 408.34 of the NEC).
- ⑥ Ground bars GBK5 and GBK520 installed.
- ⑦ Rainproof panels are furnished with hub closure plates. For rainproof hubs, refer to **Page V1-T1-66**.
- ⑧ Ground bar GBK1220 installed.
- ⑨ Has notch for BRHDK125 hold-down kit.
- ⑩ Includes through-feed lugs for both phase and neutral conductors.
- ⑪ Includes main lugs. Loadcenters can convert to main breaker using kit.

# 1.2

## Loadcenters and Circuit Breakers

### Type BR Loadcenters and Circuit Breakers

1

#### Single-Phase—Main Lug Loadcenters—400 and 600 A

4242DFN



#### Single-Phase Three-Wire—120/240 Vac—Insulated/Bondable Split Neutral

Main Ampere Rating	Maximum Number 1-Inch (25.4 mm)		Enclosure Type	Box Size	Wire Size Range Cu/Al 60 °C or 75 °C for Main Lugs	Commercial Loadcenter Catalog Number <sup>①②③</sup>	
	Spaces	Circuits				With Flush or NEMA Type 3R Cover	With Surface Cover
400	12	24	Outdoor	42	(2) #3/0–400 kcmil	BR1224L400R <sup>④⑤</sup>	—
	42	42	Indoor	22		BR4242L400F	BR4242L400S
	42	42	Outdoor	46		BR4242L400R <sup>④</sup>	—
600	42	42	Indoor	22	(2) #2–500 kcmil	—	BR4242L600S

#### Notes

- ① Ground bar kits priced separately unless otherwise noted. See **Page V1-T1-66**.
- ② Has notch for BRHDK125 hold-down kit.
- ③ Ground bar GBK8 installed.
- ④ Rainproof panels are furnished with hub closure plates. For rainproof hubs, refer to **Page V1-T1-66**.
- ⑤ Suitable for use as service equipment when not more than six main disconnecting means are provided and when not used as a lighting and appliance panelboard (see Article 408.34 of the NEC).

**Convertible Loadcenters MCB or MLO—Base Units and Main Devices 10/22/25 kAIC, Complete Assembly Consists of: Loadcenter and Either Main Breaker Kit or Main Lug Kit**

**Note:** Interrupting rating depends on main circuit breaker selected.

BR3040N200



**Base Units—Single-Phase Three-Wire—120/240 Vac—Insulated/Bondable Split Neutral (Unless Otherwise Noted)**

Main Ampere Rating <sup>①</sup>	Maximum Number 1-Inch (25.4 mm)		Enclosure Type	Box Size	Wire Size Range Cu/Al 60 °C or 75 °C for Main	Loadcenter Catalog Number With Combination or NEMA Type 3R Cover <sup>②③</sup>
	Spaces	Circuits				
125 <sup>④</sup>	12	24	Indoor	B2	See main breaker and main lug kit tables Page V1-T1-54.	BR1224N125 <sup>⑤⑥</sup>
	12	24	Outdoor	B2R		BR1224N125R <sup>⑤⑥⑦</sup>
	16	24	Indoor	C1		BR1624N125 <sup>⑤</sup>
	16	24	Outdoor	C1R		BR1624N125R <sup>⑤⑦</sup>
	20	24	Indoor	C2		BR2024N125 <sup>⑤</sup>
	20	24	Outdoor	C3R		BR2024N125R <sup>⑤⑦</sup>
200 <sup>⑧</sup>	8	16	Outdoor	C3R	BR816N200RF <sup>⑦⑨⑩⑪</sup>	
	12	24	Indoor	C4	BR1224N200 <sup>⑩</sup>	
	12	24	Outdoor	C3R	BR1224N200R <sup>⑦⑩</sup>	
	16	32	Indoor	C4	BR1632N200 <sup>⑩</sup>	
	20	40	Indoor	D1	BR2040N200 <sup>⑩</sup>	
	20	40	Indoor	D1	BR2040N200G <sup>⑫</sup>	
	20	40	Outdoor	D1R	BR2040N200R <sup>⑦⑩</sup>	
	20	40	Outdoor	D1R	BR2040N200RG <sup>⑫</sup>	
	24	40	Indoor	G1	BR2440N200 <sup>⑦⑩</sup>	
	30	40	Indoor	G1	BR3040N200 <sup>⑩</sup>	
	30	40	Indoor	G1	BR3040N200G <sup>⑫</sup>	
	30	40	Outdoor	G1R	BR3040N200R <sup>⑦⑩</sup>	
	30	40	Outdoor	G1R	BR3040N200RG <sup>⑫</sup>	
	40	40	Indoor	L1	BR4040N200 <sup>⑩</sup>	
	40	40	Indoor	L1	BR4040N200G <sup>⑫</sup>	
	40	40	Outdoor	L1R	BR4040N200R <sup>⑦⑩</sup>	
	40	40	Outdoor	L1R	BR4040N200RG <sup>⑫</sup>	
	40	50	Indoor	L1	BR4050N200	
	40	50	Outdoor	L1R	BR4050N200R	

**Notes**

- ① The maximum rating of the loadcenter is the main circuit breaker rating when used as service entrance equipment.
- ② 100, 125 and 200 A convertible base unit catalog numbers include interior, box and cover only. Main devices and accessories must be ordered separately for field installation. All convertible base units are listed as suitable for use as service entrance equipment when used per Article 384 of the NEC.
- ③ Ground bar kits priced separately except as noted, refer to Page V1-T1-66.
- ④ For main breaker, use Type BR. For main lug use Type BRSF.
- ⑤ BREQS125 hold-down screw comes with loadcenter for back-fed Types BR and BRH main circuit breakers.
- ⑥ Convertible to maximum of 100 A main circuit breaker and 125 A main lug.
- ⑦ Rainproof loadcenters are furnished with hub closure plates. For rainproof hubs, refer to Page V1-T1-66.
- ⑧ For main breaker, use Type BW or CSR. For main lug, use Type BRL.
- ⑨ Includes through-feed lugs for both phase and neutral conductors.
- ⑩ No hold-down provisions for back-fed Types BR and BRH main circuit breakers.
- ⑪ Insulated/bondable single neutral.
- ⑫ Includes GBK2120 ground bar.

# 1.2

## Loadcenters and Circuit Breakers

Type BR Loadcenters and Circuit Breakers

### 1 Convertible Loadcenters MCB or MLO—Base Units and Main Devices 10/22/25 kAIC, Complete Assembly Consists of: Loadcenter and Either Main Breaker Kit or Main Lug Kit

Note: Interrupting rating depends on main circuit breaker selected.

BW2200



#### Main Devices—Two- and Three-Pole Main Circuit Breakers—120/240 Vac or 208Y/120 Vac or 240 Vac

Ampere Rating	Wire Size Range Cu/Al 60 °C or 75 °C for Main Breaker	10 kAIC Catalog Number	22/25 kAIC Catalog Number ①
<b>Two-Pole</b>			
100	#4–1/0	BR2100	BRH2100
110	#4–1/0	BR2110	BRH2110
125	#4–2/0	BR2125	BRH2125
125	#2–300 kcmil	BW2125	CSR2125N
150	#2–300 kcmil	BW2150	CSR2150N
175	#2–300 kcmil	BW2175	CSR2175N
200	#2–300 kcmil	BW2200	CSR2200N
<b>Three-Pole</b>			
100	#1	BR3100	BRH3100

BRL200



#### Main Devices—Two- and Three-Pole Main Lug Kits—120/240 Vac or 208Y/120 Vac or 240 Vac

Ampere Rating	Wire Size Range Cu/Al 60 °C or 75 °C for Main Lugs	Catalog Number
<b>Two-Pole</b>		
125	#6–2/0	BRSF125
150	#1–300 kcmil	BRL200
175	#1–300 kcmil	BRL200
200	#1–300 kcmil	BRL200
<b>Three-Pole</b>		
150	#6–3/0	3BRSF150

#### Main Circuit Breaker with Accessory

Example: BW22005R01 (Put description with catalog number on order. See Page V1-T1-87.)

### Main Circuit Breaker Loadcenters—Copper Bus 10/22/25 kAIC

BR303BC100



#### Main Circuit Breaker Loadcenters—With Copper Bus—Single-Phase Three-Wire—120/240 Vac—Insulated/Bondable Split Neutral

Main Breaker Type	Main Ampere Rating	Maximum Number 1-Inch (25.4 mm)		Enclosure Type	Box Size	Wire Size Range Cu/Al 60 °C or 75 °C for Main Breaker	Loadcenter Catalog Number with Combination Cover ②③	
		Spaces	Circuits					
BR 10 kAIC	100	20	20	Indoor	C2	#4–1/0	BR2020BC100	
		30	30	Indoor	D1	#4–1/0	BR3030BC100	
BRH 22 kAIC ④	100	30	30	Indoor	D1	#4–1/0	BR3030HC100	
CSR 25 kAIC	150	30	30	Indoor	G1	#2–300 kcmil	BR3030BC150	
		200	20	40	Indoor	D1	#2–300 kcmil	BR2040BC200
			30	40	Indoor	G1	#2–300 kcmil	BR3040BC200
		40	40	Indoor	L1	#2–300 kcmil	BR4040BC200	

### Main Lug Only Loadcenters—Copper Bus

BR816LC125FDP



#### Single-Phase Three-Wire—120/240 Vac—Insulated/Bondable Single Neutral with Copper Bus

Main Ampere Rating	Maximum Number 1-Inch (25.4 mm)		Enclosure Type	Trim Type	Box Size	Wire Size Range Cu/Al 60 °C or 75 °C for Main Lugs	Loadcenter Catalog Number
	Spaces	Circuits					
125	8	16	Indoor	Surface (with door)	7	#14–1	BR816LC125SDP
	8	16	Indoor	Flush (with door)	7		BR816LC125FDP

#### Notes

- Series combination rating with Types BD, BR, BQ, BQC and GFCB is 22 kAIC with BRH main and 25 kAIC with CSR main.
- All main circuit breaker loadcenters are listed for use as service entrance equipment and are shipped with neutral bonding strap preattached. The maximum rating of the panel is the main circuit breaker rating when used as service entrance equipment.
- Ground bar kits priced separately. See Page V1-T1-66.
- 22 kAIC series combination rating is obtained when Types BD, BR, BQ, BQC and GFCB 10 kAIC branch breakers are used in series with Type BRH main breaker.

Box sizes Pages V1-T1-67 through V1-T1-70.



### Convertible Loadcenters—Copper Bus 10/22/25 kAIC

BR3040NC200



### Convertible—Single-Phase, Three-Wire—120/240 Vac—Insulated/Bondable Split Neutral

Main Ampere Rating	Maximum Number 1-Inch (25.4 mm)		Enclosure Type	Box Size	Wire Size Range Cu/Al 60 °C or 75 °C for Main	Loadcenter Catalog Number (With Combination or NEMA Type 3R Cover) ①②③
	Spaces	Circuits				
125 10/22 kAIC ④⑤	12	24	Indoor	B2	See main breaker and main lug kit tables on <b>Page V1-T1-54</b> .	<b>BR1224NC125</b> ⑥⑦
	12	24	Outdoor	B2R		<b>BR1224NC125R</b> ⑥⑦⑧
	20	24	Indoor	C2		<b>BR2024NC125</b> ⑦
	20	24	Outdoor	C3R		<b>BR2024NC125R</b> ⑦⑧
200 10/25 kAIC ④⑤	20	40	Indoor	D1	<b>BR2040NC200</b>	
	20	40	Outdoor	D1R	<b>BR2040NC200R</b> ⑨	
	30	40	Indoor	G1	<b>BR3040NC200</b>	
	30	40	Outdoor	G1R	<b>BR3040NC200R</b> ⑨	
	40	40	Indoor	L1	<b>BR4040NC200</b>	
	40	40	Outdoor	L1R	<b>BR4040NC200R</b> ⑨	

#### Notes

- ① 100, 125 and 200 A convertible base unit catalog numbers include interior, box and cover only. Main devices and accessories must be ordered separately for field installation. All convertible base units are listed as suitable for use as service entrance equipment when used per Article 384 of the NEC.
- ② Ground bar kits priced separately, refer to **Page V1-T1-66**.
- ③ All main circuit breaker loadcenters are listed for use as service entrance equipment and are shipped with a neutral bonding strap preattached. The maximum main rating of the loadcenter is the main breaker rating when used as service entrance equipment.
- ④ Interrupting rating depends on main circuit breaker selected. See **Page V1-T1-66** for mains.
- ⑤ For main breaker, use Type BW or CSR. For main lug, use Type BRL.
- ⑥ Rainproof loadcenters are furnished with hub closure plates. For rainproof hubs, refer to **Page V1-T1-66**.
- ⑦ Hold-down screw BREQS125 comes with loadcenter for back-fed Types BR and BRH main circuit breakers.
- ⑧ For main breaker, use Type BR. For main lug, use Type BRSF.
- ⑨ Suitable for use as service equipment when not more than six main disconnecting means are provided and when not used as a lighting and appliance panelboard. (see Article 408.34 of the NEC).

# 1.2

## Loadcenters and Circuit Breakers

### Type BR Loadcenters and Circuit Breakers

1

#### Three-Phase—Type BR Main Circuit Breaker Loadcenters

#### Three-Phase, Four-Wire—Main Lug Loadcenters—Copper Bus—208Y/120 Vac or 240 Vac, Insulated/Bondable Split Neutral

Main Ampere Rating	Maximum Number 1-Inch (25.4 mm)		Enclosure Type	Box Size	Wire Size Range Cu/Al 60 °C or 75 °C for Main	Loadcenter Catalog Number (With Combination or NEMA Type 3R Cover)
	Spaces	Circuits				
125	12	24	Indoor	C1	#6–3/0	3BR1224LC125
125	12	24	Outdoor	C1R	#6–3/0	3BR1224LC125R
150	24	42	Indoor	D1	#4–300 kcmil	3BR2442LC150
150	24	42	Outdoor	D1R	#4–300 kcmil	3BR2442LC150R
200	12	24	Indoor	C4	#4–300 kcmil	3BR1224LC200
200	12	24	Outdoor	C3R	#4–300 kcmil	3BR1224LC200R
200	30	42	Indoor	G1	#4–300 kcmil	3BR3042LC200
200	30	42	Outdoor	G1R	#4–300 kcmil	3BR3042LC200R
200	42	42	Indoor	L1	#4–300 kcmil	3BR4242LC200
200	42	42	Outdoor	L1R	#4–300 kcmil	3BR4242LC200R
225	30	42	Indoor	L1	#4–300 kcmil	3BR3042LC225
225	30	42	Outdoor	L1R	#4–300 kcmil	3BR3042LC225R
400	42	42	Indoor	24	(2) 3/0–250 kcmil	3BR4242LC400S
	42	42	Outdoor	47		3BR4242BC400R
600	42	42	Indoor	24	(2) 3/0–500 kcmil	3BR4242LC600S

#### Three-Phase, Four-Wire—Main Circuit Breaker Loadcenters—Copper Bus—208Y/120 Vac or 240 Vac, Insulated/Bondable Split Neutral

Main Breaker Type	Main Ampere Rating	Maximum Number 1-Inch (25.4 mm)		Enclosure Type	Box Size	Wire Size Range Cu/Al 60 °C or 75 °C for Main Breaker	Loadcenter Catalog Number (With Combination or NEMA Type 3R Cover)
		Spaces	Circuits				
BR 10 kAIC	100	12	24	Indoor	C1	#14–1/0	3BR1224BC100
		12	24	Outdoor	C1R	#14–1/0	3BR1224BC100R
CC 10 kAIC	150	30	42	Indoor	L1	#6–4/0	3BR3042BC150
		30	42	Outdoor	L1R	#6–4/0	3BR3042BC150R
		42	42	Indoor	L2	2/0–300 kcmil	3BR4242BC200
		42	42	Outdoor	L2R	2/0–300 kcmil	3BR4242BC200R
		42	42	Indoor	L2	2/0–300 kcmil	3BR4242BC225
DK 22 kAIC	400	42	42	Outdoor	L2R	2/0–300 kcmil	3BR4242BC225R
		42	42	Indoor	24	(2) 3/0–250 kcmil	3BR4242BC400S
		42	42	Outdoor	47		3BR4242BC400R
HLD 10 kAIC	600	42	42	Indoor	24	(2) 3/0–500 kcmil	3BR4242BC600S

3BR4242B200



#### Three-Phase, Four-Wire—Main Circuit Breaker Loadcenters—Aluminum Bus—208Y/120 Vac or 240 Vac Insulated/Bondable Split Neutral

Main Breaker Type	Main Ampere Rating	Maximum Number 1-Inch (25.4 mm)		Enclosure Type	Box Size	Wire Size Range Cu/Al 60 °C or 75 °C for Main Breaker	Loadcenter Catalog Number <sup>①②</sup> (With Combination or NEMA Type 3R Cover)	
		Spaces	Circuits					
BR 10 kAIC	100	12	24	Indoor	C1	#14–1/0	3BR1224B100	
		12	24	Outdoor	C1R		3BR1224B100R <sup>③</sup>	
CC 10 kAIC	125	30	42	Indoor	L1	#6–4/0	3BR3042B125	
		30	42	Indoor	L1	#6–4/0	3BR3042B150	
		30	42	Outdoor	L1R		3BR3042B150R <sup>③</sup>	
		200	30	42	Indoor	L1	#1–250 kcmil	3BR3042B200
			30	42	Outdoor	L1R		3BR3042B200R <sup>③</sup>
			42	42	Indoor	L2		3BR4242B200
CHH 100 kAIC	200	42	42	Outdoor	L2R		3BR4242B200R <sup>③</sup>	
		42	42	Indoor	L2	2/0–300 kcmil	3BR4242H200 <sup>④</sup>	
		42	42	Outdoor	L2R	2/0–300 kcmil	3BR4242B225	
DK <sup>④</sup> 22 kAIC	400	42	42	Outdoor	L2R		3BR4242B225R <sup>④</sup>	
		42	42	Indoor	24	(2) #3/0–250 kcmil	3BR4242B400S <sup>⑤</sup>	
		42	42	Indoor	24		3BR4242B400F	
LD <sup>⑤</sup>	600	42	42	Outdoor	47		3BR4242B400R <sup>⑤</sup>	
		42	42	Indoor	24	(2) #3/0–500 kcmil	3BR4242B600F	

#### Notes

- ① All main circuit breaker loadcenters are listed for use as service entrance equipment and are shipped with a neutral bonding strap pre-attached (commercial loadcenters do not have a pre-attached bonding strip). The maximum main rating of the panel is the main circuit breaker rating when used as service entrance equipment.
- ② Ground bar kits priced separately. See **Page V1-T1-66**.
- ③ Rainproof loadcenters are furnished with hub closure plates. For rainproof hubs, refer to **Page V1-T1-66**.
- ④ Type DK main circuit breaker is rated 65 kAIC at 240 Vac and allows a 22 kAIC series rating on the loadcenter when Types BR, BD and BJ branch circuit breakers are used.
- ⑤ The LD main circuit breaker is rated 65 kAIC at 240 Vac. Type LD circuit breaker **is not** series rated with Types BR, BD and BJ branch circuit breakers.
- ⑥ Includes CHH 100 kAIC rated MCB. 100 kAIC series rating combination is obtained when types BD, BR, BQ, BQC and GFGB branch breakers are used with CHH main.
- ⑦ With surface cover.

**3BR1224L125**



**Three-Phase, Four-Wire—Main Lug Loadcenters—Aluminum Bus—208Y/120 Vac or 240 Vac, Insulated/Bondable (Unless Otherwise Noted)**

Main Ampere Rating	Maximum Number 1-Inch (25.4 mm)		Enclosure Type	Box Size	Wire Size Range Cu/Al 60 °C or 75 °C for Main Lugs	Loadcenter Catalog Number <sup>①</sup> (With Combination or NEMA Type 3R Cover)
	Spaces	Circuits				
100	3	3	Indoor	9	#6-1/0	3BR3L100S <sup>②③</sup>
	3	3	Outdoor	9R		3BR3L100R <sup>③④</sup>
125	12	24	Indoor	C1	#6-3/0	3BR1224L125 <sup>⑤⑥</sup>
	12	24	Outdoor	C1R		3BR1224L125R <sup>④⑤⑥</sup>
150	18	36	Indoor	C2	#6-4/0	3BR1836L150
	18	36	Outdoor	C3R		3BR1836L150R
	24	42	Indoor	D1		3BR2442L150
	24	42	Outdoor	D1R		3BR2442L150R <sup>④</sup>
200	12	24	Indoor	C4	#4-300 kcmil	3BR1224L200 <sup>⑥</sup>
	12	24	Outdoor	C3R		3BR1224L200R <sup>④⑥</sup>
	18	36	Indoor	C4		3BR1836L200
	18	36	Outdoor	C3R		3BR1836L200R
	30	42	Indoor	G1		3BR3042L200
	30	42	Outdoor	G1R		3BR3042L200R <sup>④</sup>
	42	42	Indoor	L1		3BR4242L200
	42	42	Outdoor	L1R		3BR4242L200R <sup>④</sup>
225	42	42	Indoor	L1	#4-300 kcmil	3BR4242L225
	42	42	Outdoor	L1R		3BR4242L225R <sup>④</sup>

**3BR4242L400F**



**Three-Phase, Four-Wire—Main Lug Loadcenters—Aluminum Bus—208Y/120 Vac or 240 Vac, Insulated/Bondable Split Neutral**

Main Ampere Rating	Maximum Number 1-Inch (25.4 mm)		Enclosure Type	Box Size	Wire Size Range Cu/Al 60 °C or 75 °C for Main Lugs	Commercial Loadcenter Catalog Number <sup>②</sup>	
	Spaces	Circuits				With Flush or NEMA Type 3R Cover	With Surface Cover
400	42	42	Indoor	22	(1) 250-750 kcmil or (2) #3/0-250 kcmil	3BR4242L400F	3BR4242L400S
	42	42	Outdoor	46		3BR4242L400R <sup>④</sup>	—
600	42	42	Indoor	22	(2) #2-500 kcmil	—	3BR4242L600S

**Notes**

- ① Ground bar kits priced separately. See **Page V1-T1-66**.
- ② Surface cover only.
- ③ Insulated/bondable single neutral.
- ④ Rainproof loadcenters are furnished with hub closure plates. For rainproof hubs, refer to **Page V1-T1-66**.
- ⑤ Has notch for BREQS125 hold-down kit.
- ⑥ Suitable for use as service equipment when not more than six main disconnecting means are provided and when not used as a lighting and appliance panelboard (see Article 408.34 of the NEC).
- Ⓞ Door lock and key included with loadcenter.

Box sizes **Pages V1-T1-67 through V1-T1-70**.

# 1.2

## Loadcenters and Circuit Breakers

### Type BR Loadcenters and Circuit Breakers

1

3BR3030N100



3BR4242N225NY



### Three-Phase, Four-Wire—Convertible Loadcenters—Aluminum Bus—208Y/120 Vac or 240 Vac, Insulated/Bondable Split Neutral

Main Ampere Rating <sup>①</sup>	Maximum Number 1-Inch (25.4 mm)		Enclosure Type	Box Size	Wire Size Range Cu/Al 60 °C or 75 °C for Main	Loadcenter Catalog Number <sup>②③</sup> (With Combination or NEMA Type 3R Cover)
	Spaces	Circuits				
100 <sup>④</sup>	30	30	Indoor	D1	See main breaker and main lug kit tables below.	3BR3030N100 <sup>⑤</sup>
	30	30	Outdoor	D1R		3BR3030N100R <sup>⑤⑥</sup>
125 <sup>④</sup>	12	24	Indoor	C1		3BR1224N125 <sup>⑤⑥⑦</sup>
	12	24	Outdoor	C1R		3BR1224N125R <sup>⑤⑥⑦⑧</sup>
200	30	42	Indoor	L1		3BR3042N200
225	42	42	Indoor	L2		3BR4242N225
	42	42	Indoor	B		3BR4242B225NY <sup>⑨</sup>

### Three-Phase Main Breaker Kits—10 kAIC

Ampere Rating	Wire Size Range Cu/Al 60 °C or 75 °C	Catalog Number
100	#6–4/0	CC3100N
125	#6–4/0	CC3125N
150	#6–4/0	CC3150N
175	#2/0–300 kcmil	CC3175N
200	#2/0–300 kcmil	CC3200N
225	#2/0–300 kcmil	CC3225N

### Three-Phase Main Lugs Kit for Convertible Loadcenters

Ampere Rating	Wire Size Range Cu/Al 60 °C or 75 °C	Catalog Number
225	#1–300 kcmil	3BRL225
225	#1–300 kcmil	3BRS225 <sup>Ⓣ</sup>

#### Notes

- ① The maximum rating of the loadcenter is the main circuit breaker rating when used as service entrance equipment.
- ② 100, 125 and 200 A convertible base unit catalog numbers include interior, box and cover only. Main devices and accessories must be ordered separately for field installation. All convertible base units are listed as suitable for use as service entrance equipment when used per Article 384 of the NEC.
- ③ Ground bar kits priced separately. See **Page V1-T1-66**.
- ④ For main breaker, use Type BR. For main lug, use Type BRSF.
- ⑤ BREQS125 hold-down screw comes with loadcenter for back-fed Types BR and BRH main circuit breakers.
- ⑥ Rainproof loadcenters are furnished with hub closure plates. For rainproof hubs, refer to **Page V1-T1-66**.
- ⑦ Convertible to maximum of 100 A main circuit breaker and 125 A main lug.
- ⑧ Suitable for use as service equipment when not more than six main disconnecting means are provided and when not used as a lighting and appliance panelboard (see Article 408.34 of the NEC).
- ⑨ Order 3BR42FTNY or 3BR42STNY cover separately.
- Ⓣ For subfeed.

Box sizes **Pages V1-T1-67** through **V1-T1-70**.

### BR Quick Connect Neutral Loadcenters



### Contents—BR Specialty Products

<i>Description</i>	<i>Page</i>
Overview . . . . .	V1-T1-42
BR Specialty Products	
BR Quick Connect Neutral Loadcenters	
Spa Panels . . . . .	V1-T1-58
Riser Panel . . . . .	V1-T1-59
Type BR Renovation Loadcenter . . . . .	V1-T1-60
Type BR Mechanical Interlock Kits . . . . .	V1-T1-62
Type BR Retrofit Interior Kits . . . . .	V1-T1-73
BR Circuit Breakers . . . . .	V1-T1-76

## BR Specialty Products

### BR Quick Connect Neutral Loadcenters

#### Product Description

The Type BR Quick Connect Neutral loadcenters coupled with Type BR Quick Connect Neutral electronic breakers provide a clean, quick connection for an installer looking to save time while providing a professional look.

#### Features and Benefits

- Full-length neutral bars provide over 300% neutral capacity while enhancing installation flexibility for the installer
- Backed-out neutral screws allow an installer to make a quick connection when terminating neutral and ground wires
- Extended circuits (30/60, 40/80) provide maximum flexibility to a contractor on every space possible
- Standard LED diagnostics on AFCI and AF/GF breakers provides installers best-in-class troubleshooting technology
- Cut-to-length neutral wires provides a clean, professional look versus traditional pigtail circuit breakers
- Solid-tip, stranded neutral wires provide a quick connection to the full length neutral bar

## Product Selection

### BR Quick Connect Neutral Loadcenters ①

Main Device	Ampere Rating	Spaces	Circuits ②	Incoming Lug Size	Enclosure Type ③	Box Size	Ground Bar	Number of Neutral Terminations	Catalog Number
BR 10 kAIC	100	30	60	#4-1/0	Indoor	D1	④	96	BR3060BQN100
CSR 25 kAIC	150	30	60	#2-300 kcmil	Indoor	G1	④	102	BR3060BQN150
CSR 25 kAIC	200	30	60	#2-300 kcmil	Indoor	G1	④	102	BR3060BQN200
CSR 25 kAIC	200	40	80	#2-300 kcmil	Indoor	L1	④	128	BR4080BQN200
CSR 25 kAIC	200	30	60	#2-300 kcmil	Outdoor	L1R	④	94	BR3060BQN200R
CSR 25 kAIC	200	40	80	#2-300 kcmil	Outdoor	G1R	④	128	BR4080BQN200R
Main lug only	125	24	48	#6-2/0	Indoor	C2	GBK14	80	BR2448LQN125G
Main lug only	125	30	60	#6-2/0	Indoor	D1	GBK10	96	BR3060LQN125G
Main lug only	200	30	60	#1-300 kcmil	Indoor	D1	GBK1020 + GBK10	96	BR3060LQN200G
Main lug only	200	40	80	#1-300 kcmil	Indoor	G1	GBK1020 + GBK10	122	BR4080LQN200G
Main lug only	125	20	40	#6-2/0	Outdoor	C1R	GBK14	68	BR2040LQN125RG
Main lug only	200	30	60	#1-300 kcmil	Outdoor	D1R	GBK1420	94	BR3060LQN200RG
Convertible	200	30	60	—	Indoor	G1	④	102	BR3060NQN200
Convertible	200	40	80	—	Indoor	L1	④	128	BR4080NQN200
Convertible	200	30	60	—	Outdoor	G1R	④	94	BR3060NQN200R
Convertible	200	40	80	—	Outdoor	L1R	④	128	BR4080NQN200R

### BR Quick Connect Neutral Electronic Breakers

Ampere Rating	Poles	Wire Size	Breaker Type	LED Diagnostics Included	Catalog Number
15	Single-pole 10 kAIC	#14-4	Combination AFCI	Yes	BRCAF115QN
20	Single-pole 10 kAIC	#14-4	Combination AFCI	Yes	BRCAF120QN
15	Single-pole 10 kAIC	#14-4	Arc fault/ground fault	Yes	BRLAFGF115QN
20	Single-pole 10 kAIC	#14-4	Arc fault/ground fault	Yes	BRLAFGF120QN

#### Notes

- ① BR Quick Connect Neutral loadcenters accept both standard and Quick Connect Neutral breakers.
- ② Loadcenters accept Type BR twin breakers.
- ③ Combination cover included with every indoor loadcenter.
- ④ Ground bar kit not included. Purchase separately.

#### Spa Panels



### Spa Panels

#### Product Description

Eaton’s BR Spa Panels distribute power to outdoor loads and provide protection for people from electric shock. Save time and money with streamlined installation procedures and easy-access features. Spa panels meet NEC requirements by providing a ground fault circuit interruption device and a disconnect switch in a single simple device. Ships assembled prewired, factory tested and ready to install.

#### Features

- 10-year warranty
- UL Listed
- Factory-installed two-pole ground fault circuit interrupter (GFCI)

#### Product Selection

##### BR Spa Panel



#### Spa Panel—Meets NEC Article 680.40 Through 680.43—Requirements for GFCI Protection

Main Ampere Rating	Maximum Number 1-Inch (25.4 mm) Space		Enclosure Type	Box Size	Wire Size Range Cu/Al 60 °C or 75 °C for Main Lugs	Catalog Number
40	—	—	Outdoor	5R	#8-#2	BR40SPA ①
50	—	—	Outdoor	5R	#8-#2	BR50SPA ②

#### Notes

- ① Includes a GFCB240 breaker, factory installed.
- ② Includes a GFCB250 breaker, factory installed.

### Contents—BR Specialty Products

Description	Page
Overview . . . . .	V1-T1-42
BR Specialty Products	
BR Quick Connect Neutral Loadcenters . . . . .	V1-T1-57
Spa Panels	
Riser Panel . . . . .	V1-T1-59
Type BR Renovation Loadcenter . . . . .	V1-T1-60
Type BR Mechanical Interlock Kits . . . . .	V1-T1-62
Type BR Retrofit Interior Kits. . . . .	V1-T1-73
BR Circuit Breakers . . . . .	V1-T1-76

### Riser Panel



### Contents—BR Specialty Products

<i>Description</i>	<i>Page</i>
Overview . . . . .	V1-T1-42
BR Specialty Products	
BR Quick Connect Neutral Loadcenters . . . . .	V1-T1-57
Spa Panels . . . . .	V1-T1-58
Riser Panel	
Type BR Renovation Loadcenter . . . . .	V1-T1-60
Type BR Retrofit Interior Kits . . . . .	V1-T1-73
BR Circuit Breakers . . . . .	V1-T1-76

## Riser Panel

### Product Description

Eaton's Riser Panel is a loadcenter with an offset interior to allow riser cables to pass through the enlarged gutter. By using lay-in tap lugs, the contractor is able to simply strip off a length of the riser cable's insulation, and tap off to the riser panel's main lugs. These panels are used in the construction of assisted living homes, dormitories, public housing complexes and apartments.

### Product Selection

#### BR1224L125RIS



#### Riser Panel

Main Ampere Rating	Maximum Number 1-Inch (25.4 mm) Space	Circuits	Enclosure Type	Box Size	Wire Size Range Cu/Al 60 °C or 75 °C for Main Lugs	Catalog Number
125	12	24	Indoor	C4	#6–2/0	BR1224L125RIS
125	12	24	Indoor	C4	#6–2/0	BR1224L125RISBP ①
125	20	24	Indoor	C4	#6–2/0	BR2024L125RIS
125	20	24	Indoor	C4	#6–2/0	BR2024L125RISBP ①
125	20	30	Indoor	C2	#6–2/0	BR2030L125RIS
200	30	40	Indoor	D1	#1–300	BR3040L200RIS

#### BRGUTTER (Shown with Loadcenter)



#### Riser Panel Accessories

##### Catalog Number

BRGUTTER ②  
GTAP250

#### Notes

- ① Bulk-packaged loadcenter without carton. Must be ordered in multiples of 16.
- ② Refer to **Page V1-T1-68** for dimensions. BRGUTTER is box size C2.

### Accessories

For riser panels not shown, contact the Flex Center at 1-800-330-6479 for both CH and BR riser panels.

# 1.2

## Loadcenters and Circuit Breakers

### Type BR Loadcenters and Circuit Breakers

1

#### BR Renovation Loadcenters

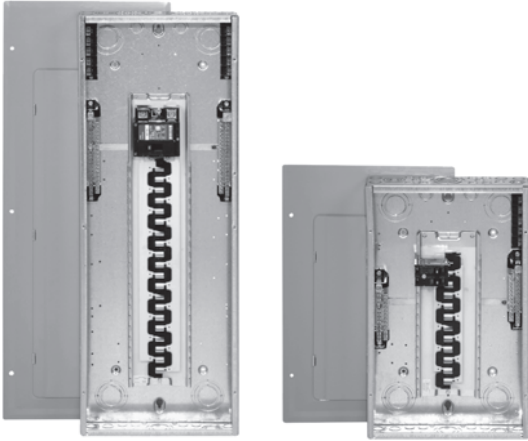

#### Contents—BR Specialty Products

<i>Description</i>	<i>Page</i>
Overview . . . . .	<b>V1-T1-42</b>
BR Specialty Products	
BR Quick Connect Neutral Loadcenters . . . . .	<b>V1-T1-57</b>
Spa Panels . . . . .	<b>V1-T1-58</b>
Riser Panel . . . . .	<b>V1-T1-59</b>
Type BR Renovation Loadcenter	
Options and Accessories . . . . .	<b>V1-T1-61</b>
Type BR Retrofit Interior Kits . . . . .	<b>V1-T1-73</b>
BR Circuit Breakers . . . . .	<b>V1-T1-76</b>

### Type BR Renovation Loadcenter

#### Product Description

- Available in 10, 20, 30 and 40 circuit main breaker styles
- Designed to replace existing loadcenters and fuse boxes
- Type BR loadcenter packaged with circuit breakers
- Factory-installed 5-circuit terminal block(s)
- Twin-stacked neutral design



#### Quick-Pro<sup>SM</sup>

All you need to know to save time and make more money.

Specified on certain Eaton products, the Quick-Pro symbol allows for immediate recognition of products that are designed for straightforward installation. When you see Quick-Pro, you know you can install quickly—sometimes up to 50% less than the usual installation time—and move on to your next job.

#### Features, Benefits and Functions

- Factory-installed terminal block(s) allows installer to terminate existing short wires without using wire nuts or junction boxes
- Twin-stacked neutrals are mounted up high in the loadcenter, which allows for all neutral and ground wires to be terminated in the top half of the loadcenter
- Specifically designed for the service contractor—this is the ONLY renovation line in the industry
- Single-pole and two-pole breakers included
- 10-year warranty on loadcenter and breakers

### Product Selection

BR2020B100RN

#### BR Value Packs ①



Main Breaker Type	Description	Wire Size Range	Number of 5-Circuit Terminal Blocks	Single-Pole Breakers	Two-Pole Breakers	Catalog Number
BR 10 kAIC	Single-phase 100 A 10k main breaker 10/20 circuit surface-mount box is 11.75" wide x 13" tall	#6-1/0	0	(2) BR115	(1) BR230	<b>BR1020B100SRNV</b>
	Single-phase 100 A 10k main breaker 10/20 circuit flush-mount box is 11.75" wide x 13" tall		0	(2) BR115	(1) BR230	<b>BR1020B100FRNV</b>

#### Note

① Indoor enclosure type.



### Options and Accessories

**BRSF125**



**3BRS225**



**BRL200**



**TDL**



### Field Installation Kits and Parts

Number of Poles	Ampere Rating	Number of 1-Inch (25.4 mm) Spaces Needed	Wire Size Range Cu/Al 60 °C or 75 °C	Ordering Quantity <sup>①</sup>	Catalog Number
<b>Main and Sub-Feed Lug Blocks</b>					
2	125	2	#8-2/0	1	<b>BRSF125</b>
	150	2	#8-2/0	1	<b>BRSF150</b> <sup>②</sup>
	225	4	#2-300 kcmil	1	<b>BRS225</b>
3	150	3	#8-2/0	1	<b>3BRSF150</b> <sup>②</sup>
	225	6	#2-300 kcmil	1	<b>3BRS225</b>
<b>Main Lugs</b>					
Two-pole, 200 A stud mounted (includes deadfront filler plate)			#1-300 kcmil	1	<b>BRL200</b>
Neutral/ground lug			#2/0 maximum	1	<b>NL20</b>
Add-on neutral or ground lug			#3/0 maximum	1	<b>NL30</b>
			300 kcmil maximum	1	<b>NL300</b>
<b>Filler Plates</b>					
1-inch (25.4 mm) circuit breaker space				25	<b>BRFP</b>
BW main circuit breaker space (with hardware)				1	<b>BWFP</b>
Door lock—12-42 circuits, and 100-225 A				1	<b>TDL</b>
Door lock—4-8 circuits, 125 A				1	<b>CH9FL</b>
ANSI-61 light gray touchup paint for current loadcenters				1	<b>SPC61</b>
Isolated neutral assembly (computer circuits)				1	<b>BINA</b>
Circuit directory—adhesive backed				10	<b>TCD</b>
Cover screws				25	<b>LCCS</b>
Cover replacement latch (gray) 14-5/16 (363.5 mm) wide loadcenters only				1	<b>BRRL</b>
Circuit marking strip (next to breaker)				10	<b>BRMS</b>
Circuit identification label (preprinted breaker labels)				25	<b>CHBL</b>
Series rated caution label				25	<b>SRL</b>
Bonding strip with screw				1	<b>BSSUSE</b>

**Notes**

- ① Must be purchased in multiples of ordering quantities indicated.
- ② #8-2/0 wire size range is 75 °C rated only.

#### Type BR Mechanical Interlock Kits



**Type BR Loadcenter with Mechanical Interlock Kit**

#### Type BR Mechanical Interlock Kits

##### Product Description

With the aging electrical infrastructure and frequent severe storms, power outages are becoming more and more frequent, affecting thousands of people nationwide. Eaton mechanical interlock kit provides an easy and cost-effective solution when using backup emergency power.

This solution expands the robust line of emergency power products and accessories.

##### Features and Benefits

- Prevents utility and generator supplies from being on at the same time
- Protects utility linemen from dangerous generator backfeed
- Robust interlock design
- Offered in two unique styles for almost any BR loadcenter, which can reduce inventory levels
- Quick and easy installation—drill points or fixtures for pilot holes are provided on all applicable BR loadcenters; no additional assembly is required

#### Contents

<b>Description</b>	<b>Page</b>
Overview . . . . .	<b>V1-T1-42</b>
BR Specialty Products	
BR Quick Connect Neutral Loadcenters . . . . .	<b>V1-T1-57</b>
Spa Panels . . . . .	<b>V1-T1-58</b>
Riser Panel . . . . .	<b>V1-T1-59</b>
Type BR Renovation Loadcenter . . . . .	<b>V1-T1-60</b>
Type BR Retrofit Interior Kits . . . . .	<b>V1-T1-73</b>
Type BR Mechanical Interlock Kits	
BR Circuit Breakers	
Product Selection . . . . .	<b>V1-T1-77</b>
Circuit Breaker Accessories . . . . .	<b>V1-T1-85</b>
Wiring Diagrams . . . . .	<b>V1-T1-87</b>

##### Standards and Certifications

- UL 67 Listed—For use with BR loadcenters
- Meets NEC® Article 702



### Product Selection



Each mechanical interlock kit includes:

- Interlock assembly
- Hold down kit ①
- New labels
- Necessary screws

Warranty information:

- 10-year warranty on all Type BR circuit breakers and loadcenters
- Refer to Eaton for complete warranty details

### Mechanical Interlock Kits ②

	Description	Catalog Number
<b>BRMIKBR</b> 	Single	<b>BRMIKBR</b>
	Bulk pack ③	<b>BRMIKBRBP</b>
<b>BRMIKCSR</b> 	Single	<b>BRMIKCSR</b>
	Bulk pack ③	<b>BRMIKCSRBP</b>

#### Notes

- ① For breakers under 70 A used in backfed applications, add “B” to the end of the catalog string to get the appropriate “hold-down” version.
- ② Clamshell packaged.
- ③ Bulk pack contains 10 units, individually packaged.

# 1.2

## Loadcenters and Circuit Breakers

### Type BR Loadcenters and Circuit Breakers

1

#### Mechanical Interlock Cover

Covers mechanically interlock two breakers—Type BW or CSR main breaker with a Type BR branch breaker.

BR816B100



#### Mechanical Interlock Cover

Fits Loadcenter Catalog Numbers	Mechanical Interlock Trim/Deadfront Catalog Numbers	Mechanical Interlock Kit Catalog Numbers
<b>Indoor</b>		
BR816B100	BRCOVC10M	BRMIKBR
BR816N100		
BR1212B100	BRCOVC12M	
BR1220B100		
BR1220H100		
BR1224N125	BRCOVC13M	
BR1616B100	BRCOVC16M	
BR1620B100		
BR1624B100		
BR1624B125	BRCOVC17M	
BR1624N125		
BR2020B100, BR2020BC100 BR2020H100, BR2020HC100	BRCOVC22M	
BR2024H100		
BR2020HC100		
BR2030B100		
BR2040B100		
BR2024B125	BRCOVC23M	
BR2024N125, BR2024NC125		
BR3030B100, BR3030BC100	BRCOVC59M	
BR3030H100, BR3030HC100		
<b>Raintight</b>		
BR1020B100R	BR3RDF1M	Field-installed interlock kits not available for these catalog numbers.
BR1224B100R		
BR1224N125R, BR1224NC125R		
BR1624B100R	BR3RDF2M	
BR1624N125R		
BR2024B100R, BR2024B125R	BR3RDF4M	
BR2024N125R, BR2024NC125R		

### BR4040B200



### Mechanical Interlock Cover, continued

Fits Loadcenter Catalog Numbers	Mechanical Interlock Trim/Deadfront Catalog Numbers	Mechanical Interlock Kit Catalog Numbers
<b>Indoor</b>		
BR1630B150	BRCOV16C4FM	BRMIKCSR
BR1224N200		
BR1632B200		
BR1632N200		
BR2030B150	BRCOV20C4FM	
BR2030H150		
BR2040B150		
BR2040B200, BR2040BC200	BRCOV20D1FM	
BR2040H200		
BR2040N200, BR2040NC200		
BR2430B150, BR2430BC150	BRCOV30G1FM	
BR3030B150		
BR3030H150		
BR3040B150		
BR2440B200		
BR2440N200		
BR3040B200, BR3040BC200		
BR3040N200, BR3040NC200		
BR3040H200		
BR4040B200, BR4040BC200	BRCOV40L1FM	
BR4040H200		
BR4040N200, BR4040NC200		
BR4242B225	BRCOV42L2FM	
<b>Raintight</b>		
BR816B150RF	BR3RDF5M ①	
BR816B200RF		
BR816N200RF		
BR1224N200R		
BR2030B150R	BR3RDF11M ①	
BR2040B150R		
BR2040B200R		
BR2040B225R		
BR2040N200R		
BR3030B150R	BR3RDF12M ①	
BR3040B200R		
BR3040N200R		
BR4040B200R	BR3RDF13M ①	
BR4040N200R		
BR48B200RF	BR3RDF14M	
BR4242B225R	BR3RDF15M ①	
<b>Mechanical Interlock Loadcenter Replacement Covers ②</b>		
BR2020B100M, BR2020BC100M	BRCOV20C2FM	Field-installed interlock kits not available for these catalog numbers.
BR2024H100M		
BR3030BC100M	BRCOV30D1FM	

#### Notes

① Deadfront only.

② Can only be provided as replacement covers for factory-installed mechanically interlock loadcenters.

# 1.2

## Loadcenters and Circuit Breakers

### Type BR Loadcenters and Circuit Breakers

1

#### DS300H2



#### Field Installation Rainproof Conduit Hubs

##### Description

Group 1—for use with 70, 100 and 125 A MLO and MCB loadcenters and circuit breaker enclosures and the following 150 and 200 A panels: BR48B200RF

Group 2—for use with 150, 200 and 225 A MLO and MCB loadcenters and circuit breaker enclosures except for the following 200 A loadcenters: BR48B200RF. Also for use with 400 and 600 A loadcenters and New York City loadcenters manufactured after November 1, 2005

Type H conduit hubs for loadcenters PL0724R and S3100RN

Adapter kit—Allows installing a Group 1 hub on devices arranged for Group 2 hubs

Group 1 small blank hub plate with bump

Group 2 Large blank hub plate with bump

Conduit Size Inches (mm)	Ordering Quantity <sup>①</sup>	Catalog Number
0.75 (19.1)	1	DS075H1
1.00 (25.4)	1	DS100H1
1.25 (31.8)	1	DS125H1
1.50 (38.1)	1	DS150H1
2.00 (50.8)	1	DS200H1
2.00 (50.8)	1	DS200H2
2.50 (63.5)	1	DS250H2
3.00 (76.2)	1	DS300H2
0.75 (19.1)	1	RH75P
1.00 (25.4)	1	RH100P
1.25 (31.8)	1	RH125P
1.50 (38.1)	1	RH150P
—	1	DS900AP
—	1	DS900CP1
—	1	DS900CP2

#### GBK14



#### BRGBK39512



#### Ground Bar Kits

Description (See Legend)	Length Inches (mm)	Ordering Quantity <sup>①</sup>	Catalog Number
●○○○○●	2.54 (64.5)	1	GBK5 <sup>②</sup>
●○○○○●■	3.59 (91.2)	1	GBK520 <sup>②</sup>
●○○○○●○○○○	4.29 (109.0)	1	GBK10 <sup>②</sup>
●○○○○●○○○○■	5.34 (135.6)	1	GBK1020 <sup>②</sup>
●○○○○●○○○○○	4.61 (117.1)	1	GBK13 <sup>②</sup>
●○○○○●○○○○○○	5.69 (144.5)	1	GBK14 <sup>②</sup>
●○○○○●○○○○○○○	6.74 (171.2)	1	GBK1420 <sup>②</sup>
●○○○○●○○○○○○○○	8.14 (206.8)	1	GBK21 <sup>②</sup>
●○○○○●○○○○○○○○○	9.19 (233.4)	1	GBK2120 <sup>②</sup>
○□□●○○□○○□○○●○○□○○□	5.78 (146.8)	1	BRGBK39512 <sup>③④</sup>
○○○○	1.84 (46.7)	1	GB4NM <sup>⑤</sup>

#### Ground Bar Legend

- (3) #14–10 Cu/Al or (1) #14–4 Cu/Al
- (1) #6–2/0 Cu/Al
- (1) #14–1/0 Cu/Al or (3) #14–10 Cu/Al
- (1) #14–6 Cu/Al or (2) #14–12 Cu/Al
- Mounting Hole

#### Notes

- ① Must be purchased in multiples of ordering quantities indicated.
- ② Distance between mounting holes is 1.75 inches (44.5 mm).
- ③ For single- and three-phase 400 and 600 A applications.
- ④ Distance between mounting holes is 2.34 inches (59.5 mm).
- ⑤ For non-metallic enclosures. Snaps into molded base.

### Dimensions

Approximate Dimensions in Inches (mm)

#### Residential/Commercial/New York City Loadcenters, Unit Enclosures—Box Sizes

**Note:** Box sizes do not include covers/fronts.

#### Residential Loadcenters—NEMA Type 1 Indoor

Box Size	Height	Width	Depth
A1	15.00 (381.0)	11.25 (285.8)	3.75 (95.3)
B1	16.75 (425.5)	14.31 (363.5)	3.88 (98.4)
B2	18.75 (476.3)	14.31 (363.5)	3.88 (98.4)
C1	21.00 (533.4)	14.31 (363.5)	3.88 (98.4)
C2	23.00 (584.2)	14.31 (363.5)	3.88 (98.4)
C4	27.00 (685.8)	14.31 (363.5)	3.88 (98.4)
D1	29.13 (739.8)	14.31 (363.5)	3.88 (98.4)
G1	34.13 (866.8)	14.31 (363.5)	3.88 (98.4)
L1	39.00 (990.6)	14.31 (363.5)	3.88 (98.4)
L2	45.00 (1143.0)	14.31 (363.5)	3.88 (98.4)
L3	48.38 (1228.3)	14.31 (363.5)	3.88 (98.4)
2	8.63 (219.1)	5.00 (127.0)	3.50 (88.9)
3	9.44 (239.7)	4.50 (114.3)	3.00 (76.2)
4	13.00 (330.2)	11.00 (279.4)	3.56 (90.5)
5	9.44 (239.7)	4.50 (114.3)	3.00 (76.2)
6	12.00 (304.8)	6.88 (174.6)	4.50 (114.3)
7	13.00 (330.2)	11.00 (279.4)	3.56 (90.5)
9	14.50 (368.3)	6.50 (165.1)	3.50 (88.9)

#### Residential Loadcenters—NEMA Type 3R Outdoor

Box Size	Height	Width	Depth
B1R	16.75 (425.5)	14.31 (363.5)	5.19 (131.8)
B2R	18.75 (476.3)	14.31 (363.5)	5.19 (131.8)
C3R	25.00 (635.0)	14.31 (363.5)	5.19 (131.8)
D1R	29.13 (739.8)	14.31 (363.5)	5.19 (131.8)
G1R	34.13 (866.8)	14.31 (363.5)	5.19 (131.8)
L1R	39.00 (990.6)	14.31 (363.5)	5.19 (131.8)
L2R	45.00 (1143.0)	14.31 (363.5)	5.19 (131.8)
L3R	48.75 (1238.2)	14.31 (363.5)	5.19 (131.8)
2R	8.63 (219.1)	5.00 (127.0)	3.50 (88.9)
3R	9.44 (239.7)	4.50 (114.3)	3.00 (76.2)
4R	13.00 (330.2)	11.00 (279.4)	3.56 (90.5)
5R	9.44 (239.7)	4.50 (114.3)	3.00 (76.2)
6R	11.75 (298.5)	6.50 (165.1)	4.50 (114.3)
7R	13.00 (330.2)	11.00 (279.4)	3.56 (90.5)
8R	27.00 (685.8)	10.50 (266.7)	4.75 (120.7)
9R	14.25 (362.0)	6.50 (165.1)	4.00 (101.6)
C1R	21.00 (533.4)	14.31 (363.5)	5.19 (131.8)

#### Commercial Loadcenters—NEMA Type 1 Indoor

Box Size	Height	Width	Depth
19	44.00 (1117.6)	16.16 (410.4)	6.25 (158.8)
20	44.00 (1117.6)	16.16 (410.4)	6.25 (158.8)
22	54.00 (1371.6)	16.22 (412.0)	6.31 (160.3)
24	66.50 (1689.1)	16.22 (412.0)	6.31 (160.3)

#### Commercial Loadcenters—NEMA Type 3R Outdoor

Box Size	Height	Width	Depth
42	38.00 (965.2)	16.31 (414.3)	6.38 (161.9)
43	44.00 (1117.6)	16.31 (414.3)	6.38 (161.9)
46	54.00 (1371.6)	16.31 (414.3)	6.38 (161.9)
47	66.56 (1690.7)	16.31 (414.3)	6.38 (161.9)

#### New York City Loadcenters—NEMA Type 1 Indoor

Box Size	Height	Width	Depth
A	38.00 (965.2)	18.13 (460.4)	5.00 (127.0)
B	44.00 (1117.6)	18.13 (460.4)	5.00 (127.0)
C	66.50 (1689.1)	18.13 (460.4)	6.25 (158.8)

#### ECC Unit Enclosures—NEMA Type 1 Indoor

Height	Width	Depth
23.25 (590.6)	8.88 (225.4)	4.50 (114.3)

#### ECC Unit Enclosures—NEMA Type 3R Outdoor

Height	Width	Depth
23.68 (601.7)	9.31 (236.5)	5.44 (138.1)

# 1.2

## Loadcenters and Circuit Breakers

### Type BR Loadcenters and Circuit Breakers

1

Approximate Dimensions in Inches (mm)

#### Residential Loadcenter Knockouts

#### Knockouts for Box Sizes A1, B1, B2, C1, C2, C4, D1, G1, L1, L2, B1R, B2R, C1R, C3R, D1R, G1R, L1R, L2R

Code	Diameter				
A	0.50 (12.7)	0.75 (19.1)	—	—	—
B	0.50 (12.7)	—	—	—	—
C	0.50 (12.7)	1.25 (31.8)	1.50 (38.1)	2.00 (50.8)	2.50 (63.5)
D	1.25 (31.8)	1.25 (31.8)	2.00 (50.8)	2.50 (63.5)	—
E	0.50 (12.7)	0.75 (19.1)	1.00 (25.4)	—	—
F	0.50 (12.7)	0.75 (19.1)	1.00 (25.4)	1.50 (38.1)	2.00 (50.8)
G	1.25 (31.8)	1.50 (38.1)	2.00 (50.8)	—	—
H	0.50 (12.7)	0.75 (19.1)	1.00 (25.4)	1.25 (31.8)	1.50 (38.1)
I	1.00 (25.4)	1.25 (31.8)	1.50 (38.1)	2.00 (50.8)	2.50 (63.5)
J	1.00 (25.4)	1.25 (31.8)	1.50 (38.1)	—	—

#### Residential NEMA Type 1 Indoor and NEMA Type 3R Outdoor Enclosures

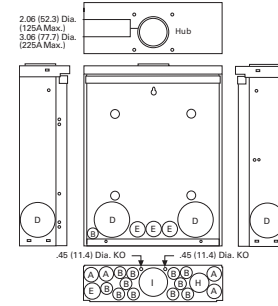

**Outdoor Boxes**  
B1R, B2R, C1R, C3R, D1R,  
G1R, L1R, L2R

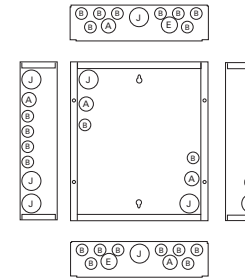

**Indoor Boxes**  
A1

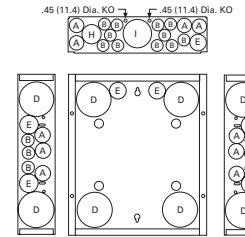

**Indoor Boxes**  
B1, B2

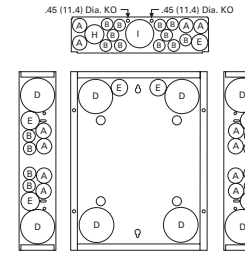

**Indoor Boxes**  
C1, C2, C4, D1, G1, L1, L2



Approximate Dimensions in Inches (mm)

### Knockouts for Box Sizes 3, 4, 5, 6, 7, 9, 2R, 3R, 4R, 5R, 6R, 7R, 8R, 9R

Code	Diameter			
A	0.50 (12.7)	—	—	—
B	0.50 (12.7)	0.75 (19.1)	—	—
C	0.50 (12.7)	0.75 (19.1)	1.00 (25.4)	—
D	0.50 (12.7)	0.75 (19.1)	1.00 (25.4)	1.25 (31.8)
E	0.75 (19.1)	1.00 (25.4)	1.25 (31.8)	—
F	0.75 (19.1)	1.00 (25.4)	1.25 (31.8)	1.50 (38.1)
G	1.00 (25.4)	1.25 (31.8)	1.50 (38.1)	—
H	1.00 (25.4)	1.25 (31.8)	1.50 (38.1)	2.00 (50.8)
I	1.25 (31.8)	1.50 (38.1)	2.00 (50.8)	—

### Residential NEMA Type 1 Indoor and NEMA Type 3R Outdoor Enclosures

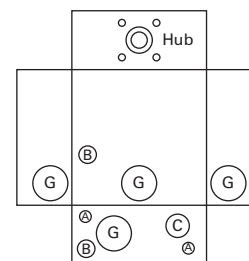
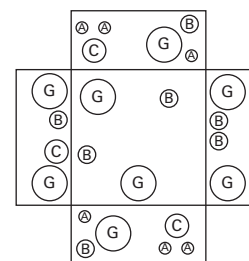
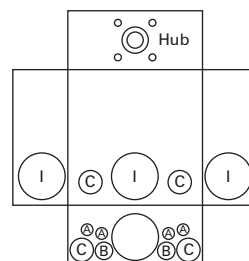
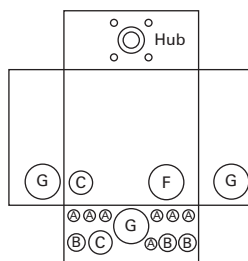
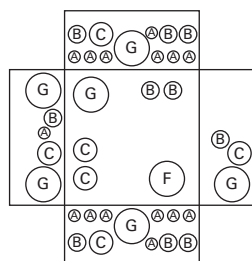
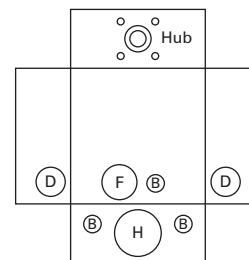
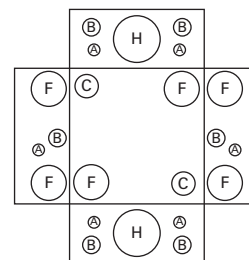
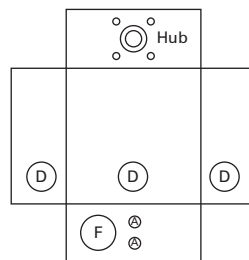
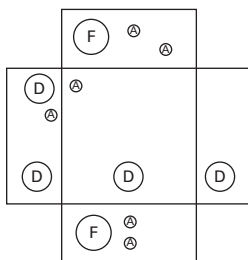
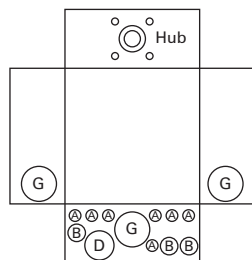
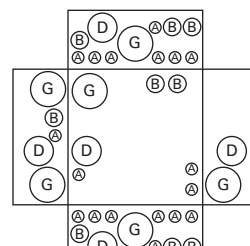
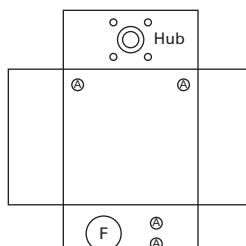
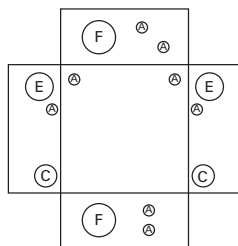
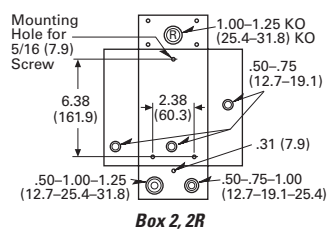

# 1.2

## Loadcenters and Circuit Breakers

### Type BR Loadcenters and Circuit Breakers

1

Approximate Dimensions in Inches (mm)

#### Commercial Loadcenter Knockouts

##### NEMA Type 1 Indoor Commercial Enclosures Knockouts for Box Sizes 19, 20, 22, 24

Code	Diameter			
A	0.50 (12.7)	—	—	—
B	0.50 (12.7)	0.75 (19.1)	—	—
C	0.75 (19.1)	1.00 (25.4)	1.50 (38.1)	—
D	1.50 (38.1)	2.00 (50.8)	2.50 (63.5)	3.00 (76.2)
E	2.00 (50.8)	2.50 (63.5)	3.00 (76.2)	—
F	2.50 (63.5)	3.00 (76.2)	3.50 (88.9)	—

##### NEMA Type 3R Outdoor Commercial Enclosures Knockouts for Box Sizes 42, 43, 46, 47

Code	Diameter			
A	0.50 (12.7)	—	—	—
B	0.50 (12.7)	0.75 (19.1)	—	—
C	0.75 (19.1)	1.00 (25.4)	1.25 (31.8)	—
D	1.50 (38.1)	2.00 (50.8)	2.50 (63.5)	—
E	2.00 (50.8)	2.50 (63.5)	3.00 (76.2)	—
F	2.50 (63.5)	3.00 (76.2)	3.50 (88.9)	—
G	1.25 (31.8)	1.50 (38.1)	2.00 (50.8)	2.50 (63.5)
H	3.25 (82.6) Sq.	—	—	—

#### Unit Enclosure Knockouts, Types ECB and ECC Knockouts

Code	Diameter			
<b>NEMA Type 1 Indoor (Flush and Surface Trims)</b>				
A	0.50 (12.7)	—	—	—
B	1.25 (31.8)	1.50 (38.1)	1.75 (44.5)	2.00 (50.8)
<b>NEMA Type 3R Outdoor</b>				
A	0.50 (12.7)	—	—	—
B	1.25 (31.8)	1.50 (38.1)	1.75 (44.5)	2.00 (50.8)

#### Indoor Commercial Enclosures

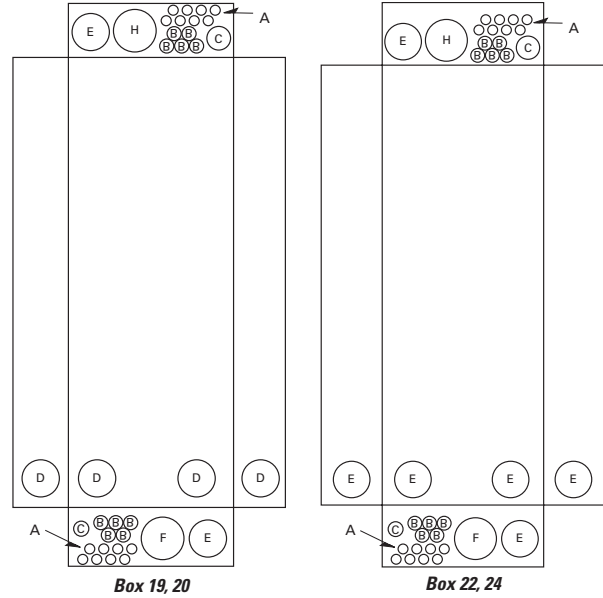

#### Outdoor Commercial Enclosures

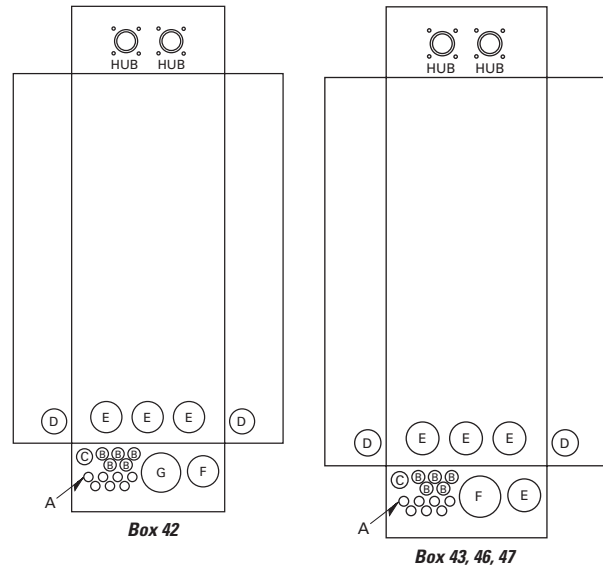

#### Unit Enclosure Knockouts

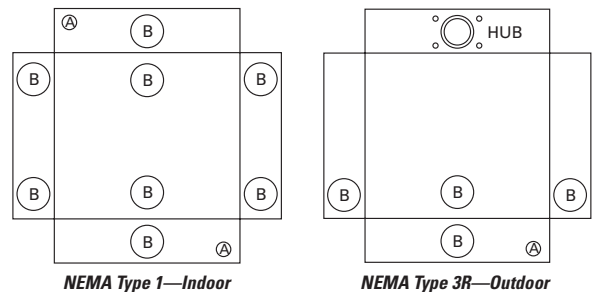

**Technical Data and Specifications****General**

- A. The Contractor shall furnish and install deadfront loadcenters incorporating circuit breakers of the number, rating and type as specified herein and as shown on the contract drawings.
- B. The loadcenter and all components shall be designed, manufactured and tested in accordance with the latest applicable standards of UL, NEMA and NEC including:
  1. UL 67—Standards for Panelboards.
- C. UL 50—Standards for Cabinets and Boxes.
- D. UL 489—Standards for Molded Case Circuit Breakers.
- E. UL 869—Standards for Service Equipment.
- F. Federal Specification W-C 375B—Circuit Breakers.
- G. Federal Specification W-C P115b—Panel Power Distribution Type 1, Class 2.

**Qualifications**

- A. The manufacturer of the loadcenter shall be the manufacturer of the circuit breaker within the loadcenter.
- B. For the equipment specified herein, the manufacturer shall be ISO 9000 certified.
- C. The manufacturer of this equipment shall have produced similar electrical equipment for a minimum period of seven (7) years.

**Manufacturers**

- A. Eaton.

**Ratings**

- A. Loadcenters shall be rated for 120/240 Vac and shall have short-circuit ratings as shown on the drawings or as herein scheduled, but not less than 10,000 amperes rms symmetrical.
- B. Circuit breakers shall be a minimum of 125 A frame. Circuit breakers 15 through 125 A trip size shall take up the same pole spacing.
- C. Loadcenters shall be labeled with a UL short-circuit rating. When series combination ratings are applied with integral or remote upstream devices, a label shall be provided. Series combination ratings shall cover all trip ratings of installed frames. It shall state the conditions of the UL series ratings including:
  1. Size and type of upstream device.
  2. Branch devices that can be used.
  3. UL series short circuit rating.

**Construction**

- A. All interiors, with the exception of the branch circuit breakers, shall be completely factory assembled with main breakers, main lugs, or no main device.
- B. Interiors shall be designed so that circuit breakers can be replaced without disturbing adjacent units and without removing the main bus connectors and shall be designed so that circuits may be changed without machining, drilling, or tapping.

- C. Physical means shall be provided to prevent the installation of more overcurrent devices than that number for which the enclosure was designed, rated and approved. Half-size breakers shall have a UL listed rejection tab over the line terminals. Loadcenter interiors must have notched stabs to accept these rejection tab class CTL breakers, if required and approved.

**Bus**

- A. Busbars for the main and cross connectors shall be [tin-plated aluminum] [copper] in accordance with Underwriters Laboratories standards. Busing shall be braced throughout to conform to industry standard practice governing short-circuit stresses in loadcenters.
- Note:** Note to spec writer—select one (copper available in limited ratings).
- B. Neutral busing shall have a suitable lug for each outgoing feeder requiring a neutral connection of same ampacity as branch.

**Wiring/Termination**

- A. All wire connectors and terminals shall be of the anti-turn solderless type and shall be suitable for copper or aluminum wire of the sizes indicated. All connectors must meet the "Requirements for Wire Connectors and Soldering Lugs" as stated in UL 486B.
- B. All loadcenters where marked shall be suitable for use with 60 °C or 75 °C rated wire.

**Circuit Breakers**

- A. Circuit breakers shall be molded case type. Circuit breakers shall have four-rivet construction (GFI Type—5 rivets). Multipole circuit breakers shall be of a stack pole design to provide electrical phase isolation.
- B. Each pole of the circuit breaker will provide inverse time delay overload and instantaneous short-circuit protection by means of both thermal and magnetic sensors.
- C. The circuit breaker calibration shall not be affected by environmental changes in relative humidity. The thermal bimetal element shall be welded to the steel frame and calibration shall be set independent of the molded case by computer controlled equipment.
- D. All circuit breakers shall be operated by a toggle-type handle and multipole circuit breakers shall have an internal common trip mechanism. The circuit breakers shall incorporate trip mechanisms that are mechanically trip-free from the handle. The handle position shall provide visual trip indication.
- E. Contacts shall be of non-welding silver alloy.
- F. All circuit breakers shall have the trip rating inscribed on the handle on each circuit breaker pole. Also, unique color-coded cases that indicate the UL listed 10 kA or 22 kA interrupting ratings. Breakers shall be able to be used as main or branch disconnect devices.

- G. Branch circuit breakers may also be used in the 1/2-inch (12.7 mm) per pole ratings that include two-pole 1-inch (25.4 mm) wide modules and four-pole 2-inch (50.8 mm) wide modules. Two-pole circuit breakers must incorporate a common trip mechanism. The exclusive CTL rejection tab feature shall be provided to limit the number of branch devices for a loadcenter to 42, in compliance with NEC Article 384.15.
- H. Circuit breakers shall be completely enclosed in a molded case of thermoset material. No internal aluminum parts shall be used. All internal ferrous parts shall be plated to prevent corrosion.
- I. All terminals shall be listed for use with copper or aluminum conductors. Terminals shall be of the box lug or clamp type design. The terminals shall meet UL 486B requirements and shall be suitable for use with either 60 °C or 75 °C wire.
- J. The calibrated bimetal assembly shall be mechanically isolated from the load terminal using a flexible braided copper shunt wire, such that movement of the terminals due to twisting and overtorquing does not affect breaker calibration.
- K. Breakers shall be SWD rated and/or HACR rated as required.
- L. Arc Fault Interrupting circuit breakers, (AFI), shall be provided on all 15 and 20 A single-phase 120/240 Vac circuits except those indicated as remote controlled breakers. AFI breakers shall be "Classified for mitigating the effects of arcing faults," or conforming to UL Standard 1699 and as defined by Article 210.12 Section A of the 1999 NEC Code.
- C. The deadfront shall have an easy adjustment feature for flush applications.
- D. Boxes shall be factory assembled into a single rigid structure.
- E. Unless otherwise noted on drawings, hinged doors covering all circuit breaker handles shall be included in all trims. Trim doors shall not uncover any live parts in making the circuit breaker handles accessible. If key locks are required, all locks shall be keyed alike.
- F. Combination trims for flush and surface panels shall be flat and shall overlap the box by at least 5/8-inch (15.9 mm) all around. Trims shall be mounted by a screwdriver without the need for special tools.

#### Surge Protection Devices

See Volume 1, Tab 2 for complete details on surge protection.

#### Enclosures

- A. Loadcenter shall have NEMA Type 1 general purpose or NEMA Type 3R rainproof enclosures as indicated on the drawings and shall be surface or combination flush/surface mounted except where noted.
- B. Boxes shall be made from galvanized sheet steel having multiple knockouts. Rainproof boxes shall use galvanized steel or an approved coating system which meets or exceeds standards for outdoor NEMA Type 3R enclosures. Boxes shall be of sufficient size to provide at least a minimum code gutter space on all sides.

#### Finish

- A. Trims shall be bonderized and finished with a light gray ANSI-61 enamel. The paint finish shall be of a type to which field applied paint will adhere.

#### Factory Testing

- A. The standard factory tests shall be performed on the equipment provided under this section. All tests shall be in accordance with the latest version of UL and NEMA.

### Type BR Retrofit Interior



**Type BR Retrofit Adjustable Interior**



**Type BR Retrofit Interior Collar and Assembly with Trim**

### Contents—BR Specialty Products

<b>Description</b>	<b>Page</b>
Overview . . . . .	<b>V1-T1-42</b>
BR Specialty Products	
BR Quick Connect Neutral Loadcenters . . . . .	<b>V1-T1-57</b>
Spa Panels . . . . .	<b>V1-T1-58</b>
Riser Panel . . . . .	<b>V1-T1-59</b>
Type BR Renovation Loadcenter . . . . .	<b>V1-T1-60</b>
Type BR Mechanical Interlock Kits . . . . .	<b>V1-T1-62</b>
Type BR Retrofit Interior Kits	
BR Circuit Breakers . . . . .	<b>V1-T1-76</b>

## Type BR Retrofit Interior Kits

### Product Description

Eaton's unique Retrofit Interior allows the customer to cost-effectively and safely upgrade an electrical service without removing the existing enclosure from the wall.



#### Quick-Pro<sup>SM</sup>

All you need to know to save time and make more money.

Specified on certain Eaton products, the Quick-Pro symbol allows for immediate recognition of products that are designed for straightforward installation. When you see Quick-Pro, you know you can install quickly—sometimes up to 50% less than the usual installation time—and move on to your next job.

### Application Description

The Retrofit Interior is designed and tested specifically for renovating an outdated electrical panel in an apartment, a condominium or a single family home. These outdated panels are being recognized by local inspectors and other authorities as a possible hazard.

#### Opportunities to Retrofit

- Single- or three-phase
- Main lug only or main breaker
- Up to 42 circuits
- Up to 225 A interiors, 400 A available upon request
- Available with CH breakers (3/4-inch) with copper bus or BR breakers (1-inch) with aluminum bus
- The minimum lifetime warranty for residential breakers shall be as follows:
  - 10-year warranty on all BR branch breakers and loadcenters
  - Refer to Eaton for complete warranty details

### Features and Benefits

#### Upgrading Existing Electrical Infrastructure Is Simple

- Replaces vintage brands that have hard to find, expensive replacement breakers
- Safety upgrade to arc fault and ground fault breakers to meet current electrical codes
- Maximizes number of circuits available with compact design
- Eco-friendly in asbestos-filled environments
- Exclusive design

#### Save Time and Money Throughout the Installation

- Uses existing panel box and wires
- Eliminates expensive and time-consuming drywall/paint repair
- Saves 2–3 hours of installation time compared to a complete panel changeout
- Eliminates precise measurements with field-adjustable kit

#### Detailed Product Guide

All standard retrofit kits are suitable for a range of existing box sizes:

- Box width ranging from 14.50 to 22.00 inches (368.3 to 558.8 mm)
- Box depth ranging from 4.00 inches (101.6 mm) for BR
- Box height ranging from 21.00 to 45.00 inches (533.4 to 1143.0 mm)

For box dimensions outside of these ranges, contact the Lincoln Flex Center at 800-330-6479. Be sure to provide the existing incoming line wire size.

#### Standards and Certifications

- Meets 2008/2011/2014 NEC wire bending requirements
- UL 67 Listed (for UL listings for specific part numbers, see the table on the following page.



# 1.2

## Loadcenters and Circuit Breakers

### Type BR Loadcenters and Circuit Breakers

#### 1

#### BR Specialty Product Selection

To select the retrofit kit:

- From the existing box size determine which retrofit groups are suitable (may be more than one).
- Use type of interior, number of phases, and type of main to find the selection chart.
- Select part number from chart (if main breaker, replace XXX with specific amp rating).
- Note that the overlap of the existing wall is the retro cover size minus the existing box size. If specific measurements are needed, communicate that you need a custom trim size.
- Contact the Lincoln Flex Center at 800-330-6479 for pricing, lead-times, and order entry instructions.

#### How to Order:

- Measure the existing panel enclosure to determine appropriate kits for your project.
- Match the existing dimensions with the table below to obtain the correct catalog number.
- Order your retrofit kit from a local Eaton authorized distributor.

Need assistance or can't find retrofit to fit existing enclosure?

Call Eaton's Residential Flex Center at 1-800-330-6479 or email for all your retrofit needs. Go to [www.eaton.com/eccn](http://www.eaton.com/eccn) to locate an Eaton Certified Contractor.

#### Retrofit Interior Kit Specifications

Five recommended groups: existing box height determines retro group size. Approximate Dimensions in Inches (mm).

Catalog Number <sup>①</sup>	Cover <sup>②</sup>	Existing Enclosure Parameters—Inches (mm)				Phase	Main	Bus	Amperes <sup>③</sup>	Spaces / Circuits	UL 67 Listed
		Minimum Depth	Maximum Depth	Minimum Width	Minimum Height						
<b>BR Retrofit Interiors and Covers</b>											
RTBR8L100P	CRTBR8ML****	3.13 (79.5)	3.63 (92.2)	10.50 (266.7)	13.00 (330.2)	Single	MLO	BR	100	16	Yes
RUBR8L100_	CRUBR8ML****	3.75 (95.3)	6.00 (152.4)	10.50 (266.7)	13.00 (330.2)	Single	MLO	BR	100	16	Yes
RTBR12L100P	CRTBR12ML****	3.13 (79.5)	3.63 (92.2)	10.50 (266.7)	14.50 (368.3)	Single	MLO	BR	100	24	Yes
RTBR10B100P	CRTBR12ML****	3.13 (79.5)	3.63 (92.2)	10.50 (266.7)	14.50 (368.3)	Single	MLO	BR	100	20	Yes
RUBR12L100_	CRUBR12ML****	3.75 (95.3)	6.00 (152.4)	10.50 (266.7)	14.50 (368.3)	Single	MLO	BR	100	24	Yes
RUBR10B100_	CRUBR12ML****	3.75 (95.3)	6.00 (152.4)	10.50 (266.7)	14.50 (368.3)	Single	MB	BR	100	20	Yes
RTBR12L125P	CRTBR12ML****	3.13 (79.5)	3.63 (92.2)	11.00 (279.4)	17.00 (431.8)	Single	MLO	BR	125	24	Yes
RTBR10B125P	CRTBR12ML****	3.13 (79.5)	3.63 (92.2)	11.00 (279.4)	17.00 (431.8)	Single	MB	BR	125	20	Yes
RUBR12L125_	CRUBR12ML****	3.75 (95.3)	6.00 (152.4)	11.00 (279.4)	17.00 (431.8)	Single	MLO	BR	125	24	Yes
RUBR10B125_	CRUBR12ML****	3.75 (95.3)	6.00 (152.4)	11.00 (279.4)	17.00 (431.8)	Single	MB	BR	125	20	Yes
RABR20B125_	CRABR20ML****	3.75 (95.3)	6.00 (152.4)	13.00 (330.2)	21.00 (533.4)	Single	MCB	BR	125	24	No
RABR20L125_	CRABR20ML****	3.75 (95.3)	6.00 (152.4)	13.00 (330.2)	21.00 (533.4)	Single	MLO	BR	125	24	No
RBBR20B200_	CRBBR20BW****	3.75 (95.3)	6.00 (152.4)	13.00 (330.2)	29.00 (736.6)	Single	MLO	BR	200	40	No
RCBR40L200_	CRCBR40ML****	3.75 (95.3)	6.00 (152.4)	13.00 (330.2)	34.00 (863.6)	Single	MLO	BR	200	40	No
RDBR40B200_	CRDBR40BW****	3.75 (95.3)	6.00 (152.4)	13.00 (330.2)	37.00 (939.8)	Single	MLO	BR	200	40	No

#### Notes

① Catalog numbers shown with "\_" at the end need one of the following suffixes to denote depth:

- J = 3.75–4.25
- K = 4.25–5.00
- L = 5.00–6.00

Example: RTBR12L125J would signify an interior set with a depth range of 3.75 to 4.25 inches.

② \*\*\*\*Denotes characters in the catalog number that relate to overall cover size.

Example: CRTBR12ML2620 would signify a cover 26.00 inches H x 20.00 inches W.

③ Amperes for MB panels is maximum; catalog number will reflect actual amperage of breaker included.

For UL applications, maximum cover sizes may apply.

### **Complete Assembly**

**Note:** For complete assembly, interior and cover need to be ordered separately.

### **Adjustable Interior**

- Factory installed ground and neutral bars positioned to accept existing wires
- Field adjustable depth matches existing panel box
- Adjustable height enables optional placement of the interior
- Field bondable for service entrance options



**Adjustable Interior**

### **Standard Trim and Collar**

- Standard trim matches new interior
- New circuit directory for updated labeling
- Oversized collar eliminates expensive wall/paint repair

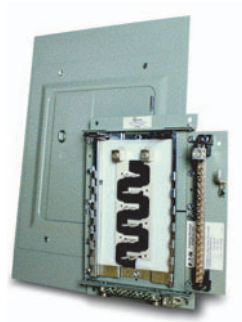

**Collar and Assembly with Trim**

BR Circuit Breakers



### BR Circuit Breakers

#### Product Description

**Plug-On Branch Feeder Type Arc Fault Circuit Breakers, Type BR—10 kAIC, 120 Vac and 120/240 Vac**

A branch feeder type arc fault circuit interrupter is a device intended to mitigate high current arcing faults in the complete circuit, including connected cords. High current arcing faults can occur from line to neutral or line to ground. These arcing faults are in parallel with the load and produce the most energy of all arcing faults.

The branch feeder type AFCI is required in the 1999 and 2002 National Electrical Code.

The Combination Type AFCI is required in the 2005, 2008, and 2011 National Electrical Code.

**Plug-On Combination Type Arc Fault Circuit Breakers, Type BR—10 kAIC, 120 Vac and 120/240 Vac**

A combination type arc fault circuit interrupter is a device that includes all of the protection offered by the branch feeder AFCI (mitigation of high current arcing faults in the complete circuit, including connected cords). In addition it provides direct detection of persistent low current arcing faults down to 5 amps with associated mitigation of fire hazards in the cords connected to the outlets. High current arcing faults can occur from line to neutral or line to ground. These arcing faults are in parallel with the load and produce the most energy of all arcing faults. The current level of low current arcing faults is limited by the load.

### Contents

<i>Description</i>	<i>Page</i>
Overview . . . . .	<b>V1-T1-42</b>
BR Specialty Products	
BR Quick Connect Neutral Loadcenters . . . . .	<b>V1-T1-57</b>
Spa Panels . . . . .	<b>V1-T1-58</b>
Riser Panel . . . . .	<b>V1-T1-59</b>
Type BR Renovation Loadcenter . . . . .	<b>V1-T1-60</b>
Type BR Mechanical Interlock Kits . . . . .	<b>V1-T1-62</b>
Type BR Retrofit Interior Kits . . . . .	<b>V1-T1-73</b>
BR Circuit Breakers	
Product Selection . . . . .	<b>V1-T1-77</b>
Circuit Breaker Accessories . . . . .	<b>V1-T1-85</b>
Wiring Diagrams . . . . .	<b>V1-T1-87</b>

**Plug-On Ground Fault Circuit Breakers, Type GFCB and GFEP—10/22 kAIC, 120 Vac and 120/240 Vac**

**Ground Fault**

**Application Notes**

Single-pole GFCBs are designed for use in two-wire, 120 Vac circuits. See **Page V1-T1-87** for a typical wiring configuration.

Two-pole GFCBs are designed for use in three-wire, 120/240 Vac circuits, 120 Vac multiwire circuits employing common, neutral and two-wire, 240 Vac circuits obtained from a 120/240 Vac source.

**Page V1-T1-87** shows typical wiring configurations for a 120/240 Vac multiwire circuits, and a 240 Vac, two-wire circuit. Note the “panel neutral” conductor connects to the neutral bar, even though the neutral is not included in the load circuit. This connection is necessary to supply a 120 Vac power source to the ground fault sensing circuit.

The figures are shown with a 120/240 Vac, single-phase, three-wire power source, but are also applicable to a 120/208 Vac, three-phase, four-wire power supply. For all figures, the electrical operation of the GFCB is not affected by the equipment ground.

**Non-CTL Plug-On Replacement—Circuit Breakers, Type BRD—10 kAIC, 120/240 Vac**

**Non-CTL 10 kAIC for Replacement Purposes Only**

For replacement in enclosures manufactured prior to 1968 with unnotched stabs. Circuit breakers do not have rejection tab.



### Product Selection

Plug-On Circuit Breakers, Types BR—10/22/42 kAIC, 120 Vac, 120/240 Vac and 240 Vac

BR120



BR215



BR320



BRH2100



BRX2125



### Type BR Breakers, 1-Inch (25.4 mm) per Pole 120/240, 10, 22 and 42 kAIC

Ampere Rating	Wire Size Range Cu/Al 60 °C or 75 °C	Single-Pole 120/240 Vac Requires One 1-Inch (25.4 mm) Space		Two-Pole 120/240 Vac Common Trip Requires Two 1-Inch (25.4 mm) Spaces		42 kAIC Catalog Number	65 kAIC Catalog Number
		10 per Shelf Carton 10 kAIC Catalog Number	22 kAIC Catalog Number	5 per Shelf Carton 10 kAIC Catalog Number	22 kAIC Catalog Number		
10	#14-4	BR110	—	BR210	—	—	—
15	#14-4	BR115 <sup>①②</sup>	BRH115	BR215 <sup>③</sup>	BRH215	—	—
20	#14-4	BR120 <sup>①②</sup>	BRH120	BR220 <sup>③</sup>	BRH220	—	—
25	#14-4	BR125	BRH125	BR225 <sup>③</sup>	BRH225	—	—
30	#14-4	BR130	BRH130	BR230 <sup>③</sup>	BRH230	—	—
35	#14-4	BR135	BRH135	BR235 <sup>③</sup>	BRH235	—	—
40	#14-4	BR140	BRH140	BR240 <sup>③</sup>	BRH240 <sup>③</sup>	—	—
45	#14-4	—	BRH145	BR245 <sup>③</sup>	BRH245	—	—
50	#14-4	BR150	BRH150	BR250 <sup>③</sup>	BRH250 <sup>③</sup>	—	—
55	#14-3	BR150	BRH155	BR255	BRH255	—	—
60	#8-1/0	BR160	BRH160	BR260	BRH260	BRHH260	BRX260
70	#8-1/0	BR170	BRH170	BR270	BRH270	BRHH270	BRX270
80	#8-1/0	—	—	BR280	BRH280	BRHH280	BRX280
90	#8-1/0	—	—	BR290	BRH290	BRHH290	BRX290
100	#8-1/0	—	—	BR2100	BRH2100	BRHH2100	BRX2100
110	#8-1/0	—	—	BR2110	BRH2110	BRHH2110	BRX2110
125	#4-2/0	—	—	BR2125	BRH2125	BRHH2125	BRX2125
150	#4-2/0	—	—	BR2150 <sup>④</sup>	—	—	—



#### Notes

- ① One pole, 1-inch (25.4 mm) per pole circuit breakers are available with high magnetic setting for switching large tungsten lamp loads. Add suffix H to catalog number.
  - ② Switching duty rated.
  - ③ On the black handle breaker, add suffix "B" to the catalog number to obtain a tapped molded opening for proper use with hold-down kits.
  - ④ For use as a branch circuit breaker in 400 and 600 ampere panels only.
- All Type BR single-, two- and three-pole circuit breakers carry listing for HACR application. For circuit breakers with a shunt trip, add ST suffix.

# 1.2

## Loadcenters and Circuit Breakers

### Type BR Loadcenters and Circuit Breakers

1

#### BR Breakers



#### Type BR Breakers, 1-Inch (25.4 mm) per Pole 240 Vac, 10, 22 and 42 kAIC

Three-Pole 240 Vac  
Common Trip Requires Three  
1-Inch (25.4 mm) Spaces  
5 per Shelf Carton



Ampere Rating	Wire Size Range Cu/Al 60 °C or 75 °C	10 kAIC Catalog Number	22 kAIC Catalog Number
10	#14-4	BR310	—
15	#14-4	BR315 ①	BRH315
20	#14-4	BR320 ①	BRH320
25	#14-4	BR325	BRH325
30	#14-4	BR330	BRH330
35	#14-4	BR335	BRH335
40	#14-4	BR340	BRH340
45	#14-4	BR345	BRH345
50	#14-4	BR350	BRH350
55	#14-3	BR355	BRH355
60	#4-1/0	BR360	BRH360
70	#4-1/0	BR370	BRH370
80	#4-1/0	BR380	BRH380
90	#4-1/0	BR390	BRH390
100	#4-1/0	BR3100	BRH3100

#### Plug-On Branch Feeder Type Arc Fault Circuit Breakers, Type BR—10 kAIC, 120 Vac and 120/240 Vac

#### Type BR AFCI Circuit Breaker



#### Type BR, 1-Inch (25.4 mm) Wide FIRE-GUARD AFCI Circuit Breakers

Poles	Ampere Rating	Configuration	Catalog Number
Single-pole 10 kAIC	15	AFCI	BR115AF ②
	20	AFCI	BR120AF ②
Single-pole 22 kAIC	15	AFCI	BRH115AF
	20	AFCI	BRH120AF
Two-pole 10 kAIC ③④	15	AFCI Common Trip	BRL215AF
	20	AFCI Common Trip	BRL220AF

#### Notes

- ① One pole, 1-inch (25.4 mm) per pole circuit breakers are available with high magnetic setting for switching large tungsten lamp loads. Add suffix H to catalog number.
  - ② Clamshell packaging available with CS modification code on the end of catalog number.
  - ③ Common trip refers to two-pole 240 V load application sourced by 120/240 Vac (see **Page V1-T1-87**).
  - ④ Independent trip refers to two-pole multi-wire, home run or shared neutral circuits (see **Pages V1-T1-87 and V1-T1-88**).
- All Type BR single-, two- and three-pole circuit breakers carry listing for HACR application. For circuit breakers with a shunt trip, add ST suffix.

### Plug-On, Dual Purpose Arc Fault/ Ground Fault Circuit Breakers, Type BR—10 kAIC, 120 Vac

BRLAFGF115



#### Type BR, 1-Inch (25.4 mm) wide Dual Purpose AF/GF Circuit Breakers ①②

Poles	Ampere Rating	Configuration	Catalog Number
Single-pole 10 kAIC	15	Combination AFCI GFCI	<b>BRLAFGF115</b>
	20	Combination AFCI GFCI	<b>BRLAFGF120</b>

### Plug-On Combination Type Arc Fault Circuit Breakers, Type BR—10 kAIC, 120 Vac and 120/240 Vac

BRCAF115



#### Type BR, 1-Inch (25.4 mm) wide FIRE-GUARD Combination Type AFCI Circuit Breakers

Poles	Ampere Rating	Configuration	Catalog Number
Single-pole 10 kAIC	15	AFCI	<b>BRCAF115</b> ③
		Diagnostic AFCI	<b>BRCAF115</b>
	20	AFCI	<b>BRCAF120</b> ③
		Diagnostic AFCI	<b>BRCAF120</b>
Single-pole 22 kAIC	15	AFCI	<b>BRHCAF115</b> ③
	20	AFCI	<b>BRHCAF120</b> ③
Two-pole 10 kAIC	15	AFCI	<b>BRL215CAF</b>
	20	AFCI	<b>BRL220CAF</b>

### Plug-On Ground Fault Circuit Breakers, Type GFCB and GFEP—10/22 kAIC, 120 Vac and 120/240 Vac

Type GFCB Single-Pole



#### Type GFCB Ground Fault Circuit Breakers—5 Milliampere—1-Inch (25.4 mm) per Pole 120 Vac or 120/240 Vac, 10 kAIC

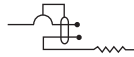

Single-Pole 120 Vac  
Requires One  
1-Inch (25.4 mm) Space  
1 per Shelf Carton  
Catalog Number ④



Two-Pole 120/240 Vac  
Common Trip Requires Two  
1-Inch (25.4 mm) Spaces  
1 per Shelf Carton  
Catalog Number

Type GFCB Two-Pole



Ampere Rating	Wire Size Range Cu/Al 60 °C or 75 °C	Single-Pole 120 Vac Requires One 1-Inch (25.4 mm) Space 1 per Shelf Carton Catalog Number ④	Two-Pole 120/240 Vac Common Trip Requires Two 1-Inch (25.4 mm) Spaces 1 per Shelf Carton Catalog Number
15	#14–4	<b>GFCB115</b>	<b>GFCB215</b>
20	#14–4	<b>GFCB120</b>	<b>GFCB220</b>
25	#14–4	<b>GFCB125</b>	<b>GFCB225</b>
30	#14–4	<b>GFCB130</b>	<b>GFCB230</b>
40	#14–4	<b>GFCB140</b>	<b>GFCB240</b>
50	#14–4	—	<b>GFCB250</b> ⑤
60	#14–6	—	<b>GFCB260</b>



#### Notes

- ① Breaker qualifies as combination arc fault, per UL 1699.
- ② Breaker qualifies as personnel protection ground fault, (5 mA) per UL 943.
- ③ Clamshell packaging available with CS modification code on the end of catalog number.
- ④ Available with bell alarm or auxiliary switch. See circuit breaker accessories on **Page V1-T1-85**.
- ⑤ For use with copper wire only.

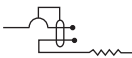
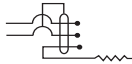
#### Type GFCBH Ground Fault Breakers—5 Milliampere— 1-Inch (25.4 mm) per Pole 120 Vac or 120/240 Vac, 22 kAIC

Ampere Rating	Wire Size Range Cu/Al 60 °C or 75 °C		
		Single-Pole 120 Vac Requires One 1-Inch (25.4 mm) Space 1 per Shelf Carton Catalog Number	Two-Pole 120/240 Vac Common Trip Requires Two 1-Inch (25.4 mm) Spaces 1 per Shelf Carton Catalog Number
15	#14-4	GFCBH115	GFCBH215
20	#14-4	GFCBH120	GFCBH220
25	#14-4	GFCBH125	GFCBH225
30	#14-4	GFCBH130	GFCBH230

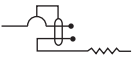
#### Type GFEP Ground Fault Equipment Protectors—30 Milliampere— 1-Inch (25.4 mm) per Pole 120 Vac or 120/240 Vac, 10 kAIC

Ampere Rating	Wire Size Range Cu/Al 60 °C or 75 °C		
		Single-Pole 120 Vac Requires One 1-Inch (25.4 mm) Space 1 per Shelf Carton Catalog Number	Two-Pole 120/240 Vac Common Trip Requires Two 1-Inch (25.4 mm) Space 1 per Shelf Carton Catalog Number
15	#14-4	GFEP115	GFEP215
20	#14-4	GFEP120	GFEP220
25	#14-4	GFEP125	GFEP225
30	#14-4	GFEP130	GFEP230
40	#14-4	—	GFEP240
50	#14-4	—	GFEP250 ①

**Note**

① For use with copper wire only.

### CTL Plug-On Circuit Breakers, Type BD Duplex, BQ and BQC Quadplex—10 kAIC, 120/240 Vac

#### Class CTL, 1-Inch (25.4 mm) per Pole 10 kAIC—All Circuit Breakers Have Rejection Tab Feature

BD2020

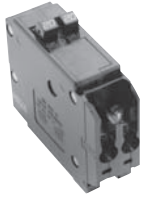

**Type BD Duplex**  
(UL Type BRD)

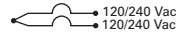

**Single-Pole** ①  
Requires One 1-Inch  
(25.4 mm) Space  
10 per Shelf Carton

BQ2302115

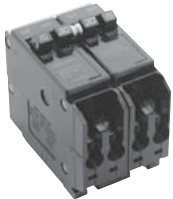

**Type BQ Quadplex Independent Trip**  
(UL Type BRD)

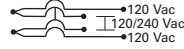

**Two-Pole** ② and **Single-Pole** ①  
Requires Two 1-Inch  
(25.4 mm) Spaces  
5 per Shelf Carton

**Type BQ Quadplex Independent Trip**  
(UL Type BRD)

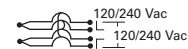

**Two-Pole**  
Requires Two 1-Inch  
(25.4 mm) Spaces  
5 per Shelf Carton

BQ230230

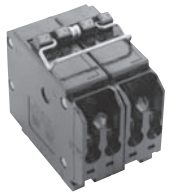

Ampere Rating	Catalog Number	Wire Size Range Cu/Al 65 °C or 75 °C	Ampere Rating			Catalog Number	Ampere Rating		
			Outer Left Single-Pole	Center Two-Pole Independent Trip	Outer Right Single-Pole		Outer Two-Pole Independent Trip	Center Two-Pole Independent Trip	Catalog Number
10–10	<b>BD1010</b>	#14–4	15	20	15	<b>BQ2202115</b>	15	15	<b>BQ215215</b>
15–15	<b>BD1515</b>	#14–4	20	20	20	<b>BQ2202120</b>	15	20	<b>BQ215220</b>
15–20	<b>BD1520</b>	#14–4	15	30	15	<b>BQ2302115</b>	15	30	<b>BQ215230</b>
15–30	<b>BD1530</b>	#14–4	20	30	20	<b>BQ2302120</b>	15	40	<b>BQ215240</b>
20–15	<b>BD2015</b>	#14–4	15	40	15	<b>BQ2402115</b>	15	50	<b>BQ215250</b>
20–20	<b>BD2020</b>	#14–4	20	40	20	<b>BQ2402120</b>	20	20	<b>BQ220220</b>
20–30	<b>BD2030</b>	#14–4	15	50	15	<b>BQ2502115</b>	20	30	<b>BQ220230</b>
25–25	<b>BD2525</b>	#14–4	20	50	20	<b>BQ2502120</b>	20	40	<b>BQ220240</b>
30–15	<b>BD3015</b>	#14–4	—	—	—	—	20	50	<b>BQ220250</b>
30–20	<b>BD3020</b>	#14–4	—	—	—	—	25	25	<b>BQ225225</b>
30–30	<b>BD3030</b>	#14–4	—	—	—	—	30	30	<b>BQ230230</b>
30–40	<b>BD3040</b>	#14–4	—	—	—	—	30	40	<b>BQ230240</b>
30–50	<b>BD3050</b>	#14–4	—	—	—	—	30	50	<b>BQ230250</b>
50–30	<b>BD5030</b>	#14–4	—	—	—	—	40	40	<b>BQ240240</b>
50–50	<b>BD5050</b>	#14–4	—	—	—	—	40	50	<b>BQ240250</b>
—	—	—	—	—	—	—	50	50	<b>BQ250250</b>

#### Notes

- ① All 15 and 20 A single poles are switch-duty rated.
- ② All Type BD duplex and BQ quadplex circuit breakers carry listing for HACR applications.

# 1.2

## Loadcenters and Circuit Breakers

### Type BR Loadcenters and Circuit Breakers

#### 1 Non-CTL Plug-On Replacement—Circuit Breakers, Type BRD—10 kAIC, 120/240 Vac

BR2020



#### Class Non-CTL, 1-Inch (25.4 mm) per Pole 10 kAIC—Breakers Do Not Have Rejection Tab Feature

##### Type BR Duplex

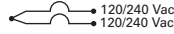

Single-Pole Requires One 1-Inch (25.4 mm) Space 10 per Shelf Carton

Ampere Rating	120 Vac Catalog Number	Wire Size Range Cu/Al 65 °C or 75 °C
15–15	BR1515	#14–4
15–20	BR1520	#14–4
20–15	BR2015	#14–4
20–20	BR2020	#14–4
30–30	BR3030	#14–4
30–50	BR3050	#14–4

##### Type Brand BRD Quadplex Independent Trip

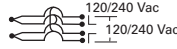

Two-Pole Requires Two 1-Inch (25.4 mm) Spaces 5 per Shelf Carton

120/240 Vac Ampere Rating	120/240 Vac Ampere Rating
Outer Two-Pole Independent Trip	Center Two-Pole Independent Trip
15	15
20	20
30	30
20	30
30	40
30	50

##### Type BRD Quadplex Common Trip Center and Outer Poles

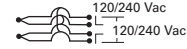

Two-Pole Requires Two 1-Inch (25.4 mm) Spaces 5 per Shelf Carton

120/240 Vac Ampere Rating	120/240 Vac Ampere Rating	Catalog Number
Outer Two-Pole Common Trip	Center Two-Pole Common Trip	Catalog Number
15	15	BR415
30	30	BR420
30	40	BR430
30	50	BRD220230
—	—	BRD230240
—	—	BRD230250

#### CTL and Non-CTL Breakers

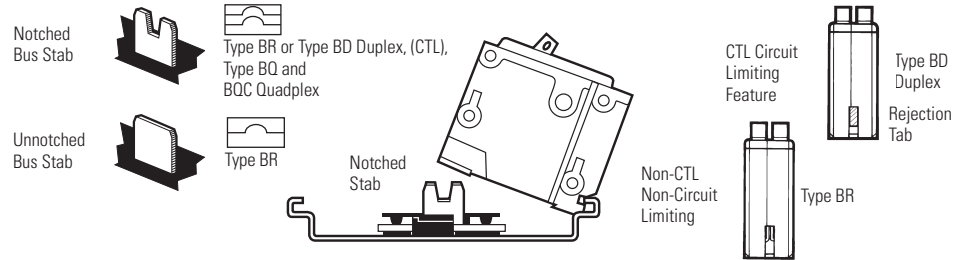

#### Note

Type BD Duplex, BQ and BQC Quadplex circuit breakers can be installed in Circuit Limiting (CTL) listed BR loadcenters. Type BR twin breakers can be installed in Non-CTL BR loadcenters.

### Common Trip Quadplex Breakers

BQC2302115

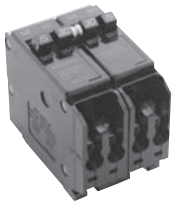

### Class CTL, 1-Inch (25.4 mm) per Pole 10 kAIC—All Circuit Breakers Have Rejection Tab Feature

Type BQC Quadplex Common Trip Center Poles (UL Type BRD)

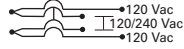

Two-Pole ① and Single-Pole ②

Requires Two 1-Inch (25.4 mm) Spaces  
5 per Shelf Carton

120 Vac      120/240 Vac      120 Vac

Ampere Rating

Outer Left Single-Pole      Center Two-Pole Common Trip      Outer Right Single-Pole      Catalog Number

15	20	15	<b>BQC2202115</b>
15	25	15	<b>BQC2252115</b>
15	30	15	<b>BQC2302115</b>
15	40	15	<b>BQC2402115</b>
15	50	15	<b>BQC2502115</b>
—	—	—	—
—	—	—	—
—	—	—	—
20	15	20	<b>BQC2152120</b>
20	20	20	<b>BQC2202120</b>
20	25	20	<b>BQC2252120</b>
20	30	20	<b>BQC2302120</b>
20	40	20	<b>BQC2402120</b>
20	50	20	<b>BQC2502120</b>
30	50	20	<b>BQC2502030</b>
—	—	—	—
—	—	—	—
—	—	—	—
—	—	—	—

Wire Size Range  
Cu/Al 65 °C  
or 75 °C

Type BQC Quadplex Common Trip Center and Outer Poles (UL Type BRD)

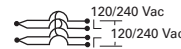

Two-Pole ①

Requires Two 1-Inch (25.4 mm) Spaces  
5 per Shelf Carton

120/240 Vac

Ampere Rating

Outer Two-Pole Common Trip      Center Two-Pole Common Trip      Catalog Number

15	15	<b>BQC215215</b>
15	20	<b>BQC215220</b>
15	30	<b>BQC215230</b>
20	15	<b>BQC220215</b>
20	20	<b>BQC220220</b>
20	30	<b>BQC220230</b>
20	40	<b>BQC220240</b>
20	50	<b>BQC220250</b>
25	25	<b>BQC225225</b>
25	30	<b>BQC225230</b>
30	15	<b>BQC230215</b>
30	30	<b>BQC230230</b>
30	40	<b>BQC230240</b>
30	50	<b>BQC230250</b>
40	30	<b>BQC240230</b>
40	40	<b>BQC240240</b>
40	50	<b>BQC240250</b>
50	20	<b>BQC250220</b>
50	50	<b>BQC250250</b>

#### Notes

- ① All Type BQC quadplex circuit breakers carry listing for HACR applications.
- ② All 15 and 20 ampere single poles are switch-duty rated.

# 1.2

## Loadcenters and Circuit Breakers

### Type BR Loadcenters and Circuit Breakers

#### 1 Plug-On Circuit Breakers, Types BJ and BJH—10/22 kAIC, 120/240 Vac and 240 Vac

For Use in Single-Phase and Three-Phase Loadcenters—150 Amperes and Above

Type BJ



#### Types BJ and BJH Breakers, 1-Inch (25.4 mm) per Pole, 120/240 or 240 Vac, 10, 22 kAIC



Two-Pole 120/240 Vac  
Common Trip Requires Four  
1-Inch (25.4 mm) Spaces <sup>①</sup>  
10 per Shelf Carton



Three-Pole 240 Vac  
Common Trip Requires Six  
1-Inch (25.4 mm) Spaces <sup>②</sup>  
5 per Shelf Carton

Ampere Rating	10 kAIC Catalog Number	22 kAIC Catalog Number	Wire Size Range Cu/Al 60 °C or 75 °C	10 kAIC Catalog Number	22 kAIC Catalog Number
125	BJ2125	BJH2125	#2–300 kcmil	BJ3125	BJH3125
150	BJ2150	BJH2150	#2–300 kcmil	BJ3150	BJH3150
175	BJ2175	BJH2175	#2–300 kcmil	BJ3175	BJH3175
200	BJ2200	BJH2200	#2–300 kcmil	BJ3200	BJH3200
225	BJ2225	BJH2225	#2–300 kcmil	BJ3225	BJH3225

#### Plug-On Special Application Circuit Breakers—10 kAIC, 120 Vac, 120/240 Vac and 240 Vac

BRWH215

Water Heater Breaker



#### Special Application Circuit Breakers, 1-Inch (25.4 mm) per Pole

Water Heater Breakers

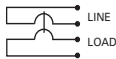

Two-Pole 120/240 Vac  
Common Trip Requires Two  
1-Inch (25.4 mm) Spaces

With Isolated Line Terminals  
for Separately Metered  
Water Heaters

5 per Shelf Carton  
10 kAIC

Switching Neutral Breakers

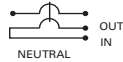

Two-Pole 120 Vac  
Common Trip Requires Two  
1-Inch (25.4 mm) Spaces

With Switching Neutral Pole  
for Gasoline Pump Applications

5 per Shelf Carton  
10 kAIC

240 V Breakers



Two-Pole 240 Vac  
Common Trip Requires Two  
1-Inch (25.4 mm) Spaces

Where Voltage to  
Ground is 240 Vac  
5 per Shelf Carton  
10 kAIC

Non-Automatic Molded Case Switches



Two-Pole 240 Vac  
Requires Two  
1-Inch (25.4 mm) Spaces

For Use as Disconnect Contains No  
Magnetic or Thermal Trip Properties

5 per Shelf Carton  
5 kAIC

BRSN220  
Switching Neutral  
Breaker



Ampere Rating	Catalog Number	Ampere Rating	Catalog Number	Wire Size Range Cu/Al 60 °C or 75 °C	Ampere Rating	Catalog Number	Ampere Rating	Catalog Number
15	BRWH215	15	BRSN215	#14–4	10	BR210H	—	—
20	BRWH220	20	BRSN220	#14–4	15	BR215H	—	—
30	BRWH230	25	BRSN225	#14–4	20	BR220H	—	—
—	—	30	BRSN230	#14–4	25	BR225H	—	—
—	—	—	—	#14–4	30	BR230H	—	—
—	—	—	—	#14–4	35	BR235H	—	—
—	—	—	—	#14–4	40	BR240H	—	—
—	—	—	—	#14–4	45	BR245H	—	—
—	—	—	—	#14–4	50	BR250H	50	BR250NA
—	—	—	—	#14–4	55	BR255H	—	—
—	—	—	—	#4–1/0	60	BR260H	60	BR260NA
—	—	—	—	#4–1/0	70	BR270H	—	—
—	—	—	—	#4–1/0	80	BR280H	—	—
—	—	—	—	#4–1/0	90	BR290H	—	—
—	—	—	—	#4–1/0	100	BR2100H	100	BR2100NA

#### Notes

<sup>①</sup> Breaker uses two 1-inch (25.4 mm) pole spaces on left side and two 1-inch (25.4 mm) pole spaces on right side of loadcenter.

<sup>②</sup> Breaker uses three 1-inch (25.4 mm) pole spaces on left side and three 1-inch (25.4 mm) pole spaces on right side of loadcenter.

If BJ or BJH breakers are used as a main or a back feed device, a hold-down kit is required. See [Page V1-T1-85](#).



### Circuit Breaker Accessories

#### Field Installation Kits and Parts

THS1

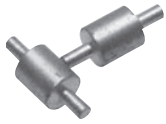

#### Description

Ordering Quantity <sup>①</sup>      Catalog Number

#### Handle Ties <sup>②</sup>

Handle tie bar for physically joining the handles of two adjacent single-pole Type BR circuit breakers (metal cylinder pin type)      10      **BHT**

BHLW2



Handle tie bar for joining two independent outside poles of Types BQ and BQC Quadplex and outside poles of two Type BD duplex circuit breakers      10      **THOW**

Handle tie bar for joining two adjacent outside poles of Types BQ and BQC Quadplex and outside poles of two Type BD duplex circuit breakers      10      **THS1**

BRQLW



#### Handle Lockoffs <sup>③④</sup>

Padlockable device for locking the handle of single-, two- or three-pole Type BR Circuit Breakers and single-pole of a Type BD Duplex or one independent outside pole of a Type BQ or BQC Quadplex circuit breakers (escutcheon mounted) <sup>⑤</sup>      10      **BRLW**

Padlockable device for locking the handle of a single-pole Type BR circuit breaker (handle mounted) <sup>⑥</sup>      10      **BRLW1**

MCBPL (Installed)



Padlockable device for locking the handle of a two- and three-pole Type BR circuit breaker (handle mounted) <sup>⑥</sup>      10      **BRLW2**

Padlockable device for locking the handle of a single-pole Type BD Duplex, BQ or BQC Quadplex breaker (handle mounted) <sup>⑥</sup>      10      **BRDL1**

Padlockable device for locking the handle of the two center poles and the two outer poles of a two-pole Types BQ and BQC quadplex circuit breakers (escutcheon mounted) <sup>⑤</sup>      10      **BRQLW**

Padlockable device for locking the handle of main circuit breaker Types CC and CHH into the ON or OFF position (screw mounted) <sup>⑦</sup>      1      **CCPL**

Padlockable device for locking the handle of main breaker Types BW and CSR into the ON or OFF position (escutcheon mounted) <sup>⑤</sup>      1      **MCBPL**

BHLW



Device used to secure handle in ON or OFF position for single-, two- or three-pole Type BR circuit breakers and single-pole of Type BD duplex and one independent outside pole of Type BQ or BQC Quadplex circuit breakers (escutcheon mounted) <sup>⑤</sup>      10      **BHLW**

Device used to secure handle in ON or OFF position for single-pole Type BR circuit breakers (handle mounted) <sup>⑥</sup>      10      **BHLW1**

BRLW2



Device used to secure handle in ON or OFF position for two- and three-pole Type BR circuit breakers (handle mounted) <sup>⑥</sup>      10      **BHLW2**

Device used to secure handle in ON or OFF position for single-pole Type GFGB ground fault circuit breakers (handle mounted) <sup>⑥</sup>      10      **BHGW**

Device used to secure handle in ON or OFF position for one independent outside pole of Types BQ and BQC Quadplex or single-pole Type BD duplex circuit breakers (handle mounted) <sup>⑥</sup>      10      **HLW1**

BREQS125



#### Hold-Down Kits <sup>⑧</sup>

Hold-down retainer kit for three-pole Type BR circuit breakers in S3100 and 3100R loadcenters only      1      **BRHDB**

Hold-down screw kit for two- and three-pole Type BR circuit breakers in single-phase MLO loadcenters through 100–125 A      1      **BREQS125**

Hold-down screw kit for two- and three-pole Type BR circuit breakers in MLO loadcenters 150–225 A      1      **BRHDK125**

BRHDK125

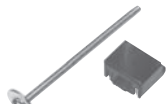

Hold-down screw kit for two-pole Types BJ and BJH circuit breakers in MLO loadcenters 125–225 A      1      **BJHDS**

Hold-down screw kit for three-pole Types BJ and BJH circuit breakers in MLO loadcenters 125–225 A      1      **BJHDS3P**

#### Main Breaker Lug Kits

Types CC and CHH main breaker lug kit (2) 300 kcmil      1      **CCL300**

Types BW/CSR main breaker lug kit (2) 300 kcmil      1      **MCBL300**

#### Notes

- ① Must be purchased in multiples of ordering quantities indicated.
- ② Handle ties: typically used to join two similar independent single-pole breakers to form a two-pole noncommon trip breaker.
- ③ Handle lockoffs: devices that use a padlock to lock the circuit breaker's handle in the ON or OFF position.
- ④ See table on **Page V1-T1-86** for handle position changeability chart.
- ⑤ Escutcheon mounted: device mounted semipermanently to the face of the circuit breaker and secured by the loadcenter deadfront.
- ⑥ Handle mounted: device mounted directly to the handle by the use of a set screw.
- ⑦ Screw mounted: device permanently mounted to the face of the circuit breaker by the use of a non-removable screw.
- ⑧ Hold-down kits: devices used to secure the circuit breaker to the loadcenter for back-feed main application. See NEC Article 384.16(g).

BRML



#### Field Installation Kits and Parts, continued

Description	Ordering Quantity <sup>①</sup>	Catalog Number
<b>Mechanical Interlocks</b>		
Types BR for two-, three- and four-pole breakers	10	<b>BRML</b>
	10	<b>BRPLOFF</b>
	10	<b>BRPLOFF2P</b>
	10	<b>BRPLOFF3P</b>
	10	<b>BJL2P</b>
	10	<b>BJL3P</b>
	10	<b>GHQRLOFF2P</b>
	10	<b>GHQRLOFF</b>
	10	<b>QCD123PLOFF</b>

#### Shunt Trips, Auxiliary and Alarm Contacts

Description	Catalog Number <sup>②</sup> Suffix Adder
<b>Shunt Trip for Types BW/CSR</b>	
12 Volts	<b>SR12</b>
24 Volts	<b>SR24</b>
120 Volts	<b>SR01</b>
<b>Shunt Trip for Types BR</b>	
120 Volts	<b>ST</b>
<b>Auxiliary Contact for Types BW/CSR</b>	
1NO and 1NC	<b>AL1</b>
2NO and 2NC	<b>AL2</b>
<b>Alarm Contacts for Types BW/CSR</b>	
Types BW/CSR	<b>CR1</b>
<b>Alarm Contacts for Type GFCB (Single-Pole)</b>	
Alarm contact for GFCB (single-pole)	<b>W1</b>
1NO and 1NC	<b>W2</b>

#### Handle Position Changeability Chart

Handle Lockoff and Lockdog Types	To Change Handle Position from ON to OFF, or OFF to ON You Must...		
	Remove Padlock	Remove Device	Remove Loadcenter Deadfront
Lockoff escutcheon mounted	Remove	—	—
Lockoff handle mounted	Remove	Remove	—
Lockoff screw mounted	Remove	—	—
Lockdog escutcheon mounted	N/A	Remove	Remove
Lockdog handle mounted	N/A	Remove	—

**Notes**

- ① Must be purchased in multiples of ordering quantities indicated.
- ② Add suffix indicated to end of breaker catalog number.

### Wiring Diagrams

**Single-Pole 120 V Load Application Sourced by 120/240 Vac**

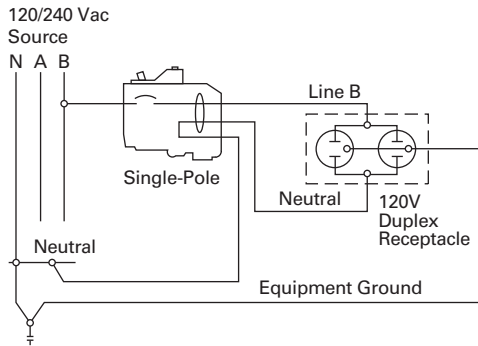

**Two-Pole Shared Neutral with Duplex Receptacle Application**

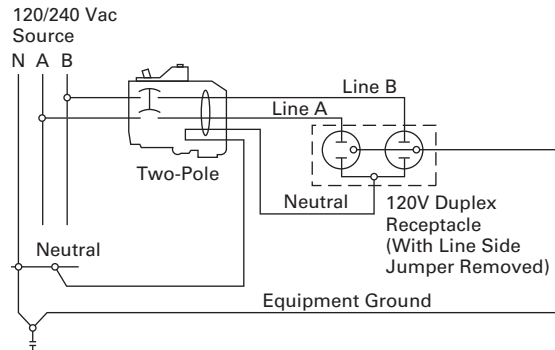

**Two-Pole Shared Neutral with Multi-Duplex Receptacle Application**

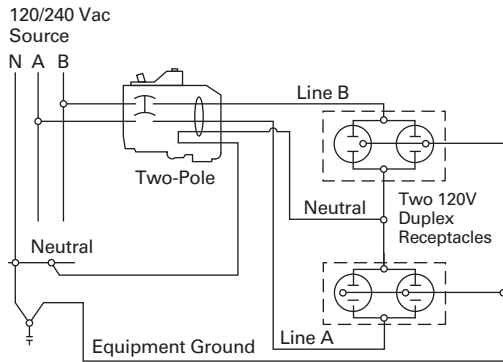

**Single-Pole 120 V Load Application Sourced by 120/240 Vac**

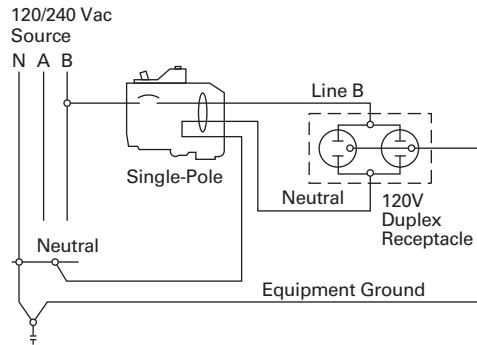

**Two-Pole 240 V Load Application Sourced by 120/240 Vac**

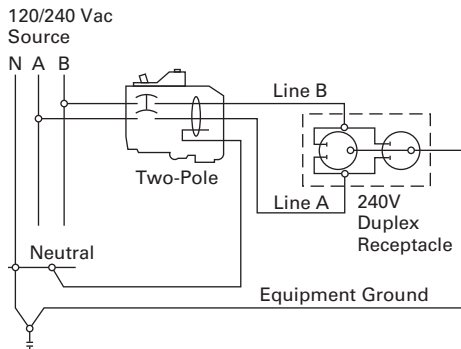

**Single-Pole 120 V Duplex Receptacle Application**

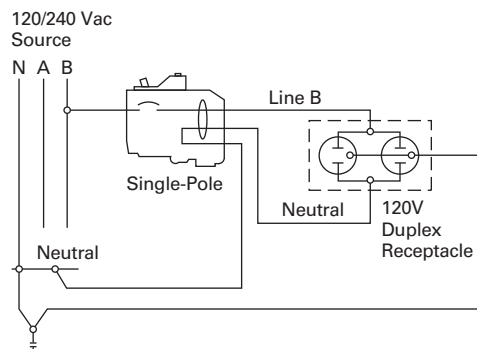

# 1.2

## Loadcenters and Circuit Breakers

Type BR Loadcenters and Circuit Breakers

1

### Two-Pole 120 V Multi-Duplex Receptacle Application

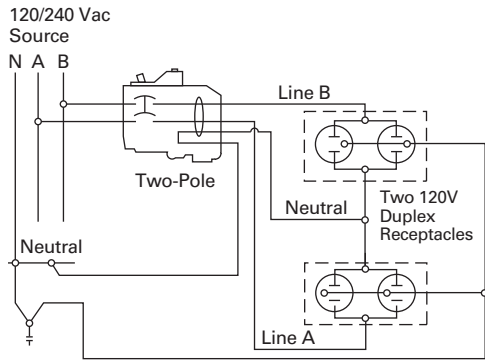

### Two-Pole 120 V Duplex Receptacle Application

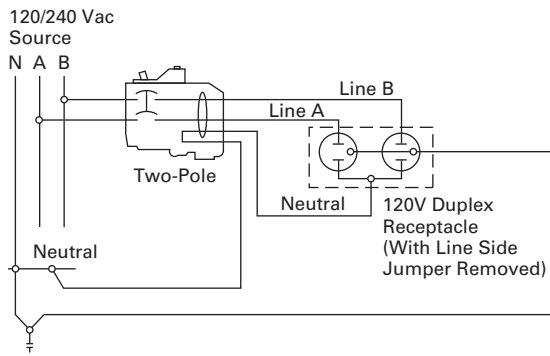

### Two-Pole 240 V Duplex Receptacle Application

