

Two-Piece Steel Surface Raceway

Available Factory Prewired

3000 Series Raceway provides wiring capacities for small to medium size installations. Power, communication, or A/V devices can be wired into the raceway for a flush appearance satisfying both aesthetic and functional requirements.

3000 Series Raceway is ideally suited for wiring applications in frequently changing environments such as labs, hospitals and other industrial applications.



3000 Series Raceway shown utilizing data inserts and electrical devices.

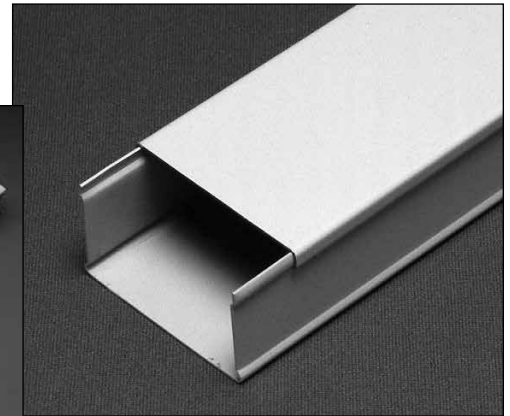

3000 Series Single Channel Raceway has an overlapping cover allowing easy installation and future changes.

FEATURES & BENEFITS

- **Entrance knockouts spaced at regular intervals along length of base.** Allows power wiring, communication, or A/V cables to be brought in at a convenient point.
- **Mounts easily on walls, modular furniture, under raised floors, or over ceiling.** Speeds installation; provides flexibility to bring wiring to points of use.
- **Removable cover.** Provides access to wiring.
- **Accommodates a variety of receptacles, three-pole circuit breaker housings, and other protective devices.** Provides flexibility for sophisticated wiring systems.
- **Complete line of fittings.** Provides a complete wiring solution and allows for interconnection between raceway systems.
- **Available prewired.** Manufactured to specified job site lengths, raceway comes electrically prewired, ready to install. Jobs can be packaged by room, area, floor, or building and shipped per your job site requirements.
- **Electrical device identification for prewired raceway.** See page six for labeling options. Eliminates guesswork or time-consuming circuit tracing and speeds additions and renovations.
- **Compatible with A/V devices by using 5507 Series Faceplates.**
- **Gray baked enamel and ivory ScuffCoat™ finish.** Durable ivory ScuffCoat finish makes a scratch resistant surface.
- **Base and cover cutters.** Manually operated cutters are lightweight and portable. Cutters offer labor savings for any size job and maintain a factory clean and square cut.
- **Datacom connectivity options.** Accepts industry standard and proprietary devices from a wide range of manufacturers to provide a seamless and aesthetically pleasing interface for voice, data, audio, and video applications at the point of use.
- **UL Listed factory wired sections.** Listed by Underwriters Laboratories Inc. Factory wired sections file number E68073 Guide (PVG7)/ Fittings file number E41751 Guide (RJPR).
- **UL5 and ADA compliant.** Raceway and fittings meet UL5 specifications and can be installed in conformance with ADA requirements.
- **UL Listed and CSA Certified raceway.** Listed by Underwriters Laboratories Inc. Raceway file number E4376 Guide (RJBT)/ Fittings file number E41751 Guide (RJPR) CSA Certified LR350.



PEP
eco
PASS
PORT®

Download this product's PEP ecopassport® environmental product declaration at www.legrand.us/resources-and-downloads. This declaration conforms with ISO 14025 and 14040 and is in alignment with EN 15804.

3000 Series System Layout

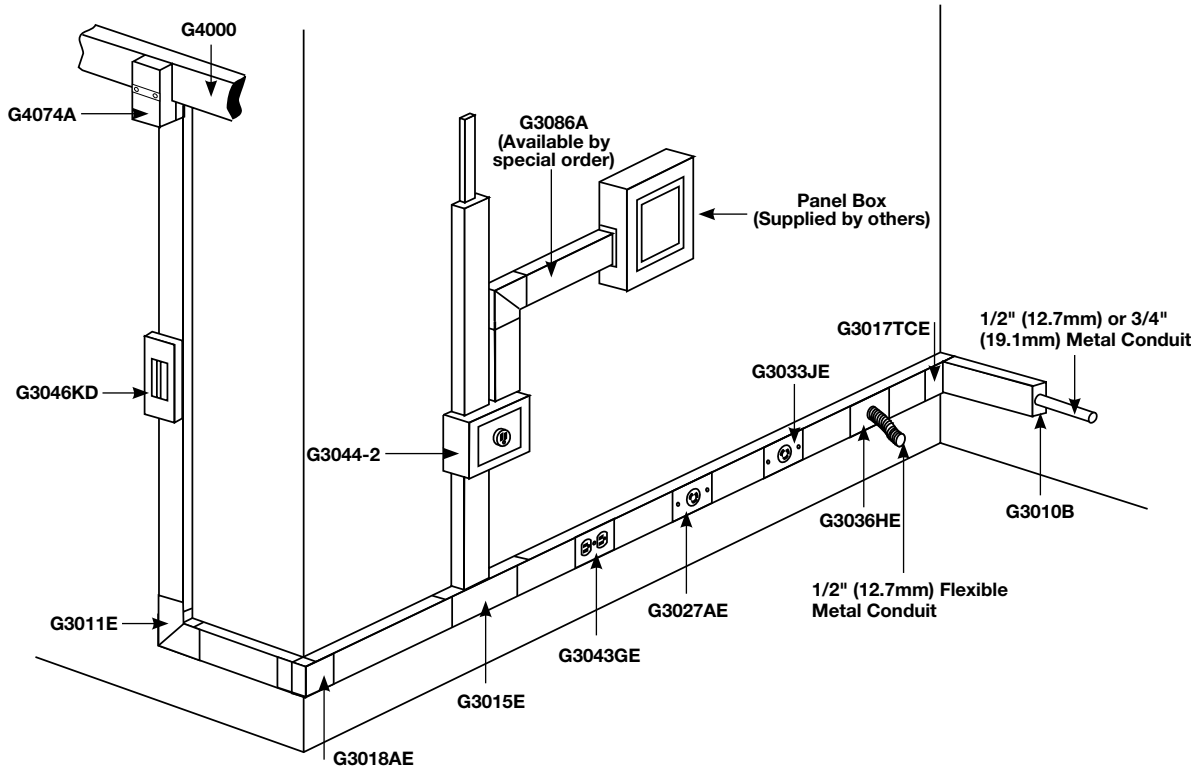

NOTE: Illustration is for showing product applications only.

3000 Series Raceway Ordering Information

Catalog No./Item	Description/Specifications	Catalog No./Item	Description/Specifications
G3000B V3000B 	Base – .040" steel, Packed 100 ft. per carton, ten 10 ft. (3.05m) lengths.	G3000C195 V3000C195 	19.5" (495mm) Precut Cover – For mounting devices on 24" (610mm) centers with 3033JE, 3036HE, 3040CE, 3043, 3048R, 3027AE, and 3051LE Series plates.
G3000CE V3000CE 	Cover – .040" steel. Packed 100 ft. per carton, (20) 5 ft. (1.50m) lengths.	630B 	Base Cutter – Portable base cutter. Provides clean and easy square cuts. Manual operation required.
G3000C075 V3000C075 	7.5" (191mm) Precut Cover – For mounting devices on 12" (305mm) centers with 3033JE, 3036HE, 3040CE, 3043, 3048R, 3027AE, and 3051LE Series plates.	630BDK 	Replacement Blade Kit –
		630C 	Cover Cutter – Portable cover cutter. Provides clean and easy square cuts. Manual operation required.
		630CDK 	Replacement Blade Kit –

3000 Series Raceway Ordering Information (continued)

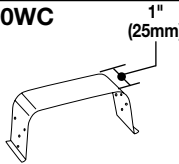
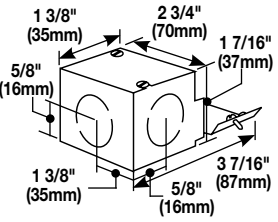
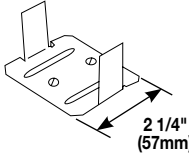
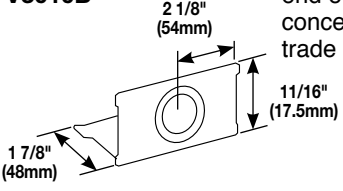
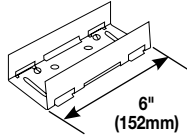
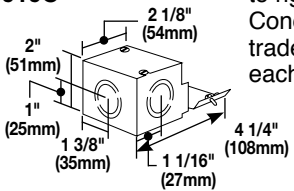
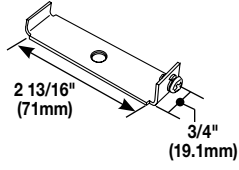
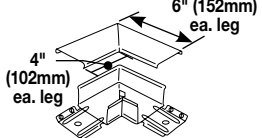
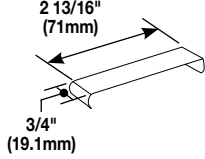
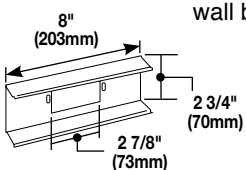
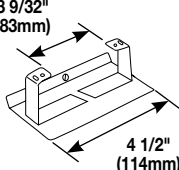
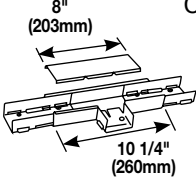
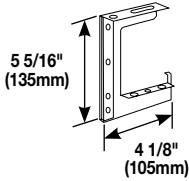
Catalog No./Item	Description/Specifications	Catalog No./Item	Description/Specifications
G3000WC 	Wire Clip (Plated) – For holding conductors in place.	V3010AE G3010AE 	Entrance End – For connecting to 1/2" conduit and armored cable connectors. 1/2" trade size KO on end and each side. May be connected to conduit boxes by using 1/2" (12.7mm) chase nipple. (not included)
G3001 	Coupling (Galvanized Steel Unpainted) – For joining lengths of 3000 Series Raceway.	G3010B V3010B 	Blank End – For closing open end of 3000 Series Raceway. Has concentric 1/2" and 3/4" trade size KOs.
G3001A 	Rigid Inside Coupling (Galvanized Steel Unpainted) – For joining lengths of 3000 Series Raceway when added rigidity is required, i.e. raceway suspended overhead.	G3010C V3010C 	Entrance End – For connecting to rigid or flexible conduit. Concentric 1/2", 3/4", and 1" trade size KOs on end and each side.
G3003 	Supporting Clip – For supporting lengths of 3000 Series Raceway at any point. Mount with #8 flat head fastener. Has set screw for locking to raceway.	G3011E V3011E 	90° Flat Elbow – For right angle turns on same surface.
G3006E/V3006E 	Cover Clip – For covering uneven cut joint of 3000 Series Raceway Cover.	G3014C V3014C 	Wall Box Connector – For connecting from flushed-in wall box.
G3007C 	Device Bracket – For mounting standard single-gang devices (with 3.3" (83.82mm) mounting straps), Activate Connectivity inserts and faceplates. Can be used with commercially available flush plate (not furnished).	G3015E V3015E 	Tee – For branches at right angles. Couplings furnished.
G3008C 	C-Hanger – For suspending 3000 Series Raceway from structural ceiling. Designed for use with 3/8" (9.5mm) threaded rod. Use one hanger at least every 5 feet (1.5m) of length.		

✱Add C prefix to denote Canadian version – CSA Certified.

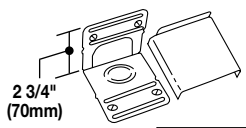
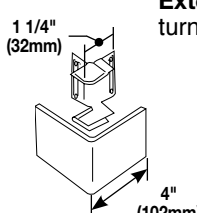
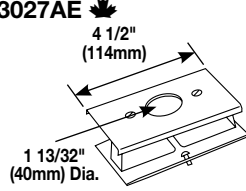
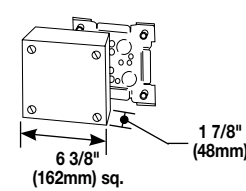
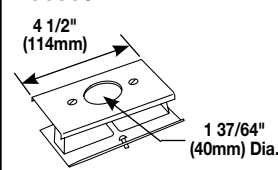
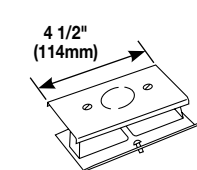

3000 Series Raceway Ordering Information (continued)

Catalog No./Item	Description/Specifications												
V3017TCE G3017TCE 	Internal Corner Coupling – For surfaces at right angles, or for use as a straight-through fitting. Solid leg of base has concentric 1/2" and 3/4" trade size KO. <table border="1" style="margin-top: 10px; width: 100%; text-align: center; border-collapse: collapse;"> <tr> <td></td> <td>#6 AWG</td> <td>#8 AWG</td> <td>#10 AWG</td> <td>#12 AWG</td> <td>#14 AWG</td> </tr> <tr> <td>THNN, THWN</td> <td>13</td> <td>18</td> <td>24</td> <td>55</td> <td>75</td> </tr> </table>		#6 AWG	#8 AWG	#10 AWG	#12 AWG	#14 AWG	THNN, THWN	13	18	24	55	75
	#6 AWG	#8 AWG	#10 AWG	#12 AWG	#14 AWG								
THNN, THWN	13	18	24	55	75								
Wire capacity when used as a straight through fitting.													
G3018AE V3018AE 	External Corner – For right angle turns around external corners.												
G3027AE 🌿 V3027AE 🌿 	Single Receptacle Cover – For installing commercially available straight blade and locking single receptacles with face diameters of 1.38-1.40" (35.1-35.6mm). G3007C Device Bracket included.												
G3028 V3028 	Utility Box – Cover has twistouts on four sides. May be used as a tee, cross, junction box, or for branch circuit extensions. Base has five 1/2" trade size KOs and four holes for fixture stud.												
G3033JE 🌿 V3033JE 🌿 	Single Receptacle Cover – For installing of commercially available straight blade and locking single receptacle with face diameters of 1.56-1.57" (39.6-40mm). G3007C Device Bracket included.												
G3036HE 🌿 V3036HE 🌿 	Blank Cover – Cover has 1/2" trade size KO in center. G3007C Device Bracket included.												

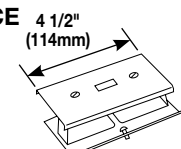
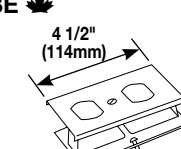
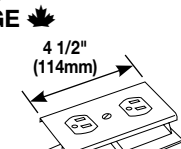
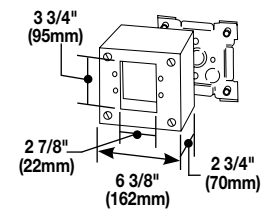
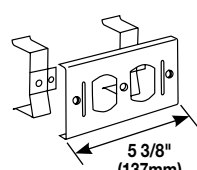
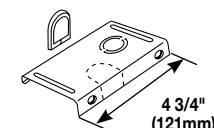
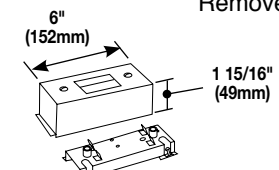
..Add C prefix to denote Canadian version – CSA certified.

Catalog No./Item	Description/Specifications
G3040CE V3040CE 	Switch Cover – For installing commercially available single-pole, two-pole, three-way or four-way switches. G3007C Device Bracket included.
G3043BE 🌿 V3043BE 🌿 	Duplex Receptacle Cover – For installing commercially available 15A and 20A duplex receptacles. G3007C Device Bracket included. Accepts 106 Frame.
G3043GE 🌿 V3043GE 🌿 	Duplex Grounding Receptacle and Cover – Same as 3043BE except with 15A/125V (NEMA 5-15R) grounding receptacle furnished. G3007C Device Bracket included.
G3044-2 🌿 V3044-2 🌿 	Extra Deep Switch and Receptacle Box – Two-gang. For standard 30, 50, and 60A receptacles. Two sides of cover have one set of combination twistouts for 3000 and 2100 Series Raceway: two sides have two sets. Rectangular hole-cut in cover: 3 3/4" x 2 7/8" (95mm x 73mm). Base has 1" and 1 1/2" trade size concentric KOs.
G3046BE 🌿 V3046BE 🌿 	Duplex Receptacle Cover – For installing commercially available 15A and 20A duplex receptacles.** Accepts 106 Frame.
G3046H-2 V3046H-2 	Tap-Off Fitting – Has concentric 1/2" and 3/4" trade size KOs and twistout for telephone cables. Grommet furnished for telephone KO.
V3046KD G3046KD 	Circuit Breaker Housing – For covering single pole breaker. Remove KO for two-pole.

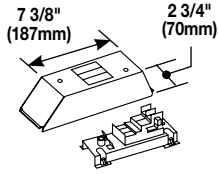
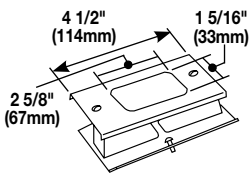
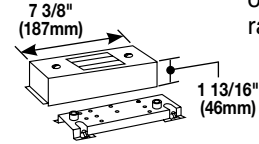
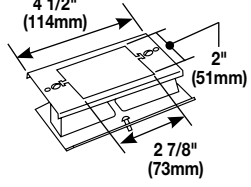
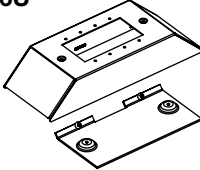
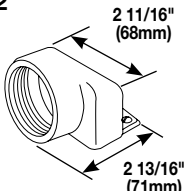
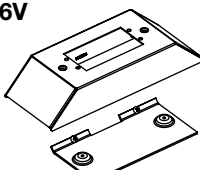
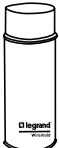
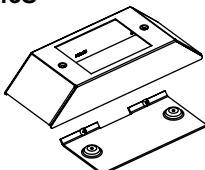
3000 Series Raceway Ordering Information (continued)

Catalog No./Item	Description/Specifications	Catalog No./Item	Description/Specifications												
G3046KTSQ/ V3046KTSQ 	Circuit Breaker Housing – For mounting Square D Quik-Gard QOB bolt-on circuit breakers rated up to 50A maximum. Furnished with Square D QON3B compact base for single to Three-pole circuit breakers. For GFI breakers, use Square D QOB-GFI Series.	G3048R V3048R 	Rectangular Receptacle Cover – For installing commercially available 15A and 20A rectangular receptacles. G3007C Device Bracket included. <ul style="list-style-type: none"> • Accepts Decorator style communication devices 												
G3046QOU V3046QOU 	Circuit Breaker Housing – For mounting Square D Type QOU one-, two-, or three-pole breakers rated up to 50A maximum.	G3051LE V3051LE 	Extension Cover – Accepts shallow-type 30A and 50A devices and flush plates. Deeper devices can be accommodated with a combination of 3051LE and any of the V5700 Series single-gang, open base boxes. G3007C Device Bracket included. <ul style="list-style-type: none"> • Accepts standard single-gang faceplates. 												
	<table border="1" style="margin-left: auto; margin-right: auto;"> <thead> <tr> <th></th> <th>#6 AWG</th> <th>#8 AWG</th> <th>#10 AWG</th> <th>#12 AWG</th> <th>#14 AWG</th> </tr> </thead> <tbody> <tr> <td>THNN, THWN</td> <td>6</td> <td>8</td> <td>10</td> <td>18</td> <td>26</td> </tr> </tbody> </table> <p>Wire capacity of 3000 Raceway with 3046KD, KTSQ, QOU circuit breaker housings.</p>		#6 AWG	#8 AWG	#10 AWG	#12 AWG	#14 AWG	THNN, THWN	6	8	10	18	26		
	#6 AWG	#8 AWG	#10 AWG	#12 AWG	#14 AWG										
THNN, THWN	6	8	10	18	26										
V3046U G3046U 	Bump-Up Extron® MAAP Plate – Device plate for use with four Extron® Electronics MAAP single space modules.	G3082 	Conduit Connector – To connect end of 3000 Series Raceway with 1 1/2" trade size conduit or armored cable.												
V3046V G3046V 	Bump-Up Extron® AAP Plate – Device plate for use with two Extron® Electronics AAP single space modules.	IWE-S GWE-S 	Spray Paint – Used for touching up large areas. Contains 12 oz. of paint. <p>NOTE: Can only be shipped via ground transportation.</p>												
V3046S G3046S 	Bump-Up Ortronics® Series II Plate – Device plate for use with two Extron® Electronics AAP single space modules.	IWE-P GWE-P 	Touch-Up Paint Pen – Used for touching up small areas. Contains 0.3 oz. of paint.												

..Add C prefix to denote Canadian version – CSA certified.

3000 Series Raceway Prewired Features

FEATURES	STANDARD	OPTIONS
Communication Devices	Ortronics or Activate Connectivity System Devices	Other manufacturers
Electrical Devices	Pass & Seymour	Other manufacturers and some International devices
Body Length	Longest = 10' (2.54m), shortest = 1' (305mm)	—
Installation	Surface mounted	—
Finish	Baked enamel finish custom colors	Standard colors of baked powder epoxy or
Wire Type	THHN stranded	Options per specification
Wiring Splices	Insulation displacement connectors	Continuous wiring or twist-on wire connector
Grounding Conductors	Wire gauge per National Electrical Code (NEC) and shared grounding wires	Oversized and/or separate grounding wires
Device Identification	Gray self-adhesive polyester label with black letters devices available	Self-adhesive engraved nameplate, Interlink labeling software for communication
Neutrals	Shared neutral	Oversized and/or separate neutral wires
Pigtails	12" (305mm) feeds and receptacle leads	Per specification
Conduit Feeds	Raceway drilled at job site	Entrance end cap
Device Mounting	Steel plates	—
Record Drawings	Three sets and two copies of marked-up blueprints	Per job requirements
Submittal Services	Detailed submittal	Submittal free

3000 Series Ordering Specifications for Prewired Applications

Two options available when ordering a prewired job:



3000 Series Raceway shown electrically prewired.

- 1. Detailed Submittal** The detailed submittal will show exactly how each raceway run will be built including lengths, number and type of receptacles, wiring schematics, circuiting information, etc. The contractor and/or distributor must review, clarify any information not clearly indicated on the drawings or specs, approve and return to the factory before production can begin.
- 2. Submittal Free** The Wiremold Prewired XPressSM Building Plan Checklist is filled out by the contractor or distributor and sent along with plans, casework and specs to the factory. No submittal is required and the project is scheduled for production upon receipt of all necessary information.

Device and Raceway Labeling Detail for Prewired Applications

- Device labeling is available in the following materials:

 - Gray self-adhesive polyester label with black lettering (standard).
 - Other color self-adhesive polyester labels.
 - Engraved phenolic nameplates with adhesive backing.
- The back of the raceway is labeled with the raceway number and the room or area number(s).



3000 Series Raceway Wire Fill Capacities

3000 Series Raceway Wire Fill Capacities For Power

WIRE SIZE THHN/THWN	O.D. inches (mm)		NUMBER OF CONDUCTORS (40% Fill)			
			WITHOUT DEVICES	WITH DUPLEX/ RECT. DEVICES 1.59 in. ² (1025mm)	WITH SURGE/ GFCI DEVICES 2.30 in. ² (1485mm)	LARGE SINGLE RECEPTACLES 3.00 in. ² (1935mm)
14 AWG	0.111	(2.8)	152	70	40	28
12 AWG	0.130	(3.3)	111	51	29	21
10 AWG	0.164	(4.2)	70	32	18	13
8 AWG	0.216	(5.5)	40	18	10	7
6 AWG	0.254	(6.5)	29	13	7	5

3000 Series Raceway Cable Fill Capacities for Communications

	CABLE/WIRE SIZE	O.D.		40% FILL
		Inches	(mm)	
UNSHIELDED TWISTED PAIR	4-PAIR, 24 AWG Cat 3	0.190	(4.8)	52
	4-PAIR, 24 AWG Cat 5e	0.210	(5.3)	42
	4-PAIR, 24 AWG Cat 6	0.250	(6.3)	30
	4-PAIR, 24 AWG Cat 6a*	0.354	(8.9)	15
	25-PAIR, 24 AWG	0.410	(10.4)	11
COAXIAL	RG6/U	0.270	(6.9)	25
FIBER	ZipCord	0.118 x 0.236	(3 x 6)	53
	Round 4 Strand Fiber	0.187	(4.5)	53
	Round 6 Strand Fiber	0.256	(6.5)	28

* Category 6 augmented (6a) cable for 10 gigabit ethernet – max allowed cable diameter per addenda No. 11 ANSI TIA/EIA 568-B.2.

NOTES



Electrical Wiring Systems

60 Woodlawn Street
West Hartford, CT 06110
Phone: 1.877.BY.LEGRAND (295-3472)
www.legrand.us

570 Applewood Crescent
Vaughan, Ontario L4K 4B4
Phone: 905.738.9195
www.legrand.ca

