

PIR CEILING MOUNT OCCUPANCY SENSOR

LMPC-100



Description

The LMPC-100 low profile Digital PIR Ceiling Mount Occupancy Sensor uses passive infrared (PIR) technology and one of three lenses to detect occupancy in different types of spaces for energy-efficient control of lighting and plug loads. It is a digital sensor, and is part of a Wattstopper Digital Lighting Management (DLM) system.

Operation

The LMPC-100 operates on Class 2 power supplied to a DLM local network by one or more DLM room controllers. It works with the room controller(s) to turn loads on and off based on occupancy. Default operation is established by Plug n' Go, which automatically configures system components to maximize energy savings. Initially, all occupancy sensors control all loads on the same local network. Each LMPC-100 may be assigned to a specific load; load assignments and load parameters may be changed using Push n' Learn. The LMPC-100 may be reconfigured either using the pushbuttons and an LCD screen conveniently located behind the snap-off front sensor cover, or with a wireless configuration tool.

Features

- Plug n' Go™ automatic configuration for quick installation and maximum energy savings
- Push n' Learn™ functionality for customization without the need for tools or a PC
- Digital Lighting Management components plug together on a free-topology Category 5e DLM local network
- Infrared (IR) transceiver for wireless configuration and control
- 360 degree PIR coverage
- Detection Signature Processing eliminates false triggers and provides immunity to RFI and EMI
- Sensor coverage tested to NEMA Guide Publication WD 7-2000
- The product meets the materials restrictions of RoHS
- BAA/TAA-compliant models available

Digital Settings and IR Communications

The LMPC-100 includes a unique, easy-to-access, LCD screen that displays sensor parameters and simplifies changing those parameters. Time delay and sensitivity can be precisely adjusted and walk through mode can be activated. Changes are made at the sensor with easy-to-use pushbuttons, or via a wireless configuration tool that communicates with the sensor using a bi-directional infrared (IR) signal. The LMPC-100 IR transceiver allows wireless system operation in addition to configuration. The LCD display also facilitates system personalization, showing load information when in Push n' Learn mode.

Applications

The LMPC-100 sensors, with different lenses for different spaces, are ideal for high and low ceiling areas including open offices, computer rooms, conference rooms, classrooms, warehouses and gyms. Sensor coverage for walking motion is approximately 1,000 square feet using the extended range lens, 450 square feet using the high density lens and 3,800 square feet using the extended height lens. The high density lens is ideal for detecting desktop activity, and small motion coverage is up to 300 square feet.

PROJECT	LOCATION/ TYPE

Specifications

- Input voltage: 24VDC from DLM network
- Current consumption: 7mA
- DLM local network connection: 2 RJ45 ports
- LCD display and pushbuttons for setting sensor and system parameters
- Infrared (IR) transceiver
- Operating conditions: for indoor use only; 32-104°F (0-40°C); 5-95% RH, non-condensing
- UL and cUL listed
- FCC part 15 compliant
- Five year warranty

Controls & Dimensions

Product Controls and Sensor Settings

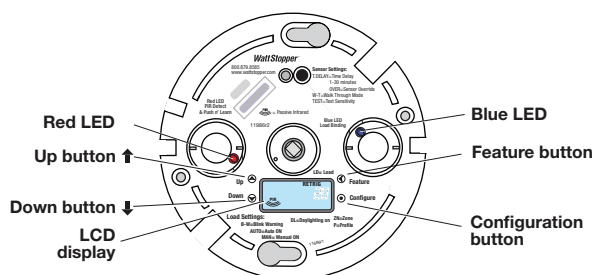

Product Dimensions

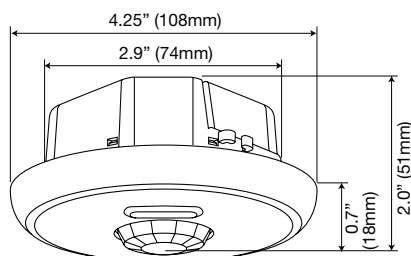

Sensor Parameter	Available Options	Default Setting
Time Delay	1-30 min. (1 min. increments) /Override	20 minutes
Walk Thru	On/Off	Off
PIR Sensitivity	10-100% (10% increments)/Off	90%
Test Mode	Activate	Off

Mounting & Connecting

Sample Connection Diagram

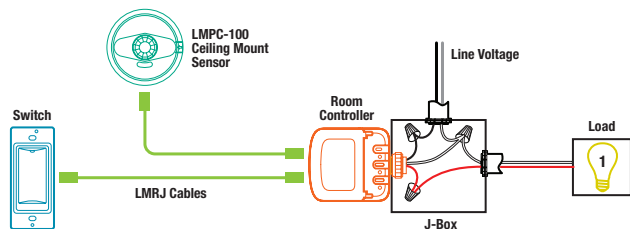

Plug DLM local network components together in any configuration using Cat 5e cables with RJ45 connectors.

Mounting Options

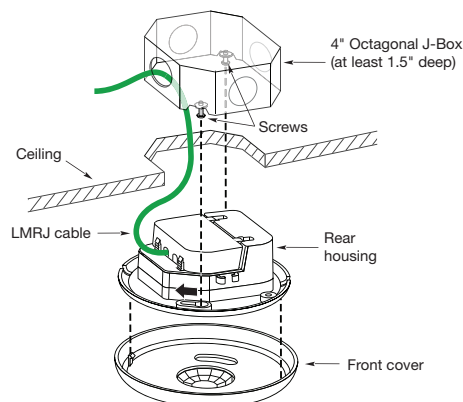

Mount to a 4" octagonal box (as shown) or directly to ceiling tile using spring clips (included). Box mounting required for plenum rating. See installation instructions for more details.

Coverage

Coverage Patterns

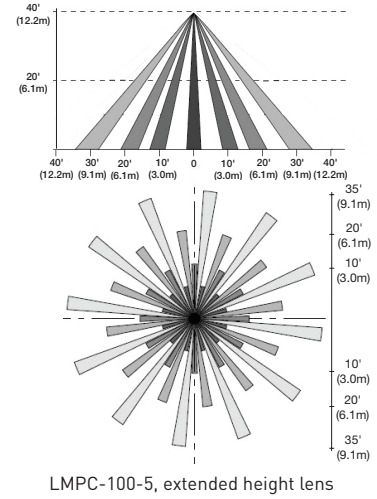
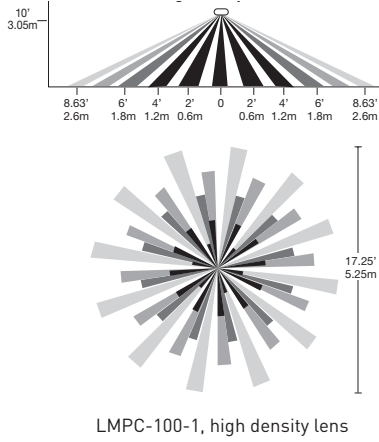
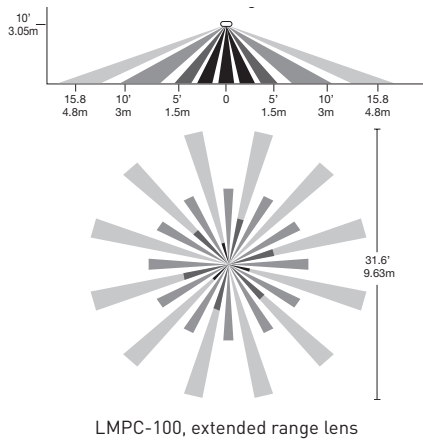

Ordering Information

Catalog #	Color	Description
<input type="checkbox"/> LMPC-100	White	Digital PIR Ceiling Mount Occupancy Sensor, extended range lens
<input type="checkbox"/> LMPC-100-U	White	Digital PIR Ceiling Mount Occupancy Sensor, extended range lens, BAA/TAA-compliant*
<input type="checkbox"/> LMPC-100-1	White	Digital PIR Ceiling Mount Occupancy Sensor, high density lens
<input type="checkbox"/> LMPC-100-1-U	White	Digital PIR Ceiling Mount Occupancy Sensor, high density lens, BAA/TAA-compliant*
<input type="checkbox"/> LMPC-100-5	White	Digital PIR Ceiling Mount Occupancy Sensor, extended height lens

*Product is compliant with Buy American Act and Trade Agreement Act