

CAT#	A	B	C
120	.814	.44	.92

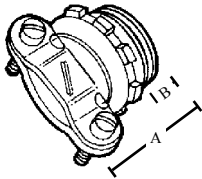

CAT#	A	B
952	1.03	.42
953	1.20	.57
954	1.32	.64
955	1.32	.60
956	1.55	.71

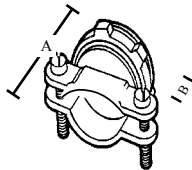

CAT#	A	B
143R	1.190	.645
144R	1.330	.660
145R	1.470	.740
146R	1.620	.750

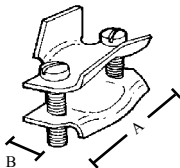

CAT#	A	B
441	1.310	.640
442	1.750	.765
444	2.120	.765
445	2.500	.780

## NM CLAMP TYPE CONNECTORS

- NON-WATERTIGHT
- TWO SCREWS

ZINC DIE CAST

TOPAZ CAT #	UPC#	SIZE	FITS CABLE	UNIT CTN	SHIP CASE	WT/ CASE
<b>3/8" NM CABLE</b>						
120	10690	1/2"	NM CABLE FROM 2#14-2 W/GROUND AND 2#12-2 W/GROUND	100	1000	50

### FOR OVAL NM CABLE

952	19500	3/4"	OVAL NM 8-2 TO 6-3	25	250	25
953	19510	1"	OVAL NM 8-3 TO 4-3	25	250	37
954	19520	1 1/4"	OVAL NM 4-3 TO 1-3	10	100	24
955	19530	1 1/2"	OVAL NM 1-3 TO 1/0-3	10	100	34
956	19540	2"	OVAL NM 1/0-3 TO 4/0-3	5	50	45

All above take 2 cables

### FOR NM & SE CABLE

- ROUND CABLE

143R	10950	1"	SE CABLE 6-3, 4-3, 4-2, 2-2 NM CABLE 12-3, 12-4, 10-3, 10-4 8-3, 8-2, 6-2, 4-2	25	250	37
144R	10960	1 1/4"	SE CABLE 10-2, 8-2, 6-2, 4-2 NM CABLE 8-3, 6-3, 4-3, 2-3	10	100	24
145R	10970	1 1/2"	SE CABLES 3-3, 3-2, 3-1	5	50	34
146R	10980	2"	SE CABLES 3-4/0	5	50	23



## NM BOX CONNECTORS

- TWO PIECE CLAMP BUTTERFLY TYPE

STEEL

TOPAZ CAT #	UPC#	SIZE	FITS CABLE	UNIT CTN	SHIP CASE	WT/ CASE
441	13990	3/8" TO 1/2"	2 OR 3#14, 12, 10, 8	100	1000	50
442	14000	3/4" TO 1"	2 OR 3#8, 6, 4	50	500	35
444	14010	1 1/4"	#2/0	25	250	25
445	14020	1 1/2"	#3/0, #4/0	25	250	40



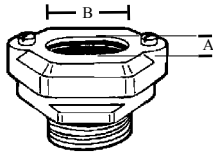

CAT#	FITS CABLE	GROMMET OPENING	
		A	B
873C	2#2	.625 X	1.00
874C	3#2	.625 X	1.00
875C	3#2	.625 X	1.00
876E	3#4/0	.830 X	1.415

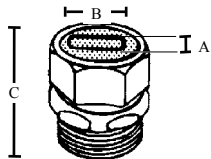

CAT#	FITS CABLE	GROMMET OPENING		
		A	B	C
873	3#8	.410 X	.650	1.875
873A	3#6	.460 X	.715	1.875
873B	3#4	.530 X	.850	1.875
874	3#3	.550 X	.910	1.937
874A	3#2	.580 X	.960	1.937
874B	3#1	.660 X	1.120	1.937
875	3#1/0	.705 X	1.195	2.375
875A	3#2/0	.740 X	1.235	2.375
876	3#1/0	.750 X	1.195	2.250
876A	3#2/0	.890 X	1.540	2.250
876B	3#3/0	.740 X	1.235	2.250
876C	3#4/0	.830 X	1.415	2.250
876D	3#4/0	.995 X	1.580	2.250
871/S	2#14	.220 X	.440	1.437
872/S	3#14	.220 X	.660	1.750

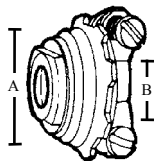

CAT#	A	B (RANGE)
140	1.192	.18-.63

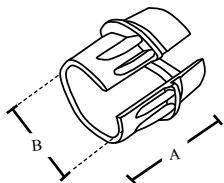

CAT#	A	B
RCR50	.93	.50
RCR75	.92	.75

## WATER TIGHT CONNECTORS

ZINC DIE CAST

TOPAZ CAT #	UPC#	WIRE SIZE	SIZE	UNIT CTN	SHIP CASE	WT/ CASE
-------------	------	-----------	------	----------	-----------	----------

FOR TYPE SE, STYLE U FLAT  
2 INSULATING CONDUCTORS, 1 BARE

• 2 SCREW TYPE

873C	18749	2#2 2 screw	1"	10	100	20
874C	18801	3#2 2 screw	1 1/4"	10	100	52
875C	18823	3#2	1 1/2"	5	50	44
876E	18871	3#4/0	2"	5	50	44

• COMPRESSION TYPE

873	18750	3#8	1"	10	100	34
873A	18760	3#6	1"	10	100	34
873B	18770	3#4	1"	10	100	34
874	18780	3#3	1 1/4"	10	100	52
874A	18790	3#2	1 1/4"	10	100	52
874B	18800	3#1	1 1/4"	10	100	52
875	18810	3#1/0	1 1/2"	5	50	33
875A	18820	3#2/0	1 1/2"	5	50	32
876	18830	3#1/0	2"	5	50	44
876A	18840	3#2/0	2"	5	50	44
876B	18850	3#3/0	2"	5	50	44
876C	18860	3#4/0	2"	5	50	44
876D	18870	3#4/0	2"	5	50	44

FOR UF CABLE

871	18730	14-2 12-2 10-2	1/2"	25	250	43
872	18740	14-3 12-3 10-3	3/4"	25	250	65
871S	18731	14-2 12-2	1/2" STEEL	25	250	30
872S	18741	14-3 12-3 10-3	3/4" STEEL	25	250	45

## COMBINATION CONNECTORS

ZINC DIE CAST

TOPAZ CAT #	UPC#	BX-FLEX SIZE	KO SIZE	UNIT CTN	SHIP CASE	WT/ CASE
-------------	------	--------------	---------	----------	-----------	----------

FOR BX-FLEX, NM, AND MC CABLE

• 2 SCREW CLAMP TYPE

140	10920	3/8"	1/2"	100	1000	60
		FITS MC RANGE .400-.500				

## CABLE CONNECTORS

• NM Sheathed

PLASTIC

TOPAZ CAT #	UPC#	SIZE	UNIT CTN	SHIP CASE	WT/ CASE
RCR50	85170	1/2"	100	1000	4.1
RCR75	85171	3/4"	50	500	3.3

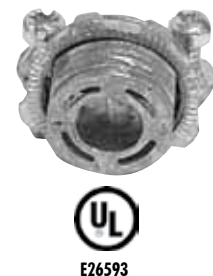

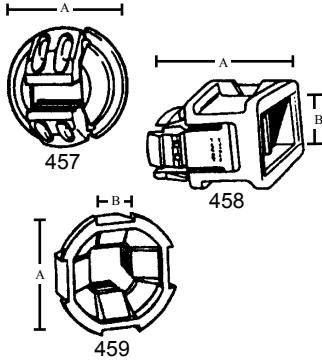

CAT#	A	B
457	1.00	—
458	1.25	.25
459	1.0938	.375

## NM SNAP-IN CONNECTORS

TOPAZ		KO		UNIT	SHIP	WT/
CAT #	UPC#	SIZE	SIZE	CTN	CASE	CASE
457	14091	1/2"	14/2 & 12/2	100	1000	1.38
458	14092	1/2" 2-WIRE	TWO: 14/2 OR 12/2 ONE: 14/2 OR 12/2 ONE: 14/2 OR 10/2 ONE: 12/2 OR 10/2	50	500	.14
459	14093	3/4"	ONE: 14/3 OR 12/3 ONE: 10/2, 8/3 OR 6/3	50	500	.44

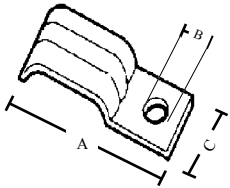

CAT#	A	B	C
510RX	1.08	.28	.50

## NM STRAP

TOPAZ		KO		UNIT	SHIP	WT/
CAT #	UPC#	SIZE	SIZE	CTN	CASE	CASE
510RX	15600	14/2, 12/2		100	1000	14

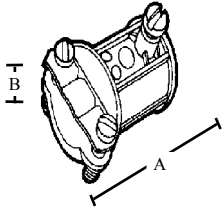

CAT#	A	B (MIN)	B (MAX)
180	1.35	.17	.63

## COMBINATION COUPLINGS

TOPAZ		KO		UNIT	SHIP	WT/
CAT #	UPC#	SIZE	SIZE	CTN	CASE	CASE
180	11410	1/2" - 3/8"		50	500	40

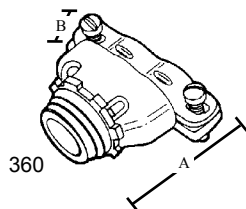
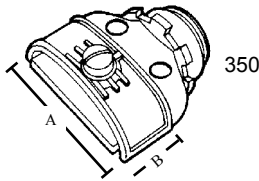
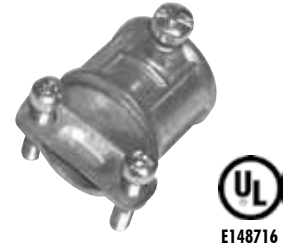

CAT#	A	B (MIN)	B (MAX)
350	1.57	.13	.650
360	1.59	.24	.630

## DUPLEX CONNECTORS

TOPAZ		KO		UNIT	SHIP	WT/
CAT #	UPC#	SIZE	SIZE	CTN	CASE	CASE
350	13490	3/8"	1/2"	25	250	32
360	13500	3/8"	1/2"	25	250	32

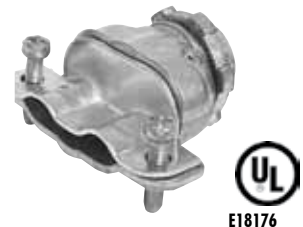
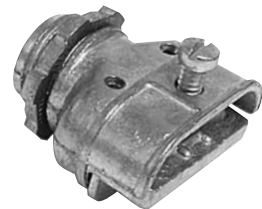

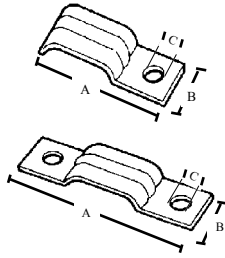

CAT#	A	B	C
501	1.695	.570	.25
502	1.950	.580	.25
503	2.480	1.000	.35
504	2.795	1.010	.35
506	2.395	.750	.25
507	2.740	.750	.25
508	3.150	.750	.25
509	3.485	.750	.25

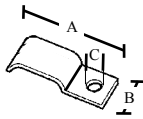

CAT#	A	B	C
232A	2.0625	.625	.25
282A	2.625	.75	.26
284A	2.9375	1.0	.32

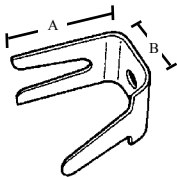

CAT#	A	B
135	1.420	.750
136	1.52	.750
137	1.620	.780
138	1.82	.890
139	2.20	1.000

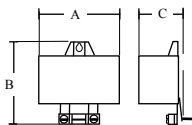

CAT#	A	B	C
709	4.25	5.00	2.00
710	6.00	5.19	2.50

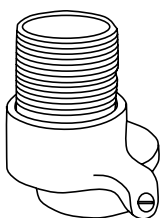

## SE STRAPS

ONE HOLE			STEEL		
TOPAZ CAT #	UPC#	SIZE	UNIT CTN	SHIP CASE	WT/ CASE
501	14870	3#8,6,4	100	1000	20
502	14880	3#3,2	100	1000	20
503	14890	3#1,1/0,2/0	25	250	18
504	14900	3#3/0,4/0	25	250	20

TWO HOLE					
TOPAZ CAT #	UPC#	SIZE	UNIT CTN	SHIP CASE	WT/ CASE
506	14910	3#3	100	1000	26
507	14920	3#3,2	100	1000	28
508	14930	3#1/0,2/0	25	250	11
509	14940	3#3/0,4/0	25	250	10

ONE HOLE			ALUMINUM		
TOPAZ CAT #	UPC#	SIZE	UNIT CTN	SHIP CASE	WT/ CASE
232A	12015	3# 8-4	100	1000	2
282A	12055	3# 1/0-2/0 SE	50	500	5
284A	12056	3# 3/0-4/0 SE	50	500	5



## SE LOCK OVER CLIPS

			ALUMINUM		
TOPAZ CAT #	UPC#	SIZE	UNIT CTN	SHIP CASE	WT/ CASE
135	10870	6/3	100	1000	8
136	10880	4/3	100	1000	10
137	10890	2/3	100	1000	15
138	10900	2/0	50	500	20
139	10910	4/0	50	500	25



## SERVICE ENTRANCE HOODS

			PVC		
TOPAZ CAT #	UPC#	SIZE	UNIT CTN	SHIP CASE	WT/ CASE
709	17432	3#3-1	-	10	28
710	17434	3#2/0-4/0	-	10	54



## RIGID OFFSET REDUCER

			ALUMINUM		
TOPAZ CAT #	UPC#	SIZE	UNIT CTN	SHIP CASE	WT/ CASE
1203	23386	2" x 1 1/4"	-	50	15



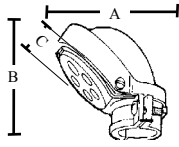

CAT#	A	B	C
731	2.93	2.62	2.00
732	3.25	2.75	2.37
733	3.50	3.25	2.62
734	4.50	3.25	3.00
735	5.00	4.75	3.31
736	6.75	6.00	4.62
737	10.50	7.50	6.00
738	11.50	9.00	8.00
739	12.00	9.00	8.00
740	12.00	9.00	8.00

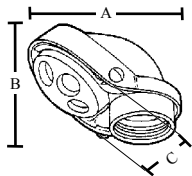

CAT#	A	B	C
741	2.68	2.60	2.00
742	3.80	2.72	2.37
743	3.32	3.11	2.62
744	4.46	3.20	3.00
745	4.85	4.34	3.31
746	6.62	5.44	4.62
747	9.74	7.80	6.00
748	10.50	8.00	8.00
749	13.02	9.39	8.00
750	13.14	8.54	8.00
750A	11.28	8.77	8.25
750B	12.25	9.76	8.25

## SERVICE ENTRANCE CAPS

ALUMINUM

TOPAZ CAT #	UPC#	SIZE	INS. HOLE SIZE	# HOLES	UNIT CTN	SHIP CASE	WT/ CASE
<b>CLAMP ON TYPE</b>							
731	17640	1/2"	19/64	4	10	50	12
732	17650	3/4"	3/8 13/32	2 3	10	50	15
733	17660	1"	7/16 1/2	2 3	5	25	8
734	17670	1 1/4"	27/64 5/8	2 3	5	25	10
735	17680	1 1/2"	19/32 7/16 3/4	2 1 3	3	15	11
736	17690	2"	17/32 3/4 1	1 2 3	-	5	9
737	17700	2 1/2"	7/8 1 1 5/16	3 1 3	-	1	4
738	17710	3"	7/8 1 1 5/16	3 1 3	-	1	6
739	17720	3 1/2"	1 1/8 1 3/4	4 3	-	1	6
740	17730	4"	1 1/8 1 3/4	4 3	-	1	7



## THREADED TYPE

ALUMINUM

TOPAZ CAT #	UPC#	SIZE	INS. HOLE SIZE	# HOLES	UNIT CTN	SHIP CASE	WT/ CASE
741	17740	1/2"	19/64	4	5	50	12
742	17750	3/4"	3/8 13/32	2 3	5	50	15
743	17760	1"	7/16 1/2	2 3	-	50	15
744	17770	1 1/4"	27/64 5/8	2 3	-	20	10
745	17780	1 1/2"	19/32 7/16 3/4	2 1 3	-	10	7
746	17790	2"	17/32 3/4 1	1 2 3	-	5	4
747	17800	2 1/2"	7/8 1 1 5/16	3 1 3	-	2	8
748	17810	3"	7/8 1 1 5/16	3 1 3	-	1	6
749	17820	3 1/2"	1 1/8 1 3/4	4 3	-	1	6
750	17830	4"	1 1/8 1 3/4	2 4	-	1	7
750A	17840	5"	1 1/8 1 3/4	2 4	-	1	12
750B	17850	6"	1 1/8 1 3/4	2 4	-	1	14



E170258

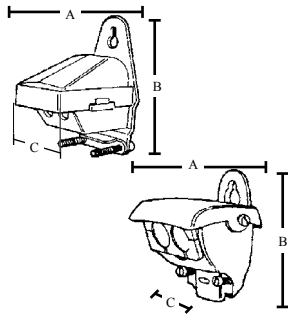

CAT#	A	B	C
727	2.75	2.75	1.87
728	4.25	4.25	3.00
729	4.25	4.25	3.00
707	2.37	2.25	2.25
708	4.93	3.12	3.75

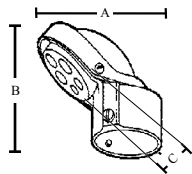

CAT#	A	B	C
704	4.75	4.00	3.12
705	5.25	4.00	3.00
706	7.00	5.50	4.50

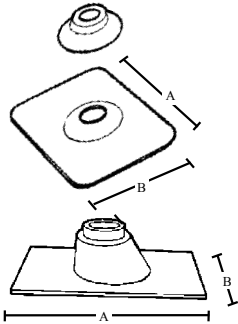

CAT#	A	B
984	12.50	8.75
985	12.50	8.75
986	14.50	10.75
987	14.50	10.75
994	11.50	9.00
995	11.50	9.00
996	11.50	9.00
997	13.50	10.00

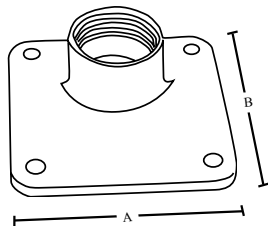

CAT#	A	B
9663	3.25	3.25
9674	3.25	3.25
9685	3.25	3.25
9696	3.25	3.25
9707	3.25	3.25

## SERVICE ENTRANCE CAPS

### THERMOPLASTIC

TOPAZ CAT #	UPC#	FITS CABLE	UNIT CTN	SHIP CASE	WT/ CASE
727	17610	2/3	—	30	8
728	17620	1/0,2/0	—	10	7
729	17630	3#2/0,#4/0	—	10	11

### WITH SPLIT INSULATOR ZINC DIE CAST

707	17400	3#8 TO 3#1	—	20	8
708	17430	1/0 TO 4/0	—	10	11

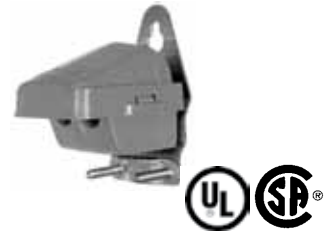

### SET SCREW TYPE

### ALUMINUM

TOPAZ CAT #	UPC#	PIPE SIZE	HEAD SIZE	UNIT CTN	SHIP CASE	WT/ CASE
704	17390	2"	1 1/4"	—	10	10
705	17400	2 1/2"	1 1/4"	—	10	20
706	17410	2 1/2"	2"	—	10	20

## ROOF FLASHINGS

### GALVANIZED WITH NEOPRENE SEAL

TOPAZ CAT #	UPC#	SIZE	UNIT CTN	SHIP CASE	WT/ CASE
984	19660	1 1/4"	—	25	9
985	19670	1 1/2"	—	25	9
986	19680	2"	—	25	12
987	19690	2 1/2"	—	25	14

### NEOPRENE

994	19730	1 1/4" - 1 1/2"	—	12	9
995	19740	2"	—	12	8
996	19750	2 1/2"	—	12	9
997	19760	3"	—	12	12

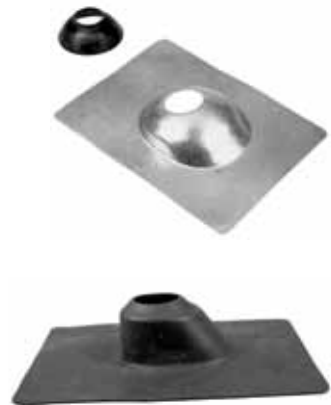

## METER HUBS

### ZINC DIE CAST

TOPAZ CAT #	UPC#	SIZE	UNIT CTN	SHIP CASE	WT/ CASE
9663	85021	1"	—	10	2.5
9674	85022	1 1/4"	—	10	2.3
9685	85023	1 1/2"	—	10	2.1
9696	85024	2"	—	10	2.0
9707	85025	2 1/2"	—	10	2.0



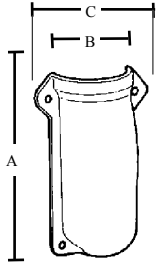

CAT#	A	B	C
591	2.37	1.00	2.61
593	2.50	1.25	3.00
594	2.61	1.56	3.76
595	3.580	1.738	3.568
596	5.81	1.88	3.48
596A	4.20	2.29	4.76

### SILL PLATES WITH SEALING COMPOUND AND SCREWS

**ALUMINUM**

TOPAZ CAT #	UPC#	SIZE	UNIT CTN	SHIP CASE	WT/ CASE
591	15790	1/2" EMT & 3/4" EMT	10	100	10
593	15800	1" EMT & 3/3 SEU	10	100	40
594	15810	1 1/4" EMT & 2/3 SEU	—	25	15
595	15811	1 1/2" EMT	—	25	11
596	15820	4/0 SEU	—	20	17
596A	15821	2" EMT	—	25	16



### DUCT-SEAL WEATHERPROOF COMPOUND

**GRAY, ASBESTOS FREE**

- PERMANENTLY SOFT
- NON-CORROSIVE TO METALS OR PLASTIC

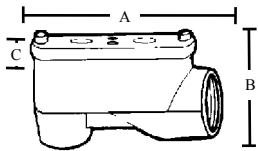
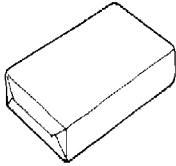

TOPAZ CAT #	UPC#	SIZE	UNIT CTN	SHIP CASE	WT/ CASE
961	19550	1 LB.	—	50	50
965	19560	5 LB.	—	10	50



R11374

### SERVICE ENTRANCE ELLS-SLB

**COPPER FREE ALUMINUM**

CAT#	A	B	WITH C
211	3.155	1.187	1.375
212	3.470	1.360	1.625
213	4.180	1.720	1.9375
214	5.515	2.178	2.4375
215	6.095	2.410	2.6875
216	6.595	2.846	3.0625
214XL	7.91	2.75	2.75
215XL	7.74	3.88	3.375

TOPAZ CAT #	UPC#	SIZE	UNIT CTN	SHIP CASE	WT/ CASE
211	11650	1/2"	10	50	13
212	11660	3/4"	10	50	16
213	11670	1"	5	25	12
214	11680	1 1/4"	2	10	8
214XL	11682	1 1/4" LONG	—	2	3
215	11690	1 1/2"	1	5	6
216	11700	2"	1	5	10
216XL	11702	2" LONG	—	1	3



E148716

### KENNY CLAMP

**BRASS**

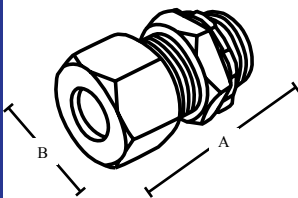

CAT#	A	B
1750	1.75	1.0625
1751	1.75	1.0625
1752	1.75	1.0625
1753	1.75	1.0625
1754	1.75	1.0625
1755	1.75	1.0625
1756	1.75	1.0625
1757	1.75	1.0625
1758	1.75	1.0625
1759	1.75	1.0625

TOPAZ CAT #	UPC#	SIZE	KO SIZE	UNIT CTN	SHIP CASE	WT/ CASE
1750	83964	3/0 Stranded	1/2"	10	80	20
1751	83965	2/0 Stranded	1/2"	10	80	20
1752	83966	1/0 Stranded	1/2"	10	80	20
1753	83967	2 Stranded	1/2"	10	80	20
1754	83968	4 Solid	1/2"	10	80	20
1755	83969	4 Stranded	1/2"	10	80	20
1756	83970	6 Solid	1/2"	10	80	20
1757	83971	6 Stranded	1/2"	10	80	20
1758	83972	8 Solid	1/2"	10	80	20
1759	83973	8 Stranded	1/2"	10	80	20



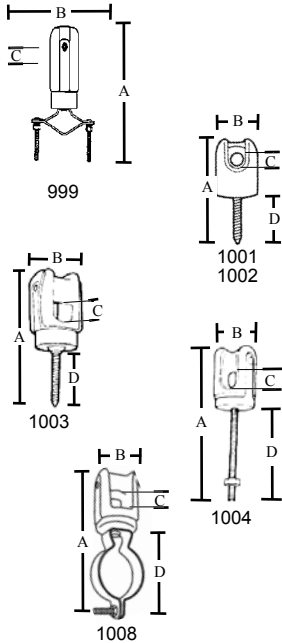

CAT#	Opening			
	A	B	C	D
999	7.62	5.60	1.0 x .875	---
1001	3.0625	1.375	.5 x .375	1.687
1002	5.25	1.968	.5 x .375	2.25
1003	6.1563	1.875	1.0 x .875	2.25
1004	8.1563	1.875	1.0 x .875	5.00
1008	6.416	1.875	1.0 x .875	3.375

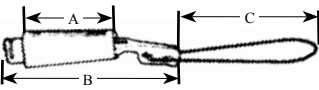

CAT#	A	B	C
1005	3.00	6.07	5.45
1006	3.75	7.26	5.45
1007	3.75	7.28	5.45

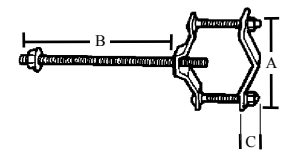

CAT#	A	B	C
998	4.125	9.75	1.25

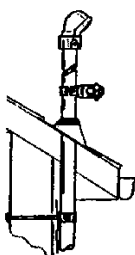

## WIREHOLDERS

PORCELAIN, STEEL

TOPAZ CAT #	UPC#	SIZE	UNIT CTN	SHIP CASE	WT/ CASE
<b>ADJUSTABLE</b>					
999	70240	1 1/4" - 3"	-	20	34
<b>LIGHT DUTY</b>					
• LAG SCREW					
<b>LAG</b>					
1001	70260	1-11/16"	10	100	25
<b>MEDIUM DUTY</b>					
1002	70270	2 1/4"	-	50	32
<b>HEAVY DUTY</b>					
PORCELAIN, STEEL REINFORCED					
• LAG SCREW					
<b>LAG</b>					
1003	70280	2 1/4"	-	50	34
• BOLT & NUT					
<b>BOLT SIZE</b>					
1004	70290	3/8" X 5"	-	25	22
<b>HANGER</b>					
1008	70322	2"	-	25	31

## WEDGE GRIP CLAMPS

• WITH SOLID 6 1/2" STAINLESS STEEL BAIL

ALUMINUM

TOPAZ CAT #	UPC#	SIZE	UNIT CTN	SHIP CASE	WT/ CASE
1005	70300	6 ACSR - 2 ACSR	-	50	8
1006	70310	4 ACSR - 1/0 ACSR	-	25	7
1007	70320	2/0 ACSR - 4/0 ACSR	-	25	8

Aluminum Conductor Steel Reinforced

## UNIVERSAL PIPE SUPPORT

• WITH 10" BOLT

STEEL

TOPAZ CAT #	UPC#	SIZE	BOLT SIZE	UNIT CTN	SHIP CASE	WT/ CASE
998	19761	1 1/4" - 3"	1/2"	-	20	18

## SE MAST KIT

TOPAZ CAT #	UPC#	PIPE SIZE	HEAD SIZE	UNIT CTN	SHIP CASE	WT/ CASE
1514	19717	2"	1 1/4"	-	1	5
Consists of 704, 986, (2) 1000, 1203, 1008						
1517	85114	2"	2"	-	1	8
Consists of 736, 986, 1008, (2) #546						
1515	19718	2 1/2"	2"	-	1	6
Consists of 706, 999, 987, (2) 998						





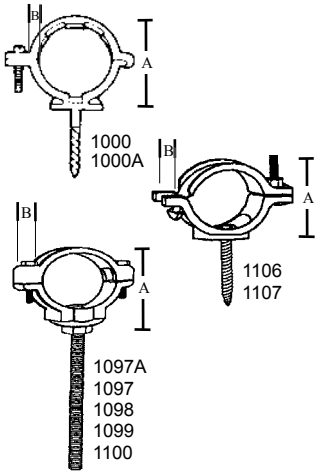

CAT#	A	B
1000	2.875	.875
1000A	3.30	.875
1106	2.70	.985
1107	3.295	1.080
1097A	2.70	.985
1097	3.33	1.071
1098	4.50	1.040
1099	5.125	1.075
1100	5.593	1.075

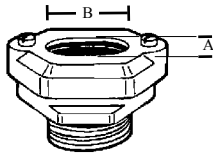

CAT#	FITS CABLE	GROMMET OPENING	
		A	B
873C	2#2	.625 X	1.00
874C	3#2	.625 X	1.00
875C	3#2	.625 X	1.00
876E	3#4/0	.830 X	1.415

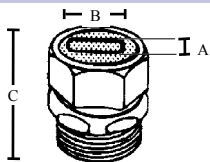

CAT#	FITS CABLE	GROMMET OPENING		
		A	B	C
873	3#8	.410 X	.650	1.875
873A	3#6	.460 X	.715	1.875
873B	3#4	.530 X	.850	1.875
874	3#3	.550 X	.910	1.937
874A	3#2	.580 X	.960	1.937
874B	3#1	.660 X	1.120	1.937
875	3#1/0	.705 X	1.195	2.375
875A	3#2/0	.740 X	1.235	2.375
876	3#1/0	.750 X	1.195	2.250
876A	3#2/0	.890 X	1.540	2.250
876B	3#3/0	.740 X	1.235	2.250
876C	3#4/0	.830 X	1.415	2.250
876D	3#4/0	.995 X	1.580	2.250
871/S	2#14	.220 X	.440	1.437
872/S	3#14	.220 X	.660	1.750

## CONDUIT SUPPORTS

### 2 1/2" LAG SCREW TYPE ALUMINUM

TOPAZ CAT #	UPC#	CONDUIT SIZE	LAG	UNIT CTN	SHIP CASE	WT/ CASE
1000	70250	2"	2.375	-	25	8
1000A	70251	2 1/2"	2.375	-	25	10

### MALLEABLE IRON

1106	19715	2"	2.375	-	25	37
1107	19716	2 1/2"	2.375	-	35	87

### SPLIT RING

TOPAZ CAT #	UPC#	CONDUIT SIZE	BOLT SIZE	UNIT CTN	SHIP CASE	WT/ CASE
1097A	83597	2"	1/2"-10"	-	25	12
1097	19711	2 1/2"	1/2"-10"	-	25	13
1098	19712	3"	5/8"-13"	-	10	25
1099	19713	3 1/2"	5/8"-13"	-	10	27
1100	19714	4"	5/8"-13"	-	10	28

## WATER TIGHT CONNECTORS

### ZINC DIE CAST

TOPAZ CAT #	UPC#	WIRE SIZE	SIZE	UNIT CTN	SHIP CASE	WT/ CASE
-------------	------	-----------	------	----------	-----------	----------

### FOR TYPE SE, STYLE U FLAT 2 INSULATING CONDUCTORS, 1 BARE

• 2 SCREW TYPE						
873C	18749	2#2	2 screw	1"	10	100 20
874C	18801	3#2	2 screw	1 1/4"	10	100 52
875C	18823	3#2		1 1/2"	5	50 44
876E	18871	3#4/0		2"	5	50 44

• COMPRESSION TYPE						
873	18750	3#8		1"	10	100 34
873A	18760	3#6		1"	10	100 34
873B	18770	3#4		1"	10	100 34
874	18780	3#3		1 1/4"	10	100 52
874A	18790	3#2		1 1/4"	10	100 52
874B	18800	3#1		1 1/4"	10	100 52
875	18810	3#1/0		1 1/2"	5	50 33
875A	18820	3#2/0		1 1/2"	5	50 32
876	18830	3#1/0		2"	5	50 44
876A	18840	3#2/0		2"	5	50 44
876B	18850	3#3/0		2"	5	50 44
876C	18860	3#4/0		2"	5	50 44
876D	18870	3#4/0		2"	5	50 44

### FOR UF CABLE

871	18730	14-2	12-2	10-2	1/2"	25 250 43
872	18740	14-3	12-3	10-3	3/4"	25 250 65
871S	18731	14-2	12-2		1/2" STEEL	25 250 30
872S	18741	14-3	12-3	10-3	3/4" STEEL	25 250 45



E148711



E148711