



Conference room



Office



Classroom



Healthcare



Powering Business Worldwide



Table of contents

Room Controller system	3
Features and benefits	4
Built-in energy savings lighting control strategies	5
Out-of-the-box control strategies	6
Stand-alone architecture	7
Network architecture	9
Ordering options	11
Model installation diagrams	13
APPLICATIONS	
Office	14
Open office	15
Conference room	16
Corridor, hall or stairwell	17
Classroom – Suspended fixtures and tree daylight zones	18
Classroom – Recessed fixtures and tree daylight zones	19
System components	21
QuickKits and starter kits	23
TYPICAL WIRING DIAGRAMS	
Small office with Daylighting	24
Office with Receptacle and Emergency Control	24
Office with HVAC output	25
Conference room with receptacle and Emergency Control, daylighting and programmable scene wallstations	25
Classroom with emergency and receptacle control	26
Classroom with daylight dimming	26
Demand Response Connections	27
Alternative Voltage Connection	27
Receptacle wiring	28
Wallstation sharing	29
Network wiring	30

Room Controller system



The Room Controller System provides energy compliant lighting, plug and emergency control capabilities that allow for out-of-the-box functionality in virtually any space. The system can be ordered based on specific budget or performance requirements.

- Simplified compliance with a product designed to meet the latest energy codes
- Reduce cost of installation with single enclosure and simplified wiring
- Save time with out-of-the-box controls functionality, no programming needed



Features and benefits

Stand-Alone Architecture

- Code compliant automatic lighting, emergency and plug load control.
- Delivers occupancy status to HVAC system via contact closure.
- Receives local Demand Response signal.

Network Architecture

- Code compliant automatic lighting, emergency and plug load control with enhanced user control and centralized time schedule control.
- Integrates with BMS via BACnet IP.
- Centralized Demand Response via network.



Contractor Benefits

- Reduce material cost with the Room Controller included wiring compartment with direct conduit connections. No need for additional junction boxes.
 - Simplified wiring with RJ45 connections for all low voltage devices saves time on the site.
 - Save time on network projects that require startup, with the Room Controller that works immediately on power up.
-



Distributor Benefits

- Give the electrical contractor what they need to start a project with convenient Room Controller starter kits.
 - Reduce inventory requirements with sensors that work with Room Controllers or with stand-alone applications.
 - Out-of-the-box functionality provides immediate verification of wiring and code compliance.
-



Specifier Benefits







- Worry free design with the Room Controller system that was designed to meet the current energy codes.
 - Simplified sequence of operations definition and training with out-of-the-box functionality.
 - Simplify complex user interaction with flexible wallstations that can be customized with zone or scene buttons.
-

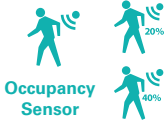

End User Benefits

- Reduce training time with simple and consistent user experience in all rooms that have the Room Controller installed.
- Remove maintenance concerns with RJ45 plug in low voltage devices that work immediately when connected.
- Save on operating costs with a system that was designed to provide consistent energy savings and drive energy efficiency throughout the building.

Built-in energy saving lighting control strategies

STRATEGY	DESCRIPTION	ESTIMATED SAVINGS
 <p>Manual Dimmer</p>	<p>Manual/personal dimming control – is one of five alternative methods to meet the Multi-level lighting control requirements.</p>	10-20%
 <p>Occupancy Sensor</p>	<p>Occupancy/vacancy sensing – provides Manual On/Automatic Off or Automatic On/Automatic Off and Partial Off capabilities.</p>	20-60%
 <p>Daylighting Control</p>	<p>Daylight dimming – provides three daylight dimming zone that automatically adjust the lighting based on daylight available in the space.</p>	20-45%
 <p>Receptacle Control</p>	<p>Plug load control – automatically turns On receptacles upon occupancy regardless of light status. Ensures receptacles are turned Off when the space is vacant.</p>	15-50% Controlled loads
 <p>Tuning Control</p>	<p>High-end/Task Tuning – lowers the maximum light level for automatic energy savings.</p>	10-30%
 <p>Demand Response</p>	<p>Demand Response – automatically reduces light level based on signal from OpenADR device or BMS closure.</p>	10-40%
 <p>Remote Signal Control</p>	<p>Remote Signal Control – Automatically sends a signal to the HVAC system based on occupancy.</p>	20%

Out-of-the-box control strategies

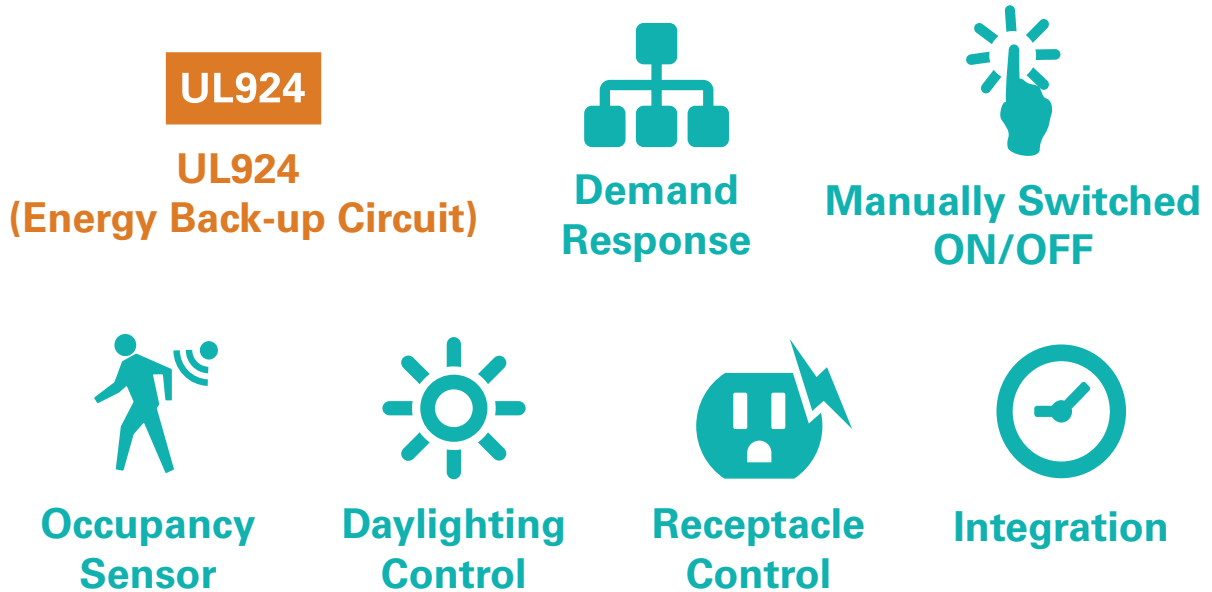

The Room Controller system can now be specified and ordered based on project needs. The Room Controller system is available in both a stand-alone and networked architecture.

- Individual components – Simple product offering list
- Room Controller Starter Kits – Basic Electrical Distributor stocking products, everything the electrical contractor will need for installation above the ceiling. Customize for each space with specific wallstations and sensor requirements.
- Room Controller QuickKits – Easy to order, designed and packaged for immediate in room installation and provide a complete all-in-one package solution, with pre-defined sequence of operations.

Supported by Eaton a global leader with expertise in power distribution and circuit protection; backup power protection; control and automation; lighting and security; structural solutions and wiring devices; solutions for harsh and hazardous environments; and engineering services. Eaton is positioned through its global solutions to answer today's most critical electrical power management challenges.

Stand-alone architecture

The Room Controller system was designed to meet the energy codes requirements of virtually any space. This application illustrates how conference rooms can use daylight dimming in conjunction with natural light entering the space, while providing Scene Control/Automatic Off and receptacle control to achieve energy savings up to 65% and achieve higher quality lighting. Providing optional control of individual lighting zones and HVAC output will allow for even greater energy savings.

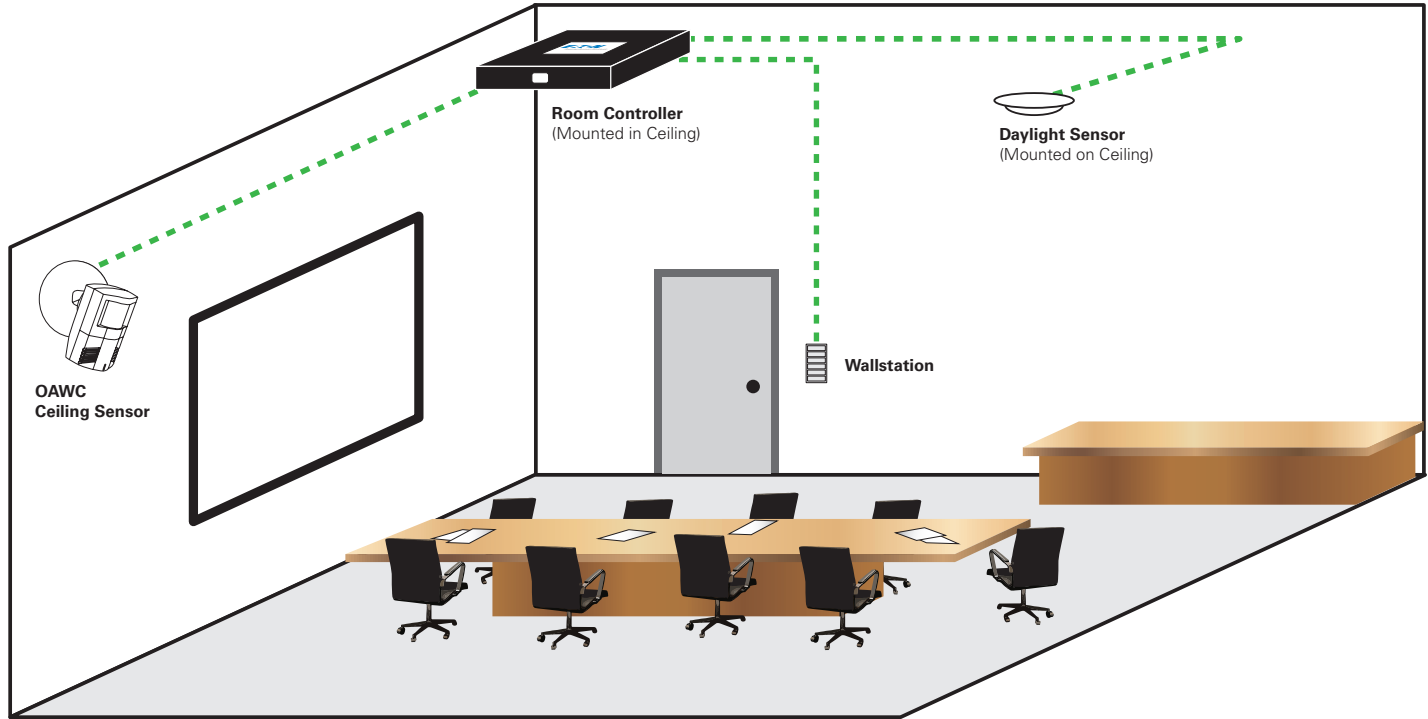

Space Assumptions

Space

100 square feet or larger

Electrical Load

Greater than 0.5 watts per square feet planned

Daylighting

Contains glazing larger than 24 square feet total requiring daylighting for both primary and secondary sidelit zones

Others

The general lighting is not intended for continuous use (24/7, 365).
Egress lighting is not part of the general lighting use.

Building

When larger than 10,000 square feet, Demand Response is required (capable of lowering lighting power by 15%)

SPACE LEVEL (AREA CONTROL)

- Must be accessible to occupants to operate the lighting



Reference:
 T24-2013
 130.1(a)
 ASHRAE 90.1-2013
 9.4.1.1.a
 IECC 2015
 C405.2.2.3

MULTI-LEVEL LIGHTING

- Luminaire must provide uniform dimming
- Capable of reducing power by at least one of five control functions
- When a dimming luminaire is present, a manual dimmer is recommended. Other functional options available

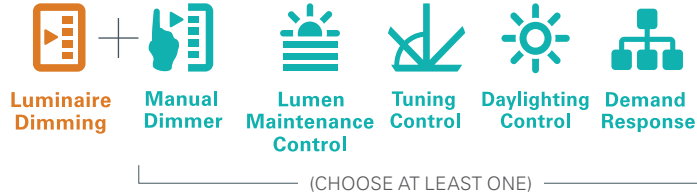

Reference:
 T24-2013
 130.1(b)
 ASHRAE 90.1-2013
 9.4.1.1.d
 IECC 2015
 C405.2.2.2

SHUTOFF CONTROL

- Luminaires turned off when vacant
- 120V receptacles only, one within 6 feet of uncontrolled
- Each 5,000 square feet to have shutoff controls

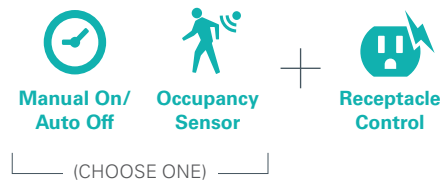

Reference:
 T24-2013
 130.1(c), 130.5(d)
 ASHRAE 90.1-2013
 9.4.1.1.h, 9.4.1.1.i, 8.4.2
 IECC 2015
 C405.2.1

AUTOMATIC DAYLIGHTING CONTROL

- Eliminate energy waste when natural light present

Exceptions when daylighting control not required:

- No skylights
- Glazing <24 square feet
- Daylit zone is less than 120W



Reference:
 T24-2013
 130.1(d)
 ASHRAE 90.1-2013
 9.4.1.1.e, 9.4.1.1.f,
 IECC 2015
 C405.2.3

Network architecture

The Room Controller products can be networked together to expand their out of the box capabilities. Perfect for projects that have multiple rooms that have similar requirements. The Room Controllers can be installed and provide control capabilities on day one without requiring network programming. As the project schedule allows network programming can be completed to provide centralized control and user training.

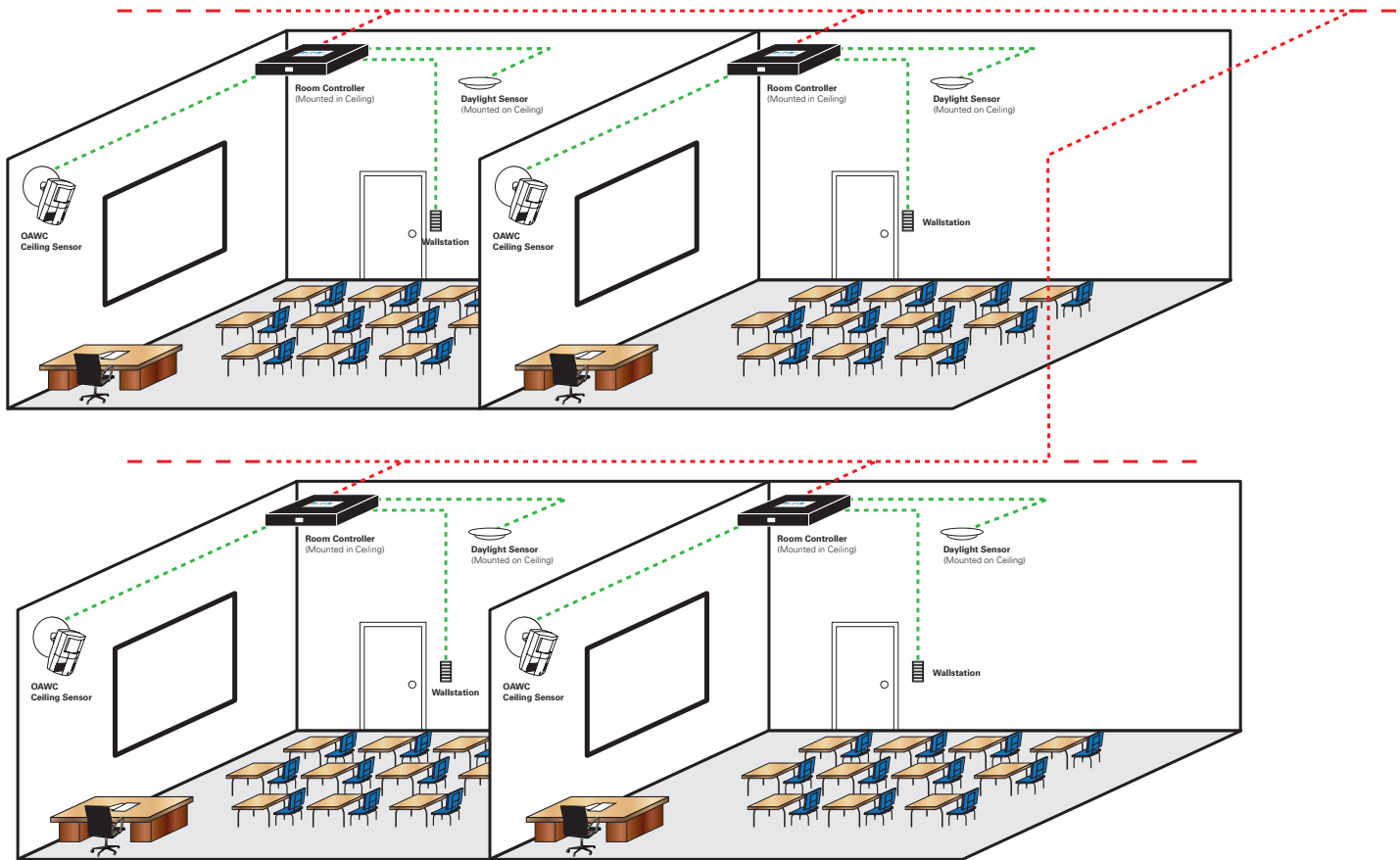

Space Assumptions

Space

Multiple spaces each less than 2000 square feet

Electrical Load

Greater than 0.5 watts per square feet planned

Daylighting

Contains glazing larger than 24 square feet total requiring daylighting for both primary and secondary sidelit zones

Others

The general lighting is not intended for continuous use (24/7, 365).
Egress lighting is not part of the general lighting use.

Building

When larger than 10,000 square feet, Demand Response is required (capable of lowering lighting power by 15%)

SPACE LEVEL (AREA CONTROL)

- Must be accessible to occupants to operate the lighting

Exceptions when space level control not required:

- Areas or sections designed to serve as egress lighting are not accessible to unauthorized personnel



Reference:

T24-2013
130.1(a)
ASHRAE 90.1-2013
9.4.1.1.a
IECC 2015
C405.2.2.3

MULTI-LEVEL LIGHTING

- Luminaire must provide uniform dimming
- Capable of reducing power by at least one of five control functions
- When a dimming luminaire is present, a manual dimmer is recommended. Other functional options available



Reference:

T24-2013
130.1(b)
ASHRAE 90.1-2013
9.4.1.1.d
IECC 2015
C405.2.2.2

SHUTOFF CONTROL

- Luminaires turned off when vacant
- 120V receptacles only, one within 6 feet of uncontrolled
- Each 5,000 square feet to have shutoff controls. Automatic Time Switch remain on for no more than 2 hours.

Exception when shutoff control not required:

- Areas designed to serve 24 hour, 365 day continuous use considered egress lighting



Reference:

T24-2013
130.1(c), 130.5(d)
ASHRAE 90.1-2013
9.4.1.1.h, 9.4.1.1.i,
8.4.2
IECC 2015
C405.2.1

AUTOMATIC DAYLIGHTING CONTROL

- Eliminate energy waste when natural light present

Exceptions when daylighting control not required:

- No skylights
- Glazing <24 square feet
- Daylit zone is less than 120W



Reference:

T24-2013
130.1(d)
ASHRAE 90.1-2013
9.4.1.1.e, 9.4.1.1.f,
IECC 2015
C405.2.3

Ordering options



Room Controller Starter Kit

Ideal for distributor stocking programs to provide Electrical Contractors with components that are required for rough-in installation. The distributor can then finalize the order with off the shelf accessories based on individual product needs.

Room Controller QuickKits

Specially built to provide all components that are needed for typical room types. QuickKits include all components for specific room types.

Room Controller System Components

When a QuickKit or Starter Pack does not meet your requirements, individual components should be specified.

ROOM CONTROLLER SYSTEM COMPONENT

ROOM CONTROLLER STARTER KIT

ROOM CONTROLLER QUICKKITS

ROOM CONTROLLER PLENUM

UL924
UL924
(Energy Back-up Circuit)



Luminaire Dimming



RC3-PL
RC3D-PL
RC3DE-PL
RC3DEHC-PL

RC3DE-PL-T24
RC3D-PL-T24
RC3DE-PL-KIT
RC3D-PL-KIT

RCQK-RC3DE-CONF
RCQK-RC3D-OFFICE
RCQK-RC3DE-CLASS
RCQK-RC3DEHC

ROOM CONTROLLER PLENUM NETWORK

UL924
UL924
(Energy Back-up Circuit)



Luminaire Dimming



RC3-PL-N
RC3D-PL-N
RC3DE-PL-N
RC3DEHC-PL-N

SCENE WALLSTATIONS



Manual Dimmer



RC-3TLB-P1-*
RC-6TSB-P2-*
RC-6TSB-P3-*
RC-6TSB-P4-*

RCQK-RC3DE-CONF

ZONE WALLSTATIONS



Manually Switched ON/OFF



RC-*

RCQK-RC3DE-CONF
RCQK-RC3D-OFFICE
RCQK-RC3DE-CLASS
RCQK-RC3DEHC

		ROOM CONTROLLER SYSTEM COMPONENT	ROOM CONTROLLER STARTER KIT	ROOM CONTROLLER QUICKKITS	
DIMMING SLIDER	 Manual Dimmer		RC-SS1-*		
OCCUPANCY SENSOR	 Occupancy Sensor		OAC- OAWC-*	RCQK-RC3DE-CONF RCQK-RC3D-OFFICE RCQK-RC3DE-CLASS	
INPUT/OUTPUT DEVICE		OCC-RJ45	RC3DE-PL-T24 RC3D-PL-T24 RC3DE-PL-KIT RC3D-PL-KIT	RCQK-RC3DE-CONF RCQK-RC3D-OFFICE RCQK-RC3DE-CLASS RCQK-RC3DEHC	
DAYLIGHT SENSOR	 Daylighting Control		DSRC-FMOIR	RCQK-RC3DE-CONF RCQK-RC3D-OFFICE RCQK-RC3DE-CLASS RCQK-RC3DEHC	
RECEPTACLE SWITCHPACK	 Receptacle Control		SPRC-R-20-120	RC3DE-PL-T24 RC3D-PL-T24	RCQK-RC3DE-CONF RCQK-RC3D-OFFICE RCQK-RC3DE-CLASS
QUICKCONNECT CABLE	 Remote Signal Control		GGRJ45-*	RC3DE-PL-T24 RC3D-PL-T24 RC3DE-PL-KIT RC3D-PL-KIT	RCQK-RC3DE-CONF RCQK-RC3D-OFFICE RCQK-RC3DE-CLASS RCQK-RC3DEHC
PERSONAL REMOTE	 Manual Dimmer		HHPR-RC	RCQK-RC3DE-CONF	
DAYLIGHT SETTING REMOTE	 Lumen Maintenance Control		HHPRG-RC		

Model installation diagrams

RC3-PL with receptacle control



RC3D-PL with receptacle control

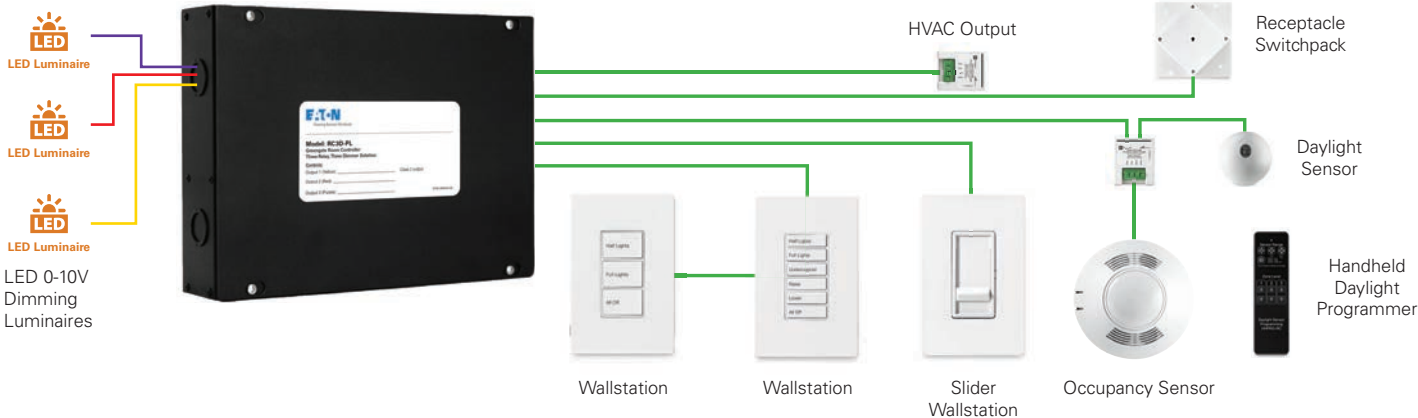

RC3DE-PL with receptacle and emergency control

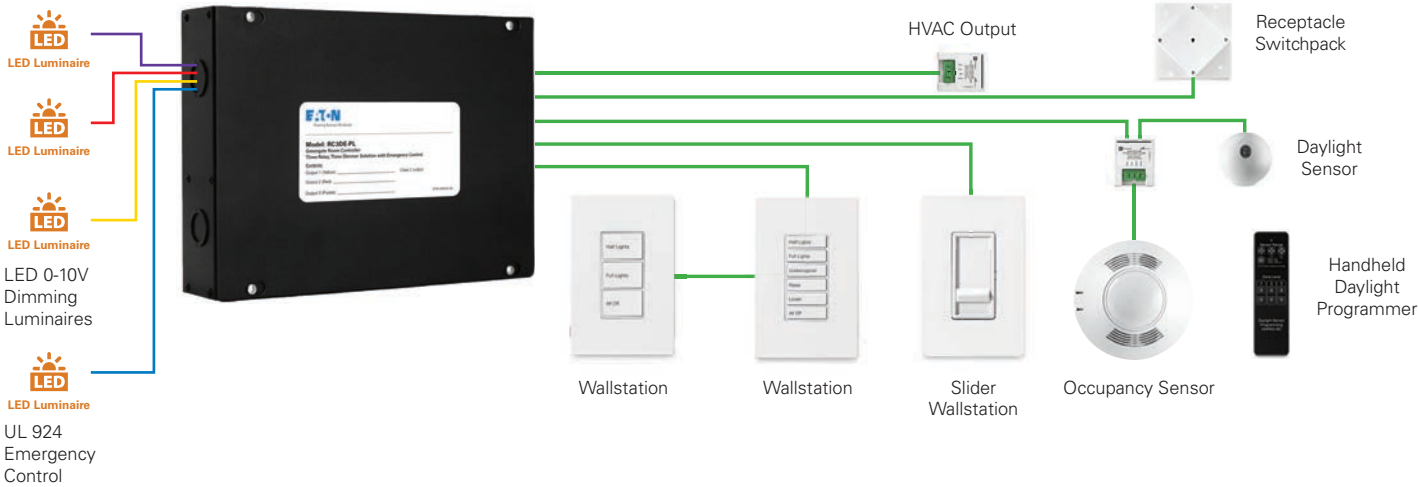

Application: Office



Space Assumptions

Space

Less than 250 square feet

Electrical Load

Greater than 0.5 watts per square feet planned

Daylighting

Contains glazing larger than 24 square feet total requiring daylighting for both primary and secondary sidelit zones

Building

When larger than 10,000 square feet, Demand Response is required (capable of lowering lighting power by 15%)

Solutions

Room Controller QuickKit RCQK-RC3DE-OFFICE
OR

Room Controller Components

RC3DE-PL	Room Controller
RC-3TLB-OS1-W	Wallstation
RC-SS1-W	Dimming Slider
DSRC-FMOIR	Daylight Sensor
OAWC-DT-120W	Wall Corner Occupancy Sensor
OCC-RJ45	Input/ Output Device
SPRC-R-20-120	Receptacle Switchpack
GGRJ45-10-G	QuickConnect Cable
GGRJ45-25-G	QuickConnect Cable

Luminaire Controls

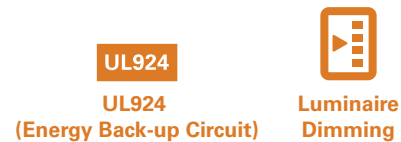

Functional Controls

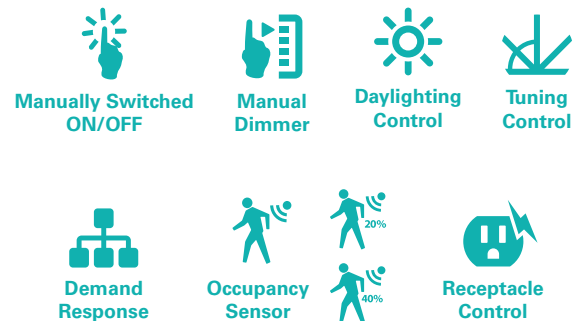

Sequence of Operations

Occupied

Lights Manual ON or Automatic ON – 50%
Receptacle ON
HVAC occupancy closed
Automatic daylight dimming
Occupant uses wallstations to control lighting
Demand Response dims lighting based on settings

Unoccupied

Lights turn Off after sensor time-out
Receptacle turns off after sensor time-out + 30 sec
HVAC occupancy opens

Application: Open office



Space Assumptions

Space

250 square feet or larger

Electrical Load

Greater than 0.5 watts per square feet planned

Daylighting

Contains glazing larger than 24 square feet total requiring daylighting for both primary and secondary sidelit zones

Building

When larger than 10,000 square feet, Demand Response is required (capable of lowering lighting power by 15%)

Solutions

Room Controller QuickKit RCQK-RC3DE-CONF

OR

Room Controller Starter Kit RC3DE-PLT24

OR

Room Controller Components

RC3DE-PL	Room Controller
RC-5TSB-OS2-W	Wallstation
DSRC-FMOIR	Daylight Sensor
OAC-DT-2000	Ceiling Occupancy Sensor
OCC-RJ45	Input/ Output Device
SPRC-R-20-120	Receptacle Switchpack
GGRJ45-10-G	QuickConnect Cable
GGRJ45-25-G	QuickConnect Cable

Luminaire Controls

UL924

UL924
(Energy Back-up Circuit)



Luminaire
Dimming

Functional Controls



Manually Switched
ON/OFF



Manual
Dimmer



Daylighting
Control



Tuning
Control



Demand
Response



Occupancy
Sensor



20%



40%



Receptacle
Control

Sequence of Operations

Occupied

- Lights Manual ON or Automatic ON – 50%
- Receptacle ON
- HVAC occupancy closed
- Three automatic daylight dimming zones
- Occupant uses wallstations to control lighting
- Demand Response dims lighting based on settings

Unoccupied

- Lights turn Off after sensor time-out
- Receptacle turns off after sensor time-out + 30 sec
- HVAC occupancy opens

Application: Conference room



Space Assumptions

Space

100 square feet or larger

Electrical Load

Greater than 0.5 watts per square feet planned

Daylighting

Contains glazing larger than 24 square feet total requiring daylighting for both primary and secondary sidelit zones

Others

The general lighting is not intended for continuous use (24/7, 365). Egress lighting is not part of the general lighting use.

Building

When larger than 10,000 square feet, Demand Response is required (capable of lowering lighting power by 15%)

Solutions

Room Controller QuickKit RCQK-RC3DE-CONF
OR

Room Controller Components

RC3DE-PL	Room Controller
RC-6TSB-P3-W	Scene Wallstation
RC-6TSB-ZAD-W	Wallstation
DSRC-FMOIR	Daylight Sensor
OAWC-DT-120W	Wall Corner Occupancy Sensor
OCC-RJ45	Input/ Output Device
SPRC-R-20-120	Receptacle Switchpack
GGRJ45-10-G	QuickConnect Cable
GGRJ45-25-G	QuickConnect Cable

Luminaire Controls

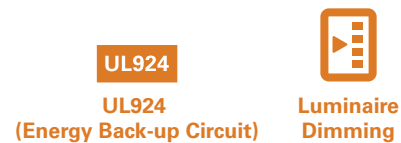

Functional Controls

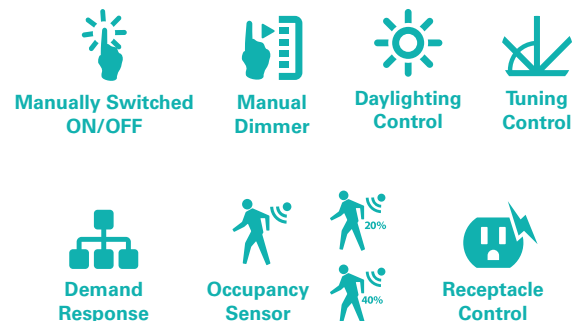

Sequence of Operations

Occupied

Lights Manual ON or Automatic ON – 50%
Receptacle ON
HVAC occupancy closed
Automatic daylight dimming
Occupant uses wallstations to control lighting
Demand Response dims lighting based on settings
Programmable Scene Wallstations

Unoccupied

Lights turn Off after sensor time-out
Receptacle turns off after sensor time-out + 30 sec
HVAC occupancy opens

Application: Corridor, hall or stairwell



Space Assumptions

Space

Accessible areas

Electrical Load

Greater than 0.5 watts per square feet planned

Daylighting

Contains glazing larger than 24 square feet total requiring daylighting for both primary and secondary sidelit zones

Building

When larger than 10,000 square feet, Demand Response is required (capable of lowering lighting power by 15%)

Solutions

Room Controller QuickKit RC3DE-PL-KIT
OR

Room Controller Components

RC3DE-PL	Room Controller
RC-6TSB-P3-W	Scene Wallstation
OAWC-DT-120W	Wall Corner Occupancy Sensor
OCC-RJ45	Input/ Output Device
GGRJ45-10-G	QuickConnect Cable
GGRJ45-25-G	QuickConnect Cable

Luminaire Controls

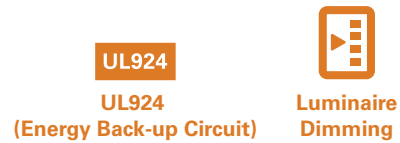

Functional Controls



Sequence of Operations

Occupied

Lights Automatic ON
Occupant uses wallstations to control lighting
Demand Response dims lighting based on settings
Programmable Scene Wallstations

Unoccupied

Lights turn Off or dim after sensor time-out
Timeclock turns lights off

Application: Classroom – Suspended fixtures and three daylight zones



Space Assumptions

Space

Less than 2000 square feet

Electrical Load

Greater than 0.7 watts per square feet planned

Daylighting

Contains glazing larger than 24 square feet total requiring daylighting for both primary and secondary sidelit zones



Building

When larger than 10,000 square feet, Demand Response is required (capable of lowering lighting power by 15%)

Solutions

Room Controller QuickKit	RCQK-RC3DE-CLASS
	OR
Room Controller Starter Kit	RC3DE-PLT24
	OR
Room Controller Components	
RC3DE-PL	Room Controller
RC-2TLB-ES1-W	Wallstation
RC-6TSB-P3-W	Scene Wallstation
DSRC-FMOIR	Daylight Sensor
OAWC-DT-120W	Wall Corner Occupancy Sensor
OCC-RJ45	Input/ Output Device
SPRC-R-20-120	Receptacle Switchpack
GGRJ45-10-G	QuickConnect Cable
GGRJ45-25-G	QuickConnect Cable

Luminaire Controls

Luminaire Dimming

Functional Controls



Manually Switched ON/OFF

Manual Dimmer

Daylighting Control

Tuning Control

Demand Response

Occupancy Sensor

Receptacle Control

Sequence of Operations

Occupied

- Lights Manual ON or Automatic ON – 50%
- Receptacle ON
- HVAC occupancy closed
- Three automatic daylight dimming zones
- Occupant uses wallstations to control lighting
- Demand Response dims lighting based on settings
- Programmable Scene Wallstations

Unoccupied

- Lights turn Off after sensor time-out
- Receptacle turns off after sensor time-out + 30 sec
- HVAC occupancy opens

Application: Classroom - Recessed fixtures and three daylight zones



Space Assumptions

Space

Less than 2000 square feet

Electrical Load

Greater than 0.7 watts per square feet planned

Daylighting

Contains glazing larger than 24 square feet total requiring daylighting for both primary and secondary sidelit zones

Building

When larger than 10,000 square feet, Demand Response is required (capable of lowering lighting power by 15%)

Solutions

Room Controller QuickKit	RCQK-RC3DE-CLASS
	OR
Room Controller Starter Kit	RC3DE-PL-T24
	OR

Room Controller Components

RC3DE-PL	Room Controller
RC-2TLB-ES1-W	Wallstation
RC-6TSB-P3-W	Scene Wallstation
DSRC-FMOIR	Daylight Sensor
OAWC-DT-120W	Wall Corner Occupancy Sensor
OCC-RJ45	Input/ Output Device
SPRC-R-20-120	Receptacle Switchpack
GGRJ45-10-G	QuickConnect Cable
GGRJ45-25-G	QuickConnect Cable

Luminaire Controls

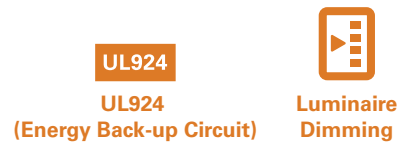

Functional Controls

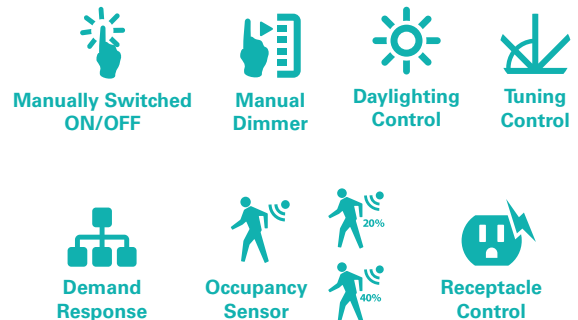

Sequence of Operations

Occupied

- Lights Manual ON or Automatic ON – 50%
- Front and back switching with mixed daylighting
- Receptacle ON
- HVAC occupancy closed
- Three automatic daylight dimming zones
- Occupant uses wallstations to control lighting
- Demand Response dims lighting based on settings

Unoccupied

- Lights turn Off after sensor time-out
- Receptacle turns off after sensor time-out + 30 sec
- HVAC occupancy opens



System components

Room Controller

This is your central relay and dimmer control as well as coordinates all the actions from wallstations, daylight sensor and occupancy sensor.

Wallstation

The intuitive user interface provides for manual override and is pre-engraved buttons describing their respective functionality.

Occupancy sensor

Any Greengate low voltage occupancy sensors can be used with the Room Controller, so select one to meet your applications needs.

Daylight sensor

Dimmable daylighting requirements have increased with the latest version of ASHRAE 90.1. The Room Controller daylight sensor allows up to three dimming zones to be controlled from a single sensor.

Plug load control

Saving additional energy by shutting off plug loads is now part of ASHRAE 90.1, and is easily achieved with the Receptacle Switchpack and the Room Controller.



CATALOG NUMBER	DESCRIPTION	COLOR
Room Controller System		
RC3-PL	Room Controller, three relay, plenum, 120/277 VAC, 60 Hz, 20A	B
RC3D-PL	Room Controller, three relay, three dimmer, plenum, 120/277 VAC, 60 Hz, 20A	B
RC3DE-PL	Room Controller, three relay, three dimmer, one emergency output, plenum, 120/277 VAC, 60 Hz, 20A	B
RC3DEHC-PL	Healthcare Room Controller for patient rooms, three relay, three dimmer, one emergency output, plenum, 120/277 VAC, 60 Hz, 20A	B
RC3-PL-N	Room Controller, network, three relay, plenum, 120/277 VAC, 60 Hz, 20A	B
RC3D-PL-N	Room Controller, network, three relay, three dimmer, plenum, 120/277 VAC, 60 Hz, 20A	B
RC3DE-PL-N	Room Controller, network, three relay, three dimmer, one emergency output, plenum, 120/277 VAC, 60 Hz, 20A	B
RC3DEHC-PL-N	Healthcare Room Controller for patient rooms, network, three relay, three dimmer, one emergency output, plenum, 120/277 VAC, 60 Hz, 20A	B
Room Controller Wallstations		
RC-2TLB-ES1-*	Room Controller Wallstation, 2 large buttons (Entry, All Off)	W, V, G, B
RC-6TSB-TS1-*	Room Controller Wallstation, 6 small buttons (General, Whiteboard, Quiet Time, A/V Mode, Raise, Lower)	W, V, G, B
RC-6TSB-TS2-*	Room Controller Wallstation, 6 small buttons (General, Whiteboard, Quiet Time, Raise, Lower, All Off)	W, V, G, B
RC-5TSB-TS3-*	Room Controller Wallstation, 5 small buttons (General, Whiteboard, Quiet Time, A/V Mode, All Off)	W, V, G, B
RC-6TSB-TS4-*	Room Controller Wallstation, 6 small buttons (General, Whiteboard, A/V Mode, Raise, Lower, All Off)	W, V, G, B
RC-4TSB-TS5-*	Room Controller Wallstation, 4 small buttons (Entry, General, Whiteboard, All Off)	W, V, G, B
RC-6TSB-TS6-*	Room Controller Wallstation, 6 small buttons (Entry, General, Whiteboard, Raise, Lower, All Off)	W, V, G, B
RC-6TSB-TS7-*	Room Controller Wallstation, 6 small buttons (Row 1, Row 2, Row 3, Raise, Lower, All Off)	W, V, G, B
RC-6TSB-TS8-*	Room Controller Wallstation, 6 small buttons (Uplights, Downlights, Accent, Raise, Lower, All Off)	W, V, G, B

CATALOG NUMBER	DESCRIPTION	COLOR
Room Controller Wallstations - Continued		
RC-6TSB-CR1-*	Room Controller Wallstation, 6 small buttons (General, Meeting, Whiteboard, Presentation, Raise, Lower)	W, V, G, B
RC-5TSB-CR2-*	Room Controller Wallstation, 5 small buttons (General, Meeting, Whiteboard, Presentation, All Off)	W, V, G, B
RC-4TSB-HC1-*	Room Controller Wallstation, 4 small buttons (General, Exam, Reading, All Off)	W, V, G, B
RC-6TSB-HC2-*	Room Controller Wallstation, 6 small buttons (General, Exam, Reading, Raise, Lower, All Off)	W, V, G, B
RC-3TLB-OS1-*	Room Controller Wallstation, 3 large buttons (Half Lights, Full Lights, All Off)	W, V, G, B
RC-5TSB-OS2-*	Room Controller Wallstation, 5 small buttons (Half Lights, Full Lights, Raise, Lower, All Off)	W, V, G, B
RC-6TSB-OS3-*	Room Controller Wallstation, 6 small buttons (Half Lights, Full Lights, Undercabinet, Raise, Lower, All Off)	W, V, G, B
RC-2TLB-OS4-*	Room Controller Wallstation, 2 large buttons (All On, All Off)	W, V, G, B
RC-6TSB-ZAD-*	Room Controller Wallstation, 6 small buttons (Zone 1 UP, Sone 1 DN, Zone 2 UP, Zone 2 DN, Zone 3 UP, Zone 3 DN)	W, V, G, B
RC-3TLB-Z1D-*	Room Controller Wallstation, 3 large buttons (Zone 1 On/Off, Zone 1 UP, Zone 1 DN)	W, V, G, B
RC-3TLB-Z2D-*	Room Controller Wallstation, 3 large buttons (Zone 2 On/Off, Zone 2 UP, Zone 2 DN)	W, V, G, B
RC-3TLB-Z3D-*	Room Controller Wallstation, 3 large buttons (Zone 3 On/Off, Zone 3 UP, Zone 3 DN)	W, V, G, B
Room Controller Slider Stations		
RC-SS1-*	Room Controller Slider Station	W, V, G, B
Room Controller Daylight Sensors		
DSRC-FMOIR	Room Controller Open Loop Daylight Sensor, fixture mount, RJ45 connection	W
DSCM-MT	Room Controller Open Loop Daylight Sensor mounting bracket	W
Handheld Remotes		
HHPRG-RC	Room Controller Open Loop Daylight Sensor handheld zone remote programmer	B
HHPR-RC	Room Controller Personal Remote	B
Room Controller Switchpacks		
SPRC-R-20-120	Room Controller receptacle rated switchpack, 120/277V AC, 50/60 Hz, 20A	W
SP-R-20-120	Occupancy sensor receptacle rated switchpack w/ Cat5 and flying leads, 120/277V AC, 50/60 Hz, 20A	W
Room Controller Input/Output Devices		
OCC-RJ45	Room Controller BMS output	W
GGRC-COUPLER	Room Controller RJ45 coupler	W
GGRC-SPLITTER	Room Controller RJ45 splitter	W
GGRJ45-006-G	Room Controller RJ45 cable, 6 inches	Gr
GGRJ45-03-G	Room Controller RJ45 cable, 3 feet	Gr
GGRJ45-10-G	Room Controller RJ45 cable, 10 feet	Gr
GGRJ45-25-G	Room Controller RJ45 cable, 25 feet	Gr
GGRJ45-50-G	Room Controller RJ45 cable, 50 feet	Gr
GGRJ45-100-G	Room Controller RJ45 cable, 100 feet	Gr
GGRJ45-10P-G	Room Controller RJ45 cable, 10 feet, plenum rated	Gr
GGRJ45-25P-G	Room Controller RJ45 cable, 25 feet, plenum rated	Gr
GGRJ45-50P-G	Room Controller RJ45 cable, 50 feet, plenum rated	Gr
GGRJ45-100P-G	Room Controller RJ45 cable, 100 feet, plenum rated	Gr

QuickKits and starter kits

QuickKits

Easy to order, designed and packaged for immediate in room installation and provide a complete all-in-one package solution.



CATALOG NUMBER	INCLUDED COMPONENTS	
RCQK-RC3DE-CONF	RC3DE-PL (QTY1)	
	SPRC-R-20-120 (QTY1)	
	DSRC-FMOIR (QTY1)	
	OAWC-DT-120W (QTY1)	
	OCC-RJ45 (QTY1)	
	GGRJ45-10P-G (QTY1)	
	GGRJ45-006-G (QTY1)	
	GGRJ45-25P-G (QTY3)	
	RC-6TSB-P2 (QTY1)	
	RC-6TSB-ZAD (QTY1)	
	HHPR-RC (QTY1)	
	RCQK-RC3D-OFFICE	RC3D-PL (QTY1)
		SPRC-R-20-120 (QTY1)
OAC-DT-2000-R (QTY1)		
DSRC-FMOIR (QTY1)		
OCC-RJ45 (QTY1)		
GGRJ45-10P-G (QTY1)		
GGRJ45-25P-G (QTY3)		
RCQK-RC3DE-CLASS	RC3DE-PL (QTY1)	
	SPRC-R-20-120 (QTY1)	
	DSRC-FMOIR (QTY1)	
	OAC-DT-2000 (QTY1)	
	OCC-RJ45 (QTY1)	
	GGRJ45-10P-G (QTY1)	
	GGRJ45-25P-G (QTY4)	
	RC-4TSB-TS5 (QTY1)	
RC-6TSB-TS4 (QTY1)		
RCQK-RC3DEHC	RC3DEHC-PL (QTY1)	
	OCC-RJ45 (QTY1)	
	DSRC-FMOIR (QTY1)	
	GGRJ45-25P-G (QTY4)	
	GG37P (QTY1)	
	GPCS-3Z-DIM (QTY1)	
	RC-6TSB-HC2 (QTY1)	
RC-4TSB-HC1 (QTY1)		

Starter Kits

Ideal stocking product for the Electrical Distributor.

CATALOG NUMBER	INCLUDED COMPONENTS
RC3DE-PLT24	RC3DE-PL (QTY1)
	SPRC-R-20-120 (QTY1)
	OCC-RJ45 (QTY1)
	GGRJ45-10P-G (QTY1)
RC3D-PLT24	GGRJ45-25P-G (QTY3)
	RC3D-PL (QTY1)
	SPRC-R-20-120 (QTY1)
RC3DE-PL-KIT	OCC-RJ45 (QTY1)
	GGRJ45-10P-G (QTY1)
	GGRJ45-25P-G (QTY3)
	RC3DE-PL
	OCC-RJ45
RC3D-PL-KIT	GGRJ45-10P-G (QTY1)
	GGRJ45-25P-G (QTY2)
	RC3D-PL (QTY1)
RC3DE-PLT24	OCC-RJ45 (QTY1)
	GGRJ45-10P-G (QTY1)
	GGRJ45-25P-G (QTY2)

Typical wiring diagrams

Figure 1: Small Office with Daylighting

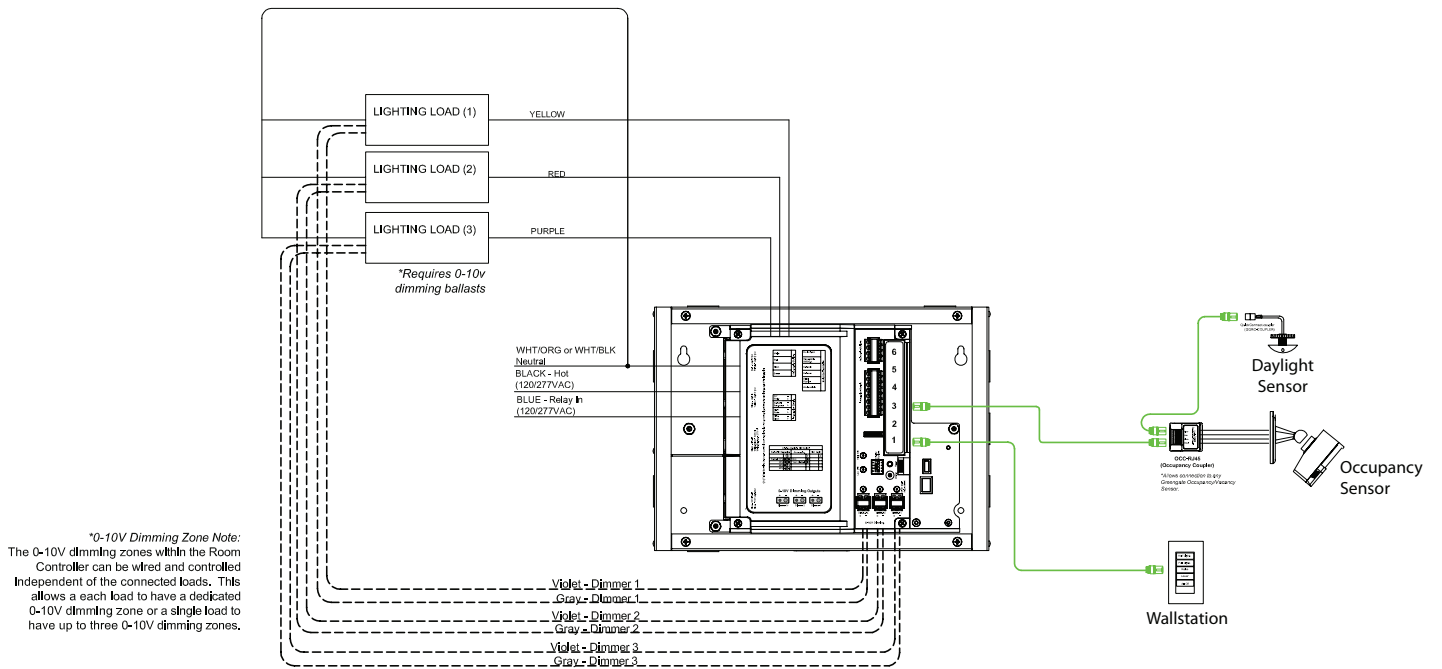
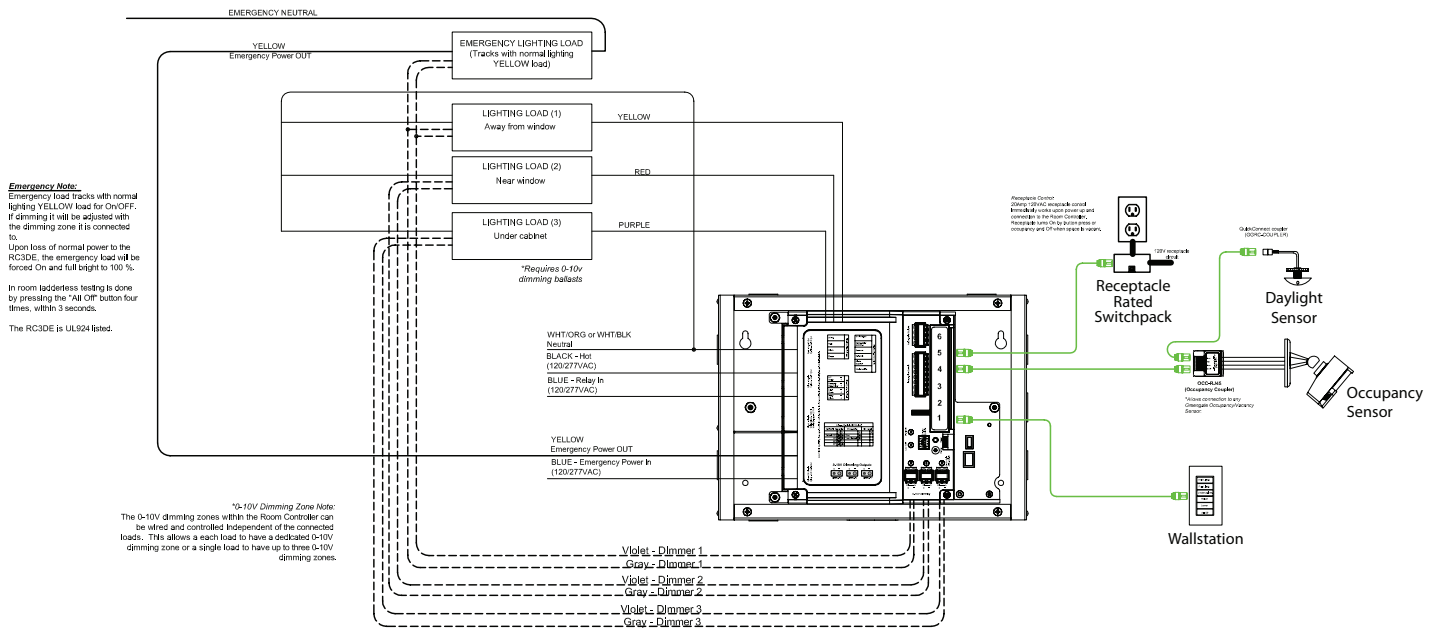

Figure 2: Office with Receptacle and Emergency Control



Typical wiring diagrams

Figure 3: Office with HVAC output

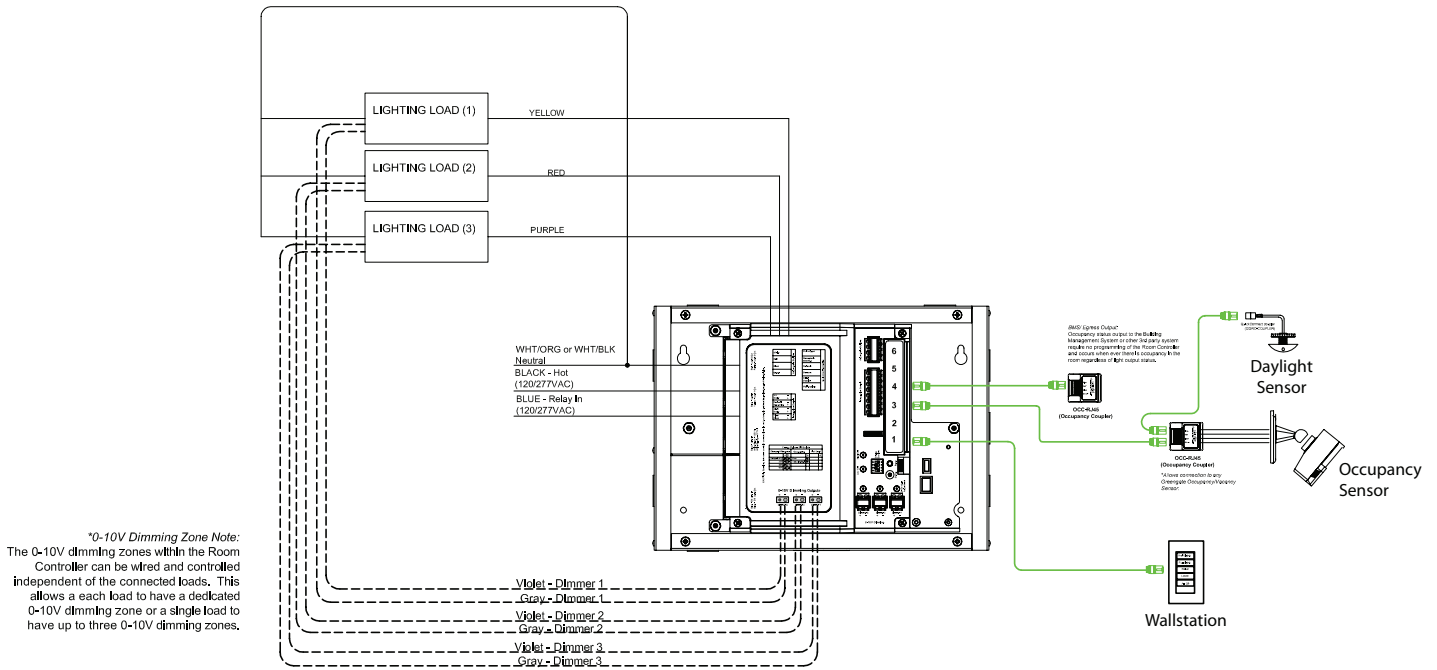
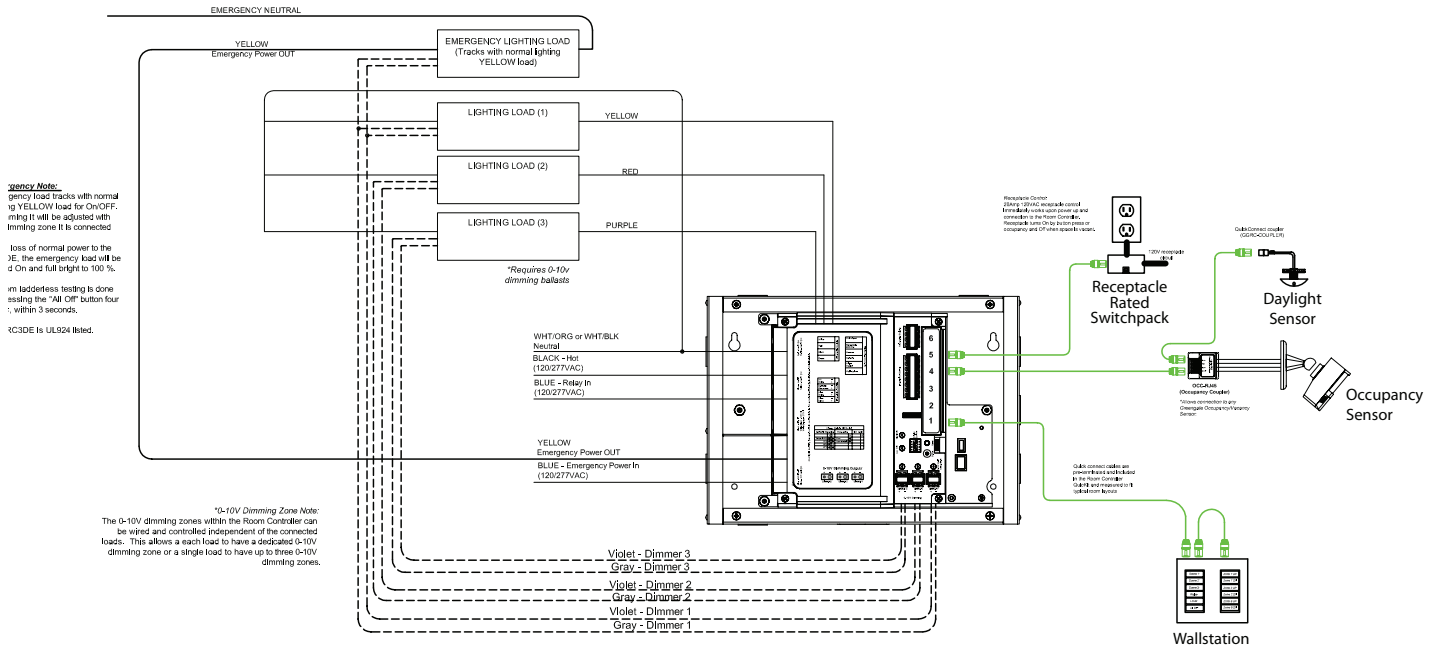

Figure 4: Conference room with receptacle and Emergency Control, daylighting and programmable scene wallstations



Typical wiring diagrams

Figure 5: Classroom with emergency and receptacle control

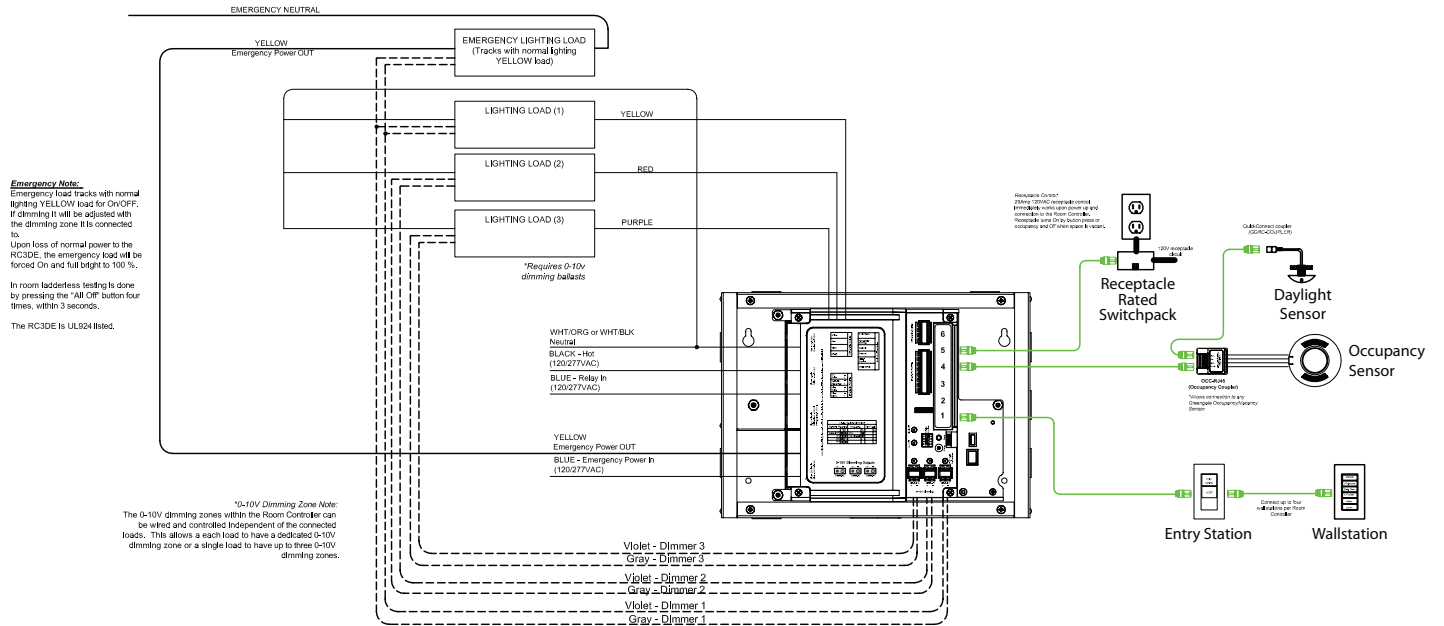
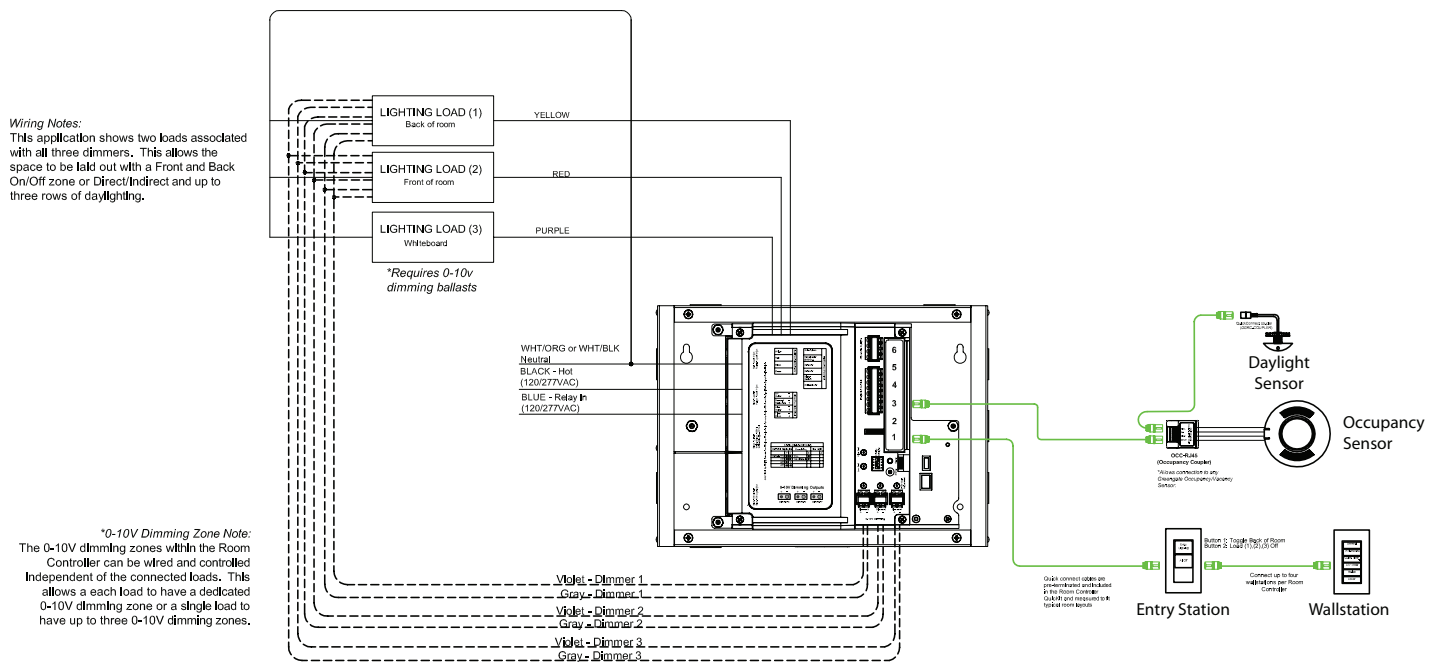

Figure 6: Classroom with daylight dimming



Typical wiring diagrams

Figure 7: Demand Response Connections

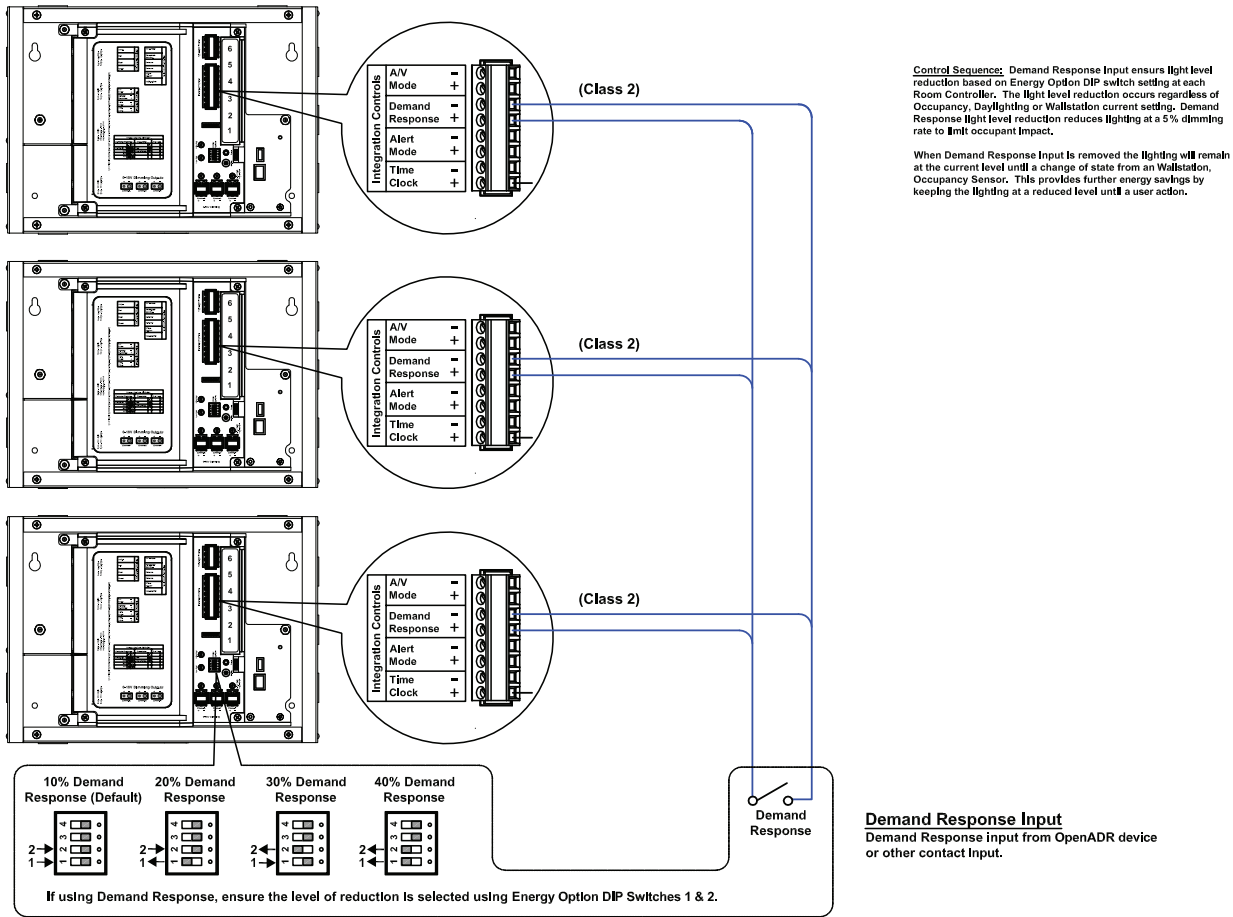
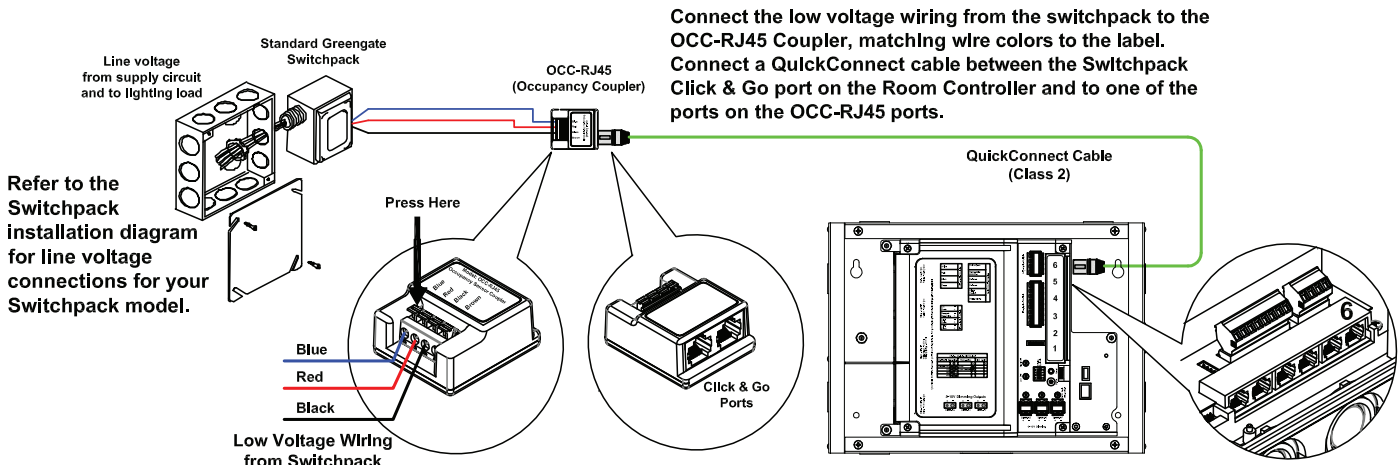
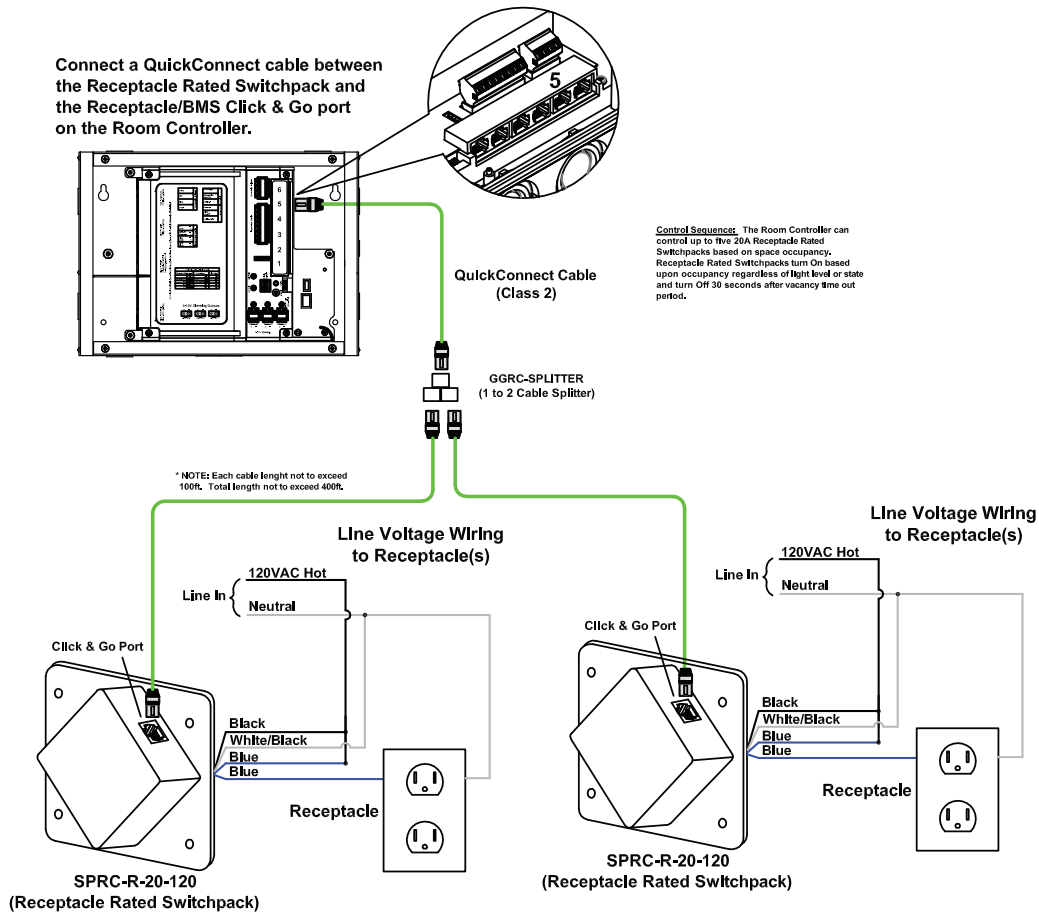

Figure 8: Alternative voltage connection



Typical wiring diagrams

Figure 9: Receptacle wiring



Typical wiring diagrams

Figure 10: Wallstation Sharing

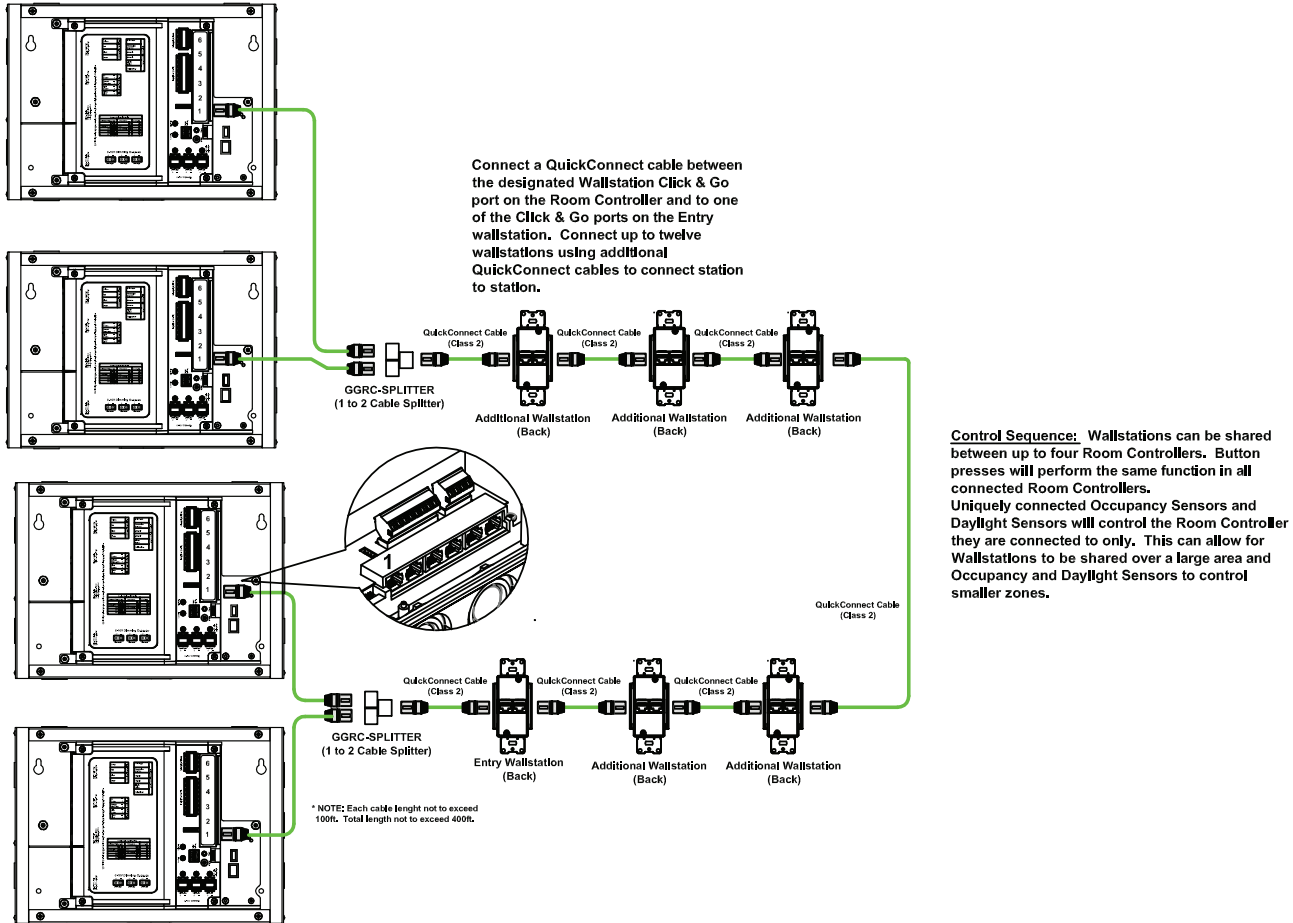

Typical wiring diagrams

Figure 11: Network Wiring

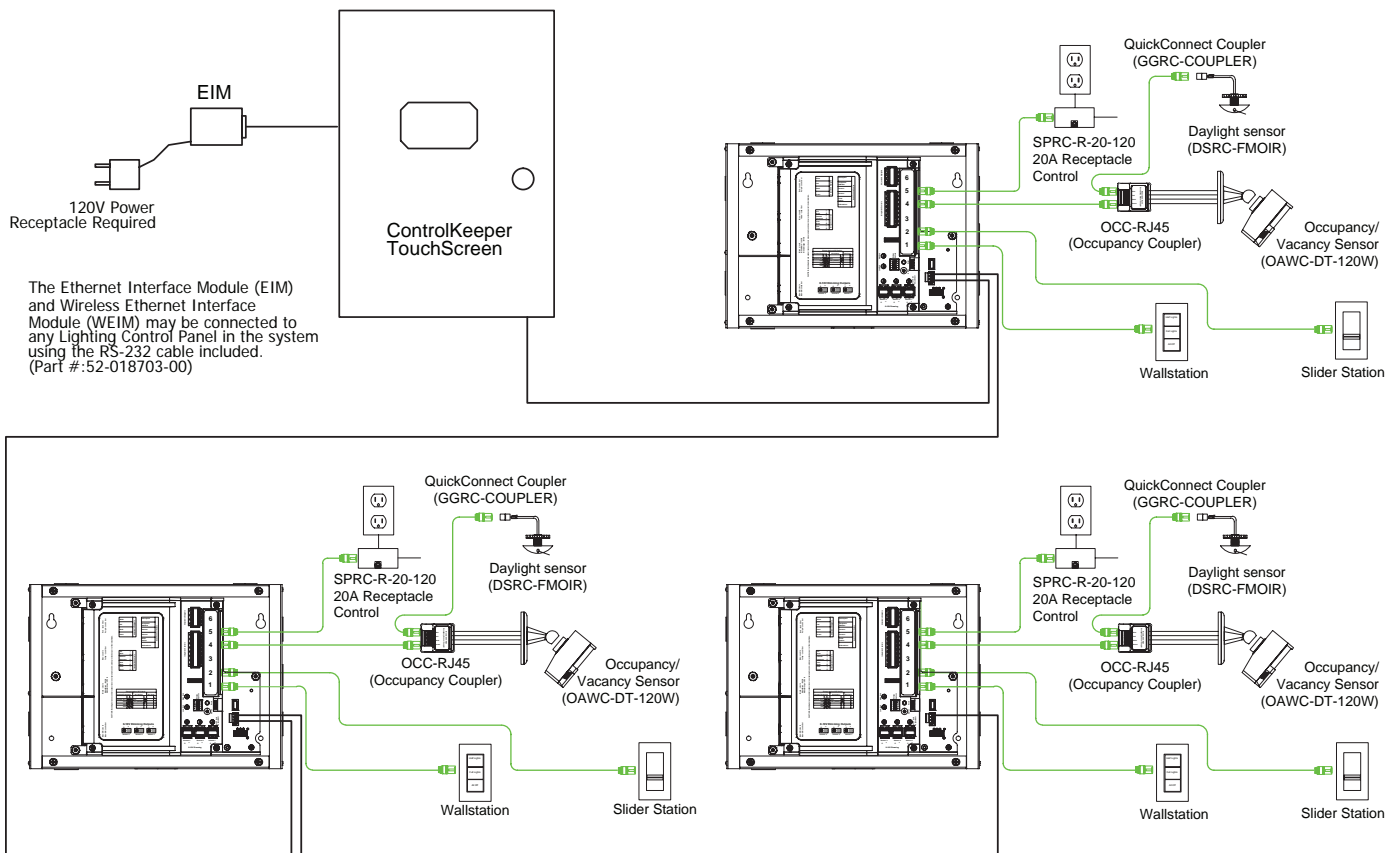

Eaton's Lighting systems –
Controls products
203 Cooper Circle
Peachtree City, GA 30269
P: 800-553-3879
F: 800-954-7016
www.eaton.com/lightingsystems

International Headquarters
Usk House, Lakeside
Llantarnam Park
Cwmbran, NP44 3HD UK
P: +44 1923 495495
F: +44 1633 867880

Canada Sales
5925 McLaughlin Road
Mississauga, Ontario L5R 1B8
P: 905-501-3000
F: 905-501-3172

Our Controls Product Brands
Greengate
iLumin
Zero 88
Fifth Light Technology
iLight (International Only)

Our Lighting Product Brands
Halo
Halo Commercial
Portfolio
IRiS
RSA
Metalux
Corelite
Neo-Ray
Fail-Safe
MWS
Ametrix
Shaper
io
Lumark
McGraw-Edison
Invue
Lumière
Streetworks
AtLite
Sure-Lites

Eaton
1000 Eaton Boulevard
Cleveland, OH 44122
United States
Eaton.com

Eaton
Lighting systems
203 Cooper Circle
Peachtree City, GA 30269
www.eaton.com/lightingsystems

© 2015 Eaton
All Rights Reserved
Publication No. BR503006EN
December 3, 2015

Eaton is a registered trademark.
All other trademarks are property
of their respective owners.