

Visit 3M Electrical Fire Protection Solutions Pages

http://solutions.3m.com/wps/portal/3M/en_US/EMDCI/Home/Products/FireProtectionProducts/

Fire Protection Products

Sealants & Packing Material	198
Pillows & Putty	201
Pass-Through & Cast-In Devices	203
Collars & Wrapstrips	207
Sheets & Mats	209
Miscellaneous	211



The complete line of 3M fire protection products helps prevent fire, smoke, toxic fumes and moisture from passing through penetrations in fire-rated walls and floors. These easy-to-install products are suitable for a wide variety of

firestop applications, including plastic pipes, metal pipes, HVAC ductwork, cables, construction gaps, grease ducts, wall tops and control joints.

Typical Firestop Applications

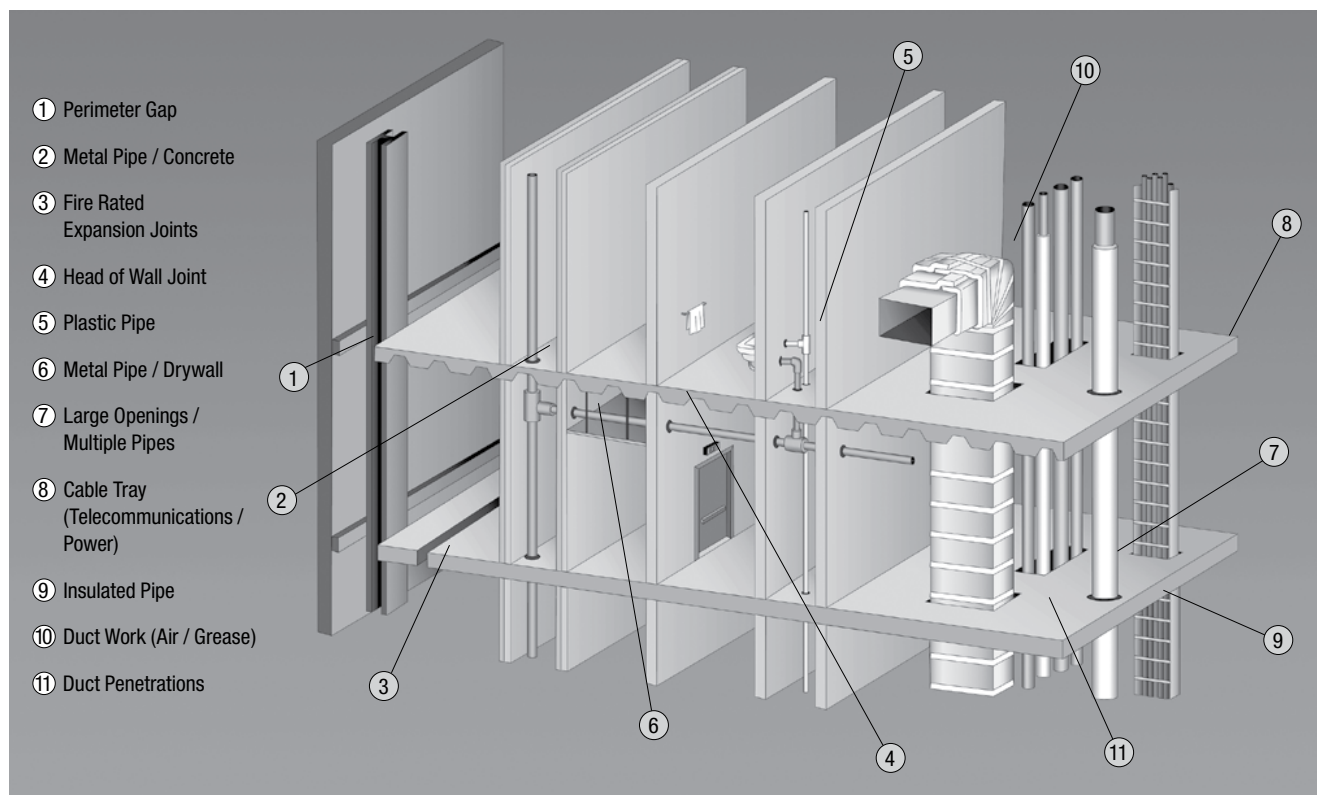

Sealants and Packing Material

3M™ Fire Barrier Sealants



All 3M Fire Barrier Sealants have either intumescent, endothermic or ablative technologies designed to provide a tight and dependable seal against fire, smoke, toxic fumes and moisture. 3M intumescent sealants expand up to 10 times their original size when exposed to temperatures over 300°F (149°C). This intumescent action forms a strong, insulating char that seals the opening for up to four hours when exposed to extreme heat.

Fire barrier sealants are ideal for new construction or retrofit in a wide variety of applications such as metal, plastic, insulated and glass pipe, construction gaps, dynamic joints, HVAC ductwork and insulated cable applications.

All come in convenient job-size packages and install easily with a standard caulking gun, pneumatic pumping equipment or putty knife.

3M™ Fire Barrier Sealant CP 25WB+



3M Fire Barrier Sealant CP 25WB+ is our premium, intumescent latex-based sealant offering outstanding fire performance plus a non-halogen formula.

- Provides up to 4 hour rating of UL systems tested
- Water base—easy cleanup, no special handling, routine disposal
- Intumescent—expands when heated to choke and seal around items consumed by fire

- Endothermic—releases chemically bound water to cool exposed surfaces
- Fast-dry—tack-free in approximately 10-15 minutes
- Red color for easy inspection



3M™ Fire Barrier Sealant IC 15WB+



A low-cost, latex based, intumescent smoke and firestopping sealant for wall and floor penetrations. Easy-to-handle formulation that bonds to concrete, metal, wood and cable

jacketing. Dries to a firm, rubber-like solid. Provides up to three hours of rating of UL systems tested.

- Water base—easy cleanup, no special handling, routine disposal
- Intumescent—expands when heated to choke and seal around items consumed by fire
- Endothermic—releases chemically bound water to cool exposed surfaces
- Fast-dry—tack-free in approximately 10-15 minutes

3M™ FireDam™ Acrylic Latex Sealant 150+



FireDam Acrylic Latex Sealant 150+ is an acrylic latex sealant used to firestop metal pipes and cables through concrete or gypsum, and for use in dynamic head-of-wall systems.

- Approved for many metal pipe through penetration applications
- Easily spread to a smooth finished surface
- Low shrinkage
- Available in blue and limestone colors



3M™ Fire Block Sealant FB 136



Lightweight, cementitious sealant with excellent adhesion—bonds to concrete, metals, wood, plastic and cable jacketing.

- Easy cleanup with water
 - No special handling, routine disposal
 - Thixotropic: will not sag or run in vertical or overhead applications
 - Halogen-free
 - Tack free in approximately 15 minutes
 - Gray color
- High caulk rate
 - Low VOC
 - Meets ASTM E136 test standard

3M™ Fire Barrier Water Tight Silicone Sealant 3000 WT



3M Fire Barrier Water Tight Silicone Sealant 3000 WT is an intumescent silicone that expands around combustible and non-combustible penetrating items to maintain a tight barrier against fire, smoke and noxious gas.

- Meets the UL Water Leakage Test – Class 1 Requirements
- Excellent weatherability
- Ideal for fast-track construction
- Excellent adhesion
- Easy application with standard or bulk caulking guns or pneumatic pumping equipment
- Cures upon exposure to atmospheric humidity

3M™ Fire Barrier Water Tight Silicone Sealant 1000 NS



3M Fire Barrier Water Tight Silicone Sealant 1000 NS is a non-slumping silicone ideal for use on fire-rated floor and wall penetrations and joints.

Meets the UL Water Leakage Test – Class 1 Requirements.

- Excellent weatherability
- Ideal for fast-track construction
- Excellent adhesion
- Easy application with standard or bulk caulking guns or pneumatic pumping equipment
- Cures upon exposure to atmospheric humidity
- Reenterable and repairable



3M™ Fire Barrier Water Tight Silicone Sealant 1003 SL

3M Fire Barrier Water Tight Silicone Sealant 1003 SL is a self-leveling silicone ideal for fire-rated floor penetrations and joints.

- Meets the UL Water Leakage Test – Class 1 Requirements
- Excellent weatherability
- Ideal for fast-track construction
- Excellent adhesion
- Easy application with standard or bulk caulking guns or pneumatic pumping equipment
- Cures upon exposure to atmospheric humidity
- Reenterable and repairable



3M™ Fire Barrier Packing Material PM 4



A light-weight packing material approved for use in all of 3M's UL Listed through-penetration firestop systems. The 20-foot roll is convenient to transport and features quick and easy hand-tear dispensing.

3M Fire Barrier Packing Material is ideal for use around metallic, nonmetallic, insulated pipe, HVAC and power and communication cable penetrants—a long-awaited alternative to mineral wool, fiberglass or backer rod.

- Approved for use in up to 4 hour firestop systems
- Convenient, hand-tear dispensing
- For almost any through-penetration firestop project
- Approved for use in all of 3M's UL Listed through-penetration firestop systems
- Less irritating to skin than competitive products



Specifications and Ordering Information for 3M Fire Barrier Sealants & Packing Material

Product	UPC (051115-)	Description	Size	Case Qty.
FIRE BARRIER SEALANTS				
CP 25WB+ Cartridge (10.1 oz.)	11638-4	Intumescent Sealant	10.1 fl. oz. (298 ml)	12 each
CP 25WB+ Sausage (20 oz.)	11642-1	Intumescent Sealant	20 fl. oz. (591 ml)	10 each
CP 25WB+ Cartridge (27 oz.)	11641-4	Intumescent Sealant	27 fl. oz. (798 ml)	6 each
CP 25WB+ Pail (2 Gal.)	11639-1	Intumescent Sealant	2 gal. (256 fl. oz.)	1 pail
CP 25WB+ Pail (5 Gal.)	11640-7	Intumescent Sealant	5 gal. (640 fl. oz.)	1 pail
IC 15WB+ Cartridge (10.1 oz.)	16557-3	Intumescent Sealant	10.1 fl. oz. (298 ml)	12 each
IC 15WB+ (20 oz.)	16560-3	Intumescent Sealant	20 fl. oz. (591 ml)	10 each
IC 15WB+ (27 oz.)	16559-7	Intumescent Sealant	27 fl. oz. (798 ml)	6 each
IC 15WB+ Pail (4.5 gal.)	16558-0	Intumescent Sealant	4.5 gal. (576 fl. oz.)	1 pail
FireDam 150+ (10.1 oz.) Blue	11574-5	Water Based Sealant	10.1 fl. oz. (298 ml)	12 cartridges
FireDam 150+ (20 oz.) Blue	11634-6	Water Based Sealant	20 fl. oz. (591 ml)	12 each
FireDam 150+ (28.5 oz.) Blue	11602-5	Water Based Sealant	28.5 fl. oz. (842 ml)	6 cartridges
FireDam 150+ (4.5 gal.) Blue	11575-7	Water Based Sealant	4.5 gal. (576 fl. oz.)	1 pail
FireDam 150+ (10.1 oz.) Limestone	16564-1	Water Based Sealant	10.1 fl. oz. (298 ml)	12 cartridges
FireDam 150+ (20 oz.) Limestone	16567-2	Water Based Sealant	20 fl. oz. (591 ml)	12 each
FireDam 150+ (28.5 oz.) Limestone	16566-5	Water Based Sealant	28.5 fl. oz. (842 ml)	6 cartridges
FireDam 150+ (4.5 gal.) Limestone	16565-8	Water Based Sealant	4.5 gal. (576 fl. oz.)	1 pail
FB 136+ Cartridge (10.1 oz.)	1659-1	Water Based Sealant	10.1 fl. oz. (298 ml)	12 each
WATER TIGHT FIRE BARRIER SEALANTS				
3000 WT (10.1 oz.)	16594	Water Tight Sealant Intumescent	4.5 gal. (576 fl. oz.)	1 pail
3000 WT (4.5 gal.)	16593	Water Tight Sealant Intumescent	10.1 fl. oz. (298 ml)	12 cartridges
1000 NS (10.1 oz.)	11537	Water Tight Sealant Non Slump	4.5 gal. (576 fl. oz.)	1 cartridge
1000 NS (4.5 gal.)	11535-6	Water Tight Sealant Non Slump	10.1 fl. oz. (298 ml)	12 cartridges
1003 SL (10.1 oz.)	11540	Water Tight Sealant Self-Leveling	4.5 gal. (576 fl. oz.)	1 cartridge
1003 SL (4.5 gal.)	11538-7	Water Tight Sealant Self-Leveling	10.1 fl. oz. (298 ml)	12 cartridges
3000 WT (20 oz.)	18788-9	Water Tight Sealant Intumescent	20 oz.	12 each
1000 NS (20 oz.)	18790-2	Water Tight Sealant Non Slump	20 oz.	12 each
1003 SL (20 oz.)	18789-6	Water Tight Sealant Self-Leveling	20 oz.	12 each
PACKING MATERIAL				
PM4-Bulk	18764-3	Hand-Tear Dispensed Packing Material	0.5" x 4" x 20.5 ft. (0.28 cu. ft.)	5 rolls

Pillows and Putty

3M™ Fire Barrier Self-Locking Pillows



Self-contained, highly intumescent pillows are designed to firestop a wide variety of through-penetrations including cable trays, conduit and blank openings. Interlocking strips hold pillows securely together yet release easily for retrofit or reuse—just remove and replace pillows as needed.

- No wire mesh reduces safety issues
- Easy to install, easy to remove and reuse
- No cutting and no mess—just lock pillows together, compress and place (use 3M™ Fire Barrier Moldable Putty+ around edges to ensure proper seal)
- No graphite
- Excellent aging properties
- Available in 2" x 4" x 9" (small), 2" x 6" x 9" (medium) and 3" x 6" x 9" (large) pillow sizes
- Provides up to 3-hour UL Listed systems (in up to a 540 square inch opening)

3M™ Fire Barrier Pillows



Stackable and conformable firestop pillows for new and retrofit projects.

- No wire mesh or graphite
- Excellent aging properties

- Available in 2" x 4" x 9" (small), 2" x 6" x 9" (medium) and 3" x 6" x 9" (large) pillow sizes
- Provides up to 3-hour UL Listed systems (in up to a 540 square inch opening)

3M™ Fire Barrier Moldable Putty+

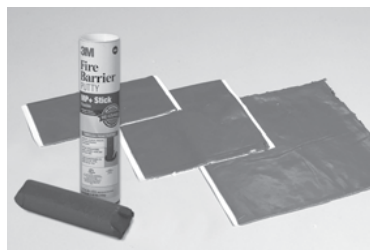

3M Fire Barrier Moldable Putty+ is designed for use as a one-part, 100% solids intumescent firestop that restores the integrity of fire-rated building construction.

- Ideal for construction gaps, cable, insulated pipe, electrical conduit and metal pipe
- Designed to provide up to a 4-hour fire rating
- UL-classified for telecommunications applications (interduct, fiber optic and cables)
- Remains pliable and flexible
- Won't dry out or crumble
- Convenient pad and stix form
- Non-halogen formula
- Reenterable
- Adheres to all common building surfaces including metal and plastic electrical boxes
- Available in both 4S and 5S electrical box sizes
- Provides draft and cold smoke seal even before temperature increases
- Intumescent and expands to form a hard char that prevents the transmission of hot gases and fire
- Great for building maintenance applications

Specifications and Ordering Information for 3M™ Fire Barrier Pillows and Putty

Product	UPC (051115-)	Size	Volume	Case Qty.
FIRE BARRIER PILLOWS				
FB 249 Pillow	16508-5	1/8" x 4" x 8" (3,2 x 102 x 203 mm)	N/A	24
FB 269 Pillow	16531-3	2" x 6" x 9"	N/A	16
FB 369 Pillow	16532-0	3" x 6" x 9"	N/A	20
FIRE BARRIER SELF-LOCKING PILLOWS				
SLP-Small	16578-3	2" x 4" x 9"	N/A	24
SLP-Medium	16579-0	2" x 6" x 9"	N/A	16
SLP-Large	16580-6	3" x 6" x 9"	N/A	20
MOLDABLE PUTTY PADS AND STIX				
MPP+ 4" x 8"	16508-5	1/8" x 4" x 8" (3,2 x 102 x 203 mm)	4 in. ³	100 each
MPP+ 7" x 7"	16509-2	1/8" x 7" x 7" (3,2 x 178 x 178 mm)	6.12 in. ³	20 each
MPP+ 9.5" x 9.5"	16510-8	1/8" x 9.5" x 9.5" (3,2 x 241,3 x 241,3 mm)	11.3 in. ³	20 each
MP+ Stix	16526-9	1.5" x 11" (40,6 x 279 mm)	21.2 in. ³	10 each
MP+ Stick	16561-0	1.4" x 6" (183 mm)	N/A	12 each

Put heat
in its
place



Pass-Through and Cast-In Devices

3M™ Fire Barrier Devices

Fire barrier devices offer an effective one-piece solution for the firestopping of penetrating items through rated walls and floors. During a fire, these devices intumesce to form a seal, which helps protect against the spread of fire, smoke and toxic gases. Fire barrier devices are easy to install and are designed to take the guesswork out of firestopping. 3M offers pass-through options for walls and cast-in place options for poured concrete floors. 3M Fire Barrier Devices offer a simple, caulk-free, code compliant alternative to complicated caulk systems. Plus, they have the added benefit of retrofit firestop capabilities, which means less hassles after buildings are occupied.

3M™ Fire Barrier Pass-Through Devices

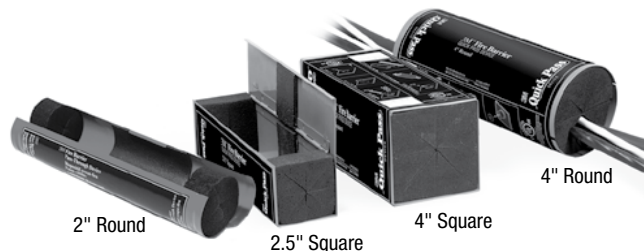

Caulk-free code-compliant devices designed for easy installation and re-enterability—perfect for firestopping structures where electrical, data and communication cables or plumbing pipes pass through fire-rated floors and walls.

- Available in 2" round, 2 1/2" square, 4" round and 4" square sizes
- UL classified L rating, hot and cold smoke seal
- Stackable for penetrant versatility
- Hinged for easy retrofit installation around cables
- UL classified 1, 2 and 3 hour fire (F) and temperature (T) ratings

3M™ Fire Barrier Pass-Through Mounting Brackets



Mounting brackets available for wall or floor mounting of 3M Fire Barrier Pass-Through Devices:

- Single mounting bracket available for all devices
- Triplex and Sixplex mounting brackets available for square devices

Specifications and Ordering Information for 3M™ Fire Barrier Pass-Through Products

Product	Description	Case Wgt	UPC (051115-)	Unit	Case Qty.
DEVICES AND BRACKET—ROUND					
PT2RD	2" Round Device	7.80	18773-5	Each	6
PT2RMB	2" Round Mounting Brackets (Pair)	11.0	18774-2	Pair	24
PT4RD	4" Round Device	12.39	16598-6	Each	6
PT4RMB	4" Round Mounting Brackets (Pair)	10.32	18754-4	Pair	24
DEVICES AND BRACKET—SQUARE					
PT2.5SD	2.5" Square Device	7.72	16596-2	Each	6
PT2.5SMB	2.5" Square Single Mounting Brackets (Pair)	11.60	18750-6	Pair	24
PT2.5TMB	2.5" Square Triple Mounting Brackets (Pair)	19.18	18751-3	Pair	24
PT4SD	4" Square Device	13.62	16597-9	Each	6
PT4SMB	4" Square Single Mounting Brackets (Pair)	16.40	18752-0	Pair	24
PT4SSB	4" Square Stud Bracket	8.20	18780-3	Each	24
PT4TMB	4" Square Triple Mounting Brackets (Pair)	29.10	18753-7	Pair	24
PT4SSMB	4" Square Sixplex Mounting Brackets (Pair)	36.00	18777-3	Pair	6

3M™ Fire Barrier Cast-In Device



These firestop devices are designed to make firestopping through concrete easy and affordable. With models available to accommodate plastic or metallic pipe, 3M™ Fire Barrier Cast-In Devices are installed prior to the concrete pour (attaching directly to the wood forms) and can be adjusted to various concrete depths.

- Penetrating item is passed through device after the concrete cures
- Easily adjustable bodies that can be adapted to concrete height (from 2-1/2" up to 8")
- Models available for metallic or non-metallic penetrating items
- Available in 2", 3", 4" and 6" diameter by 8" height
- Provides up to a 3-hour fire rating

3M™ Fire Barrier Cast-In Metal Deck Adapter



- One-piece plastic body assembly to accommodate fluted metal decks
- Use in conjunction with 3M Fire Barrier Cast-In Devices

3M™ Fire Barrier Cast-In Device Height Adapter

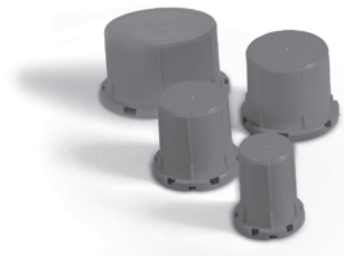

- One-piece plastic body assembly allows 3M Fire Barrier Cast-In Devices to be used in up to 12" concrete thickness
- Designed to accommodate pipe sizes from 1 1/2" to 4"
- Easily snaps into place—no additional fastening required
- Available for use with 2", 3", 4" and 6" 3M Fire Barrier Cast-In Device

3M™ Fire Barrier Cast-In Tub Box Assembly



- Fastens to a 2" metallic 3M Fire Barrier Cast-In Device and creates a void for plumbing access
- Available with 2" or 3" foam insert depending on desired depth of access void
- Easily snaps into place and then attaches directly to wood forms
- Accommodates 1-1/2" and 2" pipe

Specifications and Ordering Information for 3M™ Fire Barrier Cast-In Devices

Product	Description	UPC (051115-)	Case Qty.
2PCID	2" Diameter Cast-In Device for Plastic Pipes	16536-8	12
3PCID	3" Diameter Cast-In Device for Plastic Pipes	16537-5	12
4PCID	4" Diameter Cast-In Device for Plastic Pipes	16538-2	6
6PCID	6" Diameter Cast-In Device for Plastic Pipes	16539-9	2
2MCID	2" Diameter Cast-In Device for Metal Pipes	16540-5	12
3MCID	3" Diameter Cast-In Device for Metal Pipes	16541-2	12
4MCID	4" Diameter Cast-In Device for Metal Pipes	16542-9	6
6MCID	6" Diameter Cast-In Device for Metal Pipes	16543-6	2
2MDA	2" Metal Deck Adaptor	16544-3	12
3MDA	3" Metal Deck Adaptor	16545-0	12
4MDA	4" Metal Deck Adaptor	16546-7	12
6MDA	6" Metal Deck Adapter	16547-4	12
2HA	2" Cast-In Height Adaptor for use with 2PCID and 2MCID	16548-1	12
3HA	3" Cast-In Height Adaptor for use with 2PCID and 2MCID	16549-8	12
4HA	4" Cast-In Height Adaptor for use with 2PCID and 2MCID	16550-4	12
6HA	6" Cast-In Height Adapter for use with 6PCID and 6MCID	16551-1	12
2TB	Tube Box	16552-8	6
3TB	Tube Box	16586-8	6
4AA	4" Aerator Adapter for use with 4PCID and 4MCID	16589-9	12

Collars and Wrapstrips

3M™ Fire Barrier Ultra Plastic Pipe Device



The proven technology of this fire barrier product's intumescent action quickly seals off plastic pipes in a fire, and is designed to meet up to three-hour fire and temperature ratings. For plastic pipe types and hourly

ratings, consult the current UL Fire Resistance Directory or ULC Volume 3 Fire Resistance Ratings.

- UL-classified for use on PVC, CPVC, CCPVC, ABS, CCABS, PVDF and FRPP
- Easy to install—one step
- Expands up to 25 times
- Factory-made, consistent quality
- Red in color for easy identification as a fire-rated device during inspections



- 100% solids
- One-part, organic/inorganic, fire-resistive elastomeric strip with foil on one side
- Intumescent for complete, rapid sealing during a fire
- Standard 2 in. width or optimized 1 in. width applications
- Superior, documented aging properties. Proven stability and performance for expected life of building
- Improved flexibility for easy, cost-effective installation
- Versatile—can be cut to fit irregular shapes
- Reenterable—no special tools required
- Non-flame supporting
- Red-brown color
- Applications include: telephone cable, metal pipe, plastic pipe, conduit, insulated metal pipe and cable trays
- Used to firestop up to 10 in. (254,0 mm) diameter PVC pipe
- UL-classified for use on PVC, CPVC, ABS, CCPVC, CCABS, PVDF, FRPP, PP and PB plastic pipe



3M Knoxville, IA Registered to ISO 9002 Certificate No. A1021

3M™ Fire Barrier Wrap/Strip FS-195+



This patented intumescent wrap/strip has 3M state-of-the-art through-penetration fire protection plus improved characteristics.

Firestops difficult through-penetrations

such as plastic pipe, insulated pipe and cables. When exposed to heat, this flexible, rubber-like strip expands up to 10 times its original volume, forming a very hard char to prevent the migration of fire and smoke.

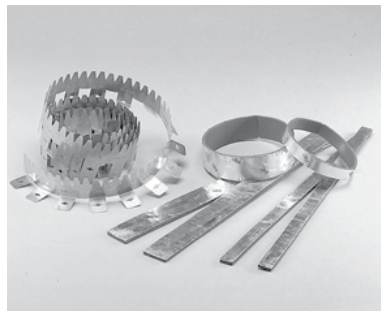

3M™ Fire Barrier Restricting Collar RC-1

- UL-classified for use on PVC, CPVC, ABS, CCPVC, CCABS, PVDF, PP and PB plastic pipe
- Easy installation
- 28 gauge steel
- Convenient 25 ft. (7,62 m) roll
- Required for firestopping plastic pipes larger than 4 in. (101,6 mm) in diameter



Specifications and Ordering Information for 3M™ Wraps, Collars and Plastic Pipe Devices

Product	UPC (051115-)	Style	Size	Case Qty.
WRAPS AND COLLARS				
Wrap/Strip FS-195+	07115-7	N/A	2" x 24" (50,8 x 609,6 mm)	10 each
Restricting Collar RC-1	08324-5*	N/A	2" x 25' (50,8 mm x 7,62 m)	1 each
E-FIS Intumescent Strip	11626-1	N/A	1/2" x 50'	10 each
PLASTIC PIPE DEVICES				
Ultra PPD 1.5	08378-5	Finger Tab	1-1/2" (38,1 mm)	10 each
Ultra PPD 2.0	08379-2	Finger Tab	2" (50,8 mm)	10 each
Ultra PPD 3.0	08380-8	Finger Tab	3" (76,2 mm)	10 each
Ultra PPD 4.0	08381-5	Finger Tab	4" (101,6 mm)	10 each
Ultra PPD 6	08253-5	Hose Clamp	6" (152,4 mm)	5 each
Ultra PPD 16 Fast Anchors	11530-1	Anchors	3/4" x 16" (19,05 x 406,4 mm)	400 each

* UPC prefix 054007-

Tough
insulation.
Easy
installation.



Sheets and Mats

3M™ Fire Barrier Composite Sheet CS-195+



Intumescent sheet used to firestop large openings. Designed to seal penetrations against flame spread, smoke and toxic fumes. This composite sheet has multiple applications, including blank openings, through penetrations of multiple cable, pipe ducts, buss ducts and cable trays.

- Intumescent (expands with heat) to form a hard char that tightly seals penetrations against flame spread, smoke and toxic fumes
- Multiple applications: through-penetration firestop, heat shield and firebreak protection
- Easy to install using common trade tools
- Lightweight—easy to handle, just cut and form to desired shape
- Easy to fasten—bolt punch or drill through and use self-tapping screws or anchor bolts
- Thermally conductive—allows unwanted heat buildup to escape
- Non-flame supporting
- UL-classified
- Cost-effective
- No mixing or damming—is clean to install
- Reenterable
- 100% solids
- Versatile—can be cut to fit irregular shapes



3M™ Interam™ Endothermic E-5A-4

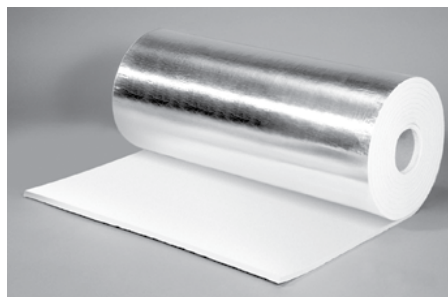

This endothermic wrap is designed to block heat penetration by chemically absorbing heat energy. When exposed to high temperatures, it keeps heat out by releasing chemically bound water to cool the outer surface.

- Outstanding performance in high-intensity fires
- Protects structural steel, cable trays and circuits in conduits
- Easy to install
- Can be installed directly over existing fire protection



3M™ Interam™ Tape T-49

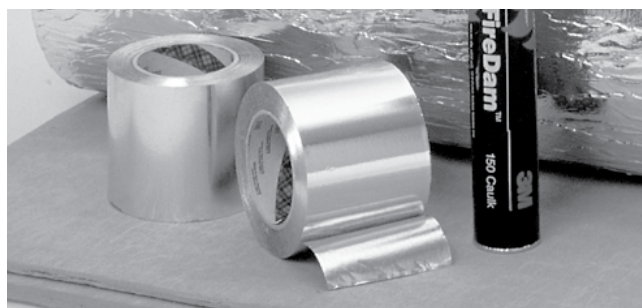

3M Interam Tape T-49 is an adhesive-backed aluminum foil tape designed to seal the cut edges of 3M Fire Barrier duct wrap and interam mats to complete the total encapsulation.

- 3-mil aluminum foil
- Acrylic adhesive
- Tensile strength: 30 lbs./in. width (525N/100 mm)



Specifications and Ordering Information for 3M™ Sheets and Rolls

Product	UPC (051115-)	Size	Case Qty.
SHEETS			
CS-195+ 16" x 28"	07437-0	16" x 28" (406,4 mm x 711,2 mm)	1
CS-195+ 3' x 2'	07220-8	24" x 36" (609,6 mm x 914,4 mm)	1
CS-195+ 3' x 3'	07222-2	36" x 36" (914,4 mm x 914,4 mm)	1
CS-195+ 3' x 41"	07224-6	36" x 41" (914,4 mm x 1041,4 mm)	1
CS-195+ 28" x 52"	08260-3	28" x 52" (711,2 mm x 1320,8 mm)	1
ROLLS			
E-5A-4 Mat	16571-9	24.5" x 20.0' x 0.4" (622,3 mm x 6,10 m x 10,16 mm)	1 roll
Aluminum Tape T-49	02240-1	4" x 180' x 0.005" (101,6 mm x 54,8 m x 0,127 mm)	2 rolls

Miscellaneous

3M™ Fire Barrier Mortar

3M Fire Barrier Mortar is a lightweight cementitious firestop product.

- Variable mix ratio—permits self-leveling as well as no-sag (no forming) application consistencies, resulting in labor savings
- Excellent adhesion—will bond to concrete, metals, wood, plastic and cable jacketing
- Reenterable without use of power tools—results in lower maintenance costs due to ease of making cable changes
- Bonds to itself—proven prior and during fire testing, resulting in proven and tested repair procedures
- Pumpability
- Warnock Hersey Certified, system number 3M/PHV 120-01 for 2-hour separations
- Mortar is available in 44 lb. bags



Specifications and Ordering Information for 3M™ Mortar, Spray and Duct Wrap

Product	UPC (051115-)	Size	Case Qty.
Mortar*	07559-9	44 lb. bag	1 bag
Firedam Spray 200	18755-1	5-gallon pail (640 fl. oz.)	1 pail
Plenum Wrap 5A	16513-9	1/2" x 24" x 50'	1 roll
Plenum Wrap 5A	16514-6	1/2" x 48" x 25'	2 each
Duct Wrap 15A	16553-5	1-1/2" x 24" x 20'	1 each
Duct Wrap 15A	16554-2	1-1/2" x 48" x 20'	1 each
Duct Wrap 20A	16555-9	2" x 24" x 20'	1 each
Duct Wrap 20A	16556-6	2" x 48" x 20'	1 each
Duct Wrap 615-24	18786-5	1-1/2" x 24" x 25'	1 each
Duct Wrap 615-48	18787-2	1-1/2" x 48" x 55'	1 each

*Mortar must be ordered in 30 bag increments

