

## T8 & T5 Linear Lamp Brochure



- Classrooms
- Offices
- Production
- Hallways
- Warehouses
- Hospitals
- Parking Garages
- Retail Spaces

LED T8



Fluorescent T8



Fluorescent T5



U-Bent T8

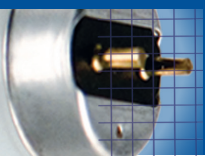

# Howard's best-in-class linear lamps.

Enjoy the benefits of Howard Lighting linear fluorescent and LED products. Whether you are lighting a warehouse, classroom, parking garage, gym, entry way, or small shop, we have just the solution you need. With a wide selection of wattages, sizes, and designs, our T5 and T8 lamp options provide energy savings and reduced maintenance costs while providing you with high color rendition and consistent quality light output. From energy saving and high lumen to long life and LED, our products will meet or exceed your expectations for quality and service. Let us be your supplier of linear fluorescent and LED lamps.



LED T8



Fluorescent T8



Lighting for life™

Visit us online at [HowardLightingProducts.com](http://HowardLightingProducts.com) or call us at 800.956.3456.

Experience the  
**Howard advantage.**

**HOWARD**<sup>TM</sup>  
LIGHTING PRODUCTS

**HI** A Division of Howard Industries, Inc.



Fluorescent T5



U-Bent T8

**We make ordering as easy as 1-2-3.**

**1.** **Order Direct**  
Contact the authorized agent that you have purchased from in the past.

**2.** **Order by phone**  
You can also contact us at 800.956.3456 to discuss your needs or place an order.

**3.** **Order by fax**  
Or if you prefer, you can reach us by fax at 601.422.1652.

# LINEAR LED LAMPS

## LED T8 Lamp

**Direct Replacement LED T8: snap in, turn on!**

Howard's Direct Replacement LED T8 lamp does not require an electrical re-wiring to install. Because the LED T8's work with instant start ballasts, they are independent of the ballast operating voltage which can be 120v, 277v, or 347v. This makes switching to LEDs as simple as changing a light bulb (no rewiring or special handling required).

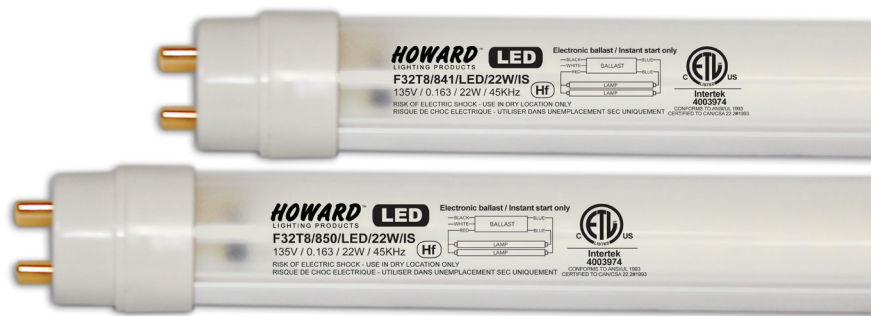

Auto-adjusts to the corresponding ballast factor

- 19w (Low Ballast Factor)
  - 22w (Standard Ballast Factor)
  - 26w (High Ballast Factor)
- Colors Available
- 4100
  - 5000

The Linear LED T8 also incorporates environmentally friendly passive components for a more reliable, longer lasting product with no UV light and no mercury. Using half the energy of a traditional linear T8, the lamp provides instant brightness, producing a 110° beam that spreads illumination uniformly, without hot spots or glare. Linear LED T8 lamps are especially well suited for difficult applications including refrigerator/freezer cases, or high-vibration, hard to reach locations. They are perfect for general lighting, merchandise displays, offices or anywhere building managers want environmentally friendly LED lighting.

### Features:

- Direct replacement – works with existing fluorescent T8 lamp fixtures and instant start ballasts
- Low energy usage: One half that of existing fluorescent T8s
- Environmentally friendly: no mercury, no UV or infrared light
- Low lumen depreciation -- maintains brightness over its 50,000 hour rated life
- Minimum heat emission, reducing load on building cooling systems.
- No flickering
- ETL tested to comply with OSHA safety standards

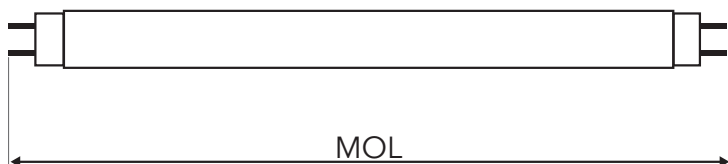

5 Year  
Warranty





Visit [www.designlights.org](http://www.designlights.org)  
for the Qualified Products List

Visit us online at [HowardLightingProducts.com](http://HowardLightingProducts.com) or call us at 800.956.3456.

**HOWARD**  
LIGHTING PRODUCTS

## 800 SERIES 48" T8 LED LAMPS

T8 Medium Bipin

| UPC #        | Howard Model #       | Lumens Initial | Avg. Life (hours) | Color Temp. (K) | MOL (in.) | CRI | Pkg. Qty. | Footnotes (see p18 for explanation)   |
|--------------|----------------------|----------------|-------------------|-----------------|-----------|-----|-----------|---|
| 799385-62008 | F32T8/841/LED/22W/IS | 1900           | 50000             | 4100            | 47.17     | 80+ | 20        | 1  |
| 799385-62009 | F32T8/850/LED/22W/IS | 1900           | 50000             | 5000            | 47.17     | 80+ | 20        | 1  |

| Specifications              | F32T8/8XX/LED/22W/IS                             |                |              |
|-----------------------------|--|----------------|--------------|
| Ballast Factor (BF)*        | Low (78%)  | Standard (88%) | High (110%)  |
| Power Consumption (P)       | 19 watts   | 22 watts       | 26 watts     |
| Luminous Flux (F)           | 1,900 lumens                                     | 2,200 lumens   | 2,600 lumens |
| Luminous Efficacy**         | 100 lm/W   | 100 lm/W       | 100 lm/W     |
| Input-voltage               | 110-277v (Instant Start Electronic Ballast Only) |                |              |
| Power Factor (PF)           | 0.9  |                |              |
| Color Temperature (CCT)     | 4100K, or 5000K                                  |                |              |
| Color Rendering Index (CRI) | 80+ CRI  |                |              |
| Rated Life                  | 50,000 hours                                     |                |              |
| Operating Temperature       | -20°C(-4°F) - 45°C(113°F)                        |                |              |
| Diameter                    | 1 in. (T8) (25.5mm)                              |                |              |
| Total Length                | 47.165 in. (1,198mm)                             |                |              |
| Nominal Length              | 48 in.   |                |              |
| Weight                      | 1.1lb (500g)                                     |                |              |

\* The LED T8 Lamp "self-adjusts" light output that matches the corresponding ballast factor of the supply (or control) ballast. The new "system matched" light output will meet or exceed that of the one it is replacing.

\*\*Efficiency measured using 4100K with clear lens.



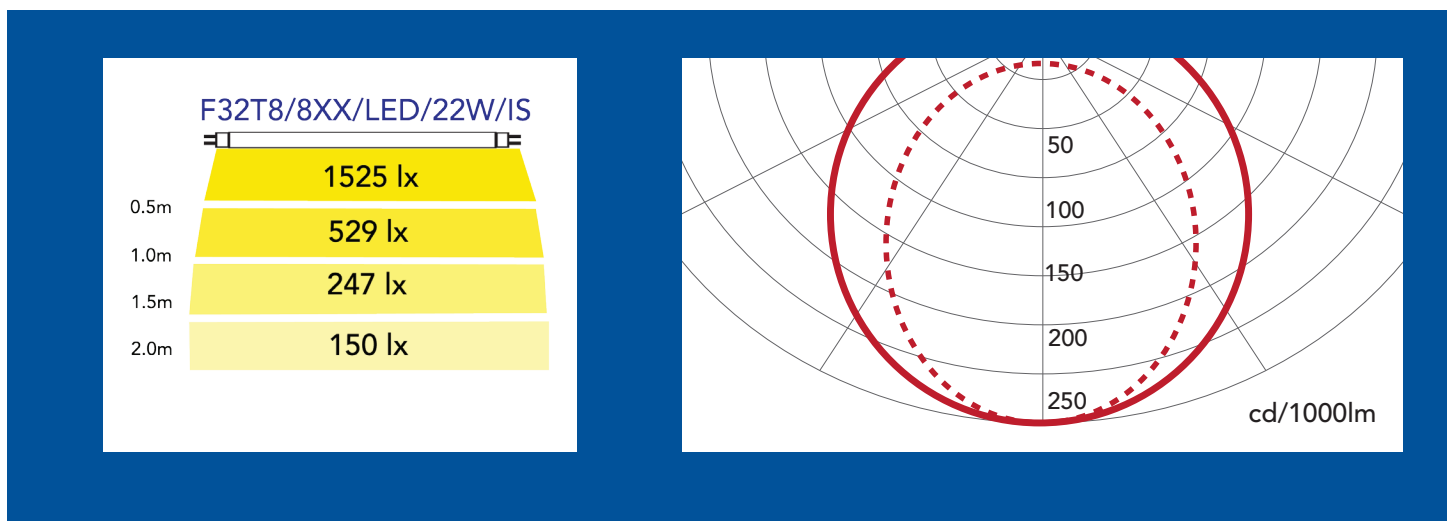

















### Lighting Distribution Chart:



# LINEAR FLUORESCENT LAMPS



## 800 SERIES 32 WATT (48") T8 HIGH LUMEN LAMPS

T8 Medium Bipin

| UPC #        | Howard Model #      | Lumens Initial | Lumens Mean | Avg. Life (hours) | Color Temp. (K) | MOL (in.) | CRI | Pkg. Qty. | Footnotes (see p18 for explanation)  |
|--------------|---------------------|----------------|-------------|-------------------|-----------------|-----------|-----|-----------|--|
| 799385-01947 | F32T8/830/HL/ECO    | 3100           | 2950        | 24000             | 3000            | 47.78     | 85  | 25        | 1, 2, 4, T    |
| 799385-03753 | F32T8/830/HL/ECO/IC | 3100           | 2950        | 24000             | 3000            | 47.78     | 85  | 25        | 1, 2, 4, T    |
| 799385-03754 | F32T8/835/HL/ECO/IC | 3100           | 2950        | 24000             | 3500            | 47.78     | 85  | 25        | 1, 2, 4, T    |
| 799385-01949 | F32T8/841/HL/ECO    | 3100           | 2950        | 24000             | 4100            | 47.78     | 85  | 25        | 1, 2, 4, T    |
| 799385-03755 | F32T8/841/HL/ECO/IC | 3100           | 2950        | 24000             | 4100            | 47.78     | 85  | 25        | 1, 2, 4, T    |
| 799385-03756 | F32T8/850/HL/ECO/IC | 3100           | 2950        | 24000             | 5000            | 47.78     | 85  | 25        | 1, 2, 4, T    |
| 799385-04933 | F32T8/865/HL/ECO/IC | 3100           | 2950        | 24000             | 6500            | 47.78     | 85  | 25        | 1, 2, 4, T    |





















## 800 SERIES 30 WATT (48") T8 ENERGY SAVING LAMPS

T8 Medium Bipin

| UPC #        | Howard Model #   | Lumens Initial | Lumens Mean | Avg. Life (hours) | Color Temp. (K) | MOL (in.) | CRI | Pkg. Qty. | Footnotes (see p18 for explanation)   |
|--------------|------------------|----------------|-------------|-------------------|-----------------|-----------|-----|-----------|---|
| 799385-01517 | F30T8/830/ES/ECO | 2850           | 2680        | 24000             | 3000            | 47.78     | 85  | 25        | 1, 2, 4, T, Ø    |



















## 800 SERIES 28 WATT (48") T8 ENERGY SAVING LAMPS

T8 Medium Bipin

| UPC #        | Howard Model #      | Lumens Initial | Lumens Mean | Avg. Life (hours) | Color Temp. (K) | MOL (in.) | CRI | Pkg. Qty. | Footnotes (see p18 for explanation)   |
|--------------|---------------------|----------------|-------------|-------------------|-----------------|-----------|-----|-----------|---|
| 799385-03910 | F28T8/830/ES/ECO/IC | 2700           | 2540        | 24000             | 3000            | 47.78     | 85  | 25        | 1, 2, 4, T, Ø    |
| 799385-01515 | F28T8/835/ES/ECO    | 2725           | 2560        | 24000             | 3500            | 47.78     | 85  | 25        | 1, 2, 4, T       |
| 799385-06991 | F28T8/835/ES/ECO/IC | 2700           | 2540        | 24000             | 3500            | 47.78     | 85  | 25        | 1, 2, 4, T       |
| 799385-01516 | F28T8/841/ES/ECO    | 2725           | 2560        | 24000             | 4100            | 47.78     | 85  | 25        | 1, 2, 4, T       |
| 799385-03757 | F28T8/841/ES/ECO/IC | 2700           | 2540        | 24000             | 4100            | 47.78     | 85  | 25        | 1, 2, 4, T       |
| 799385-03422 | F28T8/850/ES/ECO    | 2725           | 2560        | 24000             | 5000            | 47.78     | 85  | 25        | 1, 2, 4, T       |
| 799385-04023 | F28T8/850/ES/ECO/IC | 2700           | 2540        | 24000             | 5000            | 47.78     | 85  | 25        | 1, 2, 4, T       |

## 800 SERIES 25 WATT (48") T8 ENERGY SAVING LAMPS



T8 Medium Bipin

| UPC #        | Howard Model #      | Lumens Initial | Lumens Mean | Avg. Life (hours) | Color Temp. (K) | MOL (in.) | CRI | Pkg. Qty. | Footnotes (see p18 for explanation)   |
|--------------|---------------------|----------------|-------------|-------------------|-----------------|-----------|-----|-----------|---|
| 799385-02922 | F25T8/830/ES/ECO    | 2500           | 2425        | 24000             | 3000            | 47.78     | 85  | 25        | 1, 2, 4, T, Ø    |
| 799385-02924 | F25T8/841/ES/ECO    | 2500           | 2425        | 24000             | 4100            | 47.78     | 85  | 25        | 1, 2, 4, T       |
| 799385-03424 | F25T8/850/ES/ECO    | 2500           | 2425        | 24000             | 5000            | 47.78     | 85  | 25        | 1, 2, 4, T       |
| 799385-04683 | F25T8/835/ES/ECO/IC | 2500           | 2425        | 24000             | 3500            | 47.78     | 85  | 25        | 1, 2, 4, T       |
| 799385-04684 | F25T8/841/ES/ECO/IC | 2500           | 2425        | 24000             | 4100            | 47.78     | 85  | 25        | 1, 2, 4, T       |
| 799385-04685 | F25T8/850/ES/ECO/IC | 2500           | 2425        | 24000             | 5000            | 47.78     | 85  | 25        | 1, 2, 4, T       |

# LINEAR FLUORESCENT LAMPS



## 800 SERIES 32 WATT (48") T8 HIGH LUMEN LONG LIFE LAMPS

T8 Medium Bipin

| UPC #        | Howard Model #      | Lumens Initial | Lumens Mean | Avg. Life IS Ballast <sup>1</sup> (hours) 3hrs/start | Avg. Life RS/PRS Ballast <sup>2</sup> (hours) 3hrs/start | Color Temp. (K) | MOL (in.) | CRI | Pkg. Qty. | Footnotes (see p18 for explanation)  |
|--------------|---------------------|----------------|-------------|--|--|-----------------|-----------|-----|-----------|--|
| 799385-08072 | F32T8/835/HL/ECO/LL | 3100           | 2976        | 60000  | 75000  | 3500            | 47.78     | 81  | 25        | 1, 2, 4, T  |
| 799385-08073 | F32T8/841/HL/ECO/LL | 3100           | 2976        | 60000  | 75000  | 4100            | 47.78     | 81  | 25        | 1, 2, 4, T  |
| 799385-08074 | F32T8/850/HL/ECO/LL | 3025           | 2904        | 60000  | 75000  | 5000            | 47.78     | 81  | 25        | 1, 2, 4, T  |

## 800 SERIES 28 WATT (48") T8 ENERGY SAVING LONG LIFE LAMPS

T8 Medium Bipin

| UPC #        | Howard Model #      | Lumens Initial | Lumens Mean | Avg. Life IS Ballast <sup>1</sup> (hours) 3hrs/start | Avg. Life RS/PRS Ballast <sup>2</sup> (hours) 3hrs/start | Color Temp. (K) | MOL (in.) | CRI | Pkg. Qty. | Footnotes (see p18 for explanation)  |
|--------------|---------------------|----------------|-------------|--|--|-----------------|-----------|-----|-----------|--|
| 799385-08069 | F28T8/835/ES/ECO/LL | 2585           | 2430        | 60000  | 75000  | 3500            | 47.78     | 84  | 25        | 1, 2, 4, T  |
| 799385-08070 | F28T8/841/ES/ECO/LL | 2585           | 2430        | 60000  | 75000  | 3500            | 47.78     | 84  | 25        | 1, 2, 4, T  |
| 799385-08071 | F28T8/850/ES/ECO/LL | 2585           | 2430        | 60000  | 75000  | 3500            | 47.78     | 84  | 25        | 1, 2, 4, T  |

### Long Life T8 Lamps Average Rated Life



Based on 3 hours per start

60,000

75,000

### Linear Fluorescent Lamp Warranty Information

Our standard lamp warranty for fluorescent T5 and T8 lamps is one (1) year from date of purchase. However, if you purchase and register ballast and lamps together under our "Security Plus" System Warranty, you get an extended warranty period. See page 19 for details.



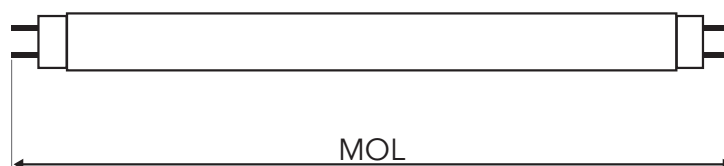





-  1. Instant Start Ballast
-  2. Program Rapid Start Ballast



# LINEAR FLUORESCENT LAMPS

## 800 SERIES 32 WATT (48") T8 LAMPS

T8 Medium Bipin

| UPC #        | Howard Model #   | Lumens Initial | Lumens Mean | Avg. Life (hours) | Color Temp. (K) | MOL (in.) | CRI | Pkg. Qty. | Footnotes (see p18 for explanation)   |
|--------------|------------------|----------------|-------------|-------------------|-----------------|-----------|-----|-----------|---|
| 799385-02255 | F32T8/830        | 3050           | 2800        | 24000             | 3000            | 47.78     | 85  | 25        | 1, 2, 4, T, Ø  |
| 799385-01524 | F32T8/835/ECO    | 2950           | 2800        | 24000             | 3500            | 47.78     | 85  | 25        | 1, 2, 4, T, Ø  |
| 799385-02257 | F32T8/841        | 3050           | 2800        | 24000             | 4100            | 47.78     | 85  | 25        | 1, 2, 4, T, Ø  |
| 799385-01525 | F32T8/841/ECO    | 2950           | 2800        | 24000             | 4100            | 47.78     | 85  | 25        | 1, 2, 4, T, Ø  |
| 799385-03760 | F32T8/841/ECO/IC | 3050           | 2800        | 24000             | 4100            | 47.78     | 85  | 25        | 1, 2, 4, T, Ø  |
| 799385-02294 | F32T8/850/ECO    | 2950           | 2800        | 24000             | 5000            | 47.78     | 85  | 25        | 1, 2, 4, T, Ø  |
| 799385-03761 | F32T8/850/ECO/IC | 3050           | 2800        | 24000             | 5000            | 47.78     | 85  | 25        | 1, 2, 4, T, Ø  |
| 799385-06629 | F32T8/865/ECO    | 2950           | 2800        | 24000             | 6500            | 47.78     | 85  | 25        | 1, 2, 4, T, Ø  |

## 700 SERIES 32 WATT (48") T8 LAMPS

T8 Medium Bipin

| UPC #        | Howard Model #   | Lumens Initial | Lumens Mean | Avg. Life (hours) | Color Temp. (K) | MOL (in.) | CRI | Pkg. Qty. | Footnotes (see p18 for explanation) |
|--------------|------------------|----------------|-------------|-------------------|-----------------|-----------|-----|-----------|-------------------------------------|
| 799385-02252 | F32T8/730        | 2850           | 2710        | 24000             | 3000            | 47.78     | 75  | 25        | 1, 2, 4, T, Ø                       |
| 799385-01521 | F32T8/735/ECO    | 2850           | 2710        | 24000             | 3500            | 47.78     | 75  | 25        | 1, 2, 4, T, Ø                       |
| 799385-03758 | F32T8/735/ECO/IC | 2850           | 2710        | 24000             | 3500            | 47.78     | 75  | 25        | 1, 2, 4, T, Ø                       |
| 799385-02254 | F32T8/741        | 2850           | 2710        | 24000             | 4100            | 47.78     | 75  | 25        | 1, 2, 4, T, Ø                       |
| 799385-03784 | F32T8/741/ECO/IC | 2850           | 2710        | 24000             | 4100            | 47.78     | 75  | 25        | 1, 2, 4, T, Ø                       |
| 799385-02344 | F32T8/750        | 2850           | 2710        | 24000             | 5000            | 47.78     | 75  | 25        | 1, 2, 4, T, Ø                       |

## 800 SERIES 32 WATT (60") T8 LAMPS

T8 Medium Bipin

| UPC #        | Howard Model # | Lumens Initial | Lumens Mean | Avg. Life (hours) | Color Temp. (K) | MOL (in.) | CRI | Pkg. Qty. | Footnotes (see p18 for explanation) |
|--------------|----------------|----------------|-------------|-------------------|-----------------|-----------|-----|-----------|-------------------------------------|
| 799385-02908 | F40T8/735/ECO  | 3500           | 3290        | 24000             | 3500            | 59.61     | 75  | 25        | 1, 2, 4, T, Ø                       |
| 799385-02909 | F40T8/741/ECO  | 3500           | 3290        | 24000             | 4100            | 59.61     | 75  | 25        | 1, 2, 4, T, Ø                       |
| 799385-02911 | F40T8/835/ECO  | 3775           | 3550        | 24000             | 3500            | 59.61     | 85  | 25        | 1, 2, 4, T, Ø                       |
| 799385-02912 | F40T8/841/ECO  | 3775           | 3550        | 24000             | 4100            | 59.61     | 85  | 25        | 1, 2, 4, T, Ø                       |

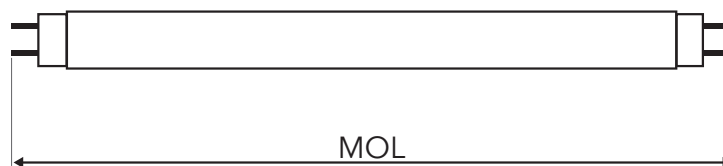



# LINEAR FLUORESCENT LAMPS

## 800 SERIES 25 WATT (36") T8 LAMPS

T8 Medium Bipin

| UPC #        | Howard Model # | Lumens Initial | Lumens Mean | Avg. Life (hours) | Color Temp. (K) | MOL (in.) | CRI | Pkg. Qty. | Footnotes (see p18 for explanation) |
|--------------|----------------|----------------|-------------|-------------------|-----------------|-----------|-----|-----------|-------------------------------------|
| 799385-01511 | F25T8/830/ECO  | 2150           | 2040        | 24000             | 3000            | 35.84     | 85  | 25        | 1, 2, 4, T                          |
| 799385-02249 | F25T8/830      | 2150           | 2040        | 24000             | 3000            | 35.84     | 85  | 25        | 1, 2, 4, T                          |
| 799385-01512 | F25T8/835/ECO  | 2150           | 2040        | 24000             | 3500            | 35.84     | 85  | 25        | 1, 2, 4, T                          |
| 799385-02250 | F25T8/835      | 2150           | 2040        | 24000             | 3500            | 35.84     | 85  | 25        | 1, 2, 4, T                          |
| 799385-02251 | F25T8/841      | 2150           | 2040        | 24000             | 4100            | 35.84     | 85  | 25        | 1, 2, 4, T                          |
| 799385-02782 | F25T8/865      | 2150           | 2040        | 24000             | 6500            | 35.84     | 85  | 25        | 1, 2, 4, T                          |

## 700 SERIES 25 WATT (36") T8 LAMPS

T8 Medium Bipin

| UPC #        | Howard Model # | Lumens Initial | Lumens Mean | Avg. Life (hours) | Color Temp. (K) | MOL (in.) | CRI | Pkg. Qty. | Footnotes (see p18 for explanation) |
|--------------|----------------|----------------|-------------|-------------------|-----------------|-----------|-----|-----------|-------------------------------------|
| 799385-01508 | F25T8/730/ECO  | 2080           | 1970        | 24000             | 3000            | 35.84     | 75  | 25        | 1, 2, 4, T, Ø                       |
| 799385-02246 | F25T8/730      | 2080           | 1970        | 24000             | 3000            | 35.84     | 75  | 25        | 1, 2, 4, T, Ø                       |
| 799385-01509 | F25T8/735/ECO  | 2080           | 1970        | 24000             | 3500            | 35.84     | 75  | 25        | 1, 2, 4, T, Ø                       |
| 799385-02247 | F25T8/735      | 2080           | 1970        | 24000             | 3500            | 35.84     | 75  | 25        | 1, 2, 4, T, Ø                       |
| 799385-02248 | F25T8/741      | 2080           | 1970        | 24000             | 4100            | 35.84     | 75  | 25        | 1, 2, 4, T, Ø                       |

## 800 SERIES 17 WATT (24") T8 LAMPS

T8 Medium Bipin

| UPC #        | Howard Model # | Lumens Initial | Lumens Mean | Avg. Life (hours) | Color Temp. (K) | MOL (in.) | CRI | Pkg. Qty. | Footnotes (see p18 for explanation) |
|--------------|----------------|----------------|-------------|-------------------|-----------------|-----------|-----|-----------|-------------------------------------|
| 799385-01505 | F17T8/830/ECO  | 1325           | 1260        | 24000             | 3000            | 23.89     | 85  | 25        | 1, 2, 4, T                          |
| 799385-02243 | F17T8/830      | 1400           | 1275        | 24000             | 3000            | 23.89     | 85  | 25        | 1, 2, 4, T                          |
| 799385-02244 | F17T8/835      | 1400           | 1275        | 24000             | 3500            | 23.89     | 85  | 25        | 1, 2, 4, T                          |
| 799385-02245 | F17T8/841      | 1400           | 1275        | 24000             | 4100            | 23.89     | 85  | 25        | 1, 2, 4, T                          |
| 799385-02781 | F17T8/865      | 1400           | 1275        | 24000             | 6500            | 23.89     | 85  | 25        | 1, 2, 4, T                          |

## 700 SERIES 17 WATT (24") T8 LAMPS



T8 Medium Bipin

| UPC #        | Howard Model # | Lumens Initial | Lumens Mean | Avg. Life (hours) | Color Temp. (K) | MOL (in.) | CRI | Pkg. Qty. | Footnotes (see p18 for explanation) |
|--------------|----------------|----------------|-------------|-------------------|-----------------|-----------|-----|-----------|-------------------------------------|
| 799385-01502 | F17T8/730/ECO  | 1325           | 1260        | 24000             | 3000            | 23.89     | 75  | 25        | 1, 2, 4, T, Ø                       |
| 799385-02240 | F17T8/730      | 1350           | 1200        | 24000             | 3000            | 23.89     | 75  | 25        | 1, 2, 4, T, Ø                       |
| 799385-01503 | F17T8/735/ECO  | 1325           | 1260        | 24000             | 3500            | 23.89     | 75  | 25        | 1, 2, 4, T, Ø                       |

# LINEAR FLUORESCENT LAMPS





## 800 SERIES 54 WATT (46") T5 HIGH OUTPUT LAMPS

T5 Miniture Bipin (G5)

| UPC #        | Howard Model # | Lumens Initial | Lumens Mean | Avg. Life (hours) | Color Temp. (K) | MOL (in.) | CRI | Pkg. Qty. | Footnotes (see p18 for explanation)   |
|--------------|----------------|----------------|-------------|-------------------|-----------------|-----------|-----|-----------|---|
| 799385-01569 | F54T5/830/HO   | 5000           | 4950        | 30000             | 3000            | 45.52     | 85  | 25        | 1, 3, 4, 5, 6, 7, Ø  |
| 799385-01571 | F54T5/841/HO   | 5000           | 4950        | 30000             | 4100            | 45.52     | 85  | 25        | 1, 3, 4, 5, 6, 7     |
| 799385-02784 | F54T5/850/HO   | 5000           | 4950        | 30000             | 5000            | 45.52     | 85  | 25        | 1, 3, 4, 5, 6, 7     |





## 800 SERIES 39 WATT (34") T5 HIGH OUTPUT LAMPS

T5 Miniture Bipin (G5)

| UPC #        | Howard Model # | Lumens Initial | Lumens Mean | Avg. Life (hours) | Color Temp. (K) | MOL (in.) | CRI | Pkg. Qty. | Footnotes (see p18 for explanation)  |
|--------------|----------------|----------------|-------------|-------------------|-----------------|-----------|-----|-----------|--|
| 799385-01561 | F39T5/830/HO   | 3500           | 3300        | 30000             | 3000            | 33.7      | 85  | 25        | 1, 3, 4, 5, 6, 7, Ø   |
| 799385-01562 | F39T5/835/HO   | 3500           | 3300        | 30000             | 3500            | 33.7      | 85  | 25        | 1, 3, 4, 5, 6, 7, Ø   |
| 799385-01563 | F39T5/841/HO   | 3500           | 3300        | 30000             | 4100            | 33.7      | 85  | 25        | 1, 3, 4, 5, 6, 7, Ø   |
| 799385-02981 | F39T5/850/HO   | 3500           | 3300        | 30000             | 5000            | 33.7      | 85  | 25        | 1, 3, 4, 5, 6, 7, Ø   |
| 799385-01564 | F39T5/865/HO   | 3500           | 3300        | 30000             | 6500            | 33.7      | 85  | 25        | 1, 3, 4, 5, 6, 7, Ø  |

## 800 SERIES 24 WATT (22") T5 HIGH OUTPUT LAMPS

T5 Miniture Bipin (G5)

| UPC #        | Howard Model # | Lumens Initial | Lumens Mean | Avg. Life (hours) | Color Temp. (K) | MOL (in.) | CRI | Pkg. Qty. | Footnotes (see p18 for explanation)   |
|--------------|----------------|----------------|-------------|-------------------|-----------------|-----------|-----|-----------|---|
| 799385-01557 | F24T5/830/HO   | 2000           | 1900        | 30000             | 3000            | 21.89     | 85  | 25        | 1, 3, 4, 5, 6, 7, Ø  |
| 799385-01558 | F24T5/835/HO   | 2000           | 1900        | 30000             | 3500            | 21.89     | 85  | 25        | 1, 3, 4, 5, 6, 7, Ø  |
| 799385-01559 | F24T5/841/HO   | 2000           | 1900        | 30000             | 4100            | 21.89     | 85  | 25        | 1, 3, 4, 5, 6, 7, Ø  |
| 799385-02980 | F24T5/850/HO   | 2000           | 1900        | 30000             | 5000            | 21.89     | 85  | 25        | 1, 3, 4, 5, 6, 7, Ø  |
| 799385-01560 | F24T5/865/HO   | 2000           | 1900        | 30000             | 6500            | 21.89     | 85  | 25        | 1, 3, 4, 5, 6, 7, Ø  |

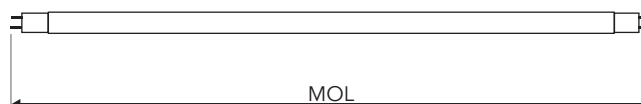

# LINEAR FLUORESCENT LAMPS

## 800 SERIES 28 WATT (46") T5 LAMPS

T5 Miniture Bipin (G5)

| UPC #        | Howard Model # | Lumens Initial | Lumens Mean | Avg. Life (hours) | Color Temp. (K) | MOL (in.) | CRI | Pkg. Qty. | Footnotes (see p18 for explanation) |
|--------------|----------------|----------------|-------------|-------------------|-----------------|-----------|-----|-----------|-------------------------------------|
| 799385-01549 | F28T5/830      | 2900           | 2700        | 30000             | 3000            | 45.52     | 85  | 25        | 1, 3, 4, 5, 6, 7, Ø                 |
| 799385-01550 | F28T5/835      | 2900           | 2700        | 30000             | 3500            | 45.52     | 85  | 25        | 1, 3, 4, 5, 6, 7                    |
| 799385-01551 | F28T5/841      | 2900           | 2700        | 30000             | 4100            | 45.52     | 85  | 25        | 1, 3, 4, 5, 6, 7                    |
| 799385-01552 | F28T5/865      | 2900           | 2700        | 30000             | 6500            | 45.52     | 85  | 25        | 1, 3, 4, 5, 6, 7, Ø                 |

## 800 SERIES 21 WATT (34") T5 LAMPS

T5 Miniture Bipin (G5)

| UPC #        | Howard Model # | Lumens Initial | Lumens Mean | Avg. Life (hours) | Color Temp. (K) | MOL (in.) | CRI | Pkg. Qty. | Footnotes (see p18 for explanation) |
|--------------|----------------|----------------|-------------|-------------------|-----------------|-----------|-----|-----------|-------------------------------------|
| 799385-01545 | F21T5/830      | 2250           | 2050        | 30000             | 3000            | 33.7      | 85  | 25        | 1, 3, 4, 5, 6, 7, Ø                 |
| 799385-01546 | F21T5/835      | 2250           | 2050        | 30000             | 3500            | 33.7      | 85  | 25        | 1, 3, 4, 5, 6, 7, Ø                 |
| 799385-01547 | F21T5/841      | 2250           | 2050        | 30000             | 4100            | 33.7      | 85  | 25        | 1, 3, 4, 5, 6, 7, Ø                 |
| 799385-02979 | F21T5/850      | 2250           | 2050        | 30000             | 5000            | 33.7      | 85  | 25        | 1, 3, 4, 5, 6, 7, Ø                 |
| 799385-01548 | F21T5/865      | 2250           | 2050        | 30000             | 6500            | 33.7      | 85  | 25        | 1, 3, 4, 5, 6, 7, Ø                 |

## 800 SERIES 14 WATT (22") T5 LAMPS

T5 Miniture Bipin (G5)



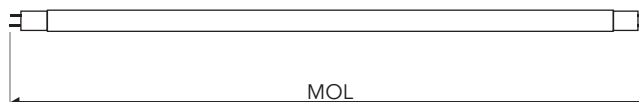





| UPC #        | Howard Model # | Lumens Initial | Lumens Mean | Avg. Life (hours) | Color Temp. (K) | MOL (in.) | CRI | Pkg. Qty. | Footnotes (see p18 for explanation) |
|--------------|----------------|----------------|-------------|-------------------|-----------------|-----------|-----|-----------|-------------------------------------|
| 799385-01541 | F14T5/830      | 1350           | 1250        | 30000             | 3000            | 21.89     | 85  | 25        | 1, 3, 4, 5, 6, 7, Ø                 |
| 799385-01543 | F14T5/841      | 1350           | 1250        | 30000             | 4100            | 21.89     | 85  | 25        | 1, 3, 4, 5, 6, 7, Ø                 |



# LINEAR FLUORESCENT LAMPS













## 800 SERIES 28 WATT 6" SPACING T8 ENERGY SAVING U-BENT LAMPS

T8 Medium Bipin

| UPC #        | Howard Model #    | Lumens Initial | Lumens Mean | Avg. Life (hours) | Color Temp. (K) | MOL (in.) | CRI | Pkg. Qty. | Footnotes (see p18 for explanation)   |
|--------------|-------------------|----------------|-------------|-------------------|-----------------|-----------|-----|-----------|---|
| 799385-01532 | FB28T8/830/ES/ECO | 2600           | -           | 24000             | 3000            | 23        | 85  | 20        | 1, 2, 4, T, Ø    |
| 799385-01533 | FB28T8/835/ES/ECO | 2600           | -           | 24000             | 3500            | 23        | 85  | 20        | 1, 2, 4, T       |
| 799385-01534 | FB28T8/841/ES/ECO | 2600           | -           | 24000             | 4100            | 23        | 85  | 20        | 1, 2, 4, T       |

## 800 SERIES 28 WATT 6" SPACING T8 ENERGY SAVING U-BENT LAMPS



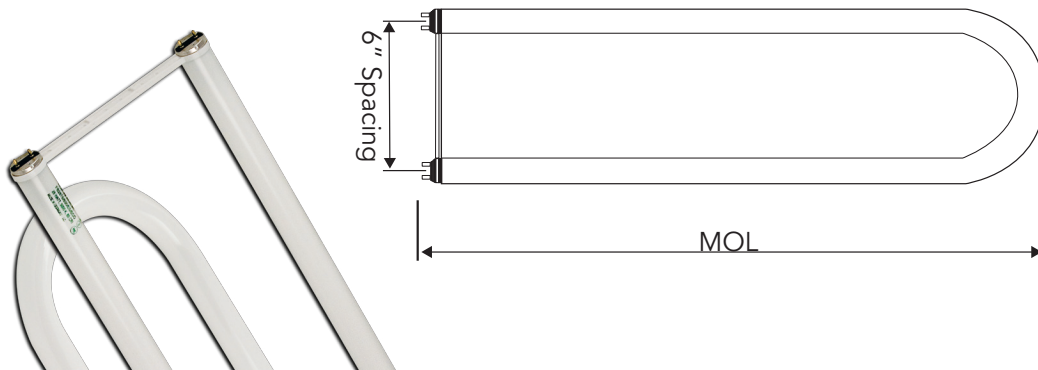

T8 Medium Bipin

| UPC #        | Howard Model #    | Lumens Initial | Lumens Mean | Avg. Life (hours) | Color Temp. (K) | MOL (in.) | CRI | Pkg. Qty. | Footnotes (see p18 for explanation)   |
|--------------|-------------------|----------------|-------------|-------------------|-----------------|-----------|-----|-----------|---|
| 799385-02925 | FB25T8/830/ES/ECO | 2400           | -           | 24000             | 3000            | 23        | 85  | 20        | 1, 2, 4, T, Ø    |
| 799385-02926 | FB25T8/835/ES/ECO | 2400           | -           | 24000             | 3500            | 23        | 85  | 20        | 1, 2, 4, T       |
| 799385-02927 | FB25T8/841/ES/ECO | 2400           | -           | 24000             | 4100            | 23        | 85  | 20        | 1, 2, 4, T       |
| 799385-03425 | FB25T8/850/ES/ECO | 2400           | -           | 24000             | 5000            | 23        | 85  | 20        | 1, 2, 4, T       |





## 800 SERIES 32 WATT 6" SPACING T8 U-BENT LAMPS

T8 Medium Bipin

| UPC #        | Howard Model #   | Lumens Initial | Lumens Mean | Avg. Life (hours) | Color Temp. (K) | MOL (in.) | CRI | Pkg. Qty. | Footnotes (see p18 for explanation)   |
|--------------|------------------|----------------|-------------|-------------------|-----------------|-----------|-----|-----------|---|
| 799385-02262 | FB32T8/830/6     | 3000           | -           | 24000             | 3000            | 23        | 85  | 20        | 1, 2, 4, T, Ø  |
| 799385-01538 | FB32T8/830/6/ECO | 2800           | -           | 24000             | 3000            | 23        | 85  | 20        | 1, 2, 4, T, Ø  |
| 799385-02263 | FB32T8/835/6     | 3000           | -           | 24000             | 3500            | 23        | 85  | 20        | 1, 2, 4, T     |
| 799385-02264 | FB32T8/841/6     | 3000           | -           | 24000             | 4100            | 23        | 85  | 20        | 1, 2, 4, T     |
| 799385-02978 | FB32T8/850/6     | 3000           | -           | 24000             | 5000            | 23        | 85  | 20        | 1, 2, 4, T     |



## 700 SERIES 32 WATT 6" SPACING T8 U-BENT LAMPS

T8 Medium Bipin

| UPC #        | Howard Model #   | Lumens Initial | Lumens Mean | Avg. Life (hours) | Color Temp. (K) | MOL (in.) | CRI | Pkg. Qty. | Footnotes (see p18 for explanation)   |
|--------------|------------------|----------------|-------------|-------------------|-----------------|-----------|-----|-----------|---|
| 799385-02259 | FB32T8/730/6     | 2700           | -           | 24000             | 3000            | 23        | 75  | 20        | 1, 2, 4, T, Ø  |
| 799385-01535 | FB32T8/730/6/ECO | 2650           | -           | 24000             | 3000            | 23        | 75  | 20        | 1, 2, 4, T, Ø  |
| 799385-01536 | FB32T8/735/6/ECO | 2650           | -           | 24000             | 3500            | 23        | 75  | 20        | 1, 2, 4, T, Ø  |

## 800 SERIES 31 WATT 1-5/8" SPACING T8 U-BENT LAMPS

T8 Medium Bipin

| UPC #        | Howard Model # | Lumens Initial | Lumens Mean | Avg. Life (hours) | Color Temp. (K) | MOL (in.) | CRI | Pkg. Qty. | Footnotes (see p18 for explanation)   |
|--------------|----------------|----------------|-------------|-------------------|-----------------|-----------|-----|-----------|---|
| 799385-02265 | FB31T8/830     | 2775           | -           | 24000             | 3000            | 23        | 85  | 20        | 1, 2, 4, T, Ø  |
| 799385-02266 | FB31T8/835     | 2775           | -           | 24000             | 3500            | 23        | 85  | 20        | 1, 2, 4, T     |
| 799385-02267 | FB31T8/841     | 2775           | -           | 24000             | 4100            | 23        | 85  | 20        | 1, 2, 4, T     |

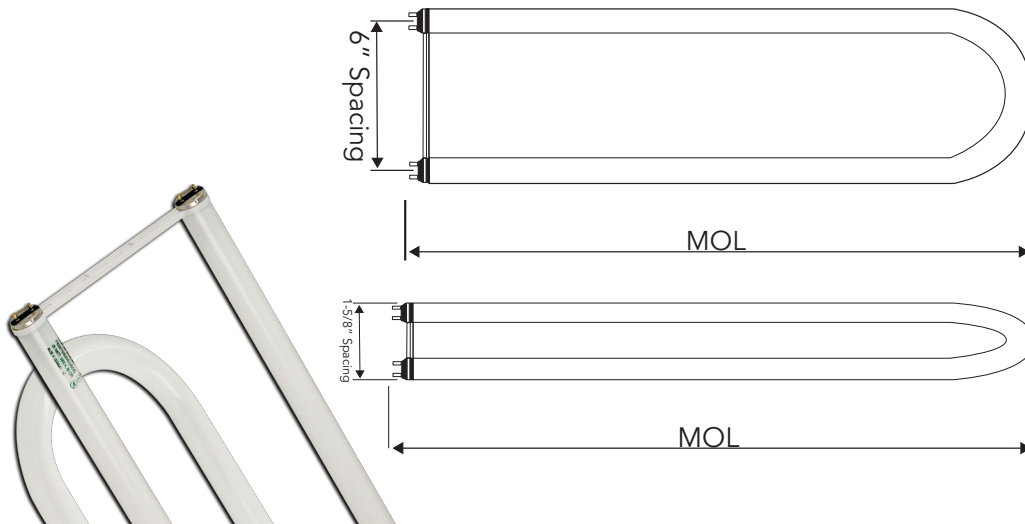

# CROSS REFERENCE

| Howard Model #                    | Sylvania               | GE                    | Philips                         | Eiko             | Satco (Hygrade)      | Halco            | Ushio |
|-----------------------------------|------------------------|-----------------------|---------------------------------|------------------|----------------------|------------------|-------|
| <b>T8 High Lumen</b>              |                        |                       |                                 |                  |                      |                  |       |
| F32T8/830/HL/ECO                  | FO32/830XPS/ECO        | F32T8/XL/SPX30/HL/ECO | F32T8/ADV830/ALTO               |                  | F32T8/830/HL/ENV     | F32T8/830/ECO/HL | -     |
| F32T8/830/HL/ECO/IC               | FO32/830XPS/ECO        | F32T8/XL/SPX30/HL/ECO | F32T8/ADV830/ALTO               | F32T8/830K/HL    | F32T8/830/HL/ENV     | F32T8/830/ECO/HL | -     |
| F32T8/835/HL/ECO/IC               | FO32/835XPS/ECO        | F32T8/XL/SPX35/HL/ECO | F32T8/ADV835/ALTO               | F32T8/835K/HL    | F32T8/835/HL/ENV     | F32T8/835/ECO/HL | -     |
| F32T8/841/HL/ECO                  | FO32/841XPS/ECO        | F32T8/XL/SPX41/HL/ECO | F32T8/ADV841/ALTO               | F32T8/841K/HL    | F32T8/841/HL/ENV     | F32T8/841/ECO/HL | -     |
| F32T8/841/HL/ECO/IC               | FO32/841XPS/ECO        | F32T8/XL/SPX41/HL/ECO | F32T8/ADV841/ALTO               | F32T8/841K/HL    | F32T8/841/HL/ENV     | F32T8/841/ECO/HL | -     |
| F32T8/850/HL/ECO/IC               | FO32/850XPS/ECO        | F32T8/XL/SPX50/HL/ECO | F32T8/ADV850/ALTO               | F32T8/850K/HL    | F32T8/850/HL/ENV     | F32T8/850/ECO/HL | -     |
| F32T8/865/HL/ECO/IC               | -                      | -                     | -                               | F32T8/865K/HL    | F32T8/865/HL/ENV     | -                | -     |
| <b>T8 Energy Saving</b>           |                        |                       |                                 |                  |                      |                  |       |
| F30T8/830/ES/ECO                  | FO30/830XP/SS/ECO      | F32T8XL/SP30/WM/ECO   | F32T8/ADV830/EW/LL/ALTO 30WATT  | -                | -                    | -                | -     |
| F28T8/830/ES/ECO/IC               | FO28/830XP/SS/ECO      | F28T8/SP30UMX/ECO     | F32T8/ADV830/EW/LL/ALTO 28WATT  | F28T8/830/ES     | F28T8/830/ES/ENV     | F28T8/830/ECO/IC | -     |
| F28T8/835/ES/ECO                  | FO28/835XP/SS/ECO      | F28T8/SP35UMX/ECO     | F32T8/ADV835/EW/LL/ALTO 28WATT  | F28T8/835/ES     | F28T8/835/ES/ENV     | F28T8/835/ECO/IC | -     |
| F28T8/835/ES/ECO/IC               | FO28/835XP/SS/ECO      | F28T8/SP35UMX/ECO     | F32T8/ADV835/EW/LL/ALTO 28WATT  | F28T8/835/ES     | F28T8/835/ES/ENV     | F28T8/835/ECO/IC | -     |
| F28T8/841/ES/ECO                  | FO28/841XP/SS/ECO      | F28T8/SP41UMX/ECO     | F32T8/ADV841/EW/LL/ALTO 28WATT  | F28T8/841/ES     | F28T8/841/ES/ENV     | F28T8/841/ECO/IC | -     |
| F28T8/841/ES/ECO/IC               | FO28/841XP/SS/ECO      | F28T8/SP41UMX/ECO     | F32T8/ADV841/EW/LL/ALTO 28WATT  | F28T8/841/ES     | F28T8/841/ES/ENV     | F28T8/841/ECO/IC | -     |
| F28T8/850/ES/ECO                  | FO28/850XP/SS/ECO      | F28T8/SP50UMX/ECO     | F32T8/ADV850/EW/LL/ALTO 28WATT  | F28T8/850/ES     | F28T8/850/ES/ENV     | F28T8/850/ECO/IC | -     |
| F28T8/850/ES/ECO/IC               | FO28/850XP/SS/ECO      | F28T8/SP50UMX/ECO     | F32T8/ADV850/EW/LL/ALTO 28WATT  | F28T8/850/ES     | F28T8/850/ES/ENV     | F28T8/850/ECO/IC | -     |
| F25T8/830/ES/ECO                  | FO32/25W/830XP/SS/ECO  | -                     | F32T8/ADV830/XEW/LL/ALTO 25WATT | F32T8/830/ES/25W | F32/25WT8/830/ES/ENV | F25T8ES/830/ECO  | -     |
| F25T8/835/ES/ECO/IC               | FO32/25W/835XP/SS/ECO  | -                     | F32T8/ADV835/XEW/LL/ALTO 25WATT | F32T8/835/ES/25W | F32/25WT8/835/ES/ENV | F25T8ES/835/ECO  | -     |
| F25T8/841/ES/ECO                  | FO32/25W/835XP/SS/ECO  | -                     | F32T8/ADV835/XEW/LL/ALTO 25WATT | F32T8/841/ES/25W | F32/25WT8/841/ES/ENV | F25T8ES/841/ECO  | -     |
| F25T8/841/ES/ECO/IC               | FO32/25W/8410XP/SS/ECO | -                     | F32T8/ADV841/XEW/LL/ALTO 25WATT | F32T8/841/ES/25W | F32/25WT8/841/ES/ENV | F25T8ES/841/ECO  | -     |
| F25T8/850/ES/ECO                  | FO32/25W/850XP/SS/ECO  | -                     | F32T8/ADV850/XEW/LL/ALTO 25WATT | F32T8/850/ES/25W | F32/25WT8/850/ES/ENV | F25T8ES/850/ECO  | -     |
| F25T8/850/ES/ECO/IC               | FO32/25W/850XP/SS/ECO  | -                     | F32T8/ADV850/XEW/LL/ALTO 25WATT | F32T8/850/ES/25W | F32/25WT8/850/ES/ENV | F25T8ES/850/ECO  | -     |
| <b>Long Life T8 High Lumen</b>    |                        |                       |                                 |                  |                      |                  |       |
| F32T8/835/HL/ECO/LL               | -                      | -                     | F32T8/TL835/XLL/ALTO            | F32T8/835K/XL    | -                    | F32T8/835/ECO/XL | -     |
| F32T8/841/HL/ECO/LL               | -                      | -                     | F32T8/TL841/XLL/ALTO            | F32T8/841K/XL    | -                    | F32T8/841/ECO/XL | -     |
| F32T8/850/HL/ECO/LL               | -                      | -                     | F32T8/TL850/XLL/ALTO            | F32T8/850K/XL    | -                    | F32T8/850/ECO/XL | -     |
| <b>Long Life T8 Energy Saving</b> |                        |                       |                                 |                  |                      |                  |       |
| F28T8/835/ES/ECO/LL               | -                      | -                     | F32T8/ADV835/XLL/ALTO 28WATT    | -                | -                    | -                | -     |
| F28T8/841/ES/ECO/LL               | -                      | -                     | F32T8/ADV841/XLL/ALTO 28WATT    | -                | -                    | -                | -     |
| F28T8/850/ES/ECO/LL               | -                      | -                     | F32T8/ADV850/XLL/ALTO 28WATT    | -                | -                    | -                | -     |

| Howard Model #   | Sylvania     | GE              | Philips          | Eiko       | Satco (Hygrade) | Halco            | Ushio            |
|------------------|--------------|-----------------|------------------|------------|-----------------|------------------|------------------|
| T8 Lamps         |              |                 |                  |            |                 |                  |                  |
| F32T8/830        | FO32/830/ECO | F32T8/SPX30/ECO | F32T8/TL830/ALTO | F32T8/830K | F32T8/830/ENV   | F32T8/830/ECO/IC | F32T8/830        |
| F32T8/835/ECO    | FO32/835/ECO | F32T8/SPX35/ECO | F32T8/TL835/ALTO | F32T8/835K | F32T8/835/ENV   | F32T8/835/ECO/IC | F32T8/835/ECO    |
| F32T8/841        | FO32/841/ECO | F32T8/SPX41/ECO | F32T8/TL841/ALTO | F32T8/841K | F32T8/841/ENV   | F32T8/841/ECO/IC | F32T8/841        |
| F32T8/841/ECO    | FO32/841/ECO | F32T8/SPX41/ECO | F32T8/TL841/ALTO | F32T8/841K | F32T8/841/ENV   | F32T8/841/ECO/IC | F32T8/841/ECO    |
| F32T8/841/ECO/IC | FO32/841/ECO | F32T8/SPX41/ECO | F32T8/TL841/ALTO | F32T8/841K | F32T8/841/ENV   | F32T8/841/ECO/IC | F32T8/841/ECO/IC |
| F32T8/850/ECO    | FO32/850/ECO | F32T8/SPX50/ECO | F32T8/TL850/ALTO | F32T8/850K | F32T8/850/ENV   | F32T8/850/ECO/IC | F32T8/850/ECO    |
| F32T8/850/ECO/IC | FO32/850/ECO | F32T8/SPX50/ECO | F32T8/TL850/ALTO | F32T8/850K | F32T8/850/ENV   | F32T8/850/ECO/IC | F32T8/850/ECO/IC |
| F32T8/730        | FO32/730/ECO | F32T8/SP30/ECO  | F32T8/TL730/ALTO |            | F32T8/730/ENV   | F32T8/730/ECO/IC | F32T8/730        |
| F32T8/735/ECO    | FO32/735/ECO | F32T8/SP35/ECO  | F32T8/TL735/ALTO | F32T8/735K | F32T8/735/ENV   | F32T8/735/ECO/IC | F32T8/735        |
| F32T8/735/ECO/IC | FO32/735/ECO | F32T8/SP35/ECO  | F32T8/TL735/ALTO | F32T8/735K | F32T8/735/ENV   | F32T8/735/ECO/IC | F32T8/735        |
| F32T8/741        | FO32/741/ECO | F32T8/SP41/ECO  | F32T8/TL741/ALTO | F32T8/741K | F32T8/741/ENV   | F32T8/741/ECO/IC | F32T8/741        |
| F32T8/741/ECO/IC | FO32/741/ECO | F32T8/SP41/ECO  | F32T8/TL741/ALTO | F32T8/741K | F32T8/741/ENV   | F32T8/741/ECO/IC | F32T8/741        |
| F32T8/750        | FO32/750/ECO | F32T8/SP50/ECO  | F32T8/TL750/ALTO |            | F32T8/750/ENV   | F32T8/750/ECO/IC | F32T8/750        |
| F32T8/865/ECO    | -            | -               | -                | F32T8/865K | F32T8/865/ENV   | F32T8/865/ECO/IC | -                |
| F40T8/735/ECO    | -            | -               | -                | -          | -               | F40T8/735/ECO    | -                |
| F40T8/741/ECO    | -            | -               | -                | -          | -               | F40T8/741/ECO    | -                |
| F40T8/835/ECO    | FO40/835/ECO | F40T8/SPX35     | F40T8/TL835/ALTO | -          | -               | -                | -                |
| F40T8/841/ECO    | FO40/841/ECO | F40T8/SPX41     | F40T8/TL841/ALTO | -          | -               | -                | -                |
| F25T8/830/ECO    | FO25/830/ECO | F25T8/SPX30/ECO | F25T8/TL830/ALTO | F25T8/830K | F25T8/830/ENV   | F25T8/830/ECO/IC | F25T8/830/ECO    |
| F25T8/830        | FO25/830/ECO | F25T8/SPX30/ECO | F25T8/TL830/ALTO | F25T8/830K | F25T8/830/ENV   | F25T8/830/ECO/IC | F25T8/830        |
| F25T8/835/ECO    | FO25/835/ECO | F25T8/SPX35/ECO | F25T8/TL835/ALTO | F25T8/835K | F25T8/835/ENV   | F25T8/835/ECO/IC | F25T8/835/ECO    |
| F25T8/835        | FO25/835/ECO | F25T8/SPX35/ECO | F25T8/TL835/ALTO | F25T8/835K | F25T8/835/ENV   | F25T8/835/ECO/IC | F25T8/835        |
| F25T8/841        | FO25/841/ECO | F25T8/SPX41/ECO | F25T8/TL841/ALTO | F25T8/841K | F25T8/841/ENV   | F25T8/841/ECO/IC | F25T8/841        |
| F25T8/865        | -            | -               | -                | -          | F25T8/865/ENV   | -                | -                |
| F25T8/730/ECO    | -            | -               | -                | -          | F25T8/730/ENV   | F25T8/730/ECO/IC | F25T8/730        |
| F25T8/730        | -            | -               | -                | -          | F25T8/730/ENV   | F25T8/730/ECO/IC | F25T8/730        |
| F25T8/735/ECO    | -            | -               | -                | -          | F25T8/735/ENV   | F25T8/735/ECO/IC | F25T8/735        |
| F25T8/735        | -            | -               | -                | -          | F25T8/735/ENV   | F25T8/735/ECO/IC | F25T8/735        |
| F25T8/741        | -            | -               | -                | -          | F25T8/741/ENV   | F25T8/741/ECO/IC | F25T8/741        |
| F17T8/830/ECO    | FO17/830/ECO | F17T8/SPX30/ECO | F17T8/TL830/ALTO | F17T8/830K | F17T8/830/ENV   | F17T8/830/ECO/IC | F17T8/830        |
| F17T8/830        | FO17/830/ECO | F17T8/SPX30/ECO | F17T8/TL830/ALTO | F17T8/830K | F17T8/830/ENV   | F17T8/830/ECO/IC | F17T8/830        |
| F17T8/835        | FO17/835/ECO | F17T8/SPX35/ECO | F17T8/TL835/ALTO | F17T8/835K | F17T8/835/ENV   | F17T8/835/ECO/IC | F17T8/835        |
| F17T8/841        | FO17/841/ECO | F17T8/SPX41/ECO | F17T8/TL841/ALTO | F17T8/841K | F17T8/841/ENV   | F17T8/841/ECO/IC | F17T8/841        |
| F17T8/865        | -            | -               | -                | -          | F17T8/865/ENV   | -                | -                |
| F17T8/730/ECO    | -            | -               | -                | F17T8/730K | F17T8/730/ENV   | F17T8/730/ECO/IC | F17T8/730        |
| F17T8/730        | -            | -               | -                | F17T8/730K | F17T8/730/ENV   | F17T8/730/ECO/IC | F17T8/730        |
| F17T8/735/ECO    | -            | -               | -                | F17T8/735K | F17T8/735/ENV   | F17T8/735/ECO    | F17T8/735        |

# CROSS REFERENCE

| Howard Model #        | Sylvania        | GE              | Philips                  | Eiko         | Satco (Hygrade)  | Halco                   | Ushio        |
|-----------------------|-----------------|-----------------|--------------------------|--------------|------------------|-------------------------|--------------|
| <b>T5 High Output</b> |                 |                 |                          |              |                  |                         |              |
| F54T5/830/HO          | FP54/830/HO/ECO | F54W/T5/830/ECO | F54T5/830/HO/<br>ALTO    | -            | F54T5/830/HO/ENV | F54T5/830/HO/<br>ECO/IC | F54T5/830/HO |
| F54T5/841/HO          | FP54/841/HO/ECO | F54W/T5/841/ECO | F54T5/841/HO/<br>ALTO    | F54T5/841/HO | F54T5/841/HO/ENV | F54T5/841/HO/<br>ECO/IC | F54T5/841/HO |
| F54T5/850/HO          | FP54/850/HO/ECO | F54W/T5/850/ECO | F54T5/850/HO/<br>ALTO    | F54T5/850/HO | F54T5/850/HO/ENV | F54T5/850/HO/<br>ECO/IC | -            |
| F39T5/830/HO          | FP39/830/HO/ECO | F39W/T5/830/ECO | FP39/830/HO/ECO/<br>ALTO | -            | F39T5/830/HO/ENV | F39T5/830/HO/<br>ECO/IC | F39T5/830/HO |
| F39T5/835/HO          | FP39/835/HO/ECO | F39W/T5/835/ECO | FP39/835/HO/ECO/<br>ALTO | F39T5/835/HO | F39T5/835/HO/ENV | F39T5/835/HO/<br>ECO/IC | F39T5/835/HO |
| F39T5/841/HO          | FP39/841/HO/ECO | F39W/T5/841/ECO | FP39/841/HO/ECO/<br>ALTO | F39T5/841/HO | F39T5/841/HO/ENV | F39T5/841/HO/<br>ECO/IC | F39T5/841/HO |
| F39T5/850/HO          | -               | F39W/T5/850/ECO | -                        | -            | F39T5/850/HO/ENV | -                       | -            |
| F39T5/865/HO          | -               | F39W/T5/865/ECO | -                        | -            | F39T5/865/HO/ENV | -                       | -            |
| F24T5/830/HO          | FP24/830/HO/ECO | F24W/T5/830/ECO | F24T5/830/HO/<br>ALTO    | -            | F24T5/830/HO/ENV | -                       | F24T5/830/HO |
| F24T5/835/HO          | FP24/835/HO/ECO | F24W/T5/835/ECO | F24T5/835/HO/<br>ALTO    | F24T5/835/HO | F24T5/835/HO/ENV | F24T5/835/HO/<br>ECO/IC | F24T5/835/HO |
| F24T5/841/HO          | FP24/841/HO/ECO | F24W/T5/841/ECO | F24T5/841/HO/<br>ALTO    | F24T5/841/HO | F24T5/841/HO/ENV | F24T5/841/HO/<br>ECO/IC | F24T5/841/HO |
| F24T5/850/HO          | -               | F24W/T5/850/ECO | -                        | -            | F24T5/850/HO/ENV | -                       | -            |
| F24T5/865/HO          | -               | F24W/T5/865/ECO | -                        | -            | F24T5/865/HO/ENV | -                       | -            |
| <b>T5 Lamps</b>       |                 |                 |                          |              |                  |                         |              |
| F28T5/830             | FP28/830/ECO    | F28W/T5/830/ECO | F28T5/830/ALTO           | -            | F28T5/830/ENV    | F28T5/830/ECO/IC        | F28T5/830    |
| F28T5/835             | FP28/835/ECO    | F28W/T5/835/ECO | F28T5/835/ALTO           | F28T5/835    | F28T5/835/ENV    | F28T5/835/ECO/IC        | F28T5/835    |
| F28T5/841             | FP28/841/ECO    | F28W/T5/841/ECO | F28T5/841/ALTO           | F28T5/841    | F28T5/841/ENV    | F28T5/841/ECO/IC        | F28T5/841    |
| F28T5/865             | -               | -               | -                        | F28T5/865    | F28T5/865/ENV    | -                       | -            |
| F21T5/830             | FP21/830/ECO    | F21W/T5/830/ECO | F21T5/830/ALTO           | -            | F21T5/830/ENV    | F21T5/830/ECO/IC        | F21T5/830    |
| F21T5/835             | FP21/835/ECO    | F21W/T5/835/ECO | F21T5/835/ALTO           | F21T5/835    | F21T5/835/ENV    | F21T5/835/ECO/IC        | F21T5/835    |
| F21T5/841             | FP21/841/ECO    | F21W/T5/841/ECO | F21T5/841/ALTO           | F21T5/841    | F21T5/841/ENV    | F21T5/841/ECO/IC        | F21T5/841    |
| F21T5/850             | FP21/850/ECO    | F21W/T5/850/ECO | -                        | -            | F21T5/850/ENV    | -                       | F21T5/850    |
| F21T5/865             | FP21/865/ECO    | F21W/T5/865/ECO | -                        | -            | F21T5/865/ENV    | -                       | -            |
| F14T5/830             | FP14/830/ECO    | F14W/T5/830/ECO | F14T5/830/ALTO           | F14T5/841    | F14T5/830/ENV    | -                       | F14T5/830    |
| F14T5/841             | FP14/841/ECO    | F14W/T5/841/ECO | F14T5/841/ALTO           | -            | F14T5/841/ENV    | F14T5/841/ECO/IC        | F14T5/841    |

## Lamp Installation Available!

Did you know?



Several of our linear fluorescent fixtures can be built and shipped with the lamps installed. Save time and money by having your fixture shipped complete to you. Contact us for available models



| Howard Model #                 | Sylvania        | GE              | Philips             | Eiko          | Satco (Hygrade)    | Halco             | Ushio        |
|--------------------------------|-----------------|-----------------|---------------------|---------------|--------------------|-------------------|--------------|
| <b>T8 U-Bent Energy Saving</b> |                 |                 |                     |               |                    |                   |              |
| FB28T8/830/ES/ECO              | -               | -               | -                   | -             | FB32T8/830/ENV/28W | FB28/830/6/ECO/IC | FB28T8/830   |
| FB28T8/835/ES/ECO              | -               | -               | -                   | -             | FB32T8/835/ENV/28W | FB28/835/6/ECO/IC | FB28T8/835   |
| FB28T8/841/ES/ECO              | -               | -               | -                   | -             | FB32T8/841/ENV/28W | FB28/841/6/ECO/IC | FB28T8/841   |
| FB25T8/830/ES/ECO              | -               | -               | -                   | -             | -                  | -                 | -            |
| FB25T8/835/ES/ECO              | -               | -               | -                   | -             | -                  | -                 | -            |
| FB25T8/841/ES/ECO              | -               | -               | -                   | -             | -                  | -                 | -            |
| FB25T8/850/ES/ECO              | -               | -               | -                   | -             | -                  | -                 | -            |
| <b>T8 U-Bent</b>               |                 |                 |                     |               |                    |                   |              |
| FB31T8/830                     | FBO31/830       | F31T8/SPX30/U   | FB31T8/TL830/ALTO   | F31T8/830/U   | FB31T8/830         | FB31/830/ECO      | -            |
| FB31T8/835                     | FBO31/835       | F31T8/SPX35/U   | FB31T8/TL835/ALTO   | F31T8/835/U   | FB31T8/835         | FB31/835/ECO      | -            |
| FB31T8/841                     | FBO31/841       | F31T8/SPX41/U   | FB31T8/TL841/ALTO   | F31T8/841/U   | FB31T8/841         | FB31/841/ECO      | -            |
| FB32T8/730/6                   | -               | -               | -                   | -             | FB32T8/730/U6/ENV  | FB32/730/6/ECO/IC | FB32T8/730/6 |
| FB32T8/730/6/ECO               | -               | -               | -                   | -             | FB32T8/730/U6/ENV  | FB32/730/6/ECO/IC | FB32T8/730/6 |
| FB32T8/735/6/ECO               | -               | -               | -                   | -             | FB32T8/735/U6/ENV  | FB32/735/6/ECO/IC | FB32T8/735/6 |
| FB32T8/830/6                   | FBO32/830/6/ECO | F32T8/SPX30/U/6 | FB32T8/TL830/6/ALTO | -             | FB32T8/830/U6/ENV  | FB32/830/6/ECO/IC | -            |
| FB32T8/830/6/ECO               | FBO32/830/6/ECO | F32T8/SPX30/U/6 | FB32T8/TL830/6/ALTO | -             | FB32T8/830/U6/ENV  | FB32/830/6/ECO/IC | -            |
| FB32T8/835/6                   | FBO32/835/6/ECO | F32T8/SPX35/U/6 | FB32T8/TL835/6/ALTO | F32T8/835K/U6 | FB32T8/835/U6/ENV  | FB32/835/6/ECO/IC | FB32T8/835/6 |
| FB32T8/841/6                   | FBO32/841/6/ECO | F32T8/SPX41/U/6 | FB32T8/TL841/6/ALTO | F32T8/841K/U6 | FB32T8/841/U6/ENV  | FB32/841/6/ECO/IC | FB32T8/841/6 |
| FB32T8/850/6                   | -               | -               | FB32T8/TL850/6/ALTO | F32T8/850K/U6 | FB32T8/850/U6/ENV  | FB32/850/6/ECO/IC | FB32T8/850/6 |

# LINEAR LAMPS

## Footnote Legend:

- 1 Average-rated life is based on 3 hours per start.
- 2 Average-rated life at 12 hours per start will increase life by approximately 25% (e.g., lamps rated at 24000 would go to 30000).
- 3 Average-rated life at 12 hours per start will increase life by approximately 25% (e.g., lamps rated at 20000 would go to 25000).
- 4 Lumen ratings, CRI and average-rated lamp life subject to change.
- 5 NEMA recommends that ballasts for this lamp have end-of-life shutdown circuitry which will safely shut the system down in the event of an abnormal end-of-life failure mode. See [www.NEMA.org](http://www.NEMA.org) for details.
- 6 Minimum start temperature is a function of the ballast; consult the ballast manufacturer.
- 7 The nominal length of linear fluorescent lamps is typically measured from back of lampholder to back of lampholder. T5 and T5HO linear lamps are exceptions. The nominal length given for T5 and T5HO linear lamps is the closest familiar nominal length.
- T Low-Mercury fluorescent lamps pass the Federal TCLP for hazardous waste. Disposal regulations may vary; check local and state regulations.
- ∅ Discontinued product. This product will be removed when current stock is depleted.



This lamp meets Federal Minimum Efficiency standards.



Consortium of Energy Efficiency listed product. Visit [CEE1.org](http://CEE1.org) for more information.



High Lumen 32W T8 lamps.



Energy Saving 25, 28, and 30W T8 Lamps



Long Life High Lumen (32W T8) Lamps and Long Life Energy Saving (28W T8) Lamps



High Output 54, 39, and 24W T5 Lamps



LED T8 Linear Lamps



DesignLights Consortium® listed product. Visit [www.designlights.org](http://www.designlights.org) for a list of qualified products.

## Combination Lamp/Ballast System Warranty "Security Plus"

Howard Industries, Inc. – Lighting Products Division warrants lamps installed on Howard electronic ballast to be free from defects in material and workmanship and to operate from the date of installation (or date of manufacture if installation date is not known or available) for the time periods and subject to the terms and conditions specified in the table below. If

lamps fail to operate for the warranty period, Howard Lighting Products will provide a free replacement lamp (no labor allowance). If a Howard electronic ballast fails to operate within the warranty period, Howard Lighting Products will provide a free replacement ballast and labor allowance in accordance with our ballast warranty guide.

| Electronic Ballast | Lamp   | Ballast Warranty          | Lamp Warranty          |
|--------------------|--|---------------------------|------------------------|
| Standard Power     | F17T8/xxx/ECO, F25T8/xxx/ECO, F30T8/8xx/ES/ECO, F32T8/xxx/ECO, F32T8/8xx/HL/ECO, FB32T8/xxx/6/ECO                                      | 60 months                 | 36 months <sup>1</sup> |
| Low Power          | F17T8/xxx/ECO, F25T8/xxx/ECO, F30T8/8xx/ES/ECO, F32T8/xxx/ECO, F32T8/8xx/HL/ECO, FB32T8/xxx/6/ECO                                      | 60 months                 | 36 months <sup>1</sup> |
| High Power         | F17T8/xxx/ECO, F25T8/xxx/ECO, F30T8/8xx/ES/ECO, F32T8/xxx/ECO, F32T8/8xx/HL/ECO, FB32T8/xxx/6/ECO                                      | 60 months                 | 36 months <sup>1</sup> |
| HE Standard Power  | F17T8/xxx/ECO, F25T8/xxx/ECO, F28T8/8xx/ES/ECO, F30T8/8xx/ES/ECO, F32T8/xxx/ECO, F32T8/8xx/HL/ECO, FB28T8/8xx/ES/ECO, FB32T8/xxx/6/ECO | 60 months                 | 36 months <sup>1</sup> |
| HE Low Power       | F17T8/xxx/ECO, F25T8/xxx/ECO, F28T8/8xx/ES/ECO, F30T8/8xx/ES/ECO, F32T8/xxx/ECO, F32T8/8xx/HL/ECO, FB28T8/8xx/ES/ECO, FB32T8/xxx/6/ECO | 60 months                 | 36 months <sup>1</sup> |
| T5HO               | F54T5/8xx/HO   | 36 months @<br><90°C case | 36 months <sup>1</sup> |
|                    |  | 60 months @<br><75°C case | 36 months <sup>1</sup> |

Note: Fluorescent lamp warranty periods are based on a 3 hour minimum cycle, unless otherwise noted, with a maximum of 4,000 hours per year. Other operating cycles may affect the warranty period. The Howard lamp warranty can renew when the installation is group relamped. For more details contact Howard Lighting Products.

1. Occupancy sensor application, 15 minute/start minimum, allowed with program start ballast
2. Maximum case temperature <70°C, for normal environmental operating conditions (40°C max., ambient) unless noted

### Terms and Conditions

1. HOWARD Industries warrants the lamps to be free from defects in material and workmanship, and warrants its ballasts as provided in HOWARD's current published ballast warranty, hereby made part of this warranty.
2. Howard lamps and electronic ballast must be installed together as a system. Lamps must be operated on ballasts indicated, within the electrical values noted on HOWARD ballast labels, and with all lamp and lighting equipment instructions and be operated within the normal specified operating range of environmental conditions for the systems. Ballasts and lamps must be installed and operated in accordance with the latest National Electric Code, UL, and ANSI specifications. Ballasts and lamps operated in any system, which has been subjected to abnormal stresses, but not limited to, excess temperatures or under or over voltage conditions are excluded from coverage under this Warranty.
3. The installation must be registered with HOWARD Industries within thirty (30) days from date of completion. HOWARD's combination T8 Lamp/Ballast System Warranty (Security Plus) Registration Form must be completed per instructions and installation acknowledged by HOWARD Industries.
4. Replacement of Howard lamps with lamps from other manufacturers will void the lamp portion of this warranty.
5. Replacement of Howard electronic ballast with any other ballast manufacturer will void the entire warranty.
6. For ballast refer to HOWARD Industries current published ballast warranty. HOWARD Industries will replace in-warranty failures by furnishing lamps in kind.
7. Howard Industries reserves the right to examine all failed ballasts and/or lamps and reserves the right to be the sole judge as to whether any ballasts and/or lamps are defective and covered under this warranty.
8. This Warranty shall be the sole remedy of the Customer and the sole liability of HOWARD Industries to Customer. NO IMPLIED WARRANTY OR MERCHANTABILITY OR FITNESS FOR A PARTICULAR PURPOSE IS MADE OR IS TO BE IMPLIED. HOWARD Industries will not under any circumstances whether as a result of breach of contract, breach of warranty, tort, strict liability or otherwise be liable for consequential, incidental, special or exemplary damages including, but not limited to, loss of profits or revenues, loss of use of ballasts or any other goods or associated equipment or damages to any associated equipment, cost of capital, cost of substitute products, facilities or services, down time costs, or claims of claimant's customers.
9. After contacting Howard Lighting Products and receiving a return authorization number, the user/customer shall promptly return the product at the user/customer's expense to Howard Lighting Products after receiving instructions as to when and where to ship product. Failure to follow this procedure shall void this warranty.
10. Refer to HOWARD Industries Ballast Limited Warranty for other terms and conditions and limitations not otherwise superseded in the foregoing HOWARD Lighting Products Combination T8 Lamp/Ballast System Warranty (Security Plus).
11. Subject to change without notice.

Surround yourself with **Howard Lighting**.

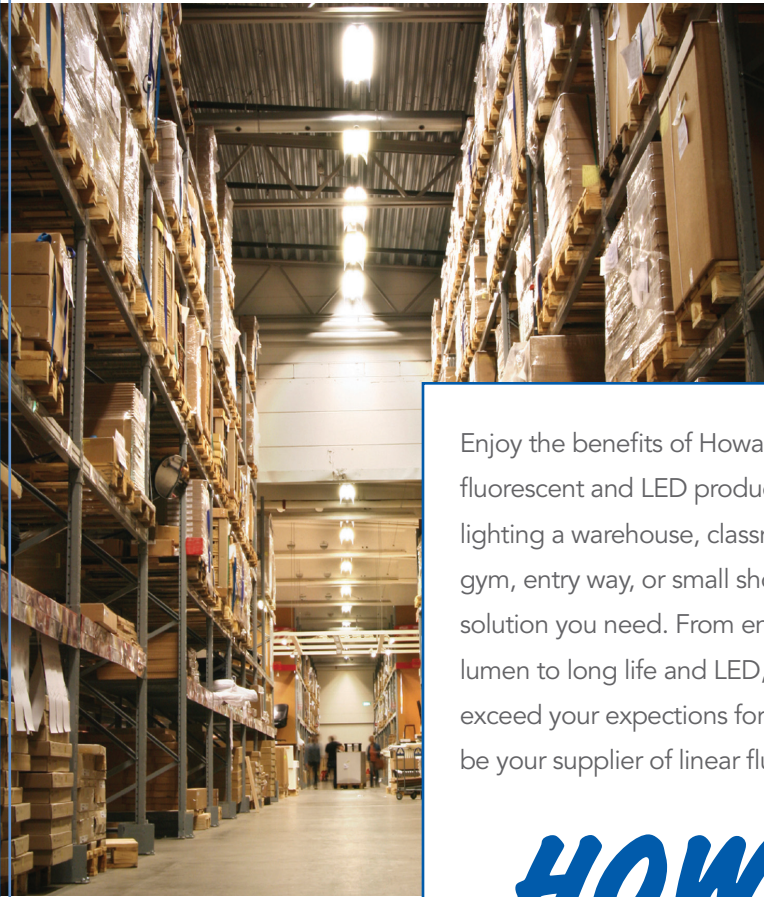

Enjoy the benefits of Howard Lighting linear fluorescent and LED products. Whether you are lighting a warehouse, classroom, parking garage, gym, entry way, or small shop, we have just the solution you need. From energy saving and high lumen to long life and LED, our products will meet or exceed your expectations for quality and service. Let us be your supplier of linear fluorescent and LED lamps

# HOWARD

## LIGHTING PRODUCTS

 *A Division of Howard Industries, Inc.*

580 Eastview Drive • Laurel, MS 39443  
P.O. Box 1590 • Laurel, MS 39441

800.956.3456 *general* • 601.422.1652 *fax*  
601.422.0033 *direct*

[www.HowardLightingProducts.com](http://www.HowardLightingProducts.com)

Revised 3/3/2014

