

Ground Fault Products Extra Heavy Duty Industrial & Hospital Grade GFCI Receptacles Tamper-Resistant and Weather Resistant



GFR5362SGI

Features

10kA Short Circuit Current Rating

Limits improper access to energized contacts

- Exclusive patented tamper-resistant protection through switching technology
- Continually tests and monitors for people protection automatically
- Patented self test diagnostics

Power indication

- Steady **“ON” GREEN LED** provides indication of power

Ground fault indicator

- Steady **“ON” RED LED** provides visual indication of a ground fault condition; flashing red indicates device has lost capability to provide protection

No power at face if reverse wired

- Open circuit condition eliminates false assumption of protection at face

Durable face with V-0 flammability rating

- Polyester face cover



AUTOGUARD® Self Test GFCI Receptacles Tamper-Resistant and Weather Resistant



Description	Rating	Color	Standard	Hospital Grade
Flush, polyester face, back and side wired, multiple drive screws.		Black	GFR5262SGBK	GFR8200SGBK
		Brown	GFR5262SG	GFR8200SG
		Gray	GFR5262SGGY	GFR8200SGGY
		Ivory	GFR5262SGI	GFR8200SGI
		Red	GFR5262SGR	GFR8200SGR
		White	GFR5262SGW	GFR8200SGW
Flush, polyester face, back and side wired, multiple drive screws.		Black	GFR5362SGBK	GFR8300SGBK
		Brown	GFR5362SG	GFR8300SG
		Gray	GFR5362SGGY	GFR8300SGGY
		Ivory	GFR5362SGI	GFR8300SGI
		Red	GFR5362SGR	GFR8300SGR
		White	GFR5362SGW	GFR8300SGW

Note: GFCI type receptacles should not be used in critical care patient areas or for electrical life support equipment applications because of the possibility of power interruption. All GFCI receptacles listed above are furnished with both a matching color nylon wallplate, and a SS26 302/304 super stainless steel wallplate. 20 amp feed-through capability. See page Tech-10 for Tamper-Resistant and Weather Resistant descriptions.

GFCI Receptacle Specifications per GFCI Products Listed (Pages K-2 to K-9)

Trip Level	4 to 6 mA.
Trip Time	.025 second nominal.
Frequency	60 Hz.
Voltage	120V AC +10% - 15% (102V to 132V).
Amperage	15A/20A, 20A Feed Thru.
Maximum Interrupting Capacity	10,000A.
Operating Temperature	-35°C to 66°C or -30°F to 150°F.
Maximum Humidity	95%.
Listings and Standards	Meets UL498 for receptacles, UL943 Class A for GFCIs UL File E41978. CSA Certified.
Codes	Meets all NEC® and CEC requirements. NEMA WD-6 ANSI 73.

NEC® is a registered trademark of the National Fire Protection Association (NFPA).



GFTRST20

Features

- Patented shutter design for tamper-resistant protection
- Compliant with NEC® 406.12 and NEC® 517-18(c)
- Patented AUTOGUARD® self test technology includes disconnecting power to the receptacle if critical components are damaged and GFCI protection is lost
- Alarm version provides audible notification of a trip condition



Tamper-Resistant



Rating	Color	Standard	Night Light Two LED Night Lights	Alarm	Combination Switch 15A 120V Switch	Standard 3-Pack Three Devices per Pack
	Almond	GFTRST15AL	GFTRST15ALNL	GFTRST15ALZ	—	—
	Black	GFTRST15BK	GFTRST15BKNL	GFTRST15BKZ	—	—
	Brown	GFTRST15	GFTRST15NL	GFTRST15Z	—	—
	Gray	GFTRST15GY	GFTRST15GYNL	GFTRST15GYZ	—	—
	Ivory	GFTRST15I	GFTRST15INL	GFTRST15IZ	GFSPST15I	GFTRST15I3
	Light Almond	GFTRST15LA	GFTRST15LANL	GFTRST15LAZ	GFSPST15LA	GFTRST15LA3
	Red	GFTRST15R	GFTRST15RNL	GFTRST15RZ	—	—
	White	GFTRST15W	GFTRST15WNL	GFTRST15WZ	GFSPST15W	GFTRST15W3
	Almond	GFTRST20AL	GFTRST20ALNL	GFTRST20ALZ	—	—
	Black	GFTRST20BK	GFTRST20BKNL	GFTRST20BKZ	—	—
	Brown	GFTRST20	GFTRST20NL	GFTRST20Z	—	—
	Gray	GFTRST20GY	GFTRST20GYNL	GFTRST20GYZ	—	—
	Ivory	GFTRST20I	GFTRST20INL	GFTRST20IZ	—	GFTRST20I3
	Light Almond	GFTRST20LA	GFTRST20LANL	GFTRST20LAZ	—	GFTRST20LA3
	Red	GFTRST20R	GFTRST20RNL	GFTRST20RZ	—	—
	White	GFTRST20W	GFTRST20WNL	GFTRST20WZ	—	GFTRST20W3



Hospital Grade • Tamper-Resistant

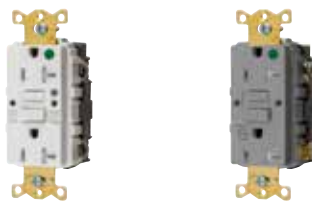

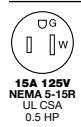
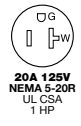
Rating	Color	Night Light Two LED Night Lights	Alarm
	Almond	GFTRST82ALNL	GFTRST82ALZ
	Black	GFTRST82BKNL	GFTRST82BKZ
	Brown	GFTRST82NL	GFTRST82Z
	Gray	GFTRST82GYNL	GFTRST82GYZ
	Ivory	GFTRST82INL	GFTRST82IZ
	Light Almond	GFTRST82LANL	GFTRST82LAZ
	Red	GFTRST82RNL	GFTRST82RZ
	White	GFTRST82WNL	GFTRST82WZ
	Almond	GFTRST83ALNL	GFTRST83ALZ
	Black	GFTRST83BKNL	GFTRST83BKZ
	Brown	GFTRST83NL	GFTRST83Z
	Gray	GFTRST83GYNL	GFTRST83GYZ
	Ivory	GFTRST83INL	GFTRST83IZ
	Light Almond	GFTRST83LANL	GFTRST83LAZ
	Red	GFTRST83RNL	GFTRST83RZ
	White	GFTRST83WNL	GFTRST83WZ

Product Dimensions Inches (mm)

	GFCI Receptacle
A	3.27 (83.1)
B	2.75 (69.8)
C	1.75 (44.5)
D	1.47 (37.4)
E	1.10 (27.9)

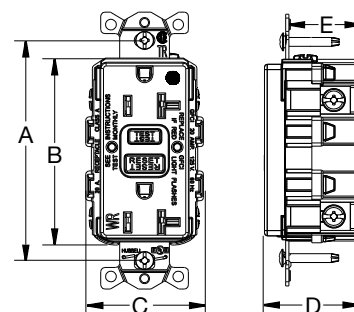



GFRST15WNL

Features

- Patented AUTOGUARD® self test technology includes disconnecting power to the receptacle if critical components are damaged and GFCI protection is lost
- Internal back wiring clamp and guide for quick and secure termination
- Night light option includes light sensor controls for automatic on and off, custom dual lens for optimum light output

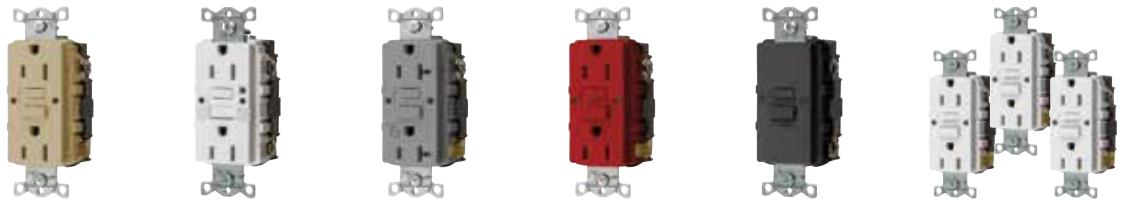

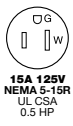
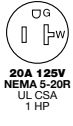

Standard

Rating	Color	Standard	Night Light Two LED Night Lights	Alarm	Assembled in USA	Blank Face Available in 20A Only	Standard 3-Pack Three Devices per Pack	
	Almond	GFRST15AL	GFRST15ALNL	GFRST15ALZ	GFRST15ALU	—	—	
	Black	GFRST15BK	GFRST15BKNL	GFRST15BKZ	GFRST15BKU	—	—	
	Brown	GFRST15	GFRST15NL	GFRST15Z	GFRST15U	—	—	
	Gray	GFRST15GY	GFRST15GYNL	GFRST15GYZ	GFRST15GYU	—	—	
	Ivory	GFRST15I	GFRST15INL	GFRST15IZ	GFRST15IU	—	GFRST15I3	
	Light Almond	GFRST15LA	GFRST15LANL	GFRST15LAZ	GFRST15LAU	—	GFRST15LA3	
	Red	GFRST15R	GFRST15RNL	GFRST15RZ	GFRST15RU	—	—	
	White	GFRST15W	GFRST15WNL	GFRST15WZ	GFRST15WU	—	GFRST15W3	
		Almond	GFRST20AL	GFRST20ALNL	GFRST20ALZ	GFRST20ALU	GFBFST20AL	—
		Black	GFRST20BK	GFRST20BKNL	GFRST20BKZ	GFRST20BKU	GFBFST20BK	—
Brown		GFRST20	GFRST20NL	GFRST20Z	GFRST20U	GFBFST20	—	
Gray		GFRST20GY	GFRST20GYNL	GFRST20GYZ	GFRST20GYU	GFBFST20GY	—	
Ivory		GFRST20I	GFRST20INL	GFRST20IZ	GFRST20IU	GFBFST20I	GFRST20I3	
Light Almond		GFRST20LA	GFRST20LANL	GFRST20LAZ	GFRST20LAU	GFBFST20LA	GFRST20LA3	
Red		GFRST20R	GFRST20RNL	GFRST20RZ	GFRST20RU	GFBFST20R	—	
White		GFRST20W	GFRST20WNL	GFRST20WZ	GFRST20WU	GFBFST20W	GFRST20W3	

Standard SNAPConnect®



Rating	Color	Standard
	Almond	GFRST15SNAPAL
	Black	GFRST15SNAPBK
	Brown	GFRST15SNAP
	Gray	GFRST15SNAPGY
	Ivory	GFRST15SNAPI
	Light Almond	GFRST15SNAPLA
	Red	GFRST15SNAPR
	Almond	GFRST20SNAPAL
	Black	GFRST20SNAPBK
	Brown	GFRST20SNAP
	Gray	GFRST20SNAPGY
	Ivory	GFRST20SNAPI
	Light Almond	GFRST20SNAPLA
	Red	GFRST20SNAPR
White	GFRST20SNAPW	

Right Angle Pigtailed Terminal



Description	Type	Catalog Number
Clear right angle terminal with 6 inch leads, 600V, #12 AWG THHN/THWN-2, Polycarbonate housing material.	Solid Stranded	SNAP1RA SNAP2RA





GFRST82WNL

Features

- Fed. Spec UL Listed, Hospital Grade
- Green power indicator and red trip indicator
- Patented AUTOGUARD® self test technology
- Flush, nylon face, back and side wired, multiple drive screws, self-grounding staple.





Hospital Grade

Rating	Color	Standard	Night Light Two LED Night Lights	Alarm	Assembled in USA
	Almond	GFRST82AL	GFRST82ALNL	GFRST82ALZ	GFRST82ALU
	Black	GFRST82BK	GFRST82BKNL	GFRST82BKZ	GFRST82BKU
	Brown	GFRST82	GFRST82NL	GFRST82Z	GFRST82U
	Gray	GFRST82GY	GFRST82GYNL	GFRST82GYZ	GFRST82GYU
	Ivory	GFRST82I	GFRST82INL	GFRST82IZ	GFRST82IU
	Light Almond	GFRST82LA	GFRST82LANL	GFRST82LAZ	GFRST82LAU
	Red	GFRST82R	GFRST82RNL	GFRST82RZ	GFRST82RU
White	GFRST82W	GFRST82WNL	GFRST82WZ	GFRST82WU	
	Almond	GFRST83AL	GFRST83ALNL	GFRST83ALZ	GFRST83ALU
	Black	GFRST83BK	GFRST83BKNL	GFRST83BKZ	GFRST83BKU
	Brown	GFRST83	GFRST83NL	GFRST83Z	GFRST83U
	Gray	GFRST83GY	GFRST83GYNL	GFRST83GYZ	GFRST83GYU
	Ivory	GFRST83I	GFRST83INL	GFRST83IZ	GFRST83IU
	Light Almond	GFRST83LA	GFRST83LANL	GFRST83LAZ	GFRST83LAU
	Red	GFRST83R	GFRST83RNL	GFRST83RZ	GFRST83RU
White	GFRST83W	GFRST83WNL	GFRST83WZ	GFRST83WU	



Hospital Grade SNAPConnect®

Rating	Color	Standard
	Almond	GFRST82SNAPAL
	Black	GFRST82SNAPBK
	Brown	GFRST82SNAP
	Gray	GFRST82SNAPGY
	Ivory	GFRST82SNAPI
	Light Almond	GFRST82SNAPLA
	Red	GFRST82SNAPR
White	GFRST82SNAPW	
	Almond	GFRST83SNAPAL
	Black	GFRST83SNAPBK
	Brown	GFRST83SNAP
	Gray	GFRST83SNAPGY
	Ivory	GFRST83SNAPI
	Light Almond	GFRST83SNAPLA
	Red	GFRST83SNAPR
White	GFRST83SNAPW	

Right Angle Pigtailed Terminal

Description	Type	Catalog Number
Clear right angle terminal with 6 inch leads, 600V, #12 AWG THHN/THWN-2, Polycarbonate housing material.	Solid Stranded	SNAP1RA SNAP2RA



Ground Fault Products Commercial Tamper-Resistant and Weather Resistant GFCI Receptacles



Features

- Patented shutter design for tamper-resistant protection
- Meets NEC requirements for TR (517-18c) and WR (406.9), UV and corrosion resistance for harsh and damp applications
- Patented AUTOGUARD® self test technology
- Protects against line and load reversal, no power to the face or downstream if device is miswired



GFTWRST20WIG



Tamper-Resistant Weather Resistant



Rating	Color	Standard	Assembled in USA	Isolated Ground	SNAPConnect®	Right Angle Pigtailed Terminal	
	Almond	GFTWRST15AL	GFTWRST15ALU	GFTWRST15ALIG	GFTWRST15SNAPAL	Clear right angle terminal with 6 inch leads, 600V, #12 AWG THHN/THWN-2, Polycarbonate housing material. Solid SNAP1RA Stranded SNAP2RA	
	Black	GFTWRST15BK	GFTWRST15BKU	GFTWRST15BKIG	GFTWRST15SNAPBK		
	Brown	GFTWRST15	GFTWRST15U	GFTWRST15IG	GFTWRST15SNAP		
	Gray	GFTWRST15GY	GFTWRST15GYU	GFTWRST15GYIG	GFTWRST15SNAPGY		
	Ivory	GFTWRST15I	GFTWRST15IU	GFTWRST15IIG	GFTWRST15SNAPI		
	Light Almond	GFTWRST15LA	GFTWRST15LAU	GFTWRST15LAIG	GFTWRST15SNAPLA		
	Red	GFTWRST15R	GFTWRST15RU	GFTWRST15RIG	GFTWRST15SNAPR		
	White	GFTWRST15W	GFTWRST15WU	GFTWRST15WIG	GFTWRST15SNAPW		
		Almond	GFTWRST20AL	GFTWRST20ALU	GFTWRST20ALIG		GFTWRST20SNAPAL
		Black	GFTWRST20BK	GFTWRST20BKU	GFTWRST20BKIG		GFTWRST20SNAPBK
		Brown	GFTWRST20	GFTWRST20U	GFTWRST20IG		GFTWRST20SNAP
Gray		GFTWRST20GY	GFTWRST20GYU	GFTWRST20GYIG	GFTWRST20SNAPGY		
Ivory		GFTWRST20I	GFTWRST20IU	GFTWRST20IIG	GFTWRST20SNAPI		
Light Almond		GFTWRST20LA	GFTWRST20LAU	GFTWRST20LAIG	GFTWRST20SNAPLA		
Red		GFTWRST20R	GFTWRST20RU	GFTWRST20RIG	GFTWRST20SNAPR		
White		GFTWRST20W	GFTWRST20WU	GFTWRST20WIG	GFTWRST20SNAPW		



Hospital Grade • Tamper-Resistant Weather Resistant



Rating	Color	Standard	Assembled in USA	Isolated Ground	SNAPConnect®	Right Angle Pigtailed Terminal	
	Almond	GFTWRST82AL	GFTWRST82ALU	GFTWRST82ALIG	GFTWRST82SNAPAL	Clear right angle terminal with 6 inch leads, 600V, #12 AWG THHN/THWN-2, Polycarbonate housing material. Solid SNAP1RA Stranded SNAP2RA	
	Black	GFTWRST82BK	GFTWRST82BKU	GFTWRST82BKIG	GFTWRST82SNAPBK		
	Brown	GFTWRST82	GFTWRST82U	GFTWRST82IG	GFTWRST82SNAP		
	Gray	GFTWRST82GY	GFTWRST82GYU	GFTWRST82GYIG	GFTWRST82SNAPGY		
	Ivory	GFTWRST82I	GFTWRST82IU	GFTWRST82IIG	GFTWRST82SNAPI		
	Light Almond	GFTWRST82LA	GFTWRST82LAU	GFTWRST82LAIG	GFTWRST82SNAPLA		
	Red	GFTWRST82R	GFTWRST82RU	GFTWRST82RIG	GFTWRST82SNAPR		
	White	GFTWRST82W	GFTWRST82WU	GFTWRST82WIG	GFTWRST82SNAPW		
		Almond	GFTWRST83AL	GFTWRST83ALU	GFTWRST83ALIG		GFTWRST83SNAPAL
		Black	GFTWRST83BK	GFTWRST83BKU	GFTWRST83BKIG		GFTWRST83SNAPBK
		Brown	GFTWRST83	GFTWRST83U	GFTWRST83IG		GFTWRST83SNAP
Gray		GFTWRST83GY	GFTWRST83GYU	GFTWRST83GYIG	GFTWRST83SNAPGY		
Ivory		GFTWRST83I	GFTWRST83IU	GFTWRST83IIG	GFTWRST83SNAPI		
Light Almond		GFTWRST83LA	GFTWRST83LAU	GFTWRST83LAIG	GFTWRST83SNAPLA		
Red		GFTWRST83R	GFTWRST83RU	GFTWRST83RIG	GFTWRST83SNAPR		
White		GFTWRST83W	GFTWRST83WU	GFTWRST83WIG	GFTWRST83SNAPW		