



**WIRING SYSTEMS**  
Wiring Device-Kellems  
Premise Wiring



	Page
SystemOne . . . . .	.70
Round Non-Metallic . . . . .	.72
Round Cast Iron. . . . .	.73
Round Stamped Steel . . . . .	.73
Round For Wood Floors . . . . .	.81
Rectangular Non-Metallic . . . . .	.74
Rectangular Cast Iron . . . . .	.76
Rectangular Stamped Steel . . . . .	.77
Rectangular For Wood Floors . . . . .	.81
Recessed 4 & 8 Gang. . . . .	.78
Recessed 6-Gang. . . . .	.79
Recessed 2-Gang. . . . .	.80
Cover/Receptacle Chart . . . . .	.82





# Hubbell Floor Boxes

Featuring the unique capabilities of Hubbell's SystemOne universal cover and sub-plate design, Hubbell has expanded its floor box offering to provide industry leading flexibility while accommodating an extensive range of applications. Hubbell SystemOne is constructed to give customers the ability to create personal solutions for their most demanding, power, data and audio/video requirements. In addition, Hubbell continues to offer a complete variety of traditional flush and recessed floor box options.

Whatever your requirement, Hubbell has a solution. Combined with Hubbell SystemOne fire-rated poke-through products that offer the same unique advantages, Hubbell's entire delivery system package is second to none in providing a consistent aesthetic and functional solution for your power, data and audio/video needs.

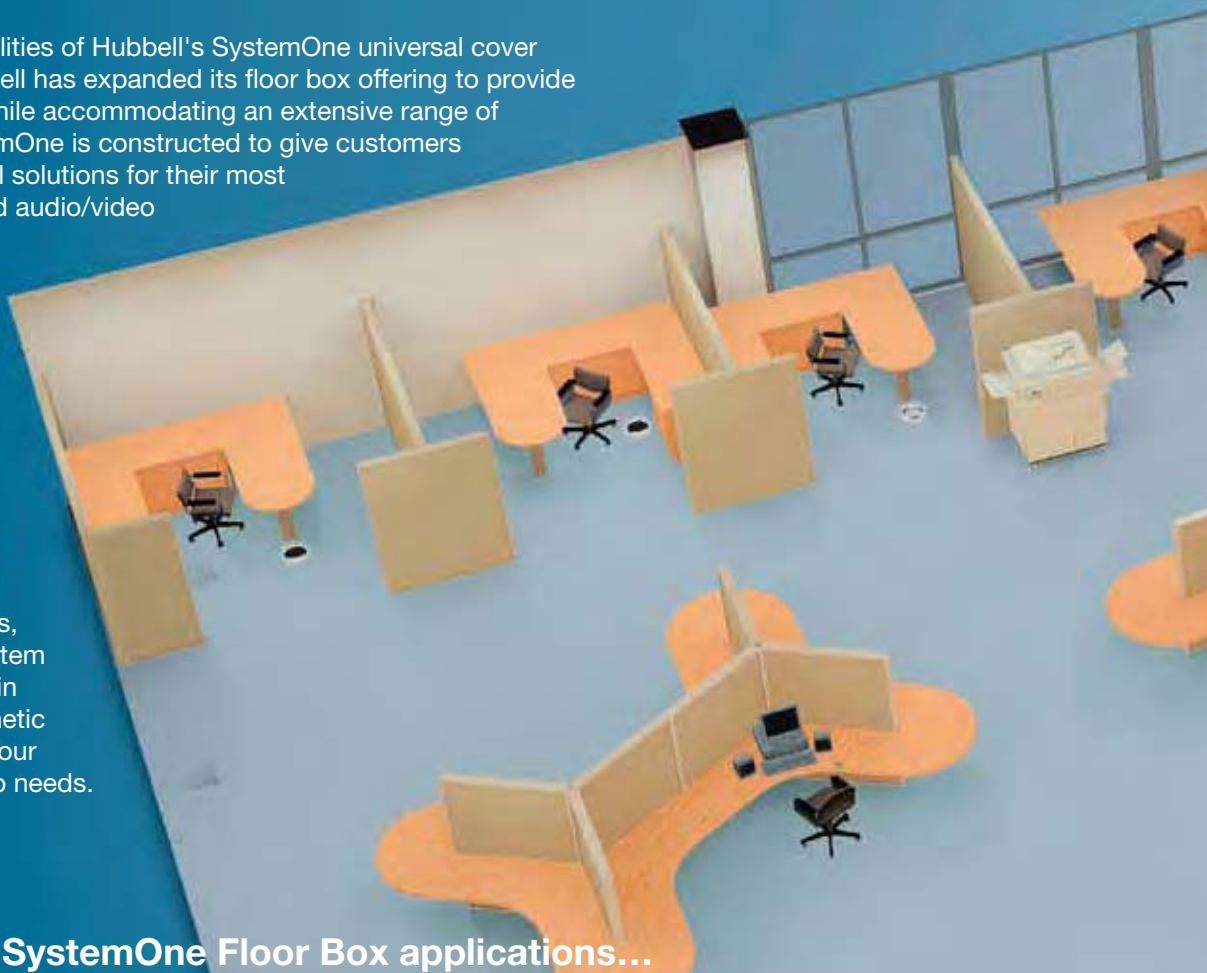

## Hubbell SystemOne Floor Box applications...



### Multi-Service Applications

This Hubbell SystemOne sub-plate incorporates 2 standard Style Line® rectangular openings. These can be used for a variety of power and/or data applications. It will accommodate 15 or 20 amp, standard, isolated ground, GFCI or surge protected receptacles. Using communication frames it can provide up to a 6-port multi-service or a 12-port all communication solution.



### Multimedia Applications

Other Hubbell SystemOne sub-plates are designed to meet the growing needs of the audio and video markets. Some sub-plates provide power outlets with Hubbell's audio/video products including 15-Pin SVGA, RCA, S-Video, 3.5mm stereo, and XLR microphone jacks. Another sub-plate can accommodate Extron® Electronics' MAAP and AAP series audio/video modules.



### 4X4 Applications

Provides maximum power capacity for flush, multi-service applications. This sub-plate features a pre-wired four outlet 20A, 125V receptacle and four openings for Snap Fit flush mount Hubbell modular jacks and audio/video Snap Fit connectors.







### Advantage

- **Best in Class Products**  
Easily upgraded as user's needs change.
- **Ease of Installation**  
Modular sub-plate design facilitates quick and efficient moves, adds and changes.
- **Application Solutions**  
Highest capacity and widest variety of power, data and audio/video solutions.

## Traditional Floor Boxes...

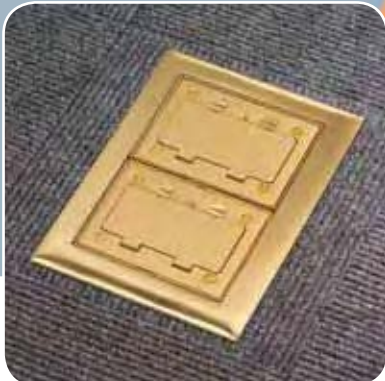

**Flush Applications**  
Hubbell offers a wide variety of traditional solutions including single and multi-gang cast iron, stamped steel and non-metallic floor boxes in both round and rectangular designs. These boxes can be finished with either brushed brass or aluminum covers and flanges to match any office décor. All Hubbell floor box assemblies exceed UL scrub water exclusion requirements.



**Recessed Applications**  
For applications where recessed connections are desired, Hubbell has a complete line of recessed stamped steel and cast iron floor boxes, from two to eight gangs. A variety of modular face plates are available to meet a wide array of power, data, voice and audio/video requirements. Carpet and tile cover/flange assemblies are offered in painted brass, aluminum, black, gray, brown and ivory colors.

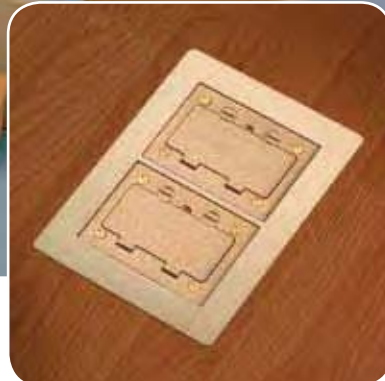

**Wooden Floor Applications**  
Hubbell offers round, single service and rectangular, multi-service floor boxes for wooden floor applications. The rectangular boxes are available in one, two and three-gang options and feature removable barriers for maximum capacity while maintaining separation of power and low voltage. A variety of covers and flanges are available in brushed aluminum or brass to meet aesthetic requirements.



## Hubbell SystemOne Non-Metallic Floor Box



Saves time and money on installation with a simple saw cut after pour adjustment.

Oversized 1 1/2" data conduit hub provides for increased cable capacity and helps maintain proper bend radius suitable for Category 6/6a, 5e, coax and fiber cables.

Parallel conduit hubs reduce labor and material costs and facilitate easier wire pulling in dual-service applications.

- Provides an economical, easy to install in-floor delivery system for large, open plan spaces.
- Accepts all Hubbell SystemOne universal covers and sub-plates for both single and dual service applications.
- Convenient cubic inch capacity markings on inside allow for easy inspection.
- Corresponding graduated cubic inch markings on dividers.
- High-strength rigid PVC construction that is non-corrosive.
- Supplied with concrete cap, conduit reducers, and conduit hub plugs.

## Hubbell SystemOne Universal Cover

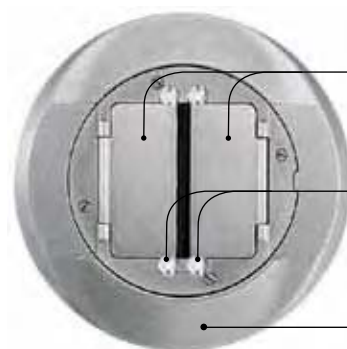

Hinged doors open 180 degrees flush to the carpet flange or tile.

Screws allow each door to be secured independently.

Universal carpet or tile flange can be used for Hubbell SystemOne Fire-Rated Poke-Through or PVC Floor Box.

- Cast aluminum construction available in durable black, gray, brass, aluminum and ivory powder coat finishes.
- Features ScrubShield™ technology that exceeds UL514C scrub water exclusion requirements.
- Provides consistent look and maximum functionality throughout the installed life.

## Hubbell SystemOne Sub-Plates

While no one can predict the future, Hubbell's modular sub-plate design allows users to economically upgrade Hubbell SystemOne Floor Boxes to accommodate future moves, adds and changes.



- Hubbell 4X4: four 20A, 125V receptacles, four openings for voice/data jacks and multimedia connectors.
- Hubbell INFINESTATION™ front loading modular connectivity.
- Accommodates Extron® Electronics' Architectural Series audio/video system integration products.
- Ortronics®, Siemon™, Panduit®, SYSTIMAX® and keystone options enable maximum data flexibility.
- Large capacity and multi-service furniture feed applications.
- Accommodates GFCI, surge and standard Style Line® receptacles.
- Twist-Lock® receptacle with or without jack openings.



# Hubbell SystemOne Non-Metallic Floor Box

## Round Multi-Service PVC Floor Box

Features (2) 1 1/2" hubs for low voltage and (2) 1" hubs for power. Includes concrete cap, conduit hub plugs, reducers and **S1DIV1** side by side divider. All other sub-plates include the appropriate dividers. Universal cover and sub-plate must be ordered separately.



Min. Depth of Pour	Ranges from 3" to 5" depending on application. See sub-plates below for details.
Capacity	100 cubic inches prior to cutting level to floor (19.5 cubic inches per inch of depth).
Diameter (External)	5.75"
Diameter (Internal)	5.00"
Height	6.00"
Hubs	(2) 1 1/2" and (2) 1" conduit hubs
Conduit Selection	Accepts 3/4", 1", 1 1/4", 1 1/2" schedule 40 and schedule 80 rigid PVC conduit and E.N.T. (electrical non-metallic tubing).

## S1DIV1 Replacement Side by Side Divider

For replacement purposes only. Used to isolate compartments when catalog number **S1SP** (Style Line®/GFCI) sub-plate is used.

# Hubbell SystemOne Universal Covers

## Universal, Cast Aluminum Carpet Flange & Cover Assembly

Catalog Number

<b>S1FCBRS</b>	Brass		■ Cast aluminum construction ■ Powder coat finish
<b>S1FCAL</b>	Aluminum		
<b>S1FCBL</b>	Black		
<b>S1FCGY</b>	Gray		
<b>S1FCI</b>	Ivory		

## Universal, Cast Aluminum Tile Flange & Cover Assembly

Catalog Number

<b>S1TFCBRS</b>	Brass		■ Cast aluminum construction ■ Powder coat finish
<b>S1TFCAL</b>	Aluminum		
<b>S1TFCBL</b>	Black		
<b>S1TFCGY</b>	Gray		
<b>S1TFCI</b>	Ivory		

## Sub-Plates

Catalog Number

**S1SP** Style Line/GFCI  
(2) Style Line openings for power and/or datacom applications.

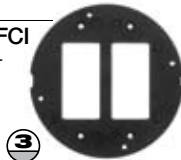

Catalog Number

**S1SP4X4** Hubbell 4 X 4  
(4) 20A, 125V receptacles. (4) Keystone openings for Hubbell jacks or flush A/V connectors.

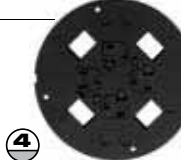

Catalog Number

**S1SPTL** Single Recept. + Data  
15 or 20A straight blade or 15, 20 or 30A TL rec. (1.39" or 1.56" OD). (2) Keystone openings for Hubbell jacks or flush A/V connectors.

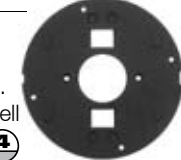

## S1SP4IM Hubbell Datacom

1 unit flush INFINESTATION™ opening. 3 unit recessed INFINESTATION opening for data, voice, and A/V applications.



## S1SP3IM Hubbell Datacom + Power

(1) 20A, 125V receptacle. 3 unit recessed INFINESTATION™ opening for data, voice, and A/V applications.



## S1SPFFBRS Brass Furniture

**S1SPFFAL** Alum. Feed Cover/  
**S1SPFFBL** Black Flange  
**S1SPFFGY** Gray  
(1) 3/4" & (1) 1 1/2" N.P.T. plugs for power and/or datacom applications. **Universal Cover not required. Includes carpet flange.**



## S1SPEXT1 Extron® MAAP + Power

(1) 20A, 125V receptacle. Recessed opening for (3) single Extron MAAP Series adapter plates.

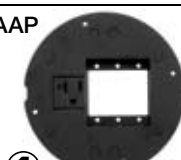

## S1SPEXT2 Extron AAP + Power

(1) 20A, 125V receptacle. Recessed opening for (1) single Extron MAAP and (2) single AAP Series adapter plates.

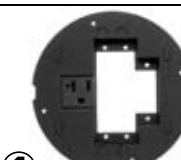

## S1SPEXT3 Extron Datacom

Recessed opening for (2) single Extron MAAP and (2) single AAP Series adapter plates.

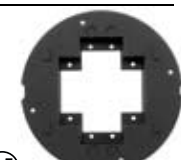

## S1SPORT Ortronics Series II® + Power

(1) 20A, 125V receptacle. Recessed opening for (3) 1 unit Ortronics Series II modules.



## S1SPTRAC Ortronics TracJack® + Power

(1) 20A, 125V receptacle. Recessed bezel for (6) Ortronics TracJack modules.



## S1SPMAX Siemon MAX® + Power

(1) 20A, 125V receptacle. Recessed bezel for (6) Siemon MAX modules.

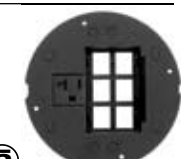

## S1SP4X4PA Panduit Mini-Com® 4 X 4

(4) 20A, 125V receptacles (4) Openings for Panduit Mini-Com Connectivity.



## S1SP4X4SYS SYSTIMAX® 4 X 4

(4) 20A, 125V receptacles. (4) Openings for SYSTIMAX Connectivity.



 Signifies minimum depth of concrete pour in inches for Hubbell SystemOne **S1PFB** Floor Box.





# Flush Round Single or Multi-Service Non-Metallic Floor Box

Catalog Number

## **PFB1** Round Single or Low Capacity Multi-Service PVC Floor Box

Features (2) 1" and (2) 3/4" conduit hubs. Includes concrete cover and four dual purpose reducer/closure plugs. (2) 1" plugs close off 1" hub or reduce 1" to 3/4". (2) 3/4" plugs close off 3/4" hub or reduce 3/4" to 1/2".



Min. Depth of Pour Capacity

3.00"  
100 cubic inches prior to cutting level to floor (19.5 cubic inches per inch of depth).

Diameter (External)  
Diameter (Internal)  
Height

5.75"  
5.00"  
6.00"

Hubs  
Conduit Selection

(2) 1" and (2) 3/4" conduit hubs  
Accepts 1/2", 3/4", 1" schedule 40 and schedule 80 rigid PVC conduit and E.N.T. (electrical non-metallic tubing). Use catalog number PFBYA1 3/4" "Y" adapter to feed parallel runs of 3/4" conduit.

## **PFBA1A** Adapter

Required for all applications.



## **PFBT1A** Low Voltage Divider

Required for use with catalog number PFB1 when used in multi-service applications. Accepts Hubbell standard duplex receptacles or 15A Twist-Lock® duplex receptacles (HBL4700 series).



## **PFBYA1** "Y" Adapter

3/4" "Y" adapter to feed parallel runs of 3/4" conduit.

# Flush Round Covers and Flanges

## Multi-Service Cover and Flange Assemblies

Includes floor box cover with duplex flaps, (2) 1/2" dia. low voltage feed through holes and matching carpet flange.

**SF39253A**



Brass

**PFBCBRA**



Brown Plastic

**PFBCIA**



Ivory Plastic

**PFBCGYA**



Gray Plastic

**PFBCBKA**



Black Plastic

## Single Service Covers

Brass

**S3925**

**S3725**

**S2525**

**S2725**

**S2925**

**S3525**

**S3325**

Aluminum

**SA3925**

**SA3725**

**SA2525**

**SA2725**

**SA2925**

—

—



Duplex Flap



Duplex Screw



2 1/8" x 3/4" Combination



2 1/8" x 1" Combination



2 1/8" Single Receptacle



2 3/8" Single Receptacle



2 1/8" Single Receptacle (Terrazzo Floor)

## Metal Carpet Flange

Use with single service covers for carpet applications.

**S3082**



Brass

## Adapter Ring

Use with single service covers for tile applications.

**S5016**



Brass

**SA5016**



Aluminum

## Furniture Feed Plate

**PFBP1**



Steel

## One Piece Cover and Carpet Flange

Brass

**SF3925\***



Duplex Flap

**SF2525\***



2 1/8" x 3/4" Combination

**SF2725\***



2 1/8" x 1" Combination

**SF2925\***



2 1/8" Single Receptacle

\* Catalog number **S5016** adapter ring is required for mounting SF series covers onto PFBA1A.





## Flush Round Single Service Floor Boxes

Box Material	Cast Iron				Stamped Steel		
Collar Material	Cast Iron		Cast Iron		Stamped Steel		Stamped Steel
Brass	B2536	B253641	B2506	B2506415	B2537	B2527	B2529
Aluminum	BA2536	—	—	—	BA2537	BA2527	BA2529
Min. Depth of Pour	3.75"	3.75"	4.75"	4.75"	3.00"	4.00"	3.00"
Adjustability (Fully, Semi, Non)	Fully	Fully	Fully	Fully	Fully	Fully	Fully
Before Pour External Height Adjustment	1.25"	1.25"	—	—	1.25"	1.25"	1.25"
After Pour Internal Height Adjustment	.38"	.38"	.63"	.63"	.38"	.38"	.38"
Cubic Inch Capacity	33.00	33.00	50.80	50.80	33.00	54.00	37.30
Dimensions - A	4.19"	4.19"	4.19"	4.19"	4.19"	4.19"	4.19"
Dimensions - B	3.09"	3.09"	4.75"	4.75"	2.81"	3.88"	2.91"
Threaded Hub Sizes	(4) ¾"	(4) 1"	(4) 1 ¼"	(4) 1 ½"	(4) ¾"	—	—
Knockouts - Opposite Sides	—	—	—	—	—	(1) 1" & (1) ¾"	(2) ½" & (1) ¾"
Knockouts - Opposite Ends	—	—	—	—	—	(1) 1 ¼" & (1) ¾"	(1) ½" & (1) ½"
Knockouts - Bottom	—	—	—	—	—	(3) ½" & (2) ¾"	(3) ½" & (2) ¾"

## Flush Round Single Service Covers and Flanges

### Single Service Covers

Brass	S3925	S3725	S2525	S2725	S2925	S3525	S3325
Aluminum	SA3925	SA3725	SA2525	SA2725	SA2925	—	—
Duplex Flap	Duplex Screw	2 1/8" x 3/4" Combination	2 1/8" x 1" Combination	2 1/8" Single Receptacle	2 3/8" Single Receptacle	2 1/8" Single Receptacle (Terrazzo Floor)	

### Carpet Flanges

5 1/4" Diameter	S3182	SA3182	S3079	Carpet Flange 6 1/4" Diameter	S3082
Brass	Aluminum	Clear Polycarbonate	Brass		

### One Piece Cover and Carpet Flange

Brass	SF3925	SF2525	SF2725	SF2925
Duplex Flang	2 1/8" x 3/4" Combination	2 1/8" x 1" Combination	2 1/8" Single Receptacle	





## Flush Rectangular Non-Metallic Floor Boxes with Non-Metallic Covers

Number of Gangs

1-Gang  
PFBRG1

2-Gang  
PFBRG2

3-Gang  
PFBRG3

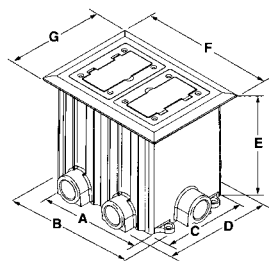

Min. Depth of Pour	3.00"	3.00"	3.00"
Cubic in. Capacity per Gang	14.3 per 1" depth	14.3 per 1" depth	14.3 per 1" depth
Dimensions – A	3.60"	6.82"	10.04"
Dimensions – B	5.44"	8.66"	11.87"
Dimensions – C	5.42"	5.42"	5.42"
Dimensions – D	6.90"	6.90"	6.90"
Dimensions – E	6.00"	6.00"	6.00"
Dimensions – F	4.88"	8.13"	11.35"
Dimensions – G	6.00"	6.00"	6.00"
Hubs	(4) 1"	(6) 1"	(8) 1"
Reducers/Plugs	(4) 1" to 3/4"	(6) 1" to 3/4"	(8) 1" to 3/4"

## Flush Rectangular Non-Metallic Covers and Flanges

### Required Components for Carpet Applications

Carpet Flanges

No. of Gangs

1-Gang

2-Gang

3-Gang

Gray  
Black  
Ivory

**PFBRFGY1**  
**PFBRFBL1**  
**PFBRFI1**

**PFBRFGY2**  
**PFBRFBL2**  
**PFBRFI2**

**PFBRFGY3**  
**PFBRFBL3**  
**PFBRFI3**



Cover with Duplex and Style Line® Inserts

One Required per Gang

**PFBR826GYA**  
**PFBR826BLA**  
**PFBR826IA**

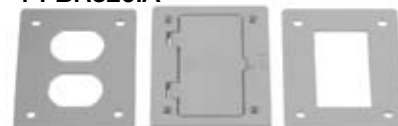

Duplex  
Insert

Cover

Style Line  
Insert

### Required Components for Tile Applications

Mounting Collar

Cover Frame

One Required per Gang

**PFBRMC**

One Required per Gang

**PFBRFRA**

Cover with Duplex and Style Line® Inserts - Gray

One Required per Gang

**PFBR826GYA**

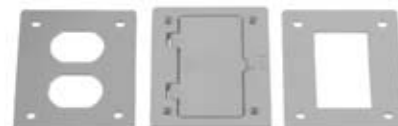

Duplex  
Insert

Cover

Style Line  
Insert





## Flush Rectangular Non-Metallic Floor Boxes with Metal Covers

Number of Gangs

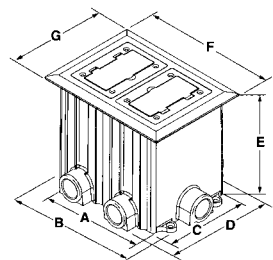

1-Gang  
PFBRG1



2-Gang  
PFBRG2



3-Gang  
PFBRG3



Min. Depth of Pour	3.00"	3.00"	3.00"
Cubic in. Capacity per Gang	14.3 per 1" depth	14.3 per 1" depth	14.3 per 1" depth
Dimensions – A	3.60"	6.82"	10.04"
Dimensions – B	5.44"	8.66"	11.87"
Dimensions – C	5.42"	5.42"	5.42"
Dimensions – D	6.90"	6.90"	6.90"
Dimensions – E	6.00"	6.00"	6.00"
Dimensions – F	4.88"	8.13"	11.35"
Dimensions – G	6.00"	6.00"	6.00"
Hubs	(4) 1"	(6) 1"	(8) 1"
Reducers/Plugs	(4) 1" to 3/4"	(6) 1" to 3/4"	(8) 1" to 3/4"

## Flush Rectangular Metal Covers and Flanges

### Required Components for Carpet and Tile Applications

Adapter Frame and Grounding Lug – One Required per Gang

Adapter Collar – Gray

One Required per Gang

PFBRAC

Brass **S5017G**  
Aluminum **SA5017G**



### Covers – One Required per Gang

Brass	<b>S3825</b>	<b>S3625</b>	<b>S3826</b>	<b>S2425</b>	<b>S2625</b>	<b>S2825</b>	<b>S3813</b>
Aluminum	<b>SA3825</b>	<b>SA3625</b>	<b>SA3826</b>	<b>SA2425</b>	<b>SA2625</b>	–	<b>SA3813</b>
							
	Duplex Flap	Duplex Screw	Style Line Opening	2 1/8" x 3/4" Combination	2 1/8" x 1" Combination	2 1/8" Single Receptacle	Blank

### Carpet Flanges (Not Required for Tile Applications)

#### Tapered Flange

No. of Gangs	1-Gang	2-Gang	3-Gang
Brass	<b>SB3083</b>	<b>SB3084</b>	<b>SB3085</b>
Aluminum	<b>SA3083</b>	<b>SA3084</b>	<b>SA3085</b>







## Flush Rectangular Cast Iron Floor Boxes

Box Material	Cast Iron								
Collar Material	B2436 B243641		B4233 B423341		B4333 B433361		B2414	B4214	B4314
Brass	B2436	B243641	B4233	B423341	B4333	B433361	B2414	B4214	B4314
Aluminum	BA2436	—	BA4233	—	BA4333	—	—	—	—
Min. Depth of Pour	3.75"	3.75"	3.75"	3.75"	3.75"	3.75"	2.00"	2.00"	2.00"
Adjustability (Fully, Semi, Non)	Fully	Fully	Fully	Fully	Fully	Fully	Semi	Semi	Semi
Before Pour External Height Adjustment	1.25"	1.25"	1.25"	1.25"	1.25"	1.25"	1.25"	1.25"	1.25"
After Pour Internal Height Adjustment	.38"	.38"	.63"	.63"	.63"	.63"	—	—	—
Cubic Inch Capacity	33.00	33.00	36.50 Per Gang	36.50 Per Gang	34.80 Middle 36.50 Ends	34.80 Middle 36.50 Ends	16.00	16.00 Per Gang	16.00 Per Gang
Dimensions – A	4.38"	4.38"	4.38"	4.38"	4.38"	4.38"	4.38"	4.38"	4.38"
Dimensions - B	3.19"	3.19"	3.44"	3.44"	3.44"	3.44"	2.00"	2.00"	2.00"
Dimensions - C	3.19"	3.19"	6.38"	6.38"	9.56"	9.56"	3.19"	6.38"	9.56"
Threaded Hub Sizes	(4) ¾" (4) 1"		(6) ¾"	(4) 1" & (2) ¾"	(8) ¾"	(6) 1" & (2) ¾"	(2) ¾"	(4) ¾"	(6) ¾"







## Flush Rectangular Floor Box Covers and Flanges

Covers	S3825	S3625	S3826	S2425	S2625	S2825	S3425	S3813
Brass	S3825	S3625	S3826	S2425	S2625	S2825	S3425	S3813
Aluminum	SA3825	SA3625	SA3826	SA2425	SA2625	—	—	SA3813
	Duplex Flap	Duplex Screw	Style Line Opening	2 1/8" x 3/4" Combination	2 1/8" x 1" Combination	2 1/8" Single Receptacle	2 3/8" Single Receptacle	Blank

Carpet Flanges	1-Gang	2-Gang	3-Gang
Brass	SB3083	SB3084	SB3085
Aluminum	SA3083	SA3084	SA3085
Clear Polycarbonate	S3083	S3084	S3085

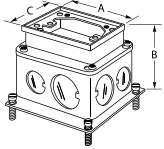

## Flush Rectangular Stamped Steel Floor Boxes

Box Material	Stamped Steel					
Collar Material	B2431 BA2431	B2432 BA2432	B2433 BA2433	B2421 BA2421	B2422 BA2422	B2423 BA2423
Brass						
Aluminum						
						
Min. Depth of Pour	3.75"	3.75"	3.75"	2.75"	2.75"	2.75"
Adjustability (Fully, Semi, Non)	Fully	Fully	Fully	Fully	Fully	Fully
Before Pour External Height Adjustment	1.25"	1.25"	1.25"	1.25"	1.25"	1.25"
After Pour Internal Height Adjustment	.50"	.50"	.50"	.50"	.50"	.50"
Cubic Inch Capacity	60.00	52.80 Per Gang	50.80 Per Gang	39.50	35.00 Per Gang	34.00 Per Gang
Dimensions – A	4.38"	4.38"	4.38"	4.38"	4.38"	4.38"
Dimensions - B	3.72"	3.72"	3.72"	2.74"	2.74"	2.74"
Dimensions - C	3.19"	6.44"	9.67"	3.19"	6.44"	9.67"
Knockouts - Opposite Sides	(1) Concentric 3/4", 1", 1 1/4"	(2) Concentric 3/4", 1", 1 1/4"	(3) Concentric 3/4", 1", 1 1/4"	(2) 1/2", (1) 3/4"	(4) Concentric 1/2", 3/4"	(6) Concentric 1/2", 3/4"
Knockouts - Opposite Ends	(1) Concentric 3/4", 1", 1 1/4"	(1) Concentric 3/4", 1", 1 1/4"	(1) Concentric 3/4", 1", 1 1/4"	(1) 1/2", (1) 3/4"	(2) Concentric 1/2", 3/4"	(2) Concentric 1/2", 3/4"
Knockouts - Bottom	(2) Concentric 3/4", 1", 1 1/4"	(4) Concentric 3/4", 1", 1 1/4"	(6) Concentric 3/4", 1", 1 1/4"	(2) Concentric 3/4", 1", 1 1/4"	(4) Concentric 3/4", 1", 1 1/4"	(6) Concentric 3/4", 1", 1 1/4"

## Flush Rectangular Floor Box Covers and Flanges

Covers	S3825 SA3825	S3625 SA3625	S3826 SA3826	S2425 SA2425	S2625 SA2625	S2825 —	S3425 —	S3813 SA3813
Brass								
Aluminum								
	Duplex Flap	Duplex Screw	Style Line Opening	2 1/8" x 3/4" Combination	2 1/8" x 1" Combination	2 1/8" Single Receptacle	2 3/8" Single Receptacle	Blank

Carpet Flanges	1-Gang	2-Gang	3-Gang
Brass	<b>SB3083</b>	<b>SB3084</b>	<b>SB3085</b>
Aluminum	<b>SA3083</b>	<b>SA3084</b>	<b>SA3085</b>
Clear Polycarbonate	<b>S3083</b>	<b>S3084</b>	<b>S3085</b>
			



# Recessed 4 and 8-Gang Floor Boxes



Box Material	Stamped Steel			Cast Iron
Style	4-Gang Deep <b>HBLCFB301BASE</b>	4-Gang Shallow <b>HBLCFB401BASE</b>	8-Gang Deep <b>HBLCFB501BASE</b>	4-Gang Shallow <b>HBLCFB401CB</b>
				
Min. Depth of Pour	4.25"	3.00"	5.25"	3.25"
Adjustability (Fully, Semi, Non)	Fully	Fully	Fully	Fully
Before Pour External Height Adjustment	1.50"	1.50"	1.50"	1.50"
After Pour Internal Height Adjustment	.75"	.75"	.75"	.75"
Wiring Chambers	4 (1 per gang)	4 (1 per gang)	4 (1 per 2 gangs)	4 (1 per gang)
Cubic Inch Capacity	29.50 per chamber	25.50 per chamber	49.50 per chamber	25.50 per chamber
L x W x H	10.0" x 10.0" x 4.0"	10.0" x 10.0" x 2.63"	10.0" x 10.0" x 5.13"	10.0" x 10.0" x 3.13"
Threaded Hubs / chamber	–	–	–	(2) 1"
Knockouts per chamber	(1) Concentric 1/2", 3/4" (1) Concentric 3/4", 1" (1) 1 1/4"	(3) Concentric 1/2", 3/4"	(1) Concentric 1/2", 3/4" (1) Concentric 3/4", 1" (1) 1 1/4"	–

## Recessed Floor Box Covers

## Screw Type Face Plates

### Steel Cover and Flange Assembly

**HBLTCGNTSW**



Granite

**HBLTCGNTBKS**



Black

**HBLST302SGY**



Duplex

**HBLDE301SGY**



Style Line

**HBLTO310SGY**



Toggle

**HBLTL318GY**



Single Receptacle  
(1.39" Boss Dia.)

**HBLTL319SGY**



Single Receptacle  
(1.56 Boss Dia.)

**HBLBL300SGY**



Blank

**HBLIMFSGY**



Hubbell  
INFIneSTATION™

**HBL317SGY**

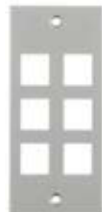

Hubbell  
6-Port

**HBLAM303SGY**



AMP-ACO

**HBLAMP313SGY**



AMP 6-Port

**HBLKR314SGY**



Krone®/Leviton®

**HBLLT309SGY**



SYSTIMAX®

**HBLPA308SGY**



Panduit  
Mini-Com®

**HBLNO309SGY**

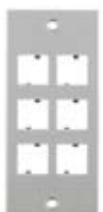

NORDX®  
6-Port

**HBLSI305SGY**



Siemon  
CT® Series

**HBLSI315SGY**



Siemon  
MAX® Series

**HBLOR306SGY**



Ortronics  
Series II®

**HBLORT322SGY**



Ortronics  
TracJack®



# Recessed 6-Gang Floor Boxes



## Stamped Steel

### LCFBSSA



Min. Depth of Pour	3.50"
Adjustability (Fully, Semi, Non)	Fully
Before Pour External Height Adjustment	1.25"
Wiring Chambers	6
Cubic Inch Capacity per Chamber	(4) at 38.20 (2) at 25.40
L x W x H	12.5" x 12.5" x 6.18"
Knockouts per Chamber	(1) Concentric 1", 1 1/4" (1) 3/4"

## Cast Iron

### LCFBCA



Min. Depth of Pour	3.65"
Adjustability (Fully, Semi, Non)	Fully
Before Pour External Height Adjustment	1.25"
Wiring Chambers	6
Cubic Inch Capacity per Chamber	(4) at 36.80 (2) at 25.40
L x W x H	13.0" x 13.0" x 6.35"
Threaded Hub Sizes per Chamber	(1) 3/4" (1) 1 1/4"

## Recessed Floor Box Covers

### Smooth Metallic Cover, Flange and Cable Doors for Carpet Applications

#### LCFBCBRSTC



Brass Finish

#### LCFBCALTC

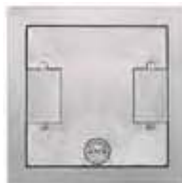

Aluminum Finish

#### LCFBCGYTC

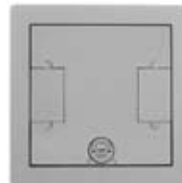

Gray

#### LCFBCBKTC



Black

### Metallic Cover, Flange and Cable Doors for Carpet Applications - Carpet Insert Required

#### LCFBCBRSC



Brass Finish

#### LCFBCALC



Aluminum Finish

#### LCFBCGYC



Gray

#### LCFBCBKC



Black

### Reinforced Non-Metallic Cover, Flange and Cable Doors for Carpet Applications - Carpet Insert Required

#### LCFBCBRA



Brown

#### LCFBCGYA



Gray

#### LCFBCIA



Ivory

#### LCFBCBKA



Black

### Smooth Metallic Cover and Cable Doors for Tile Applications

#### LCFBCBRST



Brass Finish

#### LCFBCALT



Aluminum Finish

#### LCFBCGYT



Gray

#### LCFBCBK



Black

## Face Plates

#### LCFBP8



Duplex

#### LCFBP26



Style Line®

#### LCFBP720



Single Receptacle  
(for 1.56" boss dia.)

#### LCFBIM

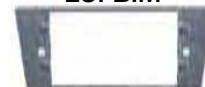

3 Unit INFINESTATION™  
(see page 118-119 for module options)

#### LCFBP14

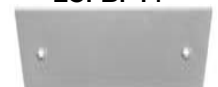

Blank





## Recessed 2-Gang Floor Boxes

### Stamped Steel

	<b>3SFBS</b>	Min. Depth of Pour	3.00"
		Adjustability (Fully, Semi, Non)	Fully
		Before Pour External Height Adjustment	1.25"
		After Pour Internal Height Adjustment	.44"
		Wiring Chambers	2
		Cubic Inch Capacity per Chamber	22.40
		L x W x H	12.25" x 5.50" x 2.88"
		Knockouts	
		Opposite Ends	(1) 1"
		Opposite Sides	(2) 3/4"
	Center Area	Concentric 1", 1 1/4" (each side)	

### Cast Iron

	<b>3SFBC</b>	Min. Depth of Pour	3.00"
		Adjustability (Fully, Semi, Non)	Fully
		Before Pour External Height Adjustment	1.25"
		After Pour Internal Height Adjustment	.44"
		Wiring Chambers	2
		Cubic Inch Capacity per Chamber	21.60
		L x W x H	12.88" x 6.00" x 3.00"
		Threaded Hub Sizes	
		Opposite Ends	(1) 1 1/4"
		Opposite Sides	(2) 3/4"
	Center Area	(1) 1 1/4" (each side)	

## Recessed Floor Box Covers – Carpet Applications

Reinforced Non-Metallic Cover, Flange and Cable Doors

**3SFBCBRA**



Brown

**3SFBCIA**



Ivory

**3SFBCGYA**



Gray

**3SFBCBKA**



Black

## Face Plates

**3SFBRP**



Duplex Knockout

**3SFBDS**



Style Line Opening

**3SFBS**



Single Receptacle Opening (for 1.39" boss dia.)

**3SFBB**



Blank

**3SFBTTP**



Voice / Data  
2 - Jack Knockouts  
(.6" x .75")

**3SF BIM**



3 unit  
INFINESTATION™  
Opening  
(see page 118-119 for module options)











## Flush Floor Boxes for Wooden Floors

Box Material	Rectangular Stamped Steel			Round Cast Iron	
Collar Material					
Brass	<b>B2481</b>	<b>B2482</b>	<b>B2483</b>	<b>B2588</b>	<b>B2588275</b>
Aluminum					
					
Gangs	Single	Two	Three	Single	Single
Adjustability (Fully, Semi, Non)	Semi	Semi	Semi	Non	Non
External Height Adjustment	1.00"	1.00"	1.00"	—	—
Cubic Inch Capacity	42.00	42.50 Per Gang	42.50 Per Gang	18.50	18.50
Dimensions - A	4.50"	4.50"	4.50"	4.19"	4.19"
Dimensions - B	3.13"	3.13"	3.13"	3.75"	3.75"
Dimensions - C	3.20"	6.42"	9.64"	—	—
Hubs/Knockouts - Opposite Sides	(1) Concentric 1/2", 3/4", 1"	(2) Concentric 1/2", 3/4", 1"	(3) Concentric 1/2", 3/4", 1"	—	(2) 3/4"
Hubs/Knockouts - Bottom	(1) Concentric 1/2" - 1 1/4"	(2) Concentric 1/2" - 1 1/4"	(3) Concentric 1/2" - 1 1/4"	(2) 1/2"	(2) 1/2"

## Flush Floor Box Covers and Flanges

### Rectangular Covers

Brass	<b>S3825</b>	<b>S3625</b>	<b>S3826</b>	<b>S2425</b>	<b>S2625</b>	<b>S2825</b>	<b>S3425</b>	<b>S3813</b>
Aluminum	<b>SA3825</b>	<b>SA3625</b>	<b>SA3826</b>	<b>SA2425</b>	<b>SA2625</b>	—	—	<b>SA3813</b>
								
	Duplex Flap	Duplex Screw	Style Line Opening	2 1/8" x 3/4" Combination	2 1/8" x 1" Combination	2 1/8" Single Receptacle	2 3/8" Single Receptacle	Blank

### Round Covers

Brass	<b>S3925</b>	<b>S3725</b>	<b>S2525</b>	<b>S2725</b>	<b>S2925</b>	<b>S3525</b>	<b>S3325</b>	<b>Round Flanges</b> <b>S3082</b> (6 1/4" Dia.) <b>SA3182</b> (5 1/4" Dia.)
Aluminum	<b>SA3925</b>	<b>SA3725</b>	<b>SA2525</b>	<b>SA2725</b>	<b>SA2925</b>	—	—	
								
	Duplex Flap	Duplex Screw	2 1/8" x 3/4" Comb.	2 1/8" x 1" Comb.	2 1/8" Single Receptacle	2 3/8" Sin. Receptacle	2 1/8" Sin. Rec.	(Terrazzo Floor)

### Rectangular Flanges (Required)

Brass	<b>SB3083W</b>	<b>SB3084W</b>	<b>SB3085W</b>
Aluminum	<b>SA3083W</b>	<b>SA3084W</b>	<b>SA3085W</b>
			
	1-Gang	2-Gang	3-Gang

### One Piece Brass Cover and Carpet Flange

<b>SF3925</b>	<b>SF2525</b>	<b>SF2725</b>	<b>SF2925</b>
			
Duplex Flap	2 1/8" x 3/4" Combination	2 1/8" x 1" Combination	2 1/8" Single Receptacle





# Hubbell Floor Box Cover to Receptacle Compatibility Chart

Cover Style		Terazzo (2 1/8")	2 3/8"	2 1/8"	2 1/8"	Single Receptacle	Duplex Flap	Duplex Plug	Style Line
Hubbell SystemOne						S1SPTL			S1SP
Round		S3325	S3525	S(A)2925 S(A)2725 S(A)2525			S(A)3925	S(A)3725	
Rectangular			S3425		S2825 S(A)2625 S(A)2425		S(A)3825	S(A)3625	S(A)3826
Rating	NEMA Config.								
2P, 3W 15A, 125V	5-15R	HBL5251 HBL5261 IG5251 IG5261	HBL5251 HBL5261 IG5251 IG5261	HBL5251 HBL5261 IG5251 IG5261	HBL5251 HBL5261 IG5251 IG5261	HBL5251 HBL5261 IG5251 IG5261	CR5252 CR5262 CR5252IG HBL5252 HBL5262 IG5262	CR5252 CR5262 CR5252IG HBL5252 HBL5262 IG5262	HBL2152 IG2152 GFR5252A GFR5252L GFR5252ST HBL5260S HBL5262SA
2P,3W 15A, 125V	L5-15R	HBL4710 IG4710	HBL4710 IG4710	HBL4710 IG4710	HBL4710 IG4710	HBL4710 IG4710	HBL4700 IG4700A HBL4792 HBL4794 HBL4795	HBL4700 IG4700A HBL4792 HBL4794 HBL4795	
2P, 3W 15A, 250V	6-15R	HBL5651 HBL5661 IG5661	HBL5651 HBL5661 IG5661	HBL5651 HBL5661 IG5661	HBL5651 HBL5661 IG5661	HBL5651 HBL5661 IG5661	HBL5652 HBL5662 IG5662	HBL5652 HBL5662 IG5662	
2P, 3W 15A, 250V	L6-15R	HBL4560 IG4560	HBL4560 IG4560	HBL4560 IG4560	HBL4560 IG4560	HBL4560 IG4560	HBL4550 IG4550A	HBL4550 IG4550A	
2P, 3W 15A, 277V	7-15R						HBL5302	HBL5302	
2P, 3W 15A, 277V	L7-15R	HBL4760	HBL4760	HBL4760	HBL4760	HBL4760	HBL4750	HBL4750	
2P, 3W 20A, 125V	5-20R	HBL5351 HBL5361 IG5361	HBL5351 HBL5361 IG5361	HBL5351 HBL5361 IG5361	HBL5351 HBL5361 IG5361	HBL5351 HBL5361 IG5361	CR5352 CR5362 CR5352IG HBL5352 HBL5362 IG5362	CR5352 CR5362 CR5352IG HBL5352 HBL5362 IG5362	HBL2162 IG2162 GFR5352A GFR5352L GFR5352ST HBL5360SA HBL5362SA
2P, 3W 20A, 125V	5-20R						HBL5392	HBL5392	
2P, 3W 20A, 125V	L5-20R	HBL2310 IG2310	HBL2310 IG2310	HBL2310 IG2310	HBL2310 IG2310	HBL2310 IG2310			
2P, 3W 20A, 250V	6-20R	HBL5461 IG5461	HBL5461 IG5461	HBL5461 IG5461	HBL5461 IG5461	HBL5461 IG5461	HBL5462 IG5462	HBL5462 IG5462	
2P, 3W 20A, 250V	L6-20R	HBL2320 IG2320	HBL2320 IG2320	HBL2320 IG2320	HBL2320 IG2320	HBL2320 IG2320			
2P, 3W 30A, 125V	L5-30R	HBL2610 IG2610	HBL2610 IG2610	HBL2610 IG2610	HBL2610 IG2610	HBL2610 IG2610			
2P, 3W 30A, 250V	L6-30R	HBL2620 IG2620	HBL2620 IG2620	HBL2620 IG2620	HBL2620 IG2620	HBL2620 IG2620			
3P, 4W, 20A 125/250V	14-20R	HBL8410	HBL8410	HBL8410	HBL8410				
	L14-20R	HBL2410 IG2410	HBL2410 IG2410	HBL2410 IG2410	HBL2410 IG2410	HBL2410 IG2410			
3P, 4W, 20A 3Ø 250V	15-20R	HBL8420	HBL8420	HBL8420	HBL8420				
	L15-20R	HBL2420 IG2420	HBL2420 IG2420	HBL2420 IG2420	HBL2420 IG2420	HBL2420 IG2420			
3P, 4W, 30A 125/250V	L14-30R	HBL2710 IG2710	HBL2710 IG2710	HBL2710 IG2710	HBL2710 IG2710	HBL2710 IG2710			
3P, 4W, 30A 3Ø 250V	L15-30R	HBL2720 IG2720	HBL2720 IG2720	HBL2720 IG2720	HBL2720 IG2720	HBL2720 IG2720			
3P, 4W, 30A 3Ø 600V	L17-30R	HBL2740	HBL2740	HBL2740	HBL2740	HBL2740			
4P, 5W, 20A 3Ø Y 120/208V	L21-20R	HBL2510 IG2510	HBL2510 IG2510	HBL2510 IG2510	HBL2510 IG2510	HBL2510 IG2510			
4P, 5W, 20A 3Ø Y 347/600V	L23-20R	HBL2530	HBL2530	HBL2530	HBL2530	HBL2530			
4P, 5W, 30A 3Ø Y 120/208V	L21-30R	HBL2810 IG2810	HBL2810 IG2810	HBL2810 IG2810	HBL2810 IG2810	HBL2810 IG2810			
4P, 5W, 30A 3Ø Y 347/600V	L23-30R	HBL2830	HBL2830	HBL2830	HBL2830	HBL2830			

NOTE: Plate/device combinations on this page represent the most common configurations. Consult the full-line catalog for additional device configurations that could fit your application. Use appropriately designed floor box for application. (ie. proper cubic inch capacity, depth, etc.)



	Page
SystemOne (4" Core) . . . . .	86
Push 2x2 (3" Core) . . . . .	90
Push Duplex (3" Core) . . . . .	91
Push Furniture Feed (3" Core) . . . . .	92
pedestal (2" & 3" Core) . . . . .	93





# Hubbell Fire-Rated Poke-Throughs

Featuring the innovative capabilities of Hubbell's SystemOne Delivery System line, Hubbell has expanded its offering of Fire-Rated Poke-Through (FRPT) products, making it the most extensive in the industry. Hubbell SystemOne FRPTs install in a 4" core hole and provide users the flexibility to create personal solutions for their most demanding applications.

For those requiring a 3" diameter FRPT, Hubbell continues to provide a wide variety of traditional solutions for flush, pedestal and furniture feed applications. All Hubbell FRPT products include a "step-down" feature, enabling wiring, installation and if necessary, removal from the floor above.

Whatever combination of power, data and audio/video connections are required, Hubbell provides the answer; bringing consistent, aesthetic and functional solutions to the desktop.

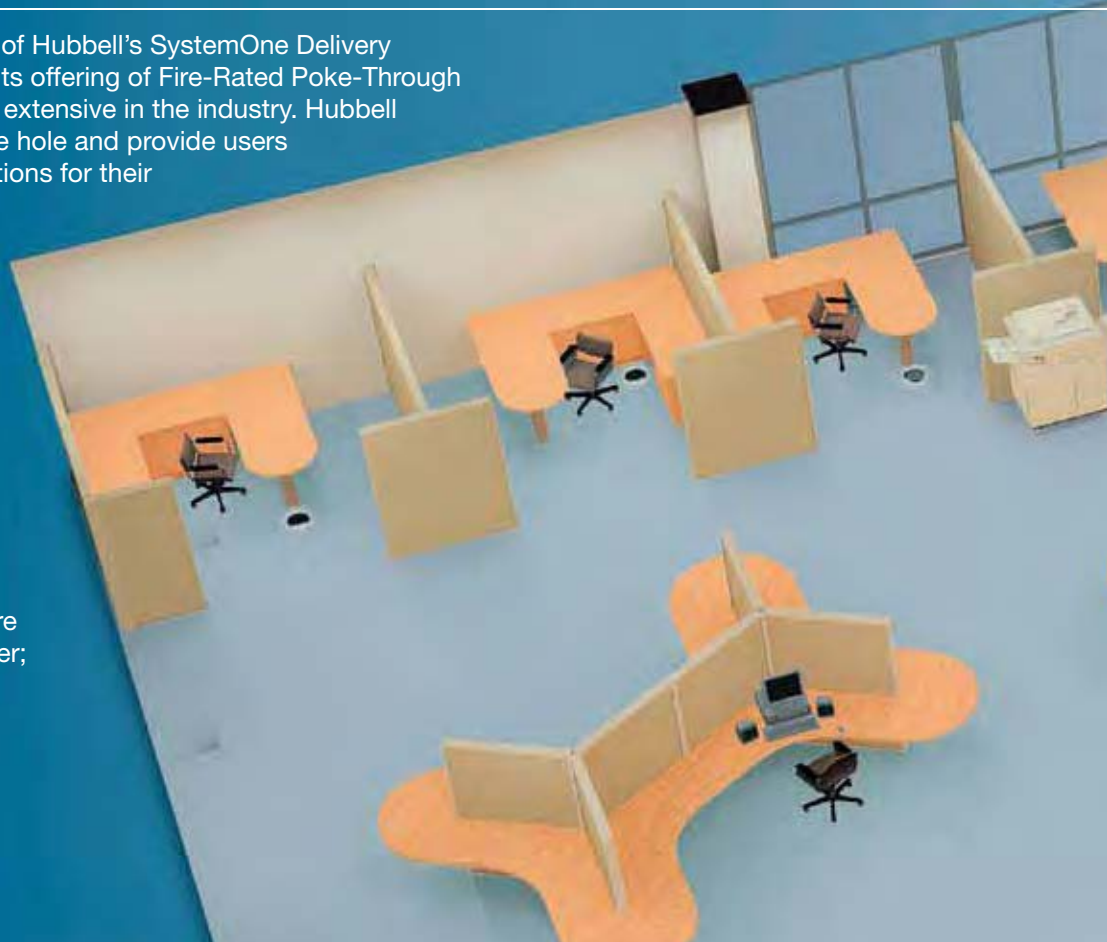

## Hubbell SystemOne FRPTs for 4" diameter applications...



### Multi-Service Applications

This Hubbell SystemOne sub-plate incorporates 2 Style Line® rectangular openings. These can be used for a variety of power and/or data applications. It will accommodate 15 or 20 amp, standard, isolated ground, GFCI or surge protected duplex receptacles. Using communication frames it can provide up to a 6-port multi-service or a 12-port all communication solution.



### Multimedia Applications

Other Hubbell SystemOne sub-plates are designed to meet the growing needs of the audio and video markets. Some sub-plates provide power outlets with Hubbell's audio/video products including 15-Pin SVGA, RCA, S-Video, 3.5mm stereo, and XLR microphone jacks. Another sub-plate can accommodate Extron® Electronics' MAAP and AAP series audio/video modules.



### 4X4 Applications

Provides maximum power capacity for flush, multi-service applications. This sub-plate features a pre-wired four outlet 20A, 125V receptacle and four openings for Hubbell's Snap Fit, flush mount modular jacks and audio/video connectors.







## Advantage HUBBELL

- Best in Class Products**  
Easily upgraded as user's needs change.
- Ease of Installation**  
Clips allow installation and removal from above the floor.
- Application Solutions**  
Highest capacity and widest variety of power, data and AVV solutions.

Traditional FRPTs for 3" and 2" diameter applications...



### Flush Applications

Hubbell offers a variety of single and multi-service flush fire-rated poke-through products. It incorporates a Hubbell Style Line®, 20 amp, duplex receptacle and two Hubbell Category 5e data jacks. The jacks mount flush to the cover for an unobtrusive appearance. Various colors and all brass versions are available.



### Pedestal Applications

Hubbell offers single and multi-service pedestal style FRPTs for those applications requiring above-the-floor connections. Available in 2, 4 or 6 gang sizes, pedestal FRPTs provide additional power and low voltage connections to the desktop than most flush configurations in a 3" core hole.



### Furniture Feed Applications

Hubbell offers single and multiple service flush and pedestal style FRPTs that deliver power and voice/data cabling to feed furniture systems. Various models can feed up to 2" conduit and can accommodate up to 36 Category 5e data cables.



## Hubbell SystemOne Through-Floor Fittings



Step down installation clips allow the fitting to be installed or removed from the floor above.

Barrier expands during fire conditions to maintain the floor's fire rating.

Adjustable lower fire barrier accommodates concrete floor thicknesses from 2 1/4" to 7".

Features dual 1" EMT conduit tubes for increased cable capacity.

- Accepts all Hubbell SystemOne covers and sub-plates.
- Excellent solution for both retrofit and new construction.
- Brings power, voice, data and multimedia precisely where needed.
- Installs in 4" core hole.
- UL listed for use in 1 - 4 hr fire rated floors.

## Hubbell SystemOne Universal Cover

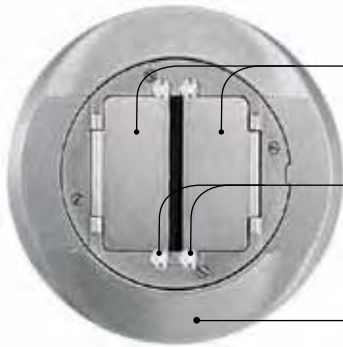

Hinged doors open 180 degrees flush to the carpet flange or tile.

Screws allow each door to be secured independently.

Universal carpet or tile flange can be used for Hubbell SystemOne Fire-Rated Poke-Through or PVC Floor Box.

- Cast aluminum construction available in durable black, gray, brass, aluminum and ivory powder coat finishes.
- Features ScrubShield™ technology that exceeds UL514A scrub water exclusion requirements.
- Provides consistent look and maximum functionality throughout.

## Hubbell SystemOne Sub-plates

While no one can predict the future, Hubbell's modular sub-plate design allows users to economically upgrade Hubbell SystemOne FRPTs to accommodate future moves, adds and changes.



- Hubbell 4X4 – four 20A, 125V receptacles and four openings for voice/data jacks and multimedia connectors.
- Hubbell INFINESTATION™ front loading modular connectivity.
- Accommodates Extron Electronics' Architectural Series™ audio/video system integration products.
- Ortronics®, Siemon™, Panduit®, SYSTIMAX® and keystone options enable maximum data flexibility.
- Large capacity and multi-service furniture feed applications.
- GFCI, surge and standard Style Line receptacles.
- Twist-Lock® receptacle with or without data jacks.





# Hubbell SystemOne – Poke-Through (One Piece Units)

## Description

### One-Piece 4X4 Poke-Through

Assembled-unit includes Hubbell SystemOne 4X4 floor fitting (**S1PT4X4FIT**) with four pre-wired 20A, 125V receptacles and four keystone opening sub-plate (**S1SP4X4**) to accept Hubbell modular jacks and flush multimedia Snap Fit connectors. Receptacles feature single or two circuit wiring as well as isolated ground capability. Finish flange and universal carpet cover (**S1CFC**) assembly are supplied in aluminum, brass, black or gray finishes.



## Color

Aluminum Finish  
Brass Finish  
Black Finish  
Gray Finish

## Catalog Number

**S1PT4X4AL**  
**S1PT4X4BRS**  
**S1PT4X4BL**  
**S1PT4X4GY**



### One-Piece Dual Style Line Poke-Through

Assembled-unit includes a Hubbell SystemOne dual channel floor fitting (**S1PTFIT**) and two Style Line opening sub-plate (**S1SP**) to accept two Style Line, surge or GFCI receptacles. Additionally, outlet frames can be used to convert the application to a 6-port multi-service or a 12-port all communication solution. Finish flange and universal carpet cover (**S1CFC**) assembly are supplied in aluminum, brass, black or gray finishes.



## Color

Aluminum Finish  
Brass Finish  
Black Finish  
Gray Finish

## Catalog Number

**S1PTAL**  
**S1PTBRS**  
**S1PTBL**  
**S1PTGY**



### One-Piece Modular A/V Poke-Through

Assembled-unit includes a Hubbell SystemOne A/V through floor fitting (**S1PTAVFIT**) and a Hubbell SystemOne sub-plate (**S1SP3IM**) to provide a 20A power outlet and a recessed single-gang 3 Unit INFINESTATION™ opening. This comprehensive data/voice/audio/and video solution can accommodate 15-Pin VGA, RCA, S-Video, 3.5mm Stereo, and XLR microphone jacks. Finish flange and universal carpet cover (**S1CFC**) assembly are supplied in aluminum, brass, black or gray finishes.



## Color

Aluminum Finish  
Brass Finish  
Black Finish  
Gray Finish

## Catalog Number

**S1PT3IMAL**  
**S1PT3IMBRS**  
**S1PT3IMBL**  
**S1PT3IMGY**



Aluminum Finish



Brass Finish



Black Finish



Gray Finish







# Hubbell SystemOne – Poke-Through (Three Piece Units)

## Step One - Choose Sub-plate

### Hubbell SystemOne Sub-plates



	Catalog Number
<b>Hubbell 4X4</b>	<b>S1SP4X4</b>
Features four pre-wired 20A, 125V receptacles and four openings for Hubbell Xcelerator™ Jacks and Snap Fit flush audio/video connectors. Use with <b>S1PT4X4FIT</b> .	



	Catalog Number
<b>Style Line/GFCI</b>	<b>S1SP</b>
Features two rectangular Style Line openings. Additionally, two data outlet frames can be used to provide 12-ports of flush connectivity. Use with <b>S1PTFIT</b> (recommended) or <b>S1PTAVFIT</b> .	



	Catalog Number
<b>Hubbell Datacom + Power</b>	<b>S1SP3IM</b>
Features one pre-wired 20A, 125V receptacle and a recessed single-gang 3-unit INFINESTATION opening. This comprehensive power/data/voice/audio/and video solution can accommodate 15-Pin VGA, RCA, S-Video, 3.5mm Stereo, and XLR microphone jacks. Use with <b>S1PTAVFIT</b> (recommended) or <b>S1PTFIT</b> .	



	Catalog Number
<b>Extron® MAAP + Power</b>	<b>S1SPEXT1</b>
Features one pre-wired 20A, 125V receptacle and a recessed opening for 3 single Extron MAAP Series Adapter Plates. Use with <b>S1PTAVFIT</b> (recommended) or <b>S1PTFIT</b> .	



	Catalog Number
<b>Extron AAP + Power</b>	<b>S1SPEXT2</b>
Features one pre-wired 20A, 125V receptacle and a recessed opening for 1 single Extron MAAP Series Adapter Plate and 2 single AAP Series Adapter Plates. Use with <b>S1PTAVFIT</b> (recommended) or <b>S1PTFIT</b> .	



	Catalog Number
<b>Extron Datacom</b>	<b>S1SPEXT3</b>
Features recessed openings for 2 single Extron MAAP Series Adapter Plates and 2 single AAP Series Adapter Plates. Use with <b>S1PTAVFIT</b> (recommended) or <b>S1PTFIT</b> .	



	Catalog Number
<b>Ortronics Series II® + Power</b>	<b>S1SPORT</b>
Features one pre-wired 20A, 125V receptacle and a recessed single-gang opening for three 1 unit size Ortronics Series II Modules. Use with <b>S1PTAVFIT</b> (recommended) or <b>S1PTFIT</b> .	

	Catalog Number
<b>All Modular Datacom</b>	<b>S1SP4IM</b>
Features a recessed single-gang 3 unit and a flush 1 unit INFINESTATION™ opening. Accepts up to eight UTP, fiber, and audio/video connectors. Use with <b>S1PTAVFIT</b> (recommended) or <b>S1PTFIT</b> .	

	Catalog Number
<b>Single Recept. + Data</b>	<b>S1SPTL</b>
15 or 20A straight blade or 15, 20 or 30A TL rec. (1.39" or 1.56" OD). (2) Keystone openings for Hubbell jacks or flush A/V connectors. Use with <b>S1PT4X4FIT</b> .	

	Catalog Number
<b>Furniture Feed Cover</b>	
Features one 1½" N.P.T. plug opening for low voltage and one ¾" N.P.T. plug opening for power. Includes carpet flange – no universal cover required.	
Aluminum Finish	<b>S1SPFFAL</b>
Brass Finish	<b>S1SPFFBRS</b>
Black Finish	<b>S1SPFFBL</b>
Gray Finish	<b>S1SPFFGY</b>
Use with <b>S1PTAVFIT</b> (recommended) or <b>S1PTFIT</b> .	



	Catalog Number
<b>Ortronics TracJack® + Power</b>	<b>S1SPTRAC</b>
Features one pre-wired 20A, 125V receptacle and a recessed bezel for six Ortronics TracJack Modules. Use with <b>S1PTAVFIT</b> (recommended) or <b>S1PTFIT</b> .	



	Catalog Number
<b>Siemon MAX® Series + Power</b>	<b>S1SPMAX</b>
Features one pre-wired 20A, 125V receptacle and a recessed bezel for six Siemon MAX Modules. Use with <b>S1PTAVFIT</b> (recommended) or <b>S1PTFIT</b> .	



	Catalog Number
<b>Panduit Mini-Com® 4X4</b>	<b>S1SP4X4PA</b>
Features four pre-wired 20A, 125V receptacles and four openings for Panduit Mini-Com Connectivity. Use with <b>S1PT4X4FIT</b> .	



	Catalog Number
<b>SYSTIMAX® 4X4</b>	<b>S1SP4X4SYS</b>
Features four pre-wired 20A, 125V receptacles and four openings for SYSTIMAX Connectivity. Use with <b>S1PT4X4FIT</b> .	





## Step Two - Choose Hubbell SystemOne Through Floor Fitting

### Description

### Catalog Number

#### 4X4 Through Floor Fitting

S1PT4X4FIT

Through floor fitting with two 3/4" E.M.T. for communications and one 3/4" E.M.T. for power. For use with Hubbell SystemOne Universal Covers and 4X4 and Twist-Lock® series sub-plates only. Universal cover and sub-plate ordered separately.

#### Dual Channel Through Floor Fitting

S1PTFIT

Through floor fitting with two 1" E.M.T. trade size conduit stems to feed power and communication services. For use with Hubbell SystemOne universal covers and all Hubbell sub-plates except 4X4 and Twist-Lock® series. Universal cover and sub-plate ordered separately.

#### A/V Through Floor Fitting

S1PTAVFIT

Through floor fitting with one 3/4" E.M.T. trade size conduit stem for power and one 1 1/2" E.M.T. trade size conduit stem for communication services. Ideal for demanding, large capacity audio/video and data requirements. For use with Hubbell SystemOne universal covers and all Hubbell sub-plates except 4X4 and Twist-Lock® series. Universal cover and sub-plate ordered separately.



## Step Three - Choose Hubbell SystemOne Universal Covers

(Not required for furniture feed applications).

Universal cover assembly installs on the new Hubbell SystemOne fire rated poke-through floor fittings and accommodates all Hubbell SystemOne sub-plates for carpet and tile applications.

### Description

### Catalog Number

#### Carpet Assembly Covers

Aluminum Finish	S1CFCAL
Brass Finish	S1FCBRS
Black Finish	S1CFCBL
Gray Finish	S1FCGY
Ivory Finish	S1FCFI

#### Tile Assembly Covers

Aluminum Finish	S1TFCAL
Brass Finish	S1TFCBRS
Black Finish	S1TFCBL
Gray Finish	S1TFCGY
Ivory Finish	S1TFCFI

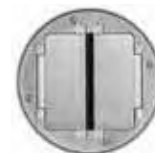



## 2X2 Flush FRPT 3" Diameter – One Piece Units

### Catalog Number

<b>PT2X2BL</b>	Black	<b>2X2 Aluminum Poke-Through</b>
<b>PT2X2GY</b>	Gray	
<b>PT2X2IGBL*</b>	Black	
<b>PT2X2IGGY*</b>	Gray	

\* Includes pre-wired 20A isolated ground duplex Style Line receptacle.

#### Complete assembled unit

- **PT2X2FIT** through-floor fitting.
- Pre-wired 20A duplex Style Line® receptacle & (2) Category 5e data jacks.
- Non-metallic cover.
- Painted aluminum flange.



### Catalog Number

<b>PT2X2BRS3</b>	Black/Brass	<b>2X2 Brass Poke-Through</b>
<b>PT2X2BRS</b>	Brass Finish/Brass	
<b>PT2X2IGBRS3*</b>	Black/Brass	
<b>PT2X2IGBRS*</b>	Brass Finish/Brass	

\* Includes pre-wired 20A isolated ground duplex Style Line receptacle.

#### Complete assembled unit

- **PT2X2FIT** through-floor fitting.
- Pre-wired 20A duplex Style Line receptacle & (2) Category 5e data jacks.
- Non-metallic cover.
- Solid brass flange.



## 2X2 Flush FRPT 3" Diameter – Two Piece Units

### Through-Floor Fitting

#### Catalog Number

**PT2X2FIT**

Through-floor fitting with (1) 3/4" trade size conduit stem with junction box for power and (2) 1/2" low voltage conduit entrances.

#### Multi-Channel Through-Floor Fitting



#### Specifications:

- UL Listed and CSA Certified.
- 1 - 4 hour fire rating (1 - 3 hour for steel floor units and concrete topping (D900 Series Design)).
- For 2 1/4" to 7" floor thickness.
- UL installation spacing. Minimum 2 ft. on center and not more than one per 65 sq. ft. of floor area.

### Service Fittings

#### Catalog Number

<b>PT2X2SFBL</b>	Black	<b>2X2 Aluminum Service Fitting</b>
<b>PT2X2SFGY</b>	Gray	

- Pre-wired 20A duplex Style Line receptacle & (2) Category 5e data jacks.
- Non-metallic cover.
- Painted aluminum flange.



#### Catalog Number

<b>PT2X2SFBR3</b>	Black/Brass	<b>2X2 Brass Service Fitting</b>
<b>PT2X2SFBR</b>	Brass Finish/Brass	

- Pre-wired 20A duplex Style Line receptacle & (2) Category 5e data jacks.
- Non-metallic cover.
- Solid brass flange.



### Accessories

#### Catalog Number



<b>PT2X2CBL</b>	Black	<b>Non-Metallic Replacement Covers</b>
<b>PT2X2CGY</b>	Gray	
<b>PT2X2CBRS</b>	Brass Finish	







## Flush Duplex FRPT 3" Diameter – One Piece Units



Catalog Number			Catalog Number		
PT7FSDBLA	Black	<b>Flush Aluminum Poke-Through</b> 	PT7FSDBRS2A	All Brass	<b>Flush Brass Poke-Through</b> 
PT7FSDGYA	Gray		PT7FSDBRS3A	Black/Brass	
PT7FSDIA	Ivory		PT7IGFSDBRSA*	All Brass	
PT7FSDBRA	Brown				* Includes pre-wired 20A isolated ground duplex receptacle.
PT7IGFSDGYA*	Gray				
PT7IGFSDIA*	Ivory				
* Includes pre-wired 20A isolated ground duplex receptacle. Complete assembled unit <ul style="list-style-type: none"> <li>■ PT7FSD through-floor fitting.</li> <li>■ Pre-wired 20A duplex receptacle.</li> <li>■ Non-metallic flip lid cover with (2) 1/2" diameter low voltage feed through holes.</li> <li>■ Painted aluminum flange.</li> </ul>			Complete assembled unit <ul style="list-style-type: none"> <li>■ PT7FSD through-floor fitting.</li> <li>■ Pre-wired 20A duplex receptacle.</li> <li>■ All brass or black non-metallic cover option.</li> <li>■ Flip lid cover with (2) 1/2" diameter low voltage feed through holes.</li> <li>■ Solid brass flange.</li> </ul>		

## Flush FRPT 3" Diameter – Two Piece Units

### Through-Floor Fitting

Catalog Number			
PT7FSD (with Junction Box)	<b>Multi-Channel Through Floor Fitting</b> 	Specifications: <ul style="list-style-type: none"> <li>■ UL Listed and CSA Certified.</li> <li>■ 1 - 4 hour fire rating (1- 3 hour for steel floor units and concrete topping, D900 Series Design).</li> <li>■ For 2 1/4" to 7" floor thickness.</li> <li>■ UL installation spacing. Minimum 2 ft. on center and not more than 1 per 65 sq. ft. of floor area.</li> </ul>	
PT73SD (without Junction Box)			
Through-floor fitting with (1) 3/4" trade size conduit stem for power and (2) 1/2" low voltage feed through holes.			

### Service Fittings

Catalog Number			Catalog Number		
FRFBLA	Black	<b>Flush Aluminum Service Fitting</b> 	FRFBRS2A	Solid Brass	<b>Flush Brass Service Fitting</b> 
FRFGYA	Gray				
FRFIA	Ivory				
FRFBRA	Brown				
<ul style="list-style-type: none"> <li>■ Pre-wired 20A duplex receptacle.</li> <li>■ Non-metallic flip lid cover with (2) 1/2" diameter low voltage feed-through holes.</li> <li>■ Painted aluminum flange.</li> </ul>			<ul style="list-style-type: none"> <li>■ Pre-wired 20A duplex receptacle.</li> <li>■ Solid brass flip lid cover with (2) 1/2" diameter low voltage feed-through holes.</li> <li>■ Solid brass flange.</li> </ul>		

### Accessories

Catalog Number			Catalog Number		
PFBRCLBA	Black	<b>Non-Metallic Replacement Covers</b> 	BRS2RCA	Solid Brass	<b>All Brass Replacement Covers</b> 
PFBRGGA	Gray				
PFBRGIA	Ivory				
PFBRCLBA	Brown				



# Large Capacity, Low Voltage Flush Furniture Feed FRPT 3" Diameter – Two Piece Units

Catalog Number

**PT2FIT**

**Large Capacity, Low Voltage Through Floor Fitting**

Through floor fitting with (1) 2" trade size conduit stem. Will accommodate up to 36 Category 5e cables.

Specifications:

- UL Listed and CSA Certified.
- 1-2 hour fire rating.
- For 2 1/4" to 7" floor thickness.
- UL installation spacing. Minimum 2 ft on center and not more than 1 per 65 sq. ft. of floor area.



Catalog Number

**FF2BRS**

Brass Finish

**FF2BK**

Black

**FF2GY**

Gray

**Large Capacity Cover/Flange**

- Cover/flange with 1 1/4" & 2" combination knockout.
- Painted aluminum cover and flange.



## Flush Furniture Feed FRPT 3" Diameter – One Piece Units

Catalog Number

**PT73FFSDGY** Gray

**3 Service Furniture Feed Poke-Through**

**PT73FFSDI** Ivory

Complete assembled unit

- **PT73SD** floor fitting.
- Aluminum cover with (2) 1/2" threaded hubs for low voltage and (1) 3/4" threaded hub for power.
- Painted aluminum flange.



Catalog Number

**PT7FFSDGY** Gray

**Single Service Furniture Feed**

**PT7FFSDI** Ivory

**Poke-Through**

Complete assembled unit

- **PT71SD** floor fitting.
- Aluminum cover with (1) KO to accept a 3/4" connector.
- Painted aluminum flange.



## Flush Furniture Feed FRPT 3" Diameter – Two Piece Units

### Through-Floor Fittings

Catalog Number

**PT73SD**

**3 Service Furniture Feed Through-Floor Fitting**

Through-floor fitting with (1) 3/4" trade size conduit stem for power and (2) 1/2" low voltage conduit holes.

Specifications:

- UL Listed and CSA Certified.
- 1 - 4 hour fire rating (1 - 3 hour for steel floor units and concrete topping, D900 Series Design).



Catalog Number

**PT71SD**

**Single Service Furniture Feed Through-Floor Fitting**

Through-floor fitting with (1) 3/4" trade size conduit stem for power or low voltage applications.

- For 2 1/4" to 7" floor thickness.
- UL installation spacing. Minimum 2 ft. on center and not more than 1 per 65 sq. ft. of floor area.



### Service Fittings

Catalog Number

**FRF3BK** Black

**3 Service Furniture Feed Service Fitting**

**FRF3GY** Gray

**FRF3I** Ivory

- Aluminum cover with (2) 1/2" threaded hubs for low voltage and (1) 3/4" threaded hub for power.
- Painted aluminum flange.



Catalog Number

**FRF1BK** Black

**Single Service Furniture Feed**

**FRF1GY** Gray

**Service Fitting**

**FRF1BRS** Brass Finish

- Aluminum cover with (1) KO to accept a 3/4" connector.
- Painted aluminum flange.





## Painted Pedestal FRPT 3" Diameter – Two Piece Unit

### Through-Floor Fitting

Catalog Number

**PT7XC**

### Large Capacity Multi-Service Pedestal Through Floor Fitting

Through floor fitting with (1) 1 ¼" trade size conduit stem for low voltage and (1) ½" trade size conduit stem for power applications.

Specifications:

- UL Listed and CSA Certified.
- 1 - 4 hour fire rating (1 - 3 hour for steel floor units and concrete topping, D900 Series Design).
- For 2 ¼" to 7" floor thickness.
- UL installation spacing. Minimum 2 ft. on center and not more than 1 per 65 sq. ft. of floor area.



## Painted Pedestal FRPT 2" Diameter – Two Piece Unit

### Through-Floor Fitting

Catalog Number

**PT27A**

### Multi-Service Pedestal Through Floor Fitting

Through floor fitting with (1) ¾" trade size conduit stem for low voltage and (1) ½" trade size conduit stem for power applications.

Specifications:

- UL Listed and CSA Certified.
- 1 - 4 hour fire rating (1 - 3 hour for steel floor units and concrete topping, D900 Series Design).
- For 2 ¼" to 7" floor thickness.
- UL installation spacing. Minimum 2 ft. on center and not more than 1 per 65 sq. ft. of floor area.



## Pedestal Service Fittings (Order 1 plate per gang)

Catalog Number

**FR280BKA** Black **2-Gang**  
**FR280GYA** Gray

Use with **PT27A** only.



Catalog Number

**FR480BKA** Black **4-Gang**  
**FR480GYA** Gray

Use with **PT27A** or **PT7XC**.



Catalog Number

**FR680BKA** Black **6-Gang**  
**FR680GYA** Gray

Use with **PT27A** or **PT7XC**.



- Painted aluminum housing with low voltage barrier(s). Plates and devices sold separately.
- For additional barriers, use catalog number **FRBR1** (see page 94).

## Pedestal Face Plates (Order 1 plate per gang)

Catalog Number

**SS2309DBKA** Black **Duplex**  
**SS2309DGYA** Gray



**SS2309SLBKA** Black **Style Line/**  
**SS2309SLGYA** Gray **GFCI**



**SS2309SBKA** Black **Single Rec.**  
**SS2309SGYA** Gray **(1.39" OD)**



**SS2309BBKA** Black **Blank**  
**SS2309BGYA** Gray



Catalog Number

**SS2309FBKA** Black **Furniture Feed**  
**SS2309FGYA** Gray **(¾" KO)**



**SS2309F1BKA** Black **Furniture Feed**  
**SS2309F1GYA** Gray **(1" KO)**



**SS2309TBKA** Black **Bushed Data**  
**SS2309TGYA** Gray **Opening (1" ID)**



- Painted aluminum plates.





# Brushed Aluminum Pedestal FRPT 3" Diameter - Two Piece Unit

## Through-Floor Fitting

Catalog Number

**PT7XC**

**Large Capacity Multi-Service Pedestal Through-Floor Fitting**

Through floor fitting with (1) 1 1/4" trade size conduit stem for low voltage and (1) 1/2" trade size conduit stem for power applications.

Specifications:

- UL Listed and CSA Certified.
- 1 - 4 hour fire rating (1 - 3 hour for steel floor units and concrete topping, D900 Series Design).
- For 2 1/4" to 7" floor thickness.
- UL installation spacing. Minimum 2 ft. on center and not more than 1 per 65 sq. ft. of floor area.



## Pedestal Service Fitting

Catalog Number

**FR80AL** Brushed Aluminum

**2-Gang Pedestal Service Fitting**

For use with **PT7XC** only.

- Brushed aluminum housing with low voltage barrier. Plates and devices sold separately.



## Plates

Catalog Number

**SS309D** Duplex



**SS309S** Single Rec. (1.39" OD)



**SS309B** Blank



**SS309DS** Style Line/GFCI



Catalog Number

**SS309T** Bushed Data Opening (1" ID)



**SS309SF\*** Furniture Feed (3/4" KO)



**SS309BF\*** Furniture Feed Blank



\* For furniture feed applications using **SS309SF**, a **SS309BF** blank must be used for 2nd plate.

- 302/304 Stainless steel plates (**SS309SF** & **SS309BF** are aluminum).

## 3" Diameter FRPT Accessories

Catalog Number

**FRP250** Gray **Closure Plug**

Textured aluminum plug seals 3" core hole when FRPT is no longer required and is removed. Maintains the floor's 1 - 4 hour fire rating.



**AP2GY** Gray **Flush FRPT**  
**AP2I** Ivory **Abandonment Plate**

Use with **PT7FSD**, **PT73SD** or **PT71SD** only. Covers the opening when FRPT is abandoned. Service fitting is removed and through-floor fitting remains.



**FF3GY** Gray **Multi-Service Furniture Feed**  
**FF3I** Ivory **Replacement Inserts**

Use as a replacement cover for **PT73FFSD** series, or to convert installed **PT7FSD** series into furniture feed FRPTs. Includes (2) 1/2" threaded hubs for low voltage and (1) 3/4" threaded hub for power. (UL listed only.)



Catalog Number

**EXT13** **PT7XC Extension Kit**

Extends **PT7XC** FRPT to accommodate between 7" and 13" floor thickness.



**AP22** 2-Gang Gray **Pedestal FRPT**  
**AP42** 4-Gang Gray **Abandonment Plate**

Use with **PT27A** or **PT7XC** Only. Covers the opening when FRPT is abandoned. Service fitting is removed and through-floor fitting remains.



**FRBR1** **Low Voltage Barrier**

Use with **FR280**, **FR480**, and **FR680** pedestal service fittings only when additional power/low voltage separation is required.

