



New Evolution Series Fire Classified Floor Boxes provide increased capacity options and a variety of innovations not available in any other floor boxes.

Evolution™ Series – Maintaining the Floor’s Fire Rating

Evolution™ Series Fire Classified Floor Boxes are the latest advancement in the most complete and innovative line of floor solutions in the industry.

In addition to the product’s many unique features, the Evolution Fire Classified Floor Boxes meet and exceed UL’s classification requirement. Evolution Series Floor Boxes are ideal for areas where large capacity audio/video, power and communication services are needed. Ranging in size from 4- to 10-gangs of capacity, these boxes have completely finished interiors with removable modules that provide easy access for reconfiguring services. Evolution Series Fire Classified Floor Boxes are an ideal option for installations where services are constantly evolving, such as commercial offices, conference rooms, and entertainment venues

PRODUCTS: EFB45S-FC, EFB45S-FC12, EFB45S-FC22, EFB6S-FC, EFB6S-FC11222, EFB6S-FC22, EFB8S-FC, EFB8S-FC1122, EFB8S-FC2222, EFB10S-FC, EFB10S-FC1122, EFB10S-FC2222,

Features & Benefits

- **Fire Classified.**

Evolution Floor Box has been designed to maintain the fire rating of the floor for up to 3 hours.



- **Audio/Video Design.**

Evolution Series Floor Boxes have been developed specifically with the A/V industry in mind. With 3 1/2" - 3 7/8" (89mm x 98mm) of wiring capacity behind each device plate, these boxes will accept devices from leading A/V manufacturers including Legrand AVIP, Extron Electronics and Crestron.



- **Suitable for use in air handling spaces.**

In accordance with Sec 300-22(c) of the National Electric Code.

- **Durable 180° articulating hinge.**

Hinge design enables covers to open a full 180° and lie flat on the floor surface with the durability to support a large cover. Provides easy access to all interior modules and activations while reducing tripping hazards.



- **Auto-close egress doors.**

Cable egress doors lock in position when open, and automatically close around wires to protect cabling and reduce trip hazards.



- **Meets ADA Accessibility Guidelines.**

Trim flange is designed to meet the ADA Accessibility Guidelines as it pertains to ADA Standard 4.5, which addresses the change in floor and ground surface levels.

Vertical Markets

- Commercial
- Entertainment
- Hospitality
- Education
- Retail
- Financial

Compliance



cULus Listed Metallic Outlet Boxes.
File E2961 Guide QCIT.
Meets Article 300.22(c) of NEC.



Protection from water, dirt, and debris.

Features & Benefits

- Finished interior.**
 Fully finished interior removes the unfinished industrial look while increasing visibility, making it easier to see where to plug in devices.



- Large capacity.**
 4- to 10-gangs of capacity to accommodate power, communications, and A/V devices. A minimum of 5" (127mm) of space between devices providing ample space for hand access when plugging and unplugging into the devices.



- Bare (polished) concrete and terrazzo applications.** Evolution Series Floor Box has been designed to be installed into bare (polished) concrete and terrazzo floors.



- Accepts standard size wall plates.**
 Evolution Series Floor Boxes accept industry standard one- to five-gang wall plates from industry leading manufacturers.



- Die cast aluminum cover assemblies.**
 Evolution Series Floor Box Covers have been designed to work on multiple floor surfaces and are manufactured from die cast aluminum to provide strength and style. Decorative powder coated colors (black, brass, bronze, gray, nickel and aluminum) will complement any room décor.



- Cable Management.**
 Allows multiple cables to be organized and controlled for easier cable egress.



- TopGuard™ Protection.** Evolution Series Floor Box covers meet and exceed UL scrub water exclusion requirements for tile, carpet, wood, bare concrete and terrazzo floor coverings.

- UL Listed and Fire Classified to U.S. and Canadian safety standards.** UL Classified to maintain the integrity of up to 3-hour fire rated floor structures.

Evolution Series Fire Classified Floor Box Specifications

Evolution Series Floor Box Compartment Volumes				
MODEL	OUTER COMPARTMENTS (Each)		CENTER COMPARTMENTS (Each)	
EFB45S Series	27.5 in. ³	(450ml)	34 in. ³	(557ml)
EFB6 Series	32 in. ³	(524ml)	38.5 in. ³	(630ml)
EFB8 Series	27.5 in. ³	(450ml)	34 in. ³	(557ml)
EFB10 Series	23.5 in. ³	(385ml)	27.5 in. ³	(450ml)
EFBFF Series	64.5 in. ³	(1056ml)	64.5 in. ³	(1056ml)

PRE-POUR BOX ADJUSTMENT RANGES

CLASSIFICATION HOUR RATING	CATALOG NUMBER	MINIMUM POUR HEIGHT		MAXIMUM POUR HEIGHT	
1, 1 1/2, 2	EFB45S-FC	2"	(51mm)	5 1/4"	(133mm)
1, 1 1/2, 2	EFB6S-FC	2"	(51mm)	5 1/4"	(133mm)
1, 1 1/2, 2	EFB8S-FC	2"	(51mm)	5 1/4"	(133mm)
1, 1 1/2, 2	EFB10S-FC	2"	(51mm)	5 1/4"	(133mm)
1, 1 1/2, 2, 3	EFB45S-FC12	2"	(51mm)	6 1/2"	(165mm)
1, 1 1/2, 2, 3	EFB45S-FC22	2"	(51mm)	6 1/2"	(165mm)
1, 1 1/2, 2, 3	EFB6S-FC1122	2"	(51mm)	6 1/2"	(165mm)
1, 1 1/2, 2, 3	EFB6S-FC2222	2"	(51mm)	6 1/2"	(165mm)
1, 1 1/2, 2, 3	EFB8S-FC1122	2"	(51mm)	6 1/2"	(165mm)
1, 1 1/2, 2, 3	EFB8S-FC2222	2"	(51mm)	6 1/2"	(165mm)
1, 1 1/2, 2, 3	EFB10S-FC1122	2"	(51mm)	6 1/2"	(165mm)
1, 1 1/2, 2, 3	EFB10S-FC1122	2"	(51mm)	6 1/2"	(165mm)

Evolution Series Fire Classified Floor Box Specifications

FIRE CLASSIFICATION RANGES & MINIMUM THICKNESS

REINFORCED CONCRETE SLAB (Plywood Decking)				
MINIMUM THICKNESS FOR FIRE RESISTANCE RATING				
CEMENT TYPE	1-Hour	1 1/2-Hour	2-Hour	3-Hour
Normal Weight	3 1/2" (89mm)	4 5/16" (109mm)	5" (127mm)	6 3/16" (158mm)
Lightweight	2 1/2" (64mm)	3 1/8" (79mm)	3 5/8" (91mm)	4 7/16" (112mm)

CORRUGATED DECKING				
MINIMUM THICKNESS FOR FIRE RESISTANCE RATING				
CEMENT TYPE	1-Hour	1 1/2-Hour	2-Hour	3-Hour
Normal Weight	3 1/2" (89mm)	4" (102mm)	4 1/2" (114mm)	5 1/5" (133mm)
Lightweight	2 5/8" (67mm)	3" (76mm)	3 1/4" (83mm)	4 3/16" (106mm)

Outlet Boxes and Fittings Classified for Fire Resistance Legrand (R8209)

Types EFB6S-FC, EFB8S-FC, EFB10S-FC preset electrical inserts for use with **Types EFB610CT, EFB610BT, EFB610CTC** and **EFB610BTC** service fitting covers in 2 hr fire rated D900 Series Floor-Ceiling designs constructed with nominal 2 in. or 3 in. deep fluted steel floor units having nominal 5 in. wide valleys and crests spaced 12 in. OC. The preset electrical inserts are for use with a minimum 3 1/4 in. thickness of structural concrete topping. For use with a max of sixty (60) No. 14 AWG Type THHN conductors. The assembled preset electrical insert with floor plate kit and service activation fitting will not reduce the 2 hr fire rating of the floor assembly when installed in accordance with the installation instructions accompanying the preset electrical insert and when the preset electrical inserts are spaced minimum 2 ft OC with not more than one unit per 4 sq ft of floor area in each span.

Type EFB45S-FC preset electrical inserts for use with **Types EFB45CT, EFT45BT, EFB45CTC, and EFB45BTC** service fitting covers in 2 hr fire rated D900 Series Floor-Ceiling designs constructed with nominal 2 in. or 3 in. deep fluted steel floor units having nominal 5 in. wide valleys and crests spaced 12 in. OC. The preset electrical inserts are for use with a minimum 3 1/4 in. thickness of structural concrete topping. For use with a max of thirty (30) No. 14 AWG Type THHN conductors. The assembled preset electrical insert with floor plate kit and service activation fitting will not reduce the 2 hr fire rating of the floor assembly when installed in accordance with the installation instructions accompanying the preset electrical insert and when the preset electrical inserts are spaced minimum 2 ft OC with not more than one unit per 4 sq ft of floor area in each span.

Types EFB6S-FC-xx, EFB8S-FC-xx, EFB10S-FC-xx, EFB10S-FC2222, EFB10S-FC1122, EFB8S-FC2222, EFB8S-FC1122, EFB6S-FC2222, and EFB6S-FC1122 preset electrical inserts for use with **Types EFB610CT, EFB610BT, EFB610CTC and EFB610BTC** service fitting covers in up to 3 hr fire rated D900 Series Floor-Ceiling designs constructed with nominal 2 in. or 3 in. deep fluted steel floor units having nominal 5 in. wide valleys and crests spaced 12 in. OC. The preset electrical inserts are for use with a minimum 3 1/4 in. thickness of structural concrete topping. For use with a max of sixty (60) No. 14 AWG Type THHN conductors. The assembled preset electrical insert with floor plate kit and service activation fitting will not reduce the 3 hr fire rating of the floor assembly when installed in accordance with the installation instructions accompanying the preset electrical insert and when the preset electrical inserts are spaced minimum 2 ft OC with not more than one device per each 4 sq. ft. of floor area.

Types EFB45S-FC-xx, EFB45S-FC12, EFB45S-FC22 preset electrical inserts for use with **Types EFB45CT, EFT45BT, EFB45CTC, and EFB45BTC** service fitting covers in up to 3 hr fire rated D900 Series Floor-Ceiling designs constructed with nominal 2 in. or 3 in. deep fluted steel floor units having nominal 5 in. wide valleys and crests spaced 12 in. OC. The preset electrical inserts are for use with a minimum 3 1/4 in. thickness of structural concrete topping. For use with a max of thirty (30) No. 14 AWG Type THHN conductors. The assembled preset electrical insert with floor plate kit and service activation fitting will not reduce the 3 hr fire rating of the floor assembly when installed in accordance with the installation instructions accompanying the preset electrical insert and when the preset electrical inserts are spaced minimum 2 ft OC with not more than one device per each 4 sq. ft. of floor area.

NOTE: "XX" in part name denotes conduit feed sizes.

Evolution Series Fire Classified Floor Box Model Selection Guide

Evolution Series Fire Classified Floor Box Model Selection Guide								
FLOOR BOX MODEL	Box Capacity	Depth Behind Device Plates	Device Plate Size	Cover Colors	Finished Floor Surface	Conduit Feed Sizes	Fire Rating	Notes
EFB45S-FC	4 & 5-Gangs	3 1/2" (89mm)	Uses Standard Size Device Plates: Single-Gang – (2 3/4" x 4 1/2") Double-Gang – (4 9/16" x 4 1/2") Triple-Gang – (6 3/8" x 4 1/2") Four-Gang – (8 1/8" x 4 1/2")	Powder-Coat Black, Gray, Brass, Bronze, Nickel & Aluminum	Carpet, Tile, Wood, Polished Concrete & Terrazzo	1 1/4"	2-Hours	Use EFB45-CTR to allow cover to be flush with finished floor surface (sold separately)
EFB45S-FC12						1 1/4" & 2"	3-Hours	
EFB45S-FC22						2"	3-Hours	
EFB6S-FC	6-Gangs	3 7/8" (98mm)	Uses Standard Size Device Plates: Single-Gang – (2 3/4" x 4 1/2")	Powder-Coat Black, Gray, Brass, Bronze & Nickel	Carpet, Tile, Wood, Polished Concrete & Terrazzo	1 1/4"	2-Hours	Use EFB610-CTR to allow cover to be flush with finished floor surface (sold separately)
EFB6S-FC1122						1 1/4" & 2"	3-Hours	
EFB6S-FC22						2"	3-Hours	
EFB8S-FC	8-Gangs	3 1/2" (89mm)	Uses Standard Size Device Plates: Single-Gang – (2 3/4" x 4 1/2") Double-Gang – (4 9/16" x 4 1/2") Triple-Gang – (6 3/8" x 4 1/2") Four-Gang – (8 1/8" x 4 1/2")	Powder-Coat Black, Gray, Brass, Bronze & Nickel	Carpet, Tile, Wood, Polished Concrete & Terrazzo	1 1/4"	2-Hours	Use EFB610-CTR to allow cover to be flush with finished floor surface (sold separately)
EFB8S-FC1122						1 1/4" & 2"	3-Hours	
EFB8S-FC2222						2"	3-Hours	
EFB10S-FC	10-Gangs	3 1/2" (89mm)	Uses Standard Size Device Plates: Single-Gang – (2 3/4" x 4 1/2") Double-Gang – (4 9/16" x 4 1/2") Triple-Gang – (6 3/8" x 4 1/2") Five-Gang – (10" x 4 1/2")	Powder-Coat Black, Gray, Brass, Bronze & Nickel	Carpet, Tile, Wood, Polished Concrete & Terrazzo	1 1/4"	2-Hours	Use EFB610-CTR to allow cover to be flush with finished floor surface (sold separately)
EFB10S-FC1122						1 1/4" & 2"	3-Hours	
EFB10S-FC2222						2"	3-Hours	

Evolution Series Fire Classified 4- & 5-Gang Floor Box Ordering Information

EFB45S-FC

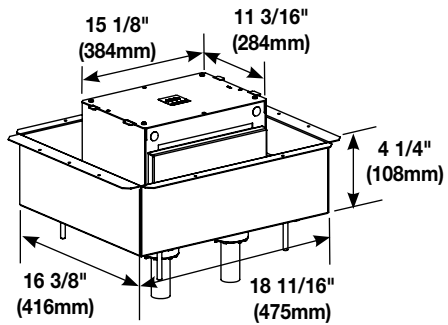

4- & 5-Gang Fire Classified Floor Box – Pre-assembled installation ready floor box has been designed to be installed in above grade (second floors and above) concrete floors while maintaining the fire classification of the floor. This box is classified to be used in 2-hour fire rated floors. Designed to accept standard size wall plates. **Box comes complete with all components needed for initial installation.**

Country of Origin: USA

Components Included:

- Protective/Disposable Cover
- Fire Classified Pan
- One (1) Removable Module
 - Back Box (1 per module)
 - Device Mounting Brackets
 - Removable Repositionable Divider
- Two (2) 1 1/4" (32mm) Intumescent Conduit Feeds
- Two (2) Cable Management Guides

Items not included with the box and sold separately:

- Receptacles
- Communication Jacks
- A/V Devices
- Device plates



NOTES: Designed for new construction applications.

Consult structural engineer before making cuts into decking. Add additional supports as instructed by the structural engineer.

When used on bare (polished) concrete or terrazzo floors EFB45-CTR must be used. (Sold separately.)

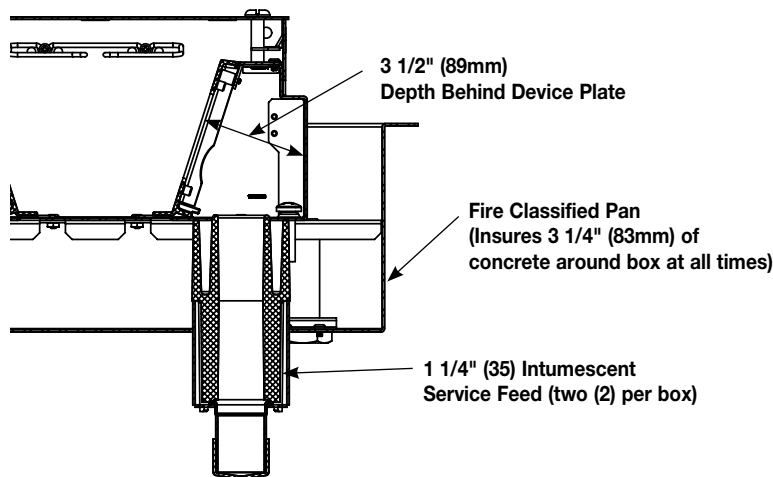

Evolution Series Fire Classified 4- & 5-Gang Floor Box Ordering Information

EFB45S-FC12

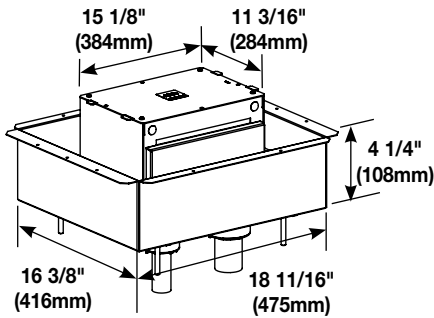

4- & 5-Gang Fire Classified Floor Box – Pre-assembled installation ready floor box has been designed to be installed in above grade (second floors and above) concrete floors while maintaining the fire classification of the floor. This box is classified to be used in 1-, 1 1/2-, 2- or 3-hour fire rated floors. Designed to accept standard size wall plates. **Box comes complete with all components needed for initial installation.**

Country of Origin: USA

Components Included:

- Protective/Disposable Cover
- Fire Classified Pan
- One (1) Removable Module
 - Back Box
 - Device Mounting Brackets
 - Removable Repositionable Divider
- One (1) 1 1/4" (32mm) Intumescent Conduit Feed
- One (1) 2" (51mm) Intumescent Conduit Feed
- Two (2) Cable Management Guides

Items not included with the box and sold separately:

- Receptacles
- Communication Jacks
- A/V Devices
- Device plates



NOTES: Designed for new construction applications.

Consult structural engineer before making cuts into decking. Add additional supports as instructed by the structural engineer.

When used on bare (polished) concrete or terrazzo floors EFB45-CTR must be used. (Sold separately.)

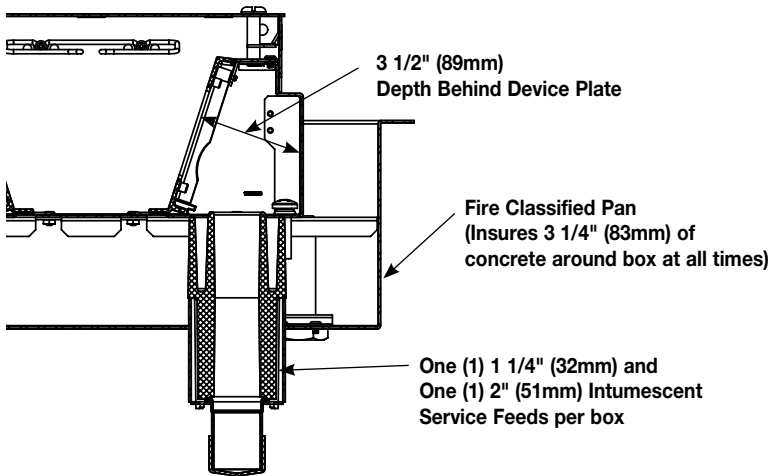

Evolution Series Fire Classified 4- & 5-Gang Floor Box Ordering Information

EFB45S-FC22

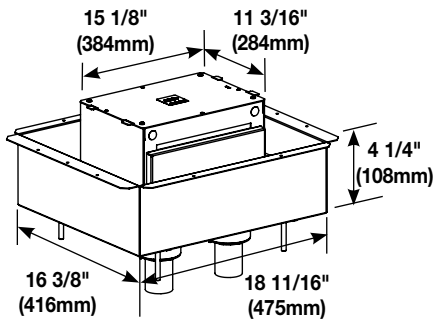

4- & 5-Gang Fire Classified Floor Box – Pre-assembled installation ready floor box has been designed to be installed in above grade (second floors and above) concrete floors while maintaining the fire classification of the floor. This box is classified to be used in 1-, 1 1/2-, 2- or 3-hour fire rated floors. Designed to accept standard size wall plates. **Box comes complete with all components needed for initial installation.**

Country of Origin: USA

Components Included:

- Protective/Disposable Cover
- Fire Classified Pan
- One (1) Removable Module
 - Back Box
 - Device Mounting Brackets
 - Removable Repositionable Divider
- Two (2) 2" (51mm) Intumescent Conduit Feeds
- Two (2) Cable Management Guides

Items not included with the box and sold separately:

- Receptacles
- Communication Jacks
- A/V Devices
- Device plates

NOTES: Designed for new construction applications.

Consult structural engineer before making cuts into decking. Add additional supports as instructed by the structural engineer.

When used on bare (polished) concrete or terrazzo floors EFB45-CTR must be used. (Sold separately.)

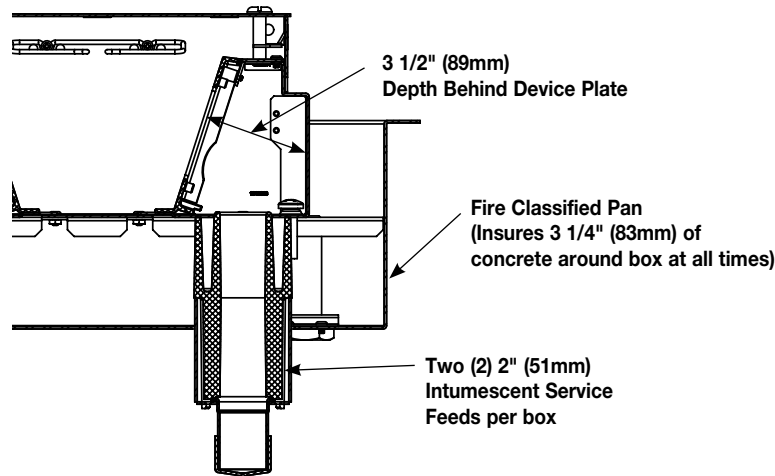

Evolution Series Fire Classified 4- & 5-Gang Floor Box Accessories Ordering Information

EFB8-MB

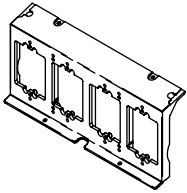

Mounting Bracket – Holds up to four (4) devices for power, communications or a/V. Bracket accepts standard size (2 3/4" x 4 1/2" (70mm x 114mm)) device plates sold separately by others.

Country of Origin: USA

EFB8S-22GMB

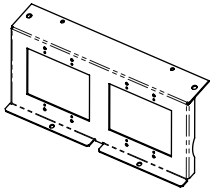

Mounting Bracket – Equipped with two (2) 2-gang standard size device openings for a standard 2-gang (4 9/16" x 4 1/2" (116mm x 114mm)). Ideal for 2-gang A/V devices such as Crestron® 2-gang digital media devices. Device plates and devices supplied by others.

Country of Origin: USA

EFB8S-4GMB

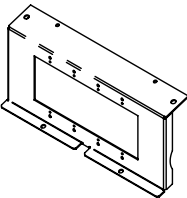

Mounting Bracket – Holds a standard 4 gang device plate. Device plate dimensions: 8 1/8" x 4 1/4" (206mm x 116mm).

Country of Origin: USA

EFB-AAP

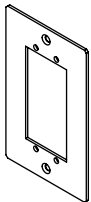

Device Plate – Holds two (2) Extron Electronics AAP devices. Device plate dimensions: 2 3/4" x 4 1/2" (69mm x 114mm).

Country of Origin: USA

EFB-MAAP

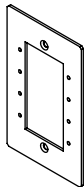

Device Plate – Holds four (4) Legrand AVIP or Extron Electronics MAAP devices. Device plate dimensions: 2 3/4" x 4 1/2" (69mm x 114mm).

Country of Origin: USA

EFB-MOS

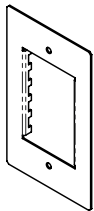

Device Plate – European device plate accepts up to 45mm x 67.5mm Arteor device. Device plate dimensions: 2 3/4" x 4 1/2" (69mm x 114mm).

Country of Origin: USA

NOTE: Not designed for use with adorne devices.

EFB-B

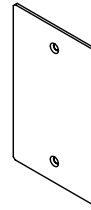

Blank Device Plate – Device plate dimensions: 2 3/4" x 4 1/2" (69mm x 114mm).

Country of Origin: USA

EFB810-DIV

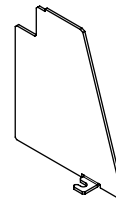

Relocatable Divider – Provides separation of services. Includes one divider plate.

Country of Origin: USA

EFB45-CMG

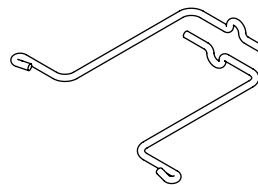

Cable Management Guides – Guides help organize and maintain cable position when opening and closing the cover.

Country of Origin: USA

EFB10-MB

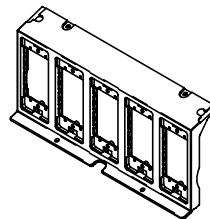

Mounting Bracket – Holds up to five (5) devices for power, communications or A/V. Bracket accepts EFB10 Series device plates (2 1/32" x 4 5/8") (58mm x 117mm) device plates sold separately.

Country of Origin: USA

EFB10S-23GMB

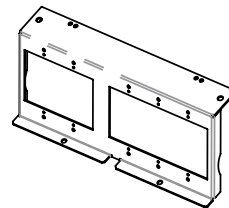

Mounting Bracket – Equipped with one 2-gang standard size device opening and one 3-gang standard size device opening. Accepts a standard 2-gang (4 9/16" x 4 1/2" (116mm x 114mm)) and a 3-gang (6 3/8" x 4 1/2" (162mm x 114mm)) device plate. Ideal for 2-gang A/V devices such as Crestron® 2-gang and 3-gang digital media devices. Device plates and devices supplied by others.

Country of Origin: USA

Evolution Series Fire Classified 4- & 5-Gang Floor Box Accessories Ordering Information

EFB10S-5GMB

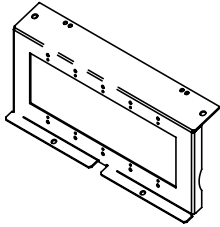

Mounting Bracket – Holds a standard 5 gang device plate
Device plate dimensions: 10" x 4 1/2" (254mm x 116mm).

Country of Origin: USA

EFB10-6AB

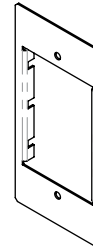

Device Plate – Accepts up to three (3) dual Wiremold CM2 Series Open System communication adapters. Adapters sold separately. Device plate dimensions: 2.3" x 4.652" (58mm x 118mm).

Country of Origin: USA

EFB10-B



Blank Device Plate – Device plate dimensions: 2 5/16" x 4 5/8" (58mm x 118mm).

Country of Origin: USA

EFB10-3S2

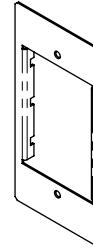

Device Plate – Accepts up to three (3) Ortronics® Series II devices. Ortronics® devices sold separately. Device plate dimensions: 2.3" x 4.652" (58mm x 118mm).

Country of Origin: USA

EFB10-DP

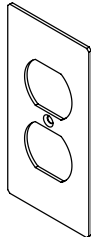

Duplex Device Plate – Device plate dimensions: 2 5/16" x 4 5/8" (58mm x 118mm). Includes receptacle spacers.

Country of Origin: USA

EFB10-2C

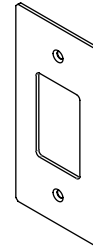

Device Plate – Accepts one dual Wiremold Open System adapter, or one Ortronics® Series II adapter, or one Ortronics® TracJack adapter. Adapters sold separately. Device plate dimensions: 2.3" x 4.652" (58mm x 118mm).

Country of Origin: USA

EFB10-DEC

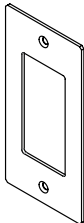

Decorator Style Device Plate – For use with decorator style receptacles, GFCI receptacle, and decorator style A/V devices. Device plate dimensions: 2.3" x 4.652" (58mm x 118mm). Includes receptacle spacers.

Country of Origin: USA

EFB10-AAP

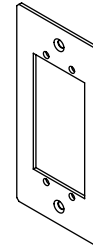

Device Plate – Holds two (2) Extron Electronics AAP devices. Device plate dimensions: 2.3" x 4.652" (58mm x 118mm).

Country of Origin: USA

EFB10-S1

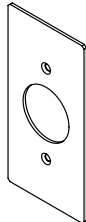

Single Receptacle Device Plate – Single receptacle 1.39" (35mm) diameter. Device plate dimensions: 2.3" x 4.652" (58mm x 118mm). Includes receptacle spacers.

Country of Origin: USA

EFB10-MAAP

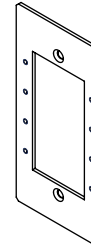

Device Plate – Holds four (4) Legrand AVIP or Extron Electronics MAAP devices. Device plate dimensions: 2.3" x 4.652" (58mm x 118mm).

Country of Origin: USA

EFB10-S2

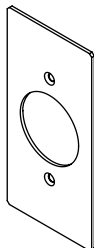

Single Receptacle Device Plate – Single receptacle 1.59" (40mm) diameter. Device plate dimensions: 2.3" x 4.652" (58mm x 118mm). Includes receptacle spacers.

Country of Origin: USA

EFB10-MOS

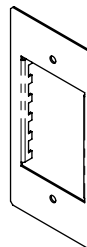

Device Plate – (45mm x 67.5mm) device plate. Device plate dimensions: 2.3" x 4.652" (58mm x 118mm).

Country of Origin: USA

Evolution Series Fire Classified 4- & 5-Gang Floor Box Accessories Ordering Information

5507B-WH

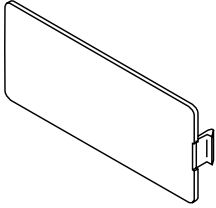

Blank Faceplate – For covering unused compartments in the device bracket.

Country of Origin: USA

5507T1-WH

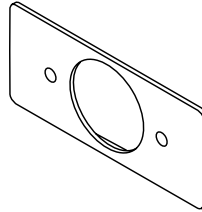

Single Receptacle Faceplate – For covering single receptacles – 1.59" (40mm) in diameter.

Country of Origin: USA

5507D-WH

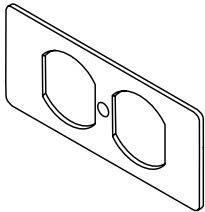

Duplex Receptacle Faceplate – For covering duplex style devices. Also accepts 106 communications frame.

Country of Origin: USA

5507T2-WH

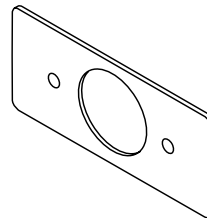

Single Receptacle Faceplate – For covering single receptacles – 1.41" (36mm) in diameter.

Country of Origin: USA

5507R-WH

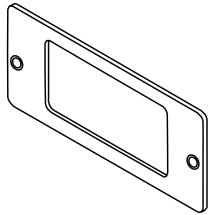

Rectangular Receptacle Faceplate – For covering rectangular decorator style devices.

Country of Origin: USA

55074TJ-WH

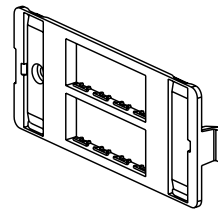

Ortronics® Faceplate – For mounting Ortronics® datacom inserts. Accepts four (4) TracJack devices.

Country of Origin: USA

5507S-WH

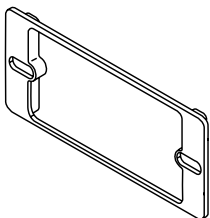

Rectangular Spacer – For mounting commercial device plates. Installs between the device bracket and a device.

Country of Origin: USA

55076TJ-WH

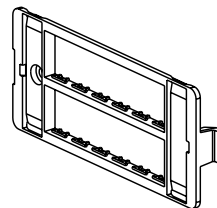

Ortronics® Faceplate – For mounting Ortronics® datacom inserts. Accepts six (6) TracJack devices.

Country of Origin: USA

Evolution Series Fire Classified 4- & 5-Gang Floor Box Covers Ordering Information

**EFB45CTCBK
EFB45CTCGY
EFB45CTCBS
EFB45CTCNK
EFB45CTCBZ
EFB45CTCAL**

Surface Style Cover with Floor Insert – Low profile cover designed to attach to the EFB45S style floor boxes. Each cover is made of die cast aluminum and is equipped with a durable hinge allowing the cover to rotate open 180°, a 1/4" deep recessed area to accept the finished floor covering, and two (2) slide egress doors that lock in the open position and automatically close around the cables when the cover is closed. The flange has a beveled edge that meets ADA guidelines and reduces tripping hazards. These cover assemblies are designed to sit on top of finished floors such as: carpet, tile, wood, polished concrete, and terrazzo. Available in six (6) powder coat finishes: black (BK), gray (GY), brass (BS), nickel (NK), aluminum (AL) and bronze (BZ).

NOTE: Depth of recess area in plate is 1/4" (6.35mm).

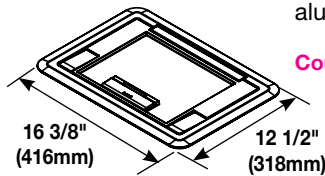

Country of Origin: India

**EFB45BTCBK
EFB45BTCGY
EFB45BTCBS
EFB45BTCNK
EFB45BTCBZ
EFB45BTCAL**

Surface Style Cover With Solid Lid – Low profile cover designed to attach to the EFB45S style floor boxes. Each cover is made of die cast aluminum and is equipped with a durable hinge allowing the cover to rotate open 180°, and two (2) slide egress doors that lock in the open position and automatically close around the cables when the cover is closed. The flange has a beveled edge that meets ADA guidelines and reduces tripping hazards. These cover assemblies are designed to sit on top of finished floors such as: carpet, tile, wood, polished concrete, and terrazzo. Available in six (6) powder coat finishes: black (BK), gray (GY), brass (BS), nickel (NK), aluminum (AL) and bronze (BZ).

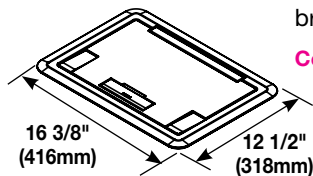

Country of Origin: India

**EFB45CTBK
EFB45CTGY
EFB45CTBS
EFB45CTNK
EFB45CTBZ
EFB45CTAL**

Flush Style Cover with Floor Insert – Low profile cover designed to attach to the EFB45S style floor boxes. Each cover is made of die cast aluminum and is equipped with a durable hinge allowing the cover to rotate open 180°, a 1/4" deep recessed area to accept the finished floor covering, and two (2) slide egress doors that lock in the open position and automatically close around the cables when the cover is closed. The cover assemblies are designed to sit flush with the finished floors such as: carpet, tile, and wood. In order to make the cover assembly flush with the polished concrete or terrazzo floor the EFB45-CTR (concrete/terrazzo) ring must be used (ring sold separately). The cover assemblies are available in six (6) powder coat finishes: black (BK), gray (GY), brass (BS), nickel (NK), aluminum (AL) and bronze (BZ).

NOTE: Depth of recess area in plate is 1/4" (6.35mm).

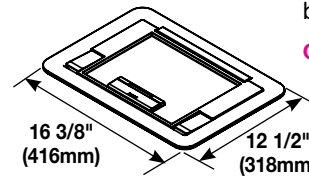

Country of Origin: India

**EFB45BTBK
EFB45BTGY
EFB45BTBS
EFB45BTNK
EFB45BTBZ
EFB45BTAL**

Flush Style Cover with Floor Insert – Low profile cover designed to attach to the EFB45S style floor boxes. Each cover is made of die cast aluminum and is equipped with a durable hinge which allows the cover to rotate open 180°, and two (2) slide egress doors that lock in the open position and automatically close around the cables when the cover is closed. The cover assemblies are designed to sit flush with the finished floors such as: carpet, tile, and wood. In order to make the cover assembly flush with the polished concrete or terrazzo floor the EFB45-CTR (concrete/terrazzo) ring must be used (ring sold separately). The cover assemblies are available in six (6) powder coat finishes: black (BK), gray (GY), brass (BS), nickel (NK), aluminum (AL) and bronze (BZ).

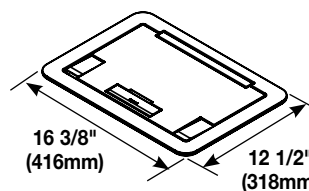

Country of Origin: India

Evolution Series Fire Classified 4- & 5-Gang Floor Box Covers Ordering Information

EFB45CTCBKTR
EFB45CTCGYTR
EFB45CTCBSTR
EFB45CTCNKTR
EFB45CTCBZTR
EFB45CTCALTR

Surface Style Cover with Floor Insert – Low profile cover designed to attach to the EFB45S style floor boxes. Each cover is made of die cast aluminum and is equipped with a tamper-resistant screw to help keep out unauthorized personnel, a durable hinge which allows the cover to rotate open 180°, a 1/4" deep recessed area to accept the finished floor covering, and two (2) slide egress doors that lock in the open position and automatically close around the cables when the cover is closed. The flange has a beveled edge that meets ADA guidelines and reduces tripping hazards. These cover assemblies are designed to sit on top of the finished floors such as: carpet, tile, wood, polished concrete, and terrazzo. Available in six (6) powder coat finishes: black (BK), gray (GY), brass (BS), nickel (NK), aluminum (AL) and bronze (BZ).

Country of Origin: India

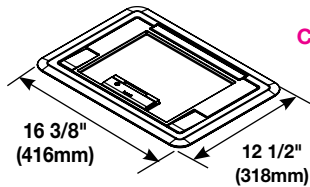

EFB45CTBKTR
EFB45CTGYTR
EFB45CTBSTR
EFB45CTNKTR
EFB45CTBZTR
EFB45CTALTR

Flush Style Cover with Floor Insert – Low profile cover designed to attach to the EFB45S style floor boxes. Each cover is made of die cast aluminum and is equipped with a tamper-resistant screw to help keep out unauthorized personnel, a durable hinge which allows the cover to rotate open 180°, a 1/4" deep recessed area to accept the finished floor covering, and two (2) slide egress doors that lock in the open position and automatically close around the cables when the cover is closed. The cover assemblies are designed to sit flush with the finished floors such as: carpet, tile, and wood. In order to make the cover assembly flush with the polished concrete or terrazzo floor the EFB45-CTR (concrete/terrazzo) ring must be used (trim ring sold separately). The cover assemblies are available in six (6) powder coat finishes: black (BK), gray (GY), brass (BS), nickel (NK), aluminum (AL) and bronze (BZ).

Country of Origin: India

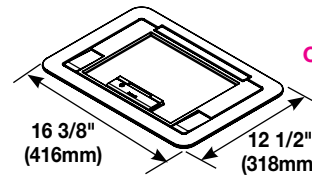

Evolution Series Floor Box Covers are available in powder-coated finishes of: (L to R) brass, black, gray, nickel, bronze and aluminum.

Evolution Series Fire Classified 4- & 5-Gang Floor Box Covers Ordering Information

EFB45BTCBKTR
EFB45BTCGYTR
EFB45BTCBSTR
EFB45BTCNKTR
EFB45BTCBZTR
EFB45BTCALTR

Surface Style Cover with Floor Insert – Low profile cover designed to attach to the EFB45S style floor boxes. Each cover is made of die cast aluminum and is equipped with a tamper-resistant screw to help keep out unauthorized personnel, a durable hinge which allows the cover to rotate open 180°, a 1/4" deep recessed area to accept the finished floor covering, and two (2) slide egress doors that lock in the open position and automatically close around the cables when the cover is closed. The flange has a beveled edge that meets ADA guidelines and reduces tripping hazards. These cover assemblies are designed to sit on top of the finished floors such as: carpet, tile, wood, polished concrete, and terrazzo. Available in six (6) powder coat finishes: black (BK), gray (GY), brass (BS), nickel (NK), aluminum (AL) and bronze (BZ).

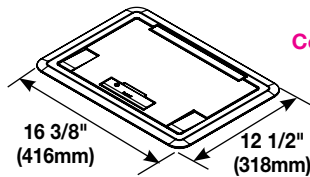

Country of Origin: India

EFB45BTBKTR
EFB45BTGYTR
EFB45BTBSTR
EFB45BTNKTR
EFB45BTBZTR
EFB45BTALTR

Flush Style Cover with Floor Insert – Low profile cover designed to attach to the EFB45S style floor boxes. Each cover is made of die cast aluminum and is equipped with a tamper-resistant screw to help keep out unauthorized personnel, a durable hinge which allows the cover to rotate open 180°, and two (2) slide egress doors that lock in the open position and automatically close around the cables when the cover is closed. The cover assemblies are designed to sit flush with the finished floors such as: carpet, tile, and wood. In order to make the cover assembly flush with the polished concrete or terrazzo floor the EFB45-CTR (concrete/terrazzo) ring must be used (ring sold separately). The cover assemblies are available in six (6) powder coat finishes: black (BK), gray (GY), brass (BS), nickel (NK), aluminum (AL) and bronze (BZ).

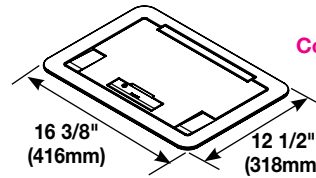

Country of Origin: India

EFB45-CTR

Bare Concrete/Terrazzo Trim Ring – Nonmetallic ring for use with bare concrete and terrazzo floor applications.

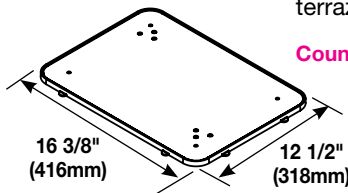

Country of Origin: USA

NOTE: Ring must be attached to the floor box before pouring concrete or terrazzo.

EFB45-Template

Floor Box Template – Designed to help mark out floor to insure a proper fit.

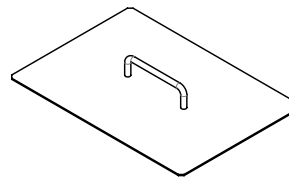

Country of Origin: USA

EFB45-TS

Tile Shim – Used for floor coverings greater than 3/16" (4.7mm). The EFB45-TS allows the finished cover assembly to be flush with the finished floor. Includes one (1) 1/16" (1.6mm), one (1) 1/8" (3.2mm) and one 1/4" (6.4mm) tile shims for 7/16" (11.1mm) of upward adjustment.

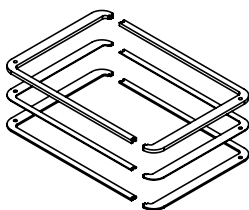

Country of Origin: USA

Evolution Series Fire Classified 6-Gang Floor Box Ordering Information

EFB6S-FC

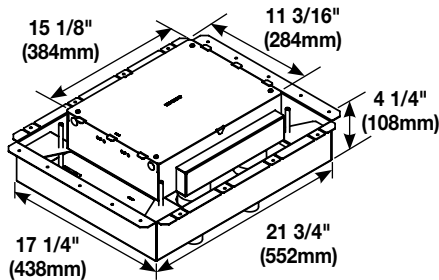

6-Gang Fire Classified Floor Box – Pre-assembled installation ready floor box has been designed to be installed in above grade concrete floors while maintaining the fire classification of the floor. This box is classified to be used in the 2-hour fire rated floors. Designed to accept standard size wall plates. **Box comes complete with all components needed for initial installation.**

Country of Origin: USA

Components Included:

- Protective/Disposable Cover
- Tunnel System connects the two modules of compartments
- Fire Classified Pan
- Two (2) Removable Modules
 - Back Box (1 per module)
 - Device Mounting Brackets (1 per module)
 - Removable Repositionable Divider (1 per module)
- Four (4) 1 1/4" (32mm) Intumescent Conduit Feeds
- Two (2) Cable Management Guides

Items not included with the box and sold separately:

- Receptacles
- Communication Jacks
- A/V Devices
- Device plates



NOTES: Designed for new construction applications.

Consult structural engineer before making cuts into decking. Add additional supports as instructed by the structural engineer.

When used on bare (polished) concrete or terrazzo floors EFB610-CTR must be used. (Sold separately.)

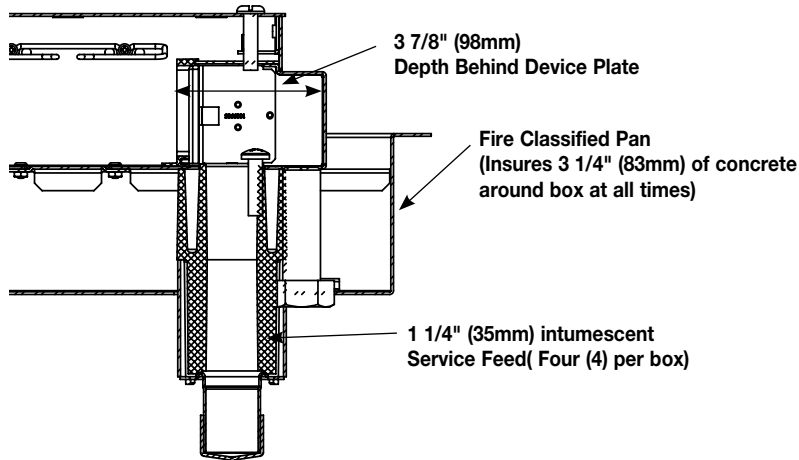

Evolution Series Fire Classified 6-Gang Floor Box Ordering Information

EFB6S-FC1122

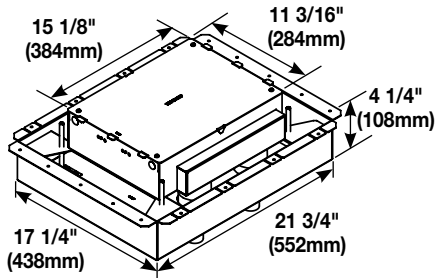

6-Gang Fire Classified Floor Box – Pre-assembled installation ready floor box has been designed to be installed in above grade concrete floors while maintaining the fire classification of the floor. This box is classified to be used in 1-, 1 1/2-, 2-, or 3-hour fire rated floors. Designed to accept standard size wall plates. **Box comes complete with all components needed for initial installation.**

Country of Origin: USA

Components Included:

- Protective/Disposable Cover
- Tunnel System connects the two modules of compartments
- Fire Classified Pan
- Two (2) Removable Modules
 - Back Box (1 per module)
 - Device Mounting Brackets (1 per module)
 - Removable Repositionable Divider (1 per module)
- Two (2) 1 1/4" (32mm) Intumescent Conduit Feeds
- Two (2) 2" (51mm) Intumescent Conduit Feeds
- Two (2) Cable Management Guides

Items not included with the box and sold separately:

- Receptacles
- Communication Jacks
- A/V Devices
- Device plates



NOTES: Designed for new construction applications.

Consult structural engineer before making cuts into decking. Add additional supports as instructed by the structural engineer.

When used on bare (polished) concrete or terrazzo floors EFB610-CTR must be used. (Sold separately.)

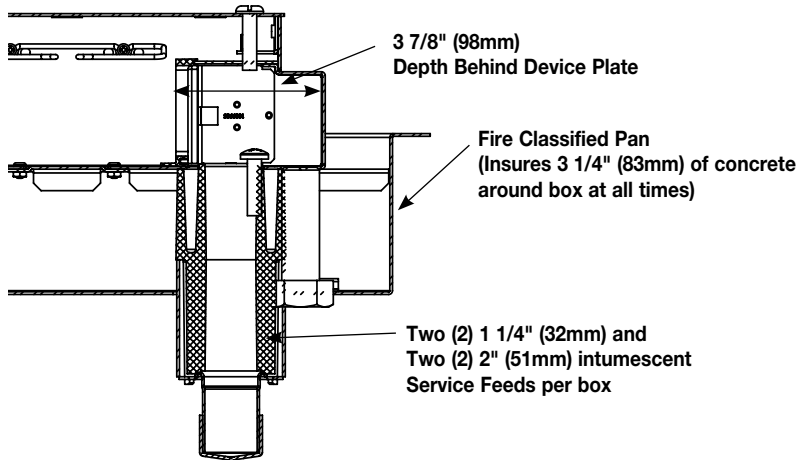

Evolution Series Fire Classified 6-Gang Floor Box Ordering Information

EFB6S-FC2222

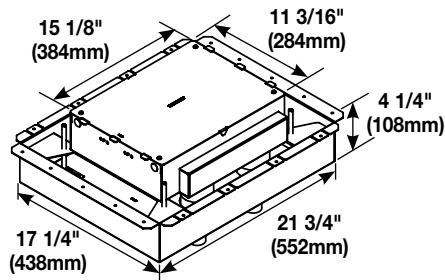

6-Gang Fire Classified Floor Box – Pre-assembled installation ready floor box has been designed to be installed in above grade concrete floors while maintaining the fire classification of the floor. This box is classified to be used in 1-, 1 1/2-, 2-, or 3-hour fire rated floors. Designed to accept standard size wall plates. **Box comes complete with all components needed for initial installation.**

Country of Origin: USA

Components Included:

- Protective/Disposable Cover
- Tunnel System connects the two modules of compartments
- Fire Classified Pan
- Two (2) Removable Modules
 - Back Box (1 per module)
 - Device Mounting Brackets (1 per module)
 - Removable Repositionable Divider (1 per module)
- Four (4) 2" (51mm) Intumescent Conduit Feeds
- Two (2) Cable Management Guides

Items not included with the box and sold separately:

- Receptacles
- Communication Jacks
- A/V Devices
- Device plates



NOTES: Designed for new construction applications.

Consult structural engineer before making cuts into decking. Add additional supports as instructed by the structural engineer.

When used on bare (polished) concrete or terrazzo floors EFB610-CTR must be used. (Sold separately.)

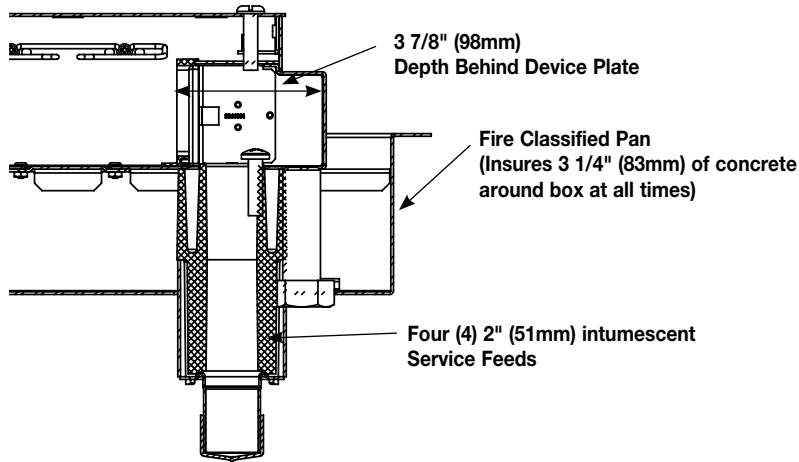

Evolution Series Fire Classified 6-Gang Floor Box Accessories Ordering Information

EFB6-MB

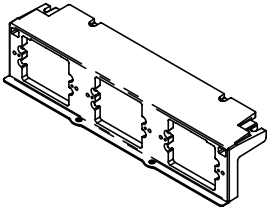

Mounting Bracket – Holds up to three (3) devices of power, communications or A/V devices. Bracket accepts standard size (2 3/4" x 4 1/2" (70mm x 114mm)) device plates sold separately by others.

Country of Origin: USA

EFB-B

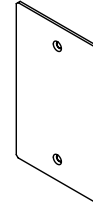

Blank Device Plate – Device plate dimensions: 2 3/4" x 4 1/2" (69mm x 114mm).

Country of Origin: USA

EFB-AAP

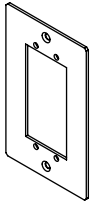

Device Plate – Holds two (2) Extron Electronics AAP devices. Device plate dimensions: 2 3/4" x 4 1/2" (69mm x 114mm).

Country of Origin: USA

EFB6-TUN

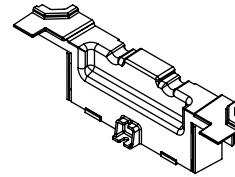

Tunnel – 6-gang tunnel allows for cables to be wrapped around box from one module to the other.

Country of Origin: USA

EFB-MAAP



Device Plate – Holds four (4) Legrand AVIP or Extron Electronics MAAP devices. Device plate dimensions: 2 3/4" x 4 1/2" (69mm x 114mm).

Country of Origin: USA

EFB6-DIV

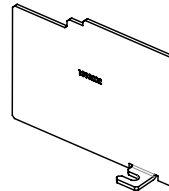

Relocatable Divider – Provides separation of services. Includes one (1) divider plate.

Country of Origin: USA

EFB-MOS

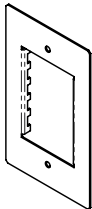

Device Plate – European device plate accepts up to 45mm x 67.5mm Arteor device. Device plate dimensions: 2 3/4" x 4 1/2" (69mm x 114mm).

Country of Origin: USA

NOTE: Not designed for use with adorne devices.

EFBCMG

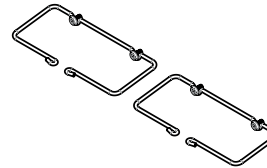

Cable Management Guides – Guides help organize and maintain cable position when opening and closing the cover.

Country of Origin: USA

Evolution Series Fire Classified 8-Gang Floor Box Ordering Information

EFB8S-FC

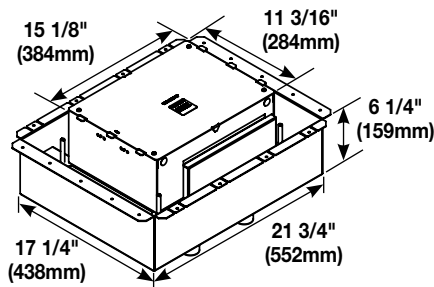

8-Gang Fire Classified Floor Box – Pre-assembled installation ready floor box has been designed to be installed in above grade concrete floors while maintaining the fire classification of the floor. This box is classified to be used in 2-hour fire rated floors. Designed to accept standard size wall plates. **Box comes complete with all components needed for initial installation.**

Country of Origin: USA

Components Included:

- Protective/Disposable Cover
- Tunnel System connects the two modules of compartments
- Fire Classified Pan
- Two (2) Removable Modules
 - Back Box (1 per module)
 - Device Mounting Brackets (1 per module)
 - Removable Repositionable Divider (1 per module)
- Four (4) 1 1/4" (32mm) Intumescent Conduit Feeds
- Two (2) Cable Management Guides

Items not included with the box and sold separately:

- Receptacles
- Communication Jacks
- A/V Devices
- Device plates



NOTES: Designed for new construction applications.

Consult structural engineer before making cuts into decking. Add additional supports as instructed by the structural engineer.

When used on bare (polished) concrete or terrazzo floors EFB610-CTR must be used. (Sold separately.)

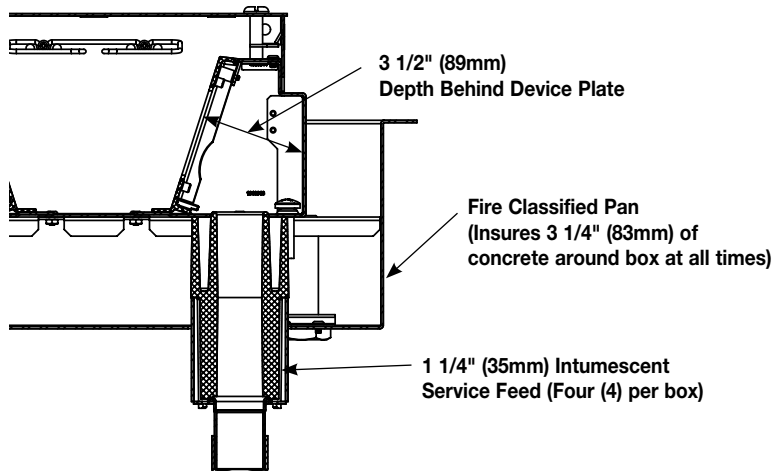

Evolution Series Fire Classified 8-Gang Floor Box Ordering Information

EFB8S-FC1122

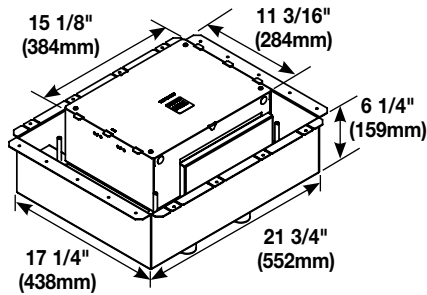

8-Gang Fire Classified Floor Box – Pre-assembled installation ready floor box has been designed to be installed in above grade concrete floors while maintaining the fire classification of the floor. This box is classified to be used in 1-, 1 1/2-, 2-, or 3-hour fire rated floors. Designed to accept standard size wall plates. **Box comes complete with all components needed for initial installation.**

Country of Origin: USA

Components Included:

- Protective/Disposable Cover
- Tunnel System connects the two modules of compartments
- Fire Classified Pan
- Two (2) Removable Modules
 - Back Box (1 per module)
 - Device Mounting Brackets (1 per module)
 - Removable Repositionable Divider (1 per module)
- Two (2) 1 1/4" (32mm) Intumescent Conduit Feeds
- Two (2) 2" (51mm) Intumescent Conduit Feeds
- Two (2) Cable Management Guides

Items not included with the box and sold separately:

- Receptacles
- Communication Jacks
- A/V Devices
- Device plates



NOTES: Designed for new construction applications.

Consult structural engineer before making cuts into decking. Add additional supports as instructed by the structural engineer.

When used on bare (polished) concrete or terrazzo floors EFB610-CTR must be used. (Sold separately.)

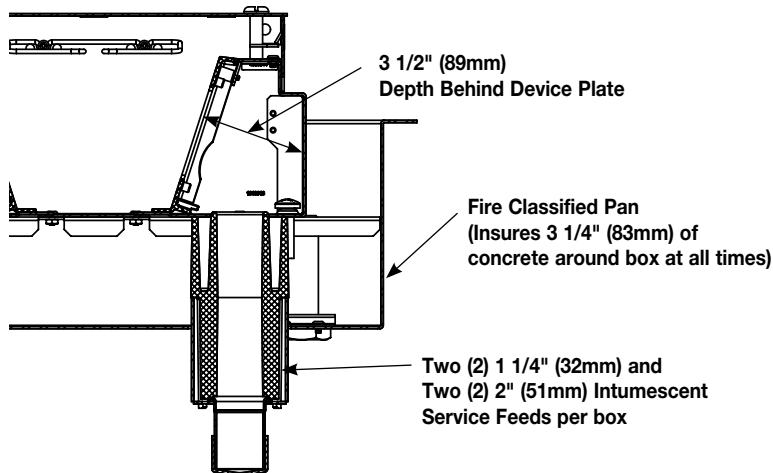

Evolution Series Fire Classified 8-Gang Floor Box Ordering Information

EFB8S-FC2222

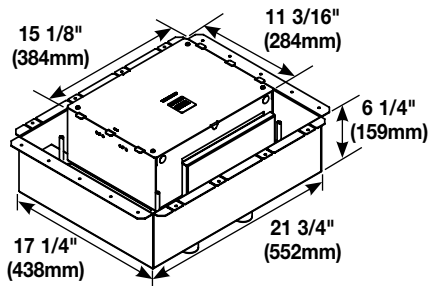

8-Gang Fire Classified Floor Box – Pre-assembled installation ready floor box has been designed to be installed in above grade concrete floors while maintaining the fire classification of the floor. This box is classified to be used in 1-, 1 1/2-, 2-, or 3-hour fire rated floors. Designed to accept standard size wall plates. **Box comes complete with all components needed for initial installation.**

Country of Origin: USA

Components Included:

- Protective/Disposable Cover
- Tunnel System connects the two modules of compartments
- Fire Classified Pan
- Two (2) Removable Modules
 - Back Box (1 per module)
 - Device Mounting Brackets (1 per module)
 - Removable Repositionable Divider (1 per module)
- Four (4) 2" (51mm) Intumescent Conduit Feeds
- Two (2) Cable Management Guides

Items not included with the box and sold separately:

- Receptacles
- Communication Jacks
- A/V Devices
- Device plates



NOTES: Designed for new construction applications.

Consult structural engineer before making cuts into decking. Add additional supports as instructed by the structural engineer.

When used on bare (polished) concrete or terrazzo floors EFB610-CTR must be used. (Sold separately.)

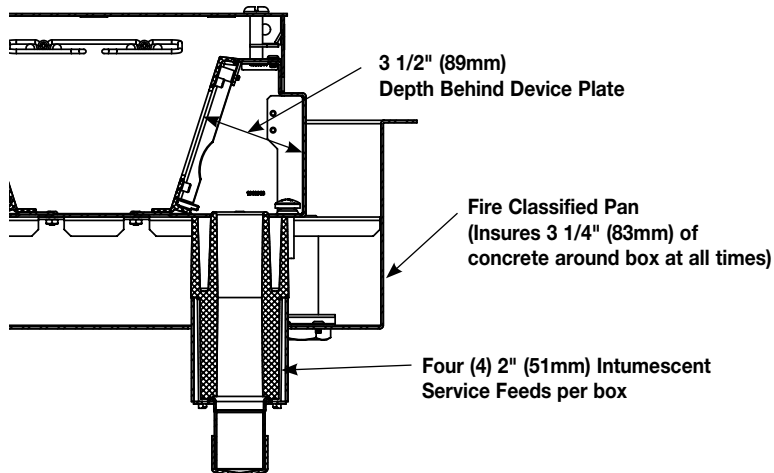

Evolution Series Fire Classified 8-Gang Floor Box Accessories Ordering Information

EFB8-MB

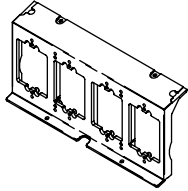

Mounting Bracket – Holds up to four (4) devices for power, communications or aA/V. Bracket accepts standard size (2 3/4" x 4 1/2" (70mm x 114mm)) device plates sold separately by others.

Country of Origin: USA

EFB8S-22GMB

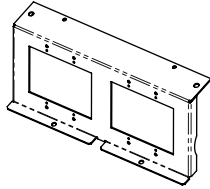

Mounting Bracket – Equipped with two (2) 2-gang standard size device openings for a standard 2-gang (4 9/16" x 4 1/2" (116mm x 114mm)). Ideal for 2-gang A/V devices such as Crestron® 2-gang digital media devices. Device plates and devices supplied by others.

Country of Origin: USA

EFB8S-4GMB

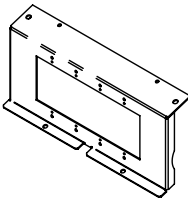

Mounting Bracket – Holds a standard 4 gang device plate. Device plate dimensions: 8 1/8" x 4 1/4" (206mm x 116mm).

Country of Origin: USA

EFB-AAP

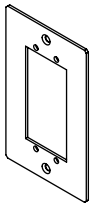

Device Plate – Holds two (2) Extron Electronics AAP devices. Device plate dimensions: 2 3/4" x 4 1/2" (69mm x 114mm).

Country of Origin: USA

EFB-MAAP

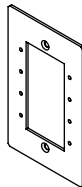

Device Plate – Holds four (4) Legrand AVIP or Extron Electronics MAAP devices. Device plate dimensions: 2 3/4" x 4 1/2" (69mm x 114mm).

Country of Origin: USA

EFB-MOS

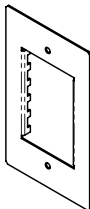

Device Plate – European device plate accepts up to 45mm x 67.5mm Arteor device. Device plate dimensions: 2 3/4" x 4 1/2" (69mm x 114mm).

Country of Origin: USA

NOTE: Not designed for use with adorne devices.

EFB-B

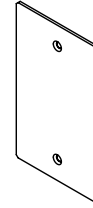

Blank Device Plate – Device plate dimensions: 2 3/4" x 4 1/2" (69mm x 114mm).

Country of Origin: USA

EFB810-DIV

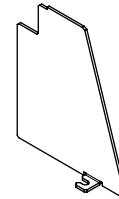

Relocatable Divider – Provides separation of services. Includes one divider plate.

Country of Origin: USA

EFB45-CMG

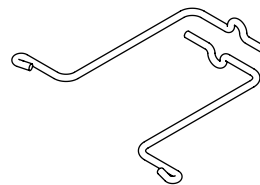

Cable Management Guides – Guides help organize and maintain cable position when opening and closing the cover.

Country of Origin: USA

EFB810-TUN

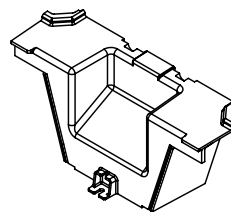

Tunnel – For EFB8 Series and EFB10 Series boxes. Tunnel allows cables to be wrapped around box from one module to the other.

Country of Origin: USA

EFB-50A

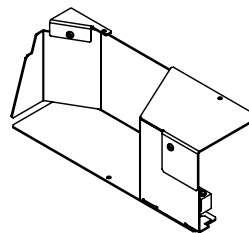

50A Adapter – Allows for a 50A device to be installed on the 8-gang and 10-gang boxes.

Country of Origin: USA

NOTE: Only fits on the side of the floor box where the device is facing the tunnel, as shown below.

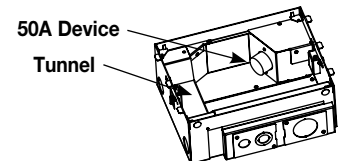

Evolution Series Fire Classified 10-Gang Floor Box Ordering Information

EFB10S-FC

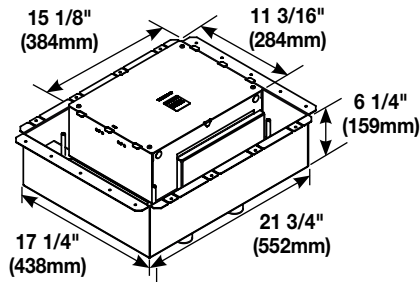

10-Gang Fire Classified Floor Box – Pre-assembled installation ready floor box has been designed to be installed in above grade concrete floors while maintaining the fire classification of the floor. This box is classified to be used in 2-hour fire rated floors. Designed to accept standard size wall plates. **Box comes complete with all components needed for initial installation.**

Country of Origin: USA

Components Included:

- Protective/Disposable Cover
- Tunnel System connects the two modules of compartments
- Fire Classified Pan
- Two (2) Removable Modules
 - Back Box (1 per module)
 - Device Mounting Brackets (1 per module)
 - Removable Repositionable Divider (1 per module)
- Four (4) 1 1/4" (32mm) Intumescent Conduit Feeds
- Two (2) Cable Management Guides

Items not included with the box and sold separately:

- Receptacles
- Communication Jacks
- A/V Devices
- Device plates



NOTES: Designed for new construction applications.

Consult structural engineer before making cuts into decking. Add additional supports as instructed by the structural engineer.

When used on bare (polished) concrete or terrazzo floors EFB610-CTR must be used. (Sold separately.)

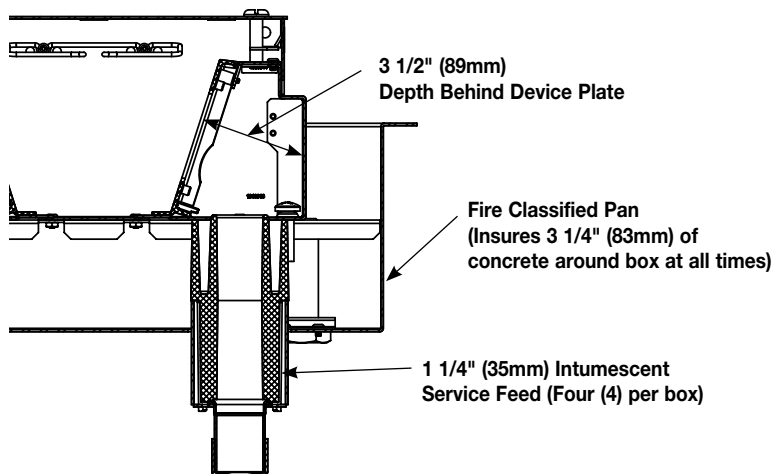

Evolution Series Fire Classified 10-Gang Floor Box Ordering Information

EFB10S-FC1122

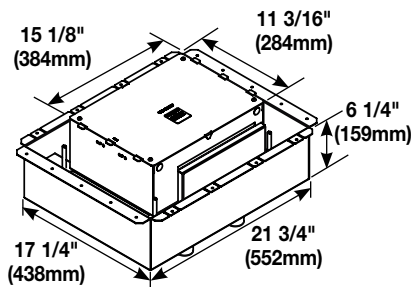

10-Gang Fire Classified Floor Box – Pre-assembled installation ready floor box has been designed to be installed in above grade concrete floors while maintaining the fire classification of the floor. This box is classified to be used in 1-, 1 1/2-, 2-, or 3-hour fire rated floors. Designed to accept standard size wall plates. **Box comes complete with all components needed for initial installation.**

Country of Origin: USA

Components Included:

- Protective/Disposable Cover
- Tunnel System connects the two modules of compartments
- Fire Classified Pan
- Two (2) Removable Modules
 - Back Box (1 per module)
 - Device Mounting Brackets (1 per module)
 - Removable Repositionable Divider (1 per module)
- Two (2) 1 1/4" (32mm) Intumescent Conduit Feeds
- Two (2) 2" (51mm) Intumescent Conduit Feeds
- Two (2) Cable Management Guides

Items not included with the box and sold separately:

- Receptacles
- Communication Jacks
- A/V Devices
- Device plates



NOTES: Designed for new construction applications.

Consult structural engineer before making cuts into decking. Add additional supports as instructed by the structural engineer.

When used on bare (polished) concrete or terrazzo floors EFB610-CTR must be used. (Sold separately.)

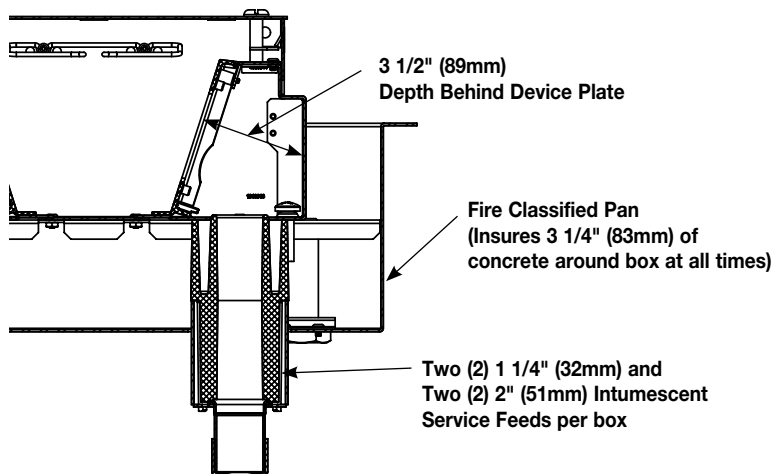

Evolution Series Fire Classified 10-Gang Floor Box Ordering Information

EFB10S-FC2222

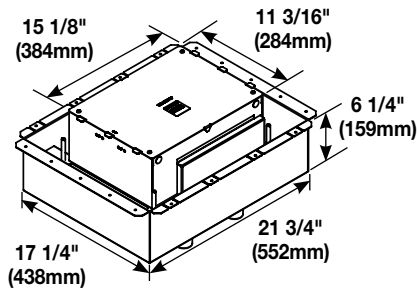

10-Gang Fire Classified Floor Box – Pre-assembled installation ready floor box has been designed to be installed in above grade concrete floors while maintaining the fire classification of the floor. This box is classified to be used in 1-, 1 1/2-, 2-, or 3-hour fire rated floors. Designed to accept standard size wall plates. **Box comes complete with all components needed for initial installation.**

Country of Origin: USA

Components Included:

- Protective/Disposable Cover
- Tunnel System connects the two modules of compartments
- Fire Classified Pan
- Two (2) Removable Modules
 - Back Box (1 per module)
 - Device Mounting Brackets (1 per module)
 - Removable Repositionable Divider (1 per module)
- Four (4) 2" (51mm) Intumescent Conduit Feeds
- Two (2) Cable Management Guides

Items not included with the box and sold separately:

- Receptacles
- Communication Jacks
- A/V Devices
- Device plates



NOTES: Designed for new construction applications.

Consult structural engineer before making cuts into decking. Add additional supports as instructed by the structural engineer.

When used on bare (polished) concrete or terrazzo floors EFB610-CTR must be used. (Sold separately.)

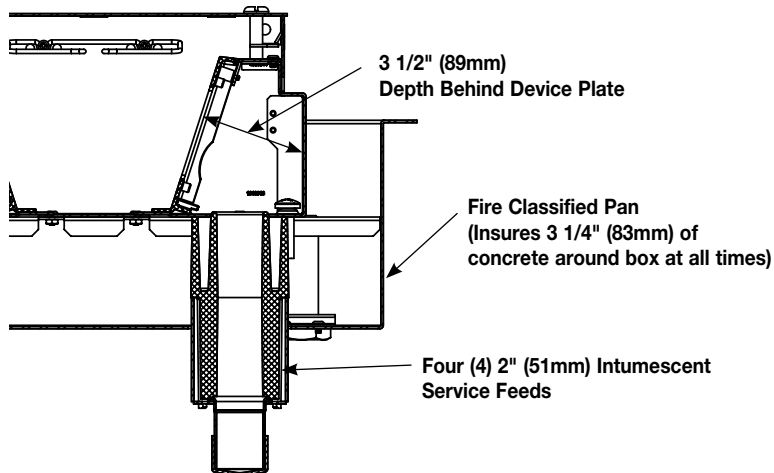

Evolution Series Fire Classified 10-Gang Floor Box Accessories Ordering Information

EFB10-MB

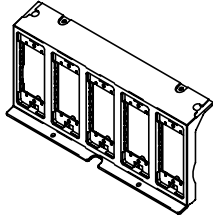

Mounting Bracket – Holds up to five (5) devices for power, communications or A/V. Bracket accepts EFB10 Series device plates (2 1/32" x 4 5/8") (58mm x 117mm) device plates sold separately.

Country of Origin: USA

EFB10S-23GMB

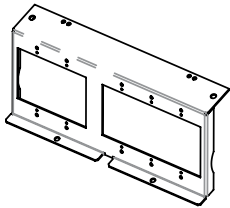

Mounting Bracket – Equipped with one 2-gang standard size device opening and one 3-gang standard size device opening. Accepts a standard 2-gang (4 9/16" x 4 1/2" (116mm x 114mm)) and a 3-gang (6 3/8" x 4 1/2" (162mm x 114mm)) device plate. Ideal for 2-gang A/V devices such as Crestron®, 2-gang and 3-gang digital media devices. Device plates and devices supplied by others.

Country of Origin: USA

EFB10S-5GMB

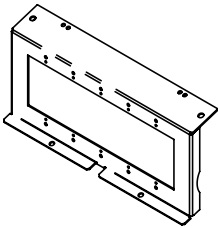

Mounting Bracket – Holds a standard 5 gang device plate. Device plate dimensions: 10" x 4 1/2" (254mm x 116mm).

Country of Origin: USA

EFB10-B



Blank Device Plate – Device plate dimensions: 2 5/16" x 4 5/8" (58mm x 118mm).

Country of Origin: USA

EFB10-DP

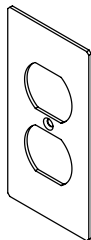

Duplex Device Plate – Device plate dimensions: 2 5/16" x 4 5/8" (58mm x 118mm). Includes receptacle spacers.

Country of Origin: USA

EFB10-DEC

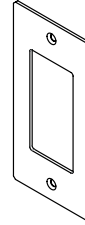

Decorator Style Device Plate – For use with decorator style receptacles, GFCI receptacle, and decorator style A/V devices. Device plate dimensions: 2.3" x 4.652" (58mm x 118mm). Includes receptacle spacers.

Country of Origin: USA

EFB10-S1

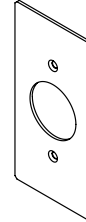

Single Receptacle Device Plate – Single receptacle 1.39" (35mm) diameter. Device plate dimensions: 2.3" x 4.652" (58mm x 118mm). Includes receptacle spacers.

Country of Origin: USA

EFB10-S2

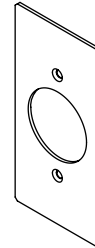

Single Receptacle Device Plate – Single receptacle 1.59" (40mm) diameter. Device plate dimensions: 2.3" x 4.652" (58mm x 118mm). Includes receptacle spacers.

Country of Origin: USA

EFB10-6AB

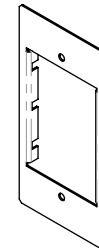

Device Plate – Accepts up to three (3) dual Wiremold CM2 Series Open System communication adapters. Adapters sold separately. Device plate dimensions: 2.3" x 4.652" (58mm x 118mm).

Country of Origin: USA

EFB10-3S2

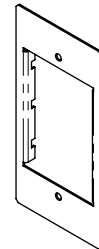

Device Plate – Accepts up to three (3) Ortronics® Series II devices. Ortronics® devices sold separately. Device plate dimensions: 2.3" x 4.652" (58mm x 118mm).

Country of Origin: USA

EFB10-2C

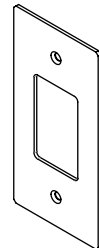

Device Plate – Accepts one dual Wiremold Open System adapter, or one Ortronics® Series II adapter, or one Ortronics® TracJack adapter. Adapters sold separately. Device plate dimensions: 2.3" x 4.652" (58mm x 118mm).

Country of Origin: USA

Evolution Series Fire Classified 10-Gang Floor Box Accessories Ordering Information

EFB10-AAP

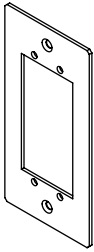

Device Plate – Holds two (2) Extron Electronics AAP devices. Device plate dimensions: 2.3" x 4.652" (58mm x 118mm).

Country of Origin: USA

5507S-WH

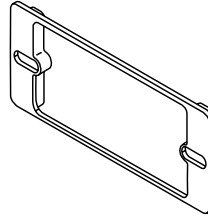

Rectangular Spacer – For mounting commercial device plates. Installs between the device bracket and a device.

Country of Origin: USA

EFB10-MAAP

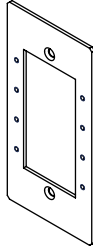

Device Plate – Holds four (4) Legrand AVIP or Extron Electronics MAAP devices. Device plate dimensions: 2.3" x 4.652" (58mm x 118mm).

Country of Origin: USA

5507T1-WH

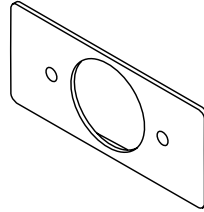

Single Receptacle Faceplate – For covering single receptacles – 1.59" (40mm) in diameter.

Country of Origin: USA

EFB10-MOS

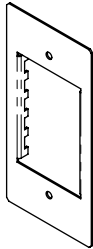

Device Plate – (45mm x 67.5mm) device plate. Device plate dimensions: 2.3" x 4.652" (58mm x 118mm).

Country of Origin: USA

5507T2-WH

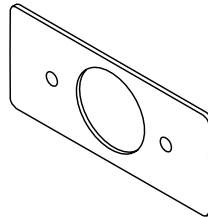

Single Receptacle Faceplate – For covering single receptacles – 1.41" (36mm) in diameter.

Country of Origin: USA

5507B-WH

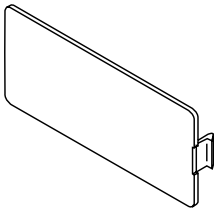

Blank Faceplate – For covering unused compartments in the device bracket.

Country of Origin: USA

55074TJ-WH

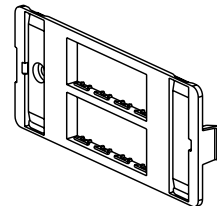

Ortronics® Faceplate – For mounting Ortronics® datacom inserts. Accepts four (4) TracJack devices.

Country of Origin: USA

5507D-WH

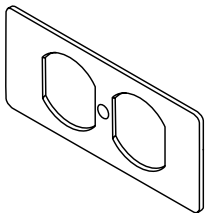

Duplex Receptacle Faceplate – For covering duplex style devices. Also accepts 106 communications frame.

Country of Origin: USA

55076TJ-WH

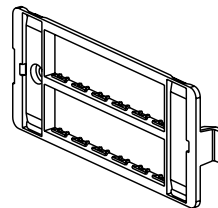

Ortronics® Faceplate – For mounting Ortronics® datacom inserts. Accepts six (6) TracJack devices.

Country of Origin: USA

5507R-WH

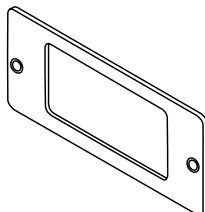

Rectangular Receptacle Faceplate – For covering rectangular decorator style devices.

Country of Origin: USA

EFB810-TUN

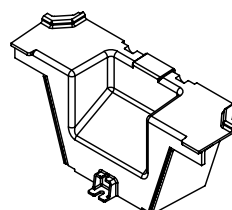

Tunnel – For EFB8 Series and EFB10 Series boxes. Tunnel allows cables to be wrapped around box from one module to the other.

Country of Origin: USA

Evolution Series Fire Classified 10-Gang Floor Box Accessories Ordering Information

EFB810-DIV

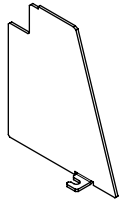

Relocatable Divider – Provides separation of services. Includes one divider plate.

Country of Origin: USA

EFB-50A

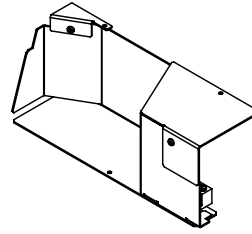

50A Adapter – Allows for a 50A device to be installed on the 8-gang and 10-gang boxes.

Country of Origin: USA

NOTE: Only fits on the side of the floor box where the device is facing the tunnel, as shown below.

EFB45-CMG

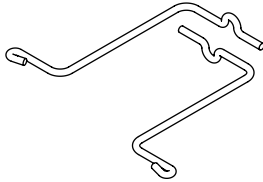

Cable Management Guides – Guides help organize and maintain cable position when opening and closing the cover.

Country of Origin: USA

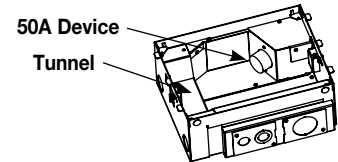

Evolution Series Fire Classified 10-Gang Floor Box Covers Ordering Information

EFB610CTCBK
EFB610CTCGY
EFB610CTCBS
EFB610CTCNK
EFB610CTCBZ

Surface Style Cover with Carpet Insert – Die cast aluminum cover assembly designed to be used on top of the floor covering. Available in the following powder coated finishes: black (BK), gray (GY), brass (BS), nickel (NK) and bronze (BZ). For use on Evolution Series 6-, 8- and 10-gang floor boxes (EFB6, EFB8 and EFB10).

Country of Origin: India

NOTE: Depth of recess area in plate is 1/4" (6.35mm).

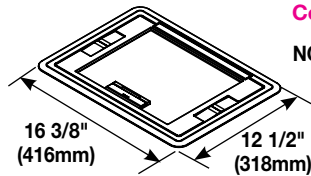

EFB610BTCBK
EFB610BTCGY
EFB610BTCBS
EFB610BTCNK
EFB610BTCBZ

Surface Style Cover with Solid Lid – Die cast aluminum cover assembly designed to be used on top of floor covering. Available in the following powder coated finishes: black (BK), gray (GY), brass (BS), nickel (NK) and bronze (BZ). For use on Evolution Series 6-, 8- and 10-gang floor boxes (EFB6, EFB8 and EFB10).

Country of Origin: India

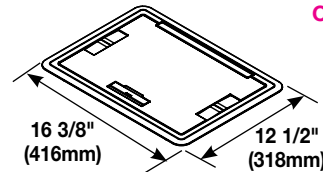

EFB610CTBK
EFB610CTGY
EFB610CTBS
EFB610CTNK
EFB610CTBZ

Flush Style Cover with Carpet Insert – Die cast aluminum cover assembly designed to be used level (flush) with finish floor covering. Available in the following powder coated finishes: black (BK), gray (GY), brass (BS), nickel (NK) and bronze (BZ). For use on Evolution Series 6-, 8- and 10-gang floor boxes (EFB6, EFB8 and EFB10).

Country of Origin: India

NOTE: Depth of recess area in plate is 1/4" (6.35mm).

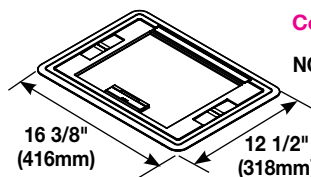

EFB610BTBK
EFB610BTGY
EFB610BTBS
EFB610BTNK
EFB610BTBZ

Flush Style Cover with Solid Lid – Die cast aluminum cover assembly designed to be used on top of floor covering. Available in the following powder coated finishes: black (BK), gray (GY), brass (BS), nickel (NK) and bronze (BZ). For use on Evolution Series 6-, 8- and 10-gang floor boxes (EFB6, EFB8 and EFB10).

Country of Origin: India

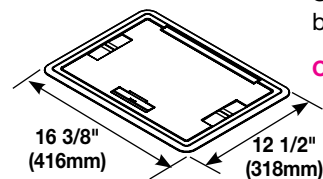

Evolution Series Fire Classified 10-Gang Floor Box Covers Ordering Information

EFB610CTR

Bare Concrete/Terrazzo Trim Ring – Nonmetallic ring for use with bare concrete and terrazzo floor applications.

Country of Origin: USA

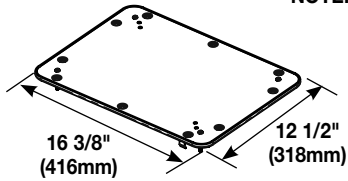

NOTE: Ring must be attached to the floor box before pouring concrete or terrazzo.

EFB610TS

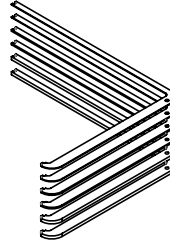

Tile Shim – Used for floor coverings greater than 3/16" (4.7mm). The EFB610-TS allows the finished cover assembly to be flush with the finished floor. Includes one (1) 1/16" (1.6mm), one (1) 1/8" (3.2mm) and one 1/4" (6.4mm) tile shims for 7/16" (11.1mm) of upward adjustment.

Country of Origin: USA

NOTE: All brand and product names referenced in this document are registered trademarks or trademarks of their respective holders.



NOTE: The paper used to print this document is an environmentally responsible paper with 10% post consumer waste, with FSC and SFI Chain of Custody certifications, Lacey Act complaint. 100% of the electricity used to manufacture Flo sheets is generated with Green-e certified renewable energy.



Legrand, North America
60 Woodlawn Street
West Hartford, CT 06110
1.877.BY.LEGRAND (295.3472)
www.legrand.us

Canada
905.738.9195
www.legrand.ca

FOLLOW US

