

Meter Mounting Equipment

MD – DC – N.VA Area

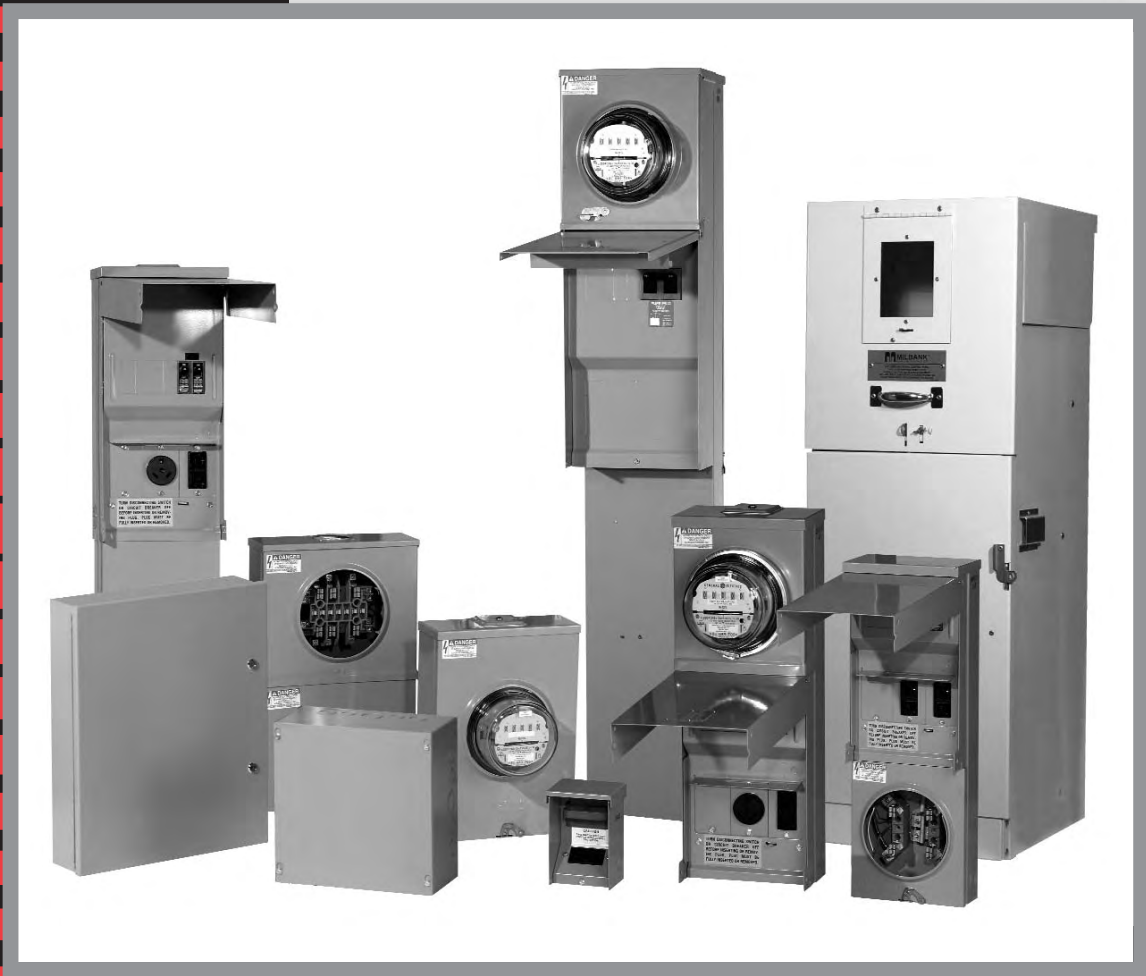

MILBANK®





Charles A. Milbank
1879-1966



Bill Martin



Robert F. Waldrop,
1922-2002



Robert F. Waldrop, II
Chairman



Katrina Waldrop Henke
Vice Chairman

Milbank—Quality Metering Products for over 75 Years

Milbank Manufacturing Company was established in 1927 by Charles A. Milbank. Originally, the company manufactured high voltage switches; however, by 1941 Milbank devoted itself primarily to the manufacture of sheet metal enclosures and related equipment for the electrical generation and distribution industry. Today we are an industry leader in the manufacture of electrical meter sockets. Through a national network of manufacturer's representatives we provide wholesale electrical distributors with quality electrical products for the utility, contractor, industrial and OEM markets.

As the meter standards have changed, Milbank has been successful in adapting its product line to these changes. Our full scale engineering department designs products to meet customer specifications and satisfy all utility requirements.

Milbank's employee base of over 1,000 with our five manufacturing facilities comprising almost 550,000 square feet gives us the flexibility to schedule, produce, and ship orders quickly. Currently, Milbank manufactures over 10,000 different catalog items, and this list continues to grow. Our unique product offering includes: & Commercial Meter Sockets; & Commercial Meter Pedestals; RV/MH Power Outlets, Pedestals, and Transformers; Commercial & Industrial Electrical Enclosures; Circuit Breakers; Disconnects & Safety Switches; Safety Sockets; Utility & Secondary Pedestals; Hubs and related accessories. If you don't find a unit in this catalog to service your needs, send us your specifications and we will be happy to work with you.

Our success has come from a loyal customer base that can rely on us to build quality products at a fair price in a timely manner.

Our willingness and ability to design and produce new products to meet our customer demands is an important factor to remain competitive in today's electrical market.

Milbank has been serving the electric utility & wholesale distribution industries for over 75 years with innovative, quality engineered products. So remember us for all of your meter mounting and related requirements, and we will be happy to serve you as we have in the past—with dependable service and quality products!

We take great pride in being one of the few family-owned businesses left in our industry. We are a third generation run business and truly believe that...

***FAMILY MAKES A
DIFFERENCE!***

CATALOG NO.	UPC	DESCRIPTION	PAGE
DISCONNECTS			
U3803	13903	30A Fusible ACD	5
U3806	13904	60A Fusible ACD	5
U3800	13902	60A Non Fusible ACD	5
U3822-20GR	28282	60A N-F ACD/ 20A GFCI	6
U4881-O	36949	Hot Tub Disc Brk Prov	6
U4881-O-50GB	26815	50A Hot Tub Disc	6
U4881-O-60GB	27930	60A Hot Tub Disc	6

SINGLE POSITION METERING
125-200 amp-4, 5 & 7 Terminal-Ringless-600 VAC

U7487-YL-TG-KK-BLG	24178	125A 4T RL OH	7
U7040-XL-TG-KK	14039	200A 4T RL OH	7
U7040-RL-KK-DPL	37108	200A 4T RL OH	7
S1619-XL	12073	200A 4T RL Stud OH	7
U3126-O-KK-BLG	24174	200A 4T RL SWY UG	8
U1980-O-KK-DPL	37109	200A 4T RL SWY UG	8
U2986-O-PEP	23936	200A 4T RL SWY Stud UG	8
U7423-RXL	14100	200A 7T RL MD LVR OU	9
U4029-X-DPL	37114	200A 7T RL MD LVR OU	9
U9551-X-DPL	37115	200A 5T RL HD LVR OU	9
S3970-XL	27377	200A 5T RL Stud HD LVR OH	9
U9700-RRL-BLG	24194	200A 7T RL HD LVR OH	9
S8930-XL	27376	200A 7T RL Stud HD LVR OH	9
U3786-O-BLG	24650	200A 7T RL SWY MD LVR UG	9

SINGLE POSITION METERING
320 - 480 amp-4, 5 & 7 Terminal-Ringless-600 VAC

U4433-X	26860	320A 4T RL SWY Stud LVT OU	10
U4980-X	27983	320A 4T RL SWY Stud HD LVR OU	10
U2120-X	13466	320A 7T RL SWY Stud HD LVR UG	10
U4168-X-K7-BLG	24475	320A 7T RL SWY HD LVR OU	10
U1779-R-K3-BLG	24594	320A 4T RL Stud HD LVR OH	10
U1729-X-DPL	37110	320A 4T RL HD LVR UG	10
U1797-O-K3L-K2L	30172	320A 4T RL SWY HD LVR UG	10
U4664-X-8522-DPL	47868	480A Cont/600 Max 4T OU	11
U4667-X-8043-DPL	47869	480A Cont/600 Max 7T OU	11

MULTIPLE METERING
100 - 200 amp/Position-4 & 5 Terminal- Horizontal Gangs-Ringless-600 VAC

U8032-XL-KK-BLG	24179	100A 4T RL 2P Ctr Wy	12
U8033-XL-KK-BLG	24180	100A 4T RL 3P Ctr Wy	12
U8034-XL-KK-BLG	24181	100A 4T RL 4P Ctr Wy	12
U8035-XL-KK-BLG	24182	100A 4T RL 5P Ctr Wy	12
U8036-XL-KK-BLG	24183	100A 4T RL 6P Ctr Wy	12
U8212-XL-KK-BLG	24184	100A 4T RL 2P End Wy	13
U8213-XL-KK-BLG	24185	100A 4T RL 3P End Wy	13
U8214-XL-KK-BLG	24186	100A 4T RL 4P End Wy	13
U8215-XL-KK-BLG	24187	100A 4T RL 5P End Wy	13
U8216-XL-KK-BLG	24188	100A 4T RL 6P End Wy	13
U1252-X-KK-K3-BLG	24169	200A 4T RL 2P Ctr Wy	14
U1252-X-KK-K3-DPL	37111	200A 4T RL 2P Ctr Wy	14
U1253-X-KK-K3-BLG	24170	200A 4T RL 3P Ctr Wy	14
U1254-X-KK-K3-BLG	24171	200A 4T RL 4P Ctr Wy	14
U1254-X-KK-K3-DPL	37112	200A 4T RL 4P Ctr Wy	14
U1255-X-KK-K3-BLG	24172	200A 4T RL 5P Ctr Wy	14
U1256-X-KK-K3-BLG	24173	200A 4T RL 6P Ctr Wy	14
U1256-X-KK-K4-DPL	37113	200A 4T RL 6P Ctr Wy	14

CT CABINETS & TRANS SOCKETS

363612-CT3R	19831	CT Enc Type3R Hinged Pdlk	15
484812-CT3R	20269	CT Enc Type3R Hinged Pdlk	15
U4051-O	25421	10X36X28 Trans Encl	15
S4244-X	28632	400A 13T RL 600V TS	15

CATALOG NO.	UPC	DESCRIPTION	PAGE
COMMERCIAL PEDESTALS & ACCESSORIES			
CP3B52119A22AOSP	N/A	200A RL HDLB	17
CP3B52110A22AOSL1	N/A	200A RL HDLB SL	17
CP-ABK5/8	16490	Anchor Bolt Kit	17
CP-16PDMNT-CALT	16485	Ped Mounting Base	17
K3865	11401	5th Term Assy RL	17
105J	10082	5th Term Assy RT	17
CP-TC7D	31795	7-day Time Clock Kit	17
CP-TC24H	31794	24-hour Time Clock Kit	17
CP-TCWIRE	31864	Wiring harness	17
CP-PE-HOA-3POS	47696	Photoelectric cell kit	17

MISCELLANEOUS
Milbank Accessories

Z703916-AC	24044	Conn 1P 3/0-800 kcmil	18
Z703917-AC	24724	Conn 2P 6-350 kcmil	18
Z703918-AC	24045	Conn 2P 4-350 kcmil	18
Z703919-AC	23511	Conn 2P 350 kcmil	18
Z703921-AC	23984	Conn 1P 3/0-800 kcmil	18
Z704693-AC	25111	Conn 2P 500 kcmil-2	18
Z704694-AC	24865	Conn 2P 4-500 kcmil	18
Z705420-AC	24046	Conn 4P 6-350 kcmil	18
Z705456-AC	24047	Conn 2P 6-350 kcmil	18
Z708145-AC	24048	Conn 3P 6-250 kcmil	18
6003	10761	Gray Plastic Closing Plate	19
6116	10763	Clear Plastic Closing Plate	19
5T8K2	10760	5th Term Assy 100/200A Sockets	19
A7514-17	11039	1 Inch Hub Unit	19
A7518	11044	2 1/2 Inch Hub Unit	19
A7551	11046	Std Closing Plate	19
A8110	11047	3 Inch Hub Unit	19
A8111	11048	3 1/2 Inch Hub Unit	19
A8112	11049	4 Inch Hub Unit	19
CP-21	11208	Metal Closing Plate	19
K1350	11329	Twin Lug Assy 350 kcmil 1Ø	19
K1539	11333	Single Lug Assy 350 kcmil 1Ø	19
K1540	11334	Single Lug Assy 600 kcmil 1Ø	19
K1541	11335	Twin Lug Assy 600 kcmil 1Ø	19
K3082	11366	Single Lug Assy 350 kcmil 3Ø	19
K3083	11367	Twin Lug Assy 600 kcmil 3Ø	19
K3441	11387	Single Lug Assy 600 kcmil 3Ø	19
K3442	11388	Twin Lug Assy 350 kcmil 3Ø	19
K5T	21256	5th Term Assy	19
S8324	12819	Hub Adapter Plate	19
S9064	12889	Large Closing Plate	19

Utility Matrix20

Other Milbank Products21

Conduit and Ampacity Information22

Energization of Electrical Equipment23

Catalog Number Logic

U = UL Listed
S = Non-UL Listed
UAP = UL / Alum / Painted

TG = Triplex Ground
QG = Quadplex Ground

KK = Horn By-Pass Provision

Specific Utility Designation

Milbank Drawing Number

Barrel Lock

U7040-RL-TG-KK-5T9-BL-AUT

HUB OPENINGS / CLOSING PLATES

O	Plain Top	WL	1"	For -RL Opening
RL	Small Hub Opening	YL	1¼"	For -RL Opening
R	Large Hub Opening	ZL	1½"	For -RL Opening
XL	Small Closing Plate	DL	2"	For -RL Opening
X	Large Closing Plate	EL	2½"	For -RL Opening
RXL	Large Hub Opening adapted to small Closing Plate.	F	3"	For -R Opening
		G	3½"	For -R Opening
RRL	Large Hub Opening adapted to small Hub Opening	H	4"	For -R Opening

Fifth Terminal Designation

- 5T6 installed at 6:00
- 5T9 installed at 9:00

Barrel Lock / Guard Provision

U2448-X-QG-5T9-K3-BLG-ARE

Milbank Drawing Number

TG = Triplex Ground
QG = Quadplex Ground

Specific Utility Designation

Lugs [1Ø or 3Ø – 350 or 600 kcmil]

- Single [K1, K3, K5, K7]
- Twin [K2, K4, K6, K8]



U3800
(No deadfront required)



U3803



U3806

PROFILE

Milbank's air conditioner disconnect has a removable hinged cover which makes wiring a breeze. Our compact design meets all wire bending space requirements in the NEC and also complies with article 440-14 in the NEC. To insure the safest conditions, we designed our disconnect pullers to be removable or they may be reinstalled in the "off" position. Another safety feature is the padlock provision on the front cover. As with all Milbank products, our enclosure is constructed of G90U galvanized steel and finished with an attractive, light gray, baked powder coating. Our state of the art finish combines epoxy and polyester hybrid resins into a hybrid powder coating which is then electrostatically applied. This offers a durable, nonfading finish.

TECHNICAL INFORMATION

AMP	TYPE	CATALOG NUMBER	MAX H.P.	WT. #	LINE & LOAD WIRE RANGE		GROUND WIRE RANGE	DIMENSIONS			WIRE RATING	
					CU	AL		CU/AL	D"	W"	H"	CU °C
30	FUSIBLE	U3803	3	3.7	#14-#2 AWG	#12-#2 AWG	#12-2 AWG	3	5	9¼	60°/75°	60°
60	FUSIBLE	U3806	10	3.7	#14-#2 AWG	#12-#2 AWG	#12-2 AWG	3	5	9¼	60°/75°	60°
60	NONFUSIBLE	U3800	10	3.25	#14-#2 AWG	#12-#2 AWG	#14-4 AWG	3	5	8	60°/75°	60°/75°

✓ U3800 is UL Listed without deadfront. Line and load terminations are fully insulated.

✓ U3803 & U3806 std. quantity is 6 per carton.

✓ U3800 std. quantity is 20 per carton.

Combination AC Disconnect / 20 Amp GFCI Receptacle—Together in 1 Box

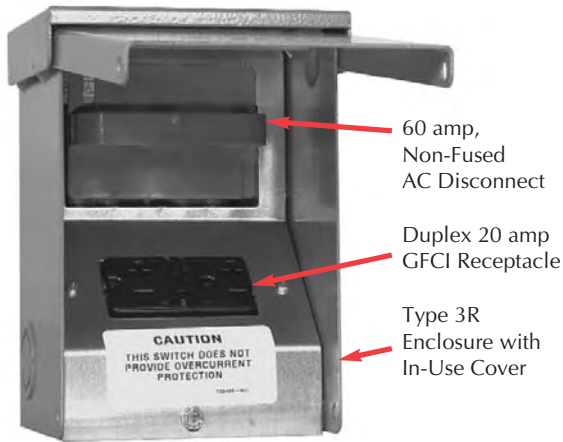

U3822-20GR

- Meets NEC # 210.63 Requirements *
- UL Listed as Power Outlet
- Type 3R Enclosure
- In-Use Cover**
- Duplex Ground Connector
- 1" Concentric Knockouts

AC DISCONNECT

- 1Ø, 240 Volt
- 60 amp, Non-Fused

GFCI RECEPTACLE

- 20 amp
- Reset/Test Button
- Padlock provision

* NEC® #210.63 Heating, Air-Conditioning and Refrigeration Equipment Outlet. ...The receptacle shall be located on the same level and within 7.5 m (25 ft.) of the heating, air-conditioning and refrigeration equipment.
 * NEC® #210.08 Ground-Fault Circuit- Interruptor protection for personnel.

AMP	TYPE	CATALOG NUMBER	MAX H.P.	WT. #	LINE & LOAD CONNECTOR WIRE RANGE		GROUND CONNECTOR WIRE RANGE	DIMENSIONS			WIRE RATING	
					CU	AL	CU/AL	D"	W"	H"	CU °C	AL °C
60	NONFUSIBLE	U3822-20GR	10	6	#14-#2 AWG	#12-#2 AWG	#14-4 AWG	4.8	5.25	7.4	60°/75°	60°/75°

To ensure the safest conditions, Milbank disconnect pullers are designed to be reversible so they may be reinstalled in the OFF position. All units are designed with a padlock provision on the cover for security.

****Note:** U3822-20GR cover rated as *IN-USE COVER* (Cover may be closed with cords plugged into receptacle).

*Reprinted with permission from NFPA 70-2002, *National Electrical Code*®, Copyright 2001, National Fire Protection Association, Quincy, MA 02269. This reprinted material is not the complete and official position of the NFPA on the referenced subject, which is represented only by the standard in its entirety. National Electrical Code® and NEC® are registered trademarks of the National Fire Protection Association, Quincy, MA.

Hot Tub Disconnect or Sub Panel Breaker Enclosure—Type 3R

Spa Box with GFCI Protection



U4881-O-50GB

- 240 volt ground fault protection
- UL listed, Type 3R rainproof
- Milbank reliability
- Easy installation
- 2 pole, 50 amp GFCI breaker protection
- Compact size:
8-1/2" H x 7-1/2" W x 3-3/4" D
- 3 or 4 wire installation
- 1Ø, 120 / 240 VAC
- Standard package of 12
- 2 extra one-pole breaker spaces
- 100 amp overall rating

Sub Panel Breaker Enclosure

- Use as a 100 amp, 4 circuit sub panel enclosure
- U4881-O has provision for (2) 2-pole or (4) 1-pole small frame breakers



AMP	TYPE	CATALOG NUMBER	WT. #	LINE & LOAD CONNECTOR WIRE RANGE		GROUND CONNECTOR WIRE RANGE	DIMENSIONS		
				CU	AL	CU/AL	D"	W"	H"
—	BREAKER PROVISION	U4881-O	7	#14-1/0	#14-1/0	#14-1/0	3 3/4	7 1/2	8 1/2
50	BREAKER	U4881-O-50GB	8	#14-1/0	#14-1/0	#14-1/0	3 3/4	7 1/2	8 1/2
60	BREAKER	U4881-O-60GB	8	#14-1/0	#14-1/0	#14-1/0	3 3/4	7 1/2	8 1/2





U7487-YL-TG-KK-BLG



U7040-XL-TG-KK

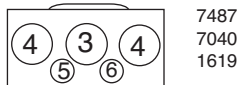
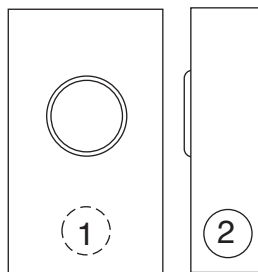

125 & 200 AMP-SINGLE POSITION-4 TERMINAL-RINGLESS-1Ø3W

AMP	SERVICE	CATALOG NUMBER	HUB	CONNECTORS CU/AL	BY-PASS	DIMENSIONS			CONCENTRIC K.O.'S					
						D"	W"	H"	1	2	3	4	5	6
125	OH	U7487-YL-TG-KK-BLG*	1 1/4"	#6 - 2/0	HORN	3 5/16	8	11 1/2	1 1/2	1 1/2	2	1 1/4	—	1/4
200	OH	U7040-XL-TG-KK*	C.P.	#6-350 kcmil	HORN	4 1/8	11	15 1/2	2 1/2	2 1/2	2 1/2	2 1/2	1/4, 1/2	1/4
200	OH	U7040-RL-KK-DPL**	H.O.	#6-350 kcmil	HORN	4 1/8	11	15 1/2	2 1/2	2 1/2	2 1/2	2 1/2	1/4, 1/2	1/4
200	OH	S1619-XL*** ^①	C.P.	3/8"-16 stud	NONE	4 1/8	11	17	2	2	2 1/2	2 1/2	1/4, 1/2	1/4

The S1619 unit is NOT UL Listed.

^①Order connector kit K1350 for single #6-350 connector. Order 2 kits to cover line and load.

*APS approved

**Conectiv approved

***PEPCO approved

Utility requirements for this equipment may vary. Always consult the serving utility for their requirements before ordering or installing equipment in this catalog.



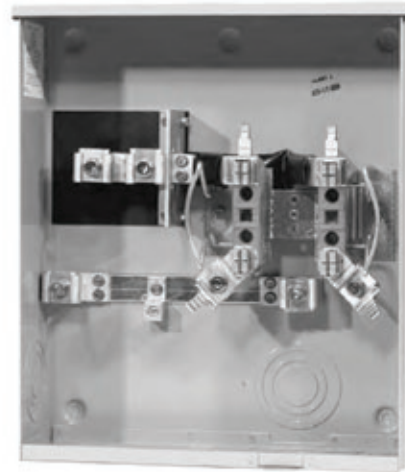
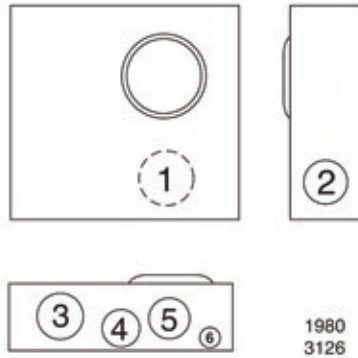

U1980-O-KK-DPL

200 AMP-SINGLE POSITION-4 TERMINAL-SIDE WIREWAY-RINGLESS-1Ø3W

AMP	SERVICE	CATALOG NUMBER	HUB	CONNECTORS CU/AL	BY-PASS	DIMENSIONS			CONCENTRIC K.O.'S					
						D"	W"	H"	1	2	3	4	5	6
200	UG	U3126-O-KK-BLG*	BLANK	#6-350 kcmil	HORN	4 1/2	13	15 1/4	2 1/2	2 1/2	3	1 1/2	3	1/4, 1/2
200	UG	U1980-O-KK-DPL**	BLANK	#6-350 kcmil	HORN	4 1/2	13	15 1/4	2 1/2	2 1/2	3	1 1/2	2 1/2	1/4, 1/2
200	UG	U2986-O-PEP***①	BLANK	3/8"-16 stud	NONE	4 1/2	13	19	2 1/2	2 1/2	2 1/2	2 1/2	1/4, 1/2	1/4

FIFTH TERMINAL: For field mounted fifth terminal order catalog number **K5T** to fit into square opening at the 9 o'clock position.

CONNECTORS: Extruded aluminum connectors are tin plated.

BY-PASS: **U3126 & U1980** provided with horn type bypass. Suffix **-KK**.

①Order connector kit **K1539** for single #6-350 connector. Order 2 kits to cover line and load.

*APS approved

**Conectiv approved

***PEPCO approved

Utility requirements for this equipment may vary. Always consult the serving utility for their requirements before ordering or installing equipment in this catalog.



200 AMP-4 TERMINAL-SIDE WIREWAY-RINGLESS-1Ø3W

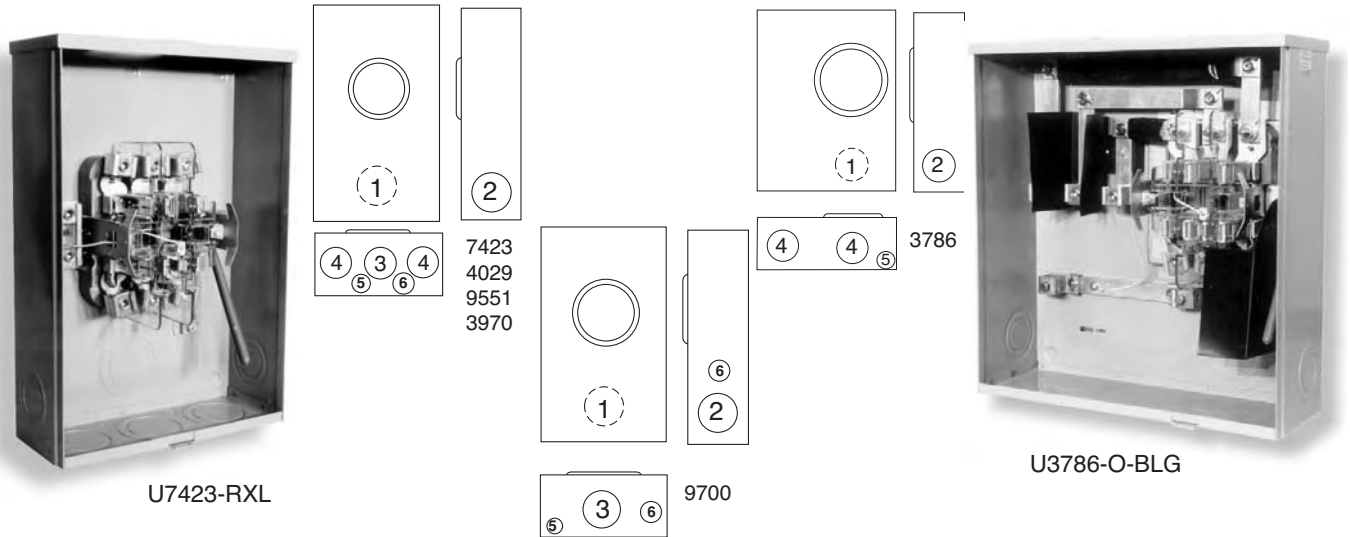

200 AMP-7 TERMINAL-MEDIUM DUTY-LEVER BYPASS-RINGLESS-3Ø4W

AMP	SERVICE	CATALOG NUMBER	HUB	CONNECTORS		BY-PASS	DIMENSIONS			CONCENTRIC K.O.'S					
				LINE	LOAD		D"	W"	H"	1	2	3	4	5	6
200	OH/UG	U7423-RXL*	C.P.	#6-350 kcmil	#6-350 kcmil	LEVER	4 ⁷ / ₈	13	19	3	2 ¹ / ₂	3	3	1/4	1/4, 1/2
200	OH/UG	U4029-X-DPL**	C.P.	#6-350 kcmil	#6-350 kcmil	LEVER	4 ⁷ / ₈	13	19	3	2 ¹ / ₂	3	3	1/4	1/4, 1/2

HUBS: For proper hub selection see the hub suffix chart on the accessory page.

LEVER BYPASS: Lever operates bypass only.

200 AMP-5 & 7 TERMINAL-HEAVY DUTY-LEVER BYPASS-RINGLESS-3Ø3W & 3Ø4W

AMP	SVC.	NO. OF TERMS.	CATALOG NUMBER	HUB	CONNECTORS		BY-PASS	DIMENSIONS			CONCENTRIC K.O.'S					
					LINE	LOAD		D"	W"	H"	1	2	3	4	5	6
200	OH/UG	5	U9551-X-DPL**	C.P.	#6-350 kcmil	#6-350 kcmil	LEVER	4 ⁷ / ₈	13	19	3	2 ¹ / ₂	3	3	1/4	1/4, 1/2
200	OH	5	S3970-XL***①	C.P.	3/8"-16 stud	3/8"-16 stud	LEVER	4 ⁷ / ₈	13	19	3	2 ¹ / ₂	3	3	1/4	1/4, 1/2
200	OH	7	U9700-RRL-BLG*	H.O.	#6-350 kcmil	#6-350 kcmil	LEVER	4 ⁷ / ₈	10	18 ¹ / ₂	3	2 ¹ / ₂	3	-	1/4, 1/2	3/4
200	OH	7	S8930-XL***①	C.P.	3/8"-16 stud	3/8"-16 stud	LEVER	4 ⁷ / ₈	13	19	3	2 ¹ / ₂	3	3	1/4	1/4, 1/2

HUBS: For proper hub selection see the hub suffix chart on the accessory page.

LEVER BYPASS: Lever supplies clamping action and operates bypass device.

UL APPROVAL: S3970 & S8930 units are NOT UL Listed or approved.

①For S3970 order connector kit K1350 for single #6-350 connector, order K1540 for single #4-600 or twin 1/0-250. For S8930, order connector kit K3082 for single #6-350 connector, order K3441 for single #4-600 or twin 1/0-250.

200 AMP-7 TERMINAL-MEDIUM DUTY-SIDE WIREWAY-LEVER BYPASS-RINGLESS-3Ø4W

AMP	SERVICE	CATALOG NUMBER	HUB	CONNECTORS		BY-PASS	DIMENSIONS			CONCENTRIC K.O.'S					
				LINE	LOAD		D"	W"	H"	1	2	3	4	5	6
200	UG	U3786-O-BLG*	BLANK	#6-350 kcmil	#6-350 kcmil	LEVER	6	18	19 ¹ / ₄	3	2 ¹ / ₂	-	4	1/4, 1/2	-

CONNECTORS: Extruded aluminum connectors are tin plated.

LEVER BYPASS: Lever operates bypass only.

*APS approved

**Conectiv approved

*** PEPCO approved

Utility requirements for this equipment may vary. Always consult the serving utility for their requirements before ordering or installing equipment in this catalog.

320 AMP-4 & 7 TERMINAL-RINGLESS-1Ø3W & 3Ø4W

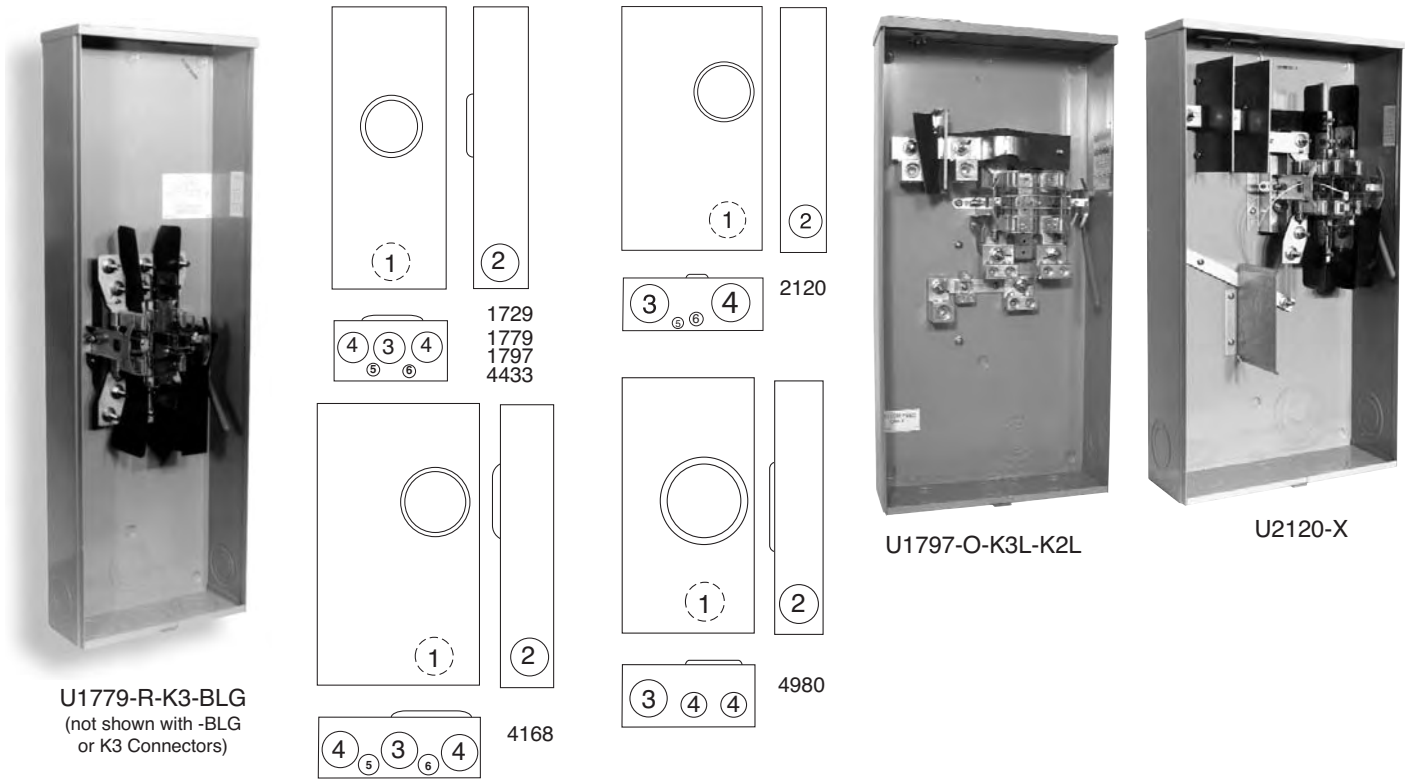

U1779-R-K3-BLG
(not shown with -BLG or K3 Connectors)

U1797-O-K3L-K2L

U2120-X

320 AMP-SINGLE POSITION-4 & 7 TERMINAL HEAVY DUTY-SIDE WIREWAY-RINGLESS-1Ø3W & 3Ø4W

TERM.	SERVICE	CATALOG NUMBER	HUB	CONNECTORS		BY-PASS	DIMENSIONS			CONCENTRIC K.O.'S					
				LINE	LOAD		D"	W"	H"	1	2	3	4	5	6
4	OH/UG	U4433-X*	C.P.	#4-600 kcmil	TWIN #6-350 kcmil	LEVER	47/8	15	31 1/2	3	3	3	3	1/4	1/4 1/2
4	UG	U1797-O-K3L-K2L*	BLANK	#4-600 kcmil (2) 1/0-250	TWIN #6-350 kcmil	LEVER	47/8	15	30	3	3	3	3	1/4	1/4 1/2
4	OH/UG	U4980-X***	C.P.	3/8"-16 stud	3/8"-16 stud	LEVER	6 1/2	17 3/4	34 1/8	3	3	3 1/2	2	-	-
7	UG	U2120-X*	C.P.	3/8"-16 stud	3/8"-16 stud	LEVER	6 1/2	17 3/4	31 3/4	4	3	4	4	1/4	1
7	OH/UG	U4168-X-K7-BLG*	C.P.	#4-600 kcmil	3/8"-16 stud	LEVER	5 3/4	16	30	3 1/2	3 1/2	4	3 1/2	3 1/2	1/2

320 AMP-SINGLE POSITION-4 TERMINAL-HEAVY DUTY-RINGLESS-1Ø3W

TERM.	SERVICE	CATALOG NUMBER	HUB	CONNECTORS		BY-PASS	DIMENSIONS			CONCENTRIC K.O.'S					
				LINE	LINE		D"	W"	H"	1	2	3	4	5	6
4	OH	U1779-R-K3-BLG*	H.O.	#4-600 kcmil (2) 1/0-250	3/8"-16 stud	LEVER	47/8	13	38 3/4	3	2 1/2	3	3	1/4	1/4 1/2
4	UG	U1729-X-DPL**	C.P.	3/8"-16 stud	3/8"-16 stud	LEVER	47/8	13	29 3/4	3	2 1/2	3	3	1/4	1/4 1/2

FIFTH TERMINAL: For field mounted fifth terminal order **K3865** for **U1729**, **K3866** for **U1779**.

HUBS: For proper hub selection see the hub suffix chart on the accessory page.

CONNECTORS: Extruded aluminum connectors are tin plated. For single lug connector kit order as extra: **K1539** (350 kcmil) or **K1540** (600 kcmil). For twin lug connectors: **K1350** (350 kcmil). Order two kits to cover both line and load on sockets not supplied with line connectors.

LEVER BYPASS: Lever bypass supplies clamping action on the meter spades and also operates the bypass device.

*APS approved

**Conectiv approved

*** PEPCO approved

Utility requirements for this equipment may vary. Always consult the serving utility for their requirements before ordering or installing equipment in this catalog.





U4664-X-8522-DPL

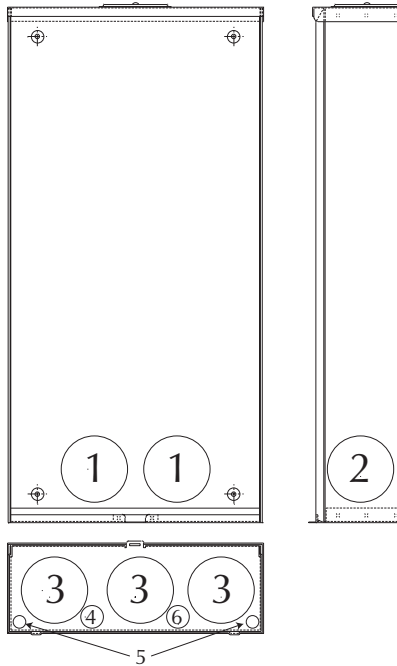

U4667-X-8043-DPL

DELMARVA APPROVED
480 AMP -4 & 7 TERMINAL-RINGLESS-OVERHEAD/UNDERGROUND

PHASE	AMP	SERV.	CATALOG NUMBER	HUB	CONNECTOR CU/AL		DIMENSIONS			CONCENTRIC K.O.'S					
					LINE	LOAD	D"	W"	H"	1	2	3	4	5	6
1Ø3W	480	OH/UG	U4664-X-8522-DPL*	(1) Large C.P. (-X)	1/2"-20 stud	1/2"-20 stud	6	17¾	36	4	4	4	½,¾	¼	½,¾
3Ø4W	480	OH/UG	U4667-X-8043-DPL*	(1) Large C.P. (-X)	1/2"-20 stud	1/2"-20 stud	6	20¼	34	4	4	4	½,¾	¼	-

480 AMP CONTINUOUS-600 AMP MAXIMUM
4 & 7 TERMINAL-K SERIES-METER MOUNTING DEVICE

HUBS: For proper hub selection see hub suffix chart in the accessory section of this catalog.

APPLICATION: For use with 1Ø3W self-contained Type MS-K watt-hour meters.

CAPACITY: 480 amperes continuous / 600 amp max.

TERMINALS: 1/2"-20 steel studs with nuts and captive Belleville washers to accommodate various bolt-on type lugs for conductors from #6 to 800 kcmil. All units come with ground lugs factory installed.

ENCLOSURE: Constructed of 14 gauge galvanized steel suitable for indoor or outdoor installations. Ringless Cover.

METER MOUNTING: Two position stud type. One set of studs provides out-of-service storage. The in-service studs are positioned so the meter cannot be installed upside-down. Use 1/2" insulated wrench. Full travel meter opening slide plate eliminates the need for repositioning the slide plate for the "IN" or "OUT OF SERVICE" position.

BLOCKS: Glass fiber reinforced polyester plastic. High arc withstand strength and track resistant. Provisions for lightning arresters.

CONNECTORS: Phase and neutral connectors not included. See page 18 for connectors.

*Conectiv approved

Utility requirements for this equipment may vary. Always consult the serving utility for their requirements before ordering or installing equipment in this catalog.

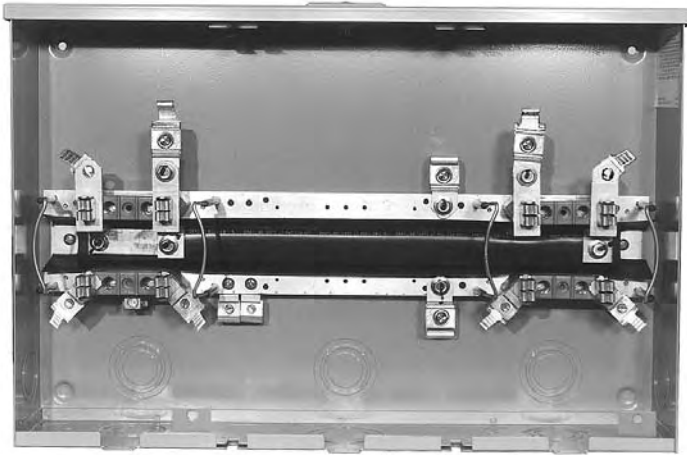

U8032-XL-KK-BLG

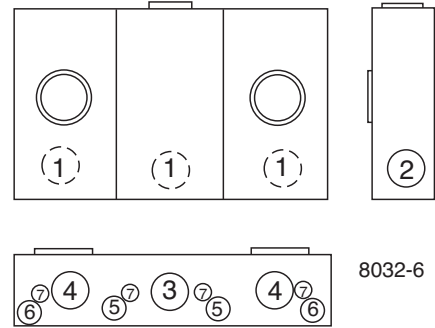

100 AMP/ POSITION-4 TERMINAL-CENTER WIREWAY-RINGLESS-OH/UG-1Ø3W

AMPS	NO. OF POS.	CATALOG NUMBER	HUB	CONNECTOR CU/AL		BY-PASS	DIMENSIONS			CONCENTRIC K.O.'S						
				LINE	LOAD		D"	W"	H"	1	2	3	4	5	6	7
100	2	U8032-XL-KK-BLG*	C.P.	#6-350 kcmil	#6-2/0	HORN	4 1/2	24 1/2	16	2	2	3	2	1/2	1/4, 1/2	5/16
100	3	U8033-XL-KK-BLG*	C.P.	#6-350 kcmil	#6-2/0	HORN	4 1/2	32 1/16	16	2	2	3	2	1/2	1/4, 1/2	5/16
100	4	U8034-XL-KK-BLG*	C.P.	#6-350 kcmil	#6-2/0	HORN	4 1/2	40 7/8	16	2	2	3	2	1/2	1/4, 1/2	5/16
100	5	U8035-XL-KK-BLG*	C.P.	#6-350 kcmil	#6-2/0	HORN	4 1/2	49 1/16	16	2	2	3	2	1/2	1/4, 1/2	5/16
100	6	U8036-XL-KK-BLG*	C.P.	#6-350 kcmil	#6-2/0	HORN	4 1/2	57 1/4	16	2	2	3	2	1/2	1/4, 1/2	5/16

HUB: For proper hub selection refer to the hub suffix chart on the accessory page.

FIFTH TERMINAL: For field mounted fifth terminal, order catalog number 5T8K2 for each meter position, 6 o'clock position only.

CONNECTORS: Extruded aluminum connectors are tin plated.

BUSSING: Bussing is 5/16" x 1" aluminum.

*APS approved

100 AMP/ POSITION-4 TERMINAL-CENTER WIREWAY
HORIZONTAL GANGS-RINGLESS-300 VAC

Utility requirements for this equipment may vary. Always consult the serving utility for their requirements before ordering or installing equipment in this catalog.



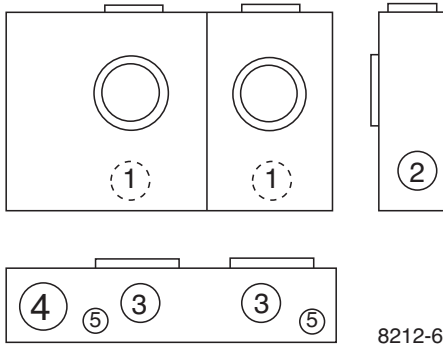

4" SIDE WIREWAY
OH/UG SERVICE

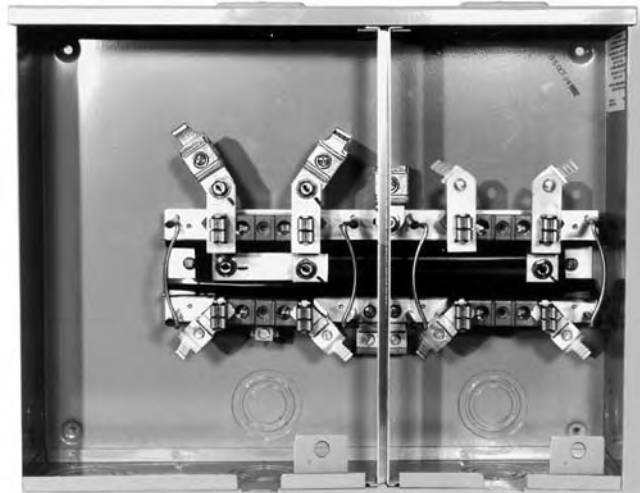

U8212-XL-KK-BLG

100 AMP / POSITION- 4 TERMINAL-END WIREWAY-RINGLESS-OH/UG-1Ø3W

AMPS	NO. OF POS.	CATALOG NUMBER	HUB	CONNECTOR CU/AL		BY-PASS	DIMENSIONS			CONCENTRIC K.O.'S				
				LINE	LOAD		D"	W"	H"	1	2	3	4	5
100	2	U8212-XL-KK-BLG*	C.P.	#6-350 kcmil	#6-2/0	HORN	4½	20 ⁵ / ₁₆	16	2	2	2	3	¼, ½
100	3	U8213-XL-KK-BLG*	C.P.	#6-350 kcmil	#6-2/0	HORN	4½	28½	16	2	2	2	3	¼, ½
100	4	U8214-XL-KK-BLG*	C.P.	#6-350 kcmil	#6-2/0	HORN	4½	40 ¹¹ / ₁₆	16	2	2	2	3	¼, ½
100	5	U8215-XL-KK-BLG*	C.P.	#6-350 kcmil	#6-2/0	HORN	4½	48 ⁷ / ₈	16	2	2	2	3	¼, ½
100	6	U8216-XL-KK-BLG*	C.P.	#6-350 kcmil	#6-2/0	HORN	4½	57 ¹ / ₁₆	16	2	2	2	3	¼, ½

HUB: For proper hub selection refer to the hub suffix chart on the accessory page. Hub opening is supplied at each end. Extra openings in top are closed with a closing plate as standard.

FIFTH TERMINAL: For field mounted fifth terminal in 6 o'clock position, order catalog number **5T8K2** for each meter position, **K9959** for 9 o'clock position.

CONNECTORS: Extruded aluminum connectors are tin plated.

BUSSING: Bussing is 5/16" x 1" aluminum.

*APS approved

100 AMP/ POSITION-4 TERMINAL
END WIREWAY-HORIZONTAL GANGS-RINGLESS-300 VAC

Utility requirements for this equipment may vary. Always consult the serving utility for their requirements before ordering or installing equipment in this catalog.





U1252-X-KK-K3-BLG

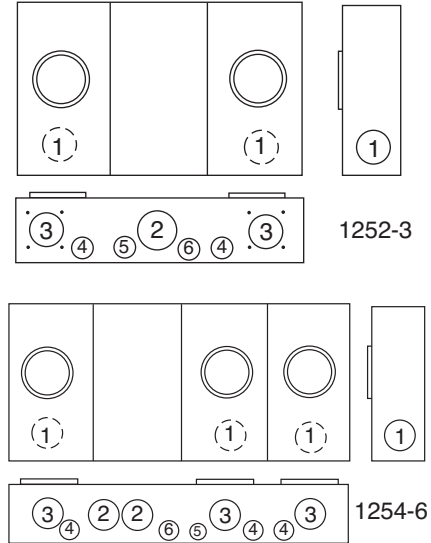

200 AMP / POSITION-4 TERMINAL-RINGLESS-1Ø3W-OH/UG*

200 AMP / POSITION-4 TERMINAL
HORIZONTAL GANGS-RINGLESS-300 VAC

AMPS	NO. OF POS.	CATALOG NUMBER	HUB	CONNECTOR CU/AL		BY-PASS	DIMENSIONS			CONCENTRIC K.O.'S					
				LINE	LOAD		D"	W"	H"	1	2	3	4	5	6
200	2	U1252-X-KK-K3-BLG*	C.P.	#4-600 kcmil	#6-350 kcmil	HORN	5 ¹ / ₈	26 ¹ / ₂	14	2 ¹ / ₂	3	2 ¹ / ₂	1 ¹ / ₂	1 ¹ / ₄	1
200	2	U1252-X-KK-K3-DPL**	C.P.	#4-600 kcmil	#6-350 kcmil	HORN	5 ¹ / ₈	26 ¹ / ₂	14	2 ¹ / ₂	3	2 ¹ / ₂	1 ¹ / ₂	1 ¹ / ₄	1
200	3	U1253-X-KK-K3-BLG*	C.P.	#4-600 kcmil	#6-350 kcmil	HORN	5 ¹ / ₈	34 ¹¹ / ₁₆	14	2 ¹ / ₂	3	2 ¹ / ₂	1 ¹ / ₂	1 ¹ / ₄	1
200	4	U1254-X-KK-K3-BLG*	C.P.	#4-600 kcmil	#6-350 kcmil	HORN	5 ¹ / ₈	42 ⁷ / ₈	16	2 ¹ / ₂	3	2 ¹ / ₂	1 ¹ / ₂	1 ¹ / ₄	1
200	4	U1254-X-KK-K3-DPL**	C.P.	#4-600 kcmil	#6-350 kcmil	HORN	5 ¹ / ₈	42 ⁷ / ₈	16	2 ¹ / ₂	3	2 ¹ / ₂	1 ¹ / ₂	1 ¹ / ₄	1
200	5	U1255-X-KK-K3-BLG*	C.P.	#4-600 kcmil	#6-350 kcmil	HORN	5 ¹ / ₈	54 ⁷ / ₈	16	2 ¹ / ₂	3	2 ¹ / ₂	1 ¹ / ₂	1 ¹ / ₄	1
200	6	U1256-X-KK-K3-BLG*	C.P.	#4-600 kcmil	#6-350 kcmil	HORN	5 ¹ / ₈	63 ¹ / ₁₆	18	2 ¹ / ₂	3	2 ¹ / ₂	1 ¹ / ₂	1 ¹ / ₄	1
200	6	U1256-X-KK-K4-DPL**	C.P.	(2)#4-600 kcmil	#6-350 kcmil	HORN	5 ¹ / ₈	63 ¹ / ₁₆	18	2 ¹ / ₂	3	2 ¹ / ₂	1 ¹ / ₂	1 ¹ / ₄	1

HUB: For proper hub selection refer to the hub suffix chart on the accessory page. For the U1255-1256 units, two hub openings are supplied and the extra opening is closed with a closing plate as standard.

FIFTH TERMINAL: For field mounted fifth terminal, order catalog number K5T for each meter position, 9 o'clock position only.

CONNECTORS: Extruded aluminum connectors are tin plated.

BUSSING: Bussing is 5/16" x 1" aluminum on the U1252-1253. On the U1254-6 gangs the bussing is 3/8" x 1" aluminum.

FOR OVERHEAD SERVICE: The U1254-1256 units are factory assembled for underground service. If overhead service is desired an extension kit is required. Order catalog number K3923 for the U1254 and U1255 units and K3955 for the U1256 unit.

*APS approved

**Conectiv approved

Utility requirements for this equipment may vary. Always consult the serving utility for their requirements before ordering or installing equipment in this catalog.





FEATURES: Supplied with studs, three point locking handle, continuous hinge and pad-lock provision. Single door provided on units less than 36" wide. *Steel panels and plywood backboard are optional.*

NOTE: Other sizes of Outdoor Transformer Cabinets are available. Please refer to the Milbank Commercial Electrical Enclosure Price List, featuring NEMA-rated sheet metal products.

UL LISTED-OUTDOOR TRANSFORMER CABINETS*-CONTINUOUS HINGE-NEMA 3R-PADLOCKABLE

CATALOG NUMBER	DIMENSIONS			GAUGE OF STEEL	PANEL SIZE		PANEL & BACKBOARD CATALOG NUMBERS	
	D"	W"	H"		W" X H"	PAINTED STEEL PANEL	WOOD BACKBOARD	
363612-CT3R ①	12	36	36	14	33	33	A-36P36	A-36P36W
484812-CT3R ①	12	48	48	14	45	45	A-48P48	A-48P48W
U4051-O*	10	36	28	14	-	-	CT mounting rack included ^②	CT mounting rack included ^②

① Double Door Units

② **C.T. MOUNTING RACK:** This unit accommodates 3 donut style C.T.s. Removable cover for easier wiring.

* Conectiv approved

OUTDOOR TRANSFORMER CABINETS & SOCKET

TRANSFORMER RATED SOCKET

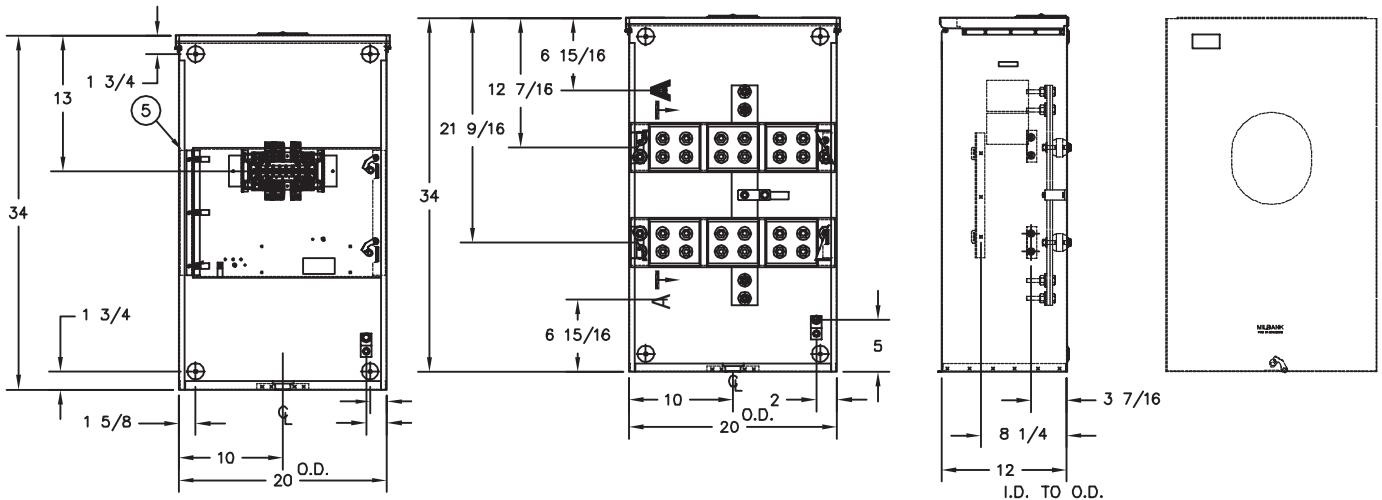

NO. OF TERMS	PHASE	CATALOG NUMBER	SERVICE	DIMENSIONS			CONCENTRIC K.O.'S							
				D"	W"	H"	1	2	3	4	5	6		
13	3∅	S4244-X***	CONSULT UTILITY	12	20	34	4	4	1	-	-	-	-	-

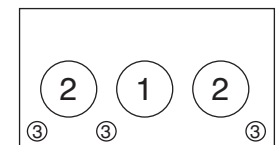

Units can be supplied with test switch prewired or test switch not prewired. Consult factory for test switch and/or wiring diagram requirements.

This unit will not accept Milbank test switch cover.

Stud type units are supplied with 1/2"-13 hex head nuts with Belleville washers.

***PEPCO approved-NOT UL Listed

Utility requirements for this equipment may vary. Always consult the serving utility for their requirements before ordering or installing equipment in this catalog.



Commercial Pedestals for the MD, DC & N.VA areas

- *Attractive*
- *Easy to install*
- *Secure*
- *Cost effective*

Un-Strut Your Stuff...

 Milbank Commercial Pedestals are pad-mounted, weatherproof electrical enclosures consisting of a utility pull section with optional meter socket, and a customer section containing distribution and control equipment. Milbank

Commercial Pedestals are an attractive, secure, easy to install and cost-effective solution when underground remote site power distribution and control equipment are required, replacing unsightly and inefficient strut and backboard structures.



APPLICATIONS

These units are ideal for controlling and metering:

- Traffic signals
- Street lighting
- Irrigation / sprinkler systems
- Cell towers / telephone vaults
- Pump stations
- Temporary power for fairgrounds, swap meets, outdoor markets, portable offices, holiday lights, etc.
- Outdoor lighting for athletic fields, tennis and basketball courts, parking lots, landscaping and subdivision entrances, etc.



AVAILABLE FACTORY-INSTALLED OPTIONS

- Meter sockets – ring-type or ringless, 200 amp (unmetered pedestals also available)
- Main and branch breakers or T fuses
- Distribution – copper load centers & panel boards
- Clocks / timers
- Photoelectric cells
- Power receptacles – pin & sleeve, twist lock or straight blade
- Contactors – definite purpose, electrical or mechanically held, IEC and mercury types
- Surge protection & lightning arrestors
- Reserve generator provisions
- Motor starters, relays
- Push button controls
- Thermostat controls, fans and heating strips
- Power blocks and terminal blocks
- Steel, aluminum and plywood back boards
- Transformers
- Interlock devices for circuit breakers
- Available in steel, aluminum or stainless steel construction with powder-coated finish available in 8 standard colors

Utility requirements for this equipment may vary. Always consult the serving utility for their requirements before ordering or installing equipment in this catalog.

**STANDARD FEATURES – MD., D.C. & N.Va. AREAS
COMMERCIAL PEDESTALS**

- Type 3R rainproof, vandal-resistant cabinet of polyurethane powder-coated steel (aluminum or stainless steel also available)
- UL listed as enclosed industrial control equipment (UL508)
- Isolated, lockable & sealable utility metering & lug landing sections
- Lockable customer section for distribution & control equipment with internal deadfront
- Print pocket inside customer section door contains wiring schematics and instructions
- Most load centers are UL Listed for use with various manufacturers' circuit breakers
- All stainless steel external hardware (rivets, screws, bolts, hinges, handles, hasps and sealing screws)



MD-DOT APPROVED BASE-MOUNTED PEDESTAL:

CP3B52119A22AOSP – 200 amp / Ringless / Heavy duty lever bypass

- 120/240V / 1Ø3W
- 200 amp M.B. / 22K AIC rated
- 24 circuit load center / Breakers as required
- Aluminum cabinet

CP3B52110A22AOSL1 – 200 amp / Ringless / Heavy duty lever bypass / Switched load center

- 120/240V / 1Ø3W
- 200 amp M.B. / 22K AIC rated
- 1-16 circuit load center / Unswitched / Breakers as required
- 1-16 circuit load center / Switched / Breakers as required
- 100 amp contactor
- PE socket
- Wiring harness for optional time clock
- HOA (hand-off-auto) switch
- Aluminum cabinet

Consult factory for wiring diagrams.

ACCESSORIES



K3865
Fifth terminal kit for use with ringless meter sockets

105J
Fifth terminal kit for use with ring-type meter sockets



CP-TC7D 7-day time clock kit
CP-TC24H 24-hour time clock kit
CP-TCWIRE Male four-pin connector and wiring harness for use with time clocks other than shown

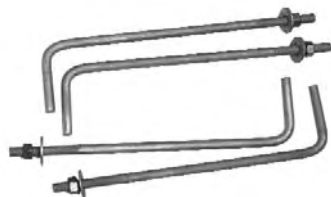

CP-ABK5/8
Anchor bolt kit (includes four 5/8 - 13 x 18" anchor bolts)



CP-16PDMNT-CALT
Pedestal mounting base (includes mounting hardware)



CP-PE-HOA-3POS
Photoelectric cell kit with HOA switch

Utility requirements for this equipment may vary. Always consult the serving utility for their requirements before ordering or installing equipment in this catalog.





#Z703916-AC #58852

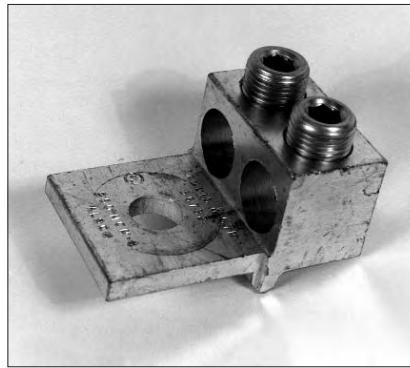

#Z703918-AC #56732
#Z704694-AC #56732-M



#Z703919-AC #58853
#Z704693-AC #56427-M

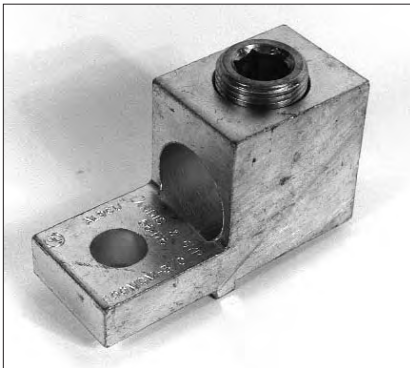

#Z703921-AC #56476

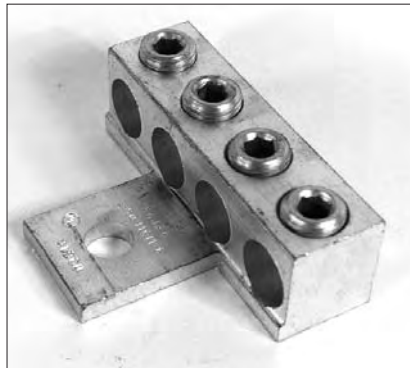

#Z705420-AC #56426

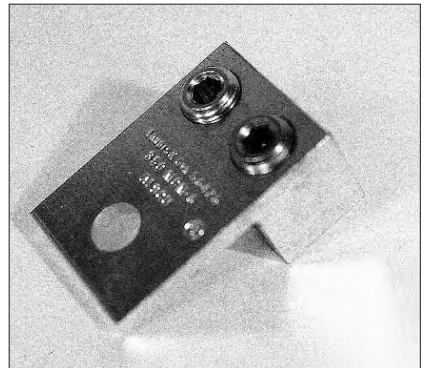

#Z705456-AC #56425

Bolt-on type lugs for Milbank stud type meter mounting devices are made of 6061-T6 aluminum to provide high strength and high conductivity. All lugs are tin-plated to ensure low contact resistance and to reduce corrosion. Allen or hex head pressure screws are furnished to provide excellent conductor spread for maximum binding action with the lug.

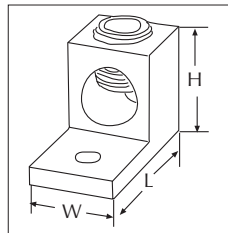

#Z708145-AC

MILBANK CONN. #	L&G CONN NO.	NO. OF CONDUCTORS & SIZE	STUD OPENING	PRESSURE SCREW HEAD	DIMENSIONS		
					L"	W"	H"
Z703916-AC	58852	3/0-800 kcmil	9/16"	1/2" Allen	3 15/16	1 3/4	1 13/16
Z703917-AC	56427	Two #6-350 kcmil	9/16"	5/16" Allen	4 5/16	1 1/8	2 1/16
Z703918-AC	56732	Two #4-350 kcmil	9/16"	5/16" Allen	2 7/8	1 59/64	1 1/4
Z703919-AC	58853	Two #6-350 kcmil	9/16"	5/16" Allen	3 15/16	1 1/8	1 1/2
Z703921-AC	56476	3/0-800 kcmil	9/16"	1/2" Allen	3 1/4	1 5/16	1 13/16
Z704693-AC	56427-M	Two #2-500 kcmil	9/16"	3/8" Allen	4 1/4	1 1/8	1 13/16
Z704694-AC	56732-M	Two #4-500 kcmil	9/16"	3/8" Allen	2 13/16	2 5/32	1 13/16
Z705420-AC	56426	Four #6-350 kcmil	17/32"	5/16" Allen	2 7/8	3 15/16	1 9/16
Z705456-AC	56425	Two #6-350 kcmil	9/16"	5/16" Allen	2 7/8	1 57/64	1 1/4
Z708145-AC	68752-1	Three #6-250 kcmil	9/16"	5/16" Allen	2 7/8	2 1/2	1 5/16

Utility requirements for this equipment may vary. Always consult the serving utility for their requirements before ordering or installing equipment in this catalog.

LUGS FOR K-SERIES



INTERCHANGEABLE UNIT HUBS

SMALL "RL" OPENING (STANDARD)

SUFFIX	SIZE	MILBANK NO.
WL	1"	A7514
YL	1¼"	A7515
ZL	1½"	A7516
DL	2"	A7517
EL	2½"	A7518



LARGE "R" OPENING (HEAVY DUTY)

SUFFIX	SIZE	MILBANK NO.
F	3"	A8110
G	3½"	A8111
H	4"	A8112



HUB ADAPTER PLATE
(Converts 4" opening to 2½" opening)
S8324



REMOVABLE HUB CLOSING PLATE

DESCRIPTION	SUFFIX	CAT. #
STANDARD (for -RL opening)	-XL	A7551
LARGE (for -R opening)	-X	S9064
ADAPTER (R to RL)	-RRL	S8324

HUB SUFFIX CHART

SUFFIX	DESCRIPTION	SUFFIX	SIZE	APPLICATION
O	Plain Top	WL	1"	For -RL Opening
RL	Small Hub Opening	YL	1¼"	For -RL Opening
R	Large Hub Opening	ZL	1½"	For -RL Opening
XL	Small Closing Plate	DL	2"	For -RL Opening
X	Large Closing Plate	EL	2½"	For -RL Opening
RXL	Large Hub Opening adapted to small Closing Plate	F	3"	For -R Opening
RRL	Large Hub Opening adapted to small Hub Opening	G	3½"	For -R Opening
		H	4"	For -R Opening

5TH TERMINAL



K5T FIFTH TERMINAL
(New style block with square hole)



"PLUG-IN" FIFTH TERMINAL 5T8K2
(Old style block with round hole)

ANTI-INVERSION CLIP

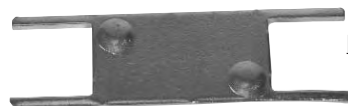

K4802

CONNECTOR KITS SINGLE LUG ASSEMBLY

SUFFIX	CATALOG #	(3 per set) – 1 Ø
K1	K1539	6-350 kcmil
K3	K1540	4-600 kcmil or (2) 1/0-250 kcmil
K3L	K1540L	4-600 kcmil or (2) 1/0-250 kcmil Non-rotating
SUFFIX	CATALOG #	(4 per set) – 3 Ø
K5	K3082	6-350 kcmil
K7	K3441	4-600 kcmil or (2) 1/0-250 kcmil



K1540

For use with 3/8"-16 stud type units only

CLOSING COVERS



GRAY PLASTIC CLOSING PLATE
Ring Type & Ringless
6003

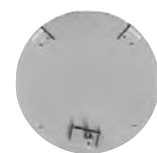

METAL CLOSING PLATE
(For Ringless sockets)
CP-21

CLEAR PLASTIC CLOSING PLATE
Ring Type & Ringless
6116

TWIN LUG ASSEMBLY

SUFFIX	CATALOG #	(3 per set) – 1 Ø
K2	K1350	6-350 kcmil
K2L	K1350L	6-350 kcmil Non-rotating
K4	K1541	4-600 kcmil
SUFFIX	CATALOG #	(4 per set) – 3 Ø
K6	K3442	6-350 kcmil
K8	K3083	4-600 kcmil



K1541

LOAD TAP CONNECTORS (3 per set)

Replaces the **load side** slide-in nut assembly on Milbank 200 amp sockets. Allows for a 100 amp tap location in addition to the #6-350 kcmil load-side connector. **K5022** Includes Safety Barrier Extensions—for applications over 300 VAC.

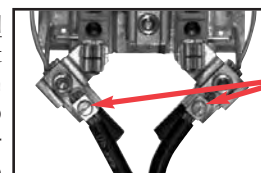

K4977-INT
K5022-INT
(Internal hex)

Utility requirements for this equipment may vary. Always consult the serving utility for their requirements before ordering or installing equipment in this catalog.

Catalog No	APS	Conectiv	PEPCO	PG NO
125A 4T OH				
U7487-YL-TG-KK-BLG	X			7
200A 4T OH				
U7040-XL-TG-KK	X			7
U7040-RL-KK-DPL		X		7
S1619-XL			X	7
200A 4T UG				
U3126-O-KK-BLG	X			8
U1980-O-KK-DPL		X		8
U2986-O-PEP			X	8
200A 5T OU				
U9551-X-DPL		X		9
200A 5T OH				
S3970-XL			X	9
200A 7T OU				
U7423-RXL-BLG	X			9
U4029-X-DPL		X		9
200A 7T OH				
U9700-RRRL-BLG	X			9
S8930-XL			X	9
200A 7T UG				
U3786-O-BLG	X			9
320A 4T OH				
U1779-R-K3-BLG	X			10
320A 4T OU				
U4433-X	X			10
U4980-X			X	10
320A 4T UG				
U1729-X-DPL		X		10
U1797-O-K3L-K2L	X			10
320A 7T UG				
U2120-X				10
320A 7T OU				
U4168-X-K7-BLG	X			10
480A CONT OU				
U4664-X-8522-DPL (4T)		X		11
U4667-X-8043-DPL (7T)		X		11
100A 4T GANG SOCKETS				
U8032-XL-KK-BLG	X			12
U8033-XL-KK-BLG	X			12
U8034-XL-KK-BLG	X			12
U8035-XL-KK-BLG	X			12
U8036-XL-KK-BLG	X			12
U8212-XL-KK-BLG	X			13
U8213-XL-KK-BLG	X			13
U8214-XL-KK-BLG	X			13

Catalog No	APS	Conectiv	PEPCO	PG NO
U8215-XL-KK-BLG	X			13
U8216-XL-KK-BLG	X			13
200A 4T GANG SOCKETS				
U1252-X-KK-K3-BLG	X			14
U1252-X-KK-K3-DPL		X		14
U1253-X-KK-K3-BLG	X			14
U1254-X-KK-K3-BLG	X			14
U1254-X-KK-K3-DPL		X		14
U1255-X-KK-K3-BLG	X			14
U1256-X-KK-K3-BLG	X			14
U1256-X-KK-K4-DPL		X		14
CT ENCLOSURES				
363612-CT3R				15
484812-CT3R				15
U4051-O		X		15
TRANSFORMER RATED SOCKETS				
S4244-X			X	15

Other quality products available from Milbank

Commercial Pedestals

- Attractive
- Easy to install
- Secure
- Cost effective



Un-
Strut Your
Stuff...

816.483.5314 phone
816.483.6357 fax
www.milbankmfg.com
ComPed 04/05 (2.5K)





**Commercial
Electrical Enclosures**

2006 PRICE LIST
Effective June 26, 2006

Supersedes and cancels all previous Milbank lists.
All prices listed within are subject to change without notice.
rev. 7-27-06



MILBANK MFG. CO.
4801 Deramus • PO Box 419028
Kansas City, MO 64141-6028
Tel: 816.483.5314
Fax: 816.483.6357
www.milbankmfg.com



**Recreational Vehicle Park
Electrical Products & Accessories**

Millennium Series

INCLUDES REPLACEMENT PARTS





In addition to your local utility's meter mounting equipment, Milbank also manufactures supporting products, such as...

- Air Conditioner Disconnects**
- Hot Tub Disconnects**
- RV/Mobile Home Power Outlets**
- Terminal Boxes**
- Temporary Power Outlets**
- Commercial Pedestals**
- Commercial Enclosures**
- CT Enclosures**
- Circuit Breakers**
- Distribution Unit Substations**
- Enclosed Circuit Breakers**
- Safety Switches**
- Test Switches**

*Contact your local distributor or go to
www.milbankmfg.com
to find additional product literature.*

MAXIMUM NUMBER OF CONDUCTORS IN CONDUIT*

TYPE	CONDUCTOR SIZE AWG, MCM	CONDUIT TRADE SIZES (INCHES)									
		1/2	3/4	1	1 1/4	1 1/2	2	2 1/2	3	3 1/2	4
RHW & RHH (without outer covering) THW	14	6	10	16	29	40	65	93	143	192	
	12	4	8	13	24	32	53	76	117	157	
	10	4	6	11	19	26	43	61	95	127	163
	8	1	3	5	10	13	22	32	49	66	85
	6	1	2	3	7	10	16	23	36	48	62
TW THW FEPB (6 thru 2), RHW and RHH (without outer covering) RH, THHW	1/0		1	1	2	3	5	8	12	16	21
	2/0		1	1	1	3	5	7	10	14	18
	3/0		1	1	1	2	4	6	9	12	15
	4/0		1	1	1	1	3	5	7	10	13
	250			1	1	1	2	4	6	8	10
	300			1	1	1	2	3	5	7	9
	350				1	1	1	3	4	6	8
	400				1	1	1	2	4	5	7
	500				1	1	1	1	3	4	6
	600					1	1	1	3	4	5
	700					1	1	1	2	3	4
	750					1	1	1	2	3	4

*This table is for concentric stranded conductors only. For cables with compact conductors refer to N.E.C.

* ALLOWABLE AMPACITIES OF INSULATED COPPER & ALUMINUM CONDUCTORS (3W IN CONDUIT) 75°C (167°F)

*CU		AL or CU-Clad AL	
A	B	A	C
18	—	—	—
16	—	—	—
14	20†	—	—
12	25†	12	20†
10	35†	10	30†
8	50	8	40
6	65	6	50
4	85	4	65
3	100	3	75
2	115	2	90
1	130	1	100
1/0	150	1/0	120
2/0	175	2/0	135
3/0	200	3/0	155
4/0	230	4/0	180
250	255	250	205
300	285	300	230
350	310	350	250
400	335	400	270
500	380	500	310
600	420	600	340
700	460	700	375
750	475	750	385

A = Size: AWG/MCM
 B = Ampere Rating for Insulation Types:
FEPW, RH, RHW, THW, THWN, XHHW, USE, 2W.
 C = Ampere Rating for Insulation Types:
RH, RHW, THW, THWN, XHHW, USE
 (Per NEC table 310-16)

AMPACITY CORRECTION FACTORS

AMBIENT TEMP. C°	CORRECTION FACTOR	AMBIENT TEMP. F°
21 - 25	1.05	70 - 77
26 - 30	1.00	79 - 86
31 - 35	.94	88 - 95
36 - 40	.88	97 - 104
41 - 45	.82	106 - 113
46 - 50	.75	115 - 122
51 - 55	.67	124 - 131
56 - 60	.58	133 - 140
61 - 65	.33	142 - 158
66 - 70	—	160 - 176

Overall ampere ratings of UL Listed Milbank multiple position meter sockets are based on **1993 N.E.C. Manual article 220-32** and **ANSI / UL-414** (except where restricted by line connector size.) These requirements provide for a diversity factor / demand factor being utilized in determining the overall (main bus / lug) rating of a gang socket. All Milbank UL Listed gang sockets meet or exceed these diversity factor/demand factor requirements. Standard overall ampacity ratings for UL Listed and non UL Listed gang sockets are as shown in the chart below. Ampere ratings of meter sockets are based on the meter socket being wired with 75° C insulated wire conductor, sized in accordance with **Table 310-16** of the **National Electric Code**.

GANG SOCKET OVERALL AMPACITIES

NO. OF METER POSITIONS	100A / POS. AMPACITY	125A / POS. AMPACITY	150A / POS. AMPACITY	200A / POS. AMPACITY
2	200A	200A	200A	200A
3	200A	225A	225A	270A
4	200A	250A	270A	360A
5	225A	285A	338A	450A
6	270A	330A	396A	528A

† Unless otherwise permitted elsewhere in the Code, the overcurrent protection for conductor types marked with an obelisk (†) shall not exceed 15 amps for 14 AWG, 20 amps for 12 AWG, and 30 amps for 10 AWG copper; or 15 amps for 12 AWG and 25 amps for 10 AWG aluminum and copper-clad aluminum after any correction factors for ambient temperature and number of conductors have been applied.

All meter sockets are 600 Volt rated unless otherwise noted.

All meter socket ampacity ratings are continuous duty unless otherwise noted.

IMPORTANT NOTE

In addition to national and local electrical codes, many utilities have specific requirements for metering equipment. Always consult the serving utility for their specifications and requirements prior to ordering or installing Milbank meter mounting equipment.

BEFORE ENERGIZING

- A. Give equipment a thorough visual examination to determine that:
 - 1) No shipping or installation damage exists.
 - 2) Proper clearances have been maintained.
 - 3) All connections have been made.
 - 4) Equipment is clean and dry.
- B. Make a thorough examination to:
 - 1) Verify tightness of all bolted connections (see table below).
 - 2) Manually operate all circuit breakers, switches, relays, etc.
 - 3) Check rigidity of all mountings, bus bars and components.
 - 4) Use test equipment to check continuity of circuitry and integrity of insulation.
- C. All switches and circuit breakers should be in the “off” position.
- D. Verify that manual meter bypass (if applicable) is in non-bypass position.
- E. Install cover and/or close doors.
- F. If installation is not being energized at this time, follow “after-energizing” steps listed below. These steps will secure the installation in case of accidental energization.

WHEN ENERGIZING

- A. Use caution and follow established safety procedures:
 - 1) Wear safety apparel.
 - 2) Use safety equipment.
 - 3) Take action to prevent injury to yourself and others in the event of failure of the installation.
 - 4) Take action to prevent/decrease damage to property in the event of failure of the installation.
 - 5) If you are unsure how to safely energize the installation, get someone who is knowledgeable to do it.

AFTER ENERGIZING

- A. Secure the installation:
 - 1) To prevent accidental contact with energized parts, cover all openings with approved filler devices.
 - 2) To prevent unauthorized access, secure all covers and/or doors with approved security devices.
 - 3) Attach/post information to advise others of potential hazards associated with the installation.

RECOMMENDED TORQUE FOR GENERAL APPLICATIONS*

NOMINAL SIZE	JOINT DESCRIPTION		HEAD TYPE	TORQUE (INCH LBS.)
	SCREW	NUT		
10	BRASS	Brass Nut or Extruded Hole	ALL	20-25 in. lbs.
10	STEEL	CU or AL Busbar $\leq 1/8"$	ALL	25-30 in. lbs.
10	STEEL	Steel Nut or EH; CU or AL Busbar $> 1/8"$	ALL	30-35 in. lbs.
12	STEEL	Aluminum Extruded Hole	ALL	30-35 in. lbs.
12	STEEL	Steel Nut or Extruded Hole	ALL	40-50 in. lbs.
1/4	STEEL	Aluminum Extruded Hole	ALL	40-50 in. lbs.
1/4	STEEL	Steel Nut or EH; CU or AL Busbar	ALL	50-60 in. lbs.
5/16	STEEL	Aluminum Extruded Hole	HEX	60-70 in. lbs.
5/16	STEEL	Steel Nut or EH; CU or AL Busbar	HEX	100-150 in. lbs.
3/8	STEEL	Steel Nut	HEX	150-200 in. lbs.
1/2	STEEL	Steel Nut	HEX	200-250 in. lbs.

*Interior labels typically indicate the required torque for wire connectors and studs, and should be referenced first.

EH: Extruded Hole

CU: Copper

AL: Aluminum

Meter Mounting Equipment & More!

Commercial Electrical Enclosures

Residential & Commercial Metering

Commercial Meter Pedestals

Disconnect Devices

Current Transformer Enclosures

RV/MH Pedestals

Temporary Power Outlets

Circuit Breakers

Distribution Unit Substations

Enclosed Circuit Breakers

Safety Switches

Test Switches



ELECTRICAL SALES ASSOCIATES, INC.

686 Route 3 North, PO Box 206

Gambrills, MD 21054

Tel: 410-987-2200

Fax: 410-987-6650

MILBANK MFG. CO.

PO Box 419028

Kansas City, MO 64141-0028

Tel: 816-483-5314 Fax: 816-483-6357

Toll Free: 877-483-5314

www.milbankmfg.com

MILBANK®



www.milbankmfg.com

MD-DC-NVa 1/07r (300)