



VAPOR TIGHT LED

CIT200 (4FT) SERIES (2' AND 8' AVAILABLE)

FULLY ENCLOSED IMPACT RESISTANT VAPOR TIGHT GASKETED LUMINAIRE

DATE	
JOB	

WWW.LALIGHTING.COM
626-454-8300

SURFACE / SUSPENSION MOUNTED VAPOR TIGHT GASKETED LED LUMINAIRE

DIMENSIONS

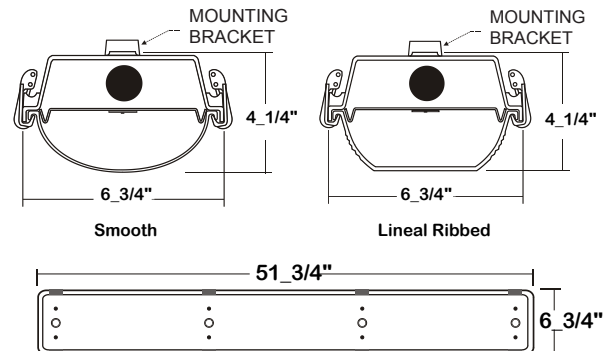

APPLICATIONS

- Commercial, Refrigeration, Dusty Areas, Freezer

FEATURES

- 0-10V dimming driver standard (See [DRIVER OPTIONS](#) for other dimming types)
- Supports California Title 24 compliance
- Safety strap attached to snap-on gear tray

OPTIONS

- Wet location available
- **High (HT)** ambient temperature version available for extreme temperature ranges (See [SYSTEM DATA](#) for ranges)
- Full customization available upon request
- Additional lumen packages and color temperatures available
- Controls and sensors available (See [SENSOR OPTIONS](#) for controls and sensors)
- Wireless control options available (See [SENSOR OPTIONS](#) for wireless controls)
- Variety of lenses available (See [OPTICAL OPTIONS](#) for lenses)
- Emergency battery pack available (See [BATTERY PACK OPTIONS](#) for battery pack options)
- Stainless steel latches available
- Tamper proof screws available
- Watertight HUB available
- NSF available
- Cable suspension systems available (See [ACCESSORIES](#) for details)
- Stainless steel V-hook available (See [ACCESSORIES](#) for details)
- Mounting bracket available (See [ACCESSORIES](#) for details)

SPECIFICATIONS

CONSTRUCTION

- IP65 / IP66 / IP67 / NEMA 4x Rated Enclosure
- 22 ga. cold rolled steel internal snap-on gear tray / cover
- Fiberglass housing with poured in place polyurethane gasket
- Lens secured to fiberglass housing by polycarbonate latches

FINISH

- Gear Tray - baked white polyester finish (powder coated finish available) / minimum reflectance 86%

OPTICAL

- Impact resistant ribbed acrylic frosted lens

ELECTRICAL

- High efficiency drivers coupled with long-life LEDs
- Service life tested at 50,000-107,000 hours (L70), 30,000 hours (L90)
- Universal voltage 120V through 277V (347V / 480V available)
- Power Factor (PF) ≥ 0.9
- Total Harmonic Distortion (THD) $\leq 20\%$

LISTING

- UL USA and Canada listed / suitable for damp locations / wet location available

WARRANTY

- 5-year limited warranty



Los Angeles Lighting Mfg. Co.
Headquarters
10141 Olney Street
El Monte, CA 91731
Made in the USA

Contact Us
T: 626-454-8300
F: 626-454-8399
www.lalighting.com



Due to continued product improvements and enhancements, Los Angeles Lighting Manufacturing Company reserves the right to alter specifications, dimensions, data, and/or materials without notice. Please visit our website to view the most current information.

MADE IN THE U.S.A.

Revised 10-26-18

WARNING

ORDERING INFORMATION

EXAMPLE: CIT200-4-4L-DRRLFR-WL-BPL10-1DRDM-UNV-1/840

SERIES	LED LUMEN PACKAGE	EFFICACY	NOMINAL LENGTH	OPTICAL	MECHANICAL	ELECTRICAL	DRIVER	VOLTAGE	# OF LED ROW	CRI / CCT
CIT200			4L				1DRDM	UNV	1	
CIT200 Fully Enclosed Impact Resistant Vapor Tight Gasketed LED Luminaire (Normal Ambient Temperature Version)	2 Nom. 2000 Lumens 4 Nom. 4000 Lumens 6 Nom. 6000 Lumens 8 Nom. 8000 Lumens 12 Nom. 12000 Lumens *Additional Lumen Packages Available	(Blank) Standard HE High Efficacy (Only 2000 / 4000 / 6000 lumens Systems)	4L 4'	DRRLFR High Impact Ribbed Acrylic Frosted DRFA High Impact Smooth Acrylic Frosted FPC Impact Resistant Polycarbonate Smooth Frosted <i>See OPTICAL OPTIONS for Options</i>	WL Wet Location (2 SSMB mounting brackets & 1 watertight hub provided) WTHUB Watertight HUB (1 per fixture) SSL Stainless Steel Latches WL-SZ NSF - Splash Zone / Non-Food Zone / Wet Location Included TP Stainless Steel Tamper Proof Screws *Leave Blank if Not Specified <i>Additional Mechanical Options</i>	BPL10 Emergency Battery Pack Constant 10W Nom. 1500 lm <i>See BATTERY PACK OPTIONS for Options</i> MSxx Motion Sensor WLC(LED RU) Wireless Control <i>See SENSOR OPTIONS for Options</i> *Leave Blank if Not Specified <i>Additional Electrical Options</i>	1DRDM 0-10V One Dimming Drive <i>See DRIVER OPTIONS for Options</i>	UNV 120V-277V <i>See DRIVER OPTIONS for Options</i>	1 One LED Row	830 80+CRI / 3000K Color Temp. 835 80+CRI / 3500K Color Temp. 840 80+CRI / 4000K Color Temp. 850 80+CRI / 5000K Color Temp. *Additional Color Temp. Available

SERIES	LED LUMEN PACKAGE	NOMINAL LENGTH	OPTICAL	MECHANICAL	ELECTRICAL	DRIVER	VOLTAGE	# OF LED ROW	CRI / CCT	AMBIENT TEMP.
CIT200		4L				1DRDM	UNV	1		HT
CIT200 Fully Enclosed Impact Resistant Vapor Tight Gasketed LED Luminaire (HT - High Ambient Temperature Version)	4 Nom. 4000 Lumens 6 Nom. 6000 Lumens 8 Nom. 8000 Lumens 12 Nom. 12000 Lumens *Additional Lumen Packages Available	4L 4'	DRRLFR High Impact Ribbed Acrylic Frosted DRFA High Impact Smooth Acrylic Frosted FPC Impact Resistant Polycarbonate Smooth Frosted <i>See OPTICAL OPTIONS for Options</i>	WL Wet Location (2 SSMB mounting brackets & 1 watertight hub provided) WTHUB Watertight HUB (1 per fixture) SSL Stainless Steel Latches WL-SZ NSF - Splash Zone / Non-Food Zone / Wet Location Included TP Stainless Steel Tamper Proof Screws *Leave Blank if Not Specified <i>Additional Mechanical Options</i>	BPL10 Emergency Battery Pack Constant 10W Nom. 1500 lm <i>See BATTERY PACK OPTIONS for Options</i> MSxx Motion Sensor WLC(LED RU) Wireless Control <i>See SENSOR OPTIONS for Options</i> *Leave Blank if Not Specified <i>Additional Electrical Options</i>	1DRDM 0-10V One Dimming Drive <i>See DRIVER OPTIONS for Options</i>	UNV 120V-277V <i>See DRIVER OPTIONS for Options</i>	1 One LED Row	835 80+CRI / 3500K Color Temp. 840 80+CRI / 4000K Color Temp. 850 80+CRI / 5000K Color Temp. *Additional Color Temp. Available	HT High Ambient Temp.

PERFORMANCE DATA

[VIEW LIGHTING FACTS](#)

[VIEW PHOTOMETRICS](#)



Los Angeles Lighting Mfg. Co.
 Headquarters
 10141 Olney Street
 El Monte, CA 91731
 Made in the USA
 Contact Us
 T: 626-454-8300
 F: 626-454-8399
 www.lalighting.com



Due to continued product improvements and enhancements, Los Angeles Lighting Manufacturing Company reserves the right to alter specifications, dimensions, data, and/or materials without notice. Please visit our website to view the most current information.

MADE IN THE U.S.A.

Revised 10-26-18

WARNING

SYSTEM DATA

THESE ARE THE MOST POPULAR LUMEN PACKAGES. PLEASE CONSULT FACTORY FOR ADDITIONAL SYSTEM DATA.

NOMINAL SIZE	LED LUMEN PACKAGE	OPTICAL OPTION	CRI / CCT	AMBIENT TEMP.	DELIVERED LUMENS	SYSTEM WATTS	LUMINAIRE EFFICACY	FLUORESCENT / HID EQUIVALENT	IES FILES
4'	2000 lm	DRRLFR	840	Normal	2075 lm	15.7 W	132.0 lm/W	1-F32T8	*
	2000HE lm	DRRLFR	840	Normal	1968 lm	12.7 W	155.0 lm/W	1-F32T8	*
	4000 lm	DRRLFR	840	Normal	3963 lm	33.1 W	119.7 lm/W	2-F32T8, 1-F54T5HO	LA-T3196
				HT	3936 lm	25.4 W	155.0 lm/W		*
	4000 lm *	DRRLFR	850	Normal	3851 lm	35 W	110 lm/W		*
	4000HE lm	DRRLFR	840	Normal	3918 lm	25.9 W	151.2 lm/W	2-F32T8, 1-F54T5HO	*
	4000HE lm**	DRFA	840	Normal	3748 lm	26.86 W	139.6 lm/W		LA-T3211
	6000 lm	DRFA	840	Normal	5666 lm	52.3 W	108.3 lm/W	3-F32T8	*
				HT	5900 lm	38.5 W	153.3 lm/W		*
	6000 lm *	DRRLFR	850	Normal	5619 lm	50.8 W	111 lm/W		*
	6000HE lm	DRRLFR	840	Normal	5813 lm	39.6 W	146.7 lm/W	3-F32T8	*
	6000HE lm**	DRFA	840	Normal	5726 lm	40 W	143.2 lm/W		*
	8000 lm	DRRLFR	840	Normal	7652 lm	53.8 W	142.2 lm/W	4-F32T8, 2-F54T5HO, 175 W (MH)	*
				HT	7820 lm	50.4 W	155.1 lm/W		LA-T3197
	8000 lm**	DRFA	840	Normal	7372 lm	56.8 W	129.8 lm/W		*
	12000 lm	DRRLFR	840	Normal	11163 lm	83.3 W	134.1 lm/W	6-F32T8, 3-F54T5HO, 250 W (MH)	*
HT				11625 lm	79.3 W	146.7 lm/W	*		
12000 lm**	DRFA	840	HT	12290 lm	91.9 W	133.8 lm/W	LA-T3212		

NOTE:
 System data above is based on 120V input voltage. DLC system data*** based on DLC testing parameters. Actual performance may differ as a result of end-user environment and application.
 HT: High Ambient Operating Temperature Minimum -30°C / Maximum 50°C
 Normal: This fixture has been tested and listed in accordance with UL Standards. L.A. Lighting certifies that it will operate safely when installed properly, and within an ambient temperature range from -20°C to 35°C.

Additional lumen packages and color temperatures available.

Due to constant updates on this product, please visit the [DLC QPL Website](#) for the most accurate system data and information.

*  **DLC part numbers:**
 CIT200-4-4L-DRRLFR-XXX-XXXX-1DRDMxx(XXX)-UNV-1/850
 CIT200-6-4L-DRRLFR-XXX-XXXX-1DRDMxx(XXX)-UNV-1/850

**  **DLC Premium part numbers:**
 CIT200-4HE-4L-DRFA-xxx-xxxxx-1DRDMxx(XXX)-UNV-1/840
 CIT200-4HE-4L-DRFA-xxx-xxxxx-1DRSDMxx(XXX)-UNV-1/840
 CIT200-6HE-4L-DRFA-xxx-xxxxx-1DRDMxx(XXX)-UNV-1/840
 CIT200-6HE-4L-DRFA-xxx-xxxxx-1DRSDMxx(XXX)-UNV-1/840
 CIT200-8-4L-DRFA-xxx-xxxxx-1DRDMxx(XXX)-UNV-1/840
 CIT200-8-4L-DRFA-xxx-xxxxx-1DRSDMxx(XXX)-UNV-1/840
 CIT200-12-4L-DRFA-xxx-xxxxx-1DRDMxx(XXX)-UNV-1/840HT



Los Angeles Lighting Mfg. Co.
 Headquarters
 10141 Olney Street
 El Monte, CA 91731
 Made in the USA
 Contact Us
 T: 626-454-8300
 F: 626-454-8399
 www.lalighting.com



Due to continued product improvements and enhancements, Los Angeles Lighting Manufacturing Company reserves the right to alter specifications, dimensions, data, and/or materials without notice. Please visit our website to view the most current information.

MADE IN THE U.S.A.

SENSOR OPTIONS**DRY AND DAMP LOCATIONS - HIGH / LOW AISLE MOUNTING APPLICATIONS - END MOUNT****MS - Motion Sensor**

- Turns light ON/OFF based on motion detection
- Fixture mounting height 8-45'
- Universal Voltage (120V-277V)
- 480V available

MSSD - Motion Sensor – Step Dimming

- Step-dims light to desired preset level (based on motion detection)
- Used in conjunction with 0-10V Ballast/Driver
- Fixture mounting height 8-45'
- Universal Voltage (120V-277V)

MSPC - Motion Sensor & Photocell

- Holds lights OFF when sufficient daylight is present regardless of motion detection
- Fixture mounting height 8-45'
- Universal Voltage (120V-277V)

MSPCD(ADC) - Motion Sensor & PhotoCell Dimming (Auto Dim Control)

- Variably dims output to desired preset footcandle level through photocell ON/OFF with motion detection
- Used in conjunction with 0-10V Ballast/Driver
- Fixture mounting height 8-45'
- Universal Voltage (120V-277V)

MSPCD(ANL) - Motion Sensor & Photocell Dimming (Auto Night Light)

- Variably dims output to desired footcandles through photocell
- Low setting when unoccupied (full on with motion)
- For 24 hour use
- Used in conjunction with 0-10V Ballast/Driver
- Fixture mounting height 8-45'
- Universal Voltage (120V-277V)

MSPCDR - Motion Sensor & Photocell Dimming (Setup with Remote Control)

- Field adjustable dimming sensor capabilities:
 - Step Dim (HIGH/LOW output)
 - Auto Dim Control (dim to desired footcandles, ON/OFF with motion)
 - Auto Night Light (dim to desired footcandles, LOW without motion)
- Used in conjunction with 0-10V dimming Ballast /Driver
- Holds lights OFF when sufficient daylight is present regardless of motion detection
- Adjustable ramp up and fade down time
- Fixture mounting height 8-40'
- Universal Voltage (120V-277V)
- Remote setup and adjustment with handheld wireless tool (sold separately)

PCS - Photocell Sensor

- Turns light ON/OFF based on light levels
- Fixture mounting height 8-45'
- Universal Voltage (120V-277V)

PCD - Photocell Dimming

- Dims output to desired footcandles through photocell
- Used in conjunction with 0-10V Ballast/Driver
- Fixture mounting height 8-45'
- Universal Voltage (120V-277V)

WET LOCATIONS - HIGH / LOW AISLE MOUNTING APPLICATIONS - END MOUNT**MSW(HI) - Motion Sensor Wet (HI)**

- Turns light ON/OFF based on motion detection
- High mounting height applications 15-30' / Universal Voltage (120V-277V)
- 480V available

MSPCW(HI) - Motion Sensor & Photocell Wet (HI)

- Holds lights OFF when sufficient daylight is present regardless of motion detection
- High mounting height applications 15-30' / Universal voltage (120V-277V)

MSSDW(HI) - Motion Sensor – Step Dimming Wet (HI)

- Step-dims light to desired preset level (based on motion detection)
- Used in conjunction with 0-10V Ballast/Driver
- Fixture mounting height 15-30' / Universal Voltage (120V-277V)

MSPCDW(HI) - Motion Sensor & Photocell Dimming Wet (HI)

- Field adjustable dimming sensor capabilities:
 - Step Dim (HIGH/LOW output)
 - Auto Dim Control (dim to desired footcandles, ON/OFF with motion)
 - Auto Night Light (dim to desired footcandles, LOW Setting without motion)
- Used in conjunction with 0-10V Ballast/Driver
- High mounting height applications 15-30' / Universal voltage (120V-277V)

MSPCDW(LOW) - Motion Sensor & Photocell Dimming Wet (LOW)

- Field adjustable dimming sensor capabilities:
 - Step Dim (HIGH/LOW output)
 - Auto Dim Control (dim to desired footcandles, ON/OFF with motion)
 - Auto Night Light (dim to desired footcandles, LOW SETTING without motion)
- Used in conjunction with 0-10V Ballast/Driver
- Low mounting height applications 8-15' / Universal voltage (120V-277V)

MSW(LOW) - Motion Sensor Wet (LOW)

- Turns light ON/OFF based on motion detection
- Low mounting height applications 8-15'
- Universal Voltage (120V-277V)
- 480V available

MSPCW(LOW) - Motion Sensor & Photocell Wet (LOW)

- Holds lights OFF when sufficient daylight is present regardless of motion detection
- Low mounting height applications 8-15'
- Universal voltage (120V-277V)

MSSDW(LOW) - Motion Sensor – Step Dimming Wet (LOW)

- Step-dims light to desired preset level (based on motion detection)
- Used in conjunction with 0-10V Ballast/Driver
- Fixture mounting height 8-15'
- Universal Voltage (120V-277V)

MSPCDRW - Motion Sensor & Photocell Dimming (Setup with Remote Control, Wet)

- Field adjustable dimming sensor capabilities:
 - Step Dim (HIGH/LOW output)
 - Auto Dim Control (dim to desired footcandles, ON/OFF with motion)
 - Auto Night Light (dim to desired footcandles, LOW without motion)
- Used in conjunction with 0-10V dimming Ballast /Driver
- Holds lights OFF when sufficient daylight is present regardless of motion detection
- Adjustable ramp up and fade down time
- Fixture mounting height 8-40'
- Universal Voltage (120V-277V)
- Remote setup and adjustment with handheld wireless tool (sold separately)

**CONTROLS AND SENSORS****WLC(LED RU) - EnOcean® LED Relay Zone Controller**

- Supports a single LED fixture or multiple daisy chained LED fixtures
- Module installed inside lighting fixture

ESRPU-W-EO - EnOcean® Rocker Switch – Single – Surface Mount

- Wireless single rocker switch with mounting plate
- No batteries needed

ESDRPU-W-EO - EnOcean® Rocker Switch – Double – Surface Mount

- Wireless double rocker switch with mounting plate
- No batteries needed

S3054-N30 - EnOcean® Navigan NWC 300U – Commissioning Tool

- Navigan Wireless Commissioner is used to configure EnOcean controllers & sensors
- It can be used to define link tables, change parameters/settings, and to edit & store projects
- Configuration settings can be saved and cloned to enable quick configuration
- Connectivity is through the NWC 300U USB Stick

EOSWU-W-EO - EnOcean® Occupancy Sensor – Wall Mount

- Wireless wall mounted occupancy sensor
- Solar powered - no batteries needed (coin battery operated in low light conditions)
- PIR motion sensor with both wide angle (50') and long range (100') options
- Mounting height: 6-8 feet

EOSCU-W-EO - EnOcean® Occupancy Sensor – Ceiling Mount

- Wireless ceiling mounted occupancy sensor
- Solar powered - no batteries needed (coin battery operated in low light conditions)
- PIR motion sensor with 360 degree viewing angle lens (34' diameter)
- Mounting height: 7-10 feet

EOSCU-W-EO - EnOcean® Light Level Sensor

- Light Level sensor that measures and reports the level of available natural light
- Solar powered - no batteries needed (coin battery operated in low light conditions)
- Enables implementation of daylight harvesting control systems
- Mounting position: At the ceiling, close to ambient light source

**Los Angeles Lighting Mfg. Co.**

Headquarters
10141 Olney Street
El Monte, CA 91731
Made in the USA

Contact Us
T: 626-454-8300
F: 626-454-8399
www.lalighting.com



Due to continued product improvements and enhancements, Los Angeles Lighting Manufacturing Company reserves the right to alter specifications, dimensions, data, and/or materials without notice. Please visit our website to view the most current information.

MADE IN THE U.S.A.

Revised 10-26-18

WARNING

OPTICAL OPTIONS

STANDARD LENSES FOR CIT200

DRRFLR	Impact Resistant Ribbed Acrylic Frosted
DRFA	Impact Resistant Smooth Acrylic Frosted
FPC	Impact Resistant Polycarbonate Smooth Frosted

ADDITIONAL AVAILABLE LENSES

PCRL	Impact Resistant Polycarbonate Clear Ribbed
PCRLFR	Impact Resistant Polycarbonate Ribbed Frosted

DRIVER OPTIONS

PLEASE CONSULT FACTORY TO SEE IF YOUR SELECTED DRIVER OPTION WORKS WITH THIS FIXTURE.

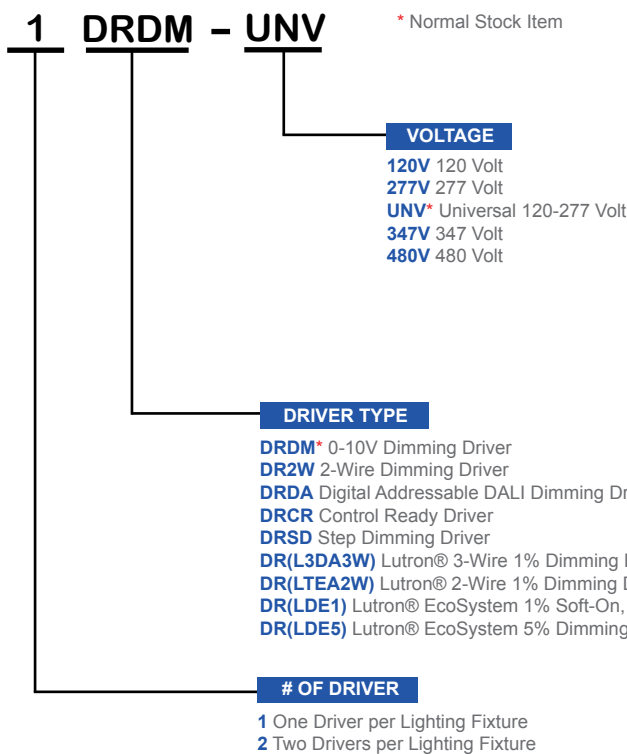

BATTERY PACK OPTIONS

PLEASE CONSULT FACTORY TO SEE IF YOUR SELECTED BATTERY PACK OPTION WORKS WITH THIS FIXTURE.

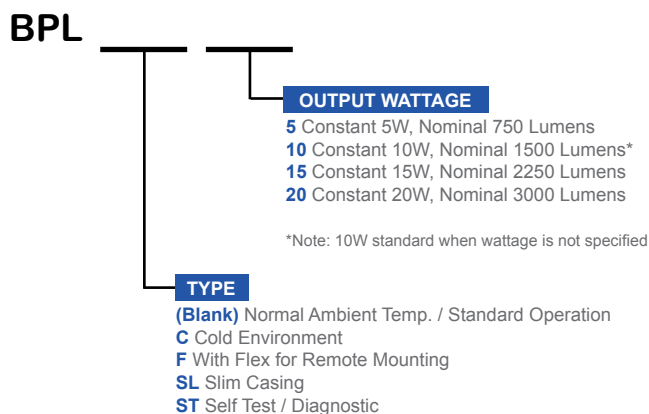

Los Angeles Lighting Mfg. Co.
 Headquarters
 10141 Olney Street
 El Monte, CA 91731
 Made in the USA

Contact Us
 T: 626-454-8300
 F: 626-454-8399
 www.lalighting.com



Due to continued product improvements and enhancements, Los Angeles Lighting Manufacturing Company reserves the right to alter specifications, dimensions, data, and/or materials without notice. Please visit our website to view the most current information.

MADE IN THE U.S.A.

Revised 10-26-18
WARNING

ACCESSORIES



CIT2/SSMB

- Corrosion resistant stainless steel mounting bracket
- Two (2) brackets per set
- Fixture snaps securely into place (mounting method does not require stud in fixture)

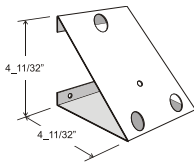

45MB

- 45-Degree Mounting Bracket
- Designed for mounting lighting fixtures at 45° angle
- Two (2) brackets needed per fixture
- Ideal for wall or ceiling mount applications
- 18 ga. electro galvanized steel
- Baked white powder coated finish

Note: Must use with CIT2/SSMB



CIT2/SSV

- Corrosion resistant stainless steel V-hooks for chain mount applications
- Two (2) hooks per set
- Hooks work in conjunction with stainless steel mounting brackets (CIT2/SSMB) (mounting bracket sold separately)



CIT2/SSMBRM

- Stainless steel mounting bracket for 3/8" threaded rods
- Corrosion resistant stainless steel mounting bracket
- Two (2) brackets per set
- Fixture snaps securely into place (mounting method does not require stud in fixture)

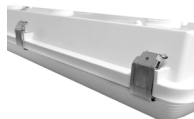

SSL

- Stainless steel latches
- Corrosion resistant stainless steel latches
- Eight (8) latches per set

CIT2/CS10

- Cable Suspension System
- Cable suspension system works in conjunction with stainless steel V-hooks (CIT2/SSV) and stainless steel mounting brackets (CIT2/SSMB)
- (2x) CIT2/SSV and (2x) CIT2/SSMB included with cable suspension system
- Two (2) cable suspension systems per set

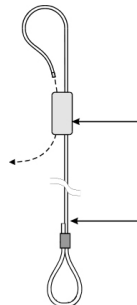

Self-Locking Device

- Secures free end to ceiling member

10' Cable Standard

- One end free and the other end secured within fixture
- 100lbs. Work Load
- 500lbs. Break Load

Cable Suspension System

- See [Mechanical Options](#) for additional Cable Suspension Systems



Los Angeles Lighting Mfg. Co.
 Headquarters
 10141 Olney Street
 El Monte, CA 91731
 Made in the USA

Contact Us
 T: 626-454-8300
 F: 626-454-8399
 www.lalighting.com



Due to continued product improvements and enhancements, Los Angeles Lighting Manufacturing Company reserves the right to alter specifications, dimensions, data, and/or materials without notice. Please visit our website to view the most current information.

MADE IN THE U.S.A.

Revised 10-26-18

WARNING

LED lighting facts

CIT200-4-4L-DRRLFR-1DRDM-UNV-1/850

- 4000 Lumens System
- L70 performance at 90,000 hours

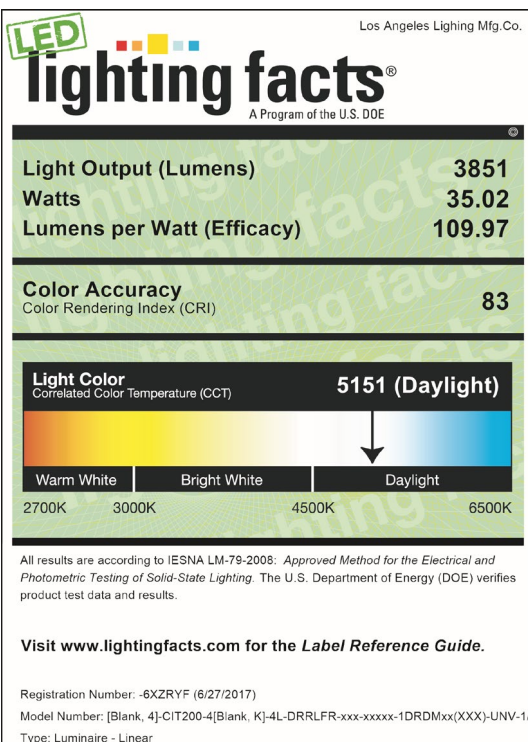

CIT200-6-4L-DRRLFR-1DRDM-UNV-1/850

- 6000 Lumens System
- L70 performance at 107,000 hours

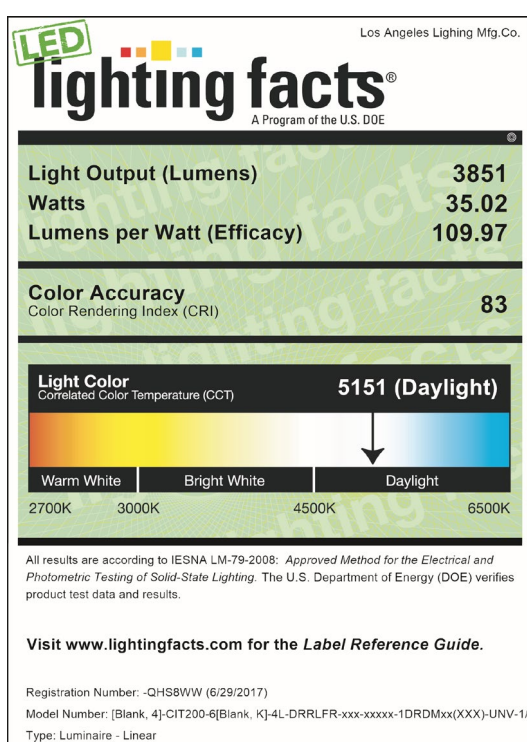

CIT200-4HE-4L-DRFA-1DRDM-UNV-1/840

- 4000HE Lumens System
- L70 performance at 90,000 hours
- L90 performance at 25,000 hours

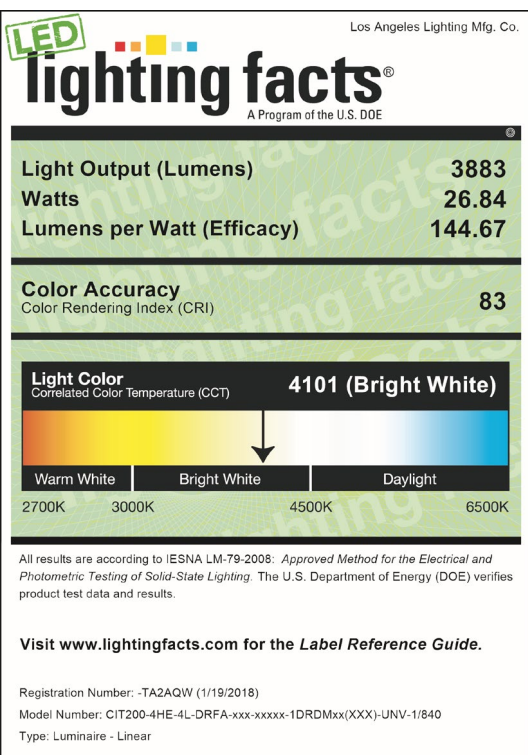

CIT200-4HE-4L-DRFA-1DRSDM-UNV-1/840

- 4000HE Lumens System
- L70 performance at 90,000 hours
- L90 performance at 25,000 hours

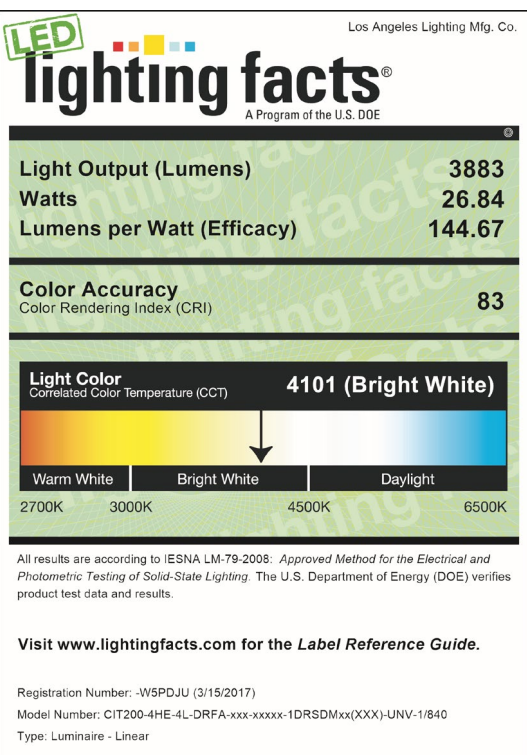

LOS ANGELES LIGHTING MFG. CO.

10141 OLNEY ST. / EL MONTE, CA 91731

TEL 626-454-8300 | FAX 626-454-8399 | www.lalighting.com

LED lighting facts

CIT200-6HE-4L-DRFA-1DRDM-UNV-1/840

- 6000HE Lumens System
- L70 performance at 107,000 hours
- L90 performance at 30,000 hours

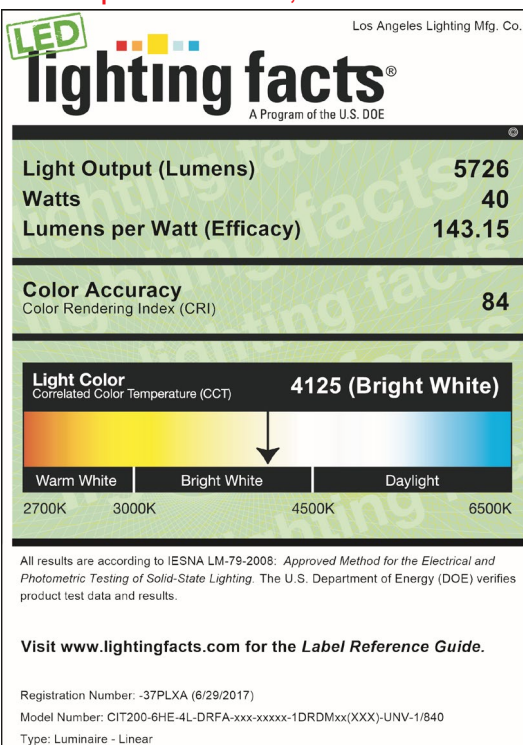

CIT200-6HE-4L-DRFA-1DRSDM-UNV-1/840

- 6000HE Lumens System
- L70 performance at 107,000 hours
- L90 performance at 30,000 hours

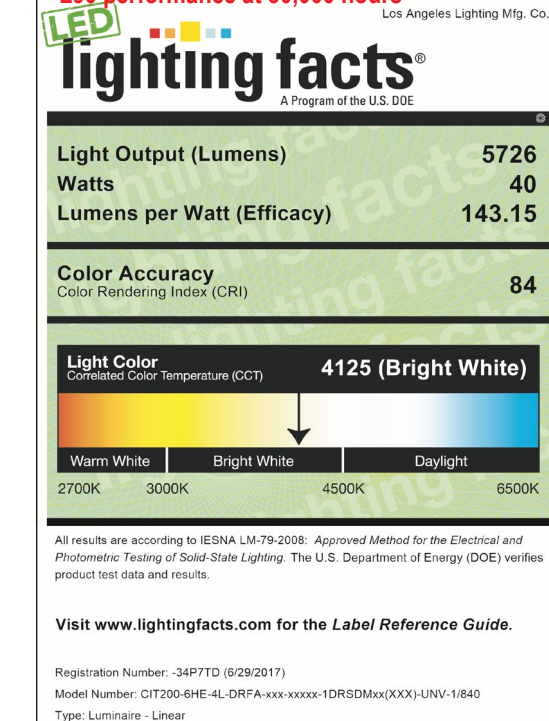

CIT200-8-4L-DRFA-1DRDM-UNV-1/840

- 8000 Lumens System
- L70 performance at 155,000 hours
- L90 performance at 44,000 hours

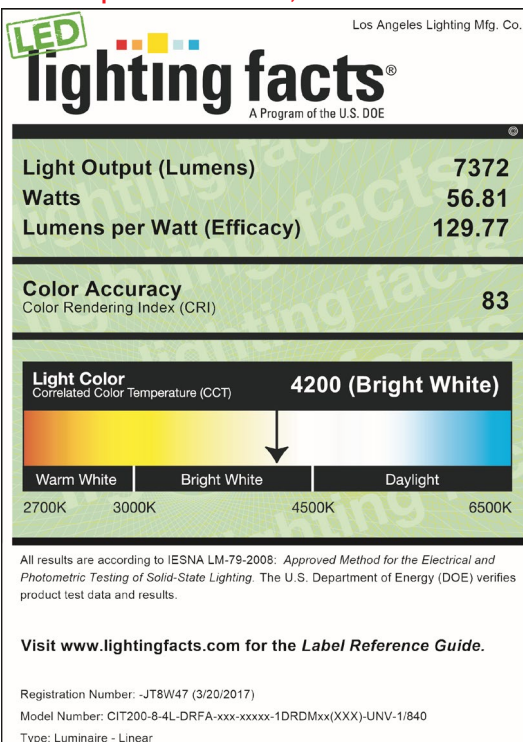

CIT200-8-4L-DRFA-1DRSDM-UNV-1/840

- 8000 Lumens System
- L70 performance at 155,000 hours
- L90 performance at 44,000 hours

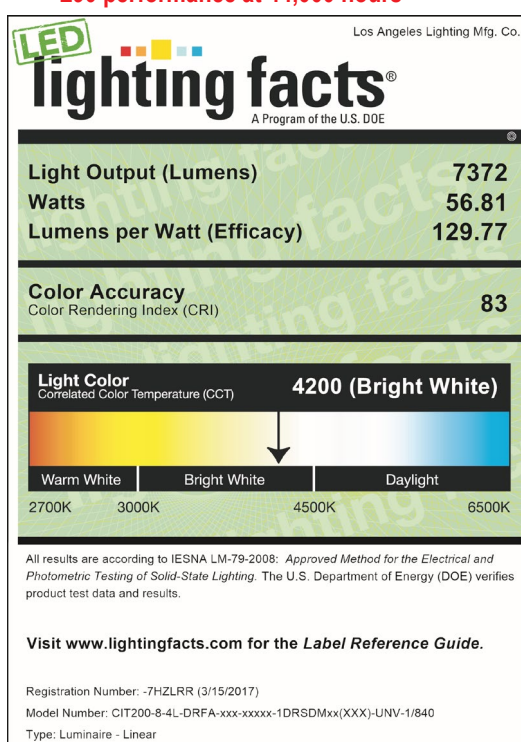

LOS ANGELES LIGHTING MFG. CO.

10141 OLNEY ST. / EL MONTE, CA 91731

TEL 626-454-8300 | FAX 626-454-8399 | www.lalighting.com

LED lighting facts

CIT200-12-4L-DRFA-1DRDM-UNV-1/840

- 12000 Lumens System
- L70 performance at 176,000 hours
- L90 performance at 57,000 hours



Los Angeles Lighting Mfg. Co.

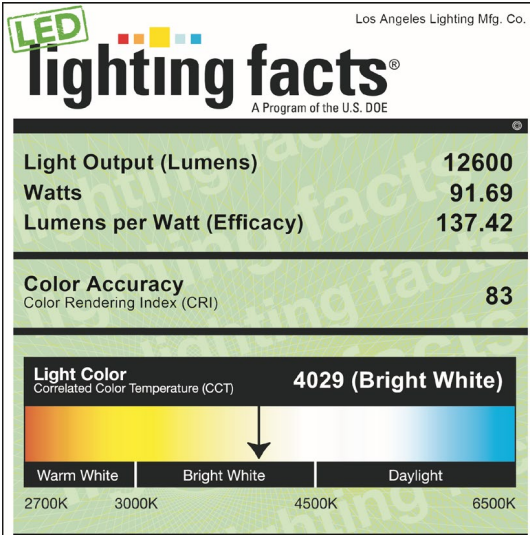

All results are according to IESNA LM-79-2008: *Approved Method for the Electrical and Photometric Testing of Solid-State Lighting*. The U.S. Department of Energy (DOE) verifies product test data and results.

Visit www.lightingfacts.com for the *Label Reference Guide*.

Registration Number: -3AKUBO (3/20/2017)

Model Number: CIT200-12-4L-DRFA-xxx-xxxxx-1DRDMxx(XXX)-UNV-1/840HT

Type: Luminaire - Linear



LOS ANGELES LIGHTING MFG. CO.

10141 OLNEY ST. / EL MONTE, CA 91731

TEL 626-454-8300 | FAX 626-454-8399 | www.lalighting.com

PHOTOMETRIC DATA - CIT200 SERIES

CIT200-4-4L-DRRLFR-1DRDM-UNV-1/840

TEST NO.=LA-T3196
 LED TYPE=48 LED MODULE
 NO. OF MODULE=2
 SYSTEM WATT (W)=33.1
 CRI ≥ 80
 L70(Hrs.) ≥ 50,000
 PHOTOMETRY TYPE=C

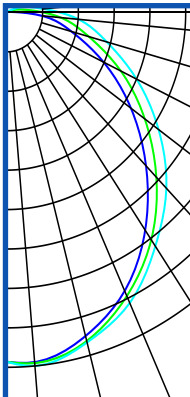
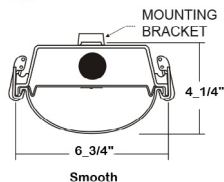

CANDLEPOWER

ANGLE	END	45	CROSS
0	1217	1217	1217
5	1223	1226	1236
15	1167	1185	1190
25	1071	1090	1117
35	926	967	994
45	756	812	866
55	582	646	711
65	410	483	550
75	256	326	397
85	135	208	277
90	52	140	203
95	19	88	141
115	4	8	26
125	2	1	1
135	0	0	0
145	0	0	0
155	0	0	0
165	0	0	0
175	0	0	0
180	0	0	0

ZONAL LUMEN SUMMARY

DEGREES	LUMENS	% LAMP	% FIXTURE
0-30	958	22.3	24.1
0-40	1563	36.5	39.4
0-60	2772	64.7	69.6
0-90	3803	88.7	95.6
90-120	159.1	3.7	4.0
90-150	160.2	3.7	4.0
90-180	160.2	3.7	4.0
0-180	3963	92.52	100.00

Luminaire Output= 3963 lumens
 Luminaire Efficacy = 119.7 lm/W

SPACING CRITERION

ALONG	ACROSS
1.21	1.27

CIT200-8-4L-DRRLFR-1DRDM-UNV-1/840HT

TEST NO.=LA-T3197
 LED TYPE=144 LED MODULE
 NO. OF MODULE=2
 SYSTEM WATT (W)=50.4
 CRI ≥ 80
 L70(Hrs.) ≥ 50,000
 PHOTOMETRY TYPE=C

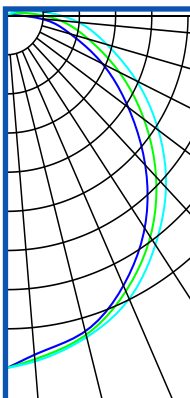
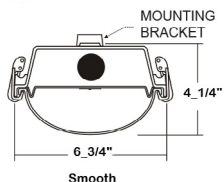

CANDLEPOWER

ANGLE	END	45	CROSS
0	2385	2385	2385
5	2428	2433	2405
15	2308	2328	2347
25	2121	2154	2195
35	1830	1905	1978
45	1500	1606	1711
55	1134	1278	1408
65	805	953	1089
75	507	641	784
85	247	275	502
90	97	173	404
95	35	15	282
115	6	1	53
125	2	0	3
135	1	0	0
145	0	0	0
155	0	0	0
165	0	0	0
175	0	0	0
180	0	0	0

ZONAL LUMEN SUMMARY

DEGREES	LUMENS	% LAMP	% FIXTURE
0-30	1889	22.3	24.1
0-40	3085	36.4	39.4
0-60	5473	64.6	69.9
0-90	7506	88.6	95.99
90-120	311.7	3.6	3.9
90-150	313.4	3.7	4.0
90-180	313.4	3.7	4.0
0-180	7820	92.33	100.00

Luminaire Output= 7820 lumens
 Luminaire Efficacy = 155.1 lm/W

SPACING CRITERION

ALONG	ACROSS
1.26	1.25

