

# RACK-A-TIERS<sup>®</sup>



"LENDING A HAND"

**SPECIALTY ELECTRICAL TOOLS**

# RACK-A-TIERS®

The ONE TOOL that does it all!



Compact...  
Interlocking Pairs



Wire Dispenser...



easy to set up...



portable...

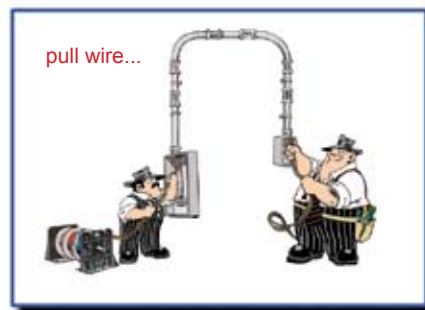

pull wire...



pipe vise...



caddy...



workbench...



saw horse.....



seat...

Versatile • Waterproof • Rustproof • Reliable • Rugged • Fast

**ONE SIZE Rack-A-Tiers FITS ALL**

Up to: 34" / .94m • 330 lb / 150 kg wire reels

# RACK-A-TIERS®

ONE TOOL • Many uses • Many configurations



Work bench frame



Versatile

Part #11455

What can Rack-A-Tiers do for you? Big wire, small wire, fast wire, long pipes, short pipes, big pipes, big butts, small butts. EVERYTHING! How? Simpler, smaller, bigger, faster, lighter, easier, waterproof, rust proof, no batteries, no motors...and they float. Tough? You bet. Rack-A-Tiers just plain work!



## THE HOOKER PIPE WRENCH ADAPTOR

Every RACK-A-TIER needs a Hooker!!!

"Turn your Rack-A-Tiers into a Pipe Vise"  
Light, Fast, Simple, Inexpensive."



Heavy, Oily

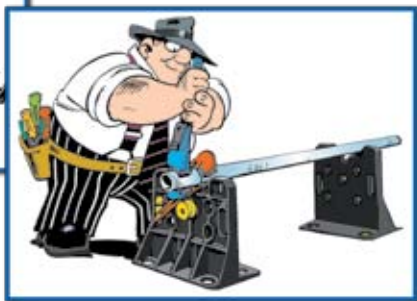

Light, Easy



NOTE: REQUIRED PIPE WRENCH (not supplied) is an 18" RIDGID® or equivalent fit.

Part #10455

Do you do industrial pipe work? The HOOKER / Rack-A-Tier combo can replace your tripod for small jobs. Don't have a tripod? With a Ridgid® 18" aluminum pipe wrench and Rack-A-Tiers, the HOOKER will put you in the pipe business. The HOOKER really can handle your rigid pipe work.

# RACK 'N ROLLER

*Roll into the Future*



Stands up for easy storage

Wire spools run on spring-loaded rollers, no axle.

**Advantages:**

- Spools can be loaded one at a time without disturbing the others
- Transport, dispense and store wire with no set up or breakdown
- No axles or loose parts
- Rugged USA construction



Length - 32"

Capacity - 4 to 5 rolls of THHN 10, 12, 14 gauge

Application - USA style 6 1/2" diameter plastic spools

Part #12888

If you use a lot of THHN, this is your unit, especially for a service truck. Easy to tow around, handles for lifting AND it's a piece of cake to change each roll out. Stores and protects your wire spools when not in use and the Rack 'N Roller is always ready to rack and roll.

# E-Z ROLL WIRE RACK

E-Z ROLL WIRE RACK is the *ultra compact* / collapsible wheeled wire dispenser.

When you're ready to pull wire, wheel the E-Z ROLL into position and dispense wire directly from your pipe bender or 1" EMT.

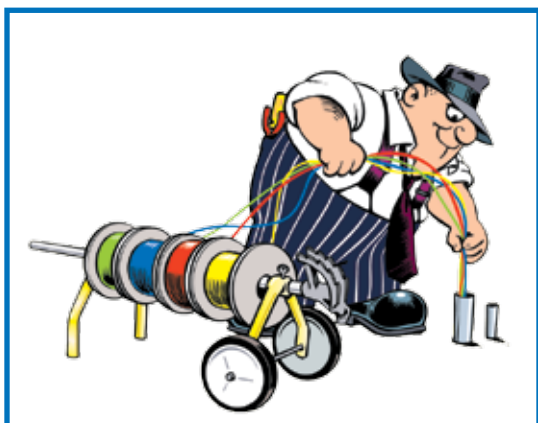

Part #55455



**Features:**

- Rigid Steel Construction
- Light-weight Design
- Durable 'Caution Yellow' Finish
- Compact (fits in any job box)
- 150 lb. Load Tested
- Holds Reels up to 18"



collapsible for easy storage & handling

Most wheeled wire dispensers are too big for your truck and they only hold little wire spools. The E-Z Roll knocks down in seconds and handles reels to 18 inches. Use a conduit bender or scrap of 1" EMT for an axle/handle. The E-Z Roll is big enough to handle 1000' rolls of Romex. Simple, effective.

# Wire Tub

## Wire Rewinder and Dispenser

**Features:**

- 360° feed adjusts automatically
- 3-way adjustable centre hub
- Removable top plate has a handle for *rewinding wire*
- Big 24" diameter capacity



MC Cable

Part #18455



Flex

Romex



Top plate on for rewinding



Salvaged wire ready for reinstallation

All coil dispensers dispense but this one **REWINDS** wire as well. Over-runs can be wound back, old wire salvaged and re-installed. And it's fast. No hanging or mounting, the **WIRE TUB** just sits on the floor. Handles Flex, Romex, MC, etc. Same tough plastic as **Rack-A-Tiers**. Awesome!

## No Wire Spool? No Problem!

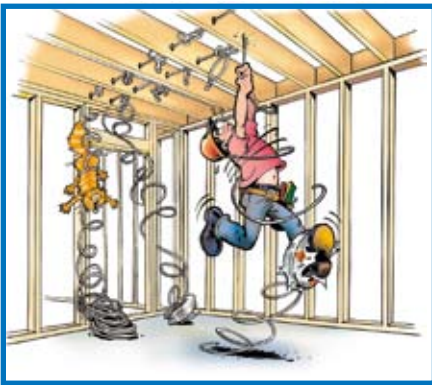

The Usual Way

This easy-to-hang wire dispenser allows fast, twist-free Romex, MC cable or Flex pulling.

- Affordable
- Dependable
- Saves Time
- Eliminates Waste
- No Maintenance
- Collapsible



## THOMAS WHEELER Wire Spool®

Hangs from a ladder



A New Way

Part #19455

Most coil dispensers are too big, cumbersome and expensive. Not this one. The Thomas Wheeler knocks down and sets up in seconds, hangs on a 2x4, in the trusses, above tee bar or on a ladder. Light, simple, rugged and it really works. A great value.

# Pull-Rite®

## 'WIRE BRAKE'

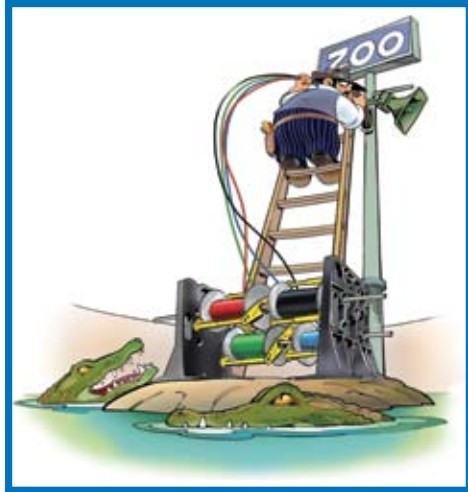

### Features:

#### Easy to install.

- Clips on each roll in seconds.
- Controls overrun.
- Wire cannot jump off the spools.
- Separates the spools; no rubbing together.
- Fits standard #12 and #14 wire spools.
- Compatible with Rack-A-Tiers and many other wire dispensers.



Tame your wire with the Pull-Rite!

Application - USA style 6 1/2" diameter plastic spools

Part #15455

Full new rolls wound to the rim? No longer a problem. Jerky pull with lots of stopping? No more "bird's nesting". Just want one or two conductors from a group? That's all that spins. One man pulls? Easy, and the PULL-RITE is easy to install!



### "Wire Spool Repair"

- salvages 'unusable' wire
- reusable over and over
- money maker



"There's gold in them thar rolls...but how do you get at it?"

Broken

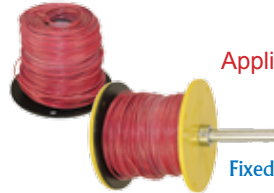

Application - USA style 6 1/2" diameter plastic spools

Part #17455

How many broken spools in your shop? A few? A bunch? There's gold in them thar rolls but how do you get at it? Fix them with the Reel-End. Pays for itself with the first roll saved and it's reusable again and again. The Reel-End fits plastic spools #10 through #18 gauge. A real money maker.



## NUT SPINNER

### WIRE NUT INSTALLATION TOOL

- Fits most wire nuts (pigtails too)
- Fast, secure wire nut installation without pre-twisting conductors

Part #89455



Fits all these wire nuts.

Do you prefer to twist your nuts or spin your nuts? Twisting is slow and can be painful, especially when carpal tunnel sets in. Why not spin your wire nuts with the NUT SPINNER? Much faster, easier and it really cinches them up.

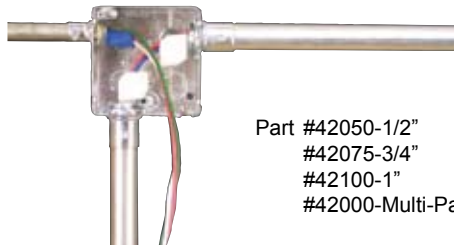

Part #42050-1/2"  
 #42075-3/4"  
 #42100-1"  
 #42000-Multi-Pack

## The All American Pull Buddy



- Reduces Time and Labour
- Reduces the chance of damaging wires
- Turns wire pulling into a one man job

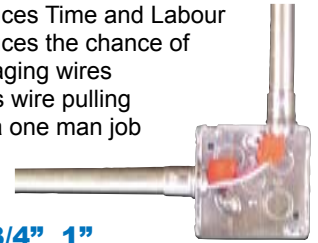

'SHOEHORNS FOR YOUR WIRE'

Three Sizes Available: 1/2" 3/4" 1"

Two man wire pulls can be costly. So can cut wires and short circuits. The All American Pull Buddy turns one guy into a 'crew'. Fast, easy to use and reusable. *Why not protect the conductors on all your pulls?*



Knuckle Buster

## BEND ALL Cable Bender



Finally,  
 the Amazing Knuckle Saver from Rack-A-Tiers®

- Captures wire
- Bend inside enclosures to the right or left
- Bend to the front or back
- Your feeders will lie in the lugs

Machined from 6061 aircraft aluminum  
 Fits a standard 1/2" ratchet.

Fits #3 to 350 MCM conductors



Part #77455

Piece of Cake

*Ever give a meter base a knuckle sandwich? Too bad it was your own. Next time, defend yourself with the Bend All. Perfectly sized for 4/0, it takes the pain out of 200 amp services or sub feeders and conductors like it too. The Bend All makes micro adjustable bends without brutalizing the wire.*

## SNATCH STRAP Wire Puller

Fast attachment  
 for conduit pulls

No stripping required  
 No taping required



3 Straps per kit

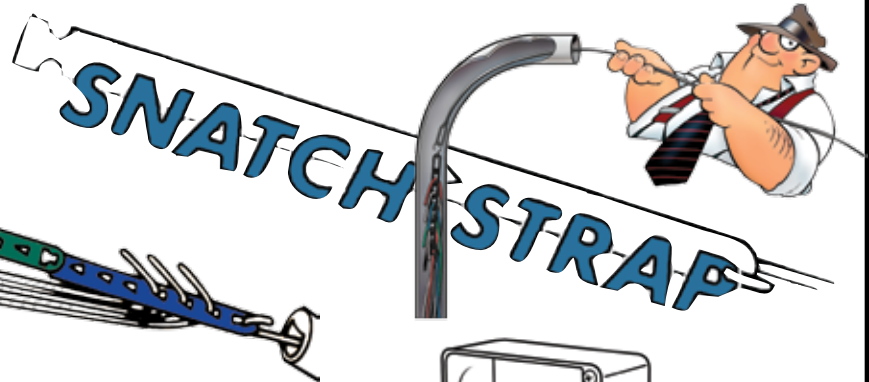

1/2" pipe?  
 90° bends?  
 Fits Easily

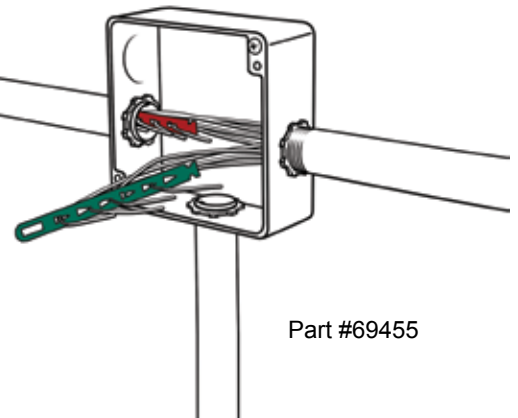

Part #69455

Time is money and when you think about it, a lot of time is spent stripping, taping and untaping wire for fishtape pulls. The SNATCH STRAP gives you back this time. Because it staggers the wire, you can pull more conductors with *less* effort. Because SNATCH STRAPS can be daisy chained, you can easily drop wire groups at boxes along the pull. Color coded for easy circuit and phase identification.

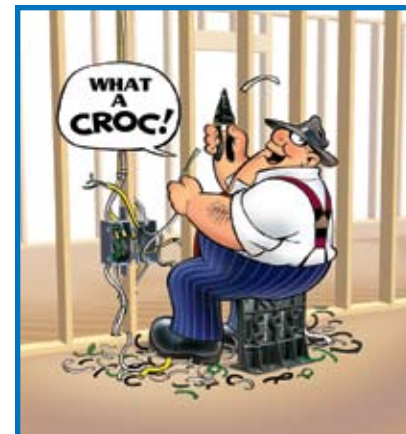
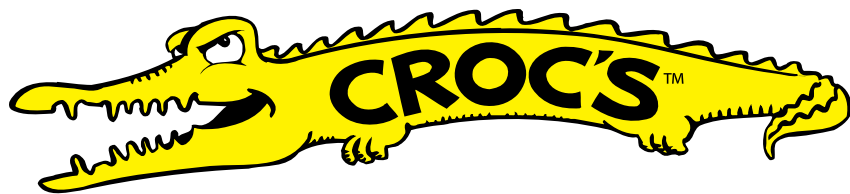

## “Needle Nose Wire Strippers”

### CHECK OUT THE FEATURES:

- Needle nose tips
- Romex sheath stripper at the “nose” where it is easier to use inside boxes
- Strips conductor sizes from #10 down to #22 AWG (for telephone wire)
- Large cutting blades for easy general purpose cuts
- Barrel sleeve crimper near the pivot
- Ergonomic “hourglass” shaped handles for comfort & speed



Part # 47000

Croc's! What a beautiful stripper. Check out those curvaceous grips. Try out those needle nose tips. Dual action sheath stripper, crimper, oversized cutters, 22 gauge stripper as well. Croc's rock. Try 'em.

## Pipe Spring Bender

## Cold PVC Pipe Bender



**YOU CAN  
COLD BEND**

RIGID PVC PIPE WITHOUT  
PIPE COLLAPSE OR FRACTURE

- NO HEAT GUNS
- NO HEAT BLANKETS
- FEWER PVC FITTINGS

**FASTER AND EASIER  
THAN CUTTING AND GLUEING  
FACTORY FITTINGS**

### HOW?

INSERT THE PIPE SPRING INTO THE PIPE  
AND BEND ACROSS YOUR KNEE!!

1/2" Part #58050  
3/4" Part #58075  
1" Part #58100

### Definition of Cold

NOTE: **Pipe should be 60° F or warmer.** PVC pipe requires slight over bending which will “pop back” a few degrees upon the release of bending pressure.

Hang up that heat gun and can that glue can. Your knee is faster and the Pipe Spring Bender makes it easy to bend 1/2" & 3/4" PVC. Add a little brute force and you can bend 1" too. Believe it!



# RACKSY PAD KNEE PADS



**Save your knees, you'll need them later!**

Sturdy and so comfortable, you'll actually wear them. Velcro/elastic straps make these knee pads easy to put on and take off.



Part #66455

**So comfortable, you'll never want to get up!**

Knee pads only protect your knees if you wear them. No excuses not to with Racksy Pads. These are the 'bedroom slippers' of knee pads and you'll have pretty knees to prove it.

# Head-LITE Hat



**Hands-Free Flashlight**

- Powerful bulb illuminates up to 40 ft
- Batteries included
- Bright efficient L.E.D.

Part #16000

The Head-Lite Hat is great for jogging, hiking, walking the dog, etc. Heck, some guys are even using them for work. They're the ones who are tired of holding a flashlight in their teeth or under their chin when working in tight places, attics, crawl spaces... All the benefits of a flashlight, and a hat in one.



Mini



Grande

# Butt Pouch Pocket Pro Pocket Tool Holder

- Quick to put on, COMFORTABLE
- These tool pouches fit in your pocket
- Large snap loop for attaching to your belt if preferred
- Made of ballistic nylon

**NO BELT  
REQUIRED**

Mini Part #43015  
Grande Part #43095



I know, lots of you guys won't wear a tool belt. Sometimes you don't need a full load of tools but your pocket's too small. The BUTT POUCH Mini or Grande fills the gap, literally and it fits in your pocket. Saves wear on your jeans.

# RACKY BITS

COLOUR CODED DRIVE BITS



Makes bit selection **FASTER**,  
**EASIER** and more  
**EFFICIENT!**



### Magnetic Hex Bits

<b>RED</b>	1/4"	Hex Drive
<b>YELLOW</b>	5/16"	Hex Drive
<b>BLUE</b>	3/8"	Hex Drive
<b>BROWN</b>	7/16"	Hex Drive
<b>BLACK</b>	1/2"	Hex Drive

Size and colour availability as shown.

3", 4" & 6" drive bits  
2 9/16" & 6" hex bits

### Phillips Bits

**BLUE** #2 Phillips  
**LIGHT BLUE** #1 Phillips

### Genuine ROBERTSON® Bits

**YELLOW** #0 Square Drive  
**GREEN** #1 Square Drive  
**RED** #2 Square Drive  
**BLACK** #3 Square Drive  
**ORANGE** #4 Square Drive



Part # 7000 Series

COLOUR coding? It's so simple but it works. Racky Bits are easier to use and harder to lose and they make your job easier. If that's not enough, our genuine Robertson® RACKY BITS have hardened tips that fit better and last longer.

Genuine

**ROBERTSON®** Square drive

## SCREW DRIVERS

Part #SD110G  
#SD210R  
#SD310BK

Great Quality - Great Fit



#1 green robbly



#2 red robbly



#3 black robbly

Robertson®, AKA Square Drive, and proven in Canada for 90 years is now popping up in the USA. The advantages of Square Drive are well documented and genuine. Why not use genuine Robertson® screw drivers for the best grip, best fit, most torque.



# CONDUIT LEVEL

Torpedo Level with Laser



Part #45630

- Anodized aluminum construction.
- Super strong magnets attach securely to any ferrous conduit.
- Grooved base aligns itself with the conduit for accurate laser projection.
- Can be attached to any compatible tripod.
- Batteries included.

Laser Torpedo Levels don't work too well if they keep falling off your pipe. Designed for metallic pipe, the Conduit Level has powerful magnets and a concave base to align the Laser Level with the pipe. Accurate too. This is a nice Level.



## Laser Plumb Bob™

- Vertical Dot

### For All Commercial, Industrial or Residential Installations

The RACK-A-TIERS® Laser Plumb Bob enables you to do the lay out on the ground.

#### Features:

- Solid brass construction
- Convenient on / off switch
- Factory aligned laser module calibrated to precise 0.15° accuracy
- Magnetic damping for quick stabilization
- Self leveling and aligning (vertically)
- Durable plastic carry case
- Battery included



Risky

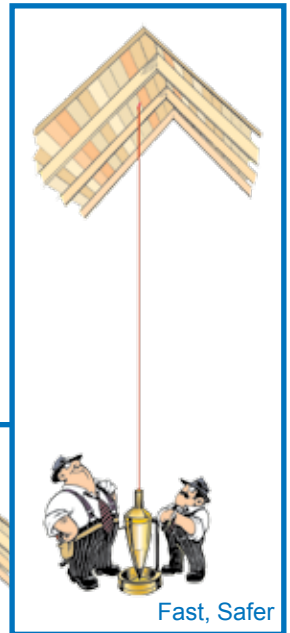

Fast, Safer

Part #88455

Cheap box store lasers will help you hang a picture. The Laser Plumb Bob will help you wire the Box Store. *High bay, curved counters, vaulted ceilings, can lights?* The Laser Plumb Bob will literally save hours on those jobs. Truly an essential electrician's tool.



## proGrabit Industrial Series

### Damaged Screw Remover

- Works on jagged, uneven and rough breaks
- Self centering tip, no walking
- Compatible with quick connect chuck systems
- Easy to use with 3/8" variable speed reversible drill
- Extracts screws up to 4 inches

	Screws	Bolts
Grabit #1	No. 4-no. 6	No. 10 (5mm)
Grabit #2	No. 8-no. 10	1/4" (6mm)



Kit Part #72120

Rounded out screw heads, what a nightmare! Not anymore. Just drill out the damaged screw / bolt with one end of the Grabit, then flip it over and the "grab end" winds out the screw.

# FRANKS StayPut

PIPE HOLDERS FOR CONCRETE SLABS



ELIMINATES Wire, Tape, Jackhammers & Heat Guns

Perfect Alignment  
The 1<sup>st</sup> Time  
Every Time

For 3/4" and 1" Conduit  
Fits Rigid Steel, Aluminum,  
PVC & Flexible PVC Conduits



#SP75S



3/4"

#SP75R



3/4" FRANKS are spaced for 4" x 4" boxes



#SP100S



1"



#SP100R

"Conduits **STAY** where  
you **PUT** them"  
INSTALLS in a few  
**SECONDS**

Careful with your pipe work in concrete? Time consuming. Fast and careless with that pipe? Even more time consuming when you have to bring out the jackhammer. FRANKS StayPuts are fast and easy to use. Just slip them on as you go or use the retro models to add a few later. 3/4" FRANKS are spaced for 4" x 4" boxes.

# KO Killers

PLASTIC KNOCKOUT FILLERS

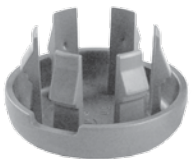

Part # KOK Series



- No tools required.
- Snap in with ease.
- Snap out with ease.
- Non-conductive, safer.

Fits **thin** (1/32") and **thick** (1/8") wall thickness.

Available in 1/2" through 2" trade designations.



"Take the fight out of those KO's  
with KO Killers!!"

All thumbs? Good, because that's all you need to install our plastic KO Killers. Just pop 'em in. No more tools, hammers, flying metal fillers, exploding buss bars, etc. Needing no tools is a big plus, especially when working space is tight. They go in easily and stay in. KO Killers fit all electrical boxes including heavy wall cabinets.

# STAND OFF BRACKET

Box Mounting Plate



Code Violation

Code  
Compliant

- Allows for stub up fittings
- Code compliant
- Pre punched for 4"x4" boxes

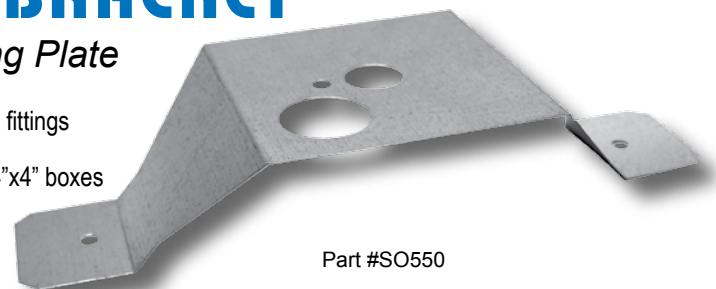

Part #SO550

Not all inspectors turn a blind eye to boxes secured only by conduit stub-ups. The STAND OFF BRACKET makes it easy to meet the code and you get a better job as well.



## FAN BOX

Ceiling (Paddle) Fans  
to 70lb/32kg

### FEATURES

- BIG 26 Cubic Inch Capacity
- 4 Fixture Mounting Screws
- Built in Cable Clamps
- 2 Hour Fire Wall Rated



## FIRE ALARM BOX

### RED COLOR BENEFITS

- Fire Alarm Bells
- Smoke/Heat Detectors
- Exit Lights
- Emergency Lighting

Part #SB400

No need for expensive single purpose fan boxes with the SUPER BOX. This box has it all. Paddle fans to 70 lb / 32 kg, double device screws, integral clamps, large capacity, fire rated and it's molded in red. *Did we forget anything?*

## RAPID FIRE ROMEX CONNECTORS

### RAT 500

1/2"

Part #RAT500



### RAT 750

3/4"

Part #RAT750



**FAST** • NO LOCKNUTS

**EASY** • NO TOOLS REQUIRED

RAT 750 3/4"	Single Cables:	8/3, 6/3
RAT 500 & TT 500 1/2"	Single Cables:	14/2, 14/3, 12/2, 12/3, 10/2, 10/3
	Two Cables:	14/2, 14/3, 12/2

### TT 500

### TOM TWO WAY

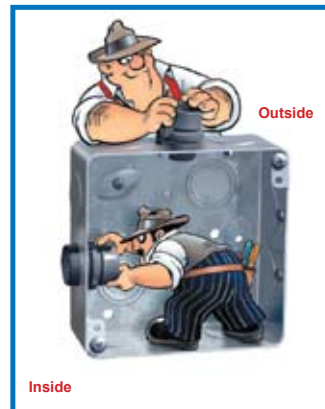

OLD WORK, NEW WORK

INSTALLS FROM **INSIDE**  
OR **OUTSIDE** THE BOX



1/2"

Part #TT500

*Doing some renovation work?* The TT500 also installs from the inside of the box after the wire is fished in. Ingenious. The RAT500 and RAT750 feature the same quality and large wire capacity but install from the outside for use in new construction. If you like the best, try these.

## LEVEL JACK

## LOW VOLTAGE DATA/COM MUD RING



### HOW DOES IT WORK?

Alignment tabs reach across wood/metal studs to level low voltage outlets with A.C. boxes.

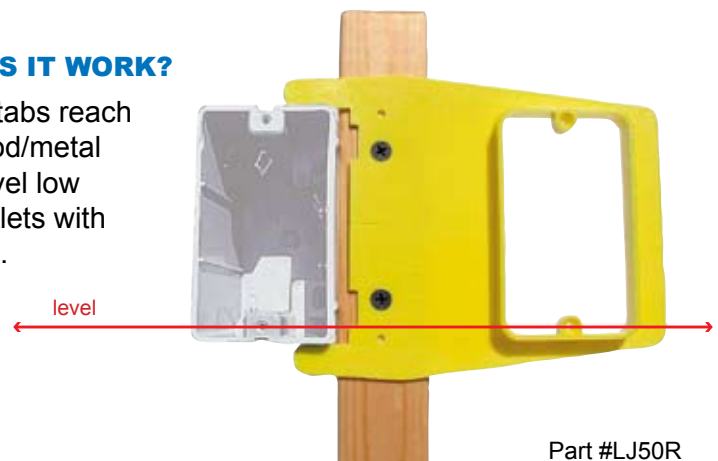

### EXTRA OFFSET:

- Allows use of all standard fittings
- Reduces A.C. interference to low voltage devices
- Improves drywall finish

Part #LJ50R  
#LJ58R  
#LJ100R

**No tape measure • No level required**

Available in 1/2", 5/8" and 1" rise

If you're fussy about your rough-in layout, the Level Jack makes life easy. If you're not, no one will notice because you can't screw up with the Level Jack. Just clip it on to the AC box and screw it down. No level, no tape measure, no special boxes, no special fittings required. Level Jacks fit most AC boxes. See the cartoon for details.



# Plug Grip™

Never hold an electrical outlet with your fingers again!



- Helps you "out muscle" stiff wires
- Handy for levelling plugs
- Keeps greasy hands away from walls
- Dual power warning lights

Part #99455

Ever worked on a "hot plug" before? Apparently just about everyone has but it's not recommended. Just in case, use the PlugGrip (it's not grounded), to hold that plug and wrestle those wires. It also has indicator lights to warn you. The PlugGrip keeps your greasy mitts off the wall and it's handy for levelling plugs.

# DRILLER'S Dust Bowl

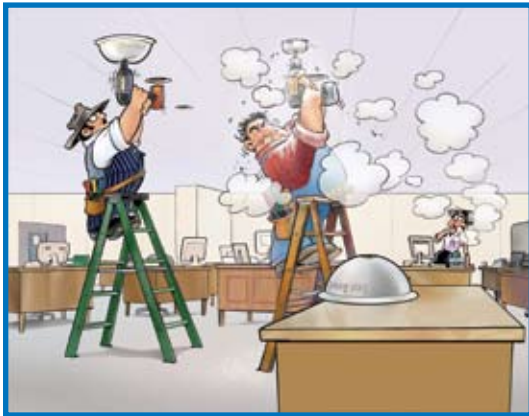

HOLE SAW  
Dust Collector

Fits  
Hole Saws  
up to 8"



Drill & saw are not included

Part #48000

EAT MY DUST? Not with this tool.

You may enjoy a face full of drywall dust but your customers might not. The flexible DRILLER'S DUST BOWL compresses against the work surface and traps all dust and debris as you drill. It fits your drill and hole saw without any adjustments. Put an end to 'unprotected hole sawing'.

# EXPLODING GARBAGE CAN

Collapsible Trash Container

Featuring an internal support spring that "Springs into Action"

Size:

19" x 24" (open)

1 1/2" x 24" (collapsed)

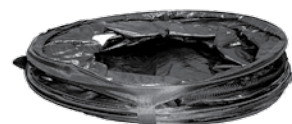

Heavy Duty, Tear Resistant Polytuf Fabric

Part #51000

Who says you're a slob? Clean up your reputation with your own trash can. The Expanding Garbage Can will dazzle your customers, especially if you use it! Pops up and folds flat...ready when needed.

# RACK-A-TIERS®

## RACK-A-TIERS? WHO ARE THOSE GUYS?

Electricians, like you. We're proud that the Rack-A-Tiers product line was designed by electricians, 20 of them so far. How about you? Our industry could use your ideas as well.

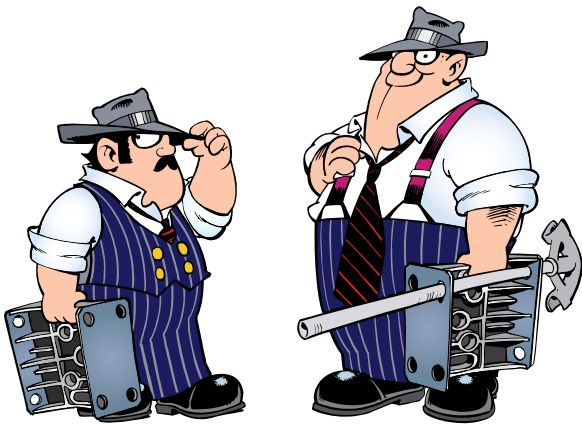

# LADDER SACK™



## The "Tube Sack"

**How else are you going to hold all those tubes?**

- Fits ALL step and extension ladders.
- Hook & loop fastener strips secure parts & tools when folded
- Tough ballistic nylon construction

## Every Ladder Needs a Ladder Sack

Holds fluorescent tubes (4' and 8')

Part #82000

Improve your ladder!! The Ladder Sack fits in the wasted space of your stepladder and safely holds just about everything that's presently falling off the top. This includes light bulbs, fluorescent tubes and expensive tools. Opens and closes automatically with the ladder and locks the cargo in.

# LASERTOOLS CHECKPOINT™ PROFESSIONAL

## Precision Levels

Available Only in Canada 🇨🇦

### MINI MAG Magnetic 'Doggone'



"Dog leg prevention" bending level.

### 880 GEN II Magnetic Laser



### ULTRA MAG Magnetic Torpedo



All models feature:

- 6061 aircraft aluminum
- rare earth magnets
- 30° vials (offset bending)

Part #45000 Series

A good tradesman requires a good level and here are three of the best. All have powerful magnets and 30° vials for working with pipe. If you have trouble with "dog legs" or non-parallel offsets, the Mini Mag "Doggone" level can make a pipe bending superstar out of you.

# RACK-A-TIERS®

Available from RACK-A-TIERS Manufacturing Inc.  
More fine tools available in Catalogue II

**RACK-A-TIERS®**  
  
 #11455

**HOOKER**  
  
 #10455

**RACK N ROLLER**  
  
 #12888

**E-Z ROLL WIRE RACK**  
  
 #55455

**Wire Tub**  
  
 #18455

**THOMAS WHEELER®**  
  
 #19455

**Pull-Rite®**  
  
 #15455

**REEL-END**  
  
 #17455

**NUT SPINNER**  
  
 #89455

**Pull Buddy**  
 1/2", 3/4", 1"  
  
 #42000  
 #42050  
 #42075  
 #42100

**BEND ALL**  
  
 #77455

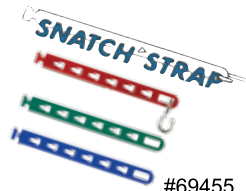
**SNATCH STRAP**  
  
 #69455

**CROCS™**  
  
 #47000

**Pipe Spring Bender**  
 1/2" Part #58050  
 3/4" Part #58075  
 1" Part #58100

**Racksy Pad KNEE PADS**  
  
 #66455

**Head-LITE Hat**  
 Hands-Free Flashlight  
  
 #16000

**Butt Pouch Pocket Pro**  
 Mini #43015 Grande #43095  



**RACKY BITS**  
 7000 Series  

**ROBERTSON® SCREW DRIVERS**  
 #SD110G  
 #SD210R  
 #SD310BK  

**CONDUIT LEVEL**  
  
 #45630

**Laser Plumb Bob™**  
  
 #88455

**proGrabit**  
 Kit Part #72120  



**FRANKS StayPut 1"**  
 (closed) (retro)  
 #SP100S #SP100R  

**FRANKS StayPut 3/4"**  
 (closed) (retro)  
 #SP75S #SP75R  

**KO Killers**  
 #KOK Series  



**STAND OFF BRACKET**  
  
 #19550

**SUPER BOX**  
  
 #SB400

**RAT 500 RAT 750**  
  
 #RAT500 #RAT750

**Tom Two Way**  
  
 #TT500

**Level Jack**  
  
 #LJ50R  
 #LJ58R  
 #LJ100R

**PlugGrip™**  
  
 #99455

**Driller's Dust Bowl**  
  
 #48000

**Exploding Garbage Can**  
  
 #51000

**Ladder Sack**  
  
 #82000

**CHECKPOINT**  
  
 #45000 Series

**RACK-A-TIERS Mfg. Inc.**

In Canada:  
 Box 24010  
 Royal Oak RPO  
 Victoria BC V8Z 7E7

In the USA:  
 PMB 221  
 136 East 8<sup>th</sup> St.  
 Port Angeles WA. 98362-6129

[www.RACK-A-TIERS.com](http://www.RACK-A-TIERS.com)

Fax: 1-250-479-1489

Toll Free 1-888-939-9991

©2006 Rack-A-Tiers  
 30M 1005 08/06