



BRICK LIGHTS SL-04 SERIES



TYPE

SPECIFICATIONS

CONSTRUCTION:

FACE PLATE: Heavy duty stamped aluminum, brass, copper or Stainless Steel
BACK BOX: Heavy duty stamped galvanized steel powder coated high reflective white

LENS (-AL & -1L MODELS ONLY): High impact white acrylic

GASKET: Black neosponge closed cell; .190" thickness

LAMP SUPPLIED: 2 x 18 watt S8 #1141; 1200 hours average rating (25w max.)

LAMP OPTIONS: We recommend 10,000 hours average rating Xenon (-X) or Halogen (-H) or 3w 50,000 hours average rating OMNI-3 LED (-LED3)

SOCKET: Single contact bayonet, brass nickel plated lamp socket screw shell (Ba15s) with 200°C silicone lead wires

WIRING: Black 3 foot 18/2 zip cord (12v only)

For 25 foot 16/2 fixture lead wire add -25F to catalog number.

CONNECTION: FA-05 Quick Connector (not supplied) from fixture to main cable (12/2, 10/2 or 8/2 only)

FINISH: Aluminum - Black texture polyester powder coat. Optional finishes available

Brass - Unfinished. Optional finishes available

Copper - Unfinished. Optional finishes available

Stainless Steel - Brushed



SL-04-COP



SL-04-1L-WBR

ORDERING INFORMATION

CATALOG NO.	DESCRIPTION	LAMP	SHIP WEIGHT
SL-04-BLT	Aluminum 4 Louver Brick Light	18w S8 #1141	2.0 lbs.
SL-04-BRS	Brass 4 Louver Brick Light	18w S8 #1141	2.0 lbs.
SL-04-COP	Copper 4 Louver Brick Light	18w S8 #1141	2.0 lbs.
SL-04-SS	Stainless Steel 4 Louver Brick Light	18w S8 #1141	2.0 lbs.
SL-04-AL-BLT	Aluminum Lensed Brick Light	18w S8 #1141	2.0 lbs.
SL-04-AL-BRS	Brass Lensed Brick Light	18w S8 #1141	2.0 lbs.
SL-04-AL-COP	Copper Lensed Brick Light	18w S8 #1141	2.0 lbs.
SL-04-AL-SS	Stainless Steel Lensed Brick Light	18w S8 #1141	2.0 lbs.
SL-04-3L-BLT	Aluminum 3 Louver Brick Light	18w S8 #1141	2.0 lbs.
SL-04-3L-BRS	Brass 3 Louver Brick Light	18w S8 #1141	2.0 lbs.
SL-04-3L-COP	Copper 3 Louver Brick Light	18w S8 #1141	2.0 lbs.
SL-04-3L-SS	Stainless Steel 3 Louver Brick Light	18w S8 #1141	2.0 lbs.
SL-04-1L-BLT	Aluminum 1 Louver Lensed Brick Light	18w S8 #1141	2.0 lbs.
SL-04-1L-BRS	Brass 1 Louver Lensed Brick Light	18w S8 #1141	2.0 lbs.
SL-04-1L-COP	Copper 1 Louver Lensed Brick Light	18w S8 #1141	2.0 lbs.
SL-04-1L-SS	Stainless 1 Louver Lensed Brick Light	18w S8 #1141	2.0 lbs.

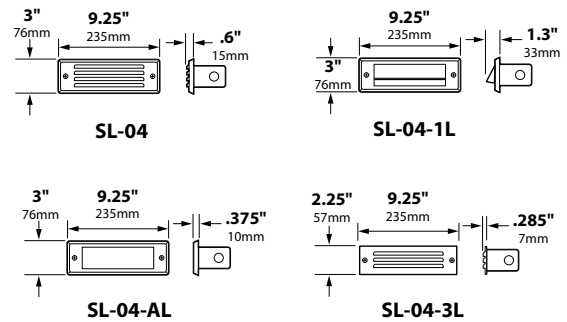

SL-04: Mounting Holes on all models 7-1/2" on center

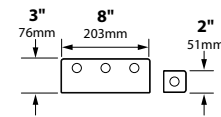

SL-04 Back Box

FACE PLATE ONLY

CATALOG NO.	DESCRIPTION
FA-52-BLT / -BRS / -COP / -SS	Stamped 4 Louver Face Plate
FA-52-3L-BLT / -BRS / -COP / -SS	Stamped 3 Louver Face Plate
FA-53-BLT / -BRS / -COP / -SS	Stamped AL Model Face Plate, White Acrylic Lens
FA-53-1L-BLT / -BRS / -COP / -SS	Stamped 1 Louver Face Plate, White Acrylic Lens
FA-52-1L-BLT / -BRS / -COP / -SS	Stamped 1 Louver Insert Only (converts -AL models to -1L)

BACK BOX/SOCKET/LAMP ONLY

CATALOG NO.	DESCRIPTION	LAMP AND VOLTAGE
FA-58	Stamped galvanized back box with lamp and socket	2x 18w SC (12v.)
FA-58-H	Stamped galvanized back box with lamp and socket	2x 20w halogen SC (12v.)
FA-58-X	Stamped galvanized back box with lamp and socket	2x 20w xenon SC (12v.)
FA-58-T7	Stamped galvanized back box with lamp and socket	2x 15w T7 DC (120v.)
FA-58-T8	Stamped galvanized back box with lamp and socket	2x 25w T8 DC (120v.)

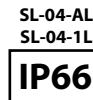
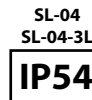

JOB INFORMATION	
Type:	Date:
Job Name:	
Cat. No.:	
Lamp(s):	
Specifier:	
Contractor:	
Notes:	
FOCUS INDUSTRIES INC. 25301 COMMERCENTRE DRIVE LAKE FOREST, CA 92630	
www.focusindustries.com sales@focusindustries.com (949) 830-1350 • FAX (949) 830-3390	

Black Texture (Standard)	Antique Verde	Bronze Texture	Camel	White Texture	Hunter Texture	Rust	Weathered Iron	Weathered Brown	Stucco	Rubbed Verde	Chrome Powder	Acid Rust	Acid Verde	Black Acid Treatment
-BLT	-ATV	-BRT	-CAM	-WTX	-HTX	-RST	-WIR	-WBR	-STU	-RBV	-CPR	-BAR/CAR	-BAV/CAV	-BAT



BRICK LIGHTS SL-04 SERIES

TYPE

LIGHT DISTRIBUTIONS AND PHOTOMETRICS

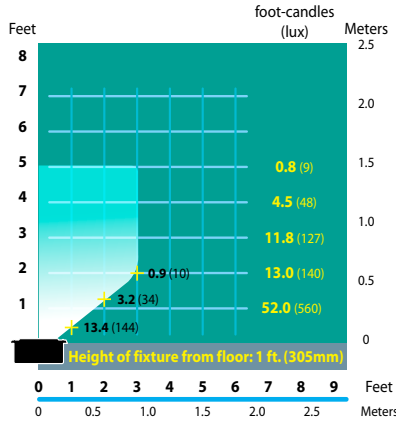

SL-04 Half Spread Photometrics

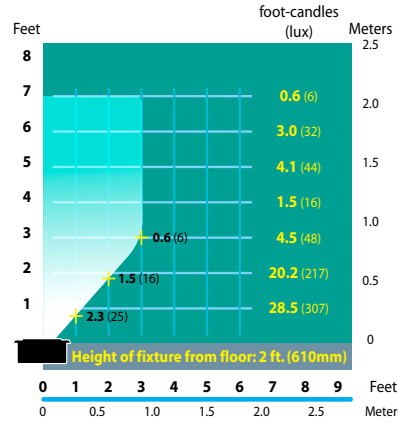

SL-04 Half Spread Photometrics

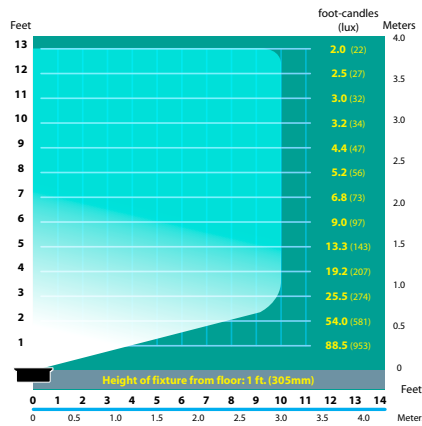

SL-04-AL Half Spread Photometrics

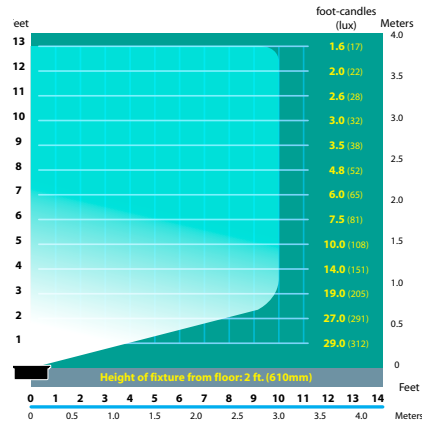

SL-04-AL Half Spread Photometrics

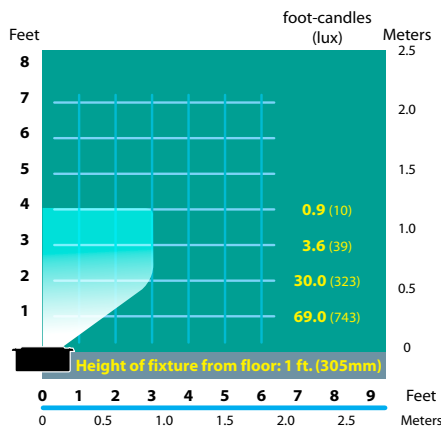

SL-04-3L Half Spread Photometrics

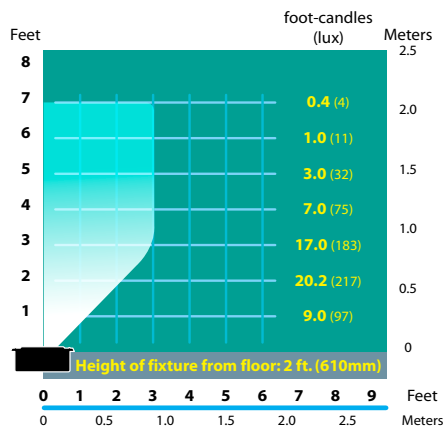

SL-04-3L Half Spread Photometrics

Black Texture (Standard)	Antique Verde	Bronze Texture	Camel	White Texture	Hunter Texture	Rust	Weathered Iron	Weathered Brown	Stucco	Rubbed Verde	Chrome Powder	Acid Rust	Acid Verde	Black Acid Treatment
-BLT	-ATV	-BRT	-CAM	-WTX	-HTX	-RST	-WIR	-WBR	-STU	-RBV	-CPR	-BAR/CAR	-BAV/CAV	-BAT