

00000 Series**Clevis Pin**

All clevis pins are manufactured from heat treated 416 stainless steel to provide superior strength and wear. Hardness is between 37-40 Rc.

The DCD Clevis Pin is a shouldered type of pin rather than a simple straight pin without any head. This design greatly improves the strength of the clevis by not allowing side loads to spread the clevis opening.

The clevis and pin are precision machined so that both surfaces contact simultaneously and therefore lock in place when screwed tight. By using the recommended torque, the pin is secured with the corresponding preload, ensuring it won't come loose. Tensile loads are carried by the pin shoulder and transferred to the swivel body, and therefore no tensile load is carried by the thread.

The hardened clevis pin also resists wear much better than conventional clevis pins. During operation there is a constant rubbing between the surface of the clevis pin and the attached item. A hard surface decreases the wear on the pin as well as increasing the strength of the pin.

Finally, the larger diameter of the shoulder will decrease wear on the attached item. If this happened to be a wire rope, a conventional pin would cause that rope to bend in a very tight radius, affecting the life of each strand. The larger DCD pins increase that radius and also increase the life of the wire.

Products 1-1/4" dia. and less are supplied with slotted clevis pins; those greater than 1-1/4" are supplied with hexagon socket clevis pins. This is based on consumer preference. Either slotted or hexagon pins are available for most sizes, but must be requested at time of ordering if not standard.

Because the DCD Clevis Pin is a precision machined product specifically designed to fit the clevis, field substitution with any other pins is not recommended. Doing so may cause serious danger to operators and equipment and will immediately void any warranty or liability for the product.

All Clevis Pin kits contain two pins.



Slotted Part No.	Hexagon Part No.	Hex Key Size	A	B	C	D	E	F	Recommended Torque	Corresponding Preload
00005-SLT*	-	-	5/8"	9/32"	3/16"	11/16"	1/4"	11/32"	1.0 ft-lb	366 lb
00010-SLT*	00010-HEX	7/32"	7/8"	3/8"	5/16"	31/32"	7/16"	3/8"	2.5 ft-lb	600 lb
00015-SLT*	00015-HEX	1/4"	1"	13/32"	3/8"	1-3/32"	1/2"	13/32"	5.4 ft-lb	1,040 lb
00020-SLT*	00020-HEX	1/4"	1-1/4"	17/32"	13/32"	1-9/32"	17/32"	9/16"	6.7 ft-lb	1,280 lb
00025-SLT	00025-HEX*	5/16"	1-3/8"	9/16"	1/2"	1-3/8"	5/8"	1/2"	16.7 ft-lb	2,667 lb
00025-SLT	00025-HEX*	5/16"	1-1/2"	19/32"	1/2"	1-9/16"	11/16"	5/8"	16.7 ft-lb	2,667 lb
00030-SLT	00030-HEX*	3/8"	1-5/8"	11/16"	5/8"	1-23/32"	3/4"	21/32"	25.0 ft-lb	3,000 lb
00035-SLT	00035-HEX*	3/8"	2"	25/32"	11/16"	2-1/16"	15/16"	25/32"	50.0 ft-lb	5,333 lb
-	00037-HEX*	3/8"	2-1/4"	7/8"	3/4"	2-3/8"	1-1/8"	3/4"	75.0 ft-lb	7,200 lb
-	00040-HEX*	3/8"	2-3/8"	1-1/32"	7/8"	2-25/32"	1-3/16"	1-5/32"	100.0 ft-lb	8,000 lb
-	00045-HEX*	3/8"	3"	1-3/16"	1-1/8"	3-5/8"	1-1/2"	1-9/16"	190.0 ft-lb	13,029 lb
-	00050-HEX*	1/2"	3-3/4"	1-1/2"	1-1/4"	4-1/4"	1-7/8"	1-3/4"	250.0 ft-lb	15,000 lb

* Standard Clevis Pin type supplied in most products.

Note: Marine grade versions are available; made to order.

00505/00505A Series

Line Swivel

DCD Line Swivels are typically constructed with a thrust bearing for tensile load and a radial bearing for bending load. They combine a high safe working load with a compact design. All sizes incorporate an oil seal and are manufactured from high strength stainless steel.

DCD Locking Line Swivels are typically constructed with a bronze thrust bearing for tensile load and a radial bearing for bending load. The bronze bearing will rotate up to a portion of the safe working load before locking. Once past this point, rotation will only occur when pulling tension is relieved.

Sizes 00505-020 and larger are supplied with a grease point for lubrication. This is particularly useful in overhead applications where high speed rotation is possible.

All sizes of both types are pull tested to verify the 3:1 safety factor. Test certificates are available upon request. Visit our website for articles with more information on 3:1 and 5:1 Safe Working Loads.

Sizes 00505-025 and larger are supplied with hexagon clevis pins. Smaller sizes have slotted clevis pins.

Under no circumstances should alternate clevis pins be used.

Permanent peen marking is now standard on all line swivels and material traceability for all batches produced.

Note: Line Swivels are not designed to run around bull wheels and severe damage or injury may be incurred if this is done.

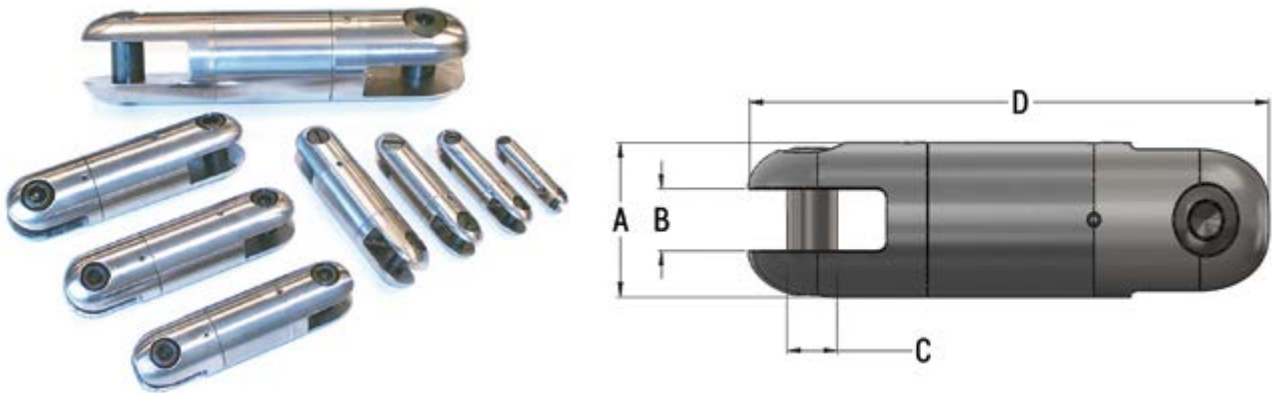

Part No.	Locking Part No.	3:1 Safe Working Load	5:1 Safe Working Load	A	B	C	D	Weight	Replacement Clevis Pin
00505-005	-	750 lb	450 lb	5/8"	9/32"	3/16"	2-1/2"	0.12 lb	00005-SLT
00506-008*	-	1,124 lb	674 lb	25/32"	9/32"	3/16"	3-3/16"	0.19 lb	00005-SLT
00505-010	00505-010A	2,250 lb	1,350 lb	7/8"	3/8"	5/16"	3-3/8"	0.32 lb	00010-SLT
00505-015	00505-015A	3,500 lb	2,100 lb	1"	13/32"	3/8"	3-7/8"	0.51 lb	00015-SLT
00505-020	00505-020A	5,000 lb	3,000 lb	1-1/4"	17/32"	13/32"	4-3/4"	1.0 lb	00020-SLT
00505-025	00505-025A	7,000 lb	4,200 lb	1-3/8"	9/16"	1/2"	5-1/8"	1.4 lb	00025-HEX
00505-027	00505-027A	9,000 lb	5,400 lb	1-1/2"	19/32"	1/2"	5-5/8"	1.8 lb	00025-HEX
00505-030	00505-030A	10,000 lb	6,000 lb	1-5/8"	11/16"	5/8"	6"	2.1 lb	00030-HEX
00505-035	00505-035A	15,000 lb	9,000 lb	2"	25/32"	11/16"	7"	3.9 lb	00035-HEX
00505-040	-	25,000 lb	15,000 lb	2-3/8"	1-1/32"	7/8"	10-5/16"	8.2 lb	00040-HEX
00505-041**	-	30,000 lb	18,000 lb	2-3/8"	1-1/32"	7/8"	10-5/16"	8.3 lb	00040-HEX
00505-045**	-	50,000 lb	30,000 lb	3"	1-3/16"	1-1/8"	13-3/4"	18 lb	00045-HEX
00505-050**	-	62,500 lb	37,500 lb	3-3/4"	1-1/2"	1-1/4"	15-9/16"	34 lb	00050-HEX

* This has a metric 3:1 Safe Working Load of 5 kN. Contact Customer Service for other metric equivalents.

** These swivels are made from alloy steel with a black oxide finish; all others are stainless steel.

Note: Marine grade versions are available; made to order.

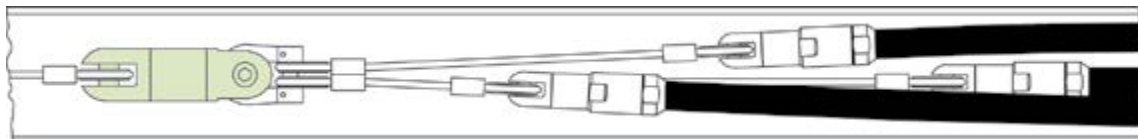

00520 Series

Can-Link™ Connector

The Can-Link™ Connector is used to connect two items with lugs or wire loop fittings. A common use is to connect a wire mesh grip to the pulling wire. The connectors are manufactured from high strength stainless steel with hardened clevis pins.

The two smaller sizes have slotted clevis pins, while the larger sizes have hexagon clevis pins, all of which are available as spares (see page 12).

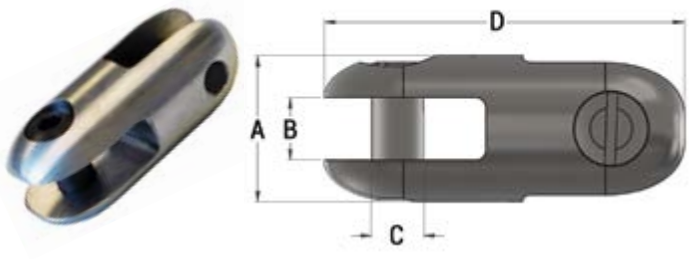

Part No.	3:1 Safe Working Load	A	B	C	D	Weight
00520-010	2,500 lb	7/8"	3/8"	5/16"	2-1/8"	0.17 lb
00520-020	5,000 lb	1-1/4"	17/32"	13/32"	2-7/8"	0.46 lb
00520-027	9,000 lb	1-1/2"	19/32"	1/2"	3-3/8"	0.73 lb
00520-035	15,000 lb	2"	25/32"	11/16"	4-9/16"	2.0 lb
00520-040	25,000 lb	7/8"	2-13/32"	1"	6-7/32"	4.0 lb

00521 Series

Rope-to-Rope Connector

This product is used to connect two ropes of up to 7/8" dia. The entire product, including sheaves, is manufactured from stainless steel.

Replacement sheaves are available by contacting the customer service department. The sheaves run on standard DCD clevis pins, which are also available as spares (see page 12).

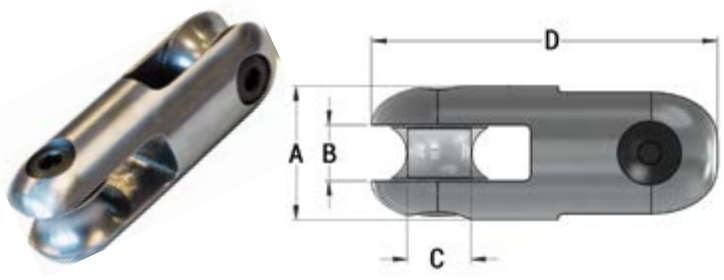

Part No.	3:1 Safe Working Load	Maximum Rope Diameter	A	B	C	D	Weight
00521-035	15,000 lb	7/8"	2"	15/16"	11/16"	5-1/2"	2.7 lb
00521-040	25,000 lb	7/8"	2-13/32"	1"	7/8"	6-7/32"	4.5 lb

00522 Series

Rope-to-Swivel Connector

This product is used to connect a swivel to pulling rope. The entire product, including sheave, is manufactured from stainless steel.

Replacement sheaves are available by contacting Customer Service. The sheaves run on standard DCD clevis pins, which are also available as spares (see page 12).

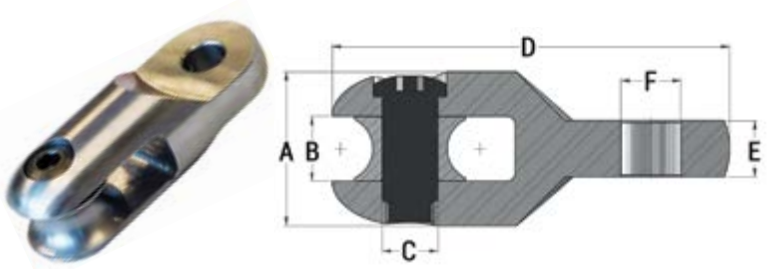

Part No.	3:1 Safe Working Load	Maximum Rope Diameter	A	B	C	D	E	F	Weight	Fits Line Swivel
00522-025	7,000 lb	7/8"	2"	15/16"	11/16"	5-5/16"	1/2"	17/32"	2.1 lb	00505-020 00505-025 00505-027
00522-025A	7,000 lb	7/8"	Same as above without sheave						1.8 lb	
00522-035	15,000 lb	7/8"	2"	15/16"	11/16"	5-3/8"	21/32"	3/4"	2.3 lb	00505-030 00505-035
00522-035A	15,000 lb	7/8"	Same as above without sheave						2.0 lb	
00522-040	30,000 lb	7/8"	2"	15/16"	11/16"	5-3/8"	21/32"	3/4"	3.9 lb	
00522-040A	30,000 lb	7/8"	Same as above without sheave						3.6 lb	00505-040

00531 Series

Wire Breakaway Connector

The Wire Breakaway Connector is our most recent addition to our family of breakaway connectors. This connector uses a wire instead of a pin to achieve the smallest of break loads. The two-piece design ensures you don't lose parts of your connector when separation does occur. The product is manufactured from stainless steel to provide years of service.

Originally designed to pull 1/2" medium density polyethylene or light duty fiber optic cable, our premier set of breakaway wires designed for this connector will break at different load capacities ensuring your product is protected from damage caused by over-pulling. Break loads from 15 to 200 lb are available. Wire kits are sold in packs of ten.

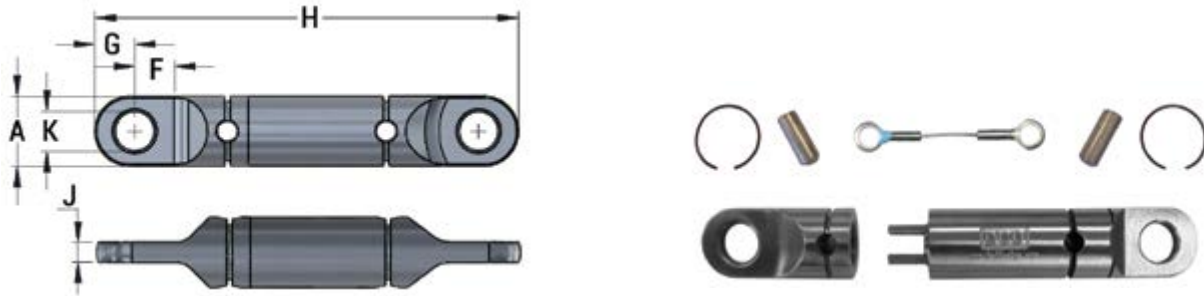

Part No.	A	B	C	D	E	F	G	H	J	K	Weight
00531-010	7/8"	-	-	-	-	1/2"	1/2"	5-11/32"	1/4"	1/2"	0.51 lb

Note: Marine grade versions are available; made to order.

00551 Series

Wire Breakaway Swivel

This product is similar to our Wire Breakaway Connector (00531 series) as it protects the utility being installed from overload with the addition of a built-in swivel. Changing a wire takes just seconds.

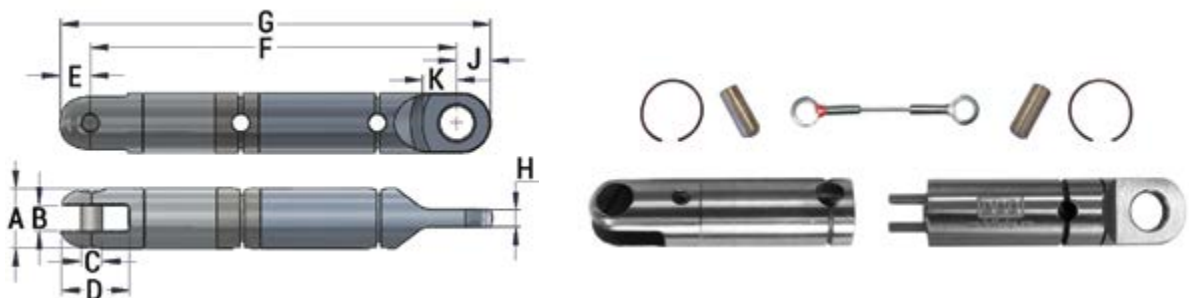

Part No.	A	B	C	D	E	F	G	H	J	K	Weight
00551-010	7/8"	3/8"	5/16"	31/32"	1/2"	5-3/8"	6-1/16"	1/4"	1/2"	1/2"	0.75 lb

Note: Marine grade versions are available; made to order.

Breakaway Wire Kits

Metric sizing is also available, as requested.

Part No. (10 wires/kit)	Breaking Point (+/- 10%)	Color Code
00536-015	15 lb	Yellow
00536-022	22 lb	Orange
00536-050	50 lb	Brown
00536-065	65 lb	Green
00536-080	80 lb	Purple

Part No. (10 wires/kit)	Breaking Point (+/- 10%)	Color Code
00536-100	100 lb	Red
00536-120	120 lb	Blue
00536-140	140 lb	Turquoise
00536-185	185 lb	Pink
00536-200	200 lb	Gray

Note: Breakaway Wire Sampler Kits (00536-KT1) are available upon request.

00530 Series

Min-E-Max™ Breakaway Connector

The purpose of this product is to protect the utility being installed from overload. Typically, they would be used during the installation of fiber optic cable or very small gas ducting where the connector can be preset to breakaway at a predetermined load, thus protecting the fibers or the duct. The breakaway pins may be changed to allow the same connector or to be used with a variety of different breakaway pins. Changing a pin takes just seconds.

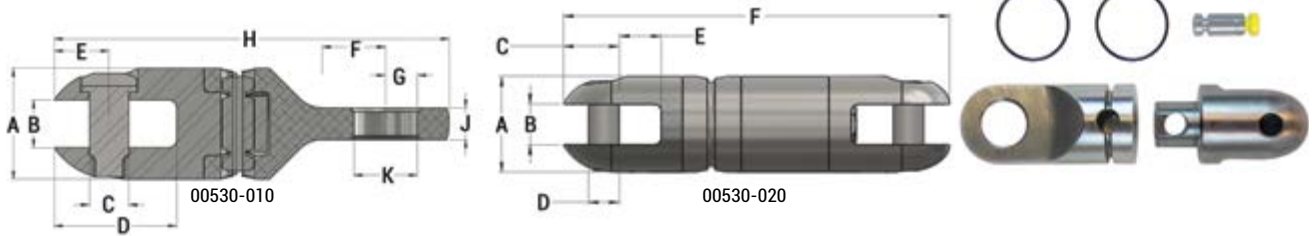

Part No.	A	B	C	D	E	F	G	H	J	K	Use Breakaway Pin Kits in	Weight
00530-010	7/8"	3/8"	5/16"	31/32"	7/16"	1/2"	1/2"	3-1/8"	1/4"	1/2"	Group B	0.25 lb
00550-020	1-1/4"	17/32"	3/4"	13/32"	9/16"	5-1/16"	-	-	-	-	Group C	1.03 lb

Note: Marine grade versions are available; made to order.

00550 Series

Breakaway Swivel

This product is similar to our Breakaway Connector (00530 series) as it protects the utility being installed from overload with the addition of a built-in swivel. The breakaway pins may be changed to allow the same connector or to be used with a variety of different breakaway pins. Changing a pin takes just seconds.

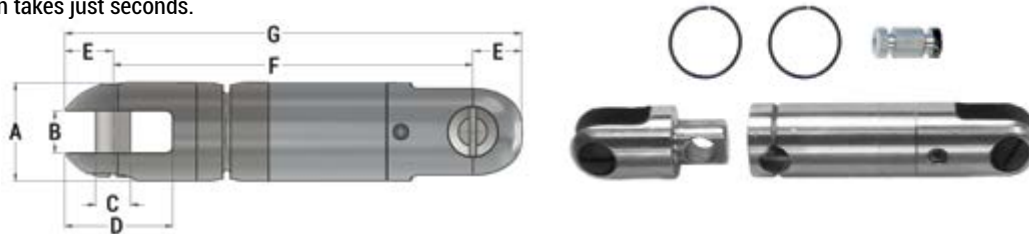

Part No.	A	B	C	D	E	F	G	Use Breakaway Pin Kits in	Weight
00550-005	5/8"	9/32"	3/16"	11/16"	1/4"	2-3/4"	3-1/4"	Group A	0.17 lb
00550-010	7/8"	3/8"	5/16"	31/32"	7/16"	3-3/16"	4-3/16"	Group B	0.42 lb
00550-020	1-1/4"	17/32"	13/32"	1-9/32"	17/32"	4-1/2"	5-9/16"	Group C	1.20 lb

Note: Marine grade versions are available; made to order.

Breakaway Pin Kits

Metric sizing is also available, as requested.

Group A

Part No. (10 pins/kit)	Breaking Point (+/- 10%)	Color Code
00555-00125*	125 lb	Green
00555-0015*	150 lb	Black
00555-002	200 lb	White
00555-0034	340 lb	Red
00555-004	400 lb	Yellow
00555-0045	450 lb	Blue
00555-006	600 lb	Orange
00555-007	675 lb	Black

Group B

Part No. (10 pins/kit)	Breaking Point (+/- 10%)	Color Code
00535-002	200 lb	White
00535-004	400 lb	Yellow
00535-005	500 lb	Green
00535-006	600 lb	Orange
00535-008	800 lb	Gray
00535-010	1,000 lb	Red

Group C

Part No. (10 pins/kit)	Breaking Point (+/- 10%)	Color Code
00555-013	1,370 lb	White
00555-018	1,800 lb	Green
00555-020	2,000 lb	Blue
00555-027	2,700 lb	Black
00555-036	3,600 lb	Yellow
00555-040	4,000 lb	Red

* Made to order.

US Patent # 5,122,007
Canadian Patent # 2,109,849

00560 Series

Heavy Duty Breakaway Connectors

These products are designed to protect polyethylene ducting from overload during installation by directional drilling and are used between the pullback swivel and the duct puller. The connectors are a three part product, held together by a group of pins. The pins are designed to break in tension at a specific load. The assembly of the connector is completed by using one or more of the breakaway pins. The sum of the values of the pins is the value at which the connector will come apart. If a single 1,000 lb pin is used, the connector will come apart at 1,000 lb. If three pins of the same value were used, the connector would come apart at 3,000 lb. Different pin values can be mixed and matched to create a number of different values, all in the same connector. Metric pins are also available. See following pages for pin combinations.

The connectors are available in two sizes. The smaller unit covers values from 750 lb up to 12,500 lb (300 kg-6,000 kg) and the larger unit covers values from 3,000 lb up to 45,000 lb (2,000 kg-20,000 kg).

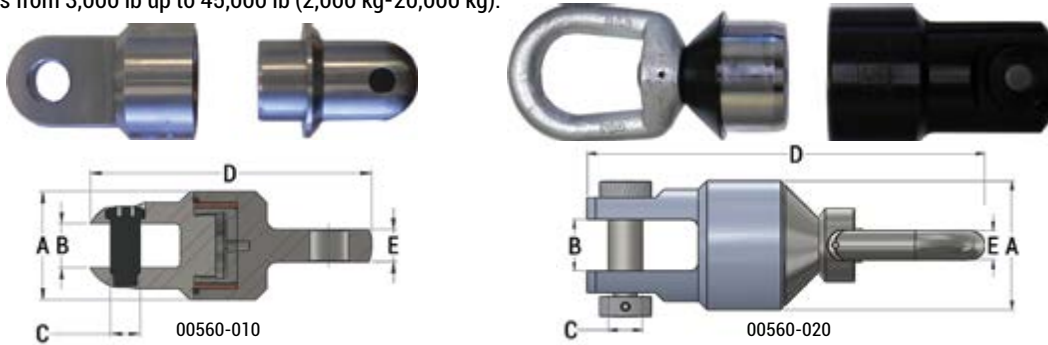

Connector Part No.	A	B	C	D	E	Weight	Replacement Clevis Pin Kit
00560-010	2-1/2"	1"	11/16"	6-1/2"	3/4"	4 lb	00035-HEX
00560-010S	2-1/2"	1"	11/16"	6-1/2"	3/4"	4 lb	00035-HEX
00560-020	3-3/4"	1-1/2"	1"	12"	7/8"	15 lb	00508-P010
00560-020S	3-3/4"	1-1/2"	1"	12"	7/8"	15 lb	00508-P010

Note: 'S' designates the connector as a marine grade stainless steel version, intended for use in a marine environment.



00560-010 Breakaway Pin Kits (lb)

Part No. (5 pins/kit)	Breaking Point (+/- 5%)	Color Code	Maximum Torque	Preload
00565-075	750 lb	Yellow	2 ft-lb	540 lb
00565-100	1,000 lb	Orange	3 ft-lb	720 lb
00565-150	1,500 lb	Red	4 ft-lb	980 lb
00565-200	2,000 lb	Blue	6 ft-lb	1,360 lb
00565-250	2,500 lb	Green	7 ft-lb	1,700 lb



00560-010 Breakaway Pin Kits (kg)

Part No. (5 pins/kit)	Breaking Point (+/- 5%)	Color Code	Maximum Torque	Preload
00566-030	300 kg	White	2.71 Nm	199 kg
00566-040	400 kg	Beige	4.07 Nm	272 kg
00566-050	500 kg	Turquoise	4.07 Nm	335 kg
00566-100	1,000 kg	Purple	8.13 Nm	635 kg
00566-120	1,200 kg	Black	9.49 Nm	743 kg

00560-020 Breakaway Pin Kits (lb)

Part No. (5 pins/kit)	Breaking Point (+/- 5%)	Color Code	Maximum Torque	Preload
00565-300	3,000 lb	Yellow	12 ft-lb	1,853 lb
00565-600	6,000 lb	Orange	23 ft-lb	3,680 lb
00565-700	7,000 lb	Red	26 ft-lb	4,160 lb
00565-800	8,000 lb	Blue	30 ft-lb	4,800 lb
00565-900	9,000 lb	Green	33 ft-lb	5,280 lb

00560-020 Breakaway Pin Kits (kg)

Part No. (5 pins/kit)	Breaking Point (+/- 5%)	Color Code	Maximum Torque	Preload
00566-200	2,000 kg	White	24.40 Nm	1,306 kg
00566-250	2,500 kg	Beige	31.18 Nm	1,669 kg
00566-300	3,000 kg	Turquoise	35.25 Nm	1,886 kg
00566-350	3,500 kg	Purple	37.96 Nm	2,032 kg
00566-400	4,000 kg	Black	42.03 Nm	2,249 kg

Originally, the DCD breakaway connectors were used by contractors installing gas ducting where it is critical to protect the duct from overload during installation. Many utilities now require the use of a breakaway connector to ensure the final integrity of the ducting.

Use of the breakaway connectors and swivels has expanded over the years to include fiber-optic pulling and line-stringing and has been incorporated into some innovative marine and vehicular towing applications. The versatility of this product is its main feature. It can easily be reset from one value to another allowing the same tool to be used for installation of many different duct sizes each requiring different load settings. To reduce fatigue, install the pin to the specified torque. The pin will not experience fatigue when the load is less than the preload value.

US Patent # 5,599,129
Canadian Patent # 2,153,743

00570 Series **NEW**

HDD Breakaway Swivel

The HDD Breakaway Swivel is similar to our Heavy Duty Breakaway Connector (00560 series), but with a swivel included. Saving you space in your pullback assembly, the HDD Breakaway Swivel is only 1.5" longer than the 00503-208 Dub-Lite, meaning it's 5" shorter than the alternative of using the DUB-Lite and a Breakaway Connector together.

It will accept the same range of 00565 and 00566 breakaway pins that we offer, which gives the HDD Breakaway Swivel a break load range from 750 lbs to 12,500 lb.

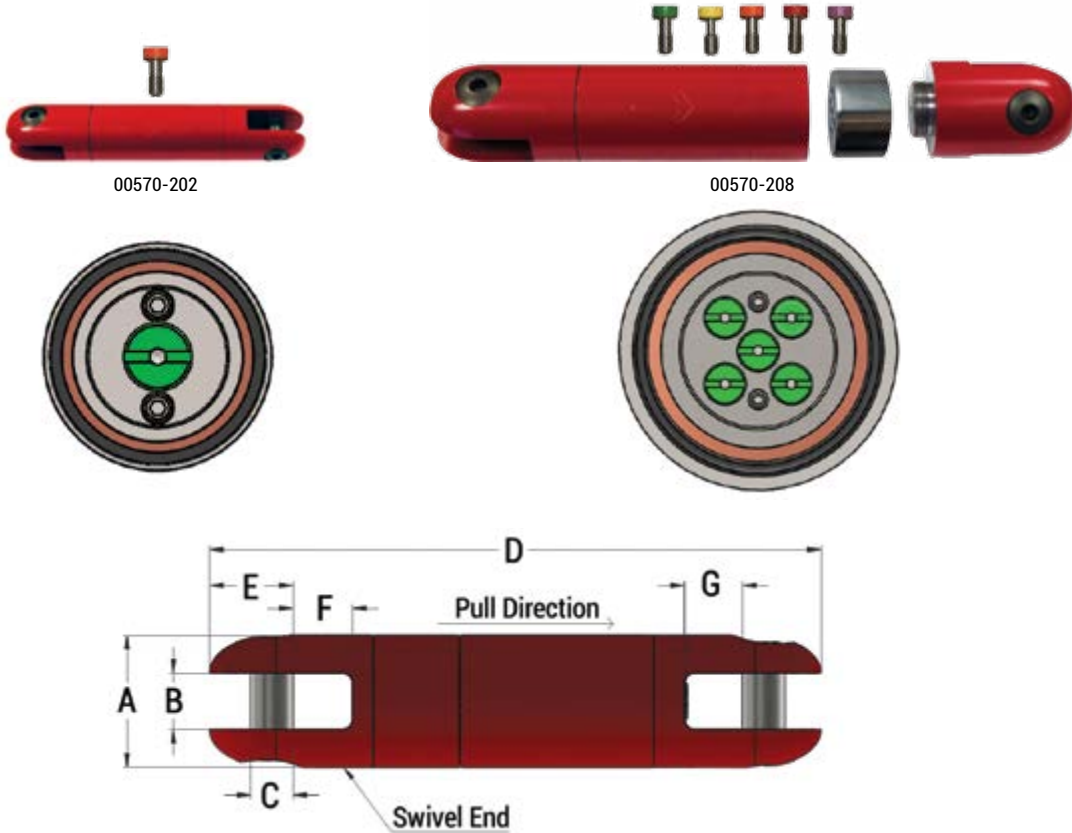

Part No.	Pin Capacity	A	B	C	D	E	F	G	Net Weight	Clevis Pin Kit
00570-202	1 pin	1-1/4" 32 mm	1/2" 13 mm	13/32" 10 mm	5-3/4" 146 mm	3/4" 19 mm	1/2" 13 mm	9/16" 14 mm	1.1 lb 0.5 kg	00020-HEX
00570-208	5 pins	2-1/2" 64 mm	1" 25 mm	7/8" 22 mm	12-3/16" 309 mm	1-3/4" 44 mm	7/8" 22 mm	1" 25 mm	12.0 lb 5.5 kg	00040-HEX



HDD Breakaway Pin Kits (lb)

Part No. (5 pins/kit)	Breaking Point (+/- 5%)	Color Code	Maximum Torque	Preload
00565-075	750 lb	Yellow	2 ft-lb	540 lb
00565-100	1,000 lb	Orange	3 ft-lb	720 lb
00565-150	1,500 lb	Red	4 ft-lb	980 lb
00565-200	2,000 lb	Blue	6 ft-lb	1,360 lb
00565-250	2,500 lb	Green	7 ft-lb	1,700 lb



HDD Breakaway Pin Kits (kg)

Part No. (5 pins/kit)	Breaking Point (+/- 5%)	Color Code	Maximum Torque	Preload
00566-030	300 kg	White	2.71 Nm	199 kg
00566-040	400 kg	Beige	4.07 Nm	272 kg
00566-050	500 kg	Turquoise	4.07 Nm	335 kg
00566-100	1,000 kg	Purple	8.13 Nm	635 kg
00566-120	1,200 kg	Black	9.49 Nm	743 kg

Suggested Set-up Values for 00560-010 Connector & 00570-208 HDD Breakaway Swivel

The following tables are suggested ways of arriving at required load values. There are usually several options other than those shown below. The five pin locations are designated as A, B, C, D & E (see diagram).

Breakload (lb)

Pin Location (See Diagram)					Break Value
A	B	C	D	E	
-	-	-	-	750	750
-	-	-	-	1,000	1,000
-	-	-	-	1,500	1,500
1,000	-	750	-	-	1,750
-	-	-	-	2,000	2,000
750	-	750	-	750	2,250
750	-	750	-	1,000	2,500
1,000	-	1,000	-	750	2,750
750	750	750	750	-	3,000
750	750	750	1,000	-	3,250
750	1,000	750	1,000	-	3,500
1,500	-	1,500	-	750	3,750
1,000	1,000	1,000	1,000	-	4,000
1,000	750	1,000	750	750	4,250
1,500	-	1,500	-	1,500	4,500
2,000	-	2,000	-	750	4,750
-	2,500	-	2,500	-	5,000
1,500	750	1,500	750	750	5,250
2,000	-	2,000	-	1,500	5,500
1,000	1,500	1,000	1,500	750	5,750
1,500	1,500	1,500	1,500	-	6,000
2,000	750	2,000	750	750	6,250
1,500	750	1,500	750	2,000	6,500
1,500	1,500	1,500	1,500	750	6,750
1,500	2,000	1,500	2,000	-	7,000
2,000	1,000	2,000	1,500	750	7,250
-	2,500	-	2,500	2,500	7,500
2,000	1,500	2,000	1,500	750	7,750
2,000	2,000	2,000	2,000	-	8,000
2,000	1,500	2,000	1,500	1,500	8,500
1,500	2,000	1,500	2,000	2,000	9,000
2,000	2,000	2,000	2,000	1,500	9,500
2,500	2,500	2,500	2,500	-	10,000
2,500	2,000	2,500	2,000	1,500	10,500
2,500	2,500	2,500	2,500	1,000	11,000
2,500	2,500	2,500	2,500	1,500	11,500
2,500	2,500	2,500	2,500	2,000	12,000
2,500	2,500	2,500	2,500	2,500	12,500

Breakload (kg)

Pin Location (See Diagram)					Break Value
A	B	C	D	E	
-	-	-	-	300	300
-	-	-	-	400	400
-	-	-	-	500	500
300	-	300	-	-	600
300	-	400	-	-	700
400	-	400	-	-	800
400	-	500	-	-	900
-	-	-	-	1,000	1,000
400	-	400	-	300	1,100
400	-	400	-	400	1,200
400	-	400	-	500	1,300
500	-	500	-	400	1,400
500	-	500	-	500	1,500
300	-	300	-	1,000	1,600
500	400	500	300	-	1,700
400	-	400	-	1,000	1,800
500	500	500	400	-	1,900
1,000	-	1,000	-	-	2,000
500	400	500	400	300	2,100
500	400	500	400	400	2,200
500	400	500	400	500	2,300
1,200	-	1,200	-	-	2,400
500	500	500	500	500	2,500
1,000	300	1,000	300	-	2,600
1,200	-	1,200	-	300	2,700
1,200	-	1,200	-	400	2,800
1,200	-	1,200	-	500	2,900
1,000	-	1,000	-	1,000	3,000
1,000	400	1,000	400	300	3,100
1,000	400	1,000	400	400	3,200
1,000	400	1,000	400	500	3,300
1,200	-	1,200	-	1,000	3,400
1,200	400	1,200	400	300	3,500
1,200	-	1,200	-	1,200	3,600
1,200	400	1,200	400	500	3,700
1,000	400	1,000	400	1,000	3,800
1,200	500	500	500	500	3,900
1,000	1,000	1,000	1,000	-	4,000
1,000	400	1,000	500	1,200	4,100
1,200	400	1,200	400	1,000	4,200
1,000	1,000	1,000	1,000	300	4,300
1,000	1,000	1,000	1,000	400	4,400
1,000	1,000	1,000	1,000	500	4,500
1,200	500	1,200	500	1,200	4,600
1,000	1,200	1,000	1,200	300	4,700
1,200	1,200	1,200	1,200	-	4,800
1,000	1,200	1,000	1,200	500	4,900
1,000	1,000	1,000	1,000	1,000	5,000
1,200	1,200	1,200	1,200	300	5,100
1,200	1,200	1,200	1,200	400	5,200
1,200	1,200	1,200	1,200	500	5,300
1,200	1,000	1,200	1,000	1,000	5,400
1,200	1,000	1,200	1,000	1,200	5,600
1,200	1,200	1,200	1,200	1,000	5,800
1,200	1,200	1,200	1,200	1,200	6,000

Note: Uneven pin distribution may result in up to 10% lower breaking point.

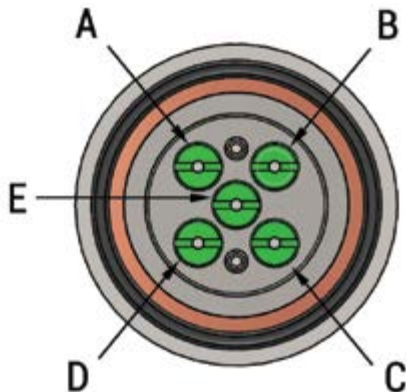

Pin Location Reference

DCD

Swivels & Connectors

Suggested Set-up Values for 00560-020 Connector

The following tables are suggested ways of arriving at required load values. There are usually several options other than those shown below. The five pin locations are designated as A, B, C, D & E (see diagram).

Breakload (lbs)

Pin Location (See Diagram)					Break Value
A	B	C	D	E	
-	-	-	-	3,000	3,000
3,000	-	3,000	-	-	6,000
3,000	-	3,000	-	3,000	9,000
6,000	-	6,000	-	-	12,000
3,000	-	3,000	-	7,000	13,000
7,000	-	7,000	-	-	14,000
3,000	-	3,000	-	9,000	15,000
8,000	-	8,000	-	-	16,000
7,000	-	7,000	-	3,000	17,000
9,000	-	9,000	-	-	18,000
8,000	-	8,000	-	3,000	19,000
7,000	-	7,000	-	6,000	20,000
7,000	-	7,000	-	7,000	21,000
7,000	-	7,000	-	8,000	22,000
7,000	-	7,000	-	9,000	23,000
8,000	-	8,000	-	8,000	24,000
8,000	-	8,000	-	9,000	25,000
9,000	-	9,000	-	8,000	26,000
9,000	-	9,000	-	9,000	27,000
7,000	7,000	7,000	7,000	-	28,000
3,000	7,000	3,000	7,000	9,000	29,000
6,000	6,000	6,000	6,000	6,000	30,000
6,000	6,000	6,000	6,000	7,000	31,000
6,000	6,000	6,000	6,000	8,000	32,000
6,000	6,000	6,000	6,000	9,000	33,000
7,000	7,000	7,000	7,000	6,000	34,000
7,000	7,000	7,000	7,000	7,000	35,000
7,000	7,000	7,000	7,000	8,000	36,000
7,000	7,000	7,000	7,000	9,000	37,000
8,000	7,000	8,000	7,000	8,000	38,000
8,000	7,000	8,000	7,000	9,000	39,000
8,000	8,000	8,000	8,000	8,000	40,000
8,000	8,000	8,000	8,000	9,000	41,000
9,000	9,000	9,000	9,000	6,000	42,000
9,000	9,000	9,000	9,000	7,000	43,000
9,000	9,000	9,000	9,000	8,000	44,000
9,000	9,000	9,000	9,000	9,000	45,000

Breakload (kg)

Pin Location (See Diagram)					Break Value
A	B	C	D	E	
-	-	-	-	2,000	2,000
-	-	-	-	3,000	3,000
2,000	-	2,000	-	-	4,000
2,500	-	2,500	-	-	5,000
3,000	-	3,000	-	-	6,000
2,000	-	2,000	-	2,500	6,500
2,000	-	2,000	-	3,000	7,000
2,000	-	2,000	-	3,500	7,500
4,000	-	4,000	-	-	8,000
3,000	-	3,000	-	2,500	8,500
3,000	-	3,000	-	3,000	9,000
3,000	-	3,000	-	3,500	9,500
3,000	-	3,000	-	4,000	10,000
4,000	-	4,000	-	2,500	10,500
4,000	-	4,000	-	3,000	11,000
4,000	-	4,000	-	3,500	11,500
4,000	-	4,000	-	4,000	12,000
2,500	2,500	2,500	2,500	2,500	12,500
2,500	2,500	2,500	2,500	3,000	13,000
2,500	2,500	2,500	2,500	3,500	13,500
2,500	2,500	2,500	2,500	4,000	14,000
3,000	3,000	3,000	3,000	2,500	14,500
3,000	3,000	3,000	3,000	3,000	15,000
3,000	3,000	3,000	3,000	3,500	15,500
3,000	3,000	3,000	3,000	4,000	16,000
3,000	3,500	3,000	3,500	3,500	16,500
3,500	3,500	3,500	3,500	3,000	17,000
3,500	3,500	3,500	3,500	3,500	17,500
3,500	3,500	3,500	3,500	4,000	18,000
4,000	3,500	4,000	3,500	3,500	18,500
4,000	3,500	4,000	3,500	4,000	19,000
4,000	4,000	4,000	4,000	3,500	19,500
4,000	4,000	4,000	4,000	4,000	20,000

Note: Uneven pin distribution may result in up to 10% lower breaking point.

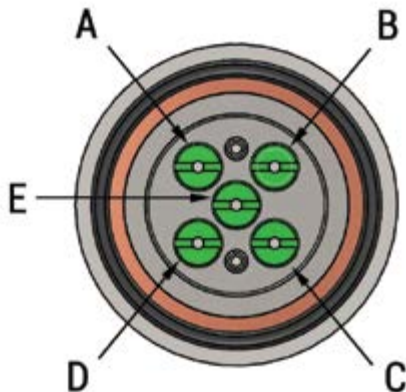

Pin Location Reference

00652/00653 Series

Eye to Eye/Clevis Connectors

These connectors are used for many applications. The two halves will not rotate under load, but are useful for aligning products. They are forged from carbon steel and galvanized for protection.



Eye to Eye Part No.	Eye to Clevis Part No.	Nominal Size	5:1 Safe Working Load	Weight
00652-037	00653-037	3/8"	2,250 lb	0.70 lb
00652-050	00653-050	1/2"	3,600 lb	1.36 lb
00652-062	00653-062	5/8"	5,200 lb	2.47 lb
00652-075	-	3/4"	7,200 lb	3.75 lb

00654/00655 Series

Connecting Shackles

These shackles provide a low cost, economical means of connecting two products together. They are available in two types: one with a bolt, nut and cotter pin for locking (00654 series), the other with a one piece bolt with a flanged head suitable for wire locking if needed (00655 series).



Part No.	Part No.	Nominal Size	6:1 Safe Working Load	Weight
-	00655-018	3/16"	1/3 ton	0.06 lb
-	00655-025	1/4"	1/2 ton	0.11 lb
00654-031	00655-031	5/16"	3/4 ton	0.18 lb
00654-037	00655-037	3/8"	1 ton	0.31 lb
00654-043	00655-043	7/16"	1-1/2 ton	0.43 lb
00654-050	00655-050	1/2"	2 ton	0.68 lb
00654-062	00655-062	5/8"	3-1/4 ton	1.33 lb
-	00655-075	3/4"	4-3/4 ton	2.22 lb
-	00655-087	7/8"	6-1/2 ton	3.39 lb
-	00655-100	1"	8-1/2 ton	4.92 lb
-	00655-112	1-1/8"	9-1/2 ton	7.63 lb
-	00655-125	1-1/4"	12 ton	10.30 lb
-	00655-137	1-3/8"	13-1/2 ton	13.65 lb
-	00655-150	1-1/2"	17 ton	17.90 lb
-	00655-175	1-3/4"	25 ton	29.29 lb
-	00655-200	2"	35 ton	44.00 lb

00656 Series

Chain-Link Connector

These Chain-Link Connectors are useful and easy to insert in any pulling line. They allow easier bending of a pulling eye or other rigid component when going around bends or sheaves. These high quality products are manufactured with grade 80 steel.



Part No.	Nominal Size	3:1 Safe Working Load	Weight
00656-028	9/32"	4,650 lb	0.29 lb
00656-037	3/8"	9,450 lb	0.77 lb
00656-050	1/2"	16,000 lb	1.59 lb
00656-062	5/8"	24,100 lb	3.13 lb

00660 Series

Quick Link Connector

The Quick Link Connector can be used in a variety of applications to connect a number of our products to each other. They provide low cost, ease of use, and no maintenance.



Part No.	Nominal Size	2:1 Safe Working Load	Loop Inside Width	Overall Outside Length	Weight
00660-187	3/16"	660 lb	1/2"	2"	0.05 lb
00660-250	1/4"	880 lb	1/2"	2-3/8"	0.08 lb
00660-312	5/16"	1,760 lb	5/8"	3"	0.17 lb
00660-375	3/8"	2,200 lb	11/16"	3-3/16"	0.23 lb
00660-437	7/16"	2,600 lb	3/4"	3-1/2"	0.31 lb
00660-500	1/2"	3,300 lb	7/8"	4-1/8"	0.51 lb

23000 Series

Wire Rope Bridle Sling

The purpose of this product is to allow multiple pulls at one time by attaching two, three, or four cables or ducts to the puller. The slings are manufactured from aircraft quality wire rope with thimble eyes for durability (tapered swages are also available). The various "legs" are staggered in length so the individual connections are not interfering with each other. The lead coupler can be easily dismantled to change out a leg or to add another leg.



Each leg is marked with load capacity and they have a three times safety factor on that rating. The safety factor is based on equal pull on all cables (horizontal pull only). Couplers and wire rope sling legs may be ordered separately. Other sling configurations are available upon request.

DUB-Lite (00503 series) or Line Swivels (00505 series) are recommended to permit free rotation of the bridle at the legs and coupler. The recommended swivels are sized to suit the load and connection: smaller swivels over the leg loop, a larger swivel to fit the shackle.

Note: 5 & 6-leg slings are available in 1/4" and 3/8" slings upon request.

Part No.	Wire Diameter	No. of Legs	3:1 Safe Working Load			Recommended DUB-Lite		Recommended Line Swivel	
			Leg Capacity	Sling Capacity	Weight	Over Shackle	Over Leg Loop	Over Shackle	Over Leg Loop
23125-020	1/8"	2	650 lb	1,300 lb	0.5 lb	00503-202 00503-204 00503-205	00503-202	00505-020	00505-005
23125-030	1/8"	3	650 lb	1,950 lb	0.6 lb			00505-025	00505-010
23125-040	1/8"	4	650 lb	2,600 lb	0.6 lb			00505-027	00505-015
23250-020	1/4"	2	2,300 lb	4,600 lb	1.2 lb	00503-204 00503-205 00503-208 00503-210	00503-202	00505-027	00505-010
23250-030	1/4"	3	2,300 lb	6,900 lb	1.6 lb			00505-030	00505-015
23250-040	1/4"	4	2,300 lb	7,100 lb	2.0 lb			00505-035	00505-020
23375-020	3/8"	2	4,800 lb	9,600 lb	2.9 lb	00503-208* 00503-210* 00503-215	00503-204 00503-205 00503-208 00503-210	00505-035	00505-020
23375-030	3/8"	3	4,800 lb	12,000 lb	3.7 lb			00505-040	00505-025
23375-040	3/8"	4	4,800 lb	18,000 lb	5.9 lb			00505-041	00505-027
23500-020	1/2"	2	6,900 lb	13,800 lb	6.7 lb	00503-215	00503-204** 00503-205 00503-208 00503-210	00505-045	00505-030
23500-030	1/2"	3	6,900 lb	20,700 lb	8.6 lb			00505-041	00505-035
23500-040	1/2"	4	6,900 lb	28,300 lb	12.7 lb			00505-045	00505-050

* These DUB-Lites do not fit the 23375-040.
** These DUB-Lites do not fit the 23500-040.

