

Carlton® PVC Elbows, Conduit & Fittings

In this section...



Carlton® PVC Elbows, Conduit & Fittings

| | |
|---|-------------|
| Elbows, Sweeps and Accessories | E-454–E-481 |
| Conduit Bodies (for use with Schedule 40 and 80 Conduit) | E-482–E-487 |
| Switch and Junction Boxes | E-488–E-492 |
| Straps, Clamps and Accessories | E-493–E-496 |
| Spacers | E-497–E-502 |
| P&C Flex® Conduit and Fittings | E-503–E-507 |
| Carflex® Liquidtight Flexible Conduit and Fittings | E-508–E-515 |
| Technical Information | E-516–E-518 |

Elbows, Sweeps and Accessories

A job that normally takes 20 minutes — DONE in two minutes or less!

Carlton® PVC Conduit Repair System

The new, revolutionary design Carlton® PVC Conduit Repair System significantly reduces the time and money associated with repairing broken PVC conduits, a.k.a. "stub-ups", in concrete slabs.

The system includes a line of couplings, adapters, reamers and plugs designed to enable contractors to quickly and easily repair broken PVC conduits without having to chip away and repour concrete, while still maintaining the inside diameter of the conduit. Simply cut off the broken conduit, ream the I.D. of the conduit and insert a coupling or adapter. It's that easy. A job that normally takes 20 minutes can now be done in two minutes or less!

Features:

- cULus Listed
- PVC repair fittings are listed in accordance with the NEC® and Section 352.6
- Non-metallic couplings, adapters and plugs won't rust or corrode
- Available in sizes ½" through 2"

Benefits:

- Saves time and money
- Maintains inside diameter of conduit
- Metallic reamers for extra strength, durability and longer life
- Quickly and easily repair broken PVC conduits

NEC and National Electrical Code are registered trademarks of the National Fire Protection Association, Inc.

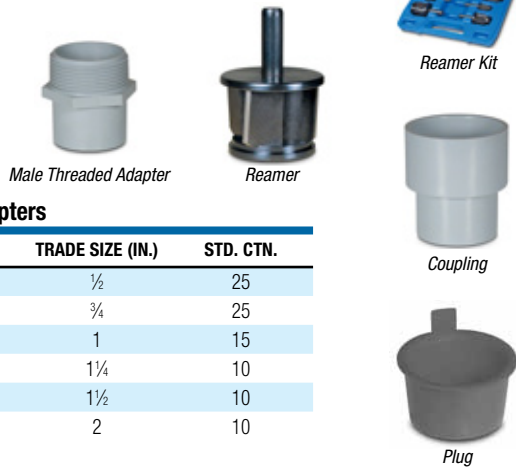
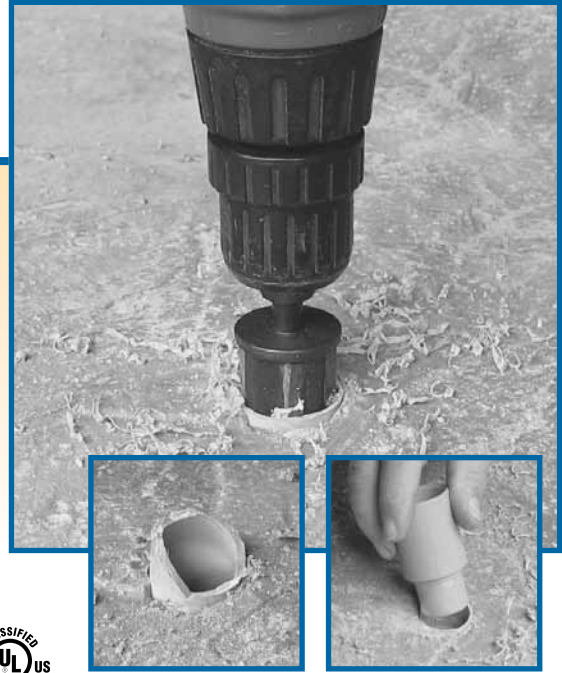

Male Threaded Adapters

| CAT. NO. | TRADE SIZE (IN.) | STD. CTN. |
|----------|------------------|-----------|
| E920D | ½ | 25 |
| E920E | ¾ | 25 |
| E920F | 1 | 15 |
| E920G | 1¼ | 10 |
| E920H | 1½ | 10 |
| E920J | 2 | 10 |

Schedule 40 Plugs

| CAT. NO. | SIZE (IN.) | COLOR | CAT. NO. | SIZE (IN.) | COLOR | CAT. NO. | SIZE (IN.) | COLOR | STD. CTN. |
|----------|------------|-------|----------|------------|-------|----------|------------|--------|-------------|
| HL-6XR | ½ | Red | HL-6XB | ½ | Blue | HL-6XY | ½ | Yellow | 1 Bag of 50 |
| HL-10R | ¾ | Red | HL-10B | ¾ | Blue | HL-10Y | ¾ | Yellow | 1 Bag of 50 |
| HL-13AR | 1 | Red | HL-13AB | 1 | Blue | HL-13AY | 1 | Yellow | 1 Bag of 50 |
| HL-16R | 1¼ | Red | HL-16B | 1¼ | Blue | HL-16Y | 1¼ | Yellow | 1 Bag of 50 |
| HL-18R | 1½ | Red | HL-18B | 1½ | Blue | HL-18Y | 1½ | Yellow | 1 Bag of 50 |
| HL-21R | 2 | Red | HL-21B | 2 | Blue | HL-21Y | 2 | Yellow | 1 Bag of 50 |

Reamers

| CAT. NO. | TRADE SIZE (IN.) | STD. CTN. |
|-------------|------------------|-----------|
| E910REAMD | ½ | 12 |
| E910REAME | ¾ | 12 |
| E910REAMF | 1 | 10 |
| E910REAMG | 1¼ | 10 |
| E910REAMH | 1½ | 10 |
| E910REAMJ | 2 | 10 |
| E910REAMKIT | All Sizes | 5 |

Couplings

| CAT. NO. | TRADE SIZE (IN.) | STD. CTN. |
|----------|------------------|-----------|
| E910D | ½ | 25 |
| E910E | ¾ | 25 |
| E910F | 1 | 15 |
| E910G | 1¼ | 10 |
| E910H | 1½ | 10 |
| E910J | 2 | 10 |

Elbows, Sweeps and Accessories

PVC Conduit Repair System Instructions

- 1** Cut broken conduit off flush.

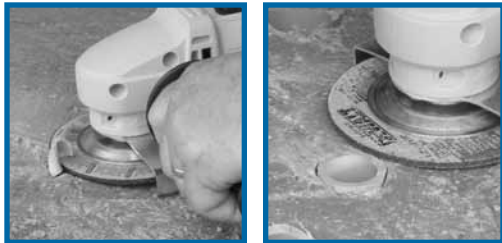

- 2** Insert plug to keep conduit clean/dry through balance of rough-in. Once rough-in is complete, remove plug and **continue with Step 3**.



Alternative to Conduit Repairs:

Prior to concrete pour, measure and saw cut all conduit stub-ups to the thickness of the concrete pour. Insert plugs. Pour concrete flush to the conduit. When pour is complete, remove plugs and **proceed with Step 3**. This alternative method saves time/money by eliminating the need for transitions or use of metal elbows.

- 3** With reamer tool and standard 1/2" drill, ream I.D. of conduit. It is recommended to use a variable speed drill. Use slower speed to avoid overheating the conduit.



- 4** The guide will direct the cutter; the stop will touch when completed.



- 5** Insert the coupling and cement into place using the cement manufacturer's instructions.

Cementing Instructions:

- Clean socket I.D. and spigot O.D. of dirt and moisture.
- Apply a uniform coat of cement to spigot end and push onto socket bottom, rotating 1/4 turn.
- Allow time to set before disturbing. This will depend upon temperature.



Apply a uniform coat of cement.



Insert fitting.



Rotate quarter turn.

Carlon® Rigid Non-Metallic Conduit (RNC) Fittings & Accessories

Carlon® Schedule 40 and Schedule 80 fittings are designed for use aboveground and underground as described in the National Electrical Code®.

- Ease of installation** — Non-metallic fittings are 1/4 to 1/5 the weight of metallic systems, can be installed in less than half the time and are easily fabricated on the job.
- Safety** — Non-metallic fittings are nonconductive, assuring a safe system.
- Impact Resistant** — Schedule 40 and Schedule 80 non-metallic fittings are resistant to sunlight and are listed for exposed for outdoor usage. The use of expansion fittings allows the system to expand and contract with temperature variations.
- Corrosion Resistant** — Carlon® fittings are non-metallic and will not rust or corrode. Carlon® non-metallic Schedule 40 and Schedule 80 elbows are manufactured to NEMA TC-2, Federal specification WC1094A and UL 651 specifications. Fittings are manufactured to NEMA TC-3, Federal specification WC1094A and UL514B. Both conduit and fittings carry respective UL or ETL Listings and UL or ETL labels.

NEC and National Electrical Code are registered trademarks of the National Fire Protection Association, Inc.

Elbows, Sweeps and Accessories

Schedule 40 Elbows — Standard Radius

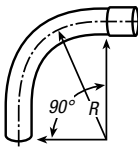
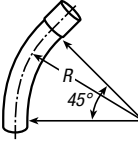
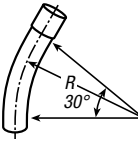
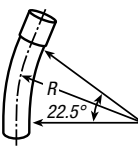

| ITEM | PLAIN END | BELLED END | SIZE | PLAIN | BELLED | |
|---|--|------------|--------|-------|--------|----|
| | CAT. NO. | CAT. NO. | | END | END | |
| | | | STD. | STD. | STD. | |
| | | | CTN. | CTN. | CTN. | |
| 90° ELBOW  | UA9AD | UA9ADB | ½ | 50 | 50 | |
| | UA9ADR-CAR | UA9ADB | ½ | 25 | 50 | |
| | UA9AE | UA9AEB | ¾ | 25 | 25 | |
| | UA9AFR-CTN | UA9AFB-CTN | 1 | 25 | 25 | |
| | UA9AG | UA9AGB | 1¼ | 20 | 20 | |
| | UA9AH | UA9AHB | 1½ | 25 | 25 | |
| | UA9AJ | UA9AJB | 2 | 20 | 20 | |
| | UA9AK-CAR | UA9AKB-CAR | 2½ | 10 | 10 | |
| | UA9AL | UA9ALB | 3 | 1 | 5 | |
| | UA9AM | UA9AMB | 3½ | 1 | 20 | |
| | UA9AN | UA9ANB | 4 | 1 | 1 | |
| | UA9AP | UA9APB | 5 | 1 | 1 | |
| | UA9AR | UA9ARB | 6 | 1 | 1 | |
| | 45° ELBOW  | UA7AD | UA7ADB | ½ | 50 | 50 |
| | | UA7AE | UA7AEB | ¾ | 25 | 25 |
| | | UA7AF | UA7AFB | 1 | 20 | 20 |
| UA7AF-CAR | | UA7AFB | 1 | 15 | 20 | |
| UA7AG | | UA7AGB | 1¼ | 20 | 20 | |
| UA7AH | | UA7AHB | 1½ | 20 | 20 | |
| UA7AJ | | UA7AJB | 2 | 20 | 20 | |
| UA7AJ-CAR | | — | 2 | 4 | — | |
| UA7AK | | UA7AKB | 2½ | 20 | 20 | |
| UA7AL | | UA7ALB | 3 | 5 | 25 | |
| UA7AM | | UA7AMB | 3½ | 1 | 20 | |
| UA7AN | | UA7ANB | 4 | 1 | 20 | |
| UA7AP | | UA7APB | 5 | 1 | 1 | |
| UA7AR | | UA7ARB | 6 | 1 | 1 | |
| 30° ELBOW  | | UA6AD | UA6ADB | ½ | 50 | 50 |
| | | UA6AE | UA6AEB | ¾ | 25 | 25 |
| | UA6AF | UA6AFB | 1 | 25 | 1 | |
| | UA6AG | UA6AGB | 1¼ | 20 | 20 | |
| | UA6AH | UA6AHB | 1½ | 25 | 1 | |
| | UA6AJ | UA6AJB | 2 | 20 | 20 | |
| | UA6AK | UA6AKB | 2½ | 10 | 20 | |
| | UA6AL | UA6ALB | 3 | 1 | 1 | |
| | UA6AM | UA6AMB | 3½ | 1 | 1 | |
| | UA6AN | UA6ANB | 4 | 1 | 1 | |
| | UA6AP | UA6APB | 5 | 1 | 1 | |
| | UA6AR | UA6ARB | 6 | 1 | 1 | |
| | 22½° ELBOW  | UA5AD | — | ½ | 1 | — |
| | | UA5AE | — | ¾ | 1 | — |
| | | UA5AF | — | 1 | 1 | — |
| | | UA5AG | — | 1¼ | 1 | — |
| UA5AH | | — | 1½ | 1 | — | |
| UA5AJ | | UA5AJB | 2 | 25 | 1 | |
| UA5AK | | — | 2½ | 20 | — | |
| UA5AL | | UA5ALB | 3 | 5 | 1 | |
| UA5AM | | — | 3½ | 1 | — | |
| UA5AN | | UA5ANB | 4 | 1 | 1 | |
| UA5AP | | UA5APB | 5 | 1 | 1 | |
| UA5AR | | UA5ARB | 6 | 1 | 1 | |

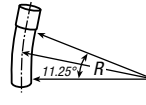
| ITEM | PLAIN END | BELLED END | SIZE | PLAIN | BELLED |
|--|-----------|------------|------|-------|--------|
| | CAT. NO. | CAT. NO. | | END | END |
| | | | STD. | STD. | STD. |
| | | | CTN. | CTN. | CTN. |
| 11¼° ELBOW  | UA3AD | — | ½ | 1 | — |
| | UA3AE | — | ¾ | 1 | — |
| | UA3AF | — | 1 | 1 | — |
| | UA3AG | — | 1¼ | 1 | — |
| | UA3AH | — | 1½ | 1 | — |
| | UA3AJ | — | 2 | 1 | — |
| | UA3AK | — | 2½ | 1 | — |
| | UA3AL | — | 3 | 1 | — |
| | UA3AM | — | 3½ | 1 | — |
| | UA3AN | UA3ANB | 4 | 1 | 1 |
| | UA3AP | — | 5 | 1 | — |
| | UA3AR | — | 6 | 1 | — |

Available in plain and integral belled end for use with non-metallic solvent weld fittings.

Standard Radius Elbow Dimensions (per NEC®)

| SIZE (IN.) | A (IN.) | B MINUS (RADIUS) (IN.) | | C MIN. (IN.) |
|------------|---------|------------------------|------|--------------|
| | | MIN. | MAX. | |
| ½ | .840 | 4 | 1½ | |
| ¾ | 1.050 | 4½ | 1½ | |
| 1 | 1.315 | 5¾ | 1¾ | |
| 1¼ | 1.660 | 7¼ | 2 | |
| 1½ | 1.900 | 8¼ | 2 | |
| 2 | 2.375 | 9½ | 2 | |
| 2½ | 2.875 | 10½ | 3 | |
| 3 | 3.500 | 13 | 3½ | |
| 3½ | 4.000 | 15 | 3¼ | |
| 4 | 4.500 | 16 | 3¾ | |
| 5 | 5.563 | 24 | 3¾ | |
| 6 | 6.625 | 30 | 3¾ | |

Integral Belled End Dimensions

| TRADE SIZE (IN.) | A (IN.) AT ENTRANCE | | B (IN.) AT BOTTOM | | C (IN.) SOCKET DEPTH | |
|------------------|---------------------|-------|-------------------|-------|----------------------|-------|
| | MAX. | MIN. | MAX. | MIN. | MAX. | MIN. |
| ½ | .860 | .844 | .844 | .828 | 1.500 | .652 |
| ¾ | 1.074 | 1.054 | 1.056 | 1.036 | 1.500 | .719 |
| 1 | 1.340 | 1.320 | 1.320 | 1.300 | 1.875 | .875 |
| 1¼ | 1.689 | 1.665 | 1.667 | 1.643 | 2.000 | .938 |
| 1½ | 1.930 | 1.906 | 1.906 | 1.882 | 2.000 | 1.062 |
| 2 | 2.405 | 2.381 | 2.381 | 2.357 | 2.000 | 1.125 |
| 2½ | 2.905 | 2.875 | 2.883 | 2.853 | 3.000 | 1.469 |
| 3 | 3.530 | 3.500 | 3.507 | 3.477 | 3.125 | 1.594 |
| 3½ | 4.065 | 3.965 | 4.007 | 3.977 | 3.250 | 1.687 |
| 4 | 4.565 | 4.465 | 4.506 | 4.476 | 3.375 | 1.750 |
| 5 | 5.643 | 5.543 | 5.583 | 5.523 | 3.625 | 1.937 |
| 6 | 6.708 | 6.608 | 6.644 | 6.584 | 3.750 | 2.125 |

NEC and National Electrical Code are registered trademarks of the National Fire Protection Association, Inc.



Elbows, Sweeps and Accessories

Schedule 40 Elbows — Special Radius

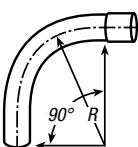

| SEGMENT | PLAIN END CAT. NO. | BELLED END CAT. NO. | NOM. DIAM. (IN.) | RADIUS (IN.) | PLAIN END STD. CTN. | BELLED END STD. CTN. |
|-----------|--------------------|---------------------|------------------|--------------|---------------------|----------------------|
| 90° ELBOW | UA9CF | UA9CFB | 1 | 18 | 1 | 1 |
| | UA9DF | UA9DFB | 1 | 24 | 1 | 1 |
| | UA9EF | UA9EFB | 1 | 30 | 1 | 1 |
| | UA9FF | — | 1 | 36 | 1 | — |
| | UA9HF | — | 1 | 48 | 1 | — |
| | UA9CG | UA9CGB | 1¼ | 18 | 1 | 1 |
| | UA9DG | UA9DGB | 1¼ | 24 | 1 | 1 |
| | UA9EG | UA9EGB | 1¼ | 30 | 1 | 1 |
| | UA9FG | UA9FGB | 1¼ | 36 | 1 | 1 |
| | UA9HG | — | 1¼ | 48 | 1 | — |
| | UA9CH | UA9CHB | 1½ | 18 | 1 | 1 |
| | UA9DH | UA9DHB | 1½ | 24 | 1 | 1 |
| | UA9EH | UA9EHB | 1½ | 30 | 1 | 1 |
| | UA9FH | UA9FHB | 1½ | 36 | 1 | 1 |
| | UA9HH | — | 1½ | 48 | 1 | — |
| | UA9CJ | UA9CJB | 2 | 18 | 1 | 1 |
| | UA9DJ | UA9DJB-UPC | 2 | 24 | 1 | 1 |
| | UA9EJ | UA9EJB | 2 | 30 | 1 | 1 |
| | UA9FJ-UPC | UA9FJB | 2 | 36 | 1 | 1 |
| | UA9HJ | UA9HJB | 2 | 48 | 1 | 1 |
| | UA9JJ | — | 2 | 72 | 1 | — |
| | UA9CK | UA9CKB | 2½ | 18 | 1 | 1 |
| | UA9DK | UA9DKB-UPC | 2½ | 24 | 1 | 1 |
| | UA9EK | UA9EKB | 2½ | 30 | 1 | 1 |
| | UA9FK-UPC | UA9FKB | 2½ | 36 | 1 | 1 |
| | UA9HK | UA9HKB | 2½ | 48 | 1 | 1 |
| | UA9CL | UA9CLB | 3 | 18 | 1 | 1 |
| | UA9DL | UA9DLB-UPC | 3 | 24 | 1 | 1 |
| | UA9EL | UA9ELB | 3 | 30 | 1 | 1 |
| | UA9FL | UA9FLB | 3 | 36 | 1 | 1 |
| | UA9HL | UA9HLB | 3 | 48 | 1 | 1 |
| | UA9IL | — | 3 | 60 | 1 | — |
| | UA9DM | UA9DMB | 3½ | 24 | 1 | 1 |
| | UA9EM | UA9EMB | 3½ | 30 | 1 | 1 |
| | UA9FM | UA9FMB | 3½ | 36 | 1 | 1 |
| | UA9HM | UA9HMB | 3½ | 48 | 1 | 1 |
| | — | UA9CNB | 4 | 18 | — | 1 |
| | UA9DN | UA9DNB | 4 | 24 | 1 | 1 |
| | UA9EN | UA9ENB | 4 | 30 | 1 | 1 |
| | UA9FN | UA9FNB | 4 | 36 | 1 | 1 |
| | UA9HN | UA9HNB | 4 | 48 | 1 | 1 |
| | UA9IN | UA9INB | 4 | 60 | 1 | 1 |
| | UA9JN | — | 4 | 72 | 1 | — |
| | UA9EP | UA9EPB | 5 | 30 | 1 | 1 |
| | UA9FP | UA9FPB | 5 | 36 | 1 | 1 |
| | UA9HP | UA9HPB | 5 | 48 | 1 | 1 |
| | UA9IP | UA9IPB | 5 | 60 | 1 | 1 |
| | UA9FR | UA9FRB | 6 | 36 | 1 | 1 |
| | UA9HR | UA9HRB | 6 | 48 | 1 | 1 |
| | UA9IR | UA9IRB | 6 | 60 | 1 | 1 |
| | — | UA9TRB | 6 | 180 | — | 1 |
| | UA9HT* | — | 8 | 48 | 1 | — |

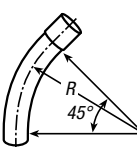

| SEGMENT | PLAIN END CAT. NO. | BELLED END CAT. NO. | NOM. DIAM. (IN.) | RADIUS (IN.) | PLAIN END STD. CTN. | BELLED END STD. CTN. |
|-----------|--------------------|---------------------|------------------|--------------|---------------------|----------------------|
| 45° ELBOW | UA7CF | — | 1 | 18 | 1 | — |
| | UA7DF | — | 1 | 24 | 1 | — |
| | UA7EF | — | 1 | 30 | 1 | — |
| | UA7FF | — | 1 | 36 | 1 | — |
| | UA7HF | — | 1 | 48 | 1 | — |
| | UA7CG | — | 1¼ | 18 | 1 | — |
| | UA7DG | — | 1¼ | 24 | 1 | — |
| | UA7EG | — | 1¼ | 30 | 1 | — |
| | UA7FG | — | 1¼ | 36 | 1 | — |
| | UA7HG | — | 1¼ | 48 | 1 | — |
| | UA7CH | — | 1½ | 18 | 1 | — |
| | UA7DH | — | 1½ | 24 | 1 | — |
| | UA7EH | — | 1½ | 30 | 1 | — |
| | UA7FH | UA7FHB | 1½ | 36 | 1 | 1 |
| | UA7HH | — | 1½ | 48 | 1 | — |
| | — | UA7BJB | 2 | 12 | — | 1 |
| | UA7CJ | UA7CJB | 2 | 18 | 1 | 1 |
| | UA7DJ | UA7DJB | 2 | 24 | 1 | 1 |
| | UA7EJ | UA7EJB | 2 | 30 | 1 | 1 |
| | UA7FJ | UA7FJB | 2 | 36 | 1 | 1 |
| | UA7HJ | UA7HJB | 2 | 48 | 1 | 1 |
| | UA7SJ | — | 2 | 150 | 1 | — |
| | UA7CK | — | 2½ | 18 | 1 | — |
| | UA7DK | UA7DKB | 2½ | 24 | 1 | 1 |
| | UA7EK | — | 2½ | 30 | 1 | — |
| | UA7FK | UA7FKB | 2½ | 36 | 1 | 1 |
| | UA7HK | — | 2½ | 48 | 1 | — |
| | UA7CL | UA7CLB | 3 | 18 | 1 | 1 |
| | UA7DL | UA7DLB | 3 | 24 | 1 | 1 |
| | UA7EL | UA7ELB | 3 | 30 | 1 | 1 |
| | UA7FL | UA7FLB | 3 | 36 | 1 | 1 |
| | UA7HL | UA7HLB | 3 | 48 | 1 | 1 |
| | UA7DM | — | 3½ | 24 | 1 | — |
| | UA7EM | — | 3½ | 30 | 1 | — |
| | UA7FM | — | 3½ | 36 | 1 | — |
| | UA7DN | UA7DNB | 4 | 24 | 1 | 1 |
| | UA7EN | UA7ENB | 4 | 30 | 1 | 1 |
| | UA7FN | UA7FNB | 4 | 36 | 1 | 1 |
| | UA7HN | UA7HNB | 4 | 48 | 1 | 1 |
| | — | UA7NNB | 4 | 120 | — | 1 |
| | UA7SN | UA7SNB | 4 | 150 | 1 | 1 |
| | UA7EP | UA7EPB | 5 | 30 | 1 | 1 |
| | UA7FP | UA7FPB | 5 | 36 | 1 | 1 |
| | UA7HP | UA7HPB | 5 | 48 | 1 | 1 |
| | — | UA7IPB | 5 | 60 | — | 1 |
| | — | UA7NPB | 5 | 120 | — | 1 |
| | — | UA7SPB | 5 | 150 | — | 1 |
| | UA7FR | UA7FRB | 6 | 36 | 1 | 1 |
| | UA7HR | UA7HRB | 6 | 48 | 1 | 1 |
| | UA7FT* | — | 8 | 36 | 1 | — |
| | UA7HT* | — | 8 | 48 | 1 | — |

Note: Elbows 72" and larger may be shipped in segments. Consult factory for specifics.
* 8" elbows are not UL Listed.

Elbows, Sweeps and Accessories

Schedule 40 Elbows — Special Radius (continued)



| SEGMENT | PLAIN END CAT. NO. | BELLED END CAT. NO. | NOM. DIAM. (IN.) | RADIUS (IN.) | PLAIN END STD. CTN. | BELLED END STD. CTN. |
|------------|--------------------|---------------------|------------------|--------------|---------------------|----------------------|
| 30° ELBOW | UA6CJ | — | 2 | 18 | 1 | — |
| | UA6DJ | UA6DJB | 2 | 24 | 1 | 1 |
| | UA6FJ | UA6FJB | 2 | 36 | 1 | 1 |
| | UA6HJ | UA6HJB | 2 | 48 | 1 | 1 |
| | UA6CK | — | 2½ | 18 | 1 | — |
| | UA6DK | — | 2½ | 24 | 1 | — |
| | UA6CL | — | 3 | 18 | 1 | — |
| | UA6DL | UA6DLB | 3 | 24 | 1 | 1 |
| | UA6FL | UA6FLB | 3 | 36 | 1 | 1 |
| | UA6HL | UA6HLB | 3 | 48 | 1 | 1 |
| | UA6DM | — | 3½ | 24 | 1 | — |
| | UA6FM | — | 3½ | 36 | 1 | — |
| | UA6HM | — | 3½ | 48 | 1 | — |
| | UA6DN | — | 4 | 24 | 1 | — |
| | UA6FN | UA6FNB | 4 | 36 | 1 | 1 |
| | UA6HN | UA6HNB | 4 | 48 | 1 | 1 |
| | UA6FP | UA6FPB | 5 | 36 | 1 | 1 |
| | UA6HP | UA6HPB | 5 | 48 | 1 | 1 |
| | UA6FR | UA6FRB | 6 | 36 | 1 | 1 |
| | UA6HR | UA6HRB | 6 | 48 | 1 | 1 |
| 11¼° ELBOW | UA3DJ | UA3DJB | 2 | 24 | 1 | 25 |
| | UA3FJ | UA3FJB | 2 | 36 | 1 | 1 |
| | UA3HJ | — | 2 | 48 | 1 | — |
| | UA3HK | — | 2½ | 48 | 1 | — |
| | UA3DL | UA3DLB | 3 | 24 | 1 | 1 |
| | UA3FL | UA3FLB | 3 | 36 | 1 | 1 |
| | UA3HL | — | 3 | 48 | 1 | — |
| | UA3DM | — | 3½ | 24 | 1 | — |
| | UA3HM | — | 3½ | 48 | 1 | — |
| | UA3DN | UA3DNB | 4 | 24 | 1 | 1 |
| | UA3FN | UA3FNB | 4 | 36 | 1 | 1 |
| | — | UA3SNB | 4 | 150 | — | 1 |
| | UA3HN | UA3HNB | 4 | 48 | 1 | 1 |
| | UA3FP | UA3FPB | 5 | 36 | 1 | 1 |
| | UA3HP | — | 5 | 48 | 1 | — |
| | — | UA3UPB | 5 | 240 | — | 1 |
| | UA3FR | UA3FRB | 6 | 36 | 1 | 1 |
| | UA3HR | — | 6 | 48 | 1 | — |
| | UA3FT* | — | 8 | 36 | 1 | — |

Consult factory for additional sizes/configurations.

| SEGMENT | PLAIN END CAT. NO. | BELLED END CAT. NO. | NOM. DIAM. (IN.) | RADIUS (IN.) | PLAIN END STD. CTN. | BELLED END STD. CTN. |
|------------|--------------------|---------------------|------------------|--------------|---------------------|----------------------|
| 22½° ELBOW | UA5FF | — | 1 | 36 | 1 | — |
| | UA5FG | — | 1¼ | 36 | 1 | — |
| | UA5FH | UA5FHB | 1½ | 36 | 1 | 1 |
| | UA5CJ | UA5CJB | 2 | 18 | 1 | 1 |
| | UA5DJ | UA5DJB | 2 | 24 | 1 | 25 |
| | UA5EJ | UA5EJB | 2 | 30 | 1 | 1 |
| | UA5FJ | UA5FJB | 2 | 36 | 1 | 1 |
| | UA5HJ | — | 2 | 48 | 1 | — |
| | UA5VJ | — | 2 | 300 | 1 | — |
| | UA5CK | — | 2½ | 18 | 1 | — |
| | UA5DK | — | 2½ | 24 | 1 | — |
| | UA5EK | — | 2½ | 30 | 1 | — |
| | UA5FK | — | 2½ | 36 | 1 | — |
| | UA5HK | — | 2½ | 48 | 1 | — |
| | — | UA5CLB | 3 | 18 | — | 1 |
| | UA5DL | UA5DLB | 3 | 24 | 1 | 1 |
| | UA5EL | UA5ELB | 3 | 30 | 1 | 1 |
| | UA5FL | UA5FLB | 3 | 36 | 1 | 1 |
| | UA5HL | — | 3 | 48 | 1 | — |
| | UA5VL | — | 3 | 300 | 1 | — |
| | UA5DM | — | 3½ | 24 | 1 | — |
| | UA5EM | — | 3½ | 30 | 1 | — |
| | UA5FM | — | 3½ | 36 | 1 | — |
| | UA5HM | — | 3½ | 48 | 1 | — |
| | UA5DN | UA5DNB | 4 | 24 | 1 | 1 |
| | UA5EN | UA5ENB | 4 | 30 | 1 | 1 |
| | UA5FN | UA5FNB | 4 | 36 | 1 | 1 |
| | UA5HN | UA5HNB | 4 | 48 | 1 | 1 |
| | UA5IN | — | 4 | 60 | 1 | — |
| | UA5JN | — | 4 | 72 | 1 | — |
| | UA5SN | UA5SNB | 4 | 150 | 1 | 1 |
| | — | UA5UNB | 4 | 240 | — | 1 |
| | — | UA5VNB | 4 | 300 | — | 1 |
| | — | UA5DPB | 5 | 24 | — | 1 |
| | UA5EP | UA5EPB | 5 | 30 | 1 | 1 |
| | UA5FP | UA5FPB | 5 | 36 | 1 | 1 |
| | UA5HP | UA5HPB | 5 | 48 | 1 | 1 |
| | UA5IP | — | 5 | 60 | 1 | — |
| | UA5SP | — | 5 | 150 | 1 | — |
| | — | UA5UPB | 5 | 240 | — | 1 |
| — | UA5VPB | 5 | 300 | — | 1 | |
| UA5FR | UA5FRB | 6 | 36 | 1 | 1 | |
| UA5HR | UA5HRB | 6 | 48 | 1 | 1 | |
| UA5IR | — | 6 | 60 | 1 | — | |
| UA5RR | — | 6 | 144 | 1 | — | |
| UA5SR | — | 6 | 150 | 1 | — | |
| UA5VR | — | 6 | 300 | 1 | — | |
| UA5FT* | — | 8 | 36 | 1 | — | |
| UA5HT* | — | 8 | 48 | 1 | — | |

Note: Elbows 72" and larger may be shipped in segments. Consult factory for specifics.
* 8" elbows are not UL Listed.



Elbows, Sweeps and Accessories

Schedule 80 Elbows

Standard Radius

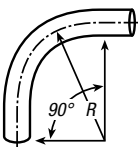
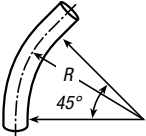
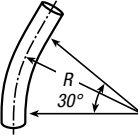
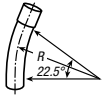
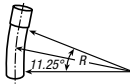
| ITEM | PLAIN END CAT. NO. | BELLED END CAT. NO. | SIZE (IN.) | PLAIN END STD. CTN. | BELLED END STD. CTN. |
|---|--------------------|---------------------|------------|---------------------|----------------------|
|  90° ELBOW | UB9AD | — | ½ | 50 | — |
| | UB9AE | — | ¾ | 25 | — |
| | UB9AF | — | 1 | 25 | — |
| | UB9AG | — | 1¼ | 20 | — |
| | UB9AH | — | 1½ | 25 | — |
| | UB9AJ | — | 2 | 20 | — |
| | UB9AK | — | 2½ | 10 | — |
| | UB9AL | — | 3 | 5 | — |
| | UB9AN | — | 4 | 1 | — |
| | UB9AP | UB9APB | 5 | 1 | 1 |
| | UB9AR | — | 6 | 1 | — |
|  45° ELBOW | UB7AD | — | ½ | 50 | — |
| | UB7AE-UPC | — | ¾ | 25 | — |
| | UB7AF-UPC | — | 1 | 20 | — |
| | UB7AG | — | 1¼ | 20 | — |
| | UB7AH | — | 1½ | 20 | — |
| | UB7AH-CAR | — | 1½ | 5 | — |
| | UB7AJ-UPC | — | 2 | 20 | — |
| | UB7AK | — | 2½ | 20 | — |
| | UB7AL | — | 3 | 1 | — |
| | UB7AN | — | 4 | 1 | — |
| | UB7AP | UB7APB | 5 | 1 | 1 |
| UB7AR | — | 6 | 1 | — | |
|  30° ELBOW | UB6AD | — | ½ | 50 | — |
| | UB6AE | — | ¾ | 25 | — |
| | UB6AF | — | 1 | 25 | — |
| | UB6AG | — | 1¼ | 5 | — |
| | UB6AH | — | 1½ | 25 | — |
| | UB6AJ | — | 2 | 20 | — |
| | UB6AK | — | 2½ | 1 | — |
| | UB6AL | — | 3 | 1 | — |
| | UB6AN | — | 4 | 1 | — |
| | UB6AP | — | 5 | 1 | — |
| | UB6AR | — | 6 | 1 | — |
|  22½° ELBOW | UB5AL | — | 3 | 5 | — |
| | UB5AN | — | 4 | 1 | — |
| | UB5AP | UB5APB | 5 | 1 | 1 |
|  11¼° ELBOW | UB3AL | — | 3 | 1 | — |
| | UB3AR | — | 6 | 1 | — |

For use with non-metallic solvent weld fittings.

Special Radius

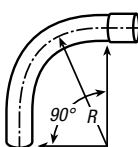
| SEGMENT | PLAIN END CAT. NO. | BELLED END CAT. NO. | NOM. DIAM. (IN.) | RADIUS (IN.) | PLAIN END STD. CTN. | BELLED END STD. CTN. |
|--|--------------------|---------------------|------------------|--------------|---------------------|----------------------|
|  90° ELBOW | UB9CF | — | 1 | 18 | 1 | — |
| | UB9DF | — | 1 | 24 | 1 | — |
| | UB9FF | — | 1 | 36 | 1 | — |
| | UB9HF | — | 1 | 48 | 1 | — |
| | UB9CG | — | 1¼ | 18 | 1 | — |
| | UB9DG | — | 1¼ | 24 | 1 | — |
| | UB9FG | — | 1¼ | 36 | 1 | — |
| | UB9HG | — | 1¼ | 48 | 1 | — |
| | UB9CH | — | 1½ | 18 | 1 | — |
| | UB9DH-UPC | UB9DHB | 1½ | 24 | 1 | 1 |
| | UB9FH | — | 1½ | 36 | 1 | — |
| | UB9HH | — | 1½ | 48 | 1 | — |
| | UB9CJ | — | 2 | 18 | 1 | — |
| | UB9DJ-UPC | UB9DJB | 2 | 24 | 1 | 1 |
| | UB9FJ | UB9FJB | 2 | 36 | 1 | 1 |
| | UB9HJ | — | 2 | 48 | 1 | — |
| | UB9CK | — | 2½ | 18 | 1 | — |
| | UB9DK-UPC | UB9DKB | 2½ | 24 | 1 | 1 |
| | UB9FK | UB9FKB | 2½ | 36 | 1 | 1 |
| | UB9HK | — | 2½ | 48 | 1 | — |
| | UB9CL | — | 3 | 18 | 1 | — |
| | UB9DL | UB9DLB | 3 | 24 | 1 | 1 |
| | UB9FL | UB9FLB | 3 | 36 | 1 | 1 |
| | UB9HL | — | 3 | 48 | 1 | — |
| | UB9DN | UB9DNB | 4 | 24 | 1 | 1 |
| | UB9FN | UB9FNB | 4 | 36 | 1 | 1 |
| | UB9HN | UB9HNB | 4 | 48 | 1 | 1 |
| | UB9NN | — | 4 | 120 | 1 | — |
| | UB9FP | — | 5 | 36 | 1 | — |
| | UB9HP | — | 5 | 48 | 1 | — |
| | UB9IP | — | 5 | 60 | 1 | — |
| | UB9FR | — | 6 | 36 | 1 | — |
| UB9HR | — | 6 | 48 | 1 | — | |
| UB9IR | — | 6 | 60 | 1 | — | |

Note: Elbows 72" and larger may be shipped in segments. Consult factory for specifics.

Elbows, Sweeps and Accessories

Schedule 80 Elbows — Special Radius (continued)

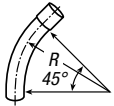
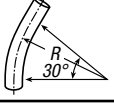
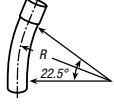
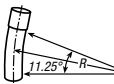
| SEGMENT | PLAIN END CAT. NO. | BELLED END CAT. NO. | NOM. DIAM. (IN.) | RADIUS (IN.) | PLAIN END STD. CTN. | BELLED END STD. CTN. |
|---|--------------------|---------------------|------------------|--------------|---------------------|----------------------|
|  45° ELBOW | UB7CF | — | 1 | 18 | 1 | — |
| | UB7DF | — | 1 | 24 | 1 | — |
| | UB7FF | — | 1 | 36 | 1 | — |
| | UB7HF | — | 1 | 48 | 1 | — |
| | UB7DG | — | 1¼ | 24 | 1 | — |
| | UB7FG | — | 1¼ | 36 | 1 | — |
| | UB7HG | — | 1¼ | 48 | 1 | — |
| | UB7CH | — | 1½ | 18 | 1 | — |
| | UB7DH | UB7DHB | 1½ | 24 | 1 | 1 |
| | UB7FH | — | 1½ | 36 | 1 | — |
| | UB7HH | — | 1½ | 48 | 1 | — |
| | UB7CJ | — | 2 | 18 | 1 | — |
| | UB7DJ | UB7DJB | 2 | 24 | 1 | 1 |
| | UB7FJ | UB7FJB | 2 | 36 | 1 | 1 |
| | UB7HJ | — | 2 | 48 | 1 | — |
| | UB7DK | UB7DKB | 2½ | 24 | 1 | 1 |
| | UB7FK | — | 2½ | 36 | 1 | — |
| | UB7HK | — | 2½ | 48 | 1 | — |
| | UB7CL | — | 3 | 18 | 1 | — |
| | UB7DL | UB7DLB | 3 | 24 | 1 | 1 |
| | UB7FL | UB7FLB | 3 | 36 | 1 | 1 |
| | UB7HL | — | 3 | 48 | 1 | — |
| | UB7DN | UB7DNB | 4 | 24 | 1 | 1 |
| | UB7FN | UB7FNB | 4 | 36 | 1 | 1 |
| | UB7HN | — | 4 | 48 | 1 | — |
| | UB7FP | — | 5 | 36 | 1 | — |
| | UB7HP | — | 5 | 48 | 1 | — |
| | UB7FR | — | 6 | 36 | 1 | — |
| UB7HR | — | 6 | 48 | 1 | — | |
| UB7IR | — | 6 | 60 | 1 | — | |
|  30° ELBOW | UB6FN | — | 4 | 36 | 1 | — |
| | UB6FR | — | 6 | 36 | 1 | — |
|  22½° ELBOW | — | UB5DHB | 1½ | 24 | — | 20 |
| | — | UB5DJB | 2 | 24 | — | 20 |
| | — | UB5FJB | 2 | 36 | — | 25 |
| | — | UB5DKB | 2½ | 24 | — | 15 |
| | UB5DL | UB5DLB | 3 | 24 | 1 | 10 |
| | — | UB5FLB | 3 | 36 | — | 1 |
| | UB5DN | UB5DNB | 4 | 24 | 1 | 5 |
| | — | UB5FNB | 4 | 36 | — | 1 |
| UB5FP | — | 5 | 36 | 1 | — | |
|  11¼° ELBOW | UB3FP | — | 5 | 36 | 1 | — |

Note: Elbows 72" and larger may be shipped in segments. Consult factory for specifics.

Flexible PVC Elbows

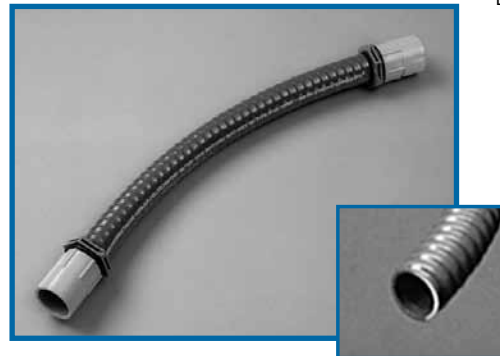

- UL Listed for exposed and direct-burial applications in accordance with Article 356 of the NEC®
- 0°–90° bending and offset applications
- O-ring seal for moisture-tight connections
- Maintains round shape throughout bend
- Sunlight resistant
- Non-corrosive — all PVC and Neoprene material
- Fully assembled and ready to use

| CAT. NO. | SIZE (IN.) | STD. CTN. | STD. WT. (LBS.) | LENGTH FULLY ASSEMBLED (IN.) |
|----------|------------|-----------|-----------------|------------------------------|
| UAFAD | ½ | 8 | 1.6 | 8.5 |
| UFAFE | ¾ | 6 | 1.9 | 9.6 |
| UFAF | 1 | 6 | 2.4 | 11.9 |

NEC and National Electrical Code are registered trademarks of the National Fire Protection Association, Inc.

Elbows, Sweeps and Accessories

Canadian Schedule 40 Elbows — Standard Radius

SP®
LR90813

Conduit & Fittings — Carlton® PVC Elbows, Conduit & Fittings

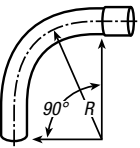
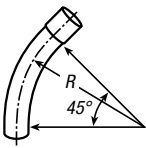
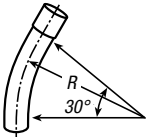
| ITEM | BELLED END CAT. NO. | BELLED END SIZE (IN.) | STD. CTN. |
|--|---------------------|-----------------------|-----------|
|  90° ELBOW | UA9ADCB-CTN | ½ | 40 |
| | UA9AECB-CTN | ¾ | 25 |
| | UA9AFCB-CTN | 1 | 25 |
| | UA9AGCB-UPC | 1¼ | 20 |
| | UA9AHC B-UPC | 1½ | 25 |
| | UA9AJCB-UPC | 2 | 20 |
| | UA9AKCB-CTN | 2½ | 10 |
| | UA9ALCB-UPC | 3 | 25 |
| | UA9AMCB | 3½ | 1 |
| | UA9ANCB | 4 | 1 |
| UA9APCB | 5 | 1 | |
| UA9ARCB | 6 | 1 | |
|  45° ELBOW | UA7AGCB | 1¼ | 1 |
| | UA7AHC B | 1½ | 20 |
| | UA7AJCB | 2 | 20 |
| | UA7AKCB | 2½ | 1 |
| | UA7ALCB | 3 | 5 |
| | UA7AMCB | 3½ | 1 |
| | UA7ANCB | 4 | 1 |
| | UA7APCB | 5 | 1 |
| UA7ARCB | 6 | 1 | |
|  30° ELBOW | UA6AJCB | 2 | 20 |
| | UA6ANCB | 4 | 1 |
| | UA6ARCB | 6 | 1 |

Available in plain and integral belled end for use with non-metallic solvent weld fittings.

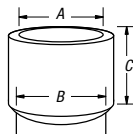

Integral Belled End Dimensions

| TRADE SIZE (IN.) | A AT ENTRANCE | | B AT BOTTOM | | C SOCKET DEPTH | |
|------------------|---------------|-------|-------------|-------|----------------|-------|
| | MAX. | MIN. | MAX. | MIN. | MAX. | MIN. |
| ½ | .860 | .844 | .844 | .828 | 1.500 | .652 |
| ¾ | 1.074 | 1.054 | 1.056 | 1.036 | 1.500 | .719 |
| 1 | 1.340 | 1.320 | 1.320 | 1.300 | 1.875 | .875 |
| 1¼ | 1.689 | 1.665 | 1.667 | 1.643 | 2.000 | .938 |
| 1½ | 1.930 | 1.906 | 1.906 | 1.882 | 2.000 | 1.062 |
| 2 | 2.405 | 2.381 | 2.381 | 2.357 | 2.000 | 1.125 |
| 2½ | 2.905 | 2.875 | 2.883 | 2.853 | 3.000 | 1.469 |
| 3 | 3.530 | 3.500 | 3.507 | 3.477 | 3.125 | 1.594 |
| 3½ | 4.065 | 3.965 | 4.007 | 3.977 | 3.250 | 1.687 |
| 4 | 4.565 | 4.465 | 4.506 | 4.476 | 3.375 | 1.750 |
| 5 | 5.643 | 5.543 | 5.583 | 5.523 | 3.625 | 1.937 |
| 6 | 6.708 | 6.608 | 6.644 | 6.584 | 3.750 | 2.125 |

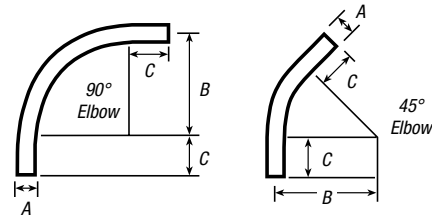

Standard Radius Elbow Dimensions (per NEC®)

| SIZE (IN.) | A (IN.) | B MIN. (RADIUS) (IN.) | C MIN. (IN.) |
|------------|---------|-----------------------|--------------|
| ½ | .840 | 4 | 1½ |
| ¾ | 1.050 | 4½ | 1½ |
| 1 | 1.315 | 5¾ | 1¾ |
| 1¼ | 1.660 | 7¼ | 2 |
| 1½ | 1.900 | 8¼ | 2 |
| 2 | 2.375 | 9½ | 2 |
| 2½ | 2.875 | 10½ | 3 |
| 3 | 3.500 | 13 | 3¾ |
| 3½ | 4.000 | 15 | 3¾ |
| 4 | 4.500 | 16 | 3¾ |
| 5 | 5.563 | 24 | 3¾ |
| 6 | 6.625 | 30 | 3¾ |

NEC and National Electrical Code are registered trademarks of the National Fire Protection Association, Inc.

Elbows, Sweeps and Accessories

Conduit & Fittings — Carlton® PVC Elbows, Conduit & Fittings

Deep-Socket Schedule 40 Utility Elbows with Integral Belled Ends

Non-UL Listed

| SEGMENT | CAT. NO. METAL, STANDARD | NOM. DIA. (IN.) | RADIUS (IN.) | STD. CTN. | STD. WT. (LBS.) |
|------------|-----------------------------|-----------------------|-----------------|--------------|-----------------------|
| 90° SWEEP | UC9BHB | 1½ | 12 | 20 | 25.00 |
| | UC9DHB | 1½ | 24 | 1 | 2.13 |
| | UC9FHB | 1½ | 36 | 1 | 3.05 |
| | UC9BJB | 2 | 12 | 1 | 1.44 |
| | UC9DJB | 2 | 24 | 1 | 2.82 |
| | UC9FJB | 2 | 36 | 1 | 4.14 |
| | UC9HJB | 2 | 48 | 1 | 5.15 |
| | UC9DKB | 2½ | 24 | 1 | 5.00 |
| | UC9FKB | 2½ | 36 | 1 | 7.15 |
| | UC9DLB | 3 | 24 | 1 | 6.57 |
| | UC9FLB | 3 | 36 | 1 | 9.15 |
| | UC9DNB | 4 | 24 | 1 | 10.59 |
| | UC9FNB | 4 | 36 | 1 | 13.64 |
| | UC9HNB | 4 | 48 | 1 | 17.72 |
| | UC9FRB | 6 | 36 | 1 | 25.80 |
| | 45° ELBOW | UC7FHB | 1½ | 36 | 1 |
| UC7FJB | | 2 | 36 | 1 | 2.07 |
| UC7CKB | | 2½ | 18 | 1 | 2.27 |
| UC7FKB | | 2½ | 36 | 1 | 4.12 |
| UC7FLB | | 3 | 36 | 1 | 5.00 |
| UC7FNB | | 4 | 36 | 1 | 8.15 |
| UC7HNB | | 4 | 48 | 1 | 9.36 |
| UC7HRB | | 6 | 48 | 1 | 17.19 |
| 22½° ELBOW | UC5CKB | 2½ | 18 | 1 | 1.45 |
| | UC5FKB | 2½ | 36 | 1 | 2.49 |
| | UC5FNB | 4 | 36 | 1 | 5.18 |
| | UC5FRB | 6 | 36 | 1 | 11.82 |
| | UC5HNB | 4 | 48 | 1 | 5.57 |

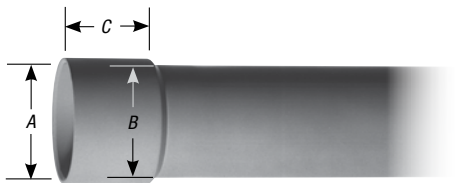
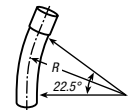
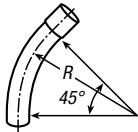
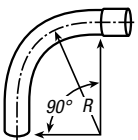

Utility Elbow Bells (Dimensions in Inches)

| TRADE SIZE | A AT ENTRANCE | B AT ENTRANCE | C NORMAL CELL |
|------------|------------------|------------------|------------------|
| 1½ | 1.921 ± .005 | 1.894 ± .006 | 2¾ ± ½ |
| 2 | 2.400 ± .005 | 2.369 ± .012 | 3¼ ± ½ |
| 2½ | 2.906 ± .005 | 2.868 ± .007 | 3 ± ½ |
| 3 | 3.538 ± .005 | 3.492 ± .008 | 3 ± ½ |
| 4 | 4.544 ± .005 | 4.491 ± .009 | 3¾ ± ½ |
| 5 | 5.614 ± .005 | 5.553 ± .010 | 4¾ ± ½ |
| 6 | 6.687 ± .005 | 6.614 ± .011 | 5¾ ± ½ |
| 8 | 8.687 ± .005 | 8.636 ± .005 | 6¾ ± ½ |

Long-Belled Utility Elbows

Non-UL Listed

| SEGMENT | CAT. NO. | NOM. DIA. (IN.) | RADIUS (IN.) | STD. CTN. | STD. WT. (LBS.) |
|------------|-----------|-----------------------|-----------------|--------------|-----------------------|
| 90° ELBOW | UC9CJBLB | 2 | 18 | 1 | 1.3 |
| | UC9DJBLB | 2 | 24 | 1 | 1.4 |
| | UC9DLBLB | 3 | 24 | 1 | 5.0 |
| | UC9DNBLB | 4 | 24 | 1 | 5.8 |
| | UC9DPBLB | 5 | 24 | 1 | 8.5 |
| | UC9FJBLB | 2 | 36 | 1 | 2.2 |
| | UC9FLBLB | 3 | 36 | 1 | 5.2 |
| | UC9FNBLB | 4 | 36 | 1 | 7.8 |
| | UC9FPBLB | 5 | 36 | 1 | 11.1 |
| | UC9FRBLB | 6 | 36 | 1 | 9.6 |
| | UC9HJBLB | 2 | 48 | 1 | 2.8 |
| | UC9HLBLB | 3 | 48 | 1 | 12.0 |
| | UC9HNBLB | 4 | 48 | 1 | 9.7 |
| | UC9HPBLB | 5 | 48 | 1 | 13.7 |
| | UC9HRBLB | 6 | 48 | 1 | 18.1 |
| | 45° ELBOW | UC7CJBLB | 2 | 18 | 1 |
| UC7DJBLB | | 2 | 24 | 1 | 1.4 |
| UC7DLBLB | | 3 | 24 | 1 | 5.0 |
| UC7DNBLB | | 4 | 24 | 1 | 5.8 |
| UC7DPBLB | | 5 | 24 | 1 | 8.5 |
| UC7FJBLB | | 2 | 36 | 1 | 2.2 |
| UC7FLBLB | | 3 | 36 | 1 | 5.2 |
| UC7FNBLB | | 4 | 36 | 1 | 7.8 |
| UC7FPBLB | | 5 | 36 | 1 | 11.1 |
| UC7FRBLB | | 6 | 36 | 1 | 9.6 |
| UC7HJBLB | | 2 | 48 | 1 | 2.8 |
| UC7HLBLB | | 3 | 48 | 1 | 6.6 |
| UC7HNBLB | | 4 | 48 | 1 | 9.7 |
| UC7HPBLB | | 5 | 48 | 1 | 13.7 |
| UC7HRBLB | | 6 | 48 | 1 | 18.1 |
| 22½° ELBOW | | UC5FRBLB | 6 | 36 | 1 |

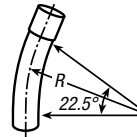
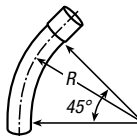
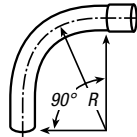

Long-Belled Utility Elbow Bells (Dimensions in Inches)

| TRADE SIZE | A AT ENTRANCE | B AT ENTRANCE | C NOMINAL BELL |
|------------|------------------|------------------|-------------------|
| 1½ | 1.918 ± .006 | 1.894 ± .006 | 2¾ ± ½ |
| 2 | 2.393 ± .006 | 2.369 ± .012 | 3¼ ± ½ |
| 2½ | 2.890 ± .007 | 2.868 ± .007 | 3¼ ± ½ |
| 3 | 3.515 ± .008 | 3.492 ± .008 | 4 ± ½ |
| 4 | 4.515 ± .009 | 4.491 ± .009 | 4¾ ± ½ |
| 5 | 5.593 ± .010 | 5.553 ± .010 | 5¾ ± ½ |
| 6 | 6.658 ± .011 | 6.614 ± .011 | 6¾ ± ½ |

Elbows, Sweeps and Accessories

P&C Duct Special California Type DB-100 Sweeps — Belled

| SEGMENT | CAT. NO. | SIZE (IN.) | STD. CTN. |
|------------------------|----------|------------|-----------|
| 90° SWEEP — 48" RADIUS | PE9HN | 4 | 1 |
| | PE9HP | 5 | 1 |

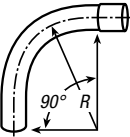

| SEGMENT | CAT. NO. | SIZE (IN.) | STD. CTN. |
|--------------------------|----------|------------|-----------|
| 11¼° SWEEP — 150" RADIUS | PE3SP | 5 | 1 |
| <i>Segmented Sweeps</i> | | | |
| | PE3SNS | 4 | 1 |
| | PE3SPS | 5 | 1 |
| | PE3SRS | 6 | 1 |

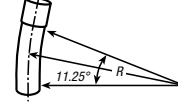

| SEGMENT | CAT. NO. | SIZE (IN.) | STD. CTN. |
|-------------------------|----------|------------|-----------|
| 45° SWEEP — 150" RADIUS | PE7SP | 5 | 1 |

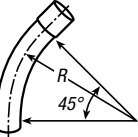

Note: Consult your Thomas & Betts Sales Team for additional sizes

P&C Duct DB-60 Sweeps

| SEGMENT | CAT. NO. | SIZE (IN.) | RADIUS (IN.) | STD. CTN. |
|-----------|----------|------------|--------------|-----------|
| 90° SWEEP | PF9CH | 1½ | 18 | 1 |
| | PF9CJ | 2 | 18 | 1 |
| | PF9CL | 3 | 18 | 1 |
| | PF9CN | 4 | 18 | 1 |
| | PF9DF | 1 | 24 | 1 |
| | PF9DH | 1½ | 24 | 1 |
| | PF9DJ | 2 | 24 | 1 |
| | PF9DL | 3 | 24 | 1 |
| | PF9DN | 4 | 24 | 1 |
| | PF9DP | 5 | 24 | 1 |
| | PF9FF | 1 | 36 | 1 |
| | PF9FJ | 2 | 36 | 1 |
| | PF9FL | 3 | 36 | 1 |
| | PF9FN | 4 | 36 | 1 |
| | PF9FP | 5 | 36 | 1 |
| | PF9FR | 6 | 36 | 1 |
| | PF9HL | 3 | 48 | 1 |
| | PF9HN | 4 | 48 | 1 |
| | PF9HP | 5 | 48 | 1 |
| | PF9HR | 6 | 48 | 1 |
| | PF9IL | 3 | 60 | 1 |
| | PF9IN | 4 | 60 | 1 |
| | PF9IP | 5 | 60 | 1 |
| | PF9IR | 6 | 60 | 1 |
| | PF9SH | 1½ | 150 | 1 |
| | PF9SJ | 2 | 150 | 1 |
| | PF9SL | 3 | 150 | 1 |
| | PF9SR | 6 | 150 | 1 |
| PF9VL | 3 | 300 | 1 | |
| PF9VN | 4 | 300 | 1 | |
| PF9VP | 5 | 300 | 1 | |

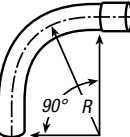

Note: Elbows 72" and larger may be shipped in segments. Consult factory for specifics.

Note: Consult your Thomas & Betts Sales Team for additional sizes

| SEGMENT | CAT. NO. | SIZE (IN.) | RADIUS (IN.) | STD. CTN. |
|-----------|----------|------------|--------------|-----------|
| 45° SWEEP | PF7CF | 1 | 18 | 1 |
| | PF7CH | 1½ | 18 | 1 |
| | PF7CJ | 2 | 18 | 1 |
| | PF7CL | 3 | 18 | 1 |
| | PF7DF | 1 | 24 | 1 |
| | PF7DH | 1½ | 24 | 1 |
| | PF7DJ | 2 | 24 | 1 |
| | PF7DL | 3 | 24 | 1 |
| | PF7DN | 4 | 24 | 1 |
| | PF7FF | 1 | 36 | 1 |
| | PF7FH | 1½ | 36 | 1 |
| | PF7FJ | 2 | 36 | 1 |
| | PF7FL | 3 | 36 | 1 |
| | PF7FN | 4 | 36 | 1 |
| | PF7FP | 5 | 36 | 1 |
| | PF7FR | 6 | 36 | 1 |
| | PF7HJ | 2 | 48 | 1 |
| | PF7HL | 3 | 48 | 1 |
| | PF7HN | 4 | 48 | 1 |
| | PF7HP | 5 | 48 | 1 |
| | PF7HR | 6 | 48 | 1 |
| | PF7IL | 3 | 60 | 1 |
| | PF7IP | 5 | 60 | 1 |
| | PF7NN | 4 | 120 | 1 |
| | PF7SH | 1½ | 150 | 1 |
| | PF7SJ | 2 | 150 | 1 |
| | PF7SL | 3 | 150 | 1 |
| | PF7SN | 4 | 150 | 1 |
| PF7SP | 5 | 150 | 1 | |
| PF7SR | 6 | 150 | 1 | |
| PF7VN | 4 | 300 | 1 | |
| PF7VP | 5 | 300 | 1 | |
| PF7VR | 6 | 300 | 1 | |

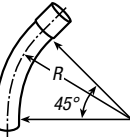

Note: Elbows 72" and larger may be shipped in segments. Consult factory for specifics.

Elbows, Sweeps and Accessories

P&C Duct DB-60 Sweeps (continued)

Note: Consult your Thomas & Betts Sales Team for additional sizes

Conduit & Fittings — Carlton® PVC Elbows, Conduit & Fittings

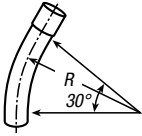
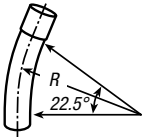
| SEGMENT | CAT. NO. | SIZE (IN.) | RADIUS (IN.) | STD. CTN. |
|---|----------|------------|--------------|-----------|
| 30° SWEEP  | PF6CJ | 2 | 18 | 1 |
| | PF6CL | 3 | 18 | 1 |
| | PF6DL | 3 | 24 | 1 |
| | PF6DN | 4 | 24 | 1 |
| | PF6DP | 5 | 24 | 1 |
| | PF6CH | 1½ | 30 | 1 |
| | PF6FJ | 2 | 36 | 1 |
| | PF6FL | 3 | 36 | 1 |
| | PF6FN | 4 | 36 | 1 |
| | PF6FR | 6 | 36 | 1 |
| | PF6HJ | 2 | 48 | 1 |
| | PF6HN | 4 | 48 | 1 |
| | PF6HP | 5 | 48 | 1 |
| | PF6HR | 6 | 48 | 1 |
| | PF6IN | 4 | 60 | 1 |
| | PF6IP | 5 | 60 | 1 |
| | PF6SJ | 2 | 150 | 1 |
| | PF6SN | 4 | 150 | 1 |
| | PF6SP | 5 | 150 | 1 |
| | PF6VJ | 2 | 300 | 1 |
| PF6VN | 4 | 300 | 1 | |
| PF6VR | 6 | 300 | 1 | |
| 22½° SWEEP  | PH5DL | 3 | 24 | 1 |
| | PF5DN | 4 | 24 | 1 |
| | PF5DP | 5 | 24 | 1 |
| | PF5FF | 1 | 36 | 1 |
| | PF5FL | 3 | 36 | 1 |
| | PF5FN | 4 | 36 | 1 |
| | PF5FP | 5 | 36 | 1 |
| | PF5FR | 6 | 36 | 1 |
| | PF5HL | 3 | 48 | 1 |
| | PF5HN | 4 | 48 | 1 |
| | PF5HR | 6 | 48 | 1 |
| | PF5IJ | 2 | 60 | 1 |
| | PF5IL | 3 | 60 | 1 |
| | PF5IP | 5 | 60 | 1 |
| | PF5IR | 6 | 60 | 1 |
| | PF5SL | 3 | 150 | 1 |
| | PF5SN | 4 | 150 | 1 |
| | PF5SP | 5 | 150 | 1 |
| | PF5SR | 6 | 150 | 1 |
| | PF5VN | 4 | 300 | 1 |
| PF5VP | 5 | 300 | 1 | |
| PF5VR | 6 | 300 | 1 | |

Note: Elbows 72" and larger may be shipped in segments. Consult factory for specifics.

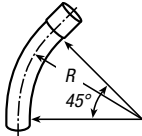
| SEGMENT | CAT. NO. | SIZE (IN.) | RADIUS (IN.) | STD. CTN. |
|---|----------|------------|--------------|-----------|
| 11¼° SWEEP  | PF3CJ | 2 | 18 | 1 |
| | PF3CL | 3 | 18 | 1 |
| | PF3DF | 1 | 24 | 1 |
| | PF3DH | 1½ | 24 | 1 |
| | PF3DP | 5 | 24 | 1 |
| | PF3FJ | 2 | 36 | 1 |
| | PF3FL | 3 | 36 | 1 |
| | PF3FN | 4 | 36 | 1 |
| | PF3FP | 5 | 36 | 1 |
| | PF3FR | 6 | 36 | 1 |
| | PF3HL | 3 | 48 | 1 |
| | PF3HN | 4 | 48 | 1 |
| | PF3HP | 5 | 48 | 1 |
| | PF3HR | 6 | 48 | 1 |
| | PF3IJ | 2 | 60 | 1 |
| | PF3IR | 6 | 60 | 1 |
| | PF3SJ | 2 | 150 | 1 |
| | PF3SN | 4 | 150 | 1 |
| | PF3SP | 5 | 150 | 1 |
| | PF3SR | 6 | 150 | 1 |
| PF3VJ | 2 | 300 | 1 | |
| PF3VL | 3 | 300 | 1 | |
| PF3VN | 4 | 300 | 1 | |
| PF3VP | 5 | 300 | 1 | |

Note: Elbows 72" and larger may be shipped in segments. Consult factory for specifics.

Elbows, Sweeps and Accessories

P&C Duct DB-120 Sweeps

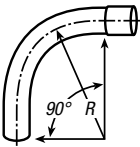
| SEGMENT | CAT. NO. | SIZE (IN.) | RADIUS (IN.) | STD. CTN. |
|--|----------|------------|--------------|-----------|
| 90° SWEEP  | PH9CJ | 2 | 18 | 1 |
| | PH9CL | 3 | 18 | 1 |
| | PH9CN | 4 | 18 | 1 |
| | PH9DJ | 2 | 24 | 1 |
| | PH9DL | 3 | 24 | 1 |
| | PH9DN | 4 | 24 | 1 |
| | PH9DP | 5 | 24 | 1 |
| | PH9FJ | 2 | 36 | 1 |
| | PH9FL | 3 | 36 | 1 |
| | PH9FN | 4 | 36 | 1 |
| | PH9FP | 5 | 36 | 1 |
| | PH9FR | 6 | 36 | 1 |
| | PH9HJ | 2 | 48 | 1 |
| | PH9HL | 3 | 48 | 1 |
| | PH9HN | 4 | 48 | 1 |
| | PH9HP | 5 | 48 | 1 |
| | PH9HR | 6 | 48 | 1 |
| | PH9IJ | 2 | 60 | 1 |
| | PH9IL | 3 | 60 | 1 |
| | PH9IN | 4 | 60 | 1 |
| | PH9IR | 6 | 60 | 1 |
| | PH9OJ | 2 | 66 | 1 |
| | PH9SJ | 2 | 150 | 1 |
| | PH9SL | 3 | 150 | 1 |
| | PH9SN | 4 | 150 | 1 |
| | PH9SP | 5 | 150 | 1 |
| | PH9SR | 6 | 150 | 1 |
| | PH9VN | 4 | 300 | 1 |
| | PH9VP | 5 | 300 | 1 |
| | PH9VR | 6 | 300 | 1 |

Note: Elbows 72" and larger may be shipped in segments. Consult factory for specifics.

Note: Consult your Thomas & Betts Sales Team for additional sizes

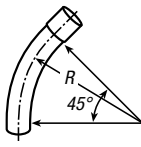
| SEGMENT | CAT. NO. | SIZE (IN.) | RADIUS (IN.) | STD. CTN. |
|--|----------|------------|--------------|-----------|
| 45° SWEEP  | PH7CJ | 2 | 18 | 1 |
| | PH7CL | 3 | 18 | 1 |
| | PH7CN | 4 | 18 | 1 |
| | PH7DJ | 2 | 24 | 1 |
| | PH7DL | 3 | 24 | 1 |
| | PH7DN | 4 | 24 | 1 |
| | PH7DP | 5 | 24 | 1 |
| | PH7FJ | 2 | 36 | 1 |
| | PH7FL | 3 | 36 | 1 |
| | PH7FN | 4 | 36 | 1 |
| | PH7FP | 5 | 36 | 1 |
| | PH7FR | 6 | 36 | 1 |
| | PH7HJ | 2 | 48 | 1 |
| | PH7HL | 3 | 48 | 1 |
| | PH7HN | 4 | 48 | 1 |
| | PH7HP | 5 | 48 | 1 |
| | PH7HR | 6 | 48 | 1 |
| | PH7IJ | 2 | 60 | 1 |
| | PH7IL | 3 | 60 | 1 |
| | PH7IP | 5 | 60 | 1 |
| PH7IR | 6 | 60 | 1 | |
| PH7SJ | 2 | 150 | 1 | |
| PH7SN | 4 | 150 | 1 | |
| PH7SP | 5 | 150 | 1 | |
| PH7SR | 6 | 150 | 1 | |

Note: Elbows 72" and larger may be shipped in segments. Consult factory for specifics.

Elbows, Sweeps and Accessories

P&C Duct DB-60 Sweeps (continued)

Note: Consult your Thomas & Betts Sales Team for additional sizes

Conduit & Fittings — Carlton® PVC Elbows, Conduit & Fittings

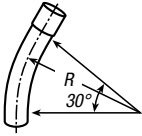
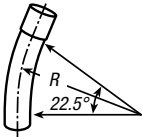
| SEGMENT | CAT. NO. | SIZE (IN.) | RADIUS (IN.) | STD. CTN. |
|---|----------|------------|--------------|-----------|
| 30° SWEEP  | PF6CJ | 2 | 18 | 1 |
| | PF6CL | 3 | 18 | 1 |
| | PF6DL | 3 | 24 | 1 |
| | PF6DN | 4 | 24 | 1 |
| | PF6DP | 5 | 24 | 1 |
| | PF6CH | 1½ | 30 | 1 |
| | PF6FJ | 2 | 36 | 1 |
| | PF6FL | 3 | 36 | 1 |
| | PF6FN | 4 | 36 | 1 |
| | PF6FR | 6 | 36 | 1 |
| | PF6HJ | 2 | 48 | 1 |
| | PF6HN | 4 | 48 | 1 |
| | PF6HP | 5 | 48 | 1 |
| | PF6HR | 6 | 48 | 1 |
| | PF6IN | 4 | 60 | 1 |
| | PF6IP | 5 | 60 | 1 |
| | PF6SJ | 2 | 150 | 1 |
| | PF6SN | 4 | 150 | 1 |
| | PF6SP | 5 | 150 | 1 |
| | PF6VJ | 2 | 300 | 1 |
| PF6VN | 4 | 300 | 1 | |
| PF6VR | 6 | 300 | 1 | |
| 22½° SWEEP  | PH5DL | 3 | 24 | 1 |
| | PF5DN | 4 | 24 | 1 |
| | PF5DP | 5 | 24 | 1 |
| | PF5FF | 1 | 36 | 1 |
| | PF5FL | 3 | 36 | 1 |
| | PF5FN | 4 | 36 | 1 |
| | PF5FP | 5 | 36 | 1 |
| | PF5FR | 6 | 36 | 1 |
| | PF5HL | 3 | 48 | 1 |
| | PF5HN | 4 | 48 | 1 |
| | PF5HR | 6 | 48 | 1 |
| | PF5IJ | 2 | 60 | 1 |
| | PF5IL | 3 | 60 | 1 |
| | PF5IP | 5 | 60 | 1 |
| | PF5IR | 6 | 60 | 1 |
| | PF5SL | 3 | 150 | 1 |
| | PF5SN | 4 | 150 | 1 |
| | PF5SP | 5 | 150 | 1 |
| | PF5SR | 6 | 150 | 1 |
| | PF5VN | 4 | 300 | 1 |
| PF5VP | 5 | 300 | 1 | |
| PF5VR | 6 | 300 | 1 | |

Note: Elbows 72" and larger may be shipped in segments. Consult factory for specifics.

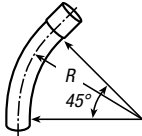
| SEGMENT | CAT. NO. | SIZE (IN.) | RADIUS (IN.) | STD. CTN. |
|---|----------|------------|--------------|-----------|
| 11¼° SWEEP  | PF3CJ | 2 | 18 | 1 |
| | PF3CL | 3 | 18 | 1 |
| | PF3DF | 1 | 24 | 1 |
| | PF3DH | 1½ | 24 | 1 |
| | PF3DP | 5 | 24 | 1 |
| | PF3FJ | 2 | 36 | 1 |
| | PF3FL | 3 | 36 | 1 |
| | PF3FN | 4 | 36 | 1 |
| | PF3FP | 5 | 36 | 1 |
| | PF3FR | 6 | 36 | 1 |
| | PF3HL | 3 | 48 | 1 |
| | PF3HN | 4 | 48 | 1 |
| | PF3HP | 5 | 48 | 1 |
| | PF3HR | 6 | 48 | 1 |
| | PF3IJ | 2 | 60 | 1 |
| | PF3IR | 6 | 60 | 1 |
| | PF3SJ | 2 | 150 | 1 |
| | PF3SN | 4 | 150 | 1 |
| | PF3SP | 5 | 150 | 1 |
| | PF3SR | 6 | 150 | 1 |
| PF3VJ | 2 | 300 | 1 | |
| PF3VL | 3 | 300 | 1 | |
| PF3VN | 4 | 300 | 1 | |
| PF3VP | 5 | 300 | 1 | |

Note: Elbows 72" and larger may be shipped in segments. Consult factory for specifics.

Elbows, Sweeps and Accessories

P&C Duct DB-120 Sweeps

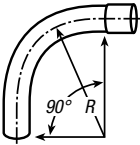
| SEGMENT | CAT. NO. | SIZE (IN.) | RADIUS (IN.) | STD. CTN. |
|--|----------|------------|--------------|-----------|
| 90° SWEEP  | PH9CJ | 2 | 18 | 1 |
| | PH9CL | 3 | 18 | 1 |
| | PH9CN | 4 | 18 | 1 |
| | PH9DJ | 2 | 24 | 1 |
| | PH9DL | 3 | 24 | 1 |
| | PH9DN | 4 | 24 | 1 |
| | PH9DP | 5 | 24 | 1 |
| | PH9FJ | 2 | 36 | 1 |
| | PH9FL | 3 | 36 | 1 |
| | PH9FN | 4 | 36 | 1 |
| | PH9FP | 5 | 36 | 1 |
| | PH9FR | 6 | 36 | 1 |
| | PH9HJ | 2 | 48 | 1 |
| | PH9HL | 3 | 48 | 1 |
| | PH9HN | 4 | 48 | 1 |
| | PH9HP | 5 | 48 | 1 |
| | PH9HR | 6 | 48 | 1 |
| | PH9IJ | 2 | 60 | 1 |
| | PH9IL | 3 | 60 | 1 |
| | PH9IN | 4 | 60 | 1 |
| | PH9IR | 6 | 60 | 1 |
| | PH9OJ | 2 | 66 | 1 |
| | PH9SJ | 2 | 150 | 1 |
| | PH9SL | 3 | 150 | 1 |
| | PH9SN | 4 | 150 | 1 |
| | PH9SP | 5 | 150 | 1 |
| | PH9SR | 6 | 150 | 1 |
| | PH9VN | 4 | 300 | 1 |
| | PH9VP | 5 | 300 | 1 |
| | PH9VR | 6 | 300 | 1 |

Note: Elbows 72" and larger may be shipped in segments. Consult factory for specifics.

Note: Consult your Thomas & Betts Sales Team for additional sizes

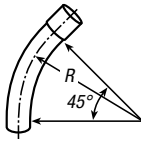
| SEGMENT | CAT. NO. | SIZE (IN.) | RADIUS (IN.) | STD. CTN. |
|--|----------|------------|--------------|-----------|
| 45° SWEEP  | PH7CJ | 2 | 18 | 1 |
| | PH7CL | 3 | 18 | 1 |
| | PH7CN | 4 | 18 | 1 |
| | PH7DJ | 2 | 24 | 1 |
| | PH7DL | 3 | 24 | 1 |
| | PH7DN | 4 | 24 | 1 |
| | PH7DP | 5 | 24 | 1 |
| | PH7FJ | 2 | 36 | 1 |
| | PH7FL | 3 | 36 | 1 |
| | PH7FN | 4 | 36 | 1 |
| | PH7FP | 5 | 36 | 1 |
| | PH7FR | 6 | 36 | 1 |
| | PH7HJ | 2 | 48 | 1 |
| | PH7HL | 3 | 48 | 1 |
| | PH7HN | 4 | 48 | 1 |
| | PH7HP | 5 | 48 | 1 |
| | PH7HR | 6 | 48 | 1 |
| | PH7IJ | 2 | 60 | 1 |
| | PH7IL | 3 | 60 | 1 |
| | PH7IP | 5 | 60 | 1 |
| PH7IR | 6 | 60 | 1 | |
| PH7SJ | 2 | 150 | 1 | |
| PH7SN | 4 | 150 | 1 | |
| PH7SP | 5 | 150 | 1 | |
| PH7SR | 6 | 150 | 1 | |

Note: Elbows 72" and larger may be shipped in segments. Consult factory for specifics.

Elbows, Sweeps and Accessories

P&C Duct Adapters

Male Adapter

| CAT. NO. | SIZE (IN.) | STD. CTN. |
|----------|------------|-----------|
| E943F | 1 | 50 |
| E943H | 1½ | 25 |
| E943J | 2 | 50 |
| E943L | 3 | 50 |
| E943N | 4 | 20 |
| E943P | 5 | 5 |
| E943R | 6 | 10 |



Female Adapter

| CAT. NO. | SIZE (IN.) | STD. CTN. |
|----------|------------|-----------|
| E942F | 1 | 50 |
| E942H | 1½ | 25 |
| E942J | 2 | 30 |
| E942L | 3 | 25 |
| E942N | 4 | 15 |
| E942P | 5 | 8 |
| E942R | 6 | 6 |



P&C Duct Swedge Reducer (Male x Male)

| CAT. NO. | SIZE (IN.) | STD. CTN. |
|----------|------------|-----------|
| E252LJ | 3 x 2 | 50 |
| E252NJS | 4 x 2 | 25 |
| E252NL | 4 x 3 | 25 |
| E252PN | 5 x 4 | 20 |
| E252RNS | 6 x 4 | 6 |
| E252RP | 6 x 5 | 10 |



P&C Duct Cable Marker

| CAT. NO. | SIZE (IN.) | STD. CTN. |
|----------|------------|-----------|
| E299JM | 2 x 42 | 1 |
| E299JP | 2 x 56 | 1 |
| E299JR | 2 x 78 | 1 |
| E299LF | 3 x 36 | 1 |
| E299LR | 3 x 60 | 1 |
| E299NX7 | 4 x 84 | 1 |



P&C Duct End Bells

End Bell

| CAT. NO. | SIZE (IN.) | STD. CTN. |
|----------|------------|-----------|
| E997F | 1 | 50 |
| E997H | 1½ | 30 |
| E997J | 2 | 40 |
| E997L | 3 | 50 |
| E997N | 4 | 30 |
| E997P | 5 | 15 |
| E997R | 6 | 10 |



Molded End Bell

| CAT. NO. | SIZE (IN.) | STD. CTN. |
|----------|------------|-----------|
| E297J | 2 | 40 |
| E297L | 3 | 50 |
| E297N | 4 | 30 |
| E297P | 5 | 15 |



Fabricated End Bell

| CAT. NO. | SIZE (IN.) | STD. CTN. |
|----------|------------|-----------|
| E297JN | 2 x 4 | 25 |
| E297LR | 3 x 6 | 20 |
| E297NT | 4 x 10 | 15 |
| E297PS | 5 x 8 | 10 |
| E297PT | 5 x 10 | 10 |
| E297RF | 6 x 5 | 10 |
| E297RT | 6 x 10 | 6 |



Long-Length End Bell P&C Duct

| CAT. NO. | SIZE (IN.) | STD. CTN. |
|----------|------------|-----------|
| E297RR | 6 (6 long) | 10 |



Elbows, Sweeps and Accessories

P&C Duct Canadian DB/2 Sweeps

LR90813

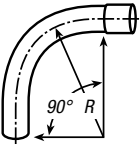
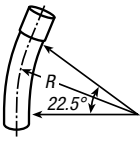
| SEGMENT | CAT. NO. | SIZE (IN.) | RADIUS (IN.) | STD. CTN. |
|--|----------|------------|--------------|-----------|
| 90° SWEEP  | CPF9DJ | 2 | 24 | 1 |
| | CPF9DL | 3 | 24 | 1 |
| | CPF9DM* | 3½ | 24 | 1 |
| | CPF9DN | 4 | 24 | 1 |
| | CPF9DP* | 5 | 24 | 1 |
| | CPF9FJ | 2 | 36 | 1 |
| | CPF9FL | 3 | 36 | 1 |
| | CPF9FM* | 3½ | 36 | 1 |
| | CPF9FN | 4 | 36 | 1 |
| | CPF9FP* | 5 | 36 | 1 |
| | CPF9FR* | 6 | 36 | 1 |
| | CPF9GJ* | 2 | 42 | 1 |
| | CPF9GL* | 3 | 42 | 1 |
| | CPF9GM* | 3½ | 42 | 1 |
| | CPF9GN* | 4 | 42 | 1 |
| | CPF9GP | 5 | 42 | 1 |
| | CPF9GR* | 6 | 42 | 1 |
| | CPF9IJ | 2 | 60 | 1 |
| | CPF9IL | 3 | 60 | 1 |
| | CPF9IM* | 3½ | 60 | 1 |
| CPF9IN | 4 | 60 | 1 | |
| CPF9IP | 5 | 60 | 1 | |
| CPF9IR | 6 | 60 | 1 | |
| 22½° SWEEP  | CPF5DJ* | 2 | 24 | 1 |
| | CPF5DL* | 3 | 24 | 1 |
| | CPF5DM* | 3½ | 24 | 1 |
| | CPF5DN* | 4 | 24 | 1 |
| | CPF5DP* | 5 | 24 | 1 |
| | CPF5FJ* | 2 | 36 | 1 |
| | CPF5FL* | 3 | 36 | 1 |
| | CPF5FM* | 3½ | 36 | 1 |
| | CPF5FN | 4 | 36 | 1 |
| | CPF5FP* | 5 | 36 | 1 |
| | CPF5GJ* | 2 | 42 | 1 |
| | CPF5GL* | 3 | 42 | 1 |
| | CPF5GM* | 3½ | 42 | 1 |
| | CPF5GN* | 4 | 42 | 1 |
| | CPF5GP | 5 | 42 | 1 |
| | CPF5IJ* | 2 | 60 | 1 |
| | CPF5IL* | 3 | 60 | 1 |
| | CPF5IM* | 3½ | 60 | 1 |
| | CPF5IN* | 4 | 60 | 1 |
| | CPF5IP* | 5 | 60 | 1 |

* Non-stock special radius sweeps are available on request — quote only.

Note: Elbows 72" and larger may be shipped in segments. Consult factory for specifics.

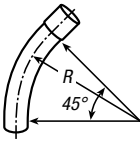
| SEGMENT | CAT. NO. | SIZE (IN.) | RADIUS (IN.) | STD. CTN. |
|---|----------|------------|--------------|-----------|
| 45° SWEEP  | CPF7DJ | 2 | 24 | 1 |
| | CPF7DL | 3 | 24 | 1 |
| | CPF7DM* | 3½ | 24 | 1 |
| | CPF7DN | 4 | 24 | 1 |
| | CPF7DP* | 5 | 24 | 1 |
| | CPF7FJ | 2 | 36 | 1 |
| | CPF7FL | 3 | 36 | 1 |
| | CPF7FM* | 3½ | 36 | 1 |
| | CPF7FN | 4 | 36 | 1 |
| | CPF7FP* | 5 | 36 | 1 |
| | CPF7FR* | 6 | 36 | 1 |
| | CPF7GJ* | 2 | 42 | 1 |
| | CPF7GL* | 3 | 42 | 1 |
| | CPF7GM* | 3½ | 42 | 1 |
| | CPF7GN* | 4 | 42 | 1 |
| | CPF7GP | 5 | 42 | 1 |
| | CPF7GR* | 6 | 42 | 1 |
| | CPF7IJ* | 2 | 60 | 1 |
| | CPF7IL* | 3 | 60 | 1 |
| | CPF7IM* | 3½ | 60 | 1 |
| CPF7IN | 4 | 60 | 1 | |
| CPF7IP* | 5 | 60 | 1 | |
| CPF7IR | 6 | 60 | 1 | |

* Non-stock special radius sweeps are available on request — quote only.

Note: Elbows 72" and larger may be shipped in segments. Consult factory for specifics.

Elbows, Sweeps and Accessories



P&C Duct Canadian DB/2 Duct Fittings

PVC 5° Coupling B x B — Solvent Weld

| CAT. NO. | SIZE (IN.) | STD. CTN. |
|----------|------------|-----------|
| CE245J | 2 | 30 |
| CE245L | 3 | 15 |
| CE245N | 4 | 10 |
| CE245P | 5 | 20 |



PE 5° Coupling — Push Fit

| CAT. NO. | SIZE (IN.) | STD. CTN. |
|----------|------------|-----------|
| CE2440L | 3 | 100 |
| CE2440N | 4 | 90 |



PE Coupling — Push Fit

| CAT. NO. | SIZE (IN.) | STD. CTN. |
|----------|------------|-----------|
| CE242J | 2 | 213 |
| CE242L | 3 | 100 |
| CE242N | 4 | 100 |
| CE242P | 5 | 12 |



PVC Coupling — Solvent Weld

| CAT. NO. | SIZE (IN.) | STD. CTN. |
|----------|------------|-----------|
| CE240J | 2 | 30 |
| CE240L | 3 | 30 |
| CE240N | 4 | 15 |
| CE240P | 5 | 20 |
| CE240R | 6 | 1 |



P&C Duct Plug with Pull Tab

| CAT. NO. | SIZE (IN.) | STD. CTN. |
|----------|------------|-----------|
| P258JT | 2 | 60 |
| P258LT | 3 | 30 |
| P258NT | 4 | 48 |
| P258PT | 5 | 30 |
| P258RT | 6 | 30 |



P&C Duct End Bell (For use with DB/2 Duct only)

| CAT. NO. | SIZE (IN.) | STD. CTN. |
|----------|------------|-----------|
| CE297J | 2 | 40 |
| CE297L | 3 | 50 |
| CE297N | 4 | 30 |
| CE297P | 5 | 15 |



P&C Duct Adapters

PVC Female Adapter — I.P.S. Solvent Weld Duct

| CAT. NO. | SIZE (IN.) | STD. CTN. |
|----------|------------|-----------|
| CE942DJ | 2 | 25 |
| CE942DL | 3 | 30 |
| CE942DN | 4 | 50 |
| CE942DP | 5 | 15 |



PVC Conduit to DB/2 Duct Adapter

| CAT. NO. | SIZE (IN.) | STD. CTN. |
|----------|------------|-----------|
| CE942RJ | 2 | 24 |
| CE942RL | 3 | 1 |
| CE942RN | 4 | 1 |



P&C Duct Cap — Solvent Weld

| CAT. NO. | SIZE (IN.) | STD. CTN. |
|----------|------------|-----------|
| CE935J | 2 | 25 |
| CE935L | 3 | 25 |
| CE935N | 4 | 50 |
| CE935P | 5 | 25 |



Elbows, Sweeps and Accessories

RUS Accepted

Manufactured from Heavy Wall "C" Duct Telephone Duct Sweeps

- Size: 4"
- Each sweep is furnished with a belled end
- Straight-end length 3"

| SEGMENT | CAT. NO. | BEND RADIUS | STD. CTN. |
|------------------|----------|-------------|-----------|
| 90° SWEEP | | | |
| GRAY | | | |
| | TP9CN | 1'6" | 1 |
| | TP9DN | 2' | 1 |
| | TP9FN | 3' | 1 |
| | TP9HN | 4' | 1 |
| | TP9IN | 5' | 1 |
| | TP9JN | 6' | 1 |
| | TP9MN | 9' | 1 |
| | TP9NN | 10' | 1 |
| | TP9SN | 12'6" | 1 |
| | TP9TN | 15' | 1 |
| | TP9UN | 20' | 1 |
| WHITE | | | |
| | TW9DN | 2' | 1 |
| | TW9FN | 3' | 1 |
| | TW9HN | 4' | 1 |
| | TW9IN | 5' | 1 |
| | TW9JN | 6' | 1 |
| | TW9MN | 9' | 1 |
| | TW9NN | 10' | 1 |
| | TW9SN | 12'6" | 1 |
| | TW9TN | 15' | 1 |
| 45° SWEEP | | | |
| GRAY | | | |
| | TP7DN | 2' | 1 |
| | TP7FN | 3' | 1 |
| | TP7HN | 4' | 1 |
| | TP7ON | 4'6" | 1 |
| | TP7IN | 5' | 1 |
| | TP7JN | 6' | 1 |
| | TP7MN | 9' | 1 |
| | TP7NN | 10' | 1 |
| | TP7RN | 12' | 1 |
| | TP7SN | 12'6" | 1 |
| | TP7TN | 15' | 1 |
| | TP7UN | 20' | 1 |
| WHITE | | | |
| | TW7DN | 2' | 1 |
| | TW7FN | 3' | 1 |
| | TW7HN | 4' | 1 |
| | TW7ON | 4'6" | 1 |
| | TW7IN | 5' | 1 |
| | TW7JN | 6' | 1 |
| | TW7MN | 9' | 1 |
| | TW7NN | 10' | 1 |
| | TW7RN | 12' | 1 |
| | TW7SN | 12'6" | 1 |
| | TW7TN | 15' | 1 |

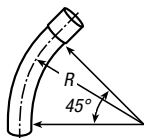
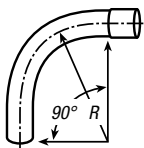

| SEGMENT | CAT. NO. | BEND RADIUS | STD. CTN. |
|-------------------|----------|-------------|-----------|
| 30° SWEEP | | | |
| GRAY | | | |
| | TP6FN | 3' | 1 |
| | TP6HN | 4' | 1 |
| | TP6JN | 6' | 1 |
| | TP6NN | 10' | 1 |
| | TP6RN | 12' | 1 |
| | TP6SN | 12'6" | 1 |
| | TP6TN | 15' | 1 |
| WHITE | | | |
| | TW6FN | 3' | 1 |
| | TW6HN | 4' | 1 |
| | TW6JN | 6' | 1 |
| | TW6MN | 9' | 1 |
| | TW6NN | 10' | 1 |
| | TW6RN | 12' | 1 |
| | TW6SN | 12'6" | 1 |
| | TW6TN | 15' | 1 |
| 22½° SWEEP | | | |
| GRAY | | | |
| | TP5DN | 2' | 1 |
| | TP5FN | 3' | 1 |
| | TP5HN | 4' | 1 |
| | TP5IN | 5' | 1 |
| | TP5JN | 6' | 1 |
| | TP5MN | 9' | 1 |
| | TP5RN | 12' | 1 |
| | TP5SN | 12'6" | 1 |
| | TP5TN | 15' | 1 |
| | TP5UN | 20' | 1 |
| | TP5VN | 25' | 1 |
| WHITE | | | |
| | TW5DN | 2' | 1 |
| | TW5FN | 3' | 1 |
| | TW5HN | 4' | 1 |
| | TW5JN | 6' | 1 |
| | TW5MN | 9' | 1 |
| | TW5SN | 12'6" | 1 |
| | TP3DN | 2' | 1 |
| 11¼° SWEEP | | | |
| GRAY | | | |
| | TP3FN | 3' | 1 |
| | TP3HN | 4' | 1 |
| | TP3IN | 5' | 1 |
| | TP3JN | 6' | 1 |
| | TP3SN | 12'6" | 1 |
| WHITE | | | |
| | TW3DN | 2' | 1 |
| | TW3FN | 3' | 1 |
| | TW3HN | 4' | 1 |

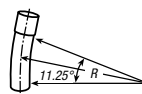
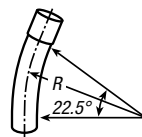
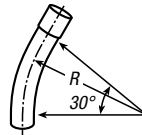

E-Bends — Riser Ells

| SEGMENT | CAT. NO. | BEND RADIUS | STD. CTN. |
|------------------|---------------------------|-------------|-----------|
| 90° SWEEP | | | |
| | TA9ENT (BELLED END) | 2'6" | 1 |
| | TA9FN (PLAIN END) | 3' | 1 |
| | TA9FNT (BELLED END) | 3' | 1 |
| | TA9FNTL (BELLED END-LONG) | 3' | 1 |

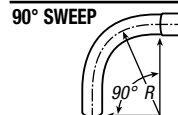

Gray only

Conduit & Fittings — Carlson® PVC Elbows, Conduit & Fittings

Elbows, Sweeps and Accessories

Telephone Duct Couplings

Sleeve Coupling

| CAT. NO. | SIZE (IN.) | STD. CTN. |
|----------|------------|-----------|
|----------|------------|-----------|

For Repair Work

| | | |
|----------------|--------|----|
| E900N | 4 x 6 | 25 |
| E900NU | 4 x 12 | 10 |
| E900NW (WHITE) | 4 x 6 | 25 |

Split-Sleeve Couplings

| | | |
|-----------------|-------|----|
| E900NS | 4 | 25 |
| E900NS8 (WHITE) | 4 x 8 | 15 |
| E900NSW (WHITE) | 4 | 25 |
| E900PS | 5 | 15 |

For Type D Duct Applications Only

| | | |
|----------------|---|----|
| E900DN (WHITE) | 4 | 25 |
|----------------|---|----|



No internal stop

Molded Coupling

| CAT. NO. | SIZE (IN.) | STD. CTN. |
|----------|------------|-----------|
|----------|------------|-----------|

Internal Stop

| | | |
|-------|---|----|
| E908N | 4 | 25 |
|-------|---|----|



5° Angle Coupling

| CAT. NO. | SIZE (IN.) | STD. CTN. |
|----------|------------|-----------|
|----------|------------|-----------|

| | | |
|-------|---|----|
| E914N | 4 | 15 |
|-------|---|----|



Telephone Duct Plug with Pull Tab

| CAT. NO. | SIZE (IN.) | STD. CTN. |
|----------|------------|-----------|
|----------|------------|-----------|

| | | |
|---------|---|----|
| P258NTB | 4 | 50 |
|---------|---|----|



Telephone Duct End Bells

Square to Round

| CAT. NO. | SIZE (IN.) | STD. CTN. |
|----------|------------|-----------|
|----------|------------|-----------|

| | | |
|-------|---------|---|
| E903N | 4 (Sq.) | 4 |
|-------|---------|---|



Molded End Bell

| CAT. NO. | SIZE (IN.) | STD. CTN. |
|----------|------------|-----------|
|----------|------------|-----------|

| | | |
|-------|---|----|
| E971N | 4 | 10 |
|-------|---|----|



Flare and Straight End Bell

| CAT. NO. | SIZE (IN.) | STD. CTN. |
|----------|------------|-----------|
|----------|------------|-----------|

| | | |
|-------|-----------------------|----|
| E907N | 4 (5 long, 5.5 flare) | 10 |
|-------|-----------------------|----|

| | | |
|--------|------------------------|---|
| E907NY | 4 (9 long, 5.75 flare) | 1 |
|--------|------------------------|---|



Split End Bell (PVC)

| CAT. NO. | SIZE (IN.) | STD. CTN. |
|----------|------------|-----------|
|----------|------------|-----------|

| | | |
|---------|---|---|
| E9098NS | 4 | 1 |
|---------|---|---|

| | | |
|---------|---|---|
| E9098PS | 5 | 1 |
|---------|---|---|



Elbows, Sweeps and Accessories

Telephone Duct Adapters

Adapts telephone duct to fiber transite MCD

Internal Adapter

| CAT. NO. | SIZE (IN.) | STD. CTN. |
|--------------|------------|-----------|
| E901N | 4 | 24 |
| <i>Split</i> | | |
| E901NS | 4 | 24 |



Adapts Threaded Metal Pipe to Telephone Duct

Female Adapter

| CAT. NO. | SIZE (IN.) | STD. CTN. |
|----------|------------|-----------|
| E902N | 4 | 10 |



Square Clay Tile Adapter

| CAT. NO. | SIZE (IN.) | STD. CTN. |
|--------------------------------------|--------------|-----------|
| <i>Adapts Clay to Telephone Duct</i> | | |
| E904M | 3¼ - 4 x 18 | 10 |
| E904M12 | 3¼ - 4 x 12 | 10 |
| E904M8 | 3¼ - 4 x 8½ | 12 |
| E904MM | 3½ - 3½ x 18 | 12 |
| E904MX | 3 - 4 x 18 | 10 |
| E904N | 3½ - 4 x 18 | 10 |
| E904N12 | 3½ - 4 x 12 | 12 |
| E904N24 | 3½ - 4 x 24 | 10 |
| E904N8 | 3½ - 4 x 8 | 10 |
| <i>Split Square Adapter</i> | | |
| E904MS | 3¼ x 4 | 10 |
| E904NS | 3½ - 4 x 18 | 10 |



Adapts Telephone Duct to Cast Iron Bends

Cast Iron Adapter

| CAT. NO. | SIZE (IN.) | STD. CTN. |
|----------|------------|-----------|
| E906N | 4 | 1 |



Round Clay Tile Adapter

| CAT. NO. | SIZE (IN.) | STD. CTN. |
|----------|------------|-----------|
| E923NM | 4 - 3¼ | 10 |



Adapts Telephone Duct to P&C Duct and Rigid Non-Metallic Conduit

P&C Duct Adapter

| CAT. NO. | SIZE (IN.) | STD. CTN. |
|----------|------------|-----------|
| E913N | 4 | 15 |
| E913NF | 4 | 15 |



Telephone Duct Reducers

Adapts Telephone Duct to P&C Duct and Rigid Non-Metallic Conduit

P&C Duct Adapter

| CAT. NO. | SIZE (IN.) | STD. CTN. |
|----------|------------|-----------|
| E908NM | 4-3½ | 15 |



Telephone Duct Expansion Fittings

Expansion Fitting — Type D

| CAT. NO. | SIZE (IN.) | STD. CTN. |
|---------------|------------|-----------|
| E905N | 4 | 5 |
| E905NL (LONG) | 4 | 1 |



Telephone Duct Wyes

For starting lateral runs

P&C Duct Adapter

| CAT. NO. | SIZE (IN.) | STD. CTN. |
|-----------------|------------|-----------|
| E916N | 4 | 1 |
| E916NW (WHITE) | 4 | 1 |
| <i>Split</i> | | |
| E916NS | 4 | 1 |
| E916NSW (WHITE) | 4 | 5 |



Elbows, Sweeps and Accessories

Split Sleeve Coupling

| CAT. NO. | SIZE IN. | DESCRIPTION | LENGTH IN. | SPLIT | STD. CTN. | STD. WT. (LBS.) |
|---------------------------|----------|----------------|------------|-------|-----------|-----------------|
| <i>Schedule 40 and 80</i> | | | | | | |
| E200JS6 | 2 | Split Coupling | 6 | 1 | 25 | 6.1 |
| E200KS7 | 2½ | Split Coupling | 7 | 1 | 25 | 21 |
| E200LS7 | 3 | Split Coupling | 7 | 1 | 25 | 15.5 |
| E200LSS* | 3 | Split Coupling | 6.5 | 1 | 25 | 10 |
| E200MS8 | 3½ | Split Coupling | 8 | 1 | 25 | 41.2 |
| E200NS8 | 4 | Split Coupling | 8 | 1 | 15 | 16 |
| E200NSS* | 4 | Split Coupling | 6 | 2 | 25 | 17 |
| E200PS8 | 5 | Split Coupling | 8 | 1 | 15 | 25 |
| E200PS9 | 5 | Split Coupling | 9 | 1 | 8 | 16.4 |
| E200RS1 | 6 | Split Coupling | 10 | 1 | 6 | 24.2 |

C Duct

| | | | | | | |
|-----------------|---|-----------------------|---|---|----|----|
| E900NS8 (WHITE) | 4 | C Duct Split Coupling | 8 | 1 | 15 | 19 |
| E900NSW (WHITE) | 4 | C Duct Split Coupling | 6 | 1 | 25 | 22 |

*Two-piece design



Split Sleeve Coupling
For joining Split Duct to existing duct.

Split Sleeve Sweeps

| SEGMENT | CAT. NO. | NOM. SIZE (IN.) | RADIUS (IN.) | STD. CTN. | STD. WT. (LBS.) |
|------------|----------|-----------------|--------------|-----------|-----------------|
| 45° SWEEP | UA7DJSD | 2 | 24 | 1 | 1.4 |
| | UA7FJSD | 2 | 36 | 1 | 2.1 |
| | UA7FLSD | 3 | 36 | 1 | 4.7 |
| | UA7HJSD | 2 | 48 | 1 | 2.7 |
| | UA7HLSD | 3 | 48 | 1 | 6.1 |
| | UA7IJSD | 2 | 60 | 1 | 3.2 |
| | UA7ILSD | 3 | 60 | 1 | 7.2 |
| | UA7INSD | 4 | 60 | 1 | 10.2 |
| 22½° SWEEP | UA5INSD | 4 | 60 | 1 | 6.1 |
| 11¼° SWEEP | UA3IJS | 2 | 60 | 1 | 1 |
| | UA3ILSD | 3 | 60 | 1 | 3.6 |
| | UA3INSD | 4 | 60 | 1 | 5.1 |

Two 45° elbows may be segmented for 90°.



Split Duct Sweeps

Elbows, Sweeps and Accessories

No waste • Sprays on in seconds • Fast setting

Multi-Purpose Spray-On Low-VOC PVC Cements

- Equivalent to a medium-bodied low-VOC, quick-setting clear cement
- No more spills
- Reuse can until empty
- Installation: 50° to 80° F; Storage: 35° to 120° F
- Meets ASTM D-2564
- Three-year shelf life
- One 4-oz. can is equivalent to 4 oz. of non-aerosol PVC cement*
- All cements are low VOC

Applications:

- For use up to 4" diameter Schedule 40 or 80 PVC electrical conduit
- For use with PVC raceways only. Not recommended for use on water, sewer, natural gas, compressed gas or air connections

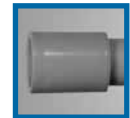

*Equivalence is subject to usage and will vary.

| TEMPERATURE RANGE | RECOMMENDED SET TIME | | |
|-------------------|---------------------------|-------------------------|-------------------------|
| | PIPE SIZES 1/2" TO 1 1/4" | PIPE SIZES 1 1/2" TO 2" | PIPE SIZES 2 1/2" TO 4" |
| 60°–100° F | 2 min. | 5 min. | 30 min. |
| 40°–60° F | 5 min. | 10 min. | 2 hrs. |
| 0°–40° F | 10 min. | 15 min. | 12 hrs. |

| CAT. NO. | SIZE | DESCRIPTION | STD. CTN. | STD. WT. (LBS.) |
|-------------|--------|---------------------------|-----------|-----------------|
| VC9AC5 | 4 oz. | PVC Spray-On Medium Clear | 12 | 5.6 |
| 🇨🇦 VC9AC5C | 4 oz. | PVC Spray-On Medium Clear | 12 | 5.6 |
| VC9AC16 | 11 oz. | PVC Spray-On Medium Clear | 12 | 12.3 |
| 🇨🇦 VC9AC16C | 11 oz. | PVC Spray-On Medium Clear | 12 | 12.3 |

Recommended set time may vary depending on humidity.

🇨🇦 Canada only

| RECOMMENDED PIPE APPLICATION AND SIZES | SET-UP TIME (EVAPORATION RATE) | RECOMMENDED INSTALLATION TEMP | LAP SHEAR @ 73° F | VISCOSITY AT 75° F AS MANUFACTURED |
|--|--------------------------------|-------------------------------|-------------------|------------------------------------|
| Recommended for all grades and types of Carlton® wireway and fittings, except Flex-Plus® Blue™ ENT (Electrical Non-Metallic Tubing). | 10°–30° F | Not recommended | 2 hrs. 350 psi | 500–900 cps |
| | 30°–50° F | 5–6 minutes | 16 hrs. 800 psi | |
| | 50°–70° F | 3–4 minutes | 72 hrs. 1,500 psi | |
| | 70°–90° F | 1–2 minutes | | |

Up through 6" diameter.

VOC emission of 490 grams/liter per the Bay and South Coast test method.

Low VOC — Gray

| CAT. NO. | SIZE | APPLICATOR | DESCRIPTION | STD. CTN. | STD. WT. (LBS.) |
|-----------|-----------|------------|--------------|-----------|-----------------|
| VC9LV4-24 | Half Pint | Dauber | Low VOC Gray | 24 | 15.5 |
| VC9LV3 | Pint | Dauber | Low VOC Gray | 24 | 27.0 |
| VC9LV2 | Quart | Dauber | Low VOC Gray | 12 | 26.0 |



Meets ASTM D-2564

Conduit & Fittings — Carlton® PVC Elbows, Conduit & Fittings

Elbows, Sweeps and Accessories

| RECOMMENDED PIPE VISCOSITY AT 75° F APPLICATION AND SIZES | SET-UP TIME (EVAPORATION RATE) | RECOMMENDED INSTALLATION TEMP. | LAP SHEAR @ 73° F | VISCOSITY AT 75° F AS MANUFACTURED |
|---|--|--------------------------------|--|------------------------------------|
| Recommended for all grades and types of Carlon® wireway and fittings, except Flex-Plus® Blue™ ENT (Electrical Non-Metallic Tubing). | 10°–30° F Not recommended 30°–50° F 5–6 minutes 50°–70° F 3–4 minutes 70°–90° F 1–2 minutes | 40° to 100° F | 2 hrs. 350 psi 16 hrs. 800 psi 72 hrs. 1,500 psi | 500–900 cps |

Up through 6" diameter.

Low-VOC Medium — Clear

| CAT. NO. | SIZE | APPLICATOR | DESCRIPTION | STD. CTN. | STD. WT. (LBS.) |
|----------|--------|------------|------------------|-----------|-----------------|
| VC9963 | Pint | Dauber | PVC Medium Clear | 24 | 29.0 |
| VC9962 | Quart | Dauber | PVC Medium Clear | 12 | 27.5 |
| VC9961P | Gallon | — | PVC Medium Clear | 6 | 53.5 |

Meets ASTM D-2564.



Low-VOC Medium — Gray

| CAT. NO. | SIZE | APPLICATOR | DESCRIPTION | STD. CTN. | STD. WT. (LBS.) |
|----------|--------|------------|-----------------|-----------|-----------------|
| VC9923 | Pint | Dauber | PVC Medium Gray | 24 | 29.0 |
| VC9922 | Quart | Dauber | PVC Medium Gray | 12 | 27.5 |
| VC9941P | Gallon | — | PVC Medium Gray | 6 | 53.5 |

Meets ASTM D-2564.



Low-VOC Regular — Clear

| CAT. NO. | SIZE | APPLICATOR | DESCRIPTION | STD. CTN. | STD. WT. (LBS.) |
|----------|-----------|------------|-------------------|-----------|-----------------|
| VC9964 | Half Pint | Dauber | PVC Regular Clear | 10 | 29.0 |

Meets ASTM D-2564.

Note: Rated for Schedule 40 through 4" and Schedule 80 through 2".



Low-VOC Regular — Gray

| CAT. NO. | SIZE | APPLICATOR | DESCRIPTION | STD. CTN. | STD. WT. (LBS.) |
|-----------|-----------|------------|------------------|-----------|-----------------|
| VC9924-24 | Half Pint | Dauber | PVC Regular Gray | 24 | 15.0 |

Meets ASTM D-2564.



Clear Primer

| CAT. NO. | SIZE | APPLICATOR | STD. CTN. | STD. WT. (LBS.) |
|----------|-------|------------|-----------|-----------------|
| VC9903 | Pint | Dauber | 24 | 27.0 |
| VC9902 | Quart | Dauber | 12 | 25.0 |

Meets ASTM F-686.



Purple Primer

| CAT. NO. | SIZE | APPLICATOR | STD. CTN. | STD. WT. (LBS.) |
|----------|-------|------------|-----------|-----------------|
| VC9932 | Quart | Dauber | 12 | 25.0 |

Meets ASTM F-686.



| RECOMMENDED PIPE APPLICATION AND SIZES | RECOMMENDED INSTALLATION TEMPERATURE |
|---|--------------------------------------|
| Recommended for use with Carlon® cement | 5° to 100° F |

| RECOMMENDED PIPE APPLICATION AND SIZES | RECOMMENDED INSTALLATION TEMPERATURE |
|---|--------------------------------------|
| Recommended for use with Carlon® cement | 5° to 100° F |

Elbows, Sweeps and Accessories

| RECOMMENDED PIPE VISCOSITY AT 75° F APPLICATION AND SIZES | SET-UP TIME (EVAPORATION RATE) | RECOMMENDED INSTALLATION TEMP. | LAP SHEAR @ 73° F | VISCOSITY AT 75° F AS MANUFACTURED |
|--|--------------------------------|--------------------------------|-------------------|------------------------------------|
| Recommended for all grades and types of Carlton® wireway and fittings, except Flex-Plus® Blue™ ENT (Electrical Non-Metallic Tubing). | -5°–10° F 6–8 minutes | -5° to 100° F | 2 hrs. 350 psi | 400–700 cps |
| Up through 6" diameter. | 10°–30° F 4–5 minutes | | 16 hrs. 800 psi | |
| | 30°–50° F 3–4 minutes | | 72 hrs. 1,500 psi | |
| | 50°–70° F 1–2 minutes | | | |
| | 70°–90° F ½–1½ minutes | | | |

Low-VOC All Weather — Clear

| CAT. NO. | SIZE | APPLICATOR | DESCRIPTION | STD. CTN. | STD. WT. (LBS.) |
|----------|-----------|------------|--------------------------------|-----------|-----------------|
| VC9984 | Half Pint | Dauber | All Weather "Quick-Set" Cement | 10 | 7.0 |
| VC9983 | Pint | Dauber | All Weather "Quick-Set" Cement | 24 | 30.0 |
| VC9982 | Quart | Dauber | All Weather "Quick-Set" Cement | 12 | 29.0 |
| VC9981P | Gallon | — | All Weather "Quick-Set" Cement | 6 | 54.0 |

Meets ASTM D-2564.



| RECOMMENDED PIPE VISCOSITY AT 75° F APPLICATION AND SIZES | SET-UP TIME (EVAPORATION RATE) | RECOMMENDED INSTALLATION TEMP. | LAP SHEAR @ 73° F | VISCOSITY AT 75° F AS MANUFACTURED |
|--|--------------------------------|--------------------------------|-------------------|------------------------------------|
| Required for use with Flex-Plus® Blue™ ENT (Electrical Non-Metallic Tubing), Riser-Gard®, P&C Flex™ and Carlton® PVC fittings. | -5°–10° F 6–8 minutes | -5° to 100° F | 2 hrs. 350 psi | 400–700 cps |
| Up through 6" diameter. | 10°–30° F 4–5 minutes | | 16 hrs. 800 psi | |
| | 30°–50° F 3–4 minutes | | 72 hrs. 1,500 psi | |
| | 50°–70° F 1–2 minutes | | | |
| | 70°–90° F ½–1½ minutes | | | |

Low-VOC All Weather — ENT Blue

| CAT. NO. | SIZE | APPLICATOR | DESCRIPTION | STD. CTN. | STD. WT. (LBS.) |
|----------|-------|------------|------------------------------|-----------|-----------------|
| VC9992 | Quart | Dauber | All Weather "Quick-Set" Blue | 12 | 29.0 |

Meets ASTM D-2564.



| RECOMMENDED PIPE VISCOSITY AT 75° F APPLICATION AND SIZES | SET-UP TIME (EVAPORATION RATE) | RECOMMENDED INSTALLATION TEMP. | LAP SHEAR @ 73° F | VISCOSITY AT 75° F AS MANUFACTURED |
|--|--------------------------------|--------------------------------|-------------------|------------------------------------|
| For use with Resi-Gard®, Riser-Gard®, P&C Flex™ and Carlton® PVC fittings. | 10°–30° F 4–5 minutes | 40° to 100° F | 2 hrs. 350 psi | 500–900 cps |
| Up through 6" diameter. | 30°–50° F 3–4 minutes | | 16 hrs. 800 psi | |
| | 50°–70° F 1–2 minutes | | 72 hrs. 1,500 psi | |
| | 70°–90° F ½–1½ minutes | | | |
| | 70°–90° F ½–1½ minutes | | | |

Low-VOC Resi-Gard® — Clear

| CAT. NO. | SIZE | APPLICATOR | DESCRIPTION | STD. CTN. | STD. WT. (LBS.) |
|----------|------|------------|---------------------------------|-----------|-----------------|
| VC9963SC | Pint | Brush | Resi-Gard® Solvent Cement Clear | 24 | 28.0 |

Meets ASTM D-2564.



Elbows, Sweeps and Accessories

No waste • Sprays on in seconds • Fast setting Multi-Purpose Weather Gard Spray-On Rubber Film

- Weatherproof
 - Forms a protective weatherproof seal on electrical connections
 - Dries in minutes to crystal clear rubber film
 - Prevents corrosion on electrical connections
 - Recommended installation temperatures: 50° to 80° F
 - Can be used on wood and plastic
 - Two-year shelf life
- Applications:**
 - Electrical connections
 - Outdoor lighting
 - Panel boxes
 - Pool motors and timers
 - Water valves and connections
 - Sprinkler connections and control box
 - Marine applications



| CAT. NO. | SIZE | DESCRIPTION | STD. CTN. | STD. WT. (LBS.) |
|------------|--------|---|-----------|-----------------|
| VC9WG5 | 4 oz. | Multi-Purpose Weather-Gard Spray-On Rubber Film | 12 | 5.6 |
| ✻ VC9WG5C | 4 oz. | Multi-Purpose Weather-Gard Spray-On Rubber Film | 12 | 5.6 |
| VC9WG16 | 11 oz. | Multi-Purpose Weather-Gard Spray-On Rubber Film | 12 | 12.3 |
| ✻ VC9WG16C | 11 oz. | Multi-Purpose Weather-Gard Spray-On Rubber Film | 12 | 12.3 |

✻ Canada only

Multi-Purpose Spray-On Rubber Thread Gasket

- Dries to rubber gasket to seal pipe threads
 - Seals out leaks
 - Protects against rust and corrosion
 - UV resistant
 - Weatherproof
 - Two-year shelf life
- Applications:**
 - PVC
 - Copper
 - Iron
 - Brass



| CAT. NO. | SIZE | DESCRIPTION | STD. CTN. | STD. WT. (LBS.) |
|-----------|-------|------------------------------------|-----------|-----------------|
| VC9TS5 | 4 oz. | Multi-Purpose Rubber Thread Sealer | 12 | 5.6 |
| ✻ VC9TS5C | 4 oz. | Multi-Purpose Rubber Thread Sealer | 12 | 5.6 |

✻ Canada only

Elbows, Sweeps and Accessories

Installation Instructions — Cement Joints



Carlon® non-metallic products are joined by means of solvent cement joints. Sizes ½" through 1½" should be cut square (using a fine-tooth handsaw) and deburred. For sizes 2" through 6", a miter box or similar saw guide should be utilized to keep the material steady. After cutting and deburring, wipe ends clean of dust, dirt and shavings.

Joining process as follows:

- Be sure that conduit end is clean and dry.
- Apply coat of Carlon® Solvent Cement (use dauber) to end of conduit for the length of the socket to be attached.
- Push conduit firmly into fitting while rotating conduit slightly, about one-quarter turn to spread cement evenly.
- Allow joint to set approximately 10 minutes.

Carlon® recommends the use of Carlon® cement for proper solvent cement joints. Because this cement is prepared particularly for our product compounds and tolerances, we cannot guarantee joints assembled with cement materials supplied by other manufacturers. Regular-grade gray solvent cement will accommodate most application situations being of a general-purpose nature. In situations requiring an extremely fast-setting joint (low temperature or difficult installation conditions), Carlon® All Weather Quick-Set Cement is recommended. Standard-grade clear cement is recommended for non-critical utility applications where gap filling and leak testing are not required.

Average Number of Joints per Can

| TRADE SIZE (IN.) | ½ PINT 8 OZ. | PINT 16 OZ. | QUART 32 OZ. | GALLON 128 OZ. | SPRAY 4 OZ. | SPRAY 16 OZ. |
|------------------|--------------|-------------|--------------|----------------|-------------|--------------|
| ½ | 140 | 275 | 550 | 2,200 | 70 | 275 |
| ¾ | 90 | 180 | 360 | 1,440 | 45 | 180 |
| 1 | 70 | 140 | 280 | 1,120 | 35 | 140 |
| 1¼ | 50 | 100 | 200 | 800 | 25 | 100 |
| 1½ | 37 | 75 | 150 | 600 | 18.5 | 75 |
| 2 | 20 | 40 | 80 | 320 | 10 | 40 |
| 2½ | 17 | 35 | 70 | 280 | 8.5 | 35 |
| 3 | 15 | 30 | 60 | 240 | 7.5 | 30 |
| 3½ | 13 | 27 | 54 | 216 | 6.5 | 27 |
| 4 | 12 | 25 | 50 | 200 | 6 | 25 |
| 5 | 9 | 19 | 38 | 150 | N/A | N/A |
| 6 | 6 | 12 | 24 | 95 | N/A | N/A |

Can: Average shelf life of all Carlon® cement is 24 months (unopened cans stored below 80° F).

Spray: Average shelf life of all Carlon® spray PVC cement is three years.

All Carlon® cements are specially formulated to be used with Carlon® PVC products, and do not require primers when parts are clean of dirt and moisture.

MSDS available at www.carlon.com.

Cementing PVC Conduit:

1. Make square saw cut with fine-tooth saw.
2. Deburr and round inside edge of the cut end.
3. Clean socket I.D. and spigot O.D. of dirt and moisture.
4. Apply a uniform coat of cement to spigot end and push onto socket bottom, rotating ¼ turn.
5. Allow time to set before disturbing. Setting time will depend upon temperature.



Cementing PVC Conduit for Submerged Areas Requiring Air or Water Tightness:

1. Follow the procedure above for cementing conduit.
2. Test workmanship by conducting a low-pressure air (3.0–5.0 psi) test after system is installed and cemented joints are set.
3. Plug and block ends to prevent movement prior to pressurization.
4. Check for leaks with soap solution.
5. Even low-pressure air can cause high-thrust loads and caution must be observed.



Cementing ENT for Concrete-Tight Applications:

1. Use Carlon® Socket tight fittings or couplings.
2. Do not use chemical primer or cleaner.
3. Apply a light uniform coat of cement labeled for use with ENT.
4. Use a brush to apply the cement.
5. Brush excess cement out of ENT grooves.
6. Promptly insert ENT into fitting while cement is wet until the fitting stop is reached and give ¼ turn.
7. Do not disturb until the joint is set.



Elbows, Sweeps and Accessories

Installation Instructions — Fittings and Adapters for Terminating Non-Metallic Rigid Conduit

Terminating Non-Metallic Rigid Conduit is quick and easy utilizing either of the methods indicated **below**. Terminations may be made in any electrical box or enclosure using standard size knockouts or drilled holes.



Method 1. Permanent Termination

Apply solvent cement to shoulder and shank of box adapter and insert through knockout from inside the enclosure. Push coupling over the shank of the box adapter, tight against the enclosure wall. Rotate the coupling about one-half turn while installing, and hold in position for a few seconds to permit setting of solvent cement. The coupling is now ready for the conduit to be installed. Only the shoulder of the box adapter extends inside the enclosure.

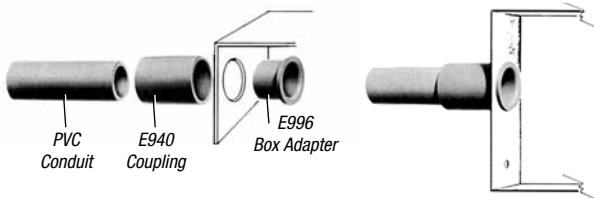

Method 2. Separable Termination

If a "wet location" as defined in Article 100 of the NEC® construction is required, place a flat washer or O-ring over the threads of the terminal adapter, securely against the shoulder. Insert the adapter threads through knockout and secure using either a standard locknut or threaded bushing. If watertight construction is not required, eliminate flat washer.

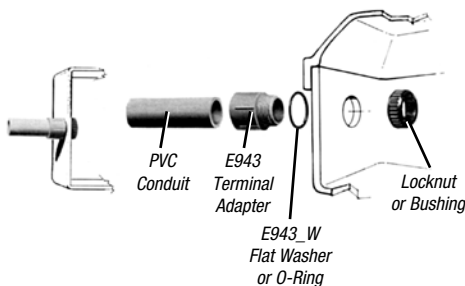

PVC Conduit Cutters

Small Cutter

For fast, smooth field cuts of 1/2" through 1" Non-Metallic Rigid Conduit, Flex-Plus® Blue™ ENT and Carflex® liquidtight flexible non-metallic conduit.



| CAT. NO. | SIZE (IN.) | STD. CTN. |
|----------|------------|-----------|
| CC120B | 8 | 10 |

Medium Cutter

Hand-held cutter makes fast, square, smooth field cuts on Non-Metallic Rigid Conduit from 1/2" through 1 1/4". Produces burr-free cut with no shavings. Fits into pocket or pouch.



| CAT. NO. | SIZE (IN.) | STD. CTN. |
|----------|------------|-----------|
| CC125 | 9 | 12 |

Large Cutter

For clean cuts of conduit 1/2" through 2".



| CAT. NO. | SIZE (IN.) | STD. CTN. |
|----------|------------|-----------|
| CC122 | 17 1/2 | 1 |

Elbows, Sweeps and Accessories

Conduit Pulling Lines for Conductors or Fiber Optics

White Diamond Braid Rope

This rope is constructed of polyethylene over polyester, designed specifically for fiber optic pulling. The polyethylene jacket has a “slippery” feel that gives less drag in pulling through conduit.

| CAT. NO. | REEL LENGTHS (FT.) | DIAMETER (IN.) | RECOMMENDED WORKING LOAD (LBS.) | APPROXIMATE AVG. TENSILE (LBS.) | APPROXIMATE STD. WT. (LBS.) |
|----------|--------------------|----------------|---------------------------------|---------------------------------|-----------------------------|
| SB14105 | 5,000 | ¼ | 260 | 1,700 | 1,000 |



Tape

Pre-lubricated, woven polyester tape made from low-friction, high abrasion-resistant yarns, provides a low coefficient of friction. Tape is printed with sequential footage markings for accurate measurements.

| CAT. NO. | SIZE (IN.) | TENSILE STRENGTH (LBS.) | REEL LENGTHS (FT.) |
|----------|------------|-------------------------|--------------------|
| TL14203 | ½ | 1,130 | 3,000 |
| TL14505 | ½ | 1,250 | 5,000 |
| TL14510 | ½ | 1,250 | 10,000 |
| TL38203 | ¾ | 1,800 | 3,000 |
| TL38265 | ¾ | 1,800 | 6,500 |
| TL38210 | ¾ | 1,800 | 10,000 |

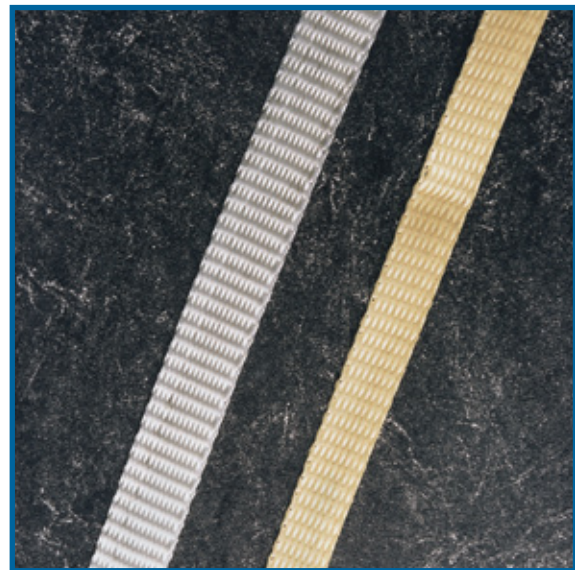

Conduit Bodies and Fittings (for use with Schedule 40 and 80 Conduit)

Expansion Fittings

E945 series expansion fittings are designed to compensate for length changes due to temperature variations in exposed conduit runs.



- Exclusive molded-in mid-point indicator on the piston
- Exclusive 2" expansion fitting with an 8" travel distance
- Two-piece molded design with lubricated seals for easier movement for the life of the product
- Ridges on the fitting for easier installation (sizes 2"–6" only)
- Male terminal adapter end design (½"–2" NPT Threads, and 2½"–6" NPSC threads)
- Two O-rings to prevent leakage
- Can be installed vertically or horizontally

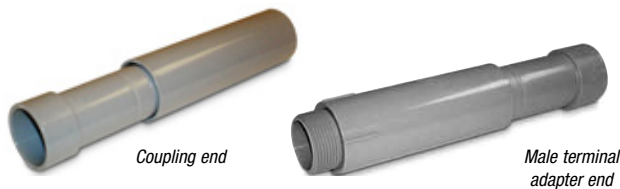

| COUPLING END CAT. NO. | MALE TERMINAL ADAPTER END CAT. NO. | SIZE (IN.) | STD. CTN. | TRAVEL LENGTH (IN.) |
|-----------------------|------------------------------------|------------|-----------|---------------------|
| E945D | E945DX | ½ | 20 | 4 |
| E945E | E945EX | ¾ | 15 | 4 |
| E945F | E945FX | 1 | 10 | 4 |
| E945G | E945GX | 1¼ | 5 | 4 |
| E945H | E945HX | 1½ | 5 | 4 |
| E945J | E945JX | 2 | 15 | 8 |
| E945K | E945KX | 2½ | 10 | 8 |
| E945L | E945LX | 3 | 10 | 8 |
| E945M | E945MX | 3½ | 5 | 8 |
| E945N | E945NX | 4 | 5 | 8 |
| E945P | E945PX | 5 | 1 | 8 |
| E945R | E945RX | 6 | 1 | 8 |

Short Expansion Couplings

Expand to a maximum of 2".



| CAT. NO. | SIZE (IN.) | STD. CTN. |
|----------|------------|-----------|
| E955D | ½ | 40 |
| E955E | ¾ | 40 |
| E955F | 1 | 25 |
| E955G | 1¼ | 15 |
| E955H | 1½ | 10 |
| E955J | 2 | 6 |



Standard Couplings

All socket fittings should be attached using Carlton® solvent cement.



Socket type for joining non-metallic conduit.

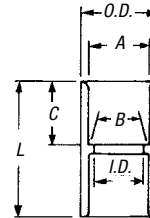

Except where noted by ▶

| CAT. NO. | SIZE (IN.) | STD. CTN. | TYPICAL (IN.) | | I.D. (IN.) | O.D. (IN.) | TYPICAL (IN.) | |
|-------------|------------|-----------|---------------|-------|------------|------------|---------------|----|
| | | | A | B | | | C | L |
| ▶ E940D | ½ | 150 | .852 | .836 | .728 | 1¼ | 1¼ | 1½ |
| CE940DR-CTN | ½ | 75 | .852 | .836 | .728 | 1¼ | 1¼ | 1½ |
| ▶ E940E | ¾ | 100 | 1.064 | 1.046 | .840 | 1½ | ¾ | 1½ |
| CE940ER-CTN | ¾ | 45 | 1.064 | 1.046 | .840 | 1½ | ¾ | 1½ |
| ▶ E940F | 1 | 50 | 1.330 | 1.310 | 1.210 | 1¾ | 1¾ | 2 |
| CE940F-UPC | 1 | 50 | 1.330 | 1.310 | 1.210 | 1¾ | 1¾ | 2 |
| E940G | 1¼ | 30 | 1.677 | 1.655 | 1.535 | 1¾ | 1 | 2½ |
| E940H | 1½ | 25 | 1.918 | 1.894 | 1.755 | 2¼ | 1½ | 2½ |
| E940J | 2 | 30 | 2.393 | 2.369 | 2.190 | 2¾ | 1¾ | 2½ |
| E940K | 2½ | 20 | 2.890 | 2.868 | 2.688 | 3¼ | 1¾ | 3¼ |
| E940L | 3 | 25 | 3.515 | 3.492 | 3.375 | 3¾ | 1¾ | 3¾ |
| E940M | 3½ | 20 | 4.015 | 3.992 | 3.780 | 4¼ | 1¾ | 3¾ |
| E940N | 4 | 15 | 4.515 | 4.491 | 4.265 | 5¼ | 1¾ | 3¾ |
| E940P | 5 | 8 | 5.593 | 5.553 | 5.097 | 6¼ | 1¾ | 4¼ |
| E940R | 6 | 5 | 6.658 | 6.614 | 6.115 | 7¼ | 2¾ | 4¾ |

▶ Canada only

Special Long-Line Couplings (with Conduit Stop)



Long-Line Couplings

| CAT. NO. | SIZE (IN.) | STD. CTN. | STD. WT. (LBS.) | LENGTH (IN.) |
|----------|------------|-----------|-----------------|--------------|
| E941H | 1½ | 40 | 9 | 3.19 |
| E941J | 2 | 25 | 8 | 3.59 |
| E941K | 2½ | 15 | 8 | 4.29 |
| E941L | 3 | 15 | 14 | 6.44 |
| E941N | 4 | 10 | 15 | 6.96 |
| E941PF | 5 | 4 | 12 | 9.63 |
| ▶ E941RF | 6 | 5 | 21 | 11.75 |

Fabricated Expansion Couplings



| CAT. NO. | SIZE (IN.) | STD. CTN. | TRAVEL LENGTH (IN.) |
|----------|------------|-----------|---------------------|
| E945KXL | 2½ | 10 | 12 |

Conduit Bodies and Fittings (for use with Schedule 40 and 80 Conduit)

Special Long-Line Sleeve Couplings

Sleeve Coupling
(For Repair Work)
No Internal Stop



| CAT. NO. | SIZE (IN.) | STD. CTN. | STD. WT. (LBS.) | LENGTH (IN.) |
|-----------|-------------------------|-----------|-----------------|--------------|
| ▶ E948H | 1½ | 25 | 6 | 4 |
| ▶ E948J | 2 | 25 | 5 | 3 |
| ▶ E948K | 2½ | 25 | 16 | 6 |
| ▶ E948L | 3 | 25 | 13 | 4 |
| ▶ E948N | 4 | 10 | 8 | 6.5 |
| ▶ E948P | 5 | 14 | 33 | 7 |
| ▶ E948R | 6 | 6 | 16 | 6 |
| ▶ E948JR | 2 | 15 | 8 | 6 |
| ▶ E948JS | 2 (Sch. 40 Split Duct) | 25 | 6 | — |
| ▶ E948KS7 | 2½ (Sch. 40 Split Duct) | 25 | 19 | 7 |
| ▶ E948L12 | 3 | 1 | 1 | 12 |
| ▶ E948L6 | 3 | 15 | 15 | 6 |
| ▶ E948LS | 3 (Sch. 40 Split Duct) | 25 | 17 | — |
| ▶ E948N12 | 4 | 10 | 28 | 12 |
| ▶ E948N7 | 4 | 15 | 25 | 7 |
| ▶ E948NS | 4 (Sch. 40 Split Duct) | 10 | 15 | — |
| ▶ E948PS | 5 (Sch. 40 Split Duct) | 1 | 2 | — |
| ▶ E948R10 | 6 | 6 | 25 | 10 |
| ▶ E948R12 | 6 | 6 | 25 | 12 |
| ▶ E948RS | 6 (Sch. 40 Split Duct) | 1 | 2 | — |

Special Schedule 40 Swedge Couplings

| CAT. NO. | SIZE (IN.) | STD. CTN. | STD. WT. (LBS.) |
|----------|------------|-----------|-----------------|
| ▶ E442K | 2½ | 20 | 13 |
| ▶ E442R | 6 | 6 | 27 |
| ▶ E442T | 8 | 2 | 17 |

*Consult factory for additional sizes



Schedule 40 Risers

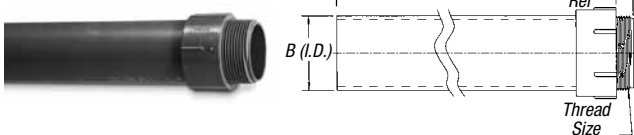

| CAT. NO. | SIZE (IN.) | A (IN.) (LENGTH) | B (IN.) | C (IN.) | THREAD SIZE (IN.) | STD. CTN. | STD. WT. (LBS.) |
|----------|------------|------------------|---------|---------|-------------------|-----------|-----------------|
| ▶ E954HX | 1½ | 80.00 | 1.567 | .950 | 1½ NPT | 1 | 3.8 |
| ▶ E954J | 2 | 60.00 | 2.024 | .825 | 2 NPT | 1 | 3.7 |
| ▶ E954JX | 2 | 80.00 | 2.024 | .825 | 2 NPT | 1 | 5.0 |
| ▶ E954K | 2½ | 60.00 | 2.418 | .812 | 2½ NPSC | 1 | 6.0 |
| ▶ E954KX | 2½ | 80.00 | 2.418 | .812 | 2½ NPSC | 1 | 8.4 |
| ▶ E954L | 3 | 60.00 | 3.616 | .798 | 3 NPSC | 1 | 8.7 |
| ▶ E954LX | 3 | 80.00 | 3.616 | .798 | 3 NPSC | 1 | 11.0 |

Female Adapters

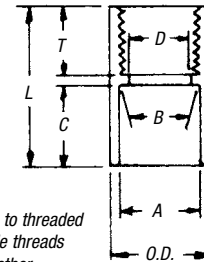

For adapting non-metallic conduits to threaded fittings, metallic systems. Female threads on one end, socket end on other.



LR31146

LISTED E23018

Except where noted by ▶

| CAT. NO. | SIZE (IN.) | STD. CTN. | TYPICAL (IN.) | | | MIN. D (IN.) | MAX. O.D. (IN.) | TYPICAL (IN.) | | |
|------------|------------|-----------|------------------------|-------|-------|--------------|-----------------|---------------|----|---|
| | | | A | B | D | | | C | S | L |
| E942D | ½ | 150 | .852 | .836 | .620 | 1¼ | 1¼ | ¾ | 1¼ | |
| E942E | ¾ | 100 | 1.064 | 1.046 | .822 | 1½ | 1½ | ¾ | 1½ | |
| E942F | 1 | 50 | 1.330 | 1.310 | 1.046 | 1¾ | 1¾ | ¾ | 1¾ | |
| E942G | 1¼ | 30 | 1.677 | 1.655 | 1.377 | 2¼ | 2¼ | 1 | 2¼ | |
| E942H | 1½ | 25 | 1.918 | 1.894 | 1.607 | 2½ | 2½ | 1 | 2½ | |
| E942J | 2 | 30 | 2.393 | 2.369 | 2.064 | 3¼ | 3¼ | 1 | 3¼ | |
| E942K | 2½ | 20 | 2.890 | 2.868 | 2.450 | 3½ | 3½ | 1 | 3½ | |
| E942L | 3 | 25 | 3.515 | 3.492 | 3.000 | 4¼ | 4¼ | 1 | 4¼ | |
| E942M | 3½ | 20 | 4.015 | 3.992 | 3.500 | 5¼ | 5¼ | 1 | 5¼ | |
| E942N | 4 | 15 | 4.515 | 4.491 | 4.000 | 6¼ | 6¼ | 1 | 6¼ | |
| ▶ E942NX9* | 4 | 15 | (Call for information) | | | | | | | |
| E942P | 5 | 8 | 5.593 | 5.553 | 5.047 | 7¼ | 7¼ | 1 | 7¼ | |
| E942R | 6 | 6 | 6.658 | 6.614 | 6.055 | 8¼ | 8¼ | 1 | 8¼ | |
| ▶ E942RX* | 6 | 6 | (Call for information) | | | | | | | |

* Long-Line Adapter

Male Terminal Adapters



For adapting non-metallic conduits to boxes, threaded fittings, metallic systems. Male threads on one end, socket end on other.

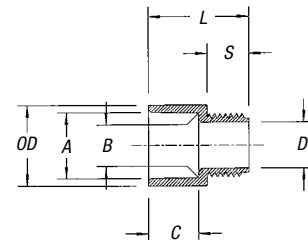

| CAT. NO. | SIZE (IN.) | STD. CTN. | TYPICAL (IN.) | | | MIN. D (IN.) | MAX. O.D. (IN.) | TYPICAL (IN.) | | |
|----------|------------|-----------|---------------|-------|-------|--------------|-----------------|---------------|-------|---|
| | | | A | B | D | | | C | S | L |
| E943D | ½ | 150 | .852 | .836 | .594 | 1.042 | .652 | .545 | 1.310 | |
| E943E | ¾ | 125 | 1.064 | 1.046 | .793 | 1.290 | .809 | .553 | 1.470 | |
| E943F | 1 | 50 | 1.330 | 1.310 | 1.025 | 1.580 | .965 | .812 | 1.902 | |
| E943G | 1¼ | 50 | 1.677 | 1.655 | 1.345 | 1.973 | 1.208 | .816 | 1.986 | |
| E943H | 1½ | 25 | 1.918 | 1.894 | 1.574 | 2.188 | 1.155 | .802 | 2.105 | |
| E943J | 2 | 50 | 2.393 | 2.369 | 1.998 | 2.713 | 1.145 | .825 | 2.093 | |
| E943K | 2½ | 25 | 2.890 | 2.868 | 2.400 | 3.290 | 1.490 | .812 | 2.480 | |
| E943L | 3 | 45 | 3.515 | 3.492 | 2.989 | 3.965 | 1.643 | .797 | 2.660 | |
| E943M | 3½ | 30 | 4.015 | 3.992 | 3.405 | 4.515 | 1.720 | .802 | 2.740 | |
| E943N | 4 | 20 | 4.515 | 4.491 | 3.895 | 5.065 | 1.788 | .733 | 2.830 | |
| E943P | 5 | 5 | 5.593 | 5.553 | 4.900 | 6.104 | 1.935 | .990 | 3.200 | |
| E943R | 6 | 10 | 6.658 | 6.614 | 5.900 | 7.288 | 2.128 | .985 | 3.410 | |

Conduit Bodies and Fittings (for use with Schedule 40 and 80 Conduit)

Adapters



Adapts non-metallic conduit to all electrical enclosures by inserting adapter through knockout and cementing into Carlton couplings.

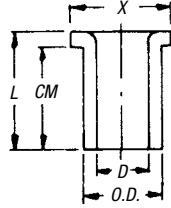

Box Adapters for Enclosures

| CAT. NO. | SIZE (IN.) | STD. CTN. | MIN D (IN.) | OD (IN.) TYPICAL | MAX X (IN.) | CM (IN.) TYPICAL | L (IN.) TYPICAL |
|----------|------------|-----------|-------------|------------------|---------------------------------|--------------------------------|---------------------------------|
| E996D | ½ | 100 | .662 | .840 | 1 ¹ / ₆₄ | 2 ⁷ / ₃₂ | 2 ⁷ / ₃₂ |
| E996E | ¾ | 100 | .824 | 1.050 | 1 ² / ₆₄ | 2 ⁷ / ₃₂ | 2 ⁷ / ₃₂ |
| E996F | 1 | 100 | 1.049 | 1.315 | 1 ¹ / ₆ | 6 ¹ / ₆₄ | 1 ³ / ₃₂ |
| E996G | 1¼ | 50 | 1.380 | 1.660 | 1 ³ / ₃₂ | 1 ¹ / ₁₆ | 1¼ |
| E996H | 1½ | 50 | 1.610 | 1.900 | 2 ¹ / ₆₄ | 1 ¹ / ₁₆ | 1 ³ / ₈ |
| E996J | 2 | 25 | 2.067 | 2.375 | 2 ²⁹ / ₃₂ | 1¼ | 1 ¹ / ₁₆ |
| E996K | 2½ | 15 | 2.469 | 2.875 | 3 ⁷ / ₁₆ | 1 ¹ / ₈ | 1 ¹⁵ / ₁₆ |
| E996L | 3 | 20 | 3.068 | 3.500 | 4 ¹ / ₆ | 2 | 2 ¹ / ₁₆ |
| E996N | 4 | 10 | 4.026 | 4.500 | 5 ¹ / ₆ | 2½ | 2¼ |

Threaded Adapters

| CAT. NO. | SIZE (IN.) | STD. CTN. |
|---------------------|------------|-----------|
| E9842D ¹ | ½ | 25 |
| E9842E ² | ¾ | 25 |

¹ Fits ¾" sockets
² Fits 1" sockets



Plugs

SP LR31146
UL LISTED E23018
Except where noted by ▶

Reducer Plugs

| CAT. NO. | SIZE (IN.) | STD. CTN. | STD. WT. (LBS.) |
|----------|------------|-----------|-----------------|
| ▶ E971C | ¾ x ½ | 100 | 2 |
| ▶ E971D | 1 x ¾ | 100 | 3 |



Plugs (Polyethylene)

| CAT. NO. | SIZE (IN.) | STD. CTN. | STD. WT. (LBS.) |
|----------|------------|-----------|-----------------|
| ▶ P258H | 1½ | 50 | 2 |
| ▶ P258K | 2½ | 25 | 1.5 |



Plugs with Pull Tabs (Polyethylene)

| CAT. NO. | SIZE (IN.) | STD. CTN. | STD. WT. (LBS.) |
|----------|------------|-----------|-----------------|
| ▶ P258JT | 2 | 60 | 3 |
| ▶ P258LT | 3 | 30 | 3 |
| ▶ P258NT | 4 | 48 | 8 |
| ▶ P258PT | 5 | 30 | 6 |
| ▶ P258RT | 6 | 30 | 9 |



Reducers



For connecting different sizes of conduit.
Bell x Spigot.

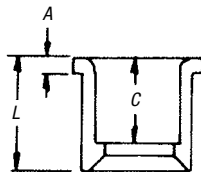

Reducer Bushings

| CAT. NO. | SIZE (IN.) | STD. CTN. | L (IN.) TYPICAL | A (IN.) TYPICAL | C (IN.) TYPICAL |
|------------|------------|-----------|---------------------------------|--------------------------------|---------------------------------|
| E950ED | ¾ x ½ | 100 | 1 ¹ / ₃₂ | 1 ¹ / ₆₄ | 1 ¹ / ₃₂ |
| E950FD-CAR | 1 x ½ | 25 | 1 ¹¹ / ₃₂ | ¾ | 5 ⁵ / ₆₄ |
| E950FE | 1 x ¾ | 100 | 1 ¹¹ / ₃₂ | ¾ | 1 ¹ / ₆₄ |
| E950GE-CAR | 1¼ x ¾ | 10 | 1 ¹⁵ / ₃₂ | ¾ | 1 ¹ / ₆₄ |
| E950GF | 1¼ x 1 | 50 | 1 ¹⁵ / ₃₂ | ¾ | 1 ¹ / ₆₄ |
| E950HF-CAR | 1½ x 1 | 10 | 1 ¹⁹ / ₃₂ | ¾ | 1 ¹ / ₆₄ |
| E950HG-CAR | 1½ x 1¼ | 10 | 1 ¹⁹ / ₃₂ | ¾ | 1 ¹ / ₆₄ |
| E950JG-CAR | 2 x 1¼ | 10 | 1¾ | 7 ¹ / ₃₂ | 1 ¹⁷ / ₆₄ |
| E950JH-CAR | 2 x 1½ | 10 | 1¾ | 7 ¹ / ₃₂ | 1 ²⁵ / ₆₄ |
| E950KJ-CAR | 2½ x 2 | 10 | 2 ⁵ / ₃₂ | ¾ | 1 ²⁷ / ₆₄ |
| E950LJ-CAR | 3 x 2 | 10 | 2 ¹ / ₆ | ¾ | 1 ¹ / ₆ |
| ▶ E950LK | 3 x 2½ | 25 | 1 ¹⁵ / ₁₆ | ¼ | 1 ¹¹ / ₁₆ |
| E950NL | 4 x 3 | 25 | 2¾ | ¾ | 1 ¹⁵ / ₁₆ |

Fabricated Reducers

| CAT. NO. | SIZE (IN.) | STD. CTN. | STD. WT. (LBS.) |
|----------------------|------------|-----------|-----------------|
| Male x Male | | | |
| ▶ E952JH | 1½ x 2 | 48 | 20 |
| ▶ E952KJ | 2½ x 2 | 48 | 26 |
| ▶ E952LJ | 3 x 2 | 36 | 21 |
| ▶ E952LK | 3 x 2½ | 36 | 32 |
| ▶ E952NL | 4 x 3 | 15 | 21 |
| ▶ E952NM | 4 x 3½ | 15 | 25 |
| ▶ E952PN | 5 x 4 | 12 | 27 |
| ▶ E952RP | 6 x 5 | 10 | 31 |
| Male x Female | | | |
| ▶ E952NJF | 4 x 2 | 15 | 16 |
| ▶ E952RNF | 6 x 4 | 10 | 28 |

Conduit Bodies and Fittings (for use with Schedule 40 and 80 Conduit)

Caps

Note: For vertical applications only.

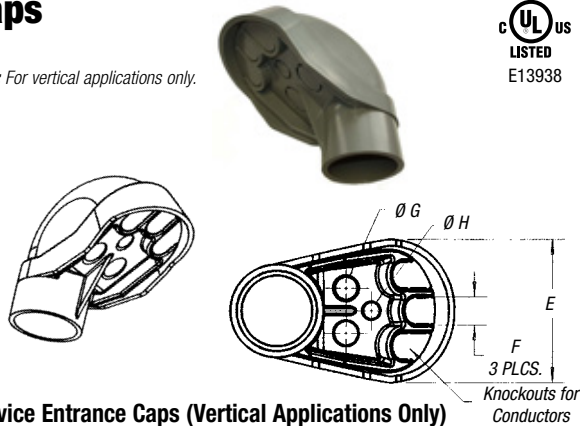

UL LISTED
E13938

Service Entrance Caps (Vertical Applications Only)

| CAT. NO. | SIZE (IN.) | STD. CTN. | DIMENSIONS (IN.) | | | |
|-----------|------------|-----------|------------------|------|------|------|
| | | | E | F | G | H |
| E998D | ½ | 5 | 1.76 | .45 | .45 | — |
| E998E | ¾ | 20 | 1.76 | .45 | .45 | — |
| E998E-CAR | ¾ | 5 | 1.76 | .45 | .45 | — |
| E998F | 1 | 15 | 2.26 | .59 | .58 | — |
| E998F-CAR | 1 | 5 | 2.26 | .59 | .58 | — |
| E998G-CAR | 1¼ | 5 | 3.52 | .74 | .71 | .50 |
| E998H-CAR | 1½ | 5 | 3.52 | .74 | .71 | .50 |
| E998J-CAR | 2 | 5 | 4.26 | .83 | .78 | .56 |
| E998K-UPC | 2½ | 2 | 7.47 | 1.70 | 1.31 | 1.00 |
| E998L | 3 | 2 | 7.47 | 1.70 | 1.31 | 1.00 |
| E998N | 4 | 2 | 10.45 | 2.25 | 1.88 | 1.31 |

End Caps

| CAT. NO. | SIZE (IN.) | STD. CTN. | STD. WT. (LBS.) |
|----------|------------|-----------|-----------------|
| ▶ E958D | ½ | 100 | 3 |
| ▶ E958E | ¾ | 100 | 4 |
| ▶ E958F | 1 | 75 | 5 |
| ▶ E958G | 1¼ | 40 | 4 |
| ▶ E958H | 1½ | 30 | 4 |
| ▶ E958J | 2 | 25 | 5 |
| ▶ E958K | 2½ | 10 | 4 |
| ▶ E958L | 3 | 10 | 5 |
| ▶ E958N | 4 | 5 | 17 |
| ▶ E958P | 5 | 5 | 11 |
| ▶ E958R | 6 | 5 | 13 |



PVC Riser Caps

| CAT. NO. | SIZE (IN.) | STD. CTN. | STD. WT. (LBS.) |
|----------|------------|-----------|-----------------|
| ▶ E935J | 2 | 25 | 3 |
| ▶ E935L | 3 | 25 | 5 |
| ▶ E935N | 4 | 25 | 7 |
| ▶ E935P | 5 | 25 | 35 |
| ▶ E935R | 6 | 10 | 7 |



Offsets

SP LISTED LR31146
UL LISTED E23018
Except where noted by ▶

Meter Offset

| CAT. NO. | SIZE (IN.) | STD. CTN. | OFFSET (IN.) | A (IN.) |
|----------|------------|-----------|--------------|---------|
| ▶ E995G | 1¼ | 15 | .758 | 4.230 |
| ▶ E995J | 2 | 8 | .684 | 4.270 |

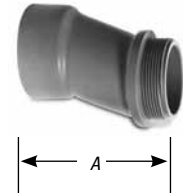

Offset

| CAT. NO. | SIZE (IN.) | OFFSET (IN.) | STD. CTN. | STD. WT. (LBS.) |
|----------|------------|--------------|-----------|-----------------|
| ▶ E994D | ½ | .250 | 25 | 3 |
| ▶ E994E | ¾ | .250 | 25 | 3 |
| ▶ E994F | 1 | .500 | 50 | 12 |



End Bells

End Bells

| CAT. NO. | SIZE (IN.) | STD. CTN. | STD. WT. (LBS.) |
|----------|------------|-----------|-----------------|
| E997F | 1 | 50 | 2.6 |
| E997G | 1¼ | 35 | 2.5 |
| E997H | 1½ | 30 | 2.5 |
| E997J | 2 | 40 | 5.0 |
| E997K | 2½ | 30 | 2 |
| E997L | 3 | 50 | 10 |
| E997M | 3½ | 40 | 11 |
| E997N | 4 | 30 | 16 |
| ▶ E997P | 5 | 15 | 8 |
| ▶ E997R | 6 | 10 | 7 |
| ▶ E997T | 8 | 3 | 15 |



Schedule 40 Fabricated End Bells

| CAT. NO. | SIZE (IN.) | STD. CTN. | STD. WT. (LBS.) |
|----------|------------|-----------|-----------------|
| ▶ E949J5 | 2 x 5 | 50 | 10 |
| ▶ E949J6 | 2 x 6 | 25 | 12 |
| ▶ E949JN | 2 x 4 | 25 | 7 |
| ▶ E949JX | 2 x 8 | 12 | 7 |
| ▶ E949LR | 3 x 6 | 20 | 21 |
| ▶ E949N5 | 4 x 5 | 20 | 2 |
| ▶ E949NR | 4 x 6 | 15 | 21 |
| ▶ E949R5 | 6 x 5 | 12 | 27 |
| ▶ E949RX | 6 x 8 | 6 | 17 |



Conduit & Fittings — Carlon® PVC Elbows, Conduit & Fittings

Conduit Bodies and Fittings (for use with Schedule 40 and 80 Conduit)

Flat Sealing Washers

Where a waterproof termination is required into any enclosure (metallic or non-metallic), install the neoprene washer over the threads of a terminal adapter before inserting into the enclosure. Use a standard locknut or threaded bushing to secure the assembly.

| CAT. NO. | SIZE (IN.) | STD. CTN. |
|----------|------------|-----------|
| ▶ E943DW | ½ | 125 |
| ▶ E943EW | ¾ | 125 |
| ▶ E943FW | 1 | 100 |
| ▶ E943GW | 1¼ | 50 |
| ▶ E943HW | 1½ | 50 |
| E943JW | 2 | 25 |



PVC Lock Nuts

| CAT. NO. | SIZE (IN.) | STD. CTN. |
|----------|------------|-----------|
| ▶ LT9LD | ½ | 1200 |
| ▶ LT9LE | ¾ | 700 |
| ▶ LT9LF | 1 | 600 |



Access Pull Elbows

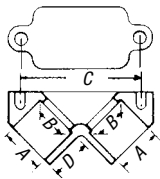

| CAT. NO. | SIZE (IN.) | STD. CTN. | A (IN.) TYPICAL | B (IN.) TYPICAL | C (IN.) TYPICAL | D (IN.) TYPICAL |
|----------|------------|-----------|-----------------|-----------------|-----------------|-----------------|
| † E990D | ½ | 75 | .852 | .836 | 2.187 | .718 |
| † E990E | ¾ | 50 | 1.064 | 1.046 | 2.531 | .781 |

Gasket included.

HOLFORM™ Concrete Sleeves

HOLFORM™ non-metallic concrete sleeve forms are the easy way to form holes in concrete. They install in seconds with nails, screws or staples and are easily removed. Concrete will not adhere to them. Sleeves are adjustable to any slab thickness.



LR31146
Except where noted by †



LISTED E23018
Except where noted by ▶

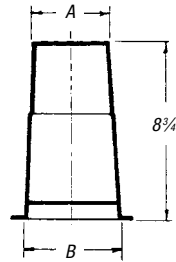

| CAT. NO. | MIN. O.D. A (IN.) | B (IN.) | STD. CTN. | STD. WT. (LBS.) |
|------------|-------------------|------------------|-----------|-----------------|
| † ▶ E92CSH | 1½ | 1¼ | 20 | 3 |
| † ▶ E92CSJ | 2 | 2¼ ₃₂ | 25 | 6 |
| † ▶ E92CSL | 3 | 3¼ ₃₂ | 25 | 8 |
| † ▶ E92CSN | 4 | 4¼ ₃₂ | 18 | 8 |
| † ▶ E92CSP | 5 | 5¼ ₃₂ | 15 | 8 |
| † ▶ E92CSR | 6 | 6¼ ₃₂ | 12 | 8 |

Conduit Bodies Type X with Cover

Four knock-out type socket openings, 90° spacing. Available with ½" or ¾" socket outlets. Includes cover and gasket.

Note: Not fixture rated.

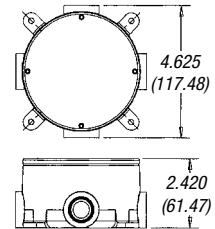
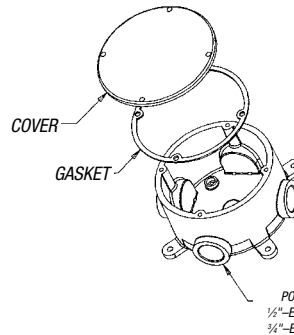

| CAT. NO. | SIZE (IN.) | VOL. CU. IN. | STD. CTN. |
|----------|------------|--------------|-----------|
| ▶ E970CD | ½ | 15.16 | 15 |
| E970CE | ¾ | 15.16 | 15 |

Supplied with four stainless steel cover screws. Diameter 4¼", thickness ¼".
Not designed for use with wiring devices or light fixtures.

Conduit Bodies and Fittings (for use with Schedule 40 and 80 Conduit)

Feature unthreaded hubs and textured lids with foam-in-place gaskets.



LR31146



LISTED
E11461

Except where noted by ▶

NEMA 4, 4X

Temperature range:
-50° C to 120° C

Conduit Bodies Type LB

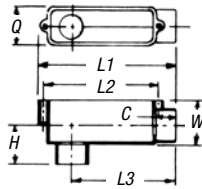

Note: Covers are not sold as separate item.

DIMENSIONS (IN.)

| CAT. NO. | SIZE (IN.) | STD. CTN. | TYPICAL C | MAX. L1 | TYPICAL L2 | MAX. L3 | MAX. H | MAX. Q | MAX. W | VOL. CU. IN. |
|----------|------------|-----------|-----------|----------|------------|----------|---------|---------|---------|--------------|
| E986D | 1/2 | 25 | 1 1/16 | 4 5/16 | 3 3/32 | 3 1/16 | 1 1/16 | 1 11/32 | 1 1/2 | 4.0 |
| E986E | 3/4 | 15 | 2 9/32 | 6 3/32 | 5 9/32 | 4 25/32 | 1 25/32 | 1 3/4 | 2 1/32 | 12.0 |
| E986F | 1 | 10 | 2 9/32 | 6 3/32 | 5 9/32 | 4 25/32 | 1 25/32 | 1 3/4 | 2 1/32 | 12.0 |
| E986G | 1 1/4 | 10 | 1 3/32 | 7 31/32 | 6 13/32 | 6 | 2 1/16 | 2 1/2 | 2 3/4 | 32.0 |
| E986H | 1 1/2 | 10 | 1 3/32 | 7 31/32 | 6 13/32 | 6 | 2 1/16 | 2 1/2 | 2 3/4 | 32.0 |
| E986J | 2 | 10 | 1 3/32 | 9 31/32 | 8 13/32 | 7 1/4 | 2 1/16 | 3 3/32 | 3 15/32 | 63.0 |
| ▶ E986K | 2 1/2 | 4 | 1 5/8 | 14 7/8 | 13 1/4 | 11 31/32 | 3 3/4 | 4 11/32 | 4 9/8 | 210 |
| ▶ E986L | 3 | 4 | 1 5/8 | 14 7/8 | 13 1/4 | 11 31/32 | 3 3/4 | 4 11/32 | 4 9/8 | 210 |
| ▶ E986M | 3 1/2 | 4 | 1 25/32 | 17 23/32 | 15 5/8 | 14 17/64 | 4 1/16 | 5 11/32 | 5 13/32 | 390 |
| ▶ E986N | 4 | 4 | 1 25/32 | 17 23/32 | 15 5/8 | 14 17/64 | 4 1/16 | 5 11/32 | 5 13/32 | 390 |

Type LR

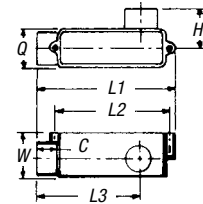

DIMENSIONS (IN.)

| CAT. NO. | SIZE (IN.) | STD. CTN. | TYPICAL C | MAX. L1 | TYPICAL L2 | MAX. L3 | MAX. H | MAX. Q | MAX. W | VOL. CU. IN. |
|-----------|------------|-----------|-----------|---------|------------|---------|---------|---------|---------|--------------|
| E985D-CAR | 1/2 | 10 | 1 1/16 | 4 5/16 | 3 3/32 | 3 1/16 | 1 1/16 | 1 11/32 | 1 1/2 | 4.0 |
| E985E-CAR | 3/4 | 10 | 2 9/32 | 6 3/32 | 5 9/32 | 4 25/32 | 1 25/32 | 1 3/4 | 2 1/32 | 12.0 |
| E985F | 1 | 10 | 2 9/32 | 6 3/32 | 5 9/32 | 4 25/32 | 1 25/32 | 1 3/4 | 2 1/32 | 12.0 |
| E985G | 1 1/4 | 10 | 1 3/32 | 7 31/32 | 6 13/32 | 6 | 2 1/16 | 2 1/2 | 2 3/4 | 32.0 |
| E985H-CAR | 1 1/2 | 5 | 1 3/32 | 7 31/32 | 6 13/32 | 6 | 2 1/16 | 2 1/2 | 2 3/4 | 32.0 |
| E985J | 2 | 10 | 1 3/32 | 9 31/32 | 8 13/32 | 7 1/4 | 2 1/16 | 3 3/32 | 3 15/32 | 63.0 |

Type E

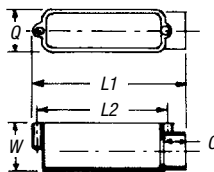

DIMENSIONS (IN.)

| CAT. NO. | SIZE (IN.) | STD. CTN. | TYPICAL C | MAX. L1 | TYPICAL L2 | MAX. Q | MAX. W | VOL. CU. IN. |
|----------|------------|-----------|-----------|---------|------------|---------|---------|--------------|
| 988D | 1/2 | 25 | 1 1/16 | 4 5/16 | 3 1/2 | 1 11/32 | 1 1/2 | 4.0 |
| E988E | 3/4 | 20 | 2 9/32 | 6 11/32 | 5 9/32 | 1 3/4 | 2 1/32 | 12.0 |
| E988F | 1 | 10 | 2 9/32 | 6 11/32 | 5 9/32 | 1 3/4 | 2 1/32 | 12.0 |
| E988G | 1 1/4 | 10 | 1 3/32 | 8 | 6 13/32 | 2 1/2 | 2 3/4 | 32.0 |
| E988H | 1 1/2 | 10 | 1 3/32 | 8 | 6 13/32 | 2 1/2 | 2 3/4 | 32.0 |
| E988J | 2 | 5 | 1 3/32 | 9 5/32 | 8 13/32 | 3 3/32 | 3 15/32 | 63.0 |

Type T

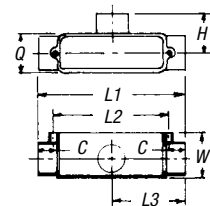

DIMENSIONS (IN.)

| CAT. NO. | SIZE (IN.) | STD. CTN. | TYPICAL C | MAX. L1 | TYPICAL L2 | MAX. L3 | MAX. H | MAX. Q | MAX. W | VOL. CU. IN. |
|-----------|------------|-----------|-----------|---------|------------|---------|---------|---------|---------|--------------|
| E983D-CAR | 1/2 | 10 | 1 1/16 | 4 11/16 | 3 3/32 | 2 11/32 | 1 1/16 | 1 11/32 | 1 1/2 | 4.0 |
| E983E | 3/4 | 15 | 2 9/32 | 6 7/8 | 5 3/32 | 4 1/16 | 1 25/32 | 1 3/4 | 2 1/32 | 12.0 |
| E983F | 1 | 20 | 2 9/32 | 6 7/8 | 5 3/32 | 3 7/16 | 1 25/32 | 1 3/4 | 2 1/32 | 12.0 |
| E983G | 1 1/4 | 10 | 1 3/32 | 8 13/32 | 6 13/32 | 4 3/16 | 2 1/16 | 2 1/2 | 2 3/4 | 32.0 |
| E983H | 1 1/2 | 10 | 1 3/32 | 8 13/32 | 6 13/32 | 4 3/16 | 2 1/16 | 2 1/2 | 2 3/4 | 32.0 |
| E983J | 2 | 10 | 1 3/32 | 10 5/16 | 8 13/32 | 5 5/32 | 2 1/16 | 3 3/32 | 3 15/16 | 63.0 |

Type C

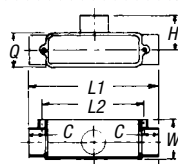

DIMENSIONS (IN.)

| CAT. NO. | SIZE (IN.) | STD. CTN. | TYPICAL C | MAX. L1 | TYPICAL L2 | MAX. Q | MAX. W | VOL. CU. IN. |
|-----------|------------|-----------|-----------|---------|------------|---------|---------|--------------|
| E987D | 1/2 | 25 | 1 1/16 | 4 11/16 | 3 1/2 | 1 11/32 | 1 1/2 | 4.0 |
| E987E-CAR | 3/4 | 10 | 2 9/32 | 6 7/8 | 5 9/64 | 1 3/4 | 2 1/32 | 12.0 |
| E987F-CAR | 1 | 10 | 2 9/32 | 6 7/8 | 5 9/32 | 1 3/4 | 2 1/32 | 12.0 |
| E987G | 1 1/4 | 10 | 1 3/32 | 8 13/32 | 6 13/32 | 2 1/2 | 2 3/4 | 32.0 |
| E987H | 1 1/2 | 10 | 1 3/32 | 8 13/32 | 6 13/32 | 2 1/2 | 2 3/4 | 32.0 |
| E987J | 2 | 15 | 1 3/32 | 10 5/16 | 8 13/32 | 3 3/32 | 3 15/32 | 63.0 |

Type LL

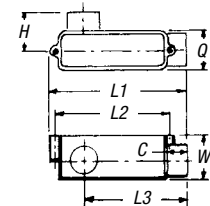

DIMENSIONS (IN.)

| CAT. NO. | SIZE (IN.) | STD. CTN. | TYPICAL C | MAX. L1 | TYPICAL L2 | MAX. L3 | MAX. H | MAX. Q | MAX. W | VOL. CU. IN. |
|-----------|------------|-----------|-----------|---------|------------|---------|---------|---------|---------|--------------|
| E984D-CAR | 1/2 | 10 | 1 1/16 | 4 5/16 | 3 3/32 | 3 1/16 | 1 1/16 | 1 11/32 | 1 1/2 | 4.0 |
| E984E | 3/4 | 20 | 2 9/32 | 6 3/32 | 5 9/32 | 4 25/32 | 1 25/32 | 1 3/4 | 2 1/32 | 12.0 |
| E984F-CAR | 1 | 10 | 2 9/32 | 6 3/32 | 5 9/32 | 4 25/32 | 1 25/32 | 1 3/4 | 2 1/32 | 12.0 |
| E984G-CAR | 1 1/4 | 5 | 1 3/32 | 7 31/32 | 6 13/32 | 6 | 2 1/16 | 2 1/2 | 2 3/4 | 32.0 |
| E984H | 1 1/2 | 10 | 1 3/32 | 7 31/32 | 6 13/32 | 6 | 2 1/16 | 2 1/2 | 2 3/4 | 32.0 |
| E984J | 2 | 10 | 1 3/32 | 9 31/32 | 8 13/32 | 7 1/4 | 2 1/16 | 3 3/32 | 3 15/32 | 63.0 |

Switch and Junction Boxes

Molded Non-Metallic Junction Boxes — 6P Rated

Non-metallic junction boxes are UL Listed with a NEMA 6P rating per Section 314.29, Exception of the National Electrical Code® and CSA Certified per Section 12 of the Canadian Electrical Code. Manufactured from PVC or PPO thermoplastic molding compound and featuring foam-in-place gasketed lids attached with stainless steel screws, these rugged enclosures offer all the corrosion resistance and physical properties you need for direct-burial applications.

Type 6P enclosures are intended for indoor or outdoor use, primarily to provide a degree of protection against contact with enclosed equipment, falling dirt, hose-directed water, entry of water during prolonged submersion at a limited depth and external ice formation.

- All Carlon® Junction Boxes are UL Listed/CSA Certified and maintain a minimum of a NEMA Type 4/4X Rating
- Part numbers with an asterisk (*) are UL Listed and maintain a NEMA Type 6P Rating and Type 4/4X Rating
- Covers are not sold as separate item
- Temperature Range: -250° F to 125° F
- UL94V-2 flammability rating

Note: Not rated for pedestrian traffic.



Except where noted by 1



LISTED E11461

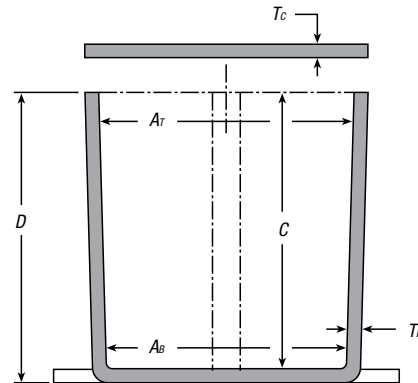
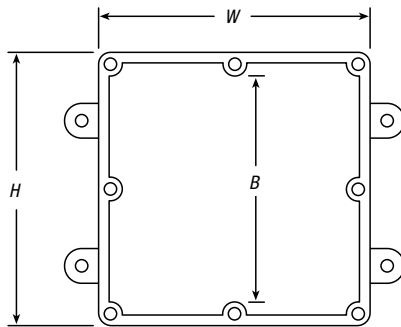

| CAT. NO. | SIZE (IN.) H X W X D | STD. CTN. | DIMENSIONS (IN.) | | | | | | MATERIAL | | STD. WT. (LBS.) |
|--------------|-------------------------|-----------|---------------------------------|---------------------------------|---------------------------------|--------|----------------|----------------|----------|----------------|-----------------|
| | | | MIN. AT | MIN. AB | MIN. B | MIN. C | T _B | T _C | PVC | THERMO-PLASTIC | |
| E989NNJ* | 4 x 4 x 2 | 10 | 3 ¹ / ₁₆ | 3 ⁵ / ₁₆ | N/A | 2 | .160 | .155 | X | | 3 |
| E987N* | 4 x 4 x 4 | 10 | 3 ¹ / ₁₆ | 3 ¹ / ₂ | N/A | 4 | .160 | .155 | X | | 4 |
| E989NNR*† | 4 x 4 x 6 | 10 | 3 ¹ / ₁₆ | 3 ⁵ / ₁₆ | N/A | 6 | .160 | .200 | X | | 5 |
| E989PPJ* | 5 x 5 x 2 | 10 | 4 ¹ / ₁₆ | 4 ¹ / ₂ | N/A | 2 | .110 | .150 | | X | 3 |
| E987R-CAR* | 6 x 6 x 4 | 2 | 6 | 5 ⁵ / ₁₆ | N/A | 4 | .190 | .190 | | X | 3 |
| E989RRR-UPC* | 6 x 6 x 6 | 8 | 5 ⁵ / ₁₆ | 5 ⁵ / ₁₆ | N/A | 6 | .160 | .150 | | X | 14 |
| E989N-CAR | 8 x 8 x 4 | 1 | 8 | 8 | N/A | 4 | .185 | .190 | | X | 2 |
| E989SSX-UPC | 8 x 8 x 7 | 2 | 7 ² / ₃₂ | 7 ⁵ / ₁₆ | N/A | 7 | .160 | .150 | | X | 6 |
| E989UUN | 12 x 12 x 4 | 3 | 11 ⁵ / ₁₆ | 11 ¹ / ₂ | 11 ⁵ / ₁₆ | 4 | .160 | .150 | | X | 12 |
| E989R-UPC | 12 x 12 x 6 | 2 | 11 ⁵ / ₁₆ | 11 ⁵ / ₁₆ | 11 ⁵ / ₁₆ | 6 | .265 | .185 | | X | 10 |

*Gaskets are FIP (foam in place).

Switch and Junction Boxes

Large PVC Junction Boxes — NEMA 4X

Large PVC Junction Boxes are fabricated from Type II PVC sheet using a unique technology. Reduce the use of steel boxes and keep your wiring connections clean, safe and dry using these high-quality, fully gasketed junction boxes.

Features and Benefits:

- PVC Type II material with “Uni-Body” construction and penetration welding providing a very strong, durable enclosure
- UL94V-0 flame rating
- Suitable for exposure of up to 90° C
- PVC material enables the use of standard solvent cements for fitting attachment
- Junction boxes are available with or without mounting flanges
- Individual mounting feet are available and provided in kits of four
- Custom features such as windows or panel mounts are available
- Custom sizes are also available upon request
- Made in the USA

Note: Not rated for pedestrian traffic.

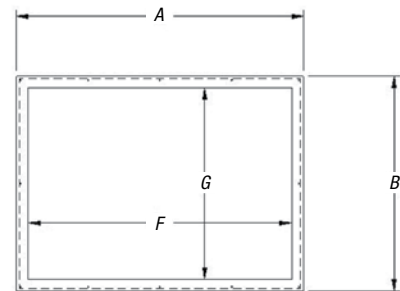
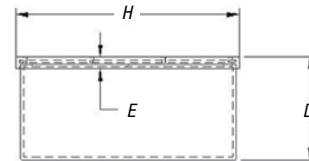
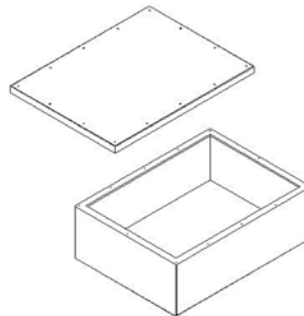

| CAT. NO. | DIMENSIONS (IN.) | | | | | | | | STD. WT. (LBS.) |
|----------|------------------|----|----|-------|------|------|------|-------|-----------------|
| | A | B | C | D | E | F | G | H | |
| EP12128 | 12 | 12 | 8 | 8.25 | 1.00 | 10.5 | 10.5 | 12.75 | 11 |
| EP181812 | 18 | 18 | 12 | 12.25 | 1.00 | 16 | 16 | 18.75 | 21 |
| EP201808 | 20 | 18 | 8 | 8.25 | 1.00 | 18 | 16 | 18.75 | 20 |
| EP202008 | 20 | 20 | 8 | 8.25 | 1.00 | 18 | 18 | 20.75 | 22 |
| EP241808 | 24 | 18 | 8 | 8.25 | 1.00 | 22 | 16 | 18.75 | 24 |
| EP242008 | 24 | 20 | 8 | 8.25 | 1.00 | 21.5 | 17.5 | 20.75 | 25 |
| EP242408 | 24 | 24 | 8 | 8.25 | 1.00 | 21.5 | 21.5 | 24.75 | 29 |
| EP302408 | 30 | 24 | 8 | 8.25 | 1.00 | 27.5 | 21.5 | 24.75 | 34 |
| EP362408 | 36 | 24 | 8 | 8.25 | 1.00 | 33.5 | 21.5 | 24.75 | 39 |

Accessories

| CAT. NO. | DESCRIPTION | STD. WT. (LBS.) |
|----------|---|-----------------|
| ESMFK-1 | “CleverMount” Mounting Feet (Four Feet and Fasteners) | 5 |



Switch and Junction Boxes

Single-Gang FS Boxes



Type FSE

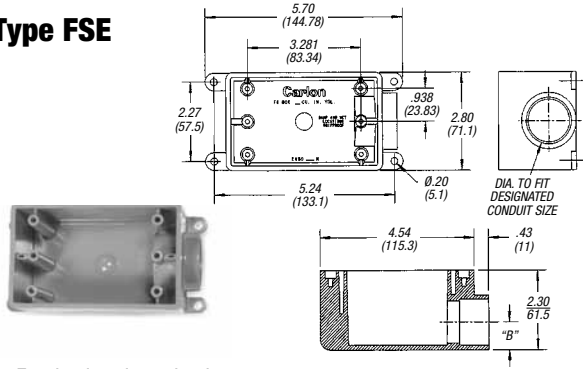

- For dead-end terminations
- All sizes take standard covers and accessories or devices
- Integral mounting feet provide easy mounting

| CAT. NO. | SIZE (IN.) | VOL. CU. IN. | STD. CTN. |
|---------------|------------|--------------|-----------|
| E980DFN | ½ | 19 | 10 |
| ☛ C980DFN-CTN | ½ | 18 | 12 |
| E980EFN | ¾ | 19 | 10 |
| ☛ C980EFN-CTN | ¾ | 18 | 12 |
| E980FFN | 1 | 19 | 18 |
| ☛ C980FFN-CTN | 1 | 18 | 8 |
| E980FFN-CAR | 1 | 19 | 10 |

☛ Canada Only

Type FSC

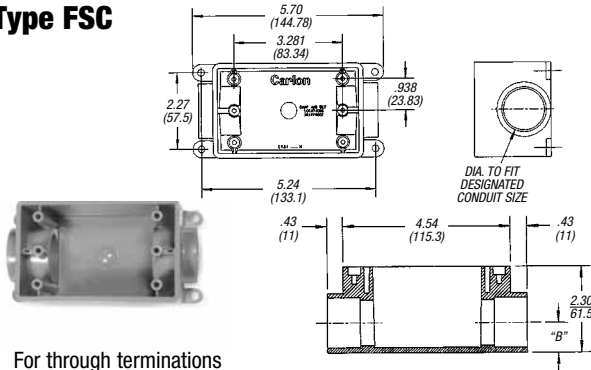

- For through terminations
- All sizes take standard covers and accessories or devices
- Detachable mounting feet provide easy mounting

| CAT. NO. | SIZE (IN.) | VOL. CU. IN. | STD. CTN. |
|---------------|------------|--------------|-----------|
| E981DFN | ½ | 19 | 15 |
| ☛ C981DFN-CTN | ½ | 18 | 12 |
| E981EFN | ¾ | 19 | 15 |
| ☛ C981EFN-CTN | ¾ | 18 | 12 |
| E981FFN | 1 | 19 | 18 |
| E981FFN-CAR | 1 | 19 | 10 |
| ☛ C981FFN-CTN | 1 | 18 | 8 |

☛ Canada Only

Type FSS

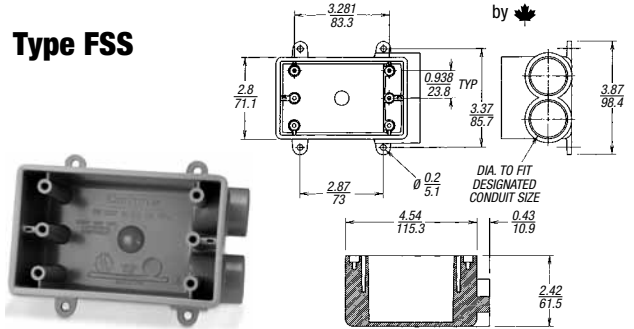

- For multiple dead-end circuit terminations or where additional support is required in stub-up applications
- All sizes take standard covers and accessories or devices
- Detachable mounting feet provide easy mounting

| CAT. NO. | SIZE (IN.) | VOL. CU. IN. | STD. CTN. |
|---------------|------------|--------------|-----------|
| E982DFN | ½ | 19 | 10 |
| ☛ C982DFN-CTN | ½ | 18 | 12 |
| E982EFN | ¾ | 19 | 10 |
| ☛ C982EFN-CTN | ¾ | 18 | 12 |
| E982FFN | 1 | 19 | 10 |
| ☛ C982FFN-CTN | 1 | 18 | 8 |

☛ Canada Only

Type FSCC

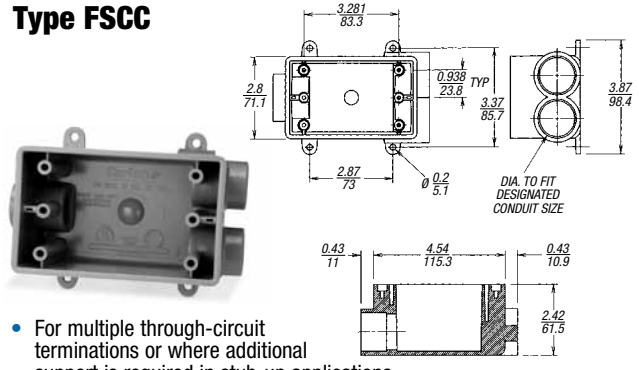

- For multiple through-circuit terminations or where additional support is required in stub-up applications
- All sizes take standard covers and accessories or devices
- Detachable mounting feet provide easy mounting

| CAT. NO. | SIZE (IN.) | VOL. CU. IN. | STD. CTN. |
|-------------|------------|--------------|-----------|
| E979DFN-CAR | ½ | 19 | 10 |
| ☛ C979DFN | ½ | 18 | 15 |
| E979EFN-CAR | ¾ | 19 | 10 |
| ☛ C979EFN | ¾ | 18 | 15 |
| E979FFN | 1 | 19 | 15 |
| ☛ C979FFN | 1 | 18 | 15 |

☛ Canada Only

Switch and Junction Boxes

Single-Gang FD Deep Device Boxes



LR31146
Where
noted
by



LISTED
E11461

Type FD

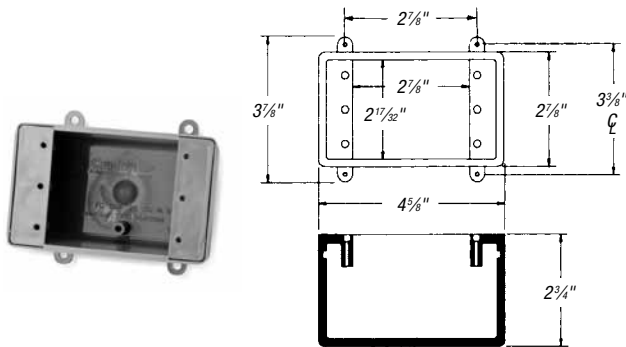

- For terminations where hub requirements vary according to application — hubs easily made with flared wood bit or hole saw
- All sizes take standard covers and accessories or devices
- Integral mounting feet provide easy mounting

| CAT. NO. | SIZE (IN.) | VOL. CU. IN. | STD. CTN. |
|---------------|------------|--------------|-----------|
| E9801 | N/A | 25 | 10 |
| ☛ CE9801-CTN | N/A | 25 | 10 |
| ☛ C9801-347 | N/A | 25 | 10 |
| ☛ Canada Only | | | |

Type FDE

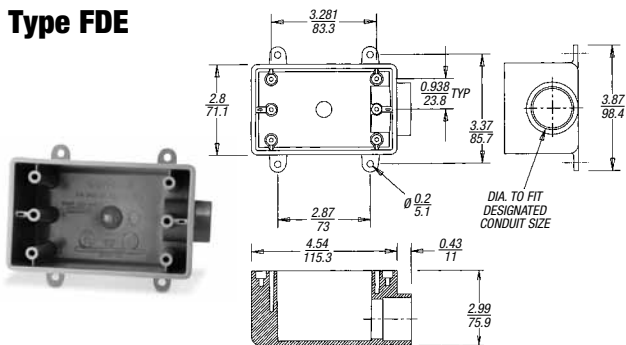

- For dead-end terminations where large devices or additional wiring capacity is required
- All sizes take standard covers and accessories or devices
- Integral mounting feet provide easy mounting

| CAT. NO. | SIZE (IN.) | VOL. CU. IN. | STD. CTN. |
|---------------|------------|--------------|-----------|
| E9801DN | 1/2 | 25 | 10 |
| ☛ C9801DN | 1/2 | 25 | 10 |
| E9801EN | 3/4 | 25 | 10 |
| ☛ C9801EN | 3/4 | 25 | 10 |
| E9801FN | 1 | 25 | 10 |
| ☛ C9801FN | 1 | 25 | 10 |
| ☛ Canada Only | | | |

Type FDC

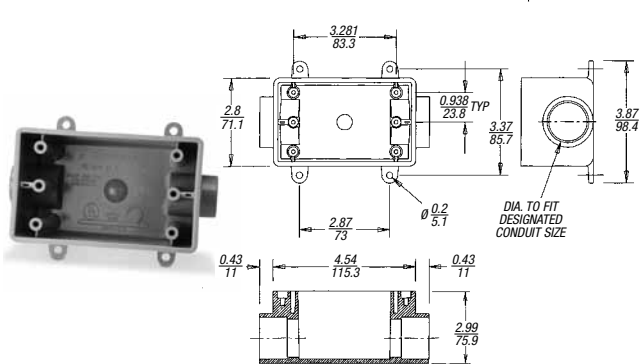

- For through terminations where large devices or additional wiring capacity is required
- All sizes take standard covers and accessories or devices
- Integral mounting feet provide easy mounting

| CAT. NO. | SIZE (IN.) | VOL. CU. IN. | STD. CTN. |
|---------------|------------|--------------|-----------|
| E9811DN | 1/2 | 25 | 10 |
| ☛ C9811DN | 1/2 | 25 | 10 |
| E9811EN | 3/4 | 25 | 10 |
| ☛ C9811EN | 3/4 | 25 | 10 |
| E9811FN | 1 | 25 | 10 |
| ☛ C9811FN | 1 | 25 | 10 |
| ☛ Canada Only | | | |

Conduit & Fittings — Carlon® PVC Elbows, Conduit & Fittings

Switch and Junction Boxes



LR31146
Where noted by



LISTED
E11461

Two-Gang FS Boxes

- For through terminations where two devices or additional wiring capacity is required
- All sizes take standard covers and accessories or devices
- Integral mounting feet provide easy mounting

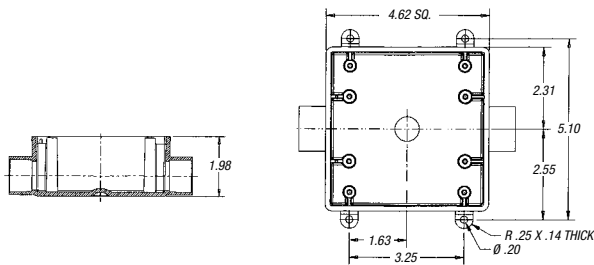
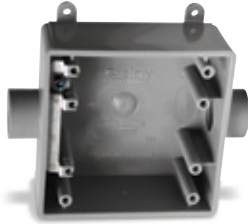

Type 2FSC

| CAT. NO. | SIZE (IN.) | VOL. CU. IN. | STD. CTN. |
|---------------|------------|--------------|-----------|
| E9812D | ½ | 32 | 10 |
| ☛ CE9812D-CTN | ½ | 32 | 10 |
| E9812E | ¾ | 32 | 10 |
| ☛ CE9812E-CTN | ¾ | 32 | 10 |
| E9812F | 1 | 32 | 10 |
| ☛ C9812F | 1 | 32 | 10 |

☛ Canada Only

- For terminations where hub requirements vary according to application — hubs easily made with flared wood bit or hole saw
- All sizes take standard covers and accessories or devices
- Integral mounting feet provide easy mounting

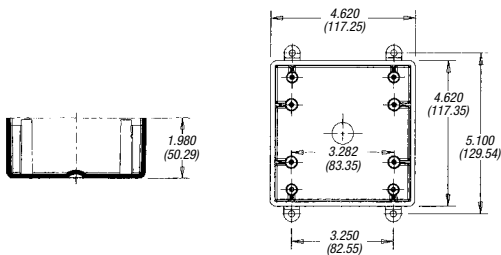

Type FS

| CAT. NO. | SIZE (IN.) | VOL. CU. IN. | STD. CTN. |
|----------|------------|--------------|-----------|
| E9802 | N/A | 32 | 10 |
| ☛ CE9802 | N/A | 32 | 10 |

☛ Canada Only

- For dead-end terminations where two devices or additional wiring capacity is required
- All sizes take standard covers and accessories or devices
- Integral mounting feet provide easy mounting

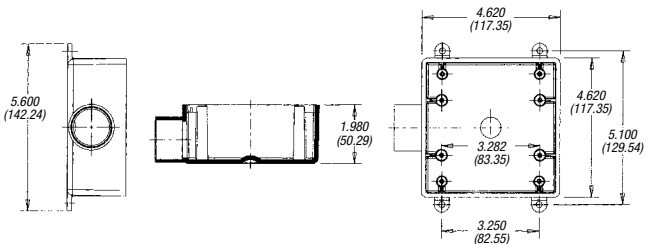

Type 2FSE

| CAT. NO. | SIZE (IN.) | VOL. CU. IN. | STD. CTN. |
|---------------|------------|--------------|-----------|
| E9802D | ½ | 32 | 10 |
| ☛ CE9802D-CTN | ½ | 32 | 10 |
| E9802E | ¾ | 32 | 10 |
| ☛ CE9802E-CTN | ¾ | 32 | 10 |
| E9802F | 1 | 32 | 10 |
| C9802F | 1 | 32 | 1 |

☛ Canada Only

Blank Covers

- Fits Carlon® single-gang FS boxes
- Supplied with stainless steel mounting screws and gasket



Single-Gang

| CAT. NO. | COLOR | STD. CTN | STD. WT. (LBS) |
|------------|-------|----------|----------------|
| E980CN-CAR | Gray | 12 | 1.60 |
| E980CM-CAR | White | 12 | 1.60 |

- Fits Carlon® two-gang FS boxes, other non-metallic and metallic FS boxes
- Supplied with stainless steel mounting screws and gasket



Two-Gang

| CAT. NO. | COLOR | STD. CTN | STD. WT. (LBS) |
|-------------|-------|----------|----------------|
| E9802CN-CAR | Gray | 10 | 2.17 |

Straps, Clamps and Accessories

Snap Strap™ Conduit Support Straps

Carlon's Snap Strap™ offers a unique support strap designed especially for the installation of PVC conduit. Also usable for installations of rigid steel. This high-strength, non-metallic clamp enables conduit to expand and contract freely, eliminating the bowing commonly seen from the expansion and contraction of conduit caused by varying temperature changes. Finished installations have a neat, attractive appearance on exposed applications.

To be used in accordance with conduit spacing requirements per NEC® Section 352.30 and 12-1114 of the CEC. This part is not supplied with screws.

- UV inhibited for use in direct sunlight

NEC and National Electrical Code are registered trademarks of the National Fire Protection Association, Inc.



Ø J THRU
3 PLACES

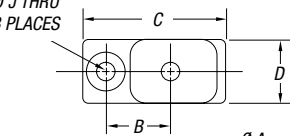

Single Mount

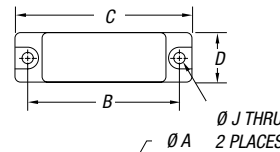

Double Mount

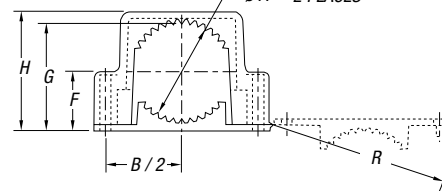
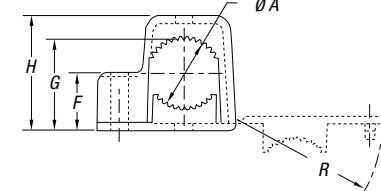

Single Mount

| CAT. NO. | SIZE IN. (MM) | STD. CTN. | STD. WT. (LBS.) | DIMENSIONS IN. (MM) | | | | | | | | |
|------------|------------------|--------------|--------------------|---------------------|----------------|----------------|---------------|---------------|----------------|----------------|---------------|----------------|
| | | | | A | B | C | D | F | G | H | J | R |
| E978DC-CAR | ½ (16) | 40 | 1 | .80 (20.3) | .75 (1.90) | 1.63 (41.4) | .75 (19.1) | .68 (14.9) | 1.08 (25.1) | 1.36 (34.5) | .21 (5.33) | 1.67 (42.4) |
| E978EC-CAR | ¾ (21) | 40 | 3 | 1.00 (25.4) | .88 (22.4) | 1.92 (48.7) | .75 (19.1) | .79 (17.8) | 1.29 (30.4) | 1.58 (39.9) | .21 (5.33) | 1.96 (49.8) |
| E978FC-CAR | 1 (27) | 30 | 4 | 1.20 (30.5) | 1.02 (25.9) | 2.17 (55.1) | .75 (19.1) | .92 (21.1) | 1.54 (36.3) | 1.84 (46.7) | .21 (5.33) | 2.22 (56.3) |

Double Mount

| CAT. NO. | SIZE IN. (MM) | STD. CTN. | STD. WT. (LBS.) | DIMENSIONS IN. (MM) | | | | | | | | |
|------------|------------------|--------------|--------------------|---------------------|----------------|-----------------|----------------|----------------|----------------|-----------------|----------------|-----------------|
| | | | | A | B | C | D | F | G | H | J | R |
| E978GC-CAR | 1¼ (35) | 15 | 4 | 1.66 (42.16) | 2.75 (69.9) | 3.23 (82.0) | 1.00 (25.4) | 1.07 (24.1) | 1.90 (45.2) | 2.15 (54.61) | .218 (5.54) | 3.28 (83.3) |
| E978HC-CAR | 1½ (41) | 15 | 5 | 1.92 (48.77) | 3.05 (77.5) | 3.53 (89.7) | 1.00 (25.4) | 1.20 (27.4) | 2.16 (51.8) | 2.40 (60.96) | .218 (5.54) | 3.58 (90.9) |
| E978JC-CAR | 2 (53) | 10 | 5 | 2.34 (59.44) | 3.50 (88.9) | 4.00 (101.6) | 1.00 (25.4) | 1.43 (33.3) | 2.59 (63.0) | 2.86 (72.64) | .218 (5.54) | 4.06 (103.1) |

Straps, Clamps and Accessories

Non-Metallic Clamps

Non-metallic clamps offer the same chemical resistance as Carlon® non-metallic conduits for a complete, corrosion-resistant system.

To be used in accordance with conduit spacing requirements per NEC® Section 352.30 and 12-1114 of the CEC.

- UV inhibited for use in direct sunlight

NEC and National Electrical Code are registered trademarks of the National Fire Protection Association, Inc.

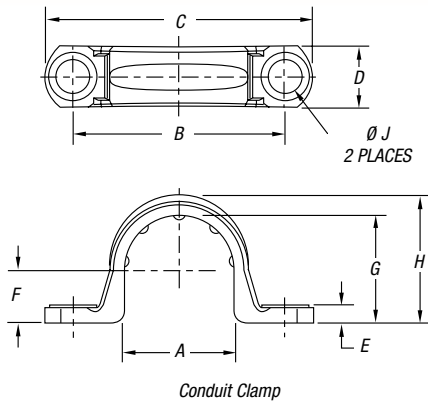

Conduit Clamps

| CAT. NO. | SIZE IN. (MM) | STD. CTN. | STD. WT. (LBS.) | DIMENSIONS IN. (MM) | | | | | | | | |
|------------|---------------|-----------|-----------------|---------------------|-----------------|-----------------|-----------------|---------------|----------------|-----------------|-----------------|---------------|
| | | | | A | B | C | D | E | F | G | H | J |
| E977DC | ½ (16) | 100 | 1.2 | .892 (22.6) | 1.71 (43.4) | 2.16 (54.8) | .50 (12.7) | .14 (3.5) | .42 (10.6) | .866 (21.9) | 1.04 (26.4) | .260 (6.6) |
| E977EC | ¾ (21) | 100 | 1.4 | 1.102 (27.9) | 1.97 (50.0) | 2.40 (60.9) | .50 (12.7) | .14 (3.5) | .525 (13.3) | 1.076 (27.3) | 1.255 (31.8) | .260 (6.6) |
| E977FC | 1 (27) | 100 | 2 | 1.39 (35.3) | 2.25 (57.1) | 2.81 (71.3) | 0.594 (15.0) | .14 (3.5) | .658 (16.7) | 1.342 (34.0) | 1.574 (39.9) | .260 (6.6) |
| E977GC | 1¼ (35) | 50 | 5 | 1.714 (43.5) | 2.68 (68.0) | 3.28 (83.3) | .64 (16.2) | .15 (3.8) | .83 (21.0) | 1.687 (42.8) | 1.89 (48.0) | .320 (8.1) |
| E977HC | 1½ (41) | 50 | 6 | 1.92 (48.7) | 2.82 (71.6) | 3.44 (87.3) | .70 (17.7) | .15 (3.8) | .97 (24.6) | 1.93 (49.0) | 2.12 (53.8) | .312 (7.9) |
| E977JC | 2 (53) | 25 | 4.5 | 2.54 (64.5) | 3.54 (89.9) | 4.18 (106.1) | .76 (19.3) | .16 (4.0) | 1.05 (26.6) | 2.29 (58.1) | 2.49 (63.2) | .315 (8.0) |
| E977KC-CAR | 2½ (63) | 25 | 1.4 | 2.86 (72.6) | 4.50 (114.3) | 5.46 (138.7) | 1.00 (25.4) | .20 (5.08) | 1.43 (36.3) | 2.86 (72.6) | 3.12 (79.2) | .36 (9.14) |
| E977LC-CAR | 3 (78) | 20 | 1.4 | 3.47 (88.2) | 5.00 (127.0) | 6.00 (152.4) | 1.00 (25.4) | .20 (5.08) | 1.74 (44.3) | 3.48 (88.4) | 3.70 (94.0) | .36 (9.14) |
| E977NC-CAR | 4 (103) | 15 | 12.2 | 4.366 (110.9) | 6.15 (156.2) | 7.20 (182.9) | 1.00 (25.4) | .20 (5.08) | 2.32 (58.8) | 4.50 (114.3) | 4.70 (119.4) | .36 (9.14) |

Note: Some clamp applications require two screws, two nuts and two washers.

Straps, Clamps and Accessories

Carlton® Masonry Pipe Clamps

Carlton® Masonry Pipe Clamps make installations faster and easier by eliminating the use of bolts and anchors. The one-piece design features an anchoring projection designed to push into a 5/16" drill hole.

The clamps are used to securely support pipe/conduit and electrical cables on concrete and masonry block, and unlike metallic clamps Carlton® Masonry Clamps won't rust or corrode.

Carlton® Masonry Pipe Clamps are available in sizes 1/2" and 3/4" and are ideal for commercial applications such as schools, hospitals, airports, condominiums, hotels, airports, office buildings and casinos.

Features

- One-piece design
- Material: Nylon PA6
- Color: Gray
- Flame resistance: V2
- Anchor length: 1.2" threaded
- Drill hole: 5/16"

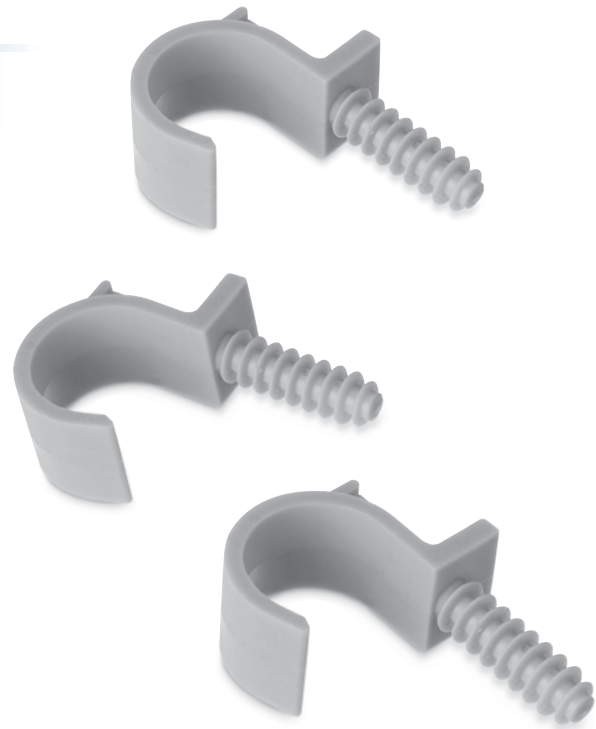

Conduit & Fittings — Carlton® PVC Elbows, Conduit & Fittings

Installation:

Note: Follow NEC® guidelines for conduit clamp spacing.



1 Using a 5/16" masonry drill bit, drill a hole into the concrete.

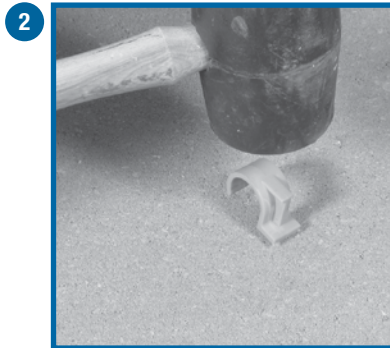

2 Tap clamp with hammer until fully inserted.

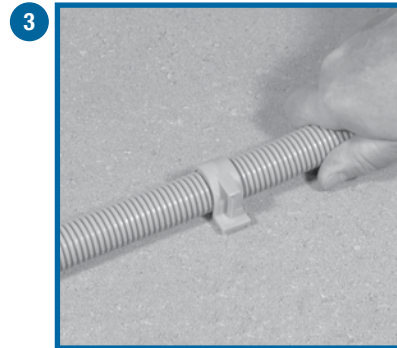

| CAT. NO. | SIZE (IN.) | STD. CTN. | STD. WT. (LBS.) |
|-------------|------------|------------------------------------|-----------------|
| E977NDC-CTN | 1/2 | 12 (Equals 12 Bags of 5 Clamps) | 1.2 |
| E977NEC-CTN | 3/4 | 12 (Equals 12 Bags of 5 Clamps) | 1.3 |

NEC and National Electrical Code are registered trademarks of the National Fire Protection Association, Inc.

Straps, Clamps and Accessories

Slip Meter Risers

Carlon® Slip Meter Risers are designed for use in electrical service entrance applications. They provide solutions for applications requiring a non-rigid connection, with incoming service conduit diameters ranging from 2" to 4".

The Slip Meter Risers are fitted with a terminal adapter for easy installation at the service entrance location and provide a low-cost method to comply with NEC® 300.5(J), which requires protection for buried cables in areas subject to ground movement due to frost or trench settling.

Note: Meter box is not included.

- Designed to provide faster and easier underground service entrance installations
- Provides cable protection from ground movement
- Accommodates incoming service conduit diameters ranging from 2" to 4"
- Fitted with Terminal Adapters for easy installing
- Allows ground water in raceway system to drain
- Complies with NEC® 300.5 paragraph 4, Schedule 80 rated

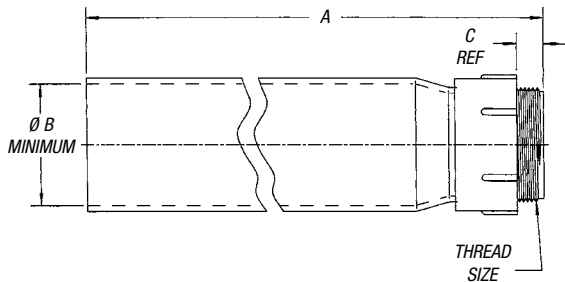

Article 300 Wiring Methods

(J) Ground Movement. Where direct buried conductors, raceways, or cables are subject to movement by settlement or frost, direct buried conductors, raceways, or cables shall be arranged to prevent damage to the enclosed conductors or to equipment connected to the raceways.



(FPN): This section recognizes "S" loops in underground direct burial to raceway transitions, expansion joints in raceway risers to fixed equipment, and, generally, the provision of flexible connections to equipment subject to settlement or frost heaves.

NEC and National Electrical Code are registered trademarks of the National Fire Protection Association, Inc.

| CAT. NO. | SIZE | A LENGTH | B (MINIMUM) | C | THREAD SIZE | STD. CARTON QTY. | STD. CARTON WT. (LBS.) |
|--------------------|------|-------------|----------------|-----|----------------|------------------------|------------------------------|
| E954JXX | 2" | 24.00 | 2.492 | .83 | 2" NPT | 20 | 46 |
| E954JXS (SPLIT) | 2" | 24.00 | 2.492 | .83 | 2" NPT | 1 | 2.2 |
| E954KXX | 2½" | 24.00 | 2.961 | .81 | 2½" NPSC | 10 | 28 |
| E954LXX | 3" | 24.00 | 3.616 | .80 | 3" NPSC | 10 | 35 |
| E954LXS (SPLIT) | 3" | 24.00 | 3.616 | .80 | 3" NPSC | 10 | 36 |
| E954NXX | 4" | 24.00 | 4.859 | .77 | 4" NPSC | 5 | 23 |

Spacers

Carlton® Snap-Loc® Spacers

Carlton® Snap-Loc® Duct Spacers provide stability, consistent separation and relieve direct stress for duct materials encased in concrete and direct-burial applications.

Carlton® Snap-Loc® Spacers provide:

- A side dovetail rail-and-groove design enabling side-by-side interchangeability of conduit spacer sizes while maintaining horizontal stability
- Locking keyways incorporated into intermediate spacers eliminate the need for costly top spacers in each size. The locking keyways provide for the use of a beaded strap that secures the top section of conduit
- 1" and 2" Snap-Loc® Reducers enable fixturing of 1" or 2" conduit inside larger spacers
- The Snap-Loc® Rebar Holder provides stabilization on large banks of spacers

Non-metallic Snap-Loc® Spacers are designed specifically for use with non-metallic duct, with maximum O.D. dimensions as specified in NEMA TC-2, TC-6 & 8 and ASTM F512. The innovative vertical and horizontal interlocking Snap-Loc® design has tapered joining slots with maximum tolerances for easy jobsite assembly.

Important:

The use of duct spacers for direct burial may result in excessive point deflections unless proper design engineering is applied, such as the proper compaction of the appropriate backfill material.

Installation Note

The Spacers and Rebar Holder are designed with a dovetail tongue-and-groove feature for easy installation.

If required to permanently fix the position of a group of Spacers and/or Rebar Holder, the following are recommended procedures:

1. Use Carlton® Quick-Set Cement glue during assembly or spot glue after assembly to secure.
2. During assembly, deform the edge of the tongue or groove portion of the dovetail slide with a pair of pliers or similar tool. This deformation will create an interference, restricting movement.
3. An assembled system may be wired together for additional support.

Important:

The use of duct spacers for direct burial may result in excessive point deflections unless proper design engineering is applied, such as the proper compaction of the appropriate backfill material.

Note: Spacers are not UL® Listed.

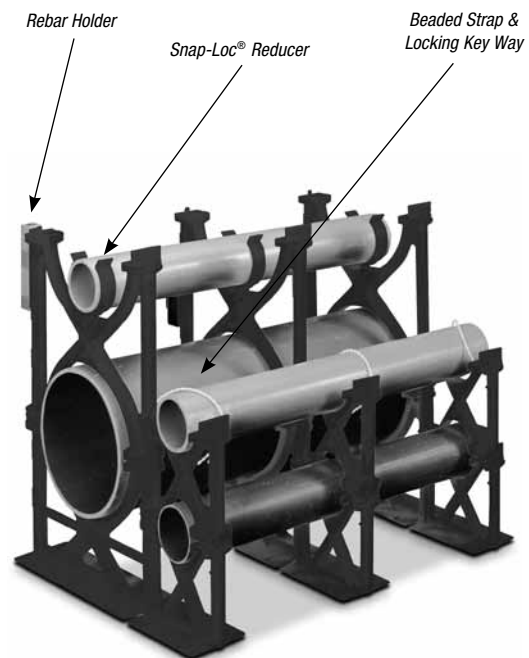

Spacers

Carlton® Snap-Loc® Spacers (continued)

Dimensions — Base Spacers

| CAT. NO. | SIZE (IN.) | A (IN.) | C (IN.) | D (DIA.) (IN.) | STD. CTN. |
|----------|------------|---------|---------|----------------|-----------|
| S288JHN | 2 x 1½ | 4.25 | 4.12 | 2.50 | 100 |
| S288JJN | 2 x 2 | 4.25 | 4.62 | 2.50 | 100 |
| S288JLN | 2 x 3 | 4.25 | 5.62 | 2.50 | 100 |
| S288LHN | 3 x 1½ | 4.81 | 5.25 | 3.63 | 90 |
| S288LJN | 3 x 2 | 4.81 | 5.75 | 3.63 | 80 |
| S288LLN | 3 x 3 | 4.81 | 6.75 | 3.63 | 60 |
| S288NFN | 4 x 1 | 4.50 | 5.75 | 4.63 | 70 |
| S288NHN | 4 x 1½ | 5.31 | 6.25 | 4.63 | 50 |
| S288NJN | 4 x 2 | 5.31 | 6.75 | 4.63 | 50 |
| S288NLN | 4 x 3 | 5.31 | 7.75 | 4.63 | 60 |
| S288PHN | 5 x 1½ | 5.84 | 7.31 | 5.69 | 50 |
| S288PJN | 5 x 2 | 5.84 | 7.81 | 5.69 | 60 |
| S288PLN | 5 x 3 | 5.84 | 8.81 | 5.69 | 50 |
| S288RHN | 6 x 1½ | 6.38 | 8.38 | 6.75 | 50 |
| S288RJN | 6 x 2 | 6.38 | 8.88 | 6.75 | 50 |
| S288RLN | 6 x 3 | 6.38 | 9.88 | 6.75 | 40 |
| S288SHN | 8 x 1½ | 7.38 | 10.30 | 8.75 | 30 |
| S288SJN | 8 x 2 | 7.38 | 10.76 | 8.75 | 30 |

Dimensions — Intermediate Spacers

| CAT. NO. | SIZE (IN.) | A (IN.) | C (IN.) | D (DIA.) (IN.) | STD. CTN. |
|----------|------------|---------|---------|----------------|-----------|
| S289JHN | 2 x 1½ | 3.88 | 4.12 | 2.50 | 120 |
| S289JJN | 2 x 2 | 4.38 | 4.62 | 2.50 | 100 |
| S289JLN | 2 x 3 | 5.38 | 5.62 | 2.50 | 80 |
| S289LHN | 3 x 1½ | 5.01 | 5.25 | 3.63 | 100 |
| S289LJN | 3 x 2 | 5.51 | 5.75 | 3.63 | 80 |
| S289LLN | 3 x 3 | 6.51 | 6.75 | 3.63 | 60 |
| S289NFN | 4 x 1 | 5.51 | 5.73 | 4.63 | 70 |
| S289NHN | 4 x 1½ | 6.01 | 6.25 | 4.63 | 60 |
| S289NJN | 4 x 2 | 6.51 | 6.75 | 4.63 | 60 |
| S289NLN | 4 x 3 | 7.51 | 7.75 | 4.63 | 50 |
| S289PHN | 5 x 1½ | 7.07 | 7.31 | 5.69 | 50 |
| S289PJN | 5 x 2 | 7.57 | 7.81 | 5.69 | 50 |
| S289PLN | 5 x 3 | 8.57 | 8.81 | 5.69 | 30 |
| S289RHN | 6 x 1½ | 8.14 | 8.38 | 6.75 | 50 |
| S289RJN | 6 x 2 | 8.64 | 8.88 | 6.75 | 40 |
| S289RLN | 6 x 3 | 9.64 | 9.88 | 6.75 | 30 |
| S289SHN | 8 x 1½ | 10.14 | 10.30 | 8.75 | 30 |
| S289SJN | 8 x 2 | 10.64 | 10.76 | 8.75 | 30 |

* First number indicates trade size of duct, second number indicates separation between conduits or ducts.

Accessories

Snap-Loc® Reducer

| CAT. NO. | SIZE (IN.) | STD. CTN. |
|----------|------------|-----------|
| S287F | 1 | 100 |
| S287J | 2 | 100 |

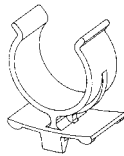

Rebar Holder

| CAT. NO. | STD. CTN. |
|----------|-----------|
| S258RH | 100 |

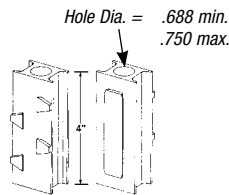

Beaded Strap

| CAT. NO. | STD. CTN. |
|----------|--------------|
| S28612 | 1 Bag of 250 |

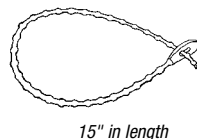

Specifications

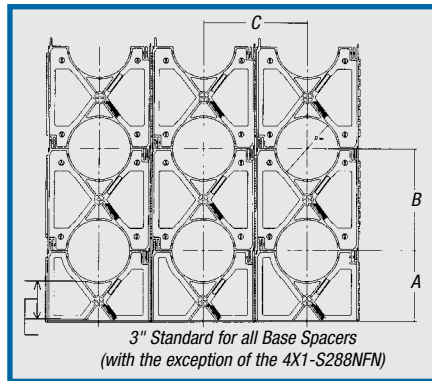

Suggested Specification:

(Duct) (Conduit) bank shall be encased in concrete with at least three inches of concrete at the top and bottom and two inches on each side. A horizontal and vertical separation between the ducts of ____* inches shall be maintained by installing Carlton® high-impact spacers with horizontal and vertical locking intervals of ____** feet.

*Standard Separations of 1", 1½", 2" and 3" are available.

**Preferred interval between spacer assemblies is 8 to 10 feet.

Spacers

Carlton® Snap-N-Stac™ Combo Spacers

Carlton® Snap-N-Stac™ Combo Duct Spacers are specifically designed to replace the two-piece base and intermediate spacer system, by combining the conventional base and intermediate spacer into a single unit.

Manufactured out of highly engineered thermoplastic material, Snap-N-Stac™ Spacers are strong, durable and able to withstand the rigors of concrete construction. They feature an innovative horizontal and EXCLUSIVE vertical locking system, and can be used as either a base or intermediate spacer.

Snap-N-Stac™ Spacers are available in one-way, two-way and three-way configurations (one-way and three-way only available in sizes 2" and 4"). They accept 2", 3", 4", 5" and 6" pipe and can be installed horizontally, vertically or turned upright for unique duct bank configurations.

This NEW one-piece design makes underground duct bank installations faster and easier than the conventional two-piece system — saving material and labor costs.

Carlton® Snap-N-Stac™ Combo Spacers...The IDEAL solution for underground duct bank installations.

Features:

- Conventional base and intermediate spacer in a single unit
- Less inventory required
- EXCLUSIVE vertical locking system
- Horizontal locking system
- Installs horizontally or turned upright
- Molded-in rebar holder on two-way and three-way
- One-, two- and three-way configurations (one-way and three-way only available in sizes 2" and 4")
- Five sizes: 2", 3", 4", 5" and 6"
- Reducer to accommodate smaller duct sizes
- Can be used as either an intermediate or base spacer
- Spacers interlock horizontally regardless of size
- Non-metallic, non-corrosive, non-conductive
- Strong and durable
- Easy to handle
- Fast installation



One-way



Three-way

Installations



Horizontal Locking

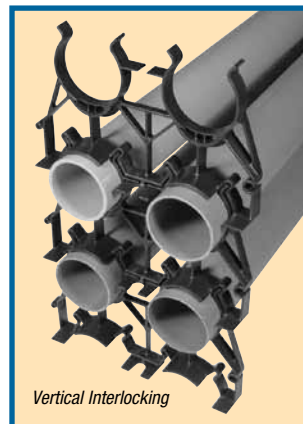

Vertical Interlocking

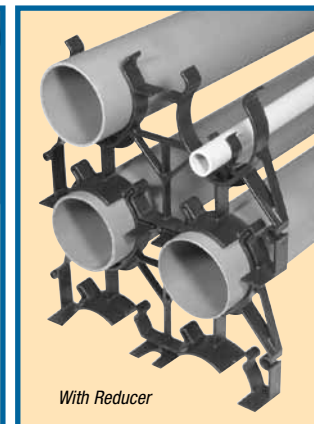

With Reducer

Spacers

Carlon® Snap-N-Stac™ Combo Spacers (continued)

Installation Instructions

IMPORTANT:

1. Snap-N-Stac™ Spacers are recommended for concrete-encased applications only.
2. The use of duct spacers for direct burial may result in excessive point deflections unless proper design engineering is applied, such as the proper compaction of the appropriate backfill material.

Vertical Interlocking

Slide spacers together “Feet Facing Feet” or “Feet Opposite.”

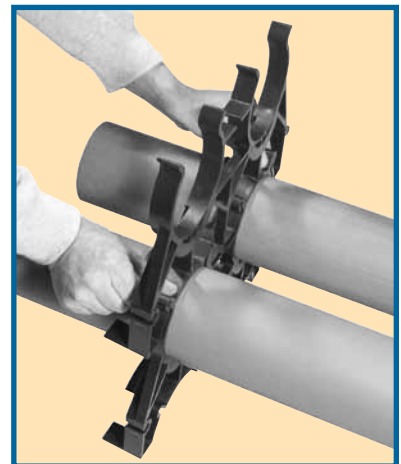
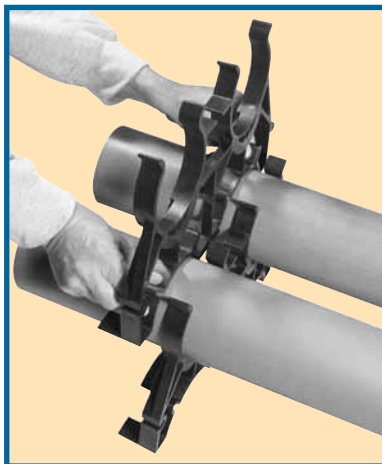
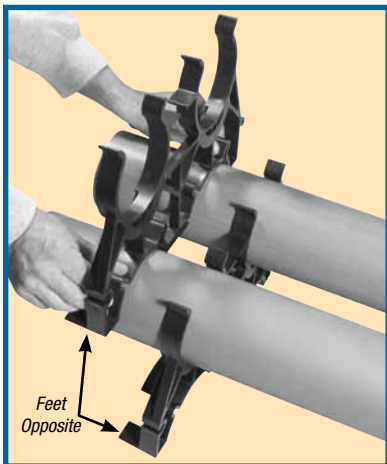
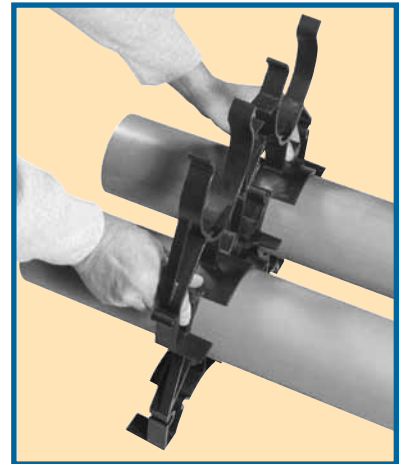
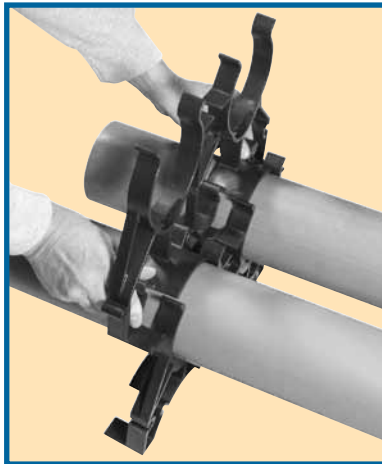
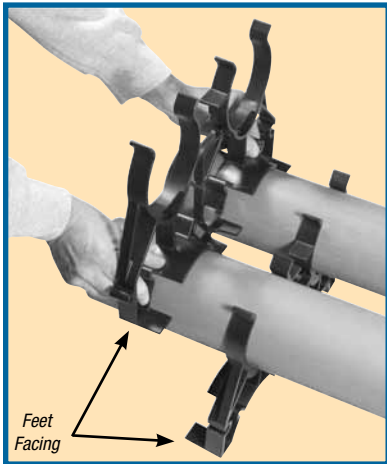

Molded-In Rebar Holder

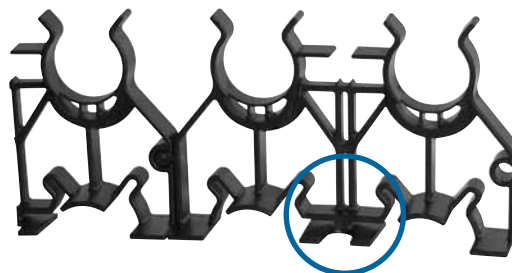
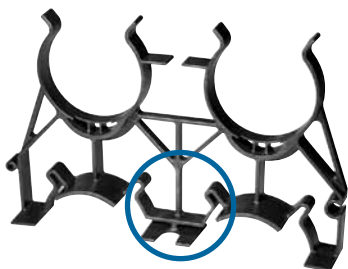

Spacers

Installation Instructions

Vertical Free Standing

If spacers are installed using free-standing method, it is recommended to install the spacer on the upper row mid-way between the two spacers on the bottom row.

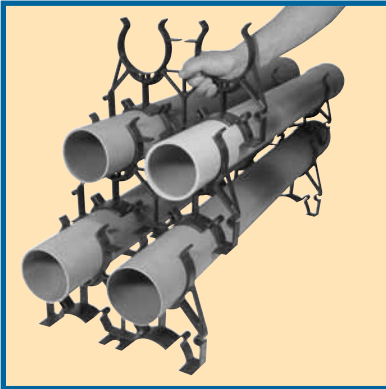

Reducer

1" and 2" Snap-Loc® Reducers enable fixturing of 1" and 2" conduit inside of larger spacers.

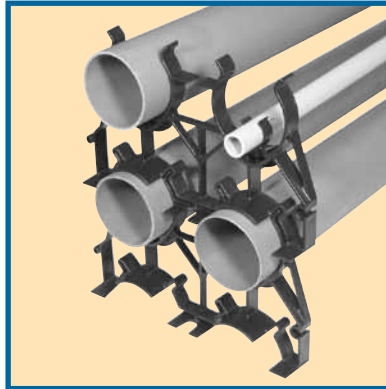

Transition to Various Duct Sizes

Install spacers side-by-side by inserting the male adapter into the female adapter.

Note: All Snap-N-Stack™ spacers are designed to interlock horizontally, regardless of size.

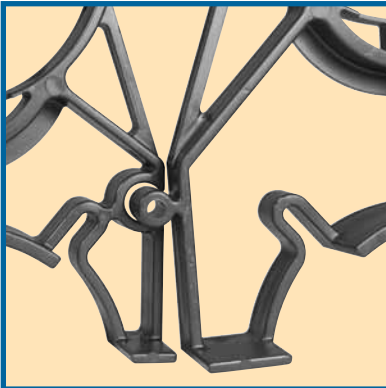

Odd Number of Ducts

Two-way spacers, size 2" and 4" only, can easily be cut apart to produce two one-way spacers. Create three-way and five-way spacers using the one-way spacer. Install spacers side-by-side by inserting the male adapter into the female adapter.

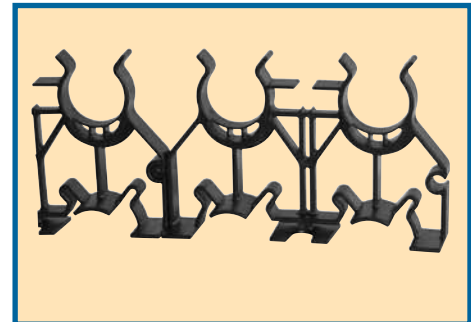
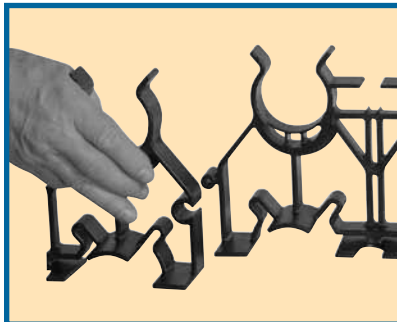
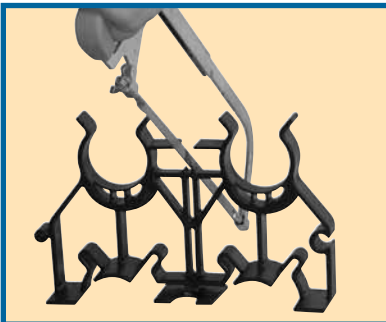

Spacers

Carlton® Snap-N-Stack™ Combo Spacers

| CAT. NO. | DESCRIPTION | SIZE (IN.) | SEPARATION (IN.) | STD. CTN. | STD. WT. (LBS.) |
|-----------|---------------|------------|------------------|-----------|-----------------|
| SP2W20-1 | 1-Way Spacers | 2 | 2 | 56 | 15.0 |
| SP2W30-1 | | 2 | 3 | 40 | 13.0 |
| SP4W15-1 | | 4 | 1½ | 26 | 9.6 |
| SP4W20-1 | | 4 | 2 | 20 | 10.0 |
| SP4W30-1 | 2-Way Spacers | 4 | 3 | 20 | 9.4 |
| SP2W20-2* | | 2 | 2 | 56 | 28.5 |
| SP2W30-2* | | 2 | 3 | 40 | 23.8 |
| SP3W20-2 | | 3 | 2 | 40 | 24.0 |
| SP3W30-2 | | 3 | 3 | 24 | 17.9 |
| SP4W15-2* | | 4 | 1½ | 26 | 18.3 |
| SP4W20-2* | | 4 | 2 | 24 | 18.8 |
| SP4W30-2* | | 4 | 3 | 20 | 17.6 |
| SP5W20-2 | 3-Way Spacers | 5 | 2 | 20 | 17.2 |
| SP5W30-2 | | 5 | 3 | 14 | 15.5 |
| SP6W20-2 | | 6 | 2 | 12 | 12.8 |
| SP6W30-2 | | 6 | 3 | 12 | 14.1 |
| SP2W20-3 | | 2 | 2 | 36 | 28.5 |
| SP2W30-3 | | 2 | 3 | 18 | 17.8 |
| SP4W15-3 | 3-Way Spacers | 4 | 1½ | 18 | 19.4 |
| SP4W20-3 | | 4 | 2 | 16 | 19.3 |
| SP4W30-3 | | 4 | 3 | 14 | 19.1 |

*Can be cut apart to make (2) one-way spacers.

How to Interpret the Part Number:

| POSITION 1 | POSITION 2 | POSITION 3 | POSITION 4 |
|--------------|---------------|--|---------------------------|
| PRODUCT TYPE | DUCT SIZE | DUCT-TO-DUCT SPACING — HORIZONTAL AND VERTICAL | HORIZONTAL DUCT POSITIONS |
| SP = Spacer | 2W = 2" Width | 15 = 1½" | -1 = One-Way |
| | 3W = 3" Width | 20 = 2" | -2 = Two-Way |
| | 4W = 4" Width | 30 = 3" | -3 = Three-Way |
| | 5W = 5" Width | | |
| | 6W = 6" Width | | |

Accessories

Snap-Loc® Reducer

| CAT. NO. | SIZE (IN.) | STD. CTN. |
|----------|------------|-----------|
| S287F | 1 | 100 |
| S287J | 2 | 100 |



Beaded Strap

| CAT. NO. | STD. CTN. |
|----------|-----------|
| S28612 | 100 |

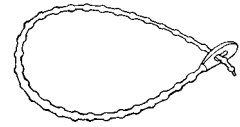

15" in length

Technical Information

| CAT. NO. | DUCT SIZE (IN.) | DUCT O.D. | HORIZONTAL DUCT POSITIONS | DUCT-TO-DUCT SPACING | | CENTER-TO-CENTER SPACING | | BOTTOM OF TRENCH TO BOTTOM OF DUCT | BOTTOM OF TRENCH TO CENTER OF BOTTOM OF DUCT | OVERALL LENGTH |
|----------|-----------------|-----------|---------------------------|----------------------|------------------|--------------------------|------------------|------------------------------------|--|----------------|
| | | | | VERTICAL (IN.) | HORIZONTAL (IN.) | VERTICAL (IN.) | HORIZONTAL (IN.) | | | |
| SP2W20-1 | 2 | 2.375 | 1 | 2 | 2 | 2.19 | 2.19 | 3.13 | 4.25 | 4.38 |
| SP2W30-1 | 2 | 2.375 | 1 | 3 | 3 | 2.69 | 2.69 | 4.13 | 5.25 | 5.38 |
| SP4W15-1 | 4 | 4.500 | 1 | 1.5 | 1.5 | 3.00 | 3.00 | 3.38 | 5.56 | 6.00 |
| SP4W20-1 | 4 | 4.500 | 1 | 2 | 2 | 3.25 | 3.25 | 3.88 | 6.06 | 6.50 |
| SP4W30-1 | 4 | 4.500 | 1 | 3 | 3 | 3.75 | 3.75 | 4.88 | 7.06 | 7.50 |
| SP2W20-2 | 2 | 2.375 | 2 | 2 | 2 | 4.38 | 4.38 | 3.13 | 4.25 | 8.75 |
| SP2W30-2 | 2 | 2.375 | 2 | 3 | 3 | 5.38 | 5.38 | 4.13 | 5.25 | 10.75 |
| SP3W20-2 | 3 | 3.500 | 2 | 2 | 2 | 5.50 | 5.50 | 3.63 | 5.38 | 11.00 |
| SP3W30-2 | 3 | 3.500 | 2 | 3 | 3 | 6.50 | 6.50 | 4.63 | 6.38 | 13.00 |
| SP4W15-2 | 4 | 4.500 | 2 | 1.5 | 1.5 | 6.00 | 6.00 | 3.38 | 5.56 | 12.00 |
| SP4W20-2 | 4 | 4.500 | 2 | 2 | 2 | 6.50 | 6.50 | 3.88 | 6.06 | 13.00 |
| SP4W30-2 | 4 | 4.500 | 2 | 3 | 3 | 7.50 | 7.50 | 4.88 | 7.06 | 15.00 |
| SP5W20-2 | 5 | 5.500 | 2 | 2 | 2 | 7.56 | 7.56 | 4.38 | 7.25 | 15.12 |
| SP5W30-2 | 5 | 5.500 | 2 | 3 | 3 | 8.56 | 8.56 | 5.38 | 8.25 | 17.14 |
| SP6W20-2 | 6 | 6.625 | 2 | 2 | 2 | 8.62 | 8.62 | 4.13 | 7.38 | 17.25 |
| SP6W30-2 | 6 | 6.625 | 2 | 3 | 3 | 9.62 | 9.62 | 5.13 | 8.38 | 19.25 |
| SP2W20-3 | 2 | 2.375 | 3 | 2 | 2 | 4.38 | 4.38 | 3.13 | 4.25 | 13.13 |
| SP2W30-3 | 2 | 2.375 | 3 | 3 | 3 | 5.38 | 5.38 | 4.13 | 5.25 | 16.13 |
| SP4W15-3 | 4 | 4.500 | 3 | 1.5 | 1.5 | 6.00 | 6.00 | 3.38 | 5.56 | 18.00 |
| SP4W20-3 | 4 | 4.500 | 3 | 2 | 2 | 6.50 | 6.50 | 3.88 | 6.06 | 19.50 |
| SP4W30-3 | 4 | 4.500 | 3 | 3 | 3 | 7.50 | 7.50 | 4.88 | 7.06 | 22.50 |

P&C Flex® Conduit and Fittings

Carlton® P&C Flex® Corrugated Flexible Conduit

Carlton® P&C Flex® Non-Metallic Corrugated Conduit makes power and communication installations faster and easier by providing maximum installation flexibility. The corrugated design is flexible enough to accommodate any degree of bend requirement. Unlike rigid conduit, it has a tight bend radius, making this product ideal for shallow trenches.

P&C Flex® is manufactured to IPS dimensions and can be used with any existing conduit system using standard fittings. It is UV resistant and suitable for a variety of applications, including direct burial, under bridges, service entrance/FTTx terminations, manhole terminations, pedestal/enclosure terminations and running up utility poles or outside of buildings.

P&C Flex® is available in sizes 3/4" though 4", with or without pull tape (1" through 4" only) and comes in a variety of convenient standard put-ups.

Features:

- Accommodates any degree of bend — ideal for shallow trenches
 - For use with HDPE — Use ELA_ Series Fittings
 - For use with PVC — Use E940_ Series Fittings
- Easily handles offsets
- Manufactured to IPS dimensions — can be used with standard IPS coupling/fittings
- UV resistant
- Can be used as a flexible sweep or raceway — one SKU can do multiple bends
- Available in sizes 3/4" though 4"
- Small put-ups for easy handling

Note: Not UL® Listed.

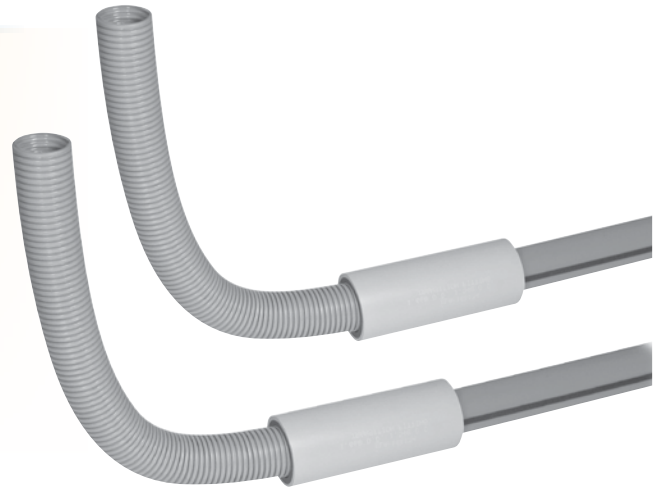

Conduit & Fittings — Carlton® PVC Elbows, Conduit & Fittings

Applications



P&C Flex® Conduit and Fittings

P&C Flex® Conduit

| CAT. NO. | SIZE (IN.) | I.D. (IN.) | O.D. (IN.) | PULL TAPE | REEL/ COIL | STD. CTN. (FT.) | STD. WT. (LBS.) |
|-------------|------------|------------|------------|-----------|------------|-----------------|-----------------|
| 11807-350* | ¾ | .83 | 1.040 | Empty | Coil | 350 | 39.9 |
| 1808-250C | 1 | 1.000 | 1.315 | Empty | Coil | 250 | 36.3 |
| 11808-5200 | 1 | 1.000 | 1.315 | Empty | Reel | 5200 | 1019.0 |
| 11809-900 | 1¼ | 1.340 | 1.660 | Empty | Reel | 900 | 243.0 |
| 11809-4500 | 1¼ | 1.340 | 1.660 | Empty | Reel | 4500 | 972.0 |
| 11810-250 | 1½ | 1.570 | 1.900 | Empty | Reel | 250 | 75.8 |
| 11810-4500 | 1½ | 1.570 | 1.900 | Empty | Reel | 4500 | 1080.0 |
| 11810T-2300 | 1½ | 1.570 | 1.900 | 1250 lb. | Reel | 2300 | 720.0 |
| 11810T-250 | 1½ | 1.570 | 1.900 | 1250 lb. | Reel | 250 | 78.0 |
| 11811-1100 | 2 | 2.045 | 2.375 | Empty | Reel | 1100 | 521.4 |
| 11811-250 | 2 | 2.045 | 2.375 | Empty | Reel | 250 | 87.0 |
| 11811-2500 | 2 | 2.045 | 2.375 | Empty | Reel | 2500 | 815.0 |
| 11811-500 | 2 | 2.045 | 2.375 | Empty | Reel | 500 | 201.6 |
| 11811-700 | 2 | 2.045 | 2.375 | Empty | Reel | 700 | 269.0 |
| 11811T-250 | 2 | 2.045 | 2.375 | 1250 lb. | Reel | 250 | 89.0 |
| 11812-250 | 2½ | 2.469 | 2.875 | Empty | Reel | 250 | 121.0 |
| 11812AG-001 | 2½ | 2.469 | 2.875 | Empty | Reel | 1300 | 516.1 |
| 11813-1200 | 3 | 3.068 | 3.500 | Empty | Reel | 1200 | 850.8 |
| 11813-250 | 3 | 3.068 | 3.500 | Empty | Reel | 250 | 192.0 |
| 11813-500 | 3 | 3.068 | 3.500 | Empty | Reel | 500 | 523.0 |
| 11813-750 | 3 | 3.068 | 3.500 | Empty | Reel | 750 | 554.3 |
| 11815-250 | 4 | 4.026 | 4.500 | Empty | Reel | 250 | 324.0 |
| 11815-800 | 4 | 4.026 | 4.500 | Empty | Reel | 800 | 778.4 |

*Pull tape not available for ¾" conduit.

P&C Flex® Fittings

Couplings

| CAT. NO. | SIZE (IN.) | STD. CTN. | STD. WT. (LBS.) |
|----------|------------|-----------|-----------------|
| E940E | ¾ | 100 | 4.6 |
| E940F | 1 | 50 | 3.5 |
| E940G | 1¼ | 30 | 3.2 |
| E940H | 1½ | 25 | 3.4 |
| E940J | 2 | 30 | 5.3 |
| E940K | 2½ | 20 | 7.5 |
| E940L | 3 | 25 | 14.7 |
| E940N | 4 | 15 | 12.5 |



Female Adapters

| CAT. NO. | SIZE (IN.) | STD. CTN. | STD. WT. (LBS.) |
|----------|------------|-----------|-----------------|
| E942E | ¾ | 100 | 4.3 |
| E942F | 1 | 50 | 3.7 |
| E942G | 1¼ | 30 | 3.3 |
| E942H | 1½ | 25 | 3.3 |
| E942J | 2 | 30 | 5.4 |
| E942K | 2½ | 20 | 6.6 |
| E942L | 3 | 25 | 11.8 |
| E942N | 4 | 15 | 10.8 |



Terminal Adapters

| CAT. NO. | SIZE (IN.) | STD. CTN. | STD. WT. (LBS.) |
|----------|------------|-----------|-----------------|
| E943E | ¾ | 125 | 4.2 |
| E943F | 1 | 50 | 3.0 |
| E943G | 1¼ | 25 | 4.1 |
| E943H | 1½ | 25 | 2.7 |
| E943J | 2 | 5 | 6.9 |
| E943K | 2½ | 20 | 6.3 |
| E943L | 3 | 45 | 16.6 |
| E943N | 4 | 15 | 11.7 |



Bell Ends (Schedule 40)

| CAT. NO. | SIZE (IN.) | STD. CTN. | STD. WT. (LBS.) |
|----------|------------|-----------|-----------------|
| E997F | 1 | 50 | 2.6 |
| E997G | 1¼ | 35 | 2.5 |
| E997H | 1½ | 30 | 2.5 |
| E997J | 2 | 10 | 4.8 |
| E997K | 2½ | 10 | 2.0 |
| E997L | 3 | 10 | 10.0 |
| E997N | 4 | 30 | 16.0 |



Plugs

| CAT. NO. | SIZE (IN.) | STD. CTN. | STD. WT. (LBS.) |
|----------|------------|-----------|-----------------|
| P258H | 1½ | 50 | 1.7 |
| P258JT | 2 | 60 | 3.1 |
| P258K | 2½ | 25 | 1.5 |
| P258LT | 3 | 30 | 3.4 |
| P258NT | 4 | 48 | 8.3 |



P&C Flex® Conduit and Fittings

Specifications

| PERFORMANCE PROPERTIES | ¾" | 1" | 1¼" | 1½" | 2" | 2½" | 3" | 4" |
|----------------------------------|-----|-----|-----|-----|-----|------|------|------|
| Stiffness F/y at 5% deflection | 200 | 200 | 200 | 200 | 200 | 130 | 130 | 90 |
| Impact Strength (ft./lbs.) 72° F | 35 | 40 | 40 | 50 | 50 | 70 | 120 | 140 |
| Impact Strength (ft./lbs.) 32° F | 5 | 8 | 8 | 15 | 25 | 35 | 60 | 60 |
| Minimum Bending Radius (inches) | 6 | 6 | 6 | 7 | 8 | 12 | 15 | 18 |
| Conduit Tensile Strength | 200 | 300 | 400 | 500 | 700 | 1000 | 1500 | 2000 |

Storage: -4° to 158° F
 Handling: -4° to 104° F

Sweep and Elbow Conversion Chart

| RADIUS (IN.) NOM. DIA. | SEGMENT | 18" REQUIRED LENGTH OF P&C FLEX (IN.) | 24" REQUIRED LENGTH OF P&C FLEX (IN.) | 36" REQUIRED LENGTH OF P&C FLEX (IN.) | 48" REQUIRED LENGTH OF P&C FLEX (IN.) | 60" REQUIRED LENGTH OF P&C FLEX (IN.) |
|---------------------------|---------|--|--|--|--|--|
| 1½ | 90° | 33 | 42 | 61 | 80 | 99 |
| | 45° | 19 | 23 | 33 | 42 | 52 |
| | 30° | 14 | 17 | 23 | 30 | 36 |
| | 22½° | 12 | 14 | 19 | 23 | 28 |
| 2 | 90° | 32 | 42 | 61 | 79 | 98 |
| | 45° | 18 | 23 | 32 | 42 | 51 |
| | 30° | 14 | 17 | 23 | 29 | 35 |
| | 22½° | 11 | 12 | 18 | 23 | 28 |
| 2½ | 90° | 34 | 44 | 63 | 81 | 100 |
| | 45° | 20 | 25 | 33 | 44 | 53 |
| | 30° | 16 | 19 | 24 | 31 | 37 |
| | 22½° | 13 | 15 | 20 | 25 | 30 |
| 3 | 90° | 35 | 44 | 63 | 82 | 101 |
| | 45° | 20 | 25 | 34 | 44 | 53 |
| | 30° | 16 | 19 | 24 | 32 | 38 |
| | 22½° | 13 | 16 | 20 | 25 | 30 |
| 4 | 90° | 37 | 46 | 65 | 84 | 103 |
| | 45° | 22 | 27 | 37 | 46 | 55 |
| | 30° | 18 | 21 | 27 | 34 | 40 |
| | 22½° | 15 | 18 | 22 | 27 | 32 |

For other radius sweeps, use this formula: $.0175 \times \text{Radius (inches)} \times \text{Angle}^\circ = \text{Required length of P\&C Flex in inches.}$

Technical Information

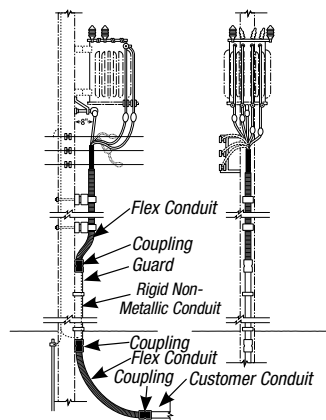

P&C Flex® conduit is flexible. Carlton® P&C Flex® Non-Metallic Corrugated Conduit is used to transition from Carlton® P&C Duct Type DB. Despite equipment being mounted away from the pole, P&C Flex® conduit remains flush to the pole.

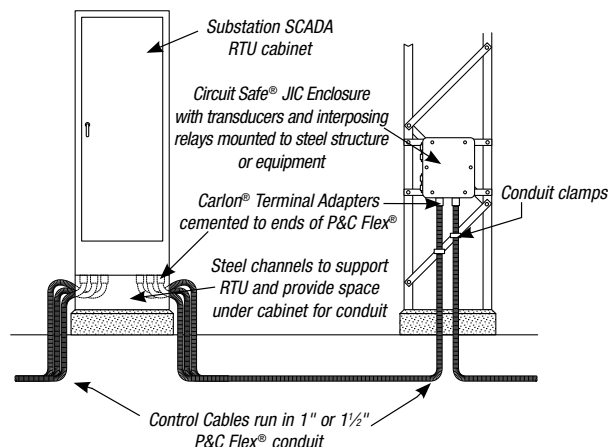

Carlton® P&C Flex® Non-Metallic Corrugated Conduit protects control cables in supervisory control and data acquisition equipment (SCADA) in distribution substations. Flexibility provides maximum utilization of equipment.



When soil conditions do not permit direct burial of cable, use Carlton® P&C Flex® Non-Metallic Corrugated Conduit to protect the cable. A lower coefficient of friction provides easy wire pulls on location. Flexibility eliminates the need for elbows.

P&C Flex® Conduit and Fittings

Suggested Applications

- Carlon® P&C Flex® Non-Metallic Corrugated Conduit is the most versatile system available for power and communications applications
- P&C Flex® combines high crush strength with flexibility.
- Longer coil lengths reduce installation time

Here are a few application ideas that illustrate how P&C Flex® can be effectively used:

In single-phase underground primary systems, lower the cost of direct buried and standard conduit systems by installing P&C Flex® Non-Metallic Corrugated Conduit with a vibratory plow.

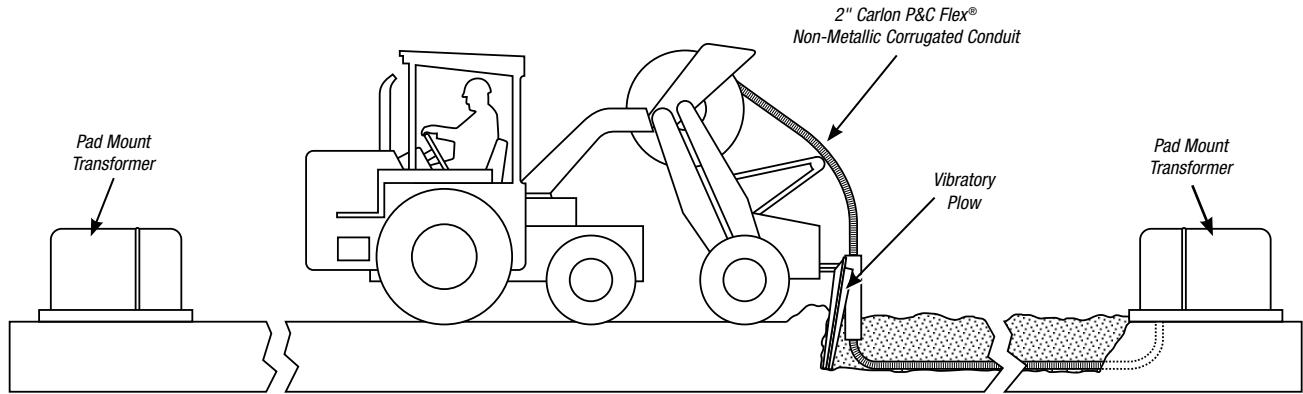

Digging up faulty cable in frozen ground can be expensive and time consuming. Use Carlon® P&C Flex® from the customer service raceway to the temporary service pedestal to restore power on an interim basis. When the service length is more than 250 feet, use a splice box and an additional length of P&C Flex® Non-Metallic Corrugated Conduit.

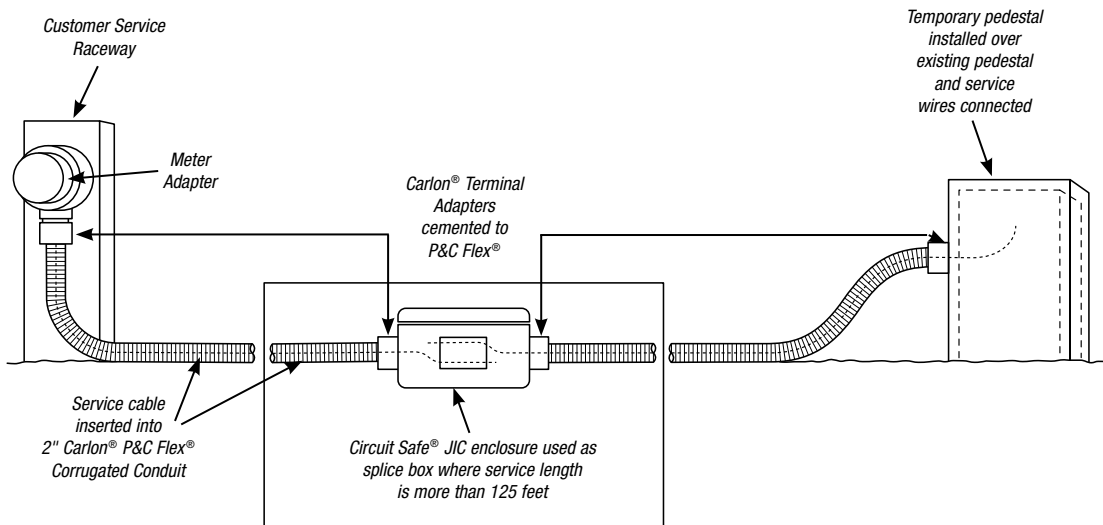

P&C Flex® Conduit and Fittings

Installation

Incorrect Method



Correct Method



Lay conduit in the trench as straight as possible. Avoid undulations up and down and side to side.

Trenching

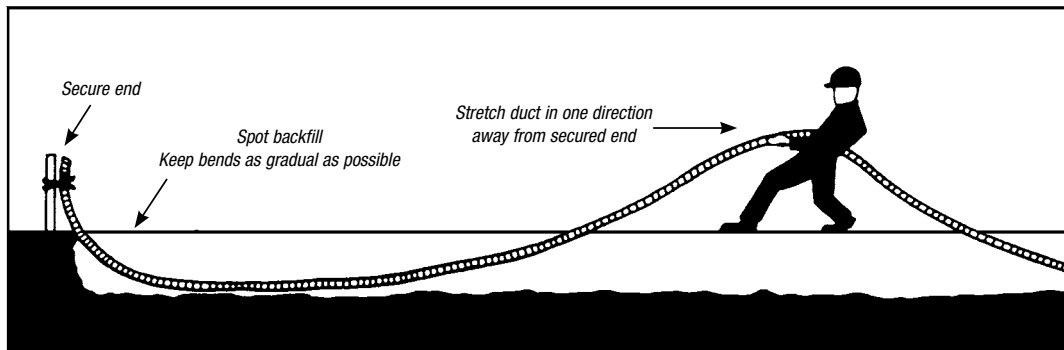

1 Trenching

Trench should be graded true and free from stones or soft spots. Backfill should also be free of stones and be firmly tamped around the sides of the conduit to develop maximum supporting strength. Tamping on top of the conduit is not recommended.

2 Backfill

In rocky soil where it is impossible to have an even trench bottom, a selected backfill should be put in before laying the conduit. Selected backfill (not tamped) at least 6" over the top of the conduit is recommended. After final backfill is placed, tamping may be used to finish the grade.

3 Duct Placement

Duct may be unreeled directly into trench or alongside trench and subsequently placed in trench. After placing in trench, secure one end and stretch it by hand to take up the slack. Spot backfill to hold in position. Do not use mechanical stretching equipment.

4 Changes in Direction

Avoid unnecessary turns, dips or changes in direction. Keep bends as gradual as possible to ensure ease of cable pull-in after duct installation.

5 Pneumatic Rodding

All commonly used vacuum or pressure rodding equipment can be used to rod P&C Flex®. The line carrier (mouse, puck, rocket) should be soft, flexible material designed to fit snugly into duct without interference.

6 Mechanical Rodding

All commonly used mechanical rodding equipment can be used to rod P&C Flex®. The tip should have a ball-type arrangement to keep rod from catching in the convolutions on the inside of duct.

Carflex® Liquidtight Flexible Conduit and Fittings

Carflex® Liquidtight Flexible Non-Metallic Conduit

Liquidtight Flexible Non-Metallic Conduit provides superior wire protection in harsh, damp environments. Carflex® Conduit is non-conductive, non-corrosive and resistant to oil, acid, ozone and alkaline. Carflex® Conduit is strong and lightweight and, because it weighs 50% less than metallic systems, it's easy to handle, transport and install. Carflex® is ideal for industrial, air conditioning, heating and outdoor lighting applications.

Features:

- Non-conductive and non-corrosive
- Lightweight for easy handling, transportation and installation
- Crush, abrasion and strain resistant
- Provides superior wire protection
- Smooth interior ideal for pulling cable
- No jagged edges
- Maintains internal I.D., even in tight-radius bends
- Type LFNC-B
- Resistant to oil, acid, ozone and alkaline
- UL® Listed for use as indicated in Article 356.2 of the NEC®, and Section 12-1300 of the Canadian Electrical Code, Part 1
- UL® Listed for outdoor use
- UL® Listed for sunlight resistance
- Trade sizes ½", ¾" and 1" are UL® Listed for direct burial and concrete encasement
- Sequentially marked footage
- Suitable for use at conduit temperatures of 80° C dry, 60° C wet and 60° C oil resistant as required by section 15-6 of ANSI/NFPA 79 and UL 1660
- Material – PVC

Coils

| CAT. NO. | NOM. SIZE (IN.) | AVG. O.D. (IN.) | AVG. I.D. (IN.) | STD. CTN. (FT.) | STD. WT. (LBS.) |
|--------------|-----------------|-----------------|-----------------|-----------------|-----------------|
| 15004-100 | ¾" | .700 | .489 | 100 | 11.70 |
| 15005C-25 | ½" | .830 | .627 | 25 | 3.25 |
| 15005-100* | ½" | .830 | .627 | 100 | 13.00 |
| 15005BK-100* | ½" | .830 | .627 | 100 | 13.00 |
| 15007-100* | ¾" | 1.040 | .825 | 100 | 18.00 |
| 15008-100* | 1" | 1.302 | 1.046 | 100 | 28.00 |
| 15009-100 | 1¼" | 1.645 | 1.385 | 100 | 37.60 |
| 15010-50 | 1½" | 1.882 | 1.580 | 50 | 22.55 |
| 15010-100 | 1½" | 1.882 | 1.580 | 100 | 47.80 |
| 15011-050 | 2" | 2.357 | 2.025 | 50 | 34.10 |

Standard color is gray.

*Joint UL Listed/CSA Approved product available



Note: Liquidtight flexible conduits, metallic and non-metallic, in contrast to rigid PVC conduit and electrical non-metallic tubing, does not have wire temperature limitations. Any temperature-rated wire (for example, 90° wire) can be used as long as the temperature conditions marked on the conduit are not exceeded. UL Listed conduits that are not marked are limited to a maximum temperature of 60° C wet or dry.

Applications:

- Control and motor
- Air conditioning and heating
- Computer power distribution
- Machine tools
- Console wiring
- Transformer connections
- Outdoor lighting

Custom Orders:

Available in gray (standard) and black.



Reels

| CAT. NO. | NOM. SIZE (IN.) | AVG. O.D. (IN.) | AVG. I.D. (IN.) | STD. CTN. (FT.) | STD. WT. (LBS.) |
|-------------|-----------------|-----------------|-----------------|-----------------|-----------------|
| 15004-001 | ¾" | .700 | .489 | 1000 | 145.0 |
| 15005-001 | ½" | .830 | .627 | 1000 | 157.0 |
| 15005BK-001 | ½" | .830 | .627 | 1000 | 157.0 |
| 15007-001 | ¾" | 1.040 | .825 | 1000 | 212.0 |
| 15008-500 | 1" | 1.302 | 1.046 | 500 | 155.0 |
| 15009-200 | 1¼" | 1.645 | 1.385 | 200 | 100.0 |
| 15010-150 | 1½" | 1.882 | 1.580 | 150 | 95.7 |
| 15011-100 | 2" | 2.357 | 2.025 | 100 | 94.6 |

Standard color is gray.

NEC and National Electrical Code are registered trademarks of the National Fire Protection Association, Inc.

Carflex® Liquidtight Flexible Conduit and Fittings

Carflex® X-Flex™ Non-Metallic Mechanical Protection Tubing

Extra-Flexible Non-Metallic Mechanical Protection Tubing is ideal for applications requiring extra strength and flexibility, such as robotics and repetitive-flexing arms. Carflex® X-Flex™ is non-conductive, non-corrosive and resistant to oil, acid, ozone and alkaline. It's designed for use with standard Carflex® fittings, providing a complete non-metallic system. Carflex® X-Flex™ is lightweight for easier handling, transportation and installation.

Features:

- Extra-strong and flexible to withstand repetitive motions
- Non-conductive and non-corrosive
- Resistant to oil, acid, ozone and alkaline
- Lightweight for easy handling, transportation and installation
- Crush, abrasion and strain resistant
- Provides superior wire protection
- Smooth interior ideal for pulling cable
- No jagged edges
- Rated for continuous use at 60° C (140° F) ambient
- Type NMPT-B
- UL® Recognized to UL® Standard 1696
- Material – PVC

Applications:

- Repetitive flexing arms
- Robotics
- Machine tools
- Automatic/moving machinery
- Control and motor



Where noted by ♦

Coils

| CAT. NO. | NOM. SIZE (IN.) | AVG. O.D. (IN.) | AVG. I.D. (IN.) | STD. CTN. (FT.) | STD. WT. (LBS.) |
|------------|-----------------|-----------------|-----------------|-----------------|-----------------|
| 15104-100 | 3/8 | .700 | .489 | 100 | 9.09 |
| 15105-100 | 1/2 | .830 | .627 | 100 | 10.01 |
| 15107-100♦ | 3/4 | 1.040 | .825 | 100 | 13.91 |
| 15108-100♦ | 1 | 1.302 | 1.046 | 100 | 18.25 |
| 15109-100♦ | 1 1/4 | 1.645 | 1.385 | 100 | 27.65 |
| 15110-100 | 1 1/2 | 1.882 | 1.580 | 100 | 38.00 |
| 15111-050 | 2 | 2.357 | 2.025 | 50 | 24.22 |

Carflex® Liquidtight Flexible Conduit and Fittings

For use with Carflex® conduit and Carflex® X-Flex™ tubing.

Carflex® Liquidtight Straight Fittings

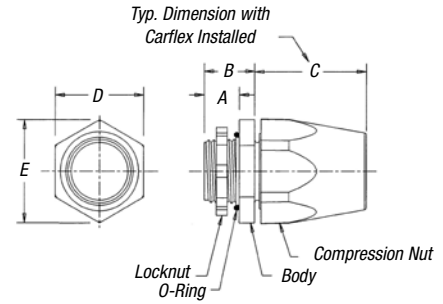
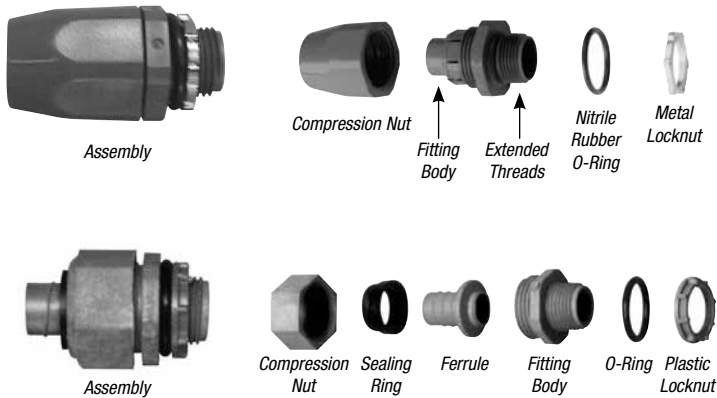

LT43C-CAR, LT43D-NEW, LT43E-NEW, LT43F

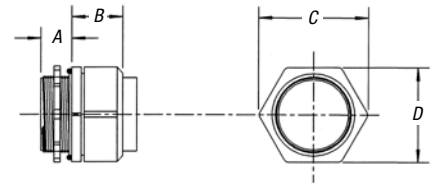

LT43G, LT43H

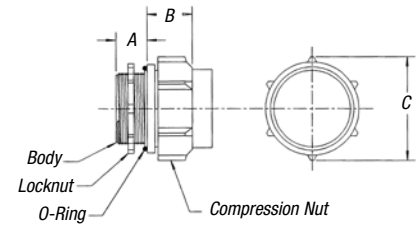

LT43J

Features:

- Non-conductive and non-corrosive
- Resistant to oil, acid, ozone and alkaline
- Easy to install
- Approved for indoor and outdoor locations
- UL® Listed for wet locations
- Nitrile rubber O-ring for a liquidtight termination
- Temperatures up to 225° F (107° C)
- Meets UL® Standard 514B
- Approved for direct burial
- Material: Nylon 6.6



| CAT. NO. | SIZE (IN.) | STD. CTN. | STD. WT. (LBS.) | A (IN.) | B (IN.) | C (IN.) | D (IN.) | E (IN.) |
|-----------|------------|-----------|-----------------|---------|---------|---------|---------|---------|
| LT43C | 3/8 | 50 | 3.6 | .55 | .75 | 1.60 | 1.30 | 1.40 |
| LT43C-CAR | 3/8 | 15 | 1.4 | .55 | .75 | 1.60 | 1.30 | 1.40 |
| LT43D-NEW | 1/2 | 50 | 4.2 | .56 | .91 | 1.62 | 1.30 | 1.40 |
| LT43E-NEW | 3/4 | 50 | 6.6 | .56 | .91 | 1.88 | 1.61 | 1.71 |
| LT43F | 1 | 25 | 5.5 | .70 | 1.00 | 2.20 | 1.90 | 2.04 |
| LT43G | 1 1/4 | 5 | 1.5 | .71 | 1.16 | 2.50 | 2.17 | |
| LT43H | 1 1/2 | 5 | 2.0 | .75 | 1.36 | 2.78 | 2.43 | |
| LT43J | 2 | 5 | 2.5 | 1.00 | 1.45 | 3.33 | | |

Carflex® Liquidtight Flexible Conduit and Fittings

For use with Carflex® conduit and Carflex® X-Flex™ tubing.

Carflex® Liquidtight 90° Fittings

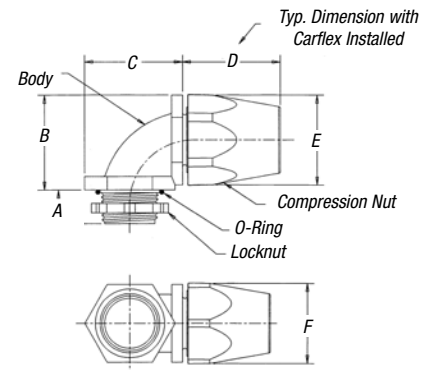
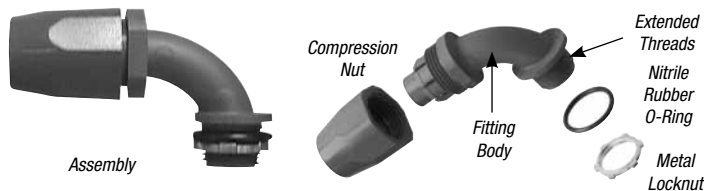

LT20C-CAR, LT20F

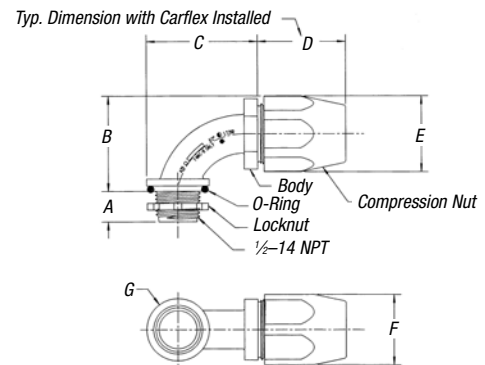

LT20D-NEW, LT20E-NEW

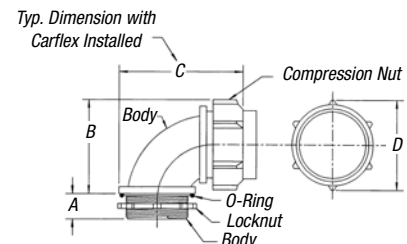

LT20G, LT20H, LT20J

Features:

- Non-conductive and non-corrosive
- Resistant to oil, acid, ozone and alkaline
- Easy to install
- Approved for indoor and outdoor locations
- UL® Listed for wet locations
- Nitrile rubber O-ring for a liquidtight termination
- Temperatures up to 225° F (107° C)
- Meets UL® Standard 514B
- Material: Nylon 6.6



| CAT. NO. | SIZE (IN.) | STD. CTN. | STD. WT. (LBS.) | A (IN.) | B (IN.) | C (IN.) | D (IN.) | E (IN.) | F (IN.) | G (IN.) |
|-----------|------------|-----------|-----------------|---------|---------|---------|---------|---------|---------|---------|
| LT20C | 3/8 | 50 | 4.9 | .56 | 1.44 | 1.44 | 1.56 | 1.39 | 1.26 | |
| LT20C-CAR | 3/8 | 15 | 1.8 | .56 | 1.44 | 1.44 | 1.56 | 1.39 | 1.26 | |
| LT20D-NEW | 1/2 | 50 | 4.9 | .56 | 1.76 | 2.05 | 1.62 | 1.40 | 1.30 | 1.15 |
| LT20E-NEW | 3/4 | 50 | 8.0 | .56 | 2.04 | 2.35 | 1.88 | 1.71 | 1.61 | 1.50 |
| LT20F | 1 | 25 | 6.9 | .70 | 2.01 | 2.01 | 2.26 | 2.04 | 1.90 | |
| LT20G | 1 1/4 | 5 | 1.9 | .75 | 2.50 | 3.55 | 2.48 | | | |
| LT20H | 1 1/2 | 5 | 2.2 | .75 | 2.80 | 3.98 | 2.77 | | | |
| LT20J | 2 | 5 | 3.4 | .94 | 3.48 | 4.56 | 3.33 | | | |

Carflex® Liquidtight Flexible Conduit and Fittings

Carflex® One-Piece Liquidtight Fittings

Unique Design

The simple, one-piece body design of the Carflex® One-Piece Liquidtight Non-Metallic Fitting requires no disassembly of components for installation. The system is so strong that there is no need for a compression nut.

PVC Construction

PVC construction of the fitting and locknut provides unparalleled protection from water, oil and dust. Totally non-metallic, the system is non-conductive and will not corrode or rust. It withstands temperatures up to 140° F (60° C).

Features:

- Approved for indoor and outdoor locations
- UL® Listed for wet locations

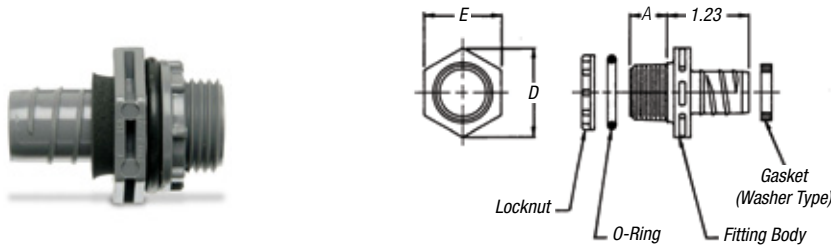

Straight Fittings

| CAT. NO. | TRADE SIZE (IN.) | THREAD SIZE | STD. CTN. | STD. WT. (LBS.) | A (IN.) | D (IN.) | E (IN.) |
|------------|------------------|-------------|-----------|-----------------|---------|---------|---------|
| LN43DA | ½ | ½-14 NPT | 100 | 2.8 | .56 | 1.34 | 1.19 |
| LN43EA | ¾ | ¾-14 NPT | 50 | 2.2 | .56 | 1.63 | 1.44 |
| LN43FA | 1 | 1-11½ NPT | 25 | 3 | .69 | 1.99 | 1.75 |
| LN43FA-CAR | 1 | 1-11½ NPT | 15 | 1 | .69 | 1.99 | 1.75 |

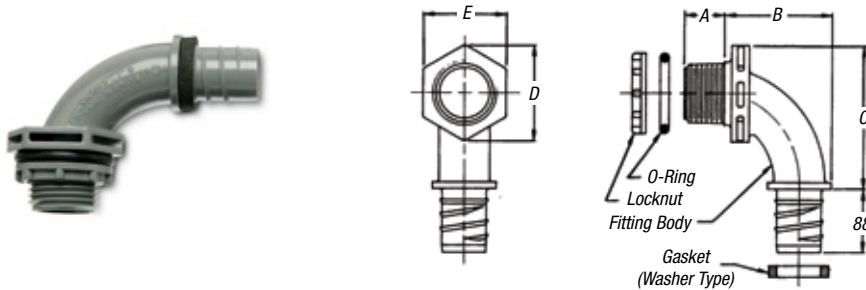

90° Fittings

| CAT. NO. | TRADE SIZE (IN.) | THREAD SIZE | STD. CTN. | STD. WT. (LBS.) | A (IN.) | B (IN.) | C (IN.) | D (IN.) | E (IN.) |
|------------|------------------|-------------|-----------|-----------------|---------|---------|---------|---------|---------|
| LN20DA | ½ | ½-14 NPT | 100 | 4.3 | .56 | 1.50 | 1.99 | 1.34 | 1.19 |
| LN20EA | ¾ | ¾-14 NPT | 50 | 3.1 | .56 | 1.73 | 2.25 | 1.63 | 1.44 |
| LN20FA | 1 | 1-11½ NPT | 25 | 3.2 | .69 | 1.86 | 2.58 | 1.99 | 1.75 |
| LN20FA-CAR | 1 | 1-11½ NPT | 10 | 1 | .69 | 1.86 | 2.58 | 1.99 | 1.75 |

Carflex® Liquidtight Flexible Conduit and Fittings

Carflex® Omni Connectors — Straight



Features:

- Available in sizes 3/8" through 1" conduit and tubing
- All-nylon construction resists saltwater, weak acids, gasoline, alcohol, oil, grease and common solvents
- No disassembly required

- No threading of the conduit or tubing required to install
- Complete conduit/connector system is reusable
- Suitable for indoor/outdoor use
- Lower installed cost
- Black connectors provided with nylon locknut
- Gray connectors provided with assembled O-ring and metal locknuts
- Protection class IP 68 per DIN 40050 up to 70 psi (5 bar) water pressure
- Molded of type 6/6 nylon. ASTM D-4066-PA 111; flammability classification 94V-2

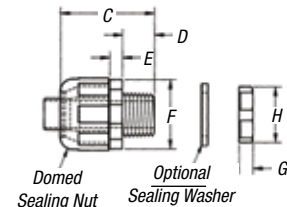

| CAT. NO. BLACK | CAT. NO. GRAY* | SIZE (IN.) | DESCRIPTION | BODY & SEALING UNIT | | | | | LOCKING NUT | | |
|-------------------|-------------------|---------------|----------------------|-------------------------------|--------------------------------|------------------------------|--|--------------------------------|-----------------------|--------------------------------|--------------|
| | | | | A | C | D | E | F | G | H | STD. CTN. |
| | | | | CLEARANCE HOLE IN. (MM) | MAX O.A. LENGTH IN. (MM) | THREAD LENGTH IN. (MM) | WRENCHING NUT THICKNESS IN. (MM) | WRENCHING FLATS IN. (MM) | THICKNESS IN. (MM) | WRENCHING FLATS IN. (MM) | |
| LT38 | LT38G | 3/8 | Straight L/T Fitting | .875 (22.2) | 2.000 (50.8) | .625 (15.9) | .250 (6.3) | 1.328 (33.7) | .266 (6.7) | 1.062 (26.9) | 50 |
| LT50 | LT50G | 1/2 | Straight L/T Fitting | .875 (22.2) | 2.000 (50.8) | .625 (15.9) | .250 (6.3) | 1.328 (33.7) | .266 (6.7) | 1.062 (26.9) | 50 |
| LT75 | LT75G | 3/4 | Straight L/T Fitting | 1.109 (28.2) | 2.031 (51.6) | .625 (15.9) | .250 (6.3) | 1.562 (39.7) | .266 (6.7) | 1.312 (33.3) | 25 |
| LT100 | LT100G | 1 | Straight L/T Fitting | 1.375 (34.9) | 2.250 (57.1) | .781 (19.8) | .250 (6.3) | 1.875 (47.6) | .266 (6.7) | 1.625 (41.3) | 20 |

*Gray connectors provided with assembled O-ring and metal locknuts. Black connectors provided with nylon locknuts only.

Carflex® Omni Connectors — 90° Angle



Features:

- Available in sizes 3/8" through 1" conduit and tubing
- Smooth internal surfaces for easier wire installation around corner angles
- All-nylon construction resists saltwater, weak acids, gasoline, alcohol, oil, grease and common solvents
- No disassembly required

- No threading of the conduit or tubing required to install
- Complete conduit/connector system is reusable
- Use of a sealing washer may be required for wet locations
- Suitable for indoor/outdoor use
- Lower installed cost
- Black connectors provided with nylon locknut, packed separately
- Gray connectors provided with assembled O-ring and metal locknuts.
- Protection class IP 68 per DIN 40050 up to 70 psi (5 bar) water pressure
- Molded of type 6/6 nylon. ASTM D-4066-PA 111; flammability classification 94V-2

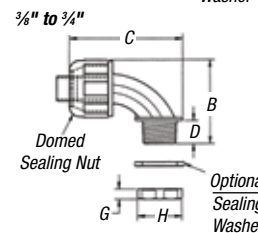
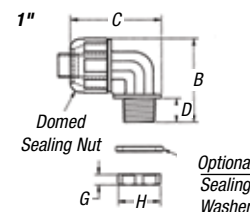

| CAT. NO. BLACK | CAT. NO. GRAY | SIZE (IN.) | DESCRIPTION | BODY & SEALING UNIT | | | | LOCKING NUT | | |
|-------------------|------------------|---------------|-----------------------|-------------------------------|--------------------------------|--------------------------------|------------------------------|-----------------------|--------------------------------|--------------|
| | | | | A | B | C | D | G | H | STD. CTN. |
| | | | | CLEARANCE HOLE IN. (MM) | MAX O.A. HEIGHT IN. (MM) | MAX O.A. LENGTH IN. (MM) | THREAD LENGTH IN. (MM) | THICKNESS IN. (MM) | WRENCHING FLATS IN. (MM) | |
| LT938 | LT938G | 3/8 | 90 Degree L/T Fitting | .875 (22.2) | 1.98 (50.3) | 2.91 (73.9) | .52 (13.2) | .27 (6.8) | 1.06 (26.9) | 25 |
| LT950 | LT950G | 1/2 | 90 Degree L/T Fitting | .875 (22.2) | 1.98 (50.3) | 2.91 (73.9) | .52 (13.2) | .27 (6.8) | 1.06 (26.9) | 25 |
| LT975 | LT975G | 3/4 | 90 Degree L/T Fitting | 1.109 (28.2) | 2.29 (58.2) | 3.17 (80.5) | .52 (13.2) | .27 (6.8) | 1.31 (33.3) | 20 |
| LT9100 | LT9100G | 1 | 90 Degree L/T Fitting | 1.375 (34.9) | 2.84 (72.1) | 3.18 (80.8) | .78 (19.8) | .27 (6.8) | 1.61 (40.9) | 10 |

Carflex® Liquidtight Flexible Conduit and Fittings

Carflex® Fittings Installation Instructions

LT43C-CAR, LT43F thru J, LT20C-CAR, LT20F thru J.

1. Cut the end of the Carflex® conduit or Carflex® X-Flex™ tubing square.
2. Install compression nut and sealing gland ring over the end of the conduit or tubing.
3. Insert the ferrule end of the fitting into the conduit using a clockwise twisting action.
4. Screw fitting body into compression nut.
5. When installation is completed, use a wrench to tighten compression nut one-quarter (¼) turn past hand-tight. Do not overtighten fitting.

**To prevent damage to conductors, conduit and fittings, do not twist Carflex during installation.*

LT43D-NEW, LT43E-NEW, LT20D-NEW, LT20E-NEW.

1. Cut the end of the Carflex® conduit or Carflex® X-Flex™ tubing square.
2. Install compression nut over the end of the conduit or tubing.
3. Insert the ferrule end of the fitting into the conduit using a clockwise twisting action. (Be sure conduit is fully inserted to the bottom of the fitting shoulder.)
4. Screw compression nut onto fitting body.
5. Use a wrench to tighten compression nut one (1) full turn past hand-tight. Do not overtighten fitting.

Carflex® Liquidtight Conduit Technical Information

1. There shall be no more than the equivalent of four (4) quarter (90°) bends (360° total) between pull points, conduit bodies and boxes.
2. The radius of the curve of the center of the conduit or tubing shall not be less than that shown in the table (**right**):

| SIZE OF CONDUIT OR TUBING | | RADIUS TO CENTER OF CONDUIT OR TUBING | |
|---------------------------|-----------------|---------------------------------------|---------|
| INCHES | (METRIC DESGR.) | INCHES | (MM) |
| ⅜ | (14) | 4 | (101.6) |
| ½ | (16) | 4 | (101.6) |
| ¾ | (21) | 4½ | (114.3) |
| 1 | (27) | 5¼ | (146.0) |
| 1¼ | (35) | 7¼ | (184.1) |
| 1½ | (41) | 8¼ | (209.5) |
| 2 | (53) | 9½ | (241.3) |

UL® Listed for Use as Indicated in Article 356 of the National Electrical Code®

- Cellular Metal Floor Raceways, Connections to Cabinets & Wall Outlets
- Class I, Div. 2, Hazardous Location
- Class II, Div. 1, Hazardous Location
- Class III, Div. 1, Hazardous Location
- Computer Room Raised Floor
- Concealed Locations
- Intrinsically Safe Systems
- Lighting Fixtures, Connection to Electric Discharge Fixture
- Non-Metallic Boxes
- RV Engine Generator
- Swimming Pool Pump Motors
- Tap Conductors (Fixture Whips)
- Underfloor Raceway, Connection to Cabinets and Wall Outlets
- Wireway, Extensions from Wireways, Wiring Methods
 - Agricultural Buildings, Flexible Connections
 - Electric Signs, 1000 Volts, Nominal, or Less
 - Electric Signs, Over 1000 Volts (per Section 600.32(A)(1))
 - Floating Buildings
 - Marinas and Boatyards
 - Service Entrance Conductors
- Wiring on Buildings, Outside Branch Circuits and Feeders
- Direct-Burial Applications

Carflex® Liquidtight Flexible Conduit and Fittings

Carflex® Liquidtight Whips

Carflex® Liquidtight Whip assemblies save the customer time and hassle of having to hunt for the needed components. Our moisture-tight non-metallic flexible conduit system is ideal for installing swimming pool motors, hot tubs, spas, air conditioners, pumps, outdoor lighting and more.

Unlike plastic-coated metal conduit, the Carlon® Carflex® system has no metal core to fatigue, rust or corrode. The Carflex® system has no sharp edges or burrs to cut into the wire insulation. Metal conduit is subject to fatigue and penetration of moisture.

The Carflex® Liquidtight Whip assembly is complete with Carflex® moisture-tight conduit, wire, one straight fitting and one 90° fitting. All this enables quick and trouble-free installation.

Features:

- Designed for easy installation
- Will not rust or corrode
- Can be used for many commercial and residential applications
- Many applications such as swimming pool filters, hot tub spas, air conditioners, pumps, etc.
- Available in ½" and ¾" diameters
- Available in 4' and 6' lengths
- Each kit contains (1) straight and (1) 90° fitting
- Complete with (3) 8-, 10- or 12-gauge wires
- Wire colors: black, green and red

Custom Orders:

Also available in special configurations including different fitting combinations, wire types and sizes and metal-fitting variations. Consult your Thomas & Betts Sales Team for details.



| CAT. NO. | DESCRIPTION | WIRE SIZE (GAUGE) | STD. CTN. | STD. WT. (LBS.) |
|----------|-------------|---------------------------------|----------------|-----------------|
| WCD4 | ½" | Carflex Whip — 4 foot, 10 gauge | 6 (poly bag) | 10.6 |
| WCD6 | ½" | Carflex Whip — 6 foot, 10 gauge | 6 (poly bag) | 15.8 |
| WCE4 | ¾" | Carflex Whip — 4 foot, 8 gauge | 6 (poly bag) | 12.4 |
| WCE6 | ¾" | Carflex Whip — 6 foot, 8 gauge | 6 (poly bag) | 15.8 |
| WCD3124 | ½" | Carflex Whip — 4 foot, 12 gauge | 20 (bulk pack) | 32.4 |
| WCD3126 | ½" | Carflex Whip — 6 foot, 12 gauge | 20 (bulk pack) | 47.9 |
| WCD3104 | ½" | Carflex Whip — 4 foot, 10 gauge | 20 (bulk pack) | 35.2 |
| WCD3106 | ½" | Carflex Whip — 6 foot, 10 gauge | 20 (bulk pack) | 52.8 |
| WCE3084 | ¾" | Carflex Whip — 4 foot, 8 gauge | 15 (bulk pack) | 30.9 |
| WCE3086 | ¾" | Carflex Whip — 6 foot, 8 gauge | 15 (bulk pack) | 39.6 |

Technical Information

Typical Properties of Conduit Raw Material Compound

| THERMAL | ASTM TEST | TYPICAL VALUES |
|--|-----------|-------------------------|
| Co-efficient of Thermal Expansion-inch/inch/° F (properties @ 73.4° F) | D696 | 3.38 x 10 ⁻⁵ |
| Heat Distortion ° F at 264 psi | D648 | 160° F |
| Thermal Conductivity BTU (hr.) (ft.) (° F/in.) | N/A | 1.3 |

| MECHANICAL | ASTM TEST | TYPICAL VALUES |
|----------------------------------|-----------|----------------|
| Specific Gravity | D792 | 1.43 - 1.6 |
| Tensile Strength (psi) @ 73.4° F | D638 | 5,000-6,500 |
| Izod Impact ft lbs./in. of notch | D256 | .65 - 1.5 |
| Flexural Strength (psi) | D790 | 12,500 |
| Compressive Strength (psi) | D695 | 9,000 |
| Hardness (Durometer D) | D2240 | 85 |

| ELECTRICAL | ASTM TEST | TYPICAL VALUES |
|------------------------------------|-----------|----------------|
| Dielectrical Strength volts/mil | D149 | 1100 |
| Dielectric Constant 60 CPS @ 30° C | D150 | 4.00 |
| Power Factor 60 CPS @ 30° C | D150 | 1.93 |

| IMPEDANCE (VOLTS LOST PER AMPERE PER 100 FEET) | 3090% P.F. | 80% P.F. | 1090% P.F. | 80% P.F. |
|---|---------------|-------------|---------------|-------------|
| Steel Conduit | .0118 | .0123 | .0136 | .0142 |
| Schedule 40 | .0105 | .0106 | .0121 | .0122 |

Using 250 kcmil copper conductor. Comparable values for other conductor sizes.

Wire Fill

Maximum number of conductors in Schedule 40 PVC conduit (Based on Table 1, Chapter 9 of the NEC®)

| TYPE LETTERS | CONDUCTOR SIZE AWG, KCMIL | TRADE SIZE | | | | | | | | | | | | | | |
|--------------------|---------------------------|------------|----|----|----|----|-----|-----|-----|-----|-----|-----|-----|-----|-----|--|
| | | ½ | ¾ | 1 | 1¼ | 1½ | 2 | 2½ | 3 | 3½ | 4 | 4½ | 5 | 6 | 8 | |
| THWN | 14 | 13 | 24 | 39 | 69 | 94 | 154 | | | | | | | | | |
| | 12 | 10 | 18 | 29 | 51 | 79 | 114 | 164 | | | | | | | | |
| THHN | 10 | 6 | 11 | 18 | 32 | 44 | 73 | 194 | 160 | | | | | | | |
| | 8 | 3 | 5 | 9 | 19 | 22 | 36 | 51 | 71 | 106 | 136 | | | | | |
| FEP (14 thru 2) | 6 | 1 | 4 | 6 | 11 | 15 | 26 | 37 | 57 | 76 | 98 | 125 | 154 | | | |
| | 4 | 1 | 2 | 4 | 7 | 9 | 16 | 22 | 35 | 47 | 60 | 75 | 94 | 137 | 236 | |
| FEPB (14 thru 8) | 3 | 1 | 1 | 3 | 6 | 8 | 13 | 19 | 29 | 39 | 51 | 64 | 90 | 116 | 201 | |
| | 2 | 1 | 1 | 3 | 5 | 7 | 11 | 16 | 25 | 33 | 43 | 54 | 67 | 97 | 169 | |
| PFA (14 thru 4/0) | 1 | 1 | 1 | 3 | 5 | 9 | 12 | 18 | 25 | 32 | 49 | 59 | 72 | 125 | | |
| | 1/0 | 1 | 1 | 3 | 4 | 7 | 10 | 15 | 21 | 27 | 33 | 42 | 61 | 105 | | |
| | 2/0 | 1 | 1 | 2 | 3 | 6 | 8 | 13 | 17 | 22 | 28 | 35 | 51 | 88 | | |
| | 3/0 | 1 | 1 | 1 | 3 | 5 | 7 | 11 | 14 | 18 | 23 | 29 | 42 | 73 | | |
| PFAH (14 thru 4/0) | 4/0 | 1 | 1 | 1 | 2 | 4 | 6 | 9 | 12 | 15 | 19 | 24 | 35 | 61 | | |
| | 250 | 1 | 1 | 1 | 3 | 4 | 7 | 10 | 12 | 16 | 20 | 28 | 49 | | | |
| | 300 | 1 | 1 | 1 | 3 | 4 | 6 | 8 | 11 | 13 | 17 | 24 | 42 | | | |
| Z (14 thru 4/0) | 350 | 1 | 1 | 1 | 2 | 3 | 5 | 7 | 9 | 12 | 15 | 21 | 37 | | | |
| | 400 | 1 | 1 | 1 | 3 | 5 | 6 | 8 | 10 | 13 | 19 | 33 | | | | |
| | 500 | 1 | 1 | 1 | 2 | 4 | 5 | 7 | 9 | 11 | 16 | 27 | | | | |
| XHHW (4 thru 500) | 600 | 1 | 1 | 1 | 1 | 3 | 4 | 5 | 7 | 9 | 13 | 22 | | | | |
| | 700 | 1 | 1 | 1 | 1 | 3 | 4 | 5 | 6 | 8 | 11 | 19 | | | | |
| | 750 | 1 | 1 | 1 | 1 | 2 | 3 | 4 | 6 | 7 | 11 | 19 | | | | |
| XHHW | 6 | 1 | 3 | 5 | 9 | 13 | 21 | 30 | 47 | 63 | 81 | 102 | 128 | 185 | 320 | |
| | 600 | 1 | 1 | 1 | 1 | 3 | 4 | 5 | 7 | 9 | 13 | 22 | | | | |
| | 700 | 1 | 1 | 1 | 1 | 3 | 4 | 5 | 6 | 7 | 11 | 19 | | | | |
| 750 | 1 | 1 | 1 | 1 | 2 | 3 | 4 | 6 | 7 | 10 | 18 | | | | | |

Maximum number of conductors in Schedule 80 PVC conduit (Based on Table 1, Chapter 9 of the NEC®)

| CONDUCTOR SIZE AWG, KCMIL | TRADE SIZE | TRADE SIZE | | | | | | | | | | | | | |
|---------------------------|------------|------------|----|----|----|----|-----|-----|-----|-----|-----|--|--|--|--|
| | | ½ | ¾ | 1 | 1¼ | 1½ | 2 | 2½ | 3 | 4 | 5 | | | | |
| #14 | THW | 4 | 8 | 13 | 24 | 34 | 57 | 82 | 128 | | | | | | |
| | THHN | 10 | 19 | 33 | 58 | 81 | 135 | 194 | 0 | | | | | | |
| 12 | THW | 3 | 6 | 11 | 20 | 28 | 47 | 67 | 105 | 183 | | | | | |
| | THHN | 8 | 14 | 24 | 43 | 60 | 100 | 144 | 0 | | | | | | |
| 10 | THW | 3 | 5 | 9 | 16 | 22 | 37 | 54 | 85 | 148 | | | | | |
| | THHN | 5 | 9 | 15 | 27 | 38 | 64 | 92 | 143 | | | | | | |
| 8 | THW | 1 | 2 | 4 | 8 | 11 | 19 | 28 | 44 | 77 | 121 | | | | |
| | THHN | 1 | 4 | 7 | 13 | 18 | 31 | 45 | 70 | 123 | 195 | | | | |
| 6 | THW | 1 | 1 | 3 | 6 | 8 | 14 | 20 | 32 | 56 | 88 | | | | |
| | THHN | 1 | 3 | 5 | 9 | 13 | 22 | 32 | 50 | 88 | 140 | | | | |
| 4 | THW | 0 | 1 | 2 | 4 | 6 | 10 | 15 | 24 | 42 | 66 | | | | |
| | THHN | 1 | 1 | 3 | 6 | 8 | 13 | 20 | 31 | 54 | 86 | | | | |
| 3 | THW | 0 | 1 | 1 | 4 | 5 | 9 | 13 | 20 | 36 | 57 | | | | |
| | THHN | 1 | 1 | 2 | 5 | 7 | 11 | 17 | 26 | 46 | 73 | | | | |
| 2 | THW | 0 | 1 | 1 | 3 | 4 | 8 | 11 | 17 | 31 | 49 | | | | |
| | THHN | 1 | 1 | 1 | 4 | 5 | 9 | 14 | 22 | 38 | 61 | | | | |
| 1 | THW | 0 | 1 | 1 | 1 | 3 | 5 | 8 | 13 | 22 | 35 | | | | |
| | THHN | 0 | 1 | 1 | 3 | 4 | 7 | 10 | 16 | 28 | 45 | | | | |
| 0 | THW | 0 | 0 | 1 | 1 | 2 | 4 | 7 | 11 | 19 | 30 | | | | |
| | THHN | 0 | 1 | 1 | 2 | 3 | 6 | 8 | 13 | 24 | 38 | | | | |
| 00 | THW | 0 | 0 | 1 | 1 | 1 | 4 | 6 | 9 | 16 | 26 | | | | |
| | THHN | 0 | 1 | 1 | 1 | 3 | 5 | 7 | 11 | 20 | 32 | | | | |
| 000 | THW | 0 | 0 | 1 | 1 | 1 | 3 | 5 | 8 | 14 | 22 | | | | |
| | THHN | 0 | 0 | 1 | 1 | 2 | 4 | 6 | 9 | 16 | 26 | | | | |
| 0000 | THW | 0 | 0 | 1 | 1 | 1 | 3 | 4 | 6 | 11 | 18 | | | | |
| | THHN | 0 | 0 | 1 | 1 | 1 | 3 | 5 | 8 | 14 | 22 | | | | |
| 250 | THW | 0 | 0 | 0 | 1 | 1 | 1 | 3 | 5 | 9 | 14 | | | | |
| | THHN | 0 | 0 | 0 | 1 | 1 | 2 | 4 | 6 | 11 | 18 | | | | |
| 300 | THW | 0 | 0 | 0 | 1 | 1 | 1 | 3 | 4 | 8 | 13 | | | | |
| | THHN | 0 | 0 | 0 | 1 | 1 | 1 | 3 | 5 | 9 | 15 | | | | |
| 350 | THW | 0 | 0 | 0 | 1 | 1 | 1 | 2 | 4 | 7 | 11 | | | | |
| | THHN | 0 | 0 | 0 | 1 | 1 | 1 | 3 | 4 | 8 | 13 | | | | |
| 400 | THW | 0 | 0 | 0 | 0 | 1 | 1 | 1 | 3 | 6 | 10 | | | | |
| | THHN | 0 | 0 | 0 | 1 | 1 | 1 | 2 | 4 | 7 | 12 | | | | |
| 500 | THW | 0 | 0 | 0 | 0 | 1 | 1 | 1 | 3 | 5 | 8 | | | | |
| | THHN | 0 | 0 | 0 | 0 | 1 | 1 | 1 | 3 | 6 | 10 | | | | |
| 600 | THW | 0 | 0 | 0 | 0 | 0 | 1 | 1 | 1 | 4 | 7 | | | | |
| | THHN | 0 | 0 | 0 | 0 | 1 | 1 | 1 | 3 | 5 | 8 | | | | |
| 700 | THW | 0 | 0 | 0 | 0 | 0 | 1 | 1 | 1 | 3 | 6 | | | | |

NEC and National Electrical Code are registered trademarks of the National Fire Protection Association, Inc.

Weight Comparison

Carlon® Schedule 40 rigid non-metallic conduit compared to other conduit in pounds per 100 feet (approx.)

| NOM. SIZE | CARLON® | | ALUMINUM | ELECTRICAL TUBING (EMT) | INTERMEDIATE METAL CONDUIT (IMC) | RIGID METAL CONDUIT (RMC) |
|-----------|--|--|----------|-------------------------|----------------------------------|---------------------------|
| | SCHEDULE 40 RIGID NON-METALLIC CONDUIT | SCHEDULE 80 RIGID NON-METALLIC CONDUIT | | | | |
| ½ | 18 | 22 | 27 | 30 | 57 | 79 |
| ¾ | 23 | 29 | 36 | 46 | 78 | 105 |
| 1 | 35 | 43 | 53 | 66 | 112 | 153 |
| 1¼ | 48 | 60 | 70 | 96 | 114 | 201 |
| 1½ | 57 | 72 | 86 | 112 | 176 | 246 |
| 2 | 76 | 100 | 116 | 142 | 230 | 334 |
| 2½ | 125 | 153 | 183 | 230 | 393 | 527 |
| 3 | 164 | 212 | 239 | 270 | 483 | 690 |
| 3½ | 198 | | 288 | 350 | 561 | 831 |
| 4 | 234 | 310 | 340 | 400 | 625 | 982 |
| 5 | 317 | 431 | 465 | Not Made | Not Made | 1344 |
| 6 | 412 | 592 | 612 | Not Made | Not Made | 1770 |

Technical Information

Expansion and Contraction

Temperature Considerations for Rigid Non-Metallic Conduit Compensation for Linear Expansion

Like all construction materials, PVC will expand or contract with variations in temperatures. The coefficient of linear expansion in PVC conduit is 3.38×10^{-5} in./in./°F as compared to 1.2×10^{-5} for aluminum and $.6 \times 10^{-5}$ for steel. An expansion fitting is needed whenever the change in length due to temperature variation will be ¼ in. or greater per 352.44 of the NEC.

Add 30° F to the estimated temperature range when conduit is installed in direct sunlight to allow for radiant heating.

An expansion fitting consists of two sections, one telescoping inside another. When installing expansion fittings, alignment of piston and barrel is important. Be sure to mount expansion fitting level for best performance.

For a vertical run, the expansion fitting must be installed close to the top of the run with the barrel jointing down, in order that rain water does not run into the opening. The lower end of the conduit run must be secured at the bottom so that any length change due to temperature variation will result in an upward movement.

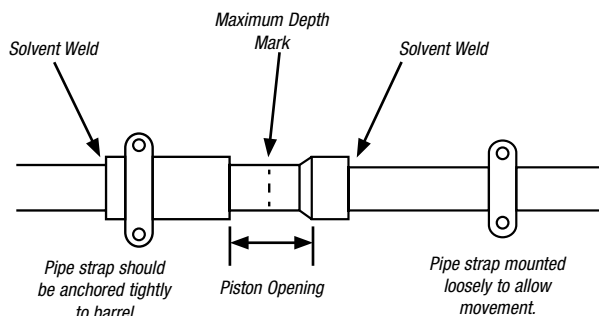

Determine the Piston Opening

The expansion joint must be installed to allow both expansion and contraction of the conduit run. The correct piston opening for any installation condition should use the following formula:

$$O = \left[\frac{T_{\text{max}} - T_{\text{installed}}}{\Delta T} \right] E$$

Example

380 ft. of conduit is to be installed on the outside of a building exposed to the sun in a single straight run. It is expected that the conduit will vary in temperature from 0° F in the winter to 140° F in the summer (this includes the 30° F for radiant heating from the sun.) The installation is to be made at a conduit temperature of 90° F. From this table, a 140° F temperature change will cause a 5.7 in. length change in 100 ft. of conduit. The total change for this example is $5.7 \times 3.8 = 21.67$ " which should be rounded to 22". The number of expansion fittings will be $22 \times$ fitting range (4" for Carlon trade sizes ½" through 1½", and 8" for sizes 2" through 6"). If the E945D fitting is used, the number will be $22 \times 4 = 5.50$ which should be rounded to 6. The fitting should be placed at 62 ft. intervals (380 ÷ 6), the proper piston setting at the time of installation is calculated as explained above.

$$O = \left[\frac{140 - 90}{140} \right] 4.0 = 1.4 \text{ in.}$$

Insert the piston into the barrel to the maximum depth. Place a mark on the piston at the end of the barrel. To properly set the piston, pull the piston out of the barrel to correspond to the 2.1 in. calculated above. See drawing at left.

Summary

1. Anticipate expansion and contraction of PVC conduit in above ground, exposed installation.
2. Use an expansion fitting when length change due to temperature variation will be ¼" or greater per 352.44 of the NEC®.
3. PVC conduit expands 4.1" for each 100 feet of run and a 100° F temperature change.
4. Align expansion fitting with the conduit run to prevent binding.
5. Follow the instructions to set the piston opening.
6. Rigidly fix the outer barrel of the expansion fitting so it cannot move. Mount the conduit connected to the piston loosely enough to allow the conduit to move as the temperature changes.

NEC and National Electrical Code are registered trademarks of the National Fire Protection Association, Inc.

Expansion Characteristics of PVC Rigid Non-Metallic Conduit Coefficient of Thermal Expansion = 3.38×10^{-5} in./in./°F

| TEMPERATURE CHANGE IN DEGREES F | LENGTH CHANGE IN INCHES PER 100 FT. OF PVC CONDUIT | TEMPERATURE CHANGE IN DEGREES F | LENGTH CHANGE IN INCHES PER 100 FT. OF PVC CONDUIT | TEMPERATURE CHANGE IN DEGREES F | LENGTH CHANGE IN INCHES PER 100 FT. OF PVC CONDUIT | TEMPERATURE CHANGE IN DEGREES F | LENGTH CHANGE IN INCHES PER 100 FT. OF PVC CONDUIT |
|---------------------------------|--|---------------------------------|--|---------------------------------|--|---------------------------------|--|
| 5 | .2 | 55 | 2.2 | 105 | 4.2 | 155 | 6.3 |
| 10 | .4 | 60 | 2.4 | 110 | 4.5 | 160 | 6.5 |
| 15 | .6 | 65 | 2.6 | 115 | 4.7 | 165 | 6.7 |
| 20 | .8 | 70 | 2.8 | 120 | 4.9 | 170 | 6.9 |
| 25 | 1.0 | 75 | 3.0 | 125 | 5.1 | 175 | 7.1 |
| 30 | 1.2 | 80 | 3.2 | 130 | 5.3 | 180 | 7.3 |
| 35 | 1.4 | 85 | 3.4 | 135 | 5.5 | 185 | 7.5 |
| 40 | 1.6 | 90 | 3.6 | 140 | 5.7 | 190 | 7.7 |
| 45 | 1.8 | 95 | 3.8 | 145 | 5.9 | 195 | 7.9 |
| 50 | 2.0 | 100 | 4.0 | 150 | 6.1 | 200 | 8.1 |

Technical Information

Corrosion Resistance of Carlon® Schedule 40 and Schedule 80 Fittings

Carlon Schedule 40 and Schedule 80 Fittings are generally acceptable for use in environments containing the chemicals **below**. These environmental-resistance ratings are based upon tests where the specimens were placed in complete submergence in the reagent listed. Schedule 40 and Schedule 80 Fittings can be used in many process areas where chemicals not on this list are manufactured or used because worker safety requirements dictate that any air presence or splashing be at a very low level.

If there are any questions about specific suitability in a given environment, prototype samples should be tested under actual conditions.

CHEMICAL ENVIRONMENT

| | | | | | |
|-------------------------------|-----------------------------------|--------------------------------------|-------------------------------|----------------------------|-------------------------------|
| Acetic Acid 0 – 20% | Breeder Pellets – Dane. Fish | Disodium Phosphate | Lead Acetate | Potassium Chromate | Sulfuric Acid – 75 – 90% |
| Acetic Acid 20 – 30% | Bromic Acid | Ethyl Alcohol | Lime Sulfur | Potassium Cyanide | Sulfurous Acid |
| Acetic Acid 30 – 60% | Bromine – Water | Ethylene Glycol | Linoleic Acid | Potassium Dichromate | Tannic Acid |
| Acetic Acid 80% | Butane | Fatty Acids | Linseed Oil | Potassium Ferricyanide | Tanning Liquors |
| Acetic Acid – Glacial | Butadiene | Ferric Chloride | Lubricating Oils | Potassium Ferrocyanide | Tartaric Acid |
| Acetic Acid Vapors | Butyl Alcohol | Ferric Nitrate | Magnesium Carbonate | Potassium Fluoride | Titanium Tetrachloride |
| Acetylene | Butyl Phenol | Ferric Sulfate | Magnesium Chloride | Potassium Hydroxide | Triethanolamine |
| Adipic Acid | Butylene | Ferrous Chloride | Magnesium Hydroxide | Potassium Nitrate | Trimethyl Propane |
| Alum | Butyric Acid | Ferrous Sulfate | Magnesium Nitrate | Potassium Perborate | Trisodium Phosphate |
| Aluminum Chloride | Calcium Bisulfite | Fluorine Gas – Wet | Magnesium Sulfate | Potassium Perchlorite | Turpentine |
| Aluminum Fluoride | Calcium Carbonate | Fluorine Gas – Dry | Maleic Acid | Potassium Permanganate 10% | Urea |
| Aluminum Hydroxide | Calcium Chlorate | Fluoroboric Acid | Malic Acid | Potassium Persulfate | Vinegar |
| Aluminum Oxychloride | Calcium Chloride | Fluorosilicic Acid | Mercuric Chloride | Potassium Sulfate | Whiskey |
| Aluminum Nitrate | Calcium Hydroxide | Formaldehyde | Mercuric Cyanide | Propane | White Liquor (Paper Industry) |
| Aluminum Sulfate | Calcium Hypochlorite | Formic Acid | Mercurous Nitrate | Propyl Alcohol | Wines |
| Ammonia-Dry Gas | Calcium Nitrate | Fructose | Mercury | Silicic Acid | Zinc Chloride |
| Ammonium Bifluoride | Calcium Sulfate | Gallic Acid | Methyl Sulfate | Silver Cyanide | Zinc Chromate |
| Ammonium Carbonate | Carbonic Acid | Gas – Coke Oven | Methylene Chloride | Silver Nitrate | Zinc Cyanide |
| Ammonium Chloride | Carbon Dioxide Gas – Wet | Gas – Natural (Dry) | Mineral Oils | Silver Plating Solutions | Zinc Nitrate |
| Ammonium Hydroxide 28% | Carbon Dioxide – Aqueous Solution | Gas – Natural (Wet) | Naphthalene | Sodium Acetate | Zinc Sulfate |
| Ammonium Metaphosphate | Carbon Monoxide | Gasoline – Sour | Nickel Chloride | Sodium Arsenite | |
| Ammonium Nitrate | Caustic Potash | Gasoline – Refined | Nickel Nitrate | Sodium Benzoate | |
| Ammonium Persulfate | Caustic Soda | Glucose | Nitric Acid, Anydrous | Sodium Bicarbonate | |
| Ammonium Phosphate – Neutral | Chloracetic Acid | Glycerine (Glycerol) | Nitric Acid 20% | Sodium Bisulfate | |
| Ammonium Sulfate | Chloral Hydrate | Glycol | Nitric Acid 40% | Sodium Bisulfite | |
| Ammonium Sulfide | Chlorine Gas (Dry) | Green Liquor (Paper Industry) | Nitric Acid 60% | Sodium Bromide | |
| Ammonium Thiocyanate | Chlorine Gas (Moist) | Heptane | Nitrobenzene | Sodium Chlorate | |
| Amyl Alcohol | Chlorine Water | Hexanol, Tertiary | Nitrous Oxide | Sodium Chloride | |
| Antraquinone | Chlorosulfonic Acid | Hydrobromic Acid 20% | Oils and Fats | Sodium Chloride | |
| Antraquinonesulfonic Acid | Chrome Alum | Hydrochloric Acid 0% – 25% | Oils – Petroleum – (See Type) | Sodium Cyanide | |
| Antimony Trichloride | Chromic Acid 10% | Hydrochloric Acid 25% – 40% | Oleic Acid | Sodium Dichromate | |
| Aqua Regia | Chromic Acid 30% | Hydrocyanic Acid or Hydrogen Cyanide | Oxalic Acid | Sodium Ferricyanide | |
| Arsenic Acid 80% | Chromic Acid 40% | Hydrofluoric Acid 10% | Palmitic Acid 10% | Sodium Ferrocyanide | |
| Arylsulfonic Acid | Chromic Acid 50% | Hydrofluorosilicic Acid | Perchloric Acid 10% | Sodium Fluoride | |
| Barium Carbonate | Citric Acid | Hydrogen Phosphide | Phenylhydrazine | Sodium Hydroxide | |
| Barium Chloride | Copper Chloride | Hydrogen Sulfide – Dry | Hydrochloride | Sodium Hypochlorite | |
| Barium Hydroxide | Copper Cyanide | Aqueous Solution | Phosgene, Gas | Sodium Nitrate | |
| Barium Sulfate | Copper Fluoride | Hydroquinone | Phosphoric Acid – 0 – 25% | Sodium Nitrite | |
| Barium Sulfide | Copper Nitrate | Hydroxylamine Sulfate | Phosphoric Acid – 25 – 50% | Sodium Sulfate | |
| Beet – Sugar Liquor | Copper Sulfate | Iodine | Phosphoric Acid – 50 – 85% | Sodium Sulfide | |
| Benzene Sulfonic Acid 10% | Cottonseed Oil | Kerosene | Photographic Chemicals | Sodium Sulfite | |
| Benzoic Acid | Cresylic Acid 50% | Lactic Acid 28% | Plating Solutions | Sodium Thiosulfate (Hypo) | |
| Bismuth Carbonate | Crude Oil – Sour | Lauric Acid | Potassium Bicarbonate | Stannic Chloride | |
| Black Liquor (Paper Industry) | Crude Oil – Sweet | Lauryl Chloride | Potassium Bichromate | Stannous Chloride | |
| Bleach – 12.5% Active CL2 | Demineralized Water | Lauryl Sulfate | Potassium Borate | Stearic Acid | |
| Borax | Dextrin | | Potassium Bromide | Sulfur | |
| Boric Acid | Dextrose | | Potassium Carbonate | Sulfur Dioxide – Gas Dry | |
| Brine | Diglycolic Acid | | Potassium Chloride | Sulfur Trioxide | |
| | | | | Sulfuric Acid – 0 – 10% | |
| | | | | Sulfuric Acid – 10 – 75% | |