

VISUAL COMFORT  
& Co. Est. 1987



20<sup>th</sup>

At Visual Comfort we greet our twentieth anniversary  
with our broadest collection ever.



Visual Comfort is the premier American resource for signature designer lighting.

Over the past twenty years we have produced lighting with some of the most influential names in design.

We will continue to partner with noteworthy talents moving forward, to enrich our extensive and creative selection of products.

We employ exceptional craftsmanship and skillful engineering in every piece we make. We remain committed to creating lighting products that are useful as well as inspired. And, we are proud to offer you extraordinary quality in fine lighting at a remarkable value.







We constantly pursue lighting craft with defining design innovation.

Together with our Chart House and Studio collections, under Chief Designer, lighting legend

Earle F. (Sandy) Chapman, the Visual Comfort offerings span from traditional to contemporary styles.

Our “living” finishes make the difference for lighting choices that are unique in personality and collectible in appeal. We use authentic and natural materials to give our products their

custom character: brass, bronze, nickel, silver and chrome in antique and polished lusters; classic enamels, ceramic and porcelain; forged irons and honed woods; handblown glass; rock crystal and alabaster; elegant parchment papers, silks and linens.





Our selection is suitable for all types of contract and residential projects, and for every decorating philosophy. Whether you are looking for the work of a particular designer or a general type of light, this catalog will help you survey and compare the range of products we proudly offer. See how the art of lighting can work for you.

## CONTENTS

Table	12
Floor	100
Ceiling	148
Wall	225
Outdoor	296
Finish Codes	315
Index	316



# TABLE

Chart House	16
Studio	56
Thomas O'Brien	70
Bill Blass	92
Eric Cohler	95
Clodagh	98







**CHA8935CG-NP**  
**Square Stacked Table Lamp**  
in Crystal with  
Natural Paper Shade  
Height: 34"  
Width: 19"  
Base: 6½" Square

**Available Finishes:**  
ALB, CG  
**Shade Treatment:** NP  
**Shade Details:**  
16" x 19" x 14" Square

**Socket:** Hi-Lo  
**Wattage:** 150 A  
©EFC DESIGNS



**CHA8934CG-NP**  
**Oval Stacked Buffet Lamp**  
in Crystal with  
Natural Paper Shade  
Height: 34"  
Width: 18"  
Base: 7¾" Oval

**Shade Treatment:** NP  
**Shade Details:**  
8½"/15" x 12"/18" x 12" Oval

**Socket:** Hi-Lo  
**Wattage:** 150 A  
©EFC DESIGNS



**CHA8933CG-NP**  
**Oval Stacked Bedside Lamp**  
in Crystal with  
Natural Paper Shade  
Height: 25"  
Width: 14"  
Base: 6½" Oval

**Shade Treatment:** NP  
**Shade Details:**  
8"/12" x 10"/14" x 9" Oval

**Socket:** Hi-Lo  
**Wattage:** 100 A  
©EFC DESIGNS



**CHA8927CG-S**  
**Mini Column Lamp**  
in Crystal with Silk Shade  
Height: 13½"  
Width: 7¼"  
Base: 3½" Square

**Available Finishes:** ALB, CG, Q  
**Shade Treatments:** L, S  
**Shade Details:** 4½" x 7¼" x 5¼"

**Socket:** Hi-Lo Nordy  
**Wattage:** 60 A  
French Wired  
©EFC DESIGNS



**CHA8940CG-NP**  
**Scored Column Bedside Lamp**  
**in Crystal with**  
**Natural Paper Shade**

Height: 22"  
 Width: 11"  
 Base: 5" Square

**Available Finishes:** ALB, CG  
**Shade Treatments:** NP, SBP

**Shade Details:**  
 8" x 11" x 7" NP or  
 8" x 11½" x 7½" SBP

**Socket:** 2-Pull Chain  
**Wattage:** 2-40 B  
 French Wired  
 ©EFC DESIGNS



**CHA8941CG-NP**  
**Scored Column Table Lamp**  
**in Crystal with**  
**Natural Paper Shade**

Height: 27"  
 Width: 15"  
 Base: 5½"

**Available Finishes:** ALB, CG  
**Shade Treatments:** NP, SBP

**Shade Details:**  
 12" x 15" x 9" NP or  
 12" x 15½" x 9½" SBP

**Socket:** 2-Pull Chain  
**Wattage:** 2-60 A  
 French Wired  
 ©EFC DESIGNS



**CHA8937CG-NP**  
**Chubby Column Bedside Lamp**  
**in Crystal with**  
**Natural Paper Shade**

Height: 23½"  
 Width: 13½"  
 Base: 5" Square

**Available Finishes:** ALB, CG, Q  
**Shade Treatments:** NP, SBP

**Shade Details:**  
 11" x 13½" x 9" NP or  
 11" x 14" x 9½" SBP

**Socket:** Hi-Lo  
**Wattage:** 100 A  
 French Wired  
 ©EFC DESIGNS



**CHA8931CG-NP**  
**Chubby Column Table Lamp**  
**in Crystal with**  
**Natural Paper Shade**

Height: 30¾"  
 Width: 19"  
 Base: 6½" Square

**Available Finishes:**  
 ALB, CG, Q

**Shade Treatments:**  
 NP, SBP  
**Shade Details:**  
 15" x 19" x 12" NP or  
 15" x 19" x 13" SBP

**Socket:** Hi-Lo  
**Wattage:** 150 A  
 French Wired  
 ©EFC DESIGNS



**CHA8926CG-NP**  
**Crystal Column Lamp on Low Plinth with Natural Paper Shade**  
Height: 30"  
Width: 17"  
Base: 6" Square

**Shade Treatments:** NP, SBP  
**Shade Details:** 13" x 17" x 10" NP or 13" x 17" x 11" SBP

**Socket:** Hi-Lo  
**Wattage:** 100 A  
French Wired  
©EFC DESIGNS



**CHA8938CG-NP**  
**Slender Column Bedside Lamp in Crystal with Natural Paper Shade**  
Height: 24"  
Width: 14"  
Base: 5½" Square

**Available Finishes:** ALB, CG  
**Shade Treatments:** NP, SBP  
**Shade Details:** 10" x 13" x 8½" NP or 10" x 12" x 9" SBP

**Socket:** Hi-Lo  
**Wattage:** 100 A  
French Wired  
©EFC DESIGNS



**CHA8932CG-NP**  
**Crystal Octagonal Column Candlestick Lamp with Natural Paper Shade**  
Height: 27¾"  
Width: 17"  
Base: 7½" Octagonal

**Shade Treatments:** NP, SBP  
**Shade Details:** 13" x 17" x 10" NP or 13" x 17" x 11" SBP

**Socket:** Hi-Lo  
**Wattage:** 100 A  
French Wired  
©EFC DESIGNS



**CHA8910CG-S**  
**Large Octagonal Crystal Column Lamp with Silk Shade**  
Height: 34"  
Width: 19"  
Base: 8" Square

**Shade Treatment:** S  
**Shade Details:** 12" x 19" x 12"

**Socket:** Hi - Lo  
**Wattage:** 100 A  
French Wired  
©EFC DESIGNS



**CHA8920CG-S**

**Tall Crystal Column Lamp with Capital on Stepped Base with Silk Shade**

Height: 29½"  
Width: 17"  
Base: 6¼" Square

**Available Finishes:** CG, Q

**Shade Treatments:**

NP, S

**Shade Details:**

9" x 17" x 11"

**Socket:** Hi-Lo

**Wattage:** 100 A

French Wired

©EFC DESIGNS



**CHA8920Q-S**

**CHA8921CG-S**

**Crystal Column Lamp with Capital on Scalloped Base with Silk Shade**

Height: 21"  
Width: 11"  
Base: 5" Scalloped

**Shade Treatment:** S

**Shade Details:** 7" x 11" x 8½"

**Socket:** Hi-Lo

**Wattage:** 100 A

French Wired

©EFC DESIGNS



**CHA8922CG-S**

**Octagonal Crystal Column Lamp with Silk Shade**

Height: 32"  
Width: 19"  
Base: 9" Octagonal

**Shade Treatment:** S

**Shade Details:**

10" x 19" x 12" Octagonal

**Socket:** Hi-Lo

**Wattage:** 100 A

French Wired

©EFC DESIGNS



**CHA8925CG-NP**

**Crystal Column on Brass Mount with Natural Paper Shade**

Height: 32"  
Width: 18"  
Base: 6¼" Square

**Shade Treatment:** NP

**Shade Details:** 11" x 18" x 12½"

**Socket:** Hi-Lo

**Wattage:** 100 A

French Wired

©EFC DESIGNS



**CHA8924CG-NP**  
**Balustrade Table Lamp in Crystal**  
**with Natural Paper Shade**

Height: 27"  
Width: 17"  
Base: 5½" Square

**Available Finishes:** ALB, CG, Q  
**Shade Treatments:** NP, SBP  
**Shade Details:**  
13" x 17" x 10" NP or  
13" x 17" x 11" SBP

**Socket:** Hi-Lo  
**Wattage:** 150 A  
French Wired  
©EFC DESIGNS



**CHA8939CG-NP**  
**Balustrade Bedside Lamp**  
**in Crystal with**  
**Natural Paper Shade**

Height: 23¼"  
Width: 13"  
Base: 4¾" Square

**Available Finishes:** ALB, CG, Q  
**Shade Treatments:** NP, SBP  
**Shade Details:**  
11" x 13½" x 9" NP or  
11" x 14" x 9½" SBP

**Socket:** Hi-Lo  
**Wattage:** 100 A  
French Wired  
©EFC DESIGNS



**CHA8950CG-NP**  
**Medium Octagonal Spire Table**  
**Lamp in Crystal with Natural**  
**Paper Shade**

Height: 25"  
Width: 13½"  
Base: 3½" Octagonal

**Available Finishes:** BM, CG,  
WM  
**Shade Treatments:** NP, SBP  
**Shade Details:**  
11" x 13½" x 9" NP or  
11" x 14" x 9½" SBP

**Socket:** Dimmer  
**Wattage:** 100 A  
French Wired  
©EFC DESIGNS



**CHA8951CG-NP**  
**Large Octagonal Spire Table**  
**Lamp in Crystal with**  
**Natural Paper Shade**

Height: 31½"  
Width: 17"  
Base: 4½" Octagonal

**Available Finishes:** BM, CG,  
WM  
**Shade Treatments:** NP, SBP  
**Shade Details:**  
13" x 17" x 10" NP or  
13" x 17" x 11" SBP

**Socket:** Dimmer  
**Wattage:** 150 A  
French Wired  
©EFC DESIGNS



**CHA8936CG-NP**  
**Bowed Pot Form Lamp**  
**in Crystal with**  
**Natural Paper Shade**  
 Height: 17"  
 Width: 9½"  
 Base: 5" Square

**Shade Treatment:** NP  
**Shade Details:**  
 8" x 9½" x 7" Square

**Socket:** Hi-Lo Nordy  
**Wattage:** 100 A  
 French Wired  
 ©EFC DESIGNS



**CHA8942CG-S**  
**Banded Pot Lamp**  
**in Crystal with Silk Shade**  
 Height: 14½"  
 Width: 10"  
 Base: 5¼" Round

**Shade Treatment:** S  
**Shade Details:** 8" x 10" x 7"

**Socket:** Hi-Lo Nordy  
**Wattage:** 75 A  
 ©EFC DESIGNS



**CHA8928CG-S**  
**Mini Urn Form Lamp**  
**in Crystal with Silk Shade**  
 Height: 13"  
 Width: 7¼"  
 Base: 3½" Square

**Available Finishes:** ALB, CG  
**Shade Treatments:** L, S  
**Shade Details:** 4½" x 7¼" x 5¼"

**Socket:** Hi-Lo Nordy  
**Wattage:** 60 A  
 French Wired  
 ©EFC DESIGNS



**CHA8929CG-S**  
**Mini Balustrade Form Lamp**  
**in Crystal with Silk Shade**  
 Height: 13½"  
 Width: 7¼"  
 Base: 3½" Square

**Available Finishes:** ALB, CG  
**Shade Treatments:** L, S  
**Shade Size:** 4½" x 7¼" x 5¼"

**Socket:** Hi-Lo Nordy  
**Wattage:** 60 A  
 French Wired  
 ©EFC DESIGNS



**CHA8923CG-S**  
**Cut Corner Rectangular**  
**Crystal Urn Form Lamp with**  
**Silk Shade**  
 Height: 24"  
 Width: 16"  
 Base: 4½" x 6"

**Shade Treatment:** S  
**Shade Details:**  
 6" / 8" x 8" / 13" x 9"

**Socket:** Hi-Lo  
**Wattage:** 100 A  
 French Wired  
 ©EFC DESIGNS



**CHA8946FLU-NP**  
**Square Chunky Stacked**  
**Bedside Lamp in Fluorite with**  
**Natural Paper Shade**  
Height: 24"  
Width: 13"  
Base: 3½" Square

**Available Finishes:** ALB, FLU,  
Q, RQ  
**Shade Treatment:** NP  
**Shade Details:**  
11½" x 13" x 10" Square  
**Socket:** Dimmer  
**Wattage:** 150 A  
©EFC DESIGNS



**CHA8946Q-NP**

**CHA8947ALB-NP**  
**Square Chunky Stacked Table**  
**Lamp in Alabaster with**  
**Natural Paper Shade**  
Height: 31"  
Width: 16"  
Base: 5" Square

**Shade Treatment:** NP  
**Shade Details:**  
14" x 16" x 12" Square  
**Socket:** Dimmer  
**Wattage:** 150 A  
©EFC DESIGNS



**CHA8960ALB-NP**  
**Rectangular Form Table Lamp**  
**in Alabaster with**  
**Natural Paper Shade**  
Height: 24"  
Width: 13½"  
Base: 5" x 6½"

**Shade Treatment:** NP  
**Shade Details:**  
8½" x 13½" x 9" Rectangle  
**Socket:** Hi-Lo  
**Wattage:** 100 A  
©EFC DESIGNS



**CHA8945ALB-NP**  
**Round Chunky Stacked Table**  
**Lamp in Alabaster with**  
**Natural Paper Shade**  
Height: 29½"  
Width: 16"  
Base: 5" Round

**Shade Treatment:** NP  
**Shade Details:**  
14" x 16" x 12"  
**Socket:** Dimmer  
**Wattage:** 150 A  
©EFC DESIGNS





**CHA8949RQ-NP**  
**Round Stacked Bedside Lamp**  
 in Rose Quartz with  
 Natural Paper Shade  
 Height: 23½"  
 Width: 11"  
 Base: 4½" Round

**Available Finishes:**  
 FLU, O, RQ  
**Shade Treatment:** NP  
**Shade Details:**  
 9½" x 11" x 8½"

**Socket:** Dimmer  
**Wattage:** 100 A  
 ©EFC DESIGNS



**CHA8949Q-NP**

**CHA8948ALB-NP**  
**Round Stacked Table Lamp**  
 in Alabaster with  
 Natural Paper Shade  
 Height: 34"  
 Width: 16"  
 Base: 5" Round

**Shade Treatment:** NP  
**Shade Details:** 14" x 16" x 12"

**Socket:** Dimmer  
**Wattage:** 150 A  
 ©EFC DESIGNS



**CHA8940ALB-NP**  
**Scored Column Bedside Lamp**  
 in Alabaster with  
 Natural Paper Shade  
 Height: 22"  
 Width: 11"  
 Base: 5" Square

**Available Finishes:** ALB, CG  
**Shade Treatments:** NP, SBP  
**Shade Details:**  
 8" x 11" x 7" NP or  
 8" x 11½" x 7½" SBP

**Socket:** 2-Pull Chain  
**Wattage:** 2-40 B  
 ©EFC DESIGNS



**CHA8941ALB-NP**  
**Scored Column Table Lamp**  
 in Alabaster with  
 Natural Paper Shade  
 Height: 27"  
 Width: 15"  
 Base: 5¼" Square

**Available Finishes:** ALB, CG  
**Shade Treatments:** NP, SBP  
**Shade Details:**  
 12" x 15" x 9" NP or  
 12" x 15½" x 9½" SBP

**Socket:** 2-Pull Chain  
**Wattage:** 2-60 A  
 ©EFC DESIGNS



**CHA8938ALB-NP**

**Slender Column Bedside Lamp in Alabaster with Natural Paper Shade**

Height: 24"  
Width: 14"  
Base: 5½" Square

**Available Finishes:** ALB, CG  
**Shade Treatments:** NP, SBP  
**Shade Details:** 10" x 13" x 8½" NP or 10" x 12" x 9" SBP

**Socket:** Hi-Lo  
**Wattage:** 100 A  
©EFC DESIGNS



**CHA8937ALB-NP**

**Chubby Column Bedside Lamp in Alabaster with Natural Paper Shade**

Height: 23½"  
Width: 13½"  
Base: 5" Square

**Available Finishes:** ALB, CG, Q  
**Shade Treatments:** NP, SBP  
**Shade Details:** 11" x 13½" x 11" NP or 11" x 14" x 9½" SBP

**Socket:** Hi-Lo  
**Wattage:** 100 A  
©EFC DESIGNS



**CHA8937Q-NP**

**CHA8931ALB-NP**

**Chubby Column Table Lamp in Alabaster with Natural Paper Shade**

Height: 30½"  
Width: 19"  
Base: 6½" Square

**Available Finishes:** ALB, CG, Q  
**Shade Treatments:** NP, SBP  
**Shade Details:** 15" x 19" x 12" NP or 15" x 19" x 13" SBP

**Socket:** Hi-Lo  
**Wattage:** 150 A  
©EFC DESIGNS



**CHA8931Q-NP**

**CHA8524ALB-NP**

**Etruscan Urn with Handles in Alabaster with Natural Paper Shade**

Height: 25"  
Width: 17"  
Base: 6" Square

**Shade Treatment:** NP  
**Shade Details:** 13" x 17" x 10"

**Socket:** Hi-Lo  
**Wattage:** 150 A  
©EFC DESIGNS



**CHA8939ALB-NP**  
**Balustrade Bedside Lamp in Alabaster with Natural Paper Shade**  
 Height: 23 3/4"  
 Width: 13"  
 Base: 4 1/2" Square

**Available Finishes:** ALB, CG, Q  
**Shade Treatments:** NP, SBP  
**Shade Details:**  
 11" x 13 1/2" x 9" NP or  
 11" x 14" x 9 1/2" SBP

**Socket:** Hi-Lo  
**Wattage:** 100 A  
 ©EFC DESIGNS



**CHA8939Q-NP**

**CHA8924ALB-NP**  
**Balustrade Table Lamp in Alabaster with Natural Paper Shade**  
 Height: 27"  
 Width: 17"  
 Base: 5 1/2" Square

**Available Finishes:** ALB, CG, Q  
**Shade Treatments:** NP, SBP  
**Shade Details:**  
 13" x 17" x 10" NP or  
 13" x 17" x 11" SBP

**Socket:** Hi-Lo  
**Wattage:** 150 A  
 ©EFC DESIGNS



**CHA8924Q-NP**

**CHA8927ALB-L**  
**Mini Column Lamp in Alabaster with Linen Shade**  
 Height: 13 1/2"  
 Width: 7 1/4"  
 Base: 3 1/2" Square

**Available Finishes:** ALB, CG, Q  
**Shade Treatments:** L, S  
**Shade Details:** 4 1/2" x 7 1/4" x 5 1/4"

**Socket:** Hi-Lo Nordy  
**Wattage:** 60 A  
 ©EFC DESIGNS



**CHA8927Q-S**

**CHA8928ALB-L**  
**Mini Urn Form Lamp in Alabaster with Linen Shade**  
 Height: 13"  
 Width: 7 1/4"  
 Base: 3 1/2" Square

**Available Finishes:** ALB, CG  
**Shade Treatments:** L, S  
**Shade Details:** 4 1/2" x 7 1/4" x 5 1/4"

**Socket:** Hi-Lo Nordy  
**Wattage:** 60 A  
 ©EFC DESIGNS



**CHA8929ALB-L**  
**Mini Balustrade Form Lamp in Alabaster with Linen Shade**  
 Height: 13 1/2"  
 Width: 7 1/4"  
 Base: 3 1/2" Square

**Available Finishes:** ALB, CG  
**Shade Treatments:** L, S  
**Shade Details:** 4 1/2" x 7 1/4" x 5 1/4"

**Socket:** Hi-Lo Nordy  
**Wattage:** 60 A  
 ©EFC DESIGNS



**CHA8970ALB-NP**

**Large Ring Table Lamp in Alabaster with Natural Paper Shade**

Height: 27¼"  
Width: 18"  
Base: 7½" Square

**Available Finishes:**

AB, ALB, BZ, PS

**Shade Treatment:** NP

**Shade Details:**

8" x 14" x 10" / 18" x 11"  
Rectangle

**Socket:** Hi – Lo

**Wattage:** 100 A

French Wired

Fabric Cord not UL Listed

©EFC DESIGNS



**CHA8905WM-NP**

**Medium Fluted Spire Table Lamp in White Marble with Natural Paper Shade**

Height: 25½"  
Width: 13½"  
Base: 3¼" Scalloped

**Available Finishes:**

AB, BZ, PS, WM

**Shade Treatment:**

NP

**Shade Details:**

11" x 13½" x 9"

**Socket:** Dimmer

**Wattage:** 100 A

©EFC DESIGNS

**CHA8905BZ-NP**



**CHA8906BZ-NP**

**Large Fluted Spire Table Lamp in Bronze with Natural Paper Shade**

Height: 31½"  
Width: 17"  
Base: 4¼" Scalloped

**Available Finishes:**

AB, BZ, PS, WM

**Shade Treatment:** NP

**Shade Size:**

13" x 17" x 10"

**Socket:** Dimmer

**Wattage:** 150 A

©EFC DESIGNS



**CHA8950BM-NP**

**Medium Octagonal Spire Table Lamp in Black Marble with Natural Paper Shade**

Height: 25"  
Width: 13½"  
Base: 3½" Octagonal

**Available Finishes:** BM, CG

**Shade Treatments:** NP, SBP

**Shade Details:**

11" x 13½" x 9" NP or

11" x 14" x 9½" SBP

**Socket:** Dimmer

**Wattage:** 100 A

©EFC DESIGNS



**CHA8252AN-B**  
**Large Classic Column Lamp in**  
**Antique Nickel with Black Shade**

Height: 31½"  
 Width: 17"  
 Base: 6" Square

**Available Finishes:**  
 AB, AN, OAK, SN  
**Shade Treatments:** B, NP, S  
**Shade Details:**  
 11" x 17" x 11¾" Square

**Socket:** Hi-Lo  
**Wattage:** 150 A  
 ©EFC DESIGNS



**CHA8251AB-B**  
**Large Classic Balustrade Lamp**  
**in Antique-Burnished Brass**  
**with Black Shade**

Height: 31½"  
 Width: 19"  
 Base: 6½" Square

**Available Finishes:**  
 AB, AN, OAK, SB  
**Shade Treatments:** B, NP  
**Shade Details:** 12" x 19" x 12"

**Socket:** Hi-Lo  
**Wattage:** 150 A  
 ©EFC DESIGNS



**CHA8511ABV-NP**  
**Large Twisted Column Lamp in**  
**Antique-Burnished Brass with**  
**Verdigris Accents with Natural**  
**Paper Shade**

Height: 42"  
 Width: 20"  
 Base: 6" Square

**Available Finishes:** ABV, BZV  
**Shade Treatment:** NP  
**Shade Details:**  
 11" x 20" x 13"

**Socket:** Hi-Lo  
**Wattage:** 100 A  
 ©EFC DESIGNS



**CHA8510ABV-NP**  
**Twisted Column Lamp in**  
**Antique-Burnished Brass with**  
**Verdigris Accents with**  
**Natural Paper Shade**

Height: 34"  
 Width: 19"  
 Base: 6" Square

**Available Finishes:** ABV, BZV  
**Shade Treatment:** NP  
**Shade Details:**  
 11" x 19" x 12"

**Socket:** Hi-Lo  
**Wattage:** 100 A  
 ©EFC DESIGNS



**CHA8513ABV-NP**  
**Classic English Column Lamp**  
**in Antique-Burnished Brass**  
**with Verdigris Accents with**  
**Natural Paper Shade**

Height: 28½"  
Width: 15"  
Base: 6¼" Square

**Available Finishes:** ABV, PS  
**Shade Treatments:** NP, SBP

**Shade Details:**  
8" x 15" x 11" NP or  
13" x 17" x 11" SBP

**Socket:** Hi-Lo  
**Wattage:** 100 A

©EFC DESIGNS



**CHA8512OAK-NP**  
**Large Classic English Column Lamp**  
**in Oak with Natural Paper Shade**

Height: 36½"  
Width: 19"  
Base: 7¾" Square

**Available Finishes:**  
ABV, OAK, PS

**Shade Treatments:** NP, S, SBP

**Shade Details:**  
14" x 19" x 12" NP or  
15" x 19" x 13" S, SBP

**Socket:** Hi-Lo  
**Wattage:** 150 A  
©EFC DESIGNS



**CHA8166AB-B**  
**Lion Passant Column Lamp**  
**in Antique-Burnished Brass**  
**with Black Shade**

Height: 31½"  
Width: 17"  
Base: 7½"

**Shade Treatments:** B, S  
**Shade Details:** 8" x 17" x 9"

**Socket:** Hi-Lo  
**Wattage:** 100 A

©EFC DESIGNS



**CHA8155AB-B**  
**Trionne Burner Lamp**  
**in Antique-Burnished Brass**  
**with Black Shade**

Height: 27"  
Width: 17"  
Base: 7½"

**Available Finishes:** AB, AN  
**Shade Treatment:** B, S  
**Shade Details:** 8" x 17" x 9"

**Socket:** Hi-Lo  
**Wattage:** 100 A  
©EFC DESIGNS



**CHA8512ABV-S**  
**Large Classic English Column Lamp**  
**in Antique-Burnished Brass with**  
**Verdigris Accents with Silk Shade**

Height: 36½"  
 Width: 19"  
 Base: 7¾" Square

**Available Finishes:**  
 ABV, OAK, PS  
**Shade Treatments:** NP, S  
**Shade Details:**  
 14" x 19" x 12" NP, S or  
 15" x 19" x 13" SBP

**Socket:** Hi-Lo  
**Wattage:** 150 A  
 ©EFC DESIGNS



**CHA8137AB-B**  
**Lion Passant Two-Light Table Lamp**  
**in Antique-Burnished Brass**  
**with Black Shades**

Height: 19"  
 Width: 13"  
 Base: 7" Round

**Shade Treatment:** B  
**Shade Details:** 4" x 6" x 5"

**Socket:** 2-Candelabra/  
 Line Switch  
**Wattage:** 2-60 C  
 ©EFC DESIGNS



**CHA8157AB-B**  
**Lion Passant Single Light Desk**  
**Lamp in Antique-Burnished**  
**Brass with Black Shade**

Height: 19"  
 Width: 13"  
 Base: 4½" x 6"

**Shade Treatment:** B  
**Shade Details:** 9" x 13" x 6"

**Socket:** 2-Keyless/  
 Line Switch  
**Wattage:** 2-60 A  
 ©EFC DESIGNS



**CHA8167AB-B**  
**Lion Passant Buffet Lamp in**  
**Antique-Burnished Brass with**  
**Black Shade**

Height: 32"  
 Width: 10"  
 Base: 4½" x 6"

**Shade Treatment:** B  
**Shade Details:** 4" x 10" x 7½"

**Socket:** Candelabra  
 with Hi-Lo Line Switch  
**Wattage:** 60 C  
 ©EFC DESIGNS



**CHA8132AB-B**  
**18th Century English Single**  
**Candle Tray Lamp in**  
**Antique-Burnished Brass with**  
**Black Shade**

Height: 18½"  
 Width: 7"  
 Base: 6" Round

**Available Finishes:** AB, AN  
**Shade Details:** 2½" x 7" x 4"

**Socket:** Candelabra  
**Wattage:** 60 C  
 ©EFC DESIGNS



**CHA8134AB-B**  
**Two-Arm Bouillotte with**  
**Balustrade Form Support in**  
**Antique-Burnished Brass with**  
**Black Shade**

Height: 24"  
 Width: 11"  
 Base: 4¼" Hexagonal  
 Candles not Included

**Available Finishes:** AB  
**Shade Treatments:** B  
**Shade Details:**  
 4¾"/8¼" x 7⅞"/11"  
 x 4¼" Oval

**Socket:** 2-Keyless  
**Wattage:** 2-60 A  
 ©EFC DESIGNS



**CHA8135AN-B**  
**Three-Arm Bouillotte with**  
**Urn Form Support on**  
**Saucer Base in Antique Nickel**  
**with Black Shade**

Height: 23"  
 Width: 11"  
 Base: 7" Round

**Available Finishes:** AB, AN  
**Shade Treatments:** B, RD  
**Shade Details:** 8½" x 11" x 7½"  
 Candles not Included

**Socket:** 2-Keyless  
**Wattage:** 2-60 A  
 ©EFC DESIGNS



**CHA8135AB-RD**

**CHA8117BZ-MP**  
**Regency Bouillotte in Bronze**  
**with Monte Patina Shade**

Height: 28"  
 Width: 14"  
 Base: 7" Round

**Available Finishes:** AB, BZ  
**Shade Treatments:** G, MP  
**Shade Details:** 11" x 14" x 8"  
 Candles not Included

**Socket:** 2-Candelabra  
**Wattage:** 2-60 C



**CHA8117AB-G**



**CHA8138SN-SN**  
**Four-Arm Column Motif**  
**Bouillotte on Saucer Base**  
**in Sheffield Nickel with**  
**Sheffield Nickel Shade**

Height: 35"  
 Width: 19"  
 Base: 10" Round  
 Candles not Included

**Available Finishes:** AB, SN  
**Shade Treatments:** G, SN  
**Shade Details:**  
 13" x 19" x 7 1/2"

**Socket:** 2-Keyless/Line Switch  
**Wattage:** 2-60 A  
 ©EFC DESIGNS



**CHA8139PS-B**  
**Large Four-Arm Bouillotte**  
**in Polished Silver**

Height: 35"  
 Width: 19"  
 Base: 9" Round  
 Candles not Included

**Shade Treatments:** B  
**Shade Details:** 13" x 19" x 7 1/2"

**Socket:** 2-Keyless/Line Switch  
**Wattage:** 2-60 A  
 ©EFC DESIGNS



**CHA8124ABC-B**  
**Overseas Adjustable Table Lamp in**  
**Antique-Burnished Brass and Faux**  
**Cordovan with Black Shade**

Height: 20"-29"  
 Width: 13"  
 Base: 6 1/2" Round

**Shade Treatment:** B  
**Shade Details:** 8" x 13" x 6"

**Socket:** 2-Pull Chain  
**Wattage:** 2-60 A  
 ©EFC DESIGNS



**CHA8125PS-S**  
**Overseas Adjustable Console Lamp**  
**in Polished Silver with Silk Shade**

Height: 26"-35"  
 Width: 15"  
 Base: 6 1/2" Round

**Available Finishes:** AB, PS  
**Shade Treatments:** B, S  
**Shade Details:**  
 6" x 15" x 8" B or  
 9" x 14" x 8 1/2" Silk Hex

**Socket:** 2-Pull Chain  
**Wattage:** 2-60 A  
 ©EFC DESIGNS



**CHA8133AB-B**  
**Edwardian Column Table Lamp**  
**in Antique-Burnished Brass**  
**with Black Shade**

Height: 20"  
Width: 10½"  
Base: 7" Round

**Available Finishes:** AB, AN  
**Shade Treatments:** B  
**Shade Details:** 6" x 10½" x 7"

**Socket:** Hi-Lo/Line Switch  
**Wattage:** 75 A  
©EFC DESIGNS



**CHA8164AB-B**  
**Edwardian Column Console**  
**Lamp in Antique-Burnished**  
**Brass with Black Shade**

Height: 31½"  
Width: 10½"  
Base: 7" Round

**Shade Treatment:** B  
**Shade Details:** 6" x 10½" x 7"

**Socket:** Hi-Lo/Line Switch  
**Wattage:** 75 A  
©EFC DESIGNS



**CHA8133AB-WG**  
**Edwardian Column Table Lamp**  
**in Antique-Burnished Brass**  
**with White Glass Shade**

Height: 21¼"  
Width: 13¼"  
Base: 7" Round

**Shade Treatments:** WG  
**Shade Details:** 6¾" x 13¼"

**Socket:** Hi-Lo/Line Switch  
**Wattage:** 100 A  
©EFC DESIGNS



**CHA8152AN/AB-B**  
**King's Road Column Lamp in**  
**Antique Nickel and**  
**Antique-Burnished Brass**  
**with Black Shade**

Height: 30"  
Width: 17"  
Base: 6" Round

**Shade Treatment:** B  
**Shade Details:**  
8" x 17" x 9"

**Socket:** Hi-Lo  
**Wattage:** 100 A



**CHA8501AB-SC**  
**Essex Accent Lamp in Antique-Burnished**  
**Brass with Silk Collar Shade**

Height: 24"  
 Width: 10"  
 Base: 5½" Square

**Available Finishes:** AB, PN  
**Shade Treatment:** SC  
**Shade Details:** 6" x 10" x 8"

**Socket:** Hi-Lo  
**Wattage:** 75 A  
 ©EFC DESIGNS



**CHA8500AB-SC**  
**Essex Adjustable Table Lamp**  
**in Antique-Burnished Brass**  
**with Silk Collar Shade**

Height: 23"-26"  
 Width: 10"  
 Base: 4½" Square

**Available Finishes:** AB, AN, PN  
**Shade Treatment:** SC  
**Shade Details:** 6" x 10" x 8"

**Socket:** Hi-Lo  
**Wattage:** 75 A  
 ©EFC DESIGNS



**CHA8500PN-SC**

**CHA8178AB-B**  
**Dorchester Adjustable**  
**Swing-Arm Desk Lamp in**  
**Antique-Burnished Brass**  
**with Black Shade**

Height: 27"-33"  
 Width: 10"  
 Extension: 16"  
 Base: 7" Round

**Available Finishes:** AB, AN  
**Shade Treatments:** B, S, SC  
**Shade Details:** 5" x 10" x 8"

**Socket:** Hi-Lo  
**Wattage:** 60 A  
 ©EFC DESIGNS



**CHA8188AB-B**  
**Dorchester Club Table Lamp in**  
**Antique-Burnished Brass with**  
**Black Shade**

Height: 22"-32"  
 Width: 13"  
 Base: 7" Round

**Available Finishes:**  
 AB, AN  
**Shade Treatments:** B, NP, S  
**Shade Details:** 8" x 13" x 7"

**Socket:** Hi-Lo  
**Wattage:** 100 A  
 ©EFC DESIGNS



**CHA8190AN/AB-B**

**Twist Column Design Lamp in  
Antique Nickel and  
Antique-Burnished Brass  
with Black Shade**

Height: 35"  
Width: 15½"  
Base: 8" Round

**Shade Treatment:** B

**Shade Details:** 7" x 15½" x 9"

**Socket:** Hi-Lo

**Wattage:** 75 A

©EFC DESIGNS



**CHA8450WI-L**

**Windsor Iron Twist Table Lamp in  
Weathered Iron and Distressed Brass  
with Linen Shade**

Height: 40"  
Width: 18"  
Base: 8" Round

**Shade Treatment:** L

**Shade Details:** 11" x 18" x 11½"

**Socket:** Hi-Lo

**Wattage:** 100 A

©EFC DESIGNS



**CHA8457AB-NP**

**Spiral Table Lamp  
in Antique-Burnished Brass  
with Natural Paper Shade**

Height: 32½"  
Width: 14"  
Base: 6½" Round

**Available Finishes:**

AB, BZ, BZV, PS

**Shade Treatment:** NP

**Shade Details:** 9" x 14" x 8½"

**Socket:** Dimmer

**Wattage:** 100 A

©EFC DESIGNS



**CHA8458AB-NP**

**Spiral Buffet Lamp in  
Antique-Burnished Brass  
with Natural Paper Shade**

Height: 36½"  
Width: 14"  
Base: 6½" Round

**Available Finishes:** AB, BZ, BZV, PS

**Shade Treatment:** NP

**Shade Details:** 9" x 14" x 8½"

**Socket:** Dimmer

**Wattage:** 100 A

©EFC DESIGNS



**CHA8123ABR-GL**  
**Console Candle Lamp in Antique-Burnished Brass and Rust with Gold Leaf Shade**

Height: 34"  
 Width: 12½"  
 Base: 6" Round

**Shade Treatment:** GL  
**Shade Details:** 4½" x 12½" x 8½"

**Socket:** Hi-Lo  
**Wattage:** 60 A  
 ©EFC DESIGNS



**CHA8112ABT-B**  
**English Foyer Candle Lamp in Antique-Burnished Brass and Tortoise with Black Shade**

Height: 35"  
 Width: 15"  
 Base: 7" Round

**Shade Treatment:** B  
**Shade Details:** 6" x 15" x 8"

**Socket:** 2-Pull Chain  
**Wattage:** 2-40 A



**CHA8110ABR-B**  
**French Stemmed Candle Lamp in Antique-Burnished Brass and Rust with Black Shade**

Height: 39"  
 Width: 15"  
 Base: 6" Round

**Shade Treatment:** B  
**Shade Details:** 6" x 15" x 8"

**Socket:** 2-Pull Chain  
**Wattage:** 2-40 A



**CHA8111ABR-B**  
**French Urn Candlestick in Antique-Burnished Brass and Rust with Black Shade**

Height: 38"  
 Width: 15"  
 Base: 7" Round

**Shade Treatment:** B  
**Shade Details:** 6" x 15" x 8"

**Socket:** 2-Pull Chain  
**Wattage:** 2-40 A



**CHA8130AB-S**

**Chinoiserie Styled Candle Lamp  
in Antique-Burnished Brass on  
Faux Marble Mount with Silk Shade**

Height: 26"  
Width: 10"  
Base: 5" Hexagonal

**Shade Treatment:** S  
**Shade Details:** 5" x 10" x 6½"

**Socket:** Candelabra  
**Wattage:** 60 C



**CHA8113ABR-B**

**English Stemmed Font in  
Antique-Burnished Brass and  
Rust with Black Shade**

Height: 29"  
Width: 15"  
Base: 6½" Round

**Shade Treatments:** B, L  
**Shade Details:** 6" x 15" x 8"

**Socket:** 2-Pull Chain  
**Wattage:** 2-40 A



**CHA8122AB-B**

**English Urn Candle Lamp in  
Antique-Burnished Brass on  
Antiqued Faux Marble Base  
with Black Shade**

Height: 25½"  
Width: 13"  
Base: 6" Square

**Shade Treatment:** B  
**Shade Details:**  
9" x 13" x 6"

**Socket:** 2-Pull Chain  
**Wattage:** 2-40 A



**CHA8156SN-B**

**Trophy Urn on Faux Marble  
Mount in Sheffield Nickel with  
Black Shade**

Height: 25½"  
Width: 15"  
Base: 6½" Round

**Shade Treatment:** B  
**Shade Details:** 6" x 15" x 8"

**Socket:** 2-Pull Chain  
**Wattage:** 2-40 A



**CHA8522AS-S**

**Antique Urn Form  
in Antique Silver with  
Silk Shade**

Height: 28"  
Width: 18"  
Base: 6" Square

**Available Finishes:** AB, AS

**Shade Treatment:** BS, S

**Shade Details:**

10" x 18" x 12" Flat Pleat

**Socket:** Hi-Lo

**Wattage:** 100 A

©EFC DESIGNS



**CHA8521AB-S**

**Florentine Urn  
in Antique-Burnished Brass  
with Black Shade**

Height: 27½"  
Width: 17"  
Base: 5½" Round

**Available Finishes:** AB, SP

**Shade Treatment:** NP, S

**Shade Details:**

13" x 17" x 11" Flat Pleat

**Socket:** Hi-Lo

**Wattage:** 150 A

©EFC DESIGNS



**CHA8173PS-NP**

**Medium Chunky Urn  
in Polished Silver with  
Natural Paper Shade**

Height: 31"  
Width: 19"  
Base: 6¾" Square

**Available Finishes:** AB, BZV, PS

**Shade Treatment:** NP, S

**Shade Details:**

12" x 18" x 13" NP or  
12" x 18" x 13" Silk Square

**Socket:** Dimmer

**Wattage:** 150 A

©EFC DESIGNS



**CHA8174AB-NP**

**Large Chunky Urn  
in Antique-Burnished Brass  
with Natural Paper Shade**

Height: 37½"  
Width: 21"  
Base: 8¾" Square

**Available Finishes:**

AB, BZV, PS

**Shade Treatment:** NP

**Shade Details:**

19" x 21" x 14"

**Socket:** Dimmer

**Wattage:** 150 A

©EFC DESIGNS



**CHA8162AB-B**

**Large Classical Urn Form on Cast Brass Mount in Antique-Burnished Brass with Black Shade**

Height: 35"  
Width: 20"  
Base: 9" Round

**Finishes:** AB, PS, SN  
**Shade Treatment:** B, S

**Shade Details:**  
11" x 20" x 13" B or  
12" x 18" x 13"  
Silk Pleated Square

**Socket:** Hi-Lo  
**Wattage:** 150 A  
©EFC DESIGNS



**CHA8162SN-B**



**CHA8162AB-S**



**CHA8172AB-B**

**Medium Classical Urn Form on Cast Brass Mount in Antique-Burnished Brass with Black Shade**

Height: 24"  
Width: 15"  
Base: 6" Round

**Available Finishes:**  
AB, AN, BZ, PS, SN  
**Shade Treatment:** B  
**Shade Details:**  
6" x 15" x 8"

**Socket:** 2-Pull Chain  
**Wattage:** 2-40 A  
©EFC DESIGNS



**CHA8172AN-B**

**CHA8970AB-NP**

**Large Ring Table Lamp in Antique-Burnished Brass with Natural Paper Shade**

Height: 27 1/4"  
Width: 18"  
Base: 7 1/2" Square

**Available Finishes:**  
AB, ALB, BZ, PS  
**Shade Treatment:** NP  
**Shade Details:**  
8" / 14" x 10" / 18" x 11"  
Rectangle

**Socket:** Hi - Lo  
**Wattage:** 100 A  
©EFC DESIGNS





**CHA8198AB**  
**Earle's Art Deco Table Lamp in**  
**Antique-Burnished Brass**  
 Height: 22"  
 Width: 17"  
 Base: 9" Round

**Available Finishes:** AB, PN/PB  
**Shade Details:** 4" x 17"

**Socket:** Hi-Lo  
**Wattage:** 100 A  
 ©EFC DESIGNS



**CHA8198PN/PB**

**CHA8196AN**  
**Earle's Draftsman Lamp in**  
**Antique Nickel**  
 Height: 22"-45"  
 Width: 6½"  
 Extension: 10"-28"  
 Base: 6½" Round

**Available Finishes:** AB, AN, BZ  
**Shade Details:** 4" x 6"

**Socket:** Hi-Lo  
**Wattage:** 60 A  
 ©EFC DESIGNS



**CHA8195AB**  
**Earle's Double Arm Functional Lamp**  
**in Antique-Burnished Brass**  
 Height: 14"-20"  
 Extension: 9"-17"  
 Base: 6" Round

**Available Finishes:** AB, AN, BZ  
**Shade Details:** 2¾" x 5¼" x 4¼"

**Socket:** Hi-Lo  
**Wattage:** 60 A  
 ©EFC DESIGNS



**CHA8192AB-B**  
**Engraver's Adjustable Desk**  
**Lamp in Antique-Burnished**  
**Brass with Black Shade**  
 Height: 26"-48"  
 Extension: 23"-36"  
 Base: 5½" x 8"

**Shade Treatment:** B  
**Shade Details:**  
 4" x 6½" x 5"

**Socket:** Hi-Lo  
**Wattage:** 60 A  
 ©EFC DESIGNS



**CHA8159AB**  
**Pimlico Boom-Arm Pharmacy**  
**Desk Lamp in Antique-**  
**Burnished Brass**  
 Height: 12½"-19"  
 Width: 7"  
 Extension: 21"-28"  
 Base: 7" Round

**Available Finishes:** AB, BZ, PN  
**Shade Details:** 3½" x 7"

**Socket:** Hi-Lo  
**Wattage:** 60 A  
 ©EFC DESIGNS



**CHA8150PN-PN**  
**Pimlico Adjustable Table Lamp**  
**in Polished Nickel with**  
**Polished Nickel Shade**  
 Height: 25"-32½"  
 Extension: 20½"  
 Base: 6" Round

**Available Finishes:**  
 AB, AN, BZ, PN  
**Shade Treatments:**  
 AB, BZ, AN, PN

**Socket:** Hi-Lo  
**Wattage:** 60 A  
 ©EFC DESIGNS



**CHA8150AB-LCF**  
**Pimlico Adjustable Table Lamp**  
**in Antique-Burnished Brass**  
**with Linen Collar Frill Shade**  
 Height: 25"-32½"  
 Extension: 20½"  
 Base: 6" Round

**Available Finishes:**  
 AB, AN, BZ, PN  
**Shade Treatments:**  
 LC, LCF  
**Shade Details:**  
 5" x 9" x 7½"

**Socket:** Hi-Lo  
**Wattage:** 60 A  
 ©EFC DESIGNS



**CHA8150AB-LC**

**CHA8106AB-NP**  
**Chunky Adjustable Swing-Arm**  
**Table Lamp in Antique-Burnished**  
**Brass with Natural Paper Shade**  
 Height: 27"-30"  
 Width: 12"  
 Extension: 24"  
 Base: 8" Round

**Available Finishes:**  
 AB, AN, BZ, PN  
**Shade Treatments:** L, NP  
**Shade Details:** 10" x 12" x 7½"

**Socket:** Dimmer  
**Wattage:** 100 A  
 ©EFC DESIGNS



**CHA8308AWG-B**  
**Italian Finial Form in Antique White Tole**  
**and Gold Leaf with Black Shade**

Height: 29"  
 Width: 18"  
 Base: 6¼" Square

**Shade Treatment:** B  
**Shade Details:** 6" x 18" x 11"

**Socket:** Hi-Lo  
**Wattage:** 75 A



**CHA8336WW-NP**  
**Ionic Fluted Column Table**  
**Lamp in Waxed Wood with**  
**Natural Paper Shade**

Height: 42"  
 Width: 19"  
 Base: 5" x 8¾"

**Available Finishes:**  
 OW, TB, WW  
**Shade Treatment:** NP  
**Shade Details:**  
 8"/17" x 10"/19" x 12"  
 Rectangle

**Socket:** Dimmer  
**Wattage:** 150 A  
 ©EFC DESIGNS



**CHA8309WGL-GL**  
**English Barley Twist Candle**  
**Lamp in Gold Leaf and White**  
**Over Waxed Wood with Gold**  
**Leaf Shade**

Height: 33"  
 Width: 12½"  
 Base: 6" Round

**Shade Treatment:** GL  
**Shade Details:**  
 4½" x 12½" x 8½"

**Socket:** Hi-Lo  
**Wattage:** 60 A



**CHA8390WGL-L**  
**Italian Candle Buffet Lamp in**  
**Wood with Distressed Gold**  
**Leaf Finish with Linen Shade**

Height: 42"  
 Width: 17"  
 Base: 10"

**Shade Treatment:** L  
**Shade Details:** 11" x 17" x 10"

**Socket:** Hi-Lo  
**Wattage:** 100 A



**CHA8391SP-NP**

**Carved Balustrade Candle Lamp  
in Scrubbed Pine Finish with  
Natural Paper Shade**

Height: 35"  
Width: 17"  
Base: 6 3/4" Round

**Shade Treatment:** NP

**Shade Details:**  
13" x 17" x 10" Natural Paper

**Socket:** Hi-Lo

**Wattage:** 150 A

©EFC DESIGNS



**CHA8523SP-L**

**Rectangular Urn Form in  
Scrubbed Pine with Linen  
Shade**

Height: 24"  
Width: 13 1/2"  
Base: 4 3/4" x 5 3/4"

**Shade Treatment:** L

**Shade Details:**  
8 1/4" / 6 1/4" x 13 1/2" / 8 1/2" x 9"  
Rectangle

**Socket:** Hi-Lo

**Wattage:** 100 A

©EFC DESIGNS



**CHA8353OGW-L**

**Cortina Urn with Handles on  
Mount in Old Garden White  
with Linen Shade**

Height: 31"  
Width: 18"  
Base: 7 1/2" Square

**Shade Treatment:** L

**Shade Details:** 10" x 18" x 12"

**Socket:** Hi-Lo

**Wattage:** 100 A

©EFC DESIGNS



**CHA8362AW-S**

**Althorp Urn Form on Mount  
in Antique White Tole with  
Silk Pleated Shade**

Height: 24"  
Width: 14"  
Base: 5" Round

**Shade Treatments:** B, NP, S

**Shade Details:** 10" x 14" x 9"

**Socket:** Hi-Lo

**Wattage:** 100 A

©EFC DESIGNS



**CHA8363B-S**

**Large Urn Form Lamp  
in Black and Gold Finish  
with Silk Shade**

Height: 35"  
Width: 20"  
Base: 8" Round

**Available Finishes:**

B, M

**Shade Treatments:**

L, NP, S

**Shade Details:**

14" x 20" x 13"

Box Pleat

**Socket:** Hi-Lo

**Wattage:** 150 A

©EFC DESIGNS

**CHA8363M-NP**



**CHA8223G-B**

**Nathan Road Reproduction of  
an Early 18th Century Tea  
Caddy in Tones of Green and  
Gold with Black Shade**

Height: 28"  
Width: 18"  
Base: 9" Round

**Shade Treatments:** B, NP

**Shade Details:**

8" x 18" x 13"

**Socket:** Hi-Lo

**Wattage:** 100 A

©EFC DESIGNS



**CHA8228BLK-S**

**Tole Urn Form Lamp  
with Double Cornucopia  
Design on Amber Brown  
Ground with Silk Shade**

Height: 24"  
Width: 15"  
Base: 6" Round

**Shade Treatment:** S

**Shade Details:** 7" x 15" x 9½"

**Socket:** Hi-Lo

**Wattage:** 75 A



**CHA8224BLK-S**

**Numeral Tea Caddy Lamp in  
Black with Silk Shade**

Height: 26"  
Width: 16"  
Base: 9" Round

**Available Finishes:** BLK, RD

**Shade Treatment:**

B, I, S

**Shade Details:**

9" x 16" x 10½"

**Socket:** Hi-Lo

**Wattage:** 60 A



**CHA8230G-L**

**No.15 Tea Caddy Lamp  
in Green with Gold Design  
with Linen Shade**

Height: 29"  
Width: 19"  
Base: 10 1/4" Round

**Shade Treatment: L**

**Shade Details:**  
12" x 19" x 13"

**Socket:** Hi-Lo  
**Wattage:** 150 A  
©EFC DESIGNS



**CHA8229CHI-L**

**Tole Tea Caddy Lamp  
in Chinoiserie Design  
with Linen Shade**

Height: 31"  
Width: 19"  
Base: 10 1/4" Round

**Shade Treatment: L**

**Shade Details:**  
12" x 19" x 13"

**Socket:** Hi-Lo  
**Wattage:** 150 A  
©EFC DESIGNS



**CHA8341CM-B**

**Chinese Marquetry Lamp  
with Black Shade**

Height: 27"  
Width: 17"  
Base: 7 1/2" x 9 1/2" Octagonal

**Shade Treatment: B**

**Shade Details:**  
5 7/8" x 11"/17" x 12 1/2" Rectangle

**Socket:** Hi-Lo  
**Wattage:** 100 A  
©EFC DESIGNS



**CHA8226FL-S**

**Chinoiserie Lamp on Hex  
Mount in Heavily Distressed  
Black with Floral and Bird  
Designs with Silk Shade**

Height: 28"  
Width: 16"  
Base: 9 1/2" Hexagonal

**Shade Treatment: S**

**Shade Details:** 13" x 16" x 11"

**Socket:** Hi-Lo  
**Wattage:** 150 A



**CHA8805AGL-B**  
**Cantonese Melon Form in**  
**Antique and**  
**Distressed Gold Leaf over**  
**Ceramic with Black Shade**  
 Height: 27½"  
 Width: 21"  
 Base: 7½" Square

**Shade Treatment:** B  
**Shade Details:** 6" x 21" x 12"

**Socket:** Hi-Lo  
**Wattage:** 75 A



**CHA8831AMB-B**  
**Ceramic Water Vessel Form on**  
**Wooden Mount in Amber Tone**  
**with Black Shade**  
 Height: 32"  
 Width: 19"  
 Base: 8" Square

**Shade Treatment:** B, L, NP  
**Shade Details:** 12" x 19" x 13"

**Socket:** Hi-Lo  
**Wattage:** 100 A  
 ©EFC DESIGNS



**CHA8351WGL-S**  
**Harp Form Table Lamp in**  
**Heavily Distressed Antique**  
**White and Gold with Silk**  
**Shade**  
 Height: 30½"  
 Width: 16"  
 Base: 8" Square

**Shade Treatment:** S  
**Shade Details:** 10" x 16" x 12"

**Socket:** Hi-Lo  
**Wattage:** 100 A



**CHA8350RD-S**  
**Melon Form Table Lamp in**  
**Heavily Distressed Tones of**  
**Red, Black, and Gold with Silk**  
**Shade**  
 Height: 33½"  
 Width: 16"  
 Base: 6" Square

**Shade Treatment:** S  
**Shade Details:** 9" x 16" x 10"

**Socket:** Hi-Lo  
**Wattage:** 100 A



**CHA8505AT-ABP**

**Umbrian Garden Urn in Terracotta with Natural Patina and Antique Black Parchment Shade**

Height: 29"  
Width: 20"  
Base: 7" Square

**Shade Treatment:** ABP, L  
**Shade Details:** 7" x 20" x 12½"

**Socket:** Hi-Lo  
**Wattage:** 100 A



**CHA8507CT-L**

**Garden Urn in Cracked Terracotta on Footed Mount with Linen Shade**

Height: 30"  
Width: 19"  
Base: 6" Square

**Shade Treatment:** L  
**Shade Details:** 12" x 19" x 13"

**Socket:** Hi-Lo  
**Wattage:** 150 A



**CHA8403R-S**

**Greens Park Urn Lamp in Rusty Iron on Antique Wooden Mount with Silk Shade**

Height: 26"  
Width: 15"  
Base: 6" Square

**Available Finishes:** GW, R  
**Shade Treatment:** S  
**Shade Details:** 10" x 15" x 9"

**Socket:** Hi-Lo  
**Wattage:** 100 A



**CHA8403GW-S**

**CHA8227BLK-S**

**Peninsula Tole Lamp in Black on Footed Mount with Silk Shade**

Height: 27½"  
Width: 10"  
Base: 9" Round

**Shade Treatment:** S  
**Shade Details:** 5" x 10" x 7"

**Socket:** Line Switch  
**Wattage:** 60 A  
©EFC DESIGNS





**CHA8452BZ-L**  
**Large Ring Handled Pot**  
**in Bronze with Linen Shade**

Height: 31"  
 Width: 19"  
 Base: 8" Round

**Available Finishes:** BZ  
**Shade Treatments:** B, L, NP  
**Shade Details:** 12" x 19" x 12"

**Socket:** Dimmer  
**Wattage:** 150 A  
 ©EFC DESIGNS



**CHA8814WHT-B**  
**Ceramic Ring Handle Oil Jar in**  
**Off White Crackle on Incised Wooden**  
**Mount with with Black Shade**

Height: 28"  
 Width: 18"  
 Base: 7"

**Shade Treatments:** B, NP  
**Shade Details:** 11" x 18" x 11½"

**Socket:** Hi-Lo  
**Wattage:** 100 A



**CHA8811WHT-S**  
**Italian Potter's Urn**  
**in Terracotta with Off White**  
**Distressed Glaze on Mount**  
**with Silk Shade**

Height: 26"  
 Width: 15"  
 Base: 6" Round

**Shade Treatment:** S  
**Shade Details:** 7" x 15" x 9½"

**Socket:** Hi-Lo  
**Wattage:** 100 A



**CHA8809WHT-ABP**  
**Italian Potter's Vase**  
**in Terracotta with Off White**  
**Distressed Glaze on**  
**Mount with Antique Black**  
**Parchment Shade**

Height: 29½"  
 Width: 20"  
 Base: 6" Round

**Shade Treatment:** ABP  
**Shade Details:** 7" x 20" x 12½"

**Socket:** Hi-Lo  
**Wattage:** 100 A



**CHA8802WHT-TSC**

**Chinese Female Figurine in Antiqued White Italian Ceramic on Wooden Base with Tea-Stained Silk Shade**

Height: 28"  
Width: 14"  
Base: 5½" x 7¾"

**Shade Treatment:** TSC

**Shade Details:**  
7" / 9" x 10" / 14" x 10¾"

**Socket:** Hi-Lo

**Wattage:** 100 A

©EFC DESIGNS



**CHA8801WHT-TSC**

**Chinese Male Figurine in Antiqued White Italian Ceramic on Wooden Base with Tea-Stained Silk Shade**

Height: 28"  
Width: 14"  
Base: 5½" x 7¾"

**Shade Treatment:** TSC

**Shade Details:**  
7" / 9" x 10" / 14" x 10¾"

**Socket:** Hi-Lo

**Wattage:** 100 A

©EFC DESIGNS



**CHA8844WHT-NP**

**French Balustrade Table Lamp in White Ceramic with Natural Paper Shade**

Height: 32½"  
Width: 19"  
Base: 6" Square

**Shade Treatment:** NP

**Shade Details:** 10" x 19" x 13"

**Socket:** Dimmer

**Wattage:** 100 A

©EFC DESIGNS



**CHA8845WHT-NP**

**French Balustrade Bedside Lamp in White Ceramic with Natural Paper Shade**

Height: 27"  
Width: 14"  
Base: 4¾" Square

**Shade Treatment:** NP

**Shade Details:** 10" x 14" x 11"

**Socket:** Dimmer

**Wattage:** 100 A

©EFC DESIGNS



**CHA8620CC-NP**  
**Small Bowed Jar Form**  
**in Celadon Crackle on Antique**  
**Brass Footed Base**  
**with Natural Paper Shade**  
 Height: 20"  
 Width: 12½"  
 Base: 7" Square

**Available Finishes:** CC, IC  
**Shade Treatment:** NP  
**Shade Details:**  
 8½" x 12½" x 9½" Square

**Socket:** Dimmer  
**Wattage:** 100 A  
 ©EFC DESIGNS



**CHA8621CC-NP**  
**Double Bowed Jar Form**  
**in Celadon Crackle on**  
**Antique Brass Footed Base**  
**with Natural Paper Shade**  
 Height: 30¾"  
 Width: 18"  
 Base: 7" Square

**Available Finishes:** CC, IC  
**Shade Treatment:** NP  
**Shade Details:** 13" x 18" x 13"  
 Square

**Socket:** Dimmer  
**Wattage:** 150 A  
 ©EFC DESIGNS



**CHA8622IC-NP**  
**Large Bowed Jar Form in**  
**Ivory Crackle on Bronze**  
**Museum Mounting with**  
**Natural Paper Shade**  
 Height: 29¾"  
 Width: 19"  
 Base: 10¾" Square

**Available Finishes:** CC, IC  
**Shade Treatment:** NP  
**Shade Details:**  
 14" x 19" x 14" Square

**Socket:** Dimmer  
**Wattage:** 150 A  
 ©EFC DESIGNS



**CHA8623IC-NP**  
**Square Column Vase in**  
**Ivory Crackle on Bronze**  
**Museum Mounting with**  
**Natural Paper Shade**  
 Height: 32"  
 Width: 19"  
 Base: 7"

**Available Finishes:** CC, IC  
**Shade Treatment:** NP  
**Shade Details:**  
 14" x 19" x 12" Square

**Socket:** Dimmer  
**Wattage:** 150 A  
 ©EFC DESIGNS



**CHA8610I-NP**  
**Elongated Square Vase Form**  
**in Ivory Porcelain on**  
**Antique Brass with**  
**Natural Paper Shade**  
Height: 34½"  
Width: 19"  
Base: 7¼" Square

**Shade Treatments:** NP  
**Shade Details:**  
14" x 19" x 14" Square

**Socket:** Dimmer  
**Wattage:** 150 A  
©EFC DESIGNS



**CHA8626IC-NP**  
**Medium Square Kuan Form**  
**Lamp in Ivory Crackle Glaze**  
**with Natural Paper Shade**  
Height: 30"  
Width: 18"  
Base: 8" Square

**Shade Treatment:** NP  
**Shade Details:**  
13" x 18" x 13" Square

**Socket:** Dimmer  
**Wattage:** 150 A  
©EFC DESIGNS



**CHA8617I-NP**  
**Large Narrow Neck Vase Form**  
**in Ivory Glaze with Natural**  
**Paper Shade**  
Height: 32"  
Width: 19"  
Base: 7½" Round

**Available Finishes:** CC, I  
**Shade Treatment:** NP  
**Shade Details:** 14" x 19" x 13"

**Socket:** Dimmer  
**Wattage:** 150 A  
©EFC DESIGNS



**CHA8618CC-NP**  
**Large Baluster Vase Form**  
**in Celadon Crackle Glaze**  
**with Natural Paper Shade**  
Height: 33"  
Width: 19"  
Base: 7½" Round

**Available Finishes:** CC, I  
**Shade Treatment:** NP  
**Shade Details:** 14" x 19" x 13"

**Socket:** Dimmer  
**Wattage:** 150 A  
©EFC DESIGNS



**CHA8614I-NP**  
**Small Hexagonal Vase Form**  
**Lamp in Ivory Glaze with**  
**Natural Paper Shade**  
 Height: 28"  
 Width: 17"  
 Base: 6" Hexagonal

**Available Finishes:** CC, I  
**Shade Treatment:** NP  
**Shade Details:** 12" x 17" x 12"

**Socket:** Dimmer  
**Wattage:** 100 A  
 ©EFC DESIGNS



**CHA8612I-NP**  
**Large Hexagonal Vase Form**  
**Lamp in Ivory Glaze with**  
**Natural Paper Shade**  
 Height: 32½"  
 Width: 19"  
 Base: 7½" Hexagonal

**Available Finishes:** CC, I  
**Shade Treatment:** NP  
**Shade Details:** 14" x 19" x 14"

**Socket:** Dimmer  
**Wattage:** 150 A  
 ©EFC DESIGNS



**CHA8619IC-NP**  
**Octagonal Narrow Neck Gourd**  
**in Ivory Crackle on**  
**Antique Brass with**  
**Natural Paper Shade**  
 Height: 32¾"  
 Width: 19"  
 Base: 7" Hexagonal

**Available Finishes:** CC, IC  
**Shade Treatment:** NP  
**Shade Details:** 14" x 19" x 13"

**Socket:** Dimmer  
**Wattage:** 150 A  
 ©EFC DESIGNS



**CHA8627AB-NP**  
**Fang Gourd Lamp in Antique**  
**Brass with Natural Paper Shade**  
 Height: 27"  
 Width: 18"  
 Base: 6¼" Square

**Available Finishes:**  
 AB, IC  
**Shade Treatment:** NP  
**Shade Details:**  
 8"/14" x 10"/18" x 11"  
 Square

**Socket:** Dimmer  
**Wattage:** 150 A  
 ©EFC DESIGNS



**CHA8627IC-NP**

**CHA8615I-NP**

**Large Gourd Form Lamp  
in Ivory Glaze with Natural  
Paper Shade**

Height: 34½"  
Width: 20"  
Base: 7½" Square

**Available Finishes:** CC, I  
**Shade Treatment:** NP  
**Shade Details:** 15" x 20" x 14"

**Socket:** Dimmer  
**Wattage:** 150 A  
©EFC DESIGNS



**CHA8613CC-NP**

**Small Gourd Form Lamp  
in Celadon Crackle Glaze  
with Natural Paper Shade**

Height: 26"  
Width: 16"  
Base: 6" Square

**Available Finishes:** CC, I  
**Shade Treatment:** NP  
**Shade Details:** 11" x 16" x 11"

**Socket:** Dimmer  
**Wattage:** 100 A  
©EFC DESIGNS



**CHA8613I-NP**

**CHA8611I-NP**

**Large Mokko Form Gourd  
Lamp in Ivory Glaze with  
Natural Paper Shade**

Height: 36½"  
Width: 20"  
Base: 7½" Square

**Available Finishes:** CC, I  
**Shade Treatment:** NP  
**Shade Details:** 15" x 20" x 14"

**Socket:** Dimmer  
**Wattage:** 150 A  
©EFC DESIGNS



**CHA8616I-NP**

**Medium Mokko Form Gourd  
Lamp in Ivory Glaze with  
Natural Paper Shade**

Height: 30"  
Width: 17"  
Base: 6" Square

**Available Finishes:** CC, I  
**Shade Treatment:** NP  
**Shade Details:** 12" x 17" x 12"

**Socket:** Dimmer  
**Wattage:** 100 A  
©EFC DESIGNS



**CHA8405ST-NP**  
**Corinthian Column Fragment**  
**Table Lamp on Museum Mount**  
**with Natural Paper Shade**  
 Height: 21"-26½"  
 Width: 17"  
 Base: 8" x 6"

**Shade Treatments:** NP  
**Shade Details:**  
 6"/12½" x 8"/17" x 11" Half Shade

**Socket:** Dimmer  
**Wattage:** 100 A  
 ©EFC DESIGNS



**CHA8406ST-NP**  
**Flame Finial Fragment Table**  
**Lamp on Museum Mount**  
**with Natural Paper Shade**  
 Height: 25½"-31½"  
 Width: 16"  
 Base: 5½" x 8"

**Shade Treatment:** NP  
**Shade Details:**  
 6"/11½" x 8"/16" x 12" Half Shade

**Socket:** Dimmer  
**Wattage:** 100 A  
 ©EFC DESIGNS



**CHA8455BR-L**  
**Gate Fragment Adjustable**  
**Table Lamp on**  
**Museum Mount with**  
**Linen Shade**  
 Height: 22½"-27½"  
 Width: 15"  
 Base: 6" x 10¾"

**Shade Treatments:** L  
**Shade Details:**  
 5½"/13" x 6½"/15" x 9" Half Shade

**Socket:** Dimmer  
**Wattage:** 100 A  
 ©EFC DESIGNS



**CHA3109AB**  
**Rolled Lip Hurricane**  
**in Antique-Burnished Brass**  
Height: 19½"  
Width: 8"  
Base: 9½"

**Available Finishes:** AB, PS



**CHA3109PS**



**CHA3121AB**  
**Large English Hurricane on**  
**Fluted Column Mount in**  
**Antique-Burnished Brass**  
Height: 20"  
Width: 10"  
Base: 8¼"

**Available Finishes:** AB, BZ, PS



**CHA3121PS**





**CHA8451WI**  
**Windsor Iron Twist Candlestick**  
**in Weathered Iron**  
**with Antique Brass Fittings**  
Height: 29"  
Width: 16"  
Base: 8"  
Candles Not Included



**SL3032HAB**

**Mini Architect's Draftsman  
Table Lamp in Hand-Rubbed**

**Antique Brass**

Height: 18"-24"

Width: 6 1/4"

Extension: 24"

Base: 6 1/4" Square

**Available Finishes:**

BZ, HAB, PS

**Shade Details:** 2" x 6 1/4" x 4 1/2"

Hexagonal

**Socket:** Hi-Lo

**Wattage:** 40 B

©EFC DESIGNS



**SL3025AN**

**The Pixie Adjustable Desk Lamp  
in Antique Nickel**

Height: 13"-18 1/2"

Width: 5 1/2"

Extension: 16"

Base: 5 1/2" Round

**Available Finishes:**

AN, BZ, HAB, PN

**Shade Details:** 2 1/4" x 4 3/4"

**Socket:** Hi-Lo

**Wattage:** 25C

©EFC DESIGNS

**SL3025HAB**



**S3064CH**

**Angle Draftsman's Lamp in Chrome**

Height: 14"-32"

Width: 6 3/4"

Extension: 17"-27"

Base: 6" Square

**Available Finishes:** CH, HAB

**Shade Details:** 2" x 5 3/4" x 6 3/4"

**Socket:** Keyless with

Hi-Lo Line Switch

**Wattage:** 40 A

©EFC DESIGNS

**S3064HAB**



**SL3BHAB**

**Adjustable Photographer's Lamp in  
Hand-Rubbed Antique Brass**

Height: 15" - 21"

Width: 5"

Extension: 7"

Base: 5" Round

**Available Finishes:** AN, HAB

**Shade Details:** 4" x 4" x 7"

**Socket:** Keyless/

Hi-Lo Line Switch

**Wattage:** 50 R20

©EFC DESIGNS

**SL3BAN**

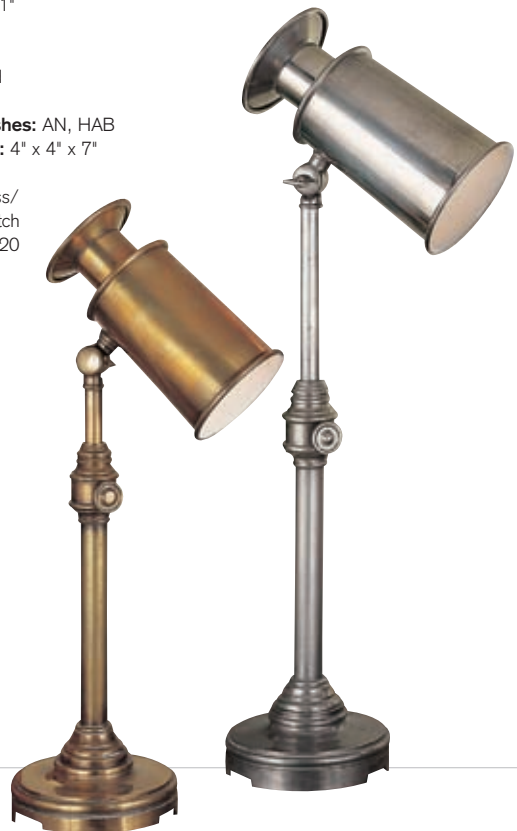

**S3061PN****Bauhaus Single-Arm Architect's Lamp in Polished Nickel**

Height: 18"-28"

Extension: 27"

Base: 6" Round

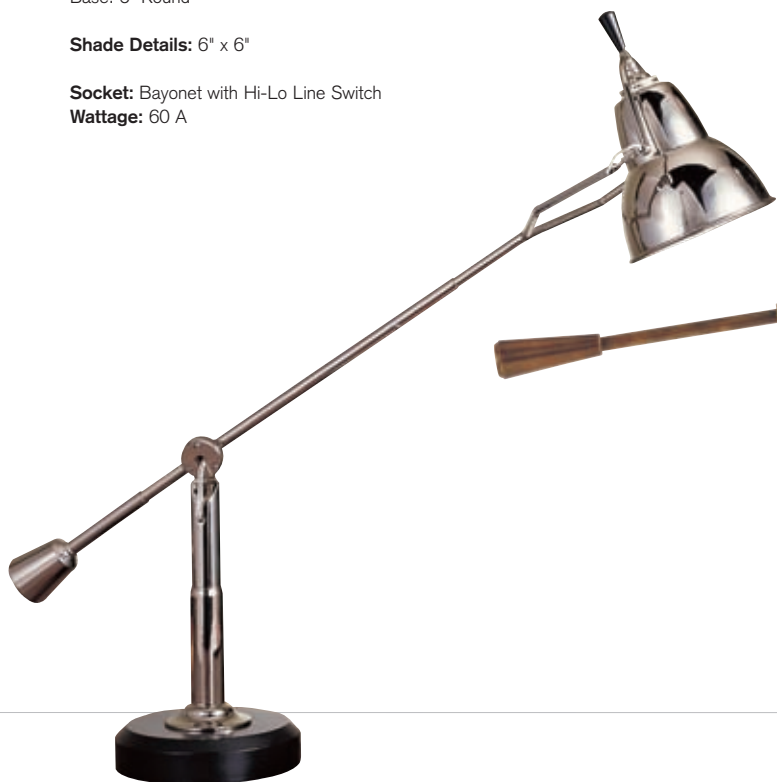
**Shade Details:** 6" x 6"**Socket:** Bayonet with Hi-Lo Line Switch**Wattage:** 60 A**SL3975HAB****Boom-Arm Table Lamp in Hand-Rubbed Antique Brass**

Height: 15"-26½"

Extension: 34"

Base: 8" Round

**Available Finishes:**

BZ, HAB, PN

**Shade Details:** 7" Round**Socket:** Hi-Lo**Wattage:** 60 A

©EFC DESIGNS

**S3060PN****Bauhaus Architect's Lamp in Polished Nickel**

Height: 15"-45"

Extension: 41"

Base: 6" Round

**Shade Details:** 6" x 6"**Socket:** Bayonet w/ Hi-Lo Line Switch**Wattage:** 60 A

**SL3910AN/SLJG-WG**  
Boston Adjustable Desk Lamp  
in Antique Nickel with  
White Glass SLJG Shade  
Height: 10½"-20"  
Extension: 17"  
Base: 6" Round

**Available Finishes:** AN, BZ, HAB  
**Shade Treatment:** SLJG-WG  
See Shade Schedule for  
Additional Shade Options

**Socket:** Hi-Lo  
**Wattage:** 60 A  
©EFC DESIGNS



**SL3910AN/SLG-AN**  
Boston Adjustable Desk Lamp  
in Antique Nickel with  
Antique Nickel SLG Shade  
Height: 10½"-20"  
Extension: 17"  
Base: 6" Round

**Available Finishes:** AN, BZ, HAB  
**Shade Treatment:** SLG-AN  
See Shade Schedule for  
Additional Shade Options

**Socket:** Hi-Lo  
**Wattage:** 60 A  
©EFC DESIGNS



**SL3910AN/SLE-AW**  
Boston Adjustable Desk Lamp  
in Antique Nickel with  
Antique White SLE Shade  
Height: 10½"-20"  
Extension: 17"  
Base: 6" Round

**Available Finishes:** AN, BZ, HAB  
**Shade Treatment:** SLE-AW  
See Shade Schedule for  
Additional Shade Options

**Socket:** Hi-Lo  
**Wattage:** 60 A  
©EFC DESIGNS



**SL3905HAB**  
Boston Functional Bookkeeper's Lamp  
in Hand-Rubbed Antique Brass  
Height: 20" - 26"  
Width: 15½"  
Base: 8" Round

**Available Finishes:** HAB, PN  
**Shade Details:** 15½" x 4¼"

**Socket:** 2 - Candelabra  
**Wattage:** 2 - 60 C  
©EFC DESIGNS



**SL3992PN-PN**

**Boston Double-Arm Down Bridge  
Table Lamp in Polished Nickel**

Height: 26" - 31½"  
Width: 35"  
Base: 9½" Round

**Available Finishes:** BZ, HAB, PN  
**Shade Details:** 4" x 7½" x 5½" Metal

**Socket:** 2 - Hi-Lo  
**Wattage:** 2 - 60 A  
©EFC DESIGNS

**SL3980HAB-WG2**

**Boston Swing-Arm Table Lamp  
in Hand-Rubbed Antique Brass**

Height: 26"-31½"  
Extension: 31"  
Base: 7" Round

**Available Finishes:**  
BZ, HAB, PN  
**Shade Details:** 7" Round

**Socket:** Hi-Lo  
**Wattage:** 60 A  
©EFC DESIGNS

**SL2BHAB-S**

**Adjustable Photographer's Lamp  
in Hand-Rubbed Antique Brass  
with Silk Shade**

Height: 17"-22"  
Width: 10"  
Base: 5" Round

**Available Finishes:** AN, HAB, PS  
**Shade Treatments:** S, TSC  
**Shade Details:** 6" x 10" x 7¾"

**Socket:** Hi-Lo  
**Wattage:** 75 A  
©EFC DESIGNS

**SL2BAN-S****SL30BHAB-S**

**Adjustable Photographer's  
Console Lamp in Hand-Rubbed  
Antique Brass with Silk Shade**

Height: 27½"-37"  
Width: 10"  
Base: 6" Round

**Available Finishes:** AN, HAB, PS  
**Shade Treatments:** S, SBP, TSC  
**Shade Details:** 6" x 10" x 7¾"  
Silk / Tea - Stained Silk Bell or  
11½" x 15" x 10" Silk Box Pleat

**Socket:** Hi-Lo  
**Wattage:** 75 A  
©EFC DESIGNS

**SL30BAN-S**

**S3200BZ-WG**

**Ian's Reading Lamp in Bronze with White Glass Shade**

Height: 21¼"  
Width: 9¾"  
Base: 8½" Round

**Available Finishes:** BZ, HAB, PN  
**Shade Treatment:** WG  
**Shade Details:** 9" x 9¾" x 6¾"

**Socket:** Dimmer  
**Wattage:** 100 A



**SL30BPS-SBP**

**Photographer's Console Lamp in Polished Silver with Silk Shade**

Height: 27¾"-37½"  
Width: 15"  
Base: 6" Round

**Available Finishes:** AN, HAB, PS  
**Shade Treatments:** S, SBP, TSC  
**Shade Details:** 6" x 10" x 7¾"  
Silk / Tea - Stained Silk Bell or  
11½" x 15" x 10" Silk Box Pleat

**Socket:** Hi-Lo  
**Wattage:** 75 A  
©EFC DESIGNS



**SL3804CHC-NP**

**Stacked Four-Ball Lamp in Chocolate Wood with Bronze Accent with Natural Paper Shade**

Height: 33¾"  
Width: 20"  
Base: 7½" Square

**Available Finishes:** CHC, HAB, PS  
**Shade Treatment:** NP  
**Shade Details:** 15" x 20" x 14"

**Socket:** Hi-Lo  
**Wattage:** 150 A  
©EFC DESIGNS



**SL3804HAB-NP**

**SL3811WG-NP**

**MOUTH BLOWN GOURD LAMP IN WHITE GLASS WITH NATURAL PAPER SHADE**

Height: 30"  
Width: 19"  
Base: 6" Round

**Available Finishes:** CG, WG  
**Shade Treatment:** NP  
**Shade Details:** 15" x 19" x 12"

**Socket:** Hi-Lo  
**Wattage:** 150 A  
©EFC DESIGNS



**SL3811CG-NP**

**SL3805HAB-NP**  
**Stacked Three-Ball Lamp in**  
**Hand-Rubbed Antique Brass**  
**on Chocolate Wood with**  
**Natural Paper Shade**  
 Height: 24"  
 Width: 14"  
 Base: 6½" Square

**SL3805PS-NP**

**SL3805Q-NP**

**Available Finishes:**  
 CHC, HAB, PS, Q  
**Shade Treatments:** NP  
**Shade Size:** 10" x 14" x 10"

**Socket:** Hi-Lo  
**Wattage:** 100 A  
 ©EFC DESIGNS



**SL3801WG-NP**  
**Gourd Lamp in White Glass**  
**with Natural Paper Shade**  
 Height: 33"  
 Width: 20"  
 Base: 8½" Square

**SL3801EG-NP**

**SL3801ASL-L**

**SL3801AGL-S**

**Available Finishes:**  
 AGL, ASL, EG, WG  
**Shade Treatment:**  
 L, NP, S  
**Shade Details:**  
 15" x 20" x 14"

**Socket:** Hi-Lo  
**Wattage:** 150 A  
 ©EFC DESIGNS



**SL3802CG-NP**  
**Conical Crystal Bedside Lamp**  
**on Faceted Base with Natural**  
**Paper Shade**

Height: 21½"  
Width: 13"  
Base: 4¾" Octagonal

**Shade Treatment:** NP  
**Shade Size:** 10" x 13" x 8"

**Socket:** Hi-Lo  
**Wattage:** 100 A  
French Wired  
©EFC DESIGNS



**SL3803CG-NP**  
**Large Conical Crystal Bedside**  
**Lamp on Faceted Base with**  
**Natural Paper Shade**

Height: 27½"  
Width: 17"  
Base: 8" Octagonal

**Shade Treatment:** NP  
**Shade Size:** 13" x 17" x 10"

**Socket:** Hi-Lo  
**Wattage:** 150 A  
French Wired  
©EFC DESIGNS



**SL3806CG-NP**  
**Variable Cube Stacked Bedside in**  
**Crystal with Natural Paper Shade**

Height: 25½"  
Width: 12"  
Base: 5½" Square

**Available Finishes:** CG, Q  
**Shade Treatment:** NP  
**Shade Details:**  
11" x 12" x 8¼"  
Square

**Socket:** Hi-Lo  
**Wattage:** 150 A  
©EFC DESIGNS



**SL3806Q-NP**

**SL3807CG-NP**  
**Variable Cube Stacked**  
**Buffet in Crystal with**  
**Natural Paper Shade**

Height: 36"  
Width: 12"  
Base: 6" Square

**Shade Treatment:** NP  
**Shade Size:** 11" x 12" x 8¼"  
Square

**Socket:** Hi-Lo  
**Wattage:** 150 A  
©EFC DESIGNS





**SL3338CG-S****Square Balustrade Table Lamp  
in Crystal with Silk Shade**

Height: 27½"  
Width: 16"  
Base: 5¼" Square

**Available Finishes:**

CG, OW, R

**Shade Treatment:**

L, NP, S

**Shade Details:**

11" x 16" x 10" Square

**Socket:** Hi-Lo**Wattage:** 150 A

French Wired

©EFC DESIGNS

**SL3339CG-SBP****Square Balustrade Table Lamp  
in Crystal with Silk Shade**

Height: 27¼"  
Width: 16"  
Base: 5¼" Square

**Available Finishes:** CG, OW

**Shade Treatment:** NP, SBP

**Shade Details:**

13' x 17" x 10" NP or

13' x 17" x 11" SBP

**Socket:** Hi-Lo**Wattage:** 150 A

French Wired

©EFC DESIGNS

**SL3944CG-NP****French Balustrade Table Lamp in  
Crystal with Natural Paper Shade**

Height: 32½"  
Width: 19"  
Base: 6" Square

**Available Finishes:** CG, ALB

**Shade Treatment:** NP

**Shade Details:**

10" x 19" x 13"

**Socket:** Dimmer**Wattage:** 100 A

French Wired (CG)

©EFC DESIGNS

**SL3944ALB-NP****SL3945CG-NP****French Balustrade Bedside Lamp in  
Crystal with Natural Paper Shade**

Height: 27"  
Width: 14"  
Base: 4¾" Square

**Available Finishes:** CG, ALB

**Shade Treatment:** NP

**Shade Size:**

10" x 14" x 11"

**Socket:** Dimmer**Wattage:** 100 A

French Wired (CG)

©EFC DESIGNS

**SL3945ALB-NP**

**SL3948IP-L**  
**Surrey Table Lamp in Irish Pine with Linen Shade**  
 Height: 35"  
 Width: 21½"  
 Base: 9" Octagonal

**Available Finishes:** IP, OW  
**Shade Treatment:** L  
**Shade Details:**  
 17½" x 21" x 12"

**Socket:** Dimmer  
**Wattage:** 150 A  
 ©EFC DESIGNS



**SL3941FPW-NP**  
**Balustrade Table Lamp in Fence Post Wash on Bronze Museum Mount with Natural Paper Shade**  
 Height: 28"-35"  
 Width: 17"  
 Base: 7½" Square

**Available Finishes:** AWG, FPW  
**Shade Treatments:** B, L, NP  
**Shade Details:** 13" x 17" x 10"

**Socket:** 2-Pull Chain  
**Wattage:** 2-60 A  
 ©EFC DESIGNS



**SL3943IP-NP**  
**Wood Balustrade Table Lamp in Irish Pine with Natural Paper Shade**  
 Height: 33"  
 Width: 17"  
 Base: 5½" Square

**Available Finishes:**  
 IP, OS  
**Shade Treatment:**  
 NP  
**Shade Size:**  
 13" x 17" x 10"

**Socket:** Hi-Lo  
**Wattage:** 150 A  
 ©EFC DESIGNS



**SL3943OS-NP**

**SL3338OW-L**  
**Square Balustrade Table Lamp in Old White with Linen Shade**  
 Height: 26"  
 Width: 16"  
 Base: 5¾" Square

**Available Finishes:** CG, OW, R  
**Shade Treatment:**  
 L, NP, S  
**Shade Size:**  
 11" x 16" x 10" Square

**Socket:** Hi-Lo  
**Wattage:** 150 A  
 ©EFC DESIGNS



**SL3338R-NP**

**SL3339OW-NP**  
**Round Balustrade Table Lamp**  
 in Old White with  
 Natural Paper Shade  
 Height: 29¼"  
 Width: 16"  
 Base: 5¾" Square

**Available Finishes:** CG, OW  
**Shade Treatment:** NP, SBP  
**Shade Details:** 11" x 16" x 10"

**Socket:** Hi-Lo  
**Wattage:** 150 A  
 ©EFC DESIGNS



**SL3336TB-NP**  
**Balustrade Candlestick Table**  
 Lamp in Tudor Brown  
 with Natural Paper Shade  
 Height: 31"  
 Width: 14"  
 Base: 10" Round

**Available Finishes:** FW, TB  
**Shade Treatment:** B, L, NP  
**Shade Details:** 10" x 14" x 11"

**Socket:** Hi-Lo  
**Wattage:** 100 A  
 ©EFC DESIGNS



**SL3324FW-B**  
**Tudor Twist Desk Lamp**  
 in French Wax Finish  
 with Black Shade  
 Height: 23"  
 Width: 13"  
 Base: 7½" Round

**Available Finishes:** FW, TB  
**Shade Treatment:** B  
**Shade Size:** 9" x 13" x 6"

**Socket:** 2-Keyless with  
 Hi-Lo Line Switch  
**Wattage:** 2-60 A  
 ©EFC DESIGNS



**SL3325TB-B**  
**Tudor Twist Table Lamp in**  
**Tudor Brown with Black Shade**  
 Height: 35½"  
 Width: 15"  
 Base: 8" Round

**Available Finishes:** FW, TB  
**Shade Treatment:** B  
**Shade Size:** 6" x 15" x 8"

**Socket:** 2-Keyless with  
 Hi-Lo Line Switch  
**Wattage:** 2-40 A  
 ©EFC DESIGNS



**SL3326FW-NP**

**Tudor Twist Adjustable Table Lamp in French Wax with Natural Paper Shade**

Height: 35"-45½"  
Width: 16"  
Base: 7½" Round

**Available Finishes:** FW, WA  
**Shade Treatments:** L, NP  
**Shade Details:**  
10" x 16" x 10"

**Socket:** Hi-Lo  
**Wattage:** 100 A  
©EFC DESIGNS



**SL3326WA-NP**

**SL3940FPW-NP**

**Twist Column Adjustable Lamp in Fence Post Wash on Bronze Museum Mount with Natural Paper Shade**

Height: 39½"-42½"  
Width: 11"  
Base: 5½" Square

**Available Finishes:** AWG, FPW  
**Shade Treatments:** B, L, NP  
**Shade Details:** 8" x 11" x 9"

**Socket:** Hi-Lo  
**Wattage:** 100 A  
©EFC DESIGNS



**SL3940AWG-NP**

**S312BB-NP**

**Bamboo Desk Lamp with Natural Paper Shade**

Height: 18½"  
Width: 10½"  
Base: 6" Round

**Shade Treatment:** NP  
**Shade Details:** 9½" x 10½" x 6¾"

**Socket:** Hi-Lo  
**Wattage:** 100 A



**S311BB-NP**

**Bamboo Table Lamp with Natural Paper Shade**

Height: 27"  
Width: 12"  
Base: 7" Round

**Shade Treatment:** NP  
**Shade Details:** 11" x 12" x 8"

**Socket:** Hi-Lo  
**Wattage:** 150 A



**S310EB-NP**  
**Tribal Form Table Lamp**  
 in Ebony with  
 Natural Paper Shade  
 Height: 26"  
 Width: 13"  
 Base: 6¼" Round

**Shade Treatment:** NP  
**Shade Details:**  
 12" x 13" x 9"

**Socket:** Hi-Lo  
**Wattage:** 150 A



**SL3700FW-NP**  
**Tripod Table Lamp**  
 in French Wax  
 with Natural Paper Shade  
 Height: 27"  
 Width: 12"  
 Base: 9" Tripod

**Shade Treatment:** NP  
**Shade Details:** 12" x 12" x 8"

**Socket:** Hi-Lo  
**Wattage:** 150 A  
 ©EFC DESIGNS



**S301AN-NP**  
**Small Oval Lamp in Antique**  
**Nickel with Natural Paper Shade**  
 Height: 17"  
 Width: 11"  
 Base: 3¾" x 5½" Oval

**Available Finishes:** AN, HAB  
**Shade Treatment:** NP  
**Shade Details:**  
 6" / 9" x 8½" / 11" x 7"

**Socket:** Keyless with  
 Hi-Lo Line Switch  
**Wattage:** 60 A



**S302HAB-NP**  
**Tall Oval Lamp in Hand-Rubbed**  
**Antique Brass**  
 Height: 26"  
 Width: 14½"  
 Base: 3¾" x 5" Oval

**Available Finishes:** AN, HAB  
**Shade Treatment:** NP  
**Shade Details:**  
 9" / 12" x 11½" / 14½" x 10"

**Socket:** Hi-Lo  
**Wattage:** 100 A



**SL3103PS-S**

**Hex Bedside Lamp in Polished Silver with Silk Shade**

Height: 24"  
Width: 11"  
Base: 4 3/4" Hexagonal

**Available Finishes:** HAB, PS  
**Shade Treatment:** S  
**Shade Details:** 8" x 11" x 8 1/2"

**Socket:** Hi-Lo  
**Wattage:** 100 A  
©EFC DESIGNS



**SL3102HAB-S**

**Hex Table Lamp in Hand-Rubbed Antique Brass with Silk Shade**

Height: 27"  
Width: 13 1/2"  
Base: 6 1/2" Hexagonal

**Available Finishes:** HAB, PS  
**Shade Treatment:** S  
**Shade Details:** 9 1/2" x 13 1/2" x 10"

**Socket:** Hi-Lo  
**Wattage:** 100 A  
©EFC DESIGNS



**SL3101PS-S**

**Tall Hex Candlestick Lamp in Polished Silver with Silk Shade**

Height: 34"  
Width: 11"  
Base: 5 1/2" Hexagonal

**Available Finishes:** HAB, PS  
**Shade Treatment:** S  
**Shade Details:** 8" x 11" x 8 1/2"

**Socket:** Hi-Lo  
**Wattage:** 100 A  
©EFC DESIGNS



**SL3100HAB-S**

**Hex Urn Lamp in Hand-Rubbed Antique Brass with Silk Shade**

Height: 26 1/2"  
Width: 15"  
Base: 6 1/2" Hexagonal

**Available Finishes:** AN, HAB, PS  
**Shade Treatment:** S  
**Shade Details:** 11" x 15" x 11"

**Socket:** Hi-Lo  
**Wattage:** 100 A  
©EFC DESIGNS



**PT3000BZ-S**

**Peter Talbot Table Lamp in Bronze with Silk Shade**

Height: 34 1/2"  
Width: 10"  
Base: 6 1/2" Square

**Available Finishes:** BC, BZ, HAB  
**Shade Treatment:** S  
**Shade Details:** 10" x 10" x 12"

**Socket:** Dimmer  
**Wattage:** 100 A



**S30HAB-NP**  
**Architectural Table Lamp in**  
**Hand-Rubbed Antique Brass**  
**with Natural Paper Shade**

Height: 23"  
 Width: 14"  
 Base: 6" Square

**Available Finishes:**

BS, HAB

**Shade Treatment:**

NP, NPS

**Shade Details:**

7" x 14" x 10"

**Socket:** Hi-Lo

**Wattage:** 75 A



**S3030BR-NP**  
**Iron Table Lamp**  
**with Natural Paper Shade**

Height: 24¼"-31¾"  
 Width: 6¼"  
 Extension: 19¾"  
 Base: 6¼" x 8¾"

**Shade Treatment:** NP

**Shade Details:** 6" x 6" x 4½"

**Socket:** Candelabra /

Hi-Lo Line Switch

**Wattage:** 60 C



**S3050BR-NP**  
**Aspen Table Lamp**  
**with Natural Paper Shade**

Height: 25"  
 Width: 14"  
 Base: 6½" Round

**Shade Treatment:** NP

**Shade Details:**

13½" x 14½" x 9"

**Socket:** Hi-Lo

**Wattage:** 150 A



**S3051BR-NP**  
**Aspen Console Lamp**  
**with Natural Paper Shade**

Height: 22½"  
 Width: 16"  
 Base: 4½" x 9"

**Shade Treatment:** NP

**Shade Details:**

7" / 15" x 8" / 16" x 8"

Rectangle

**Socket:** 2-Candelabra /

Hi-Lo Switch

**Wattage:** 2-60 C



**TOB3039BZ/HAB-NP**  
**Ryan Puzzle Lamp in Bronze and Hand-Rubbed Antique Brass with Natural Paper Shade**  
 Height: 15"  
 Width: 9 1/4"  
 Base: 5" x 9 1/4"

**Shade Treatment:** NP  
**Shade Details:** 5 1/2" x 6 1/2" x 6 1/2"

**Socket:** Pull Chain  
**Wattage:** 60 A



**TOB3038BZ**  
**Eclipse Table Lamp in Bronze with Half Shade**  
 Height: 9"  
 Width: 6 1/2"  
 Base: 6 1/2" Round

**Available Finishes:** BZ, BZ/PN, HAB, PN, PS

**Socket:** Keyless/Hi-Lo Switch  
**Wattage:** 60 A

**TOB3038HAB**

**TOB3038PN**



**TOB3043PN**  
**Small David Table Lamp in Polished Nickel with Wood Tray**  
 Height: 10"  
 Width: 10 1/4"  
 Base: 3" x 10 1/4"

**Available Finishes:** BZ, HAB, PN

**Socket:** Keyless/Hi-Lo Switch  
**Wattage:** 40 T

**TOB3043HAB**

**TOB3042PS**  
**David Mantel Light in Polished Silver**  
 Height: 4 1/4"  
 Width: 3"  
 Base: 3" x 8 3/4"

**Available Finishes:** BZ, HAB, PN, PS

**Socket:** Hi-Lo  
**Wattage:** 40 T

**TOB3042BZ**

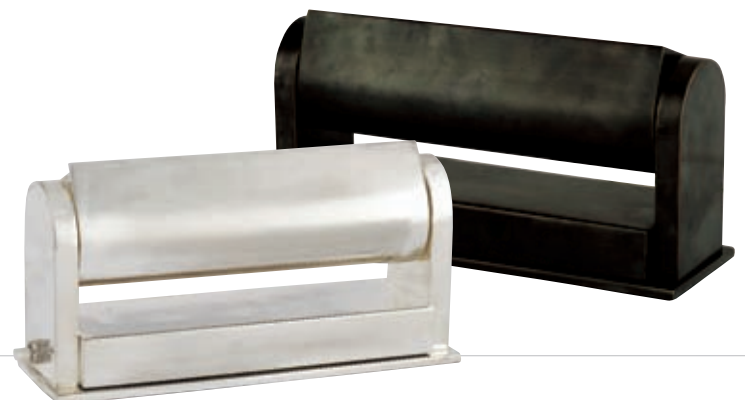



**TOB3040BZ**  
**Trent Lamp in Bronze**  
 Height: 8"  
 Width: 17 1/4"  
 Extension: 5 1/2"  
 Base: 5 1/2" x 17 1/4"

**Available Finishes:** BZ, HAB, PN

**Socket:** 2-Candelabra/  
 Line Switch  
**Wattage:** 2 - 40 C



**TOB3052PN**  
**Tommy Task Lamp**  
**in Polished Nickel**  
 Height: 5 1/4"-9 1/2"  
 Extension: 10 1/2"  
 Base: 3 1/4" Round

**TOB3052BZ**

**TOB3052HAB**

**Available Finishes:** AN, BZ, HAB, PN

**Socket:** Push  
**Wattage:** 25 B



Wall "Pin-Up" Feature

**TOB3009BC**  
**Greenwich Desk Lamp**  
**in Brushed Chrome**  
 Height: 23"  
 Extension: 15"  
 Base: 10" Round

**Available Finishes:** BC, BZ, HAB, PN  
**Shade Details:** 13"

**Socket:** Dimmer  
**Wattage:** 60 T



**TOB3037PN-BZ**  
**Vernon Task Lamp in Polished Nickel and Bronze**  
 Height: 14 1/2"  
 Width: 8 1/4"  
 Extension: 14"  
 Base: 8 1/4" Round

**TOB3037BZ**

**Available Finishes:** BZ, BZ-HAB, HAB, PN-BZ

**Socket:** Hi-Lo  
**Wattage:** 60 T



**TOB3036PS-NP**  
**Ziyi Pivoting Table Lamp**  
**in Polished Silver with**  
**Natural Paper Shade**

Height: 27 $\frac{3}{4}$ "  
Width: 8"  
Extension: 13"  
Base: 8" Round

**Available Finishes:**  
BZ, HAB, PN, PS  
**Shade Treatment:** NP  
**Shade Details:** 5" x 5" x 9"

**Socket:** Hi-Lo  
**Wattage:** 60 A

**TOB3036BZ-NP**



**TOB3005CH**  
**Thurston Pivoting**  
**Desk Lamp in Chrome**

Height: 14"  
Width: 14 $\frac{1}{2}$ "  
Extension: 22"  
Base: 9 $\frac{1}{4}$ " Square

**Available Finishes:**  
AN, BZ, CH, HAB  
**Shade Details:** 14 $\frac{1}{2}$ " Round

**Socket:** Dimmer  
**Wattage:** 75 A



**TOB3061BLK/HAB**  
**Selecta Task Lamp in Black**  
**and Hand-Rubbed Antique**  
**Brass with Black Shade**

Height: 25 $\frac{3}{4}$ "  
Width: 8 $\frac{1}{4}$ "  
Extension: 14 $\frac{1}{4}$ "  
Base: 8 $\frac{1}{4}$ " Round

**Available Finishes:**  
BLK/HAB, HAB, PN/AW

**Socket:** Keyless/  
Hi-Lo Switch  
**Wattage:** 60 A



**TOB3060BZ/HAB**  
**Selecta Desk Lamp in Bronze**  
**with Hand-Rubbed Antique Brass**  
**Accents with Bronze Shade**

Height: 30 $\frac{3}{4}$ "  
Width: 11 $\frac{1}{2}$ "  
Extension: 20 $\frac{1}{2}$ "  
Base: 8 $\frac{1}{4}$ " Round

**Available Finishes:**  
BZ/HAB, HAB, PN,  
PN/AW

**Socket:** 2-Keyless/  
Hi-Lo Switch  
**Wattage:** 2-40 B



**TOB3065PN**  
**Elkins Pivoting Task Lamp**  
**in Polished Nickel**  
 Height: 19½"-36½"  
 Width: 8"  
 Extension: 45¼"  
 Base: 8" Round

**TOB3065BZ**

**Available Finishes:** BZ, BZ/PN, HAB, PN

**Socket:** Keyless with Hi-Lo Switch  
**Wattage:** 60 A



**TOB3066BZ**  
**Elkins Clamp On Desk Lamp**  
**in Bronze**  
 Height: 36"  
 Width: 7¼"  
 Extension: 31"  
 Clamp On: ¼" Round

**Available Finishes:**  
 BZ, BZ/PN, HAB, PN

**Socket:** Keyless/  
 Hi-Lo Line Switch  
**Wattage:** 60 A



**TOB3081AN/PN-NP**

**Alton Pivoting Accent Lamp in  
Antique Nickel and Polished  
Nickel with Natural Paper Shade**

Height: 12½"  
Width: 6"  
Extension: 10½"  
Base: 4½" x 5½" Oval

**Available Finishes:** AN/PN, BZ,  
BZ/HAB, HAB, PN  
**Shade Treatments:** NP, NP/BT  
**Shade Details:** 4" x 6" x 6½"

**Socket:** Hi-Lo  
**Wattage:** 60 A



**TOB3018HAB/BZ-NP/BT**  
**Jack Table Lamp in Hand-Rubbed  
Antique Brass and Bronze with  
Natural Paper Shade**

Height: 18½"  
Width: 12"  
Base: 3" Round

**Available Finishes:**  
HAB/BZ, PS  
**Shade Treatments:**  
NP/BT, NP/ST  
**Shade Details:** 9" x 12" x 9"

**Socket:** Pull Chain  
**Wattage:** 100 A



**TOB3018PS-NP/ST**

**TOB3025HAB-C**

**Nina Table Lamp in  
Hand-Rubbed Antique Brass  
with Cotton Shade**

Height: 27½"  
Width: 8"  
Base: 8" Round

**Available Finishes:**  
AN, BZ, HAB, PS, R  
**Shade Treatments:**  
C, C/BT, C/RT  
**Shade Details:**  
4½" x 6" x 8"

**Socket:** Hi-Lo  
**Wattage:** 60 A



**TOB3026BZ-C/BT**

**Nina Tapered Table Lamp  
in Bronze with Cotton Shade**

Height: 31"  
Width: 15"  
Base: 12" Round

**Available Finishes:**  
AN, BZ, HAB, PS, R  
**Shade Treatments:**  
C, C/BT, C/RT  
**Shade Details:**  
14" x 15" x 9½"

**Socket:** Hi-Lo  
**Wattage:** 150 A



**TOB3019HAB-C**  
**Jackie Table Lamp in**  
**Hand-Rubbed Antique Brass**  
**with Cotton Shade**  
 Height: 26½"-28"  
 Width: 16"  
 Base: 13½" Round

**Available Finishes:**  
 AN, HAB, PS, R  
**Shade Treatment:** C  
**Shade Details:**  
 12½" x 16" x 10"

**Socket:** 2-Pull Chain  
**Wattage:** 2-75 A



**TOB3019PS-C**



**TOB3076BZ-NP**  
**Stanford Bedside Lamp in**  
**Bronze with Natural Paper**  
**Shade**  
 Height: 20"-21"  
 Width: 11"  
 Base: 4½" Round

**Available Finishes:**  
 ALB, AN, BZ, HAB, PS  
**Shade Treatment:** NP  
**Shade Details:**  
 11" x 11" x 7½"

**Socket:** 2-Pull Chain  
**Wattage:** 2-40 B



**TOB3076ALB-NP**

**TOB3077HAB-NP**  
**Stanford Table Lamp in Hand-**  
**Rubbed Antique Brass with**  
**Natural Paper Shade**  
 Height: 26½"-28¾"  
 Width: 14"  
 Base: 6½" Round

**Available Finishes:**  
 ALB, AN, BZ, HAB, PS  
**Shade Treatment:** NP  
**Shade Details:**  
 14" x 14" x 9½"

**Socket:** 2-Pull Chain  
**Wattage:** 2-60 A



**TOB3077ALB-NP**

**TOB3072ROP-NP**

**Watson Table Lamp in Rope  
with Natural Paper Shade**

Height: 26¼"

Width: 15"

Base: 5½" Square

**Shade Treatments:** CP, NP

**Shade Details:** 14" x 15" x 10"

**Socket:** 2-Pull Chain

**Wattage:** 2-75 A



**TOB3012CHC-NP**

**Nelson Table Lamp in Chocolate  
with Natural Paper Shade**

Height: 34¼"

Width: 19"

Base: 7" Square

**Available Finishes:**

CAR, CHC

**Shade Treatment:** NP

**Shade Details:**  
9" x 19½" x 15½"

**Socket:** 2-Pull Chain

**Wattage:** 2-60 A



**TOB3074DBS-S**

**Maison Accent Lamp in Dark  
Brown Shagreen with Silk Shade**

Height: 23"

Width: 11"

Base: 4¾" x 5¼" Oval

**Available Finishes:**

DBS, WS

**Shade Treatment:** S

**Shade Details:**

10½" x 11" x 11½"

**Socket:** Hi-Lo

**Wattage:** 100 A



**TOB3006HAB-NP**

**Porter Table Lamp  
in Hand-Rubbed Antique Brass  
with Natural Paper Shade**

Height: 26"

Width: 14"

Base: 3½" x 4½"

**Available Finishes:**

BC, BZ, HAB

**Shade Treatment:** NP

**Shade Details:**

10" x 14" x 10¾"

**Socket:** 2-Pull Chain

**Wattage:** 2-60 A



**TOB3000HAB-NP**  
**Longacre Small Table Lamp**  
**in Hand-rubbed Antique Brass**  
**with Natural Paper Shade**  
 Height: 16"  
 Width: 9"  
 Base: 5" Round

**Available Finishes:** BZ, HAB,  
 PN, PS  
**Shade Treatment:** NP  
**Shade Details:** 9" x 9" x 6"

**Socket:** 2-Pull Chain  
**Wattage:** 2-25 B



**TOB3000PN-NP**

**TOB3001BZ-NP/BT**  
**Longacre Tall Table Lamp in Bronze**  
**with Natural Paper Shade**  
 Height: 32½"  
 Width: 20"  
 Base: 10¼" Round

**Available Finishes:**  
 BZ, HAB, PN, PS  
**Shade Treatments:**  
 NP, NP/BT  
**Shade Details:**  
 20" x 20" x 7½"

**Socket:** 2-Pull Chain  
**Wattage:** 2-60 B



**TOB3008BZ-WP**  
**Beekman Table Lamp in Acrylic**  
**with White Paper Shade**  
 Height: 17½"  
 Width: 8"  
 Base: 6" Round

**Shade Treatment:** WP  
**Shade Details:** 7" x 8" x 8½"

**Socket:** Hi-Lo  
**Wattage:** 75 A



**TOB3073CG-NP**  
**Zoe Table Lamp in Crystal**  
**with Natural Paper Shade**  
 Height: 31¼"  
 Width: 15"  
 Base: 6" Square

**Available Finishes:** CG, CHC  
**Shade Treatment:** NP  
**Shade Details:** 12" x 15" x 14"

**Socket:** Hi-Lo  
**Wattage:** 150 A



**TOB3016SDL-L**

**Palin Table Lamp in Saddle  
Leather with Linen Shade**

Height: 31¾"  
Width: 18"  
Base: 10½" Square

**Available Finishes:** SDL, BLK  
**Shade Treatment:** L  
**Shade Details:** 11" x 18" x 13"

**Socket:** Pull Chain  
**Wattage:** 150 A



**TOB3017CG-L**

**Palin Crystal Table Lamp with  
Polished Nickel Accents with  
Linen Shade**

Height: 31¾"  
Width: 18½"  
Base: 10½" Square

**Shade Treatment:** L  
**Shade Details:** 11" x 18" x 13"

**Socket:** Pull Chain  
**Wattage:** 150 A



**TOB3031CG-C**

**Small Crystal Block Table  
Lamp with Cotton Shade**

Height: 18"-19½"  
Width: 11½"  
Base: 4" x 6"

**Shade Treatment:** C  
**Shade Details:**  
11½" x 11½" x 8"

**Socket:** 2-Pull Chain  
**Wattage:** 2-40 B



**TOB3030CG-C**

**Large Crystal Block Table  
Lamp with Cotton Shade**

Height: 24"-26"  
Width: 16¾"  
Base: 6" x 9"

**Shade Treatment:** C  
**Shade Details:**  
9½"/15" x 11"/16¾" x  
10½" Oval

**Socket:** 2-Pull Chain  
**Wattage:** 2-60 B





**TOB3082CG-S**  
**Luca Etched Crystal Lamp**  
 with Silk Shade  
 Height: 25"-27½"  
 Width: 14"  
 Base: 6¾" x 11½"

**Shade Treatment:** S  
**Shade Details:** 14" x 14" x 10"

**Socket:** 2-Pull Chain  
**Wattage:** 2-40 B



**TOB3083CG-S**  
**Daphne Etched Crystal Lamp**  
 with Silk Shade  
 Height: 26"-28½"  
 Width: 16½"  
 Base: 6¾" x 13½"

**Shade Treatment:** S  
**Shade Details:**  
 9½"/15" x 11"/16½" x 10½"  
 Oval

**Socket:** 2-Pull Chain  
**Wattage:** 2-60 B



**TOB3084CG-S**  
**Cynthia Etched Crystal Lamp**  
 with Silk Shade  
 Height: 26½"-29½"  
 Width: 16½"  
 Base: 6¾" x 14"

**Shade Treatments:** S  
**Shade Details:**  
 9½"/15" x 11"/16½" x 10½"  
 Oval

**Socket:** 2-Pull Chain  
**Wattage:** 2-60 B



**TOB3075GS-S**  
**Val Accent Lamp in Gray**  
 Shagreen with Silk Shade  
 Height: 16½"  
 Width: 7"  
 Base: 6¾" Square

**Available Finishes:** GS, RS  
**Shade Treatment:** S  
**Shade Details:** 7" x 7" x 7¾"  
 Hardback Square

**Socket:** Pull Chain  
**Wattage:** 75 A

**TOB3075RS-S**



**TOB3003BZ-NP**

**Soho Lamp in Bronze with Natural Paper Shade**

Height: 28"  
Width: 16"  
Base: 11" Square

**Available Finishes:**

AN, BZ, HAB

**Shade Treatment:** NP

**Shade Details:**

16" x 16" x 13" NPS

**Socket:** 2-Pull Chain

**Wattage:** 2-60 A with 60 A in Base



**TOB3002GBC-NP**

**Spring Street Table Lamp in Grey Book Cloth with Saddle Leather with Natural Paper Shade**

Height: 27"  
Width: 16"  
Base: 11" Square

**Available Finishes:** GBC, SBC

**Shade Treatment:** NP

**Shade Details:**

16" x 16" x 13" NPS

**Socket:** 2-Pull Chain

**Wattage:** 2-60 A



**TOB3032GBC/AN-GBC**  
**Small Dixon Table Lamp in Grey Book Cloth and Antique Nickel with Grey Book Cloth Shade**

Height: 20½"  
Width: 13½"  
Base: 6¾" x 4½"

**Available Finishes:**

AN/PN, BL/BZ, BZ/HAB, HAB/BZ, GBC/AN, SBC/HAB

**Shade Treatments:**

BZ, GBC, NP, PN, SBC

**Shade Details:**

8½"/13¼" x 8½"/13¼" x 9"

**Socket:** 2-Pull Chain

**Wattage:** 2-60 A



**TOB3032SBC/HAB-NP**



**TOB3032BZ/HAB-BZ**  
**Small Dixon Table Lamp in**  
**Bronze and Hand-Rubbed**  
**Antique Brass with Bronze**  
**Shade**

Height: 21"  
 Width: 13 1/4"  
 Base: 4 1/2" x 6 3/4"

**Available Finishes:**

AN/PN, BL/BZ, BZ/HAB,  
 HAB/BZ, GBC/AN, SBC/HAB

**Shade Treatments:** BZ, GBC,  
 NP, PN, SBC

**Shade Details:**

8 1/2" / 13 1/4" x 8 1/2" / 13 1/4" x 9"

**Socket:** 2-Pull Chain

**Wattage:** 2-60 A



**TOB3032AN/PN-PN**



**TOB3033HAB/BZ-BZ**  
**Tall Dixon Table Lamp**  
**in Hand-Rubbed**  
**Antique Brass and Bronze**  
**with Bronze Shade**

Height: 30 1/2"  
 Width: 18"  
 Base: 7 3/4" x 9 1/2"

**Available Finishes:**

AN/PN, BL/BZ, BZ/HAB,  
 HAB/BZ, GBC/AN, SBC/HAB

**Shade Treatments:**  
 BZ, GBC, NP, PN, SBC

**Shade Details:**

13 1/2" / 18" x 13 1/2" / 18" x 11 1/2"

**Socket:** 2-Pull Chain

**Wattage:** 2-60 A



**TOB3033BL/BZ-BZ**



**TOB3011ALB-NP**  
**London Column Lamp**  
**in Alabaster with**  
**Natural Paper Shade**

Height: 38¼"  
Width: 19"  
Base: 7" Round

**Shade Treatment:** NP  
**Shade Details:**  
9" x 19½" x 15½"

**Socket:** 2-Pull Chain  
**Wattage:** 2-75 A



**TOB3013ALB-NP**  
**Leland Table Lamp**  
**in Alabaster with**  
**Natural Paper Shade**

Height: 38½"  
Width: 21"  
Base: 8½" Round

**Shade Treatment:** NP  
**Shade Details:**  
9½" x 21" x 15"

**Socket:** 2-Pull Chain  
**Wattage:** 2-75 A



**TOB3020ALB-NP**  
**Terri Cube Lamp in Alabaster**  
**with Natural Paper Shade**

Height: 12½"  
Width: 6"  
Base: 4½" Square

**Available Finishes:** ALB, CG, Q  
**Shade Treatment:** NP  
**Shade Details:** 4" x 6" x 6"

**Socket:** Hi-Lo  
**Wattage:** 60 A



**TOB3020CG-NP**  
French Wired



**TOB3022ALB-NP**  
**Terri Pyramid Lamp**  
**in Alabaster with**  
**Natural Paper Shade**

Height: 12½"  
Width: 6½"  
Base: 6½" Square

**Available Finishes:** ALB, CG, Q  
**Shade Treatment:** NP  
**Shade Details:** 4" x 6" x 6"

**Socket:** Hi-Lo  
**Wattage:** 60 A



**TOB3022CG-NP**  
French Wired



**TOB3021ALB-NP**  
**Terri Cone Lamp in Alabaster**  
 with Natural Paper Shade  
 Height: 16"  
 Width: 6"  
 Base: 4½" Round

**Available Finishes:** ALB, CG  
**Shade Treatment:** NP  
**Shade Details:** 4" x 6" x 6"

**Socket:** Hi-Lo  
**Wattage:** 60 A



**TOB3021CG-NP**  
 French Wired

**TOB3023ALB-NP**  
**Terri Large in Alabaster**  
 with Natural Paper Shade  
 Height: 15"  
 Width: 8"  
 Base: 3" Round

**Available Finishes:** ALB, CG  
**Shade Treatment:** NP  
**Shade Details:** 5" x 8" x 8"

**Socket:** Hi-Lo  
**Wattage:** 75 A



**TOB3023CG-NP**  
 French Wired

**TOB3051PS-NP**  
**Tiny Terri Lamp in**  
 Polished Silver with  
 Natural Paper Shade  
 Height: 10¼"  
 Width: 5"  
 Base: 2¼"

**Available Finishes:**  
 ALB, CG, HAB, PS  
**Shade Treatment:** NP  
**Shade Details:** 3" x 5" x 5½"

**Socket:** Candelabra with  
 Hi-Lo Line Switch  
**Wattage:** 40 C  
 French Wired

**TOB3051HAB-NP**

**TOB3051ALB-NP**

**TOB3051CG-NP**

**TOB3014CG-NP**  
**Terri Crystal Accent Lamp**  
 with Natural Paper Shade  
 Height: 12½"  
 Width: 6"  
 Base: 3" Round

**Shade Treatment:** NP  
**Shade Details:** 4" x 6" x 6"

**Socket:** Hi-Lo  
**Wattage:** 60 A  
 French Wired



**TOB3070CHC-NP/BT**  
**Gladding Table Lamp in**  
**Chocolate Wood and Crystal**  
**with Natural Paper Shade**

Height: 23¼"  
Width: 15"  
Base: 9¼" Square

**Shade Treatment:** NP/BT  
**Shade Details:** 11½" x 15" x 11"

**Socket:** 2-Pull Chain  
**Wattage:** 2-60 A



**TOB3069PN/CAR-NP/RT**  
**Morgan Table Lamp in Polished**  
**Nickel and Caramel Wood**  
**with Natural Paper Shade**

Height: 27½"  
Width: 16"  
Base: 9¼" Square

**Shade Treatment:** NP/RT  
**Shade Details:** 12" x 16" x 13"

**Socket:** 2-Pull Chain  
**Wattage:** 2-60 A



**TOB3024ALB-NP/BT**  
**Terri Tall in Alabaster with**  
**Natural Paper Shade**

Height: 24"  
Width: 16"  
Base: 8" Round

**Shade Treatments:** NP/BT  
**Shade Details:**  
14" x 16" x 5"

**Socket:** 2-Hi-Lo  
**Wattage:** 2-40 B



**TOB3067PN/BZ-NP/BT**  
**Elkins Table Lamp in Polished**  
**Nickel and Bronze with Natural**  
**Paper Shade**

Height: 25"-27½"  
Width: 13½"  
Base: 9¼" Round

**Available Finishes:**  
HAB, PN/BZ, PS  
**Shade Treatments:** NP, NP/BT  
**Shade Details:**  
8¼" x 13½" x 10½"

**Socket:** 2-Pull Chain  
**Wattage:** 2-40 A



**TOB3068PN/CHC-NP**  
**Ryder Table Lamp in Polished Nickel and Chocolate Wood with Natural Paper Shade**  
 Height: 28¾"  
 Width: 6¾"  
 Base: 6¾" Round

**Available Finishes:**  
 BZ, HAB, PN/CHC, PS/CG  
**Shade Treatment:** NP  
**Shade Details:**  
 4½" x 6" x 7½"

**Socket:** Hi-Lo  
**Wattage:** 60 A

**TOB3068PS/CG-NP**

**TOB3068HAB-NP**

**TOB3010ALB-NP**  
**Jacqueline Lamp in Alabaster on Chocolate Wood Base with Natural Paper Shade**  
 Height: 32½"  
 Width: 16"  
 Base: 5¼" Square

**Available Finishes:**  
 ALB, CAR  
**Shade Treatment:** NP  
**Shade Details:**  
 10" x 16" x 13½"

**Socket:** 2-Pull Chain  
**Wattage:** 2-75 A

**TOB3010CAR-NP**



**TOB3141GS-WG**  
**Brandt Accent Lamp in Grey Shagreen with White Glass Shade**  
 Height: 14½"  
 Width: 7"  
 Base: 6" Round

**Available Finishes:** BL, BZ, DBS, GS, HAB, HAB/BZ, PN, RS, WS  
**Shade Treatment:** WG  
**Shade Details:** 4¾" x 6¾"

**Socket:** Pull Chain  
**Wattage:** 60 A

**TOB3141WS-WG**

**TOB3141HAB/BZ-WG**

**TOB3041HAB-WG**  
**Brandt Round Lamp in Hand-Rubbed Antique Brass with White Glass Shade**  
 Height: 21¾"  
 Width: 11¼"  
 Base: 8½" Round

**Available Finishes:**  
 BZ, HAB, PN  
**Shade Treatment:** WG  
**Shade Details:** 11¼" Round

**Socket:** Pull Chain  
**Wattage:** 100 A



**TOB3071CHC-NP**

**Xavier Table Lamp in Chocolate Wood with Natural Paper Shade**

Height: 29¾"  
Width: 15½"  
Base: 7¾"

**Shade Treatment:** NP

**Shade Details:** 13" x 15½" x 11½"

**Socket:** Hi-Lo

**Wattage:** 150 A



**TOB3015BZ-NP**

**Jackson Lamp in Bronze with Natural Paper Shade**

Height: 33¾"  
Width: 13½"  
Base: 7" Round

**Available Finishes:**

BZ, HAB, PS

**Shade Treatment:** NP

**Shade Details:** 7½" x 13½" x 12"

**Socket:** Hi-Lo

**Wattage:** 100 A



**TOB3090BR-NP/BT**

**Hugo Accent Lamp in Black Rust and Hand-Rubbed Antique Brass with Natural Paper Shade**

Height: 22"  
Width: 10½"  
Base: 8¼" Round

**Shade Treatment:** NP/BT

**Shade Details:** 6¼" x 10½" x 8½"

**Socket:** Hi-Lo

**Wattage:** 75 A



**TOB3091BR-NP/BT**

**Hugo Table Lamp in Black Rust and Hand-Rubbed Antique Brass with Natural Paper Shade**

Height: 26"-28½"  
Width: 11½"  
Base: 10" Round

**Shade Treatment:** NP/BT

**Shade Details:** 8¼" x 13½" x 11½"

**Socket:** 2-Pull Chain

**Wattage:** 2-40 A





**TOB3004BC-WP/ST**  
**Academy Pivoting Desk Lamp in**  
**Brushed Chrome with**  
**White Paper Shade**

Height: 24"  
 Width: 19"  
 Extension: 32¼"  
 Base: 14½" Round

**Available Finishes:**  
 BC, BZ, CH

**Shade Treatment:**  
 WP/ST, NP/BT

**Shade Details:**  
 19" x 19" x 7"

**Socket:** 2-Keyless  
 with Hi-Lo Line Switch  
**Wattage:** 2-60 A



**TOB3080HAB-NP**  
**Studio Tripod Table Adjustable Lamp**  
**in Hand-Rubbed Antique Brass**  
**with Natural Paper Shade**

Height: 32"-75"  
 Width: 20"  
 Base: 11"-20" Tripod

**Available Finishes:**  
 BZ, HAB, PN

**Shade Treatment:** NP

**Shade Details:**  
 15" x 20" x 13½"

**Socket:** 2-Pull Chain  
**Wattage:** 2-75 A



**TOB3080BZ-NP**



**TOB3007PS-NP**  
**Bryant Table Lamp in Polished Silver with Natural Paper Shade**  
 Height: 24½"-30½"  
 Width: 6"  
 Base: 4¼" Round

**Available Finishes:**  
 AS, BZ, HAB, PS  
**Shade Treatment:** NP  
**Shade Size:** 4" x 6" x 6½"

**Socket:** Keyless with Hi-Lo Line Switch  
**Wattage:** 60 A



**TOB3007HAB-NP**



**TOB3088OAK-NP**  
**Nicky Candlestick in Oak with Natural Paper Shade**  
 Height: 44¾"  
 Width: 10½"  
 Base: 10½" Round

**Shade Treatment:** NP  
**Shade Size:** 4" x 6" x 6½"

**Socket:** Pull Chain  
**Wattage:** 60 A



**TOB3049BZ-CP**  
**Olivia Candlestick Lamp in Bronze with Chocolate Paper Shade**  
 Height: 43¾"  
 Width: 10"  
 Base: 10" Round

**Available Finishes:**  
 AN, BZ, CHC  
**Shade Treatments:** CP, NP  
**Shade Details:** 9" x 10" x 12"

**Socket:** Pull Chain  
**Wattage:** 100 A



**TOB3049CHC-NP**



**TOB3050AN-NP**  
**Oliver Candlestick Lamp in Antique Nickel with Natural Paper Shade**  
 Height: 49¾"  
 Width: 10"  
 Base: 10" Round

**Available Finishes:**  
 AN, BZ, CHC  
**Shade Treatments:** CP, NP  
**Shade Details:** 9" x 10" x 12"

**Socket:** Pull Chain  
**Wattage:** 100 A



**TOB3050CHC-CP**



**TOB3028WG-NP**  
**Chloe Table Lamp**  
 in White Glass with  
 Natural Paper Shade  
 Height: 31½"-33"  
 Width: 15"  
 Base: 6½" Round

**Available Finishes:**  
 BG, EG, WG  
**Shade Treatment:** NP  
**Shade Size:** 9" x 15" x 12½"

**Socket:** 2-Pull Chain  
**Wattage:** 2-60 A



**TOB3028BG-NP**

**TOB3027SG-NP**  
**Miro Table Lamp**  
 in Clear-Seeded Glass with  
 Natural Paper Shade  
 Height: 32"-34"  
 Width: 20"  
 Base: 8½" Square

**Available Finishes:**  
 BG, SG, WG  
**Shade Treatment:** NP  
**Shade Details:**  
 12" x 20" x 15½"

**Socket:** 2-Pull Chain  
**Wattage:** 2-75 A



**TOB3047WG-NP**  
**Small Emily Table Lamp**  
 in Clear-Seeded Glass with  
 Natural Paper Shade  
 Height: 19"  
 Width: 11"  
 Base: 3¼" Round

**Available Finishes:** BG, SG, WG  
**Shade Treatment:** NP  
**Shade Details:** 9" x 11" x 8"

**Socket:** Hi-Lo  
**Wattage:** 100 A



**TOB3048BG-NP**  
**Large Emily Table Lamp**  
 in Blue Glass with  
 Natural Paper Shade  
 Height: 26½"  
 Width: 15½"  
 Base: 5" Round

**Available Finishes:**  
 BG, SG, WG  
**Shade Treatment:**  
 NP  
**Shade Details:**  
 12½" x 15½" x 12¼"

**Socket:** Hi-Lo  
**Wattage:** 150 A



**TOB3046LB-NP**  
**Elcy Ceramic Table Lamp**  
 in Light Blue with  
 Natural Paper Shade  
 Height: 22¼"  
 Width: 14"  
 Base: 4¾" Round

**Available Finishes:** I, LB, LC  
**Shade Treatment:** NP  
**Shade Size:**  
 8"/12" x 10"/14" x 9½" Oval

**Socket:** Pull Chain  
**Wattage:** 100 A



**TOB3112AN-CG**

**Austin Hurricane  
in Antique Nickel  
with Clear Glass**

Height: 17¾"

Width: 11¾"

Base: 11¾" Round

**Available Finishes:**

AN-CG, BZ-CG, CHC-CG



**TOB3114AN-BG**

**Andre Hurricane  
in Antique Nickel  
with Blue Glass**

Height: 19½"

Width: 9½"

Base: 9½" Round

**Available Finishes:**

AN-BG, AN-CG,  
BZ-CG, CHC-CG



**TOB3113CHC-CG**

**Augusta Hurricane  
in Chocolate Wood  
with Clear Glass**

Height: 20¼"

Width: 10¼"

Base: 8" Round

**Available Finishes:**

AN-CG, BZ-CG, CHC-CG



**TOB3111CHC-CG**  
**Atwood Hurricane**  
**in Chocolate Wood**  
**with Clear Glass**

Height: 18"  
Width: 8 1/4"  
Base: 8 1/4" Round

**Available Finishes:**  
AN-CG, BZ-CG, CHC-CG



**TOB3110AN-BG**  
**Adam Hurricane**  
**in Antique Nickel**  
**with Blue Glass**

Height: 16 1/4"  
Width: 8 1/4"  
Base: 8 1/4" Round

**Available Finishes:**  
AN-BG, AN-CG, BZ-CG, CHC-CG



**TOB3110CHC-BG**



**BB3102BZV-HAB**

**Columnar Candlestick Table Lamp  
in Bronze Verdigris with  
Hand-Rubbed Antique Brass Shade**

Height: 32"  
Width: 15"  
Base: 7½" Square

**Shade Details:**  
8½" x 14" x 10½"

**Socket:** Hi-Lo  
**Wattage:** 100 A



**NYPL2**

**New York Public Library  
Mini Table Lamp in Bronze  
with Hand-Rubbed Antique  
Brass Shade**

Height: 24"  
Width: 12½"  
Base: 6¾" Round

**Shade Treatment:** HAB  
**Shade Details:**  
7" x 12½" x 8½"

**Socket:** 2-Pull Chain  
**Wattage:** 2-60 A



**NYPL1**

**New York Public Library  
Reading Room Lamp in Bronze  
with Hand-Rubbed Antique  
Brass Shade**

Height: 31"  
Width: 15"  
Base: 8" Round

**Shade Treatment:** HAB  
**Shade Details:**  
8" x 15" x 10½"

**Socket:** 2-Pull Chain  
**Wattage:** 2-60 A



**BB3101HAB-S**

**Small Trophy Lamp in  
Hand-Rubbed Antique Brass  
with Silk Shade**

Height: 23"  
Width: 11½"  
Base: 7" Round

**Available Finishes:**

AN, HAB

**Shade Treatments:**

B, NP, S

**Shade Details:**

8" x 11" x 8½"

**Socket:** Hi-Lo  
**Wattage:** 100 A



**BB3100HAB-B**

**Classic Trophy Lamp in  
Hand-Rubbed Antique Brass  
with Black Shade**

Height: 25¼"  
Width: 15"  
Base: 6" Round

**Available Finishes:**

AN, HAB, PB

**Shade Treatments:**

B, NP

**Shade Details:**

6" x 15" x 10"

**Socket:** Dimmer  
**Wattage:** 75 A



**BB3821BLK-B**  
**31" Candlestick Lamp**  
**in Black with Black Shade**

Height: 31"  
 Width: 15"  
 Base: 7 1/4" Round

**Available Finishes:**  
 BLK, OX  
**Shade Treatments:**  
 B, L, NP  
**Shade Details:**  
 5" x 15" x 9 1/2"

**Socket:** Keyless with  
 Hi-Lo Line Switch  
**Wattage:** 60 A



**BB3820OX-NP**  
**24" Candlestick Lamp**  
**in Oxblood with**  
**Natural Paper Shade**

Height: 24"  
 Width: 10"  
 Base: 6" Round

**Available Finishes:**  
 BLK, OX  
**Shade Treatments:**  
 B, L, NP  
**Shade Details:**  
 4" x 10" x 7"

**Socket:** Keyless with  
 Hi-Lo Line Switch  
**Wattage:** 60 A



**BB3002HAB-MP**  
**Large Bouillotte Lamp**  
**in Hand-Rubbed Antique Brass**  
**with Monte Patina Shade**

Height: 24"  
 Width: 17 1/2"  
 Base: 4" x 9"

**Available Finishes:** HAB, PB  
**Shade Treatments:** MP, OX  
**Shade Details:** 8" x 17 1/2"

**Socket:** 2-Candelabra with  
 Hi-Lo Line Switch  
**Wattage:** 2-60 C



**BB3002HAB-OX**

**BB3040HAB-NP**  
**Hobbs Table Lamp**  
**in Hand-Rubbed Antique Brass**  
**with Natural Paper Shade**

Height: 31"  
 Width: 12 1/2"  
 Extension: 7 1/4"  
 Base: 5" Round

**Available Finishes:**  
 AN, BZ, HAB, PN  
**Shade Treatment:** NP  
**Shade Details:**  
 9 1/2" x 12 1/2" x 9 3/4"

**Socket:** Hi-Lo  
**Wattage:** 100 A



**BB3110HAB-NP**

**French Candlestick Buffet Lamp in Hand-Rubbed Antique Brass with Natural Paper Shade**

Height: 35"  
Width: 11"  
Base: 6" Round

**Available Finishes:**  
AN, BZ, HAB, PB, PN  
**Shade Treatments:**  
L, NP, T  
**Shade Details:**  
5" x 11" x 8 1/4"

**Socket:** Dimmer  
**Wattage:** 75 A



**BB3510HABL2-NP**

**Adjustable Miniature Library Lamp in Antique Brass with Braided Leather with Natural Paper Shade**

Height: 19"-29"  
Width: 7"  
Base: 5" Round

**Available Finishes:**  
AN, BZ, HAB, HABL2  
**Shade Treatments:**  
B, NP  
**Shade Details:**  
3 1/2" x 7" x 6"

**Socket:** Candelabra with  
Hi-Lo Line Switch  
**Wattage:** 40 C



**BB3500HABL2-NP**

**Adjustable French Library Lamp in Antique Brass with Braided Leather with Natural Paper Shade**

Height: 27" - 38"  
Width: 11"  
Base: 6 1/2" Round

**Available Finishes:**  
AN, BZ, HAB, HABL2  
**Shade Treatments:**  
B, NP  
**Shade Details:**  
9" x 11" x 8 3/4"

**Socket:** Hi-Lo  
**Wattage:** 100 A



**BB3510BZ-NP**

**Adjustable Miniature Library Lamp in Bronze with Natural Paper Shade**

Height: 19"-29"  
Width: 9"  
Base: 5" Round

**Available Finishes:**  
AN, BZ, HAB, HABL2  
**Shade Treatments:**  
B, NP  
**Shade Details:** 3" x 9" x 6 1/2"

**Socket:** Candelabra with  
Hi-Lo Line Switch  
**Wattage:** 40 C



**BB3500BZ-NP**

**Adjustable French Library Lamp in Bronze with Natural Paper Shade**

Height: 27"-38"  
Width: 15"  
Base: 6 1/2" Round

**Available Finishes:**  
AN, BZ, HAB, HABL2  
**Shade Treatments:** B, NP  
**Shade Details:**  
4" x 15" x 9"

**Socket:** Hi-Lo  
**Wattage:** 60 A





**SC3008IC-NP**  
**Small Tang Lamp in Ivory Crackle with Natural Paper Shade**

Height: 18½"  
 Width: 14"  
 Base: 4¼" Round

**Available Finishes:** BLK, IC  
**Shade Treatment:** NP  
**Shade Details:** 6" x 14" x 9"

**Socket:** Dimmer  
**Wattage:** 75 A



**SC3009IC-NP**  
**Medium Tang Lamp in Ivory Crackle with Natural Paper Shade**

Height: 26"  
 Width: 21"  
 Base: 8½" Round

**Available Finishes:** BLK, IC  
**Shade Treatment:** NP  
**Shade Details:** 12" x 21" x 13½"

**Socket:** Dimmer  
**Wattage:** 150 A



**SC3002IC-NP**  
**Tang Lamp in White with Natural Paper Shade**

Height: 34"  
 Width: 27½"  
 Base: 8½" Round

**Available Finishes:** BLK, IC  
**Shade Treatment:** NP  
**Shade Details:** 11½" x 27½" x 17"

**Socket:** Dimmer  
**Wattage:** 150 A



**SC3002BLK-NP**



**SC3004CRC-NP**

**Geige Double Lamp in Cream Crackle Finish  
with Natural Paper Shade**

Height: 30"

Width: 15"

Base: 7½" Round

**Shade Treatment:** NP

**Shade Details:** 9" x 15" x 11½"

**Socket:** Dimmer

**Wattage:** 100 A



**SC3012HAB-S**

**"U-Fill It" Table Lamp in Hand-Rubbed  
Antique Brass with Silk Shade**

Height: 33"

Width: 18"

Base: 11½" Square

**Available Finishes:** AN, HAB

**Shade Treatment:** S

**Shade Details:**  
12¼" x 18" x 11¼"

**Socket:** Hi-Lo

**Wattage:** 150 A



**SC3000BW-NP**  
**Small Shore Line Lamp**  
**with Natural Paper Shade**

Height: 25"  
Width: 21"  
Base: 9" Round

**Shade Treatment:** NP

**Shade Details:**  
8½" x 21" x 11¾"

**Socket:** Hi-Lo

**Wattage:** 100 A



**SC3001BW-NP**  
**Tall Shore Line Lamp**  
**with Natural Paper Shade**

Height: 31"  
Width: 21"  
Base: 8" Round

**Shade Treatment:** NP

**Shade Details:**  
8½" x 21" x 11¾"

**Socket:** Hi-Lo

**Wattage:** 100 A



**CL3170BZ**

**Noho Double-Yoke Accent Lamp  
in Bronze**

Height: 12"-13½"

Width: 7"

Base: 5" x 7"

**Available Finishes:** BC, BZ

**Shade Details:** 4" x 6"

**Socket:** Keyless with  
Hi-Lo Line Switch

**Wattage:** 60 A



**CL3100BZ-WP**

**Tribeca Table Lamp in Bronze  
with White Paper Shade**

Height: 24"

Width: 8"

Base: 8" Square

**Available Finishes:** BS, BZ

**Shade Treatments:** FG, WP

**Shade Details:** 7½" x 7½" x 9"  
Square

**Socket:** Pull Chain

**Wattage:** 100 A



**CL3001BZ-L**

**Chelsea Mini Table Lamp  
in Bronze with Linen Shade**

Height: 15"

Width: 5"

Base: 4" Square

**Shade Treatment:** L

**Shade Details:** 5"⁄5" x 5"⁄5" x 11½"

**Socket:** Keyless with  
Hi-Lo Line Switch

**Wattage:** 60 A



**CL3005BZ-L**

**Chelsea Horizontal Table Lamp  
in Bronze with Linen Shade**

Height: 9"

Width: 13"

Base: 11½" x 3½"

**Shade Treatment:** L

**Shade Details:**

13"⁄5" x 13"⁄5" x 5"

**Socket:** 4-Candelabra with  
Hi-Lo Line Switch

**Wattage:** 4-40 C



**CL3004BZ-L**  
**Chelsea Rectangle Table Lamp**  
**in Bronze with Linen Shade**

Height: 24"  
 Width: 16"  
 Base: 7" x 13"

**Shade Treatment:** L  
**Shade Details:**  
 16"/11½" x 16"/11½" x 9"

**Socket:** 2-Keyless with  
 Hi-Lo Line Switch  
**Wattage:** 2-60 A



**CL3002BZ-L**  
**Chelsea Small Square Table Lamp**  
**in Bronze with Linen Shade**

Height: 25"  
 Width: 9"  
 Base: 7" Square

**Shade Treatment:** L  
**Shade Details:**  
 9"/9" x 9"/9" x 11½"

**Socket:** Keyless with  
 Hi-Lo Line Switch  
**Wattage:** 60 A

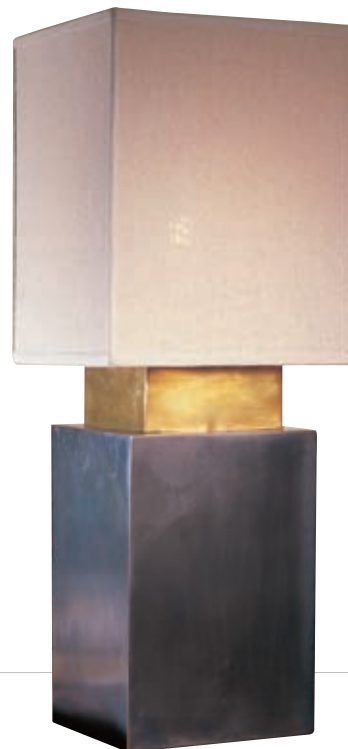

**CL3003BZ-L**  
**Chelsea Large Square Table Lamp**  
**in Bronze with Linen Shade**

Height: 28"  
 Width: 12½"  
 Base: 9" Square

**Shade Treatment:** L  
**Shade Details:**  
 12½"/12½" x 12½"/12½" x 16"

**Socket:** Keyless with  
 Hi-Lo Line Switch  
**Wattage:** 60 A





# FLOOR

Chart House	104
Studio	122
Thomas O'Brien	132
Bill Blass	141
Clodagh	145
Eric Cohler	146







**CHA9153AB**  
**Edwardian Boom Arm Floor**  
**Lamp in Antique-Burnished Brass**  
Height: 50"-56"  
Extension: 58"  
Base: 11" Round

**Available Finishes:** AB, AN, BZ  
**Shade Details:** 11" X 6"

**Socket:** Hi-Lo  
**Wattage:** 75 A  
©EFC DESIGNS

**CHA9151AB**  
**Pimlico Tripod Boom-Arm**  
**Pharmacy Floor Lamp in**  
**Antique-Burnished Brass**  
Height: 55"  
Extension: 38"  
Base: 22" Tripod

**Available Finishes:** AB, BZ, PN  
**Shade Details:** 3½" x 7"

**Socket:** Hi-Lo  
**Wattage:** 60 A  
©EFC DESIGNS



**CHA9134AB-S**  
**Overseas Adjustable Height  
Downbridge Lamp in Antique-  
Burnished Brass with Silk  
Shade**

Height: 51"-62"  
Extension: 33"  
Base: 9" Round

**Shade Treatment:** S  
**Shade Details:** 7½" x 12" x 8"

**Socket:** Hi-Lo  
**Wattage:** 100 A  
©EFC DESIGNS

**CHA9150AB-LC**  
**Pimlico Adjustable Floor Lamp  
in Antique-Burnished Brass  
with Linen Collar Shade**

Height: 47"-60"  
Extension: 29½"  
Base: 9" Round

**Finishes:** AB, AN, BZ, PN  
**Shade Treatment:** LC  
**Shade Details:** 7" x 12" x 9"

**Socket:** Hi-Lo  
**Wattage:** 100 A  
©EFC DESIGNS



**CHA9152AB-TSF**

**Pimlico Two-Arm Adjustable Chair Lamp  
in Antique-Burnished Brass  
with Tissue Silk Shades**

Height: 54"-64"

Extension: 31"-38"

Base: 9" Round

**Shade Treatment:** TSF

**Shade Details:** 7" x 12" x 9"

**Socket:** 2-Hi-Lo

**Wattage:** 2-100 A



**CHA9132AB-WG**

**Edwardian Torchiere Floor  
Lamp in Antique-Burnished  
Brass with White Glass Shade**

Height: 74"

Base: 11" Round

**Available Finishes:**

AB, AN, BZ, PN

**Shade Treatment:**

AB, AN, BZ, PN, WG

**Socket:** Hi-Lo

**Wattage:** 100 A

©EFC DESIGNS

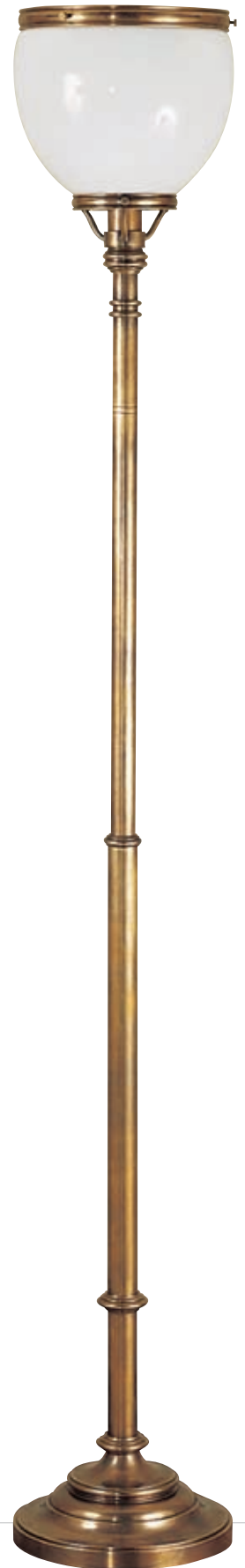

**CHA9154AN/AB-S**

**Star Motif Boom-Arm Floor Lamp  
in Antique-Burnished Brass with  
Antique Nickel Accents with Silk Shade**

Height: 41"-74"  
Width: 10"  
Extension: 22"-26¼"  
Base: 10" Round

**Available Finishes:** AB/AN, AN/AB  
**Shade Treatment:** L, S  
**Shade Details:** 7" x 10" x 9"

**Socket:** Hi-Lo Nordy  
**Wattage:** 100 A  
©EFC DESIGNS

**CHA9154AB/AN-S**

**CHA9155AB/AN-NP**

**Adjustable Star Motif Club Floor Lamp  
in Antique-Burnished Brass with  
Antique Nickel Trim with Natural Paper Shade**

Height: 55"-72"  
Width: 19"  
Base: 10" Round

**Shade Treatment:** NP  
**Shade Details:**  
14" x 19" x 12"

**Socket:**  
2-Pull Chain  
**Wattage:** 2-75 A  
©EFC DESIGNS



**CHA9450WI-L**  
**Windsor Iron Twist Adjustable**  
**Floor Lamp in Weathered Iron**  
**with Linen Shade**

Height: 57½"-66"

Width: 19"

Base: 11" Round

**Shade Treatment:** L

**Shade Details:** 14" x 19" x 12"

**Socket:** Hi-Lo

**Wattage:** 150 A

©EFC DESIGNS



**CHA9451WI-L**  
**Windsor Iron Twist Candlestick**  
**Floor Lamp in Weathered Iron**  
**with Linen Shade**

Height: 63"

Width: 23"

Base: 11" Round

**Shade Treatment:** L

**Shade Details:**  
17" x 23" x 13" Rectangle

**Socket:** 2-Pull Chain

**Wattage:** 2-75 A

©EFC DESIGNS



**CHA9452AB/AN-L**  
**Castle Floor Lamp in Antique-Burnished Brass with Antique Nickel Accents with Linen Shade**  
Height: 63"  
Width: 21"  
Base: 17"

**Available Finishes:** AB/AN, WI  
**Shade Treatment:** L  
**Shade Details:** 15" x 21" x 12"

**Socket:** 2-Pull Chain  
**Wattage:** 2-75 A  
©EFC DESIGNS

**CHA9452WI-L**



**CHA9135ABL-L**  
**Edwardian Club Floor Lamp**  
**in Natural Leather Wrapped**  
**Antique-Burnished Brass**  
Height: 60½" - 83"  
Width: 19"  
Base: 11"

**Available Finishes:** ABL, ANL  
**Shade Treatments:** B, L  
**Shade Details:** 14" x 19" x 12"

**Socket:** 2-Pull Chain  
**Wattage:** 2-75 A  
©EFC DESIGNS



**CHA9124ABC-B**  
**Overseas Adjustable Club Floor Lamp**  
**in Antique-Burnished Brass and**  
**Faux Cordovan with Black Shade**  
Height: 40"-64½"  
Width: 15"  
Base: 9" Round

**Available Finishes:** ABC, PS  
**Shade Treatment:** B, S  
**Shade Details:** 9" x 15" x 9"

**Socket:** 2-Pull Chain  
**Wattage:** 2-60 A  
©EFC DESIGNS





**CHA9125AB-B**  
**Overseas Adjustable Height Floor Lamp**  
**with Glass Tray in Antique-Burnished Brass**  
**with Black Shade**  
Height: 40"-65"  
Width: 15"  
Base: 9" Round

**Available Finishes:** AB, PS  
**Shade Treatment:** B, S  
**Shade Details:** 9" x 15" x 9"

**Socket:** 2-Pull Chain  
**Wattage:** 2-60 A  
©EFC DESIGNS



**CHA9140AB-S**  
**Earle's Adjustable Tray Floor Lamp**  
**in Antique Burnished-Brass**  
**with Silk Shade**  
Height: 59"-72"  
Width: 18"  
Base: 14" Tripod

**Shade Treatment:** S  
**Shade Details:** 14" x 18" x 11"

**Socket:** Hi-Lo  
**Wattage:** 150 A  
©EFC DESIGNS



**CHA9314BLK-SC**  
**Adjustable Tray Floor Lamp**  
**in Black and Gold Tole**  
**with Silk Collar Shade**  
Height: 55"-63"  
Width: 18"  
Tray: 15½" Round  
Base: 11½"

**Shade Treatment:** SC  
**Shade Size:** 12" x 18" x 12"

**Socket:** Hi-Lo  
**Wattage:** 150 A  
©EFC DESIGNS



**CHA9315BLK-L**  
**Column Form Floor Lamp**  
**in Black with Linen Shade**  
Height: 56½"  
Width: 16"  
Base: 10" Square

**Available Finishes:** BLK, OAK  
**Shade Treatments:** L, NP  
**Shade Details:** 12" x 16" x 11"

**Socket:** Hi-Lo  
**Wattage:** 150 A  
©EFC DESIGNS



**CHA9313BLK-S**  
**Candle Floor Lamp in Black and Gold with Silk Shade**

Height: 60"  
Width: 18"  
Base: 12" Round

**Available Finishes:** ASL, BLK  
**Shade Treatment:** S

**Shade Details:**  
12" x 18" x 13" Silk Pleat Square or  
12" x 19" x 13" Silk Bell

**Socket:** Hi-Lo  
**Wattage:** 150 A  
©EFC DESIGNS

**CHA9313ASL-S**

**CHA9312CHI-NP**  
**Turned Wood Floor Lamp in Black with Gold Chinoiserie Floral Designs with Natural Paper Shade**

Height: 67½"  
Width: 20"  
Base: 12" Round

**Shade Treatment:** NP

**Shade Details:**  
13½" x 20" x 12½"

**Socket:** Hi-Lo  
**Wattage:** 150 A  
©EFC DESIGNS



**CHA9316AB-NP**

**Torned Adjustable Floor Lamp with  
Lion Feet in Antique-Burnished Brass  
with Natural Paper Shade**

Height: 60"-69"

Width: 23"

Base: 15" Round

**Available Finishes:** AB, BZ, PS, TB

**Shade Treatment:** NP

**Shade Details:** 9¼" x 23" x 12½"

**Socket:** Dimmer

**Wattage:** 150 A

**CHA9316TB-NP**

**CHA9122AB-S**

**English Candlestand Floor  
Lamp in Antique-Burnished  
Brass with Silk Shade**

Height: 58½"

Width: 18"

Base: 9"

**Available Finishes:** AB, PS

**Shade Treatments:** B, L, NP, S

**Shade Details:**  
11" X 18" X 11½"

**Socket:** Hi-Lo

**Wattage:** 150 A

©EFC DESIGNS



**CHA9310WGL-B**  
**Large Italian Wood Candle**  
**Floor Lamp in Distressed White**  
**and Gold with Black Shade**  
Height: 60"  
Width: 19"

**Shade Treatment:** B  
**Shade Details:**  
10" x 19" x 11½"

**Socket:** Hi-Lo  
**Wattage:** 100 A



**CHA9160AB-L**  
**Sloane Street Floor Lamp**  
**in Antique-Burnished Brass**  
**with Linen Shade**  
Height: 62"  
Width: 15½"  
Base: 12"

**Available Finishes:** AB, BR  
**Shade Treatment:** L  
**Shade Details:**  
11½" x 15½" x 10"

**Socket:** 2-Pull Chain  
**Wattage:** 2-60 A  
©EFC DESIGNS



**CHA9402NR-NP**

**Large Mediterranean  
Candlestick Floor Lamp in Rust  
with Natural Paper Shade**

Height: 62"

Width: 19"

Base: 12½"

**Shade Treatments:** B, NP  
**Shade Details:** 14" x 19" x 12"

**Socket:** Hi-Lo  
**Wattage:** 150 A

©EFC DESIGNS



**CHA9401WI-B**

**Etruscan Floor Lamp in  
Weathered Iron with Black Shade**

Height: 68"

Width: 20"

Base: 20" Tripod

**Shade Treatment:** B  
**Shade Details:** 7" x 20" x 12½"

**Socket:** Hi-Lo  
**Wattage:** 75 A  
©EFC DESIGNS



**CHA9131AB-NP**  
Dorchester Floor Lamp in  
Antique-Burnished Brass with  
Natural Paper Shade  
Height: 51"-64"  
Width 14"  
Base: 9" Round

**Available Finishes:** AB, ABC  
**Shade Treatment:** B, NP, S  
**Shade Details:** 9" x 14" x 8½"

**Socket:** Hi-Lo  
**Wattage:** 100 A  
©EFC DESIGNS

**CHA9131ABC-B**

**CHA9128ABV-TSBC**  
Adjustable Reeded Club Lamp in  
Antique-Burnished Brass Verdigris  
with Tissue Silk Bell Shade  
Height: 60"-70"  
Width: 18"  
Base: 10" Round

**Shade Treatment:** TSBC  
**Shade Details:** 12" x 18" x 12"

**Socket:** Hi-Lo  
**Wattage:** 150 A  
©EFC DESIGNS



**CHA9455AB-NP**  
**Spiral Floor Lamp**  
**in Antique-Burnished Brass**  
**with Natural Paper Shade**

Height: 62"  
Width: 16"  
Base: 9" Round

**Available Finishes:** AB, BZV, PS  
**Shade Treatment:** NP  
**Shade Details:** 10" x 16" x 10"

**Socket:** Dimmer  
**Wattage:** 100 A



**CHA9102ABT-B**  
**Chelsea Floor Lamp in**  
**Antique-Burnished Brass and**  
**Tortoise Shell with Black Shade**

Height: 58"  
Width: 17"  
Base: 10" Round

**Shade Treatment:** B  
**Shade Details:** 8" x 17" x 9"

**Socket:** 2-Pull Chain  
**Wattage:** 2-60 A  
©EFC DESIGNS



**CHA9103ABC-B**  
**Kensington Library Floor Lamp**  
**in Antique-Burnished Brass**  
**and Faux Cordovan Leather**  
**with Black Shade**

Height: 58"  
Extension: 17"  
Base: 10" Round

**Shade Treatment:** B  
**Shade Details:** 5½" x 15" x 9"

**Socket:** Hi-Lo  
**Wattage:** 75 A  
©EFC DESIGNS





**CHA9105AN-B**  
**Sloane Club Swing Arm Floor Lamp**  
in Antique Nickel with Black Shade  
Height: 52"-65"  
Extension: 21"  
Base: 10½" Round

**Available Finishes:** AB, AN  
**Shade Treatment:** B, NP  
**Shade Details:** 9" x 13" x 8½"

**Socket:** Hi-Lo  
**Wattage:** 100 A

**CHA9121AB-B**  
**Dorchester Swing-Arm Floor Lamp**  
in Antique-Burnished Brass  
with Black Shade  
Height: 51"-64"  
Extension: 21"  
Base: 9" Round

**Available Finishes:** AB, BZ, PN  
**Shade Treatment:** B, S  
**Shade Details:** 6" x 12" x 8½"

**Socket:** Hi-Lo  
**Wattage:** 75 A  
©EFC DESIGNS

**CHA9106AB-NP**  
**Chunky Swing-Arm Floor Lamp**  
in Antique-Burnished Brass  
with Natural Paper Shade  
Height: 54½"-70½"  
Extension: 26"  
Base: 12½" Round

**Available Finishes:**  
AB, AN, BZ, PN  
**Shade Treatment:** L, NP  
**Shade Details:** 10" x 12" x 7½"

**Socket:** Dimmer  
**Wattage:** 100 A  
©EFC DESIGNS



**CHA9107AB**

**Dorchester Swing-Arm Floor Lamp  
with Pharmacy Shade in  
Antique-Burnished Brass**

Height: 37"-63"

Extension: 22"

Base: 9" Round

**Finishes:** AB, AN, BZ, PN

**Shade Details:** 8 $\frac{3}{4}$ " x 3 $\frac{1}{8}$ " x 2"

**Socket:** Hi-Lo

**Wattage:** 60 T

©EFC DESIGNS

**CHA9127ABV**

**Adjustable Reeded Floor Lamp in  
Antique-Burnished Brass Verdigris**

Height: 39 $\frac{1}{2}$ "-63"

Extension: 20"

Base: 10" Round

**Shade Details:** 5 $\frac{1}{2}$ " x 9 $\frac{3}{4}$ "

**Socket:** Hi-Lo

**Wattage:** 50 R20

©EFC DESIGNS

**CHA9161AN**

**Apothecary Floor Lamp in  
Antique Nickel on Black Mount**

Height: 40"-54"

Extension: 14 $\frac{1}{2}$ "

Base: 10" Round

**Available Finishes:** AB, AN, BZ, SN

**Shade Details:** 6 $\frac{1}{2}$ " Round

**Socket:** Hi-Lo

**Wattage:** 60 A

©EFC DESIGNS

**CHA9161AB**



**CHA9336TB-NP**  
**Ionic-Fluted Column Floor Lamp in**  
**Tudor Brown with Natural Paper Shade**

Height: 60"  
Width: 20"  
Base: 6" X 9½"

**Available Finishes:** OW, TB, WW  
**Shade Treatment:** NP  
**Shade Details:** 8"/18" x 10"/20" x 13"  
Rectangle

**Socket:** Dimmer  
**Wattage:** 150 A  
©EFC DESIGNS



**CHA9461AB-NP**  
**Fluted Spire Floor Lamp in**  
**Antique-Burnished Brass with**  
**Natural Paper Shade**

Height: 60½"  
Width: 19"  
Base: 6½" Fluted

**Available Finishes:** AB, BZ, BZV  
**Shade Treatment:** NP  
**Shade Details:** 14" x 19" x 12"

**Socket:** Dimmer  
**Wattage:** 150 A  
©EFC DESIGNS



**SL1975BZ**

**Boom-Arm Floor Lamp  
in Bronze**

Height: 39½"-50"

Extension: 35"

Base: 11" Round

**Available Finishes:** AN, BZ,  
HAB, PN

**Shade Details:** 7" Round

**Socket:** Hi-Lo

**Wattage:** 60 A

©EFC DESIGNS

**SL1031HAB**

**Mini Architect's Boom-Arm  
Floor Lamp in Hand-Rubbed  
Antique Brass**

Height: 35"-64½"

Width: 8"

Extension: 28"

Base: 8" Square

**Available Finishes:** BZ, HAB,  
PS

**Shade Details:** 2" x 6¼" x 4½"

**Socket:** Hi-Lo

**Wattage:** 40 B

©EFC DESIGNS



**SL1702AN-B**  
**New York Functional Floor**  
**Lamp in Antique Nickel with**  
**Black Shades**  
Height: 45½"  
Extension: 27"  
Base: 9½" Square

**Shade Details:** 3" x 7"

**Socket:** 2-Hi-Lo  
**Wattage:** 2-60 A  
©EFC DESIGNS



**SL1950HAB**  
**Big Boston Pharmacy Floor**  
**Lamp in Hand-Rubbed**  
**Antique Brass**  
Height: 63"-68½"  
Extension: 25½"  
Base: 11" Round

**Available Finishes:** AN, BZ,  
HAB, PN  
**Shade Details:** 5" x 11"

**Socket:** Hi-Lo  
**Wattage:** 100 A  
©EFC DESIGNS

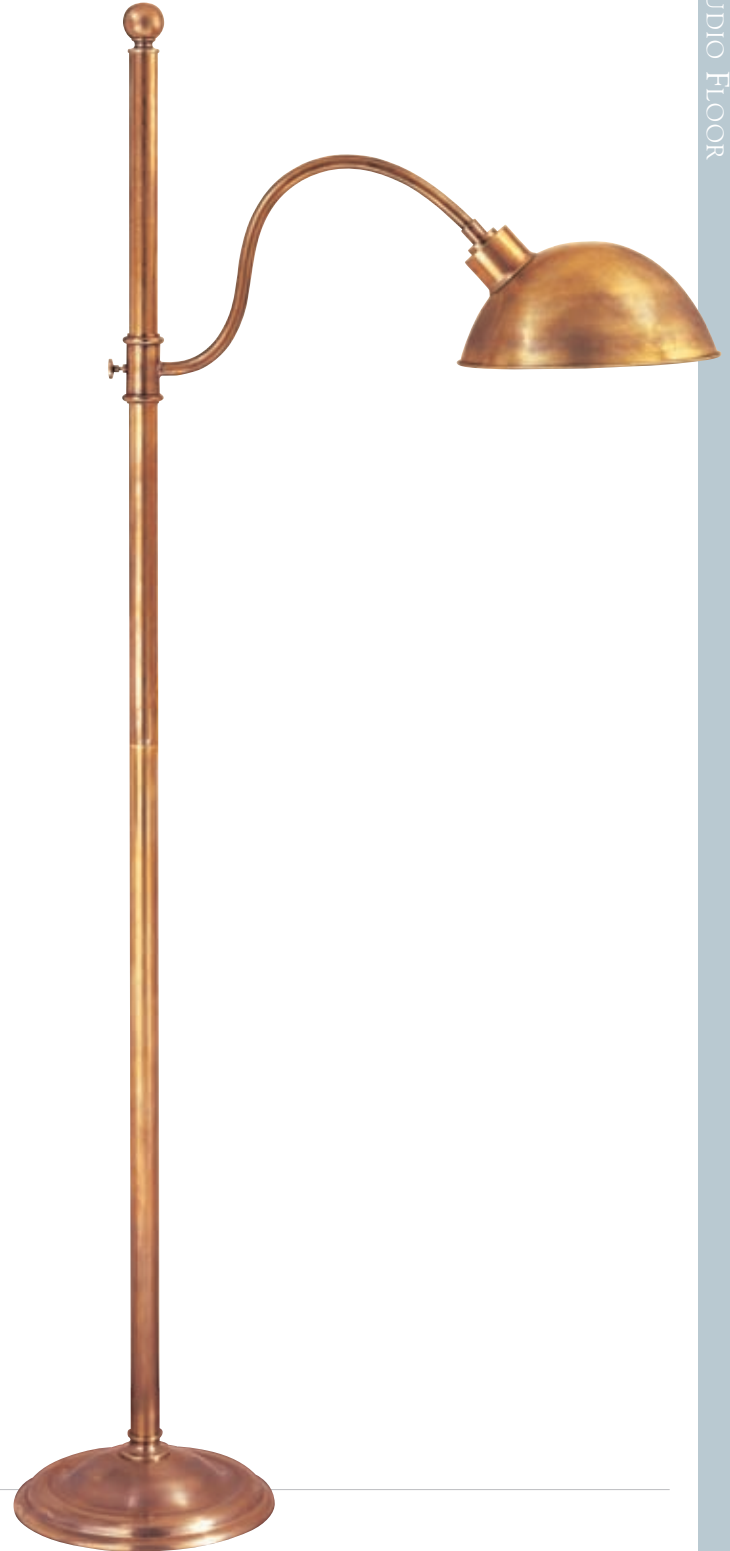

**SL1900BZ/SLG-BZ**

**Boston Adjustable Floor Lamp  
in Bronze with  
Bronze SLG Shade**

Height: 35"-57"

Extension: 17"

Base: 10" Round

**Available Finishes:** AN, BZ,  
HAB, SN

**Shade Treatment:** SLG-BZ

See Shade Schedule for  
Additional Shade Options

**Shade Details:** 2½" x 5¼" x 5½"

**Socket:** Hi-Lo

**Wattage:** 60 A

©EFC DESIGNS

**SL1900HAB/SLB-AW**

**Boston Adjustable Floor Lamp  
in Hand-Rubbed Antique Brass  
with Antique White SLB Shade**

Height: 35"-57"

Extension: 17"

Base: 10" Round

**Available Finishes:** AN, BZ,  
HAB, SN

**Shade Treatment:** SLB-AW

See Shade Schedule for  
Additional Shade Options

**Shade Details:** 2½" x 5¼" x 5½"

**Socket:** Hi-Lo

**Wattage:** 60 A

©EFC DESIGNS

**SL1930BZ/SLE-BZ**

**Boston Adjustable Downbridge  
Floor Lamp in Bronze  
with Bronze SLE Shade**

Height: 35"-57"

Extension: 17"

Base: 10" Round

**Shade Treatment:** SLE-BZ

See Shade Schedule for  
Additional Shade Options

**Shade Details:** 2¼" x 5¾" x 4½"

**Socket:** Hi-Lo

**Wattage:** 60 A

©EFC DESIGNS



**81134HAB**  
**Adjustable Floor Lamp in**  
**Hand-Rubbed Antique Brass**  
Height: 43"-57"  
Extension: 20"  
Base: 6" x 9"

**Available Finishes:**  
AN, BLK, BZ, CH, HAB, PB  
**Shade Details:** 5½" x 3¼" x 2"

**Socket:** Dimmer  
**Wattage:** 60 T

**91025AN**  
**Adjustable Floor Lamp in**  
**Hand-Rubbed Antique Nickel**  
Height: 34"-45"  
Width: 13"  
Base: 6" x 9"

**Available Finishes:** AN, BLK,  
BZ, CH, HAB, PB, WHT  
**Shade Details:** 3½" x 6" x 2"

**Socket:** Dimmer  
**Wattage:** 60 T

**91025HAB**



**SL1126WA-NP**

**Tudor Twist Adjustable Floor  
Lamp in Walnut with Natural  
Paper Shade**

Height: 54"-74"

Width: 15"

Base: 9½" Round

**Available Finishes:** FW, WA  
**Shade Treatments:** B, L, NP  
**Shade Details:** 9" x 15" x 9"

**Socket:** Hi-Lo  
**Wattage:** 100 A

©EFC DESIGNS



**SL1125FW-B**

**Tudor Twist Floor Lamp in  
French Wax with Black Shade**

Height: 53½"

Width: 15"

Base: 10" Round

**Available Finishes:** FW, TB  
**Shade Treatments:** B, L, NP  
**Shade Details:** 9" x 15" x 9"

**Socket:** Hi-Lo  
**Wattage:** 100 A

©EFC DESIGNS





**SL1143IP-NP**  
**Entasis Floor Lamp in Irish Pine**  
**on Museum Mount with**  
**Natural Paper Shade**  
Height: 58"-64"  
Width: 17"  
Base: 10 3/4" Square

**Shade Treatment:** NP  
**Shade Details:** 13" x 17" x 10"

**Socket:** Hi-Lo  
**Wattage:** 150 A  
©EFC DESIGNS



**SL1142FPW-NP**  
**Twist Balustrade Floor Lamp in**  
**Fence Post Wash on Bronze Museum Mount**  
**with Natural Paper Shade**  
Height: 57 1/2"-71"  
Width: 17"  
Base: 9" Square

**Available Finishes:** AWG, FPW  
**Shade Treatments:** B, L, NP  
**Shade Details:** 13" x 17" x 10"

**Socket:** Hi-Lo  
**Wattage:** 150 A  
©EFC DESIGNS



**SL1135FW-NP**

**Balustrade Candle Floor Lamp  
in French Wax with Natural  
Paper Shade**

Height: 59"  
Width: 19"  
Base: 12" Round

**Available Finishes:** FW, OW, TB  
**Shade Treatments:** B, L, NP  
**Shade Details:** 14" x 19" x 12"

**Socket:** Hi-Lo  
**Wattage:** 150 A  
©EFC DESIGNS



**SL1137FW-L**

**Sussex Floor Lamp in French  
Wax with Linen Shade**

Height: 62"  
Width: 19"  
Base: 12" Round

**Available Finishes:** FW, TB  
**Shade Treatments:** B, L, NP  
**Shade Details:** 14" x 19" x 12"

**Socket:** Hi-Lo  
**Wattage:** 150 A  
©EFC DESIGNS



**SL1138OW-L**  
**Surrey Tray Table Floor Lamp**  
in Old White with Linen Shade  
Height: 63"  
Width: 21"  
Tray: 21" Round, 24" to Tray  
Base: 9½" Octagonal

**Available Finishes:** IP, OW  
**Shade Treatment:** L  
**Shade Details:** 14" x 20" x 12½"

**Socket:** Hi-Lo  
**Wattage:** 150 A  
©EFC DESIGNS

**SL1138IP-L**

**SL1920HAB-L**  
**Boston Adjustable Library Floor Lamp**  
in Hand-Rubbed Antique Brass  
with Linen Shade  
Height: 51"-61"  
Width: 13"  
Base: 10" Round

**Available Finishes:** AN, BZ, HAB  
**Shade Treatment:** L  
**Shade Details:** 9" x 13" x 8½"

**Socket:** Hi-Lo  
**Wattage:** 100 A  
©EFC DESIGNS



**S111BB-NP**

**Bamboo Floor Lamp with  
Natural Paper Shade**

Height: 52½"

Width: 17"

Base: 9½" Round

**Shade Treatment:** NP

**Shade Details:** 13" x 17" x 11"

**Socket:** Hi-Lo

**Wattage:** 150 A

©EFC DESIGNS

**S110EB-NP**

**Tribal Form Floor Lamp in Ebony  
with Natural Paper Shade**

Height: 52"

Width: 19"

Base: 7½" Round

**Shade Treatment:** NP

**Shade Details:** 14" x 19" x 12"

**Socket:** 3-Way

**Wattage:** 150 A



**SL1700FW-NP**  
**Wood Tripod Floor Lamp in French**  
**Wax with Natural Paper Shade**  
Height: 61"  
Width: 21"  
Base: 21" Tripod

**Shade Treatment:** NP  
**Shade Details:** 20" x 20" x 11"

**Socket:** Hi-Lo  
**Wattage:** 150 A



**S1001BZ-L**  
**Stage Floor Lamp in Bronze with**  
**Linen Shade**  
Height: 53"-75"  
Width: 22"  
Base: 24½"

**Available Finishes:** BC, BZ  
**Shade Treatment:** L  
**Shade Details:** 22" x 22" x 6½"

**Socket:** 2-Keyless/Foot Switch  
**Wattage:** 2-60 A



**TOB1007PS-NP**

**Parke Floor Lamp in Polished Silver  
with Natural Paper Shade**

Height: 69"

Width: 19"

Base: 20 3/4" Tripod

**Available Finishes:** AN, BZ, HAB, PS

**Shade Treatment:** NP

**Shade Details:** 12" x 19" x 15 1/2"

**Socket:** 2-Pull Chain

**Wattage:** 2 - 75 A

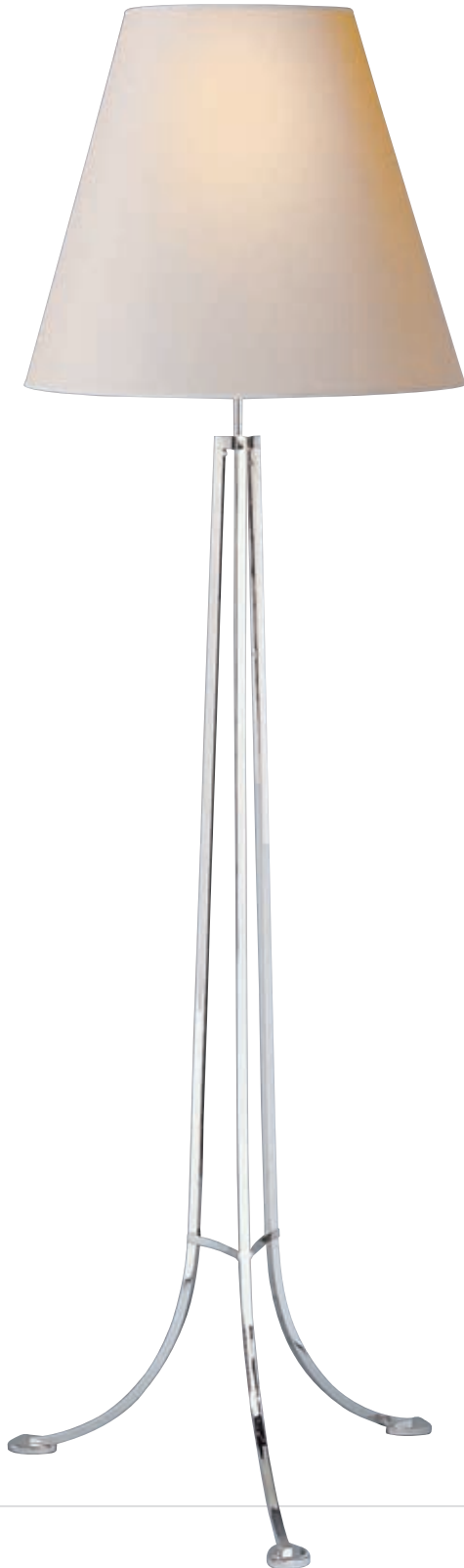

**TOB1009CAR-NP**

**Linden Floor Lamp in  
Caramel Wood Finish**

Height: 69"

Width: 19"

Base: 23 1/2" Tripod

**Available Finishes:** CAR, CHC

**Shade Treatment:** NP

**Shade Details:** 12" x 19" x 15 1/2"

**Socket:** 2 - Pull Chain

**Wattage:** 2 - 75 A



**TOB1090BR-NP/BT**  
**Hugo Floor Lamp in Black Rust**  
**with Natural Paper Shade**  
Height: 66"-69"  
Width: 21"  
Base: 14½" Round

**Shade Treatment:** NP/BT  
**Shade Details:** 12" x 21" x 16½"

**Socket:** 2 - Pull Chain  
**Wattage:** 2 - 75 A



**TOB1000PN-NP**  
**Longacre Floor Lamp in Polished Nickel**  
**with Natural Paper Shade**  
Height: 64½"  
Width: 22"  
Base: 15" Round

**Available Finishes:** BZ, HAB, PN, PS  
**Shade Treatment:** NP  
**Shade Details:** 22" x 22" x 12½"

**Socket:** 2 - Pull Chain  
**Wattage:** 2 - 75 A



**TOB1006BL-NP**

**Essex Floor Lamp in Black Leather  
with Natural Paper Shade**

Height: 70"  
Width: 21"  
Base: 14" Square

**Available Finishes:** BL, SL  
**Shade Treatment:** NP  
**Shade Details:** 11" x 21" x 16"

**Socket:** Hi-Lo  
**Wattage:** 100 A

**TOB1006SL-NP**

**TOB1016CHC-NP**

**Highland Floor Lamp in Chocolate Wood  
with Natural Paper Shade**

Height: 71"  
Width: 21½"  
Base: 18" Round

**Shade Treatment:** NP  
**Shade Details:** 14½" x 21½" x 19½"

**Socket:** 2 - Pull Chain  
**Wattage:** 2 - 75 A





**TOB1004AN-WP/ST**  
**Hudson Floor Lamp in Antique Nickel**  
**with White Paper Shade**

Height: 60"  
Width: 22"  
Base: 15 1/4"

**Available Finishes:** AN, BZ, HAB, PN  
**Shade Treatments:** NP/BT, WP/ST  
**Shade Details:** 22" x 22" x 6 1/4"

**Socket:** 2-Keyless / Hi-Lo Pull Chain  
**Wattage:** 2-60 A



**TOB1011BZ-C/BT**  
**Nina Floor Lamp in Bronze**  
**with Cotton Shade**

Height: 54 3/4"  
Width: 8"  
Extension: 22"  
Base: 12" Round

**Available Finishes:**  
AN, BZ, HAB  
**Shade Treatments:**  
C, C/BT, C/RT  
**Shade Details:** 6" x 8" x 9"

**Socket:** Pull Chain  
**Wattage:** 75 A

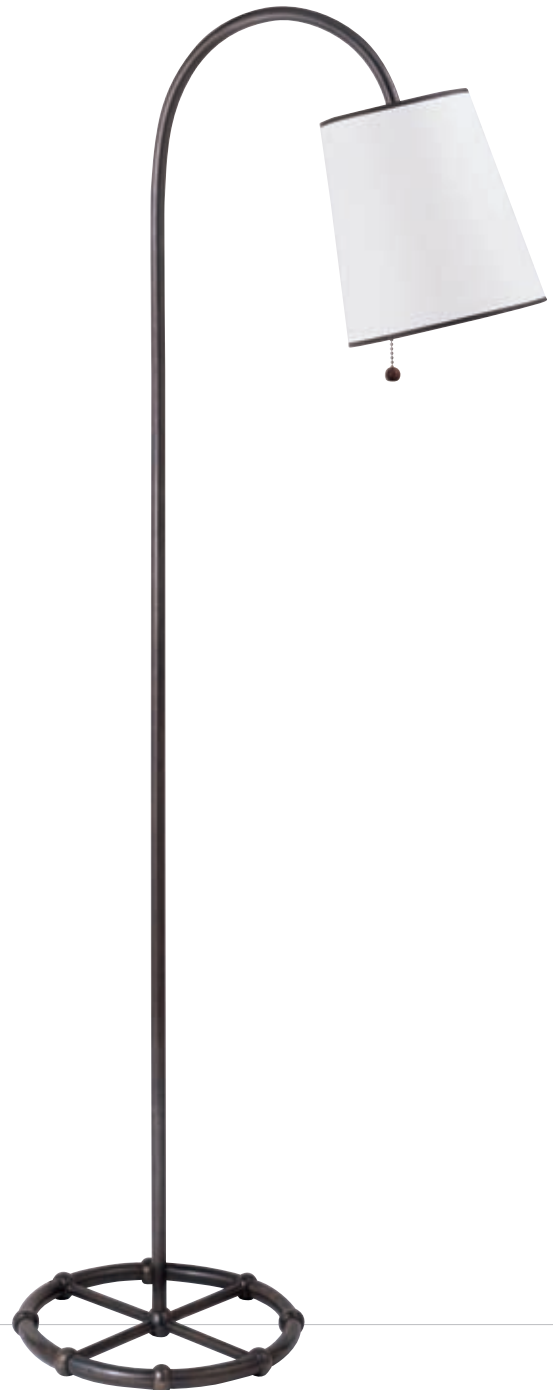

**TOB1068PN/CHC-NP**  
**Jones Floor Lamp in Polished Nickel**  
**and Chocolate Wood with**  
**Natural Paper Shade**  
Height: 63"  
Width: 19"  
Base: 11" Round

**Shade Treatment:** NP  
**Shade Details:** 10" x 19" x 15½"

**Socket:** Hi-Lo  
**Wattage:** 150 A



**TOB1002HAB-NP**  
**Bryant Adjustable Floor Lamp**  
**in Hand-Rubbed Antique Brass**  
**with Natural Paper Shade**  
Height: 44"-60"  
Width: 12"  
Base: 10½" Round

**Available Finishes:**  
AS, BZ, HAB, PN  
**Shade Treatment:** NP  
**Shade Details:** 11" x 12" x 12"

**Socket:** Hi-Lo  
**Wattage:** 100 A



**TOB1008AN-NP**

**Giorgio Floor Lamp in Acrylic and  
Antique Nickel with Natural Paper Shade**

Height: 74"

Width: 16"

Base: 13½" Round

**Available Finishes:** AN, BZ

**Shade Treatments:** NP

**Shade Details:** 15" x 16" x 14"

**Socket:** Hi-Lo

**Wattage:** 150 A



**TOB1012BZ-NP**

**Ziyi Pivoting Floor Lamp in Bronze  
with Natural Paper Shade**

Height: 58"

Width: 10½"

Extension: 10½"

Base: 10½" Round

**Available Finishes:**

BZ, HAB, PN

**Shade Treatment:** NP

**Shade Details:** 7½" x 8½" x 11"

**Socket:** Hi-Lo

**Wattage:** 75 A



**TOB1001BZ**  
**Greenwich Adjustable Floor Lamp**  
**in Bronze**

Height: 42"-54"  
Extension: 17"  
Base: 12" Round

**Available Finishes:**  
BC, BZ, HAB, PN

**Socket:** Dimmer  
**Wattage:** 60 T

**TOB1014HAB**  
**Studio Arc Task Lamp in**  
**Hand-Rubbed Antique Brass**

Height: 48"-77½"  
Extension: 31"  
Base: 20" Tripod

**Available Finishes:**  
AN, BZ, HAB, PN

**Socket:** Keyless/Floor Dimmer  
**Wattage:** 75 A

**TOB1014PN**



**TOB1015AN**  
**Studio Pivoting Task Lamp**  
**in Antique Nickel**  
Height: 43½"-86"  
Extension: 53"  
Base: 20" Tripod

**Available Finishes:**  
AN, BZ, HAB, PN

**Socket:** Keyless/Floor Dimmer  
**Wattage:** 75 A



**TOB1013BZ/HAB-NP**  
**Ziyi Tension Pole Lamp in Bronze with**  
**Hand-Rubbed Antique Brass Accents**  
**with Natural Paper Shade**  
Height: 8"-10"  
Extension: 14½"  
Base: 2" Round

**Available Finishes:** BZ/HAB, PN  
**Shade Treatments:** NP  
**Shade Details:** 4" x 5" x 6½"

**Socket:** 3 - Hi-Lo  
**Wattage:** 3 - 60 A



**TOB1010HAB-NP**  
**Studio Adjustable Floor Lamp**  
**in Hand-Rubbed Antique Brass**

Height: 53"-122"  
Width: 28"  
Base: 20" - 34"

**Available Finishes:**  
BZ, HAB, PN

**Shade Treatment:**  
NP, NP2  
**Shade Details:**  
25" x 28" x 22" NP  
17" x 20" X 17" NP2

**Socket:** 2-Pull Chain  
**Wattage:** 2-100 A



**TOB3080BZ-NP**  
**Studio Tripod Adjustable Floor/Table Lamp**  
**in Bronze with Natural Paper Shade**

Height: 32"-75"  
Width: 20"  
Base: 11" - 20"

**Available Finishes:**  
BZ, HAB, PN  
**Shade Treatment:** NP, NP2  
**Shade Details:** 15" x 20" x 13½"

**Socket:** Dimmer  
**Wattage:** 150 A



**NYPL3**

**New York Public Library Reading  
Room Lamp in Bronze with  
Hand-Rubbed Antique Brass Shade**

Height: 50"-60"

Width: 15"

Base: 11" Round

**Shade Treatment:** HAB

**Shade Details:** 8" x 15" x 10½"

**Socket:** 2-Pull Chain

**Wattage:** 2-60 A



**BB1230HAB-NP**

**Downbridge Loop Adjustable Floor Lamp  
in Hand-Rubbed Antique Brass  
with Natural Paper Shade**

Height: 47"-71"

Extension: 16"

Base: 10" Round

**Available Finishes:** BZ, HAB

**Shade Treatments:** NP, T

**Shade Details:** 7½" x 12" x 8"

**Socket:** Hi-Lo

**Wattage:** 100 A



**BB1040HAB-NP**  
**Hobbs Floor Lamp in**  
**Hand-Rubbed Antique Brass**  
**with Natural Paper Shade**

Height: 64"  
Width: 20"  
Extension: 20"  
Base: 11" Round

**Available Finishes:**  
AN, BZ, HAB, PN  
**Shade Treatment:** NP  
**Shade Details:**  
10½" x 16¼" x 11"

**Socket:** Hi-Lo  
**Wattage:** 100 A



**BB1200HAB-T**  
**Triple Swing-Arm Adjustable Floor Lamp**  
**in Hand-Rubbed Antique Brass**  
**with Tissue Silk Shade**

Height: 47"-71"  
Extension: 22"  
Base: 10" Round

**Available Finishes:** AN, BZ, HAB, PB  
**Shade Treatment:** L, S, T  
**Shade Details:** 7" x 11" x 8½"

**Socket:** Dimmer  
**Wattage:** 100 A





**BB1010HAB-NP**  
Candlestick Floor Lamp in  
Hand-Rubbed Antique Brass  
with Natural Paper Shade  
Height: 57½"  
Width: 12"  
Base: 8" Round

**Available Finishes:** AN, BZ, HAB, PN  
**Shade Treatment:** L, NP, S, T  
**Shade Details:**  
5" x 13" x 9" L, NP, T or  
8" x 11" x 8¼" S

**Socket:** Dimmer  
**Wattage:** 100 A

**BB1010AN-T**

**BB1500HABL2-NP**  
Adjustable Floor Lamp in  
Hand-Rubbed Antique Brass  
with Braided Leather Accents  
with Natural Paper Shade  
Height: 41"-56"  
Width: 14"  
Base: 8" Round

**Finishes:** AN, BZ, HAB, HABL2  
**Shade Treatment:** B, K, NP  
**Shade Details:**  
10" x 14" x 11" on HABL2 or  
5" x 19" x 11" on AN, BZ, HAB

**Socket:** Hi-Lo  
**Wattage:** 100 A

**BB1500HAB-NP**



**BB1600HAB**  
**Adjustable Floor Lamp in**  
**Hand-Rubbed Antique Brass**  
Height: 40½"-57"  
Width: 10"  
Extension: 18"  
Base: 10" Round

**Available Finishes:** AN, BZ, HAB, PN  
**Shade Details:** 5¼" x 5¼"

**Socket:** Floor Dimmer  
**Wattage:** 50 R20

**BB1100HAB**  
**Adjustable Old Pharmacy Lamp in**  
**Hand-Rubbed Antique Brass**  
Height: 36"-54"  
Width: 10"  
Extension: 15"  
Base: 10" Round

**Available Finishes:** AN, BZ, HAB, PN  
**Shade Details:** 6" Round

**Socket:** Hi-Lo  
**Wattage:** 60 A

**BB1101HAB**  
**Adjustable Shell Pharmacy**  
**Floor Lamp in Hand-Rubbed**  
**Antique Brass**  
Height: 40"-51"  
Width: 10"  
Extension: 14"  
Base: 10" Round

**Available Finishes:** AN, HAB  
**Shade Details:** 7" Long Shell

**Socket:** Hi-Lo  
**Wattage:** 60 A



**CL1001BZ-WP**  
**Tribeca Floor Lamp in Bronze**  
**with White Paper Shade**

Height: 70"  
Width: 15"  
Base: 15" Square

**Available Finishes:** BS, BZ  
**Shade Treatment:** WP  
**Shade Details:** 15" x 15" x 13½"

**Socket:** 2-Pull Chain  
**Wattage:** 2-75 A



**CL1002BZ-WP**  
**Small Tribeca Floor Lamp in Bronze**  
**with White Paper Shade**

Height: 53"  
Width: 8"  
Base: 8" Square

**Available Finishes:** BS, BZ  
**Shade Treatment:** FG, WP  
**Shade Details:** 7½" x 7½" x 9"

**Socket:** Pull Chain  
**Wattage:** 100 A



**CL1100BZ**  
**Noho Torchiere Floor Lamp**  
**with Casters in Bronze**

Height: 75½"  
Width: 15"  
Base: 15"

**Available Finishes:** BS, BZ  
**Shade Details:** 9" x 10"

**Socket:** Keyless with Foot Switch  
**Wattage:** 100 A



**CL1100BS**



**SC1102BZ-S**

**Adjustable Puzzle Floor Lamp  
in Bronze with Silk Shade**

Height: 54"-68"  
Width: 12"  
Extension: 12"  
Base: 8½" x 10½"

**Shade Treatment:** S

**Shade Details:**  
11" x 12" x 12" Silk

**Socket:** Hi-Lo  
**Wattage:** 100 A

**SC1106BZ-NP**

**Rope Floor Lamp in Bronze  
with Natural Paper Shade**

Height: 76"  
Width: 17"  
Base: 17" Tripod

**Available Finishes:** BZ, HAB, PN

**Shade Treatments:** NP  
**Shade Details:** 16" x 16" x 16"

**Socket:** Dimmer  
**Wattage:** 150 A

**SC1101HAB-L**

**Paris Floor Lamp in  
Hand-Rubbed Antique Brass and  
Mahogany with Linen Shade**

Height: 58" - 77½"  
Width: 20"  
Base: 14"

**Available Finishes:** HAB, PN

**Shade Treatment:** L  
**Shade Details:**  
10"/20" x 10"/20" x 11" Oval

**Socket:** 2-Pull Chain  
**Wattage:** 2-75 A



**SC1105BZ-NP**  
**Rome Floor Lamp in Bronze**  
**with Natural Paper Shade**  
Height: 79½"  
Width: 24½"  
Base: 16½" Round

**Shade Treatment:** NP  
**Shade Details:**  
15½" x 24½" x 18"

**Socket:** Pull Chain  
**Wattage:** 150 A



**SC1100BZ**  
**Socrates Floor Lamp in Bronze**  
Height: 70"  
Width 16"  
Base: 12" Round

**Shade Details:** 4" x 16"

**Socket:** Keyless/Floor Dimmer  
**Wattage:** 150 A





# CEILING

Chart House	152
Studio	196
Thomas O'Brien	208
Bill Blass	219
Eric Cohler	220







**CHC1154CG**  
**Large Faceted George II**  
**Chandelier in Crystal**

Height: 31"  
Width: 30"  
Canopy: 5½" Round

**Available Finishes:**  
AB, AN, CG, PS, Q

**Socket:** 6-Candelabra  
**Wattage:** 6-60 C  
©EFC DESIGNS



**CHC1155CG**  
**Small George II Chandelier**  
**in Crystal**

Height: 23½"  
Width: 22"  
Canopy: 5½" Round

**Available Finishes:**  
AB, AN, CG, PS, Q

**Socket:** 6-Candelabra  
**Wattage:** 6-60 C  
©EFC DESIGNS



**CHC1154AB**  
**Large George II Chandelier**  
**in Antique Burnished Brass**

Height: 31"  
Width: 30"  
Canopy: 5½" Round

**Available Finishes:**  
AB, AN, CG, PS, Q

**Socket:** 6-Candelabra  
**Wattage:** 6-60 C  
©EFC DESIGNS



**CHC1155AN**  
**Small George II Chandelier**  
**in Antique Nickel**

Height: 23½"  
Width: 22"  
Canopy: 5½" Round

**Available Finishes:**  
AB, AN, CG, PS, Q

**Socket:** 6-Candelabra  
**Wattage:** 6-60 C  
©EFC DESIGNS



**CHC1152CG**  
**Large Faceted George II**  
**Chandelier in Crystal**  
Height: 31"  
Width: 30"  
Canopy: 5½" Round

**Available Finishes:**  
AB, CG, PS

**Socket:** 6-Candelabra  
**Wattage:** 6-60 C  
©EFC DESIGNS



**CHC1152PS**



**CHC1153PS**  
**Small Faceted George II**  
**Chandelier in Polished Silver**  
Height: 23½"  
Width: 22"  
Canopy: 5½" Round

**Available Finishes:**  
AB, CG, PS

**Socket:** 6-Candelabra  
**Wattage:** 6-60 C  
©EFC DESIGNS



**CHC1153AB**



**CHC1173AB**

**Large Two-Tier Twelve-Light  
Sussex Chandelier in  
Antique-Burnished Brass**

Height: 44½"

Width: 44"

Canopy: 5¾" Round

**Available Finishes:**

AB, AB/AN, AN, BZ, PS

**Shade Treatment:** CHS-114NP

Shade Sold Separately

**Shade Details:** 4" x 6" x 5"

**Socket:** 12-Medium Candle

**Wattage:** 12-60 B

©EFC DESIGNS



**CHC1171AN**

**Large Eight-Light Sussex  
Chandelier in Antique Nickel**

Height: 32½"

Width: 44"

Canopy: 5¾" Round

**Available Finishes:**

AB, AB/AN, AN, BZ, PS

**Shade Treatment:** CHS-114NP

Shade Sold Separately

**Shade Details:** 4" x 6" x 5"

**Socket:** 8-Medium Candle

**Wattage:** 8-60 B

©EFC DESIGNS



**CHC1172AB**  
**Medium Two-Tier Nine-Light**  
**Sussex Chandelier in**  
**Antique Brass**  
Height: 33¼"  
Width: 35"  
Canopy: 5¼" Round

**Available Finishes:**  
AB, AB/AN, AN, BZ, PS  
**Shade Treatment:** CHS-114NP  
Shade Sold Separately  
**Shade Details:** 4" x 6" x 5"

**Socket:** 9-Medium Candle  
**Wattage:** 9-60 B  
©EFC DESIGNS



**CHC1170AB/AN**  
**Medium Six-Light Sussex**  
**Chandelier in Antique Brass**  
**and Antique Nickel**  
Height: 39"  
Width: 35"  
Canopy: 5¼" Round

**Available Finishes:**  
AB, AB/AN, AN, BZ, PS  
**Shade Treatment:** CHS-114NP  
Shade Sold Separately  
**Shade Details:** 4" x 6" x 5"

**Socket:** 6-Medium Candle  
**Wattage:** 6-60 B  
©EFC DESIGNS



**CHC1166BZ**  
**Single Tier Six-Light Sussex**  
**Chandelier in Bronze**

Height: 33"  
Width: 26"  
Canopy: 6" Round

**Available Finishes:**  
AB, AN, BZ, PS

**Socket:** 6-Candelabra  
**Wattage:** 6-60 C  
©EFC DESIGNS



**CHC1169AB**  
**Double Tier Nine-Light**  
**Sussex Chandelier in**  
**Antique-Burnished Brass**

Height: 33"  
Width: 26"  
Canopy: 6" Round

**Available Finishes:**  
AB, AN, BZ, PS

**Socket:** 9-Candelabra  
**Wattage:** 9-60 C  
©EFC DESIGNS



**CHC1126PS**  
**Chelsea Six-Light Chandelier**  
**in Polished Silver**

Height: 34"  
Width: 39½"  
Canopy: 6" Round

**Available Finishes:**  
AB, BZ, PS

**Socket:** 6-Candelabra  
**Wattage:** 6-60 C  
©EFC DESIGNS



**CHC1118AN**  
**18th Century Twelve-Light**  
**Chandelier in**  
**Antique Burnished Nickel**  
Height: 38¼"  
Width: 39"  
Canopy: 5¾" Round

**Available Finishes:** AB, AN

**Socket:** 12-Candelabra  
**Wattage:** 12-60 C  
©EFC DESIGNS



**CHC1112AN**  
**Large 18th Century**  
**Eight-Light Chandelier in**  
**Antique Burnished Nickel**  
Height: 29"  
Width: 38"  
Canopy: 5¾" Round

**Available Finishes:** AB, AN

**Socket:** 8-Candelabra  
**Wattage:** 8-60 C



**CHC1114AB**  
**18th Century Eight-Light**  
**Chandelier in**  
**Antique-Burnished Brass**  
Height: 24"  
Width: 28"  
Canopy: 5¾" Round

**Available Finishes:** AB, AN

**Socket:** 8-Candelabra  
**Wattage:** 8-60 C  
©EFC DESIGNS



**CHC1117AB**  
**18th Century Two-Tier**  
**Eight-Light Chandelier in**  
**Antique-Burnished Brass**  
Height: 33"  
Width: 28"  
Canopy: 5 3/4" Round

**Available Finishes:** AB, AN

**Socket:** 8-Candelabra  
**Wattage:** 8-60 C  
©EFC DESIGNS



**CHC1113AB**  
**18th Century Six-Light Chandelier in**  
**Antique-Burnished Brass**  
Height: 24"  
Width: 28"  
Canopy: 5 3/4" Round

**Available Finishes:**  
AB, AN

**Socket:** 6-Candelabra  
**Wattage:** 6-60 C  
©EFC DESIGNS



**CHC1115AB**  
**18th Century Four-Light Chandelier in**  
**Antique-Burnished Brass**  
Height: 19"  
Width: 18"  
Canopy: 5 3/4" Round

**Available Finishes:** AB, AN  
**Shade Treatment:** CHS-104B  
Shade Sold Separately  
**Shade Details:** 3" x 4" x 4"

**Socket:** 4-Candelabra  
**Wattage:** 4-60 C  
©EFC DESIGNS



**CHC1116AB**  
**18th Century Six-Light Chandelier in**  
**Antique-Burnished Brass**  
Height: 19"  
Width: 18"  
Canopy: 5 3/4" Round

**Available Finishes:** AB, AN  
**Shade Treatment:** CHS-109S  
Shade Sold Separately  
**Shade Details:** 2 1/2" x 5" x 4 1/2"

**Socket:** 6-Candelabra  
**Wattage:** 6-60 C  
©EFC DESIGNS





**CHC1168AB**  
**Balustrade Form Four-Light**  
**English Chandelier in**  
**Antique Burnished Brass**  
 Height: 32"  
 Width: 15"  
 Canopy: 5 7/8" Round

**Available Finishes:** AB, AN  
**Shade Treatment:** CHS-104B  
 Shade Sold Separately  
**Shade Details:** 3" x 4" x 4"

**Socket:** 4-Candelabra  
**Wattage:** 4-60 C  
 ©EFC DESIGNS



**CHC2150AB**  
**Four-Light Pimlico Chandelier**  
**in Antique-Burnished Brass**  
 Height: 13"  
 Width: 13 1/2"  
 Canopy: 5 7/8" Round

**Available Finishes:**  
 AB, AN, PN  
**Shade Treatment:** CHS-104S  
 Shade Sold Separately  
**Shade Details:** 3" x 4" x 4"

**Socket:** 4-Candelabra  
**Wattage:** 4-60 C  
 ©EFC DESIGNS



**CHC1120AB**  
**English Four-Light Chandelier**  
**in Antique-Burnished Brass**  
 Height: 12"  
 Width: 13"  
 Canopy: 5 7/8" Round

**Available Finishes:** AB, AN, BZ

**Socket:** 4-Candelabra  
**Wattage:** 4-60 C  
 ©EFC DESIGNS



**CHC1138AB-G**  
**Balustrade Form Four-Light**  
**English Chandelier in**  
**Antique Burnished Brass**  
**with Tole Shade**  
 Height: 36"  
 Width: 19"  
 Canopy: 5 7/8" Round

**Available Finishes:** AB, SN

**Socket:** 4-Candelabra  
**Wattage:** 4-60 C



**CHC1138SN-SN**

**CHC1150ABV**  
**Large Eaton Eight-Light Chandelier in**  
**Antique-Burnished Brass Verdigris**

Height: 32"  
Width: 46"  
Canopy: 5 7/8" Round

**Shade Treatment:** CHS-112S  
Shade Sold Separately  
**Shade Details:** 4" x 5" x 5"

**Socket:** 8-Candelabra  
**Wattage:** 8-60 C  
©EFC DESIGNS



**CHC1151ABV**  
**Eaton Eight-Light Chandelier in**  
**Antique-Burnished Brass Verdigris**

Height: 23"  
Width: 31"  
Canopy: 5 7/8" Round

**Socket:** 8-Candelabra  
**Wattage:** 8-60 C  
©EFC DESIGNS



**CHC1111AN**  
**Georgian Six-Light Chandelier**  
**in Antique Nickel**

Height: 24"  
Width: 39"  
Canopy: 5 7/8" Round

**Available Finishes:** AB, AN, BZ, PS  
**Shade Treatment:** CHS-101B  
Shade Sold Separately  
**Shade Details:** 3" x 6" x 4"

**Socket:** 6-Candelabra  
**Wattage:** 6-60 C  
©EFC DESIGNS



**CHC1131AB**  
**Small Georgian Six-Light Chandelier**  
**in Antique-Burnished Brass**

Height: 19"  
Width: 28"  
Canopy: 5 7/8" Round

**Available Finishes:** AB, AN, BZ, PS  
**Shade Treatment:** CHS-104B  
Shade sold separately  
**Shade Details:** 3" x 4" x 4"

**Socket:** 6-Candelabra  
**Wattage:** 6-60 C  
©EFC DESIGNS



**CHC1408AB-SG**  
**Large Paris Flea Market Chandelier**  
**in Antique-Burnished Brass**  
**with Seeded Glass Trim**  
Height: 33"  
Width 32"  
Canopy: 5 3/4" Round

**Socket:** 8 - Candelabra  
**Wattage:** 8 - 60 C  
©EFC DESIGNS



**CHC1426AB-SG**  
**Medium Paris Flea Market Chandelier**  
**in Antique-Burnished Brass**  
**with Seeded Glass Trim**  
Height: 26"  
Width: 24"  
Canopy: 5 3/4" Round

**Socket:** 8-Candelabra  
**Wattage:** 8-60 C  
©EFC DESIGNS



**CHC1407AB-SG**  
**Petite Paris Flea Market Chandelier**  
**in Antique-Burnished Brass**  
**with Seeded Glass Trim**  
Height: 17 1/2"  
Width: 16 1/4"  
Canopy: 5 3/4" Round

**Socket:** 6 - Candelabra  
**Wattage:** 6 - 60 C  
©EFC DESIGNS



**CHC1424BR-SG**

**La Cour Chandelier in Black Rust and Tudor Brown Wood with Seeded Glass Trim**

Height: 33¼"

Width: 33¾"

Canopy: 5½" Round

**Available Finishes:**

AB-SG, BR-SG

**Socket:** 6-Candelabra

**Wattage:** 6-60 C

©EFC DESIGNS



**CHC1425BZ-Q**

**St. Helier Six-Light Chandelier in Bronze with Quartz Trim**

Height: 32¼"

Width: 33¾"

Canopy: 5½" Round

**Available Finishes:**

AN-Q, BZ-Q, PS-Q

**Socket:** 6-Candelabra

**Wattage:** 6-60 C

©EFC DESIGNS



**CHC1420AN**

**Piedmont Six-Light Chandelier in Antique Burnished Nickel**

Height: 33"

Width: 32"

Canopy: 5¾" Round

**Available Finishes:** AB, AN, R

**Shade Treatment:** CHS-104NP

Shade Sold Separately

**Shade Details:** 3" x 4" x 4"

**Socket:** 6-Candelabra

**Wattage:** 6-60 C

©EFC DESIGNS



**CHC1420R**



**CHC1415R**  
**Marigot Six-Light Chandelier in**  
**Rusted Iron and Distressed Brass**  
**with Tudor Brown Wooden Beads**  
 Height: 30"  
 Width: 33"  
 Canopy: 5½" Round

**Available Finishes:** AB, OW, R

**Socket:** 6-Candelabra  
**Wattage:** 6-60 C  
 ©EFC DESIGNS



**CHC1413R**  
**Marigot Eight-Light Chandelier in**  
**Rusted Iron and Distressed Brass**  
**with Tudor Brown Wooden Beads**  
 Height: 36"  
 Width: 44"  
 Canopy: 5½" Round

**Available Finishes:** OW, R  
**Shade Treatment:** CHS-104NP  
 Shade Sold Separately  
**Shade Details:** 3" x 4" x 4"

**Socket:** 8-Candelabra  
**Wattage:** 8-60 C  
 ©EFC DESIGNS



**CHC1419OW**  
**Bead and Tassel Chandelier in**  
**Old White**  
 Height: 37"  
 Width: 31"  
 Canopy: 5½" Round

**Socket:** 6-Candelabra  
**Wattage:** 6-60 C  
 ©EFC DESIGNS



**CHC1423AB-SG**  
**Venetian Chandelier in**  
**Antique-Burnished Brass**  
**and French Wax Wood**  
**with Seeded Glass Trim**  
 Height: 41"  
 Width: 32"  
 Canopy: 5½"

**Available Finishes:**  
 AB-SG, AN-SG, OW  
**Shade Treatment:** CHS-104NP  
 Shade Sold Separately  
**Shade Details:** 3" x 4" x 4"

**Socket:** 6-Candelabra  
**Wattage:** 6-60 B  
 ©EFC DESIGNS



**CHC142R**  
**Sans Crystal Eight-Light Chandelier**  
**in Rusted Iron**  
Height: 28"  
Width: 30"  
Canopy: 5 3/4" Round

**Available Finishes:** AB, R

**Socket:** 6-Candelabra  
**Wattage:** 6-60 C  
©EFC DESIGNS



**CHC142AB**



**CHC1421AB**  
**Brettonne Six-Light Chandelier**  
**in Antique-Burnished Brass**  
Height: 44"  
Width: 32"  
Canopy: 5 3/4" Round

**Available Finishes:** AB, AN, BZ, R  
**Shade Treatment:** CHS-104NP  
Shade Sold Separately  
**Shade Details:** 3" x 4" x 4"

**Socket:** 6-Candelabra  
**Wattage:** 6-60 C  
©EFC DESIGNS



**CHC1421R**



**CHC1411R**  
**"La Cage" Eight-Light French**  
**Chinoiserie Chandelier in**  
**Rusty Iron with Heavily**  
**Antiqued Brass Accents**  
Height: 32"  
Width: 32"  
Canopy: 5½" Round

**Socket:** 8-Candelabra  
**Wattage:** 8-60 C  
©EFC DESIGNS



**CHC1415AB-SG**  
**Marigot Six-Light Chandelier in**  
**Antique-Burnished Brass and**  
**Seeded Glass**  
Height: 30"  
Width: 33"  
Canopy: 5½" Round

**Available Finishes:**  
AB, OW, R

**Socket:** 6-Candelabra  
**Wattage:** 6-60 C  
©EFC DESIGNS



**CHC1409R**  
**Louis XVI De-Provence**  
**Eight-Light Chandelier in**  
**Rusted Iron with Heavily**  
**Antiqued Brass Accents**  
Height: 32"  
Width: 32"  
Canopy: 5½" Round

**Shade Treatment:** CHS-104NP  
Shade Sold Separately  
**Shade Details:** 3" x 4" x 4"

**Socket:** 8-Candelabra  
**Wattage:** 8-60 C  
©EFC DESIGNS



**CHC1410R**  
**"Petite Trianon" Eight-Light**  
**Plume and Crown Motif Chandelier**  
**in Rusted Iron with Heavily**  
**Antiqued Brass Accents**  
Height: 30"  
Width: 28"  
Canopy: 5½" Round

**Shade Treatment:** CHS-104NP  
Shade Sold Separately  
**Shade Details:** 3" x 4" x 4"

**Socket:** 8-Candelabra  
**Wattage:** 8-60 C  
©EFC DESIGNS



**CHC1432BR**  
**Windsor Iron Two-Tier  
Twelve-Light Chandelier  
in Black Rust**  
Height: 42"  
Width: 41"  
Canopy: 5 3/4" Round

**Socket:** 12-Candelabra  
**Wattage:** 12-60 C  
©EFC DESIGNS



**CHC1435BR**  
**Windsor Iron Two-Tier  
Eight-Light Chandelier  
in Black Rust**  
Height: 24"  
Width: 21"  
Canopy: 5 3/4" Round

**Socket:** 8-Candelabra  
**Wattage:** 8-60 C  
©EFC DESIGNS



**CHC1436BR**  
**Six-Light J Arm Chandelier in Black Rust  
with Wrapped Leather Accents**  
Height: 31"  
Width: 31"  
Canopy: 5 3/4" Round

**Shade Treatment:** CHS-101NP  
Shade Sold Separately  
**Shade Details:**  
3" x 6" x 4"

**Socket:** 6-Candelabra  
**Wattage:** 6-60 C  
©EFC DESIGNS



**CHC1437BR**  
**Four-Light J Arm Chandelier in Black Rust  
with Wrapped Leather Accents**  
Height: 15"  
Width: 21"  
Canopy: 5 3/4" Round

**Shade Treatment:** CHS-101NP  
Shade Sold Separately  
**Shade Details:**  
3" x 6" x 4"

**Socket:** 4-Candelabra  
**Wattage:** 4-60 C  
©EFC DESIGNS





**CHC3108R**  
**Grande Diego Classical French Lantern**  
with Perching Birds in Rust  
with Light Verdi Accents  
Height: 25"  
Width: 16"  
Canopy: 5 3/4" Round

**Socket:** 4-Candelabra  
**Wattage:** 4-60 C  
©EFC DESIGNS



**CHC3109R**  
**Petite Diego Classical French Lantern**  
with Perching Birds in Rust  
with Light Verdi Accents  
Height: 14"  
Width: 8"  
Canopy: 5 3/4" Round

**Socket:** 3-Candelabra  
**Wattage:** 3-60 C  
©EFC DESIGNS



**CHC1158R**  
**Classical French Perching Birds Chandelier**  
in Rust with Light Verdi Accents  
Height: 23"  
Width: 20"  
Canopy: 5 3/4" Round

**Socket:** 5-Candelabra  
**Wattage:** 5-60 C  
©EFC DESIGNS



**CHC1472RG**  
**Fifteen-Light Crystal Petal Chandelier**  
**in Rust and Antique Gold Leaf**

Height: 45"  
Width: 44"  
Canopy: 5" Round

**Available Finishes:** AWG, R, RG

**Socket:** 15-Candelabra  
**Wattage:** 15-60 C

©EFC DESIGNS



**CHC1471RG**  
**Nine-Light Crystal Petal Chandelier**  
**in Rust and Antique Gold Leaf**

Height: 36"  
Width: 29"  
Canopy: 5" Round

**Available Finishes:**  
AWG, R, RG

**Socket:** 9-Candelabra  
**Wattage:** 9-60 C

©EFC DESIGNS



**CHC1470RG**  
**Eight-Light Crystal Petal Chandelier**  
**in Rust and Antique Gold Leaf**

Height: 26"  
Width: 29"  
Canopy: 5" Round

**Available Finishes:** AWG, R, RG  
**Shade Treatment:** CHS-104TSC  
Shade Sold Separately  
**Shade Details:** 3" x 4" x 4"

**Socket:** 8-Candelabra  
**Wattage:** 8-60 C  
©EFC DESIGNS



**CHC1405NR**  
**De Provence Six-Light Fixture**  
**in Natural Rust**  
Height: 41"  
Width: 44"  
Canopy: 5" Round

**Socket:** 6-Candelabra  
**Wattage:** 6-60 C  
©EFC DESIGNS



**CHC1401NR**  
**Large French Country Inn Chandelier**  
**in Natural Rust**  
Height: 40"  
Width: 36"  
Canopy: 5" Round

**Socket:** 6-Candelabra  
**Wattage:** 6-60 C  
©EFC DESIGNS



**CHC1402NR**  
**Small French Country Inn Chandelier**  
**in Natural Rust**  
Height: 32"  
Width: 28½"  
Canopy: 5" Round

**Socket:** 6-Candelabra  
**Wattage:** 6-60 C  
©EFC DESIGNS



**CHC1451WI**  
**Windsor Iron Six-Light Ring Chandelier**  
**in Weathered Iron with**  
**Heavily Antiqued Brass Accents**

Height: 28"  
Width: 28"  
Canopy: 5 3/4" Round

**Shade Treatment:** FG

**Shade Details:**  
4 3/4" x 4 3/4" x 5 3/4"

**Socket:** 6-Keyless

**Wattage:** 6-60 A

©EFC DESIGNS



**CHC1450WI**  
**Windsor Iron Twist Chandelier**  
**in Weathered Iron with**  
**Heavily Antiqued Brass Accents**

Height: 62"  
Width: 25 1/2" x 37 1/2"  
Canopy: 5 3/4" Round

**Shade Treatment:** FG

**Shade Details:** 4 3/4" x 4 3/4" x 5 3/4"

**Socket:** 6-Keyless

**Wattage:** 6-60 A

©EFC DESIGNS



**CHC1414WI**  
**Oval Ring Torch Chandelier**  
**in Weathered Iron**  
Height: 41"  
Width: 31½" x 45½" Oval  
Canopy: 6½" Round

**Shade Treatment:** CHS-112NP  
Shade Sold Separately  
**Shade Size:** 4" x 9" x 6"

**Socket:** 6-Keyless  
**Wattage:** 6-60 A  
©EFC DESIGNS



**CHC1416BR**  
**Large French Country Iron Chandelier**  
**in Black Rust**  
Height: 39"  
Width: 35"  
Canopy: 5½" Round

**Shade Treatment:** CHS-112NP  
Shade Sold Separately  
**Shade Details:** 4" x 9" x 6"

**Socket:** 4-Candelabra  
**Wattage:** 4-60 C  
©EFC DESIGNS



**CHC1406BR**  
**Small French Country Iron Chandelier**  
**in Black Rust**  
Height: 24"  
Width: 21"  
Canopy: 5½" Round

**Shade Treatment:** CHS-101NP  
Shade Sold Separately  
**Shade Details:** 3" x 6" x 4"

**Socket:** 4-Candelabra  
**Wattage:** 4-60 C  
©EFC DESIGNS



**CHC1461BR**  
**Dorset Two-Tier Nine-Light Chandelier**  
**in Black Rust**

Height: 43"  
Width: 47"  
Canopy: 5 $\frac{3}{4}$ " Round

**Shade Treatment:** CHS-114NP  
Shade Sold Separately  
**Shade Details:** 4" x 6" x 5"

**Socket:** 9-Candelabra  
**Wattage:** 9-60 C  
©EFC DESIGNS



**CHC1463BR**  
**Small Nine-Light Two-Tier Chandelier**  
**in Black Rust**

Height: 43"  
Width: 42"  
Canopy: 5 $\frac{3}{4}$ " Round

**Shade Treatment:** CHS-114NP  
Shade Sold Separately  
**Shade Details:** 4" x 6" x 5"

**Socket:** 9-Candelabra  
**Wattage:** 9-60 C  
©EFC DESIGNS



**CHC1462WI**  
**Dorset Two-Tier Chandelier with**  
**Torch Arms in Weathered Iron**  
Height: 49"  
Width: 57"  
Canopy: 6½" Round

**Shade Treatment:** SH5X8X6NP  
Shades Sold Separately  
**Shade Details:** 5" x 8" x 6"

**Socket:** 9-Keyless  
**Wattage:** 9-60 A  
©EFC DESIGNS



**CHC1460BR**  
**Six-Light Scroll Chandelier**  
**in Black Rust**  
Height: 28"  
Width: 35"  
Canopy: 5¾" Round

**Shade Treatment:** CHS-106NP  
Shade Sold Separately  
**Shade Details:** 3" x 6" x 4¼"

**Socket:** 6-Candelabra  
**Wattage:** 6-60 C  
©EFC DESIGNS



**CHC1443AB**  
**Round Flatline Chandelier in**  
**Antique-Burnished Brass**

Height: 35"  
Width: 32"  
Canopy: 5 $\frac{3}{4}$ " Round

**Available Finishes:** AB, AN, BZ, PN  
**Shade Treatment:** CHS-106NP  
Shade Sold Separately  
**Shade Details:** 3" x 6" x 4 $\frac{1}{4}$ "

**Socket:** 6-Candelabra  
**Wattage:** 6-60 C  
©EFC DESIGNS



**CHC1442BZ**  
**Rectangular Flatline Chandelier in Bronze**

Height: 35"  
Width: 38"  
Depth: 18"  
Canopy: 5 $\frac{3}{4}$ " Square

**Available Finishes:** AB, AN, BZ, PN  
**Shade Treatment:** CHS-106L  
Shade Sold Separately  
**Shade Details:** 3" x 6" x 4 $\frac{1}{4}$ "

**Socket:** 8-Candelabra  
**Wattage:** 8-60 C  
©EFC DESIGNS





**CHC1444AB**  
**Oval Flatline Chandelier in**  
**Antique-Burnished Brass**  
Height: 35"  
Width: 36"  
Canopy: 5 $\frac{1}{4}$ " Round

**Available Finishes:** AB, AN, BZ, PN  
**Shade Treatment:** CHS-106NP  
Shade Sold Separately  
**Shade Details:** 3" x 6" x 4 $\frac{1}{4}$ "

**Socket:** 6-Candelabra  
**Wattage:** 6-60 C  
©EFC DESIGNS



**CHC1441BZ**  
**Linear Flatline Fixture in Bronze**  
Height: 33"  
Width: 48"  
Depth: 3"  
Canopy: 5 $\frac{1}{4}$ " Square

**Available Finishes:** AB, AN, BZ, PN  
**Shade Treatment:** CHS-106LS  
Shade Sold Separately  
**Shade Details:** 3" x 6" x 4 $\frac{1}{4}$ "

**Socket:** 5-Candelabra  
**Wattage:** 5-60 C  
©EFC DESIGNS



**CHC5106AB-AB**

**Large Chelsea Linear Chandelier in  
Antique-Burnished Brass with  
Antique Brass Shades**

Height: 32"

Width: 62"

Canopy: 5½" Round

24" Stem or 6' Chain Included

**Available Finishes:** AB, AN, BZ

**Shade Treatments:** AB, AN, BZ

**Shade Details:** 12" x 15" x 7"

**Socket:** 6-Candelabra

**Wattage:** 6-60 C

©EFC DESIGNS



**CHC5107BZ-BZ**

**Medium Chelsea Linear Chandelier in  
Bronze with Bronze Shades**

Height: 32"

Width: 47"

Canopy: 5½" Round

24" Stem or 6' Chain Included

**Available Finishes:** AB, AN, BZ

**Shade Treatments:** AB, AN, BZ

**Shade Details:** 12" x 15" x 7"

**Socket:** 6-Candelabra

**Wattage:** 6-60 C

©EFC DESIGNS



**CHC5102AB-L**  
**Double Sloane Street**  
**Shop Light Ceiling**  
**Mounted Fixture in**  
**Antique Burnished Brass**

Height: 57"  
Width: 54"  
Canopy: 5 3/4" Round  
Custom Height Available

**Available Finishes:**

AB, AN, BZ

**Shade Treatment:**

AB, AN, BZ, L

**Shade Details:**

11 1/2" x 15 1/2" x 10"

**Socket:** 4-Keyless

**Wattage:** 4-60 A

©EFC DESIGNS

**CHC5101AB-L**  
**Sloane Street**  
**Shop Light Fixture in**  
**Antique-Burnished Brass**  
**with Linen Shade**

Height: 49"  
Width: 15 1/2"  
Canopy: 5 3/4" Round  
Custom Height Available

**Available Finishes:** AB, AN, BZ

**Shade Treatment:**

AB, AN, BZ, L

**Shade Details:**

11 1/2" x 15 1/2" x 10"

**Socket:** 2-Keyless

**Wattage:** 2-60 A

©EFC DESIGNS



**CHC5102AB-AB**  
**Sloane Street Two-Light**  
**Ceiling Mounted Fixture in**  
**Antique Burnished Brass with**  
**Antique-Burnished Brass Shades**

Height: 57"  
Width: 54"  
Canopy: 5 3/4" Round  
Custom Height Available

**Available Finishes:**

AB, AN, BZ

**Shade Treatment:**

AB, AN, BZ, L

**Shade Details:**

11 1/2" x 15 1/2" x 10"

**Socket:** 4-Keyless

**Wattage:** 4-60 A

©EFC DESIGNS

**CHC5101AB-AB**  
**Sloane Street Shop Light Fixture in**  
**Antique-Burnished Brass with**  
**Antique-Burnished Brass Shade**

Height: 49"  
Width: 15 1/2"  
Canopy: 5 3/4" Round  
Custom Height Available

**Available Finishes:** AB, AN, BZ

**Shade Treatment:**

AB, AN, BZ, L

**Shade Details:**

11 1/2" x 15 1/2" x 10"

**Socket:** 2-Keyless

**Wattage:** 2-60 A

©EFC DESIGNS



**CHC1480BZ-L**  
**Grosvenor One-Light in**  
**Bronze with Linen Shade**  
Height: 54½"  
Width: 17½"  
Canopy: 6" Round  
Custom Height Available

**Available Finishes:**  
AB, AN, BZ, PN  
**Shade Treatment:** L  
**Shade Details:**  
14" x 17½" x 10½"

**Socket:** 2-Keyless  
**Wattage:** 2-75 A  
©EFC DESIGNS



**CHC1481PN-L**  
**Grosvenor Two-Light in**  
**Polished Nickel with Linen**  
**Shades**  
Height: 42½"  
Width: 51"  
Canopy: 6" Round  
Custom Height Available

**Available Finishes:**  
AB, AN, BZ, PN  
**Shade Treatment :** L  
**Shade Details:** 12" x 15" x 10½"

**Socket:** 4-Keyless  
**Wattage:** 4-75 A

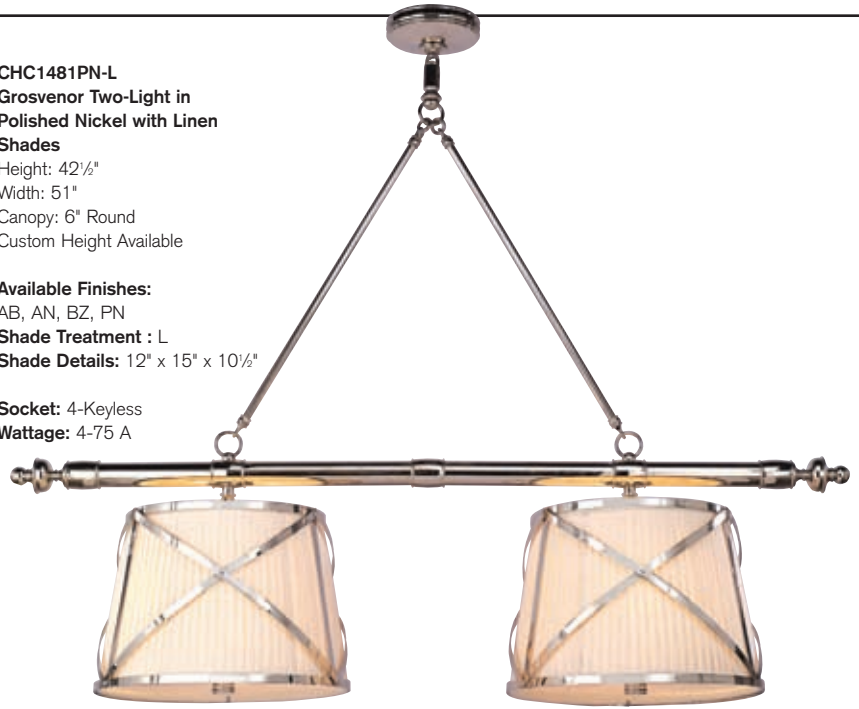

**CHC1482AB-L**  
**Grosvenor Three-Light**  
**in Antique-Burnished Brass**  
**with Linen Shades**  
Height: 42½"  
Width: 74½"  
Canopy: 6" Round  
Custom Height Available

**Available Finishes:** AB, AN, BZ, PN  
**Shade Treatment:** L  
**Shade Details:** 12" x 15" x 10½"

**Socket:** 6-Keyless  
**Wattage:** 6-75 A  
©EFC DESIGNS

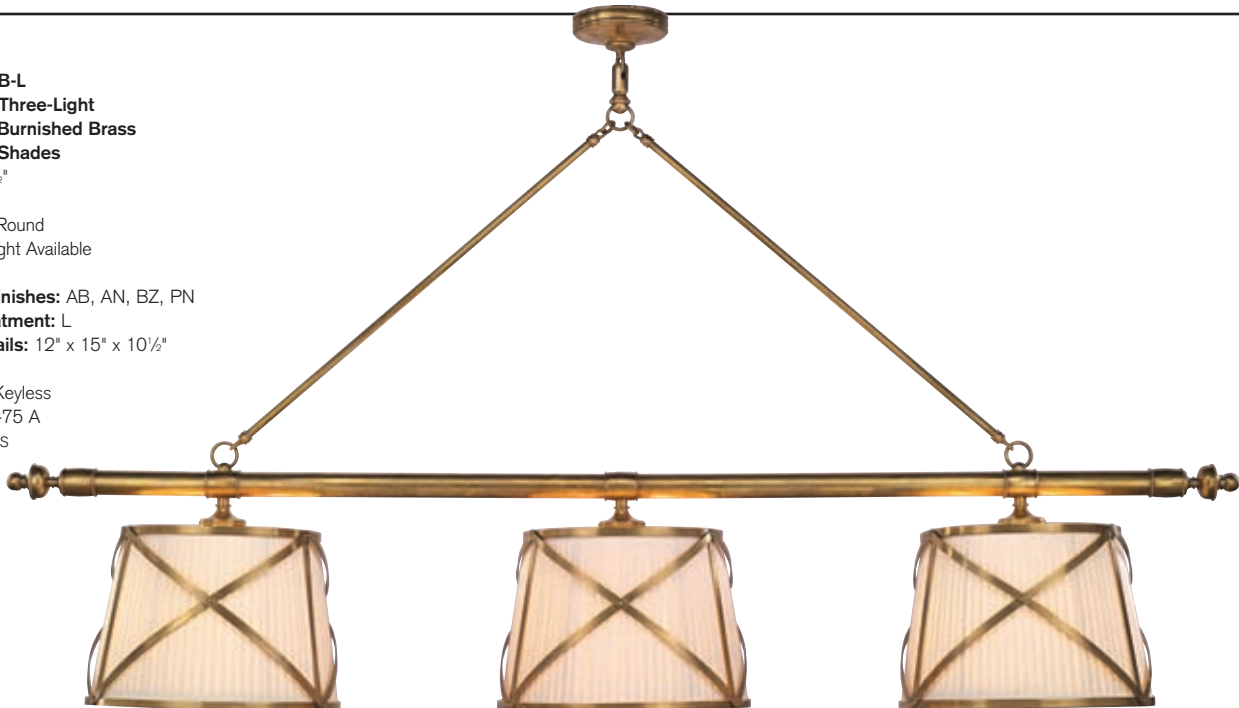

**CHC5104AB**  
**Sloane Street Two-Light**  
**Fixture in Antique-Burnished**  
**Brass**

Height: 71"  
Width: 48"  
Canopy: 5 $\frac{1}{4}$ " Round  
Custom Height Available

**Available Finishes:** AB, AN  
**Shade Treatments:** AB, AN  
**Shade Details:** 10" x 13" x 8"

**Socket:** 2-Keyless  
**Wattage:** 2-100 A  
©EFC DESIGNS



**CHC1440BR**  
**Windsor Iron Island**  
**Fixture in Rust**

Height: 55"  
Width: 62"  
Canopy: 5 $\frac{1}{4}$ " Round  
Custom Height Available

**Shade Treatment:** R  
**Shade Details:** 10" x 15 $\frac{1}{2}$ " x 8 $\frac{1}{4}$ "

**Socket:** 2-Keyless  
**Wattage:** 2-100 A  
©EFC DESIGNS



**CHC5132AN-WG**  
**Edwardian Single**  
**Pendant in Antique**  
**Burnished Nickel with**  
**White Glass Shade**  
Height: 44"  
Width: 10"  
Canopy: 5 3/4"  
Custom Height Available

**Available Finishes:**  
AB, AN, BZ, PN  
**Shade Treatment:**  
AB, AN, BZ, PN, WG  
**Shade Details:** 5" x 10" x 9"

**Socket:** Keyless  
**Wattage:** 100 A  
©EFC DESIGNS



**CHC5132AB-AB**



**CHC5105AB-WG**  
**Triple Sloane Street**  
**Shop Light in Antique-**  
**Burnished Brass with**  
**White Glass Shade**  
Height: 76"  
Width: 58"  
Canopy: 5 3/4" Round  
Custom Height Available

**Available Finishes:**  
AB, AN, BZ, PN  
**Shade Treatment:**  
AB, AN, BZ, PN, WG  
**Shade Size:**  
5" x 10" x 9"

**Socket:** 3-Keyless  
**Wattage:** 3-100 A  
©EFC DESIGNS



**CHC5150AN-SCC**  
**Three-Light Pimlico Chandelier**  
**in Polished Nickel**  
Height: 65"  
Width: 47"  
Canopy: 5 3/4" Round  
Custom Height Available

**Available Finishes:** AB, AN, PN  
**Shade Treatment:** SCC  
**Shade Details:** 6" x 11" x 9"

**Socket:** 3-Keyless  
**Wattage:** 3-100 A  
©EFC DESIGNS



**CHC5121AB**  
**Cornice Double Tier**  
**Rectangular Hanging Light in**  
**Antique-Burnished Brass with**  
**White Dressage Glass**

Height: 55"  
Cage Height: 16"  
Width: 36"  
Depth: 16"  
Canopy: 5½" Square,  
24" On Center  
Custom Height Available

**Available Finishes:**  
AB, AN, BZ, PN

**Socket:** 3-Keyless  
**Wattage:** 3-75 A  
©EFC DESIGNS



**CHC5120BZ**  
**Cornice Single Tier Rectangular**  
**Hanging Light in Bronze with**  
**White Dressage Glass**

Height: 49"  
Cage Height: 10"  
Width: 36"  
Depth: 16"  
Canopy: 5½" Square,  
24" On Center  
Custom Height Available

**Available Finishes:**  
AB, AN, BZ, PN

**Socket:** 3-Keyless  
**Wattage:** 3-75 A  
©EFC DESIGNS



**CHC2112AB-WG**  
**Zodiac Pendant in**  
**Antique-Burnished Brass**  
**with White Glass**  
Height: 46½"  
Width: 23½"  
Canopy: 5½" Round

**Socket:** 2-Keyless  
**Wattage:** 2-100 A  
©EFC DESIGNS



**CHC2111BR-WG**  
**Crown Top Banded**  
**Globe Fixture in Black Rust**  
**with White Glass**  
Height: 21"  
Width: 15"  
Canopy: 5½" Round

**Available Finishes:**  
AB, AW, BR, BZ/AB  
**Glass Options:**  
CG, WG

**Socket:** 3-Candelabra  
**Wattage:** 3-60 C  
©EFC DESIGNS



**CHC2111AB-CG**



**CHC2111AW-CG**





**CHC1447AB**  
**Arrow Chandelier in**  
**Antique-Burnished Brass**  
Height: 21"  
Width: 34½"  
Canopy: 5¾" Round

**Available Finishes:**  
AB, AB/AN, BZ, BZ/AB, PS  
**Shade Treatment:** CHS-104NP  
Shade Sold Separately  
**Shade Size:** 3" x 4" x 4"

**Socket:** 8-Candelabra  
**Wattage:** 8-60 C  
©EFC DESIGNS



**CHC1446AB**  
**Twelve-Arm Normandy**  
**Chandelier in Antique Brass**  
Height: 28"  
Width: 28"  
Canopy: 6" Round

**Available Finishes:** AB, AN, BZ  
**Shade Treatment:** CHS-104NP  
Shade Sold Separately  
**Shade Details:**  
3" x 4" x 4"

**Socket:** 12-Candelabra  
**Wattage:** 12-60 C  
©EFC DESIGNS



**CHC1500PN-NP**  
**Manhattan Eight-Light**  
**Chandelier in Polished Nickel**  
**with Natural Paper Shades**  
Height: 44"  
Width: 32½"  
Canopy: 6" Round

**Available Finishes:**  
AB, AN, BZ, PN  
**Shade Treatment:** NP  
**Shade Details:** 3¾" x 5" x 6"

**Socket:** 8-Candelabra  
**Wattage:** 8-60 B  
©EFC DESIGNS



**CHC5133AB-WG**  
**Country Industrial Pendant**  
**in Antique-Burnished Brass**  
**with White Glass Shade**

Height: 59"  
Width: 14"  
Canopy: 5½" Round  
Custom Height Available

**Available Finishes:**  
AB, AC, AN, BZ, PN  
**Shade Treatments:**  
AB, AC, AN, BZ, PN, WG  
**Shade Details:** 14" x 10"

**Socket:** Keyless  
**Wattage:** 100 A

©EFC DESIGNS

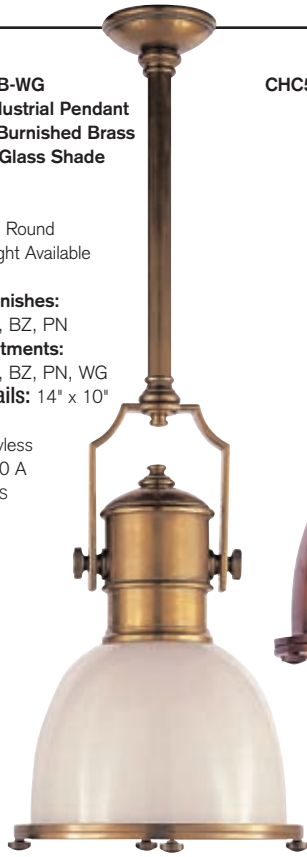

**CHC5133AC-AC**



**CHC5136BZ-BZ**  
**Large Country Industrial**  
**Pendant in Bronze with Bronze**  
**Shade**

Height: 59"  
Width: 19½"  
Canopy: 5½" Round  
Custom Height Available

**Available Finishes:**  
AB, AC, AN, BZ, PN  
**Shade Treatments:**  
AB, AC, AN, BZ, PN, WG  
**Shade Details:** 19½" x 10"

**Socket:** Keyless  
**Wattage:** 100 A

©EFC DESIGNS



**CHC5137BZ**  
**French Basin**  
**Pendant in Bronze**

Height: 48"  
Width: 15"  
Canopy: 5½" Round  
Custom Height Available

**Available Finishes:**  
AB, BZ, CH, PN  
**Shade Details:** 15" x 9"

**Socket:** Keyless  
**Wattage:** 100 A

©EFC DESIGNS



**CHC5160AB-AB**  
**Pimlico Street Lamp in**  
**Antique-Burnished Brass**  
**with Antique Brass Shade**

Height: 26"  
Width: 17½"  
(10" without shade)  
Canopy: 5½" Round

**Available Finishes:**  
AB, AN, PN, SB, SN  
**Shade Treatments:**  
AB, AN, PN, SB, SN  
Shade Sold Separately  
**Shade Details:**  
17½" Round

**Socket:** Keyless  
**Wattage:** 100 A

©EFC DESIGNS



**CHC5160AN**



**CHC2103AN**  
**Georgian Four-Light**  
**Hanging Globe**  
**with Smoke Bell**  
**in Antique Nickel**  
Height: 35"  
Width: 13½"  
Canopy: 5½" Round

**Available Finishes:**  
AB, AN, BZ, PS

**Socket:** 3 - Candelabra  
**Wattage:** 3 - 60 C  
©EFC DESIGNS



**CHC2103AB**



**CHC5135AB-WG**  
**Edwardian Lantern**  
**in Antique Burnished Brass**  
Height: 26"  
Width: 10"  
Canopy: 5½" Round

**Available Finishes:**  
AB, AN, BZ, PN

**Socket:** 3 - Candelabra  
**Wattage:** 3 - 60 C  
©EFC DESIGNS



**CHC2101PS**  
**Classic Smoke Bell**  
**in Polished Silver**  
Height: 29"  
Width: 15"  
Canopy: 5½" Round

**Available Finishes:**  
AB, AN, BZ, PS

**Socket:** 3 - Candelabra  
**Wattage:** 3 - 60 C  
©EFC DESIGNS



**CHC2102AB**  
**Rolled Lip Smoke Bell in**  
**Antique-Burnished Brass**  
Height: 23½"  
Width: 11½"  
Canopy: 5½" Round

**Available Finishes:**  
AB, AN, BZ, PS

**Socket:** 2 - Candelabra  
**Wattage:** 2 - 60 C  
©EFC DESIGNS



**CHC2104BZ**  
**Chelsea Smoke Bell**  
**in Bronze**  
Height: 31½"  
Width: 15"  
Canopy: 6" Round

**Available Finishes:**  
AB, AN, BZ, PS

**Socket:** 4-Candelabra  
**Wattage:** 4-60 C  
©EFC DESIGNS



**CHC2110AB**  
**Large Country Bell Jar**  
**Lantern with Antique-**  
**Burnished Brass Trim**  
Height: 25¾"  
Width: 21"  
Canopy: 6" Round

**Available Finishes:**  
AB, AN, BZ, PS

**Socket:** 6-Candelabra  
**Wattage:** 6-60 C  
©EFC DESIGNS



**CHC2109AB**  
**Country Semi-Flush**  
**Bell Jar Lantern with**  
**Antique-Burnished**  
**Brass Trim**  
Height: 14½"  
Width: 13"  
Canopy: 6" Round

**Available Finishes:**  
AB, AN, BZ, PS

**Socket:** 3-Candelabra  
**Wattage:** 3-60 C  
©EFC DESIGNS

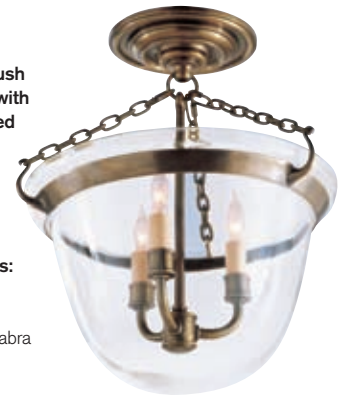

**CHC3423PN**  
**Medium-Round Edwardian**  
**Entry Lantern in Polished**  
**Nickel**  
Height: 29½"  
Width: 18"  
Canopy: 5¾" Round

**Available Finishes:**  
AB, AN, BZ, PN

**Socket:** 5-Candelabra  
**Wattage:** 5-60 C  
©EFC DESIGNS



**CHC3441AB**  
**Large Tapered Arch Top**  
**Lantern in**  
**Antique-Burnished Brass**  
Height: 43½"  
Width: 25"  
Canopy: 5½" Round

**Available Finishes:**  
AB, AN, BZ, PN

**Socket:** 5-Candelabra  
**Wattage:** 5-60 C  
©EFC DESIGNS



**CHC3425AN**  
**Large Arch Top Lantern**  
in Antique Nickel  
Height: 34½"  
Width: 20¼"  
Canopy: 5¾" Round

**Available Finishes:**  
AB, AN, BZ, PN

**Socket:** 5-Candelabra  
**Wattage:** 5-60 C  
©EFC DESIGNS



**CHC3422AB**  
**Medium Arch Top Lantern**  
in Antique-Burnished Brass  
Height: 29½"  
Width: 17½"  
Canopy: 5¾" Round

**Available Finishes:**  
AB, AN, BZ, PN

**Socket:** 4-Candelabra  
**Wattage:** 4-60 C  
©EFC DESIGNS



**CHC3421BZ**  
**Small Arch Top Lantern**  
in Bronze  
Height: 24"  
Width: 14½"  
Canopy: 5¾" Round

**Available Finishes:**  
AB, AN, BZ, PN

**Sockets:** 4-Candelabra  
**Wattage:** 4-60C  
©EFC DESIGNS



**CHC3420AB**  
**Mini Arch Top Lantern**  
in Antique-Burnished Brass  
Height: 16¾"  
Width: 8¼"  
Canopy: 5¾" Round

**Available Finishes:**  
AB, AN, BZ, PN

**Socket:** 3-Candelabra  
**Wattage:** 3-60 C  
©EFC DESIGNS



**CHC2200AB**  
**Crown Top Hanging Lantern**  
**in Antique-Burnished Brass**

Height: 30 3/4"  
Width: 16 1/2"  
Canopy: 5 1/2" Round

**Available Finishes:**  
AB, AW, GP

**Socket:** 3-Candelabra  
**Wattage:** 3-60 C  
©EFC DESIGNS

CHC2200GP



**CHC2106AB**  
**Tall English Hall Lantern in**  
**Antique-Burnished Brass**

Height: 49"  
Width: 20 1/2"  
Canopy: 5 1/2" Round

**Available Finishes:**  
AB, AN, BZ, PN

**Socket:** 6-Candelabra  
**Wattage:** 6-60 C  
©EFC DESIGNS



**CHC2113AB**  
**St. Honore Entry Lantern**  
**in Antique-Burnished Brass**

Height: 27 1/2"  
Width: 16 1/4"  
Canopy: 5 3/4" Round

**Available Finishes:**  
AB, AB-Q

**Socket:** 6-Candelabra  
**Wattage:** 6-60 C  
©EFC DESIGNS



**CHC2105AN**  
**English Hall Lantern**  
**in Antique Nickel**

Height: 26"  
Width: 12"  
Canopy: 5 3/4" Round

**Available Finishes:**  
AB, AN, BZ, PN

**Socket:** 3-Candelabra  
**Wattage:** 3-60 C  
©EFC DESIGNS



**CHC2108AB**  
Small Scroll Motif  
Pendant Lantern in  
Antique-Burnished Brass  
Height: 15½"  
Width: 8"  
Canopy: 5½" Round

**Available Finishes:**  
AB, BR

**Socket:** 3-Candelabra  
**Wattage:** 3-60 C  
©EFC DESIGNS



**CHC2108BR**



**CHC2107AB**  
Large Scroll Motif  
Pendant Lantern in  
Antique-Burnished Brass  
Height: 27¼"  
Width: 16"  
Canopy: 5½" Round

**Available Finishes:** AB, BR

**Socket:** 4-Candelabra  
**Wattage:** 4-60 C  
©EFC DESIGNS



**CHC3411BR**  
Provencal French Hanging Lantern  
in Black Rust  
Height: 24"  
Width: 15"  
Canopy: 5¾" Round

**Socket:** 2-Candelabra  
**Wattage:** 2-60 C



**CHC3414BR**  
Three-Light French Market  
Lantern in Black Rust  
Height: 30½"  
Width: 16½"  
Canopy: 5¾" Round

**Socket:** 3-Candelabra  
**Wattage:** 3-60 C  
©EFC DESIGNS



**CHC3415NR**  
**Gothic Four-Light Hanging Lantern**  
in Natural Rust  
Height: 31½"  
Width: 20"  
Canopy: 5" Round

**Available Finishes:** BLK, NR

**Socket:** 4-Candelabra  
**Wattage:** 4-60 C  
©EFC DESIGNS



**CHC3405NR**  
**Gothic Three-Light Hanging Lantern**  
in Natural Rust  
Height: 26"  
Width: 15"  
Canopy: 5" Round

**Available Finishes:** BLK, NR

**Socket:** 3-Candelabra  
**Wattage:** 3-60 C  
©EFC DESIGNS



**CHC3406NR**  
**Breton Four-Light Hanging Lantern**  
in Natural Rust  
Height: 38"  
Width: 29½"  
Canopy: 5" Round

**Available Finishes:** BLK, NR

**Socket:** 4-Candelabra  
**Wattage:** 4-60 C  
©EFC DESIGNS



**CHC3409NR**  
**Breton Three-Light Hanging Lantern**  
in Natural Rust  
Height: 24"  
Width: 18"  
Canopy: 5" Round

**Available Finishes:** BLK, NR

**Socket:** 3-Candelabra  
**Wattage:** 3-60 C  
©EFC DESIGNS





**CHC3407NR**  
**Large French Provencal Lantern**  
**in Natural Rust**  
Height: 28"  
Width: 19"  
Canopy: 5" Round

**Available Finishes:** BLK, NR

**Socket:** 3-Candelabra  
**Wattage:** 3-60 C



**CHC3401NR**  
**Medium French Provencal Lantern**  
**in Natural Rust**  
Height: 24"  
Width: 19"  
Canopy: 5" Round

**Available Finishes:** BLK, NR

**Socket:** 6-Candelabra  
**Wattage:** 6-60 C  
©EFC DESIGNS



**CHC3408NR**  
**Small French Provencal Lantern**  
**in Natural Rust**  
Height: 20 1/4"  
Width: 14"  
Canopy: 5" Round

**Available Finishes:** BLK, NR

**Socket:** 3-Candelabra  
**Wattage:** 3-60 C  
©EFC DESIGNS



**CHC4140PN**  
Cornice Hexagonal  
Flush Mount in  
Polished Nickel with  
White Dessage Glass  
Height: 7"  
Width: 18½"



**Available Finishes:**  
AB, AN, BZ, PN  
**Available Glass:** WG

**Socket:** 2-Keyless  
**Wattage:** 2-60 A  
©EFC DESIGNS

**CHC4170AB**  
Cornice Tiered  
Flush Mount in  
Antique-Burnished Brass  
with White Dessage Glass  
Height: 12½"  
Width: 18½"



**Available Finishes:**  
AB, AN, BZ, PN  
**Available Glass:** WG

**Socket:** 2-Keyless  
**Wattage:** 2-60 A  
©EFC DESIGNS

**CHC5180AB**  
Cornice Hanging Prism Form in  
Antique-Burnished Brass with  
White Dessage Glass  
Overall Height: 23¼" to Center Chain  
Cage Height: 11½"  
Width: 24"  
Canopy: 5½" Hexagonal



**Available Finishes:**  
AB, AN, BZ, PN  
**Available Glass:** WG

**Socket:** 2-Keyless  
**Wattage:** 2-100 A  
©EFC DESIGNS

**CHC5170PN**  
Cornice Hanging Tiered Form  
in Polished Nickel with  
White Dessage Glass  
Overall Height: 24½" to Center Chain  
Cage Height: 12½"  
Width: 18½"  
Canopy: 5½" Hexagonal

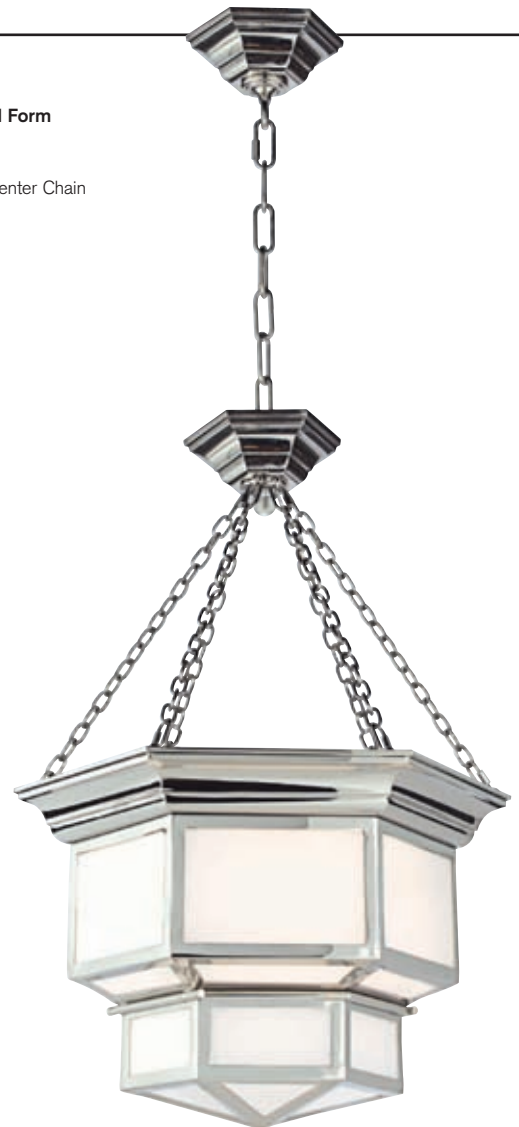

**Available Finishes:**  
AB, AN, BZ, PN  
**Available Glass:** WG

**Socket:** 2-Keyless  
**Wattage:** 2-100 A  
©EFC DESIGNS

**CHC4128PN-FG**  
**Small Club Square Flush Mount**  
in Polished Nickel with  
**Frosted Glass**  
Height: 8½"  
Width: 9"

**Available Finishes:**  
AB, AN, BZ, PN  
**Available Glass:** CG, FG

**Socket:** 3-Candelabra  
**Wattage:** 3-60 C



**CHC4129AB-CG**  
**Large Club Square Flush Mount**  
in Antique-Burnished Brass  
with **Clear Glass**  
Height: 9"  
Width: 13"

**Available Finishes:**  
AB, AN, BZ, PN  
**Available Glasses:** CG, FG

**Socket:** 3-Candelabra  
**Wattage:** 3-60 C



**CHC4120PN**  
**Cornice Square Flush Mount**  
in Polished Nickel with  
**White Message Glass**  
Height: 10¼"  
Width: 16"

**Available Finishes:**  
AB, AN, BZ, PN  
**Available Glass:** WG

**Socket:** 2-Keyless  
**Wattage:** 2-60 A  
©EFC DESIGNS



**CHC4215AB**  
**Square Flush Mount in**  
Antique-Burnished Brass  
Height: 6¼"  
Width: 14"  
Canopy: 14" Square

**Available Finishes:**  
AB, AN, BZ, PN

**Socket:** 2-Keyless  
**Wattage:** 2-60 A  
©EFC DESIGNS



**CHC4125BZ-FG**  
**Small Club Hexagonal**  
Flush Mount in Bronze  
with **Frosted Glass**  
Height: 8¼"  
Width: 10"

**Available Finishes:**  
AB, AN, BZ, PN  
**Available Glass:** CG, FG

**Socket:** 3-Candelabra  
**Wattage:** 3-60 C



**CHC4126PN-CG**  
**Large Club Hexagonal**  
Flush Mount in  
Polished Nickel with  
**Clear Glass**  
Height: 9"  
Width: 10½"

**Available Finishes:**  
AB, AN, BZ, PN  
**Available Glass:** CG, FG

**Socket:** 3-Candelabra  
**Wattage:** 3-60 C  
©EFC DESIGNS



**CHC4134AB**  
**Edwardian Flush Mount**  
**in Antique Burnished Brass**

Height: 16"  
Width: 13"

**Available Finishes:**  
AB, AN, BZ, PN  
**Available Glass:** WG

**Socket:** 2-Keyless  
**Wattage:** 2-60 A  
©EFC DESIGNS



**CHC4132AN-WG**  
**Edwardian Open-Bottom Flush Mount**  
**in Antique-Burnished Nickel**

Height: 11½"  
Width: 10"  
Canopy: 8" Round

**Available Finishes:**  
AB, AN, BZ, PN  
**Shade Treatment:**  
AB, AN, BZ, PN, WG  
**Shade Details:** 5" x 10" x 9"

**Socket:** Keyless  
**Wattage:** 60 A  
©EFC DESIGNS



**CHC4107AB**  
**Small English Hall Flush Mount**  
**in Antique-Burnished Brass**

Height: 6¼"  
Width: 10"

**Available Finishes:**  
AB, AN, BZ, PN

**Socket:** Keyless  
**Wattage:** 60 A  
©EFC DESIGNS



**CHC4105AB**  
**English Hall Flush Mount**  
**in Antique-Burnished Brass**

Height: 12"  
Width: 14½"

**Available Finishes:**  
AB, AN, BZ, PN

**Socket:** 3-Candelabra  
**Wattage:** 3-60 C  
©EFC DESIGNS



**CHC4106AB**  
**Large English Hall Flush Mount**  
**in Antique-Burnished Brass**

Height: 8"  
Width: 17"

**Available Finishes:**  
AB, AN, BZ, PN

**Socket:** 2-Keyless  
**Wattage:** 2-60 A  
©EFC DESIGNS



**CHC4211PN**  
Small Bolection Molding  
Flush Mount in  
Polished Nickel  
Height: 8½"  
Width: 12"



**Available Finishes:**  
AB, AN, BZ, PN  
**Available Glass:** WG

**Socket:** Keyless  
**Wattage:** 60 A  
©EFC DESIGNS

**CHC4212AB**  
Bolection Molding  
Flush Mount in  
Antique-Burnished Brass  
Height: 8½"  
Width: 16¾"



**Available Finishes:**  
AB, AN, BZ, PN  
**Available Glass:** WG

**Socket:** Keyless  
**Wattage:** 60 A  
©EFC DESIGNS

**CHC4201AB**  
Small Crown Flush Mount in  
Antique-Burnished Brass  
Height: 4¾"  
Width: 7"



**Available Finishes:**  
AB, AN, BZ, PN  
**Available Glass:** WG

**Socket:** Keyless  
**Wattage:** 60 A  
©EFC DESIGNS

**CHC4202PN**  
Crown Flush Mount in  
Polished Nickel  
Height: 7"  
Width: 12"



**Available Finishes:**  
AB, AN, BZ, PN  
**Available Glass:** WG

**Socket:** 2-Keyless  
**Wattage:** 2-60 A  
©EFC DESIGNS

**CHC4203AB**  
Large Crown  
Flush Mount in  
Antique-Burnished Brass  
Height: 7½"  
Width: 15½"



**Available Finishes:**  
AB, AN, BZ, PN  
**Available Glass:** WG

**Socket:** 2-Keyless  
**Wattage:** 2-60 A  
©EFC DESIGNS

**CHC4213BZ**  
Large Bolection  
Molding Flush  
Mount in Bronze  
Height: 8½"  
Width: 19½"



**Finishes:** AB, AN, BZ, PN  
**Available Glass:** WG

**Socket:** 2-Keyless  
**Wattage:** 2-60 A  
©EFC DESIGNS

**SL5811BZ-NP**

**Classic Linear Chandelier in Bronze**

Height: 37½"

Width: 45¼"

Canopy: 5¾" Round

**Available Finishes:**

AN, BZ, HAB, PN

**Shade Treatment:** NP

**Shade Details:** 3" x 6½" x 5"

**Socket:** 5-Candelabra

**Wattage:** 5-40 C

©EFC DESIGNS



**SL5812HAB-NP**

**Classic Ring Chandelier  
in Hand-Rubbed Antique Brass**

Height: 24"

Width: 33¼"

Canopy: 5¾" Round

**Available Finishes:**

AN, BZ, HAB, PN

**Shade Treatment:** NP

**Shade Details:** 3" x 6½" x 5"

**Socket:** 6-Candelabra

**Wattage:** 6-40 C

©EFC DESIGNS



**SL5870HAB**  
**Semi-Flush Cornice Lantern in Hand-Rubbed Antique Brass**

Overall Height: 14½"  
Width: 9½"  
Canopy: 6" Round

**Available Finishes:**  
BR, BZ, HAB, PN

**Socket:** 3-Candelabra

**Wattage:** 3-40 C  
©EFC DESIGNS



**SL5871PN**  
**Small Cornice Hanging Lantern in Polished Nickel**

Height: 23"  
Width: 14½"  
Canopy: 6" Round

**Available Finishes:**  
BR, BZ, HAB, PN

**Socket:** 4-Candelabra  
**Wattage:** 4-60 C  
©EFC DESIGNS



**SL5872BR**  
**Large Cornice Hanging Lantern in Black Rust**

Height: 30½"  
Width: 20"  
Canopy: 6" Round

**Available Finishes:**  
BR, BZ, HAB, PN

**Socket:** 4-Candelabra  
**Wattage:** 4-60 C  
©EFC DESIGNS



**SL5863HAB**  
**TT Linear Branched Ten-Light Chandelier in Hand-Rubbed Antique Brass**

Height: 52"  
Width: 36"  
Canopy: 5¼" Round  
Custom Height Available

**Available Finishes:**  
AN, BZ, HAB, PN  
**Shade Treatment:** CHS-104NP  
Shade Sold Separately  
**Shade Details:** 3" x 4" x 4"

**Socket:** 10-Candelabra  
**Wattage:** 10-60 C  
©EFC DESIGNS



**SL5830BZ-NP**  
**Nine-Light Retro Chandelier in Bronze with Natural Paper Shades**

Height: 23¼"  
Width: 37"  
Canopy: 6" Round

**Available Finishes:**  
AN, BZ, HAB, PN  
**Shade Treatment:** NP  
**Shade Details:**  
4" x 6" x 5"

**Socket:** 9-Candelabra  
**Wattage:** 9-60 C  
©EFC DESIGNS



**SL5130AN-AN**  
**Mini Cornice Pendant in**  
**Antique Nickel with**  
**Antique Nickel Shade**  
Height: 55"  
Width: 10½"  
Canopy: 6" Round  
Custom Height Available

**Available Finishes:**  
AN, BZ, HAB, PN  
**Shade Treatments:**  
AN, BZ, HAB, NP, PN  
**Shade Details:**  
9½" x 10½" x 7" Square

**Socket:** 3-Candelabra  
**Wattage:** 3-60 C  
©EFC DESIGNS



**SL5131PN-PN**  
**Small Cornice Pendant in**  
**Polished Nickel with Polished**  
**Nickel Shade**  
Height: 55"  
Width: 16¼"  
Canopy: 6" Round  
Custom Height Available

**Available Finishes:**  
AN, BZ, HAB, PN  
**Shade Treatments:**  
AN, BZ, HAB, NP, PN  
**Shade Details:**  
14½" x 16¼" x 11½" Square

**Socket:** 2-Keyless  
**Wattage:** 2-100 A  
©EFC DESIGNS



**SL5132BZ-BZ**  
**Medium Cornice Pendant in**  
**Bronze with Bronze Shade**  
Height: 55"  
Width: 19½"  
Canopy: 6" Round  
Custom Height Available

**Available Finishes:**  
AN, BZ, HAB, PN  
**Shade Treatments:**  
AN, BZ, HAB, NP, PN  
**Shade Details:**  
17" x 19½" x 14¼" Square

**Socket:** 2-Keyless  
**Wattage:** 2-100 A  
©EFC DESIGNS



**SL5133HAB-NP**  
**Large Cornice Pendant in**  
**Hand-Rubbed Antique Brass**  
**with Natural Paper Shade**  
Height: 55"  
Width: 24"  
Canopy: 6" Round  
Custom Height Available

**Available Finishes:**  
AN, BZ, HAB, PN  
**Shade Treatments:**  
AN, BZ, HAB, NP, PN  
**Shade Details:**  
20" x 24" x 16¼" Square

**Socket:** 2-Keyless  
**Wattage:** 2-100 A  
©EFC DESIGNS





**SL5820PN-NP**  
**Six-Light Square Tube**  
**Chandelier in Polished Nickel**  
**with Natural Paper Shade**  
 Height: 19"  
 Width: 24"  
 Canopy: 5 3/4" Square

**Available Finishes:**  
 AN, BZ, HAB, PN  
**Shade Treatment:** NP  
**Shade Details:**  
 20" x 24" x 11"

**Socket:** 6-Candelabra  
**Wattage:** 6-60 C  
 ©EFC DESIGNS



**S5031BR-NP**  
**Iron Ceiling Light**  
**in Black Rust with**  
**Natural Paper Shade**  
 Height: 11 1/2"  
 Width: 8 1/2"  
 Canopy: 6" Round

**Available Finishes:** BR  
**Shade Treatment:** NP  
**Shade Details:**  
 7 7/8" x 8 1/4" x 7"

**Socket:** Candelabra  
**Wattage:** 60 C  
 ©EFC DESIGNS



**S5030BR-NP**  
**Iron Ceiling Light**  
**in Black Rust with**  
**Natural Paper Shade**  
 Height: 20 3/4"  
 Width: 19 1/4"  
 Canopy: 6" Round

**Available Finishes:** BR  
**Shade Treatment:** NP  
**Shade Details:**  
 19" x 19 1/2" x 10 1/4"

**Socket:** 4 - Candelabra  
**Wattage:** 4 - 60 C  
 ©EFC DESIGNS

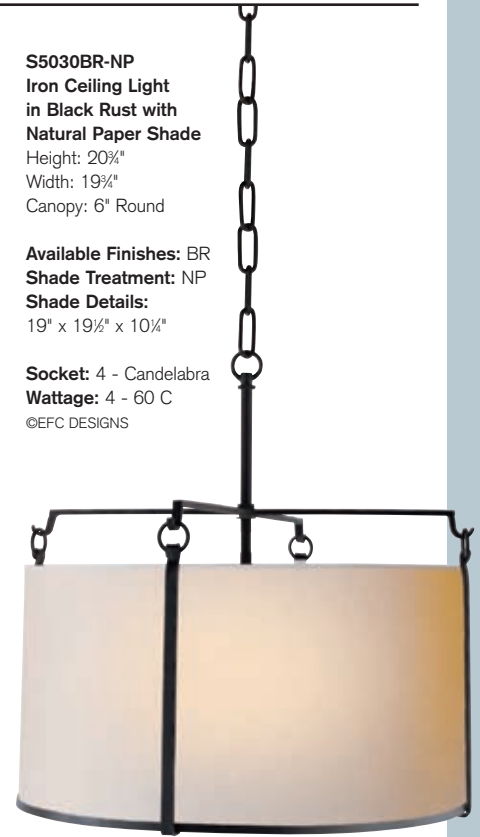

**SL5175HAB-HAB1**  
**Yoke Pendant in Hand-Rubbed**  
**Antique Brass with Large Shade**  
 Height: 56 3/4"  
 Width: 18"  
 Canopy: 5 1/2" Round  
 Custom Height Available

**Available Finishes:**  
 AN, BC, BZ, HAB, PN  
**Shade Treatments:**  
 AN1, BC1, BZ1, HAB1, PN1  
**Shade Details:** 10 1/4" x 17 1/2"

**Socket:** Keyless  
**Wattage:** 150 A  
 ©EFC DESIGNS



**SL5175BC-BC2**  
**Yoke Pendant in Brushed Chrome**  
**with Small Shade**  
 Height: 55 3/4"  
 Width: 11"  
 Canopy: 5 1/2" Round  
 Custom Height Available

**Available Finishes:**  
 AN, BC, BZ, HAB, PN  
**Shade Treatments:**  
 AN2, BC2, BZ2, HAB2, PN2  
**Shade Details:** 9 1/4" x 11"

**Socket:** Keyless  
**Wattage:** 150 A  
 ©EFC DESIGNS



**SL5175BZ-BZ2**



**SL5851HAB-HABH**  
**Flanders Double Pendant in Hand-Rubbed Antique Brass with Hammered Hand-Rubbed Antique Brass Shades**

Height: 50½"  
Width: 32"  
Canopy: 5½" Round  
Custom Height Available  
Slope Mount Included

**Available Finishes:**

AN, BZ, HAB, PN

**Shade Treatments:**

AN, BZ, HAB, PN

Hammered or Non-Hammered

**Shade Details:** 3¼" x 8" x 8½"

**Socket:** 2-Keyless

**Wattage:** 2-100 A

©EFC DESIGNS



**SL5850HAB-BZH**  
**Flanders Single Pendant in Hand-Rubbed Antique Brass with Hammered Bronze Shade**

Height: 50½"  
Width: 8"  
Canopy: 5½" Round  
Custom Height Available  
Slope Mount Included

**Available Finishes:**

AN, BZ, HAB, PN

**Shade Treatments:**

AN, BZ, HAB, PN

Hammered or Non-Hammered

**Shade Details:** 3¼" x 8" x 8½"

**Socket:** Keyless

**Wattage:** 100 A

©EFC DESIGNS



**S5103AN/HAB-AN**  
**Houston Industrial Triple Hanging Light in Antique Nickel and Hand-Rubbed Antique Brass with Antique Nickel Shades**

Height: 36"-60"  
Width: 36"  
Canopy: 6" Round  
Custom Height Available  
Slope Mount Included

**Available Finishes:**

AN, AN/HAB, BZ, HAB, PN

**Shade Treatments:**

AN, BZ, HAB, PN

**Shade Details:**

3" x 7¼" x 9¼"

**Socket:** 3-Keyless

**Wattage:** 3-75 A



**S5101PN-PN**  
**Houston Industrial Pendant in Polished Nickel with Polished Nickel Shade**

Height: 28"-52"  
Width: 7¼"  
Canopy: 6" Round  
Custom Height Available  
Slope Mount Included

**Available Finishes:**

AN, AN/HAB, BZ, HAB, PN

**Shade Treatments:**

AN, BZ, HAB, PN

**Shade Details:**

3" x 7¼" x 9¼"

**Socket:** Keyless

**Wattage:** 75 A



**SS5002HAB-WG**  
**Siena Four-Light Pendant**  
**in Hand-Rubbed**  
**Antique Brass with**  
**White Glass Shade**

Height: 12½"  
Width: 15"  
Canopy: 5" Square  
Custom Height Available

**Available Finishes:**  
HAB, PN  
**Shade Treatment:** WG  
**Shade Details:**  
4¾" x 2½" x 5½"

**Socket:** 4-Keyless  
**Wattage:** 4-60 A



**SS5005HAB-WG**  
**Siena One-Light Pendant**  
**in Hand-Rubbed Antique Brass**  
**with White Glass Shade**

Height: 58"  
Width: 5"  
Canopy: 5" Square  
Custom Height Available

**Available Finishes:** HAB, PN  
**Shade Treatment:** WG  
**Shade Details:**  
4¾" x 2½" x 5½"

**Socket:** Keyless  
**Wattage:** 60 A



**SL5151HAB-WG**  
**NY Subway Flush Mount**  
**in Hand-Rubbed Antique Brass**  
**with White Glass Shade**

Height: 10½"  
Width: 5"  
Canopy: 4½" Square

**Available Finishes:**  
AN, BZ, CH, HAB  
**Shade Treatment:** WG  
**Shade Details:** 3" x 5" x 5"

**Socket:** Keyless  
**Wattage:** 60 A  
©EFC DESIGNS



**SL5150HAB-WG**  
**NY Subway One-Light Pendant**  
**in Hand-Rubbed Antique Brass**  
**with White Glass Shade**

Height: 49"  
Width: 5"  
Canopy: 4½" Square  
Custom Height Available

**Available Finishes:**  
AN, BZ, CH, HAB  
**Shade Treatment:** WG  
**Shade Details:** 3" x 5" x 5"

**Socket:** Keyless  
**Wattage:** 60 A  
©EFC DESIGNS



**SL5156HAB-WG**

**NY Subway Four-Arm Up Light  
in Hand Rubbed Antique Brass  
with White Glass Shades**

Height: 45"  
Width: 28½"  
Canopy: 4½" Square  
Custom Height Available

**Available Finishes:**

AN, BZ, CH, HAB

**Shade Treatment:** WG

**Shade Details:** 3" x 5" x 5"

**Socket:** 4-Keyless

**Wattage:** 4-60 A

©EFC DESIGNS



**SL5154BZ-WG**

**NY Subway Four Light Linear Fixture  
in Bronze with White Glass Shades**

Height: 49"  
Width: 28½"  
Canopy: 4½" Square  
Custom Height Available

**Available Finishes:** AN, BZ, CH, HAB

**Shade Treatment:** WG

**Shade Details:** 3" x 5" x 5"

**Socket:** 4-Keyless

**Wattage:** 4-60 A

©EFC DESIGNS



**SL5153CH-WG**  
NY Subway Two-Arm Up Light  
in Chrome with  
White Glass Shades  
Height: 45"  
Width: 17"  
Canopy: 4½" Square  
Custom Height Available

**Available Finishes:**  
AN, BZ, CH, HAB  
**Shade Treatment:** WG  
**Shade Details:** 3" x 5" x 5"

**Socket:** 2-Keyless  
**Wattage:** 2-60 A  
©EFC DESIGNS



**SL5152HAB-WG**  
NY Subway Two-Arm Down Light  
in Hand Rubbed Antique Brass  
with White Glass Shades  
Height: 49"  
Width: 17"  
Canopy: 4½" Square  
Custom Height Available

**Available Finishes:** AN, BZ, CH, HAB  
**Shade Treatment:** WG  
**Shade Details:** 3" x 5" x 5"

**Socket:** 2-Keyless  
**Wattage:** 2-60 A  
©EFC DESIGNS



**SL5003HAB/SLEG-WG**  
Boston Double Down-Light  
in Hand-Rubbed Antique Brass  
with White Glass SLEG Shade  
Height: 14"  
Width: 15½"  
Canopy: 4½" Round  
Custom Height Available

**Available Finishes:**  
AN, BZ, CH, HAB, PN, SN  
**Shade Treatment:**  
SLEG-WG  
See Shade Schedule for  
Additional Shade Options  
**Shade Details:**  
2¼" x 5¾" x 4½"

**Socket:** 2-Keyless  
**Wattage:** 2-60 A  
©EFC DESIGNS



**SL5002BZ/SLEG-WG**  
Boston Double Up-Light  
in Bronze with  
White Glass SLEG Shade  
Height: 15½"  
Width: 15½"  
Canopy: 4½" Round  
Custom Height Available

**Available Finishes:**  
AN, BZ, CH,  
HAB, PN, SN  
**Shade Treatment:**  
SLEG-WG  
See Shade Schedule for  
Additional Shade Options  
**Shade Details:**  
2¼" x 5¾" x 4½"

**Socket:** 2-Keyless  
**Wattage:** 2-60 A  
©EFC DESIGNS



**SL5001HAB/SLEG-WG**  
**Boston Single Flush Mount in Hand-Rubbed Antique Brass with White Glass SLEG Shade**  
Height: 8½"  
Width: 5½"  
Canopy: 5" Round



**Available Finishes:**  
AN, BZ, CH, HAB, PN, SN  
**Shade Treatment:**  
SLEG-WG  
See Shade Schedule for Additional Shade Options  
**Shade Details:**  
2¼" x 5¾" x 4½"  
**Socket:** Keyless  
**Wattage:** 60 A  
©EFC DESIGNS

**SL4128BZ-WG**  
**Bronze Industrial Fitter Flush Mount with Amphora Shaped White Glass**  
Height: 11½"  
Width: 8"



**Available Finishes:**  
AN, BZ, HAB  
**Shade Treatment:** WG  
**Shade Details:**  
8" x 9", 4" Fitter  
**Socket:** Keyless  
**Wattage:** 60 A  
©EFC DESIGNS

**SL4000HAB-WG**  
**Small Marine Flush Mount Fixture in Hand-Rubbed Antique Brass with White Drop Glass**  
Height: 8"  
Width: 5"



**Available Finishes:**  
AN, BZ, CH, HAB  
**Shade Treatment:** WG  
**Socket:** Keyless  
**Wattage:** 60 A  
©EFC DESIGNS

**SL5125HAB/SLE-AW**  
**Boston Functional Single Pendant in Hand-Rubbed Antique Brass with Antique White SLE Shade**  
Height: 44½"  
Width: 5½"  
Canopy: 4½" Round  
Custom Height Available



**Available Finishes:**  
AN, BZ, CH, HAB, PN, SN  
**Shade Treatments:**  
SLD, SLE, SLEG, SLF, WG1, WG2, WG3  
**Shade Details:**  
SLE: 2¼" x 5¾" x 4½"  
**Socket:** Keyless  
**Wattage:** 100 A  
©EFC DESIGNS

**SL5125HAB/SLF-HAB**  
**Boston Functional Single Pendant in Hand-Rubbed Antique Brass with Hand-Rubbed Antique Brass SLF Shade**  
Height: 47"  
Width: 12¾"  
Canopy: 4½" Round  
Custom Height Available

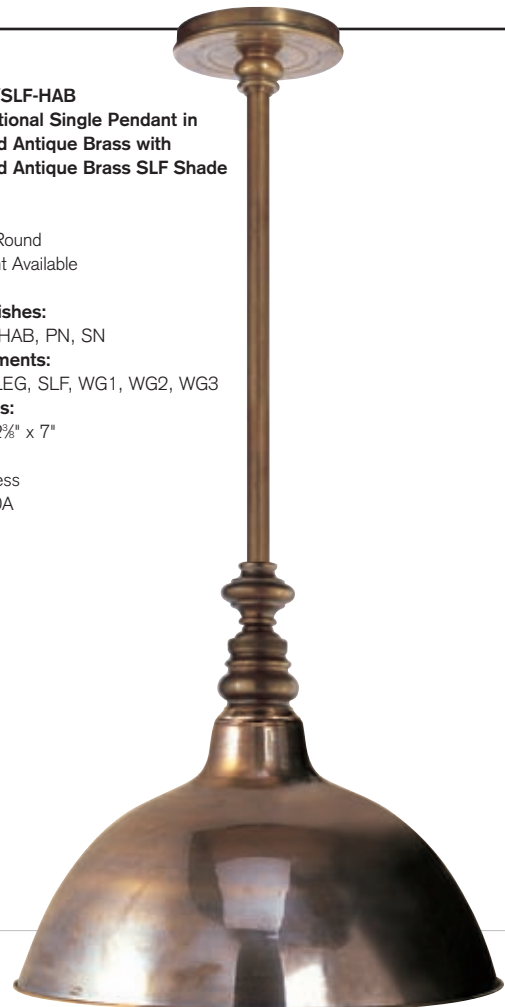

**Available Finishes:**  
AN, BZ, CH, HAB, PN, SN  
**Shade Treatments:**  
SLD, SLE, SLEG, SLF, WG1, WG2, WG3  
**Shade Details:**  
SLF: 2¼" x 12¾" x 7"  
**Socket:** Keyless  
**Wattage:** 100A  
©EFC DESIGNS

**SL5125AN/SLEG-WG**  
**Boston Functional Single Pendant**  
**in Antique Nickel with**  
**White SLEG Shade**  
 Height: 44½"  
 Width: 5¼"  
 Canopy: 4½" Round  
 Custom Height Available

**Available Finishes:**  
 AN, BZ, CH, HAB, PN, SN  
**Shade Treatments:**  
 SLD, SLE, SLEG, SLF, WG1, WG2, WG3  
**Shade Details:**  
 SLEG: 2¼" x 5¾" x 4½"

**Socket:** Keyless  
**Wattage:** 100 A  
 ©EFC DESIGNS



**SL5125HAB/SLD-HAB**  
**Boston Functional Single Pendant in**  
**Hand-Rubbed Antique Brass with**  
**Hand-Rubbed Antique Brass SLD Shade**  
 Height: 45"  
 Width: 7¼"  
 Canopy: 4½" Round  
 Custom Height Available

**Available Finishes:**  
 AN, BZ, CH, HAB, PN, SN  
**Shade Treatments:**  
 SLD, SLE, SLEG, SLF, WG1, WG2, WG3  
**Shade Details:**  
 SLD: 2" x 7¼" x 6"

**Socket:** Keyless  
**Wattage:** 100 A  
 ©EFC DESIGNS



**SL5125BZ-WG1**  
**Boston Functional Single**  
**Pendant with Fitter in Bronze**  
**with White Glass Shade**  
 Height: 47"  
 Width: 10"  
 Canopy: 4½" Round  
 Custom Height Available

**Available Finishes:**  
 AN, BZ, CH, HAB, SN  
**Shade Treatments:**  
 SLD, SLE, SLEG, SLF,  
 WG1, WG2, WG3  
**Shade Details:**  
 WG1: 2¼" x 10" x 7"

**Socket:** Keyless  
**Wattage:** 100A

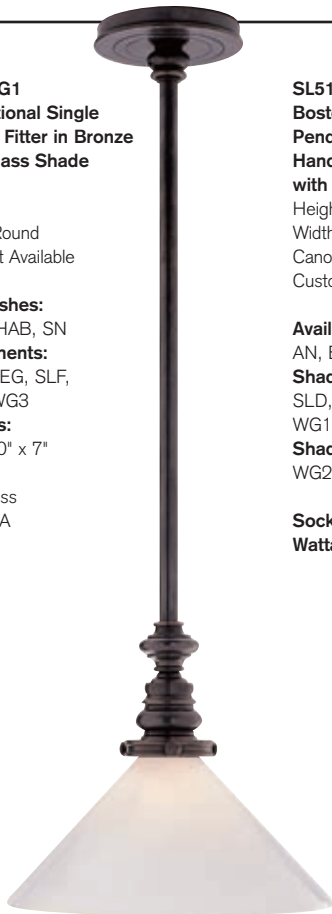

**SL5125HAB-WG2**  
**Boston Functional Single**  
**Pendant with Fitter in**  
**Hand-Rubbed Antique Brass**  
**with Small Dish Glass**  
 Height: 45"  
 Width: 10½"  
 Canopy: 4½" Round  
 Custom Height Available

**Available Finishes:**  
 AN, BZ, CH, HAB, SN  
**Shade Treatments:**  
 SLD, SLE, SLEG, SLF,  
 WG1, WG2, WG3  
**Shade Details:**  
 WG2: 2¼" x 10½" x 3"

**Socket:** Keyless  
**Wattage:** 100A

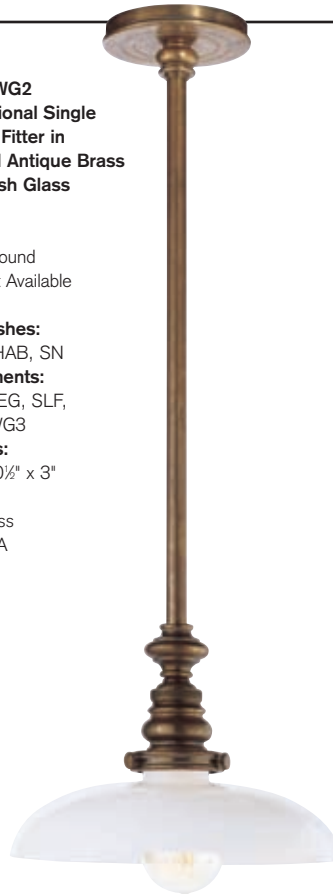

**SL5125BZ-WG3**  
**Boston Functional Single**  
**Pendant with Fitter in Bronze**  
**with Large Dish Glass**  
 Height: 45"  
 Width: 15¾"  
 Canopy: 4½" Round  
 Custom Height Available

**Available Finishes:**  
 AN, BZ, CH, HAB, SN  
**Shade Treatments:**  
 SLD, SLE, SLEG, SLF,  
 WG1, WG2, WG3  
**Shade Details:**  
 WG3: 2¼" x 16" x 3"

**Socket:** Keyless  
**Wattage:** 100A

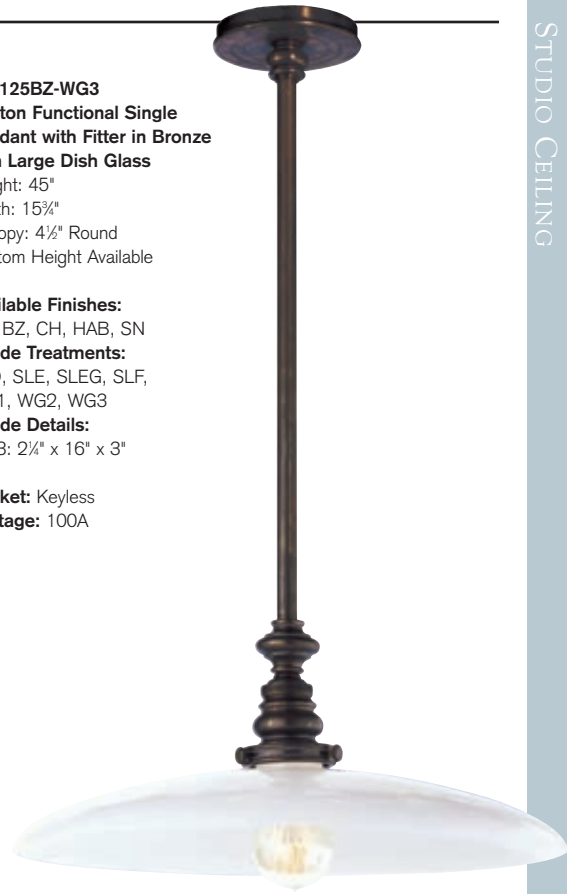

**SL4120HAB-WG**  
Round School House Flush  
Mount in Hand-Rubbed  
Antique Brass with  
White Glass Shade  
Height: 21½"  
Width: 13"  
Canopy: 5¾" Round

**Available Finishes:**  
AN, BZ, HAB, PN  
**Shade Treatment:**  
WG

**Socket:** Keyless  
**Wattage:** 100 A  
©EFC DESIGNS



**SL4122HAB-WG**  
Long School House Flush  
Mount in Hand-Rubbed  
Antique Brass with  
White Glass Shade  
Height: 23"  
Width: 15½"  
Canopy: 5¾" Round

**Available Finishes:**  
AN, BZ, HAB, PN  
**Shade Treatment:**  
WG  
**Shade Details:**  
15½" x 15½"

**Socket:** Keyless  
**Wattage:** 100 A  
©EFC DESIGNS

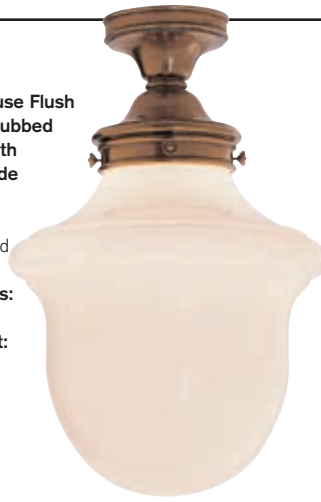

**SL4121HAB-WG**  
Short School House Flush  
Mount in Hand-Rubbed  
Antique Brass with  
White Glass Shade  
Height: 16"  
Width: 14½"  
Canopy: 5¾" Round

**Available Finishes:**  
AN, BZ, HAB, PN  
**Shade Treatment:**  
WG

**Socket:** Keyless  
**Wattage:** 100 A  
©EFC DESIGNS



**SL5120PN-WG**  
Round School House  
Pendant in Polished Nickel  
with White Glass Shade  
Height: 46½"  
Width: 13"  
Canopy: 5¾" Round  
Custom Height Available

**Available Finishes:**  
AN, BZ, HAB, PN  
**Shade Treatment:** WG

**Socket:** Keyless  
**Wattage:** 100 A  
©EFC DESIGNS



**SL5122HAB-WG**  
Long School House  
Pendant in Hand-Rubbed  
Antique Brass with  
White Glass Shade  
Height: 49"  
Width: 15½"  
Canopy: 5¾" Round  
Custom Height Available

**Available Finishes:**  
AN, BZ, HAB, PN  
**Shade Treatment:** WG  
**Shade Details:** 15½" x 15½"

**Socket:** Keyless  
**Wattage:** 100 A  
©EFC DESIGNS



**SL5121BZ-WG**  
Short School House  
Pendant in Bronze with  
White Glass Shade  
Height: 43"  
Width: 14½"  
Canopy: 5¾" Round  
Custom Height Available

**Available Finishes:**  
AN, BZ, HAB, PN  
**Shade Treatment:** WG

**Socket:** Keyless  
**Wattage:** 100 A  
©EFC DESIGNS





**SS4010BZ-FG**  
Openwork Small Flush Mount  
Fixture in Bronze with  
Frosted Drop Glass  
Height: 4"  
Width: 10"



**Available Finishes:**  
AN, BZ, CH, HAB, PN  
**Shade Treatment:** FG

**Socket:** 2-Candelabra  
**Wattage:** 2-60 C

**SS4011CH-FG**  
Openwork Large Flush Mount  
Fixture in Chrome with  
Frosted Drop Glass  
Height: 5"  
Width: 13½"



**Available Finishes:**  
AN, BZ, CH, HAB, PN  
**Shade Treatment:** FG

**Socket:** 2-Candelabra  
**Wattage:** 2-60 C

**SL4001CH-WG**  
Medium Marine Flush Mount  
in Chrome with  
White Drop Glass  
Height: 4¾"  
Width: 8¾"



**Available Finishes:**  
AN, BZ, CH, HAB, PN  
**Shade Treatment:** WG

**Socket:** Keyless  
**Wattage:** 60 A  
©EFC DESIGNS

**SL4002HAB-WG**  
Large Marine Flush Mount  
in Hand-Rubbed Antique Brass  
with White Drop Glass  
Height: 6¾"  
Width: 12½"



**Available Finishes:**  
AN, BZ, CH, HAB, PN  
**Shade Treatment:** WG

**Socket:** 2 - Keyless  
**Wattage:** 2 - 60 A  
©EFC DESIGNS

**SS4012HAB-FG**  
Small Siena Flush Mount  
in Hand-Rubbed Antique Brass  
with Frosted Drop Glass  
Height: 5"  
Width: 11¾"



**Available Finishes:**  
BZ, CH, HAB, PN  
**Shade Treatment:** FG

**Socket:** 2-Candelabra  
**Wattage:** 2-60 C

**SS4013CH-FG**  
Large Siena Flush Mount  
in Chrome with  
Frosted Drop Glass  
Height: 5"  
Width: 14"



**Available Finishes:**  
BZ, CH, HAB, PN  
**Shade Treatment:** FG

**Socket:** 2-Candelabra  
**Wattage:** 2-60 C

**SS4015BZ-WG**  
Small Bronze Siena Flush Mount  
with Flat Panel Glass  
Height: 4¾"  
Width: 11¾"



**Available Finishes:**  
AN, BZ, CH, HAB, PN  
**Shade Treatment:** WG

**Socket:** 2-Keyless  
**Wattage:** 2-40 A

**SS4016CH-WG**  
Large Chrome Siena Flush Mount  
with Flat Panel Glass  
Height: 4¾"  
Width: 14"



**Available Finishes:**  
AN, BZ, CH, HAB, PN  
**Shade Treatment:** WG

**Socket:** 2-Keyless  
**Wattage:** 2-40 A

**TOB5008BZ-NP**

**Vendome Large Chandelier in  
Bronze with Natural Paper Shades**

Height: 44"

Width: 36"

Canopy: 5¼" Round

Custom Height Available

Slope Mount Included

**Available Finishes:**

AS, BZ, HAB, PS, R

**Shade Treatment:**

NP, NP/BT, NP/ST

**Shade Details:** 4" x 5½" x 6"

**Socket:** 8-Candelabra

**Wattage:** 8-60 C



**TOB5007HAB-NP/BT**

**Vendome Small Chandelier  
in Hand-Rubbed Antique Brass  
with Natural Paper Shades**

Height: 44"

Width: 26"

Canopy: 5¼" Round

Custom Height Available

Slope Mount Included

**Available Finishes:**

AS, BZ, HAB, PS, R

**Shade Treatment:**

NP, NP/BT, NP/ST

**Shade Details:** 4" x 5½" x 6"

**Socket:** 4-Candelabra

**Wattage:** 4-60 C



**TOB5010PS-NP**  
**Reed Eight-Light Chandelier in**  
**Polished Silver with Natural**  
**Paper Shades**

Height: 37 $\frac{3}{4}$ "  
Width: 26 $\frac{1}{2}$ "  
Canopy: 5 $\frac{1}{4}$ " Round  
Custom Height Available

**Available Finishes:** AN, BZ,  
HAB, PS

**Shade Treatment:** NP

**Shade Details:** 4" x 5" x 5 $\frac{1}{2}$ "

**Socket:** 8-Candelabra

**Wattage:** 8-60 C



**TOB5009HAB-NP**  
**Reed Small Chandelier in**  
**Hand-Rubbed Antique Brass**  
**with Natural Paper Shades**

Height: 30"  
Width: 20"  
Canopy: 5 $\frac{1}{4}$ " Round  
Custom Height Available

**Available Finishes:** AN, BZ,  
HAB, PS

**Shade Treatment:** NP

**Shade Details:** 4" x 5" x 6"

**Socket:** 3-Candelabra

**Wattage:** 3-60 C



**TOB5003BZ-NP**  
**Bryant Large Chandelier in**  
**Bronze with Natural Paper Shades**  
Height: 48"  
Width: 36"  
Canopy: 7" Round  
Custom Height Available  
Slope Mount Included

**Available Finishes:**  
AN, BZ, HAB, PS  
**Shade Treatments:**  
NP, NP/BT, NP/ST  
**Shade Details:** 4" x 5½" x 6"

**Socket:** 4-Keyless  
**Wattage:** 4-60 A



**TOB5002HAB-NP**  
**Bryant Small Chandelier**  
**in Hand-Rubbed Antique Brass**  
**with Natural Paper Shades**  
Height: 48"  
Width: 26"  
Canopy: 7" Round  
Custom Height Available  
Slope Mount Included

**Available Finishes:**  
AN, BZ, HAB, PS  
**Shade Treatments:**  
NP, NP/BT, NP/ST  
**Shade Details:** 4" x 5½" x 6"

**Socket:** 4-Keyless  
**Wattage:** 4-60 A



**TOB5017BZ/HAB-NP**  
**Farlane Chandelier in Bronze**  
**with Hand-Rubbed Antique**  
**Brass Accents and Natural**  
**Paper Shades**

Height: 42"-60"  
Width: 48"  
Canopy: 5 $\frac{3}{4}$ " Round  
Custom Height Available  
Slope Mount Included

**Available Finishes:**  
AN, BZ/HAB, HAB, PS  
**Shade Treatments:** NP, NP/RT  
**Shade Details:** 3" x 5" x 7"

**Socket:** 12-Candelabra  
**Wattage:** 12-40 C



**TOB5018HAB-NP**  
**Small Farlane Chandelier**  
**in Hand-Rubbed Antique Brass**  
**with Natural Paper Shades**

Height: 42"-60"  
Width: 34"  
Canopy: 5 $\frac{3}{4}$ " Round  
Custom Height Available  
Slope Mount Included

**Available Finishes:**  
AN, BZ/HAB, HAB, PS  
**Shade Treatments:** NP, NP/RT  
**Shade Details:** 3" x 5" x 7"

**Socket:** 6-Candelabra  
**Wattage:** 6-40 C



**TOB5016HAB-NP**  
**Ziyi Large Chandelier in**  
**Hand-Rubbed Antique Brass**  
**with Natural Paper Shades**  
Height: 44½"  
Width: 33½"  
Canopy: 4¼" Round  
Custom Height Available

**Available Finishes:**  
BZ, HAB, PN  
**Shade Treatment:** NP  
**Shade Details:**  
4" x 4" x 9½"

**Socket:** 8-Candelabra  
**Wattage:** 8-40 C



**TOB5015PS-NP**  
**Ziyi Small Chandelier in**  
**Polished Silver with**  
**Natural Paper Shades**  
Height: 44½"  
Width: 24"  
Canopy: 4¼" Round  
Custom Height Available

**Available Finishes:**  
BZ, HAB, PN, PS  
**Shade Treatment:** NP  
**Shade Details:**  
4" x 4" x 9½"

**Socket:** 4-Candelabra  
**Wattage:** 4-40 C



**TOB5020HAB/CHC-NP**  
**Julia Chandelier in**  
**Hand-Rubbed Antique Brass**  
**and Chocolate Wood Accents**  
**with Natural Paper Shades**  
Height: 29"-54"  
Width: 29¼"  
Canopy: 5¾" Round  
Custom Height Available  
Slope Mount Included

**Available Finishes:**  
BZ, BZ/HAB, HAB/CHC, PS  
**Shade Treatment:** NP  
**Shade Details:** 3½" x 5" x 6½"

**Socket:** 10-Candelabra  
**Wattage:** 10-40 C



**TOB5005BZ-NP**  
**Bryant Large Billiard Light in Bronze**  
**with Natural Paper Shades**

Height: 32"  
Width: 60"  
Custom Height Available

**Available Finishes:**  
AN, BZ, HAB  
**Shade Treatment:** NP  
**Shade Details:**  
10½" x 12" x 7½"

**Socket:** 3-Keyless  
**Wattage:** 3-75 A



**TOB5004AN-NP**  
**Bryant Small Billiard Light**  
**in Antique Nickel with**  
**Natural Paper Shades**

Height: 32"  
Width: 36"  
Custom Height Available

**Available Finishes:**  
AN, BZ, HAB  
**Shade Treatment:** NP  
**Shade Details:**  
6½" x 8" x 7½"

**Socket:** 3-Keyless  
**Wattage:** 3-75 A



**TOB5011BZ-NP/BT**  
**Reed Hanging Light in Bronze**  
**with Natural Paper Shade**

Height: 29½"  
Width: 22"  
Canopy: 5¼" Round  
Custom Height Available

**Available Finishes:** AN, BZ, HAB, PS  
**Shade Treatment:** NP, NP/BT  
**Shade Details:** 22" x 22" x 7½"

**Socket:** 2-Keyless  
**Wattage:** 2-100 A



**TOB5014BZ/HAB-NP/BT**  
**Goodman Hanging Lamp**  
**in Bronze and Hand-Rubbed**  
**Antique Brass with**  
**Natural Paper Shade**

Height: 48½"  
Width: 24½"  
Canopy: 5¼" Round  
Custom Height Available

**Available Finishes:**  
AN, BZ, BZ/HAB, HAB  
**Shade Treatments:**  
AN, AW, BZ, HAB, NP, NP/BT  
**Shade Details:**  
7½" x 24" x 22½"

**Socket:** 2-Keyless  
**Wattage:** 2 -100 A



**TOB5014HAB-AW**





**TOB5061PN-AW**  
**Large Selecta Ceiling Light**  
**in Polished Nickel**  
**with Antique White Shade**  
Height: 48"  
Width: 18 1/4"  
Canopy: 5 1/2" Round  
Custom Height Available  
Slope Mount Included

**Available Finishes:**  
AN-AW, HAB-BZ, HAB-HAB,  
PN-AW, PN-PN

**Socket:** 3-Keyless  
**Wattage:** 3-75 A



**TOB5060PN-PN**  
**Small Selecta Ceiling Light**  
**in Polished Nickel with**  
**Polished Nickel Shade**  
Height: 48"  
Width: 14 1/4"  
Canopy: 5 1/2" Round  
Custom Height Available  
Slope Mount Included

**Available Finishes:**  
AN-AW, HAB-BZ, HAB-HAB,  
PN-AW, PN-PN

**Socket:** 2-Keyless  
**Wattage:** 2-75 A



**TOB5063BZ/HAB-WG**  
**Large Hicks Pendant**  
**in Bronze with Hand-Rubbed**  
**Antique Brass Accents**  
**with White Glass Shade**  
Height: 16 3/4"  
Width: 12 1/2"  
Canopy: 4 3/4" Round

**Available Finishes:**  
AN, AW/HAB, BZ/HAB,  
HAB, PN

**Socket:** 2 - Porcelain  
**Wattage:** 2 - 75 A



**TOB5062AN-WG**  
**Small Hicks Pendant Light**  
**in Antique Nickel with White**  
**Glass Shade**  
Height: 11 3/4"  
Width: 8 1/2"  
Canopy: 4 3/4" Round

**Available Finishes:**  
AN, AW/HAB, BZ/HAB,  
HAB, PN

**Socket:** Porcelain  
**Wattage:** 75 A

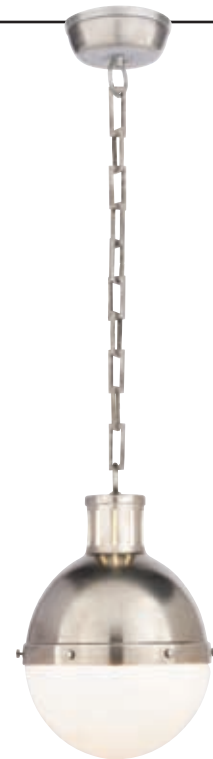

**TOB5000AW**  
**Eugene Pendant in**  
**Antique White**  
Height: 49"  
Width: 21"  
Canopy: 4" Round

**Available Finishes:**  
AN, AW, BZ, HAB  
**Shade Details:** 11" x 21"

**Socket:** Keyless  
**Wattage:** 150 A



**TOB5013AN**  
**Eugene Medium Hanging Light**  
**in Antique Nickel**  
Height: 24" - 12'  
Width: 15½"  
Canopy: 4" Round

**Available Finishes:**  
AN, AW, BZ, HAB

**Socket:** Keyless  
**Wattage:** 150 A



**TOB5012BZ**  
**Eugene Small Hanging Light**  
**in Bronze**  
Height: 24" - 12'  
Width: 12"  
Canopy: 4" Round

**Available Finishes:**  
AN, AW, BZ, HAB

**Socket:** Keyless  
**Wattage:** 150 A



**TOB4003CH**  
**Ted Ceiling Light in**  
**Chrome with**  
**White Dessage Glass**  
Height: 4"  
Width: 14"

**Available Finishes:**  
BZ, CH, HAB, PN  
**Shade Treatment:** WG

**Socket:** 2-Keyless  
**Wattage:** 2-60 A



**TOB4005AN-WG**  
**Grove Ceiling Light**  
in Antique Nickel with  
**White Glass Shade**  
Height: 12½"  
Width: 11"  
Canopy: 9½" Round

**Available Finishes:**  
AN, AW, BZ, HAB, PN

**Socket:** Porcelain  
**Wattage:** 75 A



**TOB4002PN**  
**Emma Ceiling Light**  
in Polished Nickel with  
**White Glass**  
Height: 6¼"  
Width: 9"

**Available Finishes:**  
AN, AW, BZ, HAB, PN  
**Shade Treatment:** WG

**Socket:** Keyless  
**Wattage:** 75 A



**TOB4000HAB**  
**Perry Ceiling Light** in  
**Hand-Rubbed Antique Brass**  
with **White Glass**  
Height: 9"  
Width: 9½"  
Canopy: 7½" Round

**Available Finishes:**  
AN, AW, BZ, HAB, PN  
**Shade Treatment:** WG

**Socket:** Keyless  
**Wattage:** 60 A



**TOB4001HAB**  
**Greene Street Ceiling Light** in  
**Hand-Rubbed Antique Brass**  
with **White Glass**  
Height: 8"  
Width: 8⅜"

**Available Finishes:**  
AN, AW, BZ, HAB, PN  
**Shade Treatment:** WG

**Socket:** Keyless  
**Wattage:** 60 A



**TOB4004AN-WG**  
**Alden Ceiling Light**  
**in Antique Nickel**  
**with White Glass**  
Height: 7½"  
Width: 8½"



**TOB4004PN-WG**



**TOB4004AW-WG**



**Available Finishes:**  
AN, AW, BZ, HAB, PN

**Socket:** Porcelain  
**Wattage:** 75 A

**TOB4006HAB-WG**  
**Clark Ceiling Light**  
**in Hand-Rubbed**  
**Antique Brass with**  
**White Glass Shade**  
Height: 12¾"  
Width: 7½"



**TOB4006BZ-WG**



**TOB4006PN-WG**



**Available Finishes:**  
AN, AW, BZ, HAB, PN

**Socket:** Porcelain  
**Wattage:** 75 A

**BB5300HAB-NP**  
**Hobbs Six-Light Chandelier**  
**in Hand-Rubbed Antique Brass**  
**with Natural Paper Shades**  
Height: 19¾"  
Width: 21½"  
Canopy: 5¾" Round

**Available Finishes:** AN, BZ,  
HAB, PN  
**Shade Treatment:** NP  
**Shade Details:** 4" x 5" x 5"

**Socket:** 6-Candelabra  
**Wattage:** 6-60 C



**SC5003BZ**  
**Venetian Sixteen-Light**  
**Chandelier**  
**in Bronze**

Height: 33½"  
Width: 38"  
Canopy: 14½" Star

**Available Finishes:**  
AS, BZ, HAB

**Socket:** 16 - Candelabra  
**Wattage:** 16 - 60 C



**SC5002HAB**  
**Venetian Nine-Light**  
**Two-Tier Chandelier in**  
**Hand-Rubbed Antique**  
**Brass**

Height: 23"  
Width: 28"  
Canopy: 14½" Star

**Available Finishes:**  
AS, BZ, HAB

**Socket:** 9-Candelabra  
**Wattage:** 9-60 C



**SC4000BZ**  
**Star Flush Mount in Bronze**  
Height: 4"  
Width: 14½"  
FerroWatt Bulb Shown

**Available Finishes:**  
AS, BZ, HAB

**Socket:** Keyless  
**Wattage:** 60 A



**SC5001AS**  
**Venetian Six-Light Chandelier in Antique Silver**  
Height: 23"  
Width: 28"  
Canopy: 14½" Star

**Available Finishes:**  
AS, BZ, HAB

**Socket:** 6-Candelabra  
**Wattage:** 6-60 C



**SC5005HAB**  
**Double Twist Five-Light Chandelier in Hand-Rubbed Antique Brass**  
Height: 29¾"  
Width: 36"  
Canopy: 5¾" Round

**Available Finishes:**  
AS, BZ, HAB, PN

**Socket:** 5 - Candelabra  
**Wattage:** 5 - 60 C



**SC5155BR**  
**Twisted Sunburst Chandelier**  
**in Black Rust**  
Height: 46"  
Width: 38"  
Canopy: 7¼" Round

**Socket:** 8-Candelabra  
**Wattage:** 8-60 C





**SC5008BR**  
**Hudson Six-Arm Chandelier**  
**in Black Rust**  
Height: 20"  
Width: 24½"  
Canopy: 6" Round

**Socket:** 6-Candelabra  
**Wattage:** 6-60 C



**SC5007BR**  
**Hudson Two-Tier Twelve-Light Chandelier**  
**in Black Rust**  
Height: 29½"  
Width: 35"  
Canopy: 5¾" Round

**Socket:** 12-Candelabra  
**Wattage:** 12-60 C



**SC5102HAB**  
**Armillary Sphere**  
**Chandelier in Hand-**  
**Rubbed Antique Brass**  
Height: 24¾"  
Width: 35"  
Canopy: 5½" Round

**Available Finishes:**  
BZ, HAB, PN

**Socket:** 6-Candelabra  
**Wattage:** 6-60 C



**SC5120PN**  
**Sasson Hanging Light**  
**in Polished Nickel with**  
**Silk Shade**  
Height: 28¾"  
Width: 10¼"  
Canopy: 4½" Square

**Available Finishes:** BZ, PN  
**Shade Treatments:** S  
**Shade Details:**  
2¼" x 4" x 3⅞" Hardback

**Socket:** Candelabra  
**Wattage:** 40 C



**SC5004BZ**  
**Tyler Three-Light**  
**Chandelier in Bronze**  
Height: 30"  
Width: 8"  
Canopy: 5" Round  
Custom Height Available

**Available Finishes:**  
AS, BZ, HAB, PN  
**Shade Treatments:**  
CHS-104S  
Shade Sold Separately  
**Shade Details:**  
3" x 4" x 4"

**Socket:** 3-Candelabra  
**Wattage:** 3-60 C



**SC5150PN**  
**Square Link Chandelier in Polished Nickel**  
Height: 19"  
Width: 27 1/2"  
Canopy: 8 3/4" Hexagonal

**Available Finishes:**  
AS, BZ, HAB, PN

**Socket:** 6-Candelabra  
**Wattage:** 6-60 C



**SC5100BZ**  
**Socrates Pendant in Bronze**  
Height: 29"  
Width: 16"  
Canopy: 12" Round  
Custom Height Available

**Socket:** 2-Keyless  
**Wattage:** 2-75 A





# WALL

Chart House	230
Studio	252
Thomas O'Brien	274
Bill Blass	285
Eric Cohler	289
Clodagh	294





**CHD1167AM/AB**  
**Large Kensington Single Sconce**  
**in Antique Mirror and**  
**Antique-Burnished Brass**

Height: 23¼"  
Width: 9"  
Extension: 8⅝"  
Backplate: 9" x 23¼"

**Available Finishes:**  
AB, AM/AB, AM/SN

**Socket:** Candelabra  
**Wattage:** 60 C  
©EFC DESIGNS



**CHD1167AB**

**CHD1173AM/AB**  
**Large Kensington Double Sconce**  
**in Antique Mirror and**  
**Antique-Burnished Brass**

Height: 23¼"  
Width: 9"  
Extension: 5"  
Backplate: 9" x 23¼"

**Available Finishes:**  
AB, AM/AB, AM/SN  
**Shade Treatment:** CHS-104S  
Shade Sold Separately  
**Shade Details:** 3" x 4" x 4"

**Socket:** 2 – Candelabra  
**Wattage:** 2 – 60 C  
©EFC DESIGNS



**CHD1171AM/AB**  
**Small Kensington Single Sconce**  
**in Antique Mirror and**  
**Antique-Burnished Brass**

Height: 12"  
Width: 4¾"  
Extension: 8⅝"  
Backplate: 4¾" x 12"

**Available Finishes:**  
AB, AM/AB, AM/SN

**Socket:** Candelabra  
**Wattage:** 60 C  
©EFC DESIGNS



**CHD1172AM/AB**  
**Medium Kensington Single Sconce**  
**in Antique Mirror and**  
**Antique-Burnished Brass**

Height: 16"  
Width: 6¼"  
Extension: 8⅝"  
Backplate: 6¼" x 16"

**Available Finishes:**  
AB, AM/AB, AM/SN

**Socket:** Candelabra  
**Wattage:** 60 C  
©EFC DESIGNS





**CHD1175AB**

**Library Wall Sconce in Antique-Burnished Brass**

Height: 13¾"  
Width: 7"  
Extension: 6½"  
Backplate: 3" x 5"

**Available Finishes:**  
AB, AN, BZ, PN, PS

**Shade Treatment:** CHS104NP  
Shade Sold Separately  
**Shade Details:** 3" x 4" x 4"

**Socket:** Candelabra  
**Wattage:** 60 C  
©EFC DESIGNS



**CHD1175PS**



**CHD1165AB**

**Cut Corner Sconce in Antique-Burnished Brass**

Height: 9"  
Width: 3½"  
Extension: 6¼"  
Backplate: 3½" x 6¼"

**Available Finishes:** AB, PN  
**Shade Treatment:** CHS-111S  
Shade Sold Separately  
**Shade Details:** 4" x 5½"

**Socket:** Candelabra  
**Wattage:** 60 C  
©EFC DESIGNS



**CHD1166PN**

**Double Cut Corner Sconce in Polished Nickel**

Height: 9"  
Width: 9"  
Extension: 5½"  
Backplate: 3½" x 6¼"

**Available Finishes:** AB, PN  
**Shade Treatment:** CHS-111S  
Shade Sold Separately  
**Shade Details:** 4" x 5½"

**Socket:** 2-Candelabra  
**Wattage:** 2-60 C  
©EFC DESIGNS



**CHD1140AB-B**

**18th Century English Swing Arm Sconce in Antique-Burnished Brass**

Height: 17"  
Extension: 15"  
Backplate: 4" x 6¼" Oval

**Available Finishes:** AB, AN  
**Shade Treatment:** B  
**Shade Details:** 4½" x 8" x 5"

**Socket:** Candelabra  
**Wattage:** 60 C

©EFC DESIGNS



**CHD1150AB-B**

**18th Century English Swing arm Wall Lamp in Antique-Burnished Brass with Black Shade**

Height: 20"  
Extension: 17"  
Backplate: 4" x 6¼" Oval  
Cord Cover Included

**Available Finishes:** AB, AN  
**Shade Treatment:** B, S  
**Shade Details:** 5" x 10" x 8"

**Socket:** Hi-Lo  
**Wattage:** 100 A

©EFC DESIGNS



**CHD1120AN**

**English One-Light Sconce in Antique Nickel**

Height: 13¼"  
Width: 4½"  
Extension: 9"  
Backplate: 4½" Round

**Available Finishes:** AB, AN, BZ  
**Shade Treatment:** CHS-104B  
Shade Sold Separately  
**Shade Details:** 3" x 4" x 4"

**Socket:** Candelabra  
**Wattage:** 60 C

©EFC DESIGNS



**CHD1122BZ**

**English Two-Light Sconce in Bronze**

Height: 13¼"  
Width: 10"  
Extension: 7"  
Backplate: 4½" Round

**Available Finishes:** AB, AN, BZ  
**Shade Treatment:** CHS-104NP Shade  
Sold Separately  
**Shade Details:** 3" x 4" x 4"

**Socket:** 2-Candelabra  
**Wattage:** 2-60 C

©EFC DESIGNS



**CHD1138AB**

**Grosvenor House Double Arm Sconce  
in Antique-Burnished Brass**

Height: 10½"  
Width: 4½"  
Extension: 8"  
Backplate: 4½" x 6¼" Oval

**Available Finishes:**

AB, AN, BZ, PS, SN

**Shade Treatment:**

CHS-109S or CHS-101B

Shade Sold Separately

**Shade Details:**

2½" x 5" x 4½" (CHS-109) or

3" x 6" x 4" (CHS-101)

**Socket:** Candelabra

**Wattage:** 60 C

©EFC DESIGNS



**CHD1138AN**



**CHD1139AB**

**Grosvenor House Double Arm Sconce  
in Antique-Burnished Brass**

Height: 10½"  
Width: 10½"  
Extension: 8"  
Backplate: 4½" x 6¼" Oval

**Available Finishes:**

AB, AN, BZ, PS, SN

**Shade Treatment:**

CHS-109S or CHS-104B

Shade Sold Separately

**Shade Details:**

2½" x 5" x 4½" (CHS-109) or

3" x 4" x 4" (CHS-104)

**Socket:** 2-Candelabra

**Wattage:** 2-60 C

©EFC DESIGNS



**CHD1139SN**



**CHD1115AB**  
**18th Century One-Light Sconce in**  
**Antique-Burnished Brass**  
Height: 20"  
Width: 6"  
Backplate: 6" Round

**Available Finishes:** AB, AN, BZ, PS  
**Shade Treatment:** CHS-101B  
Shade Sold Separately  
**Shade Details:** 3" x 6" x 4"

**Socket:** Candelabra  
**Wattage:** 60 C  
©EFC DESIGNS



**CHD1116AN**  
**18th Century Two-Light Sconce**  
**in Antique Nickel**  
Height: 20"  
Width: 10½"  
Backplate: 6" Round

**Available Finishes:**  
AB, AN, BZ, PS  
**Shade Treatment:**  
CHS-101B  
Shade Sold Separately  
**Shade Details:** 3" x 6" x 4"

**Socket:** 2-Candelabra  
**Wattage:** 2-60 C  
©EFC DESIGNS



**CHD1117AB**  
**18th Century Three-Light Sconce in**  
**Antique-Burnished Brass**  
Height: 20"  
Width: 13½"  
Extension: 9½"  
Backplate: 6" Round

**Available Finishes:** AB, AN, BZ, PS

**Socket:** 3-Candelabra  
**Wattage:** 3-60 C  
©EFC DESIGNS



**CHD1409AB-SG**  
**Petite Paris Flea Market**  
**Sconce in Antique-Burnished**  
**Brass with Antique Mirror and**  
**Seeded Glass**

Height: 12"  
Width: 7"  
Extension: 6½"  
Backplate: 7" x 12"

**Socket:** 3-Candelabra  
**Wattage:** 3-60 C  
©EFC DESIGNS



**CHD1408AB-SG**  
**Paris Flea Market Sconce**  
**in Antique-Burnished Brass**  
**with Antique Mirror and**  
**Seeded Glass**

Height: 16½"  
Width: 12½"  
Extension: 8¼"  
Backplate: 10" x 16½"

**Socket:** 3-Candelabra  
**Wattage:** 3-60 C  
©EFC DESIGNS



**CHD1470AWG**  
**Crystal Petal Three-Light**  
**Sconce in Antique White Gold**

Height: 26½"  
Width: 23"  
Extension: 14½"  
Backplate: 4¾" Round

**Available Finishes:** AWG, R, RG

**Socket:** 3-Candelabra  
**Wattage:** 3-60 C  
©EFC DESIGNS



**CHD1168AN**  
**Normandy Two-Light Sconce**  
**in Antique Nickel**

Height: 12½"  
Width: 7¾"  
Extension: 5½"  
Backplate: 4¾" x 5"

**Available Finishes:**  
AB, AN, BZ, PN

**Shade Treatment:** CHS-104NP  
Shade Sold Separately  
**Shade Details:** 3" x 4" x 4"

**Socket:** 2 – Candelabra  
**Wattage:** 2 – 60 C  
©EFC DESIGNS



**CHD1169BZ**  
**Normandy Three-Light Sconce**  
**in Bronze**

Height: 20"  
Width: 7¾"  
Extension: 5½"  
Backplate: 4¾" x 5"

**Available Finishes:**  
AB, AN, BZ, PN

**Shade Treatment:** CHS-104NP  
Shade Sold Separately  
**Shade Details:** 3" x 4" x 4"

**Socket:** 3 – Candelabra  
**Wattage:** 3 – 60 C  
©EFC DESIGNS



**CHD4132AB**  
**Edwardian Wall Wash in**  
**Antique-Burnished Brass**

Height: 13½"  
Width: 9½"  
Extension: 6¼"  
Backplate: 9¼" x 9¼"

**Available Finishes:** AB, AN  
**Shade Treatment:** WG

**Socket:** Keyless  
**Wattage:** 60 A  
©EFC DESIGNS



**CHD4133AB-B**  
**Edwardian Wall Wash in**  
**Antique-Burnished Brass**

Height: 13½"  
Width: 9½"  
Extension: 6"  
Backplate: 4" Round

**Shade Treatment:** B

**Socket:** Keyless  
**Wattage:** 60 A  
©EFC DESIGNS



**CHD1112AB**  
**Dorchester Swing Arm Sconce**  
in Antique-Burnished Brass

Height: 10½"  
Extension: 7"  
Backplate: 2" x 4¼"

**Available Finishes:** AB, AN  
**Shade Treatment:** CHS-109  
Shade Sold Separately  
**Shade Details:** 2½" x 5" x 4½"

**Socket:** Candelabra  
**Wattage:** 60 C  
©EFC DESIGNS



**CHD5101AB-B**  
**Dorchester Swing-Arm Wall**  
**Lamp in Antique-Burnished**  
**Brass with Black Shade**

Height: 15"  
Extension: 22"  
Backplate: 2¼" x 4½"  
Cord Cover Included

**Available Finishes:**  
AB, AN, PS  
**Shade Treatments:** B, S  
**Shade Details:**  
5" x 10" x 8"

**Socket:** Hi-Lo  
**Wattage:** 100 A  
©EFC DESIGNS



**CHD5102AB-NP**  
**Dorchester Double Backplate**  
**Swing-Arm Wall Lamp in**  
**Antique-Burnished Brass with**  
**Natural Paper Shade**

Height: 24"  
Extension: 24"  
Backplates: 2½" x 4"  
Cord Cover Included

**Available Finishes:** AB, AN  
**Shade Treatment:** B, NP  
**Shade Details:** 6" x 10" x 7"

**Socket:** Hi-Lo  
**Wattage:** 100 A  
©EFC DESIGNS



**CHD1502AB-SC**  
**Essex Pivoting Swing-Arm Wall**  
**Lamp in Antique-Burnished Brass**  
**with Silk Collar Shade**

Height: 14"  
Extension: 21"  
Backplate: 4½" Square  
Cord Cover Included

**Available Finishes:** AB, AN, PN  
**Shade Treatment:** SC  
**Shade Details:** 6" x 10" x 8"

**Socket:** Hi-Lo  
**Wattage:** 100 A  
©EFC DESIGNS



**CHD1161PN**

**Horn Sconce in Polished Nickel**

Height: 12½"  
Width: 2½"  
Extension: 5¾"  
Backplate: 2½" x 6½"

**Available Finishes:** AB, PN  
**Shade Treatment:** CHS-111S  
Shade Sold Separately  
**Shade Details:** 4" x 5½"

**Socket:** Candelabra  
**Wattage:** 60 C  
©EFC DESIGNS



**CHD1161AB**

**CHD1162AB**

**Double Horn Sconce in**

**Antique-Burnished Brass**  
Height: 12½"  
Width: 8"  
Extension: 5¾"  
Backplate: 2½" x 6½"

**Available Finishes:** AB, PN  
**Shade Treatment:** CHS-111S  
Shade Sold Separately  
**Shade Details:** 4" x 5½"

**Socket:** 2-Candelabra  
**Wattage:** 2-60 C  
©EFC DESIGNS



**CHD1176AB**

**Horn Sconce with Oval Backplate in**

**Antique-Burnished Brass**  
Height: 17½"  
Width: 4½"  
Extension: 8"  
Backplate: 4½" x 6½" Oval

**Available Finishes:**  
AB, AN, BZ, PS  
**Shade Treatment:** CHS-112S  
Shade Sold Separately  
**Shade Details:** 4" x 5" x 5"

**Socket:** Candelabra  
**Wattage:** 60 C  
©EFC DESIGNS



**CHD1170AB**

**Sussex Sconce with Cove**

**Corner Backplate in**  
**Antique-Burnished Brass**  
Height: 11½"  
Width: 4½"  
Extension: 10¼"  
Backplate: 4½" x 6¾"

**Available Finishes:**  
AB, AN, BZ, PS  
**Shade Treatment:** CHS-112S  
Shade Sold Separately  
**Shade Details:** 4" x 5" x 5"

**Socket:** Candelabra  
**Wattage:** 60 C  
©EFC DESIGNS





**CHD1500AB**  
**Essex Library Sconce in**  
**Antique-Burnished Brass**

Height: 14"  
Width: 5"  
Extension: 4½"  
Backplate: 4½" Square

**Available Finishes:** AB, AN, PN  
**Shade Treatment:** CHS-104S  
Shade Sold Separately  
**Shade Details:** 3" x 4" x 4"

**Socket:** Candelabra  
**Wattage:** 60 C  
©EFC DESIGNS



**CHD1501AB**  
**Essex Pivoting Wall Sconce in**  
**Antique-Burnished Brass**

Height: 10½"  
Width: 5"  
Extension: 11½"  
Backplate: 4½" Square

**Available Finishes:** AB, AN, PN  
**Shade Treatment:** CHS-112S  
Shade Sold Separately  
**Shade Details:** 4" x 5" x 5"

**Socket:** Candelabra  
**Wattage:** 60 C  
©EFC DESIGNS



**CHD1163ABV**  
**Scallop Sconce in**  
**Antique-Burnished Brass Verdigris**

Height: 12"  
Width: 6"  
Extension: 7"  
Backplate: 6" Round

**Available Finishes:** ABV, PN  
**Shade Treatment:** CHS-112S  
Shade Sold Separately  
**Shade Details:** 4" x 5" x 5"

**Socket:** Candelabra  
**Wattage:** 60 C  
©EFC DESIGNS



**CHD1164ABV**  
**Double Scallop Sconce in**  
**Antique-Burnished Brass Verdigris**

Height: 13"  
Width: 8"  
Extension: 6½"  
Backplate: 6" Round

**Available Finishes:** ABV, PN  
**Shade Treatment:** CHS-104S  
Shade Sold Separately  
**Shade Details:** 3" x 4" x 4"

**Socket:** 2-Candelabra  
**Wattage:** 2-60 C  
©EFC DESIGNS



**CHD147AB**  
**Shield Sconce in**  
**Antique-Burnished Brass**

Height: 13"  
Width: 4½"  
Extension: 7"  
Backplate: 4½"

**Available Finishes:** AB, AN, SN  
**Shade Treatment:** CHS-104B  
Shade Sold Separately  
**Shade Details:** 3" x 4" x 4"

**Socket:** Candelabra  
**Wattage:** 60 C  
©EFC DESIGNS



**CHD148AN**  
**Ribbon Sconce in**  
**Antique Nickel**

Height: 19"  
Width: 9½"  
Extension: 3¾"  
Backplate: 4½" Round

**Available Finishes:**  
AB, AN, SN  
**Shade Treatment:**  
CHS-104B  
Shade Sold Separately  
**Shade Details:** 3" x 4" x 4"

**Socket:** 2 – Candelabra  
**Wattage:** 2 – 60 C  
©EFC DESIGNS



**CHD1137AB-B**  
**Lion Passant Wall Lamp in**  
**Antique-Burnished Brass**  
**with Black Shades**

Height: 23"  
Width: 14½"  
Extension: 10½"  
Backplate: 4" x 6½"  
Cord Cover Included

**Shade Treatment:** B, S  
**Shade Details:** 3" x 6" x 4"

**Socket:** 2 – Candelabra  
**Wattage:** 2 – 60 C  
©EFC DESIGNS



**CHD1448AB**  
**Arrow Wall Sconce**  
**Antique-Burnished Brass**

Height: 12"  
Width: 12"  
Extension: 6¼"  
Backplate: 4½" Round

**Available Finishes:**  
AB, AB/AN, BZ,  
BZ/AB, PS  
**Shade Treatment:**  
CHS-104NP  
Shade Sold Separately  
**Shade Details:**  
3" x 4" x 4"

**Socket:** 2 – Candelabra  
**Wattage:** 2 – 60 C  
©EFC DESIGNS



**CHD113ABV**  
**Plume Motif Wall Sconce in**  
**Antique-Burnished Brass Verdigris**

Height: 16½"  
Width: 11"  
Extension: 6½"  
Backplate: 4¾" Round

**Shade Treatment:**  
CHS-108  
Shade Sold Separately  
**Shade Details:** 3" x 5" x 4"

**Socket:** 2 – Candelabra  
**Wattage:** 2 – 60 C  
©EFC DESIGNS



**CHD146ABV**  
**French Pierced Back Country Sconce in**  
**Antique-Burnished Brass Verdigris**

Height: 15½"  
Width: 13"  
Extension: 9½"  
Backplate: 5"

**Shade Treatment:**  
CHS-109  
Shade Sold Separately  
**Shade Details:**  
2½" x 5" x 4½"

**Socket:** 2 – Candelabra  
**Wattage:** 2 – 60 C  
©EFC DESIGNS



**CHD1110R**  
**Petite Fleur-de-Lis Two-Light**  
**Sconce in Rust**

Height: 15½"  
Width: 8"  
Extension: 5"  
Backplate: 5"

**Shade Treatment:**  
CHS-104B  
Shade Sold Separately  
**Shade Details:** 3" x 4" x 4"

**Socket:** 2 – Candelabra  
**Wattage:** 2 – 60 C  
©EFC DESIGNS



**CHD1109R**  
**Fleur-de-Lis Two-Light**  
**Sconce in Rust**

Height: 17"  
Width: 13"  
Extension: 6"  
Backplate: 5"

**Shade Treatment:**  
CHS-104B  
Shade Sold Separately  
**Shade Details:** 3" x 4" x 4"

**Socket:** 2 – Candelabra  
**Wattage:** 2 – 60 C  
©EFC DESIGNS



**CHD1406BR**

**Two-Light Iron Shield in Black Rust**

Height: 15"  
Width: 15"  
Extension: 6"  
Backplate: 5" x 7½"

**Available Finishes:**

BR, BRG

**Shade Treatment:**

CHS-104NP

Shade Sold Separately

**Shade Details:** 3" x 4" x 4"

**Socket:** 2 – Candelabra

**Wattage:** 2 – 60 C

©EFC DESIGNS



**CHD1402BR**

**Two-Light Fleur-de-Lis Hand Forged Iron Sconce in Black Rust**

Height: 12"  
Width: 11½"  
Extension: 6"  
Backplate: 4½" Round

**Shade Treatment:**

CHS-104B

Shade Sold Separately

**Shade Details:**

3" x 4" x 4"

**Socket:** 2 – Candelabra

**Wattage:** 2 – 60 C

©EFC DESIGNS



**CHD1401BR**

**One-Light Hand Forged Sconce in Black Rust**

Height: 8¾"  
Width: 4½"  
Extension: 5½"  
Backplate: 4½" Round

**Shade Treatment:**

CHS-104NP

Shade Sold Separately

**Shade Details:** 3" x 4" x 4"

**Socket:** 2 – Candelabra

**Wattage:** 2 – 60 C

©EFC DESIGNS



**CHD1403BR**

**Two-Light Hand Forged Iron Sconce in Black Rust**

Height: 11½"  
Width: 11"  
Extension: 6"  
Backplate: 4½" Round

**Shade Treatment:**

CHS-104NP

Shade Sold Separately

**Shade Details:**

3" x 4" x 4"

**Socket:** 2 – Candelabra

**Wattage:** 2 – 60 C

©EFC DESIGNS



**CHD1404BR-NP**  
**Iron Torch Sconce in Black Rust**  
**with Natural Paper Shade**

Height: 18"  
Width: 8"  
Extension: 9"  
Backplate: 5½" Round

**Shade Treatment:** NP  
**Shade Details:** 5" x 8" x 6"

**Socket:** Keyless  
**Wattage:** 75 A  
©EFC DESIGNS



**CHD1437BR**  
**Two-Light J-Arm Wall Sconce in**  
**Black Rust with Wrapped Leather Accents**

Height: 16"  
Width: 15"  
Extension: 8"  
Backplate: 4½" Round

**Shade Treatment:**  
CHS-104NP  
Shade Sold Separately  
**Shade Details:**  
3" x 4" x 4"

**Socket:** 2 – Candelabra  
**Wattage:** 2 – 60 C  
©EFC DESIGNS



**CHD1405BR**  
**Iron Plume Two-Light Sconce**  
**in Black Rust**

Height: 18½"  
Width: 15¼"  
Extension: 7¼"  
Backplate: 4½" Round

**Shade Treatment:**  
CHS-104NP  
Shade Sold Separately  
**Shade Details:** 3" x 4" x 4"

**Socket:** 2 – Candelabra  
**Wattage:** 2 – 60 C  
©EFC DESIGNS



**CHD1455BR-L**  
**Gate Fragment Adjustable Wall Mount**  
**Fixture in Black Rust with Linen Shade**

Height: 21½"-26"  
Width: 15"  
Extension: 7¾"  
Backplate: 2½" x 4¼"

**Shade Treatment:** L  
**Shade Details:**  
6½"/13" x 7 ½"/15" x 9"  
Half Shade

**Socket:** Hi-Lo  
**Wattage:** 60 A  
©EFC DESIGNS



**CHD1158R**

**Single Light Perching Bird Sconce in Rust with Light Verdis Accents**

Height: 14"  
Width: 5"  
Extension: 7"  
Backplate: 7½" Oval

**Shade Treatment:** CHS-104B

Shade Sold Separately

**Shade Details:** 3" x 4" x 4"

**Socket:** Candelabra

**Wattage:** 60 C

©EFC DESIGNS



**CHD1103ABV**

**Graceful Loop Candle Sconce in Antique Brass Verdigris**

Height: 19½"  
Width: 5½"  
Extension: 9½"  
Backplate: 4¾" Round

**Shade Details:** 5" x 3" x 9"

**Socket:** Candelabra

**Wattage:** 60 C

©EFC DESIGNS



**CHD1106AB-B**

**Regency Hand Motif Sconce in Antique-Burnished Brass (Hand Faces Right)**

Height: 12½"  
Width: 6¾"  
Extension: 12"  
Backplate: 6" Round

**Shade Treatment:** B

**Shade Details:** 4" x 8" x 5"

**Socket:** Keyless

**Wattage:** 60 A

©EFC DESIGNS



**CHD1107AB-B**

**Regency Hand Motif Sconce in Antique-Burnished Brass (Hand Faces Left)**

Height: 12½"  
Width: 6¾"  
Extension: 12"  
Backplate: 6" Round

**Shade Treatment:** B

**Shade Details:** 4" x 8" x 5"

**Socket:** Keyless

**Wattage:** 60 A

©EFC DESIGNS



**CHD1450WI-NP**  
**Windsor Iron Twist Sconce**  
**in Weathered Iron and**  
**Heavily Distressed Brass**  
**with Natural Paper Shade**

Height: 24"  
Width: 10"  
Extension: 10"  
Backplate: 4½" Round

**Shade Treatment:** NP  
**Shade Details:** 7" x 10" x 7½"

**Socket:** Keyless  
**Wattage:** 100 A  
©EFC DESIGNS



**CHD1435BR**  
**Four-Light Twisted Iron**  
**Sconce in Black Rust**  
Height: 23"  
Width: 15"  
Extension: 10½"  
Backplate: 4½" Round

**Shade Treatment:**  
CHS-104NP  
Shade Sold Separately  
**Shade Details:**  
3" x 4" x 4"

**Socket:** 4-Candelabra  
**Wattage:** 4-60 C  
©EFC DESIGNS



**CHD1460WI**  
**Small Castle Torch Sconce**  
**in Weathered Iron and Heavily**  
**Distressed Brass with Frosted Glass**

Height: 14"  
Width: 5½"  
Extension: 6½"  
Backplate: 4¾" x 6¼"

**Shade Treatment:** FG  
**Shade Details:** 4¾" x 4¾" x 5¾"

**Socket:** Keyless  
**Wattage:** 100 A  
©EFC DESIGNS



**CHD1461WI**  
**Large Castle Torch Sconce**  
**in Weathered Iron and Heavily**  
**Distressed Brass with Frosted Glass**

Height: 25¼"  
Width: 5½"  
Extension: 9½"  
Backplate: 4¾" x 6¼"

**Shade Treatment:** FG  
**Shade Details:** 4¾" x 4¾" x 5¾"

**Socket:** Keyless  
**Wattage:** 100 A  
©EFC DESIGNS



**CHD2154PN-LCC**

**Pimlico Swing-Arm Wall Lamp  
in Polished Nickel with Linen  
Collar Shade**

Height: 17"  
Width: 11"  
Extension: 27"  
Backplate: 3" x 6½"  
Cord Cover Included

**Available Finishes:** AB, AN, PN  
**Shade Treatment:** LCC  
**Shade Details:** 7" x 12" x 9"  
Nordy Fitter

**Socket:** Hi-Lo  
**Wattage:** 100 A  
©EFC DESIGNS



**CHD2151PN-SC**

**Pimlico Swing-Arm Wall Lamp  
in Polished Nickel with Silk  
Collar Shade**

Height: 20"  
Extension: 19"  
Backplate: 3" x 6½"  
Cord Cover Included

**Available Finishes:** AB, AN, PN  
**Shade Treatment:**  
AB, AN, PN, SC, WG  
**Shade Details:** 6" x 10" x 8"

**Socket:** Hi-Lo  
**Wattage:** 60 A  
©EFC DESIGNS



**CHD2150AB-AB**

**Pimlico Double Swing-Arm  
Wall Lamp in Antique-  
Burnished Brass with Antique  
Brass Shade**

Height: 16"  
Extension: 24"  
Backplate: 3" x 6½"  
Cord Cover Included

**Available Finishes:**  
AB, AN, PN  
**Shade Treatment:**  
AB, AN, PN, SCF, WG  
**Shade Details:** 6" x 6½"

**Socket:** Hi-Lo  
**Wattage:** 60 A  
©EFC DESIGNS



**CHD2153PN-WG**

**Pimlico Adjustable Single Light  
Sconce in Polished Nickel with  
White Glass Shade**

Height: 11"  
Width: 6"  
Extension: 12¾"  
Backplate: 3" x 6½"  
Cord Cover Included

**Available Finishes:** AB, AN, PN  
**Shade Treatment:** WG  
**Shade Details:** 2¼" x 6" x 6½"

**Socket:** Hi-Lo  
**Wattage:** 60 A  
©EFC DESIGNS





**CHD5106BZ-NP**  
**Chunky Swing-Arm Wall Lamp in**  
**Bronze with Natural Paper Shade**

Height: 18 1/4"  
Width: 12"  
Extension: 25 1/2"  
Backplate: 4" x 5"  
Cord Cover Included

**Available Finishes:**  
AB, AN, BZ, PN  
**Shade Treatments:**  
L, NP  
**Shade Details:**  
10" x 12" x 7 1/2"

**Socket:** Dimmer  
**Wattage:** 100 A  
©EFC DESIGNS



**CHD5105AN-B**  
**Sloane Swing-Arm Club Wall Lamp in**  
**Antique Nickel with Black Shade**

Height: 16"  
Extension: 18"  
Backplate: 4 1/2" Square  
Cord Cover Included

**Available Finishes:** AB, AN  
**Shade Treatments:** B, L, NP  
**Shade Details:** 8" x 12" x 7"

**Socket:** Dimmer  
**Wattage:** 100 A



**CHD2155PN**  
**Pimlico One-Light Sconce in**  
**Polished Nickel**

Height: 9 1/2"  
Width: 3 1/4"  
Extension: 7 1/2"  
Backplate: 3" x 6 1/2"

**Available Finishes:**  
AB, AN, BZ, PN  
**Shade Treatment:** CHS-112S  
Shade Sold Separately  
**Shade Details:** 4" x 5" x 5"

**Socket:** Candelabra  
**Wattage:** 60 C  
©EFC DESIGNS



**CHD2156AB**  
**Pimlico Two-Light Sconce in**  
**Antique-Burnished Brass**

Height: 9 1/2"  
Width: 9"  
Extension: 8 1/2"  
Backplate: 3" x 6 1/2"

**Available Finishes:**  
AB, AN, BZ, PN  
**Shade Treatment:** CHS-104S  
Shade Sold Separately  
**Shade Details:** 3" x 4" x 4"

**Socket:** 2- Candelabra  
**Wattage:** 2-60 C  
©EFC DESIGNS



**CHD5117AB**  
**8" Dorchester Picture Light in**  
**Antique-Burnished Brass**

Height: 4½"  
Width: 8"  
Extension: 10½"  
Backplate: 2½" x 4½"

**Available Finishes:**

AB, AN, BZ, PN

**Shade Details:** 8" x 3½" x 2"

**Socket:** Keyless/Line Switch

**Wattage:** 60 T

©EFC DESIGNS

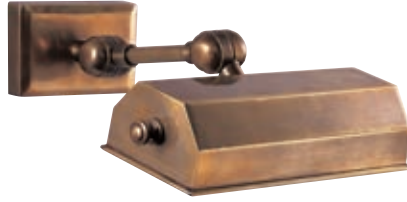

**CHD5107BZ**  
**Dorchester Loop Arm**  
**Picture Light in Bronze**

Height: 7½"  
Width: 8¾"  
Extension: 11½"  
Backplate: 2¾" x 4½"

**Available Finishes:**

AB, AN, BZ, PN

**Shade Details:** 8¾" x 3½" x 2"

**Socket:** Keyless/Line Switch

**Wattage:** 60 T

©EFC DESIGNS



**CHD5137AN**  
**18" Dorchester Picture Light in**  
**Antique Nickel**

Height: 4½"  
Width: 18"  
Extension: 9½"  
Backplate: 4½" x 14"

**Available Finishes:**

AB, AN, BZ, PN

**Shade Details:** 18" x 3½" x 2"

**Socket:** 2-Keyless/Line Switch

**Wattage:** 2-60 T

©EFC DESIGNS



**CHD5147AB**  
**24" Dorchester Picture Light in**  
**Antique-Burnished Brass**

Height: 4½"  
Width: 24"  
Extension: 9½"  
Backplate: 4½" x 18½"

**Available Finishes:**

AB, AN, BZ, PN

**Shade Details:** 24" x 3½" x 2"

**Socket:** 2-Keyless/Line Switch

**Wattage:** 2-60 T

©EFC DESIGNS

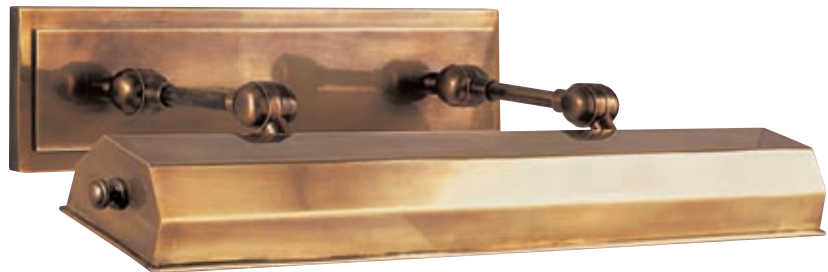

**CHD1550PN-FG**  
**Oxford Short Linear Wall Sconce in Polished Nickel with Frosted Glass**

Height: 8½"  
Width: 3"  
Extension: 4"  
Backplate: 3" x 8½"

**Available Finishes:**  
AB, AN, BZ, CH, PN

**Socket:** Keyless  
**Wattage:** 60 T  
©EFC DESIGNS



**CHD1551CH-FG**  
**Oxford Medium Linear Wall Light in Chrome with Frosted Glass**

Height: 12"  
Width: 3¾"  
Extension: 4"  
Backplate: 3¾" x 12"

**Available Finishes:**  
AB, AN, BZ, CH, PN

**Socket:** Keyless  
**Wattage:** 60 T



**CHD1552AB-FG**  
**Oxford Tall Linear Wall Light in Antique-Burnished Brass with Frosted Glass**

Height: 18"  
Width: 4¼"  
Extension: 4"  
Backplate: 4¼" x 18"

**Available Finishes:**  
AB, AN, BZ, CH, PN

**Socket:** 2-Keyless  
**Wattage:** 2-60 T



**CHD1541PN-FG**

**Normandie Faceted One-Light  
Sconce in Polished Nickel with  
Frosted Glass Shade**

Height: 10½"  
Width: 5"  
Extension: 9"  
Backplate: 4½" x 5½"

**Available Finishes:** AB, AN, PN  
**Shade Treatment:** FG  
**Shade Details:** 2¾" x 5½" x 4¾"

**Socket:** Hi-Lo  
**Wattage:** 60 A  
©EFC DESIGNS



**CHD1541AB-FG**



**CHD1542AN-FG**

**Normandie Faceted Two-Light  
Sconce in Antique Nickel with  
Frosted Glass Shades**

Height: 10½"  
Width: 14"  
Extension: 9"  
Backplate: 4½" x 5½"

**Available Finishes:** AB, AN, PN  
**Shade Treatment:** FG  
**Shade Details:** 2¾" x 5½" x 4¾"

**Socket:** 2-Hi-Lo  
**Wattage:** 2-60 A  
©EFC DESIGNS



**CHD1543AB-FG**

**Normandie Faceted Three-Light  
Sconce in Antique-Burnished  
Brass with Frosted Glass Shades**

Height: 10½"  
Width: 23"  
Extension: 9"  
Backplate: 4½" x 5½"

**Available Finishes:** AB, AN, PN  
**Shade Treatment:** FG  
**Shade Details:** 2¾" x 5½" x 4¾"

**Socket:** 3-Hi-Lo  
**Wattage:** 3-60 A  
©EFC DESIGNS



**CHD1510PN-WG**  
**Belgrania Bath Light in Polished Nickel with White Glass Shade**

Height: 9½"  
Width: 5¼"  
Extension: 7"  
Backplate: 5" Square

**Available Finishes:**  
AB, AN, BZ, CH, PN  
**Shade Treatment:** WG  
**Shade Details:** 3" x 5¼" x 5½"

**Socket:** Keyless  
**Wattage:** 60 A  
©EFC DESIGNS



**CHD1510AB-WG**



**CHD1521AB-FG**  
**Essex Single Wall Fixture in Antique-Burnished Brass with Frosted Glass Shade**

Height: 10½"  
Width: 6"  
Extension: 7½"  
Backplate: 4½" Square

**Available Finishes:**  
AB, AN, PN  
**Shade Treatment:** FG

**Socket:** Hi-Lo  
**Wattage:** 60 A  
©EFC DESIGNS



**CHD1522PN-FG**  
**Essex Double Wall Fixture in Polished Nickel with Frosted Glass Shades**

Height: 10½"  
Width: 14"  
Extension: 7½"  
Backplate: 4½" Square

**Available Finishes:**  
AB, AN, PN  
**Shade Treatment:** FG

**Socket:** 2- Hi-Lo  
**Wattage:** 2-60 A  
©EFC DESIGNS



**CHD1531AB-FG**  
**Essex Single Formal Sconce in Polished Nickel with Frosted Glass Shade**

Height: 10"  
Width: 6"  
Extension: 9½"  
Backplate: 4½" Square

**Available Finishes:**  
AB, AN, PN  
**Shade Treatment:** FG  
**Shade Details:**  
3½" x 6" x 6"

**Socket:** Keyless  
**Wattage:** 60 A  
©EFC DESIGNS



**CHD1532AN-FG**  
**Essex Double Formal Sconce in Antique Nickel with Frosted Glass Shades**

Height: 10"  
Width: 15"  
Extension: 9½"  
Backplate: 4½" Square

**Available Finishes:**  
AB, AN, PN  
**Shade Treatment:** FG  
**Shade Details:**  
3½" x 6" x 6"

**Socket:** 2-Keyless  
**Wattage:** 2-60 A  
©EFC DESIGNS



**CHD2908PN**  
**Short Linear Lantern**  
**in Polished Nickel**

Height: 15"  
Width: 9"  
Extension: 5"

**Available Finishes:**  
AB, AN, BZ, PN

**Socket:** 2-Candelabra  
**Wattage:** 2-60 C  
©EFC DESIGNS



**CHD2910AN**  
**Tall Linear Lantern**  
**in Antique Nickel**

Height: 22½"  
Width: 9"  
Extension: 5"

**Available Finishes:**  
AB, AN, BZ, PN

**Socket:** 2-Candelabra  
**Wattage:** 2-60 C  
©EFC DESIGNS



**CHD2103AB**  
**Georgian Hurricane Candle Sconce in**  
**Hand-rubbed Antique Brass**  
Height: 33½"  
Width: 11¼"  
Extension: 12¾"  
Candle Not Included  
Electrification Available

**Available Finishes:** AB, AN, BZ, PS  
©EFC DESIGNS



**SL2500HAB/SLT-SC**

**Boston Hi-Lo Wall Lamp in Hand-Rubbed Antique Brass with SLT Shade**

Height: 20½"  
Extension: 19"  
Backplate: 3" Round  
Cord Cover Included

**Available Finishes:**

AN, BZ, HAB, SN

**Shade Treatment:**

SLT-SC

See Shade Schedule for Additional Shade Options

**Shade Details:**

6" x 10" x 8"

**Socket:** Hi-Lo

**Wattage:** 60 A

©EFC DESIGNS



**SL2921HAB/SLE-HAB**

**Boston Single-Arm Wall Lamp in Hand-Rubbed Antique Brass with Antique Brass SLE Shade**

Height: 9"  
Extension: 17"  
Backplate: 5" Round  
Cord Cover Included

**Available Finishes:**

AN, BZ, HAB, SN

**Shade Treatment:** SLE-HAB

See Shade Schedule for Additional Shade Options

**Shade Details:** 2¼" x 5¼" x 4¼"

**Socket:** Hi-Lo

**Wattage:** 60 A

©EFC DESIGNS



**SL2922HAB**

**Boston Functional Library Wall Light in Hand-Rubbed Antique Brass**

Height: 25"  
Extension: 25"  
Backplate: 4¾" Round  
Cord Cover Included

**Available Finishes:** AN, BZ, HAB, PN

**Shade Details:** 2" x 7" x 5"

**Socket:** Hi-Lo

**Wattage:** 60 A

©EFC DESIGNS



**SL2923BZ**

**Boston Functional Library Two-Arm Wall Light in Bronze**

Height: 35½"  
Extension: 35½"  
Backplate: 4¾" Round  
Cord Cover Included

**Available Finishes:**

AN, BZ, HAB, PN

**Shade Details:** 2" x 7" x 5"

**Socket:** Hi-Lo

**Wattage:** 60 A

©EFC DESIGNS





**SL2920HAB-L**  
**Boston Swing-Arm Wall Lamp**  
**in Hand-Rubbed Antique Brass**  
**with Linen Shade**

Height: 13"  
Extension: 19"  
Backplate: 5" Round  
Cord Cover Included

**Available Finishes:**  
AN, BZ, HAB, SN  
**Shade Treatment:** L  
See Shade Schedule for  
Additional Shade Options

**Shade Details:**  
8" x 12" x 7"

**Socket:** Hi-Lo  
**Wattage:** 60 A  
©EFC DESIGNS



**SL2920HAB/SLJ-HAB**  
**Boston Swing-Arm Wall Lamp**  
**in Hand-Rubbed Antique Brass**  
**with Antique Brass SLJ Shade**

Height: 5"  
Extension: 19"  
Backplate: 5" Round  
Cord Cover Included

**Available Finishes:**  
AN, BZ, HAB, SN  
**Shade Treatment:** SLJ-HAB  
See Shade Schedule for  
Additional Shade Options  
**Shade Details:** 3 3/4" x 6"

**Socket:** Hi-Lo  
**Wattage:** 60 A  
©EFC DESIGNS



**SL2920HAB/SLE-AW**  
**Boston Swing-Arm Wall Lamp**  
**in Hand-Rubbed Antique Brass**  
**with Antique White SLE Shade**

Height: 13"  
Extension: 13"  
Backplate: 5" Round  
Cord Cover Included

**Available Finishes:**  
AN, BZ, HAB, SN  
**Shade Treatment:** SLE-AW  
See Shade Schedule for  
Additional Shade Options  
**Shade Size:** 2 1/4" x 5 3/4" x 4 1/2"

**Socket:** Hi-Lo  
**Wattage:** 60 A  
©EFC DESIGNS



**SL2800HAB-S**

**Classic Swing-Arm Wall Lamp  
in Hand-Rubbed Antique Brass  
with Silk Bell Shade**

Height: 17 1/4"  
Width: 11"  
Extension: 19"  
Backplate: 4 1/4" Round  
Cord Cover Included

**Available Finishes:**  
AN, BZ, HAB, PN  
**Shade Treatment:** S  
**Shade Details:**  
8" x 11" x 8 1/2"

**Socket:** Dimmer  
**Wattage:** 100 A  
©EFC DESIGNS



**SL2815BZ**

**Classic Round Back Wall Sconce  
in Bronze with Natural Paper Shade**

Height: 8"  
Width: 4 1/2"  
Extension: 7"  
Backplate: 4 1/2" Round

**Available Finishes:**  
AN, BZ, HAB, PN  
**Shade Treatments:**  
CHS-104NP  
Shade Sold Separately  
**Shade Details:**  
3" x 4" x 4"

**Socket:** Candelabra  
**Wattage:** 60 C  
©EFC DESIGNS



**SL2815PN**

**SL2813HAB**

**One-Light Classic Wall Sconce  
in Hand-Rubbed Antique Brass  
with Natural Paper Shade**

Height: 8 1/4"  
Width: 3 1/2"  
Extension: 6"  
Backplate: 2 3/4" x 4 1/2"

**Available Finishes:**  
AN, BZ, HAB, PN  
**Shade Treatments:**  
CHS-104NP Shade  
Sold Separately  
**Shade Details:**  
3" x 4" x 4"

**Socket:** Candelabra  
**Wattage:** 60 C  
©EFC DESIGNS



**SL2814BZ**

**Two-Light Classic Wall Sconce in  
Bronze with Natural Paper Shade**

Height: 8 1/4"  
Width: 10 1/4"  
Extension: 6"  
Backplate: 2 3/4" x 4 1/2"

**Available Finishes:**  
AN, BZ, HAB, PN  
**Shade Treatments:**  
CHS-104NP Shade  
Sold Separately  
**Shade Details:**  
3" x 4" x 4"

**Socket:** 2-Candelabra  
**Wattage:** 2-60 C  
©EFC DESIGNS



**SL2817PN-NP**  
**Double Classic Wall Light in Polished Nickel with Natural Paper Shade**  
Height: 17"  
Width: 13"  
Extension: 8½"  
Backplate: 4½" Round  
Cord Cover Included

**Available Finishes:**  
AN, BZ, HAB, PN  
**Shade Treatments:** NP  
**Shade Details:**  
5½"/11" x 7"/13" x 7½" Oval

**Socket:** 2-Candelabra/  
Hi-Lo Switch  
**Wattage:** 2-60 C  
©EFC DESIGNS



**SL2816AN**  
**Two Light Classic Round Back Wall Sconce in Antique Nickel**  
Height: 8"  
Width: 11"  
Extension: 7"  
Backplate: 4½" Round

**Available Finishes:**  
AN, BZ, HAB, PN

**Socket:** 2-Candelabra  
**Wattage:** 2-60 C  
©EFC DESIGNS



**S2020BZ-L**  
**French Deco Horn Wall Lamp in Bronze with Linen Shade**  
Height: 23½"  
Width: 5"  
Extension: 7"  
Backplate: 3" x 7"

**Available Finishes:**  
BZ, HAB, PN  
**Shade Treatment:** L  
**Shade Details:**  
5" x 5" x 6"

**Socket:** Candelabra  
**Wattage:** 60 C



**S2020HAB-L**



**92000DBZ-L**  
**Classic Swing Arm Wall Lamp**  
**in Bronze with Linen Shade**

Height: 11"  
Extension: 25"  
Backplate: 4½" Square  
Cord Cover Included

**Available Finishes:**

AN, BLK, BZ, CH,  
HAB, PB, WHT

**Shade Treatment:** L, PL, NP

**Shade Details:** 6" x 12" x 7"

**Socket:** Dimmer

**Wattage:** 75 A



**82034HAB**  
**Swing-Arm Wall Lamp in**  
**Hand-Rubbed Antique Brass**

Height: 4½"  
Extension: 24"  
Backplate: 4½" Square  
Cord Cover Included

**Available Finishes:**

AN, BLK, BZ, CH,  
HAB, PB, WHT

**Shade Details:** 3¼" x 5½" x 2"

**Socket:** Dimmer

**Wattage:** 60 T



**92025BZ**  
**Swing-Arm Wall Lamp in**  
**Bronze**

Height: 4½"  
Extension: 25"  
Backplate: 4½" Square  
Cord Cover Included

**Available Finishes:**

AN, BLK, BZ, CH,  
HAB, PB, WHT

**Shade Details:** 3½" x 6" x 2"

**Socket:** Dimmer

**Wattage:** 60 T



**SL2701HAB**  
**Frame Makers 8" Picture Light in**  
**Hand-Rubbed Antique Brass**

Height: 1½"  
Width: 8"  
Extension: 8"  
Frame Mounted

**Available Finishes:**  
AN, BZ, HAB, PN

**Socket:** Keyless/  
Hi-Lo Line Switch  
**Wattage:** 25 T



**SL3971HAB**  
**Frame Makers Cabinet Light in**  
**Hand-Rubbed Antique Brass**

Height: 3½"  
Width: 8"  
Extension: 9½"  
Backplate: 3" Round  
Cabinet Mounted

**Available Finishes:**  
AN, BZ, HAB, PN

**Socket:** Keyless /  
Hi-Lo Line Switch  
**Wattage:** 25 T



**SL2702AN**  
**Frame Makers 18" Picture Light**  
**in Antique Nickel**

Height: 1½"  
Width: 18"  
Extension: 8"  
Frame Mounted

**Available Finishes:**  
AN, BZ, HAB, PN

**Socket:** 2-Keyless/  
Hi-Lo Line Switch  
**Wattage:** 2- 25 T

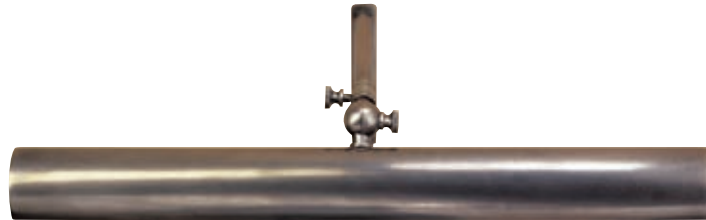

**SL2703HAB**  
**Frame Makers 24" Picture Light in**  
**Hand-Rubbed Antique Brass**

Height: 1½"  
Width: 24"  
Extension: 8"  
Frame Mounted

**Available Finishes:**  
AN, BZ, HAB, PN

**Socket:** 2-Keyless/  
Hi-Lo Line Switch  
**Wattage:** 2-25 T



**SL2975HAB-AN**

**Yoke-Style Sconce in  
Hand-Rubbed Antiqued Brass  
with Antique Nickel Shade**

Height: 10¼"

Width: 5"

Extension: 9½"

Backplate: 4½" Round

**Available Finishes:**

AN, BZ, CH, HAB, PN, SN

**Shade Treatments:**

AN, BZ, CH, HAB, PN, WG

**Shade Details:** 2¼" x 4¾" x 5"

**Socket:** Keyless

**Wattage:** 60 A

©EFC DESIGNS



**SL2975BZ-HAB**



**SL2975HAB-WG**

**Yoke-Style Sconce in  
Hand-Rubbed Antique Brass  
with White Glass Shade**

Height: 10¼"

Width: 5"

Extension: 9½"

Backplate: 4½" Round

**Available Finishes:**

AN, BZ, CH, HAB, PN, SN

**Shade Treatments:**

AN, BZ, CH, HAB, PN, WG

**Shade Details:** 2¼" x 4¾" x 5"

**Socket:** Keyless

**Wattage:** 60 A

©EFC DESIGNS



**SL2975AN-WG**



**SL2711BZ**  
**Haberdasher One-Light Sconce**  
**in Bronze**

Height: 11"  
Width: 2¾"  
Extension: 6"  
Backplate: 2¾" x 4½"

**Available Finishes:**  
AN, BZ, HAB, PN  
**Shade Treatment:** CHS-104L  
Shade Sold Separately  
**Shade Details:** 3" x 4" x 4"

**Socket:** Candelabra  
**Wattage:** 60 C  
©EFC DESIGNS



**SL2712PN**  
**Haberdasher Two-Light Sconce**  
**in Polished Nickel**

Height: 11"  
Width: 8"  
Extension: 6"  
Backplate: 2¾" x 4½"

**Available Finishes:**  
AN, BZ, HAB, PN  
**Socket:** 2-Candelabra  
**Wattage:** 2-60 C  
©EFC DESIGNS



**SL2811AN**  
**Haberdasher Round One Light Sconce**  
**in Antique-Burnished Nickel**

Height: 11"  
Width: 5"  
Extension: 6"  
Backplate: 5" Round

**Available Finishes:**  
AN, BZ, HAB, PN  
**Shade Treatment:** CHS-104L  
Shade Sold Separately  
**Shade Details:** 3" x 4" x 4"

**Socket:** Candelabra  
**Wattage:** 60 C  
©EFC DESIGNS



**SL2812BZ**  
**Haberdasher Round Two-Light**  
**Sconce in Bronze**

Height: 11"  
Width: 8"  
Extension: 6"  
Backplate: 5" Round

**Available Finishes:**  
AN, BZ, HAB, PN  
**Socket:** 2-Candelabra  
**Wattage:** 2-60 C  
©EFC DESIGNS



**SL2865HAB**  
**RA Single Wall Light Sconce**  
**in Hand-Rubbed Antique Brass**

Height: 18"  
Width: 4"  
Extension: 7"  
Backplate: 4" x 6"

**Available Finishes:**  
AN, BZ, HAB, PN  
**Shade Treatment:**  
CHS-104NP  
Shade Sold Separately  
**Shade Details:** 3" x 4" x 4"

**Socket:** Candelabra  
**Wattage:** 60 C



**SL2866AN**  
**RA Double Wall Light Sconce**  
**in Antique Nickel**

Height: 18"  
Width: 10"  
Extension: 7"  
Backplate: 4" x 6"

**Available Finishes:**  
AN, BZ, HAB, PN  
**Shade Treatment:**  
CHS-104NP  
Shade Sold Separately  
**Shade Details:** 3" x 4" x 4"

**Socket:** 2 – Candelabra  
**Wattage:** 2 – 60 C



**SL2860PN**  
**TT Single Wall Light Sconce in**  
**Polished Nickel**

Height: 18"  
Width: 4"  
Extension: 7"  
Backplate: 4" x 6"

**Available Finishes:**  
AN, BZ, HAB, PN  
**Shade Treatment:** CHS-104NP  
Shade Sold Separately  
**Shade Details:** 3" x 4" x 4"

**Socket:** Candelabra  
**Wattage:** 60 C



**SL2861BZ**  
**TT Double Wall Light Sconce**  
**in Bronze**

Height: 18"  
Width: 10"  
Extension: 7"  
Backplate: 4" x 6"

**Available Finishes:**  
AN, BZ, HAB, PN  
**Shade Treatment:** CHS-104NP  
Shade Sold Separately  
**Shade Details:** 3" x 4" x 4"  
Natural Paper

**Socket:** 2 – Candelabra  
**Wattage:** 2 – 60 C





**SL2845PN-NP**  
**Wilton Single Sconce in Polished Nickel with Natural Paper Shade**  
 Height: 13¾"  
 Width: 5"  
 Extension: 8"  
 Backplate: 5" Round

**Available Finishes:**  
 AN, BZ, CH, HAB, PN  
**Shade Treatment:** NP  
**Shade Details:**  
 4¼" x 4½" x 5½"

**Socket:** Candelabra  
**Wattage:** 60 C  
 ©EFC DESIGNS



**SL2845BZ-NP**



**SL2846HAB-NP**  
**Wilton Double Double Sconce in Hand-Rubbed Antique Brass with Natural Paper Shades**  
 Height: 13¾"  
 Width: 12½"  
 Extension: 8"  
 Backplate: 5" Round

**Available Finishes:**  
 AN, BZ, CH, HAB, PN  
**Shade Treatment:** NP  
**Shade Details:**  
 4¼" x 4½" x 5½"

**Socket:** 2 - Candelabra  
**Wattage:** 2 - 60 C  
 ©EFC DESIGNS



**PT2000HAB-S**  
**Architect's Swing Arm in Hand-Rubbed Antique Brass with Silk Shade**  
 Height: 13"  
 Width: 8"  
 Extension: 21½"  
 Backplate: 3" x 4½"  
 Cord Cover Included

**Available Finishes:**  
 BC, BZ, HAB  
**Shade Treatment:** S  
**Shade Details:** 8" x 8" x 8"

**Socket:** Dimmer  
**Wattage:** 100 A



**PT2001BC-S**  
**Architect's Wall Sconce in Brushed Chrome with Silk Shade**  
 Height: 12"  
 Width: 4½"  
 Extension: 5½"  
 Backplate: 3" x 4½"

**Available Finishes:**  
 BC, BZ, HAB  
**Shade Treatment:** S  
**Shade Details:** 4½" x 4½" x 6¼"

**Socket:** Nurdy Keyless  
**Wattage:** 60 A



**S20BS-NPS**

**Architectural Wall Sconce in  
Brushed Steel with  
Natural Paper Shade**

Height: 13½"  
Extension: 7"  
Backplate: 4½" Square

**Available Finishes:** BS, HAB  
**Shade Treatments:** NP, NPS  
**Shade Details:**  
4" x 7" x 6½" Square

**Socket:** Candelabra  
**Wattage:** 60 C



**SS2031PN-NP**

**Box Sconce in Polished Nickel  
with Natural Paper Shade**

Height: 11"  
Width: 7½"  
Extension: 7¼"  
Backplate: 4½" x 11"  
Cord Cover Included

**Available Finishes:**  
BZ, HAB, PN  
**Shade Treatment:** NP  
**Shade Details:**  
5" x 7½" x 6½"

**Socket:** Keyless/  
Hi-Lo Line Switch  
**Wattage:** 60 A



**SL2820BZ-NP**

**Two-Light Square Tube Sconce in  
Bronze with Natural Paper Shades**

Height: 14"  
Width: 15"  
Extension: 7¼"  
Backplate: 4" x 4½"

**Available Finishes:**  
AN, BZ, HAB, PN  
**Shade Treatment:** NP  
**Shade Details:** 4½" x 6¼" x 6¼"

**Socket:** 2-Candelabra  
**Wattage:** 2-60 C  
©EFC DESIGNS



**SS2030BZ-FG**

**Mission Bracket Sconce in Bronze with Frosted Glass**

Height: 14"  
Width: 6½"  
Extension: 5½"  
Backplate: 4¾" x 6¾"

**Available Finishes:**

BZ, HAB, PN

**Shade Details:** 4" x 4" x 6½"

**Socket:** Keyless

**Wattage:** 60 A



**S2030BR-NP**

**Aspen Iron Wall Lamp in Black Rust with Natural Paper Shade**

Height: 15½"  
Width: 7½"  
Extension: 9½"  
Backplate: 4¾" x 12¾"

**Shade Treatment:** NP

**Shade Details:** 7½" x 7½" x 6"

**Socket:** Candelabra

**Wattage:** 60 C

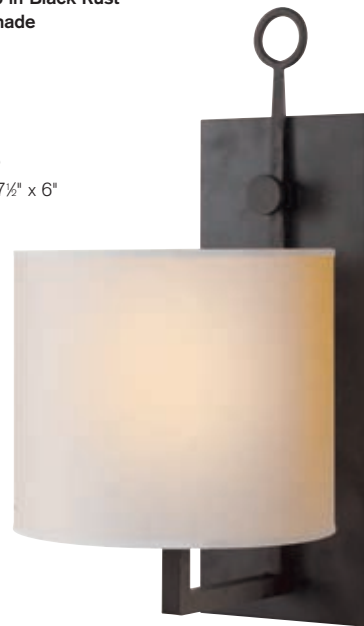

**S2050BR-NP**

**Aspen Sconce in Black Rust with Natural Paper Shade**

Height: 18½"  
Width: 9"  
Extension: 4½"  
Backplate: 5" Round

**Shade Treatment:** NP

**Shade Details:** 4" x 9" x 5¾"

**Socket:** Candelabra

**Wattage:** 60 C



**SL2151BZ-WG**

**New York Subway One-Light Sconce  
in Bronze with White Glass Shade**

Height: 9 3/4"  
Width: 5"  
Extension: 8"  
Backplate: 4 1/2" Square

**Available Finishes**

AN, BZ, CH, HAB, PN

**Shade Treatment:** WG

**Shade Details:** 3" x 5" x 5"

**Socket:** Keyless

**Wattage:** 60 A

©EFC DESIGNS



**SL2151CH-WG**



**SL2152HAB-WG**

**New York Subway Two-Light Sconce  
in Hand-Rubbed Antique Brass  
with White Glass Shades**

Height: 9 3/4"  
Width: 14"  
Extension: 8"  
Backplate: 4 1/2" Square

**Available Finishes:**

AN, BZ, CH, HAB, PN

**Shade Treatment:** WG

**Shade Details:** 3" x 5" x 5"

**Socket:** 2-Keyless

**Wattage:** 2-60 A

©EFC DESIGNS



**SL2153BZ-WG**

**New York Subway Three-Light Sconce  
in Bronze with White Glass Shades**

Height: 9 3/4"  
Width: 22 3/4"  
Extension: 8"  
Backplate: 4 1/2" Square

**Available Finishes:**

AN, BZ, CH, HAB, PN

**Shade Treatment:** WG

**Shade Details:** 3" x 5" x 5"

**Socket:** 3-Keyless

**Wattage:** 3-60 A

©EFC DESIGNS



**SS2001PN-WG**  
**Siena One-Light Sconce**  
**in Polished Nickel**  
**with White Glass Shade**

Height: 8¼"  
Width: 4¾"  
Extension: 6½"  
Backplate: 4¾" Square

**Available Finishes:** BZ, HAB, PN  
**Shade Treatment:** WG  
**Shade Details:** 4¾" x 2½" x 5½"

**Socket:** Keyless  
**Wattage:** 60 A  
©EFC DESIGNS



**SS2001HAB-WG**



**SS2002HAB-WG**  
**Siena Two-Light Sconce**  
**in Hand-Rubbed Antique Brass**  
**with White Glass Shades**

Height: 8½"  
Width: 15"  
Extension: 6"  
Backplate: 4¾" Square

**Available Finishes:** BZ, HAB, PN  
**Shade Treatment:** WG  
**Shade Details:** 4¾" x 2½" x 5½"

**Socket:** 2-Keyless  
**Wattage:** 2-60 A  
©EFC DESIGNS



**SS2003PN-WG**  
**Siena Three-Light Sconce**  
**in Polished Nickel**  
**with White Glass Shade**

Height: 8¼"  
Width: 23"  
Extension: 10¼"  
Backplate: 4¾" Square

**Available Finishes:** BZ, HAB, PN  
**Shade Treatment:** WG  
**Shade Details:** 4¾" x 2½" x 5½"

**Socket:** 3-Keyless  
**Wattage:** 3-60 A  
©EFC DESIGNS



**SL2941HAB-FG**

**Boston Square One-Light Sconce in Hand-Rubbed Antique Brass with Frosted Glass Shade**

Height: 11"  
Width: 5"  
Extension: 8½"  
Backplate: 4½" x 5"

**Available Finishes:**  
AN, BZ, CH, HAB, PN  
**Shade Treatment:** FG  
**Shade Details:**  
2¼" x 4¼" x 5¼"

**Socket:** Hi-Lo  
**Wattage:** 60 A  
©EFC DESIGNS



**SL2944CH-FG**

**Boston Square Up and Down Sconce in Chrome with Frosted Glass Shades**

Height: 16½"  
Width: 5"  
Extension: 8½"  
Backplate: 4½" x 5"

**Available Finishes:**  
AN, BZ, CH, HAB, PN  
**Shade Treatment:** FG  
**Shade Details:**  
2¼" x 4¼" x 5¼"

**Socket:** 2-Hi-Lo  
**Wattage:** 2-60 A  
©EFC DESIGNS



**SL2942BZ-FG**

**Boston Square Two-Light Sconce in Bronze with Frosted Glass Shades**

Height: 11"  
Width: 14"  
Extension: 8½"  
Backplate: 4½" x 5"

**Available Finishes:**  
AN, BZ, CH, HAB, PN  
**Shade Treatment:** FG  
**Shade Details:** 2¼" x 4¼" x 5¼"

**Socket:** 2-Hi-Lo  
**Wattage:** 2-60 A  
©EFC DESIGNS



**SL2943HAB-FG**

**Boston Square Three-Light Sconce in Hand-Rubbed Antique Brass with Frosted Glass Shades**

Height: 11"  
Width: 22"  
Extension: 8½"  
Backplate: 4½" x 5"

**Available Finishes:**  
AN, BZ, CH, HAB, PN  
**Shade Treatment:** FG  
**Shade Details:** 2¼" x 4¼" x 5¼"

**Socket:** 3-Hi-Lo  
**Wattage:** 3-60 A



**SL2841BZ-WG**  
**Wilton Single Bath Light**  
**in Bronze with**  
**White Glass Shade**

Height: 10"  
Width: 5"  
Extension: 8½"  
Backplate: 5" Round

**Available Finishes:**  
AN, BZ, CH, HAB, PN  
**Shade Treatment:** WG  
**Shade Details:** 1¾" x 5" x 5½"

**Socket:** Keyless  
**Wattage:** 60 A  
©EFC DESIGNS



**SL2841CH-WG**



**SL2842HAB-WG**  
**Wilton Double Bath Light in**  
**Hand-Rubbed Antique Brass**  
**with White Glass Shades**

Height: 10"  
Width: 13"  
Extension: 8½"  
Backplate: 5" Round

**Available Finishes:**  
AN, BZ, CH, HAB, PN  
**Shade Treatment:** WG  
**Shade Details:** 1¾" x 5" x 5½"

**Socket:** 2-Keyless  
**Wattage:** 2-60 A  
©EFC DESIGNS



**SL2843PN-WG**  
**Wilton Triple Bath Light**  
**in Polished Nickel**  
**with White Glass Shades**

Height: 10"  
Width: 21"  
Extension: 8½"  
Backplate: 5" Round

**Available Finishes:**  
AN, BZ, CH, HAB, PN  
**Shade Treatment:** WG  
**Shade Details:** 1¾" x 5" x 5½"

**Socket:** 3-Keyless  
**Wattage:** 3-60 A  
©EFC DESIGNS



**SL2931SN/SLEG-WG**

**Boston Functional Single Sconce  
in Sheffield Nickel  
with White Glass SLEG Shade**

Height: 9"  
Width: 5 3/4"  
Extension: 9 1/2"  
Backplate: 4 1/2" Round

**Available Finishes:**

AN, BZ, CH, HAB, PN, SN

**Shade Treatment:** SLEG-WG

See Shade Schedule for  
Additional Shade Options

**Shade Details:** 2 1/4" x 5 3/4" x 4 1/2"

**Socket:** Hi-Lo

**Wattage:** 60 A

©EFC DESIGNS



**SL2931BZ/SLEG-WG**



**SL2932CH/SLEG-WG**

**Boston Functional Double Sconce  
in Chrome with White Glass SLEG Shade**

Height: 9"  
Width: 14 1/2"  
Extension: 9 1/2"  
Backplate: 4 1/2" Round

**Available Finishes:**

AN, BZ, CH, HAB, PN, SN

**Shade Treatment:** SLEG-WG

See Shade Schedule for Additional Shade Options

**Shade Details:** 2 1/4" x 5 3/4" x 4 1/2"

**Socket:** 2-Hi-Lo

**Wattage:** 2-60 A

©EFC DESIGNS



**SL2933HAB/SLEG-WG**

**Boston Functional Triple Sconce  
in Hand-Rubbed Antique Brass  
with White Glass SLEG Shade**

Height: 9"  
Width: 23"  
Extension: 9 1/2"  
Backplate: 4 1/2" Round

**Available Finishes:**

AN, BZ, CH, HAB, PN, SN

**Shade Treatment:** SLEG-WG

See Shade Schedule for Additional  
Shade Options

**Shade Details:** 2 1/4" x 5 3/4" x 4 1/2"

**Socket:** 3-Hi-Lo

**Wattage:** 3-60 A

©EFC DESIGNS





**SL2935HAB-WG**  
**Boston Diffuser Wall Sconce in**  
**Hand-Rubbed Antique Brass**

Height: 11½"  
Width: 6"  
Extension: 6¼"  
Backplate: 4¾" Round

**Available Finishes:**  
AN, BZ, CH, HAB, PN  
**Shade Treatment:** WG  
**Shade Details:** 6" Round

**Socket:** Hi-Lo  
**Wattage:** 60 A  
©EFC DESIGNS



**SL2934HAB-WG**  
**Boston Loop Arm Wall Sconce**  
**in Hand-Rubbed Antique Brass**  
**with White Glass Shade**

Height: 12½"  
Width: 4¾"  
Extension: 7½"  
Backplate: 4¾" Round

**Available Finishes:**  
AN, BZ, CH, HAB, PN  
**Shade Treatment:** WG

**Socket:** Hi-Lo  
**Wattage:** 60 A  
©EFC DESIGNS



**SL2000BZ-WG**  
**Marine Wall Light in**  
**Bronze and White Glass**

Height: 10½"  
Width: 4½"  
Extension: 7¾"  
Backplate: 4¾" x 6½"

**Available Finishes:**  
AN, BZ, CH, HAB, PN  
**Shade Treatment:** WG  
**Shade Details:**  
3½" x 6½"

**Socket:** Keyless  
**Wattage:** 60 A  
©EFC DESIGNS



**SL2000CH-WG**



**SLO2001BZ-SG**  
**Indoor/Outdoor Marine Wall Light**  
**in Bronze and Seeded Glass**

Height: 10½"  
Width: 8½"  
Extension: 10"  
Backplate: 4¾" x 6½"

**Available Finishes:**  
BZ, CH, HAB  
**Shade Treatments:** CG, SG  
**Shade Details:**  
3½" x 6½"

**Socket:** Keyless  
**Wattage:** 60 A  
©EFC DESIGNS



**SL2111BZ-FG**  
**Edwardian Articulating Wall Light in**  
**Bronze with Frosted Glass Shade**

Height: 7¾"-10¼"  
Width: 4"  
Extension: 5½"-10½"  
Backplate: 2½" x 4¾"

**Available Finishes:** BZ, CH, HAB  
**Shade Treatment:** FG  
**Shade Details:** 3" x 4" x 5¼"

**Socket:** Keyless  
**Wattage:** 60 A  
©EFC DESIGNS



**SL2111CH-FG**



**SS2014PN-FG**

**Openwork Over-the-Mirror  
Bath Fixture in Polished Nickel  
with Frosted Glass Shade**

Height: 4 $\frac{3}{4}$ "  
Width: 24"  
Extension: 5"  
Backplate: 4 $\frac{3}{4}$ " Square

**Available Finishes:**  
AN, BZ, CH, HAB, PN  
**Shade Treatment:** FG

**Socket:** 2-Keyless  
**Wattage:** 2-60 A



**SS2011BZ-FG**

**Openwork Single Wall Sconce  
in Bronze with  
Frosted Glass Shade**

Height: 9"  
Width: 4 $\frac{3}{4}$ "  
Extension: 5"  
Backplate: 4 $\frac{3}{4}$ " Square

**Available Finishes:**  
AN, BZ, CH, HAB, PN  
**Shade Treatment:** FG

**Socket:** Keyless  
**Wattage:** 60 A



**SS2012PN-FG**

**Openwork Double Wall Sconce  
in Polished Nickel  
with Frosted Glass Shades**

Height: 9"  
Width: 8 $\frac{3}{4}$ "  
Extension: 5"  
Backplate: 4 $\frac{3}{4}$ " Square

**Available Finishes:**  
AN, BZ, CH, HAB, PN  
**Shade Treatment:** FG

**Socket:** 2-Keyless  
**Wattage:** 2-60 A



**SS2015BZ-WG**

**Faceted Glass Sconce  
in Bronze with  
White Glass Shade**

Height: 9 $\frac{1}{2}$ "  
Width: 4 $\frac{3}{4}$ "  
Extension: 6"  
Backplate: 4 $\frac{3}{4}$ " Square

**Available Finishes:**  
AN, BZ, CH, HAB, PN  
**Shade Treatment:** WG  
**Shade Details:** 3 $\frac{3}{8}$ " x 6"

**Socket:** Keyless  
**Wattage:** 60 A



**SS2015CH-WG**



**S2003BZ-WG**  
**Square Glass Shield Sconce**  
**in Bronze with White Glass**  
**Diffuser** Height: 13"  
 Width: 7"  
 Extension: 4 1/4"  
 Backplate: 5 1/2" Round

**Available Finishes:**  
 BZ, HAB, PN  
**Shade Details:** 4 1/4" x 8"  
 Flat Glass Panel (No Sides)

**Socket:** Candelabra  
**Wattage:** 60 C



**S2003PN-WG**



**S2006PN-WG**  
**One-Light Cylinder Sconce**  
**in Polished Nickel**  
**with White Glass Shade**  
 Height: 13"  
 Width: 5 1/2"  
 Extension: 5 1/2"  
 Backplate: 5 1/2" Round

**Available Finishes:**  
 BZ, HAB, PN  
**Shade Details:** 4 1/4" x 8" Cylinder

**Socket:** Keyless  
**Wattage:** 60 A



**S2007BZ-WG**  
**Two-Light Cylinder Sconce**  
**in Bronze with**  
**White Glass Shades**  
 Height: 12"  
 Width: 14 1/2"  
 Extension: 6 3/4"  
 Backplate: 5 1/2" Round

**Available Finishes:**  
 BZ, HAB, PN  
**Shade Details:**  
 8" x 4 1/4" Cylinder

**Socket:** 2-Keyless  
**Wattage:** 2-60 A



**S2001PN-WG**  
**One-Light Deco Sconce**  
**in Polished Nickel**  
**with White Glass Shade**  
 Height: 9 1/2"  
 Width: 6 1/4"  
 Extension: 7 1/2"  
 Backplate: 4 3/4" x 6 1/2" Oval

**Available Finishes:**  
 BZ, HAB, PN  
**Shade Details:** 6 1/4" Oval

**Socket:** Keyless  
**Wattage:** 60 A



**S2002BZ-WG**  
**Two-Light Deco Sconce**  
**in Bronze with**  
**White Glass Shades**  
 Height: 9 1/2"  
 Width: 15 1/2"  
 Extension: 7 1/2"  
 Backplate: 6 1/2" x 4 3/4" Oval

**Available Finishes:**  
 BZ, HAB, PN  
**Shade Details:** 6 1/4" Oval

**Socket:** 2-Keyless  
**Wattage:** 2-60 A



**TOB2010PS-NP**

**Longacre Sconce in Polished Silver with Natural Paper Shade**

Height: 14"  
Width: 6"  
Extension: 7"  
Backplate: 5" Round

**Available Finishes:**

BZ, HAB, PN, PS

**Shade Treatment:** NP

**Shade Details:** 4" x 6" x 6"

**Socket:** Hi-Lo

**Wattage:** 60 A



**TOB2011HAB-NP**

**Metropolitan Sconce in Hand-Rubbed Antique Brass with Natural Paper Shade**

Height: 11"  
Width: 5"  
Extension: 6 1/4"  
Backplate: 4 1/2" Round

**Available Finishes:**

AW, BZ, CH, HAB, PN

**Shade Treatments:**

NP, NP/BT, NP/ST

**Shade Details:**

5" x 5" x 5 1/2"

**Socket:** Keyless

**Wattage:** 60 A



**TOB2011BZ-NP/BT**



**TOB2011CH-WG**

**Metropolitan Sconce in Chrome with White Glass Shade**

Height: 11"  
Width: 5"  
Extension: 6 1/4"  
Backplate: 4 1/2" Round

**Available Finishes:**

AW, BZ, CH, HAB, PN

**Shade Details:** 2 7/8" x 6"

**Socket:** Keyless

**Wattage:** 60 A



**TOB2011HAB-WG**



**TOB2012AN-C/RT**

**Nina Sconce in Antique Nickel with Cotton Shade**

Height: 14"  
Width: 5 1/2"  
Extension: 8"  
Backplate: 4" x 8"

**Available Finishes:**

AN, BZ, HAB, PS, R

**Shade Treatments:**

C, C/BT, C/RT

**Shade Details:**

3 1/2" x 5 1/2" x 7"

**Socket:** Keyless

**Wattage:** 60 A



**TOB2012BZ-C/BT**



**TOB2067AN/PN-NP**  
**Elkins Sconce in Antique Nickel and Polished Nickel with Natural Paper Shade**  
 Height: 12¾"  
 Width: 5½"  
 Extension: 7"  
 Backplate: 5½" Round

**Available Finishes:**  
 AN/PN, BZ/HAB, HAB/CHC, PS  
**Shade Treatments:**  
 FS, NP, NP/BT  
**Shade Details:** 3½" x 4" x 6"

**Socket:** Candelabra  
**Wattage:** 40 C



**TOB2068BZ/HAB-NP/BT**  
**Elkins Double Sconce in Bronze and Hand-Rubbed Antique Brass with Natural Paper Shades**  
 Height: 13¾"  
 Width: 9½"  
 Extension: 8¾"  
 Backplate: 5½" Round

**Available Finishes:**  
 AN/PN, BZ/HAB, HAB/CHC, PS  
**Shade Treatments:**  
 FS, NP, NP/BT  
**Shade Details:**  
 3½" x 4" x 6"

**Socket:**  
 2 – Candelabra  
**Wattage:** 2 – 40 C



**TOB2035BZ/HAB**  
**Selecta Sconce in Bronze with Hand-Rubbed Antique Brass Accents with Bronze Shade**  
 Height: 15½"  
 Width: 4½"  
 Extension: 9"  
 Backplate: 4½" x 9½" Oval

**Available Finishes:**  
 BLK/HAB, BZ/HAB, HAB, PN, PN/AW

**Socket:** Candelabra  
**Wattage:** 60 C



**TOB2035HAB**



**TOB2064PS-NP**  
**Selecta Sconce in Polished Silver with Natural Paper Shade**  
 Height: 16"  
 Width: 5"  
 Extension: 8¾"  
 Backplate: 4¾" x 9¾" Oval

**Available Finishes:**  
 AN, BZ/HAB, HAB, PN, PS  
**Shade Treatments:**  
 NP, NP/BT, NP/RT  
**Shade Details:** 3½" x 5" x 8"

**Socket:** Candelabra  
**Wattage:** 60 C



**TOB2013CH-WG**

**Jamie Sconce in Chrome  
on Chocolate Wood Mount  
with White Glass Shade**

Height: 13"  
Width: 5"  
Extension: 12 1/2"  
Backplate: 5 3/4" Round

**Available Finishes:**

AS, BZ, CH, HAB

**Shade Treatment:** WG

**Shade Details:** 2" x 5" x 7"

**Socket:** Pull Chain

**Wattage:** 60 A



**TOB2013HAB-WG**



**TOB2002BZ-NP/BT**

**Bryant Sconce in Bronze with  
Natural Paper Shade**

Height: 14 1/4"  
Width: 5 1/2"  
Extension: 8 3/4"  
Backplate: 4 1/8" Round

**Available Finishes:**

AN, BZ, HAB, PN, PS

**Shade Treatment:**

NP, NP/BT, NP/ST

**Shade Size:**

4" x 5 1/2" x 6"

**Socket:** Keyless

**Wattage:** 60 A



**TOB2002PN-NP/ST**



**TOB2081AN/PN-NP**  
**Alton Pivoting Sconce in**  
**Antique Nickel and Polished Nickel**  
**with Natural Paper Shade**  
 Height: 16½"  
 Width: 5"  
 Extension: 8"  
 Backplate: 4½" x 5½" Oval

**Available Finishes:**  
 AN/PN, BZ, BZ/HAB, HAB, PN  
**Shade Treatments:**  
 NP, NP/BT, NP/RT  
**Shade Details:**  
 4" x 6" x 6½"

**Socket:** Hi – Lo  
**Wattage:** 60 A



**TOB2081HAB-NP**



**TOB2081PN-NP**



**TOB2046PS-NP**  
**Farlane Double Sconce**  
**in Polished Silver**  
**with Natural Paper Shades**  
 Height: 12"  
 Width: 12½"  
 Extension: 8"  
 Backplate: 3½" x 8½"

**Available Finishes:**  
 AN, BZ, BZ/HAB, HAB, PS  
**Shade Treatments:**  
 NP, NP/BT, NP/RT  
**Shade Details:** 3" x 5" x 7"

**Socket:** 2-Candelabra  
**Wattage:** 2-40 C



**TOB2045HAB-NP**  
**Farlane Sconce in**  
**Hand-Rubbed Antique Brass**  
**with Natural Paper Shade**  
 Height: 12"  
 Width: 5"  
 Extension: 8"  
 Backplate: 3½" x 8½"

**Available Finishes:**  
 AN, BZ, BZ/HAB, HAB, PS  
**Shade Treatments:**  
 NP, NP/BT, NP/RT  
**Shade Details:** 3" x 5" x 7"

**Socket:** Candelabra  
**Wattage:** 40 C



**TOB2017BZ-NP**

**Ziyi Sconce in Bronze with Natural Paper Shade**

Height: 13 3/4"  
Width: 4 1/4"  
Extension: 5 1/2"  
Backplate: 4 1/4" Round

**Available Finishes:**  
BZ, HAB, PN, PS  
**Shade Treatment:** NP  
**Shade Details:**  
3" x 3 1/2" x 7 1/4"

**Socket:** Candelabra  
**Wattage:** 25 C



**TOB2017PS-NP**



**TOB2017HAB-NP**



**TOB2018HAB-NP**

**Ziyi Pivoting Sconce in Hand-Rubbed Antique Brass with Natural Paper Shade**

Height: 22"  
Width: 4 1/4"  
Extension: 7 1/2"  
Backplate: 4 1/4" Round

**Available Finishes:**  
BZ, HAB, PN, PS  
**Shade Treatment:** NP  
**Shade Details:** 3 1/2" x 4" x 7 1/4"

**Socket:** Candelabra  
**Wattage:** 40 C



**TOB2018BZ-NP**



**TOB2029PS-NP**

**Ziyi Five-Light Sconce in Polished Silver with Natural Paper Shades**

Height: 20 3/4"  
Width: 17"  
Extension: 12"  
Backplate: 4" Round

**Available Finishes:**  
BZ, HAB, PN, PS  
**Shade Treatment:** NP  
**Shade Details:**  
3 1/2" x 4" x 7 1/4"

**Socket:** 5-Candelabra  
**Wattage:** 5-40 C



**TOB2027BZ-NP**

**Ziyi Two-Light Sconce in Bronze with Natural Paper Shades**

Height: 19"  
Width: 10 1/2"  
Extension: 8"  
Backplate: 4" Round

**Available Finishes:**  
BZ, HAB, PN, PS  
**Shade Treatments:** NP  
**Shade Details:**  
3 1/2" x 4" x 7 1/4"

**Socket:** 2-Candelabra  
**Wattage:** 2-40 C





**TOB2300PN**  
**Eclipse Wall Light**  
**in Polished Nickel**  
Height: 21"  
Width: 4"  
Extension: 8½"  
Backplate: 4" x 21"

**Available Finishes:**  
AN, BZ, HAB, PN

**Socket:** Keyless  
**Wattage:** 60 T



**TOB2301BZ**  
**Tall Eclipse Wall Light**  
**in Bronze**  
Height: 32½"  
Width: 4"  
Extension: 8½"  
Backplate: 4" x 32½"

**Available Finishes:**  
AN, BZ, HAB, PN

**Socket:** 3 – Keyless  
**Wattage:** 3 – 25 T



**TOB2000PN**  
**Academy Map Light in**  
**Polished Nickel**  
Height: 4"  
Width: 9"  
Extension: 12¾"-16½"  
Backplate: 4" Square  
With Cord and Plug

**Available Finishes:**  
BZ, HAB, PN  
**Shade Details:** 2" x 5¾"

**Socket:** Keyless/Line Switch  
**Wattage:** 40 T



**TOB2000BZ**

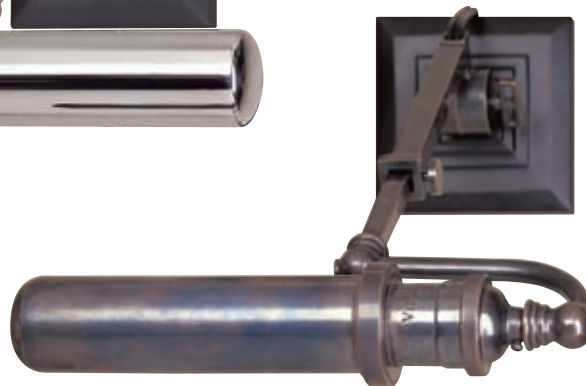

**TOB2007HAB-NP**  
**Vendome Single Light Sconce**  
**in Hand-Rubbed Antique Brass**  
**with Natural Paper Shade**

Height: 14"  
Width: 5½"  
Extension: 8½"  
Backplate: 5¼" Round

**Available Finishes:**

AS, BZ, HAB, PS

**Shade Treatment:**

NP, NP/BT, NP/ST

**Shade Details:** 4" x 5½" x 6"

**Socket:** Keyless

**Wattage:** 60 A



**TOB2007PS-NP/ST**



**TOB2008BZ-NP**  
**Vendome Two-Light Sconce**  
**in Bronze with**  
**Natural Paper Shades**

Height: 14"  
Width: 18"  
Extension: 9"  
Backplate: 5¼" Round

**Available Finishes:**

AS, BZ, HAB, PS

**Shade Treatment:**

NP, NP/BT, NP/ST

**Shade Details:** 4" x 5½" x 6"

**Socket:** 2-Keyless

**Wattage:** 2-60 A



**TOB2009HAB-NP**  
**Vendome Three-Light Sconce**  
**in Hand-Rubbed Antique Brass**  
**with Natural Paper Shades**

Height: 14"  
Width: 22"  
Extension: 11"  
Backplate: 5¼" Round

**Available Finishes:**

AS, BZ, HAB, PS

**Shade Treatment:**

NP, NP/BT, NP/ST

**Shade Details:** 4" x 5½" x 6"

**Socket:** 3-Keyless

**Wattage:** 3-60 A



**TOB2020PN**  
**Small David Sconce**  
**in Polished Nickel**

Height: 7"  
Width: 3¾"  
Extension: 5¾"  
Backplate: 3" x 3¾"

**Available Finishes:**  
BZ, BZ-HAB, HAB, HAB-BZ, PN

**Socket:** Keyless  
**Wattage:** 40 T



**TOB2021HAB**  
**Medium David Sconce in**  
**Hand-Rubbed Antique Brass**

Height: 12"  
Width: 3¾"  
Extension: 5¾"  
Backplate: 3¾" x 6"

**Available Finishes:**  
BZ, BZ-HAB, HAB, HAB-BZ, PN

**Socket:** Keyless  
**Wattage:** 40 T



**TOB2021HAB-BZ**



**TOB2019BZ-HAB**  
**David Pivoting Wall Sconce**  
**in Bronze with Hand-Rubbed**  
**Antique Brass Shade**

Height: 18"  
Width: 4"  
Extension: 6"  
Backplate: 4" x 6"

**Available Finishes:**  
BZ-HAB, HAB, HAB-BZ, PN

**Socket:** 2-Keyless  
**Wattage:** 2 40 T



**TOB2014BC**  
**Greenwich Sconce**  
 in Brushed Chrome  
 Height: 17½"  
 Width: 4"  
 Extension: 4¼"  
 Backplate: 3½" x 6¾"

**Available Finishes:**  
 AN, BC, BZ, HAB, PN

**Socket:** Keyless/  
 Hi-Lo Switch

**Wattage:** 60 T



**TOB2014HAB**



**TOB2016HAB/BZ**  
**Greenwich Glass Sconce**  
 in Hand-Rubbed Antique Brass  
 and Bronze  
 Height: 10½"  
 Width: 4¼"  
 Extension: 4"  
 Backplate: 3" x 8"

**Available Finishes:**  
 AN, BZ, BZ/HAB,  
 HAB, HAB/BZ, PN

**Socket:** Keyless  
**Wattage:** 60 T



**TOB2016AN**

**TOB2006CH**  
**Ted Sconce in Chrome**  
 Height: 14¾"  
 Width: 3¾"  
 Extension: 3¾"  
 Backplate: 3¾" x 14¾"

**Available Finishes:**  
 BZ, CH, HAB, PN

**Socket:** 2-Keyless  
**Wattage:** 2-40 A-15



**TOB2001BZ**  
**Bellport Sconce**  
 in Bronze  
 Height: 10"  
 Width: 4½"  
 Extension: 4"  
 Backplate: 4½" Round

**Available Finishes:** BZ, CH  
**Shade Treatment:** WG

**Socket:** Candelabra /  
 Hi-Lo Switch  
**Wattage:** 60 C



**TOB2030PN-WG**  
**Keeley Pivoting Bath Light**  
**in Polished Nickel**  
**with White Glass**

Height: 12"  
Width: 3½"  
Extension: 6½"  
Backplate: 3½" x 5½"

**Available Finishes:** BZ, CH,  
HAB, HAB/AN, PN

**Socket:** Keyless  
**Wattage:** 60 T



**TOB2030HAB/AN-WG**



**TOB2031PN-WG**  
**Tall Keeley Pivoting**  
**Bath Light in Polished Nickel**  
**with White Glass**

Height: 20¾"  
Width: 3½"  
Extension: 6½"  
Backplate: 3½" x 20¾"

**Available Finishes:**  
BZ, CH, HAB, HAB/AN, PN

**Socket:** 2-Keyless  
**Wattage:** 2-60 T



**TOB2061PN-WG**  
**Selecta Glass Bath Light in**  
**Polished Nickel with White**  
**Glass**

Height: 4¼"  
Width: 11"  
Extension: 3"  
Backplate: 4¾" x 11" Oval

**Available Finishes:**  
BZ, BZ/HAB, CH, HAB, PN

**Socket:** Keyless  
**Wattage:** 60 T



**TOB2062BZ/HAB-WG**  
**Selecta Long Glass Bath Light**  
**in Bronze with Hand-Rubbed**  
**Antique Brass Accents with**  
**White Glass**

Height: 4¾"  
Width: 21¾"  
Extension: 3¼"  
Backplate: 4¾" x 21¾" Oval

**Available Finishes:**  
BZ, BZ/HAB, CH, HAB, PN

**Socket:** 2-Keyless  
**Wattage:** 2-60 T



**TOB2003PN**  
**Mercer Box Light Sconce in Polished Nickel**

Height: 9½"  
Width: 5½"  
Extension: 4"  
Backplate: 5½" x 9½"

**Available Finishes:**  
BZ, CH, HAB, PN

**Socket:** Keyless  
**Wattage:** 60 T



**TOB2004PN**  
**Mercer Square Box Light Sconce in Polished Nickel**

Height: 12"  
Width: 12"  
Extension: 4"  
Backplate: 12" Square

**Available Finishes:**  
BZ, CH, HAB, PN

**Socket:** 2-Keyless  
**Wattage:** 2-60 T



**TOB2103PN**  
**Mercer Medium Box Light Sconce in Polished Nickel**

Height: 15"  
Width: 5½"  
Extension: 4"  
Backplate: 5½" x 15"

**Available Finishes:**  
BZ, CH, HAB, PN

**Socket:** 2-Keyless  
**Wattage:** 2-60 T



**TOB2005HAB**  
**Mercer Long Box Light Sconce in Hand-Rubbed Antique Brass**

Height: 24"  
Width: 5½"  
Extension: 4"  
Backplate: 5½" x 24"

**Available Finishes:**  
BZ, CH, HAB, PN

**Socket:** 3-Keyless  
**Wattage:** 3-60 T



**BB2010HAB-S**  
**Swing Arm Candlestick Wall Lamp in Hand-Rubbed Antique Brass with Silk Shade**  
 Height: 16"  
 Extension: 19"  
 Backplate: 5" Round  
 Cord Cover Included

**Available Finishes:**  
 AN, BZ, HAB, PB, PN  
**Shade Treatments:**  
 B, L, NP, S, T  
**Shade Details:**  
 5" x 11" x 8 1/4" B, L, NP, T or  
 8" x 11" x 8 3/8" Silk Box Pleat

**Socket:** Dimmer  
**Wattage:** 100 A



**BB2040HAB-NP**  
**Hobbs Wall Sconce in Hand-Rubbed Antique Brass with Natural Paper Shade**  
 Height: 17 1/4"  
 Width: 9"  
 Extension: 10"  
 Backplate: 6 1/2" Round

**Available Finishes:**  
 AN, BZ, HAB, PN  
**Shade Treatment:** NP  
**Shade Details:** 6 1/2" x 9" x 7"

**Socket:** Candelabra  
**Wattage:** 60 C



**BB2000HAB-S**  
**Triple Swing Arm Wall Lamp in Hand-Rubbed Antique Brass**  
 Height: 13"  
 Extension: 18 1/2"  
 Backplate: 3 1/2" x 4 1/2"  
 Cord Cover Included

**Available Finishes:**  
 AN, BZ, HAB, PB, PN  
**Shade Treatments:**  
 B, L, NP, S, T  
**Shade Details:**  
 5" x 11" x 8 1/4" B, L, NP, T or  
 8" x 11" x 8 3/8" Silk Box Pleat

**Socket:** Dimmer  
**Wattage:** 100 A



**BB2500AN-NP**  
**Primitive Swing Arm Wall Lamp in Antique Nickel with Natural Paper Shade**  
 Height: 14"  
 Extension: 18 1/4"  
 Backplate: 3 1/2" x 5"  
 Cord Cover Included

**Available Finishes:**  
 AN, HAB  
**Shade Treatments:**  
 L, NP  
**Shade Details:**  
 5" x 12" x 8 3/4"

**Socket:** Hi-Lo  
**Wattage:** 100 A



**BB2005HAB-L**  
**Single Swing-Arm Sconce**  
**in Hand-Rubbed Antique Brass**  
**with Linen Shade**

Height: 12"  
Extension: 7"  
Backplate: 3½" x 5"

**Available Finishes:**  
AN, BZ, HAB, PB, PN  
**Shade Treatments:**  
B, L, NP, T  
**Shade Details:** 3" x 6" x 5"

**Socket:** Candelabra  
**Wattage:** 60 C



**BB2007HAB-L**  
**Double Swing-Arm Sconce**  
**in Hand-Rubbed Antique Brass**  
**with Linen Shade**

Height: 12"  
Extension: 11½"  
Backplate: 3½" x 5"

**Available Finishes:**  
AN, BZ, HAB, PB, PN  
**Shade Treatments:**  
B, L, NP, T  
**Shade Details:** 3" x 6" x 5"

**Socket:** Candelabra  
**Wattage:** 60 C



**BB2001PB-T**  
**Classic Single Sconce**  
**in Polished Brass**  
**with Tissue Silk Shade**

Height: 12"  
Width: 6"  
Extension: 9¼"  
Backplate: 5" Round

**Available Finishes:**  
AN, BZ, HAB, PB, PN  
**Shade Treatments:**  
B, L, NP, T  
**Shade Details:** 3" x 6" x 5"

**Socket:** Candelabra  
**Wattage:** 60 C



**BB2002BZ-NP**  
**Classic Double Wall Sconce**  
**in Bronze with**  
**Natural Paper Shades**

Height: 12"  
Width: 15"  
Extension: 9¼"  
Backplate: 5" Round

**Available Finishes:**  
AN, BZ, HAB, PB, PN  
**Shade Treatments:**  
B, L, NP, T  
**Shade Details:**  
3" x 6" x 5"

**Socket:** 2-Candelabra  
**Wattage:** 2-60 C





**BB2210HAB-L**  
**Single French Library Sconce**  
**in Hand-Rubbed Antique Brass**  
**with Linen Shade**

Height: 12"  
Extension: 8 3/4"  
Backplate: 2 1/2" x 4 1/2"

**Available Finishes:**  
AN, BZ, HAB, PB, PN  
**Shade Treatments:**  
B, L, NP, T  
**Shade Details:** 3" x 6" x 5"

**Socket:** Candelabra  
**Wattage:** 60 C



**BB2212PN-B**  
**Double French**  
**Library Sconce in**  
**Polished Nickel**  
**with Black Shades**

Height: 12"  
Extension: 6 1/4"  
Backplate: 2 1/2" x 4 1/2"

**Available Finishes:**  
AN, BZ, HAB, PB, PN  
**Shade Treatments:**  
B, L, NP, T  
**Shade Details:**  
3" x 5" x 4"

**Socket:** 2-Candelabra  
**Wattage:** 2-60 C



**BB2110PB-B**  
**Single French Sconce**  
**in Polished Brass**  
**with Black Shade**

Height: 12"  
Width: 6"  
Extension: 8 3/4"  
Backplate: 4 1/2" Round

**Available Finishes:**  
AN, BZ, HAB, PB, PN,  
**Shade Treatments:**  
B, L, NP, T  
**Shade Details:** 3" x 6" x 5"

**Socket:** Candelabra  
**Wattage:** 60 C



**BB2112PB-B**  
**Double French Sconce**  
**in Polished Brass**  
**with Black Shades**

Height: 12"  
Width: 12 1/2"  
Extension: 8 3/4"  
Backplate: 4 1/2" Round

**Available Finishes:**  
AN, BZ, HAB, PB, PN,  
**Shade Treatments:**  
B, L, NP, T  
**Shade Details:**  
3" x 6" x 5"

**Socket:** 2-Candelabra  
**Wattage:** 2-60 C



**BB2650HAB-HAB**  
**Swivel Head Wall Lamp in**  
**Hand-Rubbed Antique Brass**

Height: 14"  
Width: 8"  
Extension: 9½"  
Backplate: 4" Square  
Cord Cover Included

**Available Finishes:**  
AN, BZ, HAB, PN  
**Shade Details:** 4" x 8" x 5"

**Socket:** Hi-Lo  
**Wattage:** 60 A



**BB2650AN-AN**



**BB2602HAB**  
**Adjustable Library Wall Lamp in**  
**Hand-Rubbed Antique Brass**

Extension: 16"-31"  
Backplate: 3½" x 4½"  
Cord Cover Included

**Available Finishes:** AN, BZ, HAB  
**Shade Details:** 5¼" x 5¼"

**Socket:** Keyless/Hi-Lo Switch  
**Wattage:** 50 R 20



**SC2100HAB**  
**Savoy One-Light Sconce in Hand-Rubbed Antique Brass and Antique Mirror**  
Height: 12"  
Width: 5½"  
Extension: 5"  
Backplate: 5¾" x 8" Oval

**Available Finishes:** HAB, SL  
**Shade Option:**  
4" x 4" x 5" Silk Pleat

**Socket:** Candelabra  
**Wattage:** 60 C



**SC2102AS**  
**Venetian Two-Light Sconce in Antique Silver and Antique Mirror**  
Height: 15½"  
Width: 9¼"  
Extension: 6½"  
Backplate: 5¾" x 8" Oval

**Available Finishes:**  
AS, BZ, HAB

**Socket:** 2-Candelabra  
**Wattage:** 2-60 C



**SC2104HAB**  
**Double-Twist Sconce in Hand-Rubbed Antique Brass**  
Height: 15½"  
Width: 12"  
Extension: 5"  
Backplate: 4½" Diamond

**Available Finishes:**  
AS, BZ, HAB, PN

**Socket:** Candelabra  
**Wattage:** 60 C



**SC2103HAB**  
**Three-Light Double-Twist Sconce in Hand-Rubbed Antique Brass**  
Height: 14½"  
Width: 22¼"  
Extension: 5"  
Backplate: 4½" Diamond

**Available Finishes:**  
AS, BZ, HAB, PN

**Socket:** 3-Candelabra  
**Wattage:** 3-60 C



**SC2105AS**

**Two-Light Double-Twist Sconce  
in Antique Silver**

Height: 11¼"  
Width: 18¾"  
Extension: 4½"  
Backplate: 4½" Diamond

**Available Finishes:**

AS, BZ, HAB, PN

**Socket:** 2-Candelabra

**Wattage:** 2-60 C



**SC2160HAB-NP**

**Catherine Sconce in  
Hand-Rubbed Antique  
Brass with  
Natural Paper Shades**

Height: 20"  
Width: 13"  
Extension: 5"  
Backplate: 3" x 5¼"

**Available Finishes:**

AS, BZ, HAB, PN, R

**Shade Treatment:** NP

**Shade Details:**

4½" x 4½" x 5¼"

**Socket:** 2-Candelabra

**Wattage:** 2-60 C



**SC2166HAB-NP**

**Troy Four-Light Sconce  
in Hand-Rubbed Antique Brass  
with Natural Paper Shades**

Height: 24½"  
Width: 17"  
Extension: 8"  
Backplate: 5" x 12½"

**Available Finishes:**

AS, BZ, HAB, PN

**Shade Treatment:** NP

**Shade Details:**

4½" x 4½" x 5¼"

**Socket:** 4-Candelabra

**Wattage:** 4-60 C



**SC2165PN-NP**

**Troy Two-Light Sconce  
in Polished Nickel with  
Natural Paper Shades**

Height: 20"  
Width: 15"  
Extension: 5"  
Backplate: 5" x 12½"

**Available Finishes:**

AS, BZ, HAB, PN

**Shade Treatment:** NP

**Shade Details:**

4½" x 4½" x 5¼"

**Socket:** 2-Candelabra

**Wattage:** 2-60 C



**SC2126BR**  
**Hudson One-Arm Sconce**  
**in Black Rust**

Height: 13 3/4"  
Width: 4 1/2"  
Extension: 9"  
Backplate: 4 1/2" Square

**Socket:** Candelabra  
**Wattage:** 60 C



**SC2127BR**  
**Hudson Sconce**  
**in Black Rust**

Height: 13 3/4"  
Width: 19 1/4"  
Extension: 5"  
Backplate: 4 1/2" Square

**Shade Details:**  
CHS-104NP  
Shade Sold Separately

**Socket:** 2-Candelabra  
**Wattage:** 2-60 C



**SC2120BZ**  
**Sasson Wall Light in Bronze**

Height: 24 3/4"  
Width: 10 1/4"  
Extension: 6 1/2"  
Backplate: 4 1/2" Square

**Available Finishes:** BZ, PN

**Shade Details:**  
2 1/4" x 4" x 3 1/8" Hardback

**Socket:** Candelabra  
**Wattage:** 40 C



**SC2155BR**  
**Twisted Sunburst Sconce**  
**in Black Rust**

Height: 36 1/2"  
Width: 19 1/4"  
Extension: 5 1/2"  
Backplate: 6 1/4" Round

**Socket:** 2-Candelabra  
**Wattage:** 2-60 C



**SC2107BZ**

**Tyler Two-Light Sconce  
in Bronze**

Height: 12½"  
Width: 9"  
Extension: 5½"  
Backplate: 3½" x 5½"

**Available Finishes:**

AS, BZ, HAB, PN

**Shade Treatment:** CHS-104S

Shade Sold Separately

**Shade Details:** 3" x 4" x 4"

**Socket:** 2-Candelabra

**Wattage:** 2-60 C



**SC2106PN**

**Tyler Sconce in Polished Nickel**

Height: 12½"  
Width: 3½"  
Extension: 5"  
Backplate: 3½" x 5½"

**Available Finishes:**

AS, BZ, HAB, PN

**Shade Treatment:** CHS-104S

Shade Sold Separately

**Shade Details:** 3" x 4" x 4"

**Socket:** Candelabra

**Wattage:** 60 C



**SC2116AM/HAB**

**Tyler Swing-Arm Sconce in  
Antique Mirror and Hand-  
Rubbed Antique Brass**

Height: 13½"  
Width: 6"  
Extension: 20"  
Backplate: 6" x 13½"

**Available Finishes:**

AM/AN, AM/HAB, AM/PN

**Shade Details:** CHS-108S

Shade Sold Separately

**Socket:** Candelabra

**Wattage:** 60 C



**SC2108PN**

**Reflections Sconce  
in Polished Nickel  
and Antique Mirror**

Height: 9"  
Width: 9"  
Extension: 5¼"  
Backplate: 4½"

**Socket:** Candelabra

**Wattage:** 40 B



**SC2109CH-WG**  
**Luxe Sconce in Chrome**  
**with White Glass Shade**  
Height: 10¼"  
Width: 4⅞"  
Extension: 5"  
Backplate: 4⅞" Square

**Available Finishes:**  
BZ, CH, HAB, PN  
**Shade Treatment:** WG  
**Shade Details:** 3¼" x 1½" x 7½"

**Socket:** Candelabra  
**Wattage:** 40 C



**SC2109HAB-WG**



**SC2110PN-WG**  
**Double Luxe Sconce in**  
**Polished Nickel with**  
**White Glass Shades**  
Height: 17"  
Width: 4⅞"  
Extension: 4⅞"  
Backplate: 4⅞" Square

**Available Finishes:**  
BZ, CH, HAB, PN  
**Shade Treatment:** WG  
**Shade Details:** 3¼" x 1½" x 7½"

**Socket:** 2-Candelabra  
**Wattage:** 2-40 C



**SC2111BZ-WG**  
**Triple Luxe Sconce in Bronze**  
**with White Glass Shades**  
Height: 10"  
Width: 21"  
Extension: 4"  
Backplate: 4⅞" Square

**Available Finishes:**  
BZ, CH, HAB, PN  
**Shade Treatment:** WG  
**Shade Details:** 3¼" x 1½" x 7½"

**Socket:** 3-Candelabra  
**Wattage:** 3-40 C



**CL2170BZ**  
**Noho Double-Yoke Torchiere**  
**Sconce in Bronze**  
Height: 5½"  
Width: 5½"  
Extension: 7"-14"  
Backplate: 3½" x 5½"  
Cord Cover Included

**Available Finishes:** BC, BZ  
**Shade Details:** 4" x 6"

**Socket:** Keyless/Hi-Lo Switch  
on Backplate  
**Wattage:** 60 A



**CL2174BZ**  
**Soho Single Sconce**  
**in Bronze**  
Height: 9"  
Width: 5¼"  
Extension: 4"  
Backplate: 5¼" x 9"  
Bottom Vented

**Available Finishes:** BS, BZ

**Socket:** Porcelain  
**Wattage:** 60 A



**CL2172BZ**  
**Soho Double Sconce**  
**in Bronze**  
Height: 9"  
Width: 11"  
Extension: 4"  
Backplate: 9" x 11"  
Bottom Vented

**Available Finishes:** BS, BZ

**Socket:** 2-Porcelain  
**Wattage:** 2-60 A





**CL2001BZ-L**  
**Small Square Sconce in**  
**Bronze with Linen Shade**

Height: 9½"  
Extension: 4⅞"  
Backplate: 2½" x 4"

**Shade Treatment:** L  
**Shade Details:**  
4" / 5¼" x 4" / 5¼" x 6¼"

**Socket:** Keyless  
**Wattage:** 60 A



**CL2002BZ-L**  
**Small Rectangle Sconce in**  
**Bronze with Linen Shade**

Height: 11½"  
Extension: 5⅞"  
Backplate: 2½" x 4"

**Shade Treatment:** L  
**Shade Details:**  
5" / 5¼" x 5" / 5¼" x 8½"

**Socket:** Keyless  
**Wattage:** 60 A





# OUTDOOR

Chart House	300
Studio	312





**CHO2024AB**

**Small 3/4 Wall Leaf Lantern in Antique-Burnished Brass**

Height: 20½"  
Width: 9¾"  
Extension: 8½"  
Backplate: 8" x 7¾"

**Available Finishes:**  
AB, BZ

**Socket:** 3-Candelabra  
**Wattage:** 3-60 C

©EFC DESIGNS



**CHO2025BZ**

**Medium 3/4 Wall Leaf Lantern in Bronze**

Height: 25"  
Width: 12½"  
Extension: 10¼"  
Backplate: 10½" x 10"

**Available Finishes:**  
AB, BZ

**Socket:** 3-Candelabra  
**Wattage:** 3-60 C

©EFC DESIGNS



**CHO2026BZ**

**Large 3/4 Wall Leaf Lantern in Bronze**

Height: 32"  
Width: 16½"  
Extension: 14"  
Backplate: 13½" x 13"

**Available Finishes:**  
AB, BZ

**Socket:** 3-Candelabra  
**Wattage:** 3-60 C

©EFC DESIGNS



**CHO2020AB**

**Small Bracket Leaf Lantern in Antique-Burnished Brass**

Height: 22½"  
Width: 10"  
Extension: 13"  
Backplate: 5½" square

**Available Finishes:**  
AB, BZ

**Socket:** 3-Candelabra  
**Wattage:** 3-60 C

©EFC DESIGNS



**CHO2021AB**

**Medium Leaf Lantern in Antique-Burnished Brass**

Height: 28½"  
Width: 12½"  
Extension: 14"  
Backplate: 5½" square

**Available Finishes:**  
AB, BZ

**Socket:** 3-Candelabra  
**Wattage:** 3-60 C

©EFC DESIGNS



**CHO2022AB**

**Large Bracket Leaf Lantern in Antique-Burnished Brass**

Height: 38"  
Width: 17"  
Extension: 18"  
Backplate: 6½" x 5¼"

**Available Finishes:**  
AB, BZ

**Socket:** 3-Candelabra  
**Wattage:** 3-60 C

©EFC DESIGNS



**CHO2034BZ**  
**Small 3/4 Wall Sussex Lantern**  
**in Bronze**

Height: 19"  
Width: 9½"  
Extension: 8¼"  
Backplate: 8¾" x 8"

**Available Finishes:**  
AB, BZ

**Socket:** 3-Candelabra  
**Wattage:** 3-60 C  
©EFC DESIGNS



**CHO2035AB**  
**Medium 3/4 Wall Sussex Lantern**  
**in Antique-Burnished Brass**

Height: 24"  
Width: 12"  
Extension: 11"  
Backplate: 11" x 10¼"

**Available Finishes:**  
AB, BZ

**Socket:** 3-Candelabra  
**Wattage:** 3-60 C  
©EFC DESIGNS



**CHO2036AB**  
**Large 3/4 Wall Sussex Lantern**  
**in Antique-Burnished Brass**

Height: 31"  
Width: 16"  
Extension: 14½"  
Backplate: 13½" x 13"

**Available Finishes:**  
AB, BZ

**Socket:** 3-Candelabra  
**Wattage:** 3-60 C  
©EFC DESIGNS



**CHO2031AB**  
**Small Sussex Bracket**  
**Lantern in Antique-**  
**Burnished Brass**

Height: 22¼"  
Width: 9½"  
Extension: 11½"  
Backplate: 5" x 4½"

**Available Finishes:**  
AB, BZ

**Socket:** 3-Candelabra  
**Wattage:** 3-60 C  
©EFC DESIGNS



**CHO2032BZ**  
**Medium Sussex Bracket**  
**Lantern in Bronze**

Height: 26½"  
Width: 12¼"  
Extension: 16½"  
Backplate: 5¼" x 4½"

**Available Finishes:**  
AB, BZ

**Socket:** 3-Candelabra  
**Wattage:** 3-60 C  
©EFC DESIGNS



**CHO2033AB**  
**Large Sussex Bracket Lantern**  
**in Antique-Burnished Brass**

Height: 36"  
Width: 16"  
Extension: 17"  
Backplate: 7" x 5"

**Available Finishes:**  
AB, BZ

**Socket:** 3-Candelabra  
**Wattage:** 3-60 C  
©EFC DESIGNS



**CHO2110AB**  
**Small Chelsea Lantern in**  
**Antique-Burnished Brass**

Height: 18½"  
Width: 7"  
Extension: 11¼"  
Backplate: 5¼" x 4"

**Available Finishes:**  
AB, BZ

**Socket:** Candelabra  
**Wattage:** 60 C  
©EFC DESIGNS



**CHO2111AB**  
**Medium Chelsea Lantern in**  
**Antique-Burnished Brass**

Height: 24½"  
Width: 9"  
Extension: 15"  
Backplate: 4" x 6"

**Available Finishes:**  
AB, BZ

**Socket:** 3-Candelabra  
**Wattage:** 3-60 C  
©EFC DESIGNS



**CHO2112AB**  
**Large Chelsea Lantern in**  
**Antique-Burnished Brass**

Height: 31½"  
Width: 12"  
Extension: 18½"  
Backplate: 7" x 5½"

**Available Finishes:**  
AB, BZ

**Socket:** 3-Candelabra  
**Wattage:** 3-60 C  
©EFC DESIGNS



**CHO2113AB**  
**Chelsea Lantern on**  
**Suspension Bracket in**  
**Antique-Burnished Brass**

Height: 31"  
Width: 9¼"  
Extension: 13¼"  
Backplate: 9" x 4¾" x 1"

**Available Finishes:**  
AB, BZ

**Socket:** 3-Candelabra  
**Wattage:** 3-60 C  
©EFC DESIGNS



**CHO2001AB**  
**French Railroad Station**  
**Lantern, All Glass in**  
**Antique-Burnished Brass**

Height: 33½"  
Width: 12"  
Extension: 13"  
Backplate: 5" X 8¼"

**Available Finishes:**  
AB, BZ

**Socket:** Keyless  
**Wattage:** 100 A  
©EFC DESIGNS





**CHO2401BZ**  
**Small Club Door Lantern**  
**in Bronze**

Height: 14"  
Width: 6½"  
Extension: 4½"  
Backplate: 4¾" x 9"

**Available Finishes:**  
AB, BZ

**Socket:** 2-Candelabra  
**Wattage:** 2-40 C  
©EFC DESIGNS



**CHO2401AB**



**CHO2400AB**  
**Large Club Door Lantern in**  
**Antique-Burnished Brass**

Height: 24½"  
Width: 8¾"  
Extension: 5½"  
Backplate: 4" Round

**Available Finishes:**  
AB, BZ

**Socket:** 2-Candelabra  
**Wattage:** 2-60 C  
©EFC DESIGNS



**CHO2500AB**  
**Club Door Lantern in**  
**Antique-Burnished Brass**

Height: 18½"  
Width: 10"  
Extension: 5½"  
Backplate: 4" Round

**Available Finishes:**  
AB, BZ, BZV

**Socket:** 2-Candelabra  
**Wattage:** 2-60 C  
©EFC DESIGNS



**CHO2500BZV**



**CHO2908BZ**  
**Short Linear Lantern**  
**in Bronze**

Height: 15"  
Width: 9"  
Extension: 5"

**Available Finishes:** AB, BZ

**Socket:** 2-Candelabra  
**Wattage:** 2-60 C

©EFC DESIGNS



**CHO2910AB**  
**Long Linear Lantern in**  
**Antique-Burnished Brass**

Height: 22½"  
Width: 9"  
Extension: 5"

**Available Finishes:** AB, BZ

**Socket:** 2-Candelabra  
**Wattage:** 2-60 C  
©EFC DESIGNS



**CHO2701AB**  
**Small Bistro Lantern**

Height: 14¼"  
Width: 9¾"  
Extension: 6¼"

**Available Finishes:**  
AB, BZ

**Socket:** 2-Candelabra  
**Wattage:** 2-60 C  
©EFC DESIGNS



**CHO2700AB**  
**Large Bistro Lantern in**  
**Antique-Burnished Brass**

Height: 28"  
Width: 14½"  
Extension: 9½"  
Backplate: 4" x 6"

**Available Finishes:**  
AB, BZ

**Socket:** 3-Candelabra  
**Wattage:** 3-60 C  
©EFC DESIGNS



**CHO2300BZ**  
**Small Arch Top Wall Lantern**  
**in Bronze**

Height: 13½"  
Width: 8¼"  
Extension: 6¼"  
Backplate: 9" x 6"

**Available Finishes:**  
AB, BZ, VG

**Socket:** 2-Candelabra  
**Wattage:** 2-60 C  
©EFC DESIGNS



**CHO2300VG**

**CHO2310AB**  
**Medium Arch Top Wall Lantern**  
**in Antique-Burnished Brass**

Height: 24"  
Width: 8¼"  
Extension: 7½"  
Backplate: 18" x 7"

**Available Finishes:**  
AB, BZ, VG

**Socket:** Keyless  
**Wattage:** 100 A  
©EFC DESIGNS



**CHO2100AB**  
**French Conductor Lantern in**  
**Antique-Burnished Brass**

Height: 21"  
Width: 12½"  
Extension: 8½"  
Backplate: 4" Round

**Available Finishes:**  
AB, BZ

**Socket:** Keyless  
**Wattage:** 100 A  
©EFC DESIGNS



**CHO2900AB**  
**Cargo Lantern in**  
**Antique-Burnished Brass**

Height: 22"  
Width: 10¼"  
Extension: 7¼"

**Available Finishes:**  
AB, BZ

**Socket:** Keyless  
**Wattage:** 100 A  
©EFC DESIGNS



**CHO2610AB**  
**Coach Lamp in**  
**Antique-Burnished Brass**

Height: 30"  
Width: 8"  
Extension: 9 1/4"  
Backplate: 5 1/4" x 8"

**Available Finishes:**  
AB, BZ

**Socket:** 2-Candelabra  
**Wattage:** 2-40 C

©EFC DESIGNS



**CHO2602AB**  
**Medium Coach Lamp in**  
**Antique-Burnished Brass**

Height: 22"  
Width: 6 1/2"  
Extension: 6 1/8"  
Backplate: 4" Round

**Available Finishes:**  
AB, BZ

**Socket:** 2-Candelabra  
**Wattage:** 2-40 C

©EFC DESIGNS



**CHO2601AB**  
**Small Carriage Lantern in**  
**Antique-Burnished Brass**

Height: 14 1/2"  
Width: 6 1/4"  
Extension: 4"

**Available Finishes:**  
AB, BZ

**Socket:** 2-Candelabra  
**Wattage:** 2-40 C

©EFC DESIGNS



**CHO2600AB**  
**Large Carriage Lantern in**  
**Antique-Burnished Brass**

Height: 22"  
Width: 7 3/4"  
Extension: 4 1/2"  
Backplate: 4" Round

**Available Finishes:**  
AB, BZ

**Socket:** 2-Candelabra  
**Wattage:** 2-40 C

©EFC DESIGNS



**CHO4110BZ-FG**  
**Small Club Hexagonal**  
**Flush Mount in Bronze**  
**with Frosted Glass**

Height: 8¼"  
Width: 10"

**Available Finishes:** AB, BZ  
**Available Glass:** CG, FG

**Socket:** 3-Candelabra  
**Wattage:** 3-60 C

©EFC DESIGNS



**CHO4111BZ-CG**  
**Large Club Hexagonal**  
**Flush Mount in Polished**  
**Nickel with Clear Glass**

Height: 9"  
Width: 14½"

**Available Finishes:** AB, BZ  
**Available Glass:** CG, FG

**Socket:** 3-Candelabra  
**Wattage:** 3-60 C

©EFC DESIGNS



**CHO4310AB-FG**  
**Small Club Square Flush Mount**  
**in Polished Nickel**  
**with Frosted Glass**

Height: 8¼"  
Width: 9"

**Available Finishes:** AB, BZ  
**Available Glass:** CG, FG

**Socket:** 3-Candelabra  
**Wattage:** 3-60 C

©EFC DESIGNS



**CHO4311AB-CG**  
**Large Club Square Flush Mount**  
**in Antique-Burnished Brass**  
**with Clear Glass**

Height: 9"  
Width: 13"

**Available Finishes:** AB, BZ  
**Available Glass:** CG, FG

**Socket:** 3-Candelabra  
**Wattage:** 3-60 C

©EFC DESIGNS



**CHO5018BZ**  
**Small Hanging Leaf Lantern in Bronze**  
Height: 21"  
Width: 9 3/4"  
Canopy: 5 1/2" Round

**Available Finishes:**  
AB, BZ

**Socket:** 3-Candelabra  
**Wattage:** 3-60 C  
©EFC DESIGNS



**CHO5019AB**  
**Medium Hanging Leaf Lantern in Antique-Burnished Brass**  
Height: 25"  
Width: 12 1/2"  
Canopy: 5 1/2" Round

**Available Finishes:**  
AB, BZ

**Socket:** 3-Candelabra  
**Wattage:** 3-60 C  
©EFC DESIGNS



**CHO5020AB**  
**Medium Hanging Leaf Lantern in Antique-Burnished Brass**  
Height: 34"  
Width: 16 1/2"  
Canopy: 5 1/2" Round

**Available Finishes:**  
AB, BZ

**Socket:** 3-Candelabra  
**Wattage:** 3-60 C  
©EFC DESIGNS



**CHO5031AB**  
**Small Sussex Hanging Lantern in Antique-Burnished Brass**  
Height: 20 1/2"  
Width: 9 1/2"  
Canopy: 5 1/2" Round

**Available Finishes:**  
AB, BZ

**Socket:** 3-Candelabra  
**Wattage:** 3-60 C  
©EFC DESIGNS



**CHO5032BZ**  
**Medium Sussex Hanging Lantern in Bronze**  
Height: 26"  
Width: 12 1/4"  
Canopy: 5 1/2" Round

**Available Finishes:**  
AB, BZ

**Socket:** 3-Candelabra  
**Wattage:** 3-60 C  
©EFC DESIGNS



**CHO5033AB**  
**Large Sussex Hanging Lantern in Antique-Burnished Brass**  
Height: 32 1/4"  
Width: 13"  
Canopy: 5 1/2" Round

**Available Finishes:** AB, BZ

**Socket:** 3-Candelabra  
**Wattage:** 3-60 C



**CHO5002AB**  
**Chelsea Stem-Mounted Lantern**  
in Antique-Burnished Brass  
Height: 33" - 68"  
Width: 16"

**Available Finishes:** AB, BZ

**Socket:** 3-Candelabra  
**Wattage:** 3-60 C  
©EFC DESIGNS



**CHO5000AB**  
**French Hanging Lantern**  
in Antique Burnished Brass  
Height: 27"  
Width: 15"

**Available Finishes:**  
AB, BZ

**Socket:** 3-Candelabra  
**Wattage:** 3-60 C  
©EFC DESIGNS



**CHO5300BZ**  
**Small Hanging Arch Top Lantern**  
in Bronze  
Height: 16½"  
Width: 7¾"  
Canopy: 5½" Round

**Available Finishes:**  
AB, BZ, VG

**Socket:** 3-Candelabra  
**Wattage:** 3-60 C  
©EFC DESIGNS



**CHO7018BZ**  
**Small Post Leaf Lantern**  
**in Bronze**

Height: 25"  
Width: 9 3/4"  
Post: 3 1/2" Round

**Available Finishes:**  
AB, BZ

**Socket:** 3-Candelabra  
**Wattage:** 3-60 C  
©EFC DESIGNS



**CHO7019BZ**  
**Medium Post Leaf Lantern**  
**in Bronze**

Height: 31"  
Width: 12 1/4"  
Post: 3 1/2" Round

**Available Finishes:**  
AB, BZ

**Socket:** 3-Candelabra  
**Wattage:** 3-60 C  
©EFC DESIGNS



**CHO7020AB**  
**Large Post Leaf Lantern in**  
**Antique-Burnished Brass**

Height: 33"  
Width: 16 1/2"  
Post: 3 1/2" Round

**Available Finishes:** AB, BZ

**Socket:** 3-Candelabra  
**Wattage:** 3-60 C  
©EFC DESIGNS



**CHO7031AB**  
**Small Post Sussex Lantern**  
**in Antique-Burnished Brass**

Height: 23 1/2"  
Width: 9 1/2"  
Post: 3" Round

**Available Finishes:**  
AB, BZ

**Socket:** 3-Candelabra  
**Wattage:** 3-60 C  
©EFC DESIGNS



**CHO7032AB**  
**Medium Post Sussex Lantern**  
**in Antique-Burnished Brass**

Height: 30 1/4"  
Width: 12 1/4"  
Post: 3" Round

**Available Finishes:**  
AB, BZ

**Socket:** 3-Candelabra  
**Wattage:** 3-60 C  
©EFC DESIGNS



**CHO7033AB**  
**Large Post Sussex Lantern in**  
**Antique-Burnished Brass**

Height: 37 1/4"  
Width: 18"  
Post: 3" Round

**Available Finishes:**  
AB, BZ

**Socket:** 3-Candelabra  
**Wattage:** 3-60 C  
©EFC DESIGNS





**CHO7111AB**  
**Large Chelsea Post Lantern in**  
**Antique Burnished Brass**  
Height: 29½"  
Width: 12"  
Post Cap: 3"

**Available Finishes:**  
AB, BZ

**Socket:** 3-Candelabra  
**Wattage:** 3-60 C  
©EFC DESIGNS



**CHO7300BZ**  
**Small Post Arch Top Lantern**  
**in Bronze**  
Height: 18¾"  
Width: 7¾"  
Post: 3" Round

**Available Finishes:**  
AB, BZ, VG

**Socket:** 3-Candelabra  
**Wattage:** 3-60 C  
©EFC DESIGNS



**SLO2001BZ-SG**  
**Indoor/Outdoor Marine**  
**Wall Light in Bronze**

Height: 10½"  
Width: 8½"  
Extension: 10"  
Backplate: 4¾" x 6½"

**Available Finishes:**  
BZ, CH, HAB

**Shade Size:** 3½" x 6½"  
**Shade Treatments:** CG, SG

**Socket:** Keyless  
**Wattage:** 60 A  
©EFC DESIGNS



# FINISH CODES AND PRODUCT INDEX

## SHADE OPTIONS

**CHS101**  
Black, Natural Paper  
3" x 6" x 4"



**CHS104**  
Black, Linen, Natural Paper, Silk, Tea-stained Silk  
3" x 4" x 4"



**CHS106**  
Linen,  
Natural Paper  
3" x 6" x 4 1/4"



**CHS106LSQ**  
Linen Square  
3" x 6" x 4 1/4"



**CHS108S**  
Off White Mesh Pleat  
3" x 5" x 4"



**CHS109S**  
Silk Bell  
2 1/2" x 5" x 4 1/2"



**CHS110**  
Linen Collar, Silk Collar  
3 1/2" x 6" x 4 1/2"



**CHS111S**  
Silk Pleated Shield  
4" x 5 1/2"



**CHS112NP**  
Natural Paper  
4" x 9" x 6"



**CHS112S**  
Silk Pleat  
4" x 5" x 5"



**CHS113S**  
Silk Square  
3 1/2" x 5" x 5"



**CHS114NP**  
Natural Paper  
4" x 6" x 5"



## BOSTON FUNCTIONAL SHADE OPTIONS

**SLB**  
Finishes:  
AN, AW, BZ, HAB, SN



**SLEG**  
Finishes:  
GG, WG



**SLE**  
Finishes:  
AN, AW, BZ, HAB, SN



**SLJ**  
Finishes:  
AN, AW, BZ, HAB, SN



**SLG**  
Finishes:  
AN, AW, BZ, HAB, PN, SN



**SLJG**  
Finishes:  
GG, WG



## LAMP AND FIXTURE FINISH CODES

<b>AB</b>	Antique-Burnished Brass	<b>FPW</b>	Fence Post Wash
<b>ABAN</b>	Antique-Burnished Brass with Antique Nickel	<b>FW</b>	French Wax on Wood
<b>ABC</b>	Antique-Burnished Brass with Faux Cordovan Leather	<b>GBC</b>	Grey Book Cloth
<b>ABL</b>	Antique-Burnished Brass with Leather	<b>GP</b>	Green Patina Painted Metal
<b>ABR</b>	Antique-Burnished Brass with Rust Accents	<b>GS</b>	Grey Shagreen
<b>ABT</b>	Antique-Burnished Brass with Faux Tortoise	<b>GW</b>	Garden White on Iron
<b>ABV</b>	Antique Brass Verdigris	<b>HAB</b>	Hand-Rubbed Antique Brass
<b>AC</b>	Antique Copper	<b>HABL2</b>	Hand-Rubbed Antique Brass with Braided Leather
<b>AGL</b>	Antique Gold Leaf	<b>I</b>	Ivory Ceramic
<b>ALB</b>	Alabaster Natural Stone	<b>IC</b>	Ivory Crackle Ceramic
<b>AM</b>	Antique Mirror	<b>IP</b>	Irish Pine on Wood
<b>AN</b>	Antique Nickel	<b>LB</b>	Light Blue Ceramic
<b>ANL</b>	Antique Nickel with Black Leather	<b>LC</b>	Light Celadon Ceramic
<b>AS</b>	Antique Silver	<b>M</b>	Marbleized Tole
<b>ASL</b>	Antique Silver Leaf	<b>MHG</b>	Mahogany Wood Finish
<b>AT</b>	Antiqued Terracotta	<b>NR</b>	Natural Rusted Iron
<b>AW</b>	Antique White	<b>OAK</b>	Natural American White Oak
<b>AWG</b>	Antique White with Gold Leaf	<b>OS</b>	Old Stone on Wood
<b>BB</b>	Bamboo	<b>OGW</b>	Old Garden White on Wood
<b>BC</b>	Brushed Chrome	<b>OW</b>	Old White on Wood
<b>BG</b>	Blue Glass	<b>OX</b>	Oxblood Tole on Wood
<b>BL</b>	Black Leather	<b>PB</b>	Polished Brass
<b>BLK</b>	Black	<b>PN</b>	Polished Nickel
<b>BM</b>	Black Crema Marble	<b>PS</b>	Polished Silver
<b>BR</b>	Blackened Rust Painted Finish	<b>Q</b>	Natural Quartz Stone
<b>BRG</b>	Burnished Rust and Gold	<b>R</b>	Painted Rust
<b>BS</b>	Brushed Steel	<b>RD</b>	Red
<b>BW</b>	Blue and White Porcelain	<b>RG</b>	Rust with Gold
<b>BZ</b>	Bronze	<b>ROP</b>	Rope Wrapped Wood
<b>BZV</b>	Bronze with Verdigris Highlights	<b>RQ</b>	Rose Quartz Natural Stone
<b>C</b>	Celadon Porcelain	<b>RS</b>	Red Shagreen
<b>CAR</b>	Caramel Wood Finish	<b>SB</b>	Sheffield Brass
<b>CC</b>	Celadon Crackle	<b>SBC</b>	Sage Book Cloth
<b>CG</b>	Crystal or Clear Glass	<b>SDL</b>	Saddle Leather
<b>CH</b>	Chrome	<b>SL</b>	Silver Leaf
<b>CHC</b>	Chocolate Wood Finish	<b>SN</b>	Sheffield Nickel
<b>CHI</b>	Chinoiserie	<b>SP</b>	Scrubbed Pine
<b>CM</b>	Chinese Marquetry	<b>TB</b>	Tudor Brown on Wood
<b>CRC</b>	Crackle Beige Ceramic	<b>VG</b>	Verdis
<b>CT</b>	Crackled Terracotta	<b>WA</b>	Walnut Wood Finish
<b>DBS</b>	Dark Brown Shagreen	<b>WG</b>	Weathered Gold or White Glass
<b>EG</b>	Eggplant (Black) Glass	<b>WGL</b>	Weathered White and Gold
<b>FL</b>	Floral	<b>WHT</b>	White Ceramic or Paint
<b>FLU</b>	Fluorite (Natural Green Stone)	<b>WI</b>	Weathered Iron
		<b>WM</b>	White Marble
		<b>WS</b>	White Shagreen
		<b>WW</b>	Waxed Wood

## METAL AND GLASS SHADE FINISH CODES

<b>AB</b>	Antique-Burnished Brass
<b>AC</b>	Antique Copper
<b>AN</b>	Antique Nickel
<b>ANH</b>	Antique Nickel (Hammered)
<b>AW</b>	Antique White
<b>BG</b>	Blue Glass
<b>BZ</b>	Bronze
<b>BZH</b>	Bronze (Hammered)
<b>FG</b>	Frosted Glass
<b>GG</b>	Green Glass
<b>HAB</b>	Hand-Rubbed Antique Brass
<b>HABH</b>	Hand-Rubbed Antique Brass (Hammered)
<b>OX</b>	Oxblood Crackle Painted Metal
<b>PN</b>	Polished Nickel
<b>PNH</b>	Polished Nickel (Hammered)
<b>PS</b>	Polished Silver
<b>SN</b>	Sheffield Nickel
<b>SNH</b>	Sheffield Nickel (Hammered)
<b>WG</b>	White Glass
<b>MP</b>	Monte Patina painted Metal

## FABRIC SHADE FINISH CODES

<b>B</b>	Black Paper (Tortoise Lining)
<b>BS</b>	Black Silk Pleated
<b>CP</b>	Chocolate Paper
<b>FS</b>	Fawn Silk
<b>G</b>	Green Painted Metal
<b>GBC</b>	Grey Book Cloth
<b>GL</b>	Gold Leaf on Paper
<b>L</b>	Linen (Hardback, Stretched, or Pleated)
<b>LC</b>	Pleated Linen (Collar Top)
<b>LCC</b>	Pleated Linen (Collar Top and Bottom)
<b>LCF</b>	Pleated Linen (Collar Top) with Frill
<b>NP</b>	Natural Paper
<b>S</b>	Silk (Stretched or Pleated)
<b>SBC</b>	Silk Bell with Collar or Sage Book Cloth
<b>SBP</b>	Silk Box Pleat
<b>SC</b>	Pleated Silk (Collar Top)
<b>SCC</b>	Pleated Silk (Collar Top and Bottom)
<b>SCF</b>	Pleated Silk (Collar Top) with Frill
<b>SF</b>	Silk Frill
<b>T</b>	Tissue
<b>TS</b>	Tea Stained Silk
<b>TSBC</b>	Tissue Silk Bell (Collar Top)
<b>TSC</b>	Tissue Silk (Collar Top)
<b>TSF</b>	Tissue Silk Frill
<b>WP</b>	White Paper

## SHADE TRIM CODES

<b>BT</b>	Brown/Black Tape
<b>RT</b>	Rust Tape
<b>ST</b>	Silver Tape

# PRODUCT INDEX

Product	Page	Product	Page	Product	Page	Product	Page	Product	Page	Product	Page
81134	125	CHA8195	39	CHA8923	21	CHC1126	156	CHC2150	159	CHD1163	239
82034	258	CHA8196	39	CHA8924	20, 25	CHC1131	160	CHC2200	188	CHD1164	239
91025	125	CHA8198	39	CHA8925	19	CHC1138	159	CHC3108	167	CHD1165	231
92000	258	CHA8223	43	CHA8926	18	CHC1150	160	CHC3109	167	CHD1166	231
92025	258	CHA8224	43	CHA8927	16, 25	CHC1151	160	CHC3401	191	CHD1167	230
BB1010	143	CHA8226	44	CHA8928	21, 25	CHC1152	153	CHC3405	190	CHD1168	236
BB1040	142	CHA8227	46	CHA8929	21, 25	CHC1153	153	CHC3406	190	CHD1169	236
BB1100	144	CHA8228	43	CHA8931	17, 24	CHC1154	152	CHC3407	191	CHD1170	238
BB1101	144	CHA8229	44	CHA8932	18	CHC1155	152	CHC3408	191	CHD1171	230
BB1200	142	CHA8230	44	CHA8933	16	CHC1158	167	CHC3409	190	CHD1172	230
BB1230	141	CHA8251	27	CHA8934	16	CHC1166	156	CHC3411	189	CHD1173	230
BB1500	143	CHA8252	27	CHA8935	16	CHC1168	159	CHC3414	189	CHD1175	231
BB1600	144	CHA8308	41	CHA8936	21	CHC1169	156	CHC3415	190	CHD1176	238
BB2000	285	CHA8309	41	CHA8937	17, 24	CHC1170	155	CHC3420	187	CHD1401	242
BB2001	286	CHA8336	41	CHA8938	18, 24	CHC1171	154	CHC3421	187	CHD1402	242
BB2002	286	CHA8341	44	CHA8939	20, 25	CHC1172	155	CHC3422	187	CHD1403	242
BB2005	286	CHA8350	45	CHA8940	17, 23	CHC1173	154	CHC3423	186	CHD1404	243
BB2007	286	CHA8351	45	CHA8941	17, 23	CHC1401	169	CHC3425	187	CHD1405	243
BB2010	285	CHA8353	42	CHA8942	21	CHC1402	169	CHC3441	186	CHD1406	242
BB2040	285	CHA8362	42	CHA8945	22	CHC1405	169	CHC4105	194	CHD1408	235
BB2110	287	CHA8363	43	CHA8946	22	CHC1406	171	CHC4106	194	CHD1409	235
BB2112	287	CHA8390	41	CHA8947	22	CHC1407	161	CHC4107	194	CHD1435	245
BB2210	287	CHA8391	42	CHA8948	23	CHC1408	161	CHC4120	193	CHD1437	243
BB2212	287	CHA8403	46	CHA8949	23	CHC1409	165	CHC4125	193	CHD1448	240
BB2500	285	CHA8405	53	CHA8950	20, 26	CHC1410	165	CHC4126	193	CHD1450	245
BB2602	288	CHA8406	53	CHA8951	20	CHC1411	165	CHC4128	193	CHD1455	243
BB2650	288	CHA8450	34	CHA8960	22	CHC1413	163	CHC4129	193	CHD146	241
BB3002	93	CHA8451	55	CHA8970	26, 38	CHC1414	171	CHC4132	194	CHD1460	245
BB3040	93	CHA8452	47	CHA9102	118	CHC1415	163, 165	CHC4134	194	CHD1461	245
BB3100	92	CHA8455	53	CHA9103	118	CHC1416	171	CHC4140	192	CHD147	240
BB3101	92	CHA8457	34	CHA9105	119	CHC1419	163	CHC4170	192	CHD1470	235
BB3102	92	CHA8458	34	CHA9106	119	CHC142	164	CHC4201	195	CHD148	240
BB3110	94	CHA8500	33	CHA9107	120	CHC1420	162	CHC4202	195	CHD1500	239
BB3500	94	CHA8501	33	CHA9121	119	CHC1421	164	CHC4203	195	CHD1501	239
BB3510	94	CHA8505	46	CHA9122	114	CHC1423	163	CHC4211	195	CHD1502	237
BB3820	93	CHA8507	46	CHA9124	110	CHC1424	162	CHC4212	195	CHD1510	251
BB3821	93	CHA8510	27	CHA9125	111	CHC1425	162	CHC4213	195	CHD1521	251
BB5300	219	CHA8511	27	CHA9127	120	CHC1426	161	CHC4215	193	CHD1522	251
CHA3109	54	CHA8512	28, 29	CHA9128	117	CHC1432	166	CHC5101	177	CHD1531	251
CHA3121	54	CHA8513	28	CHA9131	117	CHC1435	166	CHC5102	177	CHD1532	251
CHA8106	40	CHA8521	37	CHA9132	106	CHC1436	166	CHC5104	179	CHD1541	250
CHA8110	35	CHA8522	37	CHA9134	105	CHC1437	166	CHC5105	180	CHD1542	250
CHA8111	35	CHA8523	42	CHA9135	110	CHC1440	179	CHC5106	176	CHD1543	250
CHA8112	35	CHA8524	24	CHA9140	111	CHC1441	175	CHC5107	176	CHD1550	249
CHA8113	36	CHA8610	50	CHA9150	105	CHC1442	174	CHC5120	181	CHD1551	249
CHA8117	30	CHA8611	52	CHA9151	104	CHC1443	174	CHC5121	181	CHD1552	249
CHA8122	36	CHA8612	51	CHA9152	106	CHC1444	175	CHC5132	180	CHD2103	253
CHA8123	35	CHA8613	52	CHA9153	104	CHC1446	183	CHC5133	184	CHD2150	246
CHA8124	31	CHA8614	51	CHA9154	107	CHC1447	183	CHC5135	185	CHD2151	246
CHA8125	31	CHA8615	52	CHA9155	107	CHC1450	170	CHC5136	184	CHD2153	246
CHA8130	36	CHA8616	52	CHA9160	115	CHC1451	170	CHC5137	184	CHD2154	246
CHA8132	30	CHA8617	50	CHA9161	120	CHC1460	173	CHC5150	180	CHD2155	247
CHA8133	32	CHA8618	50	CHA9310	115	CHC1461	172	CHC5160	184	CHD2156	247
CHA8134	30	CHA8619	51	CHA9312	113	CHC1462	173	CHC5170	192	CHD2908	252
CHA8135	30	CHA8620	49	CHA9313	113	CHC1463	172	CHC5180	192	CHD2910	252
CHA8137	29	CHA8621	49	CHA9314	112	CHC1470	168	CHD1103	244	CHD4132	236
CHA8138	31	CHA8622	49	CHA9315	112	CHC1471	168	CHD1106	244	CHD4133	236
CHA8139	31	CHA8623	49	CHA9316	114	CHC1472	168	CHD1107	244	CHD5101	237
CHA8150	40	CHA8626	50	CHA9336	121	CHC1480	178	CHD1109	241	CHD5102	237
CHA8152	32	CHA8627	51	CHA9401	116	CHC1481	178	CHD1110	241	CHD5105	247
CHA8155	28	CHA8801	48	CHA9402	116	CHC1482	178	CHD1112	237	CHD5106	247
CHA8156	36	CHA8802	48	CHA9450	108	CHC1500	183	CHD1115	234	CHD5107	248
CHA8157	29	CHA8805	45	CHA9451	108	CHC2101	185	CHD1116	234	CHD5117	248
CHA8159	40	CHA8809	47	CHA9452	109	CHC2102	185	CHD1117	234	CHD5137	248
CHA8162	38	CHA8811	47	CHA9455	118	CHC2103	185	CHD1120	232	CHD5147	248
CHA8164	32	CHA8814	47	CHA9461	121	CHC2104	186	CHD1122	232	CHO2001	302
CHA8166	28	CHA8831	45	CHC1111	160	CHC2105	188	CHD113	241	CHO2020	300
CHA8167	29	CHA8844	48	CHC1112	157	CHC2106	188	CHD1137	240	CHO2021	300
CHA8172	38	CHA8845	48	CHC1113	158	CHC2107	189	CHD1138	233	CHO2022	300
CHA8173	37	CHA8905	26	CHC1114	157	CHC2108	189	CHD1139	233	CHO2024	300
CHA8174	37	CHA8906	26	CHC1115	158	CHC2109	186	CHD1140	232	CHO2025	300
CHA8178	33	CHA8910	18	CHC1116	158	CHC2110	186	CHD1150	232	CHO2026	300
CHA8188	33	CHA8920	19	CHC1117	158	CHC2111	182	CHD1158	244	CHO2031	301
CHA8190	34	CHA8921	19	CHC1118	157	CHC2112	182	CHD1161	238	CHO2032	301
CHA8192	39	CHA8922	19	CHC1120	159	CHC2113	188	CHD1162	238	CHO2033	301

# PRODUCT INDEX

Product	Page	Product	Page	Product	Page	Product	Page	Product	Page	Product	Page
CHO2034	301	S20B	264	SL1950	123	SL3948	64	TOB1090	133	TOB3040	71
CHO2035	301	S30	69	SL1975	122	SL3971	259	TOB2000	279	TOB3041	85
CHO2036	301	S301	67	SL2000	271	SL3975	57	TOB2001	282	TOB3042	70
CHO2100	305	S302	67	SL2111	271	SL3980	59	TOB2002	276	TOB3043	70
CHO2110	302	S3030	69	SL2151	266	SL3992	59	TOB2003	284	TOB3046	89
CHO2111	302	S3050	69	SL2152	266	SL3B	56	TOB2004	284	TOB3047	89
CHO2112	302	S3051	69	SL2153	266	SL4000	204	TOB2005	284	TOB3048	89
CHO2113	302	S3060	57	SL2500	254	SL4001	207	TOB2006	282	TOB3049	88
CHO2300	305	S3061	57	SL2701	259	SL4002	207	TOB2007	280	TOB3050	88
CHO2310	305	S3064	56	SL2702	259	SL4120	206	TOB2008	280	TOB3051	83
CHO2400	303	S310	67	SL2703	259	SL4121	206	TOB2009	280	TOB3052	71
CHO2401	303	S311	66	SL2711	261	SL4122	206	TOB2010	274	TOB3060	72
CHO2500	303	S312	66	SL2712	261	SL4128	204	TOB2011	274	TOB3061	72
CHO2600	306	S3200	60	SL2800	256	SL5001	204	TOB2012	274	TOB3065	73
CHO2601	306	S5030	199	SL2811	261	SL5002	203	TOB2013	276	TOB3066	73
CHO2602	306	S5031	199	SL2812	261	SL5003	203	TOB2014	282	TOB3067	84
CHO2610	306	S5101	200	SL2813	256	SL5120	206	TOB2016	282	TOB3068	85
CHO2700	304	S3103	200	SL2814	256	SL5121	206	TOB2017	278	TOB3069	84
CHO2701	304	SC1100	147	SL2815	256	SL5122	206	TOB2018	278	TOB3070	84
CHO2900	305	SC1101	146	SL2816	257	SL5125	204, 205	TOB2019	281	TOB3071	86
CHO2908	304	SC1102	146	SL2817	257	SL5130	198	TOB2020	281	TOB3072	76
CHO2910	304	SC1105	147	SL2820	264	SL5131	198	TOB2021	281	TOB3073	77
CHO4110	307	SC1106	146	SL2841	269	SL5132	198	TOB2027	278	TOB3074	76
CHO4111	307	SC2100	289	SL2842	269	SL5133	198	TOB2029	278	TOB3075	79
CHO4310	307	SC2102	289	SL2843	269	SL5150	201	TOB2030	283	TOB3076	75
CHO4311	307	SC2103	289	SL2845	263	SL5151	201	TOB2031	283	TOB3077	75
CHO5000	309	SC2104	289	SL2846	263	SL5152	203	TOB2035	275	TOB3080	87, 140
CHO5002	309	SC2105	290	SL2860	262	SL5153	203	TOB2045	277	TOB3081	74
CHO5018	308	SC2106	292	SL2861	262	SL5154	202	TOB2046	277	TOB3082	79
CHO5019	308	SC2107	292	SL2865	262	SL5156	202	TOB2061	283	TOB3083	79
CHO5020	308	SC2108	292	SL2866	262	SL5175	199	TOB2062	283	TOB3084	79
CHO5031	308	SC2109	293	SL2920	255	SL5811	196	TOB2064	275	TOB3088	88
CHO5032	308	SC2110	293	SL2921	254	SL5812	196	TOB2067	275	TOB3090	86
CHO5033	308	SC2111	293	SL2922	254	SL5820	199	TOB2068	275	TOB3091	86
CHO5300	309	SC2116	292	SL2923	254	SL5830	197	TOB2081	277	TOB3110	91
CHO7018	310	SC2120	291	SL2931	270	SL5850	200	TOB2103	284	TOB3111	91
CHO7019	310	SC2126	291	SL2932	270	SL5851	200	TOB2300	279	TOB3112	90
CHO7020	310	SC2127	291	SL2933	270	SL5863	197	TOB2301	279	TOB3113	90
CHO7031	310	SC2155	291	SL2934	271	SL5870	197	TOB3000	77	TOB3114	90
CHO7032	310	SC2160	290	SL2935	271	SL5871	197	TOB3001	77	TOB3141	85
CHO7033	310	SC2165	290	SL2941	268	SL5872	197	TOB3002	80	TOB4000	217
CHO7111	311	SC2166	290	SL2942	268	SLO2001	271, 312	TOB3003	80	TOB4001	217
CHO7300	311	SC3000	97	SL2943	268	SS2001	267	TOB3004	87	TOB4002	217
CL1001	145	SC3001	97	SL2944	268	SS2002	267	TOB3005	72	TOB4003	216
CL1002	145	SC3002	95	SL2975	260	SS2003	267	TOB3006	76	TOB4004	218
CL1100	145	SC3004	96	SL2B	59	SS2011	272	TOB3007	88	TOB4005	217
CL2001	295	SC3008	95	SL3025	56	SS2012	272	TOB3008	77	TOB4006	218
CL2002	295	SC3009	95	SL3032	56	SS2014	272	TOB3009	71	TOB5000	216
CL2170	294	SC3012	96	SL30B	59, 60	SS2015	272	TOB3010	85	TOB5002	210
CL2172	294	SC4000	221	SL3100	68	SS2030	265	TOB3011	82	TOB5003	210
CL2174	294	SC5001	221	SL3101	68	SS2031	264	TOB3012	76	TOB5004	213
CL3001	98	SC5002	220	SL3102	68	SS4010	207	TOB3013	82	TOB5005	213
CL3002	99	SC5003	220	SL3103	68	SS4011	207	TOB3014	83	TOB5007	208
CL3003	99	SC5004	224	SL3324	65	SS4012	207	TOB3015	86	TOB5008	208
CL3004	99	SC5005	221	SL3325	65	SS4013	207	TOB3016	78	TOB5009	209
CL3005	98	SC5007	223	SL3326	66	SS4015	207	TOB3017	78	TOB5010	209
CL3100	98	SC5008	223	SL3336	65	SS4016	207	TOB3018	74	TOB5011	214
CL3170	98	SC5100	225	SL3338	63, 64	SS5002	201	TOB3019	75	TOB5012	216
NYPL1	92	SC5102	224	SL3339	63, 65	SS5005	201	TOB3020	82	TOB5013	216
NYPL2	92	SC5120	224	SL3700	67	TOB1000	133	TOB3021	83	TOB5014	214
NYPL3	141	SC5150	225	SL3801	61	TOB1001	138	TOB3022	82	TOB5015	212
PT2000	263	SC5155	222	SL3802	62	TOB1002	136	TOB3023	83	TOB5016	212
PT2001	263	SL1031	122	SL3803	62	TOB1004	135	TOB3024	84	TOB5017	211
PT3000	68	SL1125	126	SL3804	60	TOB1006	134	TOB3025	74	TOB5018	211
S1001	131	SL1126	126	SL3805	61	TOB1007	132	TOB3026	74	TOB5020	212
S110	130	SL1135	128	SL3806	62	TOB1008	137	TOB3027	89	TOB5060	215
S111	130	SL1137	128	SL3807	62	TOB1009	132	TOB3028	89	TOB5061	215
S2001	273	SL1138	129	SL3811	60	TOB1010	140	TOB3030	78	TOB5062	215
S2002	273	SL1142	127	SL3905	58	TOB1011	135	TOB3031	78	TOB5063	215
S2003	273	SL1143	127	SL3910	58	TOB1012	137	TOB3032	80, 81		
S2006	273	SL1700	131	SL3940	66	TOB1013	139	TOB3033	81		
S2007	273	SL1702	123	SL3941	64	TOB1014	138	TOB3036	72		
S2020	257	SL1900	124	SL3943	64	TOB1015	139	TOB3037	71		
S2030	265	SL1920	129	SL3944	63	TOB1016	134	TOB3038	70		
S2050	265	SL1930	124	SL3945	63	TOB1068	136	TOB3039	70		

Visual Comfort & Co.  
2021 Bingle Road  
Houston, TX 77055

713 686 5999

Printed in China by Pure Agency