



TECH LIGHTING®

www.techlighting.com



MonoRail Satin Nickel / Remote 300 Watt 12 Volt
Transformers / 4" Round Single-Feed Canopies /
12" Power Extenders / 12" Rigid Standoffs /
1" Sprocket Heads / MR16 Lamps

LOCATION: MANIFESTO, CHICAGO, IL
PHOTOGRAPHER: LES BOSCHKE



Lighting is our Passion

www.techlighting.com



We care about the environment too.

Tech Lighting has made a commitment to conservation, energy efficiency and recycling. Here are just a few ways we are currently reducing our carbon footprint:

Product Design:

- Most of our line-voltage fixtures, have a compact fluorescent option (CF)
- Our low-voltage systems available in LED
- In-house rapid prototyping reduces the back and forth of product changes with vendors all over the world

Recycling:

- We donate all glass that does not meet our exacting standards to a manufacturer of recycled glass countertops
- We recycle all cardboard and scrap metal
- We recycle old computers
- We use recycling bins throughout our facility

Literature:

- Reduced the number of printed pages in our collateral materials — some by as much as 70%
- Our catalogs are printed at a facility that uses wind-generated electricity
- Comprehensive website with the most up to date product offerings — along with an online catalog viewer

Energy Management:

- All computers are turned off at night
- All major lighting is turned off after business hours
- Energy efficient fluorescent lighting throughout facility

From our inception in 1988 to the industry leader we are today, Tech Lighting has always set its sights on bringing you refined, timeless design combined with the latest advancements in lighting technology and expert craftsmanship.

At our core is an intense appreciation of art and science, sophistication and imagination. Balanced by rigorous testing and quality control standards, we race against time to bring innovations to the market. In this catalog we share our passion.

Our passion does not end with design. We are fanatical about exceeding our customers' highest expectations. Need your system right away? Most of our products ship within one week of order. Need it faster? Just ask. Your mind will rest easy knowing that your order is backed by an unsurpassed level of customer service and technical assistance.

What will you have gained? Endless new ways to make a distinctive, emphatic statement in your environment.

How to buy Tech Lighting Lighting Professional?

Tech Lighting products can be purchased through a network of helpful and knowledgeable sales representatives located throughout North America. To contact the representative nearest you, visit www.techlighting.com, or call us at 847.410.4400.

Consumer?

Tech Lighting products are available in select lighting showrooms throughout North America. To find the showroom nearest you, visit www.techlighting.com.

For More Information

Our Full Line Catalog is very extensive, however, more information is available. For detailed specification sheets, product instructions, bill of material reference guides and much more, visit www.techlighting.com.



TECH LIGHTING®



Meets
2008 NEC
STANDARDS

Certain products shown in this catalog have patent protection or patents pending. Tech Lighting reserves the right to discontinue or to change the technical or design specifications of its products at any time without notice. Copyright © 2010 Tech Lighting L.L.C. All rights reserved. The "Tech Lighting" graphic is a registered trademark of Tech Lighting L.L.C.



FreeJack 4" Round Flush Canopies Satin Nickel /
Mini Mulberry Sage Wave Pendants / Bi-pin Lamps



Product Sections

To help you choose the type of fixtures best suited for your project, we have **color-coded** the sections of this catalog. Each section describes a product category in detail, including step-by-step instructions on how to configure our architectural grade **low-voltage lighting systems**, the most **common components** for each system, and how to use one of our system **kits** to make basic installations as easy as possible.

To easily reference the dimensions, color and finish choices of **elements**, see pp. 30-135. To check which elements are compatible with each system, please consult the *Compatible Elements* section on pp. 266-269 .

For more complex applications, our *Special Installations* pages offer options that make virtually any layout you can imagine configurable with standard, readily available components.

Many of our sections are organized by style and shape, making it easy to browse through like-items.

This catalog also features **item number grids** for ease of ordering. For example, below is the item number grid for a Firefrost pendant. Select from the **bolded** codes to build your item number of choice: **700MOFIRFHS-LED** means you have selected the MonoRail option for the Firefrost pendant in chartreuse with a satin nickel finish and LED lamp type.

700	SYSTEM	MO	FIRF	COLOR	H	FINISH	S	VOLTAGE	-LED
FJ	FREEJACK	A	AMBER	Z	ANTIQUE BRONZE	12	VOLT HALOGEN		
MO	MONORAIL	H	CHARTREUSE	C	CHROME	24	VOLT HALOGEN		
MO2	TWO-CIRCUIT MONORAIL	B	COBALT	S	SATIN NICKEL	-LED	12 VOLT LED 3000K		
		R	RED						
		W	WHITE						

Need help designing *your* system? Visit our online order configurator at configurator.techlighting.com



	LED Overview pp. 24-29
	Low-Voltage Pendants pp. 30-101
	Low-Voltage Heads pp. 102-135
	Line-Voltage Pendants pp. 136-181
	Wall Collection pp. 182-217
	Bath Collection pp. 218-229
	Ceiling Collection pp. 230-265
	MonoRail pp. 270-293
	Two-Circuit MonoRail pp. 294-309
	Wall MonoRail pp. 310-323
	Kable Lite pp. 324-343
	FreeJack pp. 344-355
	Display & Exhibit pp. 356-365
	Accessories & Optical Controls pp. 366-379
	Compatible Elements pp. 266-269
	Lamps & Transformers pp. 380-385
	Index pp. 386-389





Lexington Pendants Desert Clay Satin Nickel /
A19 Lamps / MonoRail Satin Nickel / End Caps /
Remote 300 Watt 12 Volt Transformers /
4" Round Single-Feed Canopies / 6" Power Extenders /
Adjustable Standoffs / 3" John Heads / MR16 Lamps

LOCATION: BRITISH AIRWAYS FIRST CLASS DEPARTURE LOUNGE,
PHILADELPHIA, PA

ARCHITECT: AGOOS LOVERA ARCHITECTS
DESIGN: THE LIGHTING PRACTICE, POMME SOCHATO
PHOTOGRAPHER: HALKIN PHOTOGRAPHY LLC.





FreeJack 4" Round Flush Canopies Satin Nickel /
Mini Larkspur Pendants Sand / Bi-pin Lamps





Boxie Large Satin Nickel / G9 Base Lamps /
Cosmo Frost White Satin Nickel /
Mini-candelabra Base Lamps

Custom Capabilities

Our in-house custom design process adapts to meet the diverse needs of our customers. We can make minor modifications to existing products or create completely unique products specific to your design criteria. By working collaboratively across many in-house disciplines and keeping you informed every step of the way, we deliver the best product possible on time and on budget.

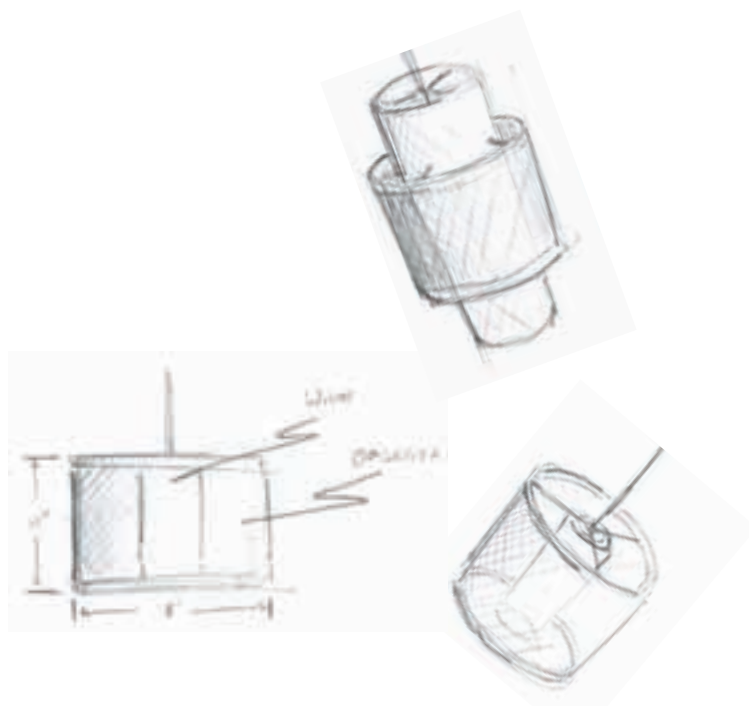

Throughout this catalog you will find thousands of distinctive light fixtures that are in-house and ready to ship right now. But this catalog can also serve as a springboard for your creativity. Every day we talk to some of the country's leading designers who are looking for something special — something truly unique. Each customer has their own set of requirements. Could be aesthetics. Could be performance. Could be price. Whatever your needs, we can deliver a solution. Because our design and engineering takes place in our facility, there is no waiting for overseas responses. We will provide timely and accurate information regarding progression and product lead-times.

STEP 1: IDENTIFY PROJECT SCOPE

Perhaps you just need help laying out a system utilizing standard product. We have CAD modeling software and extensive experience to help you lay out a room. Or, perhaps you are looking for something a little different than our cataloged products. We have done it all. From cutting-edge design to value engineering. From simple design tweaks to ground up development. Small runs. Large runs. We will ask a series of questions to understand the scope of your project and then deliver a customized proposal to suit your needs.

STEP 2: CONCEPT DEVELOPMENT

Our design team will create a series of design concepts and realistic computer renderings for your review. With your input, we will further refine the concepts. Our rapid-prototype printer makes it very easy for us to show you a scaled plastic 3D model.

STEP 3: PRODUCT DEVELOPMENT / DELIVERY

Once you have approved the concept, our design team will handoff to engineering. From there, we will create 3D computer models and drawings for our vendors. We source from the best vendors in the U.S. and around the globe. Often, they can create a rapid-sample for your review. With your approval we will proceed to tooling. Once tooling is complete, your final product is brought to life. After approving off-tool samples, we will test for quality and safety and apply for all necessary certifications. Finally, we will inspect the production run and deliver product on time based on a pre-determined fixture schedule.

Contact our Quotations Department at 847.410.4400 for assistance with any custom requests.



Energy Efficient Solutions

We have hundreds of energy efficient alternatives across our six brands. All will significantly reduce your energy bill *and* help protect the environment without compromising the beauty and style you desire. You also have your choice of numerous lamping options, so you can pick the ones that are right for your application.

Tech Lighting has a long track record when it comes to energy efficient luminaires. That is why, throughout this catalog, almost every line-voltage fixture you see is offered with a compact fluorescent alternative.

After years of research and extensive testing, we are very excited to introduce a more energy efficient solution for our low-voltage lighting systems. Our LED fixtures reduce energy consumption by **over 80%**, are dimmable, field replaceable, and do not contain any mercury or hazardous materials —making them completely recyclable. Available in a variety of materials, shapes, colors and finishes, our expansive offering of LED fixtures makes LED a realistic choice for applications previously not quite ready for solid state lighting.

Look to our other brands including **Wilmette Lighting**, **T-trak**, **ELEMENT**, and **tiella** for hundreds of additional energy efficient alternatives utilizing LED, compact fluorescent and ceramic metal halide lamping options.

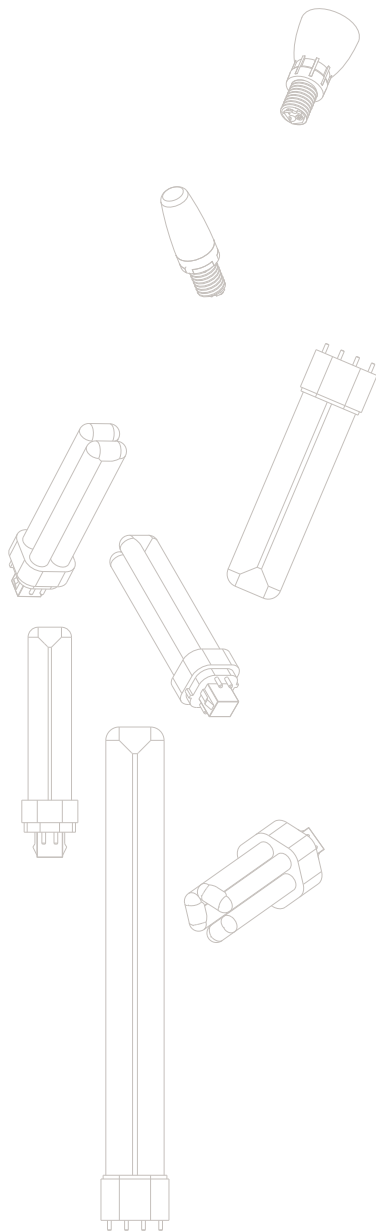

Product Overview

 Throughout the catalog, this icon indicates which fixtures are available in **LED**.

 Throughout the catalog, this icon indicates which fixtures are available in **Compact Fluorescent**.

 Throughout the catalog, this icon indicates which fixtures are **ADA Compliant**.

LOW-VOLTAGE PENDANTS



Autumn Wind
p. 36



Biz
p. 74



Boreal
p. 38



Brulée
p. 54



Cabo
p. 45



Camille
p. 94



Cheers
p. 76



Cone
p. 64



Coronado
p. 44



Cube
p. 72



Cue
p. 78



Diz
p. 74



Egypt
p. 50



Essex
p. 44



Fab
p. 53



Fire
p. 66



Firebird
p. 70



Firefrit
p. 70



Firefrost
p. 68



Hanging Wok
p. 96



Inner Fire
p. 68



Kiev
p. 32



Melrose
p. 86



Melt
p. 84



Meteor
p. 92



Meteor Frit
p. 92



Mini Echo
p. 62



Mini Edge
p. 52



Mini Hudson
p. 54

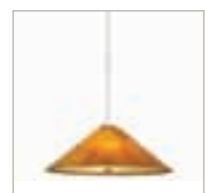

Mini Larkspur
p. 48





Mini Melrose
p. 86



Mini Mulberry
p. 34



Mini Ovation
p. 88



Mini Starry Night
p. 90



Mini Taza
p. 91



Monet
p. 93



Moon
p. 82



Nebbia
p. 56



Niko
p. 90



Oak Park
p. 50



Pelé
p. 78



Peyton
p. 42



Pinnacle
p. 58



Piper
p. 100



Playa
p. 40

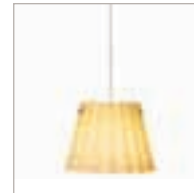

Pleat
p. 48



Prism
p. 99



Pyramid
p. 73



Raindrop
p. 96



River Rock Oblong Oval
p. 46



River Rock Soft Round
p. 46



River Rock Wedge
p. 47



Sahara
p. 80



Savoy
p. 84



Scavo
p. 80



Silva
p. 43



Silver Glaze
p. 57



Sky
p. 100



Small Nest
p. 99



Soleil
p. 60



Solitude
p. 72



Sophia
p. 93



Sugar
p. 88



Summit
p. 58



Sydney
p. 76



Tetra
p. 94



*Shown accessorized. See pp. 366-379 for Accessories and Optical Controls.



Torpedo*
p. 98



Trimble
p. 36



Veil
p. 42



Vino
p. 82



Waffle
p. 52



LOW-VOLTAGE HEADS



Aero*
p. 120



Cam
p. 118



Curly Moon
p. 126



Curly Raindrop
p. 126



Curly Torpedo*
p. 129



Elton
p. 114



Envision
p. 106



Helios*
p. 104



John
p. 114



K-Bye-Bye
p. 128



K-Giro
p. 130



K-Hello
p. 130



K-Jane
p. 129



K-Johnny*
p. 129



K-Pivot
p. 131



K-Telescope*
p. 128



Mini Om*
p. 108



MO-Pivot*
p. 127



Pod
p. 125



Scania
p. 110



Sportster
p. 116



Spot
p. 116



Sprocket
p. 112



Swivel*
p. 124



T156
p. 118



Tele*
p. 124



Tilt*
p. 122



Wall Archie*
p. 132



Wall Georgi
p. 132



Wall Telescope*
p. 133

*Shown accessorized. See pp. 366-379 for Accessories and Optical Controls.





Wally Lite
p. 133

FUNCTIONAL ART



Biplane
p. 135

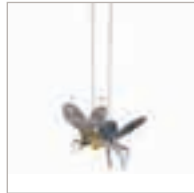

Bugs
p. 134



Dragonfly
p. 134



Metal Man
p. 134



Parachute
p. 135

LINE-VOLTAGE PENDANTS



Cabo Grande
p. 156



Delancey
p. 146



Dillon
p. 140



Echo
p. 158



Edge
p. 164



Emerge
p. 179



Fino Large
p. 160



Fino Small
p. 160



Fire Grande
p. 154



Fire Onyx
p. 156



Hudson
p. 162



Kami
p. 152



Kiev Large
p. 147



Larkspur
p. 150



Lexington
p. 144



Madison
p. 146



Melrose
p. 174



Monarch
p. 148



Montana
p. 170



Mulberry
p. 142



Ovation
p. 176



Palma
p. 166



Playa
p. 153



Powell Street
p. 162



Rohe
p. 152



Scavo Large
p. 173



Serengeti
p. 166



Small Nest
p. 168



Soda
p. 170



Spirit
p. 178



Starry Night
p. 172



Taza
p. 172



Trimble Grande
p. 147



WALL COLLECTION



Atlantis With Cone
p. 216



Aviza
p. 214



Boreal
p. 190



Bouquet With
Moon
p. 217



Bouquet With
Raindrop
p. 217



Cabo
p. 200



Cabo Grande
p. 200



Coronado
p. 202



Corva
p. 202



Cosmo
p. 196



Cube
p. 206



Echo
p. 204



Eden with Shade
p. 216



Emerge
Roxanne
p. 208



Essex
p. 188



Fire
p. 194



Fire Onyx
p. 192



Firebird
p. 195



Firefrit
p. 194



Firefrost
p. 195



Hudson
p. 201



Larkspur
p. 186



Lexington
p. 184



Melrose Flush
p. 214





Mini Larkspur
p. 186  



Monarch
p. 212  



Nebbia
p. 212 



Ovation
p. 210 



Playa
p. 198 



Playa Flush
p. 198  





Serengeti
p. 192  

BATH COLLECTION

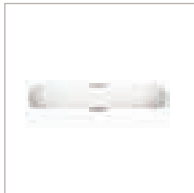

Corva Bath
p. 225  



Luna
p. 222  



Lynn Bath
p. 225  

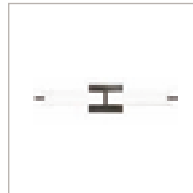



Metro
p. 224   



Metro Long
p. 224 





Siber Mirror
p. 226  



Solace
p. 222  



Tigris Mirror
Oval
p. 227  



Tigris Mirror
Round
p. 228  

CEILING COLLECTION



Boxie
p. 240  



Chambers Ceiling
p. 246 



Cirque
p. 242  



Crescendo
p. 258



Eve Suspension
p. 256 



Larkspur
Suspension
p. 256 



Melody
p. 264



Mercer Suspension
p. 248 



Mini Crescendo
p. 260



Monarch
Suspension
p. 252 



Mulberry Ceiling
p. 246 



Nebbia
Suspension
p. 254 



Pelé Chandelier
p. 232



Pendenza
Ceiling
p. 238



Polly
p. 244



Presto
p. 262



Rhapsody
p. 260



River Rock
Chandelier
p. 236



Shui Chandelier
p. 234



Staccato
p. 262



Symphony
p. 264



Telesto Ceiling
p. 244



Trace Suspension
p. 250



DISPLAY & EXHIBIT



CP Screw-On*
p. 360



CP1 Clamp-On Light*
p. 360

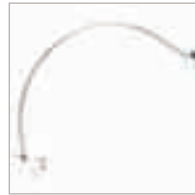

DJ-Archie
p. 363



DJ-Georgi
p. 363



DJ-Telescope
p. 363



DJ-Wally Lite
p. 363



LC-Archie*
p. 361



LC-Georgi
p. 361



LC-Wally Lite
p. 361

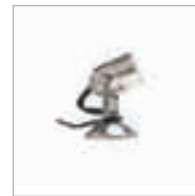

Lil Wonder
p. 365



Lil Big Wonder
p. 365



Joshua 2" Canopy*
p. 364



Joshua 4" Round
Flush Canopy
p. 364



Joshua and Meg
Picture Lights
p. 365

ACCESSORIES



Aero Wood Handle
Accessory
p. 120, 376



Backlight Shield
p. 374



Bell
p. 373



Belladonna
p. 373



Cone Glass Shield
p. 367



Cone Onyx Shield
p. 367

*Shown accessorized. See pp. 366-379 for Accessories and Optical Controls.





Dichroic Glass Shield
p. 371



Firebird Glass Shield
p. 368



Flight Paper
p. 372



Gobo Holder
p. 118, 378



Gobo Magnifying Lens
p. 118, 378



Customizable Gobo
Template
p. 118, 378



Lil Egypt
p. 371



Lil Wok
p. 374



Martini Glass Shield
p. 368



Meteorite
p. 370



Mini Om Accessory
p. 108, 371



Mini Ovation Iron
Wrap Accessory
p. 88



Ovation Iron Wrap
Accessory
p. 176



Prism Glass Shield
p. 372



Round Glass Shield
p. 367



Scavo Glass Shade
p. 368



Soda Glass Shade
p. 370



Sugar Accessory
p. 370



Swag Hook
p. 180, 377



Taza Accessory
p. 372



Tinkerbell
p. 373

OPTICAL CONTROLS



Barndoors
p. 374



Colored & Dichroic
Lenses
p. 376



Diffuser, Spread & Soft
Focus Lenses
p. 377



Eggcrate Louver
p. 377



LED Snap Louver
Lens Holder
p. 375



Louver Lens Holder
p. 375



MR16 Snout
p. 375



Snap Louver
Lens Holder
p. 375



UV Filters
p. 376



Bacchus Signature Glass

Frank and Julie Cavaz founded Bacchus Glass in the heart of the Carneros wine growing region in Sonoma, California in 1995. Under the direction of master glass blower Frank and designer Julie, Bacchus produces stunning works of art and beautiful light fixtures. Tech Lighting is honored to partner with Bacchus as we showcase some of their signature pieces in our collection and introduce several new designs.

www.techlighting.com



Monarch
p. 148 



Monarch Wall
p. 212  



Monarch
Suspension
p. 252 



Nebbia
p. 56 



Nebbia Wall
p. 212 



Nebbia
Suspension
p. 254 



River Rock
Chandelier
p. 236



River Rock Oblong Oval
p. 46



River Rock Soft
Round
p. 46



River Rock Wedge
p. 47



Silver Glaze
p. 57 



Frank and Julie Cavaz, Bacchus Glass





FreeJack 4" Round Flush Canopies Antique Bronze /
Cabo Pendants / LED Lamp Modules



LED Features & Specifications

High-performance, energy-saving light-emitting diode (LED) lighting was, until recently, not considered practical for our applications. After years of research, development and testing, we are introducing two unique, *proprietary* LED solutions that integrate our LED modules into over 40 signature pendants and one head design. Both solutions are available for use on our industry leading architectural grade low-voltage lighting systems, including MonoRail, Wall MonoRail, Kable Lite and FreeJack.

www.techlighting.com



Key Features of our LED

- Reduces energy consumption 83% compared to a halogen bi-pin or MR16 lamp
- Two proprietary LED lamp modules — one for pendants and one for heads — easily field replaceable
- An integrated power conditioning board maintains a constant current
- No UV rays
- Dimmable
- Minimum waste: heat sink stays with fixture at end of the LED lamp module life
- No mercury and RoHS compliant – no hazardous materials of any kind
- 3-year warranty

For additional features and technical specifications visit www.techlighting.com

www.techlighting.com

LED Product

Tech Lighting offers the largest selection of LED pendants in the industry with over 40 unique low-voltage pendants in a wide selection of colors and finishes. Please refer to p.27 for an overview of our LED pendant offerings and p. 104 for details on our high performance LED Helios head and compatible accessories.

www.techlighting.com



Throughout the catalog this icon indicates which fixtures are available in LED

Note: We are constantly looking to improve our LED performance. Therefore, be sure to visit www.techlighting.com for the most updated LED product information.

LED HELIOS HEAD (p. 104)*

Power Consumption:	Initial 5.8 watts Stabilized 4.9 watts
Color Temperature:	3000° K
Lumens:	Initial 360 lms Stabilized 327 lms
Lumens/Watt:	Initial 62 lms/watt Stabilized 67 lms/watt
Color Rendering Index:	>80 CRI
Rated Average Life:	>30,000 hours to 70%

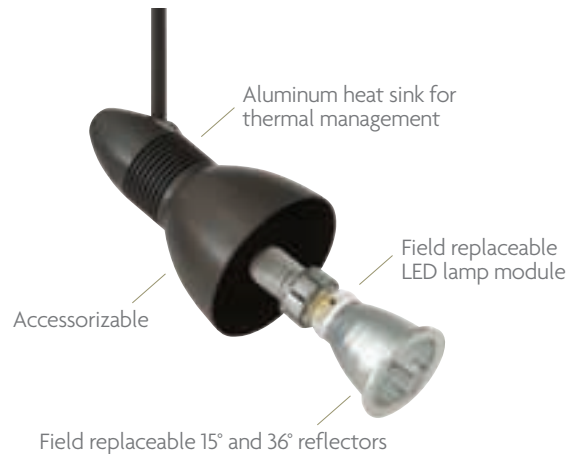

LED PENDANT ASSEMBLY*

Power Consumption:	Initial 5.8 watts Stabilized 4.7 watts
Color Temperature:	3000° K
Lumens:	Initial 300 lms Stabilized 250 lms
Lumens/Watt:	Initial 52 lms/watt Stabilized 53 lms/watt
Color Rendering Index:	>80 CRI
Rated Average Life:	>30,000 hours to 70%



*Patents Pending





Autumn Wind
p. 36



Boreal
p. 38



Brulée
p. 54



Cabo
p. 45



Camille
p. 94



Cone
p. 64



Coronado
p. 44



Egypt
p. 50



Essex
p. 44



Fab
p. 53



Firefrit
p. 70



Firefrost
p. 68



Kiev
p. 32



Melrose and
Mini Melrose
p. 86



Melt
p. 84



Mini Echo
p. 62



Mini Edge
p. 52



Mini Hudson
p. 54



Mini Ovation
p. 88



Mini Starry Night
p. 90



Mini Taza
p. 91



Monet
p. 93



Nebbia
p. 56



Niko
p. 90



Pelé
p. 78



Peyton
p. 42



Pinnacle
p. 58



Playa
p. 40



Pleat
p. 48



Prism
p. 99



Sahara
p. 80



Savoy
p. 84



Scavo
p. 80



Silver Glaze
p. 57



Small Nest
p. 99



Solitude
p. 72



Sugar
p. 88



Tetra
p. 94



Trimble
p. 36



Veil
p. 42



Vino
p. 82



Waffle
p. 52



Ordering an LED system is easy. All hardware components are identical to our other low-voltage systems with the exception of the transformer. Simply specify a MonoRail, Wall MonoRail, Kable Lite or FreeJack system and choose one of the LED-compatible transformers found on p. 29.

Please note: Two-Circuit MonoRail is not being offered in LED at this time.



Throughout the catalog this icon indicates which fixtures are available in LED



LED Transformers

All of our magnetic transformers will work with our LED heads and pendants, but only electronic transformers that end in -LED are compatible with our LED heads and pendants.

Please refer to the chart below for a complete list of compatible transformers.

ITEM NUMBER	DESCRIPTION	WATTAGE	Compatible 5.8 watt Elements		COMPATIBLE DIMMERS	PAGE #
			MIN	MAX ³		
REMOTE TRANSFORMER						
700AT075T ¹	Magnetic	75W	1	12	Low-Voltage Magnetic, 600 watts	284
700AT075P	Magnetic with Cord & Plug	75W	1	12	Low-Voltage Magnetic, 600 watts	284
700AT150T ¹	Magnetic	150W	1	25	Low-Voltage Magnetic, 600 watts	284
700AT150P	Magnetic with Cord & Plug	150W	1	25	Low-Voltage Magnetic, 600 watts	284
700AT300T ¹	Magnetic	300W	1	51	Low-Voltage Magnetic, 600 watts	284
700AT300P	Magnetic with Cord & Plug	300W	1	51	Low-Voltage Magnetic, 600 watts	284
700AT300TR ¹	Recessed Remote Magnetic	300W	1	51	Low-Voltage Magnetic, 600 watts	284
MONORAIL SURFACE TRANSFORMERS						
700MOPRT60E (Z, B, C, S, W)-LED ²	Electronic Flush	60W	2	10	Low-Voltage Electronic, 600 watts	286
700MOSRT60E (Z, B, C, S, W)-LED	Electronic Surface	60W	2	10	Low-Voltage Electronic, 600 watts	286
700MOSRT100E (Z, B, C, S, W)-LED	Electronic Surface	100W	5	17	Low-Voltage Electronic, 600 watts	286
700MOSRT75D (Z, B, C, S, W)	Magnetic Surface	75W	1	12	Low-Voltage Magnetic, 600 watts	286
700MOSRT15D (Z, B, C, S, W)	Magnetic Surface	150W	1	25	Low-Voltage Magnetic, 600 watts	286
700MOSRT30D (Z, B, C, S, W)	Magnetic Surface	300W	1	51	Low-Voltage Magnetic, 600 watts	286
WALL MONORAIL SURFACE TRANSFORMERS						
700WOP4R60E (Z, C, S, W)-LED ²	Electronic Flush	60W	2	10	Low-Voltage Electronic, 600 watts	319
700MOPEND60E (Z, C, S, W)-LED ²	Electronic Flush	60W	2	10	Low-Voltage Electronic, 600 watts	319
700MOPCEN60E (Z, C, S, W)-LED ²	Electronic Flush	60W	2	10	Low-Voltage Electronic, 600 watts	319
700SRT60E (Z, B, C, S, W)-LED	Electronic Surface	60W	2	10	Low-Voltage Electronic, 600 watts	320
700SRT100E (Z, B, C, S, W)-LED	Electronic Surface	100W	5	17	Low-Voltage Electronic, 600 watts	320
700SRT75D (Z, B, C, S, W)	Magnetic Surface	75W	1	12	Low-Voltage Magnetic, 600 watts	320
700SRT15D (Z, B, C, S, W)	Magnetic Surface	150W	1	25	Low-Voltage Magnetic, 600 watts	320
700SRT30D (Z, B, C, S, W)	Magnetic Surface	300W	1	51	Low-Voltage Magnetic, 600 watts	320
KABLE LITE SURFACE TRANSFORMERS						
700FRT60E (B, C, S, W)-LED ²	Electronic Flush	60W	2	10	Low-Voltage Electronic, 600 watts	336
700SRT60E (B, C, S, W)-LED	Electronic Surface	60W	2	10	Low-Voltage Electronic, 600 watts	336
700SRT100E (B, C, S, W)-LED	Electronic Surface	100W	5	17	Low-Voltage Electronic, 600 watts	336
700SRT75D (B, C, S, W)	Magnetic Surface	75W	1	12	Low-Voltage Magnetic, 600 watts	336
700SRT15D (B, C, S, W)	Magnetic Surface	150W	1	25	Low-Voltage Magnetic, 600 watts	336
700SRT30D (B, C, S, W)	Magnetic Surface	300W	1	51	Low-Voltage Magnetic, 600 watts	336
FREEJACK (MONOPOINT) CANOPIES WITH TRANSFORMER						
700FJ4RF (Z, B, C, S, W) -LED ^{1,2}	4" Round Flush Canopy	10W	1	1	Low-Voltage Electronic, 600 watts	352
700FJ4SQ (Z, B, C, S, W) -LED ^{1,2}	4" Square Flush Canopy	10W	1	1	Low-Voltage Electronic, 600 watts	352
700FJ2SQ67 (Z, B, C, S, W) -LED ¹	2" Square Flush Canopy	10W	1	1	Low-Voltage Electronic, 600 watts	352
700FJ5F4 (Z, B, C, S, W) -LED ¹	Surface Canopy	10W	1	1	Low-Voltage Electronic, 600 watts	352
700FJ5F4V (Z, B, C, S, W) -LED ¹	Surface Canopy, Vaulted	10W	1	1	Low-Voltage Electronic, 600 watts	352
700FJ5FV (Z, B, C, S, W) -LED ¹	Venus Canopy	10W	1	1	Low-Voltage Electronic, 600 watts	352
700FJ54 (Z, B, C, S, W) -LED	4-Port Square Canopy	40W	4	4	Low-Voltage Electronic, 600 watts	353
700FJL3 (Z, B, C, S, W) -LED	3-Port Linear Canopy	30W	3	3	Low-Voltage Electronic, 600 watts	353
700FJR3 (Z, B, C, S, W) -LED	3-Port Round Canopy	30W	3	3	Low-Voltage Electronic, 600 watts	353
700FJR4 (Z, S) -LED	4-Port Round Canopy	40W	4	4	Low-Voltage Electronic, 600 watts	353
700FJR5 (Z, B, C, S, W) -LED	5-Port Round Canopy	50W	5	5	Low-Voltage Electronic, 600 watts	353
700FJRCAD (Z, C, S, W) -LED	Recessed Can Adapter	10W	1	1	Low-Voltage Electronic, 600 watts	354
700TTCHEDFJ (Z, S, W) -LED	T-trak FJ Connector	10W	1	1	Low-Voltage Electronic, 600 watts	354
700TT2CHEDFJ (Z, S, W) -LED	2-Circuit T-trak FJ Connector	10W	1	1	Low-Voltage Electronic, 600 watts	354
700FJHASP (B, W) -LED	Track Adapter to fit Juno/Halo ⁴	10W	1	1	Low-Voltage Electronic, 600 watts	354
700FJLISP (B, W) -LED	Track Adapter to fit Lightolier ⁴	10W	1	1	Low-Voltage Electronic, 600 watts	354

FINISH OPTIONS

(Z) Antique Bronze (B) Black (C) Chrome (S) Satin Nickel (W) White

¹ 277 input voltage available. Add 277 to end of item number

² Transformer fits inside standard 4" square junction box

³ Maximum recommended run length is 100 ft for MonoRail and 50 ft for Kable Lite

⁴ Tech Lighting is not affiliated with, nor is it endorsed by, any of the companies listed above. Tech Lighting does not distribute or sell any of the products listed above.

Low-voltage Pendants and Heads

The ultimate in design flexibility. Elevate any space throughout the home or commercial environment. All low-voltage pendants ship standard with 6 feet of field-cuttable suspension cable. However, we can easily accommodate longer cable lengths, so please contact us with any custom requests.

www.techlighting.com



Throughout the catalog this icon indicates which fixtures are available in **LED**





FreeJack 4" Round Flush Canopies Antique Bronze /
Essex Pendants Amber / Bi-pin Lamps



KIEV



Antique meets modern with a turned ornate glass fount and simple tapered fabric shade with rolled edges. Includes low-voltage, 50 watt halogen bi-pin lamp or 5.8 watt replaceable LED module and six feet of field-cutttable suspension cable.

700	SYSTEM	KIE	SHADE COLOR	FOUNT COLOR	FINISH	VOLTAGE
FJ	FREEJACK	B	BLACK	C	Z	12 VOLT HALOGEN
MO	MONORAIL	N	BROWN	F	C	-24 24 VOLT HALOGEN
MO2	TWO-CIRCUIT MONORAIL	W	WHITE	K	S	-LED 12 VOLT LED 3000K*
KL	KABLE LITE					

* NOT AVAILABLE ON MO2 AT THIS TIME

** ANTIQUE BRONZE IS NOT AVAILABLE FOR KABLE LITE

COMPLEMENTARY
LINE-VOLTAGE
PENDANT P. 147

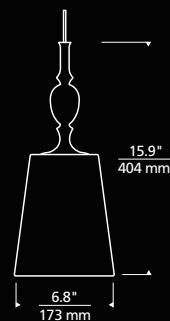



BROWN WITH
FROST FOUNT



WHITE WITH
CLEAR FOUNT



BLACK WITH
SMOKE FOUNT

MINI MULBERRY



BLACK



DESERT CLAY



RED



CHOCOLATE BROWN



OLIVE GREEN



WHITE



BROWN WAVE



LIGHT TAUPE WAVE



RUST WAVE



SAGE WAVE



COMPLEMENTARY
CEILING P. 246
LINE-VOLTAGE
PENDANT P. 142

Modern simple or textured wave patterned round fabric shade with glass diffuser provides a glare free wash of light; highlighted with metal detail. Includes two low-voltage, 35 watt halogen bi-pin lamps and six feet of field-cutable suspension cable.

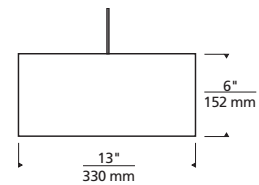

700	SYSTEM	MUL	COLOR	FINISH	VOLTAGE
FJ	FREEJACK		SOLID	Z ANTIQUE BRONZE	12 VOLT
MO	MONORAIL		B BLACK	C CHROME	-24 24 VOLT
MO2	TWO-CIRCUIT MONORAIL		N CHOCOLATE BROWN	S SATIN NICKEL	
			C DESERT CLAY		
			V OLIVE GREEN		
			R RED		
			W WHITE		
			WAVE		
			O BROWN WAVE		
			T LIGHT TAUPE WAVE		
			U RUST WAVE		
			G SAGE WAVE		





FreeJack 4" Round Flush Canopies Satin Nickel /
Mini Mulberry Pendants Chocolate Brown /
Bi-pin Lamps

TRIMBLE



BROWN



DESERT CLAY



WHITE



Modern long fabric cylinder. Includes low-voltage, 50 watt halogen bi-pin lamp or 5.8 watt replaceable LED module and six feet of field-cutable suspension cable.

COMPLEMENTARY
LINE-VOLTAGE
PENDANT P. 147

700	SYSTEM	TRM	COLOR	FINISH	VOLTAGE
FJ	FREEJACK	N	BROWN	Z ANTIQUE BRONZE**	12 VOLT HALOGEN
MO	MONORAIL	C	DESERT CLAY	C CHROME	-24 24 VOLT HALOGEN
MO2	TWO-CIRCUIT MONORAIL	W	WHITE	S SATIN NICKEL	-LED 12 VOLT LED 3000K*
KL	KABLE LITE				

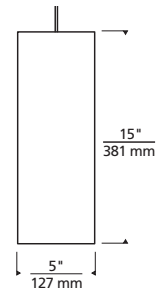

AUTUMN WIND



Cream-colored handmade paper embedded with real leaves. Includes low-voltage, 35 watt halogen bi-pin lamp or 5.8 watt replaceable LED module and six feet of field-cutable suspension cable.

700	SYSTEM	AUTM	FINISH	VOLTAGE
FJ	FREEJACK	Z	ANTIQU BRONZE**	12 VOLT HALOGEN
MO	MONORAIL	C	CHROME	-24 24 VOLT HALOGEN
MO2	TWO-CIRCUIT MONORAIL	S	SATIN NICKEL	-LED 12 VOLT LED 3000K*
K	KABLE LITE			

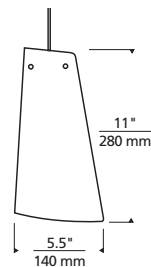



FreeJack 4" Round Flush Canopies Satin Nickel /
Trimble Pendants White / Bi-pin Lamps

BOREAL



IVORY

KHAKI GREEN

BOREAL FREEJACK 4" ROUND FLUSH CANOPY



ANTIQUE BRONZE



WHITE BRONZE

700FJ4RB	FINISH	VOLTAGE
Z	ANTIQUE BRONZE	120V IN / 12V OUT
S	WHITE BRONZE	120V IN / 24V OUT
	024	120V IN / 24V OUT
	277	277V IN / 12V OUT
	-LED	120V IN / 12V OUT LED
	-LED277	277V IN / 12V OUT

TIP: 120V FreeJack canopies are dimmable with a standard incandescent dimmer. 120V LED FreeJack canopies are dimmable with a low-voltage electronic dimmer. 277V FreeJack canopies are dimmable with 277V incandescent dimmer. 277V LED canopies are dimmable with 277V low-voltage electronic dimmer.



NATURAL HEMP
IVORY FABRIC DETAIL

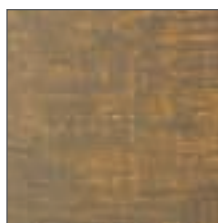

NATURAL HEMP
KHAKI GREEN FABRIC DETAIL



RECYCLED SAND-CAST
CROSSBAR DETAIL



RECYCLED SAND-CAST
CANOPY DETAIL



COMPLEMENTARY
SCONCE P. 190

Natural hemp fabric shade with recycled paper backing topped with recycled sand-cast bronze metal work. The fabric shade and recycled bronze are both sourced locally within 20 miles of our facility. The product also ships in environmentally-friendly recycled packaging. Includes low-voltage, 50 watt halogen bi-pin lamp or 5.8 watt replaceable LED module and six feet of field-cuttable suspension cable.

700	SYSTEM	BOR	COLOR	FINISH***	VOLTAGE	
FJ	FREEJACK	I	IVORY	Z	ANTIQUE BRONZE**	12 VOLT HALOGEN
MO	MONORAIL	G	KHAKI	S	WHITE BRONZE	-24 24 VOLT HALOGEN
MO2	TWO-CIRCUIT MONORAIL		GREEN			-LED 12 VOLT LED 3000K*
KL	KABLE LITE					

* NOT AVAILABLE ON MO2 AT THIS TIME
 ** ANTIQUE BRONZE IS NOT AVAILABLE FOR KABLE LITE
 *** WHILE WE FEEL THEY LOOK VERY NICE TOGETHER, THE BOREAL FINISHES WILL NOT BE AN EXACT MATCH TO EXISTING SATIN NICKEL AND ANTIQUE BRONZE HARDWARE.

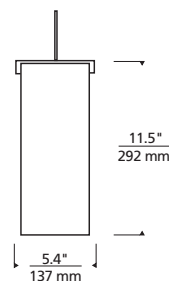



Boreal FreeJack 4" Round Flush Canopies Antique Bronze / Boreal Pendants Ivory / Bi-pin Lamps



WHITE

PLAYA



Elegant multi-toned cylindrical shade comprised of natural shell panels. The shells are burnished to remove rough edges, meticulously polished, cut to size, and carefully adhered by hand to an inner glass cylinder. Includes low-voltage, 50 watt halogen bi-pin lamp or 5.8 watt replaceable LED module and six feet of field-cutable suspension cable.

700	SYSTEM	PLA	COLOR	FINISH	VOLTAGE	
FJ	FREEJACK	B	BROWN	Z	ANTIQUÉ BRONZE**	12 VOLT HALOGEN
MO	MONORAIL	N	NATURAL	C	CHROME	-24 24 VOLT HALOGEN
MO2	TWO-CIRCUIT MONORAIL	W	WHITE	S	SATIN NICKEL	-LED 12 VOLT LED 3000K*
KL	KABLE LITE					

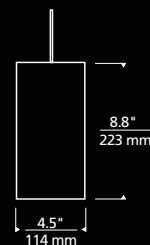

COMPLEMENTARY
SCONCE P. 188, 198
LINE-VOLTAGE
PENDANT P. 153





NATURAL

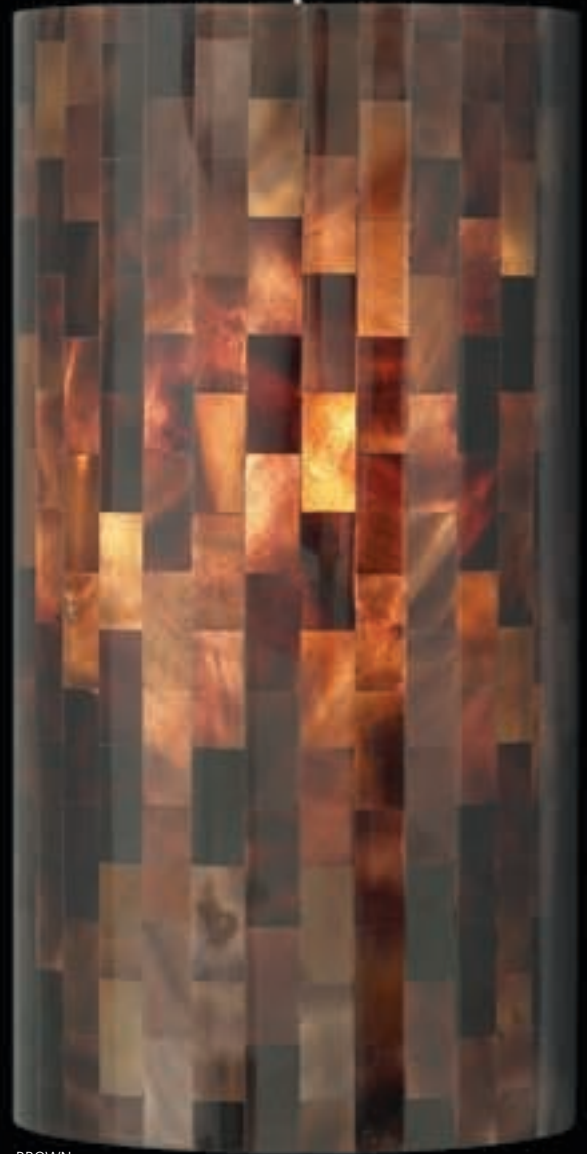

BROWN

VEIL



Cylindrical shade with crushed glass texture accented with inner layer of gold or silver. Includes low-voltage, 50 watt halogen bi-pin lamp or 5.8 watt replaceable LED module and six feet of field-cutttable suspension cable.

700	SYSTEM	VEI	COLOR	FINISH	VOLTAGE
FJ	FREEJACK	N	BROWN	Z ANTIQUE BRONZE	12 VOLT HALOGEN
MO	MONORAIL	L	LATTE	C CHROME	-24 24 VOLT HALOGEN
MO2	TWO-CIRCUIT	W	WHITE	S SATIN NICKEL	-LED 12 VOLT LED 3000K*
	MONORAIL				

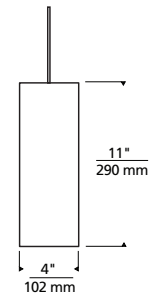

PEYTON

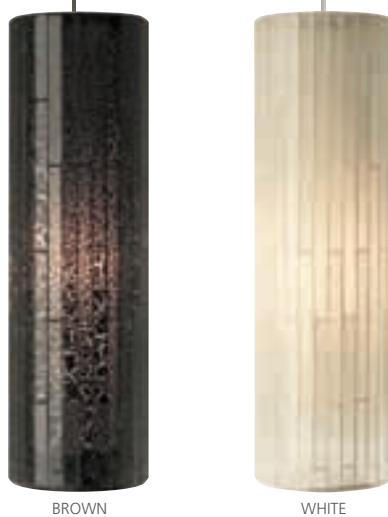

Cylindrical shade composed of glass mosaic tiles and inner frost glass diffuser. Includes low-voltage, 50 watt halogen bi-pin lamp or 5.8 watt replaceable LED module and six feet of field-cutttable suspension cable.

700	SYSTEM	PEY	COLOR	FINISH	VOLTAGE
FJ	FREEJACK	N	BROWN	Z ANTIQUE BRONZE	12 VOLT HALOGEN
MO	MONORAIL	W	WHITE	C CHROME	-24 24 VOLT HALOGEN
MO2	TWO-CIRCUIT			S SATIN NICKEL	-LED 12 VOLT LED 3000K*
	MONORAIL				

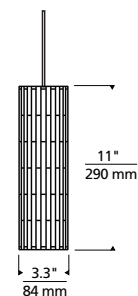

SILVA



Blown glass cylinder with unique organic pattern. Includes low-voltage, 50 watt halogen bi-pin lamp and six feet of field-cuttable suspension cable.

700	SYSTEM	SLVAC	FINISH	VOLTAGE
FJ	FREEJACK		Z ANTIQUE BRONZE**	12 VOLT HALOGEN
MO	MONORAIL		C CHROME	-24 24 VOLT HALOGEN
MO2	TWO-CIRCUIT MONORAIL		S SATIN NICKEL	
KL	KABLE LITE			

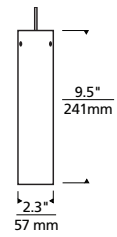

** ANTIQUE BRONZE IS NOT AVAILABLE FOR KABLE LITE

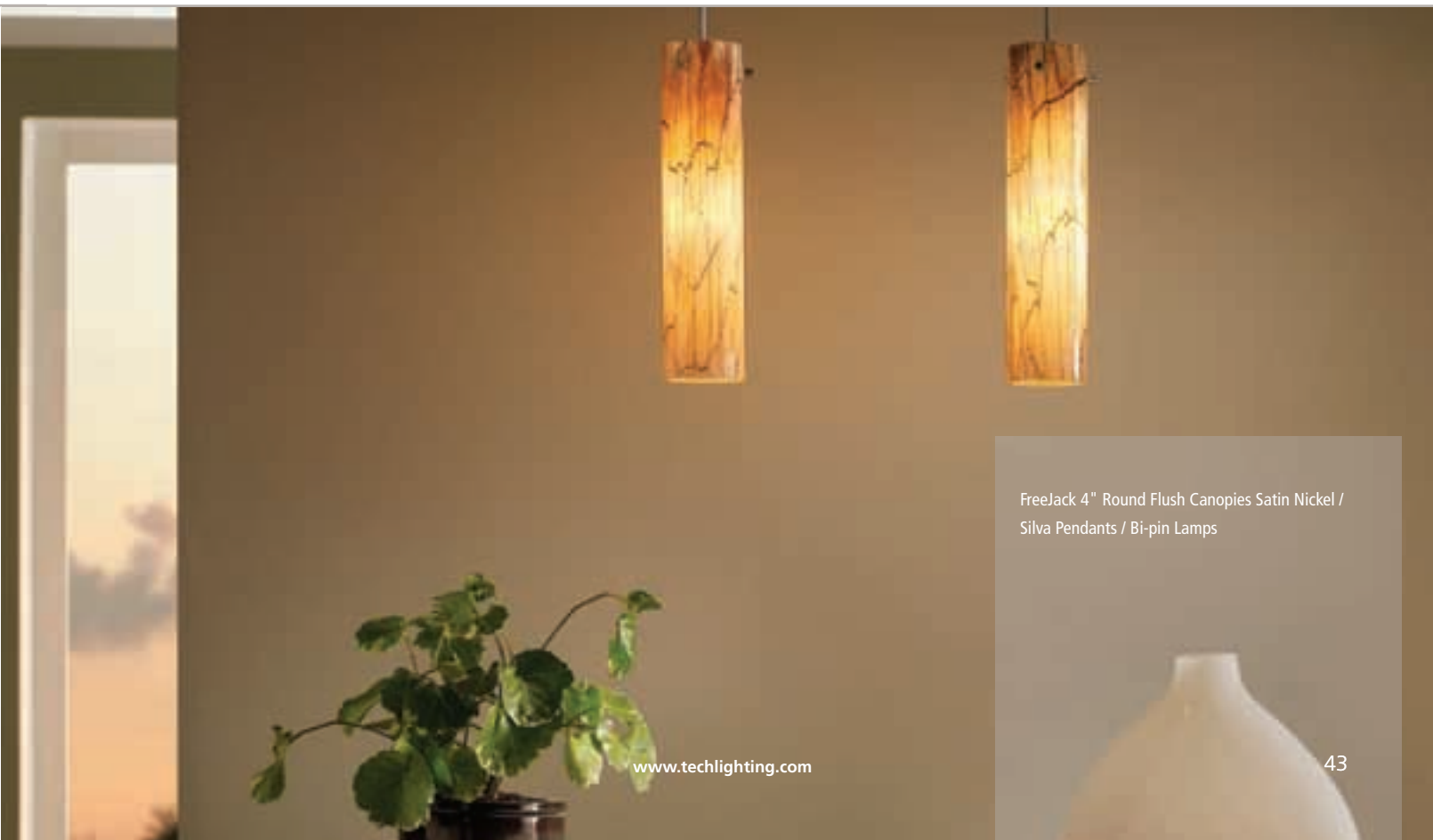

FreeJack 4" Round Flush Canopies Satin Nickel /
Silva Pendants / Bi-pin Lamps

CORONADO



Rectangular onyx shade with metal frame. Includes low-voltage, 35 watt halogen bi-pin lamp or 5.8 watt replaceable LED module and six feet of field-cutable suspension cable.

COMPLEMENTARY
SCONCE P. 202

700	SYSTEM	CORH	FINISH	VOLTAGE
FJ	FREEJACK		Z ANTIQUE BRONZE	12 VOLT HALOGEN
MO	MONORAIL		S SATIN NICKEL	-24 24 VOLT HALOGEN
MO2	TWO-CIRCUIT MONORAIL			-LED 12 VOLT LED 3000K*

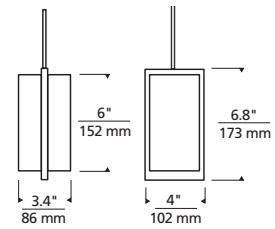

ESSEX



BEACH AMBER

SAND

SURF WHITE



Individually slumped glass panels joined with a metal frame. Includes low-voltage, 50 watt halogen bi-pin lamp or 5.8 watt replaceable LED module and six feet of field-cutable suspension cable.

COMPLEMENTARY
SCONCE P. 188

700	SYSTEM	ESX	COLOR	FINISH	VOLTAGE
FJ	FREEJACK	A	BEACH AMBER	Z ANTIQUE BRONZE	12 VOLT HALOGEN
MO	MONORAIL	S	SAND	S SATIN NICKEL	-24 24 VOLT HALOGEN
MO2	TWO-CIRCUIT MONORAIL	W	SURF WHITE		-LED 12 VOLT LED 3000K*

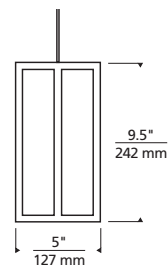

CABO



Onyx cylinder provides a warm textured look. Includes low-voltage, 50 watt halogen bi-pin lamp or 5.8 watt replaceable LED module and six feet of field-cutttable suspension cable.

COMPLEMENTARY
SCNCE P. 200
LINE-VOLTAGE
PENDANT P. 156

700	SYSTEM	CBO	FINISH	VOLTAGE
FJ	FREEJACK		Z ANTIQUE BRONZE	12 VOLT HALOGEN
MO	MONORAIL		C CHROME	-24 24 VOLT HALOGEN
MO2	TWO-CIRCUIT MONORAIL		S SATIN NICKEL	-LED 12 VOLT LED 3000K*

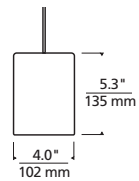

* NOT AVAILABLE ON MO2 AT THIS TIME



FreeJack 4" Round Flush Canopies Satin Nickel /
Coronado Pendants / Bi-pin Lamps

RIVER ROCK SOFT ROUND

DESIGNED BY JULIE CARCIONE CAVAZ



ILLUMINATED

NOT ILLUMINATED

COMPLEMENTARY
CHANDELIER P. 236

Inspired by rocks along a river bed and captured through a hand-blown glass process. Please note: the bottoms of the pendants will not hang parallel to the floor. This is by design and part of the natural look and feel we are going after with pieces inspired by the natural world. Includes low-voltage, 35 watt halogen bi-pin lamp and six feet of field-cutttable suspension cable.

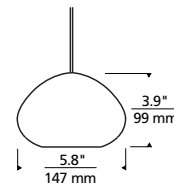

700	SYSTEM	RIVR	COLOR	FINISH	VOLTAGE
FJ	FREEJACK	S	SAND	Z ANTIQUE BRONZE**	12 VOLT HALOGEN
MO	MONORAIL			S SATIN NICKEL	-24 24 VOLT HALOGEN
MO2	TWO-CIRCUIT				
	MONORAIL				
KL	KABLE LITE				

RIVER ROCK OBLONG OVAL

DESIGNED BY JULIE CARCIONE CAVAZ



ILLUMINATED

NOT ILLUMINATED

COMPLEMENTARY
CHANDELIER P. 236

Inspired by rocks along a river bed and captured through a hand-blown glass process. Please note: the bottoms of the pendants will not hang parallel to the floor. This is by design and part of the natural look and feel we are going after with pieces inspired by the natural world. Includes low-voltage, 35 watt halogen bi-pin lamp and six feet of field-cutttable suspension cable.

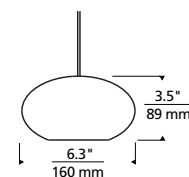

700	SYSTEM	RIVO	COLOR	FINISH	VOLTAGE
FJ	FREEJACK	B	BLUE SLATE	Z ANTIQUE BRONZE**	12 VOLT HALOGEN
MO	MONORAIL			S SATIN NICKEL	-24 24 VOLT HALOGEN
MO2	TWO-CIRCUIT				
	MONORAIL				
KL	KABLE LITE				

** ANTIQUE BRONZE IS NOT AVAILABLE FOR KABLE LITE





RIVER ROCK WEDGE

DESIGNED BY JULIE CARCIONE CAVAZ



GREEN SLATE ILLUMINATED



GREEN SLATE NOT ILLUMINATED



PEBBLE BROWN ILLUMINATED



PEBBLE BROWN NOT ILLUMINATED

COMPLEMENTARY CHANDELIER P. 236

Inspired by rocks along a river bed and captured through a hand-blown glass process. Please note: the bottoms of the pendants will not hang parallel to the floor. This is by design and part of the natural look and feel we are going after with pieces inspired by the natural world. Includes low-voltage, 35 watt halogen bi-pin lamp and six feet of field-cutable suspension cable.

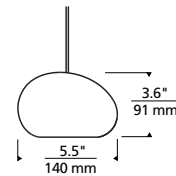

700	SYSTEM	RIVW	COLOR	FINISH	VOLTAGE
FJ	FREEJACK	G	GREEN SLATE	Z	ANTIQUE BRONZE** 12 VOLT HALOGEN
MO	MONORAIL	N	PEBBLE BROWN	C	CHROME -24 24 VOLT HALOGEN
MO2	TWO-CIRCUIT			S	SATIN NICKEL
	MONORAIL				
KL	KABLE LITE				

** ANTIQUE BRONZE IS NOT AVAILABLE FOR KABLE LITE



FreeJack 4" Round Flush Canopies Antique Bronze / River Rock Wedge Pebble Brown Pendants / Bi-pin Lamps

MINI LARKSPUR



BEACH AMBER

SAND

SURF WHITE

COMPLEMENTARY
SCONCE P. 186
LINE-VOLTAGE
PENDANT P. 150
CEILING P. 256

Fused and slumped plate glass shade, warm with color and pattern, highlighted with metal details. Glass disc diffuser provides glare free light. Includes two low-voltage, 35 watt halogen bi-pin lamps and six feet of field-cutttable suspension cable.

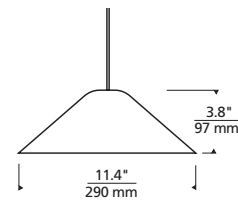

700	SYSTEM	LRK	COLOR	FINISH	VOLTAGE
	FJ	FREEJACK	A BEACH AMBER	Z ANTIQUE BRONZE	12 VOLT
	MO	MONORAIL	S SAND	C CHROME	-24 24 VOLT
	MO2	TWO-CIRCUIT MONORAIL	W SURF WHITE	S SATIN NICKEL	

PLEAT



FROST

LATTE



Pleated patterned Murano case glass shade, highlighted with three metal bead details. Includes low-voltage, 50 watt halogen bi-pin lamp or 5.8 watt replaceable LED module and six feet of field-cutttable suspension cable.

700	SYSTEM	PLT	COLOR	FINISH	VOLTAGE
	FJ	FREEJACK	F FROST	Z ANTIQUE BRONZE**	12 VOLT HALOGEN
	MO	MONORAIL	L LATTE	C CHROME	-24 24 VOLT HALOGEN
	MO2	TWO-CIRCUIT MONORAIL	S SATIN NICKEL	S SATIN NICKEL	-LED 12 VOLT LED 3000K*
	KL	KABLE LITE			

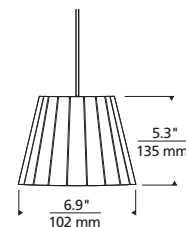



FreeJack 4" Round Flush Canopies Satin Nickel /
Mini Larkspur Pendants Sand / Bi-pin Lamps

OAK PARK

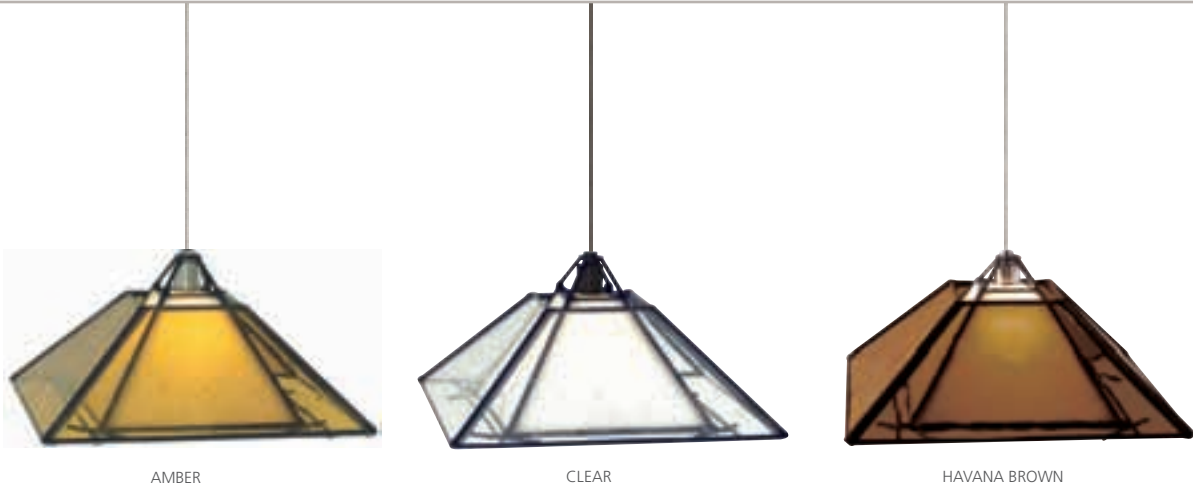

Craftsman-style four-sided seeded glass shade with black metal frame. White inner shade diffuses a low-voltage, 50 watt halogen bi-pin lamp (included). Includes six feet of field-cutttable suspension cable.

700	SYSTEM	OAKB	COLOR	FINISH	VOLTAGE
	FJ	FREEJACK	A AMBER	Z ANTIQUE BRONZE**	12 VOLT
	MO	MONORAIL	W CLEAR	C CHROME	-24 24 VOLT
	MO2	TWO-CIRCUIT MONORAIL	N HAVANA BROWN	S SATIN NICKEL	
	K	KABLE LITE			

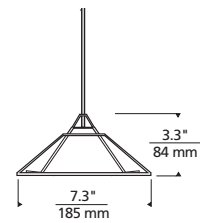

EGYPT



Exotic, finely handcrafted beaded shade. Includes low-voltage, 50 watt MR16 flood lamp or 5.8 watt replaceable LED module and six feet of field-cutttable suspension cable.



COMPLEMENTARY ACCESSORY P. 371

700	SYSTEM	EGY	COLOR	FINISH	VOLTAGE
	FJ	FREEJACK	AM AMBER	Z ANTIQUE BRONZE**	12 VOLT HALOGEN
	MO	MONORAIL	DA DARK AMBER	C CHROME	-24 24 VOLT HALOGEN
	MO2	TWO-CIRCUIT MONORAIL	RD RED	S SATIN NICKEL	-LED 12 VOLT LED 3000K*
	K	KABLE LITE			

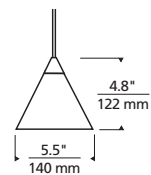



FreeJack 4" Round Flush Canopies Satin Nickel /
Egypt Pendants Red / MR16 Lamps

MINI EDGE



Hand-etched glass shade provides a rich organic textured look. Includes low-voltage, 50 watt halogen bi-pin lamp or 5.8 watt replaceable LED module and six feet of field-cuttable suspension cable.

COMPLEMENTARY
LINE-VOLTAGE
PENDANT P. 164

700	SYSTEM	EDGPM	COLOR	FINISH	VOLTAGE
FJ	FREEJACK		A AMBER	Z ANTIQUE BRONZE	12 VOLT HALOGEN
MO	MONORAIL		B BROWN	C CHROME	-24 24 VOLT HALOGEN
MO2	TWO-CIRCUIT		C CRYSTAL	S SATIN NICKEL	-LED 12 VOLT LED 3000K*
	MONORAIL		G GRAY		

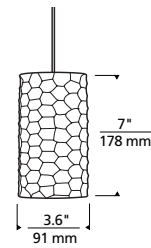

WAFFLE



Beautifully pressed square patterned Murano case glass cylinder, highlighted with three metal details. Includes low-voltage, 50 watt halogen bi-pin lamp or 5.8 watt replaceable LED module and six feet of field-cuttable suspension cable.

700	SYSTEM	WFL	COLOR	FINISH	VOLTAGE
FJ	FREEJACK		F FROST	Z ANTIQUE BRONZE	12 VOLT HALOGEN
MO	MONORAIL		L LATTE	C CHROME	-24 24 VOLT HALOGEN
MO2	TWO-CIRCUIT			S SATIN NICKEL	-LED 12 VOLT LED 3000K*
	MONORAIL				

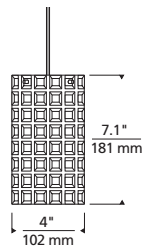



Cylinder shaped shade, constructed of Indian silk with hand-rolled edges. Includes low-voltage, 50 watt halogen bi-pin lamp or 5.8 watt replaceable LED module and six feet of field-cutttable suspension cable.

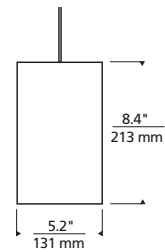

700	SYSTEM	FAB	COLOR	FINISH	VOLTAGE
FJ	FREEJACK	A	ALMOND	Z ANTIQUE BRONZE**	12 VOLT HALOGEN
MO	MONORAIL	R	RED	C CHROME	-24 24 VOLT HALOGEN
MO2	TWO-CIRCUIT MONORAIL	W	WHITE	S SATIN NICKEL	-LED 12 VOLT LED 3000K*
KL	KABLE LITE				

* NOT AVAILABLE ON MO2 AT THIS TIME
 ** ANTIQUE BRONZE IS NOT AVAILABLE FOR KABLE LITE



FreeJack 4" Round Flush Canopies Antique Bronze / Fab Pendants Almond / Bi-pin Lamps

LOCATION: WASHINGTON CENTER FOR DENTISTRY, WASHINGTON, DC
 PHOTOGRAPHER: VICKY POMBO
 LIGHTING DESIGNER: CHESAPEAKE LIGHTING
 INTERIOR DESIGNER: SALLY LEVITT, INTERIOR RESOURCES
 ARCHITECT: CH3 ARCHITECTURE
 CONTRACTOR: THE JOHN VALENTINE CO.

MINI HUDSON



Clean, modern cylindrical glass shade topped with a simple metal cap detail. Includes low-voltage, 50 watt halogen bi-pin lamp or 5.8 watt replaceable LED module and six feet of field-cutable suspension cable.

COMPLEMENTARY
SCONCES PP. 200, 201
LINE-VOLTAGE
PENDANT P. 162

700	SYSTEM	MHUD	COLOR	FINISH	VOLTAGE
	FJ	FREEJACK	N BROWN	Z ANTIQUE BRONZE**	12 VOLT HALOGEN
	MO	MONORAIL	L LATTE	C CHROME	-24 24 VOLT HALOGEN
	MO2	TWO-CIRCUIT MONORAIL	W WHITE	S SATIN NICKEL	-LED 12 VOLT LED 3000K*
	KL	KABLE LITE			

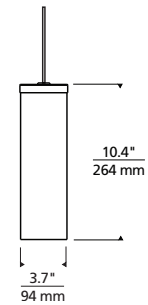

BRULÉE



Teardrop shaped glass with caramelized exterior finish. Includes low-voltage, 50 watt halogen bi-pin lamp or 5.8 watt replaceable LED module and six feet of field-cutable suspension cable.

700	SYSTEM	BRU	COLOR	FINISH	VOLTAGE
	FJ	FREEJACK	A AMBER	Z ANTIQUE BRONZE**	12 VOLT HALOGEN
	MO	MONORAIL	N BROWN	C CHROME	-24 24 VOLT HALOGEN
	MO2	TWO-CIRCUIT MONORAIL	Y GRAY	S SATIN NICKEL	-LED 12 VOLT LED 3000K*
	KL	KABLE LITE	W WHITE		

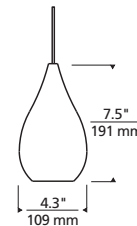



FreeJack 3 Port Round Canopy Antique Bronze /
Brulée Pendants Brown / LED Lamp Modules

NEBBIA

DESIGNED BY
JULIE CARCIONE CAVAZ



Hand-blown glass with an elegant swirl topped with metal detail. Includes low-voltage, 50 watt halogen bi-pin lamp or 5.8 watt replaceable LED module and six feet of field-cuttable cable.

COMPLEMENTARY
SCONCE P. 212
CEILING P. 254

700	SYSTEM	NEBL	COLOR	FINISH	VOLTAGE
FJ	FREEJACK	A	AMBER	Z	12 VOLT HALOGEN
MO	MONORAIL	N	BROWN	S	12 VOLT LED 3000K*
MO2	TWO-CIRCUIT MONORAIL	W	WHITE		

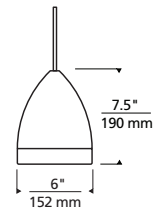

* NOT AVAILABLE ON MO2 AT THIS TIME
** ANTIQUE BRONZE IS NOT AVAILABLE FOR KABLE LITE

FreeJack 4" Round Flush Canopy Satin Nickel /
Nebbia Pendant Brown / Bi-pin Lamp





SILVER GLAZE

DESIGNED BY FRANK CAVAZ



AQUA/CLEAR
ILLUMINATED



BROWN
ILLUMINATED



AQUA/CLEAR
NOT ILLUMINATED



BROWN
NOT ILLUMINATED



Hand-blown transparent glass highlighted with a brilliant silver glaze and topped with metal detail. Height of transparent band may vary as a result of the hand-blown glass process. Includes low-voltage, 50 watt halogen bi-pin lamp or 5.8 watt replaceable LED module and six feet of field-cuttable suspension cable.

700	SYSTEM	SGZ	COLOR	FINISH	VOLTAGE
FJ	FREEJACK	Q	AQUA/CLEAR	Z ANTIQUE BRONZE	12 VOLT HALOGEN
MO	MONORAIL	N	BROWN	S SATIN NICKEL	-24 24 VOLT HALOGEN
MO2	TWO-CIRCUIT MONORAIL				-LED 12 VOLT LED 3000K*

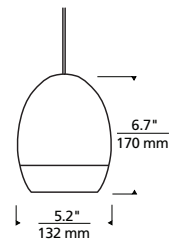

* NOT AVAILABLE ON MO2 AT THIS TIME

PINNACLE



Sleek glass cone, available in large and small versions. Black includes low-voltage, 35 watt MR16 flood lamp. Brown, latte and white include low-voltage, 50 watt halogen bi-pin lamp or 5.8 watt replaceable LED module. Each include six feet of field-cutttable suspension cable.

700	SYSTEM	PIN	SIZE	COLOR	FINISH	VOLTAGE
	FJ	FREEJACK	L LARGE	B BLACK	Z ANTIQUE	12 VOLT HALOGEN
	MO	MONORAIL	S SMALL	N BROWN	BRONZE**	-24 24 VOLT HALOGEN
	MO2	TWO-CIRCUIT MONORAIL		L LATTE	C CHROME	-LED 12 VOLT LED 3000K* †
	KL	KABLE LITE (SMALL ONLY)		W WHITE	S SATIN NICKEL	

†LED OPTION NOT AVAILABLE IN BLACK

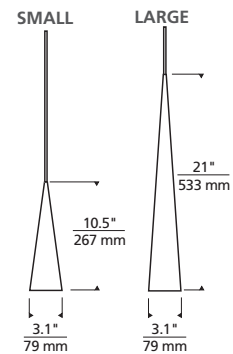

SUMMIT



SMALL LARGE

Sleek satin nickel metal cone, available in large and small versions. Includes low-voltage, 35 watt MR16 flood lamp and six feet of field-cutttable suspension cable.

700	SYSTEM	SUM	SIZE	FINISH	VOLTAGE
	FJ	FREEJACK	L LARGE	S SATIN NICKEL	12 VOLT
	MO	MONORAIL	S SMALL		-24 24 VOLT
	MO2	TWO-CIRCUIT MONORAIL			

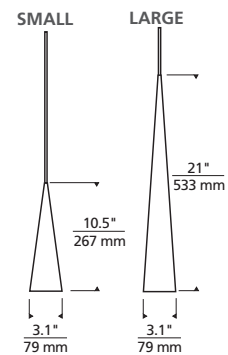



FreeJack 4" Round Flush Canopies Satin Nickel /
Summit Large Pendants / MR16 Lamps



SOLEIL



AMBER

HAVANA BROWN

OLIVE GREEN

Teardrop-shaped transparent colored glass that gently fades to clear and is diffused by a matching colored inner glass. Includes low-voltage, 35 watt halogen bi-pin lamp and six feet of field-cutable suspension cable.

700	SYSTEM	SOL	COLOR	FINISH	VOLTAGE
FJ	FREEJACK	A	AMBER	Z ANTIQUEBRONZE	12 VOLT
MO	MONORAIL	N	HAVANA BROWN	C CHROME	-24 24 VOLT
MO2	TWO-CIRCUIT MONORAIL	V	OLIVE GREEN	S SATIN NICKEL	

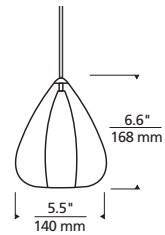



FreeJack 4" Round Flush Canopies Antique Bronze /
Soleil Pendants Havana Brown / Bi-pin Lamps

MINI ECHO



AMBER



AQUAMARINE



CLEAR



HAVANA BROWN



OLIVE GREEN



SMOKE



STEEL BLUE



Translucent cylinder over a white case glass cylinder, highlighted with three metal details. Includes low-voltage, 50 watt halogen bi-pin lamp or 5.8 watt replaceable LED module and six feet of field-cutttable suspension cable.

COMPLEMENTARY
SCONCE P. 204
LINE-VOLTAGE
PENDANT P. 158

700	SYSTEM	ECP	COLOR	FINISH	VOLTAGE
FJ	FREEJACK	A	AMBER	Z ANTIQUE BRONZE	12 VOLT HALOGEN
MO	MONORAIL	Q	AQUAMARINE	C CHROME	-24 24 VOLT HALOGEN
MO2	TWO-CIRCUIT MONORAIL	C	CLEAR	S SATIN NICKEL	-LED 12 VOLT LED 3000K*
		B	HAVANA BROWN		
		V	OLIVE GREEN		
		S	SMOKE		
		U	STEEL BLUE		

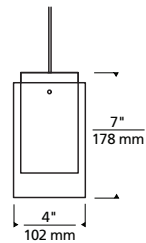



FreeJack 4" Round Flush Canopies Satin Nickel /
Mini Echo Pendants Clear / Bi-pin Lamps

LOCATION: CHICAGO, IL
PHOTOGRAPHER: MIKE KASKEL
DESIGNER: CHRISTINE JULIAN, JULIAN KITCHEN DESIGN, INC.

CONE



COMPLEMENTARY
SCONCE P. 216
ACCESSORY P. 367

Case glass cone with reflective white interior or transparent glass cone. Case glass Includes low-voltage, 50 watt halogen bi-pin lamp or 5.8 watt replaceable LED module. Transparent glass includes low-voltage, 50 watt MR16 flood lamp. Each include six feet of field-cuttable suspension cable.

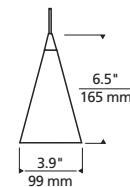

700	SYSTEM	CON	COLOR	FINISH	VOLTAGE
FJ	FREEJACK	A	AMBER	Z ANTIQUE BRONZE**	12 VOLT HALOGEN
MO	MONORAIL	C	CLEAR	C CHROME	-24 24 VOLT HALOGEN
MO2	TWO-CIRCUIT	P	COBALT	S SATIN NICKEL	-LED 12 VOLT LED 3000K* ***
	MONORAIL	G	GREEN		
	KABLE LITE	R	RED		
		NT	TRANSPARENT HAVANA BROWN		
		VT	TRANSPARENT OLIVE GREEN		
		UT	TRANSPARENT STEEL BLUE		
		W	WHITE		



* NOT AVAILABLE ON MO2 AT THIS TIME
** ANTIQUE BRONZE IS NOT AVAILABLE FOR KABLE LITE



4" Round Flush Canopies Satin Nickel / Cone Pendants
Clear / Aero Head / Prism Glass Shield Accessory /
MR16 Lamps



STEEL
BLUE

FIRE

Rich, translucent Murano glass surrounds a small frost raindrop glass. Includes low-voltage, 35 watt halogen bi-pin lamp and six feet of field-cuttable suspension cable.

700	SYSTEM	FIR	COLOR	FINISH	VOLTAGE
FJ	FREEJACK	A	AMBER	Z	ANTIQUE BRONZE 12 VOLT
MO	MONORAIL	B	COBALT	C	CHROME -24 24 VOLT
MO2	TWO-CIRCUIT MONORAIL	N	HAVANA BROWN	S	SATIN NICKEL
		V	OLIVE GREEN		
		R	RED		
		K	SMOKE		
		U	STEEL BLUE		

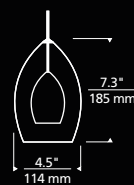

COMPLEMENTARY
SCONCE P. 194
LINE-VOLTAGE
PENDANT P. 154





OLIVE GREEN



COBALT



HAVANA BROWN



AMBER



RED



SMOKE

FIREFROST



Murano glass with frosted or case glass interior. Includes low-voltage, 50 watt halogen bi-pin lamp or 5.8 watt replaceable LED module and six feet of field-cutttable suspension cable.

COMPLEMENTARY
SCONCE P. 195

700	SYSTEM	FIRF	COLOR	FINISH	VOLTAGE
FJ	FREEJACK	A	AMBER	Z	12 VOLT HALOGEN
MO	MONORAIL	H	CHARTREUSE	C	24 VOLT HALOGEN
MO2	TWO-CIRCUIT	B	COBALT	S	12 VOLT LED 3000K*
	MONORAIL	R	RED		
KL	KABLE LITE	W	WHITE		

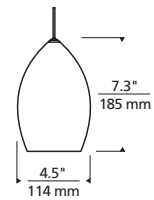

INNER FIRE



Clear glass surrounds a small raindrop glass in frost or a color. Includes low-voltage, 35 watt halogen bi-pin lamp and six feet of field-cutttable suspension cable.

700	SYSTEM	FIRC	COLOR	FINISH	VOLTAGE
FJ	FREEJACK	M	AMBER	Z	12 VOLT
MO	MONORAIL	B	COBALT	C	24 VOLT
MO2	TWO-CIRCUIT	F	FROST	S	12 VOLT LED 3000K*
	MONORAIL	R	RED		

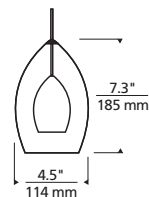



MonoRail Satin Nickel / End Caps / Remote 600 Watt
12 Volt Transformer / 4" Round Dual-Feed Canopy /
6" Rigid Standoffs / Flexible Connector / 6" Power
Extenders / Fire Pendants Amber / Bi-pin Lamps /
FreeJack 4" Round Flush Canopies Satin Nickel /
Aero Heads / Round Glass Shield Accessories Frost /
MR16 Lamps

FIREFRIT



FERRARI RED

MULTICOLOR

TAHOE PINE AMBER

WHITE FRIT



A colorful twist on our popular Fire pendant with brilliant frit glass. Includes low-voltage, 50 watt halogen bi-pin lamp or 5.8 watt replaceable LED module and six feet of field-cuttable suspension cable.

COMPLEMENTARY
SCONCE P. 194

700	SYSTEM	FIRY	COLOR	FINISH	VOLTAGE	
FJ	FREEJACK	R	FERRARI RED	Z	ANTIQUE BRONZE**	12 VOLT HALOGEN
MO	MONORAIL	M	MULTICOLOR	C	CHROME	-24 24 VOLT HALOGEN
MO2	TWO-CIRCUIT	A	TAHOE PINE AMBER	S	SATIN NICKEL	-LED 12 VOLT LED 3000K*
KL	MONORAIL	W	WHITE FRIT			
	KABLE LITE					

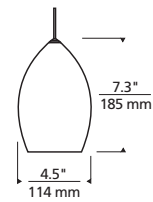

FIREBIRD



BLUEBIRD

CARDINAL

PARROT

PEACOCK

OWL

SWAN

COMPLEMENTARY
SCONCE P. 195
ACCESSORY P. 368

Patterned Murano glass surrounds a small frost raindrop glass. Includes low-voltage, 35 watt halogen bi-pin lamp and six feet of field-cuttable suspension cable.

700	SYSTEM	FIR	COLOR	FINISH	VOLTAGE	
FJ	FREEJACK	L	BLUEBIRD	Z	ANTIQUE BRONZE	12 VOLT
MO	MONORAIL	D	CARDINAL	C	CHROME	-24 24 VOLT
MO2	TWO-CIRCUIT	O	OWL	S	SATIN NICKEL	
	MONORAIL	T	PARROT			
		P	PEACOCK			
		S	SWAN			

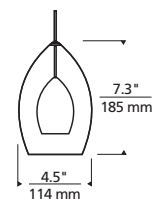



FreeJack Venus Canopies Satin Nickel /
Firebird Pendants Peacock / Bi-pin Lamps

LOCATION: PRIVATE RESIDENCE, IL
INTERIOR DESIGNER: DRURY DESIGN KITCHEN & BATH STUDIO
GLEN ELLYN, IL

CUBE



AMBER

AMETHYST

COBALT

FROST

COMPLEMENTARY
SCONCE P. 206

Classic geometric cube shape made of pressed glass. Includes low-voltage, 35 watt halogen bi-pin lamp and six feet of field-cutttable suspension cable.

700	SYSTEM	CUB	COLOR	FINISH	VOLTAGE
FJ	FREEJACK		A AMBER	Z ANTIQUE BRONZE**	12 VOLT
MO	MONORAIL		M AMETHYST	C CHROME	-24 24 VOLT
MO2	TWO-CIRCUIT		C COBALT	S SATIN NICKEL	
	MONORAIL		F FROST		
KL	KABLE LITE				

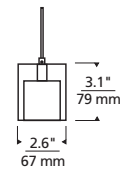

SOLITUDE



AMBER

FROST



Rectangular pressed glass shade. Includes low-voltage, 35 watt halogen bi-pin lamp or 5.8 watt replaceable LED module and six feet of field-cutttable suspension cable.

COMPLEMENTARY
SCONCE P. 206

700	SYSTEM	SLD	COLOR	FINISH	VOLTAGE
FJ	FREEJACK		A AMBER	Z ANTIQUE BRONZE	12 VOLT HALOGEN
MO	MONORAIL		F FROST	C CHROME	-24 24 VOLT HALOGEN
MO2	TWO-CIRCUIT			S SATIN NICKEL	-LED 12 VOLT LED 3000K*
	MONORAIL				

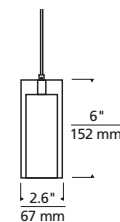

PYRAMID



AMBER

AMETHYST

COBALT

FROST

Classic pyramid shape enhanced with a subtle step pattern inside. Made of pressed glass. Includes low-voltage, 35 watt halogen bi-pin lamp and six feet of field-cuttable suspension cable.

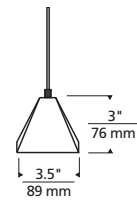

700	SYSTEM	PYR	COLOR	FINISH	VOLTAGE		
	FJ	FREEJACK	A	AMBER	Z	ANTIQUÉ BRONZE*	12 VOLT
	MO	MONORAIL	M	AMETHYST	C	CHROME	-24 24 VOLT
	MO2	TWO-CIRCUIT MONORAIL	P	COBALT	S	SATIN NICKEL	
	K	KABLE LITE	F	FROST			

* ANTIQUÉ BRONZE IS NOT AVAILABLE FOR KABLE LITE



FreeJack 4" Round Flush Canopies Satin Nickel /
Cube Pendants Frost / Bi-pin Lamps

DIZ



Transparent slumped glass plate floats around the exposed, secured MR16. May be mounted up or down. Includes low-voltage, 50 watt MR16 flood lamp and six feet of field-cutttable suspension cable.

700	SYSTEM	DIZ	COLOR	FINISH	VOLTAGE
	FJ	FREEJACK	C CLEAR	Z ANTIQUE BRONZE*	12 VOLT
	MO	MONORAIL	N HAVANA BROWN	C CHROME	-24 24 VOLT
	MO2	TWO-CIRCUIT MONORAIL	V OLIVE GREEN	S SATIN NICKEL	
	KL	KABLE LITE	U STEEL BLUE		

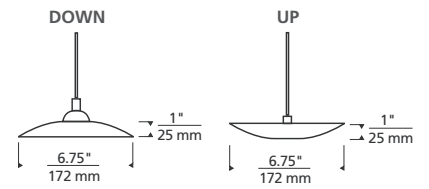

BIZ



Transparent glass disk floats around the exposed, secured MR16. Includes low-voltage, 50 watt MR16 flood lamp and six feet of field-cutttable suspension cable.

700	SYSTEM	BIZ	COLOR	FINISH	VOLTAGE
	FJ	FREEJACK	C CLEAR	Z ANTIQUE BRONZE*	12 VOLT
	MO	MONORAIL	N HAVANA BROWN	C CHROME	-24 24 VOLT
	MO2	TWO-CIRCUIT MONORAIL	V OLIVE GREEN	S SATIN NICKEL	
	K	KABLE LITE	U STEEL BLUE		

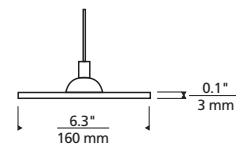



FreeJack 4" Round Flush Canopies Satin Nickel /
Diz Pendants Steel Blue / MR16 Lamps

CHEERS



Cheer with single fused globe includes one low-voltage, 10 watt xenon bi-pin lamp. Cheers with seven clear glass globes with fused center tubes suspended from one central hub. Cheers includes seven low-voltage, 10 watt xenon bi-pin lamps. Each include six feet of field-cutttable suspension cable.

700	SYSTEM	CHR	TYPE	FINISH	VOLTAGE
FJ	FREEJACK		1 CHEER	Z ANTIQUE BRONZE	12 VOLT
MO	MONORAIL		7 CHEERS	C CHROME	-24 24 VOLT
MO2	TWO-CIRCUIT MONORAIL			S SATIN NICKEL	

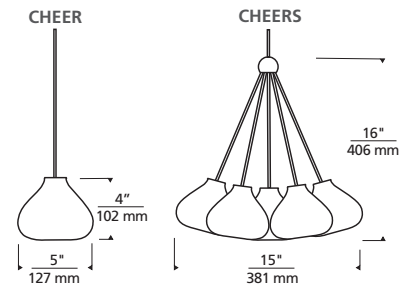

SYDNEY



Inspired by the world-famous Sydney Opera House, three concentric glass shades form the structure of this glass pendant. Includes low-voltage, 50 watt halogen bi-pin lamp and six feet of field-cutttable suspension cable.

700	SYSTEM	SYD	COLOR	FINISH	VOLTAGE
FJ	FREEJACK		A AMBER	Z ANTIQUE BRONZE	12 VOLT
MO	MONORAIL		W WHITE	C CHROME	-24 24 VOLT
MO2	TWO-CIRCUIT MONORAIL			S SATIN NICKEL	

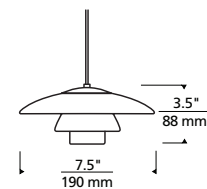



FreeJack 4" Round Flush Canopies Satin Nickel / Cheers 7 Pendants / Bi-pin Lamps

LOCATION: PRIVATE RESIDENCE, CHICAGO, IL
DESIGN: CONTRAST DESIGN GROUP INC.
PHOTOGRAPHER: L3 PHOTOGRAPHY

CUE



CAP DETAIL



DARK AMBER



WHITE

Hand-blown glass shade that fades to clear. Finished with an intricately patterned metal detail. Includes low-voltage, 35 watt halogen and six feet of field-cutable suspension cable.

700	SYSTEM	CUE	COLOR	FINISH	VOLTAGE
FJ	FREEJACK		A DARK	Z ANTIQUE BRONZE**	12 VOLT
MO	MONORAIL		AMBER	S SATIN NICKEL	-24 24 VOLT
MO2	TWO-CIRCUIT		W WHITE		
	MONORAIL				
KL	KABLE LITE				

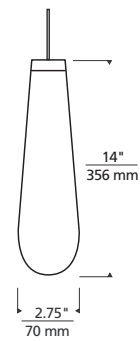

PELÉ



Modern glass sphere topped with glass detail. Includes low-voltage, 50 watt frosted halogen bi-pin lamp or 5.8 watt replaceable LED module and six feet of field-cutable suspension cable.

COMPLEMENTARY
CHANDELIER P. 232

700	SYSTEM	PELÉ	COLOR	FINISH	VOLTAGE
FJ	FREEJACK		W WHITE	Z ANTIQUE BRONZE**	12 VOLT HALOGEN
MO	MONORAIL			C CHROME	-24 24 VOLT HALOGEN
MO2	TWO-CIRCUIT			S SATIN NICKEL	-LED 12 VOLT LED 3000K*
	MONORAIL				
KL	KABLE LITE				

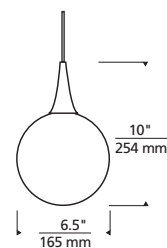



FreeJack 4" Round Flush Canopies Satin Nickel /
Cue Pendants White / Bi-pin Lamps

SCAVO



AMBER

AMETHYST

FROST

GREEN



Curve shaped glass with a frosted old world charm. Includes low-voltage, 50 watt halogen bi-pin lamp or 5.8 watt replaceable LED module and six feet of field-cuttable suspension cable.

COMPLEMENTARY
ACCESSORY P. 368
LINE-VOLTAGE
PENDANT P. 173

700	SYSTEM	SCA	COLOR	FINISH	VOLTAGE
FJ	FREEJACK	A	AMBER	Z ANTIQUE BRONZE**	12 VOLT HALOGEN
MO	MONORAIL	M	AMETHYST	C CHROME	-24 24 VOLT HALOGEN
MO2	TWO-CIRCUIT	F	FROST	S SATIN NICKEL	-LED 12 VOLT LED 3000K*
MO2	MONORAIL	G	GREEN		
KL	KABLE LITE				

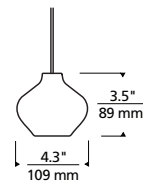

SAHARA



AMBER

AMETHYST

BROWN

GREEN



Embedded grains of sand provide this glass with a rustic finish. Includes low-voltage, 50 watt halogen bi-pin lamp or 5.8 watt replaceable LED module and six feet of field-cuttable suspension cable.

700	SYSTEM	SAHA	COLOR	FINISH	VOLTAGE
FJ	FREEJACK	A	AMBER	Z ANTIQUE BRONZE**	12 VOLT HALOGEN
MO	MONORAIL	M	AMETHYST	C CHROME	-24 24 VOLT HALOGEN
MO2	TWO-CIRCUIT	N	BROWN	S SATIN NICKEL	-LED 12 VOLT LED 3000K*
MO2	MONORAIL	G	GREEN		
KL	KABLE LITE				

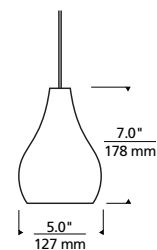



FreeJack 4" Round Flush Canopies Chrome /
Scavo Pendants Amber / Bi-pin Lamps

VINO



Murano glass shade, rich with opaque color and etched detail. Includes low-voltage, 50 watt halogen bi-pin lamp or 5.8 watt replaceable LED module and six feet of field-cuttable suspension cable.

700	SYSTEM	VNO	COLOR	FINISH	VOLTAGE
FJ	FREEJACK	A	AMBER	Z	12 VOLT HALOGEN
MO	MONORAIL	F	FROST	C	24 VOLT HALOGEN
MO2	TWO-CIRCUIT	R	RED	S	12 VOLT LED 3000K*
	MONORAIL				

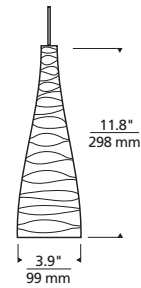

MOON



COMPLEMENTARY
HEAD P. 126
SCONCE P. 217

Includes a low-voltage, 20 watt xenon bi-pin lamp and six feet of field-cuttable suspension cable.

700	SYSTEM	TYPE	FINISH	VOLTAGE	
FJ	FREEJACK	BMN	BLUE MOON	Z	12 VOLT
MO	MONORAIL	MNW	MOON	C	24 VOLT
MO2	TWO-CIRCUIT	MNS	MOONSTRUCK	S	
	MONORAIL	MNO	OWL MOON		
KL	KABLE LITE				

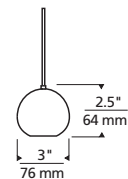



FreeJack 4" Round Flush Canopies Satin Nickel / Owl Moon Pendants / Bi-pin Lamps

PHOTOGRAPHER: ERIC ROTH

MELT



Inverted teardrop shaped, richly colored frit glass accented with a clear glass draw at the bottom and three metal beads at the top. Includes low-voltage, 50 watt halogen bi-pin lamp or 5.8 watt replaceable LED module and six feet of field-cutttable suspension cable.

700	SYSTEM	MLT	COLOR	FINISH	VOLTAGE		
	FJ	FREEJACK	A	AMBER FRIT	Z	ANTIQU BRONZE**	12 VOLT HALOGEN
	MO	MONORAIL	C	COBALT FRIT	C	CHROME	-24 24 VOLT HALOGEN
	MO2	TWO-CIRCUIT MONORAIL	W	WHITE FRIT	S	SATIN NICKEL	-LED 12 VOLT LED 3000K*
	KL	KABLE LITE					

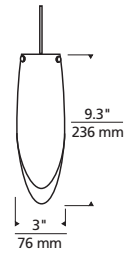

SAVOY



Delicately shaped glass shade, layered in vibrant colors. Includes low-voltage, 35 watt halogen bi-pin lamp or 5.8 watt replaceable LED module and six feet of field-cutttable suspension cable.

700	SYSTEM	SAV	COLOR	FINISH	VOLTAGE		
	FJ	FREEJACK	A	AMBER	Z	ANTIQU BRONZE**	12 VOLT HALOGEN
	MO	MONORAIL	R	RED	C	CHROME	-24 24 VOLT HALOGEN
	MO2	TWO-CIRCUIT MONORAIL	W	WHITE	S	SATIN NICKEL	-LED 12 VOLT LED 3000K*
	KL	KABLE LITE					

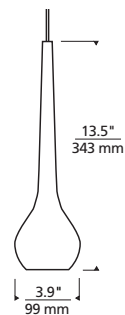



FreeJack 4" Round Flush Canopies Satin Nickel /
Melt Pendants White Frit / Bi-pin Lamps



MELROSE



BLUE-VIOLET

FERRARI RED

MULTICOLOR

TAHOE PINE AMBER

WHITE FRIT



Gracefully shaped glass shade, richly layered in brilliant frit, with machined top detail. Includes low-voltage, 50 watt halogen bi-pin lamp or 5.8 watt replaceable LED module and six feet of field-cutttable suspension cable.

COMPLEMENTARY
SCONCE P. 214
LINE-VOLTAGE
PENDANT P. 174

700 SYSTEM	MLP	COLOR	FINISH	VOLTAGE
FJ	FREEJACK	B	Z	12 VOLT HALOGEN
MO	MONORAIL	R	C	-24 24 VOLT HALOGEN
MO2	TWO-CIRCUIT	M	S	-LED 12 VOLT LED 3000K*
	MONORAIL	A		
		W		

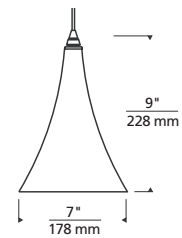

MINI MELROSE



BLUE-VIOLET

FERRARI RED

MULTICOLOR

TAHOE PINE AMBER

WHITE FRIT



Gracefully shaped glass shade, richly layered in brilliant frit, with machined top detail. Includes low-voltage, 50 watt halogen bi-pin lamp or 5.8 watt replaceable LED module and six feet of field-cutttable suspension cable.

COMPLEMENTARY
SCONCE P. 214
LINE-VOLTAGE
PENDANT P. 174

700 SYSTEM	MML	COLOR	FINISH	VOLTAGE
FJ	FREEJACK	B	Z	12 VOLT HALOGEN
MO	MONORAIL	R	C	-24 24 VOLT HALOGEN
MO2	TWO-CIRCUIT	M	S	-LED 12 VOLT LED 3000K*
	MONORAIL	A		
KL	KABLE LITE	W		

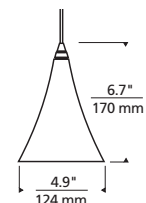



2-Circuit MonoRail Satin Nickel / End Caps /
Remote 2x300 Watt 12 Volt Transformers / 4" Round
Single-Feed Canopies / Power Vault Adapters /
Standoff Vault Adapters / 6" Rigid Standoffs /
6" Power Extenders / 6" Aero Heads / 12" Aero
Heads / Tinkerbell Accessories / MR16 Lamps /
Melrose Pendants Tahoe Pine Amber / Bi-pin Lamps

DESIGN: NORSK REMODELING
PHOTOGRAPHER: ROGER TURK

MINI OVATION



FERRARI RED WITH CLEAR GLASS BALL

TAHOE PINE AMBER

TORTOISE SHELL WITH IRON WRAP ACCESSORY

WHITE FRIT WITH RED GLASS BALL

MINI OVATION IRON WRAP ACCESSORY

700FJMOV R FINISH

I BLACK IRON
S SATIN NICKEL



Hand pulled glass shade, richly layered in brilliant color, with machined top or glass ball detail. Handmade wrought iron wrap accessory sold separately above. Includes low-voltage, 50 watt halogen bi-pin lamp or 5.8 watt replaceable LED module and six feet of field-cuttable suspension cable.

COMPLEMENTARY SCONCE P. 210
LINE-VOLTAGE PENDANT P. 176

700 SYSTEM	MOV	COLOR	GLASS BALL	FINISH	VOLTAGE
FJ	FREEJACK	R FERRARI RED	N NO BALL	Z ANTIQUE BRONZE**	12 VOLT HALOGEN
MO	MONORAIL	A TAHOE PINE AMBER	A AMBER	C CHROME	-24 24 VOLT HALOGEN
MO2	TWO-CIRCUIT MONORAIL	T TORTOISE SHELL	C CLEAR	C CHROME	-LED 12 VOLT LED 3000K*
KL	KABLE LITE	W WHITE FRIT	R RED	S SATIN NICKEL	

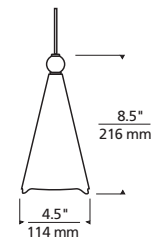

SUGAR



AMBER

AQUA

VIOLET

WHITE



Streams of glass piping formed into a graceful glass shade. Includes low-voltage, 50 watt halogen bi-pin lamp or 5.8 watt replaceable LED module and six feet of field-cuttable suspension cable.

COMPLEMENTARY ACCESSORY P. 370

700 SYSTEM	SUG	COLOR	FINISH	VOLTAGE
FJ	FREEJACK	A AMBER	Z ANTIQUE BRONZE**	12 VOLT HALOGEN
MO	MONORAIL	Q AQUA	C CHROME	-24 24 VOLT HALOGEN
MO2	TWO-CIRCUIT MONORAIL	V VIOLET	S SATIN NICKEL	-LED 12 VOLT LED 3000K*
KL	KABLE LITE	W WHITE		

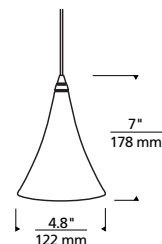

* NOT AVAILABLE ON MO2 AT THIS TIME
** ANTIQUE BRONZE IS NOT AVAILABLE FOR KABLE LITE





FreeJack 4" Round Flush Canopies Satin Nickel /
Sugar Pendants Amber / Bi-pin Lamps

MINI STARRY NIGHT



DARK AMBER

CARAMEL

WHITE



Cone shaped glass shade richly layered in hand twisted colors with reflective white interior. Includes low-voltage, 50 watt halogen bi-pin lamp or 5.8 watt replaceable LED module and six feet of field-cutttable suspension cable.

COMPLEMENTARY
LINE-VOLTAGE
PENDANT P. 172

700	SYSTEM	STR	COLOR	FINISH	VOLTAGE		
	FJ	FREEJACK	C	CARAMEL	Z	ANTIQU BRONZE**	12 VOLT HALOGEN
	MO	MONORAIL	A	DARK AMBER	C	CHROME	-24 24 VOLT HALOGEN
	MO2	TWO-CIRCUIT MONORAIL	W	WHITE	S	SATIN NICKEL	-LED 12 VOLT LED 3000K*
	KL	KABLE LITE					

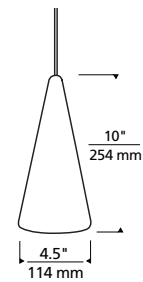

NIKO



AMBER

AMETHYST

FROST

GREEN



Cone shaped glass shade embedded with large murini and canes of glass. Includes low-voltage, 50 watt halogen bi-pin lamp or 5.8 watt replaceable LED module and six feet of field-cutttable suspension cable.

700	SYSTEM	NKO	COLOR	FINISH	VOLTAGE		
	FJ	FREEJACK	A	AMBER	Z	ANTIQU BRONZE**	12 VOLT HALOGEN
	MO	MONORAIL	M	AMETHYST	C	CHROME	-24 24 VOLT HALOGEN
	MO2	TWO-CIRCUIT MONORAIL	F	FROST	S	SATIN NICKEL	-LED 12 VOLT LED 3000K*
	KL	KABLE LITE	G	GREEN			

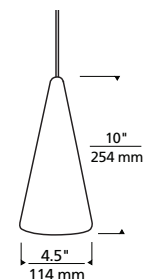

MINI TAZA



AMBER

BLUE-GREEN

BROWN

CREAM

RED



Blown glass shade with intensely twisted rich glass color. Includes low-voltage, 50 watt halogen bi-pin lamp or 5.8 watt replaceable LED module and six feet of field-cutable suspension cable.

COMPLEMENTARY ACCESSORY P. 372 LINE-VOLTAGE PENDANT P. 172

700	SYSTEM	TAZA	COLOR	FINISH	VOLTAGE
FJ	FREEJACK	A	AMBER	Z ANTIQUE BRONZE**	12 VOLT HALOGEN
MO	MONORAIL	B	BLUE-GREEN	C CHROME	24 VOLT HALOGEN
MO2	TWO-CIRCUIT MONORAIL	N	BROWN	S SATIN NICKEL	-24
		C	CREAM		-LED 12 VOLT LED 3000K*
KL	KABLE LITE	R	RED		

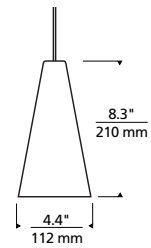

* NOT AVAILABLE ON MO2 AT THIS TIME
 ** ANTIQUE BRONZE IS NOT AVAILABLE FOR KABLE LITE



FreeJack 4" Round Flush Canopies Satin Nickel / Niko Pendants Green / Bi-pin Lamps / Lexington Pendant Desert Clay Satin Nickel / A19 Lamps

METEOR FRIT



Dome shaped glass shade, richly layered in brilliant frit. Includes low-voltage, 50 watt halogen bi-pin lamp and six feet of field-cutttable suspension cable.

700	SYSTEM	ME	COLOR	FINISH	VOLTAGE
FJ	FREEJACK	AF	AMBER FRIT	Z ANTIQUE BRONZE*	12 VOLT
MO	MONORAIL	MF	MULTICOLOR FRIT	C CHROME	-24 24 VOLT
MO2	TWO-CIRCUIT MONORAIL	RF	RED FRIT	S SATIN NICKEL	
KL	KABLE LITE	WF	WHITE FRIT		

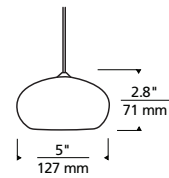

METEOR



Dome shaped cased glass shade. Includes low-voltage, 50 watt halogen bi-pin lamp and six feet of field-cutttable suspension cable.

700	SYSTEM	ME	COLOR	FINISH	VOLTAGE
FJ	FREEJACK	A	AMBER	Z ANTIQUE BRONZE*	12 VOLT
MO	MONORAIL	W	FROST	C CHROME	-24 24 VOLT
MO2	TWO-CIRCUIT MONORAIL	R	RED	S SATIN NICKEL	
KL	KABLE LITE				

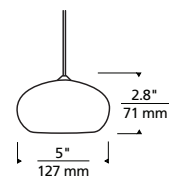

COMPLEMENTARY ACCESSORY P. 370



MONET



AMBER

CARAMEL CREAM

MULTICOLOR



Dome shaped richly colored glass inspired by Monet's paintings. Includes low-voltage, 50 watt halogen bi-pin lamp or 5.8 watt replaceable LED module and six feet of field-cuttable suspension cable.

700	SYSTEM	MONET	COLOR	FINISH	VOLTAGE
FJ	FREEJACK		A AMBER	Z ANTIQUE BRONZE**	12 VOLT HALOGEN
MO	MONORAIL		C CARAMEL	C CHROME	-24 24 VOLT HALOGEN
MO2	TWO-CIRCUIT MONORAIL		CREAM	S SATIN NICKEL	-LED 12 VOLT LED 3000K*
KL	KABLE LITE		M MULTICOLOR		

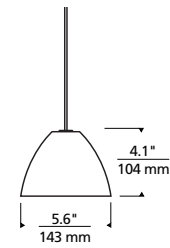

SOPHIA



Bell shaped shade of multicolored millefiore glass. Includes low-voltage, 50 watt halogen bi-pin lamp and six feet of field-cuttable suspension cable.

700	SYSTEM	SOPH	FINISH	VOLTAGE
FJ	FREEJACK		Z ANTIQUE BRONZE**	12 VOLT
MO	MONORAIL		C CHROME	-24 24 VOLT
MO2	TWO-CIRCUIT MONORAIL		S SATIN NICKEL	
K	KABLE LITE			

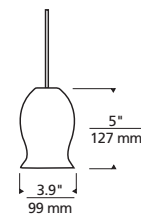

* NOT AVAILABLE ON MO2 AT THIS TIME
 ** ANTIQUE BRONZE IS NOT AVAILABLE FOR KABLE LITE

TETRA



Tall rectilinear glass in frost white accented with four metal beads. Includes low-voltage, 50 watt halogen bi-pin lamp or 5.8 watt replaceable LED module and six feet of field-cutttable suspension cable.

700	SYSTEM	TETW	FINISH	VOLTAGE
	FJ	FREEJACK	Z ANTIQUE BRONZE**	12 VOLT HALOGEN
	MO	MONORAIL	C CHROME	-24 24 VOLT HALOGEN
	MO2	TWO-CIRCUIT MONORAIL	S SATIN NICKEL	-LED 12 VOLT LED 3000K*

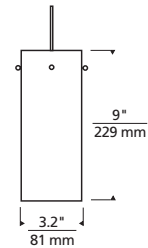

CAMILLE



INNER COBALT
ILLUMINATED

INNER AMBER
NOT ILLUMINATED

INNER WHITE
NOT ILLUMINATED



Multi-layered glass with frost white outer layer and colored inner layer. Appears white with colored inner detail when off and becomes soft pastel version of inner color when illuminated. Includes low-voltage, 50 watt halogen bi-pin lamp or 5.8 watt replaceable LED module and six feet of field-cutttable suspension cable.

700	SYSTEM	CML	COLOR	FINISH	VOLTAGE
	FJ	FREEJACK	IA INNER AMBER	Z ANTIQUE BRONZE	12 VOLT HALOGEN
	MO	MONORAIL	IC INNER COBALT	C CHROME	-24 24 VOLT HALOGEN
	MO2	TWO-CIRCUIT MONORAIL	IF INNER WHITE	S SATIN NICKEL	-LED 12 VOLT LED 3000K*

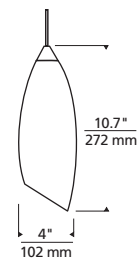



MonoRail Satin Nickel / End Caps / Remote 600 Watt
12 Volt Transformer / 4" Round Dual-Feed Canopy /
6" Power Extenders / 4" Rigid Standoffs / 3" Aero
Heads / Cone Glass Shield Accessories Frost / MR16
Lamps / Camille Pendants Inner White / Bi-pin Lamps

TRENDS PUBLISHING INTERNATIONAL
ARCHITECT: JEFFERY SWEITZER
PHOTOGRAPHER: BRIAN DROEGE

HANGING WOK



COMPLEMENTARY
ACCESSORY P. 374

Wok-shaped metal shade with clear or colored glass disk that glows from within. Includes low-voltage, 50 watt MR16 flood lamp and six feet of field-cutable suspension cable.

700	SYSTEM	WKS	COLOR	FINISH	VOLTAGE		
	FJ	FREEJACK	A	AMBER	Z	ANTIQUÉ BRONZE*	12 VOLT
	MO	MONORAIL	W	CLEAR	C	CHROME	-24 24 VOLT
	MO2	TWO-CIRCUIT	C	COBALT	S	SATIN NICKEL	
		MONORAIL	G	GREEN			
	K	KABLE LITE	B	LIGHT BLUE			
			R	RED			

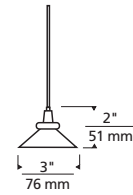

RAINDROP



COMPLEMENTARY
HEAD P. 126
SCONCE P. 217

Opaque white or colored raindrop shaped glass. Includes low-voltage, 50 watt halogen bi-pin lamp and six feet of field-cutable suspension cable.

700	SYSTEM	RD	COLOR	FINISH	VOLTAGE		
	FJ	FREEJACK	M	AMBER	Z	ANTIQUÉ BRONZE*	12 VOLT
	MO	MONORAIL	B	COBALT	C	CHROME	-24 24 VOLT
	MO2	TWO-CIRCUIT	R	RED	S	SATIN NICKEL	
		MONORAIL	W	WHITE			
	KL	KABLE LITE					

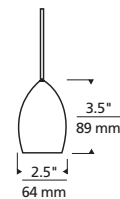



FreeJack 4" Round Flush Canopies Satin Nickel /
Hanging Wok Pendants Amber / MR16 Lamps

LOCATION: PRIVATE RESIDENCE
DESIGNER: ARTERIORS ARCHITECTURE
PHOTOGRAPHER: TOM MALONEY
PHOTOGRAPHY: TRENDS PUBLISHING INTERNATIONAL
US KITCHEN TRENDS 17/5 P. 138

TORPEDO PENDANT



TORPEDO PENDANT
WITH SUGAR ACCESSORY

COMPLEMENTARY
HEAD P. 127

Stylish pendant to customize with Round, Cone, Cone Onyx, Soda, Dichroic, Martini, Firebird or Prism Glass Shield, Belladonna, Bell, Tinkerbell, Lil Egypt, Meteorite, Sugar, Scavo or Taza accessory. Accessory required; sold separately (pp. 366-379). Low-voltage, MR16 of up to 50 watts (not included). Includes six feet of field-cuttable suspension cable.

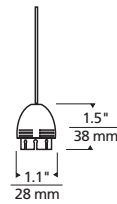

700	SYSTEM	TRPN	FINISH
FJ	FREEJACK	Z	ANTIQU BRONZE*
MO	MONORAIL	C	CHROME
MO2	TWO-CIRCUIT MONORAIL	S	SATIN NICKEL
K	KABLE LITE		

ANTIQU BRONZE



TORPEDO PENDANT WITH BELL
ACCESSORY



TORPEDO PENDANT WITH ROUND
GLASS SHIELD ACCESSORY



TORPEDO PENDANT WITH
BELLADONNA ACCESSORY

CHROME



TORPEDO PENDANT WITH
TINKERBELL ACCESSORY



TORPEDO PENDANT WITH
LIL EGYPT ACCESSORY



TORPEDO PENDANT WITH
METEORITE ACCESSORY

SATIN NICKEL



TORPEDO PENDANT WITH DICHROIC
GLASS SHIELD ACCESSORY



TORPEDO PENDANT WITH
FIREBIRD ACCESSORY



TORPEDO PENDANT WITH
ONYX CONE ACCESSORY



SMALL NEST



AMBER

COBALT BLUE

FROST WHITE

RED



Glass shade with clear glass wrap and metal detail. Includes low-voltage, 50 watt halogen bi-pin lamp or 5.8 watt replaceable LED module and six feet of field-cutable suspension cable.

COMPLEMENTARY
LINE-VOLTAGE
PENDANT P. 168

700	SYSTEM	NSP	COLOR	FINISH	VOLTAGE
FJ	FREEJACK	A	AMBER	Z	12 VOLT HALOGEN
MO	MONORAIL	B	COBALT BLUE	C	24 VOLT HALOGEN
MO2	TWO-CIRCUIT MONORAIL	W	FROST WHITE	S	12 VOLT LED 3000K*
		R	RED		

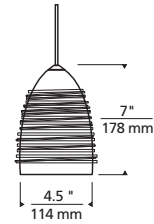

PRISM



AMBER

CLEAR



Retro transparent ribbed glass. Includes low-voltage, 50 watt MR16 flood lamp or 5.8 watt replaceable LED module and six feet of field-cutable suspension cable.

COMPLEMENTARY
ACCESSORY P. 372

700	SYSTEM	PRIS	COLOR	FINISH	VOLTAGE
FJ	FREEJACK	A	AMBER	Z	12 VOLT HALOGEN
MO	MONORAIL	C	CLEAR	C	24 VOLT HALOGEN
MO2	TWO-CIRCUIT MONORAIL	S		S	12 VOLT LED 3000K*
KL	KABLE LITE				

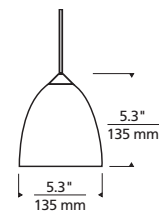

* NOT AVAILABLE ON MO2 AT THIS TIME
** ANTIQUE BRONZE IS NOT AVAILABLE FOR KABLE LITE

PIPER



ANTIQU BRONZE

BLACK

CHROME

SATIN NICKEL

Sleek cylinder shaped metal shade provides crisp down light. Includes low-voltage, 50 watt MR16 flood lamp and six feet of field-cutttable suspension cable.

700	SYSTEM	PPR	COLOR/FINISH	VOLTAGE
	FJ	FREEJACK	ZZ ANTIQU BRONZE/ANTIQU BRONZE	12 VOLT
	MO	MONORAIL	B5 BLACK/SATIN NICKEL	-24 24 VOLT
	MO2	TWO-CIRCUIT MONORAIL	CC CHROME/CHROME	
			SS SATIN NICKEL/SATIN NICKEL	

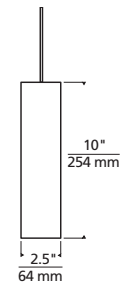

SKY

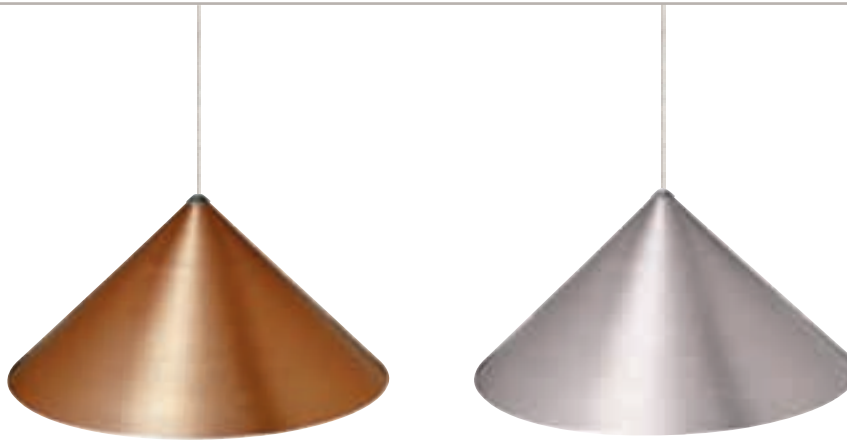

COPPER

SATIN NICKEL

Lightweight anodized metal pendant. Available in 8" or 12" diameter. Includes low-voltage, 50 watt MR16 flood lamp and six feet of field-cutttable suspension cable.

700	SYSTEM	SKY	SIZE	COLOR	FINISH	VOLTAGE
	FJ	FREEJACK	08 8" DIAMETER	CP COPPER	Z ANTIQU BRONZE**	12 VOLT
	MO	MONORAIL	12 12" DIAMETER	SN SATIN NICKEL	C CHROME	-24 24 VOLT
	MO2	TWO-CIRCUIT MONORAIL			S SATIN NICKEL	
	K	KABLE LITE				

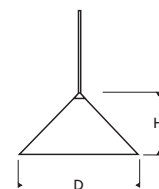

Size	D	H
SKY 8"	8" (203 mm)	4" (102 mm)
SKY 12"	12" (305 mm)	6" (152 mm)

** ANTIQU BRONZE IS NOT AVAILABLE FOR KABLE LITE





FreeJack 5 Port Round Canopy Satin Nickel /
Piper Pendants / MR16 Lamps



MonoRail Satin Nickel / Remote 300 Watt 12 Volt Transformer / 4" Round Single-Feed Canopy / 2" Rigid Standoffs / End Caps / Custom-length Aero Heads / Round Glass Shield Accessories Frost / MR16 Lamps

LOCATION: LUCENT TECHNOLOGIES
DESIGN: JACK ROUSE ASSOCIATES





MonoRail Satin Nickel / Remote 600 Watt 12 Volt Transformers / 4" Round Dual-Feed Canopies / 12" Power Extenders / 12" Rigid Standoffs / End Caps / 6" Sprocket Heads / MR16 Lamps

LOCATION: AA FIRST CLASS DEPARTURE LOUNGE - CHICAGO, IL
DESIGN: OWR&P - CHICAGO, IL
PHOTOGRAPHER: CHRISTOPHER BARRETT - HEDRICH BLESSING

HELIOS LED HEAD

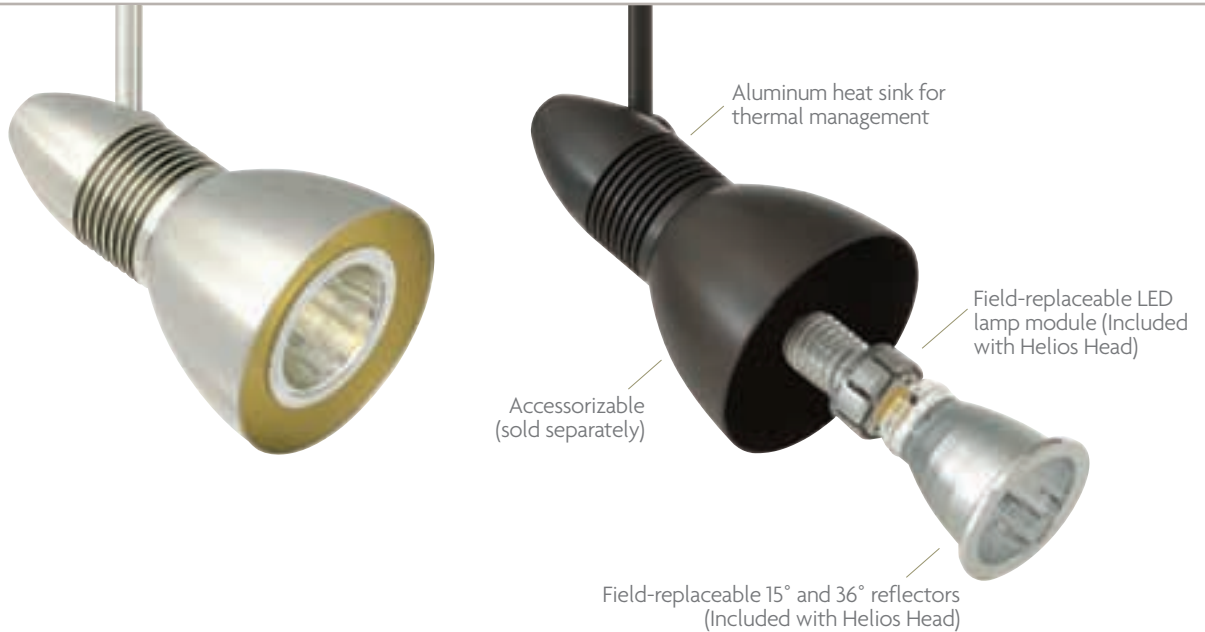

- Power Consumption:	Initial 5.8 watts Stabilized 4.9 watts	- Lumens/Watt:	Initial 62 lms/watt Stabilized 67 lms/watt
- Color Temperature:	3000° K	- Color Rendering Index:	>80 CRI
- Lumens:	Initial 360 lms Stabilized 327 lms	- Rated Average Life:	>30,000 hours to 70%

Note: We are constantly looking to improve our LED performance. Therefore, be sure to visit www.techlighting.com for the most updated LED product information.



5.8 watt directional LED head. LED module is easily field-replaceable with the screw-in base specifically designed for our head. The heat sink remains with the fixture minimizing any waste at the end of the lamp module life. Head rotates 360° and pivots 260° to direct the beam. Accessories in myriad styles and colors allow you to create the ideal custom LED fixture (accessories required; sold separately).

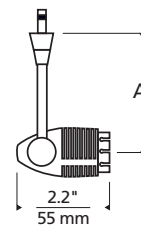

700	SYSTEM	HEL	BEAM SPREAD	LENGTH (A)	FINISH	-LED
FJ	FREEJACK	15	15°	03	3"	Z ANTIQUE BRONZE
MO	MONORAIL	36	36°	06	6"	S SATIN NICKEL
WMO	WALL MONORAIL			12	12"	
				18	18"	
				24	24"	

Accessory required. Compatible accessories and optical controls (sold separately pp. 366-379): Cone, Cone Onyx, Dichroic, Firebird, Martini, Prism, Round or Soda Glass Shield; Bell, Belladonna, Lil Egypt, Meteorite, Scavo, Sugar, Taza or Tinkerbell.







ENVISION

Specification grade head with precision internal gearing mechanisms that allow for hot aiming and are self-locking. Rotates 360° and pivots 0° to 90°. Up to two lenses or louvers (sold separately) are held captive inside the lamp cartridge which includes an integral glare reducing snoot. Lamp cartridge and lens orientation adjust 180°. Lamp cartridge is keyed to maintain accurate focus during relamping. All functionality can be fine-tuned using a phillips or flat head screwdriver and with the guide of accompanying markings. Low-voltage, MR16 lamp of up to 50 watts (not included).

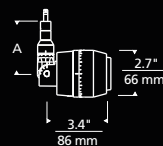

700	SYSTEM	ENV	LENGTH (A)	FINISH
	FJ	FREEJACK	03 3.5"	S SATIN NICKEL
	MO	MONORAIL	07 7.5"	
	MO2	TWO-CIRCUIT MONORAIL		

Compatible optical controls (sold separately pp. 366-379):
Glass Lens or Eggcrate Louver.





Rotates 360°, pivots 0° to 90°; both are self locking



Lamp cartridge can be easily adjusted by turning the lens rotation screw.



Up to two lenses or louvers are held captive inside the lamp cartridge which includes integral glare reducing snoot

MINI OM



MINI OM WITH SOLID METAL ACCESSORY AND EGGCRATE LOUVER



MINI OM WITH SOLID METAL ACCESSORY



MINI OM WITH SOLID METAL ACCESSORY AND EGGCRATE LOUVER

Flexible, clean head rotates 360°; pivots 260° to direct the beam.
Low-voltage, MR16 lamp of up to 50 watts (not included). Accessory required; sold separately.

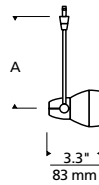

MINI OM ACCESSORY

Metal backlight shield with built in colored glass, onyx, or solid metal ring. Includes Snap Louver Lens Holder. Can hold a single lens or louver. MR16 lamp of up to 50 watts (not included).

700	SYSTEM	OM	LENGTH (A)	FINISH
FJ	FREEJACK		03 3"	Z ANTIQUE BRONZE
MO	MONORAIL		06 6"	S SATIN NICKEL
MO2	TWO-CIRCUIT MONORAIL		12 12"	
			18 18"	
WMO	WALL MONORAIL			

700MR16OM	COLOR	FINISH
AC	AMBER	Z ANTIQUE BRONZE
A	AMBER FROST	S SATIN NICKEL
CC	CLEAR	
F	FROST	
O	ONYX	
S	SOLID METAL	

Compatible optical controls (sold separately pp. 366-379):
Glass Lens or Eggcrate Louver.



MINI OM WITH AMBER ACCESSORY



MINI OM WITH AMBER FROST ACCESSORY



MINI OM WITH CLEAR ACCESSORY



MINI OM WITH FROST ACCESSORY



MINI OM WITH ONYX ACCESSORY





MonoRail Satin Nickel / End Caps / Remote 300 Watt
12 Volt Transformer / 4" Round Single-Feed Canopy /
2" Rigid Standoffs / 3" Mini Om Heads / Mini Om
Accessories Solid Metal / MR16 Lamps /
FreeJack 4" Round Flush Canopy / 3" Mini Om Head /
Mini Om Accessory Solid / MR16 Lamp

SCANIA



LINEN, SATIN NICKEL



METAL, SATIN NICKEL



METAL, SATIN NICKEL

Clean modern European-inspired head with a plated or matte painted finish. Head rotates 360°, pivots 180° to direct the beam. Includes Snap Louver Lens Holder. Can hold a single lens or louver (sold separately). Low-voltage, MR16 lamp of up to 50 watts (not included).

700	SYSTEM	SCAN	LENGTH (A)	BODY COLOR	FINISH
FJ	FREEJACK	03	3"	R BURNT SIENNA	S SATIN NICKEL
MO	MONORAIL	06	6"	L LINEN	
MO2	TWO-CIRCUIT MONORAIL	12	12"	M METAL	

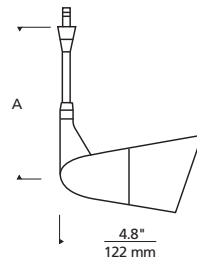

Compatible optical controls (sold separately pp. 366-379):
Glass Lens or Eggcrate Louver.



BURNT SIENNA,
SATIN NICKEL





MonoRail Satin Nickel / End Caps / Remote 300 Watt
12 Volt Transformer / 4" Round Low Profile Single-Feed
Canopy / 1" Rigid Standoffs / 6" Scania Heads Metal
Satin Nickel / MR16 Lamps

SPROCKET



SPROCKET WITH MESH BACKLIGHT SHIELD ACCESSORY AND EGGRATE LOUVER



SPROCKET WITH MESH BACKLIGHT SHIELD ACCESSORY



SPROCKET WITH MESH BACKLIGHT SHIELD ACCESSORY AND EGGRATE LOUVER

Sleek Sprocket, with its removable handle, has many accessory options. Head rotates 360° and pivots 260° on vertical axis. Low-voltage, MR16 lamp of up to 75 watts (not included).

700	SYSTEM	SP	LENGTH (A)	FINISH
FJ	FREEJACK	1	1.2"	Z ANTIQUE BRONZE
MO	MONORAIL	3	3"	C CHROME
MO2	TWO-CIRCUIT MONORAIL	6	6"	S SATIN NICKEL
		12	12"	
WMO	WALL MONORAIL	18	18"	
		24	24"	

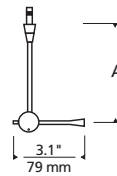

SPY ACCESSORY



SPY

700SPSPY

FINISH

- Z ANTIQUE BRONZE
- C CHROME
- S SATIN NICKEL

Compatible accessories and optical controls (sold separately pp. 366-379): Backlight Shield, Barndoors, Eggcrate Louver, Flight Paper, Glass Lens, Louver Lens Holder, MR16 Snout, Snap Louver Lens Holder; plus Spy Accessory.



SPROCKET IN ANTIQUE BRONZE WITH SOLID BACKLIGHT SHIELD ACCESSORY



SPROCKET IN ANTIQUE BRONZE (NO ACCESSORY)



SPROCKET IN SATIN NICKEL WITH SPY ACCESSORY



SPROCKET IN SATIN NICKEL WITH BARNDOORS ACCESSORY





MonoRail Satin Nickel / End Caps / Remote
600 Watt 12 Volt Transformer / 2" Square Dual-Feed
Canopy / 2" Rigid Standoffs / 6" Sprocket Heads /
Spy Accessories / MR16 Lamps

TRENDS PUBLISHING INTERNATIONAL
ARCHITECT: MARK DZIEWULSKI AIA
PHOTOGRAPHER: KETH CRONIN

JOHN



JOHN WITH EGGCRATE LOUVER

Adjustable head tilts and rotates infinitely. Integral louver lens holder can hold a single glass lens (sold separately) or an eggcrate louver (included). Low-voltage, MR16 lamp of up to 50 watts (not included).

700	SYSTEM	JON	LENGTH (A)	FINISH
FJ	FREEJACK	03	3"	C CHROME
MO	MONORAIL	06	6"	S SATIN NICKEL
MO2	TWO-CIRCUIT MONORAIL	12	12"	
		18	18"	
WMO	WALL MONORAIL	24	24"	

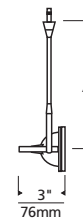

Compatible optical controls (sold separately pp. 366-379): Glass Lens or Eggcrate Louver.

ELTON



ELTON WITH EGGCRATE LOUVERS

Adjustable double head tilts and rotates infinitely. Integral louver lens holders can hold a single glass lens (sold separately) or an eggcrate louver (two included). Two low-voltage, MR16 lamps of up to 35 watts each (not included).

700	SYSTEM	ELT	LENGTH (A)	FINISH
FJ	FREEJACK	03	3"	C CHROME
MO	MONORAIL	06	6"	S SATIN NICKEL
MO2	TWO-CIRCUIT MONORAIL	12	12"	
		18	18"	
WMO	WALL MONORAIL	24	24"	

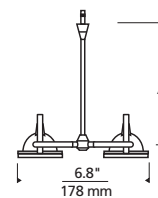

Compatible optical controls (sold separately pp. 366-379): Glass Lens or Eggcrate Louver.





FreeJack 4" Round Flush Canopies Satin Nickel /
3" Elton Heads / Eggcrate Louvers / MR16 Lamps

LOCATION: PRIVATE RESIDENCE
PHOTOGRAPHER: PATRICIA PARINEJAD

SPOT



SPOT WITH EGGCRATE LOUVER



SPOT WITH EGGCRATE LOUVER

Classic head rotates 360° around stem, pivots 290°. Can hold one lens or louver (sold separately). Low-voltage, MR16 lamp of up to 50 watts (not included).

700	SYSTEM	SPT6	LENGTH (A)	FINISH
FJ	FREEJACK	04	4.5"	C CHROME
MO	MONORAIL	06	6"	S SATIN NICKEL
MO2	TWO-CIRCUIT MONORAIL	12	12"	
		18	18"	
WMO	WALL MONORAIL			

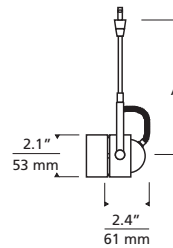

Compatible optical controls (sold separately pp. 366-379): Eggcrate Louver, Glass Lens.

SPORTSTER



SPORTSTER WITH EGGCRATE LOUVER



SPORTSTER WITH EGGCRATE LOUVER

Minimal stylish head rotates 360° and pivots 180°. Eggcrate louver included. Low-voltage, MR16 lamp of up to 75 watts (not included).

700	SYSTEM	SS6	LENGTH (A)	FINISH
FJ	FREEJACK	04	4.5"	C CHROME
MO	MONORAIL	06	6"	S SATIN NICKEL
MO2	TWO-CIRCUIT MONORAIL	12	12"	
		18	18"	
WMO	WALL MONORAIL	24	24"	

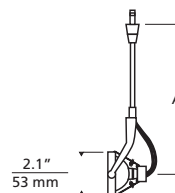

Compatible accessories and optical controls (sold separately pp. 366-379): Eggcrate Louver, Glass Lens, MR16 Snout.





MonoRail Satin Nickel / End Caps / Remote 300 Watt
12 Volt Transformers / 4" Round Single-Feed Canopies /
6" Power Extenders / 6" Rigid Standoffs / Spot Heads /
MR16 Lamps

TRENDS PUBLISHING INTERNATIONAL
ARCHITECT: LANE WILLIAMS ARCHITECT
PHOTOGRAPHER: JAMIE COBELDICK

CAM



Clean-lined head rotates 360° around stem; pivots 340°. Low-voltage, MR16 lamp of up to 75 watts (not included).

700	SYSTEM	CAM	LENGTH (A)	FINISH
FJ	FREEJACK		03 3"	C CHROME
MO	MONORAIL		06 6"	S SATIN NICKEL
MO2	TWO-CIRCUIT MONORAIL		12 12"	
			18 18"	
WMO	WALL MONORAIL		24 24"	

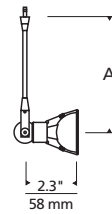

T156



GOBO HOLDER
Add this magnifying lens, gobo holder and a gobo template (sold separately) to the T156 and project a pattern or logo onto any surface. Includes MR16 snout.

700AC156	FINISH
	C CHROME
	S SATIN NICKEL



GOBO MAGNIFYING LENS
Add this optional lens to the gobo holder to increase the size of the projected image.

700MAGGL	FINISH
	C CHROME
	S SATIN NICKEL



GOBO CUSTOMIZABLE TEMPLATE
Gobos are available in standard and custom patterns. For additional information on standard and custom gobos, please call 847.410.4400

High-tech head swivels 360°; head tilts in yoke. Low-voltage, MR16 lamp of up to 75 watts (not included). May be accessorized with Gobo Holder (see above).

700	SYSTEM	156	LENGTH (A)	FINISH
FJ	FREEJACK		45 5.5"	C CHROME
MO	MONORAIL		06 6"	S SATIN NICKEL
MO2	TWO-CIRCUIT MONORAIL		12 12"	
			18 18"	

Compatible accessories and optical controls (sold separately pp. 366-379): Eggcrate Louver, Glass Lens, MR16 Snout, plus Gobo Holder (above).

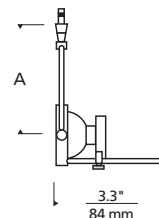



TECH LIGHTING

MonoRail Satin Nickel / End Caps / Remote 300 Watt
12 Volt Transformer / 4" Round Canopy / 6" Power
Extenders / 6" Rigid Standoffs / T156 Head / Gobo
Holder / Gobo Customizable Template / MR16 Lamp

AERO



AERO, ANTIQUE BRONZE
WITH ROUND GLASS SHIELD ACCESSORY

Dozens of design possibilities. Accessories in myriad styles and colors allow you to create the ideal custom element (accessory required; sold separately). Aero's head rotates 360°, pivots 260° to direct the beam. Removable glass handle. Low-voltage, MR16 lamp of up to 50 watts (not included).

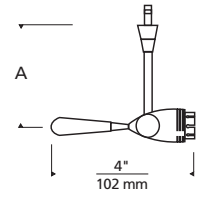

700	SYSTEM	AE	LENGTH (A)	FINISH
FJ	FREEJACK	3	3"	Z ANTIQUE BRONZE
MO	MONORAIL	6	6"	C CHROME
MO2	TWO-CIRCUIT MONORAIL	12	12"	S SATIN NICKEL
WMO	WALL MONORAIL	18	18"	
		24	24"	

Accessory required. Compatible accessories and optical controls (sold separately pp. 366-379): Cone, Cone Onyx, Dichroic, Firebird, Martini, Prism, Round or Soda Glass Shield; Bell, Belladonna, Lil Egypt, Meteorite, Scavo, Sugar, Taza, or Tinkerbell, plus Wood Handle Accessory.

WOOD HANDLE ACCESSORY

700AERWOOD	TYPE	FINISH
W	WALNUT	Z ANTIQUE BRONZE
N	STAINABLE BARE	C CHROME
		S SATIN NICKEL



WALNUT WOOD HANDLE

ANTIQUE BRONZE



AERO WITH EGGCRATE LOUVER
AND BELL ACCESSORY



AERO WITH LIL EGYPT
ACCESSORY



AERO WITH ONYX CONE
ACCESSORY

CHROME



AERO WITH METEORITE
ACCESSORY



AERO WITH TINKERBELL
ACCESSORY



AERO WITH PRISM GLASS
SHIELD ACCESSORY

SATIN NICKEL



AERO WITH CONE GLASS
SHIELD ACCESSORY



AERO WITH FIREBIRD GLASS
SHIELD ACCESSORY



AERO WITH TAZA
ACCESSORY

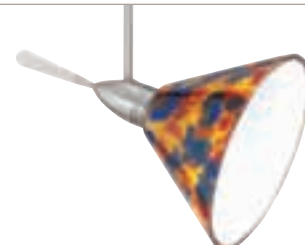

AERO WITH MARTINI GLASS
SHIELD ACCESSORY





MonoRail Antique Bronze / Remote 600 Watt 12 Volt Transformer / 4" Round Dual-Feed Canopy / Isolating Connectors / 96" Power Extenders / Adjustable Standoffs / 3" Aero Heads / Round Glass Shield Accessories Amber / MR16 Lamps

TRENDS PUBLISHING INTERNATIONAL
DESIGNER: KIMBERLEY WARREN
PHOTOGRAPHER: JOHN UMBERGER

TILT



TILT WITH ROUND GLASS SHIELD ACCESSORY

Flexible minimalist head with multiple accessory options; rotates 360°, pivots 90°. Low-voltage, MR16 lamp of up to 50 watts (not included).

700	SYSTEM	TLT	LENGTH (A)	FINISH
FJ	FREEJACK		2"	Z ANTIQUE BRONZE
MO	MONORAIL		06 6"	C CHROME
MO2	TWO-CIRCUIT MONORAIL		12 12"	S SATIN NICKEL
WMO	WALL MONORAIL		18 18"	

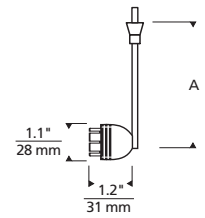

Accessory required. Compatible accessories and optical controls (sold separately pp. 366-379): Cone, Cone Onyx, Dichroic, Firebird, Martini, Prism, Round or Soda Glass Shield; Bell, Belladonna, Lil Egypt, Meteorite, Scavo, Sugar, Taza or Tinkerbell.

ANTIQU BRONZE



TILT WITH BRONZE MESH SHIELD ACCESSORY



TILT WITH FIREBIRD GLASS SHIELD ACCESSORY



TILT WITH SCAVO GLASS SHIELD ACCESSORY

CHROME



TILT WITH ONYX CONE ACCESSORY



TILT WITH PRISM GLASS SHIELD ACCESSORY



TILT WITH SODA GLASS SHIELD ACCESSORY

SATIN NICKEL



TILT WITH DICHOIC GLASS SHIELD ACCESSORY



TILT WITH BELL ACCESSORY



TILT WITH MARTINI GLASS SHIELD ACCESSORY



TILT WITH LIL EGYPT ACCESSORY





MonoRail Satin Nickel / End Caps / Remote 600 Watt
12 Volt Transformer / 4" Round Dual-Feed Canopy /
12" Power Extenders / 12" Rigid Standoffs / Tilt Heads /
Round Glass Shield Accessories Green / MR16 Lamps

Two-Circuit MonoRail Satin Nickel / End Caps / Remote
2x300 Watt 12 Volt Transformer / 4" Round Single-Feed
Canopy / 12" Power Extender / Flexible Connectors /
12" Rigid Standoffs / Tilt Heads / Round Glass Shield
Accessories Green / MR16 Lamps

SWIVEL



SWIVEL WITH
ROUND GLASS SHIELD ACCESSORY



SWIVEL WITH
LIL EGYPT ACCESSORY



SWIVEL BARE



SWIVEL WITH MESH
BACKLIGHT SHIELD ACCESSORY

A highly adjustable, minimal head rotates 360° around stem, swivels 240° at “elbow”; lamp pivots 240°. Customize with any of dozens of available accessories (sold separately). Low-voltage, MR16 lamp of up to 75 watts (not included).

700 SYSTEM	SW	LENGTH (A)	FINISH
FJ FREEJACK	03	3"	C CHROME
MO MONORAIL	06	6"	S SATIN NICKEL
MO2 TWO-CIRCUIT MONORAIL	12	12"	
	18	18"	
WMO WALL MONORAIL			

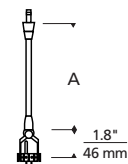

Compatible accessories and optical controls (sold separately pp. 366-379): Backlight Shield, Barndoors, Cone Glass Shield, Eggcrate Louver, Flight Paper, Glass Lens, Lil Egypt, Lil Wok, Louver Lens Holder, MR16 Snout, Round Glass Shield, Snap, Louver Lens Holder, or Taza Accessory.

TELE



TELE IN SATIN NICKEL WITH
ROUND GLASS SHIELD ACCESSORY



TELE IN ANTIQUE BRONZE
SHOWN BARE

Tele telescopes from 9" to 25" to bring the light right where you need it. Head rotates 360°, swivels 130° at the bracket, and the lamp rotates 290°. Low-voltage, MR16 lamp of up to 75 watts (not included).

700 SYSTEM	TEL	FINISH
FJ FREEJACK	Z	ANTIQUÉ BRONZE
MO MONORAIL	C	CHROME
MO2 TWO-CIRCUIT MONORAIL	S	SATIN NICKEL
WMO WALL MONORAIL		

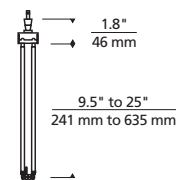

Compatible accessories and optical controls (sold separately pp. 366-379): Backlight Shield, Barndoors, Cone Glass Shield, Eggcrate Louver, Flight Paper, Glass Lens, Lil Egypt, Lil Wok, Louver Lens Holder, MR16 Snout, Round Glass Shield, Snap, Louver Lens Holder, or Taza Accessory.



POD



Modern head surrounded by a translucent glass orb. Head rotates 360°; pivots 260° to direct the beam. MR16 lamp of up to 50 watts (not included).

700	SYSTEM	POD	LENGTH (A)	COLOR	FINISH
FJ	FREEJACK		03 4"	A AMBER	C CHROME
MO	MONORAIL		06 6"	M AMETHYST	S SATIN NICKEL
MO2	TWO-CIRCUIT MONORAIL		12 12"	C CLEAR	
WMO	WALL MONORAIL		18 18"		

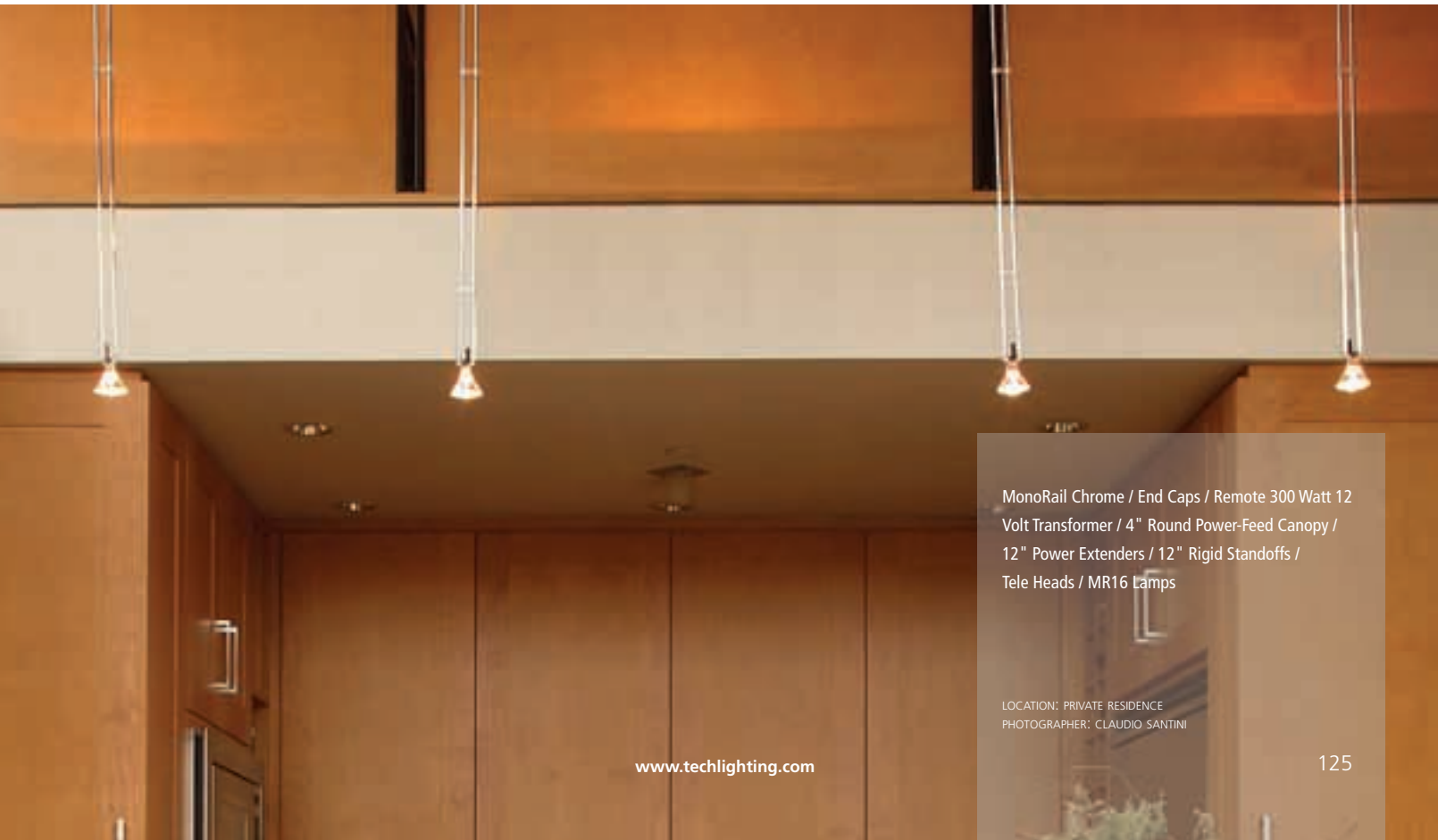
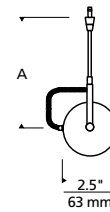

MonoRail Chrome / End Caps / Remote 300 Watt 12 Volt Transformer / 4" Round Power-Feed Canopy / 12" Power Extenders / 12" Rigid Standoffs / Tele Heads / MR16 Lamps

LOCATION: PRIVATE RESIDENCE
 PHOTOGRAPHER: CLAUDIO SANTINI

CURLY MOON



COMPLEMENTARY
PENDANT P. 82
SCONCE P. 217

Frost white Moon glass, blue and green Blue Moon glass, clear and frost Moonstruck glass, or amber and clear Owl Moon glass on a hand-bendable stem. Curly Moon includes low-voltage, 20 watt xenon bi-pin lamp. Curly Blue Moon, Curly Moonstruck, and Curly Owl Moon each include a low-voltage, 35 watt MR11 lamp.

700	SYSTEM	TYPE	LENGTH (A)	FINISH	VOLTAGE
FJ	FREEJACK	CBMN	06 6"	C CHROME	12 VOLT
MO	MONORAIL	CMN	12 12"	S SATIN NICKEL	-24 24 VOLT
MO2	TWO-CIRCUIT	CMNS	18 18"		
	MONORAIL	CMNO	24 24"		

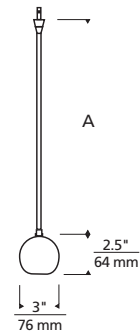

CURLY RAINDROP



COMPLEMENTARY
PENDANT P. 96
SCONCE P. 217

Raindrop glass on a bendable stem. Includes low-voltage, 50 watt halogen bi-pin lamp.

700	SYSTEM	CRD	COLOR	LENGTH (A)	FINISH	VOLTAGE
FJ	FREEJACK	M	AMBER	06 6"	C CHROME	12 VOLT
MO	MONORAIL	B	COBALT	12 12"	S SATIN NICKEL	-24 24 VOLT
MO2	TWO-CIRCUIT	F	FROST	18 18"		
	MONORAIL	R	RED	24 24"		

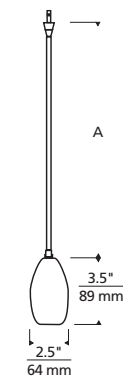

CURLY TORPEDO



CURLY TORPEDO WITH TINKERBELL ACCESSORY



CURLY TORPEDO WITH BELLADONNA ACCESSORY



CURLY TORPEDO WITH METEORITE ACCESSORY



CURLY TORPEDO WITH SUGAR ACCESSORY

COMPLEMENTARY LOW-VOLTAGE PENDANT P. 98

Sleek head with multiple accessory options on hand-bendable stem. Low-voltage, MR16 lamp of up to 50 watts (not included).

700	SYSTEM	CTOR	LENGTH (A)	FINISH
FJ	FREEJACK		06 6"	C CHROME
MO	MONORAIL		12 12"	S SATIN NICKEL
MO2	TWO-CIRCUIT MONORAIL		18 18"	
			24 24"	

Accessory required. Compatible accessories and optical controls (sold separately pp. 366-379): Cone, Cone Onyx, Dichroic, Firebird, Martini, Prism, Round or Soda Glass Shield; Bell, Belladonna, Lil Egypt, Meteorite, Scavo, Sugar, Taza or Tinkerbell.

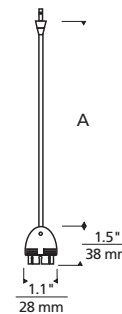

MO-PIVOT



MO-PIVOT WITH ROUND GLASS SHIELD ACCESSORY



MO-PIVOT WITH LIL EGYPT SHIELD ACCESSORY



MO-PIVOT WITH BACKLIGHT SHIELD ACCESSORY



MO-PIVOT BARE

Directs the beam right where you want it. Head swivels 220°, pivots on vertical and horizontal axes. Specify for low-voltage, MR16 of up to 75 watts (lamp sold separately). For MonoRail system only.

700MOPIV	FINISH
Z	ANTIQUÉ BRONZE
C	CHROME
S	SATIN NICKEL

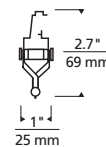

Compatible accessories and optical controls (sold separately pp. 366-379): Backlight Shield, Barndoors, Cone Glass Shield, Eggcrate Louver, Flight Paper, Glass Lens, Lil Egypt, Lil Wok, Louver Lens Holder, MR16 Snout, Round Glass Shield, Snap Louver Lens Holder, or Taza Accessory.

K-BYE-BYE



Adjustable arms rotate individually. For cable separations of 3.5" to 8". Lamp rotates 360°. Satin aluminum finish. Low-voltage, MR16 lamp of up to 75 watts (not included). For Kable Lite system only.

700KBYENC

Compatible accessories and optical controls (sold separately pp. 366-379): Louver Lens Holder, Round Glass Shield.

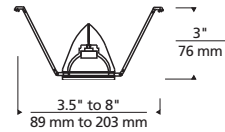

K-TELESCOPE



K-TELESCOPE WITH MESH BACKLIGHT SHIELD ACCESSORY

Arms telescope individually from 12-42", creating unlimited angles. For cable separations of 1" to 48". Head rotates 330° and has swivel and pivot action to direct the beam. Low-voltage, MR16 lamp of up to 75 watts, (not included). For Kable Lite system only.

700KTEL16	FINISH
C	CHROME
S	SATIN NICKEL

Compatible accessories and optical controls (sold separately pp. 366-379): Backlight Shield, Barndoors, Cone Glass Shield, Eggcrate Louver, Flight Paper, Glass Lens, Lil Egypt, Lil Wok, Louver Lens Holder, MR16 Snout, Round Glass Shield, Snap Louver Lens Holder, or Taza Accessory.

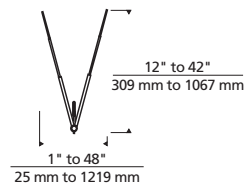

K-JANE



K-Jane drops below the cables; head pivots 220° on two axes. For cable separations of up to twice the length. Field-cuttable. Low-voltage, MR16 lamp of up to 75 watts (not included). For Kable Lite system only.

700KJAN	LENGTH (A)	FINISH
05	5"	C CHROME
12	12"	S SATIN NICKEL
24	24"	
36	36"	

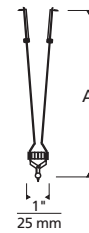

Compatible accessories and optical controls (sold separately pp. 366-379): Backlight Shield, Barndoors, Cone Glass Shield, Eggcrate Louver, Flight Paper, Glass Lens, Lil Egypt, Lil Wok, Louver Lens Holder, MR16 Snout, Round Glass Shield, Snap Louver Lens Holder, or Taza Accessory.

K-JOHNNY



K-JOHNNY WITH LIL WOK ACCESSORY

Versatile, field-cuttable, with a pivoting head to direct the beam. Low-voltage, MR16 lamp of up to 75 watts (not included). For Kable Lite system only.

700KJOH	CABLE SEPARATION (A)	FINISH
05	UP TO 5.5"	C CHROME
12	UP TO 12"	S SATIN NICKEL
18	UP TO 18"	
24	UP TO 24"	
48	UP TO 48"	
144	UP TO 144"	

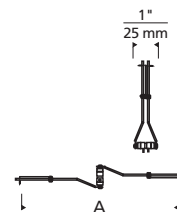

Compatible accessories and optical controls (sold separately pp. 366-379): Backlight Shield, Barndoors, Cone Glass Shield, Eggcrate Louver, Flight Paper, Glass Lens, Lil Egypt, Lil Wok, Louver Lens Holder, MR16 Snout, Round Glass Shield, Snap Louver Lens Holder, or Taza Accessory.

K-GIRO



K-GIRO WITH MESH BACKLIGHT SHIELD ACCESSORY

Direct the beam right where you want it: Giro rotates 350° between parallel cables; lamp rotates 360°. Low-voltage, MR16 lamp of up to 75 watts (not included). For Kable Lite system only.

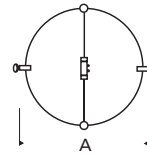

700KGIR	CABLE SEPARATION (A)	FINISH
05	5.5"	C CHROME
08	8"	S SATIN NICKEL

Compatible accessories and optical controls (sold separately pp. 366-379): Backlight Shield, Barndoors, Cone Glass Shield, Eggcrate Louver, Flight Paper, Glass Lens, Lil Egypt, Lil Wok, Louver Lens Holder, MR16 Snout, Round Glass Shield, Snap Louver Lens Holder, or Taza Accessory.

K-HELLO



Highly adjustable head tilts between cables and rotates 140° within its ring. Integral louver lens holder can hold glass lens (sold separately) or eggcrate louver (included). Satin aluminum finish. Specify low-voltage, MR16 lamp of up to 50 watts or AR111 lamp of up to 75 watts (not included). For Kable Lite system only.

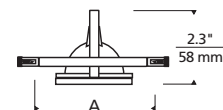

700KHELLO	TYPE/CABLE SEPARATION (A)
3	MR16 / 3.5"
5	MR16 / 5.5"
6	AR111 / 6.6"

Compatible MR16 optical controls (sold separately pp. 366-379): Eggcrate Louver, Glass Lens, MR16 Snout.



K-PIVOT



Head swivels 220°, 2" to 8" versions pivot on horizontal axis, 1" version pivots on vertical axis only. Low-voltage, MR16 lamp of up to 75 watts (not included). For Kable Lite system only.

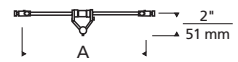

700KPIV	CABLE SEPARATION (A)	FINISH
01	1"	C CHROME
02	2"	S SATIN NICKEL
03	3.5"	
05	5.5"	
08	8"	

Compatible accessories and optical controls (sold separately pp. 366-379): Backlight Shield, Barndoors, Cone Glass Shield, Eggcrate Louver, Flight Paper, Glass Lens, Lil Egypt, Lil Wok, Louver Lens Holder, MR16 Snout, Round Glass Shield, Snap Louver Lens Holder, or Taza Accessory.



Bare Cable / Remote 300 Watt 12 Volt Transformer /
4" Round Single-Feed Canopy Satin Nickel /
Universal Turnbuckles / K-Hello Heads / MR16 Lamps

LOCATION: PRIVATE RESIDENCE - LOUISVILLE, KY
PHOTOGRAPHER: POWER CREATIVE

WALL ARCHIE



Clamps to Wall MonoRail. 17" long with a 11" high swooping curve. Pivots at head to direct beam.
Low-voltage, MR16 lamp of up to 75 watts (not included). For Wall MonoRail system only.

700WMARCH	FINISH
Z	ANTIQUÉ BRONZE
C	CHROME
S	SATIN NICKEL

Compatible accessories and optical controls (sold separately pp. 366-379): Backlight Shield, Barndoors, Cone Glass Shield, Eggcrate Louver, Flight Paper, Glass Lens, Lil Egypt, Lil Wok, Louver Lens Holder, MR16 Snout, Round Glass Shield, Snap Louver Lens Holder, or Taza Accessory.

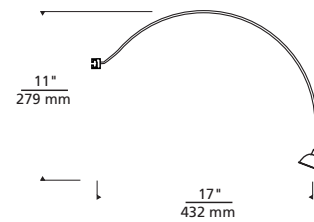

WALL GEORGI



Clamps to Wall MonoRail. 18" long with 3" high gentle curve. Pivots at head to direct beam.
Low-voltage, MR16 lamp of up to 75 watts (not included). For Wall MonoRail system only.

700WMGRG	FINISH
Z	ANTIQUÉ BRONZE
C	CHROME
S	SATIN NICKEL

Compatible accessories and optical controls (sold separately pp. 366-379): Backlight Shield, Barndoors, Cone Glass Shield, Eggcrate Louver, Flight Paper, Glass Lens, Lil Egypt, Lil Wok, Louver Lens Holder, MR16 Snout, Round Glass Shield, Snap Louver Lens Holder, or Taza Accessory.

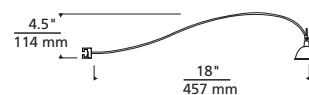

WALL TELESCOPE



WALL TELESCOPE WITH MESH BACKLIGHT SHIELD ACCESSORY

Clamps to Wall MonoRail. Telescopes from 9" to 25". Pivots at head to direct beam. Low-voltage, MR16 lamp of up to 75 watts (not included). For Wall MonoRail system only.

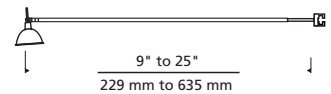

700WMTEL FINISH

Z	ANTIQUÉ BRONZE
C	CHROME
S	SATIN NICKEL

Compatible accessories and optical controls (sold separately pp. 366-379): Backlight Shield, Barndoors, Cone Glass Shield, Eggcrate Louver, Flight Paper, Glass Lens, Lil Egypt, Lil Wok, Louver Lens Holder, MR16 Snout, Round Glass Shield, Snap Louver Lens Holder, or Taza Accessory.

WALLY LITE



WALLY LITE WITH ROUND GLASS SHIELD ACCESSORY

Clamps to Wall MonoRail. Available in two lengths. Pivots at head to direct beam. Low-voltage, MR16 lamp of up to 75 watts (not included). For Wall MonoRail system only.



700MMWAL LENGTH (A) FINISH

12	12"	Z	ANTIQUÉ BRONZE
24	24"	C	CHROME
		S	SATIN NICKEL

Compatible accessories and optical controls (sold separately pp. 366-379): Backlight Shield, Barndoors, Cone Glass Shield, Eggcrate Louver, Flight Paper, Glass Lens, Lil Egypt, Lil Wok, Louver Lens Holder, MR16 Snout, Round Glass Shield, Snap Louver Lens Holder, or Taza Accessory.

DRAGONFLY



Aluminum wings; glass body in white or blue. Two 18" hand-bendable, field-cuttable wire leads. Includes low-voltage, 20 watt halogen bi-pin lamp.

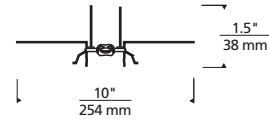

700	SYSTEM	BUGDF	GLASS	VOLTAGE
MO	MONORAIL	B	BLUE	12 VOLT
K	KABLE LITE	W	WHITE	-24 24 VOLT

BUGS



Aluminum wings and legs; glass body. Two 18" hand-bendable, field-cuttable wire leads. Includes low-voltage, 20 watt halogen bi-pin lamp.

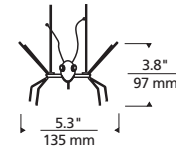

700	SYSTEM	BUG	GLASS	VOLTAGE
MO	MONORAIL	B	BEE (YELLOW)	12 VOLT
K	KABLE LITE	L	LADYBUG (RED)	-24 24 VOLT

METAL MAN

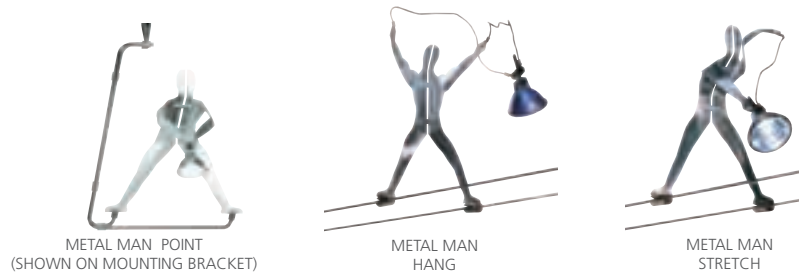

Whimsical art fixture of a metal man holding a positionable low-voltage, MR16 lamp of up to 75 watts. Ground aluminum finish. Two sizes, three styles. Lamp not included. System mounting bracket or Kable Lite mounting feet included.

700	SYSTEM	MM	SIZE (W X H)	STYLE	FINISH		
FJ	FREEJACK	5	5.5" X 8"	HA	HANG	C	CHROME
MO	MONORAIL	8	8" X 12"	PO	POINT	S	SATIN NICKEL
MO2	TWO-CIRCUIT MONORAIL			ST	STRETCH		
KL	KABLE LITE						

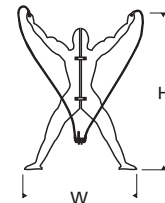

Compatible accessories and optical controls (sold separately pp. 366-379): Backlight Shield, Barndoors, Eggcrate Louver, Flight Paper, Glass Lens, Lil Egypt, Lil Wok, Louver Lens Holder, MR16 Snout, Snap Louver Lens Holder, or Taza Accessory.



PARACHUTE



Cast paratrooper holding an adjustable searchlight dangles beneath a finely crafted mesh parachute. Parachute suspends from two six-foot lengths of field-cutttable cable. Low-voltage, 10 watt Xenon bi-pin lamp (included) in chute. Low-voltage, MR16 lamp of up to 75 watts (not included).

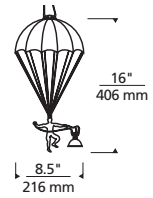

700	SYSTEM	PARA	VOLTAGE
	MO	MONORAIL	12 VOLT
	K	KABLE LITE	-24 24 VOLT

Compatible accessories and optical controls (sold separately pp. 366-379): Backlight Shield, Barndoors, Cone Glass Shield, Eggcrate Louver, Flight Paper, Glass Lens, Lil Egypt, Lil Wok, Louver Lens Holder, MR16 Snout, Snap Louver Lens Holder, or Taza Accessory.

BIPLANE



Finely handcrafted biplane suspends from two three-foot lengths of field-cutttable and bendable wire leads. Includes two low-voltage, 20 watt MR11 lamps, one behind the propeller and one behind the wheels.



700	SYSTEM	AIRBI	VOLTAGE
	MO	MONORAIL	12 VOLT
	K	KABLE LITE	-24 24 VOLT

KABLE LITE 4" ROUND MONOPOINT CANOPY



4" ROUND CANOPY SHOWN WITH METAL MAN POINT, P. 134

4" round flush canopy mounts to a standard 4" junction box with round plaster ring (provided by electrician). Allows for monopoint mounting of any Kable Lite head. 12 volt, 75 watt electronic transformer (included) fits inside junction box. Two 24" long, field-cutttable and bendable wire leads.

700KC4R	FINISH
	CH CHROME
	SN SATIN NICKEL

Line-voltage Pendants

At 2thousand degrees, it is all about color, texture, vision and bringing a sense of the truly artistic to light. Shape, proportion and innovative materials create intriguing, unique fixtures; with energy efficient options that result in a perfect choice for almost any application.

For years, 2thousand degrees has been the primary choice for designers and homeowners alike seeking to make a bold design statement in hospitality, commercial and residential environments.

The line-voltage pendants in this collection are larger in size to add drama and define the style of your environment. All line-voltage pendants ship standard with 6 feet of field-cuttable cable. However, we can easily accomodate longer cable lengths, so please conatct us with any custom requests.

2thousand
degrees™

www.techlighting.com



Throughout the catalog this icon indicates which fixtures are available in **Compact Fluorescent**





Melrose Pendants Tahoe Pine Amber Satin Nickel /
Mini-candelabra Base Lamps

DESIGN: DANIEL MINZNER
PHOTOGRAPHER: WWW.PETERRYMWID.COM



Echo Large Pendants Clear Satin Nickel /
A19 Lamps

PHOTOGRAPHER: CESAR RUBIO





Delancey Pendant White Satin Nickel / A19 Lamps



BROWN



WHITE



Translucent organza drum with inner glass cylinder to provide a soft wash of light. Black, satin nickel, and white finish options highlighted with a satin nickel detail and clear cable; antique bronze finish includes antique bronze detail and brown cable. Includes 120 volt, 75 watt medium base A19 lamp or GX24Q-3 base 32w triple tube compact fluorescent lamp (electronic ballast included). Fixture provided with six feet of field-cuttable cable. Incandescent version dimmable with standard incandescent dimmer.

700TDDLNPW	COLOR	CANOPY	LAMP
N	BROWN	Z	ANTIQUE BRONZE
W	WHITE	B	BLACK
		S	SATIN NICKEL
		W	WHITE
		-CF	INCANDESCENT 120V
		-CF277	COMPACT FLUORESCENT 120V
			COMPACT FLUORESCENT 277V

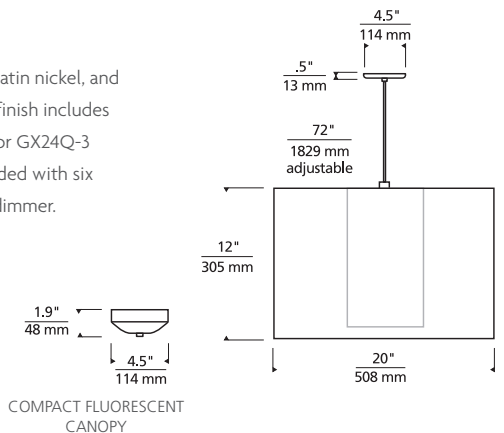



Dillon Pendant Brown Satin Nickel / Triple Tube Lamp



OLIVE GREEN

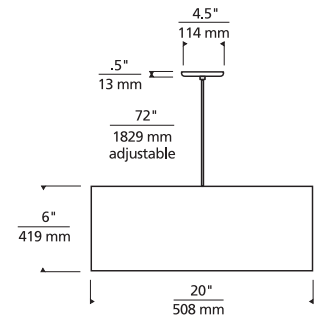

CHOCOLATE BROWN



DESERT CLAY



WHITE



COMPLEMENTARY
LOW-VOLTAGE
PENDANT P. 34
CEILING P. 246

Short drum fabric shade suspended from a round canopy. Glass diffuser provides a glare free wash of light. Black, satin nickel, and white finish options highlighted with satin nickel detail and clear cable; antique bronze highlighted with antique bronze detail and brown cable. Available in two lamp configurations: incandescent and fluorescent. Incandescent version includes four 75 watt A19 medium base lamps. Fluorescent version includes four 120 volt 18 watt GU24 base self-ballasted compact fluorescent lamps. Fixture is provided with six feet of field-cuttable cable. Incandescent version dimmable with standard incandescent dimmer.

700TDMULP

COLOR	CANOPY	LAMP
N CHOCOLATE BROWN	Z ANTIQUE BRONZE	INCANDESCENT
C DESERT CLAY	B BLACK	-CF COMPACT FLUORESCENT
V OLIVE GREEN	S SATIN NICKEL	
W WHITE	W WHITE	





Mulberry Pendant White Satin Nickel / A19 Lamps



CHOCOLATE BROWN

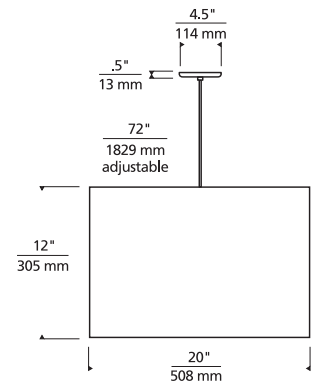

BLACK



DESERT CLAY



OLIVE GREEN



RED



WHITE



Large drum shaped fabric shade suspended from a round canopy. Glass diffuser provides a glare free wash of light. Black, satin nickel, and white finish options highlighted with satin nickel detail and clear cable; antique bronze highlighted with antique bronze detail and brown cable. Available in two lamp configurations: incandescent and fluorescent. Incandescent version includes four 100 watt A19 medium base lamps. Fluorescent version includes electronic ballasts hidden inside the shade and can be lamped with either four 26 watt or 32 watt GX24Q-3 base triple tube lamps (sold separately). Fixture is provided with six feet of field-cuttable cable. Incandescent version dimmable with standard incandescent dimmer.

COMPLEMENTARY
WALL P. 184

700TDLEXP

COLOR	CANOPY	LAMP
B BLACK	Z ANTIQUE BRONZE	INCANDESCENT 120V
N CHOCOLATE BROWN	B BLACK	-CF COMPACT FLUORESCENT 120V
C DESERT CLAY	S SATIN NICKEL	-CF277 COMPACT FLUORESCENT 277V
V OLIVE GREEN	W WHITE	
R RED		
W WHITE		





Lexington Pendant Black Satin Nickel / A19 Lamps /
tiella Rail Bronze / 300 Watt Remote Transformer /
Single-Feed Canopy / 2" Rigid Standoffs / End Caps /
tiella Sola Heads / MR16 Lamps

LOCATION: MOJO'S ON 86TH, JOHNSTON, IA
DESIGNER: REBECCA CARTWRIGHT
PHOTOGRAPHER: TERRY WIECKERT

DELANCEY

2 thousand



CHOCOLATE BROWN



DESERT CLAY



RED



WHITE



Large cylindrical shaped fabric shade suspended from a round canopy. Glass diffuser provides a glare free wash of light. Black, satin nickel, and white finish options highlighted with satin nickel detail and clear cable; antique bronze highlighted with antique bronze detail and brown cable. Available in two lamp configurations: incandescent and fluorescent. Incandescent version includes four 100 watt A19 medium base lamps. Fluorescent version includes electronic ballasts hidden inside the shade and can be lamped with either four 26 watt or 32 watt GX24Q-3 base triple tube lamps (sold separately). Fixture is provided with six feet of field-cutable cable. Incandescent version dimmable with standard incandescent dimmer.

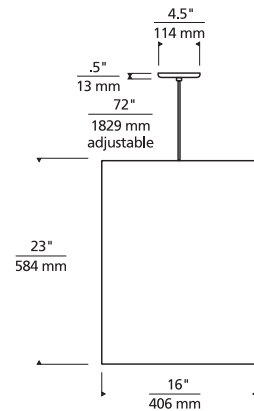

700TDELP

COLOR	CANOPY	LAMP
N CHOCOLATE BROWN	Z ANTIQUE BRONZE	INCANDESCENT 120V
C DESERT CLAY	B BLACK	-CF COMPACT FLUORESCENT 120V
R RED	S SATIN NICKEL	-CF277 COMPACT FLUORESCENT 277V
W WHITE	W WHITE	

MADISON

2 thousand



BLACK



CHOCOLATE BROWN



DESERT CLAY



RED



WHITE



Large square tapered fabric shade suspended from a round canopy. Glass diffuser provides a glare free wash of light. Black, satin nickel, and white finish options highlighted with satin nickel detail and clear cable; antique bronze highlighted with antique bronze detail and brown cable. Available in two lamp configurations: incandescent and fluorescent. Incandescent version includes four 100 watt A19 medium base lamps. Fluorescent version includes electronic ballasts hidden inside the shade and can be lamped with either four 26 watt or 32 watt GX24Q-3 base triple tube lamps (sold separately). Fixture is provided with six feet of field-cutable cable. Incandescent version dimmable with standard incandescent dimmer.

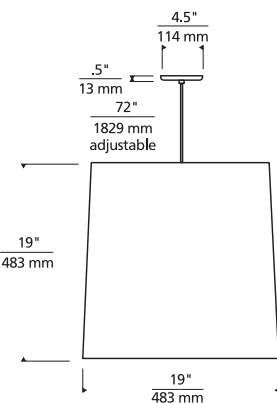

700TDMADP

COLOR	CANOPY	LAMP
B BLACK	Z ANTIQUE BRONZE	INCANDESCENT 120V
N CHOCOLATE BROWN	B BLACK	-CF COMPACT FLUORESCENT 120V
C DESERT CLAY	S SATIN NICKEL	-CF277 COMPACT FLUORESCENT 277V
R RED	W WHITE	
W WHITE		



KIEV LARGE



Antique meets modern with a turned ornate glass fount and simple tapered fabric shade with rolled edges. Black, satin nickel, and white finish options highlighted with a satin nickel detail and clear cable; antique bronze finish includes antique bronze detail and brown cable. Includes 120 volt, 75 watt A19 medium base lamp or GX24Q-3 base 32 watt triple tube compact fluorescent lamp (electronic ballast included). Fixture provided with six feet of field-cutable cable. Incandescent version dimmable with standard incandescent dimmer.

COMPLEMENTARY LOW-VOLTAGE PENDANT P. 32

700TDKIELP		SHADE COLOR	FOUNT COLOR	CANOPY	LAMP	
B	BLACK	C	CLEAR	Z	ANTIQUE BRONZE	INCANDESCENT 120V
W	WHITE	F	FROST	B	BLACK	-CF COMPACT FLUORESCENT 120V
		K	SMOKE	S	SATIN NICKEL	-CF277 COMPACT FLUORESCENT 120V
				W	WHITE	

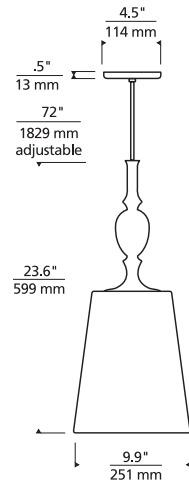
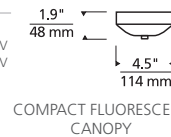

TRIMBLE GRANDE



Grand modern fabric cylinder. Glass diffuser provides a glare free wash of light. Black, satin nickel, and white finish options highlighted with a clear cable; antique bronze finish highlighted with brown cable. Includes four 120 volt, 75 watt medium base A19 lamps or three 24 watt T5 high output linear fluorescent lamps (electronic ballast included). Fixture provided with six feet of field-cutable cable. Incandescent version dimmable with standard incandescent dimmer.

COMPLEMENTARY LOW-VOLTAGE PENDANT P. 36

700TDTRMG		COLOR	CANOPY	LAMP
C	DESERT CLAY	Z	ANTIQUE BRONZE	INCANDESCENT 120V
W	WHITE	B	BLACK	-CF FLUORESCENT 120V
		S	SATIN NICKEL	-CF277 FLUORESCENT 277V
		W	WHITE	

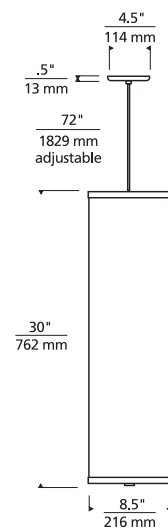

MONARCH

DESIGNED BY FRANK CAVAZ



IVORY/HAVANA BROWN

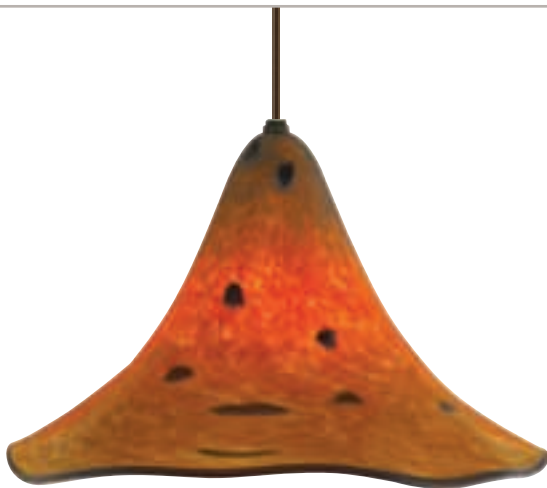

GOLD/HAVANA BROWN



WHITE/CLEAR



Hand-blown glass with a rich field of color and a brilliant clear or colored lip. Black, satin nickel, and white finish options highlighted with a satin nickel detail and clear cable; antique bronze finish includes antique bronze detail and brown cable. Includes 120 volt, 75 watt medium base A19 lamp or GX24Q-3 base 32 watt triple tube compact fluorescent lamp (electronic ballast included). Fixture provided with six feet of field-cutttable cable. Incandescent version dimmable with standard incandescent dimmer.

COMPLEMENTARY
SCONCE P. 212
CEILING P. 252

700TDMNAP

COLOR(GLASS/LIP)	CANOPY	LAMP
GN GOLD/HAVANA BROWN	Z ANTIQUE BRONZE	INCANDESCENT 120V
IN IVORY/HAVANA BROWN	B BLACK	-CF COMPACT FLUORESCENT 120V
WC WHITE/CLEAR	S SATIN NICKEL	-CF277 COMPACT FLUORESCENT 277V
	W WHITE	

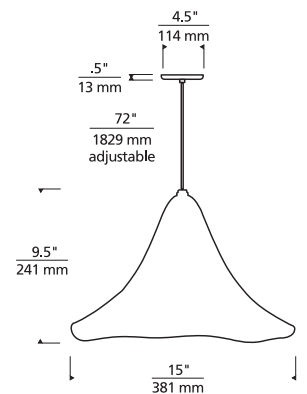
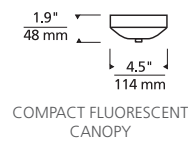



Monarch Pendant Ivory Havana Brown Antique Bronze / A19 Lamp



BEACH AMBER WITH
DIFFUSER SHOWN



SAND



SURF WHITE



COMPLEMENTARY
LOW-VOLTAGE
PENDANT P. 48
SCONCE P. 186
CEILING P. 256

Fused and slumped plate glass shade, warm with color and pattern, highlighted with metal detail and suspended from a round canopy. Glass disc diffuser provides a glare free wash of light. Black, satin nickel and white finish options highlighted with satin nickel detail and clear cable; antique bronze highlighted with antique bronze detail and brown cable. Includes 120 volt, 100 watt A19 medium base lamp or 18 watt GX24Q-2 base triple tube compact fluorescent lamp (electronic ballast included). Fixture is provided with six feet of field-cutable cable. Incandescent version dimmable with standard incandescent dimmer.

700TDLRKP	COLOR	CANOPY	LAMP
A	BEACH AMBER	Z ANTIQUE BRONZE	INCANDESCENT 120V
S	SAND	B BLACK	COMPACT FLUORESCENT 120V
W	SURF WHITE	S SATIN NICKEL	-CF277 COMPACT FLUORESCENT 277V
		W WHITE	

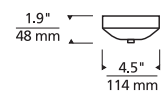

COMPACT FLUORESCENT
CANOPY

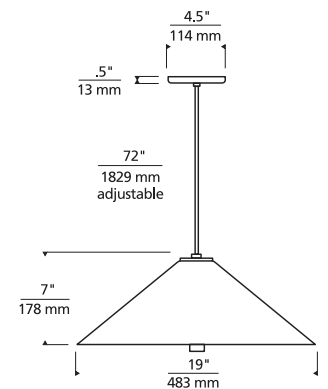



Larkspur Pendant Surf White Satin Nickel /
A19 Lamp

KAMI



BROWN

SAND

WHITE



Plate glass is cut into individual panels to create a beautiful, multi-faceted shade. Includes inner glass diffuser. Black, satin nickel, and white finish options highlighted with a satin nickel detail and clear cable; antique bronze finish includes antique bronze detail and brown cable. Includes 120 volt, 100 watt medium base A19 lamp or 120 volt GU24 base 27 watt self-ballasted compact fluorescent lamp. Fixture provided with six feet of field-cutable cable. Incandescent version dimmable with standard incandescent dimmer.

700TDKAMP

COLOR	CANOPY	LAMP
B BROWN	Z ANTIQUE BRONZE	INCANDESCENT 120V
S SAND	B BLACK	-CF COMPACT FLUORESCENT 120V
W WHITE	S SATIN NICKEL	
	W WHITE	

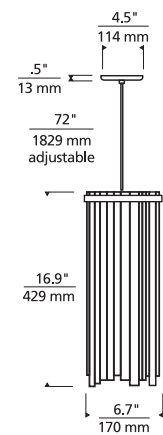

ROHE



DEEP RED/CLEAR

HAVANA BROWN/CLEAR

WHITE/CLEAR



Patterned transparent glass pyramid with a metal black frame highlighted with a white or colored inner case glass pyramid. Black, satin nickel, and white finish options are provided with clear cable; antique bronze finish is provided with brown cable. Includes 120 volt, 75 watt A19 medium base lamp or GX24Q-3 base 32 watt triple tube compact fluorescent lamp (electronic ballast included). Fixture provided with six feet of field-cutable cable. Incandescent version dimmable with standard incandescent dimmer.

700TDROHP

INNER/OUTER COLOR	CANOPY	LAMP
RC DEEP RED / CLEAR	Z ANTIQUE BRONZE	INCANDESCENT 120V
BC HAVANA BROWN / CLEAR	B BLACK	-CF COMPACT FLUORESCENT 120V
WC WHITE / CLEAR	S SATIN NICKEL	-CF277 COMPACT FLUORESCENT 277V
	W WHITE	

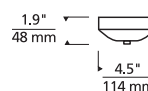

COMPACT FLUORESCENT CANOPY

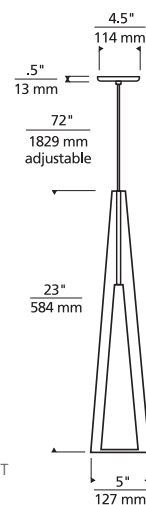



BROWN

NATURAL

WHITE



COMPLEMENTARY
LOW-VOLTAGE
PENDANT P. 40
SCONCES P. 188, 198

Elegant multi-toned shade comprised of natural shell panels. The shells are burnished to remove rough edges, meticulously polished, cut to size, and carefully adhered by hand to an inner glass cylinder; suspended from a round canopy. Includes 120 volt, 60 watt A19 medium base lamp or GX24Q-3 base 26 watt triple tube compact fluorescent lamp (electronic ballast included). Black, satin nickel, and white finish are provided with six feet of field-cuttable clear cable; antique bronze finish provided with six feet of field-cuttable brown cable. Incandescent version dimmable with standard incandescent dimmer.

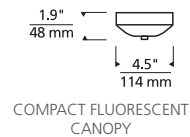
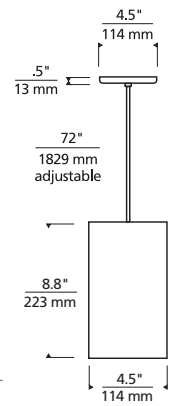

700TDPLAP

COLOR	CANOPY	LAMP
B BROWN	Z ANTIQUE BRONZE	INCANDESCENT 120V
N NATURAL	B BLACK	COMPACT FLUORESCENT 120V
W WHITE	S SATIN NICKEL	-CF COMPACT FLUORESCENT 277V
	W WHITE	-CF277

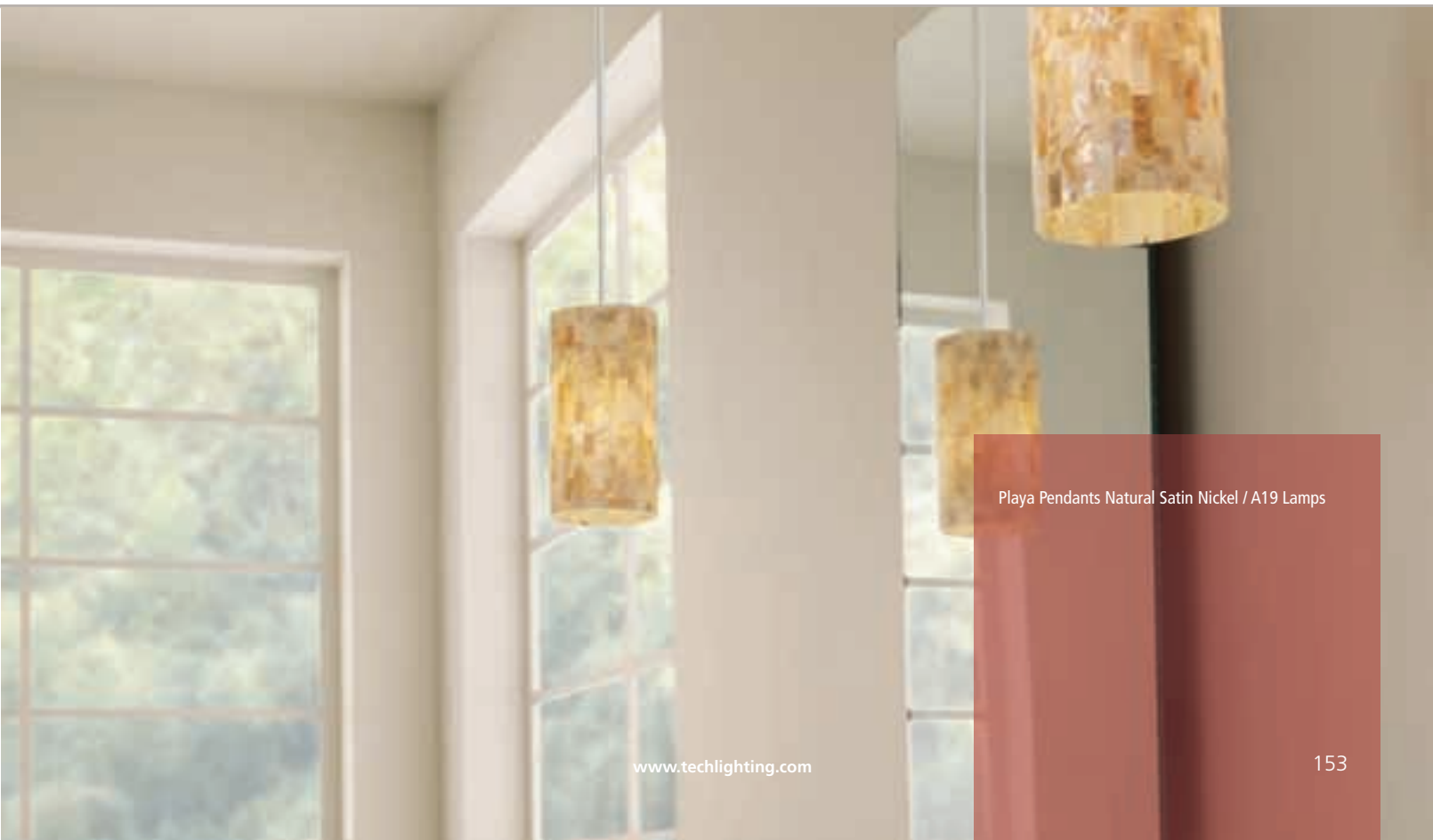

Playa Pendants Natural Satin Nickel / A19 Lamps



AMBER



CLEAR



HAVANA BROWN



SMOKE



STEEL BLUE



Rich translucent glass surrounds a frost glass diffuser. Black, satin nickel, and white finish options highlighted with a satin nickel detail and clear cable; antique bronze finish includes antique bronze detail and brown cable. Includes 120 volt, 60 watt G9 base halogen lamp or 120 volt GU24 base 27 watt self-ballasted compact fluorescent lamp. Fixture provided with six feet of field-cuttable cable. Incandescent version dimmable with standard incandescent dimmer.

COMPLEMENTARY
LOW-VOLTAGE
PENDANT P. 66
SCONCE P. 194

700TDFIRGP

COLOR	CANOPY	LAMP
A AMBER	Z ANTIQUE BRONZE	-CF INCANDESCENT 120V COMPACT FLUORESCENT 120V
C CLEAR	B BLACK	
N HAVANA BROWN	S SATIN NICKEL	
K SMOKE	W WHITE	
U STEEL BLUE		

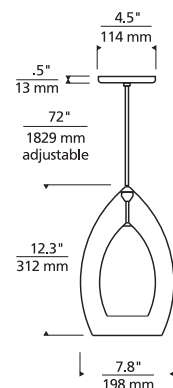



Fire Grande Pendant Havana Brown Antique Bronze /
G9 Lamp

FIRE ONYX

2 thousandsm



COMPLEMENTARY
SCONCE P. 192

Warm onyx in an elegant teardrop shape. Black, satin nickel, and white finish options highlighted with a satin nickel detail and clear cable; antique bronze finish includes antique bronze detail and brown cable. Includes 120 volt, 60w A19 medium base lamp or GX24Q-1 base 13w triple tube compact fluorescent lamp (electronic ballast included). Fixture is provided with six feet of field-cuttable cable. Incandescent version dimmable with standard incandescent dimmer.

700TDFIRXH	CANOPY	LAMP
Z	ANTIQUE BRONZE	INCANDESCENT 120V
B	BLACK	-CF COMPACT FLUORESCENT 120V
S	SATIN NICKEL	-CF277 COMPACT FLUORESCENT 277V
W	WHITE	

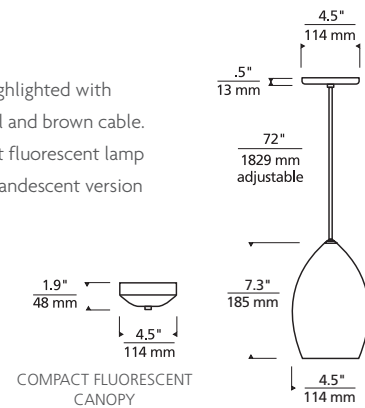

CABO GRANDE

2 thousandsm



COMPLEMENTARY
LOW-VOLTAGE
PENDANT P. 45
SCONCE P. 200

Onyx cylinder provides a warm textured look. Finished with minimal top detail and suspended from a round canopy. Black, satin nickel, and white canopy options include satin nickel top detail and clear cable; antique bronze includes antique bronze detail and brown cable. Includes 120 volt 75w A19 medium base lamp or GX24Q-3 base 32w triple tube compact fluorescent lamp (electronic ballast included). May also be lamped with GX24Q-3 base 26W triple tube compact fluorescent lamp (not included). Fixture is provided with six feet of field-cuttable cable. Incandescent version dimmable with standard incandescent dimmer.

700TDCBOGPH	CANOPY	LAMP
Z	ANTIQUE BRONZE	INCANDESCENT 120V
B	BLACK	-CF COMPACT FLUORESCENT 120V
S	SATIN NICKEL	-CF277 COMPACT FLUORESCENT 277V
W	WHITE	

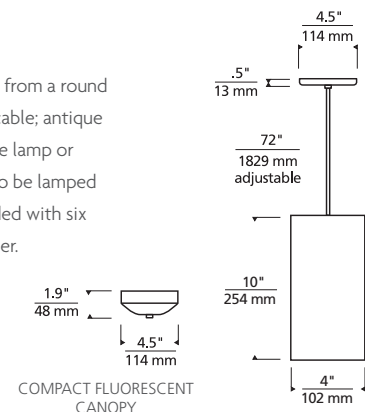



Fire Onyx Pendants Satin Nickel / A19 Lamps



AMBER

AQUAMARINE

CLEAR

HAVANA BROWN



OLIVE GREEN

SMOKE

STEEL BLUE

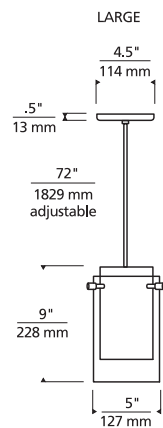
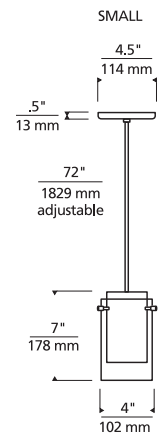

COMPLEMENTARY
LOW-VOLTAGE
PENDANT P. 62
SCONCE P. 204

Transparent cylinder shade over a white case glass cylinder suspended from a round canopy and highlighted with three satin nickel cylinder details. Available in two sizes: large and small. Large includes 120 volt, 75 watt A19 medium base lamp or 18 watt GX24Q-2 base triple tube compact fluorescent lamp (electronic ballast included). Small includes 120 volt, 60 watt mini-candelabra base lamp. Fixture is provided with six feet of field-cuttable clear cable. Incandescent version dimmable with standard incandescent dimmer.

700TDECP	SIZE	COLOR	CANOPY	LAMP
	LARGE	A AMBER	B BLACK	INCANDESCENT 120V
	S SMALL	Q AQUAMARINE	S SATIN NICKEL	COMPACT FLUORESCENT 120V (LARGE ONLY)
		C CLEAR	W WHITE	COMPACT FLUORESCENT 277V (LARGE ONLY)
		B HAVANA BROWN		-CF277
		V OLIVE GREEN		
		S SMOKE		
		U STEEL BLUE		

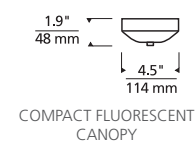



Echo Pendants Clear Satin Nickel / A19 Lamps

FINO LARGE

2 thousand



AMBER

BROWN

LATTE

WHITE



Slender case glass shade topped with metal detail. Black, satin nickel, and white finish options highlighted with a satin nickel detail and clear cable; antique bronze finish includes antique bronze detail and brown cable. Includes 2G11 base 36 watt twin tube compact fluorescent lamp (electronic ballast included). Fixture provided with six feet of field-cutable cable. Not dimmable.

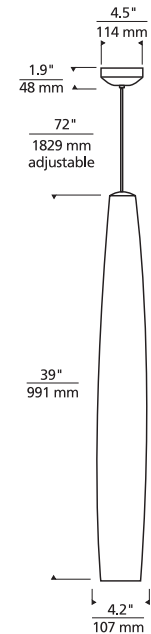

700TDFINPL

COLOR	CANOPY	LAMP
A AMBER	Z ANTIQUE BRONZE	-CF COMPACT FLUORESCENT 120V
B BROWN	B BLACK	-CF277 COMPACT FLUORESCENT 277V
L LATTE	S SATIN NICKEL	
W WHITE	W WHITE	

FINO SMALL

2 thousand



AMBER

BROWN

LATTE

WHITE



Slender case glass shade topped with metal detail. Black, satin nickel, and white finish options highlighted with a satin nickel detail and clear cable; antique bronze finish includes antique bronze detail and brown cable. Includes 120 volt, 75 watt medium base A19 lamp or G24Q-3 base 26 watt quad tube compact fluorescent lamp (electronic ballast included). Fixture provided with six feet of field-cutable cable. Incandescent version dimmable with standard incandescent dimmer.

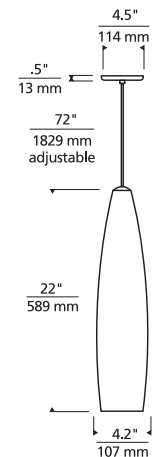

700TDFINPS

COLOR	CANOPY	LAMP
A AMBER	Z ANTIQUE BRONZE	INCANDESCENT 120V
B BROWN	B BLACK	-CF COMPACT FLUORESCENT 120V
L LATTE	S SATIN NICKEL	-CF277 COMPACT FLUORESCENT 277V
W WHITE	W WHITE	

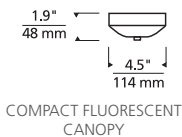



Fino Small Pendants Brown Satin Nickel /
Quad Tube Lamps

HUDSON

2 thousand



BROWN

LATTE

RED

WHITE



Clean pure style with presence. A long cylindrical glass shade topped with a simple metal cap detail, suspended from a round canopy. Choose from a selection of rich glass colors with a gloss finish. Black, satin nickel, and white finish options come standard with a satin nickel cap and clear cable; antique bronze finish with an antique bronze cap and brown cable. Includes 120 volt, 75 watt A19 medium base lamp or 32 watt GX24Q-3 base triple tube compact fluorescent lamp (electronic ballast included). May also be lamped with GX24Q-3 base 26 watt triple tube compact fluorescent lamp (not included). Fixture is provided with six feet of field-cuttable cable. Incandescent version dimmable with standard incandescent dimmer.

COMPLEMENTARY
LOW-VOLTAGE
PENDANT P. 54
SCONCES P. 200, 201

700TDHUDP

COLOR	CANOPY	LAMP
N BROWN	Z ANTIQUE BRONZE	INCANDESCENT 120V
L LATTE	B BLACK	-CF COMPACT FLUORESCENT 120V
R RED	S SATIN NICKEL	-CF277 COMPACT FLUORESCENT 277V
W WHITE	W WHITE	

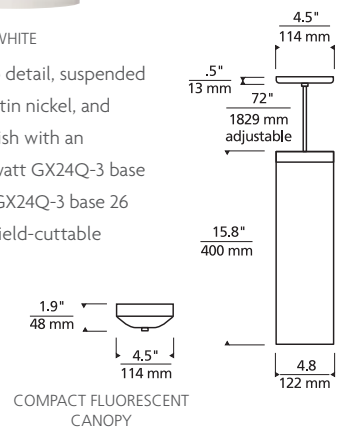

POWELL STREET

2 thousand



SATIN NICKEL/SUNRISE ORANGE

SATIN NICKEL/WHITE

Spun metal shade, coated to provide a wash of white or tinted light, suspended from a round canopy. Includes 120 volt, 150 watt medium base G40 globe lamp. Fixture is provided with six feet of field-cuttable clear cable. Dimmable with standard incandescent dimmer.

700TDPSP24

OUTER/INNER COLOR	CANOPY
SO SATIN NICKEL/SUNRISE ORANGE	B BLACK
SW SATIN NICKEL/WHITE	S SATIN NICKEL
	W WHITE

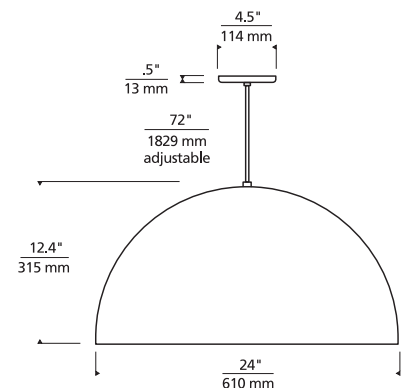



Powell Street Pendants Satin Nickel/Sunrise Orange /
G40 Globe Lamps

PHOTOGRAPHER: ERIC ROTH



AMBER



BROWN



CRYSTAL



GRAY



COMPLEMENTARY
LOW-VOLTAGE
PENDANT P. 52

Hand etched glass shade provides a rich textured look suspended from a round canopy. Includes 120 volt, 75 watt A19 medium base lamp or 32 watt GX24Q-3 base triple tube compact fluorescent lamp (electronic ballast included). May also be lamped with GX24Q-3 base 26 watt triple tube compact fluorescent lamp (not included). Black, satin nickel, and white finish are provided with six feet of field-cutttable clear cable; antique bronze finish provided with six feet of field-cutttable brown cable. Incandescent version dimmable with standard incandescent dimmer.

700TDEDGP	COLOR	CANOPY	LAMP
A	AMBER	Z ANTIQUE BRONZE	INCANDESCENT 120V
B	BROWN	B BLACK	-CF COMPACT FLUORESCENT 120V
C	CRYSTAL	S SATIN NICKEL	-CF277 COMPACT FLUORESCENT 277V
G	GRAY	W WHITE	

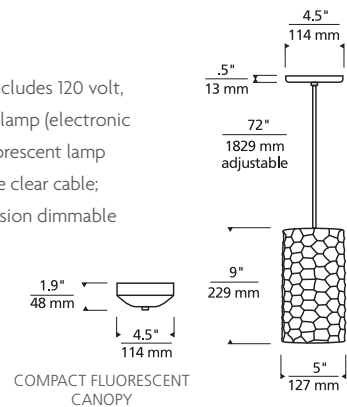

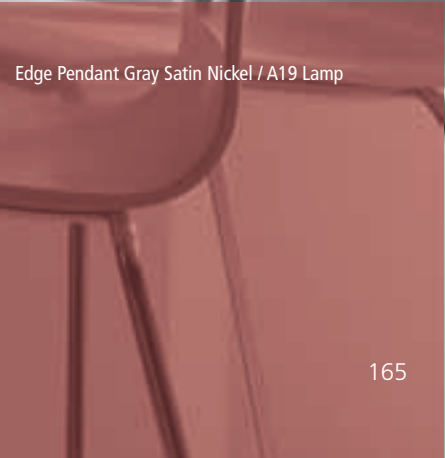

Edge Pendant Gray Satin Nickel / A19 Lamp

SERENGETI

2 thousand



COMPLEMENTARY
SCONCE P. 192

Classically shaped glass shade with unique hand-carving, suspended from a round canopy. Black, satin nickel, and white canopy options highlighted with satin nickel detail and clear cable; antique bronze highlighted with antique bronze detail and brown cable. Includes 120 volt, 100 watt A19 medium base lamp or 18 watt GX24Q-2 base triple tube compact fluorescent lamp (electronic ballast included). Fixture is provided with six feet of field-cutable cable. Incandescent version dimmable with standard incandescent dimmer.

700TDSRNP	COLOR	CANOPY	LAMP
A	LATTE/WHITE	Z ANTIQUE BRONZE	INCANDESCENT 120V
B	BLACK/WHITE	B BLACK	COMPACT FLUORESCENT 120V
N	BROWN/WHITE	S SATIN NICKEL	-CF -CF277 COMPACT FLUORESCENT 277V
R	RED/WHITE	W WHITE	
W	WHITE/CLEAR		

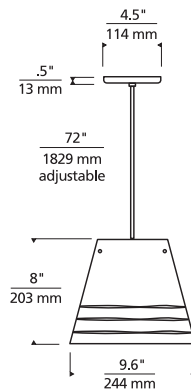
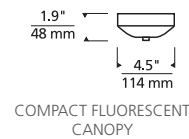

PALMA

2 thousand



Classically shaped glass shade suspended from a round canopy. Black, satin nickel, and white canopy options highlighted with satin nickel detail and clear cable; antique bronze highlighted with antique bronze detail and brown cable. Includes 120 volt, 150 watt A21 medium base lamp or 32 watt GX24Q-3 base triple tube compact fluorescent lamp (electronic ballast included). May also be lamped with GX24Q-3 base 26 watt triple tube compact fluorescent lamp (not included). Fixture is provided with six feet of field-cutable cable. Incandescent version dimmable with standard incandescent dimmer.

700TDPLP	COLOR	CANOPY	LAMP
F	FROST WHITE	Z ANTIQUE BRONZE	INCANDESCENT 120V
A	TAHOE PINE AMBER	B BLACK	COMPACT FLUORESCENT 120V
W	WHITE FRIT	S SATIN NICKEL	-CF -CF277 COMPACT FLUORESCENT 277V
		W WHITE	

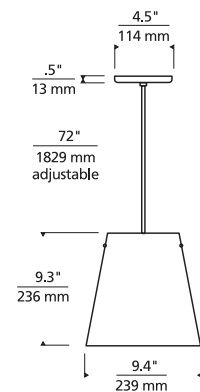
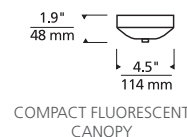



Palma Pendants Frost White Satin Nickel / A21 Lamps / MonoRail Satin Nickel / End Caps / 300 Watt 12 Volt Remote Transformer / 4" Round Power Feed Canopy / 2" Rigid Standoffs / John Heads / MR16 Lamps

SMALL NEST



AMBER



COBALT BLUE



FROST WHITE



RED

COMPLEMENTARY
LOW-VOLTAGE
PENDANT P. 99

Glass shade with clear glass wrap, suspended from a round canopy. Black, satin nickel, and white canopy options include satin nickel ball detail and clear cable; antique bronze includes antique bronze detail and brown cable. Includes 120 volt 60 watt mini-candelabra base lamp. Black, satin nickel, and white finish are provided with six feet of field-cuttable clear cable; antique bronze finish provided with six feet of field-cuttable brown cable. Dimmable with standard incandescent dimmer.

700TDNSP COLOR		CANOPY
A	AMBER	Z ANTIQUE BRONZE
B	COBALT BLUE	B BLACK
W	FROST WHITE	S SATIN NICKEL
R	RED	W WHITE

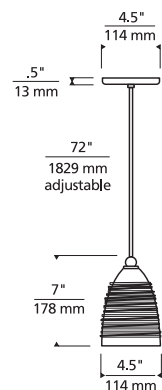



Small Nest Pendants Amber Antique Bronze /
Mini-candelabra Base Lamps

LOCATION: 1705 PRIME - RALEIGH, NC
DESIGN: J DAVIS INTERIORS GROUP, J DAVIS ARCHITECTS
PHOTOGRAPHER: GIL STOSE PHOTOGRAPHY

SODA

2 thousand



AMBER

BLUE

FROST



Sleek glass shade infused with bubbles, suspended from a round canopy. Includes 120 volt, 75 watt A19 medium base lamp or 32 watt GX24Q-3 base triple tube compact fluorescent lamp (electronic ballast included). May also be lamped with GX24Q-3 base 26 watt triple tube compact fluorescent lamp (not included). Black, satin nickel, and white finish are provided with six feet of field-cuttable clear cable; antique bronze finish provided with six feet of field-cuttable brown cable. Incandescent version dimmable with standard incandescent dimmer.

COMPLEMENTARY ACCESSORY P. 370

700TDSDALP

COLOR	CANOPY	LAMP
A AMBER	Z ANTIQUE BRONZE	INCANDESCENT 120V
B BLUE	B BLACK	-CF COMPACT FLUORESCENT 120V
F FROST	S SATIN NICKEL	-CF277 COMPACT FLUORESCENT 277V
	W WHITE	

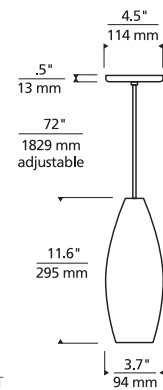
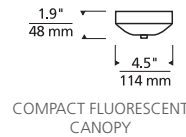

MONTANA

2 thousand

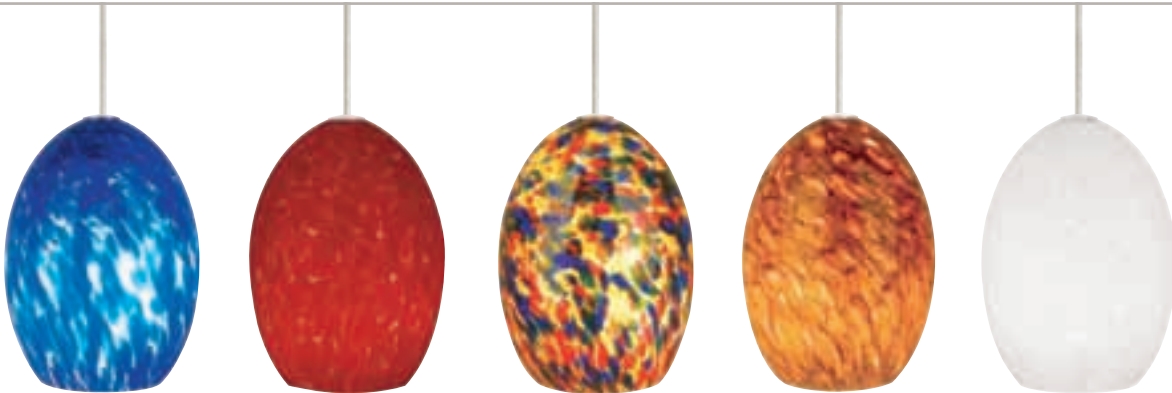

BLUE-VIOLET

FERRARI RED

MULTICOLOR

TAHOE PINE AMBER

WHITE FRIT



Well rounded and full in form glass shade, richly layered in brilliant colored frit suspended from a round canopy. Black, satin nickel, and white canopy options include satin nickel top detail and clear cable; antique bronze includes antique bronze detail and brown cable. Includes 120 volt, 75 watt A19 medium base lamp or 32 watt GX24Q-3 base triple tube compact fluorescent lamp (electronic ballast included). May also be lamped with GX24Q-3 base 26 watt triple tube compact fluorescent lamp (not included). Fixture is provided with six feet of field-cuttable cable. Incandescent version dimmable with standard incandescent dimmer.

700TDMNTP

COLOR	CANOPY	LAMP
B BLUE-VIOLET	Z ANTIQUE BRONZE	INCANDESCENT 120V
R FERRARI RED	B BLACK	-CF COMPACT FLUORESCENT 120V
M MULTICOLOR	S SATIN NICKEL	-CF277 COMPACT FLUORESCENT 277V
A TAHOE PINE AMBER	W WHITE	
W WHITE FRIT		

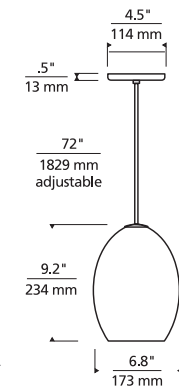
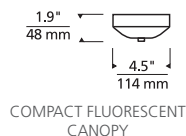



Montana Pendants White Frit Satin Nickel /
A19 Lamps / Single-Circuit T-trak White /
4" Round Power Feed Canopy without Connector /
2" Rigid Standoffs with Connector / 2" Rigid
Standoffs without Connector / T-trak Om with
Incandescent PAR Heads / PAR20 Lamps

TAZA

2 thousand™



AMBER

BLUE/GREEN

BROWN

CREAM

RED



Blown glass shade with intense color twists suspended from a round canopy. Includes 120 volt, 75 watt A19 medium base lamp or 18 watt GX24Q-2 base triple tube compact fluorescent lamp (electronic ballast included). Black, satin nickel, and white finish are provided with six feet of field-cuttable clear cable; antique bronze finish provided with six feet of field-cuttable brown cable. Incandescent version dimmable with standard incandescent dimmer.

COMPLEMENTARY ACCESSORY P. 372
LOW-VOLTAGE PENDANT P. 91

700TDTAZP

COLOR	CANOPY	LAMP
A AMBER	Z ANTIQUE BRONZE	INCANDESCENT 120V
B BLUE/GREEN	B BLACK	-CF COMPACT FLUORESCENT 120V
N BROWN	S SATIN NICKEL	-CF277 COMPACT FLUORESCENT 277V
C CREAM	W WHITE	
R RED		

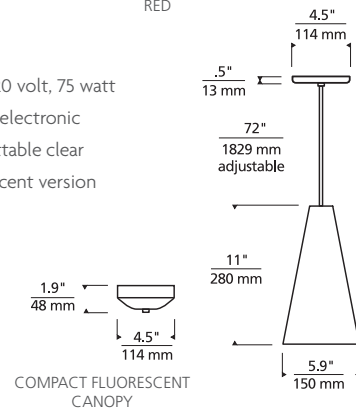

STARRY NIGHT

2 thousand™



CARAMEL

DARK AMBER

WHITE



Blown glass shade of richly layered color where selected areas are hand twisted, suspended from a round canopy. Includes 120 volt, 75 watt A19 medium base lamp or 18 watt GX24Q-2 base triple tube compact fluorescent lamp (electronic ballast included). Black, satin nickel, and white finish are provided with six feet of field-cuttable clear cable; antique bronze finish provided with six feet of field-cuttable brown cable. Incandescent version dimmable with standard incandescent dimmer.

COMPLEMENTARY LOW-VOLTAGE PENDANT P. 90

700TDSTRLP

COLOR	CANOPY	LAMP
C CARAMEL	Z ANTIQUE BRONZE	INCANDESCENT 120V
A DARK AMBER	B BLACK	-CF COMPACT FLUORESCENT 120V
W WHITE	S SATIN NICKEL	-CF277 COMPACT FLUORESCENT 277V
	W WHITE	

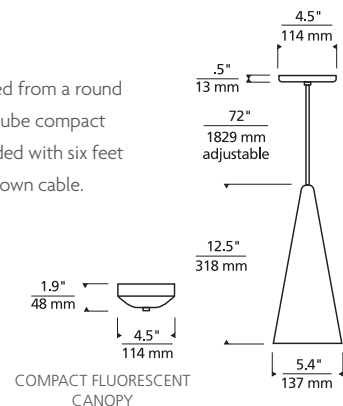



AMBER

AMETHYST

FROST

GREEN



COMPLEMENTARY
ACCESSORY P. 368
LOW-VOLTAGE
PENDANT P. 80

Curve shaped glass with a frosted old world charm suspended from a round canopy. Includes 120 volt, 60 watt mini-candelabra base lamp or 18 watt GX24Q-2 base triple tube compact fluorescent lamp (electronic ballast included). Black, satin nickel, and white finish are provided with six feet of field-cuttable clear cable; antique bronze finish provided with six feet of field-cuttable brown cable. Incandescent version dimmable with standard incandescent dimmer.

700TDSALP

COLOR	CANOPY	LAMP
A AMBER	Z ANTIQUE BRONZE	INCANDESCENT 120V
M AMETHYST	B BLACK	-CF COMPACT FLUORESCENT 120V
F FROST	S SATIN NICKEL	-CF277 COMPACT FLUORESCENT 277V
G GREEN	W WHITE	

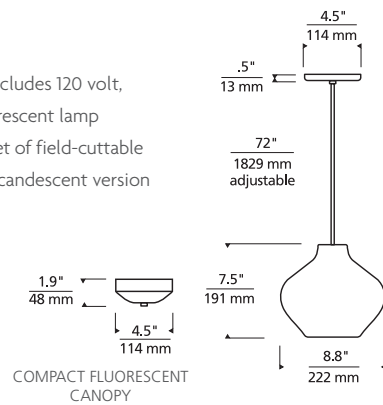

Taza Pendants Satin Nickel / A19 Lamps

MELROSE

2 thousand™



BLUE-VIOLET

FERRARI RED

MULTICOLOR



TAHOE PINE AMBER

WHITE



COMPLEMENTARY
LOW-VOLTAGE
PENDANTS P. 86
SCONCE P. 214

Gracefully shaped glass shade, richly layered in brilliant color, with machined top detail suspended from either a modern canopy or a round canopy. Black, satin nickel, and white canopy options include satin nickel top detail and clear cable; antique bronze includes antique bronze detail and brown cable. Includes 120 volt, 60 watt mini-candelabra base lamp or 18 watt GX24Q-2 base triple tube compact fluorescent lamp (electronic ballast included). Fixture is provided with six feet of field-cuttable cable. Incandescent version dimmable with standard incandescent dimmer.

700TDMLP

COLOR	CANOPY	LAMP
B BLUE-VIOLET	MS MODERN SATIN NICKEL	INCANDESCENT 120V
R FERRARI RED	MS MODERN SATIN NICKEL	-CF COMPACT FLUORESCENT 120V*
M MULTICOLOR	RZ ROUND ANTIQUE BRONZE	-CF277 COMPACT FLUORESCENT 277V*
A TAHOE PINE AMBER	RB ROUND BLACK	
W WHITE	RS ROUND SATIN NICKEL	
	RW ROUND WHITE	

* NOT FOR USE WITH MODERN CANOPY

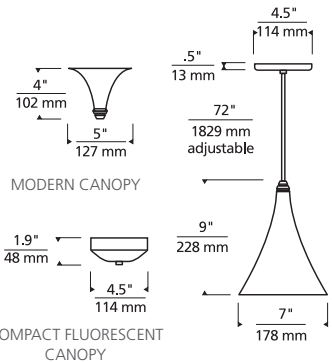



Melrose Pendants Tahoe Pine Amber with Modern Canopy Satin Nickel / Mini-candelabra Base Lamps

DESIGNER: RUI PONTE
PHOTOGRAPHER: KENNETH M. WYNER



FERRARI RED

TAHOE PINE AMBER W/ CLEAR GLASS BALL AND SATIN NICKEL IRON WRAP ACCESSORY

TORTOISE SHELL W/ AMBER GLASS BALL AND BLACK IRON WRAP ACCESSORY

WHITE FRIT



Hand pulled glass shade, richly layered in brilliant color, with machined top or glass ball detail suspended from a round canopy. Black, satin nickel, and white canopy options include satin nickel top detail and clear cable; antique bronze includes antique bronze detail and brown cable. Handmade wrought iron wrap accessory sold separately below. Includes 120 volt, 75 watt A19 medium base lamp or 18 watt GX24Q-2 base triple tube compact fluorescent lamp (electronic ballast included). Fixture is provided with six feet of field-cuttable cable. Incandescent version dimmable with standard incandescent dimmer.

COMPLEMENTARY LOW-VOLTAGE PENDANT P. 88 SCONCE P. 210

700TDOVP

	COLOR	GLASS BALL	CANOPY	LAMP
R	FERRARI RED	NN NO BALL	Z ANTIQUE BRONZE	INCANDESCENT 120V
A	TAHOE PINE AMBER	AN AMBER	B BLACK	-CF COMPACT FLUORESCENT 120V
T	TORTOISE SHELL	CN CLEAR	S SATIN NICKEL	-CF277 COMPACT FLUORESCENT 277V
W	WHITE FRIT	RN RED	W WHITE	

IRON WRAP ACCESSORY

700FJMOVLR

FINISH
I BLACK IRON
S SATIN NICKEL

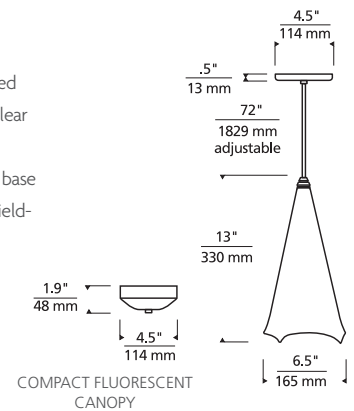



Ovation Pendant Tortoise Shell with Amber Ball
Satin Nickel / A19 Lamp

DESIGN: PETER SALERNO KITCHENS
PHOTOGRAPHER: WWW.PETERRYMWD.COM



BLUE-VIOLET WITH COBALT
BLUE GLASS BALL



FERRARI RED WITH
RED GLASS BALL



FROST WHITE WITH COBALT
BLUE GLASS BALL



LIME GREEN WITH
CLEAR GLASS BALL



MULTICOLOR WITH COBALT
BLUE GLASS BALL



TAHOE PINE AMBER
WITH AMBER GLASS BALL

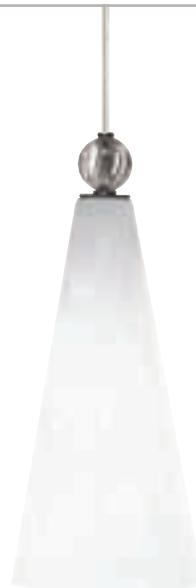

WHITE FRIT WITH CLEAR
GLASS BALL



Conical shaped glass shade, richly layered in brilliant color, with glass ball detail, suspended from a round canopy. Black, satin nickel, and white canopy options include satin nickel detail and clear cable; antique bronze includes antique bronze detail and brown cable. Includes 120 volt, 75 watt A19 medium base lamp or 18 watt GX24Q-2 base triple tube compact fluorescent lamp (electronic ballast included). Fixture is provided with six feet of field-cuttable cable. Incandescent version dimmable with standard incandescent dimmer.

700TDSPP	COLOR	GLASS BALL	CANOPY	LAMP
B	BLUE-VIOLET	A AMBER	Z ANTIQUE BRONZE	INCANDESCENT 120V
R	FERRARI RED	C CLEAR	B BLACK	-CF COMPACT FLUORESCENT 120V
F	FROST WHITE	B COBALT	S SATIN NICKEL	-CF277 COMPACT FLUORESCENT 277V
G	LIME GREEN	BLUE	W WHITE	
M	MULTICOLOR	R RED		
A	TAHOE PINE AMBER			
W	WHITE FRIT			

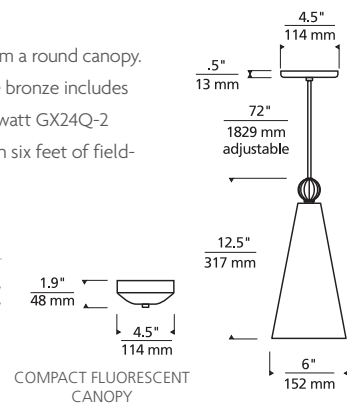

2 thousand



BLUE-VIOLET

FERRARI RED

FROST WHITE

LIME GREEN



MULTICOLOR

TAHOE PINE AMBER

WHITE FRIT



Conical shaped glass shade, richly layered in brilliant color, suspended from a round canopy. Black, satin nickel, and white canopy options include satin nickel detail and clear cable; antique bronze includes antique bronze detail and brown cable. Includes 120 volt, 75 watt A19 medium base lamp or 18 watt GX24Q-2 base triple tube compact fluorescent lamp (electronic ballast included). Fixture is provided with six feet of field-cuttable cable. Incandescent version dimmable with standard incandescent dimmer.

COMPLEMENTARY
SCONCE P. 208

700TDEMP

COLOR	CANOPY	LAMP
B BLUE-VIOLET	Z ANTIQUE BRONZE	INCANDESCENT 120V
R FERRARI RED	B BLACK	-CF COMPACT FLUORESCENT 120V
F FROST WHITE	S SATIN NICKEL	-CF277 COMPACT FLUORESCENT 277V
G LIME GREEN	W WHITE	
M MULTICOLOR		
A TAHOE PINE AMBER		
W WHITE FRIT		

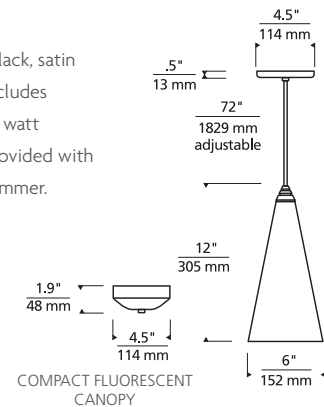

Pendant Cluster Canopies / Track Adapter / Swag Hook



3 PENDANT ROUND CLUSTER CANOPY, SATIN NICKEL
SHOWN WITH HUDSON WHITE PENDANTS



3 PENDANT ROUND

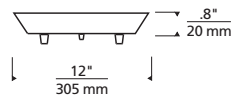

5 PENDANT ROUND

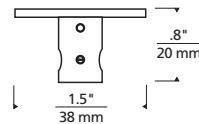
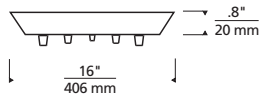

PENDANT CLUSTER CANOPIES

Use to suspend a combination of pendants from a single mounting location (pendants sold separately, pp. 136-179). Available in two styles: suspend three pendants or five pendants from a single round canopy. For use with incandescent pendants only.

700TDCLP	STYLE	FINISH
3R	3 PENDANT ROUND	Z ANTIQUE BRONZE
5R	5 PENDANT ROUND	B BLACK
		S SATIN NICKEL
		W WHITE

SWAG HOOK

Use as a creative tool to gracefully change a pendant's point of suspension from the mounting canopy to any point on the ceiling. Order one for each pendant.

700TDSWG	FINISH
Z	ANTIQUE BRONZE
B	BLACK
S	SATIN NICKEL
W	WHITE

TRACK ADAPTER

Allows pendants to be used on most popular single-circuit track lighting systems. Black or white housing. For use with incandescent pendants only.

700TD	TYPE	FINISH
HASP	FITS HALO*	B BLACK
JUSP	FITS JUNO*	W WHITE
LISP	FITS LIGHTOLIER*	

*Tech Lighting is not affiliated with, nor is it endorsed by, any of the companies listed above. Tech Lighting does not distribute or sell any of the products listed above. Call for more information.





Lexington Pendants Desert Clay Satin Nickel /
A19 Lamps / Emerge Roxanne Wall Tahoe Pine Amber
Antique Bronze / Mini-candelabra Base Lamps

LOCATION: 1705 PRIME - RALEIGH, NC
DESIGN: J DAVIS INTERIORS GROUP, J DAVIS ARCHITECTS
PHOTOGRAPHER: GIL STOSE PHOTOGRAPHY

The Wall Collection

Beautiful and versatile. Bring cohesion throughout your space with an additional layer of lighting.

www.techlighting.com



Throughout the catalog this icon indicates which fixtures are available in **Compact Fluorescent**



Throughout the catalog this icon indicates which fixtures are **ADA Compliant**



Throughout the catalog this icon indicates which fixtures are available in **LED**





Coronado Wall Antique Bronze /
Double-ended Halogen Lamp

LEXINGTON



WHITE
THREE-QUARTER VIEW



DESERT CLAY



Half-cylinder fabric shade with rolled edges and minimal metal base. Includes 120 volt, 60 watt medium base BT15 halogen lamp or 2G11 base 18 watt twin tube compact fluorescent lamp (electronic ballast included). Incandescent version dimmable with standard incandescent dimmer. ADA compliant.

COMPLEMENTARY
LINE-VOLTAGE
PENDANT P. 144

700WSLEX		COLOR	FINISH	LAMP
C	DESERT CLAY	Z	ANTIQUÉ BRONZE	INCANDESCENT 120V
W	WHITE	S	SATIN NICKEL	-CF COMPACT FLUORESCENT 120V

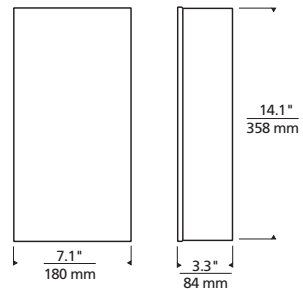



Lexington Wall Desert Clay Satin Nickel /
BT15 Lamp



SURF WHITE
THREE-QUARTER VIEW



SAND



BEACH AMBER



Cone shaped, slumped glass shade, rich with color and pattern. Provides ambient, up- and down-light. Includes 120 volt, 75 watt T8 medium base lamp or 36 watt 2G11 base twin tube compact fluorescent lamp (electronic ballast included). Incandescent version dimmable with standard incandescent dimmer. ADA compliant.

COMPLEMENTARY
LINE-VOLTAGE
PENDANT P. 150
LOW-VOLTAGE
PENDANT P. 48
CEILING P. 256

700TDLRKS		COLOR	FINISH	LAMP
A	BEACH AMBER	Z	ANTIQUE BRONZE	INCANDESCENT
S	SAND	S	SATIN NICKEL	-CF
W	SURF WHITE			COMPACT FLUORESCENT

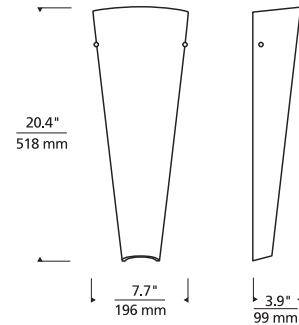

MINI LARKSPUR



BEACH AMBER
THREE-QUARTER VIEW



SAND



SURF WHITE



Cone shaped, slumped glass shade, rich with color and pattern. Provides ambient up-light. Includes 120 volt, 40 watt G9 bi-pin lamp or 13 watt 2GX7 base twin tube compact fluorescent lamp (electronic ballast included). Incandescent version dimmable with standard incandescent dimmer. ADA compliant.

COMPLEMENTARY
LINE-VOLTAGE
PENDANT P. 150
LOW-VOLTAGE
PENDANT P. 48
CEILING P. 256

700WSLRKS		COLOR	FINISH	LAMP
A	BEACH AMBER	Z	ANTIQUE BRONZE	INCANDESCENT
S	SAND	C	CHROME	-CF
W	SURF WHITE	S	SATIN NICKEL	COMPACT FLUORESCENT

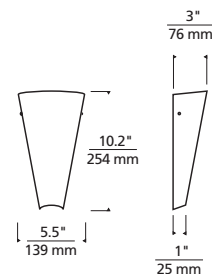



Mini Larkspur Wall Surf White Satin Nickel /
G9 Base Lamps

ESSEX

GLASS



SAND GLASS
THREE-QUARTER VIEW



BEACH AMBER GLASS



IVORY/BROWN/AMBER GLASS



SURF WHITE GLASS

FABRIC



WHITE FABRIC



DESERT CLAY FABRIC

SHELL



BROWN



NATURAL



WHITE

ADA



Glass or fabric shade options with minimal metal detail. Provides ambient, up- and down-light. Includes 120 volt, 60 watt G9 base halogen lamp or 120 volt 18 watt GU24 base self-ballasted compact fluorescent lamp. Incandescent version dimmable with standard incandescent dimmer. ADA compliant.

COMPLEMENTARY
LOW-VOLTAGE
PENDANTS P. 40, 44

700WSESX

COLOR	FINISH	LAMP
GLASS	Z ANTIQUE BRONZE	INCANDESCENT
IBA IVORY/BROWN/AMBER	C CHROME	-CF COMPACT FLUORESCENT
GA BEACH AMBER	S SATIN NICKEL	
GS SAND		
GW SURF WHITE		
FABRIC		
FC DESERT CLAY		
FW WHITE		
SHELL		
PB BROWN		
PN NATURAL		
PW WHITE		

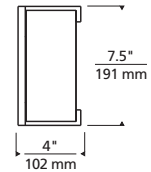
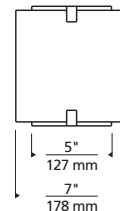



Essex Wall Surf White Satin Nickel /
G9 Base Lamp

BOREAL

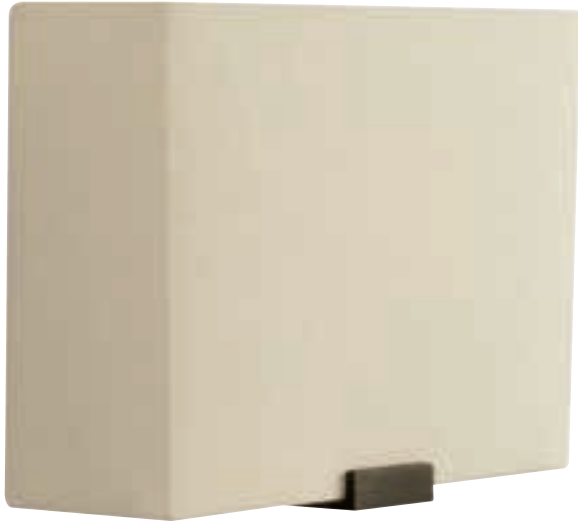

IVORY
THREE-QUARTER VIEW



NATURAL HEMP
IVORY FABRIC DETAIL



NATURAL HEMP
KHAKI GREEN FABRIC DETAIL



RECYCLED SAND-CAST
BRACKET DETAIL



KHAKI GREEN



COMPLEMENTARY
LOW-VOLTAGE
PENDANT P. 38

Natural hemp fabric shade with recycled paper backing and recycled sand-cast bronze metalwork. The fabric shade and recycled bronze are both sourced locally within 20 miles of our facility. The product also ships in environmentally-friendly recycled packaging. Includes 120 volt, 60 watt medium base BT15 halogen lamp or 2G10 base 18 watt flat quad tube compact fluorescent lamp (electronic ballast included). Incandescent may also use 75 watt medium base BT15 halogen lamp (not included). Incandescent version dimmable with standard incandescent dimmer. ADA compliant.

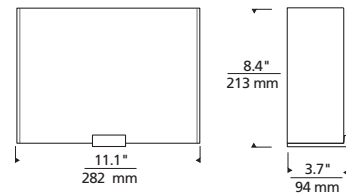

700WSBOR	COLOR	FINISH*	LAMP	
I	IVORY	Z	ANTIQUE BRONZE	INCANDESCENT 120V COMPACT FLUORESCENT 120V
G	KHAKI GREEN	S	WHITE BRONZE	

* WHILE WE FEEL THEY LOOK VERY NICE TOGETHER, THE BOREAL FINISHES WILL NOT BE AN EXACT MATCH TO EXISTING SATIN NICKEL AND ANTIQUE BRONZE HARDWARE.



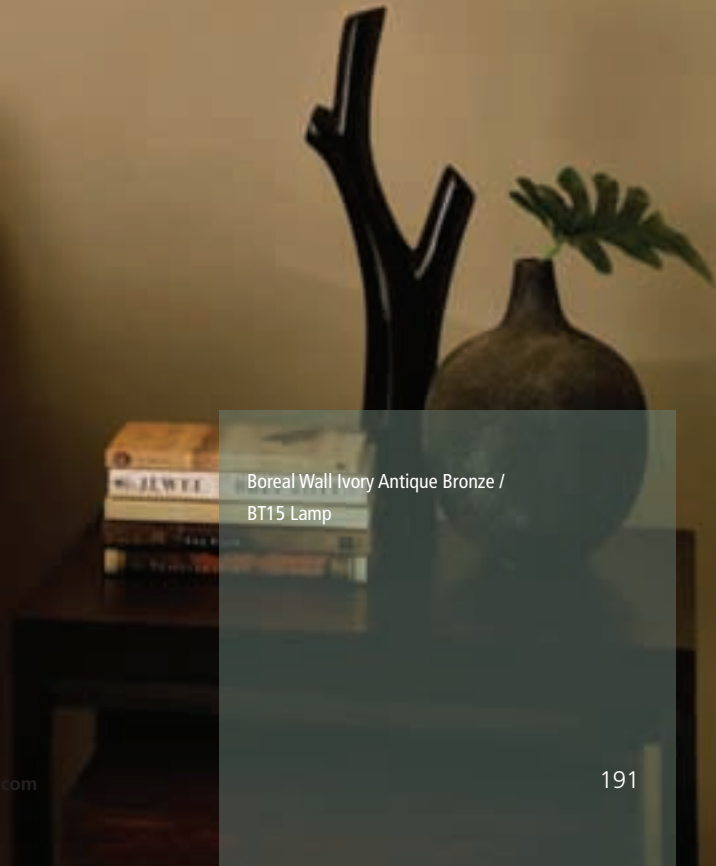
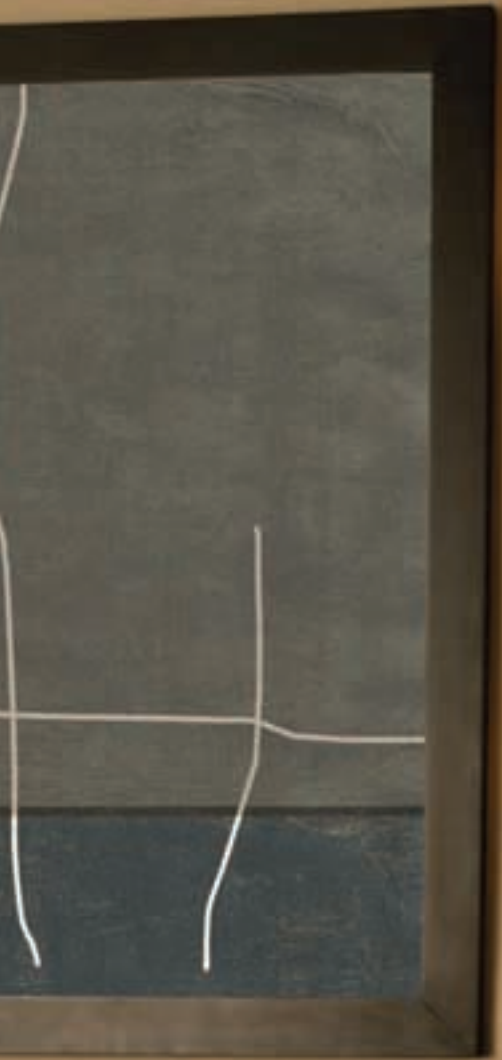

Boreal Wall Ivory Antique Bronze /
BT15 Lamp



WHITE/CLEAR
THREE-QUARTER VIEW



LATTE/WHITE



Curved glass shade with unique hand carvings mounts to minimalist base. Provides ambient light. Includes 120 volt, 75 watt A19 medium base lamp or 18 watt GU24 base self-ballasted compact fluorescent lamp. Incandescent version dimmable with standard incandescent dimmer. ADA compliant.

COMPLEMENTARY
LINE-VOLTAGE
PENDANT P. 166

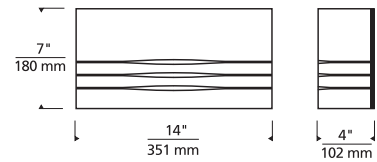

700TDSRNS		COLOR	FINISH	LAMP
A	LATTE/WHITE	Z	ANTIQUE BRONZE	INCANDESCENT
W	WHITE/CLEAR	S	SATIN NICKEL	-CF COMPACT FLUORESCENT

FIRE ONYX



Popular Fire Wall in natural onyx. Includes 120 volt, 60 watt G9 base halogen lamp or 7 watt 2G7 base twin tube compact fluorescent lamp (electronic ballast included). Incandescent version dimmable with standard incandescent dimmer. ADA compliant.

COMPLEMENTARY
LINE-VOLTAGE
PENDANT P. 156

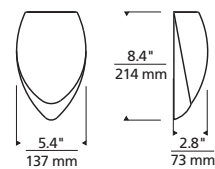

700WSFIRXH		FINISH	LAMP
Z	ANTIQUE BRONZE		INCANDESCENT
C	CHROME		-CF COMPACT FLUORESCENT
S	SATIN NICKEL		





Serengeti Wall Latte/White Antique Bronze /
A19 Lamps

FIRE



COBALT
THREE-QUARTER VIEW



AMBER



CLEAR



RED



Colored or clear Murano glass surrounds a small frost interior glass. Die-cast base. Provides ambient and up-light. Includes 120 volt, 60 watt G9 base halogen lamp. Dimmable with standard incandescent dimmer. ADA compliant.

COMPLEMENTARY
LOW-VOLTAGE
PENDANT P. 66
LINE-VOLTAGE
PENDANT P. 154

700WSFIR

COLOR	FINISH
A AMBER	Z ANTIQUE BRONZE
CF CLEAR	C CHROME
B COBALT	S SATIN NICKEL
R RED	

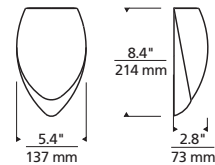

FIREFRIT



TAHOE PINE AMBER
THREE-QUARTER VIEW



WHITE FRIT



A colorful twist on our popular Fire Wall sconce. Die-cast base. Provides ambient and up-light. Includes 120 volt, 60 watt G9 base halogen lamp or 7 watt 2G7 base twin tube compact fluorescent lamp (electronic ballast included). Incandescent version dimmable with standard incandescent dimmer. ADA compliant.

COMPLEMENTARY
LOW-VOLTAGE
PENDANT P. 70

700WSFIRY

COLOR	FINISH	LAMP
A TAHOE PINE AMBER	Z ANTIQUE BRONZE	INCANDESCENT
W WHITE FRIT	C CHROME	-CF COMPACT FLUORESCENT
	S SATIN NICKEL	

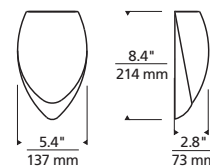

FIREFROST



AMBER



CHARTREUSE



WHITE



RED
THREE-QUARTER VIEW



COMPLEMENTARY
LOW-VOLTAGE
PENDANT P. 68

Frosted colored Murano glass with die-cast base. Provides ambient up-light. Includes 120 volt, 60 watt G9 base halogen lamp or 7 watt 2G7 base twin tube compact fluorescent lamp (electronic ballast included). Incandescent version dimmable with standard incandescent dimmer. ADA compliant.

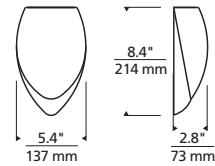

700WSFIR

COLOR	FINISH	LAMP
A AMBER	Z ANTIQUE BRONZE	INCANDESCENT
H CHARTREUSE	C CHROME	-CF COMPACT FLUORESCENT
R RED	S SATIN NICKEL	
W WHITE		

FIREBIRD



BLUEBIRD



CARDINAL

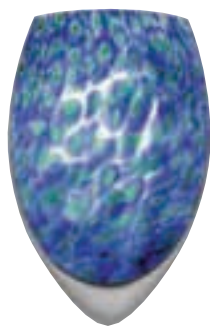

PEACOCK



SWAN



OWL
THREE-QUARTER VIEW



COMPLEMENTARY
ACCESSORY P. 368
LOW-VOLTAGE
PENDANT P. 70

Patterned Murano glass surrounds a small frost interior glass. Die-cast base. Provides ambient and up-light. Includes 120 volt, 60 watt G9 base halogen lamp. Dimmable with standard incandescent dimmer. ADA compliant.

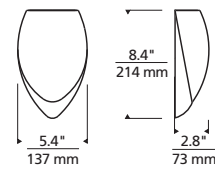

700WSFIR

COLOR	FINISH
L BLUEBIRD	Z ANTIQUE BRONZE
D CARDINAL	C CHROME
O OWL	S SATIN NICKEL
P PEACOCK	
S SWAN	

COSMO



AMBER
THREE-QUARTER VIEW



AMBER FRIT



FROST WHITE

LED PERFORMANCE

Power Consumption:	10 watts
Color Temperature:	3000K
Bare Lumens:	460 lms
Net Lumens Including Shade:	350 lms
Rated Average Life:	50,000 hours to 70%
Color Rendering Index:	80

Note: We are constantly looking to improve our LED performance. Therefore, be sure to visit www.techlighting.com for the most updated LED product information.



WHITE FRIT



WHITE ACRYLIC



COMPLEMENTARY
BATH P. 224

Rectilinear glass with metal base. Provides ambient and up-light. Includes two 120 volt, 40 watt mini-candelabra base lamps, 18 watt 2G11 base twin tube compact fluorescent lamp (electronic ballast included), or energy saving 10 watt, 460 lumen 3000K LED module. Incandescent version dimmable with standard incandescent dimmer. LED version dimmable with low-voltage electronic dimmer. ADA compliant.

700WSCOS	COLOR	FINISH	LAMP
B	AMBER	Z ANTIQUE BRONZE	INCANDESCENT 120V
A	AMBER FRIT	C CHROME	-CF COMPACT FLUORESCENT 120V
F	FROST WHITE	S SATIN NICKEL	-CF277 COMPACT FLUORESCENT 277V
W	WHITE FRIT		-LED LED 3000K 120V
Y	WHITE ACRYLIC*		

*WHITE ACRYLIC NOT AVAILABLE WITH INCANDESCENT LAMP

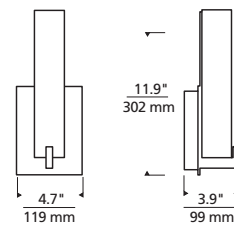



Cosmo Wall Frost Satin Nickel / Mini-candelabra
Base Lamps / Boxie Large Satin Nickel /
G9 Base Lamps

PLAYA FLUSH



WHITE
THREE-QUARTER VIEW

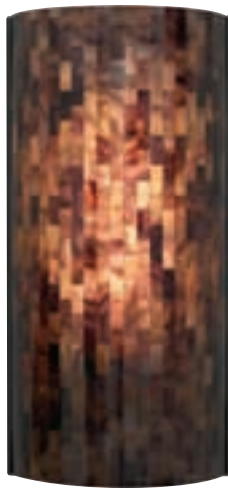

BROWN



NATURAL



Elegant multi-toned shade comprised of natural shell panels with a minimal metal base. Mounts vertically only. Includes 120 volt, 75 watt medium base T8 lamp or 2G11 base 18 watt twin tube compact fluorescent lamp (electronic ballast included). Incandescent version dimmable with standard incandescent dimmer. ADA compliant.

COMPLEMENTARY
LINE-VOLTAGE
PENDANT P. 153
LOW-VOLTAGE
PENDANT P. 40

700WSPLAF	COLOR	FINISH	LAMP
B	BROWN	Z ANTIQUE BRONZE	INCANDESCENT
N	NATURAL	S SATIN NICKEL	-CF COMPACT FLUORESCENT
W	WHITE		

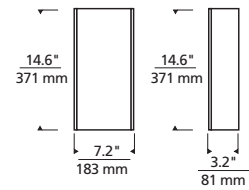

PLAYA



BROWN
THREE-QUARTER VIEW



NATURAL
THREE-QUARTER VIEW



WHITE
THREE-QUARTER VIEW



Elegant multi-toned shade comprised of natural shell panels with die-cast base. Provides ambient, up- and down-light. Includes 120 volt, 60 watt A19 medium base lamp or 18 watt GU24 base self-ballasted compact fluorescent lamp. Incandescent version dimmable with standard incandescent dimmer.

COMPLEMENTARY
LINE-VOLTAGE
PENDANT P. 153
LOW-VOLTAGE
PENDANT P. 40

700WSPLA	COLOR	FINISH	LAMP
B	BROWN	Z ANTIQUE BRONZE	INCANDESCENT
N	NATURAL	C CHROME	-CF COMPACT FLUORESCENT
W	WHITE	S SATIN NICKEL	

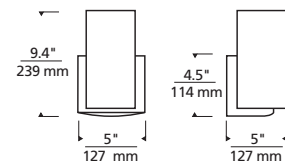



Playa Flush Brown Satin Nickel / Twin Tube Lamp

CABO



WHITE GLASS
THREE-QUARTER VIEW



HONEY ONYX

COMPLEMENTARY
LOW-VOLTAGE
PENDANT P. 45
LINE-VOLTAGE
PENDANT P. 156

Onyx or glass cylinder with die-cast base. Provides ambient and up-light. Mounts up only. Includes transformer and 12 volt, 50 watt halogen bi-pin lamp. Dimmable with standard incandescent dimmer.

700WSCBO	COLOR	FINISH
H	HONEY ONYX	Z ANTIQUE BRONZE
W	WHITE GLASS	C CHROME
		S SATIN NICKEL

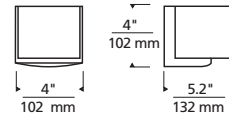

CABO GRANDE



HONEY ONYX
THREE-QUARTER VIEW



WHITE GLASS



Onyx or glass cylinder and die-cast base. Mounts up only. Includes 120 volt, 60 watt G9 base halogen lamp or 120 volt, GU24 base 18 watt self-ballasted compact fluorescent lamp. Incandescent version dimmable with standard incandescent dimmer.

COMPLEMENTARY
LOW-VOLTAGE
PENDANT P. 45
LINE-VOLTAGE
PENDANT P. 156

700WSCBOG	COLOR	FINISH	LAMP
H	HONEY ONYX	Z ANTIQUE BRONZE	INCANDESCENT 120V
W	WHITE GLASS	C CHROME	-CF COMPACT FLUORESCENT 120V
		S SATIN NICKEL	

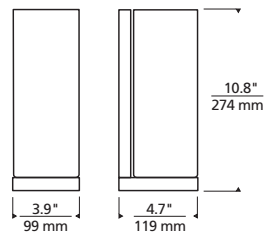

HUDSON



THREE-QUARTER VIEW



Clean pure style up- and down-light. Cylindrical glass shades with a simple metal base. Includes two 120 volt, 75 watt A19 medium base lamps or two 18 watt G24Q-2 base quad tube compact fluorescent lamps (electronic ballast included). Incandescent version dimmable with standard incandescent dimmer. ADA compliant.

COMPLEMENTARY
LOW-VOLTAGE
PENDANT P. 54
LINE-VOLTAGE
PENDANT P. 162

700WSHUD2W

FINISH	LAMP
Z ANTIQUE BRONZE	INCANDESCENT
C CHROME	-CF COMPACT FLUORESCENT
S SATIN NICKEL	

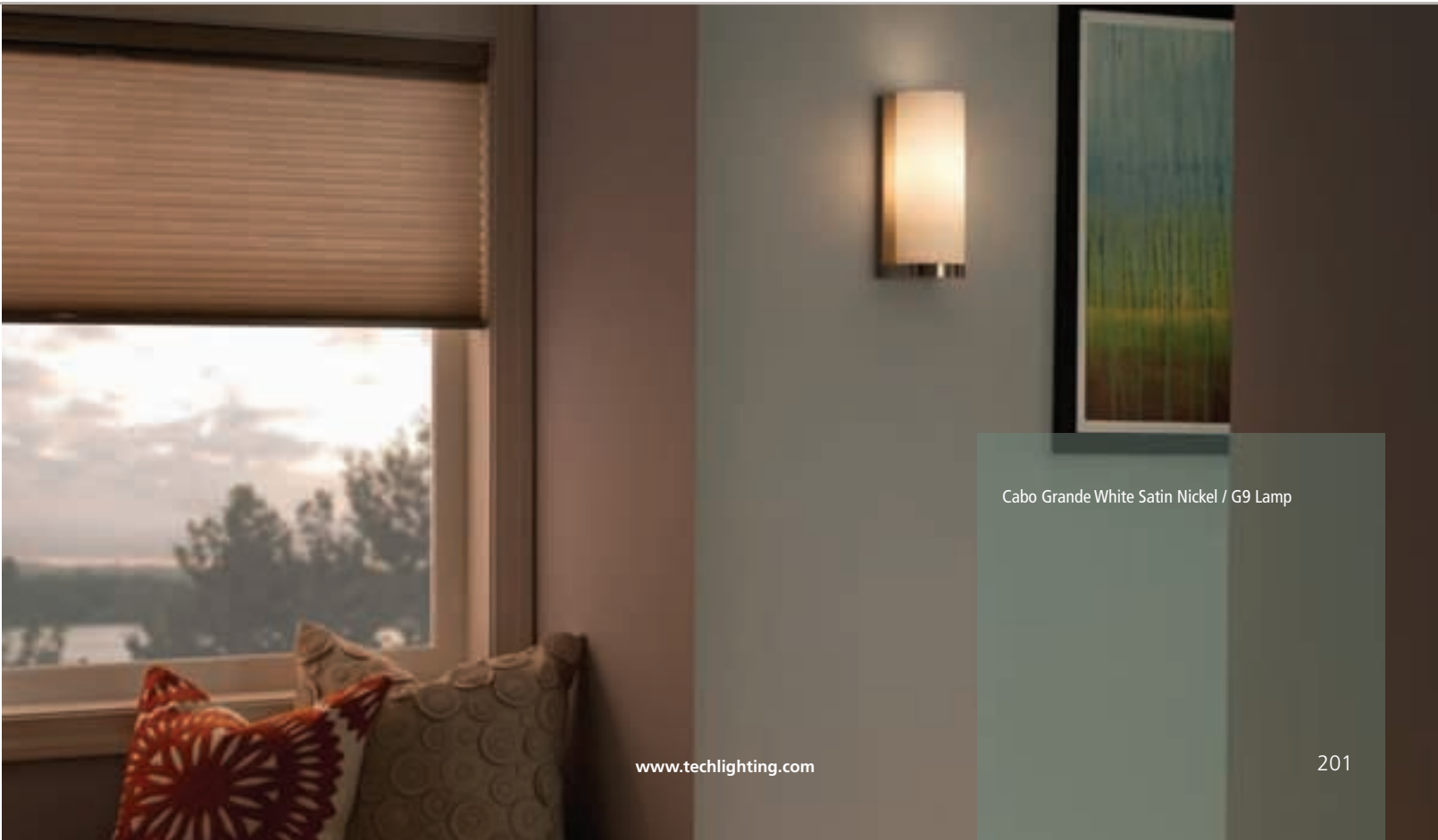
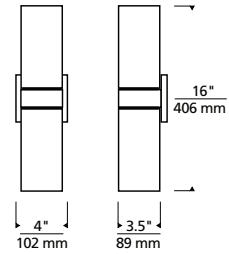

Cabo Grande White Satin Nickel / G9 Lamp

CORONADO



HONEY ONYX
THREE-QUARTER VIEW



HONEY ONYX



WHITE GLASS



Rectangular onyx or glass shade with metal frame. Provides ambient, up- and down-light.

Includes 120 volt, 100 watt R7S base, 118mm double-ended halogen lamp or 18 watt 2G11 base twin tube compact fluorescent lamp (electronic ballast included). Incandescent version dimmable with standard incandescent dimmer. ADA compliant.

COMPLEMENTARY
LOW-VOLTAGE
PENDANT P. 44

700WSCOR

COLOR	FINISH	LAMP
H HONEY ONYX	Z ANTIQUE BRONZE	INCANDESCENT
W WHITE GLASS	S SATIN NICKEL	-CF COMPACT FLUORESCENT

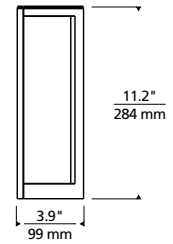
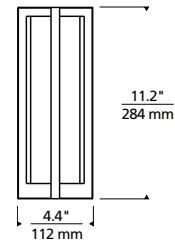

CORVA



THREE-QUARTER VIEW



Elliptical glass shade with metal band detail. Provides task and ambient light. May be mounted vertically or horizontally. Includes 120 volt, 60 watt medium base BT15 halogen lamp or 13 watt 2GX7 base twin tube compact fluorescent lamp (electronic ballast included). Incandescent version dimmable with standard incandescent dimmer. ADA compliant.

COMPLEMENTARY
BATH P. 225

700WSCRWV

FINISH	LAMP
Z ANTIQUE BRONZE	INCANDESCENT
C CHROME	-CF COMPACT FLUORESCENT
S SATIN NICKEL	

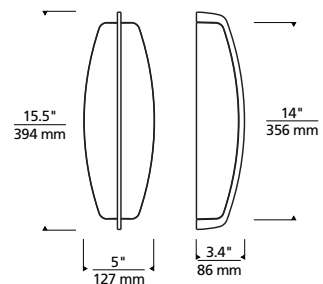



Corva Wall Satin Nickel / BT15 Lamps



AMBER



AQUAMARINE



CLEAR



HAVANA BROWN



OLIVE GREEN



SMOKE



STEEL BLUE



Vivid glass shade over white case glass inner cylinder suspended from a round base and highlighted with three satin nickel cylinder details. Provides ambient, up- and down-light. Includes 120 volt, 75 watt A19 medium base lamp or 18 watt GU24 base self-ballasted compact fluorescent lamp. Incandescent version dimmable with standard incandescent dimmer.

COMPLEMENTARY
LINE-VOLTAGE
PENDANT P. 158
LOW-VOLTAGE
PENDANT P. 62

700TDECS	COLOR	FINISH	LAMP
A	AMBER	S SATIN NICKEL	INCANDESCENT
Q	AQUAMARINE		-CF COMPACT FLUORESCENT
C	CLEAR		
B	HAVANA BROWN		
V	OLIVE GREEN		
S	SMOKE		
U	STEEL BLUE		

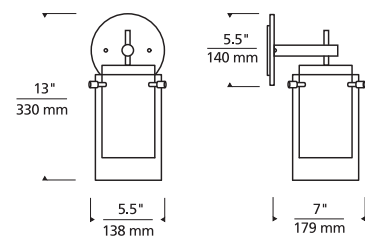



Echo Wall Clear Satin Nickel / A19 Lamps

CUBE



FROST
THREE-QUARTER VIEW



AMBER



AMETHYST

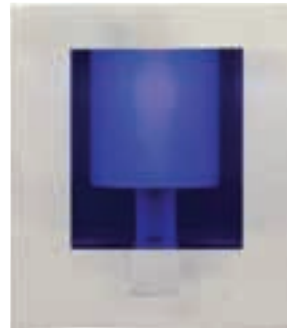

COBALT



Classic geometric shape made of pressed glass. Die-cast base. Provides ambient and up-light. Includes transformer and 12 volt, 35 watt halogen bi-pin lamp. Dimmable with standard incandescent dimmer. Incandescent version dimmable with standard incandescent dimmer. ADA compliant.

COMPLEMENTARY
LOW-VOLTAGE
PENDANT P. 72

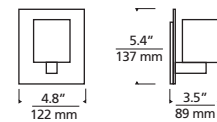

700WSCUB

COLOR		FINISH
A	AMBER	Z ANTIQUE BRONZE
M	AMETHYST	C CHROME
C	COBALT	S SATIN NICKEL
F	FROST	





Cube Wall Clear Satin Nickel / Bi-pin Lamps



BLUE-VIOLET WITH ROXANNE BASE



FERRARI RED WITH SIMPLE BALL BASE



LIME GREEN WITH SIMPLE BALL BASE



FROST WHITE WITH ROXANNE BASE THREE-QUARTER VIEW



MULTICOLOR WITH SIMPLE BALL BASE



TAHOE PINE AMBER WITH SIMPLE BALL BASE



WHITE FRIT WITH SIMPLE BALL BASE



Glass shade, richly layered in brilliant color, mounts to a plated base with either a hammered iron crisscross or a simple ball detail. Provides ambient and up-light. Includes 120 volt, 75 watt mini-candelabra base lamp or 13 watt 2GX7 base twin tube compact fluorescent lamp (electronic ballast included). Incandescent version dimmable with standard incandescent dimmer. ADA compliant.

COMPLEMENTARY LINE-VOLTAGE PENDANT P. 179

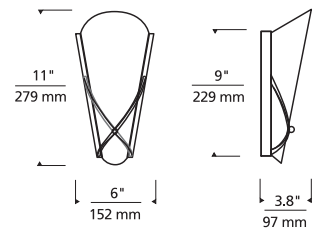

ROXANNE

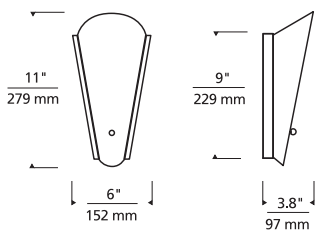

SIMPLE BALL

700TDEMS	COLOR	BASE	FINISH	LAMP
B	BLUE-VIOLET	X ROXANNE	Z ANTIQUE BRONZE	INCANDESCENT
R	FERRARI RED	B SIMPLE BALL	S SATIN NICKEL	-CF COMPACT FLUORESCENT
F	FROST WHITE			
G	LIME GREEN			
M	MULTICOLOR			
A	TAHOE PINE AMBER			
W	WHITE FRIT			





Emerge Roxanne Wall Blue-Violet Satin Nickel /
Mini-Candelabra Lamp



FERRARI RED



TAHOE PINE AMBER



TORTOISE SHELL



WHITE FRIT



Hand pulled glass shade, richly layered in brilliant color, with handmade wrought iron base. Provides ambient and up-light. Includes 120 volt, 100 watt A19 medium base lamp or 120 volt, 18 watt GU24 base self-ballasted compact fluorescent lamp. Incandescent version dimmable with standard incandescent dimmer.

COMPLEMENTARY
LOW-VOLTAGE
PENDANT P. 88
LINE-VOLTAGE
PENDANT P. 176

700TDOVS

COLOR	FINISH	LAMP
R FERRARI RED	B BLACK IRON	INCANDESCENT
A TAHOE PINE AMBER	Z ANTIQUE BRONZE	-CF COMPACT FLUORESCENT
T TORTOISE SHELL	S SATIN NICKEL	
W WHITE FRIT		

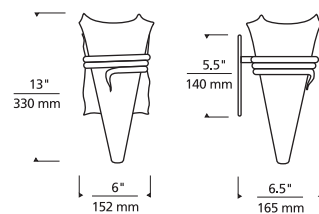



Ovation Wall Tortoise Shell Antique Bronze /
A19 Lamps / Ovation Pendants Tortoise Shell with
Black Iron Wrap Satin Nickel / A19 Lamps

PHOTOGRAPHER: ROGER TURK
DESIGNER: BILLIE JOE HYLAND, HYLAND CABINET WORKS

NEBBIA

DESIGNED BY FRANK CAVAZ



BROWN
THREE-QUARTER VIEW



AMBER



WHITE



Hand-blown glass with an elegantly fused glass wrap and a metal base. Incandescent includes 120 volt, 40 watt G9 base halogen lamp. Incandescent may also use 120 volt, 60 watt G9 base halogen lamp (not included). Fluorescent includes 120 volt, 18 watt GU24 base self-ballasted compact fluorescent lamp. Fluorescent may also use 120 volt, 27 watt GU24 base self-ballasted compact fluorescent lamp (not included). Incandescent version dimmable with standard incandescent dimmer.

COMPLEMENTARY
LOW-VOLTAGE
PENDANT P. 56
CEILING P. 254

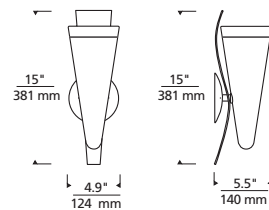

700WSNEB	COLOR	FINISH	LAMP
A	AMBER	Z ANTIQUE BRONZE	INCANDESCENT
N	BROWN	S SATIN NICKEL	-CF COMPACT FLUORESCENT
W	WHITE		

MONARCH

DESIGNED BY FRANK CAVAZ



WHITE/CLEAR
THREE-QUARTER VIEW



GOLD/HAVANA BROWN



IVORY/HAVANA BROWN



Hand-blown glass with a rich field of color and a brilliant clear or colored lip finished with a minimal metal base. Mounts up only. Incandescent includes two 120 volt, 60 watt G9 base halogen lamps. Fluorescent includes two 120 volt, 18 watt GU24 base self-ballasted compact fluorescent lamps. Incandescent version dimmable with standard incandescent dimmer. ADA compliant.

COMPLEMENTARY
LINE-VOLTAGE
PENDANT P. 148
CEILING P. 252

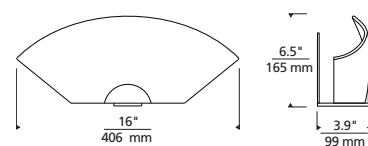

700WSMNA	COLOR	FINISH	LAMP
GN	GOLD/HAVANA BROWN	Z ANTIQUE BRONZE	INCANDESCENT
IN	IVORY/HAVANA BROWN	S SATIN NICKEL	-CF COMPACT FLUORESCENT
WC	WHITE/CLEAR		





Monarch Wall White/Clear Satin Nickel / G9 Lamps

AVIZA



TAHOE PINE AMBER
THREE-QUARTER VIEW



FROST



WHITE FRIT



Richly layered glass mounts flush to the wall with minimal hardware. Provides ambient and up-light. Includes 120 volt, 75 watt A19 medium base lamp or 120 volt 27 watt GU24 base self-ballasted compact fluorescent lamp. Incandescent version dimmable with standard incandescent dimmer. ADA compliant.

700WSAVI	COLOR	FINISH	LAMP
F	FROST	Z ANTIQUE BRONZE	INCANDESCENT
A	TAHOE PINE AMBER	C CHROME	-CF COMPACT FLUORESCENT
W	WHITE FRIT	S SATIN NICKEL	

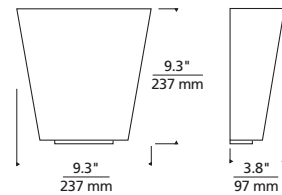

MELROSE FLUSH



TAHOE PINE AMBER
THREE-QUARTER VIEW



WHITE FRIT



Gracefully shaped glass, richly layered in brilliant color frit, mounts flush to the wall. Provides ambient and up-light. Includes 120 volt, 40 watt G9 base halogen lamp or 13 watt 2GX7 twin tube compact fluorescent lamp (electronic ballast included). Incandescent version dimmable with standard incandescent dimmer. ADA compliant.

COMPLEMENTARY
LINE-VOLTAGE
PENDANT P. 174
LOW-VOLTAGE
PENDANTS P. 86

700WSMLF	COLOR	FINISH	LAMP
A	TAHOE PINE AMBER	Z ANTIQUE BRONZE	INCANDESCENT
W	WHITE FRIT	C CHROME	-CF COMPACT FLUORESCENT
		S SATIN NICKEL	

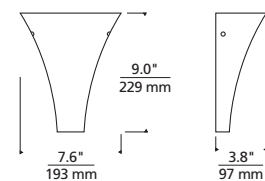



Aviza Wall Tahoe Pine Amber Satin Nickel /
A19 Lamp

ATLANTIS WITH CONE



RED
THREE-QUARTER VIEW



AMBER



COBALT



GREEN



WHITE



Inverted case glass cone with reflective white interior. Die-cast base. Provides ambient and up-light. Includes transformer and 12 volt, 50 watt halogen bi-pin lamp. Dimmable with standard incandescent dimmer. ADA compliant.

COMPLEMENTARY
LOW-VOLTAGE
PENDANT P. 64

700WSATCON

COLOR	FINISH
A AMBER	Z ANTIQUE BRONZE
P COBALT	C CHROME
G GREEN	S SATIN NICKEL
R RED	
W WHITE	

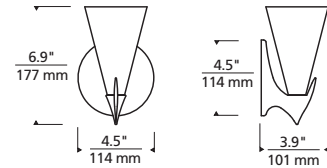

EDEN WITH SHADE



CHARTREUSE
THREE-QUARTER VIEW



AMBER



FROST

Case glass shade with reflective white interior. Die-cast base. Provides ambient, up- and down-light. Includes transformer and 12 volt, 50 watt halogen bi-pin lamp. Dimmable with standard incandescent dimmer.

700WSEDSDE

COLOR	FINISH
A AMBER	Z ANTIQUE BRONZE
H CHARTREUSE	C CHROME
W FROST	S SATIN NICKEL

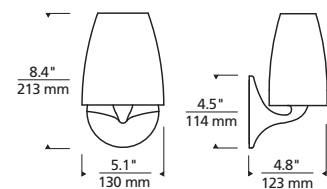

BOUQUET WITH RAINDROP

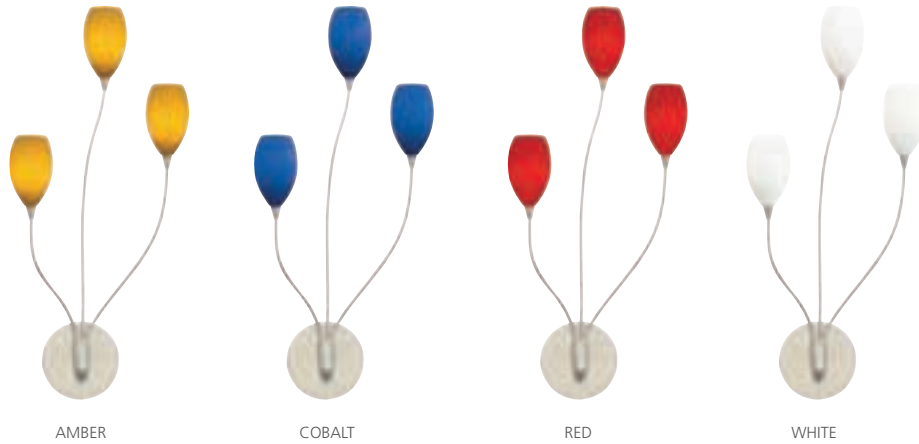

ADA Inverted white or colored glass raindrops on field bendable stems. Die-cast base. Provides ambient and up-light. Includes transformer and three 12 volt, 20 watt Xenon bi-pin lamps. Dimmable with standard incandescent dimmer. ADA compliant.

COMPLEMENTARY
LOW-VOLTAGE
PENDANT P. 96
LOW-VOLTAGE
HEAD P. 126

700WSBQRD		COLOR	FINISH
M	AMBER	C	CHROME
B	COBALT	S	SATIN NICKEL
R	RED		
W	WHITE		

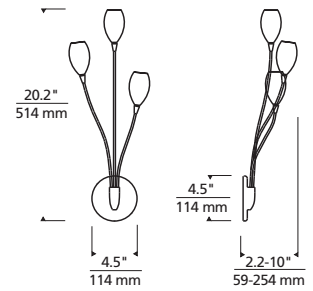

BOUQUET WITH MOON



ADA Frost white moon glass or patterned glass on field bendable stems. Die-cast base. Provides ambient and up-light. Includes transformer and three 12 volt, 20 watt Xenon bi-pin lamps. Dimmable with standard incandescent dimmer. ADA compliant.

COMPLEMENTARY
LOW-VOLTAGE
PENDANT P. 82
LOW-VOLTAGE
HEAD P. 126

700WSBQ		COLOR	FINISH
BMN	BLUE MOON	C	CHROME
MNW	MOON	S	SATIN NICKEL
MNS	MOONSTRUCK		
OMN	OWL MOON		

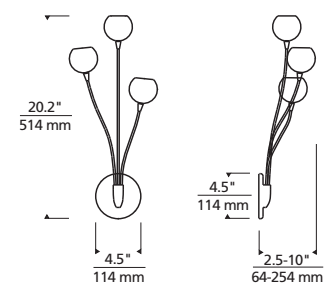

The Bath Collection

Create a sense of style and sophistication.

www.techlighting.com



Throughout the catalog this icon indicates which fixtures are available in **Compact Fluorescent***



Throughout the catalog this icon indicates which fixtures are **ADA Compliant**

* Our bath bars use linear fluorescent lamps, though for consistency we use the same logo treatment throughout the catalog.

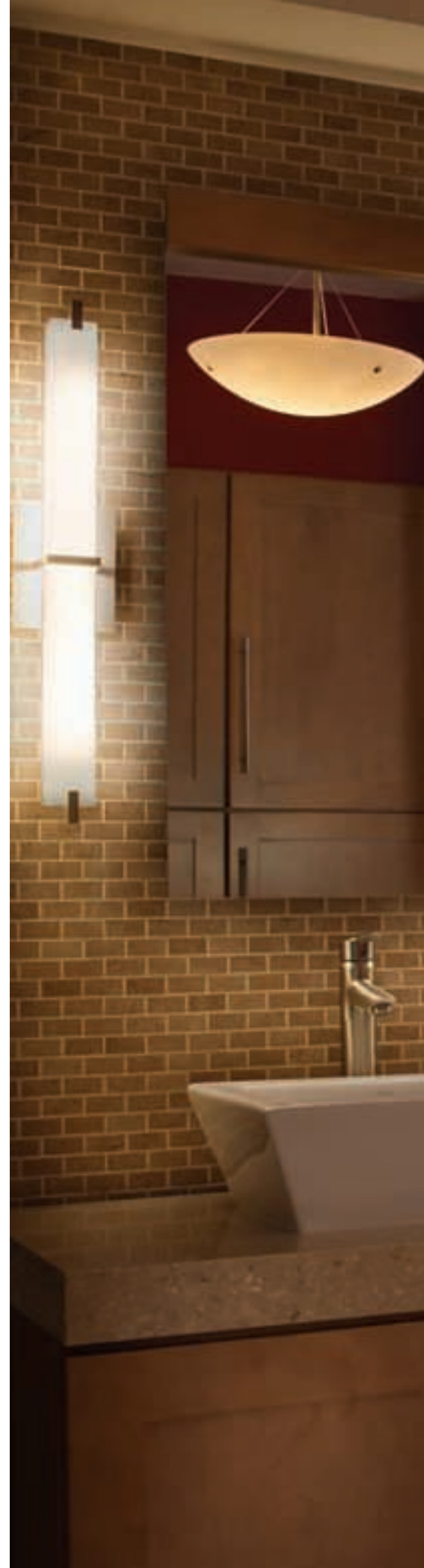



Metro Bath Satin Nickel / T5 High Output
Fluorescent Lamps / Larkspur Suspension Sand
Satin Nickel / A19 Lamps



Solace Bath Satin Nickel / T5 High Output
Fluorescent Lamps



Tigris Mirror Oval Recessed Satin Nickel /
Bi-pin Lamps

SOLACE

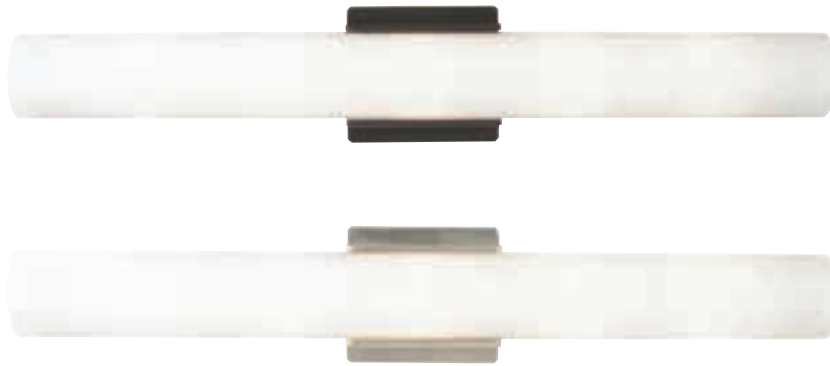

Clean frosted glass on a minimal metal base. Provides task and ambient light. May be mounted vertically or horizontally. Incandescent includes five 120 volt 40 watt G9 base halogen lamps; fluorescent includes two 24 watt T5 high output linear fluorescent lamps and electronic ballast. Incandescent version dimmable with standard incandescent dimmer. ADA compliant.

700BCSLC26W	FINISH	LAMP
Z	ANTIQUE BRONZE	INCANDESCENT 120V
C	CHROME	-CF FLUORESCENT 120V
S	SATIN NICKEL	-CF277 FLUORESCENT 277V

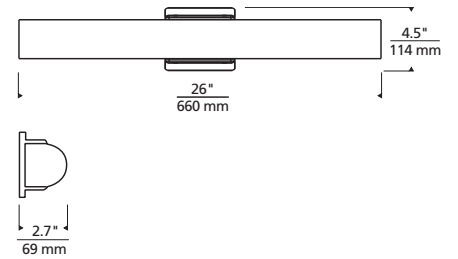

LUNA



Floating crescent of multi-layered white case glass. Plated pressure formed base. Provides task and ambient light. May be mounted vertically or horizontally. Available in two lamp configurations: two 14 watt T5 linear fluorescent lamps (lamps and electronic ballast included); or four 120 volt, 60 watt mini-candelabra base lamps (included). Incandescent version dimmable with standard incandescent dimmer. ADA compliant.

700BCLUN24	FINISH	LAMP
C	CHROME	FLUORESCENT 120V
S	SATIN NICKEL	-CF277 FLUORESCENT 277V
		-HL INCANDESCENT 120V

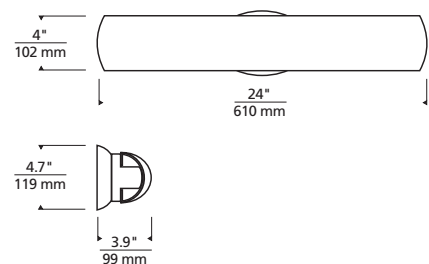



Luna Bath Satin Nickel / T5 Fluorescent Lamps

METRO



LED PERFORMANCE

Power Consumption:	20 watts
Color Temperature:	3000K
Bare Lumens:	920 lms
Net Lumens	
Including Shade:	700 lms
Rated Average Life:	50,000 hours to 70%
Color Rendering Index:	80

Note: We are constantly looking to improve our LED performance. Therefore, be sure to visit www.techlighting.com for the most updated LED product information.

ADA **CF** **LED**

COMPLEMENTARY SCENCE P. 196

Rectilinear shaped light bar with multi-layered white glass or white acrylic. Plated pressure formed frame. Provides task and ambient light. May be mounted vertically or horizontally. Available in three lamp configurations: 24 watt high output T5 linear fluorescent lamp (lamp and electronic ballast included); four 120 volt, 40 watt halogen mini-candelabra base lamps, or energy saving 20 watt, 920 lumen, 3000K LED module. Incandescent version dimmable with standard incandescent dimmer. LED version dimmable with low-voltage electronic dimmer. ADA compliant.

700BCMET	COLOR	FINISH	LAMP
	WHITE	Z ANTIQUE BRONZE	INCANDESCENT 120V
Y	WHITE ACRYLIC*	C CHROME	-CF FLUORESCENT 120V
		S SATIN NICKEL	-CF277 FLUORESCENT 277V
			-LED LED 3000K 120V

* WHITE ACRYLIC NOT AVAILABLE WITH INCANDESCENT LAMP

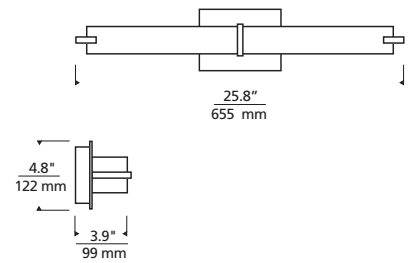

METRO LONG



COMPLEMENTARY SCENCE P. 196

Rectilinear shaped light bar with white acrylic shade and pressure formed frame. Provides task and ambient light. May be mounted vertically or horizontally. Includes 54 watt high output T5 linear fluorescent lamp and electronic ballast. Dimmable fluorescent version requires a dimmer that is designed to work with a dimmable ballast. Consult the specification sheet on our website, www.techlighting.com for the dimmable ballast used in this product.

700BCMETL	COLOR	FINISH	LAMP
Y	WHITE ACRYLIC	Z ANTIQUE BRONZE	-CF FLUORESCENT 120V
		C CHROME	-CF277 FLUORESCENT 277V
		S SATIN NICKEL	-CFD FLUORESCENT 120V DIMMABLE
			-CFD277 FLUORESCENT 277V DIMMABLE

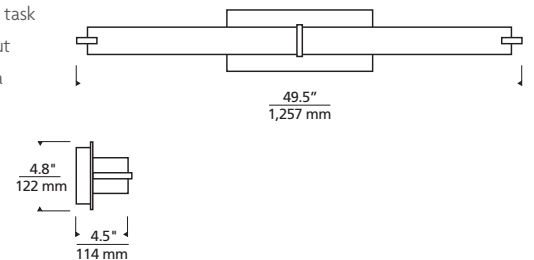

LYNN BATH



Sleek linear glass shade finished with metal end caps. Provides task and ambient light. May be mounted horizontally or vertically. Available in two lamp configurations; incandescent and fluorescent. Incandescent includes five 120 volt, 40 watt G9 base halogen lamps; fluorescent includes one 24 watt T5 high output linear fluorescent lamp and electronic ballast. Incandescent version dimmable with a standard incandescent dimmer. ADA compliant.

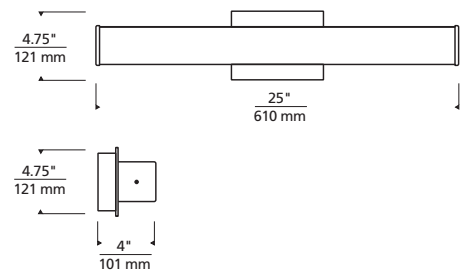

700BCLYNNW	FINISH	LAMP
Z	ANTIQUE BRONZE	INCANDESCENT 120V
C	CHROME	-CF COMPACT FLUORESCENT 120V
S	SATIN NICKEL	-CF277 COMPACT FLUORESCENT 277V

CORVA BATH



COMPLEMENTARY SCENCE P. 202

Elliptical shade with metal band detail. Provides task and ambient light. May be mounted vertically or horizontally. Incandescent includes four 120 volt 40 watt G9 base halogen lamps; fluorescent includes two 14 watt T5 linear fluorescent lamps and electronic ballast. Incandescent version dimmable with standard incandescent dimmer. ADA compliant.

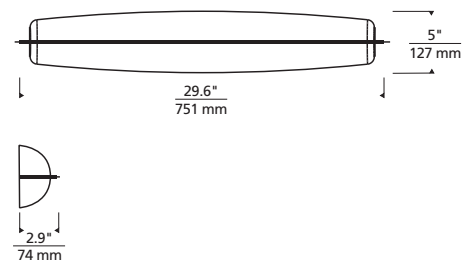

700BCCR30W	FINISH	LAMP
Z	ANTIQUE BRONZE	INCANDESCENT 120V
C	CHROME	-CF FLUORESCENT 120V
S	SATIN NICKEL	-CF277 FLUORESCENT 277V

SIBER MIRROR



RECESSED



SURFACE



Rectangular mirror surrounded by a cove of diffused white light. Available in two styles: recessed and surface. Provides shadow-free task and ambient light. Halogen includes eight 120 volt, 40 watt G9 base halogen lamps; compact fluorescent includes two 39 watt T5 high output linear fluorescent lamps and electronic ballast. Halogen version dimmable with a standard incandescent dimmer. Recessed version requires modifications to existing wall construction. ADA compliant.

700BCSIB	STYLE	FINISH	LAMP
R	RECESSED	C CHROME	HALOGEN
S	SURFACE	S SATIN NICKEL	FLUORESCENT 120V
			-CF 277

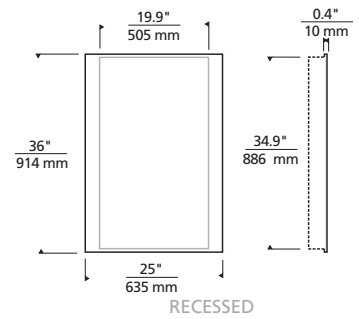

RECESSED

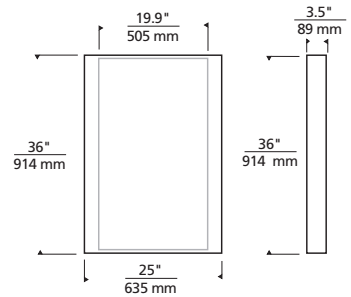

SURFACE



TIGRIS MIRROR OVAL



RECESSED



SURFACE



Oval mirror surrounded by a cove of diffused white light. Available in two styles: recessed and surface. Plated pressure formed frame. Provides shadow-free task and ambient light. Halogen includes transformer and eight 12 volt, 20 watt halogen bi-pin lamps; compact fluorescent includes six 9 watt 2G7 base twin tube lamps and electronic ballast. Halogen version dimmable with a standard incandescent dimmer. Recessed version requires modifications to existing wall construction. ADA compliant.

700BCTIGO

STYLE	FINISH	LAMP
R24 RECESSED	C CHROME	HALOGEN
S26 SURFACE	S SATIN NICKEL	-CF COMPACT FLUORESCENT 120V (SURFACE ONLY)
		-CF277 COMPACT FLUORESCENT 277V (SURFACE ONLY)

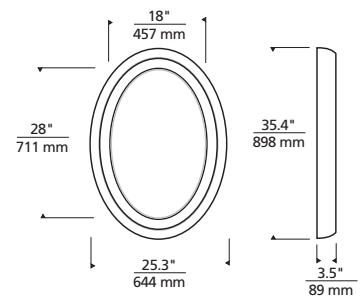

SURFACE

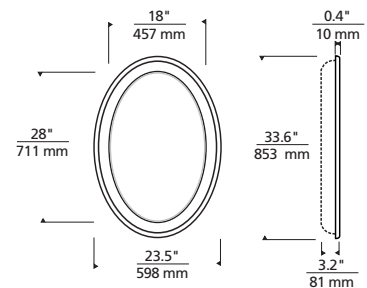

RECESSED



SURFACE

TIGRIS MIRROR ROUND



Round mirror surrounded by a cove of diffused white light. Available in two styles: recessed and surface. Plated pressure formed frame. Provides shadow-free task and ambient light. Halogen includes transformer and nine 12 volt, 20 watt halogen bi-pin lamps; compact fluorescent includes six 9 watt 2G7 base twin tube lamps and electronic ballast. Halogen version dimmable with a standard incandescent dimmer. Recessed version requires modifications to existing wall construction. ADA compliant.

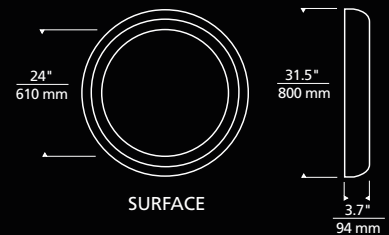
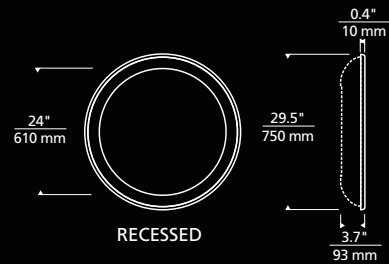

700BTIGR	STYLE	FINISH	LAMP
R30	RECESSED	C CHROME	HALOGEN
S32	SURFACE	S SATIN NICKEL	-CF COMPACT FLUORESCENT 120V (SURFACE ONLY)
			-CF277 COMPACT FLUORESCENT 277V (SURFACE ONLY)



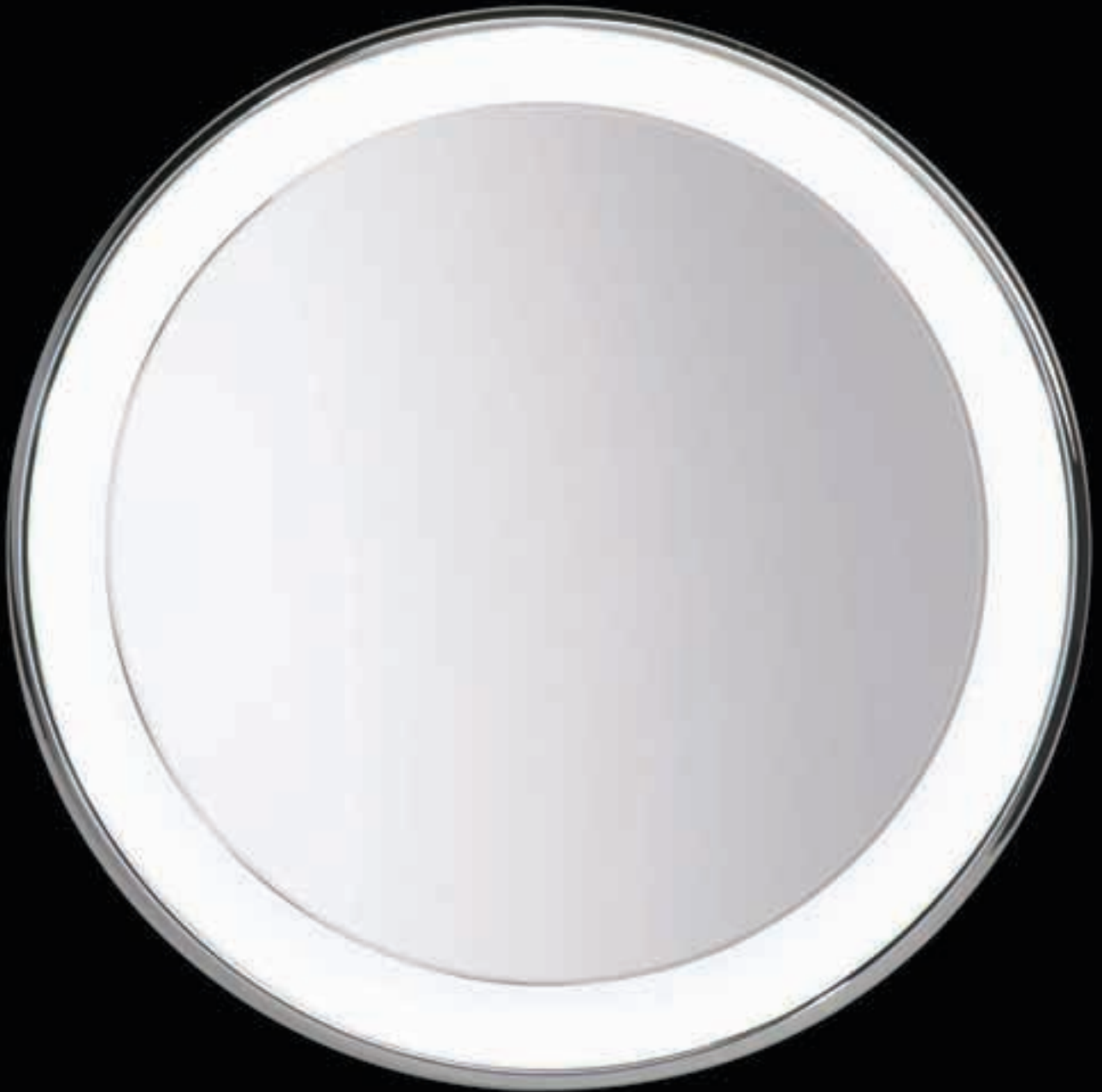

RECESSED

The Ceiling Collection

Create bold, unique expressions overhead with Tech Lighting's ceiling collection.

www.techlighting.com



Throughout the catalog this icon indicates which fixtures are available in **Compact Fluorescent**



Throughout the catalog this icon indicates which fixtures are available in **LED**



Throughout the catalog this icon indicates which fixtures are **Suitable for Wet Locations**

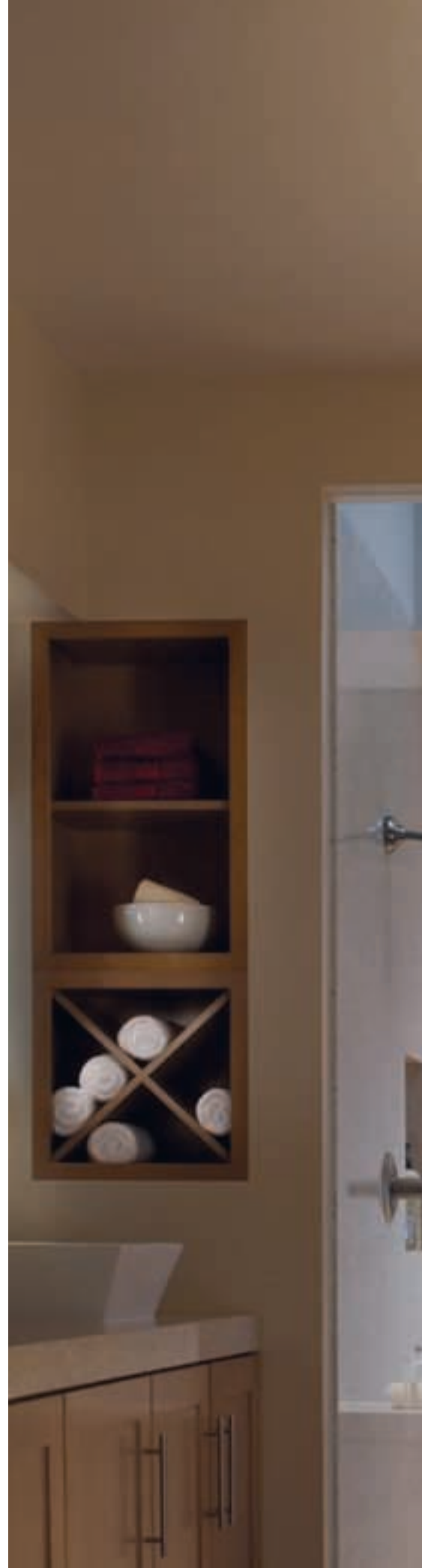



Eve Suspension 24" Frost Satin Nickel / A19 Lamps



PELE CHANDELIER



Modern glass spheres topped with glass details. Rectilinear canopy features a warm walnut wood finish. Includes an electronic transformer and seven 12 volt, 50 watt frosted halogen bi-pin lamps or seven 5.8 watt replaceable LED modules. Dimmable with a 600 watt low-voltage electronic dimmer.

700CHPEL7	LENGTH (A)	COLOR	FINISH	LAMP
36	36"	W WHITE	Z ANTIQUE BRONZE S SATIN NICKEL	HALOGEN -LED LED 3000K

COMPLEMENTARY
LINE-VOLTAGE
PENDANT P. 78

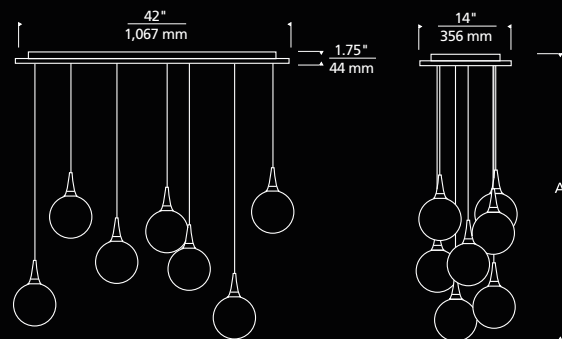



Detail of warm walnut wood canopy



SHUI CHANDELIER

Modern chandelier with sophisticated threads of fabric forming an elegant shade that creates a soft motion. The appearance may be customized simply by raising or lowering the shade ring. Includes three 120 volt, 60 watt medium base Classic Edison lamps. Dimmable with standard incandescent dimmer.

700CHSHU	LENGTH (A)	COLOR	FINISH
12	126" MAX.	W WHITE	S SATIN NICKEL
14	144" MAX.		

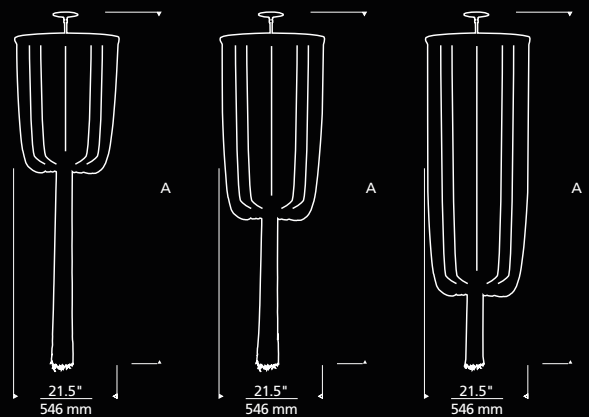



RIVER ROCK CHANDELIER

DESIGNED BY JULIE CARCIONE CAVAZ



COMPLEMENTARY
LINE-VOLTAGE
PENDANTS P. 46-47

Four shades inspired by rocks along a river bed captured through a hand-blown glass process consisting of (1) Oblong Oval in Blue Slate, (1) Round in Sand, (1) Wedge in Green Slate, and (1) Wedge in Pebble Brown Pendants. All pendants are suspended from a Freejack 4 port round canopy. Includes four low-voltage, 35 watt halogen bi-pin lamps. Each pendant includes six feet of field-cutable suspension cable, however, for best appearance we recommend cutting the cables to 12, 14, 17 and 22" length. Dimmable with standard incandescent dimmer.

700CHRIV4 FINISH
 Z ANTIQUE BRONZE
 S SATIN NICKEL

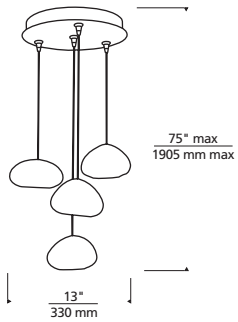



FreeJack 4 Port Round Canopy Antique
Bronze / River Rock Chandelier Antique
Bronze / Bi-pin Lamps



Brilliant energy saving 15 watt 3000K LED light finished with a soft glass disc and crisp metal base. Dimmable with 300 watt low-voltage electronic dimmer.

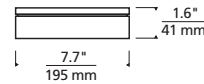

700PENFMR	FINISH	LAMP
	S SATIN NICKEL	-LED LED 3000K

FEATURES AND BENEFITS

Energy Savings: Consumes 15 watts; up to 85% less than incandescent and 40% less than equivalent 26 watt compact fluorescent recessed downlight.

Usable Light: Delivers over 600 lumens and greater footcandles at 8' than most 26 watt CFL recessed housings.

Long Life: Designed to last 35,000 hours, or approximately 20 years under normal use of 4-5 hours per day.

Dimmable: Dimmable down to 10% using any approved low-voltage dimmer.

Easy Installation: Easily installed on a standard junction box. Trim quickly snaps on to unit.

Environmental Benefits: LED's energy savings and long life helps protect the environment by using less energy and keeping numerous other types of lamps, with shorter life, out of landfills.

3000K and 82 CRI: Warm color temperature. Excellent for residential or commercial applications.



PENDENZA CEILING RECESSED CAN RETROFIT KIT

Adapts the Pendenza Ceiling to most 5" or 6" 120 volt incandescent recessed downlights.

700PENRCAD





Pendenza Ceiling Satin Nickel / LED Lamp



SMALL

BOXIE



Clean square pressed glass shade with polished surface suspended from a die-cast base. Available in two lamp configurations incandescent and fluorescent. Large incandescent includes two 120 volt, 40 watt G9 base halogen lamps; small incandescent includes one 120 volt 40 watt G9 base halogen lamp; large fluorescent includes two 13 watt 2GX7 base twin tube lamps and electronic ballast. Incandescent version dimmable with a standard incandescent dimmer. Ceiling mount suitable for wet locations. ADA compliant.

SMALL

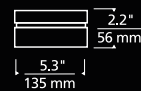

LARGE



700BX	SIZE	FINISH	LAMP
S	SMALL	C CHROME	INCANDESCENT
L	LARGE	S SATIN NICKEL	-CF COMPACT FLUORESCENT (LARGE ONLY)





LARGE



SMALL



CIRQUE



Beautiful round pressed glass shade with polished surface suspended from a die-cast base.

Available in two lamp configurations incandescent and fluorescent. Large incandescent includes two 120 volt, 40 watt G9 base halogen lamps; small incandescent includes one 120 volt 40 watt G9 base halogen lamp; large fluorescent includes two 13 watt 2GX7 base twin tube lamps and electronic ballast. Incandescent version dimmable with a standard incandescent dimmer. Ceiling mount suitable for wet locations. ADA compliant.

SMALL



LARGE

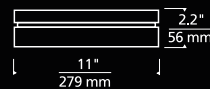

700CQ	SIZE	FINISH	LAMP
S	SMALL	C CHROME	INCANDESCENT
L	LARGE	S SATIN NICKEL	-CF COMPACT FLUORESCENT (LARGE ONLY)





LARGE

TELESTO CEILING



LARGE



SMALL



This low-profile flush mount features a hand-blown case white glass shade and suits a wide variety of décor and applications. Ceiling mount only. Large includes one 55 watt 2GX13 base T5 high output circline fluorescent lamp. The small version includes one 40 watt 2GX13 base T5 circline fluorescent lamp. Both versions include an electronic ballast. Not dimmable.

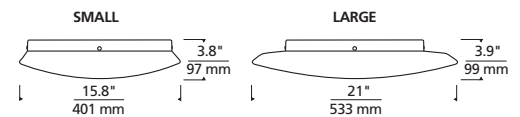

700TLSFM	SIZE	FINISH	LAMP
	L LARGE	S SATIN NICKEL	-CF FLUORESCENT 120V
	S SMALL		-CF277 FLUORESCENT 277V

POLLY



LARGE



SMALL



This simple and elegant flush mount ceiling light features a frosted white glass shade supported by nickel plated clips. Available in two lamp configurations; incandescent and fluorescent. Large incandescent includes three 120 volt 40 watt G9 base halogen lamps; small incandescent includes two 120 volt 40 watt halogen lamps; large fluorescent includes three 13 watt 2GX7 base twin tube lamps and electronic ballast; small fluorescent includes two 13 watt 2GX7 base twin tube lamps and electronic ballast. Incandescent version dimmable with a standard incandescent dimmer.

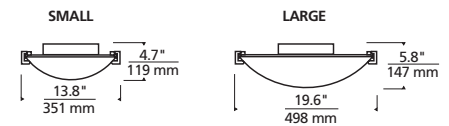

700PY	SIZE	FINISH	LAMP
	12 (SMALL)	C CHROME	INCANDESCENT
	18 (LARGE)	S SATIN NICKEL	-CF COMPACT FLUORESCENT





Polly Ceiling Large White Satin Nickel /
G9 Lamps

MULBERRY CEILING

2 thousand™



WHITE, LARGE



DESERT CLAY, SMALL



Round fabric flush mount. Glass diffuser provides a glare free wash of light highlighted with satin nickel detail. Available in two sizes and two lamp configurations. Small version includes two 75 watt A19 medium base lamps or two 18 watt GU24 base self-ballasted compact fluorescent lamps. Large version includes four 75 watt A19 medium base lamps or four 18 watt GU24 base self-ballasted compact fluorescent lamps.

COMPLEMENTARY
LOW-VOLTAGE
PENDANT P. 34
LINE-VOLTAGE
PENDANT P. 142

700TDMULFM	SIZE	COLOR	FINISH	LAMP
	L LARGE	C DESERT CLAY	S SATIN NICKEL	INCANDESCENT
	S SMALL	W WHITE		-CF COMPACT FLUORESCENT

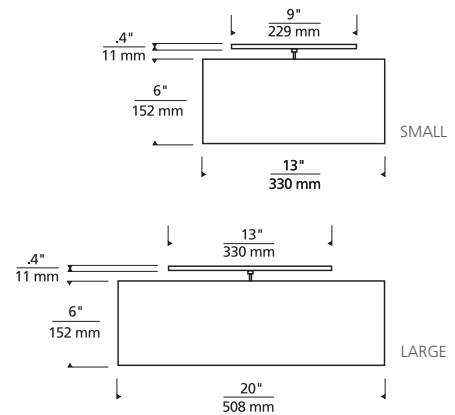

CHAMBERS CEILING

2 thousand™



DESERT CLAY, LARGE



WHITE, SMALL



Square fabric flush mount. Glass diffuser provides a glare free wash of light highlighted with satin nickel detail. Available in two sizes and two lamp configurations. Small version includes two 75 watt A19 medium base lamps or two 18 watt GU24 base self-ballasted compact fluorescent lamps. Large version includes four 75 watt A19 medium base lamps or four 18 watt GU24 base self-ballasted compact fluorescent lamps.

700TDCHAFM	SIZE	COLOR	FINISH	LAMP
	L LARGE	C DESERT CLAY	S SATIN NICKEL	INCANDESCENT
	S SMALL	W WHITE		-CF COMPACT FLUORESCENT

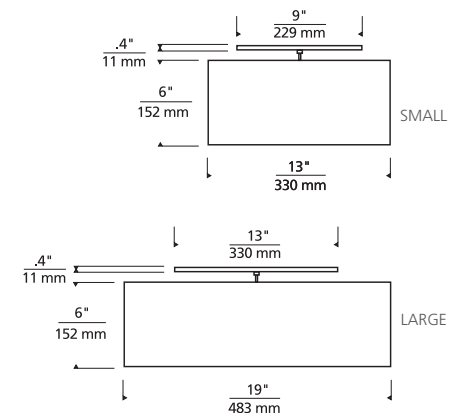



Mulberry Ceiling Large White Satin Nickel /
A19 Lamps



Large rectangular tapered fabric shade suspended by rigid stems from a rectangular canopy. Acrylic diffuser provides a glare free wash of light. Available in two lamp configurations: incandescent and fluorescent. Incandescent version includes four 100 watt A19 medium base lamps. Fluorescent version includes four 27 watt GU24 base self-ballasted compact fluorescent lamps. Incandescent version dimmable with standard incandescent dimmer.

700TDMERC	LENGTH (A)	COLOR	FINISH	LAMP		
36	36"	N	CHOCOLATE BROWN	Z	ANTIQUE BRONZE	INCANDESCENT
48	48"	C	DESERT CLAY	S	SATIN NICKEL	-CF
60	60"	W	WHITE			

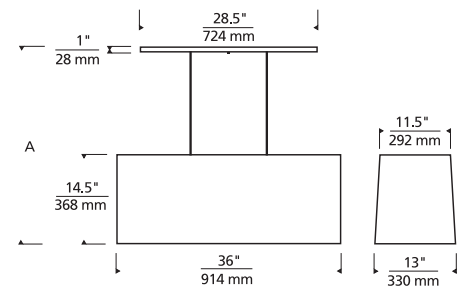



Mercer Suspension Desert Clay Satin Nickel
/ A19 Lamps

LOCATION: PRIVATE RESIDENCE - CHICAGO, IL
DESIGN: KAREN GERSON, INNERSPACE

TRACE SUSPENSION

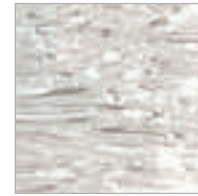

Streams of glass piping formed into a graceful glass bowl and highlighted with metal details. Incandescent includes four 120 volt, 60 watt clear A19 medium base lamps. Fluorescent includes four 120 volt, 18 watt GU24 base self-ballasted compact fluorescent lamps. Incandescent version dimmable with standard incandescent dimmer.

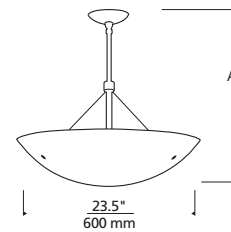

700TRAS23	LENGTH (A)	COLOR	FINISH	LAMP
15	15"	C CRYSTAL	Z ANTIQUE BRONZE	INCANDESCENT
24	24"		S SATIN NICKEL	-CF COMPACT FLUORESCENT
36	36"			

SLOPED CEILING ADAPTOR

45° maximum slope. Available for use on Eve, Larkspur, and Trace Suspension.

700HNGST	FINISH
Z	ANTIQU BRONZE
S	SATIN NICKEL





Trace Suspension 36" Satin Nickel / A19 Lamps

MONARCH SUSPENSION

DESIGNED BY JULIE CARCIONE CAVAZ



GOLD/HAVANA BROWN



IVORY/HAVANA BROWN



WHITE/CLEAR



Hand-blown glass with a rich field of color and a brilliant clear or colored lip highlighted with metal details. Large Incandescent includes 120 volt, 250 watt mini-candelabra base lamp; large fluorescent includes 120 volt GU24 base 42 watt self-ballasted compact fluorescent lamp; small Incandescent includes 120 volt, 150 watt mini-candelabra base lamp; small fluorescent includes 120 volt GU24 base 32 watt self-ballasted compact fluorescent lamp. Incandescent version dimmable with standard incandescent dimmer.

COMPLEMENTARY
LINE-VOLTAGE
PENDANT P. 148
SCONCE P. 212

700MNA	SIZE	LENGTH (A)	COLOR(GLASS/LIP)	FINISH	LAMP
	L LARGE	24 24"	GN GOLD/HAVANA BROWN	Z ANTIQUE BRONZE	INCANDESCENT
	S SMALL	36 36"	IN IVORY/HAVANA BROWN	S SATIN NICKEL	-CF COMPACT FLUORESCENT
			WC WHITE/CLEAR		

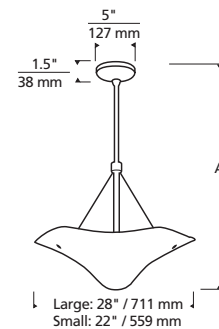



Monarch Suspension 22" Ivory/Havana Brown Satin
Nickel / Mini-candelabra Lamp

NEBBIA SUSPENSION

DESIGNED BY JULIE CARCIONE CAVAZ



BROWN



AMBER



WHITE



Hand-blown glass with an elegantly fused glass wrap. Features integral sloped ceiling adapter for up to a 45° slope. Incandescent includes 120 volt, 150 watt mini-candelabra base lamp. Fluorescent includes GU24 base 32 watt self-ballasted compact fluorescent lamp. Incandescent version dimmable with standard incandescent dimmer.

COMPLEMENTARY
LOW-VOLTAGE
PENDANT P. 56
SCONCE P. 212

700NEBS	LENGTH (A)	COLOR(GLASS/LIP)	FINISH	LAMP
24	24"	A AMBER	Z ANTIQUE BRONZE	INCANDESCENT
36	36"	N BROWN	S SATIN NICKEL	-CF COMPACT FLUORESCENT
		W WHITE		

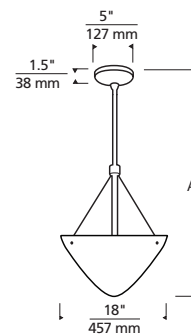



Nebbia Suspension 24" Antique Bronze /
Mini Candelabra Lamps

EVE SUSPENSION



TAHOE PINE AMBER



FROST



WHITE FRIT



Hand blown glass bowl richly layered in brilliant color and highlighted with metal details. Incandescent includes two 120 volt, 100 watt A19 medium base lamps. Fluorescent includes two 120 volt, 27 watt GU24 base self-ballasted compact fluorescent lamps. Incandescent version dimmable with standard incandescent dimmer.

700EVES19

LENGTH (A)	COLOR	FINISH	LAMP
14 14"	F FROST	Z ANTIQUE BRONZE	INCANDESCENT
24 24"	A TAHOE PINE AMBER	S SATIN NICKEL	-CF COMPACT FLUORESCENT
36 36"	W WHITE FRIT		

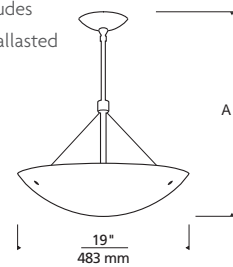

LARKSPUR SUSPENSION



SAND



BEACH AMBER



SURF WHITE



Slumped glass bowl embedded with soft, textured pattern and highlighted with metal details. Incandescent includes two 120 volt, 100 watt A19 medium base lamps. Fluorescent includes two 120 volt, 27 watt GU24 base self-ballasted compact fluorescent lamps. Incandescent version dimmable with standard incandescent dimmer.

700LRKS19

LENGTH (A)	COLOR	FINISH	LAMP
14 14"	A BEACH AMBER	Z ANTIQUE BRONZE	INCANDESCENT
24 24"	S SAND	S SATIN NICKEL	-CF COMPACT FLUORESCENT
36 36"	W SURF WHITE		

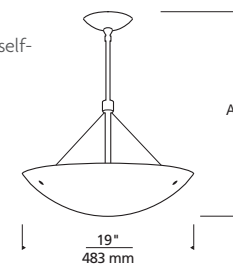

COMPLEMENTARY
SCONCE P. 186
LOW-VOLTAGE
PENDANT P. 48
LINE-VOLTAGE
PENDANT P. 150

SLOPED CEILING ADAPTOR

45° maximum slope. Available for use on Eve, Larkspur, and Trace Suspension.

700HNGST

FINISH
Z ANTIQUE BRONZE
S SATIN NICKEL





Larkspur Suspension 36" Sand Satin Nickel /
A19 Lamps



CRESCENDO

Seven free-floating arms suspended by aerial cable, each tipped on both ends with frosted lamps and white flight paper. 9" diameter round canopy houses a 300 watt electronic transformer with short circuit protection. Includes fourteen 12 volt, 20 watt Frostline™ MR16 lamps. Dimmable with a low-voltage electronic dimmer.

700CRES	WIDTH (W)	LENGTH (L)	FINISH
	36 36"	STANDARD	C CHROME
	48 48"	L LONG	S SATIN NICKEL

(W) WIDTH	(L) STANDARD	(L) LONG
36" (914 mm)	6' (1829 mm)	14' (4267 mm)
48" (1219 mm)	8' (2438 mm)	14' (4267 mm)

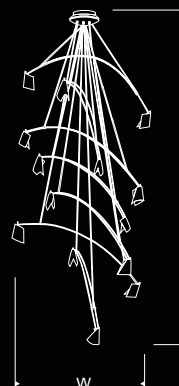

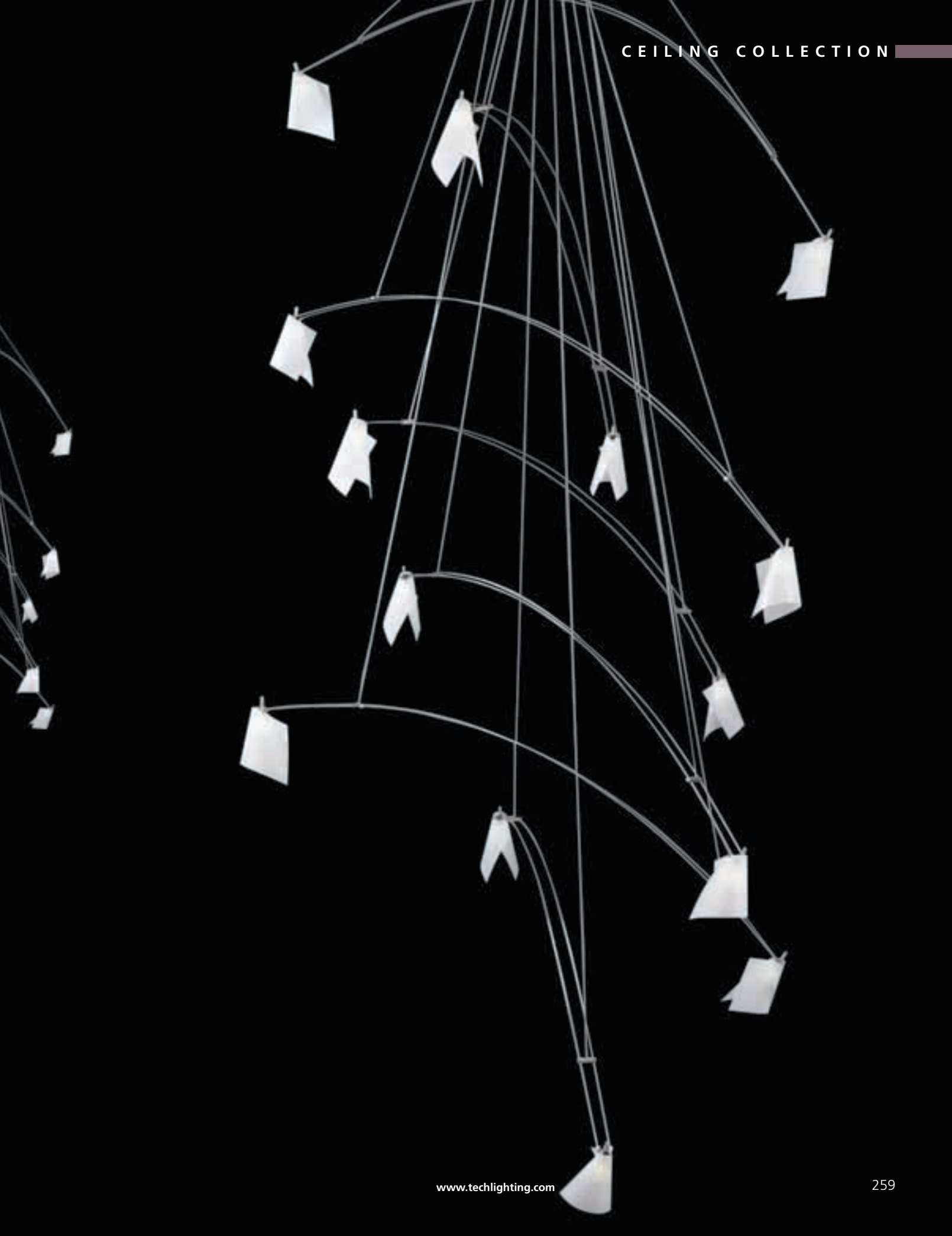

MINI CRESCENDO

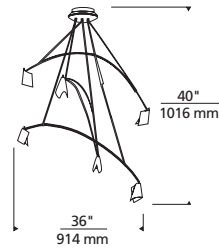

Three free-floating arms suspended by aerial cable, each tipped on both ends with frosted lamps and white flight paper. 6.5" diameter round canopy houses a 150 watt transformer with short circuit protection. 36" width and 40" length. Includes six 12 volt, 20 watt Frostline™ MR16 lamps. Dimmable with a low-voltage electronic dimmer.

700CRES36S	FINISH
C	CHROME
S	SATIN NICKEL

RHAPSODY

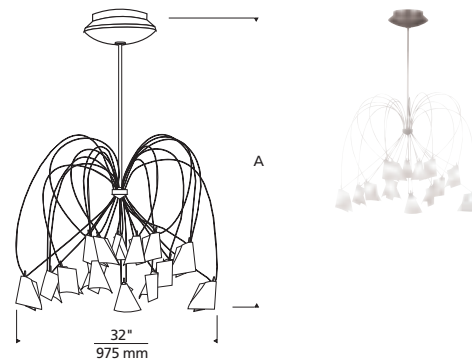

Fifteen whimsical arms wrapped from a central core, each tipped with a frosted lamp and white flight paper. 9" diameter round canopy houses a 300 watt electronic transformer with short circuit protection. Includes fifteen 12 volt, 20 watt Frostline™ MR16 lamps. Dimmable with a low-voltage electronic dimmer.

700RHAP	LENGTH (A)	FINISH
32	32"	C CHROME
44	44"	S SATIN NICKEL
56	56"	
68	68"	





Rhapsody Satin Nickel 32" Width /
Frostline™ MR16 Lamps

STACCATO



Twenty-four gracefully arched rods, each tipped with a sparkling lamp. 9" diameter round canopy houses a 300 watt electronic transformer with short circuit protection. Includes twenty-four 12 volt, 10 watt Xenon bi-pin lamps. Dimmable with a low-voltage electronic dimmer.

700STAC	LENGTH (A)	FINISH
20	20"	C CHROME
32	32"	S SATIN NICKEL
44	44"	

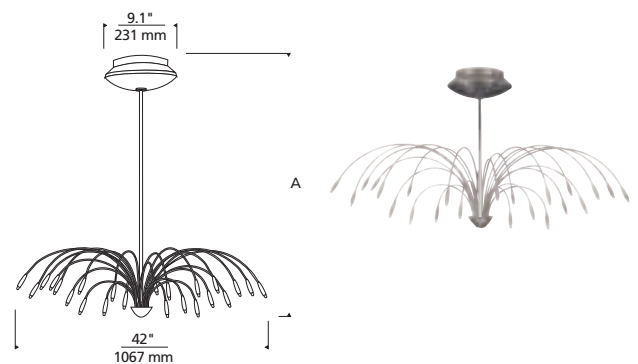

PRESTO



Twelve gracefully arched rods, each tipped with a sparkling lamp. 6.5" diameter round canopy houses a 150 watt electronic transformer with short circuit protection. Includes twelve 12 volt, 10 watt Xenon bi-pin lamps. Dimmable with a low-voltage electronic dimmer.

700PRES	LENGTH (A)	FINISH
12	12"	C CHROME
20	20"	S SATIN NICKEL
32	32"	
44	44"	

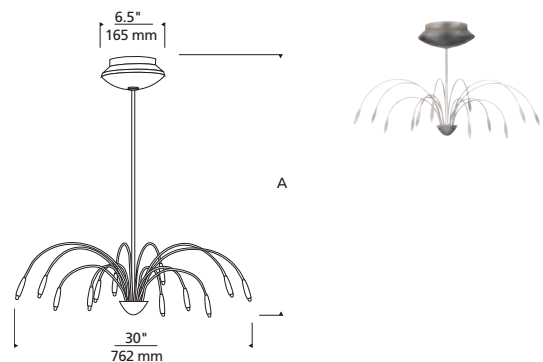



Staccato 32" Chrome / Xenon Bi-pin Lamps

LOCATION: PRIVATE RESIDENCE — ANN ARBOR, MI
DESIGN: ELAN DESIGNS

MELODY

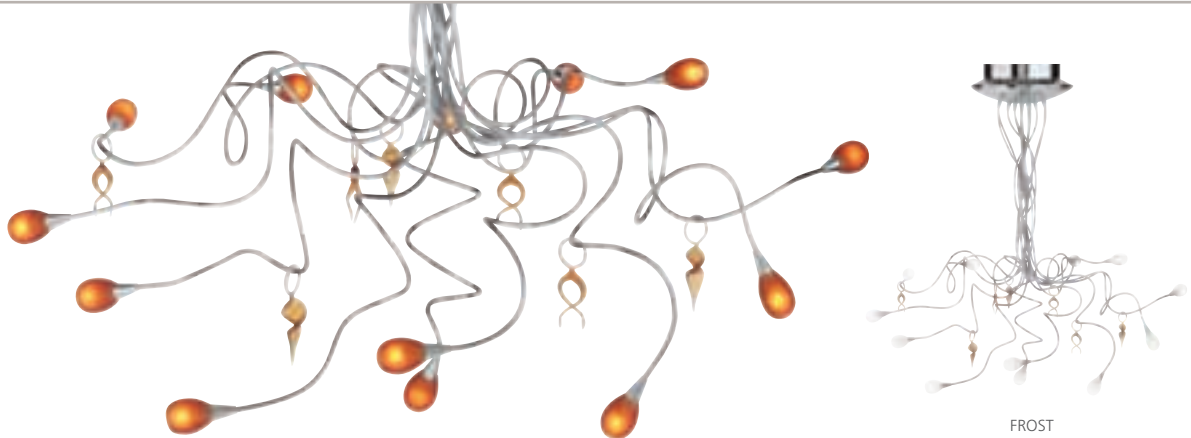

AMBER, SHOWN WITH
DECORATIVE GLASS TRINKETS (INCLUDED)

FROST

Thirteen hand-bendable rods, each tipped with amber or frost glass barrel. 9" diameter round canopy houses a 300 watt electronic transformer with short circuit protection. Includes thirteen 12 volt, 15 watt Xenon bi-pin lamps. Dimmable with a low-voltage electronic dimmer.

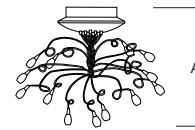

700MELO	LENGTH (A)	GLASS	FINISH
32	32"	A AMBER	C CHROME
44	44"	F FROST	S SATIN NICKEL

SYMPHONY

WINNER



LIGHTFAIR
DESIGN
EXCELLENCE
AWARD

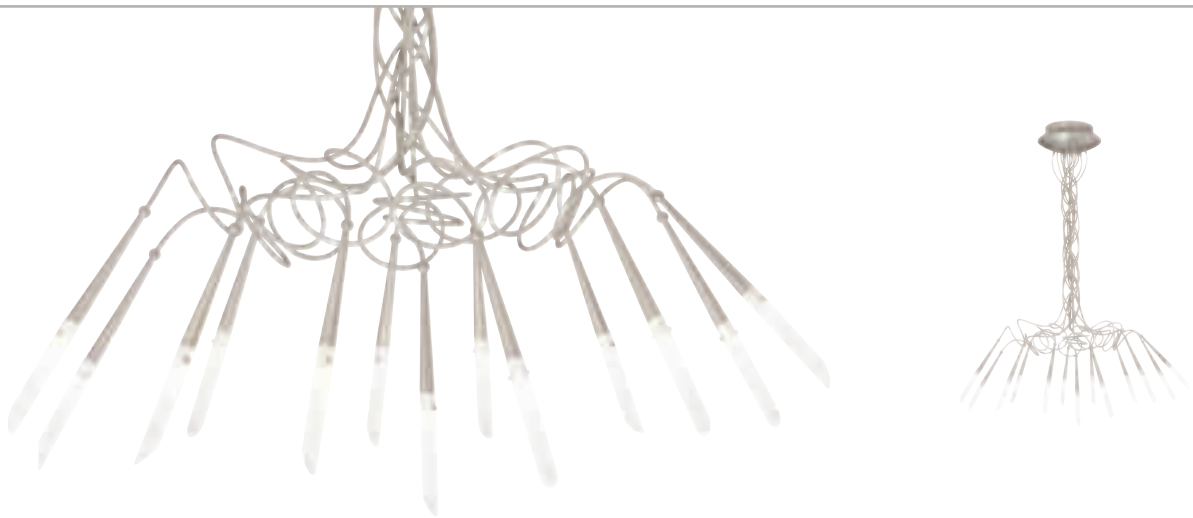

Thirteen hand-bendable rods, each tipped with a frost-white cylinder. 9" diameter round canopy houses a 300 watt electronic transformer with short circuit protection. Includes thirteen 12 volt, 20 watt Xenon bi-pin lamps. Dimmable with a low-voltage electronic dimmer.

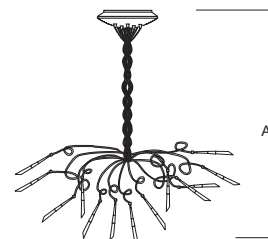

700SYMP	LENGTH (A)	FINISH
32	32"	C CHROME
44	44"	S SATIN NICKEL





Melody 32" Chandelier Amber Satin Nickel /
Bi-pin Lamps

TRENDS PUBLISHING INTERNATIONAL
ARCHITECT: BURNS & BEYERL
PHOTOGRAPHER: MIKE KASKEL

Compatible Elements

Our low-voltage pendants and heads are compatible with many of our low-voltage systems. For each element's compatibility, please refer to either the product pages on pp. 30-135 or to the simple reference guide below.

Many of our low-voltage heads can be used on Kable Lite using the Kable Lite FreeJack Connector on p. 355.

Any pendant and many of our heads can be used on our T-trak line-voltage system (separate catalog) using the T-trak FreeJack Connector on p. 354.

KEY:	FJ FreeJack	WMO Wall MonoRail
	MO MonoRail	KL Kable Lite
	MO2 2-Circuit MonoRail	

www.techlighting.com

LOW-VOLTAGE PENDANTS



Autumn Wind
p. 36



Biz
p. 74



Boreal
p. 38



Brulée
p. 54



Cabo
p. 45



Camille
p. 94



Cheers
p. 76

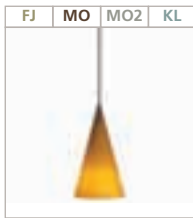

Cone
p. 64



Coronado
p. 44



Cube
p. 72



Cue
p. 78



Diz
p. 74



Egypt
p. 50



Essex
p. 44



Fab
p. 53



Fire
p. 66



Firebird
p. 70



Firefrit
p. 70

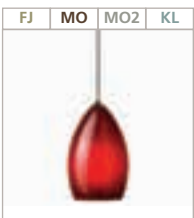

Frost
p. 68



Hanging Wok
p. 96



Inner Fire
p. 68



Kiev
p. 32



Melrose
p. 86



Melt
p. 84

Throughout the catalog, this icon indicates which fixtures are available in LED.



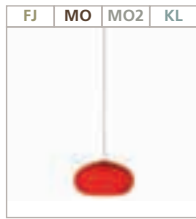

Meteor
p. 92



Meteor Frit
p. 92



Mini Echo
p. 62



Mini Edge
p. 52

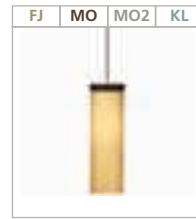

Mini Hudson
p. 54



Mini Larkspur
p. 48

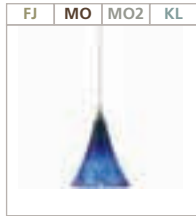

Mini Melrose
p. 86



Mini Mulberry
p. 34



Mini Ovation
p. 88



Mini Starry Night
p. 90



Mini Taza
p. 91



Monet
p. 93

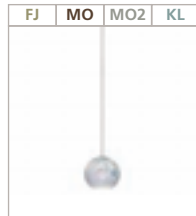

Moon
p. 82



Nebbia
p. 56



Niko
p. 90



Oak Park
p. 50



Pelé
p. 78



Peyton
p. 42



Pinnacle
p. 58



Piper
p. 100

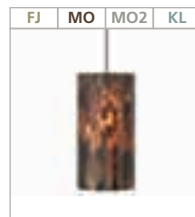

Playa
p. 40



Pleat
p. 48



Prism
p. 99

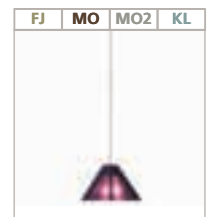

Pyramid
p. 73

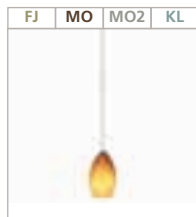

Raindrop
p. 96



River Rock Oblong Oval
p. 46



River Rock Soft Round
p. 46



River Rock Wedge
p. 47



Sahara
p. 80



Savoy
p. 84



Scavo
p. 80



Silva
p. 43



Silver Glaze
p. 57



Sky
p. 100



Small Nest
p. 99



Soleil
p. 60



Throughout the catalog, this icon indicates which fixtures are available in LED.



Solitude
p. 72 



Sophia
p. 93



Sugar
p. 88 



Summit
p. 58



Sydney
p. 76



Tetra
p. 94 



Torpedo*
p. 98



Trimble
p. 36 



Veil
p. 42 



Vino
p. 82 

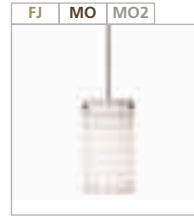

Waffle
p. 52 

HEADS



Aero*
p. 120



Cam
p. 118



Curly Moon
p. 126



Curly Raindrop
p. 126



Curly Torpedo*
p. 127



Elton
p. 114



Envision
p. 106



Helios*
p. 104 

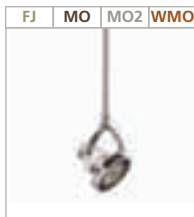

John
p. 114



K-Bye-Bye
p. 128



K-Giro
p. 130



K-Hello
p. 130



K-Jane
p. 129



K-Johnny*
p. 129



K-Pivot
p. 131



K-Telescope*
p. 128



Mini Om*
p. 108



MO-Pivot*
p. 127



Pod
p. 125



Scania
p. 110



Sportster
p. 116



Spot
p. 116



Sprocket
p. 112



Swivel*
p. 124

 Throughout the catalog, this icon indicates which fixtures are available in LED.

*Shown accessorized. See pp. 366-379 for Accessories and Optical Controls.





T156
p. 118



Tele*
p. 124



Tilt*
p. 122



Wall Archie*
p. 132



Wall Georgi*
p. 132



Wall Telescope*
p. 133



Wally Lite
p. 133

FUNCTIONAL ART



Biplane
p. 135



Bugs
p. 134



Dragonfly
p. 134



Metal Man
p. 134



Parachute
p. 135

*Shown accessorized. See pp. 336-379 for Accessories and Optical Controls.

MonoRail

Our low-voltage, hand-bendable rail system lets you shape your vision to complement or contrast any architectural feature or style.

www.techlighting.com



MonoRail Satin Nickel / End Caps / Remote 600
Watt 12 Volt Transformer / 2" Square Dual-Feed
Canopy / 2" Rigid Standoffs / 6" Sprocket Heads /
Spy Accessories / MR16 Lamps

TRENDS PUBLISHING INTERNATIONAL
ARCHITECT: MARK DZIEWULSKI AIA
PHOTOGRAPHER: KEITH CRONIN



MonoRail Satin Nickel / End Caps / Remote 300 Watt
12 Volt Transformers / 4" Round Single-Feed Canopies /
Power Extenders / Power Vault Adapters / Adjustable
Standoffs / 6" Aero Heads / Round Glass Shield
Accessories Frost / MR16 Lamps

TRENDS PUBLISHING INTERNATIONAL
DESIGNER: STAINBACK-HESS STUDIO
PHOTOGRAPHER: JOHN UMBERGER





MonoRail Satin Nickel / End Caps / Remote 300 Watt
12 Volt Transformer / 4" Round Single-Feed Canopy
Satin Nickel / 6" Power Extender / 6" Rigid Standoffs /
T156 Heads / MR16 Lamps / MO-Pivot Heads /
MR16 Lamps

TRENDS PUBLISHING INTERNATIONAL
ARCHITECT: LDA
PHOTOGRAPHER: SAM GRAY



MonoRail Satin Nickel / End Caps / Remote 300 Watt
12 Volt Transformer / 4" Round Single-Feed Canopy /
Power Extender / Adjustable Standoffs / Small Nest
Pendants Frost White / Bi-pin Lamps

PHOTOGRAPHER: ERIC ROTH





MonoRail Satin Nickel / End Caps / Remote 600 Watt
 12 Volt Transformer / 4" Round Dual-Feed Canopy Satin
 Nickel / 24" Power Extenders / 24" Rigid Standoffs /
 MO-Pivot Heads / MR16 Lamps

PHOTOGRAPHER: ERIC ROTH

The Basics of MonoRail

ONE DESIGN YOUR MONORAIL SYSTEM



The first step in designing your MonoRail system is to determine what it is you are trying to light. You'll need to decide where the elements should be installed to put light where you want it. See Compatible Elements on pp. 266-269 for thumbnails. Refer to the indicated pages for detailed specifications. Choose your elements then add accessories if desired. We offer a broad range of colorful and decorative accessories and functional optical controls (pp. 336-379).



Draw in your MonoRail run. Remember, MonoRail can be shaped by hand to follow architectural details or to create an organic shape. Factory pre-bent shapes are also offered in several configurations. Your MonoRail run must be placed so it runs directly beneath the junction box with surface transformer or power feed canopy. Determine how many pieces of rail you'll need (p. 280). Add a pair of end caps to each end of the run for an elegant finishing touch (p. 281).

TWO ADD POWER AND HARDWARE TO COMPLETE YOUR SYSTEM

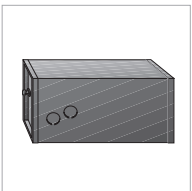

Add up the wattages of the lamps you'll be using on the system: this will help you select a transformer. A remote transformer with power feed canopy provides the cleanest look, but the remote transformer must be installed in an accessible, remote location. A surface transformer simply mounts to a junction box. The new remodel recessed transformer provides the same clean look of a remote transformer but doesn't require access to a remote location. However, it will not work with concrete ceilings. Use the information on pp. 384-385 to help you choose the right transformer for your installation; see pp. 284-288 for MonoRail transformer and power feed options. If you are using LED heads or pendants, be sure to choose a transformer that is compatible with LED fixtures. See pp. 266-269 for a list of Compatible LED Elements.



Determine how far from the ceiling you want the system to drop. Power feed canopies place the rail one or two inches from the ceiling; surface transformers drop it from two to five inches, depending on the type of transformer. If this drop is shorter than you require, you'll need to add a power extender (p. 285) to your canopy or surface transformer. The maximum standard drop for MonoRail is eight feet.



Next, add standoffs that match the drop of your power feed to support the system (p. 282). Adjustable standoffs provide a clean, elegant look. Choose rigid standoffs for curvy runs, or runs with multiple glass pendants. You'll need one standoff for every three feet of MonoRail. The power feed counts as a support, so begin adding standoffs three feet from the power feed. Note: Power extenders and standoffs are field-cuttable, so it's easy to achieve a custom drop length.

MonoRail Kits To simplify ordering, we offer several convenient MonoRail Kits (pp. 292-293).



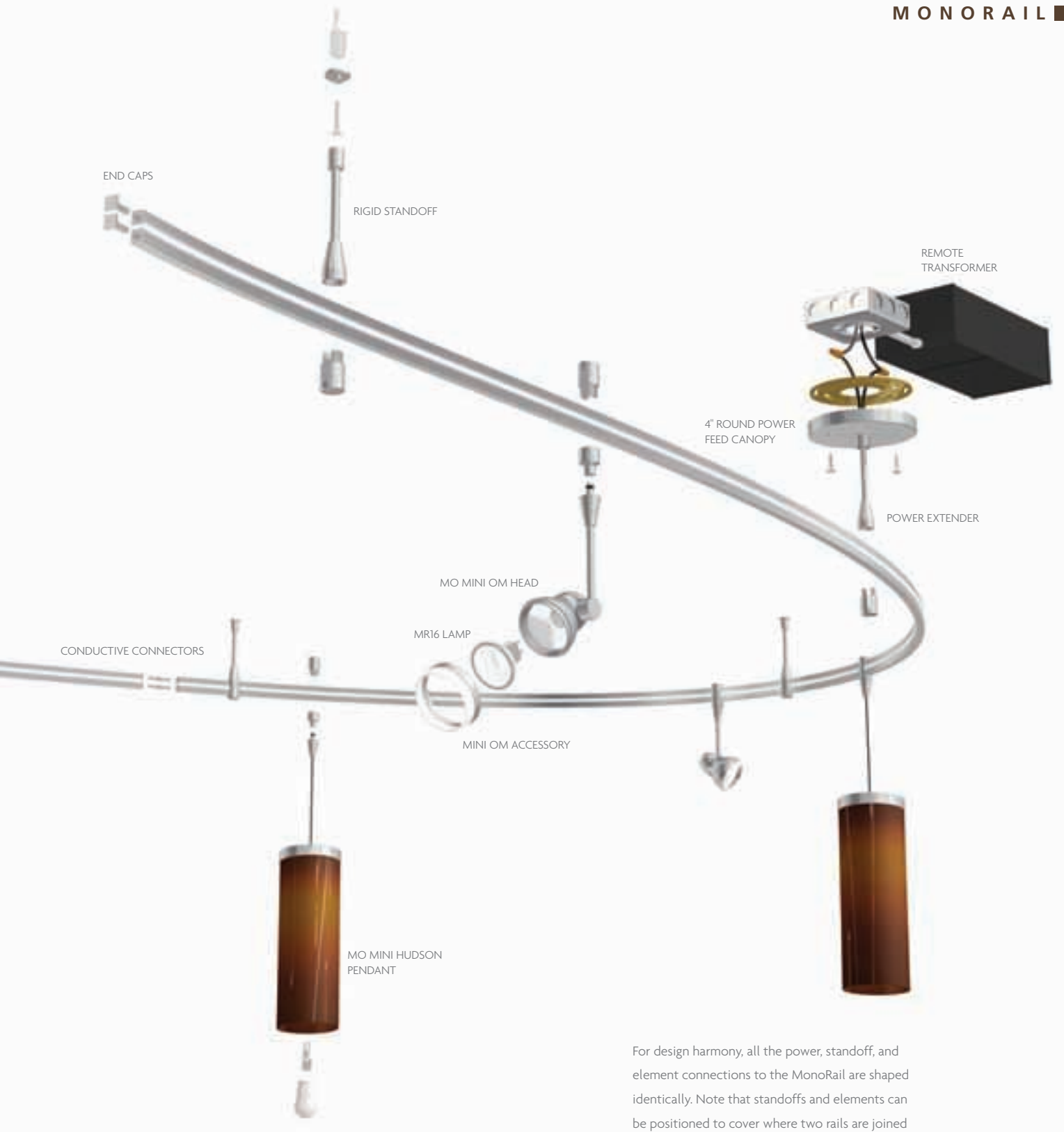

For design harmony, all the power, standoff, and element connections to the MonoRail are shaped identically. Note that standoffs and elements can be positioned to cover where two rails are joined to maintain the smooth line.

For other MonoRail system options, such as mounting to a vaulted or T-bar ceiling or to a wall, see Special Installations on pp. 288-291.



MonoRail Satin Nickel / End Caps / Remote 300 Watt
12 Volt Transformer / 4" Round Low Profile Single-Feed
Canopy / 1" Rigid Standoffs / 6" John Heads
Satin Nickel / MR16 Lamps

What's New With MonoRail

Remodel Recessed Transformers (p. 287)

Combines the aesthetics of Remote Transformers and Power Feed Canopies with the flexibility of Surface Transformers

- Looks similar from below the ceiling to the power feed canopies used with remote transformers; however, it does not require access to a remote location because the transformer sits just above the ceiling
- The decorative canopy is the only visible portion of the transformer once installed
- Access to the back-of the ceiling is not needed

Easy installation

- Installs similar to a remodel recessed downlight
- In remodel applications, the electrician will need to install the Remodel Recessed Transformer in close proximity to an existing junction box, drill through the finished ceiling in the location where the Remodel Recessed Transformer will be installed, and cover the existing junction box with a thin, field-paintable metal cover (included) as UL requires
- In new construction, the electrician can simply bring power to the Remodel Recessed Transformer directly
- Insulation must be kept at least 3" from the transformer and housing

The transformer is concealed inside a housing that recesses above the ceiling

- Available with a 150 watt or 300 watt electronic transformer
- The transformer is equipped with a fast-acting short circuit and overload protection that will safely turn off the system should a short occur
- The unit can be reset simply by flipping the wall switch on and off



1" Standoffs (p. 287) and Low-Profile Power Feed Canopies (p. 285)

Allows MonoRail to sit closer to the ceiling



1" Standoff



Low-Profile Power Feed Canopy

MonoRail

MONORAIL

Hand-bendable, field-cuttable MonoRail is rated for 300 watts at 12 volts, 600 watts at 24 volts. Each piece of rail is shipped with conductive connectors to join rail pieces end to end. Order additional connectors (p. 281) if cutting and rejoining rails.

700MOA	LENGTH	FINISH / INSULATOR
24	24" (.61 m)	BRZ ANTIQUE BRONZE WITH BROWN INSULATOR
48	48" (1.2 m)	Z ANTIQUE BRONZE WITH CLEAR INSULATOR
96	96" (2.4 m)	C CHROME WITH CLEAR INSULATOR
		S SATIN NICKEL WITH CLEAR INSULATOR

ANTIQUe BRONZE - BROWN INSULATOR



For a holistic antique bronze finish, a brown insulator is recommended.

ANTIQUe BRONZE - CLEAR INSULATOR



CHROME - CLEAR INSULATOR



SATIN NICKEL - CLEAR INSULATOR



Actual Size



Standard MonoRail bends horizontally to a radius as small as 6" and vertically to a radius as small as 24". For custom factory bends, provide degree and radius of curve.

TIP: To calculate the amount of rail you'll need for an organic shape, draw the MonoRail run to scale (for example, 1/4" = 1'). Use a piece of string to "trace" the drawing. Measure the length of string, then convert from your scale.

PRE-BENT S CURVE MONORAIL

MonoRail pre-bent into a horizontal S curve. Consult the drawing for approximate dimensions. For a factory bend not shown, please call for a custom quotation.

700MOBHSC60	FINISH / INSULATOR
BRZ	ANTIQUe BRONZE WITH BROWN INSULATOR
Z	ANTIQUe BRONZE WITH CLEAR INSULATOR
C	CHROME WITH CLEAR INSULATOR
S	SATIN NICKEL WITH CLEAR INSULATOR

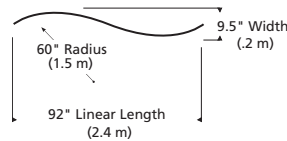

PRE-BENT 90° CURVE MONORAIL

Horizontal 90° curves are sold by radius, or the distance from the center of the circle to the outside edge. Join four 90° curves to create a circle with a diameter (overall width) equal to twice the specified radius. For a factory bend not shown, please call for a custom quotation.

700MOBH90	RADIUS	FINISH / INSULATOR
12	12"	BRZ ANTIQUe BRONZE WITH BROWN INSULATOR
18	18"	Z ANTIQUe BRONZE WITH CLEAR INSULATOR
24	24"	C CHROME WITH CLEAR INSULATOR
36	36"	S SATIN NICKEL WITH CLEAR INSULATOR
48	48"	
60	60"	

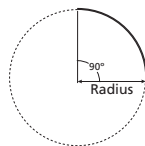

Connectors

CONDUCTIVE CONNECTORS

Conductive connectors join sections of rail together end to end and are included with all MonoRail pieces. Order separately if cutting and rejoining rails. Pair.



700MOCCN FINISH

- Z ANTIQUE BRONZE
- C CHROME
- S SATIN NICKEL



ISOLATING CONNECTORS

Isolating connectors join sections of rail and isolate power feeds from each other. Two common uses are in runs using more than 300w or in runs over 30ft where two power feeds are required to avoid voltage drop. All dual-feed canopies and dual-feed surface transformers are shipped with isolating connectors; order additional if required by layout. Pair.



700MOCINC

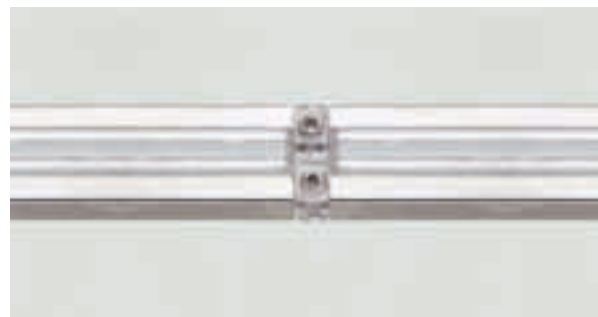

FLEXIBLE HORIZONTAL CONNECTORS

These conductive connectors join sections of rail together end to end at desired sharp horizontal angle. Pair.



700MOCFXH FINISH

- Z ANTIQUE BRONZE
- C CHROME
- S SATIN NICKEL

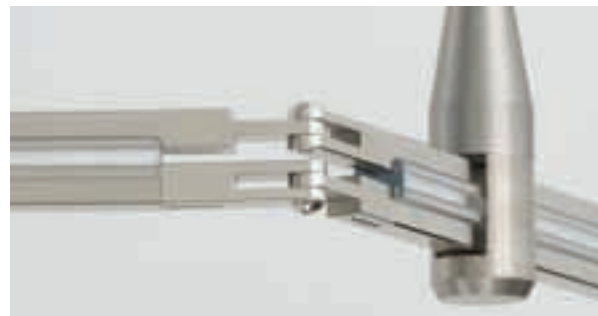

END CAPS

Decorative end caps fit into ends of MonoRail run for a finished look. Pair; order one pair for each end.



700MOCCAP FINISH

- Z ANTIQUE BRONZE
- C CHROME
- S SATIN NICKEL



Standoffs

Use standoff supports every three feet of MonoRail run and at corners. Standoffs can be positioned to cover points where rails are joined.

RIGID STANDOFF

The field-cuttable rigid standoff is recommended for curvy runs or runs with heavier Heads, Pendants or Functional art, such as glass pendants. Rigid standoffs are compatible with various power feed options: Use the chart below to determine the appropriate standoff for your run.

To determine the shortest compatible standoff for any power feed or surface transformer option, see pp. 285-287.

LENGTH	STANDOFF	FINISH
1" (1.0")*	700MOS01	(Z, C, or S)**
2" (1.9")*	700MOS02	(Z, C, or S)
3" (3.6")*	700MOS03	(Z, C, or S)
4" (4.8")*	700MOS04	(Z, C, or S)
5" (5.8")*	700MOS05	(Z, C, or S)
6" *	700MOS06	(Z, C, or S)
12" *	700MOS12	(Z, C, or S)
24" *	700MOS24	(Z, C, or S)
36" *	700MOS36	(Z, C, or S)
48" *	700MOS48	(Z, C, or S)
96" *	700MOS96	(Z, C, or S)

*actual length from ceiling to top of rail

**May only be used with MonoRail Low-Profile Power Feed Canopy (p. 285) or MonoRail Low-Profile Remodel Recessed Transformer (p. 287). Not compatible with Standoff Vault Adapter. Not field-cuttable



RIGID STANDOFF
1"



RIGID STANDOFF
2" - 96"



ADJUSTABLE STANDOFF

The adjustable standoff's cable virtually disappears for a clean and elegant look. It is best used on fairly straight runs with a drop greater than 6". A wire grip allows you to easily shorten or lengthen the cable to size it for use.

700MOSADJ	LENGTH	FINISH
	12' OF CABLE	Z ANTIQUE BRONZE
3	30' OF CABLE	C CHROME
		S SATIN NICKEL



ADJUSTABLE STANDOFF

TIP: For best appearance, place the last standoff 4-6" from the end of the rail, and place standoffs symmetrically.





MonoRail Satin Nickel / Remote 300 Watt 12 Volt Transformer / 4" Round Single-Feed Canopy / 36" Power Extender / Adjustable Standoffs / Flexible Connectors / Pyramid Pendants Frost / Bi-pin Lamps

LOCATION: PRIVATE RESIDENCE — ANN ARBOR, MI
DESIGN: ELAN DESIGNS

Remote Transformers

Remote transformers install in an accessible location behind the ceiling or wall. For technical information on remote transformers, see pp. 384-385. Requires canopy (p. 285) or special power feed (pp. 288-289).

INPUT VOLTAGE OUTPUT VOLTAGE WATTAGE TYPE	ITEM NUMBER	COMPATIBLE DIMMER TYPE	COMPATIBLE DIMMING COIL	PLUG-IN TRANSFORMER OPTION <i>INCLUDES 16' CORD</i>	RECESSED REMOTE TRANSFORMER OPTION*	277 VOLT INPUT OPTION
--	----------------	------------------------------	-------------------------------	--	--	--------------------------

SINGLE-FEED OPTIONS

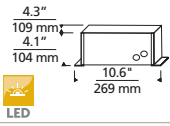
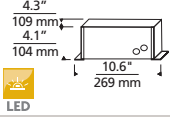
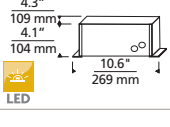
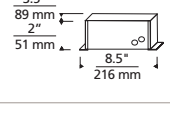
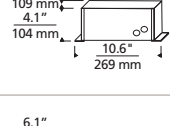
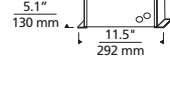
	1 x 120v 12v 1 x 75 watts Magnetic	700AT075T	low-voltage magnetic 600 watts	—	700AT075P	—	700AT075T277
	1 x 120v 12v 1 x 150 watts Magnetic	700AT150T	low-voltage magnetic 600 watts	700DIM150 (p. 385)	700AT150P	—	700AT150T277
	1 x 120v 12v 1 x 300 watts Magnetic	700AT300T	low-voltage magnetic 600 watts	700DIM300 (p. 385)	700AT300P	700AT300TR	700AT300T277 700AT300TR277*
	1 x 120v 12v 1 x 300 watts Electronic	700AT300EL	low-voltage electronic 600 watts	—	700AT300ELP	—	—
	1 x 120v 24v 1 x 300 watts Magnetic	700AT3024T	low-voltage magnetic 600 watts	700DIM300 (p. 385)	700AT3024P	700AT3024TR	700AT3024T277 700AT3024TR277*
	1 x 120v 24v 1 x 600 watts Magnetic	700AT6024T	low-voltage magnetic 1000 watts	700DIM600 (p. 385)	700AT6024P	700AT6024TR	700AT6024T277 700AT6024TR277*

DUAL-FEED OPTIONS

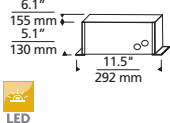
	1 x 120v 12v 2 x 300 watts Magnetic	700AT600T	low-voltage magnetic 1000 watts	700DIM600 (p. 385)	700AT600P	700AT600TR	700AT600T277 700AT600TR277*
---	--	-----------	---------------------------------------	-----------------------	-----------	------------	--------------------------------

* In-wall recessed remote transformers also available for magnetic 300 and 600 watt models for use in applications where a remote transformer is desired but there isn't access to a remote location. See www.techlighting.com for dimensions and further details.







Indicates which transformers are compatible with LED elements.







Power Feed Canopies

ITEM NUMBER	MOUNTS TO	SHORTEST COMPATIBLE RIGID STANDOFF	TO DROP FROM CEILING GREATER THAN SHORTEST COMPATIBLE RIGID STANDOFF
-------------	-----------	------------------------------------	--

SINGLE-FEED OPTIONS USE WITH ONE SINGLE-FEED REMOTE TRANSFORMER

 <p>4" Round Low-Profile Single-Feed**</p>	Bronze: 700MOP4C01Z Chrome: 700MOP4C01C Satin Nickel: 700MOP4C01S	standard 4" junction box with round plaster ring (provided by electrician)	Only compatible with 1" Rigid Standoff (p. 282)	Not compatible with power extenders
 <p>4" Round Single-Feed</p>	Bronze: 700MOP4C02Z Black: 700MOP4C02B* Chrome: 700MOP4C02C Satin Nickel: 700MOP4C02S White: 700MOP4C02W*	standard 4" junction box with round plaster ring (provided by electrician)	2" (p. 282)	add one power extender (below)
 <p>2" Square Single-Feed</p>	Bronze: 700MOP2C02Z Black: 700MOP2C02B* Chrome: 700MOP2C02C Satin Nickel: 700MOP2C02S White: 700MOP2C02W*	special 2" square junction box (included)	2" (p. 282)	add one power extender (below)
 <p>2" x 4" Rectangular Single-Feed</p>	Bronze: 700MOPRC02Z Black: 700MOPRC02B* Chrome: 700MOPRC02C Satin Nickel: 700MOPRC02S White: 700MOPRC02W*	standard single gang or gem box (provided by electrician)	2" (p. 282)	add one power extender (below)

DUAL-FEED OPTIONS USE WITH ONE DUAL-FEED REMOTE TRANSFORMER (ISOLATING CONNECTORS INCLUDED)

 <p>4" Round Low-Profile Dual-Feed**</p>	Bronze: 700MOP4C401Z Chrome: 700MOP4C401C Satin Nickel: 700MOP4C401S	standard 4" junction box with round plaster ring (provided by electrician)	Only compatible with 1" Rigid Standoff (p. 282)	Not compatible with power extenders
 <p>4" Round Dual-Feed</p>	Bronze: 700MOP4C402Z Black: 700MOP4C402B* Chrome: 700MOP4C402C Satin Nickel: 700MOP4C402S White: 700MOP4C402W*	standard 4" junction box with round plaster ring (provided by electrician)	2" (p. 282)	add two power extenders (below)
 <p>2" Square Dual-Feed</p>	Bronze: 700MOP2C402Z Black: 700MOP2C402B* Chrome: 700MOP2C402C Satin Nickel: 700MOP2C402S White: 700MOP2C402W*	special 2" square junction box (included)	2" (p. 282)	add two power extenders (below)
 <p>2" x 4" Rectangular Dual-Feed</p>	Bronze: 700MOPRC402Z Black: 700MOPRC402B* Chrome: 700MOPRC402C Satin Nickel: 700MOPRC402S White: 700MOPRC402W*	standard single gang or gem box (provided by electrician)	2" (p. 282)	add two power extenders (below)

*Black and White finish options have Satin Nickel feeds.
 **Not compatible with Power Extenders or Power Vault Adapter

POWER EXTENDER

Add to power feed canopy or surface transformer to drop power from ceiling. For dual-feed canopies and transformers, order two. Field-cuttable.

700MOP	LENGTH	FINISH
03	3"	Z ANTIQUE BRONZE
06	6"	C CHROME
12	12"	S SATIN NICKEL
24	24"	
36	36"	
48	48"	
96	96"	

PLUG OPTION

16' cord and plug for standard 120 volt power outlets.

700A1-	COLOR
WHT	WHITE
BLK	BLACK























Surface Transformers

All surface transformers mount to a standard 4" ceiling junction box with round plaster ring (provided by electrician). For technical information on surface transformers, see pp. 384-385.

INPUT VOLTAGE OUTPUT VOLTAGE WATTAGE TYPE	ITEM NUMBER	COMPATIBLE DIMMER TYPE	COMPATIBLE DIMMING COIL	COMPATIBLE RIGID STANDOFF	TO DROP FROM CEILING	TO PLUG IN
--	-------------	------------------------------	-------------------------------	---------------------------------	-------------------------	------------

SINGLE-FEED OPTIONS

  1.9" (48 mm) 4" (102 mm)	1 x 120v 12v 1 x 60 watts Electronic	Bronze: 700MOFRT60EZ-LED Black: 700MOFRT60EB-LED* Chrome: 700MOFRT60EC-LED Satin Nickel: 700MOFRT60ES-LED White: 700MOFRT60EW-LED*	low-voltage electronic 600 watts	—	2" (p. 282)	add one power extender (p. 285)	add plug option (p. 285)
  3.5" (89 mm) 5.1" (130 mm)	1 x 120v 12v 1 x 60 watts Electronic	Bronze: 700MOSRT60EZ-LED Black: 700MOSRT60EB-LED* Chrome: 700MOSRT60EC-LED Satin Nickel: 700MOSRT60ES-LED White: 700MOSRT60EW-LED*	low-voltage electronic 600 watts	—	3" (p. 282)	add one power extender (p. 285)	add plug option (p. 285)
  3.5" (89 mm) 5.1" (130 mm)	1 x 120v 12v 1 x 75 watts Magnetic	Bronze: 700MOSRT75DZ Black: 700MOSRT75DB* Chrome: 700MOSRT75DC Satin Nickel: 700MOSRT75DS White: 700MOSRT75DW*	low-voltage magnetic 600 watts	—	3" (p. 282)	add one power extender (p. 285)	add plug option (p. 285)
  3.5" (89 mm) 5.1" (130 mm)	1 x 120v 12v 1 x 100 watts Electronic	Bronze: 700MOSRT100EZ-LED Black: 700MOSRT100EB-LED* Chrome: 700MOSRT100EC-LED Satin Nickel: 700MOSRT100ES-LED White: 700MOSRT100EW-LED*	low-voltage electronic 600 watts	—	3" (p. 282)	add one power extender (p. 285)	add plug option (p. 285)
  3.6" (91 mm) 6.5" (165 mm)	1 x 120v 12v 1 x 150 watts Magnetic	Bronze: 700MOSRT15DZ Black: 700MOSRT15DB* Chrome: 700MOSRT15DC Satin Nickel: 700MOSRT15DS White: 700MOSRT15DW*	low-voltage magnetic 600 watts	included	3" (p. 282)	add one power extender (p. 285)	add plug option (p. 285)
  3.6" (91 mm) 6.5" (165 mm)	1 x 120v 12v 1 x 150 watts Electronic	Bronze: 700MOSRT15EZ Black: 700MOSRT15EB* Chrome: 700MOSRT15EC Satin Nickel: 700MOSRT15ES White: 700MOSRT15EW*	low-voltage electronic 600 watts	—	3" (p. 282)	add one power extender (p. 285)	add plug option (p. 285)
  4.8" (122 mm) 9.1" (231 mm)	1 x 120v 12v 1 x 300 watts Magnetic	Bronze: 700MOSRT30DZ Black: 700MOSRT30DB* Chrome: 700MOSRT30DC Satin Nickel: 700MOSRT30DS White: 700MOSRT30DW*	low-voltage magnetic 600 watts	included	4" (p. 282)	add one power extender (p. 285)	add plug option (p. 285)
  4.8" (122 mm) 9.1" (231 mm)	1 x 120v 12v 1 x 300 watts Electronic	Bronze: 700MOSRT30EZ Black: 700MOSRT30EB* Chrome: 700MOSRT30EC Satin Nickel: 700MOSRT30ES White: 700MOSRT30EW*	low-voltage electronic 600 watts	—	4" (p. 282)	add one power extender (p. 285)	add plug option (p. 285)
  4.8" (122 mm) 9.1" (231 mm)	1 x 120v 24v 1 x 300 watts Magnetic	Bronze: 700MOSRT324DZ Black: 700MOSRT324DB* Chrome: 700MOSRT324DC Satin Nickel: 700MOSRT324DS White: 700MOSRT324DW*	low-voltage magnetic 600 watts	included	4" (p. 282)	add one power extender (p. 285)	add plug option (p. 285)
  4.8" (122 mm) 9.1" (231 mm)	1 x 120v 24v 1 x 600 watts Magnetic	Bronze: 700MOSRT624DZ Black: 700MOSRT624DB* Chrome: 700MOSRT624DC Satin Nickel: 700MOSRT624DS White: 700MOSRT624DW*	low-voltage magnetic 1000 watts	included	5" (p. 282)	add one power extender (p. 285)	add plug option (p. 285)

DUAL-FEED OPTIONS

  5.8" (146 mm) 9.1" (231 mm)	1 x 120v 12v 2 x 300 watts Magnetic	Bronze: 700MOSRT60DZ Black: 700MOSRT60DB* Chrome: 700MOSRT60DC Satin Nickel: 700MOSRT60DS White: 700MOSRT60DW*	low-voltage magnetic 1000 watts	included	5" (p. 282)	add two power extenders (p. 285)	add plug option (p. 285)
---	--	--	---------------------------------------	----------	----------------	---	--------------------------------

*Black and White finish options have Satin Nickel feeds

 Indicates which transformers are compatible with LED elements.



Remodel Recessed Transformers

Remodel Recessed Transformers install in a similar fashion as remodel recessed downlights and are concealed inside a housing that recesses above the ceiling. The decorative canopy is the only visible portion of the transformer once installed.



Remodel Recessed Transformers look similar from below the ceiling to the power feed canopies used with remote transformers and are preferred for their clean look. An additional benefit they have over remote transformers is that they do not require access to a remote location because the transformer sits just above the ceiling. However, they are not compatible with all finished ceilings because an electrician will need to install the Remodel Recessed Transformer in close proximity to an existing junction box, drill through the finished ceiling in the location where the Remodel Recessed Transformer will be installed, and cover the existing junction box with the provided field-paintable metal cover. In new construction, an electrician can simply bring power to the Remodel Recessed Transformer directly.

The Remodel Recessed Transformer has an integral power feed so there is no need for a separate power feed; however, the transformer must be installed directly above the rail run. Insulation must be kept at least 3 inches away from the transformer and housing. This transformer is equipped with fast-acting short circuit and overload protection that will safely turn off the system should a short occur. Once the short is removed, the unit can be reset by simply flipping the wall switch off and back on.





INPUT VOLTAGE OUTPUT VOLTAGE WATTAGE TYPE	ITEM NUMBER	COMPATIBLE DIMMER TYPE	COMPATIBLE RIGID RIGID STANDOFF	TO DROP FROM CEILING GREATER THAN SHORTEST COMPATIBLE RIGID STANDOFF
--	-------------	---------------------------	------------------------------------	--

LOW-PROFILE SINGLE-FEED OPTIONS**

	1 x 120v 12v 1 x 150 watts Electronic	Bronze: 700MOSRR151EZ Chrome: 700MOSRR151EC Satin Nickel: 700MOSRR151ES White: 700MOSRR151EW*	low-voltage electronic 600 watts	1" (p. 282)	not compatible with power extenders
	1 x 120v 12v 1 x 300 watts Electronic	Bronze: 700MOSRR301EZ Chrome: 700MOSRR301EC Satin Nickel: 700MOSRR301ES White: 700MOSRR301EW*	low-voltage electronic 600 watts	1" (p. 282)	not compatible with power extenders

EXTENDABLE SINGLE-FEED OPTIONS

	1 x 120v 12v 1 x 150 watts Electronic	Bronze: 700MOSRR15EZ Chrome: 700MOSRR15EC Satin Nickel: 700MOSRR15ES White: 700MOSRR15EW*	low-voltage electronic 600 watts	2" (p. 282)	add one power extender (p. 285)
	1 x 120v 12v 1 x 300 watts Electronic	Bronze: 700MOSRR30EZ Chrome: 700MOSRR30EC Satin Nickel: 700MOSRR30ES White: 700MOSRR30EW*	low-voltage electronic 600 watts	2" (p. 282)	add one power extender (p. 285)

*White finish option has Satin Nickel feed

**Not compatible with Power Extenders or Power Vault Adapter

Special Installations

USING A DIRECT-END POWER FEED

These direct-end power feeds bring power from a remote transformer to the rail at an end of the run and mount to a wall perpendicular to the run. Use with a single-feed remote transformer (p. 284).

4" ROUND DIRECT-END POWER FEED

Mounts to a standard 4" junction box with round plaster ring (provided by electrician).

700MOP4CD FINISH

- Z ANTIQUE BRONZE
- C CHROME
- S SATIN NICKEL



2" SQUARE DIRECT-END POWER FEED

Mounts to special 2" square junction box (included).

700MOP2CD FINISH

- Z ANTIQUE BRONZE
- C CHROME
- S SATIN NICKEL

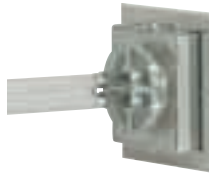

RECTANGULAR DIRECT-END POWER FEED

Mounts to a gem or single gang junction box (provided by electrician).

700MOPRCD FINISH

- Z ANTIQUE BRONZE
- C CHROME
- S SATIN NICKEL



TO CANTILEVER FROM A WALL

There are two types of outside riggers—one for power, one for support. Both types of outside rigger extend 36" from the wall and are field-cuttable.

POWER OUTSIDE RIGGER

Supports and power feeds rail from a remote transformer. Includes 4" round canopy and 2" square canopy. Use with a single-feed remote transformer (p. 284).

700MOPORG2 FINISH

- Z ANTIQUE BRONZE
- C CHROME
- S SATIN NICKEL



SUPPORT OUTSIDE RIGGER

Extends from the wall to support rail. Use every three feet of run.

700MOSORG FINISH

- Z ANTIQUE BRONZE
- C CHROME
- S SATIN NICKEL



USING END AND CENTER POWER FEEDS

End and center power feeds are generally used to bring power to a MonoRail system when the transformer cannot be located directly above the run. The power feed can be mounted to a standard 4" junction box with round plaster ring (provided by electrician), directly to a Remote Transformer (p. 284), or to a Kable Lite Surface Transformer (pp. 336-337).

END POWER FEED

The end power feed pushes into an end of the MonoRail and includes a removable 4" round canopy and 12' field-cuttable softwire leads.

700MOPEND FINISH

- Z ANTIQUE BRONZE
- C CHROME
- S SATIN NICKEL



CENTER POWER FEED

The center power feed can be used anywhere within the run and includes a removable 4" round canopy and 12' field-cuttable softwire leads. Specify dual-feed when using a dual-feed transformer.

700MOPCEN

- | TYPE | FINISH |
|-------------|------------------|
| SINGLE-FEED | Z ANTIQUE BRONZE |
| 4 DUAL-FEED | C CHROME |
| | S SATIN NICKEL |



SINGLE-FEED



Special Installations

INSTALLING MONORAIL TO A VAULTED CEILING

To install a MonoRail system to a vaulted ceiling, add a power vault adapter to each power feed and add a standoff vault adapter to each standoff.

POWER VAULT ADAPTER

Installs to the power feed (sold separately) and adjusts to any angle to position rail parallel to the floor.

700MOPVLT	FINISH
Z	ANTIQUÉ BRONZE
C	CHROME
S	SATIN NICKEL



STANDOFF VAULT ADAPTER

Installs between the rigid or adjustable standoff (sold separately) and the ceiling to position rail parallel to the floor. Includes several rod lengths to achieve the proper pitch when used with a surface transformer.

700MOCVLT	FINISH
Z	ANTIQUÉ BRONZE
C	CHROME
S	SATIN NICKEL



INSTALLING MONORAIL TO A T-BAR DROP CEILING

To install a MonoRail system to a T-bar drop ceiling, add a T-bar connector to every standoff (sold separately). The T-bar clip twists into the slat. (Use only if local electrical codes allow).

T-BAR CONNECTOR

Specify 15/16" or 9/16" slat.

700MOTBAR	SLAT	FINISH
C	15/16"	B BLACK
9C	9/16"	W WHITE



USING A "T" OR "X" CONNECTOR

Use the special "T" or "X" connectors to make a clean splice into a straight horizontal rail run. These connectors are conductive, so you may power the system from any of the runs.

"T" CONNECTOR

The "T" connector joins three pieces of MonoRail to form a "T". At least one standoff must be located near the connector.

700MOCTT	FINISH
Z	ANTIQUÉ BRONZE
C	CHROME
S	SATIN NICKEL



"X" CONNECTOR

The "X" connector joins four pieces of MonoRail to form an "X". At least one standoff must be located near the connector.

700MOCTX	FINISH
Z	ANTIQUÉ BRONZE
C	CHROME
S	SATIN NICKEL

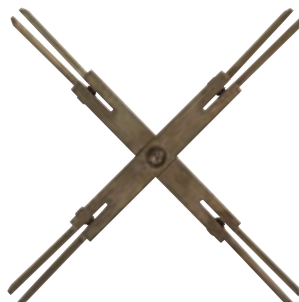

USING A RECESSED CAN TRANSFORMER

Use to retrofit an existing recessed down light to power a MonoRail system. Mounts to any recessed can that is 6-1/4" to 6-1/2" in diameter and has "C" shaped hooks on the inside can wall.

RECESSED CAN TRANSFORMER

Compatible with 2" Rigid Standoff. Includes white canopy, antique bronze, chrome or satin nickel Power Feed and 150 watt electronic transformer. Dimmable with a low-voltage electronic dimmer.

700MOREC15E	FINISH
Z	ANTIQUÉ BRONZE
C	CHROME
S	SATIN NICKEL



ETL classified for use with the following recessed cans: Juno IC2, Juno IC22, TC2, and TC2R; Halo H7T and H7RT; Cooper Lighting H27RT; Capri (Thomas) Lighting PR75ASIC/TPR75ASIC/DY6431; Progress Lighting P7TG, P8-TG, and P-8TG & PIO8-TG.

Tech Lighting is not affiliated with, nor is it endorsed by, any of the companies listed above. Tech Lighting does not distribute or sell any of the products listed above. Call for more information.

MonoRail Kits

ALL MONORAIL KITS INCLUDE:

8' long hand-bendable MonoRail. Choose between:

ANTIQUÉ BRONZE - BROWN INSULATOR



CHROME - CLEAR INSULATOR



SATIN NICKEL - CLEAR INSULATOR



Actual Size

Two sets of decorative end caps



Two rigid standoffs. Size will vary depending on kit.



12 volt 150 or 300 watt magnetic surface transformer with power feed or 300 watt magnetic remote transformer with power feed.



Surface Transformers



Remote Transformer



LOCATION: PRIVATE RESIDENCE — ANN ARBOR, MI DESIGN: ELAN DESIGNS

PICKING A KIT IS EASY, BELOW ARE TWO SIMPLE STEPS TO WALK YOU THROUGH CHOOSING YOUR MONORAIL KIT.

ONE CHOOSE A KIT (P. 293)

You may choose between a 12 volt 150 watt surface transformer, 300 watt surface transformer or 300 watt remote transformer kit.

TWO SELECT YOUR ELEMENTS (PP. 30-135)

You can choose from over 100 heads and pendants to complete your system.



SURFACE TRANSFORMER KITS

150 WATT KIT

Magnetic Surface Transformer mounts to a standard 4" junction box with round plaster ring (provided by electrician), rail drops 3.6" from ceiling. Add up to three 50 watt elements or up to four 35 or 37 watt elements.

700MOKTS150 FINISH

- Z ANTIQUE BRONZE
- C CHROME
- S SATIN NICKEL



300 WATT KIT

Magnetic Surface Transformer mounts to a standard 4" junction box with round plaster ring (provided by electrician), rail drops 4.8" from ceiling. Add up to six 50 watt elements or up to eight 35 or 37 watt elements.

700MOKTS300 FINISH

- Z ANTIQUE BRONZE
- C CHROME
- S SATIN NICKEL

REMOTE TRANSFORMER KIT

300 WATT KIT

Magnetic Remote Transformer installs in an accessible location behind the ceiling or wall. Canopy mounts to a standard 4" junction box with round plaster ring (provided by electrician), rail drops 2" from ceiling. Add up to six 50 watt elements or up to eight 35 or 37 watt elements.

700MOKTA300 FINISH

- Z ANTIQUE BRONZE
- C CHROME
- S SATIN NICKEL



Two-Circuit MonoRail

Two-Circuit MonoRail gives you two independently controllable, low-voltage circuits on a hand-bendable rail for maximum flexibility and design.

www.techlighting.com





Two-Circuit MonoRail Satin Nickel / End Caps / Isolating Connectors / Remote 2x300 Watt 12 Volt Transformers / 4" Round Single-Feed Canopies / 96" Power Extenders / Adjustable Standoffs / 1" Sprocket Heads / MR16 Lamps

LOCATION: NICOLE MILLER, CHICAGO, IL
DESIGN: MICHAEL WAECHTER, AIA
PHOTOGRAPHER: JEFF MILLIES, HEDRICH BLESSING



Two-Circuit MonoRail Satin Nickel / End Caps /
Remote 2x300 Watt 12 Volt Transformers /
4" Round Single-Feed Canopies / 6" Rigid Standoffs /
6" Power Extenders / 6" Spot Heads / 6" John Heads /
MR16 Lamps / MR16 Lamps

LOCATION: CARMICHAEL RESIDENCE, AMELIA ISLAND, FL
DESIGNER: AMANDA WEBSTER DESIGN
PHOTOGRAPHER: SHAWN FENTRESS, JACKSONVILLE BEACH, FL





TWO INDIVIDUALLY SWITCHED CIRCUITS ARE BOTH ON, USING FUNCTIONAL TASK HEADS AND DECORATIVE PENDANTS.



ONLY THE FUNCTIONAL HEAD CIRCUIT IS POWERED ON.



ONLY THE DECORATIVE PENDANT CIRCUIT IS POWERED ON.

Two-Circuit MonoRail Satin Nickel / End Caps / Remote 2x300 Watt 12 Volt Transformer / 4" Round Single-Feed Canopy / 2" Rigid Standoffs / 6" Aero Heads / Round Glass Shield Accessories Frost / MR16 Lamps / Savoy Pendants White / Bi-pin Lamps

The Basics of Two-Circuit MonoRail

ONE DESIGN YOUR TWO-CIRCUIT MONORAIL SYSTEM



The first step in designing your Two-Circuit MonoRail system is to determine what it is you are trying to light. You'll need to decide where the elements should be installed to put light where you want it, and which elements will be controlled by each circuit. The placement of the conductive metal set screw on the Two-Circuit MonoRail FreeJack connector determines which circuit is controlling the element. See Compatible Elements on pp. 266-269 for thumbnails of all available elements. Refer to the indicated pages for detailed specifications. Choose your elements then add accessories if desired. We offer a broad range of colorful and decorative accessories and functional optical controls (pp. 366-379).



Draw your Two-Circuit MonoRail run. Remember, Two-Circuit MonoRail can be shaped by hand to follow architectural details or to create an organic shape. Factory pre-bent shapes are also offered in several configurations. Your run must be placed so it runs directly beneath the surface transformer or power feed and intersects the locations of all the elements. Determine how many pieces of rail you'll need (p. 300). Add one set of end caps to each end of the run for an elegant finishing touch (p. 301).

TWO ADD POWER AND HARDWARE TO COMPLETE YOUR SYSTEM



Add up the wattages of the lamps you'll be using on the system: this will help you select a transformer. A remote transformer with power feed canopy provides the cleanest look, but the remote transformer must be installed in an accessible, remote location. The surface transformer simply mounts to a junction box. Two-Circuit MonoRail transformers come pre-wired with either two or four 120 volt input lines to allow for independent switching of the circuits. 24 volt transformers cannot be used with Two-Circuit MonoRail. Use the information on pp. 384-385 to help you choose the right transformer for your installation; see pp. 304-306 for Two-Circuit MonoRail transformer and power feed options.

Determine how far from the ceiling you want the system to drop. Power feed canopies place the rail two inches from the ceiling; Two-Circuit MonoRail surface transformers place the rail six inches from the ceiling. If this drop is shorter than you require, you'll need to add a power extender (p. 305) to your canopy or surface transformer. The maximum standard drop for Two-Circuit MonoRail is eight feet.



Next, add standoffs that match the drop of your power feed to support the system (p. 302). Adjustable standoffs provide a clean, elegant look. Choose rigid standoffs for curvy runs, or runs with multiple glass pendants. You'll need one standoff for every three feet of Two-Circuit MonoRail. The power feed counts as a support, so begin adding standoffs three feet from the power feed. Note: Power extenders and standoffs are field-cuttable, so it's easy to achieve a custom drop length.





For design harmony, all the power, standoff, and elements connections to the Two-Circuit MonoRail are shaped identically. Note that standoffs and elements can be positioned to cover where rails are joined to maintain the smooth line.

For other Two-Circuit MonoRail system options, such as mounting to a vaulted or T-bar ceiling or to a wall, see Special Installations on pp. 306-308.

Two-Circuit MonoRail



TWO-CIRCUIT MONORAIL

Hand-bendable, field-cutttable Two-Circuit MonoRail is rated for 300 watts per circuit at 12 volts. Each piece of rail is shipped with conductive connectors to join rail pieces end to end. Order additional connectors (p. 301) if cutting and rejoining rails.

700MO2A	LENGTH	FINISH / INSULATOR
24	24" (.61 m)	BRZ ANTIQUE BRONZE WITH BROWN INSULATOR
48	48" (1.2 m)	Z ANTIQUE BRONZE WITH CLEAR INSULATOR
96	96" (2.4 m)	C CHROME WITH CLEAR INSULATOR
		S SATIN NICKEL WITH CLEAR INSULATOR

ANTIQU BRONZE - BROWN INSULATOR



For a holistic antique bronze finish, a brown insulator is recommended.

ANTIQU BRONZE - CLEAR INSULATOR



Actual Size

CHROME - CLEAR INSULATOR



SATIN NICKEL - CLEAR INSULATOR



Two-Circuit MonoRail bends horizontally to a radius as small as 12". It cannot be bent vertically in the field. For custom factory bends, provide degree and radius of curve.

TIP: To calculate the amount of rail you'll need for an organic shape, draw the Two-Circuit MonoRail run to scale (for example, 1/4" = 1'). Use a piece of string to "trace" the drawing. Measure the length of string, then convert from your scale.

PRE-BENT S CURVE TWO-CIRCUIT MONORAIL

Two-Circuit MonoRail pre-bent into a horizontal S curve. Consult the drawing for approximate dimensions. For a factory bend not shown below, please call for a custom quotation.

700MO2BHSC60	FINISH / INSULATOR
BRZ	ANTIQU BRONZE WITH BROWN INSULATOR
Z	ANTIQU BRONZE WITH CLEAR INSULATOR
C	CHROME WITH CLEAR INSULATOR
S	SATIN NICKEL WITH CLEAR INSULATOR

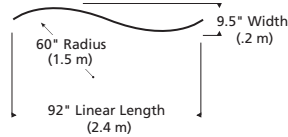

PRE-BENT 90° CURVE TWO-CIRCUIT MONORAIL

Horizontal 90° curves are sold by radius, or the distance from the center of the circle to the outside edge. Join four 90° curves to create a circle with a diameter (overall width) equal to twice the specified radius. For a factory bend not shown below, please call for a custom quotation.

700MO2BH90	RADIUS	FINISH / INSULATOR
12	12"	BRZ ANTIQU BRONZE WITH BROWN INSULATOR
18	18"	Z ANTIQU BRONZE WITH CLEAR INSULATOR
24	24"	C CHROME WITH CLEAR INSULATOR
36	36"	S SATIN NICKEL WITH CLEAR INSULATOR
48	48"	
60	60"	

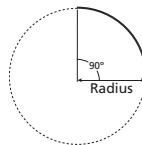

Connectors

CONDUCTIVE CONNECTORS

Conductive connectors join sections of rail together end to end and are included with all Two-Circuit MonoRail pieces. Order separately if cutting and rejoining rails. Set of three.

700MO2CCN FINISH

- Z ANTIQUE BRONZE
- C CHROME
- S SATIN NICKEL

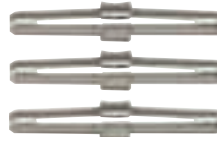

ISOLATING CONNECTORS

Isolating connectors join sections of rail and isolate power feeds from each other. Two common uses are in runs using more than 300w or in runs over 30ft where a two power feeds are required to avoid voltage drop. All dual-feed canopies are shipped with isolating connectors; order additional if required by layout. Set of three.

700MO2CINC



FLEXIBLE HORIZONTAL CONNECTORS

These conductive connectors join sections of rail together end to end at desired sharp horizontal angle. Set of three.

700MO2CFXH FINISH

- Z ANTIQUE BRONZE
- C CHROME
- S SATIN NICKEL



END CAPS

Decorative end caps fit into ends of Two-Circuit MonoRail run for a finished look. Set of three; order one set for each end.

700MO2CCAP FINISH

- Z ANTIQUE BRONZE
- C CHROME
- S SATIN NICKEL



Standoffs

Use standoff supports every three feet of Two-Circuit MonoRail run and at corners. Standoffs can be positioned to cover points where rails are joined.

RIGID STANDOFF

The field-cutttable rigid standoff is recommended for curvy runs or runs with heavier elements, such as glass pendants. Rigid standoffs are compatible with various power feed options: Use the chart below to determine the appropriate standoff for your run.

To determine the shortest compatible standoff for any power feed or surface transformer option, see pp. 305-306.

LENGTH	STANDOFF	FINISH
2" (1.9")*	700MO2S02	(Z, C, or S)
3" (3.6")*	700MO2S03	(Z, C, or S)
6" (5.8")*	700MO2S06	(Z, C, or S)

12"*	700MO2S12	(Z, C, or S)
24"*	700MO2S24	(Z, C, or S)
36"*	700MO2S36	(Z, C, or S)
48"*	700MO2S48	(Z, C, or S)
96"*	700MO2S96	(Z, C, or S)

*actual length from ceiling to top of rail

ADJUSTABLE STANDOFF

The adjustable standoff's cable virtually disappears for a clean and elegant look. It is best used on fairly straight runs with a drop greater than 6". A wire grip allows you to easily shorten or lengthen the cable to size it for use.

700MO2SADJ	LENGTH	FINISH
	12' OF CABLE	Z ANTIQUE BRONZE
3	30' OF CABLE	C CHROME
		S SATIN NICKEL

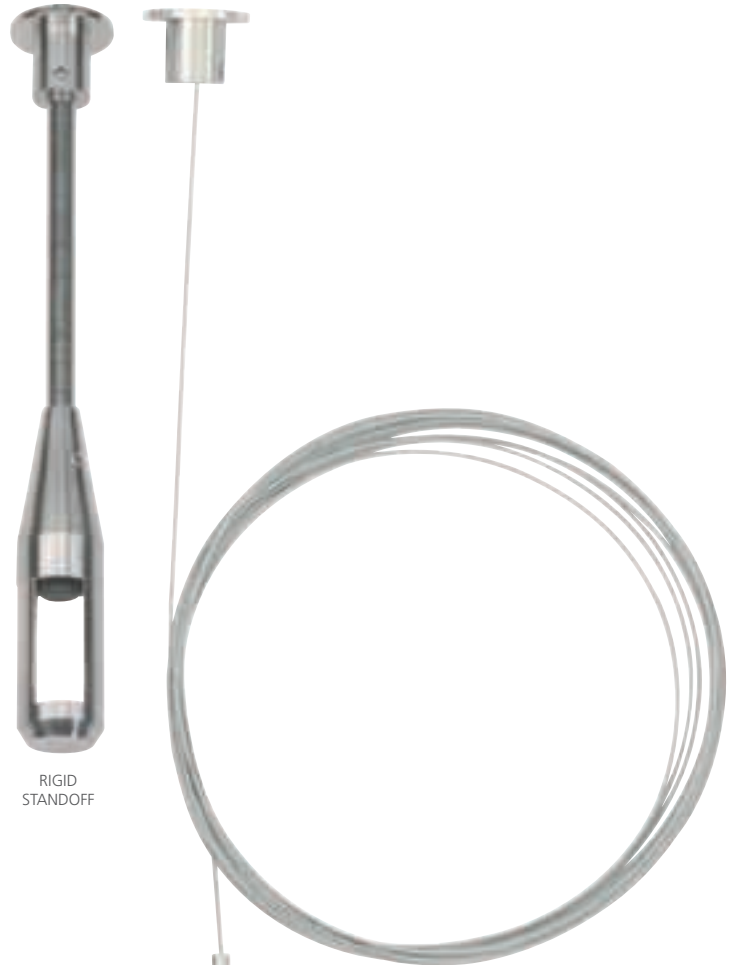

RIGID
STANDOFF

ADJUSTABLE
STANDOFF

TIP: For best appearance, place the last standoff 4-6" from the end of the rail, and place standoffs symmetrically.





ginkgo cafe

Two-Circuit MonoRail Satin Nickel / End Caps /
Remote 4x300 Watt 12 Volt Transformer /
4" Round Dual-Feed Canopy / 2" Rigid Standoffs /
3" Swivel Heads / Round Glass Shield Accessories
Amber / MR16 Lamps

LOCATION: MORTON ARBORETUM — LISLE, IL
ARCHITECT: DAVID WOODHOUSE
PHOTOGRAPH: HOTSHOTS IMAGING — CHICAGO, IL

Remote Transformers

Remote transformers install in an accessible location behind the ceiling or wall. For technical information on remote transformers, see p. 384-385. Requires canopy (p. 305) or special power feed (p. 306).

INPUT VOLTAGE OUTPUT VOLTAGE WATTAGE TYPE	ITEM NUMBER	COMPATIBLE DIMMER TYPE	COMPATIBLE DIMMING COIL	PLUG-IN TRANSFORMER OPTION	277 VOLT INPUT OPTION
--	-------------	---------------------------	----------------------------	----------------------------------	--------------------------

SINGLE-FEED OPTIONS

	2 x 120v 12v 2 x 300 watts Magnetic	700AT2X300T	up to two low-voltage magnetic 600 watts	add two 700DIM300 (p. 385)	add two plug options (p. 305)	700AT2X300T277
	2 x 120v 12v 2 x 300 watts Electronic	700AT2X300EL	up to two low-voltage electronic 600 watts	—	add two plug options (p. 305)	—

DUAL-FEED OPTIONS

	4 x 120v 12v 4 x 300 watts Magnetic	700AT4X300T	up to four low-voltage magnetic 600 watts	add four 700DIM300 (p. 385)	add four plug options (p. 305)	700AT4X300T277
	4 x 120v 12v 4 x 300 watts Electronic	700AT4X300EL	up to four low-voltage electronic 600 watts	—	add four plug options (p. 305)	—



Power Feed Canopies

ITEM NUMBER	MOUNTS TO	SHORTEST COMPATIBLE RIGID STANDOFF	TO DROP FROM CEILING GREATER THAN SHORTEST COMPATIBLE RIGID STANDOFF
-------------	-----------	------------------------------------	--

SINGLE-FEED OPTIONS USE WITH ONE SINGLE-FEED REMOTE TRANSFORMER

4" Round Single-Feed 	Bronze: 700MO2P4C02Z Black: 700MO2P4C02B* Chrome: 700MO2P4C02C Satin Nickel: 700MO2P4C02S White: 700MO2P4C02W*	standard 4" junction box with round plaster ring (provided by electrician)	2" (p. 302)	add one power extender (below)
--	--	--	----------------	--------------------------------

DUAL-FEED OPTIONS USE WITH ONE DUAL-FEED REMOTE TRANSFORMER (ISOLATING CONNECTORS INCLUDED)

4" Round Dual-Feed 	Bronze: 700MO2P4C402Z Black: 700MO2P4C402B* Chrome: 700MO2P4C402C Satin Nickel: 700MO2P4C402S White: 700MO2P4C402W*	standard 4" junction box with round plaster ring (provided by electrician)	2" (p. 302)	add two power extenders (below)
--	---	--	----------------	---------------------------------

*Black and White finish options have Satin Nickel feeds.

PLUG OPTION

16' cord and plug for standard 120V power outlets.

700A1-	COLOR
	WHT WHITE BLK BLACK



POWER EXTENDER

Add to power feed canopy or surface transformer to drop power from ceiling. For dual-feed canopies and transformers, order two. Field-cuttable.

700MO2P	LENGTH	FINISH
03	3"	Z ANTIQUE BRONZE
06	6"	C CHROME
12	12"	S SATIN NICKEL
24	24"	
36	36"	
48	48"	
96	96"	



Surface Transformers

All surface transformers mount to a standard 4" junction box with round plaster ring (provided by electrician). For technical information on surface transformers, see p. 344.

INPUT VOLTAGE OUTPUT VOLTAGE WATTAGE TYPE	ITEM NUMBER	COMPATIBLE DIMMER TYPE	COMPATIBLE DIMMING COIL	SHORTEST COMPATIBLE RIGID STANDOFF	TO DROP FROM CEILING	PLUG IN TRANSFORMER OPTION
--	-------------	------------------------	-------------------------	------------------------------------	----------------------	----------------------------

SINGLE-FEED OPTIONS

	2 x 120v 12v 2 x 150 watts Magnetic	Bronze: 700MO2SRT30DZ Black: 700MO2SRT30DB* Chrome: 700MO2SRT30DC Satin Nickel: 700MO2SRT30DS White: 700MO2SRT30DW*	up to two low-voltage magnetic 600 watts	included	6" (p. 302)	add one power extender (above)	add two plug options (above)
	2 x 120v 12v 2 x 250 watts Magnetic	Bronze: 700MO2SRT50DZ Black: 700MO2SRT50DB* Chrome: 700MO2SRT50DC Satin Nickel: 700MO2SRT50DS White: 700MO2SRT50DW*	up to two low-voltage magnetic 600 watts	included	6" (p. 302)	add one power extender (above)	add two plug options (above)

*Black and White finish options have Satin Nickel feeds.

Special Installations

USING A DIRECT-END POWER FEED

The direct-end power feed brings power from a remote transformer to the rail at an end of the run and mounts to a wall perpendicular to the run. Use with a single-feed remote transformer (p. 304).

4" ROUND DIRECT-END POWER FEED

Mounts to a standard 4" junction box with round plaster ring (provided by electrician).

700MO2P4CD	FINISH	
Z	ANTIQUÉ BRONZE	
C	CHROME	
S	SATIN NICKEL	



USING A CENTER POWER FEED

A center power feed is generally used to bring power to a Two-Circuit MonoRail system when the transformer or junction box cannot be located directly above the run. The power feed can be mounted to a standard 4" junction box with round plaster ring (provided by electrician) or directly to a Remote Transformer.

CENTER POWER FEED

The center power feed can be used anywhere within the run and includes a removable 4" round canopy and 12' field-cutttable softwire leads. Specify dual-feed when using a dual-feed transformer.

700MO2PCEN	TYPE	FINISH
	SINGLE-FEED	Z ANTIQUÉ BRONZE
4	DUAL-FEED	C CHROME
		S SATIN NICKEL



INSTALLING TWO-CIRCUIT MONORAIL TO CANTILEVER FROM A WALL

There are two types of outside riggers—one for power, one for support. Both types of outside rigger extend 36" from the wall and are field-cuttable.

POWER OUTSIDE RIGGER

Supports and power feeds rail from a remote transformer. Includes 4" round canopy and two support outside riggers. Use with a single-feed remote transformer (p. 304).

700MO2PORG4 FINISH

- BRZ ANTIQUE BRONZE WITH BROWN INSULATOR
- Z ANTIQUE BRONZE
- C CHROME
- S SATIN NICKEL

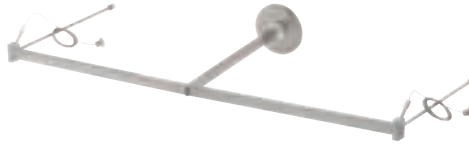

SUPPORT OUTSIDE RIGGER

Extends from the wall to support rail. Use every three feet of run.

700MO2SORG FINISH

- Z ANTIQUE BRONZE
- C CHROME
- S SATIN NICKEL

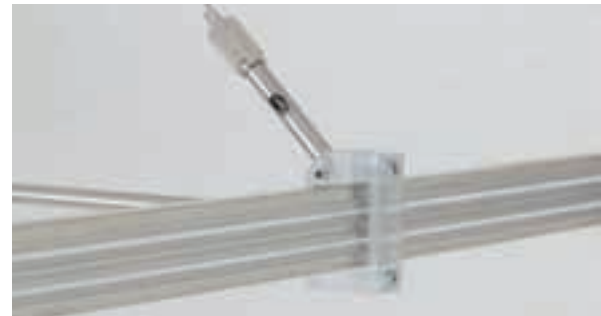

USING A "T" OR "X" CONNECTOR

Use the special "T" or "X" connector to make a clean splice into a straight rail run.

"T" CONNECTOR

The "T" connector joins three pieces of Two-Circuit MonoRail to form a "T". It is conductive, so you may power the system from any of the runs. At least one standoff must be located near the connector.

700MO2CTT FINISH

- Z ANTIQUE BRONZE
- C CHROME
- S SATIN NICKEL



"X" CONNECTOR

The "X" connector joins four pieces of Two-Circuit MonoRail to form an "X". It is conductive, so you may power the system from any of the runs. At least one standoff must be located near the connector.

700MO2CTX FINISH

- Z ANTIQUE BRONZE
- C CHROME
- S SATIN NICKEL



Special Installations

INSTALLING TWO-CIRCUIT MONORAIL TO A VAULTED CEILING

To install a Two-Circuit MonoRail system to a vaulted ceiling, add a power vault adapter to each power feed and add a standoff vault adapter to each standoff.

POWER VAULT ADAPTER

Installs to the power feed (sold separately) and adjusts to any angle to position rail parallel to the floor.

700MO2PVL

FINISH	
Z	ANTIQUÉ BRONZE
C	CHROME
S	SATIN NICKEL



STANDOFF VAULT ADAPTER

Installs between the rigid or adjustable standoff (sold separately) and the ceiling to position rail parallel to the floor. Includes additional rod length to achieve the proper pitch when using a surface transformer.

700MO2CVLT

FINISH	
Z	ANTIQUÉ BRONZE
C	CHROME
S	SATIN NICKEL



INSTALLING TWO-CIRCUIT MONORAIL TO A T-BAR DROP CEILING

To install a Two-Circuit MonoRail system to a T-bar drop ceiling, add a T-bar connector to every standoff (sold separately). The T-bar clip twists into the slat. (Use only if local electrical codes allow).

T-BAR CONNECTOR

Specify 15/16" or 9/16" slat.

700MO2TBAR

SLAT	FINISH	
C 15/16"	B	BLACK
9C 9/16"	W	WHITE





Two-Circuit MonoRail Antique Bronze / End Caps /
Remote 600 Watt 12 Volt Transformer /
4" Round Single-Feed Canopy / 2" Rigid Standoffs /
3" Aero Heads / Round Glass Shield Accessories
Amber / MR16 Lamps / Ovation Pendants with Iron
Wrap Accessories Tortoise Shell / Bi-pin Lamps

LOCATION: PRIVATE RESIDENCE
DESIGNER: KAREN LEHMAN NORSK REMODELING
PHOTOGRAPHER: ROGER TURK

Wall MonoRail

The Wall MonoRail system perfectly suits gallery style illumination, bringing focus to artwork, display merchandise or signage.

Wall MonoRail can also be ceiling mounted for a more *flush* version of MonoRail (see pp. 314-315).

www.techlighting.com





Wall MonoRail Antique Bronze / End Caps / Remote
300 Watt 12 Volt Transformer / 2" Square Single-Feed
Canopy / Wall MonoRail Standoffs / Wally Lite Heads /
MR16 Lamps

The Basics of Wall MonoRail

ONE DESIGN YOUR WALL MONORAIL SYSTEM



The first step in designing your Wall MonoRail system is to determine what it is you are trying to light. You will need to decide where the elements should be installed to put light where you want it. See Compatible Elements on pp. 266-269 for thumbnails of all available elements. Refer to indicated pages for detailed specifications. Choose your elements, then add accessories if desired. We offer a broad range of colorful and decorative accessories and functional optical controls (pp. 366-379).

If mounting Wall MonoRail to the ceiling and using pendants, order the FJ version of the pendant and one Wall MonoRail FreeJack Connector (p. 355) for every pendant.

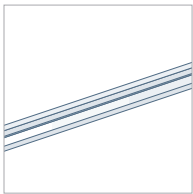

Draw in your Wall MonoRail run. Remember, Wall MonoRail can be shaped by hand to follow a curved wall or soffit. Your Wall MonoRail must be placed so it runs directly in front of the junction box if using a remote transformer or within two feet of the junction box if using a surface transformer. Determine how many pieces of rail you'll need (p. 316). Add a pair of end caps to each end of the run for an elegant finishing touch (p. 317).

TWO ADD POWER AND HARDWARE TO COMPLETE YOUR SYSTEM



Add up the wattages of the lamps you'll be using on the system: this will help you select a transformer. A remote transformer with power feed canopy provides the cleanest look, but the remote transformer must be installed in an accessible, remote location. A surface transformer simply mounts to a nearby junction box and requires end or center power feed connectors to bring power from the transformer to the run. Use the information on pp. 384-385 to help you choose the right transformer for your installation; see pp. 318-321 for Wall MonoRail transformer and power feed options. If you are using LED fixtures, be sure to choose a transformer that is compatible with LED elements. See pp. 266-269 for a list of Compatible LED Elements.

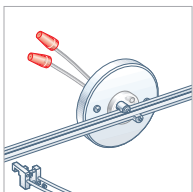

If using a remote transformer, determine what shape power feed canopy you would like to use (p. 319).



Next, add standoffs (p. 316). You'll need one standoff for every three feet of Wall MonoRail. The power feed canopy counts as a support, so begin adding standoffs three feet from the power feed canopy.



Wall Mounted

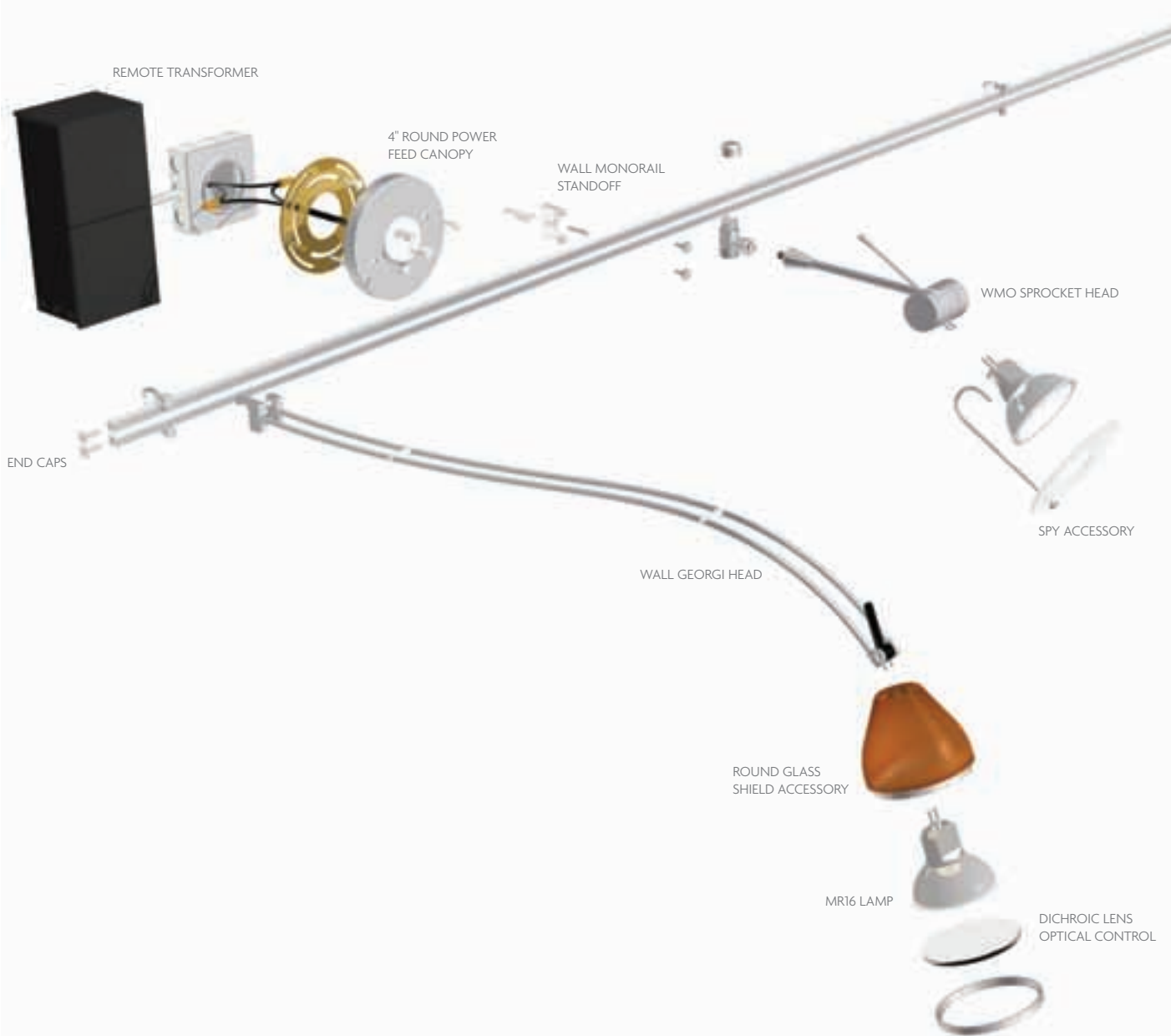

Ceiling Mounted Wall MonoRail

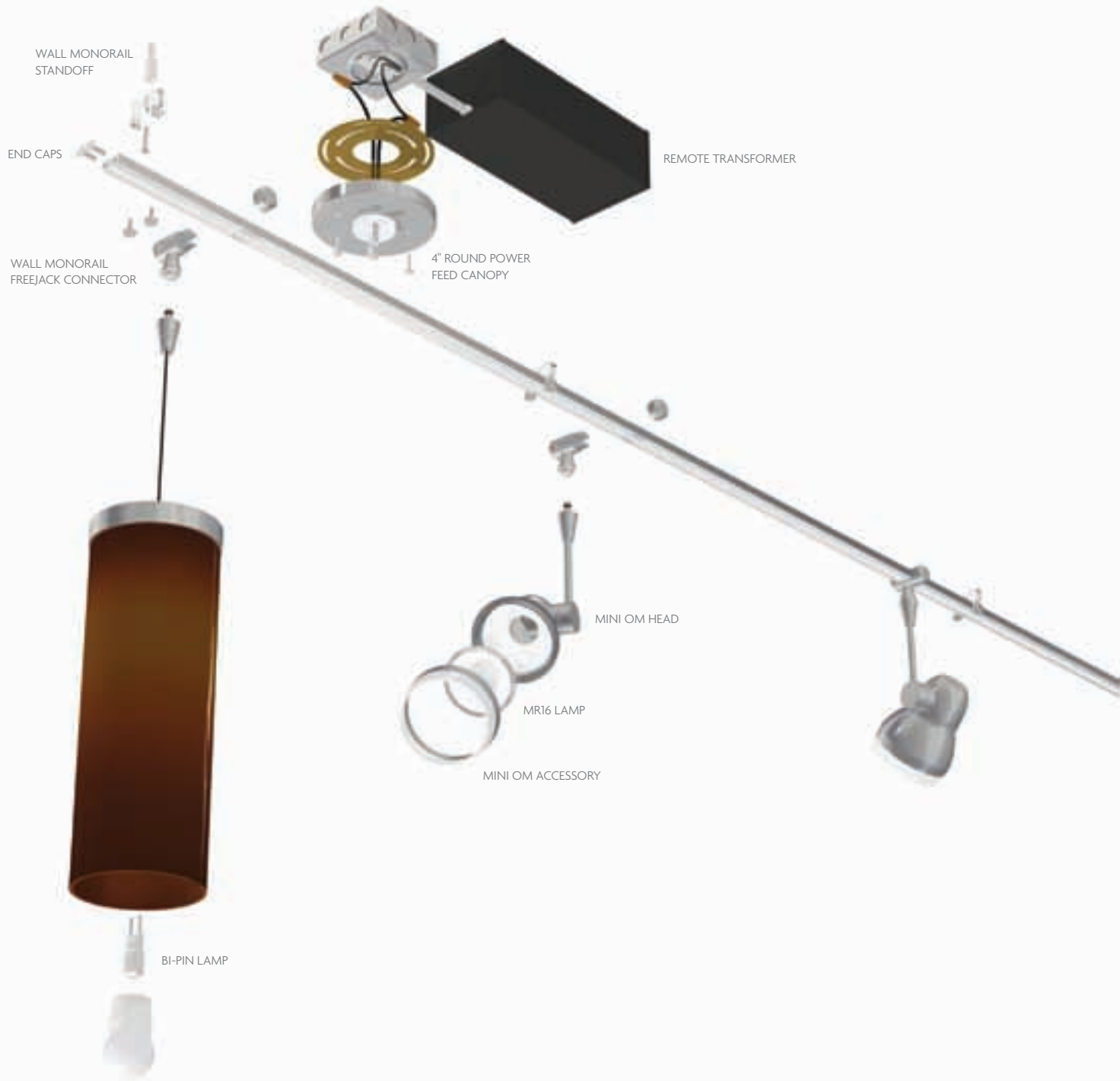



Wall MonoRail Satin Nickel (Ceiling Mounted) /
End Caps / Remote 300 Watt 12 Volt Transformer /
4" Round Single-Feed Canopy / Wall MonoRail
Standoffs / Aero Heads / Prism Accessories Clear /
FreeJack 4" Round Flush Canopies, Satin Nickel /
Cone Pendants Clear Satin Nickel / MR16 Lamps

Wall MonoRail

WALL MONORAIL

Hand-bendable, field-cuttable Wall MonoRail is rated for 300 watts at 12 volts, 600 watts at 24 volts. Each piece of rail is shipped with conductive connectors to join rail pieces end to end. Order additional connectors (p. 317) if cutting and rejoining rails.

700MOA	LENGTH	FINISH / INSULATOR
24	24" (.61 m)	BRZ ANTIQUE BRONZE WITH BROWN INSULATOR
48	48" (1.2 m)	Z ANTIQUE BRONZE WITH CLEAR INSULATOR
96	96" (2.4 m)	C CHROME WITH CLEAR INSULATOR
		S SATIN NICKEL WITH CLEAR INSULATOR

ANTIQUÉ BRONZE - BROWN INSULATOR



For a holistic antique bronze finish, a brown insulator is recommended.

ANTIQUÉ BRONZE - CLEAR INSULATOR



CHROME - CLEAR INSULATOR



SATIN NICKEL - CLEAR INSULATOR



Actual Size

Wall MonoRail bends horizontally to a radius as small as 6" and vertically to a radius as small as 24". For custom factory bends, provide degree and radius of curve.

TIP: To calculate the amount of rail you'll need for an organic shape, draw the Wall MonoRail run to scale (for example, 1/4" = 1'). Use a piece of string to "trace" the drawing. Measure the length of string, then convert from your scale.

Standoffs

Use standoff supports every three feet of Wall MonoRail run and at corners. Standoffs can be positioned to cover points where rails are joined.

WALL MONORAIL STANDOFF

Positions rail 1" from the wall. Order one for every three feet of run.

700WMOS01	FINISH
Z	ANTIQUÉ BRONZE
C	CHROME
S	SATIN NICKEL

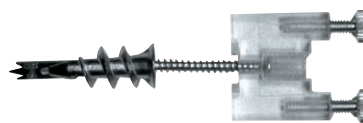

TIP: For best appearance, place the last standoff 4-6" from the end of the rail, and place standoffs symmetrically.



Connectors

CONDUCTIVE CONNECTORS

Conductive connectors join sections of rail together end to end and are included with all Wall MonoRail pieces. Order separately if cutting and rejoining rails. Pair.

700MOCCN FINISH

- Z ANTIQUE BRONZE
- C CHROME
- S SATIN NICKEL



ISOLATING CONNECTORS

Isolating connectors join sections of rail and isolate power feeds from each other. All dual-feed canopies are shipped with isolating connectors; order additional if required by layout. Pair.

700MOCINC



FLEXIBLE HORIZONTAL CONNECTORS

These conductive connectors join sections of rail together end to end at desired sharp horizontal angle. Pair.

700MOCFXH FINISH

- Z ANTIQUE BRONZE
- C CHROME
- S SATIN NICKEL



FLEXIBLE VERTICAL CONNECTORS

These conductive connectors join sections of rail together end to end at desired verticle angle. Pair.

700MOCFXV FINISH

- Z ANTIQUE BRONZE
- C CHROME
- S SATIN NICKEL



END CAPS

Decorative end caps fit into ends of Wall MonoRail run for a finished look. Pair; order one pair for each end.

700MOCCAP FINISH

- Z ANTIQUE BRONZE
- C CHROME
- S SATIN NICKEL



Remote Transformers

Remote transformers install in an accessible location behind the ceiling or wall. For technical information on remote transformers, see pp. 384-385. Requires canopy (p. 319) or special power feed (p. 321).

INPUT VOLTAGE OUTPUT VOLTAGE WATTAGE TYPE	ITEM NUMBER	COMPATIBLE DIMMER TYPE	COMPATIBLE DIMMING COIL	PLUG-IN TRANSFORMER OPTION <i>INCLUDES 16' CORD</i>	RECESSED REMOTE TRANSFORMER OPTION*	277 VOLT INPUT OPTION
--	----------------	------------------------------	-------------------------------	--	--	--------------------------

SINGLE-FEED OPTIONS

 	1 x 120v 12v 1 x 75 watts Magnetic	700AT075T	low-voltage magnetic 600 watts	—	700AT075P	—	700AT075T277
 	1 x 120v 12v 1 x 150 watts Magnetic	700AT150T	low-voltage magnetic 600 watts	700DIM150 (p. 385)	700AT150P	—	700AT150T277
 	1 x 120v 12v 1 x 300 watts Magnetic	700AT300T	low-voltage magnetic 600 watts	700DIM300 (p. 385)	700AT300P	700AT300TR	700AT300T277 700AT300TR277*
	1 x 120v 12v 1 x 300 watts Electronic	700AT300EL	low-voltage electronic 600 watts	—	700AT300ELP	—	—
	1 x 120v 24v 1 x 300 watts Magnetic	700AT3024T	low-voltage magnetic 600 watts	700DIM300 (p. 385)	700AT3024P	700AT3024TR	700AT3024T277 700AT3024TR277*

*In-wall recessed remote transformers also available for magnetic 300 watt models for use in applications where a remote transformer is desired but there isn't access to a remote location. See www.techlighting.com for dimensions and further details.

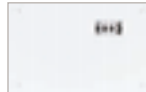



Indicates which transformers are compatible with LED elements.



Power Feed Canopies

ITEM NUMBER	MOUNTS TO
-------------	-----------

SINGLE-FEED OPTIONS USE WITH ONE SINGLE-FEED REMOTE TRANSFORMER

<p>4" Round Single-Feed</p> 	<p>Bronze: 700WMOP4RZ Chrome: 700WMOP4RC Satin Nickel: 700WMOP4RS White: 700WMOP4RW*</p>	<p>standard 4" junction box with round plaster ring (provided by electrician)</p>
<p>2" Square Single-Feed</p> 	<p>Bronze: 700WMOP2SQZ Chrome: 700WMOP2SQC Satin Nickel: 700WMOP2SQS White: 700WMOP2SQW*</p>	<p>special 2" square junction box (included)</p>
<p>2" x 4" Rectangular Single-Feed</p> 	<p>Bronze: 700WMOPRBZ Chrome: 700WMOPRBC Satin Nickel: 700WMOPRBS White: 700WMOPRBW*</p>	<p>standard single gang or gem box (provided by electrician)</p>

TIP: If using a dual-feed transformer, order 2 single-feed canopies and 1 isolating connector.

*White finish options have Satin Nickel feeds.





INPUT VOLTAGE OUTPUT VOLTAGE WATTAGE TYPE	ITEM NUMBER	COMPATIBLE DIMMER TYPE
--	-------------	------------------------

POWER FEED CANOPIES WITH LED TRANSFORMER

<p>4" Round Direct Single-Feed</p> 	<p>1 X 120V 12V 1 X 60 WATTS ELECTRONIC</p>	<p>Bronze: 700WMOP4R60EZ-LED Chrome: 700WMOP4R60EC-LED Satin Nickel: 700WMOP4R60ES-LED White: 700WMOP4R60EW-LED*</p>	<p>LOW-VOLTAGE ELECTRONIC 600 WATTS</p>
<p>4" Round Flexible End Power Feed</p> 	<p>1 X 120V 12V 1 X 60 WATTS ELECTRONIC</p>	<p>Bronze: 700MOPEND60EZ-LED Chrome: 700MOPEND60EC-LED Satin Nickel: 700MOPEND60ES-LED White: 700MOPEND60EW-LED*</p>	<p>LOW-VOLTAGE ELECTRONIC 600 WATTS</p>
<p>4" Round Flexible Center Power Feed</p> 	<p>1 X 120V 12V 1 X 60 WATTS ELECTRONIC</p>	<p>Bronze: 700MOPCEN60EZ-LED Chrome: 700MOPCEN60EC-LED Satin Nickel: 700MOPCEN60ES-LED White: 700MOPCEN60EW-LED*</p>	<p>LOW-VOLTAGE ELECTRONIC 600 WATTS</p>

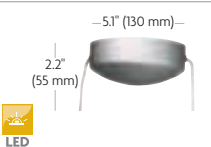
Surface Transformers

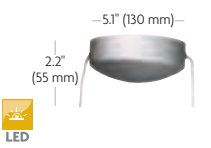
All surface transformers mount to a nearby standard 4" junction box with round plaster ring (provided by electrician). For technical information on surface transformers, see pp. 384-385. Requires end or center power feed (p. 321). Surface transformers cannot be placed directly between Wall MonoRail and the wall.

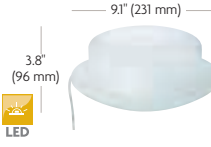
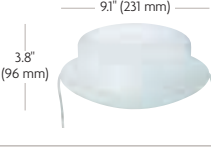
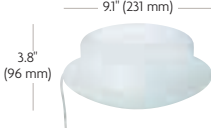
INPUT VOLTAGE OUTPUT VOLTAGE WATTAGE TYPE	ITEM NUMBER	COMPATIBLE DIMMER TYPE	COMPATIBLE DIMMING COIL	REQUIRED FEEDS	TO PLUG IN	
SINGLE-FEED OPTIONS						
 2.2" (55 mm)	1 x 120v 12v 1 x 60 watts Electronic	Bronze: 700SRT60EZ-LED Black: 700SRT60EB-LED* Chrome: 700SRT60EC-LED Satin Nickel: 700SRT60ES-LED White: 700SRT60EW-LED*	low-voltage electronic 600 watts	—	requires one end or single-feed center power feed (p. 321)	add plug option (p. 321)
 2.2" (55 mm)	1 x 120v 12v 1 x 75 watts Magnetic	Bronze: 700SRT75DZ Black: 700SRT75DB* Chrome: 700SRT75DC Satin Nickel: 700SRT75DS White: 700SRT75DW*	low-voltage magnetic 600 watts	—	requires one end or single-feed center power feed (p. 321)	add plug option (p. 321)
 2.2" (55 mm)	1 x 120v 12v 1 x 100 watts Electronic	Bronze: 700SRT100EZ-LED Black: 700SRT100EB-LED* Chrome: 700SRT100EC-LED Satin Nickel: 700SRT100ES-LED White: 700SRT100EW-LED*	low-voltage electronic 600 watts	—	requires one end or single-feed center power feed (p. 321)	add plug option (p. 321)
 2.3" (58 mm)	1 x 120v 12v 1 x 150 watts Magnetic	Bronze: 700SRT15DZ Black: 700SRT15DB* Chrome: 700SRT15DC Satin Nickel: 700SRT15DS White: 700SRT15DW*	low-voltage magnetic 600 watts	included	requires one end or single-feed center power feed (p. 321)	add plug option (p. 321)
 2.3" (58 mm)	1 x 120v 12v 1 x 150 watts Electronic	Bronze: 700SRT15EZ Black: 700SRT15EB* Chrome: 700SRT15EC Satin Nickel: 700SRT15ES White: 700SRT15EW*	low-voltage electronic 600 watts	—	requires one end or single-feed center power feed (p. 321)	add plug option (p. 321)
 3.8" (96 mm)	1 x 120v 12v 1 x 300 watts Magnetic	Bronze: 700SRT30DZ Black: 700SRT30DB* Chrome: 700SRT30DC Satin Nickel: 700SRT30DS White: 700SRT30DW*	low-voltage magnetic 600 watts	included	requires one end or single-feed center power feed (p. 321)	add plug option (p. 321)
 3.8" (96 mm)	1 x 120v 12v 1 x 300 watts Electronic	Bronze: 700SRT30EZ Black: 700SRT30EB* Chrome: 700SRT30EC Satin Nickel: 700SRT30ES White: 700SRT30EW*	low-voltage electronic 600 watts	—	requires one end or single-feed center power feed (p. 321)	add plug option (p. 321)
 3.8" (96 mm)	1 x 120v 24v 1 x 300 watts Magnetic	Bronze: 700SRT3024DZ Black: 700SRT3024DB* Chrome: 700SRT3024DC Satin Nickel: 700SRT3024DS White: 700SRT3024DW*	low-voltage magnetic 600 watts	included	requires one end or single-feed center power feed (p. 321)	add plug option (p. 321)

*Black and White finish options have Chrome leads.



Indicates which transformers are compatible with LED elements.



INPUT VOLTAGE OUTPUT VOLTAGE WATTAGE TYPE	ITEM NUMBER	COMPATIBLE DIMMER TYPE	COMPATIBLE DIMMING COIL	REQUIRED FEEDS	TO PLUG IN
--	-------------	------------------------------	-------------------------------	----------------	------------

SINGLE-FEED OPTIONS (CONTINUED)

	1 x 120v 24v 1 x 600 watts Magnetic	Bronze: 700SRT6024DZ Black: 700SRT6024DB* Chrome: 700SRT6024DC Satin Nickel: 700SRT6024DS White: 700SRT6024DW*	low-voltage magnetic 1000 watts	included	requires one end or single-feed center power feed (below)	add plug option (below)
--	--	--	---------------------------------------	----------	--	-------------------------------

DUAL-FEED OPTIONS

	1 x 120v 12v 2 x 300 watts Magnetic	Bronze: 700SRT60DZ Black: 700SRT60DB* Chrome: 700SRT60DC Satin Nickel: 700SRT60DS White: 700SRT60DW*	low-voltage magnetic 1000 watts	included	requires two end power feeds and one isolating connector or one dual-feed center power feed (below)	add plug option (below)
--	--	--	---------------------------------------	----------	--	-------------------------------

*Black and White finish options have Chrome leads.

PLUG OPTION

16' cord and plug for standard 120 volt power outlets.

700A1-

COLOR	
WHT	WHITE
BLK	BLACK



Special Installations

End and center power feeds are generally used to bring power to a Wall MonoRail system when the junction box cannot be located directly behind the rail. The power feed can be mounted to a standard 4" junction box with round plaster ring (provided by electrician), directly to a Remote Transformer (p. 318), or nearby Surface Transformer (pp. 320-321).

END POWER FEED

The end power feed pushes into an end of the MonoRail and includes a removable 4" round canopy and 12' field-cuttable softwire leads.

700MOPEND FINISH

Z	ANTIQUE BRONZE
C	CHROME
S	SATIN NICKEL



CENTER POWER FEED

The center power feed can be used anywhere within the run and includes a removable 4" round canopy and 12' field-cuttable softwire leads. Specify dual-feed when using a dual-feed transformer.

700MOPCEN TYPE FINISH

SINGLE-FEED	Z	ANTIQUE BRONZE
4 DUAL-FEED	C	CHROME
	S	SATIN NICKEL



SINGLE-FEED



Wall MonoRail Kits

ALL WALL MONORAIL KITS INCLUDE:

8' long Wall MonoRail. Choose between:

ANTIQUE BRONZE - BROWN INSULATOR



CHROME - CLEAR INSULATOR



SATIN NICKEL - CLEAR INSULATOR



Actual Size

One set of decorative end caps



Three Wall MonoRail standoffs

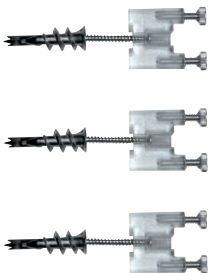

12 volt 300 watt plug-in magnetic remote transformer with end power feed.



LOCATION: PRIVATE RESIDENCE — ANN ARBOR, MI DESIGN: ELAN DESIGNS

WALL MONORAIL KIT

700WMKTA300 FINISH

- Z ANTIQUE BRONZE
- C CHROME
- S SATIN NICKEL

SELECT YOUR ELEMENTS (PP. 30-135)





Wall MonoRail Satin Nickel / End Caps / Remote 300
Watt 12 Volt Transformer / 2" Square Single-Feed
Canopy / Wall MonoRail Standoffs / Wall Georgi
Heads / MR16 Lamps

LOCATION: PRIVATE RESIDENCE
PHOTOGRAPHER: WWW.PETERRYMWD.COM

Kable Lite

Create your own artistic illusion of floating lights with Kable Lite. Integrated parallel, low-voltage cables virtually disappear when installed.

www.techlighting.com





Bare Cable / Remote 300 Watt 12 Volt Transformer /
4" Round Single-Feed Canopy Satin Nickel /
Slimline Turnbuckles / Slimline Anchors /
K-Hello Heads / MR16 Lamps

TRENDS PUBLISHING INTERNATIONAL
DESIGN: RAO DESIGN STUDIO
PHOTOGRAPHER: JOHN UMBERBER



Bare Cable / Remote 300 Watt 12 Volt Transformer /
4" Round Single-Feed Canopy Satin Nickel /
Universal Turnbuckles / Slimline Anchors /
K-Johnny Heads / MR16 Lamps

TRENDS PUBLISHING INTERNATIONAL
ARCHITECT: KANNER ARCHITECTS
PHOTOGRAPHER: JOHN LINDEN





Bare Cable / Remote 300 Watt 12 Volt Transformer /
4" Round Single-Feed Canopy Satin Nickel /
Universal Turnbuckles / K-Giro Heads / Owl Moon
Pendants / MR16 Lamps / MR11 Lamps

TRENDS PUBLISHING INTERNATIONAL
ARCHITECTURE: ALTUS ARCHITECTURE
PHOTOGRAPHER: JOHN UMBERBER

The Basics of Kable Lite

ONE DESIGN YOUR KABLE LITE SYSTEM

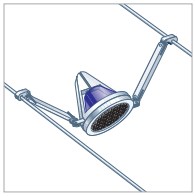

The first step in designing your Kable Lite system is to determine what it is you are trying to light. You'll need to decide where the elements should be installed to put light where you want it. See Compatible Elements on pp. 266-269 for thumbnails of all available elements. Refer to the indicated pages for detailed specifications. Choose your elements then add accessories if desired. We offer a broad range of colorful and decorative accessories and functional optical controls (pp. 366-379).

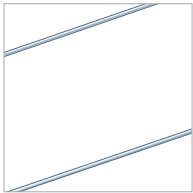

Determine the cable separation of the run. Generally, the higher the ceiling, the wider the cable separation can be. We recommend the following:

Ceiling height	Cable separation not to exceed
8'	3.5"
9'	5.5"
10'	8"

Different elements have different cable separation requirements, so make sure the elements you've chosen are compatible with the cable separation.

Draw in your Kable Lite run. Remember, Kable Lite is designed to make straight lines and simple turns. The cables must be placed so they pass over the locations of all the elements. Kable Lite surface transformers and power feed canopies have 24" feeds, so your Kable Lite run must pass within two feet of the junction box. Determine how many feet of cable you'll need (p. 330).

TWO ADD POWER AND HARDWARE TO COMPLETE YOUR SYSTEM

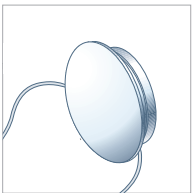

Add up the wattages of the lamps you'll be using on the system: this will help you select a transformer. A remote transformer with power feed canopy provides the cleanest look, but the remote transformer must be installed in an accessible, remote location. The surface transformer simply mounts to a junction box. Use the information on pp. 384-385 to help you choose the right transformer for your installation; see pp. 334-337 for Kable Lite transformer and power feed options. If you are using LED heads or pendants, be sure to choose a transformer that is compatible with LED fixtures. See pp. 266-269 for a list of Compatible LED Elements. Kable Lite power feed canopies and surface transformers have 24" feeds. If this drop is shorter than you require, or if you prefer the look of hardwire, you'll need to add optional hardwire feeds (p. 335).

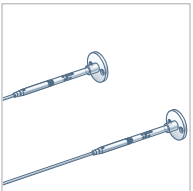

See p. 331 for guidelines on selecting turnbuckles. We recommend putting a pair of turnbuckles on each side of the run for visual symmetry.

You will not need to add supports to your run unless it's long (over twenty feet) or has heavier elements (such as glass pendants). Review pp. 331-333 and add support or turn hardware if required.

Kable Lite Kits To simplify ordering, we offer several convenient Kable Lite Kits that include all the power and hardware required for most basic installations (pp. 342-343).



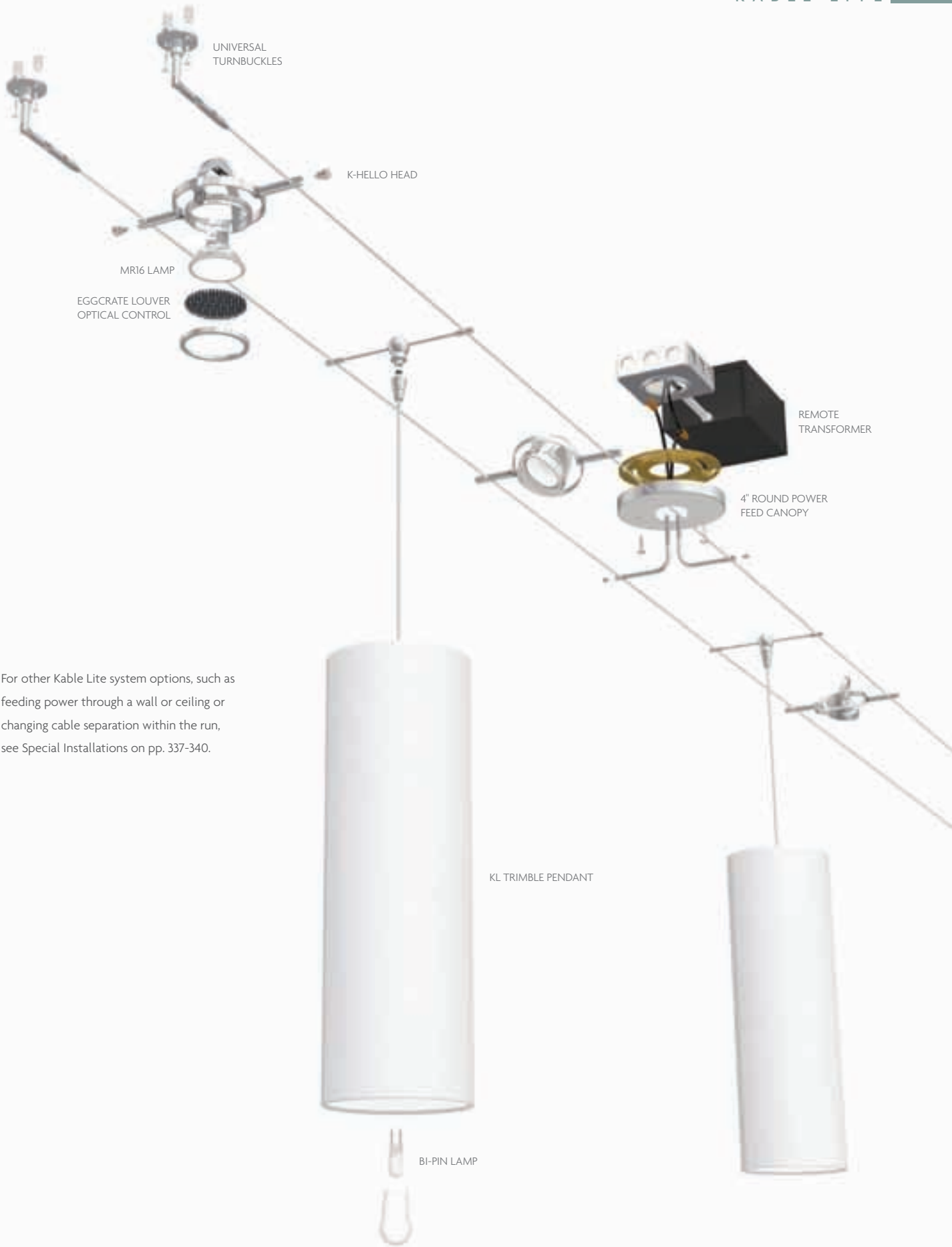

For other Kable Lite system options, such as feeding power through a wall or ceiling or changing cable separation within the run, see Special Installations on pp. 337-340.

Cable

BARE CABLE

Rated for 300 watts at 12 volts, 600 watts at 24 volts. Load: 300 watt maximum at 12 volts to 30' before voltage drop occurs; 600 watt maximum at 24 volts to 60' before voltage drop occurs.



#10 gauge tin-plated copper cable with kevlar core.

700KLABAREC

INSULATED CABLE

Use insulated cable where required by local codes or in coastal areas, where salty air might oxidize bare cables.



#10 gauge tin-plated copper cable with kevlar core; sheathed in clear.

700KLAINSCL

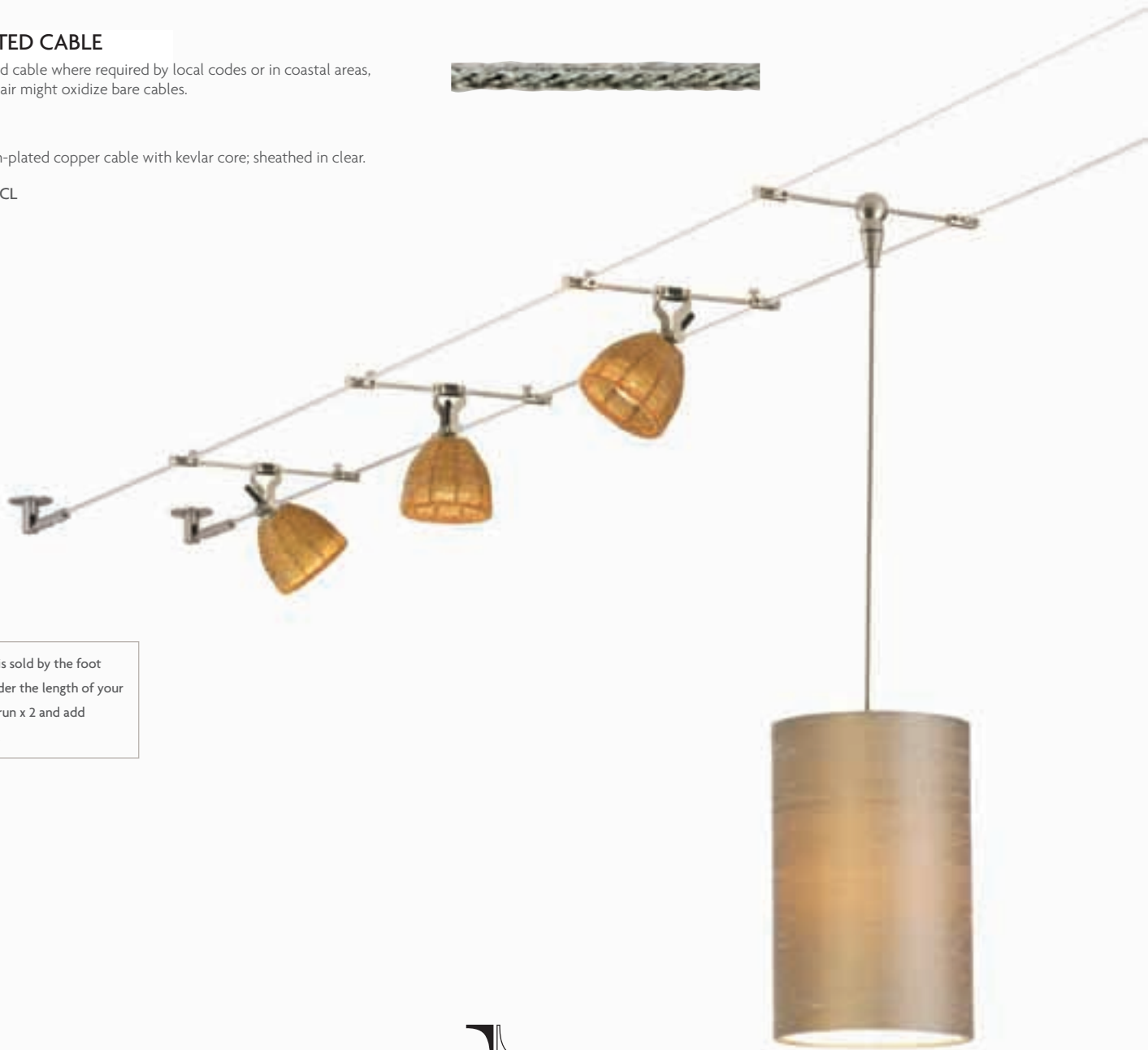

Tip: Cable is sold by the foot (0.3 m). Order the length of your Kable Lite run x 2 and add 10 percent.



Turnbuckles

Turnbuckles are the key to the Kable Lite system. They tighten and secure the cables and provide the necessary tension for a clean look. All turnbuckles include mounting hardware for drywall. Special hardware is available for brick, cement, or plaster surfaces (see p. 338). For long runs of over twenty feet, turnbuckles should be reinforced with wood blocking behind the wall.

FOR LONG OR TURNING RUNS (RUNS OVER 20') (WALL-TO-WALL OR CEILING MOUNTED)

UNIVERSAL TURNBUCKLES

5.5" long, 1.75" diameter. When ceiling mounted, cables drop 2.5" from ceiling. Pair. If mounting to metal, order isolating connector for each pair of turnbuckles (sold separately, p. 333).

700PARTT	FINISH
C	CHROME
S	SATIN NICKEL

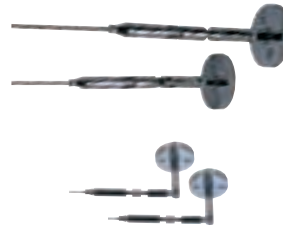

FOR CEILING MOUNTED RUNS ONLY (RUNS UNDER 20')

WAVE TURNBUCKLES

Use on both ends of the run. For ceiling only. Cables drop 5" from ceiling. Pair. If mounting to metal, order isolating connectors for each pair of turnbuckles (sold separately, p. 333).

700KWAVE	FINISH
C	CHROME
S	SATIN NICKEL



FOR SHORT, STRAIGHT RUNS (RUNS UNDER 20') (WALL-TO-WALL OR CEILING MOUNTED)

SLIMLINE TURNBUCKLES

4" long, 0.5" diameter. When ceiling mounted, cables drop 1" from ceiling. Pair. If mounting to metal, order isolating version.

700PRTTI	FINISH
C	CHROME
S	SATIN NICKEL
IC	ISOLATING CHROME
IS	ISOLATING SATIN NICKEL



SLIMLINE ANCHORS

Use to secure cables at one end of run (with turnbuckles at other end). 1" long, 0.5" diameter. Pair.

700PRTTO	FINISH
C	CHROME
S	SATIN NICKEL



SOFT TURNBUCKLES

Stylish satin nickel turnbuckle. 4" long, 0.5" diameter. When ceiling mounted, cables drop 1" from ceiling. Pair. If mounting to metal, order isolating connectors for each pair of turnbuckles (sold separately p. 333).

700KSOFTTS



SOFT ANCHORS

Use to secure cables at one end of run (with turnbuckles at other end). 1" long, 0.5" diameter. Satin nickel. Pair.

700KSOFTOS



Ceiling Supports

SUPPORTING RUNS OVER TWENTY FEET

ADJUSTABLE STANDOFF

Suspension cable virtually disappears for a clean and elegant look. Wire grip allows easy adjustability. Standard with twelve feet of field-cuttable suspension cable; may also be specified with thirty feet of cable. Horizontal rod is 12" wide; field cut to desired cable separation (3.5" minimum).

700PRTD3	LENGTH	FINISH
	12' OF CABLE	C CHROME
3	30' OF CABLE	S SATIN NICKEL



SUPPORTING RUNS OVER TWENTY FEET OR CHANGING CABLE DROP

RIGID T STANDOFF

Mounts to ceiling. Offered for a range of drops and cable separations. Not field-cuttable.

700KTSO	DROP	SEPARATION	FINISH
	01 1"	01 1"	C CHROME
	02 2.5"	02 2"	S SATIN NICKEL
	05 5"	03 3.5"	
	12 12"	05 5.5"	
		08 8"	



CHANGING CABLE DROP OR TURNING

RIGID POST STANDOFF/STANDOFF TURN

Can be used for cable separations from 2" to 36". Standoffs can also be specified with a turn support to provide tension for clean turns. Pair. Not field-cuttable.

700	TYPE	DROP	FINISH
KSO	STANDOFF ALONE	01 1"	C CHROME
KSOT	STANDOFF TURN	02 2.5"	S SATIN NICKEL
		05 5"	
		12 12"	

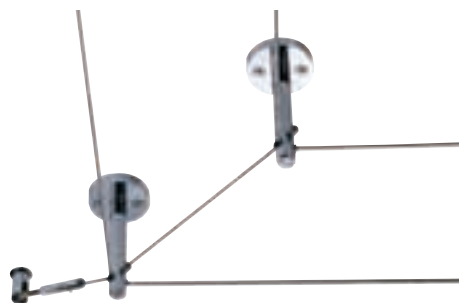

STANDOFF TURN



Wall Supports

TURNING CABLE AT THE WALL

A wall turn attaches to a surface to make simple turns. Includes insulating tubing to cover where cables cross. Pair.

WALL TURN

700KWSO01 FINISH
C CHROME
S SATIN NICKEL



TURNING CABLE HORIZONTALLY OR VERTICALLY FROM A WALL

Directional hardware for making a floating horizontal or vertical turn when the ceiling is inaccessible. Each includes six feet of field-cutttable cable to provide tension for turn.

VERTICAL TURN

700PRTC8 FINISH
C CHROME
S SATIN NICKEL



HORIZONTAL TURN

700PRTC6 FINISH
C CHROME
S SATIN NICKEL

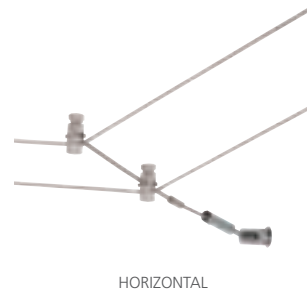

INSTALLING CABLE TO CANTILEVER FROM A WALL

This outside rigger attaches to the wall to secure cables 12" from the wall at 2" cable separation. Use when a wall-to-wall installation is impractical and the ceiling is not accessible. Not field-cutttable. Pair.

OUTSIDE RIGGER

700KWSO1202 FINISH
C CHROME
S SATIN NICKEL



Connectors

JOINING CABLE END TO END

CONDUCTIVE CONNECTORS

Connectors join cables end to end.

700PARTD2 FINISH
C CHROME
S SATIN NICKEL

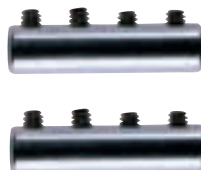

ISOLATING CONNECTORS

Plastic connectors join cables end to end and isolate power feeds from each other. All dual-feed canopies and dual-feed surface transformers are shipped with isolating connectors; order additional if required by layout. Pair.

For Use with Bare Cable: **700PARTD1**
For Use with Insulated Cable: **700PRTD1L**



Remote Transformers

Remote transformers install in an accessible location behind the ceiling or wall. For technical information on remote transformers, see pp. 384-385. Requires canopy (p. 335) or special power feed (p. 340).

INPUT VOLTAGE OUTPUT VOLTAGE WATTAGE TYPE	ITEM NUMBER	COMPATIBLE DIMMER TYPE	COMPATIBLE DIMMING COIL	PLUG-IN TRANSFORMER OPTION <i>INCLUDES 16' CORD</i>	RECESSED REMOTE TRANSFORMER OPTION*	277 VOLT INPUT OPTION
--	----------------	------------------------------	-------------------------------	--	--	--------------------------

SINGLE-FEED OPTIONS

	1 x 120v 12v 1 x 75 watts Magnetic	700AT075T	low-voltage magnetic 600 watts	—	700AT075P	—	700AT075T277
	1 x 120v 12v 1 x 150 watts Magnetic	700AT150T	low-voltage magnetic 600 watts	700DIM150 (p. 385)	700AT150P	—	700AT150T277
	1 x 120v 12v 1 x 300 watts Magnetic	700AT300T	low-voltage magnetic 600 watts	700DIM300 (p. 385)	700AT300P	700AT300TR	700AT300T277 700AT300TR277*
	1 x 120v 12v 1 x 300 watts Electronic	700AT300EL	low-voltage electronic 600 watts	—	700AT300ELP	—	—
	1 x 120v 24v 1 x 300 watts Magnetic	700AT3024T	low-voltage magnetic 600 watts	700DIM300 (p. 385)	700AT3024P	700AT3024TR	700AT3024T277 700AT3024TR277*
	1 x 120v 24v 1 x 600 watts Magnetic	700AT6024T	low-voltage magnetic 1000 watts	700DIM600 (p. 385)	700AT6024P	700AT6024TR	700AT6024T277 700AT6024TR277*

DUAL-FEED OPTIONS

	1 x 120v 12v 2 x 300 watts Magnetic	700AT600T	low-voltage magnetic 1000 watts	700DIM600 (p. 385)	700AT600P	700AT600TR	700AT600T277 700AT600TR277*
--	--	-----------	---------------------------------------	-----------------------	-----------	------------	--------------------------------

*In-wall recessed remote transformers also available for magnetic 300 and 600 watt models for use in applications where a remote transformer is desired but there isn't access to a remote location. See www.techlighting.com for dimensions and further details.

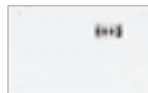



Indicates which transformers are compatible with LED elements.





Power Feed Canopies

ITEM NUMBER	MOUNTS TO	COMPATIBLE RIGID STANDOFF	FEED LENGTH	TO DROP FROM CEILING GREATER THAN FEED LENGTH
-------------	-----------	---------------------------	-------------	---

SINGLE-FEED OPTIONS USE WITH ONE SINGLE-FEED REMOTE TRANSFORMER

4" Round Single-Feed 	Black: 700KP4C24B* Chrome: 700KP4C24C Satin Nickel: 700KP4C24S White: 700KP4C24W*	standard 4" junction box with round plaster ring (provided by electrician)	any (p. 332)	24"	add one pair hardwire feeds (below)
2" Square Single-Feed 	Black: 700KP2C24B* Chrome: 700KP2C24C Satin Nickel: 700KP2C24S White: 700KP2C24W*	special 2" square junction box (included)	any (p. 332)	24"	add one pair hardwire feeds (below)
2" x 4" Rectangular Single-Feed 	Black: 700KPREC24B* Chrome: 700KPREC24C Satin Nickel: 700KPREC24S White: 700KPREC24W*	standard single gang or gem box (provided by electrician)	any (p. 332)	24"	add one pair hardwire feeds (below)

DUAL-FEED OPTIONS USE WITH ONE DUAL-FEED REMOTE TRANSFORMER (ISOLATING CONNECTORS INCLUDED)

4" Round Dual-Feed 	Black: 700KP4C424B* Chrome: 700KP4C424C Satin Nickel: 700KP4C424S White: 700KP4C424W*	standard 4" junction box with round plaster ring (provided by electrician)	any (p. 332)	24"	add two pair hardwire feeds (below)
2" Square Dual-Feed 	Black: 700KP2C424B* Chrome: 700KP2C424C Satin Nickel: 700KP2C424S White: 700KP2C424W*	special 2" square junction box (included)	any (p. 332)	24"	add two pair hardwire feeds (below)
2" x 4" Rectangular Dual-Feed 	Black: 700KPREC424B* Chrome: 700KPREC424C Satin Nickel: 700KPREC424S White: 700KPREC424W*	standard single gang or gem box (provided by electrician)	any (p. 332)	24"	add two pair hardwire feeds (below)

*Black and White finish options have Chrome feeds.

HARDWIRE FEEDS

Pair of field-cutttable, hand bendable hardwire feeds to replace standard feeds. For dual-feed canopies and dual-feed surface transformers, order two pair.

700HWD	LENGTH	FINISH
24	24"	C CHROME
48	48"	S SATIN NICKEL
72	72"	



Surface Transformers

All surface transformers mount to a nearby standard 4" junction box with round plaster ring (provided by electrician). For technical information on surface transformers, see pp. 384-385. Surface transformers cannot be placed directly between Kable Lite and the wall.

INPUT VOLTAGE OUTPUT VOLTAGE WATTAGE TYPE	ITEM NUMBER	COMPATIBLE DIMMER TYPE	COMPATIBLE DIMMING COIL	FEEDS	FOR HARDWARE FEEDS	TO PLUG IN
--	-------------	------------------------------	-------------------------------	-------	--------------------------	------------

SINGLE-FEED OPTIONS

 <p>4" (102 mm) 5" (13 mm)</p> <p>LED</p>	<p>1 x 120v 12v 1 x 60 watts Electronic</p>	<p>Black: 700FRT60EB-LED* Chrome: 700FRT60EC-LED Satin Nickel: 700FRT60ES-LED White: 700FRT60EW-LED*</p>	<p>low-voltage electronic 600 watts</p>	—	24" softwire	—	add plug option (p. 337)
 <p>5.1" (130 mm) 2.2" (55 mm)</p> <p>LED</p>	<p>1 x 120v 12v 1 x 60 watts Electronic</p>	<p>Black: 700SRT60EB-LED* Chrome: 700SRT60EC-LED Satin Nickel: 700SRT60ES-LED White: 700SRT60EW-LED*</p>	<p>low-voltage electronic 600 watts</p>	—	24" softwire	add one pair (p. 335)	add plug option (p. 337)
 <p>5.1" (130 mm) 2.2" (55 mm)</p> <p>LED</p>	<p>1 x 120v 12v 1 x 75 watts Magnetic</p>	<p>Black: 700SRT75DB* Chrome: 700SRT75DC Satin Nickel: 700SRT75DS White: 700SRT75DW*</p>	<p>low-voltage magnetic 600 watts</p>	—	24" softwire	add one pair (p. 335)	add plug option (p. 337)
 <p>5.1" (130 mm) 2.2" (55 mm)</p> <p>LED</p>	<p>1 x 120v 12v 1 x 100 watts Electronic</p>	<p>Black: 700SRT100EB-LED* Chrome: 700SRT100EC-LED Satin Nickel: 700SRT100ES-LED White: 700SRT100EW-LED*</p>	<p>low-voltage electronic 600 watts</p>	—	24" softwire	add one pair (p. 335)	add plug option (p. 337)
 <p>6.5" (165 mm) 2.3" (58 mm)</p> <p>LED</p>	<p>1 x 120v 12v 1 x 150 watts Magnetic</p>	<p>Black: 700SRT15DB* Chrome: 700SRT15DC Satin Nickel: 700SRT15DS White: 700SRT15DW*</p>	<p>low-voltage magnetic 600 watts</p>	included	24" softwire	add one pair (p. 335)	add plug option (p. 337)
 <p>6.5" (165 mm) 2.3" (58 mm)</p> <p>LED</p>	<p>1 x 120v 12v 1 x 150 watts Electronic</p>	<p>Black: 700SRT15EB* Chrome: 700SRT15EC Satin Nickel: 700SRT15ES White: 700SRT15EW*</p>	<p>low-voltage electronic 600 watts</p>	—	24" softwire	add one pair (p. 335)	add plug option (p. 337)
 <p>9.1" (231 mm) 3.8" (96 mm)</p> <p>LED</p>	<p>1 x 120v 12v 1 x 300 watts Magnetic</p>	<p>Black: 700SRT30DB* Chrome: 700SRT30DC Satin Nickel: 700SRT30DS White: 700SRT30DW*</p>	<p>low-voltage magnetic 600 watts</p>	included	24" softwire	add one pair (p. 335)	add plug option (p. 337)
 <p>9.1" (231 mm) 3.8" (96 mm)</p> <p>LED</p>	<p>1 x 120v 12v 1 x 300 watts Electronic</p>	<p>Black: 700SRT30EB* Chrome: 700SRT30EC Satin Nickel: 700SRT30ES White: 700SRT30EW*</p>	<p>low-voltage electronic 600 watts</p>	—	24" softwire	add one pair (p. 335)	add plug option (p. 337)
 <p>9.1" (231 mm) 3.8" (96 mm)</p> <p>LED</p>	<p>1 x 120v 24v 1 x 300 watts Magnetic</p>	<p>Black: 700SRT3024DB* Chrome: 700SRT3024DC Satin Nickel: 700SRT3024DS White: 700SRT3024DW*</p>	<p>low-voltage magnetic 600 watts</p>	included	24" softwire	add one pair (p. 335)	add plug option (p. 337)

*Black and White finish options have Chrome leads.



INPUT VOLTAGE OUTPUT VOLTAGE WATTAGE TYPE	ITEM NUMBER	COMPATIBLE DIMMER TYPE	COMPATIBLE DIMMING COIL	FEEDS	FOR HARDWIRE FEEDS	TO PLUG IN
--	-------------	------------------------------	-------------------------------	-------	--------------------------	------------

SINGLE-FEED OPTIONS (CONTINUED)

	1 x 120v 24v 1 x 600 watts Magnetic	Black: 700SRT6024DB* Chrome: 700SRT6024DC Satin Nickel: 700SRT6024DS White: 700SRT6024DW*	low-voltage magnetic 1000 watts	included	24" softwire	add one pair (p. 335)	add plug option (below)
--	--	--	---------------------------------------	----------	--------------	-----------------------------	-------------------------------

DUAL-FEED OPTIONS

	1 x 120v 12v 2 x 300 watts Magnetic	Black: 700SRT60DB* Chrome: 700SRT60DC Satin Nickel: 700SRT60DS White: 700SRT60DW*	low-voltage magnetic 1000 watts	included	24" softwire	add one pair (p. 335)	add plug option (below)
--	--	--	---------------------------------------	----------	--------------	-----------------------------	-------------------------------

*Black and White finish options have Chrome leads.

PLUG OPTION

16' cord and plug for standard 120 volt power outlets.

700A1-	COLOR
WHT	WHITE
BLK	BLACK



Special Installations

FEEDING POWER THROUGH A WALL OR CEILING

Use the power feed turnbuckles to pipe power from a single feed remote transformer (p. 334) through an accessible wall or ceiling and terminate the run. Power feed standoffs bring power to the cables within the run. **Back of wall or ceiling must be accessible.**

POWER FEED TURNBUCKLES

Pair of insulated slimline turnbuckles with power feed capability. Minimum cable separation: 2"; maximum cable run: twenty feet, unless reinforced.

700PRC14	FINISH
C	CHROME
S	SATIN NICKEL

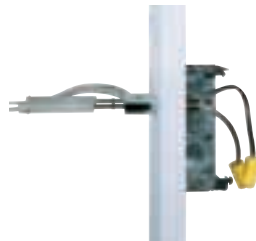

POWER FEED STANDOFFS

Pair of rigid standoffs with power feed capability. Minimum cable separation: 3.5".

700KPFSO	DROP	FINISH
01	1"	C CHROME
02	2.5"	S SATIN NICKEL
12	12"	

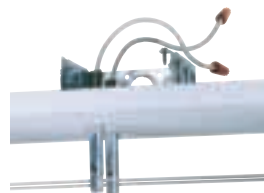

Special Installations

MOUNTING TO BRICK, CEMENT, OR PLASTER

Turnbuckles and anchors come standard with mounting hardware for drywall. To mount to other surfaces, order this special hardware. Sold in pairs.

BRICK OR CEMENT ANCHORS

700PRTD14

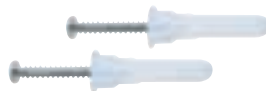

PLASTER ANCHORS

700PRTD15

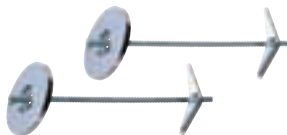

CRIS-CROSSING CABLE RUNS

POWER JUMPERS

Pair of power jumpers transfers power from one cable run to another. Includes 24" of insulating tubing to cover where cables cross.

700PARTD9

FINISH	
C	CHROME
S	SATIN NICKEL



INSULATING TUBING

Clear plastic tubing insulates bare cable from another cable or metal. Sold by the foot.

700PARTD4



SUPPORTING CABLE ON RUNS WITH LONGER DROPS

Use these heavy duty standoffs to support Kable Lite systems that drop 18" or 24" from the ceiling.

HEAVY DUTY STANDOFFS

These longer standoffs have 4" diameter bases for stability and require a minimum 5.5" cable separation. Pair. Not field-cuttable. May require longer hardwire feeds (p. 335).

700KSOHD

DROP		FINISH	
18	18"	C	CHROME
24	24"	S	SATIN NICKEL





Bare Cable / Remote 300 Watt 12 Volt Transformer /
4" Round Single-Feed Canopy Satin Nickel /
Universal Turnbuckles / K-Johnny Heads / MR16 Lamps

TRENDS PUBLISHING INTERNATIONAL
ARCHITECT: KANNER ARCHITECTS
PHOTOGRAPHER: JOHN LINDEN

Special Installations

MOUNTING ELEMENTS PARALLEL TO CABLES

ELEMENT ADAPTERS

Element adapters allow Kable Lite elements to be mounted parallel to cables. Pair.

700PRTD11	FINISH	
	C	CHROME
	S	SATIN NICKEL

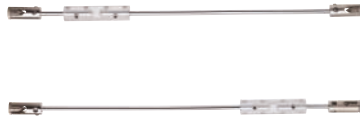

MAINTAINING TENSION IN TURN-HEAVY RUNS

Kable Lite systems with several turns will require inline turnbuckles to provide tension within the run.

INLINE TURNBUCKLES

Conductive (T2) turnbuckles continue power; insulated (T3) turnbuckles isolate power feeds from each other. Pair.

700PART	TYPE	FINISH
T2	CONDUCTIVE	C CHROME
T3	INSULATED	S SATIN NICKEL

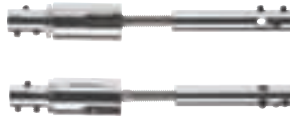

USING A CENTER POWER FEED

A center power feed is generally used to bring power to a Kable Lite system when the transformer or junction box cannot be located directly above the run. The power feed can be mounted to a standard 4" junction box with round plaster ring (provided by electrician), directly to a Remote Transformer, or Kable Lite Surface Transformer when the available junction box is not located directly above the run.

CENTER POWER FEED

The center power feed can be used anywhere within the run and includes 12' field-cutttable softwire leads. Specify single or dual-feed.

700KPCEN	FINISH	FINISH
	SINGLE-FEED	C CHROME
4	DUAL-FEED	S SATIN NICKEL

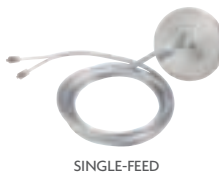



Bare Cable / Remote 300 Watt 12 Volt Transformer /
4" Round Single-Feed Canopies Satin Nickel /
Slimline Turnbuckles / Slimline Anchors /
K-Bye-Bye Heads / MR16 Lamps

TRENDS PUBLISHING INTERNATIONAL
DESIGN: FU TUNG CHENG, CHENG DESIGN (BERKELEY, CA)
PHOTOGRAPHER: TIM MALONEY

Kable Lite Kits

ALL KABLE LITE KITS INCLUDE:

- 45' of bare cable—enough for a twenty foot wall-to-wall run



- Two pair of slimline turnbuckles



- 12 volt 150 or 300 watt magnetic transformer with power feed



SURFACE TRANSFORMERS



REMOTE TRANSFORMER



PICKING A KIT IS EASY, BELOW ARE TWO SIMPLE STEPS TO WALK YOU THROUGH CHOOSING YOUR KABLE LITE KIT.

ONE CHOOSE A KIT (p. 343)

You may choose between a 12 volt 150 watt surface transformer, 300 watt surface transformer or 300 watt remote transformer kit.

TWO SELECT YOUR ELEMENTS (pp. 30-135)

You can choose from over 100 heads and pendants to complete your system.



SURFACE TRANSFORMER KITS

150 WATT KIT

Magnetic Surface Transformer mounts to a standard 4" junction box with round plaster ring (provided by electrician) and includes 24" softwire feeds. Add up to three 50 watt elements or up to four 35 or 37 watt elements.

700KLKTS150	HARDWARE FINISH	TRANSFORMER FINISH
C	CHROME	MATCHES HARDWARE
S	SATIN NICKEL	W WHITE



300 WATT KIT

Magnetic Surface Transformer mounts to a standard 4" junction box with round plaster ring (provided by electrician) and includes 24" softwire feeds. Add up to six 50 watt elements or up to eight 35 or 37 watt elements.

700KLKTS300	HARDWARE FINISH	TRANSFORMER FINISH
C	CHROME	MATCHES HARDWARE
S	SATIN NICKEL	W WHITE



REMOTE TRANSFORMER KIT

300 WATT KIT

Magnetic Remote Transformer installs in an accessible location behind the ceiling or wall. Canopy mounts to a standard 4" junction box with round plaster ring (provided by electrician) and includes 24" softwire leads. Add up to six 50 watt elements or up to eight 35 or 37 watt elements.

700LKTA300	FINISH
C	CHROME
S	SATIN NICKEL



FreeJack

Let your imagination run free with the simple, versatile FreeJack system.

www.techlighting.com





JANSPORT

FreeJack 4" Round Flush Canopies Chrome /
Cube Frost Pendants / Bi-pin Lamps

INTERIOR DESIGN: POLLACK ARCHITECTURE
PHOTOGRAPHER: CESAR RUBIO



FreeJack 4" Round Flush Canopies Satin Nickel /
Fire Pendants Amber / Bi-pin Lamps





FreeJack 3 Port Round Canopy Antique Bronze /
Mini Hudson Pendants Latte / Bi-pin Lamps



FreeJack 4" Round Flush Canopies Antique Bronze /
Mini Ovation Pendants Tahoe Pine Amber with Iron
Wrap Accessory / Bi-pin Lamps

DESIGN: CHRIS RIDDLE, RIDDLE CONSTRUCTION
PHOTOGRAPHER: ROGER TURK





FreeJack 3 Port Round Canopy Satin Nickel / Firebird
 Pendants Bluebird / Bi-pin Lamps / MonoRail Satin
 Nickel / End Caps / Remote 300 Watt 12 Volt
 Transformer / 4" Round Single-Feed Canopy /
 3" Power Extender / 3" Rigid Standoffs /
 3" Sprocket Heads / MR16 Lamps

LOCATION: PRIVATE RESIDENCE
 PHOTOGRAPHER: WWW.PETERRYMWID.COM

The Basics of FreeJack

ONE DESIGN YOUR FREEJACK SYSTEM



The first step in designing your FreeJack system is to determine what it is you are trying to light. You'll need to decide where the elements should be installed to put light where you want it. See Compatible Elements on pp. 266-269 for thumbnails. Refer to the indicated pages for detailed specifications. Choose your elements then add accessories if desired. We offer a broad range of colorful and decorative accessories and functional optical controls (pp. 366-379).

TWO CHOOSE YOUR CANOPY



Use the information on pp. 352-354 to help you choose the right FreeJack Canopy. Select one Single-Port Canopy for every Element or a Multi-Port Canopy that contains the same number of ports as the number of elements you have chosen. The Single- and Multi-Port Canopies include a transformer or transformers. The Single Ports on p. 354 are used to power a series of Elements from a remote transformer which is sold separately (p. 284). Select from one of the FreeJack Adapters (p. 354) to hang FreeJack Elements on standard track lighting, T-trak systems or existing recessed cans. If you are using LED heads or pendants, be sure to choose a canopy that is compatible with LED fixtures. See pp. 266-269 for a list of Compatible LED elements.

NOTE ADJUSTING CABLE TO DESIRED LENGTH



Adjusting FreeJack cable is easy. Loosen, but do not remove, the set screw on the tip of the FreeJack connector and the oval head set screw on the conical connector. Pull out the coaxial cable and cut it to the desired length. Gently twist the end of the cable between your thumb and forefinger, then feed it through the conical connector. The outer wire will come to a stop point about 3/4 of an inch into the connector. Keep pushing the cable into the connector while rotating the connector, which makes feeding the inner wire into the connector tip easier. Look into the sight hole on the top of the connector to ensure that the inner wire makes contact with the end of the connector. Hold the cable in place and tighten the set screw on the tip of the connector. *Make sure the connection is tight!* Tighten the oval head set screw on the conical connector firmly. Finally, pull the coaxial cable toward the fixture to smooth out the wrinkles in the outer wire.





FJ TRIMBLE PENDANT

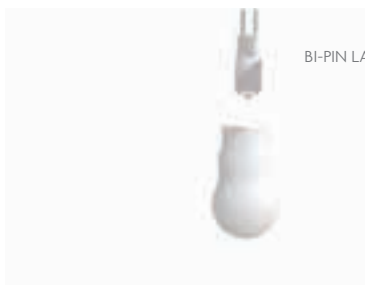

BI-PIN LAMP

Canopies

SINGLE-PORT CANOPIES

4" ROUND FLUSH CANOPY

Mounts to a standard 4" junction box with round plaster ring (provided by electrician). Vaulted version available for ceilings up to a 45° slope. Electronic transformer (included) fits in junction box. One FreeJack port; for ceiling or wall.

700FJ4RF	FINISH	VOLTAGE
Z	ANTIQUÉ BRONZE	120V IN/12V OUT
B	BLACK	024 120V IN/24V OUT
C	CHROME	277 277V IN/12V OUT
S	SATIN NICKEL	-LED 120V IN/12V OUT LED
W	WHITE	-LED277 277V IN/12V OUT LED



4" SQUARE FLUSH CANOPY

Mounts to a standard 4" junction box with round plaster ring (provided by electrician). Electronic transformer (included) fits in junction box. One FreeJack port; for ceiling or wall.

700FJ4SQ	FINISH	VOLTAGE
Z	ANTIQUÉ BRONZE	120V IN/12V OUT
B	BLACK	024 120V IN/24V OUT
C	CHROME	277 277V IN/12V OUT
S	SATIN NICKEL	-LED 120V IN/12V OUT LED
W	WHITE	-LED277 277V IN/12V OUT LED



2" SQUARE FLUSH CANOPY

Mounts to a special 2" square, 6" deep junction box (included). Electronic transformer (included) fits in junction box. One FreeJack port; for ceiling only.

700FJ2SQ67	FINISH	VOLTAGE
Z	ANTIQUÉ BRONZE	120V IN/12V OUT
B	BLACK	024 120V IN/24V OUT
C	CHROME	277 277V IN/12V OUT
S	SATIN NICKEL	-LED 120V IN/12V OUT LED
W	WHITE	-LED277 277V IN/12V OUT LED



SURFACE CANOPY

Mounts to a standard 4" junction box with round plaster ring (provided by electrician). Vaulted version available for ceilings up to 45°. Electronic transformer inside 2" high, 4.5" diameter housing. One FreeJack port; for ceiling or wall.

700FJSF	CEILING	FINISH	VOLTAGE
4	FLAT	Z ANTIQUÉ BRONZE	120V IN/12V OUT
4V	VAULTED	B BLACK	024 120V IN/24V OUT
		C CHROME	277 277V IN/12V OUT
		S SATIN NICKEL	-LED 120V IN/12V OUT LED
		W WHITE	-LED277 277V IN/12V OUT LED



VENUS CANOPY

Mounts to a standard 4" junction box with round plaster ring (provided by electrician). Electronic transformer inside 3" high, 4.5" diameter housing. One FreeJack port; for ceiling or wall.

700FJSFV	FINISH	VOLTAGE
Z	ANTIQUÉ BRONZE	120V IN/12V OUT
C	CHROME	024 120V IN/24V OUT
S	SATIN NICKEL	277 277V IN/12V OUT
B	BLACK	-LED 120V IN/12V OUT LED
W	WHITE	-LED277 277V IN/12V OUT LED



FLAT

VAULTED



Indicates which canopies are compatible with LED elements.



MULTI-PORT CANOPIES

4-PORT SQUARE CANOPY

Mounts to a standard 4" junction box with round plaster ring (provided by electrician). Electronic transformers inside an 11" by 11" housing. Four Freejack ports; for ceiling only.

700FJS4	FINISH	TYPE
Z	ANTIQUÉ BRONZE	120V IN/12V OUT
C	CHROME	-LED 120V IN/12V OUT LED
S	SATIN NICKEL	
B	BLACK	
W	WHITE	



3-PORT LINEAR CANOPY

Mounts to a standard 4" junction box with round plaster ring (provided by electrician). Electronic transformers inside a 28" by 4" housing. Three Freejack ports; for ceiling only.

700FJL3	FINISH	TYPE
Z	ANTIQUÉ BRONZE	120V IN/12V OUT
C	CHROME	-LED 120V IN/12V OUT LED
S	SATIN NICKEL	
B	BLACK	
W	WHITE	



3 AND 5-PORT ROUND CANOPIES

Mounts to a standard 4" junction box with round plaster ring (provided by electrician). Available in two styles. 3-port canopy has electronic transformers inside 12" diameter housing. 5-port canopy has electronic transformers inside 16" diameter housing. Three or five Freejack ports: for ceiling only.

700FJR	STYLE	FINISH	TYPE
3	3-PORT	Z ANTIQUÉ BRONZE	120V IN/12V OUT
5	5-PORT	C CHROME	-LED 120V IN/12V OUT LED
		S SATIN NICKEL	
		B BLACK	
		W WHITE	



3-PORT



5-PORT

4-PORT ROUND CANOPY

Mounts to a standard 4" junction box with round plaster ring (provided by electrician). Electronic transformers in a 12" diameter housing. Four Freejack ports. For ceiling only.

700FJR4	FINISH	TYPE
Z	ANTIQUÉ BRONZE	120V IN/12V OUT
S	SATIN NICKEL	-LED 120V IN/12V OUT LED



4-PORT ANTIQUÉ BRONZE



4-PORT SATIN NICKEL

TIP: 120V FreeJack canopies are dimmable with a standard incandescent dimmer. 120V LED FreeJack canopies are dimmable with a low-voltage electronic dimmer. 277V FreeJack canopies are dimmable with 277V incandescent dimmer. 277V LED canopies are dimmable with 277V low-voltage electronic dimmer.



Indicates which canopies are compatible with LED elements.

Canopies

SINGLE PORTS

Use to power a series of Heads or Pendants from a remote transformer (sold separately; see p. 284).

PORT ALONE

Minimal 1-1/2" diameter, 2-1/2" deep. Can be installed in a range of locations. Access to back of ceiling is not needed.

700FJFCP FINISH

- Z ANTIQUE BRONZE
- C CHROME
- S SATIN NICKEL



PORT WITH CANOPY

4" round and 4" square canopies mount to a standard 4" junction box with round plaster ring (provided by electrician). 2" square canopy mounts to our special 2" square, 3.5" deep junction box (included).

700FJFCP CANOPY FINISH

- | | | | |
|----|-----------|---|----------------|
| 4R | 4" ROUND | Z | ANTIQUÉ BRONZE |
| 2S | 2" SQUARE | C | CHROME |
| 4S | 4" SQUARE | S | SATIN NICKEL |
| | | B | BLACK |
| | | W | WHITE |



4" ROUND



2" SQUARE



4" SQUARE

ADAPTERS

TRACK ADAPTER

Allows FreeJack Heads or Pendants to be used on most popular track lighting systems. Transformer concealed in black or white housing.

700FJ TYPE FINISH TYPE

- | | | | | | |
|------|------------------|---|-------|-------------------------------------|-----|
| HASP | FITS JUNO/HALO* | B | BLACK | 12V 75W ELECTRONIC TRANSFORMER | LED |
| LISP | FITS LIGHTOLIER* | W | WHITE | -LED 12V 60W ELECTRONIC TRANSFORMER | |

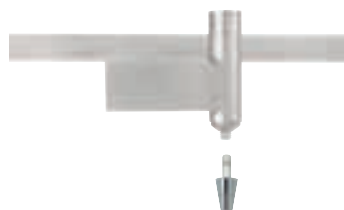

T~TRAK FREEJACK CONNECTOR

Use to adapt any low-voltage FreeJack head or pendant to T-trak system. Order one T-trak FreeJack Connector for each FreeJack head or pendant. Specify Single-Circuit T-trak or Two-Circuit T-trak. Includes transformer. 75 watt version dimmable with a standard incandescent dimmer. 10 watt version dimmable with low-voltage electronic dimmer.

700 SYSTEM CHEDFJ FINISH TYPE

- | | | | | | |
|-----|-----------------------|---|----------------|-------------------------------------|-----|
| TT | SINGLE-CIRCUIT T~TRAK | Z | ANTIQUÉ BRONZE | 12V 75W ELECTRONIC TRANSFORMER | LED |
| TT2 | TWO-CIRCUIT T~TRAK | S | SATIN NICKEL | -LED 12V 10W ELECTRONIC TRANSFORMER | |
| | | W | WHITE | | |

RECESSED CAN ADAPTER

Use to retrofit existing recessed down- lights for use with FreeJack elements. Includes transformer. 75 watt version dimmable with a standard incandescent dimmer. 10 watt version dimmable with low-voltage electronic dimmer. Mounts to any recessed can that is 6-1/4" to 6-1/2" in diameter and has "C" shaped hooks on the inside can wall.

700FJRCAD FINISH TYPE

- | | | | |
|---|----------------|-------------------------------------|-----|
| Z | ANTIQUÉ BRONZE | 12V 75W ELECTRONIC TRANSFORMER | LED |
| C | CHROME | -LED 12V 10W ELECTRONIC TRANSFORMER | |
| S | SATIN NICKEL | | |
| W | WHITE | | |



ETL classified for use with the following recessed cans: Juno IC2, Juno IC22, TC2, and TC2R; Halo H7T and H7RT; Cooper Lighting H27RT; Capri (Thomas) Lighting PR75ASIC/TPR75ASIC/DY6431; Progress Lighting P7TG, P8-TG, and P-8TG & PIO8-TG.*

*Tech Lighting is not affiliated with, nor is it endorsed by, any of the companies listed above. Tech Lighting does not distribute or sell any of the products listed above. Call for more information.



Indicates which canopies are compatible with LED elements.



SYSTEM CONNECTORS

Use to adapt any FreeJack element to any Tech Lighting system.

MONORAIL FREEJACK CONNECTOR

700MOCHED	FINISH
Z	ANTIQUÉ BRONZE
C	CHROME
S	SATIN NICKEL



TWO-CIRCUIT MONORAIL FREEJACK CONNECTOR

700MO2CHED	FINISH
Z	ANTIQUÉ BRONZE
C	CHROME
S	SATIN NICKEL



WALL MONORAIL FREEJACK CONNECTOR

700WMOCHED	FINISH
Z	ANTIQUÉ BRONZE
C	CHROME
S	SATIN NICKEL



KABLE LITE FREEJACK CONNECTOR

For cable separations of 8" or less. May be field cut to desired separation (2" minimum).

700KABCO	FINISH
C	CHROME
S	SATIN NICKEL



Display and Exhibit

Stylish, flexible solutions combine aesthetics
with function and control to make your display
come to life.

www.techlighting.com





Display Jack 4" Round Canopies Chrome /
DJ-Georgi Heads / MR16 Lamps

TRENDS PUBLISHING INTERNATIONAL
ARCHITECT: ALTUS ARCHITECTURE
PHOTOGRAPHER: JOHN UMBERGER



FreeJack 4" Round Flush Canopies Satin Nickel /
12" Sportster Heads / MR16 Lamps

LOCATION: PRIVATE RESIDENCE
PHOTOGRAPHER: CLAUDIO SANTINI





Display Jack 4" Round Canopy Chrome / DJ-Telescope / MR16 Lamp

CP Display Fixtures

Flexibility is the hallmark of all Compact Series (CP) display fixtures. The CP's arms telescope from 9" to 25" and angle up to 180°; the lamp rotates 330° and the CP holds steady however it's positioned. It automatically shuts itself off in case of short circuit (if arms cross), then turns on again when the short is corrected.

Compatible accessories and optical controls (sold separately pp. 366-379): Backlight Shield, Barndoors, Cone Glass Shield, Eggcrate Louver, Flight Paper, Glass Lens, Lil Egypt, Lil Wok, Louver Lens Holder, MR16 Snout, Round Glass Shield, Snap Louver Holder or Taza Accessory.

CP1 CLAMP-ON LIGHT

Lightweight and versatile, CP1 features a universal clamp that provides a secure grip on any surface shape—from 1/2" pipe to 4" wall. Complete with 12 volt plug-in transformer with in-line switch and 10' cord. Chrome arms with black or white clamp. Specify 50 or 75 watts. 12 volt, MR16 lamp not included.

700CP1	WATTAGE	CLAMP
-	50 WATT	BK BLACK
7	75 WATT	WH WHITE



TIP: For more telescoping fixture options see the Tele fixture on p. 124 and FreeJack canopy options on pp. 352-354.

CP1 CLAMP-ON LIGHT WITH MESH BACKLIGHT SHIELD ACCESSORY
DESIGN PATENT # D362,323

CP SCREW-ON

Designed with a special screw-on bracket to fit lightweight portable booths. Leave two screws in or on top of the wall for quick mounting of the keyhole bracket. Complete with plug-in transformer with in-line switch and 10' cord. Specify 50 or 75 watts. 12 volt, MR16 lamp not included.

700CPSO	WATTAGE	CLAMP
-	50 WATT	C CHROME
7	75 WATT	B BLACK



CP SCREW-ON LIGHT WITH MESH BACKLIGHT SHIELD ACCESSORY

CP CORD EXTENDER

Use to add an additional 8' of cord to CP1 and Display Jack connector ports (p. 362)

700CPEXT	COLOR
B	BLACK
W	WHITE



Lite Clamp Fixtures

A lightweight clamp-on display light specially designed for banner frames and portable booths. The Lite Clamp's attractive round clamp grips securely to a panel as slim as 1/4" or as thick as 1". The banner channel allows a tight hold to 5/16" banner frames. The length of the fixture may be adjusted by sliding the arms back and forth through the clamp. Includes 12 volt, 75 watt plug-in transformer on a 10' cord to plug into a standard outlet.

Compatible accessories and optical controls (sold separately pp. 366-379): Backlight Shield, Barndoors, Cone Glass Shield, Eggcrate Louver, Firebird Glass Shield Flight Paper, Glass Lens, Lil Egypt, Lil Wok, Louver Lens Holder, MR16 Snout, Round Glass Shield, Snap Louver Holder or Taza Accessory.

LC-ARCHIE

17.5" long, with a 10" high swooping curve. Pivots at head to direct beam. 12 volt, MR16 lamp of up to 75 watts (not included). Chrome finish.

700LCARCHC



LC-ARCHIE WITH LIL WOK ACCESSORY

LC-GEORGI

18" long with a 3" high gentle curve. Pivots at head to direct beam. 12 volt, MR16 lamp of up to 75 watts (not included). Chrome finish.

700LCGRGC



LC-WALLY LITE

Available in two lengths. Pivots at head to direct beam. 12 volt, MR16 lamp of up to 75 watts (not included). Chrome finish.

700LCWALC 24" LONG

700LCWAL12C 12" LONG



Display Jack

The cleanest, easiest display lighting solution yet. Select a mounting option: 4" round canopy, 2" square canopy, connector ports, 4" round swivel canopy, or DJ Screw-on and install. Push the DisplayJack element's arms (p. 363) into the canopy or port. After the show, pull the DisplayJack element out—the canopy or ports stay in place for next time. No need for an electrician.

4" ROUND CANOPY

Mounts to a standard 4" junction box with round plaster ring (provided by electrician). 12 volt, 75 watt electronic transformer (included) fits inside junction box.

700DJ4RF CANOPY
C CHROME
B BLACK



2" SQUARE CANOPY

Mounts to our special 2" square, 6" deep junction box (included). 12 volt, 75 watt electronic transformer (included) fits inside junction box.

700DJSQ6 CANOPY
C CHROME
B BLACK



CONNECTOR PORTS

Install these two receptacle ports through panel up to 4" thick. Access to back of panel required. 12 volt, 75 watt plug-in transformer with 10' cord plugs into a standard outlet. Chrome only.

700DJFCPC



4" ROUND SWIVEL CANOPY

Mounts to a standard 4" junction box with round plaster ring (provided by electrician). 12 volt, 75 watt electronic transformer (included) fits inside junction box. Fixture pivots up and down at canopy.

700DJ4RS CANOPY
C CHROME
B BLACK



DJ SCREW-ON

Designed with a special screw-on bracket to fit lightweight portable booths. Leave two screws in or on top of wall for quick mounting of the keyhole bracket. Complete with 12 volt, 75 watt plug-in transformer and 10' cord. Chrome only.

700DJSOC



Display Jack Elements

Compatible accessories and optical controls (sold separately pp. 366-379): Backlight Shield, Barndoors, Cone Glass Shield, Eggcrate Louver, Flight Paper, Glass Lens, Lil Egypt, Lil Wok, Louver Lens Holder, MR16 Snout, Round Glass Shield, Snap Louver Holder or Taza Accessory.

DJ-ARCHIE

17.5" long, with a 10" high swooping curve. Pivots at head to direct beam. 12 volt, MR16 lamp of up to 75 watts (not included). Chrome finish.

700DJARCHC



DJ-ARCHIE WITH CONNECTOR PORTS

DJ-GEORGI

18" long with a 3" high gentle curve. Pivots at head to direct beam. 12 volt, MR16 lamp of up to 75 watts (not included). Chrome finish.

700DJGRGC



DJ-GEORGI WITH CONNECTOR PORTS

DJ-WALLY LITE

Available in two lengths. Pivots at head to direct beam. Field-cuttable. 12 volt, MR16 lamp of up to 75 watts (not included). Chrome finish.

700DJWALC 24" LONG
700DJWAL12C 12" LONG



DJ-WALLY LITE WITH CONNECTOR PORTS

DJ-TELESCOPE

Telescopes from 9" to 25". Pivots at head to direct beam 12 volt, MR16 lamp of up to 75 watts (not included). Chrome finish.

700DJTELC



DJ-TELESCOPE WITH 4" ROUND CANOPY

Joshua Ceiling

Joshua comes in a range of lengths to bring the light right where you need it. Joshua pivots left to right and the lamp rotates 330°. Specify chrome arms with chrome or black canopy. May be dimmed with a standard incandescent dimmer. Custom lengths and bends available.

Compatible accessories and optical controls (sold separately pp. 366-379): Backlight Shield, Barndoors, Cone Glass Shield, Eggcrate Louver, Flight Paper, Glass Lens, Lil Egypt, Lil Wok, Louver Lens Holder, MR16 Snout, Round Glass Shield, Snap Louver Holder or Taza Accessory.

JOSHUA 2" CANOPY

2" square flush canopy mounts to our special 2" square, 6" deep junction box (included). Electronic transformer fits inside junction box. For ceiling only. 3" length: 12 volt, MR16 up to 50 watts. Other lengths: 12 volt, MR16 up to 75 watts. Lamp not included.

700JS2C	LENGTH	FINISH
03	3"	C CHROME
067	6"	B BLACK
127	12"	
367	36"	
607	60"	
727	72"	



JOSHUA 2" CANOPY WITH
BACKLIGHT SHIELD ACCESSORY

JOSHUA 4" ROUND FLUSH CANOPY

4" round flush canopy mounts to a standard 4" square junction box with round plaster ring (provided by electrician). Electronic transformer fits inside junction box. 3" to 24" versions for wall or ceiling mount, 36" to 72" versions for ceiling only. 3" length: 12 volt, MR16 up to 50 watts. Other lengths: 12 volt, MR16 up to 75 watts. Lamp not included.

700JSC	LENGTH	FINISH
03	3"	C CHROME
067	6"	B BLACK
127	12"	
247	24"	
367	36"	
487	48"	
607	60"	
727	72"	



JOSHUA 4" ROUND FLUSH CANOPY



Portable Fixtures & Picture Lights

LIL WONDER

Just 4" tall, Lil Wonder goes anywhere! The canopy can screw onto a wall or sit on the floor. Automatic shut-off if tipped over. Complete with 12 volt plug-in transformer with in-line switch and 10' cord and 35 watt MR11 lamp.

700F2-	FINISH
BLK	BLACK
WHT	WHITE
SN	SATIN NICKEL

LIL BIG WONDER

A compact, powerful accent lamp with a plug-in transformer, 4.75" tall. The canopy can screw onto a wall or sit on the floor. Automatic shut-off if tipped over. Complete with 12 volt plug-in transformer with in-line switch and 10' cord and 50 watt MR16 lamp.

700F1-	FINISH
BLK	BLACK
WHT	WHITE
SN	SATIN NICKEL



JOSHUA AND MEG PICTURE LIGHTS

These elegant, unobtrusive picture lights are designed to properly illuminate your artwork and eliminate glare. Choose a lamp that will provide the proper beam spread. By changing lamps or adding a lens, you can light an area as small as four inches square or as large as four feet square!

Both Joshua and Meg are available to plug in or junction box mount. Plug-in version has 10' cord with in-line switch and plug-in transformer. Each includes 12 volt 60 watt transformer, matching Lil Wok accessory, lens holder clip, and UV-protected MR16.

Joshua and Meg junction box are dimmable with a standard incandescent dimmer.

700	TYPE	MOUNTING	FINISH
JOS	JOSHUA	CP J-BOX MOUNT	C CHROME
MEG	MEG	PL PLUG-IN	G GOLD (BRASS)
			B BLACK

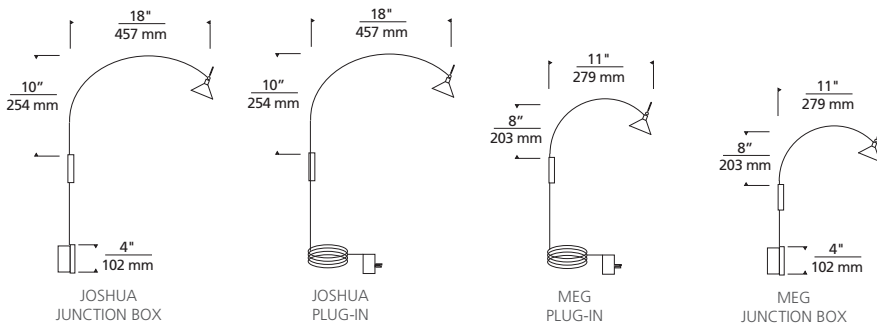

PICTURE HANGING WIRE FITS INTO GROOVE IN MOUNTING BRACKET FOR SECURE HOLD.

FIXTURE	LAMP	ALONE	WITH DIFFUSOR LENS	WITH SPREAD LENS
JOSHUA	7° 20w	4" x 4"	20" x 24"	4" w x 36" h
	15° 50w	6" x 6"	24" x 30"	6" w x 36" h
	27° 20w	10" x 10"	30" x 36"	12" w x 36" h
	36° 20w	13" x 13"	29" x 30"	12" w x 36" h
	38° 50w*	20" x 32"	36" x 42"	12" w x 36" h
MEG	60° 50w	30" x 45"	48" x 48"	12" w x 36" h
	36° 20w*	8" x 8"	16" x 20"	7" w x 24" h
	60° 50w	14" x 14"	24" x 24"	10" w x 26" h

*Included with picture light.

Accessories & Optical Controls

MonoRail Satin Nickel / End Caps / Remote 600 Watt
12 Volt Transformer / 4" Round Dual-Feed Canopy /
12" Power Extenders / 2" Rigid Standoffs /
6" Aero Heads / Tinkerbell Accessories / MR16 Lamps

LOCATION: FALLON MCELLIOTT
DESIGN: PERKINS & WILL
PHOTOGRAPHER: CHRISTOPHER BARRETT, HEDRICH BLESSING





ROUND GLASS SHIELD

Colorful translucent round glass. Integrated Louver Lens Holder in aluminum or antique bronze. Can hold up to two lenses or louvers. MR16 of up to 50 watts. Available for use on Aero, CP1, Curly Torpedo, DJ-Archie, DJ-Georgi, DJ-Telescope, DJ-Wally Lite, Helios, Joshua Ceiling, LC-Archie, LC-Georgi, LC-Wally Lite, K-Bye-Bye, K-Giro, K-Jane, K-Johnny, K-Pivot, K-Telescope, MO-Pivot, Swivel, Tele, Tilt, Torpedo Pendant, Wall Archie, Wall Georgi, Wall Telescope, Wally Lite (sold separately).



AERO WITH ROUND GLASS SHIELD



700MR16G

COLOR	FINISH
A AMBER	ALUMINUM
B COBALT	ANTIQUE BRONZE
F FROST	
G GREEN	

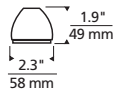

CONE GLASS SHIELD

Colored frosted cone glass. Includes optional cone louver lens holder. Can hold up to two lenses or louvers. MR16 of up to 50 watts. Available for use on Aero, CP1, Curly Torpedo, DJ-Archie, DJ-Georgi, DJ-Telescope, DJ-Wally Lite, Helios*, Joshua Ceiling, K-Giro, K-Jane, K-Johnny, K-Pivot, K-Telescope, LC-Archie, LC-Georgi, LC-Wally Lite, MO-Pivot, Swivel, Tele, Tilt, Torpedo Pendant, Wall Archie, Wall Georgi, Wall Telescope, Wally Lite (sold separately).



AERO WITH CONE GLASS SHIELD



700LICO

COLOR
AM AMBER
CO COBALT
FR FROST
GR GREEN
RO ROSE

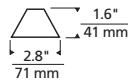

CONE ONYX SHIELD

Natural onyx cone. Includes optional Snap Louver Lens Holder. Can hold one lens or louver. Low-voltage MR16 lamp of up to 50 watts. Available for use on Aero, Curly Torpedo, Helios*, Tilt, Torpedo Pendant (sold separately).



TILT WITH CONE ONYX SHIELD



700LICOHX

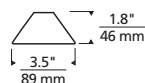

Shows lamp type and maximum wattage.



Includes a Louver Lens Holder



Includes a Snap Louver Lens Holder

* The standard louver lens holders accommodate either one or two MR16 sized optical controls as noted. To use a lens or louver with the Helios LED Head order the LED Snap Louver Lens Holder p. 375 and an MR11 sized optical control pp. 376-377.

FIREBIRD GLASS SHIELD

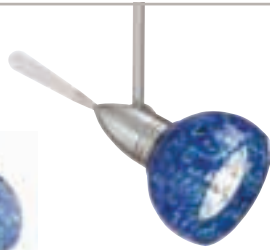

AERO WITH
FIREBIRD GLASS SHIELD

Patterned Murano glass. Includes Snap Louver Lens Holder. Can hold a single lens or louver. MR16 of up to 50 watts. Available for use on Aero, Curly Torpedo, Helios*, Tilt, Torpedo Pendant (sold separately).

700FIRA		COLOR	FINISH
O	OWL (AMBER)	Z	ANTIQU BRONZE
P	PEACOCK (BLUE)	C	CHROME
S	SWAN (WHITE)	S	SATIN NICKEL

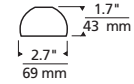

SCAVO GLASS SHADE



AERO WITH
SCAVO GLASS SHADE

Curve shaped scavo glass finish provides old world charm. Includes Snap Louver Lens Holder. Can hold a single lens or louver. MR16 of up to 50 watts. Available for use on Aero, Curly Torpedo, Helios*, Tilt, Torpedo Pendant (sold separately).

700SCAVO		COLOR	FINISH
A	AMBER	Z	ANTIQU BRONZE
M	AMETHYST	C	CHROME
F	FROST	S	SATIN NICKEL
G	GREEN		

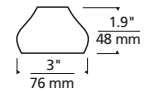

MARTINI GLASS SHIELD

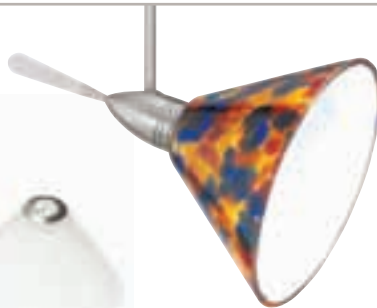

AERO WITH
MARTINI GLASS SHIELD

Layers of brilliant glass. Includes Snap Louver Lens Holder. Can hold a single lens or louver. MR16 of up to 50 watts. Available for use on Aero, Curly Torpedo, Helios*, Tilt, Torpedo Pendant (sold separately).

700MRT		COLOR	FINISH
A	AMBER FRIT	Z	ANTIQU BRONZE
M	MULTICOLOR FRIT	C	CHROME
P	PURPLE FRIT	S	SATIN NICKEL
W	WHITE FRIT		

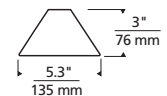

Shows lamp type and maximum wattage.



Includes a Louver Lens Holder



Includes a Snap Louver Lens Holder

* The standard louver lens holders accommodate either one or two MR16 sized optical controls as noted. To use a lens or louver with the Helios LED Head order the LED Snap Louver Lens Holder p. 375 and an MR11 sized optical control pp. 376-377.





Two-Circuit MonoRail Satin Nickel / End Caps /
 Remote 2x300 Watt 12 Volt Transformer /
 4" Round Single-Feed Canopy / 2" Rigid Standoffs /
 T-Bar Connectors / 24" Aero Heads / Round Glass
 Shield Accessories Cobalt / MR16 Lamps /
 FreeJack 4" Round Flush Canopies Satin Nickel /
 Large Summit Pendants / Bi-pin Lamps

LOCATION: SPA ARIEL - CHICAGO, IL
 PHOTOGRAPHER: HOTSHOTS IMAGING, CHICAGO, IL

SODA GLASS SHADE Ⓢ



AERO WITH
SODA GLASS SHADE

Cone shaped glass shade infused with bubbles. Includes Snap Louver Lens Holder. Can hold a single lens or louver. MR16 of up to 50 watts. Available for use on Aero, Curly Torpedo, Tilt, Helios*, Torpedo Pendant (sold separately).

700SDA		COLOR	FINISH
A	AMBER	Z	ANTIQUÉ BRONZE
B	BLUE	C	CHROME
F	FROST	S	SATIN NICKEL

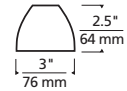

METEORITE Ⓢ



CURLY TORPEDO
WITH METEORITE

Case glass or clear. Includes Snap Louver Lens Holder for MR16, can hold a single lens or louver. MR16 of up to 50 watts or bi-pin of up to 50 watts. Available for use on Aero, Curly Torpedo, Helios*, Tilt and Torpedo pendant (sold separately).

700MET		COLOR	FINISH
AM	AMBER	Z	ANTIQUÉ BRONZE
CR	CLEAR	C	CHROME
BL	COBALT	S	SATIN NICKEL
FR	FROST		
RD	RED		

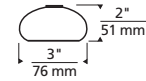

SUGAR ACCESSORY Ⓢ



CURLY TORPEDO WITH
SUGAR ACCESSORY

Streams of glass piping formed into a coned shape. Includes Snap Louver Lens Holder. Can hold a single lens or louver. MR16 of up to 50 watts. Available for use on Aero, Curly Torpedo, Helios*, Tilt, Torpedo Pendant (sold separately).

700SUG		COLOR	FINISH
A	AMBER	Z	ANTIQUÉ BRONZE
Q	AQUA	C	CHROME
R	RED	S	SATIN NICKEL
V	VIOLET		
W	WHITE		

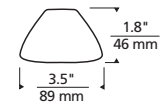

Shows lamp type and maximum wattage.



Includes a Louver Lens Holder



Includes a Snap Louver Lens Holder

* The standard louver lens holders accommodate either one or two MR16 sized optical controls as noted. To use a lens or louver with the Helios LED Head order the LED Snap Louver Lens Holder p. 375 and an MR11 sized optical control pp. 376-377.



50  **DICHROIC GLASS SHIELD**

Iridescent spectrum of colored glass. Includes Snap Louver Lens Holder. Can hold a single lens or louver. MR16 of up to 50 watts. Available for use on Aero, Curly Torpedo, Tilt, Helios*, Torpedo Pendant (sold separately).

700DCH FINISH

- Z ANTIQUE BRONZE
- C CHROME
- S SATIN NICKEL

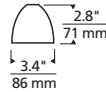

TILT WITH
DICHROIC GLASS SHIELD



50  **LIL EGYPT**

Finely handcrafted beaded shade. Includes Snap Louver Lens Holder. Can hold a single lens or louver. MR16 of up to 50 watts. Available for use on Aero, CPI, Curly Torpedo, DJ-Archie, DJ-Georgi, DJ-Telescope, DJ-Wally Lite, Helios*, Joshua Ceiling, K-Giro, K-Jane, K-Johnny, K-Pivot, K-Telescope, LC-Archie, LC-Georgi, LC-Wally Lite, Metal Man, MO-Pivot, Parachute, Swivel, Tele, Tilt, Torpedo Pendant, Wall Archie, Wall Georgi, Wall Telescope, Wally Lite (sold separately).

700LEGY COLOR

- AM AMBER
- CB COBALT
- DA DARK AMBER
- FR FROST
- RD RED

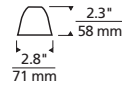

AERO WITH
LIL EGYPT



50  **MINI OM ACCESSORY**

Metal, frost and translucent glass, or onyx backlight shield. Includes Snap Louver Lens Holder. Can hold a single lens or louver. MR16 lamp of up to 50 watts (not included). Available for use on Mini Om (sold separately).

700MR16OM

- | COLOR | FINISH |
|---------------|------------------|
| AC AMBER | Z ANTIQUE BRONZE |
| A AMBER FROST | S SATIN NICKEL |
| CC CLEAR | |
| F FROST | |
| S SOLID METAL | |
| O ONYX | |



OM WITH
MINI OM ACCESSORY



* The standard louver lens holders accommodate either one or two MR16 sized optical controls as noted. To use a lens or louver with the Helios LED Head order the LED Snap Louver Lens Holder p. 375 and an MR11 sized optical control pp. 376-377.

TAZA ACCESSORY



AERO WITH TAZA ACCESSORY

Cone glass accessory with intensely twisted rich color. Includes optional cone louver lens holder. Can hold up to two lenses or louvers. Low-voltage MR16 lamp of up to 50 watts (not included). Available for use on Aero, CPI, Curly Torpedo, DJ-Archie, DJ-Georgi, DJ-Telescope, DJ-Wally Lite, Helios*, Joshua Ceiling, K-Giro, K-Jane, K-Johnny, K-Pivot, K-Telescope, LC-Archie, LC-Georgi, LC-Wally Lite, MO-Pivot, Swivel, Tele, Tilt, Torpedo Pendant, Wall Archie, Wall Georgi, Wall Telescope, Wally Lite (sold separately).

700TAZA

COLOR	
A	AMBER
C	CREAM
N	BROWN
R	RED

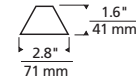

PRISM GLASS SHIELD



TILT WITH PRISM GLASS SHIELD

700PRISM

COLOR	
AS	AMBER
CS	CLEAR

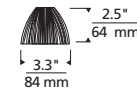

Ribbed glass. Includes Snap Louver Lens Holder. Can hold a single lens or louver. MR16 of up to 50 watts. Available for use on Aero, Helios*, Curly Torpedo, Tilt, Torpedo Pendant (sold separately).

FLIGHT PAPER



SPROCKET WITH FLIGHT PAPER

Decorative shade of white heat-resistant paper. MR16 of up to 50 watts; MR11 of up to 35 watts. Available for use on CPI, DJ-Archie, DJ-Georgi, DJ-Telescope, DJ-Wally Lite, Joshua Ceiling, K-Giro, K-Jane, K-Johnny, K-Pivot, K-Telescope, LC-Archie, LC-Georgi, LC-Wally Lite, Metal Man, MO-Pivot, Parachute, Sprocket, Swivel, Tele, Wall Archie, Wall Georgi, Wall Telescope, Wally Lite (sold separately).

700FP TYPE WH

11	MR11
16	MR16

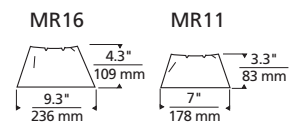

Shows lamp type and maximum wattage.

 Includes a Snap Louver Lens Holder

* The standard louver lens holders accommodate either one or two MR16 sized optical controls as noted. To use a lens or louver with the Helios LED Head order the LED Snap Louver Lens Holder p. 375 and an MR11 sized optical control pp. 376-377.



Ⓢ  35  50 **TINKERBELL**

Small Metal Shade. Includes Snap Louver Lens Holder. Can hold a single lens or louver. Antique bronze, antique bronze mesh and black MR16 of up to 35 watts. Chrome, satin nickel and chrome mesh MR16 of up to 50 watts. Available for use on Aero, Curly Torpedo, Helios®, Tilt, Torpedo Pendant (sold separately).



AERO WITH TINKERBELL

700TNKBELL

COLOR	
BZ	ANTIQU BRONZE
ZM	ANTIQU BRONZE MESH
BK	BLACK
CH	CHROME
CM	CHROME MESH
SN	SATIN NICKEL

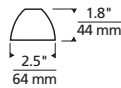

 50 **BELLADONNA**

Large bell-shaped metal shade with plated finish. Includes Eggcrate Louver. MR16 of up to 50 watts. Available for use on Aero, Curly Torpedo, Helios, Tilt, Torpedo Pendant (sold separately).



CURLY TORPEDO WITH BELLADONNA

700BELL

COLOR	
BZ	ANTIQU BRONZE
CH	CHROME
SN	SATIN NICKEL

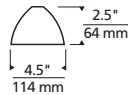

 35 **BELL**

Bell-shaped metal shade with plated or painted finish. Includes Eggcrate Louver. MR16 of up to 35 watts. Available for use on Aero, Curly Torpedo, Helios, Tilt, Torpedo Pendant (sold separately).



AERO WITH BELL

700AERBELL

COLOR	
BZ	ANTIQU BRONZE
BK	BLACK
CH	CHROME
SN	SATIN NICKEL

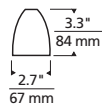

* The standard louver lens holders accommodate either one or two MR16 sized optical controls as noted. To use a lens or louver with the Helios LED Head order the LED Snap Louver Lens Holder p. 375 and an MR11 sized optical control pp. 376-377.

LIL WOK



K-JOHNNY
WITH LIL WOK

Decorative metal shade. Includes Snap Louver Lens Holder. Can hold a single lens or louver. Silver and black for MR16 of up to 50 watts. Antique bronze for MR16 up to 20 watts only. Available for use on CPI, DJ-Archie, DJ-Georgi, DJ-Telescope, DJ-Wally Lite, Joshua Ceiling, K-Giro, K-Johnny, K-Pivot, K-Telescope, LC-Archie, LC-Georgi, LC-Wally Lite, Metal Man, MO-Pivot, Parachute, Swivel, Tele, Wall Archie, Wall Georgi, Wall Telescope, Wally Lite (sold separately).

700LMPCO

COLOR	
Z	ANTIQUE BRONZE
B	BLACK
S	SILVER

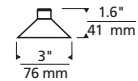

BACKLIGHT SHIELD



SWIVEL WITH
BACKLIGHT SHIELD

Decorative mesh or solid metal shade. Includes Louver Lens Holder. MR16 holds up to two lenses or louvers. MR11 (solid only) can hold up to two lenses or louvers. Available for use on CPI, DJ-Archie, DJ-Georgi, DJ-Telescope, DJ-Wally Lite, Joshua Ceiling, K-Giro, K-Jane, K-Johnny, K-Pivot, K-Telescope, LC-Archie, LC-Georgi, LC-Wally Lite, Metal Man, MO-Pivot, Parachute, Sprocket, Swivel, Tele, Wall Archie, Wall Georgi, Wall Telescope, Wally Lite (sold separately).

700MR

TYPE	FINISH
11S MR11 SOLID	CH ALUMINUM
16S MR16 SOLID	BZ ANTIQUE BRONZE
16M MR16 MESH	BK BLACK

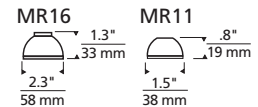

BARNDOORS



SPROCKET WITH
BARNDOORS

Secures to front of MR16 lamp to control light. Includes Louver Lens Holder. Can hold up to two lenses or louvers. Available for use on CPI, DJ-Archie, DJ-Georgi, DJ-Telescope, DJ-Wally Lite, Joshua Ceiling, K-Giro, K-Jane, K-Johnny, K-Pivot, K-Telescope, LC-Archie, LC-Georgi, LC-Wally Lite, Metal Man, MO-Pivot, Parachute, Sprocket, Swivel, Tele, Wall Archie, Wall Georgi, Wall Telescope, Wally Lite (sold separately).

700A08-BK

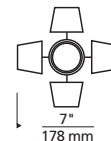

Shows lamp type and maximum wattage.



Includes a Louver Lens Holder



Includes a Snap Louver Lens Holder



LOUVER LENS HOLDER

Secures to front of lamp to hold lenses or louvers. MR16 holds up to two lenses or louvers. MR11 can hold a single lens or louver. Available for use on CPI, DJ-Archie, DJ-Georgi, DJ-Telescope, DJ-Wally Lite, Joshua Ceiling, K-Giro, K-Jane, K-Johnny, K-Pivot, K-Telescope, LC-Archie, LC-Georgi, LC-Wally Lite, Metal Man, MO-Pivot, Parachute, Sprocket, Swivel, Tele, Wall Archie, Wall Georgi, Wall Telescope, Wally Lite (sold separately).

700A01	TYPE	FINISH
-	MR16	BZ ANTIQUE BRONZE
1	MR11	BK BLACK
		AL ALUMINUM

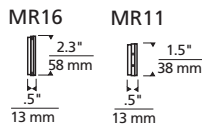

SPROCKET WITH LOUVER LENS HOLDER AND COLORED LENS



SNAP LOUVER LENS HOLDER

Snaps on front of MR16 lamp to hold a single lens or louver. Available for use on CPI, DJ-Archie, DJ-Georgi, DJ-Telescope, DJ-Wally Lite, Joshua Ceiling, K-Giro, K-Jane, K-Johnny, K-Pivot, K-Telescope, LC-Archie, LC-Georgi, LC-Wally Lite, Metal Man, MO-Pivot, Parachute, Sprocket, Swivel, Tele, Wall Archie, Wall Georgi, Wall Telescope, Wally Lite (sold separately).



SPROCKET WITH SNAP LOUVER LENS HOLDER



MR16 SNOUT

Prevents side glare from MR16 lamp. Requires Louver Lens Holder (sold separately). Available for use on CPI, DJ-Archie, DJ-Georgi, DJ-Telescope, DJ-Wally Lite, Joshua Ceiling, K-Bye-Bye, K-Giro, K-Hello, K-Jane, K-Johnny, K-Pivot, K-Telescope, LC-Archie, LC-Georgi, LC-Wally Lite, Metal Man, MO-Pivot, Parachute, Sprocket, Swivel, TT56, Tele, Wall Archie, Wall Georgi, Wall Telescope, Wally Lite (sold separately).



SWIVEL WITH MR16 SNOUT



LED SNAP LOUVER LENS HOLDER

Snaps on front of LED reflector to hold a single MR11 size lens or louver. Available for use on Helios LED Head (sold separately).



COLORED & DICHOIC LENSES



SPROCKET WITH LOUVER LENS HOLDER AND COLORED LENS

Colored lenses wash the light with color; dichroic lenses filter for a pure effect.

MR16

140	TYPE	COLOR	DIMENSIONS A	DIMENSIONS B
FIL	COLORED LENS	RED	1.4" (35 mm)	.1" (3 mm)
DIC	DICHOIC LENS	BLU	2.0" (51 mm)	.1" (3 mm)
		YEL	4.0" (101 mm)	.1" (3 mm)
		GRN		



MR11

140	TYPE	COLOR	DIMENSIONS A	DIMENSIONS B
FIL11	COLORED LENS	RED	1.4" (35 mm)	.1" (3 mm)
		BLU	2.0" (51 mm)	.1" (3 mm)
		YEL	4.0" (101 mm)	.1" (3 mm)
		GRN		

UV FILTERS



SPROCKET WITH SNAP LOUVER LENS HOLDER AND UV FILTER

Efficiently blocks UV radiation while transmitting high quality visible light.

140UV

SIZE	DIMENSIONS A	DIMENSIONS B
MR11	1.4" (35 mm)	.1" (3 mm)
MR16	2.0" (51 mm)	.1" (3 mm)
PAR36	4.0" (101 mm)	.1" (3 mm)



AERO WOOD HANDLE ACCESSORY



WALNUT WOOD HANDLE

AERO WITH SODA GLASS SHADE AND WOOD HANDLE ACCESSORY

700AERWOOD

TYPE	FINISH
W	WALNUT
N	STAINABLE BARE
Z	ANTIQUE BRONZE
C	CHROME
S	SATIN NICKEL



Shows lamp type and maximum wattage.



Includes a Louver Lens Holder



Includes a Snap Louver Lens Holder



EGGCRATE LOUVER

Hexcell louver cuts glare from lamp.

700	TYPE	DIMENSIONS A	DIMENSIONS B
A03-BK	MR11	1.4" (35 mm)	.1" (3 mm)
A02-BK	MR16/PAR16	2.0" (51 mm)	.1" (3 mm)
A03-36	AR111	4.0" (101 mm)	.1" (3 mm)



SPOT WITH EGGCRATE LOUVER



DIFFUSER, SPREAD & SOFT FOCUS LENSES

Diffuser lenses diffuse the beam; linear spread lenses elongates the beam; soft focus lenses reduce lamp glare and blur the sharp lines of lamp images.

140	SIZE	TYPE	DIMENSIONS A	DIMENSIONS B
MR11	MR11	LL LINEAR	1.4" (35 mm)	.1" (3 mm)
MR16	MR16/PAR16	SPREAD	2.0" (51 mm)	.1" (3 mm)
		DF DIFFUSER		
		SF SOFT FOCUS		



SPROCKET WITH SNAP LOUVER LENS HOLDER AND DIFFUSER



SWAG HOOK

Use to change a low-voltage pendant's point of suspension to any point on the ceiling. Order one for each pendant.

700FJSWG	FINISH
Z	ANTIQUÉ BRONZE
C	CHROME
S	SATIN NICKEL

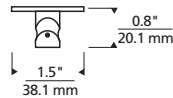

Use to change a line-voltage pendant's point of suspension to any point on the ceiling. Order one for each pendant.

700TDSWG	FINISH
B	BLACK
Z	ANTIQUÉ BRONZE
S	SATIN NICKEL
W	WHITE

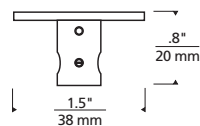

GOBO HOLDER

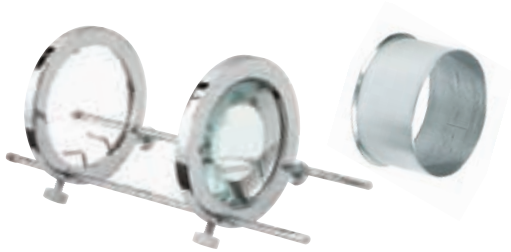

Two threaded rods plus gobo holder and one magnifying lens. Attaches to T156 fixture (p. 112). The result is a projected pattern or logo onto any surface. Includes MR16 Snout.

700AC156 FINISH
C CHROME
S SATIN NICKEL

SEE P. 118 FOR T156 FIXTURE.

GOBO MAGNIFYING LENS



Add this optional magnifying lens to the gobo holder to increase the size of the projected image.

700MAGGL FINISH
C CHROME
S SATIN NICKEL

CUSTOMIZABLE GOBO TEMPLATE



Gobos are available in standard and custom patterns; metal and glass. For additional information on standard and custom gobos, please call 847.410.4400.









TECH LIGHTING



MonoRail Satin Nickel / End Caps /
Remote 300 Watt 12 Volt Transformers /
4" Round Single-Feed Canopies / 2" Rigid Standoffs /
18" Aero Heads / Round Glass Shield Accessories
Amber / MR16 Lamps / FreeJack Port Alone /
3" Sprocket Heads / MR16 Lamps

LOCATION: L.A.R.D. INVESTMENTS, L.P., SANTA FE SPRINGS, CA
DESIGN: H. HENDY ASSOCIATES
PHOTOGRAPHER: PAUL BIELENBERG

Lamp Information

ITEM #	DESCRIPTION	VOLTS	WATTS	LAMP SHAPE	BASE TYPE	BEAM SPREAD	COLOR TEMP (K)	CRI	CENTER BEAM CANDLE POWER	INITIAL LUMENS	RATED AVG LIFE	
12 VOLT INCANDESCENT LAMPS												
12 Volt Halogen Bi-Pin												
	300BLV034	12v Hal T3 G4 20w Bi-pin	12	20	T3	G4	na	3000	100	na	320	2,000
	300BLV026	12v Hal T4 GY6.35 35w Bi-pin	12	35	T4	GY6.35	na	3000	100	na	600	2,000
	300BLV035	12v Hal T4 GY6.35 50w Bi-pin	12	50	T4	GY6.35	na	3000	100	na	930	2,000
12 Volt Xenon Bi-Pin												
	300BLV030	12v Xenon T3 G4 5w Bi-pin	12	5	T3	G4	na	2800	100	na	60	10,000
	300BLV032	12v Xenon T3 G4 10w Bi-pin	12	10	T3	G4	na	2800	100	na	125	10,000
	300BLV031	12v Xenon T3 G4 15w Bi-pin	12	15	T3	G4	na	2800	100	na	180	10,000
	300BLV025	12v Xenon T3 G4 20w Bi-pin	12	20	T3	G4	na	2800	100	na	250	10,000
	300BLV359	12v Xenon T4 GY6.35 35w Bi-pin	12	35	T4	GY6.35	na	2900	100	na	525	10,000
12 Volt MR11												
	300BLV052	12v Hal MR11 GZ4 10° 20w	12	20	MR11	GZ4	10	2925	100	3,000	na	2,000
	300BLV063	12v Hal MR11 GZ4 17° 20w	12	20	MR11	GZ4	17	2925	100	1,400	na	2,000
	300BLV067	12v Hal MR11 GZ4 30° 20w	12	20	MR11	GZ4	30	2925	100	600	na	2,000
	300BLV055	12v Hal MR11 GZ4 10° 35w	12	35	MR11	GZ4	10	2925	100	6,000	na	2,000
	300BLV056	12v Hal MR11 GZ4 20° 35w	12	35	MR11	GZ4	20	2925	100	2,400	na	2,000
	300BLV068	12v Hal MR11 GZ4 30° 35w	12	35	MR11	GZ4	30	2800	100	2,925	1,300	2,000
12 Volt MR16												
	300BLV129	12v Hal MR16 GU5.3 12° 20w	12	20	MR16	GU5.3	12	2950	100	3,500	na	5,000
	300BLV128	12v Hal MR16 GU5.3 36° 20w	12	20	MR16	GU5.3	36	2950	100	600	na	5,000
	300BLV102	12v Hal MR16 GU5.3 24° 35w	12	35	MR16	GU5.3	24	2950	100	2,300	na	5,000
	300BLV105	12v Hal MR16 GU5.3 36° 35w	12	35	MR16	GU5.3	36	2950	100	1,300	na	5,000
	300BLV132	12v Hal MR16 GU5.3 12° 50w	12	50	MR16	GU5.3	12	3000	100	11,000	na	5,000
	300BLV133	12v Hal MR16 GU5.3 24° 50w	12	50	MR16	GU5.3	24	3000	100	3,600	na	5,000
	300BLV131	12v Hal MR16 GU5.3 36° 50w	12	50	MR16	GU5.3	36	3000	100	2,000	na	5,000
	300BLV110	12v Hal MR16 GU5.3 60° 50w	12	50	MR16	GU5.3	60	3000	100	850	na	5,000
	300BLV112	12v Hal MR16 GU5.3 12° 75w	12	75	MR16	GU5.3	12	3000	100	13,000	na	5,000
	300BLV115	12v Hal MR16 GU5.3 24° 75w	12	75	MR16	GU5.3	24	3000	100	4,800	na	5,000
	300BLV116	12v Hal MR16 GU5.3 36° 75w	12	75	MR16	GU5.3	36	3000	100	2,700	na	5,000
12 Volt MR16 GE Constant Color												
	300BLV130	12v GE CC. Hal MR16 GU5.3 15° 20w	12	20	MR16	GU5.3	15	2900	100	3,150	na	5,000
	300BLV127	12v GE CC. Hal MR16 GU5.3 40° 20w	12	20	MR16	GU5.3	40	2900	100	475	na	5,000
	300BLV124	12v GE CC. Hal MR16 GU5.3 20° 35w	12	35	MR16	GU5.3	20	3000	100	3,200	na	5,000
	300BLV126	12v GE CC. Hal MR16 GU5.3 40° 35w	12	35	MR16	GU5.3	40	3000	100	900	na	5,000
	300BLV141	12v GE CC. Hal MR16 GU5.3 15° 50w	12	50	MR16	GU5.3	15	3050	100	8,400	na	6,000
	300BLV138	12v GE CC. Hal MR16 GU5.3 25° 50w	12	50	MR16	GU5.3	25	3050	100	2,900	na	6,000
	300BLV139	12v GE CC. Hal MR16 GU5.3 40° 50w	12	50	MR16	GU5.3	40	3050	100	1,500	na	6,000
	300BLV136	12v GE CC. Hal MR16 GU5.3 55° 50w	12	50	MR16	GU5.3	55	3050	100	850	na	6,000
	300BLV140	12v GE CC. Hal MR16 GU5.3 40° 71w	12	71	MR16	GU5.3	40	3050	100	2,000	na	4,000
12 Volt MR16 IR												
	300BLV254	12v IR MR16 GU5.3 10° 37w	12	37	MR16	GU5.3	10	3000	100	12,500	na	5,000
	300BLV255	12v IR MR16 GU5.3 25° 37w	12	37	MR16	GU5.3	25	3000	100	4,400	na	5,000
	300BLV256	12v IR MR16 GU5.3 35° 37w	12	37	MR16	GU5.3	35	3000	100	2,200	na	5,000



ITEM #	DESCRIPTION	VOLTS	WATTS	LAMP SHAPE	BASE TYPE	BEAM SPREAD	COLOR TEMP (K)	CRI	CENTER BEAM CANDLE POWER	INITIAL LUMENS	RATED AVG LIFE
--------	-------------	-------	-------	------------	-----------	-------------	----------------	-----	--------------------------	----------------	----------------

12 VOLT INCANDESCENT LAMPS (CONTINUED)

12 Volt MR16 10,000 Hour

	300BLV411 12v MR16 GU5.3 24° 50w	12	50	MR16	GU5.3	24	3100	100	2,700	na	10,000
	300BLV410 12v MR16 GU5.3 36° 50w	12	50	MR16	GU5.3	36	3100	100	1,500	na	10,000

12 Volt MR16 Aluminized Reflector

	300BLV412 12v Sld Bk MR16 GU5.3 12° 50w alu	12	50	MR16	GU5.3	12	3000	100	11,000	na	3,500
	300BLV413 12v Sld Bk MR16 GU5.3 24° 50w alu	12	50	MR16	GU5.3	24	3000	100	3,600	na	3,500
	300BLV414 12v Sld Bk MR16 GU5.3 36° 50w alu	12	50	MR16	GU5.3	36	3000	100	2,000	na	3,500

12 Volt MR16 Solid Back

	300BLV144 12v Sld Bk MR16 GU5.3 24° 50w blk	12	50	MR16	GU5.3	24	3000	100	3,000	na	3,500
	300BLV145 12v Sld Bk MR16 GU5.3 36° 50w blk	12	50	MR16	GU5.3	36	3000	100	1,580	na	3,500
	300BLV146 12v Sld Bk MR16 GU5.3 24° 50w sil	12	50	MR16	GU5.3	24	3000	100	3,000	na	3,500
	300BLV147 12v Sld Bk MR16 GU5.3 36° 50w sil	12	50	MR16	GU5.3	36	3000	100	1,580	na	3,500

12 Volt Frost Line

	300BLV415 12v Frostline MR16 GU5.3 20w	12	20	MR16	GU5.3	na	2900	100	na	na	4,000
---	---	----	----	------	-------	----	------	-----	----	----	-------

12 Volt AR111

	300BLV280 12v AR111 G53 4° 35w	12	35	AR111	G53	4	3000	100	40,000	na	3,000
	300BLV285 12v AR111 G53 4° 50w	12	50	AR111	G53	4	3000	100	45,000	na	3,000
	300BLV286 12v AR111 G53 8° 50w	12	50	AR111	G53	8	3000	100	20,000	na	3,000
	300BLV287 12v AR111 G53 25° 50w	12	50	AR111	G53	25	3000	100	4,000	na	3,000
	300BLV290 12v AR111 G53 8° 75w	12	75	AR111	G53	8	3000	100	30,000	na	3,000
	300BLV291 12v AR111 G53 25° 75w	12	75	AR111	G53	25	3000	100	5,300	na	3,000
	300BLV292 12v AR111 G53 45° 75w	12	75	AR111	G53	45	3000	100	2,000	na	3,000

24 VOLT INCANDESCENT LAMPS

24 Volt Halogen Bi-Pin

	300BLV350 24v Hal T3 G4 20w Bi-pin	24	20	T3	G4	na	na	100	na	na	2,000
	300BLV351 24v Hal T3 GY6.35 35w Bi-pin	24	35	T3	GY6.35	na	na	100	na	na	2,000
	300BLV352 24v Hal T3 GY6.35 50w Bi-pin	24	50	T3	GY6.35	na	na	100	na	na	2,000

24 Volt Xenon Bi-Pin

	300BLV356 24v Xenon T3 G4 5w Bi-pin	24	5	T3	G4	na	2800	100	na	55	10,000
	300BLV357 24v Xenon T3 G4 10w Bi-pin	24	10	T3	G4	na	2800	100	na	125	10,000
	300BLV358 24v Xenon T3 G4 20w Bi-pin	24	20	T3	G4	na	2800	100	na	250	10,000
	300BLV360 24v Xenon T3 G4 35w Bi-pin	24	35	T4	GY6.35	na	2900	100	na	525	10,000

24 Volt MR11

	300BLV310 24v Hal MR11 GZ4 30° 20w	24	20	MR11	GZ4	30	2950	100	600	na	2,000
	300BLV314 24v Hal MR11 GZ4 10° 35w	24	35	MR11	GZ4	10	2950	100	4,100	na	2,000
	300BLV315 24v Hal MR11 GZ4 30° 35w	24	35	MR11	GZ4	30	2950	100	1,300	na	2,000

24 Volt MR16

	300BLV301 24v Hal MR16 GU5.3 12° 50w	24	50	MR16	GU5.3	12	2950	100	7,000	na	4,000
	300BLV302 24v Hal MR16 GU5.3 24° 50w	24	50	MR16	GU5.3	24	2950	100	2,900	na	4,000
	300BLV303 24v Hal MR16 GU5.3 36° 50w	24	50	MR16	GU5.3	36	2950	100	1,600	na	4,000

24 Volt MR16 GE Constant Color

	300BLV306 24v GE CC. Hal MR16 GU5.3 40° 35w	24	35	MR16	GU5.3	40	2950	100	920	na	4,000
	300BLV307 24v GE CC. Hal MR16 GU5.3 15° 50w	24	50	MR16	GU5.3	15	2950	100	8,400	na	4,000
	300BLV308 24v GE CC. Hal MR16 GU5.3 40° 50w	24	50	MR16	GU5.3	40	2950	100	1,570	na	4,000

Lamp Information

ITEM #

DESCRIPTION

VOLTS

WATTS

LAMP SHAPE

BASE TYPE

BEAM SPREAD

COLOR TEMP (K)

CRI

CENTER BEAM
CANDLE POWER

INITIAL LUMENS

RATED AVG LIFE

LINE-VOLTAGE INCANDESCENT LAMPS

A-Lamp Incandescent

	300BHV396	120v A19 E26 Med 60w Cl.	120	60	A19	E26 Med	na	2700	100	na	790	2,000
	300BHV108	120v A19 E26 Med 60w Wh.	120	60	A19	E26 Med	na	2700	100	na	805	1,000
	300BHV109	120v A19 E26 Med 75w Wh.	120	75	A19	E26 Med	na	2700	100	na	1,190	750
	300BHV111	120v A19 E26 Med 100w Wh.	120	100	A19	E26 Med	na	2700	100	na	1,710	750
	300BHV392	120v A21 E26 Med 150w Wh.	120	150	A21	E26 Med	na	2700	100	na	2,780	750

BT15 Lamp Halogen

	300BHV114	120v BT15 E26 Med 60w WH	120	60	BT15	E26 Med	na	2800	100	na	760	3,000
--	------------------	--------------------------	-----	----	------	---------	----	------	-----	----	-----	-------

Classic Edison Style A-Lamp Incandescent

	300BHV389	120v EDISON A19 E26 Med 40w Cl.	120	40	A19 EDISON	E26 Med	na	2700	na	na	118	3,000
	300BHV466	120v EDISON A19 E26 Med 60w Cl.	120	60	A19 EDISON	E26 Med	na	2700	na	na	500	2,500

Medium Globe Incandescent

	300BHV122	120v G40 E26 Med 150w WH	120	150	G40	E26 Med	na	2700	100	na	1,770	2,500
--	------------------	--------------------------	-----	-----	-----	---------	----	------	-----	----	-------	-------

Medium T8 Incandescent

	300BHV126	120v T8 E26 Med 75w Fr.	120	60	T8	E26 Med	na	2700	100	na	874	2,000
--	------------------	-------------------------	-----	----	----	---------	----	------	-----	----	-----	-------

Mini-Candelabra Krypton/Halogen

	300BHV153	120v T3 E11 Mini-can. 40w Cl. Kry	120	40	T3	E11 Mini-Cand.	na	2800	100	na	560	2,000
	300BHV439	120v T3 E11 Mini-can. 60w Cl. Kry	120	60	T3	E11 Mini-Cand.	na	2800	100	na	960	2,000
	300BHV150	120v T4 E11 Mini-can. 75w Cl. Hal	120	75	T4	E11 Mini-Cand.	na	2850	100	na	1,125	1,000
	300BHV151	120v T4 E11 Mini-can. 100w Cl. Hal	120	100	T4	E11 Mini-Cand.	na	2850	100	na	1,600	1,000

Double-Ended Halogen

	300BHV438	120v T3 R75 100w 78mm	120	100	T3	RS7	NA	2950	100	NA	1,650	2,000
	300BHV443	120v T3 R75 100w 118mm	120	100	T3	RS7	NA	2950	100	NA	1,650	2,000

G9 Bi-Pin Halogen

	300BHV361	120v Hal G9 bi-pin T4 40w Fr.	120	40	T4	G9 Bi-Pin	NA	2900	100	NA	480	2,000
	300BHV364	120v Hal G9 bi-pin T4 60w Fr.	120	60	T4	G9 Bi-Pin	NA	2900	100	NA	790	2,000

FLUORESCENT LAMPS

Compact Fluorescent Twin Tube

	300BHV388	Flr 2G7 Twin Tube 7w	na	7	CFL Twin	2G7	na	2700	82	na	400	10,000
	300BHV454	Flr 2G7 Twin Tube 9w	na	9	CFL Twin	2G7	na	2700	82	na	580	10,000
	300BHV367	Flr 2GX7 Twin Tube 13w	na	13	CFL Twin	2GX7	na	3000	82	na	800	10,000
	300BHV387	Flr 2G11 Twin Tube 18w	na	18	CFL Twin	2G11	na	3000	82	na	1,250	12,000
	300BHV381	Flr 2G11 Twin Tube 36w	na	36	CFL Twin	2G11	na	3000	82	na	2,900	12,000

Compact Fluorescent Flat Quad Tube

	300BHV380	Flr 2G10 Flat Quad 18w	na	18	CFL Flat Quad	2G10	na	3000	82	na	1,100	10,000
--	------------------	------------------------	----	----	---------------	------	----	------	----	----	-------	--------

Compact Fluorescent Quad Tube

	300BHV458	Flr G24Q-2 Quad Tube 18w	na	18	CFL Quad	G24Q-2	na	2700	82	na	1,200	12,000
	300BHV395	Flr G24Q-3 Quad Tube 26w	na	26	CFL Quad	G24Q-3	na	2700	82	na	1,710	12,000

Compact Fluorescent Triple Tube

	300BHV370	Flr GX24Q-1 Triple Tube 13w	na	13	CFL Triple	GX24Q-1	na	2700	82	na	900	12,000
	300BHV371	Flr GX24Q-2 Triple Tube 18w	na	18	CFL Triple	GX24Q-2	na	2700	82	na	1,200	12,000
	300BHV378	Flr GX24Q-3 Triple Tube 26w	na	26	CFL Triple	GX24Q-3	na	2700	82	na	1,800	12,000
	300BHV386	Flr GX24Q-3 Triple Tube 32w	na	32	CFL Triple	GX24Q-3	na	2700	82	na	2,328	12,000

Compact Fluorescent GU24 Self-Ballasted

	300BHV450	120v Flr Self-Ballasted GU24 Spiral 13w	120	13	CFL Spiral	GU24	na	2700	82	na	900	10,000
	300BHV451	120v Flr Self-Ballasted GU24 Spiral 18w	120	18	CFL Spiral	GU24	na	2700	82	na	1,200	10,000
	300BHV452	120v Flr Self-Ballasted GU24 Spiral 27w	120	27	CFL Spiral	GU24	na	2700	82	na	1,800	10,000
	300BHV471	120v Flr Self-Ballasted GU24 Spiral 32w	120	32	CFL Spiral	GU24	na	2700	82	na	2,100	10,000
	300BHV472	120v Flr Self-Ballasted GU24 Spiral 42w	120	42	CFL Spiral	GU24	na	2700	82	na	2,800	10,000

Linear Fluorescent

	300BHV369	Flr T5 Mini Bi-Pin 14w 22"	na	14	T5	Mini Bi-Pin	na	3000	82	na	1,350	20,000
	300BHV382	Flr T5HO Mini Bi-Pin 24w 22"	na	24	T5 HO	Mini Bi-Pin	na	3000	82	na	2,000	20,000
	300BHV467	Flr T5HO Mini-Bi-Pin 39w 34"	na	39	T5 HO	Mini Bi-Pin	na	3000	85	na	3,100	20,000
	300BHV468	Flr T5HO Mini-Bi-Pin 54w 46"	na	54	T5 HO	Mini Bi-Pin	na	3000	85	na	4,450	25,000

Circline Fluorescent

	300BHV469	Flr T5 2GX13 Circline 40w 12" dia.	na	40	T5 Circular	2GX13	na	3000	82	na	3,200	12,000
	300BHV470	Flr T5HO 2GX13 Circline 55w 12" dia.	na	55	T5 HO Circular	2GX13	na	3000	82	na	4,000	12,000



Selected Lamp Photometrics

12 VOLT MR11

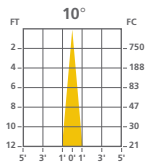

10° 20w
300BLV052
FTB

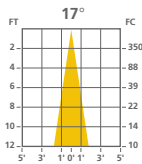

17° 20w
300BLV063
FTC

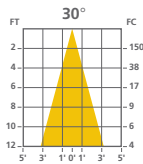

30° 20w
300BLV067
FTD

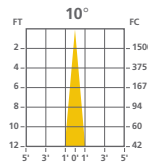

10° 35w
300BLV055
FTE

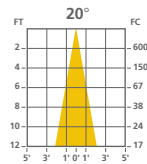

20° 35w
300BLV056
FTF

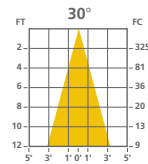

30° 35w
300BLV068
FTH

12 VOLT MR16

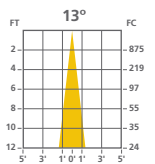

12° 20w
300BLV129
ESX

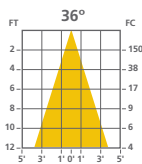

36° 20w
300BLV128
BAB

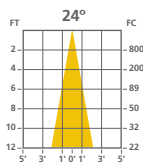

24° 35w
300BLV102
FMV

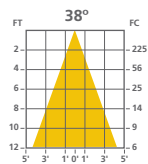

36° 35w
300BLV105
FMW

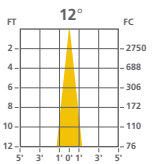

12° 50w
300BLV132
EXT

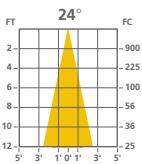

24° 50w
300BLV133
EXZ

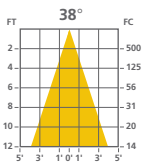

36° 50w
300BLV131
EXN

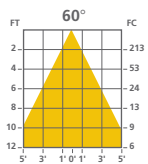

60° 50w
300BLV110
FNV

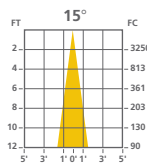

15° 75w
300BLV112
EYF

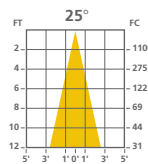

25° 75w
300BLV115
EYJ

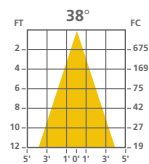

36° 75w
300BLV116
EYC

Transformer Information

SELECTING A TRANSFORMER

The transformer is the key to a low-voltage system. It reduces standard line-voltage to 12 or 24 volts, which is safe to the touch. The total output wattage of the transformers determines the total wattage of the elements that can be used on the system. For example, a 300 watt transformer can power up to six 50 watt heads ($6 \times 50 = 300$).

There are several transformer options from which to choose. Knowing the advantages of each will help you to select the best transformer for your application.

REMOTE

Remote transformers are preferred for their clean look and range of power feed options. They are mounted in accessible locations, but out of view. Power is brought to the rail or cable system through a low-profile power feed canopy or other power feed option (sold separately).



VS.



SURFACE

Surface transformers are decorative and will be visible in the room. They are best suited for applications where there is an existing junction box in a finished ceiling. The surface transformer has an integral power feed—there is no need for a separate power feed; however, the surface transformer must be placed within range of the rail or cable run.

REMODEL RECESSED

Remodel Recessed Transformers look similar from below the ceiling to the power feed canopies used with remote transformers and are preferred for their clean look. An additional benefit they have over remote transformers is that they do not require access to a remote location because the transformer sits just above the ceiling. However, they are not compatible with all finished ceilings because an electrician will need to install the Remodel Recessed Transformer in close proximity to an existing junction box, drill through the finished ceiling in the location where the Remodel Recessed Transformer will be installed, and cover the existing junction box with the field-paintable provided metal cover. The Remodel Recessed Transformer has an integral power feed – there is no need for a separate power feed; however, the transformer must be installed directly above the rail run.

VS.



MAGNETIC

Magnetic transformers have historically been the choice of lighting professionals due to their reliability and can be used to power both halogen and LED elements. We offer a wide range of output wattages for magnetic transformers. When dimming a magnetic transformer, it is important to use a low-voltage magnetic dimmer.



VS.



ELECTRONIC

Electronic transformers are much smaller and lighter than their magnetic counterparts and have the advantage of being resettable at the wall switch in the event of a system short circuit. We offer 12 volt electronic remote and surface transformers in a variety of output options. Not all electronic transformers can be used to power LED elements. Any electronic transformer ending in -LED is compatible with our LED elements. When dimming an electronic transformer, it is important to use a low-voltage electronic dimmer.

12 VOLT

12 volt transformers are most common. A 12 volt system requires that the elements on the system have 12 volt lamps, which are readily available in a range of wattages and beam spreads. A 12 volt transformer can power a run with 300 watts per power feed (600 watts for a dual-feed), running up to thirty feet in each direction from the power feed.



VS.



24 VOLT

24 volt transformers are best suited for installations with limited power feed locations. The elements on the system must have 24 volt lamps, which are not as widely available and offer fewer beam spreads. A 24 volt transformer can power a run with 600 watts per power feed (1200 watts for a dual feed canopy), running up to sixty feet in each direction from the power feed. 24 volt transformers cannot be used on Two-Circuit MonoRail.

All of our transformers comply with guidelines established by the National Electrical Code, with a maximum wattage on a 12 volt system at 300 watts per feed and a maximum wattage on a 24 volt system at 600 watts per feed.



ABOUT SURFACE TRANSFORMERS

Surface transformers mount to a standard 4" junction box with round plaster ring (provided by electrician) and are best suited for applications where there is an existing junction box. The magnetic or electronic transformer is concealed inside a decorative housing with an integral power feed—there is no need to purchase a separate power feed. The surface transformer for a MonoRail or Two-Circuit MonoRail system must be placed directly above the system. The surface transformer for a Kable Lite system must be placed within two feet of the system. Surface transformers have a specific minimum drop depending on

the wattage of the transformer—this dimension must be considered in determining how far the run will drop from the ceiling. Longer drops can be achieved by adding a power extender (for MonoRail or Two-Circuit MonoRail), or hardwire feeds or center power feeds (for Kable Lite).

Tech Lighting's magnetic surface transformers come standard with a debuzzing dimming coil to reduce noise when using a low-voltage magnetic dimmer.

ABOUT REMODEL RECESSED TRANSFORMERS

Remodel recessed transformers provide a clean, minimal look because the transformer is installed above the ceiling out of view. Power is brought to the system through the integral power feed. In a remodel situation, the remodel recessed transformer should be installed within close proximity to an existing junction box. UL requires that the existing junction box still be accessible, so we include a removable, field-paintable cover. In new construction, an electrician can simply bring power to the remodel recessed transformer

directly. In either situation, the remodel recessed transformer must be placed directly above the system. At this time, we are only offering electronic remodel recessed transformers which can easily be reset at the wall switch in the event of a system short circuit.

ABOUT REMOTE TRANSFORMERS

Remote transformers provide a clean, minimal look because the transformer is installed in a remote, accessible location (such as above the ceiling or in a closet) out of view. Power is brought to the system with a system-compatible power feed canopy or other power feed option (sold separately).

The remote transformer can be anchored to the wall or ceiling with screws or toggle bolts and should be installed no more than twenty feet from the power feed. It is important that the electrician supply the correct gauge of THHN wire from the transformer to the junction box to prevent voltage drop, which can cause fixtures to appear dim. See the chart below for proper wire gauge. For optimum performance, remote transformers should be loaded to at least 80 percent of capacity.

Power Taps

Magnetic remote transformers have multiple secondary power taps to compensate for variations in voltage. An input voltage exceeding 120 volts may result in more than 12 or 24 volts on the system, which can shorten lamp life. Follow the installation instructions packaged with the transformer to determine which power tap to use.

Voltages

Tech Lighting transformers are standard for 120 volt input and for 277 volt input where noted. Other input voltages are available upon request.

LOW-VOLTAGE WIRE SIZE TABLE

Use to determine the correct THHN wire size for a recommended 3 percent drop in voltage at the specified wattage. The length shown is the length of wire from the transformer to the power feed.

12 VOLT	5 ft.	6-15 ft.	16-20 ft.	21-40 ft.	41-60 ft.	61-90 ft.
150 watt	#12 GA	#8 GA	#6 GA	#4 GA	#2 GA	#1 GA
300 watt	#10 GA	#6 GA	#4 GA	#1 GA	1/O	3/O
24 VOLT	5 ft.	6-15 ft.	16-20 ft.	21-40 ft.	41-60 ft.	61-90 ft.
300 watt	#14 GA	#12 GA	#10 GA	#6 GA	#6 GA	#4 GA
600 watt	#12 GA	#8 GA	#6 GA	#4 GA	#2 GA	#1 GA

DIMMING

All Tech Lighting transformers may be dimmed with the appropriate dimmer: a low voltage magnetic dimmer for a magnetic transformer; a low voltage electronic dimmer for an electronic transformer, or a standard incandescent dimmer where indicated. The dimmer is placed on the line voltage side of the input line. Consult the transformer charts in each system section of the catalog for the compatible dimmer type. **It is very important to use the compatible dimmer type: failure to do so will substantially shorten the useful life of the transformer.**

Remote transformers are generally placed outside the room, so any buzzing that may be caused by dimming is not noticeable. If using a remote magnetic transformer and a buzzing noise is apparent, a debuzzing dimming coil may be wired in series on one of the 120 volt input lines. Select the correct dimming coil (see below) based on the wattage of your transformer.



DEBUZZING DIMMING COIL ALONE

	DIAMETER	DEPTH
700DIM150	1.75"	.75"
700DIM300	2.25"	1.00"
700DIM600	4.75"	1.00"

Index Hardware and Fixtures

FIXTURE.....	PAGE	SECTION
2" Square Direct-End Power Feed	288.....	MonoRail
2" Square Flush Canopy	352	FreeJack
2" Square Canopy	362	Display & Exhibit
3-Port Linear Canopy	353	FreeJack
3-Port Round Canopies	353	FreeJack
4" Round Direct-End Power Feed	288.....	MonoRail
4" Round Direct-End Power Feed	306.....	Two-Circuit MonoRail
4" Round Flush Canopy	352	FreeJack
4" Square Flush Canopy	352	FreeJack
4" Round Canopy	362	Display & Exhibit
4" Round Swivel Canopy	362	Display & Exhibit
4-Port Round Canopy.....	353	FreeJack
4-Port Square Canopy	353	FreeJack
5-Port Round Canopies	353	FreeJack
Adjustable Standoff	282.....	MonoRail
Adjustable Standoff	302.....	Two-Circuit MonoRail
Adjustable Standoff	332	Kable Lite
Aero	120.....	Low-Voltage Heads
Aero Wood Handle Accessory	376.....	Accessories & Optical Controls
Atlantis With Cone	216.....	Wall Collection
Autumn Wind.....	36.....	Low-Voltage Pendants
Aviza.....	214.....	Wall Collection
Backlight Shield	374.....	Accessories & Optical Controls
Barndoors	374.....	Accessories & Optical Controls
Bell	373.....	Accessories & Optical Controls
Belladonna	373.....	Accessories & Optical Controls
Biplane.....	135.....	Low-Voltage Heads
Biz.....	74.....	Low-Voltage Pendants
Boreal	38.....	Low-Voltage Pendants
Boreal	190.....	Wall Collection
Bouquet With Moon.....	217.....	Wall Collection
Bouquet With Raindrop	217.....	Wall Collection
Boxie.....	240.....	Ceiling Collection
Brick Or Cement Anchors	338	Kable Lite
Brulée	54.....	Low-Voltage Pendants
Bugs.....	134.....	Low-Voltage Heads
Cabo.....	45.....	Low-Voltage Pendants
Cabo	200.....	Wall Collection
Cabo Grande	156.....	Line-Voltage Pendants
Cabo Grande	200.....	Wall Collection
Cam	118.....	Low-Voltage Heads
Camille	94.....	Low-Voltage Pendants
Center Power Feed	289.....	MonoRail
Center Power Feed	306.....	Two-Circuit MonoRail
Center Power Feed	321.....	Wall MonoRail
Center Power Feed	340	Kable Lite
Chambers Ceiling.....	246	Ceiling Collection
Cheers.....	76.....	Low-Voltage Pendants

FIXTURE.....	PAGE	SECTION
Cirque	242	Ceiling Collection
Colored & Dichroic Lenses	376.....	Accessories & Optical Controls
Conductive Connectors	281.....	MonoRail
Conductive Connectors	301.....	Two-Circuit MonoRail
Conductive Connectors	317.....	Wall MonoRail
Conductive Connectors	333	Kable Lite
Cone	64.....	Low-Voltage Pendants
Cone Glass Shield	367.....	Accessories & Optical Controls
Cone Onyx Shield	367.....	Accessories & Optical Controls
Connector Ports	362	Display & Exhibit
Coronado	44.....	Low-Voltage Pendants
Coronado.....	202	Wall Collection
Corva.....	202	Wall Collection
Corva Bath	225	Bath Collection
Cosmo.....	196.....	Wall Collection
CP Cord Extender	360.....	Display & Exhibit
CP Screw-On	360.....	Display & Exhibit
CPI Clamp-On Light.....	360.....	Display & Exhibit
Crescendo	258	Ceiling Collection
Cube.....	72.....	Low-Voltage Pendants
Cube	206.....	Wall Collection
Cue	78.....	Low-Voltage Pendants
Curly Moon	126.....	Low-Voltage Heads
Curly Raindrop	126.....	Low-Voltage Heads
Curly Torpedo.....	127.....	Low-Voltage Heads
Customizable Gobo Template	378.....	Accessories & Optical Controls
Delancey	146.....	Line-Voltage Pendants
Dichroic Glass Shield.....	371.....	Accessories & Optical Controls
Diffuser, Spread & Soft Focus Lenses	377.....	Accessories & Optical Controls
Dillon.....	140.....	Line-Voltage Pendants
Diz	74.....	Low-Voltage Pendants
DJ Screw-On	362.....	Display & Exhibit
DJ-Archie	363.....	Display & Exhibit
DJ-Georgi	363.....	Display & Exhibit
DJ-Telescope	363.....	Display & Exhibit
DJ-Wally Lite	363.....	Display & Exhibit
Dragonfly	134.....	Low-Voltage Heads
Echo	158.....	Line-Voltage Pendants
Echo	204.....	Wall Collection
Eden With Shade	216.....	Wall Collection
Edge	164.....	Line-Voltage Pendants
Eggcrate Louver	377.....	Accessories & Optical Controls
Egypt	50.....	Low-Voltage Pendants
Element Adapters	340	Kable Lite
Elton	114.....	Low-Voltage Heads
Emerge	179.....	Line-Voltage Pendants
Emerge Roxanne.....	208.....	Wall Collection
End Caps	281.....	MonoRail



FIXTURE.....	PAGE	SECTION	FIXTURE.....	PAGE	SECTION
End Caps	301.....	Two-Circuit MonoRail	Kable Lite 4" Round		
End Caps.....	317.....	Wall MonoRail	Monopoint Canopy	135.....	Low-Voltage Heads
End Power Feed.....	289.....	MonoRail	Kable Lite Freejack Connector	355	FreeJack
End Power Feed	321.....	Wall MonoRail	Kable Lite Kits.....	342	Kable Lite
Envision	106.....	Low-Voltage Heads	Kami	152.....	Line-Voltage Pendants
Essex.....	44.....	Low-Voltage Pendants	K-Bye-Bye	128.....	Low-Voltage Heads
Essex.....	188.....	Wall Collection	K-Giro	130.....	Low-Voltage Heads
Eve Suspension	256	Ceiling Collection	K-Hello	130.....	Low-Voltage Heads
Fab	53.....	Low-Voltage Pendants	Kiev	32.....	Low-Voltage Pendants
Fino Large	160.....	Line-Voltage Pendants	Kiev Large.....	147.....	Line-Voltage Pendants
Fino Small	160.....	Line-Voltage Pendants	K-Jane.....	129.....	Low-Voltage Heads
Fire	66.....	Low-Voltage Pendants	K-Johnny.....	129.....	Low-Voltage Heads
Fire.....	194.....	Wall Collection	K-Pivot	131.....	Low-Voltage Heads
Fire Grande	154.....	Line-Voltage Pendants	K-Telescope	128.....	Low-Voltage Heads
Fire Onyx	156.....	Line-Voltage Pendants	Lamps	380	Lamps
Fire Onyx	192.....	Wall Collection	Larkspur	150.....	Line-Voltage Pendants
Firebird	70.....	Low-Voltage Pendants	Larkspur	186.....	Wall Collection
Firebird	195.....	Wall Collection	Larkspur Suspension.....	256	Ceiling Collection
Firebird Glass Shield.....	368.....	Accessories & Optical Controls	LC-Archie	361.....	Display & Exhibit
Firefrit	70.....	Low-Voltage Pendants	LC-Georgi.....	361.....	Display & Exhibit
Firefrit	194.....	Wall Collection	LC-Wally Lite	361.....	Display & Exhibit
Firefrost	68.....	Low-Voltage Pendants	LED Snap Louver Lens Holder	375.....	Accessories & Optical Controls
Firefrost	195.....	Wall Collection	Lexington.....	144.....	Line-Voltage Pendants
Flexible Horizontal Connectors	281.....	MonoRail	Lexington.....	184.....	Wall Collection
Flexible Horizontal Connectors	301.....	Two-Circuit MonoRail	Lil Big Wonder	365.....	Display & Exhibit
Flexible Horizontal Connectors	317.....	Wall MonoRail	Lil Egypt	371.....	Accessories & Optical Controls
Flexible Vertical Connectors.....	317.....	Wall MonoRail	Lil Wok	374.....	Accessories & Optical Controls
Flight Paper.....	372.....	Accessories & Optical Controls	Lil Wonder	365.....	Display & Exhibit
Gobo Holder.....	378.....	Accessories & Optical Controls	Louver Lens Holder	375.....	Accessories & Optical Controls
Gobo Magnifying Lens	378.....	Accessories & Optical Controls	Luna	222	Bath Collection
Hanging Wok	96.....	Low-Voltage Pendants	Lynn Bath	225	Bath Collection
Hardwire Feeds	335	Kable Lite	Madison.....	146.....	Line-Voltage Pendants
Heavy Duty Standoffs	338	Kable Lite	Martini Glass Shield	368.....	Accessories & Optical Controls
Helios LED Head	104.....	Low-Voltage Heads	Melody	264	Ceiling Collection
Horizontal Turn	333	Kable Lite	Melrose	86.....	Low-Voltage Pendants
Hudson	162.....	Line-Voltage Pendants	Melrose.....	174.....	Line-Voltage Pendants
Hudson.....	201.....	Wall Collection	Melrose Flush	214.....	Wall Collection
Inline Turnbuckles	340	Kable Lite	Melt	84.....	Low-Voltage Pendants
Inner Fire	68.....	Low-Voltage Pendants	Mercer	248	Ceiling Collection
Insulating Tubing.....	338	Kable Lite	Metal Man.....	134.....	Low-Voltage Heads
Isolating Connectors.....	281.....	MonoRail	Meteor	92.....	Low-Voltage Pendants
Isolating Connectors.....	301.....	Two-Circuit MonoRail	Meteor Frit.....	92.....	Low-Voltage Pendants
Isolating Connectors	317.....	Wall MonoRail	Meteorite	370.....	Accessories & Optical Controls
Isolating Connectors.....	333	Kable Lite	Metro	224	Bath Collection
John	114.....	Low-Voltage Heads	Metro Long	224	Bath Collection
Joshua 2" Canopy	364.....	Display & Exhibit	Mini Crescendo	260.....	Ceiling Collection
Joshua 4" Round Flush Canopy.....	364.....	Display & Exhibit	Mini Echo	62.....	Low-Voltage Pendants
Joshua And Meg Picture Lights	365.....	Display & Exhibit	Mini Edge.....	52.....	Low-Voltage Pendants

Index Hardware and Fixtures

FIXTURE.....	PAGE	SECTION
Mini Hudson	54.....	Low-Voltage Pendants
Mini Larkspur	48.....	Low-Voltage Pendants
Mini Larkspur.....	186.....	Wall Collection
Mini Melrose.....	86.....	Low-Voltage Pendants
Mini Mulberry.....	34.....	Low-Voltage Pendants
Mini Om.....	108.....	Low-Voltage Heads
Mini Om Accessory	371.....	Accessories & Optical Controls
Mini Ovation.....	88.....	Low-Voltage Pendants
Mini Starry Night	90.....	Low-Voltage Pendants
Mini Taza	91.....	Low-Voltage Pendants
Monarch.....	148.....	Line-Voltage Pendants
Monarch.....	212.....	Wall Collection
Monarch Suspension	252.....	Ceiling Collection
Monet	93.....	Low-Voltage Pendants
MonoRail	280.....	MonoRail
MonoRail Freejack Connector	355.....	FreeJack
MonoRail Kits.....	292.....	MonoRail
Montana.....	170.....	Line-Voltage Pendants
Moon.....	82.....	Low-Voltage Pendants
Mo-Pivot	127.....	Low-Voltage Heads
MRI6 Snout	375.....	Accessories & Optical Controls
Mulberry.....	142.....	Line-Voltage Pendants
Mulberry Ceiling.....	246.....	Ceiling Collection
Nebbia	56.....	Low-Voltage Pendants
Nebbia.....	212.....	Wall Collection
Nebbia Suspension	254.....	Ceiling Collection
Niko.....	90.....	Low-Voltage Pendants
Oak Park.....	50.....	Low-Voltage Pendants
Outside Rigger	333.....	Kable Lite
Ovation.....	176.....	Line-Voltage Pendants
Ovation	210.....	Wall Collection
Palma	166.....	Line-Voltage Pendants
Parachute	135.....	Low-Voltage Heads
Pelé	78.....	Low-Voltage Pendants
Pelé Chandelier	232.....	Ceiling Collection
Pendant Cluster Canopies.....	180.....	Line-Voltage Pendants
Pendenza Ceiling	238.....	Ceiling Collection
Peyton.....	42.....	Low-Voltage Pendants
Pinnacle	58.....	Low-Voltage Pendants
Piper.....	100.....	Low-Voltage Pendants
Plaster Anchors	338.....	Kable Lite
Playa.....	40.....	Low-Voltage Pendants
Playa	153.....	Line-Voltage Pendants
Playa	198.....	Wall Collection
Playa Flush Wall	198.....	Wall Collection
Pleat.....	48.....	Low-Voltage Pendants
Plug Option.....	285.....	MonoRail
Plug Option.....	305.....	Two-Circuit MonoRail

FIXTURE.....	PAGE	SECTION
Plug Option.....	321.....	Wall MonoRail
Plug Option	337.....	Kable Lite
Pod.....	125.....	Low-Voltage Heads
Polly.....	244.....	Ceiling Collection
Port Alone	354.....	FreeJack
Port With Canopy	354.....	FreeJack
Powell Street	162.....	Line-Voltage Pendants
Power Extender	285.....	MonoRail
Power Extender.....	305.....	Two-Circuit MonoRail
Power Feed Canopies	285.....	MonoRail
Power Feed Canopies	305.....	Two-Circuit MonoRail
Power Feed Canopies	319.....	Wall MonoRail
Power Feed Canopies.....	335.....	Kable Lite
Power Feed Canopies With LED Transformer	319.....	Wall MonoRail
Power Feed Standoffs.....	337.....	Kable Lite
Power Feed Turnbuckles.....	337.....	Kable Lite
Power Jumpers	338.....	Kable Lite
Power Outside Rigger	307.....	Two-Circuit MonoRail
Power Vault Adapter	290.....	MonoRail
Power Vault Adapter	308.....	Two-Circuit MonoRail
Pre-Bent 90° Curve	300.....	Two-Circuit MonoRail
Pre-Bent 90° Curve MonoRail.....	280.....	MonoRail
Pre-Bent S Curve	300.....	Two-Circuit MonoRail
Pre-Bent S Curve MonoRail	280.....	MonoRail
Presto	262.....	Ceiling Collection
Prism	99.....	Low-Voltage Pendants
Prism Glass Shield.....	372.....	Accessories & Optical Controls
Pyramid.....	73.....	Low-Voltage Pendants
Raindrop	96.....	Low-Voltage Pendants
Recessed Can Adapter	354.....	FreeJack
Recessed Can Transformer	291.....	MonoRail
Rectangular Direct-End Power Feed	288.....	MonoRail
Remodel Recessed Transformers	287.....	MonoRail
Remote Transformers	284.....	MonoRail
Remote Transformers	304.....	Two-Circuit MonoRail
Remote Transformers.....	318.....	Wall MonoRail
Remote Transformers.....	334.....	Kable Lite
Rhapsody	260.....	Ceiling Collection
Rigid Post Standoff/Standoff Turn.....	332.....	Kable Lite
Rigid Standoff	282.....	MonoRail
Rigid Standoff	302.....	Two-Circuit MonoRail
Rigid T Standoff.....	332.....	Kable Lite
River Rock Chandelier	236.....	Ceiling Collection
River Rock Oblong Oval.....	46.....	Low-Voltage Pendants
River Rock Soft Round	46.....	Low-Voltage Pendants
River Rock Wedge	47.....	Low-Voltage Pendants



FIXTURE.....	PAGE	SECTION	FIXTURE.....	PAGE	SECTION
Rohe	152.....	Line-Voltage Pendants	Swivel	124.....	Low-Voltage Heads
Round Glass Shield	367.....	Accessories & Optical Controls	Sydney.....	76.....	Low-Voltage Pendants
Sahara	80.....	Low-Voltage Pendants	Symphony	264	Ceiling Collection
Savoy	84.....	Low-Voltage Pendants	“T” Connector.....	291.....	MonoRail
Scania	110.....	Low-Voltage Heads	“T” Connector	307.....	Two-Circuit MonoRail
Scavo.....	80.....	Low-Voltage Pendants	T-Trak Freejack Connector	354	FreeJack
Scavo Glass Shade.....	368.....	Accessories & Optical Controls	T156	118.....	Low-Voltage Heads
Scavo Large	173.....	Line-Voltage Pendants	Taza	172.....	Line-Voltage Pendants
Serengeti	166.....	Line-Voltage Pendants	Taza Accessory	372.....	Accessories & Optical Controls
Serengeti	192	Wall Collection	T-Bar Connector.....	290.....	MonoRail
Shui Chandelier	234	Ceiling Collection	T-Bar Connector.....	308.....	Two-Circuit MonoRail
Siber Mirror	226	Bath Collection	Tele	124.....	Low-Voltage Heads
Silva.....	43.....	Low-Voltage Pendants	Telesto	244	Ceiling Collection
Silver Glaze.....	57.....	Low-Voltage Pendants	Tetra.....	94.....	Low-Voltage Pendants
Sky	100.....	Low-Voltage Pendants	Tigris Mirror Oval	227	Bath Collection
Slimline Anchors	331	Kable Lite	Tigris Mirror Round.....	228	Bath Collection
Slimline Turnbuckles	331	Kable Lite	Tilt	122.....	Low-Voltage Heads
Small Nest	99.....	Low-Voltage Pendants	Tinkerbell.....	373.....	Accessories & Optical Controls
Small Nest.....	168.....	Line-Voltage Pendants	Torpedo Pendant	98.....	Low-Voltage Pendants
Snap Louver Lens Holder	375.....	Accessories & Optical Controls	Trace Suspension	250	Ceiling Collection
Soda	170.....	Line-Voltage Pendants	Track Adapter	180.....	Line-Voltage Pendants
Soda Glass Shade	370.....	Accessories & Optical Controls	Track Adapter.....	354	FreeJack
Soft Anchors	331	Kable Lite	Trimble	36.....	Low-Voltage Pendants
Soft Turnbuckles	331	Kable Lite	Trimble Grande.....	147.....	Line-Voltage Pendants
Solace	222	Bath Collection	Turnbuckles.....	331	Kable Lite
Soleil	60.....	Low-Voltage Pendants	Two-Circuit MonoRail	300	Two-Circuit MonoRail
Solitude	72.....	Low-Voltage Pendants	Two-Circuit MonoRail Freejack Connector	355	FreeJack
Sophia	93.....	Low-Voltage Pendants	Universal Turnbuckles.....	331	Kable Lite
Spirit.....	178.....	Line-Voltage Pendants	UV Filters	376.....	Accessories & Optical Controls
Sportster.....	116.....	Low-Voltage Heads	Veil	42.....	Low-Voltage Pendants
Spot.....	116.....	Low-Voltage Heads	Venus Canopy.....	352	FreeJack
Sprocket	112.....	Low-Voltage Heads	Vertical Turn	333	Kable Lite
Staccato.....	262	Ceiling Collection	Vino	82.....	Low-Voltage Pendants
Standoff Vault Adapter	290.....	MonoRail	Waffle	52.....	Low-Voltage Pendants
Standoff Vault Adapter	308.....	Two-Circuit MonoRail	Wall Archie	132	Low-Voltage Heads
Starry Night	172.....	Line-Voltage Pendants	Wall Georgi.....	132	Low-Voltage Heads
Sugar	88.....	Low-Voltage Pendants	Wall MonoRail	316.....	Wall MonoRail
Sugar Accessory	370.....	Accessories & Optical Controls	Wall MonoRail Freejack Connector.....	355	FreeJack
Summit	58.....	Low-Voltage Pendants	Wall MonoRail Kits	322	Wall MonoRail
Support Outside Rigger	289.....	MonoRail	Wall MonoRail Standoff	316.....	Wall MonoRail
Support Outside Rigger	307.....	Two-Circuit MonoRail	Wall Telescope	133.....	Low-Voltage Heads
Surface Canopy	352	FreeJack	Wall Turn	333	Kable Lite
Surface Transformers.....	286.....	MonoRail	Wally Lite.....	133.....	Low-Voltage Heads
Surface Transformers.....	305.....	Two-Circuit MonoRail	Wave Turnbuckles.....	331	Kable Lite
Surface Transformers	320	Wall MonoRail	“X” Connector.....	291.....	MonoRail
Surface Transformers	336	Kable Lite	“X” Connector	307.....	Two-Circuit MonoRail
Swag Hook	180.....	Line-Voltage Pendants			
Swag Hook	377.....	Accessories & Optical Controls			



FreeJack 4" Round Flush Canopies Satin Nickel /
Summit Pendants / MR16 Lamps

LOCATION: PRIVATE RESIDENCE
PHOTOGRAPHER: CLAUDIO SANTINI



Tech Lighting started small – by manufacturing Kable Lite back in 1988. Since then, we’ve added eleven complete systems and launched several new brands to help service your lighting needs. The goal – build a company offering products and services based on timeless design, precision engineering and trust. This is where function and beauty intersect to produce lighting of undeniable attraction.

Looking for something more? These other Tech Lighting Brands offer thousands of additional choices and everything else you would expect from Tech Lighting:

WILMETTE LIGHTING
COMPANY

Authentic period lighting infused with modern technology

Extensive offering of vintage ceiling, suspension, wall and bath fixtures – damp and wet listed

Historically-inspired low-voltage systems with vast collection of pendants and directional heads

Wide assortment of LED and compact fluorescent products

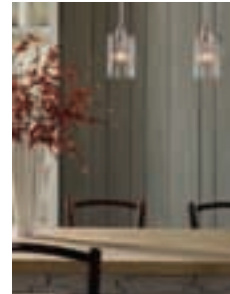

www.wilmettelighting.com

T~trak™

First ever hand-bendable line-voltage track

Winner of Lightfair Design Excellence Award

Vast assortment of line-voltage directional heads and pendants with many energy efficient lamping options

Incandescent PAR, CMH, CFL lamping & full offering of Tech Lighting’s low-voltage heads and pendants

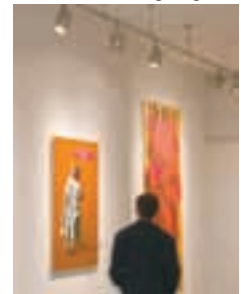
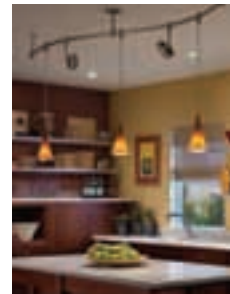

www.ttraklighting.com

ELEMENT 

Sets the standard in downlighting with an architectural appearance

Small aperture, fully adjustable and lockable fixture with minimalist look and many modern finish options

Ever expanding line including wall wash and 6" aperture for a seamless take on general illumination downlights

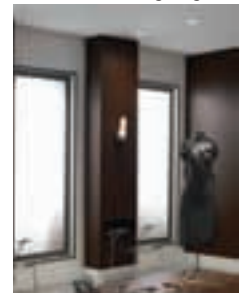
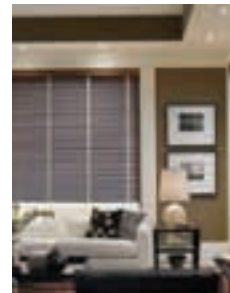

www.element-lighting.com

tiella

A great alternative when price may be the primary driver

Flexible low-voltage rail and monopoint systems with many pendant and directional heads

Complementary and affordable sconce and ceiling offering

“Easy Kits” contain a complete lighting system making it even easier to order

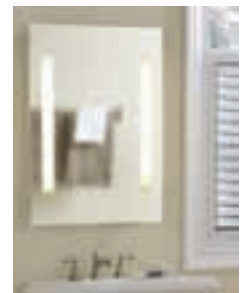
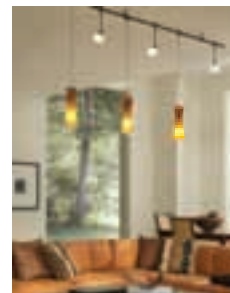

www.tiella.com

Tech Lighting Full Line Catalog is printed at an ISO 14001:2004 certified plant with Forest Stewardship Council (FSC) Chain of Custody certification (BVCO-080903). It was printed with the use of certified renewable wind power resulting in nearly zero volatile organic compound (VOC) emissions.

By printing at a facility that uses wind-generated electricity:

 29,135 lbs of greenhouse gases prevented

 equivalent to 25,278 miles not driven in a year

 equivalent to 1,982 acres of trees saved



TECH LIGHTING®

7400 Linder Ave.
Skokie, IL 60077
T 847 410 4400
F 847 410 4500
www.techlighting.com