

**Steel City<sup>®</sup>**

# **Steel City<sup>®</sup> Metallic Boxes & Covers**

**In this section...**



## **Steel City<sup>®</sup> Metallic Boxes & Covers**

Overview .....	A-2-A-5
Pre-Fab Components and Assemblies .....	A-6-A-16
Switch Boxes and Accessories .....	A-17-A-28
Round/Octagon Boxes and Accessories .....	A-29-A-33
Ceiling Fan Boxes and Accessories .....	A-34-A-35
Square Boxes and Accessories .....	A-36-A-49
Utility Boxes and Accessories .....	A-50-A-51
Handy Boxes and Accessories .....	A-51-A-52
Gang Boxes and Accessories .....	A-52-A-55
Concrete/Masonry Boxes and Accessories .....	A-56-A-58
Box Hangers and Supports .....	A-59-A-61
Stud Wall and Drywall Accessories .....	A-62-A-66

**Thomas & Betts**

[www.tnb.com](http://www.tnb.com)

## Overview

### Steel City® Metallic Boxes and Covers

Steel City® is the industry-leading product line of metallic switch and outlet boxes used in electrical construction. Since 1904, Steel City® products have symbolized the highest quality standards in manufacturing and innovative design, with one of the most complete offerings available.

Steel City® products are known for their simple improvements, such as being the first box offering to standardize combination slotted/phillips screws on all boxes. Thomas & Betts is also recognized as a leader in design innovation, as in our new metal stud bracket.

Thomas & Betts continues to listen to contractors and responds to their ever-changing needs. Contact a T&B distributor nearest you to select the right Steel City® product for your requirements.

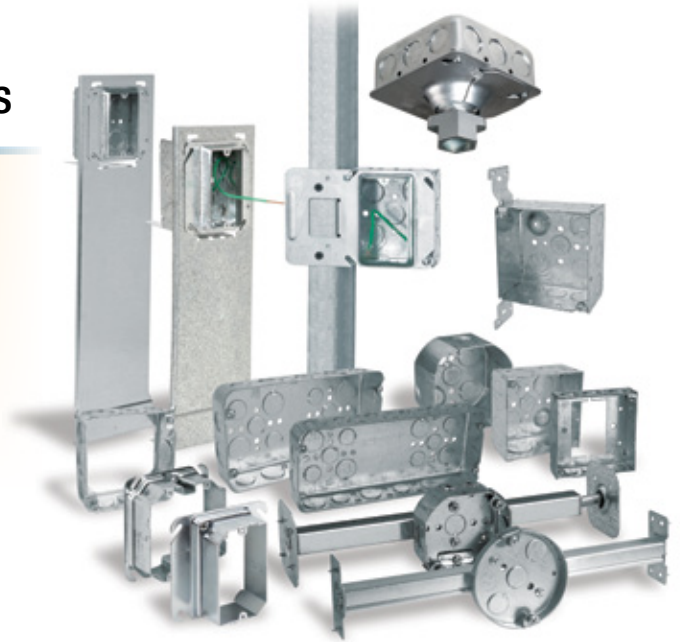

### Advantages of Steel City® Boxes and Covers

#### Notched Ears on Switch Boxes

- Steel City® Switch Boxes feature a longer ear and a special notch. This provides clearance for the screws that are used to attach wall plates to GFCI or rocker-type light switches

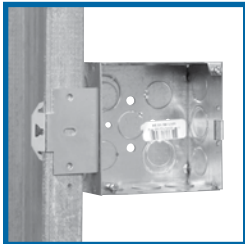

#### MS Bracket Boxes

- Mounts without the use of screws
- Mounts to the open or closed side of the stud
- Works on stud depths up to 4"

#### Eccentric Knockouts on Square Boxes

- Provide better contact with conduit fitting and locknut to the box, improve grounding path, stronger than 3/4" knockout
- Available in all four standard-size square boxes
- Improved 3/4" knockout position on square boxes
- Less labor required to install 3/4" conduit to box

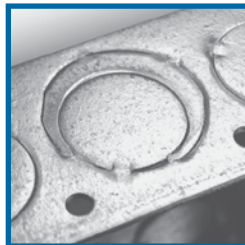

#### Raised Ground Screw Bump in 4" Square, 4 1/16" and Utility Boxes

- Quicker surface mounting by eliminating the need to remove the portion of the screw that threads through the back of the box
- Allows for improved repositioning of grounding conductor
- Ground bump standard in 2 1/8" boxes
- Ground bump optional in 1 1/2" boxes



#### Pre-Installed Screws are Packaged in Raised Position

- Eliminates extra step of having to back out the screw during cover installation

Steel City® switch and outlet boxes are protected from rust and corrosion by zinc-galvanizing. All clamps and other component parts are electrogalvanized separately, before assembly in the box, to ensure corrosion protection of every surface. Steel City® galvanized finish meets the requirements of Underwriters Laboratories, Inc. and Federal Specifications.

## Overview

### Guide to Steel City® Knockouts, Pryouts, Ears, Brackets and Clamps

#### Knockouts and Pryouts

Steel City® conduit KOs have standard trade size dimensions. KOs are uniform and true for attachment of cable or conduit connectors. Pryouts for cable entrance are slotted — a twist with a screwdriver removes them. KOs and Pryouts are precision stamped to permit easy removal, but remain sufficiently strong and sturdy when not removed.

#### Outlet Box Ears

Mounting ears support the box independent of the electrical system attachments. Switch boxes have a fixed ear for old work installations.

Ears for plaster are set 1/16" forward of the box face in position for old work (modernization), except where specifically noted.

#### Tapped Holes for Grounding

All Steel City® boxes have a 10-32 tapped hole in the bottom of the box for attaching separate ground wire.

#### Knockouts

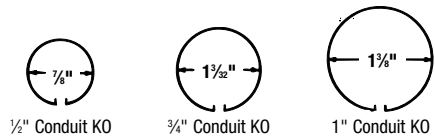

#### Eccentric Knockouts



#### Pryouts

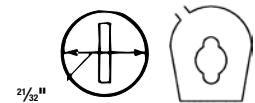

#### Brackets

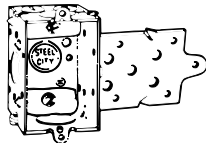

#### S or B Type

Mounts to face of stud. Used on switch, handy or square boxes. 2" long x 2 1/8" wide



#### T Type

Positions handy box against the face and side of stud. 5 1/2" long x 3/8" wide

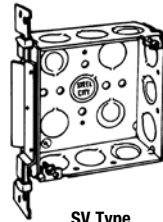

#### SV Type

Mounts box to side of stud with positioning spikes. 7 7/8" long x 1" wide x 3/8" offset

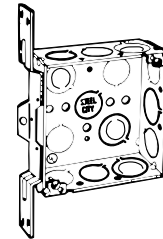

#### CV Type (Outlet Boxes)

Mounts to flat side of metal studs or wood studs. 7 3/8" long x 1" wide x 3/8" offset

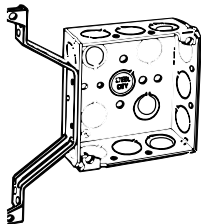

#### DV Type

Mounts box offset from stud 1 1/2". 6 3/8" long x 1" wide x 1 1/2" offset

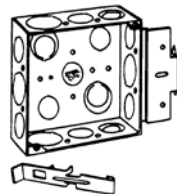

#### MS Type (For Metal Studs)

Mounts to any depth of metal stud, open or closed side. 2 1/2" long x 1 1/16" wide x 3/8" offset; Far side support to 4" only

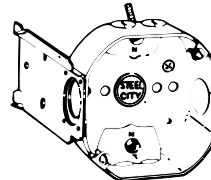

#### L Type

Used to mount octagon boxes. 2 5/8" long x 3 5/8" wide x 1/4" offset

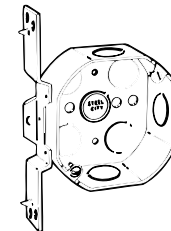

#### V Type

Mounts to flat side of stud. 7 3/8" long x 1" wide x 3/8" offset

#### Clamps

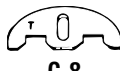
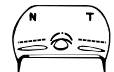
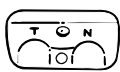

(Loom only)



#### For Non-Metallic Sheathed Cable and Non-Metallic Tubing (Loom)

UNDERWRITERS LABORATORIES INC. and CANADIAN STANDARDS ASSOCIATION file numbers for individual items available upon request.

#### Listing Information for Armored Cable Clamp — Type C-3

Armored Cable (BX) — Steel	Sizes 14-2 through 10-3	MCAP™ — Aluminum*	.370–.580
Armored Cable (BX) — Aluminum	Sizes 14-2 through 10-3	Flex Metal Conduit — Steel	1/8" Trade Size
MC Interlocked (MCI) — Steel	.449–.570 Diameter	Flex Metal Conduit — Aluminum	3/8" Trade Size
MC Interlocked (MCI) — Aluminum	.476–.606 Diameter	C-3 Clamp Acceptable for Grounding	
MC Corrugated (MCC) — Aluminum	.375–.515 Diameter	*MCAP™ is a trademark of Southwire Company	

"Products listed in this catalog are subject to alteration or discontinuation without prior notice."

## Overview

### NEC® Reference

Article 314 of the National Electrical Code® covers the installation and use of boxes. The article includes table references that guide the electrician in the selection of the proper box size necessary to safely accommodate electrical service requirements. The box capacity table shown (page A-5) is reproduced in part from the NEC® as a quick reference and guide. The NEC® should be consulted for complete details.

### Article 314 — Boxes and Fittings

#### 314.16 Number of Conductors in Outlet, Device, and Junction Boxes, and Conduit Bodies.

Boxes and conduit bodies shall be of sufficient size to provide free space for all enclosed conductors. In no case shall the volume of the box, as calculated in 314.16(A), be less than the fill calculation as calculated in 314.16(B). The minimum volume for conduit bodies shall be as calculated in 314.16(C).

The provisions of this section shall not apply to terminal housings supplied with motors or generators. Informational Note: For volume requirements of motor or generator terminal housings, see Article 430.12. Boxes and conduit bodies enclosing conductors #4 AWG or larger shall also comply with the provisions of 314.28.

#### (A) Box Volume Calculations.

The volume of a wiring enclosure (box) shall be the total volume of the assembled sections and, where used, the space provided by plaster rings, domed covers, extension rings and so forth, that are marked with their volume or are made from boxes the dimensions of which are listed in Table 314.16(A).

- (1) **Standard Boxes.** The volumes of standard boxes that are not marked with their volume shall be as given in Table 314.16(A).
- (2) **Other Boxes.** Boxes 1650 cm<sup>3</sup> (100 in.<sup>3</sup>) or less, other than those described in Table 314.16(A), and nonmetallic boxes shall be durably and legibly marked by the manufacturer with their volume. Boxes described in Table 314.16(A) that have a volume larger than is designated in the table shall be permitted to have their volume marked as required by this section.

#### (B) Box Fill Calculations.

The volumes in paragraphs 314.16(B)(1) through (B)(5), as applicable, shall be added together. No allowance shall be required for small fittings such as locknuts and bushings.

- (1) **Conductor Fill.** Each conductor that originates outside the box and terminates or is spliced within the box shall be counted once, and each conductor that passes through the box without splice or termination shall be counted once. Each loop or coil of unbroken conductor not less than twice the minimum length required for free conductors in 300.14 shall be counted twice. The conductor fill shall be calculated using Table 314.16(B). A conductor, no part of which leaves the box, shall not be counted.

**Exception:** An equipment grounding conductor or conductors not over four fixture wires smaller than #14 AWG, or both, shall be permitted to be omitted from the calculations where they enter a box from a domed luminaire or similar canopy and terminate within that box.

- (2) **Clamp Fill.** Where one or more internal cable clamps, whether factory or field supplied, are present in the box, a single volume allowance in accordance with Table 314.16(B) shall be made based on the largest conductor present in the box. No allowance shall be required for a cable connector with its clamping mechanism outside the box.



- (3) **Support Fittings Fill.** Where one or more luminaire studs or hickies are present in the box, a single volume allowance in accordance with Table 314.16(B) shall be made for each type of fitting based on the largest conductor present in the box.
  - (4) **Device or Equipment Fill.** For each yoke or strap containing one or more devices or equipment, a double volume allowance in accordance with Table 314.16(B) shall be made for each yoke or strap based on the largest conductor connected to a device(s) or equipment supported by that yoke or strap. A device or utilization equipment wider than a single 50mm (2 in.) device box as described in Table 314.16(A) shall have double volume allowances provided for each gang required for mounting.
  - (5) **Equipment Grounding Conductor Fill.** Where one or more equipment grounding conductors or equipment bonding jumpers enter a box, a single volume allowance in accordance with Table 314.16(B) shall be made based on the largest equipment grounding conductor or equipment bonding jumper present in the box. Where an additional set of equipment grounding conductors, as permitted by 250.146(D), is present in the box, an additional volume allowance shall be made based on the largest equipment grounding conductor in the additional set.
- #### (C) Conduit Bodies.
- (1) **General.** Conduit bodies enclosing #6 AWG conductors or smaller, other than short-radius conduit bodies as described in 314.16(C)(2), shall have a cross-sectional area not less than twice the cross-sectional area of the largest conduit or tubing to which they can be attached. The maximum number of conductors permitted shall be the maximum number permitted by Table 1 of Chapter 9 for the conduit or tubing to which it is attached.
  - (2) **With Splices, Taps or Devices.** Only those conduit bodies that are durably and legibly marked by the manufacturer with their volume shall be permitted to contain splices, taps or devices. The maximum number of conductors shall be calculated in accordance with 314.16(B). Conduit bodies shall be supported in a rigid and secure manner.
  - (3) **Short-Radius Conduit Bodies.** Conduit bodies such as capped elbows and service-entrance elbows that enclose conductors #6 AWG or smaller, and are only intended to enable the installation of the raceway and the contained conductors, shall not contain splices, taps or devices and shall be of sufficient size to provide free space for all conductors enclosed in the conduit body.

## Overview

### Article 314 — Boxes and Fittings (continued)

**Table 314.16(A)**  
**Metal Boxes**

MM	BOX TRADE SIZE (IN.)		MINIMUM VOLUME		MAXIMUM NUMBER OF CONDUCTORS*						
			CM <sup>3</sup>	IN. <sup>3</sup>	18	16	14	12	10	8	6
100 x 32	(4 x 1¼)	Round/Octagonal	205	12.5	8	7	6	5	5	5	2
100 x 38	(4 x 1½)	Round/Octagonal	254	15.5	10	8	7	6	6	5	3
100 x 54	(4 x 2¼)	Round/Octagonal	353	21.5	14	12	10	9	8	7	4
100 x 32	(4 x 1¼)	Square	295	18.0	12	10	9	8	7	6	3
100 x 38	(4 x 1½)	Square	344	21.0	14	12	10	9	8	7	4
100 x 54	(4 x 2¼)	Square	497	30.3	20	17	15	13	12	10	6
120 x 32	(4L x 1¼)	Square	418	25.5	17	14	12	11	10	8	5
120 x 38	(4L x 1½)	Square	484	29.5	19	16	14	13	11	9	5
120 x 54	(4L x 2¼)	Square	689	42.0	28	24	21	18	16	14	8
75 x 50 x 38	(3 x 2 x 1½)	Device	123	7.5	5	4	3	3	3	2	1
75 x 50 x 50	(3 x 2 x 2)	Device	164	10.0	6	5	5	4	4	3	2
75 x 50 x 57	(3 x 2 x 2¼)	Device	172	10.5	7	6	5	4	4	3	2
75 x 50 x 65	(3 x 2 x 2½)	Device	205	12.5	8	7	6	5	5	4	2
75 x 50 x 70	(3 x 2 x 2¾)	Device	230	14.0	9	8	7	6	5	4	2
75 x 50 x 90	(3 x 2 x 3½)	Device	295	18.0	12	10	9	8	7	6	3
100 x 54 x 38	(4 x 2½ x 1½)	Device	169	10.3	6	5	5	4	4	3	2
100 x 54 x 48	(4 x 2½ x 1¾)	Device	213	13.0	8	7	6	5	5	4	2
100 x 54 x 54	(4 x 2½ x 2¼)	Device	238	14.5	9	8	7	6	5	4	2
95 x 50 x 65	(3¾ x 2 x 2½)	Masonry Box/Gang	230	14.0	9	8	7	6	5	4	2
95 x 50 x 90	(3¾ x 2 x 3½)	Masonry Box/Gang	344	21.0	14	12	10	9	8	7	4
Min. 44.5 depth FS — Single-Cover/Gang (1¾)			221	13.5	9	7	6	6	5	4	2
Min. 60.3 depth FD — Single-Cover/Gang (2¾)			295	18.0	12	10	9	8	7	6	3
Min. 44.5 depth FS — Multiple-Cover/Gang (1¾)			295	18.0	12	10	9	8	7	6	3
Min. 60.3 depth FD — Multiple-Cover/Gang (2¾)			395	24.0	16	13	12	10	9	8	4

\*Where no volume allowances are required by 314.16(B)(2) through 314.16(B)(5).  
Underwriters Laboratories Inc. File Number: E2969 (U.L. 514A)  
Canadian Standards Association File Number: LR 12798  
Federal Manufacture Number: 56501 (Cage Code)  
Products designed to meet Federal Specification Number: W-J-800  
Verification of file numbers and compliance with federal specifications for individual items available upon request.  
Box and cover material and plating specification; .062" minimum thickness, hot rolled, pre-galvanized steel, minimum spangle.  
ASTM G-60-U, AISI C-1008  
Bracket material: All brackets except MS style; 16 gauge (.060") hot rolled, pre-galvanized steel AISI C-1008, G-90-U. MS style bracket; 20 gauge (.036") cold rolled spring steel AISI C-1055, heat treated to R. 35 zinc plated .0005 thick.

**Table 314.16(B)**  
**Volume Allowance Required per Conductor**

SIZE OF CONDUCTOR (AWG)	FREE SPACE WITHIN BOX FOR EACH CONDUCTOR	
	CM <sup>3</sup>	IN. <sup>3</sup>
No. 18	24.6	1.50
No. 16	28.7	1.75
No. 14	32.8	2.00
No. 12	36.9	2.25
No. 10	41.0	2.50
No. 8	49.2	3.00
No. 6	81.9	5.00

Reprinted with permission from National Fire Protection Association NFPA70-2011. National Electrical Code, Copyright© 2010, National Fire Protection Association, Quincy, MA 02269. This reprinted material is not the complete and official position of the NFPA on the referenced subject which is represented only by the standard in its entirety. NEC® is a registered trademark of the National Fire Protection Association, Inc., Quincy, MA 02269.  
Underwriters Laboratories Inc. File Number: E2969 (U.L. 514A)  
Canadian Standards Association File Number: LR 12798  
Federal Manufacture Number: 56501  
Products designed to meet Federal Specification Number: A-A5924 (formerly W-J-800).  
Verification of file numbers and compliance with federal specifications for individual items available upon request.  
Box and cover material and plating specification; .062" minimum thickness, hot-rolled, pre-galvanized steel, minimum spangle.  
ASTM G-60-U, AISI C-1008  
Bracket material: All brackets except MS style; 16 gauge (.060") hot rolled, pre-galvanized steel AISI C-1008, G-60-U. MS Style bracket; 20 gauge (.036") cold rolled spring steel AISI C-1055, heat treated to R. 35 zinc plated .0005 thick.

## Metallic Boxes — Fire Resistance Rating

### Wall Penetrations

Listed single- and double-gang metallic outlet and switch boxes and octagon ceiling boxes with metallic or non-metallic cover plates may be used in bearing and non-bearing wood stud and steel stud walls with ratings not exceeding 2 hours. These walls shall have gypsum wallboard facings similar to those shown in Design Nos. U301, U411, and U425. 4 in. square boxes may be used in 2 hr. fire rated ceilings.

The surface area of individual metallic outlet or switch boxes shall not exceed 16 sq. in. The aggregate surface area of the boxes shall not exceed 100 sq. inches per 100 sq. ft. of wall. Boxes located on opposite sides of walls or partitions shall be separated by a horizontal distance of 24 inches.

The metallic outlet or switch boxes shall be securely fastened to the studs and the opening in the wallboard facing shall be cut so that the clearance between the box and the wallboard does not exceed ¼ in.

## Pre-Fab Components and Assemblies

### Faster Installation for Increased Profit Margin!

#### Pre-Assemblies

Paying to assemble outlet boxes, grounding pigtails, device covers and mounting brackets on the job site can quickly become an expensive proposition. Instead, choose Steel City® Pre-Assemblies and realize significant labor savings. This UL Listed product line includes over 75 combinations of popular boxes, brackets and covers that speed installation because the time-consuming assembly work is already done for you.

**Steel City® Pre-Assemblies include:**

- Outlet box with pre-installed grounding pigtail
- Your choice of cover options, including single- and double-device covers, raised 1/2", 5/8" or 3/4"
- Your choice of bracket options to allow mounting to steel and wood stud or floor track, including Steel City® Box Support Covers, which combine a bracket and cover in one component
- All UL Listed components



### Box with Pre-Installed 10 1/2" Pigtail

- Popular 4" square boxes and switch boxes
- Pre-installed 10 1/2" insulated grounding pigtails
- Save on labor costs by eliminating multiple installation steps



#### Pre-Assembled Installation **VS.** Standard Installation

<ol style="list-style-type: none"> <li>1. Install box in desired location — <b>DONE!</b></li> </ol>	<ol style="list-style-type: none"> <li>1. Purchase pre-stripped pigtail</li> <li>2. Install pigtail and ground screw in box</li> <li>3. Install box in desired location</li> </ol>
---	--



CAT. NO.	BOX TYPE INCLUDED	KNOCKOUTS	PRE-INSTALLED PIGTAIL	STD. CTN.
521511234EWP	52151234EW — 4"-sq. x 1 1/2" D Welded Box	Eccentric	10 1/2"	50
521511234P	521511234 — 4"-sq. x 1 1/2" D Drawn Box	1/2" & 3/4"	10 1/2"	50
521711234EP	521711234E — 4"-sq. x 2 1/8" D Welded Box	1/2" & 3/4" Eccentric	10 1/2"	50
52151XP	52151X — 4"-sq. x 1 1/2" D Welded Box	1/2" & 3/4" Eccentric	10 1/2"	50
52151CVNP	52151CVN — 4"-sq. x 1 1/2" D Welded Box	1/2" & 3/4" Eccentric	10 1/2"	25
LXWOWP	LXWOW-25 — 3"H x 2"W x 2 1/2" D Gangable Switch Box	1/2"	10 1/2"	25
LXVP	LXV-25 — 3"H x 2"W x 2 1/2" D Gangable Switch Box	1/2"	10 1/2"	25
CXWOWP	CXWOW — 3"H x 2"W x 3 1/2" D Gangable Switch Box	1/2" & 3/4"	10 1/2"	25
CXWVP	CXWV — 3"H x 2"W x 3 1/2" D Gangable Switch Box	1/2" & 3/4"	10 1/2"	25
CXP	CX — 3"H x 2"W x 3 1/2" D Gangable Switch Box	1/2" & 3/4"	10 1/2"	25

## Pre-Fab Components and Assemblies

### Box with Pre-Installed 10½" Pigtail and Box Support Cover

- 52CM and 52CMD box support covers
- 10½" insulated pigtail
- One- and two-device covers
- Raised ½", ⅝" and ¾"
- 1½" and 2⅝" box depths

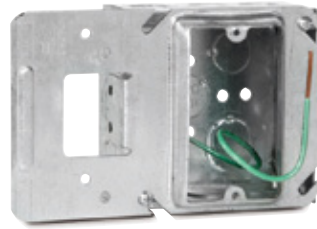

52171-CM14-5/8

CAT. NO.	BOX TYPE INCLUDED	BOX DEPTH (IN.)	PIGTAIL TYPE INCLUDED	BOX SUPPORT COVER INCLUDED	RAISED (IN.)	NO. OF DEVICES	STD. CTN.
52151-CM13	521511234EW	1½	GSC12	52CM13	½	1	25
52151-CM14-5/8	521511234EW	1½	GSC12	52CM14-5/8	⅝	1	25
52151-CM14	521511234EW	1½	GSC12	52CM14	¾	1	25
52151-CMD17	521511234EW	1½	GSC12	52CMD17	½	2	25
52151-CMD18-5/8	521511234EW	1½	GSC12	52CMD18-5/8	⅝	2	25
52151-CMD18	521511234EW	1½	GSC12	52CMD18	¾	2	25
52171-CM13	521711234E	2⅝	GSC12	52CM13	½	1	25
52171-CM14-5/8	521711234E	2⅝	GSC12	52CM14-5/8	⅝	1	25
52171-CM14	521711234E	2⅝	GSC12	52CM14	¾	1	25
52171-CMD17	521711234E	2⅝	GSC12	52CMD17	½	2	25
52171-CMD18-5/8	521711234E	2⅝	GSC12	52CMD18-5/8	⅝	2	25
52171-CMD18	521711234E	2⅝	GSC12	52CMD18	¾	2	25



Boxes & Covers — Steel City® Metallic Boxes

### Box with Pre-Installed 10½" Pigtail, Raised Cover and Box-to-Stud Bracket

- SSF-SH2346 bracket
- 10½" insulated pigtail
- One- and two-device covers
- Raised ½", ⅝" and ¾"
- 1½" and 2⅝" box depths

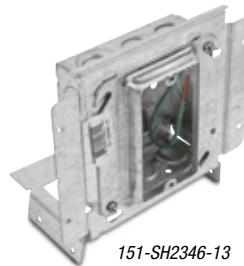

151-SH2346-13

CAT. NO.	BOX TYPE INCLUDED	BOX DEPTH (IN.)	PIGTAIL TYPE INCLUDED	BRACKET TYPE INCLUDED	COVER TYPE INCLUDED	RAISED (IN.)	NO. OF DEVICES	STD. CTN.
151-SH2346-13	521511234EW	1½	GSC12	SSF-SH2346	52-C-13	½	1	10
151-SH2346-1458	521511234EW	1½	GSC12	SSF-SH2346	52-C-14-5/8	⅝	1	10
151-SH2346-14	521511234EW	1½	GSC12	SSF-SH2346	52-C-14	¾	1	10
151-SH2346-17	521511234EW	1½	GSC12	SSF-SH2346	52-C-17-25	½	2	10
151-SH2346-1858	521511234EW	1½	GSC12	SSF-SH2346	52-C-18-5/8-25	⅝	2	10
151-SH2346-18	521511234EW	1½	GSC12	SSF-SH2346	52-C-18	¾	2	10
171-SH2346-13	521711234E	2⅝	GSC12	SSF-SH2346	52-C-13	½	1	10
171-SH2346-1458	521711234E	2⅝	GSC12	SSF-SH2346	52-C-14-5/8	⅝	1	10
171-SH2346-14	521711234E	2⅝	GSC12	SSF-SH2346	52-C-14	¾	1	10
171-SH2346-17	521711234E	2⅝	GSC12	SSF-SH2346	52-C-17-25	½	2	10
171-SH2346-1858	521711234E	2⅝	GSC12	SSF-SH2346	52-C-18-5/8-25	⅝	2	10
171-SH2346-18	521711234E	2⅝	GSC12	SSF-SH2346	52-C-18	¾	2	10



## Pre-Fab Components and Assemblies

### MS Series Pre-Assemblies

- 4" square and 4<sup>11</sup>/<sub>16</sub>" square boxes
- 1½" deep or 2½" deep
- Pre-installed 10½" insulated grounding pigtail
- Available with conduit KOs or clamps for flexible/armored/MC cable
- Save on labor costs by eliminating multiple installation steps

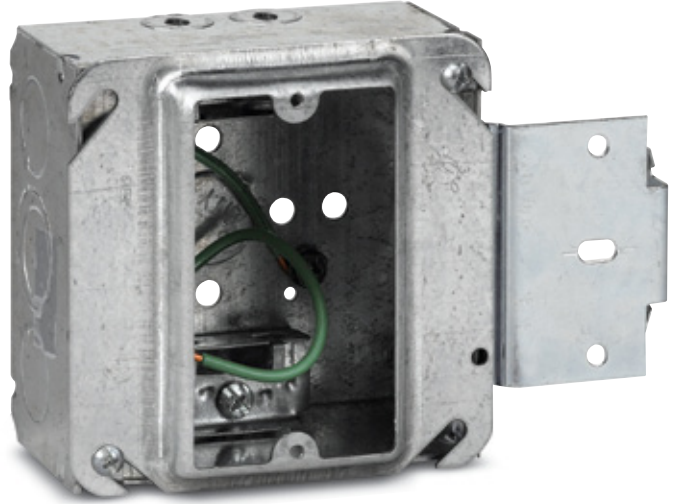

### Pre-Assembled Installation **VS.** Standard Installation

<ol style="list-style-type: none"> <li>1. Snap box — DONE!</li> </ol>	<ol style="list-style-type: none"> <li>1. Purchase pre-stripped pigtail</li> <li>2. Install pigtail and ground screw in box</li> <li>3. Mount box support cover to box</li> <li>4. Mount assembly to stud</li> </ol>
---	--



CAT. NO.	BOX TYPE INCLUDED	BOX DEPTH (IN.)	PIGTAIL INCLUDED (IN.)	BOX COVER INCLUDED	RAISED (IN.)	NO. OF DEVICES	STD. CTN.
151-MS-13	52151-MS-1/2 3/4	1½	10½	52-C-13	½	1	25
151-MS-14	52151-MS-1/2 3/4	1½	10½	52-C-14	¾	1	25
151-MS-1458	52151-MS-1/2 3/4	1½	10½	52-C-14-5/8	¾	1	25
171MS13	52171-MS-1/2 3/4	2½	10½	52-C-13	½	1	25
171-MS-14	52171-MS-1/2 3/4	2½	10½	52-C-14	¾	1	25
171-MS-1458	52171-MS-1/2 3/4	2½	10½	52-C-14-5/8	¾	1	25
171MS18	52171-MS-1/2 3/4	2½	10½	52-C-18	¾	2	25
171-MS-18 5/8	52171-MS-1/2 3/4	2½	10½	52-C-18-5/8-25	¾	2	25
171MSX13	52171-MSX	2½	10½	52-C-13	½	1	25
171-MSX-14	52171-MSX	2½	10½	52-C-14	¾	1	25
171-MSX-1458	52171-MSX	2½	10½	52-C-14-5/8	¾	1	25
171MSX18	52171-MSX	2½	10½	52-C-18	¾	2	25
171-MSX-18 5/8	52171-MSX	2½	10½	52-C-18-5/8-25	¾	2	25
72171MS14	72171-MS-1/2 3/4	2½	10½	72-C-14	¾	1	25
72171-MS-1458	72171-MS-1/2 3/4	2½	10½	72-C-14-5/8	¾	1	25
72171MS18	72171-MS-1/2 3/4	2½	10½	72-C-18	¾	2	25
72171-MS-18 5/8	72171-MS-1/2 3/4	2½	10½	72-C-18-5/8	¾	2	25
72171MSX14	72171-MS-1/2 3/4	2½	10½	72-C-14	¾	1	25
72171-MSX-1458	72171-MSX	2½	10½	72-C-14-5/8	¾	1	25
72171MSX18	72171-MS-1/2 3/4	2½	10½	72-C-18	¾	2	25
72171-MSX-1858	72171-MS-1/2 3/4	2½	10½	72-C-18-5/8	¾	2	25



## Pre-Fab Components and Assemblies

### Box with Pre-Installed 10½" Pigtail, Raised Cover and Vertical Mounting Bracket

- 12" (SSF-SV12) or 18" (SSF-SV18) vertical mounting bracket
- 10½" insulated pigtail
- One- and two-device covers
- Raised ½", ⅝" and ¾"
- 1½" and 2⅛" box depths

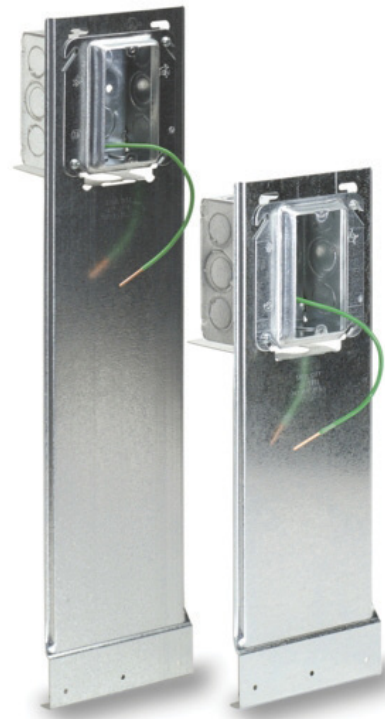

151-SV18-13

151-SV12-13

Boxes & Covers — Steel City® Metallic Boxes

### Pre-Assembled Installation **VS.** Standard Installation

1. Mount assembly to floor stud — **DONE!**

1. Purchase pre-stripped pigtail
2. Install pigtail and ground screw in box
3. Insert box into vertical bracket
4. Insert device cover to vertical bracket
5. Mount assembly to floor stud



CAT. NO.	BOX TYPE INCLUDED	BOX DEPTH (IN.)	PIGTAIL TYPE INCLUDED	BRACKET TYPE INCLUDED	COVER TYPE INCLUDED	RAISED (IN.)	NO. OF DEVICES	STD. CTN.
151-SV12-13	521511234EW	1½	GSC12	SSF-SV12	52-C-13	½	1	10
151-SV12-1458	521511234EW	1½	GSC12	SSF-SV12	52-C-14-5/8	⅝	1	10
151-SV12-14	521511234EW	1½	GSC12	SSF-SV12	52-C-14	¾	1	10
151-SV12-17	521511234EW	1½	GSC12	SSF-SV12	52-C-17-25	½	2	10
151-SV12-1858	521511234EW	1½	GSC12	SSF-SV12	52-C-18-5/8-25	⅝	2	10
151-SV12-18	521511234EW	1½	GSC12	SSF-SV12	52-C-18	¾	2	10
171-SV12-13	521711234E	2½	GSC12	SSF-SV12	52-C-13	½	1	10
171-SV12-1458	521711234E	2½	GSC12	SSF-SV12	52-C-14-5/8	⅝	1	10
171-SV12-14	521711234E	2½	GSC12	SSF-SV12	52-C-14	¾	1	10
171-SV12-17	521711234E	2½	GSC12	SSF-SV12	52-C-17-25	½	2	10
171-SV12-1858	521711234E	2½	GSC12	SSF-SV12	52-C-18-5/8-25	⅝	2	10
171-SV12-18	521711234E	2½	GSC12	SSF-SV12	52-C-18	¾	2	10
151-SV18-13	521511234EW	1½	GSC12	SSF-SV18	52-C-13	½	1	10
151-SV18-1458	521511234EW	1½	GSC12	SSF-SV18	52-C-14-5/8	⅝	1	10
151-SV18-14	521511234EW	1½	GSC12	SSF-SV18	52-C-14	¾	1	10
151-SV18-17	521511234EW	1½	GSC12	SSF-SV18	52-C-17-25	½	2	10
151-SV18-1858	521511234EW	1½	GSC12	SSF-SV18	52-C-18-5/8-25	⅝	2	10
151-SV18-18	521511234EW	1½	GSC12	SSF-SV18	52-C-18	¾	2	10
171-SV18-13	521711234E	2½	GSC12	SSF-SV18	52-C-13	½	1	10
171-SV18-1458	521711234E	2½	GSC12	SSF-SV18	52-C-14-5/8	⅝	1	10
171-SV18-14	521711234E	2½	GSC12	SSF-SV18	52-C-14	¾	1	10
171-SV18-17	521711234E	2½	GSC12	SSF-SV18	52-C-17-25	½	2	10
171-SV18-1858	521711234E	2½	GSC12	SSF-SV18	52-C-18-5/8-25	⅝	2	10
171-SV18-18	521711234E	2½	GSC12	SSF-SV18	52-C-18	¾	2	10

## Pre-Fab Components and Assemblies

**UL® Listed Adjustable Mud Ring**  
now available in both single-  
and two-gang.

**NEW!**

### Adjustable Mud Rings

Mud Rings feature an inner ring that adjusts from 1/2" to 1 1/2" in depth to accommodate various drywall thicknesses. Marked with a measured rule and equipped with two adjustment screws, the inner ring can be set to the anticipated depth prior to installation and then easily adjusted after drywall installation to accommodate any variation in depth (1/2" to 1 1/2").

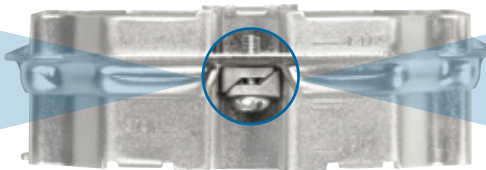

**Wedge Locking Blocks**  
Designed to ensure grounding continuity

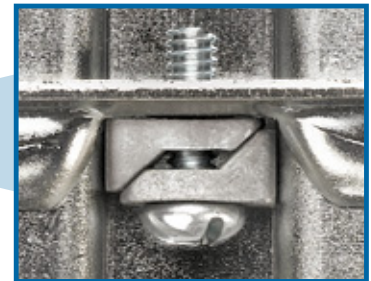

### Adjustable Mud Ring Installation/Adjustment Steps:



**Loosen...**  
The two adjustment screws located on opposing corners of the mud ring.

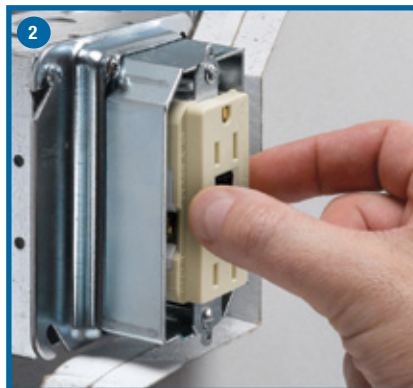

**Adjust...**  
Inner ring to be flush with wall surface.



**Re-tighten...**  
Adjustment screws.

CAT. NO.	DESCRIPTION	STD. CTN.
52-C-ADJ	Single-Gang Adjustable Mud Ring, 1/2" to 1 1/2"	25
52-C-ADJ2	Two-Gang Adjustable Mud Ring, 1/2" to 1 1/2"	20

## Pre-Fab Components and Assemblies

### Three Products in One!

#### Pre-Fab Box Bracket with Far-Side and Cable Support

The savings can add up, particularly on a large job, when a box bracket, far-side support and cable support are combined in one product to reduce your labor and inventory costs. It is designed for maximum flexibility with flanges for either left or right stud mount, and compatibility with either 4" and 4 1/16" boxes.

- Box bracket, far-side support and cable support combined in one product to reduce your labor and inventory costs
- Built-in cable support secures cable 6" above the box, satisfying NEC® code requirements
- Flexible design accommodates both 4" and 4 1/16" boxes
- Key-hole box mounting slots maintain box position if mud ring needs to be removed
- Provides clear access to knock-outs once the box is installed for installation of fittings
- Mounts to either side of the stud

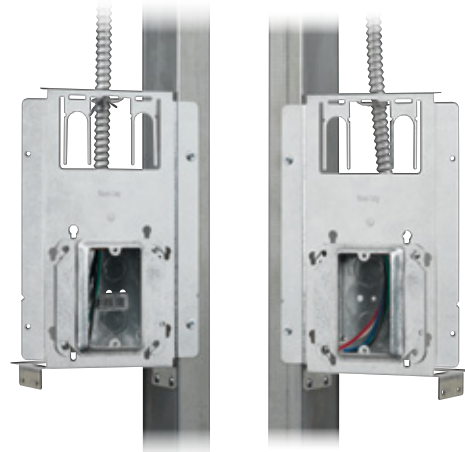

Can be mounted either left or right of the stud

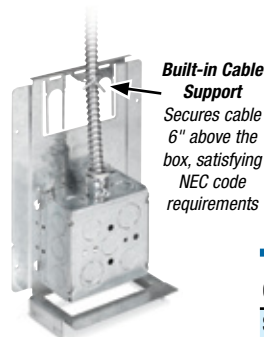
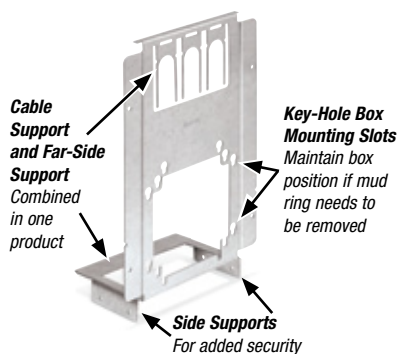

Back view of bracket with box, fitting and cable installed

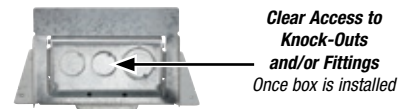

Bottom view of bracket with box installed

CAT. NO.	DESCRIPTION	STD. PKG. QTY.
SSF-SH2346-CS	Pre-Fab Box Bracket with Far-Side and Cable Support	50

NEC and National Electrical Code are registered trademarks of the National Fire Protection Association, Inc.

### Mounting Bracket

- Attaches 4" and 4 1/16" electrical boxes to metal stud
- Support leg can be attached to stud to eliminate movement of box in wall
- Attaches to metal or wood stud using self-tapping screws and screw gun or nails
- One part mounts boxes for 1 1/2", 2 1/2", 3 1/2", 4" and 6" stud which means less inventory

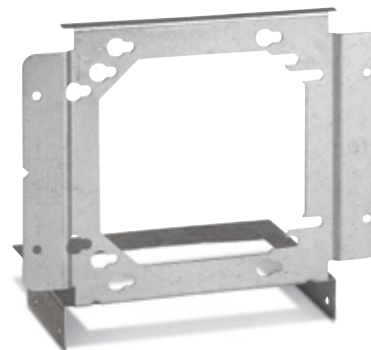

CAT. NO.	DESCRIPTION	STD. CTN.
SSF-SH2346	4" & 4 1/16" outlet boxes to 2 1/2", 3 1/2", 4" & 6" metal studs	100

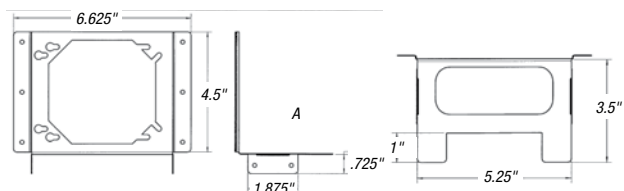

## Pre-Fab Components and Assemblies

### Box Mounting Brackets for Between Studs

- Supports electrical boxes, plaster rings or low-voltage devices from one bracket
- Accommodates 4" or 4<sup>1</sup>/<sub>16</sub>" boxes
- Bendable leg serves as a bracket stabilizer
- SB brackets allow box mounting in all four 90° orientations

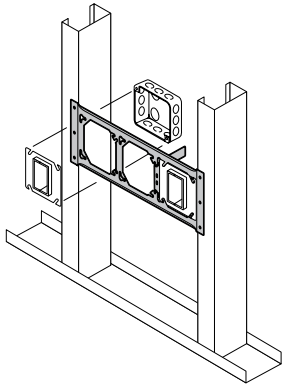

Fig. 1



Fig. 2

CAT. NO.	FIG. NO.	DESCRIPTION	STD. CTN.
SSF-SB16	1	Box mounting bracket for between studs, 16" stud spacing	25
SSF-SB24	2	Box mounting bracket for between studs, 24" stud spacing	25

### Screw-Gun Box Bracket

- Self-tapping screws are aligned with the dimples so that the box is straight
- Enables mounting of multiple boxes
- Depth set for 1<sup>1</sup>/<sub>2</sub>" - or 2<sup>1</sup>/<sub>8</sub>" -deep electrical box
- Installs easily with a screw gun
- SGA brackets have adjustable tabs for 1<sup>1</sup>/<sub>2</sub>" - or 2<sup>1</sup>/<sub>8</sub>" -deep boxes
- SGA brackets adjustable for non-standard stud spacing

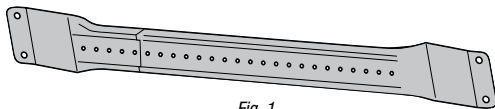

Fig. 1

CAT. NO.	FIG. NO.	DESCRIPTION	STUD SPACING	BOX DEPTH	STD. CTN.
SSF-SG16A	1	Adjustable box bracket	11"-18"	1 <sup>1</sup> / <sub>2</sub> " or 2 <sup>1</sup> / <sub>8</sub> "	50
SSF-SG24A	1	Adjustable box bracket	17"-26"	1 <sup>1</sup> / <sub>2</sub> " or 2 <sup>1</sup> / <sub>8</sub> "	50

### Extension-Plate Bracket

- Improved bracket with bendable stabilizer leg for use on 2<sup>1</sup>/<sub>2</sub>" and 3<sup>1</sup>/<sub>2</sub>" metal studs
- Mounts outlet boxes 12" or 18" offset from either a metal stud track or a stud
- When mounted, drywall ring is brought to within 1/8" of drywall every time and will not bulge or break out drywall
- Mounts 4" or 4<sup>1</sup>/<sub>16</sub>" outlet boxes, 1<sup>1</sup>/<sub>2</sub>" or 2<sup>1</sup>/<sub>8</sub>" deep
- SV18 provides compliance with Americans with Disabilities Act (ADA) requirements



Fig. 1

CAT. NO.	FIG. NO.	DESCRIPTION	STD. CTN.
SSF-SV12	1	Extension plate bracket, 12" height	50
SSF-SV18	1	Extension plate bracket, 18" height	50

## Pre-Fab Components and Assemblies

### Consistent Box Locations and Box Height...Every Time!

#### Pre-Fab T Bracket

Consistency results in efficiency and labor savings on the job. With three fixed-box locations and a fixed height of 18", the new Steel City® Pre-Fab T Bracket provides a consistent installation every time. For added efficiency, the bracket includes integral mounting screws that help reduce installation time. A handy locator tab at the base of the bracket saves you the time of looking for installed boxes that have been hidden by wall coverings. The base also features unique floor track tabs. The inner tab slides in front of the floor track and the two outer tabs slide behind the floor track to provide stability when positioning the bracket.

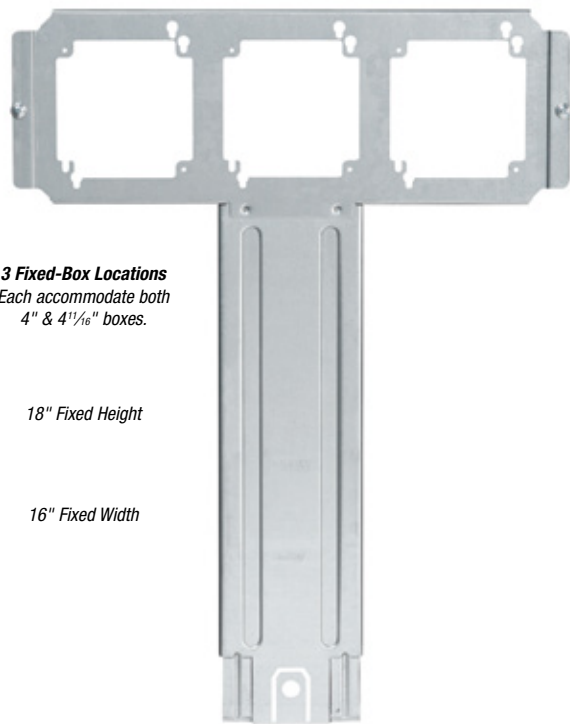

**3 Fixed-Box Locations**  
Each accommodate both 4" & 4 1/16" boxes.

18" Fixed Height

16" Fixed Width

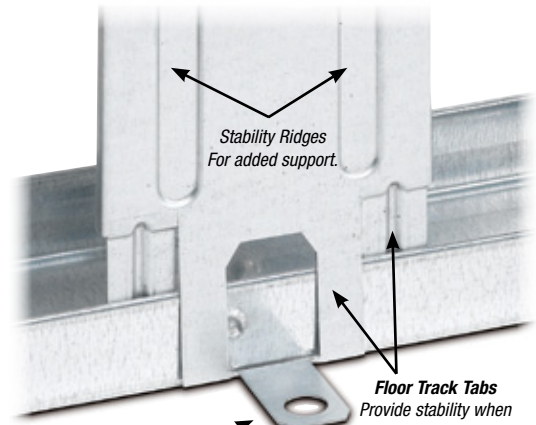

**Locator Tab**  
Helps locate installed boxes hidden by wall coverings.

**Stability Ridges**  
For added support.

**Floor Track Tabs**  
Provide stability when positioning the bracket.

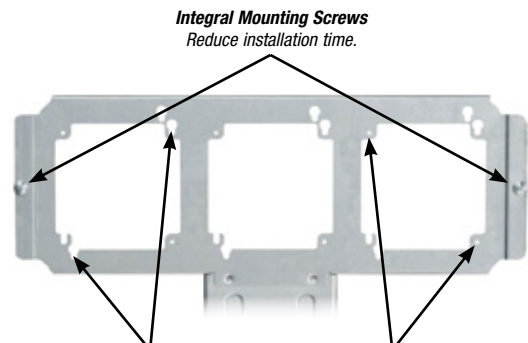

**Integral Mounting Screws**  
Reduce installation time.

**Key Hole Slots**  
Maintain box position if mud ring is removed.

**Mud Ring Mounting Screw Holes**  
For low-voltage applications where no box is required.

#### Pre-Fab Box Bracket with Far-Side and Cable Support

CAT. NO.	DESCRIPTION	STD. CTN.
H16V18S	Pre-Fab T Bracket	10

## Pre-Fab Components and Assemblies

**Easily  
Pre-Assembled  
Off Site  
for Faster  
Installation  
On Site!**

### Pre-Fabricated Components

Rather than assembling box mounting brackets and device covers on site, keep an eye on profit and use Steel City® Pre-Fab Components to set up jobs off site for a quick and easy installation on site. They accommodate a wide variety of Steel City covers and they're readily available for fast-track projects.

- Ideal for use in hotels, casinos, hospitals, large office buildings and any other commercial or institutional application where rough-in products can be pre-fabricated to match floor plans for quicker on-site installation
- Items readily available for fast-track projects — no special lead time required
- All products are UL approved and meet applicable building codes

## SB016 and SB024 Stud-to-Stud Horizontal Mounting Brackets

- Constructed of 24-gauge steel
- Pre-measured on center for 16" (SB016) or 24" (SB024) stud spacing
- SB016 accepts three 4" square or two 4<sup>1</sup>/<sub>16</sub>" boxes (deep or shallow)
- SB024 accepts five 4" square or four 4<sup>1</sup>/<sub>16</sub>" boxes (deep or shallow)
- Can be mounted at any height to meet individual project requirements
- Versatile, open design enables mounting of box in any location across horizontal plane between studs
- Device cover (mud ring) mounts to front of bracket to set box in desired location
- Stamped rule on bracket with ¼", ½" and 1" markings enables fast box setting



*SB016 mounted to 16" studs with one 4" square box installed.*



*SB024 mounted to 24" studs with one 4" square box installed.*



*SB016 mounted to 16" studs with three 4" square boxes (full capacity) installed.*



*SB024 mounted to 24" studs with five 4" square boxes (full capacity) installed.*



CAT. NO.	DESCRIPTION	STD. CTN.
SB016	16" stud-to-stud horizontal mounting bracket	25
SB024	24" stud-to-stud horizontal mounting bracket	25

## Pre-Fab Components and Assemblies

### VAFB Vertically Adjustable Floor Brackets

**Built-in Far-Side Support for Both 4" and 6" Studs**  
Stabilizes box and bracket assembly, providing versatility on the job and ease of installation.

**UL Listed**

**Flexible Design**  
Accommodates both 4" and 4 1/16" boxes.

**Single-Screw Vertical Height Adjustment**  
Up to 6 additional inches.



**NEW!**



Boxes & Covers — Steel City® Metallic Boxes

CAT. NO.	DESCRIPTION	STD. CTN.
VAFB	Pre-Fab Vertically Adjustable Floor Bracket	10

### DBB1 Dual-Box Mounting Bracket

**Locator Hole**  
In mounting bracket enables installer to position box on marked stud for fast, precise installation.

Accommodates both 4" and 4 1/16" boxes

**UL Listed**

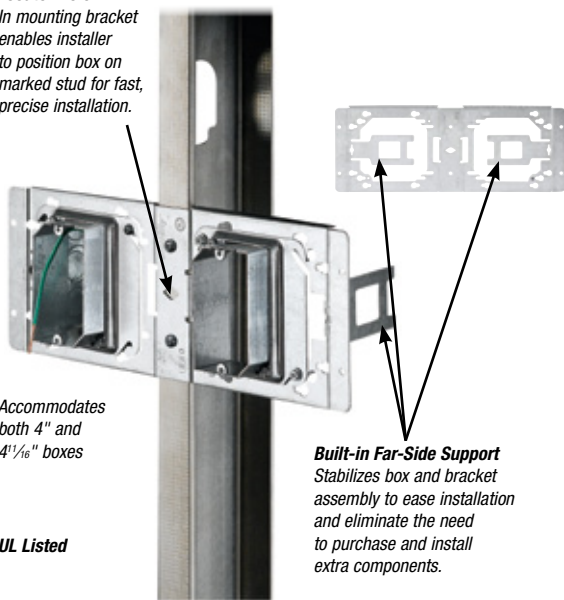

**NEW!**



Power on Both Sides of the Stud

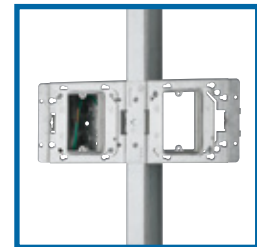

Power Left of Stud and Low Voltage Right of the Stud

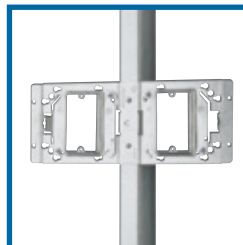

Low Voltage on Both Sides of the Stud

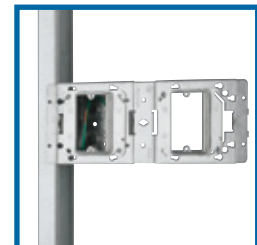

Power and Low Voltage on the Same Side of the Stud

CAT. NO.	DESCRIPTION	STD. CTN.
DBBI	Pre-Fab Dual-Box Bracket	50

## Pre-Fab Components and Assemblies

Meet Code Requirements for Supporting and Securing Installed MC Cable.



### Cable Support Bracket

- Provides a simple means of complying with NEC® 330.30 requirements for securing and supporting MC cable
- Quick and easy locking tab snaps through slot to secure cable
- Ribs maintain separation of cables
- Durable steel construction retains integrity
- Versatile design — use with Romex or MC cable
- UL Listed



CAT. NO.	DESCRIPTION	STD. CTN.
CSB1	Cable Support Bracket	100

NEC and National Electrical Code are registered trademarks of the National Fire Protection Association, Inc.

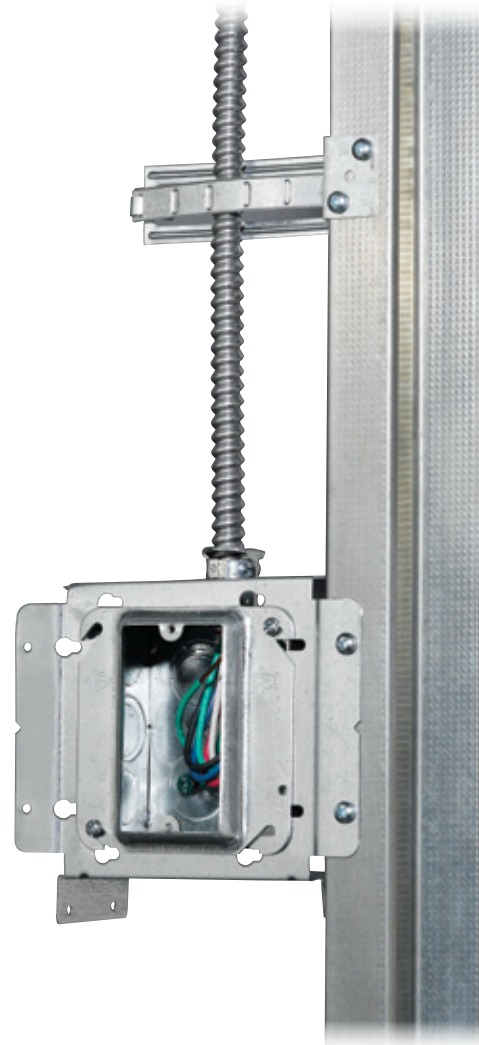



## Switch Boxes and Accessories

### Steel City® Super Deep 4" Square Wall Boxes

- Increased capacity accommodates large devices in commercial and industrial applications, such as fire alarm systems
- Red-painted version available for quick and easy identification of life safety electrical systems
- Available with or without integrally mounted support bracket

**NEW!**

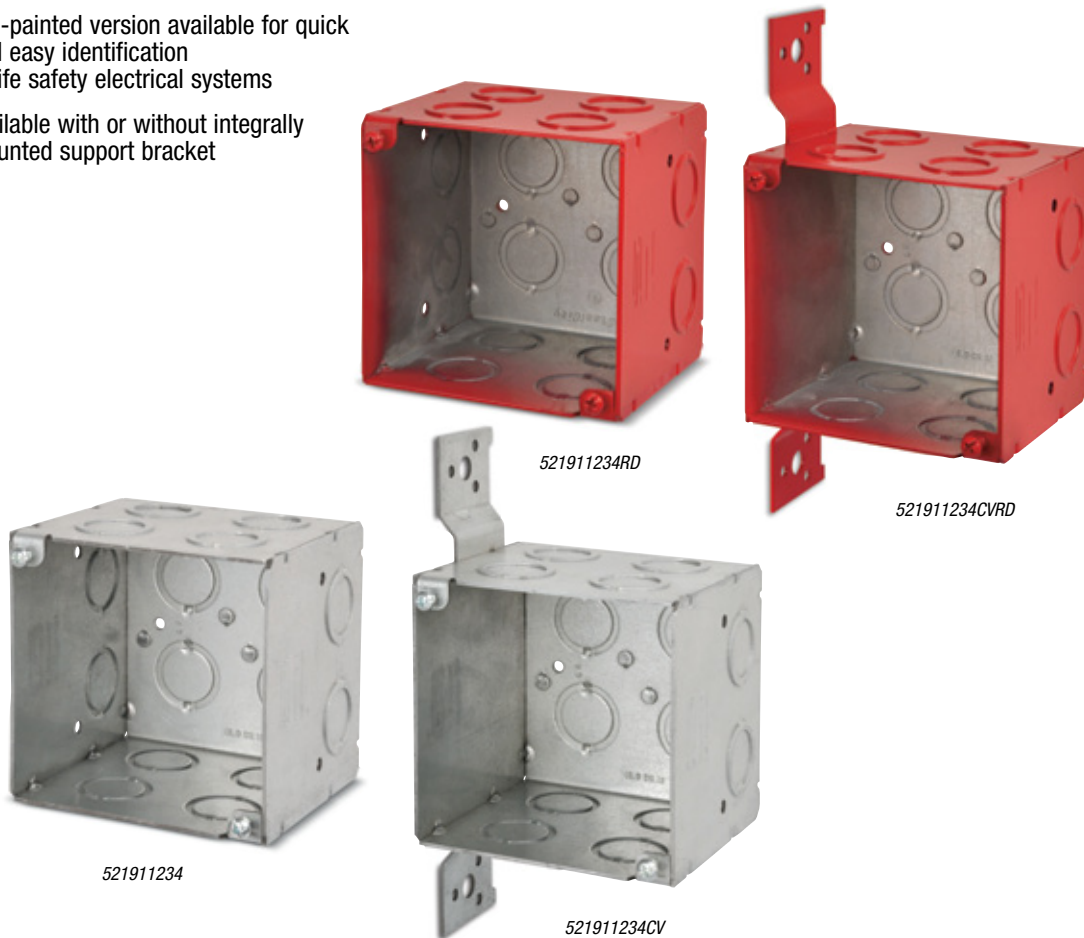

Boxes & Covers — Steel City® Metallic Boxes

CAT. NO.	DESCRIPTION	EARS	BRACKETS	EACH SIDE KO	EACH END KO	BOTTOM KO	CU. IN. CAPACITY	STD. CTN.
521911234RD	3½"-Deep, 4"-Square Red Box	—	—	(4) ½" & ¾" Combo	(2) ½" & ¾" Combo	(4) ½" & ¾" Combo	46	24
521911234CVRD	3½"-Deep, 4"-Square Red Box with Side Mounting Bracket	—	CV	(4) ½" & ¾" Combo	(2) ½" & ¾" Combo	(4) ½" & ¾" Combo	46	10
521911234	3½"-Deep, 4"-Square Box	—	—	(4) ½" & ¾" Combo	(2) ½" & ¾" Combo	(4) ½" & ¾" Combo	46	24
521911234CV	3½"-Deep, 4"-Square Box with Side Mounting Bracket	—	CV	(4) ½" & ¾" Combo	(2) ½" & ¾" Combo	(4) ½" & ¾" Combo	46	10

## Switch Boxes and Accessories

### Easy Depth Adjustment After Wall Covering Installation.

#### Adjust-A-Box®

The Adjust-A-Box System adapts to a variety of wall coverings. Its unique design enables the installer to adjust the box to various depths with the turn of a screw.

**Features:**

- Unique design allows for adjustment of depth after the wall covering has been installed
- Adjusts to any wall covering
- Mounts square and secure every time
- Removes easily to enable inner-wall access
- Accommodates high- and low-voltage applications
- Pre-installed ground screw
- Accommodates non-metallic cable, flexible metal cable and EMT

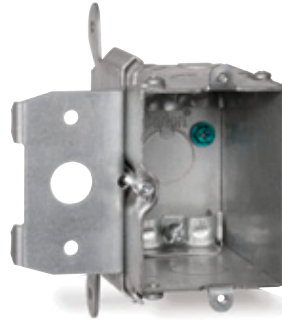

MB120ADJ

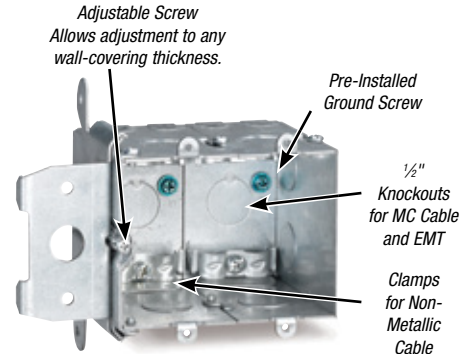

MB238ADJ

#### Installation:

**Screw bracket to stud**



Single-Gang



Two-Gang

**Adjust box in or out to any wall thickness**



Single-Gang



Two-Gang



CAT. NO.	VOLUME (CU. IN.)	DESCRIPTION	KNOCKOUTS	SIZE (IN.)	STD. CTN.	STD. WT. (LBS.)
MB120ADJ	20	One-Gang Adjustable Wall Box	1/2" (5)	2.20W x 3.28H x 3.52D	18	19.25
MB238ADJ	38	Two-Gang Adjustable Wall Box	1/2" (8)	4.01W x 3.28H x 3.52D	12	17.60

### 3 3/4" x 2" Switch Boxes

CAT. NO.	DEPTH (IN.)	CU. IN. CAPACITY	CLAMPS	EARS	BRKTS.	KNOCKOUTS	STD. CTN.
<b>Non-Gangable</b>							
SSV	1	6.5	—	—	Flat	2 pry-outs one end	25
SSQV	1	6.5	Yes	—	Flat	2 pry-outs one end with non-metallic cable clamps	25

Not UL Listed.



SSV

SSQV with non-metallic sheathed cable clamps



## Switch Boxes and Accessories

### 3" x 2" Switch Boxes



**SWB-25**  
Ears flush  
for old work

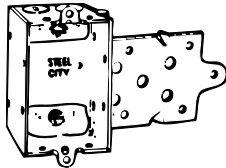

**811-SW-25**  
S bracket recessed 5/8"



**LXMWOW-25**  
Ears flush  
for old work



**LCOW-25**  
Ears flush  
old work



**LCOWC**  
Adapts to any wall  
thickness up to 3/4"



**LCLE-25**

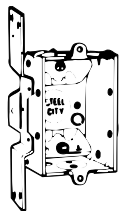

**LCV-25**  
CV bracket  
recessed 3/4"

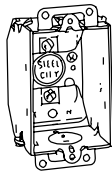

**LCNOW-25**  
Ears flush  
for old work

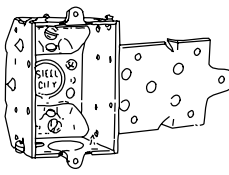

**802-S**  
S bracket recessed 5/8"

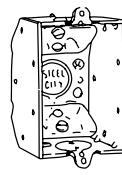

**A12-25**



**A12E-25**  
Ears flush

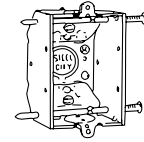

**A16-25**  
With nails



**LXWOW-25**  
Ears flush  
for old work



**LXWOWP**



**LXWLE-25**



**LXWOWC-25**  
Adapts to any wall  
thickness up to 3/4"



**LXWSV**  
SV bracket  
recessed 7/16"



**LXWV-25**  
CV bracket  
recessed 3/4"

### With Non-Metallic Sheathed Cable Clamps

CAT. NO.	DEPTH (IN.)	GANGABLE	CU. IN. CAPACITY	CLAMPS	EARS	BRKTS.	KNOCKOUTS (IN.)					STD. CTN.
							EA. END CONDUIT	EA. END CABLE	CABLE	BOTTOM CABLE	BOTTOM CONDUIT	
SWB-25	1½	—	7.5	C-5	Yes	—	—	2	—	2	—	25
811 SW-25	1½	—	7.5	C-5	—	S	—	2	—	2	—	50
LXMWOW-25	2	Yes	10.5	C-5	Yes	—	—	2	—	—	1-½	25
LCOW-25*	2¼	Yes	10.5	C-1	Yes	—	1-½	—	2	—	1-½	25
LCOWC*	2¼	Yes	10.5	C-1	Yes	—	1-½	—	2	—	1-½	25
LCLE-25*	2¼	Yes	10.5	C-1	—	—	1-½	—	2	—	1-½	25
LCV-25*	2¼	Yes	10.5	C-1	—	CV	1-½	—	2	—	1-½	25
LCNOW-25*	2¼	Yes	10.5	C-1	Yes	—	1-½	—	2	—	1-½	25
802 S*	2¼	Yes	10.5	C-1	—	S	1-½	—	2	—	1-½	25
A12-25	2¼	—	10.5	C-1	—	—	1-½	—	2	—	1-½	25
A12E-25	2¼	—	10.5	C-1	Yes	—	1-½	—	2	—	1-½	25
A16-25	2¼	—	10.5	C-1	—	—	1-½	—	2	—	1-½	25
LXWOW-25	2½	Yes	12.5	C-5	Yes	—	1-½	—	2	—	1-½	25
LXWOWP	2½	Yes	12.5	C-5	Yes	—	1-½	—	2	—	1-½	25
LXWLE-25	2½	Yes	12.5	C-5	—	—	1-1½	1-½	2	—	1-½	25
LXWOWC-25	2½	Yes	12.5	C-5	Yes	—	1-½	—	2	—	1-½	25
LXWSV	2½	Yes	12.5	C-5	—	SV	1-½	1-½	2	—	1-½	25
LXWV-25	2½	Yes	12.5	C-5	—	CV	1-½	1-1½	2	—	1-½	25

\* Beveled corners.

## Switch Boxes and Accessories

### 3" x 2" Switch Boxes (continued)

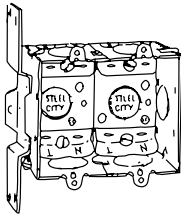

**LXWV 2G**  
2-gang with CV  
bracket recessed 1/8"



**806 SW**  
S bracket recessed 1/8"

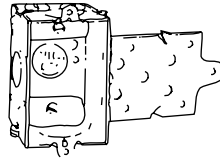

**806 SW 1/4**  
S bracket recessed 1/8"

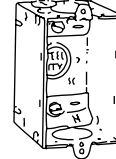

**A254-25**

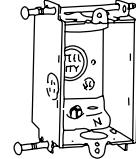

**A257-25**  
With nails slanted  
for easy drive-in



**A-258**  
Without nails



**CWN-25**  
Ears flush



**CWNLE**

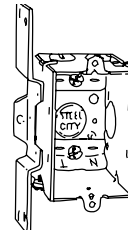

**CWNV-25**  
CV bracket  
recessed 1/8"



**CXWLE**



**CXWOW**  
Ears flush  
for old work

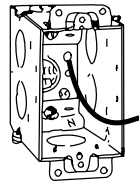

**CXWOWP**

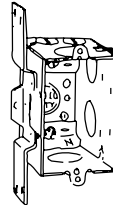

**CXWV**  
CV bracket  
recessed 1/8"



**CXWVP**

### With Non-Metallic Sheathed Cable Clamps (continued)

CAT. NO.	DEPTH (IN.)	GANGABLE	CU. IN. CAPACITY	CLAMPS	EARS	BRKTS.	KNOCKOUTS (IN.)					STD. CTN.
							EA. END CONDUIT	EA. END CABLE	CABLE	BOTTOM CABLE	BOTTOM CONDUIT	
LXWV 2G	2 1/2	Yes	12.5	C-5	—	CV	1-1/2	2-1/2	4	—	2-1/2	25
806 SW	2 1/2	Yes	12.5	C-5	—	S	1-1/2	1-1/2	2	—	1-1/2	25
806 SW 1/4	2 1/2	Yes	12.5	C-5	—	S	1-1/2	1-1/2	2	—	1-1/2	25
A254-25	2 1/2	—	12.5	C-5	—	—	—	1-1/2	2	—	1-1/2	25
A257-25	2 1/2	—	12.5	C-5	—	—	—	1-1/2	2	—	1-1/2	25
A-258	2 1/2	—	12.5	C-5	—	—	—	1-1/2	2	—	1-1/2	25
CWN-25	2 1/2	Yes	14.0	C-5	Yes	—	1-1/2	—	2	—	1-1/2	25
CWNLE	2 1/2	Yes	14.0	C-5	—	—	1-1/2	—	2	—	1-1/2	25
CWNV-25	2 1/2	Yes	14.0	C-5	—	CV	1-1/2	—	2	—	1-1/2	25
CXWLE	3 1/2	Yes	18.0	C-5	—	—	2-1/2	1-1/2	2	—	1-1/2	25
CXWOW	3 1/2	Yes	18.0	C-5	Yes	—	2-1/2	1-1/2	2	—	1-1/2	25
CXWOWP	3 1/2	Yes	18.0	C-5	Yes	—	2-1/2	1-1/2	2	—	1-1/2	25
CXWV	3 1/2	Yes	18.0	C-5	—	CV	2-1/2	1-1/2	2	—	1-1/2	25
CXWVP	3 1/2	Yes	18.0	C-5	—	CV	2-1/2	1-1/2	2	—	1-1/2	25

## Switch Boxes and Accessories

### 3" x 2" Switch Boxes (continued)



CDOW  
Ears flush



CDOWTG-25  
Ears flush



CDLE-25

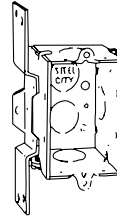

CDV-25  
CV bracket  
recessed 1/8"

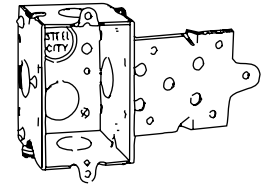

804 S  
S bracket recessed 3/8"



CW 1/2  
Ears flush



CW3/4-25  
Ears flush



CWLE1/2-25

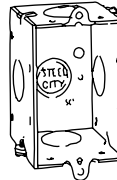

CWLE 3/4

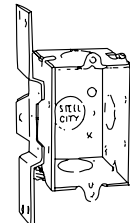

CWV 1/2  
CV bracket  
recessed 1/8"



CY 1/2  
Ears flush

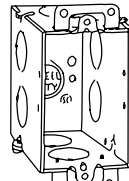

CY 3/4  
Ears flush

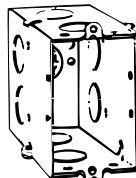

CYLE 1/2

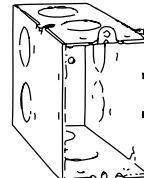

CYLE 3/4

#### With Conduit KOs

CAT. NO.	DEPTH (IN.)	GANGABLE	CU. IN. CAPACITY	EARS	BRKTS.	KNOCKOUTS (IN.)			STD. CTN.
						EA. END CONDUIT	EA. END CABLE	BOTTOM CONDUIT	
CDOW	2 1/2	Yes	12.5	Yes	—	1 1/2	1 1/2	2 1/2	50
CDOWTG-25	2 1/2	Yes	12.5	Yes	—	1 1/2	1 1/2	2 1/2	25
CDLE-25	2 1/2	Yes	12.5	—	—	1 1/2	1 1/2	2 1/2	25
CDV-25	2 1/2	Yes	12.5	—	CV	1 1/2	1 1/2	2 1/2	25
804 S	2 1/2	Yes	12.5	—	S	1 1/2	1 1/2	2 1/2	25
CW 1/2	2 3/4	Yes	14.0	Yes	—	1-3/4	1-3/4	1-3/4	50
CW3/4-25	2 3/4	Yes	14.0	Yes	—	1-3/4	1-3/4	1-3/4	25
CWLE1/2-25	2 3/4	Yes	14.0	—	—	1-3/4	1-3/4	1-3/4	25
CWLE 3/4	2 3/4	Yes	14.0	—	—	1-3/4	1-3/4	1-3/4	25
CWV 1/2	2 3/4	Yes	14.0	—	CV	1-3/4	1-3/4	1-3/4	25
CY 1/2	3 1/2	Yes	18.0	Yes	—	2-3/4	2-3/4	1-3/4	25
CY 3/4	3 1/2	Yes	18.0	Yes	—	2-3/4	2-3/4	1-3/4	25
CYLE 1/2	3 1/2	Yes	18.0	—	—	2-3/4	2-3/4	1-3/4	25
CYLE 3/4	3 1/2	Yes	18.0	—	—	2-3/4	2-3/4	1-3/4	25

## Switch Boxes and Accessories

### 3" x 2" Switch Boxes (continued)

Boxes & Covers — Steel City® Metallic Boxes



**LXMOV-25**  
Ears flush  
for old work



**LXOW-25**  
Ears flush  
for old work



**LXOWC-25**  
Adapts to 3/4"  
wall thickness



**LXLE**



**LXV-25**  
CV bracket  
recessed 1/8"

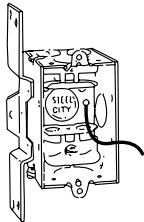

**LXVP**

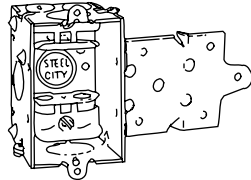

**806 S**  
S bracket recessed 3/8"

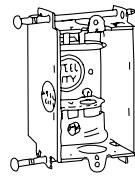

**A-256**  
With nails slanted  
for easy drive-in



**CWX-25**  
Ears flush



**CWXV-25**  
CV bracket  
recessed 1/8"



**CX**  
Ears flush

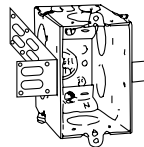

**CXLE-SSX**  
For metal stud

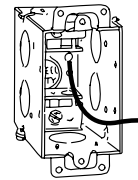

**CXP**



**CXV**  
CV bracket  
recessed 1/8"

#### With Armored Cable/Metal Clad Clamps

CAT. NO.	DEPTH (IN.)	GANGABLE	CU. IN. CAPACITY	CLAMPS	EARS	BRKTS.	KNOCKOUTS (IN.)				STD. CTN.
							EA. END CONDUIT	EA. END CABLE	CABLE	BOTTOM CONDUIT	
LXMOV-25	2	Yes	10.5	C-3	Yes	—	—	2	—	1-1/2	25
LXOW-25	2 1/2	Yes	12.5	C-3	Yes	—	1-1/2	—	2	1-1/2	25
LXOWC-25	2 1/2	Yes	12.5	C-3	Yes	—	1-1/2	—	2	1-1/2	25
LXLE	2 1/2	Yes	12.5	C-3	—	—	1-1/2	1-1/2	2	1-1/2	25
LXV-25	2 1/2	Yes	12.5	C-3	—	CV	1-1/2	1-1/2	2	1-1/2	25
LXVP	2 1/2	Yes	12.5	C-3	—	CV	1-1/2	1-1/2	2	1-1/2	25
806 S	2 1/2	Yes	12.5	C-3	—	S	1-1/2	1-1/2	2	1-1/2	25
A-256	2 1/2	—	12.5	C-3	—	—	—	1-1/2	2	1-1/2	25
CWX-25	2 3/4	Yes	14.0	C-3	Yes	—	1-1/2	—	2	1-1/2	25
CWXV-25	2 3/4	Yes	14.0	C-3	—	CV	1-1/2	—	2	1-1/2	25
CX	3 1/2	Yes	18.0	C-3	Yes	—	2-1/2	1-1/2	2	1-1/2	25
CXLE-SSX	3 1/2	Yes	18.0	C-3	No	SSX	2-1/2	1-1/2	2	1-1/2	25
CXP	3 1/2	Yes	18.0	C-3	Yes	—	2-1/2	1-1/2	2	1-1/2	25
CXV	3 1/2	Yes	18.0	C-3	—	CV	2-1/2	1-1/2	2	1-1/2	25

## Switch Boxes and Accessories

### Gangable Switch Boxes — 2" Deep



51

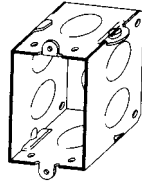

51-NE

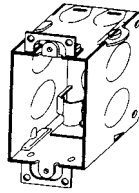

51-LC

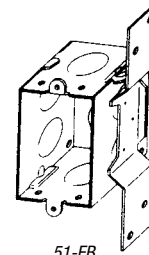

51-FB

CAT. NO.	CU. IN. CAPACITY	DESCRIPTION	STD. CTN.
51	10.0	<b>2" deep x 3" long x 2" wide</b> Two ½" KOs in each of two sides, one ½" KO in each end and two ½" KOs in bottom. Two nail holes in sides. Furnished with plaster ears*	50
51-NE	10.0	<b>2" deep x 3" long x 2" wide</b> Two ½" KOs in each of two sides, one ½" KO in each end and two ½" KOs in bottom. Two nail holes in sides*	50
51-LC	10.0	<b>For Non-Metallic Cable, 2" deep x 3" long x 2" wide</b> Two ½" KOs in each of two sides, two Loom KOs in each end and one ½" KO in bottom. Furnished with plaster ears. One Loom clamp for use on non-metallic sheathed cable with 10/32 deep-slotted screw assembled. Two nail holes in sides*	50
51-FB	10.0	<b>2" deep x 3" long x 2" wide</b> Two ½" KOs in one side, flat bracket on other side, one ½" KO in each end and two ½" KOs in bottom. Bracket offset ¼" from face*	50

\*Uses Steel City® 100 series covers.

### Gangable Switch Boxes — 2½" Deep

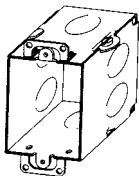

52

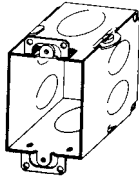

52-3/4-BW

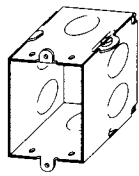

52-NE

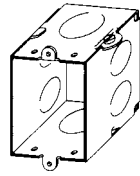

52-NE-3/4

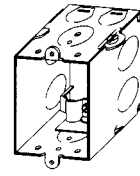

52-LCNE

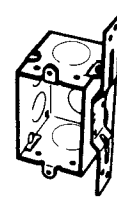

52-FB-3/4

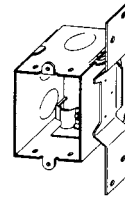

52-FBC

CAT. NO.	CU. IN. CAPACITY	DESCRIPTION	STD. CTN.
52	12.5	<b>2½" deep x 3" long x 2" wide</b> Two ½" KOs in each of two sides, one ½" KO in each end and two ½" KOs in bottom. Furnished with plaster ears. Four nail holes in sides*	50
52-3/4-BW	12.5	<b>2½" deep x 3" long x 2" wide</b> Two ½" KOs in each of two sides, one ¾" KO in each end and two ½" KOs in bottom. Furnished with plaster ears. Four nail holes in sides*	50
52-NE	12.5	<b>2½" deep x 3" long x 2" wide</b> Two ½" KOs in each of two sides, one ½" KO in each end and two ½" KOs in bottom. Four nail holes in sides*	50
52-NE-3/4	12.5	<b>2½" deep x 3" long x 2" wide</b> Two ½" KOs in each of two sides, one ¾" KO in each end and two ½" KOs in bottom. Four nail holes in sides*	50
52-LCNE	12.5	<b>For Non-Metallic Cable, 2½" deep x 3" long x 2" wide</b> Two ½" KOs in each side, two Loom KOs and one ½" KO in each end. One ½" KO in bottom. One Loom clamp for use on non-metallic sheathed cable with 10/32 deep-slotted screw assembled. Four nail holes in sides*	50
52-FB-3/4	12.5	<b>2½" deep x 3" long x 2" wide</b> Two ½" KOs in one side, flat bracket on other side, one KO in each end and two ¾" KOs in bottom. Flat bracket offset ¼" from face*	50
52-FBC	12.5	<b>For Non-Metallic Cable, 2½" deep x 3" long x 2" wide</b> Two ½" KOs in one side, flat bracket on other side, two Loom KOs and one ½" KO in each end and one ½" KO in bottom. One Loom clamp for use on non-metallic sheathed cable with 10/32 deep-slotted screw assembled. Flat bracket offset ¼" from face*	50

\*Uses Steel City® 100 series covers.

## Switch Boxes and Accessories

### Gangable Switch Boxes — 2¾" Deep

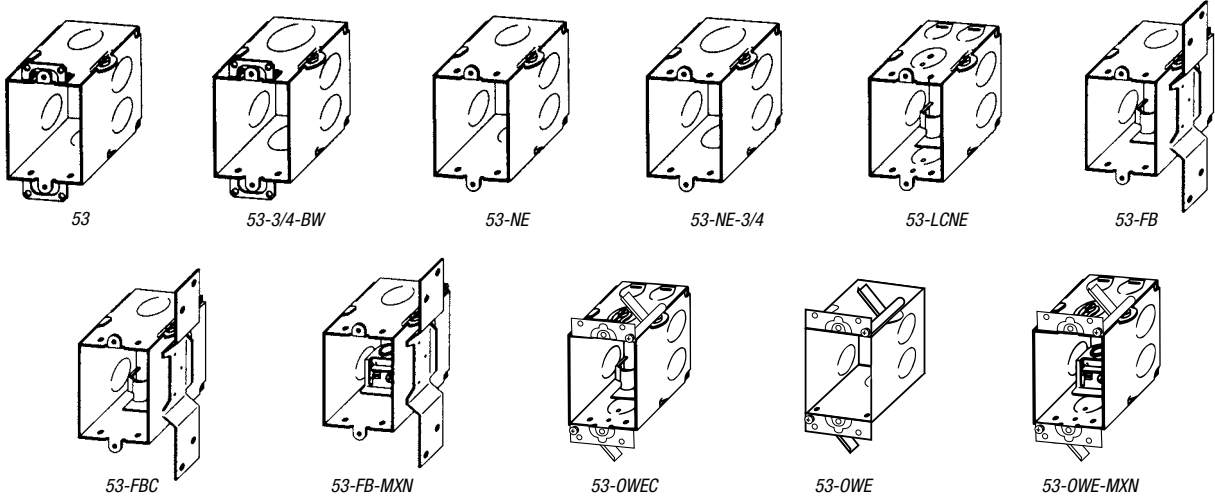

CAT. NO.	CU. IN. CAPACITY	DESCRIPTION	STD. CTN.
53	14.0	<b>2¾" deep x 3" long x 2" wide</b> Two ½" KOs in each side, one ½" KO in each end and two ½" KOs in bottom. Furnished with plaster ears. Four nail holes in sides*	50
53-3/4-BW	14.0	<b>2¾" deep x 3" long x 2" wide</b> Two ½" KOs in each side, one ¾" KO in each end and two ½" KOs in bottom. Furnished with plaster ears. Four nail holes in sides*	50
53-NE	14.0	<b>2¾" deep x 3" long x 2" wide</b> Two ½" KOs in each side, one ½" KO in each end and two ½" KOs in bottom. Four nail holes in sides*	50
53-NE-3/4	14.0	<b>2¾" deep x 3" long x 2" wide</b> Two ½" KOs in each side, one ¾" KO in each end and two ½" KOs in bottom. Four nail holes in sides*	50
53-LCNE	14.0	<b>For Non-Metallic Cable, 2¾" deep x 3" long x 2" wide</b> Two ½" KOs in each side, two Loom KOs and one ½" KO in each end and one ½" KO in bottom. One Loom clamp for use on non-metallic sheathed cable with 10/32 deep-slotted screw assembled. Four nail holes in sides*	50
53-FB	14.0	<b>2¾" deep x 3" long x 2" wide</b> Two ½" KOs in one side, flat bracket on other side, one ½" KO in each end and two ½" KOs in bottom. Flat bracket offset ¼" from face*	50
53-FBC	14.0	<b>For Non-Metallic Cable, 2¾" deep x 3" long x 2" wide</b> Two ½" KOs in one side, flat bracket on other side, two Loom KOs and one ½" KO in each end and one ½" KO in bottom. Flat offset ¼" from face. One Loom clamp for use on non-metallic sheathed cable with 10/32 deep-slotted screw assembled*	50
53-FB-MXN	14.0	<b>For Metal Clad Cable, 2¾" deep x 3" long x 2" wide</b> Two ½" KOs in one side, flat bracket on other side, two Loom KOs and one ½" KO in each end, and one ½" KO in bottom. One MXN clamp for MC, AC/BX, and non-metallic sheathed cable (NM) included with 10/32 deep-slotted screw. Clamp is UL Listed for use with cable sizes 14/2 through 10/3 with ground*	50
53-OWEC	14.0	<b>For Non-Metallic Cable, 2¾" deep x 3" long x 2" wide</b> Two ½" KOs in each side, two Loom KOs and one ½" KO in each end and one ½" KO in bottom. Furnished with plaster ears. One Loom clamp for use on non-metallic sheathed cable with 10/32 deep-slotted screw assembled. With old-work swing brackets*	50
53-OWE	14.0	<b>2¾" deep x 3" long x 2" wide</b> Two ½" KOs in each side, one ½" KO in each end and two ½" KOs in bottom. Furnished with plaster ears. With old-work swing brackets*	50
53-OWE-MXN	14.0	<b>For Metal-Clad Cable, 2¾" deep x 3" long x 2" wide</b> Two ½" KOs in each side. Two Loom KOs and one ½" KO in each end and one ½" KO in bottom. One MXN clamp for MC, AC/BX and non-metallic sheathed cable (NM) included with 10/32 deep-slotted screw. Clamp is UL Listed for use with cable sizes 14/2 through 10/3 with ground. Furnished with plaster ears. With old-work swing brackets*	50

\*Uses Steel City® 100 series covers.



## Switch Boxes and Accessories

### Gangable Switch Boxes — 3½" Deep

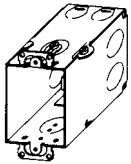

54-LC

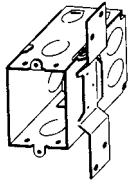

54-FBC

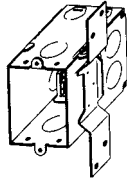

54-FB-MXN

CAT. NO.	CU. IN. CAPACITY	DESCRIPTION	STD. CTN.
54-LC	18.0	<b>For Non-Metallic Cable</b> <b>3½" deep x 3" long x 2" wide</b> Two ½" KOs in each side, two Loom KOs and one ½" KO in each end and one ½" KO in bottom. Two Loom clamps for use on non-metallic sheathed cable with 10/32 deep-slotted screws assembled. Furnished with plaster ears. Four nail holes in sides*	50
54-FBC	18.0	<b>For Non-Metallic Cable</b> <b>3½" deep x 3" long x 2" wide</b> Two ½" KOs in one side, flat bracket and two ½" KOs in other side, two Loom KOs and one ½" KO in each end and one ½" KO in bottom.  Two Loom clamps for use on non-metallic sheathed cable with 10/32 deep-slotted screws assembled. Flat bracket offset ⅜" from face*	50
54-FB-MXN	18.0	<b>For Metal Cable, 3½" deep x 3" long x 2" wide</b> Two ½" KOs in one side, flat bracket and two ½" KOs in other side, two Loom KOs and one ½" KO in each end and one ½" KO in bottom.  Two MXN clamps for MC, AC/BX, and non-metallic sheathed cable (NM) included with 10/32 deep-slotted screws. Clamps are UL Listed for use with cable sizes 14/2 through 10/3 with ground. Flat bracket offset ⅜" from face*	50

\*Uses Steel City® 100 series covers.

### Welded Non-Gangable Switch Boxes — 2½" Deep

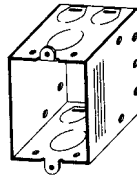

72

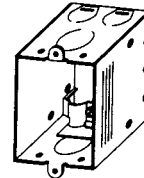

72-C

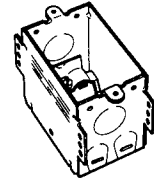

72-OC

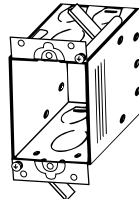

72-OWE

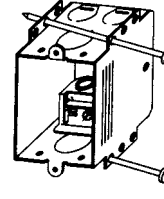

72-ONS-MXN

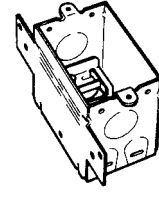

72-FB-MXN

CAT. NO.	CU. IN. CAPACITY	DESCRIPTION	STD. CTN.
72	12.5	<b>2½" deep x 3" long x 2" wide</b> Two Loom KOs and one ½" KO in each end and one ½" KO in bottom. Four nail holes included*	50
72-C	12.5	<b>For Non-Metallic Cable</b> <b>2½" deep x 3" long x 2" wide</b> Two Loom KOs and one ½" KO in each end and one ½" KO in bottom. Four nail holes included. One Loom clamp for use on non-metallic sheathed cable with 10/32 deep-slotted screw assembled*	50
72-OC	12.5	<b>For Non-Metallic Cable</b> <b>2½" deep x 3" long x 2" wide</b> Two Loom KOs and one ½" KO in each end and one ½" KO in bottom. One Loom clamp for use on non-metallic sheathed cable with 10/32 deep-slotted screw assembled. Four nail holes included. Provisions for external nails included*	50
72-OWE	12.5	<b>2½" deep x 3" long x 2" wide</b> Two Loom KOs and one ½" KO in each end and one ½" KO in bottom. With old-work swing brackets*	50
72-ONS-MXN	12.5	<b>For Metal-Clad Cable</b> <b>2½" deep x 3" long x 2" wide</b> Two Loom KOs and one ½" KO in each end and one ½" KO in bottom. One MXN clamp for MC, AC/BX and nonmetallic sheathed cable (NM) included with 10/32 deep-slotted screw. Clamp is UL Listed for use with cable sizes 14/2 through 10/3 with ground. Four nail holes included. Two 16-penny nails swaged at an angle in box*	50
72-FB-MXN	12.5	<b>For Metal-Clad Cable</b> <b>2½" deep x 3" long x 2" wide</b> Two Loom KOs and one ½" KO in each end, one ½" KO in bottom and flat bracket on one side offset ⅜" from face. Two MXN clamps for MC, AC/BX and non-metallic sheathed cable (NM) included with 10/32 deep-slotted screws. Clamps are UL Listed for use with cable sizes 14/2 through 10/3 with ground. Four nail holes included*	50

\*Uses Steel City® 100 series covers.

## Switch Boxes and Accessories

### Welded Non-Gangable Switch Boxes — 2<sup>13</sup>/<sub>16</sub>" Deep

CAT. NO.	CU. IN. CAPACITY	DESCRIPTION	STD. CTN.
73-ONCS	15.8	<b>For Non-metallic Cable, 2<sup>13</sup>/<sub>16</sub>" deep x 3" long x 2<sup>9</sup>/<sub>16</sub>" wide</b> Two Loom KOs and one 1/2" KO in each end and one 1/2" KO in bottom. One Loom clamp for use on non-metallic sheathed cable with 10/32 deep-slotted screw assembled. Two 16-penny nails swaged at an angle in box*	50
73-FBC	15.8	<b>For Non-metallic Cable, 2<sup>13</sup>/<sub>16</sub>" deep x 3" long x 2<sup>9</sup>/<sub>16</sub>" wide</b> Two Loom KOs and one 1/2" KO in each end, one 1/2" KO in bottom and flat bracket on one side offset 3/16" from face. One Loom clamp for use on non-metallic sheathed cable with 10/32 deep-slotted screw assembled. Four nail holes included*	50
73-FB-MXN	15.8	<b>For Metal-Clad Cable, 2<sup>13</sup>/<sub>16</sub>" deep x 3" long x 2<sup>9</sup>/<sub>16</sub>" wide</b> Two Loom KOs and one 1/2" KO in each end, one 1/2" KO in bottom and flat bracket on one side offset 3/16" from face. One MXN clamp for MC, AC/BX and non-metallic sheathed cable (NM) included with 10/32 deep-slotted screw. Clamp is UL Listed for use with cable sizes 14/2 through 10/3 with ground. Four nail holes included*	50

\*Uses Steel City® 100 series covers.

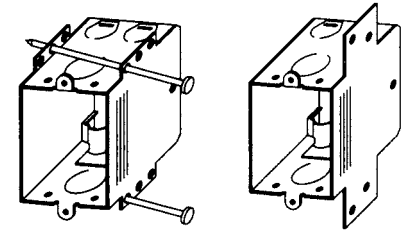

73-ONCS

73-FBC

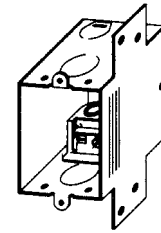

73-FB-MXN

### Welded Non-Gangable Switch Boxes — 3" Deep

CAT. NO.	CU. IN. CAPACITY	DESCRIPTION	STD. CTN.
74-CE	18	<b>For Non-metallic Cable, 3" deep x 3" long x 2 1/4" wide</b> Two Loom KOs and one 1/2" KO in each end and one 1/2" KO in bottom. One Loom clamp for use on non-metallic sheathed cable with 10/32 deep-slotted screw assembled. Furnished with ears. Four nail holes included*	50
74-ONCS	18	<b>For Non-metallic Cable, 3" deep x 3" long x 2 1/4" wide</b> Two Loom KOs and one 1/2" KO in each end and one 1/2" KO in bottom. One Loom clamp for use on non-metallic sheathed cable with 10/32 deep-slotted screw assembled. Two 16-penny nails swaged at an angle in box*	50
74-FBC	18	<b>For Non-metallic Cable, 3" deep x 3" long x 2 1/4" wide</b> Two Loom KOs and one 1/2" KO in each end, one 1/2" KO in bottom and flat bracket on one side offset 3/16" from face. One Loom clamp for use on non-metallic sheathed cable with 10/32 deep-slotted screw assembled. Four nail holes included*	50

\*Uses Steel City® 100 series covers.

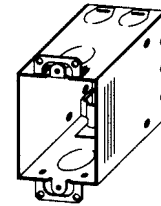

74-CE

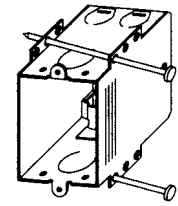

74-ONCS

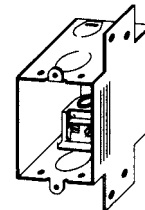

74-FBC

### Welded Non-Gangable Switch Box — 3<sup>13</sup>/<sub>32</sub>" Deep

CAT. NO.	CU. IN. CAPACITY	DESCRIPTION	STD. CTN.
75-ONCS	20.0	<b>For Non-metallic Cable, 3<sup>13</sup>/<sub>32</sub>" deep x 3" long x 2 1/4" wide</b> Two Loom KOs and one 1/2" KO in each end and one 1/2" KO in bottom. Two Loom clamp for use on non-metallic sheathed cable with 10/32 deep-slotted screw assembled. Four nail holes included. Two 16-penny nails swaged at angle in box*.	50

\*Uses Steel City® 100 series covers.

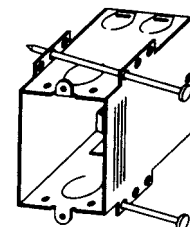

75-ONCS

## Switch Boxes and Accessories

### Welded Multi-Gangable Switch Boxes — 2½" Deep

CAT. NO.	CAPACITY	DESCRIPTION	STD. CTN.
271-FBC	25.0	<b>A Two-Gang Box — For Non-Metallic Cable, 2½" deep x 3" long x 4" wide</b> Two Loom KOs and two ½" KOs in each end, flat bracket on one side and one ½" KO in bottom. Two Loom clamps for use on non-metallic sheathed cable with 10/32 deep-slotted screws assembled. Flat bracket offset ⅜" from face*	25
271-FB-MXN	25.0	<b>A Two-Gang Box — For Metal-Clad Cable, 2½" deep x 3" long x 4" wide</b> Two Loom KOs and two ½" KOs in each end, flat bracket on one side and one ½" KO in bottom. Two MXN clamps for MC, AC/BX and non-metallic sheathed cable (NM) included with 10/32 deep-slotted screws. Clamps are UL Listed for use with cable sizes 14/2 through 10/3 with ground. Flat bracket offset ⅜" from face*	25

\*Uses Steel City® SB-2 covers.

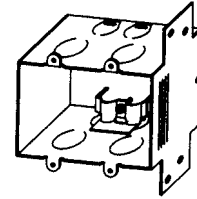

271-FBC

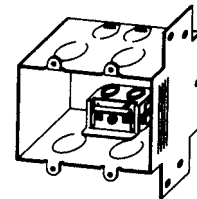

271-FB-MXN

Boxes & Covers — Steel City® Metallic Boxes

### 4" x 2½" Thru-Wall Box

CAT. NO.	CU. IN. CAPACITY	DESCRIPTION	BOX DEPTH (IN.)	STD. CTN.
<b>With Conduit KOs for Plaster or Dry Wall</b>				
CTDW	32.0	Drywall, partition type; one ½" and one ¾" KO both ends; one ½" KO on one side, V bracket other side	4⅝	25



CTDW

### Switch Box Extension

CAT. NO.	DESCRIPTION	STD. CTN.
SBEX	Cubic content 3.5 inches; fits snugly inside of all single-gang switch boxes; maximum adjustable depth ⅞"; furnished with 1¼"-long screws for mounting	50

UL Listing not applicable — subject to approval by local inspector.



SBEX

## Switch Boxes and Accessories

### Old-Work Box Support

- Quickly attaches box through finished drywall
- For up to 1½" thick drywall
- New 820D shipped in one-piece break-apart design
- Easy to install

CAT. NO.	FIG. NO.	DESCRIPTION	STD. CTN.
820D	1	Old-work switch box steel-mounting holder	500 sets

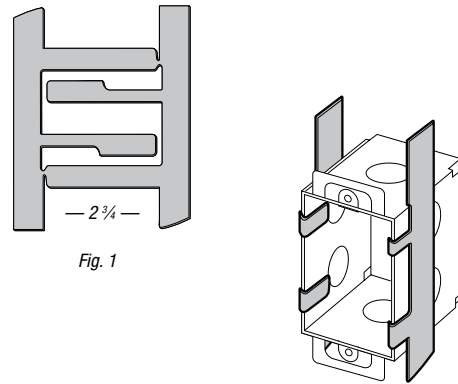

Fig. 1

### Steel Low-Voltage Bracket

- Fixes to the switch box easily with the screws provided
- Works with any Steel City® switch box, regardless of depth
- Single-screw fixing as well as two-screw fixing
- Low-voltage cable support is provided by fitting location tabs
- UL Listed for low-voltage support



CAT. NO.	DESCRIPTION	BOX DEPTH (IN.)	STD. CTN.
LVB	Bracketed to T&B boxes; provides means of installing a low-voltage device alongside a regular switch or outlet	1 5/8	25

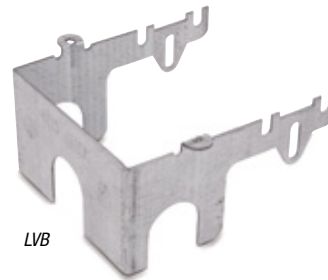

LVB

### Old-Work Box Support Clips

- Adapts to any wall thickness up to ¾"

CAT. NO.	DESCRIPTION	STD. CTN.
OWC	Clips lock old-work steel switch boxes tightly to wall plaster, drywall, concrete block, brick or concrete. 2 required per box, (1 set)	250 sets
OW SWING EAR	Swing ears only (for field installations) with self-threading screws	50 (25 pair)

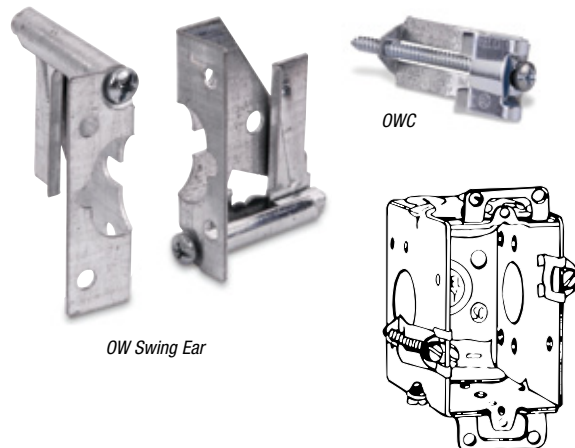

OW Swing Ear

## Round/Octagon Boxes and Accessories

### 4" Round Boxes

CAT. NO.	DEPTH (IN.)	CU. IN. CAPACITY	DESCRIPTION	KNOCKOUTS (IN.)	
				CONDUIT BOTTOM	STD. CTN.
<b>With Conduit KOs</b>					
56111	½	6.0	Steel outlet box	4-½	50
56111-CFB*	½	6.0	Ceiling fan box with plastic Romex connector included. NC501-SC	2-½	10

\*Meets NEC® 314.27(c) up to 35 lb. fan.

56111-CFB is shipped with plastic cover and all hardware.

50 lb. maximum loading for fixtures.

NEC and National Electrical Code are registered trademarks of the National Fire Protection Association, Inc.



56111

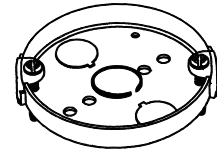

56111-CFB

### 4" Pancake Boxes

CAT. NO.	CU. IN. CAPACITY	DESCRIPTION	STD. CTN.
410-LC	5.8	<b>For Non-Metallic Sheathed Cable, 4" diameter — ½" deep</b> Three ½" KOs in a line and four Loom KOs at opposite ends in bottom. Furnished with two Loom clamps for non-metallic cable with 10/32 deep-slotted screws and two 8/32 x ½" screws in ears*	50

\*Uses Steel City® 500 series covers.

50 lb. maximum loading for fixtures.

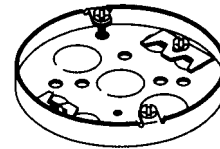

410-LC

### 3½" Round Boxes

CAT. NO.	DEPTH (IN.)	CU. IN. CAPACITY	CLAMPS	KNOCKOUTS (IN.)		STD. CTN.
				BOTTOM CONDUIT	CABLE	
<b>With Non-Metallic Sheathed Cable Clamps</b>						
36115 C30	½	4.0	C-8	1-½	4	30
36125 D	¾	4.0	C-10	1-½	4	25

50 lb. maximum loading for fixtures.

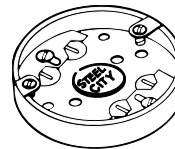

36115 C30  
Cover screws supplied

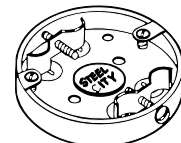

36125 D  
Cover screws supplied

### 3¼" Pancake Boxes

CAT. NO.	CU. IN. CAPACITY	DESCRIPTION	STD. CTN.
210-L	4.0	For Non-Metallic Sheathed Cable, 3¼" diameter — ½" deep. Three ½" KOs in a line with four Loom KOs at opposite ends in bottom. Furnished with two 8/32 x ½" screws*	100

\*Uses Steel City® 300 series covers.

50 lb. maximum loading for fixtures.

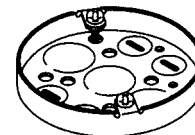

210-L

### Covers for 3½" Round and Octagon Boxes

CAT. NO.	DESCRIPTION	STD. CTN.
24C1-25	Flat, blank	100
24-C-6	Flat with ½" KO	25

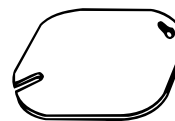

24C1-25



24-C-6

## Round/Octagon Boxes and Accessories

### 3½" Octagon Boxes

CAT. NO.	DEPTH (IN.)	CU. IN. CAPACITY	CLAMPS	KNOCKOUTS (IN.)					STD. CTN.
				EA. SIDE CLAMPS	EA. SIDE CONDUIT	EA. END CONDUIT	EA. END CABLE	BOTTOM CONDUIT	
<b>With Conduit KOs</b>									
241511/2-25	1½	11.8	—	—	1-½	1-½	—	1-½	50
25151 1/2	1½	11.8	—	—	1-½	1-½	—	—	50
<b>With Non-Metallic Sheathed Cable Clamps</b>									
24151N-25	1½	11.8	C-5	—	1-½	—	2	1-½	50
24151-NV	1½	11.8	C-5	—	1-½	—	2	1-½	50

50 lb. maximum loading for fixtures.



241511/2-25

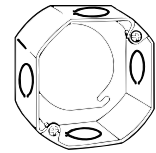

25151 1/2

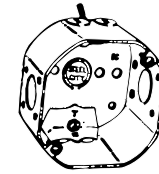

24151N-25

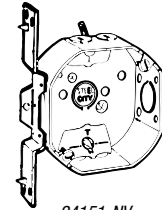

24151-NV  
V bracket  
recessed ½"

### 3½" Octagon Boxes

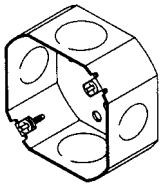

3-0-SPL

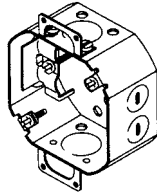

3-0-LCE

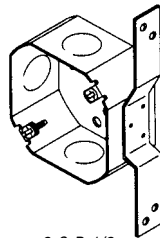

3-0-B-1/2

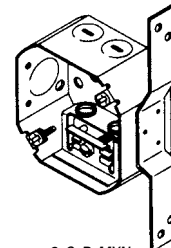

3-0-B-MXN

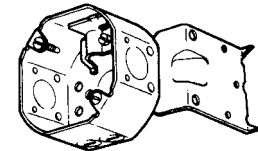

3-0-LCH

CAT. NO.	DEPTH (IN.)	CU. IN. CAPACITY	DESCRIPTION	CONSTRUCTION TYPE	STD. CTN.
3-0-SPL	1½	11.8	One ½" KO in each of two opposite sides, one ¼" KO in other two sides and one ½" KO in bottom*	Drawn	50
3-0-LCE	1½	11.8	<b>For Non-Metallic Sheathed Cable</b> Two Loom KOs in each of two opposite sides, two ½" KOs in other two sides and one ½" KO in bottom. Two ears, one on each of two opposite sides. Two Loom clamps for use on non-metallic sheathed cable with 10/32 deep-slotted screws assembled*	Drawn	50
3-0-B-1/2	1½	11.8	One ½" KO in each of three sides, flat bracket on fourth side, with one ½" KO in bottom. Flat bracket offset ½" from face*	—	50
3-0-B-MXN	1½	11.8	<b>For Metal-Clad Cable</b> Two Loom KOs in each of two opposite sides, one ½" KO in side opposite bracket and one ½" KO in bottom. Two MXN clamps for MC, AC/BX and non-metallic sheathed cable (NM) included with 10/32 deep-slotted screws. Clamps are UL Listed for use with cable sizes 14/2 through 10/3 with ground. Flat bracket offset ½" from face*	Drawn	50
3-0-LCH	1½	11.8	<b>For Non-Metallic Sheathed Cable</b> Two Loom KOs in each of two opposite sides, one ½" KO in other two sides and one ½" KO in bottom. Two Loom clamps for use on non-metallic sheathed cable with 10/32 deep-slotted screws assembled. Hanger bracket for overhead work*	Drawn	50

\*Uses Steel City® 3½" octagonal extension rings and 300 series rings and covers.

50 lb. maximum loading for fixtures.

## Round/Octagon Boxes and Accessories

### 4" Octagon Boxes



54151 N

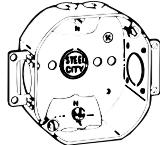

54151 NE  
Adjustable ears  
recessed 3/8"

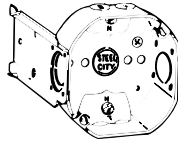

54151 NL  
L bracket flush mounted

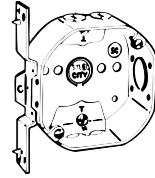

54151 NV  
V bracket recessed 1/2"



54171N-25

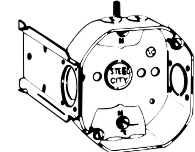

54171 NL  
L bracket mounted flush

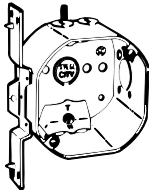

54171NV-25  
V bracket recessed 1/2"



54151 1/2



54151 3/4



54151 1/2 & 3/4

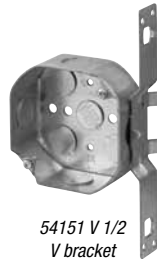

54151 V 1/2  
V bracket  
recessed 1/2"

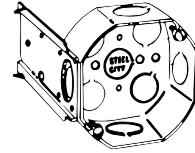

54151 L 1/2  
L bracket flush mounted

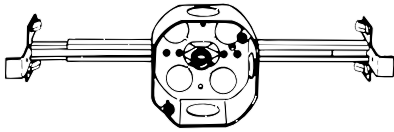

54151 J 1/2 — Mounted on 6010-DW bar adjustable  
10 1/2" to 18 1/2". Offset for 1/2", 3/4" or 5/8" plaster. Maximum  
horizontal positioning. 3/8" fixture stud.



541711/2-25

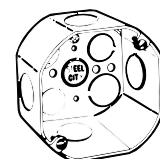

54171 3/4



54171 1/2 3/4



54171 1



54151 A

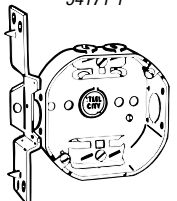

54151AV-25  
V bracket recessed 1/2"

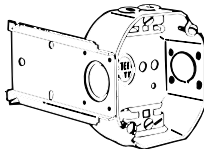

54151 AL  
L bracket mounted flush

CAT. NO.	DEPTH (IN.)	CU. IN. CAPACITY	CLAMPS	BRKTS.	KNOCKOUTS (IN.)				STD. CTN.
					EA. SIDE CONDUIT	EA. END CONDUIT	EA. END CABLE	BOTTOM CONDUIT	
<b>With Non-Metallic Sheathed Cable Clamps</b>									
54151 N	1 1/2	15.8	C-5	—	1-1/2	—	2	1-1/2	50
54151 NE	1 1/2	15.8	C-5	—	1-1/2	—	2	1-1/2	50
54151 NL	1 1/2	15.8	C-5	L	1-1/2	—	2	1-1/2	50
54151 NV	1 1/2	15.8	C-5	V	1-1/2	—	2	1-1/2	50
54171N-25	2 1/8	22.5	C-5	—	1-1/2	—	2	1-1/2	50
54171 NL	2 1/8	22.5	C-5	L	1-1/2	—	2	1-1/2	50
54171NV-25	2 1/8	22.5	C-5	V	1-1/2	—	2	1-1/2	25
<b>With Conduit KOs</b>									
54151 1/2	1 1/2	15.8	—	—	1-1/2	1-1/2	—	5-1/2	50
54151 3/4	1 1/2	15.8	—	—	1-3/4	1-3/4	—	3-1/2	50
								2-3/4	
54151 1/2 & 3/4	1 1/2	15.8	—	—	1-1/2	1-3/4	—	3-1/2	50
								2-3/4	
54151 V 1/2	1 1/2	15.8	—	V	1-1/2	1-1/2	—	5-1/2	25
54151 L 1/2	1 1/2	15.8	—	L	1-1/2	1-1/2	—	5-1/2	25
54151 J 1/2	1 1/2	15.8	—	With bar hanger	1-1/2	1-1/2	—	4-1/2	25
541711/2-25	2 1/8	22.5	—	1-1/2"	1-1/2	—	5-1/2	50	—
54171 3/4	2 1/8	22.5	—	1-3/4"	1-3/4	—	3-1/2	25	—
								2-3/4	—
54171 1/2 3/4	2 1/8	22.5	—	1-1/2"	1-3/4	—	3-1/2	25	—
								2-3/4	—
54171 1	2 1/8	22.5	—	—	1-1	1-1	—	3-1/2	25
								2-3/4	—
<b>With Armored Cable/Metal-Clad Clamps</b>									
54151 A	1 1/2	15.8	C-3	—	1-1/2	—	2	1-1/2	25
54151AV-25	1 1/2	15.8	C-3	V	1-1/2	—	2	1-1/2	50
54151 AL	1 1/2	15.8	C-3	L	1-1/2	—	2	1-1/2	25

50 lb. maximum loading for fixtures.

## Round/Octagon Boxes and Accessories

### 4" Octagon Boxes (continued)

CAT. NO.	DEPTH (IN.)	CU. IN. CAPACITY	BAR HANGER NUMBER	BAR LGTH. (IN.)	OFFSET FOR	STUD (IN.)	STD. CTN.
<b>For Non-Metallic Sheathed Cable</b>							
54151 NF	1½	15.8	6010-DW	10½–18½	—	¾	25
54151 NO	1½	15.8	6010-ADW	14½–26½	—	¾	25
54151 NG	1½	15.8	6011-DW	10½–18½	—	Fastener	25
54151 NP	1½	15.8	6011-ADW	14½–26½	—	Fastener	25
<b>For Armored Cable/Metal Clad</b>							
54151 AF	1½	15.8	6010-DW	10½–18½	Drywall	¾	25

50 lb. maximum loading for fixtures.



54151 NF  
Octagon box mounted on adjustable bar hanger. 50 lb. load max rating.

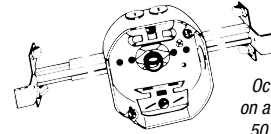

54151 AF  
Octagon box mounted on adjustable bar hanger. 50 lb. load max rating.

### 4" Octagon Boxes

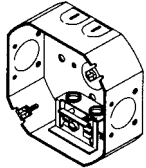

4-OW-MXN

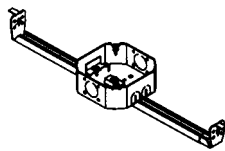

4-OW-LC-BHC

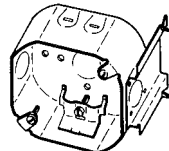

4-O-ULC

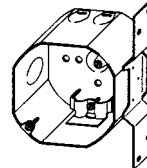

4-OD-LCB

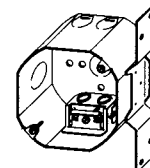

4-OD-FB-MXN

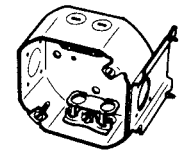

4-OD-U-MXN

CAT. NO.	DEPTH (IN.)	CU. IN. CAPACITY	DESCRIPTION	CONSTRUCTION TYPE	STD. CTN.
4-OW-MXN	1½	15.5	<b>For Metal-Clad Cable</b> Two Loom KOs in each of two opposite sides, one ½" KO in other two sides and one ½" KO in bottom. Two MXN clamps for MC, AC/BX and non-metallic sheathed cable (NM) included with 10/32 deep-slotted screws. Clamps are UL Listed for use with cable sizes 14/2 through 10/3 with ground*	Welded	50
4-OW-LC-BHC	1½	15.5	<b>For Non-Metallic Sheathed Cable</b> Two Loom KOs in each of two opposite sides, one ½" KO in other two sides. Box mounted with clip to adjustable hanger. Two Loom clamps for use on non-metallic sheathed cable with 10/32 deep-slotted screws assembled*	Welded	25
4-O-ULC	1½	15.5	<b>For Non-Metallic Sheathed Cable</b> Two Loom KOs in each of two opposite sides, ½" KOs in other two sides and one ½" KO in bottom. Two Loom clamps for use on non-metallic sheathed cable with 10/32 deep-slotted screws assembled. U bracket for overhead work*	Drawn	50
4-OD-LCB	2½	21.5	<b>For Non-Metallic Sheathed Cable</b> Two Loom KOs in each of two opposite sides, one ½" KO in side opposite bracket and one ½" KO in bottom. Two Loom clamps for use on non-metallic sheathed cable with 10/32 deep-slotted screws assembled. Flat bracket offset ½" from face*	Drawn	25
4-OD-FB-MXN	2½	21.5	<b>For Metal-Clad Cable</b> Two Loom KOs in each of two opposite sides, one ½" KO in side opposite bracket and one ½" KO in bottom. Two MXN clamps for MC, AC/BX and non-metallic sheathed cable (NM) included with 10/32 deep-slotted screws. Clamps are UL Listed for use with cable sizes 14/2 through 10/3 with ground. Flat bracket offset ½" from face*	Drawn	25
4-OD-U-MXN	2½	21.5	<b>For Metal-Clad Cable</b> Two Loom KOs in each of two opposite sides, one ½" KO in other two sides and one ½" KO in bottom. Two MXN clamps for MC, AC/BX and non-metallic sheathed cable (NM) included with 10/32 deep-slotted screws. Clamps are UL Listed for use with cable sizes 14/2 through 10/3 with ground. U bracket for overhead work*	Drawn	25

\*Uses Steel City® 4" octagonal extension rings and 500 series rings and covers. 50 lb. maximum loading for fixtures.

### 3" Octagon Box Covers

CAT. NO.	DESCRIPTION	STD. CTN.
300-DR	<b>Flat — 3½" diameter</b> For duplex receptacle in center. Screw-hole countersunk*	25
300-SR	<b>Flat — 3½" diameter</b> For single receptacle in center. Opening 1.4" in diameter. Screw-holes countersunk*	25

\*Fits any Steel City® 3" octagonal outlet box or extension ring.

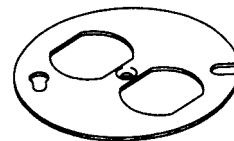

300-DR

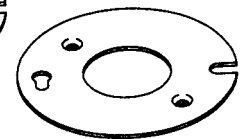

300-SR



## Round/Octagon Boxes and Accessories

### 4" Round and Octagon Box Covers

CAT. NO.	RAISED (IN.)	DESCRIPTION	CU. IN. CAP.	STD. CTN.
54 C 1	—	Flat, blank	—	50
54 C 6	—	Flat, with 1/2" KO	—	50
54 C 7	5/8	With 1/2" KO	3.5	25
54 C 3 1/2	1/2	Center blanked with tapped ears on 2 3/4" centers	3.0	25
54 C 3	5/8	Center blanked with tapped ears on 2 3/4" centers	3.5	25
54 C 3 1	1	Center blanked with tapped ears 2 23/32" centers	5.8	25
54 C 3 1 1/4	1 1/4	Center blanked with tapped ears on 2 23/32" centers	7.3	25
54 C 14	5/8	For single device	3.5	25
5401-LR	—	Flat, center blanked for single receptacle — 1 13/32" dia. hole	—	25
5402 LR	—	Flat, center blanked for duplex receptacle	—	25

For swivel covers, see accessories section on [page A-46](#).

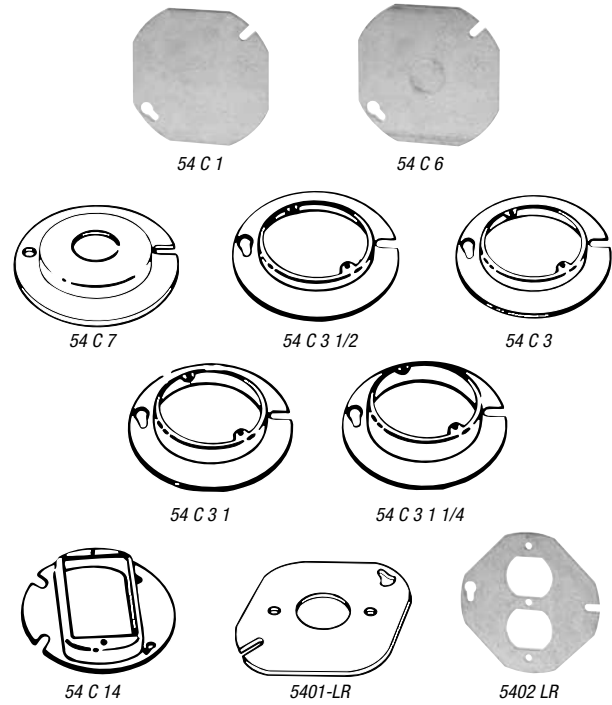

### 4" Octagon Box Extension Rings

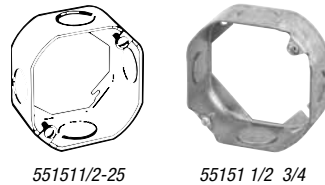

551511/2-25      55151 1/2 3/4

CAT. NO.	DEPTH (IN.)	CU. IN. CAPACITY	KNOCKOUTS (IN.)		STD. CTN.
			EA. SIDE CONDUIT	EA. END CONDUIT	
<i>With Conduit KOs</i>					
551511/2-25	1 1/2	15.8	1-1/2	1-1/2	50
55151 1/2 3/4	1 1/2	15.8	1-1/2	1-3/4	25

### 4" Octagon Box Extension Rings

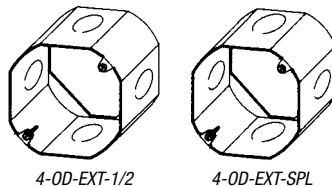

4-OD-EXT-1/2      4-OD-EXT-SPL

CAT. NO.	DEPTH (IN.)	CU. IN. CAPACITY	DESCRIPTION	CONSTRUCTION TYPE	STD. CTN.
4-OD-EXT-1/2	2 1/2	21.5	<b>Extension Ring</b> One 1/2" KO in each of four sides*	Drawn	25
4-OD-EXT-SPL	2 1/2	21.5	<b>Extension Ring</b> One 1/2" KO in each of two opposite sides and one 3/4" KO in other two sides*	Drawn	25

\*Uses Steel City® 4" octagonal outlet boxes and 500 series rings and covers.

### 4" Octagon Box Rings and Covers

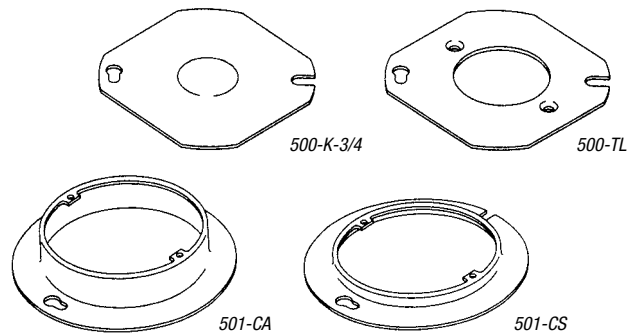

CAT. NO.	CU. IN. CAPACITY	DESCRIPTION	STD. CTN.
500-K-3/4	—	<b>Flat — 4" octagonal</b> One 3/4" KO in center*	50
500-TL	—	<b>Flat — 4" octagonal</b> Four-wire twistlock in center. Screw holes countersunk. Opening 1.594" diameter*	25
501-CA	4.5	<b>3/4" raised — 4" diameter</b> Open plaster ring with ears. Ears tapped 5/32-2 23/32" on centers. Special screw-lock feature in slots*	25
501-CS	1.5	<b>1/4" raised — 4" diameter</b> Open plaster ring with ears. Ears tapped 5/32-2 23/32" on centers. Special screw-lock feature in slots*	25

\*Fits any Steel City® 4" octagonal outlet box or extension ring.

## Ceiling Fan Boxes and Accessories

### Fan and Fixture Support Steel and Non-Metallic Boxes and Bar Hangers for Fan and Fixture Installation

Exhaustive research and development has resulted in an innovative line of Ceiling Fan Support Boxes that give Thomas & Betts the competitive advantage. Ceiling fan and fixture installation is faster, easier and safer with Steel City® Ceiling Fan Support Boxes.

- Gold finish on ears/screws easily identifies boxes as meeting UL and NEC® requirements for fan support
- UL Listed up to 50 lbs. for fixture and 35 lbs. for fan
- Each box comes complete with instructions and installation hardware

#### Ceiling Fan and Light Fixture Bar Hanger

- Square end plates keep the bar parallel with sheetrock
- Square section tube is easy to grip, allowing high torque for safe installation
- UL Listed up to 50 lbs. for fixture and 35 lbs. for fan
- Expandable for joists spaced from 16 to 24 inches

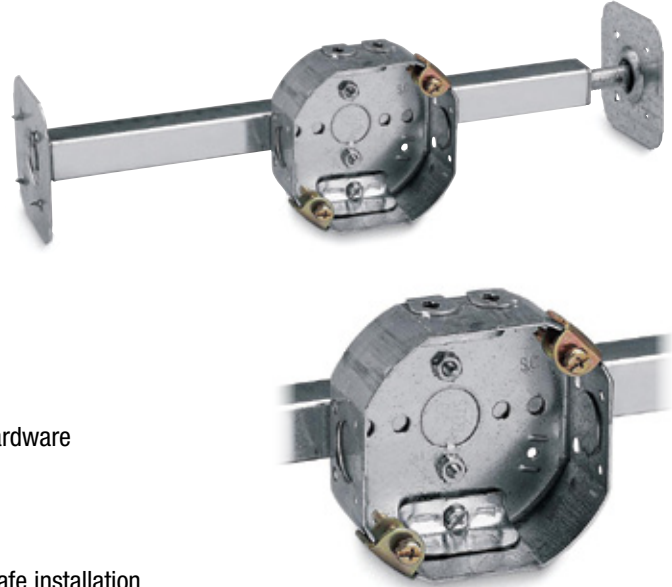

Intended for retrofit installations, the unique design of the Old-Work Bar Hanger ensures a trouble-free installation that surpasses the competition.

NEC and National Electrical Code are registered trademarks of the National Fire Protection Association, Inc.

CAT. NO.	CAPACITY CU. IN.	DESCRIPTION	NEW/OLD WORK	STD. CTN.
54151CFB-BHL-OW	15.8	Old-Work Bar Hanger with 1½" deep ceiling fan box with 3 x ½" KOs and clamps for non-metallic sheathed cable	Old	10

Max. rec. loads 35 lbs. fan and 50 lbs. fixture.

#### Ceiling Fan Support Boxes



CAT. NO.	CAPACITY CU. IN.	DESCRIPTION	DIMENSIONS (IN.)		NEW/OLD WORK	STD. CTN.
			DIA.	DEPTH		
56111-CFB	6.0	Pan type ceiling fan box with 3 x ½" KOs and non-metallic sheathed cable connector	4	½	Both	10
54151-CFB	15.8	1½" deep ceiling fan box with 3 x ½" KOs and clamps for non-metallic sheathed cable	4	1½	New	10
54151-1/2-CFB-BP	15.8	1½" deep ceiling fan box with 5 x ½" KOs. Bulk pack	4	1½	New	50
54171-CFB	22.0	2½" deep ceiling fan box with 3 x ½" KOs and clamps for non-metallic sheathed cable	4	2½	New	10
54171-F-CFB*	22.0	As 54171-CFB, but with "F" style mounting bracket	4	2½	New	10
54171-1/2-F-CFB-BP	22.0	2½" deep ceiling fan box with 5 x ½" KOs and "F" style mounting bracket	4	2½	New	50



CAT. NO.	CLAMPS	EARS	BRKTS.	KNOCKOUTS (IN.)				STD. CTN.
				EA. SIDE CONDUIT	EA. END CONDUIT	EA. END CABLE	BOTTOM CONDUIT	
54541-CFB	2½" DP	—	Concrete ring	½-¾	—	—	—	50
54551-CFB	3" DP	—	Concrete ring	½-¾	—	—	—	50

Max. loads 35 lbs. fan and 50 lbs. fixture.

Cover — CBP or CBP-3/8. 35# fan rating, 50# fixture rated.

\* Maximum load for 54171-F-CFB is 70 lbs. fan and 200 lbs. fixture.

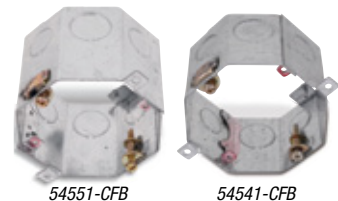

## Ceiling Fan Boxes and Accessories

### Extra Heavy-Duty New-Work Bar Hangers Ceiling Fan and Light Fixture Bar Hangers

This innovative extruded-aluminum bar hanger was designed for strength. It is UL Listed for up to 70 lbs. for fan support and an industry-leading 200 lbs. for fixture support

- Gold end plates easily identify the hanger as meeting UL and NEC® requirements for fan support
- Screwed-on end plates are consistently strong and avoid unsightly welds
- End plates feature temporary fixing spikes for hands-free installation
- Expandable for joists spaced from 16 to 24 inches



Boxes & Covers — Steel City® Metallic Boxes



56111CFB-BHL



54151CFB-BHL



4070CFB-BHL



CFB-BHL



CAT. NO.	CAPACITY CU. IN.	DESCRIPTION	MAX. REC. LOAD		NEW/OLD WORK	STD. CTN.
			FAN	FIXTURE		
56111CFB-BHL	6.0	New-work bar hanger with ½" pan-type ceiling fan box with 3 x ½" KOs and non-metallic sheathed cable connector	70 lbs.	200 lbs.	New	10
54151CFB-BHL	15.8	New-work bar hanger with 1½" deep ceiling fan box with 3 x ½" KOs and clamps for non-metallic sheathed cable	70 lbs.	200 lbs.	New	10
4070CFB-BHL	21.5	New-work bar hanger with non-metallic ceiling fan box with clamps for non-metallic sheathed cable	35 lbs.	50 lbs.	New	10
CFB-BHL	*	New-work bar hanger without outlet box. Mounting bracket for outlet box included	—	*	New	10

\* Dependent on box used.

NEC and National Electrical Code are registered trademarks of the National Fire Protection Association, Inc.

## Square Boxes and Accessories

Easy to identify and install!

### Fire Alarm Boxes and Fittings

Steel City® Fire Alarm Boxes and Fittings can meet all of your visual identification requirements for fire alarm systems — and make installation and upgrades faster and easier than ever before! Available in a variety of sizes to accommodate new or old work configurations, these boxes are simple to install with high-quality Thomas & Betts fittings. Plus, the bright red finish eliminates time-consuming painting of existing fixtures and provides long-lasting identification in even the harshest environments.



52171-1234RD



72171-1234RD



52171-EXTRD



52-C-1RD



52151-1234RD



52171-CV-1234RD



52171-EXTOWRD

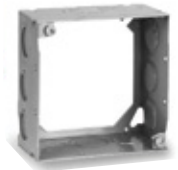

53171-1234RD

#### Fire Alarm Boxes



CAT. NO.	DESCRIPTION	EARS	BRACKETS	EACH SIDE CONDUIT	EACH END CONDUIT	BOTTOM CONDUIT	CU. IN. CAPACITY	STD. CTN.
52171-1234RD	2 1/8"-deep 4"-square red box	—	—	2 1/2", 1 1/2" & 3/4"E	2 1/2", 1 1/2" & 3/4"E	3 1/2", 2 1/2" & 3/4"E	30.3	50
52151-1234RD	1 1/2"-deep 4"-square drawn red box	—	—	2 1/2", 1 3/4"	2 1/2", 1 3/4"	3 1/2", 2 3/4"	21.0	50
72171-1234RD	2 1/8"-deep 4 1/16" red box	—	—	3 1/2" & 3/4"E	3 1/2" & 3/4"E	3 1/2", 2 1/2" & 3/4"E	42.0	20
52171-CV-1234RD	2 1/8"-deep 4"-square red box with CV bracket	—	CV	2 1/2", 1 1/2" & 3/4"E	2 1/2", 1 1/2" & 3/4"E	3 1/2", 2 1/2" & 3/4"E	30.3	50
52171-EXTRD	2 1/8"-deep 4"-square red box with ext. ring	—	—	4 1/2", 2 1/2" & 3/4"E	4 1/2", 2 1/2" & 3/4"E	3 1/2", 2 1/2" & 3/4"E	60.6	25
52171-EXTOWRD	2 1/8"-deep 4"-square red box with ext. ring and old work ears	Yes	—	4 1/2", 2 1/2" & 3/4"E	4 1/2", 2 1/2" & 3/4"E	3 1/2", 2 1/2" & 3/4"E	60.6	25
52 C 1RD	Flat 4"-square red cover	—	—	—	—	—	—	100
53171-1234RD	2 1/8"-deep 4"-square red extension ring	—	—	2 1/2", 1 1/2" & 3/4"E	2 1/2", 1 1/2" & 3/4"E	—	30.3	25
521911234RD	3 1/2"-deep 4"-square red box	—	—	4 x 1 1/2" & 3/4" Combo	2 x 1 1/2" & 3/4" Combo	4 x 1 1/2" & 3/4" Combo	46	24
521911234CVRD	3 1/2"-deep 4"-square red box w/side mounting bracket	—	CV	4 x 1 1/2" & 3/4" Combo	2 x 1 1/2" & 3/4" Combo	4 x 1 1/2" & 3/4" Combo	46	10

#### Fire Alarm Fittings



CAT. NO.	DESCRIPTION	STD. CTN.
TC121A-FA	1/2" Red Steel EMT Set Screw Connector	50
TC122A-FA	3/4" Red Steel EMT Set Screw Connector	50
TC123A-FA	1" Red Steel EMT Set Screw Connector	25
TC721A-FA	1/2" Red Insulated Steel EMT Set Screw Connector	50
TC722A-FA	3/4" Red Insulated Steel EMT Set Screw Connector	50
TC723A-FA	1" Red Insulated Steel EMT Set Screw Connector	25
TK121A-FA	1/2" Red Steel EMT Set Screw Coupling	50
TK122A-FA	3/4" Red Steel EMT Set Screw Coupling	50
TK123A-FA	1" Red Steel EMT Set Screw Coupling	25



TK122A-FA



TK121A-FA



TC122A-FA



TC121A-FA

## Square Boxes and Accessories

### 4" Square Old-Work Box with Swing Ears

CAT. NO.	DESCRIPTION	STD. CTN.
52171-OW	Metallic 4"-Sq. x 2½"D Old-Work Box with factory-mounted swing ears	25
OW SWING EAR	Swing Ears only (for field installation) with self-threading screws	50 (25 pair)



52171-OW



OW Swing Ears

### 4" Square Boxes

CAT. NO.	DEPTH (IN.)	CU. IN. CAPACITY	CLAMPS	BRKTS.	KNOCKOUTS (IN.)			STD. CTN.
					EA. SIDE CONDUIT	EA. END CONDUIT	BOTTOM CONDUIT	
<b>With Non-Metallic Sheathed Cable Clamps</b>								
52151 N	1½	21.0	C-5	—	2-½, 1-½, ¾E	2	1-½	50
52151 MS N*	1½	21.0	C-5	MS	2-½, 1-½, ¾E	2	1-½	25
52151 BN*	1½	21.0	C-5	B	2-½, 1-½, ¾E	2	1-½	25
52151 VN*	1½	21.0	C-5	SV	2-½, 1-½, ¾E	2	1-½	25
52151 CVN*	1½	21.0	C-5	CV	2-½, 1-½, ¾E	2	1-½	25
52151 CVNP*	1½	21.0	C-5	CV	2-½, 1-½, ¾E	2	1-½	25
52171 N	2½	30.3	C-5	—	2-½, 1-½, ¾E	2	1-½	25
52171-VN*	2½	30.3	C-5	SV	2-½, 1-½, ¾E	2	1-½	25
<b>With Conduit KOs</b>								
52141-1/2	1¼	18.0	—	—	2-½	3-½	5-½	50
52151 1/2	1½	21.0	—	—	3-½	3-½	5-½	50
52151-3/4	1½	21.0	—	—	2-¾	2-¾	3-¾, 2-¾	50
52151 1/2 3/4	1½	21.0	—	—	2-½, 1-¾	2-½, 1-¾	3-½, 2-¾	50
521511234P	1½	21.0	—	—	2-½, 1-¾	2-½, 1-¾	3-½, 2-¾	50
52151-3/4-W	1½	21.0	—	—	2-¾	2-¾	3-½, 2-¾	50
52151B1234*	1½	21.0	—	B	2-½, 1-½, ¾E	2-½, 1-¾, ¾E	3-½, 2-½, ¾E	25
52151-1/2 & 3/4-EW	1½	21.0	—	—	2-½, 1-½, ¾E	2-½, 1-½, ¾E	3-½, 2-½, ¾E	50
521511234EWGB (Ground bump)	1½	21.0	—	—	2-½, 1-½, ¾E	2-½, 1-½, ¾E	2-½, 2-½, ¾E	50
521511234EWGBP (Ground bump with 10½" ground wire)	1½	21.0	—	—	2-½, 1-½, ¾E	2-½, 1-½, ¾E	2-½, 2-½, ¾E	50

\* All Bracketed boxes come complete with eccentric knockouts.

Per UL 514A, suitable for use without a bonding jumper in circuits above or below 250 volts. Pigtail wire is #12 AWG insulated, 10½" long.

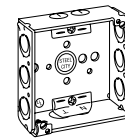

52151 N

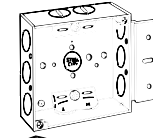

52151 MS N\*  
MS bracket for  
1½", 2½", 3½", 4"

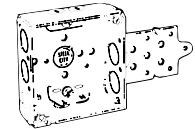

52151 BN\*  
B bracket  
mounted flush

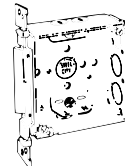

52151 VN\*  
SV bracket  
mounted flush

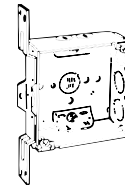

52151 CVN\*  
CV bracket  
mounted flush

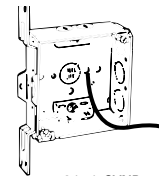

52151 CVNP



52171 N

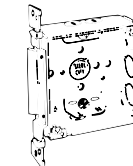

52171-VN\*  
SV bracket  
mounted flush



52141-1/2



52151 1/2



52151-3/4



52151 1/2 3/4

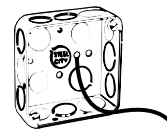

521511234P

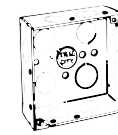

52151-3/4-W

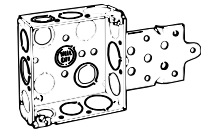

52151B1234  
B Bracket mounted flush



52151-1/2 & 3/4-EW

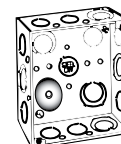

521511234EWGB

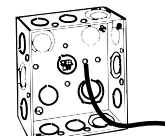

521511234EWGBP

## Square Boxes and Accessories

### 4" Square Boxes (continued)

CAT. NO.	DEPTH (IN.)	CU. IN. CAPACITY	CLAMPS	BRKTS.	KNOCKOUTS (IN.)			STD. CTN.
					EA. SIDE CONDUIT	EA. END CONDUIT	BOTTOM CONDUIT	
<b>With Conduit KOs (continued)</b>								
521511234EWP*	1½	21.0	—	—	2-½, 1-½, ¾E	2-½, 1-½, ¾E	3-½, 2-½, ¾E	50
52151 MS 1/2 & 3/4*	1½	21.0	—	MS	2-½, 1-½, ¾E	2-½, 1-¾, ¾E	3-½, 2-½, ¾E	25
52151-V-1/2 & 3/4*	1½	21.0	—	SV	2-½, 1-½, ¾E	2-½, 1-¾, ¾E	3-½, 2-½, ¾E	25
52151 CV 3/4*	1½	21.0	—	CV	2-¾	2-¾	3-½	25
52151 CV 1/2 3/4*	1½	21.0	—	CV	2-½, 1-½, ¾E	2-½, 1-¾, ¾E	3-½, 2-½, ¾E	25
52151DV12*	1½	21.0	—	DV	2-½, ¾E	3-½, ¾E	3-½, ¾E	25
521711234E	2½	30.3	—	—	2-½, 1-½, ¾E	2-½, 1-½, ¾E	3-½, 2-½, ¾E	50
521711234EP (With 10½" ground wire)	2½	30.3	—	—	2-½, 1-½, ¾E	2-½, 1-½, ¾E	2-½, 2-½, ¾E	50
52171 MS 1/2 3/4*	2½	30.3	—	MS	2-½, 1-½, ¾E	2-½, 1-½, ¾E	3-½, 2-½, ¾E	25
52171MSP* (With 10½" ground wire)	2½	30.3	—	MS	2-½, 1-½, ¾E	2-½, 1-½, ¾E	3-½, 2-½, ¾E	25
52171 3/4	2½	30.03	—	—	2-¾	2-¾	3-½, 2-¾	50
52171 1	2½	30.03	—	—	2-1	2-1	3-½, 2-¾	50
52171 V 1/2 & 3/4*	2½	30.03	—	SV	2-½, 1-½, ¾E	2-½, 1-½, ¾E	3-½, 2-½, ¾E	25
52171-CV-1/2 & 3/4*	2½	30.03	—	CV	2-½, 1-½, ¾E	2-½, 1-½, ¾E	3-½, 2-½, ¾E	25
52171-EW-SSX*	2½	30.03	—	SSX	—	—	—	—
521711234EP*	2½	30.03	—	v	2-½, 1-½, ¾E	2-½, 1-½, ¾E	3-½, 2-½, ¾E	25
52171-B-1/2 & 3/4	2½	30.03	—	—	2-½, 1-½, ¾E	2-½, 1-½, ¾E	3-½, 2-½, ¾E	25

\* All bracketed boxes come complete with eccentric knockouts. Per UL514A, suitable for use without a bonding jumper in circuits above or below 250 volts. Pigtail wire is #12 AWG insulated, 10½" long.

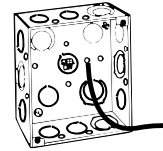

521511234EWP

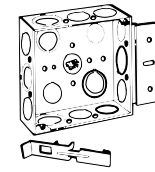

52151 MS 1/2 & 3/4  
For use on 1½", 2½", 3¾", 4" studs

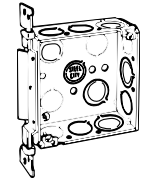

52151-V-1/2 & 3/4  
SV Bracket mounted flush

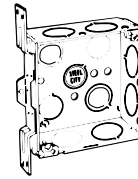

52151 CV 3/4  
CV Bracket mounted flush



52151 CV 1/2 3/4  
CV Bracket mounted flush

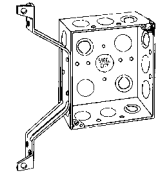

52151DV1/2  
DV Bracket provides offset



521711234E



521711234EP



52171 MS 1/2 3/4\*  
MS bracket for 1½", 2½", 3¾", 4", 6" metal studs

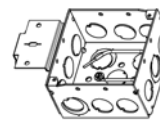

52171MSP

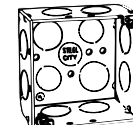

52171 3/4



52171 1



52171 V 1/2 & 3/4  
SV bracket mounted flush



52171-CV-1/2 & 3/4  
CV bracket mounted flush

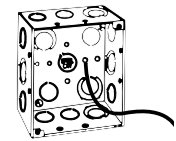

521711234EP

CAT. NO.	DESCRIPTION	EARS	BRACKETS	EACH SIDE KO	EACH END KO	BOTTOM KO	CU. IN. CAPACITY	STD. CTN.
521911234	3½"-deep 4"-square red box	—	—	4 x ½" & ¾" Combo	2 x ½" & ¾" Combo	4 x ½" & ¾" Combo	46	24
521911234CV	3½"-deep 4"-square red box w/side mounting bracket	—	CV	4 x ½" & ¾" Combo	2 x ½" & ¾" Combo	4 x ½" & ¾" Combo	46	10

## Square Boxes and Accessories

### 4" Square Boxes (continued)

CAT. NO.	DEPTH (IN.)	CU. IN. CAPACITY	CLAMPS	BRKTS.	KNOCKOUTS (IN.)			STD. CTN.
					EA. SIDE CONDUIT	EA. END CONDUIT	BOTTOM CONDUIT	
<b>With Armored Cable/Metal-Clad Clamps</b>								
52151 X	1¼	21.0	C-3	—	2-½, 1-½, ¾E	2	1-½	50
52151XP	1¼	21.0	C-3	—	2-½, 1-½, ¾E	2	1-½	50
52151 BX*	1¼	21.0	C-3	B	2-½, 1-½, ¾E	2	1-½	25
52151 VX*	1¼	21.0	C-3	SV	2-½, 1-½, ¾E	2	1-½	25
52151 CVX*	1¼	21.0	C-3	CV	2-½, 1-½, ¾E	2	1-½	25
52151 MS X*	1¼	21.0	C-3	MS	2-½, 1-½, ¾E	2	1-½	25
<b>For Armored Cable and Metal-Clad Cable Clamps</b>								
52171 X*	2½	30.3	C-3	—	2-½, 1-½, ¾E	2	1-½	25
52171 MSX*	2½	30.3	C-3	MS	2-½, 1-½, ¾E	2	1-½	25
52171MSXP (With 10½" ground wire)	2½	30.3	C-3	MS	2-½, 1-½, ¾E	2	1-½	25
52171-CVX*	2½	30.3	C-3	CV-2	½-¾	—	—	25

\* All bracketed boxes come complete with eccentric knockouts. Per UL514A, suitable for use without a bonding jumper in circuits above or below 250 volts. Pigtail wire is #12 AWG insulated, 10½" long. All 52171 series boxes have a raised ground bump.

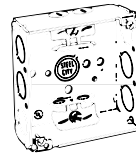

52151 X

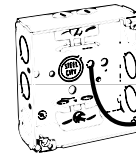

52151XP

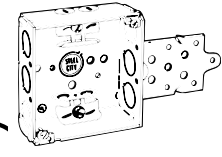

52151 BX\*  
B bracket  
mounted flush

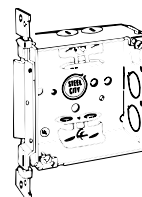

52151 VX\*  
SV bracket  
mounted flush

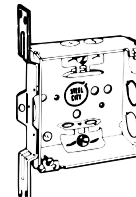

52151 CVX\*  
CV bracket  
mounted flush

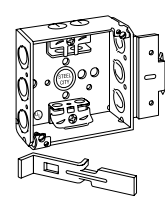

52151 MS X\*  
MS bracket for 1½",  
2½", 3½", 4" metal studs

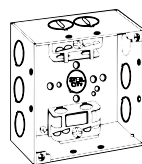

52171 X

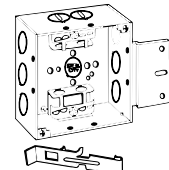

52171 MSX\*  
MS bracket for 1½",  
2½", 3½", 4" metal studs

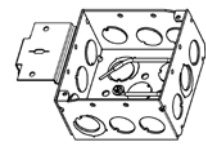

52171MSXP\*

CAT. NO.	DESCRIPTION	CLAMPS	EACH SIDE CONDUIT	EACH END CONDUIT	BOTTOM CONDUIT	CU. IN. CAPACITY	STD. PKG.
52171-EW-SSX	2½"-deep with conduit KOs	—	1½", 1½" & ¾"E	2½", 1½" & ¾"E	2½", 2½" & ¾"E	30	20
52151-EF-SSX	1½"-deep with conduit KOs	—	1½", 1½" & ¾"E	2½", 1½" & ¾"E	2½", 2½" & ¾"E	21	20
52171-X-SSX	2½"-deep with armored cable clamps	C3	1½", 1½" & ¾"E	2 Cable	1½"	30	20
52151-X-SSX	1½"-deep with armored cable clamps	C3	1½", 1½" & ¾"E	2 Cable	1½"	21	20
CXLESSX	3½"-deep with armored cable clamps	C3	2½"	1½" & 2 Cable	1½"	15	20

### Vapor Tite Boxes

- All K.O.'s pressed flush but still easy to remove
- No holes anywhere
- Top edge of boxes are flush at ears so gasket seals out all air

CAT. NO.	DESCRIPTION	DEPTH	STD. PKG.
52151-SVT	4" Sq. Box, ½" and ¾" K.O. Side and Bottom	1½"	50
52G1-VT	4" Sq. Blank Cover with Gasket	Flat	50
52171-SVT	4" Sq. Box, ½" and ¾" K.O. Side and Bottom	2½"	25
72G1-VT	4½" Sq. Blank Cover with Gasket	Flat	50
72171-SVT	4½" Sq. Box, ½" and ¾" K.O. Side and Bottom	2½"	25
54151-VT	4" Sq. Box, ½" K.O. Side and Bottom	1½"	50
54G1-VT	4" Oct. and Round Box Blank Cover	Flat	50

## Square Boxes and Accessories

### 4" Square Boxes

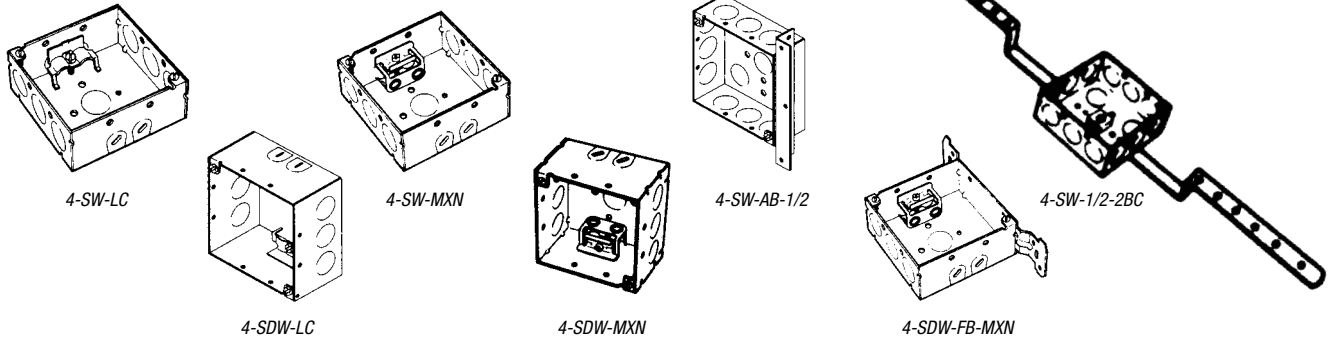

CAT. NO.	DEPTH (IN.)	CU. IN. CAPACITY	DESCRIPTION	CONSTRUCTION TYPE	STD. CTN.
<b>4-SW-LC</b>	1½	21.0	<b>For Non-Metallic Sheathed Cable</b> Two Loom KOs in each of two opposite sides, three ½" KOs in other two sides and one ½" KO in bottom. Two Loom clamps for use on non-metallic sheathed cable with 10/32 deep-slotted screws assembled*	Welded	50
<b>4-SW-MXN</b>	1½	21.0	<b>For Metal-Clad Cable</b> Two Loom KOs in each of two opposite sides, three ½" KOs in other two sides and one ½" KO in bottom. Two MXN clamps for MC, AC/BX and non-metallic sheathed cable (NM) included with 10/32 deep-slotted screws. Clamps are UL Listed for use with cable sizes 14/2 through 10/3 with ground*	Welded	50
<b>4-SW-AB-1/2</b>	1½	21.0	Three KOs in each of three sides, angle bracket on other side, and five ½" KOs in bottom. Angle bracket offset ¾" from top of box*	Welded	50
<b>4-SW-1/2-2BC</b>	1½	21.0	Three ½" KOs in each side and four ½" KOs in bottom. Mounted with clip on 2-BC bar hanger. Hanger is offset correct depth to set box flush with ceiling joist*	Welded	25
<b>4-SDW-LC</b>	2½	30.3	<b>For Non-Metallic Sheathed Cable</b> Two Loom KOs in each of two opposite sides, three ½" KOs in other two sides and one ½" KO in bottom. Two Loom clamps for use on non-metallic sheathed cable with 10/32 deep-slotted screws assembled*	Welded	25
<b>4-SDW-MXN</b>	2½	30.3	<b>For Metal-Clad Cable</b> Two Loom KOs in each of two opposite sides, three ½" KOs in other two sides and one ½" KO in bottom. Two MXN clamps for MC, AC/BX and non-metallic sheathed cable (NM) included with 10/32 deep-slotted screws. Clamps are UL Listed for use with cable sizes 14/2 through 10/3 with ground*	Welded	25
<b>4-SDW-FB-MXN</b>	2½	30.3	<b>For Metal-Clad Cable</b> Two Loom KOs in each of two opposite sides, three ½" KOs in side opposite flat bracket and one ½" KO in bottom. Two MXN clamps for MC, AC/BX and non-metallic sheathed cable (NM) included with 10/32 deep-slotted screws. Clamps are UL Listed for use with cable sizes 14/2 through 10/3 with ground*	Welded	25

\*Uses Steel City® 4" square extension rings and 400 series rings and covers.

### 4" Square Thru-Wall Box



X1-1/2 & 3/4

CAT. NO.	DEPTH (IN.)	CU. IN. CAPACITY	KNOCKOUT (IN.)		STD. CTN.
			EA. SIDE CONDUIT	EA. END CONDUIT	
<b>With Conduit KOs</b>					
<b>X1-1/2 &amp; 3/4</b>	1½	21.0	2-½, 1-¾	2-½, 1-¾	25

### 4" Square Two-Device Boxes



2G4D 1/2 & 3/4



2G4DV 1/2 & 3/4  
CV bracket recessed ½"

CAT. NO.	DEPTH (IN.)	CU. IN. CAPACITY	BRACKETS	KNOCKOUTS (IN.)			STD. CTN.
				EA. SIDE CONDUIT	EA. END CONDUIT	BOTTOM CONDUIT	
<b>With Conduit KOs</b>							
<b>2G4D 1/2 &amp; 3/4</b>	2½	30.3	—	2-½, 1-¾	2-½, 1-¾	3-½, 2-¾	25
<b>2G4DV 1/2 &amp; 3/4</b>	2½	30.3	CV	2-½, 1-¾	2-½, 1-¾	3-½, 2-¾	25



## Square Boxes and Accessories

### 4" Square Box Partitions

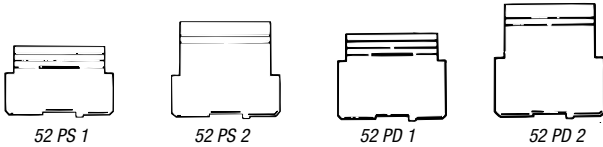

CAT. NO.	DESCRIPTION	STD. CTN.
<b>For 1½" Deep Box with Square-Cut Tile Wall Two-Device Covers</b>		
52 PS 1	For ½", ¾" and 1" raised covers	25
52 PS 2	For 1¼", 1½" and 2" raised covers	25
<b>For 2⅝" Deep Box with Square-Cut Tile Wall Two-Device Covers</b>		
52 PD 1	For ½", ¾" and 1" raised covers	25
52 PD 2	For 1¼", 1½" and 2" raised covers	25

### 4" Square Wall Rings

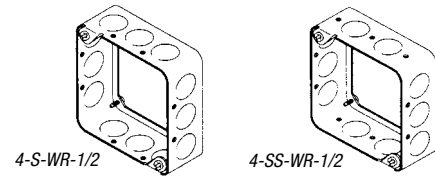

CAT. NO.	DEPTH (IN.)	CU. IN. CAPACITY	DESCRIPTION	CONSTRUCTION TYPE	STD. CTN.
4-S-WR-1/2	1½	21.0	<b>Wall Ring</b> Three ½" KOs in each side. Four 8/32 screws furnished (two in top and two in bottom)*	Drawn	50
4-SS-WR-1/2	1½	18.0	<b>Wall Ring</b> Three ½" KOs in each of two opposite sides, two ½" KOs in other two sides. Four 8/32 screws furnished (two in top and two in bottom)**	Drawn	50

\*For use with two Steel City® 403-O rings for back to back devices in 2" partitions.  
\*\*For use with two Steel City® 403-O rings for back to back devices in 1¼" partitions

### 4" Square Rings and Covers

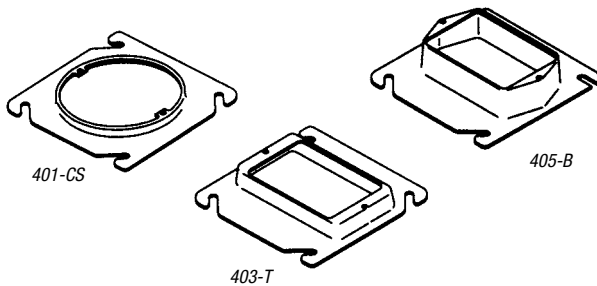

CAT. NO.	CU. IN. CAPACITY	DESCRIPTION	STD. CTN.
401-CS	1.0	<b>¼" raised — 4" square</b> Open plaster ring with ears. Ears tapped 8/32-2 <sup>23</sup> / <sub>32</sub> " on centers. Special screw lock feature in slots*	25
403-T	3.5	<b>Tile Ring, ½" raised — 4" square</b> For single switch or receptacle. Ears tapped 8/32-2 <sup>23</sup> / <sub>32</sub> " on centers*	50
405-B	5.0	<b>⅞" raised — 4" square</b> For single switch or receptacle*	25

\*Fits any Steel City® 4" square outlet box or extension ring.

### 4" Square Industrial Device Covers

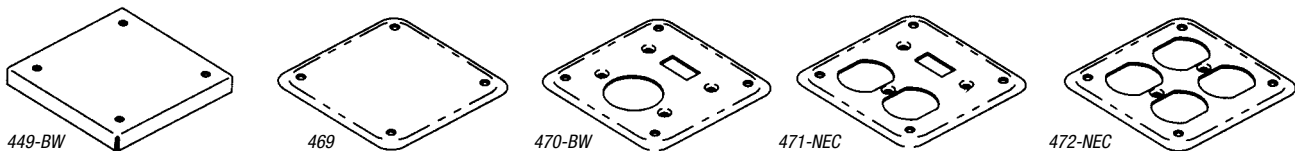

CAT. NO.	DESCRIPTION	STD. CTN.
449-BW	<b>½" raised — 4" square</b> Surface blank. Each cover individually packaged with the necessary screws for mounting*	25
469	<b>⅛" raised — 4" square</b> Surface blank. Each cover individually packaged with the necessary mounting screws*	25
470-BW	<b>⅛" raised — 4" square</b> For one toggle switch and one single receptacle. Opening 1.4" diameter. Each cover individually packaged with the necessary mounting screws*	25
471-NEC	<b>⅛" raised — 4" square</b> For one toggle switch and one duplex receptacle. Each cover individually packaged with the necessary mounting screws*	25
472-NEC	<b>⅛" raised — 4" square</b> For two duplex receptacles. Each cover individually packaged with the necessary mounting screws*	25

\*Fits any Steel City® 4" square outlet box or extension ring.

## Square Boxes and Accessories

### 4" Square Industrial Device Covers (continued)

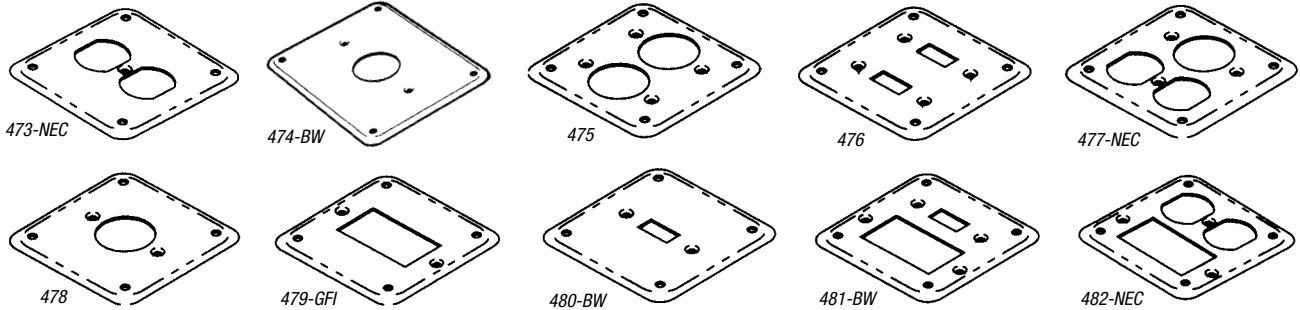

CAT. NO.	DESCRIPTION	STD. CTN.
473-NEC	<b>1/8" raised — 4" square</b> For one duplex receptacle in center. Each cover individually packaged with the necessary mounting screws*	25
474-BW	<b>1/8" raised — 4" square</b> For one single receptacle in center. Opening 1.4" diameter. Each cover individually packaged with the necessary mounting screws*	25
475	<b>1/8" raised — 4" square</b> For two single receptacles. Openings 1.4" diameter. Each cover individually packaged with the necessary mounting screws*	25
476	<b>1/8" raised — 4" square</b> For two toggle switches. Each cover individually packaged with the necessary mounting screws*	25
477-NEC	<b>1/8" raised — 4" square</b> For one duplex and one single receptacle. Opening 1.4" diameter. Each cover individually packaged with the necessary mounting screws*	25
478	<b>1/8" raised — 4" square</b> For one four-wire twist lock receptacle in center. Opening 1.594" diameter. Each cover individually packaged with the necessary mounting screws*	25
479-GFI	<b>1/8" raised — 4" square</b> For one GFI receptacle in center. Each cover individually packaged with the necessary mounting screws*	25
480-BW	<b>1/8" raised — 4" square</b> For one toggle switch in center. Each cover individually packaged with the necessary mounting screws*	25
481-BW	<b>1/8" raised — 4" square</b> For one GFI receptacle and one toggle switch. Each cover individually packaged with the necessary mounting screws*	25
482-NEC	<b>1/8" raised — 4" square</b> For one GFI and one duplex receptacle. Each cover individually packaged with the necessary mounting screws*	25

\*Fits any Steel City® 4" square outlet box or extension ring.

### 4" Square Extension Rings

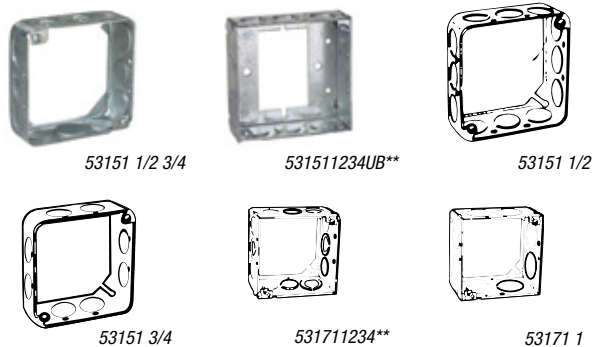

CAT. NO.	KNOCKOUTS (IN.)		STD. CTN.
	EA. SIDE CONDUIT	EA. END CONDUIT	
<b>1 1/2" Deep — with Conduit KOs — 21.0 Cubic Inch Capacity</b>			
53151 1/2	3-1/2	3-1/2	50
53151 3/4	2-3/4	2-3/4	25
53151 1/2 3/4	2-1/2, 1-3/4	2-1/2, 1-3/4	50
531511234UB**	2-1/2, 1-1/2, 3/4E	2-1/2	50

<b>2 1/2" Deep — with Conduit KOs — 30.3 Cubic Inch Capacity</b>			
531711234*	2-1/2, 1-1/2, 3/4E	2-1/2, 1-3/4	25
53171 1	2-1	2-1	25

\* Per UL 514-A, suitable for use without a bonding jumper in circuits above or below 250 volts.

\*\* ECC, KOs on sides.

## Square Boxes and Accessories

### 4" Square-Cut Tile Wall Covers

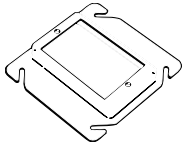

52 C 49 1/2

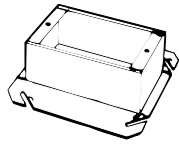

52C5011/2-25

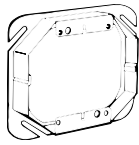

52 C 52 1/2

CAT. NO.	RAISED (IN.)	DESCRIPTION	CU. IN. CAP.	STD. CTN.
<b>For Single Device — Steel</b>				
52 C 49 1/2*	1/2	—	3.5	50
52-C-49-3/4*	3/4	—	5.3	50
52-C-49-1*	1	—	7.0	10
52-C-49-1-1/4	1 1/4	—	9.3	10
52C5011/2-25	1 1/2	—	11.0	25
52C512-25	2	—	14.8	25
<b>For Two Devices — Steel</b>				
52 C 52 1/2	1/2	—	6.0	10
52-C-52-3/4	3/4	—	9.0	10
52-C-52-1	1	Square corners	12.5	10
52-C-52-1-1/4	1 1/4	facilitate tile installation	15.5	10
52 C 53 1 1/2	1 1/2	—	19.0	10
52 C 54 2	2 5/64	—	25.5	10

\* Drawn style.

### 4" Square Covers



52 C 1



52 C 3 1



52 C 6



CAT. NO.	RAISED (IN.)	DESCRIPTION	CU. IN. CAP.	STD. CTN.
52 C 1	—	Flat, blank	—	100
52-C-3-25	5/8	Center blanked with tapped	4.3	25
52-C-3-1/2-25	1/2	ears on 2 3/4" centers	3.5	25
52-C-3-3/4	3/4	Center blanked with	4.3	25
52 C 3 1	1	tapped ears on	5.8	25
52-C-3-1-1/4	1 1/4	2 23/32" centers	7.3	25
52 C 6	—	Flat, with 1/2" KO	—	100

### 4" Square Device Covers



52 C 16



52 C 19



52 C 21



52 C 0



52 C 10

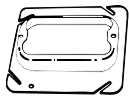

52 C 14



52-C-36

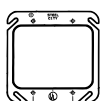

52 C 00



52-C-17-25

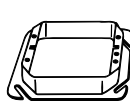

52 C 21

CAT. NO.	RAISED (IN.)	DESCRIPTION	CU. IN. CAP.	STD. CTN.
<b>For Single Device — Steel</b>				
52 C 0	—	Flat	—	25
52 C 62	1/4	Keyed for plaster	1.5	25
52 C 10	1/4	Offset, keyed for plaster	1.0	25
52 C 13	1/2	—	3.0	50
52 C 14	3/4	—	5.0	50
52 C 14 5/8	5/8	—	4.0	50
52 C 15	1	—	7.0	25
52 C 16	1 1/4	—	8.3	25
52-C-36	1/4	For drywall construction	1.0	25
<b>For Two Devices</b>				
52 C 00	—	Flat	—	25
52C20-25	1/4	—	2.3	25
52-C-17-25	1/2	—	6.3	25
52 C 18	3/4	—	9.0	25
52-C-18-5/8-25	5/8	For drywall construction	7.3	25
52 C 19	1	—	12.0	25
52 C 21	1 1/4	—	15.0	25
52 C 37	1/8	—	2.3	25

## Square Boxes and Accessories

### Box Support Covers

Steel City® Box Support Covers combine a box-to-stud mounting bracket with a device cover in one, easy-to-use product. Designed for use with 4" square boxes, Steel City® Box Support Covers can be used with both steel and wood studs.

- Combines cover and bracket in one component
- Available in one- and two-device versions
- ½", ⅝" and ¾" raised covers
- Speeds installation time
- Needs no far side support
- Can be used with both steel and wood stud
- Can be used without a box as a low voltage device support
- UL and CSA Listed (UL File #E2969, CSA File #LR5043)

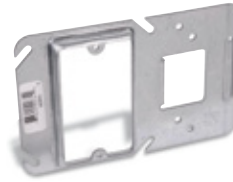

52CM13



52CMD17



CAT. NO.	RAISED (IN.)	# OF DEVICES	CU. IN. CAPACITY	STD. CTN.
52CM13	½	1	3.0	25
52CM14-5/8	⅝	1	4.0	25
52CM14	¾	1	5.0	25
52CMD17	½	2	6.3	25
52CMD18-5/8	⅝	2	7.3	25
52CMD18	¾	2	9.0	25

### 4" Square Surface Covers



RS 4

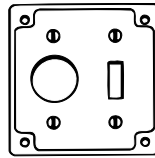

RS 1

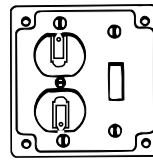

RS 2

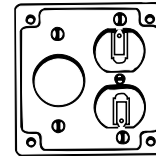

RS 3

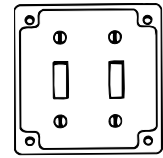

RS 5

CAT. NO.	DEPTH (IN.)	CU. IN. CAPACITY	DIA. HOLE (IN.)	DESCRIPTION	STD. CTN.
RS 1	½	5.0	1 13/32	For one toggle switch and one single flush receptacle	50
RS 2*	½	5.0	—	For one toggle switch and one duplex flush receptacle	50
RS 3*	½	5.0	1 13/32	For one single and one duplex flush receptacle	50
RS 4	½	5.0	1 19/32	For one 4-wire twist-lock single receptacle	50
RS 5	½	5.0	—	For two toggle switches	50
RS 8*	½	5.0	—	For two duplex, flush receptacles	50
RS 9	½	5.0	—	For one toggle switch	50
RS 10	½	5.0	1 13/32	For two single, flush receptacles	50
RS 11	½	5.0	1 13/32	For one single, flush receptacle	50
RS 12*	½	5.0	—	For one duplex, flush receptacle	50
RS 13	½	5.0	2 5/32	For one 30 or 50 amp. dryer or range receptacle	50
RS 14	½	5.0	2 15/32	—	50
RS 15	½	5.0	1 ¼	For #3330-30A 250 V twist-lock receptacle	50
RS-16-CC	½	5.0	—	For one ground fault receptacle	25
RS-17-CC	½	5.0	—	For two ground fault receptacles	25
RS-18-CC	½	5.0	—	For one ground fault receptacle and one toggle switch	25
RS-19-CC*	½	5.0	—	For one ground fault receptacle and one duplex receptacle	25

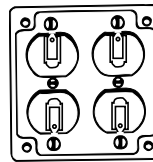

RS 8

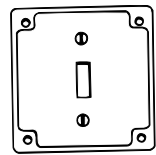

RS 9

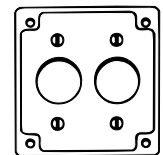

RS 10

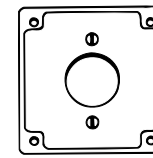

RS 11

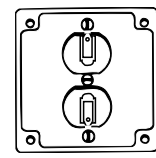

RS 12

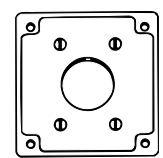

RS 13

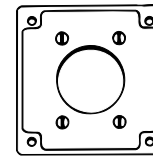

RS 14

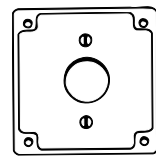

RS 15



RS-16-CC

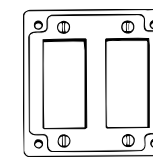

RS-17-CC

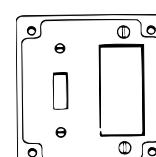

RS-18-CC

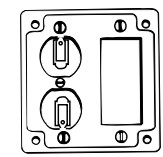

RS-19-CC

Remove portion of G.F.I. receptacle ear to mount receptacle to cover. Screws captivated.

## Square Boxes and Accessories

UL® Listed Adjustable Mud Ring now available in both single- and two-gang.

### Adjustable Mud Rings

Mud Rings feature an inner ring that adjusts from ½" to 1½" in depth to accommodate various drywall thicknesses. Marked with a measured rule and equipped with two adjustment screws, the inner ring can be set to the anticipated depth prior to installation and then easily adjusted after drywall installation to accommodate any variation in depth (½" to 1½").

**NEW!**

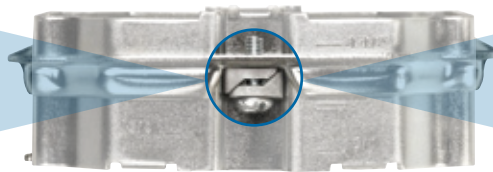

**Wedge Locking Blocks**  
Designed to ensure grounding continuity

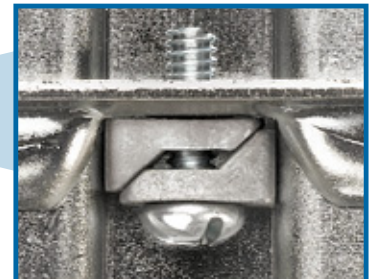

### Adjustable Mud Ring Installation/Adjustment Steps:



**1 Loosen...**  
The two adjustment screws located on opposing corners of the mud ring.

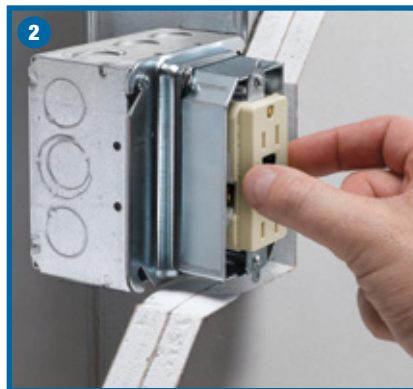

**2 Adjust...**  
Inner ring to be flush with wall surface.



**3 Re-tighten...**  
Adjustment screws.



CAT. NO.	DESCRIPTION	STD. CTN.
52-C-ADJ	Single-Gang Adjustable Mud Ring, ½" to 1½"	25
52-C-ADJ2	Two-Gang Adjustable Mud Ring, ½" to 1½"	20

## Square Boxes and Accessories

### Steel City® Hands-Free Swivel Hanger

The new Steel City® Hands-Free Swivel Hanger allows you to quickly install high- and low-bay lighting fixtures without the need for an extra set of hands. The hanger design enables the fixture to be set in place, giving users access to the conductors while wiring is being completed. The Hands-Free Swivel Hanger can support a fixture up to 50 pounds and is ideal for gyms or other commercial sites.

- Fits standard 3½" or 4" octagon (SHHFR1234)
- Fits 4" square (SHHF1234) boxes
- A single installer can complete the installation — saving time, labor and cost
- Fixtures can be set in place before wiring is completed
- Design enables users to access the conductors after the fixture has been mounted onto the box
- Accommodates ½" or ¾" threaded fixture pipes
- Permits 20° swing from vertical
- Ideal for gyms or other commercial sites

**Material:** Zinc-plated sheet-metal hanger and malleable iron swivel connector.

**Listing:** UL and CSA Listed.



CAT. NO.	DESCRIPTION	STD. CTN.
SHHF 1/2 3/4	Hands-free Swivel Hanger	25
SHHFR 1/2 3/4	Hands-free Swivel Hanger (round)	25

### Swivel Hangers

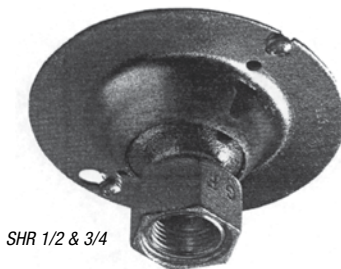

SHR 1/2 & 3/4



CAT. NO.	DESCRIPTION	STD. CTN.
SHR 1/2 & 3/4	Swivel hanger for 4" octagonal boxes	25

UL Listed for 50 lb. fixture support.

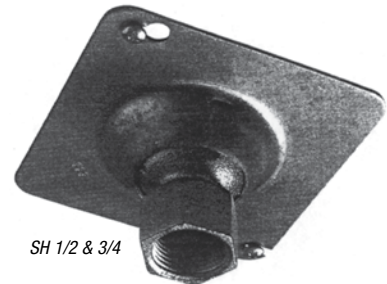

SH 1/2 & 3/4



CAT. NO.	DESCRIPTION	STD. CTN.
SH 1/2 & 3/4	Swivel hanger for 4" square boxes	25

UL Listed for 50 lb. fixture support.

## Square Boxes and Accessories

### 4<sup>11</sup>/<sub>16</sub>" Square Boxes

CAT. NO.	DEPTH (IN.)	CU. IN. CAPACITY	EA. SIDE CONDUIT	EA. END CONDUIT	BOTTOM CONDUIT	STD. CTN.
<b>With Conduit KOs</b>						
72151-1/2 & 3/4-E*	1½	29.5	3-½", ¾- <sup>33</sup> / <sub>64</sub> "	2-½", ¾- <sup>33</sup> / <sub>64</sub> "	2-½", ¾"-E, 4-½"	20
72171-1/2 & 3/4-E*	2½	42.0	3-½" & ¾"-E	3-½" & ¾"-E	2-½", ¾"-E, 3-½"	20
72171 1	2½	42.0	*2-1"	2-1"	3-½", 2-¾"	20
72171 3/4 1*	2½	42.0	1-¾", 1-1"	1-¾", 1-1"	3-½", 3-¾", 2-1"	20
72171 1 1/4*	2½	42.0	2-1¼"	1-1¼"	3-½", 2-¾"	20
72171CV 1/2 3/4*	2½	42.0	2-½", 1-¾"	2-½", 1-¾"	3-½", 2-¾"	25
72151 MS 1/2 3/4*	2½	42.0	3-½", ¾- <sup>33</sup> / <sub>64</sub> "	3-½", ¾- <sup>33</sup> / <sub>64</sub> "	2-½", ¾- <sup>33</sup> / <sub>64</sub> ", 3-½"	20
72151 MS 1/2 3/4	2½	42.0	3-½", ¾- <sup>33</sup> / <sub>64</sub> "	2-½", ¾- <sup>33</sup> / <sub>64</sub> "	2-½", 2-¾- <sup>33</sup> / <sub>64</sub> ", 4-½"	25
72171 MS 1/2 3/4*	2½	42.0	3-½", ¾- <sup>33</sup> / <sub>64</sub> "	3-½", ¾- <sup>33</sup> / <sub>64</sub> "	2-½", ¾- <sup>33</sup> / <sub>64</sub> ", 3-½"	25
72151MSX	2½	42.0	3-½", ¾- <sup>33</sup> / <sub>64</sub> "	2-½", ¾- <sup>33</sup> / <sub>64</sub> "	2-½", 2-¾- <sup>33</sup> / <sub>64</sub> ", 4-½"	25
72151MSXP	2½	42.0	3-½", ¾- <sup>33</sup> / <sub>64</sub> "	2-½", ¾- <sup>33</sup> / <sub>64</sub> "	2-½", 2-¾- <sup>33</sup> / <sub>64</sub> ", 4-½"	25
72151MSP	2½	42.0	3-½", ¾- <sup>33</sup> / <sub>64</sub> "	3-½", ¾- <sup>33</sup> / <sub>64</sub> "	3-½", 2-½", ¾- <sup>33</sup> / <sub>64</sub> "	25
72171MSX	2½	42.0	3-½", ¾- <sup>33</sup> / <sub>64</sub> "	3-½", ¾- <sup>33</sup> / <sub>64</sub> "	3-½", 2-½", ¾- <sup>33</sup> / <sub>64</sub> "	25
72171MSXP	2½	42.0	3-½", ¾- <sup>33</sup> / <sub>64</sub> "	3-½", ¾- <sup>33</sup> / <sub>64</sub> "	3-½", 2-½", ¾- <sup>33</sup> / <sub>64</sub> "	25



72171 MS 1/2 & 3/4  
MS bracket for 1½", 2½", 3¾", 4" metal studs

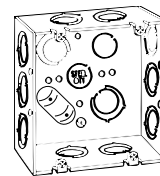

72151-1/2 & 3/4-E



72171-1/2 & 3/4-E

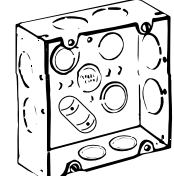

72171 1

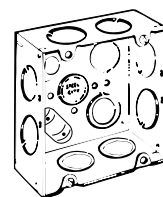

72171 3/4 1

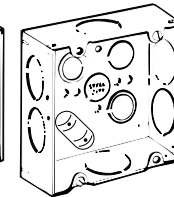

72171 1 1/4

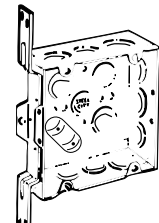

72171CV 1/2 & 3/4

\* Per UL 514-A, suitable for use without a bonding jumper in circuits above or below 250 volts.

### 4<sup>11</sup>/<sub>16</sub>" Square Boxes

CAT. NO.	DEPTH (IN.)	CU. IN. CAPACITY	DESCRIPTION	CONSTRUCTION TYPE	STD. CTN.
5-SDW-FB-1	2½	42.0	Two 1" KOs in each of three sides, flat bracket on other side and three ½" KOs in a line in bottom with two ¾" KOs at opposite ends in bottom. Four tapped ears*	Welded	25

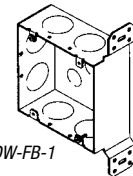

5-SDW-FB-1

### 4<sup>11</sup>/<sub>16</sub>" Square Box Extension Rings

CAT. NO.	DEPTH (IN.)	CU. IN. CAPACITY	KNOCKOUT (IN.)		STD. CTN.
			EA. SIDE CONDUIT	EA. END CONDUIT	
<b>With Conduit KOs</b>					
73151 1/2 3/4*	1½	29.5	2-½", 1¼"	2-½", 1¼"	20
73171 1/2 3/4*	2½	42.0	2-½", 1¼"	2-½", 1¼"	20
73171 1	2½	42.0	2-1"	2-1"	20

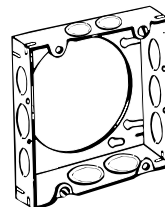

73151 1/2 & 3/4

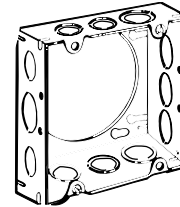

73171 1/2 & 3/4

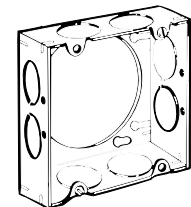

73171 1

### 4<sup>11</sup>/<sub>16</sub>" Square Covers

CAT. NO.	CU. IN. CAPACITY	RAISED (IN.)	DESCRIPTION	STD. CTN.
72 C 1	—	—	Flat blank	50
72 C 6	—	—	Flat with ½" KO	25
72 C 3	3.5	¾"	Center blanked with tapped ears on 2 <sup>23</sup> / <sub>32</sub> " centers	10
72-C-3-1/2	3.0	½"		25
72-C-3-3/4	4.3	¾"		10
72-C-3-1	5.8	1"		25



72 C 1



72 C 6

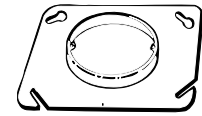

72 C 3

## Square Boxes and Accessories

### 4<sup>1</sup>/<sub>16</sub>" Square Rings and Covers

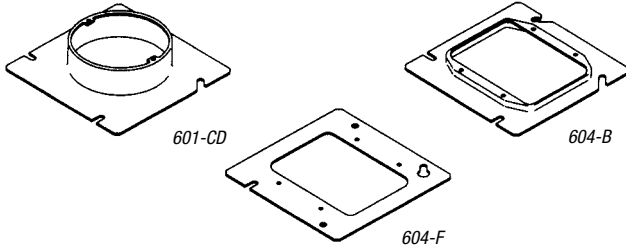

CAT. NO.	CU. IN. CAPACITY	DESCRIPTION	STD. CTN.
601-CD	8.8	1 <sup>1</sup> / <sub>4</sub> " raised — 4 <sup>1</sup> / <sub>16</sub> " square Open plaster ring with ears. Ears tapped 8/32–2 <sup>3</sup> / <sub>32</sub> " on centers. Special screw lock feature in slots*	25
604-F	—	Flat — 4 <sup>1</sup> / <sub>16</sub> " square For two switches or receptacles*	25
604-B	2.8	¼" raised — 4 <sup>1</sup> / <sub>16</sub> " square For two switches or receptacles*	25

\*Fits any Steel City® 4<sup>1</sup>/<sub>16</sub>" square outlet box or extension ring.

### 4<sup>1</sup>/<sub>16</sub>" Square Tile Rings

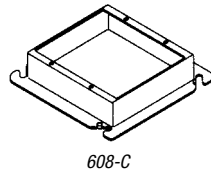

CAT. NO.	CU. IN. CAPACITY	DESCRIPTION	STD. CTN.
608-C	12.5	1" raised — 4 <sup>1</sup> / <sub>16</sub> " square For two switches or receptacles*	10

\*Fits any Steel City® 4<sup>1</sup>/<sub>16</sub>" square outlet box or extension ring.

### 4<sup>1</sup>/<sub>16</sub>" Square Box Partitions

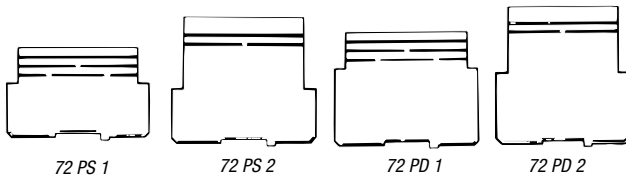

CAT. NO.	DESCRIPTION	STD. CTN.
<b>For 1<sup>1</sup>/<sub>2</sub>" Deep Box with Square-Cut Tile Wall — Two-Device Covers</b>		
72 PS 1	For ½", ¾" and 1" raised covers	25
72 PS 2	For 1¼", 1½" and 2" raised covers	25
<b>For 2<sup>1</sup>/<sub>8</sub>" Deep Box with Square-Cut Tile Wall — Two-Device Covers</b>		
72 PD 1	For ½", ¾" and 1" raised covers	25
72 PD 2	For 1¼", 1½" and 2" raised covers	25

### 4<sup>1</sup>/<sub>16</sub>" Square Surface Covers

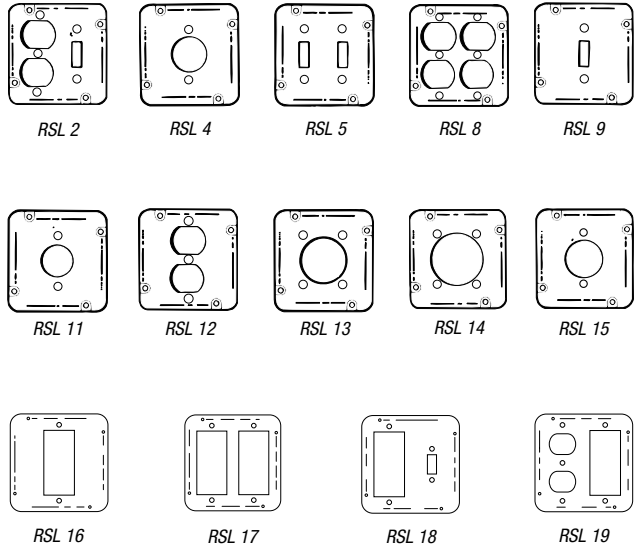

CAT. NO.	DEPTH (IN.)	CU. IN. CAPACITY	DIA. HOLE (IN.)	DESCRIPTION	STD. CTN.
RSL 2	½	7.5	—	For one toggle switch and one duplex flush receptacle	10
RSL 4	½	7.5	1 <sup>1</sup> / <sub>32</sub>	For one 4-wire twist-lock single receptacle	10
RSL 5	½	7.5	—	For two toggle switches	10
RSL 8	½	7.5	—	For two duplex, flush receptacles	10
RSL 9	½	7.5	1 <sup>5</sup> / <sub>32</sub>	For one toggle switch	10
RSL 11	½	7.5	1 <sup>55</sup> / <sub>64</sub>	For one single, flush receptacle	10
RSL 12	½	7.5	—	For one duplex, flush receptacle	10
RSL 13	½	7.5	2 <sup>5</sup> / <sub>32</sub>	For one 30A to 50A dryer or range receptacle	10
RSL 14	½	7.5	2 <sup>15</sup> / <sub>32</sub>	—	10
RSL 15	½	7.5	1 <sup>3</sup> / <sub>4</sub>	For #3330–30A 250 V twist-lock receptacle	10
RSL 16	½	7.5	—	For one ground fault receptacle	10
RSL 17	½	7.5	—	For two ground fault receptacles	10
RSL 18	½	7.5	—	For one ground fault receptacle and one toggle switch	10
RSL 19	½	7.5	—	For one ground fault receptacle and one duplex receptacle	10



## Square Boxes and Accessories

### 4<sup>1</sup>/<sub>16</sub>" Square Device Covers

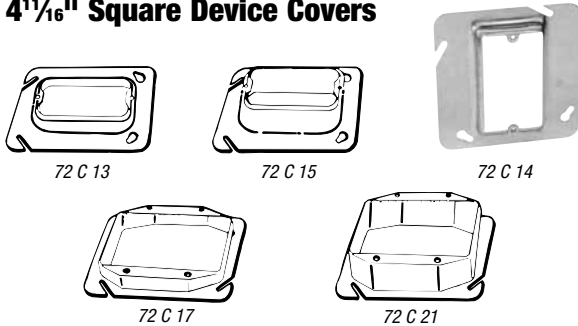

CAT. NO.	RAISED (IN.)	CU. IN. CAPACITY	STD. CTN.
<b>For Single Device</b>			
72 C 62	¼	1.0	25
72 C 13	½	3.0	25
72 C 14	¾	5.0	25
72 C 14 5/8	¾	4.0	25
72 C 15	1	7.0	10
72 C 16	1¼	8.3	10
<b>For Two Devices</b>			
72 C 17	½	6.3	25
72 C 18	¾	9.0	25
72 C 18 5/8	¾	7.5	25
72 C 19	1	12.0	25
72 C 21	1¼	15.0	25

### 4<sup>1</sup>/<sub>16</sub>" Square-Cut Tile Wall Covers

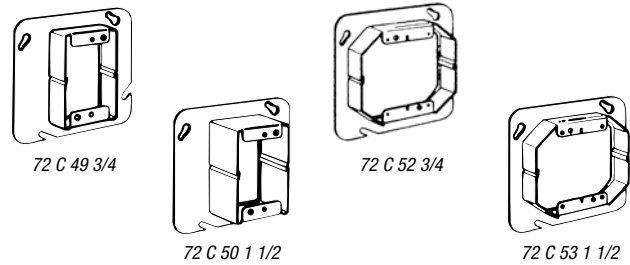

CAT. NO.	RAISED (IN.)	CU. IN. CAPACITY	STD. CTN.
<b>For Single Device — Steel</b>			
72-C-49-1/2	½	3.5	10
72 C 49 3/4	¾	5.3	10
72-C-49-1	1	7.0	10
72-C-49-1-1/4	1¼	7.0	10
72 C 50 1 1/2	1½	9.0	10
72 C 51 2	2	14.5	20
<b>For Two Devices — Steel</b>			
72-C-52-1/2	½	6.0	10
72 C 52 3/4	¾	9.0	10
72-C-52-1	1	12.5	25
72-C-52-1-1/4	1¼	15.5	25
72 C 53 1 1/2	1½	19.0	10
72 C 54 2	2	25.5	10

### 4<sup>1</sup>/<sub>16</sub>" Square Industrial Device Covers

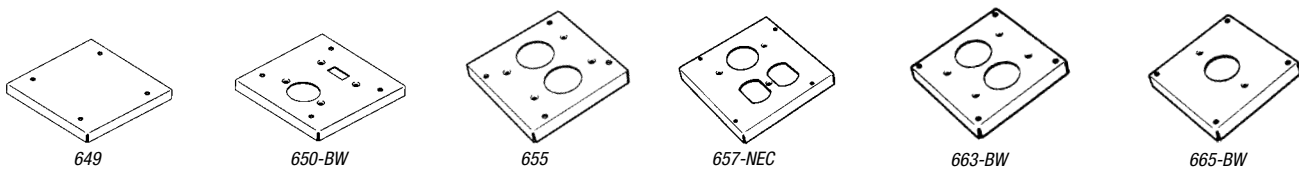

CAT. NO.	CU. IN. CAPACITY	DESCRIPTION	STD. CTN.
649	7.5	½" raised — 4 <sup>1</sup> / <sub>16</sub> " square Surface blank. Each cover individually packaged with the necessary screws for mounting*	10
650-BW	7.5	½" raised — 4 <sup>1</sup> / <sub>16</sub> " square For one toggle switch and one single receptacle. Opening 1.4" diameter. Each cover individually packaged with the necessary screws for mounting*	10
655	7.5	½" raised — 4 <sup>1</sup> / <sub>16</sub> " square For two single receptacles. Opening 1.4" diameter. Each cover individually packaged with the necessary screws for mounting*	10
657-NEC	7.5	½" raised — 4 <sup>1</sup> / <sub>16</sub> " square For one duplex and one single receptacle. Opening 1.4" diameter. Each cover individually packaged with the necessary screws for mounting*	10
663-BW	7.5	½" raised — 4 <sup>1</sup> / <sub>16</sub> " square For two three-wire twist lock receptacles. 1 <sup>1</sup> / <sub>16</sub> " spacing between 1.4" diameter openings. Each cover individually packaged with the necessary screws for mounting*	10
665-BW	7.5	½" raised — 4 <sup>1</sup> / <sub>16</sub> " square Opening to accommodate Hubbell 3330 receptacle in center. Opening 1.75" diameter. Each cover individually packaged with the necessary screws for mounting*	10

\*Fits any Steel City® 4<sup>1</sup>/<sub>16</sub>" square outlet box or extension ring.

## Utility Boxes and Accessories

### 4" x 2 1/8" Utility Boxes



58351 1/2\*

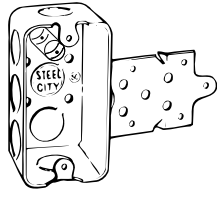

58351 B 1/4  
B bracket recessed 1/4"



58361 1/2\*

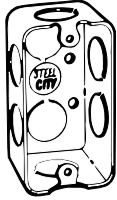

58361 3/4

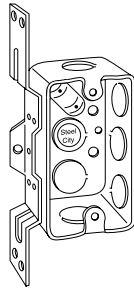

58361 V 1/2\*  
CV bracket recessed 1/2"

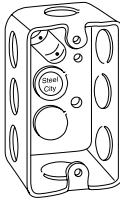

58371 1/2\*

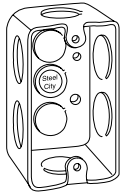

58371 3/4



58371 T 1/2  
T bracket recessed 3/8"



58371V1/2-25\*  
CV bracket recessed 1/2"

CAT. NO.	DEPTH (IN.)	CU. IN. CAPACITY	KNOCKOUTS (IN.)			STD. CTN.	
			EA. SIDE CONDUIT	EA. END CONDUIT	BOTTOM CONDUIT		
<b>With Conduit KOs</b>							
58351 1/2*	1 1/2	10.3	—	3-1/2	1-1/2	2-1/2	50
58351 B 1/4	1 1/2	10.3	B	3-1/2	1-1/2	2-1/2	25
58361 1/2*	1 1/8	13.0	—	3-1/2	1-1/2	2-1/2	50
58361 3/4	1 1/8	13.0	—	2-3/4	1-3/4	2-3/4	50
58361 V 1/2*	1 1/8	13.0	CV	3-1/2	1-1/2	2-1/2	50
58371 1/2*	2 1/8	14.5	—	3-1/2	1-1/2	2-1/2	50
58371 3/4	2 1/8	14.5	—	2-3/4	1-3/4	2-3/4	50
58371 T 1/2*	2 1/8	14.5	T	3-1/2	1-1/2	2-1/2	25
58371V1/2-25*	2 1/8	14.5	CV	3-1/2	1-1/2	2-1/2	25

\* Factory-provided raised ground-screw location.

### 4 1/8" x 2 1/2" Utility Boxes

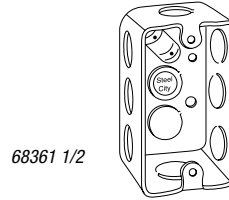

68361 1/2

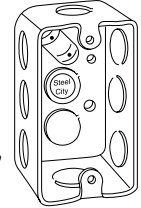

68371 1/2

CAT. NO.	DEPTH (IN.)	CU. IN. CAPACITY	KNOCKOUTS (IN.)			STD. CTN.
			EA. SIDE CONDUIT	EA. END CONDUIT	BOTTOM CONDUIT	
<b>With Conduit KOs</b>						
68361 1/2*	1 13/16	17.0	3-1/2	1-1/2	2-1/2	25
68371 1/2*	2 1/16	18.8	3-1/2	1-1/2	2-1/2	50

\* Factory-provided raised ground-screw location.

### 4" x 2 1/8" Utility Box Covers



58 C 1

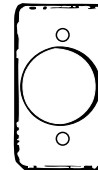

58 C 4



58 C 5



58 C 6



58 C 7

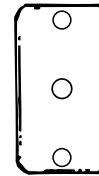

58 C 11



58 C 16



58 C 30

CAT. NO.	DIA. HOLE (IN.)	DESCRIPTION	STD. CTN.
58 C 1	—	Blank	100
58 C 4	1 1/32	For 4-wire twist-lock single flush receptacle	25
58 C 5	1 1/32	For single receptacle	25
58 C 6	—	With 1/2" KO	25
58 C 7	—	For duplex flush receptacle	100
58 C 11	—	With 1 1/32" bushed hole	25
58 C 16	—	For single GFCI receptacle	25
58 C 30	—	For one toggle switch	100

Includes captivated Phillips head screws.

## Utility/Handy Boxes and Accessories

### 4 1/8" x 2 1/2" Utility Box Covers Raised 3/16"

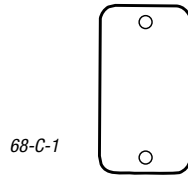

68-C-1

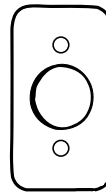

68 C 5

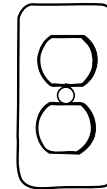

68 C 7

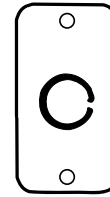

68 C 6

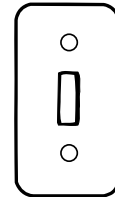

68 C 30

CAT. NO.	DIA. HOLE (IN.)	DESCRIPTION	STD. CTN.
68 C 1	—	Blank	25
68 C 5	1 13/32	For single receptacle	25
68 C 6	—	With 1/2" KO	25
68 C 7	—	For duplex flush receptacle	25
68 C 30	—	For one toggle switch	25

Includes captivated Phillips head screws.

### 4" x 2 1/8" Utility Box Extension Rings

CAT. NO.	DEPTH (IN.)	CU. IN. CAPACITY	KNOCKOUTS(IN.)		STD. CTN.
			EA. SIDE CONDUIT	EA. END CONDUIT	
<i>With Conduit KOs</i>					
59361 1/2	1 1/8	13.0	3-1/2	1-1/2	50
59361 3/4	1 1/8	13.0	2-3/4	1-3/4	25

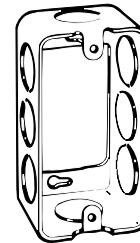

59361 1/2

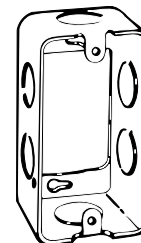

59361 3/4

### Handy Boxes

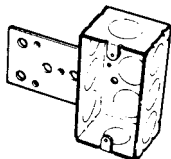

102-W-LB-1/4

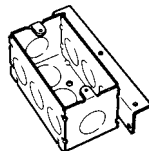

103-W-AB

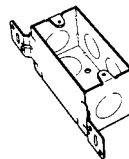

104-W-FB-3/4

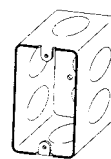

106-3/4

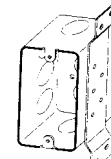

106-FB-1/2

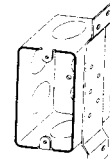

106-FB-3/4

CAT. NO.	DEPTH (IN.)	CU. IN. CAPACITY	DESCRIPTION	CONSTRUCTION TYPE	STD. CTN.
102-W-LB-1/4	1 1/2	10.3	<b>1 1/2" deep x 4" long x 2 1/8" wide</b> Three 1/2" KOs in one side, lateral bracket on other side, one 1/2" KO in each end and three 1/2" KOs in bottom. Furnished with four mounting holes in bottom. Bracket offset 1/4" from face*	Welded	50
103-W-AB	1 1/8	13.0	<b>1 1/8" deep x 4" long x 2 1/8" wide</b> Three 1/2" KOs in one side, angle bracket on other side, one 1/2" KO in each end and three 1/2" KOs in bottom. Bracket offset 3/16" from face*	Welded	50
104-W-FB-3/4	2 1/8	14.5	<b>2 1/8" deep x 4" long x 2 1/8" wide</b> Two 3/4" KOs in one side, flat bracket on other side, one 3/4" KO in each end and two 3/4" KOs in bottom. Flat bracket offset 3/16" from face*	Welded	50
106-3/4	2 3/16	18.0	<b>2 3/16" deep x 4 1/8" long x 2 3/8" wide</b> Two 3/4" KOs in each side, one 3/4" KO in each end and three 1/2" KOs in bottom. Two mounting holes in bottom	Drawn	50
106-FB-1/2	2 3/16	18.0	<b>2 3/16" deep x 4 1/8" long x 2 3/8" wide</b> Three 1/2" KOs in one side, flat bracket on other side, one 1/2" KO in each end and three 1/2" KOs in bottom. Flat bracket offset 3/16" from face	Drawn	50
106-FB-3/4	2 3/16	18.0	<b>2 3/16" deep x 4 1/8" long x 2 3/8" wide</b> Two 3/4" KOs in each side, flat bracket on other side, one 3/4" KO in each end and three 1/2" KOs in bottom. Flat bracket offset 3/16" from face	Drawn	50

\*Uses Steel City® 100 series covers.

## Handy/Gang Boxes and Accessories

### Multi-Gang Handy Boxes

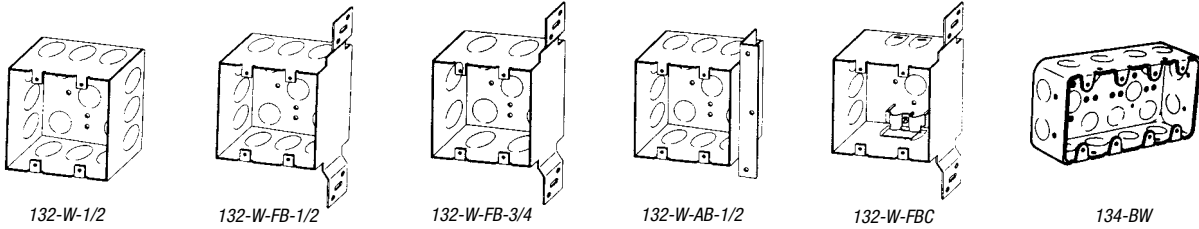

CAT. NO.	DEPTH (IN.)	CU. IN. CAPACITY	DESCRIPTION	STD. CTN.
132-W-1/2	2 1/8	30.3	<b>A Two-Gang Box, 2 1/8" deep — 4" square</b> Three 1/2" KOs in each of four sides and three 1/2" KOs in a line in bottom with two 3/4" KOs at opposite ends in bottom*	25
132-W-FB-1/2	2 1/8	30.3	<b>A Two-Gang Box, 2 1/8" deep — 4" square</b> Three 1/2" KOs in each of three sides, flat bracket on fourth side and five 1/2" KOs in bottom. Flat bracket offset 3/16" from face*	25
132-W-FB-3/4	2 1/8	30.3	<b>A Two-Gang Box, 2 1/8" deep — 4" square</b> Two 3/4" KOs in each of three sides, flat bracket on fourth side and three 1/2" KOs in a line with two 3/4" KOs at opposite ends in bottom. Flat bracket offset 3/16" from face*	25
132-W-AB-1/2	2 1/8	30.3	<b>A Two-Gang Box, 2 1/8" deep — 4" square</b> Three 1/2" KOs in each of three sides, angle bracket on fourth side and five 1/2" KOs in bottom. Bracket offset 3/16" from face*	25
132-W-FBC	2 1/8	30.3	<b>For Non-Metallic Cable — A Two-Gang Box, 2 1/8" deep — 4" square</b> Two Loom KOs in each of two opposite sides, two 1/2" KOs in side opposite flat bracket and one 1/2" KO in bottom. Two Loom clamps for use on non-metallic sheathed cable with 10/32 deep-slotted screws assembled. Flat bracket offset 3/16" from face*	25
134-BW	2 1/8	58.0	<b>A Four-Gang Box</b> Four 1/2" KOs in each side, two 1/2" KOs in each end and ten 1/2" KOs in bottom. Uses Steel City SB-4 cover	20

\*Uses Steel City® SB-2 covers.

### Drawn-Style Gang Boxes

CAT. NO.	DEPTH (IN.)	CU. IN. CAPACITY	HEIGHT (IN.)	LGTH. (IN.)	KNOCKOUTS (IN.)			STD. CTN.
					EA. SIDE CONDUIT	EA. END CONDUIT	BOTTOM CONDUIT	
<b>With Conduit KOs</b>								
2G 1/2 3/4	1 5/8	45.0	4 1/2	6 3/16	2-1/2 2-3/4	1-1/2 1-3/4	3-1/2 2-3/4	5
3G 1/2 3/4	1 5/8	58.0	4 1/2	8 5/8	3-1/2 2-3/4	1-1/2 1-3/4	6-1/2 4-3/4	5
4G 1/2 3/4	1 5/8	70.0	4 1/2	10 7/16	3-1/2 3-3/4	1-1/2 1-3/4	6-1/2 4-3/4	5
5G 1/2 3/4	1 5/8	85.0	4 1/2	12 1/4	4-1/2 3-3/4	1-1/2 1-3/4	6-1/2 4-3/4	1
6G 1/2 3/4	1 5/8	95.0	4 1/2	14 1/16	4-1/2 4-3/4	1-1/2 1-3/4	6-1/2 4-3/4	1
H2BD 3/4 1	2 1/2	71.0	4 1/2	6 3/16	2-3/4 1-1	1-3/4 1-1	3-1/2 2-3/4	10
H3BD 3/4 1	2 1/2	90.0	4 1/2	8 5/8	4-3/4 1-1	1-3/4 1-1	6-1/2 4-3/4	10
H4BD 3/4 1	2 1/2	110.0	4 1/2	10 7/16	2-3/4 2-1	1-3/4 1-1	6-1/2 4-3/4	5
H5BD 3/4 1	2 1/2	132.0	4 1/2	12 1/4	3-3/4 2-1	1-3/4 1-1	6-1/2 4-3/4	5
H6BD 3/4 1	2 1/2	150.0	4 1/2	14 1/16	3-3/4 3-1	1-3/4 1-1	6-1/2 4-3/4	5



2G 1/2 & 3/4



3G 1/2 & 3/4

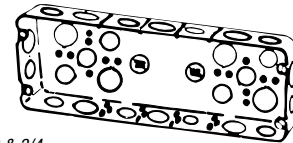

5G 1/2 & 3/4

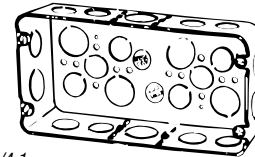

H3BD 3/4 1

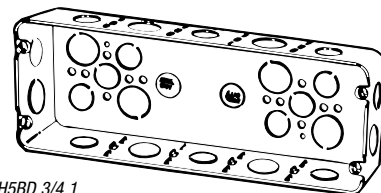

H5BD 3/4 1

## Gang Boxes and Accessories

### Multi-Gang Boxes

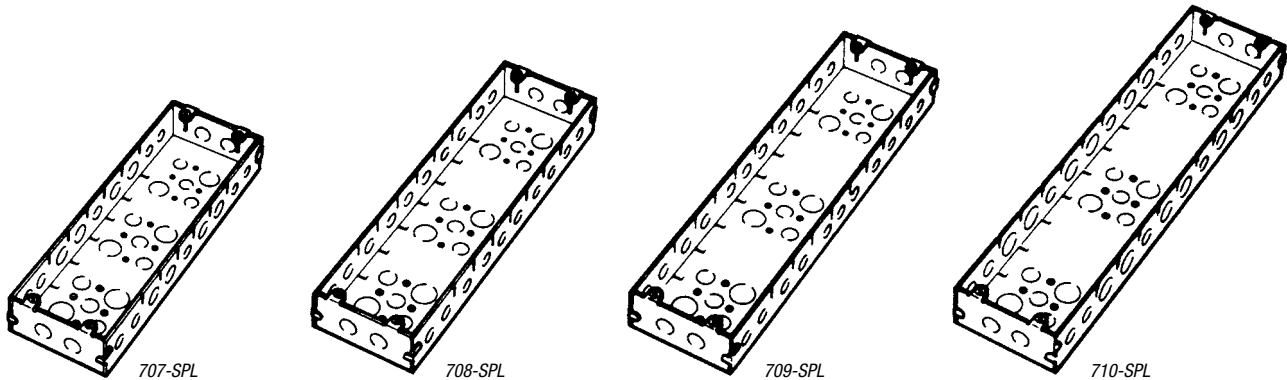

CAT. NO.	CU. IN. CAPACITY	DESCRIPTION	STD. CTN.
707-SPL	126.5	<b>Seven-Gang Box, 1<sup>13</sup>/<sub>16</sub>" deep x 4<sup>9</sup>/<sub>16</sub>" long x 15<sup>1</sup>/<sub>16</sub>" wide</b> Five 1/2" KOs and four 3/4" KOs in each side, two 1/2" KOs in each end and nine 1/2" KOs with six 3/4" KOs in bottom. Furnished with four 8/32 screws. For use with either Steel City® 807 and SB-7, 808 and SB-8, or just GB-7 rings and covers	1
708-SPL	141.3	<b>Eight-Gang Box, 1<sup>13</sup>/<sub>16</sub>" deep x 4<sup>9</sup>/<sub>16</sub>" long x 17<sup>3</sup>/<sub>16</sub>" wide</b> Six 1/2" KOs and four 3/4" KOs in each side, two 1/2" KOs in each end and nine 1/2" KOs with six 3/4" KOs in bottom. Furnished with four 8/32 screws. For use with either Steel City® 808 and SB-8, 809 and SB-9, or just GB-8 rings and covers	1
709-SPL	155.8	<b>Nine-Gang Box, 1<sup>13</sup>/<sub>16</sub>" deep x 4<sup>9</sup>/<sub>16</sub>" long x 19<sup>1</sup>/<sub>16</sub>" wide</b> Six 1/2" and five 3/4" KOs in each side and two 1/2" KOs in each end and nine 1/2" KOs with six 3/4" KOs in bottom. Furnished with four 8/32 screws. For use with either Steel City® 809 and SB-9, 810 and SB-10, or just GB-9 rings and covers	1
710-SPL	170.5	<b>Ten-Gang Box, 1<sup>13</sup>/<sub>16</sub>" deep x 4<sup>9</sup>/<sub>16</sub>" long x 21<sup>3</sup>/<sub>16</sub>" wide</b> Six 1/2" KOs and six 3/4" KOs in each side, two 1/2" KOs in each end and nine 1/2" KOs with six 3/4" KOs in bottom. Furnished with four 8/32 screws. For use with either Steel City® 810 and SB-10, or just GB-10 rings and covers	1

### Gang Box Partitions

CAT. NO.	DESCRIPTION	STD. CTN.
SGP	Hi/low-voltage partition for 1 <sup>1</sup> / <sub>2</sub> "-deep box	25
DGP	Hi/low-voltage partition for 2 <sup>1</sup> / <sub>2</sub> "-deep box	50



SGP

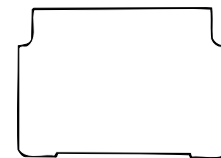

DGP

### 2-, 3- and 4-Gang Drawn-Style Device Boxes

CAT. NO.	GANG	DEPTH (IN.)	CU. IN. CAPACITY	EA. SIDE BRACKETS	EA. SIDE CONDUIT	EA. END CONDUIT	STD. CTN.
2G4DV 1/2 3/4	2	2 <sup>1</sup> / <sub>2</sub>	30.3	CV	2 - 1/2", 1 - 3/4"	2 - 1/2", 1 - 3/4"	25
3G4D 1/2	3	2 <sup>1</sup> / <sub>2</sub>	44.3	—	3 - 1/2"	2 - 1/2"	20
3G4D B 1/2	3	2 <sup>1</sup> / <sub>2</sub>	44.3	B	3 - 1/2"	2 - 1/2"	20
3G4D V 1/2	3	2 <sup>1</sup> / <sub>2</sub>	44.3	CV	3 - 1/2"	2 - 1/2"	20
4G4D 1/2	4	2 <sup>1</sup> / <sub>2</sub>	58.0	—	4 - 1/2"	2 - 1/2"	20
4G4D B 1/2	4	2 <sup>1</sup> / <sub>2</sub>	58.0	B	4 - 1/2"	2 - 1/2"	20
4G4D V 1/2	4	2 <sup>1</sup> / <sub>2</sub>	58.0	CV	4 - 1/2"	2 - 1/2"	20

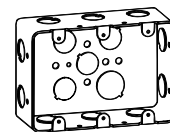

3G4D 1/2

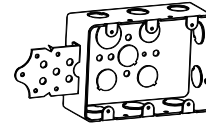

3G4D B 1/2



3G4D V 1/2

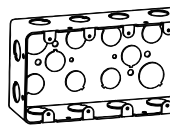

4G4D 1/2

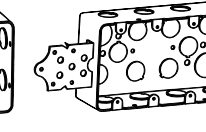

4G4D B 1/2

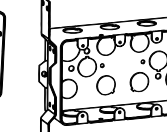

4G4D V 1/2

## Gang Boxes and Accessories

### Gang Box Covers

When covers are required to accommodate various combinations of devices, use the following catalog numbers plus the suffix "SPECIAL," and then indicate the combinations desired. When necessary, also indicate the sequence of devices.

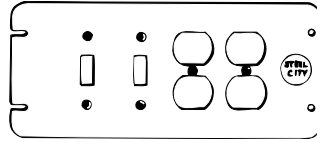

EXAMPLE: 4-GCS Special

- As illustrated (above), this is a 4-GCS Special for two toggle switches on left side and two duplex receptacles on right side

CAT. NO.	LGTH. (IN.)	CU. IN. CAPACITY	DESCRIPTION	STD. CTN.
<b>4 1/16" Wide—Raised 1 3/16" for Plaster</b>				
2-GC	7	8.5	Holes between gangs are spaced on	5
3-GC	8 1/16	13.5	1 3/16" centers; tapped holes in ears;	5
4-GC	10 5/16	18.3	spaced on 3 5/16" centers to accommodate	5
5 GC	12 1/16	23.0	all standard receptacles and switches;	5
6 GC	14 1/4	28.3	furnished with extra plugged screw holes; if these screw holes are used, the cover will fit the next smaller size box	5
<b>4 1/16" Wide — Flat, Blank</b>				
2-GCB	7	—	—	25
3-GCB	8 1/16	—	—	25
4-GCB	10 5/16	—	—	25
5 GCB	12 1/16	—	—	25
6 GCB	14 1/4	—	—	25
<b>4 1/16" Wide — Flat for Toggle Switches</b>				
2-GCS	7	—	For 2 toggle switches	25
3-GCS	8 1/16	—	For 3 toggle switches	25
4-GCS	10 5/16	—	For 4 toggle switches	25
5 GCS	12 1/16	—	For 5 toggle switches	25
6 GCS	14 1/4	—	For 6 toggle switches	25

4 1/16" wide — special covers — flat to accommodate combinations of devices.



4-GC

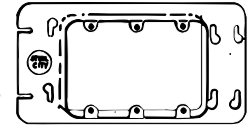

3-GC

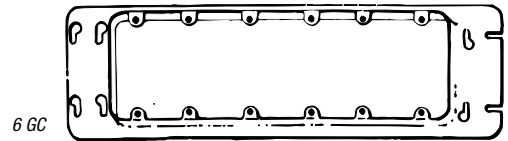

6 GC

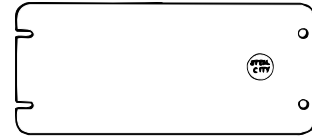

3-GCB



5 GCB

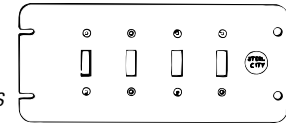

4-GCS

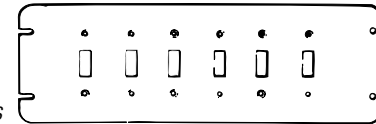

6 GCS

### Multi-Gang Rings

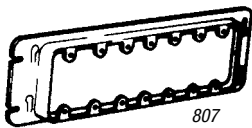

807

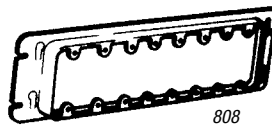

808

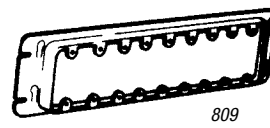

809

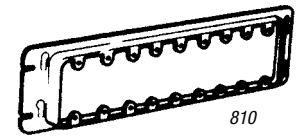

810

CAT. NO.	CU. IN. CAPACITY	DESCRIPTION	STD. CTN.
807	36.3	<b>A seven-gang switch ring, 3/4" raised x 4 9/16" long x 1 15/16" wide</b> Fits Steel City® 706 or 707 outlet boxes and uses GB-7 covers	1
808	41.0	<b>An eight-gang switch ring, 3/4" raised x 4 9/16" long x 1 7/4" wide</b> Fits Steel City® 707 or 708 outlet boxes and uses GB-8 covers	1
809	46.5	<b>A nine-gang switch ring, 3/4" raised x 4 9/16" long x 1 9/16" wide</b> Fits Steel City® 708 or 709 outlet boxes and uses GB-9 covers	1
810	51.5	<b>A ten-gang switch ring, 3/4" raised x 4 9/16" long x 2 1/16" wide</b> Fits Steel City® 709 or 710 outlet boxes and uses GB-10 covers	1

## Gang Boxes and Accessories

### Multi-Gang Covers — SB Series

CAT. NO.	DESCRIPTION	STD. CTN.
SB-2	2-gang cover	1
SB-3	3-gang cover	1
SB-4	4-gang cover	1
SB-5	5-gang cover	1
SB-6	6-gang cover	1
SB-7	7-gang cover	1
SB-8	8-gang cover	1
SB-9	9-gang cover	1
SB-10	10-gang cover	1

Fits Steel City® 132, 133 and 134 series handy boxes (both welded and drawn) and 800 series multi-gang rings.

### Multi-Gang Covers — GB Series

CAT. NO.	DESCRIPTION	STD. CTN.
GB-2	2-gang cover	1
GB-3	3-gang cover	1
GB-4	4-gang cover	1
GB-5	5-gang cover	1
GB-6	6-gang cover	1
GB-7	7-gang cover	1
GB-8	8-gang cover	1
GB-9	9-gang cover	1
GB-10	10-gang cover	1

Fits Steel City® 700 series multi-gang boxes.

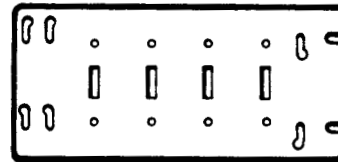
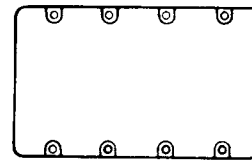
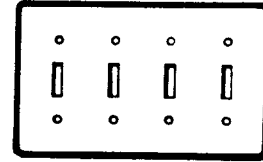

Typical Mounting Arrangement

### How To Order.

1. Indicate style of cover "GB" or "SB"
2. Use symbols for each opening
3. Separate each symbol with a dash (-)
4. Allow 4 to 6 weeks for shipment

Symbols	Example:
DR Duplex Receptacle	
TS Toggle Switch	
SR Single Receptacle — Opening 1.4"	
B Blank	
TL Twist Lock (4-Wire) — Opening 1.594"	

↑ SB-5:DR
↑ TS
↑ SR
↑ B
↑ TL

## Concrete/Masonry Boxes and Accessories

### Bars for Hanging Ceiling Boxes

CAT. NO.	LENGTH (IN.)	STD. CTN.
HBB 18	18	40
HBB-24	24	40
HBB-30	30	40

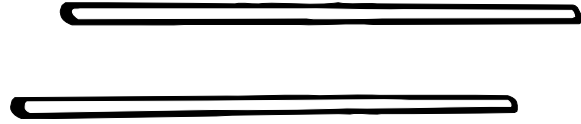

Two bars required for each box.

### Concrete Box Covers

CAT. NO.	DESCRIPTION	STD. CTN.
911	Flat — 4" octagon Two 1/2" KOs and two 3/4" KOs with 3/8" fixture stud*	25

Fits any Steel City® concrete box.

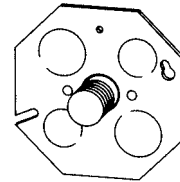

911

### Concrete Box Cover Plate

- Thread size: 3/8"-18 NPS

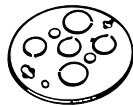

CBP

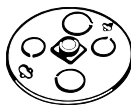

CBP 3/8

CAT. NO.	DESCRIPTION	STD. CTN.
CBP	No Stud; 3/8" and 2 3/4" KOs	25
CBP 3/8	With 3/8" fixture stud; 2 1/2" and 3/4" KOs	25

### Concrete Box Adapter

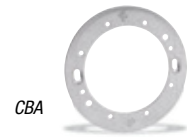

CBA

CAT. NO.	DESCRIPTION	STD. CTN.
CBA	For quick mounting and alignment of 4" octagon extension ring on concrete box or hung ceiling box	25

### 4" Octagon Concrete Boxes

CAT. NO.	DEPTH (IN.)	CU. IN. CAPACITY	KNOCKOUTS	STD. CTN.
<i>With Conduit KOs</i>				
54531 1/2 3/4	2	23.0	1/2" & 3/4" single row	25
54541 1/2 3/4	2 1/2	29.0	1/2" & 3/4" single row	25
54551 1/2 & 3/4	3	35.0	1/2" & 3/4" single row	20
54551-3/4 & 1	3	35.0	3/4" & 1" single row	20
54561 1/2	3 1/2	41.0	1/2" double row	20
54561-1/2 & 3/4	3 1/2	41.0	1/2" & 3/4" double row	20
54561-3/4 & 1	3 1/2	41.0	3/4" & 1" double row	20
54571 1/2 3/4	4	47.0	1/2" & 3/4" double row	10
54571-3/4 & 1	4	47.0	3/4" & 1" double row	10
54581 1/2 & 3/4	5	58.0	1/2" & 3/4" double row	10
54591 1/2 & 3/4	6	70.0	1/2" & 3/4" three rows	10

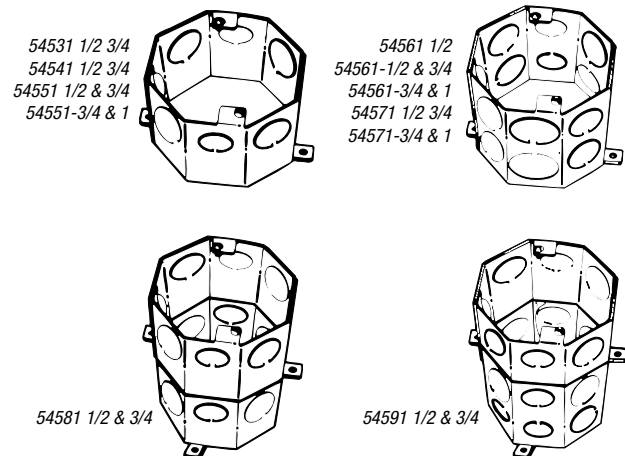

### 4" Octagon Hanging Ceiling Boxes

CAT. NO.	DEPTH (IN.)	CU. IN. CAPACITY	KNOCKOUTS	STD. CTN.
<i>With Conduit KOs</i>				
H-54561-1/2 & 3/4	3 1/2	41.0	1/2" & 3/4" double row	20
H-54561-3/4	3 1/2	41.0	3/4" double row	20

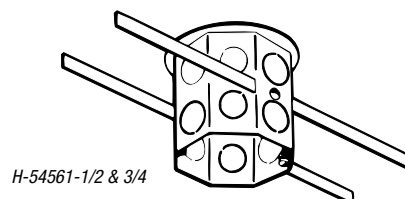

H-54561-1/2 & 3/4



## Concrete/Masonry Boxes and Accessories

### Gangable Masonry Boxes



#### ECCENTRIC KNOCKOUTS ½" & ¾"

CAT. NO.	DEPTH (IN.)	HEIGHT (IN.)	LENGTH (IN.)	CU. IN. CAPACITY	EA. SIDE	EA. END	BOTTOM	STD. CTN.
<b>With Eccentric Conduit KOs</b>								
GW 125 G*	2½	3¾	1½ <sup>16</sup>	15.0	2	2	2	20
GW 225 G*	2½	3¾	3¾	31.6	2	4	4	10
GW 325 G*	2½	3¾	5½ <sup>16</sup>	47.4	2	6	6	5
GW 425 G	2½	3¾	7¾	64.0	2	8	8	5
GW 525 G	2½	3¾	9½ <sup>16</sup>	79.0	2	10	10	5
GW-625-G*	2½	3¾	11	94.8	2	12	12	1
GW 135 G*	3½	3¾	1½ <sup>16</sup>	22.0	4	2	2	20
GW 235 G*	3½	3¾	3¾	46.9	4	4	4	10
GW 335 G	3½	3¾	5½ <sup>16</sup>	71.0	4	6	6	10
GW 435 G*	3½	3¾	7¾	93.5	4	8	8	5
GW-535-G	3½	3¾	9½ <sup>16</sup>	111.7	4	10	10	5
GW-635-G	3½	3¾	**11	134.0	4	12	12	1

\* Per NEC®, suitable for use without a bonding jumper in circuits above or below 250 volts.

† 4-, 5- and 6-gang supplied with partitions.

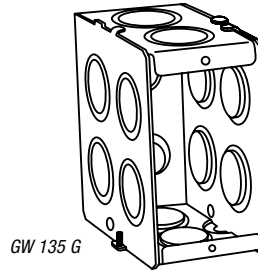

GW 135 G

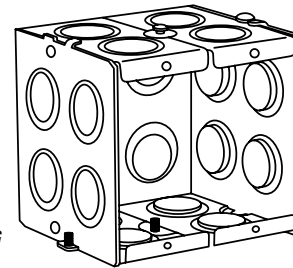

GW 235 G

Boxes & Covers — Steel City® Metallic Boxes

### Masonry Box Partitions



CAT. NO.	DESCRIPTION	STD. CTN.
PGW-25-G	Non-metallic partition for 2½"-deep steel tile wall boxes	25
PGW-35-G	Non-metallic partition for 3½"-deep steel tile wall boxes	25



PGW-25-G

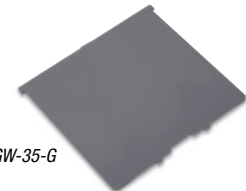

PGW-35-G

### Shallow Masonry Boxes

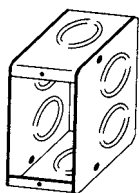

1-MBS

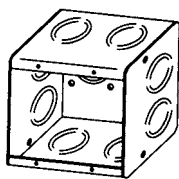

2-MBS

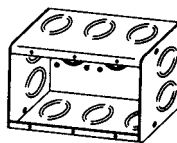

3-MBS

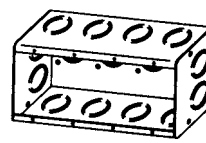

4-MBS

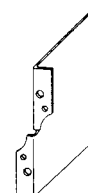

MBPS

CAT. NO.	DEPTH (IN.)	CU. IN. CAPACITY	DESCRIPTION	STD. CTN.
1-MBS	2½	16.5	<b>A one-gang masonry box, 2½" deep x 3¾" long x 1½" wide</b> Six ½" and two ¾" concentric KOs. Two in each side and one in each end. Uses Steel City® 100 cover	10
2-MBS	2½	33.0	<b>A two-gang masonry box, 2½" deep x 3¾" long x 3¾" wide</b> Eight ½" and two ¾" concentric KOs. Two in each side and two in each end. Uses Steel City® SB-2 cover	10
3-MBS	2½	49.0	<b>A three-gang masonry box, 2½" deep x 3¾" long x 5½" wide</b> Ten ½" and ¾" concentric KOs. Three in each side and two in each end. Uses Steel City® SB-3 cover	5
4-MBS	2½	67.0	<b>A four-gang masonry box, 2½" deep x 3¾" long x 7¾" wide</b> Twelve ½" and ¾" concentric KOs Four in each side and two in each end. Uses Steel City® SB-4 cover	5
MBPS	2½	—	<b>Masonry Box Partition, 2½" deep x 3¾" wide</b> A low-voltage partition drilled and tapped for mounting. Furnished with two 8/32 screws. For use with 2-MBS, 3-MBS or 4-MBS boxes	50

## Concrete/Masonry Boxes and Accessories

### Deep Masonry Boxes

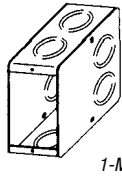

1-MB

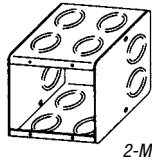

2-MB

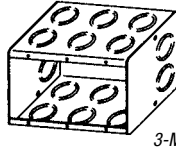

3-MB

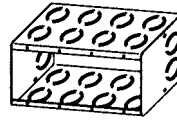

4-MB

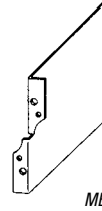

MBP

CAT. NO.	DEPTH (IN.)	CU. IN. CAPACITY	DESCRIPTION	STD. CTN.
1-MB	3½	23.3	<b>One-Gang Masonry Box, 3½" deep x 3¾" long x 1½" wide</b> Eight ½" and ¾" concentric KOs. Two in each side and two in each end. Uses Steel City® 100 series covers	10
2-MB	3½	46.8	<b>Two-Gang Masonry Box, 3½" deep x 3¾" long x 3¾" wide</b> Twelve ½" and ¾" concentric KOs. Four in each of two sides and two in each end. Uses Steel City® SB-2 cover	10
3-MB	3½	69.5	<b>Three-Gang Box, 3½" deep x 3¾" long x 5½" wide</b> Sixteen ½" and ¾" concentric KOs. Six in each of two sides and two in each end. Uses Steel City® SB-3 cover	5
4-MB	3½	92.0	<b>Four-Gang Masonry Box, 3½" deep x 3¾" long x 7½" wide</b> Twenty ½" and ¾" concentric KOs. Eight in each of two sides and two in each end. Uses Steel City® SB-4 cover	5
MBP	3½	—	<b>Masonry Box Partition, 3½" deep x 3¾" wide</b> A low-voltage partition drilled and tapped for mounting. Furnished with two 8/32 screws. For use with 2-MB, 3-MB or 4-MB boxes	50

### 1" KO Masonry Box

CAT. NO.	LENGTH (IN.)	CU. IN. CAPACITY	1" KNOCKOUTS			STD. CTN.
			EA. SIDE	EA. END	BOTTOM	
<i>Non-Gangable Single Gang</i>						
GW 135 NG-1	1⅞	22	2	1	2	10

GW 135 NG-1



### Thru-Wall Boxes for Concrete Block

CAT. NO.	WIDTH (IN.)	HEIGHT (IN.)	DEPTH (IN.)	CU. IN. CAPACITY	KNOCKOUTS (IN.)		STD. CTN.
					EA. SIDE CONDUIT	EA. END CONDUIT	
<i>With Concentric Conduit KOs</i>							
CBTW 4	2½	3⅞	3½	24.0	(2) ½-¾	(1) ½-¾	10
CBTW 6	2½	3⅞	5½	38.0	(4) ½-¾	(2) ½-¾	10
CBTW 8	2½	3⅞	7½	52.3	(6) ½-¾	(3) ½-¾	10

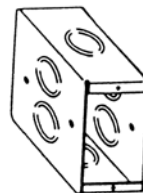

CBTW 4



CBTW 6

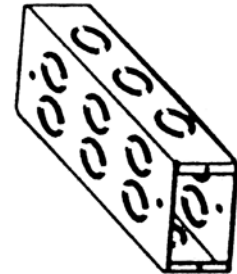

CBTW 8

### Welded Thru Boxes

CAT. NO.	CU. IN. CAPACITY	DESCRIPTION	STD. CTN.
4-DWS	25.5	<b>3⅞" deep x 4" long x 2½" wide</b> One ½" KO and one ¾" KO both on top, one ½" KO bottom side and one ½" KO on side opposite two flat brackets*	25

\*Uses Steel City® and 100 series covers.

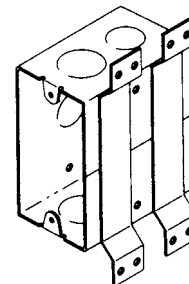

4-DWS

## Box Hangers and Supports

### Adjustable Bar Hangers for Plaster and Drywall

Packaged complete with either...

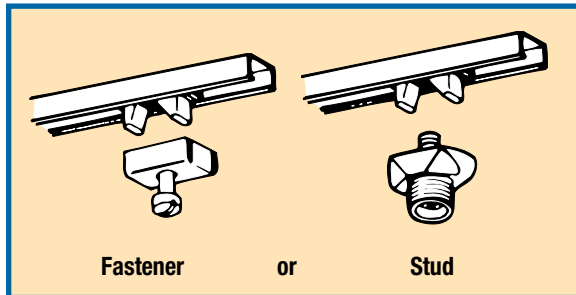

1/2", 3/4", 7/8" Lath and Plaster

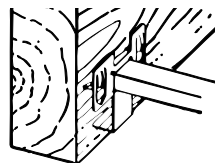
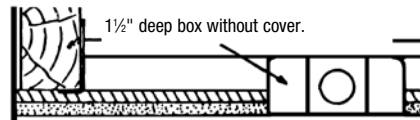

Accurate and automatic positioning on joist.

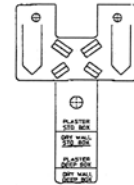

Endplate locator tab is scored and marked for lath and plaster drywall applications with standard and deep boxes.

#### Ease of Installation:

Claws provide temporary support for proper positioning until permanently installed.

#### Two adjustable lengths:

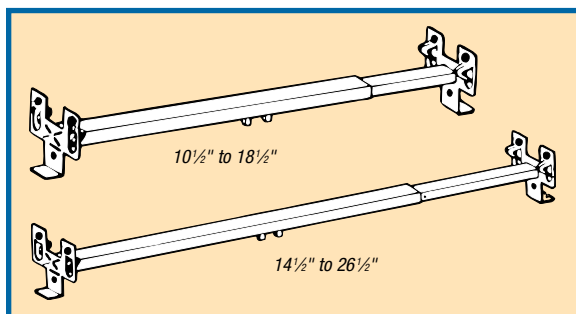

3/8", 1/2", 5/8" Drywall Board

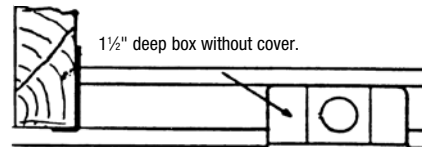

Foot straightened gauges for 1/2"-deep box with cover or 2 1/8"-deep box without cover. With foot broken off gauges for shallow pan box.



CAT. NO.	DEPTH OF END PLATE (IN.)	BR LENGTH (IN.)	STUD OR FASTENER	STD. CTN.
<i>For 3/8", 1/2" and 5/8" Wall Board and Plaster — 50 lb. Max. Load Rating</i>				
6010DW-25	13/16	10 1/2–18 1/2	Stud	25
6010ADW-25	13/16	14 1/2–26 1/2	Stud	25
6011DW-25	13/16	10 1/2–18 1/2	Fastener	25
6011ADW-25	13/16	14 1/2–26 1/2	Fastener	25

\*Score marks for drywall and plaster depths.

## Box Hangers and Supports

### Bar Hangers

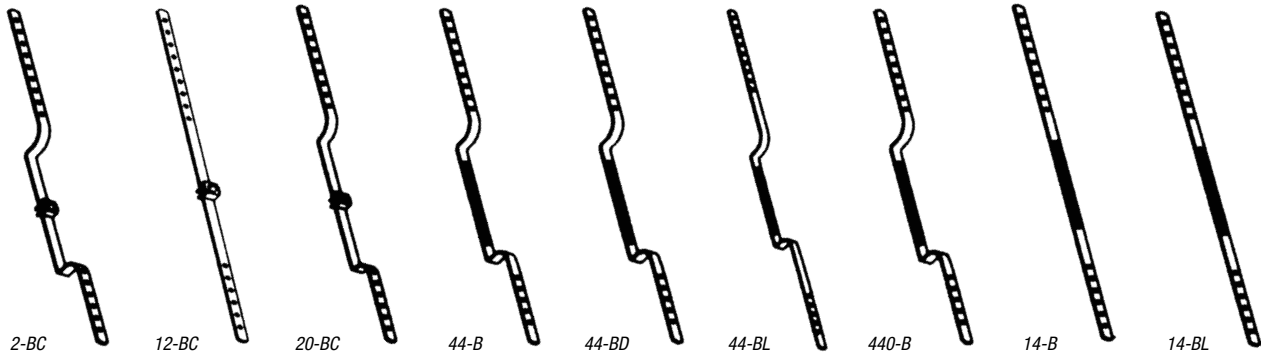

CAT. NO.	DESCRIPTION	STD. CTN.
2-BC	<b>21" LONG</b> Deep offset bar hanger. Offset 1/2" for mounting boxes with plaster ring. Furnished with clip	50
12-BC	<b>20" LONG</b> Straight bar hanger for mounting pancake boxes. Furnished with clip	50
20-BC	<b>22" LONG</b> Shallow offset bar hanger. Offset 1" for mounting 1/2"-deep boxes without rings. Furnished with clips	50
44-B	<b>22" LONG</b> Deep offset bar hanger. Offset 1/2" for mounting 1/2"-deep boxes with plaster ring to bring cover flush with plaster. Furnished with stovebolt	50
44-BD	<b>22" LONG</b> Extra deep offset bar hanger. Offset 2/8" for mounting 2/8"-deep box. Furnished with stovebolt	50
44-BL	<b>26" LONG</b> Deep offset bar hanger. Offset 1/2" for mounting 1/2"-deep boxes with plaster ring to bring cover flush with plaster. Furnished with stovebolt	50
440-B	<b>21" LONG</b> Shallow offset bar hanger. Offset 1" for mounting 1/2"-deep boxes without rings. Furnished with stovebolt	50
14-B	<b>20" LONG</b> Straight bar hanger for mounting ceiling boxes. Furnished with stovebolt	50
14-BL	<b>24" LONG</b> Straight bar hanger for mounting ceiling boxes. Furnished with stovebolt	50

### Far-Side Box Support

- Provides side support for electrical boxes
- Works with most electrical boxes for 2 1/2", 3 1/2" and 4" metal stud depths

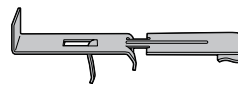
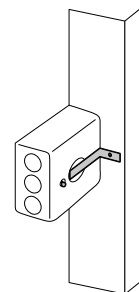
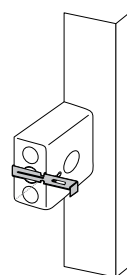

Fig. 1



Fig. 2

CAT. NO.	FIG. NO.	DESCRIPTION	STD. CTN.
SS1-TB	1	Far-side box support	100
50-SC	2	Box brace for 4" square or octagonal box	100



## Box Hangers and Supports

### Floor-Mounted Box Supports

- Mounts on metal or wood studding
- Used as conduit rack or spacer for rigid conduit, IMC or EMT
- Ideal for schools, hospitals, industrial and commercial jobs
- Galvanized steel

CAT. NO.	FIG. NO.	DESCRIPTION	STD. CTN.
7502	1	Footed box supports, 20" height	25
7503-SC	1	Footed box supports, 30" height	50

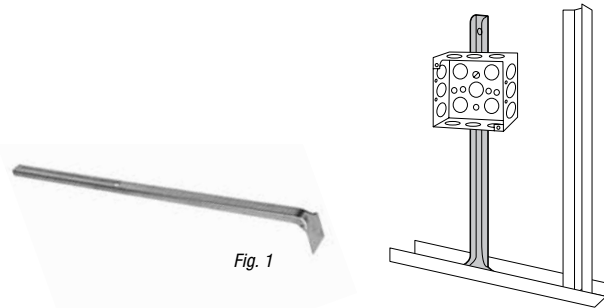
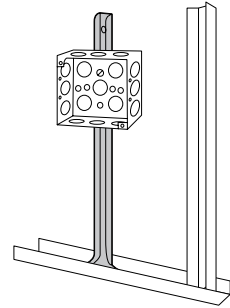
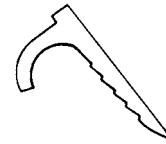

Fig. 1



### Pipe Nailers

CAT. NO.	DESCRIPTION	STD. CTN.
PN-3-1	1"	1,000



### Snap-On Box Clip

- Fits most electrical boxes requiring plaster rings
- Fits most metal stud sizes
- Will not move on stud
- Wider part for more secure fastening
- No screws required
- Support leg braces box against stud
- Installs easily with a hammer
- Adjustable offset enables box to protrude through drywall sizes: 1/4", 3/8", 1/2", 5/8" or 3/4"

CAT. NO.	FIG. NO.	DESCRIPTION	STD. CTN.
SSF-SMX	1	Snap-on box support for mounting to stud	100
SSF-SK	2	Screw to stud, box support	100
SF-SFA	3	Snap-on box support for mounting to stud, adjustable	25
SSF-SF0	4	Snap-on box support for mounting to stud, riveted for flush to stud face	25
SSF-SF1/4	4	Snap-on box support for mounting to stud, riveted for 1/4" drywall	25
SSF-SF3/8	4	Snap-on box support for mounting to stud, riveted for 3/8" drywall	25
SSF-SF1/2	4	Snap-on box support for mounting to stud, riveted for 1/2" drywall	25
SSF-SF5/8	4	Snap-on box support for mounting to stud, riveted for 5/8" drywall	25
SSF-SF3/4	4	Snap-on box support for mounting to stud, riveted for 3/4" drywall	25
SSF-SFT	5	Snap-on box support for mounting to stud with 1/4"-20 thread impression	25

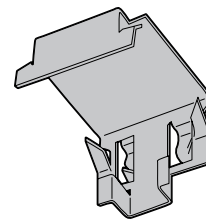
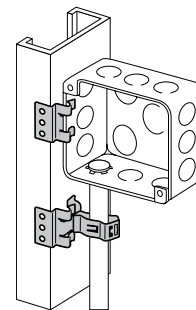

Fig. 1

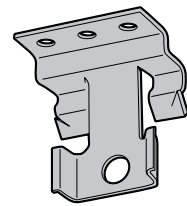

Fig. 2

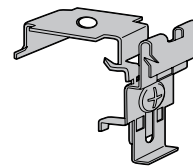
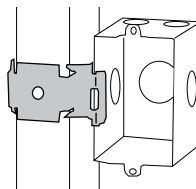

Fig. 3

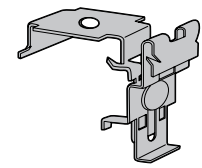

Fig. 4

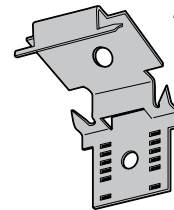

Fig. 5

## Stud Wall and Drywall Accessories

### Grounding Devices



GEE

#### Grounding Clip

- For grounding switch and outlet boxes using non-metallic sheathed cables with ground wire
- Grounds #12 and #14 copper and #12 aluminum conductors

#### Grounding Pigtail

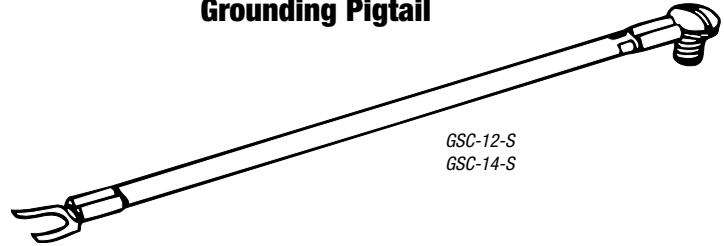

GSC-12-S  
GSC-14-S

#### Grounding Screw and Wire

- A prelooped 6"-long bare or insulated copper ground wire attached to a 10-32 x 3/8" hexagon-head washer-face screw, colored green

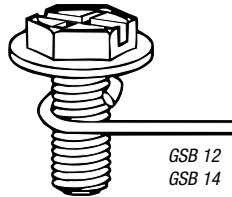

GSB 12  
GSB 14

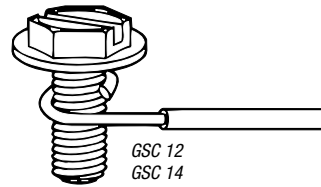

GSC 12  
GSC 14

#### Grounding Screw

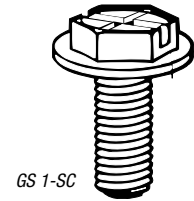

GS 1-SC

CAT. NO.	DESCRIPTION	STD. CTN.	UNIT PKG.
<b>Grounding Clip</b>			
GEE	Zinc-plated, spring-steel, colored green accommodates #12 and #14 copper and #12 aluminum solid conductors in non-metallic sheathed cable. Also approved for connecting bonding jumper from receptacle to grounded metal device box. 50 per unit package	1,000	—
<b>Grounding Screws and Pigtails</b>			
GSC 12	10-32 x 3/8" slotted hexagon-head washer-face ground screw with green dye finish and a six-inch solid copper #12 AWG insulated wire	1,000	100
GSC-12-S*	#12 AWG insulated eight-inch stranded pigtail with a captive 10-32 x 3/8" round head screw on one end and a fork-tongue terminal on the other end	1,000	100
GSC-12-10 1/2	10-32 x 3/8" slotted hexagon-head washer-face ground screw with green dye finish and a 10 1/2 inch solid-copper #12 AWG insulated wire	1,000	100
GSC 14	10-32 x 3/8" slotted hexagon-head washer-face ground screw with green dye finish and a six-inch solid-copper #14 AWG insulated wire	1,000	100
GSC 14 S*	#14 AWG insulated eight-inch stranded pigtail with a captive 10-32 x 3/8" round head screw on one end and a fork-tongue terminal on the other end	1,000	100
GSB 12	10-32 x 3/8" slotted hexagon-head washer-face ground screw with green dye finish and a six-inch solid-copper #12 AWG bare wire	1,000	100
GSB 14	10-32 x 3/8" slotted hexagon-head washer-face ground screw with green dye finish and a six-inch solid-copper #14 AWG bare wire	1,000	100
GS 1-SC	10-32 x 3/8" slotted hexagon-head washer-face screw with green dye finish. Provides positive ground continuity in boxes with a #10-32 tapped hole	1,000	100

\* Eight-inch stranded pigtail is also available with a captive 10-32 x 3/8" round-head screw on one end and a fork-tongue terminal on the other end.

## Stud Wall and Drywall Accessories

### Channel Bar

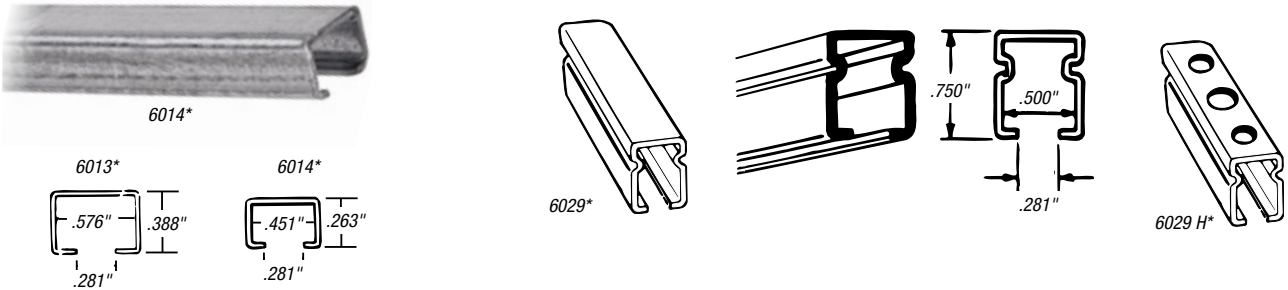

CAT. NO.	DESCRIPTION	MIN. ORDER (FT.)	STD. CTN.
<b>Mounts Fixtures, Boxes and Conduits in Suspended Ceilings</b>			
6013*	20 ga. single channel bar	100	100
6014*	18 ga. single channel bar	100	100
6029*	16 ga. (.060") ribbed	100	100
6029 H*	16 ga. (.060") ribbed — with holes for #12 sheet-metal screw and 1/4" threaded rod	100	100

\*10-ft. lengths.

### Box and Channel Fasteners

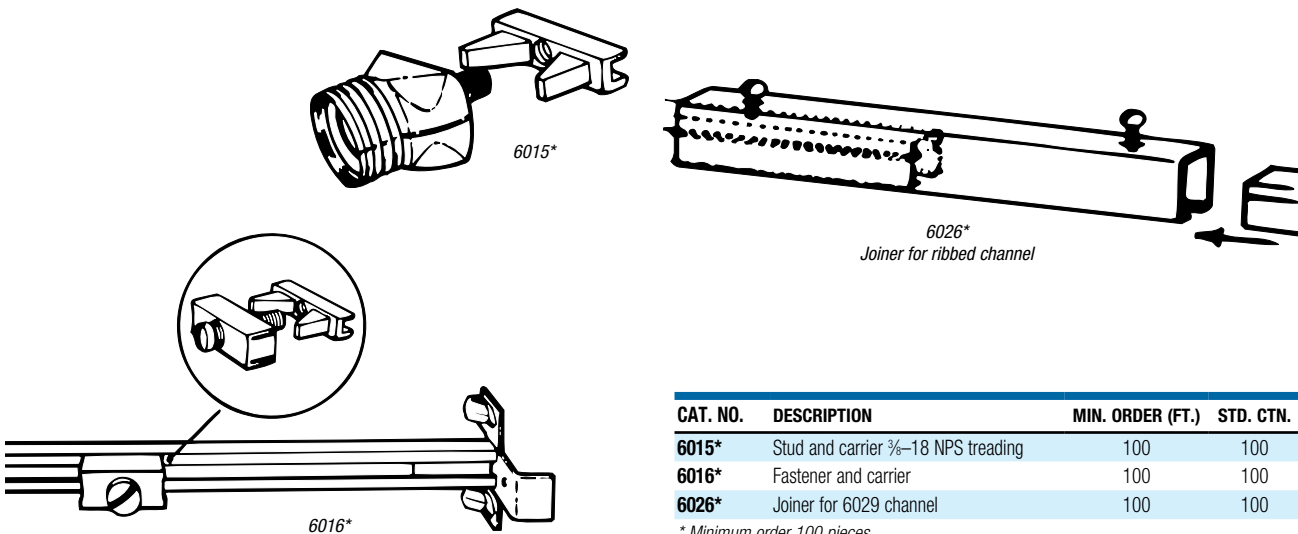

CAT. NO.	DESCRIPTION	MIN. ORDER (FT.)	STD. CTN.
6015*	Stud and carrier 3/8"-18 NPS treading	100	100
6016*	Fastener and carrier	100	100
6026*	Joiner for 6029 channel	100	100

\* Minimum order 100 pieces.

## Stud Wall and Drywall Accessories

### Conduit-to-Metal Stud

- Attaches securely to most metal stud sizes
- Riveted to accommodate your drywall requirements

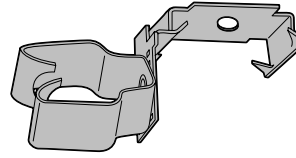

Fig. 1

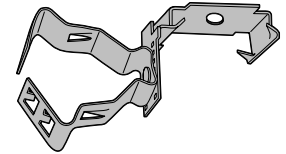

Fig. 2

CAT. NO.	FIG. NO.	DESCRIPTION	STD. CTN.
SSF-SF-S1/2	1	Snap on stud, push-in conduit clip, 1/2" conduit	25
SSF-SF-S3/4	1	Snap on stud, push-in conduit clip, 3/4" conduit	25
SSF-SF-S1	1	Snap on stud, push-in conduit clip, 1" conduit	25
SSF-SF-C3/8	2	Snap on stud, conduit support clip, 3/8" conduit or MC/AC cable	25
SSF-SF-C1/2 3/4	2	Snap on stud, conduit support clip, 1/2"-3/4" conduit	25
SSF-SF-C1	2	Snap on stud, conduit support clip, 1" conduit	25
SSF-SK-C1/2 3/4	3	1/2"-3/4" finger close conduit clip	25
SSF-SK-C1	3	1" finger close conduit clip	25
SSF-SK-S1/2	4	1/2" snap-in conduit clip	25
SSF-SK-S3/4	4	3/4" snap-in conduit clip	25
SSF-SK-S1	4	1" snap-in conduit clip	25

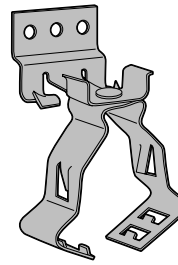

Fig. 3

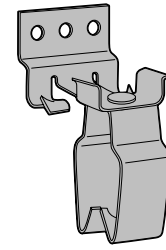

Fig. 4

### Easy-Snap Grommet

- Fits any size or shape metal stud hole
- Provides complete 360° protection for cable

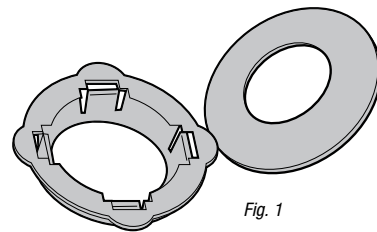
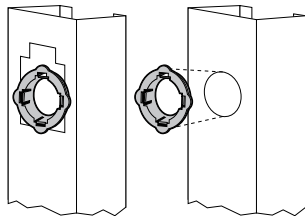

Fig. 1

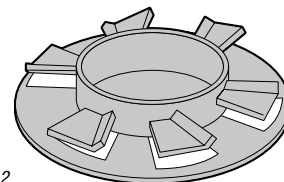

Fig. 2

CAT. NO.	FIG. NO.	DESCRIPTION	STD. CTN.
1300	1	Plastic bushing for metal stud 1" trade size opening (1 1/2")	100
1216-EN	2	Twisted universal bushing for metal stud	50



## Stud Wall and Drywall Accessories

### Through-Stud Cable Conduit Support

- A quick means of support for horizontal runs of conduits or MC/AC through metal stud
- Installs easily with a screw gun
- SSF-SPI enables ENT conduit and MC/AC cable to be easily pulled through metal stud

CAT. NO.	FIG. NO.	DESCRIPTION	STD. CTN.
SSF-SAB-C1/2 3/4	1	1/2" or 3/4" finger close conduit clip	25
SSF-SAB-C3/8	1	Finger-close conduit clip 14-2 thru 12-3 MC/AC cable and 3/8" conduit	25
SSF-SAB-S1/2	2	Snap-in conduit clip — 1/2" conduit	25
SSF-SAB-S3/4	2	Snap-in conduit clip — 3/4" conduit	25
SSF-SP1	3	Supports up to 1" conduit	100

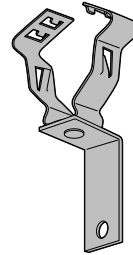

Fig. 1

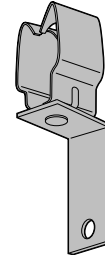
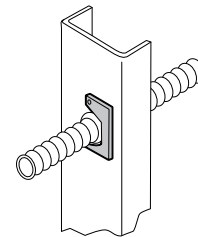

Fig. 2

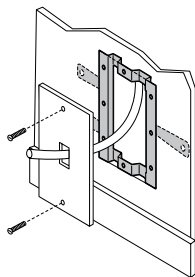

Fig. 3



### Low-Voltage Mounting Brackets — Screw-On Support

- Eliminates the need for an electrical box when installing low-voltage Class 2 wiring
- For old work or new work



CAT. NO.	FIG. NO.	DESCRIPTION	STD. CTN.
SSF-SLV	1	Old-work or new work low-voltage bracket	100
VN1	2	Non-metallic single-gang new-work low-voltage bracket	50
VN2	—	Non-metallic two-gang new-work low-voltage bracket	50
VW1	3	Non-metallic single-gang old-work low-voltage bracket	50
VW2	—	Non-metallic two-gang old-work low-voltage bracket	50
WBF-1	4	Low-voltage mounting bracket with screws	100



Fig. 1



Fig. 2



Fig. 3

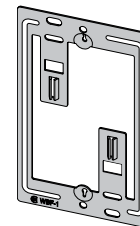
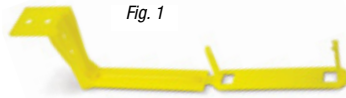

Fig. 4

## Stud Wall and Drywall Accessories

### Cable Support

- Supports up to four runs of MC and AC cable and up to six runs of non-metallic sheathed cable
- Installs with nails or staples or sheet-metal screws
- Complies with NEC® 300-4d for all wood and metal studs
- Made with high-strength plastic



CABLE TYPE	CABLE SIZE	MAX. QTY./FASTENER
Non-Metallic Sheathed Cable	#14-2, #12-2, #10-2, #14-3, #12-3 and #10-3 with Ground	6
Non-Metallic	#8-2 and #6-2 with Ground	4
Metallic Clad (MC) Cable and #10-4 with Ground	#14-2, #12-2, #10-2, #14-3, #12-3, #10-3, #14-4, #12-4	4
Armored Cable (AC)	#14-4, #12-2, #10-2, #8-2, #14-3, #12-3, #10-3, #14-4, #12-4 and #10-4 with Ground	4
Flexible Conduit (BX)	½", ¾"	4

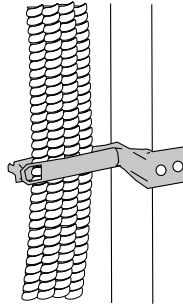

CAT. NO.	FIG. NO.	DESCRIPTION	STD. CTN.
SSF-SC6	1	Non-Metallic Sheathed MC/AC Cable to Stud Clip	100

### Device Leveler and Retainer

- Use for oversized drywall openings
- Prevents broken cover plates
- Stops device from being pushed back in wall
- Makes floating device rigid

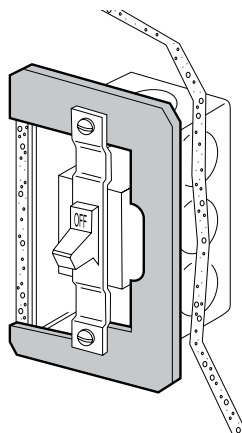
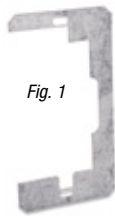

CAT. NO.	FIG. NO.	DESCRIPTION	STD. CTN.
SSF-SR	1	Single-Gang Device Leveler and Retainer	100

NEC and National Electrical Code are registered trademarks of the National Fire Protection Association, Inc.

### Screw-On Conduit Support

- Supports ½" and ¾" EMT conduit and MC/AC cable
- Works with wood or metal stud
- Preset bend provides alignment with knockouts for 1½"-deep boxes or 2½"-deep boxes

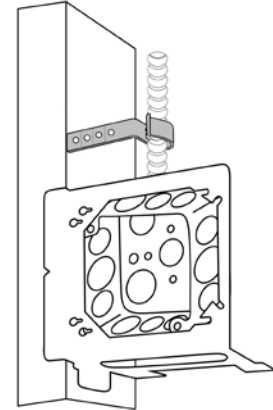

CAT. NO.	FIG. NO.	DESCRIPTION	STD. CTN.
SSF-SS1/2 3/4	1	½" and ¾" EMT Conduit and MC/AC to Metal or Wood Stud. For 1½"-Deep Box	100
SSF-SS1/2 3/4D	1	½" and ¾" EMT Conduit Metal or Wood Stud. For 2½"-Deep Box	100

### Protector Plates

- Protects cable(s) from damage when installing drywall or paneling
- No nails or screws required
- Fits all stud sizes
- Both products meet requirements for NEC® 300-4
- ST66 legs are crimped with pliers to stud to provide secure fit

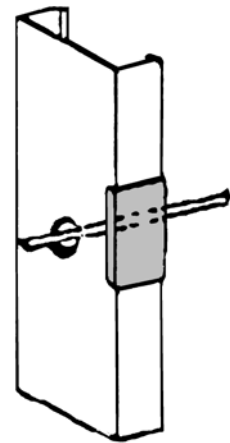

CAT. NO.	FIG. NO.	DESCRIPTION	STD. CTN.
SSF-ST66	1	Protector Plate for Metal Stud	100
66EP	2	Protector Plate for Wood Stud	100