

Steel City[®]

Steel City[®] Floor Boxes

In this section...



Steel City[®] Floor Boxes

Overview	A-122-A-128
Recessed Service Floor Boxes.....	A-129-A-142
Flush Service Floor Boxes	A-143-A-169
Above-Floor Service Fittings	A-170
Replacement Parts and Accessories	A-171-A-172
Poke Through Systems	A-173-A-185
Access Floor Modules	A-186-A-196

Thomas & Betts

www.tnb.com

Overview

Recessed Service Floor Boxes

The aesthetic and technical needs of today's buildings are as diverse as the equipment that fills them. Small wonder, then, that floor boxes can continue to solve the needs of today and the future as they did in the early 1900s when they were invented. They are still a contemporary, capable and cost-effective wire-management system. Steel City®, a pioneer in both the design and applications of floor boxes since 1904, invites you to discover or rediscover the possibilities.

Visit www.tnb.com/floorboxselect to use our online floor box selection tool to quickly and easily identify an appropriate in-floor solution for your needs.



Overview

Recessed Service Floor Boxes — Outlets Below Floor Level

663-SC (2-Gang)

- Material: Stamped Steel
- Covers: P62 and P60 Series



See page A-129.

664-SC/664-S (2-Gang)

- Material: Stamped Steel
- Covers: MopTite® 664-CST SW Series



See page A-130.

664-CI (2-Gang)

- Material: Cast Iron
- Covers: MopTite® 664-CST-SW Series



See page A-130.

665-SC/665-CI/665-AV2 (4-Gang)

- Material: Stamped Steel/Cast Iron
- Covers: MopTite® 665-CST-SW Series



See pages A-132–A-135.

668-S (4-Gang)

- Material: Stamped Steel
- Covers: MopTite® 668-CST



See pages A-136–A-137.

667-SC (8-Gang)

- Material: Stamped Steel
- Covers: MopTite® 667-CST-SW Series



See pages A-138–A-139.

Access Floor Modules

- Material: Stamped Steel
- Covers: MopTite® covers, assembled

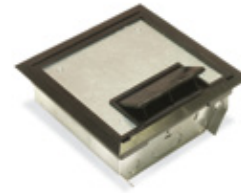

See pages A-186–A-195.

Poke-Through Systems

 File No. E2969



Flush Service

See pages A-174–A-179.



Furniture Feed

See pages A-180–A-182.



Pedestal

See page A-183.

Overview

Flush-Service Floor Boxes — Outlets at Floor Level

68-HP Series

- Material: Non-Metallic
- Covers: 68-HP Series



See pages A-143–A-146.

68 Series

- Material: Stamped Steel
- Covers: MopTite® P60 Series



See pages A-147–A-149.

600 Series

- Material: Cast Iron
- Covers: MopTite® P60 Series



See pages A-147–A-149.

68P Series

- Material: Non-Metallic
- Covers: MopTite® P60 & P68 Series



See pages A-150–A-153.

78 Series

- Material: Cast Iron
- Covers: MopTite® P90 Series



See pages A-154–A-155.

88 Series

- Material: Stamped Steel
- Covers: MopTite® P90 Series



See pages A-154–A-155.

640 Series (1-, 2-, 3- & 4-Gang) 840 Series (1-, 2- & 3-Gang)

- Material: Cast Iron
- Covers: MopTite® P64 Series



See pages A-158–A-161.

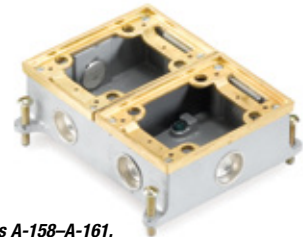

See pages A-158–A-161.

640P Series (1-, 2- & 3-Gang)

- Material: Non-Metallic
- Covers: 640P Series Activations with MopTite® P64 Series Covers



See pages A-162–A-163.

740 Series (1-, 2- & 3-Gang)

- Material: Stamped Steel
- Covers: 640P Series Activations with MopTite® P64 Series Covers



File No. E2969

File No. L12798

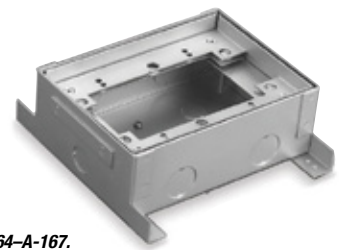

See pages A-164–A-167.

Overview

Floor Box Selection Guide

CAT. NO.	SERVICE CAPABILITIES				FLOOR BOX BODY MATERIAL			MINIMUM DEPTH OF POUR							ADJUSTABILITY		
	RECEPTACLES			MULTIPLE SERVICE CAPABILITIES	CAST IRON	STAMPED STEEL	NON-METALLIC	2"	2½"	3"	3½"	4"	4½"	WOOD FLOOR	FULLY-	SEMI-	NON-
	SINGLE	DUPLEX	GFCI														
GAB-4, GAB-6		•	•	•										•			
SFH-40 SERIES	•	•															•
SFH-50 SERIES	•	•															•
SFL-10 SERIES																	•
600	•	•	•														
601	•	•	•														
602	•	•	•														
603	•	•	•														
604	•	•			•												•
61-W		•	•			•											•
62-W			•			•											•
641	•	•	•		•												•
641P	•	•	•		•												•
642	•	•	•		•												•
642P	•	•	•		•												•
643	•	•	•		•												•
643P	•	•	•		•												•
644	•	•	•		•												•
663-SC		•				•											•
664-CI		•	•		•												•
664-S		•				•											•
664-SC		•	•			•											•
665		•	•			•											•
665-CI		•	•		•												•
667-SC		•	•			•											•
668-S		•	•			•											•
671-SC	•																•
672	•																•
68-D	•	•	•		•												•
68-P	•	•															•
68-S	•	•	•		•												•
71-W		•	•			•											•
78-S	•																•
78-SC	•																•
841-SC	•	•	•		•												•
842-SC	•	•	•		•												•
843-SC	•	•	•		•												•
88-D	•				•												•
88-S	•				•												•
GAB-8-S	•	•	•			•								6"			•

Overview

Floor Box Cover Selection Guide

FLOOR BOX CAT. NO.	DESCRIPTION	COVER PLATES	BRASS	CARPET ACTIVATIONS			TILE ACTIVATION		
				ALUMINUM	NON-METALLIC	BRASS	ALUMINUM	NON-METALLIC	
663-SC	Concealed Service — Steel	P60 Series	P60-CP	P60-CPL	P62-CP	P62-TAR	SP-P62-TAR-A	N/A	
664-SC	Concealed Service — Steel	664-CST-Series	N/A	N/A	664-CST-Series	N/A	N/A	N/A	
664-S	Shallow Concealed Service — Steel	664-CST-Series	N/A	N/A	664-CST-Series	N/A	N/A	N/A	
664-CI	Concealed Service — Cast Iron	664-CST-Series	N/A	N/A	664-CST-Series	N/A	N/A	N/A	
68-S	Flush Service — Steel	P60 Series	P60-CP P60-CACP	P60-CPAL P60-CACPAL	P60-LCP	*	**	—	
68-D	Flush Service — Steel	P60 Series	P60-CP P60-CACP	P60-CPAL P60-CACPAL	P60-LCP	*	**	—	
68-P	Flush Service — Non-Metallic	P60 Series	P60-CP P60-CACP	P60-CPAL P60-CACPAL	P68-SRC Color P68-DRC-Color P68-ECC-Color	68-PAR-W/ 600-4-FL	68-PAR-W/ 600-4-FL-AL	—	
600-SC SERIES	Flush Service — Cast Iron	P60 Series	P60-CP P60-CACP	C60-CPAL P60-CACPAL	N/A	*	**	—	
601-SC SERIES	Flush Service — Cast Iron	P60 Series	P60-CP P60-CACP	C60-CPAL P60-CACPAL	N/A	*	**	—	
602-SC SERIES	Flush Service — Cast Iron	P60 Series	P60-CP P60-CACP	C60-CPAL P60-CACPAL	N/A	*	**	—	
603-SC SERIES	Flush Service — Cast Iron	P60 Series	P60-CP P60-CACP	C60-CPAL P60-CACPAL	N/A	*	**	—	
604-SC SERIES	Flush Service — Cast Iron	P60 Series	P60-CP P60-CACP	C60-CPAL P60-CACPAL	N/A	*	**	—	
641	Flush Service — Cast Iron	P64 Series	P64-CP	P64-CPAL	P64-CP Series P-64-LCP	*	**	N/A	
641P	Flush Service — Non-Metallic	P64 Series P64P Series	641P-CACB	641P-CACA	641P-CAC Series	641P-TACB	641P-TACA	641P-TAC-Series	
642	Flush Service — Cast Iron	P64 Series	P64-2GCP	P64-2GCPAL	P64P-2GCP Series P64-2LCP	*	**	N/A	
642P	Flush Service — Non-Metallic	P64 Series P64P Series	642P-CACB	642P-CACA	642P-CAC Series	642P-TACB	642P-TACA	642P-TAC Series	
643	Flush Service — Cast Iron	P64 Series	P64-3GCP	P64-3GCPAL	P64P-3GCP Series P64-3LCP	*	**	N/A	
643P	Flush Service — Non-Metallic	P64 Series P64P Series	643P-CACB	643P-CACA	643P-CAC Series	633P-TACB	643P-TACA	643P-TAC Series	
644	Flush Service — Cast Iron	P64 Series	P64-4GCP	P64-4GCPAL	N/A	*	**	N/A	
841-SC	Shallow Flush Service — Cast Iron	P64 Series	P64-CP	P64CPAL	P64P-CP Series P64-LCP	*	**	N/A	
842-SC	Shallow Flush Service — Cast Iron	P64 Series	P64-2GCP	P64-2GCPAL	P64P-2GCP Series P64-2LCP	*	**	—	
843-SC	Shallow Flush Service — Cast Iron	P64 Series	P64-3GCP	P64-3GCPA	P64-3GCP Series P64-3LCP	*	**	N/A	
78-SC	Flush Service — Cast Iron	P90 Series	P90-CP	P90-CPAL	N/A	*	**	N/A	
78S	Flush Service — Cast Iron	P90 Series	P90-CP	P90-CPAL	N/A	*	**	N/A	
671	Flush Service — Cast Iron	P67 Series	P90-CP	P90-CPAL	N/A	—	**	N/A	
672	Flush Service — Cast Iron	P67 Series	P90-CP	P90-CPAL	N/A	*	**	N/A	
88D	Flush Service — Steel	P90 Series	P90-CP	P90-CPAL	N/A	*	**	N/A	
88DA	Flush Service — Steel	P90 Series	P90-CP	P90-CPAL	N/A	*	**	N/A	
88S	Flush Service — Steel	P90 Series	P90-CP	P90-CPAL	N/A	*	**	N/A	
98	Flush Service	P90 Series	P90-CP	P90-CPAL	N/A	*	**	N/A	
665-SC	Concealed Service	665-CST Series	N/A	N/A	665-CST Series	—	—	—	
667	Concealed Service	665-CST Series	N/A	N/A	665-CST Series	—	—	—	
61W	Flush Service — Steel	P64 Series	P64-CP	P64-CPAL	P64-CP Series	N/A	N/A	N/A	
62W	Flush Service — Steel	P64 Series	P64-2GCP	P64-2GCPAL	P64-2GCP Series	N/A	N/A	N/A	

* Supplied standard with box.

** Supplied standard with -AL suffix box.

N/A Not Available.

Overview

Floor Box Cover Selection Guide

COVER SERIES	COVER CAT. NO.	DESCRIPTION	STANDARD FINISH
P60 4" Dia.	P-60-1/2	½" N.P.S. Plug	Brushed Brass
	P-60-1/2-AL	½" N.P.S. Plug	Brushed Aluminum
	P-60-3/4	¾" N.P.S. Plug	Brushed Brass
	P-60-3/4-AL	¾" N.P.S. Plug	Brushed Aluminum
	P-60-1	1" N.P.S. Plug	Brushed Brass
	P-60-1-AL	1" N.P.S. Plug	Brushed Aluminum
	P-60-1 1/4	1¼" N.P.S. Plug	Brushed Brass
	P-60-1 1/4-AL	1¼" N.P.S. Plug	Brushed Aluminum
	P-60-2	2" Dia. Plug	Brushed Brass
	P-60-2-AL	2" Dia. Plug	Brushed Aluminum
	P-60-2 5/8	2⅝" Dia. Plug	Brushed Brass
	P-60-2 5/8-AL	2⅝" Dia. Plug	Brushed Aluminum
	P-60-1/2-2	½" N.P.S. & 2" Dia. Plugs	Brushed Brass
	P-60-1/2-2-AL	½" N.P.S. & 2" Dia. Plugs	Brushed Aluminum
	P-60-3/4-2	¾" N.P.S. & 2" Dia. Plugs	Brushed Brass
	P-60-3/4-2-AL	¾" N.P.S. & 2" Dia. Plugs	Brushed Aluminum
	P-60-DU	Two 1⅞" Dia. Plugs	Brushed Brass
	P-60-DU-AL	Two 1⅞" Dia. Plugs	Brushed Aluminum
	P-60-DS	Two Hinged Lift Lids	Brushed Brass
	P-60-DS-AL	Two Hinged Lift Lids	Brushed Aluminum
P-60-DR	Single Hinged Lift Lid	Brushed Brass	
P-60-DR-AL	Single Hinged Lift Lid	Brushed Aluminum	
P-60-GFCI	GFCI Hinged Lift Lid	Brushed Brass	
P60-CACP One-Piece 5⅜" Dia.	P-60-CACP	One-Piece Carpet Plate with Two Hinged Lift Lids for Duplex	Brushed Brass
	P-60-CACP-AL	One-Piece Carpet Plate with Two Hinged Lift Lids for Duplex	Brushed Aluminum
	P-60-CACP-GFCI	One-Piece Carpet Plate with Two GFCI Hinged Lift Lids	Brushed Brass
	P-60-3/4-2-CACP	One-Piece Carpet Plate with 3⅝" N.P.S. & 2" Dia. Plug	Brushed Brass
	P-60-3/4-2-CACP-AL	One-Piece Carpet Plate with ¾" & 2" N.P.S. Plugs	—
P67 3½" Dia.	P-67-1/2	½" N.P.S. Plug	Brushed Brass
	P-67-3/4	¾" N.P.S. Plug	Brushed Brass
	P-67-3/4-AL	¾" N.P.S. Plug	Brushed Aluminum
	P-67-1	1" N.P.S. Plug	Brushed Brass
	P-67-1AL	1" N.P.S. Plug	Brushed Aluminum
	P-67-1 1/4	1¼" N.P.S. Plug	Brushed Brass
	P-67-2	2" Dia. Plug	Brushed Brass
	P-67-2AL	2" Dia. Plug	Brushed Aluminum
	P-67-1/2-2	½" N.P.S. & 2" Dia. Plugs	Brushed Brass
	P-67-3/4-2	¾" N.P.S. & Dia. Plugs	Brushed Brass

COVER SERIES	COVER CAT. NO.	DESCRIPTION	STANDARD FINISH
P64 3" x 4 ½" Rectangular	P-64-1/2	½" N.P.S. Plug	Polished Brass
	P-64-1/2AL	½" N.P.S. Plug	Brushed Aluminum
	P-64-3/4	¾" N.P.S. Plug	Polished Brass
	P-64-3/4AL	¾" N.P.S. Plug	Brushed Aluminum
	P-64-1	1" N.P.S. Plug	Polished Brass
	P-64-1AL	1" N.P.S. Plug	Brushed Aluminum
	P-64-1 1/4	1¼" N.P.S. Plug	Polished Brass
	P-64-1 1/4AL	1¼" N.P.S. Plug	Brushed Aluminum
	2" N.P.S. PLUG	2" N.P.S. Plug	Polished Brass
	2" N.P.S. PLUG	2" N.P.S. Plug	Brushed Aluminum
	P-64-1/2-2	½" & 2" N.P.S. Plug	Polished Brass
	P-64-1/2-2AL	½" & 2" N.P.S. Plug	Brushed Aluminum
	P-64-3/4-2	¾" & 2" N.P.S. Plug	Polished Brass
	P-64-3/4-2AL	¾" & 2" N.P.S. Plug	Brushed Aluminum
P-64-2-5/8	2⅝" N.P.S. Plug	Polished Brass	
P-64-2-5/8AL	2⅝" N.P.S. Plug	Brushed Aluminum	
P-64-DU	Two 1⅞" Dia. Plugs	Polished Brass	
P-64-DUAL	Two 1⅞" Dia. Plugs	Brushed Aluminum	
P-64-D8	Two Hinged Lift Lids	Polished Brass	
P64P	P-64-GFCI	GFCI Hinged Lift Lid	Polished Brass
	P-64P-BP	Blank Plate	Non-Metallic
	P-64P-URC	Universal Cover	Non-Metallic
P90 2¾" Dia.	P-90-1/2	½" N.P.S. Plug	Polished Brass
	P-90-1/2AL	½" N.P.S. Plug	Brushed Aluminum
	P-90-3/4	¾" N.P.S. Plug	Polished Brass
	P-90-3/4AL	¾" N.P.S. Plug	Brushed Aluminum
	P-90-1	1" N.P.S. Plug	Polished Brass
	P-90-1AL	1" N.P.S. Plug	Brushed Aluminum
	P-90-1 1/4	1¼" N.P.S. Plug	Polished Brass
	P-90-1 1/4AL	1¼" N.P.S. Plug	Brushed Aluminum
	P-90-2	2" Dia. Plug	Polished Brass
	P-90-2AL	2" Dia. Plug	Brushed Aluminum
P68 6" Dia.	P-90-1/2-2	½" N.P.S. & 2" Dia. Plugs	Polished Brass
	P-90-1/2-2AL	½" N.P.S. & 2" Dia. Plugs	Brushed Aluminum
	P-90-3/4-2	¾" N.P.S. & 2" Dia. Plugs	Polished Brass
	P-90-3/4-2AL	¾" N.P.S. & 2" Dia. Plugs	Brushed Aluminum
	P-68-SRC-GRY	Carpet & Cover Plate for Single Receptacle	Non-Metallic Gray
	P-68-SRC-BRN	Carpet & Cover Plate for Single Receptacle	Non-Metallic Brown
	P-68-SRC-BGE	Carpet & Cover Plate for Single Receptacle	Non-Metallic Beige
	P-68-FSC-GRY	Carpet & Cover Plate with 1" N.P.S. Plug	Non-Metallic Gray
	P-68-FSC-BRN	Carpet & Cover Plate with 1" N.P.S. Plug	Non-Metallic Brown
	P-68-FSC-BGE	Carpet & Cover Plate with 1" N.P.S. Plug	Non-Metallic Beige
P-68-DRG-GRY	Carpet & Cover Plate for Duplex Receptacle	Non-Metallic Gray	
P-68-DRG-BRN	Carpet & Cover Plate for Duplex Receptacle	Non-Metallic Brown	
P-68-DRG-BGE	Carpet & Cover Plate for Duplex Receptacle	Non-Metallic Beige	

Overview

Standard Specification — Flush Floor Boxes

Cast Iron Formed Steel

Considerations when writing specifications:

Floor boxes are manufactured in various sizes, configurations and materials. The specifier should determine the most suitable product for his application. Refer to the T&B floor box catalog and select the appropriate paragraphs listed below. Plans should supply wiring capacity, conduit sizes, adjustability and floor finish. Construction Specifications Institute (CSI) references sections: 16132 Floor Boxes; 16141 Wiring Devices; Part 2-206 Floor Mounted Service Fittings; and 16741 Telephone Raceway Systems, Part 2-201 G Floor Boxes. Section 16132 Floor Boxes is preferable.

PART 2: PRODUCTS

2.01 ACCEPTABLE MANUFACTURERS — FLOOR BOXES

A. Shall be as manufactured by Thomas & Betts, Memphis, TN

2.02 MATERIALS — FLOOR BOXES

2.02.1

A. Shall be cast iron, painted inside and out with weatherproof paint intended for use on metal as indicated on the plans.

2.02.1

B. Shall be formed steel with a zinc plating at least .0005 in. thick on the outside and .00015 in. thick on the inside as indicated on the plans.

2.02.2

A. Construction shall be as required by UL 514A.

2.02.2

B. Carpet or tile frame shall be (brass, aluminum, polycarbonate, nylon).

2.02.2

C. Cover assembly shall protect against the ingress of water or foreign material with a gasket and shall be UL Listed as moptight.

2.03 GENERAL DESIGN — FLOOR BOXES

A. Shall deliver electric power from receptacles installed at the surface of the floor or from service fittings (Reference 16141 as shown on the plans).

B. 640/840 Series shall deliver power and telephone/data cable without interference from electric power delivery (see Section 16741).

C. Cubic inch capacity shall be as shown on the plans.

D. Boxes shall accept conduit sizes as required on the plans.

E. Shall be listed by Underwriters Laboratories.

PART 3: EXECUTION

3.01 GENERAL

A. Locate position for floor boxes and runs of conduit as shown on the plans.

3.01 INSTALLATION

A. Position floor boxes and conduit runs.

B. After concrete pour, pull wires and install devices according to manufacturers recommendations.

C. Activate in accordance with the National Electrical Code®.

D. Coordinate with floor covering contractor to complete installation.

Standard Specification — Concealed Service

Service Floor Outlet Multiple Service, Power and Communications

Considerations when writing specifications:

The 664 Concealed Service Floor Box provides both electric power and telephone (data) services from the same device for economy of space and cost, as well as affording a flush delivery (no above floor service fitting). For these reasons, your specification may reference this product in three sections: Floor Boxes, Wiring Devices and Telephone Raceway Systems. Construction Specifications Institute (CSI) references them in: 16132 Floor Boxes; 16141 Wiring Devices; Part 2 — 2.06 Floor Mounted Service Fittings; and 16741 Telephone Raceway Systems, Part 2 — 2.01 G Floor Boxes. Section 16132 Floor Boxes is preferable. For clarification include a reference in 16141, Part 2, 2.06 Floor Mounted Service Fittings as follows: Surface type service fittings are not acceptable.

PART 2: PRODUCTS

2.01 ACCEPTABLE MANUFACTURERS — FLOOR BOXES, MULTIPLE SERVICE

A. Shall be series 664 concealed service floor box as manufactured by Thomas & Betts.

2.02 MATERIALS — FLOOR BOXES, MULTIPLE SERVICE.

A. Shall be electrogalvanized, 14 gauge sheet steel. (Alternate A shall be cast iron).

B. Construction shall be as required by UL 514A.

C. Carpet frame shall be nylon UL Recognized Component QMFZ2.

D. Hinged outer cover shall be reinforced with a ½" steel plate.

2.03 GENERAL DESIGN — FLOOR BOXES, MULTIPLE SERVICE.

A. Shall deliver electric power from one or two duplex receptacles installed below the surface of the floor.

B. Shall deliver telephone or data cable without interference from the electric power delivery.

C. Shall protect delivery of both services by a hinged cover with a retractable opening and foam plastomer dust seal.

D. Hinged cover shall accept carpet or tile to match floor covering and be 180 degrees reversible.

E. Shall have 90 cubic inch total capacity with 24 cubic inch power chambers.

F. Shall accept conduit sizes up to 1½ inches.

G. Shall afford 18 square inches of access with cover open.

H. Box shall be listed by Underwriters Laboratories.

I. When hinged cover is closed and no services in place, device shall have no obstructions above surface of floor.

PART 3: EXECUTION

3.01 GENERAL

A. Locate position for floor boxes and runs of conduit as shown on the plans.

3.02 INSTALLATION

A. Position floor boxes and conduit runs.

B. After concrete pour pull wires and install devices according to manufacturer's recommendations.

C. Activate in accordance with the National Electrical Code®.

D. Coordinate with floor covering contractor to complete installation.

Standard Specification — Above-Floor Service

Service Floor Outlet Multiple Service, Power and Communications

Considerations when writing specifications: The 664 Concealed Service Floor Box provides both electric power and telephone (data) services from the same device for economy of space and cost, as well as affording a flush delivery (no above floor service fitting). For these reasons, your specification may reference this product in three sections: Floor Boxes, Wiring Devices and Telephone Raceway Systems. Construction Specifications Institute (CSI) references them in: 16132 Floor Boxes; 16141 Wiring Devices; Part 2 — 2.06 Floor Mounted Service Fittings; and 16741 Telephone Raceway Systems, Part 2 — 2.01 G Floor Boxes. Section 16132 Floor Boxes is preferable. For clarification include a reference in 16141, Part 2, 2.06 Floor Mounted Service Fittings as follows: Surface type service fittings are not acceptable.

PART 2: PRODUCTS

2.01 ACCEPTABLE MANUFACTURERS — FLOOR BOXES, MULTIPLE SERVICE

A. Shall be series 664 concealed service floor box as manufactured by Thomas & Betts.

2.02 MATERIALS — FLOOR BOXES, MULTIPLE SERVICE.

A. Shall be electrogalvanized, 14 gauge sheet steel. (Alternate A shall be cast iron).

B. Construction shall be as required by UL 514A.

C. Carpet frame shall be nylon UL Recognized Component QMFZ2.

D. Hinged outer cover shall be reinforced with a ½" steel plate.

2.03 GENERAL DESIGN — FLOOR BOXES, MULTIPLE SERVICE.

A. Shall deliver electric power from one or two duplex receptacles installed below the surface of the floor.

B. Shall deliver telephone or data cable without interference from the electric power delivery.

C. Shall protect delivery of both services by a hinged cover with a retractable opening and foam plastomer dust seal.

D. Hinged cover shall accept carpet or tile to match floor covering and be 180 degrees reversible.

E. Shall have 90 cubic inch total capacity with 24 cubic inch power chambers.

F. Shall accept conduit sizes up to 1½ inches.

G. Shall afford 18 square inches of access with cover open.

H. Box shall be listed by Underwriters Laboratories.

I. When hinged cover is closed and no services in place, device shall have no obstructions above surface of floor.

PART 3: EXECUTION

3.01 GENERAL

A. Locate position for floor boxes and runs of conduit as shown on the plans.

3.02 INSTALLATION

A. Position floor boxes and conduit runs.

B. After concrete pour pull wires and install devices according to manufacturer's recommendations.

C. Activate in accordance with the National Electrical Code®.

D. Coordinate with floor covering contractor to complete installation.

NEC and National Electrical Code are registered trademarks of the National Fire Protection Association, Inc.

Recessed Service Floor Boxes

663-SC Floor Box

- Multiple service floor box that delivers power, communications and data from standard conduit with no exposed service fittings
- Result: Open office planning flexibility
- Ideal for workstations that require power, communications and data service
- Stamped steel, concrete-tight, semi-adjustable
- Electro-galvanized body and hardware
- Shipped complete with expendable cap to prevent ingress of concrete
- Blank- and duplex-face plates can be mounted at either end of the box
- Does not include duplex faceplate; faceplate is included with P-62-CP and P-60-3B cover plates
- Uses P-62 and P-60 Series covers*



663-SC

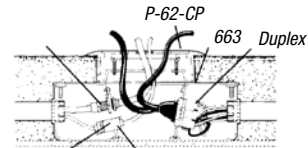

Communications Connector

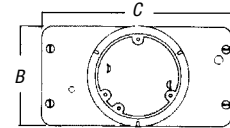
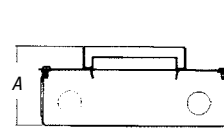

Engineering Data for 663 Series Floor Box



CAT. NO.	DIMENSIONS (IN.)			BEFORE POUR ADJ.	AFTER POUR ADJ.	MAXIMUM CAPACITY (CU. IN.)	CONDUIT KOS	
	A	B	C				SIDES	BOTTOM
663-SC	3 $\frac{5}{8}$	4 $\frac{11}{16}$	8 $\frac{3}{16}$	None	$\frac{3}{4}$ "	25 per gang 90 Total	(2) 1–1 $\frac{1}{4}$ "	None (4) $\frac{3}{4}$ "



CAT. NO.	COVERS AND CARPET PLATES	WIRING DEVICE	STD. CTN.
663-SC	P-62 Series P-60* Series	Duplex and/or Data/Voice	4

*P-62-TAR is required when using P-60 series covers.

Caution: To abandon 663 you must use a P-60 series brass cover plate.

Covers, Carpet Plates and Adjusting Rings for 663 Series

P-60-3B

- Polished brass finish with non-metallic bronze insert
- Plastic insert has one $\frac{7}{8}$ " cutout and two $\frac{1}{2}$ " cutouts
- Furnished complete with sealing gasket, 8-32 x $\frac{7}{16}$ " brass screws and one P-60-Q device plate

- Split cover sections have access notch for screwdriver lift



P-60-3B

P-62-CP

- High-strength polycarbonate
- Furnished with one $\frac{7}{8}$ " cutout and two $\frac{1}{2}$ " cutouts and P-60-Q device plate
- 5 $\frac{1}{16}$ " outside diameter



P-62-CP

P-62-TAR

- Gives $\frac{3}{4}$ " adjustment when mounted on 663 Floor Box
- Accepts P-60-3B, P-60-CP and all P-60 Series cover plates



P-62-TAR

P-60-CP

- Polished-brass finish
- P-62-TAR is required when used on 663 floor box
- 5 $\frac{1}{16}$ " outside diameter



P-60-CP



CAT. NO.	DESCRIPTION	STD. CTN.
P-60-3B* ¹	Brass Cover Plate — Includes 1 P60Q	4
P-62-CP-AS* ²	Polycarbonate Cover and Carpet Plate (charcoal) — Includes 1 P60Q	4
P-62-CP-BRN* ²	Polycarbonate Cover and Carpet Plate (brown) — Includes 1 P60Q	4
P-62-CP-G* ²	Polycarbonate Cover and Carpet Plate (gold) — Includes 1 P60Q	4
P-60-CP	Carpet Plate (polished brass)	4
P-60-CP-AL	Carpet Plate (aluminum)	4
P-62-TAR	Flange and Adjusting Ring for 663 Box (brass)	4
P-62-TAR-AL	Flange and Adjusting Ring for 663 Box (aluminum)	4
P-60-Q	Duplex Receptacle Plate for 663 Floor Box	4
P-60-QB	Blank Plate for 663 Floor Box	4
P-60-Q-GFCI	GFCI Plate for 663 Floor Box	4

* For use as cover only when box is in service.

¹ When not in use, replace P-60-3B Grommet with 697 Plug.

² When not in use, the P-62-CP Series Cover should be replaced by P-60-CP, P-60 and P-62 TAR Series Covers.

Caution: These covers are not to be used in high traffic areas.

For communications accessories, see **page A-140**.

Recessed Service Floor Boxes

Multiple-Service Floor Boxes for Power, Communications and Data: 664 Series

Multiple-service floor boxes deliver power, communications and data from standard conduit with no exposed service fittings. Result: Open office planning flexibility. Ideal for the modern office with workstations that have power, communications and data equipment. Power receptacles and low-voltage connections can be enclosed underfloor in either steel or cast-iron bodies. Galvanized 14-gauge steel boxes are provided with knockouts from 3/4" to 1 1/4" (see engineering data). Cast-iron bodies have threaded openings for 3/4" and 1" conduit.

- Two-compartment box is available in three configurations: stamped steel (664-SC), shallow (664-S) and cast iron (664-CI)
- Durable non-metallic covers include a steel reinforcement plate for added strength
- NEW! Metallic covers in solid brass and aluminum provide aesthetics and durability
- Four leveling screws enable quick leveling to desired concrete depth
- Cover flange self-levels with the finished floor for easy installation

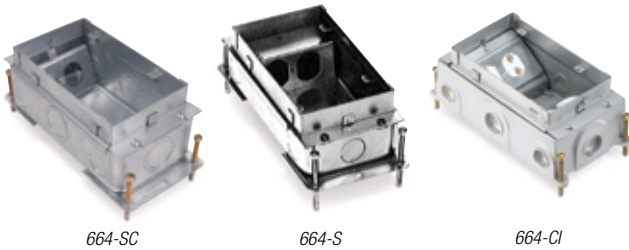
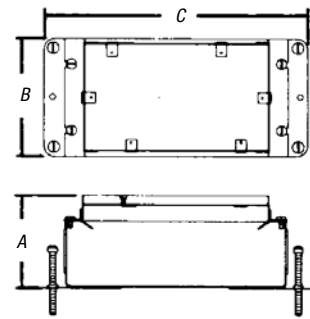

CAT. NO.	DESCRIPTION	STD. CTN.
664-SC	Stamped-Steel Box which Accepts Two Plates, One Duplex Plate Provided	4
664-CI	Cast-Iron Box which Accepts Two Plates, One Duplex Plate Provided	1
664-S	Shallow Stamped-Steel Box which Accepts Two Plates, One Duplex Plate Provided	4

Note: When ordering a 664 Series box, the cover must be ordered separately. See [page A-131](#).

For communications accessories, see [page A-140](#).

Engineering Data for 664 Series

CAT. NO.	DIMENSIONS (IN.)			BEFORE POUR ADJ. (IN.)	AFTER POUR ADJ. (IN.)	MAXIMUM CAPACITY (CU. IN.)	CONDUIT HUBS	CONDUIT KOS		
	A	B	C					SIDES	BOTTOM	COVERS
664-SC	3 3/4	4 11/16	10 1/4	2 1/2	3/4	24 per gang, 90 total	—	(4) 1"–1 1/2" (4) 3/4"	None	664-CST Series
664-CI	3 3/4	5 3/32	9 15/16	2 1/2	3/4	24 per gang, 90 total	(4) 3/4" (4) 1"	—	—	664-CST Series
664-S	2 5/8	4 11/16	10 1/4	1 1/2	3/4	16.5 per gang, 70 total	—	(6) 3/4"	None	664-CST Series

CAUTION: When using the center side KOs, Cat. No. 664-RP must be assembled to the box prior to installing the conduit.



Recessed Service Floor Boxes

Non-Metallic Covers for 664 Series Floor Boxes

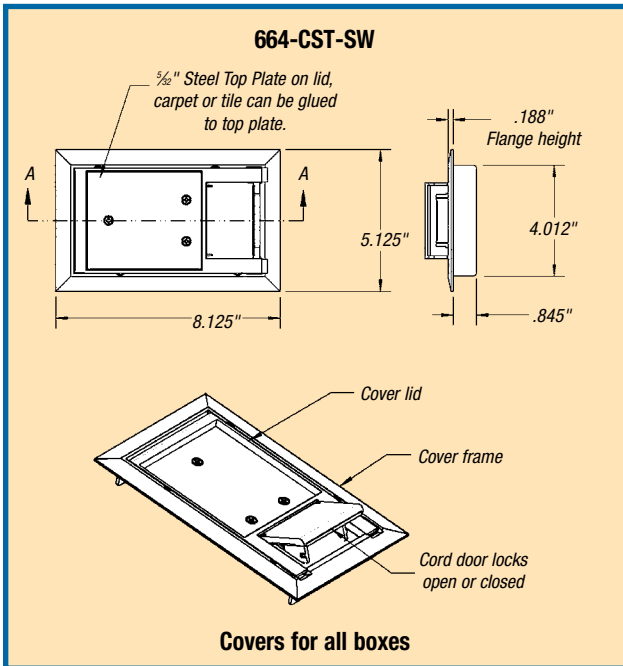

MopTite® covers meet UL scrubwater exclusion requirements for carpet, tile and wood.



CAT. NO.	DESCRIPTION	LOAD RATING	STD. CTN.
664-CST-SW-GRY	Gray Cover	1,500 lbs.	1
664-CST-SW-BRN	Brown Cover	1,500 lbs.	1
664-CST-SW-BGE	Beige Cover	1,500 lbs.	1
664-CST-SW-BLK	Black Cover	1,500 lbs.	1

Material: Polycarbonate with 1/2" steel plate.

Device Plates — 664-S

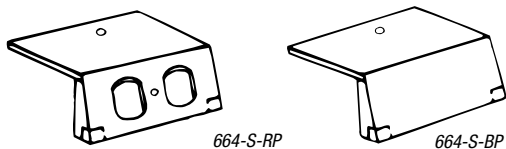

CAT. NO.	DESCRIPTION	STD. CTN.
664-S-RP	Blank Plate for Use with 664-S Floor Box	4
664-S-BP	Blank Plate for Use with 664-S Floor Box	4

Wire Tunnel for 664 Series

- Wire tunnel for protecting electrical connections between the two duplex receptacles when the box is used for power/power application



CAT. NO.	DESCRIPTION	STD. CTN.
664-WT	For Use with 664 and 664-CI Floor Boxes	4
664-S-WT	For Use with 664-S Floor Box	4



Metallic Covers for 664 Series Floor Boxes



664-CST-SW-BRS
Solid Brass

664-CST-SW-ALM
Solid Aluminum

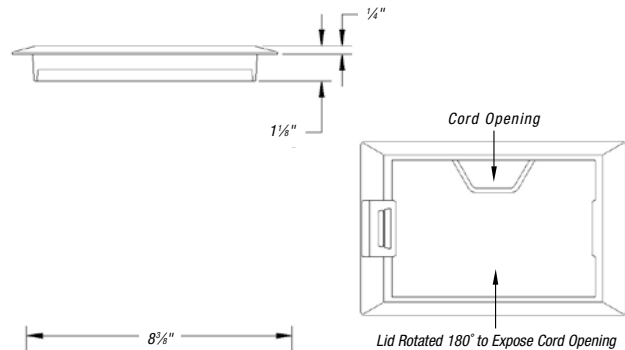

MopTite® covers meet UL scrubwater exclusion requirements for carpet, tile and wood.



CAT. NO.	DESCRIPTION	LOAD RATING	STD. CTN.
664-CST-SW-BRS	Solid Brass Cover for 664 Series Floor Boxes	2,250 lbs.	1
664-CST-SW-ALM	Solid Aluminum Cover for 664 Series Floor Boxes	2,250 lbs.	1

Device Plates — 664-SC & 664-CI

- Duplex receptacle face plate for 664 Series floor box for additional power service
- Does not include duplex receptacle. Can be placed at either end of floor box

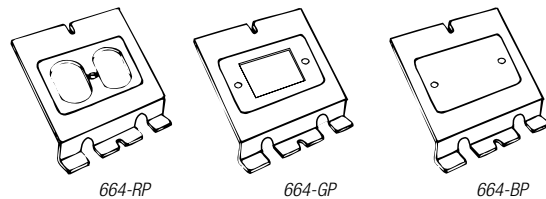

CAT. NO.	DESCRIPTION	STD. CTN.
664-RP	For Use with 664 and 664-CI Floor Boxes	4
664-BP	Blank Plate for Use with 664 & 664-CI Floor Boxes	4
664-GP	GFCI Receptacle Plate	4

CAUTION: When using the center side KOs, all 664 plates must be assembled to the box prior to installing the conduit.

Recessed Service Floor Boxes

665 Series Floor Boxes: 665-SC

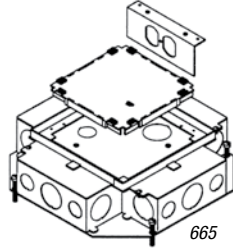

- Four (4) device compartments can accommodate any combination of devices. For example: (3) duplex power devices and (1) duplex telephone device, or (2) voice and data connectors and (1) GFCI device and (1) blank, etc.
- Overall height of 3½" allows for shallow pours when needed
- High-strength polycarbonate cover with a 5/32" steel plate assures structural integrity
- Metallic Covers also available in solid brass and aluminum
- Four-side feed-through allows installer to feed through power or data/comm service from any orientation
- Non-metallic wire tunnels aesthetically clean. Full-width tunnel provides maximum feed-through capacity; non-metallic material prevents conductor damage
- Total access area of 126 cu. in. allows for friendly installation of workstation cables
- Contains 28 knockouts (16–1¼" and 12¾" KOs) that provide increased flexibility when installed
- The 665 line is an extension of the industry-leading 664 Series; our concealed service line now allows the customer to install up to four device panels in one box
- Through the use of a unique non-metallic wire tunnel, the installer can easily partition the power, voice/data requirements
- This UL Listed, stamped-steel floor box can be installed with Thomas & Betts voice and data connector products
- Four 2½" levelling screws provided with all boxes
- Device panels ordered separately

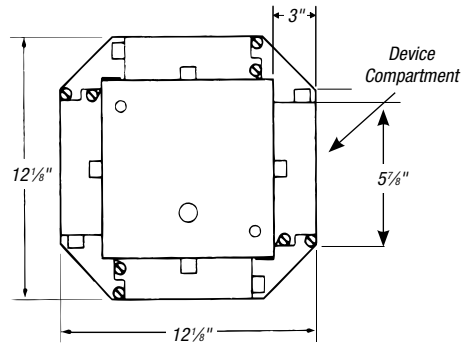

Top View

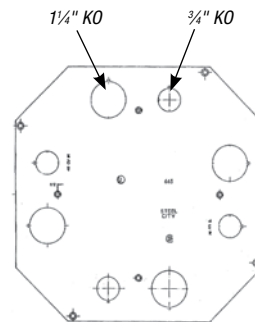

Bottom Plate

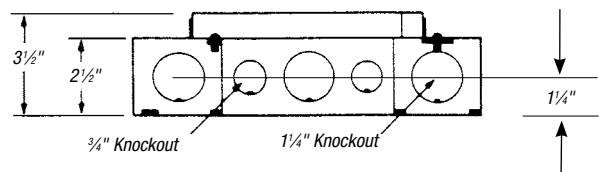

CAT. NO.	DESCRIPTION	DEVICE COMPARTMENTS (IN.)				DEVICE ACCESS AREA	STD. CTN.
		LENGTH	WIDTH	HEIGHT	AREA		
665-SC	Stamped Steel Box	5¾	2¾	2½	40 cu. in.	126 cu. in.	1

665-SC floor box does not include device plates or covers. Order separately (see page A-135).

Material: Pre-Galvanized Steel.

For communication accessories, see page A-140.

Recessed Service Floor Boxes

Cast Iron for Slab-On-Grade Applications

665 Series Floor Boxes: 665-CI

The new Steel City® 665 Cast Iron Floor Box provides a high-capacity power and data solution for ground-floor installations. This 4-gang recessed-service floor box is ideal for slab-on-grade applications. Removable voltage dividers enable users to customize wiring configurations by feeding two or more adjacent compartments with a single conduit. Aesthetic covers feature a recess to accept floor covering to match the surrounding floor.

- 4-gang, recessed service for a high-capacity aesthetic floor-box solution
- Removable voltage dividers between compartments enable a single conduit to feed two or more adjacent compartments
- Heavy-duty, non-metallic covers with steel-reinforcement plates are available in a wide variety of colors to match any decor (black, gray, brown and beige)
- Metallic Covers
- Separate cord door in the cover latches firmly in the open position to prevent damage to cables
- MopTite® covers meet UL scrubwater exclusion requirements for carpet, tile and wood
- Largest cubic-inch capacity of any cast iron recessed 4-gang floor box
- Inline 1 1/4" hubs allow high-capacity straight runs for communicator wiring
- Custom device panels and hub sizes are available — contact technical service about these offerings

Specifications

- Material: Box — Cast Iron
Cover — Polycarbonate with steel reinforcement plate
- Listing: UL and CSA Listed

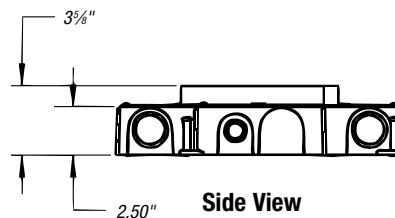
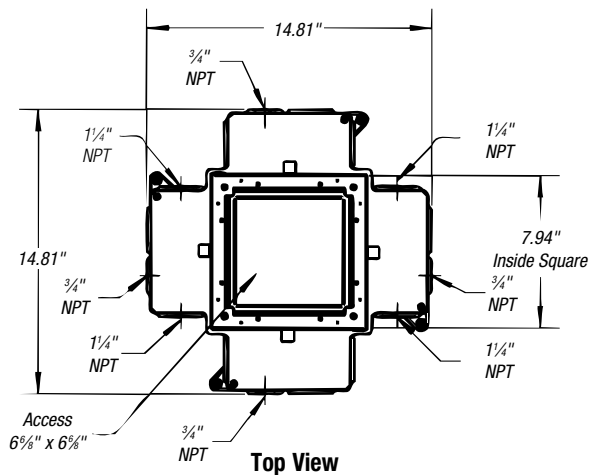
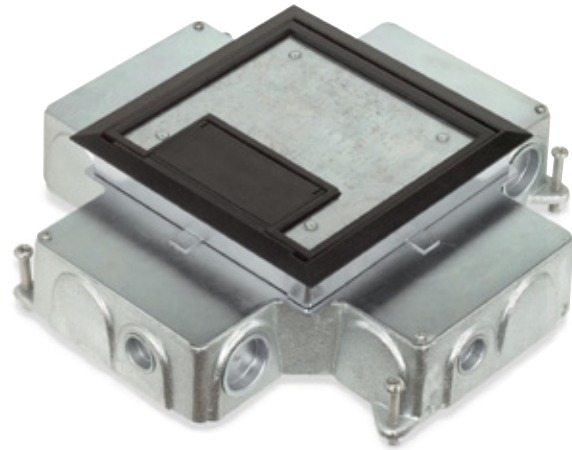

CAT. NO.	DESCRIPTION	DEVICE COMPARTMENTS (IN.)				DEVICE ACCESS AREA	STD. CTN.
		LENGTH	WIDTH	HEIGHT	AREA		
665-CI	Cast Iron Box	5 3/4	3 1/2	2 1/4	45 cu. in.	126 cu. in.	1

665-CI floor box does not include device plates or cover. Order separately. (See page A-135)
Material: Pre-Galvanized Steel.

For communications accessories, see page A-140.

Recessed Service Floor Boxes

2" KOs for Audio Visual Applications

NEW!

665 Series Floor Boxes: 665-AV2

- 2" KOs enable pre-terminated AV cables and connectors to be pulled directly through the conduit
- Accepts standard 665 Series covers and device plates for power, voice, data and audio visual connections
- **NEW!** Rectangular adapters allow voice, data and AV connectors to be mounted in a standard GFCI device plate
- **NEW!** Keystone style voice, data and AV connectors meet a wide range of low-voltage applications. All connectors are recessed for flush mounting in floor box applications
- **NEW!** Device plates are available that accept Extron® MAAP plates to accommodate any AV requirements (Extron® MAAP plates purchased from an authorized Extron distributor)
- **NEW!** Metallic covers provide a durable, aesthetic installation, including industry-exclusive solid brass covers (not painted or plated), aluminum also available



Rectangular adapters and Keystone Inserts for GFCI Device Plates (see page A-140)

CAT. NO.	DESCRIPTION	STD. CTN.
665-AV2	4-Compartment Recessed Service Floor Box with 2" KOs for AV Applications	1
<p><i>665-AV2 floor box does not include device plates or cover. Order separately. (See page A-135)</i> <i>Extron® is a registered trademark of RGB Systems, Inc.</i> <i>For communication accessories, see page A-140</i></p>		

Engineering Information

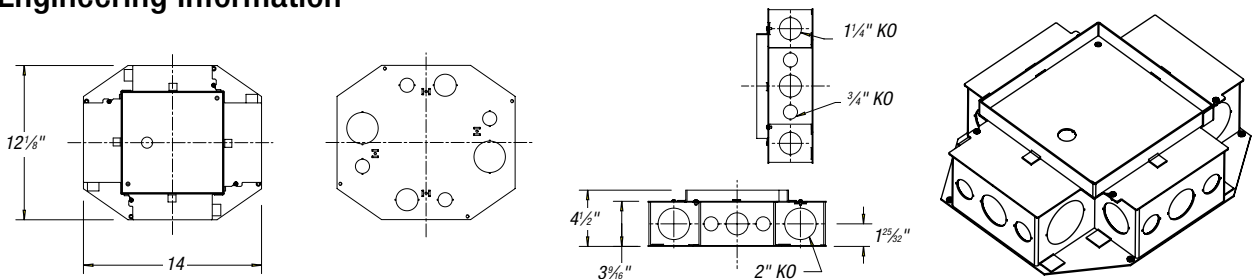

665-AV2 Floor Box Engineering Data

CAT. NO.	BEFORE POUR ADJ. (IN.)	AFTER POUR ADJ. (IN.)	LENGTH (IN.)	COMPARTMENT SIZE & CAPACITY (QTY = 4)			CONDUIT KOS (IN.)	
				WIDTH (IN.)	HEIGHT (IN.)	VOLUME	SIDES	BOTTOM
665-AV2	2 1/2	3/4	(2) 5 3/4	3 3/4	3 3/8	72 cu. in.	(4) 2	(2) 2
			(2) 5 3/4	2 3/4	3 3/8	52 cu. in.	(8) 1 1/4	(2) 1 1/4
							(8) 3/4	(4) 3/4

Recessed Service Floor Boxes

Metallic Covers for 665 Series Floor Boxes



665-CST-SW-BRS
Solid Brass



665-CST-SWR-ALM
Solid Aluminum with Recess for Floor Covering

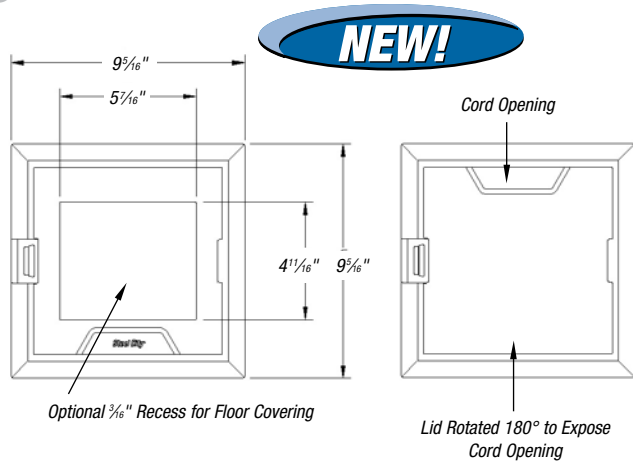

CAT. NO.	DESCRIPTION	LOAD RATING (LBS.)	STD. CTN.
665-CST-SW-BRS	Solid Brass Cover for 665 Series Floor Boxes	1,500	1
665-CST-SWR-BRS	Solid Brass Cover with Recess for Floor Covering, 665 Series	1,500	1
665-CST-SW-ALM	Solid Aluminum Cover for 665 Series Floor Boxes	1,500	1
665-CST-SWR-ALM	Solid Aluminum Cover with Recess for Floor Covering, 665 Series	1,500	1

Non-Metallic Covers for 665 Series Floor Boxes

1/32" Steel Top Plate on Lid. Carpet or Tile can be Glued to Top Plate.

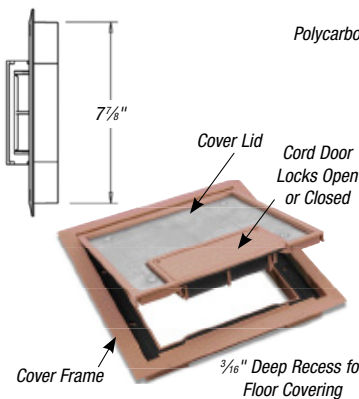
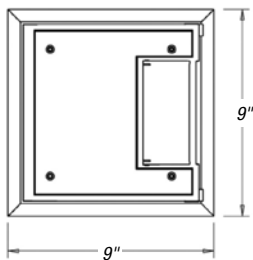

Polycarbonate Flange & Lid

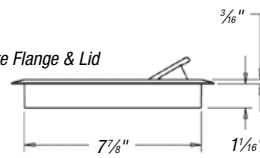

665-CST-SW-BLK
Black Non-Metallic Cover



CAT. NO.	DESCRIPTION	LOAD RATING	STD. CTN.
665-CST-SW-BLK	Non-Metallic Cover for 665 Series Floor Boxes, Black	750 lbs.	1
665-CST-SW-GRY	Non-Metallic Cover for 665 Series Floor Boxes, Gray	750 lbs.	1
665-CST-SW-BGE	Non-Metallic Cover for 665 Series Floor Boxes, Beige	750 lbs.	1
665-CST-SW-BRN	Non-Metallic Cover for 665 Series Floor Boxes, Brown	750 lbs.	1

Material: Polycarbonate with 1/32" steel plate.
Furnished with (4) #8-32 x 3/8" mounting screws.
Contact T&B Technical Service for Color Chip samples.

Device Plates and Accessories for 665 Series Floor Boxes

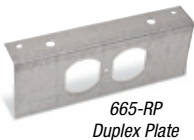

665-RP
Duplex Plate



665-GP
GFCI Plate



665-BP
Blank Plate



665-6RJ
Data Plate for 6
Keystone Jacks

665-WT
Wire Tunnel feeds multiple
compartments from a single
conduit (one included with
each 665-AV2 and 665-SC)

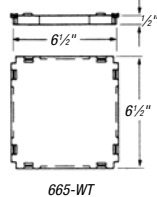
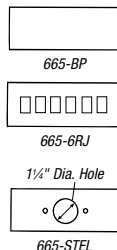
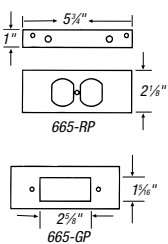

CAT. NO.	DESCRIPTION	STD. CTN.
665-RP	Duplex Plate for 665 Series Floor Boxes	4
665-GP	GFCI Plate for 665 Series Floor Boxes	4
665-BP	Blank Plate for 665 Series Floor Boxes	4
665-6RJ	Data Plate for 665 Series Floor Boxes, Accepts 6 Keystone Jacks	4
665-STEL	Telephone Data Plate for 665 Series Floor Boxes	4
665-WT	Replacement Wire Tunnel for 665-SC & 665-AV2 Floor Boxes	4

Each box requires (4) device plates. Material: Pre-galvanized steel.

Recessed Service Floor Boxes

668-S Ultra-Shallow Floor Box

The new 668-S Ultra-Shallow Floor Box from Thomas & Betts provides a high-capacity power and data solution for shallow concrete floors. The low-profile 4-gang box is constructed of galvanized stamped steel. Removable voltage dividers enable users to customize wiring configurations by feeding two or more adjacent compartments with a single conduit. Metallic covers with durable powder-coat finish are designed to match any decor, while optional trim rings enable covers to be mounted completely flush with the floor in tile or wood floor applications.

- Low profile (2½" height) for shallow concrete pours
- 4-gang, recessed service for a high-capacity, aesthetic floor box solution
- Stamped-steel box construction
- Removable voltage dividers between compartments enable a single conduit to feed two or more adjacent compartments
- Metallic covers feature durable powder-coat paint to match any decor (black, gray, brown and beige)
- Heavy-duty cord door in the cover latches firmly in the open position to prevent damage to cables
- Optional tile trim enables flush mounting for tile and wood floor applications
- MopTite® covers meet UL scrubwater exclusion requirements for carpet, tile and wood
- Largest cubic-inch capacity of any shallow, recessed 4-gang floor box
- Additional KOs (up to 2") on the bottom of the box enable installation flexibility
- Custom device panels are available — contact technical service about these offerings

Specifications

- Material: Box — Galvanized Steel; Cover — Die-Cast Zinc
- Listing: UL and CSA Listed



CAT. NO.	DESCRIPTION	STD. CTN.
668-S	Shallow, Concealed Service Floor Box	1

For covers and device plates, see [page A-137](#).

For communications accessories, see [page A-140](#).

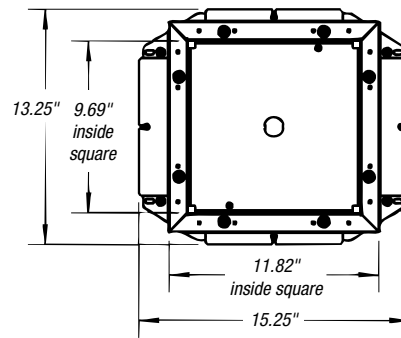

Top View

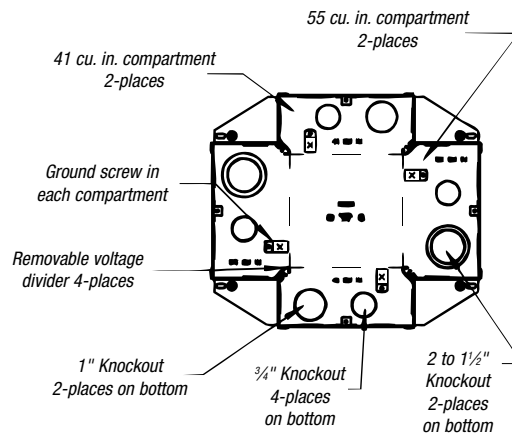

Top View — Compartment Layout

Note: Shown with Top Plate Removed

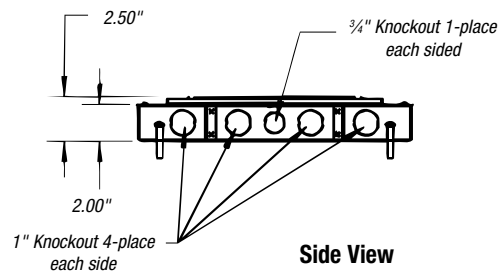

Side View

Recessed Service Floor Boxes

Covers and Tile Trims for 668-S Floor Box

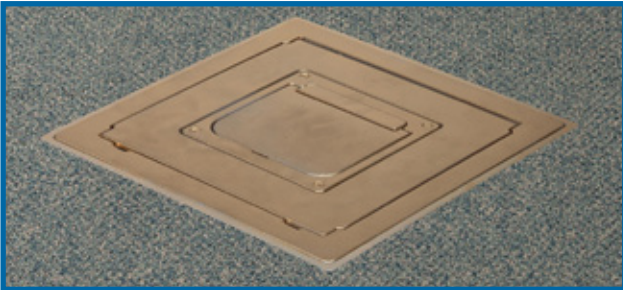

Standard mounting configuration: Flange on cover overlaps carpet, tile or wood floors.



Flush mounting configuration: Optional trim ring allows cover to be mounted flush with tile or wood floors.

Cover

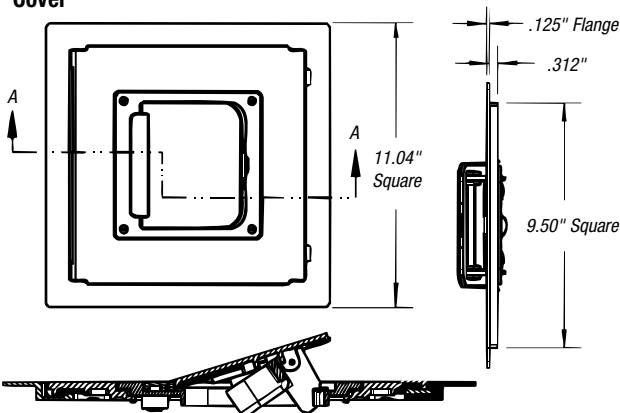

Section A-A

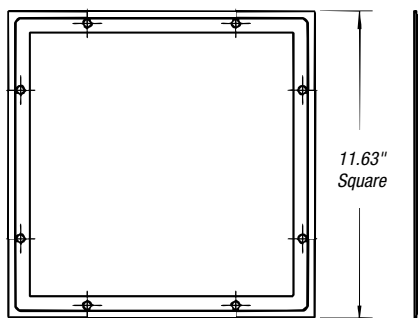

Trim Rings



CAT. NO.	DESCRIPTION	STD. CTN.
668-CST-ALM	668-S Metal Cover — Aluminum Powder Coat	1
668-CST-BRS	668-S Metal Cover — Brass Powder Coat	1
668-CST-BLK	668-S Metal Cover — Black Powder Coat	1
668-CST-BRN	668-S Metal Cover — Brown Powder Coat	1
668-CST-BGE	668-S Metal Cover — Beige Powder Coat	1
668-TRIM-ALM	668-S Trim Ring — Aluminum Powder Coat	4
668-TRIM-BRS	668-S Trim Ring — Brass Powder Coat	4
668-TRIM-BLK	668-S Trim Ring — Black Powder Coat	4
668-TRIM-BRN	668-S Trim Ring — Brown Powder Coat	4
668-TRIM-BGE	668-S Trim Ring — Beige Powder Coat	4

Contact Technical Service for color samples.

Device Plates for 668-S Floor Box



CAT. NO.	DESCRIPTION	STD. CTN.
668-S-1RP	668-S Single-Gang Duplex Plate	1
668-S-1G	668-S Single-Gang GFCI Plate	1
668-S-BP	668-S Blank Plate	1

CAT. NO.	DESCRIPTION	STD. CTN.
668-S-6RJ	668-S Data Plate — 6 Keystone Jacks	1
668-S-6PAN	668-S Data Plate — 6 Panduit® Jacks	1
668-S-6ORT	668-S Data Plate — 6 Ortonics® Jacks	4
668-S-6AVA	668-S Data Plate — 6 Avaya® Jacks	4

Recessed Service Floor Boxes

667-SC Floor Box

- Largest capacity concealed-service floor box on the market
 - Four “double-gangs” allow for two duplex receptacles per gang, for a total of eight receptacles per box
 - Each gang has 40 cu. in. of capacity
 - Box interior has 128 cu. in. of capacity
- Standard box configuration is for up to eight power and/or low-voltage devices
 - Box design allows for feed-through cabling for power and low-voltage conductors
- Shallow design
 - 3" overall height is ideal for renovations and upper level floor installations
- Full line of low-profile covers
 - Utilizes same quality cover as AFM-8 Access Floor Module
 - High-strength polycarbonate
 - Steel reinforced for added durability
 - Two retractable cable exit ports
 - 64 sq. in. opening provides easy access to device panels
 - ¼" recess for carpet/tile insert
 - Available in gray, black, brown and beige
- Box is manufactured with (1) ¾", (3) 1" and (1) 1¼" KOs per gang
 - This includes a 1" and 1¼" KO located in the bottom
- Full complement of device panels
 - Device panels available with one or two duplex openings, one or two GFI openings, six standard “keystone” with Omni 110 bezels and blanks
- Provided with leveling legs and base feet
 - Base feet can be attached to form preventing box movement during concrete pour
 - Leveling legs provide up to 1½" pre-pour adjustment
- Manufactured from 14-gauge pre-galvanized steel
 - Quality construction provides added durability and rust protection
- MopTite® covers meet UL® scrubwater exclusion requirements for carpet, tile and wood

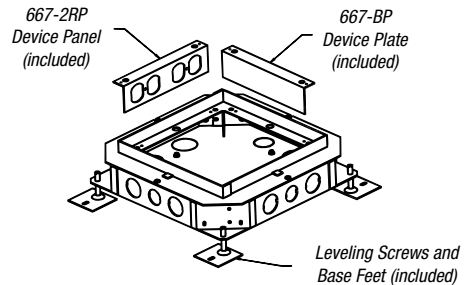
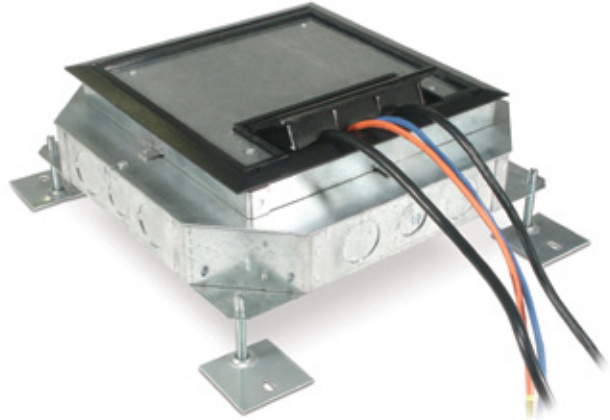

Floor Box Bottom

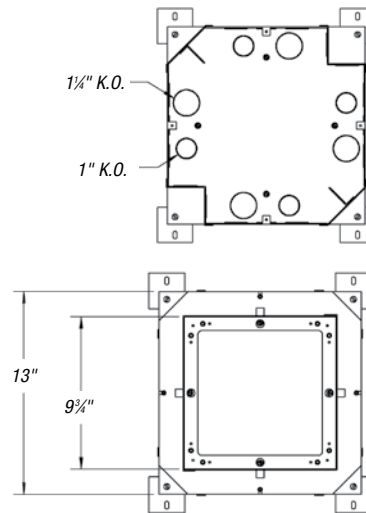

Floor Box Top

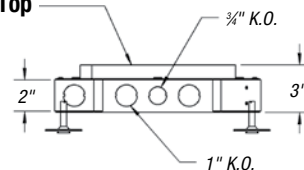

CAT. NO.	DESCRIPTION	STD. CTN.
667-SC	Four-Gang Recessed Floor Box	1

Supplied with (1) 667-2RP for 2 duplex receptacles and (1) 667-BP Blank Plate. For covers and other device plates, see [page A-139](#).

For communications accessories, see [page A-140](#).



Recessed Service Floor Boxes

Covers and Device Plates for 667-SC

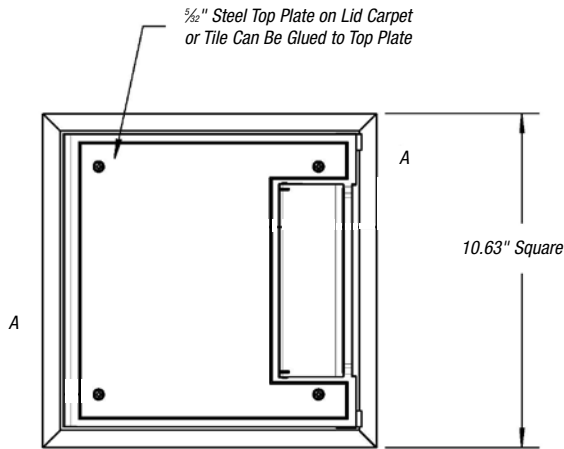

667-CST-SW-XXX

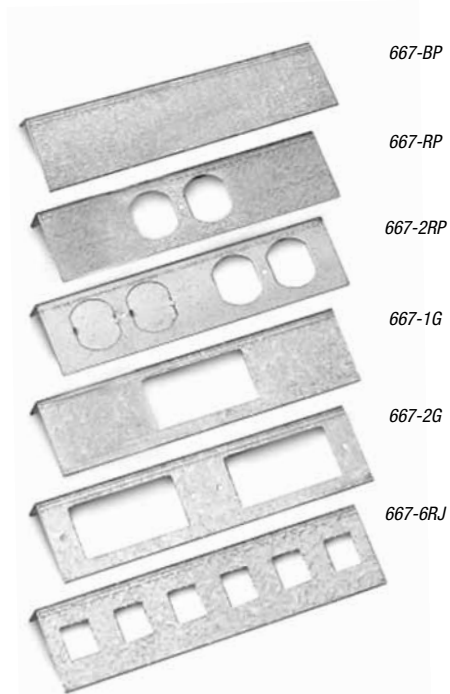
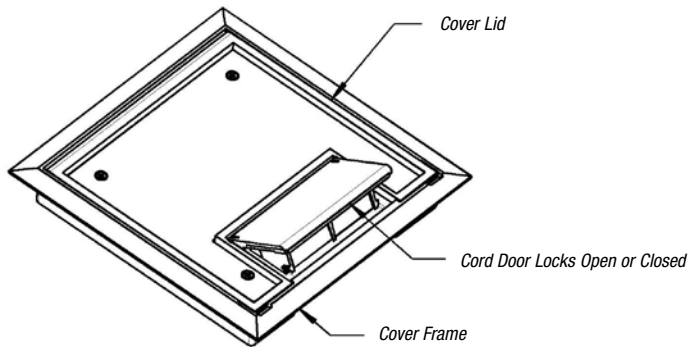
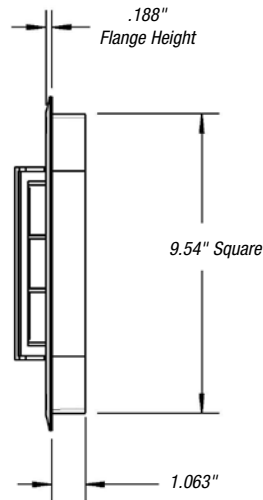

CAT. NO.	DESCRIPTION	STD. CTN.
667-BP*	Blank Device Panel	4
667-RP	Single Duplex Receptacle Plate	4
667-2RP*	Device Panel for 2 Duplex Receptacles with Duplex KOs	4
667-1G	Device Panel for 1 GFCI Receptacle	4
667-2G	Device Panel for 2 GFCI Receptacles	4
667-6RJ**	Device Panel for 6 Keystone Data Jacks	4
667-CST-SW-GRY	Cover and Flange — Gray	4
667-CST-SW-BLK	Cover and Flange — Black	4
667-CST-SW-BRN	Cover and Flange — Brown	4
667-CST-SW-BGE	Cover and Flange — Beige	4

**For data connectors and adapters, see page A-140.

New MopTite® Covers exceed UL® scrubwater exclusion requirements.

Recessed Service Floor Boxes

Communication Accessories

Rectangular/Duplex Adapters

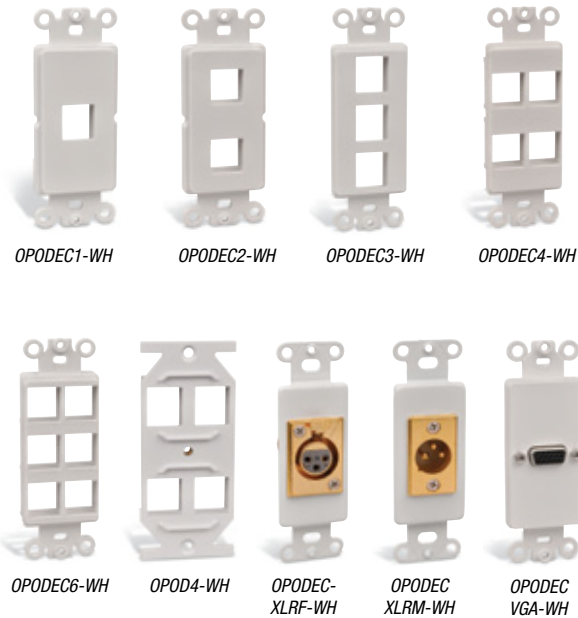

Rectangular/Duplex Adapters for Use with Standard Floor Box Device Plates

CAT. NO.	DESCRIPTION	STD. CTN.
OPODEC1-WH	Rectangular Adapters for GFCI Device Plate, 1-Port, Keystone, White	5
OPODEC2-WH	Rectangular Adapters for GFCI Device Plate, 2-Port, Keystone, White	5
OPODEC3-WH	Rectangular Adapters for GFCI Device Plate, 3-Port, Keystone, White	5
OPODEC4-WH	Rectangular Adapters for GFCI Device Plate, 4-Port, Keystone, White	5
OPODEC6-WH	Rectangular Adapters for GFCI Device Plate, 6-Port, Keystone, White	5
OPOD4-WH	Duplex Adapter, 4-Port, Keystone, White	10
OPODEC-XLRF-WH	Rectangular Adapters, Female XLR Microphone Jack, Solder Leads, White	5
OPODEC-XLRM-WH	Rectangular Adapters, Male XLR Microphone Jack, Solder Leads, White	5
OPODEC-VGA-WH	Rectangular Adapters, VGA Connector, Female-to-Female, White	5

Keystone Inserts



Keystone Inserts for Data, Voice and Audio Visual Applications

CAT. NO.	DESCRIPTION	STD. CTN.
OPJDU5EL-WH	CAT5e Data Jack, Keystone, White	5
OPJU6L-WH	CAT6 Data Jack, Keystone, White	5
OPJV6CL-WH	Phone Jack, 6-Conductor, Keystone, White	5
OPA35-WH*	3.5mm Stereo Connector, Recessed, Keystone, Female-to-Female, White	5
OPARCAW*	RCA Connector — White, Recessed, Keystone, Female-to-Female	5
OPARCAR*	RCA Connector — Red, Recessed, Keystone, Female-to-Female	5
OPARCAY*	RCA Connector — Yellow, Recessed, Keystone, Female-to-Female	5
OPAFR*	F-Connector, Recessed, Keystone, 1 GHz, Female-to-Female, Red	5
OPAS-WH	S-Video Connector, 4-Pin, Recessed, Keystone, Female-to-Female, White	5
OPAHDMI-WH	HDMI Connector, Recessed, Keystone, Female-to-Female, White	5
OPAB-WH	Blank Insert, Keystone, White	25

***Special Installation Note:** When using these AV connectors with OPODEC4-WH & OPODEC6-WH Rectangular Adapters, only a Blank Insert (OPAB-WH) can be used in the same horizontal row. Trim the ears off one side of the Blank Insert and install prior to installing the AV connector in the row.

Recessed Service Floor Boxes

68R Recessed Covers

Plug in power and communication cords, and then close the lid to hide unsightly plugs and receptacles below the floor!

- Unique cover provides aesthetic recessed service with cost-effective box options for concrete, wood sub-floor and raised-floor applications
- Lid can be rotated to expose a small opening for cords, enabling the lid to close flush with the floor while in use
- Cover accepts one duplex or GFCI receptacle — no special device plates required (receptacle purchased separately)
- Cover accepts up to two communications jacks — includes one 2-port keystone data plate and one blank data plate for custom cut-outs or power-only applications (communications jacks purchased separately)
- Non-metallic covers are available in black, gray, beige and brown. Black covers are available with an optional brass or aluminum flange
- Two set screws lock the cover in place — no gluing required



Use a Steel City® Round PVC Floor Box, catalog number 68-P (purchased separately) See page A-150



Use an appropriate Steel City® 3" x 2" Metal Switch Box with mounting ears (purchased separately). See pages A-19-22

NEW!

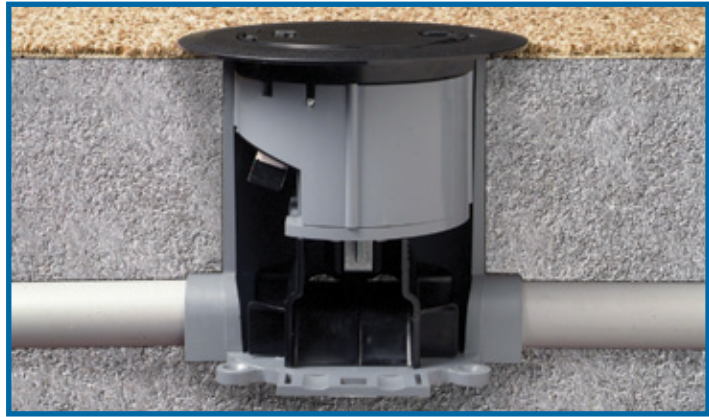

Concrete applications



Wood sub-floor/raised floor applications



Lid closes flush with the floor, even with cords plugged in.

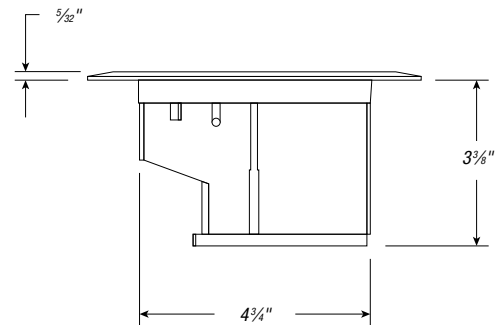
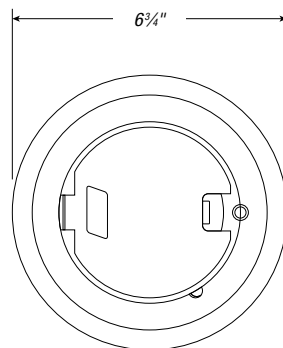

Recessed Service Floor Boxes

68R Recessed Covers (continued)

Cover kit includes:

- Cover assembly
- Receptacle mounting plate
- Duplex receptacle insert
- 2-port keystone data plate
- Blank data plate
- Voltage divider

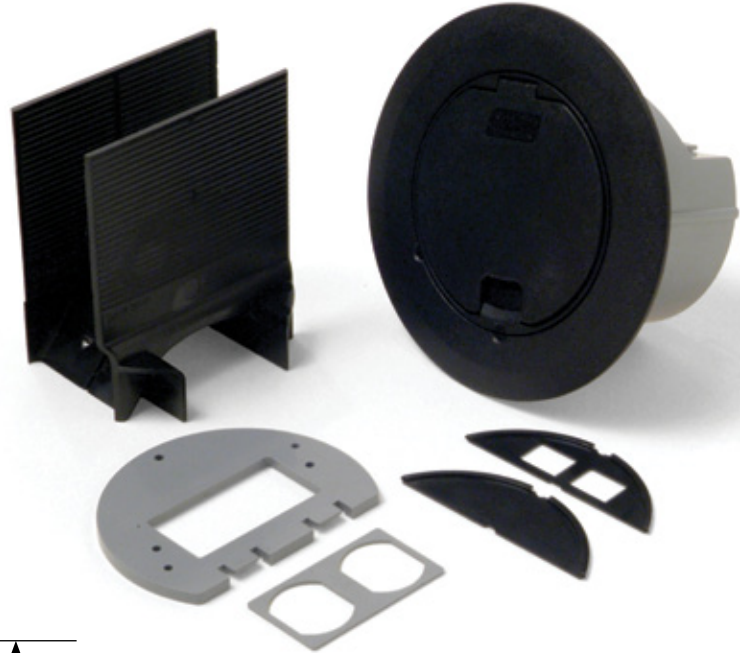

Technical Information

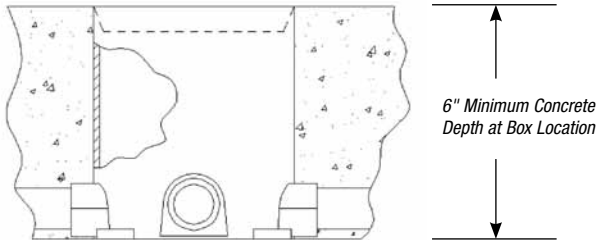

Important Application Note:

When using the 68R Recessed Cover with the 68-P floor box for concrete applications, the entire box depth (6") is required. Prior to concrete pour, level the top of the box with the screed line of the concrete.



Power and Communications

CAT. NO.	DESCRIPTION	STD. CTN.
68R-CST-BLK	Non-Metallic Recessed Floor Box Cover Kit, Black	4
68R-CST-GRY	Non-Metallic Recessed Floor Box Cover Kit, Gray	4
68R-CST-BGE	Non-Metallic Recessed Floor Box Cover Kit, Beige	4
68R-CST-BRN	Non-Metallic Recessed Floor Box Cover Kit, Brown	4
68R-CST-BRS	Non-Metallic Recessed Floor Box Cover Kit, Black with Brass Flange	4
68R-CST-ALM	Non-Metallic Recessed Floor Box Cover Kit, Black with Aluminum Flange	4
68-P	Round PVC Floor Box for Concrete Applications	8
CXWOW	3" x 2" Metal Switch Box, 3½" Deep, for Non-Metallic Sheathed Cable, Wood Subfloors	25
CY 1/2	3" x 2" Metal Switch Box, 3½" Deep, ½" KOs	25

Flush Service Floor Boxes

Innovative 3-Gang Round Floor Box for Power, Data and AV.

Round Floor Boxes for Power and Communications: 68-HP Series



Unmatched Flexibility to configure any combination of power and communications devices

- Accepts standard devices from any manufacturer, including duplex, GFCI, locking, hospital grade or isolated ground receptacles
- Accommodates a wide variety of multi-media devices through the use of rectangular adapters

Combines the Capacity of a 3-gang box with the Affordability of a round non-metallic floor box

- 6" diameter round non-metallic floor box — the largest in the industry
- Large inline hubs for power and data wiring: 1" for power, 1½" for data



No leveling, gluing or aligning for an Easy Installation

- No wasted time leveling the box before the concrete is poured — simply cut the box at the appropriate height after the pour
- No gluing — stainless steel retention bars secure the mounting frame to the box
- Round design — no need to align the box with walls during installation



Stainless Steel Barbs

Easy-to-Use Covers Made of Durable solid brass and aluminum

- Stands up to heavy carts, cleaning equipment, and general floor traffic
- Convenient slide latch provides tool-less access to devices
- Lid lies flat while in use to minimize obstructions above floor level



Furniture-Feed and Cast Iron options for a Comprehensive floor box solution

- Dual-voltage furniture-feed covers transition power and communications wiring from the floor into modular furniture
- Cast iron box with a non-metallic collar for slab-on-grade or metallic conduit applications



1" Hub for Power,
1½" Hub for Data



Slide Latch for Tool-less Access

Flush Service Floor Boxes

68-HP Floor Boxes (continued)



68-HP
6" Round Non-Metallic
Floor Box



68-HP-CI
Cast Iron Floor Box with 6" Round
Non-Metallic Collar

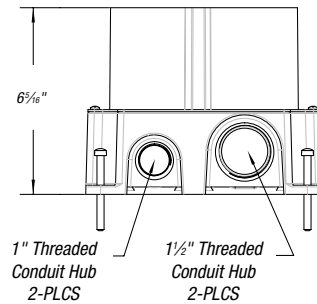
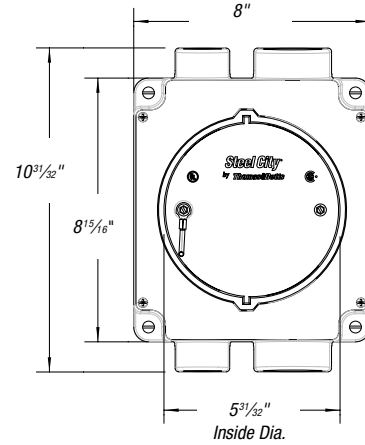
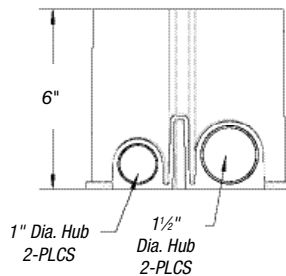
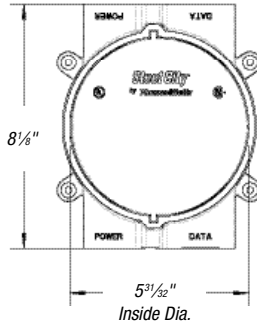

MINIMUM CONCRETE DEPTH

CAT. NO.	DESCRIPTION	FLUSH	FURNITURE FEED	STANDARD PACK QTY.
68-HP	6" Round Non-Metallic Floor Box	4"	3 1/2"	4
68-HP-CI	Cast Iron Floor Box with 6" Round Non-Metallic Collar	4 1/2"	4"	1

Flush Covers for 68-HP Series

- Slide latch for tool-less access to devices
- Lid lies flat when box is in use
- Requires Flush Mounting Kit (Cat. No. 68-HP-FMK) to mount cover (see page A-145)

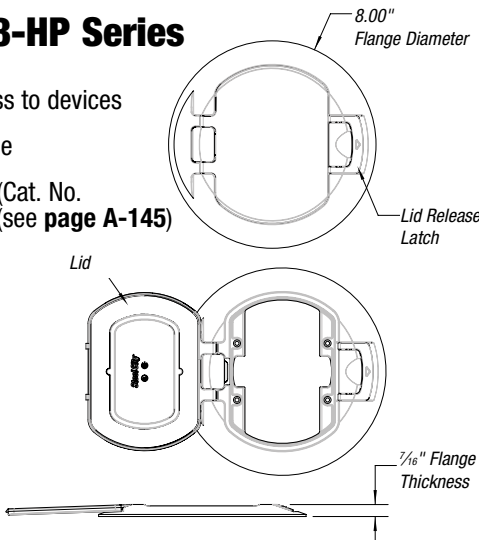

68-HP-FC-ALM
Solid brass cover
with brushed finish

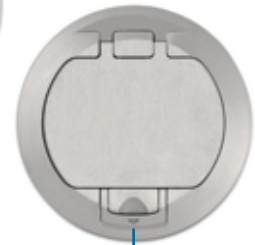

Pull slide latch to release lid



CAT. NO.	DESCRIPTION	STD. PACK QTY.
68-HP-FC-ALM	Flush Cover — Solid Aluminum with Brushed Finish, 1,000 lb. Load Rating	4
68-HP-FC-BRS	Flush Cover — Solid Brass with Brushed Finish, 1,500 lb. Load Rating	4
68-HP-FC-BLK	Flush Cover — Solid Aluminum with Black Powder-Coated Finish, 1,000 lb. Load Rating	4

Flush Service Floor Boxes

Flush Mounting Kit and Accessories for 68-HP Series

- Flush Mounting Kit required in order to mount devices and covers to the 68-HP Series floor box
- Stainless steel barbs — no gluing required
- Includes (3) compartments for standard devices
- Voltage dividers allow any combination of power and communications devices
- Each compartment includes (1) knockout for power and (1) knockout for data for access to either power or communications wiring

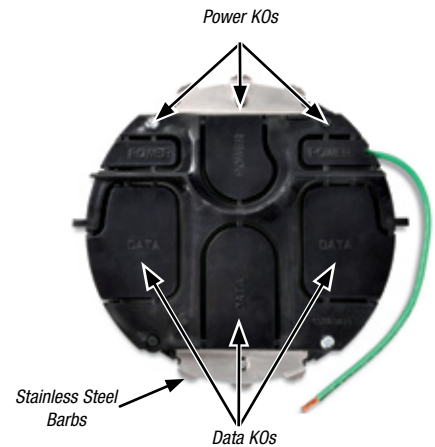

Boxes & Covers — Steel City® Floor Boxes

Kit Includes:

- Mounting Frame
- Voltage Divider
- (3) Device Plates
 - (1) Center Plate: GFCI/Rectangular
 - (2) Side Plates: Rectangular
- (3) Duplex Inserts

68-HP-FMK
Flush Mounting Kit

Optional Accessories

Device Plates

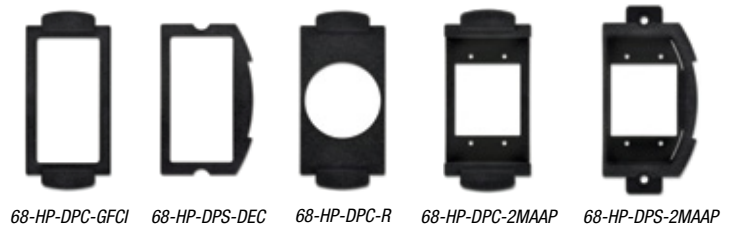

Regular Inserts

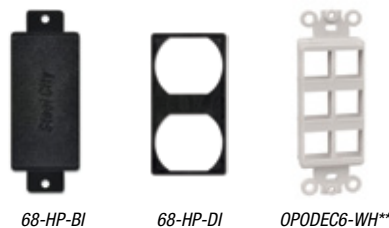

Extron® AV Plate

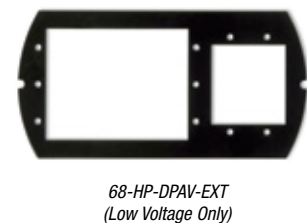

CAT. NO.	DESCRIPTION	STD. PACK QTY.
68-HP-FMK	Mounting Kit for Flush Covers	4
68-HP-DPC-GFCI	Center Device Plate — GFCI/Rectangular Receptacle	10
68-HP-DPS-DEC	Side Device Plate — Rectangular Receptacle	10
68-HP-DPC-R	Center Device Plate — Single Round Receptacle, 1½" Opening	10
68-HP-DPC-2MAAP	Center Device Plate — 2 Extron® MAAP Plates*	10
68-HP-DPS-2MAAP	Side Device Plate — 2 Extron® MAAP Plates*	10
68-HP-BI	Rectangular Insert — Blank (for unused compartments)	10
68-HP-DI	Rectangular Insert — Duplex Receptacle	10
OPODEC6-WH	Rectangular Adapter for GFCI/Rectangular Device Plate — 6-Port Data, Keystone, White**	5
68-HP-DPAV-EXT	Extron® AV Plate — 3 AAP Plates, 2 MAAP Plates*	1

* Extron® MAAP Plates purchased from an authorized Extron® distributor. Extron® is a registered trademark of RGB Systems, Incorporated.
 ** Additional rectangular adapters available for low voltage applications — see Communications Accessories on page A-140.

Flush Service Floor Boxes

Furniture Feed Covers and Mounting Kit for 68-HP Series

- Dual-voltage covers for feeding power and communications wiring to modular furniture
- Furniture Feed Mounting Kit required to mount covers to 68-HP Series floor box



68-HP-FFC-ALM
Solid aluminum cover
with brushed finish



68-HP-FFC-BRS
Aluminum cover
with brushed finish



68-HP-FFC-BLK
Aluminum cover
with powder-coated black finish

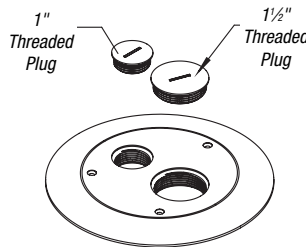
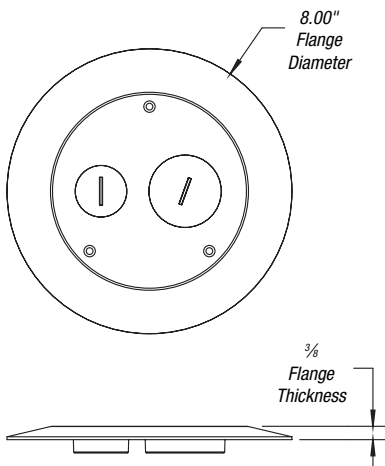

68-HP-FFMK
Furniture Feed Mounting Kit



CAT. NO.	DESCRIPTION	STANDARD PACK QTY.
68-HP-FFC-ALM	Furniture Feed Cover — Solid Aluminum with Brushed Finish	4
68-HP-FFC-BRS	Furniture Feed Cover — Solid Brass with Brushed Finish	4
68-HP-FFC-BLK	Furniture Feed Cover — Solid Aluminum with Black Powder-Coated Finish	4
68-HP-FFMK	Mounting Kit for Furniture Feed Covers	4

Flush Service Floor Boxes

Round Floor Boxes for Power or Communications: 68 and 600 Series

68 and 600 Series Floor Boxes provide flush service for power or communications/data.
68 and 600 Series Floor Boxes can be used for carpet or tile applications.



Features — 68 Series

- **Stamped steel**, concrete-tight, fully adjustable
- Electro-galvanized body and hardware
- Interior and exterior leveling screws permit adjustment to meet finished floor
- Shipped complete with expendable cap to prevent ingress of concrete during pour ½", ¾" and 1" knockouts — all bottom knockouts are accessible
- Uses P60 Series MopTite® covers and carpet plate
- For brushed aluminum, add AL after catalog number



68-D

CAT. NO.	DESCRIPTION	STD. CTN.
68-D	Stamped-Steel Floor Box, Deep	4
68-D-AL	Stamped-Steel with Aluminum Trim Ring, Deep	4
68-S	Stamped-Steel Floor Box, Shallow	4
68-S-AL	Stamped-Steel with Aluminum Trim Ring, Shallow	4

Features — 600 Series

- **Cast iron**, watertight body, fully adjustable
- Painted silver enamel inside and out for additional corrosion resistance
- Interior and exterior leveling screws permit adjustment to meet finished floor
- Shipped complete with expendable cap to prevent ingress of concrete during pour
- ¾" threaded conduit openings are standard
- Uses P60 Series MopTite® covers and carpet plate
- For brushed aluminum, add AL after catalog number

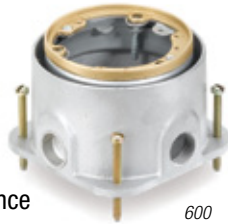

600



CAT. NO.	DESCRIPTION	STD. CTN.
600-SC	Cast-Iron Floor Box ¾" Conduit Tapping	4
600-AL-SC	Cast-Iron Floor Box ¾" Conduit Tapping with Aluminum Trim Ring	4
600-1-SC	Cast-Iron Floor Box 1" Conduit Tapping	4
600-2-SC	Cast-Iron Floor Box 2" Conduit Tapping	4
601-1/2-SC	Cast-Iron Floor Box ½" Conduit Tapping	4
601-AL-SC	Cast-Iron Floor Box ¾" Conduit Tapping with Aluminum Trim Ring	4
601-SC	Cast-Iron Floor Box ¾" Conduit Tapping	4
601-1	Cast-Iron Floor Box 1" Conduit Tapping	4
601-1-1/4	Cast-Iron Floor Box 1¼" Conduit Tapping	4
602-SC	Cast-Iron Floor Box ¾" Conduit Tapping	4
602-AL-SC	Cast-Iron Floor Box ¾" Conduit Tapping with Aluminum Trim Ring	4
602-1	Cast-Iron Floor Box 1" Conduit Tapping	4
603-SC	Cast-Iron Floor Box ¾" Conduit Tapping	4
603-AL-SC	Cast-Iron Floor Box ¾" Conduit Tapping with Aluminum Trim Ring	4
604-SC	Cast-Iron Floor Box ¾" Conduit Tapping	4
604-AL-SC	Cast-Iron Floor Box ¾" Conduit Tapping with Aluminum Trim Ring	4

P-60 Covers sold separately.



601



602

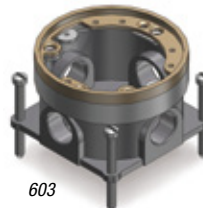

603

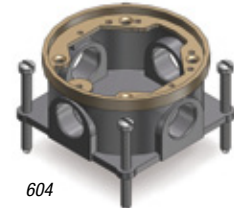

604

Flush Service Floor Boxes

Engineering Data — 68 and 600 Series



CAT. NO.	DIMENSIONS (IN.)			BEFORE POUR ADJ. (IN.)	AFTER POUR ADJ. (IN.)	MAXIMUM CAPACITY KOS (CU. IN.)	CONDUIT HUBS	CONDUIT KOS (IN.)	
	A	B	C					SIDES	BOTTOM
68-D	4¼	3¾	4⅛	2½	½	60	—	(4) ¾ (4) 1	(2) ½ (2) ¾
68-S	4¼	2¾	4⅛	1½	½	47	—	(4) ¾	(2) ¾
600-SC	4¼	4¼	5⅞	2½	1⅞	64	¾	—	—
600-1-SC	4¼	4¼	5⅞	2½	1⅞	64	1	—	—
600-11/4	4¼	4¼	5⅞	2½	1⅞	64	1¼	—	—
600-2-SC	4¼	4¼	5⅞	2½	1⅞	64	2	—	—
601-SC	4¼	3⅞	5⅞	2½	1⅞	56	¾	—	—
601-1	4¼	3⅞	5⅞	2½	1⅞	56	1	—	—
601-11/4	4¼	3⅞	5⅞	2½	1⅞	56	1¼	—	—
602-SC	4¼	3⅜	4	2½	1⅞	36	¾	—	—
602-1	4¼	3⅜	4	2½	1⅞	36	¾	—	—
603-SC	4¼	2½	4	2½	1⅞	27	¾	—	—
604-SC	4¼	2	4	1½	—	15	¾	—	—

Use P60 Series covers and carpet plates.

Wiring Device: Duplex, single or voice/data plates.



600-SC



68-D

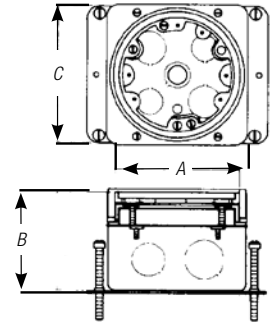

MopTite® Carpet Plates for 68 and 600 Series

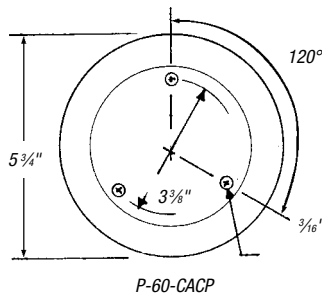

P-60-CACP



CAT. NO.	DESCRIPTION	STD. CTN.
P-60-CP	Brass Carpet Plate, 5⅞" Diameter	4
P-60-CPAL	Aluminum Carpet Plate	4
P-60-LCP	Polycarbonate Carpet Plate, 5⅞" Diameter	4
P-60-CACP	Brass One-Piece Carpet Cover Plate	4
P-60-CACP-AL	Aluminum One-Piece Carpet	4
P-60-3/4-2-CACP	Brass One-Piece Carpet Plate with ¾"-2" Plugs	4
P60-3/4-2-CACP-AL	Aluminum One-Piece Carpet Plate with ¾"-2" Plugs	4
P60-CACP-GFCI	Brass One-Piece Carpet Plate for GFCI Devices	4
P60-CACP-GFCI-AL	Aluminum One-Piece Carpet Plate for GFCI Devices	4

New MopTite® Covers exceed UL® scrubwater exclusion requirements.



P-60-3/4-2-CACP

- Polished brass finish
- Integrated carpet plate and ¾"-2" floor plate in one unit
- Furnished complete with sealing gasket and 8-32 x 1" brass screws
- 5¾" outside diameter



P-60-CP

- Polished brass finish
- Furnished complete with 8-32 x 1" brass screws
- For brushed aluminum, add AL after catalog number



P-60-LCP

- Translucent polycarbonate
- Textured finish



P-60-CACP

- Polished-brass finish
- Integrated carpet plate and duplex floor plate in one unit



P-60-CACP-GFCI

- Furnished complete with sealing gasket and 8-32 x 1" brass screws
- 5¾" outside diameter

Flush Service Floor Boxes

MopTite® Cover Plates for 68 and 600 Series

- Polished finish
- Furnished complete with sealing gasket and 8-32 x 7/16" brass screws
- 4" outside diameter
- For brushed aluminum, add AL after catalog number

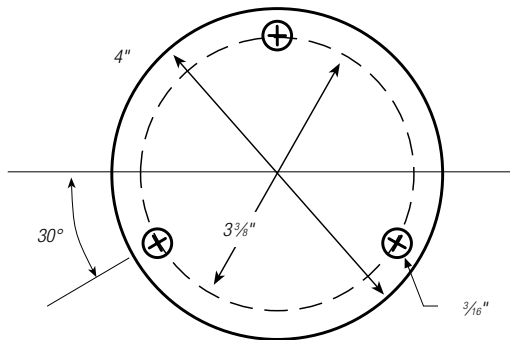

* Also includes steel seating plate for receptacles.



CAT. NO.	DESCRIPTION	STD. CTN.
P-60-1/2	Brass Cover Plate 1/2" NPS Plug Size	4
P-60-1/2-AL	Aluminum Cover Plate 1/2" NPS Plug Size	4
P-60-3/4	Brass Cover Plate 3/4" NPS Plug Size	4
P-60-3/4-AL	Aluminum Cover Plate 3/4" NPS Plug Size	4
P-60-1	Brass Cover Plate 1" NPS Plug Size	4
P-60-1-AL	Aluminum Cover Plate 1" NPS Plug Size	4
P-60-1-1/4	Brass Cover Plate 1 1/4" NPS Plug Size	4
P-60-1-1/4-AL	Aluminum Cover Plate 1 1/4" NPS Plug Size	4
P-60-2	Brass Cover Plate 2" Diameter Plug Size	4
P-60-2-AL	Aluminum Cover Plate 2" Diameter Plug Size	4
P-60-2-5/8	Brass Cover Plate 2 5/8" Diameter Plug Size	4
P-60-2-5/8-AL	Aluminum Cover Plate 2 5/8" Diameter Plug Size	4
P-60-1/2-2	Brass Cover Plate 1/2"-2" Diameter Plug Size	4
P-60-1/2-2-AL	Aluminum Cover Plate 1/2"-2" Diameter Plug Size	4
P-60-3/4-2	Brass Cover Plate 3/4"-2" Diameter Plug Size	4
P-60-3/4-2-AL	Aluminum Cover Plate 3/4"-2" Diameter Plug Size	4
P-60-DR	Brass Cover with Duplex Lift Lid	4
P-60-DR-AL	Aluminum Cover with Duplex Lift Lid	4
P-60-DS	Brass Cover for Duplex with Individual Lift Lids	4
P-60-DS-AL	Aluminum Cover for Duplex with Individual Lift Lids	4
P-60-DU	Brass Cover Plate with Two 1 1/16" Plugs for Duplex	4
P-60-DU-AL	Aluminum cover with Two 1 1/16" Plugs for Duplex	4
P-60-GFCI	Brass Cover Plate for GFCI Devices	4
P-60-GFCI-AL	Aluminum Cover Plate for GFCI Devices	4

68P-FL or 68P-FL-AL required to attach cover plates to 68-P floor box.

New MopTite® Covers exceed UL® watertight requirements for 514A, 514C.

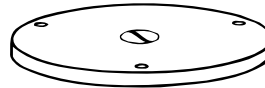

P-60-1/2
1/2" N.P.S. Plug Size

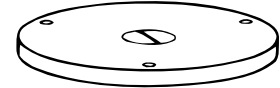

P-60-3/4
3/4" N.P.S. Plug Size



P-60-1
1" N.P.S. Plug Size



P-60-1-1/4
1 1/4" N.P.S. Plug Size



P-60-2*
2" dia. Plug Size



P-60-2-5/8*
2 5/8" dia. Plug Size



P-60-1/2-2*
1/2" & 2" dia. Plug Size



P-60-3/4-2*
3/4" & 2" dia. Plug Size

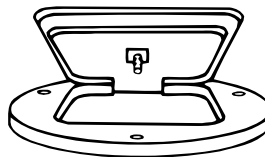

P-60-DR*
Duplex Lift Lid



P-60-DU*
Duplex 1 1/16" Plugs



P-60-DS*
Hinged Lift Lids

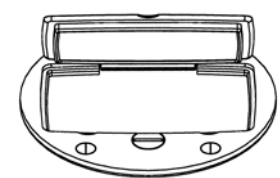

P-60-GFCI*

Flush Service Floor Boxes

68-P Round Non-Metallic Floor Box

The 68-P floor box provides flush service for power or communications and data. The non-metallic floor box is used in concrete floors and is suitable for carpet, tile or wood applications.

- High-strength rigid PVC construction, non-corrosive
- Easy installation with no leveling required — just cut the box level with the concrete after the pour
- Compatible with standard-schedule PVC conduit (1", 3/4" and 1/2", reducers included)
- Pre-packaged with concrete cap and six hub plugs

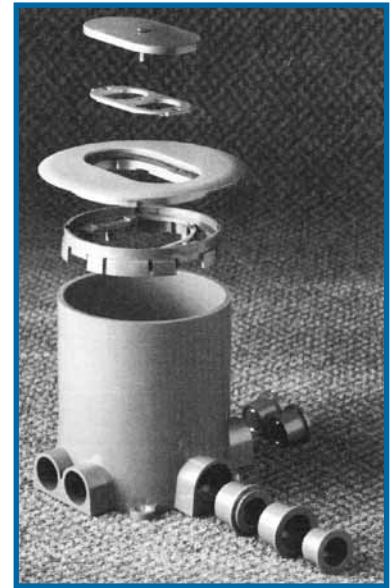
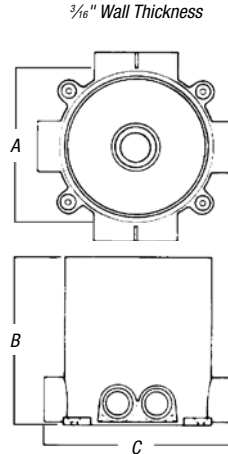

CAT. NO.	DIMENSIONS (IN.)			AFTER POUR ADJ.	MAXIMUM CAPACITY (CU. IN.)	STANDARD CONDUIT TAPPING	COVERS AND CARPET PLATES	WIRING DEVICE	STD. CTN.
	A	B	C						
68-P	5 7/8	6	6 5/8	None	100	(4) 3/4"	P60	Single	8
						(2) 1"	P68 series	duplex or data/voice	

Minimum pour 3 inches.

Cubic in. capacity is 17 cubic inches per inch of box height.

Note: Must use 68-PAR to attach cover plates to 68-P floor box.



68-P

Adjusting Ring for 68-P Floor Box

- Non-metallic adjusting ring includes pigtail and clips



CAT. NO.	DESCRIPTION	STD. CTN.
68-PAR	Non-Metallic Adjusting Ring	8

Required to mount P60 and P68 Series covers to 68P floor box (not needed for dual-voltage kits).



68-PAR

Metallic Tile Trims for 68-P Floor Box

- Tile trim rings are available in brass or aluminum for flush installation of metallic plates in linoleum, wood or carpeted floors. Must be used to mount P60 series plates. (Not required for P-68 covers, P60-CACP or P60-3/4-2-CACP)



CAT. NO.	DESCRIPTION	STD. CTN.
68P-FL	Tile Trim Ring, Brass	4
68P-FL-AL	Tile Trim Ring, Aluminum	4

Required to attach P60 Series cover plates to 68-P floor box.



68P-FL/68P-FL-AL

Flush Service Floor Boxes

Dual-Voltage Kits for 68-P Non-Metallic Series

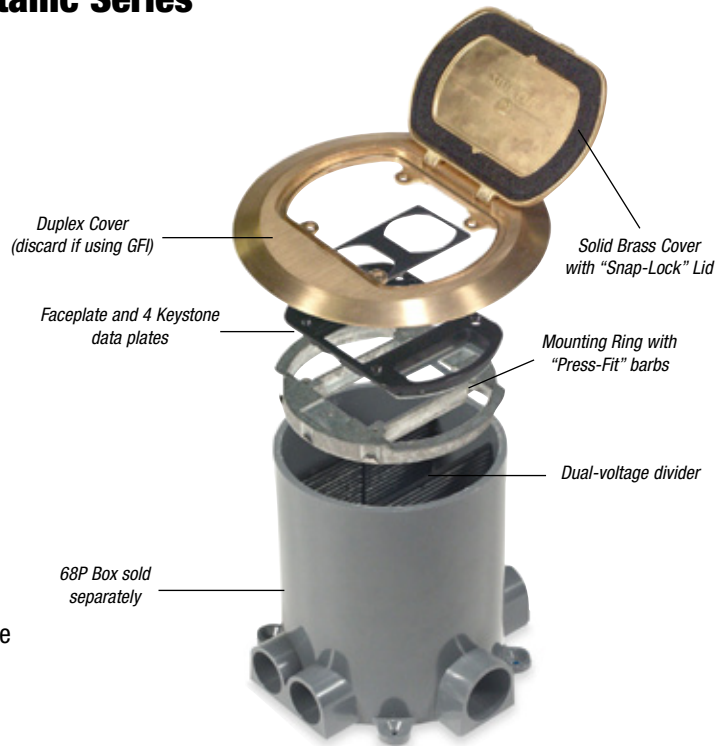

- Voltage divider has easy-cut score lines to accommodate concrete depths of 3 to 6 inches
- Faceplate has removable data plates and can accommodate GFCI or standard duplex receptacles
- Kit comes equipped with 4 standard keystone-size openings in the data plates. Other styles available include openings sized for Ortronics, Avaya, Panduit and Hubbell
- MopTite® cover uses a "snap-lock" to close the lid. No screws to turn...just push down the lid and it snaps in place. The cover uses a factory-installed gasket and exceeds all UL scrubwater exclusion requirements for carpet, wood and tile floors
- MopTite® cover available in solid brass or aluminum
- Includes everything required for a standard installation (68P floor box, data jacks and receptacles not included)



CAT. NO.	DESCRIPTION	STD. CTN.
68P-DV-KIT-BRS	Dual-Voltage Divider Kit with MopTite® Brass Cover	1
68P-DV-KIT-AL	Dual-Voltage Divider Kit with MopTite Aluminum Cover	1
68P-DV-DP-ORT	Ortronics Data Plate to Accommodate 2 Jacks	10
68P-DV-DP-AVA	Avaya Data Plate to Accommodate 4 Jacks	10
68P-DV-DP-PAN	PANDUIT Data Plate to Accommodate 2 Jacks	10
68P-DV-DP	Standard Data Plate to Accommodate 4 Keystone Jacks	10
68P-EXT	6" Extension for 68P Floor Box *	4
68P-EXT-DIV	Voltage Dividers for 68P-EXT *	4

*Keystone data plates come standard with the kit. Other style data plates are available from T&B and can be ordered separately.

6-Inch Extension for 68-P Floor Box

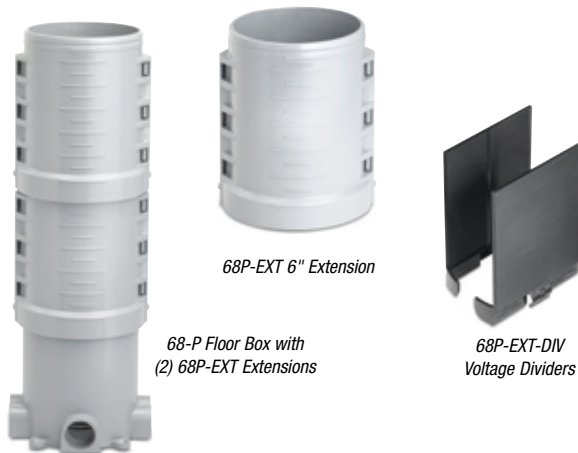

CAT. NO.	DESCRIPTION	STD. CTN.
68P-EXT	6" Extension for 68-P Floor Box *	4
68P-EXT-DIV	Voltage Dividers for 68P-EXT *	4
68-P	Round PVC Floor Box for Concrete Applications	8

* For use with Steel City® round PVC floor box only, catalog number 68-P.

Flush Service Floor Boxes

MopTite® Metallic Carpet Plates for 68-P Series

- Polished brass finish
- Furnished complete with 8-32 x 1" brass screws
- For brushed aluminum, add AL after catalog number



P60-CACP
One-piece solid-brass duplex plate with screw-lock lids. 5 3/4" O.D. Mounting holes on a 3 3/4" dia.



P60-3/4-2-CACP
One-piece solid-brass communications carpet plate. 5 3/4" O.D. Mounting holes on a 3 3/4" dia.



P60-CACP-GFCI



P60-CP



CAT. NO.	DESCRIPTION	FINISH	STD. CTN.
P60-CACP	One-Piece Duplex Cover and Carpet Flange Brass	—	4
P60-CACP-AL	One-Piece Duplex Cover and Carpet Flange Aluminum	—	4
P60-3/4-2-CACP	One-Piece Cover & Carpet Flange with 3/4" and 2" Plugs	Brass	4
P60-3/4-2-CACP-AL	One-Piece Cover & Carpet Flange with 3/4" and 2" Plugs	Aluminum	4
P60-CACP-GFCI*	One-Piece GFCI Cover and Carpet Flange	Brass	4
P60-CACP-GFCI-AL*	One-Piece GFCI Cover and Carpet Flange	Aluminum	4
P60-CP*	Carpet Flange	Brass	4
P60-CP-AL*	Carpet Flange	Aluminum	4

*Requires 68P-FL or 68P-FL-AL to attach covers to 68-P Floor Box.

New MopTite® Covers exceed UL watertight requirements for 514A, 514C.

MopTite® Non-Metallic Carpet Plates for 68-P Series

Non-metallic, single receptacle plate (SRC) with matching carpet plate and cover. 6" O.D.

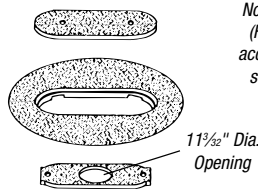

Non-metallic floor service cover (FSC) with 1" NPS screw plug accommodates most above-floor service fittings with matching carpet plate. 6" O.D.

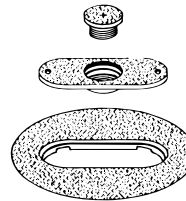

Non-metallic, duplex/voice data receptacle plates (DRC) with matching carpet plate and cover. 6" O.D.

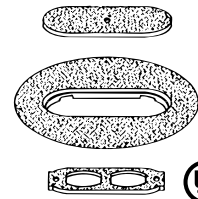

CAT. NO.	COLOR	DESCRIPTION	STD. CTN.
P-68-SRC-GRY	Gray	Non-Metallic Carpet Plate and Cover for Single Receptacle	4
P-68-SRC-BRN	Brown	Non-Metallic Carpet Plate and Cover for Single Receptacle	4
P-68-SRC-BGE	Beige	Non-Metallic Carpet Plate and Cover for Single Receptacle	4
P-68-SRC-BLK	Black	Non-Metallic Carpet Plate and Cover for Single Receptacle	4
P-68-FSC-GRY	Gray	Non-Metallic Carpet Plate and Cover with 1" NPS Screw Plug	4
P-68-FSC-BRN	Brown	Non-Metallic Carpet Plate and Cover with 1" NPS Screw Plug	4

New MopTite® Covers exceed UL watertight requirements for 514A, 514C.

CAT. NO.	COLOR	DESCRIPTION	STD. CTN.
P-68-FSC-BGE	Beige	Non-Metallic Carpet Plate and Cover with 1" NPS Screw Plug	4
P-68-FSC-BLK	Black	Non-Metallic Carpet Plate and Cover with 1" NPS Screw Plug	4
P-68-DRC-GRY	Gray	Non-Metallic Carpet Plate and Cover for Duplex Receptacle	4
P-68-DRC-BRN	Brown	Non-Metallic Carpet Plate and Cover for Duplex Receptacle	4
P-68-DRC-BGE	Beige	Non-Metallic Carpet Plate and Cover for Duplex Receptacle	4
P-68-DRC-BLK	Black	Non-Metallic Carpet Plate and Cover for Duplex Receptacle	4

New MopTite® Covers exceed UL watertight requirements for 514A, 514C.

Flush Service Floor Boxes

MopTite® Metallic Cover Plates for 68-P Series

- Polished finish
- Furnished complete with sealing gasket and 8-32 x 7/16" brass screws
- 4" outside diameter
- For brushed aluminum, add AL after catalog number

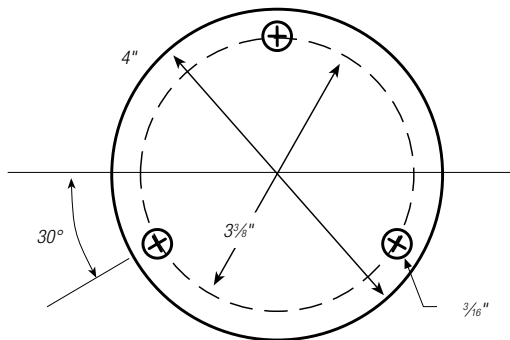

* Also includes steel seating plate for receptacles.



CAT. NO.	DESCRIPTION	STD. CTN.
P-60-1/2	Brass Cover Plate 1/2" NPS Plug Size	4
P-60-1/2-AL	Aluminum Cover Plate 1/2" NPS Plug Size	4
P-60-3/4	Brass Cover Plate 3/4" NPS Plug Size	4
P-60-3/4-AL	Aluminum Cover Plate 3/4" NPS Plug Size	4
P-60-1	Brass Cover Plate 1" NPS Plug Size	4
P-60-1-AL	Aluminum Cover Plate 1" NPS Plug Size	4
P-60-1-1/4	Brass Cover Plate 1 1/4" NPS Plug Size	4
P-60-1-1/4-AL	Aluminum Cover Plate 1 1/4" NPS Plug Size	4
P-60-2	Brass Cover Plate 2" Diameter Plug Size	4
P-60-2-AL	Aluminum Cover Plate 2" Diameter Plug Size	4
P-60-2-5/8	Brass Cover Plate 2 5/8" Diameter Plug Size	4
P-60-2-5/8-AL	Aluminum Cover Plate 2 5/8" Diameter Plug Size	4
P-60-1/2-2	Brass Cover Plate 1/2"-2" Diameter Plug Size	4
P-60-1/2-2-AL	Aluminum Cover Plate 1/2"-2" Diameter Plug Size	4
P-60-3/4-2	Brass Cover Plate 3/4"-2" Diameter Plug Size	4
P-60-3/4-2-AL	Aluminum Cover Plate 3/4"-2" Diameter Plug Size	4
P-60-DR	Brass Cover with Duplex Lift Lid	4
P-60-DR-AL	Aluminum Cover with Duplex Lift Lid	4
P-60-DS	Brass Cover for Duplex with Individual Lift Lids	4
P-60-DS-AL	Aluminum Cover for Duplex with Individual Lift Lids	4
P-60-DU	Brass Cover Plate with Two 1 1/16" Plugs for Duplex	4
P-60-DU-AL	Aluminum cover with Two 1 1/16" Plugs for Duplex	4
P-60-GFCI	Brass Cover Plate for GFCI Devices	4
P-60-GFCI-AL	Aluminum Cover Plate for GFCI Devices	4

68P-FL or 68P-FL-AL required to attach cover plates to 68-P floor box.

New MopTite® Covers exceed UL watertight requirements for 514A, 514C.

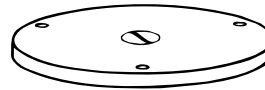

P-60-1/2
1/2" N.P.S. Plug Size



P-60-3/4
3/4" N.P.S. Plug Size

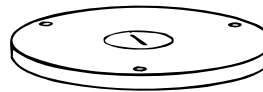

P-60-1
1" N.P.S. Plug Size

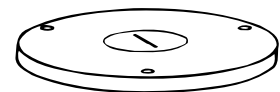

P-60-1-1/4
1 1/4" N.P.S. Plug Size

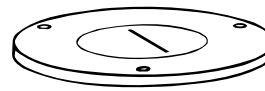

P-60-2*
2" dia. Plug Size

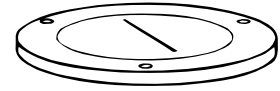

P-60-2-5/8*
2 5/8" dia. Plug Size



P-60-1/2-2*
1/2" & 2" dia. Plug Size



P-60-3/4-2*
3/4" & 2" dia. Plug Size



P-60-DR*
Duplex Lift Lid



P-60-DS*
Hinged Lift Lids



P-60-DU*
Duplex 1 1/16" Plugs

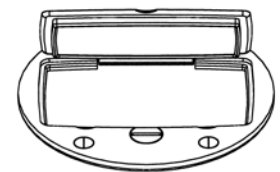

P-60-GFCI*

Flush Service Floor Boxes

Floor Boxes for Single Short-Strap Receptacles or Communications

Service Fitting Application

78 and 88 Series Floor Boxes provide flush service for power or communications and data. They can be used for either carpet or tile applications.

78 Series



78SC

- Cast iron, watertight body, semi-adjustable
- Painted silver enamel inside and out for additional corrosion resistance
- Exterior leveling screws and threaded vertical adjusting ring permit adjustment to meet finish floor
- Shipped complete with expandable cap to prevent ingress of concrete during pour
- 3/4" threaded conduit openings
- Uses P90 Series MopTite® covers

88 Series



88-D

- Stamped steel, concrete-tight, semi-adjustable
- Electro-galvanized body and hardware
- Exterior leveling screws and threaded vertical adjusting ring permit adjustment to meet finish floor
- Shipped complete with expandable cap to prevent ingress of concrete during pour
- 1/2" and 3/4" knockouts — all bottom knockouts accessible
- Uses P90 Series MopTite® covers



CAT. NO.	DESCRIPTION	STD. CTN.
78SC	Cast-Iron Single-Gang Floor Box with 3/4" Conduit Tapping	4
78-S	Cast-Iron Single-Gang Floor Box (shallow)	4
88-D	Stamped-Steel Single-Gang Floor Box with 1/2" and 3/4" Conduit Tapping	4
88-S	Shallow Version Stamped Steel	4

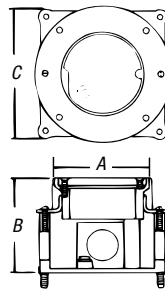
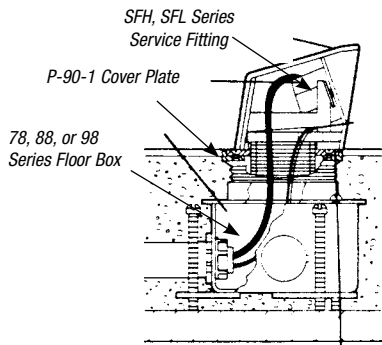

Engineering Data



CAT. NO.	DIMENSIONS (IN.)			BEFORE POUR ADJ. (IN.)	AFTER POUR ADJ. (IN.)	MAXIMUM CAPACITY CU. IN.	STANDARD CONDUIT TAPPING (IN.)
	A	B	C				
78SC	3	2 13/16	3 1/8	2 1/2	3/4	24	3/4
78-S	3	2 3/4	3 1/8	1 1/2	3/4	20	3/4
88-D	3	3 1/4	5 1/4	2 1/2	3/4	29	—
88-S	3	2 3/4	5 1/4	1 1/2	3/4	23	—

Flush Service Floor Boxes



Engineering Data (continued)

CAT. NO.	MAXIMUM CONDUIT TAPPING (IN.)		CONDUIT KOS (IN.)		COVERS AND CARPET PLATES	WIRING DEVICE
	W/BUSHING	W/O BUSHING	SIDES	BOTTOM		
78SC	3/4	1	—	—	P90 series	Sing. short, Strap rec.
78-S	3/4	1	—	—	P90 series	Sing. short, Strap rec.
88-D	—	—	(2) 1/2 (2) 3/4	(3) 1/2 (2) 3/4	P90 series	Sing. short Strap rec.
88-S	—	—	(2) 1/2 (2) 3/4	(3) 1/2 (2) 3/4	P90 series	Sing. short Strap rec.

MopTite® Cover Plates for 78 and 88 Series

- Polished-brass finish
- Furnished complete with sealing gasket and 6-32 x 1/2" brass screws
- 2 13/16" outside diameter
- For brushed aluminum, add AL after catalog number



P-90-1/2
1/2" N.P.S. plug



P-90-3/4
3/4" N.P.S. plug



P-90-1
1" N.P.S. plug

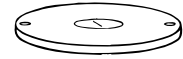

P-90-1-1/4
1 1/4" N.P.S. plug

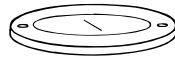

P-90-2*
2" dia. plug

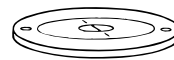

P-90-1/2-2*
1/2" & 2" dia. plugs

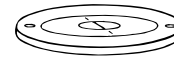

P-90-3/4-2*
3/4" & 2" dia. plugs



CAT. NO.	DESCRIPTION	FINISH	STD. CTN.
P-90-1/2	Cover Plate 1/2" NPS Plug	Brass	4
P-90-3/4	Cover Plate 3/4" NPS Plug	Brass	4
P-90-3/4-AL	Cover Plate 3/4" NPS Plug	Aluminum	4
P-90-1	Cover Plate 1" NPS Plug	Brass	4
P-90-1-AL	Cover Plate 1" NPS Plug	Aluminum	4
P-90-1-1/4	Cover Plate 1 1/4" NPS Plug	Brass	4

CAT. NO.	DESCRIPTION	FINISH	STD. CTN.
P-90-1-1/4-AL	Cover Plate 1 1/4" NPS Plug	Aluminum	4
P-90-2	Cover Plate 2" UN Plug	Brass	4
P-90-2-AL	Cover Plate 2" UN Plug	Aluminum	4
P-90-1/2-2	Cover Plate 1/2" & 2" Plug	Brass	4
P-90-3/4-2	Cover Plate 3/4" & 2" Plug	Brass	4
P-90-3/4-2-AL	Cover Plate 3/4" & 2" Plug	Aluminum	4

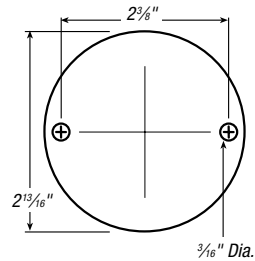

New MopTite® Covers exceed UL watertight requirements for 514A, 514C.

*Also includes steel seating plates for receptacles.

For above-floor service fittings for 78, 88 and 98 series floor boxes, see page A-170

Accessories for 78 and 88 Series Floor Boxes

- Extends vertical adjusting ring 1 1/8"
- Seven cubic inch capacity
- 15-Amp, 125-Volt, NEMA grounding type
- Mounted on steel seating plate
- For use with 2" diameter-opening floor plate



478-G-12



8805-E



CAT. NO.	DESCRIPTION	STD. CTN.
8805-E	Extension Adjusting Ring	4
478-G-12	15-Amp 125-Volt NEMA Grounding Receptacle	4

Carpet Plate for 78 and 88 Series Floor Boxes

- Polished-brass finish
- Furnished complete with 6-32 x 1" brass flathead screws and gasket
- Threaded 2-20UN-2B to accept 694 plug
- 3 3/8" O.D. with 5/8" flange
- For brushed aluminum, add AL after catalog number

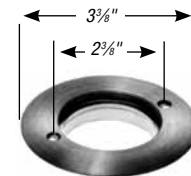

P-90-CP



CAT. NO.	DESCRIPTION	FINISH	STD. CTN.
P-90-CP	Carpet Plate	Brass	4
P-90-CP-AL	Carpet Plate	Aluminum	4

Will not accept P90 covers. Will accept 694 threaded plug.

Flush Service Floor Boxes

Floor Boxes for Single Short-Strap Receptacles or Communications

671 and 672 Series Floor Boxes provide flush service for power or communications and data. They can be used in either wood or concrete floors and are suitable for carpet, tile or wood applications.



671SC



672

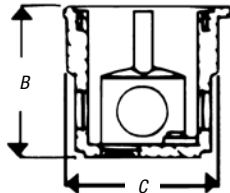
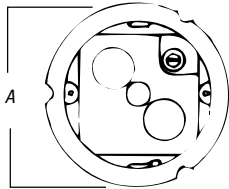

671 and 672 Floor Boxes

- Cast iron, watertight, non-adjustable
- Painted silver enamel inside and out for additional corrosion resistance
- For use in wood or concrete floors
- 1/2" and 3/4" threaded conduit openings; uses P67 Series covers
- Cat. No. 672 is the 671 floor box with factory-mounted 15-ampere, 125-volt, NEMA grounding receptacle and P67-2 MopTite® cover plate



CAT. NO.	DIMENSIONS (IN.)			MAXIMUM CAPACITY (CU. IN.)	STANDARD CONDUIT TAPPING	MAXIMUM CONDUIT TAPPING (IN.)	
	A	B	C			W/BUSHING	W/O BUSHING
671SC	3 1/2	3	2 31/32	13	(2)-3/4"	3/4	3/4
672	3 1/2	3 1/16	2 31/32	13	(4)-1/2"	3/4	3/4

CAT. NO.	CONDUIT KOS (IN.)		COVERS/ CARPET PLATES	WIRING DEVICE	STD. CTN.
	SIDES	BOTTOM			
671SC	(2) 1/2	(2) 1/2	P67 series	Sing. short Strap rec.	4
	(2) 3/4	—			
672	(2) 1/2	(2) 1/2	P67 series	Sing. short Strap rec.	4
	(2) 3/4	—			

New MopTite® Covers exceed UL watertight requirements for 514A, 514C.

MopTite® Plates for 671 and 672 Series

- Polished brass finish
- Furnished complete with sealing gasket and 6-32 x 1/2" brass screws
- 3 1/2" outside diameter

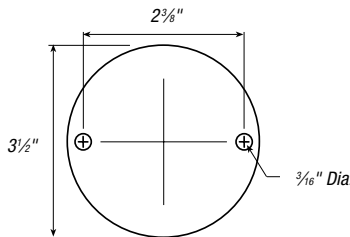

P-67-1/2
1/2" N.P.S. plug



P-67-3/4
3/4" N.P.S. plug



P-67-1
1" N.P.S. plug



P-67-1-1/4*
1 1/4" N.P.S. plug



P-67-2
2" dia. plug



P-67-1/2-2*
1/2" & 2" dia. plugs



P-67-3/4-2*
3/4" & 2" dia. plugs

*Also includes seating plate for receptacle.



CAT. NO.	DESCRIPTION	FINISH	STD. CTN.
P-67-1/2	Cover Plate with 1/2" NPS Plug	Brass	4
P-67-3/4	Cover Plate with 3/4" NPS Plug	Brass	4
P-67-3/4-AL	Cover Plate with 3/4" NPS Plug	Aluminum	4
P-67-1	Cover Plate with 1" NPS Plug	Brass	4
P-67-1-AL	Cover Plate with 1" NPS Plug	Aluminum	4
P-67-1-1/4	Cover Plate with 1 1/4" NPS Plug	Brass	4
P-67-2	Cover Plate with 2" UN Thread Plug	Brass	4
P-67-2-AL	Cover Plate with 2" UN Thread Plug	Aluminum	4
P-67-1/2-2	Cover Plate with 1/2" & 2" Plug	Brass	4
P-67-3/4-2	Cover Plate with 3/4" & 2" Plug	Brass	4

New MopTite® Covers exceed UL scrubwater exclusion requirements.

Flush Service Floor Boxes

Carpet Plates for 671 and 672 Floor Boxes

- Polished-brass finish
- Furnished complete with 6-32 x 1"-long brass flathead screws and gasket
- For brushed aluminum, add AL after catalog number
- 3 $\frac{3}{8}$ " outside diameter



P-90-CP



CAT. NO.	DESCRIPTION	STD. CTN.
P-90-CP	Carpet Plate — Brass	4
P-90-CP-AL	Carpet Plate — Aluminum	4

Accessories for 671 and 672 Floor Boxes

- Use brass edge ring for neat appearance when non-adjustable floor box is installed in concrete
- Edge ring has 3 $\frac{3}{4}$ " OD and adds $\frac{3}{8}$ " to floor box height
- 15-amp, 125-volt, NEMA grounding type
- Mounted on steel seating plate
- For use with 2" diameter opening floor plate



P-67-F Edge Ring



478-G-12 Short Strap Receptacle



CAT. NO.	DESCRIPTION	STD. CTN.
P-67-F	Brass Edge Ring for Concrete	4
478-G-12	15-Amp, 125-Volt NEMA Grounding Receptacle	4

Floor Plate Plug Inserts for 78, 88, 671 or 672 Series



CAT. NO.	SIZE OR DESCRIPTION	STD. CTN.
690-SC	1/2"-14" NPS Thread	4
691-SC	3/4"-14" NPS Thread	4
692-SC	1"-11 1/2" NPS Thread	4
693-SC	1 1/4"-11 1/2" NPS Thread	4
694	2"-20" UN Thread	4
695	1/2"-2"	4
696-SC	3/4"-2"	4
697	2 5/8"-20" UN 2A Thread	4
698	1 7/8" for Duplex P-60-DU	4

For standard plug inserts 1/2" through 2", see **page A-155**

Catalog numbers are for brass.

For aluminum, add AL after catalog number.

Floor Box Body Parts

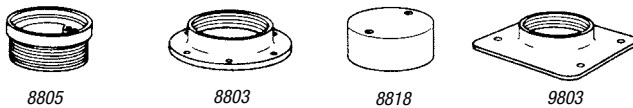

CAT. NO.	DESCRIPTION	STD. CTN.
8805	Brass Adjusting Ring	4
8803	Threaded Steel Body Cover of 78 and 88 Series	4
8818	Metal Protective Cap	4
9803	Threaded Steel Body Cover for 98 Series	4

2 5/8"-20 UN 2A Thread.

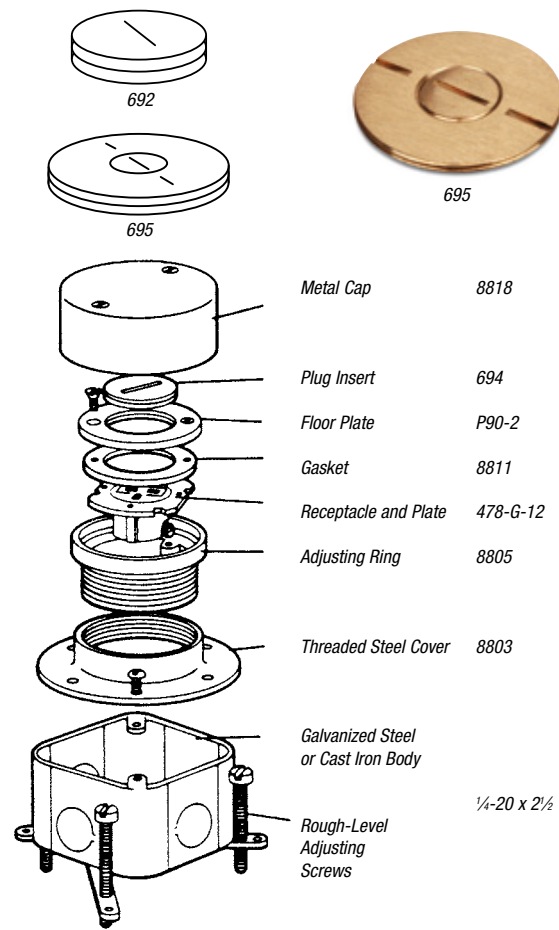

Floor Box Assembly with Floor Plate

Flush Service Floor Boxes

Multiple-Gang Floor Boxes for Power and Communications

640 and 840 Series Floor Boxes provide flush service for power, communications and data. Multiple-gang boxes enable the user to place high- and low-voltage in a single floor box. Floor boxes up to four-gangs are available. 640 and 840 Series boxes can be used for either carpet or tile applications.

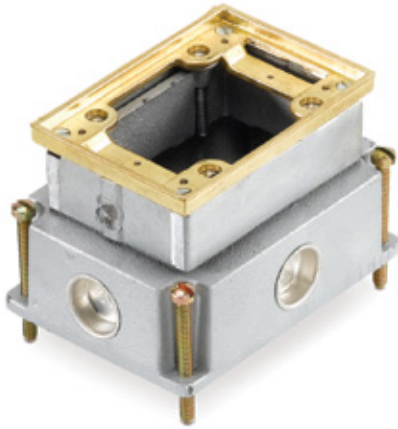

641

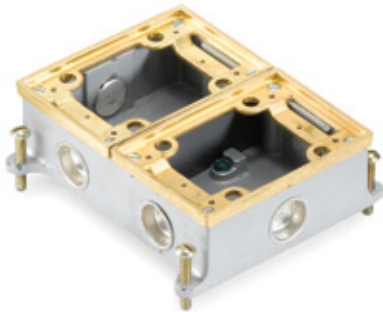

842-SC

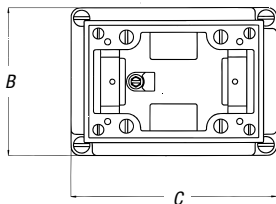
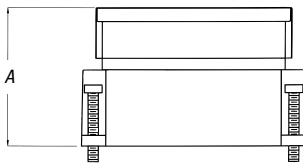

640 Series

- Cast iron, watertight body, fully adjustable
- Painted silver enamel inside and out for additional corrosion resistance
- Interior and exterior leveling screws permit adjustment to finished floor
- Removable partitions for large capacity requirements on 2-, 3- and 4-gang
- Shipped complete with expendable cap to prevent ingress of concrete during pour
- 3/4" threaded conduit openings are standard
- Uses P64 Series MopTite® covers (one cover per gang)
- For brushed aluminum, add AL after catalog number

840SC Series (Shallow)

- Cast iron, watertight body, semi-adjustable
- Painted silver enamel inside and out for additional corrosion resistance
- Exterior leveling screws for adjustment to finished floor
- Removable partitions for large capacity requirements on 2- and 3-gang
- Shipped complete with expendable cap to prevent ingress of concrete during pour
- 3/4" threaded conduit openings are standard
- Uses P64 Series MopTite® covers (one cover per gang)
- For brushed aluminum, add AL after catalog number

Engineering Data



CAT. NO.	DIMENSIONS (IN.)			BEFORE POUR ADJ. (IN.)	AFTER POUR ADJ. (IN.)
	A	B	C		
641	3 3/8	4	5 1/2	2 1/2	3/8
642	3 3/8	7	5 1/2	2 1/2	3/8
643	3 3/8	10	5 1/2	2 1/2	3/8
644	3 3/8	12 5/16	5 1/2	2 1/2	3/8
841-SC	2	4	5 1/2	1 1/2	—
842-SC	2	7	5 1/2	1 1/2	—
843-SC	2	10	5 1/2	1 1/2	—

CAT. NO.	NUMBER OF GANGS	MAXIMUM CAPACITY (CU. IN.)	CONDUIT HUBS (IN.)
641	1	35	3/4
642	2	37 per gang	3/4
643	3	37 per gang	3/4
644	4	37 per gang	3/4
841-SC	1	15	3/4
842-SC	2	16.5 per gang	3/4
843-SC	3	16.5 per gang	3/4

Use P64 Series covers and carpet plates.

Wiring Device: Duplex, single or voice/data plates.

*Additional hub sizes available — see next page.

Flush Service Floor Boxes

640 and 840 Series Floor Boxes

- Polished brass finish
- Furnished complete with sealing gasket and 8-32 x 7/16" brass screws
- 3" x 4 1/2" outside dimension
- For brushed aluminum, add AL after catalog number
- All covers meet MopTite® requirements

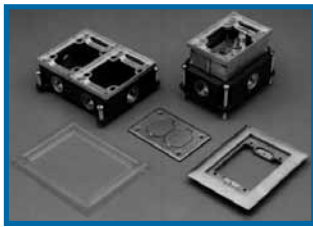
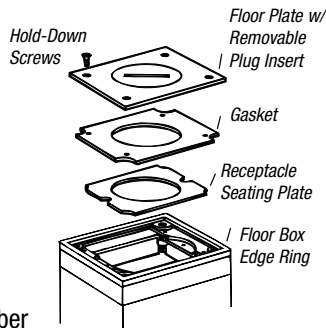

CAT. NO.	DESCRIPTION	STD. CTN.
641	Cast-Iron Single-Gang Floor Box with 3/4" Conduit Hubs	4
641-AL	Cast-Iron Single-Gang Floor Box with 3/4" Conduit Hubs & Aluminum Trim	4
641-1	Cast-Iron Single-Gang Floor Box with 1" Conduit Hubs	4
SP-641-1-AL	Cast-Iron Single-Gang Floor Box with 1" Conduit Hubs & Aluminum Trim	4
642	Cast-Iron Two-Gang Floor Box with 3/4" Conduit Hubs	2
642-AL	Cast-Iron Two-Gang Floor Box with 3/4" Conduit Hubs & Aluminum Trim	2
642-1	Cast-Iron Two-Gang Floor Box with 1" Conduit Hubs	2
SP-642-1-AL	Cast-Iron Two-Gang Floor Box with 1" Conduit Hubs & Aluminum Trim	2
643	Cast-Iron Three-Gang Floor Box with 3/4" Conduit Hubs	1
643-AL	Cast-Iron Three-Gang Floor Box with 3/4" Conduit Hubs & Aluminum Trim	1
SP-643-1	Cast-Iron Three-Gang Floor Box with 1" Conduit Hubs	1
SP-643-1-AL	Cast-Iron Three-Gang Floor Box with 1" Conduit Hubs & Aluminum Trim	1
644	Cast-Iron Four-Gang Floor Box with 3/4" Conduit Hubs	1
SP-644-AL	Cast-Iron Four-Gang Floor Box with 3/4" Conduit Hubs & Aluminum Trim	1
841-SC	Shallow Cast-Iron Single-Gang Floor Box with 3/4" Conduit Hubs	4
841-AL	Shallow Cast Iron Single-Gang Floor Box with 3/4" Conduit Hubs & Aluminum Trim	4
842-SC	Shallow Cast-Iron Two-Gang Floor Box with 3/4" Conduit Hubs	2
842-AL-SC	Shallow Cast-Iron Two-Gang Floor Box with 3/4" Conduit Hubs & Aluminum Trim	2
843-SC	Shallow Cast-Iron Three-Gang Floor Box with 3/4" Conduit Hubs	1
843-AL-SC	Shallow Cast-Iron Three-Gang Floor Box with 3/4" Conduit Hubs & Aluminum Trim	1

Boxes supplied with brass tile trim unless otherwise specified.

MopTite® Cover Plates for 640 and 840 Series

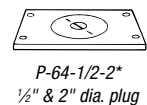
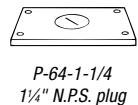
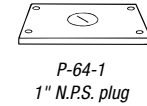
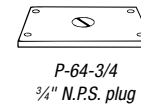
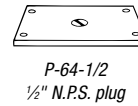
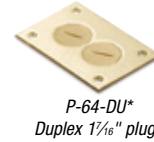
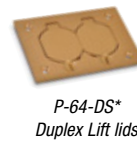
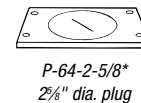
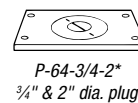
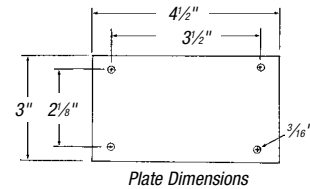

*Also includes seating plate for receptacle like others.



CAT. NO.	DESCRIPTION	FINISH	STD. CTN.
P-64-1/2	Cover Plate 1/2" NPS Plug	Brass	4
P-64-1/2-AL	Cover Plate 1/2" NPS Plug	Aluminum	4
P-64-3/4	Cover Plate 3/4" NPS Plug	Brass	4
P-64-3/4-AL	Cover Plate 3/4" NPS Plug	Aluminum	4
P-64-1	Cover Plate 1" NPS Plug	Brass	4
P-64-1-AL	Cover Plate 1" NPS Plug	Aluminum	4
P-64-1-1/4	Cover Plate 1 1/4" NPS Plug	Brass	4
P-64-1-1/4-AL	Cover Plate 1 1/4" NPS Plug	Aluminum	4
P-64-2	Cover Plate 2" UN Plug	Brass	4
P-64-2-AL	Cover Plate 2" UN Plug	Aluminum	4
P-64-1/2-2	Cover Plate 1/2" & 2" UN Plug	Brass	4
P-64-1/2-2-AL	Cover Plate 1/2" & 2" UN Plug	Aluminum	4
P-64-3/4-2	Cover Plate 3/4" & 2" UN Plug	Brass	4
P-64-3/4-2-AL	Cover Plate 3/4" & 2" UN Plug	Aluminum	4
P-64-DS	Cover Plate Duplex Lift Lids	Brass	4
P-64-DS-AL	Cover Plate Duplex Lift Lids	Aluminum	4
P-64-2-5/8	Cover Plate 2 5/8" UN Plug	Brass	4
P-64-2-5/8-AL	Cover Plate 2 5/8" UN Plug	Aluminum	4
P-64-DU	Cover Plate Duplex 1 1/8" Plugs	Brass	4
P-64-DU-AL	Cover Plate Duplex 1 1/8" Plugs	Aluminum	4
P-64-GFCI	Cover Plate GFCI Flip Lid	Brass	4
P-64-GFCI-AL	Cover Plate GFCI Flip Lid	Aluminum	4

New MopTite® Covers exceed UL® scrubwater exclusion requirements for 514A, 514C.

Flush Service Floor Boxes

Metallic Carpet Plates for 640 and 840 Series

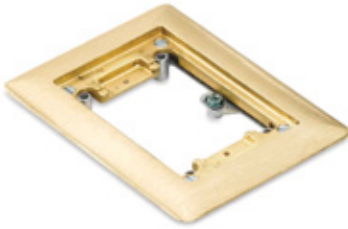

P-64-CP

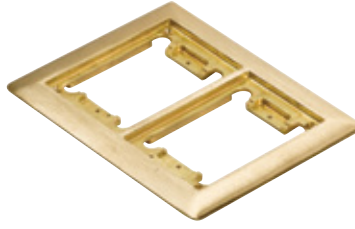

P-64-2G-CP

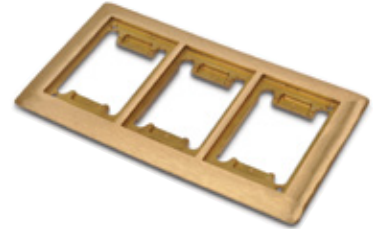

P-64-3G-CP



CAT. NO.	NUMBER OF GANGS	OUTSIDE DIMENSION (IN.)	MATERIAL	STD. CTN.
P64-CP	1	4% x 6%	Brass	4
P64-CP-AL	1	4% x 6%	Aluminum	4
P64-2G-CP	2	7% x 6%	Brass	4
P64-2G-CP-AL	2	7% x 6%	Aluminum	4
P64-3G-CP	3	10% x 6%	Brass	4
P64-3G-CP-AL	3	10% x 6%	Aluminum	4
P64-4G-CP	4	13% x 6%	Brass	4
P64-4G-CP-AL	4	13% x 6%	Aluminum	4

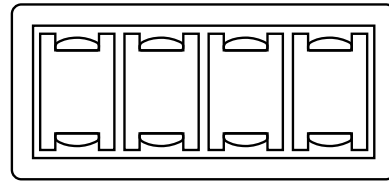

P-64-4G-CP

Non-Metallic Carpet Plates for 640 and 840 Series

- Polycarbonate material
- Textured finish

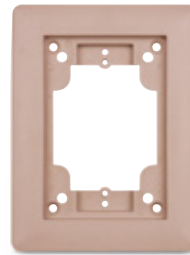

P-64P-CP Series

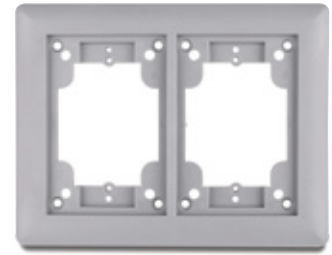

P-64P-2G-CP Series

CAT. NO.	NUMBER OF GANGS	DESCRIPTION	FINISH	STD. CTN.
P64P-CP-BLK	1	Single-Gang Carpet Plate	Black	4
P64P-CP-GRY	1	Single-Gang Carpet Plate	Gray	4
P64P-CP-BGE	1	Single-Gang Carpet Plate	Beige	4
P64P-2G-CP-BLK	2	Two-Gang Carpet Plate	Black	4
P64P-2G-CP-GRY	2	Single-Gang Carpet Plate	Gray	4
P64P-2G-CP-BGE	2	Two-Gang Carpet Plate	Beige	4
P64P-3G-CP-BLK	3	Three-Gang Carpet Plate	Black	4
P64P-3G-CP-GRY	3	Three-Gang Carpet Plate	Gray	4
P64P-3G-CP-BGE	3	Three-Gang Carpet Plate	Beige	4

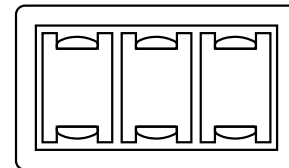

P-64P-3G-CP Series

Flush Service Floor Boxes

MopTite® Non-Metallic Covers for 640 and 840 Series



CAT. NO.	DESCRIPTION	COLOR	STD. CTN.
P64P-URC-BLK	Universal Cover	Black	4
P64P-URC-GRY	Universal Cover	Gray	4
P64P-URC-BGE	Universal Cover	Beige	4
P64P-BP-BLK	Blank Cover	Black	4
P64P-BP-GRY	Blank Cover	Gray	4
P64P-BP-BGE	Blank Cover	Beige	4

New MopTite® Covers exceed UL® scrubwater exclusion requirements.

Floor Plate Plug Inserts



CAT. NO.	SIZE OR DESCRIPTION	STD. CTN.
690-SC	1/2"-14 NPS Thread	4
691-SC	3/4"-14 NPS Thread	4
692-SC	1"-11 1/2" NPS Thread	4
693-SC	1 1/4"-11 1/2" NPS Tthread	4
694	2"-20 UN Thread	4
695	1/2"-2"	4
696-SC	3/4"-2"	4
697	2 5/8"-20 UN 2A Thread	4
698	1 7/8" for Duplex P-60-DU	4

For standard plug inserts 1/2" through 2", see **page A-155**. Catalog numbers are for brass. For aluminum, add AL after catalog number.



692



695

Gaskets for Floor Plate Assemblies



CAT. NO.	FOR USE WITH	STD. CTN.
SP650	P-64 Series Floor Plate Assemblies	4
SP651	P-64-DU Floor Plate Assemblies	10
SP-P64-DS-P2	P-64-DS Floor Plate Assembly	4



Flush Service Floor Boxes

Multiple-Gang Floor Boxes for Power and Communications.

640P Series Non-Metallic Floor Boxes

- Significant savings over metal boxes
- Die-cast adjusting ring with unique “snap-on” feature which eliminates gluing
- Reduced installation time; no leveling required
- Compatibility with standard-schedule PVC conduit; 1", ¾" and ½"
- Removable adjusting ring accepts wide variety of service accessories
- One-piece housing unit with premolded conduit holes
- Molded from a high-grade polymer material which is fully compatible with standard-schedule PVC conduit
- 640P Series Floor Boxes utilize both plastic and brass carpet (P64 series) plates and covers
- Available in one-, two- and three-gang versions. Two- and three-gang boxes provided with partitions in corresponding activation kits
- Min. concrete pour 2½"

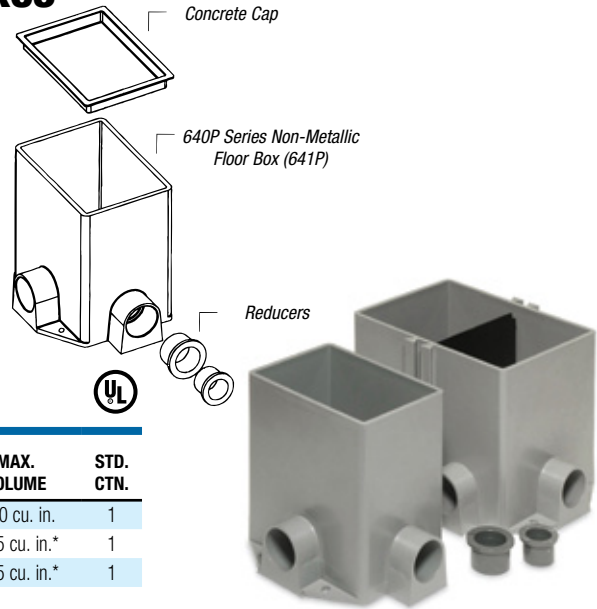

CAT. NO.	DESCRIPTION	DIMENSIONS (IN.)			MAX. VOLUME	STD. CTN.
		LENGTH	WIDTH	HEIGHT		
641P	One-Gang Box	4	5%	6	85.0 cu. in.	1
642P	Two-Gang Box	7	5%	6	85.5 cu. in.*	1
643P	Three-Gang Box	10%	5%	6	85.5 cu. in.*	1

* Per gang.

Carpet Activations for 640P Series

CAT. NO.	DESCRIPTION	FINISH	STD. CTN.
Carpet Activations for 640 Series			
641P-CACA	One-Gang Carpet Trim	Aluminum	4
641P-CACB	One-Gang Carpet Trim	Brass	4
641P-CAC-BGE	One-Gang Carpet Trim	Non-Metallic Beige	4
641P-CAC-BLK	One-Gang Carpet Trim	Non-Metallic Black	4
641P-CAC-GRY	One-Gang Carpet Trim	Non-Metallic Gray	4
642P-CACA	Two-Gang Carpet Trim	Aluminum	4
642P-CACB	Two-Gang Carpet Trim	Brass	4
642P-CAC-BGE	Two-Gang Carpet Trim	Non-Metallic Beige	4

CAT. NO.	DESCRIPTION	FINISH	STD. CTN.
Carpet Activations for 640 Series			
642P-CAC-BLK	Two-Gang Carpet Trim	Non-Metallic Black	4
642P-CAC-GRY	Two-Gang Carpet Trim	Non-Metallic Gray	4
643P-CACA	Three-Gang Carpet Trim	Aluminum	4
643P-CACB	Three-Gang Carpet Trim	Brass	4
643P-CAC-BGE	Three-Gang Carpet Trim	Non-Metallic Beige	4
643P-CAC-BLK	Three-Gang Carpet Trim	Non-Metallic Black	4
643P-CAC-GRY	Three-Gang Carpet Trim	Non-Metallic Gray	4

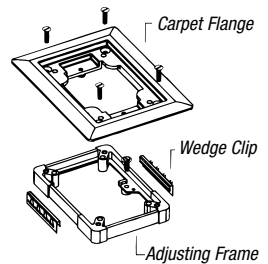

Carpet Activation Kit

Tile Activations for 640P Series

CAT. NO.	DESCRIPTION	FINISH	STD. CTN.
Tile Activations for 640 Series			
641P-TACA	One-Gang Tile Trim	Aluminum	4
641P-TACB	One-Gang Tile Trim	Brass	4
641P-TAC-BGE	Non-Metallic	Beige	4
641P-TAC-BLK	Non-Metallic	Black	4
641P-TAC-GRY	Non-Metallic	Gray	4
642P-TACA	Two-Gang Tile Trim	Aluminum	4
642P-TACB	Two-Gang Tile Trim	Brass	4
642P-TAC-BGE	Non-Metallic	Beige	4

CAT. NO.	DESCRIPTION	FINISH	STD. CTN.
Tile Activations for 640 Series			
642P-TAC-BLK	Non-Metallic	Black	4
642P-TAC-GRY	Non-Metallic	Gray	4
643P-TACA	Three-Gang Tile Trim	Aluminum	4
643P-TACB	Three-Gang Tile Trim	Brass	4
643P-TAC-BGE	Non-Metallic	Beige	4
643P-TAC-BLK	Non-Metallic	Black	4
643P-TAC-GRY	Non-Metallic	Gray	4

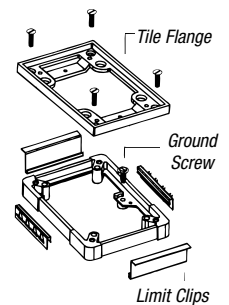

Tile Activation Kit

Flush Service Floor Boxes

MopTite® Cover Plates for 640 Series



CAT. NO.	DESCRIPTION	FINISH	STD. CTN.
P-64-1/2	Cover Plate 1/2" NPS Plug	Brass	4
P-64-1/2-AL	Cover Plate 1/2" NPS Plug	Aluminum	4
P-64-3/4	Cover Plate 3/4" NPS Plug	Brass	4
P-64-3/4-AL	Cover Plate 3/4" NPS Plug	Aluminum	4
P-64-1	Cover Plate 1" NPS Plug	Brass	4
P-64-1-AL	Cover Plate 1" NPS Plug	Aluminum	4
P-64-1-1/4	Cover Plate 1 1/4" NPS Plug	Brass	4
P-64-1-1/4-AL	Cover Plate 1 1/4" NPS Plug	Aluminum	4
P-64-2	Cover Plate 2" UN Plug	Brass	4
P-64-2-AL	Cover Plate 2" UN Plug	Aluminum	4
P-64-1/2-2	Cover Plate 1/2" & 2" UN Plug	Brass	4
P-64-1/2-2-AL	Cover Plate 1/2" & 2" UN Plug	Aluminum	4
P-64-3/4-2	Cover Plate 3/4" & 2" UN Plug	Brass	4
P-64-3/4-2-AL	Cover Plate 3/4" & 2" UN Plug	Aluminum	4
P-64-2-5/8	Cover Plate 2 5/8" UN Plug	Brass	4
P-64-2-5/8-AL	Cover Plate 2 5/8" UN Plug	Aluminum	4
P-64-DU	Cover Plate Duplex 1 1/16" Plugs	Brass	4
P-64-DU-AL	Cover Plate Duplex 1 1/16" Plugs	Aluminum	4
P-64-DS	Cover Plate Duplex Lift Lids	Brass	4
P-64-DS-AL	Cover Plate Duplex Lift Lids	Aluminum	4
P-64-GFCI	Cover Plate GFCI Flip Lid	Brass	4
P-64-GFCI-AL	Cover Plate GFCI Flip Lid	Aluminum	4

New MopTite® Covers exceed UL® Scrubwater exclusion requirements.

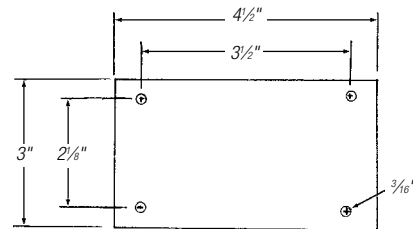
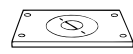

Plate Dimensions



P-64-3/4-2*
3/4" & 2" dia. plug



P-64-2-5/8*
2 5/8" dia. plug



P-64-DS*
Duplex Lift lids



P-64-DU*
Duplex 1 1/16" plugs



P-64-GFCI

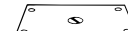

P-64-1/2
1/2" N.P.S. plug

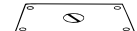

P-64-3/4
3/4" N.P.S. plug



P-64-1
1" N.P.S. plug



P-64-1-1/4
1 1/4" N.P.S. plug



P-64-2*
2" dia. plug



P-64-1/2-2*
1/2" & 2" dia. plug

*Also includes seating plate for receptacle like others.

MopTite® Non-Metallic Covers for 640P Series

- Polished-brass finish
- Furnished complete with sealing gasket and 8-32 x 7/16" brass screws
- 3" x 4 1/2" outside dimension
- For brushed aluminum, add AL after catalog number
- All covers meet MopTite® requirements



P-64P-URC



CAT. NO.	DESCRIPTION	COLOR	STD. CTN.
P64P-URC-BLK	Universal Cover	Black	4
P64P-URC-GRY	Universal Cover	Gray	4
P64P-URC-BGE	Universal Cover	Beige	4
P64P-BP-BLK	Blank Cover	Black	4
P64P-BP-GRY	Blank Cover	Gray	4
P64P-BP-BGE	Blank Cover	Beige	4

New MopTite® Covers exceed UL® scrubwater exclusion requirements.

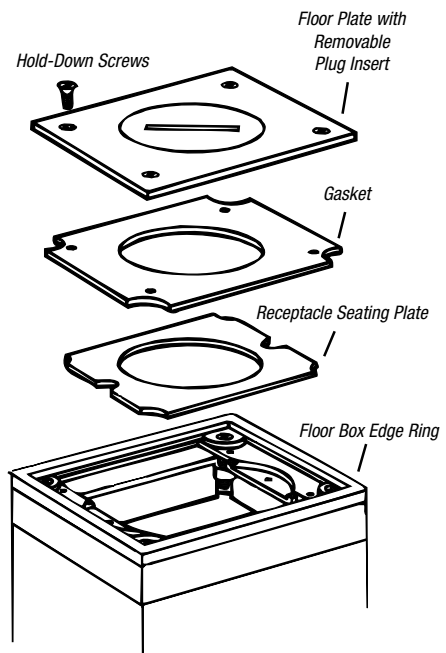

Flush Service Floor Boxes

Multiple-Gang Floor Boxes for Power and Communications: 740 Series

The new 740 Series line of stamped-steel floor boxes are an extension of T&B's industry-leading 640 and 840 series cast-iron floor boxes. The new boxes provide flush service for power, communications and data. Multiple-gang boxes allow the user to place high- and low-voltage in a single floor box. The 740 series can be used for carpet or tile applications.

- Available in shallow (2 $\frac{5}{8}$ ") and deep (3 $\frac{5}{8}$ ") versions
- UL Listed and CSA certified
- Available in one-, two- and three-gang versions
- Two- and three-gang boxes are supplied with customer-installed dividers
- 16 ga. pre-galvanized steel construction
- Adjustable with four exterior leveling legs capable of 2" pre-pour adjustment and an interior leveling ring capable of 1 $\frac{1}{4}$ " after-pour adjustment
- Made with a variety of KOs ranging from $\frac{1}{2}$ " to 1 $\frac{1}{4}$ "
- Boxes utilize the 640P series metallic and non-metallic floor box accessories with the unique one-step installation method
- Shipped with expendable steel cap to prevent ingress of concrete at installation

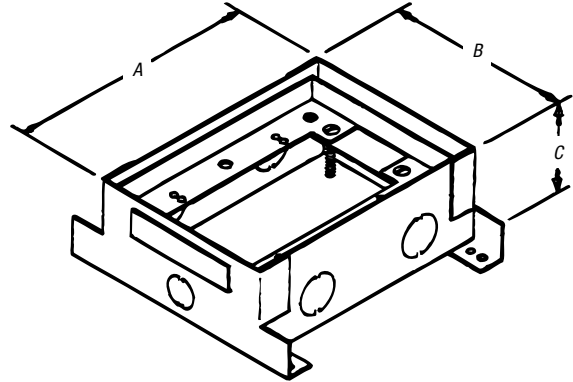
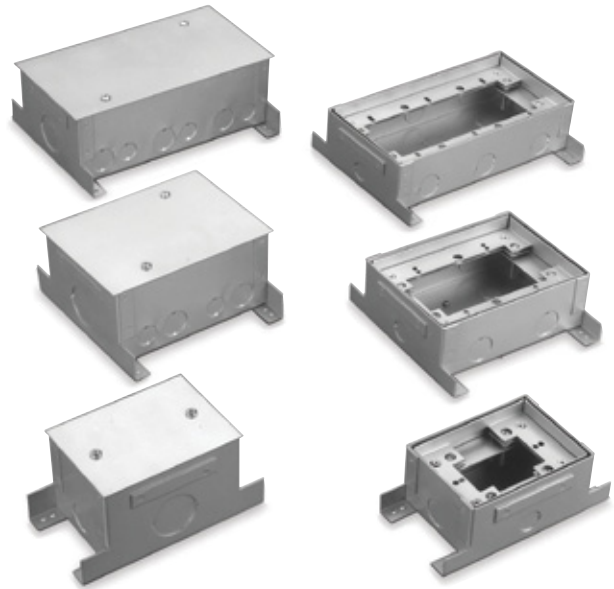

CAT. NO.	DESCRIPTION	STD. CTN.
741-S	Shallow One-Gang Steel Floor Box for Concrete Construction	4
742-S	Shallow Two-Gang Steel Floor Box for Concrete Construction	1
743-S	Shallow Three-Gang Steel Floor Box for Concrete Construction	1
741-D	Deep One-Gang Steel Floor Box for Concrete Construction	4
742-D	Deep Two-Gang Steel Floor Box for Concrete Construction	1
743-D	Deep Three-Gang Steel Floor Box for Concrete Construction	1

Engineering Data for 740 Series



CAT. NO.	DIMENSIONS (IN.)			ADJUSTMENT (IN.)		CAPACITY PER GANG	CONDUIT KOS (IN.)		
	A	B	C	BEFORE POUR	AFTER POUR		SIDES	ENDS	BOTTOM
741-S	4	5 $\frac{1}{2}$	2 $\frac{5}{8}$	2	1 $\frac{1}{2}$	29 cu. in.	(2) $\frac{3}{4}$	(2) $\frac{1}{2}$	(1) $\frac{1}{2}$ & (1) $\frac{3}{4}$
742-S	7 $\frac{1}{4}$	5 $\frac{1}{2}$	2 $\frac{5}{8}$	2	1 $\frac{1}{2}$	26 cu. in.	(4) $\frac{3}{4}$	(2) $\frac{1}{2}$	(2) $\frac{1}{2}$ & (2) $\frac{3}{4}$
743-S	10 $\frac{1}{4}$	5 $\frac{1}{2}$	2 $\frac{5}{8}$	2	1 $\frac{1}{2}$	26 cu. in.	(6) $\frac{3}{4}$	(2) $\frac{1}{2}$	(3) $\frac{1}{2}$ & (3) $\frac{3}{4}$
741-D	4	5 $\frac{1}{2}$	3 $\frac{5}{8}$	2	1 $\frac{1}{2}$	48 cu. in.	(2) $\frac{3}{4}$	(2) 1 $\frac{1}{4}$	(1) $\frac{3}{4}$ & (1) $\frac{3}{4}$
742-D	7 $\frac{1}{4}$	5 $\frac{1}{2}$	3 $\frac{5}{8}$	2	1 $\frac{1}{2}$	41 cu. in.	(4) $\frac{3}{4}$	(2) 1 $\frac{1}{4}$	(2) $\frac{1}{2}$ & (2) $\frac{3}{4}$
743-D	10 $\frac{1}{4}$	5 $\frac{1}{2}$	3 $\frac{5}{8}$	2	1 $\frac{1}{2}$	41 cu. in.	(6) $\frac{3}{4}$	(2) 1 $\frac{1}{4}$	(3) $\frac{1}{2}$ & (3) $\frac{3}{4}$

Flush Service Floor Boxes

Carpet and Tile Activations for 740 Series

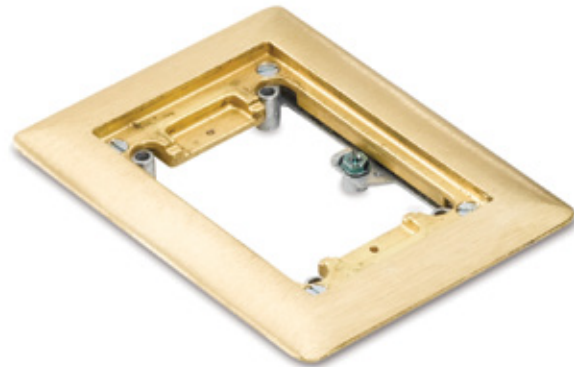

641P-CACB

Carpet Activation Kit

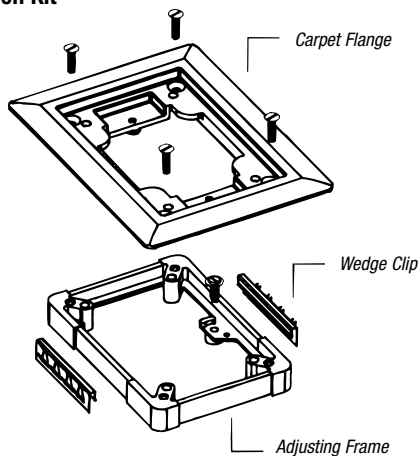

Tile Activation Kit

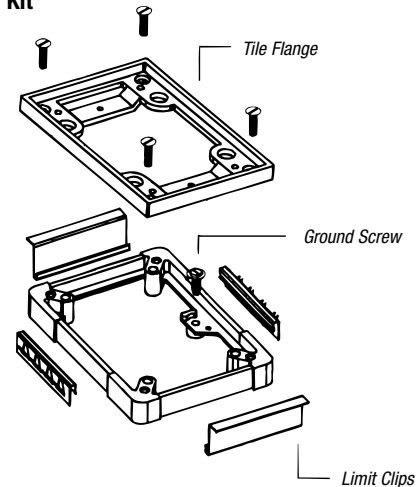

CAT. NO.	DESCRIPTION	FINISH	STD. CTN.
Carpet Activations for 740 Series			
641P-CACA	One-Gang Carpet Trim	Aluminum	4
641P-CACB	One-Gang Carpet Trim	Brass	4
641P-CAC-BGE	One-Gang Carpet Trim	Non-Metallic Beige	4
641P-CAC-BLK	One-Gang Carpet Trim	Non-Metallic Black	4
641P-CAC-GRY	One-Gang Carpet Trim	Non-Metallic Gray	4
642P-CACA	Two-Gang Carpet Trim	Aluminum	4
642P-CACB	Two-Gang Carpet Trim	Brass	4
642P-CAC-BGE	Two-Gang Carpet Trim	Non-Metallic Beige	4
642P-CAC-BLK	Two-Gang Carpet Trim	Non-Metallic Black	4
642P-CAC-GRY	Two-Gang Carpet Trim	Non-Metallic Gray	4
643P-CACA	Three-Gang Carpet Trim	Aluminum	4
643P-CACB	Three-Gang Carpet Trim	Brass	4
643P-CAC-BGE	Three-Gang Carpet Trim	Non-Metallic Beige	4
643P-CAC-BLK	Three-Gang Carpet Trim	Non-Metallic Black	4
643P-CAC-GRY	Three-Gang Carpet Trim	Non-Metallic Gray	4

CAT. NO.	DESCRIPTION	FINISH	STD. CTN.
Tile Activations for 740 Series			
641P-TACA	One-Gang Tile Trim	Aluminum	4
641P-TACB	One-Gang Tile Trim	Brass	4
641P-TAC-BGE	Non-Metallic	Beige	4
641P-TAC-BLK	Non-Metallic	Black	4
641P-TAC-GRY	Non-Metallic	Gray	4
642P-TACA	Two-Gang Tile Trim	Aluminum	4
642P-TACB	Two-Gang Tile Trim	Brass	4
642P-TAC-BGE	Non-Metallic	Beige	4
642P-TAC-BLK	Non-Metallic	Black	4
642P-TAC-GRY	Non-Metallic	Gray	4
643P-TACA	Three-Gang Tile Trim	Aluminum	4
643P-TACB	Three-Gang Tile Trim	Brass	4
643P-TAC-BGE	Non-Metallic	Beige	4
643P-TAC-BLK	Non-Metallic	Black	4
643P-TAC-GRY	Non-Metallic	Gray	4

Flush Service Floor Boxes

MopTite® Cover Plates for 740 Series

Boxes & Covers — Steel City® Floor Boxes

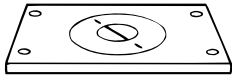

P-64-3/4-2*
3/4" & 2" dia. plug



P-64-2-5/8*
2 5/8" dia. plug



P-64-DS*
Duplex Lift lids

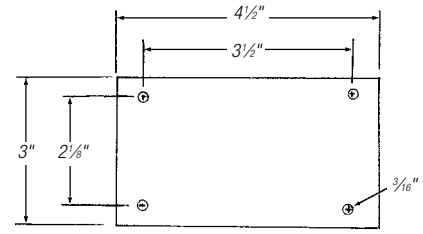

Plate Dimensions



P-64-DU*
Duplex 1 1/16" plugs



P-64-GFCI



P-64-1/2
1/2" N.P.S. plug

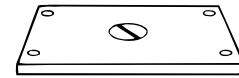

P-64-3/4
3/4" N.P.S. plug

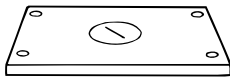

P-64-1
1" N.P.S. plug

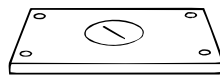

P-64-1-1/4
1 1/4" N.P.S. plug

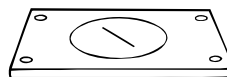

P-64-2*
2" dia. plug



P-64-1/2-2*
1/2" & 2" dia. plug

*Also includes seating plate for receptacle like others.



CAT. NO.	DESCRIPTION	FINISH	STD. CTN.
P-64-1/2	Cover Plate 1/2" NPS Plug	Brass	4
P-64-1/2-AL	Cover Plate 1/2" NPS Plug	Aluminum	4
P-64-3/4	Cover Plate 3/4" NPS Plug	Brass	4
P-64-3/4-AL	Cover Plate 3/4" NPS Plug	Aluminum	4
P-64-1	Cover Plate 1" NPS Plug	Brass	4
P-64-1-AL	Cover Plate 1" NPS Plug	Aluminum	4
P-64-1-1/4	Cover Plate 1 1/4" NPS Plug	Brass	4
P-64-1-1/4-AL	Cover Plate 1 1/4" NPS Plug	Aluminum	4
P-64-2	Cover Plate 2" UN Plug	Brass	4
P-64-2-AL	Cover Plate 2" UN Plug	Aluminum	4
P-64-1/2-2	Cover Plate 1/2" & 2" UN Plug	Brass	4
P-64-1/2-2-AL	Cover Plate 1/2" & 2" UN Plug	Aluminum	4
P-64-3/4-2	Cover Plate 3/4" & 2" UN Plug	Brass	4
P-64-3/4-2-AL	Cover Plate 3/4" & 2" UN Plug	Aluminum	4
P-64-2-5/8	Cover Plate 2 5/8" UN Plug	Brass	4
P-64-2-5/8-AL	Cover Plate 2 5/8" UN Plug	Aluminum	4
P-64-DU	Cover Plate Duplex 1 1/16" Plugs	Brass	4
P-64-DU-AL	Cover Plate Duplex 1 1/16" Plugs	Aluminum	4
P-64-DS	Cover Plate Duplex Lift Lids	Brass	4
P-64-DS-AL	Cover Plate Duplex Lift Lids	Aluminum	4
P-64-GFCI	Cover Plate GFCI Flip Lid	Brass	4
P-64-GFCI-AL	Cover Plate GFCI Flip Lid	Aluminum	4

New MopTite® Covers exceed UL® scrubwater exclusion requirements.

Flush Service Floor Boxes

MopTite® Non-Metallic Cover Plates for 740 Series

- Polished-brass finish
- Furnished complete with sealing gasket and 8-32 x 7/16" brass screws
- 3" x 4½" outside dimension
- For brushed aluminum, add AL after catalog number
- All covers meet MopTite® requirements

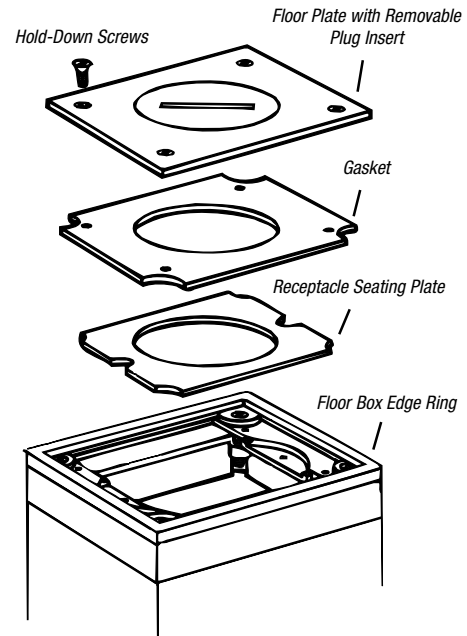
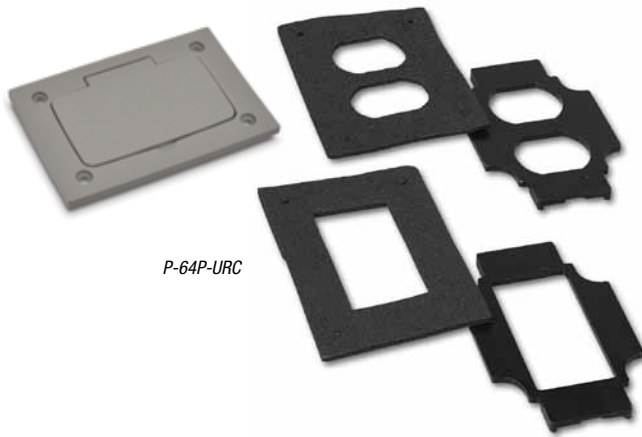

CAT. NO.	DESCRIPTION	FINISH	STD. CTN.
P64P-URC-BLK	Universal Cover	Black	4
P64P-URC-GRY	Universal Cover	Gray	4
P64P-URC-BGE	Universal Cover	Beige	4
P64P-BP-BLK	Blank Cover	Black	4
P64P-BP-GRY	Blank Cover	Gray	4
P64P-BP-BGE	Blank Cover	Beige	4

New MopTite® Covers exceed UL® scrubwater exclusion requirements.

Flush Service Floor Boxes

Single-Gang Residential Floor Box Kit for Wood Floors.

Steel City® Single-Gang Residential Floor Box Kit

Tired of tripping over extension cords? Look no further than the Steel City® Single-Gang Residential Floor Box Kit from Thomas & Betts. This affordable and conveniently packaged kit for the residential market provides power right where you need it most.

- Kit includes switch box, cover, flange and receptacle
- Durable metallic covers and flanges are available in aesthetic brass or nickel finishes
- Available with duplex or GFCI receptacle
- MopTite® covers meet UL® scrubwater requirements for wood, tile and carpet
- 3" x 2" Switch Box is 3½" deep with 18 cu. in. capacity
- Box includes integral non-metallic sheathed cable clamps



NEW!



Brass finish with duplex receptacle.



Nickel finish with GFCI receptacle.

Specifications

- Material: Box — Galvanized Steel
Cover — Brass or Nickel plated
Aluminum Flange — Die-cast Zinc with Brass or Nickel finish
- Listing: UL® and CSA Listed



CAT. NO.	DESCRIPTION	STD. CTN.
71W-DS	1-Gang Residential Floor Box — Duplex Recp., Brass Finish	4
71W-DS-N	1-Gang Residential Floor Box — Duplex Recp., Nickel Finish	4
71W-GFCI	1-Gang Residential Floor Box — GFCI Recp., Brass Finish	4
71W-GFCI-N	1-Gang Residential Floor Box — GFCI Recp., Nickel Finish	4

Flush Service Floor Boxes

For Wood Subfloors!

60W Series Floor Boxes

Steel City® 60W Series Floor Boxes provide single- and multi-gang solutions for wood subfloor applications.

- **NEW!** Three-gang configuration for high-capacity, multi-service installations
- **NEW!** Larger KOs ($\frac{3}{4}$ " and 1") have been added to each gang for application flexibility
- Adjustable mounting brackets allow for various finished floor-material heights (hardwoods, tile or carpet)
- Ideal for open-layout residential applications, school auditoriums or commercial office space
- Voltage dividers are included with multi-gang boxes to accommodate power, voice and data services in the same floor box
- Full range of metallic and non-metallic cover and flange options

New Construction (New Work) Applications

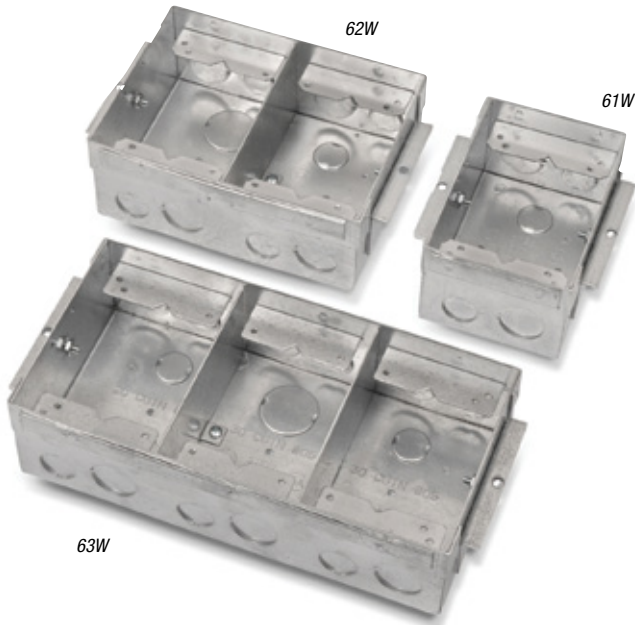
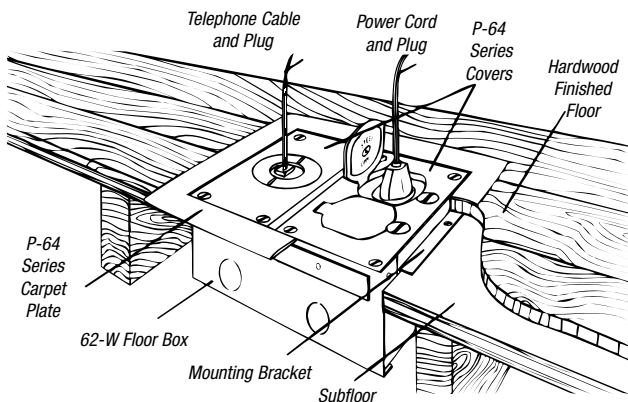

Retrofit Construction (Old Work) Application

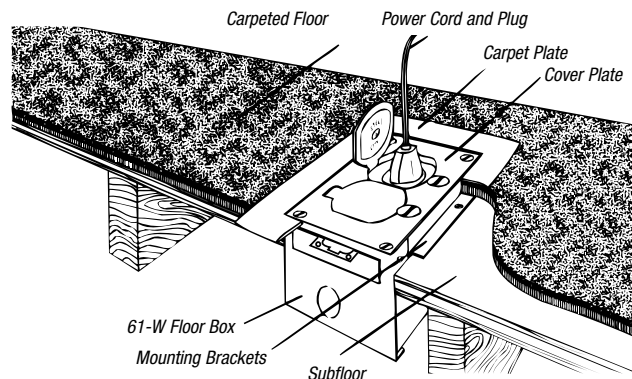

CAT. NO.	DIMENSION	A (IN.)	CAPACITY	STD. CTN.
61W	1-Gang Floor Box for Wood Subfloors $3\frac{1}{16}$ " Ends: (2) $\frac{1}{2}$ ", (2) $\frac{3}{4}$ " Bottom: (1) $\frac{1}{2}$ ", (1) 1"	$3\frac{1}{16}$	31 cu. in.	1
62W	2-Gang Floor Box for Wood Subfloors $7\frac{1}{16}$ " Ends: (4) $\frac{1}{2}$ ", (4) $\frac{3}{4}$ " Bottom: (2) $\frac{1}{2}$ ", (2) 1"	$7\frac{1}{16}$	60 cu. in.	1
63W	NEW! 3-Gang Floor Box for Wood Subfloors $10\frac{1}{4}$ " Ends: (6) $\frac{1}{2}$ ", (6) $\frac{3}{4}$ " Bottom: (3) $\frac{1}{2}$ ", (3) 1"	$10\frac{1}{4}$	90 cu. in.	1

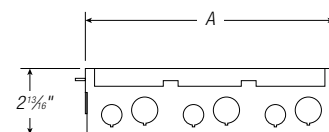
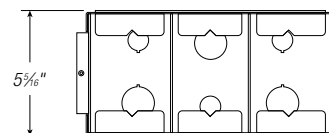

Above-Floor Service Fittings

Steel City® Service Fittings Provide Above-Floor Service for Power, Communications and Data.

Service Fittings for Power

SFH-40 Series

- Brushed-aluminum finish
- Low-profile design
- Furnished with 1" conduit nipple

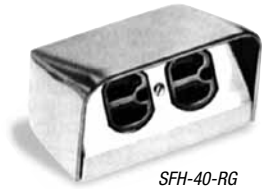

SFH-50 Series

- Brushed-aluminum finish
- Interchangeable face plates
- Furnished with 1" conduit nipple for direct screw-threading into a floor box plate with 1" cover opening



CAT. NO.	DESCRIPTION	FINISH	DIMENSIONS (IN.)			STD. CTN.
			W	D	H	
SFH-40-RG	Furnished with One 15-Amp, 125-Volt, 3-Wire NEMA Duplex Receptacle	Brushed Aluminum	4 $\frac{3}{4}$ "	3"	2 $\frac{1}{2}$ "	4
SFH-40	Same as SFH-40-RG Above, Less Duplex Receptacle	Brushed Aluminum	4 $\frac{3}{4}$ "	3"	2 $\frac{1}{2}$ "	4
SFH-50-2RG	Furnished with Two Back-to-Back 15-Amp, 125-Volt, 3-Wire NEMA Duplex Receptacles	Brushed Aluminum	5"	3 $\frac{3}{4}$ "	3"	4
SFH-50	Same as SFH-50-2RG, Less Duplex Receptacles	Brushed Aluminum	5"	3 $\frac{3}{4}$ "	3"	4
SFH-51	Furnished with Cover Plate to Accommodate One 30- or 50-Amp, 240-Volt, 3-Wire Receptacle and Blank Cover	Brushed Aluminum	5"	3 $\frac{3}{4}$ "	3"	4

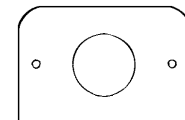
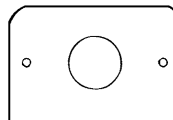
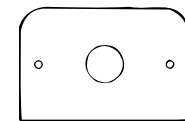
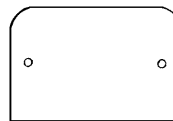
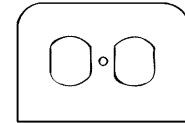
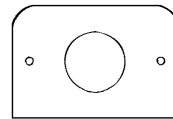
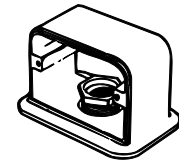
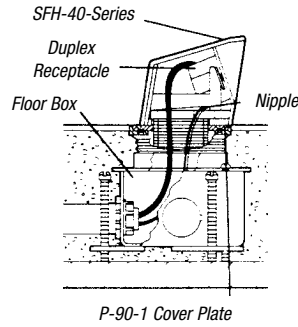

Service Fittings for Communications and Data

- Brushed-aluminum finish
- Low-profile design
- Furnished with 1" conduit nipple



CAT. NO.	DESCRIPTION	FINISH	DIMENSIONS (IN.)			STD. CTN.
			W	D	H	
SFL-10	$\frac{3}{4}$ " x 1 $\frac{1}{8}$ " Bushed Opening for Telephone or Computer	Brushed Aluminum	4 $\frac{3}{4}$ "	3 $\frac{3}{4}$ "	2 $\frac{1}{2}$ "	4

Sample Application

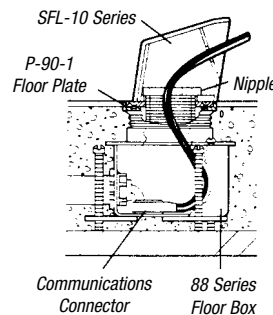

Replacement Parts and Accessories

68, 600, 640, 740 and 840 Series — 1-, 2-, 3-Gang Floor Plate Plug Inserts



692



695



CAT. NO.	SIZE OR DESCRIPTION	STD. CTN.
690-SC	1/2"-14" NPS Thread	4
691-SC	3/4"-14" NPS Thread	4
692-SC	1"-11 1/2" NPS Thread	4
693-SC	1 1/4"-11 1/2" NPS Thread	4
694	2"-20" UN Thread	4
695	1/2"-2"	4
696-SC	3/4"-2"	4
697	2 5/8"-20" UN 2A Thread	4
698	1 1/8" for Duplex P-60-DU	4

For standard plug inserts 1/2" through 2", see **page A-155**.

Catalog numbers are for brass.

For aluminum, add AL after catalog number.

2 5/8"-20" UN 2A thread.

Gaskets for Floor Plate Assemblies



CAT. NO.	DESCRIPTION FOR USE WITH:	STD. CTN.
630-SC	P-60 Series Floor Plate Assemblies	4
631	(except duplex) P-60-DR, P-60-DU, P-60-DC-AL Floor Plate Assemblies	4
SP-60-DS-P3	P-60-DS Floor Plate Assembly	1

Seating Plates for Receptacles — Steel



CAT. NO.	DESCRIPTION FOR USE WITH:	STD. CTN.
SP-620-MA	P-60-2, P-60-1/2-2, P-60-3/4-2 Floor Plate Assemblies	1
SP-621	P-60-DR, P-60-DU, P-60-DC-AL and P-60-DS Floor Plate Assemblies	1

Tile Trims

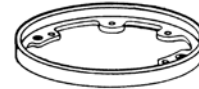

CAT. NO.	DESCRIPTION	STD. CTN.
600-4-FL-AL	Aluminum	4
600-4-FL	Brass	4

Gaskets for Floor Plate Assemblies



CAT. NO.	DESCRIPTION FOR USE WITH:	STD. CTN.
SP650	P-64 Series Floor Plate Assemblies	4
SP651	P-64-DU Floor Plate Assemblies	10
SPP-64-DS-P2	P-64-DS Floor Plate Assemblies	4

Seating Plates for Receptacles — Steel



CAT. NO.	DESCRIPTION FOR USE WITH:	STD. CTN.
640	P-64-2, P-64-1/2-2, P-64-3/4-2 Floor Plate Assemblies	4
639	P-64-2-5/8 Floor Plate Assemblies	1
638	P-64-DS and P-64-DU Floor Plate Assemblies	2 5/8"-20 UN 2A Thread

Floor Plate Plug Inserts



CAT. NO.	DESCRIPTION FOR USE WITH:	STD. CTN.
697	2 5/8"	4
698	1 1/8" for Duplex P-64-DU	4

For standard plug inserts 1/2" through 2", see **page A-155**. Catalog numbers are for brass. For aluminum, add AL after catalog number.

Replacement Parts and Accessories

For 78, 88 and 98, 671 or 672 Series Floor Box Body Parts

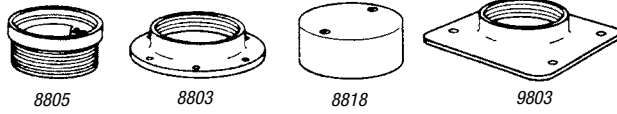

CAT. NO.	DESCRIPTION	STD. CTN.
8805	Brass Adjusting Ring	4
8803	Threaded Steel Body Cover of 78 and 88 Series	4
8818	Metal Protective Cap	4
9803	Threaded Steel Body Cover for 98 Series	4

2 1/4"-20" UN 2A Thread.

Gasket for Floor Plate Assembly



CAT. NO.	FOR USE WITH:	STD. CTN.
8811	P-90 Series Floor Plates	4

Plate for Short Strap Receptacle



CAT. NO.	FOR USE WITH:	STD. CTN.
889	Series 78, 88, 98, 671, 672 Boxes	4

Extension Collar



CAT. NO.	FOR USE WITH:	STD. CTN.
8805-E	Provides an Extension of Floor Box Throat Upwards 1 1/8"; for Extreme Depths (7 cu. in.) 2 1/4"-20 UN 2A Thread	4

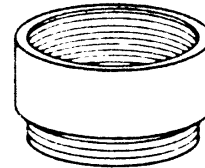
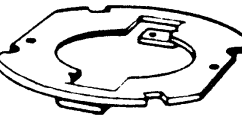

Microphone Adapter for Floor Boxes



CAT. NO.	FOR USE WITH:	STD. CTN.
489-MA	27-ga. Galvanized Steel with 1 1/4" Dia. Opening for Standard Microphone Jacks: for Steel City® Floor Box Series 78, 88, 98 and 671	4

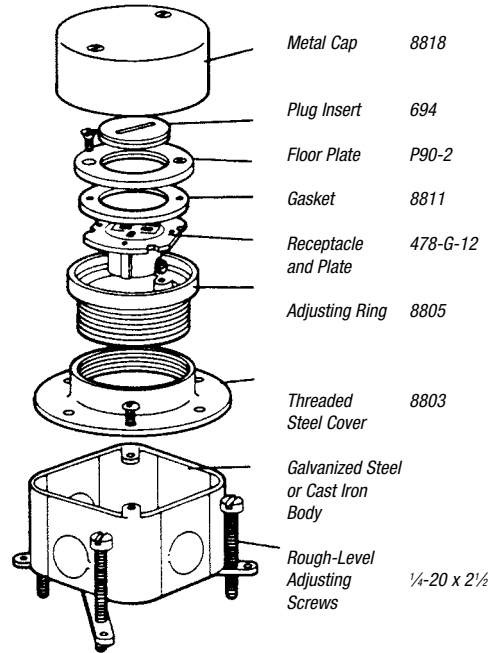
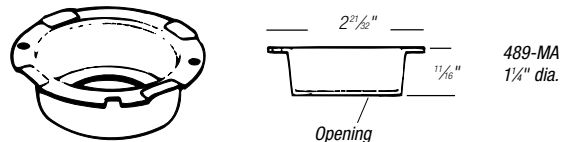

Floor Box Assembly with Floor Plate

Poke Through Systems

Capacity, Durability, Flexibility — Everything You've Been Looking for in a Poke Through.

Fire-Rated Poke Through Systems

Flush Power & Communications

FPT4 Series

- Maximum capacity and flexibility for flush-mounted power and communications devices, including the popular "4 x 4" configuration (4 power outlets, 4 communications devices)
- Core Drill Size: 4"

FPT3 Series

- Accommodates 1 duplex receptacle and 2 data jacks
- Core Drill Size: 3"

FPT Flush Series

- Accepts 1 duplex receptacle
- Core Drill Size: 3"

Furniture Feed

FFPT4 Series

- 2 Conduit Hubs: ¾" for power and 1¼" for communications
- Core Drill Size: 4"

FFPT3 Series

- Concentric 2" and 1¼" Hub for power or communications
- Core Drill Size: 3"

FPT Furniture Feed Series

- 3 Conduit Hubs: (2) ½" and (1) ¾" for power and communications
- Core Drill Size: 3"

Above Floor Pedestals

FPT Above-Floor Pedestals

- Available in 2 compartment and 4 compartment for power and communications
- Core Drill Size: 3"



Poke Through Systems

FPT4 Series

The FPT4 Series provides everything you look for in a flush Poke Through — capacity, durability, flexibility, accessibility and aesthetics.

Capacity:

- Four standard configurations:
 - 4 power receptacles + 4 communications devices (4 x 4)
 - 2 power receptacles + 6 communications devices
 - 8 communications devices
 - 1 locking receptacle + 2 communications devices
- Core Drill Size: 4"

Durability:

- Solid brass or aluminum covers protect devices from damage and debris when not in use — no exposed plastic components
- Unique latching lid eliminates easily damaged, hard-to-use locking screws

Accessibility:

- Full access to communications compartment through the cover without exposing power compartments — even after it's installed in the floor
- "Straight-through" wiring of communications cabling for easy installation and changes

Flexibility:

- Configurable design to meet any project requirements:
 - 4 standard configurations for power and communications devices
 - 20A receptacles can be wired as isolated ground (orange labels provided)
 - Communications plates available to accommodate data jacks from many manufacturers
 - Accepts Extron MAAP plates for A/V components
- Threaded conduit hubs enable all communications cabling to be enclosed in a single conduit
 - Integral 1" hub on the 4 x 4 — no extra parts needed
 - Optional hubs available for other configurations
- Junction box features (5) ½" and (5) ¾" knockouts (27 cubic inch capacity)

Aesthetics:

- The only 4" core poke through for power and communications with the entire cover made of solid brass — features an aesthetic brushed finish
- Solid aluminum covers also available with brushed finish or powder-coated finishes in black, gray, brown and beige to match any décor — the most colors in the industry



4 Power +
4 Communications, [page A-175](#).



2 Power +
6 Communications, [page A-175](#).



8 Communications,
[page A-176](#).



1 Locking Receptacle
+ 2 Communications, [page A-176](#).

Poke Through Systems

Poke Through: 4 Power and 4 Communications

- Four 20A Receptacles, two circuits, six 12 AWG wires, prewired, pigtail ends in junction box (can be wired as isolated ground, labels provided)
- Keystone Communications Device Plate with four Keystone Category 5e Data Jacks — see **page A-177** for optional Communications Device Plates for Compartment A
- Integral 1" threaded conduit hub for communication wiring (cast iron)



CAT. NO.	DESCRIPTION	STD. CTN.
FPT4-4P-4C-TBRS	Poke-Through Assembly: Base with Brass Cover	1
FPT4-4P-4C-TALM	Poke-Through Assembly: Base with Aluminum Cover	1
FPT4-4P-4C-TBLK	Poke-Through Assembly: Base with Black Cover	1
FPT4-4P-4C	Poke-Through Base (Cover Purchased Separately)	1

Device Layout

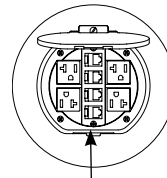

Compartment A

Cable Entry

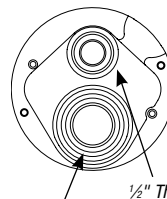

1" Threaded Hub for Power
1/2" Threaded Hub for Communications

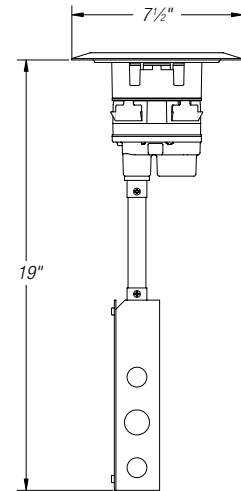

Poke Through Covers

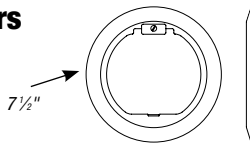

CAT. NO.	DESCRIPTION	STD. CTN.
FPT4-CVR-TBRS	Cover, FPT4 Series Poke Through — Brushed Brass	4
FPT4-CVR-TALM	Cover, FPT4 Series Poke Through — Brushed Aluminum	4
FPT4-CVR-TBLK	Cover, FPT4 Series Poke Through — Aluminum with Black Powder Coat Finish	4
FPT4-CVR-TBGE	Cover, FPT4 Series Poke Through — Aluminum with Beige Powder Coat Finish	4
FPT4-CVR-TBRN	Cover, FPT4 Series Poke Through — Aluminum with Brown Powder Coat Finish	4

Forged solid brass and aluminum covers.

Latching lid closes easily without the need for locking screws.

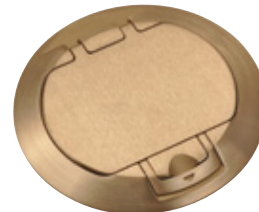

Brass



Aluminum



Black

Poke Through: 2 Power and 6 Communications

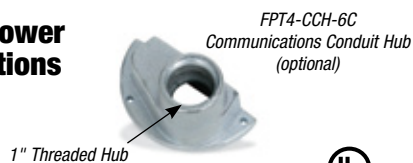

FPT4-CCH-6C
Communications Conduit Hub
(optional)

1" Threaded Hub



CAT. NO.	DESCRIPTION	STD. CTN.
FPT4-2P-6C	Poke-Through Base Unit only (cover purchased separately)	1
FPT4-CCH-6C	Optional 1" Threaded Conduit Hub for Communications Wiring (cast iron)	1

Two 20A Receptacles, one circuit, three 12 AWG wires, prewired, pigtail ends in junction box (can be wired as isolated ground, labels provided).

Includes Keystone Communications Device Plates with six Keystone Category 5e Data Jacks — see **page A-177** for optional Communications Device Plates for Compartment A and Compartment B.

Device Layout

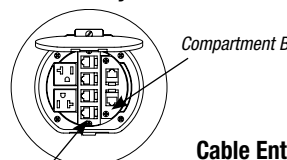

Compartment A

Compartment B

Cable Entry

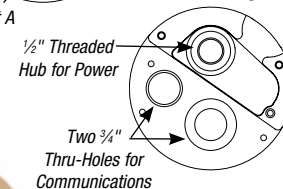

Two 3/4" Thru-Holes for Communications

(Cover purchased separately)

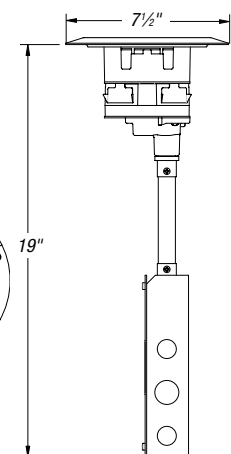

Poke Through Systems

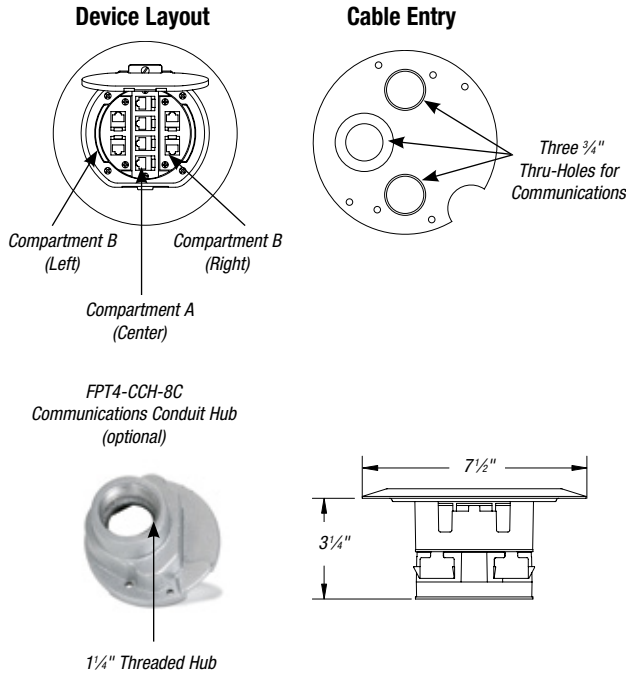

FPT4 Series (continued)

Poke Through: 8 Communications

- Keystone Communications Device Plates with eight Keystone Category 5e Data Jacks — see **page A-177** for optional Communications Device Plates for Compartment A and Compartment B
- No junction box



CAT. NO.	DESCRIPTION	STD. CTN.
FPT4-8C	Poke-Through Base (Cover Purchased Separately)	1
FPT4-CCH-8C	Optional 1/4" Threaded Conduit Hub for Communications Wiring (Cast Iron)	4

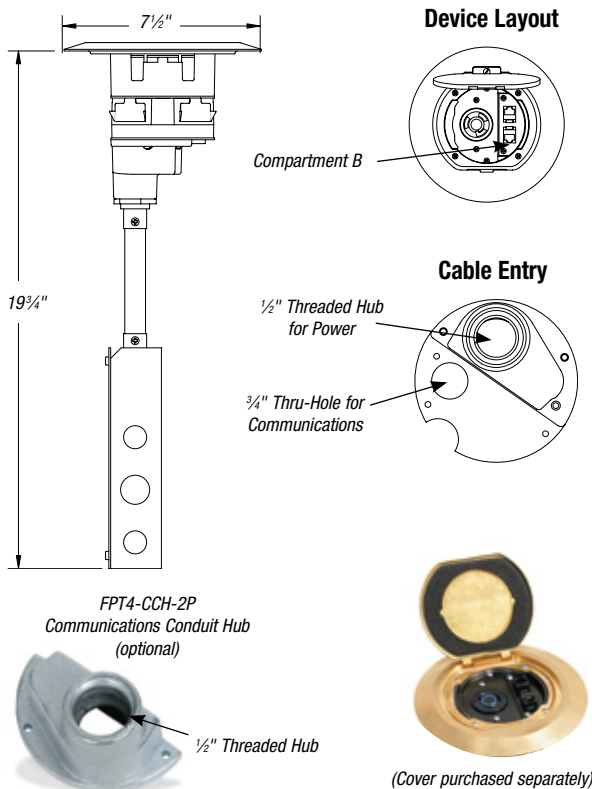

Poke Through: 1 Locking Receptacle & 2 Communications

- 20A Receptacle: pre-wired, three 12 AWG wires, pigtail ends in junction box
- 30A Receptacle: pre-wired, three 10 AWG wires, pigtail ends in junction box
- Cover purchased separately
- Includes Keystone Communications Device Plates with two Keystone Category 5e Data Jacks — see **page A-177** for optional Communications Device Plates for Compartment B

CAT. NO.	DESCRIPTION	STD. CTN.
FPT4-1TL21-2C	Poke-Through Base, NEMA L5-20R, 20A/125V Locking Receptacle, 2 Communications Receptacles	1
FPT4-1TL22-2C	Poke-Through Base, NEMA L6-20R, 20A/250V Locking Receptacle, 2 Communications Receptacles	1
FPT4-1TL31-2C	Poke-Through Base, NEMA L5-30R, 30A/125V Locking Receptacle, 2 Communications Receptacles	1
FPT4-1TL32-2C	Poke-Through Base, NEMA L6-30R, 30A/250V Locking Receptacle, 2 Communications Receptacles	1
FPT4-CCH-2P	Optional 1/2" Threaded Conduit Hub for Communications Wiring (Cast Iron)	4

Poke Through Systems

Optional Communications Device Plates

- Device Plate only — no jacks included

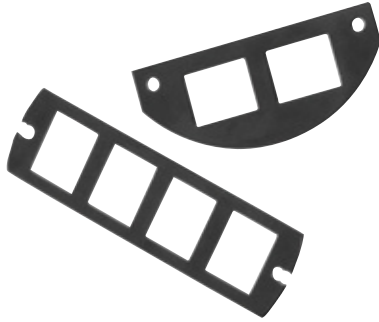

CAT. NO.	DESCRIPTION	STD. CTN.
FPT4-CPA-4KEY	For 4 Keystone Jacks — Compartment A*	4
FPT4-CPA-4SYS	For 4 Systemax® Jacks — Compartment A	4
FPT4-CPA-3PAN	For 3 Panduit Jacks — Compartment A**	4
FPT4-CPA-1MAAP	For Extron® MAAP Plate, Single Space — Compartment A	4
FPT4-CPA-4ORT	For 4 Ortronics® Jacks — Compartment A	4
FPT4-CPA-BLANK	Blank — Compartment A	4
FPT4-CPB-2KEY	For 4 Keystone Jacks — Compartment B*	4
FPT4-CPB-2SYS	For 4 Systemax® Jacks — Compartment B	4
FPT4-CPB-2PAN	For 2 Panduit Jacks — Compartment B**	4
FPT4-CPB-1MAAP	For Extron® MAAP Plate, Single Space — Compartment B	4
FPT4-CPB-2ORT	For 4 Ortronics® Jacks — Compartment B	4
FPT4-CPB-BLANK	Blank — Compartment B	4
FPT4-CPAB-2MAAP	For Extron® MAAP Plate, Double Space — Compartment A-B	4

* Keystone plates also accept Leviton® and Hubbell® devices.

** Requires CMNZABL-X adapter from Panduit® to mount Panduit® MiniCom jacks.

*** For use with FPT4-2P-6C and FPT4-8C Series only; replaces one Compartment A plate and one Compartment B plate.

Compartment A Plates

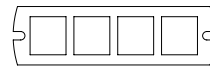

FPT4-CPA-4SYS

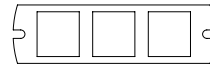

FPT4-CPA-3PAN**

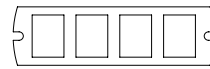

FPT4-CPA-4KEY

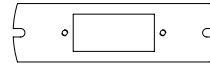

FPT4-CPA-1MAAP



FPT4-CPA-4ORT



FPT4-CPA-BLANK

Compartment B Plates

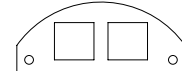

FPT4-CPB-2SYS

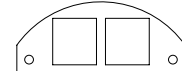

FPT4-CPB-2PAN**

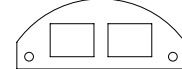

FPT4-CPB-2KEY



FPT4-CPB-1MAAP

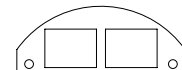

FPT4-CPB-2ORT



FPT4-CPB-BLANK

Compartment A-B Plate ***

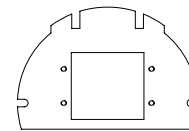

FPT4-CPAB-2MAAP

Replacement Power Insert — 2 Receptacles

- For use with FPT4-4P-4C and FPT4-2P-6C Series Poke-Through Systems



CAT. NO.	DESCRIPTION	STD. CTN.
FPT4-2P-RPL	Replacement Power Insert with 18" Wire Whip — Two 20A Receptacles	4



Poke Through Systems

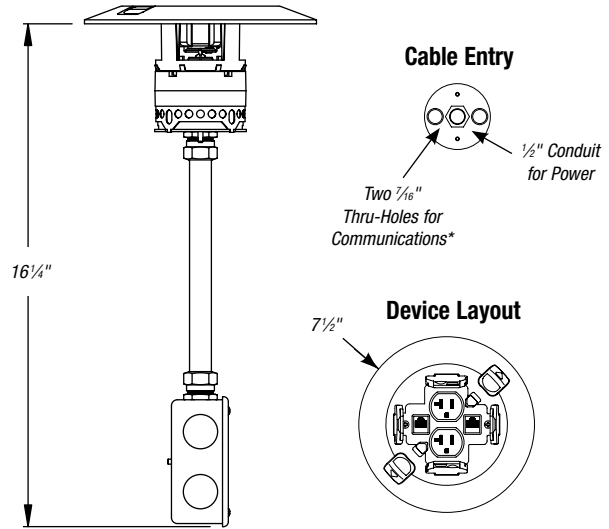
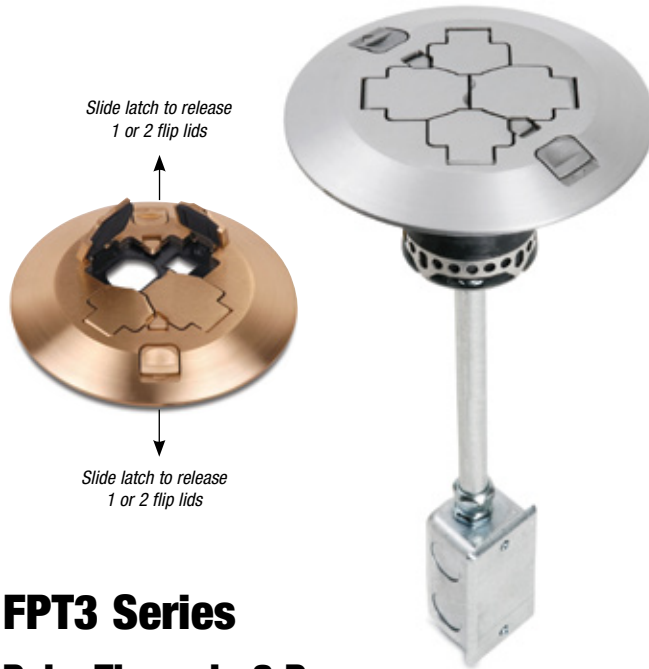

* If 1/2" EMT conduit stubs are required for communications cabling, use "City of Chicago" base unit, catalog # FPT3-2P-2C-C (see [page A-184](#)).

FPT3 Series

Poke Through: 2 Power and 2 Communications

This aesthetic, easy-to-use poke through provides an ideal power and data solution — great for new construction or upgrading existing 3" core installations.

- Capacity: 1 duplex receptacle and 2 data jacks (included)
- Core drill Size: 3"
- Durable solid brass or aluminum covers protect devices from damage and debris when not in use — no exposed plastic components
- Powder-coated aluminum covers are available in black, gray, brown and beige to match any décor — the most colors in the industry
- Brushed brass and aluminum finishes provide superior aesthetics
- Slide latches enable tool-less access to individual receptacles — eliminates the need for hard-to-use locking screws
- Accepts Keystone, Leviton® or Hubbell® data jacks
- Junction box features (3) 1/2" and (4) 3/4" knockouts (13 cubic inch capacity)
- Includes (1) 20A duplex receptacle, pre-wired, pigtail ends in junction box
- Includes (2) Leviton® CAT5e data jacks



CAT. NO.	DESCRIPTION	STD. CTN.
FPT3-2P-2C-BRS	FPT3 Series Poke-Through Assembly: Base Unit with Brushed-Brass Cover	1
FPT3-2P-2C-ALM	FPT3 Series Poke-Through Assembly: Base Unit with Brushed-Aluminum Cover	1
FPT3-2P-2C-BLK	FPT3 Series Poke-Through Assembly: Base Unit with Black Powder-Coat Cover	1
FPT3-2P-2C	FPT3 Series Poke-Through Base Unit Only: Cover Purchased Separately (see below)	1



Poke Through Covers

CAT. NO.	DESCRIPTION	STD. CTN.
FPT3-CVR-BRS	Cover, FPT3 Series Poke Through — Solid Brass, Brushed Finish	4
FPT3-CVR-ALM	Cover, FPT3 Series Poke Through — Solid Aluminum, Brushed Finish	4
FPT3-CVR-BLK	Cover, FPT3 Series Poke Through — Aluminum with Black Powder-Coat Finish	4
FPT3-CVR-GRY	Cover, FPT3 Series Poke Through — Aluminum with Gray Powder-Coat Finish	4
FPT3-CVR-BGE	Cover, FPT3 Series Poke Through — Aluminum with Beige Powder-Coat Finish	4
FPT3-CVR-BRN	Cover, FPT3 Series Poke Through — Aluminum with Brown Powder-Coat Finish	4

See [page A-179](#) to view typical brushed metal and powder coat finishes.

Poke Through Systems

FPT Flush Series

The Steel City® FPT Poke Through Series provides an economical solution for installing a duplex receptacle in an existing floor — right where you need it.

- Capacity: 1 duplex receptacle
- Core drill size: 3"
- Brushed brass and aluminum covers provide superior aesthetics and durability
- Non-metallic covers are available in black, gray, beige and brown
- Non-metallic covers include openings for 3 communications cables
- Integral junction box features (5) ½" and (5) ¾" knockouts (27 cubic inch capacity)
- Assembled units include (1) 20A duplex receptacle, pre-wired with pigtail ends in junction box

Poke Through: 2 Power



CAT. NO.	DESCRIPTION	STD. CTN.
FPT-449	FPT Flush Poke-Through Assembly: Base Unit with Solid-Brass Cover	1
FPT-450	FPT Flush Poke-Through Assembly: Base Unit with Solid-Aluminum Cover	1
FPT-445-SW-BLK	FPT Flush Poke-Through Assembly: Base Unit with Black Non-Metallic Cover	1
FPT-445-SW-GRY	FPT Flush Poke-Through Assembly: Base Unit with Gray Non-Metallic Cover	1
FPT-445-SW-BGE	FPT Flush Poke-Through Assembly: Base Unit with Beige Non-Metallic Cover	1
FPT-445-SW-BRN	FPT Flush Poke-Through Assembly: Base Unit with Brown Non-Metallic Cover	1
FPT-400B	FPT Poke-Through Base Unit Only (no duplex): Cover Purchased Separately	1

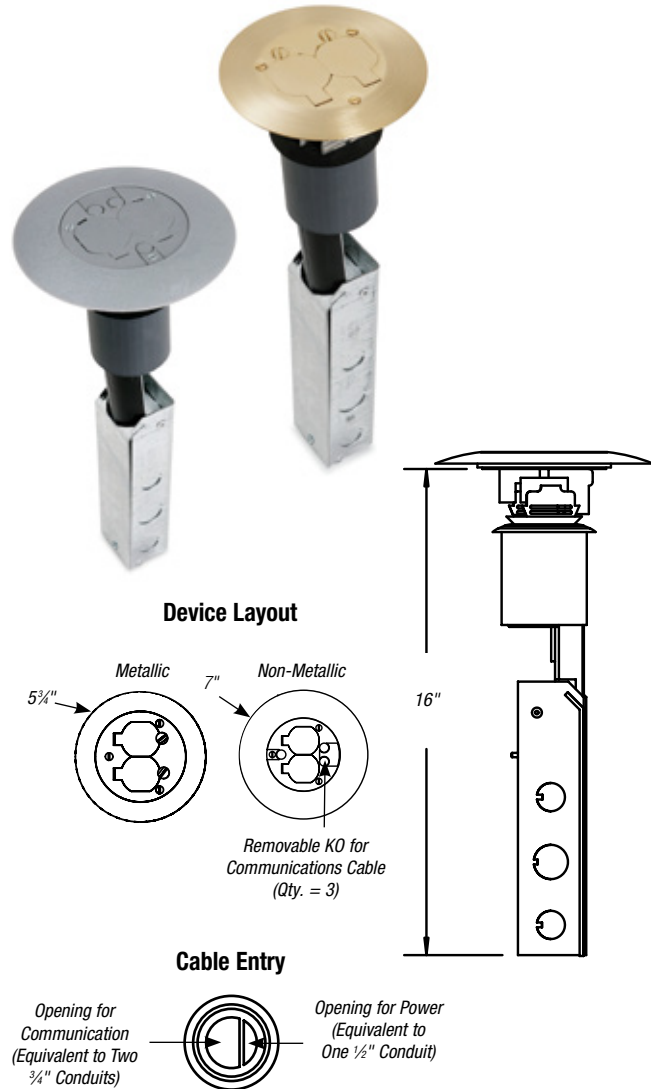

Poke-Through Covers

- Non-metallic covers feature 3 openings for communications cables



CAT. NO.	DESCRIPTION	STD. CTN.
FPT-CACP	Solid Brass, Brushed Finish, 5 3/4" Diameter	10
FPT-CACP-AL	Solid Aluminum, Brushed Finish, 5 3/4" Diameter	10
FPT-441-SW-BLK	Black, Non-Metallic, 7" Diameter	10
FPT-441-SW-GRY	Gray, Non-Metallic, 7" Diameter	10
FPT-441-SW-BGE	Beige, Non-Metallic, 7" Diameter	10
FPT-441-SW-BRN	Brown, Non-Metallic, 7" Diameter	10

Brushed Metal Finishes



FPT-CACP



FPT-CACP-AL

Non-Metallic Colors and Finishes



FPT-441-SW-BLK



FPT-441-SW-GRY



FPT-441-SW-BGE



FPT-441-SW-BRN

Poke Through Systems

FFPT4 Series Poke Through



With limitations on the number of holes that can be drilled in a floor, it is important to maximize the capacity of each location. The FFPT4 Series provides high capacity for both power wiring and communications cabling when feeding modular furniture — in a single-core drill location!

- Capacity: 3/4" hub for power wiring and 1 1/4" hub for communications cabling (plugs included)
- Core drill size: 4"
- Solid brass and aluminum finishes provide superior aesthetics and durability
- Powder-coated aluminum covers are available in black, gray, brown and beige to match any décor — the most colors in the industry
- Integral junction box features (5) 1/2" and (5) 3/4" knockouts (27 cubic inch capacity)



CAT. NO.	DESCRIPTION	STD. CTN.
FFPT4-BRS	FFPT4 Series Poke-Through Assembly: Base Unit with Brushed-Brass Cover	1
FFPT4-ALM	FFPT4 Series Poke-Through Assembly: Base Unit with Brushed-Aluminum Cover	1
FFPT4-BLK	FFPT4 Series Poke-Through Assembly: Base Unit with Black Powder-Coat Cover	1
FFPT4	FFPT4 Series Poke-Through Base Unit Only: Cover Purchased Separately (see page A-179)	1



Hub Layout — Cover

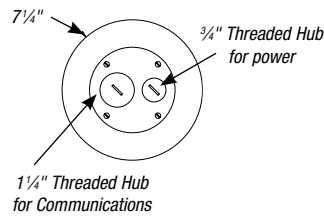

Cable Entry

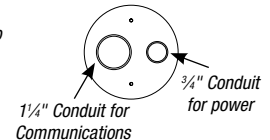

Poke-Through Covers



CAT. NO.	DESCRIPTION	STD. CTN.
FFPT4-CVR-BRS	Solid Brass, Brushed Finish	4
FFPT4-CVR-ALM	Solid Aluminum, Brushed Finish	4
FFPT4-CVR-BLK	Aluminum with Black Powder-Coat Finish	4
FFPT4-CVR-GRY	Aluminum with Gray Powder-Coat Finish	4
FFPT4-CVR-BGE	Aluminum with Beige Powder-Coat Finish	4
FFPT4-CVR-BRN	Aluminum with Brown Powder-Coat Finish	4

See page A-179 to view typical brushed metal and powder coat colors and finishes.



Poke Through Systems

FFPT3 Series Poke Through



When feeding large bundles of communications cables through a fire-rated floor, the FFPT3 Series provides a high-capacity, straight-through wiring solution. It can also be used for power wiring.

- Capacity: Concentric 1¼" and 2" hub for power or communications wiring (plugs included)
- Core Drill Size: 3"
- Solid brass and aluminum finishes provide superior aesthetics and durability
- Powder-coated aluminum covers are available in black, gray, brown and beige to match any décor — the most colors in the industry
- Junction box not included



CAT. NO.	DESCRIPTION	STD. CTN.
FFPT3-BRS	FFPT3 Series Poke-Through Assembly: Base Unit with Brushed-Brass Cover	1
FFPT3-ALM	FFPT3 Series Poke-Through Assembly: Base Unit with Brushed-Aluminum Cover	1
FFPT3-BLK	FFPT3 Series Poke-Through Assembly: Base Unit with Black Powder-Coat Cover	1
FFPT3	FFPT3 Series Poke-Through Base Unit Only: Cover Purchased Separately (see Below)	1

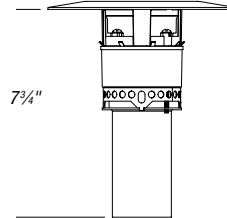

Hub Layout — Cover

Cable Entry

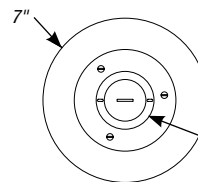

2" & 1¼"
Concentric
Threaded Hub

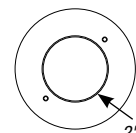

2" Conduit

Poke-Through Covers



CAT. NO.	DESCRIPTION	STD. CTN.
FFPT3-CVR-BRS	Solid Brass, Brushed Finish	4
FFPT3-CVR-ALM	Solid Aluminum, Brushed Finish	4
FFPT3-CVR-BLK	Aluminum with Black Powder-Coat Finish	4
FFPT3-CVR-GRY	Aluminum with Gray Powder-Coat Finish	4
FFPT3-CVR-BGE	Aluminum with Beige Powder-Coat Finish	4
FFPT3-CVR-BRN	Aluminum with Brown Powder-Coat Finish	4

See **page A-179** to view typical brushed metal and powder coat colors and finishes.



Poke Through Systems

FPT Furniture Feed Series

With three conduit hubs for power and communications and an integral junction box, the FPT Series provides a flexible, cost-effective furniture feed solution.

- Capacity: (2) ½" hubs and (1) ¾" hub for power and data (plugs included)
- Core drill size: 3"
- Non-metallic covers are available in black, gray, beige and brown
- Provided with Steel City® die cast fittings for flexible metal conduit: (2) ½" and (1) ¾"
- Integral junction box features (5) ½" and (5) ¾" knockouts (27 cubic inch capacity)

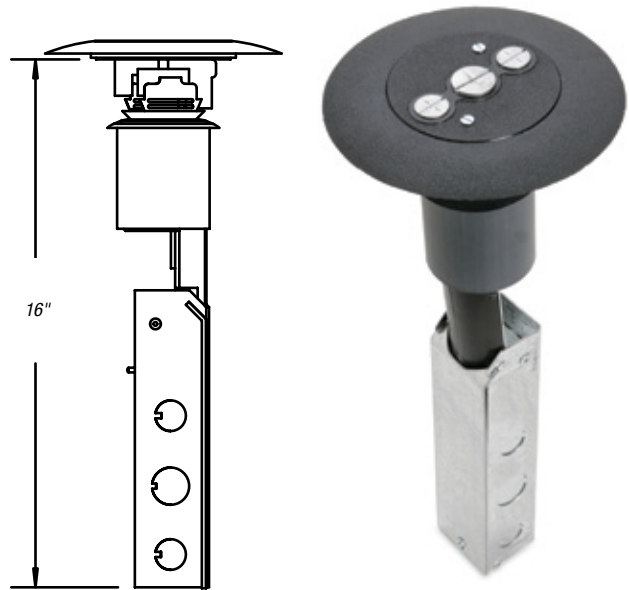

Poke Through



CAT. NO.	DESCRIPTION	STD. CTN.
FPT-448-SW-BLK	FPT Furniture Feed Poke-Through Assembly: Base Unit with Black Non-Metallic Cover	1
FPT-448-SW-GRY	FPT Furniture Feed Poke-Through Assembly: Base Unit with Gray Non-Metallic Cover	1
FPT-448-SW-BGE	FPT Furniture Feed Poke-Through Assembly: Base Unit with Beige Non-Metallic Cover	1
FPT-448-SW-BRN	FPT Furniture Feed Poke-Through Assembly: Base Unit with Brown Non-Metallic Cover	1
FPT-400B	FPT Poke-Through Base Unit Only: Cover Purchased Separately (see Below)	1

Cable Entry

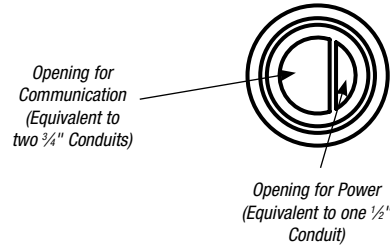

Poke-Through Covers



CAT. NO.	DESCRIPTION	STD. CTN.
FPT-442-SW-BLK	Black, Non-Metallic, 7" Diameter	10
FPT-442-SW-GRY	Gray, Non-Metallic, 7" Diameter	10
FPT-442-SW-BGE	Beige, Non-Metallic, 7" Diameter	10
FPT-442-SW-BRN	Brown, Non-Metallic, 7" Diameter	10

See page A-179 to view typical non-metallic cover colors and finishes.

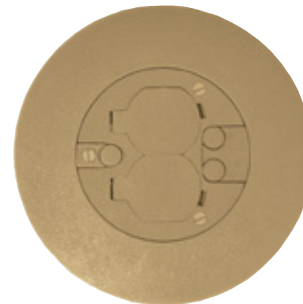

Hub Layout — Cover

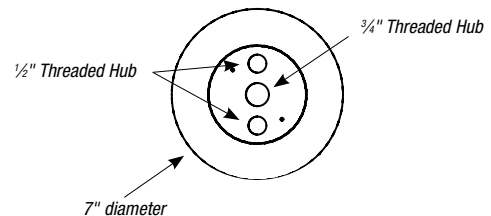

Poke Through Systems

FPT Pedestal Series

By mounting all outlets above floor level and at a 90° angle to the floor, the FPT Pedestal Series protects power receptacles and communications devices from dirt and debris. An overhanging housing provides additional protection for the outlets.

- Pedestals available in 2 compartment and 4 compartment for power and communications applications
- Core drill size: 3"
- Housings and device plates feature a brushed-aluminum finish
- Integral junction box features (5) ½" and (5) ¾" knockouts (27 cubic inch capacity)

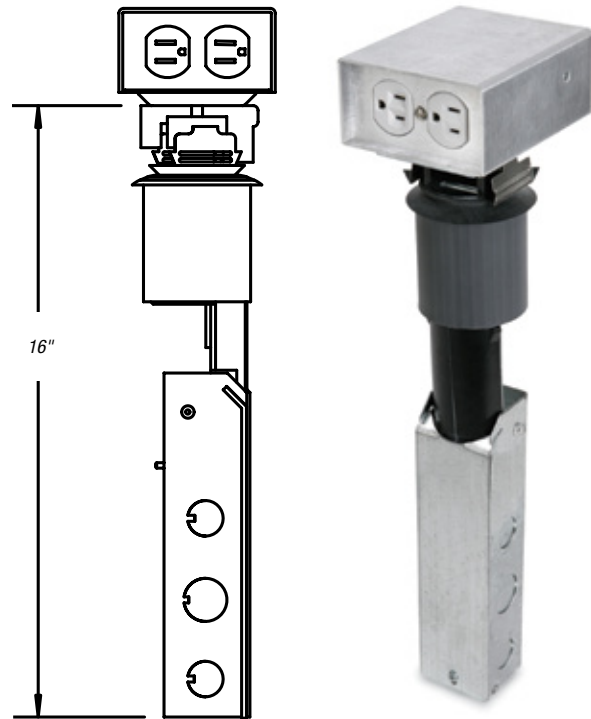

Cable Entry

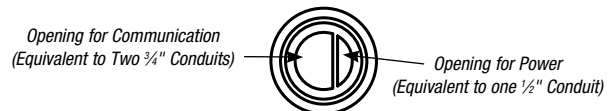

Poke Through



CAT. NO.	DESCRIPTION	STD. CTN.
FPT-401A	FPT Pedestal, Accepts 2 Device Plates, Poke-Through Base Unit Purchased Separately (2½" high x 4" wide x 4¾" deep)	10
FPT-421	FPT Pedestal, Accepts 4 Device Plates, Poke-Through Base Unit Purchased Separately, (2½" high x 4" wide x 4¾" deep)	5
FPT-400B	FPT Poke-Through Base Unit Only	1

Device Plates & Accessories



CAT. NO.	DESCRIPTION	STD. CTN.
FPT-424	Duplex Device Plate, Aluminum with Anodized Finish	50
FPT-425	Blank Device Plate, Aluminum with Anodized Finish	50
OPOD4-WH	4-Port "106" Duplex Adapter for Keystone Jacks (for use with FPT-424 plate)	100
FPT-408A	Voltage Divider for FPT-401A Pedestal	10
FPT-422A	Voltage Divider for FPT-421 Pedestal	10
FPT-416	Adapter for Conduit Stub Ups	50

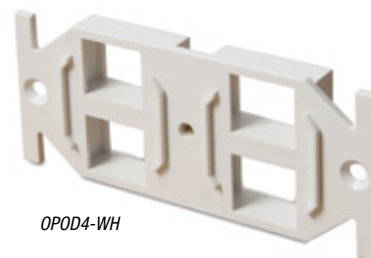

Poke Through Systems

City of Chicago Approved Base Units

FPT4 Poke Through

- Covers purchased separately, see **page A-179**
- All base units include appropriate communications conduit hub
- All base units include appropriate Keystone Communications Device Plate and Category 5e Keystone Data Jacks, see **page A-140** for additional device plates
- Power junction box not included — use City of Chicago approved box
- See **page A-174** for additional details on FPT4 Series

NEW!



(Cover purchased separately)



CAT. NO.	DESCRIPTION	STD. CTN.
FPT4-4P-4C-C	FPT4 Poke-Through Base Unit Only, (4) 20A Power Receptacles, (4) Communications Devices	1
FPT4-2P-6C-C	FPT4 Poke-Through Base Unit Only, (2) 20A Power Receptacles, (6) Communications Devices	1
FPT4-8C-C	FPT4 Poke-Through Base Unit Only, (8) Communications Devices	1
FPT4-1TL21-2C-C	FPT4 Poke-Through Base Unit Only, 20A/125V Twist Lock Receptacle, NEMA L5-20R (2) Communications Devices	1
FPT4-1TL22-2C-C	FPT4 Poke-Through Base Unit Only, 20A/250V Twist Lock Receptacle, NEMA L6-20R (2) Communications Devices	1
FPT4-1TL31-2C-C	FPT4 Poke-Through Base Unit Only, 30A/125V Twist Lock Receptacle, NEMA L5-30R (2) Communications Devices	1
FPT4-1TL32-2C-C	FPT4 Poke-Through Base Unit Only, 30A/250V Twist Lock Receptacle, NEMA L6-30R (2) Communications Devices	1

FPT3 Poke Through

- Covers purchased separately, see **page A-179**
- Includes (1) 20A duplex receptacle, pre-wired
- Includes (2) CAT5e data jacks
- Power junction box not included — use City of Chicago approved box
- See **page A-178** for additional details on FPT3 Series



(Cover purchased separately)



CAT. NO.	DESCRIPTION	STD. CTN.
FPT3-2P-2C-C	FPT3 Poke-Through Base Unit Only, (1) 20A Duplex Receptacle, (2) Communications Devices	1

FFPT4 Poke Through

- Covers purchased separately, see **page A-180**
- Power junction box not included — use City of Chicago approved box
- See **page A-180** for additional details on FFPT4 Series



(Cover purchased separately)



CAT. NO.	DESCRIPTION	STD. CTN.
FFPT4-C	FFPT4 Poke-Through Base Unit Only	1

FFPT3 Poke Through

- Covers purchased separately, see **page A-181**
- Power junction box not included — use City of Chicago approved box
- See **page A-181** for additional details on FFPT3 Series



(Cover purchased separately)



CAT. NO.	DESCRIPTION	STD. CTN.
FFPT3	FFPT3 Poke-Through Base Unit Only	1

Poke Through Systems

Flush Power and Communications Poke Through Systems

Fire Rating and Concrete Thickness Min./Max. (All Series)

- For use in 1-, 1½- and 2-hour rated floors
- 1-hour rated floor
 - 2¼" minimum concrete over steel decking
 - 3" minimum concrete for reinforced slab
 - 7½" maximum concrete thickness
- 2-hour rated floor
 - 3¼" minimum concrete over steel decking
 - 4" minimum concrete for reinforced slab
 - 7½" maximum concrete thickness

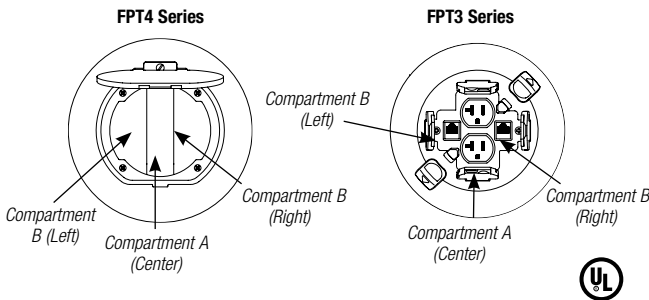

MAXIMUM ALLOWABLE COPPER CROSS-SECTIONAL AREA FOR COMMUNICATIONS CABLING

POKE-THROUGH SERIES	COMPARTMENT B (LEFT)	COMPARTMENT A (CENTER)	COMPARTMENT B (RIGHT)
FPT4-4P-4C	Power	.01630 sq. in.	Power
FPT4-2P-6C	Power	.01630 sq. in.	.01536 sq. in.
FPT4-8C	.01536 sq. in.	.01630 sq. in.	.01536 sq. in.
FPT4-1TL-2C	Power	Power	.01536 sq. in.
FPT3-2P-2C	.00321 sq. in.	Power	.00321 sq. in.

CROSS-SECTIONAL AREA FOR COMMON COPPER CONDUCTORS

24 AWG	.00032 sq.in.
22 AWG	.00050 sq. in.
14 AWG	.00323 sq. in.
12 AWG	.00512 sq. in.
10 AWG	.00615 sq. in.
8 AWG	.01296 sq. in.

Solid or stranded wires.

RPT Series

The RPT Series has been superseded by the FPT4 Series:

RPT SERIES	FPT4 SERIES
RPT-4P-2RJ	FPT4-4P-4C
RPT-2P-4RJ	FPT4-2P-6C
RPT-6RJ	FPT4-8C

Maximum Allowable Copper Cross-Sectional Area for Communications Cabling — Furniture Feed Poke-Through Systems.

- FFPT4 Series:
 - ¾" Hub for Power: .08192 sq. in.
 - 1¼" Hub for Communications: .07168 sq. in.
- FFPT3 Series:
 - 2" Hub for Power or Communications: .1024 sq. in.

Materials:

- FPT4 Series:
 - Covers: Solid brass or aluminum
 - Conduit Hubs: Cast iron
 - Base: Die-cast zinc, galvanized steel & intumescent fire-stop material
 - Junction box: Galvanized steel
- FPT3 Series:
 - Covers: Solid brass or aluminum
 - Base: Die-cast zinc, galvanized steel & intumescent fire-stop material
 - Junction box: Galvanized steel
- FPT Flush/Furniture Feed/Pedestal Series:
 - Covers: Solid brass or aluminum, non-metallic — polycarbonate
 - Base: Phenolic, galvanized steel & intumescent fire-stop material
 - Junction box: Galvanized steel
- FFPT4 Series:
 - Covers: Solid brass or aluminum
 - Base: Die-cast zinc, galvanized steel & intumescent fire-stop material
 - Junction box: Galvanized steel
- FFPT3 Series:
 - Covers: Solid brass or aluminum
 - Base: Die-cast zinc, galvanized steel & intumescent fire-stop material

Installation Spacing:

- Minimum of 2-ft. on center
- Not more than one poke through per 65 sq. ft. of floor area in each span

Access Floor Modules



Steel City® Access Floor Modules from Thomas & Betts eliminate the clutter of power, voice and data lines by keeping everything out of sight but conveniently close at hand. Our easy-to-install Access Floor Modules are designed to blend with any decor, while providing the durability and versatility you need to meet the growing demands of today's high-tech offices.

You can use our Access Floor Modules with virtually any type of raised floor. Our system is designed to provide a simple, strong and adaptable solution to even the most demanding wire-management needs.

Range of Box Sizes Designed to Meet the Needs of any Application. Now and Later.

With five sizes to choose from, our Access Floor Modules handle a broad range of wiring needs, from single power lines to complex data and voice systems. In fact, our largest unit offers 325 cu. in. of space, making it the roomiest in the industry. And, because our modules are easy to install and relocate, you can easily change box sizes or reposition modules as office configurations change.

New, Low-Profile Box Fits Right In with Shallower Raised Floors.

For installations where shallower raised floors are needed, Thomas & Betts has developed a low-profile Access Floor Module to provide the same accessibility and convenience where space is at a premium. Just 2½-inches deep, it can still accommodate a variety of power, voice and data connections.

Wide Variety of Interchangeable Power and Data Panels Adapt to Changing Demands.

Our extensive line of panels and connection devices maximizes the versatility of our Access Floor Modules. All our panels are designed to be easy to connect, disconnect and rearrange to reduce on-site installation time. And Thomas & Betts is continually developing new configurations to meet the requirements of virtually any installation, especially for the fast-growing needs of voice and data communication.

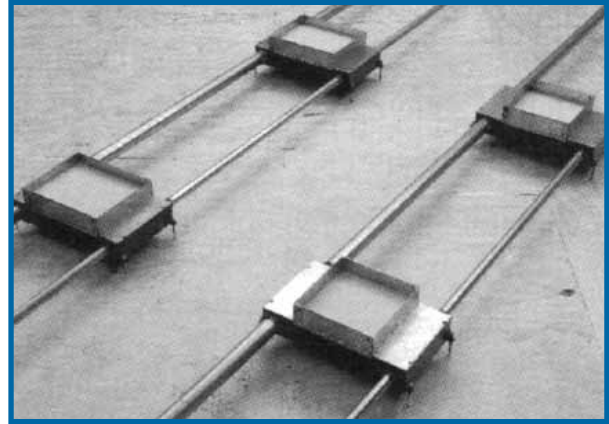

Durable, Solid Steel Covers Support Heavy Loads to Protect Important Connections.

We've reinforced the resilient nylon covers of our modules with a 5/32" steel plate to prevent buckling under heavy furniture and equipment. The beveled sides enable quick and unobstructed installation in the raised floor.

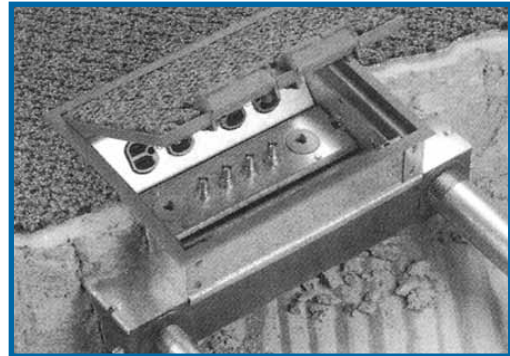

In addition, our retractable exit not only helps prevent tripping, but protects cable connections by sealing out dust and debris. And, as with all Thomas & Betts products, our Access Floor Modules are constructed to meet your high standards for durability, safety and reliability.

Steel City® Access Floor Modules Provide Outstanding Performance Without Standing Out.

The hinged service top on our modules sits flush with the floor and provides complete access to the connections within. The nylon frame comes in gray, brown, beige and black.





Our Access Floor Modules keep wire connections close at hand but not under foot. The widest variety of box sizes, panels and devices in the industry provides exceptional versatility for changing office needs.

Look below the surface and see how Steel City® Access Floor Modules can manage all your power, voice and data connections — today and tomorrow.

Access Floor Modules

AFM-2 Series Access Floor Module — Non-Metallic Covers



AFM PANELS	POWER	
AFM-2-BLK GRY BRN BGE	 AFP-2A* Single Duplex	 AFP-2B Blank
DATA PANEL	ACCESSORIES	
 AFD-2 3RJ 3 T&B Omnijacks or Keystone-Style Jacks	AFT-2 Power Tunnel	 AFR-2** Mounting Flange

* (1) supplied with box.

** Used to correct opening in floor. Not required for all installations.

ACCESS FLOOR MODULE SIZE	AFM-2
AFM depth	4"
Access floor cut-out	7 $\frac{1}{8}$ " x 4 $\frac{1}{8}$ "
AFM cover size	6 $\frac{3}{4}$ " x 3 $\frac{3}{8}$ "
AFM cover access area	17 sq. in.
Box volume (less panels)	75 cu in.
Device compartment volume — 45° Power	16.2 cu in.
Base opening	—
Power panel included**	AFP-2A
Closure panel included	—
Cover/carpet flange material	Polycarbonate
Body material	14-ga. galvanized steel
Prewiring available	Yes*
Max. no. of device panels	2

* Special panels available — consult factory.

** Devices not included.

Available with black (-BLK), brown (-BRN), beige (-BGE) or gray (-GRY) cover flange.

Replacement covers: see 664 series covers on **page A-131**.

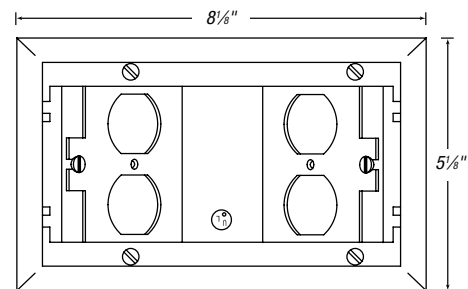
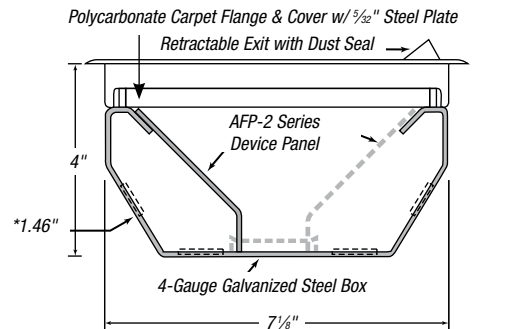

AFM-2

Shown with supplied power panel and optional panel (sold separately).

Access Floor Modules

AFM-2 Series Access Floor Module — Metallic Covers

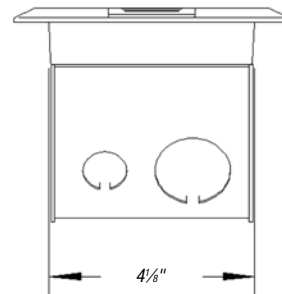
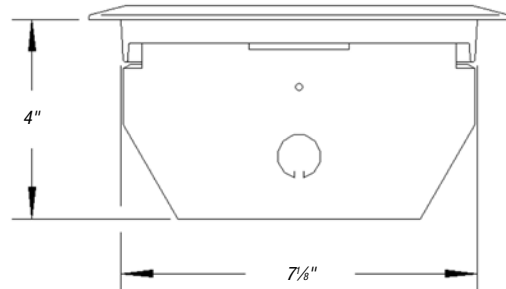
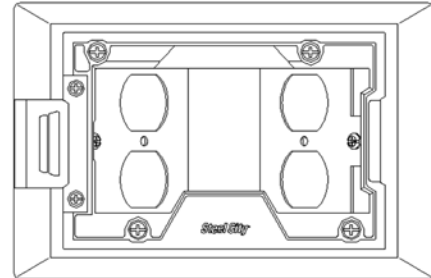

AFM-2 Access Floor Module

ACCESS FLOOR MODULE SIZE	AFM-2
AFM depth	4"
Access floor cut-out	7 1/8" x 4 1/8"
AFM cover size	6 3/4" x 3 3/8"
AFM cover access area	17 sq. in.
Box volume (less panels)	75 cu in.
Device compartment volume	16.2 cu in.
Base opening	—
Power panel included**	AFP-2A
Closure panel included	—
Cover/carpet flange material	Brass, Aluminum
Body material	14-ga. galvanized steel
Prewiring available	Yes*
Max. no. of device panels	2

* Special panels available — consult factory.

** See **previous page** for device plates and accessories.

Replacement covers: see 664 Series covers on **page A-131**.

AFM-2 Series Raised Floor Boxes

CAT. NO.	DESCRIPTION	STD. CTN.
AFM-2-BRS	AFM-2 Raised Floor Box, 2 Compartment, Solid Brass Cover	1
AFM-2-ALM	AFM-2 Raised Floor Box, 2 Compartment, Solid Aluminum Cover	1

For additional device plate options see **previous page**.

Access Floor Modules

AFM-4 Series Access Floor Module — Non-Metallic Covers

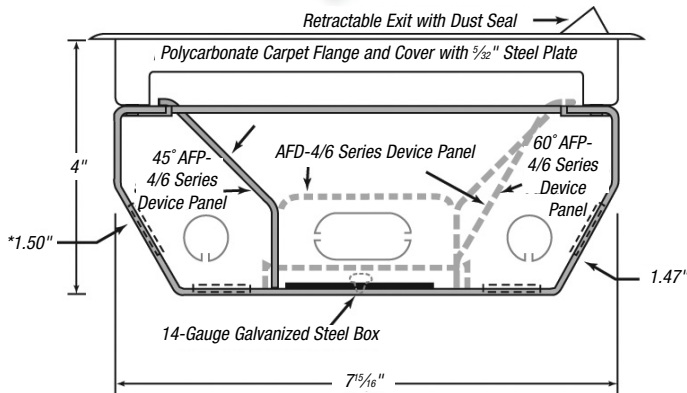
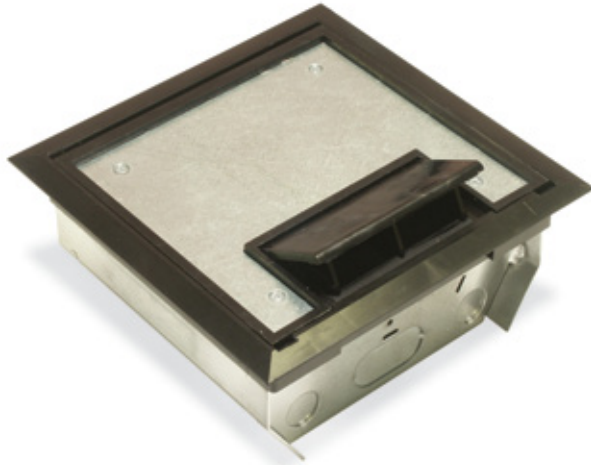

ACCESS FLOOR MODULE SIZE		AFM-4
AFM Depth		4"
Access floor cut-out		7 1/8" x 7 1/8"
AFM cover size		7 7/8" x 7 7/8"
AFM cover access area		39 sq. in.
Box volume (less panels)		150 cu. in.
Device compartment volume	45° power	27.3 cu. in.
	60° power	25.2 cu. in.
	Center data	20.6 cu. in.
Base opening		2" x 2 1/8"
Power panel included**		AFP-4A
Closure panel included		AFC-C
Cover/carpet flange material		Polycarbonate
Body material		14-ga. galvanized steel
Prewiring available		Yes*
Max. no. of device panels		3

* Special panels available — consult factory.

** Devices not included.

Available with black (-BLK), brown (-BRN), beige (-BGE) or gray (-GRY) cover flange.

Replacement covers: see 665 Series covers on **page A-135**.

POWER PANELS

AFM-4-BLK
GRY
BRN
BGE



AFP-4A*
Single Duplex-45°



AFP-4A60
Single Duplex-60°



AFP-4GFCL
Single GFCL-60°



AFP-4B
Blank-45°



AFP-4B60
Blank-60°



AFP-4-GFCL-45
Single GFCL-45°

* (1) supplied with box.

** Used to correct opening in floor. Not required for all installations.

DATA PANELS



AFD-4A
Single Duplex Data



AFD-4B
Blank



AFD-4 4RJ
Keystone
Style Jacks

ACCESSORIES



AFT-46
Power Tunnel



AFT-4
Mounting Flange



AFC-N
Grommets
Closure Panel



AFM-4EX
Extension Collar

* (1) supplied with box.

** Used to correct opening in floor. Not required for all installations.

Shown with Supplied Power Panel and Optional Data Panel and 45° Power Panel (sold separately).

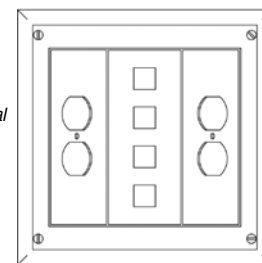

45° Angle Plates

Shown with Optional 60° Panels (sold separately).

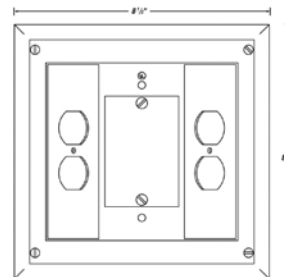

60° Angle Plates

Access Floor Modules

AFM-4 Series Access Floor Module — Metallic Covers



ACCESS FLOOR MODULE SIZE	AFM-4
AFM Depth	4"
Access floor cut-out	7 ¹⁵ / ₁₆ " x 7 ¹⁵ / ₁₆ "
AFM cover size	7 ⁷ / ₈ " x 7 ⁷ / ₈ "
AFM cover access area	39 sq. in.
Box volume (less panels)	150 cu in.
Device compartment volume	27.3 cu in. 25.2 cu in. 20.6 cu in.
Base opening	2" x 2 ⁷ / ₈ "
Power panel included**	AFP-4A
Closure panel included	AFC-C
Cover/carpet flange material	Brass, Aluminum
Body material	14-ga. galvanized steel
Prewiring available	Yes*
Max. no. of device panels	3

* Special panels available — consult factory.

** Devices not included.

See **previous page** for device plates and accessories.

Replacement covers: see 665 Series covers on **page A-135**.

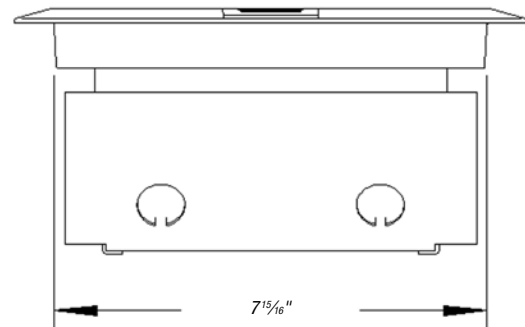
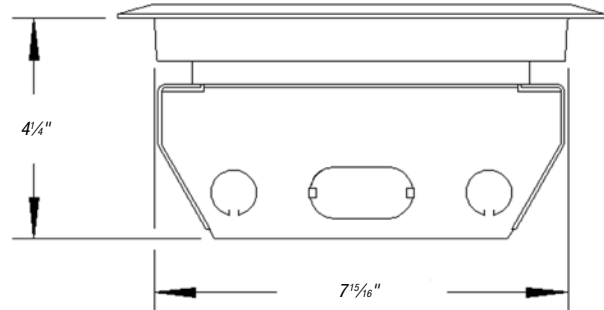
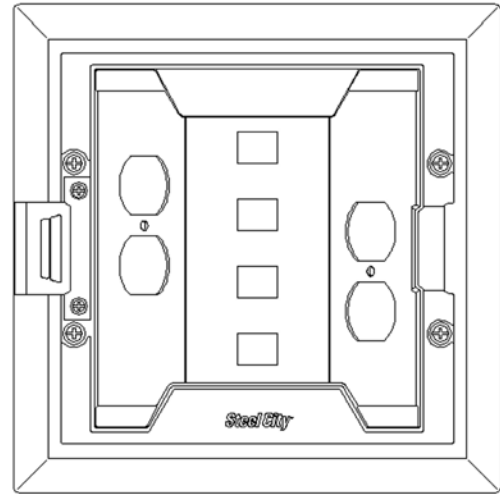

AFM-4 Series Raised Floor Boxes

CAT. NO.	DESCRIPTION	STD. CTN.
AFM-4-BRS	AFM-4 Raised Floor Box, 3 Compartment, Solid Brass Cover	1
AFM-4-BRS-R	AFM-4 Raised Floor Box, 3 Compartment, Solid Brass Cover with Recess	1
AFM-4-ALM	AFM-4 Raised Floor Box, 3 Compartment, Solid Aluminum Cover	1
AFM-4-ALM-R	AFM-4 Raised Floor Box, 3 Compartment, Solid Aluminum Cover with Recess	1

Access Floor Modules

AFM-6 Series Access Floor Module

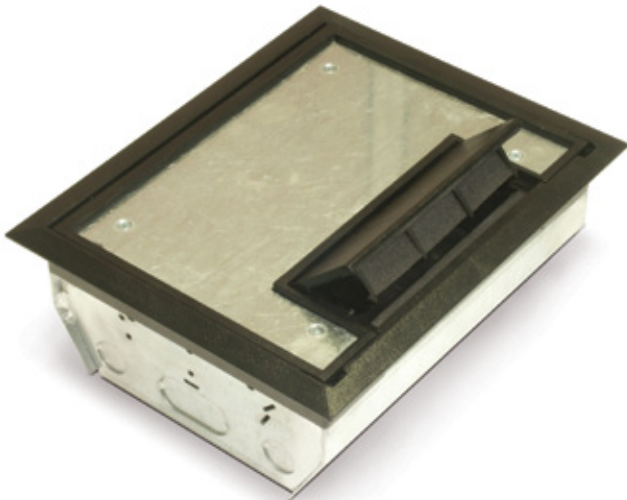

ACCESS FLOOR MODULE SIZE		AFM-6
AFM Depth		4
Access floor cut-out		7 ¹⁵ / ₁₆ " x 10"
AFM cover size		7 ⁷ / ₈ " x 9 ³ / ₄ "
AFM cover access area		60 sq. in.
Box volume (less panels)		225 cu. in.
Device compartment volume	45° power	41.5 cu. in.
	60° power	38.3 cu. in.
	Center data	31.3 cu. in.
Base opening		2" x 2 ⁷ / ₈ "
Power panel included**		AFP-6Q
Closure panel included		AFC-C
Cover/carpet flange material		Polycarbonate
Body material		14-ga. galvanized steel
Prewiring available		Yes*
Max. no. of device panels		3

* Special panels available — consult factory.

* Devices not included.

Available with black (-BLK), brown (-BRN), beige (-BGE) or gray (-GRY) cover flange.

Replacement cover: AFM-6-CST-SW black (-BLK), brown (-BRN), beige (-BGE) or gray (-GRY) cover flange.



File No. E2969



File No. L12798

45° Angle Plates
Shown with Supplied
Power Panel and Optional
Data Panel and 45° Power
Panel (sold separately).

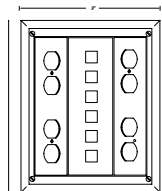

60° Angle Plates
Shown with Optional
60° Panels
(sold separately).

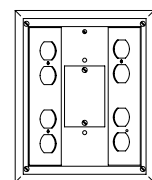

AFM	POWER PANELS		
AFM-6-BLK GRY BRN BGE			
	AFP-6Q* Double Duplex-45°	AFP-6B Single Duplex-60°	AFP-6A Single Duplex-45°
	AFP-6B60 Blank-45°	AFP-6R60 Double Duplex-60°	AFP-6-GFCI-45 Single GFCI-60°
	AFP-6A60 Single Duplex-60°	AFP-6-GFCI-45 Double GFCI-60°	

DATA PANELS		ACCESSORIES	
AFD-4A Double Duplex Data	AFD-6B Blank	AFT-46 Power Tunnel	AFR-6 Mounting Flange
AFD-6 4RJ T&B Omni jacks or Keystone style jacks	AFD-6A Single Duplex	AFC-N Grommets Closure Panel	AFM-6EX Extension Collar

* (1) supplied with box.

** Used to correct opening in floor. Not required for all installations.

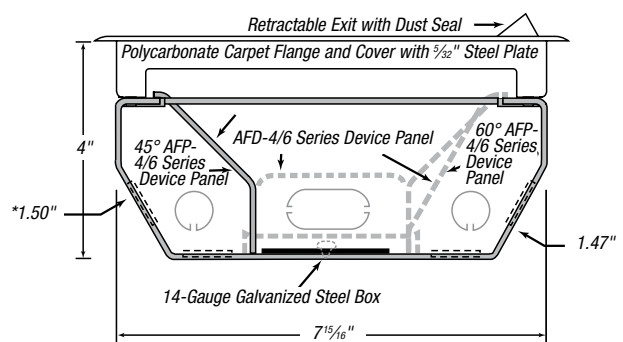

Access Floor Modules

AFM-6S2 Series Access Floor Module

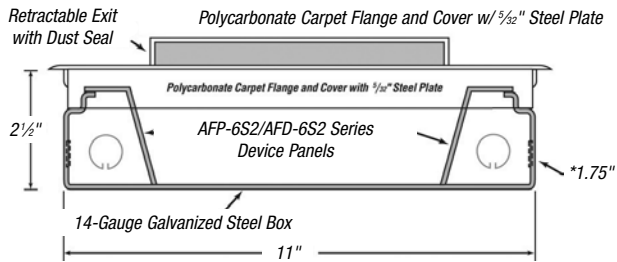
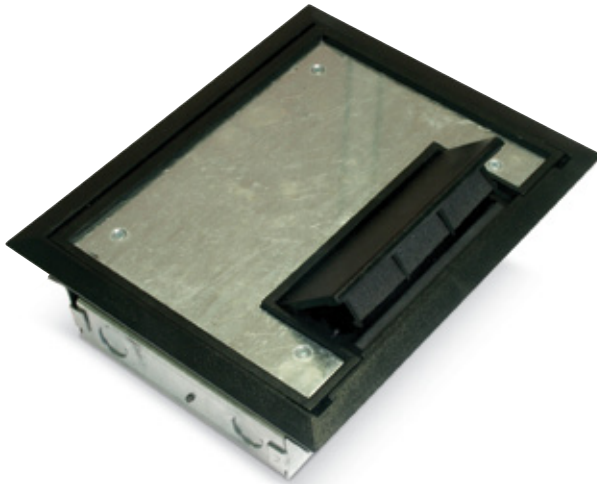

ACCESS FLOOR MODULE SIZE		AFM-6S
AFM depth		2 1/2"
Access floor cut-out		7 15/16" x 10"
AFM cover size		7 7/8" x 9 3/4"
AFM cover access area		60 sq. in.
Box volume (less panels)		172 cu. in.
Device compartment volume	Power	13.1 cu. in.
	Data	6.6 cu. in.
Base opening		—
Power panel included**		AFP-6S2-L, AFP-6S2-R
Wire tunnel included		—
Cover/carpet flange material		Polycarbonate
Body material		14-ga. galvanized steel
Prewiring available		Yes*
Max. no. of device panels		4

* Special panels available — consult factory.

** Devices not included.

Available with black (-BLK), brown (-BRN), beige (-BGE) or gray (-GRY) cover flange.

Replacement cover: AFM-6-CST-SW black (-BLK), brown (-BRN), beige (-BGE) or gray (-GRY) cover flange.



File No. E2969



File No. L12798

AFM	POWER PANELS	
AFM-6S-BLK GRY BRN BGE		

DATA PANELS	ACCESSORIES

* (1) AFP-6S2-R & (1) AFP-6S2-L supplied with box.

** Used to correct opening in floor. Not required for all installations.

Replacement cover: AFM-6-CST-SW black (-BLK), brown (-BRN), beige (-BGE) or gray (-GRY) cover flange.

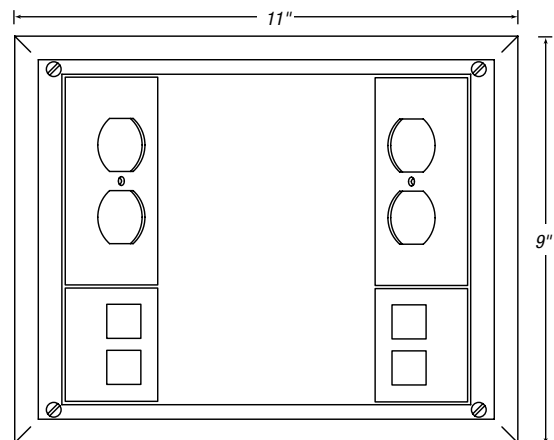

AFM-6S2

Shown with supplied power panels and optional data panels (sold separately).

Access Floor Modules

AFM-8 Series Access Floor Module

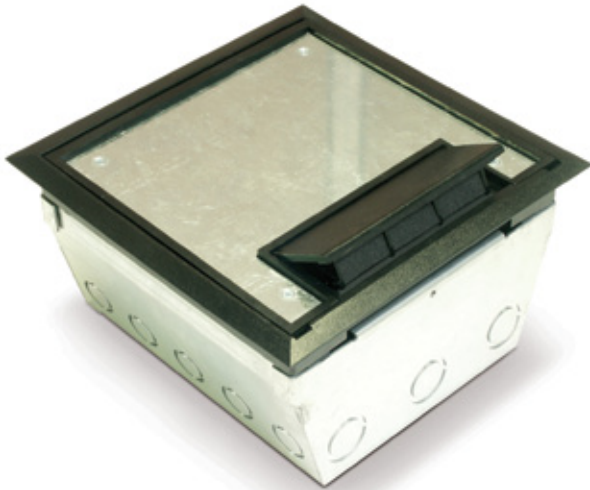





ACCESS FLOOR MODULE SIZE	AFM-6
AFM Depth	5 5/8"
Access floor cut-out	9 5/8" x 9 5/8"
AFM cover size	9 5/8" x 9 5/8"
AFM cover access area	74 sq. in.
Box volume (less panels)	325 cu in.
Device compartment volume	45° power 60° power Power or Data
	15.75 cu in.
Base opening	—
Power panel included**	—
Closure panel included	—
Cover/carpet flange material	Polycarbonate
Body material	14-ga. galvanized steel
Prewiring available	Yes*
Max. no. of device panels	10

* Special panels available — consult factory.

Available with black (-BLK), brown (-BRN), beige (-BGE) or gray (-GRY) cover flange.

Replacement covers: see 667 Series covers on **page A-139**.



AFM	POWER PANELS	
AFM-8-BLK GRY BRN BGE	 <p>AFP-8A Single Duplex</p>	 <p>AFP-8G* Single GFCI</p>
	 <p>AFP-8B Blank</p>	
	 <p>AFD-8-3RJ Keystone</p>	
	 <p>AFR-8** Mounting Flange</p>	

* Power panels include a voltage partition for use between power and data panels.

** Used to correct opening in floor. Not required for all installations.

Retractable Exit
with Dust Seal

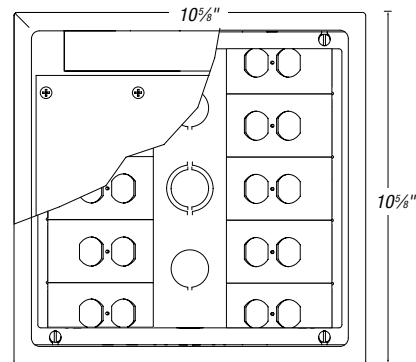
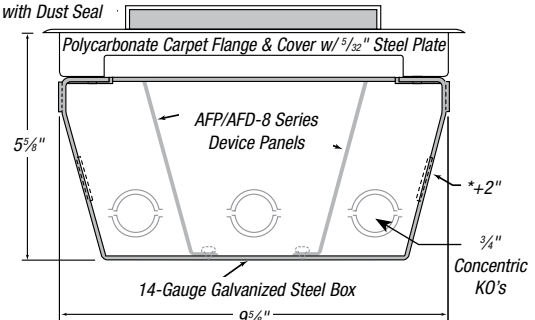

AFM-8

Shown with Optional Power Panels (sold separately).

Accepts 10 device panels.

Each compartment can accept voltage dividers for any combination of power and data (included with device panels).

Access Floor Modules

Because a Square Peg Doesn't Fit in a Round Hole!

AFM-4R Series Access Floor Module

In response to industry demand for a more symmetrical approach to raised-floor power and data access, Thomas & Betts introduces the latest addition to the Steel City® Access Floor Module (AFM) line. The AFM-4R features a round construction that matches the aesthetics of air diffusers commonly used in raised-floor applications.



AFM-4R-BLK



Air Diffuser

- Round design enables the box to be installed in the same size hole as standard air diffusers — eliminates the need for multiple raised-floor tiles with custom-sized cutouts (and round holes are faster and easier to cut than square/rectangular ones)
- Three-compartment stamped-steel box with voltage dividers accommodates both power and data outlets
- Durable black polycarbonate cover features two cable-entry lids that lock in the open position to prevent cable damage
- Optional power tunnel links outside power compartments to feed both compartments with a single conduit — while still allowing for communications wiring in the center
- Two thumbscrews secure AFM-4R firmly in place, but remove easily for reconfiguration
- Fits into holes ranging from 8¼" to 8¾" in diameter
- Outside compartments: 21 cu. in. capacity, ¾" KO on side, ½" KO on each end, ½" KO and ¾" KO on bottom
- Center compartment: 40 cu. in. capacity, 1¼" KO on each end, two removable access plates with ¾" KO on bottom

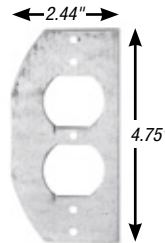
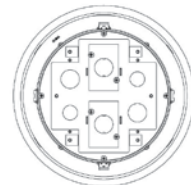
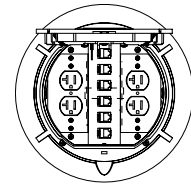
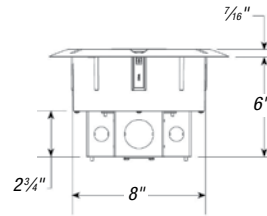
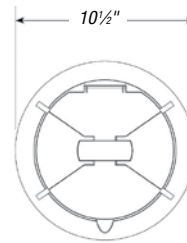

AFP-4R-A



AFP-4R-GFCI



AFP-4R-B



CAT. NO.	DESCRIPTION	STD. CTN.
Access Floor Module		
AFM-4R-BLK	Three Compartment Round Access Floor Module with Black Cover, (1) AFP-4R-A Duplex Panel	1
Panels for Outside Compartments		
AFP-4R-A	Duplex Panel for Outside Compartment	1
AFP-4R-GFCI	GFCI Panel for Outside Compartment	1
AFP-4R-B	Blank Panel for Outside Compartment	1
Panels for Center Compartment		
AFD-4R-A	Duplex Panel for Center Compartment	1
AFD-4R-GFCI	GFCI Panel for Center Compartment	1
AFD-4R-GRJ	Data Panel for 6 Keystone Jacks for Center Compartment	1
AFD-4R-B	Blank Panel for Center Compartment	1
Accessories/Replacement Parts		
AFT-2	Optional Power Tunnel to Link Outside Compartments	1
AFM-4R-CST-BLK	Replacement Cover and Mounting Ring, Black	1

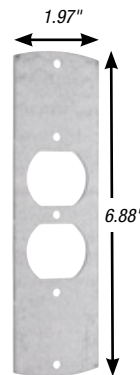

AFD-4R-A



AFD-4R-GFCI

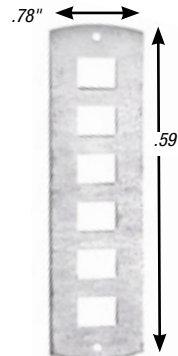

AFD-4R-GRJ



AFD-4R-B

Access Floor Modules

Concrete Inserts

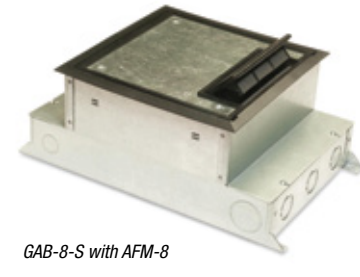
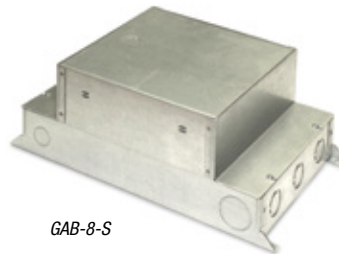
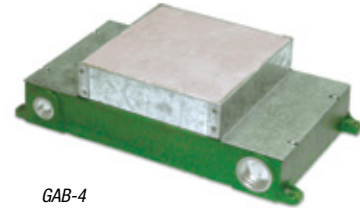
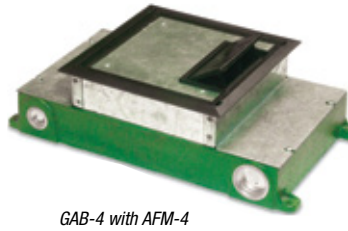
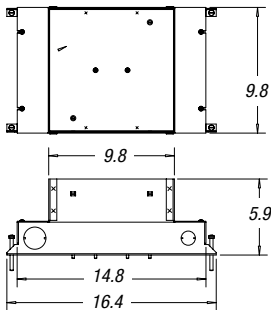
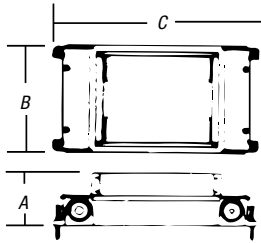

CAT. NO.	DIMENSIONS (IN.)			MAXIMUM CAPACITY (CU. IN.)	STANDARD CONDUIT TAPPING	MAXIMUM CONDUIT TAPPING	AFM INSERT	STD. CTN.
	A	B	C					
GAB-4	4¼	9	16	150	2-¾" 2-1¼"	1½"	AFM-4	1
GAB-6	4¼	9	16	225	2-¾" 2-1¼"	1½"	AFM-6	1
GAB-8-S	5½	9¼	16¾	325	2-¾" 2-1¼"	—	AFM-8	1

*Required for installation in concrete pours only.

For use with the AFM insert. The GAB cast Pre-Set includes center collar and styrene insert to prevent concrete ingress. Standard conduit hubs are ¾" and 1¼". Specify either -4 or -6.

Access Floor Modules

Standard Specification — GAB Series Access Floor Box Pre-Set Insert

Considerations when writing specification:

The installation of access floor box pre-set inserts must be in compliance with the National Electrical Code®. These specifications may be used in three sections of the Construction Specification Institute (C.S.I.) format: 16132 Floor Boxes; 16141 Wiring Devices; and 16741 Telephone Raceway Systems. For accuracy, 16132 is preferred.

Part 2: Products

2.01 Pre-Set Insert

- A. Shall be GAB Multiple Service Floor Outlet Assembly as manufactured by Thomas & Betts, Memphis, TN, (trade name, Steel City) consisting of:
 - 1. Pre-set insert, Series GAB.
 - 2. Activating unit, Series AFM-4 and AFM-6.
- B. Call for approved suppliers of power and cable systems.

2.02 Materials

- A. Cast-iron components to be gray iron per ASTM Specification A48, Class 20A.
- B. Cast-iron components shall be protected with a painted coating as specified in UL 514A.
- C. Steel components to be fabricated from cold rolled steel, .070 inch minimum thickness, conforming to ASTM A366.
- D. Steel components to have an electrogalvanized zinc finish conforming to ASTM A386. Sheet metal steel fabrications shall be made of UL approved component G-90-U material.
- E. Non-metallic components shall be glass-filled polyamide nylon, UL recognized component QMFZ2.

2.03 General Design Gab Series

- A. The GAB series shall consist of pre-set insert, activation unit and cover for the distribution of electrical power and data/communication signal systems.

2.03.1 Pre-Set Insert

- A. Following sizes as shown on the drawings:
 - 1. 8" x 8" nominal concrete opening (Ref.: Steel City GAB-4).
 - 2. 8" x 10" nominal concrete opening (Ref.: Steel City GAB-6).
- B. Overall size: 8" x 14" x 4³/₁₆" high.
- C. Shall be installed with conduit sizes as shown on the drawings.

(Note: Standard 3/4" conduit thread on power side, in and out. Standard 1/4" conduit thread on data side, in and out. Special drilling and tapping up to 1 1/2" conduit size. Reducing bushings may be used to downsize conduit.)

- D. Conduits for power shall enter and leave in-line and on same side so as to maintain separation of services.
- E. Foam blocks shall exclude concrete from the interior.
 - 1. Foam blocks shall permit a minimum of 1/4" of concrete over opening prior to activation.
 - 2. Foam blocks shall be manufactured for the intended purpose.

2.03.2 Activation Unit

- A. Following sizes shall match pre-set insert opening as shown on drawings:
 - 1. 8" x 8" nominal size steel box (Ref.: Steel City AFM-4). Provides a minimum interior capacity of 150 cubic inches.
 - 2. 8" x 10" nominal size steel box (Ref.: Steel City AFM-6). Provides a minimum interior capacity of 225 cubic inches.
- B. Device panels may be data or telephone as shown on drawings.
- C. If two duplex power receptacles are required on a single panel, the pre-set insert and activation unit shall be Steel City GAB-6 and AFM-6 respectively.
- D. Data panels shall be designed to mount the data connectors and telephone connectors as shown on the drawings.
- E. Cover shall be (gray, brown, black or beige) as specified on the drawings.
 - 1. Shall accept floor covering material as required.
 - 2. Shall be self-leveling when installed.
- F. Cover, when closed, shall protect exiting cables and cords from abuse and abrasion by retractable cable exits. Cover shall install flush with floor and be 180° reversible.
- G. Carpet edge shall be protected from fraying by a carpet trim ring of a matching color.

Part 3: Execution

3.01 General

- A. All pre-set inserts shown on the drawings shall be installed with the specified runs of conduit.
- B. Wire-pulling cords shall be in place in the conduit prior to pouring concrete.
- C. Activate only the pre-set inserts as directed by the supervising engineer or owner.
- D. Install and activate the assembly as directed by the manufacturer's installation instructions.

NEC and National Electrical Code are registered trademarks of the National Fire Protection Association, Inc.