

BROAN[®]

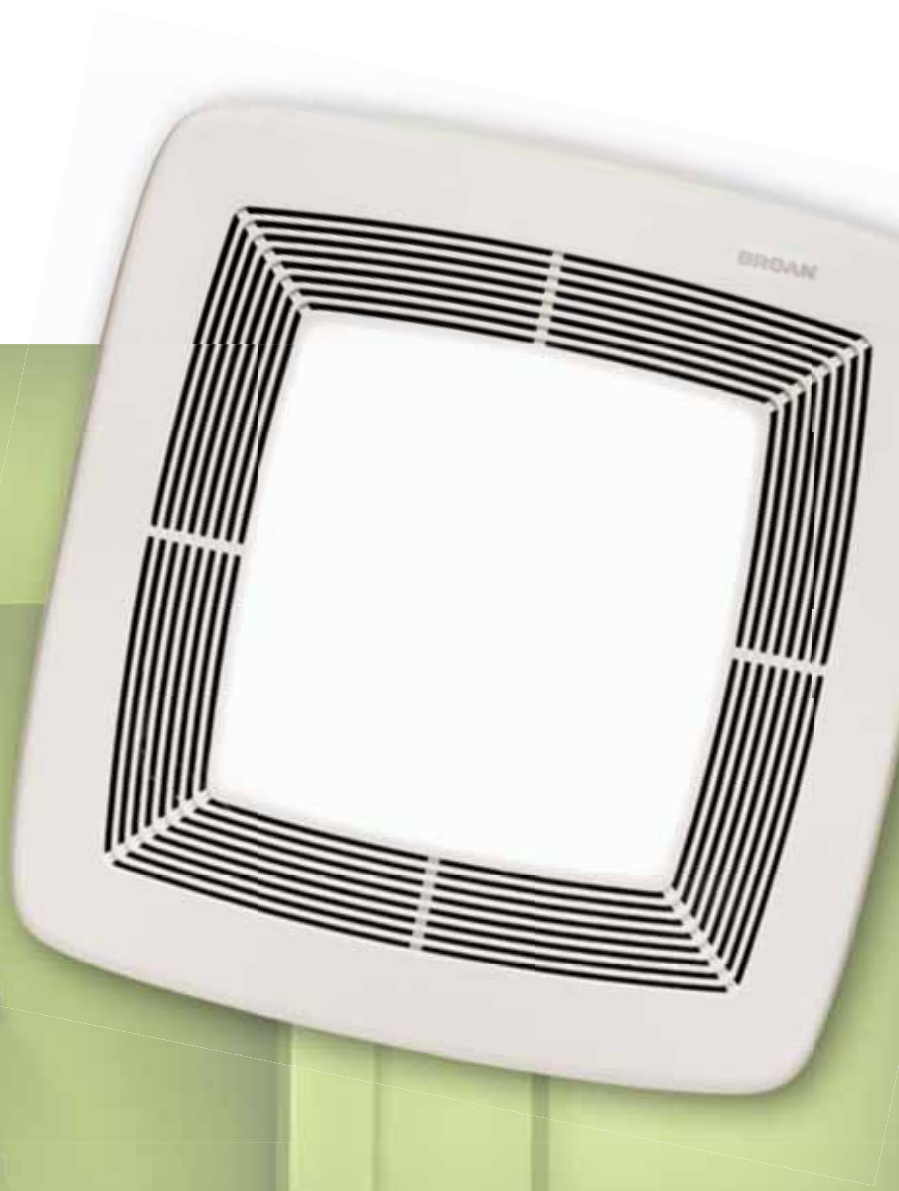

RESIDENTIAL VENTILATION FANS



MAY 2013

2-9

Selection,
Installation,
Sizing &
Questions

10-17

ULTRA™ Fans
& Fan/Lights

18-25

QT Series Fans
& Fan/
Lights,
Humidity
Sensing,
SmartSense®

We don't build products.

26–31

Ventilation
Fans &
Fan/Lights

32–41

Specialty Fans
& Fan/Lights,
Hidden Ventilation,
Decorative
Fan/Lights,
Utility Fans,
In-Line Fans

42–45

Heater/Fan/Lights

46–59

Attic Ventilation,
Wall Controls &
Specifications

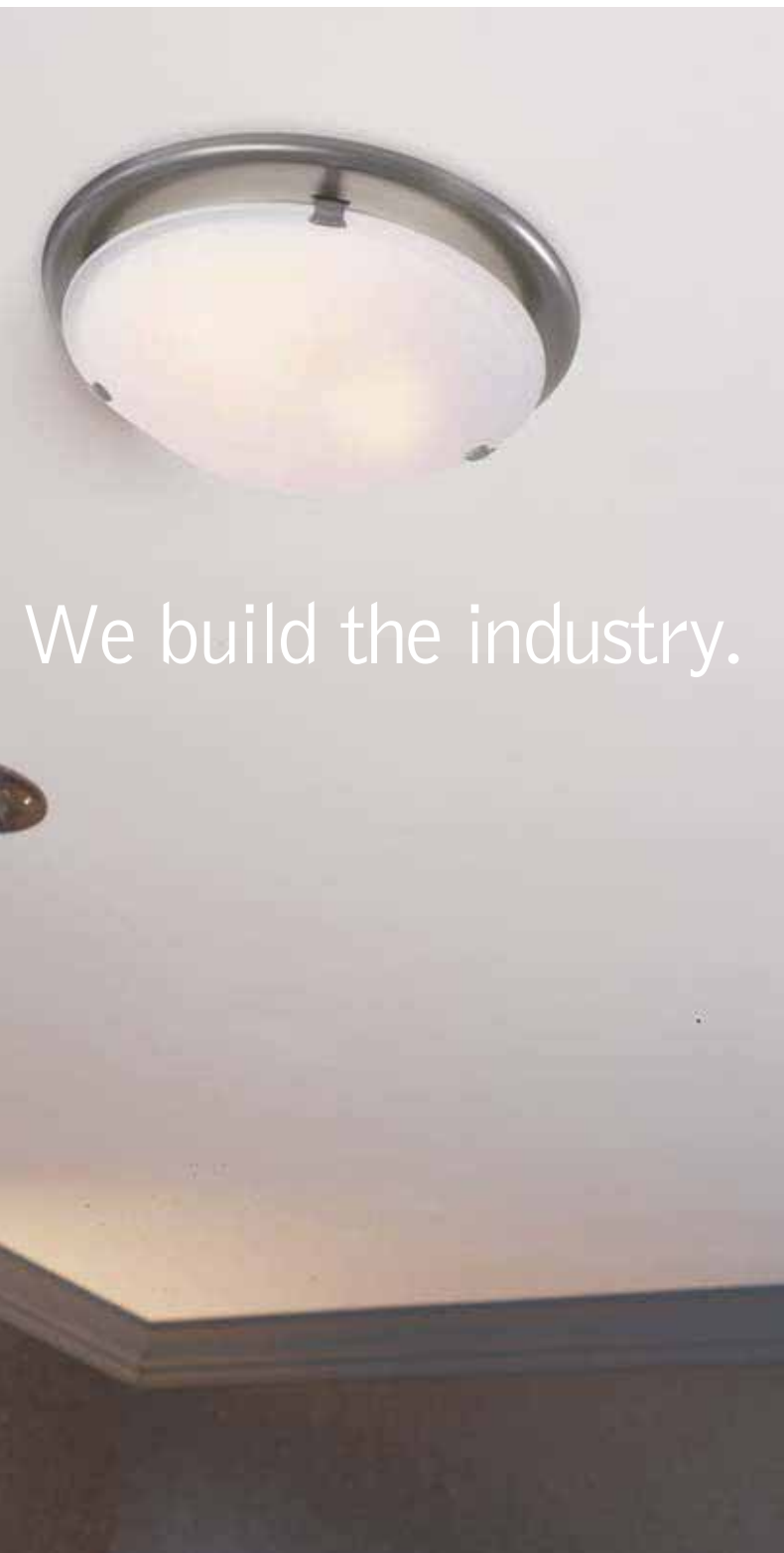

We build the industry.

Leadership is measured in all kinds of ways. We define it with innovation, from spot ventilation products to whole-house indoor air quality systems. The greatest compliment we receive is seeing our product ideas become the industry standards.

Silence is what consumers demand more than any other feature in a ventilation fan. We hear you, and proudly offer the most quiet ventilation fans available. Proven in real-world installations, they deliver what we promise on the package.

Performance Powerful operation is the ultimate test. And a clear bathroom mirror after a long relaxing shower is the true measure of bath fan performance. That's why Broan engineers the right product for every type of application, room size and need.

Installation Ease is extremely important, especially when it comes to retrofit situations. Broan understands and appreciates this and continually strives to design products such as our new Broan ULTRA™ series that are the fastest, easiest and most universal to install, up to 60% faster in retrofit installations and 20% faster in new construction. Fear of a difficult installation no longer needs to be an obstacle to upgrading to the powerful performance and quiet operation you deserve.

Style can be difficult to define. What's compelling to one may be passe to another. Broan solves the issue with a broad variety of product styles, finishes, and shapes—all designed around you.

Selection No one provides more ways to improve indoor air quality. From the spot ventilation and heating products listed above, to our whole-house Broan Fresh Air Systems, trust Broan to keep your home safe and comfortable.

What you should consider when buying a bath fan or home ventilation system.

Steamy mirrors, damp walls and fogged windows. They're more than annoying. They could indicate developing problems like mold and mildew, ruined insulation, and wood rot. Spot ventilation solutions from Broan clear the air quickly and efficiently, removing potential problems before they invite themselves into your home.

What's in stays in today's airtight homes.

Today's homes are built airtight for efficiency. But that means moisture and airborne pollutants stay where they are unless they are vented away. Eliminating excess moisture keeps your home dry and comfortable and can help avoid mold and mildew. Volatile organic compounds (VOCs) "outgas" from construction materials such as plywood, carpet, fabric, paint, adhesive, insulation and other common items. Allergens, dust, cooking vapor and what the kids bring home from school are more reasons why good ventilation is critical.

Which product is best suited to my application?

Take a moment to consider what you're looking for in a spot ventilation product. Do you want quiet operation, a powerful blower, decorative designs or something that's virtually invisible? Could you use more light, or ventilation in a walk-in closet? Broan has what you need.

Sones measure the "sound level" of your fan.

A sone is a measurement of sound in terms of comfortable hearing level for an average listener. The lower the sone value, the more comfortable the environment. Sones are not decibels or volume, but rather how sound is "sensed." One sone is half as loud as two sones, and is equivalent to a quiet refrigerator.

leadership

More than 80 years ago Broan invented the spot ventilation industry. Today, Broan is engineering and testing the next generation of ventilation solutions to keep your home and family comfortable.

What "HVI certified" means to you.

The Home Ventilating Institute (HVI) is an independent organization that certifies the airflow and sound performance claimed by manufacturers of ventilation products. Broan certifies every product through HVI to ensure the product you purchase will perform as claimed. For more information visit www.hvi.org.

ENERGY STAR®: Conserve energy and energy expenditures.

If you're concerned about saving money and energy, choose Broan bath fans that feature the ENERGY STAR® logo. These products use high efficiency motors and lighting that can reduce energy consumption by as much as 65%—all without sacrificing performance. For extreme energy efficiency, the Broan Ultra Series with ULTRA Green™ DC Motor Technology is nearly 10 times more efficient than ENERGY STAR® requirements. Learn more about ENERGY STAR® at www.energystar.gov.



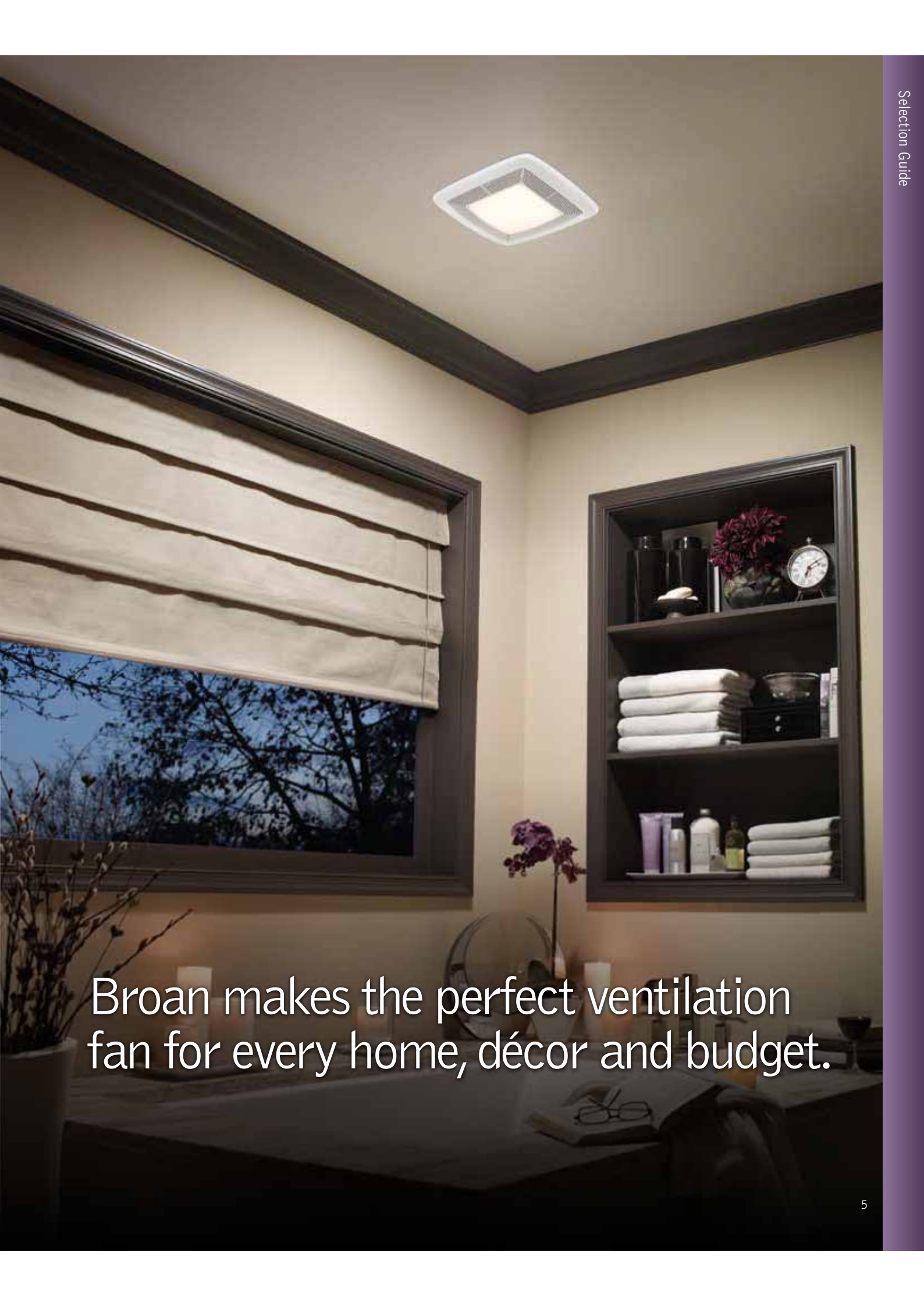

Broan makes the perfect ventilation fan for every home, décor and budget.

Ventilation Fans—Installation Guide

Proper installation makes all the difference.

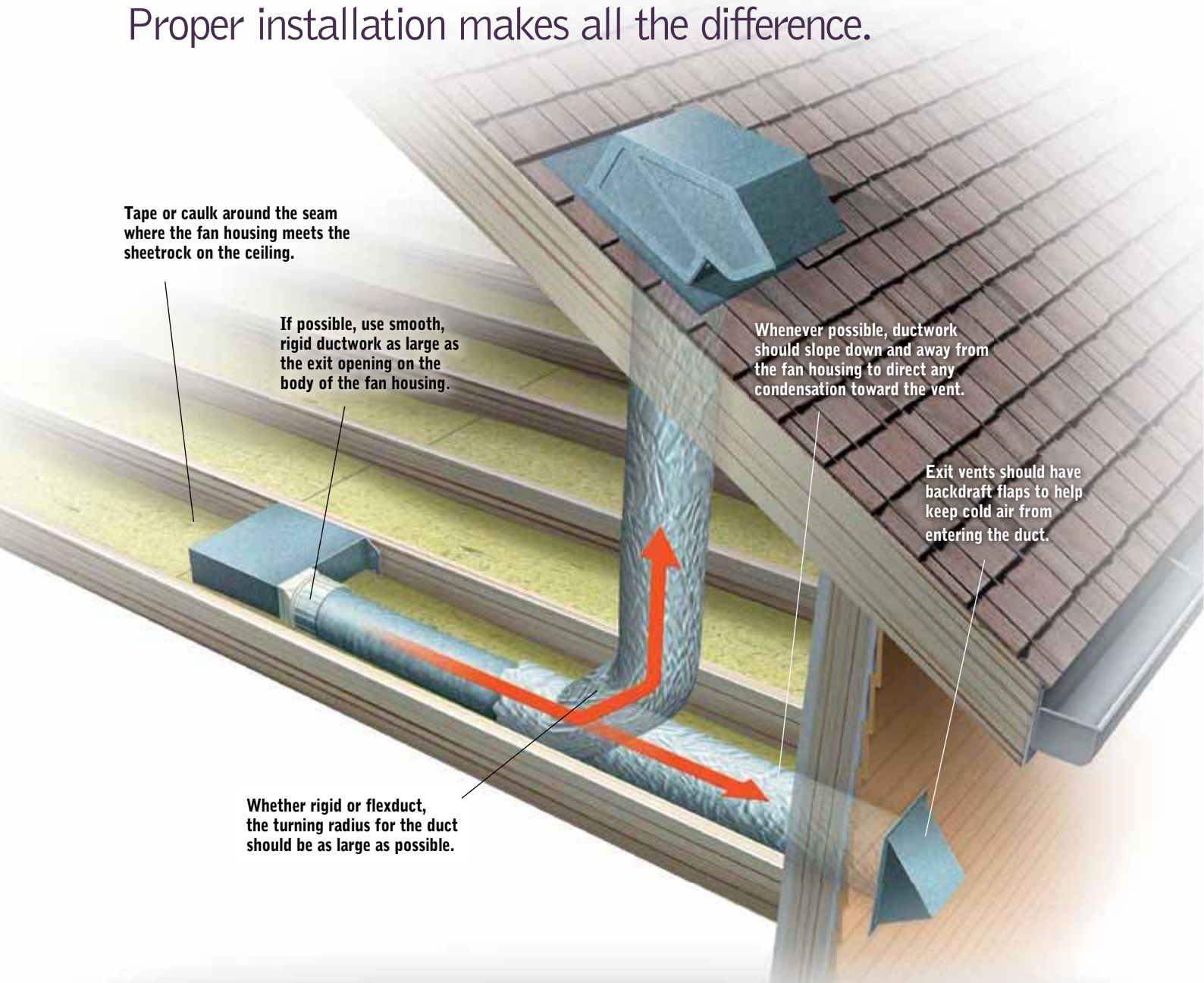

Pre-installed screws, keyhole slots and alignment tabs facilitate installation, taking the guesswork out of proper mounting.

Elbows, turns, long ducts and ductwork smaller than the fan's exit outlet will reduce performance.

Use wide aluminum foil or duct tape to join smooth metal ductwork seams.

Do not let flexible ductwork sag as this impedes airflow. During installation, orient the bath fan outlet in the direction of the home's exit point to minimize duct turns.

Before adding an elbow or bend, allow 24" to 36" of straight run from the fan outlet point.

Duct-wrap insulation (R-5 or above) will help minimize condensation in cold climates, especially on long duct runs.

Quick guideline: For bathrooms up to 100 square feet, the HVI recommends ventilation of at least 1 CFM per square foot (about eight air changes per hour). For bathrooms over 100 square feet, add up the needs of each fixture to determine the total ventilation rate:

- Toilet 50 CFM
- Shower 50 CFM
- Bathtub 50 CFM
- Jetted tub 100 CFM

Easy steps for choosing and sizing the right ventilation fan for your home.

Determine which rooms could use ventilation, and how much is needed.

Spot ventilation is used in localized areas to remove moisture, odor and airborne pollutants quickly. Most commonly used in the bath or powder room, spot ventilation can also be used in a laundry room, exercise area, closet, or bedroom, wherever air should be changed frequently. Decorative and recessed models can be ideal solutions for these situations. According to the Home Ventilating Institute, Air Changes per Hour (ACH) for comfortable and healthy living should be as follows: Bathrooms: 8 changes, Kitchens: 15 changes, Living/Bedrooms: 6 changes. Broan bath fans, utility fans and high capacity fans meet these needs.

Calculate the air movement necessary for proper ventilation.

Air movement is measured in Cubic Feet per Minute (CFM). To determine CFM requirements, first determine the size of your room. Measure and multiply the length, width and ceiling height of your

room to determine cubic footage. Then use the multiplication factor of .13 and round up to the next "ten." See the three examples that follow.

Example 1: Bathroom with 8' ceiling: 7' wide x 9' long x 8' high x .13 = 66. Select a bath fan with at least 70 CFM.

Example 2: Bathroom with 9' ceiling: 10' wide x 9' long x 9' high x .13 = 105. Select a bath fan with at least 110 CFM.

Example 3: For a bathroom with a vaulted ceiling, use the average ceiling height at the wall and the peak: 8' wide x 12' long x ((8' at wall + 12' at peak) / 2 = 10') average height x .13 = 125. Select a fan(s) with at least 130 CFM.

Account for long duct runs and ductwork that turns before it reaches the exterior vent. When airflow is restricted in any way it slows down. Just as a car must slow down for a sharp corner, air decelerates when going through a turn in a duct run. Whenever possible, create a straight duct run with large radius turns, if they're

performance

A good ventilation fan is the product of research, testing and listening to the needs of consumers. At Broan we build these desires into ventilation products that provide the best mix of power, sound and quality for every budget.

necessary at all. Rigid ductwork is optimal because airflow restriction is minimized. Flexible tubing may be convenient to install, but resistance is created as air is moved over the spiral metal frame of the tubing. With long duct runs or ducts with multiple turns the fan works harder, noise increases and fan performance (CFM) is compromised. Select a fan model with an even greater CFM rating compensate.

6" ducting overcomes most performance-related installation issues.

Broan's ULTRA and QTX Series fans deliver high performance in virtually any real-world installation. They are engineered with a 6" duct connector for peak air movement and extremely quiet operation, even when the duct run is not short and straight.

Everything you need to know about home ventilation.

What is a sone, and how is it measured?

A sone is a measurement of sound in terms of comfortable hearing level for an average listener. The lower the sone value, the more comfortable the listening environment. Sones are not decibels or volume, but rather how sound is “sensed.” One sone is the equivalent of a quiet refrigerator. Broan ULTRA™ fans feature the quietest rating possible at <0.3 sones.

air quality

Broan has long been a leader in indoor air quality solutions.

Our spot ventilation products for bathrooms and kitchens control problems at the source.

ULTRA™ Series Ventilation Fans featuring ULTRA Green™ Energy Saving DC Motor Technology are a virtually silent continuous ventilation solution.

Multi-speed models will quietly solve not only your excess humidity and odor problems when called upon but can pull double-duty as a great continuous ventilation solution.

What does CFM mean?

CFM is the acronym for Cubic Feet per Minute—the measure of air volume moved by the fan blower. Choose a fan with a CFM rating appropriate for your room size to ensure adequate ventilation.

What is continuous ventilation?

Continuous ventilation provides today’s airtight homes with a relatively constant and controlled lower level

of ventilation. Broan’s ULTRA™ Series Ventilation Fans featuring ULTRA Green™ Energy Saving DC Motor Technology are a virtually silent continuous ventilation solution for ASHRAE 62.2 and programs such as LEED, ENERGY STAR® for Homes and CA Title 24. Because they are available in both single-speed (X1) and multi-speed (X2) versions, you can choose the functionality you require for the job.

Can I mount Broan fans above my tub and shower?

Most Broan fans are rated for use over a shower or bathtub with a GFCI (Ground Fault Circuit Interrupter).

Can my bath fan be surrounded by insulation?

Yes. Broan bath fans are designed to provide adequate cooling for motors and lighting, as well as products with integral heaters.

Will Broan fans work in wall-mount applications?

Some Broan bath and utility fans may be wall mounted. See the product matrix for specific models. Improper installation may affect fan life, safety and your warranty.

Will a bath fan or wall-mount utility fan serve as a range hood?

No. Range hoods are specifically designed to handle grease and high temperature environments. Broan bath fans supplement odor and moisture removal in the kitchen, but are not intended for use as a range hood.

What does “static pressure” mean?

Static pressure is the measurement of airflow resistance as it is pushed through ductwork which reduces the effectiveness of the fan. Learn more on the Home Ventilating Institute web site www.hvi.org.

How long should a bath fan run after a shower is used?

The Home Ventilating Institute recommends that a fan should be left on for 20 minutes more to clear humidity adequately and to ensure moisture and condensation in the fan body or ducting is minimized.

How can I assure that fog will automatically be cleared from my mirrors as quickly as possible?

The Broan ULTRA™ Series with ULTRASense™ H Humidity Sensing Technology automatically turns the fan on to eliminate excess moisture. They can sense a rapid rise in humidity and respond faster than fans or controls that wait for a relative humidity set point to be reached.

Is there a solution for family members that forget to turn the fan on?

The Broan ULTRA™ Series with ULTRASense™ M Motion Sensing Technology will automatically turn these multi-speed fans up to maximum power for humidity or odor when someone enters the room and include adjustable delay-off timers.

What are the timer features?

Delay-off timers automatically shut your fan off after a specified time interval. It’s a nice feature in high traffic bathrooms where you may wish to let the fan run to clear moisture adequately. A timer counts down the minutes of fan operation selected by the user.

Where should the exhaust fan be located?

Exhaust fans should be located in or near the shower or tub, and in an enclosed water closet. Keep exhaust points opposite the supply air source to ensure that the fresh air is drawn through the room. Bathroom doors should not be sealed too tightly at the bottom in order to allow “makeup air” to enter the room when the door is closed.



Do I need attic access to install a fan in a retrofit situation?

In many cases you do, but the Broan ULTRA™ Series Ventilation Fans with ULTRA Quick™ Installation Technology allows fan installation in any type of joist or truss system without access from above in most applications. Easy retrofit installation from the room-side means not having to worry about installation conditions. ULTRA™ Series Ventilation Fans have exclusive installation features such as a telescoping mounting frame, snap-in housing, snap-in blower and inside-out mounting duct connector and wiring bracket that can be installed from the room-side.

How do I size a fan properly for my room size and the duct run?

See the sizing guidelines on page 7 for details on proper sizing. This section provides an explanation and examples to help you make the right decision.

Where is the exhaust outlet on the ventilation fan?

The exhaust outlet is the point where air is discharged through the body of the fan housing into the ductwork. During installation, orient your fan with the exhaust outlet pointing toward the exit vent on your roof or wall to minimize turns in ductwork that impede airflow.

Why do the windows and mirrors fog even when the fan is running?

If windows and mirrors are very cold, condensation can still form on these surfaces. And if your bathroom is sealed tightly, replacement air may not be entering the room fast enough to displace the moist air. Be sure to undercut your door sufficiently to draw fresh air into the room. Fan placement can also be a factor. Your fan should be located far from the replacement air source to ensure the moist air is drawn out first. Finally, too many twists and turns in the ducting will significantly reduce the ability of the blower to remove moist air. Make sure your ductwork is as short and straight as it can be, with gradual turns rather than tight corners where necessary.

Why is water dripping from the grille of the fan?

Dripping water is either condensation (usually due to cold ductwork or improper duct installation), or a problem with the seal on a wall or roof vent. Insulated ductwork can help solve condensation problems, and running the fan longer will ensure moisture is completely removed from the duct. Ductwork should slope down toward a wall vent to direct condensation out of the exterior vent opening rather than back into the fan housing.

Can I install a heater over the bathtub or in a shower?

No. Heaters are not UL Listed (Underwriter’s Laboratory) for installation over a bathtub or in a shower.

Can I use an inline or multi-port fan in one large bathroom?

Yes, this works the best for large rooms because you can install the ports over the areas where the

ventilation is needed the most (source control). The size of the multi-port would be determined by the size of the room.

Can larger diameter ducting be used with my bath fan?

Yes, larger diameters will result in improved performance.

Can I use a smaller diameter duct than what the fan is designed for?

This is not recommended. It will cause the fan to run harder, greatly reducing the CFM performance of the fan and create excess noise.

What type of duct is recommended, rigid or flexible?

It is recommended, where possible, to use rigid duct. It has less resistance to air flow and allows the fan to operate much more efficiently. If aluminum flexible duct is used, be sure the duct is as straight as possible.

Can I exhaust my fan into my attic instead of out the roof or wall?

Never exhaust air into spaces within walls, ceilings, attics, crawl spaces or garages. Humidity may damage the structure and insulation.

What type of exhaust fan is best for a sauna or hot tub area?

High CFM-rated devices are normally recommended for this type of application.

Can I use a fan in a steam shower?

No. Since these are normally sealed chambers, a vacuum will be created.

Can I vent more than one bath fan out of a roof or wall cap?

No. Always follow the manufacturer’s recommended ventilation requirements.

style

Style is a curious thing.

To each individual it is something different.

So Broan makes a range of unique products—some that stand out, others that blend in.

But all suit every sense of style beautifully.

Premium ventilation helps reduce airborne pollutants.

Today's homes are built tightly for energy efficiency. But what's good for heating and air-conditioning bills means unwanted and unhealthy pollutants stay trapped inside unless they are mechanically vented away.

Intermittent and continuous ventilation.

Intermittent or "spot" ventilation focuses on removing contaminants from a specific area at a specific time, such as running a bath fan during a shower. Continuous ventilation—also known as whole-house ventilation—is becoming increasingly popular and continually removes contaminants generated in our homes every day.

Continuous ventilation is being required to meet building codes such as California Title 24, or green building standards such as LEED or ENERGY STAR® for Homes. These types of programs reference the ASHRAE 62.2 residential ventilation standard that details the amount

of air in cubic feet per minute (CFM) needed for whole-house ventilation, based on square footage and the number of bedrooms in the home (see chart below).













Broan offers multiple solutions for these applications. They not only meet the continuous or whole-house needs but also the spot or local ventilation needs traditionally associated with ventilation fans such as removing excess shower humidity or bathroom odors.

Our new ULTRA Series ventilation fans have the ability to easily and efficiently handle the job—especially multi-speed models and those with ULTRA Sense™ humidity or motion sensing technology.

Or you can choose our Broan SmartSense® system (see page 24–25) which allows multiple fans to communicate wirelessly for evenly distributed multi-point ventilation throughout the home.

ASHRAE 62.2

Whole Building Ventilation Requirements

| | Number of Bedrooms | 0–1 | 2–3 | 4–5 |
|---------------------|--------------------|-------------------------------------------------------------------------------------------|-------------------------------------------------------------------------------------------|--------------------------------------------------------------------------------------------|
| Home Square Footage | < 1500 |  30 |  45 |  60 |
| | 1501 to 3000 |  45 |  60 |  75 |
| | 3001 to 4500 |  60 |  75 |  90 |
| | 4501 to 6000 |  75 |  90 |  105 |

Use this simple formula or the chart to calculate the required CFM for continuous ventilation.

CFM = .01 x floor area (in square feet) plus 7.5 x (number of bedrooms + 1).

Example: A 3,000 square foot home with 3 bedrooms would require 60 cfm:

$$.01 \times 3,000 = 30$$

$$7.5 \times (3+1) = 30$$

Add together for a total of 60 CFM



All ULTRA™ Series Ventilation Fans are ENERGY STAR® qualified.

For more details see ASHRAE Standard 62.2-2010

ULTRA™ Series Ventilation Fans. The solution for spot and continuous ventilation needs.

Our exclusive ULTRA Smart™ Control Technology enables these fans to maintain their powerful operation even at high static pressures, and supply the required air movement levels for whole-house ventilation while meeting the spot ventilation needs of a bathroom. Available in multi-speed versions, the continuous lower CFM levels of ULTRA™ Series Ventilation Fans can be adjusted to meet the specific needs of each home.

For even greater ease of use, models with ULTRA Sense™ Humidity or Motion Sensing Technology will automatically adjust to maximum CFM levels when the need is detected.

Since whole-house fans may run at all times, quiet operation is extremely important. The last thing that anybody wants is to be kept awake by a loud fan. The ASHRAE 62.2 standard requires whole-house fans to be rated at 1.0 sones or less. All ULTRA™ Series Ventilation Fans feature ULTRA Silent™ Sound Technology, greatly surpassing this requirement by measuring a barely audible ≤ 0.3 sones. Choosing an ENERGY STAR® qualified fan is always a good idea, but it is even more important for whole-house fans that may run all the time. ULTRA™ Series Ventilation Fans with ULTRA Green™ DC Motor Technology meet ENERGY STAR® CFM-per-watt requirements and in some cases are nearly 10 times more efficient.

Excess humidity, for example, can cause damaging and unhealthy mold growth. Other pollutants include pollen and volatile organic compounds (VOCs) which off-gas from building materials or exist in products we use every day such as cosmetics and cleaning chemicals. Visit www.epa.gov for more information on pollutants.

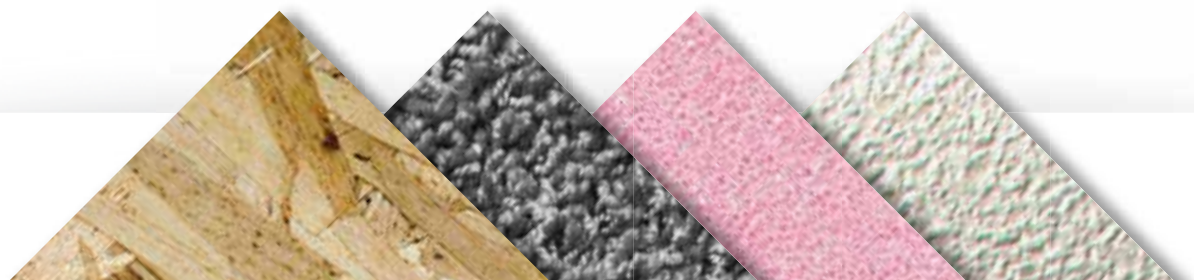

ULTRAQUICK™

INSTALLATION TECHNOLOGY

ULTRA™ Series Ventilation Fans are engineered to be the fastest, easiest, most universal installation in remodel, retrofit and new construction—in any type of joist or truss system. Exclusive features simplify room-side installation to save valuable time and money.

Pre-installed screws in the mounting frame enable quick installation.



Inside/outside wiring capability provides flexible new or retrofit installation.



For room-side installation, pull the duct through the opening, attach the duct to the connector, push the connector into place and fasten to the housing with only one screw.



Vertical positioning tabs ensure the housing is in the right place.



For no-hassle installation, the blower simply snaps into the housing.



You can hear—and feel—when fan housing snaps into place. The easy-to-position carriage enables location adjustment between joists to ensure desired ceiling placement.



The expandable mounting frame adjusts from 14"–24" and fits any type of joist, I-Joist or truss construction.

A revolution in ventilation fan technology engineered to simplify installation.

We didn't just change one thing to make installations faster, we changed everything. From a unique telescoping mounting frame that installs room-side to an easy-to-insert housing and blower that snap into place, we designed the ULTRA™ Series for fast, easy, universal application.

No matter what's behind the drywall on your next job, you'll never have to do another difficult installation. ULTRA™ Series Ventilation Fans and Fan/Lights are up to 60% faster in retrofits and up to 20% faster in new construction.

And just as important, the ULTRA™ Series meets whole-house mechanical ventilation codes and green building program requirements. It's a revolutionary way to install and a revolutionary way to ventilate.



ULTRA™ Series Fans and Fan/Lights



ULTRAGREEN™ DC MOTOR TECHNOLOGY

ULTRA™ Series Ventilation Fans are a virtually silent continuous ventilation solution for ASHRAE 62.2 and programs such as LEED, ENERGY STAR® for Homes and CA Title 24. Choose single speed or multi-speed versions to get functionality you require for the job. Our DC Motor is the most efficient in our line—80 CFM models use only 5.8 watts.

ULTRALUCENT™ LIGHTING TECHNOLOGY

The design of the ULTRA™ Series light lens distributes illumination evenly while using less wattage. 2–18 watt bulbs deliver the brightness of models previously requiring 60 watts of CFL output, maximizing the lumen output per watt of the bulb.



ULTRASMART™ CONTROL TECHNOLOGY

To virtually ensure full-rated performance—regardless of the ducting situation—ULTRA™ Series fans automatically monitor and adjust CFM output. For continuous ventilation needs, multi-speed models may be precisely set as low as 30 CFM to avoid costly over-ventilating. A second dial controls runtime at maximum CFM when lingering humidity and odors need to be cleared. Both dials need only be set once.

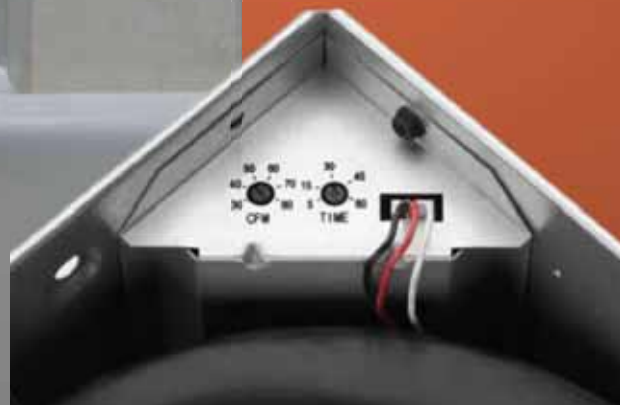

ULTRASILENT™ SOUND TECHNOLOGY

ULTRA™ Series Ventilation Fans are HVI certified at a remarkable <0.3 Sones; the quietest sound rating obtainable. A dynamically balanced DC motor mounted behind the wheel, a state-of-the-art blower that reduces turbulence, and a free-flowing 6" duct outlet opening that won't inhibit airflow make it possible. There's no quieter fan available.

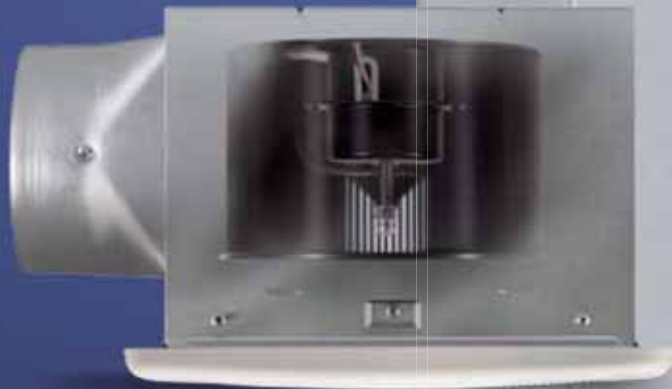

ULTRASENSE™ H HUMIDITY SENSING TECHNOLOGY

ULTRA Sense™ H sensing fans detect the rapid rise in humidity at the ceiling level. This means that they will react to shower humidity much faster than other competitive fans or wall controls that wait for a relative humidity set-point to be reached. You can enjoy a humidity-free, comfortable environment much more quickly when taking a shower or bath. Multi-speed models turn the fan speed up from the lower continuous CFM level. Single-speed models turn the fan on automatically. As humidity decreases the sensor initiates the shut-down timer (can be set from five to 60 minutes) and returns multi-speed fans to continuous ventilation levels, and switches single-speed models off.

ULTRASENSE™ M MOTION SENSING TECHNOLOGY

ULTRA Sense™ M fans with multi-speed capability automatically turn the fan up to maximum speed from the lower continuous setting when motion is detected which is ideal for family members who forget to turn the fan on.

Fresh, comfortable air—not to mention a mold-free environment—becomes a constant companion without having to think about it. After motion is no longer present, the user-set delay timer (five to 60 minutes) will automatically turn the fan back down to ensure that humidity and odor have been fully cleared while saving energy. Once it's set, forget about it.



ULTRA™ Series Fans and Fan/Lights

Broan ULTRA™ Series Fans and Fan/Lights. Built for easy installation in either new construction or retrofit applications, the ULTRA™ Series makes it simple to ventilate any room in the house. In today's tightly built homes, unhealthy pollutants and excess humidity stay trapped inside unless they are mechanically vented away. Exclusive ULTRA Smart™ Control Technology enables fans to maintain their powerful operation—even at high static pressures—and provide required air movement levels for whole-house ventilation, all while meeting spot ventilation needs on demand. Continuous CFM levels can be precisely adjusted to meet the specific needs of each home.

ULTRA™ Series Fans

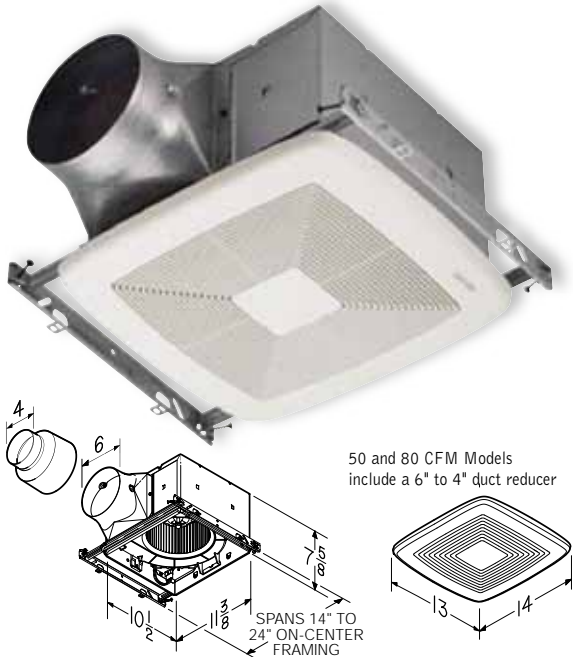

ULTRA™ Series Fan/Lights



ULTRA Sense™ Fans



ULTRA Sense™ Fan/Lights

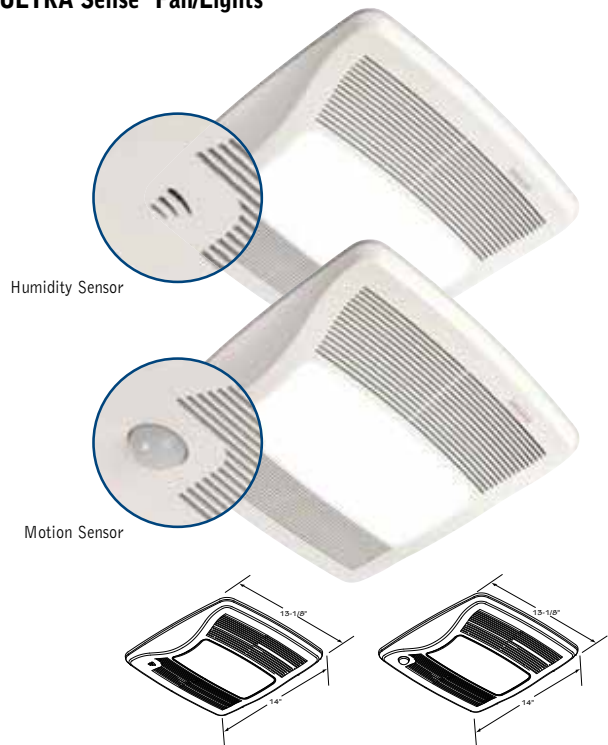

ULTRA™ Series Fans and Fan/Lights

ULTRA™ Series Fan and Fan/Light Features

- HVI certified at <0.3 Sones, ULTRA Silent™ Sound Technology provides the quietest sound rating obtainable
- 50, 80 or 110 CFM
- Intermittent and continuous ventilation
- ULTRA Smart™ Control Technology monitors performance and adjusts motor speed to ensure rated air movement
- Energy Star® qualified with ULTRA Green™ DC Motor Technology
- ULTRA Quick™ Installation Technology saves time with the fastest, easiest, most universal installation
- XB and ZB models feature 6" ducting—50 and 80 CFM models include an optional 6" to 4" duct reducer
- Bright, energy efficient 36-watt fluorescent lighting
- UL Listed for use over bathtub or shower when connected to a GFCI protected branch circuit
- Type IC
- Fits 2" x 8" ceiling construction
- Optional RDFI Premium Radiation Damper Kit available for models ZB110, ZB80, XB110, XB80 & XB50

| Model | CFM | Sones | Light/ Night Light | Humidity Sensing | Motion Sensing | Ducting | ENERGY STAR® |
|--------------------------------|-----|-------|-----------------------|---------------------|-------------------|------------------|-----------------|
| Single-speed Fans | | | | | | | |
| XB50 | 50 | <0.3 | — | — | — | 6" | Yes |
| | 50 | <0.3 | — | — | — | 6" to 4" reducer | |
| XB80 | 80 | <0.3 | — | — | — | 6" | Yes |
| | 80 | 0.3 | — | — | — | 6" to 4" reducer | |
| XB110 | 110 | <0.3 | — | — | — | 6" | Yes |
| XB110H | 110 | <0.3 | — | Yes | — | 6" | Yes |
| Single-speed Fan/Lights | | | | | | | |
| XB50L | 50 | <0.3 | 2-18W GU24 / 4W | — | — | 6" | Yes |
| | 50 | <0.3 | | | | | |
| XB80L | 80 | <0.3 | 2-18W GU24 / 4W | — | — | 6" | Yes |
| | 80 | 0.3 | | | | | |
| XB110L | 110 | <0.3 | 2-18W GU24 / 4W | — | — | 6" | Yes |
| XB110HL | 110 | <0.3 | 2-18W GU24 / 4W | Yes | — | 6" | Yes |
| Multi-speed Fans | | | | | | | |
| ZB80 | 80 | <0.3 | — | — | — | 6" | Yes |
| | 80 | 0.3 | | | | | |
| ZB80M | 80 | <0.3 | — | — | Yes | 6" | Yes |
| | 80 | 0.3 | | | | | |
| ZB110 | 110 | <0.3 | — | — | — | 6" | Yes |
| ZB110H | 110 | <0.3 | — | Yes | — | 6" | Yes |
| ZB110M | 110 | <0.3 | — | — | Yes | 6" | Yes |
| Multi-speed Fan/Lights | | | | | | | |
| ZB80L | 80 | <0.3 | 2-18W GU24 / 4W | — | — | 6" | Yes |
| | 80 | 0.3 | | | | | |
| ZB80ML | 80 | <0.3 | 2-18W GU24 / 4W | — | Yes | 6" | Yes |
| | 80 | 0.3 | | | | | |
| ZB110L | 110 | <0.3 | 2-18W GU24 / 4W | — | — | 6" | Yes |
| ZB110HL | 110 | <0.3 | 2-18W GU24 / 4W | Yes | — | 6" | Yes |
| ZB110ML | 110 | <0.3 | 2-18W GU24 / 4W | — | Yes | 6" | Yes |

 ENERGY STAR® fans use 65% less energy, on average, than standard models and may qualify for local utility rebates. ▲ See page 54 for 6" ducting (DT6W) product specifications.



¹Bulb included

RDFI Premium Radiation Damper

When the air temperature passing through the damper exceeds 165°F the fusible link melts, triggering the thermal fabric to automatically close across the damper. Airflow is interrupted by a flame and heat barrier, preventing the rapid spread of fire to other areas.

- Galvanized steel frame
- High temperature, non-asbestos, reinforced fiber thermal fabric
- Stainless steel closure springs
- 165°F fusible link
- Use the same grille provided with the ULTRA™ Series fan
- For use with models ZB110, ZB80, XB110, XB80 and XB50

Also works with LoProfile fan LP80.



Some of our quietest fans are also some of our most powerful and stylish.



Well designed styles that blend into your room.

The Broan QT Series.

There's a time for noise and excitement, and there's a time for more simple pleasures. The peaceful moment needn't be lost simply because your bath ventilation fan is uncomfortably loud. The very quiet Broan QT Series solves everything.

Lower sones and more power.

The Broan QT Series™ continues to provide very low operating noise levels—most under one sone. However, quiet operation doesn't mean you have to sacrifice powerful operation. The QT Series is one of Broan's best when it comes to maintaining strong airflow in real world installations. Whether you choose a bath fan, a fan/light or a combination heater/fan/light, Broan has a perfect solution for every room.

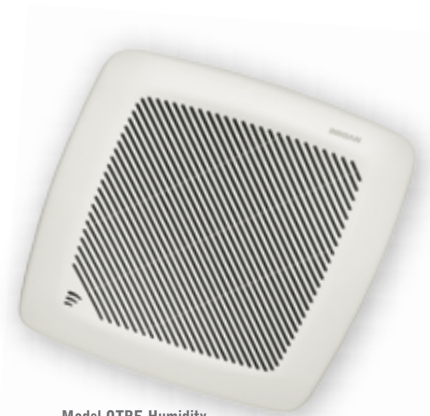

Model QTRE Humidity Sensing Fan, page 22



Model QTXE Humidity Sensing Fan, page 22



Model QTRE & QTR Fans, page 20



Model QTXE Fans, page 20



Model QTXE Fan/Lights, page 21



Model QTXE Humidity Sensing Fan/Lights, page 22



Model QTRE & QTR Fan/Lights, page 21

QT Series™ — Fans

Broan QT Series™ Bath Fans. A bath fan needn't call attention to itself, especially when you don't want it to overpower the design of your bath or powder room. More important, it shouldn't call attention to itself when it's working. So we developed the QT Series™ to provide very relaxing ventilation. With an energy efficient option, it simply does its job quietly, in every sense of the word.

QTXE, QTRE and QTR Fan Features

- Very quiet operation <0.3 to 1.5 sones
- 50 CFM to 150 CFM
- QTXE features 6" ducting for superior performance
- QTRE and QTR models feature 4" ducting
- QTRE and QTXE models are ENERGY STAR® qualified
- HVI Certified
- QTXE, QTRE and Housing Project Packs include hanger bar system for fast, flexible installation for all types of construction
- Motor engineered for continuous operation
- UL Listed for use over bathtub or shower when connected to a GFCI protected branch circuit
- Fits 2" x 8" ceiling construction

QTXE Models

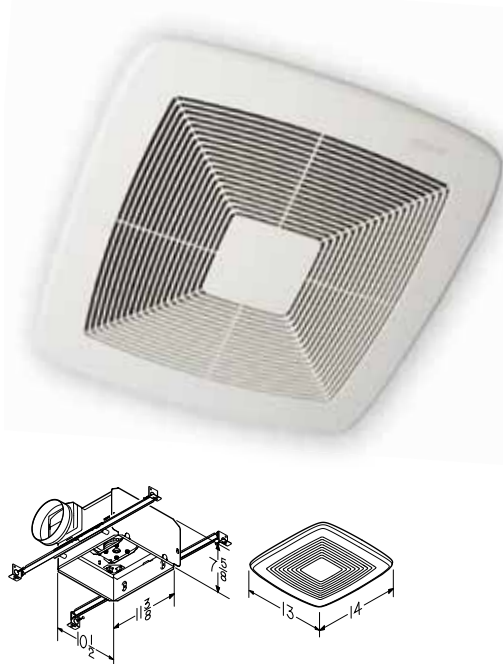

| Fan Model | CFM | Sones | ENERGY STAR® | Bath Sq. Ft. | Ducting |
|-----------|-----|-------|--------------|--------------|---------|
| QTXE050 | 50 | <0.3 | Yes | 45 | 6"▲ |
| QTXE080 | 80 | 0.3 | Yes | 75 | 6"▲ |
| QTXE110 | 110 | 0.7 | Yes | 100 | 6"▲ |
| QTXE150 | 150 | 1.4 | Yes | 140 | 6"▲ |

 ENERGY STAR® fans use 65% less energy, on average, than standard models and may qualify for local utility rebates.
▲ See page 54 for 6" ducting (DT6W) product specifications.
+ Only available in project packs.



QTRE & QTR Models

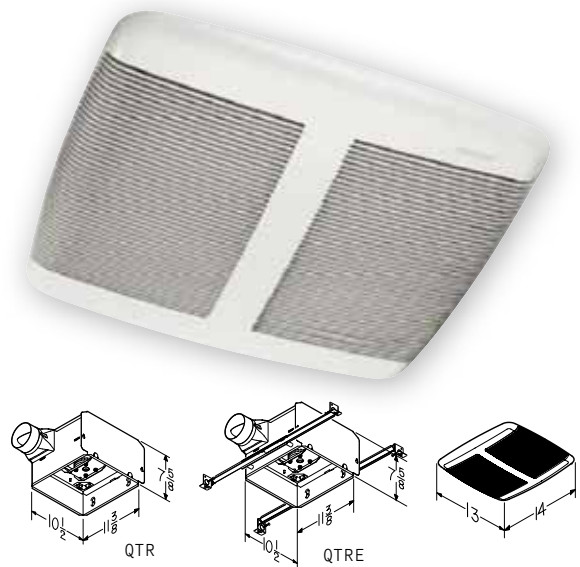

QTRE080C2S QT Select Air™ ventilation fan

Many rooms in the home can benefit from extra ventilation—not just the bathroom. Kitchens, laundry rooms, media rooms and closets are just a few examples. Now you can provide these rooms with extremely quiet ventilation at a more continuous lower level or in a boost mode whenever needed.

- 80 CFM at 0.8 Sones in boost mode
- 40 CFM at <0.3 Sones in normal mode
- Energy Star® qualified
- 4" ducting
- HVI certified

| Fan Model | CFM | Sones | ENERGY STAR® | Bath Sq. Ft. | Ducting |
|------------|-------|----------|--------------|--------------|---------|
| QTRE080C2S | 80/40 | 0.8/<0.3 | Yes | 75 | 4" |
| QTRE080 | 80 | 0.8 | Yes | 75 | 4" |
| QTRE110 | 110 | 1.3 | Yes | 100 | 4" |
| QTR050+ | 50 | 0.4 | — | 45 | 4" |
| QTR080 | 80 | 1.0 | — | 75 | 4" |
| QTR110 | 110 | 1.5 | — | 100 | 4" |

 ENERGY STAR® fans use 65% less energy, on average, than standard models and may qualify for local utility rebates.
▲ See page 54 for 6" ducting (DT6W) product specifications.
+ Only available in project packs.



Broan QT Series™ Fan/Lights. The QT Series™ is the ultimate bath fan solution for today's homes. Select a QT Series™ fan/light to bring simple elegance to any bath or powder room. By sight or by sound, you'll barely notice a QT Series™ fan. Except, of course, when you need just the right amount of ventilation and light at the touch of a switch.

QTXE, QTRE and QTR Fan/Light Features

- Very quiet operation <0.3 to 1.5 sones
- 80 CFM to 150 CFM
- QTXE models feature 6" ducting for superior performance
- QTRE and QTR models feature 4" ducting
- QTRE and QTXE models are ENERGY STAR® qualified
- Bright, energy efficient 36-watt fluorescent lighting (2-18 watt GU24 based bulbs) included with non-sensing QTXE and QTRE models
- 100 watt lighting from an incandescent bulb on QTR models
- 4 watt night light on all models
- QTXE, QTRE and Housing Project Packs include hanger bar system for fast and flexible installation for all types of construction
- Motor engineered for continuous operation
- UL Listed for use over bathtub or shower when connected to a GFCI protected branch circuit
- HVI Certified
- Type IC
- Fits 2" x 8" ceiling construction

QTXE Models

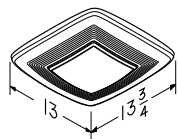
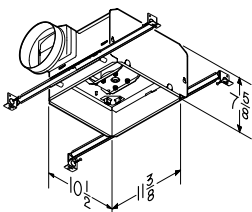

QTRE & QTR Models

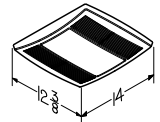
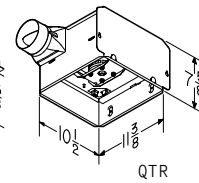
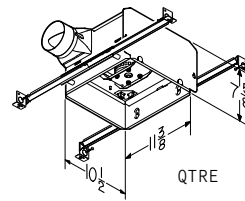

| Model | CFM | Sones | Light/ Night Light | ENERGY STAR® | Ducting |
|------------|-----|-------|-----------------------|-----------------|---------|
| QTXE080FLT | 80 | 0.3 | 36W* / 4W | Yes | 6"▲ |
| QTXE110FLT | 110 | 0.7 | 36W* / 4W | Yes | 6"▲ |
| QTXE150FLT | 150 | 1.4 | 36W* / 4W | Yes | 6"▲ |
| QTRE080FLT | 80 | 0.8 | 36W* / 4W | Yes | 4" |
| QTRE110FLT | 110 | 1.3 | 36W* / 4W | Yes | 4" |
| QTR080L | 80 | 1.0 | 100W / 4W | — | 4" |
| QTR110L | 110 | 1.5 | 100W / 4W | — | 4" |



ENERGY STAR® fans use 65% less energy, on average, than standard models and may qualify for local utility rebates.

▲ See page 54 for 6" ducting (DT6W) product specifications.

*2, 18-watt GU24 based fluorescent bulbs



New styling and improved lighting make Broan's QT fan lights even better.

- Light output has been significantly increased, while using 14 fewer watts.
- Lighting design enhancements provide a brighter, broader flood-light effect.
- Improved light diffusion hides hotspots/bulbs.
- Convenient GU24 bulbs are readily available.
- A restyled, low-profile grille on QTXE models blends with any decor.
- Design and lighting improvements were made without increasing sound levels.

QT Series™ Fans and Fan/Lights—Humidity Sensing

QT Series™ Humidity Sensing Fans with Sensaire® Technology. Broan Sensaire® technology is a hands-free solution to fighting excess humidity and possible mold problems. It detects rapid increases in moisture levels at the ceiling, where steam and humidity naturally rise, and automatically turns the fan on. With a fan this quiet, we included automatic shutoff to save worry, and money. Broan Sensaire® technology is a perfect solution for high traffic bathrooms, the kids' bathroom, or for anyone who leaves the house before humidity is properly vented.

QTXE and QTRE Sensing Fan Features

- Detects a rapid rise in humidity
- Humidity is sensed at the ceiling level
- QTXE110S features easily accessible sensitivity adjustment
- Easy-to-set shut-off timer: 5–60 minutes on QTXE110S
- Auto shut-off timer: 20 minutes on QTRE100S
- Fits 2" x 8" ceiling construction
- UL Listed for use over bathtub and shower when connected to a GFCI protected branch circuit
- Includes hanger bar system for fast and flexible installation for all types of construction
- ENERGY STAR® qualified
- HVI Certified

QTXE110S Model

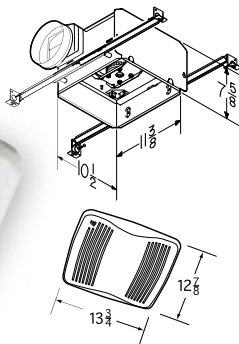

QTRE100S Models

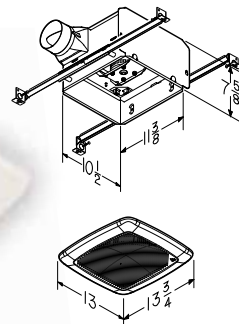

| Fan Model | CFM | Sones | ENERGY STAR® | Bath Sq. Ft. | Ducting |
|-----------|-----|-------|--------------|--------------|---------|
| QTXE110S | 110 | 0.7 | Yes | 100 | 6" ▲ |
| QTRE100S | 100 | 1.5 | Yes | 90 | 4" |



ENERGY STAR® fans use 65% less energy, on average, than standard models and may qualify for local utility rebates. ▲ See page 54 for 6" ducting (DT6W) product specifications.



QTX110SL & QTXE110SFLT Models

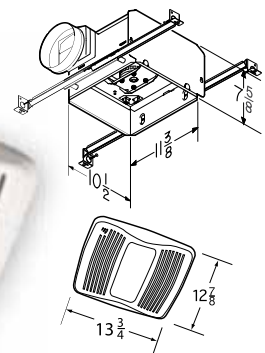

| Model | CFM | Sones | Light/ Night Light | ENERGY STAR® | Ducting |
|-------------|-----|-------|-----------------------|--------------|---------|
| QTXE110SFLT | 110 | 0.7 | 2-18W / 4W | Yes | 6" ▲ |
| QTX110SL | 110 | 0.9 | 100W / 4W | — | 6" ▲ |



ENERGY STAR® fans use 65% less energy, on average, than standard models and may qualify for local utility rebates. ▲ See page 54 for 6" ducting (DT6W) product specifications.



Hands-free solutions to fighting excess humidity and mold. Broan's humidity sensing fan/light turns the fan on and off automatically to help prevent cosmetic and possible mold problems associated with excess moisture.

- Detects a rapid rise in humidity
- Humidity is sensed at the ceiling level
- Sensitivity level is adjustable
- Easy-to-set shut-off timer: 5–60 minutes
- UL Listed for use over tub or shower when installed in a GFCI protected branch circuit
- Includes hanger bars for fast, flexible installation in all types of construction
- HVI Certified
- Fits 2"x 8" ceiling construction

QT Series™ Fan and Fan/Lights—Project Packs

Project Packs Available for QTRE100S model

To simplify installation, a Project Pack is available with four fan housings. When drywall work and painting is complete, the fan components needed to finish the job are available in a single pack under a separate model number. The finish kit includes the motor plate, motor, wheel and grille. See the matrix below for Project Pack order information.

| Project Pack | Kit number: | For model: |
|--------------------------------------|-------------|------------|
| Four-pack of FAN housings only: | HQTS4 | |
| One-pack finish kits for FAN models: | FQTRE100S | QTRE100S |



Retrofit a QT Series™ fan in less time, with less work.

With a telescoping frame and a unique duct attachment system, installation is simplified. The fan goes in faster, connects to joists more solidly, and eliminates unprofessional “rigging.” There’s also no patching, priming or painting when you’re done.

That’s what the Broan QTRE080R Retrofit Fan does for you.

- UL Listed for use over tub or shower when installed in a GFCI protected branch circuit
- HVI Certified
- ENERGY STAR® qualified
- Fits 2" x 8" ceiling construction

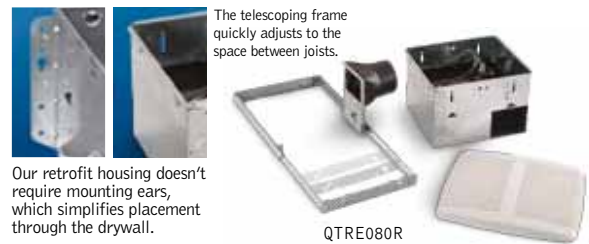

| Fan Model | CFM | Sones | ENERGY STAR® Bath | Sq. Ft. | Ducting |
|-----------|-----|-------|-------------------|---------|---------|
| QTRE080R | 80 | 0.8 | Yes | 75 | 4" |

Project Packs Available for QTRE and QTR models

To simplify installation, Project Packs are available with either four fan or fan/light housings only. When drywall work and painting is complete, the fan components needed to finish the job are available in single packs under separate model numbers. These finish kits include the motor plate, motor, wheel and grille. See the matrix below for Project Pack order information.

| Project Pack | Kit number: | For model: |
|--------------------------------------|-------------|------------|
| Four-pack of FAN housings only: | QTXR000HF | |
| One-pack finish kits for FAN models: | QTRE080F | QTRE080 |
| | QTRE110F | QTRE110 |
| | QTR050F* | QTR050* |
| | QTR080F | QTR080 |
| | QTR110F | QTR110 |



*Only available in Project Packs.

Project Packs Available for QTRE Models

To simplify installation, Project Packs are available with either four fan or fan/light housings only. When drywall work and painting is complete, the fan components needed to finish the job are available in single packs under separate model numbers. These finish kits include the motor plate, motor, wheel and grille. See the matrix below for Project Pack order information.

| Project Pack | Kit number: | For model: |
|--------------------------------------------|-------------|------------|
| Four-pack of FAN/LIGHT housings only: | QTXR000HL | |
| One-pack finish kits for FAN/LIGHT models: | QTRE080FLFT | QTRE080FLT |
| | QTRE110FLFT | QTRE110FLT |



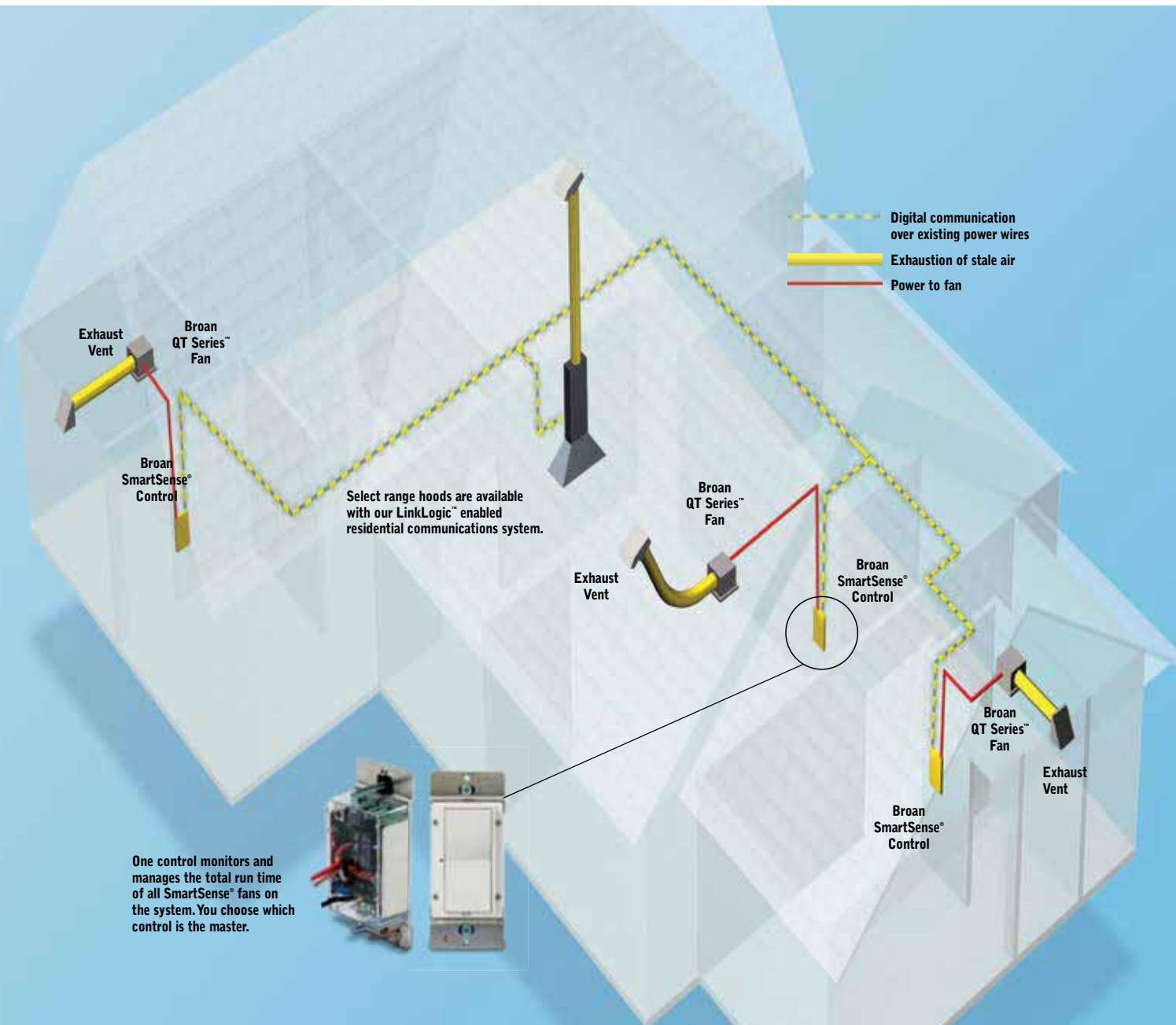

Broan SmartSense® and QT Series ventilation fans work together.



Broan SmartSense® uses LinkLogic®, a powerful, wireless home control technology powered by INSTEON™

- New timed-off and delayed-off features with new firmware.
- Automatically operates the SMD series Make-Up Air Damper for installations requiring make-up air.
- Interfaces with other LinkLogic® enabled products by Broan® or Best®.



| Model | CFM | Dimension |
|-----------|-----|-------------------------|
| SSQTXE080 | 80 | 11-3/8 x 10-1/2 x 7-3/4 |
| SSQTXE110 | 110 | 11-3/8 x 10-1/2 x 7-3/4 |



Broan SmartSense®

Ventilate your home intelligently.

Broan SmartSense® is another smart choice to meet ASHRAE Standard 62.2 and related codes/guidelines (see information on page 10). Like the Broan ULTRA™ Series (pages 11–17), SmartSense will take care of both continuous and spot ventilation requirements.

An economic alternative to other systems.

Every home will have several ventilation fans. Why not install a system that will automatically operate your fans and ventilate your home properly? With multiple fans around the home working together, a SmartSense® system results in stale air being exhausted from various points throughout the home so everyone can enjoy the benefits of fresh, healthy air. Broan SmartSense fans can be wired as easily as the average ventilation fans, no separate control wiring is necessary. The LinkLogic control is programmed to match the home's size, and adjusts total run-time based on the square footage and number of bedrooms. This system is more cost and energy efficient than other ventilation strategies that require the use of the home's air handler. With only one fan running at a time, Broan SmartSense® uses less than 40 watts during ventilation cycles.

How does it work?

The Broan SmartSense system monitors and activates Broan QT Series fans 24/7 throughout the home. Broan QT Series fans operate at a barely audible 0.3 and 0.7 sones, so even in a bedroom you'll never know they're running.

Broan Automatic Make-Up Air Dampers enable efficient and effective home ventilation.

The damper communicates with every SSQTXE080 and SSQTXE110 fan in the home to ensure a supply of fresh air is available while fans are being operated. They can also be linked with select Best® and Broan range hoods to form a complete balanced ventilation system. This assists in maintaining a healthy air-pressure balance in the home while preventing unwanted air infiltration and wasted energy. SmartSense™ automatically operates the SMD Series Make-Up Air Damper for those installations requiring make-up air.

Easy Installation of Broan Make-Up Air Dampers

- Located in a 6-inch or 8-inch duct running between an exterior wall fresh air inlet (641FA or 643FA) to an interior location such as a cold-air return or supply duct.
- Damper is locally powered by a 24 VAC transformer.
- Damper and fans communicate over existing home electrical wiring. No additional interconnection required.

Broan Make-Up Air Dampers feature:

- Heavy-duty galvanized steel construction.
- 24 VAC transformer.
- 6-inch round (SMD6), 8-inch round (SMD8).
- Use with any single fan or combination of SSQTXE080 or SSQTXE110 fans.

New Features

- Flexible enough to work a single fan or as part of a system of up to 10 fans.
- Automatic Off—Prevents the homeowner from leaving a QTXE SmartSense® fan on for extended periods of time because the fan could not be heard.
- Delayed Off—Automatically continues to run the SmartSense® fan for 20 minutes after the SmartSense control is manually turned off. This feature ensures all excess moisture is removed from shower areas.
- Includes control label required by ASHRAE 62.2, California Title 24 and other building codes and standards. Meets intermittent and whole-building ventilation requirements of green building programs such as Leadership in Energy Efficient Design (LEED), NAHB Green Building Guidelines and ENERGY STAR Indoor Air Package.

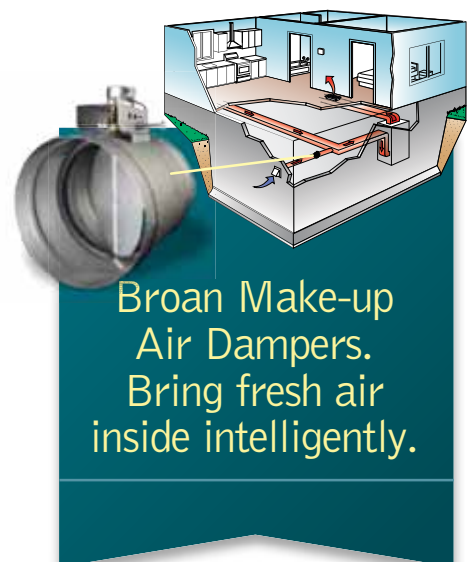

*American Society of Heating, Refrigerating and Air-Conditioning Engineers standard for ventilation and acceptable indoor air quality for low-rise residential building.

Elegant designs to meet any need and complement any room.



Broan Ventilation Fans. Where high function meets practical design.

In the short span of less than an hour each day, steamy showers can produce mold and mildew-fostering vapor. Look to Broan, the ventilation experts, to help you keep your house fresh.

Broan engineers the right product to fit every application, room size and need. Select from a variety of features that best meet your spot ventilation needs. Begin by assessing your application, room size and needs to determine how powerful the blower should be or whether you could use additional lighting in your space. Think about what product style, finish or shape would look best in your space.

Rest assured, if you're concerned about saving money and energy, Broan bath fans that feature the Energy Star® logo can reduce energy consumption by as much as 65%. Broan has the perfect product designed around your needs.



selection

There's a
Broan ventilation solution
perfectly matched to
your needs for power, size,
style and budget.

Ventilation—Fans and Fan/Lights

LoProfile



Model LP80

The right fan for a tight fit.

The new Broan LoProfile™ Fan is our latest solution for installations where conventional ventilation simply won't fit. Where multi-family applications require it, the LoProfile™ fan is narrow enough to be installed in a wall between 2x4 studs. When plumbing or electrical obstructions are found behind the drywall in ceiling remodel applications our LoProfile™ fan can still fit without having to move anything. And that means most any room with space constraints can have powerful, quiet, efficient ventilation.

- Fits in 2x4 ceiling or wall construction
- 80 CFM with 4" duct ensures ample air movement; 70 CFM with 3" duct reducer
- >50 CFM at 0.25" static pressure meets ASHRAE 62.2 local ventilation requirements (with 4" oval duct or 3" round duct)
- Only 1.1 sones for extremely quiet operation
- 4" oval or 3" round duct connection for installation flexibility
- Efficient operation lowers utility bills
- Ideal for multi-family applications
- Compatible with RDF1 Premium Radiation Damper (see page 17)

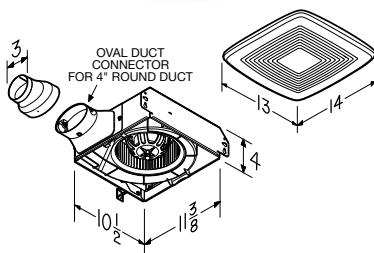

The oval connector accepts standard 4" duct, or 3" duct with the supplied adapter.



Electrical connections can be made through the top or the side of the housing.

| Model | CFM | Sones |
|-------|-----|-------|
| LP80* | 80 | 1.1 |

*ENERGY STAR® qualified.

HVI CERTIFIED

Ceiling Mount Model 770 and 784

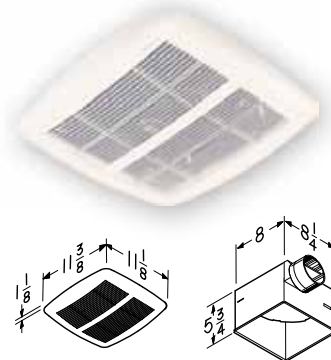

- 50 to 80 CFM
- Centrifugal blower wheel and 4-pole motor deliver high exhaust capacity at low sound levels
- White polymeric grille complements virtually any decor
- Torsion spring grille mounting—no tools necessary
- Metal grille kits (available separately)
- Project Packs available

| Model | CFM | Sones | Ducting |
|-------|-----|-------|---------|
| 770* | 50 | 1.5 | 4" |
| 784* | 80 | 2.0 | 4" |



*ENERGY STAR® qualified.

Model 778WH

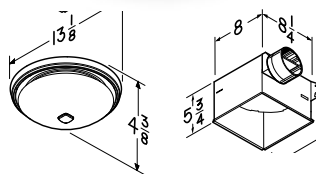

- White finish with White Opal glass globe
- Energy-efficient 26 watt fluorescent lighting—uses two 13 watt GU24 based bulbs (included)
- Hanger bars included

| Model | CFM | Sones | Lighting | Ducting |
|--------|-----|-------|--------------------|---------|
| 778WH* | 80 | 2.0 | 2-13 W GU24 fluor. | 4" |



*ENERGY STAR® qualified.

Model 657 & 696

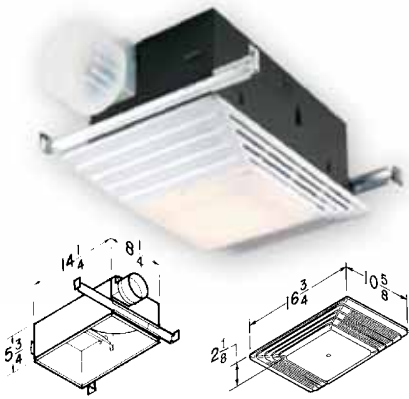

Model 750 & 751

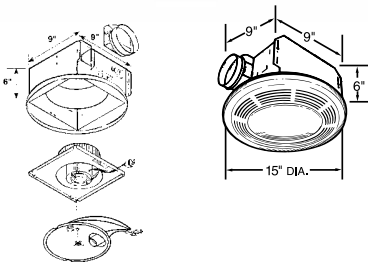

- Round design eliminates squaring with bathroom walls
- Model 751 is the same as Model 750 without a night light

| Model | CFM | Sones | Light/ Night Light | Ducting |
|-------|-----|-------|-----------------------|---------|
| 657 | 70 | 4.0 | 100 W | 4" |
| 696 | 100 | 4.5 | 100 W | 4" |
| 750 | 100 | 3.5 | 100 W/7 W | 4" |
| 751 | 100 | 3.5 | 100 W | 4" |



Model 678, 679, 680

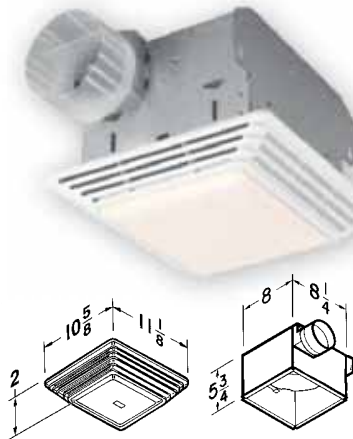

Model CFM Sones Lighting Ducting

| | | | | |
|-----|-----|-----|-------|----|
| 678 | 50 | 2.5 | 100 W | 4" |
| 679 | 70 | 3.5 | 100 W | 4" |
| 680 | 100 | 4.0 | 100 W | 4" |



Ceiling/Wall Mount

Model 676 & 684

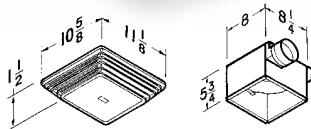

- 50 to 110 CFM
- Centrifugal blower wheel and 4-pole motor deliver high exhaust capacity at low sound levels
- White polymeric grille complements virtually any decor
- Torsion spring grille mounting — no tools necessary
- Metal grille kits (available separately)
- Project Packs available

| Model | CFM | Sones | Ducting |
|-------|-----|-------|---------|
| 676 | 110 | 4.0 | 4" |
| 684 | 80 | 2.5 | 4" |

Model 670, 671, 688, 689

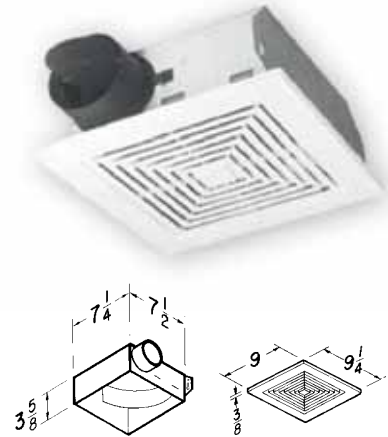

- 50 to 70 CFM
- Powerful centrifugal blower wheel
- Compact housing fits between ceiling joists or wall studs
- Double-strength steel mounting flanges with keyhole slots for fast installation
- Metal grille kits (available separately)
- *Project Packs available for most models

Model CFM Sones Ducting Mounts

| | | | | |
|-----|----|-----|----|--------------|
| 670 | 50 | 3.5 | 3" | Wall/Ceiling |
| 671 | 70 | 6.0 | 3" | Wall/Ceiling |
| 688 | 50 | 4.0 | 3" | Wall/Ceiling |
| 689 | 60 | 5.5 | 3" | Wall/Ceiling |

Project Packs are convenient options for today's contractor. Broan "H" Packs include rough-in housings only, making multi-unit installation more convenient. "F" Packs allow motor/blower and grille assemblies to be ordered separately, nearer project completion, to help avoid losing or having to store components.



Bath Fans and Fan/Lights

Heavy-duty operation

Model HD50, HD80

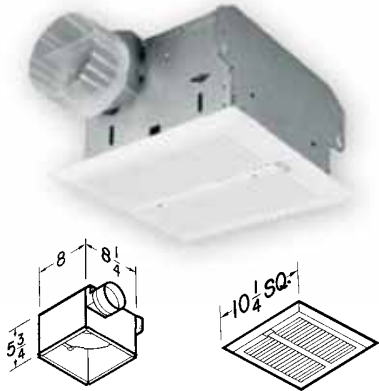

Model HD50L, HD80L

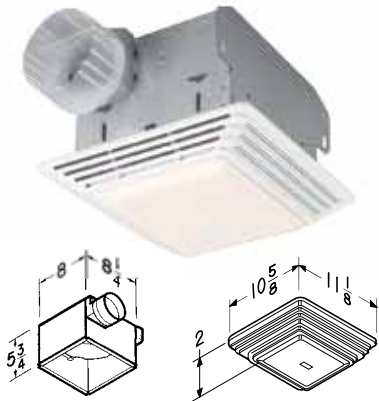

- Enclosed motors with long-life bearings for continuous operation
- Rugged metal fan grille for added durability (HD50 and HD80)
- HD50 and HD80 can be mounted in wall or ceiling
- Grille torsion spring-mounted for easy installation
- Pre-wired outlet for plug-in motor plate
- AMCA licensed for both air and sound (HD50 and HD80)

| Model | CFM | Sones | Lighting | Ducting |
|-------|-----|-------|----------|---------|
| HD50* | 50 | 1.5 | — | 4" |
| HD50L | 50 | 1.5 | 100W | 4" |
| HD80 | 80 | 2.5 | — | 4" |
| HD80L | 80 | 2.5 | 100W | 4" |



*ENERGY STAR® qualified.

Radiation/Fire Damper Fan Project Packs

A fire resistant screen automatically closes when excessive heat is detected. The breakaway fusible link triggers the closing of the radiation damper's fire resistant screen to prevent smoke and fire from traveling through the ductwork.



- 165° fusible link
- Galvanized Steel Frame
- Stainless steel negator-type closure spring
- UL Classified (UL Standard 555C) for use in 1-, 2-, 3-hour fire-rated floor-ceiling or roof-ceiling designs
- All models offered as Project Packs
- HD models feature a heavy-duty motor

Project Housing Pack includes:

- Rough-in housing with attached radiation/fire damper
- Adjustable hanger bars that span up to 24"
- 4" metal duct connector with damper

| Model | CFM | Sones | Type/Pack | Quantity | Notes |
|----------|-----|-------|-----------|----------|------------------|
| RDH | — | — | Housing | 4 | — |
| RDJ1 | — | — | Housing | 1 | — |
| 80RDF | 80 | 2.5 | Finish | 4 | — |
| 110RDF | 110 | 4.0 | Finish | 4 | — |
| HD50RDF* | 50 | 1.5 | Finish | 4 | Heavy-duty Motor |
| HD80RDF | 80 | 2.5 | Finish | 4 | Heavy-duty Motor |



* ENERGY STAR® qualified

Model RDH



Project Finish Packs include:

- Assembled motor plate, wheel and plug-in motor
- Rugged metal grille for added durability
- Works with 80RDF, 110RDF, HD50RDF and HD80RDF

Models 80RDF, 110RDF, HD50RDF & HD80RDF



Model RDJ1



Radiation Damper Accessory Kit includes:

- Radiation damper accessory with metal grille, metal duct connector, hanger bars and plaster guard (no housing)
- Works with 770, 784, 676, 684, HD50 and HD80



690 Bath Fan Upgrade Kit



The Broan bath fan upgrade kit lets you convert your old bath fan to a brand new unit in just 10 minutes. Improve performance, reduce the sound level, and upgrade the appearance of your economy fan in minutes.

- Cut sound levels up to 50%
- Boost air movement up to 20%
- 10 minute installation
- 60 CFM, 3.0 Sones
- Modern white grille
- No special tools needed

Broan 690 Upgrade Kit replaces the models below:

| If your grille looks like this: | The fan is very likely one of these models: | Housing dimensions: |
|---------------------------------|-------------------------------------------------|-------------------------------------------|
| | NuTone 693, 695, 696N | 7½" x 7¼" or 8" x 7¼" |
| | Broan 670, 671, 688, 689 Nautilus N671, N688 | 7½" x 7¼" Not compatible with 8" x 8¼" |

Measure your existing fan housing to ensure proper fit.

| For use only with these bath fan models* | Measurement (inches) | Yes No | |
|------------------------------------------|----------------------|--------|----|
| | | Yes | No |
| NuTone 693, 695, 696N | 7-1/2 x 7-1/4 | • | |
| | 8 x 7-1/4 | | • |
| Broan 670, 671, 688, 689 | 7-1/2 x 7-1/4 | • | |
| | 8 x 8-1/4 | | • |
| Nautilus N671, N688 | 7-1/2 x 7-1/4 | • | |
| | 8 x 8-1/4 | | • |

*No other usage has been tested or authorized by Broan-NuTone LLC.



Duct-free

This easy-to-install solution is ideal where air circulation is needed but ducting is impossible or impractical. Use it as a solution for half baths or rooms where humidity isn't a concern.

Model 682

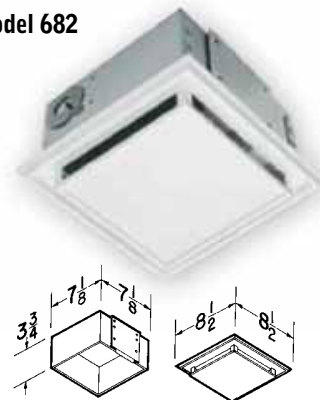

- Patented, fast snap-in metal housing installation
- Fan circulates air past replaceable activated charcoal filter
- Fits 2" x 4" ceiling or wall construction

Model CFM Sones Lighting Notes

| | | | | |
|-----|---|---|---|-----------------------|
| 682 | — | — | — | Duct-free Circulation |
|-----|---|---|---|-----------------------|

The broadest variety of ventilation options for any room in your home.

Keep any room in your home fresh with Broan fans.

Broan knows that living in your home means needing ventilation in a variety of rooms. That's why our specialty line of utility fans, in-line fans and hidden ventilation solutions allow you to ventilate clean, fresh air where you need it most. Whether it's the specialized bath needs, laundry room, recreation room, workshop or kitchen, we have it covered. Look to our room-to-room, wall/ceiling mount, through-wall or vertical discharge utility fans for spot ventilation. Or, install our remote mounted in-line ventilation fan for a quiet whole-house solution. And, prepare to be blown away with our recessed fan/lights that disappear into the ceiling by matching perfectly with other recessed lights. Our humidity sensing recessed fan light even starts automatically when it detects a rapid rise in humidity so you never have to turn the fan on again. Elegant, simple, practical, high-performance. Exactly what you've come to expect from Broan.

power and style

Broan has powerful ventilation products for residential and commercial applications, as well as elegant designs that coordinate perfectly with your decor. Choose a fan that fits the needs of any room.



Hidden Ventilation



Decorative Fan/Lights



Utility Ventilation



In-Line Ventilators

You'd never know it's a fan,
and that's the point.



Specialty Fans and Fan/Lights—Hidden Ventilation

Broan took recessed lighting a step further by incorporating powerful, quiet ventilation in the same design.

These fan/lights disappear into the ceiling and match perfectly with other recessed lights. Models 744, 744FL and 744LED are practical ventilation solutions for any room in the house, such as the utility room, kitchen or high-traffic family room—any space you wish to keep fresh and comfortable. In the bath, Model 744SFL starts automatically when a rapid rise in humidity is detected. You'll never forget to turn the fan on again.

744 Series Recessed Fan/Light Features

- High efficiency centrifugal fan
- 70 CFM at 1.5 sones
- Trim matched to designs of major recessed light manufacturers
- Put multiple units in larger rooms
- Model 744 uses a 75 watt max bulb (R30 or BR30 for standard applications)
- Models 744FL and 744SFL include a 16 watt, GU24 based, R30 shaped CFL bulb (included)
- Model 744LED includes a 14 watt, GU24 based LED bulb (included)
- All models UL Listed for use over bathtub or shower when connected to a GFCI protected branch circuit. Model 744 requires a PAR30L or PAR30LN type bulb (not included)
- 6-7/8" high housing appropriate for new construction and 2" x 8" ceiling joists
- 4" round duct connector
- Optional wall control switches available
- Type IC, sealed housing
- Not for use over cooking surfaces

Humidity Sensing Model 744SFL Features

- SensAire® technology detects the rapid rise in humidity and automatically turns the fan on and off
- Humidity is sensed at the ceiling level
- Easily accessible sensitivity adjustment
- Easy-to-set 5–60 minute shut-off timer

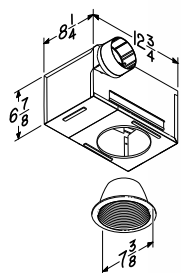

SensAire® technology behind the trim detects changes in humidity and automatically turns the fan on and off.

| Model | CFM | Sones | Lighting | Humidity Sensing | ENERGY STAR® | Ducting |
|---------------|-----|-------|------------|------------------|--------------|---------|
| 744 | 70 | 1.5 | 75W max | — | — | 4" |
| 744FL | 70 | 1.5 | 16W Fluor. | — | Yes | 4" |
| 744LED | 70 | 1.5 | 14W LED | — | Yes | 4" |
| 744SFL | 70 | 1.5 | 16W Fluor. | Yes | Yes | 4" |



ENERGY STAR® fans use 65% less energy, on average, than standard models and may qualify for local utility rebates.



Specialty Fans and Fan/Lights—Decorative Fan/Lights

A beautiful balance of elegance and performance. Now you can ventilate while adding quiet elegance and exceptional design to your bathroom or any other room in your home. The Broan series of decorative fan/lights delivers quality ventilation performance and complements your room with beautifully styled glass globe lighting. These fan/lights are available in corrosion-resistant decorator finishes.

Decorative Fan/Light Fixture Features

- 70 or 80 CFM
- 3.5 or 2.5 Sones
- Corrosion-resistant finishes
- Beautifully styled glass globes
- Use two 60-watt incandescent candelabra bulbs (not included)
- Plug-in lighting fixture and permanently lubricated motor
- Polymeric blower wheel
- Not UL approved for use over bathtubs or showers
- Sturdy, keyholed mounting brackets for quick, accurate installation
- Fits 2" x 6" ceiling construction
- Tapered, polymeric 4" round duct fitting for easy, positive duct connection and no metallic clatter
- Type IC

Model 761BN



Model 766BN



Model 741SN



Model 761RB



Model 766RB



Model 741WH



Model 761WHA



| Model | CFM | Sones | Watts | Bulb Type | Finish | Glass |
|---------------|-----|-------|-------|------------|-------------------|-----------------|
| 761BN | 80 | 2.5 | 2-60W | Candelabra | Brushed Nickel | White Opal |
| 761RB | 80 | 2.5 | 2-60W | Candelabra | Oil-Rubbed Bronze | Ivory Alabaster |
| 761WHA | 80 | 2.5 | 2-60W | Candelabra | White | White Alabaster |
| 766BN | 80 | 2.5 | 2-60W | Candelabra | Brushed Nickel | White Alabaster |
| 766RB | 80 | 2.5 | 2-60W | Candelabra | Oil-Rubbed Bronze | Ivory Alabaster |
| 741SN | 70 | 3.5 | 2-60W | Standard | Satin Nickel | Frosted |
| 741WH | 70 | 3.5 | 2-60W | Standard | Gloss White | Frosted |



Specialty Fans and Fan/Lights—Decorative Fan/Lights

Model 764BN



Model 764RB



Models 764WH



Model 754RB



Model 754SN



Models 757SN

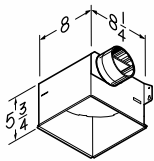

Model 761

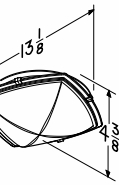
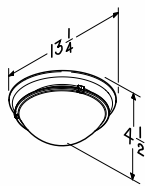

Model 766

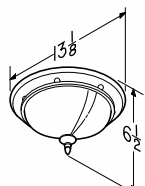

Model 741

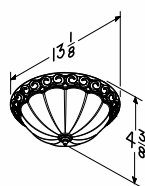

Model 764

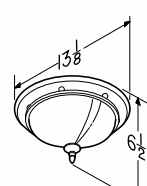

Model 754

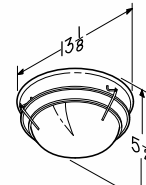

Model 757

| Model | CFM | Sones | Watts | Bulb Type | Finish | Glass |
|--------------|-----|-------|-------|------------|-------------------|-----------------|
| 764BN | 80 | 2.5 | 2-60W | Candelabra | Brushed Nickel | White Alabaster |
| 764RB | 80 | 2.5 | 2-60W | Candelabra | Oil-Rubbed Bronze | Ivory Alabaster |
| 764WH | 80 | 2.5 | 2-60W | Candelabra | White | White Alabaster |
| 754RB | 70 | 3.5 | 2-60W | Candelabra | Oil-Rubbed Bronze | White Alabaster |
| 754SN | 70 | 3.5 | 2-60W | Candelabra | Satin Nickel | White Alabaster |
| 757SN | 80 | 2.5 | 2-60W | Candelabra | Satin Nickel | Frosted |



Specialty Fans and Fan/Lights—Utility Fans



Powerful solutions for problem rooms.

Eliminate humidity or tobacco smoke from recreation rooms, workshops, or cooking odors from kitchens with these powerful utility ventilators. Aluminum filters are available for most models. All feature powerful, permanently lubricated motors and rugged steel housings. Paint the low-profile white polymeric grilles to match any décor.

Chain-Operated utility fan

- Pull-chain opens the door and starts fan
- Housing adjusts to fit walls from 4-1/2" – 9-1/2" thick
- Specially designed polymeric fan blade
- Housing features foam-insulated door for energy efficiency



Model 506

- 10" Wall Fan

Model 506

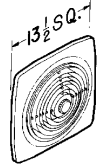

Model 507

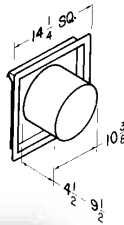
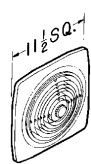

Model 507

- 8" Wall Fan (8-3/8" diameter sleeve)



Room-to-Room

- Room-to-Room ventilators provide quick solutions where more ventilation is needed – without installing new ductwork
- Built-in variable speed control
- Easy installation through wall 3" – 5-1/2" thick
- Permanently lubricated motor
- Paintable white polymeric grilles

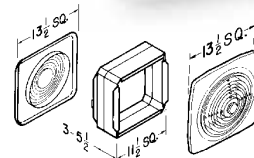

Model 510

- 10" Room-to-Room fan
- Not for use in kitchens

Model 511 (shown)

- 8" Room-to-Room fan
- Not for use in kitchens

Wall/Ceiling Mount – Side Discharge

- Installs easily between ceiling joists or wall studs
- Built-in damper prevents backdrafts
- Fits 3-1/4" x 10" duct

Model 502 (shown)

- 10" Side Discharge

Model 503

- 8" Side Discharge



Model 502

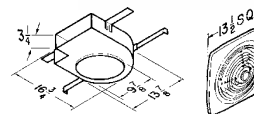

Model 503

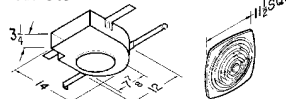

| | CFM | Sones | Diameter | Sizing Specifications |
|-------------------------------------------|-----|-------|----------|----------------------------------|
| Wall/Ceiling-Mount, Side Discharge | | | | |
| 502 | 270 | 8.0 | 10" | Fits 3-1/4" x 10" duct |
| 503 | 160 | 5.0 | 8" | Fits 3-1/4" x 10" duct |
| Chain-Operated | | | | |
| 506 | 470 | 8.0 | 10" | Fits 4-1/2" – 9-1/2" thick walls |
| 507 | 250 | 7.0 | 8" | Fits 4-1/2" – 9-1/2" thick walls |
| Room-to-Room | | | | |
| 510 | 380 | 6.5 | 10" | Fits 3" – 5-1/2" thick walls |
| 511 | 180 | 4.5 | 8" | Fits 3" – 5-1/2" thick walls |

Specialty Fans and Fan/Lights—Utility Fans

Through-Wall fans

- Housing adjusts to fit walls from 4-1/2" – 9-1/2" thick
- Specially designed polymeric fan blade
- Built-in damper minimizes backdrafts for energy efficiency
- Paintable polymeric grilles
- Accessorize with wall switch or variable speed wall control

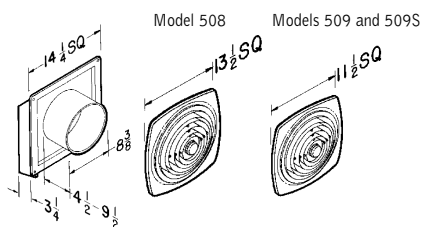

Model 508

- 10" Through-Wall

Models 509 and 509S

- 8" Through-Wall
- Model 509S features an integral ON/OFF rotary switch – no wall switch to wire

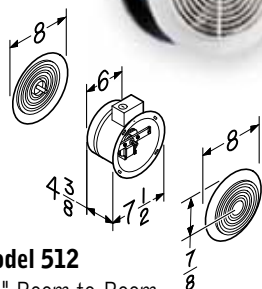

Model 512

- 6" Room-to-Room
- Use 57W or 57V variable speed control separately



Model 512M

- 6" Through-Wall
- Louvered exterior wall cap with built-in bird screen
- 6" diameter flexible aluminum duct included

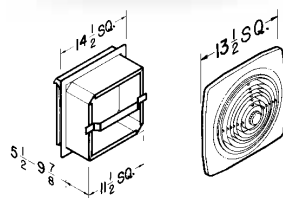

Model 12C Motordor®

- 10" Through-Wall
- Separate motor opens and closes the vent door automatically

Vertical Discharge

- Installs easily between ceiling joists
- Built-in backdraft damper
- Galvanized steel housing
- Strong steel mounting brackets with keyhole slots for fast installation

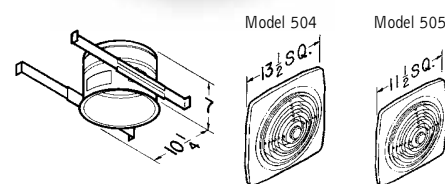

Model 504 (shown)

- 10" Vertical Discharge
- Fits 10" round duct – use Model 472 transition/damper (available separately) for 8" round duct (performance will be reduced)

Model 505

- 8" Vertical Discharge
- 8-1/4" diameter housing



Model 673

- 6" Vertical Discharge
- Paintable, spin-on, white polymeric grille

| Through-Wall | CFM | Sones | Diameter | Sizing Specifications |
|----------------------|-----|-------|----------|------------------------------------------------------------------------|
| 12C Motordor® | 360 | 8.0 | 10" | Fits 5-1/2" – 9-7/8" thick walls |
| 508 | 270 | 6.0 | 10" | Fits 4-1/2" – 9-1/2" thick walls |
| 509/509S | 180 | 6.5 | 8" | Fits 4-1/2" – 9-1/2" thick walls 509S Integral ON/OFF Rotary Switch |
| 512 | 90 | 3.5 | 6" | Fits up to 5-1/8" thick walls |
| 512M | 70 | 3.5 | 6" | Fits 5-1/4" – 10" thick walls |
| Vertical Discharge | | | | |
| 504 | 350 | 6.5 | 10" | Fits 10" round duct |
| 505 | 180 | 6.5 | 8" | Fits 8" round duct |
| 673 | 60 | 4.5 | 6" | Fits 6" round duct |



Specialty Fans and Fan/Lights—In-Line Fans

Remote Mounted In-Line Ventilation Fans are quiet and efficient residential solutions. The concept is simple: mount a high-performance ventilator in an out-of-the-way spot and you get the power with virtually no sound. Install the housing in the attic or the basement, wherever it's most convenient and discrete.

Multi- and Single-port In-Line Ventilators Features

- Energy-efficient, permanently lubricated motors
- High pressure centrifugal blowers easily accommodate long duct runs
- Designed for quick, easy installation
- HVI certified and AMCA licensed
- Suitable for intermittent or continuous ventilation applications
- Removable panels offer easy access to the motor without disturbing ductwork
- Plug-in blower simplifies wiring

Multi-Port In-Line Ventilators

- Ventilate multiple bathrooms or other rooms simultaneously
- Great solution for large, open spaces
- Install in virtually any orientation
- 6" round outlet; 4" round inlets (two inlet duct covers included)
- Use 2, 3 or all 4 inlet ports

Model MP100, MP140, MP200

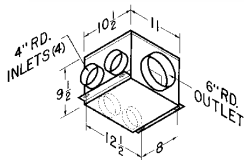

Model MP280

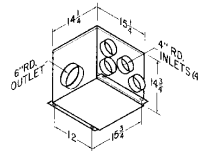

| Multi-Port | CFM | Sones | Notes |
|--------------|-----|-------|-------------|
| MP100 | 110 | 1.0 | Four inlets |
| MP140 | 150 | 1.5 | Four inlets |
| MP200 | 210 | 2.0 | Four inlets |
| MP280 | 290 | 3.0 | Four inlets |

HVI rated air flow at 0.2" static pressure. Sound test procedures are similar to HVI tests for other exhaust fans.

With a multi-port, In-line ventilation solution the blower is mounted away from the living area for virtually silent operation. Multi-port installations allow ventilation of up to four rooms, or use multiple inlet ports to clear the air in larger rooms. Single-port, In-line ventilators provide the same noise reduction benefits.

Specialty Fans and Fan/Lights—In-Line Fans

Single-Port In-Line Ventilators

- Ventilate any room in virtual silence
- 6" round outlet and inlet for easy duct connections (two inlet duct covers)

Model SP100, SP140, SP200

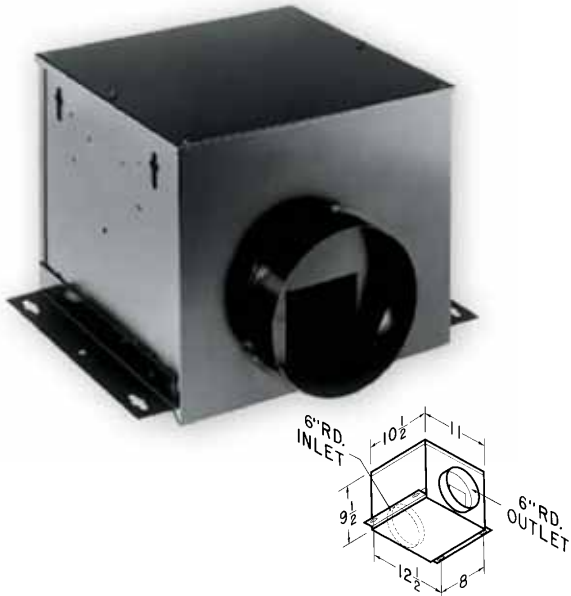

| Single Port | CFM | Sones | Notes |
|--------------|-----|-------|----------------|
| SP100 | 110 | 1.0 | One inlet only |
| SP140 | 150 | 1.5 | One inlet only |
| SP200 | 210 | 2.0 | One inlet only |

HVI rated air flow at 0.2" static pressure. Sound test procedures are similar to HVI tests for other exhaust fans.

Room Inlets

- Models available for 6" (CVG6) or 4" (CVG4) round duct
- Install in ceiling or wall
- Paint to match room décor

Room Inlet Models CVG4 and CVG6



| Grilles/Intakes | Ducting | Notes |
|-----------------|---------|-----------------------|
| CVG4 | 4" | Round Grille |
| CVG6 | 6" | Round Grille |
| Sleeves | | |
| CVLD4 | 4" | Sleeve with damper |
| CVLD5* | 5" | Sleeve with damper |
| CVLD6 | 6" | Sleeve with damper |
| CVL4 | 4" | Sleeve without damper |
| CVL6 | 6" | Sleeve without damper |

* Use with CVG4.

Y Adapters Only

| Model | Size |
|-------------|--------------|
| FY6 | 6" x 6" x 6" |
| FY86 | 8" x 6" x 6" |

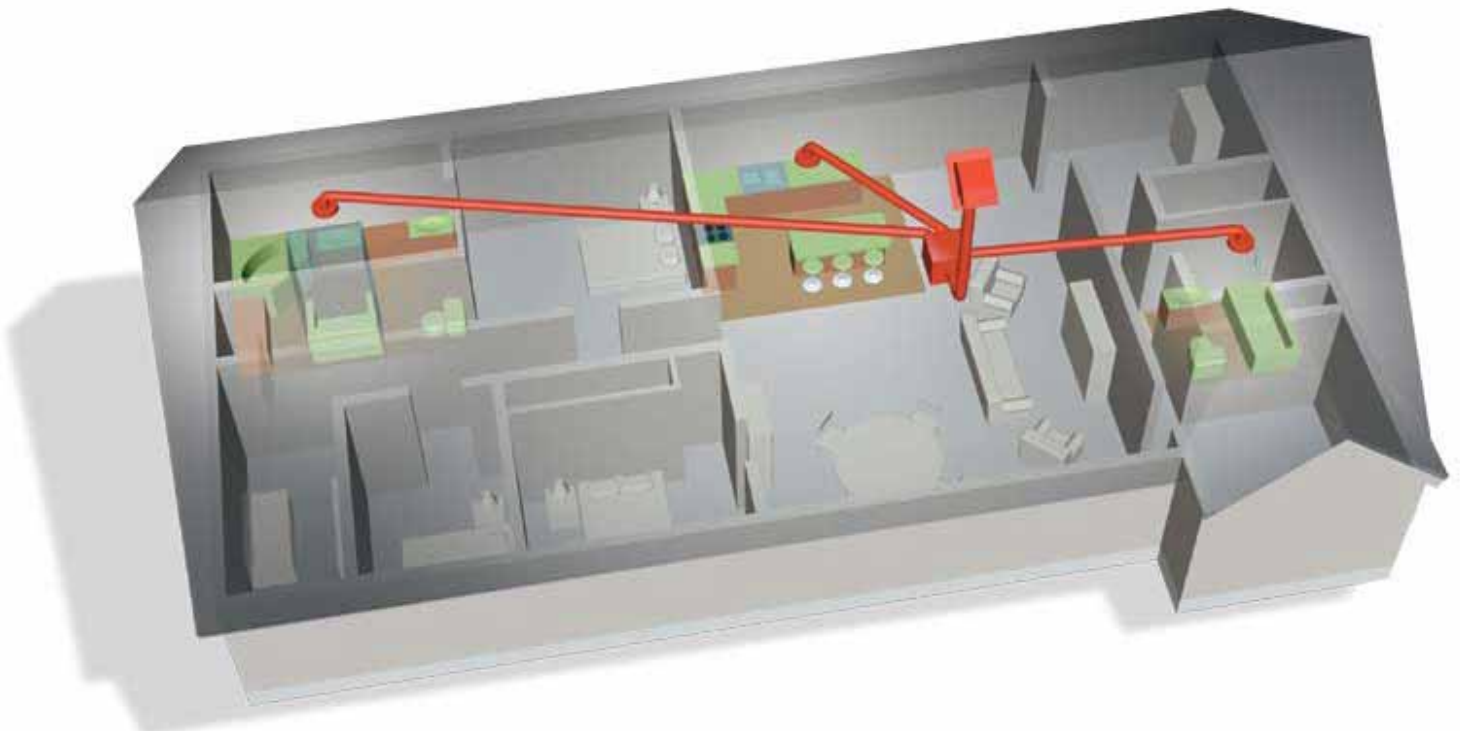

Comfort and convenience combined.



Broan QT Series Heater/Fan/Lights. You could wait 15 minutes for your central heating system to take the chill from your bathroom, all while it heats every other room in the house. Or, you could select instant heat when it's needed with the QTX line. Powerful heating, light and ventilation are available at the touch of a switch. And with our PowerHeat™ design, you're assured that the energy converted to heat is efficiently delivered back to you.

QTX Heater/Fan/Light Features

- Heater/Fan/Light/Night light brings convenient, comforting warmth to your bathroom
- Nearly silent operation – 0.9 sone, 110 CFM fan
- Quiet, high-output 1500 watt heater with exclusive PowerHeat™ design (see below)
- 6" ducting for superior performance
- 7 watt night light
- Choice of bright 120 watt incandescent (2-60W) or energy efficient 36 watt GU24 fluorescent (2-18W, bulbs included)
- Fan motor is engineered for continuous operation
- HVI Certified
- Type IC
- Requires a dedicated 20 amp circuit
- Fits in 2" x 8" ceiling construction

QTX Heater/Fan/Light

PowerHeat™ is a Broan design which maximizes heat output per watt. By placing the heater element very close to the forced air exit grille, the internal components are not heated. Heat is delivered into the bathroom and does not escape into the ceiling or attic space.

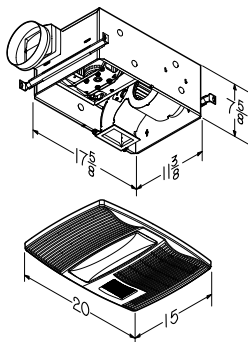

| Model | CFM | Sones | Bath Sq. Ft. | Lighting/ Night Light | Heater Watts |
|------------|-----|-------|--------------|--------------------------------|-----------------|
| QTX110HL | 110 | 0.9 | 100 | 120W Incandescent (2-60W) / 7W | 1500 |
| QTX110HFLT | 110 | 0.9 | 100 | 36W Fluorescent (2-18W)* / 7W | 1500 |

* Bulbs Included



Heater/Fan/Lights

Broan Directionally-Adjustable Heater/Fan/Lights. You don't need to heat the entire house to have a comfortable bathroom first thing in the morning. And it simply doesn't make sense to wait for your central heating system to do what Broan can do instantly. Our Heater/Fan/Light provides powerful heating, light and ventilation at the touch of a switch. And with our 360° directionally-adjustable heat outlet, you're assured the heat will end up exactly where you need it.

Heater/Fan/Light Features

- Heater/Fan/Light brings convenient, comforting warmth to your bathroom
- Quiet operation – 2.0 sone, 100 CFM ventilation fan
- Quiet, high-output 1500-watt heater with exclusive directionally adjustable design (see below)
- 4" ducting for new construction or retrofit
- Multi-function wall switches sold separately
- Choice of bright 100-watt incandescent or energy-efficient 27-watt GU24 (bulb included) fluorescent lighting
- Fan motor is engineered for continuous operation
- HVI Certified
- Type IC
- Requires a dedicated 20 amp circuit
- Fits 2" x 6" ceiling construction

100HL & 100HFL Heater/Fan/Light



| Model | CFM | Sones | Bath Sq. Ft. | Lighting | Heater Watts | Ducting |
|---------------|-----|-------|--------------|-----------------------|--------------|---------|
| 100HL | 100 | 2.0 | 90 | 100W Incandescent | 1500 | 4" |
| 100HFL | 100 | 2.0 | 90 | 27W GU24 Fluorescent* | 1500 | 4" |

* Bulb Included



Heaters & Heater Fans

- Designer white polymeric grilles complement virtually any décor
- Two- or three-function wall controls are available separately
- 1300-watt heaters
- Fan, light and heater function independently or together
- Type IC
- Fits 2" x 6" ceiling construction

Model 655, 659, 656

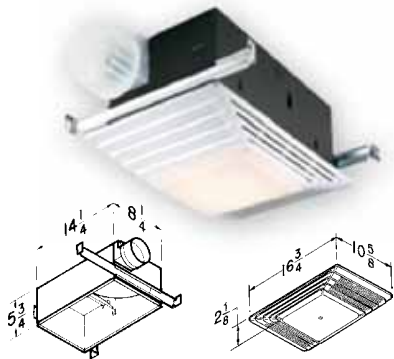

Model 655

- 20-amp circuit required

Model 659

- 15-amp circuit required

Model 656

- 15-amp circuit required
- Heater/Light ONLY

Model 658

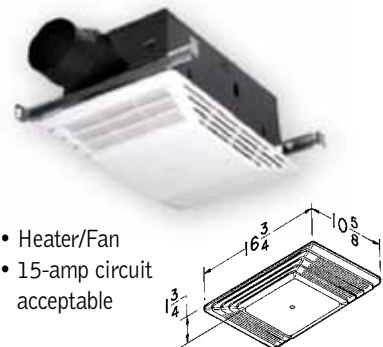

- Heater/Fan
- 15-amp circuit acceptable

Model CFM Sones Lighting Ducting Heater

| Model | CFM | Sones | Lighting | Ducting | Heater |
|-------|-----|-------|----------|---------|--------|
| 655 | 70 | 4.0 | 100W | 4" | 1300W |
| 656 | — | — | 100W | — | 1300W |
| 658 | 70 | 4.0 | No Light | 4" | 1300W |
| 659 | 50 | 2.5 | 100W | 4" | 1300W |

Bulb Heater Fans. Silent warmth and superior ventilation.

Trust Broan Bulb Heater/Fans and Bulb Heaters for energy-saving warmth and instant comfort without ever having to touch your central thermostat. These units deliver superior performance and excellent ventilation in a compact package.

Bulb Heater/Fan Features

- Quiet, highly efficient polymeric blower wheels
- Polymeric dampers prevent backdrafts and eliminate mechanical noise
- Polymeric 4" round duct connectors with tapered sleeves simplify ducting
- Operate fan and heater independently or together
- Attractive white polymeric grilles
- Compact steel housings with adjustable mounting brackets with keyhole slots that span up to 24"
- 250-watt R40 or BR40 size infrared bulbs (not included)
- Type IC, UL Listed for 60°C wiring (retrofits)

Model 162

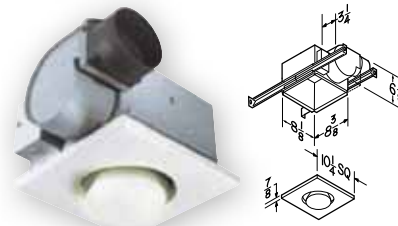

- One-Bulb Heater/Fan

Model 164

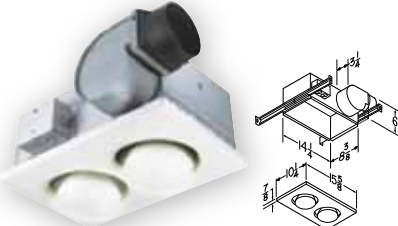

- Two-Bulb Heater/Fan
- Two-function control (available separately)

| Model | CFM | Sones | Heat |
|-------|-----|-------|-------|
| 162 | 70 | 3.5 | 250W* |
| 164 | 70 | 3.5 | 500W* |

*Bulbs not included



One or Two-Bulb Heaters—No Fan

- Infrared bulbs deliver energy-saving warmth
- Get instant comfort in the bathroom without turning up the central thermostat
- 250-watt R40/BR40 size infrared bulbs (not included)
- Attractive, white polymeric grilles
- Compact steel housings
- Adjustable mounting brackets with keyhole slots span up to 24"

Model 161



- One-Bulb Heater
- UL Listed for 75°C wiring

Model 163



- Two-Bulb Heater
- Type IC

| Model | Watts | Volts | Amps |
|-------|-------|-------|------|
| 161* | 250 | 120 | 2.1 |
| 163 | 500 | 120 | 4.3 |

*161 is not IC rated

Attic Ventilation—Powered

Attic Ventilation 101

The purpose of ventilating your attic is to equalize temperatures inside with those outside the attic to prevent the build-up of heat and moisture. Without adequate ventilation, air inside your attic can reach 150°F or more during the summer, warming your living area, increasing the load on your air conditioner, and adding to your energy bill. In the winter, ice dams can result from poor ventilation, and moist air from inside the home can condense on attic surfaces causing mildew, rotting wood and wet insulation if not properly ventilated. Year round ventilating of your attic minimizes harmful moisture in the winter and lowers the temperature of your home in the summer. Keeping your attic cool and dry can extend the life of your roof, by preventing rot,

premature aging, and damaging shingle distortion that can result from excessive heat. A cool attic in summer also saves you money on your energy bill and extends the life of your air conditioner.

How Much Ventilation Do You Need?

Effective attic ventilation requires air to exit at or near the peak of the roof and replacement air to be drawn in under the eaves of the house, via soffit venting. The Home Ventilating Institute (HVI) recommends that powered attic ventilators provide at least 10 air changes per hour to equalize attic temperature. Below are instructions on how to determine the recommended ventilation needs for your attic, or **try the Attic Ventilation Calculator at broan.com**.

Determine Your Ventilation Needs

- 1) Calculate the volume of your attic, in cubic feet, depending on the style of your home's roof.

Attic Volume for Gable Roof

Volume = Length x Width x Height x 1/2



Attic Volume for Hip Roof

Volume = Length x Width x Height x 1/3



- 2) Attic Volume x 10 Air Changes per Hour = Total Cubic Feet per Hour of ventilation recommended.
- 3) Total Cubic Feet per Hour ÷ 60 Minutes/Hour = **Cubic Feet Per Minute (CFM) of Ventilation Recommended.**

Example: Average Gable Attic Volume =
 $58.75' \times 29' \times 7.25' \times \frac{1}{2} = 6,176$ Cubic Feet
 $6,176$ Cubic Feet x 10 Air Changes/Hour =
 $61,760$ Cubic Feet/Hour ÷ 60 Min./Hour =
1,029 CFM

- 4) Replacement air is drawn through vents in your soffit. To determine the minimum soffit vent area required (in square inches) multiply the total CFM of your powered ventilator(s) by 0.48. This number is the total square inches of soffit venting required by your powered ventilator(s).

Example: $1,029$ CFM x 0.48 = 494 Square Inches of soffit vent area recommended.

Attic Ventilation Accessories

Model 433 Automatic Shutter for Gable Mount Attic Ventilators

Feature counter-balanced aluminum vanes that automatically open and close when the ventilator turns on and off.

- Better air flow than stationary attic louvers
- Extruded aluminum frame fits flush with outside wall
- Weather-tight closure
- Easy to install



For use with Broan Models 353, 35316, 345G0BK or 345G0WW.

Model DH100W Humidistat

Sold separately for use with all Broan powered attic ventilators. Humidistats automatically turn on the fan when moisture in the attic is detected.



Model 73 High Temperature Cut-off sold separately for use with all Broan powered attic ventilators. High temperature controls automatically turn off the ventilator at 204°F.

Roof Mount



Model 349BR



Model 358



Models

350BK/355BK/356BK



Models

350BR/355BR/356BR

Gable Mount



Model 35316 Gable Mount Fan

Powered Attic Ventilator Specifications

| | Roof Mount | | | | Gable Mount | | |
|----------------------|--------------------|--------------------|--------------------|--------------------|--------------------|--------------------|--------------------|
| | Model 349BR | Models 350BR/350BK | Models 355BR/355BK | Models 356BR/356BK | Model 358 | Model 353† | Model 35316† |
| Attic Size | Up to 1400 sq. ft. | Up to 1500 sq. ft. | Up to 1715 sq. ft. | Up to 2285 sq. ft. | Up to 1715 sq. ft. | Up to 1460 sq. ft. | Up to 2285 sq. ft. |
| Amps | 4 | 3.6 | 4.3 | 8.0 | 4.3 | 3.4 | 3.9 |
| CFM* | 1000 | 1050 | 1200 | 1600 | 1200 | 1020/760** | 1600/1160 |
| RPM | 1050 | 1000 | 1050 | 1500 | 1050 | 1030 | 1420 |
| Height | 9" | 8" | 8" | 8" | 8" | - | - |
| Dome Dia. | 24-1/2" | 23-1/4" | 23-1/4" | 23-1/4" | 23-1/4" | - | - |
| Dome Material | Painted Steel | PVC | PVC | PVC | Aluminum | - | - |
| Dome Color | Dark Brown | Brown/Black | Brown/Black | Brown/Black | Silver | - | - |

Wall Control Switches: See page 50–51

† Model 433 Automatic Shutter Accessory sold separately. See page 46.

*Exhaust capacity HVI certified @ .03" static pressure.

**Higher CFM with Model 433 shutter. Lower CFM with standard wood louver. The Home Ventilating Institute (HVI) recommends 1 sq. ft. of open air inlet per 300 CFM of fan capacity. The best location for these air intake vents is under the eaves with direct access to the attic. Vents for gable installations should be placed at the end of the house opposite the installed ventilator. Failure to provide these intakes could cause natural-draft gas appliances to backdraft.

Determining the CFM* requirements for your attic

| Roof Pitch | Gable Mount | | | | Roof Mount | | | | | |
|---------------------|-------------|------------|--------------|-----------|--------------|-------------------|-------------------|-------------------|--------------|--------------|
| | Model 353 | | Model 35316 | | Model 349BR | Model 350BR/350BK | Model 355BR/355BK | Model 356BR/356BK | Model 358 | |
| | 760 | 1020 CFM** | 1160 | 1600CFM** | 1000 CFM | 1050 CFM | 1200 CFM | 1600 CFM | 1200 CFM | |
| 8/12 or Less | Light | 1085 | 1460 sq. ft. | 1658 | 2285 sq. ft. | 1490 sq. ft. | 1500 sq. ft. | 1715 sq. ft. | 2285 sq. ft. | 1715 sq. ft. |
| | Dark | 950 | 1275 sq. ft. | 1442 | 1985 sq. ft. | 1290 sq. ft. | 1304 sq. ft. | 1495 sq. ft. | 1985 sq. ft. | 1495 sq. ft. |
| 9/12 | Light | 1015 | 1360 sq. ft. | 1549 | 2135 sq. ft. | 1180 sq. ft. | 1399 sq. ft. | 1600 sq. ft. | 2135 sq. ft. | 1600 sq. ft. |
| | Dark | 880 | 1185 sq. ft. | 1347 | 1855 sq. ft. | 1200 sq. ft. | 1219 sq. ft. | 1390 sq. ft. | 1855 sq. ft. | 1390 sq. ft. |
| 12/12 | Light | 570 | 765 sq. ft. | 870 | 200 sq. ft. | 782 sq. ft. | 790 sq. ft. | 900 sq. ft. | 1200 sq. ft. | 900 sq. ft. |
| | Dark | 500 | 670 sq. ft. | 757 | 1055 sq. ft. | 684 sq. ft. | 694 sq. ft. | 790 sq. ft. | 1055 sq. ft. | 790 sq. ft. |
| 15/12 | Light | 355 | 385 sq. ft. | 559 | 770 sq. ft. | 501 sq. ft. | 508 sq. ft. | 575 sq. ft. | 770 sq. ft. | 575 sq. ft. |
| | Dark | 315 | 425 sq. ft. | 486 | 670 sq. ft. | 427 sq. ft. | 430 sq. ft. | 505 sq. ft. | 670 sq. ft. | 505 sq. ft. |



Attic Ventilation—Solar-Powered

Best Ventilation Performance in its Class—537 Max CFM

Solar Panel

Integrated, low profile, 28-watt Solar Panel efficiently captures sunlight from dawn to dusk without the unsightly props or pivoting stands used by some manufacturers. Rugged, tempered glass withstands large hail and resists delaminating.

Housing

Attractive, low profile, molded design, of UV-stabilized, color-dyed, rugged ABS plastic withstands impact from hail and resists fading. May also be painted to match roof color for installation flexibility.

Optional Thermostat—Model CWT45

Easy to install, this optional accessory disables the motor below 50° for climates where cold-weather condensation isn't a concern and to extend motor life. The thermostat activates the motor at temperatures above 61° to vent air from dawn through dusk.



Surface Mount—345SOBK and 345SOWW

For most roofs, our one piece SPAV is the perfect solution. Because our solar cells are highly efficient at capturing the sun's energy, there is no need for unsightly raised panels or tracking systems. Instead, what you see is a low profile ventilator in a contoured design that integrates well with the roof.

Available in Black (345SOBK) and Weathered Wood (345SOWW).



Weathered Wood



Black Model

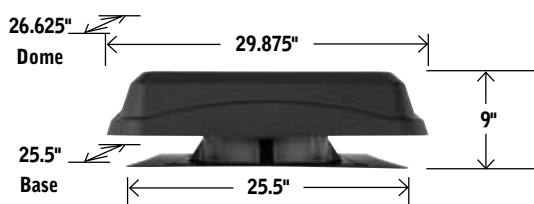

Curb Mount—345CSOBK and 345CSOWW

Identical in design to the Surface Mount unit but with an added lip for flat, tiled, or unusually steep roof installations. A Curb Mount installation requires the fabrication of a simple curb box frame made from treated 2x4s to create a solid platform and better manage water runoff.

Available in Black (345CSOBK) and Weathered Wood (345CSOWW).



Black Model shown with a flat roof installation



Weathered Wood Model shown with a steep roof installation

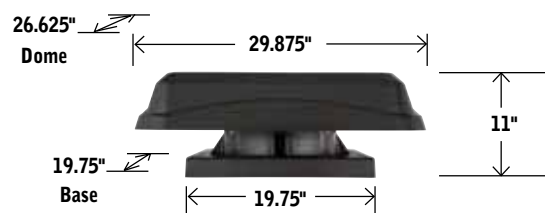

Attic Ventilation—Solar-Powered



Visit broan.com for more information.



Motor

Direct-current, variable speed 17 volt motor is dynamically balanced for superior performance and silent operation.

Fan

12" Diameter, one-piece aluminum 5-blade fan pitched for maximum air flow.

Hardware

Stainless steel fasteners secure galvanized steel brackets and aluminum, heavy gauge screen for durability and corrosion resistance. Screen keeps out insects, animals, and birds without impeding airflow.

Ranked Most Attractive Solar Ventilator by home owners more than 2 to 1 over competitive models!

Remote Mount—345RSOBK and 345RSOWW

In some cases, installing the ventilator in a location that is either less visible, more convenient to reach from the roof-side, or more accessible from the attic-side, is desirable. Remote mount enables the ventilator to be installed independent of the solar panel, up to 50' away (15' of wire included). Locate the remote, flat panel to receive the best sunlight exposure and hide the ventilator from view.

Available in Black (345RSOBK) and Weathered Wood (345RSOWW).



Gable Mount—345GOBK and 345GOWW

If roof mounting is not possible or desired, gable installation provides the benefits of the SPAV with a remote-mounted, flat solar panel positioned to best capture the sun's energy, up to 50' away (15' of wire included). Finish the outside with a Broan model 433 gable shutter.

Available in Black (345GOBK) and Weathered Wood (345GOWW).



Wall Controls



Indicator Light Control for convenience



Multi-function Control to suit every need



Speed Control for quieter operation or full power



Timer and Off-delay Controls for unattended moisture removal

Indicator Light Controls

Model 69WL

- Single-Function Controls
- Ideal for use with quiet models, or Remote In-Line Ventilators
- 120V, 20 amps
- Red light lets you know power is on
- Blister packs (P69WL, P69VL)



Model 269WL, 269VL

- Two-Function Controls
- For use especially with quiet models and an auxiliary light source
- Lighted fan control 120V, 20 amps; unlighted 120/240/277V, 15 amps
- Fits two-gang box
- Controls available in White (W) or Ivory (V)



Model 685WL, 685VL

- Three-Function Controls
- For use especially with quiet models
- Lighted fan control 120V, 20 amps; two additional on/off rocker switches 120V, 15 amps each (20 amps total)
- Fits two-gang box
- Blister packs (P685WL, P685VL)
- Controls available in White (W) or Ivory (V)



Thermostat and Dehumidistat Controls

Model 70TW

- Thermostat for any fan
- 120, 250, 277 VAC,
- 22 amp capacity



Model DH100W

- Dehumidistat
- Dual voltage (24V/120V)
- Variable setting from 20–80% relative humidity
- Usage guide included



Multi-Function Controls

Model 65W, 65V, 66W, 66V, 67W, 67V

- Three-Function Controls
- Three independent, 120V, 15 amp rocker switches (20 amps total)
- Fits single-gang opening
- Blister packs available (P65W, P65V, P66W, P66V, P67W, P67V)
- Controls available in White (W) or Ivory (V)
- Wall plates available in: Polished brass finish (65W, 65V); White (66W) or Ivory (66V); Polished chrome finish (67W, 67V)



Model 68W, 68V

- Two-Function Controls
- Two independent, 120V, 15 amp rocker switches (20 amps total)
- Fits single-gang box
- Blister packs available (P68W, P68V)
- Controls available in White (W) or Ivory (V)



Model 69W

- Single-Function Controls
- 120V, 15 amps



Model 77DW, 77DV

- Four-Function Controls
- Single switch provides three settings for fan sensor (On-Auto-Off) on Sensing models
- Remaining switches for light/night light
- Works with QTX110HL heater/fan/light/night light
- Controls available in White (W) or Ivory (V)
- Fits single-gang opening
- Blister packs available (P77DW)



Speed Controls

Model 57W, 57V (3-amp)

- 120V, 3 amps
- Fits single-gang box
- Positive on/off action—dial for variable selection of air speeds and sound levels
- Built-in radio noise suppressor
- Controls available in White (W) or Ivory (V)
- Blister packs available (P57W)



Model 72W, 72V (6-amp)

- 120V, 6 amps—Models 72W, 72V
- Fits single-gang box
- Positive on/off action—dial for variable selection of air speeds and sound levels
- Built-in radio noise suppressor
- Controls available in White (W) or Ivory (V)



Model 78W, 78V

- 4-speed “no-hum” ceiling fan speed control
- Decorator wall plate
- Screws included
- 120V AC 1.5 amp
- Controls available in White (W) or Ivory (V)



Model T24H

- 24-Hour Programmable Timer
- 120V, 8 amps
- Sets up to 36 on/off cycles as short as 20 minutes
- Manual on/off override switch
- Fits single-gang box



Timer and Off-Delay Controls

Model 59W, 59V, 71V

- Model 59W, 59V—up to 60 minutes
- Model 71V—up to 12 hours
- Fits single-gang box
- 120V, 20 amps; 240V, 10 amps
- Operate continuously or for any set period
- Controls available in White (W) or Ivory (V)
- Blister packs available (P59W, P59V)



Model 61W, 61V

- 15 Minute
- Operate for any set period up to 15 minutes (no “continuous on” position)
- Fits single-gang box
- 120V, 20 amps; 240V, 10 amps
- Operate continuously or for any set period
- Controls available in White (W) or Ivory (V)



Model 62W, 62V

- 60 Minute
- Two separate 120V, 15 amp on/off rocker switches (20 amps total)
- 120V, 20 amps or 240V, 10 amp timer
- Timer operates continuously or for any set period up to 60 minutes
- Fits two-gang box
- Controls available in White (W) or Ivory (V)



Model 63W, 63V

- 60 Minute
- Separate 120V, 15 amp on/off rocker switch
- Timer operates continuously or for any set period up to 60 minutes
- Fits two-gang box
- Controls available in White (W) or Ivory (V)



Model 64W, 64V

- Fan/Light Control with Off-Delay
- Fan and light operate together when control is turned on
- Fan continues to operate for a user adjustable time period 5–60 minutes after light is turned off
- Center position bypasses timer and turns fan and light off immediately
- Fits single-gang box
- 120V, 4 amps (fan), 4 amps (light)
- Requires hot and neutral wires in the switch box
- Controls available in White (W) or Ivory (V)



Wall Control Selection Guide

| | | 57W 57V | 59W 59V | 61W 61V | 62W 62V | 63W 63V | 64W 64V | 65W 65V | 66W 66V | 67W 67V | 68W 68V | 69W | 69WL 69VL | 70TW | 71V | 72W 72V | 73 | 77DW 77DV | 78W 78V | 269WL 269VL | 685WL 685VL | DH 100W | T24H |
|------------------------|------------------|----------------|------------|------------|------------|------------|------------|------------|------------|------------|------------|-----|--------------|------|-----|------------|----|--------------|------------|----------------|----------------|------------|------|
| Utility Fans | 12C | | • | • | | | • | | | | | • | • | • | • | • | | | • | | | • | • |
| | 502 | • | • | • | | | • | | | | | • | • | • | • | • | | | • | | | • | • |
| | 503 | • | • | • | | | • | | | | | • | • | • | • | • | | | • | | | • | • |
| | 504 | • | • | • | | | • | | | | | • | • | • | • | • | | | • | | | • | • |
| | 505 | • | • | • | | | • | | | | | • | • | • | • | • | | | • | | | • | • |
| | 506 & 507 | chain operated | | | | | | | | | | | | | | | | | | | | | |
| | 508 | • | • | • | | | • | | | | | • | • | • | • | • | | | • | | | • | • |
| | 509 | • | • | • | | | | | | | | • | • | • | | • | | | • | | | • | |
| | 509 ¹ | | • | • | | | • | | | | | | | • | • | | | | • | | | • | • |
| | 510 ² | | • | • | | | • | | | | | | | • | • | | | | • | | | • | • |
| | 511 ² | | | | | | | | | | | | | • | | | | | • | | | | |
| | 512 & 512M | • | • | • | | | | | | | | • | • | • | • | • | | | • | | | • | • |
| | 673 | | • | • | | | • | | | | | • | • | • | • | | | | • | | | • | • |
| Ventilation Fans | 670 | • | • | • | | | • | | | | | • | • | • | • | • | | | • | | | • | • |
| | 671 | • | • | • | | | • | | | | | • | • | • | • | • | | | • | | | • | • |
| | 676 | • | • | • | | | • | | | | | • | • | • | • | • | | | • | | | • | • |
| | 682 | • | • | • | | | • | | | | | • | • | • | • | • | | | • | | | • | • |
| | 684 | • | • | • | | | • | | | | | • | • | • | • | • | | | • | | | • | • |
| | 688 | • | • | • | | | • | | | | | • | • | • | • | • | | | • | | | • | • |
| | 689 | • | • | • | | | • | | | | | • | • | • | • | • | | | • | | | • | • |
| | 690 | • | • | • | | | • | | | | | • | • | • | • | • | | | • | | | • | • |
| | 770 | • | • | • | | | • | | | | | • | • | • | • | • | | | • | | | • | • |
| | 784 | • | • | • | | | • | | | | | • | • | • | • | • | | | • | | | • | • |
| | HD50 | • | • | • | | | • | • | • | • | | • | • | • | • | • | | | • | | | • | • |
| | HD80 | • | • | • | | | • | | | | | • | • | • | • | • | | | • | | | • | • |
| | LP80 | • | • | • | | | • | | | | | • | • | • | • | • | | | • | | | • | • |
| | QT Fans | • | • | • | | • | • | | | | | • | • | • | • | • | | | • | • | | • | • |
| | QTXE100S | | | | | | | | | | | • | • | • | | | | | | | | | |
| | QTXE110S | | | | | | | | | | | • | • | • | | | | | | | | | |
| | XB50 | | | | | | | | | | | | • | • | | | | | | | • | | |
| | XB80 | | | | | | | | | | | | • | • | | | | | | | • | | |
| | XB110 | | | | | | | | | | | | • | • | | | | | | | • | | |
| | XB110H | | | | | | | | | | | • | • | • | | | | | | | • | | |
| ZB80 | | | | | | | | | | | • | | | | | | | | | • | • | | |
| ZB80M | | | | | | | | | | | • | • | • | | | | | | | • | | | |
| ZB110 | | | | | | | | | | | • | | | | | | | | | • | • | | |
| ZB110H | | | | | | | | | | | • | • | • | | | | | | | • | | | |
| ZB110M | | | | | | | | | | | • | • | • | | | | | | | • | | | |
| Ventilation Fan/Lights | 657 | • | • | • | | • | • | | | | • | | | • | • | • | | | | | | • | • |
| | 678 | • | • | • | | • | • | | | | • | | | • | • | • | | | | | | • | • |
| | 679 | • | • | • | | • | • | | | | • | | | • | • | • | | | | | | • | • |
| | 680 | • | • | • | | • | • | | | | • | | | • | • | • | | | | | | • | • |
| | 696 | • | • | • | | • | • | | | | • | | | • | • | • | | | | | | • | • |
| | 741SN 741WH | • | • | • | | • | • | | | | • | | | • | • | • | | | | | | • | • |
| | 744 | | | | | • | | | | | • | | | • | | | | | | | | • | |
| | 744FL | | | | | • | | | | | • | | | • | | | | | | | | • | |
| | 744LED | | | | | • | | | | | • | | | • | | | | | | | | • | |
| | 744SFL | | | | | • | | • | • | • | • | | | • | | | | | | | | • | |
| | 750 | • | • | • | • | | • | • | • | • | • | | | • | • | • | | | | • | • | • | • |
| | 751 | • | • | • | | • | • | | | | • | | | • | • | • | | | | • | | • | • |
| | 754RB, 754SN | • | • | • | | • | • | | | | • | | | • | • | • | | | | • | | • | • |
| | 757SN | • | • | • | | • | • | | | | • | | | • | • | • | | | | • | | • | • |

¹Built-in on/off switch. ²Built-in on/off variable switch.

Wall Control Selection Guide

| | | 57W 57V | 59W 59V | 61W 61V | 62W 62V | 63W 63V | 64W 64V | 65W 65V | 66W 66V | 67W 67V | 68W 68V | 69W | 69WL 69VL | 70TW | 71V | 72W 72V | 73 | 77DW 77DV | 78W 78V | 269WL 269VL | 685WL 685VL | DH 100W | T24H | |
|-------------------------------------|-------------------------|------------|------------|------------|------------|------------|------------|------------|------------|------------|------------|-----|--------------|------|-----|------------|----|--------------|------------|----------------|----------------|------------|------|---|
| Ventilation Fans & Fan/Lights | 761BN, 761RB, 761WHA | • | • | • | | • | • | | | | • | | | • | • | • | | | | | | • | • | |
| | 764BN, 764RB, 764WH | • | • | • | | • | • | | | | • | | | • | • | • | | | | | | • | • | |
| | 766BN, 766RB | • | • | • | | • | • | | | | • | | | • | • | • | | | | | | • | • | |
| | 778WH | • | • | • | | • | • | | | | • | | | • | • | • | | | | | | • | • | |
| | HD50L | • | • | • | | • | • | | | | • | | | • | • | • | | | | | • | • | • | |
| | HD80L | • | • | • | | • | • | | | | • | | | • | • | • | | | | | • | • | • | |
| | QT Fan/Lights | | • | • | • | • | • | | • | | | | | • | • | • | | | | | | • | • | • |
| | QT Sensing Fan/Lights | | | | | | | | • | • | • | | | | | | | | • | | | | | |
| | XB50L | | | | | | | | • | • | • | | | | | | | | | | | • | | |
| | XB80L | | | | | | | | • | • | • | | | | | | | | | | | • | | |
| | XB110L | | | | | | | | • | • | • | | | | | | | | | | | • | | |
| | XB110HL | | | | | | | | • | • | • | | | | | | | | | | | • | | |
| | ZB80L | | | | | | | | | | | | | | | | | | | | | • | | |
| | ZB80ML | | | | | | | | | | | | | | | | | | | | | • | | |
| | ZB110L | | | | | | | | | | | | | | | | | | | | | • | | |
| | ZB110HL | | | | | | | | • | • | • | | | | | | | | | | | • | | |
| ZB110ML | | | | | | | | | | | | | | | | | | | | | • | | | |
| Heater/Fan/ Lights | 100HL | • | • | • | • | | | • | • | • | | | | • | • | • | | | | | | • | • | |
| | 100HFL | • | • | • | • | | | • | • | • | | | | • | • | • | | | | | | • | • | |
| | 161 | | • | • | | | • | | | | | | • | | | | | | | | | • | • | |
| | 162 | • | • | • | | • | • | | | | • | | | • | • | • | | | | | • | • | • | |
| | 163 | | • | • | | • | | | | | | | • | • | | | | | | | | • | • | |
| | 164 | • | • | • | • | • | | • | • | • | • | | | • | • | • | | | | | • | • | • | |
| | 655 | • | • | • | • | | | • | • | • | | | | • | • | • | | | | | • | • | • | |
| | 656 | | • | • | | • | | | | | | | | • | • | | | | | | | • | • | |
| | 658 | • | • | • | | • | | | | | • | | | • | • | • | | | | | • | • | • | |
| | 659 | • | • | • | • | | | • | • | • | | | | • | • | • | | | | | • | • | • | |
| | QTX110HL | • | • | • | • | | | • | • | • | | | | • | • | • | | | | | • | • | • | |
| | QTX110HFL | • | • | • | • | | | • | • | • | | | | • | • | • | | | | | • | • | • | |
| In-Line | MP100, MP140 MP200 | • | • | • | | | | | | | | | • | • | • | • | | | | | | • | • | |
| | MP280 | • | • | • | | | | | | | | | • | • | • | • | | | | | | • | • | |
| | SP100, SP140 SP200 | • | • | • | | | | | | | | | • | • | • | • | | | | | | • | • | |
| Attic Ventilation | 349BR | | • | • | | | | | | | | | • | • | • | • | • | | | | | • | • | |
| | 350BK | | • | • | | | | | | | | | • | • | • | • | • | | | | | • | • | |
| | 350BR | | • | • | | | | | | | | | • | • | • | • | • | | | | | • | • | |
| | 353 | | • | • | | | | | | | | | • | • | • | • | • | | | | | • | • | |
| | 35316 | | • | • | | | | | | | | | • | • | • | • | • | | | | | • | • | |
| | 355BK | | • | • | | | | | | | | | • | • | • | • | • | | | | | • | • | |
| | 355BR | | • | • | | | | | | | | | • | • | • | • | • | | | | | • | • | |
| | 356BK | | • | • | | | | | | | | | | • | • | • | • | | | | | • | • | |
| | 356BR | | • | • | | | | | | | | | | • | • | • | • | | | | | • | • | |
| | 358 | | • | • | | | | | | | | | | • | • | • | • | | | | | • | • | |

¹Built-in on/off switch. ²Built-in on/off variable switch.

Ducting Accessories

Roof Caps

Model 437

- High-capacity design up to 1200 CFM
- Built-in bird screen
- Steel housing, black electrically bonded epoxy finish

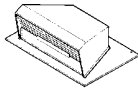

Model 611 Roof Cap

- For flat roof installation
- Aluminum natural finish
- For up to 8" round duct

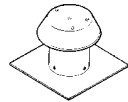

Model 611CM Roof Cap

- For curb mount installation
- Other features same as Model 611

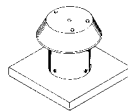

Model 612 Roof Cap

- For flat roof installation
- Aluminum natural finish
- For up to 12" round duct

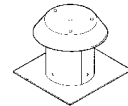

Model 612CM Roof Cap

- For curb mount installation
- Other features same as Model 612

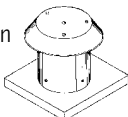

Model 634 Roof Cap*

- For 3-1/4" x 10" or up to 8" round duct
- Built-in backdraft damper and bird screen
- Steel baked black enamel finish

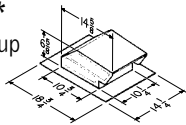

Model 634M Roof Cap*

- Same as Model 634 except for 6" round duct

Model 636 Roof Cap*

- For 3" or 4" round duct
- Built-in backdraft damper and bird screen
- Steel baked black enamel finish

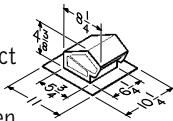

Model 636AL Roof Cap

- Same as Model 636, except aluminum natural finish

Model 644 Roof Cap

- Same as Model 634, except for aluminum natural finish

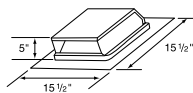

Ducting

Model 401 Duct

- 3-1/4" x 10" duct
- 2' galvanized section



Ducting Continued

Model 406 Round Duct

- 6" round duct
- 2' galvanized section



Model 407 Round Duct

- 7" round duct
- 2' galvanized section

Model 410 Round Duct

- 10" round duct
- 2' galvanized section

Models DT4C, DT6C Non-Insulated Flexible Duct

- 4" (DT4C) or 6" (DT6C) round
- DT4C is a 4-pack
- 25' standard length

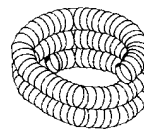

Models DT4W, DT6W Insulated Flexible Duct

- 4" (DT4W) or 6" (DT6W) round
- 25' standard length

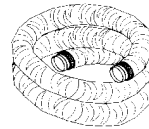

Transitions

Model 475 Transition

- Converts 6" round duct to 4" round duct
- Not for use with ULTRA™ Models
- Available in 6 Pack (475B)



Wall Caps

Model 613 Wall Cap*

- For 12" round duct
- Built-in backdraft damper and bird screen
- Aluminum natural finish

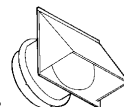

Model 639 Wall Cap*

- For 3-1/4" x 10" duct
- Spring-loaded backdraft damper
- Built-in bird screen
- Steel baked black enamel finish

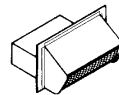

Model 641 Wall Cap*

- For 6" round duct
- Built-in backdraft damper and bird screen
- Aluminum natural finish
- Model 647 for 7" Round duct

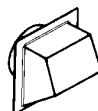

Model 647 Wall Cap

- For 7" round duct
- Other features same as Model 641



Wall Caps Continued

Model 649 Wall Cap

- Same as Model 639, except aluminum natural finish

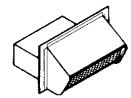

Model 843BL*

- For 6" round duct
- Built-in backdraft damper and bird screen
- Black finish



Model 885BL Wall Cap*

- For 3" or 4" round duct
- 4" to 3" transition included
- Steel baked black enamel finish
- Standard package—6 to a carton
- Built-in bird screen and damper

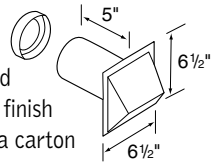

Model 885AL Wall Cap*

- For 3" or 4" round duct
- 4" to 3" transition included
- Aluminum natural finish
- Standard package—4 to a carton
- Built in bird screen and damper

Model 643 Wall Cap

- For 8" round duct
- Aluminum natural finish

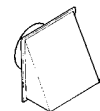

Model 645 Louvered

- Wall Cap for 3" Round Duct
- White polymeric
- 6 to a carton

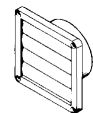

Model 646 Louvered Wall Cap for 6" Round Duct

- Single pack
- White polymeric

Model WC650 Wall Cap

- For 4" round duct
- White polymeric
- 4 to a carton



Ducting Kits

**Model RVK1A
Flexible Roof Ducting Kit**

- Includes Model 636 Roof Cap
- 4" diameter metal duct connector
- 2 duct clamps
- 4" to 3" reducer
- 8' of 4" flexible aluminum ducting



**Model WVK2A*
Flexible Wall Ducting Kit**

- Includes white polymeric wall cap
- 4" diameter metal duct connector
- 2 duct clamps
- 4" to 3" reducer
- 5' of 4" flexible aluminum ducting



Filters

Model 99010042 Aluminum Filter

- Fits Utility Ventilator Models 503, 503MG, 505, 505MG, 509, 509MG, 509S and 509SMG



Model 99010271 Aluminum Filter

- Fits Utility Ventilator Models 12C, 12CMG, 502, 502MG, 504, 504MG, 508, 508MG, 510, 510MG, 511 and 511MG

Metal Grille Kit

Model 97011308

- Steel baked white enamel finish
- Fits fan Models 670, 671, 676, 684, 688 and 689
- Grille size is 10-1/4" square

Elbows

**Model 415
Adjustable Elbow**

- Fits 7" round duct

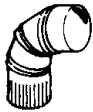

**Model 418
Adjustable Elbow**

- Fits 10" round duct

**Model 419
Adjustable Elbow**

- Fits 6" round duct

**Model 428
Vertical Elbow**

- Fits 3-1/4" x 10" duct



**Model 429
Horizontal Elbow**

- Fits 3-1/4" x 10" duct

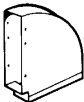

Model 430 Short Eave Elbow

- For 3-1/4" x 10" duct
- Includes backdraft damper and grille
- Only recommended for fans with more than 160 CFM

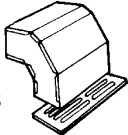

Model 431 Long Eave Elbow

- For 3-1/4" x 10" duct
- Includes backdraft damper and grille
- Only recommended for fans with more than 160 CFM

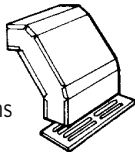

Specifications

Fans

| Model | Page | CFM | Sones, HVI-certified | Baths up to () Sq Ft | ENERGY STAR* | Duct Size" | Housing Dims | | | Grille Dims | | Grille finish | Amps |
|------------|------|-------|----------------------|-----------------------|--------------|------------|--------------|-----|----|-------------|-----|---------------------|------|
| | | | | | | | L" | W" | H" | L" | W" | | |
| 80RDF** | 30 | 80 | 2.5 | 75 | — | 4 | 8 | 8¼ | 5¼ | 10¼ | 10¼ | White Acrylic Metal | 0.6 |
| 110RDF** | 30 | 110 | 4.0 | 105 | — | 4 | 8 | 8¼ | 5¼ | 10¼ | 10¼ | White Acrylic Metal | 0.6 |
| 670 | 29 | 50 | 3.5 | 45 | — | 3 | 7¼ | 7¼ | 3% | 9 | 9¼ | White Polymeric | 0.8 |
| 671 | 29 | 70 | 6.0 | 65 | — | 3 | 7¼ | 7¼ | 3% | 9 | 9¼ | White Polymeric | 1.2 |
| 676 | 29 | 110 | 4.0 | 100 | — | 4 | 8 | 8¼ | 5¼ | 10% | 11% | White Polymeric | 1.3 |
| 682 | 31 | — | — | — | — | Duct-free | 7¼ | 7¼ | 3% | 8¼ | 8¼ | White Polymeric | 1.0 |
| 684 | 29 | 80 | 2.5 | 75 | — | 4 | 8 | 8¼ | 5¼ | 10% | 11% | White Polymeric | 0.5 |
| 688 | 29 | 50 | 4.0 | 45 | — | 3 | 7¼ | 7¼ | 3% | 9 | 9¼ | White Polymeric | 0.9 |
| 689 | 29 | 60 | 5.5 | 55 | — | 3 | 7¼ | 7¼ | 3% | 9 | 9¼ | White Polymeric | 1.5 |
| 690* | 31 | 60 | 3.0 | 55 | — | — | — | — | — | 9% | 11% | White Polymeric | 1.5 |
| 770 | 28 | 50 | 1.5 | 45 | Yes | 4 | 8 | 8¼ | 5¼ | 10% | 11% | White Polymeric | 0.2 |
| 784 | 28 | 80 | 2.0 | 75 | Yes | 4 | 8 | 8¼ | 5¼ | 10% | 11% | White Polymeric | 0.5 |
| HD50 | 30 | 50 | 1.5 | 45 | Yes | 4 | 8 | 8¼ | 5¼ | 10¼ | 10¼ | White Painted Metal | 0.4 |
| HD50RDF** | 30 | 50 | 1.5 | 45 | Yes | 4 | 8 | 8¼ | 5¼ | 10¼ | 10¼ | White Acrylic Metal | 0.4 |
| HD80 | 30 | 80 | 2.5 | 75 | — | 4 | 8 | 8¼ | 5¼ | 10¼ | 10¼ | White Painted Metal | 0.6 |
| HD80RDF** | 30 | 80 | 2.5 | 75 | — | 4 | 8 | 8¼ | 5¼ | 10¼ | 10¼ | White Acrylic Metal | 0.6 |
| LP80 | 28 | 80 | 1.1 | 75 | Yes | 4 / 3 | 11% | 10% | 4 | 13 | 14 | White Polymeric | 0.3 |
| SSQTXE080 | 24 | 80 | — | — | Yes | — | 11% | 10% | 7¼ | — | — | — | — |
| SSQTXE110 | 24 | 110 | — | — | Yes | — | 11% | 10% | 7¼ | — | — | — | — |
| QTXE050 | 20 | 50 | <0.3 | 45 | Yes | 6 | 11% | 10% | 7% | 13 | 14 | White Polymeric | 0.3 |
| QTXE080 | 20 | 80 | 0.3 | 75 | Yes | 6 | 11% | 10% | 7% | 13 | 14 | White Polymeric | 0.4 |
| QTXE110 | 20 | 110 | 0.7 | 100 | Yes | 6 | 11% | 10% | 7% | 13 | 14 | White Polymeric | 0.3 |
| QTXE110S | 22 | 110 | 0.7 | 100 | Yes | 6 | 11% | 10½ | 7% | 12% | 13¾ | White Polymeric | 0.3 |
| QTXE150 | 20 | 150 | 1.4 | 140 | Yes | 6 | 11% | 10% | 7% | 13 | 14 | White Polymeric | 0.5 |
| QTRE100S | 22 | 100 | 1.5 | 90 | Yes | 4 | 11% | 10½ | 7% | 12% | 13¾ | White Polymeric | 0.3 |
| QTRE080 | 20 | 80 | 0.8 | 75 | Yes | 4 | 11% | 10½ | 7% | 13 | 14 | White Polymeric | 0.4 |
| QTRE080C2S | 20 | 80/40 | 0.8/<0.3 | 75 | Yes | 4 | 11% | 10% | 7% | 13 | 14 | White Polymeric | 0.3 |
| QTRE080R | 23 | 80 | 0.8 | 75 | Yes | 4 | 11% | 10½ | 7% | 13 | 14 | White Polymeric | 0.3 |
| QTRE110 | 20 | 110 | 1.3 | 100 | Yes | 4 | 11% | 10½ | 7% | 13 | 14 | White Polymeric | 0.3 |
| QTR080 | 20 | 80 | 1.0 | 75 | — | 4 | 11% | 10% | 7% | 13 | 14 | White Polymeric | 0.7 |
| QTR110 | 20 | 110 | 1.5 | 100 | — | 4 | 11% | 10% | 7% | 13 | 14 | White Polymeric | 0.9 |
| XB50 | 17 | 50 | <0.3 | 45 | Yes | 6 / 4 | 10% | 11% | 7% | 13 | 14 | White Polymeric | 0.1 |
| XB80 | 17 | 80 | <0.3 | 75 | Yes | 6 / 4 | 10% | 11% | 7% | 13 | 14 | White Polymeric | 0.1 |
| XB110 | 17 | 110 | <0.3 | 100 | Yes | 6 | 10% | 11% | 7% | 13 | 14 | White Polymeric | 0.2 |
| XB110H | 17 | 110 | <0.3 | 100 | Yes | 6 | 10% | 11% | 7% | 13% | 14 | White Polymeric | 0.2 |
| ZB80 | 17 | 80 | <0.3 | 75 | Yes | 6 / 4 | 10% | 11% | 7% | 13 | 14 | White Polymeric | 0.1 |
| ZB80M | 17 | 80 | <0.3 | 75 | Yes | 6 / 4 | 10% | 11% | 7% | 13% | 14 | White Polymeric | 0.1 |
| ZB110 | 17 | 110 | <0.3 | 100 | Yes | 6 | 10% | 11% | 7% | 13% | 14 | White Polymeric | 0.2 |
| ZB110H | 17 | 110 | <0.3 | 100 | Yes | 6 | 10% | 11% | 7% | 13% | 14 | White Polymeric | 0.2 |
| ZB110M | 17 | 110 | <0.3 | 100 | Yes | 6 | 10% | 11% | 7% | 13% | 14 | White Polymeric | 0.2 |

Radiation Dampers can be found on page 30. *Replacement grille and motor kit. **Model RDA fan housing only sold separately for radiation dampers/fans.

Utility Fans

| Model | Page | CFM | Sones | Housing Dimensions | | | Grille Dimensions | | Amps | Duct Size |
|-------|------|-----|-------|--------------------|--------|----|-------------------|-----|-----------------------|-----------|
| | | | | L" | W" | H" | L" | W" | | |
| 12C | 39 | 360 | 8.0 | — | 11½ Sq | — | 13½ Sq | 1.7 | Direct Discharge | |
| 502 | 38 | 270 | 8.0 | 16% | 13% | 3% | 13½ Sq | 1.7 | 3¼" x 10" | |
| 503 | 38 | 160 | 5.0 | 14 | 12 | 3% | 11½ Sq | 1.5 | 3¼" x 10" | |
| 504 | 39 | 350 | 6.5 | — | 10% Rd | 7 | 13½ Sq | 1.7 | 10" | |
| 505 | 39 | 180 | 6.5 | — | 8% Rd | 7 | 11½ Sq | 1.5 | 8" | |
| 506 | 38 | 470 | 8.0 | — | 10% Rd | — | 13½ Sq | 1.7 | Direct Discharge | |
| 507 | 38 | 250 | 7.0 | — | 8% Rd | — | 11½ Sq | 1.5 | Direct Discharge | |
| 508 | 39 | 270 | 6.0 | — | 10% Rd | — | 13½ Sq | 1.7 | Direct Discharge | |
| 509 | 39 | 180 | 6.5 | — | 8% Rd | — | 13½ Sq | 1.5 | Direct Discharge | |
| 509S | 39 | 180 | 6.5 | — | 8% Rd | — | 13½ Sq | 1.5 | Direct Discharge | |
| 510 | 38 | 380 | 6.5 | — | 11½ Sq | — | 13½ Sq | 1.7 | Room to room wall fan | |
| 511 | 38 | 180 | 4.5 | — | 11½ Sq | — | 13½ Sq | 0.9 | Room to room wall fan | |
| 512 | 39 | 90 | 3.5 | — | 6 Rd | — | 8 Dia | 0.7 | Room to room wall fan | |
| 512M | 39 | 70 | 3.5 | — | 6 Rd | — | 8 Dia | 0.7 | Direct Discharge | |
| 673 | 39 | 60 | 4.5 | — | 6¼ Rd | 5¼ | 8 Dia | 1.0 | 6" | |

*Not for use with dryers.

Fan/Lights

| Model | Page | CFM | Sones, HVI-certified | Baths up to () Sq Ft | Lighting Watts Main/ Night Light | ENERGY STAR® | Fluorescent Lighting | Duct Size" | Housing Dims | | | Grille Dims | | Grille finish | Amps |
|-------------|------|-----|----------------------|-----------------------|----------------------------------|--------------|----------------------|------------|--------------|-----|----|-------------|-----|-------------------|------|
| | | | | | | | | | L" | W" | H" | L" | W" | | |
| 657 | 29 | 70 | 4.0 | 65 | 100 | — | — | 4 | 14¼ | 8¼ | 5¼ | 16¼ | 10½ | White Polymeric | 2.0 |
| 678 | 29 | 50 | 2.5 | 45 | 100 | — | — | 4 | 8¼ | 8 | 5¼ | 11¼ | 10½ | White Polymeric | 1.6 |
| 679 | 29 | 70 | 3.5 | 65 | 100 | — | — | 4 | 8¼ | 8 | 5¼ | 11¼ | 10½ | White Polymeric | 2.0 |
| 680 | 29 | 100 | 4.0 | 90 | 100 | — | — | 4 | 8¼ | 8 | 5¼ | 11¼ | 10½ | White Polymeric | 2.2 |
| 696 | 29 | 100 | 4.5 | 90 | 100 | — | — | 4 | 14¼ | 8¼ | 5¼ | 16¼ | 10½ | White Polymeric | 2.0 |
| 741SN | 36 | 70 | 3.5 | 65 | 120 (2-60W) | — | — | 4 | 8¼ | 8 | 5¼ | 13¼ Dia | — | Satin Nickel | 2.2 |
| 741WH | 36 | 70 | 3.5 | 65 | 120 (2-60W) | — | — | 4 | 8¼ | 8 | 5¼ | 13¼ Dia | — | White | 2.2 |
| 744 | 35 | 70 | 1.5 | 65 | 75 | — | — | 4 | 8¼ | 12¼ | 6¼ | 7¼ Dia | — | Matte White | 1.2 |
| 744FL | 35 | 70 | 1.5 | 65 | 14 | Yes | Yes | 4 | 8¼ | 12¼ | 6¼ | 7¼ Dia | — | Matte White | 0.7 |
| 744LED | 35 | 70 | 1.5 | 65 | 14W LED | Yes | — | 4 | 8¼ | 12¼ | 6¼ | 7¼ Dia | — | Matte White | 0.55 |
| 744SFL | 35 | 70 | 1.5 | 65 | 14 | Yes | Yes | 4 | 8¼ | 12¼ | 6¼ | 7¼ Dia | — | Matte White | 0.7 |
| 750 | 29 | 100 | 3.5 | 90 | 100/7 | — | — | 4 | 9 | 9 | 6 | 15 Dia | — | White Polymeric | 1.9 |
| 751 | 29 | 100 | 3.5 | 90 | 100 | — | — | 4 | 9 | 9 | 6 | 15 Dia | — | White Polymeric | 1.9 |
| 754RB | 37 | 70 | 3.5 | 65 | 120 (2-60W) | — | — | 4 | 8¼ | 8 | 5¼ | 13¼ Dia | — | Oil-rubbed Bronze | 2.2 |
| 754SN | 37 | 70 | 3.5 | 65 | 120 (2-60W) | — | — | 4 | 8¼ | 8 | 5¼ | 13¼ Dia | — | Nickel | 2.2 |
| 757SN | 37 | 80 | 2.5 | 75 | 120 (2-60W) | — | — | 4 | 8¼ | 8 | 5¼ | 13¼ Dia | — | Satin Nickel | 1.6 |
| 761BN | 36 | 80 | 2.5 | 75 | 120 (2-60W) | — | — | 4 | 8¼ | 8 | 5¼ | 13¼ Dia | — | Brushed Nickel | 1.6 |
| 761RB | 36 | 80 | 2.5 | 75 | 120 (2-60W) | — | — | 4 | 8¼ | 8 | 5¼ | 13¼ Dia | — | Oil-rubbed Bronze | 1.6 |
| 761WHA | 36 | 80 | 2.5 | 75 | 120 (2-60W) | — | — | 4 | 8¼ | 8 | 5¼ | 13¼ Dia | — | White | 1.6 |
| 764BN | 37 | 80 | 2.5 | 75 | 120 (2-60W) | — | — | 4 | 8¼ | 8 | 5¼ | 13¼ Dia | — | Brushed Nickel | 1.6 |
| 764RB | 37 | 80 | 2.5 | 75 | 120 (2-60W) | — | — | 4 | 8¼ | 8 | 5¼ | 13¼ Dia | — | Oil-rubbed Bronze | 1.6 |
| 764WH | 37 | 80 | 2.5 | 75 | 120 (2-60W) | — | — | 4 | 8¼ | 8 | 5¼ | 13¼ Dia | — | White | 1.6 |
| 766BN | 36 | 80 | 2.5 | 75 | 120 (2-60W) | — | — | 4 | 8¼ | 8 | 5¼ | 13¼ Dia | — | Brushed Nickel | 1.6 |
| 766RB | 36 | 80 | 2.5 | 75 | 120 (2-60W) | — | — | 4 | 8¼ | 8 | 5¼ | 13¼ Dia | — | Oil-rubbed Bronze | 1.6 |
| 778WH | 28 | 80 | 2.0 | 75 | 2-13W GU24 | Yes | Yes | 4 | 8¼ | 8 | 5¼ | 13¼ Dia | — | White | 0.5 |
| HD50L | 30 | 50 | 1.5 | 45 | 100 | — | — | 4 | 8 | 8¼ | 5¼ | 10¼ | 10¼ | White Polymeric | 0.4 |
| HD80L | 30 | 80 | 2.5 | 75 | 100 | — | — | 4 | 8 | 8¼ | 5¼ | 10¼ | 10¼ | White Polymeric | 0.6 |
| QTR080L | 21 | 80 | 1.0 | 75 | 100/4 | — | — | 4 | 11½ | 10½ | 7½ | 12½ | 14 | White Polymeric | 1.6 |
| QTR110L | 21 | 110 | 1.5 | 100 | 100/4 | — | — | 4 | 11½ | 10½ | 7½ | 12½ | 14 | White Polymeric | 1.8 |
| QTRE080FLT | 21 | 80 | 0.8 | 75 | 2-18W fluor/4 | Yes | Yes | 4 | 11½ | 10½ | 7½ | 12½ | 14 | White Polymeric | 1.0 |
| QTRE110FLT | 21 | 110 | 1.3 | 100 | 2-18W fluor/4 | Yes | Yes | 4 | 11½ | 10½ | 7½ | 12½ | 14 | White Polymeric | 1.0 |
| QTX110SL | 22 | 110 | 0.9 | 100 | 100/4 | — | — | 6 | 11½ | 10½ | 7½ | 13 | 13¼ | White Polymeric | 0.3 |
| QTXE080FLT | 21 | 80 | 0.3 | 75 | 2-18W fluor/4 | Yes | Yes | 6 | 11½ | 10½ | 7½ | 13¼ | 14¼ | White Polymeric | 1.0 |
| QTXE110FLT | 21 | 110 | 0.7 | 100 | 2-18W fluor/4 | Yes | Yes | 6 | 11½ | 10½ | 7½ | 13¼ | 14¼ | White Polymeric | 1.0 |
| QTXE110SFLT | 22 | 110 | 0.7 | 100 | 2-18W fluor/4 | Yes | Yes | 6 | 11½ | 10½ | 7½ | 12½ | 13¼ | White Polymeric | 0.3 |
| QTXE150FLT | 21 | 150 | 1.4 | 140 | 2-18W fluor/4 | Yes | Yes | 6 | 11½ | 10½ | 7½ | 13¼ | 14¼ | White Polymeric | 1.2 |
| XB50L | 17 | 50 | <0.3 | 45 | 2-18W fluor/4 | Yes | Yes | 6 / 4 | 10½ | 11½ | 7½ | 13 | 13¼ | White Polymeric | 0.7 |
| XB80L | 17 | 80 | <0.3 | 75 | 2-18W fluor/4 | Yes | Yes | 6 / 4 | 10½ | 11½ | 7½ | 13 | 13¼ | White Polymeric | 0.7 |
| XB110L | 17 | 110 | <0.3 | 100 | 2-18W fluor/4 | Yes | Yes | 6 | 10½ | 11½ | 7½ | 13 | 13¼ | White Polymeric | 0.9 |
| XB110HL | 17 | 110 | <0.3 | 100 | 2-18W fluor/4 | Yes | Yes | 6 | 10½ | 11½ | 7½ | 13¼ | 14 | White Polymeric | 0.9 |
| ZB80L | 17 | 80 | <0.3 | 75 | 2-18W fluor/4 | Yes | Yes | 6 / 4 | 10½ | 11½ | 7½ | 13 | 13¼ | White Polymeric | 0.8 |
| ZB80ML | 17 | 80 | <0.3 | 75 | 2-18W fluor/4 | Yes | Yes | 6 / 4 | 10½ | 11½ | 7½ | 13¼ | 14 | White Polymeric | 0.8 |
| ZB110L | 17 | 110 | <0.3 | 100 | 2-18W fluor/4 | Yes | Yes | 6 | 10½ | 11½ | 7½ | 13 | 13¼ | White Polymeric | 0.9 |
| ZB110HL | 17 | 110 | <0.3 | 100 | 2-18W fluor/4 | Yes | Yes | 6 | 10½ | 11½ | 7½ | 13¼ | 14 | White Polymeric | 0.9 |
| ZB110ML | 17 | 110 | <0.3 | 100 | 2-18W fluor/4 | Yes | Yes | 6 | 10½ | 11½ | 7½ | 13¼ | 14 | White Polymeric | 0.9 |

In-Line Ventilators

| Model | Page | CFM | 0.2" Ps Sones | Housing Dimensions | | | Amps | Duct Size |
|-------|------|-----|---------------|--------------------|-----|-----|------|--------------------------------|
| | | | | L" | W" | H" | | |
| MP100 | 40 | 110 | 1.0 | 11 | 10½ | 9½ | 0.5 | 4 - 4" Rd Inlets, 6" Rd Outlet |
| MP140 | 40 | 150 | 1.5 | 11 | 10½ | 9½ | 0.8 | 4 - 4" Rd Inlets, 6" Rd Outlet |
| MP200 | 40 | 210 | 2.0 | 11 | 10½ | 9½ | 1.3 | 4 - 4" Rd Inlets, 6" Rd Outlet |
| MP280 | 40 | 290 | 3.0 | 15¼ | 14¼ | 14¼ | 2.5 | 4 - 4" Rd Inlets, 6" Rd Outlet |
| SP100 | 41 | 110 | 1.0 | 11 | 10½ | 9½ | 0.5 | 6" Rd Inlet and Outlet |
| SP140 | 41 | 150 | 1.5 | 11 | 10½ | 9½ | 0.8 | 6" Rd Inlet and Outlet |
| SP200 | 41 | 210 | 2.0 | 11 | 10½ | 9½ | 1.3 | 6" Rd Inlet and Outlet |

Specifications

Heater/Fan/Lights

| Model | Page | CFM | Sones, HVI Certified | Lighting Watts Main/Night Light | Housing Dimensions | | | Grille Dimensions | | Grille Finish | Duct Size" | Total Connected | | | |
|------------|------|-----|----------------------|---------------------------------|--------------------|-----|----|-------------------|-----|-----------------|------------|-----------------|---------------|----------------|------|
| | | | | | L" | W" | H" | L" | W" | | | Amps | Load In Watts | Heater Wattage | BTU |
| QTX110HL | 43 | 110 | 0.9 | 120W/7W | 17% | 11% | 7% | 20 | 15 | White Polymeric | 6 | 14.6 | 1710 | 1500 | 5120 |
| QTX110HFLT | 43 | 110 | 0.9 | 36W Fluor. (GU24 Incl.)/7W | 17% | 11% | 7% | 20 | 15 | White Polymeric | 6 | 13.9 | 1626 | 1500 | 5120 |
| 100HL | 44 | 100 | 2.0 | 100W | 16 | 10% | 5% | 17% | 11% | White Polymeric | 4 | 14.5 | 1830 | 1500 | 5120 |
| 100HFL | 44 | 100 | 2.0 | 27W Fluor. (Incl.) | 16 | 10% | 5% | 17% | 11% | White Polymeric | 4 | 14.0 | 1760 | 1500 | 5120 |
| 162 | 45 | 70 | 3.5 | *250W (1) | 8% | 8% | 6% | 10% | 10% | White Polymeric | 4 | 2.5 | 300 | 250* | 853 |
| 164 | 45 | 70 | 3.5 | *250W (2) | 14% | 8% | 6% | 15% | 10% | White Polymeric | 4 | 4.5 | 545 | 500* | 1707 |
| 655 | 45 | 70 | 4.0 | 100W | 14% | 8% | 5% | 16% | 10% | White Polymeric | 4 | 12.8 | 1545 | 1300 | 4437 |
| 656 | 45 | — | — | 100W | 14% | 8% | 5% | 16% | 10% | White Polymeric | — | 11.9 | 1448 | 1300 | 4437 |
| 658 | 45 | 70 | 4.0 | n/a | 14% | 8% | 5% | 16% | 10% | White Polymeric | 4 | 11.9 | 1448 | 1300 | 4437 |
| 659 | 45 | 50 | 2.5 | 100W | 14% | 8% | 5% | 16% | 10% | White Polymeric | 4 | 12.0 | 1472 | 1300 | 4437 |

Bulb Heaters*

| Model | Page | Heater | | Amps | BTU/hr | Housing Dimensions | | | Grille Dimensions | | Grille Finish |
|-------|------|---------|-------|------|--------|--------------------|----|----|-------------------|-----|-----------------|
| | | Wattage | Volts | | | W" | H" | D" | W" | H" | |
| 161 | 45 | 250 | 120 | 2.1 | 853 | 8% | 6% | 8% | 10% | 10% | White Polymeric |
| 163 | 45 | 500 | 120 | 4.3 | 1707 | 14% | 6% | 8% | 15% | 10% | White Polymeric |

*See models 162 and 164 above for Ventilation Fan/Bulb Heater versions.

Powered Attic Ventilators, Gable and Roof Mount

| Model | Page | Description | Housing Dimensions | | | CFM | Sones | Amps | Dome Color | Dome Material |
|-------|------|-----------------|--------------------|--------------|----|------|-------|------|------------|---------------|
| | | | L" | W" | H" | | | | | |
| 349BR | 47 | PAV—Roof Mount | 22¼ Sq | 24½ Dia Dome | 9 | 1000 | n/a | 4 | Dark Brown | Metal |
| 350BK | 47 | PAV—Roof Mount | 22¼ Sq | 23¾ Dia Dome | 8 | 1050 | n/a | 3.6 | Black | PVC |
| 350BR | 47 | PAV—Roof Mount | 22¼ Sq | 23¾ Dia Dome | 8 | 1050 | n/a | 3.6 | Brown | PVC |
| 353 | 47 | PAV—Gable Mount | 15 Dia | — | 8 | 1020 | n/a | 3.4 | — | — |
| 35316 | 47 | PAV—Gable Mount | 15 Dia | — | 8 | 1600 | n/a | 3.9 | — | — |
| 355BK | 47 | PAV—Roof Mount | 22¼ Sq | 23¾ Dia Dome | 8 | 1200 | n/a | 4.3 | Black | PVC |
| 355BR | 47 | PAV—Roof Mount | 22¼ Sq | 23¾ Dia Dome | 8 | 1200 | n/a | 4.3 | Brown | PVC |
| 356BK | 47 | PAV—Roof Mount | 22¼ Sq | 23¾ Dia Dome | 8 | 1600 | n/a | 8 | Black | PVC |
| 356BR | 47 | PAV—Roof Mount | 22¼ Sq | 23¾ Dia Dome | 8 | 1600 | n/a | 8 | Brown | PVC |
| 358 | 47 | PAV—Roof Mount | 22¼ Sq | 23¾ Dia Dome | 8 | 1200 | n/a | 4.3 | Silver | Metal |

Solar-Powered Attic Ventilators—Surface, Curb, Remote and Gable

| Model* | Page | Mount | Color | Housing Material* | Solar Panel | | Dome/Panel Dimensions (inches) | | |
|----------|------|---------|----------------|-------------------|--------------|--------|--------------------------------|-------------|-----------------|
| | | | | | Power Output | Pieces | Height" | Width" | Length" |
| 345CSOBK | 48 | Curb | Black | ABS Plastic | 28 Watts | 1 pc | 11 | 29.875 | 26.625 |
| 345CSOWW | 48 | Curb | Weathered Wood | ABS Plastic | 28 Watts | 1 pc | 11 | 29.875 | 26.625 |
| 345GOBK | 49 | Gable | Black | ABS Plastic | 28 Watts | 2 pcs | .75 / 11 | 30 / 19.75 | 26.625 / 19.75 |
| 345GOWW | 49 | Gable | Weathered Wood | ABS Plastic | 28 Watts | 2 pcs | .75 / 11 | 30 / 19.75 | 26.625 / 19.75 |
| 345RSOBK | 49 | Remote | Black | ABS Plastic | 28 Watts | 2 pcs | .75 / 9 | 30 / 29.875 | 26.625 / 26.625 |
| 345RSOWW | 49 | Remote | Weathered Wood | ABS Plastic | 28 Watts | 2 pcs | .75 / 9 | 30 / 29.875 | 26.625 / 26.625 |
| 345SOBK | 48 | Surface | Black | ABS Plastic | 28 Watts | 1 pc | 9 | 29.875 | 26.625 |
| 345SOWW | 48 | Surface | Weathered Wood | ABS Plastic | 28 Watts | 1 pc | 9 | 29.875 | 26.625 |

*All UV-enhanced ABS plastic housings may be painted to match roof color.



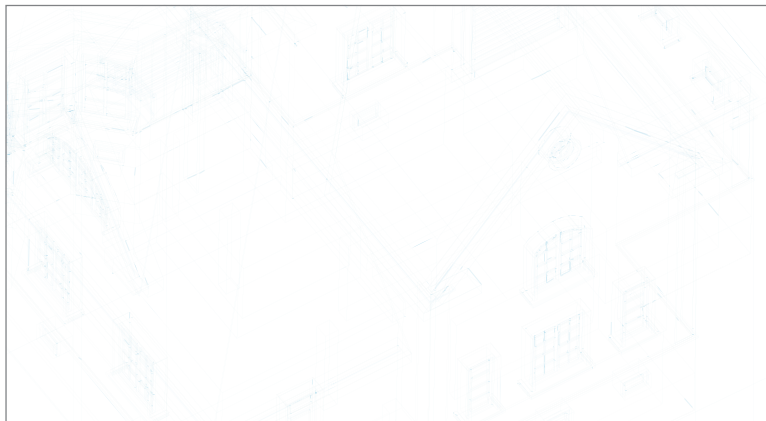

Broan® is America's leading brand of residential ventilation products including range hoods, ventilation fans, heater/fan/light combination units, Indoor Air Quality (IAQ) Systems, built-in heaters, whole-house fans, electric and solar-powered attic ventilators and trash compactors.

NuTone® is America's leading brand of residential built-in convenience products including door chimes, central vacuum systems, intercom systems, ceiling fans, home theater speakers, medicine cabinets, ironing centers and ventilation fans.

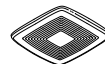

VENTILATION FANS



CHIMES



TRASH COMPACTORS



SOLAR-POWERED ATTIC VENTILATORS

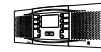

INTERCOMS



INDOOR AIR QUALITY (IAQ) SYSTEMS

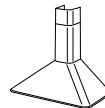

RANGE HOODS



IRONING CENTERS



HEATERS



CEILING FANS



MEDICINE CABINETS



CENTRAL VACUUMS

Make yours a Broan-NuTone home.

BROAN®

Broan.com

Broan-NuTone LLC, 926 W. State Street
Hartford, WI 53027 **800-558-1711**
In Canada call **877-896-1119**

America's Choice For Green Builders.® Proud to be ENERGY STAR® partners.

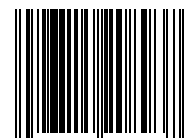

0 26715 20893 7