

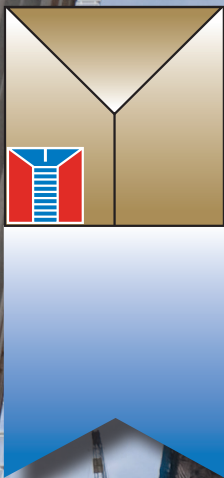

THE METALLICS QUICK REFERENCE GUIDE



Metallics Distributor Catalogue 2014-2015

Anchors, Fasteners,
Tools, and Specialty Products
for the Electrical,
Plumbing, Heating and
Air Conditioning Industries



Screws &
Screw Kits

A



Nuts &
Nut Kits

B



Washers &
Washer Kits

C



Hexagon
Bolts

D

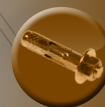

Anchoring
Devices

E



Telecom Access.
Cable Ties
Plastic Fasteners

F



Fixture Hanging
Accessories

G



Special Purpose
Electrical
Fasteners

H



Tools • Drills
and Accessories

I



Chemicals • Tape
Hand Cleaner
DAP Products

J



Accessories
Pro. Eyewear
First Aid Kits

K



Point of
Purchase
Displays

L



TO OUR DISTRIBUTOR

**OFFERING YOU
NEW PRODUCTS
FOR 2014-2015**

The Metallics Difference

Here at Metallics, we realize our distributors' needs for competitive products at competitive prices. We also believe that the reason to take on the Metallics line is to maximize profits. We understand that you, the distributor, are in this business to make a profit. Metallics works closely with distributors in order to grow their bottom-line profitability and increase revenues.

Our company constantly employs more efficient and streamlined methods of doing business. These techniques allow us to operate at peak efficiency in order to pass on our savings to you. In fact, our distributors named the Metallics line the highest Gross Margin Rate of Return over all other lines. In addition to a higher profit margin, we offer:

- Manufacturing
- Live Customer Support
- Exclusive "Hardbody" Packaging
- Same Day Shipping
- Highest Fill Rate
- Distributor Price Catalogue on CD
- Highest Ratio of American-made to Foreign-made Product
- Locations in Bristol, Connecticut and Mancos, Colorado



With Metallics, you can be sure that a strong relationship will be built not only with us, but between you and the customers you serve. Our knowledgeable sales and support staff is always available to answer your questions.

We Lead, They Follow

In the highly competitive world of fasteners and related supplies, companies need to differentiate themselves. Metallics is not just a supplier of fasteners and related supplies. We are also one of the few suppliers that design and manufacture fastener components to your specifications. In coordination with our affiliate, Avanti Screw, we are able to design and produce new and innovative fasteners in our Bristol, Connecticut, plant. We are the gold standard in fasteners!



At Metallics, we are always looking toward the future to provide innovative and profitable solutions for our distributors. Since we sell solely to distributors, you can be confident you will not see the products in this catalogue sold at any of America's "Depot-Marts" or sold directly to your contractors. With new products such as Tri-Drive, and QuaDrive Screws, and Hardbody Packaging, you can offer your customers the most unique and profitable products available. This all leads to maximum profitability for you. This new catalogue will reflect many new exciting fasteners available for 2014 and 2015.

YOU DESERVE THE PERSONAL TOUCH

Always speak to live people!

In a world ruled by voice mail, answering machines, emails and computerized operators, it can sometimes be difficult to reach a live representative. When you call Metallics, you can be assured you will always be able to speak to a person, not a machine. And with two locations in Bristol, Connecticut, and Mancos, Colorado, there is always someone available. When time matters, voice mail and answering services will only slow you down. We are proud to have an extremely knowledgeable and readily available team to aid you with answers to your fastener questions. All this because YOU deserve the personal touch.

With this new catalogue, Metallics has made it easier for you to find products. We understand the importance of removing the hassle from catalogue searching; this is the reason for our new user-friendly format. Color-coded reference tabs make it a snap to stay organized and to quickly find the section you need. The time saved searching will mean more efficiency in securing new projects. After all, time is money.

None of our competitors selling to the Distribution trade can claim they manufacture screws. We can and do, right in Bristol, CT.

There is no doubt: We know the American fastener market and are ahead of our competitors. Avanti Screw, Inc., our fastener manufacturing facility in Bristol, CT, guarantees that we are the only American fastener company that makes a portion of its product sold through distribution.

We know the fastener market and have been serving it since 1959. Our Avanti Screw, Inc. manufacturing facilities guarantees that we are different. We are able to fill the need for unique fasteners for today's industry.

Terms

1% 10th net prox., Minimum order \$25.00

Prepaid shipments:

\$650.00 Continental U.S.

\$1,100.00 Alaska and Hawaii

see page 178 for Co-Labeling and Reduced Price on Large Quantity Orders of Anchors.

Remember, Metallics has an east and west warehouse and a manufacturing facility.

Same Day Shipments = 98.3% Fill Rate = 98.1%

We get product to you, easier and faster!



This symbol denotes a product made by a quality American producer. In the case of fasteners, many are produced at Avanti Screw, Inc., a Metallica affiliate.

All salespeople act as if they are selling the same commodity as Metallica. We sell something better: value, service, trust, consistency, and profit building for you and your customer.



We believe Metallica has the largest ratio of American-made to foreign-produced product of any other American fastener company.

It appears that our competitors in the past, and today, have failed to copy our lead in denoting a place of origin in their catalogues. We need to ask, "Why?"

NAED Reference Number: 39720
 Electronic Data Interchange (EDI) at one central location.
 Please call for further information:
 East: 1.800.243.8272
 West: 1.800.269.5183



PRODUCTS SHOWN WITH "MADE IN USA" MAY CHANGE WITHOUT NOTICE

QUICK REFERENCE PRODUCT INDEX

A SCREWS

DECK • DRILL • DRYWALL • MACHINE • SHEET METAL • STOVE TAPPING • WOOD	PAGE	10 thru 102
SECURITY SCREWS • TOOLS • ORGANIZERS	PAGE	14, 36, 37, 41, 49, 59, 60, 61, 89 thru 98, 102
KITS	PAGE	12, 13, 51 thru 56, 72, 76, 81, 83, 96 thru 101

USA PRODUCTS – LOOK FOR 

B NUTS

CAP • HEX • LOCK • SQUARE • WING • THREAD INSERT	PAGE	103 thru 111
KITS	PAGE	104, 107, 111, 112
SECURITY	PAGE	105
METRIC	PAGE	106
CHANNEL	PAGE	109

USA PRODUCTS – LOOK FOR 

C WASHERS

CONICAL • FENDER • FLAT SAE • FLAT USS • LOCK • REDUCING • FINISHING OCTAGONAL • SEALING	PAGE	112 thru 120
KITS	PAGE	112, 118, 120
METRIC	PAGE	114, 115
CHANNEL	PAGE	109

USA PRODUCTS – LOOK FOR 

D BOLTS

HEX • CAP • CARRIAGE • LAG • TAP • U-BOLT	PAGE	121 thru 138
METRIC	PAGE	128, 131, 132, 133

USA PRODUCTS – LOOK FOR 

E ANCHORING DEVICES

CONCRETE SCREW ANCHORS • DRILLS • DRIVERS • DROP-IN WEDGE • SLEEVE • ROD • EXPANSION.....	PAGE	139 thru 191
MECHANICAL ANCHORS • NAILS • DRIVE PINS • TOOL • NAIL-INS	PAGE	164 thru 172
PLASTIC DRYWALL ANCHORS.....	PAGE	154 thru 158
TOGGLE BOLT ANCHORS • TOGGLE BOLTS • TOGGLE HEADS	PAGE	150 thru 153
KITS (VOLUME DISCOUNTS) • PLASTIC ANCHORS CONCRETE SCREWS TOGGLE BOLTS.....	PAGE	143, 149, 150, 153 thru 158, 174, 175

USA PRODUCTS – LOOK FOR 

F TELECOM, CABLE TIES & CLAMPS

CABLE TIES • TOOLS • WRAPS.....	PAGE	192 thru 202
CABLE TIE MOUNTS • CLAMPS • HOSE CLAMPS • GROMMET.....	PAGE	197 thru 201

USA PRODUCTS – LOOK FOR 

G FIXTURE HANGING ACCESSORIES

CHAIN • CEILING WIRE.....	PAGE	211, 212, 220
THREADED RODS • COUPLINGS • CLAMPS • LOCK NUTS	PAGE	203, 204, 205, 207
HOOKS • SCREW • EYEBOLTS • “J” BOLTS	PAGE	208, 209, 210
THREADED ROD HANGERS	PAGE	213 thru 223
TIE WIRE AND DISPENSER	PAGE	211
KITS	PAGE	207, 208, 215, 223

USA PRODUCTS – LOOK FOR 

H SPECIAL PURPOSE ELECTRICAL FASTENERS

GROUNDING SCREWS • PIGTAILS • CLIPS	PAGE	224 thru 228
CAGE NUTS • CAGE NUT KITS.....	PAGE	230, 231
KNOCK-OUT SEALS • CONDUIT LOCK NUTS	PAGE	240, 247
BOX SUPPORTS • BRIDLE RINGS • GASKETS.....	PAGE	238, 241, 244
NAILS • NAIL APRON • NAIL PLATES • DRIVE RINGS PLATE STRAP • PLUMBERS TAPE.....	PAGE	241 thru 244
RECEPTACLE AND SWITCH PLATE SCREWS • THUMB	PAGE	235 thru 238
STAPLES.....	PAGE	245 thru 251
TERMINALS.....	PAGE	233, 234

USA PRODUCTS – LOOK FOR 

QUICK REFERENCE PRODUCT INDEX

TOOLS, DRILLS AND ACCESSORIES

SCREW DRIVERS • TAPE MEASURES • UTILITY KNIVES	
STAPLE GUNS • IMPACT DRIVER AND BITS	PAGE 252, 252, 255, 256
BITS • NUT SETTERS • SAW-CABLE • KEYHOLE SAW • MARKERS	
SETTING TOOLS • CRAYON • HAMMER • TAPS • CAULK GUNS	PAGE 259 thru 266, 268 thru 270
DRILLS • DRIVER	PAGE 260 thru 263, 265, 266, 268, 278, 285
ROOF JACKS AND KITS • FLOOR FLANGES • MARKERS • LOCKS	
ORGANIZERS • STRAPS	PAGE 257, 286 thru 290
BOLT & NUT GAUGE	PAGE 264
ROPE	PAGE 267
LAGMASTER	PAGE 272 thru 275
USA PRODUCTS – LOOK FOR 	

CHEMICAL PRODUCTS

WIPES • INSULATING FOAM	PAGE 291, 292
DUCT SEAL • FIREBLOCK FOAM • FIRE PATCH	PAGE 292 thru 296
ROOF PATCH • SPACKLE • CAULK • CAULK GUNS	PAGE 294, 295, 296
OXIDE INHIBITOR	PAGE 292
USA PRODUCTS – LOOK FOR 	

ACCESSORIES, TAPES, EYE WARE, FIRST AID

CONDUIT MEASURING TAPE	PAGE 299
ELECTRICAL • DUCT • TEFLON • ALUMINUM	PAGE 299, 300
TAPES (DETECTABLE - NON-DETECTABLE) • CAUTION	PAGE 300
CHILL OUTS • SAFETY GLASSES • FIRST AID KITS	PAGE 301 thru 305
SHOE COVERS • RAGS	PAGE 306, 307
USA PRODUCTS – LOOK FOR 	

POINT OF PURCHASE DISPLAYS

DISPLAYS • HEADER CARDS • SHELF LABELS	PAGE 308 thru 311
USA PRODUCTS – LOOK FOR 	

MISCELLANEOUS

QUICK REFERENCE GUIDE	PAGE 314
MANUFACTURING DETAILS	PAGE 312, 313
FASTENER REFERENCE GUIDE	PAGE 314
QUICK REFERENCE PRODUCT INDEX	PAGE 315 thru 327
SALES FORCE INDEX	PAGE INSIDE BACK COVER

TO OUR ELECTRICAL DISTRIBUTORS: WE ASK YOU TO UNDERSTAND OUR POSITION.

Since 1968, Metallics has not included yearly stock balancing of distributor's inventory as part of our catalogue fastener program. We have chosen instead to provide the lowest prices in America, superior packaging, same-day shipment, lower prepaids, best fastener fill rate in America, and logistical support in the way of promotions, advertising and sales representative training. At this time we do not anticipate offering stock balancing.

New Customer Buyout of Competitor Inventory: Over the years, many fastener suppliers have gone in and purchased competitor inventories from the electrical distributor, then replaced that inventory with their own products. Metallics has never had this as a catalogue option, and we do not anticipate such a program.

An Honest Mistake or Customer Cancellation: We do offer to take back any single item resulting from a distributor's order entry error. We will also consider taking back an item cancelled by a customer of our electrical distributors. Call to inquire about our RMA System.

The QuaDrive

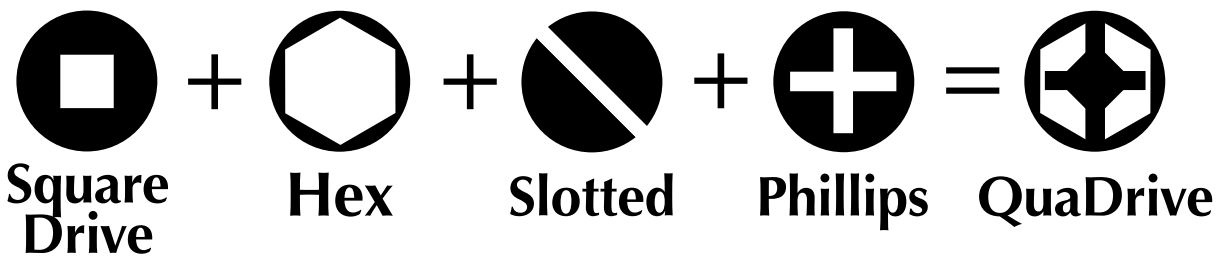

**America's Newest Drive - Designed, Developed and
Manufactured by Metallics/Avanti Screw**

EASTERN

8:00 A.M.
to
5:00 P.M.



Metallics, Inc. CT

CENTRAL



MOUNTAIN

8:00 A.M.
to
5:00 P.M.



Metallics, West Inc. CO

In the event Metallics East, Bristol is CLOSED, call Metallics West at 1-800-269-5183 if you require technical information or overnight shipments

Our goal at Metallics is to present information accurately. Metallics is not responsible for claims traceable to typographical or other errors that may be contained herein. Metallics makes no warranties as to the accuracy of the information contained in this catalogue.



SCREWS

ONLY METALLICS!

AN INDUSTRY FIRST!
A free square drive bit with each jar of Tri-Drive Machine Screws



A

-  Slotted
-  Phillips
-  Square Drive



ROUND TRI-DRIVE MACHINE SCREWS

STEEL ZINC CHROMATE

MADE IN USA



Manufactured by
Avanti Screw, Inc.,
A Metallics
Affiliate

Three drives
in one head!

Introduced nationally by Metallics in 1994

STOCK NO.	UPC NO.	DIAMETER	LENGTH	WT. PER PKG.	STD. PKG./MSTR. SLEEVE	SUGGESTED TRADE LIST PRICE PER
JTRM80	80003	6-32	1/2	.28	100/500	4.08/c
JTRM81	80004	6-32	3/4	.36	100/500	4.08/c
JTRM63	80005	6-32	1	.43	100/500	4.43/c
JTRM82	80006	6-32	1 1/2	.58	100/500	5.18/c
JTRM83	80007	6-32	2	.73	100/500	6.35/c
JTRM84	80008	8-32	1/2	.45	100/500	6.05/c
JTRM85	80009	8-32	3/4	.51	100/500	6.08/c
JTRM86	80010	8-32	1	.65	100/500	6.10/c
JTRM87	80011	8-32	1 1/4	.75	100/500	6.15/c
JTRM88	80012	8-32	1 1/2	.86	100/500	7.83/c
JTRM89	80013	8-32	2	1.07	100/500	8.03/c
JTRM16	81255	10-32	1/4	.49	100/500	3.45/c
JTRM33	80014	10-32	1/2	.57	100/500	4.93/c
JTRM98	80015	10-32	1	.89	100/500	6.65/c
JTRM22	80016	1/4-20	3/8	.95	100/500	8.48/c
JTRM99	80017	1/4-20	1/2	1.10	100/500	8.53/c
JTRM100	80018	1/4-20	3/4	1.33	100/500	8.55/c
JTRM101	80019	1/4-20	1	1.58	100/500	10.13/c
JTRM102	80020	1/4-20	1 1/4	1.77	100/500	12.33/c
JTRM103	80021	1/4-20	1 1/2	2.08	100/500	12.38/c
JTRM104	80022	1/4-20	2	2.62	100	15.78/c

ALSO AVAILABLE—TRI-DRIVE™ SHEET METAL SCREWS
OTHER SIZES AND QUANTITIES AVAILABLE BY REQUEST

QUALITY GUARANTEED

METALLICS STANDS TALL BEHIND AUTHORIZED DISTRIBUTORS AND THEIR PROFESSIONAL USERS:

Any product purchased from this catalogue may be returned within 30 days of purchase if our distributor or contractor is not fully satisfied with the quality.

Distributor—please include Metallics or Metallics West invoice with item, if deemed faulty or of poor quality, we will replace the individual item or issue full credit .

Our goal is to please you. Call to Inquire about our RMA Policy.

AMERICA'S SOURCE FOR PREMIER & INNOVATIVE FASTENERS AND ANCHORS

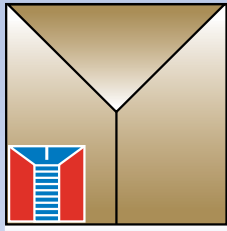

Metallics 1000 Pack

**[CONTRACTOR
APPROVED]**



Round Head Tri-Drive Machine Screw - Zinc



Manufactured by
Avant Screw Inc.
a Metallics Affiliate

-  Slotted
 -  Phillips
 -  Square Drive
- Three drives
in one head!*



Drive bit included in each pack.

PART #	UPC #	DESCRIPTION	QTY / PKG	SUG. TRADE LIST / PKG
TRM80M	27780	6-32 x 1/2 Round Head Tri-Drive Screw - Zinc	1000	\$ 43.35
TRM81M	27781	6-32 x 3/4 Round Head Tri-Drive Screw - Zinc	1000	\$ 45.83
TRM63M	27763	6-32 x 1 Round Head Tri-Drive Screw - Zinc	1000	\$ 50.05
TRM82M	27782	6-32 x 1 1/2 Round Head Tri-Drive Screw - Zinc	1000	\$ 53.05
TRM83M	27783	6-32 x 2 Round Head Tri-Drive Screw - Zinc	1000	\$ 70.80
TRM84M	27784	8-32 x 1/2 Round Head Tri-Drive Screw - Zinc	1000	\$ 67.43
TRM85M	27785	8-32 x 3/4 Round Head Tri-Drive Screw - Zinc	1000	\$ 68.02
TRM86M	27786	8-32 x 1 Round Head Tri-Drive Screw - Zinc	1000	\$ 68.18
TRM87M	27787	8-32 x 1 1/4 Round Head Tri-Drive Screw - Zinc	1000	\$ 68.63
TRM88M	27788	8-32 x 1 1/2 Round Head Tri-Drive Screw - Zinc	1000	\$ 70.40
TRM89M	27789	8-32 x 2 Round Head Tri-Drive Screw - Zinc	1000	\$ 73.40
TRM33M	27733	10-32 x 1/2 Round Head Tri-Drive Screw - Zinc	1000	\$ 69.90
TRM98M	27798	10-32 x 1 Round Head Tri-Drive Screw - Zinc	1000	\$ 72.25
TRM99M	27799	1/4-20 x 1/2 Round Head Tri-Drive Screw - Zinc	1000	\$ 93.11
TRM100M	27800	1/4-20 x 3/4 Round Head Tri-Drive Screw - Zinc	1000	\$ 95.30
TRM101M	27801	1/4-20 x 1 Round Head Tri-Drive Screw - Zinc	1000	\$ 110.68
TRM102M	27802	1/4-20 x 1 1/4 Round Head Tri-Drive Screw - Zinc	1000	\$ 133.32
TRM103M	27803	1/4-20 x 1 1/2 Round Head Tri-Drive Screw - Zinc	1000	\$ 134.75
TRM104M	27804	1/4-20 x 2 Round Head Tri-Drive Screw - Zinc	1000	\$ 169.75

Other sizes, materials and quantities available by request.

“Growth Through Innovation”

Metallics

229 Cross Street, Bristol, CT 06010
Tel 800-243-8272 • Fax 800-831-9358
Email sales@metallicsonline.com

Metallics West

651 North Main Street, Mancos, CO 81328
Tel 800-269-5183 • Fax 800-269-6278
Email saleswest@metallicsonline.com

www.metallicsonline.com

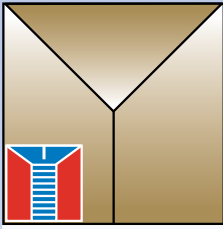

Metallics

[CONTRACTOR APPROVED]

NEW!
2014-2015

Round Head Tri-Drive Machine Screw Kits

- Slotted
 - Phillips
 - Square Drive
- Three drives in one head!**

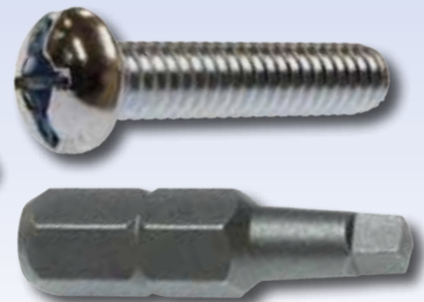

Drive bit included in each pack.

PART #	UPC #	DESCRIPTION	QTY / PKG	SUG. TRADE LIST / PKG
TRMK632 (415 pcs)	76877	6-32 x 1/2 Round Head Tri-Drive Screw - Zinc	50 pcs	\$ 48.98/EA
		6-32 x 3/4 Round Head Tri-Drive Screw - Zinc	50 pcs	
		6-32 x 1 Round Head Tri-Drive Screw - Zinc	75 pcs	
		6-32 x 1 1/2 Round Head Tri-Drive Screw - Zinc	100 pcs	
		6-32 x 2 Round Head Tri-Drive Screw - Zinc	140 pcs	
		#1 Square Power Bit 1" Long	1 pc	
TRMK832 (375 pcs)	76878	8-32 x 1/2 Round Head Tri-Drive Screw - Zinc	75 pcs	\$ 39.85/EA
		8-32 x 3/4 Round Head Tri-Drive Screw - Zinc	75 pcs	
		8-32 x 1 Round Head Tri-Drive Screw - Zinc	75 pcs	
		8-32 x 1 1/4 Round Head Tri-Drive Screw - Zinc	50 pcs	
		8-32 x 1 1/2 Round Head Tri-Drive Screw - Zinc	50 pcs	
		8-32 x 2 Round Head Tri-Drive Screw - Zinc	50 pcs	
#2 Square Power Bit 1" Long	1 pc			
TRMK1032 (600 pcs)	76879	10-32 x 1/4 Round Head Tri-Drive Screw - Zinc	200 pcs	\$ 47.03/EA
		10-32 x 1/2 Round Head Tri-Drive Screw - Zinc	200 pcs	
		10-32 x 1 Round Head Tri-Drive Screw - Zinc	200 pcs	
		#3 Square Power Bit 2" Long	1 pc	

Chart continued on next page.

"Growth Through Innovation"

Metallics

229 Cross Street, Bristol, CT 06010
Tel 800-243-8272 • **Fax** 800-831-9358
Email sales@metallicsonline.com

Metallics West

651 North Main Street, Mancos, CO 81328
Tel 800-269-5183 • **Fax** 800-269-6278
Email saleswest@metallicsonline.com

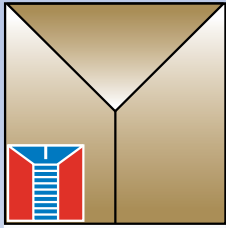

Metallics



Round Head Tri-Drive Machine Screw Kits



Manufactured by
Avant Screw Inc.
a Metallics Affiliate

-  Slotted
 -  Phillips
 -  Square Drive
- Three drives
in one head!*



Drive bit included in each pack.

Chart continued from previous page.

PART #	UPC #	DESCRIPTION	QTY / PKG	SUG. TRADE LIST / PKG
TRMK1420 (124 pcs)	76880	1/4-20 x 1/2 Round Head Tri-Drive Screw - Zinc	35 pcs	\$ 22.25/EA
		1/4-20 x 3/4 Round Head Tri-Drive Screw - Zinc	30 pcs	
		1/4-20 x 1 Round Head Tri-Drive Screw - Zinc	20 pcs	
		1/4-20 x 1 1/4 Round Head Tri-Drive Screw - Zinc	15 pcs	
		1/4-20 x 1 1/2 Round Head Tri-Drive Screw - Zinc	12 pcs	
		1/4-20 x 2 Round Head Tri-Drive Screw - Zinc	12 pcs	
		#3 Square Power Bit 2" Long	1 pc	

* * * * * *"Growth Through Innovation"* * * * * *

Metallics

229 Cross Street, Bristol, CT 06010
Tel 800-243-8272 • **Fax** 800-831-9358
Email sales@metallicsonline.com

Metallics West

651 North Main Street, Mancos, CO 81328
Tel 800-269-5183 • **Fax** 800-269-6278
Email saleswest@metallicsonline.com

A

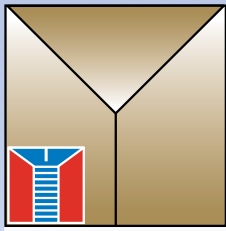

Metallics

Tamper Resist Flat Head Hex Pin Machine Screw

(Stainless Steel) 18-8 Series Type



**[CONTRACTOR
APPROVED]**



Hex Head

PART #	UPC #	DESCRIPTION	QTY / PKG	SUG. TRADE LIST / PKG
TP122SFC	30521	6-32 x 3/8 Flat Head Hex Pin Machine Screw	100	\$ 105.08
TP125SFC	30534	8-32 x 3/8 Flat Head Hex Pin Machine Screw	100	\$ 107.10
TP126SFC	30547	10-24 x 3/8 Flat Head Hex Pin Machine Screw	100	\$ 119.10
TP127SFC	30560	10-32 x 3/8 Flat Head Hex Pin Machine Screw	100	\$ 118.73
TP128SFC	30561	10-32 x 1/2 Flat Head Hex Pin Machine Screw	100	\$ 187.50
TP129SFC	30563	10-32 x 3/4 Flat Head Hex Pin Machine Screw	100	\$ 135.00
TP130SFC	30564	10-32 x 1 Flat Head Hex Pin Machine Screw	100	\$ 140.10
TP131SFC	30566	10-32 x 1-1/2 Flat Head Hex Pin Machine Screw	100	\$155.03
TP133SFC	30587	5/16-18 x 1/2 Flat Head Hex Pin Machine Screw	100	\$ 315.90
TP134SFC	30589	5/16-18 x 3/4 Flat Head Hex Pin Machine Screw	100	\$ 331.05
TP135SFC	30590	5/16-18 x 1 Flat Head Hex Pin Machine Screw	100	\$ 335.78
TP136SFC	30591	5/16-18 x 1-1/4 Flat Head Hex Pin Machine Screw	100	\$ 352.80
TP137SFC	30592	5/16-18 x 1-1/2 Flat Head Hex Pin Machine Screw	100	\$ 391.50
TP138SFC	30593	5/16-18 x 2 Flat Head Hex Pin Machine Screw	100	\$ 437.03
TP139SFC	30599	3/8-16 x 1/2 Flat Head Hex Pin Machine Screw	100	\$ 600.00
TP140SFC	30602	3/8-16 x 3/4 Flat Head Hex Pin Machine Screw	100	\$ 473.03
TP141SFC	30603	3/8-16 x 1 Flat Head Hex Pin Machine Screw	100	\$ 476.18
TP142SFC	30604	3/8-16 x 1-1/4 Flat Head Hex Pin Machine Screw	100	\$ 497.18
TP143SFC	30605	3/8-16 x 1-1/2 Flat Head Hex Pin Machine Screw	100	\$ 550.95
TP144SFC	30606	3/8-16 x 2 Flat Head Hex Pin Machine Screw	100	\$ 566.10

"Growth Through Innovation"

Metallics

229 Cross Street, Bristol, CT 06010
Tel 800-243-8272 • **Fax** 800-831-9358
Email sales@metallicsonline.com

Metallics West

651 North Main Street, Mancos, CO 81328
Tel 800-269-5183 • **Fax** 800-269-6278
Email saleswest@metallicsonline.com

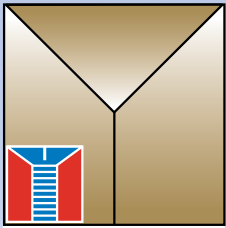

Metallics



Flat Head Slotted Machine Screw

(Stainless Steel) 18-8 Series Type

[CONTRACTOR APPROVED]



Slotted

PART #	UPC #	DESCRIPTION	QTY / PKG	SUG. TRADE LIST / PKG
JFM63SS	91963	6-32 x 1 Flat Head Slotted Machine Screw (Stainless Steel)	100	\$ 17.77
JFM17SS	91917	8-32 x 3/8 Flat Head Slotted Machine Screw (Stainless Steel)	100	\$ 8.25
JFM97SS	91997	8-32 x 5/8 Flat Head Slotted Machine Screw (Stainless Steel)	100	\$ 9.87
JFM95SS	91995	8-32 x 7/8 Flat Head Slotted Machine Screw (Stainless Steel)	100	\$ 18.55
JFM103SS	93203	1/4-20 x 1 1/2 Flat Head Slotted Machine Screw (Stainless Steel)	100	\$ 45.90
JFM107SS	93207	1/4-20 x 2 1/2 Flat Head Slotted Machine Screw (Stainless Steel)	100	\$ 84.00

Other sizes, materials and quantities available by request.

“Growth Through Innovation”

Metallics

229 Cross Street, Bristol, CT 06010
Tel 800-243-8272 • **Fax** 800-831-9358
Email sales@metallicsonline.com

Metallics West

651 North Main Street, Mancos, CO 81328
Tel 800-269-5183 • **Fax** 800-269-6278
Email saleswest@metallicsonline.com

A

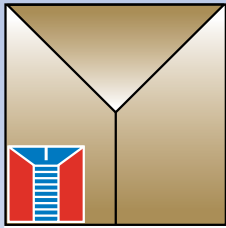

Metallics



Flat Head Phillips Machine Screw Steel (Zinc)

**[CONTRACTOR
APPROVED]**



PART #	UPC #	DESCRIPTION	QTY / PKG	SUG. TRADE LIST / PKG
JFMP68	84068	6-32 x 1 1/4 Flat Head Phillips Machine Screw (Zinc)	100	\$ 10.83
JFMP64	84064	6-32 x 4 Flat Head Phillips Machine Screw (Zinc)	100	\$ 18.75
JFMP70	84070	10-24 x 1/2 Flat Head Phillips Machine Screw (Zinc)	100	\$ 5.55
JFMP72	84072	10-24 x 1 Flat Head Phillips Machine Screw (Zinc)	100	\$ 10.13
JFMP30	72030	10-24 x 1 1/4 Flat Head Phillips Machine Screw (Zinc)	100	\$ 11.98
JFMP31	72031	10-24 x 2 Flat Head Phillips Machine Screw (Zinc)	100	\$ 18.13
JFMP127	85727	10-24 x 3 Flat Head Phillips Machine Screw (Zinc)	100	\$ 24.95
JFMP47	72047	10-32 x 3/8 Flat Head Phillips Machine Screw (Zinc)	100	\$ 8.88
JFMP49	72049	10-32 x 1/2 Flat Head Phillips Machine Screw (Zinc)	100	\$ 6.68
JFMP48	72048	10-32 x 3/4 Flat Head Phillips Machine Screw (Zinc)	100	\$ 4.03
JFMP69	84069	10-32 x 1 1/4 Flat Head Phillips Machine Screw (Zinc)	100	\$ 14.00
JFMP92	84128	10-32 x 1 1/2 Flat Head Phillips Machine Screw (Zinc)	100	\$ 14.13
JFMP93	84129	10-32 x 2 Flat Head Phillips Machine Screw (Zinc)	100	\$ 15.55
JFMP94	84130	10-32 x 3 Flat Head Phillips Machine Screw (Zinc)	100	\$ 19.23
JFMP96	84132	10-32 x 4 Flat Head Phillips Machine Screw (Zinc)	50	\$ 17.50
JFMP194	85794	12-24 x 3/4 Flat Head Phillips Machine Screw (Zinc)	100	\$ 8.23
JFMP22	72022	1/4-20 x 3/8 Flat Head Phillips Machine Screw (Zinc)	100	\$ 20.00
JFMP103	84139	1/4-20 x 1 1/2 Flat Head Phillips Machine Screw (Zinc)	100	\$ 18.50

Other sizes, materials and quantities available by request.

“Growth Through Innovation”

Metallics

229 Cross Street, Bristol, CT 06010
Tel 800-243-8272 • **Fax** 800-831-9358
Email sales@metallicsonline.com

Metallics West

651 North Main Street, Mancos, CO 81328
Tel 800-269-5183 • **Fax** 800-269-6278
Email saleswest@metallicsonline.com

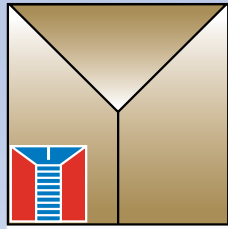

Metallics Flat Head Wood Phillips Screw (Brass)



**[CONTRACTOR
APPROVED]**



Phillips

PART #	UPC #	DESCRIPTION	QTY / PKG	SUG. TRADE LIST / PKG
JFWPB45	73145	#4 x 1/2 Flat Head Wood Screw - Brass	1	\$ 7.58
JFWPB61	73161	#4 x 3/4 Flat Head Wood Screw - Brass	1	\$ 10.10
JFWPB62	73162	#4 x 1 Flat Head Wood Screw - Brass	1	\$ 12.55
JFWPB63	73163	#4 x 1 1/4 Flat Head Wood Screw - Brass	1	\$ 19.93
JFWPB64	73164	#4 x 1 1/2 Flat Head Wood Screw - Brass	1	\$ 24.40
JFWPB9	73109	#6 x 1/2 Flat Head Wood Screw - Brass	1	\$ 14.38
JFWPB10	73110	#6 x 3/4 Flat Head Wood Screw - Brass	1	\$ 15.15
JFWPB11	73111	#6 x 1 Flat Head Wood Screw - Brass	1	\$ 20.20
JFWPB12	73112	#6 x 1 1/4 Flat Head Wood Screw - Brass	1	\$ 25.28
JFWPB13	73113	#6 x 1 1/2 Flat Head Wood Screw - Brass	1	\$ 28.33
JFWPB14	73114	#6 x 2 Flat Head Wood Screw - Brass	1	\$ 49.68
JFWPB15	73115	#6 x 2 1/2 Flat Head Wood Screw - Brass	1	\$ 64.38
JFWPB16	73116	#6 x 3 Flat Head Wood Screw - Brass	1	\$ 79.75
JFWPB17	73117	#8 x 1/2 Flat Head Wood Screw - Brass	1	\$ 16.88
JFWPB18	73118	#8 x 3/4 Flat Head Wood Screw - Brass	1	\$ 24.75
JFWPB19	73119	#8 x 1 Flat Head Wood Screw - Brass	1	\$ 26.39
JFWPB20	73120	#8 x 1 1/4 Flat Head Wood Screw - Brass	1	\$ 32.28
JFWPB21	73121	#8 x 1 1/2 Flat Head Wood Screw - Brass	1	\$ 37.88
JFWPB22	73122	#8 x 2 Flat Head Wood Screw - Brass	1	\$ 52.55
JFWPB23	73123	#8 x 2 1/2 Flat Head Wood Screw - Brass	1	\$ 74.75
JFWPB24	73124	#8 x 3 Flat Head Wood Screw - Brass	1	\$ 111.11

Other sizes, materials and quantities available by request.

Chart continued to next page.

“Growth Through Innovation”

Metallics

229 Cross Street, Bristol, CT 06010
Tel 800-243-8272 • **Fax** 800-831-9358
Email sales@metallicsonline.com

Metallics West

651 North Main Street, Mancos, CO 81328
Tel 800-269-5183 • **Fax** 800-269-6278
Email saleswest@metallicsonline.com

A

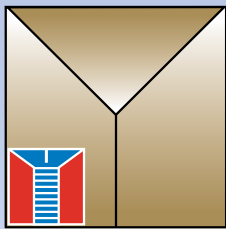

Metallics Flat Head Wood Phillips Screw (Brass)



Chart continued from previous page.

PART #	UPC #	DESCRIPTION	QTY / PKG	SUG. TRADE LIST / PKG
JFWPB27	73127	#10 x 1/2 Flat Head Wood Screw - Brass	1	\$ 26.87
JFWPB28	73128	#10 x 3/4 Flat Head Wood Screw - Brass	1	\$ 42.93
JFWPB29	73129	#10 x 1 Flat Head Wood Screw - Brass	1	\$ 43.35
JFWPB30	73130	#10 x 1 1/4 Flat Head Wood Screw - Brass	1	\$ 47.02
JFWPB31	73131	#10 x 1 1/2 Flat Head Wood Screw - Brass	1	\$ 50.55
JFWPB32	73132	#10 x 2 Flat Head Wood Screw - Brass	1	\$ 63.13
JFWPB33	73133	#10 x 2 1/2 Flat Head Wood Screw - Brass	1	\$ 99.20
JFWPB34	73134	#10 x 3 Flat Head Wood Screw - Brass	1	\$ 124.70
JFWPB38	73138	#12 x 3/4 Flat Head Wood Screw - Brass	1	\$ 40.00
JFWPB39	73139	#12 x 1 Flat Head Wood Screw - Brass	1	\$ 49.38
JFWPB40	73140	#12 x 1 1/4 Flat Head Wood Screw - Brass	1	\$ 58.07
JFWPB41	73141	#12 x 1 1/2 Flat Head Wood Screw - Brass	1	\$ 66.63
JFWPB42	73142	#12 x 2 Flat Head Wood Screw - Brass	1	\$ 85.63
JFWPB43	73143	#12 x 2 1/2 Flat Head Wood Screw - Brass	1	\$ 143.65
JFWPB44	73144	#12 x 3 Flat Head Wood Screw - Brass	1	\$ 197.95

Other sizes, materials and quantities available by request.

“Growth Through Innovation”

Metallics

229 Cross Street, Bristol, CT 06010
Tel 800-243-8272 • **Fax** 800-831-9358
Email sales@metallicsonline.com

Metallics West

651 North Main Street, Mancos, CO 81328
Tel 800-269-5183 • **Fax** 800-269-6278
Email saleswest@metallicsonline.com

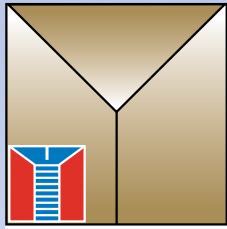

Metallics



Stainless Steel Wood Screws Flat Head Phillips

18-8 Series Type

[CONTRACTOR APPROVED]



PART #	UPC #	DESCRIPTION	QTY / PKG	SUG. TRADE LIST / PKG
JFWP9SS	92209	#6 x 1/2 SS Wood Screws Flat Head Phillips	100	\$ 15.33
JFWP10SS	92210	#6 x 3/4 SS Wood Screws Flat Head Phillips	100	\$ 21.25
JFWP11SS	92211	#6 x 1 SS Wood Screws Flat Head Phillips	100	\$ 26.58
JFWP12SS	92212	#6 x 1-1/4 SS Wood Screws Flat Head Phillips	100	\$ 33.13
JFWP13SS	92213	#6 x 1-1/2 SS Wood Screws Flat Head Phillips	100	\$ 21.88
JFWP14SS	92214	#6 x 2 SS Wood Screws Flat Head Phillips	100	\$ 46.88
JFWP18SS	92218	#8 x 3/4 SS Wood Screws Flat Head Phillips	100	\$ 26.58
JFWP19SS	92219	#8 x 1 SS Wood Screws Flat Head Phillips	100	\$ 28.13
JFWP20SS	92220	#8 x 1-1/4 SS Wood Screws Flat Head Phillips	100	\$ 43.75
JFWP21SS	92221	#8 x 1-1/2 SS Wood Screws Flat Head Phillips	100	\$ 47.50
JFWP65SS	92315	#8 x 1-3/4 SS Wood Screws Flat Head Phillips	100	\$ 56.88
JFWP22SS	92222	#8 x 2 SS Wood Screws Flat Head Phillips	100	\$ 43.75
JFWP23SS	92223	#8 x 2-1/2 SS Wood Screws Flat Head Phillips	100	\$ 79.38
JFWP24SS	92224	#8 x 3 SS Wood Screws Flat Head Phillips	100	\$100.63
JFWP28SS	92228	#10 x 3/4 SS Wood Screws Flat Head Phillips	100	\$ 27.50
JFWP29SS	92229	#10 x 1 SS Wood Screws Flat Head Phillips	100	\$ 30.95
JFWP30SS	92230	#10 x 1-1/4 SS Wood Screws Flat Head Phillips	100	\$ 50.63
JFWP31SS	92231	#10 x 1-1/2 SS Wood Screws Flat Head Phillips	100	\$ 53.75
JFWP67SS	92317	#10 x 1-3/4 SS Wood Screws Flat Head Phillips	100	\$ 68.75
JFWP32SS	92232	#10 x 2 SS Wood Screws Flat Head Phillips	100	\$ 75.00
JFWP33SS	92233	#10 x 2-1/2 SS Wood Screws Flat Head Phillips	100	\$106.25
JFWP34SS	92234	#10 x 3 SS Wood Screws Flat Head Phillips	100	\$122.50
JFWP35SS	92235	#10 x 3-1/2 SS Wood Screws Flat Head Phillips	100	\$131.25

Other sizes, materials and quantities available by request.

Chart continued to next page.

“Growth Through Innovation”

Metallics

229 Cross Street, Bristol, CT 06010
Tel 800-243-8272 • **Fax** 800-831-9358
Email sales@metallicsonline.com

Metallics West

651 North Main Street, Mancos, CO 81328
Tel 800-269-5183 • **Fax** 800-269-6278
Email saleswest@metallicsonline.com

A

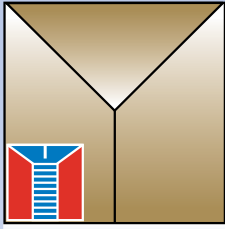

Metallics



Stainless Steel Wood Screws Flat Head Phillips

18-8 Series Type



Chart continued from previous page.

PART #	UPC #	DESCRIPTION	QTY / PKG	SUG. TRADE LIST / PKG
JFWP39SS	92239	#12 x 1 SS Wood Screws Flat Head Phillips	100	\$ 68.75
JFWP40SS	92240	#12 x 1-1/4 SS Wood Screws Flat Head Phillips	100	\$ 72.50
JFWP41SS	92241	#12 x 1-1/2 SS Wood Screws Flat Head Phillips	100	\$ 89.38
JFWP42SS	92242	#12 x 2 SS Wood Screws Flat Head Phillips	100	\$120.63
JFWP43SS	92243	#12 x 2-1/2 SS Wood Screws Flat Head Phillips	100	\$131.25
JFWP44SS	92244	#12 x 3 SS Wood Screws Flat Head Phillips	100	\$124.75

Other sizes, materials and quantities available by request.

★ ★ ★ ★ ★ *"Growth Through Innovation"* ★ ★ ★ ★ ★

Metallics

229 Cross Street, Bristol, CT 06010
Tel 800-243-8272 • **Fax** 800-831-9358
Email sales@metallicsonline.com

Metallics West

651 North Main Street, Mancos, CO 81328
Tel 800-269-5183 • **Fax** 800-269-6278
Email saleswest@metallicsonline.com

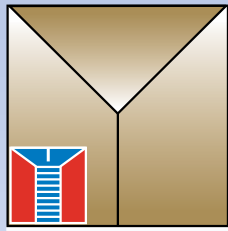

Metallics



Flat Head Slotted Machine Screw (Brass)

[CONTRACTOR APPROVED]



Slotted

PART #	UPC #	DESCRIPTION	QTY / PKG	SUG. TRADE LIST / PKG
JFMB106	76606	6-32 x 1/4 Flat Head Slotted Machine Screw (Brass)	100	\$ 7.32
JFMB62	72862	6-32 x 3/4 Flat Head Slotted Machine Screw (Brass)	100	\$ 13.25
JFMB107	76607	8-32 x 1/4 Flat Head Slotted Machine Screw (Brass)	100	\$ 7.48
JFMB83	72883	8-32 x 1/2 Flat Head Slotted Machine Screw (Brass)	100	\$ 15.75
JFMB85	72885	8-32 x 3/4 Flat Head Slotted Machine Screw (Brass)	100	\$ 18.03
JFMB86	72886	8-32 x 1 Flat Head Slotted Machine Screw (Brass)	100	\$ 20.83
JFMB87	72887	8-32 x 1 1/4 Flat Head Slotted Machine Screw (Brass)	100	\$ 14.89
JFMB108	76608	10-24 x 1/4 Flat Head Slotted Machine Screw (Brass)	100	\$ 21.25
JFMB49	72849	10-24 x 1/2 Flat Head Slotted Machine Screw (Brass)	100	\$ 24.93
JFMB92	72892	10-24 x 3/4 Flat Head Slotted Machine Screw (Brass)	100	\$ 29.98
JFMB93	72893	10-24 x 1 Flat Head Slotted Machine Screw (Brass)	100	\$ 37.40
JFMB103	76603	10-32 x 1/4 Flat Head Slotted Machine Screw (Brass)	100	\$ 20.25
JFMB95	72895	10-32 x 1/2 Flat Head Slotted Machine Screw (Brass)	100	\$ 24.18
JFMB48	72848	10-32 x 3/4 Flat Head Slotted Machine Screw (Brass)	100	\$ 28.70
JFMB98	72898	10-32 x 1 Flat Head Slotted Machine Screw (Brass)	100	\$ 35.90
JFMB76	72876	12-24 x 1/2 Flat Head Slotted Machine Screw (Brass)	100	\$ 46.13
JFMB79	72879	12-24 x 3/4 Flat Head Slotted Machine Screw (Brass)	100	\$ 61.10
JFMB80	72880	12-24 x 1 Flat Head Slotted Machine Screw (Brass)	100	\$ 65.83
JFMB99	72899	1/4-20 x 1/2 Flat Head Slotted Machine Screw (Brass)	100	\$ 49.75
JFMB100	77600	1/4-20 x 3/4 Flat Head Slotted Machine Screw (Brass)	100	\$ 49.53
JFMB30	72830	1/4-20 x 1 Flat Head Slotted Machine Screw (Brass)	100	\$ 57.37

Other sizes, materials and quantities available by request.

“Growth Through Innovation”

Metallics

229 Cross Street, Bristol, CT 06010
 Tel 800-243-8272 • Fax 800-831-9358
 Email sales@metallicsonline.com

Metallics West

651 North Main Street, Mancos, CO 81328
 Tel 800-269-5183 • Fax 800-269-6278
 Email saleswest@metallicsonline.com

A

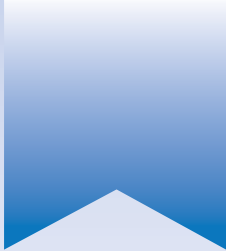
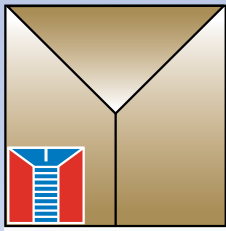

Metallics

Flat Head Phillips Machine Screw

(Stainless Steel) 18-8 Series Type



**[CONTRACTOR
APPROVED]**



PART #	UPC #	DESCRIPTION	QTY / PKG	SUG. TRADE LIST / PKG
JFMP64SS	93464	6-32 x 1/4 Flat Head Phillips Machine Screw (SS)	100	\$ 3.67
JFMP68SS	93468	6-32 x 1 1/4 Flat Head Phillips Machine Screw (SS)	100	\$ 6.91
JFMP82SS	93482	6-32 x 1 1/2 Flat Head Phillips Machine Screw (SS)	100	\$ 11.73
JFMP83SS	93483	6-32 x 2 Flat Head Phillips Machine Screw (SS)	100	\$ 11.79
JFMP140SS	98440	6-32 x 2 1/2 Flat Head Phillips Machine Screw (SS)	100	\$ 16.49
JFMP142SS	98442	6-32 x 3 Flat Head Phillips Machine Screw (SS)	100	\$ 19.23
JFMP70SS	93970	10-24 x 1/2 Flat Head Phillips Machine Screw (SS)	100	\$ 9.87
JFMP71SS	93971	10-24 x 3/4 Flat Head Phillips Machine Screw (SS)	100	\$ 12.80
JFMP72SS	93972	10-24 x 1 Flat Head Phillips Machine Screw (SS)	100	\$ 16.05
JFMP49SS	93949	10-32 x 1/2 Flat Head Phillips Machine Screw (SS)	100	\$ 11.85
JFMP50SS	93950	10-32 x 5/8 Flat Head Phillips Machine Screw (SS)	100	\$ 12.38
JFMP48SS	91948	10-32 x 3/4 Flat Head Phillips Machine Screw (SS)	100	\$ 19.76
JFMP51SS	93951	10-32 x 1 Flat Head Phillips Machine Screw (SS)	100	\$ 20.16
JFMP69SS	93469	10-32 x 1 1/4 Flat Head Phillips Machine Screw (SS)	100	\$ 11.81
JFMP92SS	93492	10-32 x 1 1/2 Flat Head Phillips Machine Screw (SS)	100	\$ 19.58
JFMP93SS	93493	10-32 x 2 Flat Head Phillips Machine Screw (SS)	100	\$ 24.15
JFMP94SS	93494	10-32 x 3 Flat Head Phillips Machine Screw (SS)	100	\$ 30.10

Other sizes, materials and quantities available by request.

Chart continued to next page.

"Growth Through Innovation"

Metallics

229 Cross Street, Bristol, CT 06010
Tel 800-243-8272 • **Fax** 800-831-9358
Email sales@metallicsonline.com

Metallics West

651 North Main Street, Mancos, CO 81328
Tel 800-269-5183 • **Fax** 800-269-6278
Email saleswest@metallicsonline.com

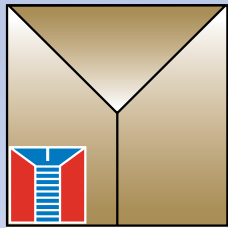

Metallics



Flat Head Phillips Machine Screw

(Stainless Steel) 18-8 Series Type



Chart continued from previous page.

PART #	UPC #	DESCRIPTION	QTY / PKG	SUG. TRADE LIST / PKG
JFMP99SS	93499	1/4-20 x 1/2 Flat Head Phillips Machine Screw (SS)	100	\$ 13.17
JFMP100SS	93500	1/4-20 x 3/4 Flat Head Phillips Machine Screw (SS)	100	\$ 23.90
JFMP101SS	92280	1/4-20 x 1 Flat Head Phillips Machine Screw (SS)	100	\$ 34.25
JFMP103SS	98403	1/4-20 x 1 1/2 Flat Head Phillips Machine Screw (SS)	100	\$ 35.22
JFMP104SS	98404	1/4-20 x 2 Flat Head Phillips Machine Screw (SS)	100	\$ 38.36
JFMP105SS	98405	1/4-20 x 3 Flat Head Phillips Machine Screw (SS)	100	\$ 42.96
JFMP65SS	93965	5/16 x 1 Flat Head Phillips Machine Screw (SS)	100	\$ 49.75

Other sizes, materials and quantities available by request.

“Growth Through Innovation”

Metallics

229 Cross Street, Bristol, CT 06010
Tel 800-243-8272 • **Fax** 800-831-9358
Email sales@metallicsonline.com

Metallics West

651 North Main Street, Mancos, CO 81328
Tel 800-269-5183 • **Fax** 800-269-6278
Email saleswest@metallicsonline.com

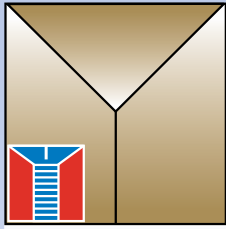

Metallics

Flat Head Slotted Machine Screw Steel (Zinc)



**[CONTRACTOR
APPROVED]**



Slotted

PART #	UPC #	DESCRIPTION	QTY / PKG	SUG. TRADE LIST / PKG
JFM30	83830	4-40 x 1/2 Flat Head Slotted Machine Screw (Zinc)	100	\$ 5.30
JFM46	83846	4-40 x 3/4 Flat Head Slotted Machine Screw (Zinc)	100	\$ 5.82
JFM47	83847	5-40 x 3/4 Flat Head Slotted Machine Screw (Zinc)	100	\$ 6.00
JFM62	83862	5-40 x 1 Flat Head Slotted Machine Screw (Zinc)	100	\$ 6.70
JFM3	83803	6-32 x 1/4 Flat Head Slotted Machine Screw (Zinc)	100	\$ 4.60
JFM39	83839	6-32 x 5/8 Flat Head Slotted Machine Screw (Zinc)	100	\$ 5.67
JFM79	83879	6-32 x 1 3/4 Flat Head Slotted Machine Screw (Zinc)	100	\$ 2.60
JFM106	83906	8-32 x 1 3/4 Flat Head Slotted Machine Screw (Zinc)	100	\$ 8.88
JFM109	83909	10-24 x 1 1/4 Flat Head Slotted Machine Screw (Zinc)	100	\$ 11.70
JFM6	83806	10-32 x 1/4 Flat Head Slotted Machine Screw (Zinc)	100	\$ 6.17
JFM8	83808	12-24 x 1/4 Flat Head Slotted Machine Screw (Zinc)	100	\$ 24.75
JFM196	76596	12-24 x 1/2 Flat Head Slotted Machine Screw (Zinc)	100	\$ 13.92
JFM9	83809	12-24 x 1 Flat Head Slotted Machine Screw (Zinc)	100	\$ 19.25
JFM7	83807	1/4-20 x 1/4 Flat Head Slotted Machine Screw (Zinc)	100	\$ 34.75
JFM14	83814	1/4-20 x 5/16 Flat Head Slotted Machine Screw (Zinc)	100	\$ 11.70
JFM134	84088	1/4-20 x 6 Flat Head Slotted Machine Screw (Zinc)	100	\$ 67.17
JFM129	76529	5/16-8 x 3 Flat Head Slotted Machine Screw (Zinc)	100	\$ 51.62
JFM114	83914	1/2-13 x 1 Flat Head Slotted Machine Screw (Zinc)	100	\$ 39.70

Other sizes, materials and quantities available by request.

“Growth Through Innovation”

Metallics

229 Cross Street, Bristol, CT 06010
Tel 800-243-8272 • **Fax** 800-831-9358
Email sales@metallicsonline.com

Metallics West

651 North Main Street, Mancos, CO 81328
Tel 800-269-5183 • **Fax** 800-269-6278
Email saleswest@metallicsonline.com

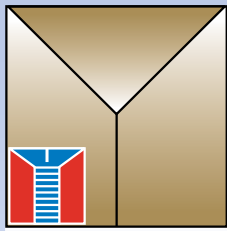

Metallics



Alloy Steel (Black) Socket Set Screws Cup Type

**[CONTRACTOR
APPROVED]**



PART #	UPC #	DESCRIPTION	QTY / PKG	SUG. TRADE LIST / PKG
JSS614	65517	6-32 x 1/4 Alloy Steel (Black) Socket Set Screws Cup Type	100	\$ 7.81
JSS638	65525	6-32 x 3/8 Alloy Steel (Black) Socket Set Screws Cup Type	100	\$ 8.75
JSS612	65533	6-32 x 1/2 Alloy Steel (Black) Socket Set Screws Cup Type	100	\$ 9.50
JSS658	64451	6-32 x 5/8 Alloy Steel (Black) Socket Set Screws Cup Type	100	\$ 15.88
JSS634	65549	6-32 x 3/4 Alloy Steel (Black) Socket Set Screws Cup Type	100	\$ 17.19
JSS8316	65581	8-32 x 3/16 Alloy Steel (Black) Socket Set Screws Cup Type	100	\$ 7.19
JSS814	65585	8-32 x 1/4 Alloy Steel (Black) Socket Set Screws Cup Type	100	\$ 7.50
JSS8516	65589	8-32 x 5/16 Alloy Steel (Black) Socket Set Screws Cup Type	100	\$ 8.13
JSS838	65593	8-32 x 3/8 Alloy Steel (Black) Socket Set Screws Cup Type	100	\$ 8.44
JSS812	65601	8-32 x 1/2 Alloy Steel (Black) Socket Set Screws Cup Type	100	\$ 9.94
JSS858	65609	8-32 x 5/8 Alloy Steel (Black) Socket Set Screws Cup Type	100	\$ 13.81
JSS834	65617	8-32 x 3/4 Alloy Steel (Black) Socket Set Screws Cup Type	100	\$ 16.81
JSS81	65632	8-32 x 1 Alloy Steel (Black) Socket Set Screws Cup Type	100	\$ 23.44
JSS24316	65651	10-24 x 3/16 Alloy Steel (Black) Socket Set Screws Cup Type	100	\$ 7.50
JSS2414	65655	10-24 x 1/4 Alloy Steel (Black) Socket Set Screws Cup Type	100	\$ 7.56
JSS24516	65659	10-24 x 5/16 Alloy Steel (Black) Socket Set Screws Cup Type	100	\$ 7.81
JSS2438	65663	10-24 x 3/8 Alloy Steel (Black) Socket Set Screws Cup Type	100	\$ 8.13
JSS2412	65671	10-24 x 1/2 Alloy Steel (Black) Socket Set Screws Cup Type	100	\$ 9.69
JSS2458	65679	10-24 x 5/8 Alloy Steel (Black) Socket Set Screws Cup Type	100	\$ 12.44
JSS2434	65687	10-24 x 3/4 Alloy Steel (Black) Socket Set Screws Cup Type	100	\$ 14.19
JSS2478	65694	10-24 x 7/8 Alloy Steel (Black) Socket Set Screws Cup Type	100	\$ 18.69
JSS241	65702	10-24 x 1 Alloy Steel (Black) Socket Set Screws Cup Type	100	\$ 23.38

*Other sizes, materials and quantities available upon request.

Chart continued to next page.

"Growth Through Innovation"

Metallics

229 Cross Street, Bristol, CT 06010
Tel 800-243-8272 • **Fax** 800-831-9358
Email sales@metallicsonline.com

Metallics West

651 North Main Street, Mancos, CO 81328
Tel 800-269-5183 • **Fax** 800-269-6278
Email saleswest@metallicsonline.com

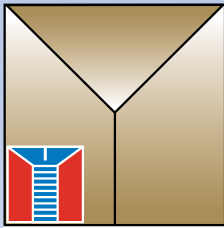

Metallics Alloy Steel (Black) Socket Set Screws Cup Type



Chart continued from previous page.

PART #	UPC #	DESCRIPTION	QTY / PKG	SUG. TRADE LIST / PKG
JSS32316	65721	10-32 x ³ / ₁₆ Alloy Steel (Black) Socket Set Screws Cup Type (Fine)	100	\$ 7.50
JSS3214	65725	10-32 x ¹ / ₄ Alloy Steel (Black) Socket Set Screws Cup Type (Fine)	100	\$ 7.81
JSS32516	65729	10-32 x ⁵ / ₁₆ Alloy Steel (Black) Socket Set Screws Cup Type (Fine)	100	\$ 7.94
JSS3238	65733	10-32 x ³ / ₈ Alloy Steel (Black) Socket Set Screws Cup Type (Fine)	100	\$ 8.13
JSS3212	65741	10-32 x ¹ / ₂ Alloy Steel (Black) Socket Set Screws Cup Type (Fine)	100	\$ 10.31
JSS3258	65749	10-32 x ⁵ / ₈ Alloy Steel (Black) Socket Set Screws Cup Type (Fine)	100	\$ 11.44
JSS3234	65757	10-32 x ³ / ₄ Alloy Steel (Black) Socket Set Screws Cup Type (Fine)	100	\$ 14.06
JSS321	65772	10-32 x 1 Alloy Steel (Black) Socket Set Screws Cup Type (Fine)	100	\$ 23.38
JSS14316	65791	¹ / ₄ -20 x ³ / ₁₆ Alloy Steel (Black) Socket Set Screws Cup Type	100	\$ 10.94
JSS1414	65795	¹ / ₄ -20 x ¹ / ₄ Alloy Steel (Black) Socket Set Screws Cup Type	100	\$ 11.10
JSS14516	65799	¹ / ₄ -20 x ⁵ / ₁₆ Alloy Steel (Black) Socket Set Screws Cup Type	100	\$ 11.30
JSS1438	65803	¹ / ₄ -20 x ³ / ₈ Alloy Steel (Black) Socket Set Screws Cup Type	100	\$ 11.40
JSS1412	65811	¹ / ₄ -20 x ¹ / ₂ Alloy Steel (Black) Socket Set Screws Cup Type	100	\$ 11.56
JSS1458	65819	¹ / ₄ -20 x ⁵ / ₈ Alloy Steel (Black) Socket Set Screws Cup Type	100	\$ 14.69
JSS1434	65827	¹ / ₄ -20 x ³ / ₄ Alloy Steel (Black) Socket Set Screws Cup Type	100	\$ 18.13
JSS1478	65834	¹ / ₄ -20 x ⁷ / ₈ Alloy Steel (Black) Socket Set Screws Cup Type	100	\$ 20.63
JSS141	65842	¹ / ₄ -20 x 1 Alloy Steel (Black) Socket Set Screws Cup Type	100	\$ 24.69
JSS14114	65858	¹ / ₄ -20 x 1 ¹ / ₄ Alloy Steel (Black) Socket Set Screws Cup Type	100	\$ 32.50
JSS14112	65874	¹ / ₄ -20 x 1 ¹ / ₂ Alloy Steel (Black) Socket Set Screws Cup Type	100	\$ 37.44
JSS51614	65921	⁵ / ₁₆ -18 x ¹ / ₄ Alloy Steel (Black) Socket Set Screws Cup Type	100	\$ 15.38
JSS516516	65925	⁵ / ₁₆ -18 x ⁵ / ₁₆ Alloy Steel (Black) Socket Set Screws Cup Type	100	\$ 13.13
JSS51638	65929	⁵ / ₁₆ -18 x ³ / ₈ Alloy Steel (Black) Socket Set Screws Cup Type	100	\$ 13.44
JSS51612	65937	⁵ / ₁₆ -18 x ¹ / ₂ Alloy Steel (Black) Socket Set Screws Cup Type	100	\$ 16.81
JSS51658	65945	⁵ / ₁₆ -18 x ⁵ / ₈ Alloy Steel (Black) Socket Set Screws Cup Type	100	\$ 19.06
JSS51634	65953	⁵ / ₁₆ -18 x ³ / ₄ Alloy Steel (Black) Socket Set Screws Cup Type	100	\$ 22.81
JSS51678	65960	⁵ / ₁₆ -18 x ⁷ / ₈ Alloy Steel (Black) Socket Set Screws Cup Type	100	\$ 27.75
JSS5161	65968	⁵ / ₁₆ -18 x 1 Alloy Steel (Black) Socket Set Screws Cup Type	100	\$ 33.06

*Other sizes, materials and quantities available upon request.

Chart continued to next page.

“Growth Through Innovation”

Metallics

229 Cross Street, Bristol, CT 06010
Tel 800-243-8272 • **Fax** 800-831-9358
Email sales@metallicsonline.com

Metallics West

651 North Main Street, Mancos, CO 81328
Tel 800-269-5183 • **Fax** 800-269-6278
Email saleswest@metallicsonline.com

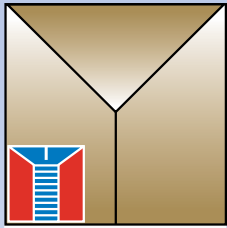

Metallics



Alloy Steel (Black) Socket Set Screws Cup Type



Chart continued from previous page.

PART #	UPC #	DESCRIPTION	QTY / PKG	SUG. TRADE LIST / PKG
JSS3814	66047	$\frac{3}{8}$ -16 x $\frac{1}{4}$ Alloy Steel (Black) Socket Set Screws Cup Type	100	\$ 24.50
JSS3838	66055	$\frac{3}{8}$ -16 x $\frac{3}{8}$ Alloy Steel (Black) Socket Set Screws Cup Type	100	\$ 17.25
JSS3812	66063	$\frac{3}{8}$ -16 x $\frac{1}{2}$ Alloy Steel (Black) Socket Set Screws Cup Type	100	\$ 20.38
JSS3858	66071	$\frac{3}{8}$ -16 x $\frac{5}{8}$ Alloy Steel (Black) Socket Set Screws Cup Type	100	\$ 26.06
JSS3834	66079	$\frac{3}{8}$ -16 x $\frac{3}{4}$ Alloy Steel (Black) Socket Set Screws Cup Type	100	\$ 27.38
JSS3878	66086	$\frac{3}{8}$ -16 x $\frac{7}{8}$ Alloy Steel (Black) Socket Set Screws Cup Type	100	\$ 38.94
JSS381	66094	$\frac{3}{8}$ -16 x 1 Alloy Steel (Black) Socket Set Screws Cup Type	100	\$ 45.38

**Other sizes, materials and quantities available upon request.*

“Growth Through Innovation”

Metallics

229 Cross Street, Bristol, CT 06010
Tel 800-243-8272 • **Fax** 800-831-9358
Email sales@metallicsonline.com

Metallics West

651 North Main Street, Mancos, CO 81328
Tel 800-269-5183 • **Fax** 800-269-6278
Email saleswest@metallicsonline.com

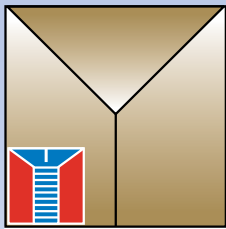

Metallics



Alloy Steel (Black) Button Head Socket Cap Screws

[CONTRACTOR APPROVED]



PART #	UPC #	DESCRIPTION	QTY / PKG	SUG. TRADE LIST / PKG
JBSC614	66172	6-32 x 1/4 Alloy Steel (Black) Button Head Socket Cap Screws	100	\$ 7.18
JBSC638	66174	6-32 x 3/8 Alloy Steel (Black) Button Head Socket Cap Screws	100	\$ 7.50
JBSC612	66176	6-32 x 1/2 Alloy Steel (Black) Button Head Socket Cap Screws	100	\$ 8.44
JBSC814	66201	8-32 x 1/4 Alloy Steel (Black) Button Head Socket Cap Screws	100	\$ 8.13
JBSC838	66023	8-32 x 3/8 Alloy Steel (Black) Button Head Socket Cap Screws	100	\$ 9.06
JBSC812	66205	8-32 x 1/2 Alloy Steel (Black) Button Head Socket Cap Screws	100	\$ 10.31
JBSC1038	66232	10-24 x 3/8 Alloy Steel (Black) Button Head Socket Cap Screws	100	\$ 9.06
JBSC1012	66234	10-24 x 1/2 Alloy Steel (Black) Button Head Socket Cap Screws	100	\$ 9.69
JBSC1034	66238	10-24 x 3/4 Alloy Steel (Black) Button Head Socket Cap Screws	100	\$ 11.88
JBSC1438	66261	1/4-20 x 3/8 Alloy Steel (Black) Button Head Socket Cap Screws	100	\$ 10.56
JBSC1412	66263	1/4-20 x 1/2 Alloy Steel (Black) Button Head Socket Cap Screws	100	\$ 12.44
JBSC1458	66265	1/4-20 x 5/8 Alloy Steel (Black) Button Head Socket Cap Screws	100	\$ 13.75
JBSC1434	66267	1/4-20 x 3/4 Alloy Steel (Black) Button Head Socket Cap Screws	100	\$ 15.44
JBSC141	66270	1/4-20 x 1 Alloy Steel (Black) Button Head Socket Cap Screws	100	\$ 18.75
JBSC51638	66415	5/16-18 x 3/8 Alloy Steel (Black) Button Head Socket Cap Screws	100	\$ 22.81
JBSC51612	66417	5/16-18 x 1/2 Alloy Steel (Black) Button Head Socket Cap Screws	100	\$ 22.50
JBSC51658	66419	5/16-18 x 5/8 Alloy Steel (Black) Button Head Socket Cap Screws	100	\$ 23.13
JBSC51634	66421	5/16-18 x 3/4 Alloy Steel (Black) Button Head Socket Cap Screws	100	\$ 26.56
JBSC51678	66423	5/16-18 x 7/8 Alloy Steel (Black) Button Head Socket Cap Screws	100	\$ 27.19
JBSC5161	66424	5/16-18 x 1 Alloy Steel (Black) Button Head Socket Cap Screws	100	\$ 29.38

*Other sizes, materials and quantities available upon request.

"Growth Through Innovation"

Metallics

229 Cross Street, Bristol, CT 06010
Tel 800-243-8272 • **Fax** 800-831-9358
Email sales@metallicsonline.com

Metallics West

651 North Main Street, Mancos, CO 81328
Tel 800-269-5183 • **Fax** 800-269-6278
Email saleswest@metallicsonline.com

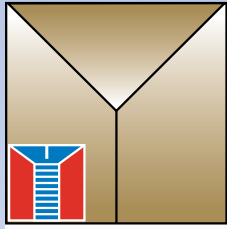

Metallics



Alloy Steel (Black) Flat Head Socket Cap Screws

[CONTRACTOR APPROVED]



PART #	UPC #	DESCRIPTION	QTY / PKG	SUG. TRADE LIST / PKG
JFSC638	66570	6-32 x 3/8 Alloy Steel (Black) Flat Head Socket Cap Screws	100	\$ 7.94
JFSC612	66572	6-32 x 1/2 Alloy Steel (Black) Flat Head Socket Cap Screws	100	\$ 8.44
JFSC658	66574	6-32 x 5/8 Alloy Steel (Black) Flat Head Socket Cap Screws	100	\$ 8.75
JFSC634	66576	6-32 x 3/4 Alloy Steel (Black) Flat Head Socket Cap Screws	100	\$ 9.38
JFSC838	66599	8-32 x 3/8 Alloy Steel (Black) Flat Head Socket Cap Screws	100	\$ 7.81
JFSC812	66601	8-32 x 1/2 Alloy Steel (Black) Flat Head Socket Cap Screws	100	\$ 8.56
JFSC858	66603	8-32 x 5/8 Alloy Steel (Black) Flat Head Socket Cap Screws	100	\$ 9.69
JFSC834	66605	8-32 x 3/4 Alloy Steel (Black) Flat Head Socket Cap Screws	100	\$ 10.94
JFSC1038	66628	10-24 x 3/8 Alloy Steel (Black) Flat Head Socket Cap Screws	100	\$ 8.13
JFSC1012	66630	10-24 x 1/2 Alloy Steel (Black) Flat Head Socket Cap Screws	100	\$ 8.44
JFSC1034	66634	10-24 x 3/4 Alloy Steel (Black) Flat Head Socket Cap Screws	100	\$ 10.63
JFSC101	66637	10-24 x 1 Alloy Steel (Black) Flat Head Socket Cap Screws	100	\$ 12.19
JFSC1412	66659	1/4-20 x 1/2 Alloy Steel (Black) Flat Head Socket Cap Screws	100	\$ 13.75
JFSC1458	66661	1/4-20 x 5/8 Alloy Steel (Black) Flat Head Socket Cap Screws	100	\$ 14.06
JFSC1434	66663	1/4-20 x 3/4 Alloy Steel (Black) Flat Head Socket Cap Screws	100	\$ 15.00
JFSC141	66666	1/4-20 x 1 Alloy Steel (Black) Flat Head Socket Cap Screws	100	\$ 18.44
JFSC14114	66669	1/4-20 x 1 1/4 Alloy Steel (Black) Flat Head Socket Cap Screws	100	\$ 22.19
JFSC14112	66673	1/4-20 x 1 1/2 Alloy Steel (Black) Flat Head Socket Cap Screws	100	\$ 25.94
JFSC51634	66817	5/16-18 x 3/4 Alloy Steel (Black) Flat Head Socket Cap Screws	100	\$ 24.38
JFSC5161	66820	5/16-18 x 1 Alloy Steel (Black) Button Head Socket Cap Screws	100	\$ 30.25
JFSC516114	66823	5/16-18 x 1 1/4 Alloy Steel (Black) Flat Head Socket Cap Screws	100	\$ 35.56
JFSC516112	66827	5/16-18 x 1 1/2 Alloy Steel (Black) Flat Head Socket Cap Screws	100	\$ 37.38

Other sizes, materials and quantities available by request.

Chart continued to next page.

"Growth Through Innovation"

Metallics

229 Cross Street, Bristol, CT 06010
Tel 800-243-8272 • **Fax** 800-831-9358
Email sales@metallicsonline.com

Metallics West

651 North Main Street, Mancos, CO 81328
Tel 800-269-5183 • **Fax** 800-269-6278
Email saleswest@metallicsonline.com

A

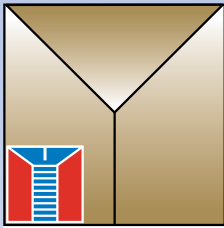

Metallics



Alloy Steel (Black) Flat Head Socket Cap Screws



Chart continued from previous page.

PART #	UPC #	DESCRIPTION	QTY / PKG	SUG. TRADE LIST / PKG
JFSC3834	66971	$\frac{3}{8}$ -16 x $\frac{3}{4}$ Alloy Steel (Black) Flat Head Socket Cap Screws	100	\$ 39.06
JFSC381	66974	$\frac{3}{8}$ -16 x 1 Alloy Steel (Black) Flat Head Socket Cap Screws	100	\$ 45.00
JFSC38114	66977	$\frac{3}{8}$ -16 x 1 $\frac{1}{4}$ Alloy Steel (Black) Flat Head Socket Cap Screws	100	\$ 50.25
JFSC38112	66981	$\frac{3}{8}$ -16 x 1 $\frac{1}{2}$ Alloy Steel (Black) Flat Head Socket Cap Screws	100	\$ 54.38
JFSC121	67128	$\frac{1}{2}$ -13 x 1 Alloy Steel (Black) Flat Head Socket Cap Screws	100	\$ 79.69
JFSC12112	67135	$\frac{1}{2}$ -13 x 1 $\frac{1}{2}$ Alloy Steel (Black) Flat Head Socket Cap Screws	50	\$ 52.85
JFSC122	67142	$\frac{1}{2}$ -13 x 2 Alloy Steel (Black) Flat Head Socket Cap Screws	50	\$ 62.91

Other sizes, materials and quantities available by request.

“Growth Through Innovation”

Metallics

229 Cross Street, Bristol, CT 06010
Tel 800-243-8272 • **Fax** 800-831-9358
Email sales@metallicsonline.com

Metallics West

651 North Main Street, Mancos, CO 81328
Tel 800-269-5183 • **Fax** 800-269-6278
Email saleswest@metallicsonline.com

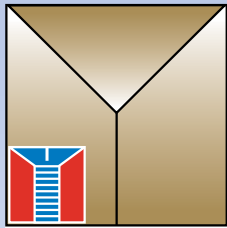

Metallics



Alloy Steel Socket Drive Cap Screws

[CONTRACTOR APPROVED]



PART #	UPC #	DESCRIPTION	QTY / PKG	SUG. TRADE LIST / PKG
JSHC614	67271	6-32 x 1/4 Alloy Steel Socket Drive Cap Screws	100	\$ 9.70
JSHC638	67273	6-32 x 3/8 Alloy Steel Socket Drive Cap Screws	100	\$ 10.06
JSHC612	67276	6-32 x 1/2 Alloy Steel Socket Drive Cap Screws	100	\$ 10.31
JSHC658	67277	6-32 x 5/8 Alloy Steel Socket Drive Cap Screws	100	\$ 11.19
JSHC634	67279	6-32 x 3/4 Alloy Steel Socket Drive Cap Screws	100	\$ 11.56
JSHC61	67282	6-32 x 1 Alloy Steel Socket Drive Cap Screws	100	\$ 12.19
JSHC814	67300	8-32 x 1/4 Alloy Steel Socket Drive Cap Screws	100	\$ 10.94
JSHC838	67302	8-32 x 3/8 Alloy Steel Socket Drive Cap Screws	100	\$ 11.19
JSHC812	67304	8-32 x 1/2 Alloy Steel Socket Drive Cap Screws	100	\$ 11.56
JSHC858	67306	8-32 x 5/8 Alloy Steel Socket Drive Cap Screws	100	\$ 11.88
JSHC834	67308	8-32 x 3/4 Alloy Steel Socket Drive Cap Screws	100	\$ 12.56
JSHC878	67310	8-32 x 7/8 Alloy Steel Socket Drive Cap Screws	100	\$ 13.13
JSHC81	67311	8-32 x 1 Alloy Steel Socket Drive Cap Screws	100	\$ 13.44
JSHC1038	67331	10-24 x 3/8 Alloy Steel Socket Drive Cap Screws	100	\$ 10.06
JSHC1012	67333	10-24 x 1/2 Alloy Steel Socket Drive Cap Screws	100	\$ 10.94
JSHC1058	67335	10-24 x 5/8 Alloy Steel Socket Drive Cap Screws	100	\$ 11.56
JSHC1034	67337	10-24 x 3/4 Alloy Steel Socket Drive Cap Screws	100	\$ 11.88
JSHC1078	67339	10-24 x 7/8 Alloy Steel Socket Drive Cap Screws	100	\$ 13.44
JSHC101	67340	10-24 x 1 Alloy Steel Socket Drive Cap Screws	100	\$ 14.06
JSHC10114	67343	10-24 x 1-1/4 Alloy Steel Socket Drive Cap Screws	100	\$ 15.75
JSHC10112	67347	10-24 x 1-1/2 Alloy Steel Socket Drive Cap Screws	100	\$ 18.44
JSHC10134	67351	10-24 x 1-3/4 Alloy Steel Socket Drive Cap Screws	100	\$ 21.88
JSHC102	67354	10-24 x 2 Alloy Steel Socket Drive Cap Screws	100	\$ 26.56

Other sizes, materials and quantities available by request.

Chart continued to next page.

"Growth Through Innovation"

Metallics

229 Cross Street, Bristol, CT 06010
Tel 800-243-8272 • **Fax** 800-831-9358
Email sales@metallicsonline.com

Metallics West

651 North Main Street, Mancos, CO 81328
Tel 800-269-5183 • **Fax** 800-269-6278
Email saleswest@metallicsonline.com

A

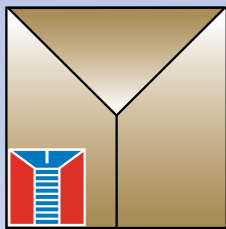

Metallics



Alloy Steel Socket Drive Cap Screws



Chart continued from previous page.

PART #	UPC #	DESCRIPTION	QTY / PKG	SUG. TRADE LIST / PKG
JSHC1438	67360	1/4-20 x 3/8 Alloy Steel Socket Drive Cap Screws	100	\$ 14.94
JSHC1412	67362	1/4-20 x 1/2 Alloy Steel Socket Drive Cap Screws	100	\$ 13.13
JSHC1458	67364	1/4-20 x 5/8 Alloy Steel Socket Drive Cap Screws	100	\$ 13.75
JSHC1434	67366	1/4-20 x 3/4 Alloy Steel Socket Drive Cap Screws	100	\$ 15.06
JSHC1478	67522	1/4-20 x 7/8 Alloy Steel Socket Drive Cap Screws	100	\$ 16.06
JSHC141	67523	1/4-20 x 1 Alloy Steel Socket Drive Cap Screws	100	\$ 18.06
JSHC14114	67526	1/4-20 x 1-1/4 Alloy Steel Socket Drive Cap Screws	100	\$ 20.94
JSHC14112	67530	1/4-20 x 1-1/2 Alloy Steel Socket Drive Cap Screws	100	\$ 24.38
JSHC14134	67534	1/4-20 x 1-3/4 Alloy Steel Socket Drive Cap Screws	100	\$ 27.81
JSHC142	67537	1/4-20 x 2 Alloy Steel Socket Drive Cap Screws	100	\$ 32.75
JSHC51612	67670	5/16-18 x 1/2 Alloy Steel Socket Drive Cap Screws	100	\$ 25.94
JSHC51658	67672	5/16-18 x 5/8 Alloy Steel Socket Drive Cap Screws	100	\$ 26.25
JSHC51634	67674	5/16-18 x 3/4 Alloy Steel Socket Drive Cap Screws	100	\$ 26.56
JSHC51678	67676	5/16-18 x 7/8 Alloy Steel Socket Drive Cap Screws	100	\$ 28.44
JSHC5161	67677	5/16-18 x 1 Alloy Steel Socket Drive Cap Screws	100	\$ 30.94
JSHC516114	67680	5/16-18 x 1-1/4 Alloy Steel Socket Drive Cap Screws	100	\$ 35.63
JSHC516112	67684	5/16-18 x 1-1/2 Alloy Steel Socket Drive Cap Screws	100	\$ 42.06
JSHC516134	67688	5/16-18 x 1-3/4 Alloy Steel Socket Drive Cap Screws	100	\$ 47.06
JSHC5162	67691	5/16-18 x 2 Alloy Steel Socket Drive Cap Screws	100	\$ 48.25
JSHC516212	67698	5/16-18 x 2-1/2 Alloy Steel Socket Drive Cap Screws	100	\$ 65.25

Other sizes, materials and quantities available by request.

Chart continued to next page.

“Growth Through Innovation”

Metallics

229 Cross Street, Bristol, CT 06010
Tel 800-243-8272 • **Fax** 800-831-9358
Email sales@metallicsonline.com

Metallics West

651 North Main Street, Mancos, CO 81328
Tel 800-269-5183 • **Fax** 800-269-6278
Email saleswest@metallicsonline.com

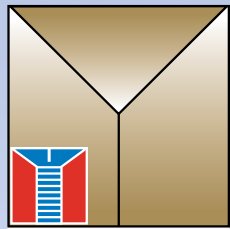

Metallics



Alloy Steel Socket Drive Cap Screws



Chart continued from previous page.

PART #	UPC #	DESCRIPTION	QTY / PKG	SUG. TRADE LIST / PKG
JSHC3812	67824	3/8-16 x 1/2 Alloy Steel Socket Drive Cap Screws	100	\$ 35.94
JSHC3858	67826	3/8-16 x 5/8 Alloy Steel Socket Drive Cap Screws	100	\$ 40.00
JSHC3834	67828	3/8-16 x 3/4 Alloy Steel Socket Drive Cap Screws	100	\$ 40.63
JSHC3878	67830	3/8-16 x 7/8 Alloy Steel Socket Drive Cap Screws	100	\$ 46.81
JSHC381	67831	3/8-16 x 1 Alloy Steel Socket Drive Cap Screws	100	\$ 48.44
JSHC38114	67834	3/8-16 x 1-1/4 Alloy Steel Socket Drive Cap Screws	100	\$ 54.06
JSHC38112	67838	3/8-16 x 1-1/2 Alloy Steel Socket Drive Cap Screws	100	\$ 60.25
JSHC38134	67842	3/8-16 x 1-3/4 Alloy Steel Socket Drive Cap Screws	100	\$ 70.06
JSHC382	67845	3/8-16 x 2 Alloy Steel Socket Drive Cap Screws	25	\$ 18.72
JSHC71634	67982	7/16-14 x 3/4 Alloy Steel Socket Drive Cap Screws	100	\$ 68.06
JSHC7161	67985	7/16-14 x 1 Alloy Steel Socket Drive Cap Screws	100	\$ 79.69
JSHC716114	67988	7/16-14 x 1-1/4 Alloy Steel Socket Drive Cap Screws	100	\$ 89.06
JSHC716112	67992	7/16-14 x 1-1/2 Alloy Steel Socket Drive Cap Screws	100	\$ 99.38
JSHC716134	67996	7/16-14 x 1-3/4 Alloy Steel Socket Drive Cap Screws	100	\$ 119.88
JSHC7162	67999	7/16-14 x 2 Alloy Steel Socket Drive Cap Screws	100	\$ 125.63
JSHC71234	68136	1/2-13 x 3/4 Alloy Steel Socket Drive Cap Screws	100	\$ 90.63
JSHC7121	68139	1/2-13 x 1 Alloy Steel Socket Drive Cap Screws	100	\$ 99.56
JSHC712114	68142	1/2-13 x 1-1/4 Alloy Steel Socket Drive Cap Screws	100	\$ 106.81
JSHC712112	68146	1/2-13 x 1-1/2 Alloy Steel Socket Drive Cap Screws	100	\$ 117.94
JSHC712134	68150	1/2-13 x 1-3/4 Alloy Steel Socket Drive Cap Screws	50	\$ 65.47
JSHC7122	68153	1/2-13 x 2 Alloy Steel Socket Drive Cap Screws	50	\$ 69.69
JSHC712212	86160	1/2-13 x 2-1/2 Alloy Steel Socket Drive Cap Screws	50	\$ 84.38
JSHC7123	68167	1/2-13 x 3 Alloy Steel Socket Drive Cap Screws	50	\$ 101.41
JSHC712312	68174	1/2-13 x 3-1/2 Alloy Steel Socket Drive Cap Screws	50	\$ 121.10
JSHC7124	68181	1/2-13 x 4 Alloy Steel Socket Drive Cap Screws	50	\$ 136.44

Other sizes, materials and quantities available by request.

Chart continued to next page.

“Growth Through Innovation”

Metallics

229 Cross Street, Bristol, CT 06010
 Tel 800-243-8272 • Fax 800-831-9358
 Email sales@metallicsonline.com

Metallics West

651 North Main Street, Mancos, CO 81328
 Tel 800-269-5183 • Fax 800-269-6278
 Email saleswest@metallicsonline.com

A

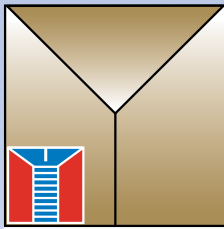

Metallics

Alloy Steel Socket Drive Cap Screws



Chart continued from previous page.

PART #	UPC #	DESCRIPTION	QTY / PKG	SUG. TRADE LIST / PKG
JSHC581	68293	5/8-11 x 1 Alloy Steel Socket Drive Cap Screws	50	\$ 94.53
JSHC58114	68296	5/8-11 x 1-1/4 Alloy Steel Socket Drive Cap Screws	50	\$ 100.63
JSHC58112	68300	5/8-11 x 1-1/2 Alloy Steel Socket Drive Cap Screws	50	\$ 110.16
JSHC58134	68304	5/8-11 x 1-3/4 Alloy Steel Socket Drive Cap Screws	50	\$ 116.16
JSHC582	68307	5/8-11 x 2 Alloy Steel Socket Drive Cap Screws	50	\$ 129.07
JSHC58214	68310	5/8-11 x 2-1/4 Alloy Steel Socket Drive Cap Screws	25	\$ 66.38
JSHC58212	68314	5/8-11 x 2-1/2 Alloy Steel Socket Drive Cap Screws	25	\$ 72.38
JSHC58234	68318	5/8-11 x 2-3/4 Alloy Steel Socket Drive Cap Screws	25	\$ 80.39
JSHC583	68321	5/8-11 x 3 Alloy Steel Socket Drive Cap Screws	25	\$ 87.11
JSHC58312	68328	5/8-11 x 3-1/2 Alloy Steel Socket Drive Cap Screws	25	\$ 98.45
JSHC584	68335	5/8-11 x 4 Alloy Steel Socket Drive Cap Screws	25	\$ 109.89
JSHC58412	58342	5/8-11 x 4-1/2 Alloy Steel Socket Drive Cap Screws	25	\$ 121.69
JSHC585	68349	5/8-11 x 5 Alloy Steel Socket Drive Cap Screws	25	\$ 136.72
JSHC34114	68444	3/4-10 x 1-1/4 Alloy Steel Socket Drive Cap Screws	25	\$ 82.88
JSHC34112	68447	3/4-10 x 1-1/2 Alloy Steel Socket Drive Cap Screws	25	\$ 85.35
JSHC34134	68458	3/4-10 x 1-3/4 Alloy Steel Socket Drive Cap Screws	25	\$ 86.60
JSHC342	68461	3/4-10 x 2 Alloy Steel Socket Drive Cap Screws	25	\$ 95.81
JSHC34214	68464	3/4-10 x 2-1/4 Alloy Steel Socket Drive Cap Screws	25	\$ 101.41
JSHC34212	68468	3/4-10 x 2-1/2 Alloy Steel Socket Drive Cap Screws	25	\$ 108.92
JSHC343	68475	3/4-10 x 3 Alloy Steel Socket Drive Cap Screws	25	\$ 127.69
JSHC34312	68482	3/4-10 x 3-1/2 Alloy Steel Socket Drive Cap Screws	25	\$ 150.55
JSHC344	68489	3/4-10 x 4 Alloy Steel Socket Drive Cap Screws	25	\$ 168.60
JSHC345	68503	3/4-10 x 5 Alloy Steel Socket Drive Cap Screws	25	\$ 203.13

Other sizes, materials and quantities available by request.

“Growth Through Innovation”

Metallics

229 Cross Street, Bristol, CT 06010
 Tel 800-243-8272 • Fax 800-831-9358
 Email sales@metallicsonline.com

Metallics West

651 North Main Street, Mancos, CO 81328
 Tel 800-269-5183 • Fax 800-269-6278
 Email saleswest@metallicsonline.com

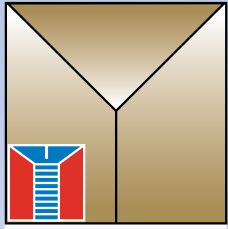

Metallics



Flat Head Tamper Resist Spanner Machine Screw (Stainless Steel) 18-8 Series Type

**[CONTRACTOR
APPROVED]**



 Spanner Head

PART #	UPC #	DESCRIPTION	QTY / PKG	SUG. TRADE LIST / PKG
TP324SFC	40313	6-32 x 1/4 Flat Head Tamper Resist Spanner Machine Screw	100	\$ 76.73
TP326SFC	34511	6-32 x 3/8 Flat Head Tamper Resist Spanner Machine Screw	100	\$ 79.58
TP327SFC	34513	6-32 x 5/8 Flat Head Tamper Resist Spanner Machine Screw	100	\$ 84.68
TP328SFC	34524	8-32 x 3/8 Flat Head Tamper Resist Spanner Machine Screw	100	\$ 79.20
TP329SFC	34526	8-32 x 5/8 Flat Head Tamper Resist Spanner Machine Screw	100	\$ 86.03
TP330SFC	34537	10-24 x 3/8 Flat Head Tamper Resist Spanner Machine Screw	100	\$ 87.83
TP331SFC	34539	10-24 x 5/8 Flat Head Tamper Resist Spanner Machine Screw	100	\$ 96.83
TP333SFC	34550	10-32 x 3/8 Flat Head Tamper Resist Spanner Machine Screw	100	\$ 89.25
TP334SFC	34551	10-32 x 1/2 Flat Head Tamper Resist Spanner Machine Screw	100	\$ 94.35
TP335SFC	34552	10-32 x 5/8 Flat Head Tamper Resist Spanner Machine Screw	100	\$ 99.38
TP336SFC	34553	10-32 x 3/4 Flat Head Tamper Resist Spanner Machine Screw	100	\$ 101.55
TP337SFC	34554	10-32 x 1 Flat Head Tamper Resist Spanner Machine Screw	100	\$ 109.05
TP338SFC	34555	10-32 x 1 1/4 Flat Head Tamper Resist Spanner Machine Screw	100	\$ 118.20
TP339SFC	34556	10-32 x 1 1/2 Flat Head Tamper Resist Spanner Machine Screw	100	\$ 127.28
TP340SFC	34557	10-32 x 2 Flat Head Tamper Resist Spanner Machine Screw	100	\$ 149.55
TP341SFC	34558	10-32 x 2 1/2 Flat Head Tamper Resist Spanner Machine Screw	100	\$ 168.23

Other sizes, materials and quantities available by request.

Chart continued to next page.

“Growth Through Innovation”

Metallics

229 Cross Street, Bristol, CT 06010
 Tel 800-243-8272 • Fax 800-831-9358
 Email sales@metallicsonline.com

Metallics West

651 North Main Street, Mancos, CO 81328
 Tel 800-269-5183 • Fax 800-269-6278
 Email saleswest@metallicsonline.com

A

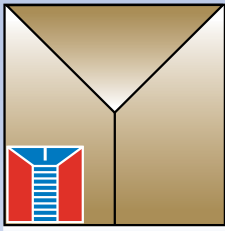

Metallics

NEW!
2014-2015

Flat Head Tamper Resist Spanner Machine Screw

(Stainless Steel) 18-8 Series Type



Spanner Head

Chart continued from previous page.

PART #	UPC #	DESCRIPTION	QTY / PKG	SUG. TRADE LIST / PKG
TP342SFC	40367	1/4-20 x 3/8 Flat Head Tamper Resist Spanner Machine Screw	100	\$ 124.95
TP343SFC	40368	1/4-20 x 1/2 Flat Head Tamper Resist Spanner Machine Screw	100	\$ 133.20
TP344SFC	34565	1/4-20 x 5/8 Flat Head Tamper Resist Spanner Machine Screw	100	\$ 141.30
TP345SFC	34566	1/4-20 x 3/4 Flat Head Tamper Resist Spanner Machine Screw	100	\$ 142.65
TP346SFC	34567	1/4-20 x 1 Flat Head Tamper Resist Spanner Machine Screw	100	\$ 157.88
TP347SFC	34568	1/4-20 x 1 1/4 Flat Head Tamper Resist Spanner Machine Screw	100	\$ 173.70
TP348SFC	34569	1/4-20 x 1 1/2 Flat Head Tamper Resist Spanner Machine Screw	100	\$ 188.70
TP349SFC	34570	1/4-20 x 2 Flat Head Tamper Resist Spanner Machine Screw	100	\$ 222.53
TP350SFC	34571	1/4-20 x 2 1/2 Flat Head Tamper Resist Spanner Machine Screw	100	\$ 246.00

Other sizes, materials and quantities available by request.

"Growth Through Innovation"

Metallics

229 Cross Street, Bristol, CT 06010
Tel 800-243-8272 • **Fax** 800-831-9358
Email sales@metallicsonline.com

Metallics West

651 North Main Street, Mancos, CO 81328
Tel 800-269-5183 • **Fax** 800-269-6278
Email saleswest@metallicsonline.com

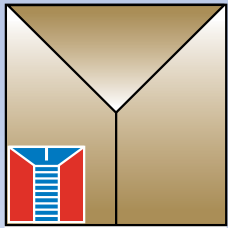

Metallics



Tamper Resist Flat Head Star Pin Machine Screw (Stainless Steel) 18-8 Series Type

[CONTRACTOR APPROVED]



 Star Head

PART #	UPC #	DESCRIPTION	QTY / PKG	SUG. TRADE LIST / PKG
TP222SFC	30754	6-32 x 1/4 Flat Head Star Pin Machine Screw	100	\$ 95.18
TP223SFC	30755	6-32 x 3/8 Flat Head Star Pin Machine Screw	100	\$ 90.00
TP224SFC	30767	8-32 x 1/4 Flat Head Star Pin Machine Screw	100	\$ 93.90
TP225SFC	30768	8-32 x 3/8 Flat Head Star Pin Machine Screw	100	\$ 97.50
TP226SFC	30781	10-24 x 3/8 Flat Head Star Pin Machine Screw	100	\$ 109.95
TP227SFC	30782	10-24 x 1/2 Flat Head Star Pin Machine Screw	100	\$ 118.20
TP228SFC	30783	10-24 x 5/8 Flat Head Star Pin Machine Screw	100	\$ 113.40
TP229SFC	30794	10-32 x 3/8 Flat Head Star Pin Machine Screw	100	\$ 109.95
TP230SFC	30795	10-32 x 1/2 Flat Head Star Pin Machine Screw	100	\$ 118.20
TP231SFC	30797	10-32 x 3/4 Flat Head Star Pin Machine Screw	100	\$ 119.70
TP232SFC	30798	10-32 x 1 Flat Head Star Pin Machine Screw	100	\$ 134.40
TP233SFC	30799	10-32 x 1 1/4 Flat Head Star Pin Machine Screw	100	\$ 148.35
TP234SFC	30806	10-32 x 1 1/2 Flat Head Star Pin Machine Screw	100	\$ 157.58
TP235SFC	30807	1/4-20 x 3/8 Flat Head Star Pin Machine Screw	100	\$ 130.58
TP236SFC	30809	1/4-20 x 5/8 Flat Head Star Pin Machine Screw	100	\$ 152.40

Other sizes, materials and quantities available by request.

“Growth Through Innovation”

Metallics

229 Cross Street, Bristol, CT 06010
 Tel 800-243-8272 • Fax 800-831-9358
 Email sales@metallicsonline.com

Metallics West

651 North Main Street, Mancos, CO 81328
 Tel 800-269-5183 • Fax 800-269-6278
 Email saleswest@metallicsonline.com

A

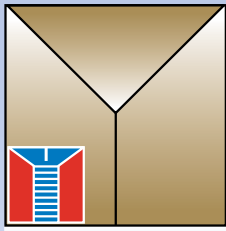

Metallics Metric Pan Head Phillips Machine Screw (Steel Zinc)



**[CONTRACTOR
APPROVED]**



Phillips

PART #	UPC #	DESCRIPTION	QTY / PKG	SUG. TRADE LIST / PKG
JMPMP36	79788	Metric Pan Head Phillips Machine Screw (Size M3 x 6)	100	\$ 3.23
JMPMP38	79790	Metric Pan Head Phillips Machine Screw (Size M3 x 8)	100	\$ 3.30
JMPMP310	79792	Metric Pan Head Phillips Machine Screw (Size M3 x 10)	100	\$ 3.68
JMPMP48	79822	Metric Pan Head Phillips Machine Screw (Size M4 x 8)	100	\$ 3.90
JMPMP410	79824	Metric Pan Head Phillips Machine Screw (Size M4 x 10)	100	\$ 3.68
JMPMP516	79860	Metric Pan Head Phillips Machine Screw (Size M5 x 16)	100	\$ 8.85
JMPMP520	79864	Metric Pan Head Phillips Machine Screw (Size M5 x 20)	100	\$ 10.20
JMPMP612	62923	Metric Pan Head Phillips Machine Screw (Size M6 x 12)	100	\$ 11.63
JMPMP616	62927	Metric Pan Head Phillips Machine Screw (Size M6 x 16)	100	\$ 12.98
JMPMP620	62931	Metric Pan Head Phillips Machine Screw (Size M6 x 20)	100	\$ 14.33

Other sizes, materials and quantities available by request.

“Growth Through Innovation”

Metallics

229 Cross Street, Bristol, CT 06010
Tel 800-243-8272 • **Fax** 800-831-9358
Email sales@metallicsonline.com

Metallics West

651 North Main Street, Mancos, CO 81328
Tel 800-269-5183 • **Fax** 800-269-6278
Email saleswest@metallicsonline.com

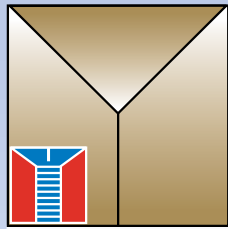

Metallics Pan Head Phillips Machine Screw (Steel Zinc)



**[CONTRACTOR
APPROVED]**



PART #	UPC #	DESCRIPTION	QTY / PKG	SUG. TRADE LIST / PKG
JPMP80	86261	6-32 x 1/2 Pan Head Phillips Machine Screw - Zinc	100	\$ 4.32
JPMP81	86262	6-32 x 3/4 Pan Head Phillips Machine Screw - Zinc	100	\$ 6.05
JPMP63	86263	6-32 x 1 Pan Head Phillips Machine Screw - Zinc	100	\$ 6.13
JPMP82	86265	6-32 x 1 1/4 Pan Head Phillips Machine Screw - Zinc	100	\$ 8.83
JPMP113	82296	6-32 x 1 1/2 Pan Head Phillips Machine Screw - Zinc	100	\$ 9.45
JPMP13	86278	6-32 x 2 Pan Head Phillips Machine Screw - Zinc	100	\$ 11.12
JPMP84	86270	8-32 x 1/2 Pan Head Phillips Machine Screw - Zinc	100	\$ 5.40
JPMP85	86271	8-32 x 3/4 Pan Head Phillips Machine Screw - Zinc	100	\$ 5.63
JPMP86	86272	8-32 x 1 Pan Head Phillips Machine Screw - Zinc	100	\$ 5.71
JPMP87	86273	8-32 x 1 1/4 Pan Head Phillips Machine Screw - Zinc	100	\$ 9.38
JPMP88	86266	8-32 x 1 1/2 Pan Head Phillips Machine Screw - Zinc	100	\$ 9.46
JPMP89	86275	8-32 x 2 Pan Head Phillips Machine Screw - Zinc	100	\$ 13.58
JPMP33	72033	10-32 x 1/2 Pan Head Phillips Machine Screw - Zinc	100	\$ 10.65
JPMP36	86307	10-32 x 3/4 Pan Head Phillips Machine Screw - Zinc	100	\$ 17.35
JPMP1032	86234	10-32 x 1 Pan Head Phillips Machine Screw - Zinc	100	\$ 13.08
JPMP69	86292	10-32 x 1 1/4 Pan Head Phillips Machine Screw - Zinc	100	\$ 13.38
JPMP75	86294	10-32 x 1 1/2 Pan Head Phillips Machine Screw - Zinc	100	\$ 10.56
JPMP114	86322	10-32 x 2 Pan Head Phillips Machine Screw - Zinc	100	\$ 22.25

Other sizes, materials and quantities available by request.

Chart continued to next page.

“Growth Through Innovation”

Metallics

229 Cross Street, Bristol, CT 06010
Tel 800-243-8272 • **Fax** 800-831-9358
Email sales@metallicsonline.com

Metallics West

651 North Main Street, Mancos, CO 81328
Tel 800-269-5183 • **Fax** 800-269-6278
Email saleswest@metallicsonline.com

A

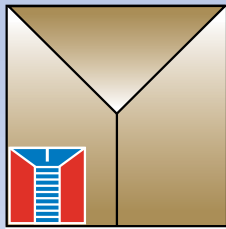

Metallics Pan Head Phillips Machine Screw (Steel Zinc)



Phillips

Chart continued from previous page.

PART #	UPC #	DESCRIPTION	QTY / PKG	SUG. TRADE LIST / PKG
JPMP99	86298	1/4-20 x 1/2 Pan Head Phillips Machine Screw - Zinc	100	\$ 15.83
JPMP100	86299	1/4-20 x 3/4 Pan Head Phillips Machine Screw - Zinc	100	\$ 17.13
JPMP101	86300	1/4-20 x 1 Pan Head Phillips Machine Screw - Zinc	100	\$ 24.63
JPMP102	86301	1/4-20 x 1 1/4 Pan Head Phillips Machine Screw - Zinc	100	\$ 25.03
JPMP103	86302	1/4-20 x 1 1/2 Pan Head Phillips Machine Screw - Zinc	100	\$ 34.38
JPMP104	86303	1/4-20 x 2 Pan Head Phillips Machine Screw - Zinc	100	\$ 35.25

Other sizes, materials and quantities available by request.

“Growth Through Innovation”

Metallics

229 Cross Street, Bristol, CT 06010
Tel 800-243-8272 • **Fax** 800-831-9358
Email sales@metallicsonline.com

Metallics West

651 North Main Street, Mancos, CO 81328
Tel 800-269-5183 • **Fax** 800-269-6278
Email saleswest@metallicsonline.com

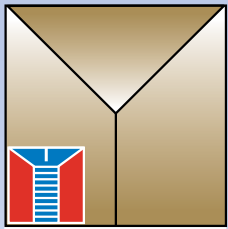

Metallics



Tamper Resist Pan Head Spanner Machine Screw (Stainless Steel) 18-8 Series Type

**[CONTRACTOR
APPROVED]**



 Spanner Head

PART #	UPC #	DESCRIPTION	QTY / PKG	SUG. TRADE LIST / PKG
TP332SPC	34667	10-32 x 1/2 Pan Head Spanner Machine Screw	100	\$ 94.35
TP333SPC	34671	10-32 x 3/4 Pan Head Spanner Machine Screw	100	\$ 101.55
TP334SPC	34672	10-32 x 1 Pan Head Spanner Machine Screw	100	\$ 109.05
TP335SPC	34673	10-32 x 1 1/4 Pan Head Spanner Machine Screw	100	\$ 118.20
TP336SPC	34674	10-32 x 1 1/2 Pan Head Spanner Machine Screw	100	\$ 127.28
TP337SPC	34675	10-32 x 2 Pan Head Spanner Machine Screw	100	\$ 149.55
TP338SPC	34676	10-32 x 2 1/2 Pan Head Spanner Machine Screw	100	\$ 168.23

Other sizes, materials and quantities available by request.

“Growth Through Innovation”

Metallics

229 Cross Street, Bristol, CT 06010
Tel 800-243-8272 • **Fax** 800-831-9358
Email sales@metallicsonline.com

Metallics West

651 North Main Street, Mancos, CO 81328
Tel 800-269-5183 • **Fax** 800-269-6278
Email saleswest@metallicsonline.com

SCREWS

 Slotted
 Phillips
 Two drives
 in one head!



ROUND "COMBO" MACHINE SCREWS

SLOTTED AND PHILLIPS. STEEL ZINC CHROMATE

In 1985, Metallics was the first fastener company in America to offer a full line of Combo's!

STOCK NO.	UPC NO.	DIAMETER	LENGTH	WT. PER PKG.	STD. PKG./MSTR. SLEEVE	SUGGESTED TRADE LIST PRICE PER	
JRM17	80023	6-32	3/8	.25	100/500	2.98/c	
JRM80	80024	6-32	1/2	.27	100/500	3.28/c	
JRM81	80025	6-32	3/4	.34	100/500	3.18/c	
JRM63	80026	6-32	1	.42	100/500	3.53/c	
JRM68	80027	6-32	1 1/4	.49	100/500	3.85/c	
JRM82	80028	6-32	1 1/2	.56	100/500	4.78/c	
JRM83	80029	6-32	2	.70	100/500	6.90/c	
JRM140	80030	6-32	2 1/2	.86	100/500	7.23/c	
JRM142	80031	6-32	3	1.02	100	8.38/c	
JRM144	81129	6-32	4	1.41	100	25.45/c	NEW
JRM18	80032	8-32	3/8	.34	100/500	2.98/c	
JRM84	80033	8-32	1/2	.40	100/500	3.33/c	
JRM85	80034	8-32	3/4	.51	100/500	3.55/c	
JRM86	80035	8-32	1	.60	100/500	4.00/c	
JRM87	80036	8-32	1 1/4	.73	100/500	4.50/c	
JRM88	80037	8-32	1 1/2	.83	100/500	5.30/c	
JRM89	80038	8-32	2	1.08	100/500	7.40/c	
JRM90	80039	8-32	2 1/2	1.27	100/500	8.03/c	
JRM91	80040	8-32	3	1.58	100	9.33/c	
JRM23	81085	8-32	4	2.01	100	13.03/c	NEW
JRM19	80041	10-24	3/8	.45	100/500	3.38/c	
JRM32	80042	10-24	1/2	.52	100/500	3.40/c	
JRM92	80043	10-24	3/4	.67	100/500	4.03/c	
JRM93	80044	10-24	1	.81	100/500	4.55/c	
JRM94	80045	10-24	1 1/4	.95	100/500	5.03/c	
JRM95	80046	10-24	1 1/2	1.12	100/500	5.88/c	
JRM96	80047	10-24	2	1.39	100/500	7.40/c	
JRM97	80048	10-24	2 1/2	1.65	100	8.93/c	
JRM127	80049	10-24	3	1.97	100	10.40/c	
JRM150	86150	10-24	4	2.57	100	23.53/c	NEW
JRM20	80050	10-32	3/8	.48	100/500	3.38/c	
JRM33	80051	10-32	1/2	.55	100/500	3.40/c	
JRM48	80052	10-32	3/4	.70	100/500	4.03/c	
JRM98	80053	10-32	1	.86	100/500	4.55/c	
JRM69	80054	10-32	1 1/4	.99	100/500	5.03/c	
JRM75	80055	10-32	1 1/2	1.14	100/500	5.88/c	
JRM113	80056	10-32	2	1.47	100/500	7.40/c	
JRM114	86114	10-32	2 1/2	1.79	100	8.23/c	NEW
JRM190	86190	10-32	3	2.11	100	13.93/c	NEW
JRM22	80057	1/4-20	3/8	.90	100/500	5.88/c	
JRM99	80058	1/4-20	1/2	1.00	100/500	6.23/c	
JRM100	80060	1/4-20	3/4	1.25	100/500	6.90/c	
JRM101	80061	1/4-20	1	1.54	100/500	7.88/c	
JRM102	80062	1/4-20	1 1/4	1.78	100/500	8.03/c	
JRM103	80063	1/4-20	1 1/2	2.00	100/500	8.15/c	
JRM104	80064	1/4-20	2	2.52	100	11.00/c	
JRM105	81105	1/4-20	2 1/2	3.06	100	13.93/c	
JRM128	81110	1/4-20	3	3.58	100	14.60/c	
JRM132	81115	1/4-20	4	4.61	100	18.85/c	
JRM133	81116	1/4-20	5	5.95	100	36.93/c	NEW
JRM134	81119	1/4-20	6	6.77	100	67.18/c	NEW

OTHER SIZES AND QUANTITIES AVAILABLE BY REQUEST

CONTINUED ON NEXT PAGE

www.metallicsonline.com

CONTINUED

ROUND "COMBO" MACHINE SCREWS

SLOTTED AND PHILLIPS. STEEL ZINC CHROMATE

In 1985, Metallics was the first fastener company in America to offer a full line of Combo's!

 Slotted
 Phillips
Two drives
in one head!



A

STOCK NO.	UPC NO.	DIAMETER	LENGTH	WT. PER PKG.	STD. PKG./ MSTR. SLEEVE	SUGGESTED TRADE LIST PRICE PER	
JRM35	83935	5/16-18	1/2	1.88	100/500	13.38/c	NEW
JRM50*	81099	5/16-18	3/4	2.12	100/500	15.15/c	NEW
JRM65	81103	5/16-18	1	2.70	100	18.48/c	NEW
JRM71	83971	5/16-18	1 1/4	3.11	100	19.43/c	NEW
JRM77*	83977	5/16-18	1 1/2	3.58	100	21.00/c	NEW
JRM115	86115	5/16-18	2	4.55	100	37.13/c	NEW
JRM36	80065	3/8-16	1/2	2.91	100/500	17.23/c	
JRM51	80066	3/8-16	3/4	3.43	100	19.65/c	
JRM66	80067	3/8-16	1	4.03	100	19.78/c	
JRM72	80068	3/8-16	1 1/4	4.47	100	20.83/c	
JRM78	80069	3/8-16	1 1/2	5.00	100	24.18/c	
JRM116	80070	3/8-16	2	6.48	100	25.95/c	
JRM123	80071	3/8-16	2 1/2	7.54	100	32.48/c	
JRM130	80072	3/8-16	3	4.34	50	37.06/c	
JRM135	81120	3/8-16	4	5.65	50	49.80/c	
RM136	10131	3/8-16	5	13.96	50	117.73/c	NEW

OTHER SIZES AND QUANTITIES AVAILABLE BY REQUEST

* = Slotted Only

 Phillips



PAN HEAD PHILLIPS MACHINE SCREW

NEW!

STEEL ZINC CHROMATE

STOCK NO.	UPC NO.	DIAMETER	LENGTH	WT. PER PKG.	STD. PKG./ MSTR. SLEEVE	SUGGESTED TRADE LIST PRICE PER	
JPMP78	86312	6-32	1/4	.23	100/500	5.43/c	NEW
JPMP63	86263	6-32	1	.42	100/500	5.48/c	NEW
JPMP4	86255	8-32	1/4	.34	100/500	4.78/c	NEW
JPMP84	86270	8-32	1/2	.43	100/500	4.83/c	NEW
JPMP85	86271	8-32	3/4	.55	100/500	5.03/c	NEW
JPMP86	86272	8-32	1	.66	100/500	5.10/c	NEW
JPMP88	86266	8-32	1 1/2	.83	100/500	8.45/c	NEW
JPMP6	86257	10-32	1/4	.47	100/500	5.25/c	NEW
JPMP20	86288	10-32	3/8	.56	100/500	4.83/c	NEW
JPMP1032	86324	10-32	1	.95	100/500	8.55/c	NEW
JPMP75	86294	10-32	1 1/2	1.27	100/500	9.43/c	NEW

OTHER SIZES AND QUANTITIES AVAILABLE BY REQUEST

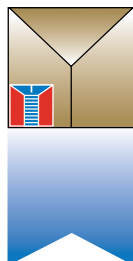

METALLICS

AMERICA'S SOURCE FOR PREMIER AND
INNOVATIVE FASTENERS & ANCHORS

SCREWS



STAINLESS STEEL ROUND HEAD SLOTTED MACHINE SCREWS

18-8 SERIES TYPE

STOCK NO.	UPC NO.	DIAMETER	LENGTH	WT. PER PKG.	STD. PKG./MSTR. SLEEVE	SUGGESTED TRADE LIST PRICE PER
JSRM50	80073	6-32	3/8	.24	100/500	7.80/c
JSRM10	80074	6-32	1/2	.29	100/500	9.55/c
JSRM51	80075	6-32	3/4	.38	100/500	13.45/c
JSRM11	80076	6-32	1	.44	100/500	14.30/c
JSRM12	80077	6-32	1 1/4	.51	100/500	15.18/c
JSRM13	80078	6-32	1 1/2	.58	100/500	15.60/c
JSRM14	80079	6-32	2	.72	100/500	17.33/c
JSRM60	80080	8-32	3/8	.35	100/500	10.33/c
JSRM15	80081	8-32	1/2	.41	100/500	10.83/c
JSRM61	80082	8-32	5/8	.43	100/500	12.13/c
JSRM16	80083	8-32	3/4	.54	100/500	12.58/c
JSRM17	80084	8-32	1	.64	100/500	12.98/c
JSRM18	80085	8-32	1 1/4	.70	100/500	19.85/c
JSRM19	80086	8-32	1 1/2	.84	100/500	21.25/c
JSRM20	80087	8-32	2	1.08	100/500	31.38/c
JSRM21	80088	10-24	1/2	.53	100/500	12.98/c
JSRM71	80089	10-24	5/8	.59	100/500	13.20/c
JSRM22	80090	10-24	3/4	.70	100/500	14.73/c
JSRM23	80091	10-24	1	.84	100/500	17.33/c
JSRM24	80092	10-24	1 1/4	.99	100/500	24.70/c
JSRM144	85144	10-24	1 1/2	1.13	100/500	29.23/c NEW
JSRM74	80093	10-24	1 3/4	1.27	100/500	32.30/c
JSRM146	85146	10-24	2	1.43	100/500	35.73/c NEW
JSRM25	80094	10-32	1/2	.57	100/500	12.98/c
JSRM26	80095	10-32	3/4	.74	100/500	16.05/c
JSRM27	80096	10-32	1	.87	100/500	19.03/c
JSRM28	80097	10-32	1 1/4	1.02	100/500	24.60/c
JSRM33	83733	10-32	1 1/2	1.18	100/500	29.68/c NEW
JSRM148	85148	10-32	2	1.33	100/500	35.73/c NEW
JSRM190	85190	10-32	3	1.68	100	54.03/c NEW
JSRM29	80098	1/4-20	3/8	.67	100/500	27.70/c
JSRM30	80099	1/4-20	1/2	1.02	100/500	32.50/c
JSRM31	80100	1/4-20	3/4	1.29	100/500	35.53/c
JSRM32	80101	1/4-20	1	1.51	100/500	35.53/c
JSRM85	80102	1/4-20	1 1/4	1.80	100/500	35.73/c
JSRM90	80103	1/4-20	1 1/2	2.07	100/500	49.38/c
JSRM95	83795	1/4-20	2	2.60	100	66.88/c NEW
JSRM97	83797	1/4-20	2 1/2	2.83	100	89.45/c NEW
JSRM100	85100	1/4-20	3	3.64	100	91.88/c NEW
JSRM132	89232	1/4-20	4	2.38	50	164.38/c NEW
SRM136	12020	1/4-20	6	6.86	100	372.40/c
JSRM133	85133	3/8-16	1/2	2.93	100/500	82.30/c NEW
JSRM66	83766	3/8-16	1	4.22	100	133.95/c NEW
JSRM134	85134	3/8-16	1 1/2	5.20	100	138.95/c NEW

OTHER SIZES AND QUANTITIES AVAILABLE BY REQUEST

Helpful Hints From Metallics:
Did You forget to ask?

GOT FASTENERS?

"We work hard to improve both Distributor Profit and Customer Satisfaction."



STAINLESS STEEL ROUND HEAD PHILLIPS MACHINE SCREWS

NEW!

18-8 SERIES TYPE

A

STOCK NO.	UPC NO.	DIAMETER	LENGTH	WT. PER PKG.	STD. PKG./MSTR. SLEEVE	SUGGESTED TRADE LIST PRICE PER
JSRM11P	93511	6-32	1	.44	100/500	PLEASE CALL FOR TRADE LIST PRICING
JSRM13P	93513	6-32	1½	1.27	100/500	
JSRM14P	93514	6-32	2	.72	100/500	
JSRM15P	93515	8-32	½	.40	100/500	
JSRM17P	93517	8-32	1	.64	100/500	
JSRM19P	93519	8-32	1½	.86	100/500	
JSRM20P	93520	8-32	2	1.03	100/500	
JSRM21P	93521	10-24	½	.55	100/500	
JSRM23P	93523	10-24	1	.84	100/500	
JSRM24P	93524	10-24	1¼	.99	100/500	
JSRM74P	93574	10-24	1¾	1.32	100/500	
JSRM27P	93527	10-32	1	.89	100/500	
JSRM33P	93533	10-32	1½	1.19	100/500	
JSRM148P	93648	10-32	2	1.53	100/500	
JSRM100P	93600	12-24	¾	.92	100/500	
JSRM101P	93601	12-24	1	1.13	100/500	
JSRM102P	93602	12-24	1½	1.51	100/500	
JSRM30P	93530	¼-20	½	1.02	100/500	
JSRM31P	93531	¼-20	¾	1.31	100/500	
JSRM32P	93532	¼-20	1	1.62	100/500	
JSRM85P	93585	¼-20	1¼	1.78	100/500	
JSRM90P	93590	¼-20	1½	2.03	100/500	
JSRM95P	93595	¼-20	2	2.55	100/500	
JSRM137P	93637	⅜-16	¾	3.66	100/500	
JSRM138P	93638	⅜-16	1	4.22	100/500	
JSRM139P	93639	⅜-16	1½	5.39	100	
JSRM140P	93640	⅜-16	2	6.49	100	

OTHER SIZES AND QUANTITIES AVAILABLE BY REQUEST

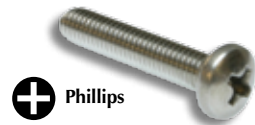

STAINLESS STEEL PAN HEAD PHILLIPS MACHINE SCREWS

NEW!

18-8 SERIES TYPE

STOCK NO.	UPC NO.	DIAMETER	LENGTH	WT. PER PKG.	STD. PKG./MSTR. SLEEVE	SUGGESTED TRADE LIST PRICE PER
JSPMP78SS	98978	6-32	¼	.22	100/500	PLEASE CALL FOR TRADE LIST PRICING
JSPMP17SS	98917	6-32	⅜	.26	100/500	
JSPMP80SS	98980	6-32	½	.28	100/500	
JSPMP15SS	98915	8-32	½	.40	100/500	
JSPMP16SS	98916	8-32	¾	.63	100/500	
JSPMP1SS	98901	8-32	1½	.83	100/500	
JSPMP20SS	98920	8-32	2	1.07	100/500	
JSPMP21SS	98921	10-24	½	.53	100/500	
JSPMP2SS	98902	10-24	¾	.69	100/500	
JSPMP7SS	98907	10-24	1	.83	100/500	
JSPMP4SS	98904	10-24	1¼	.98	100/500	
JSPMP5SS	98905	10-24	1½	1.01	100/500	
JSPMP33SS	98933	10-32	½	.36	100/500	
JSPMP3SS	98903	10-32	¾	.73	100/500	
JSPMP23SS	98923	10-32	7/8	.77	100/500	
JSPMP35SS	98935	10-32	1	.86	100/500	
JSPMP38SS	98938	10-32	2½	1.90	100	
JSPMP29SS	98929	¼-20	⅜	1.01	100/500	

OTHER SIZES AND QUANTITIES AVAILABLE BY REQUEST

SCREWS

A



BRASS ROUND HEAD SLOTTED MACHINE SCREWS

STOCK NO.	UPC NO.	DIAMETER	LENGTH	WT. PER PKG.	STD. PKG./ MSTR. SLEEVE	SUGGESTED TRADE LIST PRICE PER
JRMB61	80104	6-32	1/2	.29	100/500	
JRMB62	80105	6-32	3/4	.37	100/500	
JRMB63	80106	6-32	1	.45	100/500	
JRMB64	83464	6-32	1 1/4	.51	100/500	
JRMB66	83466	6-32	2	.73	100/500	
JRMB140	83540	6-32	2 1/2	.89	100/500	
JRMB8	83408	8-32	3/8	.34	100/500	
JRMB83	80107	8-32	1/2	.43	100/500	
JRMB85	80108	8-32	3/4	.54	100/500	
JRMB86	80109	8-32	1	.61	100/500	
JRMB87	83487	8-32	1 1/4	.70	100/500	
JRMB88	83488	8-32	1 1/2	.88	100/500	
JRMB91	80110	8-32	2	1.16	100/500	
JRMB90	83490	8-32	2 1/2	1.29	100/500	
JRMB78	83478	8-32	3	1.60	100/500	
JRMB7	83407	10-24	3/8	.53	100/500	
JRMB49	83449	10-24	1/2	.55	100/500	
JRMB92	83450	10-24	3/4	.73	100/500	
JRMB93	83493	10-24	1	.84	100/500	
JRMB94	83494	10-24	1 1/4	.99	100/500	
JRMB95	80111	10-32	1/2	.57	100/500	
JRMB48	80112	10-32	3/4	.73	100/500	
JRMB73	83473	10-32	1 1/2	1.16	100/500	
JRMB113	83537	10-32	2	1.46	100/500	
JRMB105	83529	10-32	2 1/2	1.80	100/500	
JRMB22	83422	1/4-20	3/8	.67	100/500	
JRMB99	83499	1/4-20	1/2	1.03	100/500	
JRMB100	83524	1/4-20	3/4	1.32	100/500	
JRMB30	86268	1/4-20	1	1.63	100/500	
JRMB102	83526	1/4-20	1 1/4	1.71	100/500	
JRMB104	83528	1/4-20	2	2.57	100/500	

PLEASE
CALL
FOR
TRADE
LIST
PRICING

OTHER SIZES AND QUANTITIES AVAILABLE BY REQUEST



FLAT HEAD SLOTTED MACHINE SCREWS

STEEL ZINC CHROMATE

STOCK NO.	UPC NO.	DIAMETER	LENGTH	WT. PER PKG.	STD. PKG./ MSTR. SLEEVE	SUGGESTED TRADE LIST PRICE PER
JFM17	83817	6-32	3/8	.21	100/500	3.20/c
JFM80	80114	6-32	1/2	.24	100/500	2.70/c
JFM81	80115	6-32	3/4	.30	100/500	2.95/c
JFM63	80116	6-32	1	.39	100/500	2.98/c
JFM68	80117	6-32	1 1/4	.46	100/500	3.38/c
JFM82	80118	6-32	1 1/2	.53	100/500	4.58/c
JFM83	80119	6-32	2	.62	100/500	5.45/c
JFM140	80120	6-32	2 1/2	.82	100/500	8.33/c
JFM142	80121	6-32	3	.97	100/500	9.60/c
JFM144	81916	6-32	4	1.28	100/500	25.45/c

OTHER SIZES AND QUANTITIES AVAILABLE BY REQUEST

CONTINUED ON NEXT PAGE

www.metallicsonline.com

CONTINUED

FLAT HEAD SLOTTED MACHINE SCREWS

STEEL ZINC CHROMATE



A

STOCK NO.	UPC NO.	DIAMETER	LENGTH	WT. PER PKG.	STD. PKG./MSTR. SLEEVE	SUGGESTED TRADE LIST PRICE PER	
JFM18	83818	8-32	3/8	.27	100/500	3.38/c	NEW
JFM84	80122	8-32	1/2	.33	100/500	3.00/c	
JFM85	80123	8-32	3/4	.48	100/500	3.40/c	
JFM86	80124	8-32	1	.55	100/500	3.58/c	
JFM87	80125	8-32	1 1/4	.64	100/500	4.88/c	
JFM88	80126	8-32	1 1/2	.77	100/500	5.45/c	
JFM89	80127	8-32	2	1.00	100/500	6.38/c	
JFM90	80128	8-32	2 1/2	1.25	100/500	10.13/c	
JFM91	80129	8-32	3	1.46	100/500	13.45/c	
JFM117	83917	8-32	4	1.94	100	23.53/c	NEW
JFM19	83819	10-24	3/8	.47	100/500	4.05/c	NEW
JFM32	83832	10-24	1/2	.50	100/500	4.28/c	NEW
JFM194	76594	10-24	3/4	.58	100/500	4.98/c	NEW
JFM113	83913	10-24	1	.76	100/500	5.58/c	NEW
JFM95	83895	10-24	1 1/2	1.04	100/500	8.65/c	NEW
JFM96	83896	10-24	2	1.41	100/500	10.28/c	NEW
JFM127	83927	10-24	3	2.01	100	26.88/c	NEW
JFM150	84430	10-24	4	2.51	100	23.53/c	NEW
JFM20	83820	10-32	3/8	.38	100/500	4.55/c	NEW
JFM33	80130	10-32	1/2	.50	100/500	3.83/c	
JFM42	83842	10-32	5/8	.56	100/500	4.68/c	NEW
JFM48	80131	10-32	3/4	.73	100/500	4.03/c	
JFM98	80132	10-32	1	.76	100/500	4.23/c	
JFM69	80133	10-32	1 1/4	.96	100/500	5.55/c	
JFM92	81175	10-32	1 1/2	1.04	100/500	5.88/c	
JFM93	81176	10-32	2	1.41	100/500	7.40/c	
JFM94	81177	10-32	3	2.01	100/500	10.40/c	
JFM22	83822	1/4-20	3/8	.69	100/500	7.68/c	NEW
JFM99	80134	1/4-20	1/2	.89	100/500	6.38/c	
JFM100	80135	1/4-20	3/4	1.06	100/500	6.75/c	
JFM101	80136	1/4-20	1	1.30	100/500	7.78/c	
JFM102	83902	1/4-20	1 1/4	1.54	100/500	9.33/c	NEW
JFM103	81900	1/4-20	1 1/2	1.83	100/500	10.40/c	NEW
JFM104	80137	1/4-20	2	2.55	100/500	10.85/c	
JFM128	83928	1/4-20	2 1/2	3.61	100	13.38/c	NEW
JFM105	81185	1/4-20	3	3.38	100	14.60/c	
JFM132	84086	1/4-20	4	4.21	100	30.90/c	NEW
JFM35	83835	5/16-18	1/2	.95	100/500	20.68/c	NEW
JFM50	83850	5/16-18	3/4	1.26	100/500	23.53/c	NEW
JFM65	83865	5/16-18	1	1.60	100/500	23.75/c	NEW
JFM36	83836	3/8-16	1/2	2.70	100/500	30.05/c	NEW
JFM51	83851	3/8-16	3/4	2.90	100	31.90/c	NEW
JFM66	83866	3/8-16	1	3.79	100	39.95/c	NEW
JFM72	83872	3/8-16	1 1/4	3.78	100	40.00/c	NEW
JFM78	83878	3/8-16	1 1/2	3.83	100	45.75/c	NEW
JFM116	83916	3/8-16	2	3.95	100	46.00/c	NEW
JFM123	83923	3/8-16	2 1/2	4.26	100	62.25/c	NEW
JFM130	84084	3/8-16	3	6.25	100	72.98/c	NEW
JFM135	84089	3/8-16	4	11.02	100	95.43/c	NEW

OTHER SIZES AND QUANTITIES AVAILABLE BY REQUEST

SCREWS



FLAT HEAD PHILLIPS MACHINE SCREW **NEW!**

STEEL ZINC CHROMATE AND BRASS

STOCK NO.	UPC NO.	DIAMETER	LENGTH	WT. PER PKG.	STD. PKG./MSTR. SLEEVE	SUGGESTED TRADE LIST PRICE PER	
JFMP80	84116	6-32	1/2	.23	100/500	4.88/c	NEW
JFMP81	84117	6-32	3/4	.33	100/500	4.93/c	NEW
JFMP63	84063	6-32	1	.39	100/500	4.95/c	NEW
JFMP82	84118	6-32	1 1/2	.54	100/500	11.25/c	NEW
JFMP83	84119	6-32	2	.69	100/500	7.50/c	NEW
JFMP140	85740	6-32	2 1/2	.83	100/500	13.33/c	NEW
JFMP142	85742	6-32	3	.74	100/500	16.80/c	NEW
JFMP84	84120	8-32	1/2	.33	100/500	3.30/c	NEW
JFMP85	84121	8-32	3/4	.44	100/500	4.70/c	NEW
JFMP86	84122	8-32	1	.55	100/500	4.75/c	NEW
JFMP87	84123	8-32	1 1/4	.64	100/500	7.38/c	NEW
JFMP88	84124	8-32	1 1/2	.74	100/500	7.43/c	NEW
JFMP89	84125	8-32	2	1.00	100/500	7.48/c	NEW
JFMP75	84075	10-24	3/4	.48	100/500	5.50/c	NEW
JFMP47	72047	10-32	3/8	.40	100/500	5.50/c	NEW
JFMP98	84134	10-32	1	.76	100/500	6.18/c	NEW
JFMP100	85700	1/4-20	3/4	1.12	100/500	7.25/c	NEW
BRASS							
JFMB88	81155	8-32	1 1/2	0.84	100/500	PLEASE CALL FOR TRADE LIST PRICING	
JFMB89	81156	8-32	2	1.05	100/500		NEW

OTHER SIZES AND QUANTITIES AVAILABLE BY REQUEST



STAINLESS STEEL FLAT HEAD SLOTTED MACHINE SCREWS **NEW!**

18-8 SERIES TYPE

STOCK NO.	UPC NO.	DIAMETER	LENGTH	WT. PER PKG.	STD. PKG./MSTR. SLEEVE	SUGGESTED TRADE LIST PRICE PER	
JFM82SS	91982	6-32	1 1/2	.50	100/500	PLEASE CALL FOR TRADE LIST PRICING	NEW
JFM83SS	91983	6-32	2	.60	100/500		NEW
JFM84SS	91984	8-32	1/2	.35	100/500		NEW
JFM85SS	91985	8-32	3/4	.45	100/500		NEW
JFM86SS	91986	8-32	1	.56	100/500		NEW
JFM87SS	91987	8-32	1 1/4	.67	100/500		NEW
JFM33SS	91933	10-32	1/2	.49	100/500		NEW
JFM48SS	91900	10-32	3/4	.71	100/500		NEW
JFM92SS	91992	10-32	1 1/2	1.08	100/500		NEW
JFM99SS	91999	1/4-20	1/2	.81	100/500		NEW
JFM100SS	92000	1/4-20	3/4	1.08	100/500		NEW
JFM101SS	93201	1/4-20	1	1.32	100/500		NEW
JFM102SS	93202	1/4-20	1 1/4	1.56	100/500		NEW
JFM104SS	93204	1/4-20	2	1.38	100/500		NEW

OTHER SIZES AND QUANTITIES AVAILABLE BY REQUEST

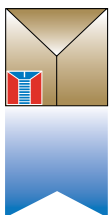

METALLICS

AMERICA'S SOURCE FOR PREMIER AND INNOVATIVE FASTENERS & ANCHORS

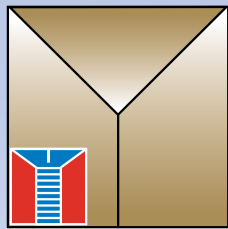

Metallics



Tamper Resist Button Head Star Pin Machine Screw (Stainless Steel) 18-8 Series Type

**[CONTRACTOR
APPROVED]**



 Star Head

PART #	UPC #	DESCRIPTION	QTY / PKG	SUG. TRADE LIST / PKG
TP223SBC	30637	6-32 x 1/4 Button Head Star Pin Machine Screw	100	\$ 90.00
TP224SBC	30638	6-32 x 3/8 Button Head Star Pin Machine Screw	100	\$ 90.00
TP225SBC	30650	8-32 x 1/4 Button Head Star Pin Machine Screw	100	\$ 90.00
TP226SBC	30651	8-32 x 3/8 Button Head Star Pin Machine Screw	100	\$ 97.50
TP227SBC	30677	10-32 x 3/8 Button Head Star Pin Machine Screw	100	\$ 109.95
TP228SBC	30678	10-32 x 1/2 Button Head Star Pin Machine Screw	100	\$ 118.20
TP229SBC	30679	10-32 x 5/8 Button Head Star Pin Machine Screw	100	\$ 119.85
TP230SBC	30680	10-32 x 3/4 Button Head Star Pin Machine Screw	100	\$ 119.70
TP231SBC	30681	10-32 x 1 Button Head Star Pin Machine Screw	100	\$ 134.40
TP232SBC	30682	10-32 x 1 1/4 Button Head Star Pin Machine Screw	100	\$ 148.35
TP233SBC	30683	10-32 x 1 1/2 Button Head Star Pin Machine Screw	100	\$ 157.58
TP234SBC	30690	1/4-20 x 3/8 Button Head Star Pin Machine Screw	100	\$ 130.58

Other sizes, materials and quantities available by request.

★ ★ ★ ★ ★ "Growth Through Innovation" ★ ★ ★ ★ ★

Metallics

229 Cross Street, Bristol, CT 06010
Tel 800-243-8272 • **Fax** 800-831-9358
Email sales@metallicsonline.com

Metallics West

651 North Main Street, Mancos, CO 81328
Tel 800-269-5183 • **Fax** 800-269-6278
Email saleswest@metallicsonline.com

A

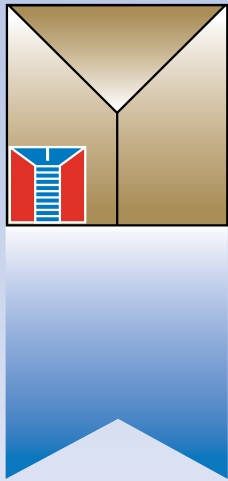

Metallics

Telecom (Black) Cabinet Screws

For use in Telecom Cabinets, Relay Racks and Patch Panels



[CONTRACTOR APPROVED]



- Three Sizes:
 - 12-24 x 5/8"
 - 10-24 x 5/8"
 - 10-32 x 5/8"
- Pan Head
- Tri-Drive (Slotted, Phillips, Square Drive)
- Lead-Point
- Black Oxide
- Steel



Tri-Drive



Manufactured by
Avant Screw Inc.
a Metallics Affiliate

PART #	UPC #	DESCRIPTION	QTY / PKG	SUG. TRADE LIST / PKG
TEL1224BLK	39097	12-24 x 5/8" Pan Head, Tri-Drive, Lead Point, Black Tel Screw	50	\$ 26.55
TEL1024BLK	39250	10-24 x 5/8" Pan Head, Tri-Drive, Lead Point, Black Tel Screw	50	\$ 25.00
TEL1032BLK	39260	10-32 x 5/8" Pan Head, Tri-Drive, Lead Point, Black Tel Screw	50	\$ 25.00

Other sizes, materials and quantities available by request.

★ ★ ★ ★ ★ "Growth Through Innovation" ★ ★ ★ ★ ★

Metallics

229 Cross Street, Bristol, CT 06010
Tel 800-243-8272 • **Fax** 800-831-9358
Email sales@metallicsonline.com

Metallics West

651 North Main Street, Mancos, CO 81328
Tel 800-269-5183 • **Fax** 800-269-6278
Email saleswest@metallicsonline.com

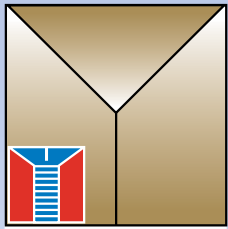

Metallics

Quik-Eze

Self Piercing Sheet Metal Screw Kit



[CONTRACTOR APPROVED]



- 4 Popular Sheet Metal Screw Sizes – 500 pieces total
- High Performance - Hex Slotted Sharp Point
- Double lead thread means twice the driving speed!
- Convenient, Reusable Container
- Plumbing, HVAC & Electrical Contractor

 Hex Slotted

PART #	UPC #	DESCRIPTION	QTY / PKG	SUG. TRADE LIST / PKG
QKK1	39291	8 x 1/2" Quik-Eze Hex Slotted	200 pcs.	\$ 24.75
		8 x 3/4" Quik-Eze Hex Slotted	150 pcs.	
		8 x 1" Quik-Eze Hex Slotted	100 pcs.	
		8 x 1-1/2" Quik-Eze Hex Slotted	50 pcs.	

★ ★ ★ ★ ★ *"Growth Through Innovation"* ★ ★ ★ ★ ★

Metallics

229 Cross Street, Bristol, CT 06010
Tel 800-243-8272 • **Fax** 800-831-9358
Email sales@metallicsonline.com

Metallics West

651 North Main Street, Mancos, CO 81328
Tel 800-269-5183 • **Fax** 800-269-6278
Email saleswest@metallicsonline.com

A

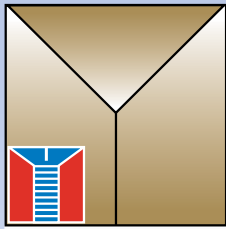

Metallics



Stainless Steel Hex Head Machine Screw Kit

18-8 Series Type

[CONTRACTOR APPROVED]



SHTBK1:

Contains #6, #8, and #10 Hex Head Stainless Steel Machine Screws 1-1/2 long with full thread.



PART #	UPC #	DESCRIPTION	QTY / PKG	SUG. TRADE LIST / PKG
SHTBK1	16461	#6 - 32 x 1-1/2" Hex Head Machine Screw Full Thread	25	\$ 56.25
		#8 - 32 x 1-1/2" Hex Head Machine Screw Full Thread	25	
		#10 - 24 x 1-1/2" Hex Head Machine Screw Full Thread	25	
		#10 - 32 x 1-1/2" Hex Head Machine Screw Full Thread	25	

"Growth Through Innovation"

Metallics

229 Cross Street, Bristol, CT 06010
Tel 800-243-8272 • **Fax** 800-831-9358
Email sales@metallicsonline.com

Metallics West

651 North Main Street, Mancos, CO 81328
Tel 800-269-5183 • **Fax** 800-269-6278
Email saleswest@metallicsonline.com

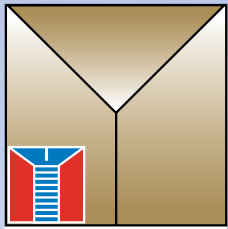

Metallics

Pan Head Stainless Steel Screw Kits



[CONTRACTOR APPROVED]

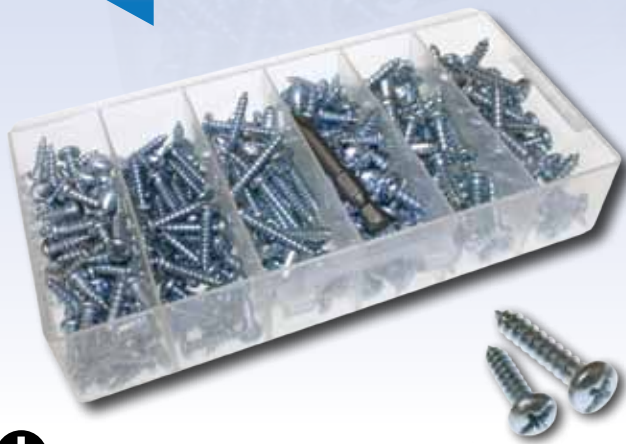

Two separate kits with the most popular sizes:

Kit **TEKPK1SS** contains #8 and #10 pan head phillips 410 SS drill screw with a #2 phillips power bit.

Kit **TSK10SS** contains #10 pan head phillips 18-8 SS tapping screw with a #2 phillips power bit.



PART #	UPC #	DESCRIPTION	QTY / PKG	SUG. TRADE LIST / PKG
TEKPK1SS	39611	#8 x 1/2" Pan Head Phillips SS Self Drilling Screw	100	\$ 64.00
		#8 x 3/4" Pan Head Phillips SS Self Drilling Screw	60	
		#8 x 1" Pan Head Phillips SS Self Drilling Screw	50	
		#10 x 1/2" Pan Head Phillips SS Self Drilling Screw	80	
		#10 x 3/4" Pan Head Phillips SS Self Drilling Screw	50	
		#10 x 1" Pan Head Phillips SS Self Drilling Screw	40	
		#2 x 2" Phillips Power Bit	1	

PART #	UPC #	DESCRIPTION	QTY / PKG	SUG. TRADE LIST / PKG
TSK10SS	39510	#10 x 1/2" Pan Head Phillips SS Tapping Screw	75	\$ 44.63
		#10 x 3/4" Pan Head Phillips SS Tapping Screw	50	
		#10 x 1" Pan Head Phillips SS Tapping Screw	45	
		#10 x 1-1/4" Pan Head Phillips SS Tapping Screw	30	
		#10 x 1-1/2" Pan Head Phillips SS Tapping Screw	25	
		#10 x 2" Pan Head Phillips SS Tapping Screw	20	
		#2 x 2" Phillips Power Bit	1	

"Growth Through Innovation"

Metallics

229 Cross Street, Bristol, CT 06010
Tel 800-243-8272 • **Fax** 800-831-9358
Email sales@metallicsonline.com

Metallics West

651 North Main Street, Mancos, CO 81328
Tel 800-269-5183 • **Fax** 800-269-6278
Email saleswest@metallicsonline.com

A

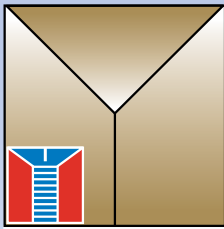

Metallics



Stainless Steel Hex Bolt, Nut and Washer Kit

18-8 Series Type

[CONTRACTOR APPROVED]



- Each kit contains Nuts, Flat Washers, Split Lock Washers and three of the most common lengths of Hex Head Bolts.
- Kits are available in 1/4-20, 3/8-16, and 1/2-13.



PART #	UPC #	DESCRIPTION	SUG. TRADE LIST / PKG
SBHK1420	94875	(50) 1/4-20 x 3/4" Hex Head Cap Screws - Stainless Steel	\$ 99.75
		(50) 1/4-20 x 1" Hex Head Cap Screws - Stainless Steel	
		(50) 1/4-20 x 1-1/2" Hex Head Cap Screws - Stainless Steel	
		(200) 1/4 Split Lock Washers - Stainless Steel	
		(200) 1/4 Flat SAE Washers - Stainless Steel	
		(150) 1/4-20 Hex Nuts - Stainless Steel	
SBHK3816	94880	(40) 3/8-16 x 1" Hex Head Cap Screws - Stainless Steel	\$ 124.75
		(30) 3/8-16 x 1-1/4" Hex Head Cap Screws - Stainless Steel	
		(20) 3/8-16 x 1-1/2" Hex Head Cap Screws - Stainless Steel	
		(150) 3/8 Split Lock Washers - Stainless Steel	
		(150) 3/8 Flat SAE Washers - Stainless Steel	
		(90) 3/8-16 Hex Nuts - Stainless Steel	
SBHK1213	94980	(20) 1/2-13 x 1" Hex Head Cap Screws - Stainless Steel	\$ 149.75
		(15) 1/2-13 x 1-1/2" Hex Head Cap Screws - Stainless Steel	
		(10) 1/2-13 x 2" Hex Head Cap Screws - Stainless Steel	
		(75) 1/2 Split Lock Washers - Stainless Steel	
		(75) 1/2 Flat SAE Washers - Stainless Steel	
		(45) 1/2-13 Hex Nuts - Stainless Steel	

★ ★ ★ ★ ★ "Growth Through Innovation" ★ ★ ★ ★ ★

Metallics

229 Cross Street, Bristol, CT 06010
Tel 800-243-8272 • **Fax** 800-831-9358
Email sales@metallicsonline.com

Metallics West

651 North Main Street, Mancos, CO 81328
Tel 800-269-5183 • **Fax** 800-269-6278
Email saleswest@metallicsonline.com

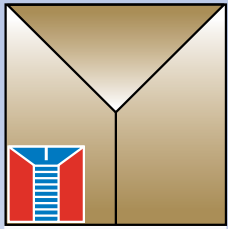

Metallics

Truss Head Receptacle & Wiring Devices Screw Kit



[CONTRACTOR APPROVED]



Made in USA

- Power Bit Foreign



Complete kit of 6 - 32 Truss Head Combo Drive (phillips/slotted) Machine Screws in the most popular sizes. Screws have a lead point and are zinc plated. Each kit includes a #1 Phillips x 2" Power Bit.

 Phillips/Slotted

PART #	UPC #	DESCRIPTION	QTY / PKG	SUG. TRADE LIST / PKG
TMSK1	39631	#6 - 32 x 1/2" Truss Head Combo with Lead Point Machine Screw	100	\$ 30.48
		#6 - 32 x 3/4" Truss Head Combo with Lead Point Machine Screw	90	
		#6 - 32 x 1" Truss Head Combo with Lead Point Machine Screw	65	
		#6 - 32 x 1-1/4" Truss Head Combo with Lead Point Machine Screw	50	
		#6 - 32 x 1-1/2" Truss Head Combo with Lead Point Machine Screw	40	
		#6 - 32 x 2" Truss Head Combo with Lead Point Machine Screw	35	

★ ★ ★ ★ ★ *"Growth Through Innovation"* ★ ★ ★ ★ ★

Metallics

229 Cross Street, Bristol, CT 06010
Tel 800-243-8272 • **Fax** 800-831-9358
Email sales@metallicsonline.com

Metallics West

651 North Main Street, Mancos, CO 81328
Tel 800-269-5183 • **Fax** 800-269-6278
Email saleswest@metallicsonline.com

SCREWS

A



STAINLESS STEEL FLAT HEAD PHILLIPS MACHINE SCREWS **NEW!**

18-8 SERIES TYPE

STOCK NO.	UPC NO.	DIAMETER	LENGTH	WT. PER PKG.	STD. PKG./MSTR. SLEEVE	SUGGESTED TRADE LIST PRICE PER	
JFMP80SS	91980	6-32	1/2	.27	100/500	PLEASE CALL FOR TRADE LIST PRICING	NEW
JFMP81SS	93481	6-32	3/4	.32	100/500		NEW
JFMP63SS	93463	6-32	1	.39	100/500		NEW
JFMP49SS	93949	10-32	1/2	.44	100/500		NEW
JFMP48SS	91948	10-32	3/4	.71	100/500		NEW
JFMP51SS	93951	10-32	1	.77	100/500		NEW
JFMP101SS	92280	1/4-20	1	1.31	100/500		NEW
JFMP103SS	98403	1/4-20	1 1/2	2.00	100/500		NEW

OTHER SIZES AND QUANTITIES AVAILABLE BY REQUEST



FLAT HEAD PHILLIPS DRIVE MACHINE SCREW KIT **NEW!**

STEEL ZINC CHROMATE

STOCK NO.	UPC NO.	DESCRIPTION OF CONTENTS	STD. PKG./MSTR. CARTON	WT. EACH	SUGGESTED TRADE LIST PRICE PER
FMKP632	10356	6-32 Flat Head Phillips Drive MS 100 - 3/4", 75 - 1", 75 - 1 1/4", 50 - 1 1/2", 40 - 2", 30 - 3"		1.84	19.18/ea

OTHER SIZES AND QUANTITIES AVAILABLE BY REQUEST



Two drives in one head!



STOVE BOLTS

Standard Package Square Plastic Jar
Round Head "Combo" (Slotted and Phillips)
STEEL ZINC CHROMATE WITH HEX NUTS

STOCK NO.	UPC NO.	DIAMETER	LENGTH	WT. PER PKG.	STD. PKG./MSTR. SLEEVE	SUGGESTED TRADE LIST PRICE PER	
RSB63	10488	6-32	1	.88	100/500	6.90/c	NEW
RSB86	10491	8-32	1	.99	100/500	7.58/c	NEW
RSB89	10492	8-32	2	1.30	100/500	11.70/c	NEW
RSB90	10493	8-32	2 1/2	1.56	100/500	13.95/c	NEW
RSB91	84291	8-32	3	1.83	100/500	15.90/c	NEW
RSB94	10173	8-32	4	2.23	100/500	17.85/c	NEW
RSB92	10466	10-24	3/4	.97	100/500	8.53/c	NEW
RSB93	10158	10-24	1	1.14	100/500	9.85/c	NEW
RSB95	10467	10-24	1 1/2	1.31	100/500	12.18/c	NEW
RSB16	10340	10-32	1/2	.86	100/500	4.93/c	
RSB17	10341	10-32	3/4	.98	100/500	5.43/c	
RSB18	10342	10-32	1	1.13	100/500	5.85/c	
RSB19	10343	10-32	1 1/4	1.28	100/500	6.25/c	
RSB20	10344	10-32	1 1/2	1.42	100/500	6.90/c	
RSB21	10345	10-32	2	1.72	100	8.05/c	
RSB22	10159	1/4-20	3/8	1.58	100/500	5.98/c	
RSB99	10160	1/4-20	1/2	1.67	100/500	6.28/c	
RSB100	10161	1/4-20	3/4	1.96	100/500	7.20/c	
RSB101	10162	1/4-20	1	2.22	100/500	7.73/c	
RSB102	10163	1/4-20	1 1/4	2.42	100/500	8.65/c	
RSB103	10164	1/4-20	1 1/2	2.68	100	9.73/c	
RSB104	10165	1/4-20	2	3.22	100	11.63/c	
RSB105	13037	1/4-20	2 1/2	3.98	100	13.65/c	
RSB106	13045	1/4-20	3	4.30	100	17.60/c	

OTHER SIZES AND QUANTITIES AVAILABLE BY REQUEST

CONTINUED ON NEXT PAGE

www.metallicsonline.com

CONTINUED

STOVE BOLTS

Standard Package Square Plastic Jar
Round Head "Combo" (Slotted and Phillips)
Machine Screws with Hex Nuts

STEEL ZINC CHROMATE

-  Slotted
 -  Phillips
- Two drives
in one head!



STOCK NO.	UPC NO.	DIAMETER	LENGTH	WT. PER PKG.	STD. PKG./ MSTR. SLEEVE	SUGGESTED TRADE LIST PRICE PER	
RSB66	10157	3/8-16	1	5.67	100	32.23/c	NEW
RSB72	10489	3/8-16	1 1/4	6.64	100	36.20/c	NEW
RSB78	10490	3/8-16	1 1/2	7.68	100	38.83/c	NEW
RSB116	13038	3/8-16	2	9.60	100	44.48/c	NEW

OTHER SIZES AND QUANTITIES AVAILABLE BY REQUEST

NEW!

STAINLESS STEEL STOVE BOLTS



18-8 SERIES TYPE

-  Slotted



STOCK NO.	UPC NO.	DIAMETER	LENGTH	WT. PER PKG.	STD. PKG./ MSTR. SLEEVE	SUGGESTED TRADE LIST PRICE PER	
RSB100S	98800	1/4-20	3/4	2.07	100/500	PLEASE CALL FOR TRADE LIST PRICING	NEW
RSB101S	98801	1/4-20	1	2.37	100/500		NEW
RSB103S	98803	1/4-20	1 1/2	2.79	100		NEW
RSB104S	98804	1/4-20	2	3.31	100		NEW

OTHER SIZES AND QUANTITIES AVAILABLE BY REQUEST

-  Slotted
-  Phillips
-  Square Drive



PAN HEAD TRI-DRIVE SHEET METAL SCREWS

STEEL ZINC CHROMATE



Tri-Drive is
manufactured by
Avanti Screw, Inc.,
A Metallics
Affiliate

Introduced nationally in 1994 by Metallics

STOCK NO.	UPC NO.	DIAMETER	LENGTH	WT. PER PKG.	STD. PKG./ MSTR. SLEEVE	SUGGESTED TRADE LIST PRICE PER
JTTS12	80138	6	1/2	.29	100/500	4.78/c
JTTS14	80139	6	3/4	.36	100/500	4.90/c
JTTS15	80140	6	1	.42	100/500	4.90/c
JTTS38	80141	6	1 1/2	.58	100/500	6.43/c
JTTS18	80142	8	1/2	.37	100/500	5.00/c
JTTS20	80143	8	3/4	.48	100/500	5.53/c
JTTS21	80144	8	1	.58	100/500	5.98/c
JTTS22	80145	8	1 1/4	.64	100/500	6.68/c
JTTS23	80146	8	1 1/2	.75	100/500	7.00/c
JTTS24	80147	8	2	.97	100/500	11.98/c
JTTS25	80148	10	1/2	.50	100/500	5.40/c
JTTS27	80149	10	3/4	.64	100/500	5.70/c
JTTS28	80150	10	1	.75	100/500	5.98/c
JTTS29	80151	10	1 1/4	.88	100/500	6.23/c
JTTS30	80152	10	1 1/2	1.01	100/500	7.00/c
JTTS31	80153	10	2	1.26	100/500	11.23/c
JTTS33	80154	12	3/4	.82	100/500	7.20/c
JTTS34	80155	12	1	.98	100/500	8.48/c
JTTS35	80156	12	1 1/4	1.23	100/500	9.90/c
JTTS36	80157	12	1 1/2	1.32	100/500	11.08/c
JTTS37	80158	12	2	1.68	100	14.98/c

OTHER SIZES AND QUANTITIES AVAILABLE BY REQUEST

A

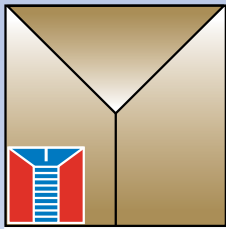

Metallics

Raceway Anchor Kit



[CONTRACTOR APPROVED]

Need to anchor your raceway?

This kit contains screws and anchors for mounting plastic or metal raceway to sheetrock, wood, metal or masonry walls.



PART #	UPC #	DESCRIPTION	QTY / PKG	SUG. TRADE LIST / PKG
RWAK1	20350	3/16 Plastic Anchors	40	\$ 17.60
		1/4 Plastic Anchors	20	
		Self Drilling Plastic Anchors	15	
		#6 x 1" Flat Head Phillips Sheet Metal Screws	40	
		#8 x 1-1/2" Flat Head Phillips Sheet Metal Screws	20	
		#10 x 1" Flat Head Phillips Sheet Metal Screws	20	
		3/16 x 4" Masonry Drill	1	
		1/4 x 4" Masonry Drill	1	

★ ★ ★ ★ ★ *"Growth Through Innovation"* ★ ★ ★ ★ ★

Metallics

229 Cross Street, Bristol, CT 06010
Tel 800-243-8272 • **Fax** 800-831-9358
Email sales@metallicsonline.com

Metallics West

651 North Main Street, Mancos, CO 81328
Tel 800-269-5183 • **Fax** 800-269-6278
Email saleswest@metallicsonline.com

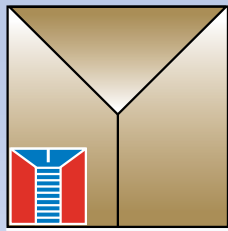

Metallics



Button Head Hex Pin Machine Screw (Stainless Steel) 18-8 Series Type

[CONTRACTOR APPROVED]



 Hex Pin Head

PART #	UPC #	DESCRIPTION	QTY / PKG	SUG. TRADE LIST / PKG
TP123SBC	30401	6-32 x 1/4 Button Head Hex Pin Machine Screw	100	\$ 100.88
TP124SBC	30402	6-32 x 3/8 Button Head Hex Pin Machine Screw	100	\$ 105.08
TP127SBC	30467	5/16-18 x 3/8 Button Head Hex Pin Machine Screw	100	\$ 450.00
TP128SBC	30468	5/16-18 x 3/8 Button Head Hex Pin Machine Screw	100	\$ 315.90
TP129SBC	30470	5/16-18 x 3/4 Button Head Hex Pin Machine Screw	100	\$ 331.05
TP130SBC	30471	5/16-18 x 1 Button Head Hex Pin Machine Screw	100	\$ 335.78
TP131SBC	30472	5/16-18 x 1 1/4 Button Head Hex Pin Machine Screw	100	\$ 352.80
TP132SBC	30473	5/16-18 x 1 1/2 Button Head Hex Pin Machine Screw	100	\$ 391.50
TP133SBC	30474	5/16-18 x 2 Button Head Hex Pin Machine Screw	100	\$ 437.03
TP134SBC	30481	3/8-16 x 1/2 Button Head Hex Pin Machine Screw	100	\$ 410.55
TP135SBC	30483	3/8-16 x 3/4 Button Head Hex Pin Machine Screw	100	\$ 473.03
TP136SBC	30484	3/8-16 x 1 Button Head Hex Pin Machine Screw	100	\$ 476.18
TP137SBC	30485	3/8-16 x 1 1/4 Button Head Hex Pin Machine Screw	100	\$ 497.18
TP138SBC	30486	3/8-16 x 1 1/2 Button Head Hex Pin Machine Screw	100	\$ 550.95
TP139SBC	30487	3/8-16 x 2 Button Head Hex Pin Machine Screw	100	\$ 566.10
TP140SBC	30510	1/2-13 x 1 Button Head Hex Pin Machine Screw	100	\$ 1,500.00
TP141SBC	30512	1/2-13 x 1 1/2 Button Head Hex Pin Machine Screw	100	\$ 1,650.00
TP142SBC	30513	1/2-13 x 2 Button Head Hex Pin Machine Screw	100	\$ 1,875.00
TP143SBC	30514	1/2-13 x 2 1/2 Button Head Hex Pin Machine Screw	100	\$ 2,025.00
TP144SBC	30515	1/2-13 x 3 Button Head Hex Pin Machine Screw	100	\$ 2,400.00
TP145SBC	30516	1/2-13 x 3 1/2 Button Head Hex Pin Machine Screw	100	\$ 2,625.00

Other sizes, materials and quantities available by request.

"Growth Through Innovation"

Metallics

229 Cross Street, Bristol, CT 06010
Tel 800-243-8272 • **Fax** 800-831-9358
Email sales@metallicsonline.com

Metallics West

651 North Main Street, Mancos, CO 81328
Tel 800-269-5183 • **Fax** 800-269-6278
Email saleswest@metallicsonline.com

A

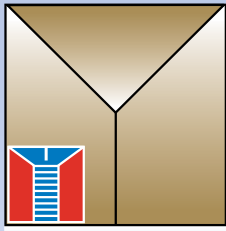

Metallics

Tamper Resist Button Head Hex Pin Sheet Metal Screw

(Stainless Steel) 18-8 Series Type



**[CONTRACTOR
APPROVED]**



 Hex Pin Head

PART #	UPC #	DESCRIPTION	QTY / PKG	SUG. TRADE LIST / PKG
TP520SBC	34747	6 x 3/8 Button Head Hex Pin Sheet Metal Screw	100	\$ 100.35
TP521SBC	34749	6 x 5/8 Button Head Hex Pin Sheet Metal Screw	100	\$ 109.50
TP522SBC	34759	8 x 3/8 Button Head Hex Pin Sheet Metal Screw	100	\$ 100.80
TP523SBC	34761	8 x 5/8 Button Head Hex Pin Sheet Metal Screw	100	\$ 112.80
TP524SBC	34766	8 x 2 Button Head Hex Pin Sheet Metal Screw	100	\$ 155.70
TP525SBC	34774	10 x 5/8 Button Head Hex Pin Sheet Metal Screw	100	\$ 119.85
TP526SBC	34780	10 x 2 1/2 Button Head Hex Pin Sheet Metal Screw	100	\$ 186.00
TP527SBC	34787	12 x 1/2 Button Head Hex Pin Sheet Metal Screw	100	\$ 110.40
TP528SBC	34789	12 x 3/4 Button Head Hex Pin Sheet Metal Screw	100	\$ 125.55
TP529SBC	34790	12 x 1 Button Head Hex Pin Sheet Metal Screw	100	\$ 132.08
TP530SBC	34792	12 x 1 1/2 Button Head Hex Pin Sheet Metal Screw	100	\$ 144.98
TP531SBC	34801	14 x 5/8 Button Head Hex Pin Sheet Metal Screw	100	\$ 133.35

Other sizes, materials and quantities available by request.

“Growth Through Innovation”

Metallics

229 Cross Street, Bristol, CT 06010
Tel 800-243-8272 • **Fax** 800-831-9358
Email sales@metallicsonline.com

Metallics West

651 North Main Street, Mancos, CO 81328
Tel 800-269-5183 • **Fax** 800-269-6278
Email saleswest@metallicsonline.com

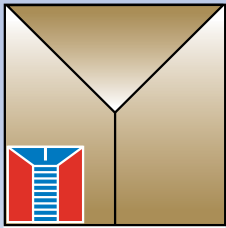

Metallics

Tamper Resist Flat Head Hex Pin Sheet Metal Screw

(Stainless Steel) 18-8 Series Type



**[CONTRACTOR
APPROVED]**



 Hex Pin Head

PART #	UPC #	DESCRIPTION	QTY / PKG	SUG. TRADE LIST / PKG
TP520SFC	34814	6 x 3/8 Flat Head Hex Pin Sheet Metal Screw	100	\$ 100.35
TP521SFC	34816	6 x 5/8 Flat Head Hex Pin Sheet Metal Screw	100	\$ 109.50
TP522SFC	34828	8 x 5/8 Flat Head Hex Pin Sheet Metal Screw	100	\$ 112.80
TP523SFC	34831	8 x 1 1/4 Flat Head Hex Pin Sheet Metal Screw	100	\$ 143.63
TP524SFC	34833	8 x 2 Flat Head Hex Pin Sheet Metal Screw	100	\$ 155.70
TP525SFC	34841	10 x 5/8 Flat Head Hex Pin Sheet Metal Screw	100	\$ 119.85
TP526SFC	34847	10 x 2 1/2 Flat Head Hex Pin Sheet Metal Screw	100	\$ 186.00
TP527SFC	34854	12 x 1/2 Flat Head Hex Pin Sheet Metal Screw	100	\$ 110.40
TP528SFC	34856	12 x 3/4 Flat Head Hex Pin Sheet Metal Screw	100	\$ 125.55
TP529SFC	34857	12 x 1 Flat Head Hex Pin Sheet Metal Screw	100	\$ 132.08
TP530SFC	34858	12 x 1 1/4 Flat Head Hex Pin Sheet Metal Screw	100	\$ 141.15
TP531SFC	34859	12 x 1 1/2 Flat Head Hex Pin Sheet Metal Screw	100	\$ 144.98
TP532SFC	34868	14 x 5/8 Flat Head Hex Pin Sheet Metal Screw	100	\$ 133.35

Other sizes, materials and quantities available by request.

“Growth Through Innovation”

Metallics

229 Cross Street, Bristol, CT 06010
Tel 800-243-8272 • **Fax** 800-831-9358
Email sales@metallicsonline.com

Metallics West

651 North Main Street, Mancos, CO 81328
Tel 800-269-5183 • **Fax** 800-269-6278
Email saleswest@metallicsonline.com

SCREWS

A

 Slotted
 Phillips
 Two drives
 in one head!



"COMBO" TAPPING SCREWS

Pan Head (Slotted and Phillips)
STEEL ZINC CHROMATE

STOCK NO.	UPC NO.	DIAMETER	LENGTH	WT. PER PKG.	STD. PKG./MSTR. SLEEVE	SUGGESTED TRADE LIST PRICE PER	
JTS1	82553	4	1/4	.14	100/500	2.65/c	NEW
JTS2	82554	4	3/8	.17	100/500	2.85/c	NEW
JTS10	80159	4	1/2	.20	100/500	3.23/c	
JTS4	80160	4	3/4	.23	100/500	3.75/c	
JTS11	80161	4	1	.28	100/500	3.98/c	
JTS6	80162	6	1/4	.19	100/500	2.75/c	
JTS7	80163	6	3/8	.23	100/500	2.78/c	
JTS12	80164	6	1/2	.26	100/500	3.20/c	
JTS13	80165	6	5/8	.28	100/500	3.28/c	
JTS14	80166	6	3/4	.33	100/500	3.45/c	
JTS15	80167	6	1	.39	100/500	3.20/c	
JTS9	80168	6	1 1/4	.47	100/500	3.55/c	
JTS38	80169	6	1 1/2	.53	100/500	4.50/c	
JTS39	82558	6	2	.66	100/500	6.05/c	NEW
JTS40	80170	7	1/2	.31	100/500	3.98/c	
JTS42	82570	7	3/4	.44	100/500	4.05/c	NEW
JTS44	82572	7	1	.52	100/500	4.28/c	NEW
JTS17	80171	8	3/8	.32	100/500	2.90/c	
JTS18	80172	8	1/2	.39	100/500	3.33/c	
JTS19	80173	8	5/8	.41	100/500	3.53/c	
JTS20	80174	8	3/4	.46	100/500	3.85/c	
JTS21	80175	8	1	.56	100/500	4.28/c	
JTS22	80176	8	1 1/4	.66	100/500	4.63/c	
JTS23	80177	8	1 1/2	.73	100/500	5.03/c	
JTS48	80178	8	1 3/4	.86	100/500	7.70/c	
JTS24	80179	8	2	.96	100/500	7.75/c	
JTS49	80180	10	3/8	.44	100/500	3.28/c	
JTS25	80181	10	1/2	.45	100/500	3.55/c	
JTS26	80182	10	5/8	.57	100/500	3.98/c	
JTS27	80183	10	3/4	.63	100/500	4.70/c	
JTS28	80184	10	1	.75	100/500	5.55/c	
JTS29	80185	10	1 1/4	.86	100/500	5.70/c	
JTS30	80186	10	1 1/2	.94	100/500	7.55/c	
JTS51	80187	10	1 3/4	1.14	100/500	7.68/c	
JTS31	80188	10	2	1.18	100/500	10.93/c	
JTS80	80189	10	2 1/2	1.54	100	13.18/c	
JTS81	80190	10	3	1.82	100	14.28/c	
JTS32	80191	12	1/2	.65	100/500	5.40/c	
JTS52	82577	12	5/8	.74	100/500	10.75/c	NEW
JTS33	80192	12	3/4	.79	100/500	5.70/c	
JTS34	80193	12	1	1.00	100/500	6.43/c	
JTS35	80194	12	1 1/4	1.15	100/500	7.48/c	
JTS36	80195	12	1 1/2	1.33	100/500	8.68/c	
JTS54	80196	12	1 3/4	1.53	100/500	11.05/c	

OTHER SIZES AND QUANTITIES AVAILABLE BY REQUEST

CONTINUED ON NEXT PAGE

Metallics was the first in America to offer the Combo Head — 1985

CONTINUED

"COMBO" TAPPING SCREWS

Pan Head (Slotted and Phillips)

STEEL ZINC CHROMATE

 Slotted
 Phillips
 Two drives
 in one head!



STOCK NO.	UPC NO.	DIAMETER	LENGTH	WT. PER PKG.	STD. PKG./MSTR. SLEEVE	SUGGESTED TRADE LIST PRICE PER
JTS37	80197	12	2	1.60	100	12.38/c
JTS82	80198	12	2 1/2	2.06	100	18.60/c
JTS83	80199	12	3	2.37	100	23.33/c
JTS55	80200	14	1/2	.93	100/500	8.40/c
JTS57	80201	14	3/4	1.13	100/500	9.30/c
JTS59	80202	14	1	1.44	100/500	10.08/c
JTS60	80203	14	1 1/4	1.55	100/500	13.13/c
JTS61	80204	14	1 1/2	1.84	100/500	14.93/c
JTS63	80205	14	2	2.34	100	15.50/c

OTHER SIZES AND QUANTITIES AVAILABLE BY REQUEST

 Phillips



FLAT HEAD PHILLIPS TAPPING SCREWS

STEEL ZINC CHROMATE

STOCK NO.	UPC NO.	DIAMETER	LENGTH	WT. PER PKG.	STD. PKG./MSTR. SLEEVE	SUGGESTED TRADE LIST PRICE PER
JTSF10	81861	4	1/2	.15	100/500	4.10/c NEW
JTSF101	81995	4	3/4	.20	100/500	5.35/c NEW
JTSF11	81862	4	1	.25	100/500	7.01/c NEW
JTSF12	80225	6	1/2	.23	100/500	3.20/c
JTSF14	80226	6	3/4	.30	100/500	3.45/c
JTSF15	80227	6	1	.35	100/500	3.50/c
JTSF9	80228	6	1 1/4	.40	100/500	3.55/c
JTSF38	83036	6	1 1/2	.49	100/500	14.15/c NEW
JTSF16	81863	6	2	.63	100/500	32.58/c NEW
JTSF18	81865	8	1/2	.26	100/500	5.18/c NEW
JTSF20	80229	8	3/4	.36	100/500	3.85/c
JTSF21	80230	8	1	.46	100/500	4.25/c
JTSF22	80231	8	1 1/4	.59	100/500	4.63/c
JTSF23	80232	8	1 1/2	.67	100/500	5.03/c
JTSF24	83027	8	2	.86	100/500	5.73/c NEW
JTSF25	83028	10	1/2	.35	100/500	4.65/c NEW
JTSF27	80233	10	3/4	.52	100/500	4.70/c
JTSF28	80234	10	1	.61	100/500	5.55/c
JTSF29	80235	10	1 1/4	.75	100/500	6.05/c
JTSF30	80236	10	1 1/2	.85	100/500	7.55/c
JTSF31	81866	10	2	1.15	100/500	10.90/c NEW
JTSF32	83030	12	1/2	.49	100/500	14.70/c NEW
JTSF33	83031	12	3/4	.68	100/500	11.81/c NEW
JTSF34	83032	12	1	.85	100/500	13.38/c NEW
JTSF35	83033	12	1 1/4	.95	100/500	23.44/c NEW
JTSF36	83034	12	1 1/2	.92	100/500	23.50/c NEW
JTSF37	83035	12	2	1.40	100	37.69/c

OTHER SIZES AND QUANTITIES AVAILABLE BY REQUEST

SCREWS

A



Slotted



STAINLESS STEEL PAN HEAD SLOTTED TAPPING SCREWS

18-8 SERIES TYPE

STOCK NO.	UPC NO.	DIAMETER	LENGTH	WT. PER PKG.	STD. PKG./MSTR. SLEEVE	SUGGESTED TRADE LIST PRICE PER
JSTS10	80206	6	1/2	.25	100/500	7.98/c
JSTS11	80207	6	3/4	.32	100/500	9.98/c
JSTS12	80208	6	1	.33	100/500	11.25/c
JSTS13	80209	8	1/2	.34	100/500	10.83/c
JSTS14	80210	8	3/4	.47	100/500	17.08/c
JSTS15	80211	8	1	.54	100/500	24.20/c
JSTS16	80212	8	1 1/4	.63	100/500	16.45/c
JSTS17	80213	8	1 1/2	.74	100/500	18.20/c
JSTS18	80214	8	2	.92	100/500	29.45/c
JSTS19	80215	10	1/2	.48	100/500	16.05/c
JSTS20	80216	10	5/8	.52	100/500	18.15/c
JSTS21	80217	10	3/4	.60	100/500	20.20/c
JSTS22	80218	10	1	.70	100/500	21.05/c
JSTS23	80219	10	1 1/4	.87	100/500	26.85/c
JSTS24	80220	10	1 1/2	.98	100/500	27.03/c
JSTS25	80221	10	2	1.23	100/500	32.90/c
JSTS26	80222	12	1/2	.66	100/500	18.88/c
JSTS27	80223	12	3/4	.88	100/500	27.48/c
JSTS28	80224	12	1	.94	100/500	26.85/c

OTHER SIZES AND QUANTITIES AVAILABLE BY REQUEST



Phillips



STAINLESS STEEL PAN HEAD PHILLIPS TAPPING SCREWS

NEW!

18-8 SERIES TYPE

STOCK NO.	UPC NO.	DIAMETER	LENGTH	WT. PER PKG.	STD. PKG./MSTR. SLEEVE	SUGGESTED TRADE LIST PRICE PER
JSTSP39	84039	6	3/8	.25	100/500	PLEASE CALL FOR TRADE LIST PRICING
JSTSP10	84010	6	1/2	.27	100/500	
JSTSP11	84011	6	3/4	.29	100/500	
JSTSP12	84012	6	1	.33	100/500	
JSTSP125	84427	6	1 1/2	.58	100/500	
JSTSP37	84037	8	3/8	.33	100/500	
JSTSP13	84013	8	1/2	.34	100/500	
JSTSP14	84014	8	3/4	.47	100/500	
JSTSP15	84015	8	1	.58	100/500	
JSTSP16	84016	8	1 1/4	.67	100/500	
JSTSP17	84017	8	1 1/2	.76	100/500	
JSTSP18	84018	8	2	.98	100/500	
JSTSP19	84019	10	1/2	.67	100/500	
JSTSP20	84020	10	5/8	.68	100/500	
JSTSP21	84021	10	3/4	.75	100/500	
JSTSP22	84022	10	1	.87	100/500	
JSTSP23	84023	10	1 1/4	1.22	100/500	
JSTSP24	84024	10	1 1/2	1.03	100/500	
JSTSP25	84025	10	2	1.46	100/500	
JSTSP29	84029	10	3	1.81	100	
JSTSP26	84026	12	1/2	.66	100/500	
JSTSP27	84027	12	3/4	.88	100/500	
JSTSP28	84028	12	1	.94	100/500	
JSTSP33	84033	12	1 1/4	1.22	100/500	
JSTSP32	84032	12	1 1/2	1.38	100/500	
JSTSP34	84034	12	2	1.65	100	
JSTSP35	84035	12	3	2.40	100	
JSTSP30	84030	14	3/4	1.15	100/500	

OTHER SIZES AND QUANTITIES AVAILABLE BY REQUEST

PAN HEAD SQUARE DRIVE TAPPING SCREWS

SQUARE DRIVE RECESS. STEEL ZINC CHROMATE



A strong, positive drive fastener that locks onto the square drive bit.
Ideal for Distributors and Users in the Canadian Market.

STOCK NO.	UPC NO.	DIAMETER	LENGTH	WT. PER PKG.	STD. PKG./MSTR. SLEEVE	SUGGESTED TRADE LIST PRICE PER
JTSS1	80237	6	1/2	.26	100/500	4.08/c
JTSS2	80238	6	3/4	.35	100/500	4.20/c
JTSS3	80239	6	1	.40	100/500	5.38/c
JTSS4	80240	6	1 1/4	.43	100/500	6.43/c
JTSS5	80241	6	1 1/2	.54	100/500	7.40/c
JTSS6	80242	6	2	.66	100/500	13.35/c
JTSS7	80243	8	1/2	.38	100/500	4.35/c
JTSS8	80244	8	3/4	.49	100/500	4.55/c
JTSS9	80245	8	1	.59	100/500	5.58/c
JTSS10	80246	8	1 1/4	.66	100/500	7.58/c
JTSS11	80247	8	1 1/2	.77	100/500	8.58/c
JTSS12	80248	8	2	.92	100/500	10.00/c
JTSS25	80249	10	1/2	.49	100/500	5.55/c
JTSS27	80250	10	3/4	.62	100/500	6.15/c
JTSS28	80251	10	1	.76	100/500	6.90/c
JTSS29	80252	10	1 1/4	.90	100/500	8.55/c
JTSS30	80253	10	1 1/2	1.02	100/500	9.23/c
JTSS31	80254	10	2	1.29	100/500	11.50/c
JTSS32	80255	10	2 1/2	1.58	100	16.13/c
JTSS81	80256	10	3	1.73	100	21.53/c
JTSS33	80257	12	3/4	.88	100/500	9.68/c
JTSS34	80258	12	1	1.04	100/500	10.65/c
JTSS35	80259	12	1 1/4	1.28	100/500	11.53/c
JTSS36	80260	12	1 1/2	1.38	100/500	13.38/c
JTSS37	80261	12	2	1.75	100	16.45/c
JTSS83	80262	12	3	2.44	100	21.53/c

OTHER SIZES AND QUANTITIES AVAILABLE BY REQUEST



STAINLESS STEEL PAN HEAD SQUARE DRIVE TAPPING SCREWS

18-8 SERIES TYPE

NEW!

STOCK NO.	UPC NO.	DIAMETER	LENGTH	WT. PER PKG.	STD. PKG./MSTR. SLEEVE	SUGGESTED TRADE LIST PRICE PER
JTSS7SS	96407	8	1/2	.39	100/500	PLEASE CALL FOR TRADE LIST PRICING
JTSS8SS	96408	8	3/4	.51	100/500	
JTSS9SS	96409	8	1	.60	100/500	
JTSS10SS	96410	8	1 1/4	.68	100/500	
JTSS11SS	96411	8	1 1/2	.79	100/500	
JTSS25SS	96425	10	1/2	.52	100/500	
JTSS27SS	96427	10	3/4	.60	100/500	
JTSS28SS	96428	10	1	.99	100/500	
JTSS29SS	96429	10	1 1/4	.87	100/500	
JTSS30SS	96430	10	1 1/2	.94	100/500	
JTSS31SS	96431	10	2	1.25	100/500	

OTHER SIZES AND QUANTITIES AVAILABLE BY REQUEST

SCREWS



Phillips



Square Drive

Two drives in one head!



ROUND WASHER HEAD TAPPING SCREWS

SQUARE-PHILLIPS RECESS. STEEL ZINC CHROMATE



STOCK NO.	UPC NO.	DIAMETER	LENGTH	WT. PER PKG.	STD. PKG./MSTR. SLEEVE	SUGGESTED TRADE LIST PRICE PER
JRWS7	80263	8	1/2	.41	100/500	5.53/c
JRWS8	80264	8	3/4	.52	100/500	5.53/c
JRWS9	80265	8	1	.59	100/500	5.98/c
JRWS10	80266	8	1 1/4	.69	100/500	6.68/c
JRWS11	80267	8	1 1/2	.83	100/500	7.00/c
JRWS12	80268	8	2	1.00	100/500	11.98/c
JRWS26	80269	10	1/2	.55	100/500	5.95/c
JRWS27	80270	10	3/4	.68	100/500	6.10/c
JRWS28	80271	10	1	.81	100/500	6.93/c
JRWS29	80272	10	1 1/4	.89	100/500	12.70/c
JRWS30	80273	10	1 1/2	1.10	100/500	13.13/c
JRWS31	80274	10	2	1.30	100/500	17.50/c

OTHER SIZES AND QUANTITIES AVAILABLE BY REQUEST



Hex



Slotted



HEX HEAD SHEET METAL SCREWS

Indented Hex Washer Slotted Head
STEEL ZINC CHROMATE, SELF-PIERCING
The ideal fastener for light gauge sheet metal*

STOCK NO.	UPC NO.	DIAMETER	LENGTH	WT. PER PKG.	STD. PKG./MSTR. SLEEVE	SUGGESTED TRADE LIST PRICE PER
1/4" HEAD—USE MT208B CHUCK, SEE PAGE 266						
JDS150	80275	6	3/8	.27	100/500	3.65/c
JDS161	80276	6	1/2	.30	100/500	3.70/c
JDS160	80277	6	3/4	.37	100/500	3.85/c
JDS163	80278	6	1	.43	100/500	4.60/c
JDS164	80279	6	1 1/4	.51	100/500	5.53/c
JDS165	80280	6	1 1/2	.62	100/500	6.35/c
JDS151	80281	7	1/2	.33	100/500	4.08/c
JDS166	80282	7	3/4	.43	100/500	4.28/c
JDS152	80283	8	1/2	.37	100/500	4.28/c
JDS153	80284	8	3/4	.45	100/500	4.78/c
JDS154	80285	8	1	.53	100/500	5.13/c
JDS162	80286	8	1 1/4	.68	100/500	6.53/c
JDS157	80287	8	1 1/2	.75	100/500	7.28/c
JDS159	80288	8	2	1.00	100/500	9.33/c
JDS84	81708	8	2 1/2	1.16	100/500	14.78/c NEW
JDS155	80289	10	1/2	.37	100/500	4.65/c
JDS156	80290	10	3/4	.51	100/500	5.45/c
JDS158	80291	10	1	.61	100/500	6.28/c
JDS168	80293	10	1 1/2	.88	100/500	9.33/c
JDS169	80294	10	2	1.12	100/500	12.40/c
5/16" HEAD—USE MT210B CHUCK, SEE PAGE 266						
JDS180	80295	10	1/2	.55	100/500	4.98/c
JDS181	80296	10	3/4	.63	100/500	5.45/c
JDS182	80297	10	1	.75	100/500	6.28/c
JDS183	80298	10	1 1/4	.88	100/500	7.55/c
JDS184	80299	10	1 1/2	1.00	100/500	8.75/c
JDS185	80300	10	2	1.25	100	12.60/c
JDS80	80301	10	2 1/2	1.53	100	14.70/c
JDS81	80302	10	3	1.81	100	16.90/c

OTHER SIZES AND QUANTITIES AVAILABLE BY REQUEST

CONTINUED ON NEXT PAGE

www.metallicsonline.com

CONTINUED

HEX HEAD SHEET METAL SCREWS



Indented Hex Washer Slotted Head
 STEEL ZINC CHROMATE, SELF-PIERCING
 The ideal fastener for light gauge sheet metal*



STOCK NO.	UPC NO.	DIAMETER	LENGTH	WT. PER PKG.	STD. PKG./MSTR. SLEEVE	SUGGESTED TRADE LIST PRICE PER
5/16" HEAD—USE MT210B CHUCK, SEE PAGE 266						
JDS170	80303	12	3/4	.79	100/500	8.48/c
JDS171	80304	12	1	1.00	100/500	8.75/c
JDS172	80305	12	1 1/4	1.17	100/500	9.83/c
JDS173	80306	12	1 1/2	1.32	100/500	11.33/c
JDS174	80307	12	2	1.63	100	13.03/c
3/8" HEAD—USE MT212B CHUCK, SEE PAGE 266						
JDS85	81709	14	1/2	.94	100/500	16.60/c NEW
JDS175	80308	14	3/4	.97	100/500	12.95/c
JDS176	80309	14	1	1.53	100/500	13.65/c
JDS177	80310	14	1 1/4	1.70	100	15.53/c
JDS178	80311	14	1 1/2	2.01	100	15.83/c
JDS179	80312	14	2	2.45	100	22.55/c
JDS187	81768	14	2 1/2	2.91	100	32.25/c NEW
JDS143	80313	14	3	3.38	100	25.88/c

OTHER SIZES AND QUANTITIES AVAILABLE BY REQUEST

*Used in light metal assembly such as electrical outlets, framing and various other sheet metal applications.



STAINLESS STEEL **NEW!** SHEET METAL SCREWS INDENTED HEX WASHER 18-8 SERIES TYPE

STOCK NO.	UPC NO.	DIAMETER	LENGTH	WT. PER PKG.	STD. PKG./MSTR. SLEEVE	SUGGESTED TRADE LIST PRICE PER	
1/4" HEAD—USE MT208B CHUCK, SEE PAGE 266							
JDS162SS	92762	8	1 1/4	.69	100/500	PLEASE CALL FOR TRADE LIST PRICING NEW	
5/16" HEAD—USE MT210B CHUCK, SEE PAGE 266							
JDS182SS	92782	10	1	.80	100/500		
JDS183SS	92783	10	1 1/4	.87	100/500		
JDS184SS	81764	10	1 1/2	1.02	100/500		
JDS185SS	81765	10	2	1.33	100		
JDS186SS	92786	12	1/2	.75	100/500		
JDS170SS	92770	12	3/4	.89	100/500		
JDS187SS	92787	14	1	1.63	100/500		
JDS177SS	92777	14	1 1/4	1.81	100		

OTHER SIZES AND QUANTITIES AVAILABLE BY REQUEST

EASTERN



8:00 A.M. to 5:00 P.M.

Metallics, Inc. CT

CENTRAL



8:00 A.M. to 5:00 P.M.

Metallics, West Inc. CO

MOUNTAIN







8:00 A.M. to 5:00 P.M.

Metallics, West Inc. CO

In the event Metallics East, Bristol is CLOSED, call Metallics West at 1-800-269-5183 if you require technical information or overnight shipments

SCREWS

Four drives in one head

-  Hex
-  Slotted
-  Phillips
-  Square Drive

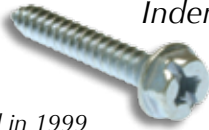

QUADRIIVE SHEET METAL SELF-PIERCING SCREWS

Indented Hex Washer, Slotted, Phillips, Square Recess Head



STEEL ZINC CHROMATE
FIRST IN THE WORLD

THE IDEAL FASTENER FOR LIGHT GAUGE SHEET METAL

MADE IN USA



Manufactured by
Avanti Screw, Inc.,
A Metallics
Affiliate

STOCK NO.	UPC NO.	DIAMETER	LENGTH	WT. PER PKG.	STD. PKG./MSTR. SLEEVE	SUGGESTED TRADE LIST PRICE PER
		1/4" HEAD				USE MT208B CHUCK, SEE PAGE 266
QDS152	39100	8	1/2	.39	100/500	7.53/c
QDS153	39101	8	3/4	.48	100/500	8.05/c
QDS154	39102	8	1	.59	100/500	8.63/c
QDS156	39103	10	3/4	.55	100/500	8.35/c
QDS158	39104	10	1	.66	100/500	9.15/c
		5/16" HEAD				USE MT210B CHUCK, SEE PAGE 266
QDS181	39106	10	3/4	.66	100/500	8.63/c
QDS182	39107	10	1	.82	100/500	9.50/c
QDS183	39108	10	1 1/4	.95	100/500	9.83/c
QDS184	39109	10	1 1/2	1.09	100/500	10.48/c
QDS185	39110	10	2	1.36	100	12.13/c
QDS80	39111	10	2 1/2	1.62	100	14.83/c
QDS171	39112	12	1	.97	100/500	11.60/c
QDS172	39113	12	1 1/4	1.12	100/500	12.28/c
QDS174	39114	12	2	1.71	100	15.30/c

OTHER SIZES AND QUANTITIES AVAILABLE BY REQUEST

AMERICA'S SOURCE FOR PREMIER AND INNOVATIVE FASTENERS & ANCHORS

ONLY METALLICS!



A Modern Up to Date Roll Threading Machine at our Affiliate, Avanti Screw.



Metallics and Avanti Screw, Inc., prime American manufacturers of fastener products, have always worked to present the latest in fastener technology to our distributors and their contractors/users.

Hex Washer Head fasteners have historically only offered three drives-the hex, phillips and the slot. In 1999, we introduced "The QuaDrive" square, hex, slotted and phillips, in fourteen of the most popular sizes of sheet metal screws.

The QuaDrive

Square Drive

+

Hex

+

Slotted

+

Phillips

=

QuaDrive

America's Newest Drive - Designed, Developed and Manufactured by Metallics/Avanti Screw

These sheet metal screws are being manufactured to fill the need of the growing demand in the North American markets.



QUIK-EZE SHEET METAL SCREWS

High Performance Self-Piercing Screw
Indented Hex Washer Slotted Head
STEEL ZINC CHROMATE

A Double Lead Thread means
twice the driving speed!



STOCK NO.	UPC NO.	DIAMETER	LENGTH	WT. PER PKG.	STD. PKG./MSTR. SLEEVE	SUGGESTED TRADE LIST PRICE PER
1/4" HEAD—USE MT208B CHUCK, SEE PAGE 266						
JQK1	80314	7	1/2	.32	100/500	4.28/c
JQK5	80315	8	1/2	.35	100/500	3.20/c
JQK10	80316	8	3/4	.43	100/500	3.53/c
JQK15	80317	8	1	.54	100/500	3.78/c
JQK17	80318	8	1 1/2	.71	100/500	5.43/c
JQK19	80319	8	2	.88	100/500	8.35/c
JQK20	80320	10	1/2	.53	100/500	3.83/c
JQK25	80321	10	3/4	.51	100/500	4.35/c
JQK30	80322	10	1	.61	100/500	4.73/c
5/16" HEAD—USE MT208B CHUCK, SEE PAGE 266						
JQK59	75859	10	1	.71	100/500	7.75/c NEW
JQK12114	85983	12	1 1/4	1.11	100/500	14.03/c NEW

1000 PACKS

1/4" HEAD—USE MT208B CHUCK, SEE PAGE 266						
QK1M	10660	7	1/2	2.76	1000	39.68/m
QK5M	10661	8	1/2	3.02	1000	29.70/m
QK10M	10662	8	3/4	3.86	1000	32.78/m
QK15M	10663	8	1	4.95	1000	35.25/m
QK17M	10664	8	1 1/2	6.59	1000	50.53/m
QK19M	10665	8	2	8.45	1000	77.78/m
QK20M	10666	10	1/2	3.53	1000	35.60/m
QK25M	10667	10	3/4	4.85	1000	40.58/m
QK30M	10668	10	1	7.10	1000	44.03/m

OTHER SIZES AND QUANTITIES AVAILABLE BY REQUEST



SELF-DRILLING & TAPPING SCREWS

Square Drive Recess Pan Head
STEEL ZINC CHROMATE

A strong, positive drive fastener that locks onto the square drive bit—used in difficult-to-apply areas.
See page 266. **SQUARE DRIVE INSERT BITS** for proper driver.

STOCK NO.	UPC NO.	DIAMETER	LENGTH	WT. PER PKG.	STD. PKG./MSTR. SLEEVE	SUGGESTED TRADE LIST PRICE PER
JTEKS1	80323	8	1/2	.36	100/500	6.98/c
JTEKS3	80324	8	5/8	.43	100/500	7.40/c
JTEKS2	80325	8	3/4	.48	100/500	8.33/c
JTEKS14	80326	8	1	.57	100/500	9.28/c
JTEKS5	80327	10	1/2	.51	100/500	11.00/c
JTEKS8	80328	10	5/8	.57	100/500	13.45/c
JTEKS6	80329	10	3/4	.66	100/500	11.70/c
JTEKS7	80330	10	1	.75	100/500	12.78/c
JTEKS15	80331	10	1 1/4	.85	100/500	14.13/c
JTEKS19	80332	10	1 1/2	1.00	100/500	16.13/c

OTHER SIZES AND QUANTITIES AVAILABLE BY REQUEST

SELF-DRILLING & TAPPING SCREWS PHILLIPS PAN HEAD



STEEL ZINC CHROMATE

STOCK NO.	UPC NO.	DIAMETER	LENGTH	WT. PER PKG.	STD. PKG./MSTR. SLEEVE	SUGGESTED TRADE LIST PRICE PER
6 HAS A #2 Drill Point 1/4" HEAD—USE MT208B CHUCK, SEE PAGE 266						
JTEK10P	80333	6	1/2	.25	100/500	6.70/c
JTEK11P	80334	6	3/4	.32	100/500	7.55/c
JTEK12P	80335	6	1	.39	100/500	8.05/c
8 HAS A #2 Drill Point 1/4" HEAD—USE MT208B CHUCK, SEE PAGE 266						
JTEK1P	80336	8	1/2	.30	100/500	7.03/c
JTEK2P	80337	8	3/4	.47	100/500	7.55/c
JTEK16P	90080	8	5/8	.41	100/500	12.18/c NEW
JTEK14P	80338	8	1	.55	100/500	8.35/c
JTEK15P	80339	8	1 1/2	.74	100/500	11.05/c
10 HAS A #2 Drill Point 1/4" HEAD—USE MT208B CHUCK, SEE PAGE 266						
JTEK4P	80340	10	1/2	.51	100/500	9.73/c
JTEK3P	80341	10	3/4	.61	100/500	10.93/c
JTEK7P	80342	10	1	.75	100/500	11.75/c
JTEK18P	80343	10	1 1/4	.87	100/500	13.25/c
JTEK19P	80344	10	1 1/2	.98	100/500	14.28/c
JTEK20P	81311	10	2	1.23	100/500	14.55/c NEW

OTHER SIZES AND QUANTITIES AVAILABLE BY REQUEST



SELF-DRILLING & TAPPING SCREWS HEX WASHER HEAD

STEEL ZINC CHROMATE

STOCK NO.	UPC NO.	DIAMETER	LENGTH	WT. PER PKG.	STD. PKG./MSTR. SLEEVE	SUGGESTED TRADE LIST PRICE PER
6-10 HAS A #2 Drill Point 1/4" HEAD—USE MT208B CHUCK, SEE PAGE 266						
JTEKD26	83324	6	3/8	.28	100/500	4.98/c NEW
JTEKD25	83323	6	1/2	.32	100/500	3.03/c NEW
JTEKD1	80345	8	1/2	.37	100/500	7.23/c
JTEKD16	80346	8	5/8	.44	100/500	7.40/c
JTEKD2	80347	8	3/4	.46	100/500	7.88/c
JTEKD14	80348	8	1	.54	100/500	8.35/c
JTEKD15	80349	8	1 1/2	.78	100/500	10.50/c
JTEKD82	83382	8	2	1.02	100/500	23.52/c NEW
JTEKD4	80350	10	1/2	.46	100/500	8.93/c
JTEKD3	80351	10	3/4	.54	100/500	9.00/c
10 HAS A #2 Drill Point 5/16" HEAD—USE MT210B CHUCK, SEE PAGE 266						
JTEKD5	80352	10	1/2	.50	100/500	8.90/c
JTEKD17	80353	10	5/8	.57	100/500	9.58/c
JTEKD6	80354	10	3/4	.65	100/500	10.40/c
JTEKD7	80355	10	1	.75	100/500	10.85/c
JTEKD18	80356	10	1 1/4	.89	100/500	11.58/c
JTEKD19	80357	10	1 1/2	1.02	100/500	12.78/c
JTEKD24	83322	10	2 1/2	1.57	100	15.25/c NEW
JTEKD23	83321	10	3	1.86	100	20.50/c NEW

OTHER SIZES AND QUANTITIES AVAILABLE BY REQUEST

CONTINUED ON NEXT PAGE

CONTINUED

SELF-DRILLING & TAPPING SCREWS HEX WASHER HEAD

STEEL ZINC CHROMATE



A

STOCK NO.	UPC NO.	DIAMETER	LENGTH	WT. PER PKG.	STD. PKG./ MSTR. SLEEVE	SUGGESTED TRADE LIST PRICE PER
10-12 HAS A #3 Drill Point 5/16" HEAD—USE MT210B CHUCK, SEE PAGE 266						
JTEKD12	80358	10	3/4	.62	100/500	11.23/c
JTEKD13	80359	10	1	.75	100/500	12.23/c
JTEKD22	80360	10	2	1.28	100/500	17.88/c
JTEKD20	80361	12	3/4	.81	100/500	13.93/c
JTEKD8	80362	12	1	1.00	100/500	15.80/c
JTEKD21	80363	12	1 1/2	1.33	100/500	18.25/c
JTEKD32	80364	12	2	1.71	100	20.48/c
JTEKD12212	90655	12	2 1/2	2.07	100	24.88/c NEW
JTEKD30	83313	12	3	2.38	100	40.30/c NEW
12 HAS A #5 Drill Point 5/16" HEAD—USE MT2110B CHUCK, SEE PAGE 266						
JTXV12114Z	25785	12	1 1/4	.65	50/250	35.50/c NEW
14 HAS A #3 Drill Point 3/8" HEAD—USE MT212B CHUCK, SEE PAGE 266						
JTEKD9	80365	14	3/4	1.23	100/500	18.15/c
JTEKD10	80366	14	1	1.41	100/500	20.65/c
JTEKD37	83337	14	1 1/4	1.69	100/500	21.22/c NEW
JTEKD11	80367	14	1 1/2	1.75	100/500	23.15/c
JTEKD34	80368	14	2	2.44	100	36.78/c
JTEKD36	83336	14	3	3.37	100	46.10/c NEW
JTEKD99	83399	14	4	4.39	100	59.75/c NEW

OTHER SIZES AND QUANTITIES AVAILABLE BY REQUEST

Not recommended for structural steel or bar joist. See PAGE 73 for heavy duty drill screws.



STAINLESS STEEL **NEW!** SELF-DRILLING & TAPPING SCREWS HEX WASHER HEAD

410 STAINLESS STEEL

STOCK NO.	UPC NO.	DIAMETER	LENGTH	WT. PER PKG.	STD. PKG./ MSTR. SLEEVE	SUGGESTED TRADE LIST PRICE PER
8-10 HAS A #2 Drill Point 5/16" HEAD—USE MT208B CHUCK, SEE PG. 266						
JTEKD1SS	85211	8	1/2	.38	100/500	16.08/c NEW
JTEKD14SS	85214	8	1	.57	100/500	23.25/c NEW
JTEKD15SS	85215	8	1 1/2	.78	100/500	42.78/c NEW
JTEKD5SS	85220	10	1/2	.43	100/500	28.75/c NEW
JTEKD6SS	85222	10	3/4	.63	100/500	29.30/c NEW
10-14 HAS A #3 Drill Point 5/16" HEAD—USE MT208B CHUCK, SEE PG. 266						
JTEKD12SS	85227	10	3/4	.60	100/500	30.08/c NEW
JTEKD7SS	85223	10	1	.78	100/500	46.15/c NEW
JTEKD22SS	85229	10	2	1.26	100/500	56.25/c NEW
JTEKD20SS	85230	12	3/4	.85	100/500	44.83/c NEW
JTEKD9SS	85235	14	3/4	1.25	100/500	56.25/c NEW
JTEKD10SS	85236	14	1	1.39	100/500	60.95/c NEW
JTEKD23SS	85238	14	3	3.32	100	143.13/c NEW

OTHER SIZES AND QUANTITIES AVAILABLE BY REQUEST

A

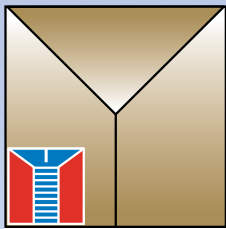

Metallics



Self Drilling Stainless Steel Screw Kit

[CONTRACTOR APPROVED]



Kit **TEKDK1SS** contains #8 and #10 hex washer head with 1/4" and 5/16" nut setters.

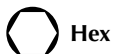

PART #	UPC #	DESCRIPTION	HEAD SIZE	QTY / PKG	SUG. TRADE LIST / PKG
TEKDK1SS	39621	#8 x 1/2" Hex Washer Head Stainless Steel Drill Screws	1/4	100	\$ 63.38
		#8 x 3/4" Hex Washer Head Stainless Steel Drill Screws	1/4	50	
		#8 x 1" Hex Washer Head Stainless Steel Drill Screws	1/4	40	
		#10 x 1/2" Hex Washer Head Stainless Steel Drill Screws	5/16	50	
		#10 x 3/4" Hex Washer Head Stainless Steel Drill Screws	5/16	35	
		#10 x 1" Hex Washer Head Stainless Steel Drill Screws	5/16	30	
		1/4" Driver	-	1	
		5/16" Driver	-	1	

"Growth Through Innovation"

Metallics

229 Cross Street, Bristol, CT 06010
Tel 800-243-8272 • **Fax** 800-831-9358
Email sales@metallicsonline.com

Metallics West

651 North Main Street, Mancos, CO 81328
Tel 800-269-5183 • **Fax** 800-269-6278
Email saleswest@metallicsonline.com



CONSTRUCTION FASTENERS METAL TO WOOD SCREWS

SELF-DRILLING FASTENERS FOR ATTACHING ROOF AND WALL METAL PANELS OVER INSULATION TO WOOD FRAMING.

GIMLET DRILL POINT.

AVAILABLE WITH OR WITHOUT WASHER.

Provides excellent corrosion resistance and lower tapping torque.



STOCK NO.	UPC NO.	DESCRIPTION	SIZE/ HEAD STYLE	STD QTY.	WT. PER PKG.	SUGGESTED TRADE LIST PRICE PER
WITH BONDED W ASHER						
TGW9151	25735	9-15 x 1	1/4" Hex Washer Head	50	.43	24.60/c



WITHOUT WASHER						
TG9151	25740	9-15 x 1	1/4" Hex Head	50	.36	12.66/c

OTHER SIZES AND QUANTITIES AVAILABLE BY REQUEST

CONSTRUCTION FASTENERS

HEAVY DUTY DRILL SCREWS



HEAVY DUTY STEEL-TO-STEEL APPLICATION

Self-drilling fasteners for structural steel or bar joists up to 1/2" thick

Milled drill point • Excellent Corrosion Resistant Finish

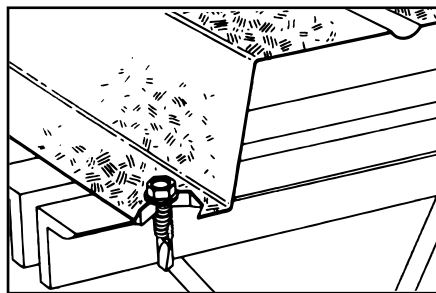

- Unique double fluted point dramatically improves drilling performance over conventional Drill screws.
- Attaches items directly to structural steel or bar joist.
- Excellent corrosion resistant finish.
- Engineered for faster drilling with less effort.
- The only fastener recommended for hanging jack chain without pre-drilling.
- We recommend using JW113 Fender Washer 1/4 x 1 with heavy duty drill screw to ensure proper grip on jack chain.

STOCK NO.	JAR UPC NO.	SIZE DESCRIPTION	SIZE/ HEAD STYLE	DRILL POINT	STD QTY.	WT. PER PKG.	SUGGESTED TRADE LIST PRICE PER
TXV12114	25730	12-24 X 1 1/4	5/16" Hex Washer Head	#5	50	.66	108.80/c
*TXV12114Z	25785	12-24 X 1 1/4	5/16" Hex Washer Head	#5	100	1.08	38.70/c
TXV12112	25728	12-24 X 1 1/2	5/16" Hex Washer Head	#5	50	.78	68.75/c NEW
TXV12200	25925	12-24 X 2	5/16" Hex Washer Head	#5	50	.97	76.25/c NEW
TXV14400	25780	1/4-14 X 4	5/16" Hex Washer Head	#5	50	1.95	97.20/c NEW

OTHER SIZES AND QUANTITIES AVAILABLE BY REQUEST

*DENOTES A PRODUCT NOT MADE IN USA

CONSTRUCTION FASTENERS



WOOD TO METAL DRILL SCREWS

FAST, EFFICIENT ATTACHMENT OF WOOD TO STEEL FRAMING WITH NO PRE-DRILLING.
MUST BE USED IN 16 GAUGE STEEL OR GREATER FOR ENGAGEMENT.



- Drill point has precise cutting edges to improve drill performance with less effort.
- Special winged fasteners ream a hole in wood preventing thread engagement during drilling.
- Wafer head design has a large bearing surface ideal for plywood.
- Flat head design countersinks and seats flush in wood.
- Excellent corrosion resistant finish.

STOCK NO.	UPC NO.	DESCRIPTION	HEAD STYLE	DRILL POINT	STD QTY.	WT. PER PKG.	SUGGESTED TRADE LIST PRICE PER
TW101716	25745	10-24 x 1 ⁷ / ₁₆	Phillips/Flat Head	#3	50	.53	53.06/c
TW12212	25750	12-24 x 2 ³ / ₄	Phillips/Flat Head	#4	50	1.22	112.36/c

OTHER SIZES AND QUANTITIES AVAILABLE BY REQUEST

CONSTRUCTION FASTENERS

METAL TO METAL DRILL SCREWS



SELF DRILLING FASTENERS FOR ATTACHING STANDING ROOF CLIPS AND WALL/ROOF METAL PANELS TO STEEL FRAMING (PURLIN/BAR JOIST).



- Hex Head Style.
- Milled drill point
- Available with or without bonded washer.
- Excellent corrosion resistant finish.

STOCK NO.	UPC NO.	DESCRIPTION	SIZE/ HEAD STYLE	DRILL POINT	STD QTY.	WT. PER PKG.	SUGGESTED TRADE LIST PRICE PER
WITHOUT WASHER							
TX1234	25755	12-14 x 3/4	5/16" Hex Head	#3	50	.44	42.00/c
TX1478	25760	1/4-14 x 7/8	3/8" Hex Head	#1	50	.54	45.20/c
WITH BONDED WASHERS							
TXW1234	25765	12-14 x 3/4	5/16" Hex Washer Head	#3	50	.62	54.36/c
TXW1478	25770	1/4-14 x 7/8	3/8" Hex Washer Head	#1	50	.75	64.20/c

410 STAINLESS STEEL WITH BONDED WASHER

TX12114SS	25775	12-14 x 1 ¹ / ₄	5/16" Hex Washer Head	#3	50	.81	135.16/c
-----------	-------	---------------------------------------	-----------------------	----	----	-----	----------

OTHER SIZES AND QUANTITIES AVAILABLE BY REQUEST

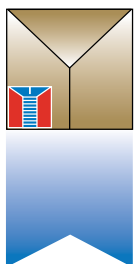

If you can't find the fastener you are looking for, call and experience the Metallics difference.





QUADRI[®] SELF-DRILLING AND TAPPING SCREWS

FIRST IN THE WORLD

STEEL ZINC CHROMATE ECONOMICAL SWAGED POINT
Four drives in one head • Introduced in 1999



Manufactured by
 Avanti Screw, Inc.,
 A Metallics
 Affiliate



STOCK NO.	UPC NO.	DIAMETER	LENGTH	WT. PER PKG.	STD. PKG./MSTR. SLEEVE	SUGGESTED TRADE LIST PRICE PER
-----------	---------	----------	--------	--------------	------------------------	--------------------------------

8-10 HAS A #2 Drill Point 1/4" HEAD



USE MT208B CHUCK see PAGE 266

QTEKD1	39120	8	1/2	.38	100/500	8.30/c
QTEKD2	39121	8	3/4	.48	100/500	9.05/c
QTEKD14	39122	8	1	.58	100/500	9.60/c
QTEKD4	39123	10	1/2	.41	100/500	10.00/c
QTEKD3	39124	10	3/4	.52	100/500	10.35/c

10 HAS A #2 Drill Point 5/16" HEAD



USE MT210B CHUCK see PAGE 266

QTEKD5	39125	10	1/2	.54	100/500	10.00/c
QTEKD17	39126	10	5/8	.59	100/500	10.35/c
QTEKD6	39127	10	3/4	.66	100/500	10.83/c
QTEKD7	39128	10	1	.79	100/500	11.98/c
QTEKD18	39129	10	1 1/4	.91	100/500	12.85/c
QTEKD19	39130	10	1 1/2	1.05	100/500	13.70/c

10-12 HAS A #3 Drill Point 5/16" HEAD



USE MT210B CHUCK see PAGE 266

QTEKD12	39135	10	3/4	.69	100/500	11.00/c
QTEKD13	39136	10	1	.81	100/500	11.98/c
QTEKD20	39137	12	3/4	.77	100/500	12.03/c
QTEKD8	39138	12	1	.95	100/500	13.58/c

OTHER SIZES AND QUANTITIES AVAILABLE BY REQUEST

AMERICA'S SOURCE FOR PREMIER AND INNOVATIVE FASTENERS & ANCHORS

HELPFUL HINTS FROM METALLICS

Selecting the proper fastener for each application is important in obtaining maximum performance.

Point Length — Length of the unthreaded point — must be greater than total thickness of material to be drilled. In jobs involving more than total thickness of material, calculation of total thickness must also include any spaces between thicknesses.

Driving Technique — Keep the driving tool perpendicular to working surface.

Drivers — Fasteners should be installed with 2500 RPM high-torque drivers equipped with a positive clutch. For wood to steel applications, drivers operating at 1700-2000 RPM should be used.

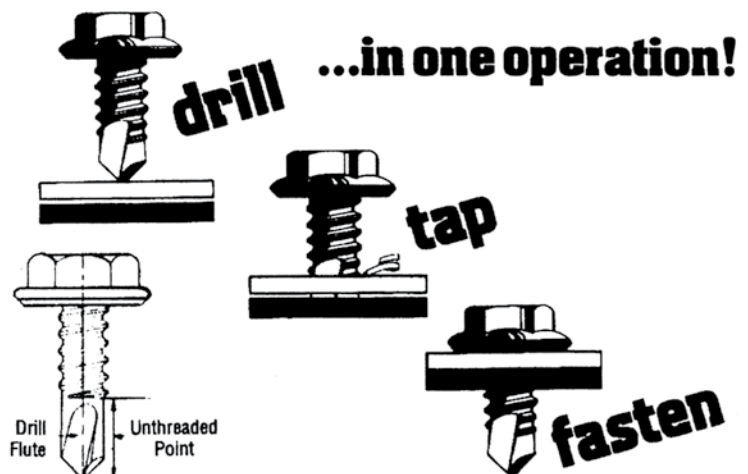

A

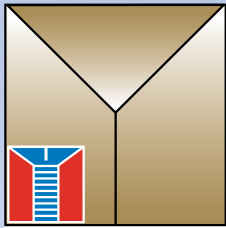

Metallics



#10 Flat Head Phillips Wood Screw Kit & Display Steel Zinc Plate

302 piece kit

[CONTRACTOR APPROVED]



WSK10

Flat Head Phillips Wood Screw - Zinc (302 pc kit)

- 150 (10 x 1)
- 86 (10 x 1 1/2)
- 86 (10 x 2)

WSK10CD1
Cardboard display case contains 14 kits - includes a 13% savings on each kit!



PART #	UPC #	DESCRIPTION	QTY / PKG	SUG. TRADE LIST / PKG
WSK10	41425	#10 Wood Screw Kit - 302 pieces	1	\$ 34.75
WSK10CD1	41426	#10 Wood Screw Kit Display Case - 14 kits total	1	\$ 423.50

"Growth Through Innovation"

Metallics

229 Cross Street, Bristol, CT 06010
Tel 800-243-8272 • **Fax** 800-831-9358
Email sales@metallicsonline.com

Metallics West

651 North Main Street, Mancos, CO 81328
Tel 800-269-5183 • **Fax** 800-269-6278
Email saleswest@metallicsonline.com

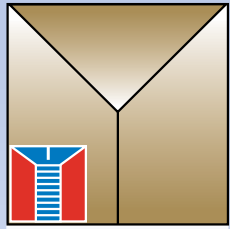

Metallics



Self-Piercing Drywall Screws Fine Thread

Phillips Bugle Head

[CONTRACTOR APPROVED]



- For use in up to 20 Gauge Steel Stud
- Black Phosphate Finish
- Fine thread for hardwood, light gauge steel and aluminum
- Three of the most popular sizes #6 x 1-1/4", 1-5/8" and 2"



PART #	UPC #	DESCRIPTION	QTY / PKG	SUG. TRADE LIST / PKG
JDWS3CD	76503	#6x1-1/4" Self-Piercing Drywall Screw, Fine Thread	100	\$ 9.25
DWS3MD	76843	#6x1-1/4" Self-Piercing Drywall Screw, Fine Thread	1000	\$ 78.20
JDWS4CD	76504	#6x1-5/8" Self-Piercing Drywall Screw, Fine Thread	100	\$ 9.83
DWS4MD	76844	#6x1-5/8" Self-Piercing Drywall Screw, Fine Thread	1000	\$ 83.46
JDWS5CD	76505	#6x2" Self-Piercing Drywall Screw, Fine Thread	100	\$ 11.00
DWS5MD	76845	#6x2" Self-Piercing Drywall Screw, Fine Thread	1000	\$ 93.18

★ ★ ★ ★ ★ "Growth Through Innovation" ★ ★ ★ ★ ★

Metallics

229 Cross Street, Bristol, CT 06010
Tel 800-243-8272 • **Fax** 800-831-9358
Email sales@metallicsonline.com

Metallics West

651 North Main Street, Mancos, CO 81328
Tel 800-269-5183 • **Fax** 800-269-6278
Email saleswest@metallicsonline.com

SCREWS



FLAT HEAD PHILLIPS WOOD SCREWS

STEEL ZINC PLATED



ZINC

STAINLESS
STEEL

BRASS

STOCK NO.	UPC NO.	DIAMETER	LENGTH	WT. PER PKG.	STD. PKG./MSTR. SLEEVE	SUGGESTED TRADE LIST PRICE PER	
JFWP120	88120	4	1/2	.11	100/500	14.75/c	NEW
JFWP61	84661	4	3/4	.20	100/500	5.38/c	NEW
JFWP62	84662	4	1	.24	100/500	7.40/c	NEW
JFWP9	84609	6	1/2	.27	100/500	4.53/c	NEW
JFWP10	80369	6	3/4	.28	100/500	4.70/c	
JFWP11	80370	6	1	.35	100/500	5.03/c	
JFWP12	81853	6	1 1/4	.43	100/500	5.10/c	NEW
JFWP13	84613	6	1 1/2	.49	100/500	6.28/c	NEW
JFWP14	81855	6	2	.55	100/500	8.88/c	NEW
JFWP18	80371	8	3/4	.34	100/500	5.03/c	
JFWP19	80372	8	1	.48	100/500	5.20/c	
JFWP20	80373	8	1 1/4	.61	100/500	5.65/c	
JFWP21	80374	8	1 1/2	.67	100/500	6.33/c	
JFWP65	84665	8	1 3/4	.69	100/500	20.00/c	NEW
JFWP22	80375	8	2	.84	100/500	8.55/c	
JFWP23	84623	8	2 1/2	1.05	100/500	10.55/c	NEW
JFWP24	80376	8	3	1.34	100	15.10/c	
JFWP25	84625	8	3 1/2	1.58	100	17.90/c	NEW
JFWP27	84627	10	1/2	.50	100/500	4.75/c	NEW
JFWP28	80377	10	3/4	.53	100/500	5.65/c	
JFWP29	80378	10	1	.67	100/500	6.23/c	
JFWP30	80379	10	1 1/4	.72	100/500	7.33/c	
JFWP31	80380	10	1 1/2	.89	100/500	8.55/c	
JFWP67	84667	10	1 3/4	1.03	100/500	37.35/c	NEW
JFWP32	80381	10	2	1.12	100/500	10.08/c	
JFWP33	80382	10	2 1/2	1.59	100	13.13/c	
JFWP34	84634	10	3	1.63	100	17.83/c	NEW
JFWP35	84635	10	3 1/2	1.85	100	27.90/c	NEW
JFWP36	84636	10	4	2.00	100	34.18/c	NEW
JFWP39	84639	12	1	.91	100	8.48/c	NEW
JFWP40	80383	12	1 1/4	.96	100/500	9.55/c	
JFWP41	80384	12	1 1/2	1.30	100/500	10.48/c	
JFWP42	80385	12	2	1.45	100/500	11.75/c	
JFWP43	80386	12	2 1/2	1.74	100	21.15/c	
JFWP44	84644	12	3	2.07	100	20.00/c	NEW
JFWP45	84645	12	3 1/2	2.89	100	27.10/c	NEW
JFWP46	84646	12	4	3.68	100	37.53/c	NEW
JFWP47	84647	14	1 3/4	1.69	100/500	15.33/c	NEW
JFWP48	84648	14	2	2.37	100	16.68/c	NEW
JFWP50	84650	14	3	2.99	100	24.75/c	NEW

STAINLESS STEEL 18-8 TYPE

JFWP18SS	92218	8	3/4	.40	100/500	PLEASE CALL FOR TRADE LIST PRICING	NEW
JFWP19SS	92219	8	1	.52	100/500		NEW
JFWP22SS	92222	8	2	.90	100/500		NEW
JFWP28SS	92228	10	3/4	.53	100/500		NEW
JFWP29SS	92229	10	1	.73	100/500		NEW

BRASS

JFWPB19	73119	8	1	.61	100/500	NEW
---------	-------	---	---	-----	---------	-----

OTHER SIZES AND QUANTITIES AVAILABLE BY REQUEST

FOR FULL THREAD REFER TO FLAT HEAD PHILLIPS SHEET METAL SCREW PAGE 63

SELF-PIERCING DRYWALL SCREWS FINE THREAD



PHILLIPS BUGLE HEAD

For use in up to "20 Gauge" Steel Stud

BLACK PHOSPHATE FINISH

Fine thread for hardwood, light gauge steel and light gauge aluminum.

This product for light applications has become the screw of choice among American tradesmen.

Prolonged use in moist conditions will cause this product to oxidize.

See page 80 and 87 for a more permanent application.

USE #2 PHILLIPS POINT INSERT OR POWER BIT - SEE PAGE 266



STOCK NO.	UPC NO.	DIAMETER	LENGTH	WT. PER PKG.	STD. PKG./MSTR. SLEEVE	SUGGESTED TRADE LIST PRICE PER
100 PACK						
JDWS1C	80387	6	1	.36	100/500	3.65/c
JDWS3C	80388	6	1 1/4	.42	100/500	3.70/c
JDWS4C	80389	6	1 5/8	.49	100/500	4.35/c
JDWS5C	80390	6	2	.61	100/500	5.98/c
JDWS6C	80391	6	2 1/4	.69	100/500	6.38/c
JDWS7C	80392	8	2 1/2	.98	100/500	9.90/c
JDWS9C	80393	8	3	1.11	100	11.58/c
JDWS10C	84099	10	3 1/2	1.86	100	13.25/c NEW

1000 PACK IN SQUARE PLASTIC JAR



Power Bit included free in 1000 pack
Save over 100 pack

DWS1M	27001	6	1	3.21	1000	33.55/m
DWS3M	27007	6	1 1/4	3.75	1000	34.25/m
DWS4M	27010	6	1 5/8	4.70	1000	40.60/m
DWS5M	27013	6	2	5.52	1000	55.73/m
DWS6M	27016	6	2 1/4	6.40	1000	59.40/m
DWS7M	27019	8	2 1/2	6.43	1000	91.98/m
DWS9M	27025	8	3	10.55	1000	107.75/m

BULK PACK IN CARTON



3 Power Bits included free in bulk pack
Save over 100 pack

DWS1B	27002	6	1	30.00	10000	288.70/ea
DWS3B	27008	6	1 1/4	32.80	8000	236.33/ea
DWS4B	27011	6	1 5/8	23.40	5000	174.58/ea
DWS5B	27014	6	2	21.35	3500	166.83/ea
DWS6B	27017	6	2 1/4	24.00	3000	153.08/ea
DWS7B	27020	8	2 1/2	27.00	2500	198.05/ea
DWS9B	27026	8	3	26.00	2000	185.30/ea
DWS10B	10695	10	3 1/2	19.50	1500	184.84/ea NEW

OTHER SIZES AND QUANTITIES AVAILABLE BY REQUEST

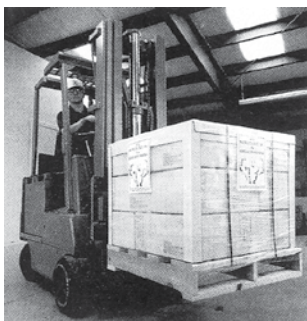

PACKED WITH PRIDE

As a part of our Quality Program, each shipment and each single carton leaving our facilities has a label affixed to it, indicating the person who packed the order.

HARD BODY PACKING

When you, the distributor, compare price and performance to other fastener suppliers, please compare our Hard Body Packing to the way they ship products.

We do it the right way—the quality way—the Metallics way.



FLAT HEAD PHILLIPS DECK SCREWS COARSE THREAD

For all-weather wood applications

HARDENED STEEL ZINC DICHROMATE
Now available in quantities of 100, 500 and 1000
GOLD DECK SCREWS "YELLOW ZINC"

STOCK NO.	UPC NO.	DIAMETER	LENGTH	WT. PER PKG.	STD. PKG./ MSTR. SLEEVE	SUGGESTED TRADE LIST PRICE PER
100 PACKS Bit NOT included						
JGDS0	81679	6	1	.35	100/500	3.70/c
JGDS1	81680	6	1 1/4	.42	100/500	3.70/c
JGDS2	81681	6	1 5/8	.51	100/500	4.35/c
JGDS3	81682	6	2	.61	100/500	5.98/c
JGDS4	81683	8	2 1/2	.96	100	9.90/c
JGDS5	81684	8	3	1.16	100	11.58/c
JGDS6	81685	10	3 1/2	1.88	100	18.48/c
JGDS7	81686	10	4	2.16	100	19.50/c

500 PACKS  1 Power Bit included free in 500 pack **Save**

GDS1V	12720	6	1 1/4	1.97	500	17.13/ea
GDS2V	12721	6	1 5/8	2.40	500	20.30/ea
GDS3V	12722	6	2	2.92	500	27.70/ea
GDS4V	12723	8	2 1/2	4.68	500	46.00/ea
GDS5V	12724	8	3	5.62	500	53.70/ea
GDS6V	12725	10	3 1/2	9.04	500	85.78/ea
GDS7V	12726	10	4	12.50	500	90.48/ea

1000 PACKS  1 Power Bit included free in 1000 pack **Save**

GDS1M	12730	6	1 1/4	3.74	1000	33.23/m
GDS2M	12731	6	1 5/8	4.69	1000	39.25/m
GDS3M	12732	6	2	6.29	1000	53.70/m
GDS4M	12733	8	2 1/2	10.42	1000	88.95/m
GDS5M	12734	8	3	11.13	1000	104.08/m
GDS6M	12735	10	3 1/2	18.18	1000	166.18/m
GDS7M	12736	10	4	25.00	1000	175.25/m

500 & 1000 PACKS SUPPLIED IN JARS

OTHER SIZES AND QUANTITIES AVAILABLE BY REQUEST

Our persistence and determination to ship the same day and maintain the highest fill rate in America among fastener suppliers to the distributor market is not by accident. In all our management offices, this quotation is displayed:

*Nothing in the world can take the place of persistence.
Talent will not; nothing is more common than unsuccessful men with talent.
Genius will not; unrewarded genius is almost a proverb.
Education will not; the world is full of educated derelicts.
Persistence and determination alone are omnipotent.*

- Calvin Coolidge

The secret is out: "Our motivation starts at the top."



SELF-PIERCING DRYWALL SCREWS

PHILLIPS BUGLE HEAD

COARSE THREAD
BLACK PHOSPHATE FINISH

COARSE THREAD USED IN MANY APPLICATIONS
WOOD TO WOOD, DRYWALL TO WOOD, AND
CABINET INSTALLATIONS



STOCK NO.	UPC NO.	DIAMETER	LENGTH	WT. PER PKG.	STD. PKG./MSTR. SLEEVE	SUGGESTED TRADE LIST PRICE PER
-----------	---------	----------	--------	--------------	------------------------	--------------------------------

100 PACKS

JDWC1C	90501	6	1	.35	100/500	4.35/c
JDWC3C	90503	6	1 1/4	.43	100/500	4.43/c
JDWC4C	90504	6	1 5/8	.51	100/500	5.23/c
JDWC5C	90505	6	2	.60	100/500	7.10/c
JDWC6C	90506	6	2 1/4	.66	100/500	7.65/c
JDWC7C	90507	8	2 1/2	1.00	100/500	9.90/c
JDWC9C	90509	8	3	1.12	100/500	11.58/c

1000 PACK IN SQUARE PLASTIC JAR — 1 Power Bit included FREE in 1000 Pack

DWC1M	90331	6	1	3.03	1000	40.53/m	NEW
DWC3M	90333	6	1 1/4	4.33	1000	39.00/m	NEW
DWC4M	90334	6	1 5/8	4.84	1000	47.50/m	NEW
DWC5M	90335	6	2	5.63	1000	67.25/m	NEW
DWC9M	90339	8	3	11.14	1000	99.75/m	NEW

BULK PACK IN CARTON — 3 Power Bits included FREE in Bulk Pack

DWC3B	83308	6	1 1/4	29.99	8000	158.00/ea	NEW
DWC4B	83309	6	1 5/8	23.40	5000	171.50/ea	NEW
DWC5B	83515	6	2	19.29	3500	147.88/ea	NEW
DWC6B	83516	6	2 1/4	18.57	3000	140.40/ea	NEW
DWC7B	83517	7	2 1/2	22.98	2500	155.63/ea	NEW
DWC9B	83519	8	3	22.25	2000	133.60/ea	NEW
DWC10B	83520	10	3 1/2	27.05	1500	185.48/ea	NEW

OTHER SIZES AND QUANTITIES AVAILABLE BY REQUEST



DRYWALL SCREW KIT

FINE THREAD

BLACK PHOSPHATE FINISH

SELF-PIERCING DRYWALL SCREWS

CAN BE USED IN HARDWOOD, LIGHT GAUGE STEEL AND LIGHT ALUMINUM

STOCK NO.	UPC NO.	DIAMETER	WT. EACH	STD. PKG. MSTR. CARTON	SUGGESTED TRADE LIST PRICE PER
DWSK1	12712	75 - 6 X 1" Drywall Screws 50 - 6 x 1 1/4" Drywall Screws 40 - 6 x 1 5/8" Drywall Screws 30 - 6 x 2" Drywall Screws 20 - 8 x 2 1/2" Drywall Screws 20 - 8 x 3" Drywall Screws 1 - #2 x 2" Phillips Power Bit	1.4	1/25	27.70/ea

OTHER SIZES AND QUANTITIES AVAILABLE BY REQUEST

A

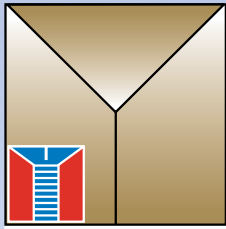

Metallics



Drywall Framing Screws Self-Piercing

Phillips Pan Head, Sharp Point or Drill Point Black Phosphate

[CONTRACTOR APPROVED]



Sharp Point



Drill Point



Made in USA

- For use in up to 20 Gauge Steel Stud
- Low profile deep Phillips recess
- Ideal for light duty steel and aluminum metal-to-metal application



PART #	UPC #	DESCRIPTION	QTY / PKG	SUG. TRADE LIST / PKG
JPDW1CD	76831	#6 x 7/16 Framing Screw, Pan Head Phillips, Sharp Point	100	\$ 10.70
PDW1MD	77151	#6 x 7/16 Framing Screw, Pan Head Phillips, Sharp Point	1000	\$ 90.75
JPDS1CD	82695	#6 x 7/16 Framing Screw, Pan Head Phillips, Drill Point	100	\$ 10.70
PDS1MD	27130	#6 x 7/16 Framing Screw, Pan Head Phillips, Drill Point	1000	\$ 90.75

★ ★ ★ ★ ★ *"Growth Through Innovation"* ★ ★ ★ ★ ★

Metallics

229 Cross Street, Bristol, CT 06010
Tel 800-243-8272 • **Fax** 800-831-9358
Email sales@metallicsonline.com

Metallics West

651 North Main Street, Mancos, CO 81328
Tel 800-269-5183 • **Fax** 800-269-6278
Email saleswest@metallicsonline.com



TRIM HEAD SCREW KIT

SQUARE DRIVE • TRIM HEAD SHARP POINT

FINE THREAD
BLACK PHOSPHATE FINISH
CAN BE USED FOR ATTACHING
WOOD TRIM TO WOOD OR METAL STUDS



STOCK NO.	UPC NO.	DESCRIPTION OF CONTENTS	WT. EACH	STD. PKG. MSTR. CARTON	SUGGESTED TRADE LIST PRICE PER
THSK1	81794	100 - 6 X 1" Screws 75 - 6 x 1 ⁵ / ₈ " Screws 50 - 6 x 2 ¹ / ₄ " Screws 50 - 8 x 3" Screws	1.6	1/25	27.70/ea

OTHER SIZES AND QUANTITIES AVAILABLE BY REQUEST

SELF-PIERCING DRYWALL FRAMING SCREWS

PHILLIPS PAN HEAD/BLACK PHOSPHATE FINISH

For use in up to "20 Gauge" Steel Stud

Ideal for light duty steel and aluminum metal-to-metal application.

Low profile deep Phillips recess.



STOCK NO.	UPC NO.	DIAMETER	LENGTH	WT. PER PKG.	STD. PKG.	SUGGESTED TRADE LIST PRICE PER
JPDW1C	80401	6	7/16	.32	100/500	3.55/c

1000 PACK IN SQUARE PLASTIC JAR  Power Bit included free in 1000 pack

PDW1M	27031	6	7/16	2.68	1000	32.90/m
-------	-------	---	------	------	------	---------

BULK PACK IN BOX CARTON  3 Power Bits included free in bulk pack

PDW1B	27032	6	7/16	39.75	15,000/carton	428.00/ea pkg
-------	-------	---	------	-------	---------------	---------------

OTHER SIZES AND QUANTITIES AVAILABLE BY REQUEST

SELF-DRILLING & TAPPING DRYWALL FRAMING SCREWS

PHILLIPS PAN HEAD/SWAGED DRILL POINT/BLACK PHOSPHATE FINISH

For use in up to "12 Gauge" Steel Stud

A drill bit point to speed installation and proper thread seating.
Ideal for light-to-medium duty steel and aluminum, metal-to-metal application.

Low profile deep Phillips recess.



STOCK NO.	UPC NO.	DIAMETER	LENGTH	WT. PER PKG.	STD. PKG.	SUGGESTED TRADE LIST PRICE PER
JPDS1C	80403	6	7/16	.33	100/500	4.23/c

1000 PACK IN SQUARE PLASTIC JAR  Power Bit included free in 1000 pack

PDS1M	27081	6	7/16	2.82	1000	39.10/m
-------	-------	---	------	------	------	---------

BULK PACK  3 Power Bits included free in bulk pack

PDS1B	27082	6	7/16	42.30	15,000/carton	671.40/ea pkg
-------	-------	---	------	-------	---------------	---------------

OTHER SIZES AND QUANTITIES AVAILABLE BY REQUEST

A



SELF-DRILLING & TAPPING DRYWALL SCREWS FINE THREAD

For use in up to "12 Gauge" Steel Stud
PHILLIPS BUGLE HEAD/ZINC FINISH/DRILL POINT

Designed to penetrate drywall, and drill and tap a hole in metal studs up to 12 gauge thickness.

This product, for light applications, has become the screw of choice among American tradesmen for wood, drywall, steel and aluminum application. Prolonged use in moist conditions will cause this product to oxidize. See pages 80 and 87 for a more permanent application. **Use Phillips point insert or power bit.**

STOCK NO.	UPC NO.	DIAMETER	LENGTH	BIT SIZE	WT. PER PKG.	WT. PER. MSTR. SLEEVE	SUGGESTED TRADE LIST PRICE PER
100 PACK							
JSDS1C	80405	6	1	#1	.39	100/500	4.28/c
JSDS3C	80406	6	1 1/4	#1	.43	100/500	5.03/c
JSDS4C	80407	6	1 5/8	#1	.53	100/500	6.88/c
JSDS5C	80408	6	1 7/8	#1	.61	100/500	8.25/c
JSDS7C	80409	8	2 5/8	#2	1.10	100	11.90/c
JSDS9C	80410	8	3	#2	1.24	100	12.28/c

1000 PACK IN SQUARE PLASTIC JAR

1 Power Bit included free in 1000 pack

SDS1M	27051	6	1	#1	3.45	1000	39.65/m
SDS3M	27057	6	1 1/4	#1	4.04	1000	47.00/m
SDS4M	27060	6	1 5/8	#1	5.80	1000	63.78/m
SDS5M	27063	6	1 7/8	#1	7.00	1000	76.55/m
SDS7M	27069	8	2 5/8	#2	10.49	1000	110.78/m
SDS9M	27075	8	3	#2	12.07	1000	113.80/m

BULK PACK IN BOX CARTON

3 Power Bits included free in bulk pack

SDS1B	27052	6	1	#1	38.00	10000	342.40/ea pkg
SDS3B	27058	6	1 1/4	#1	36.80	8000	322.25/ea pkg
SDS4B	27061	6	1 5/8	#1	29.00	5000	273.58/ea pkg
SDS5B	27064	6	1 7/8	#1	28.00	4000	263.18/ea pkg
SDS7B	27070	8	2 5/8	#2	23.00	2000	187.98/ea pkg
SDS9B	27076	8	3	#2	18.45	1500	147.05/ea pkg

OTHER SIZES AND QUANTITIES AVAILABLE BY REQUEST

MANUFACTURING CAPABILITIES

Diameter range #2 thru 5/16" / 1.5mm thru 8mm • Length range 1/8" thru 3" / 3.5mm thru 75mm
Materials: Steel, Brass, Stainless, Aluminum, Bronze.

NEED SCREWS...
Let Us Make Them For You!



A METALLICS AFFILIATE

P.O. Box 1600 • 231 Cross Street
Bristol, CT 06011-1600
Tel: 800-984-8945 • Fax: 800-984-8946

CAPABILITIES LIST

PLANT SIZE: 100,000 SQUARE FEET
LOCATION: Bristol, Connecticut
EQUIPMENT: 27 Hi-Speed Cold Headers
8 Burr-Free Screw Slotters
3 Shank Slotters
2 Pointers
14 High Speed Thread Rollers

ADDITIONAL PLANT INFO: Modern shipping facility utilizing digital scale counting machines. In-house packaging facilities - boxing, sorting, baggings. All material boxed, palletized & labeled with your needs in mind for domestic or export shipping.

SECONDARY WORK: All plating & heat treating is done on the outside and certified for your guarantee.

INFORMATION SYSTEMS: Our facility has new and upgraded Technology to meet your customers specific requirements.

MADE IN USA





SELF-PIERCING DRYWALL WAFER HEAD SCREWS FINE THREAD

PHILLIPS WAFER HEAD/ZINC FINISH
FOR USE IN UP TO "20 GAUGE" STEEL STUD

Ideal for light-duty steel and aluminum, metal-to-metal application. Large diameter head provides greater holding surface.

STOCK NO.	UPC NO.	DIAMETER	LENGTH	WT. PER PKG.	STD. PKG./MSTR. SLEEVE	SUGGESTED TRADE LIST PRICE PER
JWDW1C	80411	8	1/2	.45	100/500	4.03/c
JWDW2C	80412	8	3/4	.51	100/500	4.43/c
JWDW3C	80413	8	1	.59	100/500	5.20/c
JWDW4C	81039	8	1 1/4	.68	100/500	5.73/c NEW

1000 PACK IN VISUAL PLASTIC JAR



Power Bit included free in 1000 pack

WDW1M	27034	8	1/2	3.91	1000	37.58/m
WDW2M	27091	8	3/4	4.77	1000	41.65/m
WDW3M	27092	8	1	5.59	1000	48.35/m
WDW4M	27089	8	1 1/4	6.97	1000	53.30/m NEW

BULK PACK IN BOX CARTON



3 Power Bits included free in bulk pack

WDW1B	27035	8	1/2	36.95	10000	322.25/ea pkg
WDW2B	27093	8	3/4	45.98	10000	355.83/ea pkg
WDW3B	27094	8	1	57.50	10000	416.28/ea pkg
WDW4B	27099	8	1 1/4	69.85	10000	470.00/ea pkg NEW

OTHER SIZES AND QUANTITIES AVAILABLE BY REQUEST



SELF-DRILLING & TAPPING DRYWALL WAFER HEAD SCREWS FINE THREAD

PHILLIPS WAFER HEAD/DRILL POINT/ZINC FINISH
FOR USE IN UP TO "12 GAUGE" STEEL STUD

For metal-to-metal application. Large diameter head provides greater holding surface. Ideal for metal lath to metal studs up to 12 gauge thickness.

STOCK NO.	UPC NO.	DIAMETER	LENGTH	WT. PER PKG.	STD. PKG./MSTR. SLEEVE	SUGGESTED TRADE LIST PRICE PER
JWDS1C	80414	8	1/2	.40	100/500	3.93/c
JWDS2C	80415	8	3/4	.56	100/500	4.30/c
JWDS3C	82043	8	1	.62	100/500	8.38/c NEW
JWDS4C	80316	8	1 1/4	.70	100/500	6.10/c
JWDS6C	82046	8	1 5/8	.87	100/500	49.00/c NEW

1000 PACK IN VISUAL PLASTIC JAR



Power Bit included free in 1000 pack

WDS1M	27084	8	1/2	3.42	1000	35.93/m
WDS2M	27095	8	3/4	4.85	1000	39.98/m
WDS3M	27040	8	1	7.90	1000	75.53/m NEW
WDS4M	27098	8	1 1/4	6.73	1000	57.08/m

BULK PACK IN BOX CARTON



3 Power Bits included free in bulk pack

WDS1B	27085	8	1/2	33.25	10000	312.20/ea pkg
WDS2B	27096	8	3/4	55.00	10000	342.40/ea pkg
WDS3B	27104	8	1	79.00	10000	637.80/ea pkg NEW
WDS4B	27097	8	1 1/4	87.10	10000	490.13/ea pkg

OTHER SIZES AND QUANTITIES AVAILABLE BY REQUEST

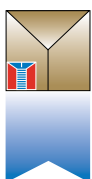

AMERICA'S SOURCE FOR PREMIER AND INNOVATIVE FASTENERS & ANCHORS

SELF-PIERCING SQUARE DRIVE DRYWALL SCREWS COARSE THREAD

BUGLE HEAD

For use in drywall-wood applications

BLACK PHOSPHATE FINISH



This product for light applications has become the screw of choice among American tradesmen for wood, drywall, steel and aluminum application.

Prolonged use in moist conditions will cause this product to oxidize.

See pages 80 and 87 for a more permanent application.

THIS PRODUCT AVAILABLE ONLY IN COARSE THREAD

USE #2 SQUARE DRIVE INSERT OR POWER BIT SEE PG. 266

STOCK NO.	UPC NO.	DIAMETER	LENGTH	WT. PER PKG.	STD. PKG./MSTR. SLEEVE	SUGGESTED TRADE LIST PRICE PER
100 PACK						
JDWSR1C	80394	6	1	.35	100/500	3.70/c
JDWSR3C	80395	6	1 ¹ / ₄	.41	100/500	3.70/c
JDWSR4C	80396	6	1 ⁵ / ₈	.52	100/500	5.45/c
JDWSR5C	80397	6	2	.60	100/500	5.98/c
JDWSR6C	80398	6	2 ¹ / ₄	.64	100/500	8.38/c
JDWSR7C	80399	8	2 ¹ / ₂	.95	100	9.90/c
JDWSR9C	80400	8	3	1.19	100	11.58/c

1000 PACK IN VISUAL PLASTIC JAR



Power Bit included free in 1000 pack

DWSR1M	26066	6	1	3.47	1000	34.25/m
DWSR3M	26069	6	1 ¹ / ₄	3.67	1000	34.25/m
DWSR4M	26072	6	1 ⁵ / ₈	5.20	1000	50.70/m
DWSR5M	26075	6	2	5.59	1000	55.73/m
DWSR6M	26078	6	2 ¹ / ₄	8.00	1000	78.20/m
DWSR7M	26081	8	2 ¹ / ₂	9.35	1000	91.98/m
DWSR9M	26084	8	3	13.0	1000	107.75/m

BULK PACK IN BOX CARTON



3 Power Bits included free in bulk pack

DWSR1B	26067	6	1	35.0	10,000	295.40/ea pkg
DWSR3B	26070	6	1 ¹ / ₄	32.8	8000	236.48/ea pkg
DWSR4B	26073	6	1 ⁵ / ₈	26.0	5000	218.20/ea pkg
DWSR5B	26076	6	2	25.9	3500	166.83/ea pkg
DWSR6B	26079	6	2 ¹ / ₄	24.0	3000	201.43/ea pkg
DWSR7B	26082	8	2 ¹ / ₂	27.0	2500	198.05/ea pkg
DWSR9B	26085	8	3	26.0	2000	185.30/ea pkg

OTHER SIZES AND QUANTITIES AVAILABLE BY REQUEST

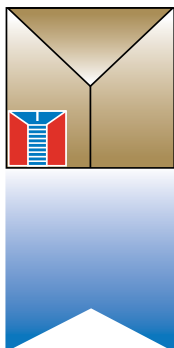

If you can't find the fastener you are looking for, call and experience the Metallics difference.

?'s = Call Us.

Metallics East • Bristol, CT
229 Cross Street
1-800-243-8272

Metallics West • Mancos, CO
651 North Main Street
1-800-269-5183

FLAT HEAD SQUARE DRIVE DECK SCREWS COARSE THREAD

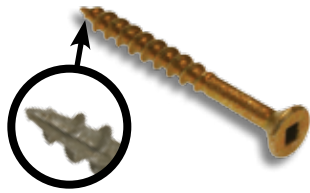

HARDENED STEEL ZINC/ALL-WEATHER COATING

Now available in quantities of 100, 500 and 1000
MOST POSITIVE ENGAGEMENT OF ALL DECK SCREWS

TYPE 17 POINT DRILLS ITS OWN HOLE

STOCK NO.	UPC NO.	DIAMETER	LENGTH	WT. PER PKG.	STD. PKG./MSTR. SLEEVE	SUGGESTED TRADE LIST PRICE PER
100 PACK						
JRDS1	81727	7	1 ¹ / ₄	.50	100	7.58/c
JRDS2	81728	8	1 ⁵ / ₈	.74	100	10.15/c
JRDS3	81729	9	2	.81	100	13.75/c
JRDS4	81737	9	2 ¹ / ₂	1.23	100	22.25/c
JRDS5	81738	9	3	1.41	100	20.63/c
JRDS6	81739	10	4	2.50	100	31.90/c



1 Power Bit included free in 500 pack

500 PACK						
RDS1V	12740	7	1 ¹ / ₄	1.87	500	35.23/ea pkg
RDS2V	12741	8	1 ⁵ / ₈	3.20	500	47.00/ea pkg
RDS3V	12742	9	2	3.34	500	63.95/ea pkg
RDS4V	12743	9	2 ¹ / ₂	5.21	500	82.75/ea pkg
RDS5V	12744	9	3	6.02	500	95.85/ea pkg
RDS6V	12745	10	4	9.09	500	148.20/ea pkg



1 Power Bit included free in 1000 pack

1000 PACK						
RDS1M	12750	7	1 ¹ / ₄	4.80	1000	66.83/m
RDS2M	12751	8	1 ⁵ / ₈	7.06	1000	89.30/m
RDS3M	12752	9	2	8.29	1000	121.15/m
RDS4M	12753	9	2 ¹ / ₂	10.42	1000	156.63/m
RDS5M	12754	9	3	13.95	1000	181.28/m
RDS6M	12755	10	4	18.18	1000	280.63/m

OTHER SIZES AND QUANTITIES AVAILABLE BY REQUEST

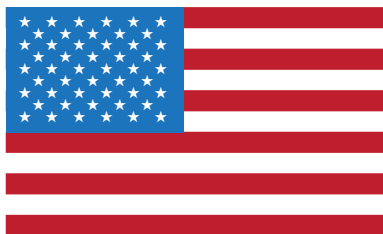

METALLICS

“Growth Through Innovation”

We believe Metallics has the largest ratio of American made to foreign produced product of any other American fastener company.

SERVING THE
ELECTRICAL, PLUMBING, HEATING AND AIR CONDITIONING
DISTRIBUTOR MARKETPLACE

www.metallicsonline.com



CERAMIC COATED DECK SCREWS

- Ceramic Polymer coating protects against corrosion
- Good wear resistance and can be used in pressure treated lumber
- Excellent resistance to UV radiation
- Flat head with Nibs
- Combo Square-Phillips Drive
- Type - 17 point
- In packages of 100, 500 or 1000 pieces

STOCK NO.	UPC NO.	DESCRIPTION	STD. PKG./MSTR. SLEEVE	SUGGESTED TRADE LIST PRICE PER
JCPD1	77007	#8 x 1-5/8" flat hd, w/nibs, sq/phl drive, typ-17pt. Ceramic coated deck screw	100	14.28
CPD1V	77057	#8 x 1-5/8" flat hd, w/nibs, sq/phl drive, typ-17pt. Ceramic coated deck screw	500	52.98
CPD1M	77107	#8 x 1-5/8" flat hd, w/nibs, sq/phl drive, typ-17pt. Ceramic coated deck screw	1000	101.83
JCPD2	77009	#8 x 2" flat hd, w/nibs, sq/phl drive, typ-17pt. Ceramic coated deck screw	100	19.25
CPD2V	77059	#8 x 2" flat hd, w/nibs, sq/phl drive, typ-17pt. Ceramic coated deck screw	500	76.95
CPD2M	77109	#8 x 2" flat hd, w/nibs, sq/phl drive, typ-17pt. Ceramic coated deck screw	1000	147.75
JCPD3	77010	#9 x 2-1/2" flat hd, w/nibs, sq/phl drive, typ-17pt. Ceramic coated deck screw	100	23.43
CPD3V	77074	#9 x 2-1/2" flat hd, w/nibs, sq/phl drive, typ-17pt. Ceramic coated deck screw	500	106.38
CPD3M	77124	#9 x 2-1/2" flat hd, w/nibs, sq/phl drive, typ-17pt. Ceramic coated deck screw	1000	195.73
JCPD4	77025	#9 x 3" flat hd, w/nibs, sq/phl drive, typ-17pt. Ceramic coated deck screw	100	26.25
CPD4V	77075	#9 x 3" flat hd, w/nibs, sq/phl drive, typ-17pt. Ceramic coated deck screw	500	120.63
CPD4M	77125	#9 x 3" flat hd, w/nibs, sq/phl drive, typ-17pt. Ceramic coated deck screw	1000	230.78
JCPD5	77040	#10 x 3-1/2" flat hd, w/nibs, sq/phl drive, typ-17pt. Ceramic coated deck screw	100	55.83
CPD5V	77090	#10 x 3-1/2" flat hd, w/nibs, sq/phl drive, typ-17pt. Ceramic coated deck screw	500	254.88
CPD5M	77140	#10 x 3-1/2" flat hd, w/nibs, sq/phl drive, typ-17pt. Ceramic coated deck screw	1000	485.45

OTHER SIZES AND QUANTITIES AVAILABLE BY REQUEST

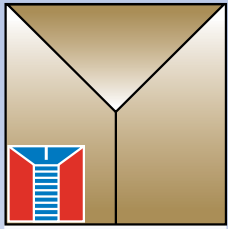

Metallics



Tamper Resist One Way Partition Bolts (Stainless Steel) 18-8 Series Type

**[CONTRACTOR
APPROVED]**

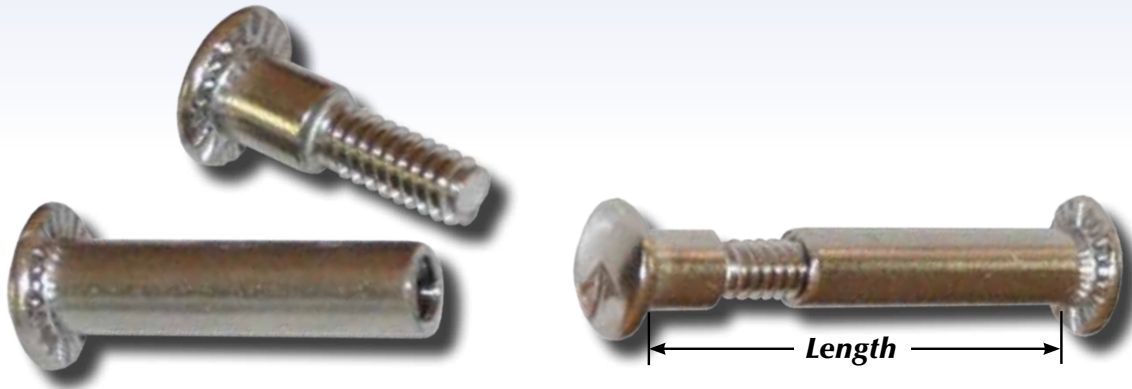

 One Way Head

PART #	UPC #	DESCRIPTION	QTY / PKG	SUG. TRADE LIST / PKG
TPPB102434	34949	10-24 x 3/4 One Way Partition Bolts (SS)	100	\$ 375.00
TPPB10241	34950	10-24 x 1 One Way Partition Bolts (SS)	100	\$ 412.50
TPPB1024114	34951	10-24 x 1-1/4 One Way Partition Bolts (SS)	100	\$ 450.00

“Growth Through Innovation”

Metallics

229 Cross Street, Bristol, CT 06010
Tel 800-243-8272 • **Fax** 800-831-9358
Email sales@metallicsonline.com

Metallics West

651 North Main Street, Mancos, CO 81328
Tel 800-269-5183 • **Fax** 800-269-6278
Email saleswest@metallicsonline.com

A

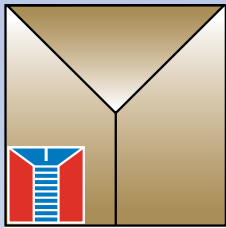

Metallics



Tamper-Resist One Way Round Head Machine Screw (Stainless Steel) 18-8 Series Type

**[CONTRACTOR
APPROVED]**



 One Way Head

PART #	UPC #	DESCRIPTION	QTY / PKG	SUG. TRADE LIST / PKG
TP424SRC	30912	10-32 x 1/2 One Way Round Head Machine Screw (SS)	100	\$ 50.10
TP425SRC	30914	10-32 x 3/4 One Way Round Head Machine Screw (SS)	100	\$ 57.90
TP426SRC	30915	10-32 x 1 One Way Round Head Machine Screw (SS)	100	\$ 66.30
TP427SRC	30917	10-32 x 1-1/2 One Way Round Head Machine Screw (SS)	100	\$ 92.63
TP428SRC	30918	10-32 x 2 One Way Round Head Machine Screw (SS)	100	\$ 135.00

Other sizes, materials and quantities available by request.

“Growth Through Innovation”

Metallics

229 Cross Street, Bristol, CT 06010
Tel 800-243-8272 • **Fax** 800-831-9358
Email sales@metallicsonline.com

Metallics West

651 North Main Street, Mancos, CO 81328
Tel 800-269-5183 • **Fax** 800-269-6278
Email saleswest@metallicsonline.com

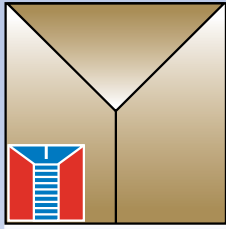

Metallics

Tamper-Resist Oval Head Spanner Machine Screw

(Stainless Steel) 18-8 Series Type



**[CONTRACTOR
APPROVED]**



 Spanner Head

PART #	UPC #	DESCRIPTION	QTY / PKG	SUG. TRADE LIST / PKG
TP800SOC	32775	6-32 x 1/4 Oval Head Spanner Machine Screw (SS)	100	\$ 112.50
TP801SOC	40432	6-32 x 5/16 Oval Head Spanner Machine Screw (SS)	100	\$ 112.50
TP802SOC	40433	6-32 x 3/8 Oval Head Spanner Machine Screw (SS)	100	\$ 112.50
TP803SOC	32777	6-32 x 3/8 Oval Head Spanner Machine Screw (SS)	100	\$ 112.50
TP804SOC	32778	6-32 x 1/2 Oval Head Spanner Machine Screw (SS)	100	\$ 120.00
TP805SOC	32779	6-32 x 5/8 Oval Head Spanner Machine Screw (SS)	100	\$ 120.00
TP806SOC	32780	6-32 x 3/4 Oval Head Spanner Machine Screw (SS)	100	\$ 120.00
TP807SOC	32871	6-32 x 1 Oval Head Spanner Machine Screw (SS)	100	\$ 120.00
TP808SOC	32782	6-32 x 1-1/4 Oval Head Spanner Machine Screw (SS)	100	\$ 127.50
TP809SOC	32783	6-32 x 1-1/2 Oval Head Spanner Machine Screw (SS)	100	\$ 135.00
TP810SOC	32784	6-32 x 2 Oval Head Spanner Machine Screw (SS)	100	\$ 150.00
TP811SOC	32790	8-32 x 1/2 Oval Head Spanner Machine Screw (SS)	100	\$ 112.50
TP812SOC	32792	8-32 x 3/4 Oval Head Spanner Machine Screw (SS)	100	\$ 112.50
TP813SOC	32793	8-32 x 1 Oval Head Spanner Machine Screw (SS)	100	\$ 112.50
TP814SOC	32794	8-32 x 1-1/4 Oval Head Spanner Machine Screw (SS)	100	\$ 120.00
TP815SOC	32795	8-32 x 1-1/2 Oval Head Spanner Machine Screw (SS)	100	\$ 127.50
TP816SOC	32796	8-32 x 2 Oval Head Spanner Machine Screw (SS)	100	\$ 157.50
TP817SOC	32797	8-32 x 2-1/2 Oval Head Spanner Machine Screw (SS)	100	\$ 195.00

Other sizes, materials and quantities available by request.

Chart continued to next page.

“Growth Through Innovation”

Metallics

229 Cross Street, Bristol, CT 06010
 Tel 800-243-8272 • Fax 800-831-9358
 Email sales@metallicsonline.com

Metallics West

651 North Main Street, Mancos, CO 81328
 Tel 800-269-5183 • Fax 800-269-6278
 Email saleswest@metallicsonline.com

A

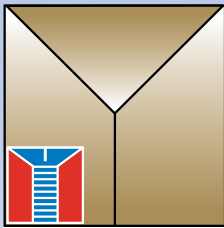

Metallics

Tamper-Resist Oval Head Spanner Machine Screw

(Stainless Steel) 18-8 Series Type



Spanner Head

Chart continued from previous page.

PART #	UPC #	DESCRIPTION	QTY / PKG	SUG. TRADE LIST / PKG
TP818SOC	32802	10-24 x 3/8 Oval Head Spanner Machine Screw (SS)	100	\$ 120.00
TP819SOC	32803	10-24 x 1/2 Oval Head Spanner Machine Screw (SS)	100	\$ 120.00
TP820SOC	32804	10-24 x 5/8 Oval Head Spanner Machine Screw (SS)	100	\$ 120.00
TP821SOC	32805	10-24 x 3/4 Oval Head Spanner Machine Screw (SS)	100	\$ 120.00
TP822SOC	32806	10-24 x 1 Oval Head Spanner Machine Screw (SS)	100	\$ 150.00
TP823SOC	32807	10-24 x 1-1/4 Oval Head Spanner Machine Screw (SS)	100	\$ 187.50
TP824SOC	32808	10-24 x 1-1/2 Oval Head Spanner Machine Screw (SS)	100	\$ 187.50
TP825SOC	32809	10-24 x 2 Oval Head Spanner Machine Screw (SS)	100	\$ 187.50
TP826SOC	32816	10-32 x 1/2 Oval Head Spanner Machine Screw (SS)	100	\$ 120.00
TP827SOC	32817	10-32 x 5/8 Oval Head Spanner Machine Screw (SS)	100	\$ 120.00
TP828SOC	32818	10-32 x 3/4 Oval Head Spanner Machine Screw (SS)	100	\$ 135.00
TP829SOC	32819	10-32 x 1 Oval Head Spanner Machine Screw (SS)	100	\$ 135.00
TP830SOC	32820	10-32 x 1-1/4 Oval Head Spanner Machine Screw (SS)	100	\$ 150.00
TP831SOC	32821	10-32 x 1-1/2 Oval Head Spanner Machine Screw (SS)	100	\$ 187.50
TP832SOC	32822	10-32 x 2 Oval Head Spanner Machine Screw (SS)	100	\$ 187.50
TP833SOC	32832	1/4-20 x 1 Oval Head Spanner Machine Screw (SS)	100	\$ 172.50
TP834SOC	32834	1/4-20 x 1-1/2 Oval Head Spanner Machine Screw (SS)	100	\$ 187.50
TP835SOC	32835	1/4-20 x 2 Oval Head Spanner Machine Screw (SS)	100	\$ 202.50

Other sizes, materials and quantities available by request.

“Growth Through Innovation”

Metallics

229 Cross Street, Bristol, CT 06010
Tel 800-243-8272 • **Fax** 800-831-9358
Email sales@metallicsonline.com



Metallics West

651 North Main Street, Mancos, CO 81328
Tel 800-269-5183 • **Fax** 800-269-6278
Email saleswest@metallicsonline.com

TAMPER-RESIST STAINLESS STEEL HEX PIN & STAR PIN MACHINE SCREWS

**SPECIAL
ORDER**

ALL ITEMS LISTED ARE
SPECIAL ORDER ITEMS
PLEASE ALLOW
1-2 WEEKS FOR DELIVERY

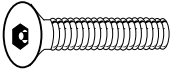
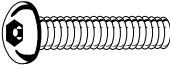
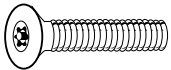
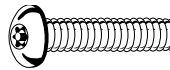
SIZE	HEX PIN		STAR PIN		  Star
	FLAT HEX PIN STOCK NO.	HEX BUTTON PIN STOCK NO.	FLAT STAR PIN STOCK NO.	STAR BUTTON PIN STOCK NO.	
	 Hex				
6-32	DRIVER SIZE 1/8		DRIVER SIZE T10		
1/2"	TP100SFC	TP100SBC	TP200SFC	TP200SBC	
3/4"	TP101SFC	TP101SBC	TP201SFC	TP201SBC	
1"	TP102SFC	TP102SBC	TP202SFC	TP202SBC	
1 1/4"	TP103SFC	TP103SBC	-	-	
1 1/2"	TP104SFC	TP104SBC	TP204SFC	TP204SBC	
8-32	DRIVER SIZE 5/32		DRIVER SIZE T25		
1/2"	TP105SFC	TP105SBC	TP205SFC	TP205SBC	
3/4"	TP106SFC	TP106SBC	TP206SFC	TP206SBC	
1"	TP107SFC	TP107SBC	TP207SFC	TP207SBC	
1 1/4"	TP108SFC	TP108SBC	TP208SFC	TP208SBC	
1 1/2"	TP109SFC	TP109SBC	TP209SFC	TP209SBC	
2"	TP110SFC	TP110SBC	-	-	
10-24	DRIVER SIZE 5/32		DRIVER SIZE T25		
1/2"	TP111SFC	TP111SBC	TP211SFC	TP211SBC	
3/4"	TP112SFC	TP112SBC	TP212SFC	TP212SBC	
1"	TP113SFC	TP113SBC	TP213SFC	TP213SBC	
1 1/4"	TP114SFC	TP114SBC	TP214SFC	TP214SBC	
1 1/2"	TP115SFC	TP115SBC	TP215SFC	TP215SBC	
1/4-20	DRIVER SIZE 5/32		DRIVER SIZE T30		
1/2"	TP116SFC	TP116SBC	TP216SFC	TP216SBC	
3/4"	TP117SFC	TP117SBC	TP217SFC	TP217SBC	
1"	TP118SFC	TP118SBC	TP218SFC	TP218SBC	
1 1/4"	TP119SFC	TP119SBC	TP219SFC	TP219SBC	
1 1/2"	TP120SFC	TP120SBC	TP220SFC	TP220SBC	
2"	TP121SFC	TP121SBC	-	-	

**CALL
METALLICS
EAST OR WEST
FOR
PRICING**

OTHER SIZES AND QUANTITIES AVAILABLE BY REQUEST

SEE PAGE 96 FOR DRIVER STOCK NUMBERS.

BECAUSE OF THE SPECIAL NATURE OF THESE PRODUCTS WE DO NOT PROVIDE A RECOMMENDED TRADE LIST PRICE

Metallics East • Bristol, CT
229 Cross Street
1-800-243-8272

Metallics West • Mancos, CO
651 North Main Street
1-800-269-5183

SCREWS

TAMPER-RESIST STAINLESS STEEL SPANNER & ONE-WAY MACHINE SCREWS

A



ALL ITEMS LISTED ARE
SPECIAL ORDER ITEMS
PLEASE ALLOW
1-2 WEEKS FOR DELIVERY



Spanner

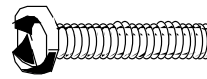
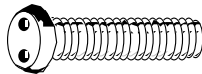
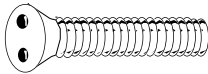

One Way Head



	SPANNER		ONE-WAY
	FLAT SPANNER STOCK NO.	PAN SPANNER STOCK NO.	ONE WAY ROUND HEAD STOCK NO.
SIZE	DRIVER SIZE #6		DRIVER SIZE #6
1/2"	TP300SFC	TP300SPC	TP400SRC
3/4"	TP301SFC	TP301SPC	TP401SRC
1"	TP302SFC	TP302SPC	TP402SRC
1 1/4"	TP303SFC	TP303SPC	TP403SRC
1 1/2"	TP304SFC	TP304SPC	TP404SRC
2"	TP305SFC	TP305SPC	-
8-32	DRIVER SIZE #8		DRIVER SIZE #8
1/2"	TP306SFC	TP306SPC	TP406SRC
3/4"	TP307SFC	TP307SPC	TP407SRC
1"	TP308SFC	TP308SPC	TP408SRC
1 1/4"	TP309SFC	TP309SPC	TP409SRC
1 1/2"	TP310SFC	TP310SPC	TP410SRC
2"	TP311SFC	TP311SPC	-
10-24	DRIVER SIZE #10		DRIVER SIZE #10
1/2"	TP312SFC	TP312SPC	TP412SRC
3/4"	TP313SFC	TP313SPC	TP413SRC
1"	TP314SFC	TP314SPC	TP414SRC
1 1/4"	TP315SFC	TP315SPC	TP415SRC
1 1/2"	TP316SFC	TP316SPC	TP416SRC
2"	TP317SFC	TP317SPC	-
1/4-20	DRIVER SIZE #14		DRIVER SIZE #14
1/2"	TP318SFC	TP318SPC	TP418SRC
3/4"	TP319SFC	TP319SPC	TP419SRC
1"	TP320SFC	TP320SPC	TP420SRC
1 1/4"	TP321SFC	TP321SPC	TP421SRC
1 1/2"	TP322SFC	TP322SPC	TP422SRC
2"	TP323SFC	TP323SPC	TP423SRC

CALL
METALLICS
EAST OR WEST
FOR
PRICING

OTHER SIZES AND QUANTITIES AVAILABLE BY REQUEST

SEE PAGE 96 FOR DRIVER STOCK NUMBERS.

BECAUSE OF THE SPECIAL NATURE OF THESE PRODUCTS WE DO NOT PROVIDE A RECOMMENDED TRADE LIST PRICE

Metallics East • Bristol, CT
229 Cross Street
1-800-243-8272

Metallics West • Mancos, CO
651 North Main Street
1-800-269-5183

TAMPER-RESIST STAINLESS STEEL HEX PIN & STAR PIN SHEET METAL SCREWS



**SPECIAL
ORDER**

ALL ITEMS LISTED ARE
SPECIAL ORDER ITEMS
PLEASE ALLOW
1-2 WEEKS FOR DELIVERY

HEX PIN			STAR PIN	
SIZE	HEX FLAT STOCK NO.	HEX BUTTON STOCK NO.	STAR FLAT STOCK NO.	STAR BUTTON STOCK NO.
	DRIVER SIZE 1/8		DRIVER SIZE T10	
6				
1/2"	TP500SFC	TP500SBC	TP600SFC	TP600SBC
3/4"	TP501SFC	TP501SBC	TP601SFC	TP601SBC
1"	TP502SFC	TP502SBC	TP602SFC	TP602SBC
1 1/2"	TP503SFC	TP503SBC	TP603SFC	TP603SBC
	DRIVER SIZE 5/32		DRIVER SIZE T15	
8				
1/2"	TP504SFC	TP504SBC	TP604SFC	TP604SBC
3/4"	TP505SFC	TP505SBC	TP605SFC	TP605SBC
1"	TP506SFC	TP506SBC	TP606SFC	TP606SBC
1 1/2"	TP507SFC	TP507SBC	TP607SFC	TP607SBC
	DRIVER SIZE 5/32		DRIVER SIZE T20	
10				
1/2"	TP508SFC	TP508SBC	TP608SFC	TP608SBC
3/4"	TP509SFC	TP509SBC	TP609SFC	TP609SBC
1"	TP510SFC	TP510SBC	TP610SFC	TP610SBC
1 1/4"	TP511SFC	TP511SBC	TP611SFC	TP611SBC
1 1/2"	TP512SFC	TP512SBC	TP612SFC	TP612SBC
2"	TP513SFC	TP513SBC	-	-
	DRIVER SIZE 5/32		DRIVER SIZE T27	
14				
1/2"	TP514SFC	TP514SBC	TP614SFC	TP614SBC
3/4"	TP515SFC	TP515SBC	TP615SFC	TP615SBC
1"	TP516SFC	TP516SBC	TP616SFC	TP616SBC
1 1/4"	TP517SFC	TP517SBC	TP617SFC	TP617SBC
1 1/2"	TP518SFC	TP518SBC	TP618SFC	TP618SBC
2"	TP519SFC	TP519SBC	-	-

CALL
METALLICS
EAST OR WEST
FOR
PRICING

OTHER SIZES AND QUANTITIES AVAILABLE BY REQUEST

SEE PAGE 96 FOR DRIVER STOCK NUMBERS.

BECAUSE OF THE SPECIAL NATURE OF THESE PRODUCTS WE DO NOT PROVIDE A RECOMMENDED TRADE LIST PRICE

Metallics East • Bristol, CT
229 Cross Street
1-800-243-8272

Metallics West • Mancos, CO
651 North Main Street
1-800-269-5183

SCREWS



TAMPER-RESIST BITS, TOOLS AND KITS

A

POWER INSERT BITS



SPANNER BIT



STOCK NO.	UPC NO.	SIZE/ DESCRIPTION	SUGGESTED TRADE LIST PRICE PER
00SP6B	25027	#6 Spanner	5.03/ea
00SP8B	10195	#8 Spanner	5.03/ea
00SP10B	10196	#10 Spanner	5.03/ea
00SP12B	10194	#12 Spanner	5.03/ea
00SP14B	10197	#14 Spanner	5.03/ea



STAR PIN (TORX)



00TP10	41200	T10	5.03/ea
00TP15	41210	T15	5.03/ea
00TP20	41215	T20	5.03/ea
00TP25	41220	T25	5.03/ea
00TP27	41222	T27	5.03/ea
00TP30	41230	T30	5.03/ea



HEX PIN



00HP18B	41255	1/8	5.03/ea
00HP32B	41260	5/32	5.03/ea

OTHER SIZES AND QUANTITIES AVAILABLE BY REQUEST



MAGNETIC HAND DRIVER BIT STORAGE IN HANDLE

(ORDER BITS SEPARATELY)



STOCK NO.	UPC NO.	DESCRIPTION	WT. EACH	STD. PKG.	SUGGESTED TRADE LIST PRICE PER
HDT14	41265	Magnetic Hand Driver 1/4" Hex	.24	1	18.15/ea

OTHER SIZES AND QUANTITIES AVAILABLE BY REQUEST



ONE-WAY REMOVAL TOOL

ONE-WAY MACHINE SCREW INSTALLATION AND REMOVAL

- Install with a standard blade screwdriver
- Remove **only** with a One-Way Removal Tool

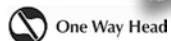

USE WITH TP400 SERIES SCREWS

STOCK NO.	UPC NO.	DESCRIPTION	SIZE	WT. EACH	STD. PKG.	SUGGESTED TRADE LIST PRICE PER
RT1W	41270	1-Way Removal Tool	6-8	.23	1	53.70/ea
RT2W	41271	1-Way Removal Tool	10-12	.30	1	53.70/ea
RT3W	41272	1-Way Removal Tool	1/4	.38	1	53.70/ea

OTHER SIZES AND QUANTITIES AVAILABLE BY REQUEST

30-PIECE TAMPER-RESIST KIT



STOCK NO.	UPC NO.	NO. OF PIECES	WT. EACH	SUGGESTED TRADE LIST PRICE PER
TPK30	41280	30	1.04	119.18/ea kit
INCLUDES		BIT/PT. SIZE		
	Driver	1/4 (magnetic w/storage handle)		
	TORX® Bits	T8, T9, T10, T15, T20, T25, T27, T30, T40		
	Hex Pin Bits	3/32; 1/8; 9/64; 1/32; 3/16; 7/32; 1/4; 5/16		
	Spanner Bits	6; 8; 10		
	TRI-WING® Bits	1; 2; 3		
	POZIDRIV® Bit	1; 2; 3		
	Socket Adapter	1"		
	Bit Holder	1"		

OTHER SIZES AND QUANTITIES AVAILABLE BY REQUEST



Isomax® is a registered trademark

ISOMAX® ASSORTMENT OF INSERT BITS 100 PC. SECURITY & NON SECURITY BIT KIT



STOCK NO.	UPC NO.	DESCRIPTION	WT. PER PKG.	SUGGESTED TRADE LIST PRICE PER
EVBK100	26720	100 Piece Security & Non Security Bit Kit	2	92.88/ea kit

OTHER SIZES AND QUANTITIES AVAILABLE BY REQUEST

Kit Contains the Following Bits

Tip Types	Tip Sizes	Length
Socket Adapters	1/4"	1"
	1/4"	2"
Female Socket Adapters	1/4"	1"
Y-Cup Hook Installer/Remover	Fits All	1"
Bit Holder	1/4" Hex	2-3/8"
Phillips® (2) each	#0	1"
	#1	1"
	#2	1"
	#3	1"
Octo-Driv® fits Pozzi-Drive® - (2) each	#0	1"
	#1	1"
	#2	1"
	#3	1"
Slotted	2	1"
	2.5	1"
	3	1"
	4	1"
	4.5	1"
	5	1"
	6	1"
	7	1"
8	1"	

Tip Types	Tip Sizes	Length
Tee*Star®	T8	1"
	T9	1"
	T10	1"
	T15	1"
	T20	1"
	T25	1"
	T27	1"
	T30	1"
	T40	1"
	Security Tee*Star® (fits Security Torx®)	T8
T9		1"
T10		1"
T15		1"
T20		1"
T25		1"
T27		1"
T30		1"
T40		1"
Hex Key (fits Allen®)		2mm
	2.5mm	1"
	3mm	1"
	4mm	1"
	5mm	1"
	5.5mm	1"
	6mm	1"
	7mm	1"
	8mm	1"
	1/16"	1"
	5/64"	1"
	3/32"	1"
	7/64"	1"
	1/8"	1"
	5/32"	1"
3/16"	1"	
7/32"	1"	
1/4"	1"	
5/16"	1"	



Tip Types	Tip Sizes	Length
Security Hex (fits Security Allen®)	2mm	1"
	2.5mm	1"
	3mm	1"
	4mm	1"
	5mm	1"
	6mm	1"
	5/64"	1"
	3/32"	1"
Spanner	7/64"	1"
	1/8"	1"
	9/64"	1"
	5/32"	1"
Triple-Y® (fits Tri-Wing®)	#4	1"
	#6	1"
	#8	1"
	#10	1"
Tee-Cross® (fits Torq-Set®)	1	1"
	2	1"
	3	1"
Square Recess	4	1"
	6	1"
	8	1"
	10	1"
Spline	R0	1"
	R1	1"
	R2	1"
	R3	1"
Clutch	#4	1"
	#5	1"
	#6	1"
Clutch	#1	1"
	#2	1"
	#3	1"

A



TAMPER RESISTANT SCREWS STAINLESS STEEL 18-8 MACHINE SCREW KIT

KEEP IT SAFE



STOCK NO.	UPC NO.	DESCRIPTION	WT. PER PKG.	SUGGESTED TRADE LIST PRICE PER
TPKRM1	41265	25 - #6-32 x 1" Hex-Pin Button Head	2.80	368.60/ea kit
 Hex Head		25 - #8-32 x 1" Hex-Pin Button Head		
		25 - #10-24 x 1" Hex-Pin Button Head		
		25 - 1/4 - 20 X 1" Hex-Pin Button Head		
		25 - #6 x 1" Star-Pin Button Head		
 Star		25 - #8 x 1" Star-Pin Button Head		
		25 - #10 x 1" Star-Pin Button Head		
		25 - 1/4 - 20 X 1" Star-Pin Button Head		
		25 - #6 x 1" Spanner Button Head		
 Spanner		25 - #8 x 1" Spanner Button Head		
		25 - #10 x 1" Spanner Button Head		
		25 - 1/4 - 20 X 1" Spanner Button Head		

OTHER SIZES AND QUANTITIES AVAILABLE BY REQUEST



TAMPER RESISTANT SCREWS STAINLESS STEEL 18-8 SHEET METAL SCREW KIT

KEEP IT SAFE

STOCK NO.	UPC NO.	DESCRIPTION	WT. PER PKG.	SUGGESTED TRADE LIST PRICE PER
TPKSM1	41320	25 - #6 x 1" Hex-Pin Button Head	1.26	167.38/ea kit
 Hex Head		25 - #8 x 1" Hex-Pin Button Head		
		25 - #10 x 1" Hex-Pin Button Head		
		25 - #6 x 1" Star-Pin Button Head		
 Star		25 - #8 x 1" Star-Pin Button Head		
		25 - #10 x 1" Star-Pin Button Head		









OTHER SIZES AND QUANTITIES AVAILABLE BY REQUEST



SHEET METAL SCREW KITS

PAN HEAD — HEX HEAD

POWER BITS AND DRIVERS INCLUDED

STOCK NO.	UPC NO.	DESCRIPTION OF CONTENTS	STD. PKG./MSTR. CARTON	WT. EACH	SUGGESTED TRADE LIST PRICE
TSK8 	10494	300 pcs - #8 Pan Head Combo (Phillips/slotted) 100 - 1/2", 75 - 3/4", 50 - 1", 30 - 1 1/4", 25 - 1 1/2", 20 - 2" 1 - #2 2" Phillips Power Bit - 100P2B	1/25	1.66	17.63/ea kit
TSK10 	10495	245 pcs - #10 Pan Head Combo (Phillips/slotted) 75 - 1/2", 50 - 3/4", 45 - 1", 30 - 1 1/4", 25 - 1 1/2", 20 - 2" 1 - #2 2" Phillips Power Bit - 100P2B	1/25	1.84	18.80/ea kit
DSK8 	10496	300 pcs - #8 1/4 Hex Slotted Washer Head 100 - 1/2", 75 - 3/4", 50 - 1", 30 - 1 1/4", 25 - 1 1/2", 20 - 2" 1 - 1/4" x 1 5/8" Hex Nut Driver - MT208B	1/25	1.69	20.65/ea kit
DSK10 	10497	245 pcs - #10 5/16 Hex Slotted Washer Head 75 - 1/2", 50 - 3/4", 45 - 1", 30 - 1 1/4", 25 - 1 1/2", 20 - 2" 1 - 5/16" x 1 5/8" Hex Nut Driver - 1 - 5/16" MT210B	1/25	1.59	24.18/ea kit
DSK12 	10473	245 pcs - #12 5/16 Hex Slotted Washer Head 75 - 1/2", 50 - 3/4", 45 - 1", 30 - 1 1/4", 25 - 1 1/2", 20 - 2" 1 - 5/16" x 1 5/8" Hex Nut Driver - 1 - 5/16" MT210B	1/25	2.00	25.00/ea kit
TSSK8 	10498	300 pcs - #8 Pan Head Square Drive Recess 100 - 1/2", 75 - 3/4", 50 - 1", 30 - 1 1/4", 25 - 1 1/2", 20 - 2" 1 - #2 2" Square Drive Power Bit - 100R2B	1/25	1.50	21.83/ea kit
TTSK10   	10499	245 pcs - #10 Pan Head Tri-Drive (square/phillips/slotted) 75 - 1/2", 50 - 3/4", 45 - 1", 30 - 1 1/4", 25 - 1 1/2", 20 - 2" 1 - #2 2" Square Drive Power Bit - 100R2B	1/25	1.75	24.18/ea kit



OTHER SIZES AND QUANTITIES AVAILABLE BY REQUEST

THE GOLD DECK SCREW KIT

ASSORTED FLAT HEAD PHILLIPS DECK SCREWS

ALL WEATHER WOOD APPLICATIONS YELLOW ZINC DICHROMATE COARSE THREAD



KIT INCLUDES: 300 screws

- 80 - 6 x 1
- 70 - 6 x 1-1/4
- 60 - 6 x 1-5/8
- 40 - 6 x 2
- 30 - 8 x 2-1/2
- 20 - 8 x 3
- 1 - 6 COMPARTMENT BOX

STOCK NO.	UPC NO.	WT. PER PKG.	STD. PKG.	SUGGESTED TRADE LIST PRICE
GDSK1	12704	1.69	1 Kit	20.13/ea kit

OTHER SIZES AND QUANTITIES AVAILABLE BY REQUEST

A





SELF DRILLING SCREW KITS

Several popular drive styles in assorted sizes

ECONOMICAL SWAGED POINT DRILL SCREWS
PACKED IN A RIGID PLASTIC BOX WITH DIVIDERS
STEEL ZINC PLATED

POWER BITS AND SETTERS INCLUDED

STOCK NO.	UPC NO.	DESCRIPTION OF CONTENTS	STD. PKG./ MSTR. CARTON	WT. EACH	SUGGESTED TRADE LIST PRICE
TEKDK1  Hex	10503	305 pcs - #8 & #10 Hex Washer Head Screws #8 WITH 1/4" HEX HEAD 100 - 1/2", 50 - 3/4", 40 - 1", #10 WITH 5/16" HEX HEAD 50 - 1/2", 35 - 3/4", 30 - 1" 1 - 1/4" Nut Setter - MT208B 1 - 5/16" Nut Setter - MT210B	1/25	1.69	32.75/ea kit
TEKSK1  Square Drive	10504	380 pcs - #8 & #10 Square Drive Pan Head Screws 100 - #8 1/2", 60 - #8 3/4", 50 - #8 1", 80 - #10 1/2", 50 - #10 3/4", 40 - #10 1" 1 - #2 2" Square Drive Power Bit - 100R2	1/25	1.18	25.18/ea kit
TEKPK1  Phillips	10505	380 pcs - #8 & #10 Pan Head Phillips Screws 100 - #8 1/2", 60 - #8 3/4", 50 - #8 1", 80 - #10 1/2", 50 - #10 3/4", 40 - #10 1" 1 - #2 2" Phillips Power Bit - 100P2B	1/25	1.96	25.18/ea kit





OTHER SIZES AND QUANTITIES AVAILABLE BY REQUEST



ROUND HEAD MACHINE SCREW KITS

Several popular drive styles in assorted sizes

Packed in a rigid plastic box with dividers
STEEL ZINC PLATED

STOCK NO.	UPC NO.	DESCRIPTION OF CONTENTS	STD. PKG./ MSTR. CARTON	WT. EACH	SUGGESTED TRADE LIST PRICE
RMK632  Phillips Slotted	10894	370 pcs - 6-32 Round Head Combo (Phillips/slotted) 100 - 3/4", 75 - 1", 75 - 1 1/4", 50 - 1 1/2", 40 - 2", 30 - 3"	1/25	1.92	32.75/ea kit
RMK832  Phillips Slotted	10264	370 pcs - 8-32 Round Head Combo (Phillips/slotted) 100 - 1/2", 75 - 3/4", 75 - 1", 50 - 1 1/4", 40 - 1 1/2", 30 - 2"v	1/25	2.28	25.18/ea kit
RMK1032  Phillips Slotted	10501	245 pcs - 10-32 Round Head Combo (Phillips/slotted) 75 - 1/2", 50 - 3/4", 40 - 1", 30 - 1 1/4", 25 - 1 1/2", 25 - 2"	1/25	2.18	25.18/ea kit
RMK1420  Phillips Slotted	10502	124 pcs - 1/4-20 Round Head Combo (Phillips/slotted) 35 - 1/2", 30 - 3/4", 20 - 1", 15 - 1 1/4", 12 - 1 1/2", 12 - 2"	1/25	2.02	25.18/ea kit

OTHER SIZES AND QUANTITIES AVAILABLE BY REQUEST



FLAT HEAD MACHINE SCREW KITS

Several popular drive styles in assorted sizes

Packed in a rigid plastic box with dividers
STEEL ZINC PLATED

A

STOCK NO.	UPC NO.	DESCRIPTION OF CONTENTS	STD. PKG./ MSTR. CARTON	WT. EACH	SUGGESTED TRADE LIST PRICE
FMK632 ⊖ Slotted	10263	370 pcs - 6-32 Flat Head Slotted 100 - 3/4", 75 - 1", 75 - 1 1/4", 50 - 1 1/2", 40 - 2", 30 - 3"	1/25	1.79	18.15/ea
FMKP632 ⊕ Phillips	10356	370 pcs - 6-32 Flat Head Phillips 100 - 3/4", 75 - 1", 75 - 1 1/4", 50 - 1 1/2", 40 - 2", 30 - 3"	1/25	1.84	19.18/ea
FMK832 ⊖ Slotted	10883	370 pcs - 8-32 Flat Head Slot 100 - 1/2", 75 - 3/4", 75 - 1", 50 - 1 1/4", 40 - 1 1/2", 30 - 2"	1/25	1.81	18.28/ea

OTHER SIZES AND QUANTITIES AVAILABLE BY REQUEST



STOVE BOLT KITS

Packed in a rigid plastic box with dividers
STEEL ZINC PLATED

STOCK NO.	UPC NO.	DESCRIPTION OF CONTENTS	STD. PKG./ MSTR. CARTON	WT. EACH	SUGGESTED TRADE LIST PRICE
RSBK1 ⊕ Phillips ⊖ Slotted	10365	6-32 Round Head Combo (Phillips and Slotted) MS 50 - 1/2", 30 - 3/4", 20 - 1", 20- 1 1/4", 15 - 1 1/2", 15 - 2" 150 - 6-32 Hex Steel Nuts 100 #6 SAE Washers 100 #6 Lock Washers	1/25	1.23	33.13/ea kit
RSBK2 ⊕ Phillips ⊖ Slotted	10366	8-32 Round Head Combo (Phillips and Slotted) MS 50 - 1/2", 30 - 3/4", 20 - 1", 20- 1 1/4", 15 - 1 1/2", 15 - 2" 150 - 8-32 Hex Steel Nuts 100 #8 SAE Washers 100 #8 Lock Washers	1/25	1.64	37.08/ea kit
RSBK3 ⊕ Phillips ⊖ Slotted	10367	10-32 Round Head Combo (Phillips and Slotted) MS 50 - 1/2", 30 - 3/4", 20 - 1", 20- 1 1/4", 15 - 1 1/2", 15 - 2" 150 - 10-32 Hex Steel Nuts 100 #10 SAE Washers 100 #10 Lock Washers	1/25	2.14	39.00/ea kit
RSBK4 ⊕ Phillips ⊖ Slotted	10368	1/4"-20 Round Head Combo (Phillips and Slotted) MS 35 - 1/2", 30 - 3/4", 20 - 1", 15- 1 1/4", 12 - 1 1/2", 12 - 2" 100 - 1/4"-20 Hex Nuts 50 1/4 SAE Washers 50 1/4 Lock Washers	1/25	3.03	32.28/ea kit

OTHER SIZES AND QUANTITIES AVAILABLE BY REQUEST



TREASURE CHEST

END OF THE RUN
ASSORTMENT OF FASTENERS

A 11 lb. Assortment of Screws,
Nuts, Bolts, Washers, Nails, Anchors, etc.

No set amount of any one item.

Find the **GOLD** Screw and Receive a
FREE GIFT from your Distributor!

STOCK NO.	UPC NO.	DESCRIPTION OF CONTENTS	WT. PER PKG	SUGGESTED TRADE LIST PRICE
FA-1	11500	Mixture of Fasteners	11.35	29.80 ea

OTHER SIZES AND QUANTITIES AVAILABLE BY REQUEST



SINGLE SIDED AND DOUBLE SIDED ORGANIZERS

Organizer boxes have clear lids to see product inside,
and dividers have dovetails to lock in place

- **ORG1** is single sided and offers 22 storage compartments. Includes 18 dovetail dividers allowing you to customize the size of the compartments.
- **ORG2** is double sided and offers 32 storage compartments. Includes 24 dovetail dividers.

STOCK NO.	UPC NO.	DESCRIPTION	QTY PKG.	SUGGESTED TRADE LIST PRICE PER
ORG1	34501	Single Sided box with up to 22 compartments, measures 13"L x 10"W x 2"H	1	27.75
ORG2	34502	Double Sided box with up to 32 compartments, measures 13"L x 10"W x 3"H	1	40.98

OTHER SIZES AND QUANTITIES AVAILABLE BY REQUEST



HEXAGON NUTS

STOCK NO.	UPC NO.	SIZE	BOLT SIZE	WT. PER PKG.	STD. PKG./MSTR. SLEEVE	SUGGESTED TRADE LIST PRICE PER
GRADE 2 STEEL ZINC PLATED						
JN157	79957	4-40	$\frac{7}{64}$.16	100/500	4.48/c
JN159	80427	6-32	$\frac{1}{8}$.26	100/500	2.68/c
JN160	80428	8-32	$\frac{5}{32}$.32	100/500	3.00c
JN161	80429	10-24	$\frac{3}{16}$.38	100/500	3.20/c
JN162	80430	10-32	$\frac{3}{16}$.36	100/500	3.20/c
JN163	80431	$\frac{1}{4}$ -20	$\frac{1}{4}$.75	100/500	3.85/c
JN164	80432	$\frac{5}{16}$ -18	$\frac{5}{16}$	1.09	100/500	6.93c
JN165	80433	$\frac{3}{8}$ -16	$\frac{3}{8}$	1.55	100/500	8.90/c
JN170	83140	$\frac{7}{16}$ -14	$\frac{7}{16}$	2.81	100/500	18.63/c
JN166	80434	$\frac{1}{2}$ -13	$\frac{1}{2}$	1.80	50/250	18.10/c
JN167	80435	$\frac{5}{8}$ -11	$\frac{5}{8}$	1.81	25	32.20/c
JN168	80436	$\frac{3}{4}$ -10	$\frac{3}{4}$	2.91	25	44.92/c
HEAVY HEX NUT GRADE 2 STEEL ZINC PLATED						
JHHN38	80437	$\frac{3}{8}$ -16	$\frac{3}{8}$	2.86	100	12.50/c
JHHN12	80438	$\frac{1}{2}$ -13	$\frac{1}{2}$	6.07	100	24.25/c
JHHN58	86658	$\frac{5}{8}$ -11	$\frac{5}{8}$	2.61	25/125	46.20/c
JHHN34	86489	$\frac{3}{4}$ -10	$\frac{3}{4}$	4.73	25/125	129.00/c
GRADE 5 HARDENED STEEL ZINC PLATED						
JG5N163	80439	$\frac{1}{4}$ -20	$\frac{1}{4}$.75	100/500	4.03/c
JG5N164	80440	$\frac{5}{16}$ -18	$\frac{5}{16}$	1.10	100/500	5.98/c
JG5N165	80441	$\frac{3}{8}$ -16	$\frac{3}{8}$	1.59	100/500	9.68/c
JG5N170	83915	$\frac{7}{16}$ -14	$\frac{7}{16}$	11.9	100/500	57.40/c
JG5N166	80442	$\frac{1}{2}$ -13	$\frac{1}{2}$	1.82	50	19.40/c
JG5N167	80443	$\frac{5}{8}$ -11	$\frac{5}{8}$	1.83	25	39.40/c
JG5N168	80444	$\frac{3}{4}$ -10	$\frac{3}{4}$	2.92	25	65.80/c
GRADE 8 HARDENED STEEL ZINC PLATED						
JG8N163	80445	$\frac{1}{4}$ -20	$\frac{1}{4}$.74	100/500	5.70/c
JG8N164	80446	$\frac{5}{16}$ -18	$\frac{5}{16}$	1.10	100/500	8.48/c
JG8N165	80447	$\frac{3}{8}$ -16	$\frac{3}{8}$	1.60	100/500	12.33/c
JG8N169	81482	$\frac{7}{16}$ -14	$\frac{7}{16}$	2.81	100/500	20.89/c
JG8N166	80448	$\frac{1}{2}$ -13	$\frac{1}{2}$	1.85	50	28.06/c
JG8N167	80449	$\frac{5}{8}$ -11	$\frac{5}{8}$	1.87	25	55.20/c
JG8N168	80450	$\frac{3}{4}$ -10	$\frac{3}{4}$	2.87	25	87.32/c
STAINLESS STEEL 18-8 TYPE						
JSN10	80451	6-32	$\frac{1}{8}$.26	100/500	7.23/c
JSN11	80452	8-32	$\frac{5}{32}$.30	100/500	7.73/c
JSN12	80453	10-24	$\frac{3}{16}$.36	100/500	8.35/c
JSN13	80454	10-32	$\frac{3}{16}$.35	100/500	8.35/c
JSN14	80455	$\frac{1}{4}$ -20	$\frac{1}{4}$.77	100/500	10.68/c
JSN15	80456	$\frac{5}{16}$ -18	$\frac{5}{16}$	1.10	100/500	21.80/c
JSN16	80457	$\frac{3}{8}$ -16	$\frac{3}{8}$	1.63	100/500	23.50/c
JSN20	82279	$\frac{7}{16}$ -14	$\frac{7}{16}$	2.85	100/500	37.53/c
JSN18	80458	$\frac{1}{2}$ -13	$\frac{1}{2}$	1.92	50	50.80c
JSN19	82278	$\frac{5}{8}$ -11	$\frac{5}{8}$	7.34	100/500	118.93/c

OTHER SIZES AND QUANTITIES AVAILABLE BY REQUEST

CONTINUED ON NEXT PAGE

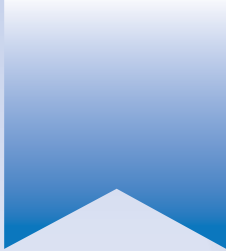
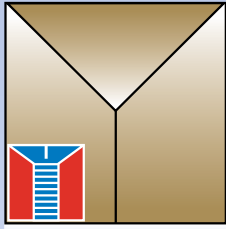

Metallics



Hex Nylon Insert Lock Nut Kit (*Steel Zinc*)

[CONTRACTOR APPROVED]



Six sizes of the most commonly used nylon lock nuts in one convenient case.

- Zinc plated
- Eliminates the need for lock washers
- For the use in high vibration areas
- Not for use in high heat situations

PART #	UPC #	DESCRIPTION	QTY / PKG	SUG. TRADE LIST / PKG
NYNK1	11570	6-32 Hex Nylon Insert Lock Nut	100	\$ 24.75
		8-32 Hex Nylon Insert Lock Nut	100	
		10-32 Hex Nylon Insert Lock Nut	100	
		1/4-20 Hex Nylon Insert Lock Nut	50	
		5/16-18 Hex Nylon Insert Lock Nut	40	
		3/8-16 Hex Nylon Insert Lock Nut	20	

Other sizes, materials and quantities available by request.

“Growth Through Innovation”

Metallics

229 Cross Street, Bristol, CT 06010
Tel 800-243-8272 • **Fax** 800-831-9358
Email sales@metallicsonline.com

Metallics West

651 North Main Street, Mancos, CO 81328
Tel 800-269-5183 • **Fax** 800-269-6278
Email saleswest@metallicsonline.com



B

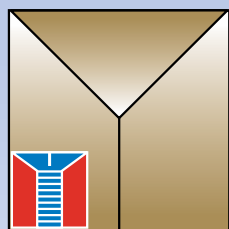

Metallics

Tamper Resist Aluminum & Zinc Breakaway Nuts

[CONTRACTOR APPROVED]



PART #	UPC #	DESCRIPTION	QTY / PKG	SUG. TRADE LIST / PKG
TPZBN1213	34988	1/2-13 Zinc Breakaway Nut	100	\$ 650.03
TPABN3816	34962	3/8-16 Aluminum Breakaway Nut	100	\$ 281.25
TPABN51618	34963	5/16-18 Aluminum Breakaway Nut	100	\$ 337.50
TPABN1420	34964	1/4-20 Aluminum Breakaway Nut	100	\$ 450.00
TPABN1024	34960	10-24 Aluminum Breakaway Nut	100	\$ 225.00

Other sizes, materials and quantities available by request.

★ ★ ★ ★ ★ *"Growth Through Innovation"* ★ ★ ★ ★ ★

Metallics

229 Cross Street, Bristol, CT 06010
Tel 800-243-8272 • **Fax** 800-831-9358
Email sales@metallicsonline.com

Metallics West

651 North Main Street, Mancos, CO 81328
Tel 800-269-5183 • **Fax** 800-269-6278
Email saleswest@metallicsonline.com

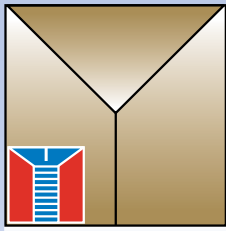

Metallics



Metric Hexagon Nut (Steel Zinc)

**[CONTRACTOR
APPROVED]**



PART #	UPC #	DESCRIPTION	QTY / PKG	SUG. TRADE LIST / PKG
JNM04	63444	Metric Hexagon Nut (Size M4)	100	\$ 2.93
JNM05	63445	Metric Hexagon Nut (Size M5)	100	\$ 3.23
JNM06	63446	Metric Hexagon Nut (Size M6)	100	\$ 5.63
JNM08	63448	Metric Hexagon Nut (Size M8)	100	\$ 9.15
JNM010	63450	Metric Hexagon Nut (Size M10)	100	\$ 19.20
JNM012	63452	Metric Hexagon Nut (Size M12)	100	\$ 25.95
JNM16	78016	Metric Hexagon Nut (Size M16)	100	\$ 5.48
JNM20	78020	Metric Hexagon Nut (Size M20)	100	\$ 12.15
JNM24	78024	Metric Hexagon Nut (Size M24)	100	\$ 23.03

**Other sizes and materials available upon request.*

“Growth Through Innovation”

Metallics

229 Cross Street, Bristol, CT 06010
Tel 800-243-8272 • **Fax** 800-831-9358
Email sales@metallicsonline.com

Metallics West

651 North Main Street, Mancos, CO 81328
Tel 800-269-5183 • **Fax** 800-269-6278
Email saleswest@metallicsonline.com



CONTINUED HEXAGON NUTS

STOCK NO.	UPC NO.	SIZE	BOLT SIZE	WT. PER PKG.	STD. PKG./MSTR. SLEEVE	SUGGESTED TRADE LIST PRICE PER	
SILICON BRONZE							
JSBN6	73306	6-32	1/8	.25	100/500	27.68/c	NEW
JSBN8	73308	8-32	5/32	.38	100/500	31.93c	NEW
JSBN24	73324	10-24	3/16	.36	100/500	40.53/c	NEW
JSBN32	73332	10-32	3/16	.38	100/500	40.53/c	NEW
JSBN14	80459	1/4-20	1/4	.46	50	29.36/c	
JSBN516	80460	5/16-18	5/16	.63	50	41.36/c	
JSBN38	80461	3/8-16	3/8	.91	50	53.86/c	NEW
JSBN12	80462	1/2-13	1/2	1.06	25	126.12/c	
JSBN58	84340	5/8-11	5/8	1.81	25	375.38/c	NEW
BRASS							
JN159BR	80463	6-32	1/8	.26	100/500	7.10/c	
JN160BR	80464	8-32	5/32	.33	100/500	7.60/c	
JN161BR	62272	10-24	3/16	.38	100/500	15.40/c	NEW
JN162BR	80465	10-32	3/16	.38	100/500	9.70/c	
JN163BR	80466	1/4-20	1/4	1.82	100/500	15.53/c	
JN165BR	62276	3/8-16	3/8	1.73	100/500	48.73/c	NEW
316 TYPE STAINLESS STEEL							
JSN14316SS	89341	1/4-20	1/4	.66	100/500	PLEASE CALL FOR TRADE LISTPRICING	NEW
JSN15316SS	89315	5/16-18	5/16	.65	100/500		NEW
JSN16316SS	96716	3/8-16	3/8	.82	50/250		NEW
JSN20316SS	89320	7/16-14	7/16	1.44	50		NEW
JSN25316SS	89325	1/2-13	1/2	1.82	50		NEW
JSN19316SS	96719	5/8-11	5/8	3.67	50		NEW
GALVANIZED							
JN163G	83163	1/4-20	1/4	.81	100/500	12.10/c	NEW
JN165G	83165	3/8-16	3/8	1.60	100/500	16.10/c	NEW
JN166G	83166	1/2-13	1/2	1.92	50/250	36.00/c	NEW
JN167G	83167	5/8-11	5/8	3.66	50/250	68.20/c	NEW
JAM NUT STEEL ZINC							
JN163J	83713	1/4-20	1/4	.55	100/500	7.03/c	NEW
JN165J	83715	3/8-16	3/8	1.55	100/500	49.75/c	

OTHER SIZES AND QUANTITIES AVAILABLE BY REQUEST



STAINLESS STEEL NUT KIT **NEW!** 18-8 SERIES TYPE

STOCK NO.	UPC NO.	DESCRIPTION OF CONTENTS	STD. PKG./MSTR. CARTON	WT. EACH	SUGGESTED TRADE LIST PRICE PER
SNK1	90210	400 pcs - Hexagon Nuts 100 - 6-32, 100 - 8-32, 100 - 10-32 50 - 1/4-20, 30 - 5/16-18, 20 - 3/8-16	1/25	1.90	31.08/ea kit

OTHER SIZES AND QUANTITIES AVAILABLE BY REQUEST

NUTS



HEX LOCK NUTS

WITH EXTERNAL TOOTH LOCK WASHER ATTACHED

STOCK NO.	UPC NO.	SIZE	BOLT SIZE	WT. PER PKG.	STD. PKG./MSTR. SLEEVE	SUGGESTED TRADE LIST PRICE PER
STEEL ZINC CHROMATE						
JTLN1	80467	6-32	1/8	.28	100/500	7.25/c
JTLN2	80468	8-32	5/32	.33	100/500	7.73/c
JTLN3	80469	10-24	3/16	.39	100/500	8.25/c
JTLN4	80470	10-32	3/16	.40	100/500	8.35/c
JTLN5	80471	1/4-20	1/4	.72	100/500	9.75/c
JTLN6	80472	5/16-18	5/16	1.20	100/500	15.80/c
JTLN7	80473	3/8-16	3/8	1.72	100/500	20.35/c
STAINLESS STEEL 18-8 TYPE						
JTLN5SS	90095	1/4-20	1/4	0.73	100/500	PLEASE CALL NEW
JTLN7SS	90097	3/8-16	3/8	1.70	100/500	

OTHER SIZES AND QUANTITIES AVAILABLE BY REQUEST



NYLON INSERT LOCK NUTS

For use in areas of high vibration • Eliminates the need for a lockwasher
Not for use in high heat situations.

STOCK NO.	UPC NO.	SIZE	BOLT SIZE	WT. PER PKG.	STD. PKG./MSTR. SLEEVE	SUGGESTED TRADE LIST PRICE PER
STEEL ZINC CHROMATE						
JNYN159	80474	6-32	1/8	.30	100/500	7.25/c
JNYN160	80475	8-32	5/32	.44	100/500	7.73/c
JNYN161	80476	10-24	3/16	.54	100/500	8.35/c
JNYN162	80477	10-32	3/16	.53	100/500	8.35/c
JNYN163	80478	1/4-20	1/4	.80	100/500	9.75/c
JNYN164	80479	5/16-18	5/16	1.18	100/500	15.80/c
JNYN165	80480	3/8-16	3/8	1.77	100/500	20.35/c
JNYN166	80481	1/2-13	1/2	2.26	50	25.40/c
JNYN167	80482	5/8-11	5/8	2.19	25	44.72/c
JNYN168	80483	3/4-10	3/4	3.10	25	84.80/c
STAINLESS STEEL 18-8 TYPE						
JNYN160SS	84471	8-32	3/32	.45	100/500	PLEASE CALL FOR TRADE LISTPRICING NEW
JNYN161SS	84472	10-24	3/16	.53	100/500	
JNYN162SS	84473	10-32	3/16	.52	100/500	
JNYN163SS	84474	1/4-20	1/4	.84	100/500	
JNYN164SS	84475	5/16-18	5/16	1.15	100/500	
JNYN165SS	84476	3/8-16	3/8	1.81	100/500	
JNYN172SS	84483	7/16-14	7/16	2.41	100/500	
JNYN166SS	84477	1/2-13	1/2	2.30	50/250	
JNYN167SS	84478	5/8-11	5/8	4.42	50/250	

OTHER SIZES AND QUANTITIES AVAILABLE BY REQUEST



SERRATED HEX FLANGE LOCK NUTS

FOR USE IN HIGH VIBRATION AREAS

STOCK NO.	UPC NO.	SIZE	BOLT SIZE	WT. PER PKG.	STD. PKG./MSTR. SLEEVE	SUGGESTED TRADE LIST PRICE PER
STEEL ZINC CHROMATE						
JSFN832	82060	8-32	3/32	.60	100/500	3.65/c
JSFN1024	82062	10-24	3/16	.66	100/500	3.83/c
JSFN1032	82064	10-32	3/16	.65	100/500	3.83/c
JSFN1420	82066	1/4-20	1/4	.93	100/500	4.60/c
JSFN51618	82068	5/16-18	5/16	1.30	100/500	8.93/c
JSFN3816	82070	3/8-16	3/8	1.90	100/500	11.23/c
STAINLESS STEEL 18-8 TYPE						
JSFN1213SS	93818	1/2-13	1/2	2.29	50/250	PLEASE CALL NEW

OTHER SIZES AND QUANTITIES AVAILABLE BY REQUEST

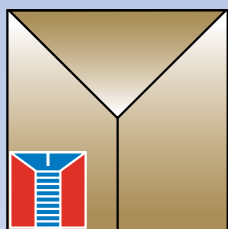

Metallics

Spring Nuts & Channel Washers



B

[CONTRACTOR APPROVED]



- For 1-5/8" Channel.
- Spring Nuts with Regular Spring 1-1/2" long or Short Spring 3/4" long.
- Available with 1/4-20, 3/8-16 or 1/2-13 Threads.
- Channel Washers for 1/4", 5/16", 3/8" or 1/2" Bolts.
- Spring Nuts & Channel Washers are Steel Zinc Plated.

PART #	UPC #	DESCRIPTION	QTY / PKG	SUG. TRADE LIST / PKG
MSNR1420	24641	1/4-20 x 1/4 Thick Spring Nut with Regular Spring	100	\$ 118.00
MSNS1420	24661	1/4-20 x 1/4 Thick Spring Nut with Short Spring	100	\$ 176.68
MSNR3816	24643	3/8-16 x 3/8 Thick Spring Nut with Regular Spring	100	\$ 145.40
MSNS3816	24663	3/8-16 x 3/8 Thick Spring Nut with Short Spring	100	\$ 123.78
MSNR1213	24645	1/2-13 x 1/2 Thick Spring Nut with Regular Spring	100	\$ 156.78
MSNS1213	24665	1/2-13 x 3/8 Thick Spring Nut with Short Spring	100	\$ 229.05
MSCW516	24652	Square Channel Washer with 11/32 Hole for 1/4 & 5/16 Bolt	100	\$ 152.82
MSCW38	24653	Square Channel Washer with 7/16 Hole for 3/8 Bolt	100	\$ 148.25
MSCW12	24655	Square Channel Washer with 9/16 Hole for 1/2 Bolt	100	\$ 150.15

Other sizes, materials and quantities available by request.

"Growth Through Innovation"

Metallics

229 Cross Street, Bristol, CT 06010
Tel 800-243-8272 • **Fax** 800-831-9358
Email sales@metallicsonline.com

Metallics West

651 North Main Street, Mancos, CO 81328
Tel 800-269-5183 • **Fax** 800-269-6278
Email saleswest@metallicsonline.com

NUTS



WING NUTS

General purpose nuts designed for rapid assembly and disassembly by hand

STOCK NO.	UPC NO.	SIZE	WT. PER PKG.	STD. PKG./MSTR. SLEEVE	SUGGESTED TRADE LIST PRICE PER	
ZINC PLATED						
JWN3	79899	8-32	.86	100/500	12.38/c	NEW
JWN4	79900	10-24	.92	100/500	14.90/c	NEW
JWN5	79901	10-32	.92	100/500	16.20/c	NEW
JWN6	80484	1/4-20	1.28	100/500	17.65/c	
JWN7	80485	5/16-18	1.47	100/500	24.43/c	
JWN8	80486	3/8-16	2.75	100/500	37.63c	
JWN9	80487	1/2-13	3.40	50/250	89.43/c	
STAINLESS STEEL 18-8 TYPE						
JWN2SS	90782	6-32	.80	100/500		NEW
JWN3SS	90783	8-32	.84	100/500		NEW
JWN4SS	90793	10-24	.93	100/500		NEW
JWN6SS	90785	1/4-20	1.36	100/500		NEW
JWN7SS	90786	5/16-18	1.99	100/500		NEW
JWN8SS	90787	3/8-16	3.35	100/500		NEW

PLEASE CALL FOR TRADE LISTPRICING

OTHER SIZES AND QUANTITIES AVAILABLE BY REQUEST



CAP NUTS

Provides a proper finish when covering exposed threaded bolt ends

STOCK NO.	UPC NO.	SIZE	WT. PER PKG.	STD. PKG./MSTR. SLEEVE	SUGGESTED TRADE LIST PRICE PER	
NICKEL PLATED						
JCN160	81798	6-32	.30	100/500	26.13/c	NEW
JCN163	80488	1/4-20	.75	100/500	10.75/c	
JCN164	80489	5/16-18	1.42	100/500	20.83/c	
JCN165	80490	3/8-16	1.88	100/500	27.05/c	
STAINLESS STEEL 18-8 TYPE						
JCN163SS	90916	1/4-20	1.31	100/500		NEW
JCN164SS	92917	5/16-18	2.18	100/500		NEW
JCN165SS	92918	3/8-16	3.36	100/500		NEW

PLEASE CALL FOR TRADE LISTPRICING

OTHER SIZES AND QUANTITIES AVAILABLE BY REQUEST



SQUARE NUTS

ZINC PLATED

Used for channel and strut applications

STOCK NO.	UPC NO.	THREAD DIAMETER	WIDTH "A"	THICKNESS "B"	WT. PER PKG.	STD. PKG./MSTR. SLEEVE	SUGGESTED TRADE LIST PRICE PER	
JSQ2	80491	6/32	5/16	7/64	.12	100/500	3.33/c	
JSQ3	80492	8/32	11/32	1/8	.36	100/500	3.45/c	
JSQ4	80493	10/24	3/8	1/8	.43	100/500	3.65/c	
JSQ5	80494	10/32	3/8	1/8	.44	100/500	3.70/c	
JSQ6	80495	1/4-20	7/16	3/16	.79	100/500	5.78/c	
JSQ7	80496	5/16-18	9/16	7/32	.47	100/500	9.03/c	
JSQ8	80497	3/8-16	5/8	1/4	2.45	100/500	14.53/c	
JSQ9	81069	1/2-13	13/16	7/16	2.90	50/250	77.23/c	NEW

OTHER SIZES AND QUANTITIES AVAILABLE BY REQUEST

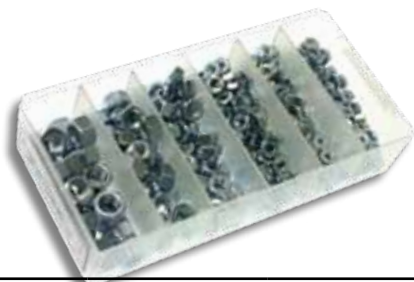

HEXAGON NUT KIT

STEEL ZINC CHROMATE

Six popular sizes!

STOCK NO.	UPC NO.	DESCRIPTION OF CONTENTS	STD. PKG./ MSTR. CARTON	WT. EACH	SUGGESTED TRADE LIST PRICE PER
NK1	10506	400 pcs - Hexagon Nuts 100 - 6-32, 100 - 8-32, 100 - 10-32, 50 - 1/4-20, 30 - 5/16-18, 20 - 3/8-16	1/25	1.92	18.80/ea kit

OTHER SIZES AND QUANTITIES AVAILABLE BY REQUEST

MASTER PLUG® SYSTEM

THREADED INSERT-FASTENING, SEALING, CUSHIONING SYSTEM

MADE IN USA



ADAPTABILITY

- Fastens blind holes and closed-end holes
- Cushions and seals similar and non-similar materials
- Absorbs vibration and seals both sides
- Tapered design enhances fastening installation
- Won't crack with ozone and ultraviolet exposure

VERSATILITY

- Removable and re-insertable
- Installs with conventional tools
- Works as a system with MASTER SEAL® washers
- Flange thickness always in proportion to size
- Grip range covers all dimensions

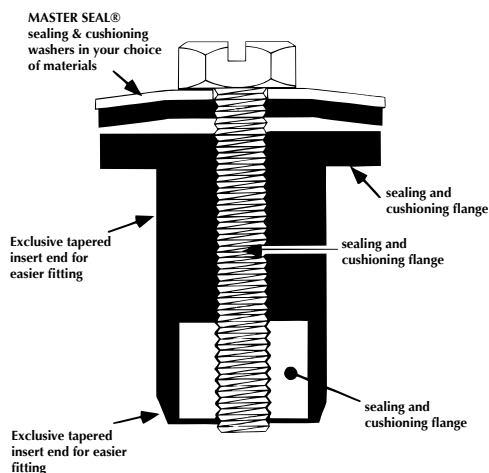

MASTER PLUG® IS A REGISTERED TRADEMARK
MASTER SEAL® IS A REGISTERED TRADEMARK

FOR STEEL BUILDING CONSTRUCTION

PACKAGED IN A PLASTIC BOX

STOCK NO.	UPC NO.	SIZE	BODY DIA.	OVERALL LENGTH	FLANGE O.D.	FLANGE THICKNESS	STD. PKG.	WT. PER PKG.	SUGGESTED TRADE LIST PRICE PER
MPS10	10383	6-32L	.250	1.062	.500	.062	25	.14	19.03/ ea pkg
MPS11	10384	10-32S	.375	.625	.562	.062	25	.20	19.13/ ea pkg
MPS12	10385	10-32R	.375	1.062	.562	.062	25	.16	22.50/ ea pkg
MPS13	10386	1/4-20S	.500	.855	.875	.090	20	.13	19.03/ ea pkg
MPS14	10387	1/4-20R	.500	1.276	.875	.100	15	.19	16.98/ ea pkg

OTHER SIZES AND QUANTITIES AVAILABLE BY REQUEST

PACKAGED IN A POLY BAG

STOCK NO.	UPC NO.	SIZE	BODY DIA.	OVERALL LENGTH	FLANGE O.D.	FLANGE THICKNESS	STD. PKG.	WT. PER PKG.	SUGGESTED TRADE LIST PRICE PER
MPS15	10388	6-32L	.250	1.062	.500	.062	100	.58	57.08/c
MPS16	10389	10-32S	.375	.625	.562	.062	100	.50	57.43/c
MPS17	10390	10-32R	.375	1.062	.562	.062	100	.56	67.43/c
MPS18	10391	1/4-20S	.500	.855	.875	.090	100	.94	71.50/c
MPS19	10392	1/4-20R	.500	1.276	.875	.100	100	1.18	84.93/c

OTHER SIZES AND QUANTITIES AVAILABLE BY REQUEST

WASHERS



WASHER KITS

Three styles in assorted sizes.
Flat - Lock

STOCK NO.	UPC NO.	DESCRIPTION OF CONTENTS	STD. PKG./ MSTR. CARTON	WT. EACH	SUGGESTED TRADE LIST PRICE PER	
STEEL ZINC CHROMATE SWK1	10507	485 pcs - Flat Washers 100 - #6, 100 - #8, 100 - #10 75 - 1/4 50 - 5/16 35 - 3/8 25 - 1/2	1/25	1.93	18.80/ea kit	
STEEL ZINC CHROMATE LWK1	10508	425 pcs - Split Lock Washers 100 - #8, 100 - #10, 100 - 1/4 60 - 5/16 40 - 3/8 25 - 1/2	1/25	1.32	18.80/ea kit	
18-8 TYPE STAINLESS STEEL SSWK1	90216	485 pcs - Flat Washers 100 - #6, 100 - #8, 100 - #10 75 - 1/4 50 - 5/16 35 - 3/8 25 - 1/2	1/25	1.93	18.80/ea kit	NEW

OTHER SIZES AND QUANTITIES AVAILABLE BY REQUEST



FLAT WASHERS

DESIGNED FOR METAL-TO-METAL APPLICATION
NOW IN MORE SIZES OF SILICON BRONZE, BRASS, STAINLESS, GALVANIZED, AND NYLON

STOCK NO.	UPC NO.	I.D./O.D.	BOLT SIZE	WT. PER PKG.	STD. PKG./ MSTR. SLEEVE	SUGGESTED TRADE LIST PRICE PER	
STEEL ZINC CHROMATE							
JSW68	71968	1/8 x 5/16	4	.14	100/500	4.78/c	NEW
JSW70	80498	5/32 x 3/8	6	.17	100/500	2.53/c	
JSW71	80499	3/16 x 7/16	8	.20	100/500	2.60/c	
JSW72	80500	7/32 x 1/2	10	.26	100/500	2.93/c	
JSW73	80501	9/32 x 5/8	1/4	.52	100/500	3.10/c	
JSW74	80502	11/32 x 11/16	5/16	.60	100/500	4.08/c	
JSW75	80503	13/32 x 13/16	3/8	.78	100/500	5.88/c	
JSW79	86379	15/32 x 59/64	7/16	1.04	100/500	18.63/c	NEW
JSW76	80504	17/32 x 1 1/16	1/2	1.71	100/500	10.73/c	
JSW77	80505	21/32 x 1 5/16	5/8	2.60	100/500	16.25/c	
JSW78	80506	13/16 x 1 1/2	3/4	4.22	100	25.55/c	
JSW82	71982	15/16 x 1 3/4	7/8	5.98	100	60.88/c	NEW
JSW80	71980	1 1/16 x 2	1	8.49	100	112.25/c	NEW
STAINLESS STEEL 18-8 TYPE							
JSSW8	81278	5/32 x 3/8	6	.13	100/500	4.18/c	NEW
JSSW10	80507	3/16 x 7/16	8	.12	100/500	4.90/c	
JSSW11	80508	7/32 x 1/2	10	.22	100/500	5.50/c	
JSSW12	80509	9/32 x 5/8	1/4	.40	100/500	7.80/c	
JSSW13	80510	11/32 x 11/16	5/16	.49	100/500	9.53/c	
JSSW14	80511	13/32 x 13/16	3/8	.61	100/500	13.58/c	
JSSW20	81327	15/32 x 59/64	7/16	.77	100/500	26.78/c	
JSSW15	80512	17/32 x 1 1/16	1/2	1.40	100/500	33.95/c	NEW
JSSW17	81324	21/32 x 1 5/16	5/8	2.00	100	64.78/c	NEW

OTHER SIZES AND QUANTITIES AVAILABLE BY REQUEST

CONTINUED ON NEXT PAGE



CONTINUED FLAT WASHERS

DESIGNED FOR METAL-TO-METAL APPLICATION

NOW IN MORE SIZES OF SILICON BRONZE, BRASS, STAINLESS, GALVANIZED AND NYLON

STOCK NO.	UPC NO.	I.D./O.D.	BOLT SIZE	WT. PER PKG.	STD. PKG./MSTR. SLEEVE	SUGGESTED TRADE LIST PRICE PER	
316 TYPE STAINLESS STEEL							
JSSW121	89521	9/32 X 5/8	1/4	.39	100/500	PLEASE CALL FOR TRADE LIST PRICING	NEW
JSSW131	89531	11/32 X 11/16	5/16	.50	100/500		NEW
JSSW141	89541	13/32 X 13/16	3/8	.65	100/500		NEW
JSSW18	81325	15/32 X 59/64	7/16	1.30	100/500		NEW
JSSW151	89551	17/32 X 1 1/16	1/2	1.62	100/500		NEW
JSSW171	89571	21/32 X 1 5/16	5/8	2.85	100		NEW
JSSW201	89772	13/16 X 1 1/2	3/4	6.17	100		NEW
SILICON BRONZE							
JSBW6	80513	5/32 X 3/8	6	.22	100/500	12.15/c	
JSBW8	80514	3/16 X 7/16	8	.13	100/500	14.35/c	
JSBW36	80515	7/32 X 1/2	10	.21	100/500	16.90/c	
JSBW14	80516	9/32 X 5/8	1/4	.45	100/500	24.40/c	
JSBW516	80517	11/32 X 11/16	5/16	.72	100/500	45.55/c	
JSBW38	80518	13/32 X 13/16	3/8	.92	100/500	56.60/c	
JSBW12	80519	17/32 X 1 1/16	1/2	2.40	100/500	138.48/c	
JSBW58	84345	21/32 X 1 5/16	5/8	3.86	100	376.90/c	NEW
BRASS							
JSWBR6	80520	5/32 X 3/8	6	.10	100/500	4.28/c	
JSWBR8	80521	3/16 X 7/16	8	.14	100/500	5.60/c	
JSWBR16	80522	7/32 X 1/2	10	.25	100/500	7.05/c	
JSWBR14	80523	9/32 X 5/8	1/4	.27	100/500	15.55/c	
JSWBR38	85838	13/32 X 13/16	3/8	0.92	100/500	48.50/c	NEW
JSWBR12	81812	17/32 X 1 1/16	1/2	2.40	100/500	165.92/c	NEW
GALVANIZED							
JSW73G	84173	9/32 X 5/8	1/4	.68	100/500	11.85/c	NEW
JSW75G	84175	13/32 X 13/16	3/8	1.67	100/500	12.95/c	NEW
JSW76G	84176	17/32 X 1 1/16	1/2	3.71	100/500	36.43/c	NEW
JSW77G	84177	21/32 X 1 5/16	5/8	1.79	50	58.10/c	NEW
NYLON							
JSWN1	71911	7/32 X 1/2	10	.40	100/500	76.62/c	NEW
JSWN73	72273	9/32 X 5/8	1/4	.10	50/250	77.40/c	NEW
JSWN74	89705	11/32 X 11/16	5/16	.70	50	78.10/c	NEW

OTHER SIZES AND QUANTITIES AVAILABLE BY REQUEST



USS FLAT WROUGHT WASHERS

STEEL ZINC CHROMATE
A strong, heavy-duty washer

STOCK NO.	UPC NO.	I.D./O.D.	BOLT SIZE	WT. PER PKG.	STD. PKG./MSTR. SLEEVE	SUGGESTED TRADE LIST PRICE PER	
JWW80	80524	5/16 X 3/4	1/4	.72	100/500	3.75/c	
JWW81	80525	3/8 X 7/8	5/16	1.22	100/500	5.78/c	
JWW82	80526	7/16 X 1	3/8	1.46	100/500	10.45/c	
JWW83	80527	9/16 X 1 3/8	1/2	3.47	100	17.20/c	
JWW84	80528	11/16 X 1 3/4	5/8	6.72	100	33.60/c	
JWW85	80529	13/16 X 2	3/4	4.84	50	45.76/c	
JWW87	84395	1 1/16 X 2 1/2	1	3.90	25	58.40/c	NEW

OTHER SIZES AND QUANTITIES AVAILABLE BY REQUEST

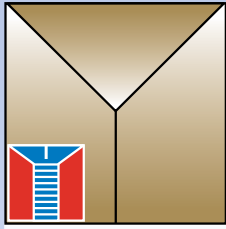

Metallics



Metric Flat Washer (Steel Zinc)

**[CONTRACTOR
APPROVED]**



PART #	UPC #	DESCRIPTION	QTY / PKG	SUG. TRADE LIST / PKG
JMSW04	60871	Metric Flat Washer (Size M4)	100	\$ 3.90
JMSW05	60295	Metric Flat Washer (Size M5)	100	\$ 4.35
JMSW06	60296	Metric Flat Washer (Size M6)	100	\$ 4.95
JMSW08	60298	Metric Flat Washer (Size M8)	100	\$ 5.70
JMSW010	60877	Metric Flat Washer (Size M10)	100	\$ 9.68
JMSW012	60879	Metric Flat Washer (Size M12)	100	\$ 15.45
JMSW016	60306	Metric Flat Washer (Size M16)	100	\$ 24.53
JMSW020	60887	Metric Flat Washer (Size M20)	100	\$ 41.03
JMSW024	60891	Metric Flat Washer (Size M24)	100	\$ 69.68

Other sizes, materials and quantities available by request.

“Growth Through Innovation”

Metallics

229 Cross Street, Bristol, CT 06010
Tel 800-243-8272 • **Fax** 800-831-9358
Email sales@metallicsonline.com

Metallics West

651 North Main Street, Mancos, CO 81328
Tel 800-269-5183 • **Fax** 800-269-6278
Email saleswest@metallicsonline.com

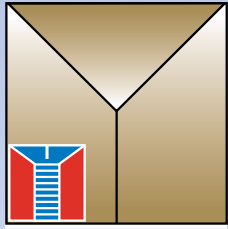

Metallics



Metric Lock Washer (Steel Zinc)

**[CONTRACTOR
APPROVED]**



PART #	UPC #	DESCRIPTION	QTY / PKG	SUG. TRADE LIST / PKG
JMLW04	63920	Metric Lock Washer (Size M4)	100	\$ 2.25
JMLW05	60335	Metric Lock Washer (Size M5)	100	\$ 4.20
JMLW06	63922	Metric Lock Washer (Size M6)	100	\$ 5.85
JMLW08	63924	Metric Lock Washer (Size M8)	100	\$ 7.20
JMLW010	63926	Metric Lock Washer (Size M10)	100	\$ 10.88
JMLW012	63928	Metric Lock Washer (Size M12)	100	\$ 18.60

Other sizes, materials and quantities available by request.

“Growth Through Innovation”

Metallics

229 Cross Street, Bristol, CT 06010
Tel 800-243-8272 • **Fax** 800-831-9358
Email sales@metallicsonline.com

Metallics West

651 North Main Street, Mancos, CO 81328
Tel 800-269-5183 • **Fax** 800-269-6278
Email saleswest@metallicsonline.com

WASHERS

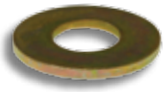

GRADE 8 FLAT WROUGHT WASHERS

HARDENED STEEL ZINC CHROMATE

For use with Grade 5 and Grade 8 Bolts and Nuts

STOCK NO.	UPC NO.	I.D./O.D.	BOLT SIZE	WT. PER PKG.	STD. PKG./MSTR. SLEEVE	SUGGESTED TRADE LIST PRICE PER
JG8WW80	80530	5/16 X 3/4	1/4	.66	100/500	13.93/c
JG8WW81	80531	3/8 X 7/8	5/16	.59	100/500	19.28/c
JG8WW82	80532	7/16 X 1	3/8	1.18	100/500	23.68/c
JG8WW87	81443	1/2 X 1 1/4	7/16	1.91	100/500	64.75/c NEW
JG8WW83	80533	9/16 X 1 3/8	1/2	3.77	100	65.50/c
JG8WW86	81442	1 1/16 X 1 3/4	5/8	7.16	100	158.75/c NEW
JG8WW85	81441	1 3/16 X 2	3/4	6.62	100	212.15/c NEW
JG8WW84	81439	1 5/16 X 2 1/4	7/8	13.07	100	274.53/c NEW

OTHER SIZES AND QUANTITIES AVAILABLE BY REQUEST



FINISHING WASHERS

STEEL NICKEL PLATED

STOCK NO.	UPC NO.	SIZE	BOLT SIZE	WT. PER PKG.	STD. PKG./MSTR. SLEEVE	SUGGESTED TRADE LIST PRICE PER
STEEL NICKEL PLATED						
JCW10	80555	6	1/8	.11	100/500	3.70/c
JCW11	80556	8	5/32	.16	100/500	5.83/c
JCW12	80557	10	3/16	.16	100/500	6.68/c
JCW14	80558	12	7/32	.26	100/500	11.08/c
STAINLESS STEEL 18-8 TYPE						
JCW12SS	81304	10	3/16	.17	100/500	7.43/c NEW

OTHER SIZES AND QUANTITIES AVAILABLE BY REQUEST



CONICAL WASHERS (Belleville)

STAINLESS STEEL 18-8 TYPE

Load bearing tension type applications

STOCK NO.	UPC NO.	I.D./O.D.	BOLT SIZE	WT. PER PKG.	STD. PKG./MSTR. SLEEVE	SUGGESTED TRADE LIST PRICE PER
JBWSS14	81691	5/16 X 3/4	1/4	.17	100/500	28.88/c NEW
JBWSS38	81676	7/16 X 3/4	3/8	.48	100/500	42.20/c
JBWSS12	81675	1 7/32 X 1 1/8	1/2	1.00	100/500	74.08/c
JBWSS34	81671	2 5/32 X 1 5/16	3/4	2.10	100	199.75/c NEW

OTHER SIZES AND QUANTITIES AVAILABLE BY REQUEST



JAR DISPLAY CENTER
Holds 18 Jars



ATTENTION

ON LARGE ORDERS OF ANCHOR KITS —
OUR PRICE CAN BE EVEN LOWER!

50 KITS

Order two master cartons of this kit and receive an added **10% Discount!**

QUANTITY DISCOUNTS:
10% DISCOUNT ON 50-99 LIKE KITS
OR
15% DISCOUNT ON 100+ LIKE KITS

Please Call Us for Co-Labeling on Kits!

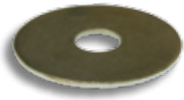

FENDER WASHERS

STEEL ZINC CHROMATE AND STAINLESS STEEL
A larger diameter for greater bearing surface.

STOCK NO.	UPC NO.	I.D./O.D.	BOLT SIZE	WT. PER PKG.	STD. PKG./MSTR. SLEEVE	SUGGESTED TRADE LIST PRICE PER	
STEEL ZINC CHROMATE							
JW110	82896	3/16 x 3/4	3/16	.49	100/500	19.50/c	NEW
JW112	80534	3/16 x 1	3/16	1.64	100/500	6.63/c	
JW111	80535	3/16 x 1 1/4	3/16	2.06	100/500	8.00c	NEW
JW126	82912	1/4 x 7/8	1/4	1.22	100/500	7.85/c	
JW113	80536	1/4 x 1	1/4	1.35	100/500	6.23/c	
JW116	80537	1/4 x 1 1/4	1/4	2.09	100/500	7.88/c	
JW114	80538	1/4 x 1 1/2	1/4	3.06	100	11.28/c	
JW122	80539	1/4 x 2	1/4	5.43	100	31.10/c	
JW115	80540	5/16 x 1 1/4	5/16	2.30	100/500	11.28/c	
JW118	80541	5/16 x 1 1/2	5/16	2.94	100/500	15.88/c	
JW127	80542	3/8 x 1	3/8	1.24	100/500	9.60/c	
JW119	80543	3/8 x 1 1/4	3/8	2.33	100/500	10.93/c	
JW117	80544	3/8 x 1 1/2	3/8	3.20	100	11.33/c	
JW123	80545	3/8 x 2	3/8	6.43	100	28.73/c	
JW120	80546	1/2 x 1 3/8	1/2	3.37	100	16.73/c	
JW1201	80547	1/2 x 1 1/2	1/2	2.56	100	18.95/c	
JW121	80548	1/2 x 2	1/2	5.18	100	27.70/c	
18-8 TYPE STAINLESS STEEL							
JW112SS	90733	3/16 x 1	3/16	1.65	100/500	22.05/c	NEW
JW111SS	90751	3/16 x 1 1/4	3/16	2.05	100/500	27.19/c	NEW
JW113SS	80549	1/4 x 1	1/4	.95	100/500	24.25/c	
JW116SS	80550	1/4 x 1 1/4	1/4	1.51	100/500	34.65/c	
JW114SS	80551	1/4 x 1 1/2	1/4	2.82	100	60.63/c	
JW115SS	90752	5/16 x 1 1/4	5/16	1.46	100/500	60.63/c	NEW
JW118SS	80552	5/16 x 1 1/2	5/16	2.75	100/500	65.85/c	
JW127SS	90761	3/8 x 1	3/8	0.91	100/500	37.90/c	NEW
JW119SS	90753	3/8 x 1 1/4	3/8	1.37	100/500	38.75/c	NEW
JW117SS	80553	3/8 x 1 1/2	3/8	1.36	50	38.90/c	NEW
JW123SS	90757	3/8 x 2	3/8	2.34	100	81.75/c	NEW
JW120SS	90754	1/2 x 1 3/8	1/2	3.10	100	86.25/c	NEW
JW1201SS	90762	1/2 x 1 1/2	1/2	2.49	100	86.85/c	NEW
JW121SS	80554	1/2 x 2	1/2	5.18	50	91.00/c	
316 TYPE STAINLESS STEEL							
JW1141SS	91513	1/4 x 1 1/2	1/4	3.06	100/500		NEW
JW1221SS	91494	1/4 x 2	1/4	3.16	100/500		NEW
JW1171SS	91489	3/8 x 1 1/2	3/8	2.33	100/500		NEW
JW1231SS	91495	3/8 x 2	3/8	6.43	100		NEW
JW12011SS	91480	1/2 x 1 1/2	1/2	2.65	100		NEW

PLEASE CALL FOR TRADE LIST PRICING

OTHER SIZES AND QUANTITIES AVAILABLE BY REQUEST



OCTAGONAL WASHERS **NEW!**

STOCK NO.	UPC NO.	I.D./O.D.	BOLT SIZE	WT. PER PKG.	STD. PKG./MSTR. SLEEVE	SUGGESTED TRADE LIST PRICE PER 100	
JHFW114	90015	1/4 x 1 1/2	1/4	2.53	100	30.87/c	NEW
JHFW117	90017	3/8 x 1 1/2	3/8	2.53	100	29.93/c	NEW

OTHER SIZES AND QUANTITIES AVAILABLE BY REQUEST

WASHERS



FENDER WASHER KIT

STEEL ZINC CHROMATE

STOCK NO.	UPC NO.	DESCRIPTION OF CONTENTS	STD. PKG./ MSTR. CARTON	WT. EACH	SUGGESTED TRADE LIST PRICE PER
FWK10	13050	180 pcs - Fender Washers 30 - $\frac{3}{16} \times 1$, $\frac{3}{16} \times 1\frac{1}{4}$, $\frac{1}{4} \times 1$, $\frac{1}{4} \times 1\frac{1}{4}$, $\frac{3}{8} \times 1$, $\frac{3}{8} \times 1\frac{1}{4}$	1/25	3.02	20.48/ea kit

OTHER SIZES AND QUANTITIES AVAILABLE BY REQUEST



SPLIT LOCKWASHERS

Now in more sizes of Steel Zinc, Stainless, 316 Stainless - Silicon Bronze - Galvanized - Nylon

STOCK NO.	UPC NO.	SIZE	BOLT SIZE	WT. PER PKG.	STD. PKG./ MSTR. SLEEVE	SUGGESTED TRADE LIST PRICE PER
STEEL ZINC CHROMATE						
JLW167	81844	4	$\frac{7}{64}$.08	100/500	3.58/c NEW
JLW169	80583	6	$\frac{1}{8}$.10	100/500	2.38/c
JLW170	80584	8	$\frac{5}{32}$.11	100/500	2.43/c
JLW171	80585	10	$\frac{3}{16}$.13	100/500	2.53/c
JLW153	81830	12	$\frac{13}{64}$.17	100/500	3.35/c NEW
JLW172	80586	$\frac{1}{4}$	$\frac{1}{4}$.26	100/500	2.68/c
JLW173	80587	$\frac{5}{16}$	$\frac{5}{16}$.45	100/500	3.13/c
JLW174	80588	$\frac{3}{8}$	$\frac{3}{8}$.66	100/500	4.73/c
JLW178	81894	$\frac{7}{16}$	$\frac{7}{16}$.95	100/500	6.38/c NEW
JLW175	80589	$\frac{1}{2}$	$\frac{1}{2}$	1.29	100/500	6.75/c
JLW176	80590	$\frac{5}{8}$	$\frac{5}{8}$	2.54	100/500	15.90/c
JLW177	80591	$\frac{3}{4}$	$\frac{3}{4}$	3.67	100	33.78/c
18-8-TYPE STAINLESS STEEL						
JSLW4	71774	6	$\frac{1}{8}$.08	100/500	2.88/c NEW
JSLW5	80592	8	$\frac{5}{32}$.10	100/500	3.83/c
JSLW6	80593	10	$\frac{3}{16}$.13	100/500	4.28/c
JSLW12	84188	12	$\frac{13}{64}$.16	100/500	6.00/c NEW
JSLW7	80594	$\frac{1}{4}$	$\frac{1}{4}$.31	100/500	7.60/c
JSLW8	80595	$\frac{5}{16}$	$\frac{5}{16}$.44	100/500	11.50/c
JSLW9	80596	$\frac{3}{8}$	$\frac{3}{8}$.69	100/500	16.98/c
JSLW11	84187	$\frac{7}{16}$	$\frac{7}{16}$.95	100/500	27.35/c NEW
JSLW10	80597	$\frac{1}{2}$	$\frac{1}{2}$	1.40	100/500	33.48/c
JSLW92	84892	$\frac{5}{8}$	$\frac{5}{8}$	3.32	100/500	59.55/c NEW
316 TYPE STAINLESS STEEL						
JSLW71	72771	$\frac{1}{4}$	$\frac{1}{4}$.28	100/500	NEW
JSLW81	84881	$\frac{5}{16}$	$\frac{5}{16}$.45	100/500	NEW
JSLW91	84891	$\frac{3}{8}$	$\frac{3}{8}$.68	100/500	NEW
JSLW111	92991	$\frac{7}{16}$	$\frac{7}{16}$	1.01	100	NEW
JSLW101	92981	$\frac{1}{2}$	$\frac{1}{2}$.67	50	NEW
SILICON BRONZE						
JBLW6	84160	6	$\frac{1}{8}$.10	100/500	3.83/c
JBLW8	84161	8	$\frac{5}{32}$.11	100/500	4.40/c
JBLW178	80598	10	$\frac{3}{16}$.13	100/500	4.25/c
JBLW14	80599	$\frac{1}{4}$	$\frac{1}{4}$.32	100/500	12.03/c
JBLW516	80600	$\frac{5}{16}$	$\frac{5}{16}$.47	100/500	18.33/c

PLEASE CALL FOR TRADE LIST PRICING

OTHER SIZES AND QUANTITIES AVAILABLE BY REQUEST

CONTINUED ON NEXT PAGE



CONTINUED

SPLIT LOCKWASHERS

STOCK NO.	UPC NO.	SIZE	BOLT SIZE	WT. PER PKG.	STD. PKG./MSTR. SLEEVE	SUGGESTED TRADE LIST PRICE PER
SILICON BRONZE						
JBLW38	80601	3/8	3/8	.75	100/500	28.53/c
JBLW12	80602	1/2	1/2	1.41	100/500	36.83/c
JBLW58	84350	5/8	5/8	2.86	100	109.75/c NEW
JBLW34	76334	3/4	3/4	3.77	100	251.35/c NEW
GALVANIZED						
JLW172G	82961	1/4	1/4	.71	100/500	14.20/c NEW
JLW174G	82963	3/8	3/8	.74	100/500	15.95/c NEW
JLW175G	82964	1/2	1/2	1.08	100/500	30.08/c NEW
JLW176G	82965	5/8	5/8	2.62	100/500	49.75/c NEW
NYLON						
JLWN7	71707	1/4	1/4	.09	50	378.00/c NEW

ALSO AVAILABLE IN A HANDY KIT, SEE PAGE 112!
OTHER SIZES AND QUANTITIES AVAILABLE BY REQUEST



EXTERNAL TOOTH LOCK WASHERS

STOCK NO.	UPC NO.	SIZE	BOLT SIZE	WT. PER PKG.	STD. PKG./MSTR. SLEEVE	SUGGESTED TRADE LIST PRICE PER
STEEL ZINC CHROMATE						
JLWX1	82521	4	7/64	.03	100/500	3.55/c NEW
JLWX3	80603	6	1/8	.07	100/500	2.38/c
JLWX4	80604	8	5/32	.09	100/500	2.43/c
JLWX5	80605	10	3/16	.10	100/500	2.53/c
JLWX12	81505	12	7/32	.12	100/500	12.60/c NEW
JLWX6	80606	1/4	1/4	.13	100/500	2.68/c
JLWX7	80607	5/16	5/16	.15	100/500	3.13/c
JLWX8	80608	3/8	3/8	.24	100/500	4.73/c
JLWX9	80609	1/2	1/2	.39	100/500	6.75/c
18-8 TYPE STAINLESS STEEL						
JLWX3SS	92953	6	1/8	.08	100/500	NEW
JLWX4SS	92954	8	5/32	.09	100/500	NEW
JLWX5SS	92955	10	3/16	.16	100/500	NEW
JLWX6SS	92956	1/4	1/4	.13	100/500	NEW
JLWX8SS	92958	3/8	3/8	.19	100/500	NEW
JLWX9SS	92959	1/2	1/2	.36	100/500	NEW

PLEASE CALL FOR TRADE LIST PRICING

OTHER SIZES AND QUANTITIES AVAILABLE BY REQUEST



INTERNAL TOOTH LOCK WASHERS

STOCK NO.	UPC NO.	SIZE	BOLT SIZE	WT. PER PKG.	STD. PKG./MSTR. SLEEVE	SUGGESTED TRADE LIST PRICE PER
STEEL ZINC CHROMATE						
JLWI3	83650	6	1/8	.10	100/500	2.38/c
JLWI4	83652	8	5/32	.10	100/500	2.43/c
JLWI5	83654	10	3/16	.10	100/500	2.53/c
JLWI6	83656	1/4	1/4	.10	100/500	2.68/c
JLWI7	83658	5/16	5/16	.17	100/500	3.13/c
JLWI8	83660	3/8	3/8	.23	100/500	4.73/c
JLWI9	83662	1/2	1/2	.38	100/500	6.75/c
18-8 TYPE STAINLESS STEEL						
JLWIX4SS	97004	8	5/32	.04	100/500	NEW
JLWIX5SS	97005	10	3/16	.09	100/500	NEW

PLEASE CALL FOR TRADE LIST PRICING

OTHER SIZES AND QUANTITIES AVAILABLE BY REQUEST

WASHERS



REDUCING WASHERS

ELECTRO-GALVANIZED STEEL

Designed to reduce larger knockouts to accept smaller connectors



STOCK NO.	UPC NO.	I.D./O.D.	WT. PER PKG.	STD. PKG./MSTR. SLEEVE	SUGGESTED TRADE LIST PRICE PER
JR100	80559	1/2 x 3/4	.92	100/500	15.33/c
JR101	80560	1/2 x 1	1.60	100/500	20.20/c
JR102	80561	3/4 x 1	1.34	100/500	20.20/c
JR103	80562	1/2 x 1 1/4	1.25	50/250	31.96/c
JR104	80563	3/4 x 1 1/4	1.11	50/250	31.96/c
JR105	80564	1 x 1 1/4	.80	50/250	31.96/c
JR106	80565	1/2 x 1 1/2	2.11	50/250	39.16/c
JR107	80566	3/4 x 1 1/2	2.12	50/250	41.50c
JR108	80567	1 x 1 1/2	2.01	50/250	41.50c
JR109	80568	1 1/4 x 1 1/2	1.42	50	41.50c
JR110	80569	1/2 x 2	3.54	50	50.30/c
JR111	80570	3/4 x 2	3.05	50	50.30/c
JR112	80571	1 x 2	3.30	50	50.30/c
JR113	80572	1 1/4 x 2	2.98	50	50.30/c
JR114	80573	1 1/2 x 2	2.63	50	50.30/c
JR115	80574	3/4 x 2 1/2	4.74	50	145.06/c
JR116	80575	1 x 2 1/2	4.22	50	145.06c
JR117	80576	1 1/4 x 2 1/2	3.10	50	145.06/c
JR118	80577	1 1/2 x 2 1/2	3.09	50	145.06/c
JR119	80578	2 x 2 1/2	2.22	50	145.06/c
JR120	80579	2 x 3	2.50	25	246.60/c
JR121	80580	2 x 3 1/2	1.50	10	544.00/c
JR122	80581	2 1/2 x 4	1.75	10	710.80/c
JR123	80582	3 x 4	2.10	10	710.80/c

OTHER SIZES AND QUANTITIES AVAILABLE BY REQUEST



Steel Building Construction

MASTER SEAL®

SEALING AND CUSHIONING WASHERS
Provides an affordable alternative to pre-assembled construction fasteners

GALVANIZED AND STAINLESS



STOCK NO.	KIT UPC NO.	DESCRIPTION	SUGGESTED TRADE LIST PRICE PER
MSWP120	12694	120 pcs - Plastic Box of Assorted Steel Galvanized Washers containing a total of 120 pieces. 20 each of #6, #8-10, #12, 1/4", 5/16", and 3/8"	8.44/ea kit

STOCK NO.	UPC NO.	DESCRIPTION	SIZE (INT. DIA.)	OVERALL DIAMETER	STD. PKG.	WT. PER PKG.	SUGGESTED TRADE LIST PRICE PER
JMSW20	82375	Galvanized Steel	6	3/8	100	.18	5.03/c
JMSW21	82376	Galvanized Steel	8-10	1/2	100	.26	5.13/c
JMSW22	82377	Galvanized Steel	12	9/16	100	.32	6.35/c
JMSW23	82378	Galvanized Steel	1/4	5/8	100	.36	6.70/c
JMSW24	82379	Galvanized Steel	5/16	3/4	100	.47	9.88/c
JMSW25	82380	Galvanized Steel	3/8	3/4	100	.40	9.88/c
JMSWS30	82381	Stainless Steel	8-10	1/2	100	.26	13.55/c

OTHER SIZES AND QUANTITIES AVAILABLE BY REQUEST

MASTER SEAL® IS A REGISTERED TRADEMARK

GALVANIZED



GRADE 2 HEXAGON CAP SCREWS

STEEL ZINC CHROMATE AND GALVANIZED

STEEL ZINC CHROMATE



STOCK NO.	UPC NO.	SIZE	LENGTH	WT. PER PKG.	STD. PKG./MSTR. SLEEVE	SUGGESTED TRADE LIST PRICE PER
STEEL ZINC CHROMATE						
JBHC11	80610	1/4-20	1/2	1.24	100/500	6.10/c
JBHC48	80611	1/4-20	5/8	1.32	100/500	7.23/c
JBHC1	80612	1/4-20	3/4	1.47	100/500	7.40/c
JBHC2	80613	1/4-20	1	1.72	100/500	8.25/c
JBHC49	80614	1/4-20	1 1/4	2.11	100	9.50/c
JBHC3	80615	1/4-20	1 1/2	2.47	100	10.73/c
JBHC50	80616	1/4-20	1 3/4	2.82	100	12.40/c
JBHC4	80617	1/4-20	2	3.15	100	12.60/c
JBHC5	80618	1/4-20	2 1/2	3.86	100	16.30/c
JBHC6	80619	1/4-20	3	4.45	100	18.80/c
JBHC7	80620	1/4-20	3 1/2	3.92	100	23.85/c
JBHC8	80621	1/4-20	4	5.95	100	27.13/c
JBHC9	80622	1/4-20	4 1/2	6.66	100	32.90/c
JBHC10	82140	1/4-20	5	7.41	100	54.23/c NEW
JBHC53	82179	1/4-20	5 1/2	8.00	100	58.33/c NEW
JBHC12	82142	1/4-20	6	8.75	100	62.28/c NEW
JBHC101	82221	5/16-18	5/8	2.18	100/500	15.63/c NEW
JBHC42	80623	5/16-18	3/4	2.48	100/500	10.73/c
JBHC43	80624	5/16-18	1	2.83	100/500	12.88/c
JBHC54	80625	5/16-18	1 1/4	3.31	100/500	14.45/c
JBHC13	80626	5/16-18	1 1/2	3.91	100	15.38/c
JBHC14	80627	5/16-18	2	4.98	100	19.88/c
JBHC15	80628	5/16-18	2 1/2	6.09	100	22.83/c
JBHC16	80629	5/16-18	3	7.11	100	27.05/c
JBHC20	82150	5/16-18	5	5.77	100	74.40/c NEW
JBHC58	82180	5/16-18	5 1/2	12.00	100	79.55/c NEW
JBHC22	82152	5/16-18	6	13.15	50	84.70/c NEW
JBHC88	80630	3/8-16	1/2	2.86	100/500	12.45/c
JBHC44	80631	3/8-16	3/4	3.80	100	14.83/c
JBHC45	80632	3/8-16	1	4.20	100	19.13/c
JBHC59	80633	3/8-16	1 1/4	4.75	100	19.40/c
JBHC23	80634	3/8-16	1 1/2	5.60	100	23.40/c
JBHC60	80635	3/8-16	1 3/4	6.47	100	27.63/c
JBHC24	80636	3/8-16	2	7.31	100	28.88/c
JBHC61	80637	3/8-16	2 1/4	3.99	50	31.26/c
JBHC25	80638	3/8-16	2 1/2	4.39	50	33.90/c
JBHC26	80639	3/8-16	3	5.19	50	40.40/c
JBHC27	80640	3/8-16	3 1/2	6.02	50	43.96/c
JBHC28	82157	3/8-16	4	6.75	50	55.56/c
JBHC29	82158	3/8-16	4 1/2	7.23	50	52.56/c
JBHC30	82159	3/8-16	5	8.24	50	100.60/c NEW
JBHC63	82183	3/8-16	5 1/2	18.09	50	108.03/c NEW
JBHC32	82161	3/8-16	6	16.23	50	116.25/c NEW

OTHER SIZES AND QUANTITIES AVAILABLE BY REQUEST

CONTINUED ON NEXT PAGE

BOLTS

GALVANIZED



CONTINUED GRADE 2 HEXAGON CAP SCREWS

STEEL ZINC
CHROMATE

STEEL ZINC CHROMATE AND GALVANIZED



STOCK NO.	UPC NO.	SIZE	LENGTH	WT. PER PKG.	STD. PKG./MSTR. SLEEVE	SUGGESTED TRADE LIST PRICE PER
STEEL ZINC CHROMATE						
JBHC93	82212	7/16-14	1	5.83	100	67.13/c
JBHC94	82213	7/16-14	1 1/4	6.80	100	73.25/c
JBHC95	82214	7/16-14	1 1/2	8.18	100	79.11/c
JBHC96	82215	7/16-14	2	9.06	100	85.33/c
JBHC97	82216	7/16-14	2 1/2	10.02	100	91.36/c
JBHC98	82217	7/16-14	3	12.75	100	94.90/c
JBHC99	82218	7/16-14	3 1/2	15.66	100	107.43/c
JBHC86	82205	1/2-13	3/4	7.39	100	43.48/c
JBHC46	80641	1/2-13	1	4.25	50	34.56/c
JBHC64	80642	1/2-13	1 1/4	4.82	50	39.26/c
JBHC47	80643	1/2-13	1 1/2	5.53	50	41.66/c
JBHC65	80644	1/2-13	1 3/4	5.85	50	47.16/c
JBHC33	80645	1/2-13	2	6.85	50	53.36/c
JBHC66	80646	1/2-13	2 1/4	7.46	50	58.36/c
JBHC34	80647	1/2-13	2 1/2	8.23	50	63.46/c
JBHC67	80648	1/2-13	2 3/4	8.75	50	71.50/c
JBHC35	80649	1/2-13	3	9.50	50	72.16/c
JBHC36	82175	1/2-13	3 1/2	5.57	25	81.40/c
JBHC37	82176	1/2-13	4	6.25	25	87.40/c
JBHC38	82167	1/2-13	4 1/2	27.00	25	139.05/c
JBHC39	82168	1/2-13	5	29.80	25	153.38/c
JBHC68	82185	1/2-13	5 1/2	32.05	25	168.10/c
JBHC41	82170	1/2-13	6	33.24	25	182.28/c
JBHC21	80650	5/8-11	1	7.79	50	59.80/c
JBHC31	80651	5/8-11	1 1/2	9.23	50	61.90/c
JBHC69	82186	5/8-11	2	10.94	50	71.86/c
JBHC71	80653	5/8-11	2 1/2	13.30	50	82.90/c
JBHC73	80654	5/8-11	3	15.15	50	96.06/c
JBHC75	80655	5/8-11	3 1/2	7.02	25	129.52/c
JBHC76	82193	5/8-11	4	9.18	25	133.20/c
JBHC80	82197	5/8-11	5	10.80	25	202.63/c
JBHC7612	82202	3/4-10	1 1/2	14.37	50	135.30/c
JBHC77	82194	3/4-10	2	17.05	50	159.80/c
JBHC79	82196	3/4-10	2 1/2	17.88	50	170.56/c
JBHC81	82181	3/4-10	3	23.60	50	201.96/c
JBHC83	82203	3/4-10	3 1/2	12.24	25	242.80/c
JBHC85	82204	3/4-10	4	17.50	25	267.12/c
GALVANIZED						
JBHC1G	85601	1/4-20	3/4	1.57	100/500	24.38/c
JBHC2G	85602	1/4-20	1	1.85	100/500	48.44/c
JBHC45G	85645	3/8-16	1	4.83	100	55.82/c
JBHC23G	85623	3/8-16	1 1/2	5.60	100	95.68/c
JBHC24G	85624	3/8-16	2	6.12	100	98.72/c
JBHC46G	85646	1/2-13	1	2.13	100	121.18/c
JBHC33G	85633	1/2-13	2 1/2	26.31	100	242.37/c
JBHC36G	85636	1/2-13	3 1/2	7.43	25	688.52/c

OTHER SIZES AND QUANTITIES AVAILABLE BY REQUEST



GRADE 5 HEXAGON CAP SCREWS

HARDENED STEEL ZINC CHROMATE
To be used with Grade 5 nuts and washers



STOCK NO.	UPC NO.	SIZE	BOLT SIZE	WT. PER PKG.	STD. PKG./MSTR. SLEEVE	SUGGESTED TRADE LIST PRICE PER
JG5HC11	80656	1/4-20	1/2	1.25	100/500	7.55/c
JG5HC1	80657	1/4-20	3/4	1.49	100/500	9.90/c
JG5HC21	82099	1/4-20	7/8	1.62	100/500	13.25/c NEW
JG5HC2	80658	1/4-20	1	1.75	100/500	11.83/c
JG5HC49	80659	1/4-20	1 1/4	2.15	100/500	13.85/c
JG5HC3	80660	1/4-20	1 1/2	2.44	100	17.05c
JG5HC4	80661	1/4-20	2	3.17	100	20.15/c
JG5HC5	80662	1/4-20	2 1/2	3.75	100	21.90/c
JG5HC6	80663	1/4-20	3	4.53	100	25.60/c
JG5HC7	80664	1/4-20	3 1/2	5.16	100	29.55/c
JG5HC8	80665	1/4-20	4	5.94	100	34.93/c
JG5HC42	80666	5/16-18	3/4	2.45	100/500	14.18/c
JG5HC41	83280	5/16-18	7/8	2.92	100/500	19.95/c NEW
JG5HC43	80667	5/16-18	1	2.85	100/500	16.13/c
JG5HC13	80668	5/16-18	1 1/2	3.87	100	21.20/c
JG5HC14	80669	5/16-18	2	4.97	100	27.45/c
JG5HC15	80670	5/16-18	2 1/2	6.10	100	32.78/c
JG5HC16	80671	5/16-18	3	7.11	100	39.20/c
JG5HC18	80672	5/16-18	3 1/2	4.28	50	49.06/c
JG5HC20	80673	5/16-18	4	4.72	50	56.16/c
JG5HC88	80674	3/8-16	1/2	2.88	100/500	17.70/c
JG5HC44	80675	3/8-16	3/4	3.51	100/500	21.78/c
JG5HC45	80676	3/8-16	1	4.19	100	25.53/c
JG5HC59	80677	3/8-16	1 1/4	4.84	100	29.95/c
JG5HC23	80678	3/8-16	1 1/2	5.53	100	34.08/c
JG5HC24	80679	3/8-16	2	7.20	100	43.50/c
JG5HC29	82827	3/8-16	2 1/4	7.82	100	44.38/c NEW
JG5HC25	80680	3/8-16	2 1/2	4.41	50	46.36/c
JG5HC26	80681	3/8-16	3	5.20	50	59.20/c
JG5HC27	82825	3/8-16	3 1/2	5.91	50	63.90/c
JG5HC28	82826	3/8-16	4	6.87	50	76.56/c
JG5HC119	76219	7/16-14	1	3.60	50	41.65/c NEW
JG5HC123	76223	7/16-14	1 1/4	3.73	50	58.55/c NEW
JG5HC120	82098	7/16-14	1 1/2	3.95	50	58.75/c NEW
JG5HC121	76221	7/16-14	2	4.15	50	66.46/c NEW
JG5HC122	76222	7/16-14	2 1/2	5.12	50	75.86/c NEW
JG5HC81	82881	1/2-13	3/4	3.73	50	56.40/c NEW
JG5HC46	80682	1/2-13	1	4.23	50	50.46/c
JG5HC64	80683	1/2-13	1 1/4	4.73	50	58.30/c
JG5HC47	80684	1/2-13	1 1/2	5.41	50	74.60/c
JG5HC33	80685	1/2-13	2	6.61	50	78.30/c
JG5HC12	82083	1/2-13	2 1/4	7.52	50	90.06/c NEW
JG5HC34	80686	1/2-13	2 1/2	8.11	50	96.76/c

OTHER SIZES AND QUANTITIES AVAILABLE BY REQUEST

CONTINUED ON NEXT PAGE

CONTINUED

GRADE 5 HEXAGON CAP SCREWS

HARDENED STEEL ZINC CHROMATE
To be used with Grade 5 nuts and washers



STOCK NO.	UPC NO.	SIZE	BOLT SIZE	WT. PER PKG.	STD. PKG./MSTR. SLEEVE	SUGGESTED TRADE LIST PRICE PER
JG5HC67	80687	1/2-13	2 ³ / ₄	8.87	50	124.40/c
JG5HC35	80688	1/2-13	3	9.14	50	98.50/c
JG5HC36	80689	1/2-13	3 ¹ / ₂	5.40	25	115.72/c
JG5HC37	82837	1/2-13	4	5.94	25	130.20/c
JG5HC38	82838	1/2-13	5	6.94	25	283.48/c NEW
JG5HC60	82853	5/8-11	1	3.96	25	92.94/c NEW
JG5HC62	80690	5/8-11	1 ¹ / ₂	4.65	50	98.30/c
JG5HC63	80691	5/8-11	2	11.07	50	117.46/c
JG5HC66	82859	5/8-11	2 ¹ / ₂	13.30	50	137.90/c
JG5HC68	82862	5/8-11	3	15.38	50	160.46/c
JG5HC70	82870	5/8-11	3 ¹ / ₂	10.80	50	176.56/c
JG5HC72	82872	5/8-11	4	20.00	50	212.26/c
JG5HC73	82873	5/8-11	4 ¹ / ₂	6.67	25	372.60/c NEW
JG5HC75	82875	5/8-11	5	7.82	25	406.80/c NEW
JG5HC74	80694	3/4-10	1 ¹ / ₂	5.30	50	188.00/c
JG5HC76	82874	3/4-10	2	6.47	50	200.46/c
JG5HC78	82877	3/4-10	2 ¹ / ₂	7.88	50	222.90/c
JG5HC80	82880	3/4-10	3	10.41	50	253.80/c
JG5HC82	82883	3/4-10	3 ¹ / ₂	12.50	50	286.00/c
JG5HC84	82886	3/4-10	4	13.10	50	318.26/c
JG5HC85	82885	3/4-10	5	5.72	20	691.25/c NEW

OTHER SIZES AND QUANTITIES AVAILABLE BY REQUEST



GRADE 8 HEXAGON CAP SCREWS

HARDENED STEEL ZINC CHROMATE
To be used with Grade 8 nuts and washers



STOCK NO.	UPC NO.	SIZE	BOLT SIZE	WT. PER PKG.	STD. PKG./MSTR. SLEEVE	SUGGESTED TRADE LIST PRICE PER
JG8HC1	80698	1/4-20	3/4	1.53	100/500	13.35/c
JG8HC2	80699	1/4-20	1	1.74	100/500	14.23/c
JG8HC114	90555	1/4-20	1 ¹ / ₄	2.10	100/500	20.18/c NEW
JG8HC3	80700	1/4-20	1 ¹ / ₂	2.46	100/500	18.53/c
JG8HC4	80701	1/4-20	2	3.07	100	27.63/c
JG8HC5	80702	1/4-20	2 ¹ / ₂	1.99	50	30.60/c
JG8HC6	80703	1/4-20	3	2.28	50	43.90/c
JG8HC8	83216	1/4-20	4	2.95	50	60.76/c
JG8HC42	80704	5/16-18	3/4	2.46	100/500	19.50/c
JG8HC17	83235	5/16-18	7/8	2.65	100/500	24.75/c NEW
JG8HC43	80705	5/16-18	1	2.87	100/500	21.65/c
JG8HC13	80706	5/16-18	1 ¹ / ₂	3.93	100	31.43/c
JG8HC14	80707	5/16-18	2	5.00	100	43.50/c
JG8HC15	80708	5/16-18	2 ¹ / ₂	3.10	50	52.10/c
JG8HC16	83234	5/16-18	3	3.67	50	61.66/c
JG8HC20	83237	5/16-18	4	4.56	50	89.16/c

OTHER SIZES AND QUANTITIES AVAILABLE BY REQUEST

CONTINUED ON NEXT PAGE

CONTINUED

GRADE 8 HEXAGON CAP SCREWS

HARDENED STEEL ZINC CHROMATE
To be used with Grade 8 nuts and washers



STOCK NO.	UPC NO.	SIZE	BOLT SIZE	WT. PER PKG.	STD. PKG./MSTR. SLEEVE	SUGGESTED TRADE LIST PRICE PER
JG8HC2334	80710	3/8-16	3/4	3.59	100/500	24.98/c
JG8HC231	80711	3/8-16	1	4.36	100	28.75/c
JG8HC214	90565	3/8-16	1 1/4	4.78	100	34.80/c NEW
JG8HC23	80712	3/8-16	1 1/2	5.58	100	40.30/c
JG8HC24	80713	3/8-16	2	3.62	50	50.36/c
JG8HC25	80714	3/8-16	2 1/2	4.37	50	65.26/c
JG8HC26	83255	3/8-16	3	5.06	50	72.46/c
JG8HC28	83258	3/8-16	4	6.60	50	96.70/c
JG8HC76114	90647	7/16-14	1 1/4	3.84	100	70.10/c NEW
JG8HC76112	90645	7/16-14	1 1/2	6.70	50	88.36/c NEW
JG8HC46	83261	1/2-13	1	4.24	50	67.20/c
JG8HC48	83287	1/2-13	1 1/4	4.75	50	70.93/c NEW
JG8HC47	81037	1/2-13	1 1/2	2.73	25	75.60/c
JG8HC33	83267	1/2-13	2	3.36	25	102.72/c
JG8HC34	83270	1/2-13	2 1/2	4.08	25	122.12/c
JG8HC35	83273	1/2-13	3	4.66	25	148.32/c
JG8HC37	83276	1/2-13	4	5.81	25	180.52/c
JG8HC38	83277	1/2-13	4 1/2	6.80	25	274.00/c NEW
JG8HC583	90595	5/8-11	3	15.50	50	253.20/c NEW
JG8HC58312	90615	5/8-11	3 1/2	16.74	50	321.20/c NEW
JG8HC584	90596	5/8-11	4	17.43	50	376.56/c NEW
JG8HC58412	90625	5/8-11	4 1/2	21.95	50	408.46/c NEW
JG8HC343	90575	3/4-10	3	9.28	20	526.15/c NEW
JG8HC34312	90605	3/4-10	3 1/2	10.5	20	573.15/c NEW

OTHER SIZES AND QUANTITIES AVAILABLE BY REQUEST



HEXAGON CAP SCREWS

18-8 TYPE STAINLESS STEEL



STOCK NO.	UPC NO.	SIZE	LENGTH	WT. PER PKG.	STD. PKG./MSTR. SLEEVE	SUGGESTED TRADE LIST PRICE PER
JSBH11	80719	1/4-20	1/2	1.23	100/500	18.93/c
JSBH5	83569	1/4-20	5/8	1.34	100/500	21.38/c NEW
JSBH1	80720	1/4-20	3/4	1.49	100/500	23.85/c
JSBH2	80721	1/4-20	1	1.75	100/500	26.65/c
JSBH49	80722	1/4-20	1 1/4	2.12	100/500	32.73/c
JSBH3	80723	1/4-20	1 1/2	2.44	100	40.40/c
JSBH4	83568	1/4-20	2	3.23	100	57.38/c NEW
JSBH51	83615	1/4-20	2 1/4	3.64	100	70.33/c NEW
JSBH41	83605	1/4-20	2 1/2	3.89	100	73.08/c NEW
JSBH412	93312	1/4-20	3	4.42	100	74.98/c NEW
JSBH86	80724	5/16-18	1/2	2.03	100/500	38.40/c
JSBH42	80725	5/16-18	3/4	2.41	100/500	42.43/c
JSBH43	80726	5/16-18	1	2.85	100/500	53.40/c
JSBH54	80727	5/16-18	1 1/4	3.28	100/500	60.13/c
JSBH13	80728	5/16-18	1 1/2	3.92	100	62.03/c

OTHER SIZES AND QUANTITIES AVAILABLE BY REQUEST

CONTINUED ON NEXT PAGE



CONTINUED
HEXAGON CAP SCREWS
 18-8 TYPE STAINLESS STEEL



STOCK NO.	JAR UPC NO.	SIZE	LENGTH	WT. PER PKG.	STD. PKG./MSTR. SLEEVE	SUGGESTED TRADE LIST PRICE PER	
JSBH12	80729	5/16-18	1 3/4	4.50	100	82.83/c	
JSBH14	80730	5/16-18	2	5.01	100	85.98/c	
JSBH15	80731	5/16-18	2 1/2	6.14	100	97.18/c	
JSBH16	80732	5/16-18	3	7.14	100	114.05/c	
JSBH17	80733	5/16-18	3 1/2	8.30	100	150.65/c	
JSBH88	80734	3/8-16	1/2	2.94	100/500	81.18/c	
JSBH44	80735	3/8-16	3/4	3.57	100	59.18/c	
JSBH48	80736	3/8-16	7/8	3.83	100	64.65/c	
JSBH45	80737	3/8-16	1	4.19	100	64.65/c	
JSBH59	80738	3/8-16	1 1/4	1.11	100	73.83/c	
JSBH23	80739	3/8-16	1 1/2	5.65	100	84.80/c	
JSBH24	80740	3/8-16	2	7.24	100	113.35/c	
JSBH25	83589	3/8-16	2 1/2	4.12	50	200.86/c	NEW
JSBH26	83590	3/8-16	3	5.23	50	324.46/c	NEW
JSBH28	83592	3/8-16	3 1/2	6.41	50	347.11/c	NEW
JSBH29	83593	3/8-16	4	6.77	50	441.00/c	NEW
JSBH30	83594	3/8-16	5	8.39	50	425.00/c	NEW
JSBH32	83596	3/8-16	6	9.51	50	431.38/c	NEW
JSBH71	83635	7/16-14	1	5.72	100	78.45/c	NEW
JSBH22	83586	7/16-14	1 1/4	6.71	100	99.25/c	NEW
JSBH82	83646	7/16-14	1 1/2	7.31	100	149.63/c	NEW
JSBH502	94302	7/16-14	2	6.02	50	192.36/c	NEW
JSBH503	94303	7/16-14	2 1/2	4.99	50	298.70/c	NEW
JSBH74	83638	7/16-14	4	8.23	50	427.25/c	NEW
JSBH81	80741	1/2-13	3/4	7.22	100	138.23/c	
JSBH46	80742	1/2-13	1	4.29	50	154.26/c	
JSBH64	80743	1/2-13	1 1/4	4.80	50	155.96/c	
JSBH47	80744	1/2-13	1 1/2	5.44	50	157.40/c	
JSBH65	80745	1/2-13	1 3/4	5.91	50	196.50/c	
JSBH33	80746	1/2-13	2	6.85	50	252.66/c	
JSBH34	80747	1/2-13	2 1/2	8.20	50	274.90/c	
JSBH35	80748	1/2-13	3	9.48	50	374.40/c	
JSBH356	94156	1/2-13	3 1/4	11.26	50	393.40/c	NEW
JSBH350	94150	1/2-13	3 1/2	10.94	50	485.00/c	NEW
JSBH355	94155	1/2-13	4	12.31	50	602.60/c	NEW
JSBH359	91459	1/2-13	4 1/2	13.64	50	603.25/c	NEW
JSBH37	83601	1/2-13	5	14.42	50	605.38/c	NEW
JSBH19	83583	1/2-13	5 1/2	8.32	25	737.52/c	NEW
JSBH913	95113	5/8-11	1	8.62	50	242.80/c	NEW
JSBH912	95112	5/8-11	1 1/2	9.28	50	448.06/c	NEW
JSBH93	83665	5/8-11	2	10.99	50	535.60/c	NEW
JSBH94	83664	5/8-11	2 1/2	13.16	50	643.76/c	NEW
JSBH96	83667	5/8-11	3	15.35	50	659.20/c	NEW
JSBH800	95000	5/8-11	3 1/2	8.81	25	860.00/c	NEW
JSBH801	95001	5/8-11	4	9.99	25	978.60/c	NEW
JSBH808	95008	5/8-11	6	12.53	25	1184.52/c	NEW
JSBH91	83661	3/4-10	1	24.75	100	398.13/c	NEW
JSBH90	83659	3/4-10	1 1/2	26.63	100	410.20/c	NEW

OTHER SIZES AND QUANTITIES AVAILABLE BY REQUEST



HEXAGON CAP SCREWS **NEW!**

316 TYPE STAINLESS STEEL



STOCK NO.	UPC NO.	SIZE	LENGTH	WT. PER PKG.	STD. PKG./MSTR. SLEEVE	SUGGESTED TRADE LIST PRICE PER	
JSBH231	98231	1/4-20	3/4	1.49	100		NEW
JSBH234	98234	1/4-20	1	1.77	100		NEW
JSBH491	93391	1/4-20	1 1/4	2.09	100		NEW
JSBH236	98236	1/4-20	1 1/2	2.52	100		NEW
JSBH238	98238	1/4-20	2	3.19	100		NEW
JSBH411	93311	1/4-20	2 1/2	3.82	100		NEW
JSBH611	94611	1/4-20	3	1.90	100		NEW
JSBH421	93321	5/16-18	3/4	2.53	100		NEW
JSBH435	93335	5/16-18	1	2.85	100		NEW
JSBH541	94341	5/16-18	1 1/4	3.38	100		NEW
JSBH131	96331	5/16-18	1 1/2	3.92	100		NEW
JSBH142	96342	5/16-18	2	4.99	100		NEW
JSBH252	98252	3/8-16	1	4.20	100		NEW
JSBH253	98253	3/8-16	1 1/4	4.85	100		NEW
JSBH254	98254	3/8-16	1 1/2	5.71	100		NEW
JSBH255	98255	3/8-16	2	7.37	100		NEW
JSBH552	94352	7/16-14	1	5.95	100		NEW
JSBH811	95011	1/2-13	3/4	7.13	100		NEW
JSBH332	94132	1/2-13	1	8.55	100		NEW
JSBH336	94136	1/2-13	1 1/4	9.71	100		NEW
JSBH337	94137	1/2-13	1 1/2	10.76	100		NEW
JSBH339	94139	1/2-13	2	13.76	100		NEW
JSBH334	94134	1/2-13	2 1/4	7.87	50		NEW
JSBH341	94141	1/2-13	2 1/2	8.20	50		NEW
JSBH351	94151	1/2-13	3	9.94	50		NEW
JSBH353	94153	1/2-13	3 1/2	11.32	50		NEW
JSBH354	12354	1/2-13	4	12.64	50		NEW
JSBH670	94670	5/8-11	1	15.31	100		NEW
JSBH671	94671	5/8-11	1 1/4	16.71	100		NEW
JSBH672	94672	5/8-11	1 1/2	18.71	100		NEW
JSBH674	94674	5/8-11	2	22.82	50		NEW
JSBH941	95141	5/8-11	2 1/2	13.57	50		NEW
JSBH961	95161	5/8-11	3	15.55	50		NEW
JSBH680	94680	5/8-11	3 1/2	17.88	50		NEW
JSBH990	95190	3/4-10	1	24.46	100		NEW
JSBH991	95191	3/4-10	1 1/2	29.66	100		NEW
JSBH992	95192	3/4-10	2	35.12	100		NEW
JSBH951	95151	3/4-10	2 1/2	20.67	50		NEW
JSBH981	95181	3/4-10	3	23.78	50		NEW
JSBH760	94960	3/4-10	3 1/2	26.89	50		NEW

PLEASE
CALL
FOR
TRADE
LIST
PRICING



OTHER SIZES AND QUANTITIES AVAILABLE BY REQUEST

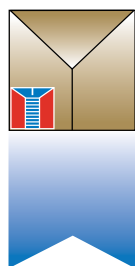

METALLICS

AMERICA'S SOURCE FOR PREMIER AND INNOVATIVE FASTENERS & ANCHORS

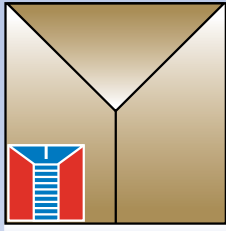

Metallics



Metric Hex Head Cap Screw (Steel Zinc)

[CONTRACTOR APPROVED]



PART #	UPC #	DESCRIPTION	QTY / PKG	SUG. TRADE LIST / PKG
JMBHC1016	64116	Metric Hex Head Cap Screw (Size M10 x 16)	100	\$ 47.58
JMBHC1020	64120	Metric Hex Head Cap Screw (Size M10 x 20)	100	\$ 51.28
JMBHC1025	64125	Metric Hex Head Cap Screw (Size M10 x 25)	100	\$ 56.80
JMBHC1030	64130	Metric Hex Head Cap Screw (Size M10 x 30)	100	\$ 62.00
JMBHC1035	64135	Metric Hex Head Cap Screw (Size M10 x 35)	100	\$ 68.58
JMBHC1040	64140	Metric Hex Head Cap Screw (Size M10 x 40)	100	\$ 74.83
JMBHC1045	64145	Metric Hex Head Cap Screw (Size M10 x 45)	100	\$ 81.98
JMBHC1216	64216	Metric Hex Head Cap Screw (Size M12 x 16)	100	\$ 94.33
JMBHC1220	64220	Metric Hex Head Cap Screw (Size M12 x 20)	50	\$ 39.33
JMBHC1225	64225	Metric Hex Head Cap Screw (Size M12 x 25)	50	\$ 43.35
JMBHC1230	64230	Metric Hex Head Cap Screw (Size M12 x 30)	50	\$ 47.19
JMBHC1235	64235	Metric Hex Head Cap Screw (Size M12 x 35)	50	\$ 51.03
JMBHC1240	64240	Metric Hex Head Cap Screw (Size M12 x 40)	50	\$ 60.84
JMBHC1245	64245	Metric Hex Head Cap Screw (Size M12 x 45)	50	\$ 64.38
JMBHC1250	64250	Metric Hex Head Cap Screw (Size M12 x 50)	50	\$ 70.25
JMBHC1260	64260	Metric Hex Head Cap Screw (Size M12 x 60)	50	\$ 79.95

Other sizes, materials and quantities available by request.

“Growth Through Innovation”

Metallics

229 Cross Street, Bristol, CT 06010
Tel 800-243-8272 • **Fax** 800-831-9358
Email sales@metallicsonline.com

Metallics West

651 North Main Street, Mancos, CO 81328
Tel 800-269-5183 • **Fax** 800-269-6278
Email saleswest@metallicsonline.com



HEXAGON CAP SCREWS

SILICON BRONZE

STOCK NO.	UPC NO.	SIZE	LENGTH	WT. PER PKG.	STD. PKG./MSTR. SLEEVE	SUGGESTED TRADE LIST PRICE PER	
JBBH11	80749	1/4-20	1/2	1.30	100/500		
JBBH48	84948	1/4-20	5/8	1.28	100/500		NEW
JBBH1	80750	1/4-20	3/4	1.64	100/500		
JBBH2	80751	1/4-20	1	1.92	100/500		
JBBH19	84919	1/4-20	1 1/4	2.14	100/500		
JBBH3	80752	1/4-20	1 1/2	2.48	100/500		
JBBH4	84904	1/4-20	2	3.04	100		
JBBH51	84951	1/4-20	2 1/4	3.52	100		NEW
JBBH5	84905	1/4-20	2 1/2	3.66	100		NEW
JBBH6	84906	1/4-20	3	4.22	100		NEW
JBBH7	84907	1/4-20	3 1/2	4.78	100		NEW
JBBH8	84908	1/4-20	4	5.34	100		NEW
JBBH42	84942	5/16-18	3/4	2.60	100		NEW
JBBH43	80753	5/16-18	1	3.27	100		NEW
JBBH54	84954	5/16-18	1 1/4	4.23	100		NEW
JBBH13	84913	5/16-18	1 1/2	4.62	100		NEW
JBBH14	84914	5/16-18	2	4.99	100		NEW
JBBH56	84956	5/16-18	2 1/4	5.32	100		NEW
JBBH15	84915	5/16-18	2 1/2	5.53	100		NEW
JBBH16	84916	5/16-18	3	6.29	100	PLEASE	NEW
JBBH17	84917	5/16-18	3 1/2	6.93	100	CALL	NEW
JBBH18	84918	5/16-18	4	7.25	100	FOR	NEW
JBBH88	80754	3/8-16	1/2	3.60	100/500	TRADE	
JBBH44	80755	3/8-16	3/4	3.92	100/500	LIST	
JBBH45	80756	3/8-16	1	4.55	100	PRICING	
JBBH59	84959	3/8-16	1 1/4	5.25	100		NEW
JBBH23	80757	3/8-16	1 1/2	5.96	100		
JBBH24	80758	3/8-16	2	7.29	100		
JBBH61	84961	3/8-16	2 1/4	8.02	100		NEW
JBBH25	84925	3/8-16	2 1/2	8.73	100		NEW
JBBH26	84926	3/8-16	3	6.31	50		NEW
JBBH27	84927	3/8-16	3 1/2	6.82	50		NEW
JBBH28	84928	3/8-16	4	6.62	50		NEW
JBBH29	84929	3/8-16	4 1/2	7.15	50		NEW
JBBH30	84930	3/8-16	5	3.91	25		NEW
JBBH32	84932	3/8-16	6	4.26	25		NEW
JBBH81	80759	1/2-13	3/4	8.11	100		
JBBH46	80760	1/2-13	1	4.71	50		
JBBH64	80761	1/2-13	1 1/4	5.31	50		
JBBH47	80762	1/2-13	1 1/2	5.87	50		
JBBH65	80763	1/2-13	1 3/4	6.54	50		
JBBH33	80764	1/2-13	2	7.17	50		
JBBH34	80765	1/2-13	2 1/2	8.38	50		
JBBH35	80766	1/2-13	3	9.64	50		
JBBH36	84936	1/2-13	3 1/2	10.87	50		NEW
JBBH37	84937	1/2-13	4	12.29	50		NEW
JBBH38	84938	1/2-13	4 1/2	13.35	50		NEW

OTHER SIZES AND QUANTITIES AVAILABLE BY REQUEST

CONTINUED ON NEXT PAGE

BOLTS



CONTINUED
HEXAGON CAP SCREWS
 SILICON BRONZE

STOCK NO.	UPC NO.	SIZE	LENGTH	WT. PER PKG.	STD. PKG./MSTR. SLEEVE	SUGGESTED TRADE LIST PRICE PER	
JBBH39	84939	1/2-13	5	8.76	25		NEW
JBBH41	84941	1/2-13	6	9.23	25		NEW
JBBH80	85080	5/8-11	1	16.37	100		NEW
JBBH82	84320	5/8-11	1 1/2	18.43	100		NEW
JBBH69	84969	5/8-11	2	24.35	100	PLEASE	NEW
JBBH71	84971	5/8-11	2 1/2	25.07	100	CALL	NEW
JBBH73	84973	5/8-11	3	28.71	100	FOR	NEW
JBBH75	84975	5/8-11	3 1/2	32.26	50	TRADE	NEW
JBBH76	84976	5/8-11	4	35.72	50	LIST	NEW
JBBH84	84984	5/8-11	4 1/2	39.35	50	PRICING	NEW
JBBH85	84985	5/8-11	5	42.75	25		NEW
JBBH86	84986	3/4-10	1 1/2	19.48	50		NEW
JBBH77	84977	3/4-10	2	19.88	50		NEW
JBBH78	84978	3/4-10	2 1/4	19.95	50		NEW
JBBH79	84979	3/4-10	2 1/2	20.18	50		NEW
JBBH87	84987	3/4-10	3	22.00	50		NEW
JBBH89	84989	3/4-10	3 1/2	24.55	50		NEW
JBBH90	84490	3/4-10	4	54.01	50		NEW

OTHER SIZES AND QUANTITIES AVAILABLE BY REQUEST



HEX TAP BOLTS
 FULL THREADED STEEL ZINC CHROMATE AND STAINLESS STEEL 18-8 TYPE
 For complete thread engagement applications

STOCK NO.	UPC NO.	DIAMETER	LENGTH	WT. PER PKG.	STD. PKG./MSTR. SLEEVE	SUGGESTED TRADE LIST PRICE PER	
STEEL ZINC CHROMATE							
JHTB11	80767	1/4-20	1/2	1.23	100/500	6.38/c	
JHTB1	80768	1/4-20	3/4	1.48	100/500	7.03/c	
JHTB2	80769	1/4-20	1	1.72	100/500	8.88/c	
JHTB49	80770	1/4-20	1 1/4	2.07	100/500	10.00/c	
JHTB3	80771	1/4-20	1 1/2	2.33	100/500	10.40/c	
JHTB4	80772	1/4-20	2	2.84	100	12.78/c	
JHTB82	82804	1/4-20	2 1/2	3.39	100	41.95/c	NEW
JHTB6	82458	1/4-20	3	3.38	100	42.75/c	NEW
JHTB56	82778	1/4-20	4	4.97	100	45.53/c	NEW
JHTB61	82783	1/4-20	5	5.95	100	68.45/c	NEW
JHTB5	82739	1/4-20	6	6.27	100	99.80/c	NEW
JHTB38	82760	5/16-18	3/4	2.39	100	12.58/c	NEW
JHTB39	82761	5/16-18	1	2.84	100	17.18/c	NEW
JHTB54	82507	5/16-18	1 1/4	3.30	100	18.20/c	NEW
JHTB13	82746	5/16-18	1 1/2	3.65	100	27.48/c	NEW
JHTB42	82764	5/16-18	2	4.49	100	28.08/c	NEW
JHTB43	82765	5/16-18	2 1/2	5.82	100	29.45/c	NEW
JHTB55	82777	5/16-18	3	3.17	50	35.70/c	NEW
JHTB88	80773	3/8-16	1/2	2.88	100/500	12.40/c	
JHTB90	82812	3/8-16	5/8	3.28	100	16.15/c	NEW
JHTB44	80774	3/8-16	3/4	3.82	100	14.70/c	

OTHER SIZES AND QUANTITIES AVAILABLE BY REQUEST

CONTINUED ON NEXT PAGE

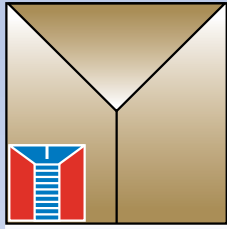

Metallics

Metric Hex Head Tap Bolt (Steel Zinc)



[CONTRACTOR APPROVED]

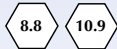

PART #	UPC #	DESCRIPTION	QTY / PKG	SUG. TRADE LIST / PKG
JMHTB38	64830	M3 x 8 (8.8 steel)	100	\$ 20.25
JMHTB310	64832	M3 x 10 (8.8 steel)	100	\$ 205.50
JMHTB312	84634	M3 x 12 (8.8 steel)	100	\$ 20.85
JMHTB316	64838	M3 x 16 (8.8 steel)	100	\$ 22.80
JMHTB320	64842	M3 x 20 (8.8 steel)	100	\$ 22.73
JMHTB48	64846	M4 x 8 (8.8 steel)	100	\$ 18.45
JMHTB410	64848	M4 x 10 (8.8 steel)	100	\$ 16.50
JMHTB412	64850	M4 x 12 (8.8 steel)	100	\$ 16.80
JMHTB416	64854	M4 x 16 (8.8 steel)	100	\$ 17.78
JMHTB420	64858	M4 x 20 (8.8 steel)	100	\$ 19.05
JMHTB425	64863	M4 x 25 (8.8 steel)	100	\$ 21.08
JMHTB430	84868	M4 x 30 (8.8 steel)	100	\$ 24.00
JMHTB58	84875	M5 x 8 (8.8 steel)	100	\$ 13.43
JMHTB510	84877	M5 x 10 (8.8 steel)	100	\$ 11.18
JMHTB512	64879	M5 x 12 (8.8 steel)	100	\$ 11.10
JMHTB516	64833	M5 x 16 (8.8 steel)	100	\$ 12.68
JMHTB520	64877	M5 x 20 (8.8 steel)	100	\$ 13.58
JMHTB525	64892	M5 x 25 (8.8 steel)	100	\$ 14.93
JMHTB530	64898	M5 x 30 (8.8 steel)	100	\$ 16.58
JMHTB535	64902	M5 x 35 (8.8 steel)	100	\$ 18.60
JMHTB540	64907	M5 x 40 (8.8 steel)	100	\$ 20.85

*Other sizes and materials available upon request.

Chart continued to next page.

"Growth Through Innovation"

Metallics

229 Cross Street, Bristol, CT 06010
Tel 800-243-8272 • **Fax** 800-831-9358
Email sales@metallicsonline.com

Metallics West

651 North Main Street, Mancos, CO 81328
Tel 800-269-5183 • **Fax** 800-269-6278
Email saleswest@metallicsonline.com

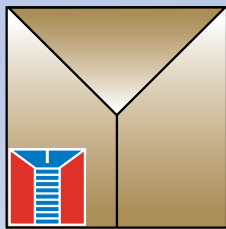

Metallics Metric Hex Head Tap Bolt (Steel Zinc)



8.8 Steel



10.9 Steel

*Other sizes and materials available upon request.

Chart continued from previous page.

Chart continued to next page.

PART #	UPC #	DESCRIPTION	QTY / PKG	SUG. TRADE LIST / PKG
JMHTB68	64912	M6 x 8 (8.8 steel)	100	\$ 20.93
JMHTB610	64914	M6 x 10 (8.8 steel)	100	\$ 17.55
JMHTB612	64916	M6 x 12 (8.8 steel)	100	\$ 14.63
JMHTB616	64920	M6 x 16 (8.8 steel)	100	\$ 15.08
JMHTB620	64924	M6 x 20 (8.8 steel)	100	\$ 16.05
JMHTB625	64929	M6 x 25 (8.8 steel)	100	\$ 17.78
JMHTB635	64939	M6 x 35 (8.8 steel)	100	\$ 23.93
JMHTB640	64944	M6 x 40 (8.8 steel)	100	\$ 26.48
JMHTB645	64949	M6 x 45 (8.8 steel)	100	\$ 31.43
JMHTB810	64999	M8 x 10 (8.8 steel)	100	\$ 44.33
JMHTB812	65001	M8 x 12 (8.8 steel)	100	\$ 36.75
JMHTB816	65005	M8 x 16 (8.8 steel)	100	\$ 25.65
JMHTB820	65009	M8 x 20 (8.8 steel)	100	\$ 28.13
JMHTB825	65014	M8 x 25 (8.8 steel)	100	\$ 30.90
JMHTB830	65019	M8 x 30 (8.8 steel)	100	\$ 34.95
JMHTB835	65024	M8 x 35 (8.8 steel)	100	\$ 41.10
JMHTB840	65029	M8 x 40 (8.8 steel)	100	\$ 45.75
JMHTB845	65034	M8 x 45 (8.8 steel)	100	\$ 53.78
JMHTB850	65039	M8 x 50 (8.8 steel)	100	\$ 58.58
JMHTB1012	65049	M10 x 12 (8.8 steel)	100	\$ 31.18
JMHTB1016	65053	M10 x 16 (8.8 steel)	100	\$ 21.65
JMHTB1020	65057	M10 x 20 (8.8 steel)	100	\$ 23.25
JMHTB1025	65062	M10 x 25 (8.8 steel)	100	\$ 25.73
JMHTB1030	65067	M10 x 30 (8.8 steel)	100	\$ 27.98
JMHTB1035	65072	M10 x 35 (8.8 steel)	100	\$ 30.95
JMHTB1040	65077	M10 x 40 (8.8 steel)	100	\$ 37.16
JMHTB1045	65082	M10 x 45 (8.8 steel)	100	\$ 40.65
JMHTB1050	65087	M10 x 50 (8.8 steel)	100	\$ 44.23
JMHTB1055	65092	M10 x 55 (8.8 steel)	100	\$ 47.83
JMHTB1060	65097	M10 x 60 (8.8 steel)	100	\$ 56.10

“Growth Through Innovation”

Metallics

229 Cross Street, Bristol, CT 06010
Tel 800-243-8272 • **Fax** 800-831-9358
Email sales@metallicsonline.com

Metallics West

651 North Main Street, Mancos, CO 81328
Tel 800-269-5183 • **Fax** 800-269-6278
Email saleswest@metallicsonline.com

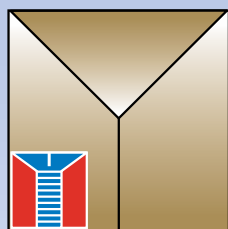

Metallics

Metric Hex Head Tap Bolt (Steel Zinc)



8.8 Steel



10.9 Steel

PART #	UPC #	DESCRIPTION	QTY / PKG	SUG. TRADE LIST / PKG
JMHTB1216	65110	M12 x 16 (8.8 steel)	50	\$ 42.98
JMHTB1220	65114	M12 x 20 (8.8 steel)	50	\$ 35.78
JMHTB1225	65119	M12 x 25 (8.8 steel)	50	\$ 39.43
JMHTB1230	65124	M12 x 30 (8.8 steel)	50	\$ 42.90
JMHTB1235	65129	M12 x 35 (8.8 steel)	50	\$ 46.35
JMHTB1240	65134	M12 x 40 (8.8 steel)	50	\$ 55.03
JMHTB1245	65139	M12 x 45 (8.8 steel)	50	\$ 61.05
JMHTB1250	65144	M12 x 50 (8.8 steel)	50	\$ 66.05
JMHTB1255	65149	M12 x 55 (8.8 steel)	50	\$ 70.95
JMHTB1260	65154	M12 x 60 (8.8 steel)	50	\$ 75.90
JMHTB6101	65160	M6 x 10 (10.9 steel)	100	\$ 21.23
JMHTB6161	65166	M6 x 16 (10.9 steel)	100	\$ 18.75
JMHTB6201	65170	M6 x 20 (10.9 steel)	100	\$ 20.03
JMHTB6251	65175	M6 x 25 (10.9 steel)	100	\$ 22.50
JMHTB6301	65180	M6 x 30 (10.9 steel)	100	\$ 24.15
JMHTB6351	65185	M6 x 35 (10.9 steel)	100	\$ 27.30
JMHTB6401	65190	M6 x 40 (10.9 steel)	100	\$ 30.45
JMHTB6451	65195	M6 x 45 (10.9 steel)	100	\$ 34.28
JMHTB8161	65211	M8 x 16 (10.9 steel)	100	\$ 32.25
JMHTB8201	65215	M8 x 20 (10.9 steel)	100	\$ 35.40
JMHTB8251	65220	M8 x 25 (10.9 steel)	100	\$ 39.23
JMHTB8301	65225	M8 x 30 (10.9 steel)	100	\$ 44.25
JMHTB8351	65230	M8 x 35 (10.9 steel)	100	\$ 47.78
JMHTB8401	65235	M8 x 40 (10.9 steel)	100	\$ 52.80

Chart continued from previous page.

*Other sizes and materials available upon request.

“Growth Through Innovation”

Metallics

229 Cross Street, Bristol, CT 06010
Tel 800-243-8272 • **Fax** 800-831-9358
Email sales@metallicsonline.com

Metallics West

651 North Main Street, Mancos, CO 81328
Tel 800-269-5183 • **Fax** 800-269-6278
Email saleswest@metallicsonline.com

BOLTS



CONTINUED

HEX TAP BOLTS

FULL THREADED STEEL ZINC CHROMATE AND STAINLESS STEEL 18-8 TYPE
For complete thread engagement applications

STOCK NO.	UPC NO.	DIAMETER	LENGTH	WT. PER PKG.	STD. PKG./ MSTR. SLEEVE	SUGGESTED TRADE LIST PRICE PER
STEEL ZINC CHROMATE						
JHTB45	80775	3/8-16	1	4.29	100	18.80/c
JHTB59	80776	3/8-16	1 1/4	4.93	100	21.50/c
JHTB23	80777	3/8-16	1 1/2	5.43	100	24.45/c
JHTB24	80778	3/8-16	2	6.75	100	29.15/c
JHTB25	80779	3/8-16	2 1/2	3.97	50	33.76/c
JHTB26	80780	3/8-16	3	4.46	50	40.20/c
JHTB60	82513	3/8-16	4	5.76	50	59.50/c NEW
JHTB93	82815	7/16-14	1	6.19	100	64.56/c NEW
JHTB81	80781	1/2-13	3/4	3.78	50	29.06/c
JHTB46	80782	1/2-13	1	4.30	50	34.96/c
JHTB64	80783	1/2-13	1 1/4	4.85	50	36.30/c
JHTB47	80784	1/2-13	1 1/2	5.47	50	40.96/c
JHTB33	80785	1/2-13	2	6.62	50	53.36/c
JHTB34	80786	1/2-13	2 1/2	7.62	50	63.06/c
JHTB35	80787	1/2-13	3	8.69	50	71.86/c
JHTB48	82501	1/2-13	4	5.56	25	108.50/c NEW
JHTB94	82816	5/8-11	3/4	8.11	25	319.40/c NEW
JHTB89	82811	5/8-11	2	24.36	25	675.25/c NEW
JHTB71	82793	5/8-11	2 1/2	6.45	25	677.20/c NEW
JHTB72	82794	5/8-11	2 3/4	6.89	25	752.00/c NEW
JHTB73	82795	5/8-11	3	7.31	25	810.00/c NEW
STAINLESS STEEL 18-8 TYPE						
JSHTB11	86011	1/4-20	1/2	1.23	100	NEW
JSHTB1	86001	1/4-20	3/4	1.41	100	NEW
JSHTB2	86002	1/4-20	1	1.85	100	NEW
JSHTB49	86049	1/4-20	1 1/4	2.03	100	NEW
JSHTB3	86003	1/4-20	1 1/2	2.33	100	NEW
JSHTB4	86004	1/4-20	2	2.84	100	NEW
JSHTB41	86041	1/4-20	2 1/2	3.17	100	NEW
JSHTB42	86042	1/4-20	3	3.72	100	NEW
JSHTB44	86044	3/8-16	3/4	3.59	100	NEW
JSHTB45	86045	3/8-16	1	4.20	100	NEW
JSHTB59	86059	3/8-16	1 1/4	4.84	100	NEW
JSHTB23	86023	3/8-16	1 1/2	5.50	100	NEW
JSHTB24	86024	3/8-16	2	6.73	100	NEW
JSHTB25	86025	3/8-16	2 1/2	7.94	100	NEW
JSHTB26	86026	3/8-16	3	9.24	100	NEW
JSHTB60	86060	3/8-16	4	11.77	100	NEW
JSHTB46	86046	1/2-13	1	4.32	50	NEW
JSHTB48	86048	1/2-13	1 1/4	9.71	100	NEW
JSHTB47	86047	1/2-13	1 1/2	6.00	50	NEW
JSHTB33	86033	1/2-13	2	6.35	50	NEW
JSHTB34	86034	1/2-13	2 1/2	15.75	50	NEW
JSHTB35	86035	1/2-13	3	8.72	50	NEW
JSHTB36	86036	1/2-13	3 1/2	4.47	25	NEW

PLEASE
CALL
FOR
TRADE
LIST
PRICING

OTHER SIZES AND QUANTITIES AVAILABLE BY REQUEST

STEEL ZINC CHROMATE GALVANIZED



CARRIAGE BOLTS

STEEL ZINC CHROMATE, STAINLESS STEEL 18-8 TYPE AND GALVANIZED

STOCK NO.	UPC NO.	SIZE	LENGTH	WT. PER PKG.	STD. PKG./MSTR. SLEEVE	SUGGESTED TRADE LIST PRICE PER
STEEL ZINC CHROMATE						
JCB42	83000	1/4-20	1/2	1.34	100/500	7.40/c
JCB1	83001	1/4-20	3/4	1.66	100/500	8.73/c
JCB2	83002	1/4-20	1	2.08	100/500	13.75/c
JCB3	83003	1/4-20	1 1/2	2.33	100/500	14.73/c
JCB4	83006	1/4-20	2	2.85	100	17.78/c
JCB6	83010	1/4-20	3	4.09	100	25.78/c
JCB36	83070	1/4-20	4 1/2	5.48	100	40.63/c NEW
JCB31	83055	1/4-20	6	1.89	25	53.75/c NEW
JCB21	76721	5/16-18	2 1/2	5.51	100	67.15/c NEW
JCB55	83041	3/8-16	3/4	4.25	100/500	26.90/c
JCB56	83042	3/8-16	1	4.77	100	29.78/c
JCB23	83044	3/8-16	1 1/2	6.02	100	37.15/c
JCB24	83046	3/8-16	2	3.61	50	45.70/c
JCB25	83048	3/8-16	2 1/2	4.28	50	61.70/c
JCB26	83050	3/8-16	3	4.98	50	55.40/c
JCB28	83052	3/8-16	4	6.10	50	70.26/c
JCB29	76729	3/8-16	5	3.61	25	124.50/c NEW
JCB40	83074	3/8-16	6	8.42	50	131.55/c NEW
JCB30	83054	3/8-16	8	11.05	50	162.75/c NEW
JCB33	83065	1/2-13	2	3.07	25	78.00/c
JCB34	83067	1/2-13	2 1/2	4.05	25	87.60/c
JCB35	83069	1/2-13	3	4.72	25	103.40/c
JCB8	76708	1/2-13	6	33.38	25	145.75/c NEW
JCB9	83013	1/2-13	8	9.92	25	250.00/c NEW
STAINLESS STEEL 18-8 TYPE						
JCB42SS	91742	1/4-20	1/2	2.09	100	NEW
JCB1SS	91701	1/4-20	3/4	1.68	100	NEW
JCB2SS	91702	1/4-20	1	2.10	100	NEW
JCB7SS	91707	1/4-20	2 1/2	2.93	100	NEW
JCB56SS	91756	5/16-18	1 1/2	3.94	100	NEW
JCB55SS	91755	3/8-16	3/4	4.14	100	NEW
JCB23SS	91723	3/8-16	1 1/2	6.01	100	NEW
JCB24SS	91724	3/8-16	2	3.64	50	NEW
JCB26SS	91726	3/8-16	3	4.95	50	NEW
JCB101SS	94701	1/2-13	1 1/2	4.98	50	NEW
GALVANIZED						
JCB33G	769334	1/2-13	2	13.96	25	NEW

OTHER SIZES AND QUANTITIES AVAILABLE BY REQUEST

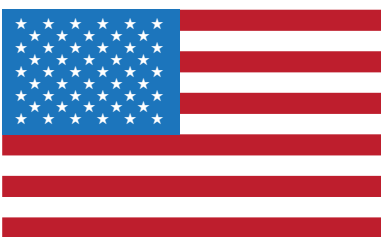

METALLICS

"Growth Through Innovation"

We believe Metallics has the largest ratio of American made to foreign produced product of any other American fastener company.

BOLTS

STEEL ZINC
CHROMATE

GALVANIZED



HEXAGON LAG BOLTS

STEEL ZINC CHROMATE,
STAINLESS STEEL 18-8 TYPE AND GALVANIZED

STOCK NO.	UPC NO.	SIZE	LENGTH	WT. PER PKG.	STD. PKG./MSTR. SLEEVE	SUGGESTED TRADE LIST PRICE PER
STEEL ZINC CHROMATE						
JBLS37	80788	1/4	1	1.55	100	12.60/c
JBLS38	80789	1/4	1 1/4	1.70	100	13.45/c
JBLS1	80790	1/4	1 1/2	1.98	100	13.60/c
JBLS39	80791	1/4	1 3/4	2.29	100	15.10/c
JBLS2	80792	1/4	2	2.62	100	15.60/c
JBLS3	80793	1/4	2 1/2	3.12	100	19.30/c
JBLS4	80794	1/4	3	3.64	100	20.83/c
JBLS5	80795	1/4	3 1/2	4.10	100	23.15/c
JBLS6	82308	1/4	4	4.58	100	25.18/c
JBLS40	76440	1/4	4 1/2	5.25	100	27.63/c NEW
JBLS8	76408	1/4	5	5.49	100	33.57/c NEW
JBLS10	76410	1/4	6	6.51	100	44.62/c NEW
JBLS41	76441	5/16	1	2.87	100	33.78/c NEW
JBLS42	76442	5/16	1 1/4	2.91	100	34.58/c NEW
JBLS11	80796	5/16	1 1/2	3.03	100	16.80/c
JBLS12	80797	5/16	2	3.72	100	18.48/c
JBLS13	80798	5/16	2 1/2	4.78	100	21.13/c
JBLS14	80799	5/16	3	5.59	100	23.00/c
JBLS15	82312	5/16	3 1/2	3.19	50	31.25/c NEW
JBLS16	82324	5/16	4	3.81	50	28.90/c
JBLS44	76444	5/16	4 1/2	4.01	50	37.40/c NEW
JBLS18	82326	5/16	5	3.40	50	38.26/c
JBLS20	82327	5/16	6	5.61	50	47.96/c
JBLS45	80800	3/8	1	3.29	100	19.50/c
JBLS46	80801	3/8	1 1/4	3.95	100	20.45/c
JBLS36	80802	3/8	1 1/2	4.50	100	21.43/c
JBLS21	80803	3/8	2	5.50	100	25.05/c
JBLS22	80804	3/8	2 1/2	3.52	50	31.16/c
JBLS23	80805	3/8	3	4.06	50	35.60/c
JBLS24	80806	3/8	3 1/2	4.53	50	38.16/c
JBLS25	10408	3/8	4	4.89	50	48.90/c
JBLS48	76448	3/8	4 1/2	11.28	50	61.75/c NEW
JBLS26	82319	3/8	5	6.50	50	62.05/c NEW
JBLS49	76449	3/8	5 1/2	13.41	50	67.69/c NEW
JBLS27	82344	3/8	6	7.36	50	68.20/c
JBLS52	76452	3/8	7	17.63	50	88.13/c NEW
JBLS53	82369	1/2	1 1/2	4.35	50	150.63/c NEW
JBLS28	80807	1/2	2	5.41	50	155.96/c
JBLS29	76429	1/2	2 1/2	13.01	50	162.35/c NEW
JBLS30	80808	1/2	3	7.54	50	79.50/c
JBLS31	76431	1/2	3 1/2	16.98	50	85.73/c NEW
JBLS32	82353	1/2	4	4.92	25	86.72/c
JBLS50	76450	1/2	4 1/2	5.32	25	96.88/c NEW
JBLS33	76433	1/2	5	5.99	25	101.00/c NEW
JBLS51	76451	1/2	5 1/2	6.42	25	112.50/c NEW
JBLS34	82355	1/2	6	7.32	25	132.50/c NEW
JBLS88	76448	3/4	3	4.02	10	347.26/c NEW

OTHER SIZES AND QUANTITIES AVAILABLE BY REQUEST

CONTINUED ON NEXT PAGE

www.metallicsonline.com

STEEL ZINC CHROMATE GALVANIZED



CONTINUED

HEXAGON LAG BOLTS

STEEL ZINC CHROMATE,
STAINLESS STEEL 18-8 TYPE AND GALVANIZED

STOCK NO.	UPC NO.	SIZE	LENGTH	WT. PER PKG.	STD. PKG./MSTR. SLEEVE	SUGGESTED TRADE LIST PRICE PER
STAINLESS STEEL 18-8 TYPE						
JBS1SS	85001	1/4	1 1/2	1.97	100	PLEASE CALL FOR TRADE PRICING
JBS2SS	85002	1/4	2	2.61	100	
JBS4SS	85004	1/4	3	3.61	100	
JBS13SS	85013	5/16	1 1/2	5.32	100	
JBS12SS	85012	5/16	2	5.61	100	
JBS14SS	85014	5/16	3	5.87	100	
JBS36SS	85036	3/8	1 1/2	5.40	100	
JBS21SS	85021	3/8	2	5.94	100	
JBS23SS	85023	3/8	3	8.23	50	
JBS30SS	85030	1/2	3	15.08	50	
JBS32SS	85032	1/2	4	19.68	25	
GALVANIZED						
JBS1G	86401	1/4	1 1/2	2.58	100	38.08/c
JBS2G	86402	1/4	2	2.78	100	39.90/c
JBS41G	86441	5/16	1	2.48	100	60.90/c
JBS21G	86421	3/8	2	2.91	50	55.00/c
JBS22G	86422	3/8	2 1/2	3.50	50	55.20/c
JBS25G	86425	3/8	4	5.34	50	86.10/c
JBS27G	86427	3/8	6	15.34	50	163.48/c
JBS30G	86430	1/2	1 1/2	9.34	50	100.18/c

OTHER SIZES AND QUANTITIES AVAILABLE BY REQUEST

MANUFACTURING CAPABILITIES

Diameter range #2 thru 5/16" / 1.5mm thru 8mm • Length range 1/8" thru 3" / 3.5mm thru 75mm
Materials: Steel, Brass, Stainless, Aluminum, Bronze.

NEED SCREWS...
Let Us Make Them For You!



A METALLICS AFFILIATE

P.O. Box 1600 • 231 Cross Street
Bristol, CT 06011-1600
Tel: 800-984-8945 • Fax: 800-984-8946

CAPABILITIES LIST

- PLANT SIZE:** 100,000 SQUARE FEET
- LOCATION:** Bristol, Connecticut
- EQUIPMENT:** 27 Hi-Speed Cold Headers
8 Burr-Free Screw Slotters
3 Shank Slotters
2 Pointers
14 High Speed Thread Rollers



ADDITIONAL PLANT INFO: Modern shipping facility utilizing digital scale counting machines. In-house packaging facilities - boxing, sorting, baggings. All material boxed, palletized & labeled with your needs in mind for domestic or export shipping.

SECONDARY WORK: All plating & heat treating is done on the outside and certified for your guarantee.

INFORMATION SYSTEMS: Our facility has new and upgraded Technology to meet your customers specific requirements.

BOLTS



ROUND BEND U-BOLTS

STEEL ZINC PLATED, 18-8 TYPE STAINLESS STEEL
With Hexagon Nuts

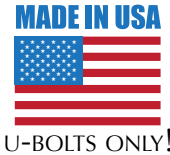

STOCK NO.	UPC NO.	THREAD DIA (A)	INSIDE LENGTH (B)	INSIDE WIDTH (C)	THREAD LENGTH (D)
-----------	---------	----------------	-------------------	------------------	-------------------

ZINC PLATED U-BOLTS WITH NUTS

UB01	25800	1/4-20	1 1/4	9/16	3/4
UB03	25810	1/4-20	2 1/4	3/4	1 1/2
UB04	25815	1/4-20	1 3/4	1	1
UB05	25820	1/4-20	2	1 1/8	1
UB06	25825	1/4-20	2 1/4	1 1/4	1 1/4
UB07	25830	1/4-20	2 3/4	1 1/2	1 3/8
UB08	25835	1/4-20	3	1 3/4	1 3/8
UB09	25840	1/4-20	3 1/4	2	1 3/8
UB010	25845	5/16-18	2 3/16	1	1 3/8
UB011	25855	5/16-18	2 3/16	1 3/8	1
UB012	25860	5/16-18	2 3/16	1 1/2	1
UB013	25865	5/16-18	2 11/16	1 3/4	1 1/8
UB014	25870	5/16-18	2 11/16	2	1
UB015	25875	5/16-18	3 3/16	2 1/2	1
UB016	25880	5/16-18	3 11/16	3	1
UB017	25885	3/8-16	2 1/4	1	1 1/4
UB018	25895	3/8-16	2 1/2	1 1/2	1 1/4
UB019	25900	3/8-16	2 3/4	1 3/4	1 1/8
UB021	25905	3/8-16	2 5/8	2	1 1/4
UB022	25910	3/8-16	3 1/8	2 1/2	1 1/4
UB023	25915	3/8-16	3 5/8	3	1 1/4
UB024	25920	3/8-16	4 1/8	3 1/2	1 1/4

STAINLESS STEEL U-BOLTS WITH NUTS 18-8 Type

UBS01	26100	1/4-20	1 1/4	9/16	3/4
UBS03	26110	1/4-20	2 1/4	3/4	1 1/2
UBS04	26115	1/4-20	1 3/4	1	1
UBS05	26120	1/4-20	2	1 1/8	1
UBS06	26125	1/4-20	2 1/4	1 1/4	1 1/4
UBS07	26130	1/4-20	2 3/4	1 1/2	1 3/8
UBS08	26135	1/4-20	3	1 3/4	1 3/8
UBS09	26140	1/4-20	3 1/4	2	1 3/8
UBS010	26145	5/16-18	2 3/16	1	1 3/8
UBS011	26150	5/16-18	2 3/16	1 3/8	1
UBS012	26155	5/16-18	2 3/16	1 1/2	1
UBS013	26160	5/16-18	2 11/16	1 3/4	1 1/8
UBS014	26165	5/16-18	2 11/16	2	1
UBS015	26170	5/16-18	3 3/16	2 1/2	1
UBS016	26175	5/16-18	3 11/16	3	1
UBS017	26180	3/8-16	2 1/4	1	1 1/4
UBS018	26190	3/8-16	2 1/2	1 1/2	1 1/4
UBS020	26195	3/8-16	2 3/4	1 3/4	1 1/8
UBS021	26200	3/8-16	2 5/8	2	1 1/4
UBS022	26205	3/8-16	3 1/8	2 1/2	1 1/4
UBS023	26210	3/8-16	3 5/8	3	1 1/4
UBS024	26215	3/8-16	4 1/8	3 1/2	1 1/4

OTHER SIZES AND QUANTITIES AVAILABLE BY REQUEST

U-BOLTS ONLY AVAILABLE BY SPECIAL QUOTATION.

MINIMUMS MAY APPLY AT THE TIME OF DISTRIBUTOR INQUIRY. GALVANIZED AVAILABLE.

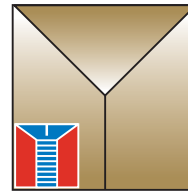
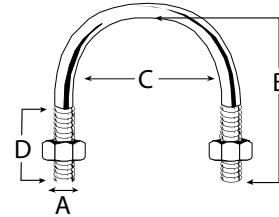

Innovative
Fasteners & Anchors:
1st Base



Highest Fill
Rates:
2nd Base



Same day Shipping:
3rd Base



Home Run!!

*"You win everytime
with Metallics"*

AMERICA'S
SOURCE FOR
PREMIER
&
INNOVATIVE
FASTENERS
&
ANCHORS

QUADRIVE CONCRETE SCREW ANCHORS





MADE IN USA



Manufactured by Avanti Screw, Inc., A Metallics Affiliate



The QuaDrive

+

+

+

=

Square Drive Hex Slotted Phillips QuaDrive

America's Newest Drive - Designed, Developed and Manufactured by Metallics/Avanti Screw

CraftCoat® 1000 coating is applied after heat-treating to provide anti-corrosion protection. CraftCoat® 1000 coating is a Rohs compliant mechanical zinc coating that offers 1000 hours to 15% red rust corrosion in salt spray testing performed to ASTM B117 specifications.

Metallics offers our Distributor/Contractor users an alternative to the blue color of standard concrete screws. Silver color is cosmetically appealing when used with zinc plated or stainless steel brackets, electrical fixtures or conduit.

CraftCoat® is a registered trademark of Donham Craft Inc.

THE METALLICS QUADRIVE CONCRETE SCREW IT'S A RE-DESIGNED TAPPING SCREW AND ANCHORING SYSTEM WITH A CRAFTCOAT® 1000 COATING

- ← Large fillet under head to fit $3/16$ and $1/4$ " holes provides greater driving strength
- ← Fluted, interrupted threads aid tapping into masonry products
- ← Twin lead threads for faster application
- ← Silver color to match conduit, strap and concrete

We will be glad to send a sample bag of 10 pieces to our Distributors for their customer trials. Please specify size

MADE IN USA



ONLY METALLICS



THE FIRST IN THE WORLD

QUADRIVE HEAD can be driven or extracted with hex, slotted, Phillips or square recess drivers.

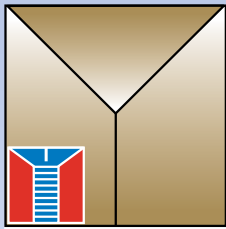

Metallics

MASTER Anchor™

The World's Strongest Fastener™



[CONTRACTOR APPROVED]

MASTER Anchor™:

- **NEVER Loosens!**
- Installs in ALL Hollow Walls - in just minutes!
- **Rated up to 300 lbs. in drywall.**
- Handles vector forces 360°.
- Objects can be easily removed or replaced.



3/4" Carbide Tipped Apache 200™ Drill Bit:

- Industrial Carbide Rated at 200 Holes in Ceramic Wall Tile.
- Designed for Ceramic, Marble and Plaster.
- **Guaranteed to NEVER Walk.**
- Fits standard and cordless drills.



Install Instructions:

Surface Preparation - Determine where to install - Drill 3/4" hole using the APACHE200. The standard MASTER Anchor is used in wall substrates up to 1.3" thick.

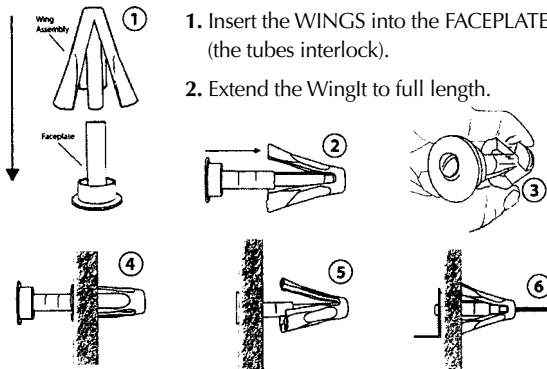

DRILL IT. INSTALL IT. MOUNT IT.

Fire Retardant, Structural Plastic & S/S Construction

3. Compress and insert the WINGS into the holes.
4. WINGS should be FLUSH with the wall surface.
5. Pop WingIt through the hole by pushing on the Faceplate.
6. Using the enclosed 3.5" Stainless Steel Screw, attach the object to the WingIt.

NOTE: For individual mounting points where the object will be subject to considerable torque (rotational forces) - use at least TWO MASTER Anchors.

NOTE: Strength and stability are greatly affected by projection off the wall surface.

WingIts are designed to be used in vertical walls only - **DO NOT USE IN CEILINGS!**

PART #	UPC #	DESCRIPTION	QTY / PKG	SUG. TRADE LIST / PKG
MAW35SD	39696	Master Anchor with #10 x 3-1/2 SS Screw	2	\$ 9.88
MAWD34	39685	3/4" Carbide Tipped Apache Drill	1	\$ 37.14

"Growth Through Innovation"

Metallics

229 Cross Street, Bristol, CT 06010
Tel 800-243-8272 • **Fax** 800-831-9358
Email sales@metallicsonline.com

Metallics West

651 North Main Street, Mancos, CO 81328
Tel 800-269-5183 • **Fax** 800-269-6278
Email saleswest@metallicsonline.com

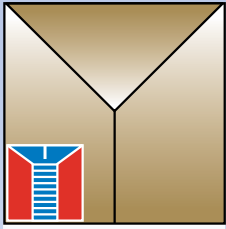

Metallics

Flat Head Concrete Screws



[CONTRACTOR APPROVED]

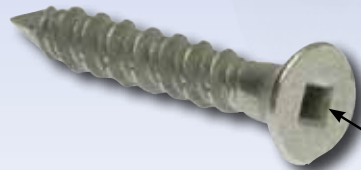

Square Drive for Greater Driving Strength.



- Full Diameter Under Head Provides Greater Driving Strength.
- Twin Lead Threads for Faster Application!
- Fluted Interrupted Threads and Tapping into Masonry.



Made in USA
Manufactured by
Avanti Screw, Inc.,
A Metallica
Affiliate

Products

- CraftCoat® 1000 Silver Coating Provides Anti-Corrosion Protection.
- Silver Color to Match Conduit Strap and Concrete.



Square Drive

PART #	UPC #	DESCRIPTION	QTY / PKG	SUG. TRADE LIST / PKG
FSCS1	39651	3/16 x 1-1/4" Flat Head Square Drive Nail Point Concrete Screw	100	\$ 34.72
FSCS2	39652	3/16 x 1-3/4" Flat Head Square Drive Nail Point Concrete Screw	100	\$ 36.38
FSCS3	39653	3/16 x 2-1/4" Flat Head Square Drive Nail Point Concrete Screw	100	\$ 37.44
FSCS10	39660	1/4 x 1-1/4" Flat Head Square Drive Nail Point Concrete Screw	100	\$ 37.93
FSCS20	39665	1/4 x 1-3/4" Flat Head Square Drive Nail Point Concrete Screw	100	\$ 39.49
FSCS30	39670	1/4 x 2-1/4" Flat Head Square Drive Nail Point Concrete Screw	100	\$ 42.38
FSCS40	39675	1/4 x 2-3/4" Flat Head Square Drive Nail Point Concrete Screw	100	\$ 49.19

"Growth Through Innovation"





Metallics

229 Cross Street, Bristol, CT 06010
Tel 800-243-8272 • Fax 800-831-9358
Email sales@metallicsonline.com

Metallics West

651 North Main Street, Mancos, CO 81328
Tel 800-269-5183 • Fax 800-269-6278
Email saleswest@metallicsonline.com

ANCHORING DEVICES

-  Hex
-  Slotted
-  Phillips
-  Square Drive

Four drives in one head



QUADRIVE CONCRETE SCREW KITS

MADE IN USA

 Manufactured by
 Avanti Screw, Inc.,
 A Metallics
 Affiliate
 SCREWS

STOCK NO.	UPC NO.	DESCRIPTION	WT. PER PKG.	SUGGESTED TRADE LIST PRICE PER
QCSHK1 3/16" Kit	39200	50 - 3/16 X 1 1/4 , 35 - 3/16 X 1 3/4 25 - 3/16 X 2 1/4 1 - 5/32 X 3 1/2 Masonry Drill 1 - 1/4 Drill Chuck	1.33	34.85/ea kit
QCSHK2 1/4" Kit	39204	50 - 1/4 X 1 1/4 , 35 - 1/4 X 1 3/4 25 - 1/4 X 2 1/4 1 - 3/16 X 3 1/2 Masonry Drill 1 - 5/16 Drill Chuck	2.11	44.13/ea kit

OTHER SIZES AND QUANTITIES AVAILABLE BY REQUEST

Metallics/Avanti Screw is Manufacturing

QUADRIVE CONCRETE SCREWS

FOUR DRIVES IN ONE HEAD
 (Hex, Slotted, Phillips & Square Drives)

CRAFTCOAT® 1000

IT'S A TAPPING SCREW AND AN ANCHORING SYSTEM

WE RECOMMEND A #2 SQUARE DRIVE BIT OR THE QUADRIVE SOCKET DRIVER



Made by
 Avanti Screw, Inc.,
 A Metallics Affiliate

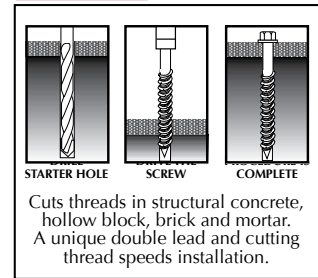

INTRODUCED IN 1999

STOCK NO.	UPC NO.	DIAMETER	LENGTH	*DRILL STOCK NO.	WT. PER PKG.	STD	SUGGESTED TRADE LIST PRICE PER
INSTALL WITH 1/4" QUADRIVE SOCKET DRIVER - SEE PAGE 145							
QCSH1	39145	3/16	1 1/4	CD1	.79	100	23.18/c
QCSH2	39146	3/16	1 3/4	CD1	1.12	100	24.83/c
QCSH3	39147	3/16	2 1/4	CD2	1.39	100	33.35/c
INSTALL WITH 5/16" QUADRIVE SOCKET DRIVER - SEE PAGE 145							
QCSH10	39148	1/4	1 1/4	CD5	1.43	100	29.08/c
QCSH20	39149	1/4	1 3/4	CD5	1.86	100	31.20/c
QCSH30	39150	1/4	2 1/4	CD6	2.29	100	35.35/c
QCSH40	39151	1/4	2 3/4	CD6	2.77	100	42.05/c

* ONE CONCRETE SCREW MASONRY DRILL PACKAGED WITH EACH HARD BODY PAC SQUARE JAR

1000 BULK PACK IN CARTON - CONCRETE SCREWS ONLY

REMEMBER TO ORDER CONCRETE SCREW MASONRY DRILLS AND QUADRIVE SOCKET DRIVER SEPARATELY

STOCK NO.	UPC NO.	DIAMETER	LENGTH	WT. PER PKG.	STD PKG.	SUGGESTED TRADE LIST PRICE PER
QCSH1B	39152	3/16	1 1/4	8.30	1000	197.05/M
QCSH2B	39153	3/16	1 3/4	15.10	1000	198.05/M
QCSH3B	39154	3/16	2 1/4	18.00	1000	283.33/M
QCSH10B	39155	1/4	1 1/4	10.35	1000	238.35/M
QCSH20B	39156	1/4	1 3/4	17.80	1000	265.20/M
QCSH30B	39157	1/4	2 1/4	22.47	1000	300.10/M
QCSH40B	39158	1/4	2 3/4	34.50	1000	357.15/M

MASONRY DRILLS NOT INCLUDED IN 1000 PACK

OTHER SIZES AND QUANTITIES AVAILABLE BY REQUEST

CRAFTCOAT® IS A REGISTERED TRADEMARK OF DONHAM CRAFT, INC.

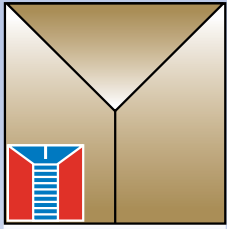

Metallics



QuaDrive Concrete Screw Anchor Display



[CONTRACTOR APPROVED]



CDQCSH10 Contains:

- 27 jars of the most common size Concrete Screw 1/4 X 1-1/4" QuaDrive.
- 100 pieces per jar.
- Free counter display and free shipping.



- Large fillet under head.
- Fluted interrupted threads.
- Twin lead threads.
- Silver seal coating (CraftCoat® 1000).

"Growth Through Innovation"

Metallics

229 Cross Street, Bristol, CT 06010
Tel 800-243-8272 • Fax 800-831-9358
Email sales@metallicsonline.com

Metallics West

651 North Main Street, Mancos, CO 81328
Tel 800-269-5183 • Fax 800-269-6278
Email saleswest@metallicsonline.com

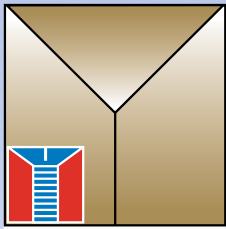

Metallics



Driller Hook™



- For light duty hanging in drywall
- No tools needed
- Anti-rotation washer prevents the hook from unscrewing

Driller Hook™ Installation Instructions:

Technical Specifications:

Driller Hook™

	Shear Max (lbs.)	Shear Safe (lbs.)
DRYWALL 3/8"	12	6
DRYWALL 1/2"	15	8
DRYWALL 5/8"	20	10

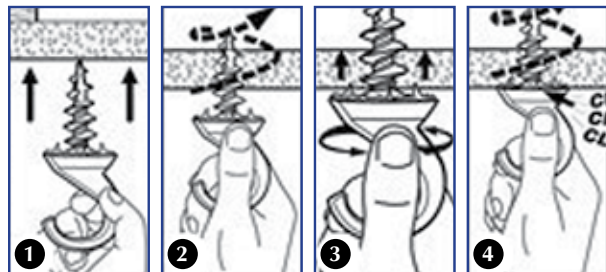

1. Using your hand, simply pierce the ceiling with the tip of the DrillHook™ and turn clockwise until you hear a locking click sound.

PART #	UPC #	DESCRIPTION	QTY / PKG	SUG. TRADE LIST / PKG
DHD1	83193	Driller Hook™ Ceiling Hook	1	\$ 6.50/ea

★ ★ ★ ★ ★ "Growth Through Innovation" ★ ★ ★ ★ ★

Metallics

229 Cross Street, Bristol, CT 06010
Tel 800-243-8272 • **Fax** 800-831-9358
Email sales@metallicsonline.com

Metallics West

651 North Main Street, Mancos, CO 81328
Tel 800-269-5183 • **Fax** 800-269-6278
Email saleswest@metallicsonline.com



QUADRIVE SOCKET DRIVER

QUADRIVE SOCKET DRIVERS - FOR QUADRIVE CONCRETE SCREWS

STOCK NO.	UPC NO.	HEAD SIZE	LENGTH	WT. PER PKG.	STD. PKG.	SUGGESTED TRADE LIST PRICE PER
1591910	39091	1/4	2 ⁵ / ₈	.26	1	9.00/ea
1513910	39092	5/16	2 ⁵ / ₈	.53	1	9.63/ea

Safety glasses should be worn for any driving applications.

OTHER SIZES AND QUANTITIES AVAILABLE BY REQUEST

BLUE CONCRETE SCREWS IT'S A TAPPING SCREW ANCHORING SYSTEM

One Masonry Drill Packaged with every jar.

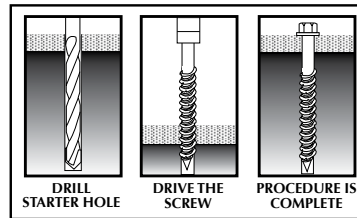

Cuts threads in structural concrete, hollow block, brick and mortar. A unique double lead and cutting thread speeds installation.

INDENTED HEX SLOTTED WASHER HEAD

STOCK NO.	UPC NO.	DIAMETER	LENGTH	DRILL STOCK NO.	WT. PER PKG.	STD. PKG.	SUGGESTED TRADE LIST PRICE PER
INSTALL WITH 1/4" HEX DRIVER—SEE PAGE 266							
CSH1F	87101	3/16	1 1/4	CD1	.80	100	23.00/c
CSH2F	87102	3/16	1 3/4	CD1	1.03	100	24.63/c
CSH3F	87103	3/16	2 1/4	CD2	1.32	100	33.03/c
CSH4F	87104	3/16	2 3/4	CD2	1.62	100	42.50/c
CSH5F	87105	3/16	3 1/4	CD3	1.88	100	49.50/c
CSH6F	87106	3/16	4	CD3	2.35	100	54.95/c
INSTALL WITH 5/16" HEX DRIVER—SEE PAGE 266							
CSH10F	87110	1/4	1 1/4	CD5	1.28	100	28.83/c
CSH20F	87120	1/4	1 3/4	CD5	1.71	100	30.95/c
CSH30F	87130	1/4	2 1/4	CD6	2.14	100	35.15/c
CSH40F	87140	1/4	2 3/4	CD6	2.57	100	41.78/c
CSH50F	87150	1/4	3 1/4	CD7	3.11	100	63.83/c
CSH60F	87160	1/4	4	CD7	3.62	100	71.45/c
CSH70F	87170	1/4	5	CD7	4.46	100	104.03/c
STAINLESS STEEL 410 TYPE INSTALL WITH 5/16" HEX DRIVER—SEE PAGE 266							
CSH10SS	90260	1/4	1 1/4	CD5	1.38	100	36.40/c
CSH20SS	90270	1/4	1 3/4	CD5	1.67	100	64.33/c

DRILL SIZES ON PAGE 150 SAFETY GLASSES SHOULD BE WORN FOR ANY DRIVING APPLICATIONS

OTHER SIZES AND QUANTITIES AVAILABLE BY REQUEST

CONTINUED ON NEXT PAGE

ANCHORING DEVICES

CONTINUED

FLAT HEAD BLUE CONCRETE SCREWS IT'S A TAPPING SCREW ANCHORING SYSTEM

One Masonry Drill Packaged with every jar.



FLAT PHILLIPS HEAD

INSTALL WITH #2 PHILLIPS BIT SEE PAGE 266

STOCK NO.	UPC NO.	DIAMETER	LENGTH	DRILL STOCK NO.	WT. PER PKG.	STD. PKG.	SUGGESTED TRADE LIST PRICE PER
CSF1F	87201	3/16	1 1/4	CD1	0.78	100	25.50/c
CSF2F	87202	3/16	1 3/4	CD1	1.05	100	27.58/c
CSF3F	87203	3/16	2 1/4	CD2	1.35	100	31.03/c
CSF4F	87204	3/16	2 3/4	CD2	1.52	100	31.38/c
CSF5F	87205	3/16	3 1/4	CD3	1.80	100	40.28/c
CSF6F	87206	3/16	4	CD3	2.12	100	64.00/c

STAINLESS STEEL 410 TYPE

INSTALL WITH #2 PHILLIPS BIT SEE PAGE 266

CSF2SS	96602	3/16	1 3/4	CD1	1.07	100	84.75/c	NEW
CSF4SS	96604	3/16	2 3/4	CD2	1.50	100	112.25/c	NEW

INSTALL WITH #3 PHILLIPS BIT SEE PAGE 266

CSF10F	87210	1/4	1 1/4	CD5	1.25	100	30.85/c	
CSF20F	87220	1/4	1 3/4	CD5	1.75	100	31.10/c	
CSF30F	87230	1/4	2 1/4	CD6	2.11	100	52.05/c	
CSF40F	87240	1/4	2 3/4	CD6	2.15	100	61.35/c	
CSF50F	87250	1/4	3 1/4	CD7	2.88	100	85.40/c	
CSF60F	87260	1/4	4	CD7	3.70	100	104.35/c	NEW
CSF70F	87270	1/4	5	CD7	4.50	100	141.03/c	NEW

OTHER SIZES AND QUANTITIES AVAILABLE BY REQUEST



KIT INCLUDES:

- 1 - Drill Driver
- 1 - Drill Adapter
- 2 - Hex Drivers
- 1 - Phillips Bit Holder
- 2 - Phillips Bits
- 1 - Allen Hex Key

DOES NOT INCLUDE DRILL BIT

IN A STURDY PLASTIC STORAGE CASE

CONCRETE SCREW INSTALLATION KIT

8 PIECE KIT

Tools and Driving Accessories

STOCK NO.	UPC NO.	DESCRIPTION	WT. PER PKG.	STD. PKG.	SUGGESTED TRADE LIST PRICE PER
IT1000	31200	Installation Tool (complete kit)	.95	1	
REPLACEMENT COMPONENTS FOR KIT					
MHD14	31205	1/4" Magnetic Hex Driver			
MHD56	31210	5/16" Magnetic Hex Driver			
PBH	31215	#2 & #3 Phillips Bit Holder			
ITSLEVE	31203	Drill/Driver Adapter			
PB2	31220	#2 Phillips Bit			
PB3	31225	#3 Phillips Bit			
HK1	31230	1/8" Allen Hex Key			

OTHER SIZES AND QUANTITIES AVAILABLE BY REQUEST

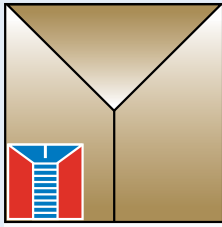

Metallics

LCS LARGE DIAMETER CONCRETE SCREW ANCHOR Self-Threading Anchor



City of Los Angeles #RR25741 #RR25560 (CMU)
Florida FL11506.7
Factory Mutual 3017082

High strength screw anchor for concrete and masonry. Designed for optimum performance in both cracked concrete and uncracked concrete under both static and seismic load conditions.

Fast Installation

- Just drill with standard ANSI bit to proper depth
- Installs with 50% less torque

Finished hex washer head

- Length identification on head
- Serrated washer

Close edge/spacing distance

Less spacing and edge distance required.

Saves Time

Installs in less than half the time of wedge or adhesive anchors.

Another NEW exciting solution from Metallics! Tired of searching for the right large diameter anchor... Here it is!

Selection Chart

Carbon Steel with Zinc Plating

Part Number	Anchor Diameter	Socket Size	Drill Bit Diameter	Effective Length
LCS3816	3/8"	9/16"	3/8"	1 3/4"
LCS3824	3/8"		3/8"	2 1/2"
LCS3830	3/8"		3/8"	3"
LCS3840	3/8"		3/8"	4"
LCS3850	3/8"		3/8"	5"
LCS1230	1/2"	3/4"	1/2"	3"
LCS1240	1/2"		1/2"	4"
LCS1250	1/2"		1/2"	5"
LCS1260	1/2"		1/2"	6"



PRODUCT SPECIFICATIONS

Diameter:
3/8" and 1/2"

Thread Form:
Serrated teeth on the tip reduces installation torque

Material:
Carbon steel with zinc plate

Head Style:
Finished hex serrated washer head

STOCK NUMBER	UPC #	DESCRIPTION	QTY PER PKG.	SUG. TRADE LIST / PKG
LCS3816	14470	3/8 x 1 3/4" Hex Washer Head Concrete Anchor	50	\$64.20
LCS3824	14471	3/8 x 2 1/2" Hex Washer Head Concrete Anchor	50	\$89.83
LCS3830	14472	3/8 x 3" Hex Washer Head Concrete Anchor	50	\$98.33
LCS3840	14473	3/8 x 4" Hex Washer Head Concrete Anchor	50	\$105.50
LCS3850	14474	3/8 x 5" Hex Washer Head Concrete Anchor	40	\$99.41
LCS1230	14480	1/2 x 3" Hex Washer Head Concrete Anchor	25	\$78.70
LCS1240	14481	1/2 x 4" Hex Washer Head Concrete Anchor	25	\$85.83
LCS1250	14482	1/2 x 5" Hex Washer Head Concrete Anchor	25	\$92.98
LCS1260	14483	1/2 x 6" Hex Washer Head Concrete Anchor	20	\$105.98

Metallics

229 Cross Street,
Bristol, Ct. 06010
Tel: 800-243-8272
Fax: 800-831-9358
Email: sales@metallicsonline.com

"Growth Through Innovation"

Metallics West

651 North Main Street
Maancos, Co. 81328
Tel: 800-269-5183
Fax: 800-269-6278
Email: saleswest@metallicsonline.com

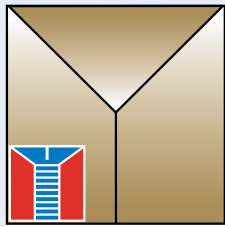

Metallics

LCSX LARGE DIAMETER CONCRETE SCREW ANCHOR Mechanically Galvanized

City of Los Angeles #RR25741 #RR25560 (CMU)
Florida FL11506.7
Factory Mutual 3017082

NEW!

Tested to
Meet
2006 IBC

High strength screw anchor for concrete and masonry. Designed for optimum performance in both cracked concrete and uncracked concrete under both static and seismic conditions.

Fast Installation

- Just drill with standard ANSI bit to proper depth
- Installs with 50% less torque

Finished hex washer head

- Length identification on head
- Serrated washer

Close edge/spacing distance

Less spacing and edge distance required.

Saves Time

Installs in less than half the time of wedge or adhesive anchors.



PRODUCT SPECIFICATIONS

Diameter:
3/8" and 1/2"

Thread Form:
Serrated teeth on the tip reduces installation torque

Material:
Carbon steel with zinc plate

Head Style:
Finished hex washer head with mechanically galvanized coating

Selection Chart

Carbon Steel with Mechanically Galvanized Coating

Part Number	Anchor Diameter	Socket Size	Drill Bit Diameter	Effective Length	Max. Thickness of Material To Be Fastened
LCSX3850	3/8"	9/16"	3/8"	5"	3 1/2"
LCSX1250	1/2"	3/4"	1/2"	5"	2 1/2"

Another NEW exciting solution from Metallics! Tired of searching for the right large diameter anchor... Here it is!

STOCK NUMBER	UPC #	DESCRIPTION	QTY PER PKG.	SUG. TRADE LIST / PKG
LCSX3850	14492	3/8 x 5" Hex Washer Head Concrete Anchor with mechanically galvanized coating	40	\$182.60
LCSX1250	14498	1/2 x 5" Hex Washer Head Concrete Anchor with mechanically galvanized coating	25	\$194.53

Metallics

229 Cross Street,
Bristol, Ct. 06010
Tel: 800-243-8272
Fax: 800-831-9358
Email: sales@metallicsonline.com

"Growth Through Innovation"

Metallics West

651 North Main Street
Maancos, Co. 81328
Tel: 800-269-5183
Fax: 800-269-6278
Email: saleswest@metallicsonline.com

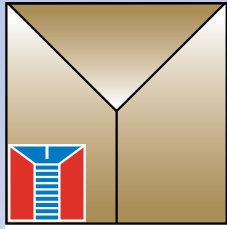

Metallics



4 Heavy Duty Ultimate Anchor Kits

*Choose the right kit that's right for you!
The right anchors for any job.*

[CONTRACTOR APPROVED]

UAKHD1



Drop-In Anchor



Double Expansion Anchor

UAKHD2



Machine Screw Anchor



Wedge Anchor

UAKHD3



Lag Screw Short & Long Anchor



Double Expansion Anchor

UAKHD4

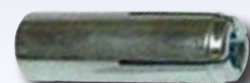

Drop-In Anchor



Sleeve Type Anchor

PART #	UPC #	DESCRIPTION	QTY / PKG	SUG. TRADE LIST / PKG
UAKHD1	33281	20 pcs 1/4-20, 15 pcs 3/8-16 and 10 pcs 1/2-13 Drop-In Anchors 20 pcs 1/4-20, 15 pcs 5/16-18 and 10 pcs 3/8-16 Double Expansion Anchors	1	\$ 47.50
UAKHD2	33282	20 pcs 1/4-20, 15 pcs 5/16-18 and 10 pcs 3/8-16 Machine Screw Anchors 20 pcs 1/4 x 1-1/4, 15 pcs 1/4 x 2-1/4 and 10 pcs 3/8 x 2-1/4 Wedge Anchors	1	\$ 50.10
UAKHD3	33283	10 pcs ea 1/4, 10 pcs ea 5/16 and 6 pcs ea 3/8 Lag Screw Short & Long Anchors 20 pcs 1/4-20, 15 pcs 5/16-18 and 10 pcs 3/8-16 Double Expansion Anchors	1	\$ 61.95
UAKHD4	33284	20 pcs 1/4-20, 15 pcs 3/8-16 and 10 pcs 1/2-13 Steel Drop-In Anchors 20 pcs 1/4 x 1-3/8, 15 pcs 5/16 x 1-1/2 and 10 pcs 3/8 x 1-7/8 Sleeve Type Anchors	1	\$ 38.70

Other sizes, materials and quantities available by request.

SETTING TOOLS SOLD SEPARATELY

"Growth Through Innovation"

Metallics

229 Cross Street, Bristol, CT 06010
Tel 800-243-8272 • **Fax** 800-831-9358
Email sales@metallicsonline.com

Metallics West

651 North Main Street, Mancos, CO 81328
Tel 800-269-5183 • **Fax** 800-269-6278
Email saleswest@metallicsonline.com

ANCHORING DEVICES



Can be used with our
QuaDrive and Blue
Concrete Screws

MASONRY DRILL BITS FOR CONCRETE SCREWS

SPECIAL SIZE AND LENGTH
For use with Installation Tool, see Page
or any standard electric rotary tool or hammer drill

STOCK NO.	UPC NO.	DIAMETER & LENGTH	SCREW DIA.	WT. PER PKG.	STD. PKG.	SUGGESTED TRADE LIST PRICE PER
CD1	31250	5/32 x 3 1/2	3/16	.02	1	3.38/ea
CD2	31255	5/32 x 4 1/2	3/16	.02	1	3.98/ea
CD3	31260	5/32 x 5 1/2	3/16	.02	1	4.53/ea
CD5	31265	3/16 x 3 1/2	1/4	.02	1	3.45/ea
CD6	31270	3/16 x 4 1/2	1/4	.02	1	4.08/ea
CD7	31275	3/16 x 5 1/2	1/4	.03	1	5.78/ea
CD8	31280	3/16 x 6	1/4	.03	1	7.43/ea

OTHER SIZES AND QUANTITIES AVAILABLE BY REQUEST



BLUE CONCRETE SCREW KITS

INDENTED HEX SLOTTED WASHER HEAD



Hex

STOCK NO.	UPC NO.	DESCRIPTION OF CONTENTS	STD. PKG./ MSTR CARTON	WEIGHT EACH	SUGGESTED TRADE LIST PRICE PER
CSH316RF	87370	50 pcs 3/16 x 1 1/4, 35 pcs 3/16 x 1 3/4 25 pcs 3/16 x 2 1/4, 1 pc 3 1/2 x 5/32 masonry drill, 1 pc MT208 1/4" chuck	1/25	1.29	40.50/ea kit NEW
CSH14RF	87365	50 pcs 1/4 x 1 1/4, 35 pcs 1/4 x 1 3/4 25 pcs 1/4 x 2 1/4, 1 pc 3 1/2 x 3/16 masonry drill, 1 pc MT210 5/16" chuck	1/25	2.00	44.88/ea kit NEW

OTHER SIZES AND QUANTITIES AVAILABLE BY REQUEST



Slotted

Phillips



SPRING WING TOGGLE BOLTS

STEEL ZINC CHROMATE

Bolts and Wings in One Package

STOCK NO.	JAR UPC NO.	DIAMETER & LENGTH	DRILL SIZE	WT. PER PKG.	STD. PKG.	SUGGESTED TRADE LIST PRICE PER
ROUND HEAD						
J1501 (slot/Phillips)	80809	1/8 x 2	1/8" WING USE 7/16" DRILL	0.72	50	24.80/c
J1502 (slot/Phillips)	80810	1/8 x 3	3/16" WING USE 9/16" DRILL	0.80	50	28.56/c
J1503 (slot/Phillips)	81203	1/8 x 4	9/16" DRILL	0.98	50	30.56/c
J1504 (slot/Phillips)	81204	1/8 x 6	1/4" WING USE 3/4" DRILL	2.60	50	49.10/c NEW
J1505 (slot/Phillips)	80811	3/16 x 2	3/4" DRILL	1.40	50	29.96/c
J1506 (slot/Phillips)	80812	3/16 x 3	5/16" WING USE 7/8" DRILL	1.71	50	33.26/c
J1507 (slot/Phillips)	81207	3/16 x 4	7/8" DRILL	1.95	50	34.76/c
J1508 (slotted)	81208	3/16 x 5	3/8" WING USE 1" DRILL	2.35	50	37.36/c
J1509 (slotted)	81209	3/16 x 6	1" DRILL	2.60	50	43.06/c
J1511 (slot/Phillips)	80813	1/4 x 3	1/2" WING USE 1-1/4" DRILL	2.93	50	37.66/c
J1512 (slot/Phillips)	10396	1/4 x 4	1-1/4" DRILL	3.45	50	41.96/c
J1513 (slotted)	81213	1/4 x 5	SELECT THE PROPER DRILL FOR MATERIAL TO BE DRILLED	3.93	50	49.00/c
J1514 (slotted)	81214	1/4 x 6		4.47	50	55.90/c

OTHER SIZES AND QUANTITIES AVAILABLE BY REQUEST

CONTINUED ON NEXT PAGE

ANCHORING DEVICES

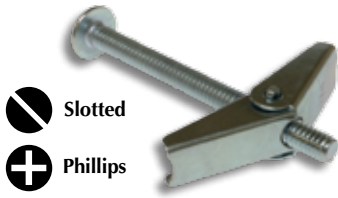

CONTINUED SPRING WING TOGGLE BOLTS

STEEL ZINC CHROMATE

Bolts and Wings in One Package

STOCK NO.	JAR UPC NO.	DIAMETER & LENGTH	DRILL SIZE	WT. PER PKG.	STD. PKG.	SUGGESTED TRADE LIST PRICE PER
ROUND HEAD						
J1516 (slotted)	10407	5/16 x 4	1/8" WING USE 7/16" DRILL	3.05	25	89.92/c
J1517 (slotted)	81217	5/16 x 5		3.81	25	127.52/c
J1518 (slotted)	81218	5/16 x 6		4.03	25	142.72/c
J1519 (slot/Phillips)	81219	3/8 x 3		3.72	25	99.92/c
J1520 (slot/Phillips)	81220	3/8 x 4		4.31	25	111.18/c
J1521 (slotted)	81221	3/8 x 5		5.06	25	136.52/c
J1522 (slot/Phillips)	81222	3/8 x 6		5.60	25	148.92/c
J1523 (slotted)	81223	1/2 x 4		3.95	10	201.80/c
J1524 (slotted)	81224	1/2 x 5		4.25	10	269.00/c
J1525 (slotted)	81225	1/2 x 6		4.85	10	295.80/c
FLAT HEAD						
J1528 (slotted)	81228	1/8 x 2	3/16" WING USE 9/16" DRILL	0.69	50	*SPECIAL ORDER ITEMS. INQUIRE ABOUT AVAIL- ABILITY AND PRICES 1-800 243-8272 EAST 1-800 269-5183 WEST
J1529 (slotted)	80814	1/8 x 3		0.87	50	
J1530 (slotted)	81230	1/8 x 4	1/4" WING USE 3/4" DRILL	0.97	50	
J1531 (slotted)	81231	3/16 x 2		1.48	50	
J1532 (slotted)	81232	3/16 x 3		1.68	50	
J1533 (slotted)	81233	3/16 x 4	5/16" WING USE 7/8" DRILL	2.10	50	
J1534 (slotted)	81234	3/16 x 5		2.24	50	
J1535 (slotted)	81235	3/16 x 6		2.62	50	
J1536 (slotted)	81236	1/4 x 3		2.82	50	
J1537 (slotted)	81237	1/4 x 4	3/8" WING USE 1" DRILL	3.31	50	
J1538 (slotted)	81238	1/4 x 5		3.96	50	
J1539 (slotted)	81239	1/4 x 6	1/2" WING USE 1-1/4" DRILL	4.46	50	
J1540 (slotted)	81240	5/16 x 3		2.55	25	
J1541 (slotted)	81241	5/16 x 4		2.88	25	
J1542 (slotted)	81242	5/16 x 5		3.22	25	
J1543 (slotted)	81243	5/16 x 6		3.79	25	
J1544 (slotted)	81244	3/8 x 3		3.49	25	
J1545 (slotted)	81245	3/8 x 4		4.22	25	
J1546 (slotted)	81246	3/8 x 5	4.90	25		
J1547 (slotted)	81247	3/8 x 6	5.75	25		
MUSHROOM - TRUSS HEAD						
J1548 (slotted)	80815	1/8 x 2	SELECT THE PROPER DRILL FOR MATERIAL TO BE DRILLED	0.75	50	24.80/c
J1549 (slot/Phillips)	80816	1/8 x 3		0.82	50	28.56/c
J1550 (slot/Phillips)	80817	1/8 x 4		1.01	50	30.56/c
J1551 (slot/Phillips)	80818	3/16 x 3		1.80	50	33.26/c
J1552 (slot/Phillips)	10397	3/16 x 4		2.01	50	34.76/c
J1553 (slot/Phillips)	10399	1/4 x 3		2.96	50	39.06/c
J1554 (slot/Phillips)	10398	1/4 x 4		3.50	50	41.96/c
SQUARE MUSHROOM - TRUSS HEAD						
J1560 (square)	80819	1/8 x 2		0.84	50	49.70/c
J1561 (square)	80820	1/8 x 3		0.95	50	28.56/c
J1562 (square)	80821	1/8 x 4		1.10	50	30.56/c
J1563 (square)	80822	3/16 x 2		1.58	50	29.96/c
J1564 (square)	80823	3/16 x 3		1.85	50	33.26/c
J1565 (square)	81265	3/16 x 4		2.00	50	34.76/c
J1566 (square)	81266	1/4 x 3		3.03	50	39.06/c

OTHER SIZES AND QUANTITIES AVAILABLE BY REQUEST

ANCHORING DEVICES

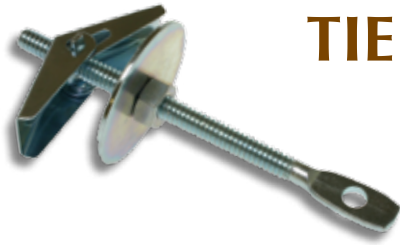

TIE WIRE ACOUSTICAL TOGGLE BOLTS

Includes: (1) Tie Wire 1/4-20 toggle bolt
 (1) 1/4-20 nut
 (1) 1/4 washer
 (1) 1/4 toggle wing

Tie wire acoustical toggle bolts are primarily for overhead applications. The winged end is inserted through the drywall, ceiling tile, etc., and expands behind that medium while the 1/4" x 1-1/4" fender washer and hex nut act to secure the anchor on the exterior of the hole.

STOCK NO.	UPC NO.	SIZE	DESCRIPTION	WT. PER PKG.	PKG. QTY.	SUGGESTED TRADE LIST PRICE PER
JTWA144	81402	1/4 x 4	Toggle bolt	2.47	50	152.00/c
JTWA145	81404	1/4 x 5	Toggle bolt	2.33	50	163.72/c
Hole Size 5/8" • Eye Size 1/4"						

OTHER SIZES AND QUANTITIES AVAILABLE BY REQUEST



SHEET ROCK TOGGLES

Vertical Mount used for hanging Threaded Rod 1/4" or 3/8"
 For use in sheetrock ceilings, metal, lath & plaster, metal liners, wood, ceiling panels.

SheetRock Toggle for 1/4 Rod (Vertical Mount)
 Use Nut Driver SMDB2

STOCK NO.	UPC NO.	SIZE	DESCRIPTION	WT. PER PKG.	PKG. QTY.	SUGGESTED TRADE LIST PRICE PER
JSRT14	81388	1/4	SheetRock Toggle	3.08	25	307.12/c

OTHER SIZES AND QUANTITIES AVAILABLE BY REQUEST



SPRING TOGGLE HEADS

STEEL ZINC CHROMATE & STAINLESS STEEL 18-8 TYPE
 For Light Duty Application

STOCK NO.	JAR UPC NO.	THREAD DIAMETER	DRILL SIZE	WT. PER PKG.	STD. PKG.	SUGGESTED TRADE LIST PRICE PER
STEEL ZINC CHROMATE						
J1590	80824	6-32	FOR APPROPRIATE DRILL SIZE SEE CHART ON PAGE 151	0.71	100	15.48/c
J1592	80825	10-24		1.38	100	18.53/c
J1593	80826	1/4-20		2.25	100	20.98/c
J1594	80827	5/16-18		4.20	100	39.25/c
J1595	80828	3/8-16		1.47	25	57.12/c
J1596	80829	1/2-13		4.42	25	132.40/c
STAINLESS STEEL 18-8 TYPE						
J1593SS	96993	1/4-20		0.94	50	200.00/c NEW
J1592SS	96992	3/16		0.74	50	225.00/c NEW

OTHER SIZES AND QUANTITIES AVAILABLE BY REQUEST

MUSHROOM HEAD TOGGLE BOLT KIT



We are at it again with Kits!

Introducing 3 of the most commonly used Mushroom Head Toggle Bolts all in one convenient kit at one great low price.

Kit Includes The Following:

- 1/8" X 3" Mushroom Head Combo Drive Bolt (50 Pieces)
- 1/8" Spring Wing Toggle (50 Pieces)
- 3/16" X 3" Mushroom Head Combo Drive Bolt (34 Pieces)
- 3/16" Spring Wing Toggle (34 Pieces)
- 1/4" X 4" Mushroom Head Combo Drive Bolt (20 Pieces)
- 1/4" Spring Wing Toggle (20 Pieces)

STOCK NO.	UPC NO.	WT. PER PKG.	SUGGESTED TRADE LIST PRICE PER
TBMK1	70060	3.7 lbs.	46.28/ea. kit

OTHER SIZES AND QUANTITIES AVAILABLE BY REQUEST



MANUFACTURING CAPABILITIES

Diameter range #2 thru 5/16" / 1.5mm thru 8mm • Length range 1/8" thru 3" / 3.5mm thru 75mm

Materials: Steel, Brass, Stainless, Aluminum, Bronze.

NEED SCREWS...
Let Us Make Them For You!



A METALLICS AFFILIATE

P.O. Box 1600 • 231 Cross Street
Bristol, CT 06011-1600
Tel: 800-984-8945 • Fax: 800-984-8946

CAPABILITIES LIST

- PLANT SIZE:** 100,000 SQUARE FEET
- LOCATION:** Bristol, Connecticut
- EQUIPMENT:** 27 Hi-Speed Cold Headers
8 Burr-Free Screw Slotters
3 Shank Slotters
2 Pointers
14 High Speed Thread Rollers



ADDITIONAL PLANT INFO: Modern shipping facility utilizing digital scale counting machines. In-house packaging facilities - boxing, sorting, baggings. All material boxed, palletized & labeled with your needs in mind for domestic or export shipping.

SECONDARY WORK: All plating & heat treating is done on the outside and certified for your guarantee.

INFORMATION SYSTEMS: Our facility has new and upgraded Technology to meet your customers specific requirements.

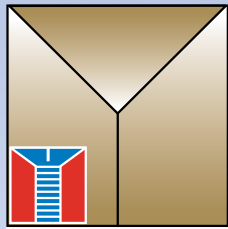

Metallics

Cobra TripleGrip™ Multi-Purpose Anchor



**[CONTRACTOR
APPROVED]**



Requires: Drill and #2 Phillips

- Two claws hold the anchor stationary while inserting the screw.
- Two powerful locking wings deploy as you screw, for strength and unparallel vibration resistance.
- The tip of the core expands for additional holding power.
- Works in 3/8", 1/2" and 5/8" Drywall; Brick; Concrete and Plaster.

MAXIMUM LOAD CAPACITY

Anchor	Drill Bit	Drywall 5/8"		Concrete 3000 psi	
		PULL	SHEAR	PULL	SHEAR
#6	1/4"	60 lbs.	91 lbs.	240 lbs.	400 lbs.
#8	1/4"	64 lbs.	102 lbs.	275 lbs.	500 lbs.
#10	5/16"	88 lbs.	154 lbs.	400 lbs.	800 lbs.
#12	3/8"	132 lbs.	204 lbs.	500 lbs.	900 lbs.



Phillips

Other sizes, materials and quantities available by request.

PART #	UPC #	DESCRIPTION	QTY / PKG	SUG. TRADE LIST / PKG
TGA6	72655	#6 Triple Grip Anchors	100	\$ 14.60
TGA8	72657	#8 Triple Grip Anchors	100	\$ 14.93
TGA10	72659	#10 Triple Grip Anchors	100	\$16.88
TGA12	72661	#12 Triple Grip Anchors	100	\$ 31.78
TGA6K	72665	#6 Triple Grip Anchors • #6 x 1-1/4" Pan Head Sheet Metal Screws • (1) 1/4 x 4" Masonry Drill	100	\$ 20.45
TGA8K	72667	#8 Triple Grip Anchors • #8 x 1-1/4" Pan Head Sheet Metal Screws • (1) 1/4 x 4" Masonry Drill	100	\$ 20.85
TGA10K	72669	#10 Triple Grip Anchors • #10 x 1-1/2" Pan Head Sheet Metal Screws • (1) 5/16 x 4" Masonry Drill	100	\$ 24.73
TGA12K	72671	#12 Triple Grip Anchors • #12 x 1-1/2" Pan Head Sheet Metal Screws • (1) 3/8 x 4" Masonry Drill	50	\$ 26.63
TGA6J	72675	#6 Triple Grip Anchors • #6 x 1-1/4" Pan Head Sheet Metal Screws • (1) 1/4 x 4" Masonry Drill	100	\$ 20.45
TGA8J	72677	#8 Triple Grip Anchors • #8 x 1-1/4" Pan Head Sheet Metal Screws • (1) 1/4 x 4" Masonry Drill	100	\$ 20.45
TGA10J	72679	#10 Triple Grip Anchors • #10 x 1-1/2" Pan Head Sheet Metal Screws • (1) 5/16 x 4" Masonry Drill	100	\$ 24.73
TGA12J	72681	#12 Triple Grip Anchors • #12 x 1-1/2" Pan Head Sheet Metal Screws • (1) 3/8 x 4" Masonry Drill	50	\$ 26.63

Note: Part numbers with a "K" are packaged in plastic boxes. Part numbers with a "J" are packaged in plastic jars.

"Growth Through Innovation"

Metallics

229 Cross Street, Bristol, CT 06010
Tel 800-243-8272 • **Fax** 800-831-9358
Email sales@metallicsonline.com

Metallics West

651 North Main Street, Mancos, CO 81328
Tel 800-269-5183 • **Fax** 800-269-6278
Email saleswest@metallicsonline.com

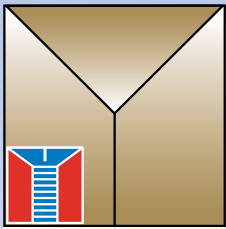

Metallics



Toggler Alligator[®] Solid Wall Anchors

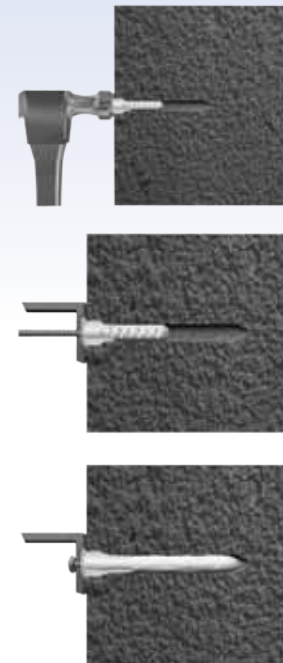
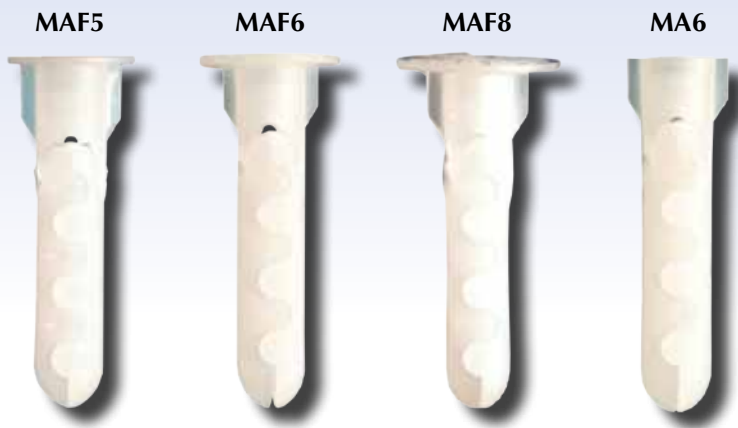

ALLIGATOR solid wall anchors are designed to support heavy loads (even under vibration).

ALLIGATOR solid wall anchors can be used in almost any material, including: Concrete, Wood, Plaster, Aerated Concrete, Brick, Masonry, Stone, Flakeboard, Cinder Block, Ceramic Tile, Stucco, Drywall

PART #	UPC #	DESCRIPTION	QTY / PKG	SUG. TRADE LIST / PKG
MAF5	73905	3/16" Toggler Alligator anchor with flange	50	\$15.88
MAF6	73905	1/4" Toggler Alligator anchor with flange	50	\$22.55
MAF8	73908	5/16" Toggler Alligator anchor with flange	50	\$30.08
MA6	73939	1/4" Toggler Alligator anchor no flange	50	\$22.55

Other sizes, materials and quantities available by request.

"Growth Through Innovation"

Metallics

229 Cross Street, Bristol, CT 06010
Tel 800-243-8272 • **Fax** 800-831-9358
Email sales@metallicsonline.com

Metallics West

651 North Main Street, Mancos, CO 81328
Tel 800-269-5183 • **Fax** 800-269-6278
Email saleswest@metallicsonline.com

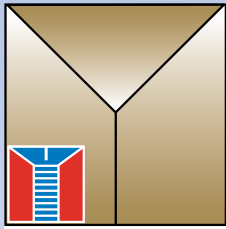

Metallics

Super Wall Plate Screw Kit

A Complete Wall Plate Kit to Make Insulation Easy and Safer



[CONTRACTOR APPROVED]



Each kit contains:

- 50 Wall plate screws in White, Ivory, and Light Almond.
- 50 Screws to secure electrical device to electrical box.
- 50 Secura-let™ spacers to shim electrical device so wall plate is flush to wall.

Other sizes, materials and quantities available by request.

PART #	UPC #	DESCRIPTION	QTY / PKG	SUG. TRADE LIST / PKG
SWPK1	20360	#6 - 32 x 1/2" Slotted Oval Head White Painted Screw	50	\$ 28.13
		#6 - 32 x 1/2" Slotted Oval Head Ivory Painted Screw	50	
		#6 - 32 x 1/2" Slotted Oval Head Almond Painted Screw	50	
		#6 - 32 x 3/4" Slotted Flat Head Machine Screw	50	
		#6 - 32 x 1" Slotted Flat Head Machine Screw	50	
		Secura-lets Stackable Spacers	50	

Secura-let spacers are stackable U.L. recognized electrical grade PVC with a U.L. 94-0 flame rating and weatherability rating.

★ ★ ★ ★ ★ *"Growth Through Innovation"* ★ ★ ★ ★ ★

Metallics

229 Cross Street, Bristol, CT 06010
Tel 800-243-8272 • **Fax** 800-831-9358
Email sales@metallicsonline.com

Metallics West

651 North Main Street, Mancos, CO 81328
Tel 800-269-5183 • **Fax** 800-269-6278
Email saleswest@metallicsonline.com

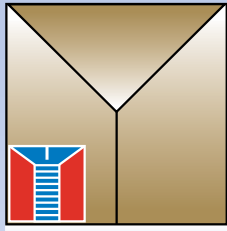

Metallics



Toggler Snapskru® Kit & Bulk

**[CONTRACTOR
APPROVED]**

Self-Drilling Drywall Anchors

Another **NEW** exciting solution from Metallics! Tired of searching for the right Anchor? **Here it is!** Toggler Snapskru®...

The Strongest, easiest-to-use self-drilling drywall anchor—

INSTALLATION INSTRUCTIONS: Tools Needed

Screw gun with #2 Phillips bit (or #2 Phillips screwdriver, or electric drill with clutch mechanism & #2 bit)

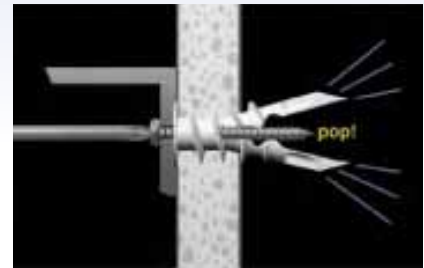
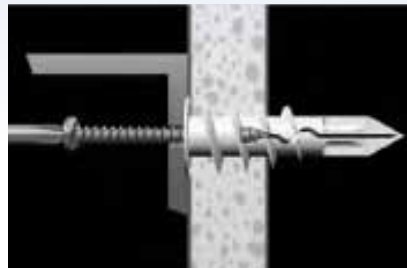

Press tip of Snapskru anchor into drywall using #2 Phillips screwdriver or screw gun. Drive anchor clockwise into drywall until anchor stops flush with the outer wall surface. *TIP: To keep anchor in precise position during installation (critical for aligning several anchors), push tip of screwdriver into drywall to mark insertion point.*

Screw for *MINI* anchor:
#6 through #8 (#6 preferred).
[3.5-4.5mm, 3.5mm preferred]

Screw for *REGULAR* anchor:
#6 through #10 (#8 preferred).
[3.5-4.5mm, 4mm preferred]

Tighten screw flush with item.

The screw pops open the anchor, looking it on the wall and holding the gypsum board in compression. This reinforces the wall, increasing its holding power significantly.

Screw Length = Thickness of item being installed plus 1-1/4".

PART #	UPC #	DESCRIPTION	SUG. TRADE LIST / PKG
ASP1K	78446	50 pcs Toggler Snapskru Reg. / 50 pcs #8 x 1-1/2" Pan Hd Combo SMS / 1 #2 Phillips Power Bit 2" lg.	\$ 28.05
ASP1J	78445	50 pcs Toggler Snapskru Reg. / 50 pcs #8 x 1-1/2" Pan Hd Combo SMS / 1 #2 Phillips Power Bit 2" lg.	\$ 28.05
ASP1M	78447	1000 pcs Toggler Snapskru Regular	\$ 276.50
ASPM1K	78461	50 pcs Toggler Snapskru Mini / 50 pcs #6 x 1-1/2" Pan Hd Combo SMS / 1 #2 Phillips Power Bit 2" lg.	\$ 28.05
ASPM1J	78460	50 pcs Toggler Snapskru Mini / 50 pcs #6 x 1-1/2" Pan Hd Combo SMS / 1 #2 Phillips Power Bit 2" lg.	\$ 28.05
ASPM1M	78462	1000 pcs Toggler Snapskru Mini	\$ 224.50

Other sizes, materials and quantities available by request.

"Growth Through Innovation"

Metallics

229 Cross Street, Bristol, CT 06010
Tel 800-243-8272 • Fax 800-831-9358
Email sales@metallicsonline.com

Metallics West

651 North Main Street, Mancos, CO 81328
Tel 800-269-5183 • Fax 800-269-6278
Email saleswest@metallicsonline.com

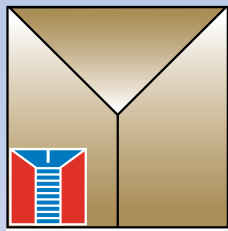

Metallics



Toggler Alligator[®] Solid Wall Anchor Kit

**[CONTRACTOR
APPROVED]**

- Alligator[®] solid-wall anchors can be used in most any material, including: Concrete, Wood, Plaster, Aerated Concrete, Block, Masonry, Stone, Flakeboard, Cinder Block, Ceramic Tile, Stucco, and Drywall.
- Alligator[®] solid-wall anchors are designed to support heavy loads. (Even under vibration!)



The Alligator anchor is the only anchor that extrudes the entire length of the screw. The screw extrudes and compresses all the plastic into the wall of the hole under tremendous pressure. The plastic molds and conforms exactly to the surface of the hole (including all the hole's imperfections). All forces supported by the screw are transmitted around the anchor to the wall of the hole. This provides greater holding power by distributing the force over the maximum area possible.



PART #	UPC #	DESCRIPTION	SUG. TRADE LIST / PKG
MAF5KJ	73985	(50) #8 x 1" Pan Head Combo Sheet Metal Screws	\$ 21.90
		(50) 3/16" Alligator Solid Wall Anchors with Flange	
		(1) 3/16" x 4" Carbide Tipped Masonry Drill Bit	
MAF6KJ	73986	(50) #10 x 1" Pan Head Combo Sheet Metal Screws	\$ 27.05
		(50) 1/4" Alligator Solid Wall Anchors with Flange	
		(1) 1/4" x 4" Carbide Tipped Masonry Drill Bit	
MAF8KJ	79388	(50) #12 x 1-1/4" Pan Head Combo Sheet Metal Screws	\$ 37.70
		(50) 5/16" Alligator Solid Wall Anchors with Flange	
		(1) 5/16" x 4" Carbide Tipped Masonry Drill Bit	

Other sizes, materials and quantities available by request.

★ ★ ★ ★ ★ "Growth Through Innovation" ★ ★ ★ ★ ★

Metallics

229 Cross Street, Bristol, CT 06010
Tel 800-243-8272 • **Fax** 800-831-9358
Email sales@metallicsonline.com

Metallics West

651 North Main Street, Mancos, CO 81328
Tel 800-269-5183 • **Fax** 800-269-6278
Email saleswest@metallicsonline.com

ANCHORING DEVICES

HOLLOW BLOCK T-ANCHORS

For Hollow Wallblock

STEEL ZINC CHROMATE



STOCK NO.	UPC NO.	SIZE	THREAD LENGTH	DRILL SIZE	WT. PER PKG.	STD. PKG.	SUGGESTED TRADE LIST PRICE PER
JTA14134	80830	1/4 x 1 3/4	1	5/16	0.93	25	241.72/c
JTA14212	80831	1/4 x 2 1/2	1 3/4	5/16	1.12	25	253.72/c
JTA14314	80832	1/4 x 3 1/4	2 3/8	5/16	0.89	25	261.80/c
JTA516212	80833	5/16 x 2 1/2	1 5/8	5/16	1.60	25	263.80/c
JTA516314	80834	5/16 x 3 1/4	2 3/8	5/16	2.03	25	274.00/c
JTA516334	80835	5/16 x 3 3/4	2 7/8	5/16	2.31	25	288.00/c
JTA38314	80836	3/8 x 3 1/4	2 1/4	3/8	2.88	25	314.32/c
JTA38334	81143	3/8 x 3 3/4	2 3/4	3/8	3.05	25	322.32/c
JTA38412	81146	3/8 x 4 1/2	3 1/2	3/8	3.59	25	352.52/c

OTHER SIZES AND QUANTITIES AVAILABLE BY REQUEST

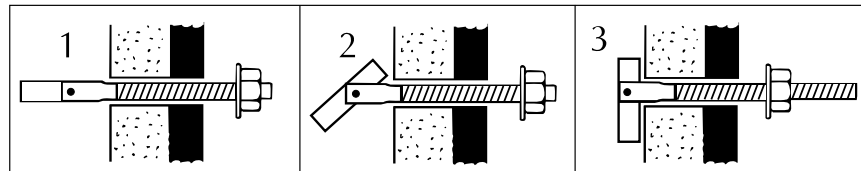

1. Drill hole using proper diameter and insert T-Anchor with washer and hex nut attached through item to be fastened.
2. Give it a quarter turn; retaining bar drops into place.
3. Tighten nut until a firm resistance is attained.

HOLLOW WALL SCREW ANCHORS, DRIVE-TYPE

STEEL ZINC CHROMATE - INCLUDES COMBO HEAD MACHINE SCREW

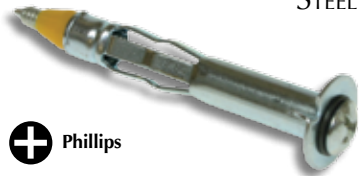

⊕ Phillips

A hammer is the only tool needed to set in place.

No predrilling required when fastening fixtures and electrical components to sheet rock.

It is a time-saver for the professional contractor.

STOCK NO.	UPC NO.	SIZE & WALL THICKNESS	GRIP RANGE	DRILL SIZE	WT. PER PKG.	STD. PKG./ MSTR SLEEVE	SUGGESTED TRADE LIST PRICE PER
J6721	80837	1/8 Short	1/8 - 1/2	5/16	1.37	100/500	38.08/C
J6726	80838	1/8 Long	1/8 - 13/16	5/16	1.84	100	39.10/C

OTHER SIZES AND QUANTITIES AVAILABLE BY REQUEST

HOLLOW WALL SCREW ANCHOR

STEEL ZINC CHROMATE

INCLUDES COMBO HEAD MACHINE SCREW



⊖ Slotted

⊕ Phillips

STOCK NO.	UPC NO.	SIZE & WALL THICKNESS	GRIP RANGE	DRILL SIZE	WT. PER PKG.	STD. PKG./ MSTR SLEEVE	SUGGESTED TRADE LIST PRICE PER
J1001	80839	1/8 X-Short	1/16 - 1/4	5/16	.91	100	33.23/c
J1002	80840	1/8 Short	1/8 - 1/2	5/16	1.36	100	33.90/c
J1003	80841	1/8 Long	5/8 - 7/8	5/16	1.81	100	36.48/c
J1004	80842	3/16 Short	1/8 - 5/8	7/16	3.45	100	66.95/c
J1005	80843	3/16 Long	5/8 - 1 3/16	7/16	2.15	50	81.96/c
J1006	80844	1/4 Short	1/8 - 5/8	1/2	2.81	50	97.30/c
J1007	80845	1/4 Long	5/8 - 1 3/16	1/2	3.65	50	110.50/c

OTHER SIZES AND QUANTITIES AVAILABLE BY REQUEST

ANCHORING DEVICES

MACHINE SCREW LEAD ANCHOR

ONE SETTING TOOL FURNISHED IN EACH JAR OF ANCHORS

We only recomend these anchors for cement floors,
not to be used overhead in ceilings or walls.



STOCK NO.	UPC NO.	SIZE	HOLE SIZE	ANCHOR LENGTH	WT. PER PKG.	STD. PKG.	SUGGESTED TRADE LIST PRICE PER
J1401	83155	6-32	5/16	17/32	0.87	100	44.75/c
J1402	80846	8-32	5/16	17/32	0.91	100	45.03/c
J1403	80847	10-24	3/8	11/16	1.78	100	45.63/c
J1404	80848	10-32	3/8	1/2	1.88	100	45.63/c
J1406	80850	1/4-20	1/2	7/8	3.75	100	51.38/c
J1407	80851	5/16-18	5/8	1 1/16	6.69	100	129.38/c
J1408	80852	3/8-16	3/4	1 5/16	5.25	50	130.50/c
J1409	80853	1/2-13	7/8	1 9/16	8.97	50	158.90/c

OTHER SIZES AND QUANTITIES AVAILABLE BY REQUEST

NOT RECOMMENDED FOR CEMENT CEILING APPLICATIONS

PLEASE NOTE THAT MACHINE SCREW ANCHORS HAVE A LEAD OUTER GRIPPING SHELL. IN APPLICATIONS WHERE LEAD IS CONSIDERED DANGEROUS, WE DO NOT RECOMMEND THEIR USE. UNTIL U.S. GOVT. SAFETY REGULATIONS TAKE A FIRM STAND ON THEIR USE, METALLICS WILL CONTINUE TO OFFER THIS PRODUCT-AS DO MANY OTHER FASTENER COMPETITORS.

E

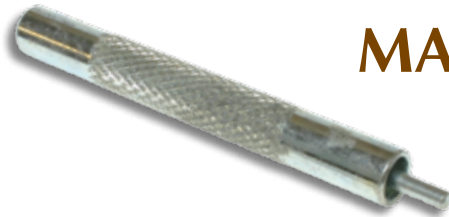

MACHINE SCREW LEAD ANCHOR SETTING TOOL

Safety glasses should be worn for any driving applications.
See Safety Glasses Pages 301, 302 and 303

STOCK NO.	UPC NO.	SIZE	WT. PER PKG.	STD. PKG.	SUGGESTED TRADE LIST PRICE PER
1401ST	17900	6-32	.04	1	4.93/ea
1402ST	17905	8-32	.07	1	4.20/ea
1403ST	17910	10-24	.08	1	5.03/ea
1404ST	17915	10-32	.14	1	5.03/ea
1406ST	17925	1/4-20	.17	1	5.58/ea
1407ST	17930	5/16-18	.27	1	5.95/ea
1408ST	17935	3/8-16	.38	1	6.28/ea
1409ST	17940	1/2-13	.58	1	12.13/ea

OTHER SIZES AND QUANTITIES AVAILABLE BY REQUEST

AMERICA'S SOURCE FOR PREMIER AND INNOVATIVE FASTENERS & ANCHORS



A Modern Up to Date
Roll Threading Machine
at our Affiliate,
Avanti Screw.





Metallics and Avanti Screw, Inc., prime American manufacturers of fastener products, have always worked to present the latest in fastener technology to our distributors and their contractors/users.

Hex Washer Head fasteners have historically only offered three drives- the hex, phillips and the slot. In 1999, we introduced "The QuaDrive" square, hex, slotted and phillips, in fourteen of the most popular sizes of sheet metal screws.

The QuaDrive

Square Drive

Hex

Slotted



Phillips

QuaDrive

+ + + + =

America's Newest Drive - Designed, Developed and
Manufactured by Metallics/Avanti Screw

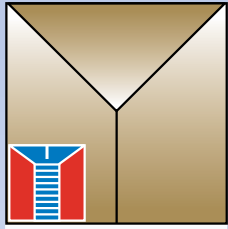
These sheet metal screws are being manufactured to fill the need of the growing demand in the North American markets.



Metallics

Multi-Purpose Anchors (Zinc Plated)



[CONTRACTOR APPROVED]



E

- Light-Duty Hammer-Drive Concrete and Masonry Anchors
- Specified for anchorage into concrete, block and brick
- As simple as using a nail – drive into predrilled holes in concrete

PART NUMBER	DRILL BIT SIZE	TOTAL LENGTH	MIN. EMBEDMENT	CLEARANCE HOLE SIZE
RD4158	1/4"	1 1/2"	1 1/4"	5/16"
RD4200	1/4"	2"	1 1/4"	5/16"
RD4212	1/4"	2 1/2"	1 1/4"	5/16"
RD4300	1/4"	3"	1 1/4"	5/16"

PART NUMBER	UPC #	DESCRIPTION	QTY / PKG.	SUG. TRADE LIST / PKG.
RD4158	74488	Mult-Purpose Mushroom Hd Anchor 1 1/2"	100	\$ 32.43
RD4200	74490	Mult-Purpose Mushroom Hd Anchor 2"	100	\$ 39.63
RD4212	74492	Mult-Purpose Mushroom Hd Anchor 2 1/2"	100	\$ 48.20
RD4300	74494	Mult-Purpose Mushroom Hd Anchor 3"	100	\$ 54.20

Other sizes, materials and quantities available by request.

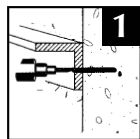

1
Drill a proper-sized diameter hole 1/2" deeper than the required embedment.

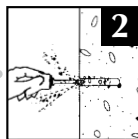

2
Clean hole.

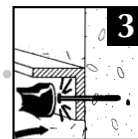

3
Insert anchor through material to be fastened and drive with hammer until head is flush with surface.

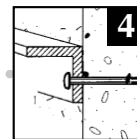

4
Multi-Purpose Anchor is now set.

"Growth Through Innovation"

Metallics

229 Cross Street, Bristol, CT 06010
Tel 800-243-8272 • **Fax** 800-831-9358
Email sales@metallicsonline.com

Metallics West

651 North Main Street, Mancos, CO 81328
Tel 800-269-5183 • **Fax** 800-269-6278
Email saleswest@metallicsonline.com

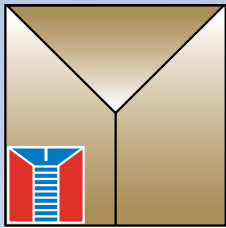

Metallics

Multi-Purpose Anchors (Zinc Plated)



Tie Wire Anchors -

For acoustical ceilings and suspended electrical fixtures.

Pipe Hanging Anchors -

For sprinkler, water lines, steam/gas and electrical conduits. Available in 1/4"-20 and 3/8"-16 internal thread.

Forming Anchors -

For wood attachments to concrete.



Selection Guide

Part Number	Drill Bit Size	Min. Embedment	Hole Size I.D.
TD4112	1/4"	1-1/8"	9/32"

Part Number	Int. Thread	Drill Bit Size	Min. Embedment
PD4112	1/4"-20"	3/16"	1-1/4"
PD8134	3/8"-16"	1/4"	1-1/2"

Part Number	Fixture Hole Size	Drill Bit Size	Min. Embedment
FD8234	5/16"	1/4"	1-1/4"

PART NUMBER	UPC #	DESCRIPTION	QTY/ PKG.	SUG. TRADE LIST / PKG
TD4112	73918	Multi-Purpose Tie Wire Anchor	100	\$116.88
PD4112	73924	Multi-Purpose Pipe Hanging Anchor 1/4"-20 Int Thread	100	\$109.13
PD8134	73925	Multi-Purpose Pipe Hanging Anchor 3/8"-16 Int Thread	100	\$131.88
FD8234	73915	Multi-Purpose Forming Anchor 2-3/4" Long	100	\$123.25

Other sizes, materials and quantities available by request.

"Growth Through Innovation"

Metallics

229 Cross Street, Bristol, CT 06010
Tel 800-243-8272 • **Fax** 800-831-9358
Email sales@metallicsonline.com

Metallics West

651 North Main Street, Mancos, CO 81328
Tel 800-269-5183 • **Fax** 800-269-6278
Email saleswest@metallicsonline.com

ANCHORING DEVICES



LAG SCREW SHIELD

ALLOY ZINC DIE CAST
Medium-Duty Application
See page 136 and 137 for Lag Bolts

A secure die cast expansion anchor of zinc rustproof alloy. Most effective for holding in brittle or soft masonry. The ideal product for mortar joints.

STOCK NO.	UPC NO.	LAG SCREW DIAMETER	HOLE SIZE	ANCHOR LENGTH	WT. PER PKG.	STD. PKG.	SUGGESTED TRADE LIST PRICE PER
SHORT							
J1201	80854	1/4	1/2	1	1.06	50	46.66/c
J1202	80855	5/16	1/2	1 1/4	1.21	50	42.70/c
J1203	80856	3/8	5/8	1 3/4	2.19	50	68.80/c
J1204	80857	1/2	3/4	2	1.73	25	111.40/c
J1205	80858	5/8	7/8	2	2.74	25	171.00/c
J1206	83081	3/4	1	2	.81	25	198.05/c
LONG							
J1207	80859	1/4	1/2	1 1/2	1.48	50	49.30/c
J1208	80860	5/16	1/2	1 3/4	1.45	50	50.26/c
J1209	80861	3/8	5/8	2	3.32	50	92.86/c
J1210	80862	1/2	3/4	3	2.57	25	141.80/c
J1211	80863	5/8	7/8	3 1/2	5.37	25	271.00/c
J1212	83086	3/4	1	3 1/2	1.06	25	365.26/c

OTHER SIZES AND QUANTITIES AVAILABLE BY REQUEST



DROP-IN ANCHOR

STEEL ZINC CHROMATE AND STAINLESS STEEL
FOR USE IN STRUCTURAL FASTENING TO CONCRETE FLOORS
ONE SETTING TOOL FURNISHED IN EACH JAR OF ANCHORS

STOCK NO.	UPC NO.	SIZE	HOLE SIZE	ANCHOR LENGTH	WT. PER PKG.	STD. PKG.	SUGGESTED TRADE LIST PRICE PER
STEEL							
JDIA14	81870	1/4-20	3/8	1	2.33	100	64.20/c
JDIA38	81875	3/8-16	1/2	1 9/16	3.30	50	88.20/c
JDIA12	81880	1/2-13	5/8	2	6.41	50	145.70/c
JDIA58	81881	5/8-11	7/8	2 1/2	8.91	25	296.60/c
JDIA34	81873	3/4-10	1	3 3/16	13.58	25	736.20/c
STAINLESS STEEL 18-8 TYPE							
JDIA14SS	81872	1/4-20	3/8	1	2.54	100	PLEASE CALL FOR TRADE LIST PRICING
JDIA38SS	81876	3/8-16	1/2	1 9/16	3.50	50	
JDIA12SS	81883	1/2-13	5/8	2	6.25	50	
JDIA58SS	81882	5/8-11	7/8	2 1/2	8.36	25	
JDIA141SS	90345	1/4-20	3/8	1	2.54	100	
STAINLESS STEEL - 316 TYPE							
JDIA381SS	90349	3/8-16	1/2	1 9/16	3.50	100	
JDIA121SS	90353	1/2-13	5/8	2	6.03	50	

OTHER SIZES AND QUANTITIES AVAILABLE BY REQUEST

STEEL DROP-IN ANCHOR SETTING TOOL

FOR SETTING DROP-IN ANCHORS
Safety glasses should be worn for any driving applications.
See our line of Safety Glasses Pages 301, 302 and 303

STOCK NO.	UPC NO.	SIZE	WT. PER PKG.	STD. PKG.	SUGGESTED TRADE LIST PRICE PER
DIA14T	12181	1/4-20	0.18	1	3.85/ea
DIA38T	12182	3/8-16	0.24	1	5.00/ea
DIA12T	12183	1/2-13	0.41	1	6.18/ea
DIA58T	12184	5/8-11	0.51	1	11.53/ea
DIA34T	17890	3/4-10	0.65	1	11.68/ea

OTHER SIZES AND QUANTITIES AVAILABLE BY REQUEST

ANCHORING DEVICES



SINGLE EXPANSION ANCHOR

ZINC ALLOY

STOCK NO.	UPC NO.	THREAD DIAMETER	HOLE SIZE	ANCHOR BODY LENGTH	WT. PER PKG.	STD. PKG.	SUGGESTED TRADE LIST PRICE PER
JSEA14	81195	1/4	1/2	1	2.57	100	63.13/c
JSEA516	81196	5/16	5/8	1 1/4	2.44	50	96.96/c
JSEA38	81197	3/8	3/4	1 1/2	2.32	50	102.36/c
JSEA12	81198	1/2	7/8	2	3.04	25	218.20/c

OTHER SIZES AND QUANTITIES AVAILABLE BY REQUEST



DOUBLE EXPANSION ANCHOR

ZINC CHROMATE

The Double Expansion Anchor is manufactured of rustproof zinc alloy and is used with machine screws or machine bolts. These Anchors work well in soft masonry, as it sets, the two opposing wedges pull towards each other, expanding the full length of the anchor body.

STOCK NO.	UPC NO.	THREAD DIAMETER	HOLE SIZE	ANCHOR BODY LENGTH	WT. PER PKG.	STD. PKG.	SUGGESTED TRADE LIST PRICE PER
ZINC ALLOY							
JDEA14	80872	1/4	1/2	1	2.94	100	126.23/c
JDEA516	80873	5/16	5/8	1 1/4	2.82	50	173.56/c
JDEA38	80874	3/8	3/4	1 1/2	4.48	50	229.50/c
JDEA12	80875	1/2	7/8	2	3.70	25	361.80/c
JDEA58	82397	5/8	1	2 1/4	8.91	25	442.12/c
JDEA34	82390	3/4	1 1/4	2 7/8	9.12	20	650.00/c

OTHER SIZES AND QUANTITIES AVAILABLE BY REQUEST



WOOD AND TAPPING SCREW LEAD ANCHOR

STOCK NO.	UPC NO.	SIZE	LENGTH	HOLE SIZE	WT. PER PKG.	STD. PKG.	SUGGESTED TRADE LIST PRICE PER
J1302	80877	6-8	1	1/4	1.47	100/500	21.50/c
J1303	80878	6-8	1 1/2	1/4	1.98	100/500	23.68/c
J1305	80879	10-14	1	5/16	2.00	100/500	27.33/c
J1306	80880	10-14	1 1/2	5/16	2.97	100/500	37.58/c
J1307	80881	16-18	1	3/8	2.75	100/500	37.58/c
J1308	80882	16-18	1 1/2	3/8	3.59	100/500	51.08/c

OTHER SIZES AND QUANTITIES AVAILABLE BY REQUEST

PLEASE NOTE THAT WOOD AND TAPPING SCREW LEAD ANCHORS HAVE A LEAD OUTER GRIPPING SHELL. IN APPLICATIONS WHERE LEAD IS CONSIDERED DANGEROUS, WE DO NOT RECOMMEND THEIR USE. UNTIL U.S. GOVT. SAFETY REGULATIONS TAKE A FIRM STAND ON THEIR USE, METALLICS WILL CONTINUE TO OFFER THIS PRODUCT, AS DO MANY OTHER FASTENER COMPETITORS.



ROD COUPLING WEDGE ANCHOR

ANCHORS THREADED ROD TO CONCRETE CEILINGS

STOCK NO.	UPC NO.	BOLT AND HOLE DIA.	BOLT LENGTH	WT. PER PKG.	STD. PKG.	SUGGESTED TRADE LIST PRICE PER
JRCA381	81585	3/8	1 7/8	9.24	100	201.23/c
JRCA38	81586	3/8	2 1/8	4.97	50	167.66/c
JRCA12	81588	1/2	2 3/4	11.40	50	271.80/c

OTHER SIZES AND QUANTITIES AVAILABLE BY REQUEST

FLAT HEAD SPLIT DRIVE ANCHOR



- Can be used in concrete, hard masonry and stone
- Load can be applied immediately
- High grade steel with a memory
- One piece, pre-expanded anchor
- Exact hole depth not required to set anchor
- Fast, permanent installation

Safety glasses should be worn for any driving applications. 301, 302, 303

STOCK NO.	UPC NO.	JAR UPC NO.	SIZE	MASONRY DRILL SIZE	WT. PER PKG.	STD. PKG.	SUGGESTED TRADE LIST PRICE PER
JFSD141	81594	81594	1/4 x 1 1/2	1/4 x 4	1.22	50	54.56/c
JFSD142	81596	81596	1/4 x 2	1/4 x 4	1.58	50	62.10/c
JFSD1421	81598	81598	1/4 x 2 1/2	1/4 x 4	1.87	50	68.20/c
JFSD143	81600	81600	1/4 x 3	1/4 x 4	2.27	50	74.26/c
JFSD1431	81602	81602	1/4 x 3 1/2	1/4 x 6	1.35	25	81.80/c
JFSD144	81604	81604	1/4 x 4	1/4 x 6	1.50	25	89.40/c

OTHER SIZES AND QUANTITIES AVAILABLE BY REQUEST

SLEEVE TYPE ANCHOR

STEEL ZINC CHROMATE



* = acorn nuts

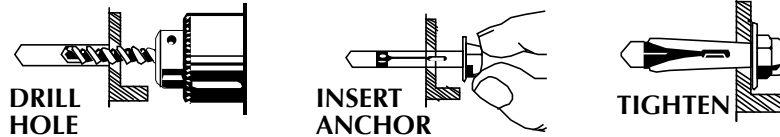

STOCK NO.	UPC NO.	DIAMETER LENGTH	BOLT DIAMETER	FASTENS MATERIAL UP TO	DEPTH IN LENGTH	WT. PER PKG.	STD. PKG.	SUGGESTED TRADE LIST PRICE PER
STEEL ZINC CHROMATE – HEX (Acorn)								
J2505	77405	1/4 x 5/8	3/16	1 1/4	1	1.57	100	41.25/c
J2513*	80883	1/4 x 1 3/8	3/16	3/8	1	2.32	100	41.55/c
J2522*	80884	1/4 x 2 1/4	3/16	1 1/4	1	3.14	100	58.98/c
J3114	80885	5/16 x 1 1/2	1/4	1/2	1	3.54	100	69.08/c
J3124	80886	5/16 x 2 1/2	1/4	1 1/2	1	5.24	100	90.50/c
J3717	80887	3/8 x 1 7/8	5/16	5/8	1 1/4	3.58	50	92.36/c
J3730	80888	3/8 x 3	5/16	1 3/4	1 1/4	5.15	50	119.20/c
J3732	77310	3/8 x 4	5/16	1 3/4	1 1/4	6.71	50	119.20/c
J5022	80889	1/2 x 2 1/4	3/8	3/4	1 1/2	3.24	25	130.72/c
J5026	80890	1/2 x 3	3/8	1 1/4	1 1/2	4.07	25	172.72/c
J5040	81131	1/2 x 4	3/8	2 1/2	1 1/2	5.02	25	285.00/c
J5060	81135	1/2 x 6	3/8	4 1/2	1 1/2	7.15	25	401.40/c
J6222	80891	5/8 x 2 1/4	1/2	1/4	2	6.60	25	251.00/c
J6242	81345	5/8 x 4 1/4	1/2	2 1/4	2	4.14	10	353.80/c
J6256	81350	5/8 x 6	1/2	3 3/4	2	5.30	10	476.00/c
J7524	80892	3/4 x 2 1/2	5/8	1/2	2	4.07	10	377.00/c
J7542	81360	3/4 x 4 1/4	5/8	1 3/4	2 1/2	3.23	5	582.00/c
J7562	81365	3/4 x 6 1/4	5/8	3 3/4	2 1/2	4.75	5	698.60/c

LARGER DIAMETERS & LENGTHS AVAILABLE BY SPECIAL REQUEST.

OTHER SIZES AND QUANTITIES AVAILABLE BY REQUEST

CONTINUED ON NEXT PAGE

ANCHORING DEVICES



* = acorn nuts

CONTINUED

SLEEVE TYPE ANCHOR

STEEL ZINC CHROMATE

STOCK NO.	UPC NO.	DIAMETER LENGTH	BOLT DIAMETER	FASTENS MATERIAL UP TO	DEPTH IN LENGTH	WT. PER PKG.	STD. PKG.	SUGGESTED TRADE LIST PRICE PER	
STEEL ZINC CHROMATE - FLAT HEAD									
J2520F	77220	1/4 x 2	3/16	1	1	3.11	100	97.38/c	NEW
J2530F	77225	1/4 x 3	3/16	2	1	4.17	100	101.85/c	NEW
STEEL ZINC CHROMATE - ROUND HEAD									
J2512R	81089	1/4 x 1 1/4	3/16	1/4	1	1.89	100	63.88/c	NEW
J2520R	82620	1/4 x 2	3/16	1	1	2.52	100	64.88/c	NEW
J2526R	82626	1/4 x 2 3/4	3/16	1	1	3.24	100	80.75/c	NEW
STAINLESS STEEL 18-8 TYPE - HEX & ACORN									
J2513SS*	82106	1/4 x 1 3/8	3/16	3/8	1	2.14	100	77.53/c	
J2522SS*	82107	1/4 x 2 1/4	3/16	1 1/4	1	3.30	100	92.58/c	
J3114SS	82108	5/16 x 1 1/2	1/4	1/2	1	4.50	100	102.85/c	
J3124SS	82109	5/16 x 2 1/2	1/4	1 1/2	1	6.30	100	147.48/c	
J3717SS	82111	3/8 x 1 7/8	5/16	5/8	1 1/4	3.62	50	223.86/c	
J3730SS	82112	3/8 x 3	5/16	1 3/4	1 1/4	4.87	50	223.86/c	
J5022SS	82113	1/2 x 2 1/4	3/8	3/4	1 1/2	3.12	25	290.92/c	
J5026SS	82114	1/2 x 3	3/8	1 1/4	1 1/2	3.88	25	467.80/c	
J5030SS	82116	1/2 x 3	3/8	1 1/2	2	4.02	25	360.40/c	
J5040SS	82117	1/2 x 4	3/8	2 1/2	1 1/2	5.50	25	466.72/c	
J6230SS	82118	5/8 x 3	1/2	1/4	2	6.60	25	630.52/c	
J6242SS	82119	5/8 x 4 1/4	1/2	2 1/4	2	4.00	10	829.00/c	
J7524SS	82121	3/4 x 2 1/2	5/8	1/2	2	5.00	10	894.80/c	
J7542SS	82123	3/4 x 4 1/4	5/8	1 3/4	2 1/2	3.50	5	1,263.00/c	
J7554SS	82124	3/4 x 5 1/2	5/8	3 3/4	2 1/2	4.70	5	1,493.60/c	

LARGER DIAMETERS & LENGTHS AVAILABLE BY SPECIAL REQUEST.

OTHER SIZES AND QUANTITIES AVAILABLE BY REQUEST

Sleeve Anchors hold more because:

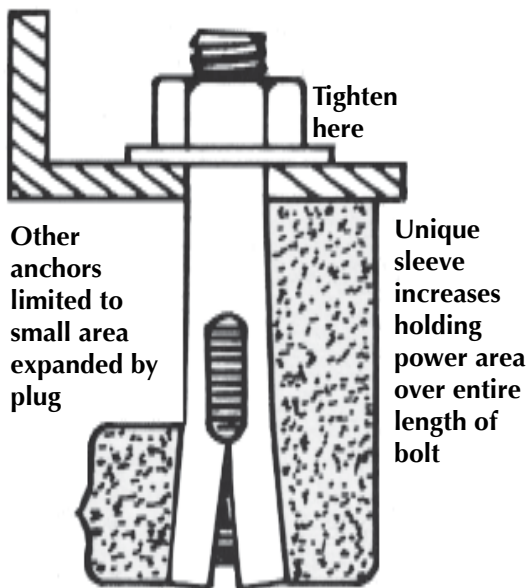

Sleeve anchors do not depend on bottom of hole to expand the anchor

Sleeve anchors work under a true expansion principle, whereby the tightening of the nut forces the expansion of an outer sleeve over a tapered portion of the bolt. The sleeve also becomes a factor in a shear load application providing increased strength in addition to the anchor's bolt.

SELECTING THE PROPER LENGTH SLEEVE ANCHOR

The selection of the proper length of sleeve anchor depends upon the thickness of the material to be fastened and the minimum depth of anchor required in masonry for maximum holding power. Add the thickness of the material (A) and the recommended depth for the anchor

(B) to determine the correct length of anchor to be used. (B) to determine the correct length of anchor to be used.

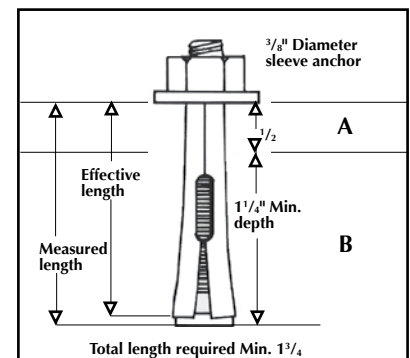

ANCHORING DEVICES



(STUD ANCHOR)

WEDGE ANCHORS

STEEL ZINC CHROMATE AND STAINLESS STEEL

A powerful product when strength is needed, eliminates drilling oversized holes; exact hole depth not required. This spring stainless steel band, when locked, acts like a fish hook that digs into concrete. Then 3 to 4 turns of the nut expands the wedge.

STOCK NO.	UPC NO.	DRILL & BODY DIAMETER/LENGTH	THREAD LENGTH	MIN. DEPTH IN LENGTH	WT. PER PKG.	STD. PKG.	SUGGESTED TRADE LIST PRICE PER
STEEL							
JTS1134	80893	1/4 x 1 3/4	3/4	1 1/8	3.12	100	66.85/c
JTS1214	80894	1/4 x 2 1/4	3/4	1 1/8	3.68	100	75.40/c
JTS103	80895	1/4 x 3 1/4	3/4	1 1/8	4.63	100	85.65/c
JTS3218	80896	3/8 x 2 1/4	7/8	1 1/2	8.05	100	108.98/c
JTS3234	81165	3/8 x 2 3/4	1 1/8	1 1/2	9.30	100	114.80/c
JTS303	80898	3/8 x 3	1 1/8	1 1/2	9.92	100	117.83/c
JTS312	80899	3/8 x 3 3/4	1 1/8	1 1/2	11.70	100	134.40/c
JTS385	81614	3/8 x 5	1 1/8	1 1/2	7.45	50	154.70/c
JTS3612	81615	3/8 x 6 1/2	1 1/4	1 5/8	9.85	50	210.46/c
JTS4234	81166	1/2 x 2 3/4	1 1/4	2 1/4	9.10	50	184.60/c
JTS4334	81770	1/2 x 3 3/4	1 1/4	2 1/4	11.00	50	206.40/c
JTS4414	81622	1/2 x 4 1/4	1 1/4	2 1/4	6.12	25	214.40/c
JTS4512	81623	1/2 x 5 1/2	1 1/4	2 1/4	7.28	25	266.00/c
JTS407	81624	1/2 x 7	1 1/4	2 1/4	9.55	25	323.72/c
JTS5312	81630	5/8 x 3 1/2	2	2 3/4	9.22	25	343.52/c
JTS5412	81631	5/8 x 4 1/2	2	2 3/4	10.48	25	377.40/c
JTS505	81632	5/8 x 5	2	2 3/4	11.60	25	395.20/c
JTS506	81633	5/8 x 6	2	2 3/4	19.00	25	432.52/c
JTS6414	81640	3/4 x 4 1/4	2	3 1/4	12.09	20	516.65/c
JTS6434	81641	3/4 x 4 3/4	2	3 1/4	13.27	20	541.50/c
JTS6512	81642	3/4 x 5 1/2	2	3 1/4	14.75	20	606.75/c
JTS6614	81643	3/4 x 6 1/4	2	3 1/4	8.25	10	672.30/c
STAINLESS STEEL 18-8 TYPE							
JTS1134SS	80900	1/4 x 1 3/4	3/4	1 1/8	1.55	50	164.16/c
JTS1214SS	80901	1/4 x 2 1/4	3/4	1 1/8	1.85	50	188.08/c
JTS103SS	80902	1/4 x 3 1/4	3/4	1 1/8	2.50	50	214.80/c
JTS3218SS	80903	3/8 x 2 1/4	7/8	1 1/2	4.02	50	304.60/c
JTS303SS	80904	3/8 x 3	1 1/8	1 1/2	5.07	50	358.96/c
JTS312SS	80905	3/8 x 3 3/4	1 1/8	1 1/2	5.96	50	517.16/c
JTS385SS	95250	3/8 x 5	1 1/8	1 1/2	7.46	50	523.26/c
JTS3612SS	95255	3/8 x 6 1/2	1 1/4	1 5/8	4.94	25	923.64/c
JTS4234SS	82126	1/2 x 2 3/4	1 1/4	2 1/4	4.11	25	592.52/c
JTS4334SS	82127	1/2 x 3 3/4	1 1/4	2 1/4	5.77	25	686.60/c
JTS4512SS	95260	1/2 x 5 1/2	1 1/4	2 1/4	14.56	50	1,285.66/c
STAINLESS STEEL 316 TYPE							
JTS1034SS	90298	1/4 x 3 1/4	3/4	1 1/8	5.02	100	PLEASE CALL
JTS3033SS	90305	3/8 x 3	1 1/8	1 1/2	5.08	50	

LARGER DIAMETERS & LENGTHS AVAILABLE BY SPECIAL REQUEST.

OTHER SIZES AND QUANTITIES AVAILABLE BY REQUEST



Metallics Avanti Screw Manufacturing Facility in Bristol, CT



None of our competitors selling to the Electrical, Plumbing and HVAC Distribution trade can claim they manufacture screws.

There is no doubt: We know the American fastener market and are ahead of our competitors. Our Avanti Screw, Inc., fastener manufacturing facility in Bristol, CT, provides you an American fastener company who makes a portion of its product, sold through electrical, plumbing and HVAC distributors.

ANCHORING DEVICES



TIE WIRE WEDGE ANCHOR

ZINC WITH STAINLESS STEEL CLIP
For various overhead suspension applications

STOCK NO.	UPC NO.	DIAMETER/LENGTH	MIN. LENGTH IN DEPTH	WT. PER PKG.	STD. PKG.	SUGGESTED TRADE LIST PRICE PER
JTWA214	80906	1/4 x 2 ³ / ₁₆	1 ³ / ₈	3.45	100	108.60/c

OTHER SIZES AND QUANTITIES AVAILABLE BY REQUEST

HAMMER DRIVE WEDGE ANCHOR

ZINC AND STAINLESS STEEL
A superior alternative
to traditional wedge anchors



- Installs six times faster than an ordinary wedge-type anchor.
- Easily installs through pre-drilled holes in plates and footings – no need for templates.
- No special tools required.
- Tensions during setting process.
- Deforms the concrete to set, eliminating creep and loss of pre-load.
- Faster, easier and more consistent installation.

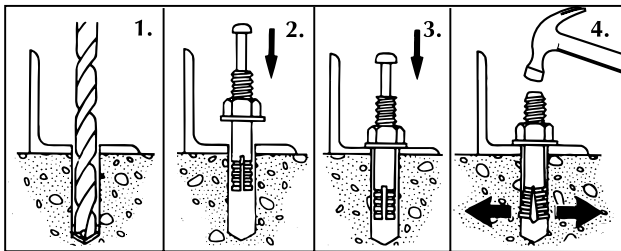

INSTALLATION:

1. Drill hole.
2. Preset nut and washer for desired embedment.
3. Hammer center pin until it is aligned with top of the bolt.
4. Anchor is set.

Safety glasses should be worn for any driving applications. See our line of Safety Glasses, pages 301, 302 and 303

STOCK NO.	UPC NO.	SIZE	THREAD LENGTH	MASONRY DRILL SIZE	WT. PER PKG.	STD. PKG.	SUGGESTED TRADE LIST PRICE PER
ZINC CHROMATE							
JHW14134	80907	1/4 x 1 ³ / ₄	5/8	1/4 x 4	1.72	50	112.46/c
JHW14238	80908	1/4 x 2 ³ / ₈	3/4	1/4 x 4	2.05	50	119.20/c
JHW5162	80909	5/16 x 2	3/4	5/16 x 4	2.70	50	146.00/c
JHW516234	80910	5/16 x 2 ³ / ₄	1	5/16 x 4	3.04	50	169.60/c
JHW38238	80911	3/8 x 2 ³ / ₈	1	3/8 x 4	4.35	50	184.60/c
JHW38312	80912	3/8 x 3 ¹ / ₂	1 ¹ / ₈	3/8 x 6	6.05	50	256.80/c
JHW38434	82630	3/8 x 4 ³ / ₄	1 ¹ / ₈	3/8 x 6	7.03	50	372.66/c
JHW12234	82635	1/2 x 2 ³ / ₄	1/2	1/2 x 4	4.80	25	305.20/c
JHW12312	82640	1/2 x 3 ¹ / ₂	1/2	1/2 x 6	5.92	25	320.92/c
JHW12434	82645	1/2 x 4 ³ / ₄	2	1/2 x 6	7.25	25	470.00/c
JHW126	82650	1/2 x 6	2	1/2 x 12	9.07	25	703.60/c
JHW584	82655	5/8 x 4	1 ⁵ / ₈	5/8 x 6	10.76	25	488.52/c
JHW58434	82660	5/8 x 4 ³ / ₄	1 ⁵ / ₈	5/8 x 6	12.22	25	676.52/c
JHW586	82665	5/8 x 6	2	5/8 x 12	6.03	10	834.50/c
JHW345	82670	3/4 x 5	2	3/4 x 12	7.36	10	904.80/c
JHW346	82675	3/4 x 6	2	3/4 x 12	8.39	10	1,326.00/c
JHW34712	82680	3/4 x 7 ¹ / ₂	2	3/4 x 12	9.21	10	1,587.80/c

LARGER DIAMETERS & LENGTHS AVAILABLE BY SPECIAL REQUEST.

OTHER SIZES AND QUANTITIES AVAILABLE BY REQUEST

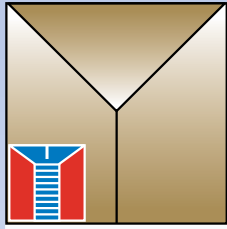

Metallics



WallClaw Anchors Hammer-In Drywall Anchors

**[CONTRACTOR
APPROVED]**

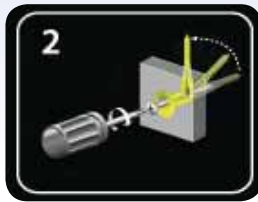
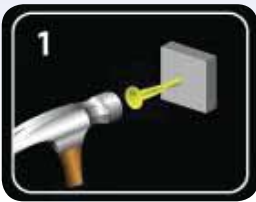

INSTALLATION

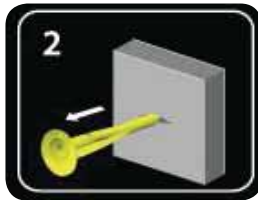
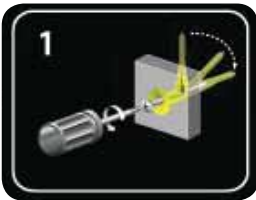

REMOVAL

- No drilling required.
- Installs in seconds.
- Industrial strength.
- Works in 1/2" and 5/8".
- Easy to remove.
- Leaves only small slit.



Phillips

PART #	UPC #	DESCRIPTION	QTY / PKG	SUG. TRADE LIST / PKG
MWCA25	83721	WallClaw Drywall Hammer-In Anchor with Screws	25	\$ 19.23
MWCA50	83723	WallClaw Drywall Hammer-In Anchor with Screws	50	\$ 23.75
MWCA100	83727	WallClaw Drywall Hammer-In Anchor with Screws	100	\$ 33.75

Other sizes, materials and quantities available by request.

"Growth Through Innovation"

Metallics

229 Cross Street, Bristol, CT 06010
Tel 800-243-8272 • **Fax** 800-831-9358
Email sales@metallicsonline.com

Metallics West

651 North Main Street, Mancos, CO 81328
Tel 800-269-5183 • **Fax** 800-269-6278
Email saleswest@metallicsonline.com

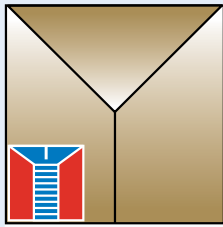

Metallics STRONG-BOLT™ Wedge Anchors

Carbon Steel Wedge Anchors for Cracked and Uncracked Concrete

NEW!

Tested to Meet 2006 IBC

INSTALLATION STEPS

1. Drill hole with carbide tipped masonry drill in base material the same size as the nominal diameter of the anchor.
2. Drill hole to proper embedment depth and blow clean.
3. Assemble anchor with nut and washer flush with top of anchor.
4. Place the anchor in fixture and drive into the hole until washer and nut are tight against fixture.
5. Tighten to the required installation torque.

DO NOT USE AN IMPACT WRENCH TO SET OR TIGHTEN.

Features:

- Tri-Segmented clip is able to adjust independently increasing follow-up expansion should the hole increase in size as a result of a crack.
- 316 stainless clip with superior corrosion resistance.
- Head is stamped with Simpson Strong-Tie® "±" sign and size ID.
- Carbon-steel zinc plated stud with 316 stainless-steel clip.

Codes:

ICC-ES ESR-1771; City of L.A. RR25705; Florida FL 11506.6

Test Criteria:

Strong-Bolt™ Wedge anchor has been tested in accordance with ICC-ES's *Acceptance Criteria for Mechanical Anchors in Concrete Elements (AC193) and ACI 355.2 for the following in cracked and uncracked concrete:*

- Static tension and shear loading in cracked and uncracked concrete
- Seismic and wind loading in cracked and uncracked concrete
- Performance in cracked concrete
- Performance in lightweight concrete over metal deck

Selection Guide

Part Number	Thread Length	Anchor Diameter & Drill Bit Size (Threads Per Inch)	Overall Length
SWA3830	1 1/4"	3/8" - 16	3"
SWA3836	2 3/8"	3/8" - 16	3 3/4"
SWA3850	3 3/8"	3/8" - 16	5"
SWA1236	2 1/8"	1/2" - 13	3 3/4"
SWA1244	2 7/8"	1/2" - 13	4 1/4"
SWA1254	3 7/8"	1/2" - 13	5 1/2"
SWA1270	5 3/8"	1/2" - 13	7"
SWA5850	3 3/16"	5/8" - 11	5"
SWA5860	4 3/16"	5/8" - 11	6"
SWA5870	5 3/16"	5/8" - 11	7"
SWA5884	5 3/4"	5/8" - 11	8 1/2"



PART #	UPC #	DESCRIPTION	QTY / PKG	SUG. TRADE LIST / PKG
SWA3830	14978	3/8 x 3" Strong-Bolt Wedge Anchor	50	\$125.45
SWA3836	14981	3/8 x 3-3/4" Strong-Bolt Wedge Anchor	50	\$158.63
SWA3850	14986	3/8 x 5" Strong-Bolt Wedge Anchor	50	\$183.25
SWA1236	15451	1/2 x 3-3/4" Strong-Bolt Wedge Anchor	25	\$111.55
SWA1244	15454	1/2 x 4-1/4" Strong-Bolt Wedge Anchor	25	\$115.33
SWA1254	15458	1/2 x 5-1/2" Strong-Bolt Wedge Anchor	25	\$126.58
SWA1270	15463	1/2 x 7" Strong-Bolt Wedge Anchor	25	\$140.58
SWA5850	16236	5/8 x 5" Strong-Bolt Wedge Anchor	10	\$73.75
SWA5860	16239	5/8 x 6" Strong-Bolt Wedge Anchor	10	\$81.68
SWA5870	16243	5/8 x 7" Strong-Bolt Wedge Anchor	10	\$87.20
SWA5884	16247	5/8 x 8-1/2" Strong-Bolt Wedge Anchor	10	\$96.63

Metallics

229 Cross Street,
Bristol, Ct. 06010
Tel: 800-243-8272
Fax: 800-831-9358
Email: sales@metallicsonline.com

"Growth Through Innovation"

Metallics West

651 North Main Street
Maancos, Co. 81328
Tel: 800-269-5183
Fax: 800-269-6278
Email: saleswest@metallicsonline.com

ANCHORING DEVICES

HAND DRIVE PINS

STEEL ZINC PLATED

An economical way of attaching wood and metal to masonry and block construction.

SAFETY GLASSES SHOULD BE WORN FOR ANY DRIVING APPLICATIONS. SEE PAGES 301, 302 AND 303



STOCK NO.	UPC NO.	HEAD SIZE	LENGTH	WT. PER PKG.	STD. PKG. MSTR/SLEEVE	SUGGESTED TRADE LIST PRICE PER
JDP1	80916	1/4	1/2	.46	100/500	12.33/c
JDP2	80917	1/4	3/4	.60	100/500	13.15/c
JDP3	80918	1/4	1	.72	100/500	13.93/c
JDP4	80919	1/4	1 1/4	.80	100/500	15.93/c
JDP5	80920	1/4	1 1/2	.87	100/500	16.13/c
JDP6	80921	1/4	2	1.18	100/500	21.13/c
JDP7	80922	1/4	2 1/2	1.28	100/500	22.83/c
JDP8	81595	1/4	3	1.32	100/500	31.18/c NEW

OTHER SIZES AND QUANTITIES AVAILABLE BY REQUEST



HAND DRIVE TOOL

FOR HAND DRIVE PINS — DP1 thru 8

SAFETY GLASSES SHOULD BE WORN FOR ANY DRIVING APPLICATIONS. SEE PAGES 301, 302 AND 303

STOCK NO.	UPC NO.	DESCRIPTION	WT. PER PKG.	STD. PKG.	SUGGESTED TRADE LIST PRICE PER
HDT2	18720	Hand Drive Tool	.51	1	96.70/ea

OTHER SIZES AND QUANTITIES AVAILABLE BY REQUEST

The Metallics Alternative to Hand Drive Pins
THE MOST ECONOMICAL ANCHORING DEVICE

HEAT TEMPERED FLUTED MASONRY NAILS

STEEL

For greater bearing surface use with sae or fender washer.
We recommend for attaching wire screening over Styrofoam and block before stucco.



STOCK NO.	UPC NO.	SIZE	WT. PER PKG.	APPROX COUNT	STD. PKG.	SUGGESTED TRADE LIST PRICE PER
MN1TM	21242	1"	2.60	435	1 Jar	10.35/ea pkg
MN112TM	21243	1-1/2"	2.55	225	1 Jar	10.35/ea pkg
MN2TM	21244	2"	2.64	180	1 Jar	10.45/ea pkg
MN212TM	21245	2-1/2"	2.63	190	1 Jar	10.48/ea pkg
MN3TM	21246	3"	2.62	135	1 Jar	10.93/ea pkg

OTHER SIZES AND QUANTITIES AVAILABLE BY REQUEST

ANCHORING DEVICES

CONTRACTOR/DISTRIBUTOR SPECIAL REQUEST

FLUTED MASONRY NAIL AND FENDER WASHER KITS IN A JAR

100 EACH MASONRY NAILS
100 EACH FENDER WASHERS
CONVENIENCE TO GO!!



STOCK NO.	UPC NO.	NAIL SIZE	WASHER SIZE	WT. PER JAR	STD. PKG.	SUGGESTED TRADE LIST PRICE PER
MNK1	81660	1	3/16 x 1	1.91	1	13.90/ea pkg
MNK112	81662	1 1/2	3/16 x 1	2.15	1	13.90/ea pkg
MNK2	81664	2	3/16 x 1	2.31	1	14.50/ea pkg
MNK212	81666	2 1/2	3/16 x 1	2.54	1	14.50/ea pkg
MNK3	81668	3	3/16 x 1	2.74	1	14.93/ea pkg

OTHER SIZES AND QUANTITIES AVAILABLE BY REQUEST



FLUTED MASONRY NAIL AND WASHER ASSORTMENT KIT

STOCK NO.	UPC NO.	DESCRIPTION OF CONTENTS	STD. PKG. MSTR. CARTON	WT. EACH KIT	SUGGESTED TRADE LIST PRICE PER
MNK10 175 PIECES	21275	70 3/16 x 1 fender washers 25 x 1", 25 x 1 1/2", 20 x 2", 20 x 2 1/2", 15 x 3 masonry nails	1/25	2.35	21.73/ea kit

OTHER SIZES AND QUANTITIES AVAILABLE BY REQUEST



METAL HAMMER DRIVE NAIL-IN ANCHOR

FOR LIGHT-DUTY APPLICATION

STOCK NO.	UPC NO.	DIAMETER/ LENGTH	HOLE SIZE	WT. PER JAR	STD. PKG./ MSTR. SLEEVE	SUGGESTED TRADE LIST PRICE PER
JNA316	80923	3/16 x 7/8	3/16	.91	100/500	27.83/c
JNA140	80924	1/4 x 3/4	1/4	1.59	100/500	32.18/c
JNA141	80925	1/4 x 1	1/4	1.87	100/500	32.83/c
JNA1414	80926	1/4 x 1 1/4	1/4	2.25	100	36.23/c
JNA1415	80927	1/4 x 1 1/2	1/4	2.49	100	40.43/c
JNA142	80928	1/4 x 2	1/4	2.98	100	52.53/c

STAINLESS STEEL 18-8 TYPE

JNA141SS	90387	1/4 x 1	1/4	1.86	100	PLEASE CALL	NEW
JNA1414SS	81987	1/4 x 1 1/4	1/4	2.23	100		NEW
JNA142SS	91381	1/4 x 2	1/4	3.33	100		NEW

OTHER SIZES AND QUANTITIES AVAILABLE BY REQUEST



HAND DRILLING HAMMER 3-LB. - WOODEN HANDLE

SAFETY GLASSES SHOULD BE WORN FOR ANY DRIVING APPLICATIONS. SEE PAGES 301, 302 AND 303

STOCK NO.	UPC NO.	HEAD WEIGHT	STD. PKG.	SUGGESTED TRADE LIST PRICE PER
HAM3	18700	3.53	1	40.38/ea

OTHER SIZES AND QUANTITIES AVAILABLE BY REQUEST

ASSORTED PLASTIC ANCHORS

"Big Red" Conical Plastic Anchor



STOCK NO.	UPC NO.	COLOR LENGTH	SCREW SIZE	HOLE SIZE	WT. PER PKG.	STD. PKG. MSTR. SLEEVE	SUGGESTED TRADE LIST PRICE PER
JRA1	80929	Red 3/4	6-8	3/16	.10	100/500	3.38/c
JRA15	80930	Red 7/8	8-10	3/16	.10	100/500	3.50/c
JRA2	80931	Red 1	10-12	1/4	.18	100/500	4.03/c
JRA3	80932	Red 1 1/2	12-14	5/16	.31	100/500	7.60/c

OTHER SIZES AND QUANTITIES AVAILABLE BY REQUEST

"Denver Blue" Conical Plastic Anchor



JBA1	80933	Blue 3/4	6-8	3/16	.10	100/500	3.38/c
JBA15	80934	Blue 7/8	8-10	3/16	.09	100/500	3.50/c
JBA2	80935	Blue 1	10-12	1/4	.17	100/500	4.03/c
JBA3	80936	Blue 1 1/2	12-14	5/16	.28	100/500	7.60/c

OTHER SIZES AND QUANTITIES AVAILABLE BY REQUEST

"Super Yellow" Plastic Wall Anchor



JSYA316	80940	Yellow 1	6-8	3/16	.13	100/500	3.50/c
JSYA14	80941	Yellow 1 1/4	8-10	1/4	.18	100/500	4.03/c
JSYA516	80942	Yellow 1 5/8	12-14	5/16	.27	100/500	8.08/c

OTHER SIZES AND QUANTITIES AVAILABLE BY REQUEST

"Gray Ribbed" Plastic Anchor



JGA1	80953	Gray 7/8	6-8	3/16	.13	100/500	3.58/c
JGA2	80954	Gray 1	10-12	1/4	.18	100/500	4.03/c
JGA3	80955	Gray 1 1/4	14-16	5/16	.24	100/500	8.08/c

OTHER SIZES AND QUANTITIES AVAILABLE BY REQUEST

"Collarless Vinyl" Wall Anchor



J1106	80945	Green 1	10-12	1/4	.25	100/500	4.20/c
J1107	80946	Green 1 1/4	10-12	1/4	.27	100/500	7.73/c
J1108	80947	Green 1 1/2	10-12	1/4	.35	100/500	11.80/c
J1110	80948	Blue 1	14	5/16	.31	100/500	5.88/c
J1111	80949	Blue 1 1/2	14	5/16	.41	100/500	7.53/c
J1114	80950	Orange 1 1/2	5/16	3/8	.39	50/250	9.70/c
J1115	80951	Orange 2	5/16	3/8	.46	50	12.20/c
J1116	80952	Orange 2 1/2	5/16	3/8	.67	50	13.86/c

OTHER SIZES AND QUANTITIES AVAILABLE BY REQUEST

"Expandet Nylon" Anchor



JELR2	80943	Red 1 1/2	8	1/4	.26	100/500	15.25/c
JELR3	80944	Blue 1 3/4	12	5/16	.48	100/500	25.85/c

OTHER SIZES AND QUANTITIES AVAILABLE BY REQUEST

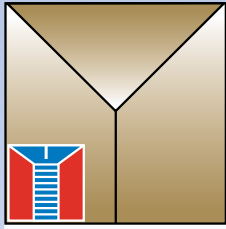

Metallics

4 Ultimate Anchor Kits



[CONTRACTOR APPROVED]

Choose the right kit that's right for you! The right anchors for any job. Same price regardless of the kit you choose.



UAK1



UAK2

PART #	UPC #	DESCRIPTION	SUG. TRADE LIST / PKG
UAK1	33241	40 pcs 1/4" Plastic Red Anchor, 40 pcs #10 x 1 Panhead tapping screw, (1) 1/4" x 4" Masonry Drill Bit, 30 pcs Plastic Self-Drilling Wall Anchor, 30 pcs #8 x 1-1/4" Panhead tapping screw, 30 pcs Zinc Alloy Self-Drilling Wall Anchor, 30 pcs #8 x 1-1/4" Panhead tapping screw, 40 pcs 1/4" Plastic Blue Anchor, 40 pcs #10 x 1 Panhead tapping screw, 40 pcs 1/4" x 1-1/4" Blue Concrete Screw Anchors - Hex, (1) 5/32" x 3-1/2" Drill Bit, 20 pcs Spring Wing Toggle, 20 pcs 3/16" x 3" MH Screws	\$ 49.75
UAK2	33242	40 pcs 1/4" Plastic Red Anchor, 40 pcs #10 x 1 Panhead tapping screw, (1) 1/4" x 4" Masonry Drill Bit, 30 pcs Plastic Self-Drilling Wall Anchor, 30 pcs #8 x 1-1/4" Panhead tapping screw, 30 pcs Zinc Alloy Self-Drilling Wall Anchor, 30 pcs #8 x 1-1/4" Panhead tapping screw, 40 pcs 1/4" Plastic Yellow Anchor, 40 pcs #10 x 1 Panhead tapping screw, 40 pcs 1/4" x 1-1/4" Blue Concrete Screw Anchors - Hex, (1) 5/32" x 3-1/2" Drill Bit, 20 pcs Spring Wing Toggle, 20 pcs 3/16" x 3" MH Screws	

Other sizes, materials and quantities available by request.

Chart continued to next page.

"Growth Through Innovation"

Metallics

229 Cross Street, Bristol, CT 06010
Tel 800-243-8272 • **Fax** 800-831-9358
Email sales@metallicsonline.com

Metallics West

651 North Main Street, Mancos, CO 81328
Tel 800-269-5183 • **Fax** 800-269-6278
Email saleswest@metallicsonline.com

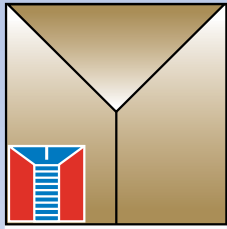

Metallics

4 Ultimate Anchor Kits



UAK3



UAK4

Chart continued from previous page.

PART #	UPC #	DESCRIPTION	SUG. TRADE LIST / PKG
UAK3	33243	40 pcs 1/4" Plastic Red Anchor, 40 pcs #10 x 1 Panhead tapping screw, (1) 1/4" x 4" Masonary Drill Bit, 30 pcs Plastic Self-Drilling Wall Anchor, 30 pcs #8 x 1-1/4" Panhead tapping screw, 30 pcs Zinc Alloy Self-Drilling Wall Anchor, 30 pcs #8 x 1-1/4" Panhead tapping screw, 40 pcs 1/4" Plastic Yellow Anchor, 40 pcs #10 x 1 Panhead tapping screw, 40 pcs 1/4" x 1-1/4" Quadrine Concrete Silver Screw Anchor, (1) 5/32" x 3-1/2" Drill Bit, 20 pcs Spring Wing Toggle, 20 pcs 3/16" x 3" MH Screws	\$ 49.75
UAK4	33244	40 pcs 1/4" Plastic Red Anchor, 40 pcs #10 x 1 Panhead tapping screw, (1) 1/4" x 4" Masonary Drill Bit, 30 pcs Plastic Self-Drilling Wall Anchor, 30 pcs #8 x 1-1/4" Panhead tapping screw, 30 pcs Zinc Alloy Self-Drilling Wall Anchor, 30 pcs #8 x 1-1/4" Panhead tapping screw, 40 pcs 1/4" Plastic Blue Anchor, 40 pcs #10 x 1 Panhead tapping screw, 40 pcs 1/4" x 1-1/4" Quadrine Concrete Silver Screw Anchor, (1) 5/32" x 3-1/2" Drill Bit, 30 pcs 1/4" x 1" Metal Hammer Drive Nail in Anchor	

Other sizes, materials and quantities available by request.

"Growth Through Innovation"

Metallics

229 Cross Street, Bristol, CT 06010
Tel 800-243-8272 • **Fax** 800-831-9358
Email sales@metallicsonline.com

Metallics West

651 North Main Street, Mancos, CO 81328
Tel 800-269-5183 • **Fax** 800-269-6278
Email saleswest@metallicsonline.com

ANCHORING DEVICES



TOGGLER ALLIGATOR® SOLID WALL ANCHORS

Alligator solid-wall anchors are designed to support heavy loads.
(even under vibration)

Alligator solid-wall anchors can be used in almost any material, including:
Concrete, Wood, Plaster, Aerated Concrete, Brick, Masonry, Stone,
Flakeboard, Cinder Block, Ceramic Tile, Stucco, Drywall.

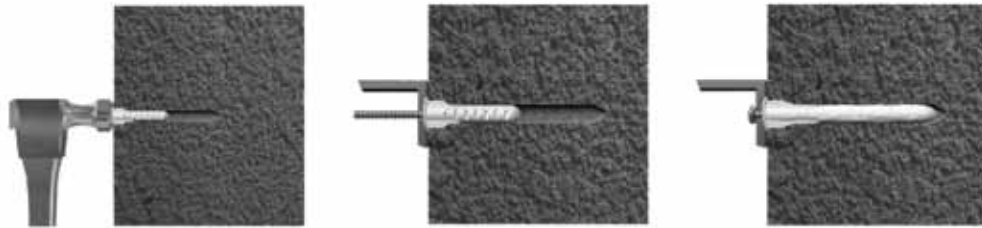

STOCK NO.	UPC NO.	DESCRIPTION	QTY. PER PKG,	SUGGESTED TRADE LIST PRICE PER
MAF5	73905	Toggler 3/16" Alligator anchor with flange	50 Anchors	15.88
MAF6	73906	Toggler 1/4" Alligator anchor with flange	50 Anchors	22.55
MAF8	73908	Toggler 5/16" Alligator anchor with flange	50 Anchors	30.08
MA6	73936	Toggler 1/4" Alligator anchor no flange	50 Anchors	22.55

OTHER SIZES AND QUANTITIES AVAILABLE BY REQUEST



TOGGLER HOLLOW WALL ANCHORS

All Toggler hollow-wall anchors install in a small 5/16" (8mm) diameter hole. With reasonable care you can even use your screwdriver to make the hole in drywall.

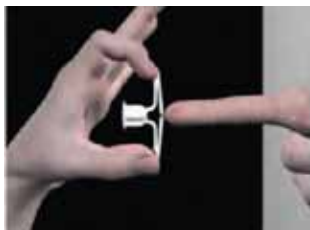

Drywall 5/16" (8mm) hole. Fold anchor in middle.



Insert anchor in hole and tap flush with wall.



Insert key to pop anchor open behind hollow wall (not necessary for thick or solid walls). Do not force or hammer key.

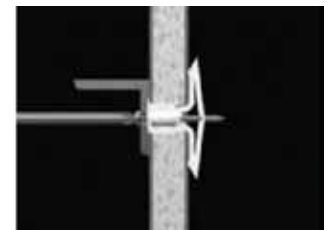

Place item over anchor and tighten until screw is flush with fixture. Then, stop.

STOCK NO.	UPC NO.	DESCRIPTION	QTY. PER PKG,	SUGGESTED TRADE LIST PRICE PER
MTB	73962	Toggler 3/8"-1/2" hollow wall anchor	50 Anchors	21.88
MTC	73963	Toggler 3/8"-3/4" hollow wall anchor	50 Anchors	25.30

OTHER SIZES AND QUANTITIES AVAILABLE BY REQUEST

TOGGLER® IS A REGISTERED TRADEMARK

NYLON DRIVE-IN ANCHORS



STOCK NO.	UPC NO.	COLOR/ LENGTH	HOLE SIZE	WT. PER PKG.	STD. PKG./ MSTR. SLEEVE	SUGGESTED TRADE LIST PRICE PER
ROUND HEAD						
J3161R	80956	White 1	3/16	.53	100/500	19.65/c
J141R	80957	White 1	1/4	.60	100/500	25.28/c
J1415R	80958	White 1 1/2	1/4	.89	100	26.75/c
J142R	80959	White 2	1/4	1.09	100	32.83/c
FLAT HEAD						
J3161F	80960	White 1	3/16	.50	100/500	19.65/c
J1434F	80961	White 3/4	1/4	.41	100/500	24.45/c
J141F	80962	White 1	1/4	.62	100/500	25.28/c
J1415F	80963	White 1 1/2	1/4	.87	100	26.75/c
J142F	80964	White 2	1/4	1.09	100	32.83/c
TRUSS - MUSHROOM HEAD						
J3161T	80965	White 1	3/16	.55	100/500	19.65/c
J1434T	80966	White 3/4	1/4	.50	100/500	24.45/c
J141T	80967	White 1	1/4	.63	100/500	25.28/c
J1415T	80968	White 1 1/2	1/4	.87	100	26.75/c
J142T	80969	White 2	1/4	1.21	100	32.83/c

OTHER SIZES AND QUANTITIES AVAILABLE BY REQUEST



PLASTIC TOGGLE

FOR LIGHT-DUTY APPLICATION

Stays in place if screw is removed. Ideal product for sheetrock.

STOCK NO.	UPC NO.	SIZE & WALL DIA.	DRILL PER PKG.	SCREW PKG.	WT. PER PKG.	STD. PKG./ MSTR. SLEEVE	SUGGESTED TRADE LIST PRICE PER
JCPT1	80970	3/8	5/16	#8	.55	100	23.45/c
JCPT2	80971	1/2	5/16	#8	.57	100	26.23/c
JCPT3	80972	5/8	5/16	#8	.59	100	27.15/c

ORDER SCREWS SEPARATELY - #8 DIAMETER - SEE SECTION A - SCREWS

OTHER SIZES AND QUANTITIES AVAILABLE BY REQUEST

PLASTIC TOGGLE ANCHOR KITS

FOR LIGHT-DUTY APPLICATION

Plastic Toggles and matching • Pan Head "Combo" Sheet Metal Screws



STOCK NO.	UPC NO.	SIZE/WALL THICKNESS	DRILL SIZE	DESCRIPTION OF CONTENTS	WT. EACH KIT	STD. PKG.	SUGGESTED TRADE LIST PRICE PER
PTK1	20480	3/8	5/16	50 3/8 Plastic Toggles 50 8 x 1 1/2 Pan Combo Screws	.67	1 Kit	13.93/ea kit
PTK2	20485	1/2	5/16	50 1/2 Plastic Toggles 50 8 x 1 1/2 Pan Combo Screws	.67	1 Kit	15.48/ea kit
PTK3	20490	5/8	5/16	50 5/8 Plastic Toggles 50 8 x 1 1/2 Pan Combo Screws	.65	1 Kit	15.93/ea kit

OTHER SIZES AND QUANTITIES AVAILABLE BY REQUEST

ATTENTION

ON LARGE ORDERS OF ANCHOR KITS — OUR PRICE CAN BE EVEN LOWER!

Please Call Us
for
Co-Labeling
on Kits!

E



JAR DISPLAY CENTER
Holds 18 Jars

**QUANTITY
DISCOUNTS:**

10% DISCOUNT ON
50-99 LIKE KITS

OR

15% DISCOUNT ON
100+ LIKE KITS





ARROW ANCHOR KIT

For Hollow Wall Use AAK68 Kit

Easy Installation And Removal
Leaves Only A Small Slit Not A Large Hole
For Use In Sheetrock Or Wallboard
Use With #6 Or #8 X 1" Sheetmetal Screw

AAK68 Kit Contains

STOCK NO.	UPC NO.	DESCRIPTION OF CONTENTS	WT. EACH KIT	SUGGESTED TRADE LIST PRICE PER
AAK68	18649	75 Hollow Wall Anchor 75 Phillips Combo T/S 1 #2x2" Phillips Pwr Bit	1.06lb	34.28/ea kit



OTHER SIZES AND QUANTITIES AVAILABLE BY REQUEST

JAA68 Anchors Only

STOCK NO.	UPC NO.	SIZE	DESCRIPTION OF CONTENTS	WT. EACH KIT	SUGGESTED TRADE LIST PRICE PER
JAA68	18643	1/8 X 1/2 X 1-7/16	Hollow Wall Anchors	.77	37.43/c

OTHER SIZES AND QUANTITIES AVAILABLE BY REQUEST



ASSORTED PLASTIC ANCHOR KIT WAKTRIO

Three Of The Most Popular Style Anchors
Screws Included
All In An E-Z To Store Plastic Case



WAKTRIO Kit Contains

STOCK NO.	UPC NO.	DESCRIPTION OF CONTENTS	WT. EACH KIT	SUGGESTED TRADE LIST PRICE PER
WAKTRIO	38990	25 - 6x1 Pan Combo Screw 25 - 3/16 Red Plastic Anchors 25 - 10x1 Pan Combo Screw 25 - 1/4 Yellow Super Anchors 25 - 10x1 Pan Combo Screw 25 - 1/4 Red Plastic Anchors	.64	8.63/ea kit

OTHER SIZES AND QUANTITIES AVAILABLE BY REQUEST



"BIG RED" CONICAL PLASTIC WALL ANCHOR KITS

FOR LIGHT-DUTY APPLICATION

NOW WITH QUADRIVE OPTION!



MASTER CARTONS CONTAIN:
25 KITS
18 JARS

STOCK NO.	UPC NO.	SIZE	DESCRIPTION OF CONTENTS	WT. EACH	SUGGESTED TRADE LIST PRICE PER
WAK13	20200/kit	3/16	100 - 3/16 Red Plastic Anchors	.55	13.25/ea kit
WAKJ13	20570/jar		100 - 6 x 1 Pan Combo Screws 1 - 3/16 Masonry Drill	.49	
WAK16	20280/kit	3/16	100 - 3/16 Red Plastic Anchors	.73	13.25/ea kit
WAKJ16	20281/jar		100 - 8 x 1 Pan Combo Screws 1 - 3/16 Masonry Drill	.68	
WAK16T	20284/kit	3/16	100 - 3/16 Red Plastic Anchors	.65	13.25/ea kit
WAKJ16T	20285/jar		100 - 8 x 1 Pan Tri-Drive 1 - 3/16 Masonry Drill	.59	
WAK16H	20288/kit	3/16	100 - 3/16 Red Plastic Anchors	.75	16.80/ea kit
WAKJ16H	20289/jar		100 - 8 x 1 Hex Slotted Screws 1/4 Head 1 - 1/4 Hex Drive 1 - 3/16 Masonry Drill	.75	

MADE IN USA
Anchors & Screws
ONLY METALLICS/Avanti Screw

OTHER SIZES AND QUANTITIES AVAILABLE BY REQUEST

CONTINUED ON NEXT PAGE

ANCHORING DEVICES



CONTINUED
"BIG RED"
**CONICAL PLASTIC
 WALL ANCHOR KITS**

FOR LIGHT-DUTY APPLICATION



**MASTER
 CARTONS
 CONTAIN:
 25 KITS
 18 JARS**

STOCK NO.	UPC NO.	SIZE	DESCRIPTION OF CONTENTS	WT. EACH	SUGGESTED TRADE LIST PRICE PER
WAK16R	20292/kit	3/16	100 - 3/16 Red Plastic Anchors	.76	13.25/ea kit
WAKJ16R	20293/jar		100 - 8 x 1 Pan Square Drive Screws 1 - 3/16 Masonry Drill	.76	
WAK14	20205/kit	1/4	100 - 1/4 Red Plastic Anchors	.95	13.25/ea kit
	20575/jar		100 - 10 x 1 Pan Combo Screws 1 - 1/4 Masonry Drill	.93	
WAK14T	20446/kit	1/4	100 - 1/4 Red Plastic Anchors	1.00	13.25/ea kit
WAKJ14T	20447/jar		100 - 10 x 1 Pan Tri-Drive 1 - 1/4 Masonry Drill, 1 - 000R2B Bit	.93	MADE IN USA Anchors & Screws ONLY METALLICS/Avanti Screw
WAK14H	20207/kit	1/4	100 - 1/4 Red Plastic Anchors	1.00	15.10/ea kit
WAKJ14H	20580/jar		100 - 10 x 1 with 5/16 Hex Slotted Screws 1 - 1/4 Masonry Drill	.93	
WAK14Q	20206/kit	1/4	100 - 1/4 Red Plastic Anchors	.79	15.10/ea kit
WAKJ14Q	20583/jar		100 - 10 x 1 with 1/4 Hex Slotted Screws 1 - 1/4 Masonry Drill	.83	
WAK14R	20445/kit	1/4	100 - 1/4 Red Plastic Anchors	.95	14.28/ea kit
WAKJ14R	20590/jar		100 - 10 x 1 Pan Combo Screws 1 - 1/4 Masonry Drill	.93	
WAK141	23841/kit	1/4	100 - 1/4 Red Plastic Anchors	1.00	13.25/ea kit
WAKJ141	20584/jar		100 - 10 x 1 1/4 Pan Combo Screws 1 - 1/4 Masonry Drill	1.00	
WAK14SS	99414/kit	1/4	100 - 1/4 Red Plastic Anchors	.96	32.38/ea kit
WAKJ14SS	99420/jar		100 - 10 x 1 Pan Slotted Screws S.S. 1 - 1/4 Masonry Drill	.94	
WAK14HSS	99415/kit	1/4	100 - 1/4 Red Plastic Anchors	.97	34.88/ea kit
WAKJ14HSS	99419/jar		100 - 10 x 1 with 5/16 Hex Slotted Screws S.S. 1 - 1/4 Masonry Drill	.95	
WAK14SSPH	99418/kit	5/16	100 - 1/4 Red Plastic Anchors	.96	32.38/ea kit
WAKJ14SSPH	99417/jar		100 - 10 x 1 with 1/4 Pan Phillips Screws S.S. 1 - 5/16 Masonry Drill	.96	
WAK15	20210/kit	5/16	50 - 5/16 Red Plastic Anchors	.85	14.28/ea kit
WAKJ15	20605/jar		50 - 12 x 1 1/4 Pan Combo Screws 1 - 5/16 Masonry Drill	.80	
WAK15R	20450/kit	5/16	50 - 5/16 Red Plastic Anchors	1.00	14.78/ea kit
WAKJ15R	20615v/jar		50 - 12 x 1 1/4 Pan Square Drive Screws 1 - 5/16 Masonry Drill	.74	
WAK15S	39162/kit	5/16	50 - 5/16 Red Plastic Anchors	.88	11.80/ea kit
WAKJ15S	39163/jar		50 - 12 x 1 1/4 Ind. Hex Slotted Screw 1 - 5/16 Masonry Drill	.81	
WAK16QD	38980/kit	5/16	100 - 3/16 Red Plastic Anchors	.79	13.25/ea kit
WAKJ16QD	38981/jar		100 - 8 x 1 QUADRIVE / 1/4 HWH 1 - 3/16 Masonry Drill	.70	MADE IN USA Anchors & Screws ONLY METALLICS/Avanti Screw
WAK14QD	39160/kit	1/4	100 - 1/4 Red Plastic Anchors	1.07	13.25/ea kit
WAKJ14QD	39161/jar		100 - 10 x 1 QUADRIVE / 5/16 HHS 1 - 1/4 Masonry Drill	1.03	MADE IN USA Anchors & Screws ONLY METALLICS/Avanti Screw
WAK15QD	39164/kit	5/16	100 - 13/16 Red Plastic Anchors	.83	13.25/ea kit
WAKJ15QD	39165/jar		100 - 12 x 1 1/4 QUADRIVE / 5/16 HHS 1 - 5/16 Masonry Drill	.77	MADE IN USA Anchors & Screws ONLY METALLICS/Avanti Screw

OTHER SIZES AND QUANTITIES AVAILABLE BY REQUEST

**METALLICS IS THE LARGEST ANCHOR KIT
 SOURCE IN AMERICA**

ANCHORING DEVICES



“DENVER BLUE” CONICAL PLASTIC WALL ANCHOR KITS

FOR LIGHT-DUTY APPLICATION

NOW WITH QUADRIVE OPTION!

IN SOME AREAS OF THE COUNTRY, TRADESMEN PREFER BLUE TO RED. SAME PRODUCT - DIFFERENT COLOR

MASTER
CARTONS
CONTAIN:
25 KITS
18 JARS

STOCK NO.	UPC NO.	SIZE	DESCRIPTION OF CONTENTS	WT. EACH	SUGGESTED TRADE LIST PRICE PER
WAK13B	20201/kit	3/16	100 - 3/16 Blue Plastic Anchors	.53	13.25/ea kit
WAKJ13B	20571/jar		100 - 6 x 1 Pan Combo Screws 1 - 3/16 Masonry Drill	.54	
WAK14B	20209/kit	1/4	100 - 1/4 Blue Plastic Anchors	.96	13.25/ea kit
WAKJ14B	20576/jar		100 - 10 x 1 Pan Combo Screws 1 - 1/4 Masonry Drill	.92	
WAK14TB	20204/kit	1/4	100 - 1/4 Blue Plastic Anchors	1.01	13.25/ea kit
WAKJ14TB	20577/jar		100 - 10 x 1 Pan Tri-Drive 1 - 1/4 Masonry Drill / 1 - 000R2B Bit	.93	
WAK14HB	20213/kit	1/4	100 - 1/4 Blue Plastic Anchors	1.01	15.10/ea kit
WAKJ14HB	20578/jar		100 - 10 x 1 with 5/16 Hex Slotted Screws 1 - 1/4 Masonry Drill	.93	
WAK14QB	20216/kit	1/4	100 - 1/4 Blue Plastic Anchors	.88	15.10/ea kit
WAKJ14QB	20581/jar		100 - 10 x 1 with 1/4 Hex Slotted Screws 1 - 1/4 Masonry Drill	.80	
WAK14HBSS	20814/kit	1/4	100 - 1/4 Blue Plastic Anchors	1.00	34.88/ea kit
WAKJ14H-BSS	99416/jar		100 - 10 x 1 with 1/4 Hex Slotted Screws S.S. 1 - 1/4 Masonry Drill	1.00	
WAK14RB	20217/kit	1/4	100 - 1/4 Blue Plastic Anchors	1.03	14.28/ea kit
WAKJ14RB	20582/jar		100 - 10 x 1 Pan Square Drive Screws 1 - 1/4 Masonry Drill	.80	
WAK141B	20585/kit	1/4	100 - 1/4 Blue Zinc Anchors	1.00	13.25/ea kit
WAKJ141B	20586/jar		100 - 10 x 1 1/4 Pan Square Drive Screws 1 - 1/4 Masonry Drill	1.00	
WAK15B	20211/kit	5/16	50 - 5/16 Blue Plastic Anchors	.84	14.28/ea kit
WAKJ15B	20606/jar		50 - 12 x 1 1/4 Pan Combo Screws 1 - 5/16 Masonry Drill	.80	
WAK15RB	20212/kit	5/16	50 - 50 - 5/16 Blue Plastic Anchors	1.00	14.78/ea kit
WAKJ15RB	20607/jar		50 - 12 x 1 1/4 Pan Square Drive Screws 1 - 5/16 Masonry Drill	.80	
WAK15SB	20417/kit	5/16	50 - 5/16 Blue Plastic Anchors	.85	11.80/ea kit
WAKJ15SB	39169/jar		50 - 12 x 1 1/4 Hex Slotted Screw 1 - 5/16 Masonry Drill	.85	



ONLY METALLICS/Avanti Screw



OTHER SIZES AND QUANTITIES AVAILABLE BY REQUEST

CONTINUED ON NEXT PAGE



Metallics Avanti Screw Manufacturing Facility in Bristol, CT



None of our competitors selling to the Electrical, Plumbing and HVAC Distribution trade can claim they manufacture screws.

There is no doubt: We know the American fastener market and are ahead of our competitors. Our Avanti Screw, Inc., fastener manufacturing facility in Bristol, CT, provides you an American fastener company who makes a portion of its product, sold through electrical, plumbing and HVAC distributors.

America's Source For Premier and Innovative Fasteners & Anchors

www.metallicsonline.com

ANCHORING DEVICES





CONTINUED

"DENVER BLUE" CONICAL PLASTIC WALL ANCHOR KITS

FOR LIGHT-DUTY APPLICATION

MASTER
CARTONS
CONTAIN:
25 KITS
18 JARS



STOCK NO.	UPC NO.	SIZE	DESCRIPTION OF CONTENTS	WT. EACH	SUGGESTED TRADE LIST PRICE PER
WAK14QDB	39166/kit	3/16	100 - 1/4 Blue Plastic Anchors	1.07	13.25/ea kit
WAKJ14QDB	39167/jar		100 - 10 x 1 QUADRIVE 3/16 Hex Head Screws 1 - 1/4 Masonry Drill	1.03	ONLY METALLICS/Avanti Screw 
WAK15QDB	39170/kit	5/16	50 - 5/16 Blue Plastic Anchors	.83	13.25/ea kit
WAKJ15QDB	39171/jar		50 - 12 x 1 1/4 QUADRIVE 5/16 Hex Head Screws 1 - 5/16 Masonry Drill	.80	ONLY METALLICS/Avanti Screw 



"SUPER YELLOW" PLASTIC WALL ANCHOR KITS

FOR LIGHT-DUTY APPLICATION

MASTER
CARTONS
CONTAIN:
25 KITS
18 JARS

STOCK NO.	UPC NO.	SIZE	DESCRIPTION OF CONTENTS	WT. EACH	SUGGESTED TRADE LIST PRICE PER
WAK18	20255/kit	3/16	100 - 3/16 Super Yellow Anchors	.58	15.93/ea kit
WAKJ18	20645/jar		100 - 6 x 1 Pan Combo Screws 1 - 3/16 Masonry Drill	.52	
WAK18T	20256/kit	3/16	100 - 3/16 Super Yellow Anchors	.75	15.93/ea kit
WAKJ18T	20646/jar		100 - 6 x 1 Pan Tri-Drive 1 - 3/16 Masonry Drill / 1 - 000R2B Bit	.55	
WAK19	20260/kit	1/4	100 - 1/4 Super Yellow Anchors	1.01	17.93/ea kit
WAKJ19	20650/jar		100 - 10 x 1 Pan Combo Screws 1 - 1/4 Masonry Drill	.92	
WAK19T	20261/kit	1/4	100 - 1/4 Super Yellow Anchors	.97	17.93/ea kit
WAKJ19T	20651/jar		100 - 10 x 1 Pan Tri-Drive 1 - 1/4 Masonry Drill 1 - 000R2B Bit	1.01	ONLY METALLICS/Avanti Screw 
WAK19H	21575/kit	1/4	100 - 1/4 Super Yellow Anchors	1.06	17.93/ea kit
WAKJ19H	20655/jar		100 - 10 x 1 with 5/16 Hex Head Screws 1 - 1/4 Masonry Drill	1.06	
WAK19S	20262/kit	1/4	100 - 1/4 Super Yellow Anchors	1.11	18.63/ea kit
WAKJ19S	20670/jar		100 - 10 x 1 1/4 with 5/16 Hex Head Screws 1 - 1/4 Masonry Drill	1.11	
WAK19SS	20263/kit	1/4	100 - 1/4 Super Yellow Anchors	1.11	34.75/ea kit
WAKJ19SS	99470/jar		100 - 10 x 1 1/2 Pan Phillips Screws S.S. 1 - 1/4 Masonry Drill	1.11	
WAK20	20265/kit	5/16	50 - 5/16 Super Yellow Anchors	.86	17.93/ea kit
WAKJ20	20680/jar		50 - 12 x 1 1/4 Pan Combo Screws 1 - 5/16 Masonry Drill	.76	
WAK191S	32192/kit	5/16	100 - 100 - 5/16 Super Yellow Anchors	1.01	18.50/ea kit
WAKJ191S	20673/jar		100 - 12 x 1 1/2 with 5/16 Hex Head Screws 1 - 5/16 Masonry Drill	1.05	
SUPER YELLOW QUADRIVE					
WAK19QD	39176/kit	1/4	100 - 1/4 Plastic Anchors	1.07	17.93/ea kit
WAKJ19QD	39177/jar		100 - 10 x 1 QUADRIVE 5/16 Hex Head Screws 1 - 1/4 Masonry Drill	1.00	ONLY METALLICS/Avanti Screw 



OTHER SIZES AND QUANTITIES AVAILABLE BY REQUEST

ANCHORING DEVICES



EXPANDET LIGHT ROSETT NYLON WALL ANCHOR KITS

FOR LIGHT-DUTY APPLICATION

STOCK NO.	UPC NO.	SIZE	DESCRIPTION OF CONTENTS	WT. EACH	SUGGESTED TRADE LIST PRICE PER
WAK33	20270/kit	1/4	50 - 1/4 Expandet Nylon Anchors	.70	12.93/ea kit
WAKJ33	22229/jar		50 - 8 x 2 Pan Combo Screws 1 - 1/4 Masonry Drill	.66	
WAK33R	20272/kit	1/4	50 - 1/4 Expandet Nylon Anchors	.80	12.93/ea kit
WAKJ33R	20761/jar		50 - 8 x 2 Square Drive Screws 1 - 1/4 Masonry Drill	.65	
WAK34	20271/kit	5/16	25 - 5/16 Expandet Nylon Anchors	.65	12.93/ea kit
WAKJ34	22240/jar		25 - 12 x 2 Pan Combo Screws 1 - 5/16 Masonry Drill	1.00	





OTHER SIZES AND QUANTITIES AVAILABLE BY REQUEST



COLLARLESS VINYL WALL ANCHOR KITS

FOR LIGHT-DUTY APPLICATION
COLOR OF ANCHOR DETERMINED BY SIZE.

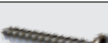
MASTER CARTONS CONTAIN:
25 KITS
18 JARS

STOCK NO.	UPC NO.	SIZE	DESCRIPTION OF CONTENTS	WT. EACH	SUGGESTED TRADE LIST PRICE PER
WAK7	20230/kit	3/16	100 - 3/16 Vinyl Anchors	.75	11.05/ea kit
WAKJ7	20500/jar		100 - 6 x 1 Pan Combo Screws 1 - 3/16 Masonry Drill		
WAK8	20235/kit	1/4	100 - 1/4 Vinyl Anchors	1.01	11.75/ea kit
WAKJ8	20505/jar		100 - 10 x 1 Pan Combo Screws 1 - 1/4 Masonry Drill		
WAK8T	20402/kit	1/4	100 - 1/4 Vinyl Anchors	1.07	11.75/ea kit
WAKJ8T	20640/jar		100 - 10 x 1 Pan Tri-Drive 1 - 1/4 Masonry Drill, 000R2B		MADE IN USA Screws ONLY METALLICS/Avanti Screw 
WAK9	20240/kit	5/16	50 - 5/16 Vinyl Anchors	.86	12.93/ea kit
WAKJ9	20510/jar		50 - 12 x 1 1/4 Pan Combo Screws 1 - 5/16 Masonry Drill		

OTHER SIZES AND QUANTITIES AVAILABLE BY REQUEST

WAK8QD	39180/kit	1/4	100 - 1/4 Vinyl Anchors	1.00	11.75/ea kit
WAKJ8QD	39181/jar		100 - 10 x 1 QUADRIVE 5/16 Hex Head 1 - 1/4 Masonry Drill	1.00	11.75/ea kit

The QuaDrive



Square Drive + Hex + Slotted + Phillips = QuaDrive

America's Newest Drive - Designed, Developed and Manufactured by Metallics/Avanti Screw



ONLY METALLICS

America's newest Drive designed, developed and manufactured by Metallics/Avanti Screw

THE QUADRIVE

ONLY METALLICS/Avanti Screw

ANCHORING DEVICES



GRAY CONICAL PLASTIC WALL ANCHOR KITS

FOR LIGHT-DUTY APPLICATION

MASTER CARTONS CONTAIN:
25 KITS
18 JARS

NOW WITH QUADRIVE OPTION!

STOCK NO.	UPC NO.	SIZE	DESCRIPTION OF CONTENTS	WT. EACH	SUGGESTED TRADE LIST PRICE PER
WAK22	10500/kit	3/16	100 - 3/16 Gray Ribbed Anchors	.55	10.93/ea kit
WAKJ22	20730/jar		100 - 6x1 Pan Combo Screws 1 - 3/16 Masonry Drill	.50	
WAK25	20410/kit	3/16	100 - 3/16 Gray Ribbed Anchors	.57	12.25/ea kit
WAKJ25	20751/jar		100 - 8x1 Pan Combo Screws 1 - 3/16 Masonry Drill	.57	
WAK23	20400/kit	1/4	100 - 1/4 Gray Ribbed Anchors	1.01	13.25/ea kit
WAKJ23	20740/jar		100 - 10 x 1 Pan Combo Screws 1 - 1/4 Masonry Drill		
ANCHOR KIT DESIGNED FOR RACEWAY					
WAK23F	39182/kit	1/4	100 - 1/4 Gray Ribbed Anchors	1.01	13.25/ea kit
WAKJ23F	20745/jar		100 - 10 x 1 Flat Head Phillips Screws 1 - 1/4 Masonry Drill		
WAK23T	20401/kit	1/4	100 - 1/4 Gray Ribbed Anchors	1.01	13.25/ea kit
WAKJ23T	20767/jar		100 - 10 x 1 Pan Tri-Drive 1 - 1/4 Masonry Drill / 1 - 000R2B Bit		ONLY METALLICS/Avanti Screw 
WAK24	20405/kit	5/16	50 - 5/16 Gray Ribbed Anchors	1.00	15.48/ea kit
WAKJ24	20750/jar		50 - 12 x 1 1/4 Pan Combo Screws 1 - 5/16 Masonry Drill		

OTHER SIZES AND QUANTITIES AVAILABLE BY REQUEST

WAK23QD	39184/kit	1/4	100 - 1/4 Gray Ribbed Anchors	1.01	13.25/ea kit
WAKJ23QD	39185/jar		100 - 10 x 1 QuaDrive 5/16 Hex Head 1 - 1/4 Masonry Drill		

The QuaDrive

Square Drive + Hex + Slotted + Phillips = QuaDrive

America's Newest Drive - Designed, Developed and Manufactured by Metallics/Avanti Screw

MADE IN USA

Screws
METALLICS/Avanti Screw

ONLY METALLICS

America's newest Drive designed, developed and manufactured by Metallics/Avanti Screws

THE QUADRIVE



JAR DISPLAY CENTER
Holds 18 Jars

ATTENTION
ON LARGE ORDERS OF ANCHOR KITS —
OUR PRICE CAN BE EVEN LOWER!



50 KITS

Order two master cartons of this kit and receive an added **10% Discount!**

QUANTITY DISCOUNTS:
10% DISCOUNT ON 50-99 LIKE KITS
OR
15% DISCOUNT ON 100+ LIKE KITS

Please Call Us for Co-Labeling on Kits!



PLASTIC ANCHOR KIT

- Four Different Style Anchors
- Drill Bits Included
- Screws And Driver Bit Included
- One Four Compartment Plastic Case

STOCK NO.	UPC NO.	DESCRIPTION	QTY. PER PKG,	SUGGESTED TRADE LIST PRICE PER PKG
WAKQUAD	38995	Super Yellow $\frac{3}{16}$ " Plastic Anchors	20	28.58
		#8 x 1" Pan Head Combo Sheet Metal Screw	20	
		$\frac{3}{16}$ " x 4" High Speed Drill Bit	1	
		Big Red $\frac{1}{4}$ " Plastic Anchors	20	
		#10 x 1" Pan Head Combo Sheet Metal Screw	20	
		$\frac{1}{4}$ x 4" High Speed Drill Bit	1	
		Super Yellow $\frac{1}{4}$ " Plastic Anchor	20	
		#10 x 1" Pan Head Combo Sheet Metal Screw	20	
		$\frac{1}{4}$ x 4" High Speed Drill Bit	1	
		Denver Blue $\frac{5}{16}$ " Plastic Anchors	20	
#12 x 1- $\frac{1}{4}$ " Pan Head Combo Sheet Metal Screw	20			
$\frac{5}{16}$ x 4- $\frac{1}{2}$ " High Speed Drill Bit	1			
#2 Phillips Power Bit 2" Long	1			

OTHER SIZES AND QUANTITIES AVAILABLE BY REQUEST



TOGGLER® ALLIGATOR® SOLID WALL ANCHOR KIT

- Alligator® solid-wall anchors can be used in most any material, including: Concrete, Wood, Plaster, Aerated Concrete, Block, Masonry, Stone, Flakeboard, Cinder Block, Ceramic Tile, Stucco, and Drywall.
- Alligator® solid-wall anchors are designed to support heavy loads. (Even under vibration!)



STOCK NO.	UPC NO.	DESCRIPTION	QTY. PER PKG,	SUGGESTED TRADE LIST PRICE PER PKG
TSWAK	73998	$\frac{3}{16}$ " Alligator Solid-Wall Anchor with Flange	20	\$ 41.95
		#8 x 1" Pan Head Combo Sheet Metal Screw	20	
		$\frac{3}{16}$ x 4" Masonry Drill Bit	1	
		1/4 Alligator Solid-Wall Anchor with Flange	20	
		#10 x 1" Pan Head Combo Sheet Metal Screw	20	
		$\frac{1}{4}$ x 4" Masonry Drill Bit	1	
		1/4 Alligator Solid-Wall Anchor No Flange	20	
		#10 x 1" Pan Head Combo Sheet Metal Screw	20	
		$\frac{1}{4}$ x 4" Masonry Drill Bit	1	
		$\frac{5}{16}$ " Alligator Solid-Wall Anchor with Flange	15	
#12 x 1- $\frac{1}{4}$ " Pan Head Combo Sheet Metal Screw	15			
$\frac{5}{16}$ x 4" Masonry Drill Bit	1			
#2 Phillips Power Bit 2" Long	1			

OTHER SIZES AND QUANTITIES AVAILABLE BY REQUEST

ANCHORING DEVICES



SELF-DRILLING WALL ANCHORS

A unique series of self-drilling Anchoring Products distributed and sold by Metallics through a special agreement

NOTE: Due to possible differences in specifications, applications and interpretation of results, purchasers must make their own evaluation of the product to determine the suitability of anchor.

**MASTER
CARTONS
CONTAIN:
25 KITS
18 JARS**

ANCHOR TYPE	Pullout <i>(ultimate average lbs)</i> Gypsum Thickness			Shear <i>(ultimate average lbs)</i> Gypsum Thickness		
	3/8"	1/2"	5/8"	3/8"	1/2"	5/8"
#6	40	45		92	103	
#8	45	50	75	100	110	105

OTHER SIZES AND QUANTITIES AVAILABLE BY REQUEST



SELF-DRILLING WALL ANCHOR ZINC

WORKS GREAT IN DOUBLE DRYWALL AND STUDS
COMBO DRIVE #3 PHILLIPS

PULLOUT <i>(ULTIMATE AVERAGE LBS)</i> GYPSUM THICKNESS		
3/8"	1/2"	5/8"
40	50	75

STOCK NO.	UPC NO.	SIZE	DESCRIPTION	PKG. QTY.	WT. PER PKG.	SUGGESTED TRADE LIST PRICE PER
ZSTU1J	81315/jar	8 x 1 1/4	Zinc Screw Anchors w/ PPH screws	50	1.5lbs	26.73/ea kit
ZSTU1K	81319/kit	8 x 1 1/4	Zinc Screw Anchors w/ PPH screws	50	1.5lbs	26.73/ea kit
ZSTU1M	81323	8 x 1 1/4	Zinc Screw Anchors w/ PPH screws	1000	15.06	246.10/M NEW

OTHER SIZES AND QUANTITIES AVAILABLE BY REQUEST



SELF-DRILLING WALL ANCHOR ZINC

WORKS GREAT IN DRYWALL
COMBO DRIVE #3 PHILLIPS



STOCK NO.	BOX UPC NO.	JAR UPC NO.	SCREW SIZE	DESCRIPTION	WT. EACH	STD. PKG.	SUGGESTED TRADE LIST PRICE PER
JZSA1		80973	#8	100 - Zinc Screw Anchors	1.40	100	41.98/c
ZSA1M	33261	-	#8	1000 - Zinc Screw Anchors	13.15	1000	335.70/M

OTHER SIZES AND QUANTITIES AVAILABLE BY REQUEST



ANCHOR KITS IN BOX AND JAR

					SUGGESTED TRADE LIST PRICE PER
ZSA1K/box	33265/box	#8	50 - Zinc Screw Anchors	1.07	26.00/ea kit
ZSA1J/jar	20710/jar		50 - 8 x 1 1/4 Pan Head Combo Screws	1.03	
ZSA1TK/box	33266/box	#8	50 - Zinc Screw Anchors	1.07	26.00/ea kit
ZSA1TJ/jar	20269/jar		50 - 8 x 1 1/4 Pan Head Tri-Drive Screws 1 - 100R2B Bit	1.01	

OTHER SIZES AND QUANTITIES AVAILABLE BY REQUEST



SELF-DRILLING WALL ANCHOR ZINC-LITE

WORKS GREAT IN DRYWALL • COMBO DRIVE #2 PHILLIPS
Uses #6-8 sheet metal **or** #6-8 drywall screws

STOCK NO.	JAR UPC NO.	SCREW SIZE	DESCRIPTION OF CONTENTS	WT. EACH	STD. PKG.	SUGGESTED TRADE LIST PRICE PER
JZSAL2	80974	#6 or #8	100 - Zinc Alloy Anchor Lite	.85	100	29.88/c

OTHER SIZES AND QUANTITIES AVAILABLE BY REQUEST



ANCHOR KITS IN BOX AND JAR

						SUGGESTED TRADE LIST PRICE PER KIT
ZSAL2K/box	33267/box	#6	50 - Zinc Alloy Anchor Lite	.66	1	18.15/ea kit
ZSAL2J/jar	33268/jar		50 - 6 x 1 Pan Head Combo Screws	.64	1	18.15/ea kit

OTHER SIZES AND QUANTITIES AVAILABLE BY REQUEST

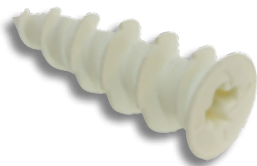

SELF-DRILLING WALL ANCHOR NYLON

WORKS GREAT IN DRYWALL • COMBO DRIVE #3 PHILLIPS

STOCK NO.	JAR UPC NO.	SCREW SIZE	DESCRIPTION OF CONTENTS	WT. EACH	STD. PKG.	SUGGESTED TRADE LIST PRICE PER
JPSA1	80975	#6, #8	100 - Plastic Anchors	.40	100	41.98/c
PSA1M	19824	#6, #8	1M/PACK - Plastic Anchors	4.50	1000	268.55/m

OTHER SIZES AND QUANTITIES AVAILABLE BY REQUEST



ANCHOR KITS IN BOX AND JAR

						SUGGESTED TRADE LIST PRICE PER KIT
PSA1K/box	29495	#6, #8	50 - Plastic Anchors	.59	1	26.00/ea kit
PSA1J/jar	20705		50 - 8 X 1-1/4 Pan Head Combo Screws	.56	1	26.00/ea kit

OTHER SIZES AND QUANTITIES AVAILABLE BY REQUEST



SELF-DRILLING WALL ANCHOR NYLON-LITE

WORKS GREAT IN DRYWALL • COMBO DRIVE #2 PHILLIPS

STOCK NO.	JAR UPC NO.	SCREW SIZE	DESCRIPTION OF CONTENTS	WT. EACH	STD. PKG.	SUGGESTED TRADE LIST PRICE PER
JPSAL2	80976	#6	100 - Plastic Anchor Lite	.23	100	29.98/c

OTHER SIZES AND QUANTITIES AVAILABLE BY REQUEST



ANCHOR KITS IN BOX AND JAR

						SUGGESTED TRADE LIST PRICE PER KIT
PSAL2K/box	19827	#6	50 - Plastic Anchor Lite	.35	1	18.15/ea kit
PSAL2J/jar	20700		50 - 6 X 1 Pan Head Combo Screws	.35	1	18.15/ea kit

OTHER SIZES AND QUANTITIES AVAILABLE BY REQUEST

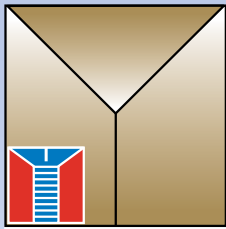

Metallics

Rapid-Set[®] Tools

The fastest, easiest and most reliable way to install machine screw lead (caulk-in) anchors



[CONTRACTOR APPROVED]



- For machine screw lead (caulk-in) anchor sizes 1/4" and 3/8".
- Designed for use with power tools.
- Automatically sets anchor just below the surface.
- Maximizes expansion of bottom portion of lead sleeve.



Made in USA

***Note:** Rapid-Set Tools draw the anchor's internal insert up into the anchor's outer sleeve; this installation process eliminates the need to maintain a back bearing surface (required by hammer setting tools).

PART #	UPC #	DESCRIPTION	QTY / PKG	SUG. TRADE LIST / PKG
MRST1420	25110	Rapid-Set Tool for 1/4-20 Machine Screw Lead (caulk-in) Anchors	1	\$ 100.35
MRST3816	25112	Rapid-Set Tool for 3/8-16 Machine Screw Lead (caulk-in) Anchors	1	\$ 142.68

"Growth Through Innovation"

Metallics

229 Cross Street, Bristol, CT 06010
Tel 800-243-8272 • **Fax** 800-831-9358
Email sales@metallicsonline.com

Metallics West

651 North Main Street, Mancos, CO 81328
Tel 800-269-5183 • **Fax** 800-269-6278
Email saleswest@metallicsonline.com

ANCHORING DEVICES

TOGGLE ANCHOR

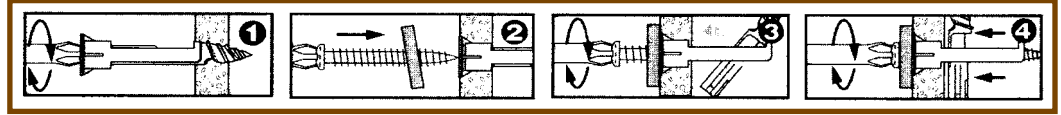

STOCK NO.	JAR UPC NO.	SCREW SIZE	DESCRIPTION OF CONTENTS	WT. EACH	STD. PKG.	SUGGESTED TRADE LIST PRICE PER
JEZT1	80977	#10	50 - Toggles 50 - 8-32 x 2 Pan Head Combo Machine Screws - Zinc Plated	2.01	50	69.18/ea kit

OTHER SIZES AND QUANTITIES AVAILABLE BY REQUEST



STOCK NO.	JAR UPC NO.	SCREW SIZE	DESCRIPTION OF CONTENTS	WT. EACH	STD. PKG.	SUGGESTED TRADE LIST PRICE PER
ANCHOR KITS IN BOX AND JAR						
EZT1K/box	33275	#10	25 Toggles	1.11	1	36.25/ea kit
EZT1J/jar	20715		25 8-32 x 2 Pan Head Combo Machine Screws Zinc Plated	1.24	1	36.25/ea kit

OTHER SIZES AND QUANTITIES AVAILABLE BY REQUEST

AMERICA'S SOURCE FOR PREMIER AND INNOVATIVE FASTENERS & ANCHORS



A Modern Up to Date Roll Threading Machine at our Affiliate, Avanti Screw.

MADE IN USA



Metallics and Avanti Screw, Inc., prime American manufacturers of fastener products, have always worked to present the latest in fastener technology to our distributors and their contractors/users.

Hex Washer Head fasteners have historically only offered three drives-the hex, phillips and the slot. In 1999, we introduced "The QuaDrive" square, hex, slotted and phillips, in fourteen of the most popular sizes of screws.

The QuaDrive

Square Drive + Hex + Slotted + Phillips = QuaDrive

America's Newest Drive - Designed, Developed and Manufactured by Metallics/Avanti Screw

These screws are being manufactured to fill the need of the growing demand in the North American markets.

ANCHORING DEVICES

STRAP-TOGGLE ANCHOR

FOR HEAVY-DUTY APPLICATION
Designed for use in plaster, wallboard,
concrete block or hollow tile

PACKAGED
IN POLY
BAG

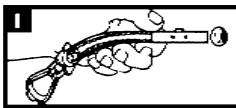
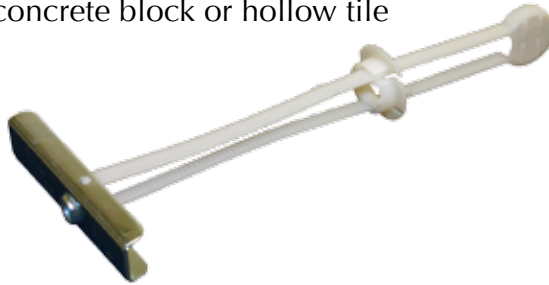

1 Drill appropriate sized hole. Hold metal channel flat alongside plastic straps and slide channel through hole.

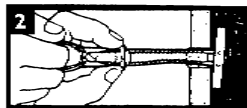

2 Pull on ring so metal channel rests flush behind wall, as you slide plastic cap along straps with other hand, until flange of cap is flush with wall.



3 Place thumb between plastic straps. Push to side, snapping off straps flush with wall.

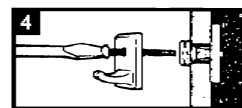

4 Insert bolt through item to be attached and tighten until flush with fixture. Minimum clearance behind wall is 17/8".

STOCK NO.	UPC NO.	SCREW SIZE	ANCHOR SIZE	DRILL	DESCRIPTION OF CONTENTS	WT. PER PKG.	STD. PKG.	SUGGESTED TRADE LIST PRICE PER
NT316	18501	10-24	3/16 x 4	1/2	50 - 3/16 x 4 Strap-Toggle Anchors	1.38	50	59.60/ea. pkg.
NT14	18502	1/4-20	1/4 x 4	1/2	50 - 1/4 x 4 Strap-Toggle Anchors	1.37	50	59.60/ea. pkg.
NT38	18510	3/8-4	3/8 x 4	1/2	100 - 3/8 x 4 Strap-Toggle Anchors	5.86	100	191.35/ea. pkg.

OTHER SIZES AND QUANTITIES AVAILABLE BY REQUEST

Because a wide variety of screws work with this Toggle Anchor, Metallics has chosen not to offer them in a kit, but rather to allow the user to choose the screw that works best for each particular application. Please see Screw/Section A for a full listing of our machine screws.

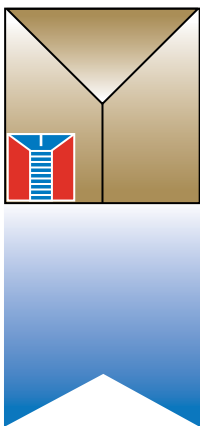

This is the
Heading Line
at
Avanti Screw, Inc.
a Metallics
Affiliate
Bristol, CT.



We work hard at trying to be the best in America!
America's Source For Premier & Innovative Fasteners.



MADE IN USA



SNAPTOGGLE

Secure Installations in Seconds – Not Minutes
Grip Range $\frac{3}{8}$ "–2 $\frac{1}{2}$ " (9mm–64mm)

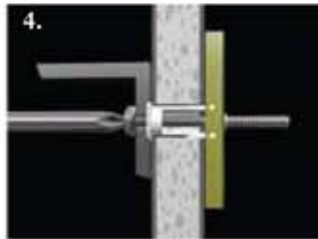
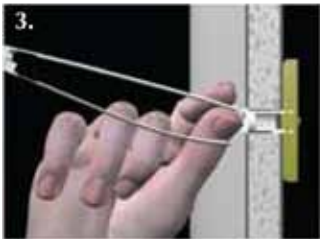
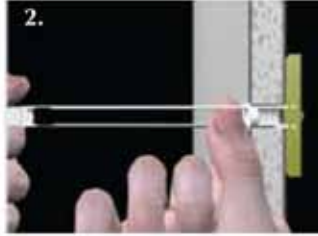
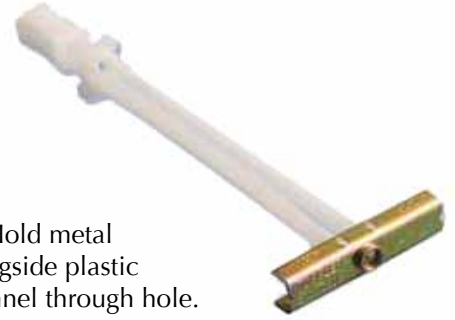

1. Drill 1/2" hole. Hold metal channel flat alongside plastic straps, slide channel through hole.
2. With one hand, pull ring so metal channel rests flush behind wall. Slide plastic cap along straps with other hand until flange of cap is flush with wall.
3. Place thumb between plastic straps. Push side to side snapping off straps flush with wall.
4. Insert bolt through item to be attached and tighten until flush with fixture. Minimum clearance behind wall: 1-7/8" (48mm)



STOCK NO.	UPC NO.	DESCRIPTION OF CONTENTS	PKG. QTY.	SUGGESTED TRADE LIST PRICE PER
MBA25	73944	Toggler Snaptoggle #10-24	25	\$41.45 Pkg.
MBA50	73971	Toggler Snaptoggle #10-24	50	\$75.83 Pkg.
MBB25	73945	Toggler Snaptoggle 1/4-20	25	\$41.45 Pkg.
MBB50	73972	Toggler Snaptoggle 1/4-20	50	\$75.83 Pkg.

OTHER SIZES AND QUANTITIES AVAILABLE BY REQUEST

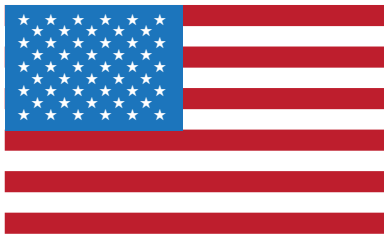

METALLICS

"Growth Through Innovation"

We believe Metallics has the largest ratio of American made to foreign produced product of any other American fastener company.

SERVING THE
ELECTRICAL, PLUMBING, HEATING AND AIR CONDITIONING
DISTRIBUTOR MARKETPLACE

AIR HANDLING CABLE TIES

PLENUM RATED



- Ideal Application: Air Handling Spaces, above drop ceilings and below raised flooring
- Meets UL 1565 low smoke generation, low heat release, and mechanical strength test
- UL Listed suitable for use in Air Handling Spaces in accordance with the Section 300.22 (C) and (D) of the National Electrical Code and Rules 12-010 (3), (4), and (5) and 12-020 of the Canadian Electrical Code, Part 1
- Strong and Pure manufactured from filtered nylon 6/6 reducing particle contamination
- Mounting Hole Style secures and positions wire bundles, cables, etc. to surfaces with one mechanical fastener
- Low Profile Style reduces head height increases safety, eliminates snags, cuts, and abrasions to cables, surrounding products, and users

STOCK NO.	UPC NO.	DESCRIPTION	LENGTH IN.	TIE TENSILE LBS.	PKG. QTY.	SUGGESTED TRADE LIST PRICE PER
CTAH7S	22672	Standard	7	50	100	16.63/c
CTAH11S	22682	Standard	11	50	100	35.38/c
CTAH14S	22693	Standard	14	50	100	46.30/c
CTAH7MH	22671	Mounting Hole	7	50	100	28.40/c
CTAH7LP	22670	Low Profile	7	50	100	38.28/c

OTHER SIZES AND QUANTITIES AVAILABLE BY REQUEST

AMERICA'S SOURCE FOR PREMIER AND INNOVATIVE FASTENERS & ANCHORS

ONLY METALLICS!



A Modern Up to Date Roll Threading Machine at our Affiliate, Avanti Screw.

MADE IN USA



Metallics and Avanti Screw, Inc., prime American manufacturers of fastener products, have always worked to present the latest in fastener technology to our distributors and their contractors/users.

Hex Washer Head fasteners have historically only offered three drives—the hex, phillips and the slot. In 1999, we introduced "The QuaDrive" square, hex, slotted and Phillips, in fourteen of the most popular sizes of sheet metal screws.

The QuaDrive

□ + ⬡ + ◯ + ⊕ = ⊕
Square Drive Hex Slotted Phillips QuaDrive

America's Newest Drive - Designed, Developed and Manufactured by Metallics/Avanti Screw

These sheet metal screws are being manufactured to fill the need of the growing demand in the North American markets.







Please note: We recommend driving these sheet metal screws with a hex driving tool. The slotted, Phillips, hex and square drives make it convenient for disassembly.

CABLE TIES AND ACCESSORIES

NYLON CABLE TIES

WHITE NYLON AND BLACK UV STABILIZED
ALL CABLE TIES PACKAGED IN PLASTIC BAGS



STOCK NO.	UPC NO.	MIN. TENSILE STRENGTH	MAX. BUNDLE DIAMETER	OVERALL LENGTH	WT. PER PKG.	STD. PKG.	SUGGESTED TRADE LIST PRICE
WHITE NYLON BENT TIP CABLE TIE - 100 PACK							
CT1	22600	18 LBS	3/4	4	.07	100	2.75/c
CT2	22605	18 LBS	1 3/8	6	.09	100	4.88/c
CT3	22610	40 LBS	1 1/4	5	.16	100	4.80/c
CT6	22615	50 LBS	2	7	.27	100	6.28/c
CT4	22620	50 LBS	2 3/4	11	.39	100	12.70/c
CT5	22625	50 LBS	4 1/2	14	.49	100	14.95/c
WHITE NYLON 1000 AND 500 PACK							
CT1B	22601	18 LBS	3/4	4	.62	1000	24.85/m
CT2B	22606	18 LBS	1 3/8	6	.89	1000	44.00/m
CT3B	22611	40 LBS	1 1/4	5	1.53	1000	43.30/m
CT6B	22616	50 LBS	2	7	3.00	1000	56.40/m
CT4B	22621	50 LBS	2 3/4	11	1.97	500	57.25/ea. pkg.
CT5B	22626	50 LBS	4 1/2	14	2.59	500	67.15/ea. pkg.
BLACK WEATHER-RESISTANT UV-STABILIZED CABLE TIE 100 PACK							
CT1UV	22645	18 LBS	3/4	4	.07	100	2.98/c
CT6UV	22650	50 LBS	2	7	.30	100	6.68/c
CT4UV	22655	50 LBS	2 3/4	11	.39	100	13.35/c
CT5UV	22660	50 LBS	4 1/2	14	.50	100	15.73/c
*CT21UV	22659	50 LBS	6	21	.75	100	121.32/c NEW
BLACK UV 1000 AND 500 PACK							
CT1UVB	22646	18 LBS	3/4	4	.62	1000	26.85/m
CT3UVB	22612	50 LBS	1 1/4	5	3.00	1000	50.00/m NEW
CT6UVB	22651	50 LBS	2	7	2.76	1000	60.10/m
CT4UVB	22656	50 LBS	2 3/4	11	2.02	500	60.10/ea. pkg.
CT5UVB	22661	50 LBS	4 1/2	14	2.41	500	70.65/ea. pkg.
WHITE NYLON - 100 PACK MOUNTING TAB CABLE TIE							
MCT10	22700	30 LBS	3/4	5	.19	100	12.63/c
MCT12	22710	50 LBS	2	7	.34	100	14.68/c
MCT13	22715	50 LBS	3	11	.43	100	23.10/c
MCT14	22720	120 LBS	4	14	.56	100	33.38/c
BLACK NYLON - 100 PACK MOUNTING TAB CABLE TIE							
MCT15BLK	22764	120 LBS	4	15 5/16	1.33	100	37.48/c NEW
HEAVY DUTY - 50 PACK WHITE NYLON ADJUSTABLE CLAMPS							
HCT19	22800	120 LBS	4 1/4	14	.65	50	16.48/ea. pkg.
HCT21	22810	175 LBS	5 7/8	24	.95	50	33.50/ea. pkg.
HCT22	22815	175 LBS	9 3/4	33	2.05	50	39.70/ea. pkg.
HEAVY DUTY - 50 PACK BLACK UV							
HCT22UV	22816	175 LBS	9 3/4	33	.85	25	30.23/ea. pkg. NEW
HORIZONTAL I.D. TIE							
*CT1HID	22602	18 LBS	3/4	4	.55	100	15.10/c NEW

OTHER SIZES AND QUANTITIES AVAILABLE BY REQUEST
*DENOTES A PRODUCT NOT MADE IN THE USA

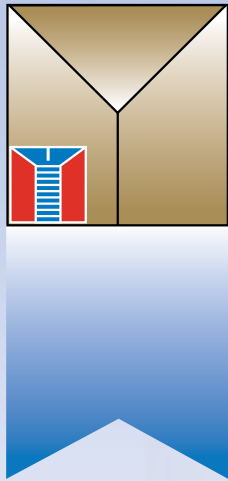

Metallics



[CONTRACTOR APPROVED]

Save **TIME**
and **MONEY**
with these
Cable Tie
Kits!

Cable Tie Kits

NOW AVAILABLE!

Packaged in an EZ Hang Reusable, Visual Plastic Box



Standard Cable Tie Kit

PART #	UPC #	LENGTH (IN.)	TIE TENSILE (LBS.)	QTY / PKG	SUG. TRADE LIST / PKG
CTKS1 Natural	23030	11	50	100	\$ 27.25
		7	50	100	
		4	18	200	
CTKS1UV Black	23031	11	50	100	\$ 27.38
		7	50	100	
		4	18	200	



Tension Tool Cable Tie Kit

PART #	UPC #	LENGTH (IN.)	TIE TENSILE (LBS.)	QTY / PKG	SUG. TRADE LIST / PKG
CTKTT1* Natural	23035	11	50	100	\$ 49.75
		7	50	100	
		4	18	200	
CTKTT1UV* Black	23036	11	50	100	\$ 50.15
		7	50	100	
		4	18	200	

*Includes one (1) Tension Tool per kit



3/4 Mounting Pad Cable Tie Kit

PART #	UPC #	LENGTH (IN.)	TIE TENSILE (LBS.)	QTY / PKG	SUG. TRADE LIST / PKG
CTKMP1° Natural	23040	11	50	100	\$ 35.00
		7	50	100	
CTKMP1UV° Black	23041	11	50	100	\$ 35.62
		7	50	100	

*Includes one hundred (100) 3/4" adhesive Mounting Pads per kit

★ ★ ★ ★ ★ "Growth Through Innovation" ★ ★ ★ ★ ★

Metallics

229 Cross Street, Bristol, CT 06010
Tel 800-243-8272 • Fax 800-831-9358
Email sales@metallicsonline.com

Metallics West

651 North Main Street, Mancos, CO 81328
Tel 800-269-5183 • Fax 800-269-6278
Email saleswest@metallicsonline.com

CABLE TIES AND ACCESSORIES



ASSORTED CABLE TIES IN A BAG



A handy assortment of popular sizes
in one convenient package so
you're ready for any job!

PACKAGED IN PLASTIC BAGS

FOUR POPULAR SIZES IN EACH BAG

BENT TIP TIES

AVAILABLE IN WHITE NYLON OR BLACK UV STABILIZED

STOCK NO.	UPC NO.	DESCRIPTION OF CONTENTS	STD. PKG.	WT. PER BAG	SUGGESTED TRADE LIST PRICE PER
WHITE NYLON					
CTA1	22825	Bag of 100 Cable Ties includes: 25 CT1 4" White Nylon Ties 25 CT6 7" White Nylon Ties 25 CT4 11" White Nylon Ties 25 CT5 14" White Nylon Ties	1 Bag	.31	11.70/ea
BLACK UV STABILIZED					
CTUVA1	22826	Bag of 100 Cable Ties includes: 25 CT1UV 4" Black Weather Resistant Ties 25 CT6UV 7" Black Weather Resistant Ties 25 CT4UV 11" Black Weather Resistant Ties 25 CT5UV 14" Black Weather Resistant Ties	1 Bag	.32	12.90/c

OTHER SIZES AND QUANTITIES AVAILABLE BY REQUEST



VELCRO® CABLE TIES

PACKAGED IN PLASTIC BAGS



FEATURES

- Eliminates the potential for damage to fiber optics or cables caused by overcinching or accidental cutting.
- Easy to install and adjust without installation tools.
- Reusable

APPLICATIONS

- Wire and cable assemblies
- Fiber optic installations
- Network installations
- Electrical/electronics products

Maximum loop tensile strength:
Roll - 50 lbs Loop ties - 40 lbs

STOCK NO.	UPC NO.	DESCRIPTION OF CONTENTS	STD. PKG.	WT. PER BAG	SUGGESTED TRADE LIST PRICE PER
VR12	22801	Velcro® Roll - 1/2" x 15'	.08	One Roll	14.68/ea
VR34	22802	Velcro® Roll - 3/4" x 15'	.13	One Roll	18.15/ea
VT8	22803	Velcro® Loop Tie - 1" tab 1/2" width x 8"	.05	10 Loop Ties	15.20/ea
VT12	22804	Velcro® Loop Tie - 1" tab 1/2" width x 12"	.07	10 Loop Ties	20.95/ea

OTHER SIZES AND QUANTITIES AVAILABLE BY REQUEST

VELCRO® IS A REGISTERED TRADEMARK

CABLE TIES AND ACCESSORIES



CABLE TIE TOOL

FEATURES A SHORT SQUEEZE STROKE

The cut-off feature ensures a consistently flush, burr-free edge

Polycarbonate Construction

STOCK NO.	UPC NO.	SIZE	WT. EACH	STD. PKG.	SUGGESTED TRADE LIST PRICE PER
RT2	23215	Accepts Cable Tie series CT-1 through MCT14	.78	1	72.93/ea

OTHER SIZES AND QUANTITIES AVAILABLE BY REQUEST



CABLE CLAMPS

WHITE & BLACK NYLON PLASTIC

Clamps are designed with bevelled inside edges to prevent damage to cables from chafing, Molded to shape and size.



STOCK NO.	UPC NO.	WIRE SIZE	MOUNTING SCREW DIA.	WT. PER PKG.	STD. PKG.	SUGGESTED TRADE LIST PRICE PER
WHITE						
NCC116	23102	1/16	3/16	.03	100	9.75/c NEW
NCC0	23100	1/8	3/16	.09	100	7.23/c
NCC1	23103	3/16	3/16	.09	100	9.83/c NEW
NCC3	23107	5/16	5/16	.09	100	16.15/c NEW
NCC2	23105	1/4	3/16	.11	100	10.15/c
NCC4	23110	3/8	3/16	.24	100	12.38/c
NCC6	23115	1/2	3/16	.28	100	14.00/c
NCC7	23117	5/8	3/16	.35	100	14.28/c NEW
BLACK						
NCC4BLK	23132	3/8	3/16	.16	100	12.83/c NEW
NCC6BLK	23137	1/2	3/16	.25	100	14.78/c NEW

OTHER SIZES AND QUANTITIES AVAILABLE BY REQUEST



CABLE CLAMPS

STEEL ZINC PLATED



STOCK NO.	UPC NO.	WIRE SIZE	MOUNTING SCREW DIA.	WT. PER PKG.	STD. PKG.	SUGGESTED TRADE LIST PRICE PER
SCC316	21546	3/16	3/16	.56	100	16.95/c
SCC14	21541	1/4	3/16	.61	100	17.35/c
SCC38	21543	3/8	3/16	.79	100	19.18/c
SCC12	21540	1/2	3/16	.46	50	10.50/ea. pkg.
SCC58	21544	5/8	3/16	.65	50	12.23/ea. pkg.
SCC34	21542	3/4	1/4	.37	25	6.60/ea. pkg.
SCC78	21545	7/8	1/4	.41	25	7.03/ea. pkg.

OTHER SIZES AND QUANTITIES AVAILABLE BY REQUEST

Helpful Hints From Metallics:
Did You forget to ask?

GOT FASTENERS?

CABLE TIES AND ACCESSORIES

NEOPRENE WRAPPED STEEL CABLE CLAMPS



Light to medium duty steel cable clamp with neoprene cushion for electrical insulation and vibration absorption

- Steel clamps are electroplated for corrosion resistance
- Silver with black neoprene
- Mounts to steel, wood or concrete
- Reusable

STOCK NO.	UPC NO.	MAX WIRE DIAMETER	MOUNTING SCREW DIA.	WT. PER PKG.	STD. PKG.	SUGGESTED TRADE LIST PRICE PER
SPN316	51165	3/16	3/16	.19	25	29.35/ea. pkg.
SPN14	51170	1/4	3/16	.23	25	21.25/ea. pkg.
SPN38	51175	3/8	3/16	.21	20	23.50/ea. pkg.
SPN12	51180	1/2	3/16	.33	20	23.35/ea. pkg.
SPN58	51185	5/8	3/16	.32	20	23.50/ea. pkg.
SPN34	51190	3/4	1/4	.43	20	23.50/ea. pkg.
SPN78	51195	7/8	1/4	.24	10	29.33/ea. pkg.
SPN1	51200	1	1/4	.29	10	29.33/ea. pkg.

OTHER SIZES AND QUANTITIES AVAILABLE BY REQUEST

4-WAY CABLE TIE MOUNTING CLIP

NYLON MOUNT WITH ACRYLIC ADHESIVE



Clean or wipe surface before mounting.
See Page 291

STOCK NO.	UPC NO.	SIZE	SCREW DIA.	WT. PER PKG.	STD. PKG.	SUGGESTED TRADE LIST PRICE PER
WHITE						
MP25	23005	3/4 sq.	#6	.18	100	26.05/c
MP20	23000	1 sq.	#8	.30	100	31.40/c
BLACK UV						
MP25UV	23020	3/4 sq.	#6	.18	100	28.65/c
MP20UV	23015	1 sq.	#8	.33	100	34.53/c

Jar packaging available

OTHER SIZES AND QUANTITIES AVAILABLE BY REQUEST



Cable Tie Not Included

SCREW MOUNT FLAT CABLE TIE HOLDER

NYLON 6/6

- Mounts with #6 or #8 Pan or Flat Head screw
- Accepts cable ties up to 3/16" width in any length



STOCK NO.	UPC NO.	MAX CABLE TIE WIDTH	MOUNTING SCREW	WT. PER PKG.	STD. PKG.	SUGGESTED TRADE LIST PRICE PER
FTHS01	51070	3/16	#6 or #8	.03	25	11.75/ea. pkg.

OTHER SIZES AND QUANTITIES AVAILABLE BY REQUEST

CABLE TIES AND ACCESSORIES

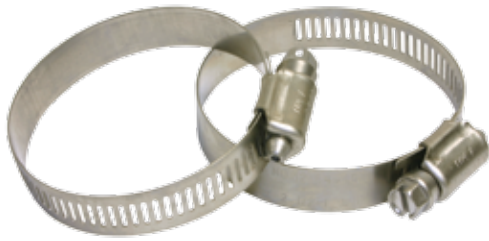

HOSE CLAMPS

STOCK NO.	UPC NO.	DESCRIPTION	STD. PKG.	SUGGESTED TRADE LIST PRICE PER
HMC6SS	23406	7/16"-7/8" ss hose clamp	10	\$28.73
HMC24SS	23424	1-1/16"-2" ss hose clamp	10	\$29.63
HMC32SS	23432	1-9/16"-2-1/2" ss hose clamp	10	\$30.15
HMC36SS	23436	1-13/16"-2-3/4" ss hose clamp	10	\$31.38
HMC40SS	23440	2-1/16"-3" ss hose clamp	10	\$35.93
HMC88SS	23488	5-1/16"-6" ss hose clamp	10	\$71.55
HMC104SS	23534	6-1/16"-7" ss hose clamp	10	\$74.60
MHC6	22906	7/16"-7/8" hose clamp	10	\$23.20
MHC24	22924	1-1/16"-2" hose clamp	10	\$24.00
MHC28	22928	1-5/16"-2-1/2" hose clamp	10	\$24.45
MHC32	22932	1-9/16"-2-1/2" hose clamp	10	\$24.45
MHC36	22936	1-13/16"-2-3/4" hose clamp	10	\$25.25
MHC48	22948	2-9/16"-3-1/2" hose clamp	10	\$34.60
MHC52	22952	2-13/16"-3-3/4" hose clamp	10	\$36.75
MHC60	22960	3-5/16"-4-1/4" hose clamp	10	\$38.05
MHC64	22964	3-9/16"-4-1/2" hose clamp	10	\$38.40

OTHER SIZES AND QUANTITIES AVAILABLE BY REQUEST

MANUFACTURING CAPABILITIES

Diameter range #2 thru 5/16" / 1.5mm thru 8mm • Length range 1/8" thru 3" / 3.5mm thru 75mm
Materials: Steel, Brass, Stainless, Aluminum, Bronze.

NEED SCREWS...

Let Us Make Them For You!



A METALLICS AFFILIATE

P.O. Box 1600 • 231 Cross Street
Bristol, CT 06011-1600
Tel: 800-984-8945 • Fax: 800-984-8946

CAPABILITIES LIST

PLANT SIZE: 100,000 SQUARE FEET

LOCATION: Bristol, Connecticut

EQUIPMENT: 27 Hi-Speed Cold Headers
8 Burr-Free Screw Slotters
3 Shank Slotters
2 Pointers
14 High Speed Thread Rollers

MADE IN USA



ADDITIONAL PLANT INFO: Modern shipping facility utilizing digital scale counting machines. In-house packaging facilities - boxing, sorting, baggings. All material boxed, palletized & labeled with your needs in mind for domestic or export shipping.

SECONDARY WORK: All plating & heat treating is done on the outside and certified for your guarantee.

INFORMATION SYSTEMS: Our facility has new and upgraded Technology to meet your customers specific requirements.

CABLE TIES AND ACCESSORIES

MASONRY MOUNT FLAT CABLE TIE HOLDER

BLACK UV STABILIZED NYLON 6/6



- Tap into 1/4" pre-drilled hole
- Affix wire and cable permanently
- Accepts cable ties up to 3/16" wide and any length

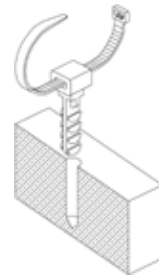

Cable Tie Not Included

STOCK NO.	UPC NO.	PRE-DRILLED HOLE SIZE	MAX CABLE TIE WIDTH	WT. PER PKG.	STD. PKG.	SUGGESTED TRADE LIST PRICE PER
FTHM14	51060	1/4	3/16	.07	25	8.35/ea. pkg.

OTHER SIZES AND QUANTITIES AVAILABLE BY REQUEST

RIVET MOUNT FLAT CABLE TIE HOLDER

YELLOW NYLON 6/6

Accepts a variety of cable tie lengths.

- Punch into pre-drilled hole (.196")
- Has built-in rivet
- One piece construction



Cable Tie Not Included

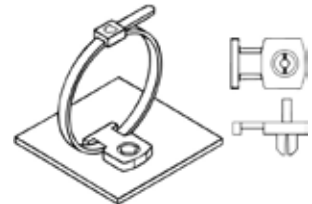

STOCK NO.	UPC NO.	RIVET HOLE DIAMETER	MAX CABLE TIE WIDTH	WT. PER PKG.	STD. PKG.	SUGGESTED TRADE LIST PRICE PER
FTHR01	51065	.196	3/16	.07	50	7.70/ea. pkg.

OTHER SIZES AND QUANTITIES AVAILABLE BY REQUEST

C STYLE CABLE CLAMP

GRAY PVC

- Great for routing all types of wire
- Adhesive backing mounts quickly and easily
- Clean or wipe surface before mounting with a solvent cleaner/degreaser

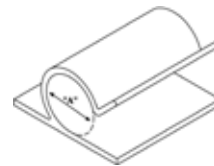

STOCK NO.	UPC NO.	MAX CABLE CAPACITY "A"	WT. PER PKG.	STD. PKG.	SUGGESTED TRADE LIST PRICE PER
KKC14	51040	1/4	.06	20	17.78/ea. pkg.
KKC38	51045	3/8	.07	20	19.83/ea. pkg.
KKC12	51050	1/2	.13	10	11.03/ea. pkg.
KKC34	51055	3/4	.15	10	15.78/ea. pkg.

OTHER SIZES AND QUANTITIES AVAILABLE BY REQUEST

America's Source For Premier And Innovative Fasteners

CABLE TIES AND ACCESSORIES



U STYLE CABLE CLAMP

GRAY PVC

- Great for routing all types of wire
 - Adhesive backing mounts quickly and easily
 - Clean or wipe surface with a solvent cleaner/degreaser before mounting.
- See Page 291

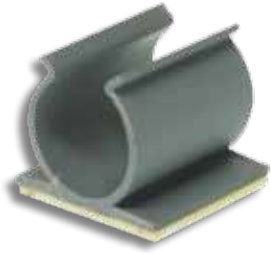
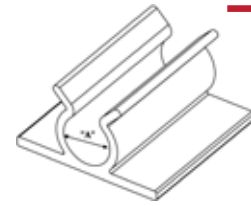

STOCK NO.	UPC NO.	MAX CABLE CAPACITY "A"	WT. PER PKG.	STD. PKG.	SUGGESTED TRADE LIST PRICE PER
KKU14	51020	1/4	.08	20	17.83/ea. pkg.
KKU38	51025	3/8	.07	20	19.88/ea. pkg.
KKU12	51030	1/2	.13	10	11.03/ea. pkg.
KKU34	51035	3/4	.08	10	15.63/ea. pkg.

OTHER SIZES AND QUANTITIES AVAILABLE BY REQUEST

ADJUSTABLE C STYLE CABLE CLAMP

NYLON 6/6

PACKAGED IN POLY BAGS

Holds cables from 5/16" to 1" in diameter

- Handles dozens of routing jobs
 - Locks securely and can be easily re-opened for routing changes
 - Adhesive backing for easy, quick installation
 - Clean or wipe surface with a solvent cleaner/degreaser before mounting
- See Page 291

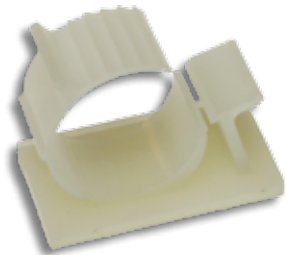
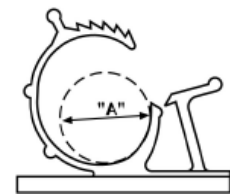

STOCK NO.	UPC NO.	BUNDLE RANGE DIAMETER "B"	WT. PER PKG.	STD. PKG.	SUGGESTED TRADE LIST PRICE PER
AKK516	51000	5/16 - 13/32	.05	10	9.68/ea. pkg.
AKK1532	51005	15/32 - 9/16	.07	10	12.08/ea. pkg.
AKK3764	51010	37/64 - 3/4	.11	10	16.68/ea. pkg.
AKK78	51015	7/8 - 1	.24	10	18.85/ea. pkg.

OTHER SIZES AND QUANTITIES AVAILABLE BY REQUEST

TIE-ON-BASE WIRE ROUTING CLIP

NYLON 6/6

Cable tie and mounting clip all in one!

- Adhesive base has slot to guide strap under locking mechanism
 - Release tab allows for load to be removed, replaced or changed when necessary
 - Tensile strength 40 lbs.
 - One size fits a variety of applications
 - Clean or wipe surface with a solvent before mounting.
- See Page 291

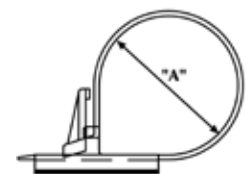

Cable Tie Not Included

STOCK NO.	UPC NO.	MAX CABLE CAPACITY "A"	WT. PER PKG.	STD. PKG.	SUGGESTED TRADE LIST PRICE PER
TOB1	51125	1-1/8	.06	10	7.40/ea. pkg.

OTHER SIZES AND QUANTITIES AVAILABLE BY REQUEST



CABLE TIES AND ACCESSORIES

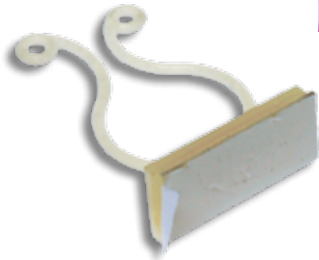

Cable Tie Not Included

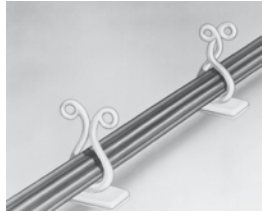

KURLLY STYLE CABLE WRAP WITH ADHESIVE BASE

NYLON 6/6

For easy cable routing in a variety of applications.

- Adhesive backing for quick and easy installation.
- Wires can be routed and re-routed after installation.
- Clean or wipe surface with a solvent cleaner/degreaser before mounting.



See Page 291

STOCK NO.	UPC NO.	MAX CABLE CAPACITY "A"	WT. PER PKG.	STD. PKG.	SUGGESTED TRADE LIST PRICE PER
KLB38	51075	$\frac{3}{8}$.02	10	5.45/ea. pkg.
KLB12	51080	$\frac{1}{2}$.03	10	6.05/ea. pkg.
KLB78	51085	$\frac{7}{8}$.04	10	6.35/ea. pkg.

OTHER SIZES AND QUANTITIES AVAILABLE BY REQUEST

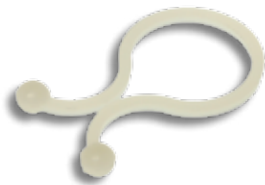

Cable Tie Not Included

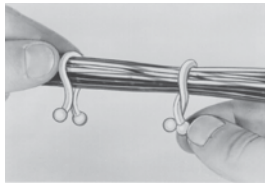

TWIST STYLE CABLE WRAP

NYLON 6/6

Simply twist to secure wire bundles. Reusable.



STOCK NO.	UPC NO.	MAX CABLE CAPACITY "A"	WT. PER PKG.	STD. PKG.	SUGGESTED TRADE LIST PRICE PER
TL516	51090	$\frac{5}{16}$.01	25	2.70/ea. pkg.
TL38	51095	$\frac{3}{8}$.02	25	2.93/ea. pkg.
TL12	51105	$\frac{1}{2}$.02	25	3.18/ea. pkg.
TL78	51110	$\frac{7}{8}$.03	25	3.83/ea. pkg.

OTHER SIZES AND QUANTITIES AVAILABLE BY REQUEST



VINYL HOLE GROMMET

BLACK FLEXIBLE VINYL

Installs instantly. Simply snap into hole in panel box, etc., to protect cable.



STOCK NO.	UPC NO.	INSIDE DIA./ OUTSIDE DIA.	HOLE SIZE	PANEL THICKNESS	WT. PER PKG.	STD. PKG.	SUGGESTED TRADE LIST PRICE PER
HG14	51130	$\frac{1}{4} \times \frac{9}{16}$.37	$\frac{3}{32}$.02	10	2.60/ea. pkg.
HG38	51135	$\frac{3}{8} \times \frac{43}{64}$.49	$\frac{1}{16}$.02	10	4.30/ea. pkg.
HG12	51140	$\frac{1}{2} \times \frac{55}{64}$.69	$\frac{1}{16}$.04	10	5.18/ea. pkg.
HG58	51145	$\frac{5}{8} \times \frac{55}{64}$.75	$\frac{1}{16}$.02	10	5.73/ea. pkg.
HG4764	51150	$\frac{47}{64} \times \frac{115}{64}$.99	$\frac{1}{16}$.09	10	10.30/ea. pkg.
HG5564	51155	$\frac{55}{64} \times \frac{13}{16}$	1.00	$\frac{1}{16}$.06	10	13.05/ea. pkg.
HG3132	51160	$\frac{31}{32} \times 1\frac{1}{2}$	1.25	$\frac{1}{16}$.13	10	15.80/ea. pkg.

OTHER SIZES AND QUANTITIES AVAILABLE BY REQUEST

CABLE TIES AND ACCESSORIES

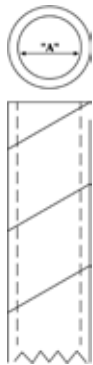

WIRE HARNESS WRAP

BLACK POLYETHYLENE/U.V. STABILIZED



- Wraps around cables to bundle and provide protection.
- Flexible enough to bend around corners, retains elasticity.
- Free assembly tool included with every 100' roll.

STOCK NO.	UPC NO.	DIAMETER "A"	CABLE BUNDLE RANGE	WT. PER ROLL	STD. PKG.	SUGGESTED TRADE LIST PRICE PER
HW14	51115	1/4	3/16-1"	1.25	100 ft. roll	80.30/ea
HW12	51120	1/2	3/4-4"	3.38	100 ft. roll	168.05/ea

WHITE WIRE HARNESS WRAP AVAILABLE BY SPECIAL ORDER

OTHER SIZES AND QUANTITIES AVAILABLE BY REQUEST

MANUFACTURING CAPABILITIES

Diameter range #2 thru 5/16" / 1.5mm thru 8mm • Length range 1/8" thru 3" / 3.5mm thru 75mm
Materials: Steel, Brass, Stainless, Aluminum, Bronze.

NEED SCREWS...

Let Us Make Them For You!



A METALLICS AFFILIATE

P.O. Box 1600 • 231 Cross Street
Bristol, CT 06011-1600
Tel: 800-984-8945 • Fax: 800-984-8946

CAPABILITIES LIST

PLANT SIZE: 100,000 SQUARE FEET

LOCATION: Bristol, Connecticut

EQUIPMENT: 27 Hi-Speed Cold Headers
8 Burr-Free Screw Slotters
3 Shank Slotters
2 Pointers
14 High Speed Thread Rollers



ADDITIONAL PLANT INFO: Modern shipping facility utilizing digital scale count ing machines. In-house packaging facilities - boxing, sorting, baggings. All material boxed, palletized & labeled with your needs in mind for domestic or export shipping.

SECONDARY WORK: All plating & heat treating is done on the outside and certified for your guarantee.

INFORMATION SYSTEMS: Our facility has new and upgraded Technology to meet your customers specific requirements.

FIXTURE HANGING ACCESSORIES



HEX ROD COUPLINGS

STEEL ZINC CHROMATE AND STAINLESS STEEL

STOCK NO.	UPC NO.	HEX SIZE	SIZE	LENGTH	WT. PER PKG.	STD. PKG.	SUGGESTED TRADE LIST PRICE PER
STEEL							
RCT26	21705	1/4-20	3/8	7/8	1.02	50	33.06/c
RCT27	21710	5/16-18	3/8	7/8	1.21	50	40.36/c
RCT28	21715	3/8-16	1/2	1	1.87	50	45.16/c
RCTL28(1-3/4 LONG)	23328	3/8-16	1/2	1 3/4	5.71	50	77.26/c NEW
RCT29	21720	1/2-13	5/8	1 1/4	1.46	25	56.20/c
RCTL29(1-3/4 LONG)	23329	1/2-13	5/8	1 3/4	2.95	25	246.20/c NEW
RCT30	21725	5/8-11	3/4	1 1/2	2.24	25	172.80/c NEW
RCT31	21728	3/4-10	7/8	1 1/4	7.19	25	471.30/c NEW
18-8 TYPE STAINLESS STEEL							
RCT26SS	10644	1/4-20	3/8	7/8	1.02	50	461.66/c
RCT27SS	10645	5/16-18	3/8	7/8	1.40	50	566.40/c
RCT28SS	21726	3/8-16	1/2	1	1.87	50	741.36/c
RCT29SS	21727	1/2-13	5/8	1 1/4	1.52	25	915.52/c
RCT30SS	22830	5/8-11	3/4	1 1/2	9.68	50	1840.46/c NEW
STAINLESS STEEL 316							
RCT28SS316	94828	3/8-16	1/2	1	1.89	50	1046.50/c NEW
RCT29SS316	94829	1/2-13	5/8	1 1/4	2.85	50	1443.46/c NEW

OTHER SIZES AND QUANTITIES AVAILABLE BY REQUEST



REDUCING ROD COUPLING

STEEL ZINC CHROMATE

STOCK NO.	UPC NO.	SIZE	WT. PER PKG.	STD. PKG.	SUGGESTED TRADE LIST PRICE PER
RCTR28	21706	3/8-16 x 1/4-20	2.02	50	72.50/c
RCTR27	21704	3/8-16 x 5/16-18	2.35	50	81.86/c NEW

OTHER SIZES AND QUANTITIES AVAILABLE BY REQUEST

THREADED ROD

STEEL ZINC CHROMATE AND STAINLESS STEEL

THREADED ROD SOLD ONLY IN FULL BUNDLE QUANTITIES



STOCK NO.	UPC NO.	SIZE
18-8 TYPE STAINLESS STEEL		
TRS6/6SS	10619	1/4-20 x 6'
TRS7/6SS	10618	5/16-18 x 6'
TRS8/6SS	10616	3/8-16 x 6'
TRS9/6SS	10617	1/2-13 x 6'
TRS106SS	21677	5/8-11 x 6'

DOMESTIC ROD AVAILABLE BY REQUEST

GALVANIZED, 316 STAINLESS STEEL, PLAIN, PLEASE CALL FOR PRICING

OTHER SIZES AND QUANTITIES AVAILABLE BY REQUEST

PLEASE CALL FOR BUNDLE QUANTITIES AND PRICING
1-800-243-8272 EAST
1-800-269-5183 WEST

STOCK NO.	UPC NO.	SIZE
STEEL ZINC CHROMATE		
TRS6/3	21613	1/4-20 x 3'
TRS7/3	21614	5/16-18 x 3'
TRS8/3	21617	3/8-16 x 3'
TRS9/3	21618	1/2-13 x 3'
TRS6/6B	21640	1/4-20 x 6'
TRS7/6	21610	5/16-18 x 6'
TRS8/6B	21645	3/8-16 x 6'
TRS9/6B	21650	1/2-13 x 6'
TRS106	21607	5/8-11 x 6'
TRS11/6	21580	3/4-10 x 6'
TRS610	21606	1/4-20 x 10'
TRS710	21604	5/16-18 x 10'
TRS810	21616	3/8-16 x 10'
TRS910	21621	1/2-13 x 10'
TRS1010	21685	5/8-11 x 10'
TRS1110	21690	3/4-10 x 10'

OTHER SIZES AND QUANTITIES AVAILABLE BY REQUEST

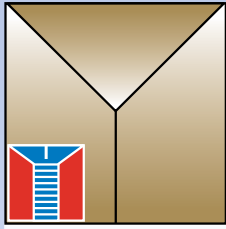

Metallics



Knock-On Spring Steel Beam Clamp

For Flanges 1/8" - 1/4" thick.

[CONTRACTOR APPROVED]



Knock-On beam clamp for flanges 1/8" - 1/4" thick, such as I-beam flanges. Made of high quality spring steel.

Features:

- For Flanges 1/8" - 1/4" thick.
- Hole will accommodate jack chain, ceiling wire or a 1/4" bolt.
- Made of high quality spring steel.

PART #	UPC #	DESCRIPTION	QTY / PKG	SUG. TRADE LIST / PKG
MHOK24C	81923	Knock-On Spring Steel Beam Clamp	100	\$ 92.50
MHOK24M	81924	Knock-On Spring Steel Beam Clamp	1000	\$ 825.00

"Growth Through Innovation"

Metallics

229 Cross Street, Bristol, CT 06010
Tel 800-243-8272 • **Fax** 800-831-9358
Email sales@metallicsonline.com

Metallics West

651 North Main Street, Mancos, CO 81328
Tel 800-269-5183 • **Fax** 800-269-6278
Email saleswest@metallicsonline.com

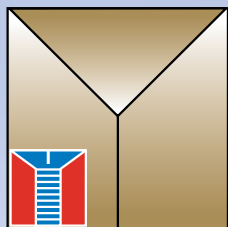

Metallics



Knock-On Spring Steel Beam Clamp

For Flanges 5/16" - 1/2" thick.

[CONTRACTOR APPROVED]



Knock-On beam clamp for flanges 5/16" - 1/2" thick, such as I-beam flanges. Made of high quality spring steel.

Features:

- For Flanges 5/16" - 1/2" thick.
- Hole will accommodate jack chain, ceiling wire or a 1/4" bolt.
- Made of high quality spring steel.

PART #	UPC #	DESCRIPTION	QTY / PKG	SUG. TRADE LIST / PKG
MHOK58C	81929	Knock-On Spring Steel Beam Clamp	100	\$ 100.00
MHOK58M	81930	Knock-On Spring Steel Beam Clamp	1000	\$ 900.00

Other sizes, materials and quantities available by request.

"Growth Through Innovation"

Metallics

229 Cross Street, Bristol, CT 06010
Tel 800-243-8272 • **Fax** 800-831-9358
Email sales@metallicsonline.com

Metallics West

651 North Main Street, Mancos, CO 81328
Tel 800-269-5183 • **Fax** 800-269-6278
Email saleswest@metallicsonline.com

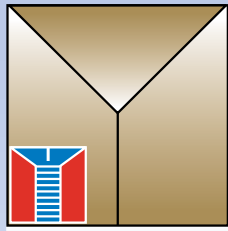

Metallics SilverHawk™ Top Beam Clamp

Check up to five results to perform an action.



**[CONTRACTOR
APPROVED]**



Made in USA

SilverHawk Top Beam Clamps are our strongest, lightweight top beam clamps. Made from cold rolled steel with a zinc plated finish, they are rust and corrosion resistant. These super strong SilverHawk clamps exceed UL and FM testing requirements. Zinc finish aesthetically works with plated rods and plated swivel ring hangers.

Tested by industry professionals, SilverHawk installation is quick and easy. Their unique counter balance design makes it easy to “spin” them onto threaded rods so installation goes faster. The open back shape provides visual verification during installation.

- Supports 3/8" rod – metric also available by request.
- 90° angle fits I-beam or T-bar up to 3/4" thick.
- Extruded tap holes meet FM Approvals requirements.
- Accommodates retaining strap usage.
- Competitively priced domestic par.

PART #	UPC #	DESCRIPTION	QTY / PKG	SUG. TRADE LIST / PKG
SHUBC38	81532	SilverHawk Top Beam Clamp for 3/8" threaded rod	10	\$ 21.70

Other sizes, materials and quantities available by request.

★ ★ ★ ★ ★ *“Growth Through Innovation”* ★ ★ ★ ★ ★

Metallics

229 Cross Street, Bristol, CT 06010
Tel 800-243-8272 • **Fax** 800-831-9358
Email sales@metallicsonline.com

Metallics West

651 North Main Street, Mancos, CO 81328
Tel 800-269-5183 • **Fax** 800-269-6278
Email saleswest@metallicsonline.com

FIXTURE HANGING ACCESSORIES



SLIP-ON LOCK NUTS

FOR THREADED ROD
STEEL ZINC PLATED
PACKAGED IN POLY BAGS

STOCK NO.	UPC NO.	SIZE	HEX SIZE	ACROSS CORNERS	HEIGHT	WT. PER PKG.	STD. PKG.	SUGGESTED TRADE LIST PRICE PER
SLN14	22030	1/4-20	.625	.715	.375	.11	5	18.63/ea pkg
SLN516	22032	5/16-18	.750	.865	.375	.17	5	21.15/ea pkg
SLN38	22034	3/8-16	.875	1.01	.490	.38	5	24.18/ea pkg
SLN12	22036	1/2-13	1.068	1.23	.625	.48	5	28.53/ea pkg

OTHER SIZES AND QUANTITIES AVAILABLE BY REQUEST



ZINC PLATED STEEL

MALLEABLE IRON

BEAM CLAMPS

ZINC PLATED STEEL AND MALLEABLE IRON
PACKAGED IN POLY BAGS

STOCK NO.	UPC NO.	DESCRIPTION	WT. PER PKG.	STD. PKG.	SUGGESTED TRADE LIST PRICE PER
BC14	81525	1/4-20 Zinc Plated	1.16	10	12.08/ea pkg
BC38	81530	3/8-16 Zinc Plated	2.86	10	23.53/ea pkg
MBC14	81535	1/4-20 Malleable Iron	2.00	10	11.43/ea pkg
MBC38	81537	3/8-16 Malleable Iron	6.81	10	50.38/ea pkg
MBC12	81539	1/2-13 Malleable Iron	13.20	10	63.78/ea pkg

OTHER SIZES AND QUANTITIES AVAILABLE BY REQUEST



SQUARE

OCTAGONAL

SWIVEL FIXTURE HANGERS

FOR 4" SQUARE AND OCTAGONAL BOXES
STEEL ZINC CHROMATE
PACKAGED 1 PER POLY BAG

STOCK NO.	UPC NO.	SIZE	WT. EACH	STD. PKG.	SUGGESTED TRADE LIST PRICE PER
MSC50	81541	Sq. box/pivot threaded for 1/2" npt pipe	.71	1	27.70/ea
MSC75	81543	Sq. box/pivot threaded for 3/4" npt pipe	.68	1	27.70/ea
MSC50R	81545	Oct. box/pivot threaded for 1/2" npt pipe	.63	1	27.70/ea
MSC75R	81547	Oct. box/pivot threaded for 3/4" npt pipe	.59	1	27.70/ea

PAINTED WHITE AVAILABLE BY SPECIAL QUOTE

OTHER SIZES AND QUANTITIES AVAILABLE BY REQUEST



SLIP-ON LOCK NUT KIT

STOCK NO.	UPC NO.	DESCRIPTION OF CONTENTS	WT. EACH	SUGGESTED TRADE LIST PRICE PER
SLNK1	22040	1/4 & 3/8 Slip-On Lock Nut Kit (25 pcs. each size)	1.98	205.33/ea kit
SLNK2	22041	3/8 Slip-On Lock Nut Kit (50 pcs.)	2.00	205.33/ea kit

OTHER SIZES AND QUANTITIES AVAILABLE BY REQUEST

FIXTURE HANGING ACCESSORIES



J-BOLTS

STEEL ZINC CHROMATE & GALVANIZED
PACKAGED 10 PER POLY BAG



STOCK NO.	UPC NO.	THREAD LENGTH	THREAD SIZE/ OVERALL LENGTH	INSIDE HOOK DIA.	WT. PER PKG.	STD. PKG.	SUGGESTED TRADE LIST PRICE PER
BTJ1	81055	1½	¼-20 x 2 ⁵ / ₁₆	7/ ₁₆	.31	10	2.80/ea pkg
BTJ4	81061	1½	¼-20 x 4	7/ ₁₆	.52	10	6.85/ea pkg
BTJ2	81057	2	5/ ₁₆ -18 x 3	1/ ₂	.66	10	5.23/ea pkg
BTJ3	81059	2¼	3/ ₈ -16 x 3¾	5/ ₈	1.18	10	9.28/ea pkg
GALVANIZED							
BTJ6G	81656	2	½-13 x 3 ½	1/ ₂	4.95	10	222.50/ea pkg

HEXAGON NUTS AND WASHERS ORDERED SEPARATELY
OTHER SIZES AND QUANTITIES AVAILABLE BY REQUEST



COMMUNICATION RACK J-BOLT KIT

STOCK NO.	UPC NO.	DESCRIPTION	WT. EACH	SUGGESTED TRADE LIST PRICE PER
BTJK516	20325	5/ ₁₆ J-Hook Kit 25 5/ ₁₆ x 3 J-Bolts 25 5/ ₁₆ x 3 Hex Lock Nuts Steel Zinc	2.13	29.88/ea kit

OTHER SIZES AND QUANTITIES AVAILABLE BY REQUEST



HOOK AND HOOK TURNBUCKLES

MALLEABLE IRON AND
STEEL ZINC CHROMATE
PACKAGED 1 EACH PER POLY BAG



STOCK NO.	UPC NO.	THREAD DIAMETER	OVERALL LENGTH CLOSED	OVERALL LENGTH OPEN	WT. PER PKG.	STD. PKG.	SUGGESTED TRADE LIST PRICE PER
TBH14	81577	¼ - 20	5½	7 ⁵ / ₈	0.18	1	6.38/ea
TBH516	81579	5/ ₁₆ - 18	6¾	9¼	0.33	1	10.03/ea
TBH38	81581	3/ ₈ - 16	7½	10½	0.52	1	14.45/ea

OTHER SIZES AND QUANTITIES AVAILABLE BY REQUEST



EYE BOLTS WITH HEX NUTS

STEEL ZINC CHROMATE & STAINLESS STEEL

STOCK NO.	UPC NO.	THREAD LENGTH	THREAD/SIZE OVERALL LENGTH	INSIDE EYE SIZE	WT. PER PKG.	STD. PKG.	SUGGESTED TRADE LIST PRICE PER
JEB6	80992	1¼	10-24 x 2	3/ ₈	2.17	100	26.58/c
JEB1	80993	¾	¼-20 x 2	1/ ₂	4.34	100	28.15/c
JEB2	80994	1¼	¼-20 x 2½	1/ ₂	4.90	100	30.63/c
JEB3	80995	1¾	¼-20 x 3	1/ ₂	5.36	100	34.80/c
JEB4	82220	2	¼-20 x 3½	1/ ₂	5.86	100	38.88/c
JEB9	82229	3	¼-20 x 5	1/ ₂	7.45	100	78.33/c

OTHER SIZES AND QUANTITIES AVAILABLE BY REQUEST

CONTINUED ON NEXT PAGE

FIXTURE HANGING ACCESSORIES



CONTINUED

EYE BOLTS WITH HEX NUTS

STEEL ZINC CHROMATE & STAINLESS STEEL

STOCK NO.	UPC NO.	THREAD LENGTH	THREAD SIZE OVERALL LENGTH	INSIDE EYE SIZE	WT. PER PKG.	STD. PKG.	SUGGESTED TRADE LIST PRICE PER
JEB5	82225	2 ³ / ₄	1/4-20 x 4	1/2	6.22	100	39.73/c
JEB15	82236	3	1/4-20 x 6	1/2	8.23	100	144.35/c NEW
JEB32	82253	2 ³ / ₄	5/16-18 x 2 ³ / ₈	1/2	8.03	100	100.73/c NEW
JEB33	82254	1/4	5/16-18 x 3	1/2	2.43	25	243.12/c NEW
JEB13	82233	1	3/8-16 x 3	1	14.80	100	213.23/c NEW
JEB12	82232	1 ¹ / ₄	3/8-16 x 3 ¹ / ₂	1	13.72	100	184.78/c NEW
JEB14	82235	2	3/8-16 x 4	1	8.84	50	231.88/c NEW
JEB8	81190	3	3/8-16 x 5	1	5.13	25	122.90/ea. pkg.
JEB11	82231	3	3/8-16 x 6	1	5.85	25	157.08/ea. pkg. NEW
JEB17	82238	3 ⁷ / ₈	3/8-16 x 8	1	7.50	25	293.95/c NEW
JEB16	82237	3	7/16-14 x 8	1	3.98	20	680.75/c NEW
JEB10	82230	3 ¹ / ₄	7/16-14 x 10	1 ¹ / ₈	4.70	10	694.80/ea. pkg.
JEB124	77824	1 ¹ / ₄	1/2-13 x 4	1 ¹ / ₈	7.00	100	495.18/c NEW

STAINLESS STEEL

JEB1SS	94451	3/4	1/4-20 x 2	1/2	4.25	100	PLEASE CALL FOR TRADE LIST PRICING	NEW
JEB3SS	94453	1 ³ / ₄	1/4-20 x 3	1/2	5.48	100		NEW
JEB13SS	94463	2 ³ / ₈	3/8-16 x 3 ⁷ / ₈	1	3.72	25		NEW
JEB14SS	22228	2	3/8-16 x 4	1	17.52	100		NEW
JEB124SS	98187	1 ¹ / ₄	1/2-13 x 4	1 ¹ / ₈	7.00	25		NEW

OTHER SIZES AND QUANTITIES AVAILABLE BY REQUEST



SCREW EYES

STEEL ZINC CHROMATE
With Lag Screw Thread



STOCK NO.	UPC NO.	OVERALL LENGTH/HOLE DIAMETER	THREAD DIAMETER	THREAD LENGTH	WT. PER PKG.	STD. PKG.	SUGGESTED TRADE LIST PRICE PER
JSE1	80996	1 ⁵ / ₁₆ x 1/2"	#8	1/2	.83	100	10.00/c
JSE2	80997	1 ⁵ / ₁₆ x 5/8"	1/4	3/4	1.58	100	22.50/c
JSE5*	81416	3 ³ / ₄ x 1/2"	1/4	3/4	5.32	100	140.80/c NEW
JSE3	80998	2 ³ / ₁₆ x 1 ¹ / ₁₆ "	9/32	7/8	4.06	100	30.28/c
JSE4	81415	2 ⁵ / ₈ x 3/4"	5/16	1	6.82	100	59.05/c
JSE7*	81414	5 ¹ / ₂ x 3/4"	7/16	2 ¹ / ₈	8.27	25	75.00/ea. pkg. NEW
JSE8*	81418	5 ¹ / ₄ x 1"	1/2	2 ¹ / ₂	6.50	25	68.34/ea. pkg.
JSE10*	81420	8 x 1 ¹ / ₈ "	9/16	2 ⁵ / ₈	11.65	25	120.80/ea. pkg.
JSE6	81417	8 x 7/16"	7/16	2 ⁷ / ₈	11.50	25	162.50/ea. pkg. NEW

OTHER SIZES AND QUANTITIES AVAILABLE BY REQUEST

*DENOTES A PRODUCT NOT MANUFACTURED IN USA

FIXTURE HANGING ACCESSORIES

SWIVEL FIXTURE HANGERS



SQUARE



OCTAGONAL

- 20° swing from vertical
- Both load rated at 50 lbs.
- Rugged hinge construction
- **Hands-free fixture hanger**
- Single Electrician Installation
- Fits 4" square and round electrical boxes
- Fits 3/4" pipe and includes a reducing bushing for 1/2" pipe

STOCK NO.	UPC NO.	SHAPE	DESCRIPTION	PKG. QTY.	WT. EACH	SUGGESTED TRADE LIST PRICE PER
MSCU	81607	Square	Fixture Hanger	1	.78	41.73/ea
MSCUR	81609	Round	Fixture Hanger	1	.72	41.73/ea

OTHER SIZES AND QUANTITIES AVAILABLE BY REQUEST



SCREW HOOKS

STEEL ZINC CHROMATE
With Lag Screw Thread

STOCK NO.	UPC NO.	LENGTH/ WIRE DIAMETER	WT. PER PKG.	STD. PKG.	SUGGESTED TRADE LIST PRICE PER
JSH1	83500	2" x .135"	1.20	100	21.93/c
JSH2	83505	3 ³ / ₈ " x .192"	3.92	100	42.38/c
JSH3	83510	4 ¹ / ₈ " x .244"	7.88	100	53.80/c

OTHER SIZES AND QUANTITIES AVAILABLE BY REQUEST

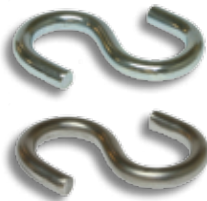

ZINC CHROMATE



STAINLESS STEEL

S-HOOKS

STEEL GALVANIZED
AND STAINLESS STEEL

For Hanging Industrial
Fluorescent Fixtures

**NOW IN
LARGER
SIZES!**

STOCK NO.	UPC NO.	LENGTH/ WIRE DIAMETER	WT. PER PKG.	USE WITH	STD. PKG.	SUGGESTED TRADE LIST PRICE PER
STEEL GALVANIZED						
JSHK1A	81006	3/4" x .071"	.35	JC14	100	8.35/c
JSHK1	81005	1 1/4" x .105"	.76	JC12/JC14	100	8.65/c
JSHK2	81007	1 1/2" x .135"	1.39	JC10/JC12	100	21.00/c
JSHK2A	81008	1 3/4" x .186"	3.12	JC10/JC12	100	31.43/c
JSHK3	81009	2" x .243"	5.63	JC10	100	94.88/c
JSHK4	82256	3" x .312"	6.16	JC10	50	117.20/c
JSHK5	82260	3 1/2" x .375"	10.61	JC10	50	225.56/c
STAINLESS STEEL						
JSHK0ASS	82301	3/4" x .092"	.38	JC14	100	89.25/c NEW
JSHK1SS	82401	1 1/4" x .148"	1.35	JC12/JC14	100	112.82/c NEW
JSHK2SS	82306	1 1/2" x .184"	2.30	JC12/JC14	100	127.30/c
JSHK2ASS	82265	1 3/4" x .192"	3.21	JC10/JC12	100	245.55/c
JSHK3SS	82270	2" x .250"	6.20	JC10	100	447.50/c

OTHER SIZES AND QUANTITIES AVAILABLE BY REQUEST

*DOMESTIC PRODUCT AVAILABLE UPON REQUEST

FIXTURE HANGING ACCESSORIES



TIE WIRE

LOW TENSILE STEEL & STAINLESS STEEL

STOCK NO.	UPC NO.	DESCRIPTION	WT. PER PKG.	STD. CARTON	SUGGESTED TRADE LIST PRICE PER	
MTW12	16120	12 Gauge 5Lb/165'	6.00	1	25.18/ea coil	NEW
MTW12-3M	16123	12 Gauge 89Lb/3000'	89.00	1	516.23/ea coil	NEW
MTW12-4M	16124	12 Gauge 118Lb/4000'	118.00	1	688.33/ea coil	NEW
MTW14M	16140	14 Gauge 17Lb/1000'	17.00	1	174.75/ea coil	NEW
MTW16	16125	350' 16 Gauge	70.60	20 Coils (min. purchase)	10.73/ea coil	
MTW17	22307	500' 16 Gauge/Galvanized	66.00	12 Spools (min. purchase)	20.65/ea coil	
MTW1725	22308	250' 16 Gauge/Galvanized	71.60	20 Coils (min. purchase)	15.48/ea coil	
MTW18	22313	350' 18 Gauge	13.00	1	10.73/ea coil	NEW
STAINLESS STEEL						
MTW16SS1LB	22293	16 Gauge 1Lb Coil	1.00	1	58.75/ea coil	NEW
MTW16SSP	22292	1152' 16 Gauge	2.40	1	220.00/ea coil	NEW

*DOMESTIC PRODUCT AVAILABLE UPON REQUEST

OTHER SIZES AND QUANTITIES AVAILABLE BY REQUEST



TIE WIRE DISPENSER

Mounts On Toolbelt • Metal
A Very Handy Way To Store & Dispense Tie Wire

STOCK NO.	UPC NO.	WT. PER PKG.	STD. PKG	SUGGESTED TRADE LIST PRICE PER	
MWDM1	16120	6.00	1	59.80/ea	NEW

OTHER SIZES AND QUANTITIES AVAILABLE BY REQUEST



PRE-TIED CEILING WIRE

STOCK NO.	UPC NO.	DESCRIPTION	WT. PER PKG.	STD. BUNDLE.	SUGGESTED TRADE LIST PRICE PER	
SWL1212	16177	12' Pretied Ceiling Wire w/ single loop	39.00	100 pcs	187.50/c	NEW
SWL612	16174	6' Pretied Ceiling Wire w/ single loop	20.00	100 pcs	110.00/c	NEW
SWP1212	26717	12' Pretied Ceiling Wire w/ pin & clip	39.00	100 pcs	189.65/c	NEW
SWP612	26612	6' Pretied Ceiling Wire w/ pin clip	20.00	100 pcs	117.68/c	NEW

OTHER SIZES AND QUANTITIES AVAILABLE BY REQUEST

FIXTURE HANGING ACCESSORIES

See Section A Fasteners to attach jack chain to structural steel or bar joists.

JACK CHAIN

STEEL GALVANIZED AND STAINLESS STEEL



STOCK NO.	UPC NO.	TRADE SIZE	SIZE ACROSS LINK	WORK LOAD/LIMIT/LBS	WT. PER PKG.	STD. PKG.	SUGGESTED TRADE LIST PRICE PER
STEEL GALVANIZED							
JC10	21515	#10	1/2	43	7.26	50' BOX	26.85/ea pkg
JC10T	21513	#10	1/2	43	37.01	250' BOX	134.28/ea pkg NEW
JC12	21500	#12	3/8	29	4.46	50' BOX	18.28/ea pkg
JC12C	21505	#12	3/8	29	9.13	100' REEL	39.45/ea pkg
JC12CB	21507	#12	3/8	29	6.83	100' BOX	36.58/ea pkg
JC12M	21510	#12	3/8	29	90.00	1000' BUCKET	359.20/ea pkg
JC14	21518	#14	1/4	16	5.35	100' BOX	35.23/ea pkg
JC16	21508	#16	5/64	11	3.12	100' BOX	73.03/ea pkg NEW
JC18CB	21535	#18	3/16	5	1.84	100' BOX	106.08/ea pkg NEW
STAINLESS STEEL 18-8 TYPE							
JC10SS	21516	#10	1/2	43	7.53	50' BOX	189.98/ea pkg NEW
JC10CBSS	21517	#10	1/2	43	15.00	100' BOX	540.60/ea pkg
JC12SS	21501	#12	3/8	29	4.46	50' BOX	230.98/ea pkg NEW
JC12CSS	21506	#12	3/8	29	8.92	100' BOX	469.10/ea pkg NEW
JC16SS	21523	#16	5/64	11	3.14	100' BOX	243.03/ea pkg NEW
JC18SS	21534	#18	3/16	5	2.54	100' BOX	197.75/ea pkg

*DOMESTIC PRODUCT AVAILABLE UPON REQUEST

OTHER SIZES AND QUANTITIES AVAILABLE BY REQUEST

FIXTURE HANGING CHAIN

PLAIN STEEL FINISH WITH LACQUER



STOCK NO.	UPC NO.	DESCRIPTION	WT. PER PKG.	STD. PKG.	SUGGESTED TRADE LIST PRICE PER
FHC1	21410	2-1/4 x 3/4 W, .148 Thick	44.15	(100) 3' Pieces	312.20/ea pkg

*DOMESTIC PRODUCT AVAILABLE UPON REQUEST

OTHER SIZES AND QUANTITIES AVAILABLE BY REQUEST

DOUBLE LOOP CHAIN

STEEL GALVANIZED AND 18-8 SERIES STAINLESS STEEL



STOCK NO.	UPC NO.	TRADE SIZE	WIRE DIA.	WORK LOAD LIMIT/LBS	WT. PER PKG.	STD. PKG.	SUGGESTED TRADE LIST PRICE PER
STEEL GALVANIZED							
DLC1	21550	#1	.105	155	10.18	100' Box	54.73/ea pkg
DLC1S	21555	#1	.105	155	26.00	250' Spool	135.13/ea pkg
DLC2	21556	#2	.0915	115	7.50	100' Spool	39.10/ea pkg NEW
DLC3	21560	#3	.080	90	6.14	100' Box	42.98/ea pkg
DLC3S	21565	#3	.080	90	16.25	250' Spool	107.43/ea pkg
DLC4	21586	#4	.072	70	5.23	100' Spool	39.65/ea pkg NEW
DLC2/0	21557	#2/0	.135	255	42.50	250' Spool	161.98/ea pkg NEW
STAINLESS STEEL							
SDLC3	21570	#3	.080	90	6.34	100' Box	320.48/ea pkg

*DOMESTIC PRODUCT AVAILABLE UPON REQUEST

OTHER SIZES AND QUANTITIES AVAILABLE BY REQUEST

FIXTURE HANGING ACCESSORIES



TOP/END

FIXTURE HOOKS

STEEL ZINC CHROMATE
For Hanging Industrial Light Fixtures
PACKAGED IN 1/4 KEG CARTONS



SIDE

STOCK NO.	UPC NO.	DESCRIPTION	WT. PER PKG.	STD. PKG.	SUGGESTED TRADE LIST PRICE PER
FHK1	21400	Top/End Mount	4.50	100	45.13/c
FHK2	21405	Side Mount	4.80	100	45.13/c

OTHER SIZES AND QUANTITIES AVAILABLE BY REQUEST

TIE WIRE ACOUSTICAL TOGGLE BOLTS

TIE WIRE ACOUSTICAL TOGGLE BOLTS ARE PRIMARILY FOR OVERHEAD APPLICATIONS. The winged end is inserted through the drywall, ceiling, tile, etc., and expands behind that medium while the 1/4" x 1-1/4" fender washer and hex nut act to secure the anchor to the exterior of the hole.

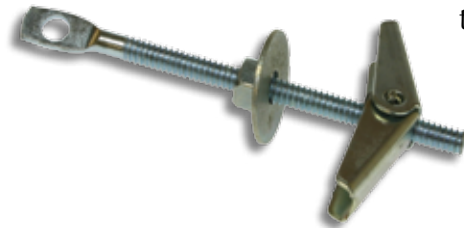

INCLUDES:
(1) TIE WIRE 1/4-20
TOGGLE BOLT
(1) 1/4-20 NUT
(1) 1/4 WASHER
(1) 1/4 TOGGLE WING

STOCK NO.	UPC NO.	DESCRIPTION	WT. PER PKG.	STD. PKG.	SUGGESTED TRADE LIST PRICE PER
JTWA144	81402	1/4" x 4" Toggle Bolt	2.47	25	38.00/ea pkg
JTWA145	81404	1/4" x 5" Toggle Bolt	2.33	25	40.93/ea pkg

OTHER SIZES AND QUANTITIES AVAILABLE BY REQUEST

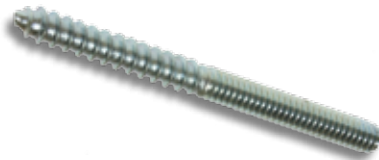

HANGER BOLTS

STEEL ZINC CHROMATE



G

STOCK NO.	UPC NO.	DESCRIPTION	STD. PKG.	WT. PER PKG.	SUGGESTED TRADE LIST PRICE PER
JHAB9	81000	10-24 x 2	1.12	100	11.75/c
JHAB10	81001	1/4-20 x 3	3.10	100	23.13/c
JHAB11	81002	3/8-16 x 3	7.65	100	50.50/c
JHAB13	84111	3/8-16 x 4	9.42	100	53.50/c
JHAB12	84110	3/8-16 x 6	7.31	50	50.03/ea. pkg.

OTHER SIZES AND QUANTITIES AVAILABLE BY REQUEST



HANGER BOLT DRIVERS

WITH 1/4" POWER HEX SHANKS
Internal threads for driving
Hanger bolts and threaded rod

STOCK NO.	UPC NO.	DESCRIPTION	WT. PER PKG.	STD. PKG.	SUGGESTED TRADE LIST PRICE PER
HABD10	23275	1/4-20 x 2 9/16 BOLT DRIVER	.06	1	11.23/ea
HABD12	23280	3/8-16 x 2 9/16 BOLT DRIVER	.08	1	14.28/ea

OTHER SIZES AND QUANTITIES AVAILABLE BY REQUEST

FIXTURE HANGING ACCESSORIES

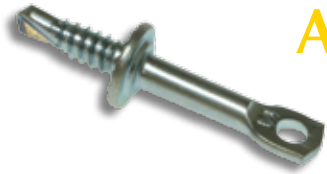

ACOUSTICAL DRILL SCREW

STEEL ZINC CHROMATE

Designed to penetrate 16-18 gauge steel stud for hanging acoustical ceilings

STOCK NO.	UPC NO.	THREAD SIZE/ OVERALL LENGTH	WT. PER PKG.	STD. PKG.	SUGGESTED TRADE LIST PRICE PER
JATEK1	82020	1/4 x 2	1.05	50	21.63/ea. pkg.

OTHER SIZES AND QUANTITIES AVAILABLE BY REQUEST



ACOUSTICAL LAG SCREW

STEEL ZINC CHROMATE

For use in tie wire and jack chain applications
For Wood Application

STOCK NO.	UPC NO.	THREAD SIZE/ OVERALL LENGTH	WT. PER PKG.	STD. PKG.	SUGGESTED TRADE LIST PRICE PER
JALS14	81003	1/4 x 3	1.19	50	9.03/ea. pkg.
JALS15	77915	1/4 x 4	2.32	100	47.53/c.

OTHER SIZES AND QUANTITIES AVAILABLE BY REQUEST



ACOUSTICAL LAG & ACOUSTICAL DRILL SCREW DRIVER

STOCK NO.	UPC NO.	DESCRIPTION	WT. PER PKG.	STD. PKG.	SUGGESTED TRADE LIST PRICE PER
ALSD	22050	Driver 3 1/4	.13	1	8.93/ea

OTHER SIZES AND QUANTITIES AVAILABLE BY REQUEST



TIE WIRE WEDGE ANCHOR

ZINC WITH STAINLESS STEEL CLIP

For various overhead suspension applications

STOCK NO.	UPC NO.	DESCRIPTION	MIN. DEPTH IN LENGTH	WT. PER PKG.	STD. PKG.	SUGGESTED TRADE LIST PRICE PER
JTWA214	80906	1/4 X 2 1/4	1 3/8	3.41	100	108.60/c

OTHER SIZES AND QUANTITIES AVAILABLE BY REQUEST



EYE COUPLING

STEEL ZINC CHROMATE

For use in tie wire and jack chain applications

STOCK NO.	UPC NO.	DESCRIPTION	WT. PER PKG.	STD. PKG.	SUGGESTED TRADE LIST PRICE PER
JEC44	81004	1/4-20 x 1 1/2	2.29	100	77.05/c

OTHER SIZES AND QUANTITIES AVAILABLE BY REQUEST

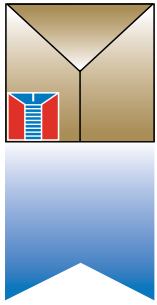

Metallics

Requested by distributors in Hurricane & Flood Prone areas

MADE IN USA



(ANCHORS ONLY)

HURRICANE / WINDOW / DOOR SHUTTER SCREW KIT

(STAINLESS STEEL CAP)

Don't get caught off guard. Be prepared!!



Installation Instructions Included



This Kit Contains The Following:

STOCK NO.	UPC NO.	DESCRIPTION	WT. PER PKG.	SUGGESTED TRADE LIST PRICE PER
SHSK1	41500	(1) 8" x 4" Plastic 6 Compartment Case (1) 3/16" Carbide Tipped Drill Bit (1) Concrete Driver (1) Wood Driver (20) 1/4" Flat Washers (20) 1/4-20 x 1" Machine Screws (20) 1/4-20 x 1-1/2" Machine Screws (10) 1-1/4" Hurricane Concrete Anchors (SS Cap) (10) 2" Hurricane Wood Anchors (SS Cap)	1.85	115.00/ea

Metallics

229 Cross Street, Bristol, CT 06010
Tel 800-243-8272 • **Fax** 800-831-9358
Email sales@metallicsonline.com

Metallics West

651 North Main Street, Mancos, CO 81328
Tel 800-269-5183 • **Fax** 800-269-6278
Email saleswest@metallicsonline.com

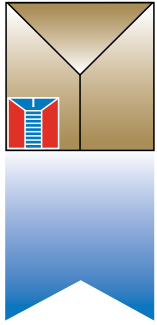

Metallics



HIGH PERFORMANCE PLASTIC SADDLE

(CABLE TRAY APPLICATION)

- PLENUM RATED
- MULTIPLE HANGERS PER ROD
- NON-CORROSIVE / NON-CONDUCTIVE
- SNAP NUT ANYWHERE ONTO THREADED ROD
- HOLDS UP TO 35 PIECES CAT 5E CABLE
- AN INEXPENSIVE ALTERNATIVE OR ENCHANCEMENT TO A CABLE TRAY

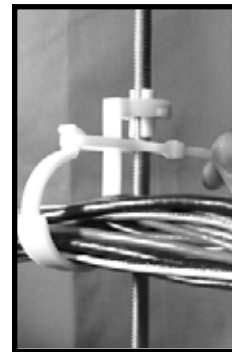

STOCK NO.	JAR UPC NO.	DESCRIPTION	WT. PER PKG.	STD. PKG.	SUGGESTED TRADE LIST PRICE PER
SMS1	41995	1/4" & 3/8" Saddle	.06	1	5.83/ea
SMS5	41996	1/4" & 3/8" Saddle	.29	5	27.13/ea

Metallics

229 Cross Street, Bristol, CT 06010
Tel 800-243-8272 • **Fax** 800-831-9358
Email sales@metallicsonline.com

Metallics West

651 North Main Street, Mancos, CO 81328
Tel 800-269-5183 • **Fax** 800-269-6278
Email saleswest@metallicsonline.com

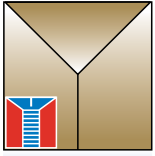

Metallics



VERTICAL MOUNT THREADED ROD ANCHOR SYSTEM

SAVES TIME AND COST FROM TRADITIONAL HANGING METHODS

Drill, Drive, Done!



STOCK NO.	JAR UPC NO.	ROD SIZE	SCREW DESCRIPTION	WT. PER PKG.	STD. PKG.	SUGGESTED TRADE LIST PRICE PER
WOOD						
JSMW14201	78360	1/4-20	5/16 X 2 1/4	1.69	25	52.45/ea pkg
JSMW38161	78365	3/8-16	5/16 X 2 1/4	1.55	25	62.98/ea pkg

FOR 1/2-13 THREADED ROD SEE THE ADAPTER BELOW.
OTHER SIZES AND QUANTITIES AVAILABLE BY REQUEST



METAL						
JSM14201	78400	1/4-20	1/4-20 x 1 1/2 #3 DRILL POINT	1.43	25	68.25/ea pkg
JSM38161	78405	3/8-16	1/4-20 x 1 1/2 #3 DRILL POINT	1.55	25	68.83/ea pkg

FOR 1/2-13 THREADED ROD SEE THE ADAPTER BELOW.
OTHER SIZES AND QUANTITIES AVAILABLE BY REQUEST



CONCRETE						
JSMC14201	78370	1/4-20	5/16 X 2 1/4 1/4 DRILL SIZE	1.78	25	76.53/ea pkg
JSMC38161	78375	3/8-16	5/16 X 1 1/2	1.64	25	65.78/ea pkg

FOR 1/2-13 THREADED ROD SEE THE ADAPTER BELOW.
OTHER SIZES AND QUANTITIES AVAILABLE BY REQUEST



**ADAPTER TO CONVERT 3/8-16 WOOD, CONCRETE AND STEEL
VERTICAL MOUNT FASTENERS TO ACCEPT 1/2-13 THREADED ROD.**

ADAPTER						
SME270	41340	3/8-16 to 1/2-13	Threaded Rod		25	45.33/ea pkg

OTHER SIZES AND QUANTITIES AVAILABLE BY REQUEST



DRIVER						
SMDB21	78420	1/4 & 3/8	Driver	.10	1	29.70/ea

PLEASE CALL FOR TECHNICAL INFORMATION
OTHER SIZES AND QUANTITIES AVAILABLE BY REQUEST

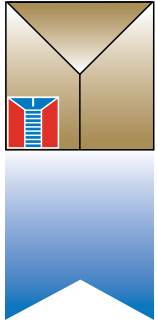

Metallics



HORIZONTAL MOUNT THREADED ROD ANCHOR SYSTEM

SAVES TIME AND COST FROM TRADITIONAL HANGING METHODS

Drill, Drive, Done!



STOCK NO.	JAR UPC NO.	ROD SIZE	SCREW DESCRIPTION	WT. PER PKG.	STD. PKG.	SUGGESTED TRADE LIST PRICE PER
WOOD						
JSMWS14201	78380	1/4-20	5/16 x 2 1/4	2.08	25	76.78/ea pkg
JSMWS38161	78385	3/8-16	5/16 x 2 1/4	1.78	25	76.78/ea pkg

FOR 1/2-13 THREADED ROD SEE THE ADAPTER BELOW.

OTHER SIZES AND QUANTITIES AVAILABLE BY REQUEST



METAL						
JSMMS14201	78410	1/4-20	1/4-20 x 1 1/2 #3 DRILL POINT	1.78	25	83.03/ea pkg
JSMMS38161	78415	3/8-16	1/4-20 x 1 1/2 #3 DRILL POINT	2.16	25	83.03/ea pkg

FOR 1/2-13 THREADED ROD SEE THE ADAPTER BELOW.

OTHER SIZES AND QUANTITIES AVAILABLE BY REQUEST



CONCRETE						
JSMCS14201	78390	1/4-20	5/16 x 2 1/4 1/4 DRILL SIZE	2.17	25	90.85/ea pkg
JSMCS38161	78395	3/8-16	5/16 x 1 1/2	1.92	25	90.85/ea pkg

FOR 1/2-13 THREADED ROD SEE THE ADAPTER BELOW.

OTHER SIZES AND QUANTITIES AVAILABLE BY REQUEST



**ADAPTER TO CONVERT 3/8-16 WOOD, CONCRETE AND STEEL
HORIZONTAL MOUNT FASTENERS TO ACCEPT 1/2-13 THREADED ROD.**

ADAPTER						
SME270	41340	3/8-16 to 1/2-13	Threaded Rod		25	45.33/ea pkg

OTHER SIZES AND QUANTITIES AVAILABLE BY REQUEST



DRIVER						
SMDB21	78420	1/4 & 3/8	Driver	.10	1	29.70/ea

PLEASE CALL FOR TECHNICAL INFORMATION

OTHER SIZES AND QUANTITIES AVAILABLE BY REQUEST

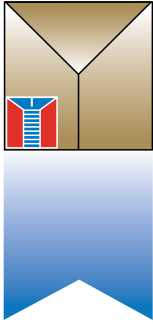

Metallics



SWIVEL HEAD® THREADED ROD ANCHOR SYSTEM Drill, Drive, Done!



STOCK NO.	JAR UPC NO.	ROD SIZE	SCREW DESCRIPTION	WT. PER PKG.	STD. PKG.	SUGGESTED TRADE LIST PRICE PER
-----------	-------------	----------	-------------------	--------------	-----------	--------------------------------

WOOD

JSHW3816	41400	3/8-16	1/4 x 2	1.69	25	72.73/ea pkg
----------	-------	--------	---------	------	----	--------------

OTHER SIZES AND QUANTITIES AVAILABLE BY REQUEST



DRIVER

SMDB2*	41330	1/4 & 3/8	Driver	.10	1	29.70/ea
--------	-------	-----------	--------	-----	---	----------

APPLICATION - METAL & WOOD DRIVER

*DENOTES A PRODUCT NOT MANUFACTURED IN USA

OTHER SIZES AND QUANTITIES AVAILABLE BY REQUEST



Don't Bend That Rod!

- 17° Deflection from Vertical
- Accomodates up to 3-1/2 x 12 Pitch roof

SAMMY SWIVEL HEAD® IS A REGISTERED TRADEMARK



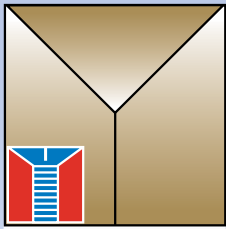

Metallics

RIZE Kwik-Loc™ System

NEW!
2014-2015

[CONTRACTOR APPROVED]

A fast and easy way to hang signs, florescent fixtures, speakers, busbars, cable trays, and piping just to name a few.

No Tools Needed and KWIK-LOCS™ are reusable!

Kwik-Locs™



Kwik-Loc™ with 3/32" cable will safely suspend 150 lbs. vertical.

NOTE: Suspension at angles does reduce safe working load.

WEIGHT CHART

Size	Vertical	15°	30°	45°	60°
3/32 in.	150 lbs.	144 lbs.	129 lbs.	105 lbs.	75 lbs.

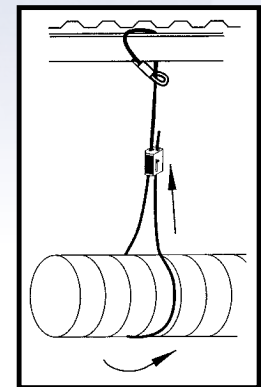

RIZE Kwik-Loc™ System can be purchased in kits or individually

PART #	UPC #	DESCRIPTION	QTY / PKG	SUG. TRADE LIST / PKG
RLCK5	23055	3/32" Diameter Loop Cable 5' Long with Kwik-Loc™ Joiner Kit	1	\$ 12.75
RLCK10	23060	3/32" Diameter Loop Cable 10' Long with Kwik-Loc™ Joiner Kit	1	\$ 14.95
MKL100	23082	Kwik-Loc™ only for 1/16" and 3/32" Cable	1	\$ 4.88
RLC5	23065	3/32" Diameter Loop Cable 5' Long	1	\$ 8.00
RLC10	23070	3/32" Diameter Loop Cable 10' Long	1	\$ 10.38



LISTED
Luminaire Fitting
14HE

All Kwik-Locs have been tested to UL 1598 and are listed under File # E246601

"Growth Through Innovation"

Metallics

229 Cross Street, Bristol, CT 06010
Tel 800-243-8272 • Fax 800-831-9358
Email sales@metallicsonline.com

Metallics West

651 North Main Street, Mancos, CO 81328
Tel 800-269-5183 • Fax 800-269-6278
Email saleswest@metallicsonline.com



Metallics



CONCRETE/WOOD INSTALLATION KIT

The Concrete/Wood Installation Kit is a quality product, that saves you money and frustration. This multi-purpose kit is convenient and very easy to use.

STOCK NO.	UPC NO.	DESCRIPTION	WT. PER PKG.	SUGGESTED TRADE LIST PRICE PER
SCK1	41589	(1) 7/32" HSD Bit (1) SDS 250 Bit (1/4") (1) SL250 Sleeve (1) HEX 250 Bit Receiver (1/4") (1) SMDB2 Driver* (1) SMDB3 Driver* (1) 1/8" Allen Wrench (1) 1/4" Concrete Bit	.90	158.78/ea

OTHER SIZES AND QUANTITIES AVAILABLE BY REQUEST

AMERICA'S SOURCE FOR PREMIER AND INNOVATIVE FASTENERS & ANCHORS



A Modern Up to Date Roll Threading Machine at our Affiliate, Avanti Screw.



Metallics and Avanti Screw, Inc., prime American manufacturers of fastener products, have always worked to present the latest in fastener technology to our distributors and their contractors/users.

Hex Washer Head fasteners have historically only offered three drives—the hex, phillips and the slot. In 1999, we introduced "The QuaDrive" square, hex, slotted and Phillips, in fourteen of the most popular sizes of sheet metal screws.

The QuaDrive

□ + ⬡ + / + + =

Square Drive Hex Slotted Phillips QuaDrive

America's Newest Drive - Designed, Developed and Manufactured by Metallics/Avanti Screw

These sheet metal screws are being manufactured to fill the need of the growing demand in the North American markets.

Please note: We recommend driving these sheet metal screws with a hex driving tool. The slotted, Phillips, hex and square drives make it convenient for disassembly.



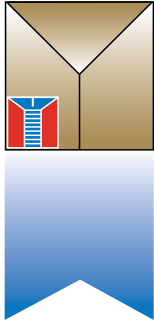

Metallics



STEEL DECKING THREADED ROD ANCHOR SYSTEM

SAVES TIME AND COST FROM TRADITIONAL HANGING METHODS

Drill, Drive, Done!



SMXB1



SMXK1



Expands to provide direct Vertical attachment in:

- Metal Deck (16-22 gauge)
- Z Purlin (16-18 gauge)
- Install in seconds
- Retaining nut is not required



Step 1



Step 2



Step 3



Step 4



Completed Installation

STOCK NO.	UPC NO.	MOUNT	ROD SIZE	WT. PER PKG.	STD. PKG.	SUGGESTED TRADE LIST PRICE PER
JSMX1	41435	Vertical	1/4 - 20	.44	5	63.10/ea pkg
JSMX2	41440	Vertical	3/8 - 16	.45	5	63.10/ea pkg
JSMX125	41570	Vertical	3/8 - 16	2.02	25	177.25/ea pkg
JSMXP35	41580	Vertical Swivel	3/8 - 16	.48	5	77.33/ea pkg
JSMXP3525	41625	Vertical Swivel	3/8 - 16	2.40	25	377.78/ea pkg
SMXK1	41445		Installation tool	1.01	1	440.40/ea
SMXB1	41450		25/64" Custom Drill Bit for Tool	.90	1	44.63/ea

Installation Kit Includes: Sleeve, bit receiver, hex wrench, and 25/64" drill bit

PLEASE CALL FOR TECHNICAL INFORMATION

OTHER SIZES AND QUANTITIES AVAILABLE BY REQUEST

FIXTURE HANGING ACCESSORIES



ASSORTED KIT FOR WOOD & STEEL THREADED ROD

Drill, Drive, Done!



- 32 piece assortment of our most popular vertical and horizontal for 3/8" threaded rod
- Threaded rod anchoring system for wood & .036", .188", .250", & .500" Steel
- Installation tools included

STOCK NO.	UPC NO.	ROD SIZE	SCREW DESCRIPTION	WT. PER PKG.	STD. PKG.	SUGGESTED TRADE LIST PRICE PER
SMSK1*	41430	Assorted	Assorted	2.44	1	156.68/pkg

OTHER SIZES AND QUANTITIES AVAILABLE BY REQUEST

* Denotes a product NOT manufactured in the USA (Drivers Only)

Don't get caught off guard. Be prepared!!

HURRICANE / WINDOW SHUTTER SCREWS (STAINLESS STEEL CAPS)



STOCK NO.	UPC NO.	SHANK DIAMETER	SCREW LENGTH	WT. PER PKG.	STD. PKG.	SUGGESTED TRADE LIST PRICE PER
WOOD						
JSMHS10	41415	#10	2	1.05	25	112.78/ea pkg



STOCK NO.	UPC NO.	SHANK DIAMETER	DESCRIPTION	WT. PER PKG.	STD. PKG.	SUGGESTED TRADE LIST PRICE PER
WOOD INSTALLATION TOOL						
SMDH1*	41427	3/16	Installation Tool for Hurricane - Shutter Screws	.03	1	8.23/ea

OTHER SIZES AND QUANTITIES AVAILABLE BY REQUEST

* Denotes a product NOT manufactured in the USA (Drivers Only)

Predrill a 9/16" diameter counter hole 3/4" deep into the building exterior trim.
Install screw flush with the exterior surface.

Note: Concrete requires a 3/16" center drilled hole 2-1/2" deep.

SPECIAL PURPOSE ELECTRICAL FASTENERS

METALLICS IS THE ONLY FASTENER SUPPLIER TO AMERICA'S DISTRIBUTORS TO MANUFACTURE ITS OWN GROUNDING SCREWS



Manufactured by Avanti Screw, Inc., A Metallics Affiliate

GROUNDING SCREW

ROUND HEAD WASHER "COMBO" SLOTTED / PHILLIPS
STEEL GREEN ZINC CHROMATE



STOCK NO.	BOX UPC NO.	JAR UPC NO.	SIZE	WT. PER PKG.	STD. PKG.	SUGGESTED TRADE LIST PRICE PER
GS20	16105		10-32 x 3/8	.58	100	6.53/c
JGS20		82643	10-32 x 3/8	.54	100	6.53/c
GS20500		82005	10-32 x 3/8	2.75	500	27.70/ea pkg

OTHER SIZES AND QUANTITIES AVAILABLE BY REQUEST

* Denotes a product NOT manufactured in the USA (Drivers Only)

GROUNDING SCREW

HEX WASHER "COMBO" SLOTTED / PHILLIPS
DOG POINT - STEEL GREEN ZINC CHROMATE



STOCK NO.	BOX UPC NO.	JAR UPC NO.	SIZE	WT. PER PKG.	STD. PKG.	SUGGESTED TRADE LIST PRICE PER
JGSH19*		82079	8/32 x 5/16 Type F	.35	100	10.55/c NEW
GSH20	16110		10-32 x 3/8	.57	100	6.53/c
JGSH20		82080	10-32 x 3/8	.55	100	6.53/c
GSH20500		82010	10-32 x 3/8	2.45	500	27.70/ea pkg

*SLOTTED ONLY

*DENOTES A PRODUCT NOT MANUFACTURED IN THE USA (DRIVERS ONLY)

OTHER SIZES AND QUANTITIES AVAILABLE BY REQUEST



Manufactured by Avanti Screw, Inc., A Metallics Affiliate

GROUNDING SCREW

HEX WASHER "COMBO" SLOTTED / PHILLIPS
TYPE 23 THREAD CUTTING
STEEL GREEN ZINC CHROMATE



STOCK NO.	BOX UPC NO.	JAR UPC NO.	SIZE	WT. PER PKG.	STD. PKG.	SUGGESTED TRADE LIST PRICE PER
GSH23	16115		10-32 x 3/8	.53	100	6.53/c
JGSH23		82091	10-32 x 3/8	.54	100	6.53/c
GSH23500		82015	10-32 x 3/8	2.55	500	27.70/ea pkg

OTHER SIZES AND QUANTITIES AVAILABLE BY REQUEST

EASTERN	CENTRAL	MOUNTAIN
8:00 A.M. to 5:00 P.M.		
Metallics, Inc. CT		Metallics, West Inc. CO
In the event Metallics East, Bristol is CLOSED, call Metallics West at 1-800-269-5183 if you require technical information or overnight shipments		

WE ARE HERE TO SERVE ALL OF YOUR FASTENER AND ANCHOR NEEDS

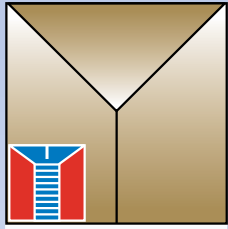

Metallics

8" Grounding Pigtails



[CONTRACTOR APPROVED]



- #12 Solid Copper Wire with Grounding Screw attached.
- 10-32 x 3/8 Hex Head Phillips/Slotted Dog Point Steel Green Zinc.



**Made in USA
Wire Only**



 Hex Head Phillips

PART #	UPC #	DESCRIPTION	QTY / PKG	SUG. TRADE LIST / PKG
PT408	16008	8" Lg. Grounding Pigtails w/Grounding Screw Attached 10-32 x 3/8 Hex Head Phillips/Slotted Dog Point Screw	100	\$ 62.83

"Growth Through Innovation"

Metallics

229 Cross Street, Bristol, CT 06010
Tel 800-243-8272 • **Fax** 800-831-9358
Email sales@metallicsonline.com





Metallics West

651 North Main Street, Mancos, CO 81328
Tel 800-269-5183 • **Fax** 800-269-6278
Email saleswest@metallicsonline.com



SPECIAL PURPOSE ELECTRICAL FASTENERS

Four drives in one head

-  Hex
-  Slotted
-  Phillips
-  Square Drive

Introduced in 1999



GROUNDING SCREW

"QUADRI"VE" HEX WASHER, SLOTTED, PHILLIPS
AND SQUARE DRIVE DOG POINT
STEEL GREEN ZINC CHROMATE



STOCK NO.	BOX UPC NO.	JAR UPC NO.	SIZE	WT. PER PKG.	STD. PKG.	SUGGESTED TRADE LIST PRICE PER
GSH21	16111		10-32 x 3/8	.65	100	6.53/c
JGSH21		82081	10-32 x 3/8	.63	100	6.53/c
GSH21500		82011	10-32 x 3/8	2.99	500	27.70/ea pkg

OTHER SIZES AND QUANTITIES AVAILABLE BY REQUEST

Four drives in one head

-  Hex
-  Slotted
-  Phillips
-  Square Drive

Introduced in 1999



GROUNDING SCREW

"QUADRI"VE" HEX WASHER, SLOTTED, PHILLIPS
AND SQUARE DRIVE - TYPE 23 THREAD CUTTING
STEEL GREEN ZINC CHROMATE



STOCK NO.	BOX UPC NO.	JAR UPC NO.	SIZE	WT. PER PKG.	STD. PKG.	SUGGESTED TRADE LIST PRICE PER
GSH22	16112		10-32 x 3/8	.53	100	6.53/c
JGSH22		82090	10-32 x 3/8	.57	100	6.53/c
GSH22500		82012	10-32 x 3/8	2.97	500	27.70/ea pkg

OTHER SIZES AND QUANTITIES AVAILABLE BY REQUEST



7 INCH

-  Phillips
-  Hex

GROUNDING PIGTAILS

WITH HEX WASHER "COMBO" SLOTTED
PHILLIPS DOG POINT
STEEL GREEN ZINC
GROUNDING SCREW ATTACHED



STOCK NO.	UPC NO.	SIZE	WT. PER PKG.	STD. PKG.	SUGGESTED TRADE LIST PRICE PER
SOLID COPPER INSULATED WIRE IN A PLASTIC BOX					
PT30	16000	#14 Wire	1.51	Box of 100	41.65/ea pkg
PT40	16005	#12 Wire	2.00	Box of 100	46.68/ea pkg
PT40K	10679	#12 Wire	4.77	Jar of 250	110.18/ea pkg

THE PT40K COMES IN A PLASTIC JAR

OTHER SIZES AND QUANTITIES AVAILABLE BY REQUEST

SPECIAL PURPOSE ELECTRICAL FASTENERS



GROUNDING PIGTAILS

WITH HEX WASHER "COMBO"
SLOTTED/PHILLIPS DOG POINT
STEEL GREEN ZINC
GROUNDING SCREW ATTACHED



7 INCH

STOCK NO.	UPC NO.	SIZE	WT. PER PKG.	STD. PKG.	SUGGESTED TRADE LIST PRICE PER
STRANDED COPPER INSULATED WIRE (with fork and ring terminal) IN A PLASTIC BOX					
PTS30	16001	#14 Wire	1.13	Box of 50	42.78/ea pkg
PTS40	16006	#12 Wire	1.41	Box of 50	58.25/ea pkg

OTHER SIZES AND QUANTITIES AVAILABLE BY REQUEST



GROUNDING PIGTAILS

WITH HEX WASHER "COMBO"
SLOTTED/PHILLIPS DOG POINT
STEEL GREEN ZINC
GROUNDING SCREW ATTACHED



7 INCH

STOCK NO.	UPC NO.	SIZE	WT. PER PKG.	STD. PKG.	SUGGESTED TRADE LIST PRICE PER
BARE SOLID COPPER WIRE (the economic alternative) IN A PLASTIC BOX					
PT30B	16015	#14 Wire	1.42	Box of 100	38.83/ea pkg
PT40B	16010	#12 Wire	1.87	Box of 100	46.15/ea pkg

OTHER SIZES AND QUANTITIES AVAILABLE BY REQUEST



GROUNDING PIGTAILS

WITH "QUADRI"VE" HEX WASHER, SLOTTED,
PHILLIPS, SQUARE DRIVE, DOG POINT
STEEL GREEN ZINC
GROUNDING SCREW ATTACHED



7 INCH

The QuaDrive

□
Square Drive

⬡
Hex

◐
Slotted

⊕
Phillips

⊕
QuaDrive

America's Newest Drive - Designed, Developed and Manufactured by Metallics/Avanti Screw

STOCK NO.	UPC NO.	SIZE	WT. PER PKG.	STD. PKG.	SUGGESTED TRADE LIST PRICE PER
SOLID COPPER INSULATED WIRE IN A PLASTIC BOX					
PT35	16021	#14 Wire	1.62	Box of 100	41.65/ea pkg
PT45	16005	#12 Wire	2.06	Box of 100	46.68/ea pkg

OTHER SIZES AND QUANTITIES AVAILABLE BY REQUEST

SPECIAL PURPOSE ELECTRICAL FASTENERS

GROUNDING PIGTAILS

WITH HEX WASHER "COMBO"
SLOTTED/PHILLIPS DOG POINT
STEEL GREEN ZINC
GROUNDING SCREW ATTACHED

Wire
MADE IN USA

Assembled in
USA

10 INCH

STOCK NO.	UPC NO.	SIZE	WT. PER PKG.	STD. PKG.	SUGGESTED TRADE LIST PRICE PER
SOLID COPPER INSULATED WIRE IN A PLASTIC BAG					
PT4010	16007	#12 Wire	.65	Bag of 25	13.45/ea pkg of 25
PT4010V	16092	#12 Wire	13.00	500	242.00/ea pkg



Hex



Phillips

OTHER SIZES AND QUANTITIES AVAILABLE BY REQUEST

GROUNDING PIGTAILS

WITH "QUADRI" HEX WASHER, SLOTTED/PHILLIPS,
SQUARE DRIVE DOG POINT
STEEL GREEN ZINC
GROUNDING SCREW ATTACHED

Wire
MADE IN USA

Screws
Manufactured by
Avanti Screw, Inc.,
A Metallics
Affiliate
Assembled in
USA

12 INCH

STOCK NO.	UPC NO.	SIZE	WT. PER PKG.	STD. PKG.	SUGGESTED TRADE LIST PRICE PER
SOLID COPPER INSULATED WIRE IN A PLASTIC BAG					
PT4012	16012	#12 Wire	.72	Bag of 25	14.28/ea pkg of 25
PT4012V	16094	#12 Wire	15.50	500	270.98/ea pkg NEW



Hex



Phillips

OTHER SIZES AND QUANTITIES AVAILABLE BY REQUEST

The QuaDrive



Square Drive + Hex + Slotted + Phillips = QuaDrive

America's Newest Drive - Designed, Developed and
Manufactured by Metallics/Avanti Screw

GROUNDING CLIPS

STEEL GREEN ZINC CHROMATE
DESIGNED TO FIT #10-#12-#14
COPPER OR ALUMINUM WIRE

STOCK NO.	BOX UPC NO.	UPC NO.	WT. PER PKG.	STD. PKG.	SUGGESTED TRADE LIST PRICE PER
CG20	16100		.42	100	16.33/c
JCG20		83100	1.78	5000 Jar	63.36/ea pkg
CG20500		82649	.40	100	16.33/c

OTHER SIZES AND QUANTITIES AVAILABLE BY REQUEST

SPECIAL PURPOSE ELECTRICAL FASTENERS



THREE-IN-ONE TAP THREAD CLEANING TOOL

STOCK NO.	UPC NO.	DESCRIPTION	WT. PER PKG.	STD. PKG.	SUGGESTED TRADE LIST PRICE PER
681032	16345	6-32,8-32,10-32 Thread Cleaning Tool	.21	1	29.00/ea

OTHER SIZES AND QUANTITIES AVAILABLE BY REQUEST



GRAY CONICAL PLASTIC WALL ANCHOR KITS

A SPECIAL USE WALL ANCHOR KIT FOR HANGING RACEWAY. THE 10 X 1 FLAT HEAD PHILLIPS SMS ZINC PLATED FITS FLUSH WITH METAL AND WILL NOT DAMAGE WIRE

MASTER
CARTONS
CONTAIN:
25 KITS
18 JARS



STOCK NO.	UPC NO.	DESCRIPTION OF CONTENTS	WT. EACH	SUGGESTED TRADE LIST PRICE PER
ANCHOR KIT DESIGNED FOR RACEWAY				
WAK23F	39182/kit	100 - 1/4 Gray Ribbed Anchors	.80	13.25/ea kit
WAKJ23F	20745/jar	100 - 10 x 1 Flat Head Phillips Screws 1 - 1/4 Masonry Drill	.80	13.25/ea kit

OTHER SIZES AND QUANTITIES AVAILABLE BY REQUEST

TELECOM CABINET SCREW



TEL1224

TEL1032BLK

For use in telecom cabinets, relay racks and patch panels
BIND HEAD (SLOTTED, PHILLIPS, SQUARE DRIVE)
TRI-DRIVE STEEL MACHINE SCREW/DOG (LEAD) POINT/ZINC PLATED/BLACK PHOSPHATE
PACKAGED IN PLASTIC VISUAL HANGING BOXES

STOCK NO.	UPC NO.	SIZE	WT. PER PKG.	STD. PKG.	SUGGESTED TRADE LIST PRICE PER	
TEL1024BLK	39250	10-24 x 5/8	.52	50	25.00/ea pkg	NEW
TEL1032BLK	39260	10-32 x 5/8	.52	50	25.00/ea pkg	NEW
TEL1224	39096	12-24 x 5/8	.48	50	8.73/ea pkg	
TEL1224BLK	39097	12-24 x 5/8	.48	50	26.55/ea pkg	NEW
TEL1228	39095	12-28 x 5/8	.52		8.73/ea pkg	NEW

OTHER SIZES AND QUANTITIES AVAILABLE BY REQUEST
JAR PACKAGING ALSO AVAILABLE

SPECIAL PURPOSE ELECTRICAL FASTENERS

CAGE NUTS

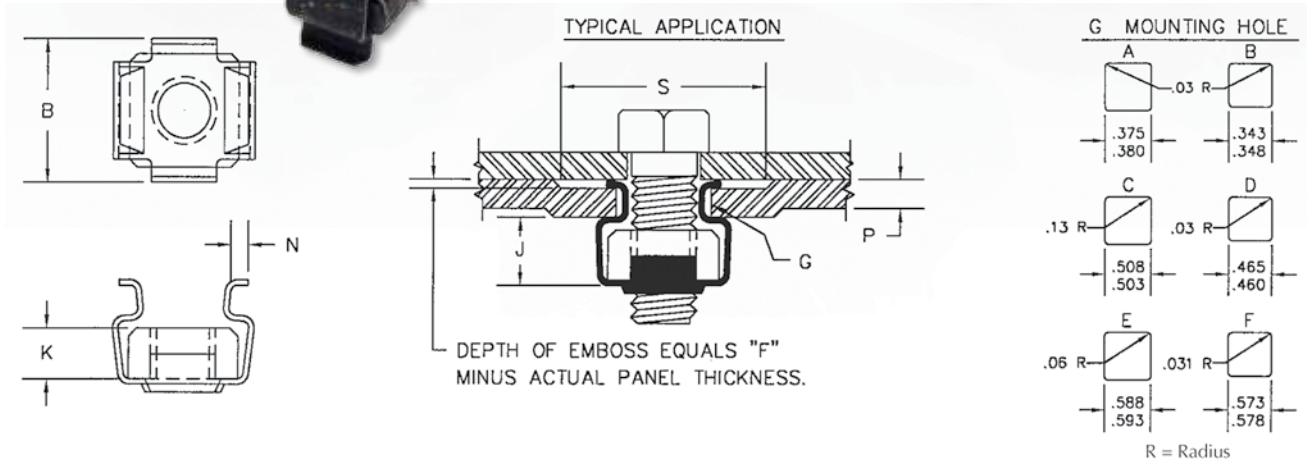

SCREW SIZE	PANEL RANGE P	F	S	MNTG. HOLE G	B	J	N	K	PART NUMBER
12-24	.025 - .063	0.1	0.531	A or B	0.52	0.06	0.6	0.156	CNN1224
10-24	.025 - .063	0.1	0.531	A or B	0.52	0.06	0.6	0.156	CNN1024
10-32	.025 - .063	0.1	0.531	A or B	0.52	0.06	0.6	0.156	CNN1032

OTHER SIZES AND QUANTITIES AVAILABLE BY REQUEST
 SOME SIZES AVAILABLE IN STAINLESS STEEL

STOCK NO.	UPC NO.	DESCRIPTION OF CONTENTS	QTY./PKG.	SUGGESTED TRADE LIST PRICE PER
CNN1224	30035	12-24 Cage Nuts .025 - .063 Panel Range .343 - .348 or .375 - .380 Mounting Hole Black Phosphate Coated	50	33.35
CNN1024	30030	10-24 Cage Nut .025 - .063 Panel Range .343 - .348 or .375 - .380 Mounting Hole Black Phosphate Coated	50	29.78
CNN1032	30025	10-32 Cage Nut .025 - .063 Panel Range .343 - .348 or .375 - .380 Mounting Hole Black Phosphate Coated	50	27.30

OTHER SIZES AND QUANTITIES AVAILABLE BY REQUEST

SPECIAL PURPOSE ELECTRICAL FASTENERS

CAGE NUT KITS

FOR USE IN TELECOM CABINETS, RELAY RACKS AND PATCH PANELS



Each kits contains 50 Cage Nuts and 50 Screws

- Three Different Sizes:
 - 12-24
 - 10-24
 - 10-32
- Screws are Pan Head, Tri-Drive (Slotted, Phillips, Square Drive), Lead-Point 5/8" Long Black Phosphate.
- Cage Nuts are for Panel thickness of range .025-.063 with a mounting hole of .343-.348 or .375-.380 and are phosphate coated.

STOCK NO.	UPC NO.	DESCRIPTION OF CONTENTS	QTY./PKG.	SUGGESTED TRADE LIST PRICE PER
CNN1224K	85595	12-24 Cage Nuts .025-.063 Panel Range Mounting Hole .343-.348 or .375-.380 12-24 x 5/8" Pan Head, Tri-Drive, Lead Point, Black Screw	50 of ea.	56.88
CNN1024K	85585	10-24 Cage Nuts .025-.063 Panel Range Mounting Hole .343-.348 or .375-.380 10-24 x 5/8" Pan Head, Tri-Drive, Lead Point, Black Screw	50 of ea.	52.08
CNN1032K	85590	10-32 Cage Nuts .025-.063 Panel Range Mounting Hole .343-.348 or .375-.380 10-32 x 5/8" Pan Head, Tri-Drive, Lead Point, Black Screw	50 of ea.	49.83

OTHER SIZES AND QUANTITIES AVAILABLE BY REQUEST

MANUFACTURING CAPABILITIES

Diameter range #2 thru 5/16" / 1.5mm thru 8mm • Length range 1/8" thru 3" / 3.5mm thru 75mm
Materials: Steel, Brass, Stainless, Aluminum, Bronze.

NEED SCREWS...
Let Us Make Them For You!



A METALLICS AFFILIATE
P.O. Box 1600 • 231 Cross Street
Bristol, CT 06011-1600
Tel: 800-984-8945 • Fax: 800-984-8946

CAPABILITIES LIST

PLANT SIZE: 100,000 SQUARE FEET

LOCATION: Bristol, Connecticut

EQUIPMENT: 27 Hi-Speed Cold Headers
8 Burr-Free Screw Slotters
3 Shank Slotters
2 Pointers
14 High Speed Thread Rollers

MADE IN USA



ADDITIONAL PLANT INFO: Modern shipping facility utilizing digital scale counting machines. In-house packaging facilities - boxing, sorting, baggings. All material boxed, palletized & labeled with your needs in mind for domestic or export shipping.

SECONDARY WORK: All plating & heat treating is done on the outside and certified for your guarantee.

INFORMATION SYSTEMS: Our facility has new and upgraded Technology to meet your customers specific requirements.

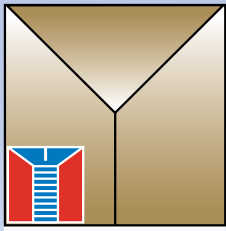

Metallics



Secura-lets™ Spacers

**[CONTRACTOR
APPROVED]**



- Stackable spacers for wiring devices
- Fill gaps and bring devices flush with surface
- Supports devices securely to wallbox
- Prevents broken faceplates
- Spacers are flame-retardant PVC
- U.L. 94 V-O flame rating and weatherability ratings
- Gray color disassociates any notion of an earth-ground connection
- U.L. recognized electrical grade PVC

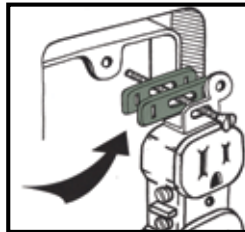

PART #	UPC #	DESCRIPTION	QTY / PKG	SUG. TRADE LIST / PKG
SLSP50	71664	Secura-Lets Spacers for Electrical Devices	50	\$ 8.08

★ ★ ★ ★ ★ *"Growth Through Innovation"* ★ ★ ★ ★ ★

Metallics

229 Cross Street, Bristol, CT 06010
Tel 800-243-8272 • **Fax** 800-831-9358
Email sales@metallicsonline.com

Metallics West

651 North Main Street, Mancos, CO 81328
Tel 800-269-5183 • **Fax** 800-269-6278
Email saleswest@metallicsonline.com

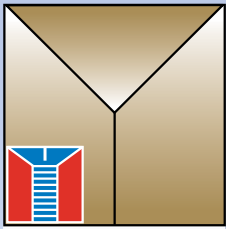

Metallics Wire Terminal Kit



MWTK1 Kit Contains 240 of the most Common Vinyl Insulated Wire Terminals, Plus Crimping Tool in a Plastic Case.

[CONTRACTOR APPROVED]

Other sizes, materials and quantities available by request.

PART #	UPC #	DESCRIPTION	QTY / PKG	SUG. TRADE LIST / PKG
MWTK1	39450	Wire Terminal Crimper 22-10 ga	1	\$ 112.03
		#22-#18 Butt Connector	20	
		#16-#14 Butt Connector	20	
		#12-#10 Butt Connector	20	
		#12-#10 Ring Connector #8 Stud	10	
		#12-#10 Ring Connector #10 Stud	10	
		#12-#10 Ring Connector 5/16 Stud	10	
		#12-#10 Ring Connector 3/8 Stud	10	
		#16-#14 Ring Connector #6 Stud	10	
		#16-#14 Ring Connector #10 Stud	10	
		#22-#18 Ring Connector #6 Stud	10	
		#22-#18 Ring Connector #10 Stud	10	
		#12-#10 Spade Connector #6 Stud	10	
		#12-#10 Spade Connector #10 Stud	10	
		#16-#14 Spade Connector #6 Stud	10	
		#16-#14 Spade Connector #10 Stud	10	
		#22-#18 Spade Connector #6 Stud	10	
		#22-#18 Spade Connector #10 Stud	10	
		#16-#14 250QDC Male	10	
		#16-#14 250QDC Female	10	
		#22-#18 250QDC Male	10	
		#22-#18 250QDC Female	10	



★ ★ ★ ★ ★ "Growth Through Innovation" ★ ★ ★ ★ ★

Metallics

229 Cross Street, Bristol, CT 06010
Tel 800-243-8272 • **Fax** 800-831-9358
Email sales@metallicsonline.com

Metallics West

651 North Main Street, Mancos, CO 81328
Tel 800-269-5183 • **Fax** 800-269-6278
Email saleswest@metallicsonline.com

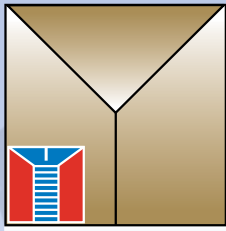

Metallics Wire Terminals



The most commonly Vinyl Insulated Terminals... Rings, Spades, Disconnects, and Butt Connectors.

[CONTRACTOR APPROVED]

Other sizes, materials and quantities available by request.

PART #	UPC #	DESCRIPTION	QTY / PKG	SUG. TRADE LIST / PKG
MWTCT1	39452	Wire Terminal Crimper 22-10 ga	1	\$ 19.82
MWBC2218	39458	#22-#18 Butt Connector	100	\$ 17.41
MWBC1614	39461	#16-#14 Butt Connector	100	\$ 19.68
MWBC1210	39464	#12-#10 Butt Connector	100	\$ 26.18
MWRC12108	40113	#12-#10 Ring Connector #8 Stud	100	\$ 28.15
MWRC121010	40114	#12-#10 Ring Connector #10 Stud	100	\$ 28.15
MWRC121056	40116	#12-#10 Ring Connector 5/16 Stud	100	\$ 34.88
MWRC121038	40117	#12-#10 Ring Connector 3/8 Stud	100	\$ 34.88
MWRC16146	40106	#16-#14 Ring Connector #6 Stud	100	\$ 19.85
MWRC161410	40108	#16-#14 Ring Connector #10 Stud	100	\$ 20.33
MWRC22186	40100	#22-#18 Ring Connector #6 Stud	100	\$ 17.25
MWRC121010	40102	#22-#18 Ring Connector #10 Stud	100	\$ 17.25
MWSC12106	40134	#12-#10 Spade Connector #6 Stud	100	\$ 24.53
MWSC121010	40136	#12-#10 Spade Connector #10 Stud	100	\$ 24.53
MWSC16146	40128	#16-#14 Spade Connector #6 Stud	100	\$ 22.25
MWSC161410	40130	#16-#14 Spade Connector #10 Stud	100	\$ 22.25
MWSC22186	40122	#22-#18 Spade Connector #6 Stud	100	\$ 20.43
MWSC221810	40124	#22-#18 Spade Connector #10 Stud	100	\$ 20.43
MQDC1614M	39470	#16-#14 250QDC Male	100	\$ 21.88
MQDC1614F	39483	#16-#14 250QDC Female	100	\$ 21.00
MQDC2218M	39469	#22-#18 250QDC Male	100	\$ 21.88
MQDC2218F	39481	#22-#18 250QDC Female	100	\$ 21.00

“Growth Through Innovation”

Metallics

229 Cross Street, Bristol, CT 06010
Tel 800-243-8272 • **Fax** 800-831-9358
Email sales@metallicsonline.com

Metallics West

651 North Main Street, Mancos, CO 81328
Tel 800-269-5183 • **Fax** 800-269-6278
Email saleswest@metallicsonline.com

SPECIAL PURPOSE ELECTRICAL FASTENERS



WALL PLATE SCREW

STEEL AND STAINLESS STEEL
SLOTTED OVAL HEAD • PLATED AND PAINTED
PACKAGED IN VISUAL PLASTIC HANGING BOX

STOCK NO.	UPC NO.	SIZE	COLOR	WT. PER PKG.	STD. PKG. MSTR. SLEEVE	SUGGESTED TRADE LIST PRICE PER	
SP170	16406	6-32 x 1/2	Stainless Steel	.29	100/500	9.55/c	
SP176	16305	6-32 x 1/2	Brass Plate	.26	100/500	8.95/c	
SP177	16310	6-32 x 1/2	Nickel Plate	.29	100/500	8.33/c	
SP178	16315	6-32 x 1/2	Antique Black	.26	100/500	7.68/c	
SP179	16320	6-32 x 1/2	White	.28	100/500	7.68/c	
SP180	16325	6-32 x 1/2	Ivory	.29	100/500	7.68/c	
SP173	16300	6-32 x 1/2	Light Almond	.30	100/500	7.68/c	
SP181	16330	6-32 x 1/2	Gray	.28	100/500	6.10/c	NEW
SP182	16335	6-32 x 3/4	Brown	.28	100/500	3.55/c	
SP190	16303	6-32 x 3/4	White	.35	100/500	9.58/c	
SP191	16304	6-32 x 3/4	Ivory	.36	100/500	9.58/c	
SP382	10323	6-32 x 7/32	Brown	.18	100/500	15.53/c	NEW
SP380	10321	6-32 x 7/32	Ivory	.18	100/500	15.53/c	NEW
SP379	10320	6-32 x 7/32	White	.18	100/500	15.53/c	NEW
SP279	16301	6-32 x 1	White	.43	100/500	9.83/c	
SP280	16302	6-32 x 1	Ivory	.43	100/500	9.83/c	
SP283	16413	6-32 x 1	Stainless Steel	.43	100/500	12.60/c	NEW
SP172	16307	6-32 x 1 1/4	Stainless Steel	.44	100/500	15.73/c	NEW
SP281	16411	6-32 x 2	Ivory Switch Plate	.72	100/500	12.05/c	NEW
SP282	16412	6-32 x 2	White Switch Plate	.72	100/500	12.05/c	NEW

OTHER SIZES AND QUANTITIES AVAILABLE BY REQUEST

SWITCH PLATE SCREW KITS

A convenient assortment of Switch Plate Screws
in the most popular colors and finishes
Plated and Painted



275 PIECE RENOVATION KIT SPK100 CONTAINS:

50 Black, 50 Nickel, 50 Light Almond, 50 Ivory, 50 White
25 6-32 x 1 1/4 Flat Head Slot Switch Plate Screw, Zinc Plated

500 PIECE NEW CONSTRUCTION SPK101 CONTAINS:

100 each 6-32 x 1/2 Ivory, White, Stainless
75 each 6-32 x 1 Ivory, White
50 6-32 x 1 1/4 Flat Head Slot Switch Plate Screw, Zinc Plated

MASTER
CARTONS
CONTAIN:
25 KITS
18 JARS

STOCK NO.	UPC NO.	DESCRIPTION OF CONTENTS	WT. EACH	SUGGESTED TRADE LIST PRICE PER
SPK100 RENOVATION	16400	6-32 x 1/2 Oval Head Steel Switch Plate Screw Assortment	1.84	21.50/ea pkg
SPK101 NEW CONSTRUCTION	16401	6-32 x 1/2 Oval Head Steel Switch Plate Screw Assortment	1.60	40.88/ea pkg

OTHER SIZES AND QUANTITIES AVAILABLE BY REQUEST

SPECIAL PURPOSE ELECTRICAL FASTENERS



NYLON SWITCH PLATE SCREW

SLOTTED OVAL HEAD
PACKAGED IN VISUAL PLASTIC HANGING BOX

STOCK NO.	UPC NO.	SIZE	STD. PKG.	WT. PER PKG.	STD. PKG./MSTR SLEEVE	SUGGESTED TRADE LIST PRICE PER
SPN300	16350	6-32 x 1/2	100	.11	100/500	8.40/c

OTHER SIZES AND QUANTITIES AVAILABLE BY REQUEST



DECORATIVE SWITCH PLATE SCREW

STEEL, SLOTTED, UNDERCUT OVAL HEAD (PAINTED)
FOR WALL PLATES NOT ACCEPTING STANDARD
1/2" SWITCH PLATE SCREWS

STOCK NO.	UPC NO.	SIZE	COLOR	WT. PER PKG.	STD. PKG.	SUGGESTED TRADE LIST PRICE PER
SPD379	16321	6-32 x 1/4	White	.14	50	3.33/ea pkg
SPD380	16326	6-32 x 1/4	Ivory	.14	50	3.33/ea pkg
SPD382	16336	6-32 x 1/4	Light Almond	.12	50	3.50/ea pkg
SPD383	16341	6-32 x 1/4	Gray	.12	50	3.50/ea pkg
SPD381	16327	6-32 x 1/4	Brown	.14	50	3.50/ea pkg NEW
SPD384	16342	6-32 x 1	White	.25	50	4.35/ea pkg
SPD385	16343	6-32 x 1	Ivory	.26	50	4.35/ea pkg

OTHER SIZES AND QUANTITIES AVAILABLE BY REQUEST



DECORATIVE SWITCH PLATE SCREW KIT

STEEL, SLOTTED, UNDERCUT OVAL HEAD
A convenient assortment of popular colors
For wall plates not accepting standard
1/2" switch plate screws.

250 PIECE SPDK200 KIT CONTAINS:

6-32 x 1/4" - 50 White, 50 Ivory, 50 Light Almond, 50 Gray
PLUS
6-32 x 1" - 25 White, 25 Ivory

STOCK NO.	UPC NO.	DESCRIPTION OF CONTENTS	WT. PER KIT	STD. PKG./MSTR. CARTON	SUGGESTED TRADE LIST PRICE PER
SPDK200	16405	6-32 x 1/4" & 1" Assorted Steel Slotted, Undercut, Oval Head Switch Plate Screws	.68	1/25 Kits	22.18/ea kit

OTHER SIZES AND QUANTITIES AVAILABLE BY REQUEST

SPECIAL PURPOSE ELECTRICAL FASTENERS

TAMPER-RESIST SPANNER OVAL HEAD SWITCH PLATE SCREW



STAINLESS STEEL

Only authorized persons would normally have a spanner driver to extract this screw

A special wall plate screw for use in public areas like restrooms where water, mist and vapors are present that could corrode ordinary steel screws. Vandalism is discouraged due to the unique nature of the Spanner Driver.*



Spanner

Packaged in Visual Plastic Hanging Boxes

STOCK NO.	UPC NO.	SIZE	WT. PER PKG.	STD. PKG.	SUGGESTED TRADE LIST PRICE PER
SPT300	10270	6-32 x 1	.27	50	36.83/ea pkg NEW
SPT200	16355	6-32 x 1/2	.19	50	35.98/ea pkg
SPT400	10275	6-32 x 1 1/2	.35	50	49.83/ea pkg

*COMES COMPLETE WITH 00SP6B SPANNER INSERT DRIVER

OTHER SIZES AND QUANTITIES AVAILABLE BY REQUEST

RECEPTACLE AND WIRING DEVICES SCREW



TRUSS HEAD COMBO (PHILLIPS/SLOTTED)

STEEL MACHINE SCREW - **HARDENED TYPE F ZINC PLATED**

For our product offering we have chosen to give an added benefit (not offered by our competition) by supplying a Type F thread-forming feature. We offer this because electricians in the field often use a screw that will thread a hole in plastic boxes or need it to clean out plaster.



Phillips

Packaged in Visual Plastic Hanging Boxes

STOCK NO.	UPC NO.	SIZE	WT. PER PKG.	STD. PKG.	SUGGESTED TRADE LIST PRICE PER
TM80	43138	6-32 x 1/2	.26	100	4.70/c
TM81	43141	6-32 x 3/4	.37	100	4.85/c
TM63	43144	6-32 x 1	.44	100	4.90/c
TM68	43147	6-32 x 1 1/4	.49	100	6.38/c
TM82	43150	6-32 x 1 1/2	.62	100	6.93/c
TM83	43153	6-32 x 2	.79	100	8.93/c

JAR PACKAGING ALSO AVAILABLE

OTHER SIZES AND QUANTITIES AVAILABLE BY REQUEST

RECEPTACLE AND WIRING DEVICES SCREW



TRUSS HEAD COMBO (PHILLIPS/SLOTTED)

STEEL MACHINE SCREW • **ZINC PLATED - LEAD POINT**

STARTS E-Z



Manufactured by Avanti Screw, Inc., A Metallics Affiliate



Phillips

Packaged in Visual Plastic Hanging Boxes

STOCK NO.	UPC NO.	SIZE	WT. PER PKG.	STD. PKG.	SUGGESTED TRADE LIST PRICE PER
TM80LP	43154	6-32 x 1/2	.28	100	4.25/c
TM81LP	43155	6-32 x 3/4	.38	100	4.35/c
TM63LP	43156	6-32 x 1	.44	100	4.38/c
TM68LP	43157	6-32 x 1 1/4	.52	100	5.73/c
TM82LP	43158	6-32 x 1 1/2	.62	100	6.23/c
TM83LP	43159	6-32 x 2	.79	100	8.03/c

OTHER SIZES AND QUANTITIES AVAILABLE BY REQUEST

JAR PACKAGING ALSO AVAILABLE

SPECIAL PURPOSE ELECTRICAL FASTENERS

INSULATING FOAM GASKETS



- Energy saving gaskets prevent heat and cold loss through outlets and switches located on outside walls.
- Constructed of UL Rated, close-cell polyethylene insulating foam.
- Available in three different designs: Toggle Switch, Duplex Receptacle & GFI or Decora

STOCK NO.	UPC NO.	DESCRIPTION	WT. PER EACH	STD. PKG.	SUGGESTED TRADE LIST PRICE PER
WGT25	71651	Toggle Switch	.14	25	6.38/ea pkg
WGR25	71652	Duplex Receptacle	.14	25	6.38/ea pkg
WGD25	71653	GFI/Decora	.14	25	6.38/ea pkg
WGT100	71654	Toggle Switch	.48	100	22.83/ea pkg
WGR100	71655	Duplex Receptacle	.48	100	22.83/ea pkg
WGD100	71656	GFI/Decora	.48	100	22.83/ea pkg
WGC100	71657	Combo Pack	.48	100	22.83/ea pkg

CONTAINS: 30 TOGGLE, 30 DUPLEX, 40 DECORA
OTHER SIZES AND QUANTITIES AVAILABLE BY REQUEST



THUMB SCREW ^{NEW}

STAINLESS STEEL 18-8 TYPE

STOCK NO.	UPC NO.	SIZE	WT. PER PKG.	STD. PKG.	SUGGESTED TRADE LIST PRICE PER
JTMS1SS	92893	1/4 - 20 x 1	1.68	100	136.55/c NEW
JTMS2SS	92894	1/4 - 20 x 2	2.67	100	235.06/c NEW

OTHER SIZES AND QUANTITIES AVAILABLE BY REQUEST



SPANNER INSERT DRIVER

For use in driving and extracting vandalism deterrent screw

STOCK NO.	UPC NO.	SIZE	WT. PER PKG.	STD. PKG.	SUGGESTED TRADE LIST PRICE PER
00SP6B	25027	#6	.01	1	5.03/ea

OTHER SIZES AND QUANTITIES AVAILABLE BY REQUEST



CONDUIT DRIVE STRAPS

ROUND TYPE
STEEL ZINC PLATED
PACKAGED IN CLEAR PLASTIC JARS



STOCK NO.	UPC NO.	SIZE EMT	SIZE PIPE & FLEX. COND.	SIZE OVERALL LENGTH	WT. PER PKG.	STD. PKG.	SUGGESTED TRADE LIST PRICE PER
STEEL ZINC PLATED For use in metal and plastic conduit and tubing							
CDS1	21200	3/8 - 1/2	3/8	2	1.93	100	21.43/c
CDS2	21205	3/4	1/2	2 1/4	2.23	100	24.33/c
CDS3	21210	1	3/4	2 1/4	2.37	100	27.73/c

OTHER SIZES AND QUANTITIES AVAILABLE BY REQUEST

CONTINUED ON NEXT PAGE

SPECIAL PURPOSE ELECTRICAL FASTENERS

CONTINUED



CONDUIT DRIVE STRAPS

ROUND TYPE
STEEL COPPER PLATED
PACKAGED IN CLEAR PLASTIC JARS



STOCK NO.	UPC NO.	SIZE COPPER TUBE	SIZE COPPER PIPE	SIZE OVERALL LENGTH	WT. PER PKG.	STD. PKG.	SUGGESTED TRADE LIST PRICE PER
-----------	---------	------------------	------------------	---------------------	--------------	-----------	--------------------------------

STEEL COPPER PLATED For use in areas requiring copper pipe and tubing

CDS5	21300	1/2	3/8 - 1/2	2	1.87	100	19.30/c
CDS6	21305	3/4	3/4	2 1/4	2.50	100	20.70/c

CONDUIT DRIVE STRAPS FOR PLUMBING ROUND TYPE, STEEL COPPER PLATED

OTHER SIZES AND QUANTITIES AVAILABLE BY REQUEST



CONDUIT DRIVE STRAPS

FLAT STAMPED TYPE GALVANIZED



EMT	UPC NO.	SIZE COPPER PIPE	SIZE	WT. PER PKG.	STD. PKG.	SUGGESTED TRADE LIST PRICE PER
-----	---------	------------------	------	--------------	-----------	--------------------------------

STAMPED GALVANIZED

SDS10	21215	3/8 - 1/2	3/8	1.70	100	18.60/c
SDS20	21220	3/4	1/2	2.13	100	21.13/c
SDS30	21225	1	3/4	2.29	100	22.55/c

OTHER SIZES AND QUANTITIES AVAILABLE BY REQUEST



PLUMBERS TAPE PERFORATED

STEEL GALVANIZED

STOCK NO.	UPC NO.	SIZE	WT. PER PKG.	STD. PKG. (100 ft total)	SUGGESTED TRADE LIST PRICE PER
HR750	22550	20 Gauge x 3/4	7.80	10 rolls of 10 ft. per pkg	34.00/ea pkg
HR770	22553	24 Gauge x 3/4	4.31	10 rolls of 10 ft. per pkg	18.25/ea pkg

COPPER AVAILABLE UPON REQUEST

OTHER SIZES AND QUANTITIES AVAILABLE BY REQUEST

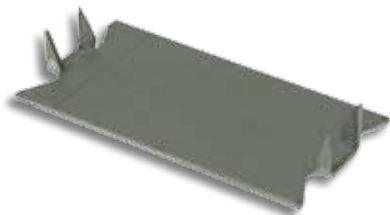

NAIL PLATES

STEEL

For Romex, BX, UF, S.E.V. and other Cables
Other sizes & gauges available by request



STOCK NO.	UPC NO.	SIZE	GAUGE	WT. PER PKG.	STD. PKG.	SUGGESTED TRADE LIST PRICE PER
*NP400	16500	2 3/4" long x 1 1/2" wide	16	6.40	100	20.83/c
*NP400B	16510	1 1/2" long x 2 3/4" wide	16	33.90	500	116.56/ea pkg NEW
*NP660	16599	1 1/2" long x 5" wide	16	7.00	100	45.00/c NEW
*NP600	16503	5" long x 1 1/2" wide	20	7.18	100	30.88/c
*NP800	16504	5" long x 3" wide	16	24.25	100	53.38/c

*DIMENSIONS ON ALL NAIL PLATES/STRAPS ARE APPROXIMATE

OTHER SIZES AND QUANTITIES AVAILABLE BY REQUEST

SPECIAL PURPOSE ELECTRICAL FASTENERS



PLATE STRAP

STEEL



STOCK NO.	UPC NO.	SIZE	GAUGE	WT. PER PKG.	STD. PKG.	SUGGESTED TRADE LIST PRICE PER	
*NS1812	22548	1-1/2" x 8" hole	12	16.15	25	38.20/ea pkg	
*NS1816	22549	1-1/2" x 8" hole	16	45.45	25	28.47/ea pkg	
*NPL12	12194	1 1/2" long x 12" wide	18	19.00	50	56.25/ea pkg	NEW
*NP580	16520	5" long x 8" wide	16	32.00	50	155.15/ea pkg	NEW
*NPL188	16480	5" long x 18" wide	16	39.19	25	155.00/ea pkg	NEW

OTHER SIZES, GAUGES, AND QUANTITIES AVAILABLE BY REQUEST.

*DIMENSIONS ON ALL NAIL PLATES/STRAPS ARE APPROXIMATE



BOX SUPPORTS

STEEL

ELECTRO-GALVANIZED

STOCK NO.	UPC NO.	WT. PER PKG.	STD. PKG.	SUGGESTED TRADE LIST PRICE PER
SB300	16200	5.29	100 pairs/200 pieces total	52.70/ea pkg

OTHER SIZES AND QUANTITIES AVAILABLE BY REQUEST



100KOS

SIZE IS STAMPED ON SEAL

KNOCK-OUT SEALS

THE ULTIMATE IN HIGH QUALITY SAFETY
3-PIECE QUICK-SEAL TO PLUG HOLES IN PANEL BOXES

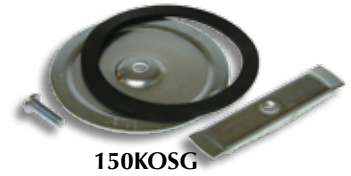

150KOSG

STOCK NO.	UPC NO.	DESCRIPTION	WT. PER PKG.	STD. PKG.	SUGGESTED TRADE LIST PRICE PER
50KOS	41301	1/2" - 3 piece K/O Seal	.25	10	15.48/ea pkg
75KOS	41302	3/4" - 3 piece K/O Seal	.33	10	20.83/ea pkg
100KOS	41303	1" - 3 piece K/O Seal	.47	10	21.15/ea pkg
125KOS	41304	1 1/4" - 3 piece K/O Seal	.74	10	22.83/ea pkg
150KOS	41306	1 1/2" - 3 piece K/O Seal	.95	10	28.88/ea pkg
200KOS	41307	2" - 3 piece K/O Seal	1.38	10	39.98/ea pkg
250KOS	41308	2 1/2" - 3 piece K/O Seal	2.10	10	69.18/ea pkg
300KOS	41309	3" - 3 piece K/O Seal	1.50	5	44.00/ea pkg
350KOS	41311	3 1/2" - 3 piece K/O Seal	1.93	5	62.08/ea pkg
400KOS	41312	4" - 3 piece K/O Seal	2.74	5	71.18/ea pkg

GASKETED

50KOSG	41650	1/2" - 4 piece K/O Seal	.30	10	29.00/ea pkg
75KOSG	41651	3/4" - 4 piece K/O Seal	.36	10	30.88/ea pkg
100KOSG	41652	1" - 4 piece K/O Seal	.45	10	34.75/ea pkg
125KOSG	41653	1 1/4" - 4 piece K/O Seal	.78	10	40.44/ea pkg
150KOSG	41654	1 1/2" - 4 piece K/O Seal	.94	10	53.58/ea pkg
200KOSG	41655	2" - 4 piece K/O Seal	1.62	10	66.75/ea pkg
250KOSG	41658	2 1/2" - 4 piece K/O Seal	2.10	10	111.63/ea pkg
300KOSG	41660	3" - 4 piece K/O Seal	1.74	5	71.45/ea pkg
400KOSG	41317	4" - 4 piece K/O Seal	2.94	5	78.63/ea pkg

OTHER SIZES AND QUANTITIES AVAILABLE BY REQUEST

SPECIAL PURPOSE ELECTRICAL FASTENERS



GALVANIZED NAIL-ON DRIVE RINGS

STEEL ZINC PLATED

PACKAGED 10 PER POLY BAG

STOCK NO.	UPC NO.	EYE SIZE	WT. PER PKG.	STD. PKG.	SUGGESTED TRADE LIST PRICE PER
MDR12	81549	1/2	.14	10	2.68/ea pkg
MDR58	81551	5/8	.14	10	3.38/ea pkg
MDR78	81553	7/8	.53	10	6.05/ea pkg
MDR114	81555	1 1/4	.78	10	8.05/ea pkg

OTHER SIZES AND QUANTITIES AVAILABLE BY REQUEST



MBR125

PACKAGED 10 PER POLY BAG

BRIDLE RINGS

STEEL ZINC PLATED



MBR150WS

STOCK NO.	UPC NO.	EYE SIZE/ THREAD SIZE	WT. PER PKG.	STD. PKG.	SUGGESTED TRADE LIST PRICE PER
MACHINE SCREW THREAD					
MBR125	81557	1 1/4 x 1/4-20	.72	10	13.45/ea pkg
MBR150	81559	1 1/2 x 1/4-20	.81	10	13.45/ea pkg
MBR200	81561	2 x 1/4-20	.97	10	13.45/ea pkg
WOOD SCREW THREAD					
MBR100WS	81560	1 x .230	.58	10	9.38/ea pkg
MBR150WS	81563	1 1/2 x .230	.79	10	19.50/ea pkg
MBR200WS	81565	2 x .230	.98	10	19.50/ea pkg

OTHER SIZES AND QUANTITIES AVAILABLE BY REQUEST

CONTRACTOR NAIL APRON

- Natural Canvas with 2 Large Pockets
- Large Pockets for Tools or Fasteners
- One Small Pocket for Pen or Pencil



STOCK NO.	UPC NO.	DESCRIPTION	QTY. PKG.	SUGGESTED TRADE LIST PRICE PER
NAP1	71740	Contractor Nail Apron - Natural Canvas - 2 Pockets	10	6.25/ea

OTHER SIZES AND QUANTITIES AVAILABLE BY REQUEST

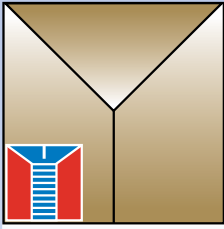

Metallics



Bright Common Nails

20D and 30D packaged in 50 lb. cartons

**[CONTRACTOR
APPROVED]**



MN30D50



MN20D50

PART #	UPC #	DESCRIPTION	APPROX. COUNT PER 50LB CARTON	SUG. TRADE LIST / PKG
MN20D50	21320	20D Bright Common Nails	1100	\$ 145.00
MN30D50	21330	30D Bright Common Nails	1450	\$ 145.00

H

★ ★ ★ ★ ★ *"Growth Through Innovation"* ★ ★ ★ ★ ★

Metallics

229 Cross Street, Bristol, CT 06010
Tel 800-243-8272 • **Fax** 800-831-9358
Email sales@metallicsonline.com

Metallics West

651 North Main Street, Mancos, CO 81328
Tel 800-269-5183 • **Fax** 800-269-6278
Email saleswest@metallicsonline.com

WE'VE GOT NAILS!



IN 2-1/2 POUND SQUARE JARS

You don't have to make an extra trip to the Home Centers to get your supply of nails. "They're Here." at your Metallics Distributor



BRIGHT COMMON NAILS

STEEL

For all types of rough-in wood construction

STOCK NO.	UPC NO.	SIZE	WT. PER PKG.	APPROX. COUNT	STD. PKG.	SUGGESTED TRADE LIST PRICE PER
MN8C	21226	8D	2.63	220	1 Jar	7.83/ea pkg
MN10C	21227	10D	2.63	140	1 Jar	7.83/ea pkg
MN16C	21228	16D	2.64	115	1 Jar	7.83/ea pkg

OTHER SIZES AND QUANTITIES AVAILABLE BY REQUEST



BRIGHT FINISH NAILS

STEEL

For interior and exterior wood finishes

STOCK NO.	UPC NO.	SIZE	WT. PER PKG.	APPROX. COUNT	STD. PKG.	SUGGESTED TRADE LIST PRICE PER
MN4F	21229	4D	2.61	1350	1 Jar	9.50/ea pkg
MN6F	21230	6D	2.62	1390	1 Jar	8.63/ea pkg

OTHER SIZES AND QUANTITIES AVAILABLE BY REQUEST



HOT GALVANIZED BOX NAILS

STEEL

For exterior areas affected by water and humidity

STOCK NO.	UPC NO.	SIZE	WT. PER PKG.	APPROX. COUNT	STD. PKG.	SUGGESTED TRADE LIST PRICE PER
MN6HG	21231	6D	2.62	450	1 Jar	10.13/ea pkg
MN8HG	21232	8D	2.63	290	1 Jar	10.13/ea pkg
MN10HG	21233	10D	2.66	190	1 Jar	9.93/ea pkg
MN16HG	21234	16D	2.64	135	1 Jar	10.13/ea pkg

OTHER SIZES AND QUANTITIES AVAILABLE UPON REQUEST



SPECIAL PURPOSE ELECTRICAL FASTENERS



Coating allows faster penetration

COATED SINKER NAILS

STEEL

For all types of rough-in wood construction

STOCK NO.	JAR UPC NO.	SIZE	WT. PER PKG.	APPROX. COUNT	STD. PKG.	SUGGESTED TRADE LIST PRICE PER
MN8S	21235	8D	2.63	340	1 Jar	7.73/ea pkg
MN10S	21236	10D	2.57	240	1 Jar	8.15/ea pkg
MN16S	21237	16D	2.67	140	1 Jar	7.55/ea pkg
MN16S50B	21295	16D	50.00	2,600	50 lb Box	180.50/ea pkg NEW
MN16SP	21285	16D	10.00	520	10 lb Pail	40.93/ea pkg NEW

OTHER SIZES AND QUANTITIES AVAILABLE UPON REQUEST



BRIGHT DUPLEX NAILS

STEEL

For temporary wood structure/Double head allows for ease of extraction and disassembly

STOCK NO.	JAR UPC NO.	SIZE	WT. PER PKG.	APPROX. COUNT	STD. PKG.	SUGGESTED TRADE LIST PRICE PER
MN8DP	21238	8D	2.61	200	1 Jar	8.73/ea pkg
MN16DP	21239	16D	2.63	105	1 Jar	8.73/ea pkg

OTHER SIZES AND QUANTITIES AVAILABLE UPON REQUEST



BRIGHT JOIST HANGER NAILS

STEEL

For all types of light brackets, straps in wood joists

STOCK NO.	JAR UPC NO.	SIZE	WT. PER PKG.	APPROX. COUNT	STD. PKG.	SUGGESTED TRADE LIST PRICE PER
MN114J	21240	1-1/4" - 9 GA	2.59	360	1 Jar	8.58/ea pkg
MN112J	21241	1-1/2" - 9 GA	2.60	300	1 Jar	8.73/ea pkg

OTHER SIZES AND QUANTITIES AVAILABLE UPON REQUEST



HEAT TEMPERED FLUTED MASONRY NAILS

STEEL

Nails designed to penetrate concrete and other masonry products

STOCK NO.	JAR UPC NO.	SIZE	WT. PER PKG.	APPROX. COUNT	STD. PKG.	SUGGESTED TRADE LIST PRICE PER
MN1TM	21242	1"	2.60	370	1 Jar	10.35/ea pkg
MN112TM	21243	1-1/2"	2.55	225	1 Jar	10.35/ea pkg
MN2TM	21244	2"	2.64	180	1 Jar	10.45/ea pkg
MN212TM	21245	2-1/2"	2.63	168	1 Jar	10.48/ea pkg
MN3TM	21246	3"	2.62	135	1 Jar	10.93/ea pkg

OTHER SIZES AND QUANTITIES AVAILABLE UPON REQUEST

SPECIAL PURPOSE ELECTRICAL FASTENERS

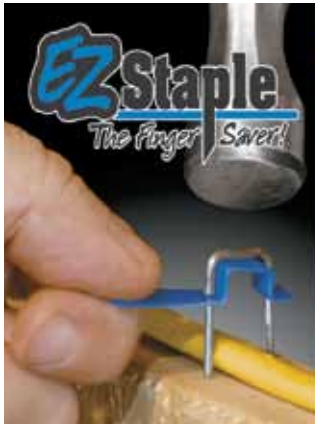

EZ STAPLES

EASY TO HANDLE, GET INTO TIGHT SPACES AND REDUCE DROPS



EZSTPL1C



EXSTPL5C



EZSTPL2M



EZ- POUR LIDS!

STOCK NO.	UPC NO.	DESCRIPTION	WT. PER PKG.	SUGGESTED TRADE LIST PRICE PER
EZSTPL1C	#85245	JAR OF 100 1/2"X1" STAPLES	.69 LBS.	4.40/C
EZSTPL5C	#85250	PAIL OF 500 1/2"X1" STAPLES	3.01 LBS.	4.25/C
EZSTPL2M	#85255	PAIL OF 2000 1/2"X1" STAPLES	12.21 LBS.	4.00/C

OTHER SIZES AND QUANTITIES AVAILABLE BY REQUEST

MANUFACTURING CAPABILITIES

Diameter range #2 thru 5/16" / 1.5mm thru 8mm • Length range 1/8" thru 3" / 3.5mm thru 75mm
Materials: Steel, Brass, Stainless, Aluminum, Bronze.

NEED SCREWS...

Let Us Make Them For You!



A METALLICS AFFILIATE

P.O. Box 1600 • 231 Cross Street
Bristol, CT 06011-1600
Tel: 800-984-8945 • Fax: 800-984-8946

CAPABILITIES LIST

PLANT SIZE: 100,000 SQUARE FEET

LOCATION: Bristol, Connecticut

EQUIPMENT: 27 Hi-Speed Cold Headers
8 Burr-Free Screw Slotters
3 Shank Slotters
2 Pointers
14 High Speed Thread Rollers



ADDITIONAL PLANT INFO: Modern shipping facility utilizing digital scale counting machines. In-house packaging facilities - boxing, sorting, baggings. All material boxed, palletized & labeled with your needs in mind for domestic or export shipping.

SECONDARY WORK: All plating & heat treating is done on the outside and certified for your guarantee.

INFORMATION SYSTEMS: Our facility has new and upgraded Technology to meet your customers specific requirements.

SPECIAL PURPOSE ELECTRICAL FASTENERS

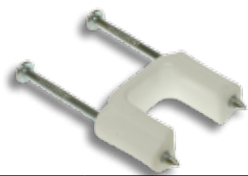

STACKING STAPLES

FOR GROUND - NON METALLIC CABLE

PACKAGED IN PLASTIC BAGS

MADE IN USA



STOCK NO.	UPC NO.	CABLE SIZE	WT. PER PKG.	STD. PKG.	SUGGESTED TRADE LIST PRICE PER
SCT6215	21755	For stacking two 2-wire #14 or #12 NM cable	.38	50	5.03/ea pkg
SCT6315	21760	For stacking three 2-wire or a 2-wire & 3-wire #14 or #12 NM cable	.42	50	5.85/ea pkg
SCT6415	21765	For stacking two 3-wire or four 2-wire #14 or #12 NM cable	.45	50	6.98/ea pkg

OTHER SIZES AND QUANTITIES AVAILABLE BY REQUEST



SERVICE ENTRANCE STAPLES

PACKAGED IN PLASTIC BAGS

MADE IN USA



STOCK NO.	UPC NO.	CABLE SIZE	WT. PER KIT	STD. PKG.	SUGGESTED TRADE LIST PRICE PER
SES4115	21770	#6 type SER (gray)	.63	50	16.98/ea pkg
SES4215	21771	#6 type SEU (gray)	.60	50	16.98/ea pkg
SES4312	21775	#2 type SER (gray)	.45	25	10.40/ea pkg
SES4412	21776	#2 type SEU (gray)	.33	25	9.63/ea pkg
SES4512	21781	4/0 type SEU (gray)	.51	25	14.28/ea pkg
SES4612	21780	4/0 type SER (gray)	.67	25	14.28/ea pkg

OTHER SIZES AND QUANTITIES AVAILABLE BY REQUEST



PLASTIC CABLE STAPLES

SECURES NON-METALLIC CABLE

PACKAGED IN PLASTIC BAGS

MADE IN USA



STOCK NO.	UPC NO.	CABLE SIZE	WT. PER KIT	STD. PKG.	SUGGESTED TRADE LIST PRICE PER
PCS125	21790	2 & 3 wire NM cable up to #12 2-wire UF cable up to #12 & other cable up to 1/2" wide	.45	100	5.55/c
PCS345	21795	2-wire NM & UF cable up to #8 3-wire UF Cable up to #12 & other cable up to 3/4" wide	.47	100	6.10/c

OTHER SIZES AND QUANTITIES AVAILABLE BY REQUEST



CO-AXIAL STAPLES

SECURES CO-AXIAL CABLE & OTHER NON-METALLIC CABLE UP TO 1/4" WIDE

PACKAGED IN PLASTIC BAGS

MADE IN USA



STOCK NO.	UPC NO.	CABLE SIZE	WT. PER KIT	STD. PKG.	SUGGESTED TRADE LIST PRICE PER
CAS5051	21800	1/4" wide	.21	100	4.88/c

OTHER SIZES AND QUANTITIES AVAILABLE BY REQUEST

SPECIAL PURPOSE ELECTRICAL FASTENERS



SMALL WIRE STAPLES

SECURES THERMOSTAT, TELEPHONE AND BELL WIRE
NON-METALLIC CABLE UP TO 1/4" WIDE
PACKAGED IN PLASTIC BAGS



STOCK NO.	UPC NO.	CABLE SIZE	WT. PER KIT	STD. PKG.	SUGGESTED TRADE LIST PRICE PER
SPS5151	21810	1/4" x 1/8"	.20	100	4.88/c

OTHER SIZES AND QUANTITIES AVAILABLE BY REQUEST

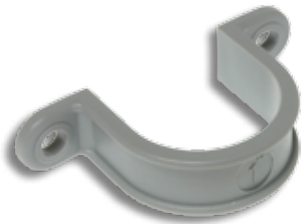

PVC CONDUIT STRAP

FOR NON-METALLIC PVC ELECTRICAL CONDUIT
PACKAGED IN PLASTIC BAGS



STOCK NO.	UPC NO.	CONDUIT SIZE	WT. PER KIT	STD. PKG.	SUGGESTED TRADE LIST PRICE PER
PCS212	21815	Gray 1/2"	.66	100	17.68/ea pkg
PCS234	21816	Gray 3/4"	.80	100	20.83/ea pkg
PCS244	21817	Gray 1"	1.05	100	29.10/ea pkg
PCS254	21818	Gray 1 1/4"	.75	50	16.98/ea pkg
PCS264	21819	Gray 1 1/2"	.95	50	18.55/ea pkg
PCS274	21821	Gray 2"	1.40	50	24.25/ea pkg
PCS284	21823	Gray 2 1/2"	.29	5	4.88/ea pkg
PCS294	21825	Gray 3"	.34	5	6.65/ea pkg
PCS204	21829	Gray 4"	.44	5	12.88/ea pkg

OTHER SIZES AND QUANTITIES AVAILABLE BY REQUEST



CONDUIT LOCK NUTS

STEEL ZINC PLATED

STOCK NO.	UPC NO.	CONDUIT SIZE	WT. PER KIT	STD. PKG.	SUGGESTED TRADE LIST PRICE PER
SFLN50	13575	1/2"	.92	100	11.20/ea pkg
SFLN75	13576	3/4"	1.65	100	15.33/ea pkg
SFLN100	13577	1"	2.80	100	22.65/ea pkg
SFLN125	13578	1 1/4"	2.01	50	15.90/ea pkg
SFLN150	13579	1 1/2"	2.49	50	18.90/ea pkg
SFLN200	13581	2"	2.90	50	25.73/ea pkg
SFLN250	13583	2 1/2"	3.05	25	35.70/ea pkg
SFLN300	13585	3"	4.35	25	45.98/ea pkg
SFLN400	13589	4"	1.49	20	210.31/ea pkg

OTHER SIZES AND QUANTITIES AVAILABLE BY REQUEST

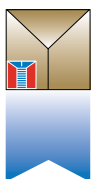

AMERICA'S SOURCE FOR PREMIER AND INNOVATIVE
FASTENERS & ANCHORS

SPECIAL PURPOSE ELECTRICAL FASTENERS

C = 100 PCS PER BOX
 F = 500 PCS PER JAR
 P = 5,000 PCS PER PAIL

NON-INSULATED CABLE STAPLES



EXAMPLE: CST40 = 100 PCS FST40 = 500 PCS PST40 = 5,000 PCS

STOCK NO.	UPC NO.	QTY. PER CONTAINER	USE	SIZE	WT. PER PKG.	SUGGESTED TRADE LIST PRICE PER
 CST40	21000	100/Box	N.M.C. 2 Romex	1 L x 1/2 W	.65	2.90/c
FST40	21005	500/Jar	#12 & #14		2.89	13.45/ea pkg
PST40	21007	5000/Pail			26.95	127.58/ea pkg

 CST100	21010	100/Box	N.M.C. & Armored	1 1/4 L x 9/16 W RX & BX	.59	3.28/c
FST100	21015	500/Jar	#14, #12, #10 w/gr		2.96	14.95/ea pkg
PST100	21017	5000/Pail			35.90	142.65/ea pkg

N.M.C. - to be used on non-metallic cable

 CST300	21020	100/Box	Service Entrance SEU3 #6	1 5/16 L x 3/4 W	1.18	6.05/c
FST300	21022	500/Jar			6.20	27.18/ea pkg

 CST350	21025	100/Box	Service Entrance SEU2 #6	1 1/2 L x 1 1/16 W For 2 #3 Full 10 Ga. Wire	1.31	7.55/c
FST350	21027	500/Jar			6.41	33.90/ea pkg

JAR PACKAGING AVAILABLE

OTHER SIZES AND QUANTITIES AVAILABLE BY REQUEST

CST100I



INSULATED CABLE STAPLES

HOT MELT PVC BONDED
 FOR BETTER CABLE PROTECTION!



STOCK NO.	UPC NO.	QTY. PER CONTAINER	USE	SIZE	WT. PER PKG.	SUGGESTED TRADE LIST PRICE PER
CST40I	21030	100/Box	#12, #14 Wire	1" x 1/2"	.59	4.55/c
CST100I	21018	100/Box	#10, #12, #14 Wire	1 1/4" x 9/16"	.71	4.43/c
CST350P	21093	2000/Pail	#10, #12, #14 Wire	1 1/4" x 9/16"	27.25	143.70/ea pkg NEW
CST100P	29006	1500/Pail	#10, #12, #14 Wire	1 1/4" x 9/16"	13.35	82.25/ea pkg NEW
FST100I	21019	250/Jar	#10, #12, #14 Wire	1 1/4" x 9/16"	2.20	10.85/ea pkg
PST100I	21021	5000/Pail	#10, #12, #14 Wire	1 1/4" x 9/16"	37.00	203.10/ea pkg
FST40I	21035	500/Jar	#10, #12, #14 Wire	1" x 1/2"	2.74	23.75/ea pkg NEW
PST40I	21040	5000/Pail	#10, #12, #14 Wire	1" x 1/2"	28.98	184.65/ea pkg NEW

JAR PACKAGING AVAILABLE

OTHER SIZES AND QUANTITIES AVAILABLE BY REQUEST

Metallics East 1-800-243-8272

Metallics West 1-800-269-5183

SPECIAL PURPOSE ELECTRICAL FASTENERS

RAFTER AND TRUSS STAPLES



- SAVE TIME AND FRUSTRATION BY FASTENING CABLE FROM THE FRONT OF THE RAFTERS AND TRUSSES
- INCREASE PRODUCTIVITY
- MADE FOR HARD TO REACH PLACES SUCH AS RAFTERS AND FLOOR JOISTS
- ELIMINATES DAMAGE TO WIRE JACKET
- REDUCES BENT OVER NAILS

STOCK NO.	UPC NO.	SIZE	DESCRIPTION	PKG. QTY.	WT. PER PKG.	SUGGESTED TRADE LIST PRICE PER
RJS1	21910	1/2	Rafter-Joist Staple	100	1.14	9.85/c
RJS2	21912	1/2	Rafter-Joist Staple	500	6.55	38.58/ea pkg

OTHER SIZES AND QUANTITIES AVAILABLE BY REQUEST



WHITE INSULATED TWO NAIL STAPLES



STOCK NO.	UPC NO.	SIZE	DESCRIPTION	PKG. QTY.	WT. PER PKG.	SUGGESTED TRADE LIST PRICE PER
CS50	21914	1/2	Plastic Staple	100	.45	8.75/c
CS50P	21916	1/2	Plastic Staple	2000	9.98	115.93/ea pkg
CS75	21918	3/4	Plastic Staple	100	.50	8.88/c
CS75P	21920	3/4	Plastic Staple	1500	8.05	96.40ea pkg
1/2 secures 14-2 or 12-2 with ground non-metallic cable and other non-metallic cable 1/2" wide						
3/4 secures 12-3 or 10-3 with ground non-metallic cable and other non-metallic cable 3/4" wide						

OTHER SIZES AND QUANTITIES AVAILABLE BY REQUEST



BLACK INSULATED TWO NAIL STAPLES



STOCK NO.	UPC NO.	SIZE	DESCRIPTION	PKG. QTY.	WT. PER PKG.	SUGGESTED TRADE LIST PRICE PER
CCS50	21926	1/2	Plastic Staple	100	.44	6.70/c
CCS50P	21928	1/2	Plastic Staple	2000	9.81	87.73/ea pkg
CCS75	21930	3/4	Plastic Staple	100	.50	7.43/c
CCS75P	21932	3/4	Plastic Staple	1500	8.50	77.58/ea pkg
1/2 secures 14-2 or 12-2 with ground non-metallic cable and other non-metallic cable 1/2" wide						
3/4 secures 12-3 or 10-3 with ground non-metallic cable and other non-metallic cable 3/4" wide						

OTHER SIZES AND QUANTITIES AVAILABLE BY REQUEST



DATA COMM. STAPLES 0.190 DIAMETER



FOR CATEGORY 5 (4 PAIR 24 GAUGE CABLE)

STOCK NO.	UPC NO.	SIZE	DESCRIPTION	PKG. QTY.	WT. PER PKG.	SUGGESTED TRADE LIST PRICE PER
DCS1	21938	0.190	Plastic Data Com. Staple	100	.23	8.05/c
DCS1B	21940	0.190	Plastic Data Com. Staple	500	1.15	31.58/ea pkg

OTHER SIZES AND QUANTITIES AVAILABLE BY REQUEST



SPECIAL PURPOSE ELECTRICAL FASTENERS

INSULATED STAPLES

FOR LOW VOLTAGE WIRING
Conforms to U.S. Government Specifications

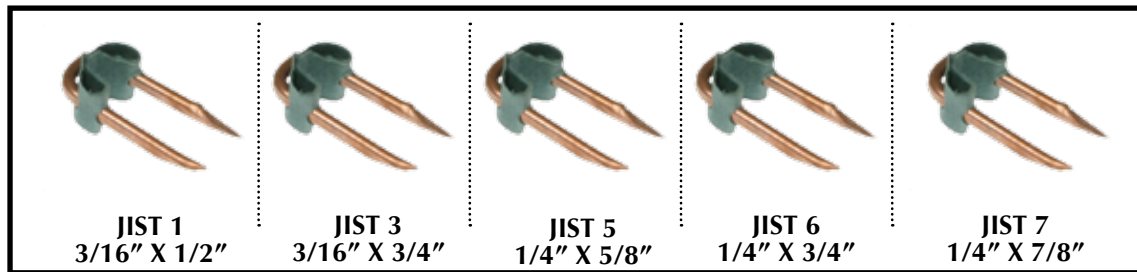

STOCK NO.	UPC NO.	SIZE	WIDTH	LENGTH OF LEGS	WT. PER PKG.	STD. PKG./MSTR. CARTON	SUGGESTED TRADE LIST PRICE PER
JIST1	81016	#1	$\frac{3}{16}$	$\frac{1}{2}$.19	100/500	3.00/c
JIST3	81017	#3	$\frac{3}{16}$	$\frac{3}{4}$.24	100/500	3.00/c
JIST5	81018	#5	$\frac{1}{4}$	$\frac{5}{8}$.22	100/500	3.73/c
JIST6	81019	#6	$\frac{1}{4}$	$\frac{3}{4}$.24	100/500	3.28/c
JIST7	81020	#7	$\frac{1}{4}$	$\frac{7}{8}$.25	100/500	4.33/c

OTHER SIZES AND QUANTITIES AVAILABLE BY REQUEST

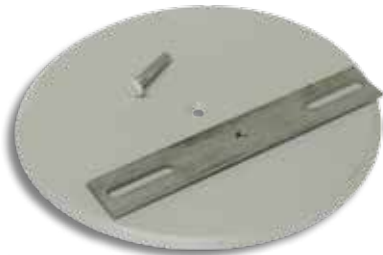

PACKAGED 10 IN POLY BAG

CEILING COVER PLATE ADJUSTABLE

ADJUSTS TO FIT 3" OR 4" OUTLET BOXES
Includes plate, strap and flat head slotted machine screw.
White color to suit most applications.



STOCK NO.	UPC NO.	DESCRIPTION	WEIGHT	STD. PKG.	SUGGESTED TRADE LIST PRICE PER
CP1A	41300	Fits 3" & 4" boxes. 5 $\frac{1}{4}$ steel canopy with adjustable strap and screws	.12	10	38.93/c

OTHER SIZES AND QUANTITIES AVAILABLE BY REQUEST



PACKAGED 10 IN POLY BAG

CEILING COVER PLATE STANDARD

ATTACHES DIRECTLY TO CEILING OUTLET BOXES
Holes predrilled. Flat head slotted machine screws included.
White color to suit most applications.



STOCK NO.	UPC NO.	DESCRIPTION	WEIGHT	STD. PKG.	SUGGESTED TRADE LIST PRICE PER
CP3S	41305	5 $\frac{1}{4}$ white canopy fits 3" boxes	.18	10	31.90/ea pkg
CP4S	41310	5 $\frac{1}{4}$ white canopy fits 4" boxes	.15	10	31.90/ea pkg

OTHER SIZES AND QUANTITIES AVAILABLE BY REQUEST



STAPLE GUNS & STAPLES

MT-72



**M721168
M721189**

MT-72 Staple Gun:

Professional wire & cable staple gun. Shoots large UL listed & C-UL listed insulated staples for non metallic sheathed cable, 12/2, 14/2 and other wire up to 1/2". Wire guide for proper fit. All steel construction and patented jam proof mechanism.

MT-50



**M591189
M591189BL**

MT-59 Staple Gun:

Wiring Tacker for UL listed & C-UL listed insulated staples. Ideal for installing RG6 and RG6 Quad shield TV/Cable/Computer wire up to 5/16" wide. Steel construction, grooved guide. Patented jam proof mechanism.

MT-25



**M256, M257,
M259**

MT-25 Staple Gun:

Low voltage wire staple gun. Fits wire up to 1/4". Built in grooved guide to prevent wire damage. All steel construction. Patented jam proof mechanism.

STOCK NO.	UPC NO.	DESCRIPTION	WEIGHT	QTY./PKG.
MT72	23672	Staple Gun	2.5 lbs	1
M721168	23676	13/64" x 31/64" Insulated Staple	0.55 lbs	300
M721189	23680	11/32" x 19/32" Insulated Staple	0.58 lbs	300
MT59	23659	Staple Gun	2.08 lbs	1
M591189	23665	5/16" x 5/16" Clear Insulated Staple	0.275 lbs	300
M591189BL	23670	5/16" x 5/16" Black Insulated Staple	0.275 lbs	300
MT25	23625	Staple Gun	2.08 lbs	1
M256	23630	1/4" x 3/8" Non-insulated Staple	0.29 lbs	1,000
M257	23635	1/4" x 7/16" Non-insulated Staple	0.34 lbs	1,000
M259	23640	1/4" x 9/16" Non-insulated Staple	0.40 lbs	1,000

OTHER SIZES AND QUANTITIES AVAILABLE BY REQUEST

WIRE TACKERS

ARROW® MODEL T75™ WIRE & CABLE STAPLER
USES T75™ STAPLES (5/8" (16MM) 7/8" (22MM))



- Durable Chrome Finish
- All-Steel Construction
- Cushioned Grip
- Grooved Guide
- Grooved Driving Blade
- Chrome Finish Resists Wear and Tear
- Patented Jam-Proof Mechanism
- Easy Squeeze Double Leverage Operation
- For wires up to 1/2" (12mm)
- NM Sheathed Cable up to #12 3-Wire
- CATV
- Communications
- Alarm Systems
- Electronics

STOCK NO.	UPC NO.	DESCRIPTION	QTY. PER PKG.	SUGGESTED TRADE LIST PRICE PER
MT75	23675	Wire & Cable Staple Gun	1	84.88/ea.
M7510S	23693	5/8 Staple UL Listed	1000	22.10/pkg.
M7510	23590	5/8 Staple Not UL Listed	1000	16.40/pkg.
M7514S	23687	7/8 Staple UL Listed	1000	24.55/pkg.
M7514	23594	7/8 Staple Not UL Listed	1000	18.05/pkg.

OTHER SIZES AND QUANTITIES AVAILABLE BY REQUEST

AMERICA'S SOURCE FOR PREMIER AND INNOVATIVE FASTENERS & ANCHORS



A Modern Up to Date Roll Threading Machine at our Affiliate, Avanti Screw.



Metallics and Avanti Screw, Inc., prime American manufacturers of fastener products, have always worked to present the latest in fastener technology to our distributors and their contractors/users.

Hex Washer Head fasteners have historically only offered three drives—the hex, phillips and the slot. In 1999, we introduced "The QuaDrive" square, hex, slotted and phillips, in fourteen of the most popular sizes of sheet metal screws.

The QuaDrive

Square Drive + Hex + Slotted + Phillips = QuaDrive

America's Newest Drive - Designed, Developed and Manufactured by Metallics/Avanti Screw

These sheet metal screws are being manufactured to fill the need of the growing demand in the North American markets.

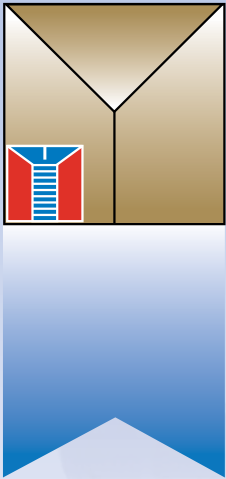

Metallics

Caulking Guns



[CONTRACTOR APPROVED]



CG77 Has Ratchet Rod

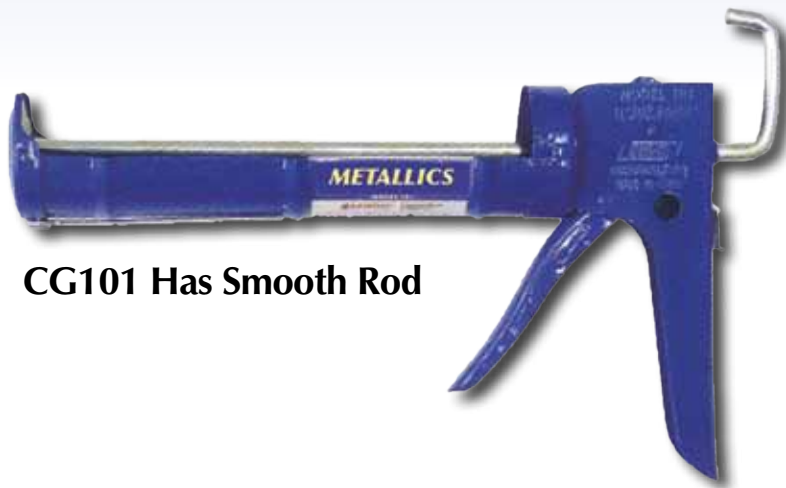

CG101 Has Smooth Rod

PART #	UPC #	DESCRIPTION	QTY / PKG	SUG. TRADE LIST / PKG
CG77	35060	Caulking Gun with Ratchet Rod, Cradle Frame 10oz.	1	\$ 12.70
CG101	35065	Caulking Gun with Smooth Rod, Seal Punctuer Tool, Spout Cutter, Ladder Hook 10oz.	1	\$ 14.65

"Growth Through Innovation"

Metallics

229 Cross Street, Bristol, CT 06010
Tel 800-243-8272 • **Fax** 800-831-9358
Email sales@metallicsonline.com

Metallics West

651 North Main Street, Mancos, CO 81328
Tel 800-269-5183 • **Fax** 800-269-6278
Email saleswest@metallicsonline.com

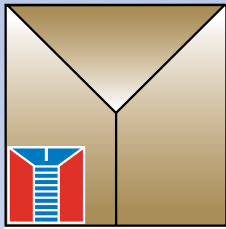

Metallics

Work Gloves



**[CONTRACTOR
APPROVED]**



- 100% Cotton Standard Weight
- Brown Jersey Glove
- Knit Wrist
- Sold in dozen pairs per pkg.
- One size fits all

PART #	UPC #	DESCRIPTION	QTY / PKG	SUG. TRADE LIST / PKG
MBJ1	17665	100% Cotton Standard Weight Brown Jersey Work Glove	12 pair	\$ 24.68

★ ★ ★ ★ ★ *"Growth Through Innovation"* ★ ★ ★ ★ ★

Metallics

229 Cross Street, Bristol, CT 06010
Tel 800-243-8272 • **Fax** 800-831-9358
Email sales@metallicsonline.com

Metallics West

651 North Main Street, Mancos, CO 81328
Tel 800-269-5183 • **Fax** 800-269-6278
Email saleswest@metallicsonline.com



ISOMAX® IMPACT DRIVER KIT

11 PIECE IMPACT DRIVER BIT KIT
PERFECT FOR REMOVING TIGHT OR STUCK SCREWS

- Perfect for Removing Tight, or Stuck Screws!
- Includes Comfortable Impact Absorbing Hand-Grip with Hand Guard
- Comes with Bit Holder, 9 Tips and Sturdy Molded Plastic Storage Case.



Square Drive

STOCK NO.	UPC NO.	DESCRIPTION	WT. PER PKG.	STD. PKG.	SUGGESTED TRADE LIST PRICE PER
IBTK11	32771	11 pc. Impact Driver Kit with plastic Handle	2.3 lbs	1	47.20

OTHER SIZES AND QUANTITIES AVAILABLE BY REQUEST



ISOMAX® IMPACT DRIVER BIT KIT

13 PIECE IMPACT DRIVER BIT KIT



Hex



Slotted



Phillips



Square Drive

STOCK NO.	UPC NO.	DESCRIPTION	WT. PER PKG.	STD. PKG.	SUGGESTED TRADE LIST PRICE PER
IBTK13	32773	13 pc. Impact Driver Bit Kit	.42 lbs	1	45.17

OTHER SIZES AND QUANTITIES AVAILABLE BY REQUEST

TOOLS, DRILLS AND ACCESSORIES

15 IN ONE RACHET SCREWDRIVER

Handle Contains 1 each
of bits listed below



STOCK NO.	UPC NO.	DESCRIPTION	QTY.	WT. PER PKG.	SUGGESTED TRADE LIST PRICE PER
SD15B	35025	Screwdriver 15-1 REPLACEMENT BITS (PKG. 6 BITS PER PKG.)	1	.50	52.23/ea
SDR1B	35028	1/8" Slotted x #0 Phillips	6	.50	31.58/ea pkg
SDR2B	35030	1/4" x 3/16" Slotted	6	.50	31.58/ea pkg
SDR3B	35032	1/4" Slotted x #2 Phillips	6	.50	31.58/ea pkg
SDR4B	35034	5/32" Slotted x #3 Phillips	6	.50	31.58/ea pkg
SDR5B	35036	#1 x #2 Phillips	6	.50	31.58/ea pkg
SDR6B	35038	T15 x T20 Torx Compatible	6	.50	38.28/ea pkg
SDR7B	35040	S1 x S2 Square	6	.50	38.28/ea pkg

OTHER SIZES AND QUANTITIES AVAILABLE BY REQUEST



25' PRO TAPE MEASURE

Cushion Grip Provides Non-slip Grip and Helps Protect Tape
Quick release and locking button
Tape 7/8" wide for extra strength

STOCK NO.	UPC NO.	DESCRIPTION	QTY.	WT. PER PKG.	SUGGESTED TRADE LIST PRICE PER
MPT1	31304	Tape Measure	1	.79	38.50/ea

OTHER SIZES AND QUANTITIES AVAILABLE BY REQUEST

LUTZ® IS A REGISTERED TRADEMARK



UTILITY KNIFE

Heavy Duty • Xtra Blades in handle • Retractable Blade

STOCK NO.	UPC NO.	DESCRIPTION	QTY.	WT. PER PKG.	SUGGESTED TRADE LIST PRICE PER
MUK1	31308	Utility Knife	1	.60	18.65/ea

OTHER SIZES AND QUANTITIES AVAILABLE BY REQUEST

FOUR-WAY SCREWDRIVER

Convenience of 4 Screwdrivers in One!



- Reversible Shaft
- Heavy Duty Black Plastic Handle with Gold Imprint

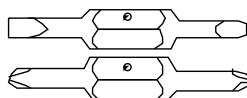

SD4W1

Includes:
3/16 & 9/32 Slotted bit
#1 & #2 Phillips bit

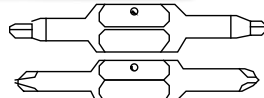

SD4W2

Includes:
#1 & #2 Square bit
#1 & #2 Phillips bit

Attractive counter display included with 12 or more!

SPECIAL ORDER

PRIVATE LABELING AVAILABLE

with purchases of 72 or more drivers
(Specify handle color: Red, Black, Light Blue, Dark Blue, Yellow, Green)

STOCK NO.	UPC NO.	DESCRIPTION	WT. EACH	STD. PKG.	SUGGESTED TRADE LIST PRICE PER
SD4W1	35001	4-way Phillips and Slotted Points	.32	1	16.30/ea
SD4W2	35002	4-way Phillips and Square Points	.31	1	16.30/ea

OTHER SIZES AND QUANTITIES AVAILABLE BY REQUEST

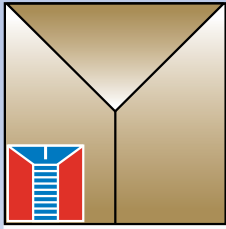

Metallics

Mighty Marker

6 Assorted Colors!

Yellow • Blue • Red • White • Black • Green



[CONTRACTOR APPROVED]



- Permanent, waterproof and quick dry paint
- Indoor and outdoor
- Marks metal and most surfaces
- Medium line
- Aluminum barrel with paint-fed fiber tip
- Oil based opaque fast dry paint
- Fade and abrasion resistant
- Conforms to ASTM 4236

PART #	UPC #	DESCRIPTION	QTY / PKG	SUG. TRADE LIST / PKG
MM01606	14637	Mighty Marker – 6 pack assorted colors	6	\$ 32.48

“Growth Through Innovation”

Metallics

229 Cross Street, Bristol, CT 06010
Tel 800-243-8272 • **Fax** 800-831-9358
Email sales@metallicsonline.com

Metallics West

651 North Main Street, Mancos, CO 81328
Tel 800-269-5183 • **Fax** 800-269-6278
Email saleswest@metallicsonline.com

TOOLS, DRILLS AND ACCESSORIES

SIX-WAY SCREWDRIVER

Same great features as our 4-Way Screwdriver **PLUS** a hardened steel tube for use as a 1/4" or 5/16" hex nut driver!

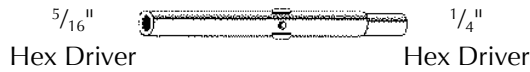

- Reversible Steel Shaft with Hex Drivers
- Heavy Duty Black Plastic Handle with Gold Imprint

Attractive counter display included with 12 or more!

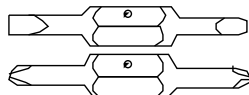

SD6W1

Includes:
3/16 & 9/32 Slotted bit
#1 & #2 Phillips bit

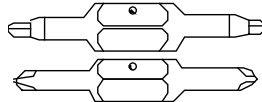

SD6W2

Includes:
#1 & #2 Square bit
#1 & #2 Phillips bit

SPECIAL ORDER

PRIVATE LABELING AVAILABLE

with purchases of 72 or more drivers
(Specify handle color: Red, Black, Light Blue, Dark Blue, Yellow, Green)

STOCK NO.	UPC NO.	DESCRIPTION	WT. EACH	STD. PKG.	SUGGESTED TRADE LIST PRICE PER
SD6W1	35010	6-way Phillips and Slotted Points	.35	1	19.95/ea
SD6W2	35011	6-way Phillips and Square Points	.35	1	19.95/ea

OTHER SIZES AND QUANTITIES AVAILABLE BY REQUEST



THREE-IN-ONE TAP THREAD CLEANING TOOL

STOCK NO.	UPC NO.	DESCRIPTION	WT. EACH	STD. PKG.	SUGGESTED TRADE LIST PRICE PER
681032	16345	6-32,8-32,10-32 Thread Cleaning Tool	.34	1	29.00/ea

OTHER SIZES AND QUANTITIES AVAILABLE BY REQUEST



MAGNETIC BIT AND NUT SETTER KIT

- Three sizes of Nut Setters and one size Bit Holders
- Magnetized for ease of use
- Be professional, be prepared

STOCK NO.	UPC NO.	DESCRIPTION	SIZE	QTY.	WT. EACH	STD. PKG.	SUGGESTED TRADE LIST PRICE PER
MTKQ	10890	Mag. Hex Bit Holder	1/4 x 2"	2	.8	1	76.30/ea
		Mag Nut Setter	1/4 x 2"	2			
		Mag Nut Setter	5/16 x 2"	2			
		Mag Nut Setter	3/8 x 2"	2			

OTHER SIZES AND QUANTITIES AVAILABLE BY REQUEST

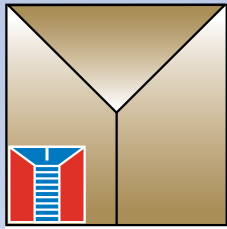

Metallica



Extra Long Power Bits

**[CONTRACTOR
APPROVED]**

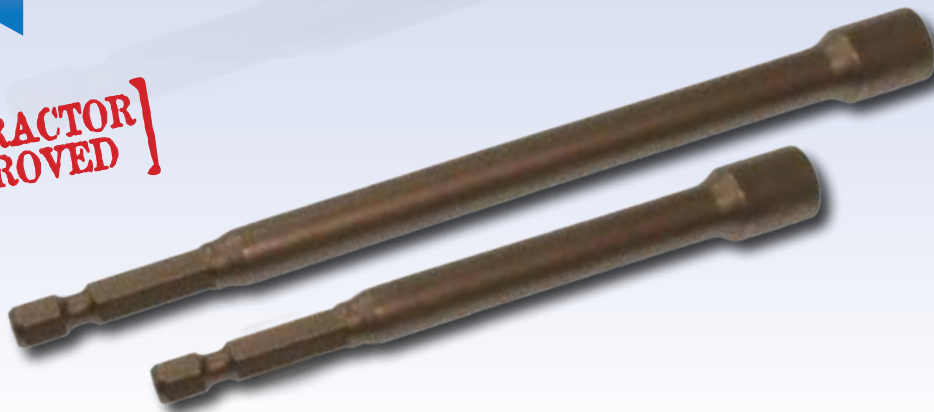

PART #	UPC #	DESCRIPTION	QTY / PKG	SUG. TRADE LIST / PKG
MT208L4	27150	1/4 x 4 Extra Long Power Bit	2	\$ 19.50
MT208L6	27155	1/4 x 6 Extra Long Power Bit	2	\$ 23.13
MT210L4	10523	5/16 x 4 Extra Long Power Bit	2	\$ 22.23
MT210L6	10526	5/16 x 6 Extra Long Power Bit	2	\$ 34.23
MT212L4	27165	3/8 x 4 Extra Long Power Bit	2	\$ 24.75
MT212L6	27170	3/8 x 6 Extra Long Power Bit	2	\$ 44.25
MT208L4B	27151	1/4 x 4 Extra Long Power Bit (bulk packed)	EACH	\$ 11.25
MT208L6B	27156	1/4 x 6 Extra Long Power Bit (bulk packed)	EACH	\$ 13.75
MT210L4B	10524	5/16 x 4 Extra Long Power Bit (bulk packed)	EACH	\$ 11.11
MT210L6B	10527	5/16 x 6 Extra Long Power Bit (bulk packed)	EACH	\$ 17.11
MT212L4B	27166	3/8 x 4 Extra Long Power Bit (bulk packed)	EACH	\$ 14.75
MT212L6B	27171	3/8 x 6 Extra Long Power Bit (bulk packed)	EACH	\$ 27.75

Other sizes, materials and quantities available by request.

“Growth Through Innovation”

Metallica

229 Cross Street, Bristol, CT 06010
Tel 800-243-8272 • **Fax** 800-831-9358
Email sales@metallicsonline.com

Metallica West

651 North Main Street, Mancos, CO 81328
Tel 800-269-5183 • **Fax** 800-269-6278
Email saleswest@metallicsonline.com

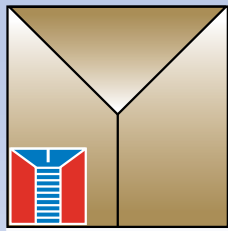

Metallics

**CONTRACTOR
APPROVED**

NEW!
2014-2015

High-Speed Twist Drills

Fractional Sizes – Individually Packaged

- Jobber length - 118° Point
- Fractional sizes
- Bright finish
- In single pouch



* 1/4 reduced shank

PART #	UPC #	DESCRIPTION	QTY / PKG	SUG. TRADE LIST / PKG
HSD1E	39801	1/16 x 1-7/8" drill	1	\$ 1.75
HSD2E	39802	5/64 x 2" drill	1	\$ 1.75
HSD3E	39803	3/32 x 2-1/4" drill	1	\$ 1.78
HSD4E	39804	7/64 x 2-5/8" drill	1	\$ 1.80
HSD5E	39805	1/8 x 2-3/4" drill	1	\$ 2.03
HSD6E	39806	9/64 x 2-7/8" drill	1	\$ 2.20
HSD7E	39807	5/32 x 3-1/8" drill	1	\$ 2.23
HSD8E	39808	11/32 x 3-1/4" drill	1	\$ 2.50
HSD9E	39809	3/16 x 3-1/2" drill	1	\$ 2.90
HSD29E	39829	13/64 x 3-5/8" drill	1	\$ 3.25
HSD10E	39810	7/32 x 3-3/4" drill	1	\$ 3.43
HSD11E	39811	15/64 x 3-7/8" drill	1	\$ 3.78
HSD12E	39812	1/4 x 4" drill	1	\$ 4.40
HSD13E	39813	17/64 x 4-1/8" drill	1	\$ 5.18
HSD14E	39814	9/32 x 4-1/4" drill	1	\$ 6.08
HSD15E	39815	19/64 x 4-3/8" drill	1	\$ 6.45
HSD16E	39816	5/16 x 4-1/2" drill	1	\$ 6.63
HSD16RE	39916	5/16 x 4" drill	1	\$ 7.33
HSD17E	39817	21/64 x 4-5/8" drill	1	\$ 7.35
HSD18E	39818	11/32 x 4-3/4" drill	1	\$ 8.25
HSD19E	39819	23/64 x 4-7/8" drill	1	\$ 9.35
HSD20E	39820	3/8 x 5" drill	1	\$ 9.63
HSD20RE	39920	3/8 x 4" drill	1	\$ 10.18
HSD21E	39821	25/64 x 5-1/8" drill	1	\$ 10.25
HSD22E	39822	13/32 x 5-1/4" drill	1	\$ 10.98
HSD23E	39823	27/64 x 5-3/8" drill	1	\$ 12.15
HSD24E	39824	7/16 x 5-1/2" drill	1	\$ 12.65
HSD24RE	39924	7/16 x 4" drill	1	\$ 12.98
HSD25E	39825	29/64 5-5/8" drill	1	\$ 15.25
HSD26E	39826	15/32 x 5-3/4" drill	1	\$ 14.70
HSD27E	39827	31/64 x 5-7/8" drill	1	\$ 15.65
HSD28E	39828	1/2 x 6" drill	1	\$ 16.28
HSD28RE	39928	1/2 x 4" drill	1	\$ 16.98

Other sizes, materials and quantities available by request.

"Growth Through Innovation"

Metallics

229 Cross Street, Bristol, CT 06010
Tel 800-243-8272 • **Fax** 800-831-9358
Email sales@metallicsonline.com

Metallics West

651 North Main Street, Mancos, CO 81328
Tel 800-269-5183 • **Fax** 800-269-6278
Email saleswest@metallicsonline.com

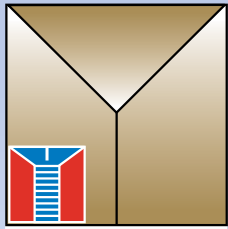

Metallics



High-Speed Twist Drills

Numbered Sizes – Individually Packaged

[CONTRACTOR APPROVED]

- Jobber length - 118° Point
- Numbered sizes
- Black oxide finish
- In single pouch



PART #	UPC #	DESCRIPTION	QTY / PKG	SUG. TRADE LIST / PKG
NHSD6E	39706	#6 x 3-3/4" drill	1	\$ 4.36
NHSD7E	39707	#7 x 3-5/8" drill	1	\$ 4.12
NHSD8E	39708	#8 x 3-5/8" drill	1	\$ 3.68
NHSD9E	39709	#9 x 3-5/8" drill	1	\$ 3.63
NHSD10E	39710	#10 x 3-5/8" drill	1	\$ 3.52
NHSD11E	39711	#11 x 3-1/2" drill	1	\$ 3.52
NHSD20E	39720	#20 x 3-1/4" drill	1	\$ 2.87
NHSD21E	39721	#21 x 3-1/4" drill	1	\$ 2.98
NHSD22E	39722	#22 x 3-1/8" drill	1	\$ 2.62
NHSD25E	39725	#25 x 3" drill	1	\$ 2.59
NHSD26E	39726	#26 x 3" drill	1	\$ 2.59
NHSD28E	39728	#28 x 2-7/8" drill	1	\$ 2.62
NHSD29E	39729	#29 x 2-7/8" drill	1	\$ 2.62
NHSD30E	39730	#30 x 2-3/4" drill	1	\$ 2.62
NHSD31E	39731	#31 x 2-3/4" drill	1	\$ 2.62
NHSD35E	39735	#35 x 2-5/8" drill	1	\$ 2.62
NHSD36E	39736	#36 x 2-1/2" drill	1	\$ 2.62
NHSD37E	39737	#37 x 2-1/2" drill	1	\$ 2.02
NHSD43E	39743	#43 x 2-1/4" drill	1	\$ 2.02

Other sizes, materials and quantities available by request.

Metallics

Bristol, Connecticut
Mancos Valley, Colorado
www.metallicsonline.com

★ ★ ★ ★ ★ "Growth Through Innovation" ★ ★ ★ ★ ★

Metallics

229 Cross Street, Bristol, CT 06010
Tel 800-243-8272 • **Fax** 800-831-9358
Email sales@metallicsonline.com

Metallics West

651 North Main Street, Mancos, CO 81328
Tel 800-269-5183 • **Fax** 800-269-6278
Email saleswest@metallicsonline.com

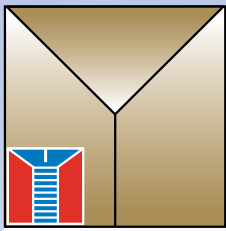

Metallics

NEW!
2014-2015

Heavy Duty Cobalt Steel - 135° Split Point Drills

Fractional Sizes – Individually Packaged

- Cobalt Steel
- Jobber Length - 135° Point
- Fractional Sizes
- Yellow Finish
- In Single Pouch

USES

- Hardened Steel
- Stainless Steel
- High Temp Alloys
- Heat Treated Material
- Abrasive Plastics
- Titanium



**[CONTRACTOR
APPROVED]**

PART #	UPC #	DESCRIPTION	QTY / PKG	SUG. TRADE LIST / PKG
HSSC1E	28201	1/16 x 1-7/8" drill	1	\$ 3.15
HSSC2E	28202	5/64 x 2" drill	1	\$ 3.53
HSSC3E	28203	3/32 x 2-1/4" drill	1	\$ 3.85
HSSC4E	28204	7/64 x 2-5/8" drill	1	\$ 4.05
HSSC5E	28205	1/8 x 2-3/4" drill	1	\$ 4.58
HSSC6E	28206	9/64 x 2-7/8" drill	1	\$ 4.95
HSSC7E	28207	5/32 x 3-1/8" drill	1	\$ 5.43
HSSC8E	28208	11/64 x 3-1/4" drill	1	\$ 5.73
HSSC9E	28209	3/16 x 3-1/2" drill	1	\$ 6.30
HSSC29E	28229	13/64 x 3-5/8" drill	1	\$ 8.33
HSSC10E	28210	7/32 x 3-3/4" drill	1	\$ 8.88
HSSC11E	28211	15/64 x 3-7/8" drill	1	\$ 9.77
HSSC12E	28212	1/4 x 4" drill	1	\$ 10.62
HSSC13E	28213	17/64 x 4-1/8" drill	1	\$ 11.45
HSSC14E	28214	9/32 x 4-1/4" drill	1	\$ 12.55
HSSC15E	28215	19/64 x 4-3/8" drill	1	\$ 14.45
HSSC16E	28216	5/16 x 4-1/2" drill	1	\$ 15.53
HSSC17E	28217	21/64 x 4-5/8" drill	1	\$ 17.03
HSSC18E	28218	11/32 x 4-3/4" drill	1	\$ 19.65
HSSC19E	28219	23/64 x 4-7/8" drill	1	\$ 22.38
HSSC20E	28220	3/8 x 5" drill	1	\$ 23.43
HSSC21E	28221	25/64 x 5-1/8" drill	1	\$ 24.68
HSSC22E	28222	13/32 x 5-1/4" drill	1	\$ 26.38
HSSC23E	28223	27/64 x 5-3/8" drill	1	\$ 27.88
HSSC24E	28224	7/16 x 5-1/2" drill	1	\$ 29.03
HSSC25E	28225	29/64 5-5/8" drill	1	\$ 34.75
HSSC26E	28226	15/32 x 5-3/4" drill	1	\$ 35.45
HSSC27E	28227	31/64 x 5-7/8" drill	1	\$ 36.28
HSSC28E	28228	1/2 x 6" drill	1	\$ 37.35

Other sizes, materials and quantities available by request.

"Growth Through Innovation"

Metallics

229 Cross Street, Bristol, CT 06010
Tel 800-243-8272 • **Fax** 800-831-9358
Email sales@metallicsonline.com

Metallics West

651 North Main Street, Mancos, CO 81328
Tel 800-269-5183 • **Fax** 800-269-6278
Email saleswest@metallicsonline.com

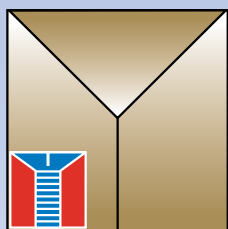

Metallics



Magnetic Bit Holder and Nut Setter Kits

[CONTRACTOR APPROVED]



9 Piece Nut Setter Kit (MTKQ9)



10 Piece Nut Setter Kit (MTKQ10)

- Each kit contains one of each of the following:
 - 1/4" x 1 5/8" magnetic nut setter,
 - 1/4" x 2 9/16" magnetic nut setter,
 - 1/4" x 4" magnetic nut setter,
 - 1/4" x 6" magnetic nut setter,
 - 5/16" x 1 5/8" magnetic nut setter,
 - 5/16" x 2 9/16" magnetic nut setter,
 - 5/16" x 4" magnetic nut setter,
 - 5/16" x 6" magnetic nut setter, and
 - 3/8" x 1 5/8" magnetic nut setter.
- The MTKQ10 also includes a 1/4" quick change drill chuck adapter.
- All pieces come in a handy X-Large 6 compartment poly box.

PART #	UPC #	DESCRIPTION	QTY / PKG	SUG. TRADE LIST / PKG
MTKQ9	13246	9 Piece Magnetic Bit Holder and Nut Setter Kit	1	\$ 87.75
MTKQ10	13251	10 Piece Magnetic Bit Holder and Nut Setter Kit	1	\$ 92.25
DCA1	32764	1/4" Quick Change Drill Chuck Adapter	1	\$ 9.75

"Growth Through Innovation"

Metallics

229 Cross Street, Bristol, CT 06010
Tel 800-243-8272 • **Fax** 800-831-9358
Email sales@metallicsonline.com

Metallics West

651 North Main Street, Mancos, CO 81328
Tel 800-269-5183 • **Fax** 800-269-6278
Email saleswest@metallicsonline.com

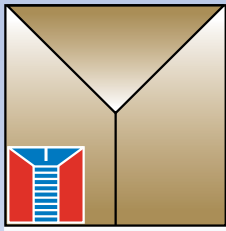

Metallics

NEW!
2014-2015

Stop Guessing! Nut & Bolt Gauge

MISTG1

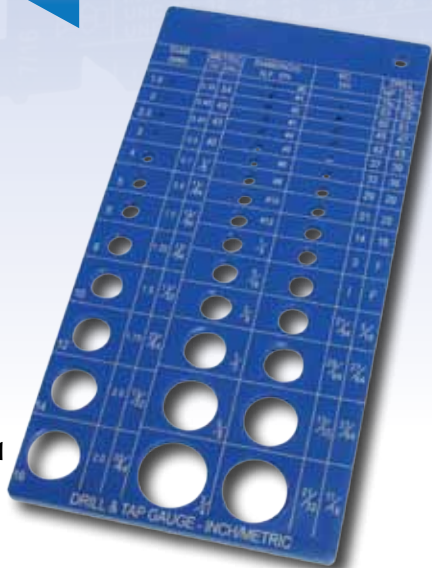

MNMG1

- Measures inch and metric bolts, nuts, screws, drill bits and washers.
- Inch and metric screw chart.

MISTG1

- Internal thread screw gauge measures inch and metric, coarse & fine.
- Tap drill chart for inch & metric.

MNMG1

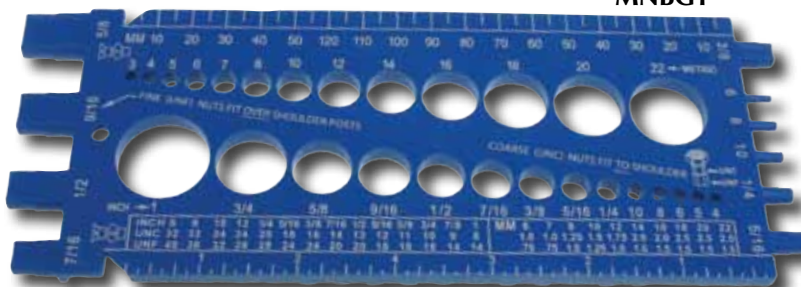

[CONTRACTOR APPROVED]

PART #	UPC #	DESCRIPTION	QTY / PKG	SUG. TRADE LIST / PKG
MNMG1	16450	Nut & Bolt Gauge (Inch & Metric)	1	\$ 9.73
MISTG1	16452	Internal Thread Gauge (Inch & Metric)	1	\$ 10.40

"Growth Through Innovation"

Metallics

229 Cross Street, Bristol, CT 06010
Tel 800-243-8272 • **Fax** 800-831-9358
Email sales@metallicsonline.com

Metallics West











651 North Main Street, Mancos, CO 81328
Tel 800-269-5183 • **Fax** 800-269-6278
Email saleswest@metallicsonline.com

TOOLS, DRILLS AND ACCESSORIES



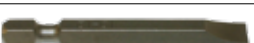
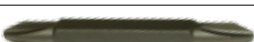
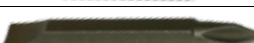

POWER BITS AND HOLDERS PROFESSIONAL POWER TOOL ACCESSORY VISUAL PACKAGES

ALL BITS "XTRA-HARD"

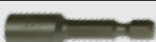

STOCK NO.	UPC NO.	DESCRIPTION	LENGTH	QTY. PER PKG.	WT. PER PKG.	SUGGESTED TRADE LIST PRICE PER
000P1X	25070	#1 Phillips Insert Bit	 1"	10	.18	12.08/ea pkg
000P2X	25074	#2 Phillips Insert Bit	 1"	10	.19	12.08/ea pkg
000P3X	25080	#3 Phillips Insert Bit	 1"	10	.19	12.08/ea pkg
000R2X	25055	#2 Square Drive Insert Bit	 1"	10	.19	14.40/ea pkg
0016X	25235	6-8 Slotted Insert Bit	 1"	10	.19	19.58/ea pkg
0018X	25240	8-10 Slotted Insert Bit	 1"	10	.19	19.58/ea pkg
00110X	25245	10-12 Slotted Insert Bit	 1"	10	.19	19.58/ea pkg
100P1X	25300	#1 Phillips Power Bit	 1 ¹⁵ / ₁₆ "	5	.19	14.20/ea pkg
100P2X	25305	#2 Phillips Power Bit	 1 ¹⁵ / ₁₆ "	5	.19	14.20/ea pkg
100P3X	25312	#3 Phillips Power Bit	 2"	5	.20	14.58/ea pkg
1008X	25415	8-10 Slotted Power Bit	 1 ¹⁵ / ₁₆ "	5	.21	22.53/ea pkg
10010X	25314	10-12 Slotted Power Bit	 1 ¹⁵ / ₁₆ "	5	.21	24.40/ea pkg
P2P2	25510	#2 Phillips Dbl Ended Bit	 1 ³ / ₄ "	2	.11	13.50/ea pkg
P2S8	25505	#2 Phillips Slotted Dbl End	 1 ¹ / ₂ "	2	.18	8.73/ea pkg

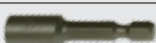
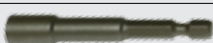
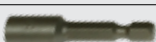
MAGNETIZED

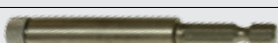



MT208	10870	1/4" Drill Chuck Nut Setter	 1 ⁵ / ₈ "	2	.15	14.78/ea pkg
MT208L	10875	1/4" Drill Chuck Long Nut Setter	 2 ⁹ / ₁₆ "	2	.20	17.88/ea pkg
MT210	10871	5/16" Drill Chuck Nut Setter	 1 ⁵ / ₈ "	2	.17	17.88/ea pkg
MT210L	10876	5/16" Drill Chuck Long Nut Setter	 2 ⁹ / ₁₆ "	2	.22	19.83/ea pkg
MT212	10872	3/8" Drill Chuck Nut Setter	 1 ⁷ / ₈ "	2	.18	19.63/ea pkg
MT212L	10877	3/8" Drill Chuck Long Nut Setter	 2 ⁹ / ₁₆ "	2	.25	22.93/ea pkg
M10	25250	1/4" Hex Insert Bit Holder	 2 ⁷ / ₈ "	1	.16	19.65/ea pkg

OTHER SIZES AND QUANTITIES AVAILABLE BY REQUEST

TOOLS, DRILLS AND ACCESSORIES

BULK PACKAGED 1/4" HEX SHANK SCREWDRIVER POWER BITS AND HOLDERS

ORDER JUST WHAT YOU NEED

	STOCK NO.	UPC NO.	SCREW SIZE	POINT SIZE	OVERALL LENGTH	WT. EACH	SUGGESTED TRADE LIST PRICE PER
PHILLIPS INSERT & POWER BITS 	000P1B	25071	4-6	#1	1"	.01	1.10/ea
	000P2B	25076	8-10	#2	1"	.01	1.10/ea
	000P3B	25081	12-14	#3	1"	.01	1.10/ea
	001P2B	25085	8-10	#2	1 1/4"	.02	2.35/ea
	100P1B	25301	4-6	#1	2"	.02	2.53/ea
	100P2B	25306	8-10	#2	2"	.02	2.53/ea
	100P3B	25310	12-14	#3	2"	.02	2.30/ea
	125P1B	25315	4-6	#1	3"	.02	2.98/ea
	125P2B	25320	8-10	#2	3"	.04	3.33/ea
	125P3B	25325	12-14	#3	3"	.03	3.78/ea
	140P1B	25345	4-6	#1	4"	.04	4.20/ea
	140P2B	25350	8-10	#2	4"	.05	4.20/ea
	140P3B	25355	12-14	#3	4"	.05	4.20/ea
SLOTTED INSERT & POWER BITS 	0014B	25225	4-5	4-5	1"	.01	1.78/ea
	0016B	25236	6-8	6-8	1"	.01	1.78/ea
	0018B	25241	8-10	8-10	1"	.01	1.78/ea
	00110B	25206	10-12	10-12	1"	.01	1.78/ea
	0006B	25195	6-8	6-8	1 1/2"	.02	2.30/ea
	0008B	25200	8-10	8-10	1 1/2"	.03	2.30/ea
	00010B	25205	10-12	10-12	1 1/2"	.03	2.30/ea
	1004B	25400	4-5	4-5	2"	.02	3.75/ea
	1006B	25410	6-8	6-8	2"	.03	3.75/ea
	1008B	25416	8-10	8-10	2"	.03	4.20/ea
	10010B	25420	10-12	10-12	2"	.03	4.50/ea
	1256B	25440	6-8	6-8	3"	.04	5.30/ea
	1258B	25445	8-10	8-10	3"	.04	5.70/ea
	12510B	25450	10-12	10-12	3"	.05	7.85/ea
	SQUARE DRIVE INSERT BITS 	000R1B	25050	4-6	#1	1"	.01
000R2B		25056	8-10	#2	1"	.01	1.33/ea
000R3B		25060	12-14	#3	1"	.01	1.33/ea
100R1B		25065	4-6	#1	2"	.01	2.60/ea
100R2B		25072	8-10	#2	2"	.02	2.60/ea
100R3B		25075	12-14	#3	2"	.02	2.60/ea
125R1B		10149	4-6	#1	3"	.03	4.55/ea
125R2B		10166	8-10	#2	3"	.04	4.55/ea
125R3B		10167	12-14	#3	3"	.04	4.55/ea
140R1B		10176	4-6	#1	4"	.04	6.53/ea
140R2B		10177	8-10	#2	4"	.05	7.28/ea
140R3B		10180	12-14	#3	4"	.05	7.28/ea
160R2B		25352	8-10	#2	6"	.07	8.68/ea
160R3B		25357	12-14	#3	6"	.07	8.68/ea
180R2B		10193	8-10	#2	8"	.11	9.35/ea
110R2B		10175	8-10	#2	12"	.12	10.45/ea
DOUBLE ENDED INSERT BITS 		P2P2B	10178	#2 Phil/#2 Phil		1 3/4"	.02
	P2S8B	10179	#2 Phil/8-10 Slot		1 3/4"	.02	3.13/ea
	00SP6B	25027		#6	1"	.01	5.03/ea
	00SP8B	10195		#8	1"	.01	5.03/ea
	00SP10B	10196		#10	1"	.04	5.03/ea
BIT HOLDER & NUT SETTERS 	M1B	25260	1/4" Mag Bit Hldr		1 3/4"	.04	15.05/ea
	M10B	25255	1/4" Mag Bit Hldr		2 7/8"	.08	17.70/ea
	MT208B	10183	1/4" Mag Nut Setter		1 5/8"	.04	6.70/ea
	MT208LB	10186	1/4" Mag Nut Setter		2 9/16"	.06	8.10/ea
	MT210B	10184	5/16" Mag Nut Setter		1 5/8"	.05	7.53/ea
	MT210LB	10187	5/16" Mag Nut Setter		2 9/16"	.07	9.00/ea
	MT212B	10185	3/8" Mag Nut Setter		1 5/8"	.05	9.33/ea
	MT212LB	10188	3/8" Mag Nut Setter		2 9/16"	.08	10.63/ea

LONGER SIZES AVAILABLE!

OTHER SIZES AND QUANTITIES AVAILABLE BY REQUEST

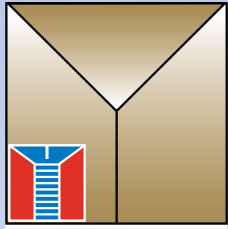

Metallics



Pull Rope

3 Strand Polypropylene

Don't Get Caught Short!

**[CONTRACTOR
APPROVED]**



PART #	UPC #	DESCRIPTION	QTY / PKG	SUG. TRADE LIST / PKG
M3161200	17175	3/16" Three Strand Twisted Polypropylene Yellow Pull Rope 1200'	1	\$ 93.25
M14250	17235	1/4" Three Strand Twisted Polypropylene Yellow Pull Rope 250'	1	\$ 32.13
M14600	17237	1/4" Three Strand Twisted Polypropylene Yellow Pull Rope 600'	1	\$ 73.45
M141200	17240	1/4" Three Strand Twisted Polypropylene Yellow Pull Rope 1200'	1	\$ 146.86
M142400	17243	1/4" Three Strand Twisted Polypropylene Yellow Pull Rope 2400'	1	\$ 293.75
M145000	17247	1/4" Three Strand Twisted Polypropylene Yellow Pull Rope 5000'	1	\$ 612.00
M38250	17252	3/8" Three Strand Twisted Polypropylene Yellow Pull Rope 250'	1	\$ 71.75
M38600	17255	3/8" Three Strand Twisted Polypropylene Yellow Pull Rope 600'	1	\$ 164.00
M381200	17258	3/8" Three Strand Twisted Polypropylene Yellow Pull Rope 1200'	1	\$ 328.00
M382400	17262	3/8" Three Strand Twisted Polypropylene Yellow Pull Rope 2400'	1	\$ 656.00
M12250	17267	1/2" Three Strand Twisted Polypropylene Yellow Pull Rope 250'	1	\$ 125.75
M12600	17270	1/2" Three Strand Twisted Polypropylene Yellow Pull Rope 600'	1	\$ 287.38
M121200	17273	1/2" Three Strand Twisted Polypropylene Yellow Pull Rope 1200'	1	\$ 574.75

Other sizes, materials and quantities available by request.

"Growth Through Innovation"

Metallics

229 Cross Street, Bristol, CT 06010
Tel 800-243-8272 • **Fax** 800-831-9358
Email sales@metallicsonline.com

Metallics West

651 North Main Street, Mancos, CO 81328
Tel 800-269-5183 • **Fax** 800-269-6278
Email saleswest@metallicsonline.com

SELECT-A-BIT KIT

10 Piece Kit

The Right Drive When You Need It!

KIT INCLUDES:

- 3 - Phillips Drive Bits
- 3 - Slotted Drive Bits
- 3 - Square Drive Bits
- 1 - Magnetic Holder for Power Driving.

Insert the Magnetic Holder into the star hole at the top of the bit case, and it becomes a screwdriver handle.



STOCK NO.	UPC NO.	STD. PKG.	WEIGHT EACH	SUGGESTED TRADE LIST PRICE PER
SAB10	28010	1 Kit	.24	29.88/ea

REPLACEMENT COMPONENTS FOR KIT

QUANTITY	DESCRIPTION	REPLACEMENT PART #
1	Bit Holder	M10B
1	#6-8 Slotted Bit	0016B
1	#8-10 Slotted Bit	0018B
1	#10-12 Slotted Bit	00110B
1	#1 Phillips Bit	000P1B
1	#2 Phillips Bit	000P2B
1	#3 Phillips Bit	000P3B
1	#1 Square Drive Bit	000R1B
1	#2 Square Drive Bit	000R2B
1	#3 Square Drive Bit	000R3B

OTHER SIZES AND QUANTITIES AVAILABLE BY REQUEST

For PVC Plastic

CABLE SAW

FOR ALL PVC PIPE

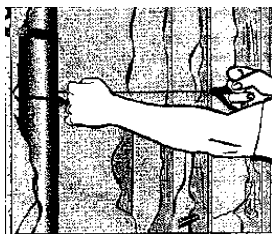

Between Joists

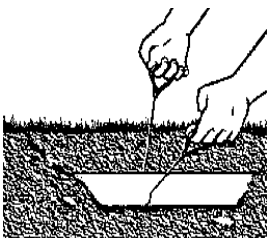

Buried

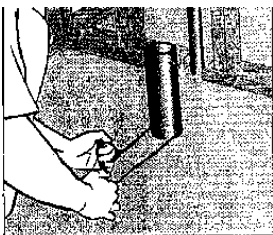

Closet Flanges and Floor

DIRECTIONS:

1. Secure PVC pipe for cutting. Loop cable around pipe at the location you wish to cut.
2. Apply pressure, while making short back and forth strokes to establish a starting cut or pilot groove in the pipe.
3. Using the middle third of the cable, make longer strokes to completely cut through PVC pipe.

- A WIRE CABLE SAW WITH VINYL COVERED HANDLES.
- SUITABLE FOR CUTTING PVC PLASTIC PIPE.



STOCK NO.	UPC NO.	DESCRIPTION	WT. PER PKG.	STD. PKG.	SUGGESTED TRADE LIST PRICE PER
MCS26	71616	26" Cable Saw	0.07	1	18.68/ea
MCS46	71617	46" Cable Saw	0.07	1	20.68/ea

OTHER SIZES AND QUANTITIES AVAILABLE BY REQUEST



SHARPIE® PERMANENT MARKER

PERMANENT MARKERS – SMEAR-PROOF, HEAT & WATER RESISTANT

- Sharpie® fine point permanent marker, perfect for labels, plastic or corrugated. Permanent ink smear proof, heat and water resistant.

STOCK NO.	UPC NO.	DESCRIPTION	STD. PKG.	SUGGESTED TRADE LIST PRICE PER
30001	13721	Sharpie Fine Point Permanent Marker – black ink	12	39.96

OTHER SIZES AND QUANTITIES AVAILABLE BY REQUEST



SHARPIE® PERMANENT MARKERS

KING-SIZED MARKERS FOR YOUR TOUGHEST MARKING JOBS

- King Size permanent marker. Designed for the toughest marking jobs. Feature a long lasting felt chisel tip with high performance ink.
- Retractable fine tip marker. Quick drying and water resistant ink. AP certified nontoxic.

STOCK NO.	UPC NO.	DESCRIPTION	STD. PKG.	SUGGESTED TRADE LIST PRICE PER
M15001	13781	Sharpie King-Size Marker – black ink	12	64.95
32701	13785	Sharpie Retractable Fine Tip Marker – black ink	1	10.45

OTHER SIZES AND QUANTITIES AVAILABLE BY REQUEST

TOOLS, DRILLS AND ACCESSORIES



MARKING CRAYONS

Weather resistant, fade resistant, lead free. For use on lumber (rough or smooth), cardboard, concrete, metal, paper, plastic and other surfaces. Each crayon 4-1/2" x 1/2".

STOCK NO.	UPC NO.	COLOR	WT. PER PKG.	STD. PKG.	SUGGESTED TRADE LIST PRICE PER
LCB12	72600	Blue	.75	12	23.40/ea pkg
LCBLK12	72602	Black	.56	12	23.40/ea pkg
LCY12	72603	Yellow	.64	12	23.40/ea pkg
LCR12	72604	Red	.74	12	23.40/ea pkg

OTHER SIZES AND QUANTITIES AVAILABLE BY REQUEST

CRAYON HOLDER



- Walnut holder fits both round or hexagonal marking crayons 1/2" in diameter.
- Walnut handle, metal chuck, hole for wrist strap.
- Aluminum holder is spring loaded and can be used with extension handle.
- Designed to hold Lumber Crayons and High Heat Metal Crayons 1/2" in diameter.

STOCK NO.	UPC NO.	DESCRIPTION	WT. EACH	STD. PKG.	SUGGESTED TRADE LIST PRICE PER
WCH1	72599	Crayon Holder-Wood	.05	1	15.10/ea

OTHER SIZES AND QUANTITIES AVAILABLE BY REQUEST

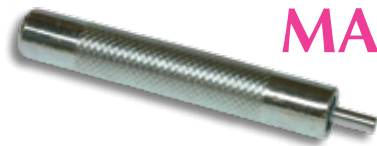

MACHINE SCREW ANCHOR SETTING TOOL

For setting Machine Screw Anchors

STOCK NO.	UPC NO.	SIZE	WT. PER PKG.	STD. PKG.	SUGGESTED TRADE LIST PRICE PER
1402ST	17905	8-32	.07	1	4.20/ea
1403ST	17910	10-24	.08	1	5.03/ea
1404ST	17915	10-32	.14	1	5.03/ea
1406ST	17925	1/4-20	.17	1	5.58/ea
1407ST	17930	5/16-18	.27	1	5.95/ea
1408ST	17935	3/8-16	.38	1	6.28/ea
1409ST	17940	1/2-13	.58	1	12.13/ea

OTHER SIZES AND QUANTITIES AVAILABLE BY REQUEST

HAND DRIVE TOOL

STEEL DROP-IN ANCHOR SETTING TOOL

For Setting DIA14, DIA12, DIA38 & DIA58



STOCK NO.	UPC NO.	SIZE	WT. PER EACH.	STD. PKG.	SUGGESTED TRADE LIST PRICE PER
DIA14T	12181	1/4-20	.18	1	3.85/ea
DIA38T	12182	3/8-16	.24	1	5.00/ea
DIA12T	12183	1/2-13	.41	1	6.18/ea
DIA58T	12184	5/8-11	.51	1	11.53/ea

OTHER SIZES AND QUANTITIES AVAILABLE BY REQUEST

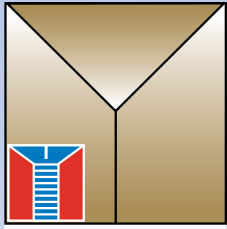

Metallics



Aviation Tin Snips

Heavy Duty Alloy Steel

**[CONTRACTOR
APPROVED]**



- Left cut – red handle
- Straight cut – yellow handle
- Right cut – green handle
- 10 inch length
- Serrated jaws
- Vinyl grips
- Safety latch
- Alloy steel construction

PART #	UPC #	DESCRIPTION	QTY / PKG	SUG. TRADE LIST / PKG
MAVSG	37468	Aviation Snip – Right Cut (Green)	1	\$ 17.25
MAVSR	37469	Aviation Snip – Left Cut (Red)	1	\$ 17.25
MAVSY	37470	Aviation Snip – Straight Cut (Yellow)	1	\$ 17.25

“Growth Through Innovation”

Metallics

229 Cross Street, Bristol, CT 06010
Tel 800-243-8272 • **Fax** 800-831-9358
Email sales@metallicsonline.com

Metallics West

651 North Main Street, Mancos, CO 81328
Tel 800-269-5183 • **Fax** 800-269-6278
Email saleswest@metallicsonline.com

LAGMASTER™ *plus*

Patent Pending

Plug Into...
The electrician's only
multipurpose tool
for hanging...

- + WIRE
- + THREADED ROD
- + SMOOTH ROD
- + JACK CHAIN
- + SCREWS

...with
interchangeable
heads!

LAGMASTER PLUS™

The Lagmaster Plus™ is the electrician's pole tool. The unique plug-in heads make it the most efficient tool of it's kind. It increases safety by keeping your men on the floor. Use it to install ceiling wire, jack chain, threaded rod, smooth rod and overhead screw installation. Power the pole with any 3/8" or 1/2" battery operated or corded drill.



One pole...many applications!

Choose from two (2) different adjustable length models.

- MLMTA Triple 4' (18' ceilings)
- MLMT6 Triple 6' (24' ceilings)

Hang it up. (wire plug)



Lagmaster Plus™ wire plug hangs 12 or 9 guage wire. No need for ladders, scaffolding or scissor lifts.

Pre-wrapped wire on eye lags require a special plug (pre-wrapped plug).



Hang Wire. Move ring into the up position with set screw

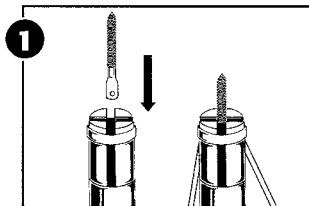

1 Insert the eye lag screw into secured wire plug. Insert the wire through the hole and bend the tails down.

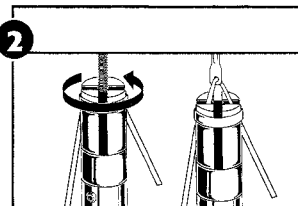

2 Adjust the pole to length and rotate the screw until it is seated. Pull down on the pole so that the wire is caught on the ring.

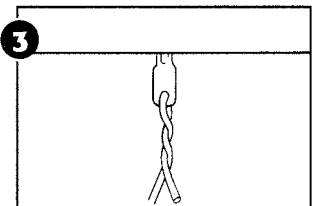

3 Rotate the pole again to twist the wire. Pull the wire through the plug to complete the installation.

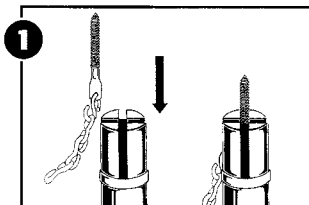

1 Secure a #1 1/2 "S" hook to an acoustical eye lag and to the proper size chain for your job. Insert it into the Lagmaster Plus™.

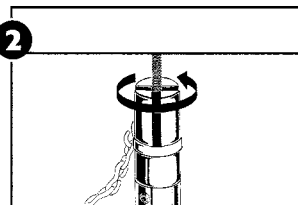

2 Secure the chain in the magazine so it does not whip when rotating the pole. Now rotate the eye lag screw until it is seated.

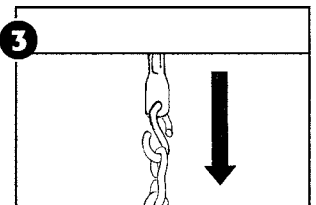

3 Lower the Lagmaster Plus™.

LAGMASTER PLUS™

DRIVE IT HOME. (socket plugs)

Install pre-cut threaded rod from the floor! Works with 3/8" or 1/4" threaded rod up to 10' long. Gets into tight spaces, vaulted ceilings, above stairwells or through ceiling grid easily.

Lagmaster Plus™ open-end socket plug-in heads work with Sammy Super Screws® and HangerMate® screws. Special twist out feature prevents over torquing and stripout even when installing from the floor.

Consult the screw manufacturer's literature for load specs and approvals on the screws.

The Lagmaster Plus™ base is the socket for Hanger-Mate® 3/8" rod screws. The 3/8" socket plug-in works with HangerMate® 1/4" rod screws. The 5/8" socket plug-in works with Sammy Super Screws®.

Hang Threaded Rod:

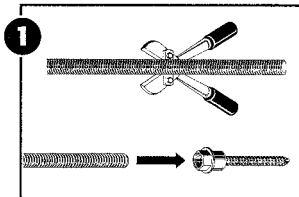

1 Cut threaded rod length and assemble to appropriate fastener.

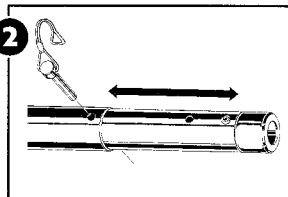

2 Adjust pole tool to length plug in the proper Lagmaster Plus™ head.

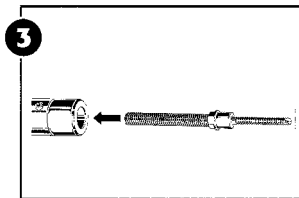

3 Load rod into Lagmaster pole tool. (The Lagmaster adjusting pin has to be 1/8" below the base or the pin may interfere with the rod.)

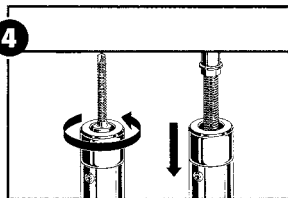

4 Install screw at proper site and pull down to remove the rod from the pole tool. The rod is now ready to receive hanger bracket.



(Patent # 5,154,104)

Turn your pole tool into a very long screwdriver. This Lagmaster Plus™ plug works with any 1/4" hex driver.

Install smooth rod with a Minerallac™ or Caddy™ spring clip assembly and screw. The Flash fastener is shown here.

Overhead Screw Applications: (1/4" hex plug)

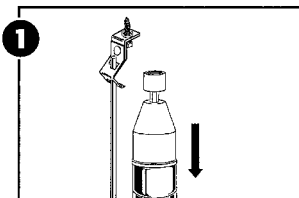

1 Plug in the Lagmaster Plus™ 1/4" hex head and insert the proper 1/4" driver. Adjust the Lagmaster pole tool to length.

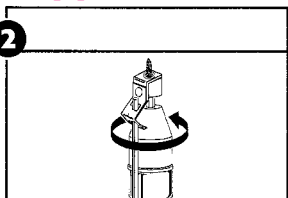

2 Push the smooth rod between the pole and the wire bale on the Lagmaster adjusting pin to keep the rod from whipping while turning in the screw for safety.

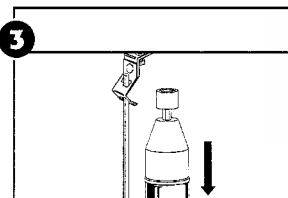

3 Turn in the screw cautiously being careful not to over torque or strip the screw. Remove the tool.



LAGMASTER PLUS™

One pole...many applications!



STOCK NO.	UPC NO.	DESCRIPTION	QTY. PKG.	SUGGESTED TRADE LIST PRICE PER
MLMT4	13329	Triple 4' Installation Tool 18' Ceiling	1	322.50/pkg.
MLMT6	13331	Triple 6' Installation Tool 24' Ceiling	1	372.50/pkg.

TOOLS, DRILLS AND ACCESSORIES

METALLICS KEYHOLE SAW WOODEN HANDLE

- Designed especially for plasterboard.
- Make cut-outs for electrical outlets, etc.
- Point sharpened for plunge cuts.



STOCK NO.	UPC NO.	LENGTH	BLADE EACH	WT. PKG.	SUGGESTED TRADE LIST PRICE PER
US6	31300	6	1.5 oz	.27	9.23/ea

OTHER SIZES AND QUANTITIES AVAILABLE BY REQUEST

METALLICS HAND DRILLING HAMMER WOODEN HANDLE

- The old standby.

SAFETY GLASSES SHOULD BE WORN FOR ANY DRIVING APPLICATIONS. SEE THE NEW LINE OF SAFETY GLASSES ON PAGES 220-222.



STOCK NO.	UPC NO.	HEAD WEIGHT	OVERALL LENGTH	STD. PKG.	SUGGESTED TRADE LIST PRICE PER
HAM3	18700	3.53	10"	1	40.38/ea

OTHER SIZES AND QUANTITIES AVAILABLE BY REQUEST



CARBON STEEL TAPS

PLUG STYLE

A STRONG, DURABLE PRODUCT

STOCK NO.	UPC NO.	SIZE	USE DRILL SIZE	WT. PER PKG.	STD. PKG.	SUGGESTED TRADE LIST PRICE PER
440CT	24900	4-40	#43	.05	5 Taps	20.83/ea pkg
632CT	24905	6-32	#36	.05	5 Taps	20.65/ea pkg
832CT	24910	8-32	#29	.07	5 Taps	20.83/ea pkg
1024CT	24915	10-24	#25	.10	5 Taps	21.83/ea pkg
1032CT	24920	10-32	#21	.10	5 Taps	21.83/ea pkg
1420CT	24925	1/4-20	#7	.15	5 Taps	23.85/ea pkg
516CT	24930	5/16-18	17/64	.16	5 Taps	26.00/ea pkg
3816CT	24935	3/8-16	5/16	.23	5 Taps	33.23/ea pkg
1213CT	24940	1/2-13	27/64	.46	5 Taps	43.48/ea pkg

OTHER SIZES AND QUANTITIES AVAILABLE BY REQUEST, TAPER OR BOTTOMING TAPS AVAILABLE UPON REQUEST



TAP WRENCH T-HANDLE STYLE

STOCK NO.	UPC NO.	CAPACITY	WT. PER PKG.	STD. PKG.	SUGGESTED TRADE LIST PRICE PER
TWH1	24970	0 to 1/4	.15	1	14.50/ea
TWH2	24975	1/4 to 1/2	.39	1	23.98/ea

OTHER SIZES AND QUANTITIES AVAILABLE BY REQUEST

TOOLS, DRILLS AND ACCESSORIES

CONCRETE SCREW INSTALLATION KIT

8 PIECE KIT
TOOLS AND DRIVING ACCESSORIES



KIT INCLUDES:

- 1 - Drill Driver 1 - Phillips Bit Holder
- 1 - Drill Adapter 2 - Phillips Bits
- 2 - Hex Drivers 1 - Allen Hex Key

DRILL BIT NOT INCLUDED

STOCK NO.	UPC NO.	DESCRIPTION	STD. PKG.	WT. EACH	SUGGESTED TRADE LIST PRICE PER
KIT					
IT1000	31200	Installation Tool (complete kit)	1	.95	110.10/ea
REPLACEMENT COMPONENTS FOR KIT					
MHD14	31205	1/4" Magnetic Hex Driver			30.55/ea
MHD56	31210	5/16" Magnetic Hex Driver			30.55/ea
PBH	31215	#2 & #3 Phillips Bit Holder			33.60/ea
ITSLEVE	31203	Drill/Driver Adapter			39.98/ea
PB2	31220	#2 Phillips Bit			1.53/ea
PB3	31225	#3 Phillips Bit			1.53/ea
HK1	31230	1/8" Allen Hex Key			1.53/ea

OTHER SIZES AND QUANTITIES AVAILABLE BY REQUEST

CAN BE USED WITH
THE METALLICS
QUADRIE CONCRETE
SCREWS



MASONRY DRILLS FOR CONCRETE SCREWS

SPECIAL SIZE AND LENGTH
FOR USE WITH INSTALLATION TOOL ABOVE

STOCK NO.	UPC NO.	SIZE	SCREW DIA.	STD. PKG.	WT. EACH	SUGGESTED TRADE LIST PRICE PER
CD1	31250	5/32 x 3 1/2	3/16	1	.02	3.38/ea
CD2	31255	5/32 x 4 1/2	3/16	1	.02	3.98/ea
CD3	31260	5/32 x 5 1/2	3/16	1	.02	4.53/ea
CD5	31265	3/16 x 3 1/2	1/4	1	.02	3.45/ea
CD6	31270	3/16 x 4 1/2	1/4	1	.02	4.08/ea
CD7	31275	3/16 x 5 1/2	1/4	1	.03	5.78/ea
CD8	31280	3/16 x 6	1/4	1	.03	7.43/ea

OTHER SIZES AND QUANTITIES AVAILABLE BY REQUEST



CAULKING GUN

PISTON ROD WITH DOUBLE FRICTION PLATE
QUICK-RELEASE LEVER

STOCK NO.	UPC NO.	TUBE SIZE	STD. PKG.	WT. EACH	SUGGESTED TRADE LIST PRICE PER
CG1	35020	10 oz	1	.90	7.55/ea
CG32	35050	32 oz	1	1.92	36.20/ea

OTHER SIZES AND QUANTITIES AVAILABLE BY REQUEST

TOOLS, DRILLS AND ACCESSORIES



HIGH-SPEED TWIST DRILLS

Jobber's Length

STOCK NO.	UPC NO.	SIZE	OVERALL LENGTH	WT. PER PKG.	STD. PKG. (DRILLS)	SUGGESTED TRADE LIST PRICE PER
NUMBERED SIZES 118° POINTS						
NHSD6	24806	#6	3 ³ / ₄	.40	10	37.58/ea pkg
NHSD7	24807	#7	3 ⁵ / ₈	.20	10	35.60/ea pkg
NHSD8	24808	#8	3 ⁵ / ₈	.21	10	31.58/ea pkg
NHSD9	24809	#9	3 ⁵ / ₈	.37	10	30.88/ea pkg
NHSD10	24810	#10	3 ⁵ / ₈	.22	10	29.55/ea pkg
NHSD11	24811	#11	3 ¹ / ₂	.22	10	29.55/ea pkg
NHSD20	24820	#20	3 ¹ / ₄	.25	10	24.18/ea pkg
NHSD21	24821	#21	3 ¹ / ₄	.14	10	24.85/ea pkg
NHSD22	24822	#22	3 ¹ / ₈	.13	10	21.83/ea pkg
NHSD25	24825	#25	3	.12	10	21.15/ea pkg
NHSD26	24826	#26	3	.11	10	21.15/ea pkg
NHSD28	24828	#28	2 ⁷ / ₈	.10	10	21.83/ea pkg
NHSD29	24829	#29	2 ⁷ / ₈	.10	10	21.83/ea pkg
NHSD30	24830	#30	2 ³ / ₄	.08	10	21.83/ea pkg
NHSD31	24831	#31	2 ³ / ₄	.08	10	21.83/ea pkg
NHSD35	24835	#35	2 ⁵ / ₈	.07	10	21.83/ea pkg
NHSD36	24836	#36	2 ¹ / ₂	.06	10	21.83/ea pkg
NHSD37	24837	#37	2 ¹ / ₂	.06	10	16.45/ea pkg
NHSD43	24843	#43	2 ¹ / ₄	.05	10	16.45/ea pkg
FRACTIONAL SIZES 118° POINTS						
HSD1	24300	1 ¹ / ₁₆	1 ⁷ / ₈	.03	10	15.80/ea pkg
HSD2	24305	5 ¹ / ₆₄	2	.04	10	15.80/ea pkg
HSD3	24310	3 ¹ / ₃₂	2 ¹ / ₄	.05	10	16.13/ea pkg
HSD4	24315	7 ¹ / ₆₄	2 ⁵ / ₈	.07	10	16.13/ea pkg
HSD5	24320	1 ¹ / ₈	2 ³ / ₄	.09	10	18.15/ea pkg
HSD6	24325	9 ¹ / ₆₄	2 ⁷ / ₈	.11	10	19.83/ea pkg
HSD7	24330	5 ¹ / ₃₂	3 ¹ / ₈	.14	10	20.15/ea pkg
HSD8	24335	11 ¹ / ₆₄	3 ¹ / ₄	.17	10	22.83/ea pkg
HSD9	24340	3 ¹ / ₁₆	3 ¹ / ₂	.21	10	26.53/ea pkg
HSD29	24345	13 ¹ / ₆₄	3 ⁵ / ₈	.26	10	30.23/ea pkg
HSD10	24350	7 ¹ / ₃₂	3 ³ / ₄	.26	10	31.90/ea pkg
HSD11	24355	15 ¹ / ₆₄	3 ⁷ / ₈	.35	10	34.90/ea pkg
HSD12	24360	1 ¹ / ₄	4	.41	10	40.98/ea pkg
HSD13	24365	17 ¹ / ₆₄	4 ¹ / ₈	.29	5	24.18/ea pkg
HSD14	24370	9 ¹ / ₃₂	4 ¹ / ₄	.28	5	28.40/ea pkg
HSD15	24375	19 ¹ / ₆₄	4 ³ / ₈	.32	5	30.23/ea pkg
HSD16	24380	5 ¹ / ₁₆	4 ¹ / ₂	.36	5	31.80/ea pkg
*HSD16R	24385	5 ¹ / ₁₆	3 ¹³ / ₁₆	.32	5	34.40/ea pkg
HSD17	24390	21 ¹ / ₆₄	4 ⁵ / ₈	.39	5	34.58/ea pkg
HSD18	24395	11 ¹ / ₃₂	4 ³ / ₄	.44	5	39.25/ea pkg
HSD19	24400	23 ¹ / ₆₄	4 ⁷ / ₈	.48	5	44.13/ea pkg
HSD20	24405	3 ³ / ₈	5	.55	5	45.33/ea pkg
*HSD20R	24410	3 ³ / ₈	4	.43	5	48.03/ea pkg
HSD21	24415	25 ¹ / ₆₄	5 ¹ / ₈	.60	5	48.68/ea pkg
HSD22	24420	13 ¹ / ₃₂	5 ¹ / ₄	.64	5	51.70/ea pkg
HSD23	24425	27 ¹ / ₆₄	5 ³ / ₈	.72	5	57.40/ea pkg
HSD24	24430	7 ¹ / ₁₆	5 ¹ / ₂	.82	5	61.28/ea pkg
*HSD24R	24435	7 ¹ / ₁₆	4 ¹¹ / ₁₆	.78	5	59.75/ea pkg
HSD25	24440	29 ¹ / ₆₄	5 ⁵ / ₈	.86	5	72.20/ea pkg
HSD26	24445	15 ¹ / ₃₂	5 ³ / ₄	.89	5	69.50/ea pkg
HSD27	24450	31 ¹ / ₆₄	5 ⁷ / ₈	1.00	5	74.03/ea pkg
HSD28	24455	1 ¹ / ₂	6	1.16	5	77.03/ea pkg
*HSD28R	24460	1 ¹ / ₂	4	.07	5	80.38/ea pkg

SEE PAGE 279

INCLUDED IN HSCD1 DRILL DISPLAY

NOT INCLUDED

NOT INCLUDED

NOT INCLUDED

NOT INCLUDED

* 1/4" Reduced Shank

OTHER SIZES AND QUANTITY AVAILABLE UPON REQUEST



HIGH-SPEED DRILL COUNTER DISPLAY

An attractive, compact "Point of Purchase" Display, 15" wide X 13" high X 8" deep. Improve sales by providing speedy selection of your complete range of high-speed drills.

- Strong metal construction
- Transparent hinged cover with lock prevents theft

Display contains standard package quantities of all 29 HSD fractional drill sizes in jobber lengths, standard shank, a total of 210 drills.
SEE PAGE 278

FRACTIONAL DRILLS FOR HSCD1 COUNTER DISPLAY

STOCK NO.	UPC NO.	DESCRIPTION	WT. PER EACH	STD. PKG.
HSCD1	24515	Display and 210 Assorted HSD drills	23.60	1 Display



SELECT-A-DRILL

SAD13 - 13 Piece Select-A-Drill Kit

Thirteen (13) high-speed jobber length drills from 1/16" to 1/4" by 64ths. Popular sizes in a unique rotating case

SAD21 - 21 Piece Select-A-Drill Kit

Twenty-one (21) high-speed jobber length drills from 1/16" to 3/8" by 64ths. Popular sizes in a unique rotating case

118° POINT



STOCK NO.	UPC NO.	WT. PER EACH	STD. PKG.	SUGGESTED TRADE LIST PRICE PER
SAD13	24520	.32	1	33.23/ea kit
SAD21	24525	.98	1	85.65/ea kit



118° POINT

HIGH-SPEED DRILL KITS

IN METAL INDEX CASE

- HSDK1 29 Drills
- HSDK2 15 Drills
- HSDK3 13 Drills

STOCK NO.	UPC NO.	DESCRIPTION	WT. PER EACH	STD. PKG.	SUGGESTED TRADE LIST PRICE PER
HSDK1	24510	29 Drills 1/16" thru 1/2" by 1/64ths	3.25	1	180.08/ea kit
HSDK2	24505	15 Drills 1/16" thru 1/2" by 1/32nds	2.08	1	95.15/ea kit
HSDK3	24500	13 Drills 1/16" thru 1/4" by 1/64ths	.80	1	31.20/ea kit



GOLD HIGH-SPEED DRILL KITS

GOLD SURFACE TREATED HEAVY DUTY DRILLS
13 PIECE KIT IN METAL INDEX CASE

HVAC SPECIAL DRILLS
LIGHT GAUGE SHEET METAL

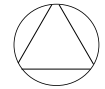

THREE FLATS ON SHANK

STOCK NO.	UPC NO.	DESCRIPTION	WT. PER KIT	STD. PKG.	SUGGESTED TRADE LIST PRICE PER
GDK13	24502	13 Drills $1/16"$ thru $1/4"$ x $1/64$ ths	.67	1	45.33/ea kit



HEX SHANK DRILL SET

5 PIECE SET

FOR DRILLS AND CORDLESS SCREWDRIVERS

118° POINT

STOCK NO.	UPC NO.	DESCRIPTION	WT. PER KIT	STD. PKG.	SUGGESTED TRADE LIST PRICE PER
DHS5	24530	5 Drills: $3/32"$ $7/64"$ $1/8"$ $9/64"$ $5/32"$.15	Set of 5 drills	29.28/ea

TO PROLONG DRILL LIFE USE CUTTING OIL FOR METAL.

TAP AND DRILL BIT SET

13 PIECE

- 6 Carbon Plug Taps - 4-40, 6-32, 8-32, 10-24, 10-32, $1/4$ -20
- 6 HSS Twist Drills - #43, #36, #29, #25, #21, #7
- 1 T-Handle Wrench



STOCK NO.	UPC NO.	WT. PER KIT	STD. PKG.	SUGGESTED TRADE LIST PRICE PER
TDS13	24945	.44	1	59.33/ea

SCREW EXTRACTOR AND DRILL BIT SET

10 PIECE

- Screw Extractors - #1, #2, #3, #4, #5
- Twist Drills - $5/64"$ $7/64"$ $5/32"$ $1/4"$ $17/64"$

118° POINT

STOCK NO.	UPC NO.	WT. PER KIT	STD. PKG.	SUGGESTED TRADE LIST PRICE PER
SEDS10	25028	.47	1	48.80/ea





COMBINATION HIGH SPEED STEEL DRILL-TAP

FOR ALL METAL APPLICATIONS

STOCK NO.	UPC NO.	DESCRIPTION	WT. PER KIT	STD. PKG.	SUGGESTED TRADE LIST PRICE PER
DT632	24094	High Speed Steel 6-32 Drill-Tap	.02	1	31.63/ea
DT832	24095	High Speed Steel 8-32 Drill-Tap	.02	1	32.38/ea
DT1032	24096	High Speed Steel 10-32 Drill-Tap	.02	1	33.55/ea
DT1420	24097	High Speed Steel 1/4-20 Drill Tap	.03	1	39.18/ea
DT3816	24098	High Speed Steel 3/8-16 Drill-Tap	.08	1	54.78/ea
DT1213	24099	High Speed Steel 1/2-13 Drill-Tap	.13	1	76.88/ea

OTHER SIZES AND QUANTITY AVAILABLE UPON REQUEST



SHIP AUGER BITS

HEX SHANK
EXTRA HIGH QUALITY

- Single twist with single cutter and side up
- Machine ground hollows, deep throat for fast chip removal
- 7/16" shank for 3 jaw chucks
- Heat treated tool steel for strength and long life
- **E-Z to display packaging!**

SPECIFICALLY DESIGNED FOR WOOD PRODUCT CONSTRUCTION

STOCK NO.	UPC NO.	BORE DIAMETER	LENGTH	WT. PER PKG.	STD. PKG.	SUGGESTED TRADE LIST PRICE PER
AS916	24600	9/16	8	.25	1 Bit	27.83/ea
AS58	24601	5/8	8	.28	1 Bit	26.78/ea
AS1116	24602	11/16	8	.31	1 Bit	37.80/ea
AS34	24603	3/4	8	.43	1 Bit	45.08/ea
AS1316	24604	13/16	8	.42	1 Bit	45.18/ea
AS78	24605	7/8	8	.54	1 Bit	53.05/ea
AS1516	24606	15/16	8	.40	1 Bit	54.05/ea
AS1	24607	1	8	.45	1 Bit	57.38/ea
AS118	24608	1 1/8	8	.79	1 Bit	64.35/ea
AS114	24609	1 1/4	8	.55	1 Bit	74.18/ea
AS138	24610	1 3/8	8	.82	1 Bit	96.48/ea
AS112	24611	1 1/2	8	1.22	1 Bit	103.40/ea
AL916	24615	9/16	18	.65	1 Bit	58.30/ea
AL58	24616	5/8	18	.72	1 Bit	64.25/ea
AL1116	24617	11/16	18	.87	1 Bit	72.58/ea
AL34	24618	3/4	18	.71	1 Bit	73.80/ea
AL1316	24619	13/16	18	1.08	1 Bit	73.80/ea
AL78	24620	7/8	18	1.24	1 Bit	76.03/ea
AL1516	24621	15/16	18	1.36	1 Bit	70.70/ea
AL1	24622	1	18	1.54	1 Bit	73.68/ea
AL118	24623	1 1/8	18	1.42	1 Bit	105.70/ea
AL114	24624	1 1/4	18	2.35	1 Bit	113.00/ea
AL138	24625	1 3/8	18	2.94	1 Bit	126.73/ea
AL112	24626	1 1/2	18	3.30	1 Bit	133.70/ea

THE METALLICS SHIP AUGER BIT IS NOT SOLD AS A NAIL BITER. IT IS ONLY RECOMMENDED FOR WOOD PRODUCTS.

OTHER SIZES AND QUANTITY AVAILABLE UPON REQUEST

TOOLS, DRILLS AND ACCESSORIES



QUIK-BIT FLAT WOOD BORING BIT

PACKED IN VINYL POUCH
E-Z TO DISPLAY PACKAGING

STOCK NO.	UPC NO.	SIZE	OVERALL LENGTH	WT. PER PKG.	STD. PKG.	SUGGESTED TRADE LIST PRICE PER
QB1	24701	1/4	6	.05	1 Bit	6.65/ea
QB2	24702	5/16	6	.06	1 Bit	6.28/ea
QB3	24703	3/8	6	.09	1 Bit	6.75/ea
QB4	24704	7/16	6	.06	1 Bit	6.75/ea
QB5	24705	1/2	6	.09	1 Bit	6.75/ea
QB6	24706	9/16	6	.09	1 Bit	7.08/ea
QB7	24707	5/8	6	.09	1 Bit	7.08/ea
QB8	24708	11/16	6	.09	1 Bit	7.33/ea
QB9	24709	3/4	6	.09	1 Bit	7.33/ea
QB10	24710	13/16	6	.10	1 Bit	7.43/ea
QB11	24711	7/8	6	.10	1 Bit	7.73/ea
QB12	24712	15/16	6	.11	1 Bit	8.28/ea
QB13	24713	1	6	.13	1 Bit	8.28/ea
QB14	24714	1 1/8	6	.13	1 Bit	11.35/ea
QB15	24715	1 1/4	6	.13	1 Bit	11.35/ea
QB16	24716	1 3/8	6	.14	1 Bit	11.48/ea
QB17	24717	1 1/2	6	.14	1 Bit	11.48/ea
QB22	24722	3/8	16	.27	1 Bit	20.50/ea
QB24	24724	1/2	16	.33	1 Bit	20.93/ea
QB26	24726	5/8	16	.28	1 Bit	22.83/ea
QB28	24728	3/4	16	.28	1 Bit	25.15/ea
QB29	24729	7/8	16	.32	1 Bit	25.15/ea
QB31	24731	1	16	.30	1 Bit	24.53/ea

OTHER SIZES AND QUANTITY AVAILABLE UPON REQUEST



BELL HANGER'S DRILL

HIGH-GRADE STEEL
E-Z TO DISPLAY PACKAGING

- Specifically designed for wood product construction
- For all telephone, electrical, small wire, protective alarm and cable T.V. uses
- Resists damage during drilling if metal is encountered
- Not for masonry products

STOCK NO.	UPC NO.	DIAMETER	LENGTH	SHANK DIAMETER	WT. PER PKG.	STD. PKG.	SUGGESTED TRADE LIST PRICE PER
BHD5	26020	1/4	18	1/4	.26	1 Drill	33.03/ea
BHD6	26025	5/16	18	5/16	.40	1 Drill	36.68/ea
BHD7	26030	3/8	18	3/8	.56	1 Drill	39.55/ea
BHD8	26035	1/2	18	3/8	.90	1 Drill	45.13/ea
BHD9	26040	1/4	24	1/4	1.00	1 Drill	46.38/ea
BHD10	26045	5/16	24	5/16	.69	1 Drill	50.40/ea
BHD11	26050	3/8	24	3/8	.70	1 Drill	52.38/ea

OTHER SIZES AND QUANTITY AVAILABLE UPON REQUEST

TOOLS, DRILLS AND ACCESSORIES



SDS-PLUS HAMMER DRILL

IDEAL FOR ROTARY AND PERCUSSION DRILLING
FOR ALL MASONRY PRODUCTS

STOCK NO.	UPC NO.	DESCRIPTION	WT. PER PKG.	SUGGESTED TRADE LIST PRICE PER
SDS31645	24101	3/16" x 4-1/2" SDS-Plus Hammer Drill Bit	.08	16.38/ea
SDS31665	24102	3/16" x 6-1/2" SDS-Plus Hammer Drill Bit	.10	16.70/ea
SDS3168	24103	3/16" x 8" SDS-Plus Hammer Drill Bit	.10	23.53/ea
SDS1445	24104	1/4" x 4-1/2" SDS-Plus Hammer Drill Bit	.09	16.38/ea
SDS1465	24106	1/4" x 6-1/2" SDS-Plus Hammer Drill Bit	.11	16.70/ea
SDS149	24107	1/4" x 9" SDS-Plus Hammer Drill Bit	.14	23.53/ea
SDS3865	24108	3/8" x 6-1/2" SDS-Plus Hammer Drill Bit	.16	21.98/ea
SDS389	24109	3/8" x 9" SDS-Plus Hammer Drill Bit	.20	42.33/ea
SDS1265	24111	1/2" x 6-1/2" SDS-Plus Hammer Drill Bit	.22	29.98/ea
SDS129	24112	1/2" x 9" SDS-Plus Hammer Drill Bit	.34	48.43/ea
SDS5865	24113	5/8" x 6-1/2" SDS-Plus Hammer Drill Bit	.26	39.88/ea
SDS589	24114	5/8" x 9" SDS-Plus Hammer Drill Bit	.31	48.43/ea
SDS3465	24116	3/4" x 9" SDS-Plus Hammer Drill Bit	.45	80.58/ea

OTHER SIZES AND QUANTITY AVAILABLE UPON REQUEST

POWER BIT EXTENSIONS

FOR USE WITH QUIK-BITS, SHIP AUGER, AND POWER BITS



- Hex wrench included
- Two set screws
- **E-Z TO DISPLAY PACKAGING**

STOCK NO.	UPC NO.	SIZE	WT. EACH	STD. PKG.	SUGGESTED TRADE LIST PRICE PER
BE1418	24875	1/4" x 18	.48	1	44.05/ea
BE5618	24880	5/16" x 18	1.50	1	41.23/ea
BE7612	24885	7/16" x 12	.86	1	43.28/ea
BE7618	24890	7/16" x 18	1.20	1	49.98/ea
BE7624	24891	7/16" x 24	1.56	1	61.48/ea

OTHER SIZES AND QUANTITIES AVAILABLE BY REQUEST



SD34

MULTI STEP DRILLS

SELF STARTING TIP ELIMINATES NEED FOR PILOT HOLE DRILLING
GOOD IN ALL SHEET METALS UP TO 1/8" THICK



SD12

STOCK NO.	UPC NO.	DESCRIPTION	WT. PER PKG.	STD. PKG.	SUGGESTED TRADE LIST PRICE PER
SD12	24080	1/8-1/2" 2 FLUTE, 13 STEP	.06	1	55.10/ea
SD34	24082	1/4-3/4" 2 FLUTE, 9 STEP	.10	1	80.00/ea
SD78	24084	7/8 TO 1 1/8" 3 STEP	.16	1	123.08/ea
3 SET COMBO PACK					
SDCP3	24088	1/8 TO 1/2" 2 FLUTE, 13 STEP 1/4 TO 3/4" 2 FLUTE, 9 STEP 7/8 TO 1 1/8" 3 STEP	.37	1	

OTHER SIZES AND QUANTITIES AVAILABLE BY REQUEST

TOOLS, DRILLS AND ACCESSORIES

SAWTOOTH MULTISPUR WOOD DRILL BITS



PACKAGED INDIVIDUALLY
WITH EXTRA DOUBLE END
SCREWS AND WRENCH

**E-Z TO DISPLAY
PACKAGING**

REPLACEMENT SCREW POINTS

STOCK NO.	UPC NO.	SIZE	FITS
SP0001	23550	1/4"	1/4 - 2 ⁹ / ₁₆
SP0002	23552	1/4"	3 - 4 ⁷ / ₁₆

STOCK NO.	UPC NO.	DESCRIPTION	SHANK DIAMETER	WT. PER PKG.	STD. PKG.	SUGGESTED TRADE LIST PRICE PER
306MS0	23500	1 ³ / ₈ for 3/4" pipes	7/16	.43	1	64.38/ea
306MS1	23505	1 ¹ / ₂ for 1" pipes	7/16	.46	1	64.38/ea
306MS2	23510	1 ³ / ₄ for 1 ¹ / ₄ " pipes	7/16	.51	1	66.23/ea
306MS3	23515	2 ¹ / ₈ for 1 ¹ / ₂ " pipes	7/16	.74	1	66.23/ea
306MS4	23520	2 ⁹ / ₁₆ for 2" pipes	7/16	.89	1	100.33/ea

EXTENSIONS FOR SHIP AUGERS & MULTISPUR

HEX WRENCH INCLUDED • TWO SET SCREWS • PACKAGED IN VINYL POUCH

BE7612	24885	7/16 x 12		.86	1	43.28/ea
BE7618	24890	7/16 x 18		1.20	1	49.98/ea

OTHER SIZES AND QUANTITIES AVAILABLE BY REQUEST

BULK PACKAGED CARBIDE MASONRY DRILLS

The Five Most Popular Sizes



STOCK NO.	UPC NO.	DIAMETER	LENGTH	SHANK DIAMETER	QTY.	WT. PER PKG.	SUGGESTED TRADE LIST PRICE PER
BFRB12	37050	1/4	4	1/4	100	3.43	268.55/ea pkg
BFRB14	37055	5/16	4	1/4	75	3.08	254.28/ea pkg
BFRB16	37060	3/8	4	1/4	50	3.14	109.95/ea pkg
BFRB21	37065	1/2	4	1/4	25	2.64	39.45/ea pkg

OTHER SIZES AND QUANTITY AVAILABLE UPON REQUEST

FLEXIBLE FISH-BITS

- Unique flexible self-feeding bits up to 72" long suitable for drilling holes with the length of wall cavities and through hidden studs with no damage to wallboard plaster or any exterior finish.
 - Bit has hole at tip and the shank which allows you to fish wire



STOCK NO.	UPC NO.	DESCRIPTION	SIZE	SHANK DIAMETER	WT. PER PKG.	STD. PKG.	SUGGESTED TRADE LIST PRICE PER
MFB1454	26455	FISH-BIT	1/4 x 54	3/16	.65	1	64.30/ea
MFB3854	26459	FISH-BIT	3/8 x 54	3/16	.65	1	67.60/ea
MFB1254	26451	FISH-BIT	1/2 x 54	3/16	.65	1	70.70/ea
MFB1472	26457	FISH-BIT	1/4 x 72	3/16	.75	1	68.18/ea
MFB3872	26461	FISH-BIT	3/8 x 72	3/16	.75	1	69.08/ea
MFB1272	26453	FISH-BIT	1/2 x 72	3/16	.65	1	71.30/ea
MSG1	26445	Steering Guide			.47	1	59.88/ea

OTHER SIZES AND QUANTITIES AVAILABLE BY REQUEST

TOOLS, DRILLS AND ACCESSORIES

CARBIDE MASONRY DRILLS

IDEAL FOR ROTARY AND PERCUSSION DRILLING
BLACK



- Specially designed spirals for fast dust removal
- **E-Z TO DISPLAY PACKAGING**
- Slow spiral drills can be used with **either rotary or hammer drills** in hard brick, sandstone, bluestone, terracotta block and hard concrete

STOCK NO.	UPC NO.	DIAMETER	LENGTH	SHANK DIAMETER	WT. PER PKG.	STD. PKG.	SUGGESTED TRADE LIST PRICE PER
BFR10	24100	1/8	3	3/32	.02	1	2.98/ea
BFR11	24105	3/16	4	9/64	.03	1	2.98/ea
BFR12	24110	1/4	4	1/4	.04	1	2.98/ea
BFR13	24115	1/4	6	1/4	.06	1	4.35/ea
BFR14	24120	5/16	4	1/4	.05	1	3.75/ea
BFR15	24125	5/16	6	1/4	.08	1	5.40/ea
BFR16	24130	3/8	4	1/4	.07	1	4.88/ea
BFR17	24135	3/8	6	1/4	.11	1	6.05/ea
BFR18	24140	7/16	6	1/4	.15	1	6.15/ea
BFR21	24145	1/2	4	1/4	.11	1	7.00/ea
BFR19	24150	1/2	6	1/4	.20	1	8.23/ea
BFR20	24155	1/2	6	3/8	.20	1	8.23/ea
BTT22	24160	9/16	6	3/8	.31	1	15.80/ea
BTT23	24165	5/8	6	3/8	.31	1	22.10/ea
BTT25	24175	7/8	6	1/2	.58	1	22.48/ea
BTT26	24180	1	6	1/2	.75	1	29.50/ea
BTT1	24185	1/4	12	1/4	.15	1	11.28/ea
BTT2	24190	5/16	12	1/4	.22	1	11.43/ea
BTT4	24200	1/2	12	3/8	.44	1	15.88/ea
BTT5	24205	5/8	12	3/8	.62	1	21.03/ea
BTT6	24210	3/4	12	1/2	.91	1	33.23/ea
BTT7	24215	7/8	12	1/2	1.24	1	34.88/ea
BTT8	24220	1	12	1/2	1.53	1	47.33/ea

OTHER QUANTITIES AVAILABLE UPON REQUEST

EXTRA LONG MASONRY DRILLS



HEAVY-DUTY CARBIDE TIPPED
E-Z TO DISPLAY PACKAGING

STOCK NO.	UPC NO.	DIAMETER	LENGTH	SHANK DIAMETER	WT. PER PKG.	STD. PKG.	SUGGESTED TRADE LIST PRICE PER
BTT9	24225	1/4	18	1/4	.22	1	19.58/ea
BTT11	24235	3/8	18	3/8	.45	1	21.50/ea
BTT12	24240	1/2	18	3/8	.64	1	25.18/ea
BTT13	24245	5/8	18	1/2	.94	1	29.90/ea
BTT14	24250	3/4	18	1/2	1.37	1	36.55/ea
BTT15	24255	7/8	18	1/2	1.79	1	71.40/ea
BTT16	24260	1	18	1/2	2.50	1	71.58/ea

OTHER SIZES AND QUANTITIES AVAILABLE BY REQUEST

TOOLS, DRILLS AND ACCESSORIES



MASTER FLASH® COMPLETE ROOF JACK KIT



(Roof Jack Only)

Everything in ONE KIT!

- The Master Flash® Roof Jack
- UV Cable Tie
- Metallics Special Sealant
- 10 x 1 Indented Hex Tek Type Self-Drilling Screws
- Easy Installation Instructions

Universal Pipe Flashing System...

- Weather Resistant
- Adapts to Many Roof Surfaces
- Easily Installed
- Uniform Plumbing Code (UPC®) Listed

Numerous Applications...

- Plumbing, Heating/Air Conditioning Equipment
- Electrical Service Entrances
- TV Aerials
- Masts, Vents or Pipes Through Decks or Bulkheads

STOCK NO.	UPC NO.	FITS PIPE SIZES/ JACK BASE SIZE	DESCRIPTION OF CONTENTS	WEIGHT EACH	STD. PKG.	SUGGESTED TRADE LIST PRICE PER
RJK1	31400	1/4" - 2" 4 1/2" Base	1 - Roof Jack, 1 - 25" Sealant Strip, 12 - Drive Screws, 1 - 11" Cable Tie	.51	1	30.08/ea
RJK2	31401	1/4" - 3" 6" Base	1 - Roof Jack, 1 - 35" Sealant Strip, 16 - Drive Screws, 1 - 15" Cable Tie	.77	1	34.95/ea
RJK3	31402	1/4" - 4" 8" Base	1 - Roof Jack, 1 - 45" Sealant Strip, 20 - Drive Screws, 1 - 21" Cable Tie	1.13	1	41.10/ea

OTHER SIZES AND QUANTITIES AVAILABLE BY REQUEST

MASTER FLASH ROOF JACKS - BULK/UNPACKAGED

STOCK NO.	UPC NO.	FITS PIPE SIZES/ JACK BASE SIZE	DESCRIPTION OF CONTENTS	WEIGHT EACH	STD. PKG.	SUGGESTED TRADE LIST PRICE PER
RJK1B	31237	1/4" - 2" for 4 1/2" Base	1 - Roof Jack	.25	1	18.48/ea
RJK2B	31238	1/4" - 3" for 6" Base	1 - Roof Jack	.50	1	21.30/ea
RJK3B	31239	1/4" - 4" for 8" Base	1 - Roof Jack	.75	1	25.05/ea

OTHER SIZES AND QUANTITIES AVAILABLE UPON REQUEST

MASTER FLASH® IS A REGISTERED TRADEMARK

DAP® DOW CORNING® SILICONE SEALANT

Protect and seal with 100% silicone rubber. Waterproof and flexible. Non-paintable.
50 year manufacturer durability guarantee. Meets ASTM C-920, Class 25, Type S, Grade NS.



STOCK NO.	UPC NO.	DESCRIPTION	WT. PER PKG.	STD. PKG.	SUGGESTED TRADE LIST PRICE PER
WDSC10	71234	CLEAR - 10.1 oz.	.86	1	12.50/ea
WDSW10	71235	WHITE - 10.1 oz.	.78	1	12.78/ea

OTHER SIZES AND QUANTITIES AVAILABLE BY REQUEST

DAP® DOW CORNING® ARE A REGISTERED TRADEMARK

GREY BUTYL TAPE FOR CAULKING

(SOLD IN PLASTIC BAGS)

STOCK NO.	UPC NO.	DESCRIPTION	WT. PER PKG.	STD. PKG.	SUGGESTED TRADE LIST PRICE PER
TC1	31236	1/8" thick x 3/4" wide x 30' long.	1.08	1	24.23/ea

OTHER SIZES AND QUANTITIES AVAILABLE BY REQUEST



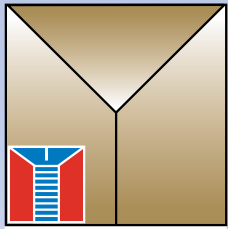

Metallics



Master Flash Complete Roof Jack Kit

**[CONTRACTOR
APPROVED]**

- New Packaging
- EZ to Display
- EZ to Store



PART #	UPC #	DESCRIPTION	FITS PIPE SIZE	JACK BASE SIZE	SUG. TRADE LIST / PKG
RJK1	31400	Roof Jack, Sealant Strip, Drive Screws and Cable Tie	1/4" - 2"	4 1/2" Base	\$ 30.08
RJK2	31401	Roof Jack, Sealant Strip, Drive Screws and Cable Tie	1/4" - 3"	6" Base	\$ 34.95
RJK3	31402	Roof Jack, Sealant Strip, Drive Screws and Cable Tie	1/4" - 4"	8" Base	\$ 41.10

"Growth Through Innovation"

Metallics

229 Cross Street, Bristol, CT 06010
Tel 800-243-8272 • **Fax** 800-831-9358
Email sales@metallicsonline.com

Metallics West

651 North Main Street, Mancos, CO 81328
Tel 800-269-5183 • **Fax** 800-269-6278
Email saleswest@metallicsonline.com

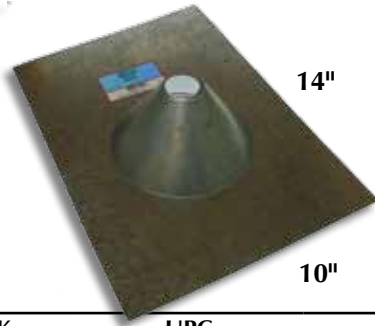

ROOF JACKS

26 GAUGE
10" x 14" Standard Base
Two-piece galvanized

STOCK NO.	UPC NO.	PIPE SIZE	WT. PER EACH	STD. PKG.	SUGGESTED TRADE LIST PRICE PER
MF50	31410	1/2"	1.00	1	8.08/ea
MF75	31411	3/4"	1.05	1	8.08/ea
MF100	31412	1"	.95	1	8.08/ea
MF125	31413	1 1/4"	.95	1	8.08/ea
MF150	31414	1 1/2"	.95	1	8.08/ea

For 0/12 - 5/12 roof pitch

OTHER SIZES AND QUANTITIES AVAILABLE BY REQUEST

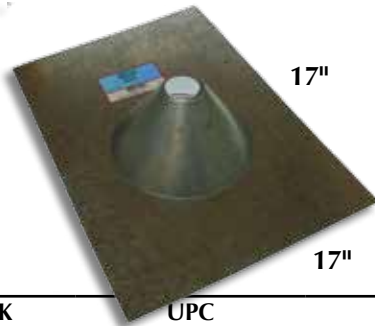

ROOF JACKS

26 GAUGE - FHA
17" x 17" Shingle Base
Two-piece galvanized

STOCK NO.	UPC NO.	PIPE SIZE	WT. PER EACH	STD. PKG.	SUGGESTED TRADE LIST PRICE PER
MFHA50	31416	1/2"	1.80	1	10.03/ea
MFHA75	31417	3/4"	1.80	1	10.03/ea
MFHA100	31418	1"	1.80	1	10.03/ea
MFHA125	31419	1 - 1/4"	1.80	1	10.03/ea
MFHA150	31420	1 - 1/2"	1.75	1	10.03/ea
MFHA200	31421	2"	1.75	1	10.03/ea

For 0/12 - 5/12 roof pitch

OTHER SIZES AND QUANTITIES AVAILABLE BY REQUEST

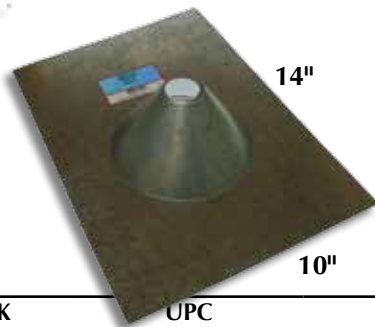

The Economical One! ROOF JACKS

26 GAUGE
One-Piece Spun Galvanized

STOCK NO.	UPC NO.	PIPE SIZE	WT. PER EACH	STD. PKG.	SUGGESTED TRADE LIST PRICE PER
SMF50	31422	1/2"	.75	1	6.95/ea
SMF75	31423	3/4"	.75	1	6.95/ea
SMF100	31424	1"	.75	1	6.95/ea
SMF125	31425	1 1/4"	.75	1	6.95/ea
SMF150	31426	1 1/2"	.75	1	6.95/ea
SMF200	31427	2"	.75	1	6.95/ea

For 0/12 - 5/12 roof pitch

OTHER SIZES AND QUANTITIES AVAILABLE BY REQUEST

3-in-1 ROOF FLASHINGS



Stock No. MRJ50

Fits pipe sizes: 1/2", 3/4", 1"

Fits base size: 8-3/4" x 12-1/2"

- Slides over pipe - for pitch to 45 degree.
- Rustproof, stamped galvanized 24 gauge.
- 18" x 18" base for code required areas.
- Rated 180°F continuous heat.
- Approved for Type B installations.

GALVANIZED BASE ROOF FLASHINGS
24 GAUGE WITH ELASTOMER COLLAR



Stock No. MRJ125

Fits pipe sizes: 1-1/2", 2", 3"*

Fits base size: 10-3/4" x 12-1/2"

* Can be modified to fit 1-1/4" pipe

- Slides over pipe. Type of base determines pitch.
- Ring on collar tears off, allowing flashings to seal different pipe diameters.
- Non-fading, cracking and rusting bases and sealing collars.
- Rated 180°F continuous heat.
- Approved for Type B installations.

STOCK NO.	UPC NO.	PIPE SIZE	WT. PER EACH	STD. PKG.	SUGGESTED TRADE LIST PRICE PER
MRJ50	31408	1/2" - 1"	.82	1	12.80/ea
MRJ125	31409	1-1/4" - 3"	1.16	1	15.78/ea

OTHER SIZES AND QUANTITIES AVAILABLE BY REQUEST



FLOOR FLANGE

ZINC PLATED

PACKAGED IN POLY BAGS

STOCK NO.	UPC NO.	PIPE SIZE	ANCHOR HOLE	WT. PER EACH	STD. PKG.	SUGGESTED TRADE LIST PRICE PER
MFF25	16201	1/2"	1/4"	.27	1	5.70/ea
MFF75	16202	3/4"	1/4"	.49	1	6.75/ea
MFF100	16203	1"	1/4"	.65	1	8.65/ea
MFF125	16204	1 1/4"	1/4"	.88	1	11.80/ea
MFF150	16205	1 1/2"	1/4"	1.16	1	12.50/ea
MFF200	16206	2"	5/16"	1.55	1	16.60/ea

OTHER SIZES AND QUANTITIES AVAILABLE BY REQUEST



**Metallics and Avanti
Screw, Inc.**
Where
Manufacturing
Quality is Job
One!

TOOLS, DRILLS AND ACCESSORIES



MASTER LOCK®

FULLY ADJUSTABLE 5/16" x 6' LOCKING VINYL COATED BRAIDED STEEL CABLE

Increased Security:

Cable length adjust to any position from 6' to 6'.

Application Flexibility:

Threads through places other cables cannot.

Cut Resistant:

5/16" (8mm) braided steel cable.

Scratch Resistant:

Vinyl coated cable and ABS plastic lock body.

Pick Resistant:

Reliable pin tumble mechanism.



Don't Just Tie It Down, Lock It Down!

STOCK NO.	UPC NO.	U/M	SUGGESTED TRADE LIST PRICE PER
PYLO1BLK	13080	1	24.33/ea.
PYLO1CAM	13085	1	27.83/ea.



RUBBER TARP STRAPS

STOCK NO.	UPC NO.	STRAP LENGTH MINUS HOOKS	WT.	SUGGESTED TRADE LIST PRICE PER	
RTS14	12060	10"	.19	2.31/ea.	NEW
RTS19	12062	15"	.24	2.81/ea.	NEW
RTS24	12064	21"	.25	3.56/ea.	NEW
RTS35	12066	31"	.33	4.44/ea.	NEW
RTS45	12068	41"	.40	6.13/ea.	NEW

OTHER SIZES AND QUANTITIES AVAILABLE BY REQUEST

CHEMICAL PRODUCTS



SIMPLE GREEN® SAFETY TOWELS



- Multi-purpose cleaning power
- Safer non-citrus formula
- Pre-Moistened
- Non-Toxic
- Versatile
- Quick

STOCK NO.	UPC NO.	DESCRIPTION	SIZE	WT. EACH	STD. PKG.	SUGGESTED TRADE LIST PRICE PER
WSGT75	71297	75 towels in each	10 x 11.75	2.28	1	38.78/ea

OTHER SIZES AND QUANTITIES AVAILABLE BY REQUEST



WYPALL® WATERLESS HAND CLEANER WIPES



- Smooth on one side and tough on the other for scrubbing
- 10-1/2" W x 12-1/2" L
- Premoistened
- Tough on greasde, grimm, ink and paint

STOCK NO.	UPC NO.	DESCRIPTION	WT. EACH	STD. PKG.	SUGGESTED TRADE LIST PRICE PER
WYP75	71390	75 Waterless Hand Cleaner Wipes	2.50	1	20.44/ea

OTHER SIZES AND QUANTITIES AVAILABLE BY REQUEST



HAND SANITIZER WIPES

Ensure personal protection from organisms that cause disease and sickness through cross-contamination.

Features and benefits:

- Kills 99.9% of disease causing germs and bacteria found on skin.
- Sanitizing formula contains enough alcohol to be highly effective, but will not dry out hands.
- Extended use will not cause dryness or cracking.

STOCK NO.	UPC NO.	DESCRIPTION	WT. EACH	STD. PKG.	SUGGESTED TRADE LIST PRICE PER
HSCB85	71295	85 count bucket	1.23	1	32.10/ea

OTHER SIZES AND QUANTITIES AVAILABLE BY REQUEST

Simple Green®, Wypall® and Scrubs® are all Registered Trademarks



DAP® KWIK FOAM® POLYURETHANE INSULATING SEALANT

Description:

A one part, moisture-cure, polyurethane foam that expands to economically fill and seal large cavities. Stops air filtration and will not degrade or shrink. Kwik Foam contains a flame retardant. The DAP trademark is a signature for products immediately recognized for their quality and leadership. It is a powerful signal to generations of do-it-yourselfers and professional tradespeople who chose and use products with the utmost confidence.

STOCK NO.	UPC NO.	WT.	SUGGESTED TRADE LIST PRICE PER
KF12	71472	12 oz.	21.63/ea.
KF24	71495	24 oz.	40.80/ea.

OTHER SIZES AND QUANTITIES AVAILABLE BY REQUEST

DAP® FIREBLOCK FOAM POLYURETHANE FIREBLOCK FOAM SEALANT

Quick, easy to use fireblock product for filling:

- Joints between ceiling and walls or floors and walls
 - Around vents, pipes, ducts and wires

For use in Type V residential construction.
Bright orange for easy code identification.
Expands 2-1/2 to 3 times its dispensed size.

STOCK NO.	UPC NO.	PACKAGE QUANTITY	COLOR	WT.	SUGGESTED TRADE LIST PRICE PER
WDFB12	71252	9 cans per case	Orange	12 oz.	21.63/ea.

OTHER SIZES AND QUANTITIES AVAILABLE BY REQUEST

DAP® Kwik Foam® are Registered Trademarks



OXIDE INHIBITOR COMPOUND

- For use on aluminum to copper and aluminum to aluminum connections.
- Seals out moisture and air to prevent oxidation.
- Improves service life of aluminum electrical applications.
- Compatible with insulating materials
- Installed product remains in place with no running or dripping.
- May be used as an anti-seizing compound.
- Available in an 8 ounce bottle.

STOCK NO.	UPC NO.	U/M	SUGGESTED TRADE LIST PRICE PER
OXIN1	60020	1	19.75/ea.

OTHER SIZES AND QUANTITIES AVAILABLE BY REQUEST



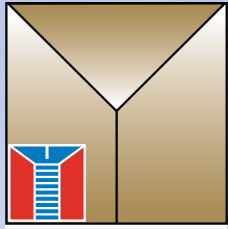

Metallics



Duct Seal

1 pound & 5 pounds

[CONTRACTOR APPROVED]



- Seals out air and moisture
- Great adhesion
- Indoor/Outdoor use
- Paintable
- Asbestos-free
- Non-hardening

PART #	UPC #	DESCRIPTION	QTY / PKG	SUG. TRADE LIST / PKG
MDUC1	60031	Duct Seal (1 lb. package)	1	\$ 3.53
MDUC5	60035	Duct Seal (5 lb. package)	1	\$ 13.64

“Growth Through Innovation”

Metallics

229 Cross Street, Bristol, CT 06010
Tel 800-243-8272 • **Fax** 800-831-9358
Email sales@metallicsonline.com

Metallics West

651 North Main Street, Mancos, CO 81328
Tel 800-269-5183 • **Fax** 800-269-6278
Email saleswest@metallicsonline.com

BLACK JACK® ROOF PATCH

WET/DRY ROOF CEMENT



Black Jack® is a registered trademark

- Seals and stops leaks
- Expands and contracts with weather
- Forms a tight, strong seal
- Stays soft and pliable
- Repairs flashings



STOCK NO.	UPC NO.	SIZE	WEIGHT	STD. PKG.	SUGGESTED TRADE LIST PRICE PER
RCT1	41350	10 oz. Tube	.92	1	7.85/ea
RCQ1	41355	1 Quart	2.32	1	15.98/ea
RCG1	41360	1 Gallon	8.75	1	33.90/ea

OTHER SIZES AND QUANTITIES AVAILABLE BY REQUEST



DAP® FAST 'N FINAL® LIGHTWEIGHT SPACKLING

A superior lightweight spackling for repairing walls, ceilings and woodwork in one fill. Easy spread formula that needs no sanding. Will not crack or shrink. Excellent for both interior and exterior use.



DAP® and Fast 'N Final® are registered trademark

STOCK NO.	UPC NO.	DESCRIPTION	WT. PER PKG.	STD. PKG.	SUGGESTED TRADE LIST PRICE PER
WDS10	71221	1/2 pint - White	.27	1	5.70/ea
WDS20	71222	Qrt. - White	.98	1	13.95/ea
WDS30	71223	Gal. - White	5.18	1	41.00/ea

OTHER SIZES AND QUANTITIES AVAILABLE BY REQUEST

DAP® 3.0 Advanced Sealants



Kitchen & Bath, All Purpose, Gutter & Flashings,
Black-Top & Roof, Self-Leveling Concrete

DAP 3.0 Advanced Sealants

All DAP 3.0 advanced sealants are technically superior with greater adhesion and flexibility so they won't crack or shrink and they are also paintable. Thanks to active quick dry technology DAP 3.0 can be exposed to water in just 3 hours.

Available in:

- 3.0 Advanced Kitchen & Bath Sealant White & Clear
- 3.0 Advanced All-Purpose Sealant White & Clear
- 3.0 Advanced Gutter & Flashing Sealant White
- 3.0 Advanced Black-Top & Roof Sealant Black
- 3.0 Advanced Self-Leveling Sealant Gray

STOCK NO.	UPC NO.	DESCRIPTION	QTY. PKG.	SUGGESTED TRADE LIST PRICE PER
WDKBW10	71532	3.0 Kitchen & Bath Sealant White (9.0 oz)	1	16.53
WDKBC12	71530	3.0 Kitchen & Bath Sealant Clear (9.0 oz)	1	20.33
WDSW30	71546	3.0 All Purpose Sealant White (9.0 oz)	1	16.53
WDSC30	71544	3.0 All Purpose Sealant Clear (9.0 oz)	1	20.33
WDGF1	71536	3.0 Gutter & Flashing Sealant White (9.0 oz)	1	16.53
WDBTR1	71540	3.0 Black-Top & Roof Sealant Black (9.0 oz)	1	16.53
WDSL1	71544	3.0 Self-Leveling Sealant Gray (9.0 oz)	1	16.53

OTHER SIZES AND QUANTITIES AVAILABLE BY REQUEST



DAP® Alex Plus® Acrylic Latex Caulk



DAP Alex Plus Acrylic Latex Caulk

is a multi-purpose acrylic latex caulk plus silicone. Highly flexible and durable with excellent adhesion and paintable. Cured caulk is mildew resistant and can be used interior/exterior. Exceeds ASTM specification C834.



STOCK NO.	UPC NO.	DESCRIPTION	QTY. PKG.	SUGGESTED TRADE LIST PRICE PER
WDEW10	71246	Alex Plus Acrylic Latex Caulk (White 10.1 oz)	1	16.53
WDEC10	71187	Alex Plus Acrylic Latex Caulk (Clear 10.1 oz)	1	20.33
WDEW5	71245	Alex Plus Acrylic Latex Caulk (Squeeze Tube 5.5 oz)	1	16.53

OTHER SIZES AND QUANTITIES AVAILABLE BY REQUEST

CHEMICAL PRODUCTS

DAP® ELASTOPATCH® SMOOTH



A high performance, smooth finish, brush-on or trowel-on terpolymer patching compound. Designed to fill cracks up to 1/4" in interior or exterior surfaces. Excellent for use on stucco, masonry, brick, wood, plaster, drywall, concrete, metal, virtually any surface requiring a permanently flexible seal.

STOCK NO.	UPC NO.	DESCRIPTION	WT. PER PKG.	STD. PKG.	SUGGESTED TRADE LIST PRICE PER
WDPS10	71224	01smooth - 10.1 oz. - White	1.15	1	8.25/ea
WDPS20	71225	01 smooth - Qt. - White	3.34	1	18.63/ea
WDPS30	71226	01 smooth - Gal. - White	13.05	1	59.10/ea

OTHER SIZES AND QUANTITIES AVAILABLE BY REQUEST

DAP® ELASTOPATCH® TEXTURED



A high performance, textured finish, brush-on, trowel-on or roll-on terpolymer patching compound. Designed to fill cracks up to 1/4" in interior or exterior surfaces, excellent for use on stucco, masonry, brick, wood, plaster, drywall, concrete, metal, virtually any surface requiring a permanently flexible seal.

STOCK NO.	UPC NO.	DESCRIPTION	WT. PER PKG.	STD. PKG.	SUGGESTED TRADE LIST PRICE PER
WDPT10	71227	02 textured - 10.1 oz. - Off White	.86	1	7.48/ea
WDPT20	71228	02 textured - Qt. - Off White	2.65	1	17.05/ea
WDPT30	71229	02 textured - Gal. - Off White	11.74	1	57.13/ea

OTHER SIZES AND QUANTITIES AVAILABLE BY REQUEST

DAP® KWIK-SEAL® TUB & TILE ADHESIVE CAULK



Tub and tile adhesive and caulk in one. Mildew resistant. Excellent adhesion and flexibility. Tools easily and dries tack free in 15 minutes. Water clean-up.

STOCK NO.	UPC NO.	DESCRIPTION	WT. PER PKG.	STD. PKG.	SUGGESTED TRADE LIST PRICE PER
WDKS1	71231	5.5 oz. - White	.56	1	5.38/ea

OTHER SIZES AND QUANTITIES AVAILABLE BY REQUEST

DAP® FIRE STOP SEALANT



Single component silicone fire barrier for sealing around piping and wiring penetrations through fire-rated walls and floors. Meets ASTM Spec. E-814, UL 1479 and UL 2079.

STOCK NO.	UPC NO.	DESCRIPTION	WT. PER PKG.	STD. PKG.	SUGGESTED TRADE LIST PRICE PER
WDFS10	71232	10.1 oz. - Lt. Gray	1.04	1	40.75/ea

OTHER SIZES AND QUANTITIES AVAILABLE BY REQUEST

DAP®, Elastopatch® and Kwik Seal® are registered trademarks

DAP® HIGH HEAT MORTAR



For firestopping at openings around vents, pipes, ducts, chimneys, in wood frame construction, also for patching fireplaces and wood-burning stoves. Withstands temperatures up to 2000°F. Non-combustible. ASTM E-136 rated.

STOCK NO.	UPC NO.	DESCRIPTION	WT. PER PKG.	STD. PKG.	SUGGESTED TRADE LIST PRICE PER
WDHM10	71233	10.1 oz. - Black	1.25	1	6.53/ea.

OTHER SIZES AND QUANTITIES AVAILABLE BY REQUEST

DAP® DOW CORNING® SILICONE SEALANT



Protect and seal with 100% silicone rubber. Waterproof and flexible. Non-paintable. 50 year manufacturer durability guarantee. Meets ASTM C-920, Class 25, Type S, Grade NS.

STOCK NO.	UPC NO.	DESCRIPTION	WT. PER PKG.	STD. PKG.	SUGGESTED TRADE LIST PRICE PER
WDSC10	71234	Clear - 10.1 oz.	.86	1	12.50/ea.
WDSW10	71235	White - 10.1 oz.	.78	1	12.78/ea.
WDSG10	71238	Gray - 10.1 oz.	.78	1	12.78/ea.

OTHER SIZES AND QUANTITIES AVAILABLE BY REQUEST

DAP® ALEX PLUS® EASY CAULK



Packaged in a convenient, easy-to-use aerosol can. Eliminates the need for a caulk gun, delivers a smooth and consistent bead with no messy overflow. Ideal for use in tight spaces and for smaller jobs either indoors or outdoors.

STOCK NO.	UPC NO.	DESCRIPTION	WT. PER PKG.	STD. PKG.	SUGGESTED TRADE LIST PRICE PER
WDEC16	71236	16 oz. - White	1.09	1	14.88/ea.

OTHER SIZES AND QUANTITIES AVAILABLE BY REQUEST

DAP® BEATS THE NAIL® CONSTRUCTION ADHESIVE



For general construction, remodeling, maintenance and repair projects. Provides a high-strength, heat and water resistant bond to a variety of substrates. Meets ASTM Specification C 557. For interior/exterior use.

STOCK NO.	UPC NO.	DESCRIPTION	WT. PER PKG.	STD. PKG.	SUGGESTED TRADE LIST PRICE PER
WDN1	71240	10.3 oz. - Gray	1.04	1	5.98/ea.
WDN2	71241	29 oz. - Gray	2.96	1	16.98/ea.

OTHER SIZES AND QUANTITIES AVAILABLE BY REQUEST

DAP® is a registered trademark
Beats The Nail® is a registered trademark
Dow Corning® is a registered trademark

CAULKING GUN

PISTON ROD WITH DOUBLE FRICTION PLATE
QUICK-RELEASE LEVER

10 oz

32 oz

STOCK NO.	UPC NO.	TUBE SIZE	WT. PER PKG.	STD. PKG.	SUGGESTED TRADE LIST PRICE PER
CG1	35020	10 oz.	.90	1	7.55/ea.
CG32	35050	32 oz.	1.92	1	36.20/ea.

OTHER SIZES AND QUANTITIES AVAILABLE BY REQUEST



ELECTRICAL TAPES

STOCK NO.	UPC NO.	DESCRIPTION	WT. PER PKG.	STD. PKG.	SUGGESTED TRADE LIST PRICE PER
COLOR CODING P.V.C. TAPE (Individually wrapped in cellophane)					
PT34R	81030	3/4" x 60' Colored Phase Tape - RED UL	1.77	1	3.00/ea
PT34W	81032	3/4" x 60' Colored Phase Tape - WHITE UL	1.78	1	3.00/ea
PT34Y	81034	3/4" x 60' Colored Phase Tape - YELLOW UL	1.72	1	3.00/ea
PT34O	81036	3/4" x 60' Colored Phase Tape - ORANGE UL	1.70	1	3.00/ea
PT34BL	81038	3/4" x 60' Colored Phase Tape - BLUE UL	1.67	1	3.00/ea
PT34BR	81040	3/4" x 60' Colored Phase Tape - BROWN UL	1.73	1	3.00/ea
PT34G	81042	3/4" x 60' Colored Phase Tape - GREEN UL	1.73	1	3.00/ea
PT34GR	81044	3/4" x 60' Colored Phase Tape - GRAY UL	1.68	1	3.00/ea

OTHER SIZES AND QUANTITIES AVAILABLE BY REQUEST



STOCK NO.	UPC NO.	DESCRIPTION	WT. PER PKG.	STD. PKG.	SUGGESTED TRADE LIST PRICE PER
BLACK P.V.C. TAPE (Individually wrapped in cellophane)					
ST34BLK	81046	3/4" x 60' 7 Mill Black Tape UL	1.89	1	1.40/ea
AW34BLK	81048	3/4" x 66' 7 Mill Black All Weather Tape	1.91	1	4.43/ea

OTHER SIZES AND QUANTITIES AVAILABLE BY REQUEST



STOCK NO.	UPC NO.	DESCRIPTION	WT. PER PKG.	STD. PKG.	SUGGESTED TRADE LIST PRICE PER
BLACK FRICTION TAPE (Individually wrapped in cellophane)					
FT34BLK	81050	3/4" x 60' Black Friction Tape	.38	1	5.35/ea

OTHER SIZES AND QUANTITIES AVAILABLE BY REQUEST

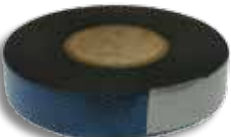

STOCK NO.	UPC NO.	DESCRIPTION	WT. PER PKG.	STD. PKG.	SUGGESTED TRADE LIST PRICE PER
BLACK RUBBER TAPE (Individually wrapped in cellophane)					
RT34BLK	81052	3/4" x 22' Black Rubber Tape UL	.39	1	4.93/ea

OTHER SIZES AND QUANTITIES AVAILABLE BY REQUEST



STOCK NO.	UPC NO.	DESCRIPTION	WT. PER PKG.	STD. PKG.	SUGGESTED TRADE LIST PRICE PER
DUCT TAPE (Individually wrapped in cellophane)					
DT260	81054	2" x 60 yd Silver Duct Tape Utility Grade	1.33	1	12.15/ea

OTHER SIZES AND QUANTITIES AVAILABLE BY REQUEST



CONDUIT MEASURING TAPE

- Printed footage marking from 0 - 3,000
- Designed to allow user to measure and fish conduit runs
- 150 lbs breaking strength
- Made of 3/16" wide waterproof polyester
- Supplied on light weight metal spools for ease of use
- 3,000 feet per spool
- Designed to be used with industry standard dispensers

STOCK NO.	UPC NO.	DESCRIPTION	WT. PER PKG.	STD. PKG.	SUGGESTED TRADE LIST PRICE PER
CMT1	35055	Measuring Tape	3.98	1	104.43/ea

OTHER SIZES AND QUANTITIES AVAILABLE BY REQUEST

Add to a Metallics order to hit prepaid Minimums.

ELECTRICAL TAPES



STOCK NO.	UPC NO.	DESCRIPTION	WT. EACH	SUGGESTED TRADE LIST PRICE PER
ALUMINUM TAPE				
AT250	81130	2" x 50 yd Aluminum Tape	1.23	24.18/ea
AT350	81140	3" x 50 yd Aluminum Tape	1.73	38.08/ea

OTHER SIZES AND QUANTITIES AVAILABLE BY REQUEST



STOCK NO.	UPC NO.	DESCRIPTION	WT. EACH	SUGGESTED TRADE LIST PRICE PER
FIBER REINFORCED ALUMINUM TAPE				
FRT250	81160	2" x 50 yd Fiber Reinforced Aluminum Tape	1.32	42.53/ea

OTHER SIZES AND QUANTITIES AVAILABLE BY REQUEST



STOCK NO.	UPC NO.	DESCRIPTION	WT. EACH	SUGGESTED TRADE LIST PRICE PER
TEFLON TAPE				
TT12	81150	1/2" x 520" Teflon Tape	.03	1.35/ea

OTHER SIZES AND QUANTITIES AVAILABLE BY REQUEST



STOCK NO.	UPC NO.	DESCRIPTION	WT. EACH	SUGGESTED TRADE LIST PRICE PER
3" X 1000' - UNDERGROUND TAPE				
BT3TVO	81056	Caution Buried CATV Cable Line Below - ORANGE	7.50	50.13/ea
BT3EY	81058	Caution Buried Electrical Line Below - YELLOW	4.37	50.13/ea
BT3ER	81060	Caution Buried Electrical Line Below - RED	4.91	50.13/ea
BT3HVR	81062	Caution Buried High Voltage Line Below - RED	7.04	50.13/ea
BT3TPO	81064	Caution Buried Telephone Line Below - ORANGE	3.69	50.13/ea
BT3UY	81066	Caution Buried Utility Line Below - YELLOW	4.32	50.13/ea
BT3FO	81068	Caution Buried Fiber Optic Line Below - ORANGE	4.10	50.13/ea

OTHER SIZES AND QUANTITIES AVAILABLE BY REQUEST

CONTINUED ON NEXT PAGE

CONTINUED
ELECTRICAL TAPES



STOCK NO.	UPC NO.	DESCRIPTION	WT. EACH	SUGGESTED TRADE LIST PRICE PER
6" x 1000' - NON-DETECTABLE UNDERGROUND TAPE				
BT6TVO	81070	Caution Buried CATV Cable Line Below - ORANGE	9.24	102.33/ea
BT6EY	81072	Caution Buried Electrical Line Below - YELLOW	8.61	102.33/ea
BT6ER	81074	Caution Buried Electrical Line Below - RED	9.21	102.33/ea
BT6HVR	81076	Caution Buried High Voltage Line Below - RED	9.20	102.33/ea
BT6TPO	81078	Caution Buried Telephone Line Below - ORANGE	8.43	102.33/ea
BT6UY	81080	Caution Buried Utility Line Below - YELLOW	8.43	102.33/ea
BT6FO	81082	Caution Buried Fiber Optic Line Below - ORANGE	9.63	102.33/ea

OTHER SIZES AND QUANTITIES AVAILABLE BY REQUEST



STOCK NO.	UPC NO.	DESCRIPTION	WT. EACH	SUGGESTED TRADE LIST PRICE PER
3" x 1000' - CAUTION BARRICADE TAPE				
CT3HVY	81086	Caution High Voltage - YELLOW	2.42	44.00/ea
CT3DNY	81088	Caution Do Not Enter - YELLOW	2.24	44.00/ea
CT3KOY	81090	Caution Keep Out - YELLOW	3.28	44.00/ea
CT3CY	81092	Caution - YELLOW	2.47	44.00/ea
CT3D	81091	Danger - RED	3.15	44.00/ea

OTHER SIZES AND QUANTITIES AVAILABLE BY REQUEST



STOCK NO.	UPC NO.	DESCRIPTION	WT. EACH	SUGGESTED TRADE LIST PRICE PER
3" x 1000' - DETECTABLE UNDERGROUND TAPE				
DT3HVR	81094	Caution Buried High Voltage Line Below - RED	7.04	136.50/ea
DT3ER	81096	Caution Buried Electrical Line Below - RED	7.12	136.50/ea
DT3TPO	81098	Caution Buried Telephone Line Below - ORANGE	6.85	136.50/ea
DT3FO	81100	Caution Buried Fiber Optic Line Below - ORANGE	6.75	136.50/ea

OTHER SIZES AND QUANTITIES AVAILABLE BY REQUEST



STOCK NO.	UPC NO.	DESCRIPTION	WT. EACH	SUGGESTED TRADE LIST PRICE PER
6" x 1000' - DETECTABLE UNDERGROUND TAPE				
DT6HVR	81102	Caution Buried High Voltage Line Below - RED	14.15	271.18/ea
DT6ER	81104	Caution Buried Electrical Line Below - RED	14.12	271.18/ea
DT6TPO	81106	Caution Buried Telephone Line Below - ORANGE	13.78	271.18/ea
DT6FO	81108	Caution Buried Fiber Optic Line Below - ORANGE	8.31	271.18/ea

OTHER SIZES AND QUANTITIES AVAILABLE BY REQUEST

WE RECOMMEND THAT IN THE INSTALLATION OF UNDERGROUND AND DETECTABLE TAPES, QUALIFIED PROFESSIONALS SHOULD BE PRESENT.

CHILL OUTS



IDEAL FOR SUMMER PROMOTION!

- Just soak in water and wear
- Use as a neckerchief or headband

CONTAINS A CRYSTAL POLYMER THAT ABSORBS WATER AND BECOMES A GEL THAT COOLS YOUR BODY FOR HOURS.

STOCK NO.	UPC NO.	WT. PER PKG.	STD. PKG.	SUGGESTED TRADE LIST PRICE PER
COHB1	41001	.10	1	10.08/ea

OTHER SIZES AND QUANTITIES AVAILABLE BY REQUEST

SHARK™

DESIGNER SAFETY GLASSES FOR FIELD ELECTRICIANS WHO WANT STRENGTH PLUS A "COOL STYLE"



- Maximum UV Protection
- Single High-Impact, Scratch Resistant Polycarbonate Lens
- Fashionable Wrap-around Styling
- Lightweight Nylon & Polycarbonate Combination Frame
- Adjustable Temples with Positive Stops
- Meets ANSI Z87.1 Standards
- Frame: Multi Colored

STOCK NO.	UPC NO.	DESCRIPTION	WT. EACH	STD. PKG.	SUGGESTED TRADE LIST PRICE PER
SSGC1	71196	Shark™ Safety Glasses with clear lens, R/W/B frame	.08	1	11.75/ea
SSGA1	71420	Shark™ Safety Glasses with amber lens, black frame	.08	1	16.38/ea

OTHER SIZES AND QUANTITIES AVAILABLE BY REQUEST

8700 STRIKE FORCE™



WARNING: THIS PRODUCT, WHEN WORN ON CONSTRUCTION JOBS, COULD CAUSE SERIOUS ENVY!

- Maximum UV Protection
- Wrap-around, high-impact, scratch-resistant polycarbonate lens
- Unobstructed peripheral vision
- Soft rubber nosepiece and foam brow pad
- Adjustable length core wire temples with positive stops
- Meets ANSI Z87.1 Standards
- Ebony Frame: Clear and Smoke Lenses

STOCK NO.	UPC NO.	DESCRIPTION	WT. EACH	STD. PKG.	SUGGESTED TRADE LIST PRICE PER
CWGC1	71216	STRIKE FORCE™ Safety Glasses with clear lens	.08	1	17.63/ea
CWGS1	71217	STRIKE FORCE™ Safety Glasses with smoke lens	.08	1	17.63/ea

OTHER SIZES AND QUANTITIES AVAILABLE BY REQUEST



PROTECTIVE EYE WEAR

COBALT™

- Maximum UV Protection
- High-impact, 6 base curved, scratch-resistant polycarbonate lens
- Sof-Touch Nylon Frame
- Meets ANSI Z87.1 Standards
- Ebony Frame: Clear, Smoke, Amber and Silver Mirror Lenses



STOCK NO.	UPC NO.	DESCRIPTION	WT. EACH	STD. PKG.	SUGGESTED TRADE LIST PRICE PER
LLGC1	71212	COBALT™ Safety Glasses with clear lens	.06	1	12.45/ea
LLGS1	71213	COBALT™ Safety Glasses with smoke lens	.06	1	13.53/ea

OTHER SIZES AND QUANTITIES AVAILABLE BY REQUEST

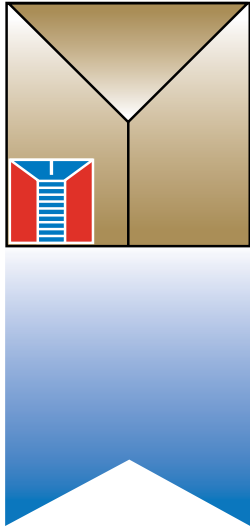

**This is the Heading Line at
Avanti Screw, Inc.,
A Metallics Affiliate
Bristol, CT.**

**We work hard at trying to be the best in America!
America's Source For Premier & Innovative Fasteners.**



MADE IN USA



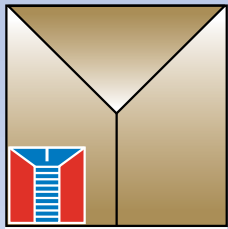

Metallics

Eye Protection



**[CONTRACTOR
APPROVED]**

MVT10



Voltage™ Safety Glasses:

- Light weight full frame
- Polycarbonate lens impact resistant
- Rubber nosepiece for comfort
- Meets ANSI Z8.1+ standards
- 99.9% UVA/UVB protection

MRV110



Revelation™ Safety Glasses:

- 5-Position ratchet plus 4-position telescoping temples
- Soft rubber nosepiece
- Ventilation channel between lens reduces fogging

MPR20

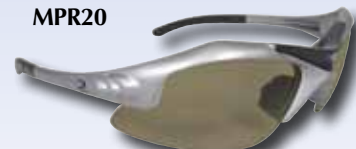

Prestige™ Safety Glasses:

- Rubber tipped temples for secure fit
- Polycarbonate lens impact resistant
- Rubber nosepiece for comfort
- Meets ANSI Z8.1+ standards
- 99.9% UVA/UVB protection

STOCK #	UPC #	DESCRIPTION	QTY / PKG	SUG. TRADE LIST / PKG
MVT10	62803	Voltage Clear Lens, Black Frame	1	\$13.50
MVT63	62810	Voltage Electric Blue Lens, Black Frame	1	\$19.13
MVT65	62812	Voltage Electric Orange Lens, Black Frame	1	\$19.13
MVT90	62818	Voltage Indoor/Outdoor Lens, Black Frame	1	\$15.19
MRV110	62830	Revelation Clear Lens, Black Frame	1	\$10.44
MRV120	62832	Revelation Smoke Lens, Black Frame	1	\$12.07
MRV140	62836	Revelation Amber Lens, Black Frame	1	\$12.56
MRV1NO	62846	Revelation Orange Lens, Black Frame	1	\$12.56
MRV160	62840	Revelation Silver Mirror Lens, Black Frame	1	\$14.44
MRV170	62842	Revelation Blue Mirror Lens, Black Frame	1	\$14.94
MPR20	62820	Prestige Smoke Lens, Silver Frame	1	\$15.75
MPR60	62824	Prestige Silver Mirror Lens, Silver Frame	1	\$16.31
MPR70	62826	Prestige Blue Mirror Lens, Silver Frame	1	\$17.44
MPROM	62828	Prestige Orange Mirror Lens, Silver Frame	1	\$17.44

★ ★ ★ ★ ★ *"Growth Through Innovation"* ★ ★ ★ ★ ★

Metallics

229 Cross Street, Bristol, CT 06010
Tel 800-243-8272 • **Fax** 800-831-9358
Email sales@metallicsonline.com

Metallics West

651 North Main Street, Mancos, CO 81328
Tel 800-269-5183 • **Fax** 800-269-6278
Email saleswest@metallicsonline.com

FIRST AID KITS

FIRST AID KIT (100 PC)

In a sturdy polypropylene case, for easy storage.



Kit Contains:

- 30 Adhesive Bandages - 3/8" x 1-1/2"
- 20 Adhesive Bandages - 3" x 3/4"
- 5 Butterfly Closure Bandages
- 10 Cotton Tip Applicators
- 4 Finger Splints
- 4 Sterile Gauze Dressings - 2" x 2" (2-in-1 pack)
- 2 Sterile Gauze Dressings - 4" x 4" (2-in-1 pack)
- 1 Adhesive Tape Roll - 1/2" x 2.5 yds.
- 2 Examination Gloves
- 1 Instant Cold Compress
- 2 Antibiotic Ointments
- 12 Alcohol Prep Pads
- 6 Antiseptic Towelettes
- 1 First Aid Instruction Guide
- Content may change without notice

STOCK NO.	UPC NO.	DESCRIPTION	QTY. PKG.	SUGGESTED TRADE LIST PRICE PER
FAK100	62280	First Aid Kit (100 pieces)	1	35.13/pkg

OTHER SIZES AND QUANTITIES AVAILABLE BY REQUEST

FIRST AID KIT (170 PC)

In a sturdy polypropylene case, for easy storage.



Kit Contains:

- 20 Adhesive Bandages - 1" x 3"
- 20 Adhesive Bandages - 3/8" x 1-1/2"
- 20 Adhesive Bandages - 3" x 3/4"
- 5 Butterfly Closure Bandages
- 1 Adhesive Tape Roll - 1" x 5 yds.
- 1 Triangle Bandage - 40" x 40" x 56"
- 10 Cotton Tip Applicators
- 1 Eye Wash - 1 oz. Bottle
- 3 Finger Splints
- 1 First Aid Instruction Guide
- 8 Sterile Sponge Dressings - 2" x 2" (2-in-1 pack)
- 6 Sterile Sponge Dressings - 4" x 4" (2-in-1 pack)
- 2 Round Eye Pads - 2"
- 1 Gauze Roll - 2" x 4.1 yds.
- 1 Sterile Trauma Pad - 5" x 9"
- 4 Examination Gloves
- 12 Alcohol Prep Pads
- 12 Antiseptic Towelettes
- 3 Sting Relief Pads
- 3 Povidone Iodine Pads
- 6 Antibiotic Ointments
- 6 Burn Cream Packets
- 1 Instant Chemical Cold Packs 5" x 6"
- 1 Tweezer Safety Pin
- 1 Scissor
- 8 Non Aspirin Tablets
- 8 Aspirin Tablets
- 5 Safety Pins
- Content may change without notice

STOCK NO.	UPC NO.	DESCRIPTION	QTY. PKG.	SUGGESTED TRADE LIST PRICE PER
FAK170	62285	OSHA-ANSI Industrial First Aid Kit (170 pieces)	1	54.25/pkg

OTHER SIZES AND QUANTITIES AVAILABLE BY REQUEST

SHOE COVERS

This item provides a cost-effective solution to keeping dirt/contamination out of your workplace, office or home.



We offer two different kinds of shoe covers:

- **SCW** is the original white heavy duty skid proof sole.
- **SCB** is our multi-purpose waterproof heavy duty blue shoe cover.

STOCK NO.	UPC NO.	DESCRIPTION	QTY. PKG.	SUGGESTED TRADE LIST PRICE PER
SCW10	50030	Shoe Covers White w/Skid Proof Sole	10/pair	22.50
SCW20	50040	Shoe Covers White w/Skid Proof Sole	20/pair	42.50
SCW150	50035	Shoe Covers White w/Skid Proof Sole	150/pair	227.23
SCB10	50045	Shoe Covers Blue Multi-Purpose Waterproof	10/pair	22.50
SCB20	50055	Shoe Covers Blue Multi-Purpose Waterproof	20/pair	42.50
SCB150	50050	Shoe Covers Blue Multi-Purpose Waterproof	150/pair	227.23

Packaged in Bags of 10 & 20 pairs and Boxes of 150 pairs. Additional Package Quantities

[OTHER SIZES AND QUANTITIES AVAILABLE BY REQUEST](#)

NEW ABSORBENT RAGS



Packaging and Quantities:

BR001 1lb Bag of Rags

BR005 5lb Bag of Rags features a convenient handle in a E-Z Open resealable poly bag

BR025 25lb Box of Rags with E-Z Open top

STOCK NO.	UPC NO.	DESCRIPTION	QTY. PKG.	SUGGESTED TRADE LIST PRICE PER
BR001	71650	1-lb Bag of Rags	1-lb	7.85
BR005	71660	5-lb Plastic Bag of Rags with handle in a E-Z Open Bottom	5-lb	31.88
BR025	71669	25-lb Box of Rags in E-Z Open Cardboard Box	25-lb	90.00

OTHER SIZES AND QUANTITIES AVAILABLE BY REQUEST

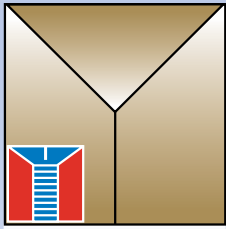

Metallics Header Cards & Shelf Tags Display

Metallics makes finding any product a snap. Our catalog color coordinates with our new color coded header cards and shelf tags.

NEW!
2014-2015

**[CONTRACTOR
APPROVED]**



EFC1



EFC3



EFC4



Screws &
Screw Kits



EFC8



Wafer Self Drill
Drywall Screw
8 x 1/2
JWSSIC

★ ★ ★ ★ ★ *"Growth Through Innovation"* ★ ★ ★ ★ ★

Metallics

229 Cross Street, Bristol, CT 06010
Tel 800-243-8272 • Fax 800-831-9358
Email sales@metallicsonline.com

Metallics West

651 North Main Street, Mancos, CO 81328
Tel 800-269-5183 • Fax 800-269-6278
Email saleswest@metallicsonline.com

FASTENER JAR SIZES

When a Distributor moves the fast-selling fastener items from the stock room to the display room, Metallics has the answer with the best Display Systems in the business.



**THE JOB SITE
AND
TRUCK SQUARE
PLASTIC JAR**



6 oz **8 oz** **15 oz**

19 oz **28 oz** **48 oz**

72 oz

COMES SINGLE OR FIVE PER SHRINK WRAP SLEEVE IN 6, 8 AND 15 OZ SIZES

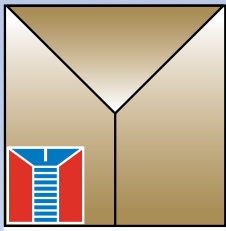

Metallics



QuaDrive Concrete Screw Anchor Display



[CONTRACTOR APPROVED]



CDQCSH10 Contains:

- 27 jars of the most common size Concrete Screw 1/4 X 1-1/4" QuaDrive.
- 100 pieces per jar.
- Free counter display and free shipping.



- Large fillet under head.
- Fluted interrupted threads.
- Twin lead threads.
- Silver seal coating (CraftCoat® 1000).

"Growth Through Innovation"

Metallics

229 Cross Street, Bristol, CT 06010
Tel 800-243-8272 • Fax 800-831-9358
Email sales@metallicsonline.com

Metallics West

651 North Main Street, Mancos, CO 81328
Tel 800-269-5183 • Fax 800-269-6278
Email saleswest@metallicsonline.com

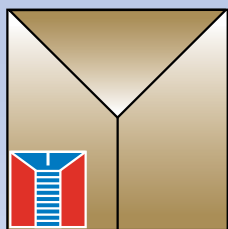

Metallics



Ultimate Anchor Kit Display Box



*This display box is stocked with a total of 40 kits.
Entire display and all the products ship prepaid.
Item# RACKU1*

The Rack-U1 display contains:

- 6 - UAK1's
- 6 - UAK2's
- 6 - UAK3's
- 6 - UAK4's
- 8 - PSA1J's
- 8 - ZSA1J's

★ ★ ★ ★ ★ "Growth Through Innovation" ★ ★ ★ ★ ★

Metallics

229 Cross Street, Bristol, CT 06010
Tel 800-243-8272 • Fax 800-831-9358
Email sales@metallicsonline.com

Metallics West

651 North Main Street, Mancos, CO 81328
Tel 800-269-5183 • Fax 800-269-6278
Email saleswest@metallicsonline.com



Avanti Screw Incorporated

Serving America's Fastener Distributors

CAPABILITIES LIST

PLANT SIZE:	100,000 Square Feet
LOCATION:	Bristol, Connecticut
EQUIPMENT:	27 Hi-Speed Cold Headers 8 Burr-Free Screw Slotters 3 Shank Slotters 2 Pointers 14 High Speed Thread Rollers

ADDITIONAL PLANT INFORMATION: Modern shipping facilities utilizing digital scale counting machines. In house packaging facilities – boxing, sorting, bagging. All material boxed, palletized & labeled with your needs in mind for domestic or export shipping.

SECONDARY WORK: All plating & heat treating is done on the outside and certified for your guarantee.

INFORMATION SYSTEMS: Our facility has new and upgraded Technology to meet your customers specific requirements.

We Make Screws It's that Simple

P.O. Box 1600 • 231 Cross Street
Bristol, CT 06011-1600
Tel: 800-984-8945 • Fax: 800-984-8946

THE QUADRIVE SYSTEM



QUADRIVE CONCRETE SCREW



CraftCoat® 1000 Coating

SCREWS FOR PLASTICS

Screws below available in type 'A' Gimlet point and can be shank slotted on request



What makes Avanti Special?

OUR SERVICES

TRU-TAP



Precision Tri-Lobular thread rolling screws that roll-form their mating threads in unthreaded pilot holes in various materials.

- We will ship direct to you or your customer
 - Inquire about our **Distributor Confidentiality Contract**
 - NOTE: Ask about **\$\$\$ Our Cash Distributor Purchase Incentives \$\$\$**
- Private labeling capabilities are available to your specifications

We can ship with your Label

00/00/0000

Your Logo here Your Name Any Name
 Your Street Your Street Any Street
 Your City, State, Zip Your City, State, Zip Any City, State, Zip

Customer # Sample
 Customer P.O.# Any PO number
 Order Number: 123456789

Part Number: Lot Number:

Customer Part Number:
 2-56 X 3/16 SPEC PAN HEAD SLOT U/C
 M/S

Gross Weight: Net Weight: Pieces:

Labels: Human Readable or Bar Coded

	your logo here
CUST PART NUMBER	Your Name Your Street Your City, State, Zip
Rev Level 999	Date Produced
Quantity 25000	Unit/Measure EA
PO Number 	LOT customer part description
	Customer your customer name your customer address your cust city, st, zip Our Part Number:

Product Packaging
now available upon request.



Our facility now offers
State of the Art
Optical Sorting

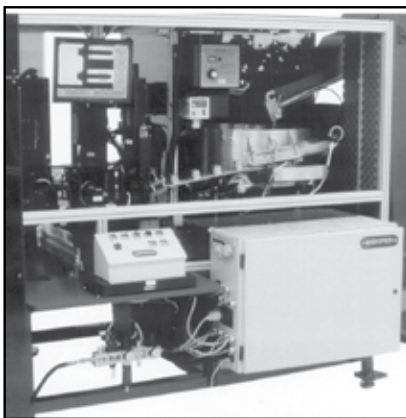

Now Proudly Featuring
Hard Body Packing
to you or your
Customer's Dock



CraftCoat® is a registered trademark of Donham Craft, Inc.

METALLICS

AMERICA'S SOURCE FOR PREMIER AND INNOVATIVE FASTENERS

Fastener Reference Guide

Measuring Threaded Fasteners (length)

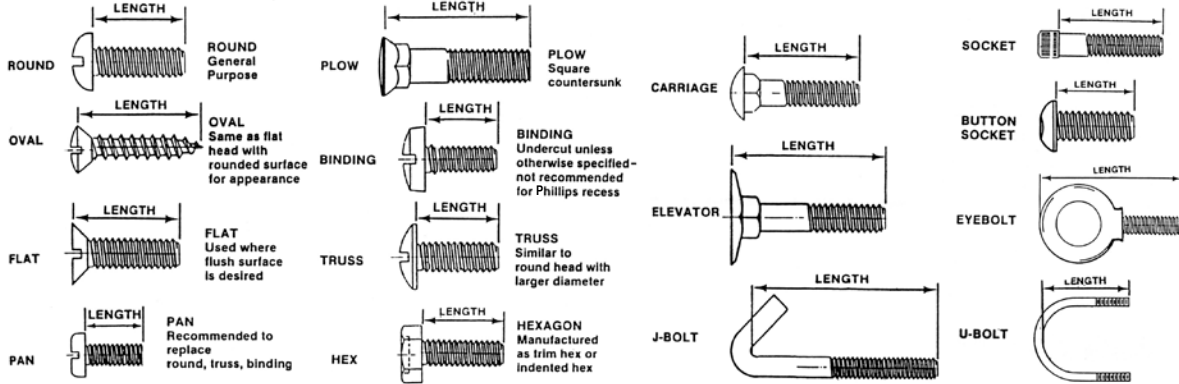

Fastener Identifier (D=Diameter)

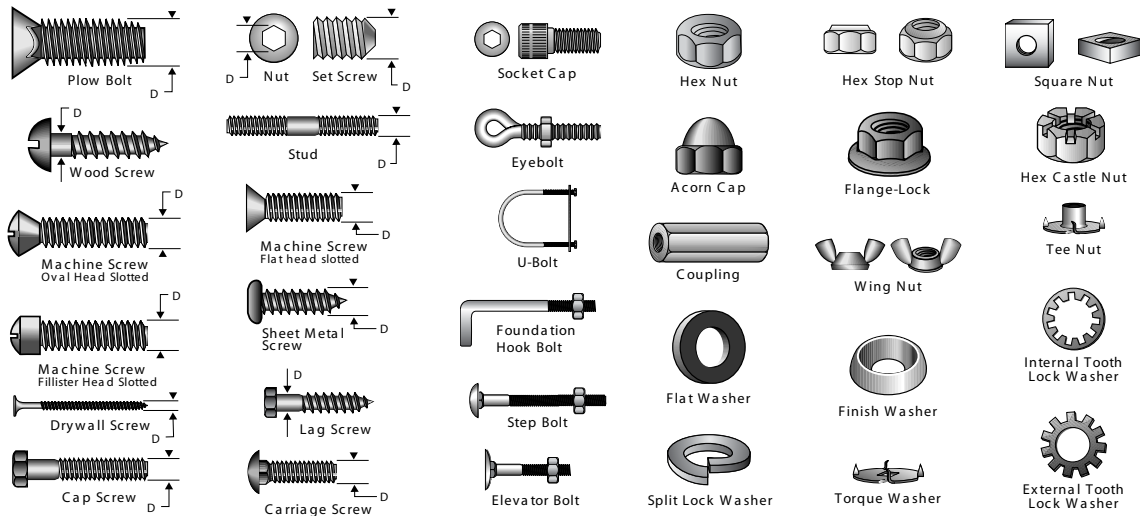

Head Styles

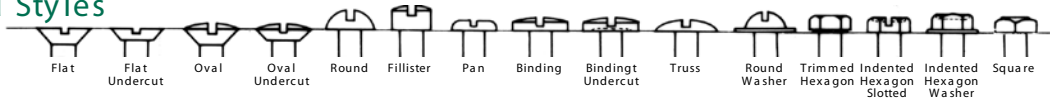

Measuring Threads

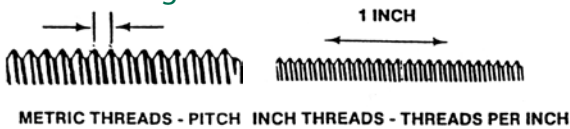

Head Markings of Fasteners

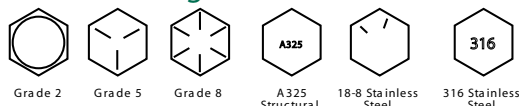

Driver Styles



To Select Phillips Driver Style

SCREW TYPE	SCREW DIAMETER & HEAD STYLE			BIT or DRIVER SIZE
	OVAL, PAN & FLAT	ROUND & FILLISTER	TRUSS & BRAZIER	
Machine & Tapping Screws	0 & 1	0 & 1	0 & 1	0
	2 thru 4	2 thru 4	2 thru 5	1
	5 thru 10	5 thru 10	6 thru 10	2
	12 thru 1/4	12 thru 5/16	12 thru 1/4	3
	5/16 thru 1/2	3/8 thru 1/2	5/16 thru 1/2	4
Wood Screws	0 & 1	0 & 1	0 & 1	0
	2 thru 4	2 thru 4	2 thru 5	1
	5 thru 9	5 thru 10	6 thru 10	2
	10 thru 16	11 thru 16	12 thru 16	3
	18 thru 24	18 thru 24	18 thru 24	4

#990030

QUICK REFERENCE PRODUCT INDEX

Part #:	PAGE										
00010B	266	1107	173	1415R	266	1552	151	440CT	276	AS1516	281
0006B	266	1108	173	1415T	266	1553	151	5022	165	AS34	281
0008B	266	110R2B	266	141F	177	1554	151	5022SS	166	AS58	281
000P1B	266	1110	173	141R	177	1560	151	5026	165	AS78	281
000P1X	265	1111	173	141T	177	1561	151	5026SS	166	AS916	281
000P2B	266	1114	173	1420CT	276	1562	151	5030SS	166	ASP1J	157
000P2X	265	1115	173	142F	177	1563	151	5040	165	ASP1K	157
000P3B	266	1116	173	142R	177	1564	151	5040SS	166	ASP1M	157
000P3X	265	1201	163	142T	177	1565	151	5060	165	ASPM1J	157
000R1B	266	1202	163	1434F	177	1566	151	50KOS	240	ASPM1K	157
000R2B	266	1203	163	1434T	177	1590	152	50KOSG	240	ASPM1M	157
000R2X	265	1204	163	1501	150	1591910	145	516CT	276	AT250	299
000R3B	266	1205	163	1502	150	1592	152	6222	165	AT350	299
00110B	266	1206	163	1503	150	1592SS	152	6230SS	166	ATEK1	214
00110X	265	1207	163	1504	150	1593	152	6242	165	AW34BLK	298
0014B	266	1208	163	1505	150	1593SS	152	6242SS	166		
0016B	266	1209	163	1506	150	1594	152	6256	165		
0016X	265	1210	163	1507	150	1595	152	632CT	276		
0018B	266	1211	163	1508	150	1596	152	6721	159	BA1	173
0018X	265	1212	163	1509	150	160R2B	266	6726	159	BA15	173
001P2B	266	1213CT	276	150KOS	240	160R3B	266	681032	229, 258	BA2	173
00HP18B	266	12510B	266	150KOSG	240	180R2B	266	7524	165	BA3	173
00HP32B	96	1256B	266	1511	150	200KOS	240	7524SS	166	BBH1	129
00SP10B	96, 266	1258B	266	1512	150	200KOSG	240	7542	165	BBH11	129
00SP12B	96	125KOS	240	1513	150	250KOS	240	7542SS	166	BBH13	129
00SP14B	96	125KOSG	240	1513910	145	250KOSG	240	7554SS	166	BBH14	129
00SP6B	96, 238, 266	125P1B	266	1514	150	2505	165	7562	165	BBH15	129
00SP8B	96, 238, 266	125P2B	266	1516	151	2512R	166	75KOS	240	BBH16	129
00TP10	96	125P3B	266	1517	151	2513	165	75KOSG	240	BBH17	129
00TP15	96	125R1B	266	1518	151	2513SS	166	832CT	276	BBH18	129
00TP20	96	125R2B	266	1519	151	2520F	166			BBH19	129
00TP25	96	125R3B	266	1520	151	2520R	166			BBH2	129
00TP27	96	1302	164	1521	151	2522	165			BBH23	129
00TP30	96	1303	164	1522	151	2522SS	166	AA68	179	BBH24	129
1001	159	1305	164	1523	151	2526R	166	AAK68	179	BBH25	129
10010B	266	1306	164	1524	151	2530F	166	AKK1532	200	BBH26	129
10010X	265	1307	164	1525	151	30001	269	AKK3764	200	BBH27	129
1002	159	1308	164	1528	151	300KOS	240	AKK516	200	BBH28	129
1003	159	1401	160	1529	151	300KOSG	240	AKK78	200	BBH29	129
1004	159	1401ST	160	1530	151	306MS0	284	AL1	281	BBH3	129
1004B	266	1402	160	1531	151	306MS1	284	AL1116	281	BBH30	129
1005	159	1402ST	160, 270	1532	151	306MS2	284	AL112	281	BBH32	129
1006	159	1403	160	1533	151	306MS3	284	AL114	281	BBH33	129
1006B	266	1403ST	160, 270	1534	151	306MS4	284	AL118	281	BBH34	129
1007	159	1404	160	1535	151	3114	165	AL1316	281	BBH35	129
1008B	266	1404ST	160, 270	1536	151	3114SS	166	AL138	281	BBH36	129
1008X	265	1406	160	1537	151	3124	165	AL1516	281	BBH37	129
100KOS	240	1406ST	160, 270	1538	151	3124SS	166	AL34	281	BBH38	129
100KOSG	240	1407	160	1539	151	3161F	177	AL58	281	BBH39	130
100P1B	266	1407ST	160, 270	1540	151	3161R	177	AL78	281	BBH4	129
100P1X	265	1408	160	1541	151	3161T	177	AL916	281	BBH41	130
100P2B	266	1408ST	160, 270	1542	151	32701	269	ALS14	214	BBH42	129
100P2X	265	1409	160	1543	151	350KOS	240	ALS15	214	BBH43	129
100P3B	266	1409ST	160, 270	1544	151	3717	165	ALSD	214	BBH44	129
100P3X	265	140P1B	266	1545	151	3717SS	166	AS1	281	BBH45	129
100R1B	266	140P2B	266	1546	151	3730	165	AS1116	281	BBH46	129
100R2B	266	140P3B	266	1547	151	3732	165	AS112	281	BBH47	129
100R3B	266	140R1B	266	1548	151	3730SS	166	AS114	281	BBH48	129
1024CT	276	140R2B	266	1549	151	3816CT	276	AS118	281	BBH5	129
1032CT	276	140R3B	266	1550	151	400KOS	240	AS1316	281	BBH51	129
1106	173	1415F	266	1551	151	400KOSG	240	AS138	281	BBH54	129

When Searching Stock # Drop "J"

QUICK REFERENCE PRODUCT INDEX

Part #:	PAGE										
BBH56	129	BHC21	122	BHC8	121	BLS32	136	BT3FO	299	CB33	135
BBH59	129	BHC22	121	BHC80	122	BLS32SS	137	BT3HVR	299	CB33G	135
BBH6	129	BHC23	121	BHC81	122	BLS33	136	BT3TPO	299	CB34	135
BBH61	129	BHC23G	122	BHC83	122	BLS34	136	BT3TVO	299	CB35	135
BBH64	129	BHC24	121	BHC85	122	BLS36	136	BT3UY	299	CB36	135
BBH65	129	BHC24G	122	BHC86	122	BLS36SS	137	BT6ER	300	CB4	135
BBH69	130	BHC25	121	BHC88	121	BLS37	136	BT6EY	300	CB40	135
BBH7	129	BHC26	121	BHC9	121	BLS38	136	BT6FO	300	CB42	135
BBH71	130	BHC27	121	BHC93	122	BLS39	136	BT6HVR	300	CB42SS	135
BBH73	130	BHC28	121	BHC94	122	BLS4	136	BT6TPO	300	CB55	135
BBH75	130	BHC29	121	BHC95	122	BLS40	136	BT6UY	300	CB55SS	135
BBH76	130	BHC2G	122	BHC96	122	BLS41	136	BTJ1	208	CB56	135
BBH77	130	BHC3	121	BHC97	122	BLS41G	137	BTJ2	208	CB56SS	135
BBH78	130	BHC30	121	BHC98	122	BLS42	136	BTJ3	208	CB6	135
BBH79	130	BHC31	122	BHC99	122	BLS44	136	BTJ4	208	CB7SS	135
BBH8	129	BHC32	121	BHD10	282	BLS45	136	BTJ6G	208	CB8	135
BBH80	130	BHC33	122	BHD11	282	BLS46	136	BTJK516	208	CB9	135
BBH81	129	BHC33G	122	BHD12	282	BLS49	136	BTT1	285	CCS50	249
BBH82	130	BHC34	122	BHD5	282	BLS4SS	137	BTT11	285	CCS50P	249
BBH84	130	BHC35	122	BHD6	282	BLS5	136	BTT12	285	CCS75	249
BBH85	130	BHC36	122	BHD7	282	BLS50	136	BTT13	285	CCS75P	249
BBH86	130	BHC36G	122	BHD8	282	BLS51	136	BTT14	285	CD1	150, 277
BBH87	130	BHC37	122	BHD9	282	BLS52	136	BTT15	285	CD2	150, 277
BBH88	129	BHC38	122	BLS1	136	BLS53	136	BTT16	285	CD3	150, 277
BBH89	130	BHC39	122	BLS10	136	BLS6	136	BTT2	285	CD5	150, 277
BBH90	130	BHC4	121	BLS11	136	BLS8	136	BTT22	285	CD6	150, 277
BC14	207	BHC41	122	BLS12	136	BLS88	136	BTT23	285	CD7	150, 277
BC38	207	BHC42	121	BLS12SS	137	BLW12	119	BTT25	285	CD8	150, 277
BE1418	283	BHC43	121	BLS13	136	BLW14	118	BTT26	285	CDQCSH10	143, 310
BE5618	283	BHC44	121	BLS13SS	137	BLW178	118	BTT4	285	CDS1	238
BE7612	283, 284	BHC45	121	BLS14	136	BLW34	119	BTT5	285	CDS2	238
BE7618	283, 284	BHC45G	122	BLS14SS	137	BLW38	119	BTT6	285	CDS3	238
BE7624	283	BHC46	122	BLS15	136	BLW516	118	BTT7	285	CDS5	239
BFR10	285	BHC46G	122	BLS16	136	BLW58	119	BTT8	285	CDS6	239
BFR11	285	BHC47	122	BLS18	136	BLW6	118	BTT9	285	CG1	277, 297
BFR12	285	BHC48	121	BLS1G	137	BLW8	118	BWSS12	116	CG101	253
BFR13	285	BHC49	121	BLS1SS	137	BR001	307	BWSS14	116	CG20	228
BFR14	285	BHC5	121	BLS2	136	BR005	307	BWSS34	116	CG20500	228
BFR15	285	BHC50	121	BLS20	136	BR025	307	BWSS38	116	CG32	277, 297
BFR16	285	BHC53	121	BLS21	136	BSC1012	28	CG77	253	CGT1	299
BFR17	285	BHC54	121	BLS21G	137	BSC1034	28	CAS5051	246	CN160	110
BFR18	285	BHC58	121	BLS21SS	137	BSC1038	28	CB1	135	CN163	110
BFR19	285	BHC59	121	BLS22	136	BSC141	28	CB101SS	135	CN163SS	110
BFR20	285	BHC6	121	BLS22G	137	BSC1412	28	CB101SS	135	CN164	110
BFR21	285	BHC60	121	BLS23	136	BSC1434	28	CB1SS	135	CN164SS	110
BFRB12	284	BHC61	121	BLS23SS	137	BSC1438	28	CB2	135	CN165	110
BFRB14	284	BHC63	121	BLS24	136	BSC1458	28	CB21	135	CN165SS	110
BFRB16	284	BHC64	122	BLS25	136	BSC5161	28	CB23	135	CNN1024	230
BFRB21	284	BHC65	122	BLS25G	137	BSC51612	28	CB23SS	135	CNN1024K	231
BHC1	121	BHC66	122	BLS26	136	BSC51634	28	CB24	135	CNN1032	230
BHC10	121	BHC67	122	BLS27	136	BSC51638	28	CB24SS	135	CNN1032K	231
BHC101	121	BHC68	122	BLS27G	137	BSC51658	28	CB25	135	CNN1224	230
BHC11	121	BHC69	122	BLS28	136	BSC51678	28	CB26	135	CNN1224K	231
BHC12	121	BHC7	121	BLS29	136	BSC612	28	CB26SS	135	COHB1	301
BHC13	121	BHC71	122	BLS2G	137	BSC614	28	CB28	135	CP1A	250
BHC14	121	BHC73	122	BLS2SS	137	BSC638	28	CB29	135	CP3S	250
BHC15	121	BHC75	122	BLS3	136	BSC812	28	CB2SS	135	CP4S	250
BHC16	121	BHC76	122	BLS30	136	BSC814	28	CB3	135	CPD1	88
BHC1G	122	BHC7612	122	BLS30G	137	BSC838	28	CB30	135	CPD1M	88
BHC2	121	BHC77	122	BLS30SS	137	BT3ER	299	CB31	135	CPC1V	88
BHC20	121	BHC79	122	BLS31	136	BT3EY	299				

When Searching Stock # Drop "J"

QUICK REFERENCE PRODUCT INDEX

Part #:	PAGE										
CPD2	88	CT1UV	193	DIA121SS	163	DS177SS	67	DWS1M	79	EB16	209
CPD2M	88	CT1UVB	193	DIA12SS	163	DS178	67	DWS3B	79	EB17	209
CPD2V	88	CT2	193	DIA12T	163, 270	DS179	67	DWS3C	79	EB2	208
CPD3	88	CT2UVB	193	DIA14	163	DS180	66	DWS3CD	77	EB3	208
CPD3M	88	CT2B	193	DIA141SS	163	DS181	66	DWS3M	79	EB3SS	209
CPD3V	88	CT3	193	DIA14SS	163	DS182	66	DWS3MD	77	EB32	209
CPD4	88	CT3YVB	193	DIA14T	163, 270	DS182SS	67	DWS4B	79	EB33	209
CPD4M	88	CT3B	193	DIA34	163	DS183	66	DWS4C	79	EB4	208
CPD4V	88	CT3CY	300	DIA34T	163, 270	DS183SS	67	DWS4CD	77	EB5	209
CPD5	88	CT3D	300	DIA38	163	DS184	66	DWS4M	79	EB6	208
CPD5M	88	CT3DNY	300	DIA38SS	163	DS184SS	67	DWS4MD	77	EB8	209
CPD5V	88	CT3HVY	300	DIA38T	163, 270	DS185	66	DWS5B	79	EB9	208
CPT1	177	CT3KOY	300	DIA381SS	163	DS185SS	67	DWS5C	79	EC44	214
CPT2	177	CT30TY	300	DIA58	163	DS186SS	67	DWS5CD	77	EFC1	308
CPT3	177	CT4	193	DIA58SS	163	DS187	67	DWS5M	79	EFC3	308
CS50	249	CT4B	193	DIA58T	163, 270	DS187SS	67	DWS5MD	77	EFC4	308
CS50P	249	CT4UV	193	DLC1	212	DS80	66	DWS6B	79	EFC8	308
CS75	249	CT4UVB	193	DLC1S	212	DS81	66	DWS6C	79	ELR2	173
CS75P	249	CT5	193	DLC2	212	DS84	66	DWS6M	79	ELR3	173
CSF10F	146	CT5B	193	DLC2/0	212	DS85	67	DWS7B	79	EVBK100	97
CSF1F	146	CT5UV	193	DLC3	212	DSK10	99	DWS7C	79	EZSTPL1C	245
CSF20F	146	CT5UVB	193	DLC3S	212	DSK12	99	DWS7M	79	EZSTPL2M	245
CSF2F	146	CT6	193	DLC4	212	DSK8	99	DWS9B	79	EZSTPL5C	245
CSF2SS	146	CT6B	193	DP1	171	DT1032	281	DWS9C	79	EZT1	189
CSF30F	146	CT6UV	193	DP2	171	DT1213	281	DWS9M	79	EZT1J	189
CSF3F	146	CT6UVB	193	DP3	171	DT1420	281	DWSK1	81	EZT1K	189
CSF40F	146	CTA1	195	DP4	171	DT260	298	DWSR1B	86		
CSF4F	146	CTAH11SS	192	DP5	171	DT3816	281	DWSR1C	86		
CSF4SS	146	CTAH14S	192	DP6	171	DT3ER	300	DWSR1M	86		
CSF50F	146	CTAH7LP	192	DP7	171	DT3FO	300	DWSR3B	86	FA1	102
CSF5F	146	CTAH7MH	192	DP8	171	DT3HVR	300	DWSR3C	86	FAK100	304
CSF60F	146	CTAH7S	192	DS143	67	DT3TPO	300	DWSR3M	86	FAK170	305
CSF6F	146	CTKMP1	194	DS150	66	DT632	281	DWSR4B	86	FD8234	162
CSF70F	146	CTKMP1UV	194	DS151	66	DT6ER	300	DWSR4C	86	FHC1	212
CSH10F	145	CTKS1	194	DS152	66	DT6FO	300	DWSR4M	86	FHK1	213
CSH10SS	145	CTKS1UV	194	DS153	66	DT6HVR	300	DWSR5B	86	FHK2	213
CSH14RF	150	CTKTT1	194	DS154	66	DT6TPO	300	DWSR5C	86	FM100	47
CSH1F	145	CTKTT1UV	194	DS155	66	DT832	281	DWSR5M	86	FM100SS	48
CSH20F	145	CTUVA1	195	DS156	66	DWC10B	81	DWSR6B	86	FM101	47
CSH20SS	145	CW10	116	DS157	66	DWC1C	81	DWSR6C	86	FM101SS	48
CSH2F	145	CW11	116	DS158	66	DWC1M	81	DWSR6M	86	FM102	47
CSH30F	145	CW12	116	DS159	66	DWC3B	81	DWSR7B	86	FM102SS	48
CSH316RF	150	CW12SS	116	DS160	66	DWC3C	81	DWSR7C	86	FM103	47
CSH3F	145	CW14	116	DS161	66	DWC3M	81	DWSR7M	86	FM103SS	15
CSH40F	145	CWGC1	301	DS162	66	DWC4B	81	DWSR9B	86	FM104	47
CSH4F	145	CWGS1	301	DS162SS	67	DWC4C	81	DWSR9C	86	FM104SS	48
CSH50F	145			DS163	66	DWC4M	81	DWSR9M	86	FM105	47
CSH5F	145			DS164	66	DWC5B	81			FM106	24
CSH60F	145			DS165	66	DWC5C	81			FM107SS	15
CSH6F	145			DS166	66	DWC5M	81			FM109	24
CSH70F	145	DCA1	263	DS168	66	DWC6B	81			FM113	47
CST100	248	DCS1	249	DS169	66	DWC6C	81	EB1	208	FM114	24
CST100I	248	DCS1B	249	DS170	67	DWC7B	81	EB1SS	209	FM116	47
CST100P	248	DEA12	164	DS170SS	67	DWC7C	81	EB10	209	FM117	47
CST300	248	DEA14	164	DS171	67	DWC9B	81	EB11	209	FM123	47
CST350	248	DEA34	164	DS172	67	DWC9C	81	EB12	209	FM127	47
CST40	248	DEA38	164	DS173	67	DWC9M	81	EB124	209	FM128	47
CST40I	248	DEA516	164	DS174	67	DWS10B	79	EB13	209	FM129	24
CT1	193	DEA58	164	DS175	67	DWS10C	79	EB124SS	209	FM130	47
CT1B	193	DHD1	144	DS176	67	DWS1B	79	EB13SS	209	FM132	47
CT1HID	193	DHS5	280	DS177	67	DWS1C	79	EB14	209	FM134	24
		DIA12	163					EB15	209		

F

E

When Searching Stock # Drop "J"

QUICK REFERENCE PRODUCT INDEX

Part #:	PAGE										
FM135	47	FM92	47	FMP63SS	56	FSC658	29	FWP32	78	FWPB42	18
FM14	24	FM92SS	48	FMP64	16	FSC812	29	FWP32SS	19	FWPB43	18
FM140	46	FM93	47	FMP64SS	22	FSC834	29	FWP33	78	FWPB44	18
FM142	46	FM94	47	FMP65SS	23	FSC838	29	FWP33SS	19	FWPB45	17
FM144	46	FM95	47	FMP68	16	FSC858	29	FWP34	78	FWPB61	17
FM150	47	FM95SS	15	FMP68SS	22	FSCS1	141	FWP34SS	19	FWPB62	17
FM17	46	FM96	47	FMP69	16	FSCS10	141	FWP35	78	FWPB63	17
FM17SS	15	FM97SS	15	FMP69SS	22	FSCS2	141	FWP35SS	19	FWPB64	17
FM18	47	FM98	47	FMP70	16	FSCS20	141	FWP36	78	FWPB9	17
FM19	47	FM99	47	FMP70SS	22	FSCS3	141	FWP39	78		
FM194	47	FM99SS	48	FMP71SS	22	FSCS30	141	FWP39SS	20	G	
FM196	24	FMB100	21	FMP72	16	FSCS40	141	FWP40	78		
FM20	47	FMB103	21	FMP72SS	22	FSD141	165	FWP40SS	20	G5HC1	123
FM22	47	FMB106	21	FMP75	48	FSD142	165	FWP41	78	G5HC11	123
FM3	24	FMB107	21	FMP80	48	FSD1421	165	FWP41SS	20	G5HC119	123
FM30	24	FMB108	21	FMP80SS	56	FSD1431	165	FWP42	78	G5HC12	123
FM32	47	FMB30	21	FMP81	48	FSD144	165	FWP42SS	20	G5HC120	123
FM33	47	FMB48	21	FMP81SS	56	FST100	248	FWP43	78	G5HC121	123
FM33SS	48	FMB49	21	FMP82	48	FST100I	248	FWP43SS	20	G5HC122	123
FM35	47	FMB62	21	FMP82SS	22	FST300	248	FWP44	78	G5HC123	123
FM36	47	FMB76	21	FMP83	48	FST350	248	FWP44SS	20	G5HC13	123
FM39	24	FMB79	21	FMP83SS	22	FST40	248	FWP45	78	G5HC14	123
FM42	47	FMB80	21	FMP84	48	FST40I	248	FWP46	78	G5HC15	123
FM46	24	FMB83	21	FMP85	48	FT34BLK	298	FWP47	78	G5HC16	123
FM47	24	FMB85	21	FMP86	48	FTHM14	199	FWP48	78	G5HC18	123
FM48	47	FMB86	21	FMP87	48	FTHR01	199	FWP50	78	G5HC2	123
FM48SS	48	FMB87	21	FMP88	48	FTHS01	197	FWP61	78	G5HC20	123
FM50	47	FMB88	48	FMP89	48	FWK10	118	FWP62	78	G5HC21	123
FM51	47	FMB89	48	FMP92	16	FWP10	78	FWP65	78	G5HC23	123
FM6	24	FMB92	21	FMP92SS	22	FWP10SS	19	FWP65SS	19	G5HC24	123
FM62	24	FMB93	21	FMP93	16	FWP11	78	FWP67	78	G5HC25	123
FM63	46	FMB95	21	FMP93SS	22	FWP11SS	19	FWP67SS	19	G5HC26	123
FM63SS	15	FMB98	21	FMP94	16	FWP120	78	FWP9	78	G5HC27	123
FM65	47	FMB99	21	FMP94SS	22	FWP12SS	19	FWP9SS	19	G5HC28	123
FM66	47	FMK632	101	FMP96	16	FWP13	78	FWPB10	17	G5HC29	123
FM68	46	FMK832	101	FMP98	48	FWP13SS	19	FWPB11	17	G5HC3	123
FM69	47	FMKP632	56, 100	FMP99SS	23	FWP14	78	FWPB12	17	G5HC33	123
FM7	24	FMP100	48	FRT250	299	FWP14SS	19	FWPB13	17	G5HC34	123
FM72	47	FMP100SS	23	FSC101	29	FWP18	78	FWPB14	17	G5HC35	124
FM78	47	FMP101SS	23, 56	FSC1012	29	FWP18SS	19, 78	FWPB15	17	G5HC36	124
FM79	24	FMP103	16	FSC1034	29	FWP19SS	19, 78	FWPB16	17	G5HC37	124
FM8	24	FMP103SS	23, 56	FSC1038	29	FWP20	78	FWPB17	17	G5HC38	124
FM80	46	FMP104SS	23	FSC121	30	FWP20SS	19	FWPB18	17	G5HC4	123
FM81	46	FMP105SS	23	FSC12112	30	FWP21	78	FWPB19	17, 78	G5HC41	123
FM82	46	FMP127	16	FSC122	30	FWP21SS	19	FWPB20	17	G5HC42	123
FM82SS	48	FMP140	48	FSC141	29	FWP22	78	FWPB21	17	G5HC43	123
FM83	46	FMP140SS	22	FSC14114	29	FWP22SS	19, 78	FWPB22	17	G5HC44	123
FM83SS	48	FMP142	48	FSC1412	29	FWP23	78	FWPB23	17	G5HC45	123
FM84	47	FMP142SS	22	FSC1434	29	FWP23SS	19	FWPB24	17	G5HC46	123
FM84SS	48	FMP194	16	FSC1458	29	FWP24	78	FWPB27	18	G5HC47	123
FM85	47	FMP22	16	FSC381	30	FWP24SS	19	FWPB28	18	G5HC49	123
FM85SS	48	FMP30	16	FSC38112	30	FWP25	78	FWPB29	18	G5HC5	123
FM86	47	FMP31	16	FSC38114	30	FWP27	78	FWPB30	18	G5HC59	123
FM86SS	49	FMP47	16, 48	FSC3834	30	FWP28	78	FWPB31	18	G5HC6	123
FM87	47	FMP48	16	FSC5161	29	FWP28SS	19, 78	FWPB32	18	G5HC60	124
FM87SS	48	FMP48SS	22, 56	FSC516112	29	FWP29	78	FWPB33	18	G5HC62	124
FM88	47	FMP49	16	FSC516114	29	FWP29SS	19, 78	FWPB34	18	G5HC63	124
FM89	47	FMP49SS	22, 56	FSC51634	29	FWP30	78	FWPB38	18	G5HC64	123
FM9	24	FMP50SS	22	FSC612	29	FWP30SS	19	FWPB39	18	G5HC66	124
FM90	47	FMP51SS	22, 56	FSC634	29	FWP31	78	FWPB40	18	G5HC67	124
FM91	47	FMP63	48	FSC638	29	FWP31SS	19	FWPB41	18	G5HC68	124

When Searching Stock # Drop "J"

QUICK REFERENCE PRODUCT INDEX

Part #:	PAGE										
G5HC7	123	G8HC8	124	HAB9	213	HSD20E	260	HSSC27E	262	HW346	168
G5HC70	124	G8N163	103	HABD10	213	HSD20R	278	HSSC28E	262	HW34712	168
G5HC72	124	G8N164	103	HABD12	213	HSD20RE	260	HSSC29E	262	HW38238	168
G5HC73	124	G8N165	103	HAM3	172, 276	HSD21	278	HSSC2E	262	HW38312	168
G5HC74	124	G8N166	103	HCT19	193	HSD21E	260	HSSC3E	262	HW38434	168
G5HC75	124	G8N167	103	HCT21	193	HSD22	278	HSSC4E	262	HW5162	168
G5HC76	124	G8N168	103	HCT22	193	HSD22E	260	HSSC5E	262	HW516234	168
G5HC78	124	G8N169	103	HCT22UV	193	HSD23	278	HSSC6E	262	HW584	168
G5HC8	123	G8WW80	116	HDT14	96	HSD23E	260	HSSC7E	262	HW58434	168
G5HC80	124	G8WW81	116	HDT2	171	HSD24	278	HSSC8E	262	HW586	168
G5HC81	123	G9WW82	116	HFV114	116	HSD24E	260	HSSC9E	262		
G5HC82	124	G8WW83	116	HFV117	116	HSD24R	278	HTB1	130		
G5HC84	124	G8WW84	116	HG12	201	HSD24RE	260	HTB11	130		
G5HC85	124	G8WW85	116	HG14	201	HSD25	278	HTB13	130		
G5HC88	123	G8WW86	116	HG3132	201	HSD25E	260	HTB2	130		
G5N163	103	G8WW87	116	HG38	201	HSD26	278	HTB23	134	IBTK11	255
G5N164	103	GA1	173	HG4764	201	HSD26E	260	HTB24	134	IBTK13	255
G5N165	103	GA2	173	HG5564	201	HSD27	278	HTB25	134	IST1	250
G5N166	103	GA3	173	HG58	201	HSD27E	260	HTB26	134	IST3	250
G5N167	103	GDK13	280	HHN12	103	HSD28	278	HTB3	130	ITS5	250
G5N168	103	GDS0	80	HHN34	103	HSD28E	260	HTB33	134	IST6	250
G5N170	103	GDS1	80	HHN38	103	HSD28R	278	HTB34	134	IST7	250
G8HC1	124	GDS1M	80	HHN58	103	HSD28RE	260	HTB35	134	IT1000	146, 277
G8HC114	124	GDS1V	80	HK1	146, 277	HSD29	278	HTB39	130	ITSLEVE	146, 277
G8HC13	124	GDS2	80	HMC104SS	198	HSD29E	260	HTB4	130		
G8HC14	124	GDS2M	80	HMC24SS	198	HSD2E	260	HTB42	130	JC10	212
G8HC15	124	GDS2V	80	HMC32SS	198	HSD3	278	HTB43	130	JC10CBS	212
G8HC16	124	GDS3	80	HMC36SS	198	HSD3E	260	HTB44	130	JC10T	212
G8HC17	124	GDS3M	80	HMC40SS	198	HSD4	278	HTB45	134	JC10SS	212
G8HC2	124	GDS3V	80	HMC6SS	198	HSD4E	260	HTB46	134	JC12	212
G8HC20	124	GDS4	80	HMC88SS	198	HSD5	278	HTB47	134	JC12C	212
G8HC214	125	GDS4M	80	HR750	239	HSD5E	260	HTB48	134	JC12CB	212
G8HC23	125	GDS4V	80	HR770	239	HSD6	278	HTB49	130	JC12CSS	212
G8HC231	125	GDS5	80	HSCB85	291	HSD6E	260	HTB5	130	JC12M	212
G8HC2334	125	GDS5M	80	HSCD1	279	HSD7	278	HTB54	130	JC12SS	212
G8HC24	125	GDS5V	80	HSD1	278	HSD7E	260	HTB55	130	JC14	212
G8HC25	125	GDS6	80	HSD10	278	HSD8	278	HTB56	130	JC16	212
G8HC26	125	GDS6M	80	HSD10E	260	HSD8E	260	HTB59	134	JC16SS	212
G8HC28	125	GDS6V	80	HSD11	278	HSD9	278	HTB6	130	JC18CB	212
G8HC3	124	GDS7	80	HSD11E	260	HSD9E	260	HTB60	134	JC18SS	212
G8HC33	125	GDS7M	80	HSD12	278	HSDK1	279	HTB61	130		
G8HC34	125	GDS7V	80	HSD12E	260	HSDK2	279	HTB64	134		
G8HC343	125	GDSK1	99	HSD13	278	HSDK3	279	HTB71	134		
G8HC34312	125	GS20	224	HSD13E	260	HSSC10E	262	HTB72	134	KF12	292
G8HC35	125	GS20500	224	HSD14	278	HSSC11E	262	HTB73	134	KF24	292
G8HC37	125	GSH19	224	HSD14E	260	HSSC12E	262	HTB81	134	KKC12	199
G8HC38	125	GSH20	224	HSD15	278	HSSC13E	262	HTB82	130	KKC14	199
G8HC4	124	GSH20500	224	HSD15E	260	HSSC14E	262	HTB88	130	KKC34	199
G8HC42	124	GSH21	226	HSD16	278	HSSC15E	262	HTB89	134	KKC38	199
G8HC43	124	GSH21500	226	HSD16E	260	HSSC16E	262	HTB90	130	KKU12	200
G8HC46	125	GSH22	226	HSD16R	278	HSSC17E	262	HTB93	134	KKU14	200
G8HC47	125	GSH22500	226	HSD16RE	260	HSSC18E	262	HTB94	134	KKU34	200
G8HC48	125	GSH23	224	HSD17	278	HSSC19E	262	HW12	202	KKU38	200
G8HC5	124	GSH23500	224	HSD17E	260	HSSC1E	262	HW12234	168	KLB12	201
G8HC583	125			HSD18	278	HSSC20E	262	HW12312	168	KLB38	201
G8HC58312	125			HSD18E	260	HSSC21E	262	HW12434	168	KLB78	201
G8HC584	125			HSD19	278	HSSC22E	262	HW126	168		
G8HC58412	125	HAB10	213	HSD19E	260	HSSC23E	262	HW14	202		
G8HC6	124	HAB11	213	HSD1E	260	HSSC24E	262	HW14134	168		
G8HC76112	125	HAB12	213	HSD2	278	HSSC25E	262	HW14238	168		
G8HC76114	125	HAB13	213	HSD20	278	HSSC26E	262	HW345	168		

When Searching Stock # Drop "J"

QUICK REFERENCE PRODUCT INDEX

Part #:	PAGE										
LCS1230.....	147	M121200.....	267	MBJ1.....	254	MHTB1020.....	132	MHTB820.....	132	MPMP38.....	38
LCS1240.....	147	M12250.....	267	MBR100WS.....	241	MHTB1025.....	132	MHTB8201.....	133	MPMP410.....	38
LCS1250.....	147	M12600.....	267	MBR125.....	241	MHTB1030.....	132	MHTB825.....	132	MPMP48.....	38
LCS1260.....	147	M141200.....	267	MBR150.....	241	MHTB1035.....	132	MHTB8251.....	133	MPMP516.....	38
LCS3816.....	147	M14250.....	267	MBR150WS.....	241	MHTB1040.....	132	MHTB830.....	132	MPMP520.....	38
LCS3824.....	147	M142400.....	267	MBR200.....	241	MHTB1045.....	132	MHTB8301.....	133	MPMP612.....	38
LCS3830.....	147	M145000.....	267	MBR200WS.....	241	MHTB1050.....	132	MHTB835.....	132	MPMP616.....	38
LCS3840.....	147	M14600.....	267	MCS26.....	268	MHTB1055.....	132	MHTB8351.....	133	MPMP620.....	38
LCS3850.....	147	M15001.....	269	MCS46.....	268	MHTB1060.....	132	MHTB840.....	132	MPR20.....	303
LCSX1250.....	148	M1B.....	266	MCT10.....	193	MHTB1216.....	133	MHTB8401.....	133	MPR60.....	303
LCSX3850.....	148	M256.....	252	MCT12.....	193	MHTB1220.....	133	MHTB845.....	132	MPR70.....	303
LCY12.....	270	M257.....	251	MCT13.....	193	MHTB1225.....	133	MHTB850.....	132	MPROM.....	303
LLGC1.....	302	M259.....	251	MCT14.....	193	MHTB1230.....	133	MISTG1.....	264	MPS10.....	111
LLGS1.....	302	M3161200.....	267	MCT15BLK.....	193	MHTB1235.....	133	MKL100.....	220	MPS11.....	111
LW13.....	119	M381200.....	267	MDR114.....	241	MHTB1240.....	133	MLMT4.....	275	MPS12.....	111
LW14.....	119	M382400.....	267	MDR12.....	241	MHTB1245.....	133	MLMT6.....	275	MPS13.....	111
LW15.....	119	M38250.....	267	MDR58.....	241	MHTB1250.....	133	MLW010.....	115	MPS14.....	111
LW16.....	119	M38600.....	267	MDR78.....	241	MHTB1255.....	133	MLW012.....	115	MPS15.....	111
LW17.....	119	M591189.....	251	MDUC1.....	293	MHTB1260.....	133	MLW04.....	115	MPS16.....	111
LW18.....	119	M591189BL.....	251	MDUC5.....	293	MHTB310.....	131	MLW05.....	115	MPS17.....	111
LW19.....	119	M721168.....	251	MF100.....	288	MHTB312.....	131	MLW06.....	115	MPS18.....	111
LWIX4SS.....	119	M721189.....	251	MF125.....	288	MHTB316.....	131	MLW08.....	115	MPS19.....	111
LWIX5SS.....	119	M7510.....	252	MF150.....	288	MHTB320.....	131	MMO1606.....	257	MPT1.....	256
LW153.....	118	M7510S.....	252	MF200.....	288	MHTB320.....	131	MN10C.....	243	MQDC1614F.....	234
LW167.....	118	M7514.....	252	MF50.....	288	MHTB38.....	131	MN10HG.....	243	MQDC1614M.....	234
LW169.....	118	M7514S.....	252	MF75.....	288	MHTB410.....	131	MN10S.....	244	MQDC2218F.....	234
LW170.....	118	MA6.....	155, 176	MFB1254.....	284	MHTB412.....	131	MN112J.....	244	MQDC2218M.....	234
LW171.....	118	MAF5.....	155, 176	MFB1272.....	284	MHTB416.....	131	MN112TM.....	171	MRJ125.....	289
LW172.....	118	MAF5KJ.....	158	MFB1454.....	284	MHTB420.....	131	MN114J.....	244	MRJ50.....	289
LW172G.....	119	MAF6.....	155, 176	MFB1472.....	284	MHTB425.....	131	MN16C.....	243	MRST1420.....	188
LW173.....	118	MAF6KJ.....	158	MFB3854.....	284	MHTB430.....	131	MN16DP.....	244	MRST3816.....	188
LW174.....	118	MAF8.....	155, 176	MFB3872.....	284	MHTB48.....	131	MN16HG.....	243	MRV110.....	303
LW174G.....	119	MAF8KJ.....	158	MFF100.....	289	MHTB510.....	131	MN16S.....	244	MRV120.....	303
LW175.....	118	MAVSG.....	271	MFF125.....	289	MHTB512.....	131	MN16S50B.....	244	MRV140.....	303
LW175G.....	119	MAVSR.....	271	MFF150.....	289	MHTB516.....	131	MN16SP.....	244	MRV160.....	303
LW176.....	118	MAVSY.....	271	MFF200.....	289	MHTB520.....	131	MN1TM.....	171	MRV170.....	303
LW176G.....	119	MAW35SD.....	140	MFF25.....	289	MHTB525.....	131	MN20D50.....	242	MRV1NO.....	303
LW177.....	118	MAWD34.....	140	MFF75.....	289	MHTB530.....	131	MN212TM.....	171	MSCU.....	210
LW178.....	118	MBA25.....	191	MFFA100.....	288	MHTB535.....	131	MN2TM.....	171	MSCUR.....	210
LWK1.....	112	MBA50.....	191	MFHA125.....	288	MHTB540.....	131	MN30D50.....	242	MSC50.....	207
LWN7.....	119	MBB25.....	191	MFHA150.....	288	MHTB58.....	131	MN3TM.....	171	MSC50R.....	207
LWX1.....	119	MBB50.....	191	MFHA200.....	288	MHTB610.....	132	MN4F.....	243	MSC75.....	207
LWX12.....	119	MBC12.....	207	MFHA50.....	288	MHTB612.....	132	MN6F.....	243	MSC75R.....	207
LWX3.....	119	MBC14.....	207	MFHA75.....	288	MHTB616.....	132	MN6HG.....	243	MSCW12.....	109
LWX3SS.....	119	MBC38.....	207	MHC24.....	198	MHTB6161.....	133	MN8C.....	243	MSCW38.....	109
LWX4.....	119	MBHC1016.....	128	MHC28.....	198	MHTB620.....	132	MN8DP.....	244	MSCW516.....	109
LWX4SS.....	119	MBHC1020.....	128	MHC32.....	198	MHTB6201.....	133	MN8HG.....	243	MSG1.....	284
LWX5.....	119	MBHC1025.....	128	MHC36.....	198	MHTB625.....	132	MN8S.....	244	MSNR1213.....	109
LWX5SS.....	119	MBHC1030.....	128	MHC48.....	198	MHTB6251.....	133	MNBG1.....	264	MSNR1420.....	109
LWX6.....	119	MBHC1035.....	128	MHC52.....	198	MHTB6301.....	133	MNK1.....	172	MSNR3816.....	109
LWX6SS.....	119	MBHC1040.....	128	MHC6.....	198	MHTB635.....	132	MNK10.....	172	MSNS1213.....	109
LWX7.....	119	MBHC1045.....	128	MHC60.....	198	MHTB6351.....	133	MNK112.....	172	MSNS1420.....	109
LWX8.....	119	MBHC1216.....	128	MHC64.....	198	MHTB640.....	132	MNK2.....	172	MSNS3816.....	109
LWX8SS.....	119	MBHC1220.....	128	MHD14.....	146, 271	MHTB6401.....	133	MNK212.....	172	MSW010.....	114
LWX9.....	119	MBHC1225.....	128	MHD56.....	146, 271	MHTB645.....	132	MNK3.....	172	MSW012.....	114
LWX9SS.....	119	MBHC1230.....	128	MHOK24C.....	204	MHTB6451.....	133	MP20.....	197	MSW016.....	114
		MBHC1235.....	128	MHOK24M.....	204	MHTB68.....	132	MP20UV.....	197	MSW020.....	114
		MBHC1240.....	128	MHOK58C.....	205	MHTB810.....	132	MP25.....	197	MSW024.....	114
		MBHC1245.....	128	MHOK58M.....	205	MHTB812.....	132	MP25UV.....	197	MSW04.....	114
M		MBHC1250.....	128	MHTB1012.....	132	MHTB816.....	132	MPMP310.....	38	MSW05.....	114
M10.....	265	MBHC1260.....	128	MHTB1016.....	132	MHTB8161.....	133	MPMP36.....	38	MSW06.....	114
M10B.....	266										

When Searching Stock # Drop "J"

QUICK REFERENCE PRODUCT INDEX

Part #:	PAGE										
MSW08.....	114	MWCA25.....	169	NCC3.....	196	NPL188.....	240	PDW1C.....	83	PT40K.....	226
MSW20.....	120	MWCA50.....	169	NCC4.....	196	NS1812.....	240	PDW1CD.....	82	PT45.....	227
MSW21.....	120	MWCA100.....	169	NCC4BLK.....	196	NS1816.....	240	PDW1M.....	83	PTK1.....	177
MSW22.....	120	MWDM1.....	211	NCC6.....	196	NT14.....	190	PDW1MD.....	82	PTK2.....	177
MSW23.....	120	MWRC121010.....	234	NCC6BLK.....	196	NT316.....	190	PMP100.....	40	PTK3.....	177
MSW24.....	120	MWRC121038.....	234	NCC7.....	196	NT38.....	190	PMP101.....	40	PTS30.....	227
MSW25.....	120	MWRC121056.....	234	NHSD10.....	278	NYN159.....	108	PMP102.....	40	PTS40.....	227
MSWP120.....	120	MWRC12108.....	234	NHSD10E.....	261	NYN160.....	108	PMP103.....	40	PYLO1BLK.....	290
MSWS30.....	120	MWRC161410.....	234	NHSD11.....	278	NYN160SS.....	108	PMP1032.....	39, 43	PYLO1CAM.....	290
MSWS31.....	120	MWRC16146.....	234	NHSD11E.....	261	NYN161.....	108	PMP104.....	40		
MT208.....	265	MWRC221810.....	234	NHSD20.....	278	NYN161SS.....	108	PMP113.....	39	Q	
MT208B.....	266	MWRC22186.....	234	NHSD20E.....	261	NYN162.....	108	PMP114.....	39	QB1.....	282
MT208L.....	265	MWSC121010.....	234	NHSD21.....	278	NYN162SS.....	108	PMP13.....	39	QB10.....	282
MT208L4.....	259	MWSC12106.....	234	NHSD21E.....	261	NYN163.....	108	PMP20.....	43	QB11.....	282
MT208L6.....	259	MWSC161410.....	234	NHSD22.....	278	NYN163SS.....	108	PMP33.....	39	QB12.....	282
MT208LB.....	266	MWSC16146.....	234	NHSD22E.....	261	NYN164.....	108	PMP36.....	39	QB13.....	282
MT210.....	265	MWSC221810.....	234	NHSD25.....	278	NYN164SS.....	108	PMP4.....	43	QB14.....	282
MT210B.....	266	MWSC22186.....	234	NHSD25E.....	261	NYN165.....	108	PMP6.....	43	QB15.....	282
MT210L.....	265	MWTCT1.....	234	NHSD26.....	278	NYN165SS.....	108	PMP63.....	39, 43	QB16.....	282
MT210L4.....	259	MWTK1.....	233	NHSD26E.....	261	NYN166.....	108	PMP69.....	39	QB17.....	282
MT208L4B.....	259			NHSD28.....	278	NYN166SS.....	108	PMP75.....	39, 43	QB2.....	282
MT208L6B.....	259	N		NHSD28E.....	261	NYN167.....	108	PMP78.....	43	QB22.....	282
MT210L4B.....	259	N157.....	103	NHSD29.....	278	NYN167SS.....	108	PMP80.....	39	QB24.....	282
MT210L6.....	259	N159.....	103	NHSD29E.....	261	NYN168.....	108	PMP81.....	39	QB26.....	282
MT210L6B.....	259	N159BR.....	107	NHSD30.....	278	NYN168SS.....	108	PMP82.....	39	QB28.....	282
MT210LB.....	266	N160.....	103	NHSD30E.....	261	NYN172SS.....	108	PMP84.....	39, 43	QB29.....	282
MT212.....	265	N160BR.....	107	NHSD31.....	278	NYNK1.....	104	PMP85.....	39, 43	QB3.....	282
MT212B.....	266	N161.....	103	NHSD31E.....	261			PMP86.....	39, 43	QB31.....	282
MT212L.....	265	N161BR.....	107	NHSD35.....	278	O		PMP87.....	39	QB4.....	282
MT212L4.....	259	N162.....	103	NHSD35E.....	261	ORG1.....	102	PMP88.....	39, 43	QB5.....	282
MT212L4B.....	259	N162BR.....	107	NHSD36.....	278	ORG2.....	102	PMP89.....	39	QB6.....	282
MT212L6.....	259	N162BR.....	107	NHSD36E.....	261	OXIN1.....	292	PMP99.....	40	QB7.....	282
MT212L6B.....	259	N163.....	103	NHSD37.....	278			PSA1.....	187	QB8.....	282
MT212LB.....	266	N163BR.....	107	NHSD37E.....	261	P		PSA1J.....	187	QB9.....	282
MT25.....	251	N163G.....	107	NHSD43.....	278	P2P2.....	265	PSA1K.....	187	QCSH1.....	142
MT59.....	251	N163J.....	107	NHSD43E.....	261	P2P2B.....	266	PSA1M.....	187	QCSH10.....	142
MT72.....	251	N164.....	103	NHSD6.....	278	P2S8.....	265	PSAL2.....	187	QCSH10B.....	142
MT75.....	252	N165.....	103	NHSD6E.....	261	P2S8B.....	266	PSAL2J.....	187	QCSH1B.....	142
MTB.....	176	N165BR.....	107	NHSD7.....	278	PB2.....	146, 277	PSAL2K.....	187	QCSH2.....	142
MTC.....	176	N165G.....	107	NHSD7E.....	261	PB3.....	146, 277	PST100.....	248	QCSH20.....	142
MTKQ.....	258	N165J.....	107	NHSD8.....	278	PBH.....	146	PST100I.....	248	QCSH20B.....	142
MTKQ10.....	263	N166.....	103	NHSD8E.....	261	PCS125.....	246	PST40.....	248	QCSH2B.....	142
MTKQ9.....	263	N166G.....	107	NHSD9.....	278	PCS204.....	247	PST40I.....	248	QCSH3.....	142
MTW12.....	211	N167.....	103	NHSD9E.....	261	PCS212.....	247	PT30.....	226	QCSH30.....	142
MTW12-3M.....	211	N167G.....	107	NK1.....	111	PCS234.....	247	PT30B.....	227	QCSH30B.....	142
MTW12-4M.....	211	N168.....	103	NM010.....	106	PCS244.....	247	PT34BL.....	298	QCSH3B.....	142
MTW14M.....	211	N170.....	103	NM012.....	106	PCS254.....	247	PT34BR.....	298	QCSH40.....	142
MTW16.....	211	NA140.....	172	NM04.....	106	PCS264.....	247	PT34G.....	298	QCSH40B.....	142
MTW16SS1LB.....	211	NA141.....	172	NM05.....	106	PCS274.....	247	PT34GR.....	298	QCSHK1.....	142
MTW16SSP.....	211	NA1414.....	172	NM06.....	106	PCS284.....	247	PT340.....	298	QCSHK2.....	142
MTW17.....	211	NA1415.....	172	NM08.....	106	PCS294.....	247	PT34R.....	298	QDS152.....	68
MTW1725.....	211	NA141SS.....	172	NM16.....	106	PCS345.....	246	PT34W.....	298	QDS153.....	68
MTW18.....	211	NA1414SS.....	172	NM20.....	106	PD4112.....	162	PT34Y.....	298	QDS154.....	68
MUK1.....	256	NA142.....	172	NM24.....	106	PD8134.....	162	PT35.....	227	QDS156.....	68
MVT10.....	303	NA142SS.....	172	NP400.....	239	PDS1B.....	83	PT40.....	226	QDS158.....	68
MVT63.....	303	NA316.....	172	NP400B.....	239	PDS1C.....	83	PT40B.....	227	QDS171.....	68
MVT65.....	303	NAP1.....	241	NP580.....	240	PDS1CD.....	82	PT4010.....	228	QDS172.....	68
MVT90.....	303	NCC0.....	196	NP600.....	239	PDS1M.....	83	PT4010V.....	228	QDS174.....	68
MWBC1210.....	234	NCC1.....	196	NP660.....	239	PDS1MD.....	82	PT4012.....	228	QDS181.....	68
MWBC1613.....	234	NCC116.....	196	NP800.....	239	PDW1B.....	83	PT4012V.....	228	QDS182.....	68
MWBC2218.....	234	NCC2.....	196	NPL12.....	240			PT408.....	225		

When Searching Stock # Drop "J"

QUICK REFERENCE PRODUCT INDEX

Part #:	PAGE										
QDS183	68	R119	120	RJS2	249	RM90	42	RSB21	56	SBH23	126
QDS184	68	R120	120	RLC10	220	RM91	42	RSB22	56	SBH231	127
QDS185	68	R121	120	RLC5	220	RM92	42	RSB63	56	SBH234	127
QDS80	68	R122	120	RLCK10	220	RM93	42	RSB66	57	SBH236	127
QK1	69	R123	120	RLCK5	220	RM94	42	RSB72	57	SBH238	127
QK1M	69	RA1	173	RM100	42	RM95	42	RSB78	57	SBH252	127
QK10	69	RA15	173	RM101	42	RM96	42	RSB86	56	SBH253	127
QK10M	69	RA2	173	RM102	42	RM97	42	RSB89	56	SBH254	127
QK12114	69	RA3	173	RM103	42	RM98	42	RSB90	56	SBH255	127
QK15	69	RACKU1	311	RM104	42	RM99	42	RSB91	56	SBH24	126
QK15M	69	RCA12	164	RM105	42	RMB100	46	RSB92	56	SBH25	126
QK17	69	RCA38	164	RM113	42	RMB102	46	RSB93	56	SBH26	126
QK17M	69	RCA381	164	RM114	42	RMB104	46	RSB94	56	SBH28	126
QK19	69	RCG1	294	RM115	43	RMB105	46	RSB95	56	SBH29	126
QK19M	69	RCQ1	294	RM116	43	RMB113	46	RSB99	56	SBH3	125
QK20	69	RCT1	294	RM123	43	RMB140	46	RSBK1	101	SBH30	126
QK20M	69	RCT26	203	RM127	42	RMB22	46	RSBK2	101	SBH32	126
QK25	69	RCT26SS	203	RM128	42	RMB30	46	RSBK3	101	SBH33	126
QK25M	69	RCT27	203	RM130	43	RMB48	46	RSBK4	101	SBH332	127
QK30	69	RCT27SS	203	RM132	42	RMB49	46	RT1W	96	SBH334	127
QK30M	69	RCT28	203	RM133	42	RMB61	46	RT2	196	SBH336	127
QK5	69	RCT28SS	203	RM134	42	RMB62	46	RT2W	96	SBH337	127
QK5M	69	RCT28SS316	203	RM135	43	RMB63	46	RT34BLK	298	SBH339	127
QK59	69	RCT29	203	RM136	43	RMB64	46	RT3W	96	SBH34	126
QKK1	51	RCT29SS	203	RM140	42	RMB66	46	RTS14	290	SBH341	127
QTEKD1	75	RCT29SS316	203	RM142	42	RMB7	46	RTS19	290	SBH35	126
QTEKD12	75	RCT30	203	RM144	42	RMB73	46	RTS24	290	SBH350	126
QTEKD13	75	RCT30SS	203	RM150	42	RMB78	46	RTS35	290	SBH351	126
QTEKD14	75	RCT31	203	RM17	42	RMB8	46	RTS45	290	SBH353	127
QTEKD17	75	RCTL28	203	RM18	42	RMB83	46	RWAK1	58	SBH354	127
QTEKD18	75	RCTL29	203	RM19	42	RMB85	46	RWS10	66	SBH355	126
QTEKD19	75	RCTR27	203	RM190	42	RMB86	46	RWS11	66	SBH356	126
QTEKD2	75	RCTR28	203	RM20	42	RMB87	46	RWS12	66	SBH359	126
QTEKD20	75	RD4158	161	RM22	42	RMB88	46	RWS26	66	SBH37	126
QTEKD3	75	RD4200	161	RM23	42	RMB90	46	RWS27	66	SBH4	125
QTEKD4	75	RD4212	161	RM32	42	RMB91	46	RWS28	66	SBH41	125
QTEKD5	75	RD4300	161	RM33	42	RMB92	46	RWS29	66	SBH411	127
QTEKD6	75	RDS1	87	RM35	43	RMB93	46	RWS30	66	SBH412	125
QTEKD7	75	RDS1M	87	RM36	43	RMB94	46	RWS31	66	SBH42	125
QTEKD8	75	RDS1V	87	RM48	42	RMB95	46	RWS7	66	SBH421	127
		RDS2	87	RM50	43	RMB99	46	RWS8	66	SBH43	125
		RDS2M	87	RM51	43	RMK1032	100	RWS9	66	SBH435	127
		RDS2V	87	RM63	42	RMK1420	100			SBH44	126
		RDS3	87	RM65	43	RMK632	100			SBH45	126
		RDS3M	87	RM66	43	RMK832	100			SBH46	126
		RDS3V	87	RM68	42	RSB100	56	SAB10	268	SBH47	126
		RDS4	87	RM69	42	RSB100S	57	SAD13	279	SBH48	126
		RDS4M	87	RM71	43	RSB101	56	SAD21	279	SBH49	125
		RDS4V	87	RM72	43	RSB101S	57	SB300	240	SBH491	127
		RDS5	87	RM75	42	RSB102	56	SBH1	125	SBH5	125
		RDS5M	87	RM77	43	RSB103	56	SBH11	125	SBH502	126
		RDS5V	87	RM78	43	RSB103S	57	SBH12	126	SBH503	126
		RDS6	87	RM80	42	RSB104	56	SBH13	125	SBH51	125
		RDS6M	87	RM81	42	RSB104S	57	SBH131	127	SBH54	125
		RDS6V	87	RM82	42	RSB105	56	SBH14	126	SBH541	127
		RJK1	286, 287	RM83	42	RSB106	56	SBH142	127	SBH552	127
		RJK1B	286	RM84	42	RSB116	57	SBH15	126	SBH59	126
		RJK2	286, 287	RM85	42	RSB16	56	SBH16	126	SBH611	127
		RJK2B	286	RM86	42	RSB17	56	SBH17	126	SBH64	126
		RJK3	286, 287	RM87	42	RSB18	56	SBH19	126	SBH65	126
		RJK3B	286	RM88	42	RSB19	56	SBH2	125	SBH670	127
		RJS1	249	RM89	42	RSB20	56	SBH22	126	SBH671	127

When Searching Stock # Drop "J"

QUICK REFERENCE PRODUCT INDEX

Part #:	PAGE										
SBH672	127	SCW10	306	SE8	209	SHC3812	33	SHK1A	210	SMCS38161	218
SBH674	127	SCW150	306	SEA12	164	SHC38112	33	SHK2	210	SBDB2	219
SBH680	127	SCW20	306	SEA14	164	SHC38114	33	SHK2A	210	SMDB21	218
SBH71	126	SD12	283	SEA38	164	SHC38134	33	SHK2ASS	210	SMDH1	223
SBH74	126	SD15B	256	SEA516	164	SHC382	33	SHKS22	210	SME270	217
SBH760	127	SD34	283	SEDS10	280	SHC3834	33	SHK3	210	SMF100	288
SBH800	126	SD4W1	256	SES4115	246	SHC3858	33	SHK3SS	210	SMF125	288
SBH801	126	SD4W2	256	SES4215	246	SHC3878	33	SHK4	210	SMF150	288
SBH808	126	SD6W1	258	SES4312	246	SHC5161	32	SHK5	210	SMF200	288
SBH81	126	SD6W2	258	SES4412	246	SHC516112	32	SHSK1	215	SMF50	288
SBH811	127	SD78	283	SES4512	246	SHC516114	32	SHTB1	134	SMF75	288
SBH82	126	SDCP3	283	SES4612	246	SHC51612	32	SHTB11	134	SMHS10	223
SBH86	125	SDLC3	212	SFLN100	247	SHC516134	32	SHTB2	134	SMM14201	217
SBH88	126	SDR1B	256	SFNL125	247	SHC5162	32	SHTB23	134	SMM38161	217
SBH90	126	SDR2B	256	SFNL150	247	SHC516212	32	SHTB24	134	SMM514201	218
SBH91	126	SDR3B	256	SFNL200	247	SHC51634	32	SHTB25	134	SMM538161	218
SBH912	126	SDR4B	256	SFNL250	247	SHC51658	32	SHTB26	134	SMS1	216
SBH913	126	SDR5B	256	SFNL300	247	SHC51678	32	SHTB3	134	SMS5	216
SBH93	126	SDR6B	256	SFLN400	247	SHC581	34	SHTB33	134	SMSK1	223
SBH94	126	SDR7B	256	SFLN50	247	SHC58112	34	SHTB34	134	SMW14201	217
SBH941	127	SDS10	239	SFLN75	247	SHC58114	34	SHTB35	134	SMW38161	217
SBH951	127	SDS1265	283	SFN1024	108	SHC58134	34	SHTB35	134	SMWS14201	218
SBH96	126	SDS129	283	SFN1032	108	SHC582	34	SHTB36	134	SMWS38161	218
SBH961	127	SDS1445	283	SFN1213SS	108	SHC58212	34	SHTB4	134	SMX1	222
SBH981	127	SDS1465	283	SFN1420	108	SHC58214	34	SHTB41	134	SMX125	222
SBH990	127	SDS149	283	SFN3816	108	SHC58234	34	SHTB42	134	SMX2	222
SBH991	127	SDS1B	84	SFN51618	108	SHC583	34	SHTB44	134	SMXB1	222
SBH992	127	SDS1C	84	SFN832	108	SHC58312	34	SHTB45	134	SMXK1	222
SBHK1212	54	SDS1M	84	SH1	210	SHC584	34	SHTB46	134	SMXP35	222
SBHK1420	54	SDS20	239	SH2	210	SHC58412	34	SHTB47	134	SMXP3525	222
SBHK3816	54	SDS30	239	SH3	210	SHC585	34	SHTB48	134	SN10	103
SBN12	107	SDS31645	283	SHC101	31	SHC61	31	SHTB49	134	SN11	103
SBN14	107	SDS31665	283	SHC10112	31	SHC612	31	SHTB59	134	SN12	103
SBN24	107	SDS3168	283	SHC10114	31	SHC614	31	SHTB60	134	SN13	103
SBN32	107	SDS3465	283	SHC1012	31	SHC634	31	SHTBK1	52	SN14	103
SBN38	107	SDS3865	283	SHC10134	31	SHC638	31	SHUBC38	206	SN14316SS	107
SBN516	107	SDS389	283	SHC102	31	SHC658	31	SHW3816	219	SN15	103
SBN58	107	SDS3B	84	SHC1034	31	SHC7121	33	SLN12	207	SN15316SS	107
SBN6	107	SDS3C	84	SHC1038	31	SHC712112	33	SLN14	207	SN16	103
SBN8	107	SDS3M	84	SHC1058	31	SHC712114	33	SLN38	207	SN16316SS	107
SBW12	113	SDS4B	84	SHC1078	31	SHC712134	33	SLN516	207	SN18	103
SBW14	113	SDS4C	84	SHC141	32	SHC7122	33	SLNK1	207	SN19	103
SBW36	113	SDS4M	84	SHC14112	32	SHC712212	33	SLNK2	207	SN19316SS	107
SBW38	113	SDS5865	283	SHC14114	32	SHC7123	33	SLSP50	232	SN20	103
SBW516	113	SDS589	283	SHC1412	32	SHC712312	33	SLW10	118	SN20316SS	107
SBW58	113	SDS5B	84	SHC14134	32	SHC71234	33	SLW101	118	SN25316SS	107
SBW6	113	SDS5C	84	SHC142	32	SHC7124	33	SLW11	118	SNK1	107
SBW8	113	SDS5M	84	SHC1434	32	SHC7161	33	SLW111	118	SP170	235
SCB10	306	SDS7B	84	SHC1438	32	SHC716112	33	SLW12	118	SP172	235
SCB150	306	SDS7C	84	SHC1458	32	SHC716114	33	SLW4	118	SP173	235
SCB20	306	SDS7M	84	SHC1478	32	SHC716134	33	SLW5	118	SP176	235
SCC12	196	SDS9B	84	SHC34112	34	SHC7162	33	SLW6	118	SP177	235
SCC14	196	SDS9C	84	SHC34114	34	SHC71634	33	SLW7	118	SP178	235
SCC316	196	SDS9M	84	SHC34134	34	SHC81	31	SLW71	118	SP179	235
SCC34	196	SE1	209	SHC342	34	SHC812	31	SL28	118	SP180	235
SCC38	196	SE10	209	SHC34212	34	SHC814	31	SLW81	118	SP181	235
SCC58	196	SE2	209	SCH34214	34	SHC834	31	SLW9	118	SP182	235
SCC78	196	SE3	209	SHC343	34	SHC838	31	SLW91	118	SP190	235
SCK1	221	SE4	209	SHC34312	34	SHC858	31	SLW92	118	SP191	235
SCT6215	246	SE5	209	SHC344	34	SHC878	31	SMC14201	217	SP279	235
SCT6315	246	SE6	209	SHC345	34	SHK0ASS	210	SMC38161	217	SP280	235
SCT6415	246	SE7	209	SHC381	33	SHK1	210	SMCS14201	218	SP281	235

When Searching Stock # Drop "J"

QUICK REFERENCE PRODUCT INDEX

Part #:	PAGE										
SP282.....	235	SRM13.....	44	SRM97.....	44	SSW12.....	112	STSP37.....	64	TBH516.....	208
SP283.....	235	SRM132.....	44	SRT14.....	152	SSW121.....	113	STSP39.....	64	TBMK1.....	153
SP379.....	235	SRM133.....	44	SS141.....	26	SSW13.....	112	SW68.....	112	TC1.....	286
SP380.....	235	SRM134.....	44	SS14112.....	26	SSW131.....	113	SW70.....	112	TD4112.....	162
SP382.....	235	SRM136.....	44	SS14114.....	26	SSW14.....	112	SW71.....	112	TDS13.....	280
SPD379.....	236	SRM137P.....	45	SS1412.....	26	SSW141.....	113	SW72.....	112	TEK10P.....	70
SPD380.....	236	SRM138P.....	45	SS1414.....	26	SSW15.....	112	SW73.....	112	TEK11P.....	70
SPD381.....	236	SRM139P.....	45	SS14316.....	26	SSW151.....	113	SW73G.....	113	TEK12P.....	70
SPD382.....	236	SRM13P.....	45	SS1434.....	26	SSW17.....	112	SW74.....	112	TEK14P.....	70
SPD383.....	236	SRM14.....	44	SS1438.....	26	SSW171.....	113	SW75.....	112	TEK15P.....	70
SPD384.....	236	SRM140P.....	45	SS14516.....	26	SSW18.....	113	SW75G.....	113	TEK16P.....	70
SPD385.....	236	SRM144.....	44	SS1458.....	26	SSW20.....	112	SW76.....	112	TEK18P.....	70
SPDK200.....	236	SRM146.....	44	SS1478.....	26	SSW201.....	113	SW76G.....	113	TEK19P.....	70
SPK100.....	235	SRM148.....	44	SS241.....	25	SSW8.....	112	SW77.....	112	TEK20P.....	70
SPK101.....	235	SRM148P.....	45	SS2412.....	25	SSWK1.....	112	SW77G.....	113	TEK1P.....	70
SPMP1SS.....	45	SRM14P.....	45	SS2414.....	25	ST34BLK.....	298	SW78.....	112	TEK2P.....	70
SPMP15SS.....	45	SRM15.....	44	SS24316.....	25	STS10.....	64	SW79.....	112	TEK3P.....	70
SPMP16SS.....	45	SRM15P.....	45	SS2434.....	25	STS11.....	64	SW80.....	112	TEK4P.....	70
SPMP17SS.....	45	SRM16.....	44	SS2438.....	25	STS12.....	64	SW82.....	112	TEK7P.....	70
SPMP2SS.....	45	SRM17.....	44	SS24516.....	25	STS13.....	64	SWA1236.....	170	TEKD1.....	70
SPMP20SS.....	45	SRM17P.....	45	SS2458.....	25	STS14.....	64	SWA1244.....	170	TEKD10.....	71
SPMP21SS.....	45	SRM18.....	44	SS2478.....	25	STS15.....	64	SWA1254.....	170	TEKD10SS.....	71
SPMP23SS.....	45	SRM19.....	44	SS321.....	26	STS16.....	64	SWA1270.....	170	TEKD11.....	71
SPMP29SS.....	45	SRM190.....	44	SS3212.....	26	STS17.....	64	SWA3830.....	170	TEKD12.....	71
SPMP3SS.....	45	SRM19P.....	45	SS3214.....	26	STS18.....	64	SWA3836.....	170	TEKD12SS.....	71
SPMP33SS.....	45	SRM20.....	44	SS32316.....	26	STS19.....	64	SWA3850.....	170	TEKD12212.....	71
SPMP35SS.....	45	SRM20P.....	45	SS3234.....	26	STS20.....	64	SWA5850.....	170	TEKD13.....	71
SPMP38SS.....	45	SRM21.....	44	SS3238.....	26	STS21.....	64	SWA5860.....	170	TEKD14.....	70
SPMP4SS.....	45	SRM21P.....	45	SS32516.....	26	STS22.....	64	SWA5870.....	170	TEKD14SS.....	71
SPMP5SS.....	45	SRM22.....	44	SS3258.....	26	STS23.....	64	SWA5884.....	170	TEKD15.....	70
SPMP7SS.....	45	SRM23.....	44	SS3381.....	27	STS24.....	64	SWBR12.....	113	TEKD15SS.....	71
SPMP78SS.....	45	SRM23P.....	45	SS3812.....	27	STS25.....	64	SWBR14.....	113	TEKD16.....	70
SPMP80SS.....	45	SRM24.....	44	SS3814.....	27	STS26.....	64	SWBR16.....	113	TEKD17.....	70
SPN1.....	197	SRM24P.....	45	SS3834.....	27	STS27.....	64	SWBR38.....	113	TEKD18.....	70
SPN12.....	197	SRM25.....	44	SS3838.....	27	STS28.....	64	SWBR6.....	113	TEKD19.....	70
SPN14.....	197	SRM26.....	44	SS3858.....	27	STSP10.....	64	SWBR8.....	113	TEKD1SS.....	71
SPN300.....	236	SRM27.....	44	SS3878.....	27	STSP11.....	64	SWK1.....	112	TEKD2.....	70
SPN316.....	197	SRM27P.....	45	SS5161.....	26	STSP12.....	64	SWL1212.....	211	TEKD20.....	70
SPN34.....	197	SRM28.....	44	SS51612.....	26	STSP125.....	64	SWL612.....	211	TEKD20SS.....	70
SPN38.....	197	SRM29.....	44	SS51614.....	26	STSP13.....	64	SWN1.....	113	TEKD21.....	71
SPN58.....	197	SRM30.....	44	SS51634.....	26	STSP14.....	64	SWN73.....	113	TEKD22.....	71
SPN78.....	197	SRM30P.....	45	SS51638.....	26	STSP15.....	64	SWN74.....	113	TEKD22SS.....	71
SPS5151.....	247	SRM31.....	44	SS516516.....	26	STSP16.....	64	SWP1212.....	211	TEKD23.....	70
SPT200.....	237	SRM31P.....	45	SS51658.....	26	STSP17.....	64	SWP612.....	211	TEKD23SS.....	71
SPT300.....	237	SRM32.....	44	SS51678.....	26	STSP18.....	64	SWPK1.....	156	TEKD24.....	70
SPT400.....	237	SRM32P.....	45	SS612.....	25	STSP19.....	64	SYA14.....	173	TEKD25.....	70
SQ2.....	110	SRM33.....	44	SS614.....	25	STSP20.....	64	SYA316.....	173	TEKD26.....	70
SQ3.....	110	SRM33P.....	45	SS634.....	25	STSP21.....	64	SYA516.....	173	TEKD3.....	70
SQ4.....	110	SRM50.....	44	SS638.....	25	STSP22.....	64			TEKD30.....	71
SQ5.....	110	SRM51.....	44	SS658.....	25	STSP23.....	64			TEKD32.....	71
SQ6.....	110	SRM60.....	44	SS81.....	25	STSP24.....	64			TEKD34.....	71
SQ7.....	110	SRM61.....	44	SS812.....	25	STSP25.....	64	TA14134.....	159	TEKD36.....	71
SQ8.....	110	SRM66.....	44	SS814.....	25	STSP26.....	64	TA14212.....	159	TEKD37.....	71
SQ9.....	110	SRM71.....	44	SS8316.....	25	STSP27.....	64	TA14314.....	159	TEKD4.....	70
SRM10.....	44	SRM74.....	44	SS834.....	25	STSP28.....	64	TS83814.....	159	TEKD5.....	70
SRM100.....	44	SRM74P.....	45	SS838.....	25	STSP29.....	64	TA38334.....	159	TEKD5SS.....	71
SRM100P.....	45	SRM85.....	44	SS8516.....	25	STSP30.....	64	TA38412.....	159	TEKD6.....	70
SRM101P.....	45	SRM85P.....	45	SS858.....	25	STSP32.....	64	TA516212.....	159	TEKD6SS.....	71
SRM102P.....	45	SRM90.....	44	SSGA1.....	301	STSP33.....	64	TA516314.....	159	TEKD7.....	70
SRM11.....	44	SRM90P.....	45	SSGC1.....	301	STSP33.....	64	TA516334.....	159	TEKD7SS.....	71
SRM11P.....	45	SRM95.....	44	SSW10.....	112	STSP34.....	64	TBH14.....	208	TEKD8.....	71
SRM12.....	44	SRM95P.....	45	SSW11.....	112	STSP35.....	64	TBH38.....	208	TEKD82.....	70

When Searching Stock # Drop "J"

QUICK REFERENCE PRODUCT INDEX

Part #:	PAGE										
TEKD9.....	71	TM83LP.....	237	TP131SBC.....	59	TP219SBC.....	93	TP315SPC.....	94	TP415SRC.....	94
TEKD9SS.....	71	TMS1SS.....	238	TP131SFC.....	14	TP219SFC.....	93	TP316SFC.....	94	TP416SRC.....	94
TEKD99.....	71	TMS2SS.....	238	TP132SBC.....	59	TP220SBC.....	93	TP316SPC.....	94	TP418SRC.....	94
TEKDK1.....	100	TMSK1.....	55	TP133SBC.....	59	TP220SFC.....	93	TP317SFC.....	94	TP419SRC.....	94
TEKDK1SS.....	72	TOB1.....	200	TP133SFC.....	14	TP222SFC.....	37	TP317SPC.....	94	TP420SRC.....	94
TEKPK1.....	53, 100	TP100SBC.....	93	TP134SBC.....	59	TP223SBC.....	49	TP318SFC.....	94	TP421SRC.....	94
TEKPK1SS.....	100	TP100SFC.....	93	TP134SFC.....	14	TP223SFC.....	37	TP318SPC.....	94	TP422SRC.....	94
TEKS1.....	69	TP101SBC.....	93	TP135SBC.....	59	TP224SBC.....	49	TP319SFC.....	94	TP423SRC.....	94
TEKS14.....	69	TP101SFC.....	93	TP135SFC.....	14	TP224SFC.....	37	TP319SPC.....	94	TP424SRC.....	90
TEKS15.....	69	TP102SBC.....	93	TP136SBC.....	59	TP225SBC.....	49	TP320SFC.....	94	TP425SRC.....	90
TEKS19.....	69	TP102SFC.....	93	TP136SFC.....	14	TP225SFC.....	37	TP320SPC.....	94	TP426SRC.....	90
TEKS2.....	69	TP103SBC.....	93	TP137SBC.....	59	TP226SBC.....	49	TP321SFC.....	94	TP427SRC.....	90
TEKS3.....	69	TP103SFC.....	93	TP137SFC.....	14	TP226SFC.....	37	TP321SPC.....	94	TP428SRC.....	90
TEKS5.....	69	TP104SBC.....	93	TP138SBC.....	59	TP227SBC.....	49	TP322SFC.....	94	TP500SBC.....	95
TEKS6.....	69	TP104SFC.....	93	TP138SFC.....	14	TP227SFC.....	37	TP322SPC.....	94	TP500SFC.....	95
TEKS7.....	69	TP105SBC.....	93	TP139SBC.....	59	TP228SBC.....	49	TP323SFC.....	94	TP501SBC.....	95
TEKS8.....	69	TP105SFC.....	93	TP139SFC.....	14	TP228SFC.....	37	TP323SPC.....	94	TP501SFC.....	95
TEKSK1.....	100	TP106SBC.....	93	TP140SBC.....	59	TP229SBC.....	49	TP324SFC.....	35	TP502SBC.....	95
TEL1024BLK..	50, 229	TP106SFC.....	93	TP140SFC.....	14	TP229SFC.....	37	TP341SPC.....	35	TP502SFC.....	95
TEL1032BLK..	50, 229	TP107SBC.....	93	TP141SBC.....	59	TP230SBC.....	49	TP326SFC.....	35	TP503SBC.....	95
TEL1224.....	229	TP107SFC.....	93	TP141SFC.....	14	TP230SFC.....	37	TP327SFC.....	35	TP503SFC.....	95
TEL1224BLK..	50, 229	TP108SBC.....	93	TP142SBC.....	59	TP231SBC.....	49	TP328SFC.....	35	TP504SBC.....	95
TEL1228.....	229	TP108SFC.....	93	TP142SFC.....	14	TP231SFC.....	37	TP329SFC.....	35	TP504SFC.....	95
TG9151.....	73	TP109SBC.....	93	TP143SBC.....	59	TP232SBC.....	49	TP330SFC.....	35	TP505SBC.....	95
TGA10.....	154	TP109SFC.....	93	TP143SFC.....	14	TP232SFC.....	37	TP331SFC.....	35	TP505SFC.....	95
TGA10K.....	154	TP110SBC.....	93	TP144SBC.....	59	TP233SBC.....	49	TP332SPC.....	41	TP506SBC.....	95
TGA10J.....	154	TP110SFC.....	93	TP144SFC.....	14	TP233SFC.....	37	TP333SFC.....	35	TP506SFC.....	95
TGA12.....	154	TP111SBC.....	93	TP145SBC.....	59	TP234SBC.....	49	TP333SPC.....	41	TP507SBC.....	95
TGA12K.....	154	TP111SFC.....	93	TP200SBC.....	93	TP234SFC.....	37	TP334SFC.....	35	TP507SFC.....	95
TGA12J.....	154	TP112SBC.....	93	TP200SFC.....	93	TP235SFC.....	37	TP334SPC.....	41	TP508SBC.....	95
TGA6.....	154	TP112SFC.....	93	TP201SBC.....	93	TP236SFC.....	37	TP335SFC.....	35	TP508SFC.....	95
TGA6K.....	154	TP113SBC.....	93	TP201SFC.....	93	TP300SFC.....	94	TP335SPC.....	41	TP509SBC.....	95
TGA6J.....	154	TP113SFC.....	93	TP202SBC.....	93	TP300SPC.....	94	TP336SFC.....	35	TP509SFC.....	95
TGA8.....	154	TP114SBC.....	93	TP202SFC.....	93	TP301SFC.....	94	TP336SPC.....	41	TP510SBC.....	95
TGA8K.....	154	TP114SFC.....	93	TP204SBC.....	93	TP301SPC.....	94	TP337SFC.....	35	TP510SFC.....	95
TGA8J.....	154	TP115SBC.....	93	TP204SFC.....	93	TP302SFC.....	94	TP337SPC.....	41	TP511SBC.....	95
TGW9151.....	73	TP115SFC.....	93	TP205SBC.....	93	TP302SPC.....	94	TP338SFC.....	35	TP511SFC.....	95
THSK1.....	83	TP116SBC.....	93	TP205SFC.....	93	TP303SFC.....	94	TP338SPC.....	41	TP512SBC.....	95
TL12.....	201	TP116SFC.....	93	TP206SBC.....	93	TP303SPC.....	94	TP339SFC.....	35	TP512SFC.....	95
TS38.....	201	TP117SBC.....	93	TP206SFC.....	93	TP304SFC.....	94	TP340SFC.....	35	TP513SBC.....	95
TL516.....	201	TP117SFC.....	93	TP207SBC.....	93	TP304SPC.....	94	TP341SFC.....	35	TP513SFC.....	95
TL78.....	201	TP118SBC.....	93	TP207SFC.....	93	TP305SFC.....	94	TP342SFC.....	36	TP514SBC.....	95
TLN1.....	108	TP118SFC.....	93	TP208SBC.....	93	TP305SPC.....	94	TP343SFC.....	36	TP514SFC.....	95
TLN2.....	108	TP119SBC.....	93	TP208SFC.....	93	TP306SFC.....	94	TP344SFC.....	36	TP515SBC.....	95
TLN3.....	108	TP119SFC.....	93	TP209SBC.....	93	TP306SPC.....	94	TP345SFC.....	36	TP515SFC.....	95
TLN4.....	108	TP120SBC.....	93	TP209SFC.....	93	TP307SFC.....	94	TP346SFC.....	36	TP516SBC.....	95
TLN5.....	108	TP120SFC.....	93	TP211SBC.....	93	TP307SPC.....	94	TP347SFC.....	36	TP516SFC.....	95
TLN5SS.....	108	TP121SBC.....	93	TP211SFC.....	93	TP308SFC.....	94	TP348SFC.....	36	TP517SBC.....	95
TLN6.....	108	TP121SFC.....	93	TP212SBC.....	93	TP308SPC.....	94	TP349SFC.....	36	TP517SFC.....	95
TLN7.....	108	TP122SFC.....	14	TP212SFC.....	93	TP309SFC.....	94	TP350SFC.....	36	TP518SBC.....	95
TLN7SS.....	108	TP123SBC.....	59	TP213SBC.....	93	TP309SPC.....	94	TP400SRC.....	94	TP518SFC.....	95
TM63.....	237	TP124SBC.....	59	TP213SFC.....	93	TP310SFC.....	94	TP402SRC.....	94	TP519SBC.....	95
TM63LP.....	237	TP125SFC.....	14	TP214SBC.....	93	TP310SPC.....	94	TP403SRC.....	94	TP519SFC.....	95
TM68.....	237	TP126SFC.....	14	TP214SFC.....	93	TP311SFC.....	94	TP404SRC.....	94	TP520SBC.....	60
TM68LP.....	237	TP127SBC.....	59	TP215SBC.....	93	TP311SPC.....	94	TP406SRC.....	94	TB520SFC.....	61
TM80.....	237	TP127SFC.....	14	TP215SFC.....	93	TP312SFC.....	94	TP407SRC.....	94	TP521SBC.....	60
TM80LP.....	237	TP128SBC.....	59	TP216SBC.....	93	TP312SPC.....	94	TP408SRC.....	94	TP521SFC.....	61
TM81.....	237	TP128SFC.....	14	TP216SFC.....	93	TP313SFC.....	94	TP409SRC.....	94	TP522SBC.....	60
TM81LP.....	237	TP129SBC.....	59	TP217SBC.....	93	TP313SPC.....	94	TP410SRC.....	94	TP522SFC.....	61
TM82.....	237	TP129SFC.....	14	TP217SFC.....	93	TP314SFC.....	94	TP412SRC.....	94	TP523SBC.....	60
TM82LP.....	237	TP130SBC.....	59	TP218SBC.....	93	TP314SPC.....	94	TP413SRC.....	94	TP523SFC.....	61
TM83.....	237	TP130SFC.....	14	TP218SFC.....	93	TP315SFC.....	94	TP414SRC.....	94	TP524SBC.....	60

When Searching Stock # Drop "J"

QUICK REFERENCE PRODUCT INDEX

Part #:	PAGE										
TP524SFC	61	TP809SOC	91	TRM83M	11	TS20	62	TS6434	167	TSS34	65
TP525SBC	60	TP810SOC	91	TRM84	10	TS21	62	TS6512	167	TSS35	65
TP525SFC	61	TP811SOC	91	TRM84M	11	TS22	62	TS6614	167	TSS36	65
TP526SBC	60	TP812SOC	91	TRM85	10	TS23	62	TS7	62	TSS37	65
TP526SFC	61	TP813SOC	91	TRM85M	11	TS24	62	TS80	62	TSS4	65
TP527SBC	60	TP814SOC	91	TRM86	10	TS25	62	TS81	62	TSS5	65
TP527SFC	61	TP815SOC	91	TRM86M	11	TS26	62	TS82	63	TSS6	65
TP528SBC	60	TP816SOC	91	TRM87	10	TS27	62	TS83	63	TSS7	65
TP528SFC	61	TP817SOC	91	TRM87M	11	TS28	62	TS9	62	TSS7SS	65
TP529SBC	60	TP818SOC	92	TRM88	10	TS29	62	TSF10	63	TSS8	65
TP529SFC	61	TP819SOC	92	TRM88M	11	TS30	62	TSF101	63	TSS8SS	65
TP530SBC	60	TP820SOC	92	TRM89	10	TS303	167	TSF11	63	TSS81	65
TP530SFC	61	TP821SOC	92	TRM89M	11	TS303SS	167	TSF12	63	TSS83	65
TP531SBC	60	TP822SOC	92	TRM98	10	TS3033SS	167	TSF14	63	TSS9	65
TP531SFC	61	TP823SOC	92	TRM98M	11	TS31	62	TSF15	63	TSS9SS	65
TP532SFC	61	TP824SOC	92	TRM9M	11	TS312	167	TSF16	63	TSSK8	99
TP600SBC	95	TP825SOC	92	TRM99	10	TS312SS	167	TSF18	63	TSWAK	185
TP600SFC	95	TP826SOC	92	TRM99M	11	TS32	62	TSF20	63	TT12	299
TP601SBC	95	TP827SOC	92	TRMK1032	12	TS3218	167	TSF21	63	TTS12	57
TP601SFC	95	TP828SOC	92	TRMK1420	13	TS3218SS	167	TSF22	63	TTS14	57
TP602SBC	95	TP829SOC	92	TRMK632	12	TS3234	167	TSF23	63	TTS15	57
TP602SFC	95	TP830SOC	92	TRMK832	12	TS33	62	TSF24	63	TTS18	57
TP603SBC	95	TP831SOC	92	TRS1010	203	TS34	62	TSF25	63	TTS20	57
TP603SFC	95	TP832SOC	92	TRS106	203	TS35	62	TSF27	63	TTS21	57
TP604SBC	95	TP833SOC	92	TRS106SS	203	TS36	62	TSF28	63	TTS22	57
TP604SFC	95	TP834SOC	92	TRS1110	203	TS3612	167	TSF29	63	TTS23	57
TP605SBC	95	TP835SOC	92	TRS11/6	203	TS3612SS	167	TSF30	63	TTS24	57
TP605SFC	95	TPABN1024	105	TRS6/3	203	TS37	63	TSF31	63	TTS25	57
TP606SBC	95	TPABN1420	105	TRS6/6B	203	TS38	62	TSF32	63	TTS27	57
TP606SFC	95	TPABN3816	105	TRS6/6SS	203	TS385	167	TSF33	63	TTS28	57
TP607SBC	95	TPABN51618	105	TRS610	203	TS385SS	167	TSF34	63	TTS29	57
TP607SFC	95	TPK30	96	TRS7/3	203	TS39	62	TSF35	63	TTS30	57
TP608SBC	95	TPKRM1	98	TRS7/6	203	TS4	62	TSF36	63	TTS31	57
TP608SFC	95	TPKSM1	98	TRS7/6SS	203	TS40	62	TSF37	63	TTS33	57
TP609SBC	95	TPPB10241	89	TRS710	203	TS407	167	TSF38	63	TTS34	57
TP609SFC	95	TPPB1024114	89	TRS8/3	203	TS42	62	TSF9	63	TTS35	57
TP610SBC	95	TPPB102434	89	TRS8/6B	203	TS4234	167	TSK10	99	TTS36	57
TP610SFC	95	TPZBN1213	105	TRS8/6SS	203	TS4234SS	167	TSK10SS	53	TTS37	57
TP611SBC	95	TRM100	10	TRS810	203	TS4334	167	TSK8	99	TTS38	57
TP611SFC	95	TRM100M	11	TRS9/3	203	TS4334SS	167	TSS1	65	TTSK10	99
TP612SBC	95	TRM101	10	TRS9/6B	203	TS44	62	TSS10	65	TW101716	74
TP612SFC	95	TRM101M	11	TRS9/6SS	203	TS4414	167	TSS10SS	65	TW12212	74
TP614SBC	95	TRM102	10	TRS910	203	TS4512	167	TSS11	65	TWA144	152, 213
TP614SFC	95	TRM102M	11	TS1	62	TS4512SS	167	TSS11SS	65	TWA145	152, 213
TP615SBC	95	TRM103	10	TS10	62	TS48	62	TSS12	65	TWA214	168, 214
TP615SFC	95	TRM103M	11	TS103	167	TS49	62	TSS2	65	TWH1	276
TP616SBC	95	TRM104	10	TS103SS	167	TS505	167	TSS25	65	TWH2	276
TP616SFC	95	TRM104M	11	TS1034SS	167	TS506	167	TSS25SS	65	TX12114SS	74
TP617SBC	95	TRM16	10	TS11	62	TS51	62	TSS27	65	TX1234	74
TP617SFC	95	TRM22	10	TS1134	167	TS52	62	TSS27SS	65	TX1478	74
TP618SBC	95	TRM33	10	TS1134SS	167	TS5312	167	TSS28	65	TXV12112	73
TP618SFC	95	TRM33M	11	TS12	62	TS54	62	TSS28SS	65	TXV12114	73
TP800SOC	91	TRM63	10	TS1214	167	TS5412	167	TSS29	65	TXV12114Z	71
TP801SOC	91	TRM63M	11	TS1214SS	167	TS55	63	TSS29SS	65	TXV12200	73
TP802SOC	91	TRM80	10	TS13	62	TS57	63	TSS3	65	TXV14400	73
TP803SOC	91	TRM80M	11	TS14	62	TS59	63	TSS30	65	TXW1234	74
TP804SOC	91	TRM81	10	TS15	62	TS6	62	TSS30SS	65	TXW1478	74
TP805SOC	91	TRM81M	11	TS17	62	TS60	63	TSS31	65		
TP806SOC	91	TRM82	10	TS18	62	TS61	63	TSS31SS	65		
TP807SOC	91	TRM82M	11	TS19	62	TS63	63	TSS32	65		
TP808SOC	91	TRM83	10	TS2	62	TS6414	167	TSS33	65		

U

UAK1 174

When Searching Stock # Drop "J"

QUICK REFERENCE PRODUCT INDEX

Part #:	PAGE									
UAK2	174	W	WAK15QDB.....	182	WAKJ15RB.....	181	WDS1B	85	WYP75	291
UAK3	175		WAK15R.....	180	WAKJ15S.....	180	WDS1C	85		
UAK4	175	W110.....	WAK15RB.....	181	WAKJ15SB.....	181	WDS1M.....	85	Z	
UAKHD1.....	149	W111.....	WAK15S	180	WAKJ16.....	179	WDS20.....	294	ZSA1.....	186
UAKHD2.....	149	W111SS.....	WAK15SB.....	181	WAKJ16H	179	WDS2B	85	ZSA1J	186
UAKHD3.....	149	W112.....	WAK16.....	179	WAKJ16QD	180	WDS2C	85	ZSA1K.....	186
UAKHD3.....	149	W112SS.....	WAK16H.....	179	WAKJ16R.....	180	WDS2M.....	85	ZSA1M.....	186
UB01	138	W113.....	WAK16QD.....	180	WAKJ16T.....	179	WDS30.....	294	ZSA1TJ.....	186
UB010	138	W113SS.....	WAK16R.....	180	WAKJ18.....	182	WDS3B	85	ZSA1TK.....	186
UB011	138	W114.....	WAK16T	179	WAKJ18T.....	182	WDS3M.....	85	ZSA1TK.....	186
UB012	138	W114SS.....	WAK18.....	182	WAKJ19.....	182	WDS4B	85	ZSAL2.....	187
UB013	138	W1141SS.....	WAK18T	182	WAKJ191S.....	182	WDS4C	85	ZSAL2J.....	187
UB014	138	W115.....	WAK19.....	182	WAKJ19H	182	WDS4M.....	85	ZSAL2K.....	187
UB015	138	W115SS.....	WAK191S.....	182	WAKJ19QD	182	WDS6C	85	ZSTU1J.....	186
UB016	138	W116.....	WAK19H.....	182	WAKJ19S.....	182	WDS10	286, 297	ZSTU1K.....	186
UB017	138	W116SS.....	WAK19QD.....	182	WAKJ19SS.....	182	WDS30	295	ZSTU1M.....	186
UB018	138	W117.....	WAK19S.....	182	WAKJ19T.....	182	WDSG10	297		
UB019	138	W117SS.....	WAK19SS.....	182	WAKJ20.....	182	WDSW10.....	286, 297		
UB021	138	W1171SS.....	WAK19T.....	182	WAKJ22.....	184	WDW1B.....	85		
UB022	138	W118.....	WAK20	182	WAKJ23.....	184	WDW1C.....	85		
UB023	138	W118SS.....	WAK22	184	WAKJ23F.....	229	WDW1M.....	85		
UB024	138	W119.....	WAK23.....	184	WAKJ23QD	184	WDW2B.....	85		
UB03	138	W119SS.....	WAK23F.....	229	WAKJ23T.....	184	WDW2C.....	85		
UB04	138	W120.....	WAK23QD.....	184	WAKJ24.....	184	WDW2M.....	85		
UB05	138	W12011SS	WAK23T	184	WAKJ25	184	WDW3B.....	85		
UB06	138	W120SS.....	WAK24	184	WAKJ33.....	183	WDW3C.....	85		
UB07	138	W1201SS.....	WAK25	184	WAKJ33R.....	183	WDW3M.....	85		
UB08	138	W121.....	WAK33.....	183	WAKJ34.....	183	WDW4B.....	85		
UB09	138	W121SS.....	WAK33R.....	183	WAKJ7.....	183	WDW4C.....	85		
UBS01	138	W122.....	WAK34.....	183	WAKJ8.....	183	WDW4M.....	85		
UBS010	138	W1221SS.....	WAK7	183	WAKJ9.....	183	WGC100.....	238		
UBS011	138	W123.....	WAK8	183	WAKQUAD.....	185	WGD100	238		
UBS012	138	W1231SS	WAK8QD.....	183	WAKTRIO	179	WGD25	238		
UBS013	138	W123SS.....	WAK8T	183	WCH1.....	270	WGR100.....	238		
UBS014	138	W126.....	WAK9	183	WDBTR1.....	295	WFR25	238		
UBS015	138	W127.....	WAKJ13.....	179	WDEC10.....	295	WGT100.....	238		
UBS016	138	W127SS.....	WAKJ13B.....	181	WDEC16.....	297	WGT25	238		
UBS017	138	WAK13.....	WAKJ14.....	180	WDEW10.....	295	WN2SS	110		
UBS018	138	WAK13B.....	WAKJ141.....	180	WDEW5.....	295	WN3.....	110		
UBS020	138	WAK14.....	WAKJ141B.....	181	WDFB12.....	292	WN3SS.....	110		
UBS021	138	WAK141.....	WAKJ14B.....	181	WDFS10.....	296	WN4.....	110		
UBS022	138	WAK141B.....	WAKJ14H	180	WDGF1.....	295	WN4SS	110		
UBS023	138	WAK14B	WAKJ14HB	181	WDHM10.....	297	WN5.....	110		
UBS024	138	WAK14H.....	WAKJ14HBSS	181	WDKBC1.....	295	WN6.....	110		
UBS03	138	WAK14HB.....	WAKJ14HSS	180	WDKBW1.....	295	WN6SS.....	110		
UBS04	138	WAK14HBSS.....	WAKJ14Q	180	WDKS1	296	WN7.....	110		
UBS05	138	WAK14HSS.....	WAKJ14QB	181	WDN1	297	WN7SS.....	110		
UBS06	138	WAK14Q.....	WAKJ14QD	180	WDN2	297	WN8.....	110		
UBS07	138	WAK14QB.....	WAKJ14QDB	182	WDPS10.....	296	WN8SS.....	110		
UBS08	138	WAK14QD.....	WAKJ14R.....	180	WDPS20.....	296	WN9.....	110		
UBS09	138	WAK14QDB.....	WAKJ14RB.....	181	WDPS30.....	296	WSGT75	291		
US6		WAK14R.....	WAKJ14SS.....	180	WDPT10.....	296	WSK10.....	76		
		WAK14RB.....	WAKJ14SSPH	180	WDPT20.....	296	WSK10CD1	76		
		WAK14SS.....	WAKJ14T.....	180	WDPT30.....	296	WW80.....	113		
		WAK14SSPH.....	WAKJ14TB.....	181	WDS3C	85	WW81.....	113		
VR12.....	195	WAK14T	WAKJ15.....	180	WDSC30	295	WW82.....	113		
VR34.....	195	WAK14TB	WAKJ15B.....	181	WDSL1C	295	WW83.....	113		
VT12.....	195	WAK15.....	WAKJ15QD	182	WDSW30	295	WW84.....	113		
VT8.....	195	WAK15B.....	WAKJ15QDB	182	WDPS30.....	296	WW85.....	113		
		WAK15QD.....	WAKJ15R.....	180	WDS10.....	294	WW87.....	113		

When Searching Stock # Drop "J"

METALLICS PEOPLE AND SALES FORCE



THE LARGEST FASTENER SALES FORCE IN AMERICA SELLING TO ELECTRICAL DISTRIBUTORS

Legend:

- ★ Metallics Distribution And Manufacturing Centers
- Bristol, CT - 100,00 sq. ft.
- Mancos, CO - 38,000 sq. ft.
- Sales Representative Organization Locations

METALLICS, INC. - Eastern Distribution • Bristol, CT Ph 800.243.8272 Fax 800.831.9358
 METALLICS WEST, INC. - Western Distribution • Mancos, CO Ph 800.269.5183 Fax 800.269.6278
 AVANTI SCREW, INC. - Manufacturing Division • Bristol, CT

www.metallicsonline.com

METALLICS SALES FORCE

METALLICS WEST (Mancos, Colorado)

SALES REPRESENTATIVES	TERRITORY	# SALES PERSONNEL
1. Albuquerque, New Mexico	New Mexico/El Paso,TX/SW Colorado	6
2. Danville, California	Northern California/Nevada	6
3. Conway, Arkansas	Arkansas	3
4. Denver, Colorado	Colorado/Wyoming/E. Montano	7
5. Council Bluffs, Iowa	Iowa/Nebraska	7
6. Honolulu, Hawaii	Hawaii	3
7. Houston, Texas	Southern Texas	8
8. Irving, Texas	Northern Texas	11
9. Olathe, Kansas	Kansas/Western Missouri	9
10. Kent, Washington	Washington/Oregon/Northern Idaho/Alaska	12
11. Minneapolis, Missesota	North and South Dakota	2
12. Oklahoma City, Oklahoma	Oklahoma	3
13. Sandy City, Utah	Utah/Southern Idaho/SW Colorado/NE Wyoming	2
14. Phoenix, Arizona	Arizona/Las Vegas, Nevada	6
15. Whittier, California	Southern California	15
	TOTAL # SALES PERSONNEL	100

METALLICS EAST (Bristol, Connecticut)

SALES REPRESENTATIVES	TERRITORY	# SALES PERSONNEL
1. New Holland, Pennsylvania	Maryland/Washington, D.C./N. Virginia	6
2. Bayside, Wisconsin	Central & Eastern Wisconsin/Upper Michigan	8
3. Canton, Massachusetts	Rhode Island/New Hampshire/Maine/Mass	13
4. Greensboro, North Carolina	North and South Carolina	11
5. Westlake, Ohio	Ohio	7
6. Atlanta, Georgia	Alabama, Georgia	11
7. Nesconset, New York	New York City/N. New Jersey/Long Island	9
8. Elk Grove Village, Illinois	Illinois	6
9. Harahan, Louisiana	Central-South Mississippi/Lousiana	6
10. Indianapolis, Indiana	Indiana	7
11. Kirkwood, Missouri	Eastern Missouri/Southern Illinois	9
12. Louisville, Kentucky	Kentucky	7
13. Memphis, Tennessee	Tennessee/N. Mississippi	2
14. Minneapolis, Minnesota	Minnesota/Western Wisconsin	10
15. Glen Falls, New York	Connecticut/W. Massachusetts/Vermont	2
16. Nashville, Tennessee	Eastern Tennessee	7
17. New Holland, Pennsylvania	Eastern Pennsylvania/S, New Jersey/Delaware	6
18. Novi, Michigan	Western Michigan/Eastern Michigan	8
19. Pittsburgh, Pennsylvania	West Virigina/West Pennsylvania	7
20. Richmond, Virginia	Virginia	3
21. Rochester, New York	Upstate New York	9
22. South Windsor, Connecticut	Connecticut/W. Massachusetts/Vermont	5
23. Tampa, Florida	Florida/Georgia/Alabama	26
24. Feasterville, Pennsylvania	S. New Jersey/E. Pennsylvania/Delaware	3
	TOTAL # SALES PERSONNEL	188

DISTRIBUTOR CATALOGUE 2014-2015

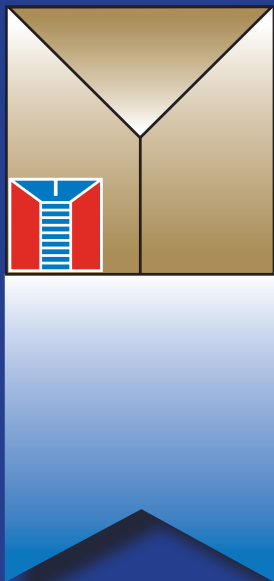

Metallics

Metallics East

229 Cross Street • Bristol, CT 06010
P: 800-243-8272 • F: 800-831-9358
E: sales@metallicsonline.com

Metallics West

651 North Main Street • Mancos, CO 81328
P: 800-269-5183 • F: 800-269-6278
E: saleswest@metallicsonline.com

America's
Source for
Premier and
Innovative
Fasteners
& Anchors

www.metallicsonline.com