

## Recessed Floor Boxes for Concrete & Wood Floors

Resource RFB® Series of Floor Boxes are versatile recessed activation solutions that provide power, communication and/or audio/video services to open space areas, or directly to workstations. Resource RFB Series Floor Boxes are available in two- to six-gang models with a variety of aesthetic cover options including colors and profiles) available.

Resource RFB Series Floor Boxes have many applications, including schools, financial institutions, commercial office buildings, hospitality and residences.



Protection from water, dirt, and debris.

RFB4 Series Floor Box with the new FloorPort Activation Cover.

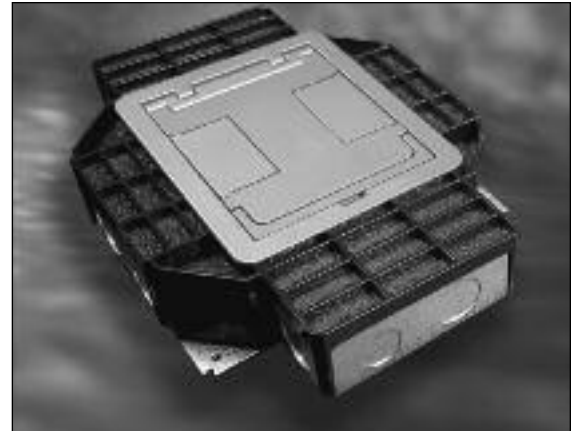

### FEATURES & BENEFITS

- **RFB6 & RFB6E have independent wiring compartments that allow capacity for up to six duplex receptacles and/or communication services.** Reduces overall cost by providing for most cabling requirements.
- **The RFB4 has three versions for various applications.** A cast iron version to meet on grade requirements, a steel version to reduce installation cost on above grade floors, and a shallow steel version that provides flexibility with varying concrete depths.
- **Fully adjustable before and after the concrete pour.** Labor savings by adapting to various pour depths and conditions.
- **Range of conduit sizes.** Allows for most conduit schemes, even feed through capability, which saves time and money during installation. KOs range from 1/2" to 2" trade size.
- **Triple service boxes.** Accommodate power, communication and/or audio/video devices which reduces the need for multiple boxes.
- **Accepts round Evolution™ Series Covers.** RFB4E Series Floor Box accept the round 6" Evolution™ Series Covers while RFB6E Series Floor Box accepts the round 8" Evolution™ Series Covers increasing the ability to match aesthetics throughout the building.
- **RFB2 & RFB4 shallow versions allow pass-around tunneling.** Flexibility in design to have adjacent compartments wired together.
- **Redesigned FloorPort Activation Covers.** Provides TopGuard protection from water, dirt and debris plus added strength and durability. Now available in brushed aluminum and five decorative powder coat finishes: Black, Brass, Nickel, Gray and Bronze.
- **Wide variety of mounting brackets.** Can adapt to most power and communication needs. Reduces overall life cycle cost.
- **RFB4E and RFB6E Series Floor Boxes available for bare concrete and terrazzo floors.** By using RFB4E-CTR or RFB6E-CTR Rings (sold separately) these boxes can be installed into bare concrete or terrazzo floors with a clean, aesthetic finish.
- **Datacom connectivity options.** Accepts industry standard and proprietary devices from a wide range of manufacturers to provide a seamless and aesthetically pleasing interface for voice, data, audio, and video applications at the point-of-use. A wide selection of data and adapter options are available for use with Ortronics® TracJack™ and Series II devices.
- **2" Conduit Hub.** By using 2HUB with the RFB4E Series Floor Box (sold separately) a greater capacity of pre-terminated cables can be brought in the a shallower box. Increasing the functionality and reducing concrete pours.
- **Installs in both concrete and wood floors.** Provides the first recessed wood floor box for both commercial and residential applications. Available for RFB2, RFB6 and RFB6E Series Floor Boxes.
- **Lightweight "slab-on-grade" version.** Special fusion-bonded epoxy corrosion resistant paint finish allows for slab-on-grade use without the weight of cast iron material. Available in RFB2, RFB4E, RFB6 and RFB6E Series Floor Boxes.
- **Accepts Floorport™ Activation Covers.** Allows a consistent aesthetic finish for the RFB2, RFB4 & RFB6 Series Recessed Floor Boxes.
- **Buy America Act/NAFTA versions.** FloorPort Service Fittings are now available in versions that meet the Buy America Act/NAFTA requirements.
- **UL Listed to U.S. and Canadian safety standards for tile, terrazzo, carpet and wood floors.**

## Resource RFB Series Floor Box Selection Guide

Box Model	Install Floor Type:		Box Type:	Box Capacity:	Depth Behind Plates:	A/V Compatibility	Trade Size Conduit Feed:	Cover Style	Country of Origin	Adjustability
	Concrete	Wood								
RFB2	Yes	Yes	Above Grade	2 Gangs	3" [76mm]	Legrand AVIP, Altinex Intera, Extron AAP, MAAP & Decorator, Ortronics Series II	3/4" – 1 1/4"	FloorPort	USA	Fully Adjustable
RFB2-SS	Yes	Yes	Above Grade	2 Gangs	3" [76mm]		3/4" – 1 1/4"	FloorPort	USA	
RFB2-OG	Yes	Yes	On-Grade	2 Gangs	3" [76mm]		3/4" – 1 1/4"	FloorPort	USA	
RFB4	Yes	No	Above Grade	4 Gangs	2" [51mm]		3/4" – 1 1/4"	FloorPort	Mexico	
RFB4-4DB	Yes	No	Above Grade	4 Gangs	2" [51mm]		1/2" – 1"	FloorPort	Mexico	
RFB4-SS	Yes	No	Above Grade	4 Gangs	2" [51mm]		3/4" – 1 1/4"	FloorPort	Mexico	
RFB4-CI-1	Yes	No	On-Grade	4 Gangs	2" [51mm]		3/4" – 1 1/4"	FloorPort	China	
RFB4-CI-1-NA	Yes	No	On-Grade	4 Gangs	2" [51mm]		3/4" – 1 1/4"	FloorPort	USA	
RFB4E	Yes	No	Above Grade	4 Gangs	3 1/2" [89mm]		3/4" – 2"	Evolution 6CT, 6CTC & 6CFFTC Series	USA	
RFB4E-OG	Yes	No	On-Grade	4 Gangs	3 1/2" [89mm]		3/4" – 2"		USA	
RFB6	Yes	Yes	Above Grade	6 Gangs	3 1/4" [83mm]		3/4" – 1 1/4"	FloorPort	USA	
RFB6-OG	Yes	Yes	On-Grade	6 Gangs	3 1/4" [83mm]		3/4" – 1 1/4"	FloorPort	USA	
RFB6E	Yes	Yes	Above Grade	6 Gangs	3 1/4" [83mm]		3/4" – 1 1/4"	Evolution 8CT & 8CTC Series	USA	
RFB6E-OG	Yes	Yes	On-Grade	6 Gangs	3 1/4" [83mm]		3/4" – 1 1/4"		USA	

NOTE: Pricing may vary depending on country of origin. Consult your local sales representative for more information.

## RFB2 Series Multiservice Steel Recessed Floor Box Ordering Information

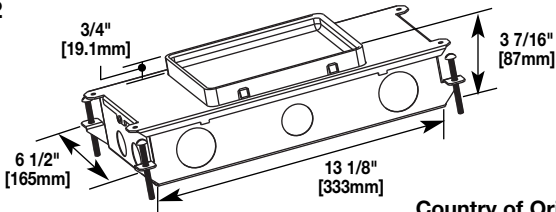
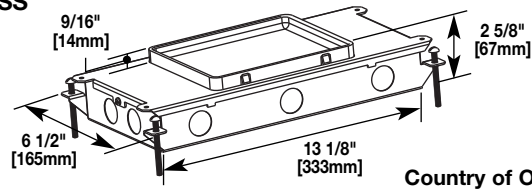
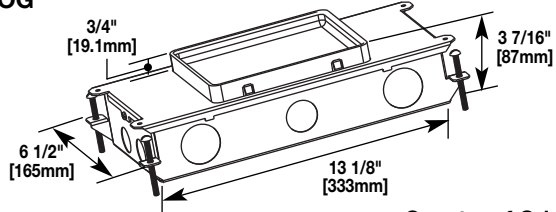
Catalog No./Item	Description/Specifications
<b>RFB2</b>  <p style="text-align: right;">Country of Origin: USA</p>	<b>Two-Compartment Box – For use in either concrete or wood floors.</b> Fully adjustable with tunnel compartment. Supplied with one (1) duplex receptacle mounting plate, and one (1) communication mounting plate (RFB22AB). Other device plates sold separately.
<b>RFB2-SS</b>  <p style="text-align: right;">Country of Origin: USA</p>	<b>Two-Compartment Shallow Stamped Steel Floor Box – For use in either concrete or wood floors.</b> Fully adjustable with tunnel compartment. Supplied with one (1) duplex receptacle mounting plate, and one (1) communication mounting plate (RFB22AB). Other device plates sold separately.
<b>RFB2-OG</b>  <p style="text-align: right;">Country of Origin: USA</p>	<b>Two-Compartment Box – For use On Grade.</b> Fully adjustable with tunnel compartment. Supplied with one (1) duplex receptacle mounting plate, and one (1) communication mounting plate (RFB22AB). Other device plates sold separately.  <b>NOTE:</b> RFB2-OG for on-grade applications is painted with a fusion-bonded epoxy designed for use on metal reinforcement bar and related accessories before encapsulating in concrete.

## RFB2 Series Floor Boxes Compartment Capacities/ Knockout Locations & Sizes

### RFB2 & RFB2-OG

**Power or Data**  
50.2 cu. in. [822.6 ml]  
Each Side  
**Top View**

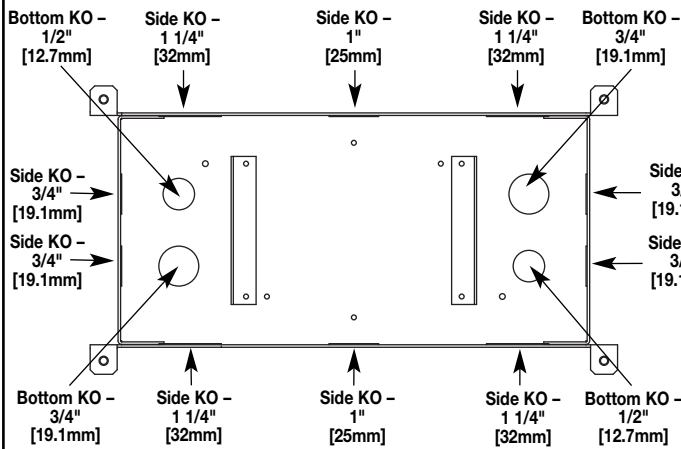

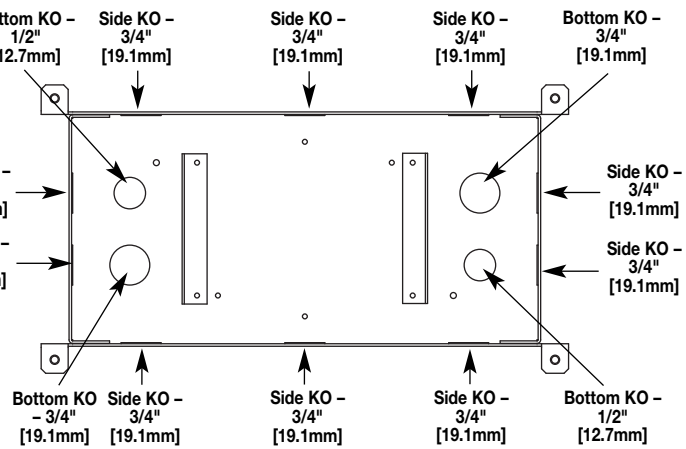

### RFB2-SS

**Power or Data**  
38.0 cu. in. [622.7 ml]  
Each Side  
**Top View**

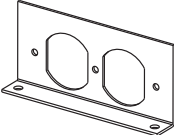
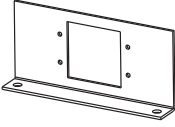

## RFB2 Series Multiservice Steel Recessed Floor Box Accessories

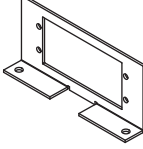
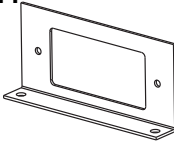
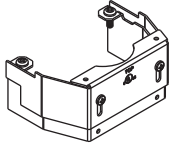
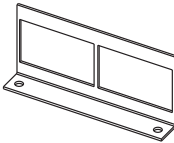
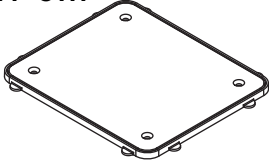
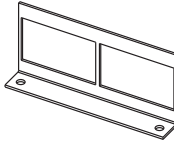
Catalog No./Item	Description/Specifications	Catalog No./Item	Description/Specifications
<b>RFB2DP</b>  <b>Internal Duplex Receptacle Bracket</b> – Accepts standard 15 Amp & 20 Amp Duplex Receptacles. Country of Origin: USA  <b>NOTE:</b> For RFB2 Series Floor Boxes only.	<b>RFB2EXT</b>  <b>Internal Audio/Video Bracket</b> – Accepts two (2) Legrand AVIP or Extron® Electronics MAAP Series devices (sold separately). Country of Origin: USA  <b>NOTE:</b> For RFB2 Series Floor Boxes only.		
<b>RFB2B</b>  <b>Internal Blank Bracket</b> – Plate used to close off unused gangs. Country of Origin: USA  <b>NOTE:</b> For RFB2 Series Floor Boxes only.	<b>RFB2-AAP</b>  <b>Internal Audio/Video Bracket</b> – Accepts Two (2) Extron® Electronics AAP Series devices (sold separately). Country of Origin: USA  <b>NOTE:</b> For RFB2 Series Floor Boxes only.		
<b>RFB2GFI</b>  <b>Internal GFI or Decorator Style Receptacle Bracket</b> – Accepts standard GFCI or Decorator Style Receptacles, Communication or Audio/Video Devices. Country of Origin: USA  <b>NOTE:</b> For RFB2 Series Floor Boxes only.	<b>RFBKIT</b>  <b>Barrier Kit</b> – Barrier kit used to separate power and communication wires in partition feed covers. Supplied with base and three extensions to adjust to cover height. Kit should be used on RFB2, RFB2-OG, RFB2-SS, RFB4 and RFB4-SS Floor Boxes. Kits are sold separately. Country of Origin: USA		
<b>RFB22AB</b>  <b>Internal Communication Bracket</b> – Includes two (2) adapters to accept Wiremold CM2 Series Open System communication inserts (sold separately). Country of Origin: USA  <b>NOTE:</b> For RFB2 Series Floor Boxes only.	<b>FP-CTR</b>  <b>Bare Concrete &amp; Terrazzo Ring</b> – Nonmetallic ring for use on bare polished concrete and terrazzo floor applications. Country of Origin: USA		
<b>RFB2RT</b>  <b>Internal Communication Bracket</b> – Includes Two (2) adapters to accept Ortronics® TracJack devices, and Two (2) adapters to accept Ortronics® Series II devices (sold separately). Country of Origin: USA  <b>NOTE:</b> For RFB2 Series Floor Boxes only.	<p style="text-align: center;"><b>NOTE:</b> All device plates and accessories shown on this page are made in the United States of America.</p>		

## FloorPort Series Cover Assemblies for RFB2 Series Floor Boxes

### FLOORPORT PART NUMBER CONFIGURATOR

FP	B	TC	NK
FloorPort	Blank Top	B Tile (Flangeless)	T Nickel
Cover	Cutout Top	C Tile/Carpet	TC Brass
	Furniture Feed	FF (Flanged)	Black
			Bronze
			Gray
			Brushed Aluminum
			NK
			BS
			BK
			BZ
			GY
			AL

### FloorPort Series Flanged Cover Assemblies Ordering Information

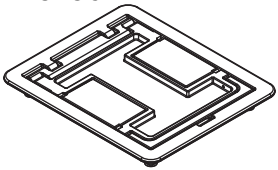
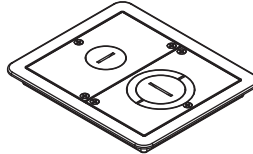
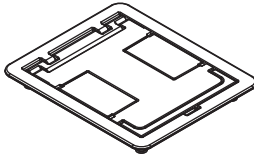
Catalog No./Item	Description/Specifications	Catalog No./Item	Description/Specifications
<b>FPCTCBK</b> <b>FPCTCBZ</b> <b>FPCTCBS</b> <b>FPCTCNK</b> <b>FPCTCAL</b> <b>FPCTCGY</b> 	<b>Cutout Cover Assembly –</b> Flanged cover for use in tile or carpet installation. Die-cast aluminum assembly available in black (BK), bronze (BZ), brass (BS), nickel (NK), gray (GY), or brushed aluminum (AL). Insert in lid allows for carpet or tile cutouts to match finished floor.	<b>FPFFTCBK</b> <b>FPFFTCBZ</b> <b>FPFFTCBS</b> <b>FPFFTCNK</b> <b>FPFFTCAL</b> <b>FPFFTCGY</b> 	<b>Furniture Feed Cover Assembly –</b> Flanged cover for use in tile or carpet installation. Die-cast aluminum assembly available in black (BK), bronze (BZ), brass (BS), nickel (NK), gray (GY), or brushed aluminum (AL). Provided with one 1" trade size screw plug for power or communication type cabling and one combination 1 1/4" and 2" trade size screw plug for communication type cabling. Allows for feeding both power and communication cabling.
<b>FPBTCBK</b> <b>FPBTCBZ</b> <b>FPBTCBS</b> <b>FPBTCNK</b> <b>FPBTCAL</b> <b>FPBTCGY</b> 	<b>Blank Cover Assembly –</b> Flanged cover for use in tile or carpet installation. Die-cast aluminum assembly available in black (BK), bronze (BZ), brass (BS), nickel (NK), gray (GY), or brushed aluminum (AL). Lid area is flush with the finished floor, no cutouts provided.		<b>Country of Origin: USA</b>
	<b>Country of Origin: India</b>		<b>Country of Origin: India</b>

### FloorPort Series Flangeless Cover Assemblies Ordering Information

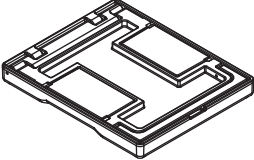
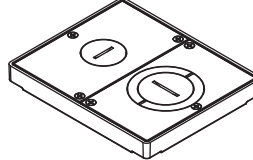
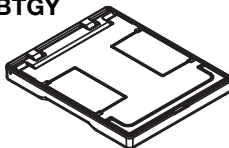
Catalog No./Item	Description/Specifications	Catalog No./Item	Description/Specifications
<b>FPCTBK</b> <b>FPCTBZ</b> <b>FPCTBS</b> <b>FPCTNK</b> <b>FPCTAL</b> <b>FPCTGY</b> 	<b>Cutout Cover Assembly –</b> Flangeless cover for use in tile installations. Die-cast aluminum assembly available in black (BK), bronze (BZ), brass (BS), nickel (NK), gray (GY), or brushed aluminum (AL). Insert in lid allows for tile cutouts to match finished floor.	<b>FPFFTBK</b> <b>FPFFTBZ</b> <b>FPFFTBS</b> <b>FPFFTNK</b> <b>FPFFTAL</b> <b>FPFFTGY</b> 	<b>Furniture Feed Cover Assembly –</b> Flangeless cover for use in tile installations. Die-cast aluminum assembly available in black (BK), bronze (BZ), brass (BS), nickel (NK), gray (GY), or brushed aluminum (AL). Provided with one 1" trade size screw plug for power or communication type cabling and one combination 1 1/4" and 2" trade size screw plug for communication type cabling. Allows for feeding both power and communication cabling.
<b>FPBTBK</b> <b>FPBTBZ</b> <b>FPBTBS</b> <b>FPBTNK</b> <b>FPBTAL</b> <b>FPBTGY</b> 	<b>Blank Cover Assembly –</b> Flangeless cover for use in tile installations. Die-cast aluminum assembly available in black (BK), bronze (BZ), brass (BS), nickel (NK), gray (GY), or brushed aluminum (AL). Lid area is flush with the finished floor, no cutouts provided.		<b>Country of Origin: USA</b>
	<b>Country of Origin: India</b>		<b>Country of Origin: India</b>

NOTE: Pricing varies depending on country of origin. Consult your local sales representative for more information.

## North American Made FloorPort Series Cover Assemblies for RFB2 Series Floor Boxes

### NORTH AMERICAN MADE FLOORPORT PART NUMBER CONFIGURATOR

FP	B	TC	NK	NA
FloorPort	Blank Top	B	Nickel	NK
Cover	Cutout Top	C	Brass	BS
	Furniture Feed	FF	Black	BK
			Bronze	BZ
			Gray	GY
			Brushed Aluminum	AL
		Tile (Flangeless) T		North American NA
		Tile/Carpet TC		Made
		(Flanged)		

### North American Made FloorPort Series Flanged Cover Assemblies Ordering Information

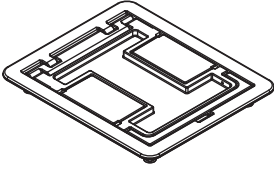
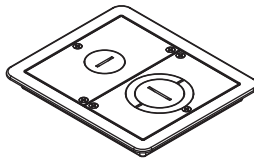
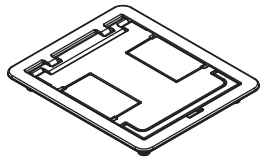
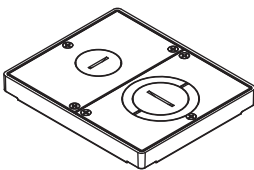
Catalog No./Item	Description/Specifications	Catalog No./Item	Description/Specifications
<b>FPCTCBK-NA</b> <b>FPCTCBZ-NA</b> <b>FPCTCBS-NA</b> <b>FPCTCNK-NA</b> <b>FPCTCGY-NA</b>	<b>Cutout Cover Assembly –</b> Flanged cover for use in tile or carpet installation. Die-cast aluminum assembly available in black (BK), bronze (BZ), brass (BS), nickel (NK), or gray (GY). Insert in lid allows for carpet or tile cutouts to match finished floor.	<b>FPFFTCBK</b> <b>FPFFTCBZ</b> <b>FPFFTCBS</b> <b>FPFFTCNK</b> <b>FPFFTCAL</b> <b>FPFFTCGY</b>	<b>Furniture Feed Cover Assembly –</b> Flanged cover for use in tile or carpet installation. Die-cast aluminum assembly available in black (BK), bronze (BZ), brass (BS), nickel (NK), gray (GY), or brushed aluminum (AL). Provided with one 1" trade size screw plug for power or communication type cabling and one combination 1 1/4" and 2" trade size screw plug for communication type cabling. Allows for feeding both power and communication cabling.
	<b>Country of Origin: USA</b>		<b>Country of Origin: USA</b>
<b>FPBTCBK-NA</b> <b>FPBTCBZ-NA</b> <b>FPBTCBS-NA</b> <b>FPBTCNK-NA</b> <b>FPBT CGY-NA</b>	<b>Blank Cover Assembly –</b> Flanged cover for use in tile or carpet installation. Die-cast aluminum assembly available in black (BK), bronze (BZ), brass (BS), nickel (NK), or gray (GY). Lid area is flush with the finished floor, no cutouts provided.	<b>FPFFTBK</b> <b>FPFFTBZ</b> <b>FPFFTBS</b> <b>FPFFTNK</b> <b>FPFFTAL</b> <b>FPFFTGY</b>	<b>Furniture Feed Cover Assembly –</b> Flangeless cover for use in tile installations. Die-cast aluminum assembly available in black (BK), bronze (BZ), brass (BS), nickel (NK), gray (GY), or brushed aluminum (AL). Provided with one 1" trade size screw plug for power or communication type cabling and one combination 1 1/4" and 2" trade size screw plug for communication type cabling. Allows for feeding both power and communication cabling.
	<b>Country of Origin: USA</b>		<b>Country of Origin: USA</b>

**NOTE:** Pricing varies depending on country of origin. Consult your local sales representative for more information.

LOAD CAPACITIES FOR FLOORPORT COVER ASSEMBLIES	
CATALOG NUMBERS	MAXIMUM LOAD IN POUNDS
FPCTC	1000
FPBTC	750
FPFFTC	1000
FPCT	1000
FPBT	750
FPFFT	1000

**NOTE:** Load applied through a 2" [51mm] mandrel in center of service fitting. Loads above are static loads only and do not pertain to rolling loads.

# RFB4 & RFB4-4DB Series Multiservice Steel Recessed Floor Box Ordering Information

Catalog No./Item	Description/Specifications
RFB4	<p><b>Four-Compartment Combination Box</b> – 12 3/4" L x 10" W x 3 7/16" D [324mm x 254mm x 87mm]. Fully adjustable with tunnel compartment and two receptacle brackets. <b>Tunneling from end power compartment to end power compartment only.</b> Communication brackets not included. See "Accessories".</p> <p><b>NOTE:</b> Only for use in concrete floors.</p> <p><b>Country of Origin:</b> Assembled in Mexico from components made in the USA</p>
RFB4-4DB	<p><b>Four-Compartment Box</b> – Includes four duplex receptacle brackets. 12 3/4" L x 10" W x 3 7/16" D [324mm x 254mm x 87mm]. Fully adjustable. <b>Tunneling from adjacent or opposite compartments only, (not cross compartments).</b> Tunneling can be set to feed all four compartments from one conduit in a single-service application.</p> <p><b>NOTE:</b> Only for use in concrete floors.</p> <p><b>Country of Origin:</b> Assembled in Mexico from components made in the USA</p>

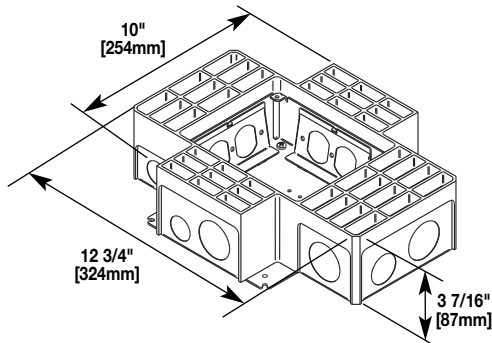
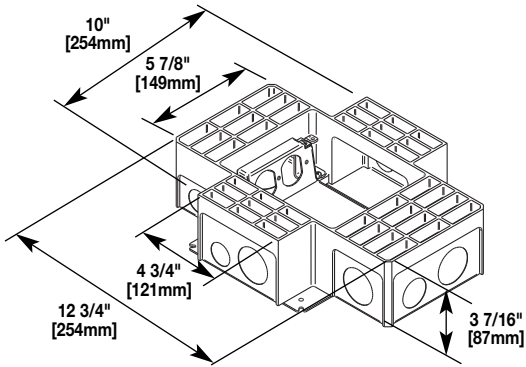

NOTE: All boxes and activations are sold separately.

## RFB4 & RFB4-4DB Series Compartment Capacities and Knockout Locations and Sizes

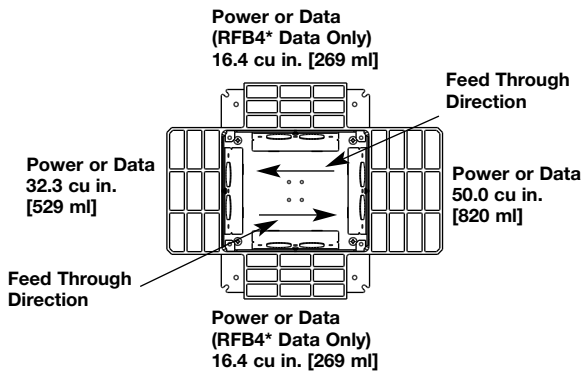

FOR RFB4

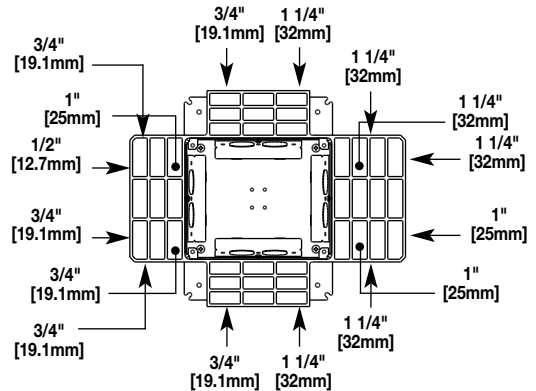

Indicates Bottom KO.

\*No feed through to opposite data compartment on RFB4.

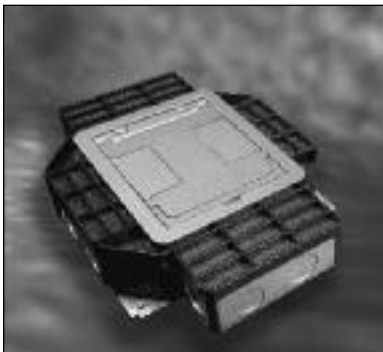

RFB4 Series Floor Box with FloorPort Activation Cover.

## RFB4 & RFB4-4DB Series Multiservice Steel Recessed Floor Box Accessories

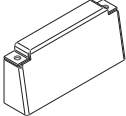
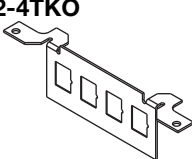
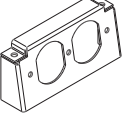
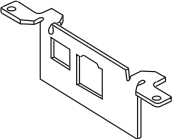
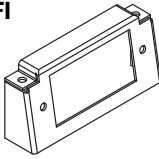
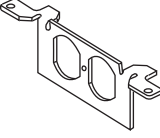
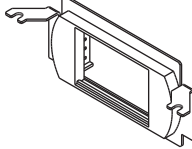
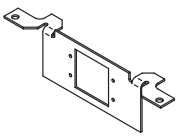
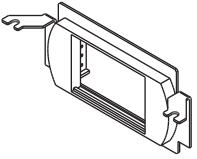
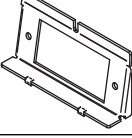
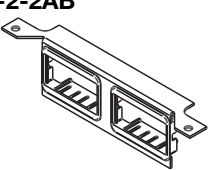
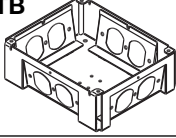
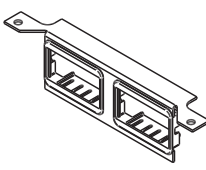
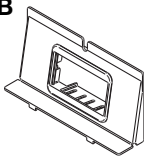
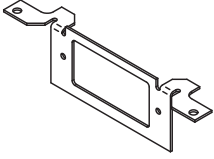
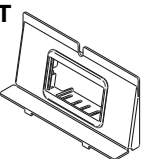
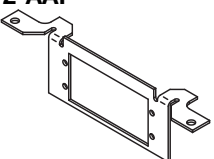
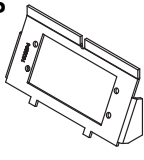
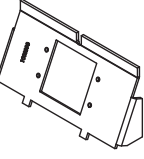
Catalog No./Item	Description/Specifications	Catalog No./Item	Description/Specifications
<b>RFB-B</b> 	<b>Internal Blank Bracket</b> – Power compartments only. Used to close off unused gangs. <b>NOTE: For RFB4 only.</b> <b>Country of Origin: USA</b>	<b>DTB-2-4TKO</b> 	<b>Communication Bracket</b> – Four (4) RJ keystone opening knockouts. Use as blank plate or for up to four (4) RJ openings. <b>NOTE: For RFB4 only. Opening dimension is 9/16" x 3/4" [14.3mm x 19.1mm].</b> <b>Country of Origin: USA</b>
<b>RFB-DR</b> 	<b>Internal Duplex Bracket</b> – Accepts standard 15 Amp & 20 Amp Duplex Receptacles. <b>NOTE: For RFB4 only.</b> <b>Country of Origin: USA</b>	<b>DTB-2-DT</b> 	<b>Communication Bracket</b> – With one IBM Type II opening and one keystone opening (devices not included). <b>NOTE: For RFB4 only.</b> <b>Country of Origin: USA</b>
<b>RFB-GFI</b> 	<b>Internal GFI Bracket</b> – Accepts standard GFCI or Decorator Style Receptacles, Communication or Audio/Video Devices. <b>NOTE: For RFB4 only.</b> <b>Country of Origin: USA</b>	<b>DTB-2-SD</b> 	<b>Communication Bracket</b> – With duplex opening for use with 106 Adapter (sold separately) (devices not included). <b>NOTE: For RFB4 only.</b> <b>Country of Origin: USA</b>
<b>RFB4-LPB</b> 	<b>Communication Bracket</b> – Activate™ low profile adapter included. Wiremold CM Series Open System inserts sold separately. <b>NOTE: For RFB4 only.</b> <b>Country of Origin: USA</b>	<b>DTB-EXT</b> 	<b>Internal Audio/Video Bracket</b> – Accepts two (2) Legrand AVIP or Extron® Electronics MAAP devices (sold separately). <b>NOTE: For RFB4 only.</b> <b>Country of Origin: USA</b>
<b>RFB4-LPBS2</b> 	<b>Communication Bracket</b> – Ortronics® Series II Low profile adapter included. <b>NOTE: For RFB4 only.</b> <b>Country of Origin: USA</b>	<b>RFB-GFI-4DB</b> 	<b>Internal GFCI Bracket</b> – Accepts standard GFCI or Decorator style receptacles, communications or A/V devices. <b>NOTE: For RFB4-4DB only.</b> <b>Country of Origin: USA</b>
<b>DTB-2-2AB</b> 	<b>Communication Bracket</b> – Two (2) 2A size adapters included. Wiremold CM2 Series Open System inserts, sold separately. <b>NOTE: For RFB4 only.</b> <b>Country of Origin: USA</b>	<b>RFB-WTB</b> 	<b>Conversion Kit</b> – To convert the RFB4 Box to a RFB4-4DB Box. <b>NOTE: For RFB4 &amp; RFB4-4DB.</b> <b>Country of Origin: Mexico</b>
<b>DTB-2-2RT</b> 	<b>Communication Bracket</b> – Ortronics® AB2TJ TracJack and ABS2 Series II adapters included. <b>NOTE: For RFB4 only.</b> <b>Country of Origin: USA</b>	<b>WTB-2-AB</b> 	<b>Communication Bracket</b> – One 2A adapter included. Wiremold CM2 Series Open System inserts sold separately. <b>NOTE: For RFB4-4DB only.</b> <b>Country of Origin: USA</b>
<b>DTB-2-DECORA</b> 	<b>Communication Bracket</b> – Decorator style opening for decorator style 106 Adapter. <b>Country of Origin: USA</b>	<b>WTB-2-RT</b> 	<b>Communication Bracket</b> – Ortronics® AB2TJ TracJack and ABS2 Series II adapters included. <b>NOTE: For RFB4-4DB only.</b> <b>Country of Origin: USA</b>
<b>DTB-2-AAP</b> 	<b>Internal Audio/Video Bracket</b> – Accepts two (2) Extron® Electronics AAP devices (sold separately). <b>NOTE: For RFB4 only.</b> <b>Country of Origin: USA</b>	<b>WTB-AAP</b> 	<b>Internal Audio/Video Bracket</b> – Accepts two (2) Extron® Electronics AAP Series Devices (sold separately). <b>NOTE: For RFB4-4DB only.</b> <b>Country of Origin: USA</b>
		<b>WTB-MAAP</b> 	<b>Internal Audio/Video Bracket</b> – Accepts two (2) Legrand AVIP or Extron® Electronics MAAP Series Devices (sold separately). <b>NOTE: For RFB4-4DB only.</b> <b>Country of Origin: USA</b>

Additional configurations available. Please consult your local Sales Representative for more information.

## RFB4 & RFB4-4DB Series Multiservice Steel Recessed Floor Box Accessories (continued)

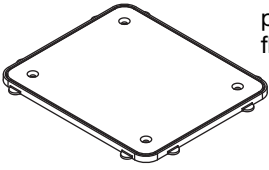
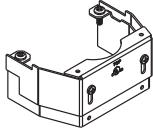
Catalog No./Item	Description/Specifications	Catalog No./Item	Description/Specifications
FP-CTR	<p><b>Bare Concrete &amp; Terrazzo Ring –</b> Nonmetallic ring for use on bare polished concrete and terrazzo floor applications.</p>  <p style="text-align: right;">Country of Origin: USA</p>	RFBKIT	<p><b>Barrier Kit –</b> Barrier kit used to separate power and communication wires in partition feed covers. Supplied with base and three extensions to adjust to cover height. Kit should be used on RFB2, RFB2-OG, RFB2-SS, RFB4 and RFB4-SS Floor Boxes. Kits are sold separately.</p>  <p style="text-align: right;">Country of Origin: USA</p>

## RFB4-CI-1 Series Multiservice Cast Iron Recessed Floor Box Ordering Information

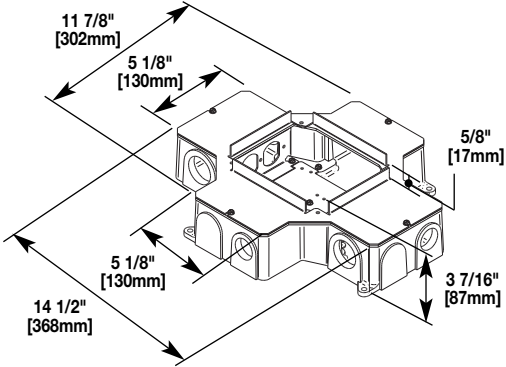
Catalog No./Item	Description/Specifications
RFB4-CI-1	 <p><b>Four-Compartment Cast Iron Box –</b> 14 1/2" L x 11 7/8" W x 3 7/16" D [368mm x 302mm x 87mm]. Fully adjustable with tunnel compartment and two receptacle brackets. <b>Feed through from adjacent or opposite compartments only, (not cross compartments).</b> Communication brackets not included. See "Accessories".</p> <p><b>NOTE: Only for use in concrete floors. All boxes and activations are sold separately.</b></p> <p style="text-align: right;">Country of Origin: China</p>

## North American Made RFB4-CI-NA Series Multiservice Cast Iron Recessed Floor Box Ordering Information

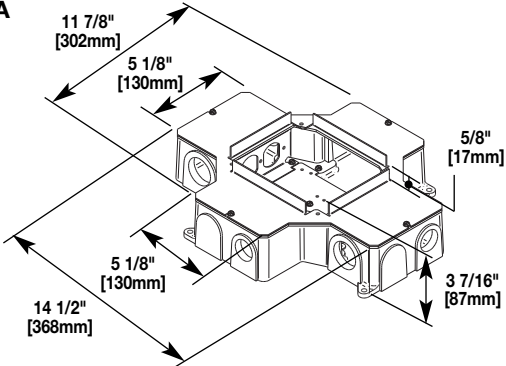
Catalog No./Item	Description/Specifications
RFB4-CI-NA	 <p><b>Four-Compartment Cast Iron Box –</b> 14 1/2" L x 11 7/8" W x 3 7/16" D [368mm x 302mm x 87mm]. Fully adjustable with tunnel compartment and two receptacle brackets. <b>Feed through from adjacent or opposite compartments only, (not cross compartments).</b> Communication brackets not included. See "Accessories".</p> <p><b>NOTE: Only for use in concrete floors. All boxes and activations are sold separately.</b></p> <p style="text-align: right;">Country of Origin: USA</p>

## RFB4-CI-1 & RFB4-CI-NA Series Compartment Capacities and Knockout Locations and Sizes

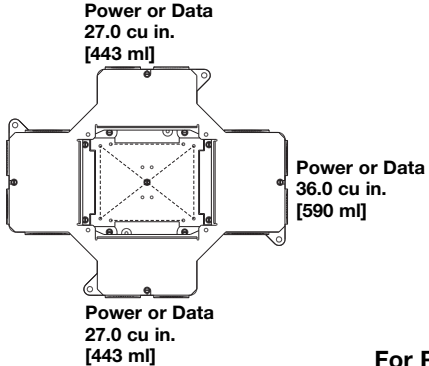
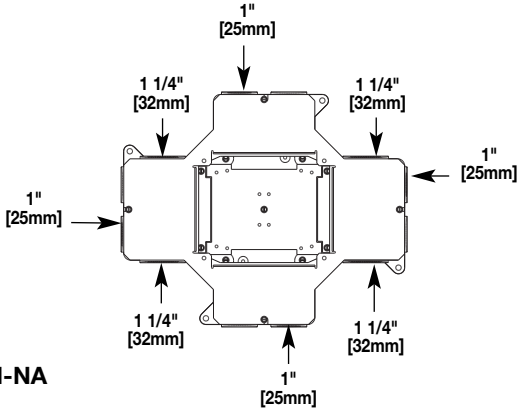
<p>Power or Data 27.0 cu in. [443 ml]</p>  <p>Power or Data 36.0 cu in. [590 ml]</p> <p>Power or Data 27.0 cu in. [443 ml]</p> <p>Power or Data 36.0 cu in. [590 ml]</p>	 <p>1" [25mm]</p> <p>1 1/4" [32mm]</p> <p>1 1/4" [32mm]</p> <p>1" [25mm]</p> <p>1" [25mm]</p> <p>1 1/4" [32mm]</p> <p>1 1/4" [32mm]</p> <p>1" [25mm]</p>
For RFB4-CI-1 & RFB4-CI-NA	

NOTE: Pricing varies depending on country of origin. Consult your local sales representative for more information.

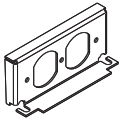
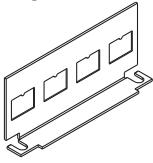
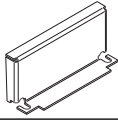
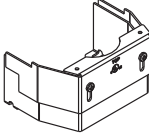
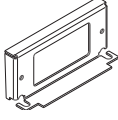
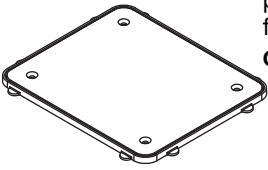
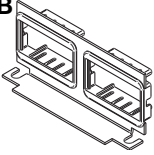
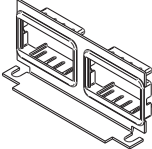

## RFB4-CI-1 Series Multiservice Cast Iron Floor Box Accessories

Catalog No./Item	Description/Specifications	Catalog No./Item	Description/Specifications
CIHT-D	 <p><b>Internal Duplex Receptacle Bracket</b> – Accepts standard 15 Amp &amp; 20 Amp Duplex Receptacles. <b>Country of Origin: USA</b></p>	CILT-4TKO	 <p><b>Communication Bracket</b> – Communication bracket with four (4) RJ opening knockouts. Use as blank plate or for up to four RJ openings. <b>NOTE: Opening dimension is 9/16" x 3/4" [14.3mm x 19.1mm].</b> <b>Country of Origin: USA</b></p>
CIH/LT-B	 <p><b>Internal Blank Bracket</b> – Used to close off unused gangs. <b>Country of Origin: USA</b></p>	RFBCIKIT	 <p><b>Barrier Kit</b> – Barrier kit used with RFB4-CI Floor Boxes. Kits are sold separately. <b>Country of Origin: USA</b></p>
CIHT-GFI	 <p><b>Internal GFI Device Bracket</b> – Accepts standard GFCI or Decorator Style Receptacles, Communication or Audio/Video Devices. <b>Country of Origin: USA</b></p>	FP-CTR	 <p><b>Bare Concrete &amp; Terrazzo Ring</b> – Nonmetallic ring for use on bare polished concrete and terrazzo floor applications. <b>Country of Origin: USA</b></p>
CILT-2AB	 <p><b>Communication Bracket</b> – Communication bracket with two 2A size Activate adapters included. Accepts Wiremold CM2 Series Open System communication modules (sold separately). <b>Country of Origin: USA</b></p>	<p><b>Additional configurations available. Please consult your local Sales Representative for more information.</b></p>	
CILT-2-RT	 <p><b>Communication Bracket</b> – Communication bracket with Ortronics® AB2TJ TracJack and ABS2 Series II adapters included. Accepts Ortronics® workstation connectivity outlets and modular inserts. <b>Country of Origin: USA</b></p>	<p><b>NOTE: All device plates and accessories shown on this page are made in the United States of America.</b></p>	

## RFB4-SS Series Multiservice Shallow Steel Recessed Floor Box Ordering Information

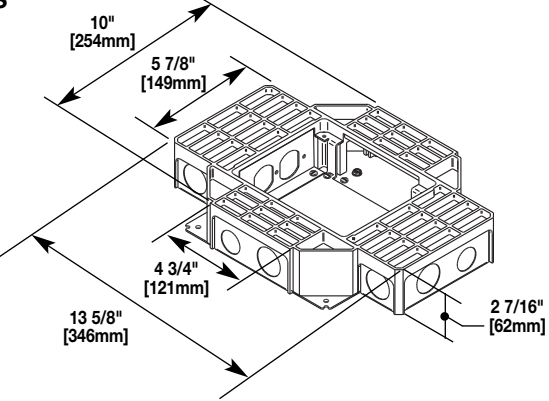
Catalog No./Item	Description/Specifications
<p>RFB4-SS</p> 	<p><b>Four-Compartment Shallow Stamped Steel Box</b> – 13 5/8" L x 10" W x 2 7/16" D [346mm x 254mm x 62mm]. Fully adjustable with tunnel compartment and two receptacle brackets. <b>Feed through tunneling to adjacent compartments only.</b> Tunneling can be set to feed all four compartments from one conduit in a single-service application. Communication brackets not included. See "Accessories".</p> <p><b>NOTE: Only for use in concrete floors. All boxes and activations are sold separately.</b></p> <p><b>Country of Origin: Assembled in Mexico from components made in the USA</b></p>

## RFB4-SS Series Compartment Capacities/Knockout Locations & Sizes

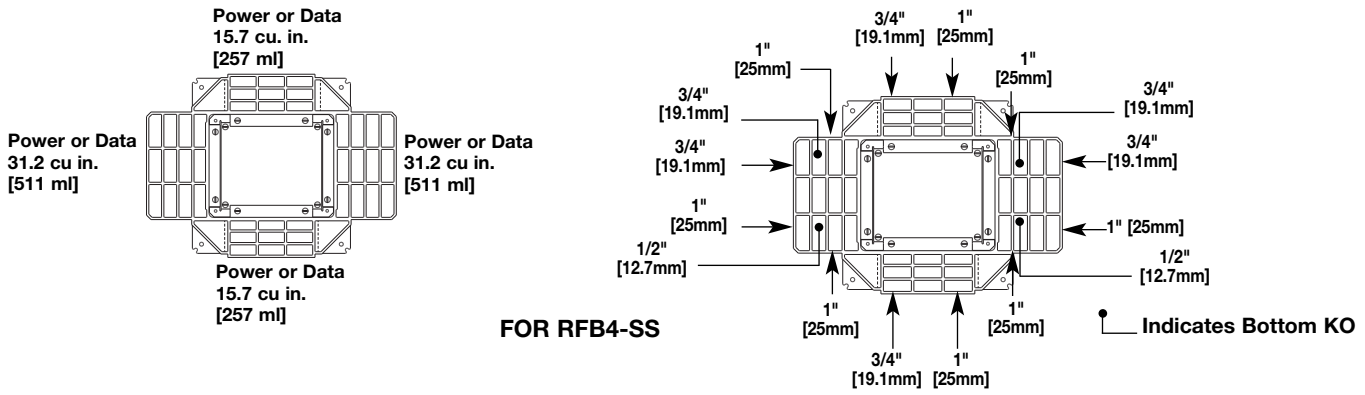

## RFB4-SS Series Multiservice Shallow Steel Floor Box Accessories

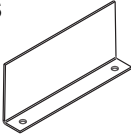
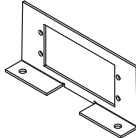
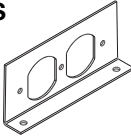
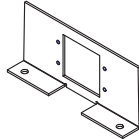
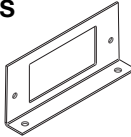
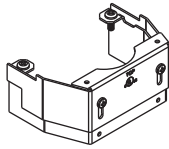
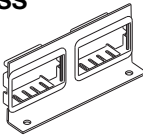
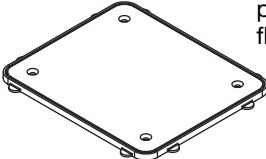
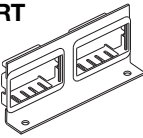
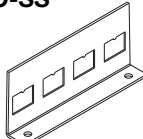
Catalog No./Item	Description/Specifications	Catalog No./Item	Description/Specifications
RFB-B-SS 	<b>Internal Blank Bracket</b> – Used to close off unused gangs.  Country of Origin: USA	RFB4-SS-AAP 	<b>Internal Audio/Video Bracket</b> – Accepts two (2) Extron® Electronics AAP Series Devices. (Sold separately)  <b>NOTE:</b> For RFB4-SS Series Floor Boxes only.  Country of Origin: USA
RFB-RB-SS 	<b>Internal Duplex Receptacle Bracket</b> – Accepts standard 15 Amp & 20 Amp Duplex Receptacles. Country of Origin: USA	RFB4-SS-MAAP 	<b>Internal Audio/Video Bracket</b> – Accepts two Extron® Electronics MAAP Series Devices. (Sold separately)  <b>NOTE:</b> For RFB4-SS Series Floor Boxes only.  Country of Origin: USA
RFB-GFI-SS 	<b>Internal GFI Receptacle Bracket</b> – Accepts standard GFCI & Decorator style Receptacles Communication or Audio/Video Devices. Country of Origin: USA	RFBKIT 	<b>Barrier Kit</b> – Barrier kit used to separate power and communication wires in partition feed covers. Supplied with base and three extensions to adjust to cover height. Kit should be used on RFB2, RFB2-OG, RFB2-SS, RFB4 and RFB4-SS Floor Boxes. Kits are sold separately. Country of Origin: USA
RFB-2AB-SS 	<b>Internal Bracket</b> – Two Pass & Seymour® Activate adapters included. Wiremold CM Series Open System inserts sold separately. Country of Origin: USA	FP-CTR 	<b>Bare Concrete &amp; Terrazzo Ring</b> – Nonmetallic ring for use on bare polished concrete and terrazzo floor applications.  Country of Origin: USA
RFB-2-SSRT 	<b>Communication Bracket</b> – Ortronics® AB2TJ TracJack and ABS2 Series II adapters included. Country of Origin: USA		
RFB-4TKO-SS 	<b>Internal Bracket</b> – Four RJ Keystone opening knockouts. Use as blank plate or for up to four RJ openings.  <b>NOTE:</b> Opening dimension is 9/16" x 3/4" [14.3mm x 19.1mm].  Country of Origin: USA		

Additional configurations available. Please consult your local Sales Representative for more information.

**NOTE:** All device plates and accessories shown on this page are made in the United States of America.

## FloorPort Series Cover Assemblies for RFB4 Series Floor Boxes

### FLOORPORT PART NUMBER CONFIGURATOR

FP	B	TC	NK		
FloorPort	Blank Top	B	Tile (Flangeless)	T	NK
Cover	Cutout Top	C	Tile/Carpet	TC	BS
	Furniture Feed	FF	(Flanged)		BK
					BZ
					GY
					Brushed Aluminum AL

### FloorPort Series Flanged Cover Assemblies Ordering Information

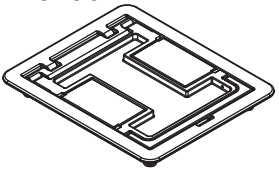
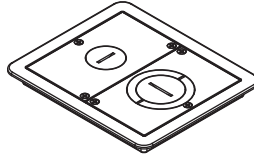
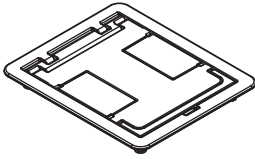
Catalog No./Item	Description/Specifications	Catalog No./Item	Description/Specifications
<b>FPCTCBK</b> <b>FPCTCBZ</b> <b>FPCTCBS</b> <b>FPCTCNK</b> <b>FPCTCAL</b> <b>FPCTCGY</b> 	<b>Cutout Cover Assembly –</b> Flanged cover for use in tile or carpet installation. Die-cast aluminum assembly available in black (BK), bronze (BZ), brass (BS), nickel (NK), gray (GY), or brushed aluminum (AL). Insert in lid allows for carpet or tile cutouts to match finished floor.  <b>Country of Origin: India</b>	<b>FPFFTCBK</b> <b>FPFFTCBZ</b> <b>FPFFTCBS</b> <b>FPFFTCNK</b> <b>FPFFTCAL</b> <b>FPFFTCGY</b> 	<b>Furniture Feed Cover Assembly –</b> Flanged cover for use in tile or carpet installation. Die-cast aluminum assembly available in black (BK), bronze (BZ), brass (BS), nickel (NK), gray (GY), or brushed aluminum (AL). Provided with one 1" trade size screw plug for power or communication type cabling and one combination 1 1/4" and 2" trade size screw plug for communication type cabling. Allows for feeding both power and communication cabling.  <b>Country of Origin: USA</b>
<b>FPBTCBK</b> <b>FPBTCBZ</b> <b>FPBTCBS</b> <b>FPBTCNK</b> <b>FPBTCAL</b> <b>FPBTCTGY</b> 	<b>Blank Cover Assembly –</b> Flanged cover for use in tile or carpet installation. Die-cast aluminum assembly available in black (BK), bronze (BZ), brass (BS), nickel (NK), gray (GY), or brushed aluminum (AL). Lid area is flush with the finished floor, no cutouts provided.  <b>Country of Origin: India</b>		

### FloorPort Series Flangeless Cover Assemblies Ordering Information

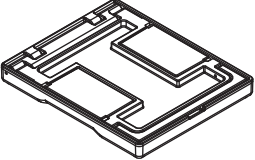
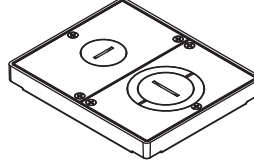
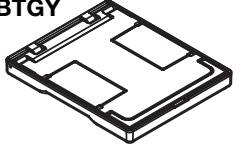
Catalog No./Item	Description/Specifications	Catalog No./Item	Description/Specifications
<b>FPCTBK</b> <b>FPCTBZ</b> <b>FPCTBS</b> <b>FPCTNK</b> <b>FPCTAL</b> <b>FPCTGY</b> 	<b>Cutout Cover Assembly –</b> Flangeless cover for use in tile installations. Die-cast aluminum assembly available in black (BK), bronze (BZ), brass (BS), nickel (NK), gray (GY), or brushed aluminum (AL). Insert in lid allows for tile cutouts to match finished floor.  <b>Country of Origin: India</b>	<b>FPFFTBK</b> <b>FPFFTBZ</b> <b>FPFFTBS</b> <b>FPFFTNK</b> <b>FPFFTAL</b> <b>FPFFTGY</b> 	<b>Furniture Feed Cover Assembly –</b> Flangeless cover for use in tile installations. Die-cast aluminum assembly available in black (BK), bronze (BZ), brass (BS), nickel (NK), gray (GY), or brushed aluminum (AL). Provided with one 1" trade size screw plug for power or communication type cabling and one combination 1 1/4" and 2" trade size screw plug for communication type cabling. Allows for feeding both power and communication cabling.  <b>Country of Origin: USA</b>
<b>FPBTBK</b> <b>FPBTBZ</b> <b>FPBTBS</b> <b>FPBTNK</b> <b>FPBTAL</b> <b>FPBTGY</b> 	<b>Blank Cover Assembly –</b> Flangeless cover for use in tile installations. Die-cast aluminum assembly available in black (BK), bronze (BZ), brass (BS), nickel (NK), gray (GY), or brushed aluminum (AL). Lid area is flush with the finished floor, no cutouts provided.  <b>Country of Origin: India</b>		

**NOTE:** Pricing varies depending on country of origin. Consult your local sales representative for more information.

## North American Made FloorPort Series Cover Assemblies for RFB4 Series Floor Boxes

### NORTH AMERICAN MADE FLOORPORT PART NUMBER CONFIGURATOR

FP	B	TC	NK	NA
FloorPort	Blank Top	B	Nickel	NK
Cover	Cutout Top	C	Brass	BS
	Furniture Feed	FF	Black	BK
			Bronze	BZ
			Gray	GY
			Brushed Aluminum	AL
		T		North American
		TC		Made
		(Flanged)		NA

### North American Made FloorPort Series Flanged Cover Assemblies Ordering Information

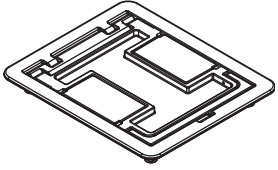
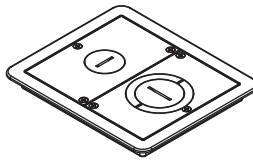
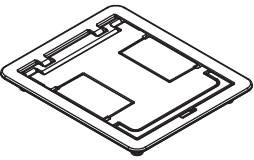
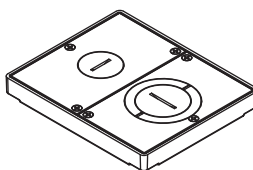
Catalog No./Item	Description/Specifications	Catalog No./Item	Description/Specifications
<b>FPCTCBK-NA</b> <b>FPCTCBZ-NA</b> <b>FPCTCBS-NA</b> <b>FPCTCNK-NA</b> <b>FPCTCGY-NA</b>	<b>Cutout Cover Assembly –</b> Flanged cover for use in tile or carpet installation. Die-cast aluminum assembly available in black (BK), bronze (BZ), brass (BS), nickel (NK), or gray (GY). Insert in lid allows for carpet or tile cutouts to match finished floor.	<b>FPFFTCBK</b> <b>FPFFTCBZ</b> <b>FPFFTCBS</b> <b>FPFFTCNK</b> <b>FPFFTCAL</b> <b>FPFFTCGY</b>	<b>Furniture Feed Cover Assembly –</b> Flanged cover for use in tile or carpet installation. Die-cast aluminum assembly available in black (BK), bronze (BZ), brass (BS), nickel (NK), gray (GY), or brushed aluminum (AL). Provided with one 1" trade size screw plug for power or communication type cabling and one combination 1 1/4" and 2" trade size screw plug for communication type cabling. Allows for feeding both power and communication cabling.
	<b>Country of Origin: USA</b>		<b>Country of Origin: USA</b>
<b>FPBTCBK-NA</b> <b>FPBTCBZ-NA</b> <b>FPBTCBS-NA</b> <b>FPBTCNK-NA</b> <b>FPBTCGY-NA</b>	<b>Blank Cover Assembly –</b> Flanged cover for use in tile or carpet installation. Die-cast aluminum assembly available in black (BK), bronze (BZ), brass (BS), nickel (NK), or gray (GY). Lid area is flush with the finished floor, no cutouts provided.	<b>FPFFTBK</b> <b>FPFFTBZ</b> <b>FPFFTBS</b> <b>FPFFTNK</b> <b>FPFFTAL</b> <b>FPFFTGY</b>	<b>Furniture Feed Cover Assembly –</b> Flangeless cover for use in tile installations. Die-cast aluminum assembly available in black (BK), bronze (BZ), brass (BS), nickel (NK), gray (GY), or brushed aluminum (AL). Provided with one 1" trade size screw plug for power or communication type cabling and one combination 1 1/4" and 2" trade size screw plug for communication type cabling. Allows for feeding both power and communication cabling.
	<b>Country of Origin: USA</b>		<b>Country of Origin: USA</b>

**NOTE:** Pricing varies depending on country of origin. Consult your local sales representative for more information.

LOAD CAPACITIES FOR FLOORPORT COVER ASSEMBLIES	
CATALOG NUMBERS	MAXIMUM LOAD IN POUNDS
FPCTC	1000
FPBTC	750
FPFFTC	1000
FPCT	1000
FPBT	750
FPFFT	1000

**NOTE:** Load applied through a 2" [51mm] mandrel in center of service fitting. Loads above are static loads only and do not pertain to rolling loads.

## RFB4E Series Multiservice Steel Recessed Floor Box Ordering Information

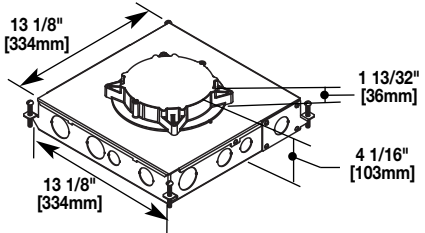
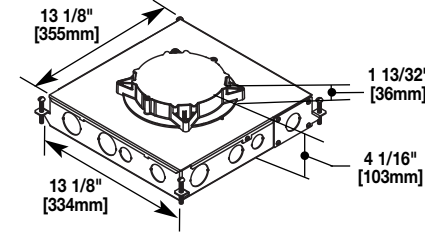
Catalog No./Item	Description/Specifications
<p><b>RFB4E</b></p>  <p>13 1/8" [334mm] 13 1/8" [334mm] 1 13/32" [36mm] 4 1/16" [103mm]</p>	<p><b>Four-Compartment Box</b> – For use in concrete floors. For use with the round Evolution cover. Fully adjustable with tunnel compartments. Device Plates sold separately.</p> <p><b>Country of Origin: USA</b></p>
<p><b>RFB4E-OG</b></p>  <p>13 1/8" [355mm] 13 1/8" [334mm] 1 13/32" [36mm] 4 1/16" [103mm]</p>	<p><b>Four-Compartment On-Grade Box</b> – For use in concrete floors. For use with the round Evolution cover. Fully adjustable with tunnel compartments. Device Plates sold separately.</p> <p><b>Country of Origin: USA</b></p>

## RFB4E Series Compartment Knockout Locations & Sizes

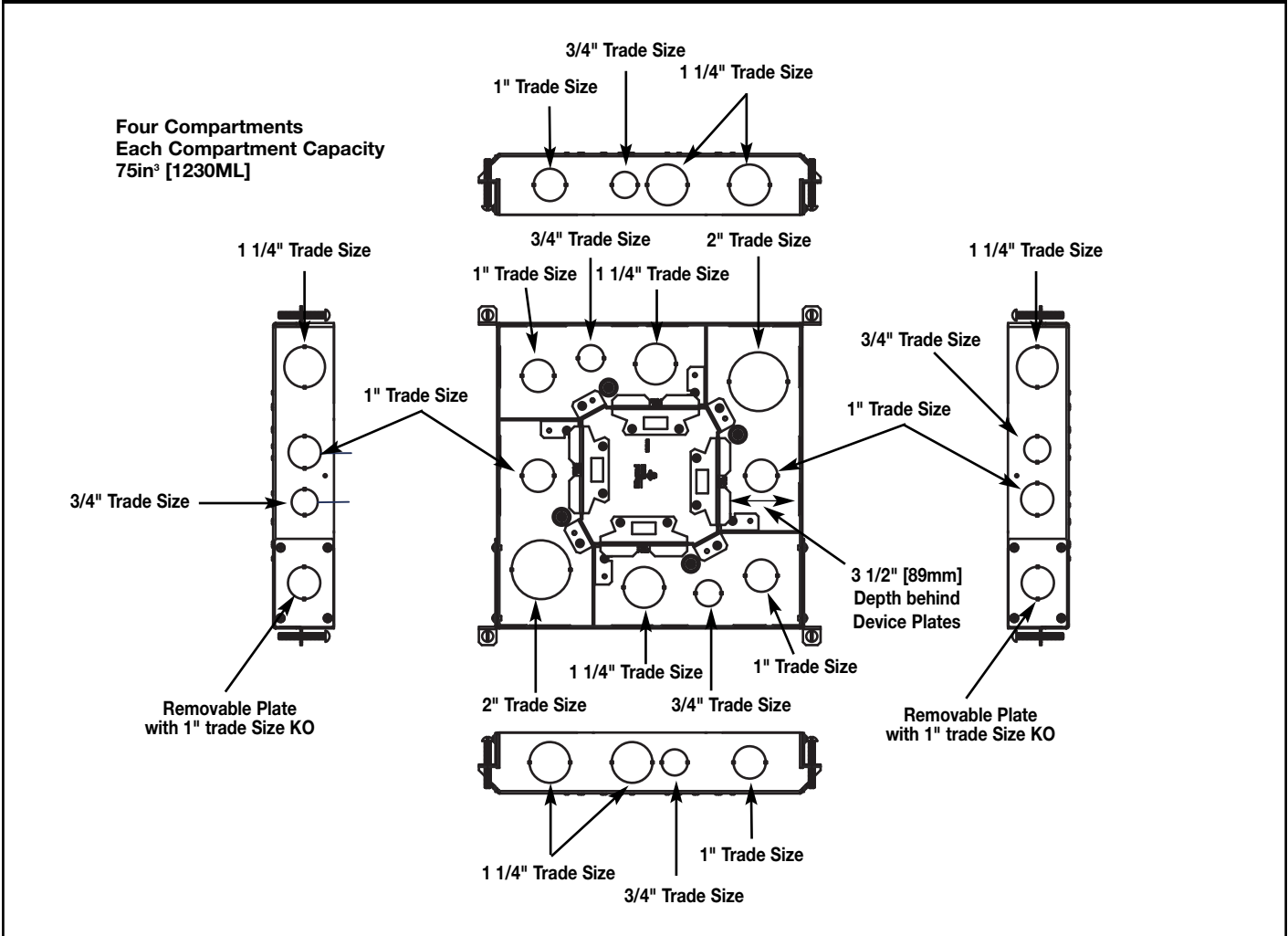

## RFB4E, RFB6 & RFB6E Series Multiservice Steel Recessed Floor Box Accessories

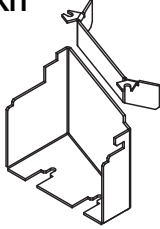
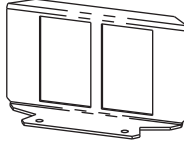
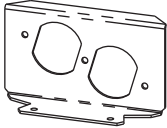
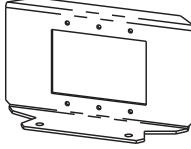
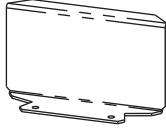
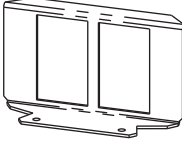
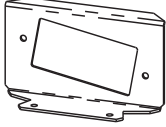
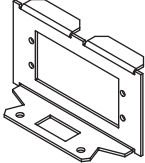
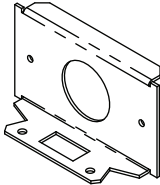
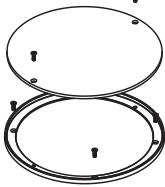
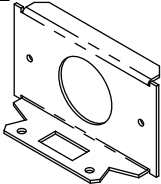
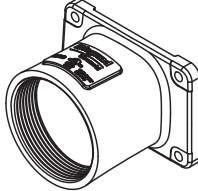
Catalog No./Item	Description/Specifications	Catalog No./Item	Description/Specifications
<b>RFB4EKIT</b> 	<b>Barrier Kit</b> – Barrier kit used to separate power and communication services in combination with a 6CFFTC Furniture Feed Cover. (sold separately).  <b>Country of Origin: USA</b>	<b>RFB6RT</b> 	<b>Internal Communication Bracket</b> – Includes one (1) adapter to accept Ortronics® TracJack devices, and one (1) adapter to accept Ortronics® Series II devices (sold separately).  <b>NOTE: For use with RFB4E, RFB6 and RFB6E Series Floor Boxes.</b>  <b>Country of Origin: USA</b>
<b>RFB6DP</b> 	<b>Internal Duplex Receptacle Bracket</b> – Accepts standard 15 & 20 Amp Duplex Receptacles.  <b>NOTE: For use with RFB4E, RFB6 and RFB6E Series Floor Boxes.</b>  <b>Country of Origin: USA</b>	<b>RFB6EXT</b> 	<b>Internal Audio/Video Bracket</b> – Accepts three (3) Legrand AVIP or Extron® Electronics MAAP Series devices (sold separately).  <b>NOTE: For use with RFB4E, RFB6 and RFB6E Series Floor Boxes.</b>  <b>Country of Origin: USA</b>
<b>RFB6B</b> 	<b>Internal Blank Bracket</b> – Closes off unused gangs.  <b>NOTE: For use with RFB4E, RFB6 and RFB6E Series Floor Boxes.</b>  <b>Country of Origin: USA</b>	<b>RFB62A</b> 	<b>Internal Communication Bracket</b> – Includes two (2) adapters to accept Wiremold CM2 Series Open System communication inserts (sold separately).  <b>NOTE: For use with RFB4E, RFB6 and RFB6E Series Floor Boxes.</b>  <b>Country of Origin: USA</b>
<b>RFB6GFI</b> 	<b>Internal GFI or Decorator Style Receptacle Bracket</b> – Accepts standard GFCI & Decorator Style Receptacles, Communication or Audio/Video Devices.  <b>NOTE: For use with RFB4E, RFB6 and RFB6E Series Floor Boxes.</b>  <b>Country of Origin: USA</b>	<b>RFB6-AAP</b> 	<b>Internal Audio/Video Bracket</b> – Accepts two (2) Extron® Electronics AAP Series Devices (sold separately).  <b>NOTE: For use with RFB4E, RFB6 and RFB6E Series Floor Boxes.</b>  <b>Country of Origin: USA</b>
<b>RFB6S1</b> 	<b>Internal Single Receptacle Bracket</b> – Receptacle opening 1 3/8" [35mm].  <b>NOTE: For use with RFB4E, RFB6 and RFB6E Series Floor Boxes.</b>  <b>Country of Origin: USA</b>	<b>RFB4E-CTR</b> 	<b>Bare Concrete &amp; Terrazzo Ring</b> – Nonmetallic ring for use with bare concrete and terrazzo floor applications.  <b>NOTE: Only for use on RFB4E and RFB4E-OG Floor Boxes.</b>  <b>NOTE: Designed to work with 6CT Series Covers only.</b>  <b>Country of Origin: USA</b>
<b>RFB6S2</b> 	<b>Internal Single Receptacle Bracket</b> – Receptacle opening 1 9/16" [40mm].  <b>NOTE: For use with RFB4E, RFB6 and RFB6E Series Floor Boxes.</b>  <b>Country of Origin: USA</b>	<b>2HUB</b> 	<b>2" Conduit Transition Hub</b> – Trade size 2" die cast zinc conduit fitting allows for 2" conduit to transition into a shallow box design. Includes: die cast fitting, gasket, and mounting screws.  <b>Country of Origin: USA</b>

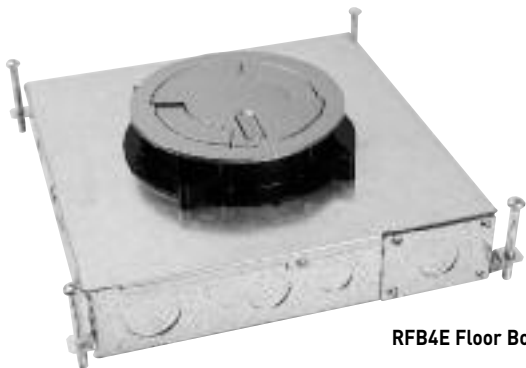

RFB4E Floor Box with Evolution Series Cover.

**NOTE: All device plates and accessories shown on this page are made in the United States of America.**

## Evolution Series Cover Assemblies for RFB4E & RFB4E-OG Floor Boxes

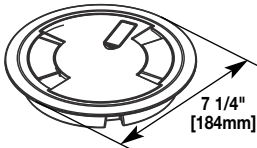
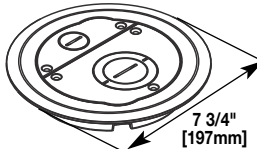
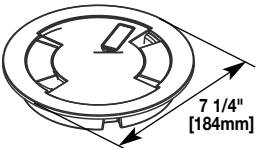
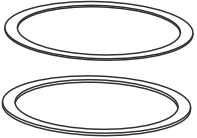
Catalog No./Item	Description/Specifications	Catalog No./Item	Description/Specifications
<p> <b>6CTCGY*</b>  <b>6CTCBK*</b>  <b>6CTCBS*</b>  <b>6CTCBZ*</b>  <b>6CTCNK*</b> </p> 	<p> <b>Surface Style Cover Assembly –</b>                      Die-cast aluminum cover assembly. Cover assembly is available in the following finishes: painted black (BK), painted gray (GY), nickel (NK), brass (BS), and bronze (BZ). 6CTC Series Cover Assemblies designed for use with 6STC and 6STCP and 6STCPAV Poke-Thru Stem Assemblies.  <b>Country of Origin: USA</b> </p>	<p> <b>6CFFTCGY</b>  <b>6CFFTCBK</b>  <b>6CFFTCBS</b>  <b>6CFFTCBZ</b>  <b>6CFFTCNK</b> </p> 	<p> <b>Furniture Feed Cover Assembly –</b>                      Surface style, die-cast aluminum cover assembly, with one (1) 3/4" trade size screw plug opening, and one (1) concentric 2"-1 1/4" trade size screw plug opening. Cover assembly is available in the following powder-coated finishes: (BK) black, (GY) gray, (NK) nickel, (BS) brass, and (BZ) bronze. 6CFFTC Series Cover Assemblies designed for use with 6STC Poke-Thru Stem Assembly. Includes one (1) 3/4" and one (1) 1" trade size conduit fittings and one (1) divider to separate devices.  <b>Country of Origin: USA</b> </p>
<p> <b>6CTGY*</b>  <b>6CTBK*</b>  <b>6CTBS*</b>  <b>6CTBZ*</b>  <b>6CTNK*</b> </p> 	<p> <b>Flush Style Cover Assembly –</b>                      Die-cast aluminum cover assembly. Cover assembly is available in the following finishes: painted black (BK), painted gray (GY), nickel (NK), brass (BS), and bronze (BZ). 6CT Series Cover Assemblies designed for use with 6STC and 6STCP and 6STCPAV Poke-Thru Stem Assemblies. Includes one (1) 6TS Tile Shim.  <b>Country of Origin: USA</b> </p>	<p> <b>6TS</b> </p> 	<p> <b>Tile Shim –</b> Used for floor coverings greater than 5/16" [7.9mm]. The 6TS will allow the top surface of the cover to be flush with the finished floor. Includes: six (6) 1/16" [1.6mm] thick shims and two (2) 1/16" [1.6mm] thick shims. Up to a total of 3/8" [9.5mm] of adjustment.  <b>Country of Origin: USA</b> </p>

\* Add suffix "TR" to the end of the part number to indicate tamper-resistant cover assembly. Tamper-resistant versions are secured with a single tamper-resistant screw.

**NOTE: All Evolution Series Poke-Thru Covers shown on this page are made in the United States of America.**

# RFB6 & RFB6E Series Multiservice Steel Recessed Floor Box Ordering Information

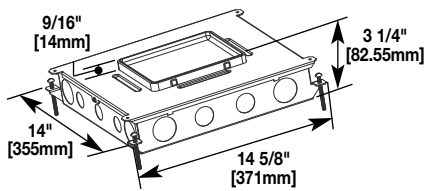
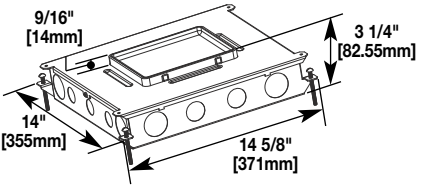
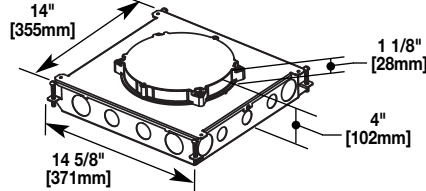
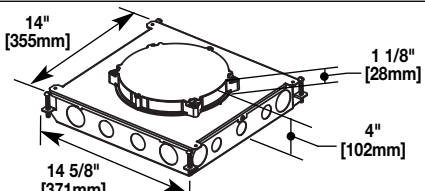
Catalog No./Item	Description/Specifications
<b>RFB6</b> 	<b>Six-Compartment Box</b> – For use in either concrete or wood floors. Fully adjustable with tunnel compartment. Supplied with two (2) duplex mounting plates, two (2) communication mounting plates (RFB62A), and (2) blank mounting plates. Other plates sold separately.  <b>Country of Origin: USA</b>
<b>RFB6-OG</b> 	<b>Six-Compartment On-Grade Box</b> – For use in either concrete or wood floors. Fully adjustable with tunnel compartment. Supplied with two (2) duplex mounting plates, two (2) communication mounting plates (RFB62A), and (2) blank mounting plates. Other plates sold separately.  <b>Country of Origin: USA</b>
<b>RFB6E</b> 	<b>Six-Compartment Box</b> – For use in concrete floors. For use with the round Evolution cover. Fully adjustable with tunnel compartments. Supplied with two (2) duplex mounting plates. Other plates sold separately.  <b>Country of Origin: USA</b>
<b>RFB6E-OG</b> 	<b>Six-Compartment On-Grade Box</b> – For use in concrete floors. For use with the round Evolution cover. Fully adjustable with tunnel compartments. Supplied with two (2) duplex mounting plates. Other plates sold separately.  <b>Country of Origin: USA</b>

## RFB6 Series Compartment Capacities/Knockout Locations & Sizes

### Side Knockout Locations

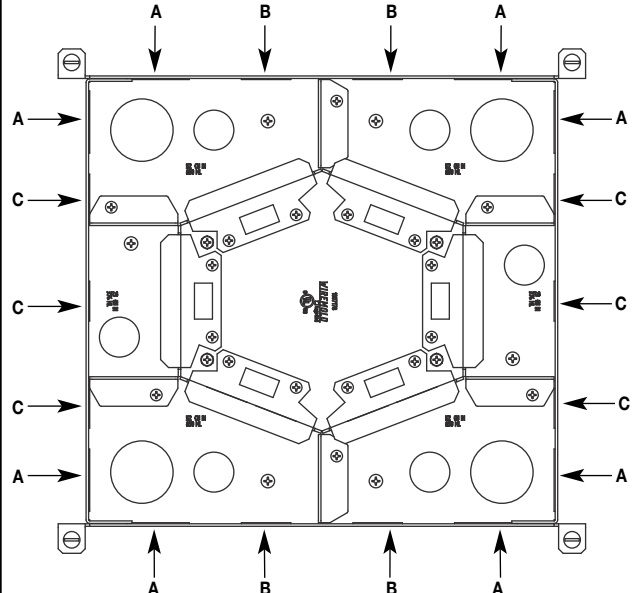

**KNOCKOUTS**  
A = Side KO 1 1/4" [32mm]  
B = Side KO 1" [25mm]  
C = Side KO 3/4" [19.1mm]

### Bottom Knockout Locations

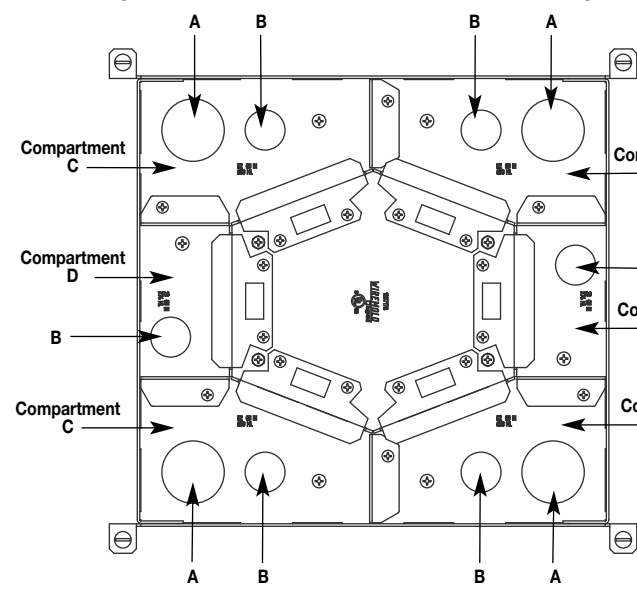

**KNOCKOUTS**  
A = Bottom KO 1 1/4" [32mm]  
B = Bottom KO 3/4" [19.1mm]

### Compartment Wire and Communication Capacities

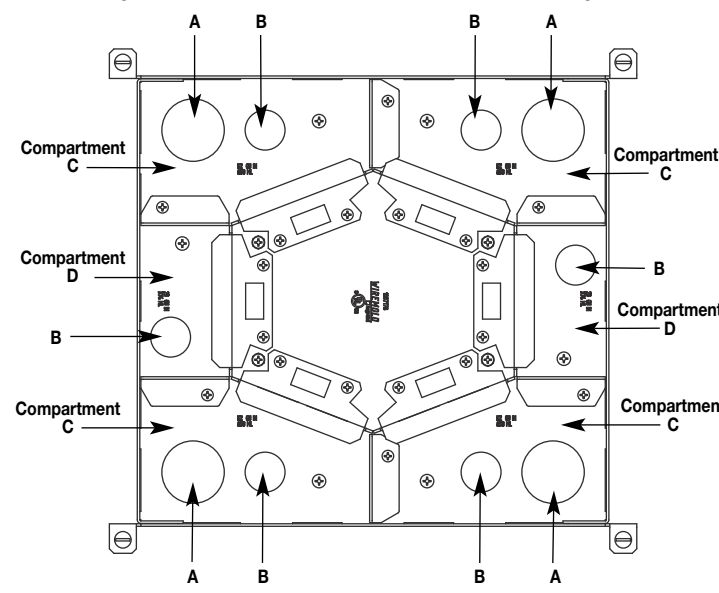

**COMPARTMENT CAPACITIES**  
C = Power or Data 52 in<sup>3</sup> [852ml]  
D = Power or Data 23 in<sup>3</sup> [376ml]

**Feed through is accomplished through removable plugs.**

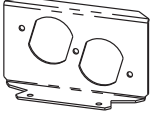
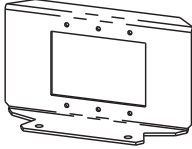
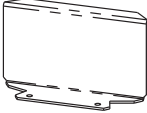
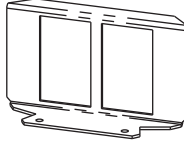
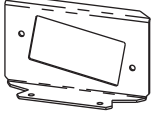
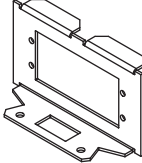
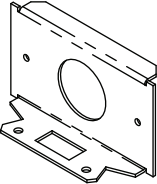
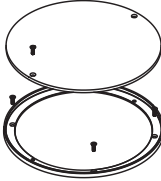
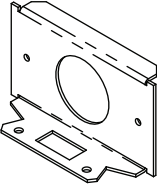
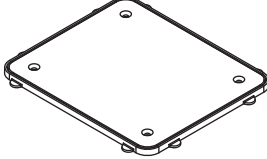
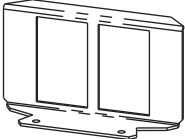

## RFB6 & RFB6E Series Multiservice Steel Recessed Floor Box Accessories

Catalog No./Item	Description/Specifications	Catalog No./Item	Description/Specifications
<b>RFB6DP</b> 	<b>Internal Duplex Receptacle Bracket</b> – Accepts standard 15 & 20 Amp Duplex Receptacles. <b>NOTE:</b> For use with RFB4E, RFB6 and RFB6E Series Floor Boxes.  Country of Origin: USA	<b>RFB6EXT</b> 	<b>Internal Audio/Video Bracket</b> – Accepts three (3) Legrand AVIP or Extron® Electronics MAAP Series devices (sold separately). <b>NOTE:</b> For use with RFB4E, RFB6 and RFB6E Series Floor Boxes.  Country of Origin: USA
<b>RFB6B</b> 	<b>Internal Blank Bracket</b> – Closes off unused gangs.  <b>NOTE:</b> For use with RFB4E, RFB6 and RFB6E Series Floor Boxes.  Country of Origin: USA	<b>RFB62A</b> 	<b>Internal Communication Bracket</b> – Includes two (2) adapters to accept Wiremold CM2 Series Open System communication inserts (sold separately). <b>NOTE:</b> For use with RFB4E, RFB6 and RFB6E Series Floor Boxes.  Country of Origin: USA
<b>RFB6GFI</b> 	<b>Internal GFI or Decorator Style Receptacle Bracket</b> – Accepts standard GFCI & Decorator Style Receptacles, Communication or Audio/Video Devices. <b>NOTE:</b> For use with RFB4E, RFB6 and RFB6E Series Floor Boxes.  Country of Origin: USA	<b>RFB6-AAP</b> 	<b>Internal Audio/Video Bracket</b> – Accepts two (2) Extron® Electronics AAP Series Devices (sold separately). <b>NOTE:</b> For use with RFB4E, RFB6 and RFB6E Series Floor Boxes.  Country of Origin: USA
<b>RFB6S1</b> 	<b>Internal Single Receptacle Bracket</b> – Receptacle opening 1 3/8" [35mm]. <b>NOTE:</b> For use with RFB4E, RFB6 and RFB6E Series Floor Boxes.  Country of Origin: USA	<b>RFB6E-CTR</b> 	<b>Bare Concrete &amp; Terrazzo Ring</b> – Nonmetallic ring for use with bare concrete and terrazzo floor applications. <b>NOTE:</b> Only for use on RFB6E and RFB6E-OG Floor Boxes. <b>NOTE:</b> Designed to work with 8CTC & 8CT Series Covers only.  Country of Origin: USA
<b>RFB6S2</b> 	<b>Internal Single Receptacle Bracket</b> – Receptacle opening 1 9/16" [40mm]. <b>NOTE:</b> For use with RFB4E, RFB6 and RFB6E Series Floor Boxes.  Country of Origin: USA	<b>FP-CTR</b> 	<b>Bare Concrete &amp; Terrazzo Ring</b> – Nonmetallic ring for use on bare polished concrete and terrazzo floor applications. <b>NOTE:</b> For use with RFB6 Series Floor Boxes.  Country of Origin: USA
<b>RFB6RT</b> 	<b>Internal Communication Bracket</b> – Includes one (1) adapter to accept Ortronics® TracJack devices, and one (1) adapter to accept Ortronics® Series II devices (sold separately). <b>NOTE:</b> For use with RFB4E, RFB6 and RFB6E Series Floor Boxes.  Country of Origin: USA	<b>NOTE: All device plates and accessories shown on this page are made in the United States of America.</b>	

RFB6 Floor Box with FloorPort Activation Cover and RFB6E Floor Box with Evolution Series Cover.

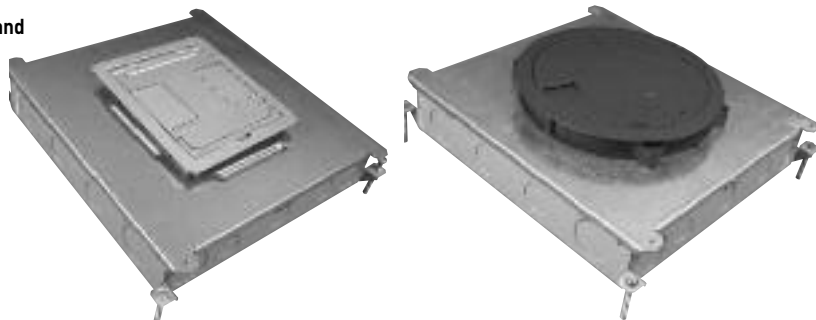

## Evolution Series Cover Assemblies for RFB6E & RFB6E-OG Floor Boxes

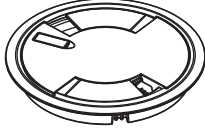
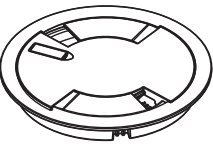
Catalog No./Item	Description/Specifications
<p>8CTCGY* 8CTCBK* 8CTCBS* 8CTCBZ* 8CTCNK*</p> 	<p><b>Surface Style Cover Assembly –</b> Die-cast aluminum cover assembly. Cover assembly is available in the following finishes: painted black (BK), painted gray (GY), nickel (NK), brass (BS), and bronze (BZ). 8CTC Series Cover Assemblies designed for use with 8STC and 8STCP Poke-Thru Stem Assemblies. <b>Country of Origin: USA</b></p>
<p>8CTGY* 8CTBK* 8CTBS* 8CTBZ* 8CTNK*</p> 	<p><b>Flush Style Cover Assembly –</b> Die-cast aluminum cover assembly. Cover assembly is available in the following finishes: painted black (BK), painted gray (GY), nickel (NK), brass (BS), and bronze (BZ). 8CTC Series Cover Assemblies designed for use with 8STC and 8STCP Poke-Thru Stem Assemblies. Includes one (1) 8TS Tile Shim. <b>Country of Origin: USA</b></p>

\* Add suffix "TR" to the end of the part number to indicate tamper-resistant cover assembly. Tamper-resistant versions are secured with a single tamper-resistant screw.

**NOTE: All Evolution Series Poke-Thru Covers shown on this page are made in the United States of America.**

### Load Capacities for Evolution™ Series Cover Assemblies

Catalog Numbers	Maximum Load in Pounds
6CT	1000
6CTC	1000
6CFFTC	1000
8CT	1000
8CTC	1000

**NOTE: Load applied through a 1" mandrel in the center of cover assembly.**

**NOTE: Loads above are static loads only and do not pertain to rolling loads.**

## FloorPort Series Cover Assemblies for RFB2, RFB4 & RFB6 Series Floor Boxes

### FLOORPORT PART NUMBER CONFIGURATOR

FP	B	TC	NK
FloorPort	Blank Top	B Tile (Flangeless) T	Nickel NK
Cover	Cutout Top	C Tile/Carpet TC	Brass BS
	Furniture Feed	FF (Flanged)	Black BK
			Bronze BZ
			Gray GY
			Brushed Aluminum AL

### FloorPort Series Flanged Cover Assemblies Ordering Information

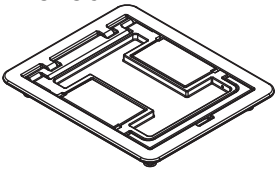
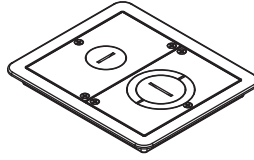
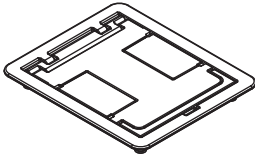
Catalog No./Item	Description/Specifications	Catalog No./Item	Description/Specifications
<b>FPCTCBK</b> <b>FPCTCBZ</b> <b>FPCTCBS</b> <b>FPCTCNK</b> <b>FPCTCAL</b> <b>FPCTCGY</b> 	<b>Cutout Cover Assembly –</b> Flanged cover for use in tile or carpet installation. Die-cast aluminum assembly available in black (BK), bronze (BZ), brass (BS), nickel (NK), gray (GY), or brushed aluminum (AL). Insert in lid allows for carpet or tile cutouts to match finished floor.  <b>Country of Origin: India</b>	<b>FPFFTCBK</b> <b>FPFFTCBZ</b> <b>FPFFTCBS</b> <b>FPFFTCNK</b> <b>FPFFTCAL</b> <b>FPFFTCGY</b> 	<b>Furniture Feed Cover Assembly –</b> Flanged cover for use in tile or carpet installation. Die-cast aluminum assembly available in black (BK), bronze (BZ), brass (BS), nickel (NK), gray (GY), or brushed aluminum (AL). Provided with one 1" trade size screw plug for power or communication type cabling and one combination 1 1/4" and 2" trade size screw plug for communication type cabling. Allows for feeding both power and communication cabling.  <b>Country of Origin: USA</b>
<b>FPBTCBK</b> <b>FPBTCBZ</b> <b>FPBTCBS</b> <b>FPBTCNK</b> <b>FPBTCAL</b> <b>FPBTCGY</b> 	<b>Blank Cover Assembly –</b> Flanged cover for use in tile or carpet installation. Die-cast aluminum assembly available in black (BK), bronze (BZ), brass (BS), nickel (NK), gray (GY), or brushed aluminum (AL). Lid area is flush with the finished floor, no cutouts provided.  <b>Country of Origin: India</b>		

### FloorPort Series Flangeless Cover Assemblies Ordering Information

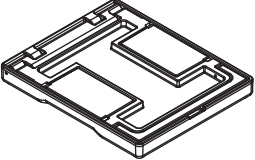
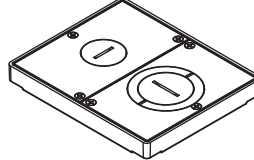
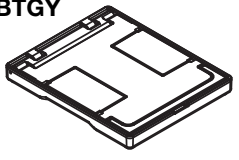
Catalog No./Item	Description/Specifications	Catalog No./Item	Description/Specifications
<b>FPCTBK</b> <b>FPCTBZ</b> <b>FPCTBS</b> <b>FPCTNK</b> <b>FPCTAL</b> <b>FPCTGY</b> 	<b>Cutout Cover Assembly –</b> Flangeless cover for use in tile installations. Die-cast aluminum assembly available in black (BK), bronze (BZ), brass (BS), nickel (NK), gray (GY), or brushed aluminum (AL). Insert in lid allows for tile cutouts to match finished floor.  <b>Country of Origin: India</b>	<b>FPFFTBK</b> <b>FPFFTBZ</b> <b>FPFFTBS</b> <b>FPFFTNK</b> <b>FPFFTAL</b> <b>FPFFTGY</b> 	<b>Furniture Feed Cover Assembly –</b> Flangeless cover for use in tile installations. Die-cast aluminum assembly available in black (BK), bronze (BZ), brass (BS), nickel (NK), gray (GY), or brushed aluminum (AL). Provided with one 1" trade size screw plug for power or communication type cabling and one combination 1 1/4" and 2" trade size screw plug for communication type cabling. Allows for feeding both power and communication cabling.  <b>Country of Origin: USA</b>
<b>FPBTBK</b> <b>FPBTBZ</b> <b>FPBTBS</b> <b>FPBTNK</b> <b>FPBTAL</b> <b>FPBTGY</b> 	<b>Blank Cover Assembly –</b> Flangeless cover for use in tile installations. Die-cast aluminum assembly available in black (BK), bronze (BZ), brass (BS), nickel (NK), gray (GY), or brushed aluminum (AL). Lid area is flush with the finished floor, no cutouts provided.  <b>Country of Origin: India</b>		

**NOTE: Pricing varies depending on country of origin. Consult your local sales representative for more information.**

# North American Made FloorPort Series Cover Assemblies for RFB2, RFB4 & RFB6 Series Floor Boxes

## NORTH AMERICAN MADE FLOORPORT PART NUMBER CONFIGURATOR

FP	B	TC	NK	NA	
FloorPort Cover	Blank Top Cutout Top Furniture Feed	B Tile (Flangeless) C Tile/Carpet FF (Flanged)	T TC	Nickel Brass Black Bronze Gray Brushed Aluminum	NK North American BS Made BK BZ GY AL

## North American Made FloorPort Series Flanged Cover Assemblies Ordering Information

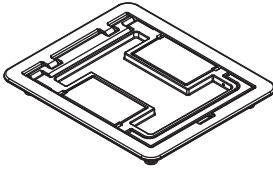
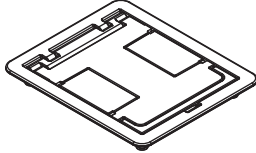
Catalog No./Item	Description/Specifications
<p><b>FPCTCBK-NA</b> <b>FPCTCBZ-NA</b> <b>FPCTCBS-NA</b> <b>FPCTCNK-NA</b> <b>FPCTCGY-NA</b></p> 	<p><b>Cutout Cover Assembly –</b> Flanged cover for use in tile or carpet installation. Die-cast aluminum assembly available in black (BK), bronze (BZ), brass (BS), nickel (NK), or gray (GY). Insert in lid allows for carpet or tile cutouts to match finished floor.</p> <p style="text-align: right;"><b>Country of Origin: USA</b></p>
<p><b>FPBTCBK-NA</b> <b>FPBTCBZ-NA</b> <b>FPBTCBS-NA</b> <b>FPBTCNK-NA</b> <b>FPBTCGY-NA</b></p> 	<p><b>Blank Cover Assembly –</b> Flanged cover for use in tile or carpet installation. Die-cast aluminum assembly available in black (BK), bronze (BZ), brass (BS), nickel (NK), or gray (GY). Lid area is flush with the finished floor, no cutouts provided.</p> <p style="text-align: right;"><b>Country of Origin: USA</b></p>

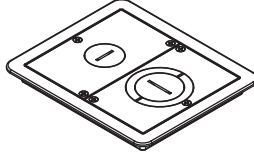
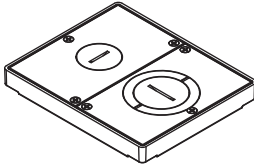
Catalog No./Item	Description/Specifications
<p><b>FPFFTCBK</b> <b>FPFFTCBZ</b> <b>FPFFTCBS</b> <b>FPFFTCNK</b> <b>FPFFTCAL</b> <b>FPFFTCGY</b></p> 	<p><b>Furniture Feed Cover Assembly –</b> Flanged cover for use in tile or carpet installation. Die-cast aluminum assembly available in black (BK), bronze (BZ), brass (BS), nickel (NK), gray (GY), or brushed aluminum (AL). Provided with one 1" trade size screw plug for power or communication type cabling and one combination 1 1/4" and 2" trade size screw plug for communication type cabling. Allows for feeding both power and communication cabling.</p> <p style="text-align: right;"><b>Country of Origin: USA</b></p>
<p><b>FPFFTBK</b> <b>FPFFTBZ</b> <b>FPFFTBS</b> <b>FPFFTNK</b> <b>FPFFTAL</b> <b>FPFFTGY</b></p> 	<p><b>Furniture Feed Cover Assembly –</b> Flangeless cover for use in tile installations. Die-cast aluminum assembly available in black (BK), bronze (BZ), brass (BS), nickel (NK), gray (GY), or brushed aluminum (AL). Provided with one 1" trade size screw plug for power or communication type cabling and one combination 1 1/4" and 2" trade size screw plug for communication type cabling. Allows for feeding both power and communication cabling.</p> <p style="text-align: right;"><b>Country of Origin: USA</b></p>

### LOAD CAPACITIES FOR FLOORPORT COVER ASSEMBLIES

CATALOG NUMBERS	MAXIMUM LOAD IN POUNDS
FPCTC	1000
FPBTC	750
FPFFTC	1000
FPCT	1000
FPBT	750
FPFFT	1000

**NOTE:** Load applied through a 2" [51mm] mandrel in center of service fitting. Loads above are static loads only and do not pertain to rolling loads.

**NOTE:** Pricing varies depending on country of origin. Consult your local sales representative for more information.



**Electrical Wiring Systems**  
60 Woodlawn Street  
West Hartford, CT 06110  
Phone: 1.877.BY.LEGRAND (295-3472)  
www.legrand.us  
570 Applewood Crescent  
Vaughan, Ontario L4K 4B4  
Phone: 905.738.9195  
www.legrand.ca

