

**Ty-Duct™**

Wiring Duct and  
Accessories



*Effective September 2005*

**United States**  
Tel: 901.252.8000  
Fax: 901.252.1354

**Canada**  
Tel: 450.347.5318  
Fax: 450.347.1976

**Technical Services**  
Tel: 888.862.3289

[www.tnb.com](http://www.tnb.com)

## In This Catalog...

### *Ty-Duct™ and Accessories*

Ty-Duct™ and Accessories Overview .....	2-4
Ordering Information for Ty-Duct™ .....	5
Solid Wall Wiring Duct .....	6-7
Wide Slot Wiring Duct .....	8-9
Narrow Slot Wiring Duct .....	10-11
Round Hole Wiring Duct .....	12-13
Wide Slot Wiring Duct, Halogen Free .....	14-15
Accessories .....	16-17
Tools .....	18-19
Wire Fill Capacity .....	20
Material Specifications .....	21
Dimensional Details .....	22-25
Agency Approvals .....	26
Product Code Index .....	27
Additional Product Lines .....	28

*Ty-Duct™ and Accessories*

**Thomas & Betts**

**United States**  
Tel: 901.252.8000  
Fax: 901.252.1354

**Canada**  
Tel: 450.347.5318  
Fax: 450.347.1976

**Technical Services**  
Tel: 888.862.3289

[www.tnb.com](http://www.tnb.com)

**Overview**

**Ty-Duct™ — The versatile configurations you need for routing and concealing wiring!**

Thomas & Betts' innovative new Ty-Duct products offer a total solution for routing and concealing wiring in control panels. Many different sizes are available to accommodate anything from the smallest wallmount panel to the larger integrated systems! Here are some of the impressive features incorporated into all of our wiring duct solutions.

**Ty-Duct Features**

- Available in Solid, Wide Slot, Narrow Slot, and Round Hole versions to meet your capacity and flexibility needs
- Widths from .75" to 6" and depths from 1" to 5"
- Optional adhesive back for quick, hassle-free installation
- Complete selection of accessories and tools for installation
- Lead-free construction
- Lightweight Halogen-free unit available for Wide Slot Wiring Duct

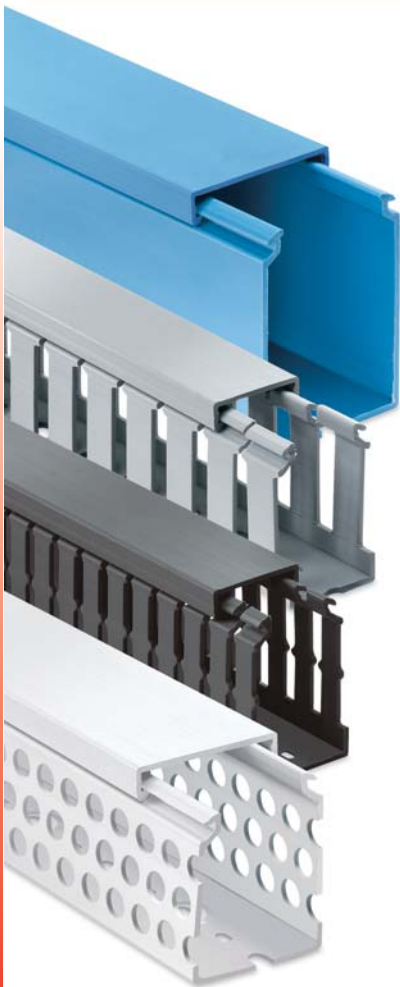
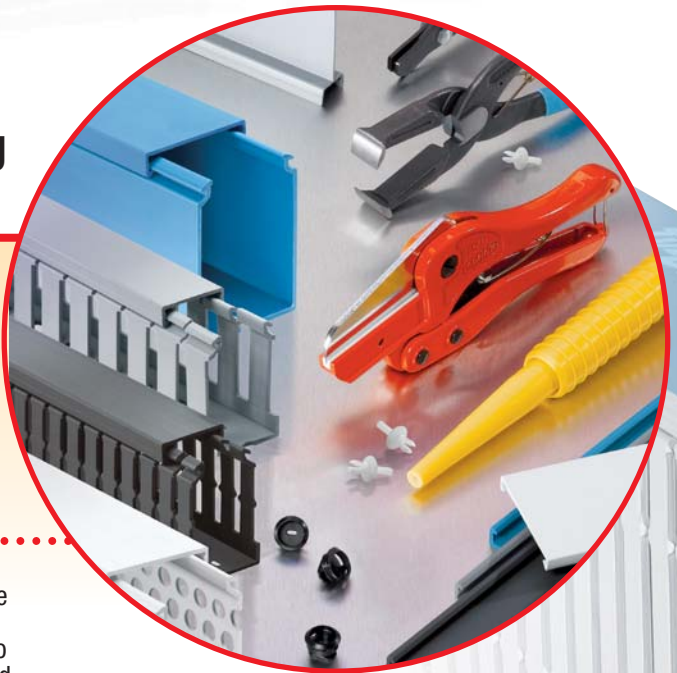

**Ty-Duct Certifications**

- UL® Recognized Continuous-Use Temperature — 122° F (50° C)
- UL 94 Flammability — Rating of V-0
- Conforms with NFPA 79-2002 Section 14.3.1 Requirement for Flame Retardant Material
- CE compliant for European shipping
- CSA Certified
- RoHs Certified



**Available in 4 Colors**



# Ty-Duct™

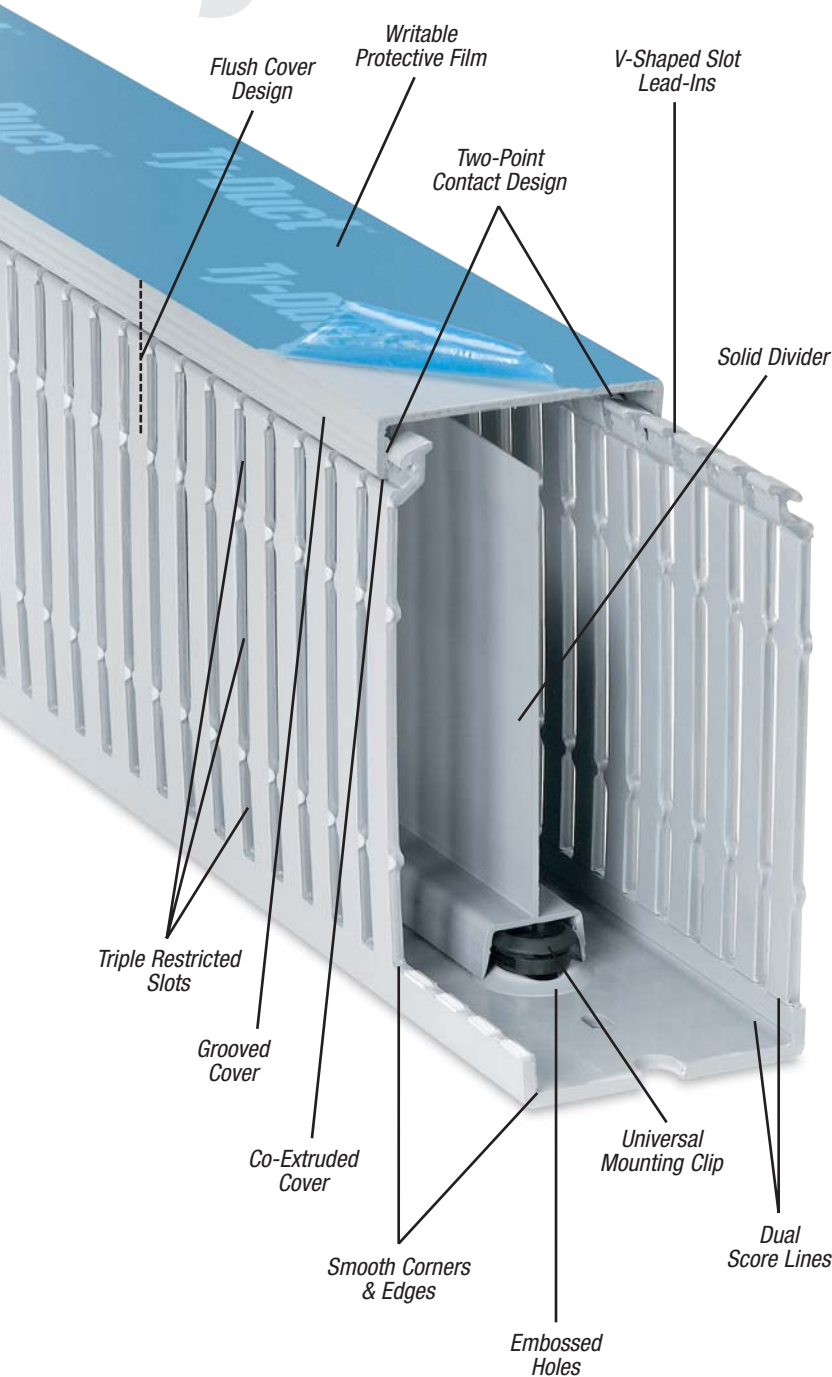

## Ty-Duct™ Advantages

- **Two-point contact** design enables the cover to be easily installed in the right place with less force
- **Co-extruded cover** ensures the cover will stay in place and will not slip once installed
- **Smooth corners and edges** will not damage or disfigure wires
- **Flush cover design** enables greater capacity and sits flush with duct side wall
- **Triple restricted slots** speed installation while enabling better wire retaining in duct
- **Dual score lines** — Upper score line allows fingers to be broken out without tools and the lower score line allows side wall sections to be removed easily
- **V-shaped slot lead-in** funnels wires into slot for easier wire insertion
- **Staggered mounting hole pattern** (larger widths)
- **Universal Mounting Clip** secures into the base to perform several tasks:
  - Enables divider to be snapped into base
  - Slots in the Universal Mounting Clip allow cable ties to pass through to hold wire bundles in place
  - 2 slot sizes on Universal Mounting Clip accommodate traditional nylon cable ties or hook and loop fasteners
- **Slotted and Solid Divider** accommodates various wiring applications
- **Grooved cover** provides better grip for removal and placement of cover onto base
- **Writable protective film** on covers protects from work site scratches and scuffs and enables temporary marking or labeling
- **Embossed holes** enable Universal Mounting Clips to be installed, even after the duct has been riveted to the panel
- **PVC construction** is excellent for flame retardancy
- **North American and DIN standard mounting holes**

**Ty-Duct™ and Accessories**

## Overview

Ty-Duct™ and Accessories

### Solid Wall Wiring Duct

- Engineered to restrict wire access for greater security
- Available in improved flush sidewall and cover style for greater wire capacity

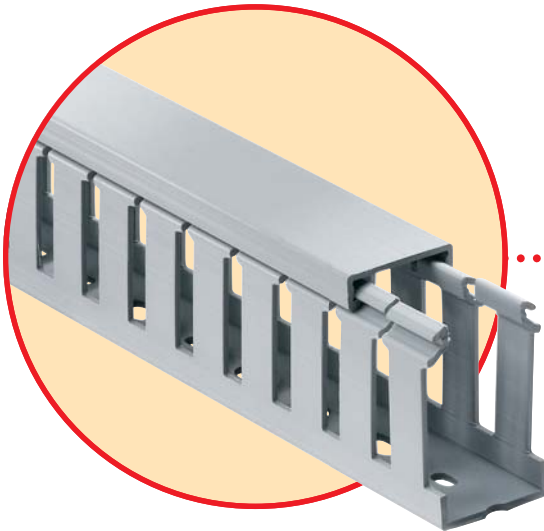
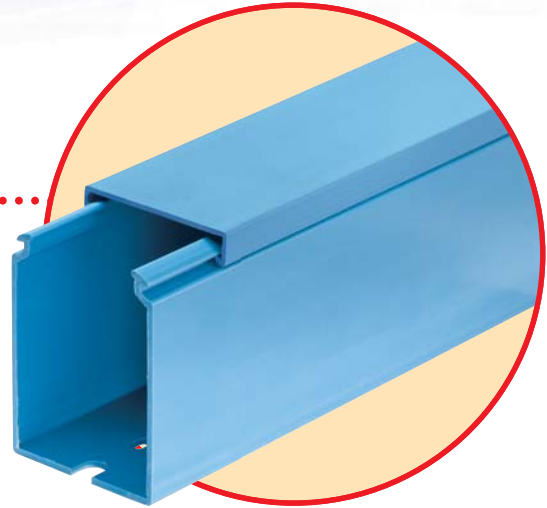

### Wide Slot Wiring Duct

- Wide fingers and slots increase rigidity and enable insertion of bundles
- Halogen-free version available

### Narrow Slot Wiring Duct

- Smaller, higher number of fingers for more concise harnessing
- Finger design restricts wire from slipping along the edge — creates two or three levels of wire service

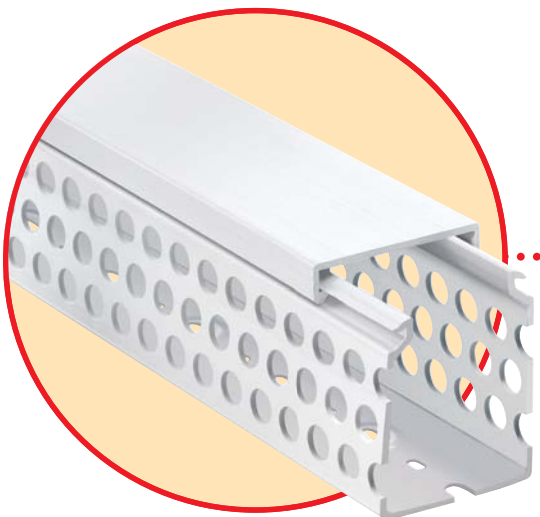

### Round Hole Wiring Duct

- Multiple rows of holes retain wire at different heights and positions with or without the cover
- Features maximum number of wire holes

### How to Order Ty-Duct™





Ordering the Ty-Duct™ products you need is as easy as 1, 2, 3!

After selecting the appropriate Ty-Duct solutions for your application, make sure you complete the following checklist.

#### For Ty-Duct Wiring Duct and Covers:

- 1 Specify color
- 2 Indicate if you want the duct without mounting holes
- 3 Indicate if you want an adhesive-backed duct (not available in Wide Slot Duct — Halogen Free)

[ ] = space for color identifier:

G	= Gray	
W	= White	
B	= Black	
I	= Intrinsic Blue	



Ty-Duct™ and Accessories

2 To order duct without mounting holes, add suffix NM to catalog number. **Example:** TY75X1WPG6NM is a .75" x 1" wide slot gray duct with no mounting holes.

3 To order Adhesive-Backed Duct, add suffix A to Catalog Number. **Example:** TY75x15WPB6A is a .75" x 1.5" wide slot black duct with adhesive backing. Shelf life for adhesive is 1 year.

CAT. NO.	DESCRIPTION	Nominal Width x Nominal Height		COVER CAT. NO.	Standard Carton Quantity		
		IN.	MM		DUCT STD. CTN. QTY.	COVER STD. CTN. QTY.	LENGTH (FT.)
TY75X1WP[G]6NM	.75 x 1 Wide Slot Duct	0.94 x 1.09	23.9 x 27.7		120		
TY75X15WP[B]6A	.75 x 1.5 Wide Slot Duct	0.94 x 1.56	23.9 x 39.6	TY75CP[ ]6	120	120	6
TY75X2WP[I]6	.75 x 2 Wide Slot Duct	0.94 x 2.07	23.9 x 52.6		120		

1 Catalog Number must be completed by adding suffix G for Gray, W for White, I for Intrinsic Blue, B for Black. **Example:** TY75x2WPI6 is a .75" x 2" wide slot intrinsic blue duct. Cover color must be specified also.

Standard lengths are 6 feet.

SP=Solid  
WP=Wide Slot  
NP=Narrow Slot  
RP=Round Hole

#### For Ty-Duct Dividers:

Catalog Number must be completed by adding suffix S for Solid or W for Wide Slot. **Example:** TY2DSPG6 is a 2" high solid wall gray divider.

CAT. NO.	DESCRIPTION	LENGTH (FT.)	STD. CTN. QTY
TY2D[SP][G]6	2" High Wall Divider	6	120

Catalog Number must be completed by adding suffix G for Gray, W for White, I for Intrinsic Blue, B for Black. **Example:** TY2DSPG6 is a 2" high solid wall gray divider.

#### For Ty-Duct Corner & Joining Strips:



Corner Strip sample shown below. Joining Strips are ordered the same way.

CAT. NO.	DESCRIPTION	LENGTH (FT.)	STD. CTN. QTY
TYCS[G]6	Corner Strip	6	120

Catalog Number must be completed by adding suffix G for Gray, W for White, I for Intrinsic Blue, B for Black. **Example:** TYCSG6 is a gray corner strip.

## Solid Wall Duct

Fire-retardant PVC offers the protection you need!

### Solid Wall Duct—PVC

- Engineered to restrict wire access
- Constructed of flame-retardant PVC
- Improved flush sidewall and cover style for greater wire capacity
- Versatile North American and DIN Standard mounting holes enable same duct for multiple applications
- Base score line
- Lead-free construction

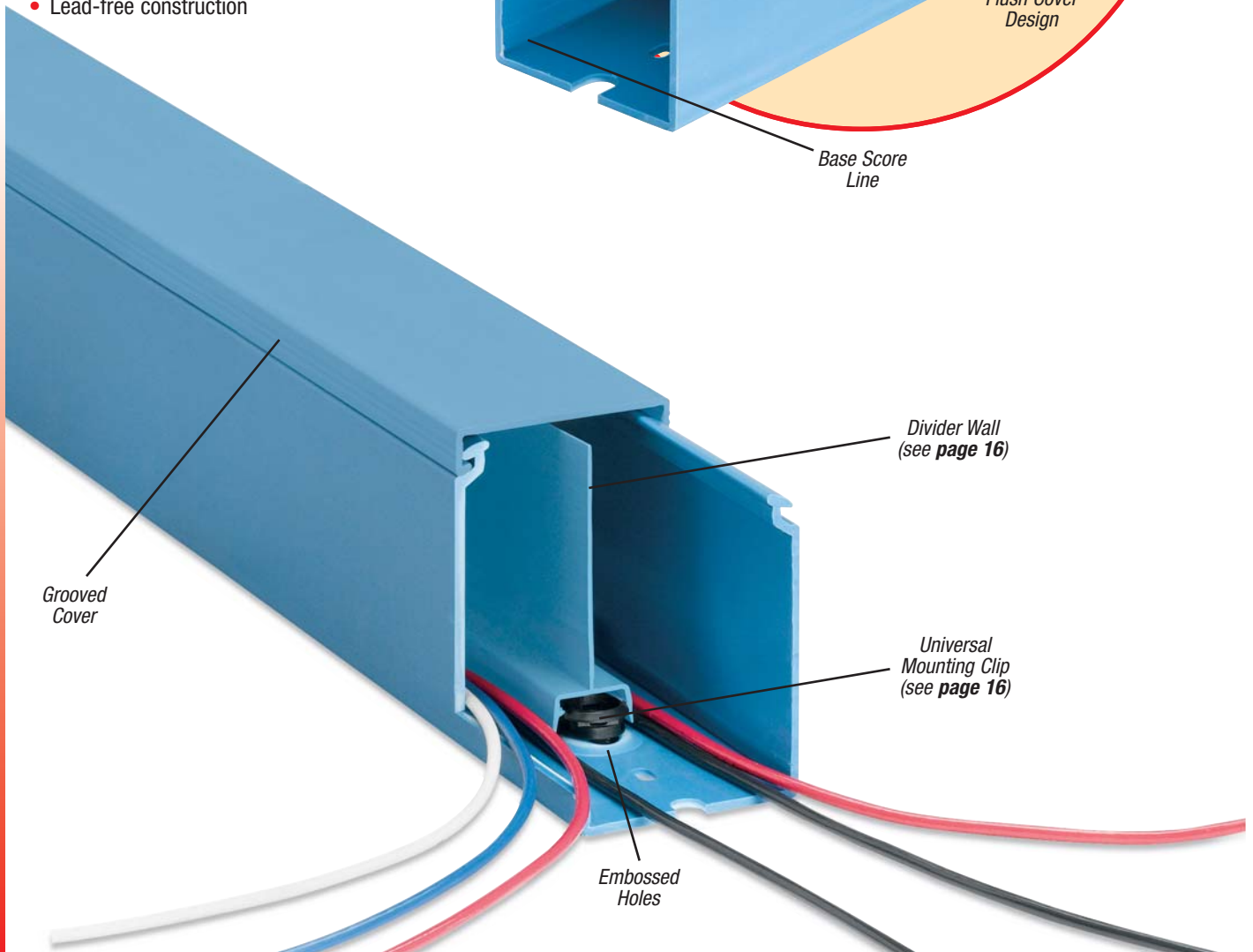
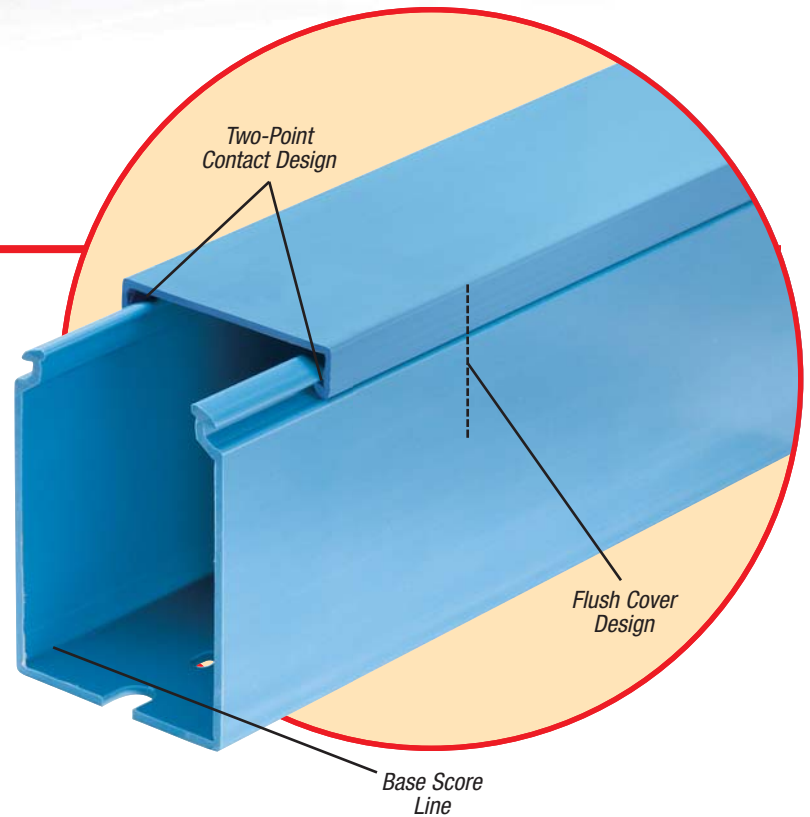

### Solid Wall Duct

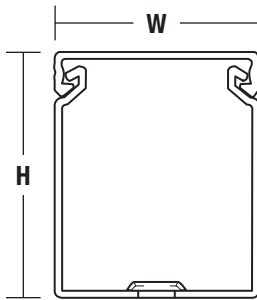

Front View w/Cover

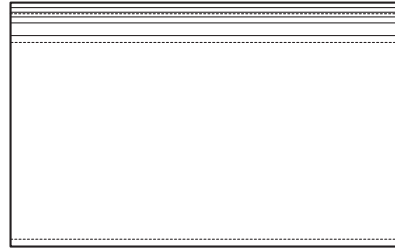

Side View

For a complete listing of Solid Wall dimensional details see page 22.

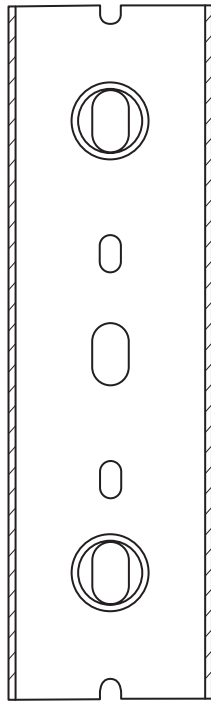

Bottom View

CAT. NO.	DESCRIPTION	SIZE (W x H)		COVER CAT. NO.	DUCT STD. CTN. QTY	COVER STD. CTN. QTY	LENGTH (FT.)
		IN.	MM				
TY75X1SP[_]6	.75 x 1 Solid Wall Duct	0.94 x 1.14	23.9 x 27.7		120		
TY75X15SP[_]6	.75 x 1.5 Solid Wall Duct	0.94 x 1.60	23.9 x 39.6	TY75CP[_]6	120	120	6
TY75X2SP[_]6	.75 x 2 Solid Wall Duct	0.94 x 2.10	23.9 x 52.6		120		
TY1X1SP[_]6	1 x 1 Solid Wall Duct	1.25 x 1.14	31.8 x 27.7		120		
TY1X15SP[_]6	1 x 1.5 Solid Wall Duct	1.25 x 1.60	31.8 x 39.9		120		
TY1X2SP[_]6	1 x 2 Solid Wall Duct	1.25 x 2.10	31.8 x 52.8	TY1CP[_]6	120	120	6
TY1X3SP[_]6	1 x 3 Solid Wall Duct	1.25 x 3.05	31.8 x 77.7		120		
TY1X4SP[_]6	1 x 4 Solid Wall Duct	1.25 x 4.37	31.8 x 111.3		60		
TY15X1SP[_]6	1.5 x 1 Solid Wall Duct	1.75 x 1.14	44.5 x 27.7		120		
TY15X15SP[_]6	1.5 x 1.5 Solid Wall Duct	1.75 x 1.60	44.5 x 39.9		120		
TY15X2SP[_]6	1.5 x 2 Solid Wall Duct	1.75 x 2.10	44.5 x 52.8	TY15CP[_]6	120	120	6
TY15X3SP[_]6	1.5 x 3 Solid Wall Duct	1.75 x 3.05	44.5 x 77.7		120		
TY15X4SP[_]6	1.5 x 4 Solid Wall Duct	1.75 x 4.37	44.5 x 111.3		60		
TY2X1SP[_]6	2 x 1 Solid Wall Duct	2.25 x 1.24	57.2 x 28.4		120		
TY2X15SP[_]6	2 x 1.5 Solid Wall Duct	2.25 x 1.70	57.2 x 40.4		120		
TY2X2SP[_]6	2 x 2 Solid Wall Duct	2.25 x 2.19	57.2 x 53.3	TY2CP[_]6	120	120	6
TY2X3SP[_]6	2 x 3 Solid Wall Duct	2.25 x 3.14	57.2 x 78.2		60		
TY2X4SP[_]6	2 x 4 Solid Wall Duct	2.25 x 4.46	57.2 x 111.8		60		
TY2X5SP[_]6	2 x 5 Solid Wall Duct	2.25 x 5.15	57.2 x 129.3		60		
TY25X2SP[_]6	2.5 x 2 Solid Wall Duct	2.75 x 2.19	69.9 x 53.6		120		
TY25X3SP[_]6	2.5 x 3 Solid Wall Duct	2.75 x 3.14	69.9 x 78.2	TY25CP[_]6	60	120	6
TY25X4SP[_]6	2.5 x 4 Solid Wall Duct	2.75 x 4.46	69.9 x 111.8		60		
TY3X1SP[_]6	3 x 1 Solid Wall Duct	3.25 x 1.24	82.6 x 29.0		120		
TY3X2SP[_]6	3 x 2 Solid Wall Duct	3.25 x 2.19	82.6 x 54.9		60		
TY3X3SP[_]6	3 x 3 Solid Wall Duct	3.25 x 3.14	82.6 x 79.8	TY3CP[_]6	60	120	6
TY3X4SP[_]6	3 x 4 Solid Wall Duct	3.25 x 4.46	82.6 x 113.5		60		
TY3X5SP[_]6	3 x 5 Solid Wall Duct	3.25 x 5.15	82.6 x 130.6		60		
TY4X15SP[_]6	4 x 1.5 Solid Wall Duct	4.25 x 1.70	108.0 x 42.4		60		
TY4X2SP[_]6	4 x 2 Solid Wall Duct	4.25 x 2.19	108.0 x 55.1		60		
TY4X3SP[_]6	4 x 3 Solid Wall Duct	4.25 x 3.14	108.0 x 80.0	TY4CP[_]6	60	120	6
TY4X4SP[_]6	4 x 4 Solid Wall Duct	4.25 x 4.46	108.0 x 113.8		30		
TY4X5SP[_]6	4 x 5 Solid Wall Duct	4.25 x 5.15	108.0 x 130.8		30		
TY6X4SP[_]6	6 x 4 Solid Wall Duct	6.25 x 4.46	158.8 x 114.0	TY6CP[_]6	30	60	6

[ \_ ] = space for color identifier:

G = Gray	
W = White	
B = Black	
I = Intrinsic Blue	

• Standard lengths are 6 feet.

+ Catalog Number must be completed by adding suffix G for Gray, W for White, I for Intrinsic Blue, B for Black.

**Example:** TY75X1SPG6 is a .75" x 1" solid wall gray duct.

To order duct without mounting holes, add suffix NM to catalog number.

**Example:** TY75X1SPGNM6 is a .75" x 1" solid wall gray duct with no mounting holes.

To order Adhesive-Backed Duct, add suffix A to Catalog Number.

**Example:** TY75X1SPGA6 is a .75" x 1" solid wall gray duct with adhesive backing. Shelf life for adhesive is 1 year.

PVC vinyl duct is UL® Recognized , CSA Certified and CE Compliant.



## Wide Slot Wiring Duct

Greater sidewall rigidity with increased versatility!

### Wide Slot Wiring Duct—PVC

- Wide fingers and slots increase rigidity and enable insertion of bundles
- Non-slip cover does not slide easily and resists vibration
- Rounded edges keep hands and wires free of abrasion
- V-shaped slot lead-in enables easier and faster wire installation
- Dual score lines are designed to yield clean breakoffs at the base of the slot and the duct
- Restricted slot design makes sure that wires are held with or without the cover inserted
- Flush cover attaches flush with sidewall for finished look
- Improved flush sidewall and cover style for greater wire capacity

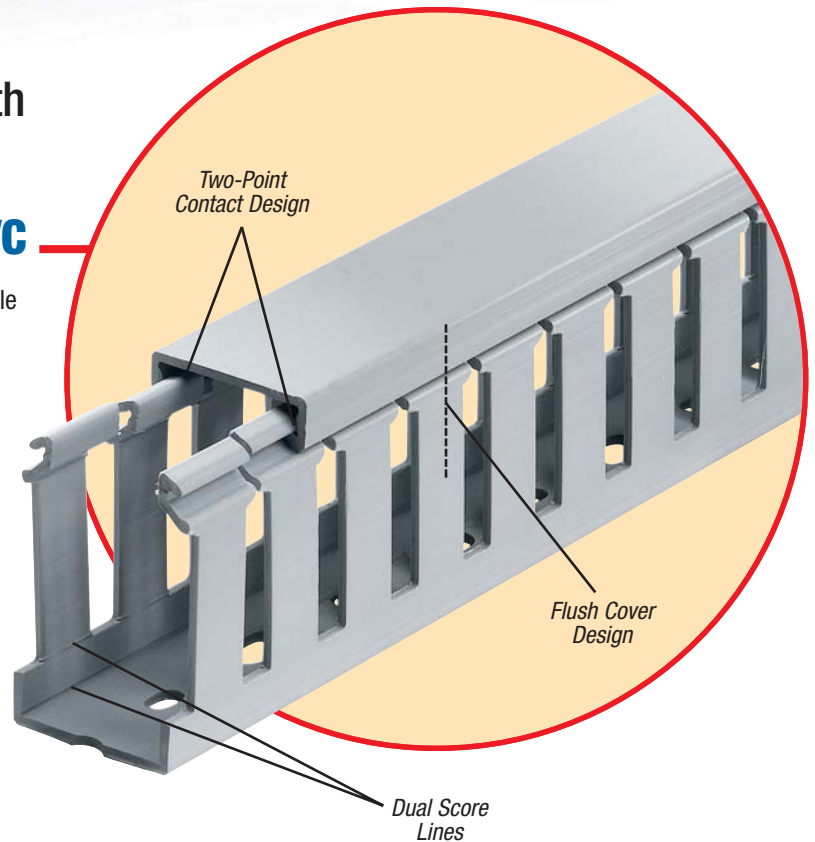

- Versatile North American and DIN Standard mounting holes enables same duct for multiple applications
- Constructed of flame-retardant PVC
- Integrated mounting holes — larger sizes include staggered holes for mounting flexibility (see **page 23** for illustration)
- Lead-free construction

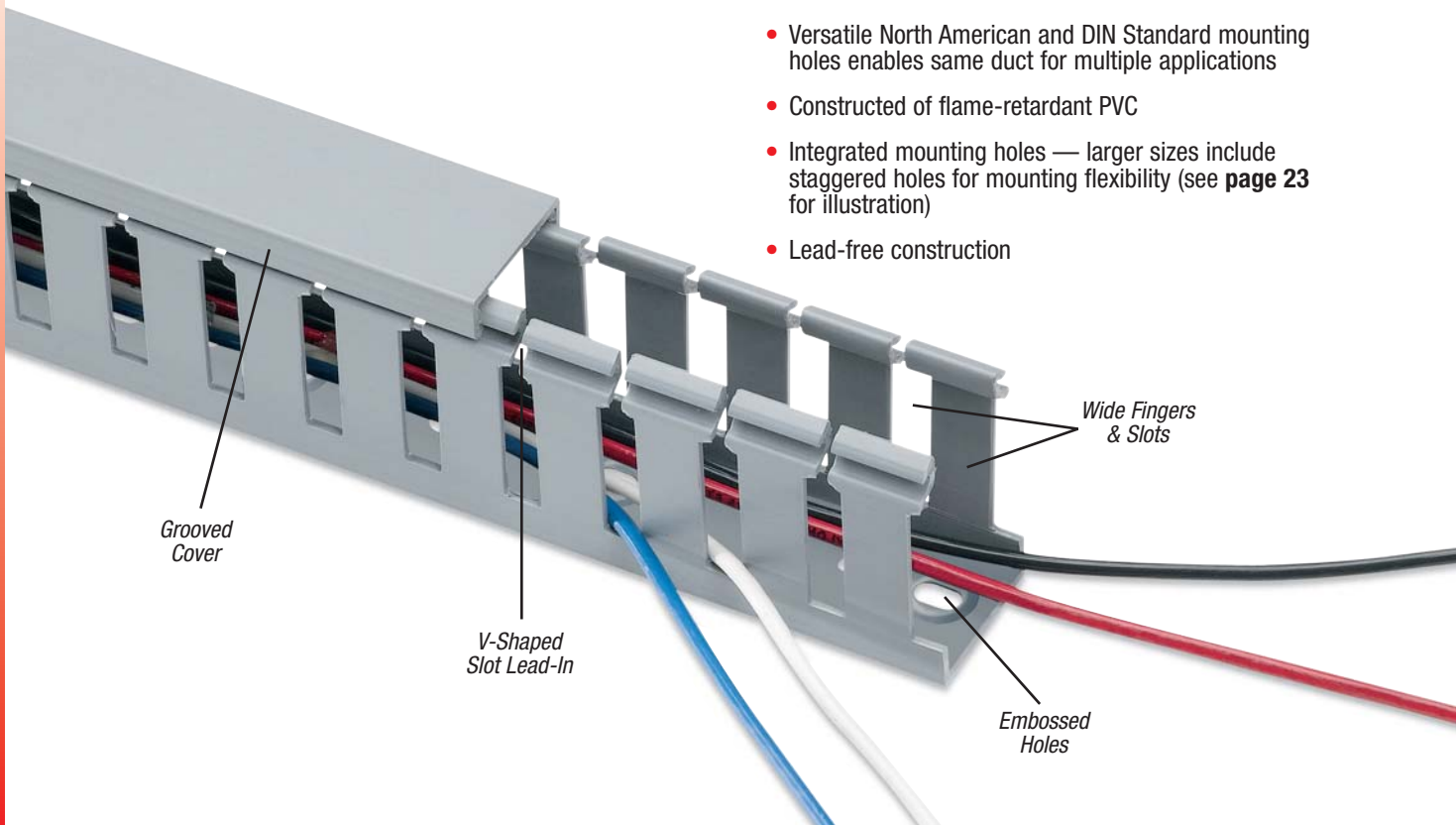

### Wide Slot Wiring Duct

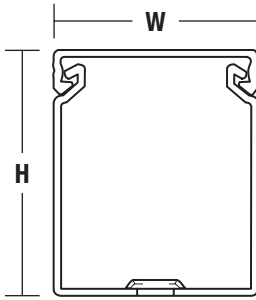

Front View w/Cover

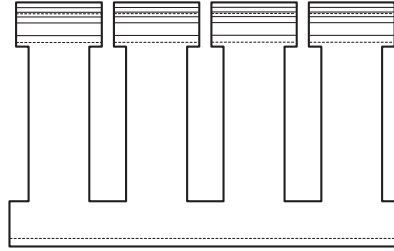

Side View

For a complete listing of Wide Slot dimensional details see page 23.

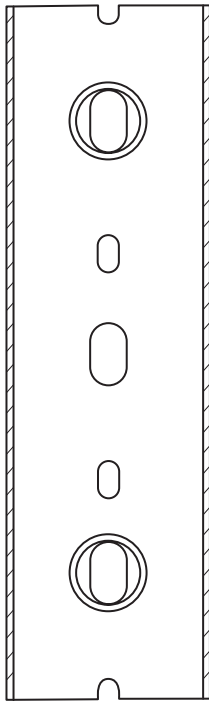

Bottom View

CAT. NO.	DESCRIPTION	SIZE (W x H)		COVER CAT. NO.	DUCT STD. CTN. QTY	COVER STD. CTN. QTY	LENGTH (FT.)
		IN.	MM				
TY75X1WP[_]6	.75 x 1 Wide Slot Duct	0.94 x 1.14	23.9 x 27.7		120		
TY75X15WP[_]6	.75 x 1.5 Wide Slot Duct	0.94 x 1.60	23.9 x 39.6	TY75CP[_]6	120	120	6
TY75X2WP[_]6	.75 x 2 Wide Slot Duct	0.94 x 2.10	23.9 x 52.6		120		
TY1X1WP[_]6	1 x 1 Wide Slot Duct	1.25 x 1.14	31.8 x 27.7		120		
TY1X15WP[_]6	1 x 1.5 Wide Slot Duct	1.25 x 1.60	31.8 x 39.9		120		
TY1X2WP[_]6	1 x 2 Wide Slot Duct	1.25 x 2.10	31.8 x 52.8	TY1CP[_]6	120	120	6
TY1X3WP[_]6	1 x 3 Wide Slot Duct	1.25 x 3.05	31.8 x 77.7		120		
TY1X4WP[_]6	1 x 4 Wide Slot Duct	1.25 x 4.37	31.8 x 111.3		60		
TY15X1WP[_]6	1.5 x 1 Wide Slot Duct	1.75 x 1.14	44.5 x 27.7		120		
TY15X15WP[_]6	1.5 x 1.5 Wide Slot Duct	1.75 x 1.60	44.5 x 39.9		120		
TY15X2WP[_]6	1.5 x 2 Wide Slot Duct	1.75 x 2.10	44.5 x 52.8	TY15CP[_]6	120	120	6
TY15X3WP[_]6	1.5 x 3 Wide Slot Duct	1.75 x 3.05	44.5 x 77.7		120		
TY15X4WP[_]6	1.5 x 4 Wide Slot Duct	1.75 x 4.37	44.5 x 111.3		60		
TY2X1WP[_]6	2 x 1 Wide Slot Duct	2.25 x 1.24	57.2 x 28.4		120		
TY2X15WP[_]6	2 x 1.5 Wide Slot Duct	2.25 x 1.70	57.2 x 40.4		120		
TY2X2WP[_]6	2 x 2 Wide Slot Duct	2.25 x 2.19	57.2 x 53.3	TY2CP[_]6	120	120	6
TY2X3WP[_]6	2 x 3 Wide Slot Duct	2.25 x 3.14	57.2 x 78.2		60		
TY2X4WP[_]6	2 x 4 Wide Slot Duct	2.25 x 4.46	57.2 x 111.8		60		
TY2X5WP[_]6	2 x 5 Wide Slot Duct	2.25 x 5.15	57.2 x 129.3		60		
TY25X2WP[_]6	2.5 x 2 Wide Slot Duct	2.75 x 2.19	69.9 x 53.6		120		
TY25X3WP[_]6	2.5 x 3 Wide Slot Duct	2.75 x 3.14	69.9 x 78.2	TY25CP[_]6	60	120	6
TY25X4WP[_]6	2.5 x 4 Wide Slot Duct	2.75 x 4.46	69.9 x 111.8		60		
TY3X1WP[_]6	3 x 1 Wide Slot Duct	3.25 x 1.24	82.6 x 29.0		120		
TY3X2WP[_]6	3 x 2 Wide Slot Duct	3.25 x 2.19	82.6 x 54.9		60		
TY3X3WP[_]6	3 x 3 Wide Slot Duct	3.25 x 3.14	82.6 x 79.8	TY3CP[_]6	60	120	6
TY3X4WP[_]6	3 x 4 Wide Slot Duct	3.25 x 4.46	82.6 x 113.5		60		
TY3X5WP[_]6	3 x 5 Wide Slot Duct	3.25 x 5.15	82.6 x 130.6		60		
TY4X15WP[_]6	4 x 1.5 Wide Slot Duct	4.25 x 1.70	108.0 x 42.4		60		
TY4X2WP[_]6	4 x 2 Wide Slot Duct	4.25 x 2.19	108.0 x 55.1		60		
TY4X3WP[_]6	4 x 3 Wide Slot Duct	4.25 x 3.14	108.0 x 80.0	TY4CP[_]6	60	120	6
TY4X4WP[_]6	4 x 4 Wide Slot Duct	4.25 x 4.46	108.0 x 113.8		30		
TY4X5WP[_]6	4 x 5 Wide Slot Duct	4.25 x 5.15	108.0 x 130.8		30		
TY6X4WP[_]6	6 x 4 Wide Slot Duct	6.25 x 4.46	158.8 x 114.0	TY6CP[_]6	30	60	6

[ \_ ] = space for color identifier:

G = Gray	
W = White	
B = Black	
I = Intrinsic Blue	

• Standard lengths are 6 feet.

+ Catalog Number must be completed by adding suffix G for Gray, W for White, I for Intrinsic Blue, B for Black.

**Example:** TY75X1WPG6 is a .75" x 1" wide slot gray duct.

To order duct without mounting holes, add suffix NM to catalog number.

**Example:** TY75X1WPGNM6 is a .75" x 1" wide slot gray duct with no mounting holes.

To order Adhesive-Backed Duct, add suffix A to Catalog Number.

**Example:** TY75X1WPGA6 is a .75" x 1" wide slot gray duct with adhesive backing. Shelf life for adhesive is 1 year.

PVC vinyl duct is UL® Recognized , CSA Certified and CE Compliant.

## Narrow Slot Wiring Duct

Designed to fit the spacing of high-density terminal blocks!

### Narrow Slot Wiring Duct

- Smaller, higher number of fingers for more concise harnessing
- Non-slip cover does not slide easily and resists vibration
- Rounded edges keep hands and wires free of abrasion
- V-shaped slot lead-in enables easier and faster wire installation
- Restricted slot design makes sure that wires are held with or without the cover inserted
- Flush cover attaches flush with sidewall for finished look
- Versatile North American and DIN Standard mounting holes enable same duct for multiple applications
- Dual score lines are designed to yield clean breakoffs at the base of the slot and the duct

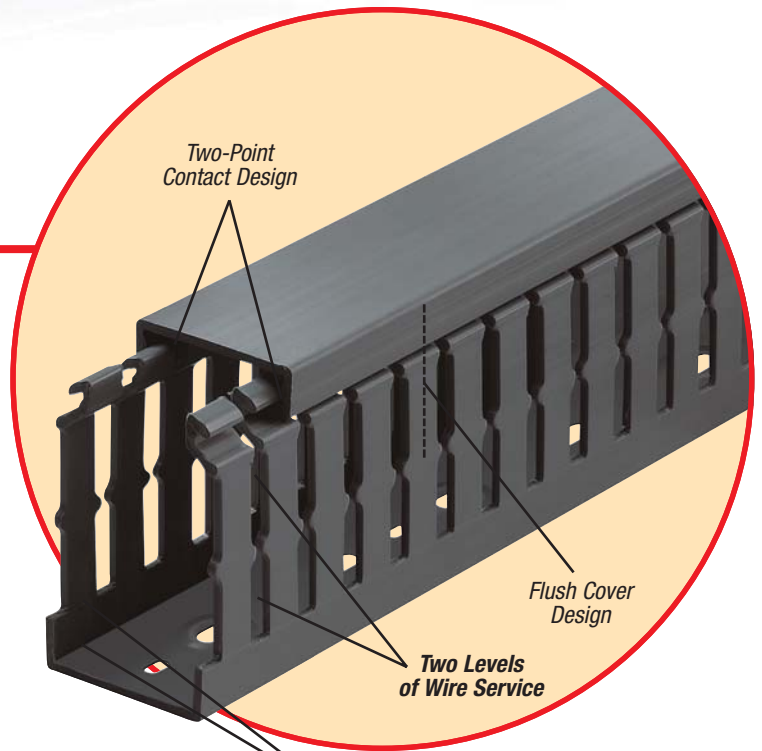

Dual Score Lines

Three Levels of Wire Service

- Finger design restricts wire from slipping along the edge; creates two or three levels of wire service (see **page 24** for illustration)
- Lead-free construction
- Constructed of flame-retardant PVC

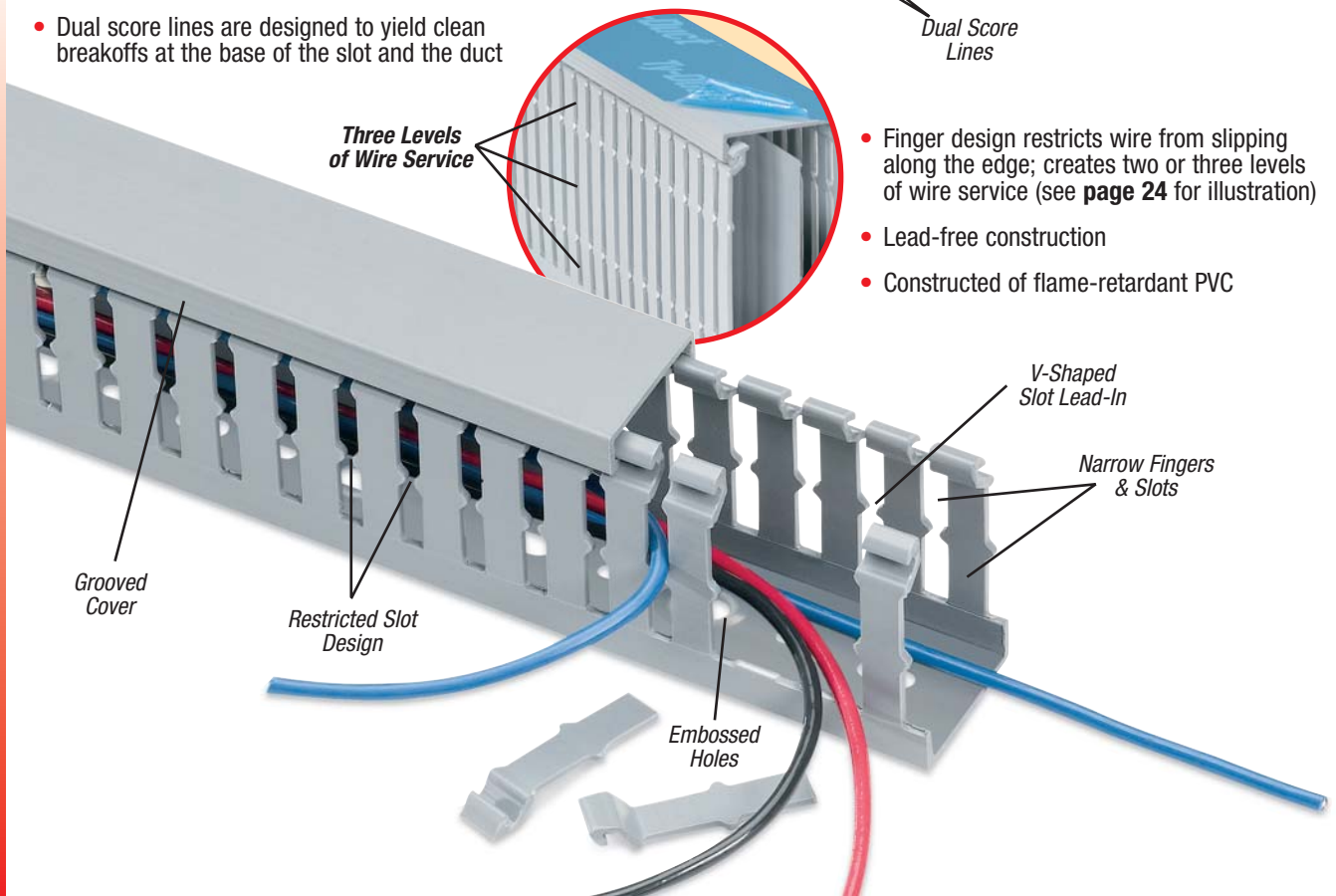

### Narrow Slot Wiring Duct

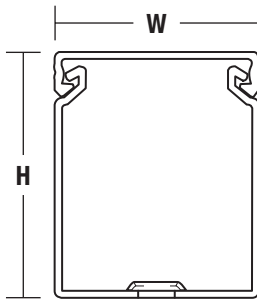

Front View w/Cover

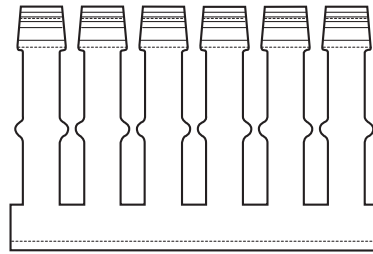

Side View

For a complete listing of Narrow Slot dimensional details see page 24.

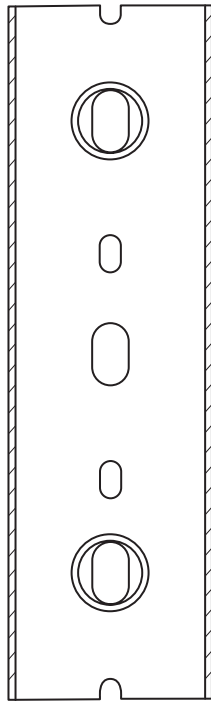

Bottom View

CAT. NO.	DESCRIPTION	SIZE (W x H)		COVER CAT. NO.	DUCT STD. CTN. QTY	COVER STD. CTN. QTY	LENGTH (FT.)
		IN.	MM				
TY75X15NP[ ]6	.75 x 1.5 Narrow Slot Duct	0.94 x 1.60	23.9 x 39.6	TY75CP[ ]6	120	120	6
TY1X1NP[ ]6	1 x 1 Narrow Slot Duct	1.25 x 1.14	31.8 x 27.7		120		
TY1X15NP[ ]6	1 x 1.5 Narrow Slot Duct	1.25 x 1.60	31.8 x 39.9		120		
TY1X2NP[ ]6	1 x 2 Narrow Slot Duct	1.25 x 2.10	31.8 x 52.8	TY1CP[ ]6	120	120	6
TY1X3NP[ ]6	1 x 3 Narrow Slot Duct	1.25 x 3.05	31.8 x 77.7		120		
TY1X4NP[ ]6	1 x 4 Narrow Slot Duct	1.25 x 4.37	31.8 x 111.3		60		
TY15X1NP[ ]6	1.5 x 1 Narrow Slot Duct	1.75 x 1.14	44.5 x 27.7		120		
TY15X15NP[ ]6	1.5 x 1.5 Narrow Slot Duct	1.75 x 1.60	44.5 x 39.9		120		
TY15X2NP[ ]6	1.5 x 2 Narrow Slot Duct	1.75 x 2.10	44.5 x 52.8	TY15CP[ ]6	120	120	6
TY15X3NP[ ]6	1.5 x 3 Narrow Slot Duct	1.75 x 3.05	44.5 x 77.7		120		
TY15X4NP[ ]6	1.5 x 4 Narrow Slot Duct	1.75 x 4.37	44.5 x 111.3		60		
TY2X1NP[ ]6	2 x 1 Narrow Slot Duct	2.25 x 1.24	57.2 x 28.4		120		
TY2X15NP[ ]6	2 x 1.5 Narrow Slot Duct	2.25 x 1.70	57.2 x 40.4		120		
TY2X2NP[ ]6	2 x 2 Narrow Slot Duct	2.25 x 2.19	57.2 x 53.3	TY2CP[ ]6	120	120	6
TY2X3NP[ ]6	2 x 3 Narrow Slot Duct	2.25 x 3.14	57.2 x 78.2		60		
TY2X4NP[ ]6	2 x 4 Narrow Slot Duct	2.25 x 4.46	57.2 x 111.8		60		
TY2X5NP[ ]6	2 x 5 Narrow Slot Duct	2.25 x 5.15	57.2 x 129.3		60		
TY25X2NP[ ]6	2.5 x 2 Narrow Slot Duct	2.75 x 2.19	69.9 x 53.6		120		
TY25X3NP[ ]6	2.5 x 3 Narrow Slot Duct	2.75 x 3.14	69.9 x 78.2	TY25CP[ ]6	60	120	6
TY25X4NP[ ]6	2.5 x 4 Narrow Slot Duct	2.75 x 4.46	69.9 x 111.8		60		
TY3X1NP[ ]6	3 x 1 Narrow Slot Duct	3.25 x 1.24	82.6 x 29.0		120		
TY3X2NP[ ]6	3 x 2 Narrow Slot Duct	3.25 x 2.19	82.6 x 54.9		60		
TY3X3NP[ ]6	3 x 3 Narrow Slot Duct	3.25 x 3.14	82.6 x 79.8	TY3CP[ ]6	60	120	6
TY3X4NP[ ]6	3 x 4 Narrow Slot Duct	3.25 x 4.46	82.6 x 113.5		60		
TY3X5NP[ ]6	3 x 5 Narrow Slot Duct	3.25 x 5.15	82.6 x 130.6		60		
TY4X2NP[ ]6	4 x 2 Narrow Slot Duct	4.25 x 2.19	108.0 x 55.1		60		
TY4X3NP[ ]6	4 x 3 Narrow Slot Duct	4.25 x 3.14	108.0 x 80.0	TY4CP[ ]6	60	120	6
TY4X4NP[ ]6	4 x 4 Narrow Slot Duct	4.25 x 4.46	108.0 x 113.8		30		
TY4X5NP[ ]6	4 x 5 Narrow Slot Duct	4.25 x 5.15	108.0 x 130.8		30		

[ ] = space for color identifier:

G = Gray	
W = White	
B = Black	
I = Intrinsic Blue	

• Standard lengths are 6 feet.

+ Catalog Number must be completed by adding suffix G for Gray, W for White, I for Intrinsic Blue, B for Black.

**Example:** TY75X15NPB6 a .75" x 1.5" narrow slot black duct.

To order duct without mounting holes, add suffix NM to catalog number.

**Example:** TY75X15NPB6NM6 a .75" x 1.5" narrow slot black duct with no mounting holes.

To order Adhesive-Backed Duct, add suffix A to Catalog Number.

**Example:** TY75X15NPBA6 a .75" x 1.5" narrow slot black duct with adhesive backing. Shelf life for adhesive is 1 year.

PVC vinyl duct is UL® Recognized , CSA Certified and CE Compliant.

## Round Hole Wiring Duct

Holes retain and support wires at different heights!

### Round Hole Wiring Duct

- Multiple rows of holes retain wire at different heights and positions with or without the cover
- Features maximum number of wire holes
- Greater wall rigidity than open slot duct
- Non-slip cover does not slide easily and resists vibration
- Rounded edges keep hands and wires free of abrasion
- Base score line enables sidewall section to be removed
- Flush cover attaches flush with sidewall for finished look

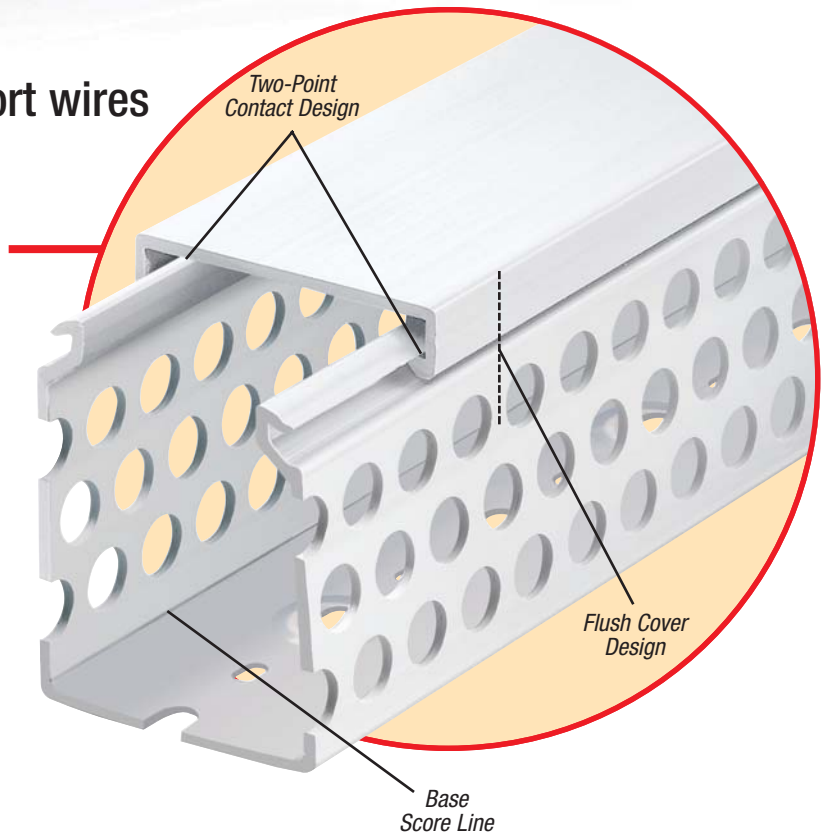

- Constructed of flame-retardant PVC
- Integrated mounting holes — larger sizes include staggered holes for mounting flexibility (see **page 25** for illustration)
- Lead-free construction

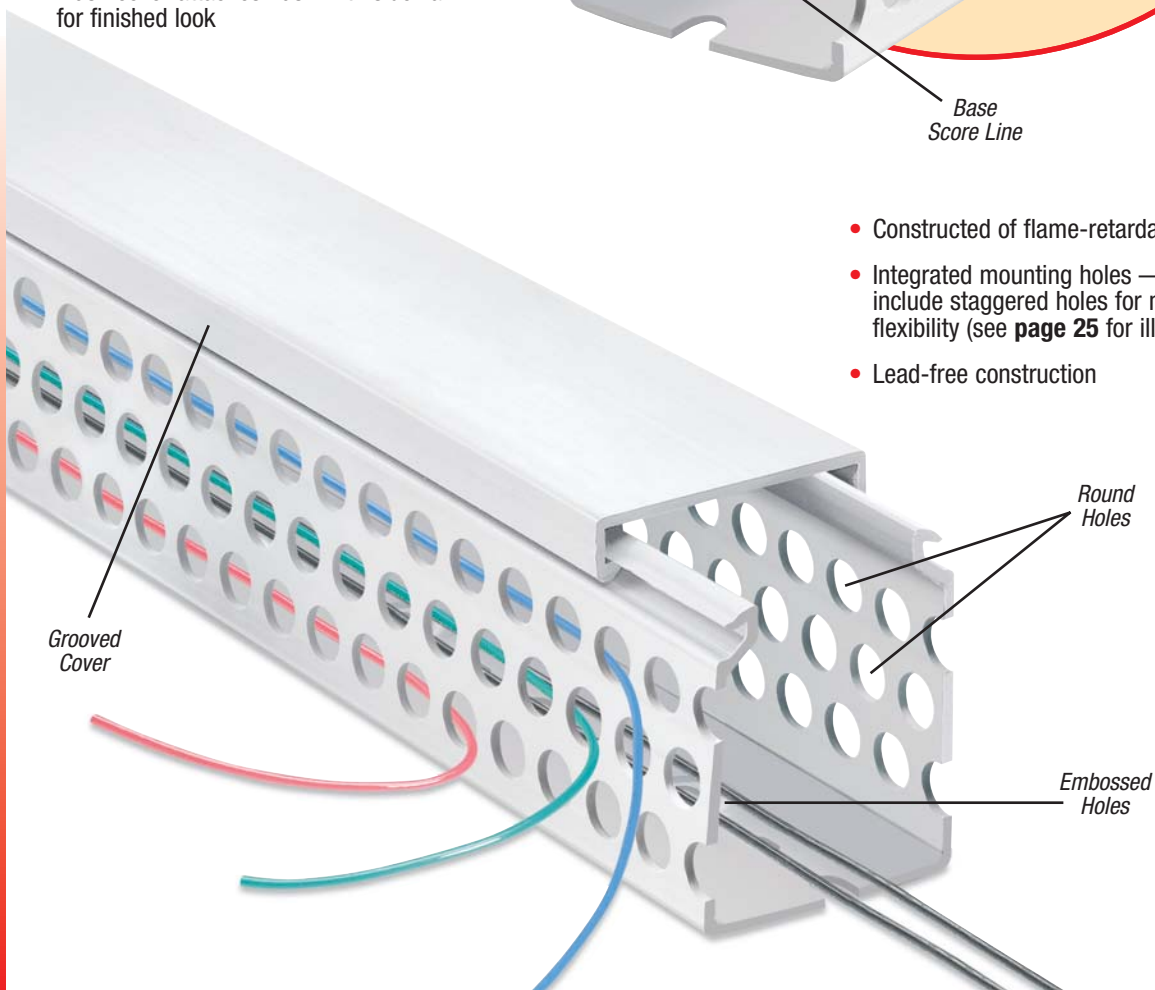

### Round Hole Wiring Duct

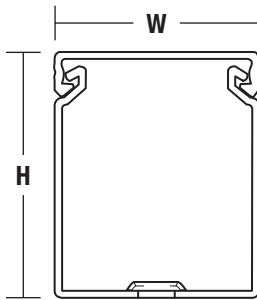

Front View w/Cover

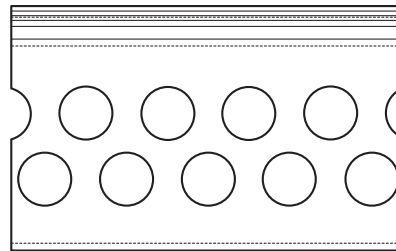

Side View

For a complete listing of Round Hole dimensional details see page 25.

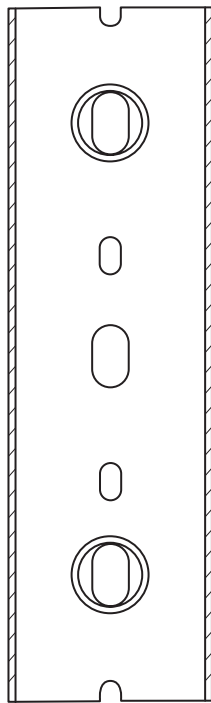

Bottom View

CAT. NO.	DESCRIPTION	SIZE (W x H)		COVER CAT. NO.	DUCT STD. CTN. QTY	COVER STD. CTN. QTY	LENGTH (FT.)
		IN.	MM				
TY1X15RP[ ][ ]6	1 x 1.5 Round Hole Duct	1.75 x 1.60	44.5 x 39.9		120		
TY1X2RP[ ][ ]6	1 x 2 Round Hole Duct	1.25 x 2.10	31.8 x 52.8	TY1CP[ ][ ]6	120	120	6
TY1X3RP[ ][ ]6	1 x 3 Round Hole Duct	1.25 x 3.05	31.8 x 77.7		120		
TY1X4RP[ ][ ]6	1 x 4 Round Hole Duct	1.25 x 4.37	31.8 x 111.3		60		
TY15X15RP[ ][ ]6	1.5 x 1.5 Round Hole Duct	1.75 x 1.60	44.5 x 39.9		120		
TY15X2RP[ ][ ]6	1.5 x 2 Round Hole Duct	1.75 x 2.10	44.5 x 52.8	TY15CP[ ][ ]6	120	120	6
TY15X3RP[ ][ ]6	1.5 x 3 Round Hole Duct	1.75 x 3.05	44.5 x 77.7		120		
TY15X4RP[ ][ ]6	1.5 x 4 Round Hole Duct	1.75 x 4.37	44.5 x 111.3		60		
TY2X15RP[ ][ ]6	2 x 1.5 Round Hole Duct	2.25 x 1.70	57.2 x 40.4		120		
TY2X2RP[ ][ ]6	2 x 2 Round Hole Duct	2.25 x 2.19	57.2 x 53.3	TY2CP[ ][ ]6	120	120	6
TY2X3RP[ ][ ]6	2 x 3 Round Hole Duct	2.25 x 3.14	57.2 x 78.2		60		
TY2X4RP[ ][ ]6	2 x 4 Round Hole Duct	2.25 x 4.46	57.2 x 111.8		60		
TY3X2RP[ ][ ]6	3 x 2 Round Hole Duct	3.25 x 2.19	82.6 x 54.9		60		
TY3X3RP[ ][ ]6	3 x 3 Round Hole Duct	3.25 x 3.14	82.6 x 79.8	TY3CP[ ][ ]6	60	120	6
TY3X4RP[ ][ ]6	3 x 4 Round Hole Duct	3.25 x 4.46	82.6 x 113.5		60		
TY4X15RP[ ][ ]6	4 x 1.5 Round Hole Duct	4.25 x 1.70	108.0 x 42.4		60		
TY4X2RP[ ][ ]6	4 x 2 Round Hole Duct	4.25 x 2.19	108.0 x 55.1	TY4CP[ ][ ]6	60	120	6
TY4X3RP[ ][ ]6	4 x 3 Round Hole Duct	4.25 x 3.14	108.0 x 80.0		60		
TY4X4RP[ ][ ]6	4 x 4 Round Hole Duct	4.25 x 4.46	108.0 x 113.8		30		

[ ][ ] = space for color identifier:

G = Gray	
W = White	
B = Black	
I = Intrinsic Blue	

• Standard lengths are 6 feet.

+ Catalog Number must be completed by adding suffix G for Gray, W for White, I for Intrinsic Blue, B for Black.

**Example:** TY1X15RPG6 is a 1" x 1.5" round hole gray duct.

To order duct without mounting holes, add suffix NM to catalog number.

**Example:** TY1X15RPGNM6 is a 1" x 1.5" round hole gray duct with no mounting holes.

To order Adhesive-Backed Duct, add suffix A to Catalog Number.

**Example:** TY1X15RPGA6 is a 1" x 1.5" round hole gray duct with adhesive backing.

PVC vinyl duct is UL® Recognized , CSA Certified and CE Compliant.

Wide Slot Wiring Duct—Halogen Free

Perfect for high-temperature areas!

Wide Slot Wiring Duct—Halogen-Free

- Halogen-free construction
- Higher temperature rating than PVC
- Wide fingers and slots increase rigidity and enable for insertion of bundles
- Non-slip cover does not slide easily and resists vibration
- Rounded edges keep hands and wires free of abrasion
- Dual score lines are designed to yield clean breakoffs at the base of the slot and the duct
- V-shaped slot lead-in enables easier and faster wire installation

Available 2006!

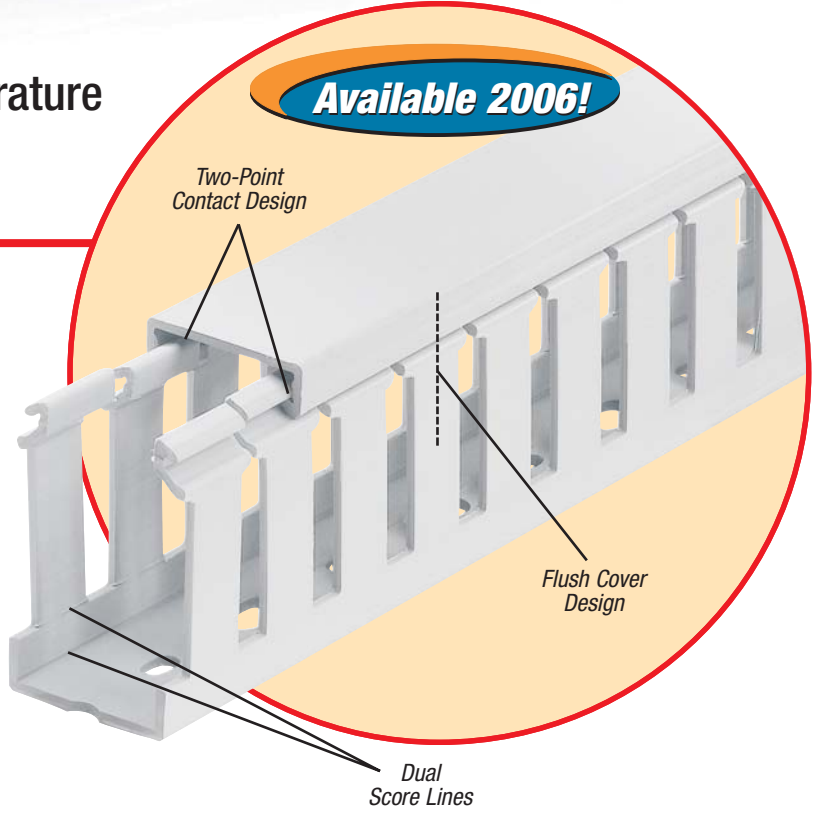

- Integrated mounting holes — larger sizes include staggered holes for mounting flexibility (see page 23 for illustration)
- Restricted slot design makes sure that wires are held with or without the cover inserted
- Available only in white

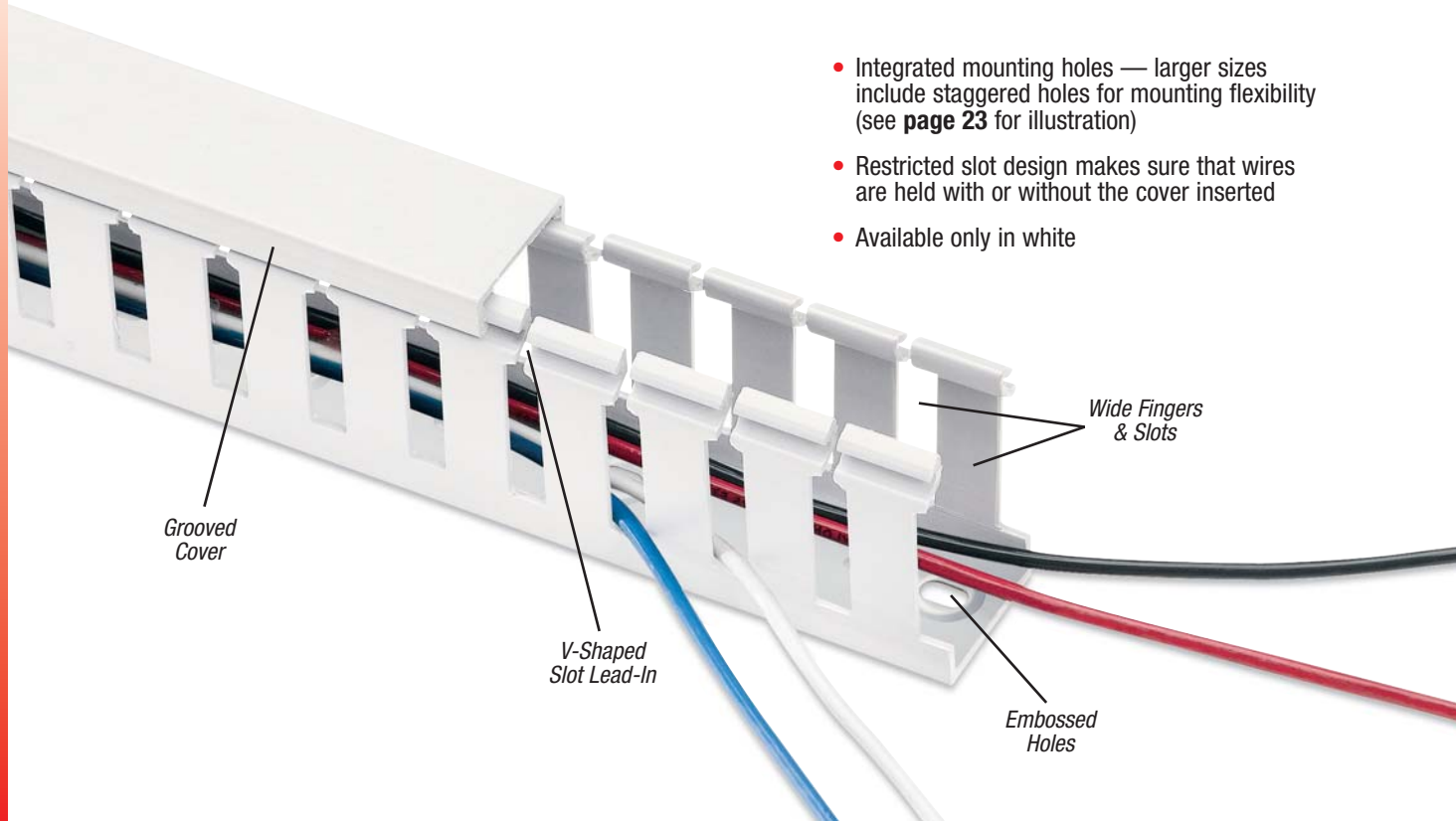

Ty-Duct™ and Accessories

### Wide Slot Wiring Duct—Halogen-Free

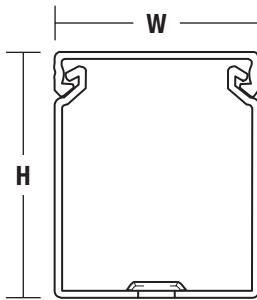

Front View w/Cover

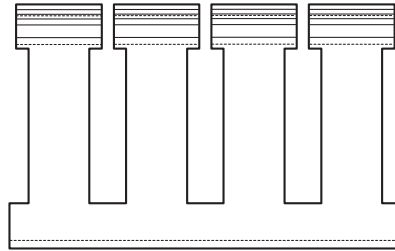

Side View

For a complete listing of Wide Slot dimensional details see page 23.

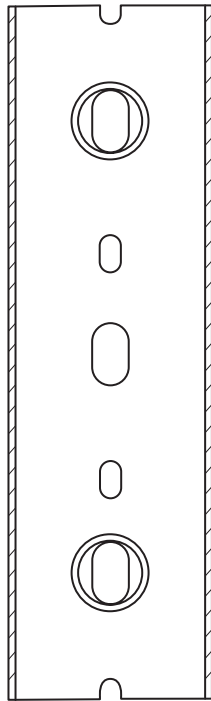

Bottom View

CAT. NO.	DESCRIPTION	SIZE (W x H)		COVER CAT. NO.	DUCT STD. CTN. QTY	COVER STD. CTN. QTY	LENGTH (FT.)
		IN.	MM				
TY1X1WHW6	1 x 1 Halogen-Free White Duct	1.25 x 1.14	31.8 x 27.7		120		
TY1X15WHW6	1 x 1.5 Halogen-Free White Duct	1.25 x 1.60	31.8 x 39.9		120		
TY1X2WHW6	1 x 2 Halogen-Free White Duct	1.25 x 2.10	31.8 x 52.8	TY1CHW6	120	120	6
TY1X3WHW6	1 x 3 Halogen-Free White Duct	1.25 x 3.05	31.8 x 77.7		120		
TY1X4WHW6	1 x 4 Halogen-Free White Duct	1.25 x 4.37	31.8 x 111.3		60		
TY15X15WHW6	1.5 x 1.5 Halogen-Free White Duct	1.75 x 1.60	44.5 x 39.9		120		
TY15X2WHW6	1.5 x 2 Halogen-Free White Duct	1.75 x 2.10	44.5 x 52.8	TY15CHW6	120	120	6
TY15X3WHW6	1.5 x 3 Halogen-Free White Duct	1.75 x 3.05	44.5 x 77.7		120		
TY15X4WHW6	1.5 x 4 Halogen-Free White Duct	1.75 x 4.37	44.5 x 111.3		60		
TY2X1WHW6	2 x 1 Halogen-Free White Duct	2.25 x 1.24	57.2 x 28.4		120		
TY2X2WHW6	2 x 2 Halogen-Free White Duct	2.25 x 2.19	57.2 x 53.3	TY3CHW6	120	120	6
TY2X3WHW6	2 x 3 Halogen-Free White Duct	2.25 x 3.14	57.2 x 78.2		60		
TY2X4WHW6	2 x 4 Halogen-Free White Duct	2.25 x 4.46	57.2 x 111.8		60		
TY25X3WHW6	2.5 x 3 Halogen-Free White Duct	2.75 x 3.14	69.9 x 78.2	TY25CHW6	60	120	6
TY3X1WHW6	3 x 1 Halogen-Free White Duct	3.25 x 1.24	82.6 x 29.0		120		
TY3X2WHW6	3 x 2 Halogen-Free White Duct	3.25 x 2.19	82.6 x 54.9		60		
TY3X3WHW6	3 x 3 Halogen-Free White Duct	3.25 x 3.14	82.6 x 79.8	TY4CHW6	60	120	6
TY3X4WHW6	3 x 4 Halogen-Free White Duct	3.25 x 4.46	82.6 x 113.5		60		
TY3X5WHW6	3 x 5 Halogen-Free White Duct	3.25 x 5.15	82.6 x 130.6		60		
TY4X2WHW6	4 x 2 Halogen-Free White Duct	4.25 x 2.19	108.0 x 55.1		60		
TY4X3WHW6	4 x 3 Halogen-Free White Duct	4.25 x 3.14	108.0 x 80.0	TY4CHW6	60	120	6
TY4X4WHW6	4 x 4 Halogen-Free White Duct	4.25 x 4.46	108.0 x 113.8		30		
TY4X5WHW6	4 x 5 Halogen-Free White Duct	4.25 x 5.15	108.0 x 130.8		30		

W = White

• Standard lengths are 6 feet.

To order duct without mounting holes, add suffix NM to catalog number.

**Example:** TY1XWHWNM6 is a 1" x 1" wide slot halogen-free white duct with no mounting holes.

Vinyl duct is UL® Recognized , CSA Certified and meets the JIC requirements.

PVC vinyl duct is UL® Recognized , CSA Certified and CE Compliant.

**Available 2006!**



Accessories

Ty-Duct™ and Accessories

Trust Thomas and Betts for all your wiring accessories!

Features include:

- Divider Walls, enabling multiple channels to be created within a duct channel
- Universal Mounting Clips that secure channels and wires
- Corner Strips that keep corners rigid at tee junctions when used for control panel applications
- Joining Strips to unite sections of duct and keep the wall rigid
- Plastic Rivets for securing ducts quickly and easily

[ ] = space for color identifier:

- G = Gray
- W = White
- B = Black
- I = Intrinsic Blue

Create multiple channels inside wiring ducts!

Divider Wall

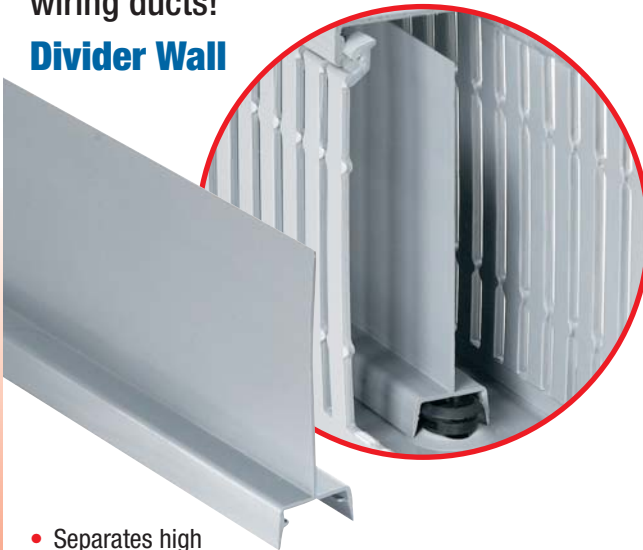

- Separates high and low voltage to reduce shortages and interference
- Mount inside any Ty-Duct™ PVC wiring duct using Universal Mounting Clips
- Score lines enable sections to be removed
- Solid and Wide Slotted style

CAT. NO.	DESCRIPTION	LENGTH (FT.)	STD. CTN. QTY
TY1D[ ][ ]6	1" High Wall Divider	6	120
TY1.5D[ ][ ]6	1.5" High Wall Divider	6	120
TY2D[ ][ ]6	2" High Wall Divider	6	120
TY3D[ ][ ]6	3" High Wall Divider	6	120
TY4D[ ][ ]6	4" High Wall Divider	6	120
TY5D[ ][ ]6	5" High Wall Divider	6	120

+ Catalog Number must be completed by adding suffix SP for Solid or WP for Wide Slot.  
 Example: TY2DSPG6 is a 2" high solid wall gray divider.

One size fits all!

Universal Mounting Clips

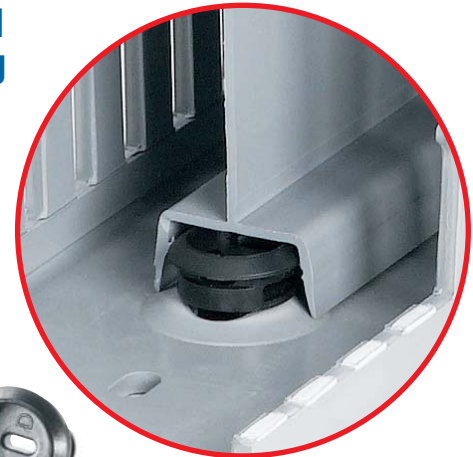

- Added before or after the duct is in place, without additional hardware
- Twists on into place—holds securely
- Installs easily using a screwdriver
- Accommodates up to 40 lb. cable ties
- Black polycarbonate

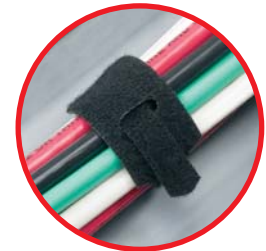

CAT. NO.	DESCRIPTION	QTY
UMC	Universal Fastener Mount	100 pk

Install smooth round corners on your wiring duct!

#### Corner Strips

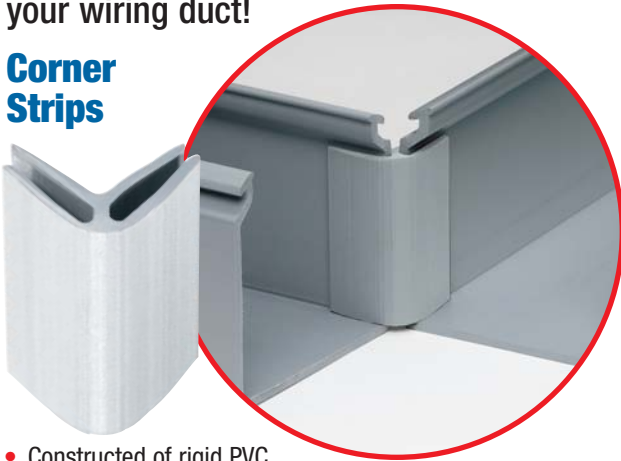

- Constructed of rigid PVC
- One-piece design makes installation a snap
- Works with any Ty-Duct™ wiring duct
- Select from a variety of sizes

CAT. NO.	DESCRIPTION	LENGTH (FT.)	STD. CTN. QTY
TYCS[_]6	Corner Strip	6	120

+ Catalog Number must be completed by adding suffix G for Gray, W for White, I for Intrinsic Blue, B for Black.

**Example:** TYCSG6 is a gray corner strip.

Join duct sections easily!

#### Joining Strips

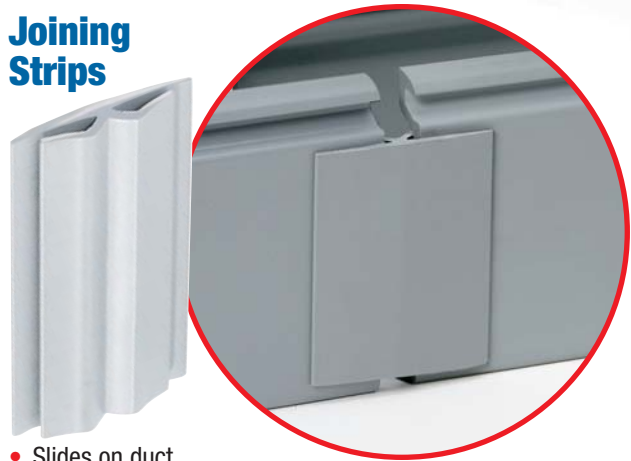

- Slides on duct
- Constructed of rigid PVC
- One-piece design makes installation easy
- Works with any Ty-Duct wiring duct

CAT. NO.	DESCRIPTION	LENGTH (FT.)	STD. CTN. QTY
TYJC[_]6	Joining Strip	6	120

+ Catalog Number must be completed by adding suffix G for Gray, W for White, I for Intrinsic Blue, B for Black.

**Example:** TYJCG6 is a gray joining strip.

Plastic rivets make mounting ducts easy!

#### Plastic Rivets

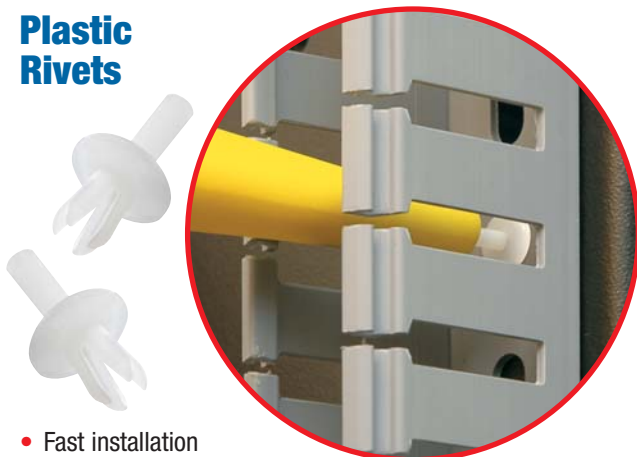

- Fast installation
- Durable and economical
- One size

STD. CAT. NO.	DESCRIPTION	QTY
08200C	3/8" Plastic Rivet	100 pk

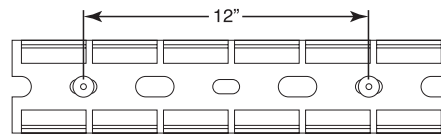

Minimum mounting rivet distance for ducts less than 1 1/2" wide.

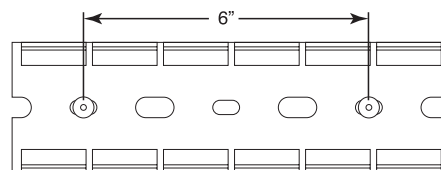

Minimum mounting rivet distance for ducts 1 1/2" to 2 1/2" wide.

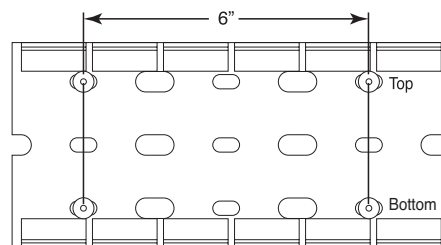

Minimum mounting rivet distance for ducts greater than 2 1/2" wide. Installed top and bottom.

Tools

Ty-Duct™ and Accessories

The wiring duct tools you need for every application!

Features include:

- Duct Cutting Tools for a clean professional finish
- Finger Cutting Tools that make modifications simple
- Notching Tools for duct sidewalls to facilitate tee and corner junctions
- Benchmount Cutting Tools for fast, high volume duct cutting
- Rivet Installation Tools for quick duct mounting

Lightweight and durable!

Duct/Cover Cutting Tool



Improved Performance!



- All-steel construction
- Sharp cutting surface
- Replaceable blades available

CAT. NO.	DESCRIPTION
SX-15TB	Handheld Duct Cutter

Cut duct fingers easily!

Finger Cutting Tool

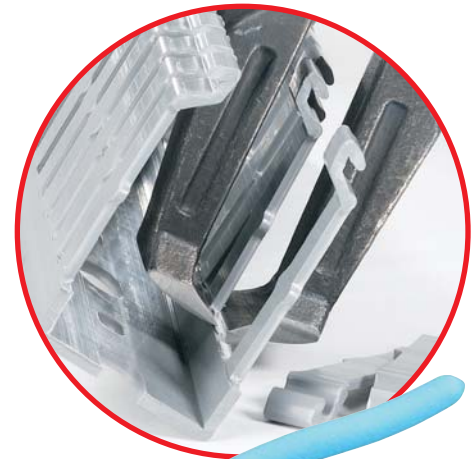

- Rugged die-cast construction with insulated handles for a comfortable, non-slip grip
- Removes duct fingers in tight places
- Works with all slotted wiring duct
- Also cuts round and solid wall duct
- Spring loaded

CAT. NO.	DESCRIPTION
DK-65TB	Duct Finger Cutter

For fast, high volume duct cutting!

### Benchmark Cutting Tool

- Engineered for use with Ty-Duct® plastic wiring ducts and covers
- All-steel construction lasts for years
- Adjustable gauge sets the desired length of duct
- Easy-to-read measuring indicator
- Adjustable stop for easy repeated cutting
- Sharp, easy-to-replace blades

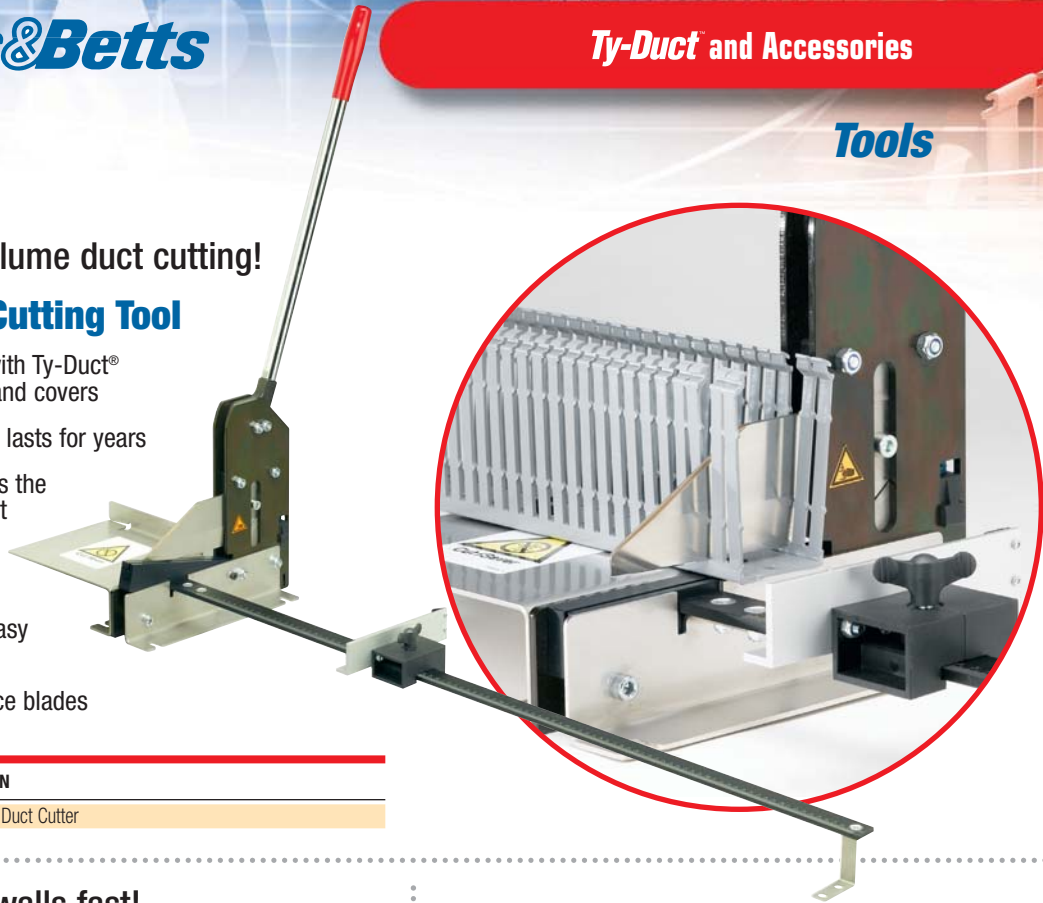

CAT. NO.	DESCRIPTION
DC-125TB	Benchmark Duct Cutter

Notch duct sidewalls fast!

### Notching Tool



- Notches sidewalls to bottom scoreline
- Facilitates tee and corner junctions
- Rugged design
- Easy to use
- Spring loaded

CAT. NO.	DESCRIPTION
DNT-100TB	Duct Notching Tool

Mount ducts quickly!

### Rivet Installation Tool



- Use for setting duct rivets
- Pressure on the tool head secures the rivet in place

CAT. NO.	DESCRIPTION
08205	08200 Series Rivet Installation Tool

Specifications

Wiring Duct — Wire Fill Capacity

NOTE: Wire fill is based on 50% fill of duct area.

Ty-Duct™ and Accessories

NOMINAL DUCT SIZE (INCHES) W H			AREA (INCHES <sup>2</sup> )			ELECTRICAL										DATA CABLE							
						8 AWG		10 AWG		12 AWG		14 AWG			16 AWG		18 AWG		22 AWG		24 AWG		
						0.216	0.153	0.122	0.158	0.105	0.139	0.165	0.096	0.125	0.084	0.113	0.065	0.217	0.250	0.422			
		THHN	THHN	THHN	MTW	THHN	MTW	MTW	THHN	MTW	THHN	MTW	MTW	UTP/CM CAT5E	UTP/CM CAT6	UTP/CM							
0.75 X 1.00	0.750	5	9	14	9	19	11	8	23	14	30	17	51	5	3	1							
0.75 X 1.50	1.125	7	14	22	13	29	17	12	35	21	46	25	76	7	5	2							
0.75 X 2.00	1.500	9	18	29	17	39	22	16	47	27	61	34	101	9	7	2							
1.00 X 1.00	1.000	6	12	19	11	26	15	10	31	18	40	22	68	6	5	2							
1.00 X 1.50	1.500	9	18	29	17	39	22	16	47	27	61	34	101	9	7	2							
1.00 X 2.00	2.000	12	24	38	23	52	30	21	62	37	81	45	135	12	9	3							
1.00 X 3.00	3.000	18	37	58	34	78	44	31	93	55	121	67	203	18	14	5							
1.00 X 4.00	4.000	24	49	77	46	104	59	42	124	73	162	90	270	24	18	6							
1.50 X 1.00	1.500	9	18	29	17	39	22	16	47	27	61	34	101	9	7	2							
1.50 X 1.50	2.250	14	27	43	26	58	33	24	70	41	91	50	152	14	10	4							
1.50 X 2.00	3.000	18	37	58	34	78	44	31	93	55	121	67	203	18	14	5							
1.50 X 3.00	4.500	27	55	86	52	117	67	47	140	82	182	101	304	27	21	7							
1.50 X 4.00	6.000	36	73	115	69	155	89	63	186	110	243	134	406	36	27	10							
2.00 X 1.00	2.000	12	24	38	23	52	30	21	62	37	81	45	135	12	9	3							
2.00 X 1.50	3.000	18	37	58	34	78	44	31	93	55	121	67	203	18	14	5							
2.00 X 2.00	4.000	24	49	77	46	104	59	42	124	73	162	90	270	24	18	6							
2.00 X 3.00	6.000	36	73	115	69	155	89	63	186	110	243	134	406	36	27	10							
2.00 X 4.00	8.000	48	98	154	92	207	118	84	248	146	324	179	541	49	37	13							
2.00 X 5.00	10.000	60	122	192	114	259	148	105	310	183	405	224	676	61	46	16							
2.50 X 2.00	5.000	30	61	96	57	130	74	52	155	91	202	112	338	30	23	8							
2.50 X 3.00	7.500	45	92	144	86	194	111	79	233	137	304	168	507	46	34	12							
2.50 X 4.00	10.000	60	122	192	114	259	148	105	310	183	405	224	676	61	46	16							
3.00 X 1.00	3.000	18	37	58	34	78	44	31	93	55	121	67	203	18	14	5							
3.00 X 2.00	6.000	36	73	115	69	155	89	63	186	110	243	134	406	36	27	10							
3.00 X 3.00	9.000	54	110	173	103	233	133	94	279	165	364	201	609	55	41	14							
3.00 X 4.00	12.000	72	146	230	137	311	177	126	372	219	486	269	811	73	55	19							
3.00 X 5.00	15.000	90	183	288	172	389	222	157	465	274	607	336	1014	91	69	24							
4.00 X 1.50	6.000	36	73	115	69	155	89	63	186	110	243	134	406	36	27	10							
4.00 X 2.00	8.000	48	98	154	92	207	118	84	248	146	324	179	541	49	37	13							
4.00 X 3.00	12.000	72	146	230	137	311	177	126	372	219	486	269	811	73	55	19							
4.00 X 4.00	16.000	96	195	307	183	415	237	168	496	293	648	358	1082	97	73	26							
4.00 X 5.00	20.000	120	244	384	229	518	296	210	620	366	810	448	1352	121	91	32							
6.00 X 4.00	24.000	144	293	461	275	622	355	252	744	439	972	537	1623	146	110	39							

Formula for Calculating Fill Capacity

$$\text{Number of wires} = \frac{\text{Duct } W \times H}{1.75 \times (\text{Wire O.D.})^2} \div 2$$

## Properties of Materials Used in Wiring Duct

Property	Units	ASTM Test	PVC	Halogen Free
Specific Gravity		D792	1.43	1.10
IZOD	ft.-lb./in.	D256	2	5.0
Flexural Strength	psi	D790	10,900	12,800
Flexural Modulus	psi	D790	382,000	360,000
Tensile Strength	psi	D638	5,500	7,800
Compressive Strength	psi	D695	8,600	16,000
Water Absorption	24 hrs.-%	D570	0.10	0.07
Hardness	Rockwell	D785	R-111	R-115
	Duro D	D676	78	
Dielectric Strength		D149		
60Hz, 25° C, s/t	vpm			400
Dielectric Constant		D150		
60Hz, Dry			1.9	2.65
1MHz, Dry				2.64
Volume Resistivity	ohm-cm	D257		1017
Heat Deflecting (° F@ 264 psi)	° F	D648	158	212
Flammability			94 V-0	94 V-1

The above information is believed reliable. The user should, however, check the applicable specifications to verify values.

### Rigid Polyvinyl Chloride (PVC)

- General-purpose material for indoor applications
- UL® flammability rating of V-0
- UL94 recognized for use in temperatures up to 50° C (122° F)
- Economical wiring duct material

### Halogen Free

- For use in halogen-free or high-temperature applications
- UL flammability rating of V-1
- UL94 recognized for use in temperatures up to 95° C (203° F)
- 20% lighter than PVC

**Technical Info—Wiring Ducts**

**Thomas & Betts Solid Wall (PVC) Wiring Duct Dimensions**

Ty-Duct<sup>®</sup> and Accessories

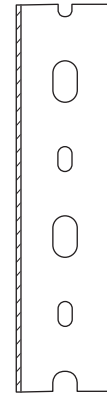
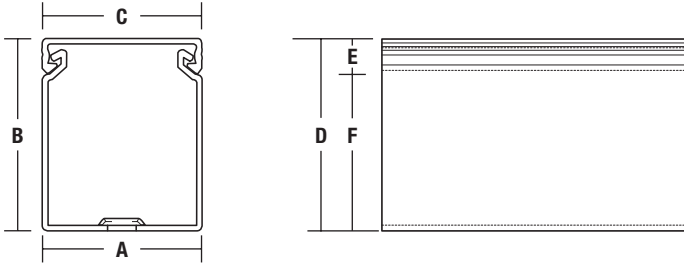

Pattern for 3/4" & 1"

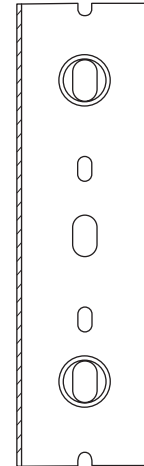

Pattern for 1 1/2", 2", & 2 1/2"

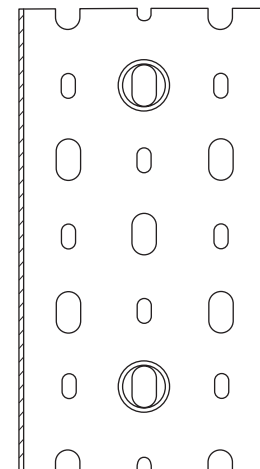

Pattern for 3", 4", & 6"

**DIMENSIONS (INCHES)**

TRADE SIZE		DIMENSIONS (INCHES)					
W	H	A	B	C	D	E	F
0.75 X	1.00	0.94	1.14	0.94	1.03	0.26	0.77
0.75 X	1.50	0.94	1.60	0.94	1.50	0.27	1.23
0.75 X	2.00	0.94	2.10	0.94	2.01	0.29	1.73
1.00 X	1.00	1.25	1.14	1.25	1.03	0.26	0.77
1.00 X	1.50	1.25	1.60	1.25	1.50	0.27	1.23
1.00 X	2.00	1.25	2.10	1.25	2.01	0.28	1.73
1.00 X	3.00	1.25	3.05	1.25	2.99	0.32	2.68
1.00 X	4.00	1.25	4.37	1.25	4.32	0.32	4.00
1.50 X	1.00	1.75	1.14	1.75	1.03	0.26	0.77
1.50 X	1.50	1.75	1.60	1.75	1.50	0.27	1.23
1.50 X	2.00	1.75	2.10	1.75	2.01	0.29	1.73
1.50 X	3.00	1.75	3.05	1.75	2.99	0.34	2.65
1.50 X	4.00	1.75	4.37	1.75	4.32	0.32	4.00
2.00 X	1.00	2.25	1.24	2.25	1.05	0.28	0.77
2.00 X	1.50	2.25	1.70	2.25	1.52	0.29	1.23
2.00 X	2.00	2.25	2.19	2.25	2.03	0.30	1.73
2.00 X	3.00	2.25	3.14	2.25	3.00	0.33	2.68
2.00 X	4.00	2.25	4.46	2.25	4.33	0.33	4.00
2.00 X	5.00	2.25	5.15	2.25	5.02	0.34	4.68
2.50 X	2.00	2.75	2.19	2.75	2.03	0.30	1.73
2.50 X	3.00	2.75	3.14	2.75	3.00	0.33	2.68
2.50 X	4.00	2.75	4.46	2.75	4.33	0.33	4.00
3.00 X	1.00	3.25	1.24	3.25	1.06	0.29	0.77
3.00 X	2.00	3.25	2.19	3.25	2.08	0.35	1.73
3.00 X	3.00	3.25	3.14	3.25	3.06	0.38	2.68
3.00 X	4.00	3.25	4.46	3.25	4.39	0.39	4.00
3.00 X	5.00	3.25	5.15	3.25	5.06	0.38	4.68
4.00 X	1.50	4.25	1.70	4.25	1.57	0.34	1.23
4.00 X	2.00	4.25	2.19	4.25	2.08	0.35	1.73
4.00 X	3.00	4.25	3.14	4.25	3.06	0.38	2.68
4.00 X	4.00	4.25	4.46	4.25	4.39	0.39	4.00
4.00 X	5.00	4.25	5.15	4.25	5.06	0.38	4.68
6.00 X	4.00	6.25	4.46	6.25	4.39	0.39	4.00

Dimensions shown are for reference only. Contact T&B for specific dimensional needs.

### Technical Info—Wiring Ducts

## Thomas & Betts Wide Slot (PVC) Wiring Duct Dimensions

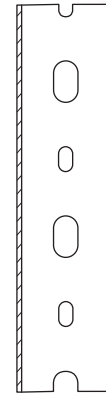
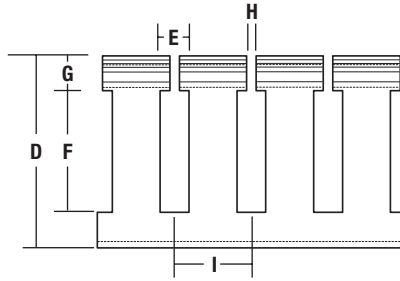
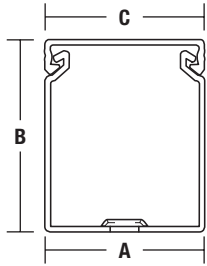

Pattern for 3/4" & 1"

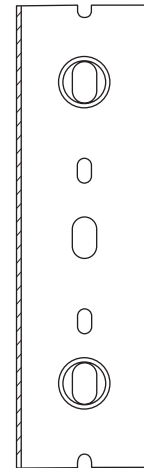

Pattern for 1 1/2", 2", & 2 1/2"

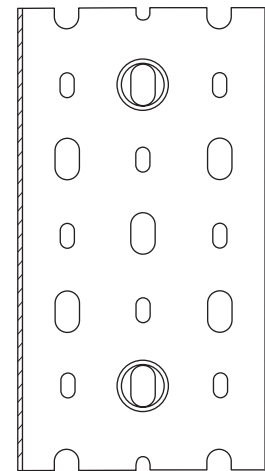

Pattern for 3", 4", & 6"

#### DIMENSIONS (INCHES)

TRADE SIZE		DIMENSIONS (INCHES)								
W	H	A	B	C	D	E	F	G	H	I
0.75	X 1.00	0.94	1.14	0.94	1.03	0.30	0.52	0.26	0.10	0.80
0.75	X 1.50	0.94	1.60	0.94	1.50	0.30	0.93	0.27	0.10	0.80
0.75	X 2.00	0.94	2.10	0.94	2.01	0.30	1.36	0.29	0.10	0.80
1.00	X 1.00	1.25	1.14	1.25	1.03	0.30	0.52	0.26	0.10	0.80
1.00	X 1.50	1.25	1.60	1.25	1.50	0.30	0.93	0.27	0.10	0.80
1.00	X 2.00	1.25	2.10	1.25	2.01	0.30	1.36	0.28	0.10	0.80
1.00	X 3.00	1.25	3.05	1.25	2.99	0.30	2.31	0.32	0.10	1.00
1.00	X 4.00	1.25	4.37	1.25	4.32	0.30	3.63	0.32	0.10	1.00
1.50	X 1.00	1.75	1.14	1.75	1.03	0.30	0.52	0.26	0.10	0.80
1.50	X 1.50	1.75	1.60	1.75	1.50	0.30	0.93	0.27	0.10	0.80
1.50	X 2.00	1.75	2.10	1.75	2.01	0.30	1.36	0.29	0.10	0.80
1.50	X 3.00	1.75	3.05	1.75	2.99	0.30	2.28	0.34	0.10	1.00
1.50	X 4.00	1.75	4.37	1.75	4.32	0.30	3.63	0.32	0.10	1.00
2.00	X 1.00	2.25	1.24	2.25	1.05	0.30	0.52	0.28	0.10	0.80
2.00	X 1.50	2.25	1.70	2.25	1.52	0.30	0.93	0.29	0.10	0.80
2.00	X 2.00	2.25	2.19	2.25	2.03	0.30	1.36	0.30	0.10	0.80
2.00	X 3.00	2.25	3.14	2.25	3.00	0.30	2.31	0.33	0.10	1.00
2.00	X 4.00	2.25	4.46	2.25	4.33	0.30	3.63	0.33	0.10	1.00
2.00	X 5.00	2.25	5.15	2.25	5.02	0.38	4.31	0.34	0.10	1.33
2.50	X 2.00	2.75	2.19	2.75	2.03	0.30	1.36	0.30	0.10	0.80
2.50	X 3.00	2.75	3.14	2.75	3.00	0.30	2.31	0.33	0.10	1.00
2.50	X 4.00	2.75	4.46	2.75	4.33	0.30	3.63	0.33	0.10	1.00
3.00	X 1.00	3.25	1.24	3.25	1.06	0.30	0.52	0.29	0.10	0.80
3.00	X 2.00	3.25	2.19	3.25	2.08	0.30	1.36	0.35	0.10	0.80
3.00	X 3.00	3.25	3.14	3.25	3.06	0.30	2.31	0.38	0.10	1.00
3.00	X 4.00	3.25	4.46	3.25	4.39	0.30	3.63	0.39	0.10	1.00
3.00	X 5.00	3.25	5.15	3.25	5.06	0.38	4.31	0.38	0.10	1.33
4.00	X 1.50	4.25	1.70	4.25	1.57	0.30	0.93	0.34	0.10	0.80
4.00	X 2.00	4.25	2.19	4.25	2.08	0.30	1.36	0.35	0.10	0.80
4.00	X 3.00	4.25	3.14	4.25	3.06	0.30	2.31	0.38	0.10	1.00
4.00	X 4.00	4.25	4.46	4.25	4.39	0.30	3.63	0.39	0.10	1.00
4.00	X 5.00	4.25	5.15	4.25	5.06	0.38	4.31	0.38	0.10	1.33
6.00	X 4.00	6.25	4.46	6.25	4.39	0.30	3.63	0.39	0.10	1.00

Dimensions shown are for reference only. Contact T&B for specific dimensional needs.



Technical Info—Wiring Ducts

Thomas & Betts Narrow Slot (PVC) Wiring Duct Dimensions

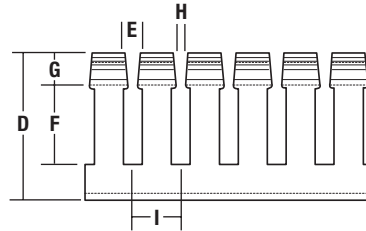
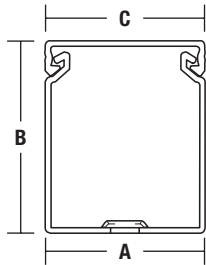

Figure 1

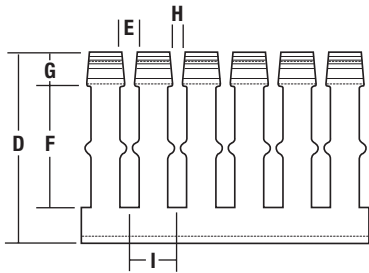

Figure 2

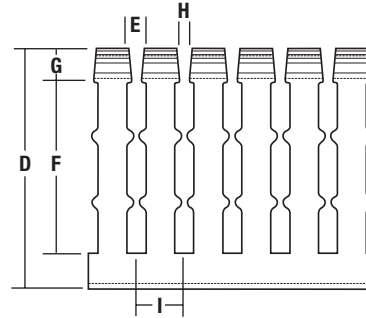
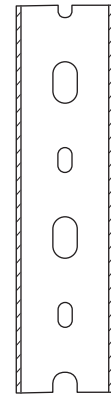
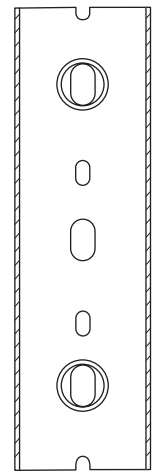

Figure 3



Pattern for 1/4" & 1"



Pattern for 1 1/2", 2", & 2 1/2"

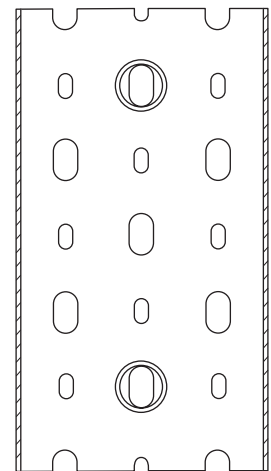

Pattern for 3", 4", & 6"

DIMENSIONS (INCHES)

TRADE SIZE	FIG.	A	B	C	D	E	F	G	H	I
0.75 X 1.50	1	0.94	1.60	0.94	1.50	0.20	0.93	0.27	0.10	0.50
1.00 X 1.00	1	1.25	1.14	1.25	1.03	0.20	0.52	0.26	0.10	0.50
1.00 X 1.50	1	1.25	1.60	1.25	1.50	0.20	0.93	0.27	0.10	0.50
1.00 X 2.00	2	1.25	2.10	1.25	2.01	0.20	1.36	0.28	0.10	0.50
1.00 X 3.00	3	1.25	3.05	1.25	2.99	0.20	2.31	0.32	0.10	0.50
1.00 X 4.00	3	1.25	4.37	1.25	4.32	0.20	3.63	0.32	0.10	0.50
1.50 X 1.00	1	1.75	1.14	1.75	1.03	0.20	0.52	0.26	0.10	0.50
1.50 X 1.50	1	1.75	1.60	1.75	1.50	0.20	0.93	0.27	0.10	0.50
1.50 X 2.00	2	1.75	2.10	1.75	2.01	0.20	1.36	0.29	0.10	0.50
1.50 X 3.00	3	1.75	3.05	1.75	2.99	0.20	2.28	0.34	0.10	0.50
1.50 X 4.00	3	1.75	4.37	1.75	4.32	0.20	3.63	0.32	0.10	0.50
2.00 X 1.00	1	2.25	1.24	2.25	1.05	0.20	0.52	0.28	0.10	0.50
2.00 X 1.50	1	2.25	1.70	2.25	1.52	0.20	0.93	0.29	0.10	0.50
2.00 X 2.00	2	2.25	2.19	2.25	2.03	0.20	1.36	0.30	0.10	0.50
2.00 X 3.00	3	2.25	3.14	2.25	3.00	0.20	2.31	0.33	0.10	0.50
2.00 X 4.00	3	2.25	4.46	2.25	4.33	0.20	3.63	0.33	0.10	0.50
2.00 X 5.00	3	2.25	5.15	2.25	5.02	0.20	4.31	0.34	0.10	0.50
2.50 X 2.00	2	2.75	2.19	2.75	2.03	0.20	1.36	0.30	0.10	0.50
2.50 X 3.00	3	2.75	3.14	2.75	3.00	0.20	2.31	0.33	0.10	0.50
2.50 X 4.00	3	2.75	4.46	2.75	4.33	0.20	3.63	0.33	0.10	0.50
3.00 X 1.00	1	3.25	1.24	3.25	1.06	0.20	0.52	0.29	0.10	0.50
3.00 X 2.00	2	3.25	2.19	3.25	2.08	0.20	1.36	0.35	0.10	0.50
3.00 X 3.00	3	3.25	3.14	3.25	3.06	0.20	2.31	0.38	0.10	0.50
3.00 X 4.00	3	3.25	4.46	3.25	4.39	0.20	3.63	0.39	0.10	0.50
3.00 X 5.00	3	3.25	5.15	3.25	5.06	0.20	4.31	0.38	0.10	0.50
4.00 X 2.00	2	4.25	2.19	4.25	2.08	0.20	1.36	0.35	0.10	0.50
4.00 X 3.00	3	4.25	3.14	4.25	3.06	0.20	2.31	0.38	0.10	0.50
4.00 X 4.00	3	4.25	4.46	4.25	4.39	0.20	3.63	0.39	0.10	0.50
4.00 X 5.00	3	4.25	5.15	4.25	5.06	0.20	4.31	0.38	0.10	0.50

Dimensions shown are for reference only. Contact T&B for specific dimensional needs.

Ty-Duct™ and Accessories

### Technical Info—Wiring Ducts

## Thomas & Betts Round Hole (PVC) Wiring Duct Dimensions

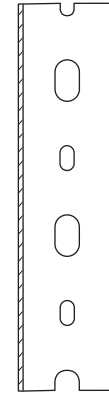
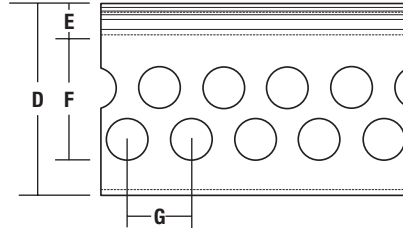
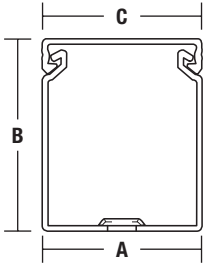

Pattern for 3/4" & 1"

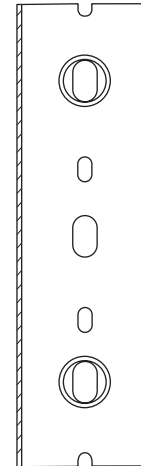

Pattern for 1 1/2", 2", & 2 1/2"

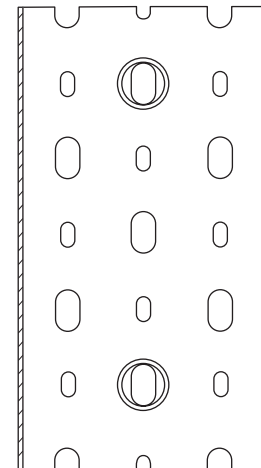

Pattern for 3", 4", & 6"

TRADE SIZE		DIMENSIONS (INCHES)							ROWS OF HOLES
W	H	A	B	C	D	E	F	G	
1.00	X 1.50	1.25	1.60	1.25	1.50	0.27	1.23	0.67	2
1.00	X 2.00	1.25	2.10	1.25	2.01	0.28	1.73	0.67	2
1.00	X 3.00	1.25	3.05	1.25	2.99	0.32	2.68	0.67	4
1.00	X 4.00	1.25	4.37	1.25	4.32	0.32	4.00	0.67	6
1.50	X 1.00	1.75	1.14	1.75	1.03	0.26	0.77	0.67	2
1.50	X 1.50	1.75	1.60	1.75	1.50	0.27	1.23	0.67	2
1.50	X 2.00	1.75	2.10	1.75	2.01	0.29	1.73	0.67	2
1.50	X 3.00	1.75	3.05	1.75	2.99	0.34	2.65	0.67	4
1.50	X 4.00	1.75	4.37	1.75	4.32	0.32	4.00	0.67	6
2.00	X 1.50	2.25	1.70	2.25	1.52	0.29	1.23	0.67	2
2.00	X 2.00	2.25	2.19	2.25	2.03	0.30	1.73	0.67	2
2.00	X 3.00	2.25	3.14	2.25	3.00	0.33	2.68	0.67	4
2.00	X 4.00	2.25	4.46	2.25	4.33	0.33	4.00	0.67	6
3.00	X 2.00	3.25	2.19	3.25	2.08	0.35	1.73	0.67	2
3.00	X 3.00	3.25	3.14	3.25	3.06	0.38	2.68	0.67	4
3.00	X 4.00	3.25	4.46	3.25	4.39	0.39	4.00	0.67	6
4.00	X 1.50	4.25	1.70	4.25	1.57	0.34	1.23	0.67	2
4.00	X 2.00	4.25	2.19	4.25	2.08	0.35	1.73	0.67	2
4.00	X 3.00	4.25	3.14	4.25	3.06	0.38	2.68	0.67	4
4.00	X 4.00	4.25	4.46	4.25	4.39	0.39	4.00	0.67	6

Dimensions shown are for reference only. Contact T&B for specific dimensional needs.

## Technical Information

Ty-Duct™ meets all of the prominent agency approvals and standards.

### Agency Approvals:

Thomas & Betts Ty-Duct wiring duct is UL recognized for all requirements set forth in UL standard 1565 "Positioning Device."



The Ty-Duct wiring duct meets all applicable requirements of the Canadian Standard Association as described in CSA C22.2 No. 18.5.



All Ty-Duct wiring duct components comply with the European Directives for CE (Conformite European) Marking.



All materials used in the making of the Ty-Duct wiring duct comply with the European Directives 2002/95/EC (RoHS), 2002/96/EC (WEEE), and 2003/11/EC.

### Standards:

#### NFPA-79-2002

Thomas & Betts Ty-Duct wiring duct is compliant with the National Fire Protection Agency NFPA-79-2002. All materials used in the manufacturing of the Ty-Duct components are selected from flame-retardant material and comply with IEC 60332-1. The testing is required in order to comply with NFPA-79-2002, Section 13.3.1.

#### UL 508/UL 508A

As required in UL508/UL508A a factory-installed conductor shall be separated from a conductor used in a different circuit when the conductors are not insulated for the maximum voltage of either circuit. The Ty-Duct wiring duct with a divider wall creates the required separation to meet this requirement.

#### DIN 43 659

This European standard specifies dimensions for slotted trunkings installed in electrical switchgear assemblies. The standard defines the following dimensions:

- The mounting hole pattern
- The mounting hole slot dimensions
- The mounting hole pitch and location
- The minimum overall product length

### Product Code Index

CATALOG NUMBER	PAGE NUMBER	CATALOG NUMBER	PAGE NUMBER	CATALOG NUMBER	PAGE NUMBER
TY75X1SP[ _ ]6	7	TY2X5WP[ _ ]6	9	TY15X4RP[ _ ]6	13
TY75X15SP[ _ ]6	7	TY25X2WP[ _ ]6	9	TY2X15RP[ _ ]6	13
TY75X2SP[ _ ]6	7	TY25X3WP[ _ ]6	9	TY2X2RP[ _ ]6	13
TY1X1SP[ _ ]6	7	TY25X4WP[ _ ]6	9	TY2X3RP[ _ ]6	13
TY1X15SP[ _ ]6	7	TY3X1WP[ _ ]6	9	TY2X4RP[ _ ]6	13
TY1X2SP[ _ ]6	7	TY3X2WP[ _ ]6	9	TY3X2RP[ _ ]6	13
TY1X3SP[ _ ]6	7	TY3X3WP[ _ ]6	9	TY3X3RP[ _ ]6	13
TY1X4SP[ _ ]6	7	TY3X4WP[ _ ]6	9	TY3X4RP[ _ ]6	13
TY15X1SP[ _ ]6	7	TY3X5WP[ _ ]6	9	TY4X15RP[ _ ]6	13
TY15X15SP[ _ ]6	7	TY4X15WP[ _ ]6	9	TY4X2RP[ _ ]6	13
TY15X2SP[ _ ]6	7	TY4X2WP[ _ ]6	9	TY4X3RP[ _ ]6	13
TY15X3SP[ _ ]6	7	TY4X3WP[ _ ]6	9	TY4X4RP[ _ ]6	13
TY15X4SP[ _ ]6	7	TY4X4WP[ _ ]6	9	TY1X1WHW6	15
TY2X1SP[ _ ]6	7	TY4X5WP[ _ ]6	9	TY1X15WHW6	15
TY2X15SP[ _ ]6	7	TY6X4WP[ _ ]6	9	TY1X2WHW6	15
TY2X2SP[ _ ]6	7	TY75X15NP[ _ ]6	11	TY1X3WHW6	15
TY2X3SP[ _ ]6	7	TY1X1NP[ _ ]6	11	TY1X4WHW6	15
TY2X4SP[ _ ]6	7	TY1X15NP[ _ ]6	11	TY15X15WHW6	15
TY2X5SP[ _ ]6	7	TY1X2NP[ _ ]6	11	TY15X2WHW6	15
TY25X2SP[ _ ]6	7	TY1X3NP[ _ ]6	11	TY15X3WHW6	15
TY25X3SP[ _ ]6	7	TY1X4NP[ _ ]6	11	TY15X4WHW6	15
TY25X4SP[ _ ]6	7	TY15X1NP[ _ ]6	11	TY2X1WHW6	15
TY3X1SP[ _ ]6	7	TY15X15NP[ _ ]6	11	TY2X2WHW6	15
TY3X2SP[ _ ]6	7	TY15X2NP[ _ ]6	11	TY2X3WHW6	15
TY3X3SP[ _ ]6	7	TY15X3NP[ _ ]6	11	TY2X4WHW6	15
TY3X4SP[ _ ]6	7	TY15X4NP[ _ ]6	11	TY25X3WHW6	15
TY3X5SP[ _ ]6	7	TY2X1NP[ _ ]6	11	TY3X1WHW6	15
TY4X15SP[ _ ]6	7	TY2X15NP[ _ ]6	11	TY3X2WHW6	15
TY4X2SP[ _ ]6	7	TY2X2NP[ _ ]6	11	TY3X3WHW6	15
TY4X3SP[ _ ]6	7	TY2X3NP[ _ ]6	11	TY3X4WHW6	15
TY4X4SP[ _ ]6	7	TY2X4NP[ _ ]6	11	TY3X5WHW6	15
TY4X5SP[ _ ]6	7	TY2X5NP[ _ ]6	11	TY4X2WHW6	15
TY6X4SP[ _ ]6	7	TY25X2NP[ _ ]6	11	TY4X3WHW6	15
TY75X1WP[ _ ]6	9	TY25X3NP[ _ ]6	11	TY4X4WHW6	15
TY75X15WP[ _ ]6	9	TY25X4NP[ _ ]6	11	TY4X5WHW6	15
TY75X2WP[ _ ]6	9	TY3X1NP[ _ ]6	11	TY1D[ _ ][ _ ]6	16
TY1X1WP[ _ ]6	9	TY3X2NP[ _ ]6	11	TY1.5D[ _ ][ _ ]6	16
TY1X15WP[ _ ]6	9	TY3X3NP[ _ ]6	11	TY2D[ _ ][ _ ]6	16
TY1X2WP[ _ ]6	9	TY3X4NP[ _ ]6	11	TY3D[ _ ][ _ ]6	16
TY1X3WP[ _ ]6	9	TY3X5NP[ _ ]6	11	TY4D[ _ ][ _ ]6	16
TY1X4WP[ _ ]6	9	TY4X2NP[ _ ]6	11	TY5D[ _ ][ _ ]6	16
TY15X1WP[ _ ]6	9	TY4X3NP[ _ ]6	11	UMC	16
TY15X15WP[ _ ]6	9	TY4X4NP[ _ ]6	11	TYCS[ _ ]6	17
TY15X2WP[ _ ]6	9	TY4X5NP[ _ ]6	11	08200C	17
TY15X3WP[ _ ]6	9	TY1X15RP[ _ ]6	13	TYJC[ _ ]6	17
TY15X4WP[ _ ]6	9	TY1X2RP[ _ ]6	13	SX-15TB	18
TY2X1WP[ _ ]6	9	TY1X3RP[ _ ]6	13	DK-65TB	18
TY2X15WP[ _ ]6	9	TY1X4RP[ _ ]6	13	DC-125TB	19
TY2X2WP[ _ ]6	9	TY15X15RP[ _ ]6	13	DNT-100TB	19
TY2X3WP[ _ ]6	9	TY15X2RP[ _ ]6	13	8205	19
TY2X4WP[ _ ]6	9	TY15X3RP[ _ ]6	13		

# For the rest of the box.

- A complete line of Liquidtight Fittings for every application
  - Designed to stand up to demanding, wet, or corrosive environments
  - Safe Edge™ ground cone design accepts variations in raceway convolutions
    - Patented double bevel sealing ring
      - U.L. and C.S.A. listed
- Suitable for both grounding and bonding applications



T&B Liquidtight Fittings

- Provides exceptional mechanical strain relief
- Dependable seal against dust, oil, and other liquids
  - Designed to handle unique connection demands of flexible cords and power cables
    - U.L. and C.S.A. listed



T&B Liquidtight Cord Fittings

- Rugged construction with zinc plating inside and out
  - Threaded conduits also feature locknuts for secure connection to threadless openings
    - U.L. and C.S.A. listed



T&B Rigid Fittings

- Meets both U.L. and International standards
  - 10 to 80 amps
  - Rugged, industrial-grade connectors provide universal raceway flexibility
  - Neoprene gasket seals out dust, oil, and moisture
  - Easy-lock cam-action latch eliminates guesswork, speeds installation



Pos-E-Kon™ Rectangular Connectors

- The original Ty-Rap® Cable Tie
  - Infinitely adjustable design ensures the right fit
    - Featuring the stainless steel barb
  - Rounded, low-profile head and smooth molded body
    - Complete accessories for every application
- Wide variety of materials for most environmental conditions
  - U.L. and Military (MS3367) listed



Ty-Rap® Fastening Products

- Permanent, safe and quick grounding connection of braided shield on cables
- Specification for the aerospace and military applications
  - Saves installation time
  - Reduces assembly costs



Shield-Kon® Terminals



E-Z-Code® Identification Solutions

- Complete labeling package, from self-laminating to heat-shrink marker
- Complete package of wire marker books and cards
- Signage for most requirements
- Two separate printers to meet changing needs

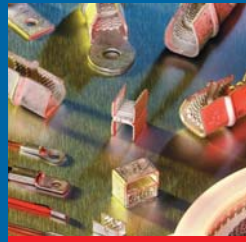

Dragon Tooth®

- Insulation piercing connectors for OEM customers terminating magnet wire
- Eliminates welding or brazing
- No longer requires removal of insulation
- Installed in seconds with compression tooling

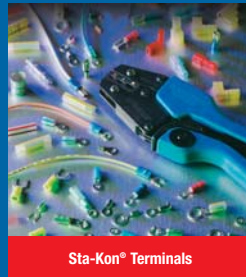

Sta-Kon® Terminals

- Available in vinyl, nylon, un-insulated, heat shrinkable, and tefzel materials
- Features a longer barrel for superior connection
- All terminals meet military standards for thickness
- Selectively annealed barrels
- Deburred and degreased
- Designs for most applications including rings, forks, locking forks, and disconnects



Shrink-Kon® Heat Shrink Products

- Proven performance for moisture-proofing connections and terminations
- Heat-shrinkable tubing, boots, and end caps can be used over lead, steel, aluminum, copper, standard plastic, and elastomeric materials
- Available in both thin and thick walls in a wide variety of colors



Blackburn® Mechanical Lugs

- Copper or aluminum dual-rated connectors
- Easy installation requires no special tools
- Tin plated for low contact resistance
- U.L. listed and C.S.A. certified

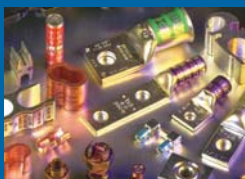

Color-Keyed® Power Connectors

- Superior compression connections
- Broad range of tooling and dies including hydraulic, pneumatic, and manual tools
- Hydraulic tools produce the hex-shape circumferential crimp preferred by many users
- Custom modifications available
- U.L. listed and C.S.A. certified
- Complete package of termination, splices, and both C and H taps
- T&B color code method ensures a superior crimp with a die-code embossing feature

**Thomas & Betts**

[www.tnb.com](http://www.tnb.com)



For U.S. Customer Service and Order Inquiries,  
call 1-800-816-7809 or fax 1-800-816-7810.

For International Service and Order Inquiries,  
call (U.S.) 901-252-5400 or fax 901-252-1330.

For Canadian Customer Service and Order Inquiries,  
call 450-347-5318 or fax 450-347-1976.

For U.S. Technical Support, call 1-888-862-3289  
or fax 901-252-1321.

For International Technical Support,  
call (U.S.) 901-252-5000, enter 1, 6672.

For tool service and repair,  
call 1-800-284-TOOL (8665).

# **Thomas & Betts**

**Thomas & Betts Corporation**  
Electrical Division  
8155 T&B Boulevard  
Memphis, Tennessee 38125

**Thomas & Betts Ltd.**  
700 Thomas Avenue  
Iberville, Québec J2X 2M9

© 2005 Thomas & Betts Corporation. All rights reserved.  
Specifications are subject to change without notice.  
Printed in U.S.A. 9/05/15M Order No. GM-1053

**United States**

Tel: 901.252.8000  
Fax: 901.252.1354

**Canada**

Tel: 450.347.5318  
Fax: 450.347.1976

**Technical Services**

Tel: 888.862.3289

[www.tnb.com](http://www.tnb.com)