

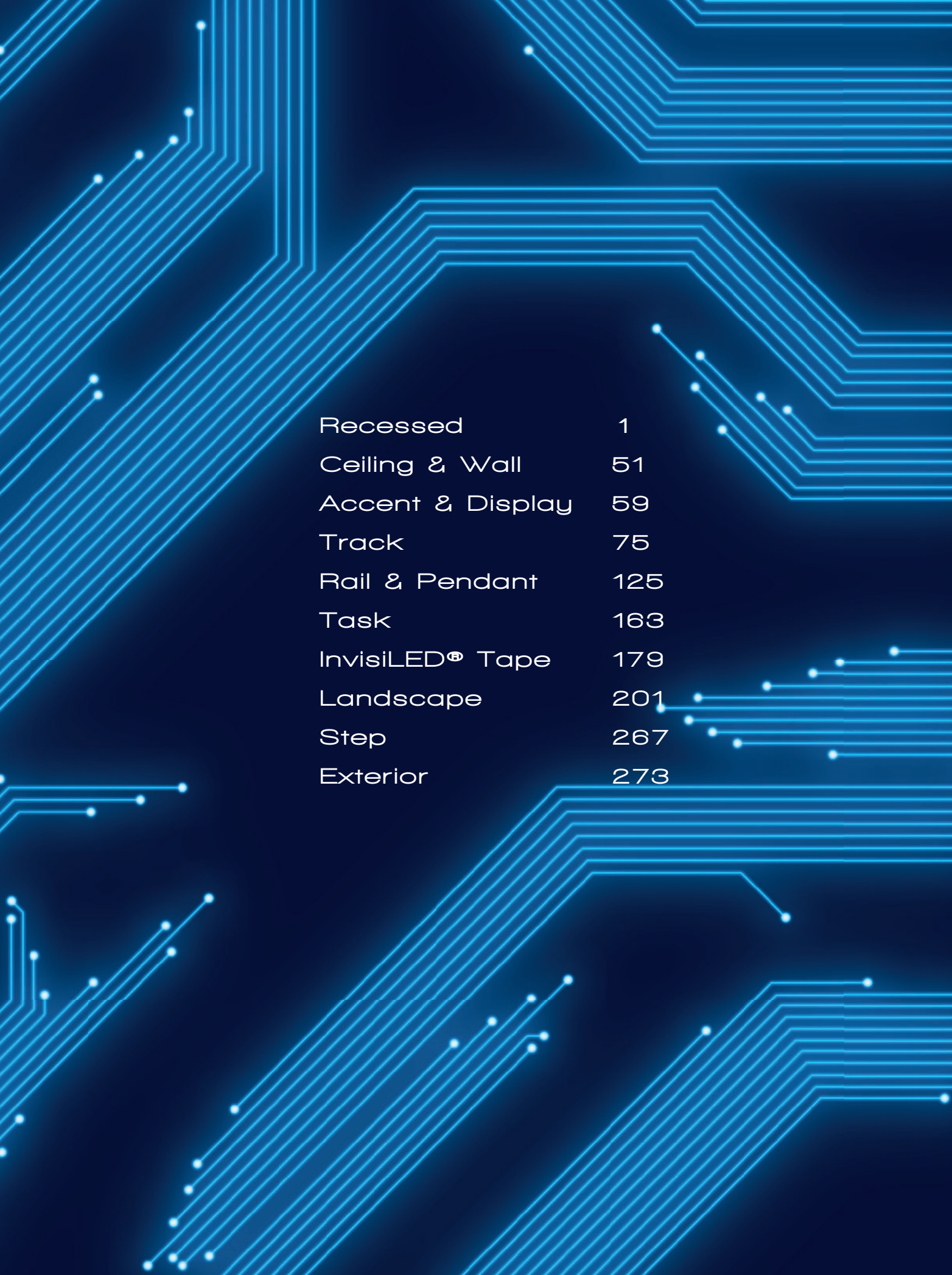

WAC LIGHTING

Responsible Lighting®



Recessed	1
Ceiling & Wall	51
Accent & Display	59
Track	75
Rail & Pendant	125
Task	163
InvisiLED® Tape	179
Landscape	201
Step	267
Exterior	273

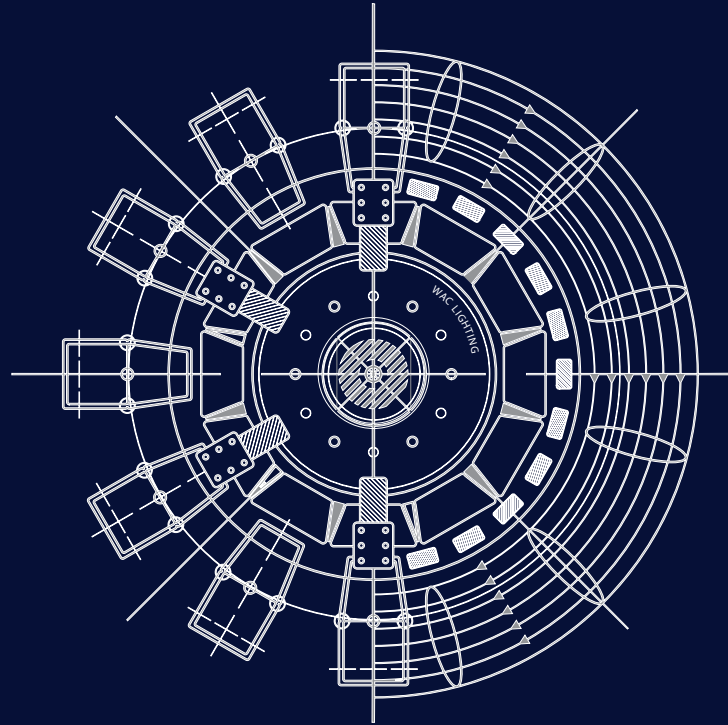

SOLVE IT

We believe that a key part of being a Responsible Lighting company is a product offering that is progressive in both design and technology. Groundbreaking innovations in LEDs, materials engineering, and creative optical design are paving the way for endless possibilities. With over 100 engineers on staff across 4 factories in the US and China, we put creative and forward-thinking minds behind solving your most challenging lighting needs with new technologies. All designs are then thoroughly tested in our internationally recognized NVLAP, UL, and ETL certified testing laboratories for safety, durability and robust long term performance far beyond required standards.

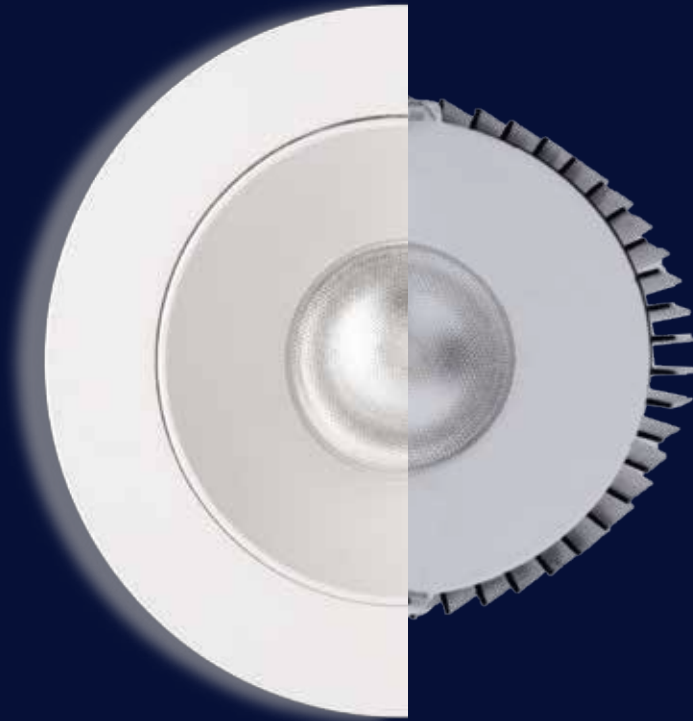

MAKE IT

With over 1 million square feet of fabrication and manufacturing capabilities, we are proud to have an industry leading infrastructure that turns concepts into fast-to-market products.

But above all, we are a company who cares about our employees, our products, our reputation, and our clients. As a family-owned business, we choose to manufacture products responsibly with zero-landfill impact and help to preserve the planet for our children and grandchildren. Together, this is part of our merit-based mission to build the most respected lighting company and be a shining example of American ingenuity.



DREAM IT

Fueled by a passion for creating, WAC is a second-generation family-owned and operated lighting company with a reputation for quality spanning over 30 years.

Our choice has consistently been to operate at a higher level of responsibility giving our customers the true benefits of a world class factory-direct relationship. We have a history of inventing and looking at things in a fresh new way to make technology leveraged products widely accessible. Our perspectives are guided by listening to everyone involved in the process from conception to installation and many ideas have come from you, the person holding this catalog.

Thank you for helping us to imagine our future as a better and brighter place!

RECESSED LIGHTING



RECESSED LIGHTING

Designed to outperform conventional light sources from even smaller apertures, our LED recessed luminaires offer glare-free visual cutoff, precise color quality and full range dimming. A comprehensive program of LED recessed options perform a multitude of tasks in all apertures ranging from 1" to 6".

One-light to Four-light Multiple Recessed offered in four distinctive families feature individual aiming elements for broad applications. With lighting control, performance and aesthetics, WAC Lighting's comprehensive series of LED recessed lighting is designed and engineered for the most challenging spaces.

Consult the factory to take advantage of our custom capabilities

RECESSED CHANNELS

*p. 1-6,
p.191-194*



1" APERTURE

LEDme® p. 27-28



2" - 3" APERTURE

Tesla Pro p. 23-24

Oculux p. 25-26

Duo p. 17-18

Traditional Low and Line Voltage p. 33-34



3.5" - 4" APERTURE

Aether p. 11-16

Tesla Pro p. 19-22

Oculux p. 25-26

Summit p. 31-32

LEDme p. 29-30

Traditional Low and Line Voltage p.33-36



4.5" - 6" APERTURE

Volta p. 7-10

Traditional Low and Line Voltage p. 35-36

I can't believe it's not recessed p. 51-52



MULTIPLE SPOTS

Precision p. 41-42

Tesla p. 43-44

Mini p. 45-46

LEDme p. 47-48

Traditional Low and Line Voltage p. 49-50



INDIRECT RECESSED CHANNEL

WAC LIGHTING

INDIRECT RECESSED CHANNEL

- Linear channel may be field cut
- Accommodates up to four runs of InvisiLED® indoor tape
- Dense foam insert to be removed in installation after spackling
- Allows option to use different color InvisiLED in one channel and switch them separately

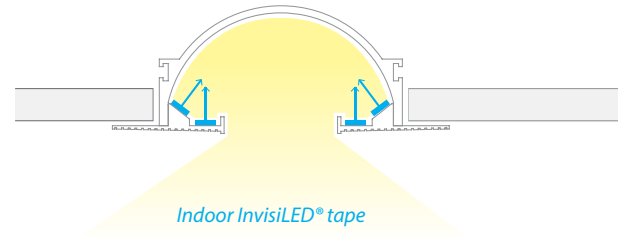
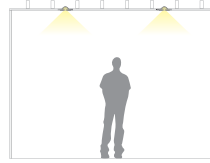

InvisiLED® indoor tape

Accommodates up to 4 runs of InvisiLED Indoor Tape

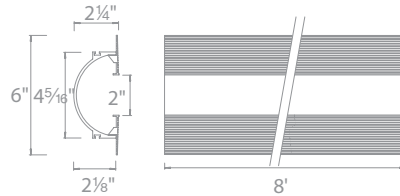

8ft linear channel **LED-T-RCH3-WT**

Includes channel connectors

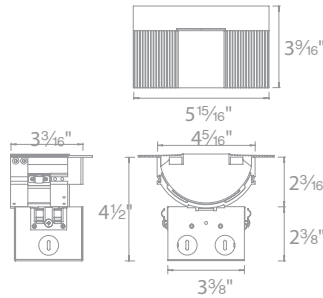

Power feed **LED-T-RBOX3-WT**

Includes a wiring box, two hanger bars, four five-pin InvisiLED® adapters, channel connectors, counter sink drill bit and two end caps. InvisiLED end cap may be placed on either side or be removed. Hanger bars may be installed on any side of the wiring box.

ASYMMETRICAL RECESSED CHANNEL

- Installs within 5/8" drywall depth
- Linear channel may be field cut
- Accommodates one run of InvisiLED® indoor tape
- Dense foam insert to be removed in installation after spackling
- Recommended installation within 15 inches of surface to be illuminated

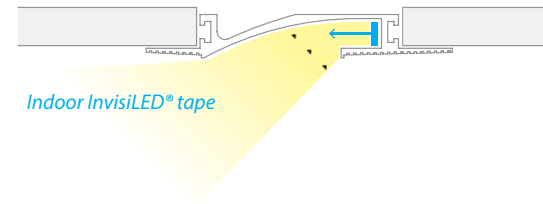
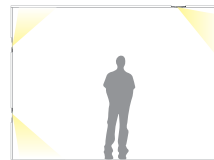

InvisiLED® indoor tape

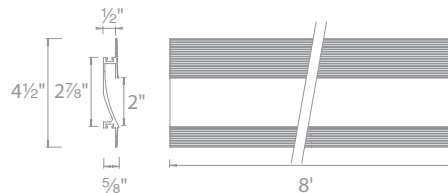

8ft linear channel **LED-T-RCH2-WT**

Includes channel connectors

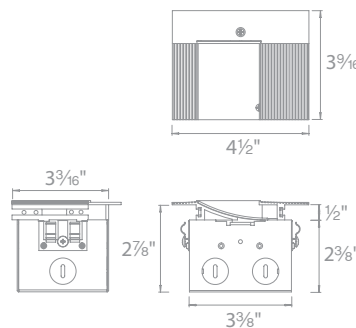

Power feed **LED-T-RBOX2-WT**

Includes a wiring box, two hanger bars, two five-pin InvisiLED® adapters, channel connectors, counter sink drill bit, and two end caps. Hanger bars may be installed on any side of the wiring box

SYMMETRICAL RECESSED CHANNEL



SYMMETRICAL RECESSED CHANNEL



- Installs within 5/8" drywall depth
- Linear channel can be field cut
- Accommodates either one or two runs of InvisiLED® indoor tape
- Includes a translucent white acrylic snap in diffuser
- Dense foam insert to be removed in installation after spackling

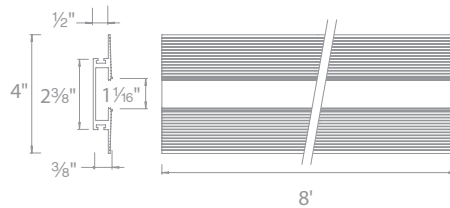

8ft linear channel **LED-T-RCH1-WT**

Includes channel connectors and diffuser

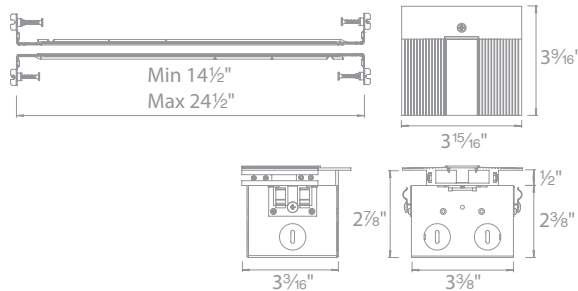

Power feed **LED-T-RBOX1-WT**

Includes a wiring box, two hanger bars, four five-pin InvisiLED® adapters, channel connectors, counter sink drill bit and two end caps. The end cap may be placed on either side or be removed. Hanger bars may be installed on any side of the wiring box

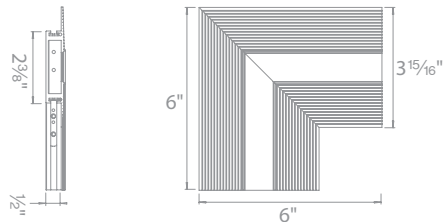

Lateral corner **LED-T-CTC1-WT**

Includes channel connectors and diffuser

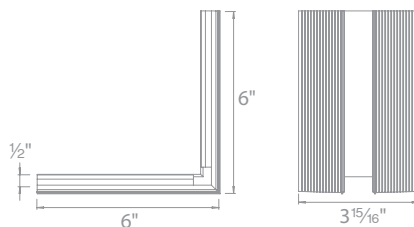

Inside corner **LED-T-WTC1-WT**

*Transitions between walls or wall to ceiling
Includes channel connectors and diffuser*

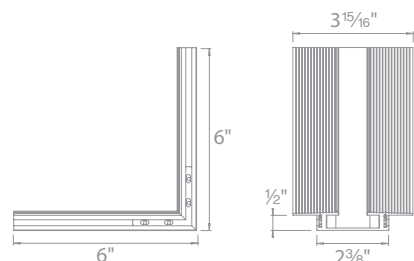

Outside corner **LED-T-WTW1-WT**

*Transitions around columns, bump outs, or soffits
Includes channel connectors and diffuser*

VOLTA 4.5" ARCHITECTURAL LED RECESSED



Delivered Lumens: Up to 3620
CBCP: Up to 12,885
Comparable to: 70W HID PAR30
ELV Dimming: 100%-5%
0-10V Dimming: 100%-0%
Input: 120-277V
Rated Life: 50,000 hours
Listing: ETL & cETL

- **FLEXIBLE** - Universal input voltage ranging from (120V-220V-277V)
- **VERSATILE** - Choice of 34W, 23W and 15W power
- **COMFORTABLE** - Wet location listed standard
- **CONTROLLABLE** - Vertical and horizontal adjustment for accenting and sloped ceilings
- **CAPABLE** - Optimized cut-off for superior glare control
- Wide range of accessories, including glare control, optic and color lenses
- Reverse phase and 0-10V dimming standard
- Field interchangeable optics
- Output over 3600 lumens and 100 lumens per watt
- Beam spreads from 15° spot to 60° wide flood

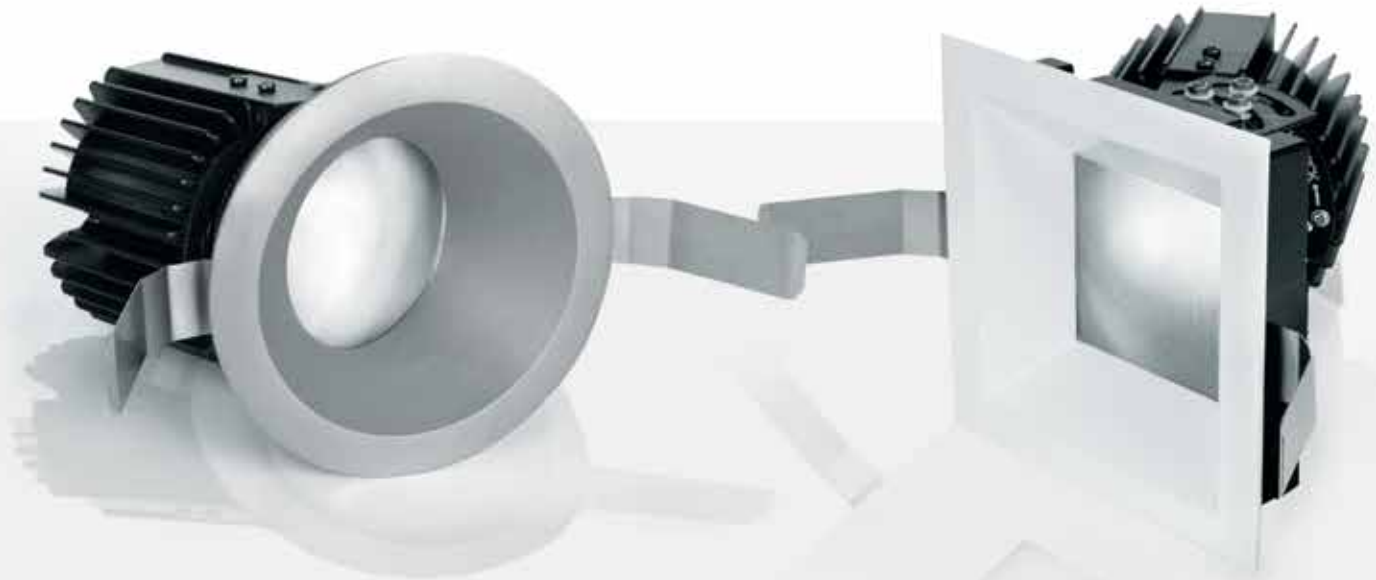

Available in six architectural grade finishes



White



Haze



Haze / White



Black / White



Black



Copper Bronze

DOWNLIGHT



- General illumination
- Superior glare control

SHALLOW REGRESSED DOWNLIGHT



- Increased field angle for reduced scalloping
- Low ceiling and close to wall applications

VOLTA 4.5" ARCHITECTURAL LED RECESSED

ADJUSTABLE



0° position



45° position

- Center beam alignment retained throughout adjustment range
- 0-45° vertical and 365° horizontal lockable hot aiming

WALL WASH



- Innovative bi-directional spread lens
- Engineered for even wall illumination both horizontally and vertically
- Patents Pending design

PRECISION AIMING



0 - 45° vertical lockable hot aiming

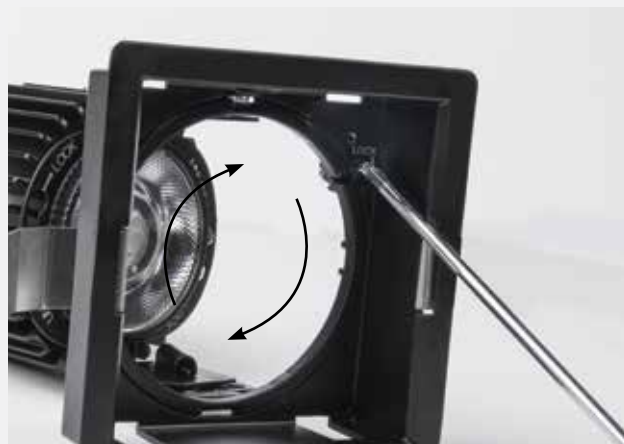

365° horizontal lockable hot aiming

BI-DIRECTIONAL SPREAD LENS

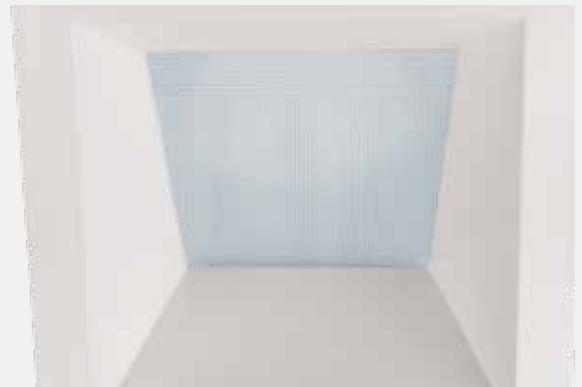

Horizontal spread
Even coverage for
greater fixture spacing

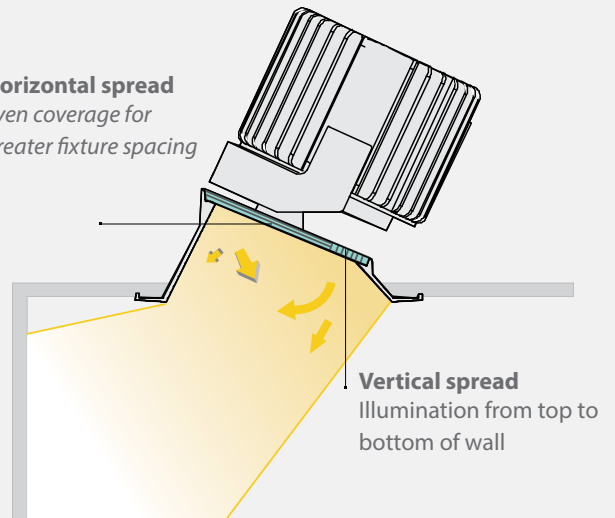

Vertical spread
Illumination from top to
bottom of wall



FIELD CHANGEABLE GLARE CONTROL AND OPTIC SYSTEM

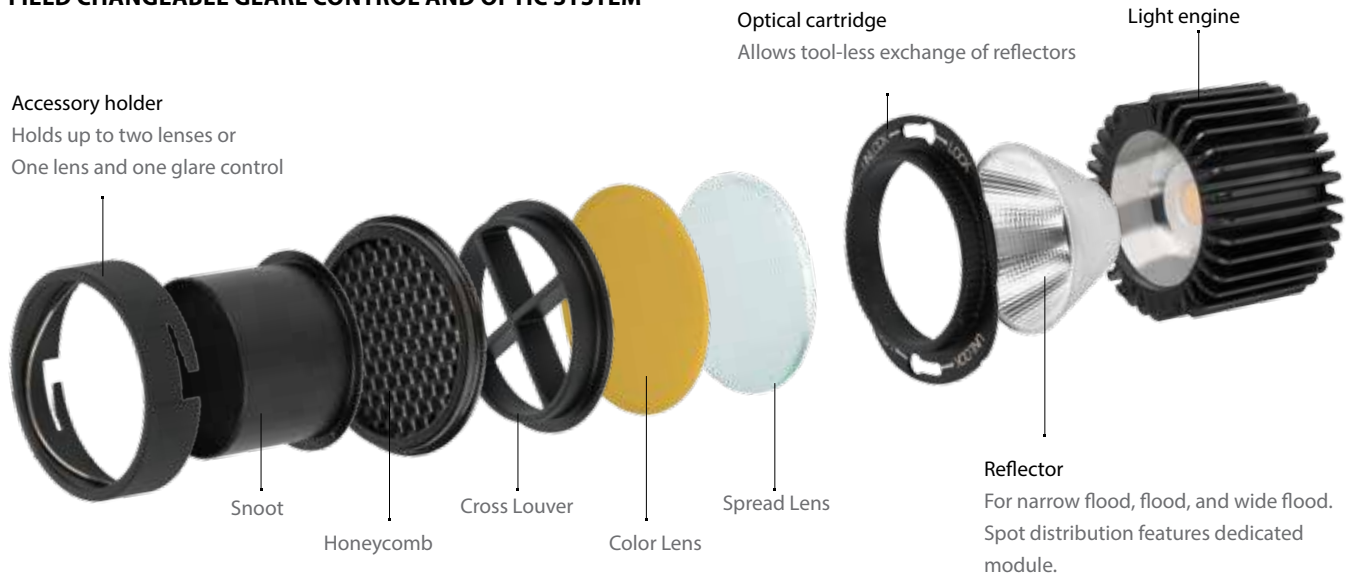

ACCESSORY HOLDER sold separately

LENS-73-HLD

Required for use with any lens or accessory

GLARE CONTROL ACCESSORIES

LENS-73

HCL Honeycomb Louver
CRL Cross Louver
SNOOT Snoot

LENS ACCESSORIES

LENS-73







AMB Amber lens
RED Red lens
FR Frosted lens
SPR Spread lens
BEL Beam Elongating

INTERCHANGEABLE REFLECTORS

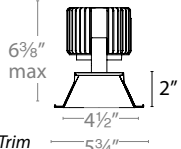
REF-R4-N Narrow Flood beam reflector
REF-R4-F Flood beam reflector
REF-R4-W Wide beam reflector

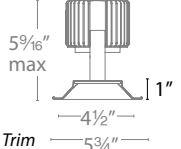
VOLTA 4.5" ARCHITECTURAL LED RECESSED

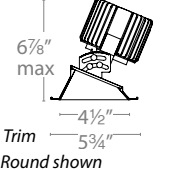
Lumens CBCP

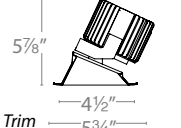
TRIM	Model	Beam	-36 Hsg@ 830	Color Temp	CRI	Finishes	Reflector/Trim		
Downlight  	R4RD2T Round Trim R4SD2T Square Trim	S 15°	Round	1405	11420	BK Black BKWT Black/White HZ Haze HZWT Haze/White WT White CB Copper Bronze	Black Black/White Haze Haze/White White Copper Bronze		
			Square	1440	11985				
		N 25°	Round	3145	9615				
			Square	3350	9820				
		F 45°	Round	3025	5005				
			Square	3200	4935				
	R4RD2L Round Invisible Trim R4SD2L Square Invisible Trim	S 15°	Round	1415	11290			827 2700K 85 830 3000K 85 835 3500K 85 840 4000K 85	BK Black BKWT Black/White HZ Haze HZWT Haze/White WT White CB Copper Bronze
			Square	1450	9650				
		N 25°	Round	3160	9655				
			Square	3385	8760				
		F 45°	Round	3035	5070				
			Square	3290	4880				
Shallow Regressed Downlight  	R4RD1T Round Trim R4SD1T Square Trim	S 15°	Round	1215	10910	927 2700K 90 930 3000K 90	BK Black BKWT Black/White HZ Haze HZWT Haze/White WT White CB Copper Bronze		
			Square	1140	9175				
		N 25°	Round	2340	9250				
			Square	1960	8340				
		F 40°	Round	2085	4720				
			Square	1770	4495				
Adjustable  	R4RAT Round Trim R4SAT Square Trim	S 15°	Round	1995	1470			BK Black BKWT Black/White HZ Haze HZWT Haze/White WT White CB Copper Bronze	Black Black/White Haze Haze/White White Copper Bronze
			Square	1140	9175				
		N 25°	Round	2340	9250				
			Square	1960	8340				
		F 40°	Round	2085	4720				
			Square	1770	4495				
Wall Wash  	R4RWT Round Trim R4SWT Square Trim	A Asym	Round	1995	1470	BK Black BKWT Black/White HZ Haze HZWT Haze/White WT White CB Copper Bronze	Black Black/White Haze Haze/White White Copper Bronze		
			Square	1140	9175				
		A Asym	Round	2405	1400				
			Square	2405	1400				
		R4RWL Round Invisible Trim R4SWL Square Invisible Trim	Round	1995	1470				
			Square	1140	9175				

Example: R4RAT-S930-BK

PHOTOMETRIC MULTIPLIER TABLE Use to determine outputs other than -36 hsg @ 830

Hsg Model	CRI and Color Temp					
	827	927	830	930	835	840
36	0.95	0.81	1.00	0.86	1.05	1.07
25	0.66	0.56	0.69	0.59	0.73	0.74
15	0.43	0.37	0.45	0.39	0.48	0.49

WATTAGE TABLE

Hsg Model	Beam Spread		
	S	A, N, F, W	
36	22W	34W	
25	15W	23W	
15	10W	15W	

HOUSING (Required)

New Construction Airtight IC

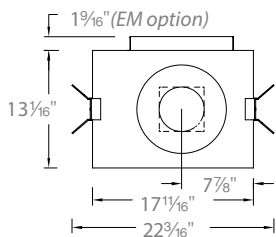
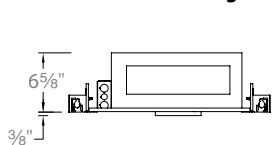

Model

R4RN Round
R4RC Round Chicago Plenum
R4SN Square
R4SC Square Chicago Plenum

Trim

T Trim
L Invisible Trim

Power

15 15W
25 23W
36 34W Non-IC

Emergency Backup

EM Optional

Remodel Non-IC

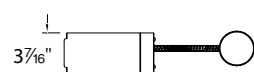
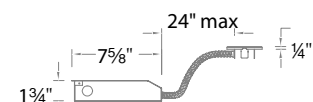

Model

R4BR

Trim

T Trim

15 15W Non-IC
25 23W Non-IC
36 34W Non-IC

N/A

Example: R4RNT-15 or R4RNT-15EM (with Emergency backup)

AETHER 3.5 SHALLOW IC LED DOWNLIGHT



AETHER 3.5 SHALLOW IC LED DOWNLIGHT

- IC rated shallow plenum family
- Universal input voltage ranging from (120V-220V-277V)
- Vertical and horizontal adjustment for accenting and sloped ceiling applications
- Beam spreads from 15° spot to 50° flood

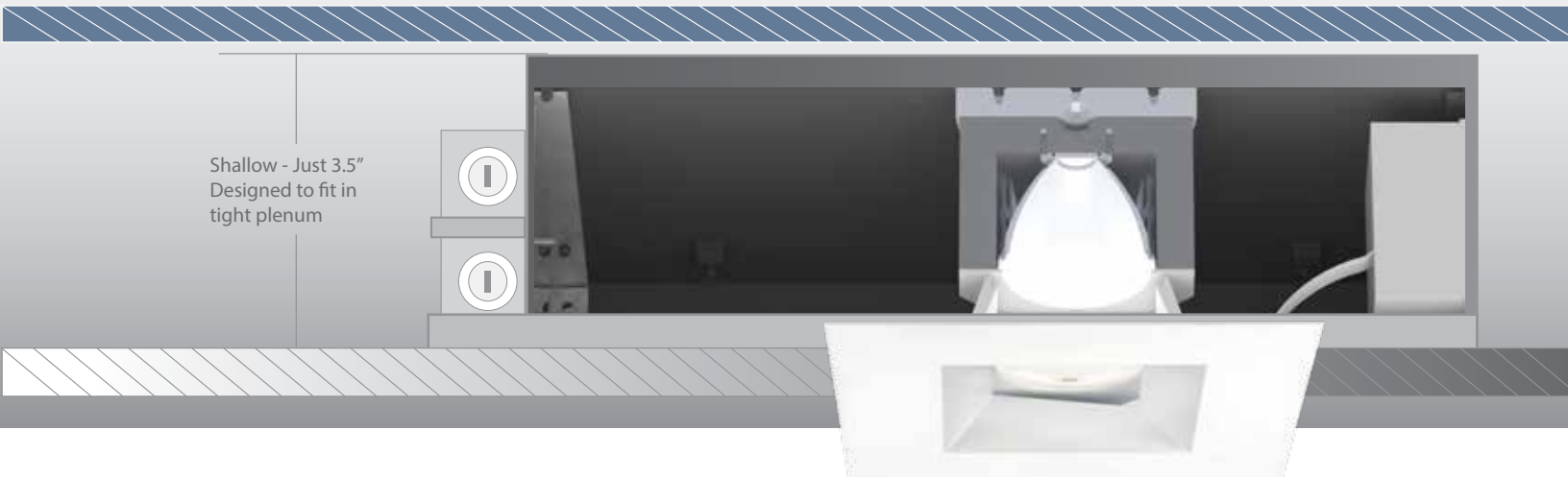

Trim finishes



White

Haze/White

Black/White

Invisible Trim™ finishes

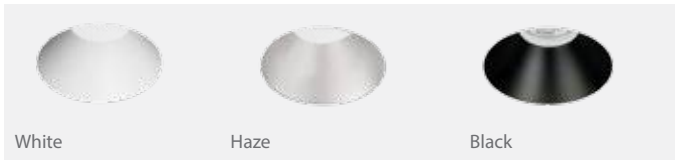

White

Haze

Black

DOWNLIGHT



- General illumination
- Ceiling thickness ½ to 1½"

WALL WASH



- Wall illumination
- Ceiling thickness ½ to 1½"

ADJUSTABLE



- Accenting and sloped ceiling
- Ceiling thickness ½ to 1½"

AETHER 3.5" SHALLOW IC LED DOWNLIGHT

- Universal input voltage (120V-220V-277V)
- Downlight Trim, Invisible™ Trim, Adjustable and Wall Wash available
- Ceiling thickness ½ to 1½"

DOWNLIGHT AND INVISIBLE TRIM

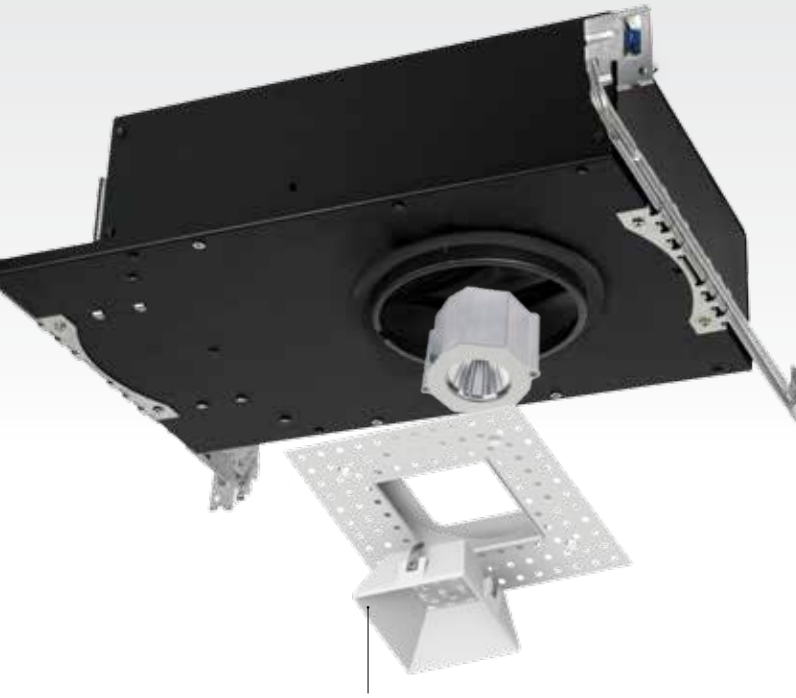

Detachable Invisible Trim finished baffle for easy installation

ADJUSTABLE AND WALL WASH TRIM



Trim assembly includes: light engine, optics, lensed trim

Housing (Order Trim Separately)

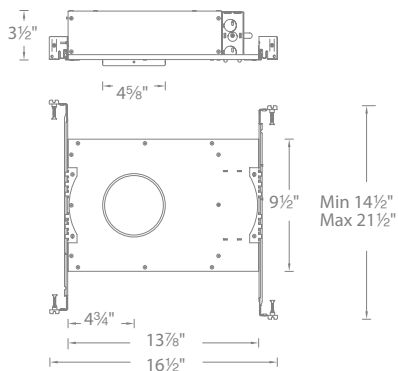

Model

HR-3LED-H17A

*New Construction
IC-rated, Airtight*

HR-3LED-H17AC











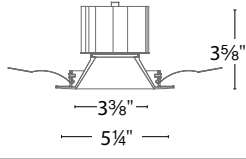

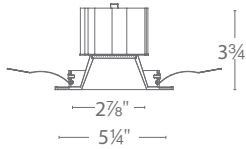

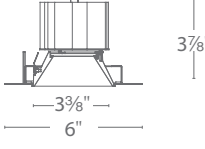
*New Construction
IC-rated, Airtight
Chicago Plenum*

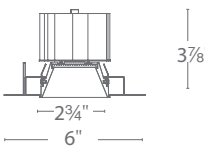
AETHER 3.5" SHALLOW IC LED DOWNLIGHT

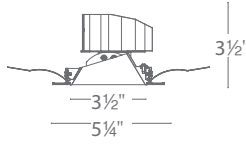
Input: 120V-277V
 Comparable to: 75W MR16
 ELV Dimming: 100%-5%
 0-10V Dimming: 100%-0%
 Rated Life: 50,000 hours

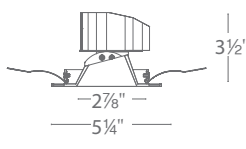
- 3.5" trim aperture and 3.5" housing height
- 35° cut-off angle for downlight

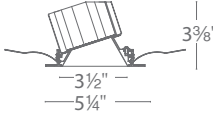

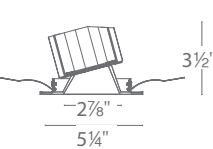
Trim (Order Housing Separately)	Model	Wattage	Beam	Max CBCP	Max Lumen	Color Temp	CRI	Finish
DOWNLIGHT TRIM								
 	R3ARDT Round	22.5W	N 25° F 40°	4775	1335	827 2700K 85 830 3000K 85 835 3500K 85 840 4000K 85	85	HZWT Haze/White WT White BKWT Black/White
 	R3ASDT Square	22.5W				927 2700K 90 930 3000K 90		
INVISIBLE TRIM™								
 	R3ARDL Round	22.5W	N 25° F 40°	4775	1335	827 2700K 85 830 3000K 85 835 3500K 85 840 4000K 85	85	HZ Haze WT White BK Black
 	R3ASDL Square	22.5W				927 2700K 90 930 3000K 90		
ADJUSTABLE								
 	R3ARAT Round	17W	S 15° N 25° F 50°	6560	1045	827 2700K 85 830 3000K 85 835 3500K 85 840 4000K 85	85	HZWT Haze/White WT White BKWT Black/White
 	R3ASAT Square	17W				927 2700K 90 930 3000K 90		
WALL WASH								
 	R3ARWT Round	17W	A Asymmetrical	880	827 2700K 85 830 3000K 85 835 3500K 85 840 4000K 85	85	HZWT Haze/White WT White BKWT Black/White	
 	R3ASWT Square	17W			927 2700K 90 930 3000K 90			

Example: **R3ARWT-A930-HZWT**

AETHER 3.5" COLOR CHANGING SHALLOW IC LED DOWNLIGHT

With **ilumenight™** you can take your space from warm white to pure white to cool white, red to violet and every color in between all with the touch of a finger.

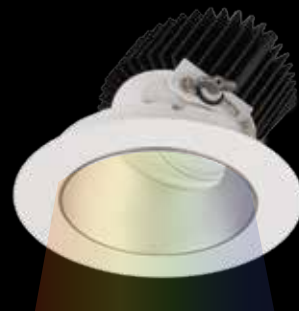

STEP 1

Download FREE "ilumenight™" app

STEP 2

Setup Login

STEP 3

Command all of your ilumenight fixtures at will







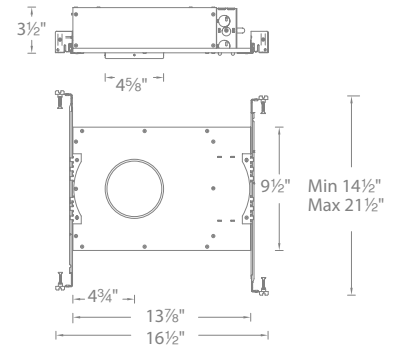



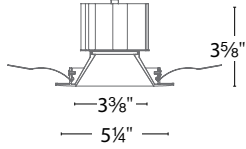

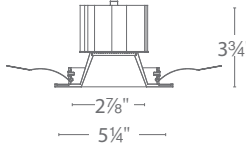

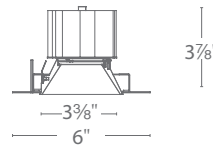

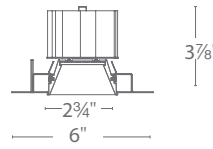
AETHER 3.5" COLOR CHANGING SHALLOW LED DOWNLIGHT

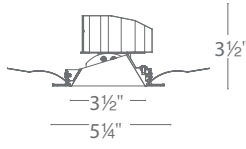
- Input:** 120V-277V
Power: 22W
Comparable to: 50W MR16
Dimming: Bluetooth, 0-10V, DMX
CRI: 90
Tunable range: 1650 - 8000K
Rated Life: 50,000 hours
- Color changing
 - App-controlled brightness
 - 3.5" trim aperture and 3.5" housing height
 - 35° cut-off angle for downlight
 - Sold as a complete unit, housing and trim included

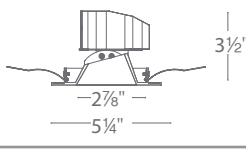

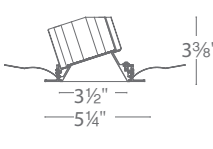
New Construction, Airtight Housing

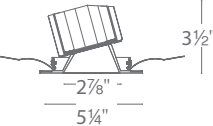
Trim	Model	Beam	Color Temp	Finish
DOWNLIGHT TRIM				
	 3 5/8" height 3 3/8" width 5 1/4" width	R3ARDT Round IC-rated	CC24 Color Changing	HZWT Haze/White WT White BKWT Black/White
	 3 3/4" height 2 7/8" width 5 1/4" width	R3ASDT Square IC-rated		
INVISIBLE TRIM™				
	 3 7/8" height 3 3/8" width 6" width	R3ARDL Round IC-rated	CC24 Color Changing	HZ Haze WT White BK Black
	 3 7/8" height 2 3/4" width 6" width	R3ASDL Square IC-rated		
ADJUSTABLE				
	 3 1/2" height 3 1/2" width 5 1/4" width	R3ARAT Round Non-IC rated	CC24 Color Changing	HZWT Haze/White WT White BKWT Black/White
	 3 1/2" height 2 7/8" width 5 1/4" width	R3ASAT Square Non-IC rated		
WALL WASH				
	 3 3/8" height 3 1/2" width 5 1/4" width	R3ARWT Round Non-IC rated	CC24 Color Changing	HZWT Haze/White WT White BKWT Black/White
	 3 1/2" height 2 7/8" width 5 1/4" width	R3ASWT Square Non-IC rated		

Example: **R3ARWT-ACC24-HZWT**

3" DUO 2.0 GLARE REDUCING WARM-DIM LED DOWNLIGHT

SET THE RIGHT ATMOSPHERE

Depending on the activity, the lighting theme can change from bright to dim, crisp white to warmer tone, and from spot to ambient distribution all in one luminaire, just by adjusting your ELV dimmer.

Specify in multi-functional residential or commercial spaces, television rooms, or areas with heavy visual display usage.

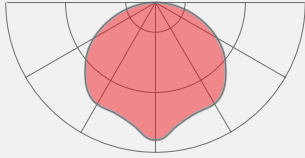

Ambient light distribution
Lower brightness
Warm white color

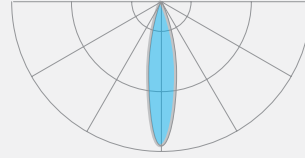

Spot light distribution
High brightness
Crisp white light color



3" DUO 2.0 GLARE REDUCING WARM-DIM LED DOWNLIGHT



Offered in two warm dimming CCT ranges from 2700K to 2200K and 3000K to 2200K

Input: 120V
Power: 15W
Rated Life: 50,000 hours

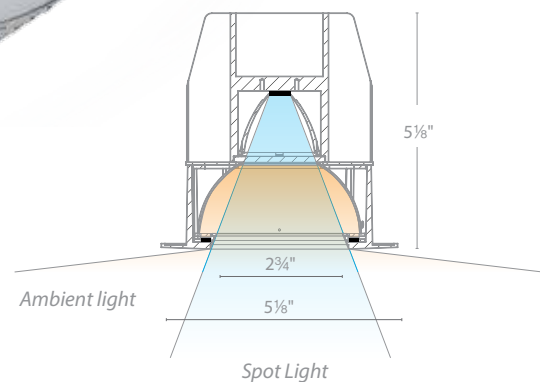

- Reduces overhead glare in the aperture with a warm-dimming mixing chamber
- 52° cut-off angle
- ELV dimming - see specification sheet for list of tested dimmers
- Patent pending design
- Sold as a complete unit, housing and trim included

A spot light at the maximum light output for task becomes a wide distribution ambient light source as it dims down

Trims and Housing included

		At the brightest output				At the lowest output				
		Color Temp	Lumen	Beam Spread	CRI	Color Temp	Lumen	Beam Spread	CRI	
	HR3D-RO92722S-N-WT New Construction IC-Rated, Airtight Ceiling thickness: 1/2"–1"	120V	2700K	810	20°	90+	2200K	15	120°	90+
		HR3D-RO93022S-N-WT New Construction IC-Rated, Airtight Ceiling thickness: 1/2"–1"	120V	3000K	890	20°	90+	2200K	15	120°
	HR3D-RO92722S-R-WT Remodel Non-IC, Airtight Ceiling thickness: 1/2"–1"	120V	2700K	810	20°	90+	2200K	15	120°	90+
	HR3D-RO93022S-R-WT Remodel Non-IC, Airtight Ceiling thickness: 1/2"–1"	120V	3000K	890	20°	90+	2200K	15	120°	90+

Premium High Performance LED

Engineered with state of the art LED and driver technology, Tesla Pro 3.5" and 2" family of recessed lighting offers various styles, designer finishes, and low glare optical distributions to beautifully illuminate a diverse range of applications.

Featuring:

- Die-cast aluminum precision plated or abrasion resistant powder coated trims
- 15° accenting spot to 55° general illumination flood optics
- Residential ready remodel to IC-rated, Airtight new construction installations
- Commercial compatible Chicago Plenum and Emergency Backup Battery options
- Full range 120-277V input with ELV and 0-10V dimming standard through 0%
- High efficacy fixtures which deliver greater lumen output than 75W MR16 while using 70% less power



TESLA PRO 3.5" LED













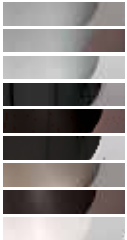









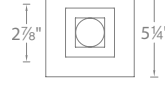

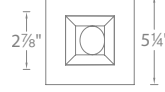
Power: 22W
Delivered Lumens: Up to 1460
Comparable to: 75W MR16
Input: 120-277V
ELV Dimming: 100%-5% (120V Only)
0-10V Dimming: 100%-0%
Rated Life: 50,000 hours

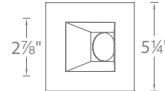
High Output LED

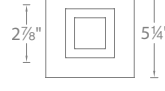









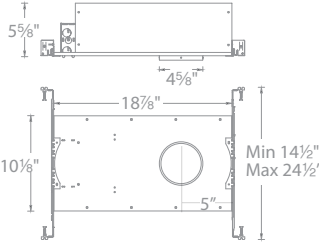

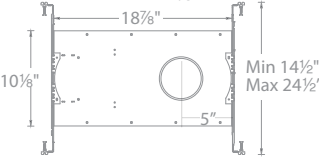
- Energy Star® rated trims on selected CCT
- Wet and Damp location listed
- 30° visual cutoff angle for glare control
- Adjustable fixtures are ideal for sloped ceiling applications
- 3.5" aperture

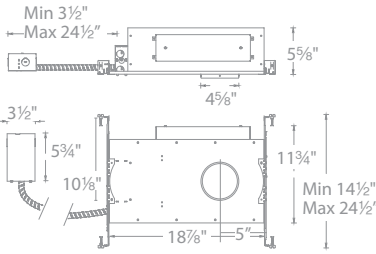
Trims (Order Housing Separately)

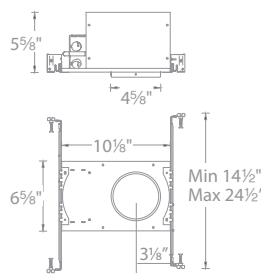
		Beam	Color Temp	CRI	Finish	Reflector/Trim
		HR3LEDT118P <i>Downlight</i>	S 15° N 30° F 55°	827 2700K 85 830 3000K 85 835 3500K 85 840 4000K 85	HBN Haze/Brushed Nickel HCB Haze/Copper Bronze HWT Haze/White BBN Black/Brushed Nickel BCB Black/Copper Bronze BWT Black/White BN Brushed Nickel CB Copper Bronze WT White	
		HR3LEDT318P <i>0°- 30° Adjustable</i>	S 15° N 30° F 55°	927 2700K 90 930 3000K 90		
		HR3LEDT618P <i>Round Pin Hole, 0°- 30° Adjustable</i>	S 15°			
		HR3LEDT418P <i>30°- 45° Adjustable</i>	S 15° N 26° F 38°			
		HR3LEDT218P <i>Shower Light Wet Location Listed</i>	N 30°	827 2700K 85 830 3000K 85 835 3500K 85 840 4000K 85		
		HR3LEDT718P <i>Open Reflector</i>	S 15° N 30° F 52°	927 2700K 90 930 3000K 90	BN Brushed Nickel CB Copper Bronze WT White	
		HR3LEDT518P <i>0°- 30° Adjustable</i>	S 15° N 30° F 52°			
		HR3LEDT918P <i>30°- 45° Adjustable</i>	S 15° N 26° F 38°			
		HR3LEDT818P <i>Shower Light Wet Location Listed</i>	N 30°			
		HR3LD-ET118P <i>High Brightness Wet Location Listed 9° visual cutoff</i>	F 48°	827 2700K 85 830 3000K 85 835 3500K 85 840 4000K 85 927 2700K 90 930 3000K 90	BN Brushed Nickel CB Copper Bronze WT White	

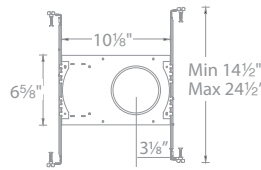
Example: **HR3LEDT718PN930WT**

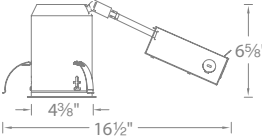
TESLA PRO 3.5" LED

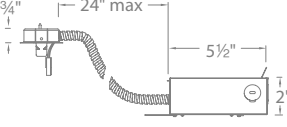
Housings (Required)	Model	Input/ Wattage	Notes
<p><i>Narrow New Construction</i></p>  	<p>HR-3LED-H18D1-ICA <i>IC-Rated, Airtight</i></p>	<p>120V-277V 21.5W</p>	<p><i>Allows adjustment in any direction when used with adjustable trims</i></p>
<p><i>Adjustable New Construction</i></p>  	<p>HR-3LED-H18D1-ICAC <i>IC-Rated, Airtight Chicago Plenum</i></p>	<p>120V-277V 21.5W</p>	<p><i>Ceiling thickness: 1/2"-3/4"</i></p>
<p><i>Adjustable New Construction</i></p>  	<p>HR3LED-H18D1-EMICA <i>IC-Rated, Airtight Emergency Backup Battery</i></p>	<p>120V-277V 21.5W</p>	<p><i>Allows adjustment in any direction when used with adjustable trims</i></p> <p><i>Ceiling thickness: 1/2"-3/4"</i></p>
<p><i>New Construction</i></p>  	<p>HR-3LED-H15D-ICA <i>IC, Airtight</i></p>	<p>120V-277V 14.5W</p>	<p><i>Does not accommodate adjustments</i></p> <p><i>Ceiling thickness: 1/2"-3/4"</i></p>
<p><i>New Construction</i></p>  	<p>HR-3LED-H22D-A <i>Non-IC, Airtight</i></p>	<p>120V-277V 21.5W</p>	<p><i>Non-IC requires 3" of clearance from insulation on all sides</i></p>
<p><i>Remodel</i></p>  	<p>HR-3LED-R18D-A <i>Non-IC, Airtight</i></p>	<p>120V-277V 21.5W</p>	<p><i>Does not accommodate adjustments</i></p> <p><i>Ceiling thickness: 1/2"-1"</i></p> <p><i>Requires 3" of clearance from insulation on all sides</i></p>
<p><i>Adjustable Remodel</i></p>  	<p>HR-3LED-R22D <i>Non-IC</i></p>	<p>120V-277V 21.5W</p>	<p><i>Allows adjustment in any direction when used with adjustable trims</i></p> <p><i>Ceiling thickness: 1/2"-5/8"</i></p> <p><i>Requires 3" of clearance from insulation on all sides</i></p>

REPLACEMENT REFLECTORS

Reflectors with different beam spreads

Reflectors

Narrow Flood **SL-REF-BL10-1-N**
Flood **SL-REF-BL10-1-F**

CHICAGO PLENUM

Chicago Plenum housings add extra building safety features that confine airflow in and out of the housing with an elastomer gasket













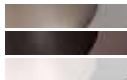

TESLA PRO 2" LED

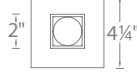

Delivered Lumens: Up to 1090
Comparable to: 50W MR16
Power: 14.5W
Input: 120V-277V
ELV Dimming: 100%-5% (120V Only)
0-10V Dimming: 100%-0%
Rated Life: 50,000 hours

High Output LED

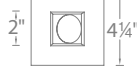
- Wet and damp location listed
- Energy Star® rated
- CEC Title 24 Compliant (see website for list of models)
- 30° visual cutoff angle for glare control
- Adjustable fixtures are ideal for sloped ceiling applications
- Universal input voltage (120V-220V-277V)
- 2" aperture

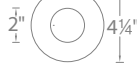
Trims (Order Housing Separately)		Model	Beam	Color Temp	CRI	Finish
		HR2LEDT109P Open Reflector Energy Star®	S 15° N 27° F 40°	827 2700K 85 830 3000K 85 835 3500K 85 840 4000K 85 927 2700K 90 930 3000K 90	BN Brushed Nickel CB Copper Bronze WT White	
		HR2LEDT309P 0°- 30° Adjustable Energy Star®	S 15° N 27° F 40°			
		HR2LEDT409P 30°- 45° Adjustable Energy Star®	S 15° N 27° F 40°			
		HR2LEDT209P Shower Light Wet Location Listed Energy Star®	N 27°			
		HR2LEDT709P Open Reflector Energy Star®	S 15° N 30° F 45°			
		HR2LEDT509P 0°- 30° Adjustable Energy Star®	S 15° N 30° F 45°			
		HR2LD-ET109P High Brightness Wet Location Listed Energy Star® 9° visual cutoff	S 15° N 30° F 55°			

Example: **HR2LEDT109PF835BN**

REPLACEMENT REFLECTORS

Reflectors with different beam spreads

Reflectors

Narrow Flood **SL-REF-BL10-1-N**
 Flood **SL-REF-BL10-1-F**

CHICAGO PLENUM

Chicago Plenum housings add extra building safety features that confine airflow in and out of the housing with an elastomer gasket

Order housing: **HR-2LED-H09D-ICAC**

TESLA PRO 2" HOUSING

Housings (Required)

Model

Input

Notes

Adjustable
New Construction

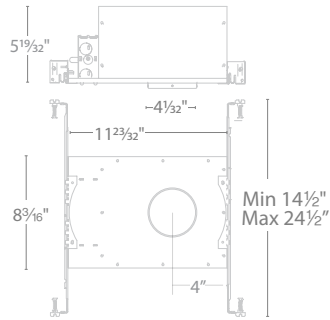

HR-2LED-H09D-ICA
IC-Rated, Airtight

120V-277V

Allows adjustment in any direction when used with adjustable trims

Ceiling thickness: 1/2" - 3/4"

HR-2LED-H09D-ICAC
IC-Rated, Airtight
Chicago Plenum

120V-277V

Smaller housing dimensions for ease of installation

Remodel

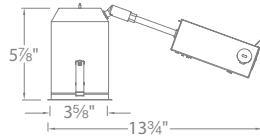

HR-2LED-R09D-A
Non-IC, Airtight

120V-277V

Does not accommodate adjustments

Ceiling thickness: 1/2" - 1"

Requires 3" of clearance from insulation on all sides

Adjustable
Remodel

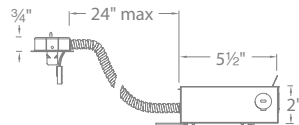

HR-2LED-R14D
Non-IC

120V-277V

Allows adjustment in any direction when used with adjustable trims

Ceiling thickness: 1/2" - 5/8"

Requires 3" of clearance from insulation on all sides









3.5" OCULUX LED RECESSED

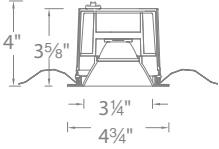

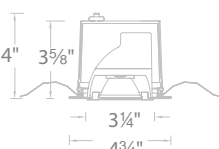
Power: 11W
Comparable to: 75W MR16
Input: 120V or 277V
Rated Life: 36,000 hours

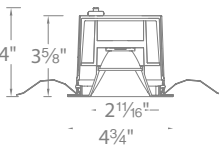
- IC-rated Remodel and New Construction
- Airtight in New Construction
- Shallow housing under 4" depth
- Cutout 4 1/4"
- Single spot light source
- Ceiling thickness: 1/2" - 1"
- ETL&cETL wet location listed
- ELV or TRIAC or 0-10V dimming compatible

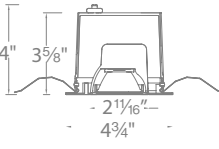
Trims (Order Housing Separately)		Model	Beam	Max Lumens	Max CBCP	Color Temp	Finish
		R3BRD Round Open Reflector Wet Location Listed 40° visual cutoff	S 15° N 25° F 50°	955	4881	927 2700K 930 3000K	BN Brushed Nickel WT White
		R3BRA Round 0 - 35° Adjustable 48° visual cutoff	S 15° N 25° F 50°	985	4712	927 2700K 930 3000K	BN Brushed Nickel WT White
		R3BSD Square Open Reflector Wet Location Listed 35° visual cutoff	S 15° N 25° F 50°	955	4710	927 2700K 930 3000K	BN Brushed Nickel WT White
		R3BSA Square 0 - 35° Adjustable 48° visual cutoff	S 15° N 25° F 50°	985	4712	927 2700K 930 3000K	BN Brushed Nickel WT White

Example: **R3BRD-S927-WT**

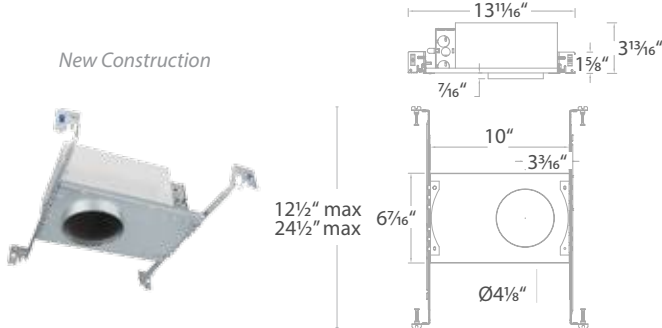
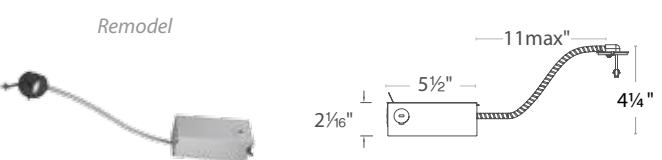
Housings (Required) - Order separately from trims	Model	Input	Dimming	Notes
<p><i>New Construction</i></p>  <p>12 1/2" max 24 1/2" max</p>	R3BNICA-10 IC-Rated, Airtight	120V	100% - 5% TRIAC, ELV, 0-10V	Less than 4" plenum depth
	R3BNICA-10U IC-Rated, Airtight	120V - 277V	120V 100% - 5% TRIAC, ELV, 0-10V 277V 100% - 1% 0-10V	Ceiling thickness: 1/2" - 1"
<p><i>Remodel</i></p>  <p>2 1/16"</p>	R3BBRT-10 IC Rated	120V	100% - 5% TRIAC, ELV, 0-10V	4 1/4" plenum depth
				Allows adjustment in any direction when used with adjustable trims
				Ceiling thickness: 1/2" - 1"

2" OCULUX LED RECESSED







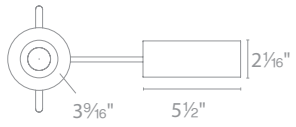

Power: 9W
 Comparable to: 50W MR16
 Input: 120V
 Rated Life: 36,000 hours

- Cutout: 3 1/16"
- Single spot light source
- Ceiling thickness: 1/2" - 1"
- ETL&cETL wet location listed
- Sold as new construction, may be reconfigured in the field for remodel
- ELV or TRIAC or 0-10V dimming compatible

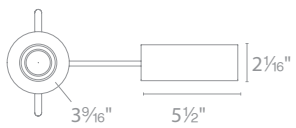

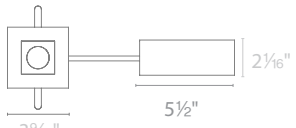
**All-in-one unit, ready to install right out of box
 IC-rated and airtight**

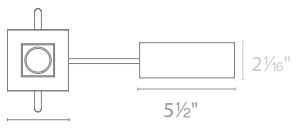
	Model	Beam	Max Lumens	Max CBCP	Color Temp	Finish
  <p>R2BRD Round Open Reflector 35° visual cutoff</p>		N 25° F 45°	680	2437	927 2700K 930 3000K	BN Brushed Nickel WT White
  <p>R2BRA Round 0 - 35° Adjustable 45° visual cutoff</p>		S 15° N 25° F 45°	685	3245	927 2700K 930 3000K	BN Brushed Nickel WT White
  <p>R2BSD Square Open Reflector 35° visual cutoff</p>		N 25° F 45°	680	2316	927 2700K 930 3000K	BN Brushed Nickel WT White
  <p>R2BSA Square 0 - 35° Adjustable 45° visual cutoff</p>		S 15° N 25° F 45°	685	3246	927 2700K 930 3000K	BN Brushed Nickel WT White

Example: **R2BRD-N930-WT**

INTEGRAL HOUSING AND TRIM: BOTH NEW CONSTRUCTION & REMODEL

NEW CONSTRUCTION CONFIGURATION
 IC-Rated, Airtight

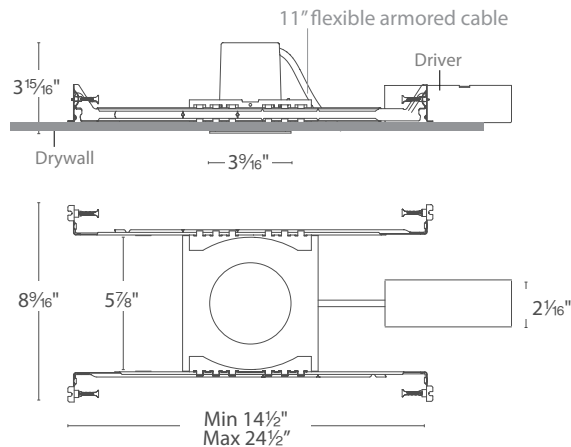

REMODEL CONFIGURATION
 IC-Rated, Airtight

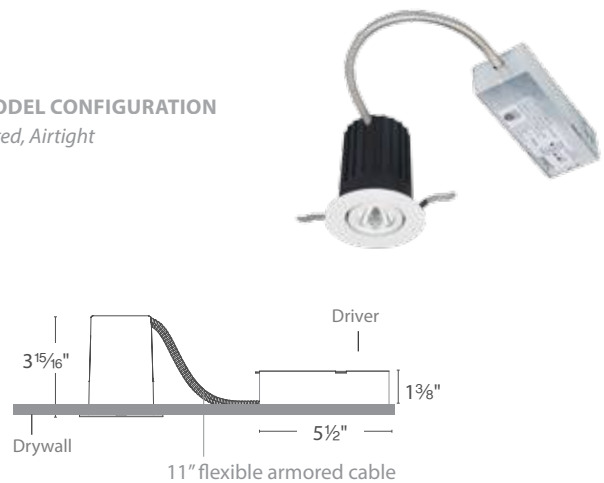

LEDME[®] 1" LED MINI RECESSED WITH INTEGRAL DRIVER

Power: 3.5W
Delivered Lumens: Up to 295
Comparable: 20W MR11
CRI: Up to 85
Dimming: 100% – 10%
Rated Life: 100,000 hours

Art & Accent Lighting

- All-in-one unit, ready to install right out of box
- Cutout: 2½", use standard hole saw
- ⅛" thick, super low profile die-cast trim
- Smooth & continuous ELV dimming

- Sold as new construction, may be re-configured in the field for remodel
- 20° Narrow flood beam spread
- 350° horizontal rotation in adjustables
- IC rated in both integral & remote driver configurations

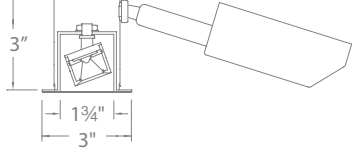
Integral Driver/Housing & Trim	Model	Max Lumens	Max CBCP	Color Temp	Finish
 	HR-LED251E Square Open Reflector	285	608		
 	HR-LED252E Square Adjustable 20° Adjustment from Vertical	280	580		
 	HR-LED211E Round Open Reflector	295	619		
 	HR-LED212E Round Adjustable 20° Adjustment from Vertical	280	580		
				27 2700K 30 3000K 35 3500K 40 4000K	BN Brushed Nickel GM Gun Metal WT White

Example: **HR-LED212E-27-GM**

NEW CONSTRUCTION CONFIGURATION

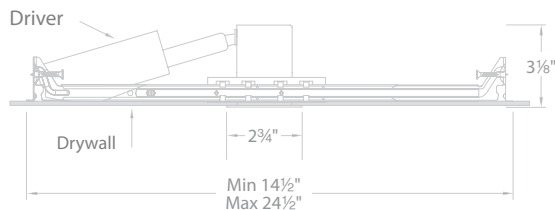

REMODEL CONFIGURATION

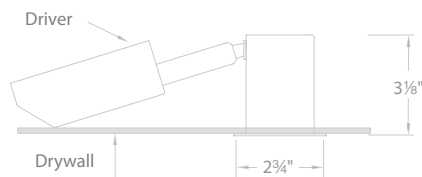

LEDME® 1" LED MINI RECESSED WITH REMOTE DRIVER

Power: 3.5W
Delivered Lumens: Up to 295
Comparable: 20W MR11
CRI: Up to 85
Dimming: 100% – 10%
Rated Life: 100,000 hours







Gun Metal



White

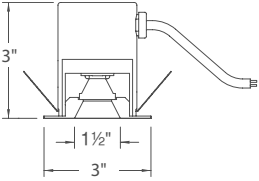

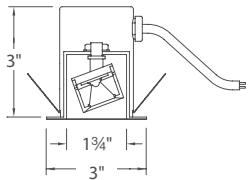
Brushed Nickel

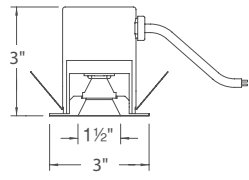
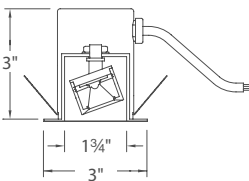
Housing & Trim (Required - order drivers separately)		Model	Max Lumens	Max CBCP	Color Temp	Finish
		HR-LED271R Square Open Reflector	285	608		
		HR-LED272R Square Adjustable 20° Adjustment from Vertical	280	580		
		HR-LED231R Round Open Reflector	295	619		
		HR-LED232R Round Adjustable 20° Adjustment from Vertical	280	580		
					27 2700K 30 3000K 35 3500K 40 4000K	BN Brushed Nickel GM Gun Metal WT White

Example: **HR-LED271R-27-WT**

REMOTE DRIVER CONFIGURATION

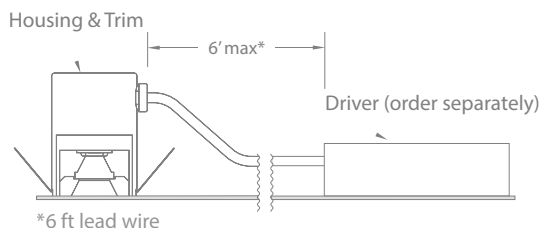

LEDME® CLASS 2 ELECTRONIC DRIVERS

Hardwire	Dimming	Watt	Dimensions
LD-700MA03-EDIM-IS 1 light	Yes	3.5W	L: 5 ⁵ / ₈ " W: 1 ⁵ / ₈ " H: 1 ¹ / ₈ "
LD-700MA09-EDIM-IS Up to 3 lights	Yes	10.5W	L: 7 ⁷ / ₈ " W: 3 ³ / ₈ " H: 1 ⁵ / ₈ "
ONLY for home-run wiring. Recommended 6' max run from driver			
Plug-In	Dimming	Watt	Dimensions
LED-700MA12-P Up to 4 lights	No	12W	L: 5" W: 3 ³ / ₈ " H: 1 ⁵ / ₈ "
BOTH series wiring and home-run wiring acceptable. Recommended 6' max run from driver			

Multiple Terminal Block

Model	Dimensions
MTB-01	L: 3 ¹ / ₄ " W: 1 ³ / ₄ " H: 7 ⁵ / ₈ "









Accommodates up to 6 output connections.

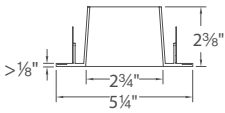

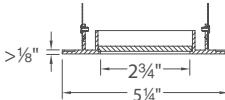

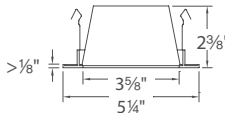
LEDME® 4" LED

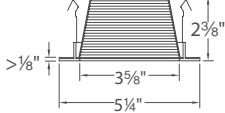
Power: 10.2W (IC-Rated), 16W (Non-IC)
Delivered Lumens: Up to 815 (IC-Rated), 1135 (Non-IC)
Comparable: 50W/75W MR16
CRI: Up to 85
Dimming: 100% – 10%
Rated Life: 100,000 hours

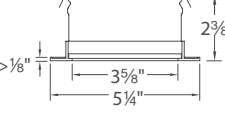
- Super low profile trim at less than 1/8" thick
- Deep regression of LEDs produces a very low glare with 40° visual cutoff
- Shower light is wet location listed
- Smooth & continuous ELV dimming

Trims (Order Housing Separately)		Model	Finish	Reflector/Trim
		HR-LED451 Square Open Reflector	BK/BN BK/WT WT/WT	Black/Brushed Nickel Black/White White/White
		HR-LED471 Square Shower Light	CH WT	Chrome White
		HR-LED411 Round Open Reflector	BK/BN BK/WT WT/WT	Black/Brushed Nickel Black/White White/White
		HR-LED421 Round Step Baffle	WT/WT	White/White
		HR-LED431 Round Shower Light	CH WT	Chrome White

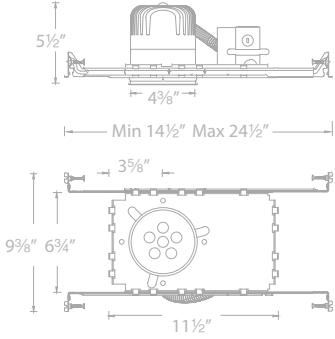
Example: **HR-LED421-WT/WT**

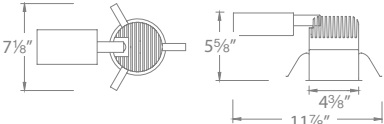
4" LEDme® Housings (Required)		Model	Rating	Color Temp	Installation
<p>New Construction</p> 		HR-LED418	NIC N	IC-Rated Non-IC	New Construction
			N	Non-IC	27 2700K 30 3000K 35 3500K 40 4000K
<p>Remodel</p> 		HR-LED418	RIC R	IC-Rated Non-IC	Remodel

Example: **HR-LED418-N-35-EM**



Non-IC housings require 3" of clearance from insulation on all sides. Accommodates ceiling thickness of up to 1/2" - 3/4" for remodel & 1/2" - 1" for new construction.

LEDME® 4" LED INVISIBLE TRIM

Power: 10.2W (IC-Rated), 16W (Non-IC)
Delivered Lumens: Up to 815 (IC-Rated), 1135 (Non-IC)
Comparable: 50W/75W PAR30
CRI: Up to 85
Dimming: 100% – 10%
Rated Life: 100,000 hours

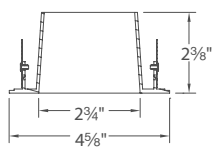

- Deep regression of LEDs produces a very low glare with 40° visual cutoff
- Trim sits flush to ceiling for a sophisticated architectural look
- Smooth & continuous ELV dimming

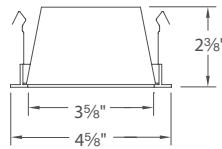

Trims (Order Housing Separately)	Model	Finish
 	HR-LED451TL Invisible Trim™ Square Open Reflector	WT/WT White/White
 	HR-LED411TL Invisible Trim™ Round Open Reflector	

Example: **HR-LED451TL-WT/WT**

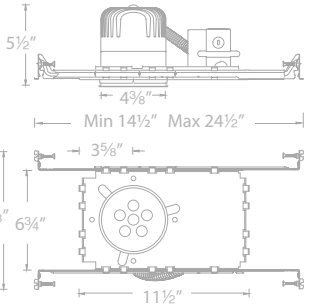
Invisible Trim™ Housings Include a Spackle Frame to Permit a Stable Finished Installation

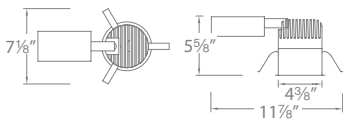
Housings (Required)	Model	Rating	Shape	Color Temp	Installation
<p><i>New Construction</i></p>  	HR-LED418	NIC IC-Rated N Non-IC	RO Round SQ Square	27 2700K 30 3000K 35 3500K 40 4000K	New Construction
<p><i>Remodel</i></p>  		RIC IC-Rated R Non-IC	RO Round SQ Square	27EM 2700K 30EM 3000K 35EM 3500K 40EM 4000K	Emergency Backup Battery Remodel

Example: **HR-LED418-NIC-SQ27**

Non-IC housings require 3" of clearance from insulation on all sides. Accommodates ceiling thickness of up to 1/2" - 3/4" for remodel & 1/2" - 1" for new construction.

SUMMIT™ 2.0 3.5" LED IC-RATED



SUMMIT™ 2.0 3.5" APERTURE LED IC-RATED



Power: 14.5W
Comparable to: 50W MR16
ELV Dimming: 100%-10%
Input: 120V
Beam Angle: 45°
Rated Life: 36,000 hours

- IC-rated downlight
- Integral housing and trim, no driver needed
- Single spot AC-LED light source
- 30° Visual cutoff angle for glare control
- Ceiling thickness: ½" - ¾"
- ETL&cETL wet location listed

Trims and Housing

	Model	Lumens	Color Temp	CRI
<p>Round Trim</p>	<p>HR3S-ICR30F-WT Round New Construction IC-Rated, Airtight</p>	1045	3000K	90
<p>Square Trim</p>	<p>HR3S-ICS30F-WT Square New Construction IC-Rated, Airtight</p>	1020	3000K	90

SUMMIT™ 2.0 3.5" APERTURE LED CONFIGURABLE NEW CONSTRUCTION OR REMODEL



Power: 14.5W
Comparable to: 50W MR16
ELV Dimming: 100%-10%
Input: 120V
Beam Angle: 45°
Rated Life: 36,000 hours

- Non-IC downlight
- Configurable for both new construction and remodel
- Integral housing and trim, no driver needed
- Single spot AC-LED light source
- 30° Visual cutoff angle for glare control
- Ceiling thickness: ½" - ¾"
- ETL&cETL wet location listed





Trims and Housing

	Model	Lumens	Color Temp	CRI
<p>Round Trim</p>	<p>HR3S-R30F-WT Round New Construction and Remodel Non-IC, Airtight</p>	1045	3000K	90
<p>Square Trim</p>	<p>HR3S-S30F-WT Square New Construction and Remodel Non-IC, Airtight</p>	1020	3000K	90

2.5" LOW VOLTAGE MR16

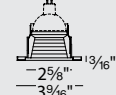

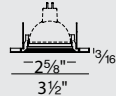

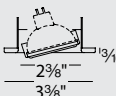





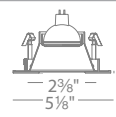

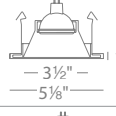

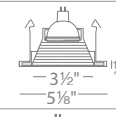

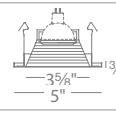

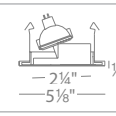

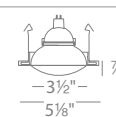
1WATT MINIMUM LOAD TRANSFORMERS

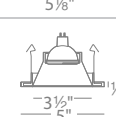
2.5" Trims (Order Housing Separately)

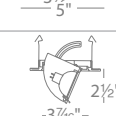
		Model	Finish	Baffle/Trim
		HR-834 Metal Trim Step Baffle	WT WT/WT	Black/White White/White
		HR-836 Metal Trim	BN CB WT	Brushed Nickel Copper Bronze White
		HR-837 Gimbal Ring, 25° Adjustment from Vertical	BK BN CB CH WT	Black Brushed Nickel Copper Bronze Chrome White

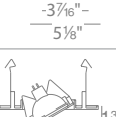
4" LOW VOLTAGE MR16

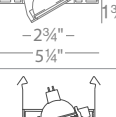
4" Downlight Trims (Order Housing Separately)

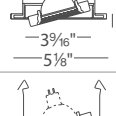
		Model	Finish	Reflector/Trim
		HR-D412-S Square Open Reflector MR16, 75W max	SC/BN SC/WT	Specular/Brushed Nickel Specular/White
		HR-D412 Round Open Reflector 35° Adjustment from Vertical, MR16, 75W max		
		HR-D411 Step Baffle 35° Adjustment from Vertical MR16, 75W max	WT/WT	White Baffle/White
		HR-8411 Step Baffle 35° Adjustment from Vertical MR16, 75W max	BN CB WT WT/WT	Brushed Nickel Copper Bronze Black Baffle/White White Baffle/White
		HR-D413 Slot Trim 35° Adjustment from Vertical MR16, 75W max	WT	White
		HR-D418 Shower Light with Drop Dish Glass Dome Wet Location Listed, MR16, 75W max	WT	White
		HR-D418-S Shower Light Clear Flat Lens 35° Adjustment from Vertical Wet Location Listed, MR16, 75W max	WT	White
		HR-D425 Directional Spot 80° Adjustment from Vertical MR16, 75W max		
		HR-D416 Directional Spot 30° Adjustment from Vertical MR16, 75W max	BN WT	Brushed Nickel White
		HR-D417 Gimbal Ring 25° Adjustment from Vertical MR16, 75W max		
		HR-8417 Gimbal Ring 25° Adjustment from Vertical MR16, 75W max	BN CB WT	Brushed Nickel Copper Bronze White

2.5" Housings (Required)

	Model
	HR-801 Electronic Non-IC Remodel 12V/120V 50W max
	HR-802 Electronic Non-IC New Construction 12V/120V 50W max
	HR-800* For Cabinet Use 12V/24V, Non-IC 35W max

*Remote Electronic Class 2 Transformer Required (Sold Separately)

- 1 Watt Minimum Load Transformers
- Non-IC housings require 3" of clearance from insulation on all sides.
- Accommodates ceiling thickness of up to 3/4" for both remodel or new construction.

For Use with HR-800 Housing

1 Watt Minimum Class 2 Enclosed Electronic Transformers

Model	Output	L	W	H
EN-1260-RB2	12V, 1 x 60W	6 5/8"	1 5/8"	1 1/8"
EN-12120-RB2	12V, 2 x 60W	6"	3 1/4"	2 5/8"
EN-12180-RB2	12V, 3 x 60W	6 3/4"	3 5/8"	2 5/8"
EN-12300-RB2	12V, 5 x 60W	8 1/2"	4 5/8"	2 5/8"
EN-2460-RB2	24V, 60W	6 1/2"	1 5/8"	1 1/4"
EN-24100-RB2	24V, 96W	6 1/2"	1 5/8"	1 1/4"

Accommodates Most LED MR16 or Halogen MR16 Lamps

- Die-cast aluminum construction
- Steel spring clips secure trim to housing
- Abrasion resistant powder coat paint or plated metal finish

4" Low Voltage Housings (Required)

	Model	Voltage	Transformer	Output	Type
	HR-8402E	120V	Electronic	12V, 50W max 1W min	New Construction Non-IC
	HR-8402HL*	120V	Magnetic	12V, 75W max	New Construction Non-IC
	HR-8403H	120V	Magnetic	12V, 50W max	New Construction IC, Airtight
	HR-8402H	120V	Magnetic	12V, 50W max	New Construction Non-IC
	HR-8401E	120V	Electronic	12V, 50W max 1W min	Remodel Non-IC
	HR-8401H	120V	Magnetic	12V, 50W max	Remodel Non-IC







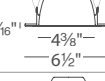

*Not Compatible with HR-D418 or HR-D418-S

Non-IC housings require 3" of clearance from insulation on all sides.
Accommodates ceiling thickness of up to 3/4" for remodel & 3/4" for new construction.

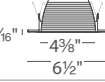

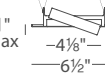

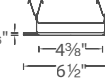

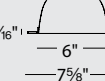

4" LINE VOLTAGE PAR20

Downlight Trims (Order Housing Separately)		Model	Lamp	Finish	Trim
		R-421 Open Reflector	PAR20, 50W; R20, 50W	CL/WT	Specular Clear/White
		R-420 Step Baffle	PAR20, 50W; R20, 50W	BN CB WT/WT	Brushed Nickel/Brushed Nickel Copper Bronze/Copper Bronze White/White
		R-432 Gimbal Ring	20° Adjustment from Vertical, PAR20, 50W	BN CB WT	Brushed Nickel Copper Bronze White
		R-422 Shower Light with Glass Lens	Wet Location Listed, A19, 40W	WT	White
		FM-304-930	LED 3000K, 570 lumens, 90 CRI	BN BZ WT	Brushed nickel Bronze White

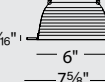
5" LINE VOLTAGE PAR30/A19

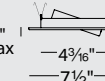
Downlight Trims (Order Housing Separately)		Model	Lamp	IC	Non-IC	Finish	Trim
		R-521 Open Reflector	A19 PAR30 R30	40W 50W 50W	60W 75W 75W	CL/WT	Specular Clear/White
		R-520 Step Baffle	A19 PAR30 R30	40W 50W 50W	60W 75W 75W	BN CB WT/WT	Brushed Nickel Copper Bronze White Baffle /White
		R-532 Gimbal Ring 20°	Adjustment from Vertical	PAR30	75W	BN WT	Brushed Nickel White
		R-522 Shower Light with Glass Lens	Wet Location Listed	A19	40W	WT	White
		FM-306-930 FM-306-940	LED 3000K, 840 lumens, 90CRI LED 4000K, 905 lumens, 90CRI			BN BZ WT	Brushed nickel Bronze White

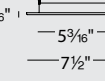
6" LINE VOLTAGE PAR30/A19

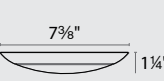
Trims (Order Housing Separately)		Model	Lamp	Finish	Reflector/Trim
		R-656 Open Reflector	PAR30, 75W; R30, 75W	CL/WT	Specular/White
		R-620 Step Baffle	PAR30, 75W; R30, 75W	BN CB WT/WT	Brushed Nickel/Brushed Nickel Copper Bronze/Copper Bronze White/White
		R-633 Gimbal Ring	20° Adjustment from Vertical PAR30, 75W	BN WT	Brushed Nickel White
		R-651 Shower Light with Glass Lens	A19, 40W Wet Location Listed	WT	White
		FM-306-930 FM-306-940	LED 3000K, 840 lumens, 90CRI LED 4000K, 905 lumens, 90CRI	BN BZ WT	Brushed nickel Bronze White

Housings (Required)

Model

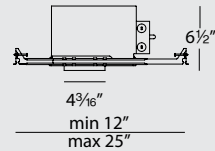

R-402S-N-ICA
120V IC-Rated
New Construction
Airtight Ready

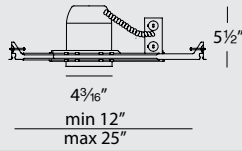

R-400S-N-A
120V Non-IC
New Construction
Airtight Ready

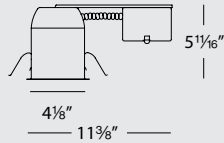

R-401S-R-A
120V Non-IC
Remodel
Airtight Ready

Interchangeable Lamps

- Durable stamped metal construction
- Retention clips hold trim firmly to housing
- Abrasion resistant powder coat paint or plated metal finish
- Various lamp options available including LED

Non-IC housings require 3" of clearance from insulation on all sides.

Accommodates ceiling thickness of up to 3/4" for remodel or new construction.

LED PAR20 Lamp

Model	Finish
PAR20LED-10N30	BK Black WT White

Housings (Required)

Model

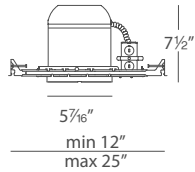

R-500-N-UA
120V IC/Non-IC Rated
New Construction
Airtight Ready
(Wet Location Listed)

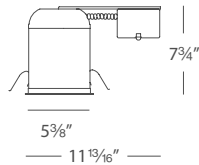

R-501-R-UA
120V IC or Non-IC
Remodel
Airtight Ready

Interchangeable Lamps

- Durable stamped metal construction
- Steel spring clips secure lamp to housing
- Provided with foam rubber gasket around outer perimeter
- Abrasion resistant powder coat paint or plated metal finish
- Snap-in socket holders secure and position lamps
- Various lamp options available including LED

Non-IC housings require 3" of clearance from insulation on all sides.

Accommodates ceiling thickness of up to 3/4" for remodel or new construction.

LED PAR30 Lamp

Model	Finish
PAR30LED-L14N30	BK Black WT White

Can be used in IC or Non-IC construction - depending on lamp type used)

Housings (Required)

Model

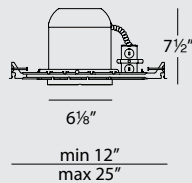

R-602D-N-ICA
120V IC-Rated
New Construction
Airtight Ready

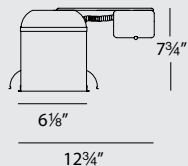

R-603D-R-ICA
120V IC-Rated
Remodel
Airtight Ready

Interchangeable Lamps

- Durable stamped metal construction
- Trims secured to housings with steel springs
- Provided with foam rubber gasket around outer perimeter
- Abrasion resistant powder coat paint or plated metal finish
- Various lamp options available including LED

Non-IC housings require 3" of clearance from insulation on all sides.

Accommodates ceiling thickness of up to 3/4" for remodel or new construction.

LED PAR30 Lamp

Model	Finish
PAR30LED-L14N30	BK Black WT White

DESIGN GUIDELINES FOR RECESSED LIGHTING

GENERAL LIGHTING – Using Downlights As The Main Source Of Illumination

General Lighting is the use of one or a group of fixtures to provide a modest amount of illumination over a large area. Recessed downlights are currently the most desirable source of general lighting in residential spaces for their architectural appeal and even light distribution.

Visit wacighting.com/downlighting-estimator for estimation tool for spacing and foot candle suggestions using WAC recessed in general lighting

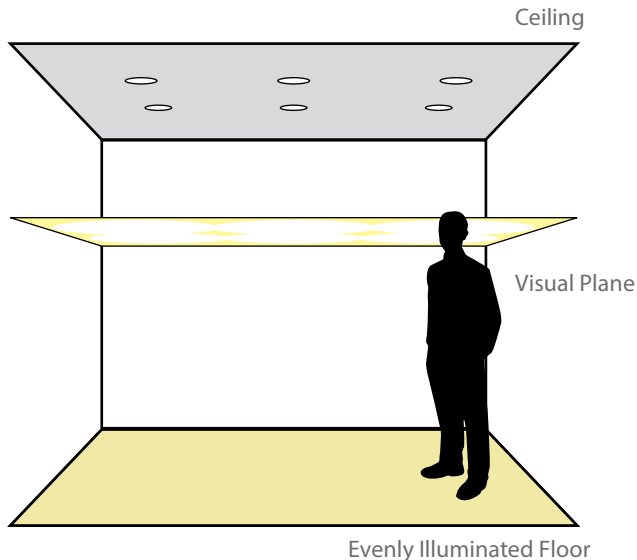

Room Type

Different rooms require different levels of illumination.

Rooms and Recommended Light Levels:

Living Room –	up to 10 Footcandles
Kitchen –	up to 30 Footcandles
Bedroom –	up to 10 Footcandles
Office –	up to 30 Footcandles

A Footcandle is the standard measurement of light on one square foot in the space.

Room Dimensions

Determining the length, width and height of the space to be illuminated helps in selecting the quantity and wattage of the downlights to use.

To obtain uniform lighting in a room using flood lamps, a rough rule of thumb to use is:

Each downlight may cover an area up to 4 times its mounting height.

Example: 10' ceiling, a single downlight should cover 40sq. feet of space on the floor (i.e. 5' x 8')

Drawing out the dimensions of a room will allow you to sketch out a lighting plan consisting of symmetrical rows and columns of downlights that will provide the proper uniformity.

Downlight Selection

General area illumination is accomplished using open reflector or baffle trims. Energy savings and extended lifespan can be found using LED downlights, while a more traditional recessed lighting plan uses low voltage or line voltage units.

TASK LIGHTING – Using Downlights For Illuminating Active Areas

Task lighting is an energy-efficient way to place extra light where you need it most. By improving the light on the surfaces you work, read, or eat on, you can maximize safety and comfort without increasing the total amount of fixtures needed to light the space.

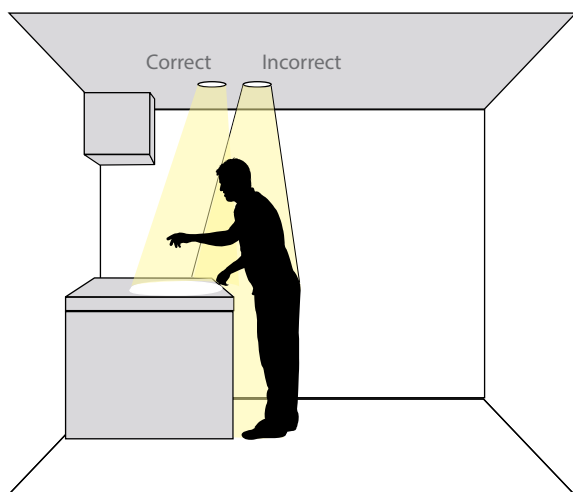

Choose Downlight

Task areas should have two times the amount of light as the general use areas. This is most often accomplished with downlights featuring more concentrated light output by selecting a fixture of narrower beam distribution or increased lumens.

Downlight Placement

The actual spacing of downlights will depend on the type of fixture and distribution used, however a quick rule of thumb calculation to estimate is:

Using a fixture with a 30° beam spread, each downlight should not cover a maximum area exceeding 3x its mounting height over the work area.

Example: 10' ceiling with a 3' table, the maximum surface area a single downlight should cover is 21 sq. feet (i.e. a 3'x7" kitchen island)

Design Factors

Visually intensive tasks require both quantity and quality illumination. Therefore, downlights should be oriented directly over the work area in front of the person. Downlights placed above or behind the person casts undesirable shadows over the work area.

DESIGN GUIDELINES

ACCENT LIGHTING – Using Downlights To Highlight Room Features

Accent lighting is a technique used to highlight certain features within a room, such as artwork, sculptures, and floral arrangements. Accent downlight trims direct light to create drama and increase the perceived value of the design.

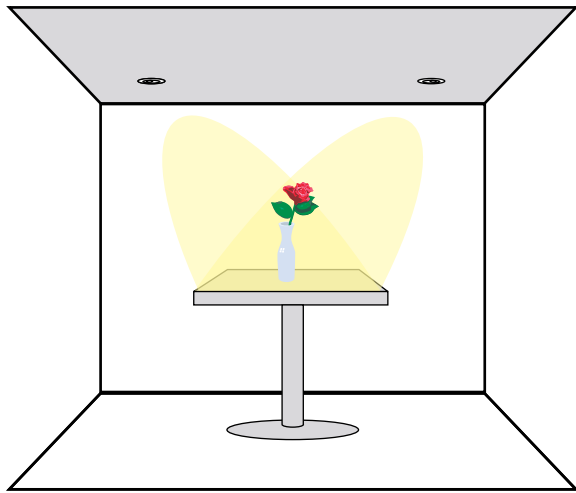

Choosing Downlight

Using a single downlight directly above a small statue can often provide an intense dose of light and dramatic contrasting shadows. When illuminating a larger object or when even illumination without shadows is desired, then two or three offset downlights works best.

Determining Quantity and Locations

Use a single downlight above a small statue or picture. When illuminating a larger object then two or even three downlights offset around the object works best.

The optimum angle to light an object is 30°. The mounting distance from the object or picture can be calculated as follows:

1. Measure the distance from the ceiling to the center of the object to be illuminated.
2. Divide this distance in half and multiply by 1.1 to determine the horizontal distance from the object to install the fixture.

Example: The center of a picture is 36 inches from ceiling. One half of 36 equals 18 inches multiplied by 1.1 is approximately 20 inches. Thus, to properly light this picture the downlight should be installed 20 inches from the picture wall.

Note: This does not apply to sloped ceiling applications.

WALL WASH – Using Downlights For Illuminating A Vertical Plane

Wall washing is a technique used to light vertical surfaces evenly. When done properly, it can make a room appear larger and more inviting. Wall washing is also helpful to reduce the appearance of textured surfaces by diminishing shadows from the ridges.

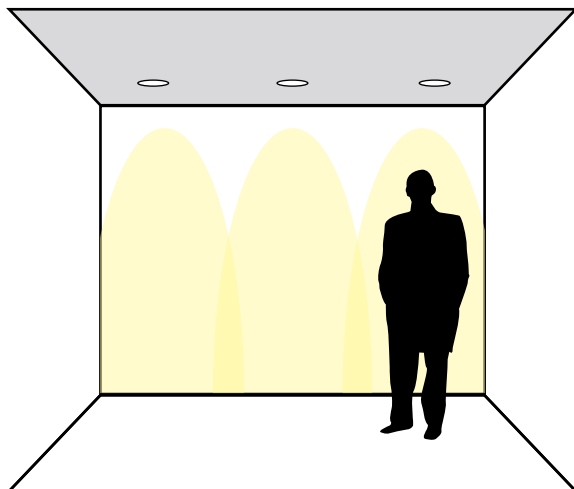

Determine setback from wall

Always measuring to the center of the downlight, use 18"-36" from the wall as a general rule for placing wall wash downlights. Fixed trims should be placed closer to the wall while adjustable trims may be placed farther away.

Spacing between each downlight

Wall wash downlights typically are spaced apart the same distance as the setback from the wall.

Properly Designed Light Level

In order to stand out, the wall should have at least 50% more light than the ambient lighting in the room. Use double the watts per square foot to illuminate the wall that you are using to illuminate the general space.

Downlight Selection

The wall wash units should be the same aperture size used in the rest of the room to maintain a clean appearance on the ceiling. Wall wash trims provide maximum uniformity without glare and scalloping. Adjustable trims are also popular choices for their general versatility.

LED MULTIPLE SPOTS





LED MULTIPLE SPOTS

PRECISION



Professional LED recessed multiples.
Up to 4 individually fully retractable and rotatable,
indexed aiming heads.

Output: up to 1,100 lm/head Dimming: 0-10V, ELV
Installation: IC, Non-IC Flange: Trim, Invisible Trim™
Voltage: 120V-277V

TESLA



High lumen output LED recessed multiples.
Up to 3 individually flush-to-face to 45° retractable aiming heads.

Output: up to 1,515 lm/head Dimming: ELV
Installation: Non-IC Flange: Trim
Voltage: 120V-277V

MINI



Compact LED recessed multiples. Up to 3 individually adjustable
aiming heads recessed above glare reducing baffled housing

Output: up to 805 lm/head Dimming: ELV
Installation: Non-IC New Construction, Remodel Flange: Trim
Voltage: 120V-277V

LEDME



LEDME family of LED recessed multiples. Up to 4 individually
adjustable aiming heads recessed in open housing.

Output: up to 1015 lm/head Dimming: ELV
Installation: IC, Non-IC Flange: Trim, Invisible Trim™
Voltage: 120V

LINE & LOW VOLTAGE



Traditional or LED PAR30 or MR16 recessed multiples.
Up to 3 individually adjustable aiming heads

Output: Per lamp type Dimming: Per lamp type
Installation: Non-IC Flange: Trim, Invisible Trim™
Voltage: 120V (Line voltage), 12V (Low voltage)

PRECISION MULTIPLES PROFESSIONAL 4" LED



Black trim shown



Comparable to: 75W MR16
 Rated Life: 50,000 hours

Retractable Spot Lights

- ELV or 0-10V dimming options
- Black, White, or Invisible Trim™ option
- Fully retractable from housing
- 365° horizontal rotation and 180° vertical aiming
- Accepts 1 accessory lens

1 LIGHT

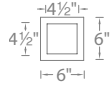
Trims (Order Housing Separately)

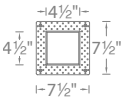
		MT-4LD116T Trim	WT White BK Black
		MT-4LD116TL-WT Invisible Trim™	

Example: **MT-4LD116T-WT**

Housings

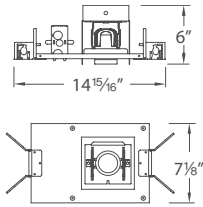

Housings	Power	Beam	Lumens	CBCP	Color Temp	CRI	Interior
MT-4LD116N 0-10V dimming Non-IC, 120V-277V input	16W	S 20° F 40°	1100 1080	5370 2390	27 2700K 30 3000K	85 85	
MT4LD116NE ELV dimming Non-IC, 120V input	16.5W	S 20° F 40°	1005 990	4700 2115	35 3500K 40 4000K	85 85	BK Black
MT4LD111NE ELV dimming IC-Rated, 120V input	11.5W	S 20° F 40°	890 885	3925 1820	927 2700K 930 3000K	90 90	

Example: **MT4LD111NE-F930-BK**

2 LIGHTS

Trims (Order Housing Separately)

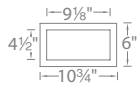
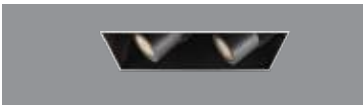
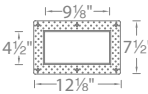
		MT-4LD216T Trim	WT White BK Black
		MT-4LD216TL-WT Invisible Trim™	

Example: **MT-4LD216T-WT**

Housings

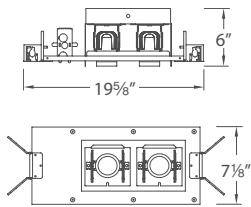

Housings	Power	Beam	Lumens	CBCP	Color Temp	CRI	Interior
MT-4LD216N 0-10V dimming Non-IC, 120V-277V input	32W	S 20° F 40°	2200 2160	5370x2 2390x2	27 2700K 30 3000K	85 85	
MT4LD216NE ELV dimming Non-IC, 120V input	33W	S 20° F 40°	2010 1980	4700x2 2115x2	35 3500K 40 4000K	85 85	BK Black
MT4LD211NE ELV dimming IC-Rated, 120V input	23W	S 20° F 40°	1785 1765	3928x2 1820x2	927 2700K 930 3000K	90 90	

Example: **MT-4LD216N-S927-BK**



REPLACEMENT LENS

Amber	LENS-16-AMB	
Blue	LENS-16-BLU	
Green	LENS-16-GRN	
Red	LENS-16-RED	

UV Filter	LENS-16-UVF	
Frosted	LENS-16-FR	
Spread	LENS-16-SPR	
Beam Elongator	LENS-16-BEL	

Trims (Order Housing Separately)

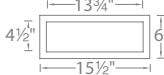
3 LIGHTS

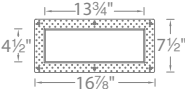
		MT-4LD316T Trim	WT White BK Black
		MT-4LD316TL-WT Invisible Trim™	

Example: **MT-4LD316T-WT**

Housings

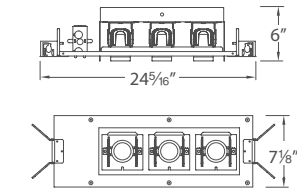



	Power	Beam	Lumens	CBCP	Color Temp	CRI	Interior
MT-4LD316N 0-10V dimming Non-IC, 120V-277V input	48W	S 20°	3300	5370x3	27 2700K	85	BK Black
		F 40°	3240	2390x3			
MT4LD316NE ELV dimming Non-IC, 120V input	49.5W	S 20°	3015	4700x3	30 3000K	85	
		F 40°	2970	2115x3	35 3500K	85	
MT4LD311NE ELV dimming IC-Rated, 120V input	34.5W	S 20°	2680	3925x3	40 4000K	85	
		F 40°	2650	1820x3	927 2700K	90	
					930 3000K	90	

Example: **MT4LD311NE-S30-BK**

Trims (Order Housing Separately)

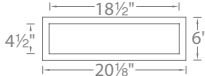
4 LIGHTS

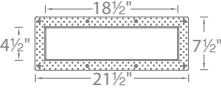
		MT-4LD416T Trim	WT White BK Black
		MT-4LD416TL-WT Invisible Trim™	

Example: **MT-4LD416T-WT**

Housings

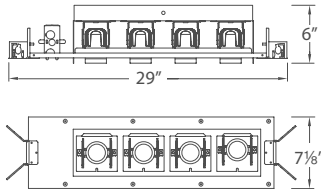



	Power	Beam	Lumens	CBCP	Color Temp	CRI	Interior
MT-4LD416N 0-10V dimming Non-IC, 120V-277V input	64W	S 20°	4400	5370x4	27 2700K	85	BK Black
		F 40°	4320	2390x4			
MT4LD416NE ELV dimming Non-IC, 120V input	66W	S 20°	4020	4700x4	30 3000K	85	
		F 40°	3960	2115x4	35 3500K	85	
MT4LD411NE ELV dimming IC-Rated, 120V input	46W	S 20°	3570	3925x4	40 4000K	85	
		F 40°	3535	1820x4	927 2700K	90	
					930 3000K	90	

Example: **MT-4LD416N-S927-BK**

Trims (Order Housing Separately)

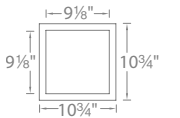
4 LIGHTS (2 X 2)

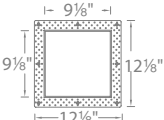
		MT-4LD226T Trim	WT White BK Black
		MT-4LD226TL-WT Invisible Trim™	

Example: **MT-4LD226T-WT**

Housings

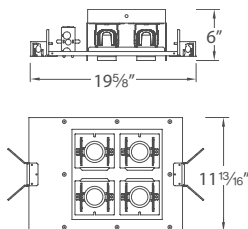

	Power	Beam	Lumens	CBCP	Color Temp	CRI	Interior
MT-4LD226N 0-10V dimming Non-IC, 120V-277V input	64W	S 20°	4400	5370x4	27 2700K	85	BK Black
		F 40°	4320	2390x4			
MT4LD226NE ELV dimming Non-IC, 120V input	66W	S 20°	4020	4700x4	30 3000K	85	
		F 40°	3960	2115x4	35 3500K	85	
MT4LD221NE ELV dimming IC-Rated, 120V input	46W	S 20°	3570	3925x4	40 4000K	85	
		F 40°	3535	1820x4	927 2700K	90	
					930 3000K	90	

Example: **MT4LD226NE-S930-BK**

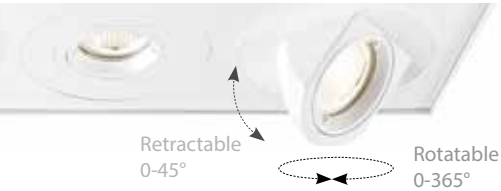

Comparable: 39W HID
CRI: Up to 90
100%-15% ELV Dimming: 120V Only
0-10V Dimming: 120V and 277V
Rated Life: 50,000 hours
Input Voltage: 120V - 277V

High Brightness Adjustable Luminaires

- ETL & cETL listed
- Individually retractable luminaires
- Accepts 1 lens and 1 accessory
- Non-IC airtight housings

Trims (Order Housing Separately)		Model	Beam	Color Temp	CRI	Finish
1 LIGHT		MT-5LD125T 1-Light	S 25° F 40°	27 2700K	85	WT White
				30 3000K	85	
		35 3500K		85		
		40 4000K		85		
		MT-5LD125TL 1-Light		927 2700K	90	
				930 3000K	90	

Example: **MT-5LD125T-F30-WT**

Housings	Model	Power	Lumens
	MT-5LD125H-NA 1 Light New Construction Non-IC Rated	22.5W	Up to 1515

Example: **MT-5LD125H-NA**

Trims (Order Housing Separately)		Model	Beam	Color Temp	CRI	Finish
2 LIGHTS		MT-5LD225T 2 Lights	S 25° F 40°	27 2700K	85	WT White
				30 3000K	85	
		35 3500K		85		
		40 4000K		85		
		MT-5LD225TL 2-Light		927 2700K	90	
				930 3000K	90	

Example: **MT-5LD225T-S927-WT**

Housings	Model	Power	Lumens
	MT-5LD225H-NA 2 Lights New Construction Non-IC Rated	45W	Up to 3030



Example: **MT-5LD225H-NA**

REPLACEMENT LENS

Amber	LENS-16-AMB	
Blue	LENS-16-BLU	
Green	LENS-16-GRN	
Red	LENS-16-RED	

Lenses & Louvers

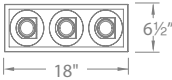
LENS-16-UVF	UV Filter Lens
LENS-16-FR	Frosted Lens
LENS-16-CRL	Cross Louver
LENS-16-SPR	Spread Lens
LENS-16-BEL	Beam Elongating Lens
LENS-16-SNOOT	Snoot
LENS-16-HCL	Honeycomb Louver

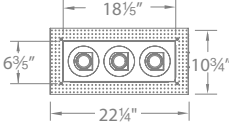
Trims (Order Housing Separately)		Model	Beam	Color Temp	CRI	Finish
3 LIGHTS		MT-5LD325T 3 Lights	S 25° F 40°	27 2700K	85	WT White
				30 3000K	85	
		MT-5LD325TL 3-Light		35 3500K	85	
					40 4000K	
				927 2700K	90	
				930 3000K	90	

Example: **MT-5LD325T-S30-WT**

Housings	Model	Power	Lumens
	MT-5LD325H-NA 3 Lights New Construction Non-IC Rated	67.5W	Up to 4545

Example: **MT-5LD325H-NA**

Non-IC housings require 3" of clearance from insulation on all sides.

Accommodates ceiling thickness of up to 1/2"-1" for new construction.



MINI LED MULTIPLE SPOTS



MINI LED MULTIPLE SPOTS



Comparable: 50W MR16
Dimming: 100 - 10%
Input Voltage: 120V-277V
CRI: 90
Rated Life: 50,000 hours

- Integral housing and trim**
- Individually adjustable luminaires
 - Complete unit includes housing & trim
 - 30° visual cutoff for glare control
 - Smooth & continuous ELV dimming



1 LIGHT

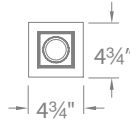

		Power	Beam	Max Lumens	Max CBCP	Color Temp	CRI	Finish			
	MT-3LD111NA <i>New Construction</i> <i>Non-IC, Airtight</i>	11W	F 25°	805	2224	927 2700K 90	90	BK White trim with black interior			
			W 45°	795	1042						
	MT-3LD111R <i>Remodel</i> <i>Non-IC</i>	11W	F 25°	805	2224				930 3000K 90	90	WT White trim with white interior
			W 45°	795	1042						
						935 3500K 90					
						940 4000K 90					

Example: **MT-3LD111NA-F927BK**

2 LIGHTS

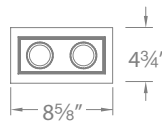

		Power	Beam	Max Lumens	Max CBCP	Color Temp	CRI	Finish			
	MT-3LD211NA <i>New Construction</i> <i>Non-IC, Airtight</i>	22W	F 25°	805x2	2224x2	927 2700K 90	90	BK White trim with black interior			
			W 45°	795x2	1042x2						
	MT-3LD211R <i>Remodel</i> <i>Non-IC</i>	22W	F 25°	805x2	2224x2				930 3000K 90	90	WT White trim with white interior
			W 45°	795x2	1042x2						
						935 3500K 90					
						940 4000K 90					

Example: **MT-3LD211R-F927BK**

3 LIGHTS

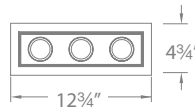

		Power	Beam	Max Lumens	Max CBCP	Color Temp	CRI	Finish			
	MT-3LD311NA <i>New Construction</i> <i>Non-IC, Airtight</i>	33W	F 25°	805x3	2224x3	927 2700K 90	90	BK White trim with black interior			
			W 45°	795x3	1042x3						
	MT-3LD311R <i>Remodel</i> <i>Non-IC</i>	33W	F 25°	805x3	2224x3				930 3000K 90	90	WT White trim with white interior
			W 45°	795x3	1042x3						
						935 3500K 90					
						940 4000K 90					

Example: **MT-3LD311R-F927BK**

LEDME® 4" LED MULTIPLE SPOT



- Die-cast aluminum heads, steel trims and housings
- Powder coat finish
- Optimal dimming with Electronic Low Voltage (ELV) dimmer
- 50,000 hour potential life
- Available in two different beam angles, Spot (10°) and Flood (25°)
- 90° vertical tilt, 350° horizontal rotation
- Caps included to cover hardware slots

Trims (Order Housing Separately)

1 LIGHT



MT-LED118-WT
Trim, White

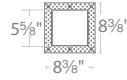

MT-LED118TL
Invisible Trim™

Example: **MT-LED118TL**

Housings	Beam	Lumens	CBCP	CRI	Color Temp	Rating	Power
	S 10°	1045	8813	85	27 2700K	HS-WT IC	11W
	F 25°	1015	5215		30 3000K		17.5W
					35 3500K		
					40 4000K		
						HS-NIC Non-IC	

Example: **MT-LED118S-30HS-WT**

Trims (Order Housing Separately)

2 LIGHTS



MT-LED218-WT
Trim, White

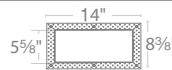

MT-LED218TL
Invisible Trim™

Example: **MT-LED218-WT**

Housings	Beam	Lumens	CBCP	CRI	Color Temp	Rating	Power
	S 10°	2 x 1045	2 x 8813	85	27 2700K	HS-WT IC	22W
	F 25°	2 x 1015	2 x 5215		30 3000K		35W
					35 3500K		
					40 4000K		
						HS-NIC Non-IC	

Example: **MT-LED218S-30HS-WT**

Trims (Order Housing Separately)

3 LIGHTS

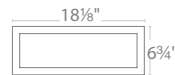

MT-LED318-WT
Trim, White



MT-LED318TL
Invisible Trim™

Example: **MT-LED318-WT**

Housings	Beam	Lumens	CBCP	CRI	Color Temp	Rating	Power
	S 10°	3 x 1045	3 x 8813	85	27 2700K	HS-WT IC	33W
	F 25°	3 x 1015	3 x 5215		30 3000K		52.5W
					35 3500K		
					40 4000K		
						HS-NIC Non-IC	

Example: **MT-LED318F-30HS-NIC**

Trims (Order Housing Separately)

4 LIGHTS

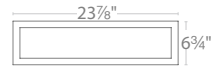

MT-LED418-WT
Trim, White



MT-LED418TL
Invisible Trim™

Example: **MT-LED418-WT**

Housings

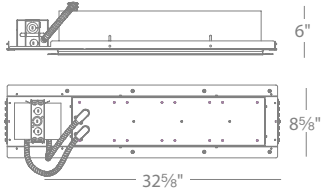

MT-LED418
120V input

Beam	Lumens	CBCP	CRI	Color Temp	Rating	Power
S 10°	4 x 1045	4 x 8813	85	27 2700K	HS-WT HSNIC	IC Non-IC 44W 70W
F 25°	4 x 1015	4 x 5215		30 3000K		
				35 3500K		
				40 4000K		

Example: **MT-LED418S-30HS-WT**

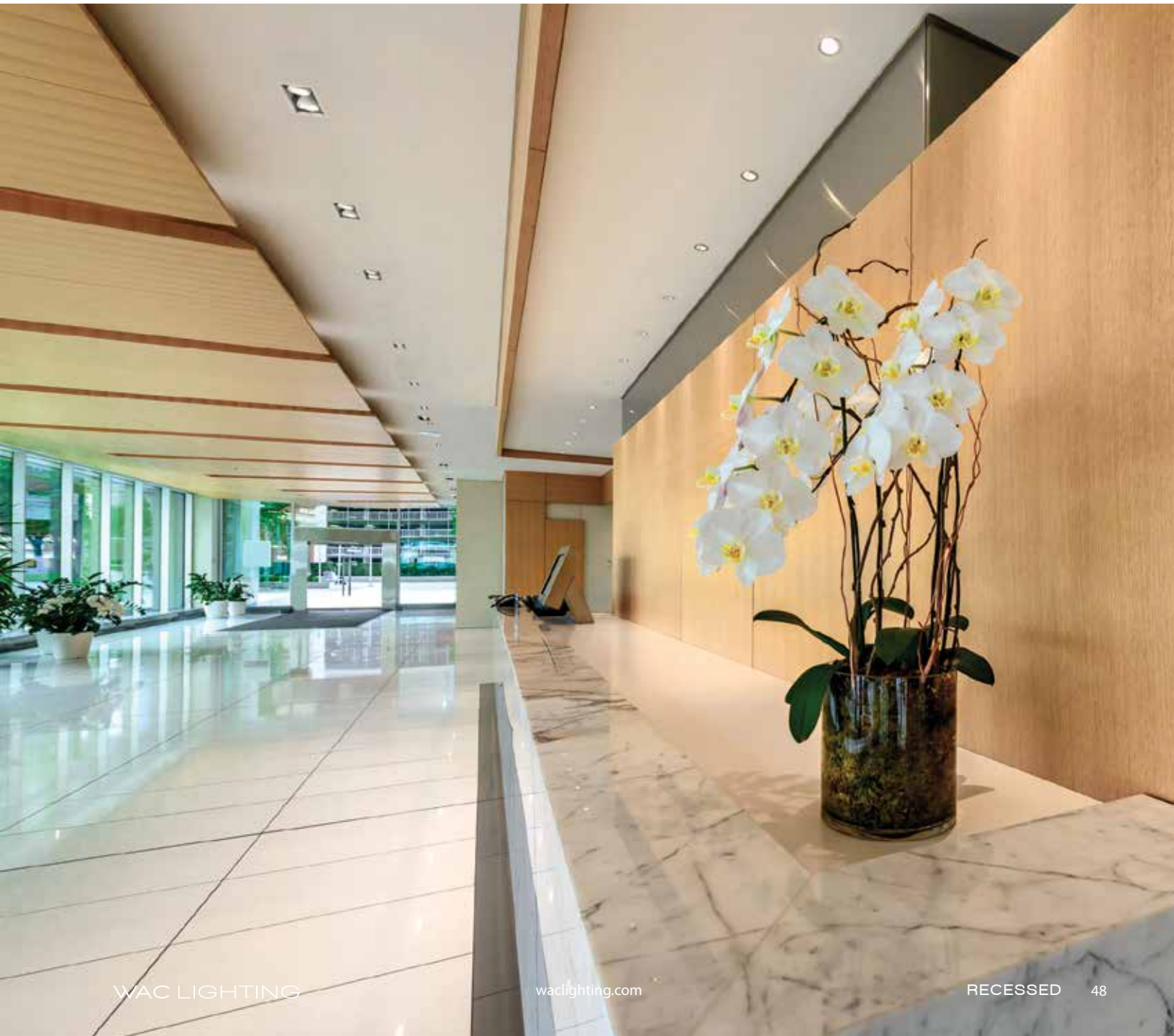

LINE VOLTAGE PAR30 MULTIPLE SPOTS

Adjustable Recessed Lights

- May be installed in new construction or drop ceilings
- 25° vertical adjustment, 350° horizontal rotation
- Order lamps separately
- Invisible Trim™ design includes patented spackle trim to ensure smooth ceiling finish and a clean look



Trims (Order Housing Separately)

1 LIGHT

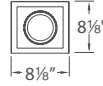

Model **Finish** **Trim/Reflector**

MT-130
1 Light Trim

WT/WT White/White
WT/BK White/Black

Example: **MT-130-WT/WT**

Housings (Required)

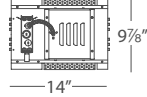
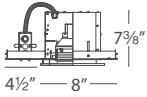

Model **Rating** **Lamp**

MT-130HS
1 Light

Non-IC

1 x PAR30, 75W
120V

Trims (Order Housing Separately)

2 LIGHTS

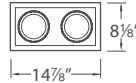

Model **Finish** **Trim/Reflector**

MT-230
2 Light Trim

WT/WT White/White
WT/BK White/Black

Example: **MT-230-WT/BK**

Housings (Required)

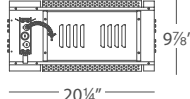
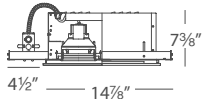

Model **Rating** **Lamp**

MT-230HS
2 Lights

Non-IC

2 x PAR30, 75W
120V

Trims (Order Housing Separately)

3 LIGHTS

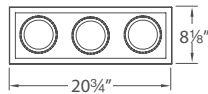

Model **Finish** **Trim/Reflector**

MT-330
3 Light Trim

WT/WT White/White
WT/BK White/Black

Example: **MT-330-WT/WT**

Housings (Required)

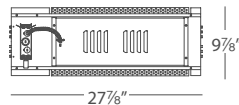
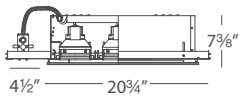

Model **Rating** **Lamp**

MT-330HS
3 Lights

Non-IC

3 x PAR30, 75W
120V

Non-IC housings require 3" of clearance from insulation on all sides.
Accommodates ceiling thickness of up to 3/4" for remodel & 3/4" for new construction.

LED PAR30 LAMP

Model	Finish
PAR30LED-L14N30	BK Black WT White

LOW VOLTAGE MR16 MULTIPLE SPOTS

1WATT MINIMUM LOAD TRANSFORMERS

1 LIGHT

Trims (Order Housing Separately)

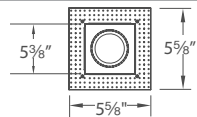
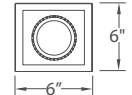

Model

MT-116
1 Light Trim

Finish

WT/WT
WT/BK

Trim/Reflector

White/White
White/Black

Example: **MT-116-WT/BK**

Low Voltage Multiple Spot Housings (Required)

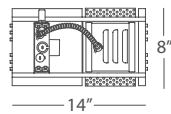
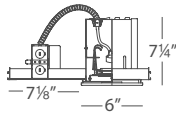

Model

MT-116HS

Type

1 Light

Lamp

1 x MR16, 50W
12V

Rating

Non-IC

2 LIGHTS

Trims (Order Housing Separately)

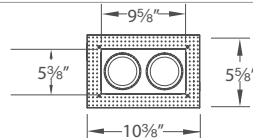
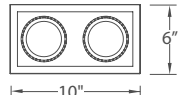

Model

MT-216
2 Light Trim

Finish

WT/WT
WT/BK

Trim/Reflector

White/White
White/Black

Example: **MT-216TL-WT**

Low Voltage Multiple Spot Housings (Required)

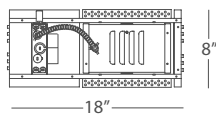
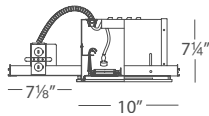

Model

MT-216HS

Type

2 Lights

Lamp

2 x MR16, 50W
12V

Rating

Non-IC

3 LIGHTS

Trims (Order Housing Separately)

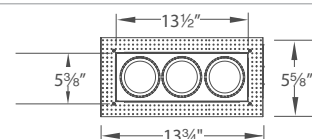
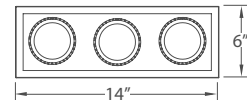

Model

MT-316
3 Light Trim

Finish

WT/WT
WT/BK

Trim/Reflector

White/White
White/Black

Example: **MT-316-WT/BK**

Low Voltage Multiple Spot Housings (Required)

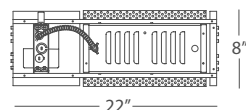
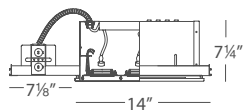

Model

MT-316HS

Type

3 Lights

Lamp

3 x MR16, 50W
12V

Rating

Non-IC

Non-IC housings require 3" of clearance from insulation on all sides. Accommodates ceiling thickness of up to 1" for remodel & 3/4" for new construction. Recommended ELV dimming

LENSES, LOUVERS & LAMPS

Colored Lenses

Color

LENS-16 Colored Lens	AMB Amber
	BLU Blue
	GRN Green
	RED Red

Lenses & Louvers

LENS-16-UVF	UV Filter Lens
LENS-16-FR	Frosted Lens
LENS-16-HCL	Honeycomb Louver
LENS-16-SPR	Spread Lens
LENS-16-BEL	Beam Elongating Lens

LED MR16 Lamp

Finish

MR16LED-BAB	BK Black
	WT White

LED FUNCTIONAL CEILING AND WALL



I CAN'T BELIEVE IT'S NOT RECESSED

LED FUNCTIONAL CEILING LIGHT



TITLE 24
CALIFORNIA



Input: 120V
CRI: 90
Dimming: 100% - 10% ELV, 100%-5% TRIAC
Rated Life: 54,000 hours

- Imitates a traditional 6" Line voltage recessed downlight with an R30 light bulb
- Install over a standard 4" junction box
- ADA compliant
- Opaque acrylic diffuser
- Multiple LED array for uniform illumination
- 120VAC - no driver needed

	Watt	Color Temp	LED Lumens	Delivered Lumens	Finish
	FM-616-930-WT 16W	3000K	1150	1050	White

Example: FM-616-930-WT

DISC LED FUNCTIONAL CEILING AND WALL



Dimming: 100% - 5% ELV, 100%-5% TRIAC
Input: 120V
Rated Life: 35,000 hours

- ADA compliant
- Wall or Ceiling Mount
- Translucent acrylic diffuser
- Multiple LED array for uniform illumination
- 120VAC - no driver needed



Install over a 4" junction box or pancake box



Retrofit over a 4", 5" or 6" recessed can

	Model	Wattage	Color Temp	LED Lumen	Delivered Lumen	CRI	Finish		
	FM-304	12W	930	3000K	670	570	90	BN Brushed nickel BZ Bronze WT White	Fits over a 4" recessed can or direct wire to a 4" junction box or pancake box
				4000K	1165	905	90		
	FM-306	15W	930	3000K	985	840	90	BN Brushed nickel BZ Bronze WT White	Fits over a 5" to 6" recessed can or direct wire to a 4" junction box or pancake box
				4000K	1165	905	90		
	FM-306	15W	930JB	3000K	985	840	90	WT White	Direct mount to 4" junction box or pancake box

Example: **FM-306-930JB-WT**



Input: 120V
CRI: 85
Dimming: 100% - 10% ELV
Rated Life: 50,000 hours

- ADA compliant for FM-211 & FM-214
- Wall or Ceiling Mount
- Translucent acrylic diffuser
- Multiple LED array for uniform illumination
- 120VAC - no driver needed
- Direct mounts to all junction boxes





			Watt	Color Temp	LED Lumens	Delivered Lumens	Finish
		FM-211	15W	27 2700K	1195	985	WT White
				35 3500K	1215	1035	
		FM-214	24W	27 2700K	1695	1395	
				35 3500K	1775	1510	
		FM-216	33.5W	27 2700K	2475	2060	
				35 3500K	2595	2150	

Example: FM-214-35-WT

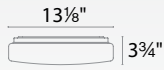

Input: 120V
 CRI: 85
 Dimming: 100% - 10% ELV
 Rated Life: 50,000 hours

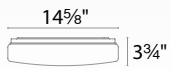
- ADA compliant
- Wall or Ceiling Mount
- Translucent acrylic diffuser
- Multiple LED array for uniform illumination
- 120VAC - no driver needed

			Watt	Color Temp	LED Lumens	Delivered Lumens	Finish
		FM-113	22W	27 2700K	1695	1395	WT White 
				35 3500K	1770	1510	
		FM-115	33W	27 2700K	2475	2060	WT White 
				35 3500K	2595	2150	

Example: FM-115-35-WT



Wall or Ceiling Mount, Suitable for Closet

Input: 120V
 CRI: 85
 Dimming: 100% - 10% ELV
 Rated Life: 35,000 hours

- ADA compliant
- Suitable for installation over bulkhead in closets
- Damp location rated
- Translucent acrylic diffuser
- Multiple LED array for uniform illumination
- 120VAC - no driver needed

			Watt	Color Temp	LED Lumens	Delivered Lumens	Finish
		WS-224	20.5W	27 2700K 35 3500K	1670 1870	1190 1340	WT White
		WS-236	31W	27 2700K 35 3500K	2570 2865	1785 2005	
		WS-248	40.5W	27 2700K 35 3500K	3280 3555	2325 2685	

Example: WS-236-35-WT

BEAUTY SPOTS™

Polished and cut by hand from optic crystals to create sparkling patterns of light.
An impressive custom crystal display arranged in a pattern or in a random array on walls or ceilings.



PRINCESS

362



EMPRESS

363



IRIX

356

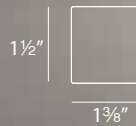

Integral LED

* Dimming is not recommended

			Color Temp	Lumens	Voltage	Wattage	Rated Life	Finish	Cutout
	DR-362LED-CL/CH	Princess							
	DR-363LED-CL/CH	Empress	3000K	150	24V	4.5 W	50,000 hours	Clear / Chrome	2 3/8"
	DR-356LED-CL/CH	Irix							
			<i>Input</i>	<i>Output</i>	<i>Min Load</i>	<i>Dimension (L x W x H)</i>	<i>Max Fixture Run</i>	<i>Max Run Length</i>	
Remote Transformer for Integral LED	EN-2460-RB2	120V	24V, 60W (class 2)	1W	6 1/2" x 1 5/8" x 1 1/4"	12 per transformer	30'		
	EN-24100-RB2	120V	24V, 96W (class 2)	1W	6 1/2" x 1 5/8" x 1 1/4"	21 per transformer	40'		

12V Xenon Bi-Pin

* Dimmable with compatible dimmer match to power supply

			Color Temp	Lumens	Voltage	Wattage	Rated Life	Finish	Cutout
	DR-362-CL/CH	Princess							
	DR-363-CL/CH	Empress	3000K	200	12V, 24V	20 W	10,000 hours	Clear / Chrome	2 3/8"
	DR-365-CL/CH	Irix							
			<i>Input</i>	<i>Output</i>	<i>Min Load</i>	<i>Dimension (L x W x H)</i>	<i>Max Fixture Run</i>	<i>Max Run Length</i>	
Remote Transformer for Xenon Bi-pin	EN-1260-RB2	120V	12V, 60W (class 2)	1W	6 5/8" x 1 5/8" x 1 1/8"	3	25'		
	EN-1275-RB-AR	120V	12V, 75W	1W	6 5/8" x 1 5/8" x 1 1/8"	3	30'		
	EN-12100-RB-AR	120V	12V, 100W	1W	6 1/4" x 3" x 1 5/8"	5	30'		
	EN-12150-RB-AR	120V	12V, 150W	1W	6 1/4" x 3" x 1 5/8"	7	35'		

DISPLAY



SILO X10 LED MONOPOINT SPOT



TITLE 24
CALIFORNIA

Power:	10W	Dimming:	100% - 5% ELV
Lumens:	Up to 790	Input:	120V
CBCP:	Up to 2575	Rated Life:	50,000 hours
Comparable to:	65W MR16	Listing:	UL & cUL
CRI:	90		



Includes 35° narrow flood optic installed and 25° spot optic in the box

	Model	Beam	Color Temp	Finish
	MO-2010	25°	930 3000K	BN Brushed Nickel
		AND		BK Black
		35°		WT White

Example: MO-2010-930-BN

Accommodates one lens accessory or one glare control accessory

LENS ACCESSORIES

Amber	LENS-11-AMB
Blue	LENS-11-BLU
Green	LENS-11-GRN
Red	LENS-11-RED
Frosted	LENS-11-FR
Spread	LENS-11-SPR
Beam Elongating	LENS-11-BEL

GLARE CONTROL ACCESSORIES

Cross Louver	LENS-11P-CRL	BN
		BK
Snoot	LENS-11-SNOOT	WT

EXTENSIONS Custom order as a complete unit

X6 6"	MO2010930	BN BK WT	
X12 12"			
X18 18"			
X24 24"			
X36 36"			
X48 48"			

Example: X12-MO2010930WT

SILO X20 LED ADJUSTABLE MONOPOINT SPOT

TITLE 24
CALIFORNIA

Power:	20W	Dimming:	100% - 5% ELV
Lumens:	Up to 1080	Input:	120V
CBCP:	Up to 6840	Rated Life:	50,000 hours
Comparable to:	75W MR16	Listing:	UL & cUL
CRI:	90		



Optional Focusing Framing Projector Accessory **FP-K**



	Model	Color Temp	Finish
	MO-2020-930	3000K	BN Brushed Nickel
			BK White
			WT Black

Example: MO-2020-930-WT

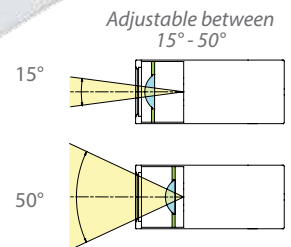

Accommodates one lens accessory and one glare control accessory

LENS ACCESSORIES

Amber	LENS-16-AMB
Blue	LENS-16-BLU
Green	LENS-16-GRN
Red	LENS-16-RED
Frosted	LENS-16-FR
Spread	LENS-16-SPR
Beam Elongating	LENS-16-BEL

FOCUSING FRAMING PROJECTOR ACCESSORIES

	FP-K-BK
	FP-K-WT
GLARE CONTROL ACCESSORIES	
Cross Louver	LENS-16P-CRL-BK LENS-16P-CRL-WT
Snoot	LENS-16-SNOOT-BK LENS-16-SNOOT-WT
Honeycomb	LENS-16-HCL

EXTENSIONS Custom order as a complete unit

X6 6"	MO2020930	BN BK WT	
X12 12"			
X18 18"			
X24 24"			
X36 36"			
X48 48"			

Example: X6-MO2020930BK



Adjustable between 15° - 50°

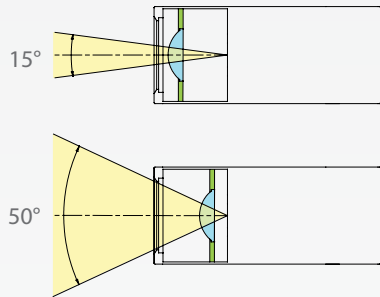

Beam alignment indicator



Optional Focusing Framing Projector Accessory **FP-K**

- Dual adjustable optical lenses precision focus light for crisp illumination
- Adjustable framing shims create a feature accenting, rectangular pattern of illumination

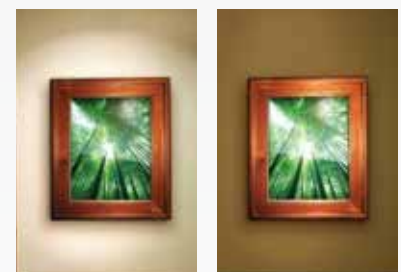

without Framing Projector

with Framing Projector

Power: 23W
Input: 120V
Comparable to: 20W HID
Dimming: 100%-5% (ELV & Triac)
Rated Life: 50,000 hours
Listing: ETL & cETL

Museum-quality LED luminaire with adjustable beam angle

- Continuously adjustable beam angle between 15° - 50°
- Die-cast aluminum construction with rotatable front face
- Stealth armature with 365° horizontal rotation and 90° vertical aiming
- Patents Pending

	Model	Color Temp	CRI	Beam	Max Lumen	Max CBCP	Finish
	MO-4023	827 2700K 85	15°	985	5265	BK Black WT White	
		830 3000K 85					
		835 3500K 85					
		840 4000K 85					
	927 2700K 90 930 3000K 90	50°	1340	1700			

Example: MO-4023-930-BK

Accommodates one lens accessory and one glare control accessory

LENS ACCESSORIES

Amber	LENS-16-AMB
Blue	LENS-16-BLU
Green	LENS-16-GRN
Red	LENS-16-RED
Frosted	LENS-16-FR
Spread	LENS-16-SPR
Beam Elongating	LENS-16-BEL

FRAMING PROJECTOR ACCESSORIES

Framing Projector	FP-K-BK FP-K-WT
-------------------	----------------------------------

GLARE CONTROL ACCESSORIES

Cross Louver	LENS-16P-CRL-BK LENS-16P-CRL-WT
Snoot	LENS-16-SNOOT-BK LENS-16-SNOOT-WT
Honeycomb Louver	LENS-16-HCL

EXTENSIONS Custom order as a complete unit

X6 6"	MO4023	BK Black WT White	
X12 12"			
X18 18"			
X24 24"			
X36 36"			
X48 48"			

Example: X12-MO4023930WT

PALOMA LED512 LED MONOPOINT SPOT

Power: 11.5W
Lumens: Up to 780
CBCP: Up to 3430
Comparable to: 50W MR16
CRI: Up to 90

Dimming: 100% - 5% ELV
Input: 120-277V
Rated Life: 50,000 hours



Model	Beam	Color Temp	CRI	Finish	
 MO-LED512	S 19° N 24° F 36°	827 2700K	85	BK Black WT White	
		830 3000K	85		
		835 3500K	85		
		840 4000K	85		
		927 2700K	90		
			930 3000K	90	

Example: MO-LED512S-927-WT

Accommodates one lens accessory or one glare control accessory

LENS ACCESSORIES

Amber	LENS-16-AMB
Blue	LENS-16-BLU
Green	LENS-16-GRN
Red	LENS-16-RED
Frosted	LENS-16-FR
Spread	LENS-16-SPR
Beam Elongating	LENS-16-BEL

GLARE CONTROL ACCESSORIES

Honeycomb	LENS-16-HCL
Louver	
Snoot	LENS-16-SNOOT-WT LENS-16-SNOOT-BK

EXTENSIONS Custom order as a complete unit

X6 6"	MOLED512	S N F	827	BK WT	
X12 12"			830		
X18 18"			835		
X24 24"			840		
X36 36"			927		
X48 48"			930		

Example: X12-MOLED512N930WT

PALOMA LED522 LED MONOPOINT SPOT

Power: 23.5W
Lumens: Up to 1310
CBCP: Up to 5780
Comparable to: 100W Halogen
CRI: Up to 90

Dimming: 100% - 5% ELV
Input: 120-277V
Rated Life: 50,000 hours



Model	Beam	Color Temp	CRI	Finish	
 MO-LED522	S 19° N 24° F 36°	827 2700K	85	BK Black WT White	
		830 3000K	85		
		835 3500K	85		
		840 4000K	85		
		927 2700K	90		
			930 3000K	90	

Example: MO-LED522F-835-BK

Accommodates one lens accessory or one glare control accessory

LENS ACCESSORIES

Amber	LENS-20-AMB
Blue	LENS-20-BLU
Green	LENS-20-GRN
Red	LENS-20-RED
Frosted	LENS-20-FR
Spread	LENS-20-SPR
Beam Elongating	LENS-20-BEL

GLARE CONTROL ACCESSORIES

Honeycomb	LENS-20-HCL
Louver	
Snoot	LENS-20-SNOOT-WT LENS-20-SNOOT-BK

EXTENSIONS Custom order as a complete unit

X6 6"	MOLED522	S N F	827	BK WT	
X12 12"			830		
X18 18"			835		
X24 24"			840		
X36 36"			927		
X48 48"			930		

Example: X12-MOLED522S927BK

14W EXTERMINATOR II LED MONOPOINT SPOT



Power: 14W
Lumens: Up to 980
CBCP: Up to 4585
Comparable to: 20W HID
CRI: Up to 90
Dimming: 100% - 5% ELV
Input: 120V
Rated Life: 100,000 hours

Model	Beam	Color Temp	CRI	Finish
 MO-1014	N 20° F 40°	827 2700K 85	BN Brushed Nickel BK Black WT White	
		830 3000K 85		
		835 3500K 85		
		840 4000K 85		
		927 2700K 90		
		930 3000K 90		

Example: MO-1014F-830-BN

Accommodates one lens accessory and one glare control accessory

LENS ACCESSORIES

Amber	LENS-11-AMB
Blue	LENS-11-BLU
Green	LENS-11-GRN
Red	LENS-11-RED
Frosted	LENS-11-FR
Spread	LENS-11-SPR
Beam Elongating	LENS-11-BEL

GLARE CONTROL ACCESSORIES

Cross Louver	LENS-11P-CRL	BN
		BK
Snoot	LENS-11-SNOOT	WT

REFLECTORS

20°	SL-REF-CXA1310-N
40°	SL-REF-CXA1310-F

EXTENSIONS Custom order as a complete unit

X6 6"	MO1014	N F	827	BN BK WT	
X12 12"			830		
X18 18"			835		
X24 24"			840		
X36 36"			927		
X48 48"			930		

Example: X12-MO1014N930WT

22W EXTERMINATOR II LED MONOPOINT SPOT



Power: 22W
Lumens: Up to 2030
CBCP: Up to 11530
Comparable to: 39W HID
Dimming: 100% - 5% ELV
Input: 120V-277V
Rated Life: 50,000 hours

Model	Beam	Color Temp	CRI	Finish
 MO-1023	N 18° F 38°	827 2700K 85	BN Brushed Nickel BK Black WT White	
		830 3000K 85		
		835 3500K 85		
		840 4000K 85		
		927 2700K 90		
		930 3000K 90		

Example: MO-1023F-930-BK

Accommodates one lens accessory and one glare control accessory

LENS ACCESSORIES

Amber	LENS-16-AMB
Blue	LENS-16-BLU
Green	LENS-16-GRN
Red	LENS-16-RED
Frosted	LENS-16-FR
Spread	LENS-16-SPR
Beam Elongating	LENS-16-BEL

GLARE CONTROL ACCESSORIES

Cross Louver	LENS-16P-CRL	BN
		BK
Snoot	LENS-16-SNOOT	WT

REFLECTORS

18°	RF-S
38°	RF-F

EXTENSIONS Custom order as a complete unit

X6 6"	MO1023	N F	827	BN BK WT	
X12 12"			830		
X18 18"			835		
X24 24"			840		
X36 36"			927		
X48 48"			930		

Example: X12-MO1023N930WT

35W EXTERMINATOR II LED MONOPOINT SPOT



Power: 35W
Lumens: Up to 2828
CBCP: Up to 9748
Comparable to: 50W HID
Dimming: 100% - 5% ELV, 0-10V
Input: 120V-277V
Rated Life: 60,000 hours

	Model	Beam	Color Temp	CRI	Finish
	MO-1035	N 25° F 55°	827 2700K 85	BN Brushed Nickel BK Black WT White	
			830 3000K 85		
			835 3500K 85		
			840 4000K 85		
			927 2700K 90		
			930 3000K 90		

Example: MO-1035F-930-WT

Accommodates one lens accessory and one glare control accessory

LENS ACCESSORIES

Amber	LENS-20-AMB
Blue	LENS-20-BLU
Green	LENS-20-GRN
Red	LENS-20-RED
Frosted	LENS-20-FR
Spread	LENS-20-SPR
Beam Elongating	LENS-20-BEL

GLARE CONTROL ACCESSORIES

Cross Louver	LENS-20P-CRL	BN BK WT
Snoot	LENS-20-SNOOT	WT

REFLECTORS

25°	SL-REF-BL18-N
55°	SL-REF-BL18-F

WALL WASH LED MONOPOINT SPOT

Power:	20W	Color Temp:	3000K
Delivered Lumens:	Up to 925	Dimming:	100% - 5% ELV
Comparable to:	20W HID	Input:	120-277V
CRI:	90	Rated Life:	50,000 hours



- Recommended install 3 to 5 feet away from wall
- Die-cast aluminum construction
- Powder-coated finishes
- Asymmetrical beam distribution for even wall illumination
- Economical performance luminaire with integral LED and driver
- UL & cUL Listed

		Model	Finish
		MO-3020W-930	BK Black
			WT White

Example: MO-3020W-930-WT

EXTENSIONS Custom order as a complete unit			
X6	6"	MO3020W930	BK WT
X12	12"		
X18	18"		
X24	24"		
X36	36"		
X48	48"		

Example: X24-MO3020W930WT

IMPULSE LED MONOPOINT SPOT

	LED 810	LED 820
Power:	14.5W	23W
Lumen:	Up to 950	Up to 1355
CBCP:	Up to 4481	Up to 6048
Comparable:	75W MR16	100W Halogen
Dimming:	100% - 10% ELV	100% - 10% ELV
Input:	120V	120V
Rated Life:	60,000 hours	60,000 hours



MO-LED810



MO-LED820

		Model	Beam	Color Temp	CRI	Finish
		MO-LED810	S 20°	827	2700K	85
				830	3000K	85
		MO-LED820	F 40°	835	3500K	85
				840	4000K	85
				927	2700K	90
				930	3000K	90

Example: MO-LED810F-930-DB

Accommodates one lens accessory and one framing projector or barn door accessory

LENS ACCESSORIES

Amber	LENS-16-AMB
Blue	LENS-16-BLU
Green	LENS-16-GRN
Red	LENS-16-RED
Frosted	LENS-16-FR
Spread	LENS-16-SPR
Beam Elongating	LENS-16-BEL

ACCESSORIES

	008FP-BK
	008FP-DB
	008FP-WT
	801BD-BK
	801BD-DB
	801BD-WT

EXTENSIONS Custom order as a complete unit

				Model	Beam	Color Temp	CRI	Finish
X6	6"	MOLED810	S	MOLED820	F	827	2700K	85
X12	12"					830	3000K	85
X18	18"					835	3500K	85
X24	24"					840	4000K	85
X36	36"					927	2700K	90
X48	48"					930	3000K	90

Example: X24-MOLED820S927BK

REFLEX PRO LED MONOPOINT SPOT

Power: 17W CRI: 85
 Lumen: Up to 1125 Dimming: 100% - 10% ELV
 CBCP: Up to 3780 Input: 120V
 Comparable: 20W HID Rated Life: 100,000 hours

Clear and Frosted lens included



Shown with Frosted Lens included

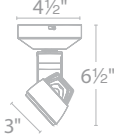

Model	Beam	Color Temp	Finish
 MO-LED17	S 20° F 45°	27 2700K	BK Black WT White
		30 3000K	
		35 3500K	
		40 4000K	

Example: MO-LED17F-30-WT

Accommodates one lens accessory

LENS ACCESSORIES

Amber	LENS-20-AMB
Blue	LENS-20-BLU
Green	LENS-20-GRN
Red	LENS-20-RED
Frost	LENS-20-FR
Spread Lens	LENS-20-SPR
Beam Elongating	LENS-20-BEL
UV Filter	LENS-20-UVF

GLARE CONTROL ACCESSORY

Honeycomb Louver	LENS-20-HCL
------------------	--------------------

EXTENSIONS Custom order as a complete unit

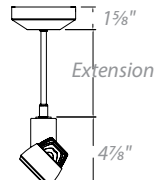
Extension	MOLED17	Beam	Color Temp	Finish
	S F	27	BK WT	
		30		
		35		
		40		

Example: X24-MOLED17S927BK

ARGOS LED MONOPOINT SPOT

Power: 25W CRI: 85
 Lumens: Up to 1525 Dimming: 100% - 10% ELV
 CBCP: Up to 5856 Input: 120V
 Comparable to: 39W HID Rated Life: 100,000 hours

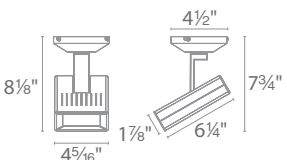
Model	Beam	Color Temp	Finish
 MO-LED25	S 20° F 42°	27 2700K	BK Black WT White
		30 3000K	
		35 3500K	
		40 4000K	

Example: MO-LED25S-30-BK



Accommodates one lens accessory

INTERCHANGEABLE TIR OPTICS

20°	OPH-10X3-20D	BK Black WT White
42°	OPH-10X3-42D	

LENS ACCESSORIES

LENS-1X3-FR	Frosted
LENS-1X3-DIC-AMB	Amber dichroic
LENS-1X3-DIC-BLU	Blue dichroic
LENS-1X3-DIC-GRN	Green dichroic
LENS-1X3-DIC-RED	Red dichroic

LOW VOLTAGE LED/MR16 FLEXIBLE SPOT LIGHTS

Power: 8W Color Temp: 3000K
 Lumens: 450 CRI: 85
 CBCP: 833 Dimming: ELV
 Comparable: 35W MR16 Rated Life: 25,000 hours

- Integral Electronic transformer
- Accepts 12V LED MR16, Halogen MR16 lamps up to 50W max
- LED MR16 included when ordered as LED
- 1 watt minimum load
- Can be wall or ceiling mounted
- Extend to 24 inches for ME-204 only

204

	Model	Lamp	Finish
	ME-204LED	LED	BK Black BN Brushed Nickel WT White
	ME-204	Halogen	

Example: **ME-204LED-WT**
 Mounts to standard junction box



BULB SHIELD ACCESSORY

MBS-16 Mesh Shield	BK Black	
SBS-16 Solid Shield	BN Brushed Nickel	
	WT White	

Example: **MBS-16-BN**

826

Power: 8W Color Temp: 3000K
 Lumens: 450 CRI: 85
 CBCP: 833 Dimming: ELV
 Comparable: 35W MR16 Rated Life: 25,000 hours

	Model	Lamp	Extension (optional)	Finish
	ME-826LED	LED	X6 6"	BK Black BN Brushed Nickel WT White
	ME-826	Halogen	X12 12"	
			X18 18"	
			X24 24"	
			X36 36"	
			X48 48"	

Example: **ME-826LED-BN** or **ME-826LEDX36-BN** (with 36" extension)



LAMPS

	Finish	Power	Color Temp	Input	Beam	CRI	Lumens	CBCP	Average Life
	MR16 MR16LED-BAB-BK	8W	3000K	12V	35°	85	450	850	25,000 Hours
	MR16LED-BAB-WT								

LOW VOLTAGE LED/MR16 DISPLAY SPOT LIGHTS

Power: 8W
 Lumens: 450
 CBCP: 833
 Comparable: 35W MR16

Color Temp: 3000K
 CRI: 85
 Dimming: ELV
 Rated Life: 25,000 hours

- Integral Electronic transformer
- Accepts 12V LED MR16, Halogen MR16 lamps up to 50W max
- LED MR16 included when ordered as LED
- 1 watt minimum load
- Can be wall or ceiling mounted
- Available extensions from 6 to 48 inches
- Clear lens included (see below for alternate lens options)

007

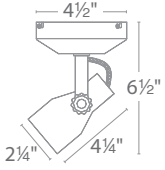
Model	Lamp	Extension (optional)	Finish
	ME-007LED LED	X6 6"	BK Black BN Brushed Nickel WT White
	ME-007 Halogen	X12 12"	
		X18 18"	
		X24 24"	
		X36 36"	
		X48 48"	

Example: **ME-007LED-BK** or **ME-007LEDX6-BK** (with 6" extension)



FRAMING PROJECTOR ACCESSORY

008FP	BK	Black
	WT	White



Example: **008FP-BK**

808

Power: 8W
 Lumens: 450
 CBCP: 833
 Comparable: 35W MR16

Color Temp: 3000K
 CRI: 85
 Dimming: 25,000 hours
 Rated Life:

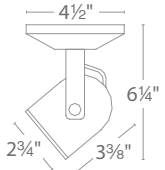
Model	Lamp	Extension (optional)	Finish
	ME-808LED LED	X6 6"	BK Black WT White
	ME-808 Halogen	X12 12"	
		X18 18"	
		X24 24"	
		X36 36"	
		X48 48"	

Example: **ME-808LED-WT** or **ME-808LEDX12-WT** (with 12" extension)



LENS ACCESSORIES

Amber	LENS-16-AMB	Blue	LENS-16-BLU	Red	LENS-16-RED	UV Filter	LENS-16-UVF	Beam Elongating	LENS-16-BEL
Yellow	LENS-16-YEL	Green	LENS-16-GRN	Frosted	LENS-16-FR	Spread	LENS-16-SPR	Honeycomb Louver	LENS-16-HCL

VECTOR FIXED RAIL



Brushed Nickel

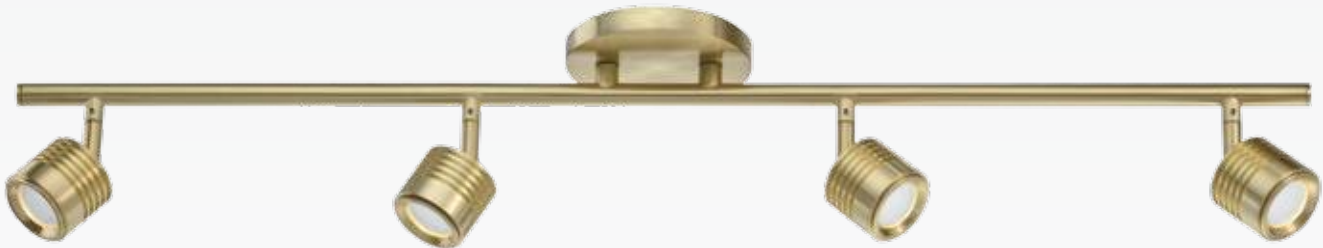

Brushed Brass



Chrome

Power: 33W
 Input: 120-277V
 Color Temp: 3000K
 Dimming: 0-10V & ELV
 Rated Life: 60,000 hours

- Individually Adjustable Heads
- Wall or Ceiling Mount
- Aluminum Construction
- Driver located in J box with minimum inside dimension of 3½" x 3½" x 1½"
- Damp Location Listed

	CRI	Lumens	Delivered Lumens	Finish
<p>TK-49534</p>	90	1500	1465	BN Brushed Nickel BR Brushed Brass CH Chrome

Example: TK-49534-CH

VECTOR MONOPOINT



Brushed Nickel



Brushed Brass



Chrome

Power: 9W
 Input: 120-277V
 Color Temp: 3000K
 Dimming: 0-10V & ELV
 Rated Life: 60,000 hours

- Adjustable Head
- Wall or Ceiling Mount
- Aluminum Construction
- Driver located in J box with minimum inside dimension of 3½" x 3½" x 1½"
- Damp Location Listed

	CRI	Lumens	Delivered Lumens	Finish
	MO-495	90	441	438
				BN Brushed Nickel BR Brushed Brass CH Chrome

Example: MO-495-BN

DL-007 LOW VOLTAGE CLAMP MOUNT SPOT LIGHTS

- Accepts 12V LED MR16, Halogen MR16 lamps up to 50W max
- Includes 2" clamp and 10' cord with plug-in transformer
- 1W minimum load

Model	Finish
DL-007 Telescoping neck	BK Black

Example: DL-007-BK

	MR16LED-BAB	BK Black
		WT White

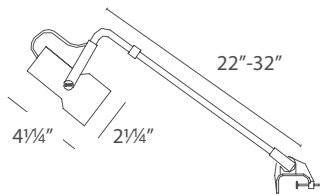

FRAMING PROJECTOR



008FP-BK	Black
008FP-WT	White

ALTERNATIVE CLAMP ACCESSORY



DLC-P Pipe Clamp	For pipes 1/2" to 2 1/2"	BK Black WT White
DLC-4 4" Clamp	For flat surfaces from 2" to 4" wide	

Example: DLC-4-WT

DL-214 LOW VOLTAGE CLAMP MOUNT SPOT LIGHTS

Model	Finish
DL-214 Gooseneck	BK Black WT White

Example: DL-214-WT

	MR16LED-BAB	BK Black
		WT White

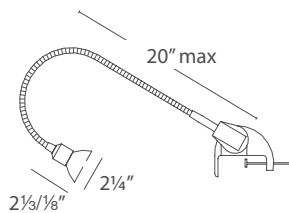

Shown with MR16 LED Lamp.
Order separately

ACCESSORY

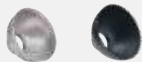

MBS-16 Mesh Shield	BK Black
SBS-16 Solid Shield	WT White

Example: MBS-16-BK

ALTERNATIVE CLAMP ACCESSORY



DLC-P Pipe Clamp	For pipes 1/2" to 2 1/2"	BK Black WT White
DLC-4 4" Clamp	For flat surfaces from 2" to 4" wide	

Example: DLC-4-WT

DL-188 LINE VOLTAGE CLAMP MOUNT SPOT LIGHTS

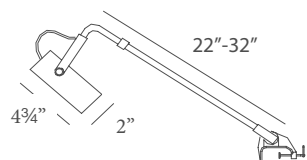

Model	Lamp (order separately)	Finish
DL-188	LED PAR20/LED PAR30 LED BR20/LED BR30/LED BR40	BK Black WT White
Telescoping neck	120V, 150W max - BR30/PAR20/PAR30/PAR38	

Example: DL-188-WT

LED LAMPS

Model	Type	Finish
PAR20LED-10N30	PAR20	BK Black WT White
PAR30LED-L14N30	PAR30	
PAR38LED-17N30	PAR38	
BR20LED-7N27	BR20	WT White
BR30LED-11N27	BR30	
BR40LED-15N27	BR40	

ALTERNATIVE CLAMP ACCESSORY













Model	Description	Finish
DLC-P Pipe Clamp	For pipes 1/2" to 2 1/2"	BK Black WT White
DLC-4 4" Clamp	For flat surfaces from 2" to 4" wide	

Example: DLC-4-WT



Shown with BR30 LED lamp
Order separately

LED LAMPS*

	Model	Finish	Lamp Type	Power	CCT	Lumens	Average Life	CRI	Ø	L
	JCLEd-2-30-WT	White	JC Bi-pin G5.3 base	12V 2W	3000K	110	30,000 hrs	85	3/4"	2 3/16"
	MR16LED-BAB-BK MR16LED-BAB-WT	Black White	MR16 G5.3 base 35° beam	12V 8W	3000K	450	25,000 hrs	85	2"	1 5/16"
	GU10LED-BAB-BK GU10LED-BAB-WT	Black White	GU10 35° beam	120V 8W	3000K	470	25,000 hrs	85	2"	5 1/16"
	PAR20LED-10N30-BK PAR20LED-10N30-WT	Black White	PAR20 med base 40° beam	120V 7W	3000K	500	25,000 hrs	90	2 1/2"	3 7/16"
	PAR30LED-L14N30-BK PAR30LED-L14N30-WT	Black White	PAR30 med base 40° beam	120V 11W	3000K	800	25,000 hrs	90	3 3/4"	4 3/4"
	PAR38LED-17N30-BK PAR38LED-17N30-WT	Black White	PAR38 med base 40° beam	120V 15W	3000K	1000	25,000 hrs	90	4 3/4"	5 3/4"
	BR20LED-7N27-WT	White	BR20 med base 100° beam	120V 7W	2700K	450	25,000 hrs	90	2 1/2"	3 7/8"
	BR30LED-11N27-WT	White	BR30 med base 100° beam	120V 11W	2700K	750	25,000 hrs	90	3 3/4"	5 5/16"
	BR40LED-15N27-WT	White	BR40 med base 100° beam	120V 15W	2700K	1050	25,000 hrs	90	4 3/4"	5 5/16"
	A19LED-12-30-WT	White	A19 med base 300° beam	120V 9.5W	3000K	800	25,000 hrs	90	2 3/8"	4 1/8"

*Dimmable

MR16 HALOGEN LAMPS

MR16 Low Voltage Dichroic Reflector – 120V Track, Flexrail1™, Recessed Downlights, Surface Mount Spots, Display Lights and Quick Connect™ Pendants and Fixtures

	Model	Power	Color Temp	Volt	CBCP	Average Life	Base	Beam
	MR16-EXN	50W	3000K	12V	1500	3,000 Hrs	GU5.3	40°
	MR16-EXN-G (With glass lens)	50W	3000K	12V	1500	3,000 Hrs	GU5.3	40°

MR16 120V GU10 Base – W, H/L/J/J2, Flexrail1™ and Display Lights

	GU10-EXN	50W	3000K	120V	650	2,000 Hrs	GU10	40°
---	-----------------	-----	-------	------	-----	-----------	------	-----

VIBE LED PICTURE LIGHT





Color Temp: 2700K
 CRI: 90
 Dimming: 100% – 10% ELV
 Rated Life: 70,000 hours

Chronophoton Technology conserves artwork while providing vibrant color rendering

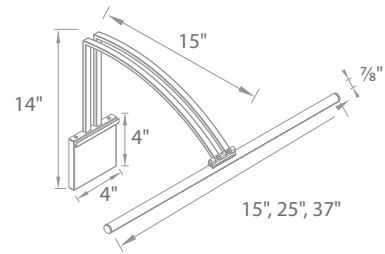
- Head rotates 35° up or down
- 110° beam angle
- Direct wire only

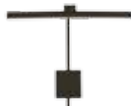

		LED Power	LED Lumens	Delivered Lumens		Finish
	15"	8.5W	595	240	PL-LED15-27	Hard Wired
	25"	16W	1186	535	PL-LED25-27	Hard Wired
	37"	23W	1785	850	PL-LED37-27	Hard Wired

BK Black

BN Brushed Nickel



Example: PL-LED25-27-BN

CHRONOPHOTON TECHNOLOGY

Conventional incandescent sources emit over 90% of the energy as heat. The heat along with ultraviolet expands and contracts pigments of the painting and degrades vibrancy of colors.

HEMMINGWAY LED PICTURE LIGHT



Color Temp: 2700K
 CRI: 90
 Dimming: 100% – 10% ELV
 Rated Life: 70,000 hours

Chronophoton Technology preserves artwork while providing vibrant color rendering

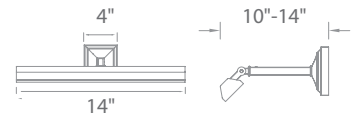

- Head rotates 90° up or down and extends out 14" from mounting surface
- Direct wire only

PL-LED14

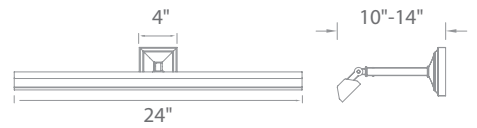

PL-LED24



		<i>Power</i>	<i>LED Lumens</i>	<i>Delivered Lumens</i>		<i>Finish</i>
	14"	9.4W	595	302	PL-LED14-27	Hard Wired
	24"	16.9W	1186	605	PL-LED24-27	Hard Wired

AN *Antique Nickel* 

BB *Burnished Brass* 

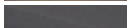
RB *Rubbed Bronze* 

PN *Polished Nickel* 

Example: PL-LED24-27-AN

Our LED picture lights with Chronophoton technology ensure minimal light outside the range of visible light to preserve the quality of artwork over a prolonged period of exposure.

TRACK SYSTEMS





TRACK SYSTEMS

WAC Lighting track systems have provided high performing technical lighting systems to the marketplace for over three decades. 6 standard track systems are offered in the product line, ranging from the museum-quality W track for upscale specifications to standard commercial-grade H, L, and J track systems complete with a full assortment of LED luminaires assembled locally for custom CCT and light distribution options.

Track Luminaires are offered to perform in most interior applications ranging from spot lighting in high-ceiling retail and commercial spaces to diminutive residential accent lighting. Available in luminous flux options ranging from around 500 lumens comparable to 35W MR16 lamps, to over 3000 lumens comparable to a 70W HID or 200W Halogen. Dozens of dedicated LED designs are offered in different distinctive looks to complement various interiors.

W TRACK SYSTEM *p. 77-80*

120V (1920W Max) or 277V(4840W Max)

Surface Mount, Suspension Mount

2-Circuit

Robust construction



W RECESSED TRACK SYSTEM *p. 81-82*

120V (1920W Max)

Flanged and Flangeless Mount

2-Circuit

Robust construction



J2 TRACK SYSTEM *p. 94*

2-Circuit

120V (1920W Max)

Surface Mount, Suspension Mount

Slim Profile



H TRACK SYSTEM *p. 95-97*

Single-Circuit

120V (1920W Max)

Surface Mount, Suspension Mount

Slim Profile



L TRACK SYSTEM *p. 95-96*

Single-Circuit

120V (1920W Max)

Surface Mount, Suspension Mount

Slim Profile



J TRACK SYSTEM *p. 95-96*

Single-Circuit

120V (1920W Max)

Surface Mount, Suspension Mount

Slim Profile



W TRACK 120V/277V SURFACE MOUNT TWO CIRCUIT ARCHITECTURAL TRACK

Description: Heavy duty architectural grade track with two independently controllable circuits (isolated neutrals) and stem or cable suspensions

Power per Circuit: 1920W max (120V), 4432W max (277V)

***Installation:** Surface mounting

Heavy duty aluminum rigid track designed for surface mounting or for suspension up to 8 feet

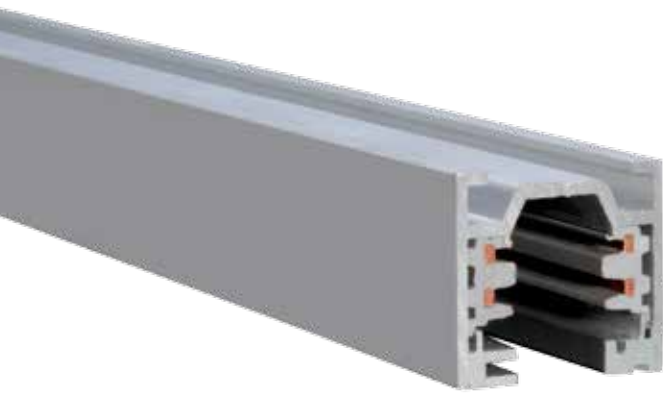

120V



277V

Surface mount

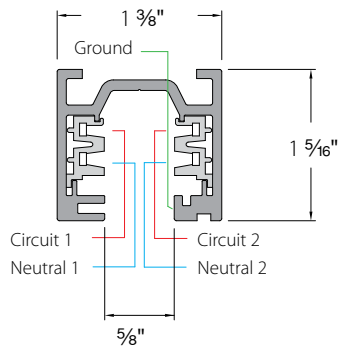

Stem or cable suspension

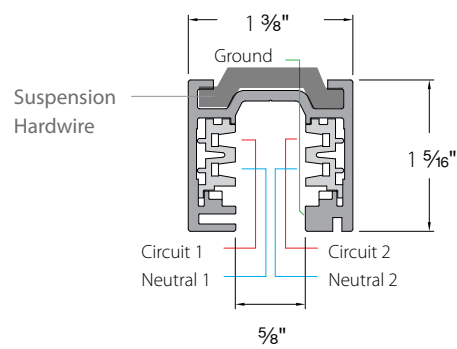

W TRACK 120V/277V SURFACE MOUNT TWO CIRCUIT ARCHITECTURAL TRACK

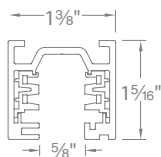

120V/277V TRACK SECTIONS

Model		Length	Finish
WT	120V	4 4'	BK Black
WHT	277V	8 8'	PT Platinum
		12 12'	WT White

Example: **WHT4-PT**

Each section includes two matching end caps.

ACCESSORIES

	Model	Volt	Finish	Description
Live End Connector - Left	WEDL WHEDL	120V 277V	BK PT WT	Direct wiring through ceiling. Polarity on left side of track
Live End Connector - Right	WEDR WHEDR	120V 277V	BK PT WT	Direct wiring through ceiling. Polarity on right side of track
"I" Connector	WPC WHPC	120V 277V	BK PT WT	Join two sections of track with electrical continuity.
"I" Power Connector	WIC WHIC	120V 277V	BK PT WT	Power entry point at the connection of two tracks.
Flexible Connector	WFC WHFC	120V 277V	BK PT WT	Transition from wall-to-wall, wall-to-ceiling, or ceiling-to-ceiling. Power feedable.
Canopy Plate	CP	120V 277V	BK PT WT	Covers a standard 4" octagonal box.
End Cap	WEC	120V 277V	BK PT WT	

= Indicates Electrical Continuity

"L" Connector - Left	WLLC WHLIC	120V 277V	BK PT WT	Join 2 track sections to make power feedable 90° left polarity turns.
"L" Connector - Right	WRLC WHRLC	120V 277V	BK PT WT	Join 2 track sections to make power feedable 90° right polarity turns.
"T" Connector - Left	WLTC WHLTC	120V 277V	BK PT WT	Join 3 track sections. Power feedable. Polarity on outside edge.
"T" Connector - Right	WRTC WHRTC	120V 277V	BK PT WT	Join 3 track sections. Power feedable. Polarity on inside edge.
"X" Connector	WXC WHXC	120V 277V	BK PT WT	Join 4 track sections. Power feedable.

SUSPENSION

	Model	Length	Finish	Description
Stem Kit With Power Feed	WMSP	6 6"	BK PT WT	Power feed to connect with a Live End or any Joiner/Feeder. Field cuttable.
		12 12"		
		24 24"		
		36 36"		
		48 48"		
Flexible Power Feed	WMFP	48 48"	BK PT WT	Flexible power feed to connect with a Live End or any Joiner/Feeder. Recommended for use with Cable Suspensions. Field cuttable.
		96 96"		
Pendant Stem Kit	WMT-X	6 6"	BK PT WT	Suspend track from the ceiling. Field cuttable.
		12 12"		
		24 24"		
		36 36"		
T-Bar Stem Kit	WMT-TB	48 48"	BK PT WT	Suspend from drop ceilings. Field cuttable.
		96 96"		
Sloped Ceiling Stem Kit	WMT	XS6 6"	BK PT WT	Suspend track from a sloped ceiling. Field cuttable.
		XS12 12"		
		XS24 24"		
		XS36 36"		
		XS48 48"		
Sloped Ceiling Cable Kit	WMST	XS48 48"	BK PT WT	Suspend track from a sloped ceiling. Field cuttable.
		XS96 96"		
Suspension Cable Kit	WMST-X	48 48"	BK PT WT	Suspend track from the ceiling. Field cuttable.
		96 96"		
T-Bar Suspension Cable Kit	WMST-TB		BK PT WT	Suspend track from drop ceilings. Field cuttable.

SUSPENSION ACCESSORIES

	Model	Finish
"I" Power Connector Suspension Mount	WMPC	BK PT WT
Power Feed Coupler Suspension Mount Use with "I" power connector	WMIC	BK PT WT
Live End Suspension Mount	WMED	BK PT WT
"L" Connector Suspension Mount	WMLC	BK PT WT
"T" Connector Suspension Mount	WMTC	BK PT WT
"X" Connector Suspension Mount	WMXC	BK PT WT
Suspension Hanger Clip	WMT	BK PT WT

W TRACK 120V/277V CURRENT LIMITER

EXAMPLE INSTALLATION

10' run of 2-circuit 120V W track in a retail environment with four 11.5 watt LED fixtures

Actual energy usage: 2 fixtures x 11.5W x 2 circuit = 46W

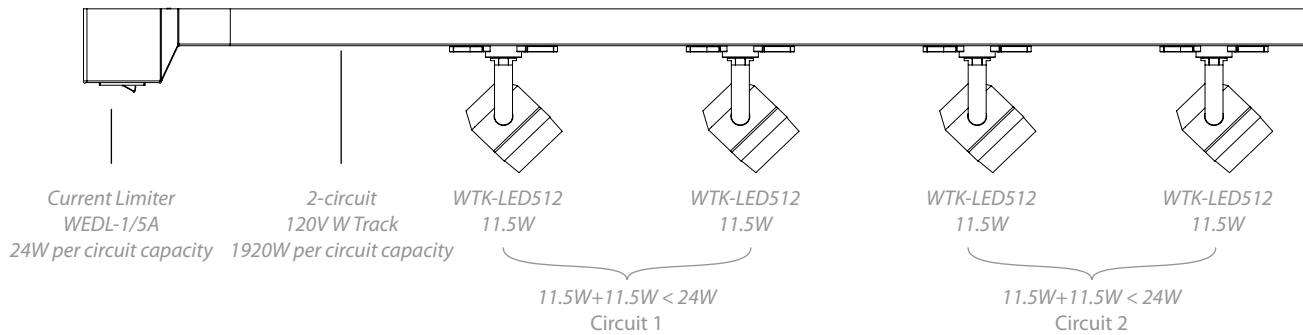

Without a current limiter

Wattage towards energy allowance

ASHRAE 90.1 and IECC

10 linear ft x 30W x 2 circuit = 600W

California's Title 24

10 linear ft x 45W x 2 circuit = 900W

With a current limiter

Wattage towards energy allowance

ASHRAE 90.1 and IECC

24W current limiter = 24W x 2 circuit = 48W - Energy allowance saving is 600W - 48W = 552W

California's Title 24

10 linear ft x 12.5W = 125W x 2 circuit = 250W - Energy allowance saving is 900W - 250W = 750W

- If the track is overloaded the current limiter circuit breaker will trip and shut down power to the circuit
- May be reset when the overall sum of fixture wattages are reduced below the circuit breaker rating

120V W TRACK

	Model	Rating	Circuit Breaker	Max Wattage	Finish				
Single Live end (Left)	WEDL Surface Mount	1/5A 2 X 0.2Amp 1/2A 2 X 0.5Amp 1A 2 X 1 Amp 2A 2 X 2.5Amp 5A 2 X 5 Amp 7A 2 X 7.5Amp 10A 2 X 10Amp	2 X 24W	2 X 60W	BK Black PT Platinum WT White				
	WEDL-RT Recessed Flanged					2 X 120W			
	WEDL-RTL Recessed Flangeless						2 X 300W		
Single Live end (Right)	WEDR Surface Mount							2 X 600W	
	WEDR-RT Recessed Flanged								2 X 900W
	WEDR-RTL Recessed Flangeless								

Example: **WEDL-1/5A-BK**

277V W TRACK

	Model	Rating	Circuit Breaker	Max Wattage	Finish		
Single Live end (Left)	WHEDL Surface Mount	1A 2 X 1 Amp 2A 2 X 2.5Amp 5A 2 X 5 Amp 7A 2 X 7.5Amp 10A 2 X 10Amp	2 X 277W	2 X 692W	BK Black PT Platinum WT White		
Single Live end (Right)	WHEDR Surface Mount					2 X 1385W	
							2 X 2077W

Example: **WHEDL-1A-BK**

W TRACK 120V/277V DESIGN GUIDELINES

STRAIGHT CONFIGURATION

- A **WEDR** Live end connector (right)
- B **WIC** I power connector
- C **WPC** I connector
- D **WEC** End cap

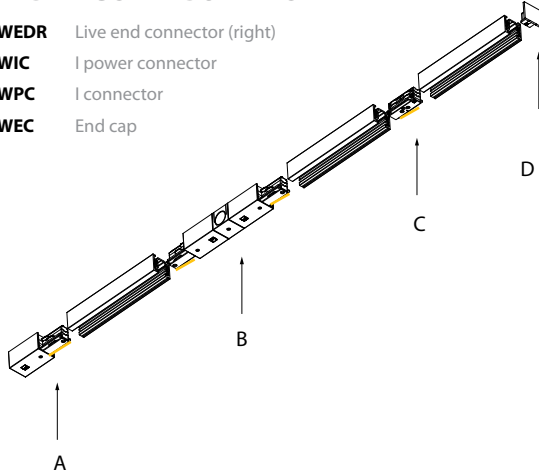

FLEXIBLE CONFIGURATIONS

- A **WEDR** Live end connector (right)
- B **WEDL** Live end connector (left)
- C **WFC** Flexible connector
- D **WEC** End cap

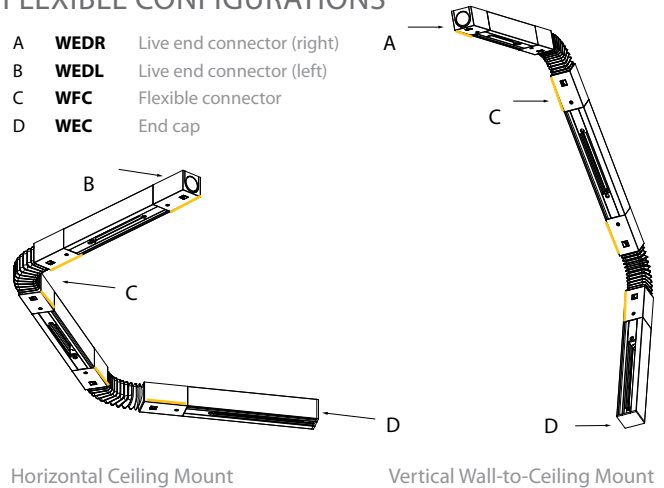

GRID CONFIGURATION

- A **WLLC** L Connector Left
- B **WLTC** T Connector Left
- C **WRTC** T Connector Right
- D **WXC** X Connector

= Indicates Electrical Continuity

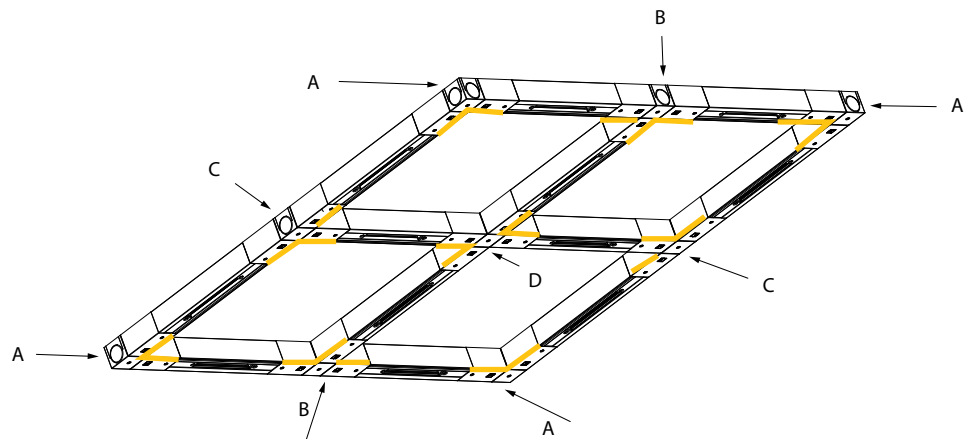

CABLE SUSPENSION MOUNT

Use one support for every 4 feet

- A **WMFP** Flexible Stem kit with power feed
- B **WMED** Live end suspension mount
- C **WEDL** Live end connector (left)
- D **WMST-X** Cable suspension kit
- E **WMT** Suspension hanger clip
- F **WMST-TB** T bar cable suspension kit
- G **WMST-XS** Sloped ceiling cable kit
- H **WMLC** L connector suspension mount
- I **WLLC** L connector left
- J **WEC** End cap

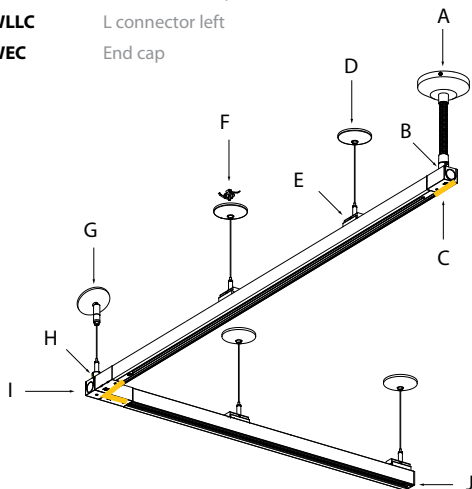

STEM SUSPENSION MOUNT

- A **WMSP** Stem kit with power feed
- B **WMED** Live end suspension mount
- C **WEDR** Live end connector (right)
- D **WMT-XS** Sloped ceiling stem kit
- E **WMT** Suspension hanger clip
- F **WMT-TB** T bar stem kit
- G **WMT-X** Stem kit
- H **WMLC** L connector suspension mount
- I **WLLC** L connector left
- J **WEC** End cap

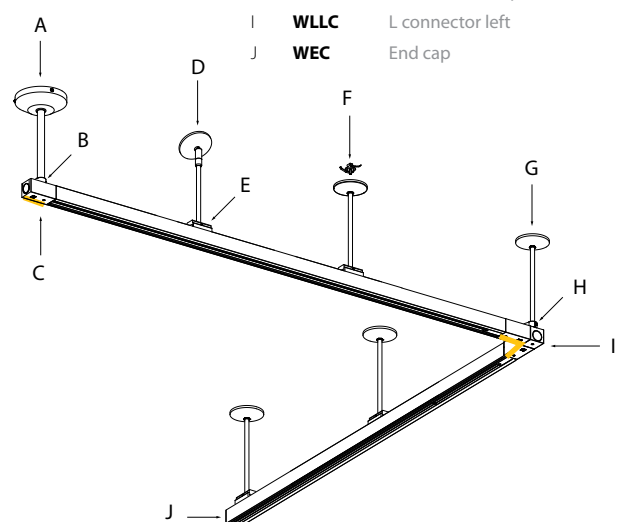

RECESSED W TRACK RECESSED MOUNTED TWO CIRCUIT ARCHITECTURAL TRACK 120V

Description: *Recessed architectural grade track with two independently controllable circuits (isolated neutral) with flangeless option*

Power per Circuit: 1920W max (120V)

Operating Current: Each circuit is rated 20A (2 x 20A = 40A max)

120V

FLANGED

A clean 1 1/8" wide reveal upon recessing track into ceilings.

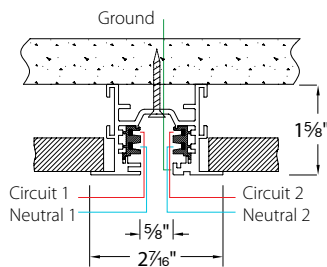

FLANGELESS

Designed to accommodate spackle and paint to create the illusion of a simple groove in the ceiling plane absent of track.

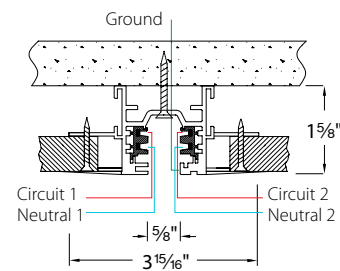
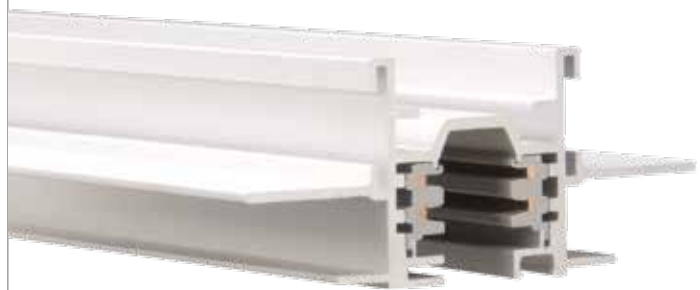

W TRACK COVER

8 Foot track cover that fits any W track section.

Can be field cut to match the length of the gap, and be painted over to match the color of the surroundings.

System	Model	Finish
W Track	W8-COV-WT	White

RECESSED W TRACK RECESSED MOUNTED TWO CIRCUIT ARCHITECTURAL TRACK

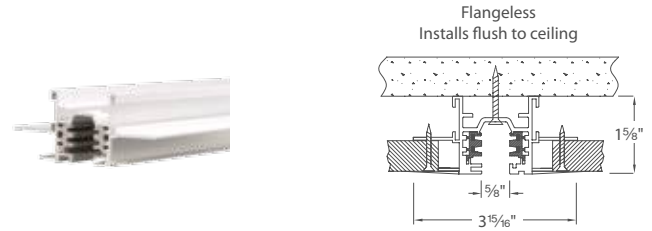
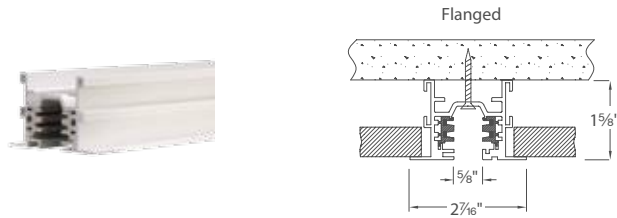

FLANGED TRACK SECTIONS

Model	Length	Track Type	Finish
WT 120V	4 4'	RT Flanged	BK Black
	8 8'		PT Platinum
	12 12'		WT White

Example: **WT8-RT-WT**

Each section includes two matching end caps.

FLANGELESS TRACK SECTIONS

Model	Length	Track Type	Finish
WT 120V	4 4'	RTL Flangeless	BK Black
	8 8'		PT Platinum
	12 12'		WT White

Example: **WT8-RTL-WT**

Each section includes two matching end caps.

= Indicates Electrical Continuity

Accessories	Flanged	Flangeless	Model	Voltage	Flanged/Flangeless	Finish	Description
Live End Connector – Left			WEDL	120V	RT Flanged RTL Flangeless	BK PT WT	Use for direct wiring through ceiling.
Live End Connector – Right			WEDR	120V			
"I" Connector			WPC	120V	RT Flanged / Flangeless	BK PT WT	Use to join two sections of track with electrical continuity.
"I" Power Connector			WIC	120V	RT Flanged RTL Flangeless	BK PT WT	Power entry point at the connection of two tracks.
"L" Connector – Left			WLLC	120V	RT Flanged RTL Flangeless	BK PT WT	Use to join 2 track sections to make power feedable 90° left polarity turns.
"L" Connector – Right			WRLC	120V			Use to join 2 track sections to make a power feedable 90° right polarity turns.
"T" Connector – Left			WLTC	120V	RT Flanged RTL Flangeless	BK PT WT	Use to join 3 track sections. Power feedable. Polarity on outside edge.
"T" Connector – Right			WRTC	120V			Use to join 3 track sections. Power feedable. Polarity on inside edge.
"X" Connector			WXC	120V	RT Flanged RTL Flangeless	BK PT WT	Use to join 4 track sections. Power feedable.
Suspension Hanger Clip			WMT	120V	RT Flanged / Flangeless		To suspend the track to superstructure. Without power feed.
End Cap			WEC	120V	RT Flanged / Flangeless	BK PT WT	

PALOMA PREMIUM LED

Museum-quality LED luminaires with high performance reflector optics and recessed drivers

- Die-cast aluminum construction
- 365° horizontal rotation and 180° vertical aiming
- 50,000 hours rated life

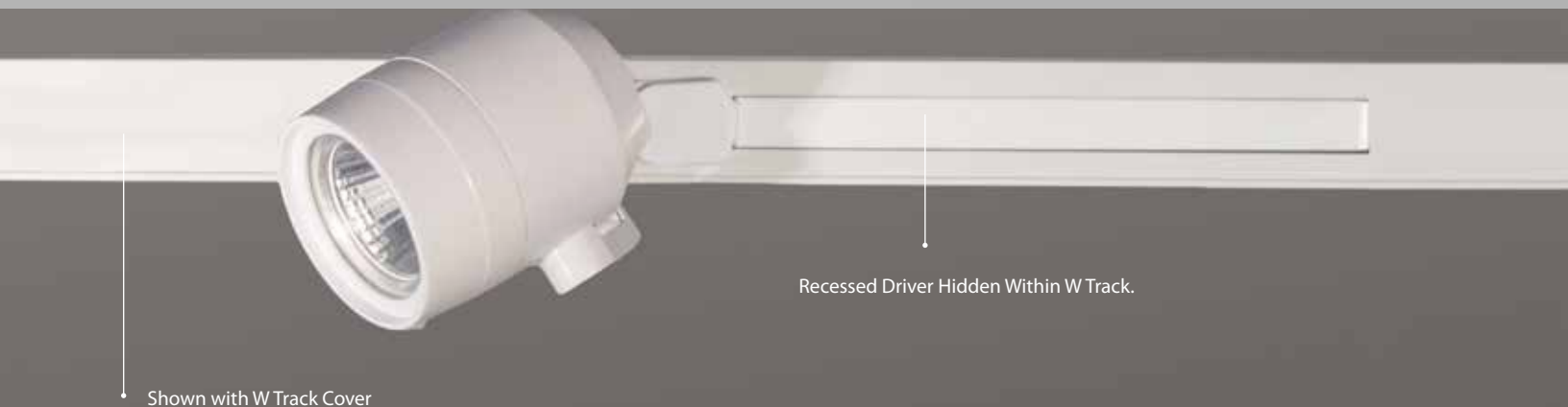

Shown with WTrack Cover

Recessed Driver Hidden Within W Track.

Accommodates 1 filter lens and 1 accessory
Color Lenses, Filter Lenses, and Beam Control



PALOMA LED512

Power: 11.5W
 Input: 120V, 277V
 Comparable: 50W MR16
 ELV Dimming: 100%-5% (120V only)
 Rated Life: 50,000 hours



System	Model	Beam	Color Temp	CRI	Lumen	CBCP	Finish
	WTK W Track 120V WHK W Track 277V	LED512	S 19° N 24° F 36°	27 2700K 85	Up to 780	Up to 3430	BK Black PT Platinum WT White
				30 3000K 85			
				35 3500K 85			
				40 4000K 85			
				927 2700K 90			
				930 3000K 90			

Example: **WTK-LED512S-27-BK**

LENSES AND ACCESSORIES (ORDER SEPARATELY)

Amber	LENS-16-AMB	Spread Lens	LENS-16-SPR
Blue	LENS-16-BLU	Beam Elongating	LENS-16-BEL
Green	LENS-16-GRN	Cross Louver	LENS-16-CRL
Red	LENS-16-RED	Honeycomb	LENS-16-HCL
Frosted Lens	LENS-16-FR	Snoot	LENS-16-SNOOT-BK
			LENS-16-SNOOT-WT



PALOMA LED522

Power: 23.5W
 Input: 120V, 277V
 Comparable: 75W MR16
 ELV dimming: 100%-5% (120V only)
 Rated Life: 50,000 hours



System	Model	Beam	Color Temp	CRI	Lumen	CBCP	Finish
	WTK W Track 120V WHK W Track 277V	LED522	S 19° N 24° F 36°	27 2700K 85	Up to 1310	Up to 5780	BK Black PT Platinum WT White
				30 3000K 85			
				35 3500K 85			
				40 4000K 85			
				927 2700K 90			
				930 3000K 90			

Example: **WTK-LED522S-30-WT**

LENSES AND ACCESSORIES (ORDER SEPARATELY)

Amber	LENS-20-AMB	Spread Lens	LENS-20-SPR
Blue	LENS-20-BLU	Beam Elongating	LENS-20-BEL
Green	LENS-20-GRN	Cross Louver	LENS-20-CRL
Red	LENS-20-RED	Honeycomb	LENS-20-HCL
Frosted Lens	LENS-20-FR	Snoot	LENS-20-SNOOT-BK
			LENS-20-SNOOT-WT



Driver hidden inside
W track



Twist to continuously
adjust beam angle

PALOMA LED523 ADJUSTABLE BEAM

Power: 24W
Input: 120V, 277V
Comparable: 20W HID
ELV Dimming: 100%-5% (120V only)
Rated Life: 50,000 hours

Museum-quality LED luminaire with adjustable beam angle

- Adjustable beam angle between 15° - 60°
- Die-cast aluminum construction
- 365° horizontal rotation and 180° vertical aiming

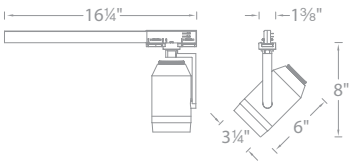
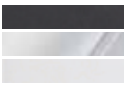
System	Model	Color Temp	CRI	Max Lumens	Max CBCP	Finish
 <p>WTK W Track 120V WHK W Track 277V</p>	LED523	27 2700K	85	1340	6840	BK Black PT Platinum WT White 
		30 3000K	85	1260	6515	
		35 3500K	85	1500	7595	
		40 4000K	85	1350	6635	
		927 2700K	90	1495	7280	
	930 3000K	90	1600	7650		

Example: **WTK-LED523-927-PT**

ADJUSTABLE BEAM ANGLE

Adjustable between 15° - 60°

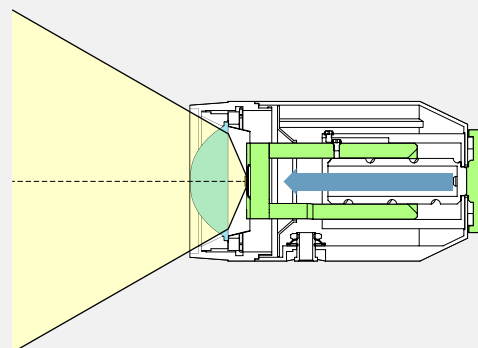
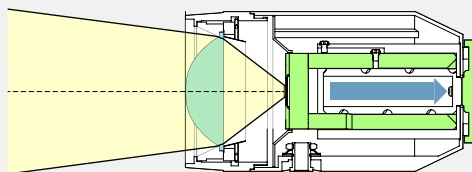

Adjustable between 15° - 50°

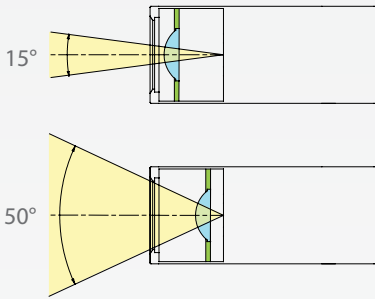

Beam alignment indicator



Optional Focusing Framing Projector Accessory **FP-K**

- Dual adjustable optical lenses precision focus light for crisp illumination
- Adjustable framing shims create a feature accenting, rectangular pattern of illumination



without Framing Projector



with Framing Projector

PALOMA LED 4023 ADJUSTABLE BEAM

TITLE 24
CALIFORNIA

Power: 23W
Input: 120V, 277V
Comparable to: 20W HID
Dimming: 100%-5% ELV & TRIAC (120V only)
Rated Life: 50,000 hours

Museum-quality LED luminaire with adjustable beam angle

- Continuously adjustable beam angle between 15° - 50°
- Die-cast aluminum construction with rotatable front face
- Stealth armature with 365° horizontal rotation and 90° vertical aiming
- Patents Pending
- UL & cUL Listed

System		Model	Color Temp	CRI	Beam	Max Lumens	Max CBCP	Finish
	WTK W Track 120V	4023	827 2700K	85	15°	985	5265	BK Black PT Platinum WT White
	WHK W Track 277V		830 3000K	85				
			835 3500K	85	50°	1340	1700	
			840 4000K	85				
			927 2700K	90				
			930 3000K	90				

Example: **WTK-4023-930-BK**

Accommodates one lens accessory and one glare control accessory

LENS ACCESSORIES

Amber	LENS-16-AMB
Blue	LENS-16-BLU
Green	LENS-16-GRN
Red	LENS-16-RED
Frosted	LENS-16-FR
Spread	LENS-16-SPR
Beam Elongating	LENS-16-BEL

GLARE CONTROL ACCESSORIES

Cross Louver	LENS-16P-CRL-BK LENS-16P-CRL-PT LENS-16P-CRL-WT
Snoot	LENS-16-SNOOT-BK LENS-16-SNOOT-PT LENS-16-SNOOT-WT
Honeycomb Louver	LENS-16-HCL

FRAMING PROJECTOR ACCESSORIES

Framing Projector	FP-K-BK FP-K-WT
-------------------	----------------------------------

Monopoint available
see page 61





EXTERMINATOR II 1014



Power: 14W
 Input: 120V
 Comparable: 20W HID
 ELV Dimming: 100% - 5%
 Rated Life: 100,000 hours

- Accommodates one lens accessory and one glare control accessory
- Reflectors and LED modules can be purchased separately for alternative beam angles and color temperatures
- 365° horizontal rotation and 180° vertical aiming
- UL & cUL Listed

System	Model	Color Temp	CRI	Max Lumens	Max CBCP	Finish
<p>WTK W Track 120V</p>	1014	N 20°	827 2700K 85	965	4585	BK Black PT Platinum WT White
			F 40°			
		835 3500K 85				
		840 4000K 85				
		927 2700K 90	980	2117		
		930 3000K 90				

Example: **WTK-1014N-927-PT**

LENS ACCESSORIES

Amber	LENS-11-AMB
Blue	LENS-11-BLU
Green	LENS-11-GRN
Red	LENS-11-RED
Frosted	LENS-11-FR
Spread	LENS-11-SPR
Beam Elongating	LENS-11-BEL

GLARE CONTROL ACCESSORIES

Snoot	LENS-11-SNOOT-BK LENS-11-SNOOT-PT LENS-11-SNOOT-WT
Cross Louver	LENS-11P-CRL-BK LENS-11P-CRL-PT LENS-11P-CRL-WT

REFLECTORS

20°	SL-REF-CXA1310-N
40°	SL-REF-CXA1310-F



EXTERMINATOR II 1023



Power: 22W
Input: 120V, 277V
Comparable: 39W HID
ELV Dimming: 100% - 5%
Rated Life: 50,000 hours

- Accommodates one lens and one glare control accessory
- Reflectors and LED modules can be purchased separately for alternative beam angles and color temperatures
- 365° horizontal rotation and 180° vertical aiming
- UL & cUL Listed

System	Model	Color Temp	CRI	Max Lumens	Max CBCP	Finish	
	WTK WTrack 120V WHK W Track 277V 1023	N 18°	827 2700K 85	2030	11530	BK Black PT Platinum WT White	
		F 38°	830 3000K 85				
		835 3500K 85					
				840 4000K 85	1955		4810
				927 2700K 90			
				930 3000K 90			

Example: **WTK-1023F-930-WT**

FLAT LENS ACCESSORIES

Amber	LENS-16-AMB
Blue	LENS-16-BLU
Green	LENS-16-GRN
Red	LENS-16-RED
Frosted	LENS-16-FR
Spread	LENS-16-SPR
Beam Elongating	LENS-16-BEL

GLARE CONTROL ACCESSORIES

Snoot	LENS-16-SNOOT-BK LENS-16-SNOOT-PT LENS-16-SNOOT-WT
Cross Louver	LENS-16P-CRL-BK LENS-16P-CRL-PT LENS-16P-CRL-WT

REFLECTORS

18°	RF-S
38°	RF-F



EXTERMINATOR II 1035



Power: 35W
Input: 120V, 277V
Comparable: 50W HID
ELV Dimming: 100% - 5%
Rated Life: 60,000 hours

- Accommodates one lens accessory and one glare control accessory
- Reflectors and LED modules can be purchased separately for alternative beam angles and color temperatures
- 365° horizontal rotation and 180° vertical aiming
- UL & cUL Listed

System	Model	Color Temp	CRI	Max Lumens	Max CBCP	Finish
	WTK WTrack 120V WHK W Track 277V 1035	N 25° F 55°	827 2700K 85	2795	9748	BK Black PT Platinum WT White
			830 3000K 85			
		835 3500K 85	2828	3886		
		840 4000K 85				
		927 2700K 90	3886			
		930 3000K 90				

Example: **WHK-1035F-830-BK**

LENS ACCESSORIES

Amber
 Blue
 Green
 Red
 Frosted
 Spread
 Beam Elongating

LENS-20-AMB
LENS-20-BLU
LENS-20-GRN
LENS-20-RED
LENS-20-FR
LENS-20-SPR
LENS-20-BEL

GLARE CONTROL ACCESSORIES

Snoot

LENS-20-SNOOT-BK
LENS-20-SNOOT-PT
LENS-20-SNOOT-WT

Cross Louver

LENS-20P-CRL-BK
LENS-20P-CRL-PT
LENS-20P-CRL-WT

REFLECTORS

25° **SL-REF-BL18-N**
 55° **SL-REF-BL18-F**



EXTERMINATOR II 1052



Power: 52W
Input: 120V, 277V
Comparable: 70WHID
ELV Dimming: 100% - 5%
Rated Life: 80,000 hours

- Accommodates one lens accessory and one glare control accessory
- Reflectors and LED modules can be purchased separately for alternative beam angles and color temperatures
- 365° horizontal rotation and 180° vertical aiming
- UL & cUL Listed

System	Model	Color Temp	CRI	Max Lumens	Max CBCP	Finish
	1052	827 2700K 85	85	4237	15970	BK Black PT Platinum WT White
		830 3000K 85				
		835 3500K 85				
		840 4000K 85				
		927 2700K 90				
		930 3000K 90				

Example: **WTK-1052N-930-WT**

LENS ACCESSORIES

Amber	LENS-25-AMB
Blue	LENS-25-BLU
Green	LENS-25-GRN
Red	LENS-25-RED
Frosted	LENS-25-FR
Spread	LENS-25-SPR
Beam Elongating	LENS-25-BEL

GLARE CONTROL ACCESSORIES

Snoot	LENS-25-SNOOT-BK LENS-25-SNOOT-PT LENS-25-SNOOT-WT
Cross Louver	LENS-25P-CRL-BK LENS-25P-CRL-PT LENS-25P-CRL-WT

REFLECTORS

25°	SL-REF-LUX1208-N
55°	SL-REF-LUX1208-F

EXTERMINATOR LED20

Driver hidden inside
W track



Power: 23W
Input: 120V, 277V
Comparable: 39W HID
ELV Dimming: 100% - 10%
Rated Life: 60,000 hours

- Accommodates one lens accessory
- Reflectors and LED modules can be purchased separately for alternative beam angles and color temperatures
- 355° horizontal rotation and 180° vertical aiming
- UL & cUL Listed

System	Model	Color Temp	CRI	Max Lumens	Max CBCP	Finish
<p>WTK W Track 120V WHK W Track 277V</p>	LED20	S 20°	27 2700K 85	1450 1390	6772 2928	BK Black PT Platinum WT White
		F 40°	30 3000K 85			
			35 3500K 85			
			40 4000K 85			
			927 2700K 90			
			930 3000K 90			

Example: **WTK-LED20F-30-PT**

W TRACK QUICK CONNECT™ ADAPTER

The Quick Connect™ collection includes a wide array of pendants and fixtures with different mounting options.

The threaded male adapter makes inter-system compatibility a snap. Simply insert the metal fitting into the system adapter and hand tighten the collar.

Order one per Quick Connect™ fixture or pendant used.



QUICK CONNECT PENDANTS

Model number begins with **QP**-
See page 140, 146, 149-160



QUICK CONNECT FIXTURES

See page 141-144
for list of fixtures

System	Specifications	Model	Finish
W Track 120V 	<ul style="list-style-type: none"> • Simple switching between 2 circuits • Recessed transformer within W track • Allows all Quick Connect™ elements to be used with the W track 120V systems • 1W minimum load transformer • Smooth and continuous ELV dimming 	EN-WQ50AR	BK Black PT Platinum WT White

Example: **EN-WQ50AR-WT**



WALL WASHER LED42W

Power: 42W
Input: 120V, 277V
Comparable: 55W CFL
ELV Dimming: 100% – 10% (120V only)
Rated Life: 100,000 hours

Optimal uniformity from an asymmetrical wall wash luminaire designed to reduce necessary mounting distance from the wall compared to fluorescent wall washers

- Replaces halogen and fluorescent wall wash luminaires
- Die-cast aluminum construction
- Thin profile
- 45° vertical tilt

System	Model	Color Temp	Max		Finish
			CRI	Lumens	
	WTK W Track 120V WHK W Track 277V LED42W	27 2700K	85	2570	BK Black PT Platinum WT White
		30 3000K	85		
		35 3500K	85		
		40 4000K	85		

Example: **WTK-LED42W-27-WT**

Average Footcandle Performance (3000K, aimed for peak illuminance)

		A		
		2'	3'	4'
B	2'	128	79	51
	4'	51	41	32
	6'	26	23	20

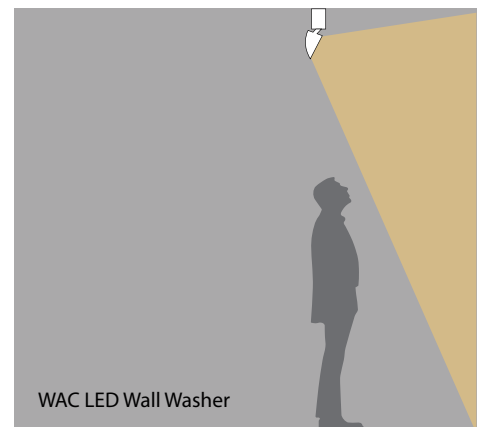
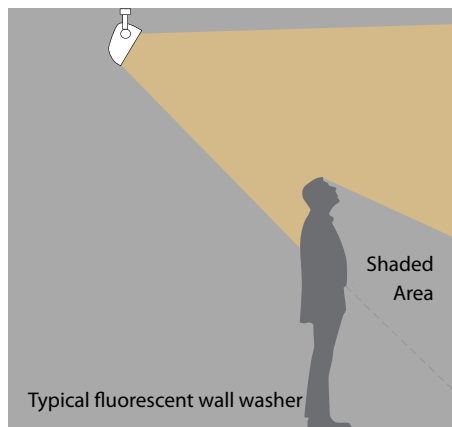

With the asymmetrical distribution WAC LED Wall Washer washes the wall at a shorter distance from the target surface to reduce chances of overshadowing from obstructions such as people standing near a wall.

J2 / H / J / L TRACK SYSTEM

A variety of 120V rigid track systems that can be used for new construction or retrofitted onto most existing track system installations.
Track luminaires are offered in H, L, J, or J2 adapters to specify as needed.

J2 TRACK



Shown Black

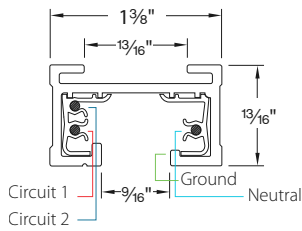

H TRACK



Shown Dark Bronze

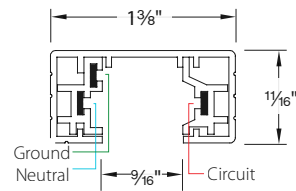

J TRACK



Shown White

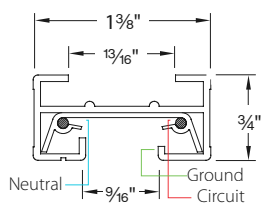

L TRACK

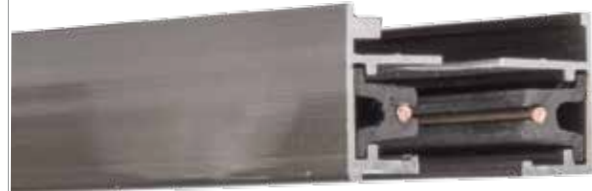

Shown Brushed Nickel

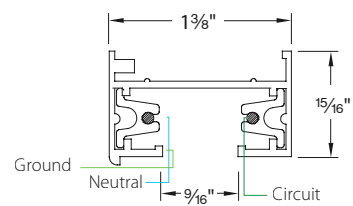

J2 TRACK TWO CIRCUIT TRACK

Description: Two circuit track with independently controllable circuits (shared neutral)
Power per Circuit: 1920 W max
Operating Current: Each circuit is rated 20A (2 x 20A = 40A max)



Saves on installation costs by eliminating the need for long separate feed runs

TRACK SECTIONS

Model	Length	Finish	Description
J2 J2 Track	T4 4'	BK Black WT White	120V 3-wire, wide style track
	T8 8'		
	T12 12'		

Example: **J2-T4-WT**

Each section includes two matching end caps.

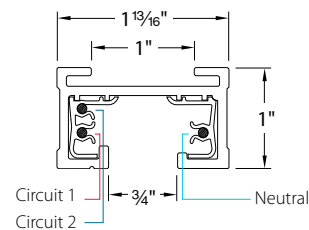

J CLIP

Model	Description
JCLIP	Each 4' section includes 3 Each 8' section includes 6 Each 12' section includes 9

Locks connectors on luminaire into 2-circuit mode

QUICK CONNECT ADAPTER

Model	Finish
EN-JQ50AR	BK WT

TRACK SUSPENSION

Model	Length	Finish
SK	18 18" 36 36"	BK WT
	24 24" 48 48"	
R	18 18" 48 48"	BK WT
	24 24" 72 72"	
	36 36"	
SK14		BK WT
RI		BK WT
SK05	Includes two collars	BK WT
X	6 6" 24 24"	BK WT
	12 12" 36 36"	
	18 18" 48 48"	
TBKT	18"	BK WT
J2-WCOV		BK WT

ACCESSORIES

Model	Finish	Dimensions
J2-LE	BK WT	4 3/4" x 1 1/4"
J2-BXLE	BK WT	5 7/8" x 1 3/8"
J2-IPWR	BK WT	7" x 1 3/8"
J2-LLEFT	BK WT	4 1/4" x 4 1/4"
J2-T	BK WT	7" x 4 1/4"
J2-X	BK WT	7" x 7"
J2-I	BK WT	4 1/2" x 1 3/8"
J2-IDEC	BK WT	3 1/2" x 1 3/8"
J2-FLX	BK WT	11 1/2" x 1 3/8"
T-BARCLIP		1 1/2" x 1 1/4"
J2-UCP	BK WT	4 1/8" x 4 1/8"
J2-TBLE	BK WT	4 1/8" x 4 1/8"

Example: **J2-FLX-BK**

H / J / L TRACK SYSTEMS

Description: Single circuit, H, L and J Track
Power per Circuit: 120V, 1920W max
Operating Current: Rated 20A max

H TRACK

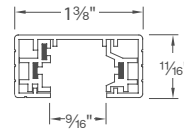

L TRACK

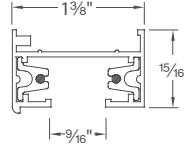

J TRACK

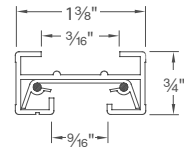

TRACK SECTIONS

Model	Length	Finish	Description
HT H Track	2' 2'	BK Black	120V 3-wire track
	4' 4'	BN Brushed Nickel	
	6' 6'	WT White	
	8' 8'	DB* Dark Bronze	
JT J Track LT L Track	2' 2'	BK Black	120V 2-wire track
	4' 4'	BN Brushed Nickel	
	6' 6'	WT White	
	8' 8'	WT White	







Example: **HT6-BK**

Each section includes two matching end caps.

QUICK CONNECT ADAPTER















Model	Finish	Description
<i>Quick Connect Adapter</i> 	EN-HQ50AR H Track EN-JQ50AR J Track EN-LQ50AR L Track	BK Black BN Brushed Nickel WT White DB* Dark Bronze
		Use to easily connect any Quick Connect pendant or fixture. Min. Load: 1W Max Load: 50W

TRACK SUSPENSION

Model	Length	Finish	Description
<i>All Track Suspension Kit</i> 	SK 18 18" 36 36" 24 24" 48 48"	BK Black BN Brushed Nickel WT White DB* Dark Bronze	Extends track from ceiling. Includes track bracket, rod and ceiling canopy.
	R 18 18" 48 48" 24 24" 72 72" 36 36"	BK Black BN Brushed Nickel WT White DB* Dark Bronze	
<i>Sloped Ceiling Adapter</i> 	SK14	BK Black BN Brushed Nickel WT White DB* Dark Bronze	Use with suspension kits to accommodate sloped ceilings. Max capacity: 7A, 800W, 120V
<i>Rod Coupler</i> 	RI	BK Black BN Brushed Nickel WT White DB* Dark Bronze	Join two rods for suspensions longer than 48".
<i>Suspension Adjustment Collar kit</i> 	SK05 Includes two collars	BK Black BN Brushed Nickel WT White DB* Dark Bronze	Used when suspension rod is field cut to custom lengths. One kit of two required for each rod.
<i>Low Voltage Track Head Extension</i> 	X 6 6" 24 24" 12 12" 36 36" 18 18" 48 48"	BK Black BN Brushed Nickel WT White DB* Dark Bronze	Extends low voltage track heads from track. Specify extension, fixture and finish. Only available as complete unit. Custom order Example: X18-HHT-809-WT
	H 18 18" 36 36" 24 24" 48 48"	BK Black BN Brushed Nickel WT White DB* Dark Bronze	
	TBKT 18"	BK Black BN Brushed Nickel WT White DB* Dark Bronze	
<i>Wall Mount Suspension Bracket</i> 	TBKT 18"	BK Black BN Brushed Nickel WT White DB* Dark Bronze	Extends track 24" from wall. Use two per 4' length, three per 8' length.

Example: **SK24-BK**

*DB finish only available for H Track

ACCESSORIES	Model	Finish	Description		
Live End Connector	 HLE LLE JLE	BK Black BN Brushed Nickel WT White DB* Dark Bronze	4¼" × 1⅜" × ¾" 4¼" × 1⅜" × ¾" 4¾" × 1¼" × ¾"	Use for direct wiring through ceiling. A canopy plate is required when using with a standard junction box.	
Live End BX Connector	 HBXLE JBXLE LBXLE	BK Black BN Brushed Nickel WT White DB* Dark Bronze	6" × 1⅜" × 1¼" 5¾" × 1⅜" × 1¼" 6¼" × 1⅜" × 1¼"	Use with surface mounted BX or non-metallic sheathed cable. Also provides through the ceiling connection.	
"I" Power Connector	 HI-PWR JI-PWR LI-PWR	BK Black BN Brushed Nickel WT White DB* Dark Bronze	6¾" × 1⅜" × ¾" 7" × 1⅜" × ¾" 7⅞" × 1⅜" × ¾"	Power entry point at the connection of 2 tracks.	
"L" Connector Left		HL-LEFT JL-LEFT LL-LEFT	2¾" × 2¾" × ¾" 4¼" × 4¼" × ¾" 4¼" × 4¼" × ¾"	Use to join 2 track sections to make power feedable 90° left polarity turns.	
"L" Connector Right		HL-RIGHT JL-RIGHT LL-RIGHT	2¾" × 2¾" × ¾" 4¼" × 4¼" × ¾" 4¼" × 4¼" × ¾"	Use to join 2 track sections to make power feedable 90° right polarity turns.	
"T" Connector	 HT JT LT	BK Black BN Brushed Nickel WT White DB* Dark Bronze	4" × 2¾" × ¾" 7¼" × 4¼" × ¾" 7⅞" × 4¼" × ¾"	Use to join 3 track sections. Power feedable on H and J only. "T" Connector with opposite polarity can be custom ordered.	
"X" Connector	 HX JX LX	BK Black BN Brushed Nickel WT White DB* Dark Bronze	4⅞" × 4⅞" × ¾" 7⅞" × 7⅞" × ¾" 7⅞" × 7⅞" × ¾"	Use to join 4 track sections. Power feedable on H and J only.	
"I" Connector	 HI JI LI	BK Black BN Brushed Nickel WT White DB* Dark Bronze	3" × 1⅜" × ¾" 3⅞" × 1⅜" × ¾" 3" × 1⅜" × ¾"	Use to join two sections of track with electrical continuity.	
"I" Dead End Connector	 HI-DEC JI-DEC LI-DEC	BK Black BN Brushed Nickel WT White DB* Dark Bronze	3" × 1⅜" × ¾" 3⅞" × 1⅜" × ¾" 3" × 1⅜" × ¾"	Joins two sections of track without electrical continuity.	
Flexible Track Connector	 HFLX JFLX LFLX	BK Black BN Brushed Nickel WT White DB* Dark Bronze	9¾" × 1⅜" × ¾" 10¼" × 1⅜" × ¾" 8½" × 1⅜" × ¾"	Connects two track sections at variable angles. Use as a transition from wall-to-wall, wall-to-ceiling, or ceiling-to-ceiling. Power feedable.	
Suspension Loop	 H-LOOP J-LOOP L-LOOP	BK Black BN Brushed Nickel WT White DB* Dark Bronze	1⅜" × 1⅜" × 3" 1⅜" × 1⅜" × 3" 1⅜" × 1⅜" × 3"	3 inch electrical loop accepts chain hung fixtures up to 35lbs. Contains compartment for electrical connections.	
15' Cord, Male Plug		HCORD use with H and J	BK Black WT White	15'	Maximum capacity: 7A, 800W, 120V.
15' Cord, Male Plug w/Switch		LCORDSET use with L			
T-Bar Drop Ceiling Attachment	 T-BARCLIP	Chrome	1½" × 1¼"	Attaches track to T-bar drop ceilings. Use two for 2 foot or 4 foot tracks, three for 6 foot or 8 foot tracks.	
Monopoint Canopy Adapter	 HMP JMP LMP	BK Black BN Brushed Nickel WT White DB* Dark Bronze	Ø 4¾" Ø 4⅜" 5⅜" × 5⅜"	Mount a single H, L or J system track fixture to a junction box. When used with a low voltage track head the transformer box will protrude off of the face of the monopoint.	
Canopy Plate	 CP	BK Black BN Brushed Nickel WT White DB* Dark Bronze	4½" × 4½"	Covers a standard 4 inch junction box. Use with any powerable connectors.	
Floating Canopy Connector	 HFC JFC LFC	BK Black BN Brushed Nickel WT White DB* Dark Bronze	4½" × 4½" × 1½" 4¼" × 4¼" × 1⅜" 4⅝" × 4⅝" × 1⅜"	Connects to octagon box. Allows track to be powered anywhere along the length of the track	

*DB finish only available for H Track

H TRACK CURRENT LIMITER (FOR H TRACK SYSTEM)

WAC Track Current Limiters are designed to address energy allowances.

WITHOUT A CURRENT LIMITER

Wattage towards energy allowance

ASHRAE 90.1 AND IECC

The greater of either:

- The sum of the maximum rated wattage of the luminaires OR
- 30 watts per linear ft of track circuit

CALIFORNIA'S TITLE 24

The greater of either:

- The sum of the maximum rated wattage of the luminaires OR
- 45 watts per linear ft of track circuit

WITH A CURRENT LIMITER

Wattage towards energy allowance







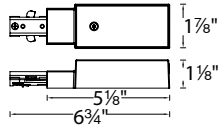

ASHRAE 90.1 AND IECC

Wattage rating of the current limiter

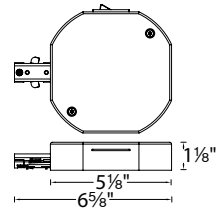
CALIFORNIA'S TITLE 24

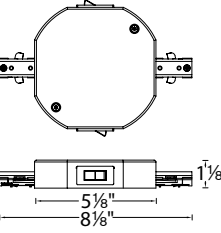
The greater of either:

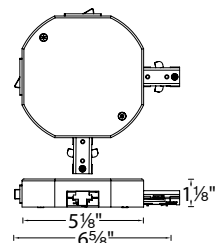
- Wattage rating of the current limiter OR
- 12.5 watts per linear foot of track circuit

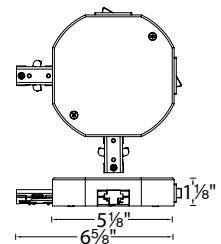
		Model	Circuit Breaker	Max Wattage	Finish
		THL-HLES			
<i>Slim Single Live End</i>			1/5A 0.2A 1/2A 0.5A 1A 1.0A 2A 2.5A 5A 5.0A 7A 7.5A 10A 10.0A	24W 60W 120W 300W 600W 900W 1200W	
		THL-HLE			
<i>Single Live End</i>					
		THL-HI			
<i>Double Live End</i>			1-1/5A 0.2A 2-1/5A 0.2A per end	24W 24W per end	
		THL-LEFT			
<i>Double Live End (Left)</i>			1-1A 1.0A 2-1A 1.0A per end 1-2A 2.5A 2-2A 2.5A per end 1-5A 5.0A 2-5A 5.0A per end	120W 120W per end 300W 300W per end 600W 600W per end	
		THL-RIGHT			
<i>Double Live End (Right)</i>			1-7A 7.5A 2-7A 7.5A per end 1-10A 10.0A 2-10A 10.0A per end	900W 900W per end 1200W 1200W per end	

- BK** Black
- BN** Brushed Nickel
- DB** Dark Bronze
- WT** White



Example: **THL-LEFT-1-1/5A-WT**

J2 / H / J / L TRACK SYSTEMS DESIGN GUIDELINES

Choose track system	WAC Lighting offers standard systems: L, H and J single circuit track systems and our J2 two circuit system.
Laying out the track design	Determine layout of track and choose appropriate connectors to achieve the look you desire. Mark along the ceiling to indicate the placement of the track.
Power	For direct ceiling mounting connect to J box using a live end connector in conjunction with a canopy plate. For suspension mounting, connect to J box using a suspension kit canopy. Your maximum load capacity per circuit is 1920W. Determine the total wattage of the fixtures before laying out the remainder of the system.
Mounting	For direct ceiling mounting, screw directly into ceiling. For drop ceilings, use two T-bar clips for 2 foot or 4 foot track and three for 6 foot or 8 foot track. In order to suspend the track, determine your ceiling type, flat or sloped, and choose appropriate standoffs. Use three supports minimum for an 8 foot section and two for a 4 foot section. Custom length suspensions are possible with the use of suspension rods.
Joining track sections	"I" connectors can be either conductive or non conductive. Non-conductive dead end "I" connectors may be used to electrically separate two runs without any visible separation to the design. Other available connectors include an "X" connector, "L" connector, "T" connector, and a flexible track connector.
Quick Connect™	Quick Connect™ Fixtures and Pendants allow for an extensive selection of glass and metal elements to complement the 120V track design. All Quick Connect™ elements require the appropriate Quick Connect™ track adapter. (e.g. EN-HQ50AR-BK)
Useful Tips	Track is supplied with two end caps. Assistance is only a phone call away. If you need help or design ideas please call WAC Lighting to speak to a friendly technical support specialist at (800)526-2588.

SAMPLE LAYOUT (EXAMPLE USING L TRACK SYSTEM)

A	SK18	18" Track suspension rod
B	LLE	Live end connector
C	LT2	2 foot Section of L Track
D	LL-LEFT	"L" Connector (Left)
E	L-LED17S-27	LEDme™ LED track head
F	L-ENDCAP	End Cap (included with track section)

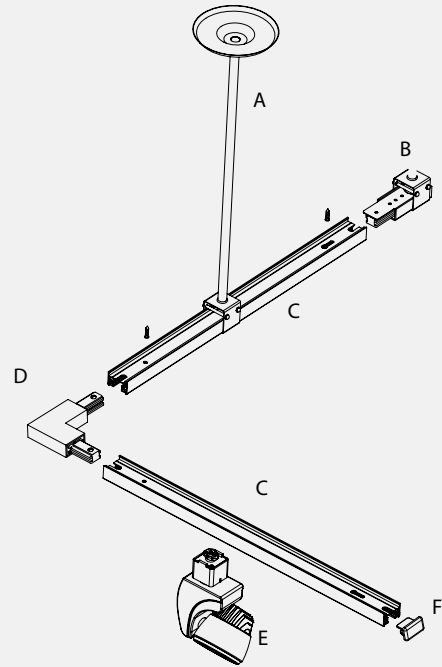

SELECTING CONNECTORS (EXAMPLE USING H TRACK)

- In order to select the appropriate connectors to maintain electrical continuity, start at your power source and walk the length of the track. If you turn left, use a left connector. If you turn right, use a right connector.

Polarity is just a matter of matching ends

The 2 wire side of an "H" Track has an indicator groove running its length

- Using a left connector, the track would run with the groove along the outside

- Using a right connector, the track would run with the groove along the inside

= Electrical Continuity

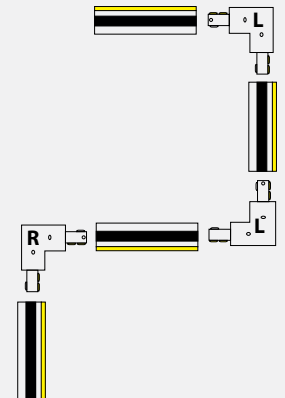
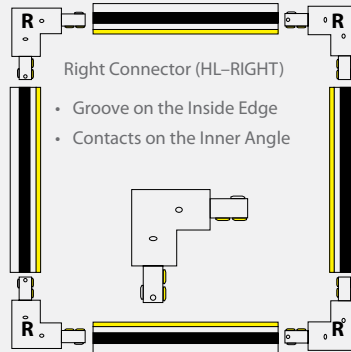
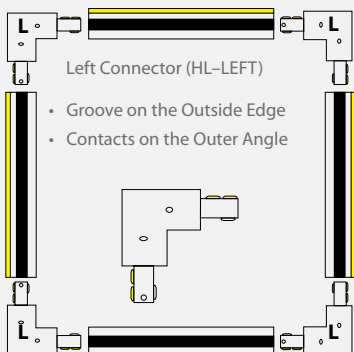





Adjustable between 15° - 50°

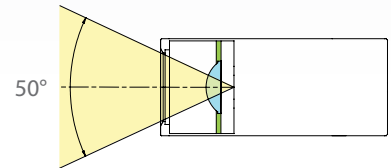
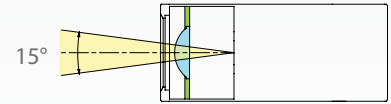

Optional Framing
Projector Accessory **FP-K**



Monopoint
available
see page 60

SILO X20 LED

TITLE 24
CALIFORNIA

Power: 20W
Input: 120V
Comparable to: 75W MR16
ELV Dimming: 100% - 5%
Rated Life: 50,000 hours

- Continuously adjustable beam angles from 15° to 50°
- Die-cast aluminum construction with rotatable front face
- Performance luminaire with integral LED and driver
- Abrasion resistant powder-coated finishes
- Accommodates one lens and one glare control accessory
- UL & cUL Listed

System	Model	Color Temp	CRI	Beam	Lumens	CBCP	Finish
	2020-930	3000K	90	15°	785	6840	BK Black BN Brushed Nickel WT White
				50°	1080	1295	

Example: L-2020-930-WT

LENS ACCESSORIES

Amber	LENS-16-AMB
Blue	LENS-16-BLU
Green	LENS-16-GRN
Red	LENS-16-RED
Frosted	LENS-16-FR
Spread	LENS-16-SPR
Beam Elongating	LENS-16-BEL

GLARE CONTROL ACCESSORIES

Cross Louver	LENS-16P-CRL-BK LENS-16P-CRL-BN LENS-16P-CRL-WT
Snoot	LENS-16-SNOOT-BK LENS-16-SNOOT-BN LENS-16-SNOOT-WT
Honeycomb Louver	LENS-16-HCL

FRAMING PROJECTOR ACCESSORIES

Framing Projector	FP-K-BK FP-K-WT
-------------------	----------------------------------



LED FRAMING PROJECTOR
 FRAME TO ILLUMINATE 4 SIDED RESTAURANT TABLETOPS

Power: 22W
 Input: 120V
 Rated Life: 60,000 hours

- Project images, signs, and corporate logos
- Uses two lenses to allow precise focus adjustment
- Accepts "D" size Glass and Metal Gobos; see spec sheet on wacighting.com for info on purchasing gobos
- 355° horizontal rotation and 90° vertical aiming
- Accepts one colored lens accessory



	System	Model	Color Temp	CRI	Finish
	H H L L J J/J2	LED009	27 2700K 85	BK Black WT White	
			30 3000K 85		
			35 3500K 85		
			40 4000K 85		
			927 2700K 90		
			930 3000K 90		

Example: **H-LED009-930-BK**

LENS ACCESSORIES

Amber **LENS-16-AMB**
 Blue **LENS-16-BLU**
 Green **LENS-16-GRN**
 Red **LENS-16-RED**





SILO X10 LED



TITLE 24
CALIFORNIA

Power: 10W
 Input: 120V
 Beam: 25° and 35° included
 Comparable to: 65W MR16
 ELV Dimming: 100% - 5%
 Rated Life: 50,000 hours

- Field replaceable TIR lens for beam control (35° installed and 25° included in the box)
- Die-cast aluminum construction in a small, and clean design
- Performance luminaire with integral LED and driver
- Abrasion resistant powder-coated finishes
- Accommodates one lens or one glare control accessory
- UL & cUL Listed

System	Model	Color Temp	CRI	Beam	Lumens	CBCP	Finish
	H H	2010-930	3000K	90	25°	790	2575
	L L						
	J J/J2						
							BK Black BN Brushed Nickel WT White

Example: H-2010-930-BN

LENS ACCESSORIES

Amber	LENS-11-AMB
Blue	LENS-11-BLU
Green	LENS-11-GRN
Red	LENS-11-RED
Frosted	LENS-11-FR
Spread	LENS-11-SPR
Beam Elongating	LENS-11-BEL

GLARE CONTROL ACCESSORIES

Cross Louver	LENS-11P-CRL-BK LENS-11P-CRL-BN LENS-11P-CRL-WT
Snoot	LENS-11-SNOOT-BK LENS-11-SNOOT-BN LENS-11-SNOOT-WT

14W EXTERMINATOR II 1014



Power: 14W
 Input: 120V
 Comparable: 20W HID
 ELV Dimming: 100% - 5%
 Rated Life: 100,000 hours



- Accommodates one lens accessory and one glare control accessory
- Reflectors and LED modules can be purchased separately for alternative beam angles and color temperatures
- 365° horizontal rotation and 180° vertical aiming

System		Model	Beam	Color Temp	CRI	Max Lumens	Max CBCP	Finish
	H	H	N 20° F 40°	827 2700K	85	965 980	4585 2117	BK Black WT White BN Brushed Nickel
	L	L		830 3000K	85			
	J	J/J2		835 3500K	85			
				840 4000K	85			
				927 2700K	90			
				930 3000K	90			

Example: **J-1014N-927-WT**

22W EXTERMINATOR II 1023



Power: 22W
 Input: 120V
 Comparable: 39W HID
 ELV Dimming: 100% - 5%
 Rated Life: 50,000 hours



- Accommodates one lens accessory and one glare control accessory
- Reflectors and LED modules can be purchased separately for alternative beam angles and color temperatures
- 365° horizontal rotation and 180° vertical aiming

System		Model	Beam	Color Temp	CRI	Max Lumens	Max CBCP	Finish
	H	H	N 18° F 38°	827 2700K	85	2030 1955	11530 4810	BK Black WT White BN Brushed Nickel
	L	L		830 3000K	85			
	J	J/J2		835 3500K	85			
				840 4000K	85			
				927 2700K	90			
				930 3000K	90			

Example: **H-1023N-930-BN**

35W EXTERMINATOR II 1035



Power: 35W
Input: 120V
Comparable: 50W HID
ELV Dimming: 100% - 5%
Rated Life: 60,000 hours



- Accommodates one lens accessory and one glare control accessory
- Reflectors and LED modules can be purchased separately for alternative beam angles and color temperatures
- 365° horizontal rotation and 180° vertical aiming

		System	Model	Beam	Color Temp	CRI	Max Lumens	Max CBCP	Finish
	H H L L J J/J2	1035	N 25° F 55°	827 2700K	85	2795	9748	BK Black WT White BN Brushed Nickel	
				830 3000K	85				
				835 3500K	85				
						2828	3886		
				927 2700K	90				
				930 3000K	90				

Example: **L-1035F-930-WT**

52W EXTERMINATOR II 1052



Power: 52W
Input: 120V
Comparable: 70W HID
ELV Dimming: 100% - 5%
Rated Life: 80,000 hours

- Accommodates one lens accessory and one glare control accessory
- Reflectors and LED modules can be purchased separately for alternative beam angles and color temperatures
- 365° horizontal rotation and 180° vertical aiming



		System	Model	Beam	Color Temp	CRI	Max Lumens	Max CBCP	Finish
	H H L L J J/J2	1052	N 25° F 55°	827 2700K	85	2795	9748	BK Black WT White BN Brushed Nickel	
				830 3000K	85				
				835 3500K	85				
						2828	3886		
				927 2700K	90				
				930 3000K	90				

Example: **H-1052N-930-BK**

LOGOS LED23



Power: 23W
 Input: 120V
 Comparable: 39W HID
 ELV Dimming: 100% – 10% (120V only)
 Rated Life: 100,000 hours

- Single tool-free lens assembly for easy change of beam angle
- 360° horizontal and 180° vertical aiming
- Die-cast aluminum construction

	System	Model	Beam	Color Temp	CRI	Max Lumens	Max CBCP	Finish
	H H L L J J/J2	LED23	S 12°	27 2700K	85	1805	18049	BK Black WT White
			N 24°	30 3000K	85	1845	7663	
			F 36°	35 3500K	85	1800	3618	
			E 19° × 32° elliptical	40 4000K	85	1780	6529	

Example: **H-LED23N-30-BK**

LOGOS LED40



Power: 40W
 Input: 120V
 Comparable: 70W HID
 ELV Dimming: 100% – 10%
 Rated Life: 100,000 hours

- Single tool-free lens assembly for easy change of beam angle
- 360° horizontal and 180° vertical aiming
- Die-cast aluminum construction

	System	Model	Beam	Color Temp	CRI	Max Lumens	Max CBCP	Finish
	H H L L J J/J2	LED40	S 12°	27 2700K	85	3010	24767	BK Black WT White
			N 24°	30 3000K	85	3080	12826	
			F 36°	35 3500K	85	2945	5787	
			E 19° × 32° elliptical	40 4000K	85	2955	10502	

Example: **L-LED40S-40-WT**

WALL WASH 3020W

Power: 20W
 Input: 120V
 Comparable: 20W HID
 ELV Dimming: 100% - 5%
 Rated Life: 50,000 hours

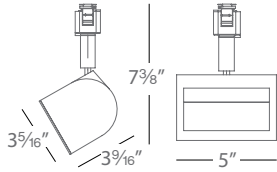

- Install 3 to 5 feet from wall and 3 to 5 feet on center for optional effect
- Die-cast aluminum construction
- Powder-coated finishes
- Asymmetrical beam distribution for even wall illumination
- Economical performance luminaire with integral LED and driver
- UL & cUL Listed

System	Model	Color Temp	CRI	Lumens	Finish			
H	H	3020W	30	3000K	90	925	BK	Black
L	L							
J	J/J2							

Example: H-3020W-30-WT

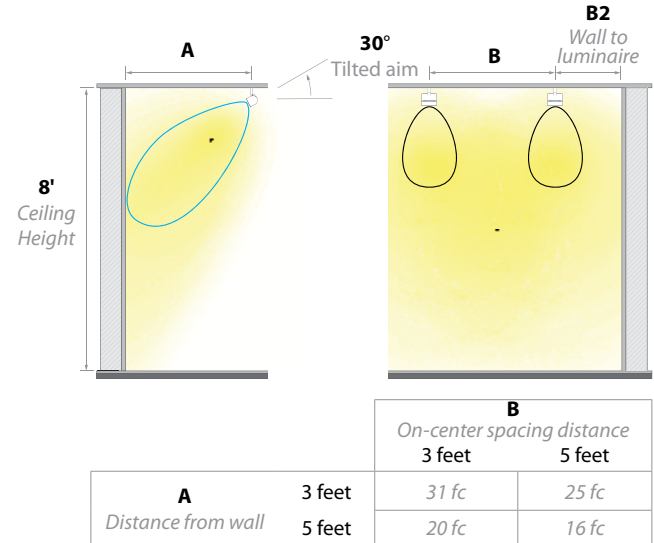

ARGOS LED25

Power: 25W
 Input: 120V
 Comparable: 39W HID
 ELV Dimming: 100% - 10%
 Rated Life: 100,000 hours



- Die-cast aluminum construction
- Tool-free lens assembly for easy change of beam angle
- 360° horizontal and 90° vertical hot aiming
- Accepts one lens

System	Model	Beam	Color Temp	CRI	Max Lumens	Max CBCP	Finish	
H	H	S 20° F 42°	27	2700K	85	1360	4923	BK Black WT White
L	L		30	3000K	85	1480	5868	
J	J/J2		35	3500K	85	1505	5087	
			40	4000K	85	1525	5472	

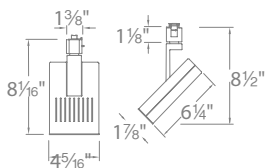

Example: J-LED25S-27-BK

SUMMIT BEAMSHIFT™ LED207 patent pending

TITLE 24
CALIFORNIA



- Power:** 15W
 - Input:** 120V
 - Comparable:** 50W MR16
 - ELV Dimming:** 100% - 10%
 - Rated Life:** 50,000 hours
- Beamshift™ enables in-field change of beam angle
 - Die-cast aluminum construction
 - AC-LED
 - UL & cUL Listed



	System	Model	Color Temp	CRI	Beam*	Lumens	CBCP	Finish					
	H	H	LED207	30	3000K	90	15°	600	3424	BK Black			
	L	L									40°	760	1417
	J	J/J2											

Example: H-LED207-30-BK
 *Comes with Flood (40°) beam setting by default, which may be reconfigured to Narrow(15°) in field.

SUMMIT BEAMSHIFT™ LED201

TITLE 24
CALIFORNIA



- Power:** 15W
 - Input:** 120V
 - Comparable:** 50W MR16
 - ELV Dimming:** 100% - 10%
 - Rated Life:** 50,000 hours
- Beamshift™ enables in-field change of beam angle
 - Die-cast aluminum construction
 - AC-LED
 - UL & cUL Listed



	System	Model	Color Temp	CRI	Beam*	Lumens	CBCP	Finish					
	H	H	LED201	30	3000K	90	15°	600	3424	BK Black			
	L	L									40°	760	1417
	J	J/J2											

Example: H-LED201-30-WT
 *Comes with Flood (40°) beam setting by default, which may be reconfigured to Narrow(15°) in field.

BEAMSHIFT™

All Summit series track luminaires come with BeamShift™, allowing in-field change of beam angle simply by changing the location of the lens

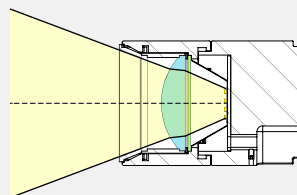

Flood Configuration
 Lens located at the back

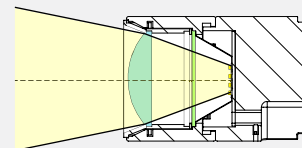

Spot Configuration
 Lens located in the front

SUMMIT BEAMSHIFT™ LED202 patent pending

TITLE 24
CALIFORNIA



- Power:** 15W
 - Input:** 120V
 - Comparable:** 50W MR16
 - ELV Dimming:** 100% - 10%
 - Rated Life:** 50,000 hours
- Beamshift™ enables in-field change of beam angle
 - Die-cast aluminum construction
 - AC-LED
 - UL & cUL Listed



	System	Model	Color Temp	CRI	Beam*	Lumens	CBCP	Finish
	H H	LED202	30 3000K	90	15°	600	3424	BK Black
	L L				40°	760	1417	
	J J/J2							
								WT White

Example: **H-LED202-30-WT**

*Comes with Flood (40°) beam setting by default, which may be reconfigured to Narrow(15°) in field.

SUMMIT BEAMSHIFT™ LED208

TITLE 24
CALIFORNIA



- Power:** 15W
 - Input:** 120V
 - Comparable:** 50W MR16
 - ELV Dimming:** 100% - 10%
 - Rated Life:** 50,000 hours
- Beamshift™ enables in-field change of beam angle
 - Die-cast aluminum construction
 - AC-LED
 - UL & cUL Listed



	System	Model	Color Temp	CRI	Beam*	Lumens	CBCP	Finish
	H H	LED208	30 3000K	90	15°	600	3424	AB Antique Bronze
	L L				40°	760	1417	
	J J/J2							

Example: **H-LED208-30-AB**

*Comes with Flood (40°) beam setting by default, which may be reconfigured to Narrow(15°) in field.

REPLACE THE HALOGEN MR16

Summit series are the perfect replacement for the halogen MR16 track luminaires as we offer:

- Lower wattage with superior lumen output
- Over 10 times the rated life
- Less maintenance
- No projected heat
- Beamshift™ In-field changeable beam angle

LUMINOUS EFFICACY

At flood (40°) Beam angle

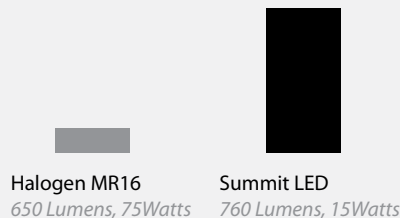

RATED LIFE

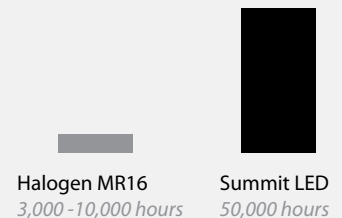



EXTERMINATOR LED20

Power: 23W
Input: 120V
Comparable: 39W HID
ELV Dimming: 100% - 10%
Rated Life: 60,000 hours

- Accommodates one lens accessory
- Reflectors and LED modules can be purchased separately for alternative beam angles and color temperatures
- 355° horizontal rotation and 180° vertical aiming



System		Model	Color Temp		CRI	Max Lumens	Max CBCP	Finish	
	H H L L J J/J2	LED20	S 20° F 40°	27 2700K	85	1450	6772	BK Black WT White BN Brushed Nickel	
				30 3000K	85				
				35 3500K	85				
				40 4000K	85				
				927 2700K	90				
				930 3000K	90				

Example: **H-LED20F-830-BN**

PRECISION LED160



Power: 14.5W
 Input: 120V
 Comparable to: 65W MR16
 ELV Dimming: 100%-10%
 Rated Life: 70,000 hours



- Compact single-diode LED
- CEC Title24 Compliant
- Die-cast aluminum construction
- 365° horizontal rotation and 180° vertical aiming

	System	Model	Beam	Color Temp	CRI	Lumens	CBCP	Finish
	H H L L J J/J2	LED160	S 20° F 40°	27 2700K 85 775				BK Black WT White
				30 3000K 85 935				
				35 3500K 85 765				
				40 4000K 85 955				
				927 2700K 90 960				
				930 3000K 90 975				

Example: **L-LED160S-930-BK**

CARTIER LED710

Power: 14W
 Input: 120V
 Comparable: 75W MR16
 ELV Dimming: 100% - 10%
 Rated Life: 60,000 hours



	System	Model	Beam	Color Temp	CRI	Max Lumens	Max CBCP	Finish
	H H L L J J/J2	LED710	S 20° F 40°	27 2700K 85				AB Antique Bronze AN Antique Nickel
				30 3000K 85				
				35 3500K 85				
				40 4000K 85				
				927 2700K 90				
				930 3000K 90				

Example: **J-LED710S-927-AN**

IMPULSE LED810

Power: 14.5W
 Input: 120V
 Comparable: 75W MR16
 ELV Dimming: 100% – 10%
 Rated Life: 60,000 hours



BEAM CONTROL ACCESSORIES

008FP Framing Projector	BK Black	 Barn Door
801BD Barn Door	DB Dark Bronze	
	WT White	

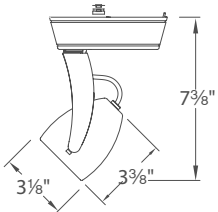
	System	Model	Beam	Color Temp	CRI	Max Lumens	Max CBCP	Finish
	H H L L J J/J2	LED810	S 20° F 40°	27 2700K 85	950	4481	BK Black DB Dark Bronze WT White	
				30 3000K 85				
				35 3500K 85				
				40 4000K 85				
				927 2700K 90				
				930 3000K 90				

Example: L-LED810S-927-BK

IMPULSE LED820

Power: 23W
 Input: 120V
 Comparable: 100W Halogen
 ELV Dimming: 100% – 10%
 Rated Life: 60,000 hours



BEAM CONTROL ACCESSORIES

008FP Framing Projector	BK Black	 Framing Projector
801BD Barn Door	DB Dark Bronze	
	WT White	

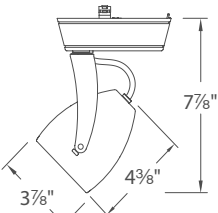
	System	Model	Beam	Color Temp	CRI	Max Lumens	Max CBCP	Finish
	H H L L J J/J2	LED820	S 20° F 40°	27 2700K 85	1305	6048	BK Black DB Dark Bronze WT White	
				30 3000K 85				
				35 3500K 85				
				40 4000K 85				
				927 2700K 90				
				930 3000K 90				

Example: H-LED820F-30-WT

REFLEX PRO LED17

Power: 17W
Input: 120V
Comparable: 20W HID
ELV Dimming: 100% – 10% (120V only)
Rated Life: 100,000 hours



- Clear and Frosted Lens included
- Die-cast aluminum construction
- Accepts one lens
- 360° horizontal rotation and 180° vertical aiming

	System	Model	Beam	Color Temp	CRI	Max Lumens	Max CBCP	Finish
	H H L L J J/J2	LED17	S 20° F 45°	27 2700K 85	85	1125	3780	BK Black BN Brushed Nickel WT White
				30 3000K 85				
				35 3500K 85				
				40 4000K 85				

Example: **H-LED17F-35-WT**

REFLEX PRO LED27

Power: 27W
Input: 120V
Comparable: 70W HID
ELV Dimming: 100% – 10% (120V only)
Rated Life: 100,000 hours



- Clear and Frosted Lens included
- Die-cast aluminum construction
- Accepts one lens, optional spread lens included
- 360° horizontal rotation and 180° vertical aiming

	System	Model	Beam	Color Temp	CRI	Max Lumens	Max CBCP	Finish
	H H L L J J/J2	LED27	S 20° F 45°	27 2700K 85	85	1890	7120	BK Black BN Brushed Nickel WT White
				30 3000K 85				
				35 3500K 85				
				40 4000K 85				

Example: **L-LED27F-30-BK**

MR16 TRACK LUMINAIRES LED AND HALOGEN

1 WATT MINIMUM LOAD

CARIBE

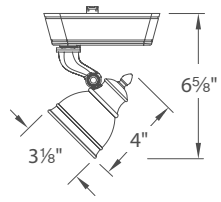

System	Model	Lamp	Optional lens holder	Finish
HHT H	874LED	MR16 LED 12V 8W Included	 LENS (accommodates two lenses)	AB Antique Bronze
LHT L	874	MR16 12V 50W max (Sold Separately)		
JHT J/J2	874L	MR16 12V 75W max (Sold Separately)		

Example: **LHT-874-AB** or **LHT-874LENS-AB**

801

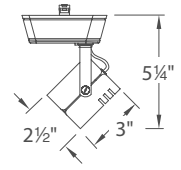

System	Model	Lamp	Finish
HHT H	801LED	MR16 LED 12V 8W Included	BK Black
LHT L	801	MR16 12V 50W max (Sold Separately)	BN Brushed Nickel
JHT J/J2	801L	MR16 12V 75W max (Sold Separately)	WT White

Example: **LHT-801-WT**
Clear lens included

Barn Door Accessory	801BD-BK	Black
	801BD-WT	White

RADIANT



LENS-16-CLIP
Lens Clip Accommodates one lens accessory

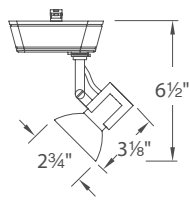

System	Model	Lamp	Finish
HHT H	856LED	MR16 LED 12V 8W Included	AB Antique Bronze
LHT L	856	MR16 12V 50W max (Sold Separately)	BK Black
JHT J/J2	856L	MR16 12V 75W max (Sold Separately)	BN Brushed Nickel
			WT White

Example: **JHT-856L-BN**

LED LAMPS	Finish	Power	Color Temp	Input	Beam	CRI	Lumens	CBCP	Average Life
 MR16 MR16LED-BAB-BK MR16LED-BAB-WT	Black White	8W	3000K	12V	35°	85	450	850	25,000 Hours

MR16 TRACK LUMINAIRES LED AND HALOGEN

1 WATT MINIMUM LOAD

802

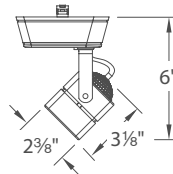

System	Model	Lamp	Finish
HHT H	802LED	MR16 LED 12V 8W Included	BK Black
LHT L	802	MR16 12V 50W max (Sold Separately)	BN Brushed Nickel
JHT J/J2	802L	MR16 12V 75W max (Sold Separately)	WT White

Example: **LHT-802-BK**

Clear lens included

DUNE

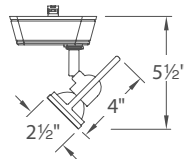

System	Model	Lamp	Finish
HHT H	826LED	MR16 LED 12V 8W Included	BK Black
LHT L	826	MR16 12V 50W max (Sold Separately)	BN Brushed Nickel
JHT J/J2			WT White

Example: **HHT-826-BN**

Clear lens included

Available in monopoint
See p.67 for detail.

007

Framing Projector Accessory

008FP-BK Black
008FP-WT White

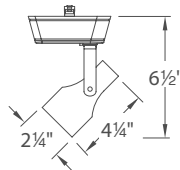

System	Model	Lamp	Finish
HHT H	007LED	MR16 LED 12V 8W Included	BK Black
LHT L	007	MR16 12V 50W max (Sold Separately)	BN Brushed Nickel
JHT J/J2	007L	MR16 12V 75W max (Sold Separately)	WT White

Example: **JHT-007-BN**

Clear lens included

LENS ACCESSORIES

Amber **LENS-16-AMB**

Blue **LENS-16-BLU**
Green **LENS-16-GRN**

Red **LENS-16-RED**
Frosted **LENS-16-FR**

UV Filter **LENS-16-UVF**
Spread **LENS-16-SPR**

Beam Elongating **LENS-16-BEL**
Honeycomb Louver **LENS-16-HCL**

MR16 TRACK LUMINAIRES LED AND HALOGEN

1 WATT MINIMUM LOAD

816

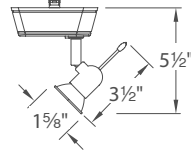

System	Model	Lamp	Finish
HHT H	816LED	MR16 LED 12V 8W Included	BK Black
LHT L	816	MR16 12V 50W max (Sold Separately)	BN Brushed Nickel
JHT J/J2	816L	MR16 12V 75W max (Sold Separately)	WT White

Example: **LHT-816-BK**

	LENS-16-CLIP Lens Clip	Accommodates one lens accessory
---	----------------------------------	---------------------------------

160

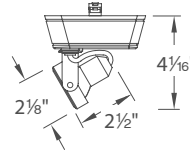

System	Model	Lamp	Finish
HHT H	160LED	MR16 LED 12V 8W Included	BK Black
LHT L	160	MR16 12V 50W max (Sold Separately)	WT White
JHT J/J2	160L	MR16 12V 75W max (Sold Separately)	

Example: **HHT-160LED-WT**

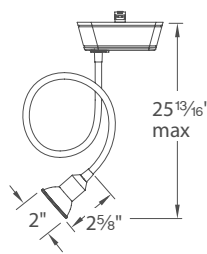

Clear lens included

204



System	Model	Lamp	Finish
HHT H	204LED	MR16 LED 12V 8W Included	BK Black
LHT L	204	MR16 12V 50W max (Sold Separately)	WT White
JHT J/J2	204L	MR16 12V 75W max (Sold Separately)	

Example: **LHT-204L-WT**

	LENS-16-CLIP Lens Clip	Accommodates one lens accessory
	MBS-16 Mesh Shield	BK Black WT White
	SBS-16 Solid Shield	

LED LAMPS

	Finish	Power	Color Temp	Input	Beam	CRI	Lumens	CBCP	Average Life
	Black White	8W	3000K	12V	35°	85	450	850	25,000 Hours

MR16 TRACK LUMINAIRES LED AND HALOGEN

1 WATT MINIMUM LOAD

809

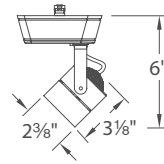

System	Model	Lamp	Finish
HHT H	809LED	MR16 LED 12V 8W Included	BK Black
LHT L	809	MR16 12V 50W max (Sold Separately)	BN Brushed Nickel
JHT J/J2	809L	MR16 12V 75W max (Sold Separately)	WT White

Example: **HHT-809-BN**

Clear lens included

180

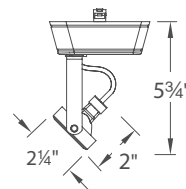

System	Model	Lamp	Finish
HHT H	180LED	MR16 LED 12V 8W Included	BK Black
LHT L	180	MR16 12V 50W max (Sold Separately)	BN Brushed Nickel
JHT J/J2	180L	MR16 12V 75W max (Sold Separately)	WT White

Example: **LHT-180-BN**

Clear lens included

808

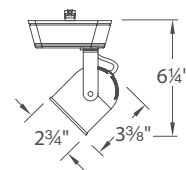

System	Model	Lamp	Finish
HHT H	808LED	MR16 LED 12V 8W Included	BK Black
LHT L	808	MR16 12V 50W max (Sold Separately)	DB Dark Bronze
JHT J/J2	808L	MR16 12V 75W max (Sold Separately)	WT White

Example: **JHT-808LED-BK**

Clear lens included

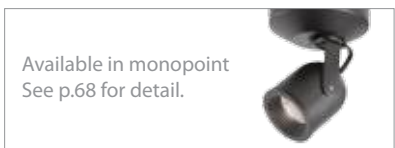

LENS ACCESSORIES

Amber **LENS-16-AMB**

Blue **LENS-16-BLU**
Green **LENS-16-GRN**

Red **LENS-16-RED**
Frosted **LENS-16-FR**

UV Filter **LENS-16-UVF**
Spread **LENS-16-SPR**

Beam Elongating **LENS-16-BEL**
Honeycomb Louver **LENS-16-HCL**

MR16 TRACK LUMINAIRES LED AND HALOGEN

1 WATT MINIMUM LOAD

814



Mesh Shield in
Brushed Nickel

HHT-8145-BN/BK H Track
LHT-8145-BN/BK L Track
JHT-8145-BN/BK J Track

Halogen MR16 12V 50W max included



Solid Shield in
Brushed Nickel

HHT-8146-BN/BK H Track
LHT-8146-BN/BK L Track
JHT-8146-BN/BK J Track

LED MR16 12V 8W included

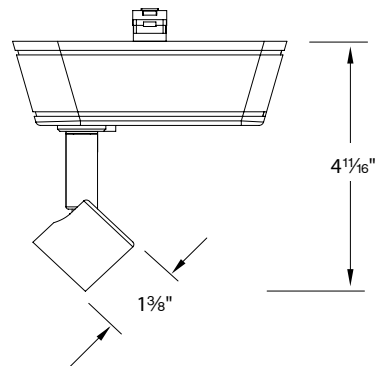

Amber Glass

HHT-8141-AM/BK H Track
LHT-8141-AM/BK L Track
JHT-8141-AM/BK J Track

Halogen MR16 12V 50W max included



Blue Glass

HHT-8141-BL/BK H Track
LHT-8141-BL/BK L Track
JHT-8141-BL/BK J Track

Halogen MR16 12V 50W max included



White Glass

HHT-8141-WT/WT H Track
LHT-8141-WT/WT L Track
JHT-8141-WT/WT J Track

Halogen MR16 12V 50W max included



Red Cased Glass

HHT-8144-RD/BK H Track
LHT-8144-RD/BK L Track
JHT-8144-RD/BK J Track

Halogen MR16 12V 50W max included



White Cased Glass

HHT-8144-WT/WT H Track
LHT-8144-WT/WT L Track
JHT-8144-WT/WT J Track

Halogen MR16 12V 50W max included



Amber Cased Glass

HHT-8144-AM/WT H Track
LHT-8144-AM/WT L Track
JHT-8144-AM/WT J Track

Halogen MR16 12V 50W max included

GU10 TRACK LUMINAIRES LED AND HALOGEN

101

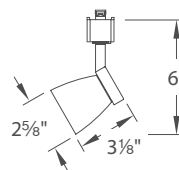

System	Model	Lamp	Finish
HTK <i>H</i>	101	<i>GU10 Halogen 50W included</i>	AM/BK <i>Amber/Black</i>
LTK <i>L</i>			WT/BK <i>White/Black</i>
JTK <i>J/J2</i>			WT/WT <i>White/White</i>

Example: **LTK-101-AM/BK**

103

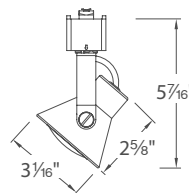

System	Model	Lamp	Finish
HTK <i>H</i>	103LED	<i>GU10 LED 8W included</i>	BK <i>Black</i>
LTK <i>L</i>	103	<i>GU10 Halogen 50W included</i>	DB <i>Dark Bronze</i>
JTK <i>J/J2</i>			WT <i>White</i>

Example: **LTK-103LED-BK**

104

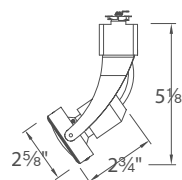

System	Model	Lamp	Finish
HTK <i>H</i>	104LED	<i>GU10 LED 8W included</i>	BK <i>Black</i>
LTK <i>L</i>	104	<i>GU10 Halogen 50W included</i>	WT <i>White</i>
JTK <i>J/J2</i>			

Example: **LTK-104LED-WT**

LED LAMPS

		Finish	Power	Color Temp	Input	Beam	CRI	Lumens	CBCP	Average Life
	<i>GU10</i>	GU10LED-BAB-BK GU10LED-BAB-WT	<i>8W</i>	<i>3000K</i>	<i>12V</i>	<i>35°</i>	<i>85</i>	<i>470</i>	<i>850</i>	<i>25,000 Hours</i>

PAR AND BR TRACK LUMINAIRES LED AND HALOGEN

704

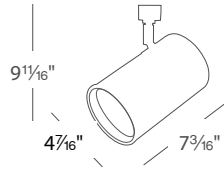

System	Model	Lamp	Finish
HTK H	704	120V BR20 and PAR20 100W Max	BK Black WT White
LTK L			
JTK J/J2			

Example: **LTK-704-WT** Order lamp separately

703

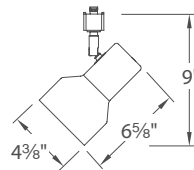

System	Model	Lamp	Finish
HTK H	703	BR30 and PAR30 100W Max	BK Black WT White
LTK L			
JTK J/J2			

Example: **HTK-703-BK** Order lamp separately

763, 764, 765



763



764



765

System	Model	Lamp	Finish
HTK H	763	LED BR20 7.5W, LED PAR20 10.3W	BK Black BN Brushed Nickel WT White
LTK L	764	LED BR30 14W, LED PAR30 14.6W	
JTK J/J2	765	LED BR40 17W, LED PAR38 17.8W	

Example: **HTK-763-WT** Order lamp separately

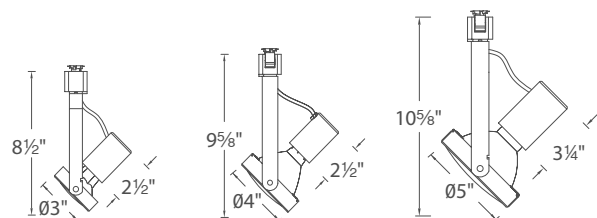

763

764

765

PAR AND BR TRACK LUMINAIRES LED AND HALOGEN

178 UNIVERSAL MEDIUM BASE

System	Model	Lamp	Finish
HTK H	178	BR20/30/40, PAR20/30/38 120V 50W Max	BK Black
LTK L			BN Brushed Nickel
JTK J/J2			WT White

Example: **LTK-178-WT** Order lamp separately

Barn Door (order separately)

PAR20BD	BK Black	
PAR30BD	BN Brushed Nickel	
PAR38BD	WT White	



Shown with **PAR20LED-10N30-BK** LED lamp

188 UNIVERSAL MEDIUM BASE

System	Model	Lamp	Finish
HTK H	188	BR20/30/40, PAR20/30/40 120V 50W Max	BK Black
LTK L			BN Brushed Nickel
JTK J/J2			WT White





Example: **HTK-188-WT** Order lamp separately

Barn Door (order separately)

PAR20BD	BK Black	
PAR30BD	BN Brushed Nickel	
PAR38BD	WT White	



Shown with **PAR30LED-L14N30-WT** LED lamp

LED LAMPS*			Finish	Power	Color Temp	Input	Beam	CRI	Lumens	CBCP	Average Life
	PAR20	PAR20LED-10N30-BK PAR20LED-10N30-WT	Black White	7W	3000K	120V 60Hz	40°	90	500	593	25,000 Hours
	PAR30	PAR30LED-L14N30-BK PAR30LED-L14N30-WT	Black White	11W	3000K	120V 60Hz	40°	90	800	1315	25,000 Hours
	PAR38	PAR38LED-17N30-BK PAR38LED-17N30-WT	Black White	15W	3000K	120V 60Hz	40°	90	1000	1758	25,000 Hours
	BR20	BR20LED-7N27-WT	White	7W	2700K	120V 60Hz	100°	90	450	N/A	25,000 Hours
	BR30	BR30LED-11N27-WT	White	11W	2700K	120V 60Hz	100°	90	750	N/A	25,000 Hours

*Dimmable

PAR AND BR TRACK LUMINAIRES LED AND HALOGEN

RADIANT

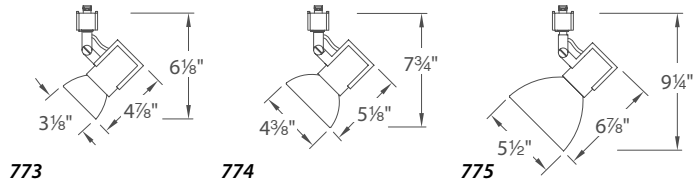

Shown **HTK-773-BN** with **PAR20 50W Halogen lamp**

System	Model	Lamp	Finish
HTK H	773	PAR20 50W max	AB Antique Bronze
LTK L	774	PAR30 75W max	BK Black
JTK J/J2	775	PAR38 150W max	BN Brushed Nickel
			WT White

Example: **HTK-774-BN** Order lamp separately

725

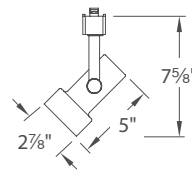

Shown **HTK-725-WT** with **PAR20 50W Halogen lamp**

System	Model	Lamp	Finish
HTK H	725	PAR20 / BR20 60W max	BK Black
LTK L			WT White
JTK J/J2			

Example: **HTK-725-WT** Order lamp separately

720, 730, 738

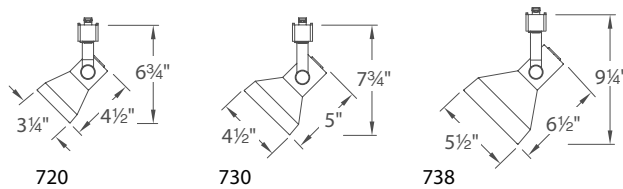

Shown **HTK-738-BK** with **PAR38 90W Halogen lamp**

System	Model	Lamp	Finish
HTK H	720	PAR20 50W max	BK Black
LTK L	730	PAR30 75W max	
JTK J/J2	738	PAR38 150W max	
			WT White

Example: **HTK-730-BK** Order lamp separately

LED LAMPS*

		Finish	Power	Color Temp	Input	Beam	CRI	Lumens	CBCP	Average Life
	PAR20	PAR20LED-10N30-BK PAR20LED-10N30-WT	7W	3000K	120V 60Hz	40°	90	500	593	25,000 Hours
	PAR30	PAR30LED-L14N30-BK PAR30LED-L14N30-WT	11W	3000K	120V 60Hz	40°	90	800	1315	25,000 Hours
	PAR38	PAR38LED-17N30-BK PAR38LED-17N30-WT	15W	3000K	120V 60Hz	40°	90	1000	1758	25,000 Hours
	BR20	BR20LED-7N27-WT	7W	2700K	120V 60Hz	100°	90	450	N/A	25,000 Hours
	BR30	BR30LED-11N27-WT	11W	2700K	120V 60Hz	100°	90	750	N/A	25,000 Hours

*Dimmable

PAR AND BR TRACK LUMINAIRES LED AND HALOGEN

RIALTO

360° horizontal rotation and 90° vertical aiming
Fully enclosed back to prevent light leaks

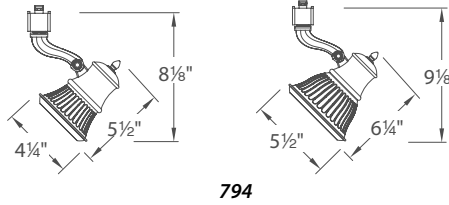

Shown **HTK-794-AB**
with **PAR30 75W Halogen** lamp

System	Model	Lamp	Finish
HTK H	793	PAR20 50W max	AB Antique Bronze
LTK L	794	PAR30 75W max	
JTK J/J2			

Example: **HTK-794-AB** Order lamp separately

CARIBE

Spun and cast aluminum construction
360° horizontal rotation and 90° vertical aiming
Fully enclosed back to prevent light leaks

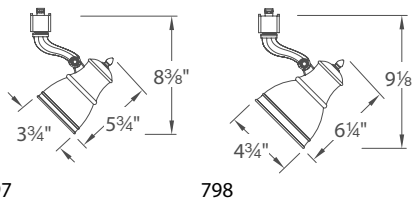

Shown **HTK-798-AB**
with **PAR30 75W Halogen** lamp

System	Model	Lamp	Finish
HTK H	797	PAR20 50W max	AB Antique Bronze
LTK L	798	PAR30 75W max	
JTK J/J2			

Example: **LTK-797-AB** Order lamp separately

STUDIO

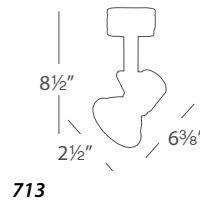

Shown **HTK-713-BK**
with **PAR20 LED** lamp

System	Model	Lamp	Finish
HTK H	713	PAR20 50W max	BK Black
LTK L			WT White
JTK J/J2			

Example: **LTK-713-BK** Order lamp separately

LED LAMPS*		Finish	Power	Color Temp	Input	Beam	CRI	Lumens	CBCP	Average Life	
	PAR20	PAR20LED-10N30-BK PAR20LED-10N30-WT	Black White	7W	3000K	120V 60Hz	40°	90	500	593	25,000 Hours
	PAR30	PAR30LED-L14N30-BK PAR30LED-L14N30-WT	Black White	11W	3000K	120V 60Hz	40°	90	800	1315	25,000 Hours
	PAR38	PAR38LED-17N30-BK PAR38LED-17N30-WT	Black White	15W	3000K	120V 60Hz	40°	90	1000	1758	25,000 Hours
	BR20	BR20LED-7N27-WT	White	7W	2700K	120V 60Hz	100°	90	450	N/A	25,000 Hours
	BR30	BR30LED-11N27-WT	White	11W	2700K	120V 60Hz	100°	90	750	N/A	25,000 Hours

*Dimmable

LENSES & ACCESSORIES



Color Lens - Changes the color of the light.

	LENS-16	MR16	AMB	Amber
	LENS-20	PAR20	BLU	Blue
	LENS-25	18W LED	GRN	Green
	LENS-30	PAR30	RED	Red

Example: **LENS-16-BLU**

UV Filter - Protect artwork and delicate fabrics from fading.

	LENS-11-UVF	
	LENS-16-UVF	
	LENS-20-UVF	
	LENS-25-UVF	
	LENS-30-UVF	

Spread Lens

Directs the lamp beam to create a diffused light in even pattern

	LENS-11-SPR	
	LENS-16-SPR	
	LENS-20-SPR	
	LENS-25-SPR	
	LENS-30-SPR	
	LENS-73-SPR	

Frosted Lens - Softens light and reduces glare

	LENS-11-FR	
	LENS-16-FR	
	LENS-20-FR	
	LENS-25-FR	
	LENS-30-FR	

Honey Comb Louver - Shields lamp and reduces glare at a 30° angle

	LENS-16-HCL	
	LENS-20-HCL	
	LENS-25-HCL	
	LENS-30-HCL	

Beam Elongator - Replaces standard MR16 and MR11 track fixture lens. Directs the lamp beam to create a horizontal or vertical strip of elongated light.

	LENS-11-BEL	
	LENS-16-BEL	
	LENS-20-BEL	
	LENS-25-BEL	
	LENS-30-BEL	

Cross Louver - Black louver shields lamp and controls spill light and glare; 45° cutoff.

	LENS-11P-CRL	
	LENS-16P-CRL	
	LENS-20P-CRL	
	LENS-25P-CRL	
	BK	
	BN	
	PT	
	WT	

Snoot - Shields lamp and reduces glare.

	LENS-11-SNOOT	
	LENS-16-SNOOT	
	LENS-20-SNOOT	
	LENS-25-SNOOT	
	LENS-30-SNOOT	
	BK	Black
	BN	Brushed Nickel
	PT	Platinum
	WT	White

Lens Clip - Snaps over lamp and holds any lens or honeycomb louver firmly in place. Use only with exposed lamp fixtures.

	LENS-16-CLIP	MR16

QUICK CONNECT



QUICK CONNECT™ PENDANTS

Model number begins with QP-, See page 146-160
For every Quick Connect™ Pendant, order one Quick Connect™ Adapter for 120V Track System



QUICK CONNECT™ FIXTURES

See page 141-144 for list of fixtures. For every Quick Connect Fixture, order one Quick Connect™ Adapter for 120V Track System



H-QADP Quick Connect™
L-QADP Adapter for
J-QADP 120V Track System

120V PENDANTS FOR TRACK OR CANOPY MOUNT

BONGO

LED **A19**
12W, 810 lumens 100W max
3000K, 85 CRI

Socket set includes 96" wire that may be cut in the field.

Model	Lamping	Shade	Socket
PLD-F4 Canopy	451LED A19 LED lamp included LED med. base	WT White	BK Black BN Brushed Nickel WT White
HTK-F4 H Track LTK-F4 L Track JTK-F4 J Track			

Example: **JTK-F4-451LEDWT/WT**



DAX

LED **A19**
12W, 810 lumens 100W max
3000K, 85 CRI

Socket set includes 96" wire that may be cut in the field.

Model	Lamping	Shade	Socket
PLD-F4 Canopy	454LED A19 LED lamp included LED med. base	WT White	BK Black BN Brushed Nickel WT White
HTK-F4 H Track LTK-F4 L Track JTK-F4 J Track			

Example: **HTK-F4-454LEDWT/BN**



FELIS

LED **A19**
12W, 810 lumens 100W max
3000K, 85 CRI

Socket set includes 96" wire that may be cut in the field.

Model	Lamping	Shade	Socket
PLD-F4 Canopy	404LED A19 LED lamp included LED med. base	BN Brushed Nickel CO Copper	BK Black BN Brushed Nickel WT White
HTK-F4 H Track LTK-F4 L Track JTK-F4 J Track			

Example: **HTK-F4-404LED/BN**

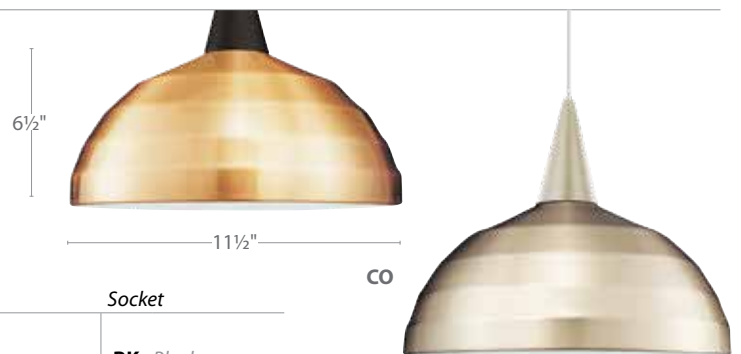



FLEXRAIL 1™

120V bendable monorail with 1920W capacity

Offering a slender profile that is easy to assemble and customize, Flexrail 1™ offers a technological and flexible system. The professional upgrade to traditional track creates bold, eye-catching, three-dimensional configurations while challenging ceilings are transformed with LED and incandescent pendants and fixtures.

This sturdy, yet distinctive system is engineered for the most demanding retail and commercial applications where versatility, high performance and robust aesthetics are required. A wide assortment of new LED spot lights and wall wash lights are available for an energy conscious lighting plan.



HOW TO ORDER FLEXRAIL1™ SYSTEM

1 Measure the amount of rail needed. Flexrail1™ comes in platinum finish

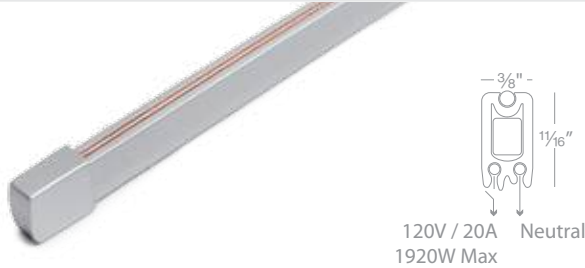

RAIL SECTIONS

HM1-T4-PT	4'
HM1-T8-PT	8'

Includes two end caps

Bending Tools



HM1-BM

Make perfect small radius bends. Clamps onto benches or flat surfaces up to 2"

2 Determine the length and the type of the power feed

POWER FEEDS

	Model	Length	Description
Stem Power Feed	HM1-PCT6-PT	6"	May be placed anywhere along the length of the rail over a junction box supplying 120 volts. Also serves as a support. Cannot be extended or field cut.
	HM1-PCT12-PT	12"	
	HM1-PCT48-PT	48"	
Flexible Ceiling Power Feed	HM1-PCC12-PT	12"	Used for power on sloped ceilings, custom suspension lengths. Can be field cut.
	HM1-PCC48-PT	48"	

3 Select the standoff type

RAIL STANDOFFS	Model	Description	RAIL CONNECTORS	Model	Description
Standard Ceiling Standoff	HM1-X6-PT	6"	"1" Connector	HM1-I6-PT	6" Connects two colinear sections of rail with electrical continuity.
	HM1-X12-PT	12"		HM1-I12-PT	12" sections of rail with electrical continuity.
	HM1-X48-PT	48"		HM1-I48-PT	48" sections of rail with electrical continuity.
T-Bar Ceiling Standoff	HM1-TB6-PT	6"	"1" Dead-End Connector	HM1-IDEC6-PT	6" Connects two colinear sections of rail with no electrical continuity.
	HM1-TB12-PT	12"		HM1-IDEC12-PT	12" sections of rail with no electrical continuity.
	HM1-TB48-PT	48"		HM1-IDEC48-PT	48" sections of rail with no electrical continuity.
Sloped Ceiling Standoff	HM1-XS6-PT	6"	Variable Angle Connector	HM1-VA6-PT	6" Connects two sections of rail with electrical continuity. Connects at any angle up to 270°.
	HM1-XS12-PT	12"		HM1-VA12-PT	12" sections of rail with electrical continuity. Connects at any angle up to 270°.
	HM1-XS48-PT	48"		HM1-VA48-PT	48" sections of rail with electrical continuity. Connects at any angle up to 270°.

Field Shortening Adapter		HM-XADJ-PT	9/16" x 13/16"	Use to customize the standoff length or connector rods to replace threaded ends.
Rod Coupler		XI-PT	1/2" x 13/16"	Connects two standoffs or connector rods together to form a longer drop.
Sloped Ceiling Adapter		SK145-PT	1 1/16" x 25/16"	Use on standoffs and connector rods to mount on a sloped ceiling. Not compatible with T-BARCLIP



SILO X10 LED FLEXRAIL1™

TITLE 24
CALIFORNIA



Power: 10W
Input: 120V
Comparable to: 65W MR16
ELV Dimming: 100% - 5%
Rated Life: 50,000 hours

- Die-cast aluminum construction in a small, and clean design
- Performance luminaire with integral LED and driver
- Abrasion resistant powder-coated finishes
- Accommodates one lens or one glare control accessory
- Field replaceable TIR lens for beam control (25° & 35° included)
- UL & cUL Listed

	Track	Model	Beam	Color Temp	CRI	Lumens	CBCP	Finish
	HM1 Flexrail1™	2010-930	25°	3000K	90	790	2575	PT Platinum
			AND 35°			790	1545	

HM1-2010-930-PT

LENS ACCESSORIES

Amber
 Blue
 Green
 Red
 Frosted
 Spread
 Beam Elongating

LENS-11-AMB
LENS-11-BLU
LENS-11-GRN
LENS-11-RED
LENS-11-FR
LENS-11-SPR
LENS-11-BEL

GLARE CONTROL ACCESSORIES

Cross Louver **LENS-11P-CRL-PT**
 Snoot **LENS-11-SNOOT-PT**



Optional Focusing Framing Projector Accessory **FP-K**



Adjustable between 15° - 50°

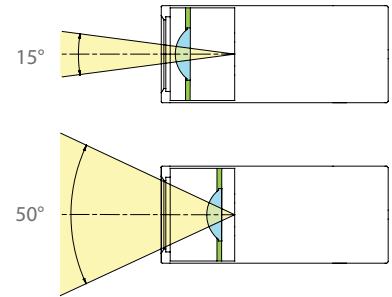

SILO X20 LED FLEXRAIL1™

TITLE 24
CALIFORNIA

Power: 20W
Comparable to: 75W MR16
Dimming: 100% - 5% ELV
Input: 120V
Rated Life: 50,000 hours

- Continuously adjustable beam angles from 15° to 50°
- Die-cast aluminum construction with rotatable front face
- Performance luminaire with integral LED and driver
- Abrasion resistant powder-coated finishes
- Accommodates one lens and one glare control accessory
- UL & cUL listed

Track	Model	Color Temp	CRI	Beam	Lumens	CBCP	Finish
	HM1 Flexrail1™	2020-930	3000K	90	15°	785	PT Platinum
					50°	1080	

HM1-2020-930-PT

LENS ACCESSORIES

Amber	LENS-16-AMB
Blue	LENS-16-BLU
Green	LENS-16-GRN
Red	LENS-16-RED
Frosted	LENS-16-FR
Spread	LENS-16-SPR
Beam Elongating	LENS-16-BEL

GLARE CONTROL ACCESSORIES

Cross Louver	LENS-16P-CRL-PT
Snoot	LENS-16-SNOOT-PT
Honeycomb Louver	LENS-16-HCL

FOCUSING FRAMING PROJECTOR ACCESSORY

FP-K-BK



WALL WASH LED FLEXRAIL1™

- | | | |
|--------------------------|--------------|---|
| Power: | 20W | • Install 3 to 5 feet from wall and 3 to 5 feet on center for optional effect |
| Delivered lumens: | Up to 925 | • Die-cast aluminum construction |
| Comparable to: | 20W HID | • Powder-coated finishes |
| ELV Dimming: | 100% - 5% | • Asymmetrical beam distribution for even wall illumination |
| Input: | 120V | • Economical performance luminaire with integral LED and driver |
| Rated Life: | 50,000 hours | • UL & cUL Listed |

	Track	Model	Color Temp	CRI	Lumens	Finish
	HM1 Flexrail1	3020W-30	3000K	90	925	PT Platinum

HM1-3020W-30-PT

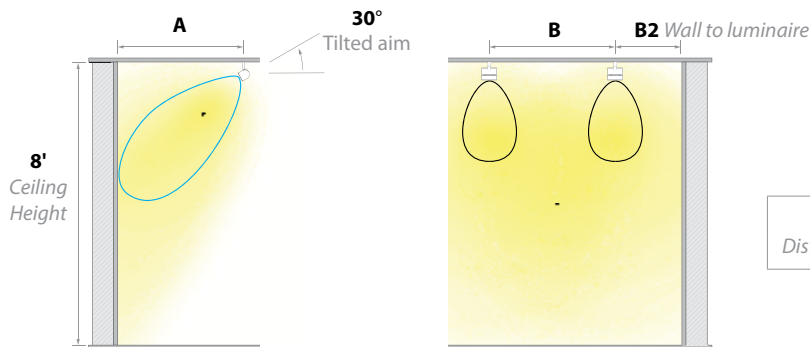

		B On-center spacing distance	
		3 feet	5 feet
A Distance from wall	3 feet	31 fc	25 fc
	5 feet	20 fc	16 fc



SUMMIT LED FLEXRAIL1™



Power: 15W
Comparable: 50W MR16
CRI: 90
ELV Dimming: 100% - 10%
Input: 120V
Rated Life: 50,000 hours

- 120VAC - no driver needed
- Beamshift™ enables in-field change of beam angle (patent pending)
- Die-cast aluminum construction
- UL & cUL Listed

Model		Color Temp	Beam*	Lumens	CBCP	Finish
HM1-LED202-30-PT	FLEXRAIL1™	3000K	15°	600	3424	Platinum 
			40°	760	1417	

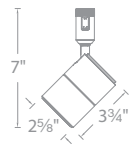

*All Summit LED track luminaires come with Flood (40°) beam setting by default, which may be reconfigured to Narrow (15°) in field.

BEAMSHIFT™

All Summit series track luminaires come with BeamShift™, allowing in-field change of beam angle simply by changing the location of the lens

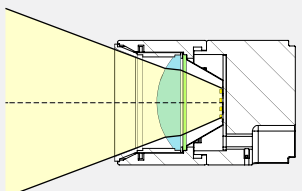

Flood Configuration
Lens located at the back

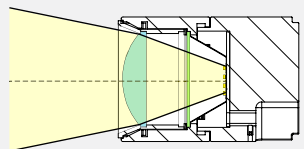

Spot Configuration
Lens located in the front



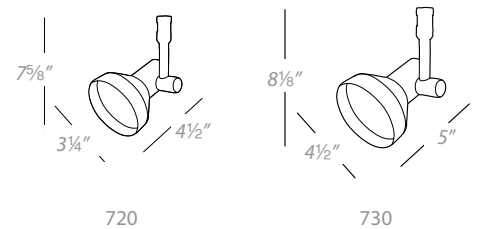

720, 730 PAR20/PAR30

- Die-cast aluminum construction
- Patented tool-free locking mechanism for precise aiming



	Lamp	Finish
HM1-720-PT	120V, 50W max, PAR20	Platinum 
HM1-730-PT	120V, 75W max, PAR30	Platinum 

*Order lamp separately

LED LAMPS		Finish	Power	CCT	Volt	Lumens	CBCP	CRI	Beam	Average Life	
	PAR20	PAR20LED-10N30-BK PAR20LED-10N30-WT	Black White	7W	3000K	120V 60Hz	500	593	90	40°	25,000 Hours
	PAR30	PAR30LED-L14N30-BK PAR30LED-L14N30-WT	Black White	11W	3000K	120V 60Hz	800	1315	90	40°	25,000 Hours

4

Three groups of luminaire choices: Quick Connect™ Pendants; Quick Connect™ Fixtures; and Flexrail1™ Fixtures.



FLEXRAIL1™ FIXTURES

See page 127-131 for list of fixtures. These line voltage fixtures do not require any adapter.



QUICK CONNECT™ PENDANTS

Model number begins with QP-, See page 146-160. For every Quick Connect™ Pendant, order one Quick Connect™ Adapter for Flexrail1™



QUICK CONNECT™ FIXTURES

See page 141-144 for list of fixtures. For every Quick Connect Fixture, order one Quick Connect™ Adapter for Flexrail1™



HM1-EN50-PT

Quick Connect™ Adapter for Flexrail1™

CREATING CURVES

Broad curves work best (24" minimum radius). When working with curves, we recommend ordering up to 25% more rail than estimated to compensate for in-field design adjustments during installation.

Rail should pass under or near a junction box. Shaping rail before mounting on the ceiling allows you to determine the best location for standoffs.

SUPPORTS & CONNECTORS

Minimum of three supports are needed for an 8 foot section and two for a 4 foot section. Custom lengths can be configured by using suspension rods with rod couplers.

Based on your layout, determine the rail connectors that you may need to join the rail together. Dead End Connectors allow you to connect runs together mechanically that exceed the max wattage per circuit.

LUMINAIRES

When ordering the Quick Connect™ pendants or fixtures, make sure to order one Quick Connect™ adapter (HM1-EN50-PT) for each. The total load should not exceed 1920W in accordance with line voltage general guidelines.

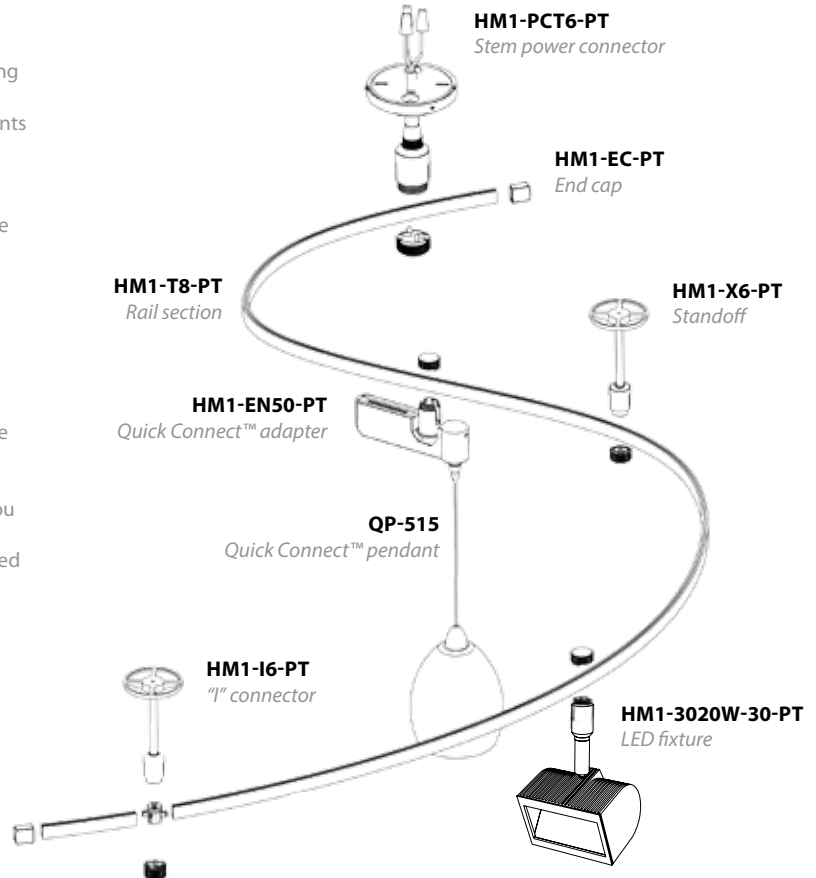



SOLORAIL™

Single Circuit Monorail System

WAC Lighting low voltage monorail system can be shaped and cut in the field to navigate curves for custom designs. The versatile Solorail™ accommodates hundreds of Quick Connect™ pendants and fixtures. Designed with the thinnest profile in the industry, $\frac{1}{16}$ " tall and $\frac{3}{8}$ " wide, Solorail™ is engineered for rigorous usage in commercial, hospitality and retail applications. Featuring electroplated solid copper bus bars and CNC precision fabricated components, with a maximum capacity of 25 amperes; or 300 watts at 12 volts and 600 watts at 24 volts.



STARTER KITS SOLORAIL™



150W, 8FT KIT

Use with any combination of pendants or fixtures totaling 150W
1Watt minimum load for compatibility with LED lamps and fixtures.

Model	Finish
LM-SK-150E-BN	Brushed Nickel

Kit Includes

- 2 4 foot rail sections
- 1 "I" connector
- 2 End caps
- 1 150W surface mount electronic transformer
- 3 4½" standoff supports



Solorail™ Quick Connect™ Adapters, Pendants and Fixtures ordered separately.
See p.139-160 for all Quick Connect™ options.

250W, 12FT KIT

Use with any combination of pendants or fixtures totaling 250W
1Watt minimum load for compatibility with LED lamps and fixtures.

Model	Finish
LM-SK-250E-BN	Brushed Nickel

Kit Includes

- 3 4 foot rail sections
- 2 "I" connectors
- 2 End caps
- 1 250W surface mount electronic transformer
- 5 4½" standoff supports



Solorail™ Quick Connect™ Adapters, Pendants and Fixtures ordered separately.
See p.139-160 for all Quick Connect™ options.

250W, 5 LIGHT FIXTURE KIT

Choose from four different combinations



LM-K8111-AS/DB



LM-K8711-WT/BN



LM-K8811-WT/BN



LM-K9415-BN/BN

Model	Shade/Fixture	Additional Fixtures
LM-K8111-AS/DB	Amber/Dark Bronze	QF-8111-AS/DB
LM-K8711-WT/BN	White/Brushed Nickel	QF-8711-WT/BN
LM-K8811-WT/BN	White/Brushed Nickel	QF-8811-WT/BN
LM-K9415-BN/BN	Brushed Nickel/Brushed Nickel	QF-9415-BN/BN

Add additional fixtures or pendants by using lower wattage lamps,
20W and 35W lamps available. Do not exceed 250W.

Kit Includes

- 3 4½ foot rail sections
- 2 "I" connectors
- 2 End caps
- 1 250W surface mount electronic transformer
- 4 4½" standoff supports
- 5 Fixtures, includes 50W MR16 lamps,
other MR16 lamps available
order separately (p.72)

HOW TO ORDER SOLORAIL™ SYSTEM

1 Measure the amount of rail needed. Solorail™ comes in Brushed Nickel finish



RAIL SECTIONS

LM-T4-BN 4'
LM-T8-BN 8'

Includes two end caps

BENDING TOOL



HM1-BM

Make perfect small radius bends. Clamps onto work benches or flat surfaces up to 2"





2 Choose the appropriate sized transformer with sufficient electrical load to accommodate the total wattage used for the system



Shown **LM-EN12-75E-BN** with **LM-X3-BN** standoff and **QF-LED173X3-BN** LED fixture





WAC Solorail™ LED transformer is the slimmest 75 watt surface mount canopy in the industry. At only 4 1/16" height and 4 1/2" in diameter, it has the capacity to power up nine 9W LED fixtures in one run while using 4 times less energy than common electronic transformers. Constructed of die-cast aluminum, this transformer mounts to a standard 4" ceiling junction box. Can be used with 3" standoffs and a power extender.

POWER FEEDS (WITH INTEGRAL TRANSFORMERS)

	Model #	Volt	Watt	Dimensions	Run Length	Description
Slim Electronic Transformer	 LM-EN12-75E-BN	12V	75W	Ø 4 1/2" H 4 1/16"	10'	Electronic transformer fits within a standard 4" junction box. Use with 3" (LM-X3) standoff
Electronic Transformer	 LM-EN12-150E-BN	12V	150W	Ø 5"	20'	Use with 4 1/2" (LM-X4) standoff
Electronic Transformer	 LM-EN12-250E-BN	12V	250W	Ø 6"	16'	Use with 4 1/2" (LM-X4) standoff
Magnetic Transformer	 LM-EN12-300M-BN	12V	300W	Ø 9"	40'	Use with 5 3/4" (LM-X5) standoff
Sloped Ceiling Feed	 LM-SCP48-BN LM-SCP96-BN			48" 96"		5A max. Use with surface mounted transformer. Use at any angle, easily shortened. Includes two LM-RI couplers.





HOW TO ORDER SOLORAIL™ SYSTEM

POWER FEEDS (FOR USE WITH REMOTE TRANSFORMERS)

		Model #	Dimensions	Description
Single Power Feed		LM-CPC-BN	Ø 4½"	25A max. Use with 3" standoff (LM-X3).
Wall Power Feed		LM-WPC-BN	Ø 4½"	25A max. Feeds power to end of the rail.
Dual Power Feed		LM-DCPC-BN	Ø 5⅝"	Two 25A max power feeds. Order with dead end "I" connector (LM-IDEC). Use with 3" standoff (LM-X3).
Cable Power Feed		LM-PCS48-BN LM-PCS96-BN	Ø 4½" × 48" Ø 4½" × 96"	25A max. Use on sloped ceilings with remote transformers. Use at any angle, easily shortened.
Wall Mount Power Feed Bracket		LM-OWP-BN		Can be mounted up to 24" from a wall. Supported by aircraft cables. Use with remote transformers. Use with two LM-OW (p.137) per 4 ft, three per 8 ft.

REMOTE TRANSFORMERS





300W is the maximum load allowable per rail channel for 12V systems
600W is the maximum load allowable per rail channel for 24V systems

	Model #	Volt	Watt	Breakers	Dimensions	Run length	Distance to power feed (based on 10 AWG)	Description
Electronic	 EN-12100-RB-AR	12V	100W		L 6¼" W 3" H 1⅝"	40' max	10ft max	Recommended for LED fixtures
Magnetic	 SRT-300M-12V	12V	300W	1	L 10¾" W 4¼" H 4⅝"	40' max	10ft max	Recommended for halogen fixtures
	 SRT-300M-24V	24V	300W	1	L 10¾" W 4¼" H 4⅝"	40' max	10ft max	Recommended for halogen fixtures
	 SRT-600M-12V	12V	600W	2	L 11½" W 6⅝" H 5⅞"	2 runs at 40' max	10ft max	Recommended for halogen fixtures
	 SRT-600M-24V	24V	600W	1	L 12½" W 6⅝" H 5⅞"	40' max	10ft max	Recommended for halogen fixtures

On a full load voltage drop can cause a system to exceed the 25A rating. Guidelines assist with layouts only. When installing a 12V system, ensure that a min. of 12V is supplied at power feeds. 10AWG wire should be used with remote transformers. Multi-tap output terminals (remote magnetic transformers) help make up for voltage drop before the power feed. Use a multimeter to verify no less than 11V is found at the end of the run and no more 25A is being drawn from the power feed.

HOW TO ORDER SOLORAIL™ SYSTEM

3 Select the suspension type and joining accessories

RAIL SUSPENSION		Model #	Dimensions	Description
Standard Ceiling Standoff		LM-X3-BN LM-X4-BN LM-X5-BN	3" 4½" 5¾"	Supports rail for flat ceilings and surfaces.
T-Bar Ceiling Standoff		LM-TB3-BN LM-TB4-BN LM-TB5-BN	3" 4½" 5¾"	Conceals a T-Bar clip under the canopy for standard 1" T-Bar ceilings.
Sloped Ceiling Standoff		LM-XS5-BN	5¾"	Supports rail for sloped ceilings. Accommodates angles up to 45°.
Aircraft Suspension Cable		LM-CS48-BN LM-CS96-BN	48" 96"	Supports monorail for flat or sloped ceilings.
Wall Mount Support Bracket		LM-OW-BN		Wall extenders allow rail to be mounted up to 24" from a wall.

Extension Rod		LM-R12-BN LM-R24-BN LM-R36-BN LM-R48-BN	12" 24" 36" 48"	Use with standoffs and power feeds. Use two per circuit with rod couplers to extend power feeds. Field cut to size and join with rod couplers.
Rod Coupler		LM-RI-BN	Ø 3/8" x 7/8"	Use two per power feed, four per dual power feed. One additional coupler per rod needed when joining two rods in excess of 48".
Jumper Set		LM-JS-BN	6"	Used to join two rails together.
"I" Dead-End Connector		LM-IDEC-BN	5/8" x 2"	Connects two sections of rail with no electrical continuity.
"I" Connector		LM-I-BN	5/8" x 2"	Connects two sections of rail with electrical continuity.
"L" Connector		LM-L-BN	5/8" x 1½" x 1½"	90° monorail connection with electrical continuity
Ceiling To Wall Connector		LM-CW-BN	5/8" x 1¾" x 1¾"	90° monorail connection in a vertical plane with electrical continuity
Variable Angle Connector		LM-VA-BN	Ø 1" x 1¼" x 3½"	Allows an angle adjustment up to 110° with electrical continuity at the connection.
"T" Connector		LM-T-BN	5/8" x 1½" x 1½"	Connects two sections of a monorail in a "T" with electrical continuity

HOW TO ORDER SOLORAIL™ SYSTEM

4 Quick Connect™ Pendants and Quick Connect™ Fixtures can mount with Quick Connect™ Adapter for Solorail™



QUICK CONNECT PENDANTS

Model number begins with **QP-**. See page 146-160.
For every Quick Connect Pendant, order one Quick Connect™ Adapter for Solorail™



QUICK CONNECT FIXTURES

See 141-144 for list of fixtures.
For every Quick Connect Fixture, order one Quick Connect™ Adapter for Solorail™



PLACEMENT

Rail should pass under or near a junction box. Shaping rail before mounting on the ceiling allows you to determine the best location for standoffs. The stem may be field cut.

POWER

300W is the maximum load allowable per rail channel for 12V systems and 600W is the maximum load allowable per rail channel for 24V systems. All Quick Connect™ LED products run at 12V.

SUPPORTS & CONNECTORS

Minimum of three supports are needed for an 8 foot section and two for a 4 foot section. Custom lengths can be configured by using extension rods with rod couplers.

Based on your layout, determine the rail connectors that you may need to join the rail together. Dead End Connectors allow you to connect runs together mechanically that exceed the max wattage per circuit.

LUMINAIRES

When ordering the Quick Connect™ pendants or fixtures, make sure to order one Quick Connect™ adapter (LM-QADP-BN) for each. The total load should not exceed 300W for each circuit.

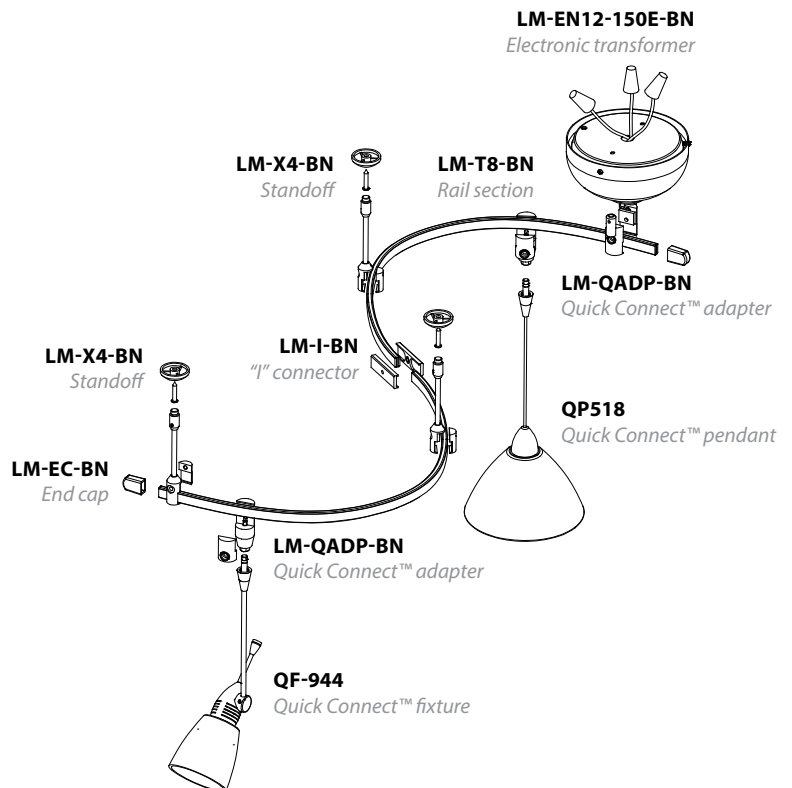





QUICK CONNECT™ FIXTURES, PENDANTS, AND SCONCES

Look to WAC Lighting's Quick Connect™ Fixtures for an assortment of track options in halogen, xenon, and LED light sources. Easy to install, WAC Quick Connect™ Fixtures enable versatility of design concepts with mounting options to any of our Quick Connect™ system adapters including various canopies, 120V Track, Flexrail1™, Solorail™ and wall sconces.



QUICK CONNECT™ ADAPTERS

The Quick Connect™ collection includes a wide array of pendants and fixtures with different mounting options. The threaded male adapter makes inter-system compatibility a snap. Simply insert the metal fitting into the system adapter and hand tighten the collar. Order one per Quick Connect™ fixture or pendant used.

System Adapter	Specifications	Model	Finish
120V Track H, L, J p. 94-95	 <p>Allows all Quick Connect™ elements to be used with the H, L, J, J2 track systems 1W minimum load transformer ELV dimming</p>	EN-HQ50AR H Track EN-LQ50AR L Track EN-JQ50AR J Track	BK Black BN Brushed Nickel WT White DB *Dark Bronze *for H Track only
W Track WTK p. 91	 <p>Recessed transformer within W track Allows all Quick Connect™ elements to be used with the W track 120V systems 1W minimum load transformer ELV dimming</p>	EN-WQ50AR	BK Black PT Platinum WT White
Solorail™ p. 135	 <p>Allows all Quick Connect™ elements to be used with the Solorail™ system</p>	LM-QADP	BN Brushed Nickel
Flexrail1™ p. 126	 <p>Allows all Quick Connect™ elements to be used with the Flexrail1™ system 1 watt minimum load transformer ELV dimming</p>	HM1-EN50	PT Platinum

Example: **LM-QADP-BN**

QUICK CONNECT™ CANOPY



See 145-147 for QC canopies and page 161-162 for wall sconces options

QUICK CONNECT™ PENDANT OVERVIEW



Genesis
p. 146



Mini Haven
p.153



Haven
p.153



Gia
p.153



Sorriso
p.154



Kalysta
p.154



Giselle
p.154



Clarity
p.149



Bullet
p.149



Über
p.149



Tulum
p.150



Ingo
p.150



Tikal
p.150



Prisma
p.151



Polaris
p.151



Roxy
p.151



Eden
p.152



Ice
p.152



Candy
p.152



Mason
p.155



Madison
p.155



Freeport
p.156



Wyandotte
p.156



Zanzibar
p.157



Passion
p.159



Fiori
p.159



Jill
p.160



Sarah
p.160



Willow
p.157



Truffle
p.158



Fabergé
p.158

QUICK CONNECT™ FIXTURES LEDME®

- Color Temp: 3000K
 CRI: 85
 Rated Life: 80,000 hours
- Strong projected light output with no projected heat
 - 360° horizontal rotation and 90° vertical adjustment
 - Machined aluminum construction
 - Dim to 10% depending on system power supply. Use ELV dimmer with electronic transformer. Use MLV dimmer with magnetic transformer

OVUM 101

	Power*	Lumen	Beam	
QF-LED101-W-F-BN	3W	110	25°	Brushed Nickel
QF-LED101-W-W-BN	3W	110	40°	Brushed Nickel

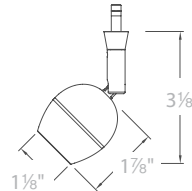

CHARGE 102

	Power*	Lumen	Beam	
QF-LED102-W-F-BN	3W	110	25°	Brushed Nickel
QF-LED102-W-W-BN	3W	110	40°	Brushed Nickel

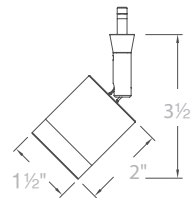

PORTAL 103

	Power*	Lumen	
QF-LED103-W-BN	4W	100	Brushed Nickel

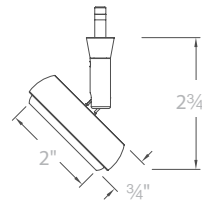

*Power consumption may vary depending on the efficiency of the power supply being used, LED may be retrofit to existing 12V systems
 Systems using older electronic transformers may need to upgrade to 1 watt minimum load transformers

QUICK CONNECT™ ADAPTERS

Solorail™		LM-QADP	BN	Brushed Nickel
Flexrail™		HM1-EN50	PT	Platinum
W Track		EN-WQ50AR	BK PT WT	Black Platinum White
H/L/J/J2 120V Track		EN-LQ50AR EN-HQ50AR EN-JQ50AR	BK BN WT	Black Brushed Nickel White

QUICK CONNECT™ CANOPY

Canopy		See p.145-147 for canopy options
--------	--	----------------------------------

EXTENSIONS

	Q-X18-BN Q-X24-BN	18" 24"	Designed for use with Quick Connect™ Fixtures to extend the stem, cannot be shortened in field
---	------------------------------------	------------	--

QUICK CONNECT™ FIXTURES LEDME® AND HALOGEN

- Color Temp:** 3000K
CRI: 85
Rated Life: 80,000 hours
- Strong projected light output with no projected heat
 - 360° horizontal rotation and 90° vertical adjustment
 - Machined aluminum construction

FORZA 173



	Power*	Lumen	Extension	
QF-LED173X3-BN	7.5W	280	3"	Brushed Nickel

Dim to 10% depending on system power supply. Use ELV dimmer with electronic transformer.
Use MLV dimmer with magnetic transformer

MERLIN 185

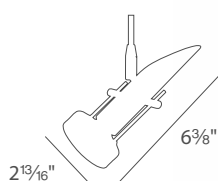

	Lamp	Extension	Finish
QF-185LEDX3-BN	LED 12V 8W MR16 Included	3"	Brushed Nickel
QF-185X3-BN	Halogen 12V 50W max MR16 (Sold Separately)	3"	Brushed Nickel

*Power consumption may vary depending on the efficiency of the power supply being used, LED may be retrofit to existing 12V systems

QUICK CONNECT™ ADAPTERS

Solorail™		LM-QADP	BN Brushed Nickel
Flexrail™		HM1-EN50	PT Platinum
W Track		EN-WQ50AR	BK Black PT Platinum WT White
H/L/J/J2 120V Track		EN-LQ50AR EN-HQ50AR EN-JQ50AR	BK Black BN Brushed Nickel WT White

QUICK CONNECT™ CANOPY

Canopy		See p.145-147 for canopy options
--------	---	----------------------------------

EXTENSIONS

	Q-X18-BN 18" Q-X24-BN 24"	Designed for use with Quick Connect™ Fixtures to extend the stem, cannot be shortened in field
---	--	--

MINT QUICK CONNECT™ FIXTURE

- 360° horizontal rotation and 90° vertical adjustment
- Machined brass construction
- Halogen version does not include a lamp
- LED version includes LED low voltage MR16 lamp

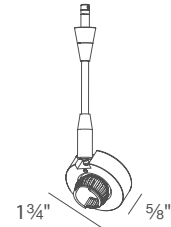

LED
QF-815LED-BN

Halogen
QF-815-BN



LED
QF-816LED-BN

Halogen
QF-816-BN



Halogen
QF-814-BL/BN



Halogen
QF-814-AM/BN



Halogen
QF-814-WT/BN



Halogen
QF-814-RD/BN



Halogen
QF-811-AM/BN



Halogen
QF-811-WT/BN



Halogen
QF-811-BL/BN

QUICK CONNECT™ ADAPTERS

Solorail™		LM-QADP	BN <i>Brushed Nickel</i>
Flexrail™		HM1-EN50	PT <i>Platinum</i>
WTrack		EN-WQ50AR	BK <i>Black</i> PT <i>Platinum</i> WT <i>White</i>
H/L/J/J2 120V Track		EN-LQ50AR EN-HQ50AR EN-JQ50AR	BK <i>Black</i> BN <i>Brushed Nickel</i> WT <i>White</i>

QUICK CONNECT™ CANOPY

Canopy		See p.145-147 for canopy options
--------	--	----------------------------------

EXTENSIONS

	Q-X18-BN 18" Q-X24-BN 24"	Designed for use with Quick Connect™ Fixtures to extend the stem, cannot be shortened in field
---	--	--

EGO QUICK CONNECT™ FIXTURE

- 360° horizontal rotation and 90° vertical adjustment
- Machined brass construction
- Halogen version does not include a lamp
- LED version includes LED low voltage MR16 lamp
- Removable hot aim adjustment pin

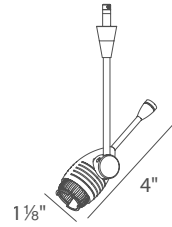

LED
QF-945LED-BN

Halogen
QF-945-BN



LED
QF-946LED-BN

Halogen
QF-946-BN



Halogen
QF-944-BL/BN



Halogen
QF-944-AM/BN



Halogen
QF-944-WT/BN



Halogen
QF-944-RD/BN



Halogen
QF-941-AM/BN



Halogen
QF-941-WT/BN



Halogen
QF-941-BL/BN

QUICK CONNECT™ ADAPTERS

Solorail™		LM-QADP	BN <i>Brushed Nickel</i>
Flexrail1™		HM1-EN50	PT <i>Platinum</i>
W Track		EN-WQ50AR	BK <i>Black</i> PT <i>Platinum</i> WT <i>White</i>
H/L/J/J2 120V Track		EN-LQ50AR EN-HQ50AR EN-JQ50AR	BK <i>Black</i> BN <i>Brushed Nickel</i> WT <i>White</i>

QUICK CONNECT™ CANOPY

Canopy		See p.145-147 for canopy options
--------	--	----------------------------------



EXTENSIONS

	Q-X18-BN 18" Q-X24-BN 24"	Designed for use with Quick Connect™ Fixtures to extend the stem, cannot be shortened in field
---	--	--

QUICK ADJUST™ CANOPIES

Quick Adjust™ Monopoint Canopies (Integral Transformers)

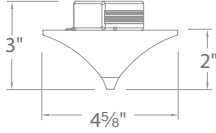



- 1W minimum load required
- 60W Integral electronic transformer
- Smooth and continuous ELV dimming

			<i>Model</i>	<i>Finish</i>
Quick Adjust™ Pendant Canopy			MP-60E	BN <i>Brushed Nickel</i> CH <i>Chrome</i> DB <i>Dark Bronze</i>
<ul style="list-style-type: none"> • UL & CUL Listed • Adjustable pendants can be raised/lowered after installation • For use with a 4" junction box; includes optional decorative collar for shallow junction box • Order as a complete unit with pendant 				

QUICK CONNECT™ CANOPIES

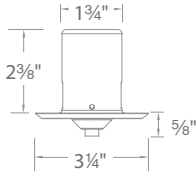
Monopoint Canopies (Remote Transformers Required)

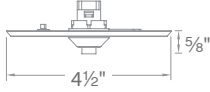
- Order remote transformer separately
- No visible hardware

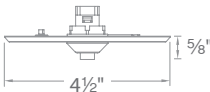
			<i>Model</i>	<i>Finish</i>
Miniature Round Canopy with Wiring Compartment			QMP-MI-TR	BN <i>Brushed Nickel</i> CH <i>Chrome</i> DB <i>Dark Bronze</i>
<ul style="list-style-type: none"> • The recessed "housing" is a wiring compartment with one knock-out that accepts trade size connectors • The housing is installed in the cutout hole and then the faceplate is attached 				
Round Canopy for Junction Box			QMP-1RN-TR	BN <i>Brushed Nickel</i> CH <i>Chrome</i> DB <i>Dark Bronze</i>
<ul style="list-style-type: none"> • Mounts over a standard 4" junction box • Base plate covers junction box opening, the canopy attaches to base plate with a metal nut 				
Square Canopy For Junction Box			QMP-1SQ-TR	BN <i>Brushed Nickel</i> CH <i>Chrome</i> DB <i>Dark Bronze</i>
<ul style="list-style-type: none"> • Mounts over a standard 4" junction box • Base plate covers junction box opening, the canopy attaches to base plate with metal nut 				

Example: **QMP-MI-TR-BN**



GENESIS SINGLE PENDANT

Power: 5W
 Delivered Lumens: Up to 240
 Color Temp: 3000K
 CRI: 85



All socket sets include 12 ft wire that may be cut in the field

System	Lamping	Shade/Canopy Finish
MP Quick Connect™ + Canopy QP* Quick Connect™ Only	LED311 Integral LED	BN/BN Brushed Nickel/Brushed Nickel

Example: **QP-LED311-BN/BN**

Dim to 15% depending on system power supply. Use ELV dimmer with electronic transformer.
 Use MLV dimmer with magnetic transformer









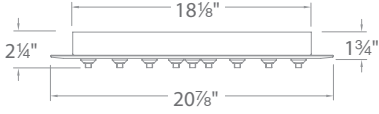

	MP: Quick Connect™ + Canopy		QP: Quick Connect™	BN: Brushed Nickel 
---	------------------------------------	---	---------------------------	---

QUICK CONNECT™ CANOPIES

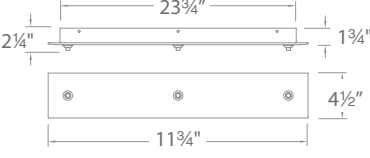

Mirrored Glass Multipoint Canopies (Integral Transformers)

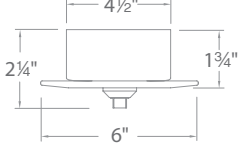
- For use with any of our hundreds of Quick Connect™ pendants and fixtures
- 1W minimum load
- 60W Integral electronic transformer for each drop
- Smooth and continuous ELV dimming

			<i>Model</i>	<i>Finish</i>
12-Point Mirrored Canopy Round			QMP-G12RN-MR	<i>Mirror</i>
6-Point Mirrored Canopy Round			QMP-G6RN-MR	<i>Mirror</i>
3-Point Mirrored Canopy Round			QMP-G3RN-MR	<i>Mirror</i>
3-Point Mirrored Canopy Rectangular			QMP-G3RE-MR	<i>Mirror</i>
1-Point Mirrored Canopy Round			QMP-G1RN-MR	<i>Mirror</i>

Monopoint Canopies (Integral Transformers)

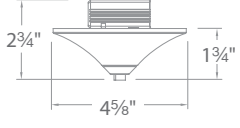
- 1W minimum load required
- 60W Integral electronic transformer
- Smooth and continuous ELV dimming
- For use with a 4" junction box; includes optional decorative collar for shallow junction box

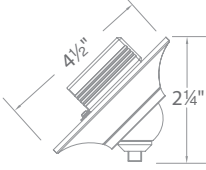
			<i>Model</i>	<i>Finish</i>
Quick Connect™ Adapter Canopy			QMP-60ERN	BN <i>Brushed Nickel</i> CH <i>Chrome</i> DB <i>Dark Bronze</i>
Sloped Ceiling Quick Connect™ Canopy			QMP-S60ERN	

- Swivels up to 45° in either direction and will accept all WAC Lighting Quick Connect™ pendants and fixtures
- For use with a 4" junction box; includes collar for shallow junction box

Example: **QMP-60ERN-CH**

GENESIS CASCADING PENDANTS

QMP-LED311-MR

1-Light
 Power: 5W
 Lumens: 240
 Color Temp: 3000K
 CRI: 85
 Canopy Finish: Mirror

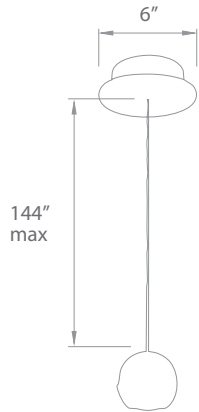

QMP-LED311/3-MR

3-Light
 Power: 15W
 Lumens: 720
 Color Temp: 3000K
 CRI: 85
 Canopy Finish: Mirror

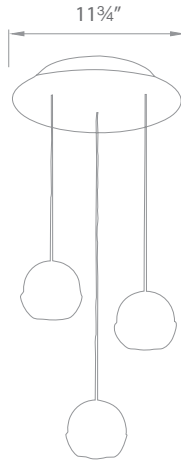

QMP-LED311/6-MR

6-Light
 Power: 30W
 Lumens: 1440
 Color Temp: 3000K
 CRI: 85
 Canopy Finish: Mirror

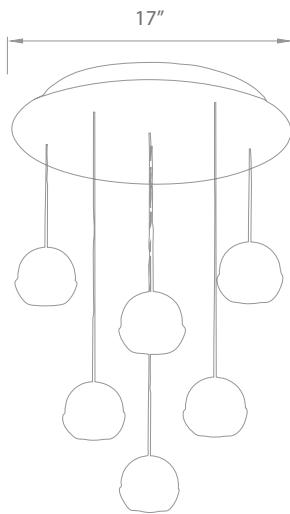

QMP-LED311/12-MR

12-Light
 Power: 60W
 Lumens: 2880
 Color Temp: 3000K
 CRI: 85
 Canopy Finish: Mirror

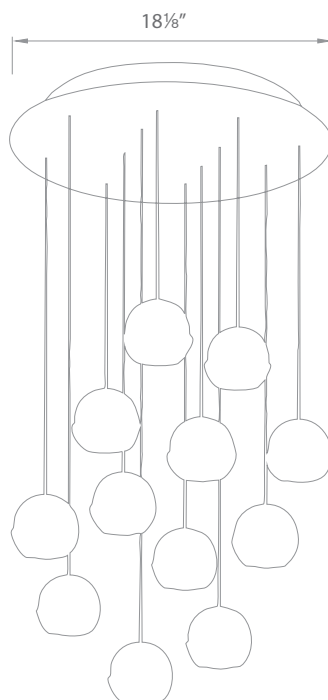

CLARITY

Power: LED Xenon BP-50
 4W 50W max, 12V
Delivered Lumens: 330
Color Temp: 3000K
CRI: 85



Model	Lamping	Glass	Socket
MP QP	LED916 LED 916 Xenon	CL Clear	BN CH

Example: **MP-LED916-CL/BN**

BULLET

Power: LED Xenon BP-50
 6.4W 50W max, 12V
Delivered Lumens: 450
Color Temp: 3000K
CRI: 85



Model	Lamping	Shade	Socket
MP QP	LED966 LED 966 Xenon	BN Brushed Nickel CH Chrome	BN CH

Example: **QP-LED966-CH/CH**





ÜBER

Power: LED
 4.5W
Delivered Lumens: 210
Color Temp: 3000K
CRI: 85



Model	Lamping	Shade	Socket
MP QP	LED315 LED	PT Platinum	BN CH

Example: **QP-LED315-PT/CH**

	MP: Quick Connect™ + Canopy		QP: Quick Connect™	BN: Brushed Nickel 	CH: Chrome 	DB: Dark Bronze 
---	------------------------------------	---	---------------------------	--	---	--

All socket sets include 6 ft wire that may be cut in the field

TULUM

Power: LED Xenon BP-50
 2W 50W max, 12V
Delivered Lumens: 110
Color Temp: 3000K
CRI: 85

Model	Lamping	Glass	Socket
MP	914 LED	FR Frosted	BN
QP	914 Xenon		CH DB

Example: **MP-914LED-FR/CH**

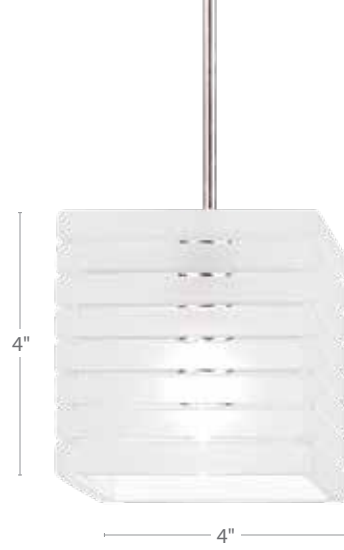

INGO

Power: Xenon BP-50
 50W max, 12V

Model	Lamping	Glass	Socket
MP	913 Xenon	CF Clear Frosted	BN
QP			CH DB

Example: **QP913-CF/CH**







TIKAL

Power: Xenon BP-50
 50W max, 12V

Model	Lamping	Glass	Socket
MP	915 Xenon	CF Clear Frosted	BN
QP			CH DB

Example: **QP915-CF/CH**



	MP: Quick Connect™ + Canopy		QP: Quick Connect™	BN: Brushed Nickel	CH: Chrome	DB: Dark Bronze
						

All socket sets include 6 ft wire that may be cut in the field

PRISMA

Xenon BP-50
 Power: 50W max, 12V



Model	Lamping	Glass	Socket
MP QP	940 Xenon	CL Clear	BN CH DB

Example: **QP940-CL/CH**

POLARIS

Xenon BP-50
 Power: 50W max, 12V



Model	Lamping	Glass	Socket
MP QP	930 Xenon	CL Clear	BN CH DB

Example: **MP-930-CL/CH**





ROXY

LED Xenon BP-50
 Power: 3.7W 50W max, 12V
 Delivered Lumens: 165
 Color Temp: 3000K
 CRI: 85



Model	Lamping	Glass	Socket
MP QP	LED335 LED 335 Xenon	CL Clear	BN CH

Example: **QP-LED335-CL/CH**

	MP: Quick Connect™ + Canopy		QP: Quick Connect™	BN: Brushed Nickel 	CH: Chrome 	DB: Dark Bronze 
---	------------------------------------	---	---------------------------	--	---	--

All socket sets include 6 ft wire that may be cut in the field

EDEN

Power: LED 4W Halogen JC-50
 Delivered Lumens: 330 50W max, 12V
 Color Temp: 3000K
 CRI: 85

Model	Lamping	Glass	Socket
MP	LED518 LED	DIC Dichroic	BN
QP	518 Halogen		CH
			DB

Example: **QP-LED518-DIC/BN**



ICE

Power: LED 6.4W Xenon BP-50
 Delivered Lumens: 450 50W max, 12V
 Color Temp: 3000K
 CRI: 85

Model	Lamping	Glass	Socket
MP	LED960 LED	CL Clear	BN
QP	960 Xenon		CH
			DB

Example: **QP-LED960-CL/BN**







CANDY

Power: LED 4W Halogen JC-50
 Delivered Lumens: 330 50W max, 12V
 Color Temp: 3000K
 CRI: 85

Model	Lamping	Glass	Socket	
MP	LED544 LED	SL Silver	BN	
QP	544 Halogen	GL Gold		CH
		CL Clear		DB

Example: **QP-LED544-SL/CH**



	MP: Quick Connect™ + Canopy		QP: Quick Connect™	BN: Brushed Nickel 	CH: Chrome 	DB: Dark Bronze 
---	------------------------------------	---	---------------------------	--	---	--

All socket sets include 6 ft wire that may be cut in the field

MINI HAVEN

Power: LED 4W Halogen JC-50 50W max, 12V
 Delivered Lumens: 330
 Color Temp: 3000K
 CRI: 85



Model	Lamping	Glass	Socket
MP	LED539 LED	BI Black Ice	BN
QP	539 Halogen	CD Champagne Diamond	CH
		WD White Diamond	DB

Example: **QP-LED539-CD/DB**

HAVEN

Power: LED 6.4W Xenon BP-50 50W max, 12V
 Delivered Lumens: 450
 Color Temp: 3000K
 CRI: 85



Model	Lamping	Glass	Socket
MP	LED939 LED	BI Black Ice	BN
QP	939 Xenon	CD Champagne Diamond	CH
		WD White Diamond	DB

Example: **QP-LED939-BI/BN**

GIA

Power: LED 4W Halogen JC-50 50W max, 12V
 Delivered Lumens: 330
 Color Temp: 3000K
 CRI: 85



Model	Lamping	Glass	Socket
MP	LED542 LED	BI Black Ice	BN
QP	542 Halogen	CD Champagne Diamond	CH
		WD White Diamond	DB

Example: **QP-LED542-WD/DB**

	MP: Quick Connect™ + Canopy		QP: Quick Connect™	BN: Brushed Nickel	CH: Chrome	DB: Dark Bronze

All socket sets include 6 ft wire that may be cut in the field

SORRISO

Power: 3.7W
Delivered Lumens: 165
Color Temp: 3000K
CRI: 85

Model	Lamping	Glass	Socket
MP	LED336 LED	CL Clear	BN
QP		GL Gold	CH
		SM Smoke	DB

Example: **QP-LED336-GL/DB**



KALYSTA

Power: 6.4W
Delivered Lumens: 450
Color Temp: 3000K
CRI: 85

Model	Lamping	Glass	Socket
MP	LED938 LED	BI Black Ice	BN
QP	938 Xenon	CD Champagne Diamond	CH
		WD White Diamond	DB

Example: **QP-LED938-BI/CH**

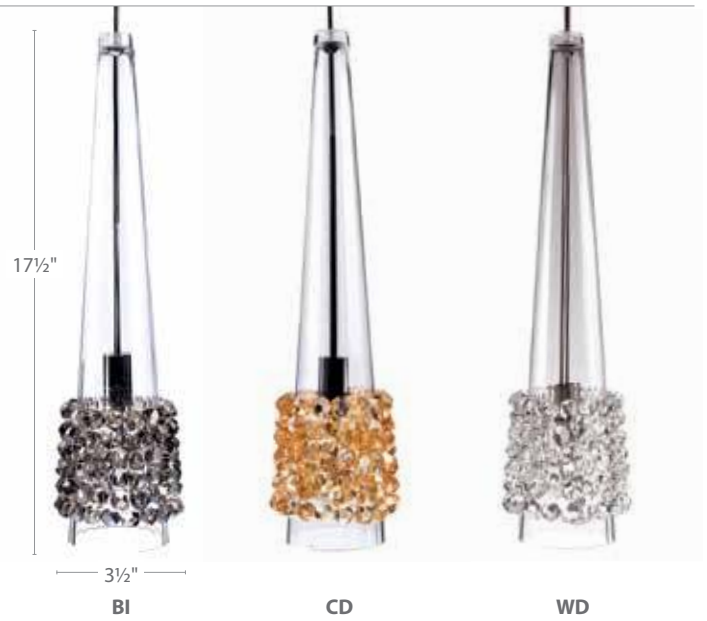

GISELLE

Power: 4W
Delivered Lumens: 330
Color Temp: 3000K
CRI: 85

Model	Lamping	Glass	Socket
MP	LED543 LED	BI Black Ice	BN
QP	543 Halogen	CD Champagne Diamond	CH
		WD White Diamond	DB

Example: **QP-LED543-CD/DB**



	MP: Quick Connect™ + Canopy		QP: Quick Connect™	BN: Brushed Nickel	CH: Chrome	DB: Dark Bronze

All socket sets include 6 ft wire that may be cut in the field

MASON

Power: 5.6W
Delivered Lumens: 350
Color Temp: 3000K
CRI: 85

LED



Model	Lamping	Glass	Socket
MP QP	LED497 LED	CL Clear	BN CH DB

Example: **QP-LED497-CL/BN**

MADISON



Power: 5.6W
Delivered Lumens: 360
Color Temp: 3000K
CRI: 85

LED



Model	Lamping	Glass	Socket
MP QP	LED499 LED	CR Clear Cracked	BN CH DB

Example: **QP-LED499-CR/DB**

 MP: Quick Connect™ + Canopy	 QP: Quick Connect™	BN: Brushed Nickel	CH: Chrome	DB: Dark Bronze
--	---	---------------------------	-------------------	------------------------

All socket sets include 6 ft wire that may be cut in the field

WYANDOTTE

Power: LED
 5.6W
 Delivered Lumens: 385
 Color Temp: 3000K
 CRI: 85



AB

BN

Model	Lamping	Glass	Socket
MP	LED483 LED	BN <i>Brushed Nickel</i>	BN
QP		AB <i>Antique Bronze</i>	DB

Example: **MP-LED483-AB/DB**

FREEPORT

Power: LED
 5.6W
 Delivered Lumens: 362
 Color Temp: 3000K
 CRI: 85







BN

AB

Model	Lamping	Glass	Socket
MP	LED481 LED	BN <i>Brushed Nickel</i>	BN
QP		AB <i>Antique Bronze</i>	DB

Example: **QP-LED481-BN/BN**

 MP: Quick Connect™ + Canopy	 QP: Quick Connect™	BN: <i>Brushed Nickel</i> 	CH: <i>Chrome</i> 	DB: <i>Dark Bronze</i> 
--	---	---	--	---

All socket sets include 6 ft wire that may be cut in the field

WILLOW

Power: LED Xenon BP-50
 6.4W 50W max, 12V
Delivered Lumens: 450
Color Temp: 3000K
CRI: 85

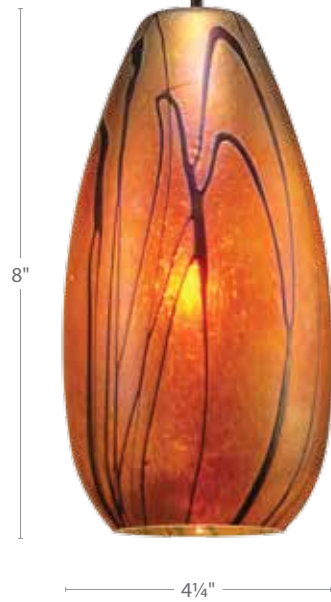

Model	Lamping	Glass	Socket
MP	LED954 LED	IR Iridescent	BN CH DB
QP	954 Xenon		

Example: **QP-LED954-IR/BN**



ZANZIBAR

Power: LED Halogen JC-50
 2W 50W max, 12V
Delivered Lumens: 110
Color Temp: 3000K
CRI: 85



Model	Lamping	Glass	Socket
MP	630LED LED	PK Peacock	BN CH DB
QP	630 Halogen		

Example: **QP630-PK/DB**

 MP: Quick Connect™ + Canopy	 QP: Quick Connect™	BN: Brushed Nickel	CH: Chrome	DB: Dark Bronze
--	---	---------------------------	-------------------	------------------------

All socket sets include 6 ft wire that may be cut in the field

TRUFFLE

Power: 6.4W
Delivered Lumens: 450
Color Temp: 3000K
CRI: 85

LED Xenon BP-50
 50W max, 12V

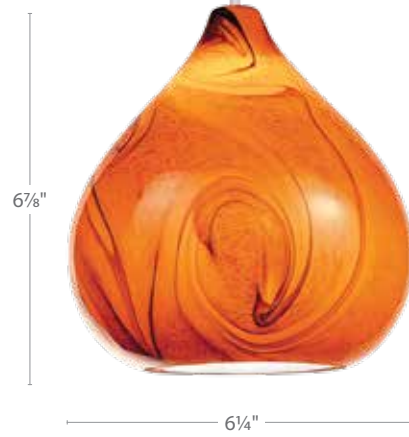

Model	Lamping	Glass	Socket
MP	LED933 LED	AM Amber	BN CH DB
QP	933 Xenon		

Example: **MP-LED933-AM/BN**

FABERGÉ





Power: 4W
Delivered Lumens: 330
Color Temp: 3000K
CRI: 85

LED Halogen JC-50
 50W max, 12V



Model	Lamping	Glass	Socket
MP	LED541 LED	AM Amber WT White	BN CH DB
QP	541 Halogen		

Example: **QP-LED541-WT/BN**

 MP: Quick Connect™ + Canopy	 QP: Quick Connect™	BN: Brushed Nickel 	CH: Chrome 	DB: Dark Bronze 
--	---	--	---	--

All socket sets include 6 ft wire that may be cut in the field

PASSION

Power: LED 2W Halogen JC-50 50W max, 12V
Delivered Lumens: 110
Color Temp: 3000K
CRI: 85



YR

BG

Model	Lamping	Glass	Socket
MP	614LED LED	YR Yellow/Red	BN
QP	614 Halogen	BG Blue/Green	CH
			DB

Example: **MP-614LED-BG/BN**





FIORI

Power: LED 4W Halogen JC-50 50W max, 12V
Delivered Lumens: 110
Color Temp: 3000K
CRI: 85



Model	Lamping	Glass	Socket
MP	515LED LED	MF Millefiori	BN
QP	515 Halogen		CH
			DB

Example: **QP-515LED-MF/BN**

	MP: Quick Connect™ + Canopy		QP: Quick Connect™	BN: Brushed Nickel	CH: Chrome	DB: Dark Bronze
						

All socket sets include 6 ft wire that may be cut in the field

JILL

Power: LED 4W
 Delivered Lumens: 330
 Color Temp: 3000K
 CRI: 85

Halogen JC-50
 50W max, 12V

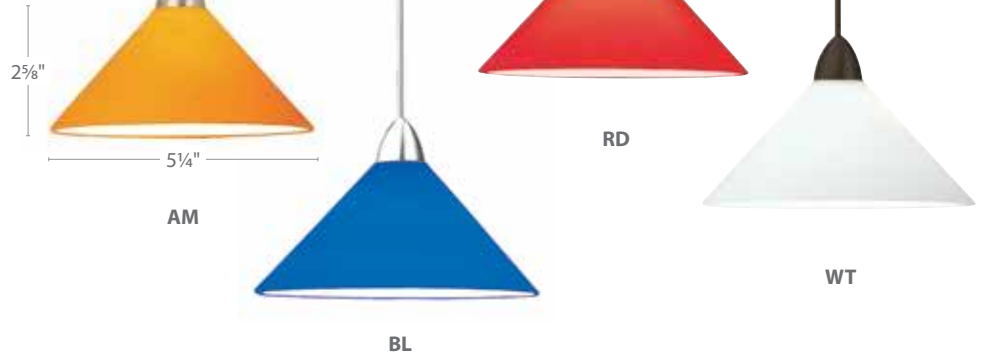

Model	Lamping	Glass	Socket
MP	LED512 LED	AM Amber	BN
QP	512 Halogen	BL Blue	CH
		RD Red	DB
		WT White	

Example: **MP-LED512-RD/CH**

SARAH





Power: LED 4W
 Delivered Lumens: 330
 Color Temp: 3000K
 CRI: 85

Halogen JC-50
 50W max, 12V



Model	Lamping	Glass	Socket
MP	LED524 LED	AM Amber	BN
QP	524 Halogen	BL Blue	CH
		RD Red	DB
		WT White	

Example: **QP-LED524-AM/DB**

 MP: Quick Connect™ + Canopy	 QP: Quick Connect™	BN: Brushed Nickel 	CH: Chrome 	DB: Dark Bronze 
--	---	--	---	--

All socket sets include 6 ft wire that may be cut in the field

WALL SCONCE SYSTEMS



Shown: **WS58LED-G544SL/CH**

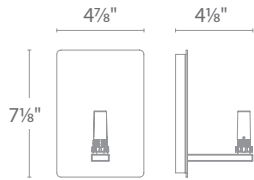

WS58 LED SCONCE

Model: *WS58LED*
Lamping: *Integral LED*
Power: *6W*
Delivered Lumens: *305*
Color Temp: *3000K*
CRI: *85*
ELV Dimming: *100% - 10%*



Shown: **WS57LED-G543CD/CH**

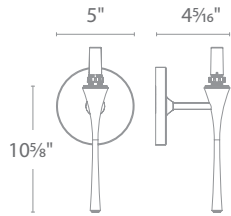

WS57 LED SCONCE

Model: *WS57LED*
Lamping: *Integral LED*
Power: *6W*
Delivered Lumens: *305*
Color Temp: *3000K*
CRI: *85*
ELV Dimming: *100% - 10%*





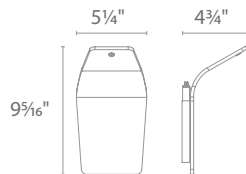



















Shown: **WS72-G311BN/BN**





WS72 SUSPENSION SCONCE

Model:	<i>WS72LED</i>	<i>WS72</i>
Lamping:	<i>12V LED Socket Sets</i>	<i>12V Halogen/ Xenon Socket Sets</i>
Power:	<i>3.7W - 5.6W</i>	<i>Up to 60W max</i>
Delivered Lumens:	<i>Up to 427</i>	
Color Temp:	<i>3000K</i>	
CRI:	<i>85</i>	
ELV Dimming:	<i>100% - 10%</i>	

System	Lamping	Glass	Reference	Glass/Shade Color	Sconce Finish
	WS58LED LED	 G539 Mini Haven p. 153	p. 153	BI Black Ice CD Champagne Diamond WD White Diamond	
		 G542 Gia			
		 G543 Giselle			
	WS57LED LED	 G518 Eden p. 152	p. 152	DIC Dichroic	BN Brushed Nickel CH Chrome RB Rubbed Bronze
		 G544 Candy			
	WS72LED LED WS72 Halogen	 G515 Fiori p. 159	p. 159	MF Millefiori	
		 G512 Jill			
		 G541 Fabergé p. 158			
	WS72LED LED WS72 Xenon	 G914 Tulum p. 150	p. 150	FR Frosted	BN Brushed Nickel CH Chrome RB Rubbed Bronze
		 G915 Tikal			
		 G939 Haven p. 153			
		 G954 Willow p. 157			
	WS72LED LED	 G311 Genesis p. 146	p. 146	BN Brushed Nickel	BN Brushed Nickel
	Halogen	 G630 Zanzibar p. 157	p. 157	PK Peacock	BN Brushed Nickel CH Chrome RB Rubbed Bronze
		 G930 Polaris p. 151			
	Xenon	 G940 Prisma p. 151	p. 151	CL Clear	

Example: **WS72LED-G541WT/BN**

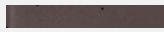
BN: Brushed Nickel	CH: Chrome	RB: Rubbed Bronze
		

TASK





TASK

Accomplish the task at hand. WAC Lighting's selection of line and low voltage task solutions add those environment enhancing localized layers of lighting

DUO AC-LED COLOR OPTION LIGHT BARS

Brushed Aluminum Finish

Minimal space between luminaires

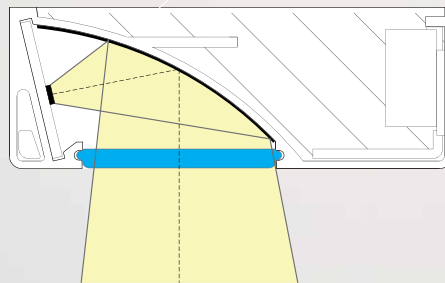

Using a 98% efficient reflector, light from the LED sources inside the housing diffuse inside the mixing chamber in order to create evenly distributed illumination. Patent Pending

DUO AC-LED COLOR OPTION LIGHT BARS



TITLE 24
CALIFORNIA



Color Temp: 2700K and 3000K
CRI: 90+
Dimming: 100% – 10% smooth and continuous ELV and TRIAC dimming
Rated Life: 54,000 hours

- Uniform Light
- 120VAC - no driver needed
- Diffused light source reduces glare
- 1 inch Profile

- Multiple knock outs for ease of wiring
- Extruded aluminum construction for optimal thermal management
- Romex® connectors included
- One "I" connector included with each luminaire

	Model	Length	Watt	Lumens	Color Temp	Finish
	BA-ACLED8-27/30	8"	6.0W	330	2700K and	BZ Bronze AL Brushed Aluminum WT White
	BA-ACLED12-27/30	12"	8.0W	475		
	BA-ACLED18-27/30	18"	10.0W	545		
	BA-ACLED24-27/30	24"	15.0W	930		
	BA-ACLED30-27/30	30"	17.5W	1095		

Example: **BA-ACLED12-27/30AL**

- May be hard-wired with 120V power or used with a plug-in power cord
- Subsequent fixtures may be powered with an "I" Connector or Interconnect Cable carrying 120V
- May be individually switched and/or wired to a wall box switch/dimmer

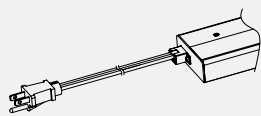

Power Cord

Model	Length
BA-PC6 WT White	6'
BK Black	

Supplies power in any application.

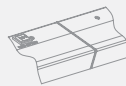

"I" Connector

Model	Max Fixture Run
BA-I-WT	6

Interconnection for seamless end to end transitions. **Each light bar includes one.**

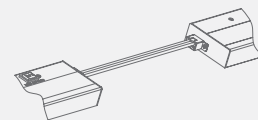

Interconnect Cable

Model	Length	Max Fixture Run
BA-IC12	12"	4
BA-IC24	24"	4
BA-IC36	36"	3

WT White
BK Black

Example: **BA-IC12-WT**

Links two light bars using a single power connection.

STRAIGHT EDGE® LED STRIP LIGHT FOR TASK AND COVE



Color Temp: 2700K, 4500K
CRI: 85
Dimming: 100% – 1% smooth and continuous ELV dimming for 120V only
Rated Life: 70,000 hours

- Each section includes two flat mounting clips, two 45° angle mounting clips and one "I" connector
- Extruded aluminum with spread diffuser lens
- "I" connector included

Adjustable angle mounting clip allows fixture to be easily aimed while securely mounted for optimal lighting performance and flexibility. **SL-C3-WT** (order separately)



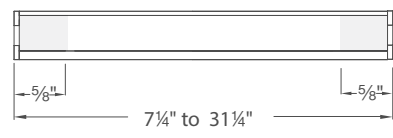

Model	Length	Color Temp	Finish	Watt	Max Lumens	Max fixture run	
						60 W	96 W
LS-LED08	7¼"	W C 2700K 4500K	WT White	2.9W	115	23	38
LS-LED14	13¼"			4.9W	215	12	20
LS-LED20	19¼"			7.3W	315	8	13
LS-LED26	25¼"			10W	485	6	10
LS-LED32	31¼"			12.5W	620	5	8







Example: **LS-LED08-C-WT**

CLASS 2 POWER SUPPLY FOR LINE™ AND LINE™ 2.0 (REQUIRED)

Type	Model	Output	Input	Dimmable	Dimensions
Remote 	EN-2460-RB2-S EN-24100-RB2-S	60W (24V) 96W (24V)	120V	Yes	6½" x 1½" x 1¼"
Remote 	EN-24100-277-RB2-T	96W (24V)	120V-277V	Yes	12½" x 3¼" x 2"
Plug-In 	EN-2460-P-AR-S EN-24100-P-AR-S	60W (24V) 96W (24V)	120V	Yes	2¾" x 1½" x 1¾" 4½" x 2" x 1½"

STRAIGHT EDGE® ACCESSORIES



CONNECTION ACCESSORIES

"I" Connector		SL-I	Ø¼" × ⅞"	For end-to-end connection of Straight Edge® sections. One "I" connector included with each luminaire
Joiner Cables		SL-IC-06 SL-IC-12 SL-IC-24 SL-IC-36	6" 12" 24" 36"	Connects two sections of Straight Edge®.
Custom Cable Extenders		SL-IF	Ø⅜" × 3⅝"	Two female ends. Connects two joiner cables to create custom lengths.
4-way "X" Connector		SL-X	Wires: 4" each Connectors: 1⅝" each	"X" connector has four male connectors and can be used to easily customize your design layout.
3-way "Y" Connector		SL-Y	Wires: 4" each Connectors: 1⅝" each	"Y" connector has three male connectors and can be used to easily customize your design layout.

LOW VOLTAGE CONTROL ACCESSORIES

Touch Panel and Motion Sensor		CT-6A-R2	Includes a Touch Panel, an Occupancy Sensor, and a Controller AC/DC input at 12V(60W Max) or 24V(96W Max) Connect on secondary side of driver/transformer
-------------------------------	---	-----------------	---

MOUNTING ACCESSORIES

Flat Mounting Clip (2 pack)		SL-C1-WT	1" × ⅝" × 1¼"	Metal clip used to mount Straight Edge® sections flat to a surface.
45° Angle Mounting Clip (2 pack)		SL-C2-WT	1" × 1" × 1½"	Metal clip used to mount Straight Edge® sections in corners. Set at 45°.
Adjustable Angle Mounting Clip (2 pack)		SL-C3-WT	⅝" × ⅝" × 1¾"	Metal clip used to mount Straight Edge® sections at variable angles.

POWER SUPPLY ACCESSORIES

Wiring Box with On/Off Switch option		TB-S	6¼" × 1⅝" × 1¼"	Use when spanning a large gap in a system layout without leaving exposed wiring (i.e. lighting kitchen cabinets on both sides of a sink or window).
Multiple Terminal Block		MTB-08	8 outputs 4⅞" × 1⅝" × ¾"	Easily wire multiple output connections for a neat installation without the use of open splices. One power supply input and either 6 or 8 outputs. 5A capacity. Three mounting screws included.
12' Extension Cable		SL-EXT-144	Wire: 144" Connector: 1⅝"	Use to extend the distance between power supply or wiring box (TB-S) to a Straight Edge® section.
Wire Clip (10 Pack)		SL-WC-1	½" × ⅜"	Use to tack power cords or joiner cables neatly to a surface.

LINE™ LED UNDERCABINET



CRI: 90+
ELV Dimming: 100% – 10% (120V only)
100% / 50% high/low settings on board
Rated Life: 80,000 hours

Detachable light panel for convenient cleaning

- Diffused light source reduces glare, eliminates hard shadows
- Asymmetrical forward throw for optimal light distribution
- Fingertip High/Low settings for localized brightness control
- ELV dimming - see specification sheet for list of tested dimmers
- Magnetized design for easy installation and maintenance

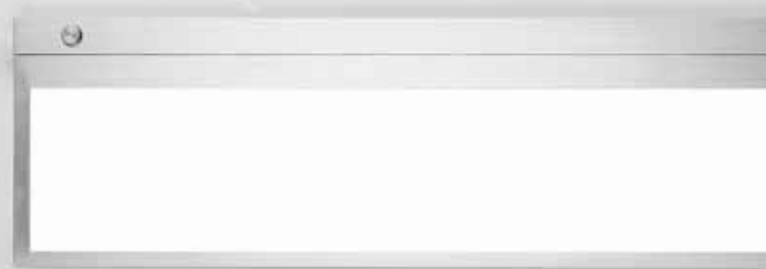

LINE™ LED UNDERCABINET

	Length	Watt	Max Lumens	Max Fixture Run		Color Temp	Finish
				60 W	96 W		
	LN-LED06	6 1/2"	7.5W	235	8	13	27 2700K 30 3000K AL Brushed Aluminum
	LN-LED12	12 1/4"	13.5W	480	4	7	
	LN-LED18	18"	19.5W	720	3	5	
	LN-LED24	24"	24W	905	2	4	
	LN-LED30	29 3/4"	30W	1195	2	3	

Example: LN-LED18-27-AL

One "I" connector included with each luminaire

CLASS 2 POWER SUPPLY FOR LINE™ AND LINE™ 2.0 (REQUIRED)

Type	Model	Output	Input	Dimming	Dimensions
Remote	EN-2460-RB2-S EN-24100-RB2-S	60W (24V) 96W (24V)	120V	ELV	6 1/2" x 1 5/8" x 1 1/4"
Remote	EN-24100-277-RB2-T	96W (24V)	120V-277V	0-10V	12 5/8" x 3 1/4" x 2"
Plug-In	EN-2460-P-AR-S EN-24100-P-AR-S	60W (24V) 96W (24V)	120V	ELV	2 3/4" x 1 5/8" x 1 3/4" 4 5/8" x 2" x 1 5/8"

LOW VOLTAGE CONTROL ACCESSORIES

Touch Panel and Motion Sensor	CT-6A-R2	Includes a Touch Panel, an Occupancy Sensor, and a Controller AC/DC input at 12V(60W Max) or 24V(96W Max) Connect on secondary side of driver/transformer
-------------------------------	-----------------	---

POWER SUPPLY ACCESSORIES

Wiring Box with On/Off Switch option	TB-S	6 1/4" x 1 5/8" x 1 1/4"	Use when spanning a large gap in a system layout without leaving exposed wiring (i.e. lighting kitchen cabinets on either side of a sink or window).
Multiple Terminal Block	MTB-08 8 outputs	4 7/8" x 1 5/8" x 3/4"	Easily wire multiple output connections for a neat installation without the use of open splices. One power supply input and 8 outputs. 5A capacity. Three mounting screws included.
12' Extension Cable	SL-EXT-144	Wire: 144" Connector: 1 1/8"	Use to extend the distance between power supply or wiring box (TB-S) to a LINE™ section.
Wire Clip (10 Pack)	SL-WC-1	1/2" x 3/8"	Use to tack power cords or joiner cables neatly to a surface.

CONNECTION ACCESSORIES

Joiner Cables	SL-IC-06 SL-IC-12 SL-IC-24 SL-IC-36	6" 12" 24" 36"	Connects two sections of LINE™.
Custom Cable Extenders	SL-IF	Ø3/8" x 3 5/8"	Two female ends. Connects two joiner cables to create custom lengths.
4-way "X" Connector	SL-X	Wires: 4" each Connectors: 1 1/8" each	"X" connector has four male connectors and can be used to easily customize your design layout.
3-way "Y" Connector	SL-Y	Wires: 4" each Connectors: 1 1/8" each	"Y" connector has three male connectors and can be used to easily customize your design layout.
"I" Connector	SL-I	Ø1/4" x 7/8"	For end-to-end connection of LINE™ sections. One "I" connector included with each luminaire

LINE™ 2.0 LED UNDERCABINET



CRI: 90+
ELV Dimming: 100% – 10% (120V only)
Rated Life: 100,000 hours

Fixed Light Panel

- Energy Star® rated
- Diffused light source reduces glare, eliminates hard shadows
- Asymmetrical forward throw for optimal light distribution
- Anti-microbial paint (white only)
- Connections made at the center of each fixture
- ELV dimming - see specification sheet for list of tested dimmers

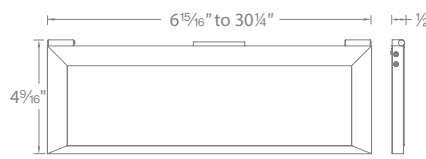

	Length	Watt	Max Lumens	Max Fixture Run		Color Temp	Finish
				60 W	96 W		
 <p>6⁵/₁₆" to 30¹/₄" 4⁹/₁₆" 1/2"</p>	LN-LED06P	6.5W	265	6	11	27 2700K 30 3000K	AL Brushed Aluminum WT White
	LN-LED12P	10.5W	515	3	6		
	LN-LED18P	16W	875	2	4		
	*LN-LED24P	20W	1160	2	3		
	*LN-LED30P	23.5W	1345	1	2		

Example: LN-LED18P-30-WT *Energy Star® Rated





CLASS 2 POWER SUPPLY FOR LINE™ AND LINE™ 2.0 (REQUIRED)

Type	Model	Output	Input	Dimming	Dimensions
Remote	EN-2460-RB2-S	60W (24V)	120V	ELV	6 ¹ / ₂ " x 1 ⁵ / ₈ " x 1 ¹ / ₄ "
	EN-24100-RB2-S	96W (24V)			
Remote	EN-24100-277-RB2-T	96W (24V)	120V-277V	0-10V	12 ⁵ / ₈ " x 3 ¹ / ₄ " x 2"
Plug-In	EN-2460-P-AR-S	60W (24V)	120V	ELV	2 ³ / ₄ " x 1 ⁵ / ₈ " x 1 ³ / ₄ " 4 ⁵ / ₈ " x 2" x 1 ⁵ / ₈ "
	EN-24100-P-AR-S	96W (24V)			





LOW VOLTAGE CONTROL ACCESSORIES

Touch Panel and Motion Sensor	 CT-6A-R2	Includes a Touch Panel, an Occupancy Sensor, and a Controller AC/DC input at 12V(60W Max) or 24V(96W Max) Connect on secondary side of driver/transformer
-------------------------------	--	---

POWER SUPPLY ACCESSORIES

Wiring Box with On/Off Switch option	 TB-S	6 ¹ / ₄ " x 1 ⁵ / ₈ " x 1 ¹ / ₄ "	Use when spanning a large gap in a system layout without leaving exposed wiring (i.e. lighting kitchen cabinets on either side of a sink or window).
Multiple Terminal Block	 MTB-08 8 outputs	4 ⁷ / ₈ " x 1 ⁵ / ₈ " x ³ / ₄ "	Easily wire multiple output connections for a neat installation without the use of open splices. One power supply input and 8 outputs. 5A capacity. Three mounting screws included.
12' Extension Cable	 SL-EXT-144	Wire: 144" Connector: 1 ¹ / ₈ "	Use to extend the distance between power supply or wiring box (TB-S) to a LINE™ section.
Wire Clip (10 Pack)	 SL-WC-1	1/2" x 3/8"	Use to tack power cords or joiner cables neatly to a surface.

CONNECTION ACCESSORIES

Joiner Cables	 SL-IC-06 6" SL-IC-12 12" SL-IC-24 24" SL-IC-36 36"	Connects two sections of LINE™.
Custom Cable Extenders	 SL-IF	Ø3/8" x 3 ⁵ / ₈ " Two female ends. Connects two joiner cables to create custom lengths.
4-way "X" Connector	 SL-X	Wires: 4" each Connectors: 1 ¹ / ₈ " each "X" connector has four male connectors and can be used to easily customize your design layout.
3-way "Y" Connector	 SL-Y	Wires: 4" each Connectors: 1 ¹ / ₈ " each "Y" connector has three male connectors and can be used to easily customize your design layout.

LED90 EDGE LIT BUTTON LIGHT



LED90 EDGE LIT BUTTON LIGHT

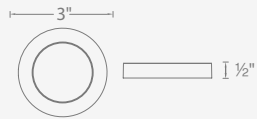

Surface mounted

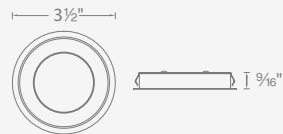

Recessed

Power: 24V, 5W
 CRI: 90
 ELV Dimming: 100% – 5%
 Rated Life: 100,000 hours
 Cutout: 3 1/4" for recessed applications



- Can be surface or recessed mounted
- Super thin profile at 1/2"
- Edge-lit LEDs reduce glare and assure even light distribution
- Anti-microbial white paint
- ELV dimming

Model	Color Temp	Lumens	Finish
HR-LED90-27	2700K	200	BK Black
HR-LED90-30	3000K	200	BN Brushed Nickel
			DB Dark Bronze
			WT White



Example: **HR-LED90-30-BN**
 Includes 6 foot lead wire

CLASS 2 ENCLOSED ELECTRONIC TRANSFORMERS (REQUIRED)

Model	Output	Input	Dimming	Min Load	Max Fixture Run	L	W	H	
 EN-2460-RB2 EN-24100-RB2 EN-24100-277-RB2-T	24V, 60W	120V	ELV	1W	7	6 1/2"	1 5/8"	1 1/4"	Fits through small openings
	24V, 96W	120V	ELV	1W	10	6 1/2"	1 5/8"	1 1/4"	
	24V, 96W	120V-277V	0-10V	1W	10	12 3/8"	3 1/4"	2"	
 EN-2460-P-AR	24V, 60W	120V	Yes	1W	7	2 3/4"	1 5/8"	1 3/4"	Plug-in power supply with on/off switch and 6' detachable cord
 MTB-01 Multiple terminal box	12.5A max accommodates up to 6 output connections for 14 AWG wires. Terminal block is used to easily wire together multiple output connections for a neat under cabinet installation without the use of open splices. 3 1/4" L x 1 3/4" W x 7/8" H								

- Secondary wiring for Class 2 transformers does not require conduit sheathed cable or clamp wiring techniques
- Intrinsically safe, Class 2 transformers permit no greater than a 5 amp current to be drawn
- Non-metallic sheathed cable may be used for secondary wiring in walls and ceilings
- Power consumption may vary depending on the efficiency of the power supply being used

BUTTON LIGHTS 24V LED



Recessed or Surface Mount with 24V transformer

Power: 24V, 4.8W
 Lumens: 180 (round), 155 (square)
 Compares To: 20W Xenon Bi-pin
 Color Temp: 2700K, 3000K

CRI: 85
 Dimming: 100% – 10% ELV dimming
 Rated Life: 70,000 hours
 Cutout: 2 1/8" for round recessed applications



Model	Color temp	Finish
Surface Mount HR-LED87 Round	27 2700K 3000K	BK Black BN Brushed Nickel CB Copper Bronze CH Chrome DB Dark Bronze WT White
Recessed Mount HR-LED87S Square		

Example: **HR-LED87S-WT** Includes 6 foot lead wire

CLASS 2 ELECTRONIC TRANSFORMERS (REQUIRED)

1W minimum load

- Plug-in power supply with on/off toggle switch and 6' detachable cord
- 1W minimum load

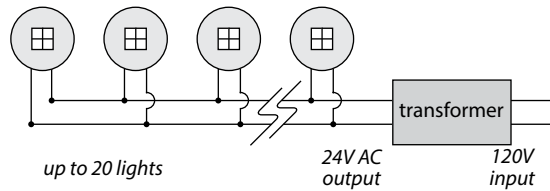

Minimizes wiring back to transformer

Type	Model	Input	Output	Dimming	Power Up To	Dimensions
Remote	EN-2460-RB2	120V	24V AC/60W	ELV	12 x LED87	6 1/2" x 1 5/8" x 1 1/4"
	EN-24100-RB2		24V AC/96W	ELV	20 x LED87	6 1/2" x 1 5/8" x 1 1/4"
	EN-24100-277-RB2-T	120V-277V	24V AC/96W	0-10V	20 x LED87	12 5/8" x 3 1/4" x 2"
Plug-In	EN-2460-P-AR	120V	24V AC/60W		12 x LED87	2 3/4" x 1 5/8" x 1 3/4"
MTB-01 Multiple terminal box		3 1/4" L x 1 3/4" W x 7/8" H				

Retrofit Housing

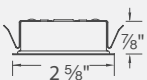

Use to replace HR-88 and HR-86 using existing wiring and cutout, LEDme® Button light not included.

Model #	Finish
HR-LED-COV	BK Black
	BN Brushed Nickel
	CB Copper Bronze
	CH Chrome
	DB Dark Bronze
	WT White

Example: **HR-LED-COV-BK**

Frosted Lens Accessory

Softens light and reduces glare for square or round

Model #

LENS-13-FR

BUTTON LIGHTS LOW VOLTAGE

Recessed or Surface Mount

Lamping: 12V 20W Xenon/Halogen Bi-Pin included
Power: 12V or 24V 20W max
Cutout: 2³/₈" for recessed applications



Xenon HR-86
Shown as surface mounted



Halogen HR-88
Shown as recessed mounted

	Model	Lamp	Finish
<p>Surface Mount</p>	HR-86	Xenon Bi-Pin	BK Black
			BN Brushed Nickel
<p>Recessed Mount</p>	HR-88	Halogen Bi-Pin	CB Copper Bronze
			DB Dark Bronze
			WT White
			BK Black
			BN Brushed Nickel
			CH Chrome
			DB Dark Bronze
			WT White

Example: HR-86-CB
Includes 6 foot lead wire

LOW VOLTAGE TRANSFORMER (REQUIRED)

	Model	Input	Output	Dimensions
<p>120V Class 2 Enclosed Electronic Transformers</p> <p>*Includes LED indicator lights and integral push in terminals</p>	EN-1260-RB2	12V	1 × 60W	6 ¹ / ₂ " x 1 ⁵ / ₈ " x 1 ¹ / ₄ "
	EN-12120-RB2*	12V	2 × 60W	6" x 3 ¹ / ₄ " x 2 ⁵ / ₈ "
	EN-12180-RB2*	12V	3 × 60W	6 ³ / ₄ " x 3 ⁵ / ₈ " x 2 ⁵ / ₈ "
	EN-12300-RB2*	12V	5 × 60W	8 ¹ / ₂ " x 4 ⁵ / ₈ " x 2 ⁵ / ₈ "
	EN-2460-RB2**	24V AC	60W	6 ¹ / ₂ " x 1 ⁵ / ₈ " x 1 ¹ / ₄ "
<p>UL Listed 120V Class 2 Plug-In Electronic Transformers</p>	EN-1260-P-AR-BK	120V	12V, 60W	2 ³ / ₄ " x 1 ⁵ / ₈ " x 1 ¹ / ₄ "
	EN-1260-P-AR-WT	120V	12V, 60W	2 ³ / ₄ " x 1 ⁵ / ₈ " x 1 ¹ / ₄ "
	EN-2460-P-AR**	120V	24V AC/60W	2 ³ / ₄ " x 1 ⁵ / ₈ " x 1 ¹ / ₄ "
Multiple terminal box	MTB-01	3 ¹ / ₄ " L x 1 ³ / ₄ " W x 7 ¹ / ₈ " H		

**For used with 24V lamps

MINIATURE RECESSED LOW VOLTAGE



Gimbal Ring HR-1137

	Model	Finish
	HR-1137	BK Black
		BN Brushed Nickel
		CB Copper Bronze
		WT White

Example: HR-1137-BN
Lamp: 12V, 20W max, MR11, order separately
Includes 36 inch lead wire

LOW VOLTAGE TRANSFORMER (REQUIRED)

	Model	Input	Output	Dimensions
<p>Class 2 Enclosed Electronic Transformers</p>	EN-1260-RB2	120V	12V, 1 × 60W	6 ¹ / ₂ " x 1 ⁵ / ₈ " x 1 ¹ / ₄ "
	EN-12120-RB2*	120V	12V, 2 × 60W	6" x 3 ¹ / ₄ " x 2 ⁵ / ₈ "
	EN-12180-RB2*	120V	12V, 3 × 60W	6 ³ / ₄ " x 3 ⁵ / ₈ " x 2 ⁵ / ₈ "
	EN-12300-RB2*	120V	12V, 5 × 60W	8 ¹ / ₂ " x 4 ⁵ / ₈ " x 2 ⁵ / ₈ "
<p>UL Listed Class 2 Plug-In Electronic Transformers</p>	EN-1260-P-AR-BK	120V	12V	2 ³ / ₄ " x 1 ⁵ / ₈ " x 1 ¹ / ₄ "
	EN-1260-P-AR-WT	120V	60W	2 ³ / ₄ " x 1 ⁵ / ₈ " x 1 ¹ / ₄ "
Multiple terminal box	MTB-01			

*Includes LED indicator lights and integral push in terminals

12V OR 24V CAPACITIVE TOUCH SWITCH AND OCCUPANCY CONTROL KIT

FOR ANY LOW VOLTAGE SYSTEM

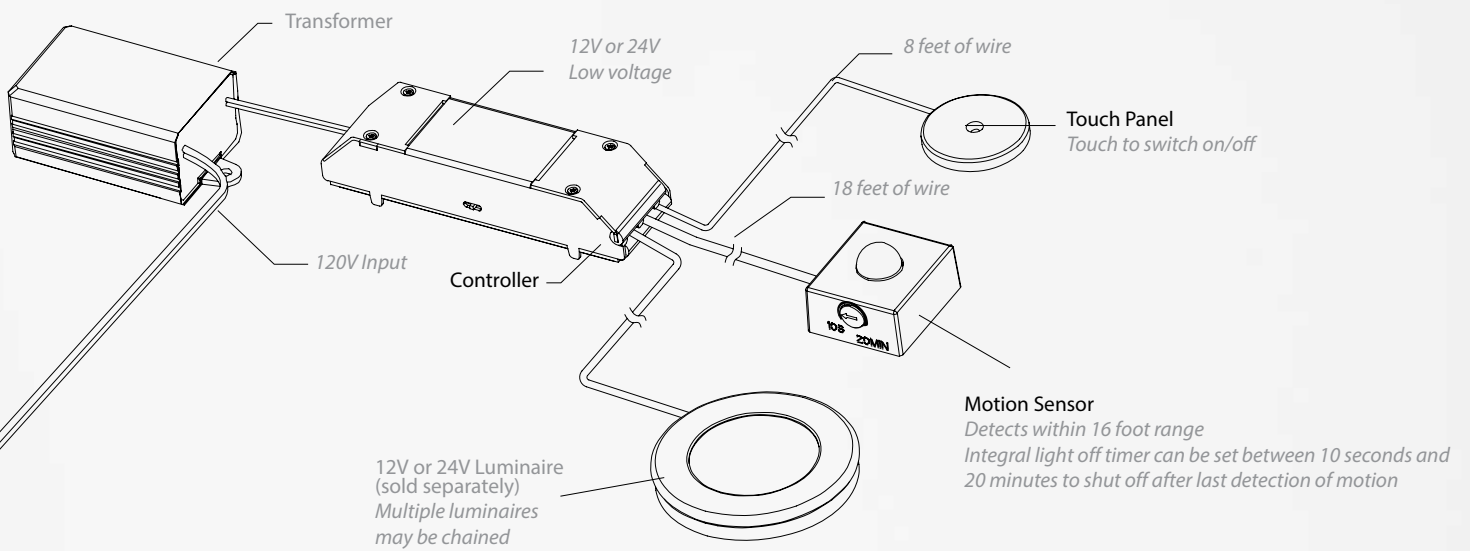

Model

CT-6A-R2

Includes a Touch Panel, an Occupancy Sensor, and a Controller
AC/DC input at 12V(60W Max) or 24V(96W Max)
Connect on secondary side of driver/transformer

THREE CUSTOM SETTINGS OF LIGHTING CONTROL

Touch and Sensor: Touch panel turns the luminaire on/off manually while the motion sensor turns it off when the space is vacant









Touch: Touch panel turns the luminaire on/off manually

Sensor: Motion sensor turns the luminaire on/off autonomously

REMOTE TRANSFORMERS 1W MINIMUM LOAD





Class 2 Enclosed Electronic Transformers

- Secondary wiring for Class 2 transformers does not require conduit sheathed cable or clamp wiring techniques
- Intrinsically safe, Class 2 transformers permit no greater than a 5 amp current be drawn
- Non-metallic sheathed cable may be used for secondary wiring in walls and ceilings
- Drop down to a smaller gauge wire if space in fixture does not permit secure connection directly with the non-metallic sheathed cable
- All transformers are UL Listed
- Dim with Electronic Low Voltage (ELV) dimmers only

		Model	Input	Output	Min Load	L	W	H		
		12V	EN-1260-RB2	120V	60W	1W	6½"	1⅝"	1¼"	
		24V	EN-2460-RB2	120V	60W	1W	6½"	1⅝"	1¼"	
			EN-24100-RB2	120V	96W	1W	6½"	1⅝"	1¼"	
		24V	EN-24100-277-RB2-T	120V-277V	96W	1W	12⅝"	3¼"	2"	Fits through small openings
		12V	EN-12120-RB2	120V	2 × 60W	1W	6"	3¼"	2⅝"	Includes LED indicator lights and integral push in terminals
			EN-12180-RB2	120V	3 × 60W	1W	6¾"	3⅝"	2⅝"	
			EN-12300-RB2	120V	5 × 60W	1W	8½"	4⅝"	2⅝"	
		12V	EN-1260-P-AR-BK	120V	12V, 60W	1W	2¾"	1⅝"	1¾"	Plug-in power supply with on/off switch and 6' detachable cord
			EN-1260-P-AR-WT	120V	12V, 60W	1W	2¾"	1⅝"	1¾"	
		24V	EN-2460-P-AR	120V	24V, 60W	1W	2¾"	1⅝"	1¾"	





ENCLOSED ELECTRONIC TRANSFORMERS

- Use for all initial installations to ensure safe and primary side connections in a wiring compartment
- Dim with Electronic Low Voltage (ELV) dimmers only



		Model	Input	Output	Min Load	L	W	H		
		12V	EN-1260-RB-AR	120V	60W	1W	6½"	1⅝"	1¼"	Enclosure has separate compartments for transformer, line and low voltage wiring
		12V	EN-12100-RB-AR	120V	100W	1W	6¼"	3"	1⅝"	Includes LED indicator lights and integral push in terminals
			EN-12150-RB-AR	120V	150W	1W	6¼"	3"	1⅝"	
			EN-B12PY-AR	120V	250W	1W	6¼"	3⅜"	2⅝"	

NON-ENCLOSED ELECTRONIC TRANSFORMERS

- UR (UL ready) components
- All connections must be made in an enclosure for proper installations
- Dim with Electronic Low Voltage (ELV) dimmers only

		Model	Input	Output	Min Load	L	W	H		
		12V	EN-1260-R2*	120V 50/60Hz	60W	1W	2⅝"	1⅜"	1"	Designed to be used as a replacement part for factory installed transformers or installed in a properly listed enclosure
			EN-1260-R-AR	120V 50/60Hz	60W	1W	2⅝"	1⅜"	1"	
			EN-1275-R-AR	120V 50/60Hz	75W	1W	2⅝"	1⅜"	1"	
		12V	EN-12100-R-AR	120V 50/60Hz	100W	1W	3½"	1½"	1⅝"	
			EN-12150-R-AR	120V 50/60Hz	150W	1W	3½"	1½"	1⅝"	
		24V	EN-24100-R2*	120V 50/60Hz	100W	1W	3½"	1½"	1⅝"	
		EN-2465-277-R2-AR	277V 50/60Hz	65W	1W	2⅝"	1⅜"	1"		

*U.L. Listed Class 2 Component

Enclosures	Model	L	W	H	
	ETB	6¼"	3"	1⅝"	Holds one EN-12100-R-AR, EN-12150-R-AR or EN-24150-R-AR
	METB	6⅝"	1⅝"	1⅝"	Holds one EN-1260-R-AR, EN-1275-R-AR or EN-1260-R2

Multiple Terminal Block	L	W	H
 MTB-01	3¼"	1¾"	⅞"

12.5A max accommodates up to 6 output connections for 14 AWG wires. Terminal block is used to easily wire together multiple output connections for a neat under cabinet installation without the use of open splices. Perfect for wiring up to 3 button lights at 20W or 6 button lights at 10W.



PRO3 INVISIBLED®

TITLE 24
CALIFORNIA

DAMP

Power: 5W / ft
Lumens: Up to 475 lm / ft
CRI: 95
Rated Life: 70,000 hours

- Ideal in straight or curved ceiling covers for general illumination
- Brightest InvisiLED® system available
- Laterally bendable design
- UV stabilized protective coating protects LEDs and circuitry for long term use in damp locations
- May field cut every 6 inches at the end of a run
- Includes an end cap and a male to male connector with each tape section
- Max run length of 20 feet per power supply
- Power supplies accommodate 120V and 277V installations

Curve clip **LED-T-CL1** shown

Longitudinally bendable over marked signs

Field-cutable every 6" at the end of a run

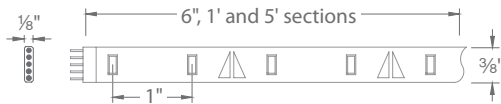

TAPE SELECTIONS

System	Color Temp	CRI	Length	Qty	Finish
LED-TE24	27 2700K	95	6IN 6 inches	1	WT White
	30 3000K	95	1 1 foot	1	
	35 3500K	90	5 5 feet	1	
	45 4500K	90	1-40 1 foot	40	

Example: **LED-TE2435-6IN-WT**

COMPATIBLE CLASS 2 POWER SUPPLY (REQUIRED)

Type	Model	Input	Output	Dimming
Remote	EN-2460-RB2-T	120VAC	24VAC / 60W	ELV
	EN-24100-RB2-T	120VAC	24VAC / 96W	ELV
Remote	EN-24100-277-RB2-T	120 - 277VAC	24VDC / 96W	0-10V
Plug-in	EN-2460-P-AR-T	120VAC	24VAC / 60W	Includes a 6 foot lead wire
	EN-24100-P-AR-T	120VAC	24VAC / 96W	



Featured Product: **Pro2** as cove ceiling light in 4000K shown



Power: 4W / ft
Lumens: Up to 330 lm / ft
CRI: 90
Rated Life: 80,000 hours

- Specially rated for installation in the storage area of a clothes closet
- UV stabilized protective coating protects LEDs and circuitry for long term use in damp locations
- May field cut every 6 inches at the end of a run
- Includes an end cap
- Max run length of 25 feet

TAPE SELECTIONS

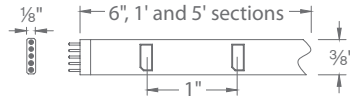

System	Color Temp	Length	Qty	Finish
LED-TX24	22 2200K	6IN 6 inches	1	WT White
	27 2700K		1	
	30 3000K		1	
	35 3500K		1	
	45 4500K		40	

Example: **LED-TX2435-6IN-WT**

"L" CONNECTOR

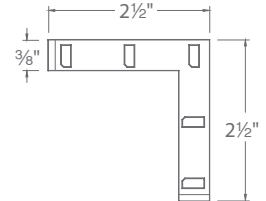

System	Color Temp	Finish
LED-TX24	22 2200K	5L-WT White
	27 2700K	
	30 3000K	
	35 3500K	
	45 4500K	

Example: **LED-TX2435-5L-WT**

Each "L" connector consumes 2 Watts

COMPATIBLE CLASS 2 POWER SUPPLY (REQUIRED)

Type	Model	Input	Output	Dimming
Remote	EN-2460-RB2-T	120VAC	24VAC / 60W	ELV
	EN-24100-RB2-T	120VAC	24VAC / 96W	ELV
Remote	EN-24100-277-RB2-T	120 - 277VAC	24VDC / 96W	0-10V
Plug-in	EN-2460-P-AR-T	120VAC	24VAC / 60W	Includes a 6 foot lead wire
	EN-24100-P-AR-T	120VAC	24VAC / 96W	

ALUMINUM CHANNELS COMPATIBLE WITH ALL DAMP RATED INVISILED TAPE SYSTEMS



Aluminum Channel **LED-T-CH** 5 feet
Additional End Caps **LED-T-CH-EC** 2 pcs

Includes a diffuser, two end caps, and five screws
Compatible with Pro, Pro2, Pro3, LITE, Classic, Palette



Deep Aluminum Channel **LED-T-CH1** 5 feet
Additional End Caps **LED-T-CH1-EC** 2 pcs

Includes a diffuser, two end caps, and five screws
Compatible with Pro, Pro2, Pro3, LITE, Classic, Palette
Eliminate visible hot spots



45° Angled Aluminum Channel **LED-T-CH2** 5 feet
Additional End Caps **LED-T-CH2-EC** 2 pcs

Includes a diffuser, two end caps, and ten screws
Compatible with Pro, Pro2, Pro3, LITE, Classic, Palette
Diffused light from InvisiLED tape

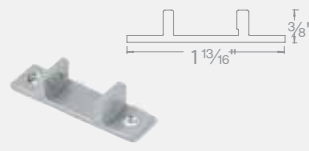

Fixed Angle Channel Clip **LED-T-CL3-PT**

Includes 2 pieces, 4 screws. Use to mount Aluminum Channel, Deep Aluminum Channel, 45° Angled Aluminum Channel

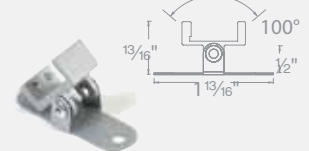

Adjustable Channel Clip **LED-T-CL2-PT**

Featured Product: **Pro** as undercabinet lighting in 3000K shown installed with 1" deep aluminum channel





Power: 3W/ft
 Lumens: Up to 215 lm/ft
 CRI: 85
 Rated Life: 50,000 hours

- Designed for bright cove or task lighting
- UV stabilized protective coating protects LEDs and circuitry for long term use in damp locations
- May field cut every 2 inches at the end of a run
- Includes an end cap
- Maximum run length of 33 feet

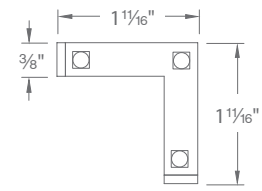
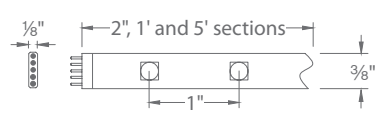

TAPE SELECTIONS

System	Color Temp	Length	Qty	Finish
LED-T24	W 2700K	2IN 2 inches	1	WT White
	P 3000K	2IN-10 2 inches	10	
	35 3500K	1 1 foot	1	
	5 4500K	5 5 feet	1	
	C 4500K	1-40 1 foot	40	



Example: **LED-T24W-1-40-WT**

"L" CONNECTOR

System	Color Temp	Finish
LED-T24	W 2700K	3L-WT White
	P 3000K	
	35 3500K	
	C 4500K	

Example: **LED-T24W-3L-WT**
 Each "L" connector consumes 1.2 Watts

COMPATIBLE CLASS 2 POWER SUPPLY (REQUIRED)

Type	Model	Input	Output	Dimming
Remote	 EN-2460-RB2-T	120VAC	24VAC / 60W	ELV
	EN-24100-RB2-T	120VAC	24VAC / 96W	ELV
Remote	 EN-24100-277-RB2-T	120 - 277VAC	24VDC / 96W	0-10V
Plug-in	 EN-2460-P-AR-T	120VAC	24VAC / 60W	Includes a 6 foot lead wire
	EN-24100-P-AR-T	120VAC	24VAC / 96W	

12V OR 24V CAPACITIVE TOUCH SWITCH AND OCCUPANCY CONTROL KIT COMPATIBLE WITH ALL DAMP RATED INVISILED TAPE SYSTEMS



CT-6A-R2
 Includes a Touch Panel, an Occupancy Sensor, and a Controller
 AC/DC input at 12V(60W Max) or 24V(96W Max)
 Connect on secondary side of driver/transformer

INVISILED®



Featured Product: **LITE** as accent light in 3000K shown

LITE INVISILED®



Power: 2W / ft
 Lumens: Up to 150 lm / ft
 CRI: 85
 Rated Life: 50,000 hours

- Specially rated for installation in the storage area of a clothes closet
- UV stabilized protective coating protects LEDs and circuitry for long term use in damp locations
- May field cut every 2 inches at the end of a run
- Includes an end cap
- Max run length of 40 feet per power supply



TAPE SELECTIONS

System	Color Temp	Length	Qty	Finish
LED-T24	27L 2700K 30L 3000K	2IN 2 inches	1	WT White
		2IN10 2 inches	10	
		1 1 foot	1	
		5 5 feet	1	
		1-40 1 foot	40	

Example: **LED-T2427L-5-WT**



"L" CONNECTOR



System	Color Temp	Finish
LED-T24	27L 2700K 30L 3000K	3L-WT White

Example: **LED-T2427L-3L-WT**

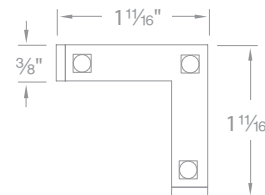
Each "L" connector consumes 0.7 Watts



COMPATIBLE CLASS 2 POWER SUPPLY (REQUIRED)

Type	Model	Input	Output	Dimming
Remote	 EN-2460-RB2-T EN-24100-RB2-T	120VAC	24VAC / 60W	ELV
		120VAC	24VAC / 96W	ELV
Remote	 EN-24100-277-RB2-T	120 - 277VAC	24VDC / 96W	0-10V
Plug-in	 EN-2460-P-AR-T EN-24100-P-AR-T	120VAC	24VAC / 60W	Includes a 6 foot lead wire
		120VAC	24VAC / 96W	

CLASSIC 24V INVISILED®

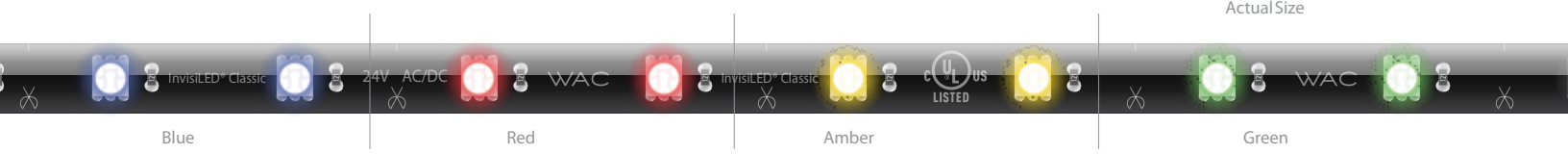

Power: 2W / ft
 Lumens: Up to 115 lm / ft
 Rated Life: 50,000 hours

- 4 colors: Amber, Blue, Green, Red
- Designed for accent lighting
- Maximum run length 40 feet
- May field cut every 2 inches at the end of a run

TAPE SELECTIONS

System	Length	Qty	Color	Peak Wavelength
LED-T24	2IN 2 inches	1	AM Amber	595nm
	1 1 foot	1	BL Blue	465nm
	5 5 feet	1	GR Green	520nm
			RD Red	630nm

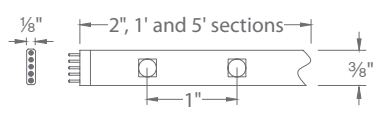

Example: **LED-T24-1-AM**

COMPATIBLE CLASS 2 POWER SUPPLY (REQUIRED)

Type	Model	Input	Output	Dimming
Remote	EN-2460-RB2-T	120VAC	24VAC / 60W	ELV
	EN-24100-RB2-T	120VAC	24VAC / 96W	ELV
Remote	EN-24100-277-RB2-T	120 - 277VAC	24VDC / 96W	0-10V
Plug-in	EN-2460-P-AR-T	120VAC	24VAC / 60W	Includes a 6 foot lead wire
	EN-24100-P-AR-T	120VAC	24VAC / 96W	





Power: 1.5W / ft
 Lumens: 40 lm/ft on 3500K setting
 Rated Life: 50,000 hours



- Variable colors with 3500K White
- DMX and wireless controller options for Palette system
- Maximum run length of 40 feet
- May field cut every 6 inches at the end of a run
- Dim with wired and wireless controller

TAPE SELECTIONS

System	Length	Qty	
LED-TC	1	1 foot	1
	5	5 feet	1
	1-40	1 foot	40
			RGB



Example: **LED-TC-1-40-RGB**

CLASS 2 POWER SUPPLY (REQUIRED)

Type	Model	Power	Dim	Input	Output
Remote	EN-2460D-C	60W	Yes via controller	120V AC	24V DC 60W
Plug-in	EN-2460D-C-P	60W	Yes via controller	120V AC	24V DC 60W

CONTROLLER (REQUIRED)

Wired controller	LED-TC-CTR-MSD	4 function wired controller with master and slave settings	Allows brightness control, preset color selection, or playing a rotation of color transitions with variable speed control
------------------	-----------------------	--	---

Wireless controller (optional remote accessory for wired controller)
LED-TO24-WS

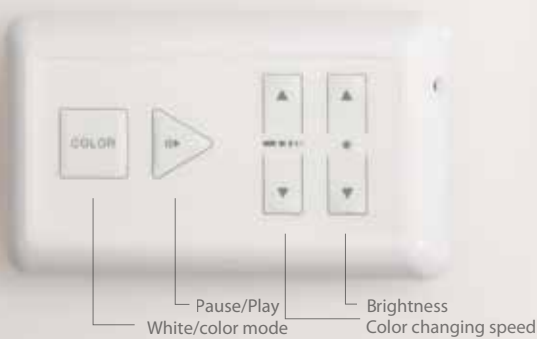

Wired controller (required)
LED-TC-CTR-MSD



INDOOR ALUMINUM CHANNELS

See pages 1-6,191-194 for recessed channels

COMPATIBLE WITH ALL DAMP RATED INVISILED TAPE SYSTEMS

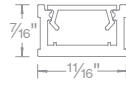

Aluminum Channel **LED-T-CH** 5 feet
Additional End Caps **LED-T-CH-EC** 2 pcs

Diffuses light from InvisiLED tape
 Includes a diffuser, two end caps, and five screws
 Compatible with Pro, Pro2, Pro3, LITE, Classic, Palette
 See pages 1-6,191-194 for recessed channels

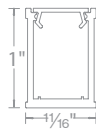

Deep Aluminum Channel **LED-T-CH1** 5 feet
Additional End Cap **LED-T-CH1-EC** 2 pcs

Eliminates visible hot spots
 Includes a diffuser, two end caps, and five screws
 Compatible with Pro, Pro2, Pro3, LITE, Classic, Palette
 See pages 1-6,191-194 for recessed channels

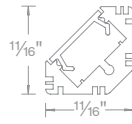

45° Angled Aluminum Channel **LED-T-CH2** 5 feet
Additional End Caps **LED-T-CH2-EC** 2 pcs

Includes a diffuser, two end caps, and ten screws
 Compatible with Pro, Pro2, Pro3, LITE, Classic, Palette
 See pages 1-6,191-194 for recessed channels



Installed with 45° Angled Aluminum Channel in toe kick and Pro 3 InvisiLED®

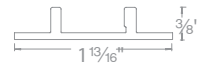
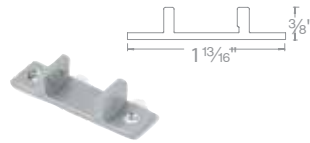

Fixed Angle Channel Clip **LED-T-CL3-PT**

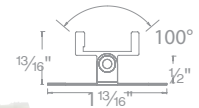
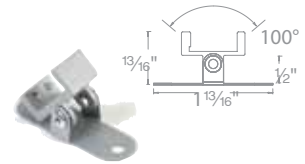

Adjustable Channel Clip **LED-T-CL2-PT**

Includes 2 pieces, 4 screws. Use to mount Aluminum Channel, Deep Aluminum Channel, 45° Angled Aluminum Channel

INDOOR MOUNTING ACCESSORIES

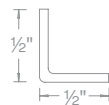

Aluminum Retrofit Channel **LED-T-RC** 3 feet

Can be bent to create fixed curves or used as a glare shield
 Compatible with Pro, Pro2, Pro3, LITE, Classic, Palette



Clear Channel **LED-TO24-CH5** 5 feet

Includes a diffuser, two end caps, and five screws
 Provides a clean mounting surface for 3M adhesive



Clip **LED-T-CL** 10 pcs
 For surfaces that are difficult to adhere 10 Screws



Curve Clip **LED-T-CL1** 10 pcs
 Secures on one edge 10 Screws

Clips to hold indoor InvisiLED tapes sections
 Compatible with Pro, Pro2, Pro3, LITE, Classic, Palette

INDOOR CONTROLLERS







Conveniently install an secondary side of power supply for adding senior friendly low voltage lighting to furniture and toe kicks









Capacitive Touch Switch and Occupancy Control Kit **CT-6A-R2**

Includes a Touch Panel, an Occupancy Sensor, and a Controller.
Compatible with WAC low voltage LED (12V or 24V) undercabinet products

INDOOR ELECTRICAL ACCESSORIES

	In Wall Rated Extension Cable <i>Extends distance between a hard wired power supply or a wiring box to a tape section.</i>	LED-TC-WEXT-144 LED-TC-WEXT-144-WT LED-TC-WEXT-240 LED-TC-WEXT-240-WT	Black White Black White	12 ft 12 ft 20 ft 20 ft
	In Wall Rated Joiner Cable <i>Connects tape sections. 2 female ends. 1 male to male connector included</i>	LED-TC-WIC-144 LED-TC-WIC-144-WT LED-TC-WIC-240 LED-TC-WIC-240-WT	Black White Black White	12 ft 12 ft 20 ft 20 ft
	Lead Wire <i>Alternative lengths for plug-in power supplies</i>	LED-TC-P-2 LED-TC-P-2-WT LED-TC-P-12 LED-TC-P-12-WT	Black White Black White	2 ft 2 ft 12 ft 12 ft
	Extension Cable <i>Extends distance between a hard wired power supply or a wiring box to a tape section</i>	LED-TC-EXT-144 LED-TC-EXT-144-WT	Black White	12 ft
	Low Voltage Wiring Box With Feed <i>Neatly houses connectors for up to two wires with 12" female feed</i>	LED-TC-B-2 LED-TC-B-2-WT	Black White	L: 1½ in W: ¾ in H: 7/8 in
	Low Voltage Wiring Box <i>Neatly houses connections for up to two wires</i>	LED-T-B		L: 1½ in W: ¾ in H: 7/8 in
	Wiring Box With Switch <i>Use when spanning a large gap in a system layout without leaving exposed wiring. Optional switch included</i>	TB-S		L: 6¼ in W: 1½ in H: 1¼ in

Compatible with Pro, Pro2, Pro3, LITE, Classic

	Joiner Cable <i>Connects tape sections</i>	LED-TC-IC2 LED-TC-IC2-WT LED-TC-IC6 LED-TC-IC6-WT LED-TC-IC12 LED-TC-IC12-WT LED-TC-IC36 LED-TC-IC36-WT LED-TC-IC72 LED-TC-IC72-WT	Black White Black White Black White Black White Black White	2 in 2 in 6 in 6 in 12 in 12 in 36 in 36 in 72 in 72 in		3-Way "Y" Connector <i>Connects tape sections</i>	LED-TC-Y LED-TC-Y-WT	Black White
						4-Way "X" Connector <i>Connects tape sections</i>	LED-TC-X LED-TC-X-WT	Black White
						"L" Connector <i>Connects tape sections</i>	LED-TC-L LED-TC-L-WT	Black White
	Male to male connector	LED-TC-MM	Black	50 Qty		End cap <i>1 cut and 1 male end cap</i>	LED-TC-EC LED-TC-EC-WT	Black White

Compatible with Pro, Pro2, Pro3, LITE, Classic, Palette
Change directionality of tape runs and reuse cut ends of tape.

Compatible with Pro, Pro2, Pro3, LITE, Classic, Palette

	Signal Wire <i>Links master and slave controllers. Can be combined for longer lengths</i>	LED-TC24-SW60 LED-TC24-SW120		60 in 120 in
---	---	---	--	-----------------

Compatible with Palette

RECESSED CHANNEL INSTALLATION GUIDE

Step 1: Install WAC Power feed wiring box



Step 2: Cut Out 2 3/8" wide and 5/8" deep opening to the length of the channel run.



Step 3: Cut channel and mount channel to studs or perforated metal sheets (provided) with screws



Step 4: Spackle, sand and Paint around the soft strip channel



Step 5: Remove and discard dense foam insert and install InvisiLED on one or both sides of the channel



Step 6: For LED-T-RCH1-WT, snap in acrylic lens to finish



SYMMETRICAL RECESSED CHANNEL

Indoor InvisiLED® tape

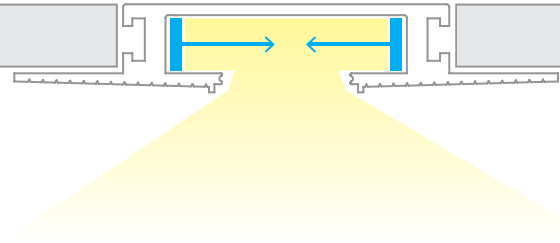

- Installs within 5/8" drywall depth
- Linear channel can be field cut
- Accomodates either one or two runs of InvisiLED® indoor tape
- Includes a translucent white acrylic diffuser
- Dense foam insert to be removed in installation after spackling

8ft linear channel

LED-T-RCH1-WT

Includes 1 diffuser
8 perforated metal sheets

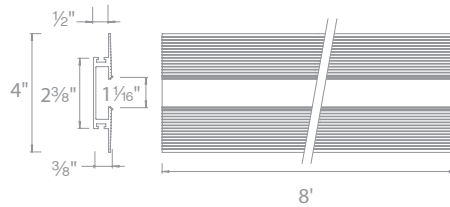

Power feed

LED-T-RBOX1-WT

The end cap may be placed on either side.
Hanger bars may be installed on any side of the wiring box
Kit includes 1 wiring box
2 hanger bars
4 five-pin InvisiLED® adapters
2 end cap
1 diffuser
2 channel connector
1 counter sink drill bit
1 drill bit
1 installation tool

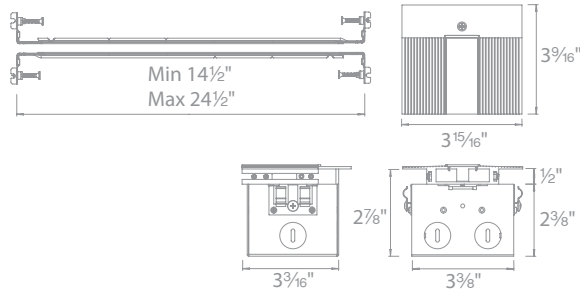

Lateral corner

LED-T-CTC1-WT

Includes: diffuser
2 channel connectors
2 perforated metal sheets

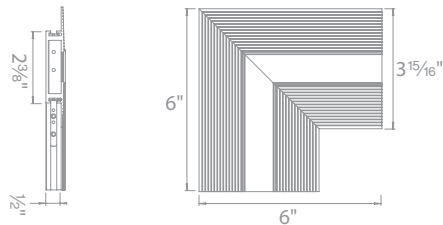

Perpendicular corner

LED-T-WTC1-WT

Transitions between walls or wall to ceiling
Includes: diffuser
2 channel connectors
2 perforated metal sheets

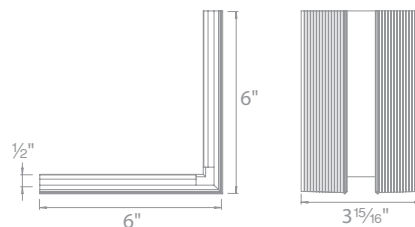

Outside corner

LED-T-WTW1-WT

Transitions around columns, bump outs, or soffits
Includes: diffuser
2 channel connectors
2 perforated metal sheets

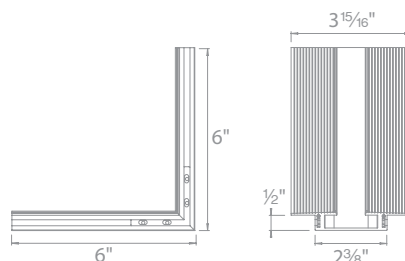

INDIRECT RECESSED CHANNEL

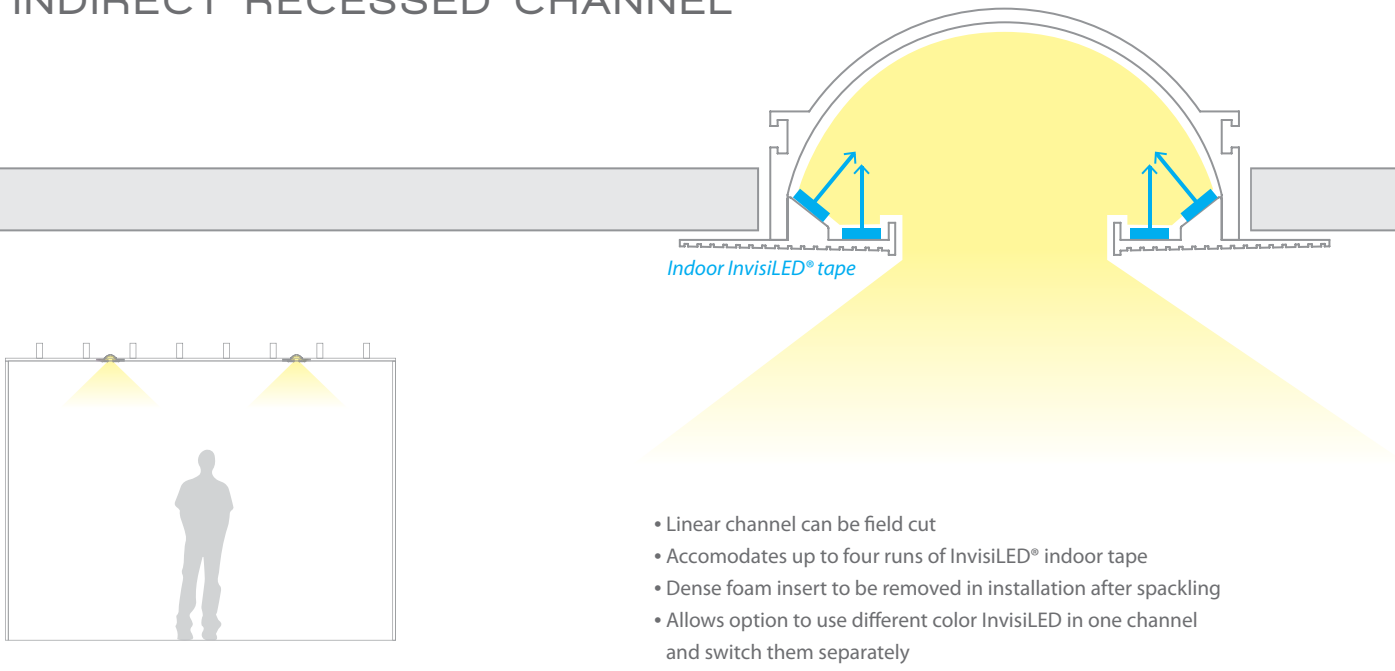

- Linear channel can be field cut
- Accomodates up to four runs of InvisiLED® indoor tape
- Dense foam insert to be removed in installation after spackling
- Allows option to use different color InvisiLED in one channel and switch them separately

8ft linear channel

LED-T-RCH3-WT

Includes: 10 perforated metal sheets
2 channel connectors

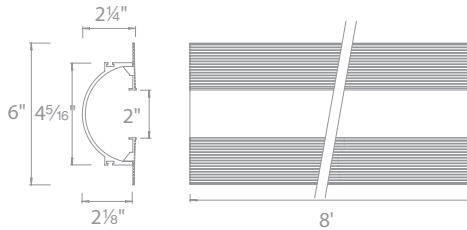

Power feed

LED-T-RBOX3-WT

The end cap may be placed on either side.
Hanger bars may be installed on any side of the wiring box
Includes: 1 wiring box
2 hanger bars
4 five-pin InvisiLED® adapters
2 end cap
2 channel connectors
1 counter sink drill bit
1 drill bit

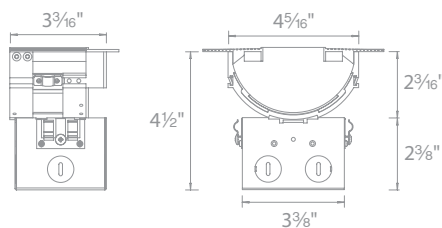
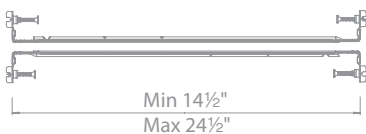
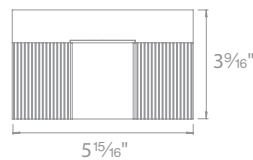

ASYMMETRICAL RECESSED CHANNEL

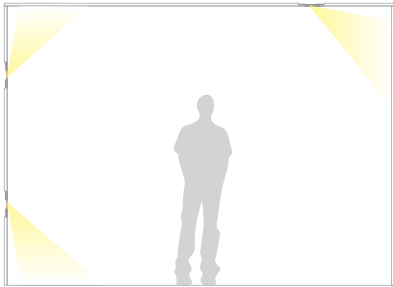

Indoor InvisiLED® tape

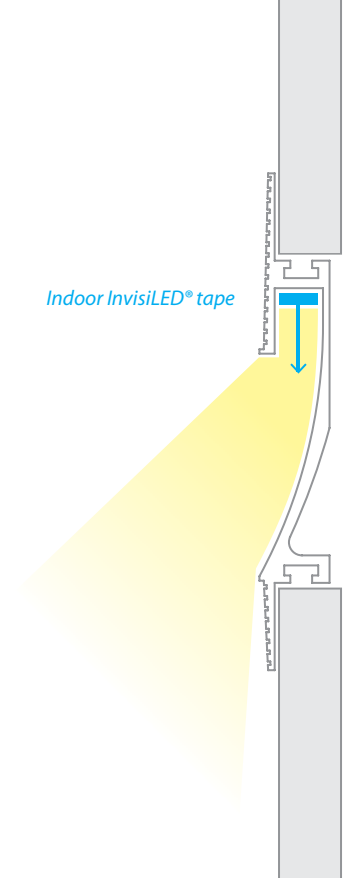

- Installs within 5/8" drywall depth
- Linear channel can be field cut
- Accommodates one run of InvisiLED® indoor tape
- Dense foam insert to be removed in installation after spackling
- Recommended installation within 15 inches of surface to be illuminated

8ft linear channel

LED-T-RCH2-WT

Includes: 8 perforated metal sheets
2 channel connectors

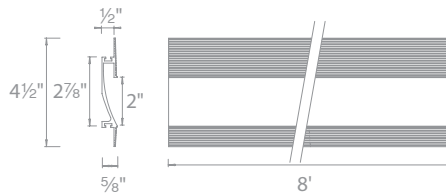

Power feed

LED-T-RBOX2-WT

The end cap may be placed on either side.
Hanger bars may be installed on any side of the wiring box
Includes: 1 wiring box
2 hanger bars
2 five-pin InvisiLED® adapters
2 end caps (left and right)
2 channel connectors
1 counter sink bit
1 drill bit

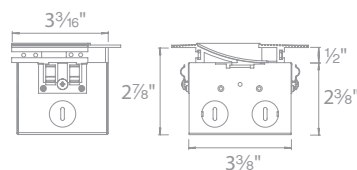
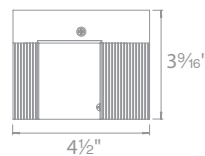

PRO WHITE OUTDOOR INVISIBLE®

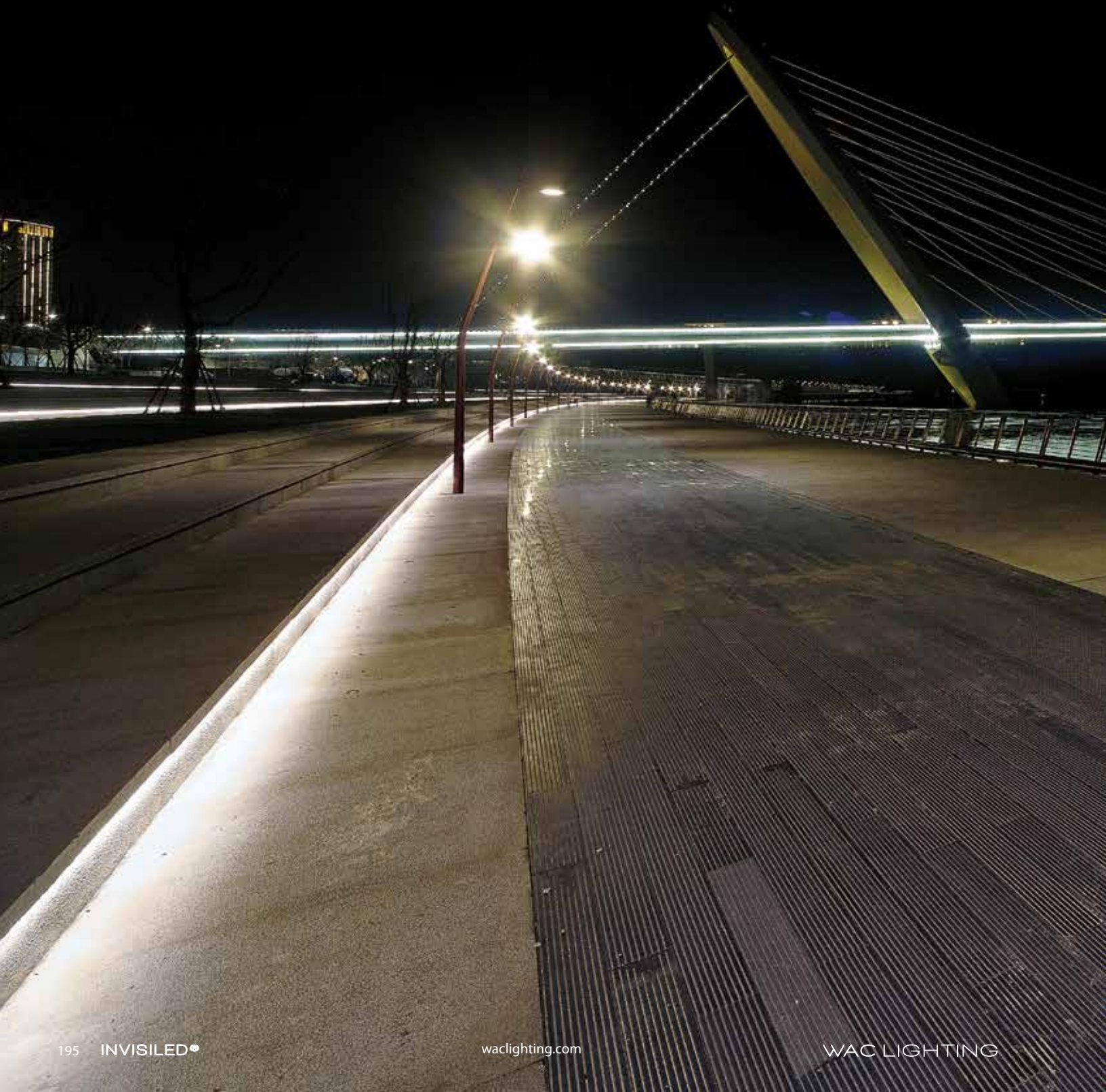

PRO WHITE OUTDOOR INVISIBLE®



Minimal spacing of LEDs when joined together

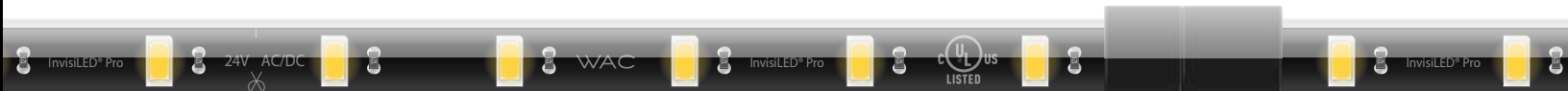

Actual Size

- Power:** 3.5W/ft
- Lumens:** up to 220 lm/ft
- CRI:** 90
- Rated Life:** 80,000 hours
- IP-68 rated, UL listed for wet location
- May be field cut every 6 inches at the end of a run
- Maximum run length of 28ft per electrical feed

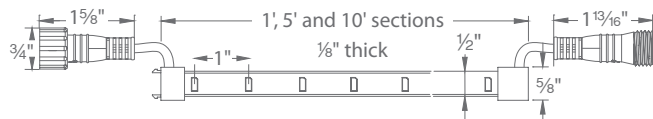
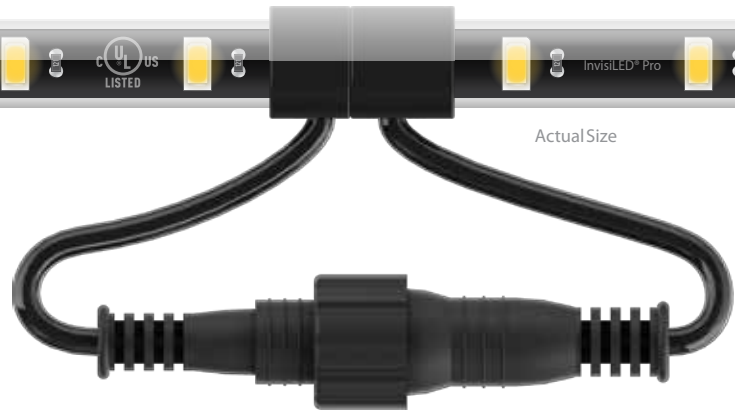



Double insulated PVC encasement and distinct electrical and mechanical junctions allow for seemingly endless runs that can be powered separately

TAPE SELECTIONS

System	Color Temp	Length	Color
LED-TO2427	2700K	1 1 foot	WT White
LED-TO2430	3000K	5 5 feet	
LED-TO2435	3500K	10 10 feet	

Example: **LED-TO2435-10-WT**



CLASS 2 POWER SUPPLY FOR PRO OUTDOOR (REQUIRED)

Type	Model	Power	Input	Output	Dimmable
Remote Damp Location	 EN-OD24100-RB2-T	96W	120V AC	24V AC	ELV Includes a 6 foot lead wire
Remote Wet Location	 EN-O24100-RB2-T	96W	120V - 277V AC	24V DC	0-10V Includes a 6 foot lead wire





Clear Channel	LED-TO24-CH5	5 feet
---------------	---------------------	--------



Includes a diffuser, two end caps, and five screws
Snap in to hold outdoor InvisiLED tape

	Type 1 Clip Secures on both edges	LED-TO24-C1	10 pcs 20 Screws
	Type 2 Clip Secures on one edge	LED-TO24-C2	10 pcs 10 Screws
	Type 3 Clip Holds from the underside	LED-TO24-C3	10 pcs 10 Screws

Clips to hold indoor InvisiLED tapes
For Pro Outdoor, Palette Outdoor, or Landscape Tape Light

	3-Way "Y" Connector Connects tape sections	LED-TO24-Y
	4-Way "X" Connector Connects tape sections	LED-TO24-X

Compatible with Pro Outdoor, Landscape Tape Light

	Joiner Cable Extends distance between transformers and controllers	LED-TO24-IC6 LED-TO24-IC12 LED-TO24-IC72 LED-TO24-IC120	6 in 12 in 72 in 120 in
	End cap 1 cut and 1 male end cap	LED-TO24-EC	Black

Compatible with Pro Outdoor, Palette Outdoor, Landscape Tape Light

PALETTE OUTDOOR INVISIBLE®



1838 listed

Minimal spacing of LEDs when joined together

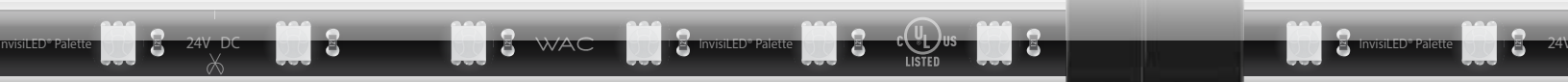

Double insulated PVC encasement and distinct electrical and mechanical junctions allow for seemingly endless runs that can be powered separately



- Power:** 1.5W / ft
- Lumens:** 40 lm/ft on 3500K setting
- Rated Life:** 80,000 hours
- IP-68 rated, UL listed for wet location
- Variable colors with 3500K White
- DMX and wireless controller options for Palette outdoor system
- Maximum run length of 40 feet
- May be field cut every 2 inches at the end of a run
- Dim with wired controller and wireless controller accessory

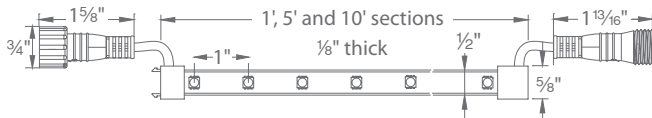

TAPE SELECTION

System	Length	Type
LED-TCO	1 1 foot	RGB Color Changing
	5 5 feet	
	10 10 feet	

Example: **LED-TCO-5-RGB**

CONTROLLER FOR PALETTE OUTDOOR (REQUIRED)

Master Controller (required)		LED-TO24-CM	4 function wired controller
Wireless Controller (required)		LED-TO24-WS	4 function wireless controller
Slave Controller (optional)		LED-TO24-CS	Connects to Master Controller, adding 40 ft run Compatible with Palette Outdoor

CLASS 2 POWER SUPPLY FOR PALETTE OUTDOOR (REQUIRED)

Type	Model	Power	Input	Output
Remote Wet Location	 EN-O24100-RB2-T	96W	120V - 277V AC	24V DC Includes a 6 foot lead wire

ACCESSORIES FOR PALETTE OUTDOOR

	Signal Wire Master to Slave controller or Slave to Slave	LED-TO24-SW60 LED-TO24-SW120	60 in 120 in
	DMX Signal Wire DMX to Master controller	LED-TO24-MW60 LED-TO24-MW120	60 in 120 in
	RGB Joiner Cable Extends distance between tape and to controllers	LED-TO24-IC6-RGB LED-TO24-IC12-RGB LED-TO24-IC72-RGB LED-TO24-IC120-RGB	6 in 12 in 72 in 120 in

	3-Way "Y" Connector Connects tape sections	LED-TO24-Y-RGB
	4 Way "X" Connector Connects tape sections	LED-TO24-X-RGB

Compatible with Palette Outdoor

PALETTE OUTDOOR INVISILED®





Featured Product: **LED-TCO-5-RGB** with **LED-TO24-CH5**

	Clear Channel	LED-TO24-CH5	5 feet
---	----------------------	---------------------	--------

*Includes a diffuser, two end caps, and five screws
Pro Outdoor, Palette Outdoor, Landscape Tape Light
Snap in to hold outdoor InvisiLED tape*

	End cap	LED-TO24-EC	Black
---	----------------	--------------------	-------

Compatible with Pro Outdoor, Palette Outdoor, Landscape Tape Light

	Type 1 Clip	LED-TO24-C1	10 pcs 20 Screws
	Type 2 Clip	LED-TO24-C2	10 pcs 10 Screws
	Type 3 Clip	LED-TO24-C3	10 pcs 10 Screws

*Clips to hold indoor InvisiLED tapes
Pro Outdoor, Palette Outdoor, Landscape Tape Light*

12V OUTDOOR INVISILED®



12V OUTDOOR INVISIBLED®



Integrates with other landscape lighting products using the same transformer

Double insulated PVC encasement and distinct electrical and mechanical junctions allow for seemingly endless runs that can be powered separately

Input: 9-15VAC
Power: 2W / 2.1VA per foot
Lumens: Up to 115lm per foot
CRI: 85
Rated Life: 60,000 hours

- Submersible up to 5 feet (IP68 rated)
- May be tied into any 12V landscape lighting system
- Maximum of 40 ft per run to stay within 5 amps
- Flexible linear lights maybe cut every 2" to desired length at the end of the run
- Various lengths may be joined together with IP68 rated connectors
- UV-stabilized PVC protects the tape sections



40ft max run length per power feed from transformer

Minimal spacing of LEDs when joined together

TAPE SELECTION

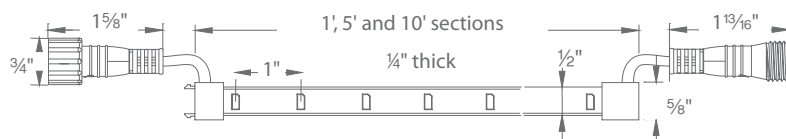

Model *Color Temp*

8011	1 foot	27BK	2700K
8051	5 feet	30BK	3000K
8101	10 feet		

Example: **8051-30BK**

TRANSFORMER FOR 12V OUTDOOR TAPE (REQUIRED)











	<i>Model</i>	<i>Power</i>	
Remote Wet Location 	9075-TRN-SS	75W Max	<i>IP65 rated. Outdoor rated stainless steel transformer with outdoor rated 3-prong plug for power, and internal receptacle for option to use with a timer.</i>
	9150-TRN-SS	150W Max	
	9300-TRN-SS	300W Max	
	9600-TRN-SS	600W Max (2 x 300W outputs)	

TRANSFORMER ACCESSORIES

	<i>Model</i>
<i>Mechanical Timer</i> 	9000-MTI-WT
<i>Photosensor</i> 	9000-PCH-GY 1000VA Max
<i>Photosensor - Remote</i> 	9000-PCR-GY 1000VA Max

See below for compatible accessories

Accessories

<i>Clear channel</i> 	LED-TO24-CH5	5 feet Includes channel mounting hardware	<i>Lead wire with 5A fuse</i> 	8000-06BK 8000-10BK	6 feet 10 feet	40 ft max tape run. Protects tape sections from over current
<i>End cap</i> 	LED-TO24-EC		<i>Joiner Cable - Short</i> 	8001-6BK 8001-12BK	6 inch 1 foot	
<i>Surface mounting clip</i> 	LED-TO24-C1	Secures on both edges (10 Qty)	<i>Joiner Cable - Long</i> 	8001-72BK 8001-120BK	6 feet 10 feet	
<i>Edge mounting clip</i> 	LED-TO24-C2	Secures on one edge (10 Qty)	<i>4 Way "X" Connector</i> 	8003-BK		
<i>Invisible clip</i> 	LED-TO24-C3	Spring clip secures beneath tape (10 Qty)	<i>3 Way "Y" Connector</i> 	8002-BK		

LANDSCAPE

FROM DRY TO WET TO UNDERWATER ALL ON ONE TRANSFORMER

Cohesively engineered to work together and make installation a snap.



Wall Wash
Variable wattage control
and patent pending wide
optical distribution



Deck Light
3 functional casted
designs



3" Inground
Durable construction
with unique features for
maintaining uniformity



Hardscape
Easily adapts to any
hardscape, step, deck or
bench applications

A TEAM EFFORT

From our fully adjustable integrated LED accent light to our submersible in-grounds, every product is engineered to work well together as a fully integrated solution. We have everything you need whether you're lighting a small jewel of a garden or a sublime outdoor oasis, all connected to the same transformer.



Outdoor Landscape Tape
IP68 and perfect for all landscape applications in or out of water



Accent
Variable wattage control and beam adjustability



1" & 2" Recessed
IP68, adapts to inground or recessed installations



Submersible
IP68 rated for underwater or other wet applications



Step Light
Extra light where it's needed the most



Bollard, Area & Path Lights
Garden spaces and pathways



Durability. Flexibility.

Every WAC Lighting fixture in our patent pending line of technology landscape products is thoroughly tested in our nationally recognized NVLAP, UL, and ETL certified laboratories for safety, durability, and robust long term performance even in the most rugged environments.



Listed to UL 1838 standard (12V)
1598 standard (120V)

LED Life Expectancy

Rated life of LED lights are based on IES (Illuminating Engineering Society) L70 standard accelerated lifetime testing for how long they will operate until only 70% of the original light output remains .

Materials that mean business



Marine Grade
Diecast Stainless Steel

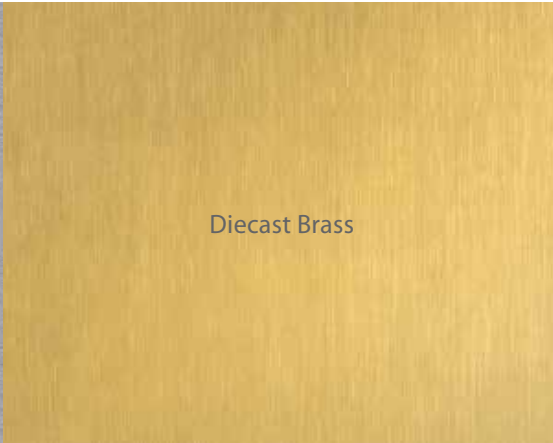

Diecast Brass



Corrosion Resistant
Diecast Aluminum

Unlike other brands of landscape lighting, we fabricate each product ourselves to a component level. Using the best UV and corrosion resistant materials available to be able to confidently support a true 10 year warranty.

Which do you NEED? ONE or DOZENS?

WAC LED One Size Fits All

Allows all brightness and beam spread adjustments to be made in the field.
Replaces the need for MR16 Halogen
(Patent Pending)

Adjustable 10° to 60° Beam
2W to 16W adjustability
190 to 1045 Lumens



=

Other Brands of Integral LED Landscape Lighting

Requires that you order different models for different wattage and beam spreads, which involves a significant investment of time in the design phase

4W
170 Lumens

6.5W
348 Lumens

13W
590 Lumens

21W
993 Lumens



60°



60°



60°

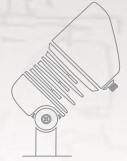

60°



35°



35°



35°

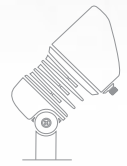

35°



10°



10°



10°



10°

What IP RATINGS mean for YOU and your CUSTOMERS

Ingress Protection ratings tell you how a fixture is tested to hold up under different conditions.



IP44

Protected from water spray from any direction.



IP65

Protected from low pressure water jets from any direction.



IP66

Protected from high pressure water jets from any direction.



IP67

Protected from short periods of immersion up to 3.2 feet in depth



IP68

Protected from long periods of immersion up to 5 feet in depth

ACCENT LED LANDSCAPE

Continuously Adjustable
Brightness Control
Indexed at
2W, 4W, 8W, 13W, 16W

Continuously Adjustable Beam Angles
Indexed at
10°, 25°, 40°, 60°

- Adjustable beam angle
- IP66 rated, Protected against high-pressure water jets
 - Includes a detachable shroud
- Solid diecast brass or corrosion resistant aluminum
 - Factory sealed water tight fixtures
- Constant output for 9V-15V or 110V-120V input
 - Can be used as an uplight or downlight

ACCENT LED LANDSCAPE



1838 listed (12V)
1598 listed (120V)

12V

Integral Brightness Control
Adjustable beam angle 10° to 60°

One Fixture replaces all older
halogen landscape accent lights.

Transformer Required (order separately)

Input	9 - 15VAC
Power	2W to 16W / 2VA - 23VA
Brightness	190 lm to 1045 lm
Beam Angle	10° to 60°
CRI	85
Rated Life	70,000 hours

2700K Warm White

5011-27BZ Bronze on Aluminum
5011-27BBR Bronze on Brass

3000K Pure White

5011-30BZ Bronze on Aluminum
5011-30BBR Bronze on Brass

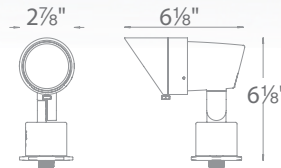

Mounting stake (12V),
Detachable shroud, 6' lead wire and
direct burial gel filled wire nuts (12V)
or standard wire nuts (120V) included

120V

Integral Brightness Control
Adjustable beam angle 15° to 60°

Simple to retrofit existing
line voltage systems or coordinate well
with a new commercial landscape job

Input	110V - 120VAC
Power	3.5W to 14.5W
Brightness	100 lm to 900 lm
Beam Angle	15° to 60°
CRI	85
Rated Life	45,000 hours

3000K Pure White

5012-30BZ Bronze on Aluminum
5012-30BBR Bronze on Brass

See pages 215-216 for color changing accent lights

Accessories

6" Long Shroud		5010-LSHR-BZ 5010-LSHR-BBR	Bronze on Aluminum Bronze on Brass	Reduce glare. Ideal for downlighting application
Additional Stake		9000-ST9-BK	Bronze	Durable PC stake
Surface Mount Flange/Stake		5000-SCP-BZ 5000-SCP-BBR	Bronze on Aluminum Bronze on Brass	Includes three 7 inch threaded stainless steel stabilizing pins for ground mounting or surface mounts with four screws or over a junction box
Guardian Mount		9000-SP9-BZ	Stainless Steel	Heavy duty stainless steel spike to position fixture
Gutter Mount Bracket		5000-GM-BZ	Stainless Steel	Stainless Steel universal mounting bracket for gutter mounting fixture
Power Stake		9000-RPT-BK	Black	Easy wiring accessory designed for 120V products; eliminates the need for a separate J-box.
Tree Mount Junction Box		5000-TCP-BZ	Bronze on Aluminum	Bronze on Aluminum box with Stainless steel mounting screws. Two 1/2" NPT threaded holes
Optics		LENS-20-AMB Amber LENS-20-GRN Green LENS-20-RED Red	LENS-20-BLU Blue LENS-20-FR Frosted LENS-20-SPR Spread	LENS-20-BEL Beam Elongating Enhances saturation of florals and foliage
Extension Rods		5000-X04-BZ 4 in 5000-X08-BZ 8 in 5000-X12-BZ 12 in	5000-X18-BZ 18 in 5000-X24-BZ 24 in	Extends distance between Accent light and Surface Mount Canopy, Stake, or Tree Mount box
Rod L-Coupler		5000-LCO-BZ	Bronze	

MINI ACCENT LED LANDSCAPE

Continuously Adjustable Beam Angles
Indexed at
10°, 25°, 40°, 50°

Continuously Adjustable
Brightness Control
Indexed at
1W, 2W, 4W, 6W, 7W



- Adjustable beam angle
- IP66 rated, Protected against high-pressure water jets
 - Includes a detachable shroud
- Solid diecast brass or corrosion resistant aluminum
 - Factory sealed water tight fixtures
 - Constant output for 9V-15V input
- Can be used as an uplight or downlight
 - 2700K or 3000K color temperature

MINI ACCENT LED LANDSCAPE



12V

*Integral Brightness Control
Adjustable beam angle 10° to 50°
One Fixture replaces all older
halogen landscape accent light.*

*Transformer Required
(order separately)*

Input Power	9 -15VAC
Brightness	1W to 7W / 2VA -10.5VA
Beam Angle	45 lm to 365 lm
Beam Angle	10° to 50°
CRI	85
Rated Life	70,000 hours

*Mounting stake (12V),
Detachable shroud, 6' lead wire and
direct burial gel filled wire nuts (12V)*



Continuously Adjustable
Brightness Control

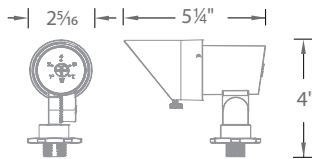

Single and Double Stem Mount
available. See pages 251-252



Shown with
gutter mount bracket
accessory

2700K *Warm White*

5111-27BZ *Bronze on Aluminum*
5111-27BBR *Bronze on Brass*

3000K *Pure White*

5111-30BZ *Bronze on Aluminum*
5111-30BBR *Bronze on Brass*

Accessories

5" Long Shroud		5111-LSHR-BZ 5111-LSHR-BBR	<i>Bronze on Aluminum</i> <i>Bronze on Brass</i>	<i>Reduce glare. Ideal for downlighting application</i>
Additional Stake		9000-ST9-BK	<i>Bronze</i>	<i>Durable PC stake</i>
Surface Mount Flange/Stake		5000-SCP-BZ 5000-SCP-BBR	<i>Bronze on Aluminum</i> <i>Bronze on Brass</i>	<i>Includes three 7 inch threaded stainless steel stabilizing pins for ground mounting or surface mounts with four screws or over a junction box</i>
Guardian Mount		9000-SP9-BZ	<i>Stainless Steel</i>	<i>Heavy duty stainless steel spike to position fixture</i>
Gutter Mount Bracket		5000-GM-BZ	<i>Stainless Steel</i>	<i>Stainless Steel universal mounting bracket for gutter mounting fixture</i>
Tree Mount Junction Box		5000-TCP-BZ	<i>Bronze on Aluminum</i>	<i>Bronze on Aluminum box with Stainless steel mounting screws. Two 1/2" NPT threaded holes</i>
Optics		LENS-16-AMB LENS-16-GRN LENS-16-RED LENS-16-BLU	<i>Amber</i> <i>Green</i> <i>Red</i> <i>Blue</i>	LENS-16-FR <i>Frosted</i> LENS-16-SPR <i>Spread</i> LENS-16-BEL <i>Elongating</i> <i>Enhances saturation of florals and foliage</i>
Extension Rods		5000-X04-BZ 5000-X08-BZ 5000-X12-BZ	<i>4 in</i> <i>8 in</i> <i>12 in</i>	5000-X18-BZ <i>18 in</i> 5000-X24-BZ <i>24 in</i> <i>Extends distance between Accent light and Surface Mount Canopy, Stake, or Tree Mount box</i>
Rod L-Coupler		5000-LCO-BZ	<i>Bronze</i>	

WALL WASH LED LANDSCAPE

Patent Pending Optical Design
Even coverage at
15° upwards, 50° x 80°

**Continuously Adjustable
Brightness Control**
Indexed at
2W, 4W, 8W, 13W, 16W

- A uniform wide distribution wall wash from a small form factor
 - IP66 rated, Protected against powerful water jets
 - Solid diecast brass or corrosion resistant aluminum alloy
 - Factory sealed water tight fixtures
 - Constant output for 9V-15V, 110V - 120V inputs

WALL WASH LED LANDSCAPE



1838 listed (12V)
1598 listed (120V)

12V

*Integral Brightness Control
Transformer Required
(order separately)*

Input	9 - 15VAC
Power	2W to 16W / 2 - 23VA
Brightness	190 lm to 980 lm
Beam Angle	15° upward (50° by 80°)
CRI	85
Rated Life	70,000 hours



120V

Integral Brightness Control

Input	110V - 120VAC
Power	3.5W to 14.5W
Brightness	95 lm to 855 lm
Beam Angle	15° upward (50° by 80°)
CRI	85
Rated Life	45,000 hours

2700K *Warm White*
5021-27BZ Bronze on Aluminum
5021-27BBR Bronze on Brass

3000K *Pure White*
5021-30BZ Bronze on Aluminum
5021-30BBR Bronze on Brass

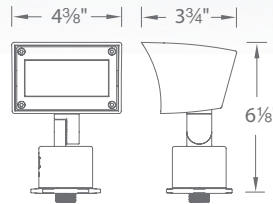

3000K *Pure White*
5022-30BZ Bronze on Aluminum
5022-30BBR Bronze on Brass

*Mounting stake (12V),
6' lead wire and direct burial
gel filled wire nuts (12V) or
standard wire nuts (120V) included*

See pages 215-216 for *color changing wall wash lights*

Accessories

Additional Stake		9000-ST9-BK	Bronze	Durable PC stake
Surface Mount Flange/Stake		5000-SCP-BZ 5000-SCP-BBR	Bronze on Aluminum Bronze on Brass	Includes three 7 inch threaded stainless steel stabilizing pins for ground mounting or surface mounts with four screws or over a junction box
Guardian Mount		9000-SP9-BZ	Stainless Steel	Heavy duty stainless steel spike to position fixture
Gutter Mount Bracket		5000-GM-BZ	Stainless Steel	Stainless Steel universal mounting bracket for gutter mounting fixture
Power Stake		9000-RPT-BK	Black	Easy wiring accessory designed for 120V products; eliminates the need for a separate J-box.
Tree Mount Junction Box		5000-TCP-BZ	Bronze on Aluminum	Bronze on Aluminum box with Stainless steel mounting screws. Two 1/2" NPT threaded holes
Optics		LENS-2X4-AMB Amber LENS-2X4-GRN Green LENS-2X4-RED Red	LENS-2X4-BLU Blue LENS-2X4-FR Frosted LENS-2X4-SPR Spread	Enhances saturation of florals and foliage and turtle friendly
Extension Rods		5000-X04-BZ 4 in 5000-X08-BZ 8 in 5000-X12-BZ 12 in	5000-X18-BZ 18 in 5000-X24-BZ 24 in	Extends distance between Accent light and Surface Mount Canopy, Stake, or Tree Mount box
Rod L-Coupler		5000-LCO-BZ	Bronze	



3" Inground

- Tilt and adjust beam angles
- Integral brightness control
- IP67 rated, Protected from temporary immersion under water
 - Drive over up to 4500lbs
- Solid diecast brass or corrosion resistant cast aluminum
 - Available concrete pour kit
- Constant output for 9V-15V or 110V-120V inputs

3" Inground Features

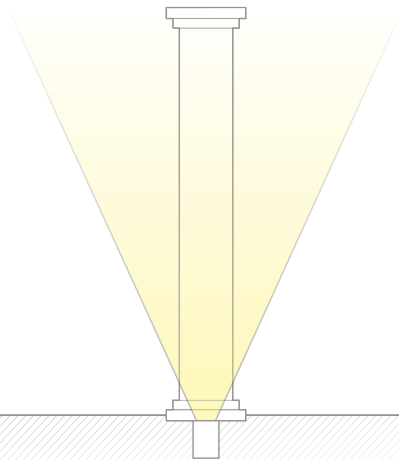

Typical Inground
 Most light output goes into the air,
 causing light pollution



Adjust Beam Angles
 Presets at
 15°, 30°, 45°, 60°

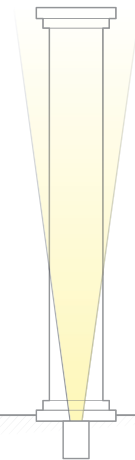

Adjustable WAC Inground
 Adjust the light to where you need it

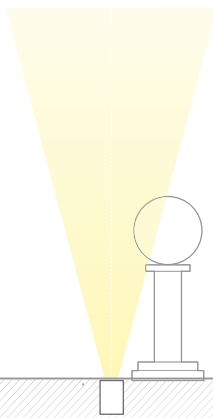

Typical Inground
 Most light output goes into the air,
 causing light pollution



Tilt and Aim
 Up to 40° of adjustability preset at
 -20°, -10°, 0°, 10°, 20°

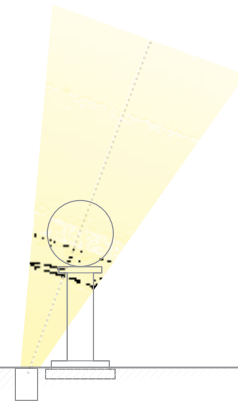

Adjustable WAC Inground
 Adjust the light to where you need it



Control Brightness
 Adjustable from 70lm to 505lm
 Presets Comparable to
 10W, 25W, 35W, 50W, 75W Halogen source



3" INGROUND LED LANDSCAPE





3" INGROUND LED LANDSCAPE

IP67

12V

*Integral Brightness Control
Adjustable beam angle
Directional aim with +/- 20° Tilt*

Input	9-15VAC
Power	2W to 12W / 2-17VA
Brightness	70 lm to 505 lm
Beam Angle	15° to 60°
CRI	85
Rated Life	55,000 hours

2700K *Warm White*
5031-27BZ | Bronze on Aluminum
5031-27BBR | Bronze on Brass

3000K *Pure White*
5031-30BZ | Bronze on Aluminum
5031-30BBR | Bronze on Brass

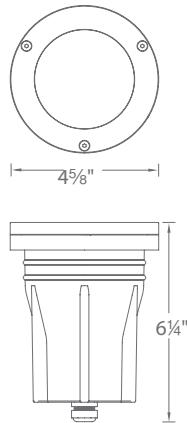

*6' lead wire and direct burial
gel filled wire nuts (12V) or
standard wire nuts (120V) included*

120V

*Integral Brightness Control
Adjustable beam angle*

Input	110V - 120VAC
Power	3W to 11.5W
Brightness	65 lm to 515 lm
Beam Angle	15° to 60°
CRI	85
Rated Life	45,000 hours

3000K *Pure White*
5032-30BZ | Bronze on Aluminum
5032-30BBR | Bronze on Brass

See pages 215-216 for *color changing 3" Inground lights*

Accessories

Rock Guard		5030-GRD-BZ 5030-GRD-BBR	Bronze on Aluminum Bronze on Brass	Protects the fixture surface
Optics		LENS-25-AMB LENS-25-GRN LENS-25-RED LENS-25-BLU LENS-25-FR LENS-25-HCL	Amber Green Red Blue Frosted Honeycomb Louver Reduces glare	Enhances saturation of florals and foliage
Concrete Pour Kit		5030-PIP-PVC	Shown with temporary dense foam cap	For installation in concrete Five 1/2" NPT threaded holes, PC



- Color Changing
- App-controlled brightness
- IP66 rated (Accent, Wall Wash), IP67 rated (Inground)
- Solid Die-cast brass
- Factory sealed water tight fixtures
- 6' lead wire
- Constant output for 9V-15V input



ACCENT 12V COLOR CHANGING

Color and brightness controlled with ilumenight™ mobile app

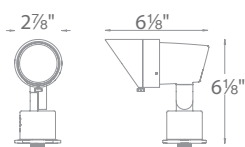

Input 9-15VAC
 Power 0.5W to 14.5W / 1VA to 17VA
 Brightness Up to 355 lm
 Beam Angle 15° to 60°
 CRI 95+
 Rated Life 45,000 hours



Model	Finishes
5011-CCBBR	Bronze on Brass
5011-CCBZ	Bronze on Aluminum

See page 206 for accessories

WALL WASH 12V COLOR CHANGING

Color and brightness controlled with ilumenight™ mobile app

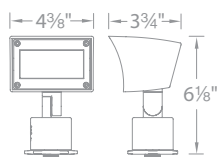

Input 9-15VAC
 Power 0.5W to 14.5W / 1VA to 17VA
 Brightness Up to 430 lm
 Beam Angle 15° upward (50° by 80°)
 CRI 95+
 Rated Life 45,000 hours



Model	Finishes
5021-CCBBR	Bronze on Brass

See page 210 for accessories

3" INGROUND 12V COLOR CHANGING

Color and brightness controlled with ilumenight™ mobile app

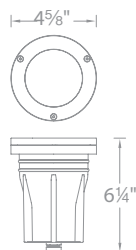

Input 9-15VAC
 Power 0.5W to 14.5W / 1VA to 17VA
 Brightness Up to 250 lm
 Beam Angle 15° to 60°
 CRI 95+
 Rated Life 45,000 hours



Model	Finishes
5031-CCBBR	Bronze on Brass

See page 214 for accessories

ilumenight LED LANDSCAPE

MAKE IT
COLORFUL!

With ilumenight™ you can take your landscape from warm white to pure white to cool white, red to violet and every color in between all with the touch of a finger.

STEP 1 Download Free "ilumenight™" app

STEP 2 Setup Login

STEP 3 Command all of your ilumenight landscape fixtures at will

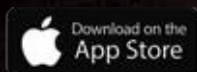

- 
- A photograph of a stone wall at night, illuminated by three recessed LED lights. The lights are mounted in the wall, casting a warm glow on the stone. The background shows dark trees and a night sky.
- Conveniently adapts into existing 12V system
 - Translucent diffuser eliminates worrisome hotspots for even light projection
 - Mounting options included: Stainless Steel Under Capstone Brackets, Clips and Hardware
 - Simple two screw mounting option into handrails, bench seats, decks, steps and fences
 - IP66 rated, protected against high pressure water jets
 - Potted electronics and conformal coated LEDs for long term moisture protection

HARDSCAPE LED LANDSCAPE

IP66  1838 listed

7181

Maximum lumen output and length make this a great fixture for large areas and where more light is needed.

18"



7121

Great for under deck hand rails in place of traditional deck lights or walls where more light is needed to evenly graze the wall surface.

12"



7061

Most popular size for masonry walls that are 40 inches tall or less. At 40 inches, spacing of 4 feet on center is recommended.

6"



7031

Perfect for those hard to access, short areas, columns, posts, walls and tight turns.

3"

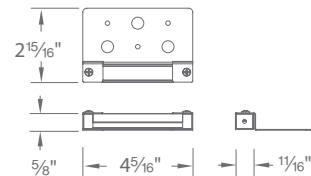
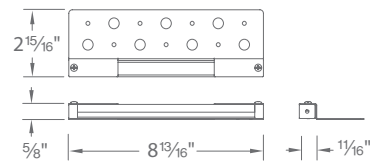
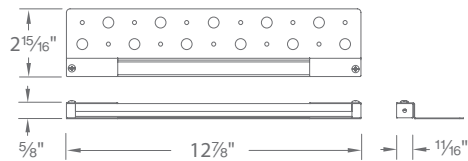
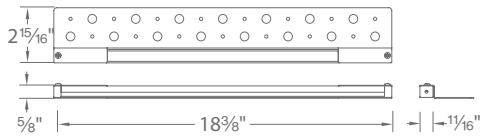
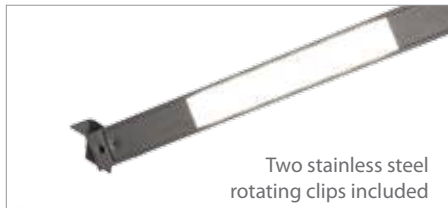

Model Color Temp Finishes

18" HARDSCAPE

Input 9 - 15VAC
 Power 9.3W, 13.4VA
 Brightness Up to 265 lm
 CRI 90+
 Rated Life 70,000 hours

7181-27BZ
7181-30BZ

2700K Warm White
 3000K Pure White

Bronze on Aluminum

12" HARDSCAPE

Input 9 - 15VAC
 Power 6.5W, 10.1VA
 Brightness Up to 185 lm
 CRI 90+
 Rated Life 70,000 hours

7121-27BZ
7121-30BZ

2700K Warm White
 3000K Pure White

Bronze on Aluminum

6" HARDSCAPE

Input 9 - 15VAC
 Power 3.1W, 5.1VA
 Brightness Up to 90 lm
 CRI 90+
 Rated Life 70,000 hours

7061-27BZ
7061-30BZ

2700K Warm White
 3000K Pure White

Bronze on Aluminum

3" HARDSCAPE

Input 9 - 15VAC
 Power 1.4W, 2.5VA
 Brightness Up to 40 lm
 CRI 90+
 Rated Life 70,000 hours

7031-27BZ
7031-30BZ

2700K Warm White
 3000K Pure White

Bronze on Aluminum

12V OUTDOOR SUBMERSIBLE LANDSCAPE TAPE LIGHTING



- Submersible up to 5 feet
- May be tied into any 12V landscape lighting system
 - Maximum of 40 ft per run to stay within 5 amps
- Flexible linear lights maybe cut to desired length at the end of the run
- Various lengths may be joined together with IP68 rated connectors
 - UV-stabilized silicone seals and protects the tape sections

12V OUTDOOR SUBMERSIBLE LANDSCAPE TAPE LIGHTING



Integrates with other landscape lighting products using the same transformer



IP68 rated for submersion up to 5ft



Distinct mechanical and electrical connections minimizes spacing between LEDs when joining sections, and allows for seemingly endless tape runs that can be powered separately

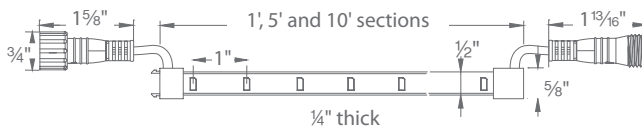

		Model	Color Temp	Brightness
Input	12VAC			
Power	1.5W / 1.7VA per foot	8011	1 foot	
Brightness	Up to 115 lm per foot	8051	5 feet	27BK 2700K Warm White 110 lm per foot
CRI	85	8101	10 feet	30BK 3000K Pure White 115 lm per foot
Rated Life	60,000 hours			

Example: **8051-30BK**

Accessories

Clear channel		LED-TO24-CH5	5 feet Includes mounting hardware	Lead wire with 5A fuse		8000-06BK 6 feet 8000-10BK 10 feet	40 ft max tape run. Protects tape sections from over current
End cap		LED-TO24-EC		Joiner Cable - Short		8001-6BK 6 inch 8001-12BK 1 foot	
Surface mounting clip		LED-TO24-C1	Secures on both edges (10 Qty)	Joiner Cable - Long		8001-72BK 6 feet 8001-120BK 10 feet	
Edge mounting clip		LED-TO24-C2	Secures on one edge (10 Qty)	4 Way "X" Connector		8003-BK	
Invisible clip		LED-TO24-C3	Spring clip secures beneath tape (10 Qty)	3 Way "Y" Connector		8002-BK	



SUBMERSIBLE 2" LED LANDSCAPE

- Constant output for 9V-15V input
- 100%-10% dimming - see specification sheet for list of tested dimmers
- May be used in conjunction with all WAC Landscape Lighting products
- Includes a detachable stainless steel mounting bracket for use in or out of water

SUBMERSIBLE 2" LED LANDSCAPE

IP68



676 listed

- Solid Stainless Steel construction
- IP68 rated, Suitable for continuous immersion under water
- Factory sealed water tight fixtures
- 30' long lead wire



2031
ROUND

Included Stainless Steel easy mount accessory for use with underwater applications and above ground on any surface.



Designed for underwater or wet application.
30ft long lead wire.

Model

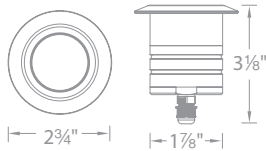

Input	9-15VAC
Power	4.1W / 6.6VA
Brightness	170 lm
Color Temp	3000 K
CRI	85
Beam Angle	25°
Rated Life	70,000 hours

2031-30SS

Stainless Steel

RECESSED INGROUND + INDICATOR LED LANDSCAPE



- IP68 rated, Suitable for continuous immersion under water
 - Factory sealed water tight fixtures
 - Solid stainless steel construction
- Options for use in outdoor downlight applications
 - Constant output for 9V-15V input
- 100%-10% dimming - see specification sheet for list of tested dimmers
- Available concrete pour kit with 18" PVC pipe which can be field shortened

RECESSED INGROUND + INDICATOR LED LANDSCAPE

2" APERTURE

Input 9-15VAC
 Power 4.1W / 6.6VA
 Brightness Up to 170 lm
 Color Temp 3000K Pure White

CRI 85
 Beam Angle 25°
 Rated Life 70,000 hours

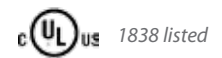

				Model	Finishes
				2011-30SS 2011-30BS	Stainless Steel Bronzed Stainless Steel
				2012-30SS 2012-30BS	Stainless Steel Bronzed Stainless Steel
				2021-30SS 2021-30BS	Stainless Steel Bronzed Stainless Steel
				2022-30SS 2022-30BS	Stainless Steel Bronzed Stainless Steel
				2051-30SS 2051-30BS	Stainless Steel Bronzed Stainless Steel
				2052-30SS 2052-30BS	Stainless Steel Bronzed Stainless Steel

6' lead wire included

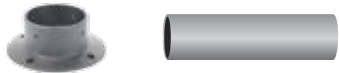

2000-CON-PVC
2" Concrete Pour Kit

For installation in concrete. Use with a 4" outdoor rated junction box and 18" PVC pipe included.

1" APERTURE

Input 9-15VAC
 Power 1.9W 3VA
 Brightness 80 lm
 Color Temp 3000K Pure White

CRI 85
 Beam Angle 50°
 Rated Life 70,000 hours

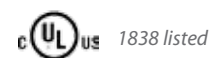

				Model	Finishes
				1011-30SS	Stainless Steel
				1021-30SS	Stainless Steel
				1051-30SS	Stainless Steel

6' lead wire included



1000-CON-PVC
1" CONCRETE POUR KIT

For installation in concrete. Use with a 4" outdoor rated junction box and 18" PVC pipe included.

2" RECESSED INGROUND + INDICATOR LED LANDSCAPE

- IP68 rated, Suitable for continuous immersion under water
 - Factory sealed water tight fixtures
 - Solid stainless steel construction
 - Constant output for 9V-15V input
- 10%-100% dimming - see specification sheet for list of tested dimmers
- Available concrete pour kit with 18" PVC pipe which can be field shorten

2" RECESSED INGROUND + INDICATOR LED LANDSCAPE

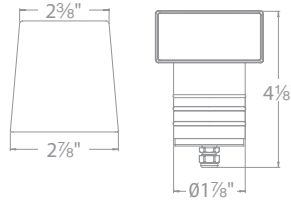
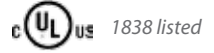

2" GROUND HOOD

Optional spring clip accessory included

Input 9-15VAC
 Power 4.1W / 6.6VA
 Brightness 25 lm
 Color Temp 3000K
 CRI 85
 Beam Angle Asymmetrical
 Rated Life 70,000 hours

2081-30SS
2081-30BS

Stainless Steel
 Bronzed Stainless Steel



6' lead wire included



2000-CON-PVC
 2" Concrete Pour Kit

For installation in concrete. Use with a 4" outdoor rated junction box and 18" PVC pipe included.

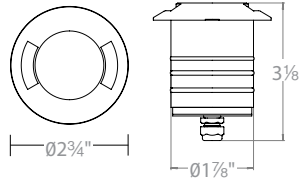

Model

Finishes

2" BI-DIRECTIONAL

Optional spring clip accessory included

Input 9-15VAC
 Power 4.1W / 6.6VA
 Brightness 5 lm
 Color Temp 3000K
 CRI 85
 Rated Life 70,000 hours

2071-30SS
2071-30BS

Stainless Steel
 Bronzed Stainless Steel



6' lead wire included



2000-CON-PVC
 2" Concrete Pour Kit

For installation in concrete. Use with a 4" outdoor rated junction box and 18" PVC pipe included.



- IP66 rated, Protected against powerful water jets
- Translucent lens provides for uniform diffused light output
- 100%-10% dimming - see specification for list of tested dimmers
 - Solid diecast brass or corrosion resistant aluminum alloy
 - ADA compliant



3031

Input 9 - 15VAC
 Power 2.8W 4.6VA
 Brightness 75 lm
 CRI 90+
 Rated Life 50,000 hours

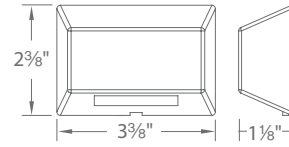

Model	Color Temp	Finishes
3031	27 2700K Warm White	BK Black on Aluminum BBR Bronze on Brass BZ Bronze on Aluminum WT White on Aluminum
	30 3000K Cool White	

Example: 3031-30BZ



3011

Input 9 - 15VAC
 Power 2.8W 4.6VA
 Brightness 60 lm
 CRI 90+
 Rated Life 50,000 hours

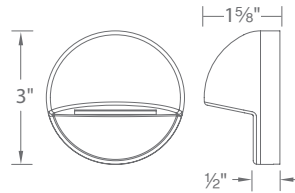

Model	Color Temp	Finishes
3011	27 2700K Warm White	BK Black on Aluminum BBR Bronze on Brass BZ Bronze on Aluminum WT White on Aluminum
	30 3000K Cool White	

Example: 3011-27WT



3021

Input 9 - 15VAC
 Power 2.8W 4.6VA
 Brightness 60 lm
 CRI 90+
 Rated Life 50,000 hours

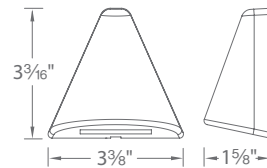

Model	Color Temp	Finishes
3021	27 2700K Warm White	BK Black on Aluminum BBR Bronze on Brass BZ Bronze on Aluminum WT White on Aluminum
	30 3000K Cool White	

Example: 3021-30BBR

STEP LIGHTS LED LANDSCAPE

- Invisible hardware
- IP66 rated, Protected against high-pressure water jets
- Constant output for 9V-15V input
- 100%-10% dimming

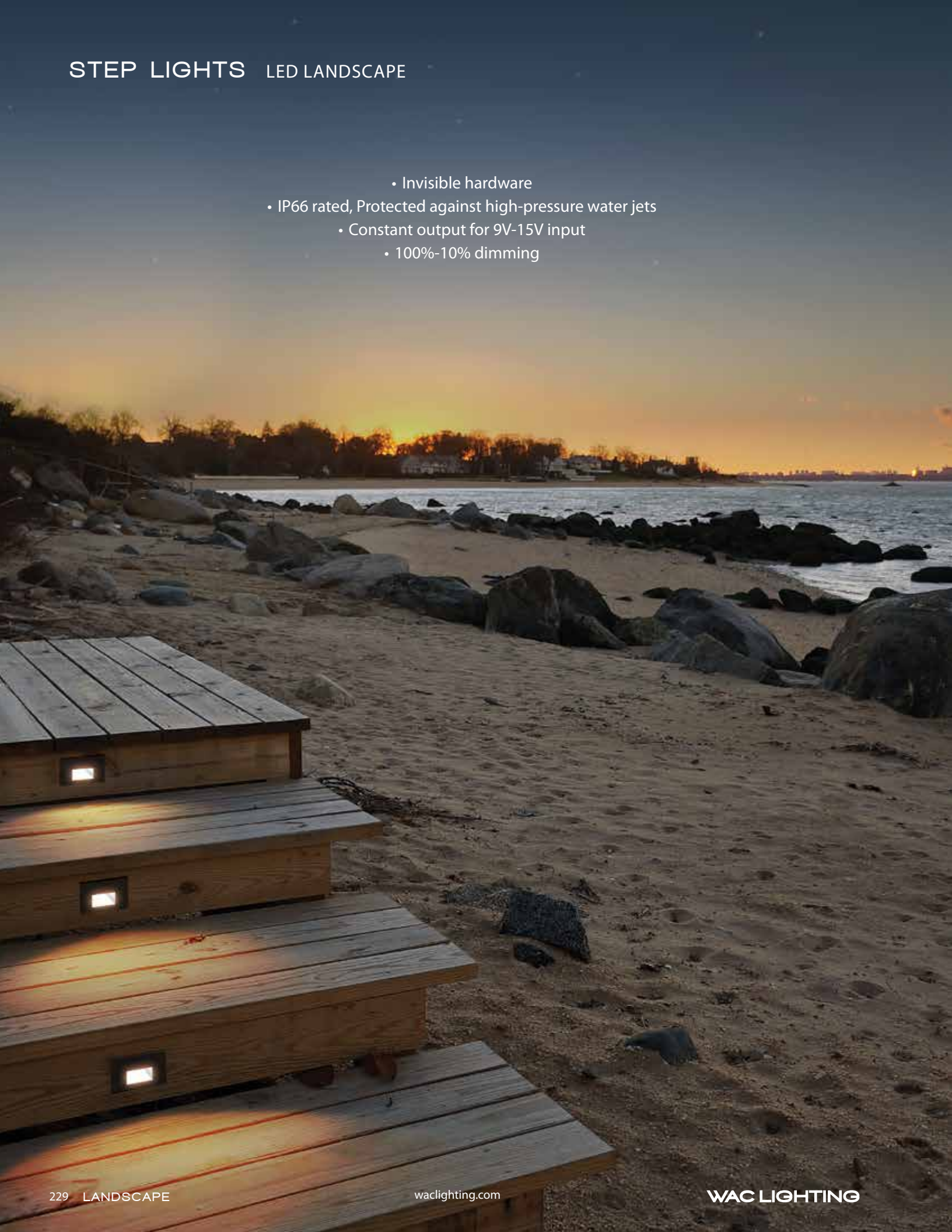

STEP LIGHTS LED LANDSCAPE



1838 listed (12V)
1598 listed (120V)

CIRCLE AND SQUARE STEP LIGHTS

- Solid stainless steel construction
- Includes a spring clip for wall or step applications
- 6' lead wire



				<i>Model</i>		
		Circle 2041	Input Power Brightness Color Temp CRI Rated Life	9-15VAC 4.1W / 6.6VA 50 lm 3000 K 85 70,000 hours	2041-30SS 2041-30BS	<i>Stainless Steel Bronzed Stainless Steel</i>
2 3/4"	1 7/8" 3 1/4"					
		Square 2061	Input Power Brightness Color Temp CRI Rated Life	9-15VAC 4.1W / 6.6VA 50 lm 3000 K 85 70,000 hours	2061-30SS 2061-30BS	<i>Stainless Steel Bronzed Stainless Steel</i>
2 3/4"	1 7/8" 3 1/4"					

RECTANGLE STEP LIGHTS

Solid Die-cast brass, corrosion resistant aluminum alloy, or cast stainless steel construction

	12V	120V
Input	9 - 15VAC	110V - 120VAC
Power	2W 3.1VA	3.5W
Brightness	Up to 38 lm	Up to 65 lm
CRI	90+	90+
Rated Life	60,000 hours	54,000 hours

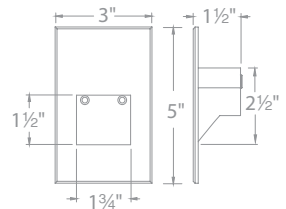
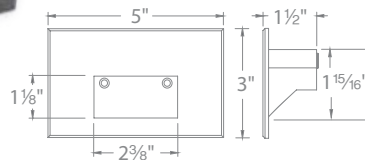

Voltage	Model	Color Temp	Finishes
12V	4011-27	2700K	BBR Bronze on Brass
	4011-30	3000K	BZ Bronze on Aluminum
	4011-AM	Amber	BK Black on Aluminum
120V**	WL-LED100-C-	3000K	WT White on Aluminum
	WL-LED100-AM-	Amber	SS* Cast Stainless Steel

Example: 4011-30BZ

*Cast Stainless Steel finish is only available in 3000K and Amber Colors.

**Available in 277V; Example: WL-LED100F-C-WT

Voltage	Model	Color Temp	Finishes
12V	4021-27	2700K	BZ Bronze on Aluminum
	4021-30	3000K	BK Black on Aluminum
	4021-AM	Amber	WT White on Aluminum
120V**	WL-LED200-C-	3000K	SS* Cast Stainless Steel
	WL-LED200-AM-	Amber	

Example: 4021-AMBK

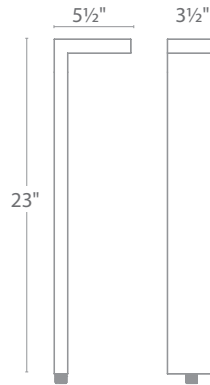

LEDGE LED PATH

- IP66 rated, Protected against high-pressure water jets
- Factory sealed water tight fixtures
- Constant output for 9V-15V input

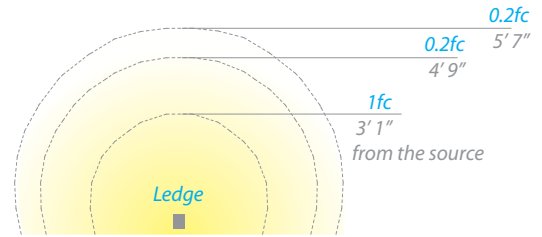

- Sleek linear design blends seamlessly into pathways while providing soft, even illumination
- Recommended spacing for installation :
Residential: 8 to 9.5ft
Commercial: 5 to 6.5ft





		Model	Color Temp	Finishes
Input	9 - 15VAC	6081	27 2700K Warm White	BZ Bronze on Aluminum  BK Black on Aluminum 
Power	3.0W, 4.5VA			
Brightness	Up to 105 lm			
CRI	90			
Rated Life	60,000 hours			

Example: 6081-27BZ

Mounting stake, 6 foot lead wire, and direct burial gel filled wire nuts included

Accessories

Additional Stake		9000-ST9-BK	Bronze	Durable PC stake
Surface Mount Flange/Stake		5000-SCP-BZ	Bronze on Aluminum	Includes three 7 inch threaded stainless steel stabilizing pins for ground mounting or surface mounts with four screws or over a junction box
Guardian Mount		9000-SP9-BZ	Stainless Steel	Heavy duty stainless steel spike to position fixture

SLIDE LED PATH

- IP66 rated, Protected against high-pressure water jets
- Factory sealed water tight fixtures
- Constant output for 9V-15V input



SLIDE LED PATH

IP66

UL US 1838 listed (12V)

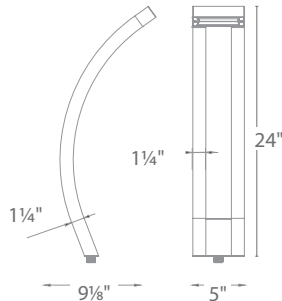

6321

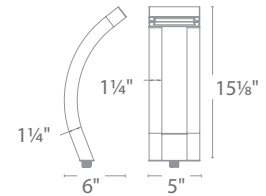

6311

- Sleek linear design blends seamlessly into pathways while providing soft, even illumination
- Recommended spacing for installation :

6321 Large
Residential: 9 to 11ft
Commercial: 5 to 6.5ft

6311 Small
Residential: 7.5 to 9ft
Commercial: 4.5 to 6ft

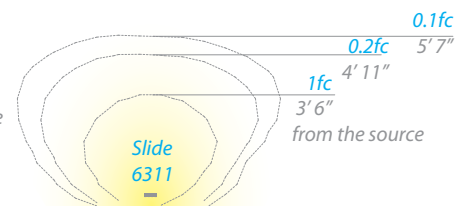
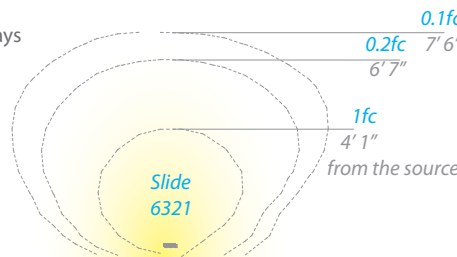

	Model	Color Temp	Finishes
Input	9 - 15VAC		
Power	3.0W, 4.5VA		
Brightness	Up to 95 lm		
CRI	90		
Rated Life	60,000 hours		
	6311	30	BZ
	Small	3000K Pure White	Bronze on Aluminum
Input	9 - 15VAC		
Power	3.0W, 4.5VA		
Brightness	Up to 95 lm		
CRI	90		
Rated Life	60,000 hours		
	6321		
	Large		

Example: 6311-30BZ

Mounting stake, 6 foot lead wire, and direct burial gel filled wire nuts included

Accessories

Additional Stake		9000-ST9-BK	Bronze	Durable PC stake
Surface Mount Flange/Stake		5000-SCP-BZ	Bronze on Aluminum	Includes three 7 inch threaded stainless steel stabilizing pins for ground mounting or surface mounts with four screws or over a junction box
Guardian Mount		9000-SP9-BZ	Stainless Steel	Heavy duty stainless steel spike to position fixture

LINEAR LED PATH

- IP66 rated, Protected against high-pressure water jets
- Factory sealed water tight fixtures
- Constant output for 9V-15V input

LINEAR LED PATH

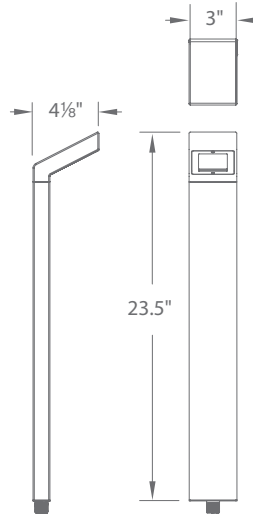
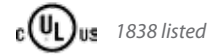

- Sleek linear design blends seamlessly into pathways while providing soft, even illumination
- Recommended spacing for installation :
Residential: 7.5 to 8.5ft
Commercial: 5 to 6ft

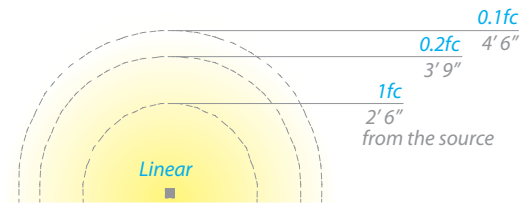

		Model	Color Temp	Finishes
Input	9 - 15VAC	6021	27 2700K Warm White 30 3000K Pure White	BZ Bronze on Aluminum BK Black on Aluminum
Power	2.9W, 4.7VA			
Brightness	Up to 95 lm			
CRI	90			
Rated Life	60,000 hours			

Example: 6021-30BK

Mounting stake, 6 foot lead wire, and direct burial gel filled wire nuts included

Accessories

Additional Stake		9000-ST9-BK	Bronze	Durable PC stake
Surface Mount Flange/Stake		5000-SCP-BZ	Bronze on Aluminum	Includes three 7 inch threaded stainless steel stabilizing pins for ground mounting or surface mounts with four screws or over a junction box
Guardian Mount		9000-SP9-BZ	Stainless Steel	Heavy duty stainless steel spike to position fixture

BALANCE SINGLE LED PATH

- IP66 rated, Protected against high-pressure water jets
- Factory sealed water tight fixtures
- Constant output for 9V-15V input



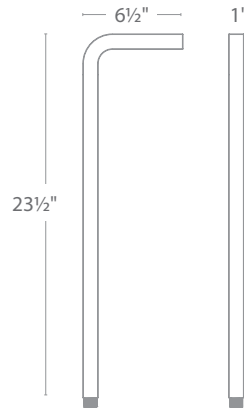

- Sleek linear design blends seamlessly into pathways while providing soft, even illumination
- Recommended spacing for installation :
Residential: 11.5 to 14ft
Commercial: 7 to 9ft

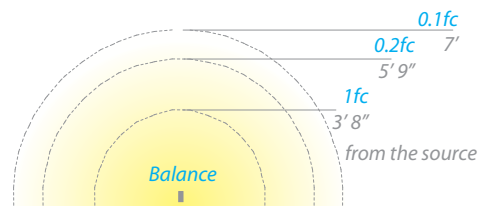

		Model	Color Temp	Finishes
Input	9 - 15VAC	6061	27 2700K Warm White 30 3000K Pure White	BZ Bronze on Aluminum BK Black on Aluminum
Power	6.5W, 11.5VA			
Brightness	Up to 275 lm			
CRI	90			
Rated Life	60,000 hours			

Example: 6061-30BZ

Mounting stake, 6 foot lead wire, and direct burial gel filled wire nuts included

Accessories

Additional Stake		9000-ST9-BK	Bronze	Durable PC stake
Surface Mount Flange/Stake		5000-SCP-BZ	Bronze on Aluminum	Includes three 7 inch threaded stainless steel stabilizing pins for ground mounting or surface mounts with four screws or over a junction box
Guardian Mount		9000-SP9-BZ	Stainless Steel	Heavy duty stainless steel spike to position fixture

BALANCE DOUBLE LED PATH



- IP66 rated, Protected against high-pressure water jets
- Factory sealed water tight fixtures
- Constant output for 9V-15V input

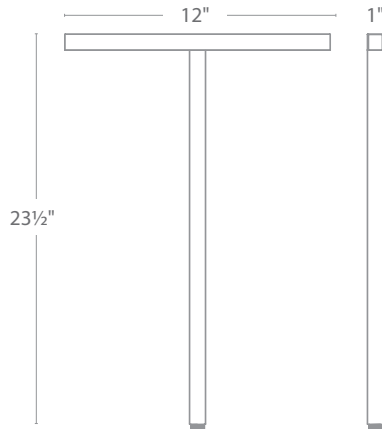

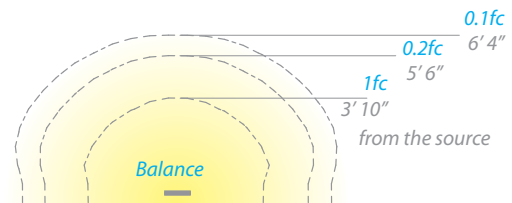

- Sleek linear design blends seamlessly into pathways while providing soft, even illumination
- Recommended spacing for installation :
Residential: 11 to 13ft
Commercial: 7.5 to 9ft





		Model	Color Temp	Finishes
Input	9 - 15VAC	6071	27 2700K Warm White	BZ Bronze on Aluminum  BK Black on Aluminum 
Power	10.0W, 14VA			
Brightness	Up to 375 lm			
CRI	90			
Rated Life	60,000 hours			

Example: 6071-30BZ

Mounting stake, 6 foot lead wire, and direct burial gel filled wire nuts included

Accessories

Additional Stake		9000-ST9-BK	Bronze	Durable PC stake
Surface Mount Flange/Stake		5000-SCP-BZ	Bronze on Aluminum	Includes three 7 inch threaded stainless steel stabilizing pins for ground mounting or surface mounts with four screws or over a junction box
Guardian Mount		9000-SP9-BZ	Stainless Steel	Heavy duty stainless steel spike to position fixture

- IP66 rated, Protected against high-pressure water jets
- Factory sealed water tight fixtures
- Constant output for 9V-15V input

QUAD LED PATH

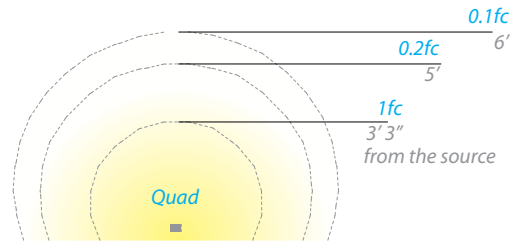
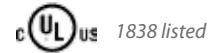

- Sleek linear design blends seamlessly into pathways while providing soft, even illumination
- Recommended spacing for installation :
Residential: 8.5 to 10ft
Commercial: 5 to 6.5ft

		Model	Color Temp	Finishes
Input	9 - 15VAC	6091	27 2700K Warm White 30 3000K Pure White	BZ Bronze on Aluminum
Power	3.0W, 4.5VA			
Brightness	Up to 100 lm			
CRI	90			
Rated Life	60,000 hours			

Example: 6091-27BZ

Mounting stake, 6 foot lead wire, and direct burial gel filled wire nuts included

Accessories

Additional Stake		9000-ST9-BK	Bronze	Durable PC stake
Surface Mount Flange/Stake		5000-SCP-BZ	Bronze on Aluminum	Includes three 7 inch threaded stainless steel stabilizing pins for ground mounting or surface mounts with four screws or over a junction box
Guardian Mount		9000-SP9-BZ	Stainless Steel	Heavy duty stainless steel spike to position fixture

ECLIPSE LED PATH

- IP66 rated, Protected against high-pressure water jets
 - Factory sealed water tight fixtures
 - Solid diecast corrosion resistant aluminum alloy
 - Constant output for 9V-15V input

ECLIPSE LED PATH

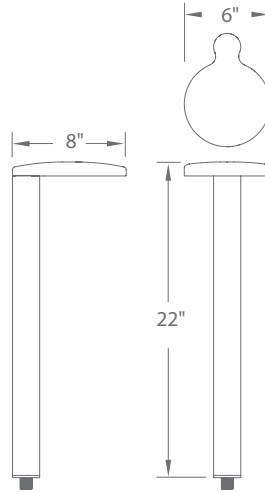
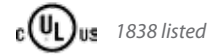

- Sturdy side mount design works well in applications where directional illumination is desired
- Recommended spacing for installation :
Residential: 8 to 9.5ft
Commercial: 5.5 to 6.5ft

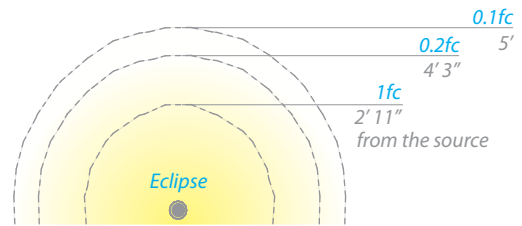

		Model	Color Temp	Finishes
Input	9 - 15VAC	6031	27 2700K Warm White 30 3000K Pure White	BBR Bronze on Brass BZ Bronze on Aluminum BK Black on Aluminum
Power	2.9W / 4.7VA			
Brightness	Up to 125 lm			
CRI	90			
Rated Life	60,000 hours			

Example: 6031-30BZ

Mounting stake, 6 foot lead wire, and direct burial gel filled wire nuts included

Accessories

Additional Stake		9000-ST9-BK	Bronze	Durable PC stake
Surface Mount Flange/Stake		5000-SCP-BZ 5000-SCP-BBR	Bronze on Aluminum Bronze on Brass	Includes three 7 inch threaded stainless steel stabilizing pins for ground mounting or surface mounts with four screws or over a junction box
Guardian Mount		9000-SP9-BZ	Stainless Steel	Heavy duty stainless steel spike to position fixture

AREA LED AREA LIGHT



- IP66 rated, Protected against high-pressure water jets
 - Factory sealed water tight fixtures
- Solid brass or corrosion resistant aluminum alloy
- Constant output for 9V-15V input

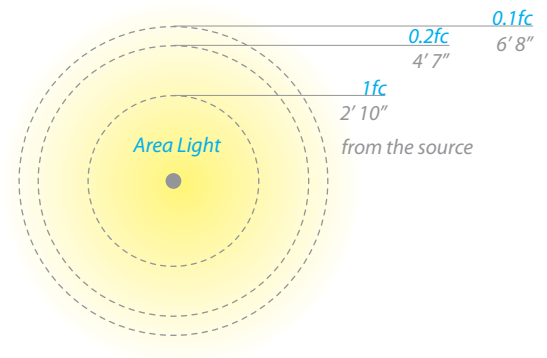
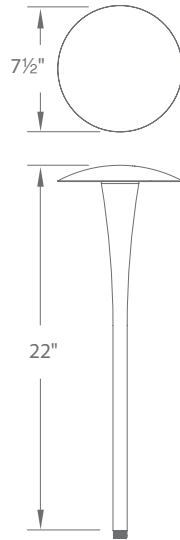

- Broad appeal makes this fixture suitable for varying landscape designs
- Recommended spacing for installation :
Residential: 8 to 10ft
Commercial: 6 to 8ft

		Model	Color Temp	Finishes
Input	9 - 15VAC	6011	27 2700K Warm White 30 3000K Pure White	BBR Bronze on Brass BZ Bronze on Aluminum BK Black on Aluminum
Power	5.8W / 9.4VA			
Brightness	Up to 150 lm			
CRI	90			
Rated Life	60,000 hours			

Example: 6011-30BK

Mounting stake, 6 foot lead wire, and direct burial gel filled wire nuts included

Accessories

Additional Stake		9000-ST9-BK	Bronze	Durable PC stake
Surface Mount Flange/Stake		5000-SCP-BZ 5000-SCP-BBR	Bronze on Aluminum Bronze on Brass	Includes three 7 inch threaded stainless steel stabilizing pins for ground mounting or surface mounts with four screws or over a junction box
Guardian Mount		9000-SP9-BZ	Stainless Steel	Heavy duty stainless steel spike to position fixture

TIKI LED AREA LIGHT

- IP66 rated, Protected against high-pressure water jets
- Factory sealed water tight fixtures
- Solid brass or corrosion resistant aluminum alloy
- Constant output for 9V-15V input

TIKI LED AREA LIGHT

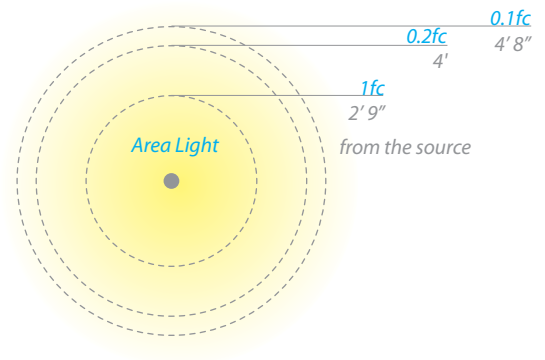
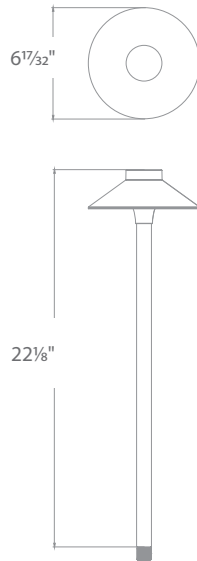
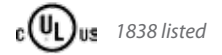

- Sturdy side mount design works well in applications where directional illumination is desired
- Recommended spacing for installation :
Residential: 8 to 9ft
Commercial: 5.5 to 6.5ft

		Model	Color Temp	Finishes		
Input	9 - 15VAC	6041	27 2700K Warm White 30 3000K Pure White	BBR	Bronze on Brass	
Power	6.5W, 9.5VA			BZ	Bronze on Aluminum	
Brightness	Up to 225 lm			BK	Black on Aluminum	
CRI	90					
Rated Life	60,000 hours					

Example: 6041-30BK

Mounting stake, 6 foot lead wire, and direct burial gel filled wire nuts included

Accessories

Additional Stake		9000-ST9-BK	Bronze	Durable PC stake
Surface Mount Flange/Stake		5000-SCP-BZ 5000-SCP-BBR	Bronze on Aluminum Bronze on Brass	Includes three 7 inch threaded stainless steel stabilizing pins for ground mounting or surface mounts with four screws or over a junction box
Guardian Mount		9000-SP9-BZ	Stainless Steel	Heavy duty stainless steel spike to position fixture

CANOPY LED AREA LIGHT

- IP66 rated, Protected against high-pressure water jets
 - Factory sealed water tight fixtures
- Solid brass or corrosion resistant aluminum alloy
 - Constant output for 9V-15V input



CANOPY LED AREA LIGHT

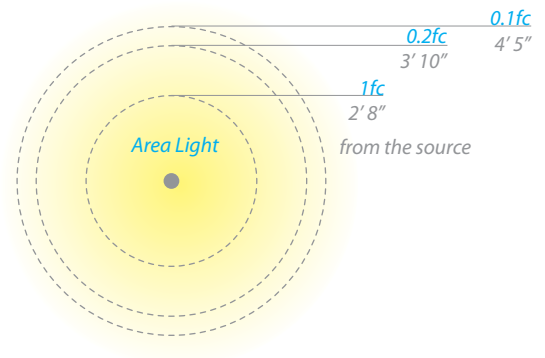
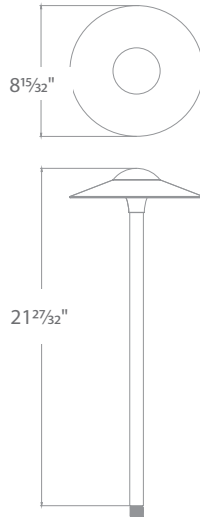
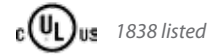

- Sturdy side mount design works well in applications where directional illumination is desired
- Recommended spacing for installation :
Residential: 7.5 to 9ft
Commercial: 5.5 to 6.5ft

		Model	Color Temp	Finishes		
Input	9 - 15VAC	6051	27 2700K Warm White 30 3000K Pure White	BBR	Bronze on Brass	
Power	6.5W, 9.5VA			BZ	Bronze on Aluminum	
Brightness	Up to 225 lm			BK	Black on Aluminum	
CRI	90					
Rated Life	60,000 hours					

Example: 6051-30BBR

Mounting stake, 6 foot lead wire, and direct burial gel filled wire nuts included

Accessories

Additional Stake		9000-ST9-BK	Bronze	Durable PC stake
Surface Mount Flange/Stake		5000-SCP-BZ 5000-SCP-BBR	Bronze on Aluminum Bronze on Brass	Includes three 7 inch threaded stainless steel stabilizing pins for ground mounting or surface mounts with four screws or over a junction box
Guardian Mount		9000-SP9-BZ	Stainless Steel	Heavy duty stainless steel spike to position fixture

MINI ACCENT LED PATH

- Includes 6", 12" and 24" extensions
- IP66 rated, Protected against high-pressure water jets
 - 10° - 50° beam adjustability
- Continuously adjustable beam angles and brightness control
 - Detachable shroud
- Constant output for 9V-15V input



MINI ACCENT LED PATH



1838 listed (12V)

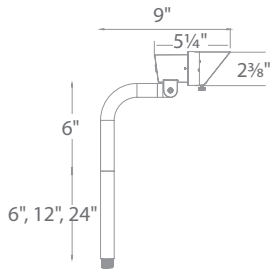

6111

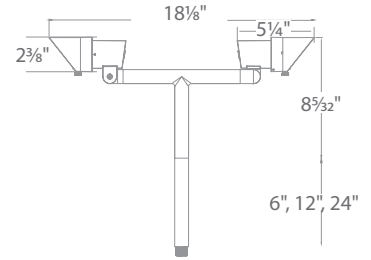
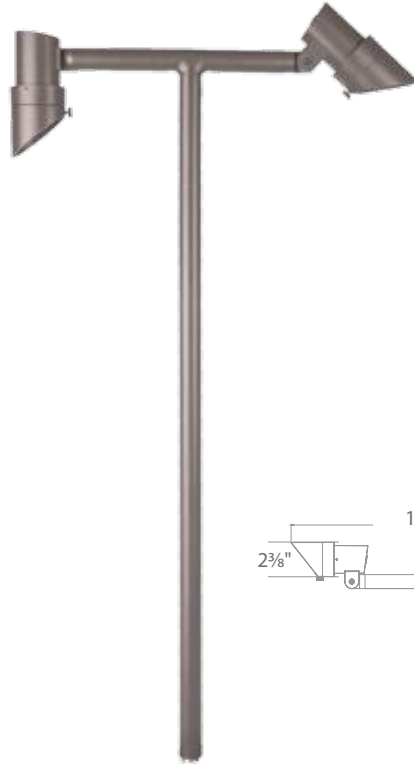

6211

		Model	Color Temp	Finishes	
Input	9-15VAC	6111 Single	27 2700K Warm White	BZ Bronze on Aluminum	
Power	1W to 7W/ 2VA-10.5VA				
Brightness	45lm to 365lm				
CRI	85				
Rated Life	70,000 hours				
Input	9-15VAC	6211 Double	30 3000K Pure White	BBR Bronze on Bronze	
Power	1W to 7W/ 2VA-10.5VA x 2				
Brightness	45lm to 365lm x 2				
CRI	85				
Rated Life	70,000 hours				

Example: 6111-30BZ

Guardian mount, 6 foot lead wire, and direct burial gel filled wire nuts included

Accessories

5" Long Shroud		5111-LSHR-BZ 5111-LSHR-BBR	Bronze on Aluminum Bronze on Brass	Reduce glare. Ideal for downlighting application
Surface Mount Flange/Stake		5000-SCP-BZ 5000-SCP-BBR	Bronze on Aluminum	Includes three 7 inch threaded stainless steel stabilizing pins for ground mounting or surface mounts with four screws or over a junction box
Additional Guardian Mount		9000-SP9-BZ	Stainless Steel	Heavy duty stainless steel spike to position fixture

GATE LED BOLLARD/PATH

- IP66 rated, Protected against high-pressure water jets
- Factory sealed water tight fixtures
- Constant output for 9V-15V input
- Mounting accessories included
- Detachable back plate for lighting control included



GATE LED BOLLARD/PATH

IP66

UL US 1838 listed (12V)



Shown without plate



Shown with plate



- Sleek linear design blends seamlessly into pathways while providing soft, even illumination

	<i>Model</i>	<i>Color Temp</i>	<i>Finishes</i>
Input	9 - 15VAC		
Power	7W, 7.5VA		
Brightness	Up to 115 lm	27 2700K Warm White	BZ Bronze on Aluminum
CRI	90	30 3000K Pure White	BK Black on Aluminum
Rated Life	60,000 hours		

Example: 6651-30BZ

Mounting stake, 6ft lead wire and detachable back plate included

LANDSCAPE LIGHTING DESIGN

2" SUBMERSIBLE

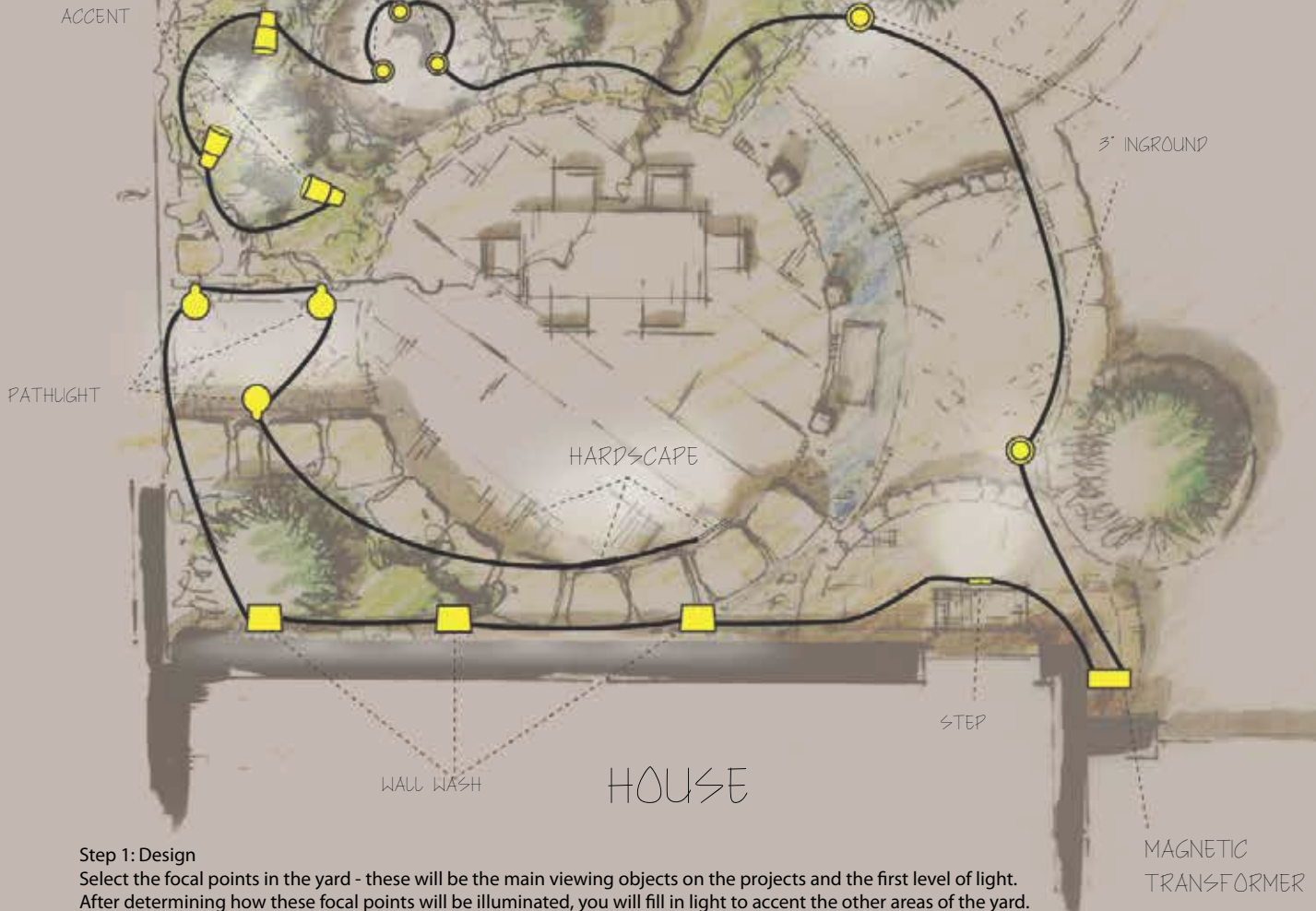

Step 1: Design

Select the focal points in the yard - these will be the main viewing objects on the projects and the first level of light. After determining how these focal points will be illuminated, you will fill in light to accent the other areas of the yard.

Step 2: Fixture Selection

Path and Area: Ideal for illuminating pathways or illuminating flower beds.

Accent: Use to create dramatic effects when up lighting or subtle moods when used for down lighting.

Wall Wash: Use to create an even wide flood of light on any surface.

Hardscape Fixtures: Perfect for under a stack stone wall, deck handrails or a bench seating.

Tape Lighting: Illuminate irregular shaped hardscapes, in or around water features and ponds, or in an outdoor kitchen for entertaining.

Submersible: Highlights ponds, water features and backyard streams.

Step/Deck/Patio/Indicator: Illuminate outdoor entertainment areas where foot traffic is prevalent

Step 3: Fixture Spacing:

Spacing is subjective. 6 feet of lead wire is provided across the offering for final location adjustments in the field

Bollard/ Path / Area: around 10' distance between each

Accents/Inground: Small objects require 1-2 fixtures, while large canopy trees with multiple viewing angles may require up to 4 fixtures.

Wall Wash: Placing 2' from your wall will cast nice even illumination

Hardscape: 3" for short, tight areas. 6" to illuminate under deck hand rails, retaining walls, or steps.

Larger sizes are available for greater illumination into areas needing a greater amount of light.

Tape Lighting: Tape lighting has approximately 40' maximum run distance, 5 amp max per run. Available in 1', 5' & 10' connectable lengths.

Indicator: Mark pathway borders with 18" spacing

Submersible: Rated for use up to 5 feet deep.

Step 4: Wire Runs

It is very likely that you will have several runs going out from the transformer to connect all of the fixtures. Adhere to transformer guidelines and above 9V at the end of the run. See waclandscapelighting.com for wire sizing guide and further installation assistance.

Step 5: Transformer Sizing

Based on the fixture runs and number of fixtures on your project, you will select your transformer size (75W, 150W, 300W, 600W etc.).

TRANSFORMER LED LANDSCAPE

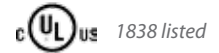





- IP65 Rated
- 12V to 15V taps
- Knock outs for power and photosensor connections
- 3-prong outlet for timer
- Outdoor rated stainless steel transformer contains an outdoor rated 3-prong plug for power





Model	
9075-TRN-SS	75W Max Dimensions: 13.97" L x 5.35"W x 5.63"H
9150-TRN-SS	150W Max Dimensions: 18.90" L x 6.69"W x 6.30"H
9300-TRN-SS	300W Max Dimensions: 18.90" L x 6.69"W x 6.30"H
9600-TRN-SS	600W Max (2 x 300W outputs) Dimensions: 14.49" L x 10.08"W x 5.94"H

ACCESSORIES LED LANDSCAPE

Mechanical Timer		9000-MTI-WT	White	Connect within the transformer
Photosensor		9000-PCH-GY	1000VA Max	Attached directly to the transformer
Photosensor - Remote		9000-PCR-GY	1000VA Max	If transformer is located in a shady spot, this photosensor has a 10 foot cord and a stainless steel bracket to secure in a sunny area
Direct Burial Water proof Wire Nuts		9020-WNT-BK		Silicone filled wire nut with gasket (Pack of 20pcs)
12V Direct Burial Outdoor Cable		9100-12G-BK 9250-12G-BK 9500-12G-BK	100 feet 12 gauge 250 feet 12 gauge 500 feet 12 gauge	

TREE MOUNTING ACCESSORIES LED LANDSCAPE



Tree Mount Junction Box		5000-TCP-BZ	Bronze on Aluminum box with Stainless steel mounting screws. Two 1/2" NPT threaded holes
6" Long Shroud For 5011/5012 Accent		5010-LSHR-BZ 5010-LSHR-BBR	Reduce glare. Ideal for downlighting application
5" Long Shroud For 5111 Accent		5111-LSHR-BZ 5111-LSHR-BBR	Reduce glare. Ideal for downlighting application

SCOOP 12V/120V/277V LED BOLLARD

- IP66 rated, Protected against high-pressure water jets
- Factory sealed water tight fixtures
- Constant output for 9V-15V input
- Mounting accessories included



SCOOP 12V/120V/277V LED BOLLARD

IP66



1838 listed (12V)
1598 listed (120V/277V)

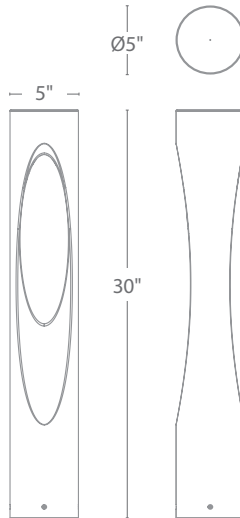

Mounting accessory included

M6000-STAKE
12V



120V/277V



- Sleek linear design blends seamlessly into pathways while providing soft, even illumination

		Model	Color Temp	Finishes
Input	9 - 15VAC	6611 12V	27 2700K Warm White 30 3000K Pure White	BZ Bronze on Aluminum BK Black on Aluminum
Power	5.7W, 6.0VA			
Brightness	Up to 135 lm			
CRI	90			
Rated Life	60,000 hours			
MLV dimming only				
Input	120V	6612 120V	27 2700K Warm White 30 3000K Pure White	BZ Bronze on Aluminum BK Black on Aluminum
Power	12.5W			
Brightness	Up to 350 lm			
CRI	90			
Rated Life	60,000 hours			
TRIAC or ELV dimming				
Input	277VAC	6613 277V	27 2700K Warm White 30 3000K Pure White	BZ Bronze on Aluminum BK Black on Aluminum
Power	10.5W			
Brightness	Up to 300 lm			
CRI	90			
Rated Life	60,000 hours			
ELV dimming only				

Example: 6611-30BZ
Mounting accessories included

CHAMBER 12V/120V/277V LED BOLLARD

- IP66 rated, Protected against high-pressure water jets
- Factory sealed water tight fixtures
- Constant output for 9V-15V input
- Mounting accessories included



CHAMBER 12V/120V/277V LED BOLLARD

IP66



1838 listed (12V)
1598 listed (120V/277V)

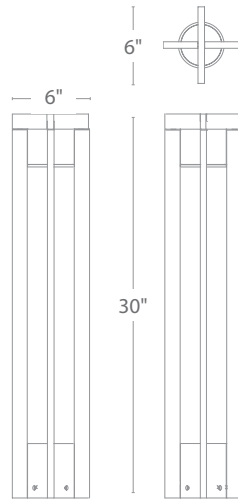

- Sleek linear design blends seamlessly into pathways while providing soft, even illumination

		Model	Color Temp	Finishes
Input	9 - 15VAC	6631 12V	27 2700K Warm White 30 3000K Pure White	BZ Bronze on Aluminum BK Black on Aluminum
Power	5.5W, 6.0VA			
Brightness	Up to 140 lm			
CRI	90			
Rated Life	60,000 hours			
MLV dimming only				
Input	120V	6632 120V	27 2700K Warm White 30 3000K Pure White	BZ Bronze on Aluminum BK Black on Aluminum
Power	12.5W			
Brightness	Up to 360 lm			
CRI	90			
Rated Life	60,000 hours			
TRIAC or ELV dimming				
Input	277VAC	6633 277V	27 2700K Warm White 30 3000K Pure White	BZ Bronze on Aluminum BK Black on Aluminum
Power	10.5W			
Brightness	Up to 400 lm			
CRI	90			
Rated Life	60,000 hours			
ELV dimming only				

Example: 6633-30BZ
Mounting accessories included

TOWER 12V/120V/277V LED BOLLARD

- IP66 rated, Protected against high-pressure water jets
 - Factory sealed water tight fixtures
 - Constant output for 9V-15V input
 - Mounting accessories included



TOWER 12V/120V/277V LED BOLLARD

IP66



1838 listed (12V)
1598 listed (120V/277V)

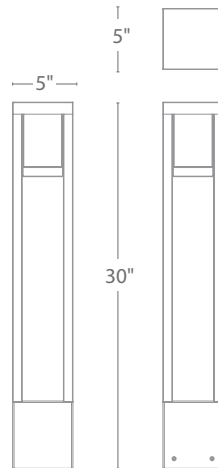

- Sleek linear design blends seamlessly into pathways while providing soft, even illumination

	Model	Color Temp	Finishes
Input 9 - 15VAC Power 5.5W, 6.0VA Brightness Up to 185 lm CRI 90 Rated Life 60,000 hours MLV dimming only	6621 12V	27 2700K Warm White 30 3000K Pure White	BZ Bronze on Aluminum BK Black on Aluminum
Input 120V Power 12.5W Brightness Up to 455 lm CRI 90 Rated Life 60,000 hours TRIAC or ELV dimming	6622 120V	27 2700K Warm White 30 3000K Pure White	BZ Bronze on Aluminum BK Black on Aluminum
Input 277VAC Power 10.5W Brightness Up to 455 lm CRI 90 Rated Life 60,000 hours ELV dimming only	6623 277V	27 2700K Warm White 30 3000K Pure White	BZ Bronze on Aluminum BK Black on Aluminum

Example: 6622-30BZ
Mounting accessories included

PARK 12V/120V/277V LED BOLLARD

- IP66 rated, Protected against high-pressure water jets
- Factory sealed water tight fixtures
- Constant output for 9V-15V input
- Mounting accessories included



PARK 12V/120V/277V LED BOLLARD

IP66



1838 listed (12V)
1598 listed (120V/277V)

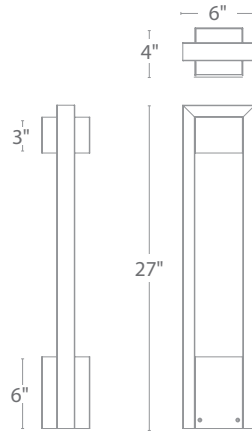

- Sleek linear design blends seamlessly into pathways while providing soft, even illumination

		<i>Model</i>	<i>Color Temp</i>	<i>Finishes</i>
Input	9 - 15VAC	6641 12V	27 2700K Warm White 30 3000K Pure White	BZ Bronze on Aluminum BK Black on Aluminum
Power	5.5W, 6.0VA			
Brightness	Up to 150 lm			
CRI	90			
Rated Life	60,000 hours			
MLV dimming only				
Input	120V	6642 120V	27 2700K Warm White 30 3000K Pure White	BZ Bronze on Aluminum BK Black on Aluminum
Power	12.5W			
Brightness	Up to 390 lm			
CRI	90			
Rated Life	60,000 hours			
TRIAC or ELV dimming				
Input	277VAC	6643 277V	27 2700K Warm White 30 3000K Pure White	BZ Bronze on Aluminum BK Black on Aluminum
Power	10.5W			
Brightness	Up to 430 lm			
CRI	90			
Rated Life	60,000 hours			
ELV dimming only				

Example: 6641-30BZ
Mounting accessories included

120V ADJUSTABLE OUTDOOR RETROFIT AND UPDATE

Line Voltage functional outdoor products have historically been gigantic. LEDs can do the same job and eliminate the need for bulky fixture housings. Older systems may now be easily updated for both commercial and residential spaces.



ACCENT 120V

Integral Brightness Control, Adjustable beam angle



Power 3.5W to 14.5W
Brightness 100 to 900
Beam Angle 15° to 60°
CRI 85
Color Temp 3000K Pure White
Rated Life 45,000 hours
Listing IP-66

*Detachable shroud
 6' lead wire and wire nuts included*

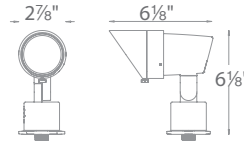

Model	Finishes
-------	----------

5012-30BZ	Bronze on Aluminum
5012-30BBR	Bronze on Brass

WALL WASH 120V

Integral Brightness Control



Power 3.5W to 14.5W
Brightness 95 to 855
Beam Angle 15° upward (50° by 80°)
CRI 85
Color Temp 3000K Pure White
Rated Life 45,000 hours
Listing IP-66

6' lead wire and wire nuts included

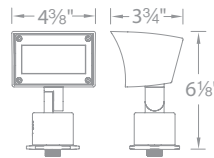

Model	Finishes
-------	----------

5022-30BZ	Bronze on Aluminum
5022-30BBR	Bronze on Brass

3" INGROUND 120V

Integral Brightness Control, Adjustable beam angle



Power 3W to 11.5W
Brightness 65 to 515
Beam Angle 15° to 60°
CRI 85
Color Temp 3000K Pure White
Rated Life 45,000 hours
Listing IP-67

6' lead wire and wire nuts included



Model	Finishes
-------	----------

5032-30BZ	Bronze on Aluminum
5032-30BBR	Bronze on Brass



SHINING FROM THE BACKGROUND

Like Professional stagehands, these high-performers easily disappear into the backdrop with their diminutive sizes while adaptably making the whole show possible

Featuring product: **5012-30BZ** Accent

LED STEP & WALL





LED100
Stainless Steel Finish

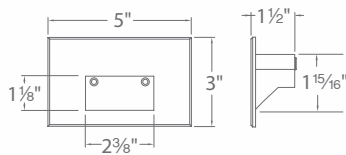

LED200
Black Finish

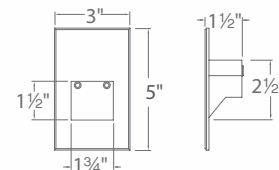

Power: 3.5W
Lumens: Up to 65
CRI: 90
Rated Life: 54,000 hours
Input: 120V, 277V

- Available in die-cast brass and 316 marine grade stainless steel
- Fits into 2"×4" J-Box with minimum inside dimensions of 3"×2"×2"
- IP66, wet location rated for indoor and outdoor installations*
- 5 year WAC warranty (lifetime warranty for brass and stainless steel)

- No driver needed
- No heat radiation
- ELV dimming - see specification sheet for list of tested dimmers

System		Color		Finish
WL-LED100 WL-LED100F	120V 277V	Horizontal Scoop	C White 3000K (CCT)	BBR Bronze on Brass
			AM Amber 610nm (Peak)	
			C White 3000K (CCT)	SS Stainless Steel BK Black on Aluminum WT White on Aluminum BZ Bronze on Aluminum *BN Brushed Nickel
			AM Amber 610nm (Peak)	
RD Red 640nm (Peak)				
BL Blue 450nm (Peak)				
WL-LED200 WL-LED200F	120V 277V	Vertical Scoop	C White 3000K (CCT)	SS Stainless Steel BK Black on Aluminum WT White on Aluminum BZ Bronze on Aluminum *BN Brushed Nickel
			AM Amber 610nm (Peak)	
			RD Red 640nm (Peak)	
			BL Blue 450nm (Peak)	

Example: WL-LED100-C-SS

*BN Finish is not warranted for contact with harsh chemicals or exterior installations.
Use Brass or Stainless Steel Step and Wall Lights for harsh outdoor environments.

SPACING RECOMMENDATIONS FOR OPTIMAL LIGHT DISTRIBUTION

Corridors / Hallways

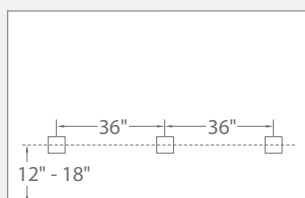

Stairs - Wall Mount

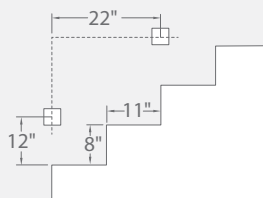

Stairs - Step Mount

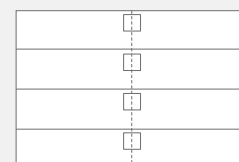

Mount in center of stair as close to the upper tread as possible. For best results use one light per step for steps narrower than 5 feet



LED300
Brushed Nickel Finish



LED310
Bronze Finish

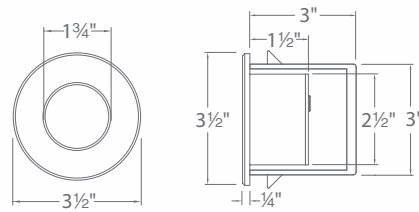
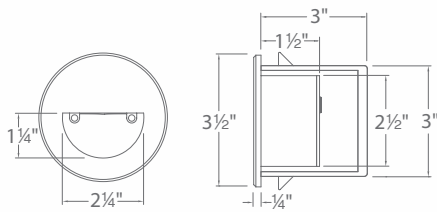

Power: 3.5 W
Lumens: Up to 60 lm
CRI: 90
Rated Life: 54,000 hours
Input: 120V direct

- Die-cast aluminum construction
- IP66, wet location rated for interior and exterior installations (Not recommended for contact with chemicals or sustained contact with water)
- Supplied with a junction box for custom recessed installation
- No driver required
- No heat radiation
- ELV dimming - see specification sheet for list of tested dimmers
- 5 year WAC warranty

System	Color	Finish
WL-LED300 Scoop	C White AM Amber RD Red BL Blue	WT White BZ Bronze *BN Brushed Nickel
WL-LED310 Opal		

Example: WL-LED300-C-BN

*BN Finish is not warranted for contact with harsh chemicals or exterior installations. Use Brass or Stainless Steel Step and Wall Lights for harsh outdoor environments.

SPACING RECOMMENDATIONS FOR OPTIMAL LIGHT DISTRIBUTION

Corridors / Hallways

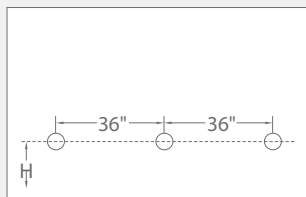

LED300 H: 12" - 18"
LED310 H: 6"

Stairs - Wall Mount

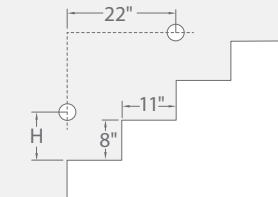

LED300 H: 12"
LED310 H: 6"

Stairs - Step Mount

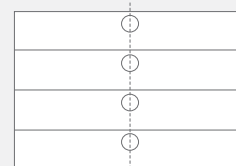

Mount in center of stair as close to the upper tread as possible. For best results use one light per step for steps narrower than 5 feet

RECTANGULAR TRIMLESS STEP & WALL LIGHTS LEDME®

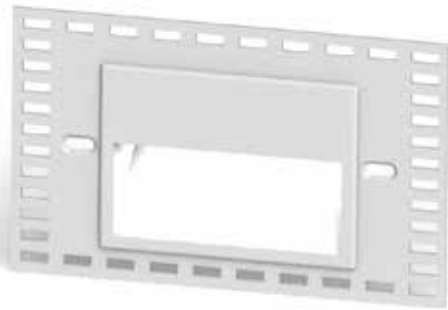

LED100TR

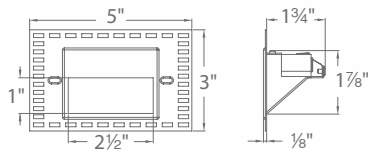

LED200TR

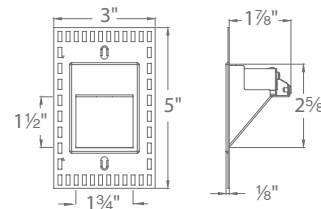

Power: 3.0W
Lumens: Up to 65 lm
CRI: 90
Rated Life: 54,000 hours
Input: 120V direct

- **Damp location listed**
- No driver required
- No heat radiation
- May be painted to match the color of wall or treads
- Fits into 2"×4" J-Box with minimum inside dimensions of 3"×2"×2"

- Ships with a dense foam insert for spackling
- Wiring is accessible even after finished installation
- 5 year WAC warranty

System	Color	Finish
WL-LED100TR <i>Trimless Horizontal Scoop</i>	C White 3000K (CCT) AM Amber 610nm (Peak) RD Red 640nm (Peak) BL Blue 450nm (Peak)	WT White
WL-LED200TR <i>Trimless Vertical Scoop</i>		

Example: WL-LED100TR-AM-WT

SPACING RECOMMENDATIONS FOR OPTIMAL LIGHT DISTRIBUTION

Corridors / Hallways

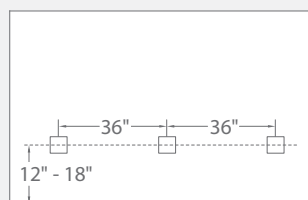

Stairs - Wall Mount

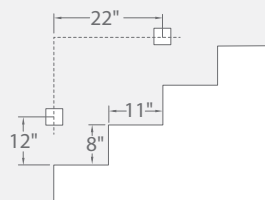

Stairs - Step Mount

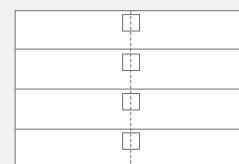

Mount in center of stair as close to the upper tread as possible. For best results use one light per step for steps narrower than 5 feet





WL-5105

Opal

Input: 120V
CRI: 90
Dimming: 100% - 10% ELV
Rated Life: 80,000 hours

WL-5205

Louver

Input: 120V
CRI: 90
Dimming: 100% - 10% ELV
Rated Life: 80,000 hours



- Factory-Sealed LED Light Engine
- Die-cast Aluminum Construction
- 120V Direct Wire - No Driver Needed
- Easily retrofit most existing incandescent brick light installations with this maintenance free LED upgrade

			<i>Max</i> <i>Delivered</i> <i>Power</i>	<i>Color</i> <i>Lumens</i>	<i>Temp</i>	<i>Finish</i>
		WL-5105-30 <i>Opal</i>	5.5W	110	3000K	aBZ <i>Architectural Bronze</i>
						aBK <i>Architectural Black</i>
<hr/>						
		WL-5205-30 <i>Louver</i>	5.5W	45	3000K	aBZ <i>Architectural Bronze</i>
						aBK <i>Architectural Black</i>
<hr/>						
aGH <i>Architectural Graphite</i>						
aWT <i>Architectural White</i>						

Example: WL-5105-30-aWT

EXTERIOR



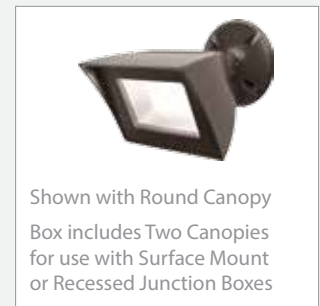

Input: 120V
CRI: 85
Dimming: 100% - 10% ELV
Rated Life: 50,000 hours

- Waterproof breathable technology to maintain stable atmospheric pressure free from condensation
- Factory-Sealed LED Light Engine
- Die-cast Aluminum Construction
- 120V Direct Wire - No Driver Needed
- 1/2" Threaded Heavy Duty Mounting Arm
- Photo/Motion Sensor Sold Separately
- Free from condensation

	Power	Comparable	Color Temp	Delivered Lumens	Finish
	WP-LED335 35.5W	100W HID	30 3000K	2450	aBZ Architectural Bronze aGH Architectural Graphite aWT Architectural White
			50 5000K	2730	

Example: WP-LED335-30-aGH

MOTION SENSOR (120V) available in 3 complementary colors

MS-120-BZ	Bronze	
MS-120-GY	Gray	
MS-120-WT	White	

PHOTOSENSOR (120V) available in 3 complementary colors

PC-120-BZ	Bronze	
PC-120-GY	Gray	
PC-120-WT	White	



Input: 120V
 CRI: 85
 Dimming: 100% - 10% ELV
 Rated Life: 39,000 hours

- Factory-sealed LED light engine
- Die-cast aluminum construction
- 120V direct wire - no driver needed
- Photo/motion sensor sold separately

	Power	Comparable	Color Temp	Delivered Lumens	Finish
	15W	75W Halogen	30	965	aBZ Architectural Bronze
			50	1030	aGH Architectural Graphite
					aWT Architectural White

Example: WP-LED415-30-aWT

MOTION SENSOR (120V) available in 3 complementary colors

	MS-120-BZ Bronze	
	MS-120-GY Gray	
	MS-120-WT White	

PHOTOSENSOR (120V) available in 3 complementary colors

	PC-120-BZ Bronze	
	PC-120-GY Gray	
	PC-120-WT White	



Input: 120V
 CRI: 85
 Dimming: 100% - 10% ELV
 Rated Life: 39,000 hours

- Factory-sealed LED light engine
- Die-cast aluminum construction
- 120V direct wire - no driver needed
- Photo/motion sensor sold separately

	Power	Comparable	Color Temp	Delivered Lumens	Finish
<p>WP-LED430</p>	30W	2 x 75W Halogen	30 3000K 50 5000K	965 x2 1030 x2	aBZ Architectural Bronze aGH Architectural Graphite aWT Architectural White

Example: WP-LED430-30-aBZ

MOTION SENSOR (120V) available in 3 complementary colors

	MS-120-BZ	Bronze	
	MS-120-GY	Gray	
	MS-120-WT	White	

PHOTOSENSOR (120V) available in 3 complementary colors

	PC-120-BZ	Bronze	
	PC-120-GY	Gray	
	PC-120-WT	White	

Endurance™ ADJUSTABLE LIGHTING FOR SIGNAGE

Safety cable recommended for extensions over 36"



Rotate to continuously adjust beam angles indexed at 15°, 25°, 40°, 60°

Detachable Shroud



Extendable rod

Rotate 180°



Safety cable and canopy included



Comes with extension rod kit to extend up to 48" total

SINGLE
WP-LED514

CRI: 85
Rated Life: 50,000 hours
Dimming: 100% - 10% ELV
Input: 120V

DOUBLE
WP-LED529

CRI: 85
Rated Life: 50,000 hours
Dimming: 100% - 10% ELV
Input: 120V

- Factory-Sealed LED Light Engine
- Die-cast Aluminum Construction
- 120V Direct Wire - No Driver Needed

	Power	Comparable	Max Delivered Lumens	Color Temp	Finish
<p>WP-LED514 <i>Single</i></p>	15W	150W PAR 38	1140	30 3000K 40 4000K	aBZ Architectural Bronze aBK Architectural Black aGH Architectural Graphite aWT Architectural White
<p>WP-LED529 <i>Double</i></p>	30W	150W x 2 PAR38	1140 x 2	30 3000K 40 4000K	aBZ Architectural Bronze aBK Architectural Black aGH Architectural Graphite aWT Architectural White

Example: WP-LED514-30-aWT



Tempered Prismatic Glass
Reduces glare while optimizing light distribution

Input: 120V-277V
CRI: 85
Dimming: 100% - 10% ELV or 0-10V
Rated Life: 100,000 hours

- Factory-Sealed LED Light Engine
- Die-cast Aluminum Construction
- 20° Forward Throw Illumination
- Built-in Level For Easy Adjustment
- Photo/Motion Sensor Sold Separately

	Power	Comparable	Max Delivered Lumens	Color Temp	Finish
	WP-LED119 19W	39W HID	1460	30 3000K 50 5000K	aBZ Architectural Bronze
	WP-LED127 27W	70W HID	2135		aGH Architectural Graphite
	WP-LED135 35W	100W HID	2825		aWT Architectural White

Example: WP-LED127-30-aWT

MOTION SENSOR (120V) available in 3 complementary colors

MS-120-BZ	Bronze	
MS-120-GY	Gray	
MS-120-WT	White	

PHOTOSENSOR (120V) available in 3 complementary colors

PC-120-BZ	Bronze	
PC-120-GY	Gray	
PC-120-WT	White	



Mounts in any orientation
For direct and indirect illumination



Includes box sleeve
For use with surface
mount junction boxes

Input: 120V-277V

CRI: 85

Dimming: 100% - 10% ELV or 0-10V

Rated Life: 100,000 hours

- Factory-Sealed LED Light Engine
- Die-cast Aluminum Construction
- 20° Forward Throw Illumination

- Built-in Level For Easy Adjustment
- Photo/Motion Sensor Sold Separately

	Power	Comparable	Max Delivered Lumens	Color Temp	Finish
	WP-LED219 19W	39W HID	1435	30 3000K	aBZ Architectural Bronze
	WP-LED227 27W	70W HID	2095	50 5000K	aGH Architectural Graphite aWT Architectural White

Example: WP-LED219-30-aBZ

MOTION SENSOR (120V) available in 3 complementary colors

MS-120-BZ	Bronze	
MS-120-GY	Gray	
MS-120-WT	White	

PHOTOSENSOR (120V) available in 3 complementary colors

PC-120-BZ	Bronze	
PC-120-GY	Gray	
PC-120-WT	White	

RUBIX LED EXTERIOR



TITLE 24
CALIFORNIA

Color Temp: 3000K **Dimming:** 100% - 10% ELV or 0-10V
CRI: 90 **Rated Life:** 70,000 hours

SINGLE LIGHT WALL MOUNT



Beam: 86° • Mounts up or down
Wattage: 16W • Die-cast aluminum construction
Lumens: 750
Input: 120-277V

		Model	Finish
		WS-W2504	AL Brushed Aluminum
			BK Black
			BZ Bronze
			GH Graphite
			WT White

Example: WS-W2504-BZ

DOUBLE LIGHT WALL MOUNT



Beam: 86° • Die-cast aluminum construction
Wattage: 30W
Lumens: 1400
Input: 120-277V

		Model	Finish
		WS-W2505	AL Brushed Aluminum
			BK Black
			BZ Bronze
			GH Graphite
			WT White

Example: WS-W2505-AL

SINGLE LIGHT WALL MOUNT



Beam: 75° • Mounts up or down
Wattage: 16W • Die-cast aluminum construction
Lumens: 805
Input: 120-277V

		Model	Finish
		WS-W2509	AL Brushed Aluminum
			BK Black
			BZ Bronze
			GH Graphite
			WT White

Example: WS-W2509-WT

DOUBLE LIGHT WALL MOUNT



Beam: 75° • Die-cast aluminum construction
Wattage: 30W
Lumens: 1385
Input: 120-277V

		Model	Finish
		WS-W2510	AL Brushed Aluminum
			BK Black
			BZ Bronze
			GH Graphite
			WT White

Example: WS-W2510-BK

RUBIX LED EXTERIOR



Color Temp: 3000K
CRI: 90

Dimming: 100% - 10% ELV or 0-10V
Rated Life: 70,000 hours

CEILING MOUNT



Beam: 86°
Wattage: 16W
Lumens: 750
Input: 120-277V

- Ceiling mount
- Die-cast aluminum construction

	Model	Finish
	FM-W2505	AL Brushed Aluminum
		BK Black
		BZ Bronze
		GH Graphite
		WT White

Example: FM-W2505-WT

CEILING MOUNT



Beam: 95°
Wattage: 30W
Lumens: 1875
Input: 120-277V

- Ceiling mount
- Die-cast aluminum construction

	Model	Finish
	FM-W2510	AL Brushed Aluminum
		BK Black
		BZ Bronze
		GH Graphite
		WT White

Example: FM-W2510-BZ

SCOOP LED EXTERIOR SINGLE LIGHT WALL MOUNT



Beam: 70°
Wattage: 16W
Lumens: 805
Input: 120-277V
Color Temp: 3000K
CRI: 90
Dimming: 100% - 10% ELV or 0-10V
Rated Life: 70,000 hours

- Mounts up or down
- Die-cast aluminum construction

	Model	Finish
	WS-W20506	AL Brushed Aluminum
		BK Black
		BZ Bronze
		GH Graphite
		WT White

Example: WS-W20506-BK



TUBE LED EXTERIOR



TITLE 24
CALIFORNIA

Color Temp: 3000K **Dimming:** 100% - 10% ELV or 0-10V
CRI: 90 **Rated Life:** 70,000 hours

4" SINGLE LIGHT WALL MOUNT



Beam: 33° • Mounts up or down
Wattage: 16W • Die-cast aluminum construction
Lumens: 800
Input: 120-277V

	Model	Finish
	AL	Brushed Aluminum
	BK	Black
	BZ	Bronze
	GH	Graphite
	WT	White

Example: WS-W2605-AL

4" DOUBLE LIGHT WALL MOUNT



Beam: 33° • Die-cast aluminum construction
Wattage: 30W
Lumens: 1750
Input: 120-277V

	Model	Finish
	AL	Brushed Aluminum
	BK	Black
	BZ	Bronze
	GH	Graphite
	WT	White

Example: WS-W2604-BZ

SINGLE LIGHT WALL MOUNT



Beam: 70° • Mounts up or down
Wattage: 16W • Die-cast aluminum construction
Lumens: 825
Input: 120-277V

	Model	Finish
	AL	Brushed Aluminum
	BK	Black
	BZ	Bronze
	GH	Graphite
	WT	White

Example: WS-W2609-BK

DOUBLE LIGHT WALL MOUNT



Beam: 70° • Die-cast aluminum construction
Wattage: 30W
Lumens: 1525
Input: 120-277V

	Model	Finish
	AL	Brushed Aluminum
	BK	Black
	BZ	Bronze
	GH	Graphite
	WT	White

Example: WS-W2610-WT

TUBE LED EXTERIOR



TITLE 24
CALIFORNIA

Color Temp: 3000K
CRI: 90

Dimming: 100% - 10% ELV or 0-10V
Rated Life: 70,000 hours

4" CEILING MOUNT



Beam: 35°
Wattage: 16W
Lumens: 800
Input: 120-277V

- Ceiling mount
- Die-cast aluminum construction
- Dark Sky Friendly

	Model	Finish
	AL	Brushed Aluminum
	BK	Black
	BZ	Bronze
	GH	Graphite
	WT	White

Example: FM-W2605-WT

CEILING MOUNT



Beam: 91°
Wattage: 30W
Lumens: 1740
Input: 120-277V

- Ceiling mount
- Die-cast aluminum construction

	Model	Finish
	AL	Brushed Aluminum
	BK	Black
	BZ	Bronze
	GH	Graphite
	WT	White

Example: FM-W2612-GH

PENDANT MOUNT



Beam: 33°
Wattage: 16W
Lumens: 800
Input: 120-277V

- Die-cast aluminum construction
- Hang straight swivel
- Three 12" and one 6" down rods included
- Dark Sky Friendly

	Finish
	AL Brushed Aluminum
	BK Black
	BZ Bronze
	GH Graphite
	WT White

Example: PD-W2605-BK

TUBE ARCHITECTURAL LED CEILING MOUNT DOWNLIGHT



5", 6" AND 8" CYLINDERS

Input: 120 - 277V
CRI: Up to 90
ELV Dimming: 100% - 5% (120V)
0-10V Dimming: 100% - 0%
Rated Life: 60,000 hours

- High performance exterior rated LED downlights
- Solid aluminum construction

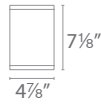

DS-CD05

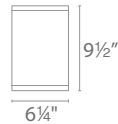

DS-CD06

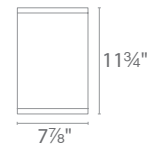

DS-CD08

	Diameter	Watt	Beam	Max Delivered Lumens	Max CBCP	Color Temp	CRI	Finish
DS-CD05	5"	27W	S 18°	2260	11483	27 2700K 30 3000K 35 3500K 40 4000K	85	BK Black WT White BZ Bronze GH Graphite
			N 25°	2330	7426			
			F 33°	2320	5719			
DS-CD06	6"	36W	S 19°	2500	11884	927 2700K 930 3000K	90	
			N 30°	2440	6191			
			F 40°	2455	4414			
DS-CD08	8"	48W	S 18°	3915	20847			
			N 21°	3915	15054			
			F 35°	3865	7890			

Example: DS-CD08-S27-BZ

TUBE ARCHITECTURAL LED PENDANT DOWNLIGHT



5", 6" AND 8" CYLINDERS

Input: 120 - 277V
CRI: Up to 90
ELV Dimming : 100% - 5% (120V)
0-10V Dimming: 100% - 0%
Rated Life: 60,000 hours

- High performance exterior rated LED downlights
- Solid aluminum construction
- Includes 45° swivel canopy and two field cuttable 24" rods



Seismic swivel tilts up to 45° to accommodate sloped ceiling

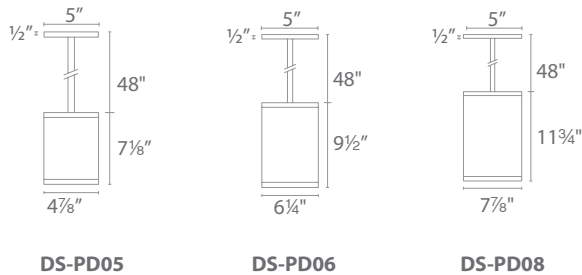

DS-PD05

DS-PD06

DS-PD08

	Diameter	Watt	Beam	Max Delivered Lumens	Max CBCP	Color Temp	CRI	Finish
DS-PD05	5"	27W	S 18°	2260	11483	27 2700K 30 3000K 35 3500K 40 4000K	85	BK Black WT White BZ Bronze GH Graphite
			N 25°	2330	7426			
			F 33°	2320	5719			
DS-PD06	6"	36W	S 19°	2500	11884	927 2700K 930 3000K	90	BK Black WT White BZ Bronze GH Graphite
			N 30°	2440	6191			
			F 40°	2455	4414			
			S 18°	3915	20847			
DS-PD08	8"	48W	N 21°	3915	15054	927 2700K 930 3000K	90	BK Black WT White BZ Bronze GH Graphite
			F 35°	3865	7890			
			F 35°	3865	7890			

Example: DS-PD05-S30-WT

MOUNTING ACCESSORY

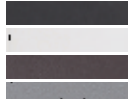
 <p>Extension Rod</p>	<p>DS-PDX24</p> <p>24" extension rod. Can be field cut Fixture may be extended up to 96" total</p>	<p>BK Black WT White BZ Bronze GH Graphite</p> 
--	---	--

Example: DS-PDX24-WT

TUBE ARCHITECTURAL LED SINGLE LIGHT WALL MOUNT



5", 6" AND 8" CYLINDERS

Input: 120 - 277V
CRI: Up to 90
ELV Dimming: 100% - 5% (120V)
0-10V Dimming: 100% - 0%
Rated Life: 60,000 hours

- High performance facade LED wall mount light
- Solid aluminum construction
- Fixture can install upside down to alter light distribution
- Specify light distribution to maximize application efficacy



DS-WS05
Single

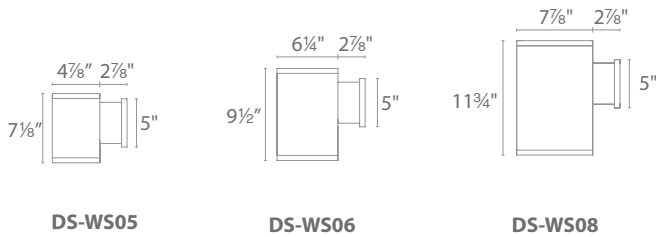

Diameter	Watt	Max Delivered Lumens	Max CBCB	Beam	Color Temp	CRI	Light Direction	Finish
Single				S 18° N 25° F 33°	27 2700K 85	5	S Straight up or down	BK Black WT White BZ Bronze GH Graphite
					30 3000K 85			
					35 3500K 85			
					40 4000K 85			
					927 2700K 90			
					930 3000K 90			
				F	DS-WS05 5" 27W 2330 11483	A Away from the wall		
					DS-WS06 6" 36W 2500 11884			
					DS-WS08 8" 48W 3915 20847			
					27 2700K 85		B Towards the wall	
					30 3000K 85			
					35 3500K 85			
40 4000K 85								
927 2700K 90								
930 3000K 90								

Example: DS-WS05-N930S-BK

TUBE ARCHITECTURAL LED DOUBLE LIGHT WALL MOUNT



5", 6" AND 8" CYLINDERS

Input: 120 - 277V
CRI: Up to 90
ELV Dimming: 100% - 5% (120V)
0-10V Dimming: 100% - 0%
Rated Life: 60,000 hours

- High performance facade LED wall mount light
- Solid aluminum construction
- Fixture can install upside down to alter light distribution
- Specify light distribution to maximize application efficacy



DS-WD06
Double

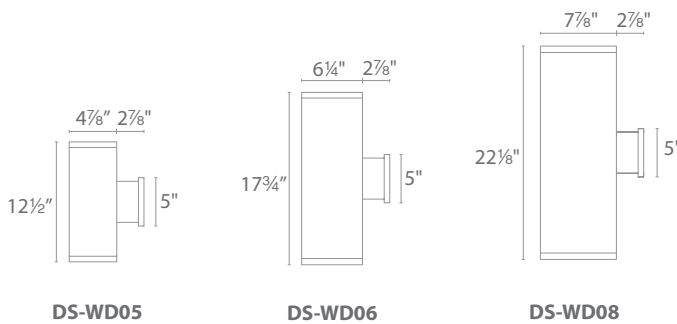

Diameter	Watt	Max Delivered Lumens	Max CBCB	Beam	Color Temp	CRI	Light Direction	Finish													
Double	5" 27W x2	2330 x2	11483 x2	S 18° N 25° F 33°	27	2700K	85	S Straight up or down	 BK Black WT White BZ Bronze GH Graphite												
					30	3000K	85														
					35	3500K	85														
					40	4000K	85														
					927	2700K	90														
					930	3000K	90														
				F	2700K 85	3000K 85	3500K 85	4000K 85	2700K 90	3000K 90	A Away from the wall	 BK Black WT White BZ Bronze GH Graphite									
													B Towards the wall								
															C One side each						
													DS-WD05	6"	36W x2	2500 x2	11884 x2				
													DS-WD06	8"	48W x2	3915 x2	20847 x2				

Example: DS-WD05-N930S-BZ

TUBE ARCHITECTURAL LED COLOR CHANGING MAKE IT COLORFUL!

ilumenight LED



With **ilumenight™** you can take your space from warm white to pure white to cool white, red to violet and every color in between all with the touch of a finger.

STEP 1 Download FREE "ilumenight™" app

STEP 2 Setup Login

STEP 3 Command all of your ilumenight fixtures at will



TUBE ARCHITECTURAL LED COLOR CHANGING



5" CYLINDERS

Input: 120 - 277V
 CRI: 90+
 Rated Life: 50,000 hours

- Color changing
- App-controlled brightness
- High performance facade LED wall mount light
- Solid aluminum construction
- Fixture can install upside down to alter light distribution



Color changable with ilumenight IOS app



DS-WS05

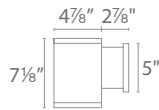

DS-WD05

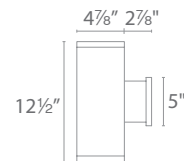

Diameter	Power	Max Delivered Lumens	Max CFCB	Beam	Light Direction	Color Temp	Finish			
Single	DS-WS05	5"	31W	960	6368	CC Color Changing	BK Black WT White BZ Bronze GH Graphite			
								S 15° N 25° F 33°	S Straight up or down	
								F	A Away from the wall	
									B Towards the wall	
Double	DS-WD05	5"	31W x 2	960 x 2	6368 x 2	CC Color Changing	BK Black WT White BZ Bronze GH Graphite			
								S 15° N 25° F 33°	S Straight up or down	
								F	A Away from the wall	
									B Towards the wall	
								C One side each		

Example: DS-WD05-FA-CC-BK

5" CYLINDERS

Input: 120 - 277V
 CRI: 90+
 Rated Life: 50,000 hours



Color changable with ilumenight IOS app

- Color changing
- App-controlled brightness
- High performance exterior rated LED downlights
- Solid aluminum construction
- DS-PD05 includes 45° swivel canopy and two field cuttable 24" rods



DS-CD05

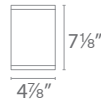

DS-PD05

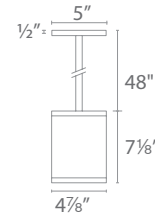

	Diameter	Watt	Beam	Max Delivered Lumens	Max CBCP	Color Temp	Finish
Ceiling	5"	31W	S 15° N 25° F 33°	835 785 775	6368 2170 1504	CC Color Changing	BK Black WT White BZ Bronze GH Graphite

Example: DS-PD05-S-CC-GH

MOUNTING ACCESSORY

<p>Extension Rod for pendant mount</p>	<p>DS-PDX24</p> <p>24" extension rod. Can be field cut Fixture may be extended up to 96" total</p>	BK Black WT White BZ Bronze GH Graphite
--	---	--

Example: DS-PDX24-WT

TUBE ARCHITECTURAL LED ULTRA NARROW BEAM WALL MOUNT



5" AND 6" CYLINDERS



DS-WS05
Single



DS-WD06
Double

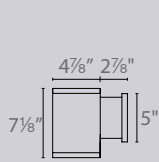

DS-WS05

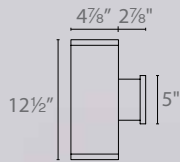

DS-WD05

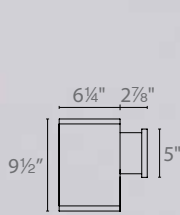

DS-WS06

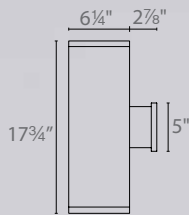

DS-WD06



Input: 120 - 277V
CRI: 85
ELV Dimming: 100% - 5% (120V)
0-10V Dimming: 100% - 0%
Rated Life: 80,000 hours

- High performance facade LED wall mount light
- Solid aluminum construction
- Fixture can install upside down to alter light distribution
- 15 feet of 6° illumination at 0.2 footcandles

	Diameter	Watt	Max Delivered Lumens	Max CBCP	Beam	Color Temp	CRI	Light Direction	Finish
Single	DS-WS05 5"	11W	155	1460	U 6°	27 2700K	85	B Towards the wall	
		11W	135	1530		30 3000K	85		
						35 3500K	85		
						40 4000K	85		
Double	DS-WD05 5"	22W	155 x2	1460 x2	U 6°	27 2700K	85	B Towards the wall	
		22W	135 x2	1530 x2		30 3000K	85		
						35 3500K	85		
						40 4000K	85		
	DS-WD06 6"	22W	135 x2	1530 x2					

- BK** Black
- WT** White
- BZ** Bronze
- GH** Graphite

Example: DS-WD05-U30B-BK

ALPHABETICAL INDEX

A			
Aether 3.5"	12-16		
Accent.....	205-206, 265, 266		
Accent Color Changing	215		
Area	245, 246		
Argos.....	106		
Asymmetrical Recessed Channel.....			
.....	2, 194		
B			
Balance.....	237-240		
Beauty Spots	34		
Bongo	124		
Blo	57		
Bullet.....	149		
Button Lights	173-176		
C			
Candy.....	152, 161, 162		
Canopy	249, 250		
Caribe.....	113		
Cartier	110		
Chamber.....	255, 256		
Clarity.....	149		
D			
Dax.....	124		
Disc	55		
Deck & Patio	227, 228		
Display.....	60-74		
Argos	66		
Exterminator II.....	63,64		
Hemmingway.....	74		
Impulse	65		
Low Voltage	67, 68		
Paloma	61,62		
Reflex Pro	66		
Silo x10.....	60		
Silo x20.....	60		
Vibe	73		
Vector	69,70		
Wall Wash.....	65		
Duo 2.0 3".....	17,18		
Duo AC-LED Bar light	165, 166		
Dune.....	114		
E			
Eclipse.....	243, 244		
Eden	152, 162		
Endurance.....	271-280		
Adjustable Signage.....	277, 278		
Brick.....	271, 272		
Double spot	276		
Fin.....	279		
Flood	273, 274		
Hawk	280		
Single Spot.....	275		
Exterior.....	273-292		
Adjustable Signage.....	277, 278		
Brick.....	271, 272		
Double spot	276		
Fin.....	279		
Flood	273, 274		
Hawk	280		
Rubix.....	281, 282		
Single Spot.....	275		
Tube.....	283, 284		
Tube Architectural.....	285-292		
Exterminator	63,64, 91, 109		
Exterminator II... 63, 64, 87-90, 103, 104			
F			
Faberge	158, 162		
Felis.....	124		
Fiori.....	159, 162		
Flo	58		
Framing Projector.....	101		
Freeport	156		
G			
Gate	261, 262		
Genesis.....	146, 148, 161, 162		
Gia.....	153, 162		
Giselle	154, 161, 162		
Glo.....	56		
H			
Hardscape	217, 218		
Haven.....	153, 162		
I			
I can't believe it's not recessed	54		
Ice.....	152		
Ilumenight	15, 215-216, 289		
Impulse	111		
Indicator	224-226		
Inground 1".....	224		
Inground 2".....	224-226		
Inground 3".....	211-214, 265		
Inground 3" Color Changing	215		
Indirect Recessed Channel.....	2, 193		
Ingo	150		
InvisiLED			
Indoor Aluminum Channels... 189			
Indoor Controllers	190		
InvisiLED Classic.....	187		
InvisiLED Lite	185-186		
InvisiLED Palette.....	188		
InvisiLED Pro.....	183-184		
InvisiLED Pro2	181-182		
InvisiLED Pro3	179-180		
Outdoor 12v	199-200		
Palette Outdoor.....	197, 198		
Pro White Outdoor	196		
Recessed Channels	191-194		
J			
Jill	160, 162		
K			
Kalysta	154		
L			
Lamps	72		
Landscape.....	201		
Accent.....	205-206, 265, 266		
Accent Color Changing	215		
Area	245, 246		
Balance.....	239, 240		
Canopy	249, 250		
Chamber	255, 256		
Deck & Patio	227, 228		
Eclipse.....	243, 244		
Gate	261, 262		
Hardscape	217, 218		
Ilumenight	215-216		
Indicator	224-226		
Inground 1".....	224		
Inground 2".....	224-226		
Inground 3".....	211-214, 265		
Inground 3" Color Changing ..	215		
InvisiLED Outdoor	219, 220		
Outdoor Transformer	264		
Ledge	231, 232		
Linear	237, 238		
Mini Accent.....	207, 208		
Mini Landscape Spot.....	251, 252		
Park.....	259, 260		
Quad.....	241, 242		
Scoop	253, 254		
Slide	233,234		

ALPHABETICAL INDEX

Step Lights.....229, 230
Submersible 2"221, 222
Tiki247, 248
Tower257, 258
Wall Wash209, 210, 265
Wall Wash Color Changing.....215

LED Functional Ceiling and Wall ..54-58

Blo57
Disc55
Flo.....58
Glo.....56
I Can't Believe It's Not Recessed54

Lenses and Accessories123

Line169, 170
Line 2.0171, 172
Ledge231, 232
LEDme
 Multiple spot49,50
 Recessed downlight29-32
Linear (Landscape).....235, 236
Logos 105

M

Madison155
Mason155
Mini Accent.....207, 208
Mini Haven.....153, 162
Mini Landscape Spot.....251, 252
Multiple spot.....
 Precision Multiples43,44
 LEDme49,50
 Line voltage51
 Low Voltage52
 Mini48
 Tesla45,46

O

Oculux 2"26
Oculux 3"25

P

Paloma.....61, 62, 84-86
Park.....259, 260
Passion159
Polaris151, 162
Precision110
Prisma151, 162

Q

Quad.....241, 242
Quick Adjust Canopy.....145
Quick Connect.....135,136, 145-160
 Bullet149
 Candy152
 Clarity.....149
 Eden.....152
 Faberge158

Fiori159
Freeport156
Genesis146, 148
Gia153
Giselle154
Haven.....153
Ice152
Ingo150
Jill160
Kalysta154
Madison155
Mason155
Mini Haven153
Passion.....159
Polaris151
Prisma151
Roxy151
Sarah160
Sorriso.....154
Tikal150
Truffle158
Tulum150
Uber.....149
Willow157
Wyandotte156
Zanzibar157

R

Radiant116

Rail

Flexrail 1125-132
 Line Voltage131
 Silo x10.....127
 Silo x20.....128
 Summit130
 Wall Wash129
Solorail.....133-140

Recessed Channels2-6, 191-194

Asymmetrical2, 194
Indirect2, 193
Symmetrical6, 191, 192

Recessed Downlights

Aether 3.5"12-16
Duo 2.0 3"17,18
LEDme 1"31,32
LEDme 4"29,30
Line Voltage 4"37,38
Line Voltage 5"37,38
Line Voltage 6"37,38
Low voltage 2.5"35,36
Low voltage 4"35,36
Oculux 2"26
Oculux 3"25
Summit 2.0.....28
Tesla Pro 2"23,24
Tesla Pro 3.5".....21,22
Volta 4.5"7-10

Reflex Pro.....112
Roxy.....151
Rubix281, 282

S

Sarah160
Scoop253, 254
Slide233,234
Silo x10.....60, 102, 127
Silo x20.....60, 100, 128
Sorriso.....154
Step and Wall Lights.....
 229, 230, 267-272
Submersible 2"221, 222
Summit (Track)107, 108, 130
Summit 2.0.....28
Symmetrical Recessed Channel
 6, 191, 192

T

Task.....165-178

 Button Lights.....173-176
 Duo AC-LED Bar light165, 166
 Line169, 170
 Line 2.0171, 172
 Straight Edge.....167, 168

Tesla.....12-24, 45, 46

Tikal150, 162

Tiki.....247, 248

Tower257, 258

Truffle.....158

Tulum150, 162

Track System

J294
H, J, L95-98
 Argos106
 Bongo.....124
 Caribe113
 Cartier.....110
 Dax124
 Dune114
 Exterminator.....109
 Exterminator II103, 104
 Felis124
 Framing Projector101
 Impulse.....111
 Logos.....105
 Lenses and Accessories.....123
 Line Voltage118-122
 Low Voltage113-117
 Pendants124
 Precision110
 Radiant.....116
 Reflex Pro112
 Silo x10.....102
 Silo x20.....100
 Summit107,108

ALPHABETICAL INDEX

Wall Wash.....	106
WTrack.....	77-82
Exterminator.....	91
Exterminator II.....	87-90
Paloma.....	84-86
Wall Washer.....	92
Tube.....	283, 284
Tube Architectural.....	285-292

U

Uber.....	149
-----------	-----

V

Volta 4.5".....	7-10
-----------------	------

W

Wall Sconce Systems.....	161-162
Wall Wash (Landscape).....	209, 210, 265
Wall Wash Color Changing (Landscape)	215
Wall Wash.....	65, 106, 129
Wall Washer.....	92
Willow.....	157, 162
Wyandotte.....	156
WTrack.....	77-82
Exterminator.....	91
Exterminator II.....	87-90
Paloma.....	84-86
Wall Washer.....	92

Z

Zanzibar.....	157, 162
---------------	----------

NUMERICAL INDEX

SYMBOLS

008FP	65, 68, 111, 71
801BD	65, 111
1000-CON-PVC	224
1011	224
1021	224
1051	224
2000-CON-PVC	224
2011	224
2012	224
2021	224
2022	224
2031	222
2041	230
2051	224
2052	224
2061	230
2071	226
2081	226
3011	228
3021	228
3031	228
4011	230
4021	230
5000-LCO	206, 208, 210
5000-SCP	206, 208, 210, 232, 234, 236, 238, 240, 242, 252
5000-TCP	206, 208, 210
5000-X	206, 208, 210
5010-LSHR	206, 256
5011-CC	215
5012	265
5021-CC	215
5022	265
5030-GRD	214
5030-PIP-PVC	214
5031-CC	215
5032	265
5111-LSHR	208, 252, 256
6011	246
6021	236
6031	244
6041	248
6051	250
6061	238
6071	240
6081	232
6091	242
6111	252
6211	252
6311	234
6321	234
6611	258
6612	258
6613	258
6621	262

6622	262
6623	262
6631	260
6632	260
6633	260
6641	264
6642	264
6643	264
6651	254
7031	218
7061	218
7121	218
7181	218
8000	200, 220
8001	200, 220
8002	200, 220
8003	200, 220
8011	200, 220
8051	200, 220
8101	200, 220
9000-MTI-WT	256, 200
9000-PCH-GY	256, 200
9000-PCR-GY	256, 200
9000-RPT	206, 210
9000-SP9	206, 208, 210, 232, 234, 236, 238, 240, 242, 246, 248, 250, 252
9000-ST9	206, 208, 210, 232, 234, 236, 238, 240, 242, 246, 248, 250
9020-WNT	256
9075-TRN-SS	200, 256
9100	256
9150-TRN-SS	200, 256
9250	256
9300-TRN-SS	200, 256
9500	256
9600-TRN-SS	200, 256
A	
A19LED-12	72
B	
BA-ACLED	166
BA-I	166
BA-IC	166
BA-IC12	166
BA-IC12-WT	166
BA-IC24	166
BA-IC24-WT	166
BA-IC36	166
BA-IC36-WT	166
BA-I-WT	166
BA-PC6	166
BA-PC6-WT	166
BR20LED-7N	27, 71, 72, 121, 122

BR30LED-11N	27, 71, 72, 121, 122
BR40LED-15N	27, 72

C

CP	78
CT-6A-R2	170, 172, 190, 177, 168

D

DL-007	71
DL-188	71
DL-214	71
DLC-4	71
DLC-P	71
DR-356	58
DR-362	58
DR-363	58
DS-CD	285, 286, 291
DS-CD05	285, 291
DS-CD06	285
DS-CD08	285
DS-PD	286, 291
DS-PD05	286, 291
DS-PD06	286
DS-PD08	286
DS-PDX24	286, 291
DS-WD05	288, 290, 292
DS-WD06	288, 292
DS-WD08	288
DS-WS05	287, 290, 292
DS-WS06	287, 292
DS-WS08	287

E

EN-1260-P-AR	174, 176, 178
EN-1260-R2	178
EN-1260-R-AR	178
EN-1260-RB2	58, 67, 176
EN-1260-RB-AR	178
EN-1275-R-AR	178
EN-1275-RB-AR	58
EN-2460D-C	188
EN-2460D-C-P	188
EN-2460-P-AR	175
EN-2460-P-AR	174, 176, 178
EN-2460-P-AR-S	167, 170, 172
EN-2460-P-AR-T	180, 182, 184, 186, 187
EN-2460-R2	178
EN-2460-RB2	175
EN-2460-RB2	58, 67, 174, 176
EN-2460-RB2-S	167, 170, 172
EN-2460-RB2-T	180, 182, 184, 186, 187, 188, 196, 197
EN-2465-277-R2-AR	178
EN-12100-R-AR	178
EN-12100-RB-AR	58, 67, 136
EN-12120-RB2	176

NUMERICAL INDEX

EN-12120-RB2	176	HHT-180	116	HR-2LED-R09D-A	24
EN-12150-R-AR	178	HHT-204	115	HR-2LED-R14D	24
EN-12150-RB-AR	58, 67, 178	HHT-801	113	HR2LEDT109P	23
EN-12180-RB2	176, 178	HHT-802	114	HR2LEDT209P	23
EN-12180-RB2	176	HHT-808	116	HR2LEDT309P	23
EN-12300-RB2	176, 178	HHT-809	116	HR2LEDT409P	23
EN-24100-277-R	180, 182, 184, 186, 187	HHT-816	115	HR2LEDT509P	23
EN-24100-277-RB2-T	167, 170, 172, 174, 175, 178, 180, 182, 184, 186, 187	HHT-826	114	HR2LEDT709P	23
EN-24100-P-AR-S	167, 170, 172	HHT-856	113	HR3D-RO	18
EN-24100-P-AR-T	180, 182, 184, 186, 187	HHT-874	113	HR3LD-ET118P	21
EN-24100-R2	178	HHT-8141	117	HR-3LED-H15D-ICA	22
EN-24100-RB2	58, 67, 174, 175, 176	HHT-8144	117	HR-3LED-H17A	13
EN-24100-RB2-S	167, 170, 172	HHT-8145	117	HR3LED-H18D1-EMICA	22
EN-24100-RB2-T	180, 182, 184, 186, 187	HHT-8146	117	HR-3LED-H18D1-ICA	22
EN-B12PY-AR	178	HI	96	HR-3LED-H22D-A	22
EN-HQ50AR	91, 95, 139, 141, 142, 143, 144	HI-DEC	96	HR-3LED-R18D-A	22
EN-JQ50AR	94, 95, 139, 141, 143	HI-PWR	96	HR-3LED-R22D	22
EN-LQ50AR	95, 139, 141, 143	HLE	96	HR3LEDT118P	21
EN-O24100-RB2-T	196, 197	H-LED009	101	HR3LEDT218P	21
EN-OD24100-RB2-T	196	H-LED17	112	HR3LEDT318P	21
EN-WQ50AR	91, 139, 141, 143	H-LED20	109	HR3LEDT418P	21
ETB	178	H-LED23	105	HR3LEDT518P	21
F		H-LED25	106	HR3LEDT618P	21
FM-113	55	H-LED27	112	HR3LEDT718P	21
FM-115	55	H-LED40	105	HR3LEDT818P	21
FM-211	54	H-LED160	110	HR3LEDT918P	21
FM-214	54	H-LED201	107	HR3S-ICR30F	32
FM-216	54	H-LED202	108	HR3S-ICS30F	32
FM-304	35, 53	H-LED207	107	HR3S-R30F	32
FM-306	35, 53	H-LED208	108	HR3S-S30F	32
FM-616	52	H-LED710	110	HR-86	176
FM-W2505	282	H-LED810	111	HR-88	176
FM-W2510	282	H-LED820	111	HR-800	34
FM-W2605	284	HL-LEFT	96	HR-801	34
FM-W2612	284	H-LOOP	96	HR-802	34
G		HL-RIGHT	96	HR-834	33
GU10-EXN	72	HM1-720	131	HR-836	33
GU10LED-BAB	72	HM1-730	131	HR-837	33
H		HM1-2010	127	HR-1137	176
H-1014	103	HM1-2020	128	HR-8401E	34
H-1023	103	HM1-3020W	129	HR-8401H	34
H-1035	104	HM1-EN50	139, 141, 143	HR-8402E	34
H-1052	104	HM1-I	126	HR-8402H	34
H-2010	102	HM1-IDEC	126	HR-8402HL	34
H-2020	100	HM1-LED202	130	HR-8403H	34
H-3020W	106	HM1-PCC	126	HR-8411	33
HBXLE	96	HM1-PCT	126	HR-8417	33
HCORD	96	HM1-T4	126	HR-D411	33
HFC	96	HM1-T8	126	HR-D412	33
HFLX	96	HM1-TB	126	HR-D413	33
HHT-007	114	HM1-VA	126	HR-D416	33
HHT-160	115	HM1-X	126	HR-D417	33
		HM1-XS	126	HR-D418	33
		HMP	96	HR-D425	33
		HM-XADJ	126	HR-LED87	175
		HR2LD-ET109P	23	HR-LED87S	175
		HR-2LED-H09D-ICA	24	HR-LED90	174

NUMERICAL INDEX

HR-LED211E.....	27	J2-IDEC	94	J-LED710	110
HR-LED212E	27	J2-IPWR	94	J-LED810	111
HR-LED231R	28	J2-LE	94	J-LED820	111
HR-LED232R	28	J2-LLEFT	94	JL-LEFT	96
HR-LED251E	27	J2-LRIGHT	94	J-LOOP	96
HR-LED252E	27	J2-T	94	JL-RIGHT	96
HR-LED271R	28	J2-T4	94	JMP	96
HR-LED272R	28	J2-T8	94	JT	96
HR-LED411	29	J2-T12	94	JT2	95
HR-LED411TL	30	J2-TBLE	94	JT4	95
HR-LED418-N	29	J2-UCP	94	JT8	95
HR-LED418-N-RO	30	J2-WCOV	94	JTK-101	118
HR-LED418-N-SQ	30	J2-X	94	JTK-103	118
HR-LED418-R	29	J-1014	103	JTK-104	118
HR-LED418-R-RO	30	J-1023	103	JTK-178	120
HR-LED418-R-SQ	30	J-1035	104	JTK-188	120
HR-LED421	29	J-1052	104	JTK-703	119
HR-LED431	29	J-2010	102	JTK-704	119
HR-LED451	29	J-2020	100	JTK-713	122
HR-LED451TL	30	J-3020W	106	JTK-720	121
HR-LED471	29	JBXLE	96	JTK-725	121
HR-LED-COV	175	JCLED-2	72	JTK-730	121
HT	96	JCLIP	94	JTK-738	121
HT2	95	JFC	96	JTK-763	119
HT4	95	JFLX	96	JTK-764	119
HT6	95	JHT-007	114	JTK-773	121
HT8	95	JHT-160	115	JTK-774	121
HTK-101	118	JHT-180	116	JTK-775	121
HTK-103	118	JHT-204	115	JTK-793	122
HTK-104	118	JHT-801	113	JTK-794	122
HTK-178	120	JHT-802	114	JTK-797	122
HTK-188	120	JHT-808	116	JTK-798	122
HTK-703	119	JHT-809	116	JTK-F4-404	124
HTK-704	119	JHT-816	115	JTK-F4-451	124
HTK-713	122	JHT-826	114	JTK-F4-454	124
HTK-720	121	JHT-856	113	JX	96
HTK-725	121	JHT-874	113		
HTK-730	121	JHT-8141	117	L	
HTK-738	121	JHT-8144	117	L-1014	103
HTK-763	119	JHT-8145	117	L-1023	103
HTK-764	119	JHT-8146	117	L-1035	104
HTK-773	121	JL	96	L-1052	104
HTK-774	121	JL-DEC	96	L-2010	102
HTK-775	121	JL-PWR	96	L-2020	100
HTK-793	122	JLE	96	L-3020W	106
HTK-794	122	J-LED009	101	LBXLE	96
HTK-797	122	J-LED17	112	LCORDSET	96
HTK-798	122	J-LED20	109	LD-700MA	28
HTK-F4-404.....	124	J-LED23	105	LED-T24	184, 186, 187
HTK-F4-451	124	J-LED25	106	LED-T-B	190
HTK-F4-454	124	J-LED27	112	LED-TC	188
HX	96	J-LED40	105	LED-TC24-SW	190
		J-LED160	110	LED-TC-B-2	190
J		J-LED201	107	LED-TC-CTR-MSD	186, 188
J2-BXLE	94	J-LED202	108	LED-TC-EC	190
J2-FLX	94	J-LED207	107	LED-TC-EXT-144	190
J2-I	94	J-LED208	108	LED-T-CH	182, 189

NUMERICAL INDEX

LED-T-CH1	182, 189	LED-T-WTW1	6, 192	L-LED25	106
LED-T-CH1-EC	182, 189	LED-TX24	180, 182, 186	L-LED27	112
LED-T-CH2	182, 189	LENS-1X3-DIC	66	L-LED40	105
LED-T-CH2-EC	182, 189	LENS-1X3-FR	66	L-LED160	110
LED-T-CH-EC	182, 189	LENS-2X4	210	L-LED201	107
LED-TC-IC	190	LENS-11	60, 63, 127	L-LED202	108
LED-TC-L	190	LENS-11-BEL	63	L-LED207	107
LED-T-CL	189, 190	LENS-11-FR	63	L-LED208	108
LED-T-CL1	189	LENS-11P-CRL	63, 87, 89, 89	L-LED710	110
LED-T-CL2	182, 189	LENS-11-SNOOT	63, 127	L-LED810	111
LED-T-CL3	182, 189	LENS-11-SPR	63	L-LED820	111
LED-TC-MM	190	LENS-13-FR	175	LL-LEFT	96
LED-TCO	197	LENS-16	43, 50, 60, 61, 65, 84, 128	L-LOOP	96
LED-TC-P-2	190	LENS-16-BEL	61, 84	LL-RIGHT	96
LED-T-CTC1	6, 192	LENS-16-CLIP	115	LM2-PCS	135
LED-TC-WEXT	190	LENS-16-CRL	84	LM2-SCP	135
LED-TC-WIC-144	190	LENS-16-FR	61	LM-CPC	136
LED-TC-WIC-240	190	LENS-16-HCL	84, 128	LM-CS	137
LED-TC-X	190	LENS-16P-CRL	61, 60, 86, 100, 88	LM-CW	137
LED-TC-Y	190	LENS-16-SNOOT	61, 60, 84, 86, 87, 100, 88	LM-DCPC	136
LED-TE24	180	LENS-16-SPR	61, 84	LM-EN12-75E	135
LED-TO24	196	LENS-20	62, 64, 84	LM-EN12-150E	135
LED-TO24-C1	196, 220, 198, 200, 200	LENS-20-BEL	64, 84	LM-EN12-250E	135
LED-TO24-C2	196, 198, 200, 220	LENS-20-CRL	84	LM-EN12-300M	135
LED-TO24-C3	196, 198, 200, 220	LENS-20-FR	64	LM-I	137
LED-TO24-CH5	196, 198, 220, 198, 200, 189	LENS-20-HCL	84	LM-IDEC	137
LED-TO24-CM	197	LENS-20P-CRL	64	LM-JS	137
LED-TO24-CS	197	LENS-20-SNOOT	64, 84	LM-K8111	134
LED-TO24-EC	196, 198, 220, 198, 200, 196	LENS-20-SPR	64, 84	LM-K8711	134
LED-TO24-IC	196, 197	LENS-25	214	LM-K8811	134
LED-TO24-IC6	196, 200	LENS-73	9	LM-K9415	134
LED-TO24-IC6-RGB	197	LFC	96	LM-L	137
LED-TO24-IC12	196, 200	LFLX	96	LM-OW	137
LED-TO24-IC12-RGB	197	LHT-007	114	LM-OWP	136
LED-TO24-IC72	196	LHT-160	115	LMP	96
LED-TO24-IC72-RGB	197	LHT-180	116	LM-PCS	136
LED-TO24-IC120	196, 200	LHT-204	115	LM-QADP	139, 141, 143
LED-TO24-IC120-RGB	197	LHT-801	113	LM-R	137
LED-TO24-MW	197	LHT-802	114	LM-RI	137
LED-TO24-MW60	197	LHT-808	116	LM-SCP	135
LED-TO24-MW120	197	LHT-809	116	LM-SK-150E	134
LED-TO24-SW	197	LHT-816	115	LM-SK-250E	134
LED-TO24-SW60	197	LHT-826	114	LM-T	137
LED-TO24-SW120	197	LHT-856	113	LM-T4	135
LED-TO24-WS	188, 197	LHT-874	113	LM-T8	135
LED-TO24-X	196	LHT-8141	117	LM-TB	137
LED-TO24-X-RGB	197	LHT-8144	117	LM-TB3	137
LED-TO24-Y	196	LHT-8145	117	LM-TB4	137
LED-TO24-Y-RGB	196, 197	LHT-8146	117	LM-TB5	137
LED-T-RBOX1	6, 192	LI	96	LM-VA	137
LED-T-RBOX2	4, 194	LI-DEC	96	LM-WPC	136
LED-T-RBOX3	4, 193	LI-PWR	96	LM-X	137
LED-T-RC	190, 200	LLE	96	LM-XS	137
LED-T-RCH1	6, 192	L-LED009	101	LM-XS5	137
LED-T-RCH2	4, 194	L-LED17	112	LN-LED	170, 172
LED-T-RCH3	4, 193	L-LED20	109	LN-LEDP	172
LED-T-WTC1	6, 192	L-LED23	105	LS-LED	167

NUMERICAL INDEX

LT	96
LT2	95
LT4	95
LT6	95
LT8	95
LTK-101	118
LTK-103	118
LTK-104	118
LTK-178	120
LTK-188	120
LTK-703	119
LTK-704	119
LTK-713	122
LTK-720	121
LTK-725	121
LTK-730	121
LTK-738	121
LTK-763	119
LTK-764	119
LTK-773	121
LTK-774	121
LTK-775	121
LTK-793	122
LTK-794	122
LTK-797	122
LTK-798	122
LTK-F4-404	124
LTK-F4-451	124
LTK-F4-454	124
LX	96

M

MBS-16	67, 71, 115
ME-007	68
ME-204	67
ME-808	68
ME-826	67
METB	178
MO-495	70
MO-1014	63
MO-1023	63
MO-1035	64
MO-2010	60
MO-2020	60
MO-3020W	65
MO-4023	61
MO-LED17	66
MO-LED25	66
MO-LED512	62
MO-LED522	62
MO-LED810	65
MO-LED820	65
MP-60E	145
MP-335	151
MP-512	160
MP-515	159
MP-518	152

MP-524	160
MP-539	153
MP-541	158
MP-542	153
MP-543	154
MP-544	152
MP-614	159
MP-914	150
MP-915	150
MP-916	149
MP-930	151
MP-933	158
MP-938	154
MP-939	153
MP-940	151
MP-954	157
MP-960	152
MP-966	149
MP-LED311	146
MP-LED315	149
MP-LED335	151
MP-LED336	154
MP-LED481	156
MP-LED483	156
MP-LED497	155
MP-LED499	155
MP-LED512	160
MP-LED518	152
MP-LED524	160
MP-LED539	153
MP-LED541	158
MP-LED542	153
MP-LED543	154
MP-LED544	152
MP-LED916	149
MP-LED933	158
MP-LED938	154
MP-LED939	153
MP-LED954	157
MP-LED960	152
MP-LED966	149
MR16-EXN	72
MR16LED-BAB	72
MS-120	274, 275, 276, 279, 280
MT-3LD111NA	46
MT-3LD111R	46
MT-3LD211NA	46
MT-3LD211R	46
MT-3LD311NA	46
MT-3LD311R	46
MT4LD111NE	41
MT-4LD116N	41
MT4LD116NE	41
MT-4LD116T	41
MT4LD211NE	41
MT-4LD216N	41
MT4LD216NE	41

MT-4LD216T	41
MT4LD221NE	42
MT-4LD226N	42
MT4LD226NE	42
MT-4LD226T	42
MT4LD311NE	42
MT-4LD316N	42
MT4LD316NE	42
MT-4LD316T	42
MT4LD411NE	42
MT-4LD416N	42
MT4LD416NE	42
MT-4LD416T	42
MT-5LD125H-NA	43
MT-5LD125T	43
MT-5LD225H-NA	43
MT-5LD225T	43
MT-5LD325H-NA	44
MT-5LD325T	44
MT-116	50
MT-116HS	50
MT-130	49
MT-130HS	49
MT-216	50
MT-216HS	50
MT-230	49
MT-230HS	49
MT-316	50
MT-316HS	50
MT-330	49
MT-330HS	49
MTB-01	28, 174, 175, 176, 178
MTB-08	168, 170, 172
MT-LED118	47
MT-LED118-HS	47
MT-LED218	47
MT-LED218-HS	47
MT-LED318	47
MT-LED318-HS	47
MT-LED418	48
MT-LED418-HS	48

O

OPH-10X3	66
OPH-10X3-20D	66
OPH-10X3-42D	66

P

PAR20BD	120
PAR20LED	36
PAR20LED-10N30	71, 72
PAR30BD	120
PAR30LED	36, 49
PAR30LED-L14N30	71, 72
PAR38BD	120
PAR38LED-17N30	71, 72
PC-120	274, 275, 276, 279, 280

NUMERICAL INDEX

PD-W2605284
 PLD-F4-404124
 PLD-F4-451124
 PLD-F4-454124
 PL-LED14 74
 PL-LED15 73
 PL-LED2474
 PL-LED2573
 PL-LED37 73

Q

QF-185 142
 QF-811 143
 QF-814 143
 QF-815143
 QF-816 143
 QF-941 144
 QF-944 144
 QF-945144
 QF-946 144
 QF-8111134
 QF-8711 134
 QF-8811 134
 QF-9415 134
 QF-LED101 141
 QF-LED102 141
 QF-LED103141
 QF-LED171 142
 QF-LED173 142, 144
 QMP-1RN-TR 145
 QMP-1SQ-TR 145
 QMP-60ERN 147
 QMP-G1RN 147
 QMP-G3RE 147
 QMP-G3RN 147
 QMP-G6RN 147
 QMP-G12RN 147
 QMP-LED311/3-MR148
 QMP-LED311/6-MR148
 QMP-LED311/12-MR148
 QMP-LED311-MR148
 QMP-MI-TR 145
 QMP-S60ERN147
 QP-335151
 QP-512160
 QP-515 159
 QP-518 152
 QP-524 160
 QP-539 153
 QP-541 158
 QP-542 153
 QP-543 154
 QP-544 152
 QP-614 159
 QP-630157
 QP-913 150
 QP-914 150

QP-915150
 QP-916149
 QP-930 151
 QP-933 158
 QP-938 154
 QP-939153
 QP-940 151
 QP-954 157
 QP-960 152
 QP-966 149
 QP-LED311146
 QP-LED315149
 QP-LED335151
 QP-LED336154
 QP-LED481 156
 QP-LED483 156
 QP-LED497 155
 QP-LED499 155
 QP-LED512 160
 QP-LED518 152
 QP-LED524 160
 QP-LED539153
 QP-LED541 158
 QP-LED542 153
 QP-LED543 154
 QP-LED544 152
 QP-LED916 149
 QP-LED933158
 QP-LED938154
 QP-LED939153
 QP-LED954 157
 QP-LED960 152
 QP-LED966 149
 Q-X 143
 Q-X 141, 142, 143, 144

R

R 95
 R2BRA 26
 R2BRD 26
 R2BSA 26
 R3ARAT 14
 R3ARAT-CC 16
 R3ARDL 14
 R3ARDL-CC 16
 R3ARDT 14
 R3ARDT-CC 16
 R3ARWT 14
 R3ARWT-CC 16
 R3ASAT 14
 R3ASAT-CC 16
 R3ASDL 14
 R3ASDL-CC 16
 R3ASDT 14
 R3ASDT-CC 16
 R3ASWT 14
 R3ASWT-CC 16

R3BBRT-10 25
 R3BNICA-10 25
 R3BRA 25
 R3BRD 25
 R3BSA 25
 R3BSD 25
 R4BR 10
 R4RAL 10
 R4RAT 10
 R4RC 10
 R4RD1L 10
 R4RD1T 10
 R4RD2L 10
 R4RD2T 10
 R4RN 10
 R4RWL 10
 R4RWT 10
 R4SAL 10
 R4SAT 10
 R4SC 10
 R4SD1L 10
 R4SD1T 10
 R4SD2L 10
 R4SD2T 10
 R4SN 10
 R4SWL 10
 R4SWT 10
 R-400S-N-A 36
 R-401S-R-A 36
 R-402S-N-ICA 36
 R-420 35
 R-421 35
 R-422 35
 R-432 35
 R-500-N-UA 36
 R-501-R-UA 36
 R-520 35
 R-521 35
 R-522 35
 R-532 35
 R-602D-N-ICA 36
 R-603D-R-ICA 36
 R-620 35
 R-633 35
 R-651 35
 R-656 35
 REF-R4 9
 RI 94, 95

S

SBS-16115
 SBS-16 67, 71
 SK 94, 95
 SK05 95
 SK14 94, 95
 SK145 126
 SL-C1168

NUMERICAL INDEX

SL-C2	168
SL-C3	168
SL-EXT-144	168, 170, 172
SL-I	168, 170
SL-IC	168, 170, 172
SL-IF	168, 170, 172
SL-REF-BL.....	10 22, 23
SL-REF-BL18	64
SL-REF-CXA1310	63
SL-WC-1	168, 170, 172
SL-X	168, 170, 172
SL-Y	168, 170, 172
SRT-300M	136
SRT-600M	136

T

T-BARCLIP	94, 96
TBKT	94, 95
TB-S	168, 170, 172, 190
THL-HI-1-1/2A	97
THL-HI-1-1/5A	97
THL-HI-1-1A	97
THL-HI-1-2A	97
THL-HI-1-5A	97
THL-HI-1-7A	97
THL-HI-1-10A	97
THL-HI-2-1/2A	97
THL-HI-2-1/5A	97
THL-HI-2-1A	97
THL-HI-2-2A	97
THL-HI-2-5A	97
THL-HI-2-7A	97
THL-HI-2-10A	97
THL-HLE-1/2A	97
THL-HLE-1/5A	97
THL-HLE-1A	97
THL-HLE-2A	97
THL-HLE-5A	97
THL-HLE-7A	97
THL-HLE-10A	97
THL-LEFT-1-1/2A	97
THL-LEFT-1-1/5A	97
THL-LEFT-1-1A	97
THL-LEFT-1-2A	97
THL-LEFT-1-5A	97
THL-LEFT-1-7A	97
THL-LEFT-1-10A	97
THL-LEFT-2-1/2A	97
THL-LEFT-2-1/5A	97
THL-LEFT-2-1A	97
THL-LEFT-2-2A	97
THL-LEFT-2-5A	97
THL-LEFT-2-7A	97
THL-LEFT-2-10A	97
THL-RIGHT-1-1/2A	97
THL-RIGHT-1-1/5A	97
THL-RIGHT-1-1A	97

THL-RIGHT-1-2A	97
THL-RIGHT-1-5A	97
THL-RIGHT-1-7A	97
THL-RIGHT-1-10A	97
THL-RIGHT-2-1/2A	97
THL-RIGHT-2-1/5A	97
THL-RIGHT-2-1A	97
THL-RIGHT-2-2A	97
THL-RIGHT-2-5A	97
THL-RIGHT-2-7A	97
THL-RIGHT-2-10A	97
TK-49534	69

W

W8-COV	81
WEC	78, 82
WED-1/2A	79
WED-1/5A	79
WED-1A	79
WED-2A	79
WED-5A	79
WED-7A	79
WED-10A	79
WEDL	78, 79, 82
WEDL-RT	82
WEDL-RTL	82
WEDR	78, 79, 82
WEDR-RT	82
WEDR-RTL	82
WFC	78
WHED-1A	79
WHED-2A	79
WHED-5A	79
WHED-7A	79
WHED-10A	79
WHEDL	78
WHEDL-RT	82
WHEDL-RTL.....	82
WHEDR	78
WHEDR-RT	82
WHEDR-RTL	82
WHFC	78
WHIC	78
WHIC-RT	82
WHIC-RTL	82
WHK-1023	88
WHK-1035.....	89
WHK-1052	90
WHK-4023	86
WHK-LED20	91
WHK-LED42W	92
WHK-LED512	84
WHK-LED522	84
WHK-LED523	85
WHLLC	78
WHLLC-RT	82
WHLLC-RTL	82

WHLTC	78
WHLTC-RT	82
WHLTC-RTL	82
WHPC	78
WHPC-RT	82
WHRLC	78
WHRLC-RT	82
WHRLC-RTL	82
WHRTC	78
WHRTC-RT	82
WHRTC-RTL	82
WHT4	78
WHT4-RT	82
WHT4-RTL	82
WHT8	78
WHT8-RT	82
WHT8-RTL	82
WHT12-RT	82
WHT12-RTL	82
WHXC.....	78
WHXC-RT	82
WHXC-RTL	82
WIC	78, 82
WIC-RT	82
WIC-RTL	82
WL-5105.....	272
WL-5205	272
WLLC	78, 82
WLLC-RT	82
WLLC-RTL	82
WL-LED100	230, 268
WL-LED100TR	270
WL-LED200.....	230, 268
WL-LED200TR	270
WL-LED300	269
WL-LED310	269
WLTC	78, 82
WLTC-RT	82
WLTC-RTL	82
WMED	78
WMFP	78
WMIC	78
WMLC	78
WMPC	78
WMSP	78
WMST	78
WMST-TB	78
WMST-X	78
WMT	78, 82
WMT-C	78
WMT-TB	78
WMT-X	78
WMXC	78
WPC	78, 82
WPC-RT	82
WP-LED119	279
WP-LED127	279

NUMERICAL INDEX

WP-LED135	279	WS72LED-G544	162
WP-LED219	280	WS72LED-G914	162
WP-LED227	280	WS72LED-G915	162
WP-LED335	274	WS72LED-G939	162
WP-LED415	275	WS72LED-G954.....	162
WP-LED430.....	276	WS-224	56
WP-LED514	278	WS-236	56
WP-LED529	278	WS-248	56
WRLC	78, 82	WS-W2504	281
WRLC-RT	82	WS-W2505	281
WRLC-RTL	82	WS-W2509	281
WRTC	78, 82	WS-W2510	281
WRTC-RT	82	WS-W2604	283
WRTC-RTL.....	82	WS-W2605	281, 283
WS57LED	162	WS-W2609	283
WS57LED-G512	162	WS-W2610	283
WS57LED-G515	162	WS-W20506	282
WS57LED-G518	162	WT4	78
WS57LED-G539	162	WT4-RT	82
WS57LED-G541	162	WT4-RTL	82
WS57LED-G542	162	WT8	78
WS57LED-G543	162	WT8-RT	82
WS57LED-G544	162	WT8-RTL	82
WS58LED	162	WT12-RT	78, 82
WS58LED-G512	162	WT12-RTL	82
WS58LED-G515	162	WTK-1014	87
WS58LED-G518	162	WTK-1023	88
WS58LED-G539	162	WTK-1035	89
WS58LED-G541.....	162	WTK-1052	90
WS58LED-G542	162	WTK-4023	86
WS58LED-G543	162	WTK-LED20	91
WS58LED-G544	162	WTK-LED42W	92
WS72	162	WTK-LED512	84
WS72-G512	162	WTK-LED522	84
WS72-G515	162	WTK-LED523	85
WS72-G518	162	WXC	78, 82
WS72-G539	162	WXC-RT	82
WS72-G541	162	WXC-RTL	82
WS72-G542	162		
WS72-G543	162	X	
WS72-G544	162	X	94, 95
WS72-G630	162	XI	126
WS72-G914	162		
WS72-G915	162		
WS72-G930	162		
WS72-G939	162		
WS72-G940	162		
WS72-G954	162		
WS72LED	162		
WS72LED-G311	162		
WS72LED-G512	162		
WS72LED-G515	162		
WS72LED-G518	162		
WS72LED-G539	162		
WS72LED-G541	162		
WS72LED-G542	162		
WS72LED-G543	162		



WAC LIGHTING
Responsible Lighting®

wacighting.com
1-800-526-2588