



Industrial Circuit Breakers

How to Order	3-2
Features	3-4
Quick Reference Guide	3-5

Q-Line Circuit Breakers

Plug-In 120/240V Class	3-11
Plug-In 240V Class	3-13
Bolt-On 240V Class	3-17
Cable-In Cable Out (lug-lug) 240V Class	3-21
DIN-Rail Mount 240V Class	3-23
Cable-In Cable Out (lug-lug) 240V Class	3-24
Molded Case Switches 240V Class	3-25
Accessories 240V Class	3-26

Thermal Magnetic Trip

15-100A Type TEY Bolt-On	3-28
15-100A E-150 Line Types TEB, TED, THED	3-29
70-150A F225 Line Types TFJ, TFK, THFK	3-31
125-600A J600 Line Types TJJ, TJK, THJK	3-32
300-1200A K1200 Line Types TKM, THMK	3-34

Replacement Breakers

Tri-Break®, Internally Fused	3-36
THLC Current Limiting 15-400 Amperes	3-38

Internal Accessories- Molded Case Circuit Breakers

Accessory Devices and Ratings	3-39
Mine Duty Circuit Breaker Undervoltage Release	3-40
Auxiliary Switches	3-41
Shunt Trip	3-42
Undervoltage Release	3-44
Heavy-Duty Undervoltage Release	3-45

Spectra® RMS

15-150A, SE150 Line	3-46
70-250A, SF250 Line	3-48
125-600A, SG600 Line	3-50
300-1200A, SK1200 Line	3-53

Spectra® RMS with MicroVersaTrip® Plus Units

Features	3-55
MicroVersaTrip® Plus Trip Unit Characteristics	3-55
How to Order	3-56

Spectra® RMS with MicroVersaTrip® PM Units

Features	3-57
MicroVersaTrip® PM Trip Unit Characteristics	3-58
How to Order	3-59
60-600A, SG600 with MicroVersaTrip® Plus and PM	3-60
300-1200A, SK1200 with MicroVersaTrip® Plus and PM	3-63

Accessories for Spectra® RMS Circuit Breakers with MicroVersaTrip® Plus and MicroVersaTrip® PM Units

Power Management System Accessories	3-66
Other Accessories	3-69
Internal Accessories	3-70

Molded Case Switches - 100-1200 A.....3-72

Motor Circuit Protectors

3-150A Mag Break	3-73
70-1200A Mag Break	3-74
125-1200A Spectra® RMS Mag Break	3-75

Special Purpose – Mine Duty Circuit Breakers,

50-1200 Amperes.....3-76

Record Plus® Circuit Breakers – FB 100

Overview	3-77
Selection Table, 1-pole	3-78
Selection Table, 2-pole	3-79
Selection Table, 3-pole	3-80
Internal Accessories	3-81
External Accessories	3-82

Record Plus® Circuit Breakers – FC 100

Overview	3-83
Selection Table, 2-pole	3-84
Selection Table, 3-pole	3-85
Internal Accessories	3-86
External Accessories	3-87

Record Plus® Circuit Breakers – FG 600

Overview	3-88
Selection Table, 2-pole	3-89
Selection Table, 3-pole	3-89
Internal Accessories	3-90
External Accessories	3-91

External Accessories

Cable Operators	3-92
Flange-Mounted Operators	3-94
Door Mounted Operators	3-96
Motor Operators and Plug-in Hardware	3-98
Mechanical Interlocks and Locking Devices	3-99
Breaker Mounting Hardware and Kits	3-100
Lugs and Associated Hardware	3-101
Neutral Grounds and Sensors	3-103
Plug-in Hardware	3-104



Molded Case Circuit Breakers Industrial Circuit Breakers

Section 3

Spectra® RMS, Spectra® RMS with MicroVersaTrip® Plus Trip Units, Spectra® RMS with MicroVersaTrip® PM Trip Units, Thermal Magnetic and J/K with MicroVersaTrip® RMS-9 and Power+ 4 Trip Units

How to Order

Q-Line

- Thermal Magnetic Circuit Breakers
- Molded-Case Switches

The product number as shown in the following pages includes the complete breaker or switch. TQD and TJD breakers are complete with Cu/Al line and load lugs.

E 150 Line

- Thermal Magnetic Circuit Breakers
- Magnetic Circuit Breakers
- Molded Case Switches

The product numbers as shown in the following pages include the complete breaker or switch. All devices listed come with Cu/Al line and load lugs. If line lugs are not required on a breaker, eliminate “WL” from product number; for molded case switches see page 3-3. Unless otherwise noted, all circuit breakers are UL listed in File E-11592. Molded case switches are UL listed in File E-57546.

F 225 Line

- Thermal Magnetic Circuit Breakers
- Magnetic Circuit Breakers
- Molded Case Switches

These breakers are available with either noninterchangeable trips (designated Type TFJ) or interchangeable trips (designated Types TFK/THFK). When ordering Type TFJ, product number includes complete breaker, trip unit, CU/Al line and load lugs factory assembled. If line lugs are not required on a breaker, eliminate “WL” from product number, and subtract price of line lugs from price of complete breaker. If interchangeable trip (Types TFK/THFK) is required order one of two ways. “Complete circuit breaker” price includes frame, trip, Cu/Al line and load lugs. Units will be shipped unassembled unless specified on order “must be factory assembled.” If line lugs are not required on a breaker, eliminate “WL” from product number, and subtract price of line lugs from price of complete breaker. To order the frame, trip, and lugs separately, select the required components from table. Magnetic breakers must be ordered as components. A complete breaker consists of frame, trip unit, one line lug per pole and one load lug per pole. Price of “Complete Circuit Breaker” vs. ordering frame, trip, and line and load lugs separately is the same.

Molded case switches can also be ordered as complete units (designated TFK---Y) or as separate components. They are UL listed only as complete units. To indicate required lugs, see page 3-3.

Unless otherwise noted, all circuit breakers are UL listed in File E-11592. Molded case switches are UL listed in File E-57546.

J 600 Line

- Thermal Magnetic Circuit Breakers
- Magnetic Circuit Breakers
- Molded Case Switches

These breakers are available with either noninterchangeable trip (designated Type TJJ) or interchangeable trip (designated Type TJK and THJK). Type TJJ product numbers include frame, trip, Cu/Al line, and load lugs factory assembled. If line lugs are not

required on the breaker, eliminate “WL” from product number, and subtract price of line lugs from price of complete breaker.

TJK breakers are available in two frames, 400 ampere frame (125 to 400 amperes) and 600 ampere frame (250 to 600 amperes). Trip units are not interchangeable between frames.

“Complete Circuit Breaker” price includes frame, trip unit, Cu/Al line, and load lugs. Unit will be shipped unassembled unless order specifies “must be factory assembled.” If line lugs are not required, eliminate “WL” from product number and subtract price of line lugs from price of complete breaker.

To order the frame, trip, and lugs separately, select the required components from table. Magnetic breakers must be ordered as components. A complete breaker consists of frame, trip, and one line and one load lug per pole.

Price of ordering “Complete Circuit Breaker” vs. frame, trip, and line and load lugs separately is the same.

Molded case switches can also be ordered as complete units (designated Type TJK---Y) or as separate components. They are UL listed only as complete units. To indicate required lugs, see page 3-3.

Unless otherwise noted, all circuit breakers are UL listed in File E-11592. Molded case switches are UL listed in File E-57546.

K 1200 Line

- Thermal Magnetic Circuit Breakers
- Magnetic Breakers
- Molded Case Switches

These breakers are available only with interchangeable trip units. Two frame sizes are available, the 800 ampere frame (300 to 800 amperes) and the 1200 ampere frame (600 to 1200 amperes). Trip units are not interchangeable between frames.

“Complete Circuit Breaker” price includes frame, trip, Cu/Al line, and load lugs. Units will be shipped unassembled unless specified “must be factory assembled.” If line lugs are not required on the breaker, eliminate “WL” from product number and subtract price of line lugs.

To order the frame, trip, and lugs separately, select the required components from table. Magnetic circuit breakers must be ordered as components. A complete breaker consists of frame, trip and one line and one load lug per pole. Price of ordering “Complete Circuit Breaker” vs. frame, trip, and line and load lugs separately is the same.

Molded case switches can also be ordered as complete units (designated Type TKMA---Y) or as separate components. They are UL listed only as complete units. To indicate required lugs, see the table on page 3-3.

Unless otherwise noted, all circuit breakers are UL listed in File E-11592. Molded case switches are UL listed in File E-57546.



Tri-Break® Line

- Integrally Fused Thermal Magnetic Circuit Breakers
- Integrally Fused Magnetic Circuit Breakers
- Integrally Fused Molded Case Switches

These breakers are available in four types. Type TB1 (15-100 amperes) product numbers include frame, trip, line and load lugs, and current limiters all factory assembled. Types TB4 (125 to 400 amperes), TB6 (300 to 600 amperes) and TB8 (600 to 800 amperes) include frame, trip and limiters, factory assembled, but do not include line or load lugs. If line and load lugs are required, order separately. Unless otherwise noted, TB1, TB4, TB6, and TB8 breaker components are UL listed in File E-42263. Fused molded case switches are UL listed in File E-57546.

Mag-Break Line

- Magnetic only circuit breakers (motor circuit protectors)

These breakers are available only with noninterchangeable adjustable magnetic trip, in frame Types E, F, J, K, and Tri-Break®. All breakers are shipped factory assembled, complete with Cu/Al line and load lugs.

All magnetic only circuit breakers and limiters are UL Component Recognized in Files E-11592 and E-66390, respectively, unless otherwise noted.

Spectra® RMS

- Circuit Breakers

Determine the required breaker frame, IC rating, and load requirements. Select frame, trip unit (rating plug), and lug, if required, product numbers from the tables on pages 3-46 to 3-54. For Spectra® breakers with MicroVersaTrip® Plus Trip Units or MicroVersaTrip® PM Trip Units refer to pages 3-60 through 3-62. Select field-mounted internal accessory product numbers, if required, on pages 3-70 and 3-71. Select field-mounted external accessory product numbers, if required, on pages 3-92 through 3-104. Order as separate items.

- Mag-Break Motor Circuit Protectors

Determine the required frame and ampere requirements. Select frame, trip unit (rating plug), and lug, if required, product numbers from the table on pages 3-73 through 3-75. Select accessories as noted above for circuit breakers. The same accessories are used with both circuit breakers and motor circuit protectors. Order as separate items.

- Molded Case Switches

Determine the required frame and ampere requirements. Select frame and lug, if required, product numbers from the table on page 3-72. Rating plugs are not used. Select accessories as noted above for circuit breakers. Internal accessories do not require dummy trips. The same accessories are used with both circuit breakers and molded case switches. Order as separate items.

Unless otherwise noted, all circuit breakers are UL listed in File E-11592. Molded case switches are UL listed in File E-57546. Field-Installable Internal Accessories are UL listed in File E-57253. Distribution Cable Accessories for MicroVersaTrip® Plus Trip Units and MicroVersaTrip® PM Trip Units are UL listed in File E-57253.

Accessories

Order accessories from the appropriate table:

- Thermal Magnetic Circuit Breakers, Magnetic Circuit Breakers, and Molded Case Switches¹—pages 3-39 to 3-45 and 3-92 to 3-104.
- Spectra® RMS Breakers—pages 3-70 to 3-71 and 3-92 to 3-104.
- Spectra® RMS Breakers with MicroVersaTrip® Plus Trip Units or MicroVersaTrip® PM Trip Units—pages 3-66 to 3-69, 3-70 to 3-71, and 3-92 to 3-104.

¹Installation of accessories in molded case switches requires dummy trip; see page 3-45 for information. Dummy trip not required for Tri-Break® or Q-Line molded case switches.

Molded Case Circuit Breaker and Switch Terminal

Configuration Code

Order standard Cu/Al lugs by using suffix codes presented. Order lugs separately if special lugs are required. For optional lugs, see pages 3-101 and 3-102.

Breaker/Switch Type	Suffix				
	Blank	WL	XL	X2	LL
TQD/TJD	Load Lugs Only	Line and Load Lugs	—	Line Lugs Only	No Lugs
Molded Case Breakers, Thermal Magnetic	Load Lugs Only	Line and Load Lugs	—	Load Lugs Only	No Lugs
Molded Case Switch	Line and Load Lugs	—	No Lugs	Line Lugs Only	Load Lugs Only
Spectra RMS™ Breakers	No Lugs			Order Lugs Separately	
J.K. MicroVersaTrip® Breakers	No Lugs			Order Lugs Separately	
Mine Duty™ Breakers	No Lugs			Order Lugs Separately	
Mag-Break® Breakers	Line and Load Lugs	—	—	—	—



Features

Spectra® RMS Molded Case Circuit Breakers

SE150, SF250, SG600, and SK1200 circuit breaker frames have a digital, solid-state, rms sensing trip system with field installable, front-mounted rating plugs to establish or change the breaker ampere rating. Adjustable instantaneous with tracking short-time is standard on all frames including SE150. The trip system uses digital sampling to determine the rms value of sinusoidal and nonsinusoidal currents.

MicroVersaTrip® Plus Trip Units or MicroVersaTrip® PM Trip Units

SG600 and SK1200 are optionally available with either MicroVersaTrip® Plus or MicroVersaTrip® PM trip units which offer expanded functionality in the same space-saving size of standard Spectra® RMS breakers. The trip system uses digital sampling to determine the rms value of sinusoidal and nonsinusoidal currents.

MicroVersaTrip® Plus Trip Units

MicroVersaTrip® Plus trip units utilize a digital, LCD display with a four-button keypad to provide local set-up and readout of trip settings. A 3-phase ammeter and trip indicators are standard, as is a clear plastic cover with provisions for sealing to allow tamper-resistant installation. The trip unit digitally measures the current waveform in each phase to determine the true rms value of the current, regardless of the waveshape.

MicroVersaTrip® Plus trip units provide accurate, predictable overload and short-circuit protection for distribution systems that include ac and dc variable speed drives, rectifiers, induction heating, and other loads that cause high harmonic distortion as well as standard circuit. They provide maximum breaker-to-breaker selectivity and custom load protection. Short-time and ground fault functions include the flexibility of coordination with or without an I^2t ramp.

MicroVersaTrip® PM Trip Unit

The MicroVersaTrip® PM trip unit adds power management system capability, advanced metering, and protective relays to the basic functions of the MicroVersaTrip® Plus trip unit. The MicroVersaTrip® PM trip unit communicates directly on the GE POWER LEADER® communication bus.

A complete circuit breaker consists of a UL listed circuit breaker frame and a rating plug (UL listed interchangeable trip unit). Terminal lugs for cable connection are available if required.

- All frames use the same UL listed, field-installable internal accessories (auxiliary switch, shunt trip, undervoltage release and bell alarm).
- All frame sizes have maximum UL listed interrupting ratings of 200 kA @ 240 Vac and 100 kA @ 480 Vac with 600 Vac ratings to 65 kA depending on frame size. UL listed current limiting versions are provided through the SG600 frame for the 65 kA @ 480 Vac and the 100 kA @ 480 Vac models, with no increase in physical frame size.
- Spectra® RMS Mag-Break instantaneous-only motor circuit protectors also use the same digital, solid-state trip unit and rating plugs as the circuit breakers. The interchangeable rating plug establishes the instantaneous pickup range (with tracking short-time) but does not change the frame ampere rating.

- Spectra® RMS molded case switches have a fixed, high-set instantaneous trip (without tracking short-time function) and have short-circuit withstand ratings equal to their equivalent breaker frame size interrupting rating in most cases.
- Spectra® RMS breakers are ambient insensitive. Trip times will not vary over the range 10–50°C breaker ambient. Refer to GET-7002 for further application information.
- Spectra® RMS breakers contain no parts that would support fungus growth and are, therefore, inherently fungusproof.

Record Plus® Molded Case Circuit Breakers

Record Plus® represents the very latest in molded case circuit breaker design. Utilizing design features such as double-break rotary contact structures and advanced ablative materials to enhance interruption, Record Plus® is capable of interrupting ratings up to 200kA. High kAIC ratings, selective coordination, reduced arc flash energy, and current limitation embody the core design principles of Record Plus®.

FC 100 and FB 100 circuit breakers are supplied with factory installed non-user interchangeable thermal-magnetic trip units and can be supplied with or without lugs. FB breakers are available in 1-, 2- and 3-pole versions. FC is available in 2- and 3-pole versions, both in a 3-pole footprint.

FG600 circuit breakers are supplied equipped with factory installed non-user interchangeable electronic trip units that feature the use of front accessible, user installed rating plugs to establish or change the breaker's amp rating. Rating plugs are user specified and ordered under separate product number. Instantaneous pickup levels are adjustable and set via a front-mounted adjusting knob. FG is available in 2- and 3-pole versions, both in a 3-pole footprint.

Record Plus® product numbers ending in R or R0 do not include lugs. An R1 suffix indicates that the breaker is supplied with line and load lugs, R2 indicates load lugs, and R3 indicates line lugs. RV suffixed product numbers include load lugs and line connections specifically designed for General Electric type AD panels.

All frames use common internal accessories (auxiliary switches, UV releases, shunt trips, and bell alarms) UL listed for field installation. UL listed maximum short circuit ratings at 480VAC are 150kA for the 100A frames and 200kA for the 600A frames.

Unless noted otherwise, all circuit breakers and accessories are listed in UL file number E11592.

Other MCCB Features

- UL489 Listed
- Broad product line to meet virtually any application need.
- Reduced downtime. A tripped breaker is easily spotted and can be immediately reset after the fault has been corrected.
- Eliminates single phasing. A common trip bar disconnects all poles simultaneously on both overloads and short circuits.
- Offers application flexibility through the use of a wide variety of accessory devices and special attachments.
- Repetitive operation—no fuses to replace.
- Breakers can be repetitively tested. Fuses must be destroyed to confirm calibration accuracy.

For more information on these products, order publications listed in Sections 21 and 22.



Quick Reference Guide

Ratings do not apply to molded case switches.

The interruption ratings and voltages shown in the table are maximum ratings. A circuit breaker of the type given in the left-hand column may be applied at the given circuit voltage in any electrical distribution system where the available fault current at the load terminals of the breaker does not exceed the value in the table. That circuit breaker type may also be applied at intermediate values of circuit voltage provided the available fault current at the load terminals of the breaker does not exceed the value in the table for the higher value of voltage.

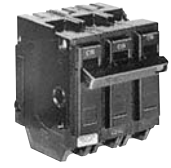
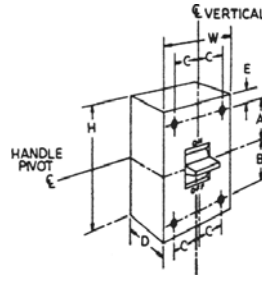

THQL 32015

Q-Line (UL file E-11592; Fixed Thermal Magnetic Trip Unit)

Circuit Breaker Type	Ampere Rating	No. Poles	Maximum Voltage Rating		UL Listed Interrupting Ratings—rms Symmetrical kA								Dimensions (in.)							Std. Pack	
					Vac						Vdc		H	W	D	A	B	C	E		
					120	120/240	240	277	480	600	125	250									
TQ	15-50	1	120/240	—	—	10	—	—	—	—	—	—	3	3/4	2 3/8	—	—	—	—	10	
	15-60	2	120/240	—	—	10	—	—	—	—	—	—	3	1 1/2	2 3/8	—	—	—	—	5	
THQP ¹	15-50	1	120/240	—	—	10	—	—	—	—	—	—	3 9/32	1/2	2 3/8	—	—	—	—	100	
		2												1							50
TQL/TQB/ TQC	10	1	120/240	—	—	5 ²	—	—	—	—	—	—	3 9/32	1	2 3/8	—	—	—	—	25	
		2					5 ²							3							15
		3					—							2							15
THQL ¹ THQB ¹ THQC ¹	15-70	1	120/240	—	—	10	—	—	—	—	—	3 9/32	1	2 3/8	—	—	—	—	15		
	15-125	2					10						2							25	
	15-100	3					—						3							15	
THHQB ¹ THHQC ¹	15-70	1	120/240	—	—	22	—	—	—	—	—	3 9/32	1	2 3/8	—	—	—	—	50		
		2					22						2							25	
	15-100	3					—						3							15	
THHQL ¹	15-70	1	120/240	—	—	22	—	—	—	—	—	3 9/32	1	2 3/8	—	—	—	—	50		
	15-125	2					22						2							25	
	15-100	3					—						3							15	
TXQL ¹ TXQB ¹ TXQC ¹	15-30	1	120/240	—	—	65	—	—	—	—	—	3 9/32	1	2 3/8	—	—	—	—	25		
		2					65						2							15	
		3					—						3							15	
TQDL	125-200	2	120/240	—	—	10	—	—	—	—	—	—	6 1/16	2	2 3/8	—	—	—	—	12	
THQDL	125-200	2	120/240	—	—	22	—	—	—	—	—	—	6 1/16	2	2 3/8	—	—	—	—	12	
TQD ¹	100-225	2	240	—	—	10	10	—	—	—	—	—	6 9/16	2 3/4	2 5/8	2 7/16	2 7/16	—	27/32	1	
	100-225	3				—	10							4 1/8							11/16
THQD ¹	100-225	2	240	—	—	22	22	—	—	—	—	—	6 9/16	2 3/4	2 5/8	2 7/16	2 7/16	—	27/32	1	
	100-225	3				—	22							4 1/8							11/16
TJD	250-400	2	240	—	—	22	22	—	—	—	—	10	10 1/8	8 1/4	3 13/16	3 15/16	3 13/16	1 3/8	1 3/16	1	
	250-400	3				—	22														1

CB3 Ground Fault, Equipment Ground Fault and Arc Fault (UL File E-51075; Fixed Thermal Magnetic Trip Unit)

THQB THQC THQL ...GF, GFEP, AF	15-30	1	120	—	10	—	—	—	—	—	—	—	3 9/32	1	2 3/8	—	—	—	—	10
		2	120/240	—	—	1	—	—	—	—	—	—	—	3 9/32	2	2 3/8	—	—	—	—
THHQL ...GF THHQB ...GF, GFEP, AF	15-30	1	120	—	22	—	—	—	—	—	—	—	3 9/32	1	2 3/8	—	—	—	—	10

¹ UL listed as HACR (heating, air conditioning and refrigeration).

² Not UL listed.



Molded Case Circuit Breakers Industrial Circuit Breakers

Section 3

Quick Reference Guide 10-1200A Circuit Breakers Thermal Magnetic Trip

Ratings do not apply to molded case switches. The interruption ratings and voltages shown in the table are maximum ratings. A circuit breaker of the type given in the left-hand column may be applied at the given circuit voltage in any electrical distribution system where the available fault current at the load terminals of the breaker does not exceed the value in the table. That circuit breaker type may also be applied at intermediate values of circuit voltage provided the available fault current at the load terminals of the breaker does not exceed the value in the table for the higher value of voltage.

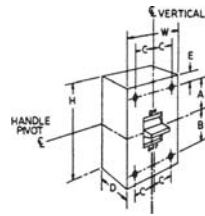

TJJ, TJK, THJK



TFJ, TFK, THFK

TEY (UL File E-11592; Fixed Thermal Magnetic Trip Unit; CSA LR57114)

Circuit Breaker Type	Ampere Rating	No. Poles	Maximum Voltage Rating		UL Listed Interrupting Ratings— kA								Dimensions (In.)							Approx. Ship Wt./Std. Pack		
					Vac				Vdc													
					ac	dc	120	120/240	240	277	480	600	125	250	500 ¹	H	W	D	A		B	C
TEY ²	15-100	1	277	125	65		14	14	—		10	—	—	5 1/4	1	3 1/16	—	—	—	—	—	—
		2	480/277	250	—	—	65	14	14 ⁵	—	—	10	—		2							
		3	—	—	—	—	—	—	—	—	—	—	3									

E150 (UL File E-11592; Fixed Thermal Magnetic Trip Unit; CSA LR 57114)

TEB ²	10-100 ³	1	120	125	10	—	—	—	—	—	5	—	—	6 5/16	1 3/8	3 3/8	2 41/64	2 15/64	—	23/32	26 lb/24
		2	240	250	—	—	10	—	—	—	—	5	—		2 3/4				24 lb/12		
		3	—	—	—	—	—	—	—	—	—	—	—		4 1/8				11/16		28 lb/8
TED ²	10-100 ³	1	277,347 ⁴	125	—	—	—	14	10	—	10	—	—	6 5/16	1 3/8	3 3/8	2 41/64	2 15/64	—	23/32	26 lb/24
		2	480	250	—	—	18	—	18	—	—	10	—		2 3/4				24 lb/12		
		3	480, 600	500	—	—	—	—	—	—	—	—	10		4 1/8				11/16		28 lb/8
THED ²	15-30	1	277,347 ⁴	125	—	—	—	65	—	—	20 ⁶	—	—	6 5/16	1 3/8	3 3/8	2 41/64	2 15/64	—	23/32	26 lb/24
		2	480	250	—	—	65	—	—	—	—	20 ⁶	—		4 1/8				11/16		24 lb/12
	15-100	2	480	250	—	—	65	—	25	—	—	—	—		4 1/8				11/16		24 lb/12
		3	600	500	—	—	65	—	25	—	—	—	—		4 1/8				11/16		28 lb/8

F225 (UL File E-11592; TFJ, Fixed Thermal Magnetic Trip Unit; TFK, THFK: Interchangeable Thermal Mag. Trip Unit; CSA LR 40350)

TFJ ²	70-225	2	480	250	—	—	25	—	22	—	—	10	—	10 1/8	4 1/8	3 13/16	3 7/8	3 7/8	11/16	1 3/16	10 lb/1
	70-250	3	600	500	—	—	—	—	—	—	—	—	10								12 lb/1
TFK ²	70-225	2	480	250	—	—	25	—	22	—	—	10	—	10 1/8	4 1/8	3 13/16	3 7/8	3 7/8	11/16	1 3/16	10 lb/1
		3	600	500	—	—	—	—	—	—	—	—	10								12 lb/1
THFK ²	70-225	2	480	250	—	—	65	—	25	—	—	10	—	10 1/8	4 1/8	3 13/16	3 7/8	3 7/8	11/16	1 3/16	10 lb/1
		3	600	500	—	—	—	—	—	—	—	—	10								12 lb/1
TFL ⁷	70-225	3	600	—	—	100	100	—	65	25	—	—	—	10 1/8	4 1/8	3 13/16	3 7/8	3 7/8	11/16	1 3/16	—

J600 (UL File E-11592; TJJ, Fixed Thermal Magnetic Trip Unit; TJK, THJK: Interchangeable Thermal Mag. Trip Unit; CSA LR 40350)

TJJ, TJK4	125-400	2	600	250	—	—	42	—	30	22	—	10	—	10 1/8	8 1/4	3 13/16	3 15/16	3 13/16	1 3/8	1 3/16	16 lb/1
		500		—								20	17 1/2 lb/1								
TJK6	250-600	2	600	250	—	—	42	—	30	22	—	10	—	10 1/8	8 1/4	3 13/16	3 15/16	3 13/16	1 3/8	1 3/16	18 lb/1
		500		—								20	20 lb/1								
THJK4	125-400	2	600	250	—	—	65	—	35	25	—	40	—	10 1/8	8 1/4	3 13/16	3 15/16	3 13/16	1 3/8	1 3/16	16 lb/1
		—		—								40	20								17 1/2 lb/1
THJK6	250-600	2	600	250	—	—	65	—	35	25	—	40	—	10 1/8	8 1/4	3 13/16	3 15/16	3 13/16	1 3/8	1 3/16	18 lb/1
		—		—								40	20								20 lb/1

K1200 (UL File E-11592; Interchangeable Thermal Magnetic Trip Unit; CSA LR 40350)

TKM8	300-800	2	600	250	—	—	42	—	30	22	—	10	—	15 1/2	8 1/4	5 1/2	8 9/16	5 11/16	1 3/8	5/8	33 lb/1
		500		—								22	39 lb/1								
TKM12	600-1200	2	600	—	—	—	42	—	30	22	—	—	—	15 1/2	8 1/4	5 1/2	8 9/16	5 11/16	1 3/8	5/8	38 lb/1
		—		—								—	41 1/2 lb/1								
THKM8	300-800	2	600	250	—	—	65	—	35	25	—	40	—	15 1/2	8 1/4	5 1/2	8 9/16	5 11/16	1 3/8	5/8	33 lb/1
		—		—								40	22								39 lb/1
THKM12	600-1200	2	600	—	—	—	65	—	35	25	—	—	—	15 1/2	8 1/4	5 1/2	8 9/16	5 11/16	1 3/8	5/8	38 lb/1
		—		—								—	41 1/2 lb/1								

¹ UL listed with poles in series for 500 Vdc ungrounded battery applications.

² UL listed as HACR (heating, air conditioning, and refrigeration).

³ 10 amp not UL listed.

⁴ UL listed/CSA Certified for 10kA @ 347 Vac (TED) and 18kA @ 347V (THED). Also rated 10kA @ 480V but not UL listed.

⁵ 480V/277 Vac.

⁶ UL listed at 10,000 amps

⁷ No longer available



Molded Case Circuit Breakers Industrial Circuit Breakers

Quick Reference Guide

15-1200A Circuit Breakers

Electric Trip Spectra® RMS Breakers

Ratings do not apply to molded case switches. The interruption ratings and voltages shown in the table are maximum ratings. A circuit breaker of the type given in the left-hand column may be applied at the given circuit voltage in any electrical distribution system where the available fault current at the load terminals of the breaker does not exceed the value in the table. That circuit breaker type may also be applied at intermediate values of circuit voltage provided the available fault current at the load terminals of the breaker does not exceed the value in the table for the higher value of voltage.

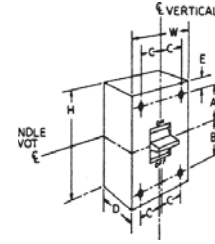

SE 150

Spectra® RMS Circuit Breakers UL/CSA Ratings

Solid-State with Interchangeable Trip Unit (Rating Plug)

Circuit Breaker Type	Ampere Rating	No. Poles	Maximum Vac	UL Listed Interrupting Rating—kA			Dimensions Inches (mm)							Approx. Ship Wt./Std. Pack						
				240 Vac	480 Vac	600 Vac	H	W	D	A	B	C	E							
SE150 Current Limiting (UL File No. E-11592; CSA LR 40350)¹																				
SED ²	15-150	2	480	18	18	—	6.31 (160)	4.12 (105)	3.38 (86)	2.41 (61)	2.47 (63)	.69 (18)	.72 (18)	5.65 lb/1						
		3	600												65	25	—			
SEH ²	2	480	100	65	—															
	3	600				200									100	—				
SEL	2	480	25	—	—															
	3	600				25									—	—				
SEP	2	480	25	—	—															
	3	600				25									—	—				
SF-250 Current Limiting (UL File No. E-11592; CSA LR 40350)¹																				
SFH ²	70-250	2	480	65	35	—									10.12 (257)	4.12 (105)	3.81 (97)	3.87 (98)	3.87 (98)	.69 (18)
		3	600				100	65	—											
SFL	70-250	2	480	25	—	—														
		3	600				25	—	—											
SFP	2	480	25	—	—															
	3	600				25	—	—												
SG600 Current Limiting (UL File No. E-11592; CSA LR 40350)^{1, 3}																				
SGH1 ^{2,4}	60-150	3	600	65	35	25	10.09 (256) 5	5.50 (140)	3.81 (97)	4.45 (113)	3.30 (84)	.91 (23)	1.18 (30) 5	15.85 lb/1						
SGD ²	125-400	2	240	65	—	—														
		3													65	35	25			
SGH4 ²	250-600	2	600	65	35	25														
		3	600																	
SGH6 ²	60-150	2	600	100	65	65														
		3	600																	
SGL1 ⁴	125-400	2	600	100	65	65														
		3	600																	
SGP1 ⁴	250-600	2	600	200	100	65														
		3	600																	
SGL4	600-1200	2	600	100	65	65														
		3	600																	
SGP4	600-1200	2	600	200	100	65														
		3	600																	
SGL6	600-1200	2	600	100	65	65														
		3	600																	
SGP6	600-1200	2	600	200	100	65														
		3	600																	
SK1200 (UL File No. E-11592; CSA LR 40350)^{1, 3}																				
SKH8	300-800	2	600	65	50	25	15.50 (394) 6	8.25 (210)	5.50 (140)	8.56 (217)	5.69 (145)	1.38 (35)	.62 (16) 6	47.6 lb/1						
		3																		
SKL8	600-1200	2	600	100	65	42														
		3																		
SKP8	600-1200	2	600	200	100	65														
		3																		
SKH12	600-1200	2	600	65	50	25														
		3																		
SKL12	600-1200	2	600	100	65	42														
		3																		
SKP12	600-1200	2	600	200	100	65														
		3																		

¹ UL listed as HACR (heating, air conditioning and refrigeration).

² Not current-limiting circuit breaker.

³ Includes MicroVersaTrip Plus™ Trip Units and MicroVersaTrip PM™ Trip Units.

⁴ MicroVersaTrip Plus™ Trip Units and MicroVersaTrip PM™ Trip Units only.

⁵ Add 1.76 inches (45 mm) to each end with lugs and lug cover installed.

⁶ Add 4.00 inches (101 mm) to upper end for SKP (100 KAIC-480V) lug cover.



Publications and Reference: See Section 22 for a complete list of additional product-related publications

Molded Case Circuit Breakers Industrial Circuit Breakers

Section 3

Quick Reference Guide

15-1200A Circuit Breakers

Electric Trip Spectra® RMS Breakers

Ratings do not apply to molded case switches

IEC/JIS Ratings

Solid-State with Interchangeable Trip Unit (Rating Plug)

Circuit Breaker Type	Ampere Rating	No. Poles	IEC 947-2 Interruption Capacity — kA								Japanese Industry Standard Interruption Capacity kA			
			220-240 Vac		380-415 Vac		500 Vac		690 Vac		Vac			
			I _{cu}	I _{cs}	I _{cu}	I _{cs}	I _{cu}	I _{cs}	I _{cu}	I _{cs}	220-240	380-415	500	690

SE150 Current Limiting, 15-32A

SED	15-32	2	18	9	10	5	—	—	—	—	18	10	—	—
		3	—	—	—	—	4	4	—	—	—	—	4	—
SEH	15-32	2	65	33	15	10	—	—	—	—	65	15	—	—
		3	—	—	—	—	6	6	—	—	—	—	6	—
SEL	15-32	2	100	50	20	15	—	—	—	—	100	20	—	—
		3	—	—	—	—	8	8	3	3	—	—	8	3
SEP	15-32	2	200	100	20	20	—	—	—	—	200	20	—	—
		3	—	—	—	—	10	10	5	5	—	—	10	5

SE150 Current Limiting, 40-160A

SED	40-160	2	18	9	14	7	—	—	—	—	18	14	—	—
		3	—	—	—	—	14	7	—	—	—	—	14	—
SEH	40-160	2	65	33	35	17	—	—	—	—	65	25	—	—
		3	—	—	—	—	25	12	—	—	—	—	18	—
SEL	40-160	2	100	50	65	33	—	—	—	—	100	65	—	—
		3	—	—	—	—	40	20	5	5	—	—	25	5
SEP	40-160	2	200	100	100	50	—	—	—	—	200	100	—	—
		3	—	—	—	—	50	25	10	5	—	—	65	10

SF250 Current Limiting

SFH	70-250	2	65	33	35	17	—	—	—	—	65	25	—	—
		3	—	—	—	—	25	12	—	—	—	—	18	—
SFL	70-250	2	100	50	65	33	—	—	—	—	100	65	—	—
		3	—	—	—	—	40	20	14	7	—	—	25	14
SFP	70-250	2	200	100	100	50	—	—	—	—	200	100	—	—
		3	—	—	—	—	65	33	18	9	—	—	65	18

SG600 Current Limiting

SGH1 ¹	60-150	3	65	33	25	13	18	9	—	—	65	25	18	—
SGL1 ¹			100	50	65	33	35	18	14	7	100	65	35	22
SGP1 ¹			200	100	100	50	50	25	18	9	200	100	65	35
SGH4	125-400	2	65	33	25	13	—	—	—	—	65	25	—	—
		3	—	—	—	—	18	9	—	—	—	—	18	—
SGL4		2	100	50	65	33	—	—	—	—	100	65	—	—
SGP4	125-400	3	—	—	—	—	35	18	14	7	—	—	35	22
		2	200	100	100	50	—	—	—	—	200	100	—	—
3		—	—	—	—	50	25	18	9	—	—	65	35	
SGH6	250-600	2	65	33	25	13	—	—	—	—	65	25	—	—
		3	—	—	—	—	18	9	—	—	—	—	18	—
SGL6		2	100	50	65	33	—	—	—	—	100	65	—	—
SGP6	250-600	3	—	—	—	—	35	18	14	7	—	—	35	22
		2	200	100	100	50	—	—	—	—	200	100	—	—
3		—	—	—	—	50	25	18	9	—	—	65	35	

SK1200

SKH8	300-800	2	65	16	50	13	25	13	—	—	65	50	25	—
		3	—	—	—	—	—	—	—	—	—	—	—	—
SKL8		2	100	25	65	16	42	21	14	14	100	65	42	14
SKP8	300-800	3	—	—	—	—	—	—	—	—	—	—	—	—
		2	140	35	85	25	50	25	18	18	140	85	50	18
3		—	—	—	—	—	—	—	—	—	—	—	—	—
SKH12	600-1250	2	65	16	50	13	25	13	—	—	65	50	25	—
		3	—	—	—	—	—	—	—	—	—	—	—	—
SKL12		2	100	25	65	21	42	16	14	14	100	65	42	14
SKP12	600-1250	3	—	—	—	—	—	—	—	—	—	—	—	—
		2	140	35	70	25	50	25	18	18	140	85	50	18
3		—	—	—	—	—	—	—	—	—	—	—	—	—

¹MicroVersaTrip Plus™ trip system only.



SE



SF



SG



SK



Quick Reference Guide

Ratings do not apply to molded case switches. The interruption ratings and voltages shown in the table are maximum ratings. A circuit breaker of the type given in the left-hand column may be applied at the given circuit voltage in any electrical distribution system where the available fault current at the load terminals of the breaker does not exceed the value in the table. That circuit breaker type may also be applied at intermediate values of circuit voltage provided the available fault current at the load terminals of the breaker does not exceed the value in the table for the higher value of voltage.

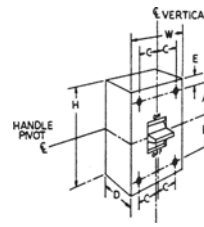

TJC



TJL6S

Tri-Break (UL File E-42263; Integrally Fused, Thermal Magnetic Trip Unit)

Circuit Breaker Type	Ampere Rating	No. Poles	Maximum Voltage Rating		UL Listed Interrupting Ratings—rms Symmetrical Amps (In Thousands)								Dimensions (In.)							Approx. Ship Wt./Std. Pack
					Vac						Vdc		H	W	D	A	B	C	E	
					ac	dc	120	120/240	240	277	480	600								
TB1 ^{1,2}	15-100	3	600	—	—	—	200	—	200	200	—	—	10 5/16	4 1/8	3 5/8	2 21/32	6 9/32	11/16	23/32	8 lb/1
TB4 ^{1,3,9}	125-400	3	600	—	—	—	200	—	200	200	—	—	16 1/8	8 1/4	4 1/2	3 15/16	9 13/16	1 3/8	1 3/16	31 lb/1 33 lb/1
TB6 ^{1,3}	300-600	3	600	—	—	—	200	—	200	200	—	—	21 7/8	8 1/4	5 7/8	8 9/16	12 1/16	1 3/8	5/8	53 lb/1 55 lb/1
TB8 ^{1,3}	600-800	3	600	—	—	—	200	—	200	100	—	—	21 7/8	8 1/4	5 7/8	8 9/16	12 1/16	1 3/8	5/8	53 lb/1 55 lb/1

Mag-Break (UL Files E-11592, E-66390; Magnetic Trip Unit)⁴

TEC	3-150	2	480	250	—	—	10	—	10	10	—	10	6 5/16	4 1/8	3 3/8	2 41/64	2 15/64	11/16	23/32	21 lb/6
		3	600	—	—	—	—	—	—	—	—	—	—	—	—	—	—	—	—	—
TEML ⁵	3-150	3	600	250	—	—	100	—	65	25	—	—	6 5/16	4 1/8	3 7/8	2 41/64	2 15/64	11/16	23/32	3 1/2 lb/1
TEC & TECL ⁶	3-150	3	600	—	—	—	100	—	100	100	—	—	8 3/16	4 1/8	3 3/8	2 41/64	2 15/64	11/16	23/32	1.2 lb/1 TECL Only
TFC	225	3	600	—	—	—	25	—	22	18	—	—	10 1/8	4 1/8	3 13/16	3 7/8	3 7/8	11/16	1 3/16	10 lb/1 12 lb/1
TBC4 ⁹	225-400	3	600	—	—	—	100	—	100	100	—	—	16 1/8	8 1/4	4 1/2	3 15/16	9 13/16	1 3/8	1 3/16	31 lb/1 33 lb/1
TJC	400-600	3	600	—	—	—	42	—	30	22	—	—	10 1/8	8 1/4	3 13/16	3 13/16	3 13/16	1 3/8	1 3/16	16 lb/1 17 1/2/1
TBC6	600	3	600	—	—	—	100	—	100	100	—	—	21 7/8	8 1/4	5 7/8	8 9/16	12 1/16	1 3/8	5/8	53 lb/1 55 lb/1
TKC	800-1200	3	600	—	—	—	42	—	30	22	—	—	15 1/2	8 1/4	5 1/2	8 9/16	5 11/16	1 3/8	5/8	38 lb/1 41 1/2/1
TBC8	800	3	600	—	—	—	100	—	100	100	—	—	21 7/8	8 1/4	5 7/8	8 9/16	12 1/16	1 3/8	5/8	53 lb/1 55 lb/1

MicroVersaTrip (UL File E-11592; Solid-State Trip Units)¹⁰

TJ4V ^{7,8}	150-600	3	600	—	—	42	42	—	30	22	—	—	10 1/8	8 1/4	3 13/16	3 15/16	3 13/16	1 3/8	1 3/16	—
THJ4V ^{7,8}						65	65	—	35	25	—	—								
TJL4V ⁷						100	100	—	65	30	—	—								
TK4V ⁷	800-1200	3	600	—	—	42	42	—	30	22	—	—	15 1/2	8 1/4	5 1/2	8 9/16	5 11/16	1 3/8	5/8	—
TKL4V ⁷	800-1200	3	600	—	—	100	100	—	65	42	—	—	15 1/2	8 1/4	5 1/2	8 9/16	5 11/16	1 3/8	5/8	—
TJH1S-6S	60-600	3	600	—	—	65	65	—	35	25	—	—	16 1/8	8 1/4	3 13/16	3 15/16	9 13/16	1 3/8	1 3/16	—
TJL1S-6S	60-600	3	600	—	—	100	100	—	65	30	—	—	16 1/8	8 1/4	3 13/16	3 15/16	9 13/16	1 3/8	1 3/16	—
TKH8S, 12S	300-1200	3	600	—	—	65	65	—	50	25	—	—	21 7/8	8 1/4	5 1/2	8 9/16	12 11/16	1 3/8	5/8	—
TKL8S, 12S	300-1200	3	600	—	—	100	100	—	65	42	—	—	21 7/8	8 1/4	5 1/2	8 9/16	12 11/16	1 3/8	5/8	—

¹ UL listed with internally mounted accessories at 100,000 amps IC. Contact GE Sales Office for availability of 200 kAIC ratings with internal accessories.

² CSA LR 57114.

³ CSA LR 40350.

⁴ Per UL 489, interrupting capacities are not shown on product label.

⁵ Discontinued.

⁶ Ratings shown for TEC in combination with TECL.

⁷ With Power+ 4 trip unit.

⁸ Suitable for single-phase, use outer two poles.

⁹ No longer available.

¹⁰ Limited availability through Parts Super Center.



Publications and Reference: See Section 22 for a complete list of additional product-related publications

Molded Case Circuit Breakers Industrial Circuit Breakers

Quick Reference Guide

15-600A Record Plus® Circuit Breakers

Section 3

The interruption ratings and voltages shown in the table are maximum ratings. A circuit breaker of the type given in the left-hand column may be applied at the given circuit voltage in any electrical distribution system where the available fault current at the load terminals of the breaker does not exceed the value in the table. That circuit breaker type may also be applied at intermediate values of circuit voltage provided the available fault current at the load terminals of the breaker does not exceed the value in the table for the higher value of voltage.

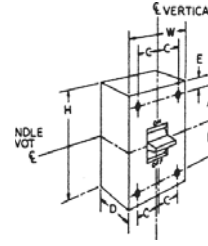

FG 600

Ratings

FC 100 Amp Frame; Current Limiting (UL File No. E-11592)

Circuit Breaker Type	Ampere Rating	No. Poles	Maximum Voltage Rating		UL Listed Interrupting Ratings - rms Symmetrical Amperes (in Thousands)					IEC Listed Interrupting Ratings, Icu, Amperes (in Thousands)				Dimensions in. (mm.)			Approx. Ship Wt./Std. Pack	
					Vac		Vdc			Vac		Vdc		H	W	D		
					240	480	600/347	250 (2p)	500 (3p)	220-240	400-415	500	250 (2p)					500 (3p)
FCS	15-100	2, 3	600	500	42	25	18	22	30	36	22	14	22	30	6.4 (162.6)	3.0 (76.2)	3.2 (81.3)	2.5 lb/1
FCV	15-100	2, 3	600	500	65	35	22	25	35	50	30	18	25	35	6.4 (162.6)	3.0 (76.2)	3.2 (81.3)	2.5 lb/1
FCN	15-100	2, 3	600	500	150	65	25	30	42	85	50	22	30	42	6.4 (162.6)	3.0 (76.2)	3.2 (81.3)	2.5 lb/1
FCH	15-100	2, 3	600	500	200	100	35	42	65	100	80	36	42	65	6.4 (162.6)	3.0 (76.2)	3.2 (81.3)	2.5 lb/1
FCL	15-100	2, 3	600	500	200	150	42	65	80	200	150	50	65	80	6.4 (162.6)	3.0 (76.2)	3.2 (81.3)	2.5 lb/1

FB 100 Amp Frame; Current Limiting (UL File No. E-11592)

Circuit Breaker Type	Ampere Rating	No. Poles	Maximum Voltage Rating		UL Listed Interrupting Ratings - rms Symmetrical Amperes (in Thousands)					Dimensions in. (mm.)			Approx. Ship Wt./Std. Pack	
					Vac					H	W	D		
					240	277	347	480	600/347					
FBV	15-100	1	600/347	—	35	—	35	22	—	—	6.45 (163.8)	1.36 (34.5)	3.28 (83.3)	1.1 lb/1
		2	600/347	—	65	—	—	—	35	22	6.45 (163.8)	2.74 (69.6)	3.28 (83.3)	2.6 lb/1
		3	600/347	—	65	—	—	—	35	22	6.45 (163.8)	4.11 (104.4)	3.28 (83.3)	3.3 lb/1
FBN	15-100	1	600/347	—	65	—	65	25	—	—	6.45 (163.8)	1.36 (34.5)	3.28 (83.3)	1.1 lb/1
		2	600/347	—	150	—	—	—	65	25	6.45 (163.8)	2.74 (69.6)	3.28 (83.3)	2.6 lb/1
		3	600/347	—	150	—	—	—	65	25	6.45 (163.8)	4.11 (104.4)	3.28 (83.3)	3.3 lb/1
FBH	15-100	1	600/347	—	100	—	100	35	—	—	6.45 (163.8)	1.36 (34.5)	3.28 (83.3)	1.1 lb/1
		2	600/347	—	200	—	—	—	100	35	6.45 (163.8)	2.74 (69.6)	3.28 (83.3)	2.6 lb/1
		3	600/347	—	200	—	—	—	100	35	6.45 (163.8)	4.11 (104.4)	3.28 (83.3)	3.3 lb/1
FBL	15-100	1	600/347	—	100	—	100	42	—	—	6.45 (163.8)	1.36 (34.5)	3.28 (83.3)	1.1 lb/1
		2	600/347	—	200	—	—	—	150	42	6.45 (163.8)	2.74 (69.6)	3.28 (83.3)	2.6 lb/1
		3	600/347	—	200	—	—	—	150	42	6.45 (163.8)	4.11 (104.4)	3.28 (83.3)	3.3 lb/1

FG 600 Amp Frame; Current Limiting (UL File No. E-11592)

Circuit Breaker Type	Ampere Rating	No. Poles	Maximum Voltage Rating		UL Listed Interrupting Ratings - rms Symmetrical Amperes (in Thousands)			EN 60947-2 Interrupting Ratings, Icu, Amperes (in Thousands)			Dimensions (in.)			Approx. Ship Wt./Std. Pack
					Vac			Vac			H	W	D	
					240	480	600	240	400-415	690				
FGN	250-600	2	600	—	150	65	25	—	—	—	10.31 (262.0)	5.46 (138.7)	4.53 (115.0)	22 lb/1
		3	600	—	150	65	25	85	50	10	10.31 (262.0)	5.46 (138.7)	4.53 (115.0)	22 lb/1
FGH	250-600	2	600	—	200	100	35	—	—	—	10.31 (262.0)	5.46 (138.7)	4.53 (115.0)	22 lb/1
		3	600	—	200	100	35	100	80	22	10.31 (262.0)	5.46 (138.7)	4.53 (115.0)	22 lb/1
FGL	250-600	2	600	—	200	150	42	—	—	—	10.31 (262.0)	5.46 (138.7)	4.53 (115.0)	22 lb/1
		3	600	—	200	150	42	200	150	40	10.31 (262.0)	5.46 (138.7)	4.53 (115.0)	22 lb/1
FGP	250-600	2	600	—	200	200	65	—	—	—	10.31 (262.0)	5.46 (138.7)	4.53 (115.0)	22 lb/1
		3	600	—	200	200	65	—	—	—	10.31 (262.0)	5.46 (138.7)	4.53 (115.0)	22 lb/1



Molded Case Circuit Breakers

Q-Line Circuit Breakers

Plug-in Circuit Breakers
120/240V Class

TQL and THQL 120/240 Vac

# of Poles	Ampere Rating	Wire Range ¹	120/240 Vac Interrupting Rating	Product Number	List Price GO-138A
1	10 ⁴		5kA	TQL1110	\$20.00
1	15 ²	(1) 14-8 Cu/12-8 Al	10kA	THQL1115	\$20.25
1	20 ²	(1) 14-8 Cu/12-8 Al	10kA	THQL1120	\$20.25
1	25	(1) 14-8 Cu/12-8 Al	10kA	THQL1125	\$20.25
1	30	(1) 14-8 Cu/12-8 Al	10kA	THQL1130	\$20.25
1	35	(1) 8-3 Cu/8-3 Al	10kA	THQL1135	\$21.25
1	40	(1) 8-3 Cu/8-3 Al	10kA	THQL1140	\$21.25
1	45	(1) 8-3 Cu/8-3 Al	10kA	THQL1145	\$21.25
1	50	(1) 8-3 Cu/8-3 Al	10kA	THQL1150	\$21.25
1	60	(1) 8-3 Cu/8-3 Al	10kA	THQL1160	\$21.25
1	70	(1) 6-1/0 Cu/4-1/0 Al	10kA	THQL1170	\$42.50



THQL1120

TQL and THQL 120/240 Vac, Internal Common Trip

# of Poles	Ampere Rating	Wire Range ¹	120/240 Vac Interrupting Rating	Product Number	List Price GO-138A
2	10 ⁴		5kA	TQL2110	\$46.00
2	15	(1) 14-8 Cu/12-8 Al	10kA	THQL2115	\$46.00
2	20	(1) 14-8 Cu/12-8 Al	10kA	THQL2120	\$46.00
2	25	(1) 14-8 Cu/12-8 Al	10kA	THQL2125	\$46.00
2	30	(1) 14-8 Cu/12-8 Al	10kA	THQL2130	\$46.00
2	35	(1) 8-3 Cu/8-3 Al	10kA	THQL2135	\$47.75
2	40	(1) 8-3 Cu/8-3 Al	10kA	THQL2140	\$47.75
2	45	(1) 8-3 Cu/8-3 Al	10kA	THQL2145	\$47.75
2	50	(1) 8-3 Cu/8-3 Al	10kA	THQL2150	\$47.75
2	60	(1) 8-3 Cu/8-3 Al	10kA	THQL2160	\$47.75
2	70	(1) 6-1/0 Cu/4-1/0 Al	10kA	THQL2170	\$95.00
2	80	(1) 6-1/0 Cu/4-1/0 Al	10kA	THQL2180	\$131.00
2	90	(1) 6-1/0 Cu/4-1/0 Al	10kA	THQL2190	\$131.00
2	100	(1) 6-1/0 Cu/4-1/0 Al	10kA	THQL21100	\$131.00
2	110	(1) 2-2/0 Cu/2-2/0 Al	10kA	THQL21110	\$284.00
2	125	(1) 2-2/0 Cu/2-2/0 Al	10kA	THQL21125 ³	\$284.00



THQP130

THQP 120/240 Vac

# of Poles	Ampere Rating	Wire Range ¹	120/240 Vac Interrupting Rating	Product Number	List Price GO-138A
1	15	14-8 Cu/12-8 Al	10kA	THQP115	\$20.25
1	20	14-8 Cu/12-8 Al	10kA	THQP120	\$20.25
1	25	14-8 Cu/12-8 Al	10kA	THQP125	\$20.25
1	30	8-4 Cu/8-4 Al	10kA	THQP130	\$20.25
1	35	8-4 Cu/8-4 Al	10kA	THQP135	\$21.25
1	40	8-4 Cu/8-4 Al	10kA	THQP140	\$21.25
1	45	8-4 Cu/8-4 Al	10kA	THQP145	\$21.25
1	50	8-4 Cu/8-4 Al	10kA	THQP150	\$21.25

THQP 120/240 Vac, Internal Common Trip

# of Poles	Ampere Rating	Wire Range ¹	120/240 Vac Interrupting Rating	Product Number	List Price GO-138A
2	15	14-8 Cu/12-8 Al	10kA	THQP215	\$46.00
2	20	14-8 Cu/12-8 Al	10kA	THQP220	\$46.00
2	25	14-8 Cu/12-8 Al	10kA	THQP225	\$46.00
2	30	8-4 Cu/8-4 Al	10kA	THQP230	\$46.00
2	35	8-4 Cu/8-4 Al	10kA	THQP235	\$47.75
2	40	8-4 Cu/8-4 Al	10kA	THQP240	\$47.75
2	45	8-4 Cu/8-4 Al	10kA	THQP245	\$47.75
2	50	8-4 Cu/8-4 Al	10kA	THQP250	\$47.75



THQP230

¹Solid or stranded for 14-10 AWG.

²UL listed as SWD (Switching Duty) rated. Suitable for switching 120 Vac fluorescent lighting loads.

³Recommended for use as main or submain breaker only.

⁴Not UL listed.

UL listed as HACR (heating, air conditioning and refrigeration).



Publications and Reference: See Section 22 for a complete list of additional product-related publications

Molded Case Circuit Breakers Q-Line Circuit Breakers

Plug-in Circuit Breakers
120/240V Class

Section 3

TQL and THQL 240 Vac, Internal Common Trip

# of Poles	Ampere Rating	Wire Range ¹	240 Vac Interrupting Rating	Product Number	List Price GO-138
2	10		5kA	TQL22010	\$133.00
2	15	14-8 Cu/12-8 Al	10kA	THQL22015	\$133.00
2	20	14-8 Cu/12-8 Al	10kA	THQL22020	\$133.00
2	25	14-8 Cu/12-8 Al	10kA	THQL22025	\$133.00
2	30	14-8 Cu/12-8 Al	10kA	THQL22030	\$133.00
2	35	8-3 Cu/8-3 Al	10kA	THQL22035	\$133.00
2	40	8-3 Cu/8-3 Al	10kA	THQL22040	\$133.00
2	45	8-3 Cu/8-3 Al	10kA	THQL22045	\$133.00
2	50	8-3 Cu/8-3 Al	10kA	THQL22050	\$133.00
2	60	8-3 Cu/8-3 Al	10kA	THQL22060	\$133.00
2	70	6-1/0 Cu/4-1/0 Al	10kA	THQL22070	\$156.00
2	80	6-1/0 Cu/4-1/0 Al	10kA	THQL22080	\$221.00
2	90	6-1/0 Cu/4-1/0 Al	10kA	THQL22090	\$221.00
2	100	6-1/0 Cu/4-1/0 Al	10kA	THQL22100	\$221.00
3	10		5kA	TQL32010	\$165.00
3	15	14-8 Cu/12-8 Al	10kA	THQL32015	\$165.00
3	20	14-8 Cu/12-8 Al	10kA	THQL32020	\$165.00
3	25	14-8 Cu/12-8 Al	10kA	THQL32025	\$165.00
3	30	14-8 Cu/12-8 Al	10kA	THQL32030	\$165.00
3	35	8-3 Cu/8-3 Al	10kA	THQL32035	\$165.00
3	40	8-3 Cu/8-3 Al	10kA	THQL32040	\$165.00
3	45	8-3 Cu/8-3 Al	10kA	THQL32045	\$165.00
3	50	8-3 Cu/8-3 Al	10kA	THQL32050	\$165.00
3	60	8-3 Cu/8-3 Al	10kA	THQL32060	\$165.00
3	70	6-1/0 Cu/4-1/0 Al	10kA	THQL32070	\$216.00
3	80	6-1/0 Cu/4-1/0 Al	10kA	THQL32080	\$245.00
3	90	6-1/0 Cu/4-1/0 Al	10kA	THQL32090	\$245.00
3	100	6-1/0 Cu/4-1/0 Al	10kA	THQL32100	\$245.00

15-100 ampere UL Listed as HACR (heating, air conditioning and refrigeration).

THQL and THHQL 120/240 Vac Arc Fault

# of Poles	Ampere Rating	Wire Range ¹	120/240 Vac Interrupting Rating	Product Number	List Price GO-146A
1	15	14-10 Cu/14-10 Al	10kA	THQL1115AF	\$170.00
1	20	14-10 Cu/14-10 Al	10kA	THQL1120AF	\$170.00
1	15	14-10 Cu/14-10 Al	22kA	THHQL1115AF	\$326.00
1	20	14-10 Cu/14-10 Al	22kA	THHQL1120AF	\$326.00
2	15	14-10 Cu/14-10 Al	10kA	THQL2115AF	\$385.00
2	20	14-10 Cu/14-10 Al	10kA	THQL2120AF	\$385.00
2	15	14-10 Cu/14-10 Al	22kA	THHQL2115AF	\$701.00
2	20	14-10 Cu/14-10 Al	22kA	THHQL2120AF	\$701.00

¹Solid or stranded for 14-10 AWG.

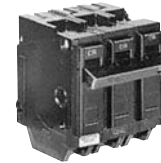

THQL32015



THQL1115AF



THQL2115AF



Molded Case Circuit Breakers Q-Line Circuit Breakers

Plug-in Circuit Breakers
240V Class

THQL and THHQL 120 Vac, Ground Fault Circuit Interrupters

# of Poles	Ampere Rating	Wire Range ¹	120 Vac Interrupting Rating	Product Number	List Price GO-146
1	15	14-8 Cu/12-8 Al	10kA	THQL1115GF	\$159.00
1	20	14-8 Cu/12-8 Al	10kA	THQL1120GF	\$159.00
1	30	14-8 Cu/12-8 Al	10kA	THQL1130GF	\$159.00
1	15	14-8 Cu/12-8 Al	22kA	THHQL1115GF	\$311.00
1	20	14-8 Cu/12-8 Al	22kA	THHQL1120GF	\$311.00
1	30	14-8 Cu/12-8 Al	22kA	THHQL1130GF	\$311.00

THQL and THHQL 120/240 Vac or 208Y/120 Vac, Ground Fault Circuit Interrupters Internal Common Trip

# of Poles	Ampere Rating	Wire Range ¹	120/240 Vac Interrupting Rating	Product Number	List Price GO-146
2	15	14-8 Cu/12-8 Al	10kA	THQL2115GF1	\$282.00
2	20	14-8 Cu/12-8 Al	10kA	THQL2120GF1	\$282.00
2	30	14-8 Cu/12-8 Al	10kA	THQL2130GF1	\$282.00
2	40	8-3 Cu/8-3 Al	10kA	THQL2140GF1	\$282.00
2	50	8-3 Cu/8-3 Al	10kA	THQL2150GF1	\$702.00

THQL and THHQL 120 Vac, Equipment Protection Ground Fault Circuit Breakers Internal Common Trip

# of Poles	Ampere Rating	Wire Range ¹	120 Vac Interrupting Rating	Product Number	List Price GO-146
1	15	14-8 Cu/12-8 Al	10kA	THQL1115GFEP	\$271.00
1	20	14-8 Cu/12-8 Al	10kA	THQL1120GFEP	\$271.00
1	30	14-8 Cu/12-8 Al	10kA	THQL1130GFEP	\$271.00

THQL and THHQL 120/240 Vac or 208Y/120 Vac, Equipment Protection Ground Fault Circuit Breakers

# of Poles	Ampere Rating	Wire Range ¹	120/240 Vac or 208Y/120 Vac Interrupting Rating	Product Number	List Price GO-146
2	15	14-8 Cu/12-8 Al	10kA	THQL2115GFEP	\$481.00
2	20	14-8 Cu/12-8 Al	10kA	THQL2120GFEP	\$481.00
2	30	14-8 Cu/12-8 Al	10kA	THQL2130GFEP	\$481.00

THQL and THHQL 120/240 Vac, High Intensity Discharge Lighting Loads

# of Poles	Ampere Rating	Wire Range ¹	120/240 Vac Interrupting Rating	Product Number	List Price GO-138A
1	15	14-8 Cu/12-8 Al	10kA	THQL1115HID ²	\$26.00
1	20	14-8 Cu/12-8 Al	10kA	THQL1120HID ²	\$26.00
1	25	14-8 Cu/12-8 Al	10kA	THQL1125HID	\$26.00
1	30	14-8 Cu/12-8 Al	10kA	THQL1130HID	\$26.00
1	15	14-8 Cu/12-8 Al	22kA	THHQL1115HID ²	\$49.50
1	20	14-8 Cu/12-8 Al	22kA	THHQL1120HID ²	\$49.50
1	25	14-8 Cu/12-8 Al	22kA	THHQL1125HID	\$49.50
1	30	14-8 Cu/12-8 Al	22kA	THHQL1130HID	\$49.50

UL listed as HID.

THQL and THHQL 120/240 Vac, Internal Common Trip For High Intensity Discharge Lighting Loads

# of Poles	Ampere Rating	Wire Range ¹	120/240 Vac Interrupting Rating	Product Number	List Price GO-138A
2	15	14-8 Cu/12-8 Al	10kA	THQL2115HID	\$57.00
2	20	14-8 Cu/12-8 Al	10kA	THQL2120HID	\$57.00
2	25	14-8 Cu/12-8 Al	10kA	THQL2125HID	\$57.00
2	30	14-8 Cu/12-8 Al	10kA	THQL2130HID	\$57.00
2	15	14-8 Cu/12-8 Al	22kA	THHQL2115HID	\$119.00
2	20	14-8 Cu/12-8 Al	22kA	THHQL2120HID	\$119.00
2	25	14-8 Cu/12-8 Al	22kA	THHQL2125HID	\$119.00
2	30	14-8 Cu/12-8 Al	22kA	THHQL2130HID	\$119.00

UL listed as HID.

¹Solid or stranded for 14-10 AWG.

²UL listed as SWD (switching duty). Suitable for 120 Vac fluorescent lighting loads.

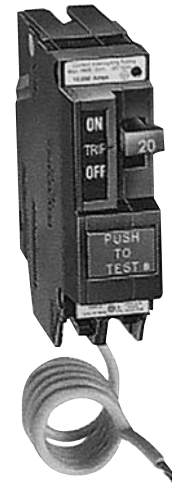

THQL1120GF



THQL2120HID



Publications and Reference: See Section 22 for a complete list of additional product-related publications

Molded Case Circuit Breakers

Q-Line Circuit Breakers

Plug-in Circuit Breakers
240V Class

Section 3

THQL 120/240 Vac, High In-Rush Loads

# of Poles	Ampere Rating	Wire Range ¹	120/240 Vac Interrupting Rating	Product Number	List Price GO-138A
1	15	14-8 Cu/12-8 Al	10kA	THQL1115HM	\$26.00
1	20	14-8 Cu/12-8 Al	10kA	THQL1120HM	\$26.00
1	25	14-8 Cu/12-8 Al	10kA	THQL1125HM	\$26.00
1	30	14-8 Cu/12-8 Al	10kA	THQL1130HM	\$26.00
1	40	8-3 Cu/8-3 Al	10kA	THQL1140HM	\$26.75
1	50	8-3 Cu/8-3 Al	10kA	THQL1150HM	\$26.75



THQL1120HM

THQL 120 Vac, For Factory Installed Shunt Trip^{2,3} Internal Common Trip

# of Poles	Ampere Rating	Wire Range ¹	120 Vac Interrupting Rating	Product Number	List Price GO-138
3	20	14-8 Cu/12-8 Al	10kA	THQL32020ST1	\$273.00

THQL 120/240 Vac, Thermal Magnetic Pole plus Nonautomatic Pole For Switching Neutral

# of Poles	Ampere Rating	Wire Range ¹	120/240 Vac Interrupting Rating	Product Number	List Price GO-138A
2	15	14-8 Cu/12-8 Al	10kA	THQL21WY15	\$74.25
2	20	14-8 Cu/12-8 Al	10kA	THQL21WY20	\$74.25
2	25	14-8 Cu/12-8 Al	10kA	THQL21WY25	\$74.25
2	30	14-8 Cu/12-8 Al	10kA	THQL21WY30	\$74.25
3	15	14-8 Cu/12-8 Al	10kA	THQL31WY15	\$111.00
3	20	14-8 Cu/12-8 Al	10kA	THQL31WY20	\$111.00
3	25	14-8 Cu/12-8 Al	10kA	THQL31WY25	\$111.00
3	30	14-8 Cu/12-8 Al	10kA	THQL31WY30	\$111.00



THLK2125

TQDL 120/240 Vac, Internal Common Trip⁴

# of Poles	Ampere Rating	Wire Range ¹	120/240 Vac Interrupting Rating	Product Number	List Price GO-138A
2	125	1/0-250 Cu/Al	10kA	TQDL21125	\$296.00
2	150	1/0-250 Cu/Al	10kA	TQDL21150	\$296.00
2	175	1/0-250 Cu/Al	10kA	TQDL21175	\$296.00
2	200	1/0-250 Cu/Al	10kA	TQDL21200	\$296.00



TQDL21200

¹Solid or stranded for 14-10 AWG.

²For additional shunt trip offerings see page 3-42.

³UL listed as HACR (heating, air conditioning and refrigeration).

⁴UL listed as HACR (heating, air conditioning and refrigeration).

Requires four one-inch spaces.



Molded Case Circuit Breakers Q-Line Circuit Breakers

Plug-in Circuit Breakers
240V Class

THHQL 120 Vac

# of Poles	Ampere Rating	Wire Range ¹	120 Vac Interrupting Rating	Product Number	List Price GO-138A
1	15	14-8 Cu/12-8 Al	22kA	THHQL1115 ²	\$40.25
1	20	14-8 Cu/12-8 Al	22kA	THHQL1120 ²	\$40.25
1	25	14-8 Cu/12-8 Al	22kA	THHQL1125	\$40.25
1	30	8-3 Cu/8-3 Al	22kA	THHQL1130	\$40.25
1	35	8-3 Cu/8-3 Al	22kA	THHQL1135	\$41.25
1	40	8-3 Cu/8-3 Al	22kA	THHQL1140	\$41.25
1	45	8-3 Cu/8-3 Al	22kA	THHQL1145	\$41.25
1	50	8-3 Cu/8-3 Al	22kA	THHQL1150	\$41.25
1	60	8-3 Cu/8-3 Al	22kA	THHQL1160	\$41.25
1	70	6-1/0 Cu/4-1/0 Al	22kA	THHQL1170	\$58.50



THHQL1120

THHQL 120/240 Vac, Internal Common Trip

# of Poles	Ampere Rating	Wire Range ¹	120/240 Vac Interrupting Rating	Product Number	List Price GO-138A
2	15	14-8 Cu/12-8 Al	22kA	THHQL2115	\$93.00
2	20	14-8 Cu/12-8 Al	22kA	THHQL2120	\$93.00
2	25	14-8 Cu/12-8 Al	22kA	THHQL2125	\$93.00
2	30	8-3 Cu/8-3 Al	22kA	THHQL2130	\$93.00
2	35	8-3 Cu/8-3 Al	22kA	THHQL2135	\$97.00
2	40	8-3 Cu/8-3 Al	22kA	THHQL2140	\$97.00
2	45	8-3 Cu/8-3 Al	22kA	THHQL2145	\$97.00
2	50	8-3 Cu/8-3 Al	22kA	THHQL2150	\$97.00
2	60	8-3 Cu/8-3 Al	22kA	THHQL2160	\$97.00
2	70	6-1/0 Cu/4-1/0 Al	22kA	THHQL2170	\$148.00
2	80	6-1/0 Cu/4-1/0 Al	22kA	THHQL2180	\$210.00
2	90	6-1/0 Cu/4-1/0 Al	22kA	THHQL2190	\$210.00
2	100	6-1/0 Cu/4-1/0 Al	22kA	THHQL21100	\$210.00
2	110	2-2/0 Cu/2-2/0 Al	22kA	THHQL21110	\$686.00
2	125	2-2/0 Cu/2-2/0 Al	22kA	THHQL21125	\$686.00

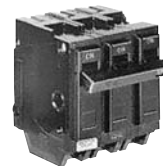

THHQL32015

THHQL 240 Vac, Internal Common Trip

# of Poles	Ampere Rating	Wire Range ¹	240 Vac Interrupting Rating	Product Number	List Price GO-138
2	15	14-8 Cu/12-8 Al	22kA	THHQL22015	\$193.00
2	20	14-8 Cu/12-8 Al	22kA	THHQL22020	\$193.00
2	25	14-8 Cu/12-8 Al	22kA	THHQL22025	\$193.00
2	30	8-3 Cu/8-3 Al	22kA	THHQL22030	\$193.00
2	35	8-3 Cu/8-3 Al	22kA	THHQL22035	\$193.00
2	40	8-3 Cu/8-3 Al	22kA	THHQL22040	\$193.00
2	45	8-3 Cu/8-3 Al	22kA	THHQL22045	\$193.00
2	50	8-3 Cu/8-3 Al	22kA	THHQL22050	\$193.00
2	60	8-3 Cu/8-3 Al	22kA	THHQL22060	\$193.00
2	70	6-1/0 Cu/4-1/0 Al	22kA	THHQL22070	\$251.00
2	80	6-1/0 Cu/4-1/0 Al	22kA	THHQL22080	\$277.00
2	90	6-1/0 Cu/4-1/0 Al	22kA	THHQL22090	\$277.00
2	100	6-1/0 Cu/4-1/0 Al	22kA	THHQL22100	\$277.00
3	15	14-8 Cu/12-8 Al	22kA	THHQL32015	\$251.00
3	20	14-8 Cu/12-8 Al	22kA	THHQL32020	\$251.00
3	25	14-8 Cu/12-8 Al	22kA	THHQL32025	\$251.00
3	30	8-3 Cu/8-3 Al	22kA	THHQL32030	\$251.00
3	35	8-3 Cu/8-3 Al	22kA	THHQL32035	\$251.00
3	40	8-3 Cu/8-3 Al	22kA	THHQL32040	\$251.00
3	45	8-3 Cu/8-3 Al	22kA	THHQL32045	\$251.00
3	50	8-3 Cu/8-3 Al	22kA	THHQL32050	\$251.00
3	60	8-3 Cu/8-3 Al	22kA	THHQL32060	\$251.00
3	70	6-1/0 Cu/4-1/0 Al	22kA	THHQL32070	\$329.00
3	80	6-1/0 Cu/4-1/0 Al	22kA	THHQL32080	\$359.00
3	90	6-1/0 Cu/4-1/0 Al	22kA	THHQL32090	\$359.00
3	100	6-1/0 Cu/4-1/0 Al	22kA	THHQL32100	\$359.00

¹Solid or stranded for 14-10 AWG.

²UL listed as SWD (switching duty) rated. Suitable for switching 120 Vac fluorescent lighting loads.

UL listed HACR (heating, air conditioning and refrigeration).



Publications and Reference: See Section 22 for a complete list of additional product-related publications

Molded Case Circuit Breakers

Q-Line Circuit Breakers

Plug-in Circuit Breakers
240V Class

Section 3

THQDL 120/240 Vac, Internal Common Trip

# of Poles	Ampere Rating	Wire Range ¹	120/240 Vac Interrupting Rating	Product Number	List Price GO-138
2	125	1/0-250 Cu/1/0-250 Al	22kA	THQDL21125	\$713.00
2	150	1/0-250 Cu/1/0-250 Al	22kA	THQDL21150	\$713.00
2	175	1/0-250 Cu/1/0-250 Al	22kA	THQDL21175	\$713.00
2	200	1/0-250 Cu/1/0-250 Al	22kA	THQDL21200	\$713.00

TXQL 120/240 Vac

# of Poles	Ampere Rating	Wire Range ¹	120/240 Vac Interrupting Rating	Product Number	List Price GO-138A
1	15	14-8 Cu/12-8 Al	65kA	TXQL1115 ²	\$74.75
1	20	14-8 Cu/12-8 Al	65kA	TXQL1120 ²	\$74.75
1	25	14-8 Cu/12-8 Al	65kA	TXQL1125	\$74.75
1	30	14-8 Cu/12-8 Al	65kA	TXQL1130	\$74.75

TXQL 120/240 Vac, Internal Common Trip

# of Poles	Ampere Rating	Wire Range ¹	120/240 Vac Interrupting Rating	Product Number	List Price GO-138A
2	15	14-8 Cu/12-8 Al	65kA	TXQL2115	\$186.00
2	20	14-8 Cu/12-8 Al	65kA	TXQL2120	\$186.00
2	25	14-8 Cu/12-8 Al	65kA	TXQL2125	\$186.00
2	30	14-8 Cu/12-8 Al	65kA	TXQL2130	\$186.00
3	15	14-8 Cu/12-8 Al	65kA	TXQL32015	\$348.00
3	20	14-8 Cu/12-8 Al	65kA	TXQL32020	\$348.00
3	25	14-8 Cu/12-8 Al	65kA	TXQL32025	\$348.00
3	30	14-8 Cu/12-8 Al	65kA	TXQL32030	\$348.00

¹Solid or stranded for 14-10 AWG.

²UL listed as SWD (switching duty) rated. Suitable for switching 120 Vac fluorescent lighting loads.

UL listed HACR (heating, air conditioning and refrigeration).



Molded Case Circuit Breakers

Q-Line Circuit Breakers

Bolt-on Circuit Breakers
240V Class



THQB2115

TQB, THQB 120/240 Vac

# of Poles	Ampere Rating	Wire Range ¹	120/240 Vac Interrupting Rating	Product Number	List Price GO-135B
1	10	14-8 Cu/12-8 Al	5kA	TQB1110 ³	\$19.75
1	15	14-8 Cu/12-8 Al	10kA	THQB1115 ²	\$19.75
1	20	14-8 Cu/12-8 Al	10kA	THQB1120 ²	\$19.75
1	25	14-8 Cu/12-8 Al	10kA	THQB1125	\$19.75
1	30	14-8 Cu/12-8 Al	10kA	THQB1130	\$19.75
1	35	8-3 Cu/8-3 Al	10kA	THQB1135	\$19.75
1	40	8-3 Cu/8-3 Al	10kA	THQB1140	\$19.75
1	45	8-3 Cu/8-3 Al	10kA	THQB1145	\$19.75
1	50	8-3 Cu/8-3 Al	10kA	THQB1150	\$19.75
1	60	8-3 Cu/8-3 Al	10kA	THQB1160	\$19.75
1	70	6-1/0 Cu/4-1/0 Al	10kA	THQB1170	\$38.00

TQB, THQB 120/240 Vac, Internal Common Trip

# of Poles	Ampere Rating	Wire Range ¹	120/240 Vac Interrupting Rating	Product Number	List Price GO-135B
2	10	14-8 Cu/12-8 Al	5kA	TQB2110 ³	\$43.50
2	15	14-8 Cu/12-8 Al	10kA	THQB2115	\$43.50
2	20	14-8 Cu/12-8 Al	10kA	THQB2120	\$43.50
2	25	14-8 Cu/12-8 Al	10kA	THQB2125	\$43.50
2	30	14-8 Cu/12-8 Al	10kA	THQB2130	\$43.50
2	35	8-3 Cu/8-3 Al	10kA	THQB2135	\$43.50
2	40	8-3 Cu/8-3 Al	10kA	THQB2140	\$43.50
2	45	8-3 Cu/8-3 Al	10kA	THQB2145	\$43.50
2	50	8-3 Cu/8-3 Al	10kA	THQB2150	\$43.50
2	60	8-3 Cu/8-3 Al	10kA	THQB2160	\$43.50
2	70	8-3 Cu/8-3 Al	10kA	THQB2170	\$82.50
2	80	6-1/0 Cu/4-1/0 Al	10kA	THQB2180	\$113.00
2	90	6-1/0 Cu/4-1/0 Al	10kA	THQB2190	\$113.00
2	100	6-1/0 Cu/4-1/0 Al	10kA	THQB21100	\$113.00

TQB, THQB 240 Vac, Internal Common Trip

# of Poles	Ampere Rating	Wire Range ¹	240 Vac Interrupting Rating	Product Number	List Price GO-135B
2	10	14-8 Cu/12-8 Al	5kA	TQB22010 ³	\$113.00
2	15	14-8 Cu/12-8 Al	10kA	THQB22015	\$113.00
2	20	14-8 Cu/12-8 Al	10kA	THQB22020	\$113.00
2	25	14-8 Cu/12-8 Al	10kA	THQB22025	\$113.00
2	30	14-8 Cu/12-8 Al	10kA	THQB22030	\$113.00
2	35	8-3 Cu/8-3 Al	10kA	THQB22035	\$113.00
2	40	8-3 Cu/8-3 Al	10kA	THQB22040	\$113.00
2	45	8-3 Cu/8-3 Al	10kA	THQB22045	\$113.00
2	50	8-3 Cu/8-3 Al	10kA	THQB22050	\$113.00
2	60	8-3 Cu/8-3 Al	10kA	THQB22060	\$113.00
2	70	6-1/0 Cu/4-1/0 Al	10kA	THQB22070	\$148.00
2	80	6-1/0 Cu/4-1/0 Al	10kA	THQB22080	\$170.00
2	90	6-1/0 Cu/4-1/0 Al	10kA	THQB22090	\$170.00
2	100	6-1/0 Cu/4-1/0 Al	10kA	THQB22100	\$170.00
3	10	14-8 Cu/12-8 Al	5kA	TQB32010 ³	\$139.00
3	15	14-8 Cu/12-8 Al	10kA	THQB32015	\$139.00
3	20	14-8 Cu/12-8 Al	10kA	THQB32020	\$139.00
3	25	14-8 Cu/12-8 Al	10kA	THQB32025	\$139.00
3	30	14-8 Cu/12-8 Al	10kA	THQB32030	\$139.00
3	35	8-3 Cu/8-3 Al	10kA	THQB32035	\$139.00
3	40	8-3 Cu/8-3 Al	10kA	THQB32040	\$139.00
3	45	8-3 Cu/8-3 Al	10kA	THQB32045	\$139.00
3	50	8-3 Cu/8-3 Al	10kA	THQB32050	\$139.00
3	60	8-3 Cu/8-3 Al	10kA	THQB32060	\$139.00
3	70	6-1/0 Cu/4-1/0 Al	10kA	THQB32070	\$175.00
3	80	6-1/0 Cu/4-1/0 Al	10kA	THQB32080	\$199.00
3	90	6-1/0 Cu/4-1/0 Al	10kA	THQB32090	\$199.00
3	100	6-1/0 Cu/4-1/0 Al	10kA	THQB32100	\$199.00

¹Solid or stranded for 14-10 AWG.

²UL listed as SWD (Switching Duty) rated. Suitable for switching 120 Vac fluorescent lighting loads.

³Not UL listed.

UL listed HACR (heating, air conditioning and refrigeration).



Publications and Reference: See Section 22 for a complete list of additional product-related publications

Molded Case Circuit Breakers Q-Line Circuit Breakers

Bolt-on Circuit Breakers
240V Class

Section 3

THQB and THHQB 120/240 Vac Arc Fault (Single pole)

# of Poles	Ampere Rating	Wire Range ¹	120/240 Vac Interrupting Rating	Product Number	List Price GO-133
1	15	14-10 Cu/14-10 Al	10kA	THQB1115AF	\$155.00
1	20	14-10 Cu/14-10 Al	10kA	THQB1120AF	\$155.00
1	15	14-10 Cu/14-10 Al	22kA	THHQB1115AF	\$272.00
1	20	14-10 Cu/14-10 Al	22kA	THHQB1120AF	\$272.00
2	15	14-10 Cu/14-10 Al	10kA	THQB2115AF	\$305.00
2	20	14-10 Cu/14-10 Al	10kA	THQB2120AF	\$305.00
2	15	14-10 Cu/14-10 Al	22kA	THHQB2115AF	\$535.00
2	20	14-10 Cu/14-10 Al	22kA	THHQB2120AF	\$535.00

THQB, THHQB 120 Vac, Ground Fault Breakers (5 ma)

# of Poles	Ampere Rating	Wire Range ¹	120 Vac Interrupting Rating	Product Number	List Price GO-133
1	15	14-8 Cu/12-8 Al	10kA	THQB1115GF	\$120.00
1	20	14-8 Cu/12-8 Al	10kA	THQB1120GF	\$120.00
1	30	14-8 Cu/12-8 Al	10kA	THQB1130GF	\$120.00
1	15	14-8 Cu/12-8 Al	22kA	THHQB1115GF	\$235.00
1	20	14-8 Cu/12-8 Al	22kA	THHQB1120GF	\$235.00
1	30	14-8 Cu/12-8 Al	22kA	THHQB1130GF	\$235.00

THQB 120/240 or 208Y/120 Vac, Ground Fault Breakers (5 ma), Internal Common Trip

# of Poles	Ampere Rating	Wire Range ¹	120/240 or 208Y/120 Vac Interrupting Rating	Product Number	List Price GO-133
2	15	14-8 Cu/12-8 Al	10kA	THQB2115GF	\$212.00
2	20	14-8 Cu/12-8 Al	10kA	THQB2120GF	\$212.00
2	30	14-8 Cu/12-8 Al	10kA	THQB2130GF	\$212.00

THQB 120 Vac, Equipment Protection Ground Fault Circuit Breakers (30 ma)

# of Poles	Ampere Rating	Wire Range ¹	120 Vac Interrupting Rating	Product Number	List Price GO-133
1	15	14-8 Cu/12-8 Al	10kA	THQB1115GFEP	\$205.00
1	20	14-8 Cu/12-8 Al	10kA	THQB1120GFEP	\$205.00
1	30	14-8 Cu/12-8 Al	10kA	THQB1130GFEP	\$205.00

THQB 120/240 or 208Y/120 Vac, Ground Fault Breakers Equipment Protection (30 ma) Ground Fault Circuit Breakers, Internal Common Trip

# of Poles	Ampere Rating	Wire Range ¹	120/240 or 208Y/120 Vac Interrupting Rating	Product Number	List Price GO-133
2	15	14-8 Cu/12-8 Al	10kA	THQB2115GFEP	\$273.00
2	20	14-8 Cu/12-8 Al	10kA	THQB2120GFEP	\$273.00
2	30	14-8 Cu/12-8 Al	10kA	THQB2130GFEP	\$273.00

THQB, THHQB 120/240 Vac, High Intensity Discharge Lighting Loads³

# of Poles	Ampere Rating	Wire Range ¹	120/240 Vac Interrupting Rating	Product Number	List Price GO-135B
1	15	14-8 Cu/12-8 Al	10kA	THQB1115HID ²	\$23.75
1	20	14-8 Cu/12-8 Al	10kA	THQB1120HID ²	\$23.75
1	25	14-8 Cu/12-8 Al	10kA	THQB1125HID	\$23.75
1	30	14-8 Cu/12-8 Al	10kA	THQB1130HID	\$23.75
1	15	14-8 Cu/12-8 Al	22kA	THHQB1115HID ²	\$41.50
1	20	14-8 Cu/12-8 Al	22kA	THHQB1120HID ²	\$41.50
1	25	14-8 Cu/12-8 Al	22kA	THHQB1125HID	\$47.00
1	30	14-8 Cu/12-8 Al	22kA	THHQB1130HID	\$47.00
2	15	14-8 Cu/12-8 Al	10kA	THQB2115HID	\$52.50
2	20	14-8 Cu/12-8 Al	10kA	THQB2120HID	\$52.50
2	25	14-8 Cu/12-8 Al	10kA	THQB2125HID	\$52.50
2	30	14-8 Cu/12-8 Al	10kA	THQB2130HID	\$52.50

¹Solid or stranded for 14-10 AWG.

²UL listed as SWD (switching duty). Suitable for switching 120 Vac fluorescent lighting loads.

³UL listed as HID (high intensity discharge).

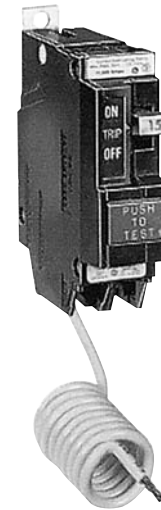

THQB1115GF



Molded Case Circuit Breakers Q-Line Circuit Breakers

Bolt-on Circuit Breakers
240V Class

THHQB 120/240 Vac, Internal Common Trip, High Intensity Discharge Lighting Loads¹

# of Poles	Ampere Rating	Wire Range ²	120/240 Vac Interrupting Rating	Product Number	List Price GO-135B
2	15	14-8 Cu/12-8 Al	22kA	THHQB2115HID	\$98.50
2	20	14-8 Cu/12-8 Al	22kA	THHQB2120HID	\$98.50
2	25	14-8 Cu/12-8 Al	22kA	THHQB2125HID	\$98.50
2	30	14-8 Cu/12-8 Al	22kA	THHQB2130HID	\$98.50

THQB 120 Vac with Factory Installed 120 Vac Shunt Trip^{3,4}

# of Poles	Ampere Rating	Wire Range ²	120 Vac Interrupting Rating	Product Number	List Price GO-135B
1	20	14-8 Cu/12-8 Al	10kA	THQB1120ST1	\$113.00

THQB 120 Vac, Internal Common Trip with Factory Installed 120 Vac Shunt Trip^{3,4}

# of Poles	Ampere Rating	Wire Range ²	120 Vac Interrupting Rating	Product Number	List Price GO-135B
2	20	14-8 Cu/12-8 Al	10kA	THQB2120ST1	\$137.00
2	30	14-8 Cu/12-8 Al	10kA	THQB2130ST1	\$137.00
2	100	6-1/0 Cu/4-1/0 Al	10kA	THQB21100ST1	\$205.00
3	20	14-8 Cu/12-8 Al	10kA	THQB32020ST1	\$234.00
3	30	14-8 Cu/12-8 Al	10kA	THQB32030ST1	\$234.00
3	40	8-3 Cu/8-3 Al	10kA	THQB32040ST1	\$234.00
3	50	8-3 Cu/8-3 Al	10kA	THQB32050ST1	\$234.00
3	60	8-3 Cu/8-3 Al	10kA	THQB32060ST1	\$234.00
3	70	6-1/0 Cu/4-1/0 Al	10kA	THQB32070ST1	\$270.00
3	80	6-1/0 Cu/4-1/0 Al	10kA	THQB32080ST1	\$295.00
3	90	6-1/0 Cu/4-1/0 Al	10kA	THQB32090ST1	\$295.00
3	100	6-1/0 Cu/4-1/0 Al	10kA	THQB32100ST1	\$295.00

THQB 120 Vac with Switching Neutral Single Thermal Magnetic Pole; Single Nonautomatic Pole

# of Poles	Ampere Rating	Wire Range ²	120 Vac Interrupting Rating	Product Number	List Price GO-135B
2	15	14-8 Cu/12-8 Al	10kA	THQB21WY15	\$58.50
2	20	14-8 Cu/12-8 Al	10kA	THQB21WY20	\$58.50
2	25	14-8 Cu/12-8 Al	10kA	THQB21WY25	\$58.50
2	30	14-8 Cu/12-8 Al	10kA	THQB21WY30	\$58.50

THQB 120 Vac with Switching Neutral Two Thermal Magnetic Pole; Single Nonautomatic Pole

# of Poles	Ampere Rating	Wire Range ²	120 Vac Interrupting Rating	Product Number	List Price GO-135B
3	15	14-8 Cu/12-8 Al	10kA	THQB31WY15	\$88.00
3	20	14-8 Cu/12-8 Al	10kA	THQB31WY20	\$88.00
3	25	14-8 Cu/12-8 Al	10kA	THQB31WY25	\$88.00
3	30	14-8 Cu/12-8 Al	10kA	THQB31WY30	\$88.00

THHQB 120/240 Vac

# of Poles	Ampere Rating	Wire Range ²	120/240 Vac Interrupting Rating	Product Number	List Price GO-135B
1	15	14-8 Cu/12-8 Al	22kA	THHQB1115 ⁵	\$35.00
1	20	14-8 Cu/12-8 Al	22kA	THHQB1120 ⁵	\$35.00
1	25	14-8 Cu/12-8 Al	22kA	THHQB1125	\$39.00
1	30	14-8 Cu/12-8 Al	22kA	THHQB1130	\$39.00
1	35	8-3 Cu/8-3 Al	22kA	THHQB1135	\$39.00
1	40	8-3 Cu/8-3 Al	22kA	THHQB1140	\$39.00
1	45	8-3 Cu/8-3 Al	22kA	THHQB1145	\$39.00
1	50	8-3 Cu/8-3 Al	22kA	THHQB1150	\$39.00
1	60	8-3 Cu/8-3 Al	22kA	THHQB1160	\$39.00
1	70	6-1/0 Cu/4-1/0 Al	22kA	THHQB1170	\$51.00

¹UL listed as HID (high intensity discharge).

²Solid or stranded for 14-10 AWG.

³For additional shunt trip offerings see page 3-42.

⁴20-60 ampere are UL listed as HACR (heating, air conditioning and refrigeration).

⁵UL listed as SWD (switching duty). Suitable for switching 120 Vac fluorescent lighting loads.



Publications and Reference: See Section 22 for a complete list of additional product-related publications

Molded Case Circuit Breakers

Q-Line Circuit Breakers

Section 3

Bolt-on Circuit Breakers
240V Class

THHQB 120/240 Vac, Internal Common Trip

# of Poles	Ampere Rating	Wire Range ¹	120/240 Vac Interrupting Rating	Product Number	List Price GO-135B
2	15	14-8 Cu/12-8 Al	22kA	THHQB2115	\$82.50
2	20	14-8 Cu/12-8 Al	22kA	THHQB2120	\$82.50
2	25	14-8 Cu/12-8 Al	22kA	THHQB2125	\$82.50
2	30	14-8 Cu/12-8 Al	22kA	THHQB2130	\$82.50
2	35	8-3 Cu/8-3 Al	22kA	THHQB2135	\$82.50
2	40	8-3 Cu/8-3 Al	22kA	THHQB2140	\$82.50
2	45	8-3 Cu/8-3 Al	22kA	THHQB2145	\$82.50
2	50	8-3 Cu/8-3 Al	22kA	THHQB2150	\$82.50
2	60	8-3 Cu/8-3 Al	22kA	THHQB2160	\$82.50
2	70	6-1/0 Cu/4-1/0 Al	22kA	THHQB2170	\$126.00
2	80	6-1/0 Cu/4-1/0 Al	22kA	THHQB2180	\$183.00
2	90	6-1/0 Cu/4-1/0 Al	22kA	THHQB2190	\$183.00
2	100	6-1/0 Cu/4-1/0 Al	22kA	THHQB21100	\$183.00



THHQB2115

THHQB 240 Vac, Internal Common Trip

# of Poles	Ampere Rating	Wire Range ¹	240 Vac Interrupting Rating	Product Number	List Price GO-135B
2	15	14-8 Cu/12-8 Al	22kA	THHQB22015	\$156.00
2	20	14-8 Cu/12-8 Al	22kA	THHQB22020	\$156.00
2	25	14-8 Cu/12-8 Al	22kA	THHQB22025	\$156.00
2	30	14-8 Cu/12-8 Al	22kA	THHQB22030	\$156.00
2	35	8-3 Cu/8-3 Al	22kA	THHQB22035	\$156.00
2	40	8-3 Cu/8-3 Al	22kA	THHQB22040	\$156.00
2	45	8-3 Cu/8-3 Al	22kA	THHQB22045	\$156.00
2	50	8-3 Cu/8-3 Al	22kA	THHQB22050	\$156.00
2	60	8-3 Cu/8-3 Al	22kA	THHQB22060	\$156.00
2	70	6-1/0 Cu/4-1/0 Al	22kA	THHQB22070	\$196.00
2	80	6-1/0 Cu/4-1/0 Al	22kA	THHQB22080	\$235.00
2	90	6-1/0 Cu/4-1/0 Al	22kA	THHQB22090	\$235.00
2	100	6-1/0 Cu/4-1/0 Al	22kA	THHQB22100	\$235.00
3	15	14-8 Cu/12-8 Al	22kA	THHQB32015	\$212.00
3	20	14-8 Cu/12-8 Al	22kA	THHQB32020	\$212.00
3	25	14-8 Cu/12-8 Al	22kA	THHQB32025	\$212.00
3	30	14-8 Cu/12-8 Al	22kA	THHQB32030	\$212.00
3	35	8-3 Cu/8-3 Al	22kA	THHQB32035	\$212.00
3	40	8-3 Cu/8-3 Al	22kA	THHQB32040	\$212.00
3	45	8-3 Cu/8-3 Al	22kA	THHQB32045	\$212.00
3	50	8-3 Cu/8-3 Al	22kA	THHQB32050	\$212.00
3	60	8-3 Cu/8-3 Al	22kA	THHQB32060	\$212.00
3	70	6-1/0 Cu/4-1/0 Al	22kA	THHQB32070	\$263.00
3	80	6-1/0 Cu/4-1/0 Al	22kA	THHQB32080	\$307.00
3	90	6-1/0 Cu/4-1/0 Al	22kA	THHQB32090	\$307.00
3	100	6-1/0 Cu/4-1/0 Al	22kA	THHQB32100	\$307.00

TXQB 120/240 Vac

# of Poles	Ampere Rating	Wire Range ¹	120/240 Vac Interrupting Rating	Product Number	List Price GO-135B
1	15	14-8 Cu/12-8 Al	65kA	TXQB1115 ²	\$63.50
1	20	14-8 Cu/12-8 Al	65kA	TXQB1120 ²	\$63.50
1	25	14-8 Cu/12-8 Al	65kA	TXQB1125	\$63.50
1	30	14-8 Cu/12-8 Al	65kA	TXQB1130	\$63.50

TXQB 120/240 Vac, Internal Common Trip

# of Poles	Ampere Rating	Wire Range ¹	120/240 Vac Interrupting Rating	Product Number	List Price GO-135B
2	15	14-8 Cu/12-8 Al	65kA	TXQB2115	\$154.00
2	20	14-8 Cu/12-8 Al	65kA	TXQB2120	\$154.00
2	25	14-8 Cu/12-8 Al	65kA	TXQB2125	\$154.00
2	30	14-8 Cu/12-8 Al	65kA	TXQB2130	\$154.00

TXQB 240 Vac, Internal Common Trip

# of Poles	Ampere Rating	Wire Range ¹	240 Vac Interrupting Rating	Product Number	List Price GO-135B
3	15	14-8 Cu/12-8 Al	65kA	TXQB32015	\$263.00
3	20	14-8 Cu/12-8 Al	65kA	TXQB32020	\$263.00
3	25	14-8 Cu/12-8 Al	65kA	TXQB32025	\$263.00
3	30	14-8 Cu/12-8 Al	65kA	TXQB32030	\$263.00

¹Solid or stranded for 14-10 AWG.

²UL listed as SWD (switching duty) rated. Suitable for switching 120 Vac fluorescent lighting loads.

UL listed HACR (heating, air conditioning and refrigeration).



Molded Case Circuit Breakers Q-Line Circuit Breakers

Cable-in Cable-out (lug-lug)
240V Class

TQC, THQC, THHQC 120/240 Vac

# of Poles	Ampere Rating	Wire Range ¹	120/240 Vac Interrupting Rating	Product Number ²	List Price GO-135B	120/240 Vac Interrupting Rating	Product Number ²	List Price GO-135B
1	10	14-4 Cu/12-2 Al	5kA	TQC1110WL	\$20.25			
1	15	14-8 Cu/12-8 Al	10kA	THQC1115WL ^{3,4}	\$20.25	22kA	THHQC1115WL ³	\$35.50
1	20	14-8 Cu/12-8 Al	10kA	THQC1120WL ^{3,4}	\$20.25	22kA	THHQC1120WL ³	\$35.50
1	25	14-8 Cu/12-8 Al	10kA	THQC1125WL ³	\$20.25	22kA	THHQC1125WL ³	\$40.50
1	30	14-8 Cu/12-8 Al	10kA	THQC1130WL ³	\$20.25	22kA	THHQC1130WL ³	\$40.50
1	35	8-3 Cu/8-3 Al	10kA	THQC1135WL ³	\$20.25	22kA	THHQC1135WL ³	\$40.50
1	40	8-3 Cu/8-3 Al	10kA	THQC1140WL ³	\$20.25	22kA	THHQC1140WL ³	\$40.50
1	45	8-3 Cu/8-3 Al	10kA	THQC1145WL ³	\$20.25	22kA	THHQC1145WL ³	\$40.50
1	50	8-3 Cu/8-3 Al	10kA	THQC1150WL ³	\$20.25	22kA	THHQC1150WL ³	\$40.50
1	60	8-3 Cu/8-3 Al	10kA	THQC1160WL ³	\$20.25	22kA	THHQC1160WL ³	\$40.50
1	70	6-1/0 Cu/4-1/0 Al	10kA	THQC1170WL	\$39.00	22kA	THHQC1170WL	\$52.00

TQC, THQC, THHQC 120/240 Vac, Internal Common Trip

# of Poles	Ampere Rating	Wire Range ¹	120/240 Vac Interrupting Rating	Product Number ²	List Price GO-135B	120/240 Vac Interrupting Rating	Product Number ²	List Price GO-135B
2	10	14-4 Cu/12-2 Al	5kA	TQC2110WL	\$46.50			
2	15	14-8 Cu/12-8 Al	10kA	THQC2115WL ³	\$43.50	22kA	THHQC2115WL ³	\$83.50
2	20	14-8 Cu/12-8 Al	10kA	THQC2120WL ³	\$43.50	22kA	THHQC2120WL ³	\$83.50
2	25	14-8 Cu/12-8 Al	10kA	THQC2125WL ³	\$43.50			
2	30	14-8 Cu/12-8 Al	10kA	THQC2130WL ³	\$43.50	22kA	THHQC2130WL ³	\$83.50
2	35	8-3 Cu/8-3 Al	10kA	THQC2135WL ³	\$43.50	22kA	THHQC2135WL ³	\$83.50
2	40	8-3 Cu/8-3 Al	10kA	THQC2140WL ³	\$43.50	22kA	THHQC2140WL ³	\$83.50
2	45	8-3 Cu/8-3 Al	10kA	THQC2145WL ³	\$43.50	22kA	THHQC2145WL ³	\$83.50
2	50	8-3 Cu/8-3 Al	10kA	THQC2150WL ³	\$43.50	22kA	THHQC2150WL ³	\$83.50
2	60	8-3 Cu/8-3 Al	10kA	THQC2160WL ³	\$43.50	22kA	THHQC2160WL ³	\$83.50
2	70	6-1/0 Cu/4-1/0 Al	10kA	THQC2170WL	\$83.50	22kA	THHQC2170WL	\$129.00
2	80	6-1/0 Cu/4-1/0 Al	10kA	THQC2180WL	\$116.00	22kA	THHQC2180WL	\$188.00
2	90	6-1/0 Cu/4-1/0 Al	10kA	THQC2190WL	\$116.00	22kA	THHQC2190WL	\$188.00
2	100	6-1/0 Cu/4-1/0 Al	10kA	THQC21100WL	\$116.00	22kA	THHQC21100WL	\$188.00

TQC, THQC, THHQC 240 Vac, Internal Common Trip

# of Poles	Ampere Rating	Wire Range ¹	240 Vac Interrupting Rating	Product Number ²	List Price GO-135B	240 Vac Interrupting Rating	Product Number	List Price GO-135B
2	10	14-4 Cu/12-2 Al	5kA	TQC22010WL	\$116.00			
2	15	14-8 Cu/12-8 Al	10kA	THQC22015WL	\$116.00	22kA	THHQC22015WL	\$159.00
2	20	14-8 Cu/12-8 Al	10kA	THQC22020WL	\$116.00	22kA	THHQC22020WL	\$159.00
2	25	14-8 Cu/12-8 Al	10kA	THQC22025WL	\$116.00	22kA	THHQC22025WL	\$159.00
2	30	14-8 Cu/12-8 Al	10kA	THQC22030WL	\$116.00	22kA	THHQC22030WL	\$159.00
2	35	8-3 Cu/8-3 Al	10kA	THQC22035WL	\$116.00	22kA	THHQC22035WL	\$159.00
2	40	8-3 Cu/8-3 Al	10kA	THQC22040WL	\$116.00	22kA	THHQC22040WL	\$159.00
2	45	8-3 Cu/8-3 Al	10kA	THQC22045WL	\$116.00	22kA	THHQC22045WL	\$159.00
2	50	8-3 Cu/8-3 Al	10kA	THQC22050WL	\$116.00	22kA	THHQC22050WL	\$159.00
2	60	8-3 Cu/8-3 Al	10kA	THQC22060WL	\$116.00	22kA	THHQC22060WL	\$159.00
2	70	6-1/0 Cu/4-1/0 Al	10kA	THQC22070WL	\$152.00	22kA	THHQC22070WL	\$200.00
2	80	6-1/0 Cu/4-1/0 Al	10kA	THQC22080WL	\$173.00	22kA	THHQC22080WL	\$240.00
2	90	6-1/0 Cu/4-1/0 Al	10kA	THQC22090WL	\$173.00	22kA	THHQC22090WL	\$240.00
2	100	6-1/0 Cu/4-1/0 Al	10kA	THQC22100WL	\$173.00	22kA	THHQC22100WL	\$240.00
3	10	14-4 Cu/12-2 Al	5kA	TQC32010WL	\$141.00			
3	15	14-8 Cu/12-8 Al	10kA	THQC32015WL	\$141.00	22kA	THHQC32015WL	\$216.00
3	20	14-8 Cu/12-8 Al	10kA	THQC32020WL	\$141.00	22kA	THHQC32020WL	\$216.00
3	25	14-8 Cu/12-8 Al	10kA	THQC32025WL	\$141.00	22kA	THHQC32025WL	\$216.00
3	30	14-8 Cu/12-8 Al	10kA	THQC32030WL	\$141.00	22kA	THHQC32030WL	\$216.00
3	35	8-3 Cu/8-3 Al	10kA	THQC32035WL	\$141.00	22kA	THHQC32035WL	\$216.00
3	40	8-3 Cu/8-3 Al	10kA	THQC32040WL	\$141.00	22kA	THHQC32040WL	\$216.00
3	45	8-3 Cu/8-3 Al	10kA	THQC32045WL	\$141.00	22kA	THHQC32045WL	\$216.00
3	50	8-3 Cu/8-3 Al	10kA	THQC32050WL	\$141.00	22kA	THHQC32050WL	\$216.00
3	60	8-3 Cu/8-3 Al	10kA	THQC32060WL	\$141.00	22kA	THHQC32060WL	\$216.00
3	70	6-1/0 Cu/4-1/0 Al	10kA	THQC32070WL	\$178.00	22kA	THHQC32070WL	\$267.00
3	80	6-1/0 Cu/4-1/0 Al	10kA	THQC32080WL	\$202.00	22kA	THHQC32080WL	\$314.00
3	90	6-1/0 Cu/4-1/0 Al	10kA	THQC32090WL	\$202.00	22kA	THHQC32090WL	\$314.00
3	100	6-1/0 Cu/4-1/0 Al	10kA	THQC32100WL	\$202.00	22kA	THHQC32100WL	\$314.00

¹Solid or stranded for 14-10 AWG.

²Use additional suffix "BP" (THQC32020WLBP) for bulk pack of 48 poles. Carton weight 20 lbs. 15-60 ampere breakers only.

³Suitable for mounting on standard 35mm DIN Rail. Refer to table on page 3-23 for termination options.

⁴UL listed as SWD (switching duty) rated. Suitable for switching 120 Vac fluorescent lighting loads.

UL listed HACR (heating, air conditioning and refrigeration). Refer to Q-Line accessories listed on pages 3-26 to 3-27.



Publications and Reference: See Section 22 for a complete list of additional product-related publications

Molded Case Circuit Breakers

Q-Line Circuit Breakers

Cable-in Cable-out (lug-lug)
240V Class

Section 3

THQC 120 Vac, Ground Fault Circuit Interrupter

# of Poles	Ampere Rating	Wire Range ¹	120 Vac Interrupting Rating	Product Number	List Price GO-133
1	15	14-8 Cu/12-8 Al	10kA	THQC1115GF ²	\$128.00
1	20	14-8 Cu/12-8 Al	10kA	THQC1120GF ²	\$128.00
1	30	14-8 Cu/12-8 Al	10kA	THQC1130GF ²	\$128.00

TXQC 120/240 Vac

# of Poles	Ampere Rating	Wire Range ¹	120/240 Vac Interrupting Rating	Product Number	List Price GO-135B
1	15	14-8 Cu/12-8 Al	65kA	TXQC1115WL	\$63.50
1	20	14-8 Cu/12-8 Al	65kA	TXQC1120WL	\$63.50
1	25	14-8 Cu/12-8 Al	65kA	TXQC1125WL	\$63.50
1	30	14-8 Cu/12-8 Al	65kA	TXQC1130WL	\$63.50

TXQC 120/240 Vac, Internal Common Trip

# of Poles	Ampere Rating	Wire Range ¹	120/240 Vac Interrupting Rating	Product Number	List Price GO-135B
2	15	14-8 Cu/12-8 Al	65kA	TXQC2115WL	\$157.00
2	20	14-8 Cu/12-8 Al	65kA	TXQC2120WL	\$157.00
2	25	14-8 Cu/12-8 Al	65kA	TXQC2125WL	\$157.00
2	30	14-8 Cu/12-8 Al	65kA	TXQC2130WL	\$157.00

TXQC 240 Vac, Internal Common Trip

# of Poles	Ampere Rating	120/240 Vac Interrupting Rating	Wire Range ¹	Product Number	List Price GO-138A
3	15	65kA	14-8 Cu/12-8 Al	TXQC32015WL	\$267.00
3	20	65kA	14-8 Cu/12-8 Al	TXQC32020WL	\$267.00
3	25	65kA	14-8 Cu/12-8 Al	TXQC32025WL	\$267.00
3	30	65kA	14-8 Cu/12-8 Al	TXQC32030WL	\$267.00

¹Solid or stranded for 14-10 AWG.

²Requires mounting plate. See page 3-26. Not suitable for use in GE column panels.

UL listed HACR (heating, air conditioning and refrigeration).

Use Q-Line mounting accessories listed on pages 3-26 to 3-27.



THQC1120GF



Molded Case Circuit Breakers

Q-Line Circuit Breakers

DIN-Rail Mount
240V Class

Section 3

Product Features

Multi-terminal Configuration Breakers

- 35 mm DIN rail mounting
- Optional front/rear panel mounting kits—THQCFMK, page 3-26.
- Optional load end terminal for up to (4) 0.25-inch quick connects.

Contact local GE sales office for ring terminal configurations—not DIN rail compatible.

THQC, THHQC 120/240 Vac

# of Poles	Ampere Rating	120/240 Vac Interrupting Rating	Product Number	List Price GO-135B	CC Suffix List Price Adder	X2 Suffix List Price Adder
1	15	10kA	THQC1115LL ¹	\$17.25		
1	20	10kA	THQC1120LL ¹	\$17.25		
1	25	10kA	THQC1125LL	\$17.25		
1	30	10kA	THQC1130LL	\$17.25		
1	35	10kA	THQC1135LL	\$17.25		
1	40	10kA	THQC1140LL	\$17.25		
1	45	10kA	THQC1145LL	\$17.25		
1	50	10kA	THQC1150LL	\$17.25		
1	60	10kA	THQC1160LL	\$17.25	\$4.00	\$1.50
1	15	22kA	THHQC1115LL	\$32.50		
1	20	22kA	THHQC1120LL	\$32.50		
1	25	22kA	THHQC1125LL	\$37.50		
1	30	22kA	THHQC1130LL	\$37.50		
1	35	22kA	THHQC1135LL	\$37.50		
1	40	22kA	THHQC1140LL	\$37.50		
1	45	22kA	THHQC1145LL	\$37.50		
1	50	22kA	THHQC1150LL	\$37.50		
1	60	22kA	THHQC1160LL	\$37.50		

15-60A UL Listed HACR (heating, air conditioning and refrigeration)

THQC, THHQC 120/240 Vac, Internal Common Trip

# of Poles	Ampere Rating	120/240 Vac Interrupting Rating	Product Number	List Price GO-135B	CC Suffix List Price Adder	X2 Suffix List Price Adder
2	15	10kA	THQC2115LL ¹	\$37.50		
2	20	10kA	THQC2120LL ¹	\$37.50		
2	25	10kA	THQC2125LL	\$37.50		
2	30	10kA	THQC2130LL	\$37.50		
2	35	10kA	THQC2135LL	\$37.50		
2	40	10kA	THQC2140LL	\$37.50		
2	45	10kA	THQC2145LL	\$37.50		
2	50	10kA	THQC2150LL	\$37.50		
2	60	10kA	THQC2160LL	\$37.50	\$8.00	\$3.00
2	15	22kA	THHQC2115LL	\$77.50		
2	20	22kA	THHQC2120LL	\$77.50		
2	25	22kA	THHQC2125LL	\$77.50		
2	30	22kA	THHQC2130LL	\$77.50		
2	35	22kA	THHQC2135LL	\$77.50		
2	40	22kA	THHQC2140LL	\$77.50		
2	45	22kA	THHQC2145LL	\$77.50		
2	50	22kA	THHQC2150LL	\$77.50		
2	60	22kA	THHQC2160LL	\$77.50		

15-60A UL Listed HACR (heating, air conditioning and refrigeration)

Terminal Configuration

Suffix ²	Line Terminal	Load Terminal
WL	TQAL3A	THQEL3
X2	TQAL3A	N/A
LL	N/A	N/A
CC	TQAL3A	THQECC
None	N/A	THQEL3

Terminal Selection

Type	Wire Range	Product Number	List Price GO-135B
Lug-Line only	14-6 Cu/12-2 Al	TQAL3A	\$1.50
Lug-Load only	14-2 Cu/12-2 Al	THQEL3	\$1.50
Quick Connector-Load only	(4) 14 Cu or (4) 12 Al	THQECC	\$2.50

¹15 and 20 ampere breakers UL listed as SWD (Switching Duty) rated. Suitable for switching 120 Vac fluorescent lighting loads.

²Use additional suffix "BP" (THQC1120CCBP) for bulk pack of 48 poles. Must be ordered in multiples of 48 poles.

Additional Q-Line mounting accessories listed on pages 3-26 to 3-27.



Publications and Reference: See Section 22 for a complete list of additional product-related publications

Molded Case Circuit Breakers Q-Line Circuit Breakers

Cable-in Cable-out (lug-lug)
240V Class

Section 3

TQD 240 Vac, Internal Common Trip

# of Poles	Ampere Rating	240 Vac Interrupting Rating	Product Number ^{1,2}	List Price GO-135F
2	100	10kA	TQD22100WL	\$249.00
2	125	10kA	TQD22125WL	\$249.00
2	150	10kA	TQD22150WL	\$249.00
2	175	10kA	TQD22175WL	\$249.00
2	200	10kA	TQD22200WL	\$249.00
2	225	10kA	TQD22225WL	\$249.00
3	100	10kA	TQD32100WL	\$641.00
3	125	10kA	TQD32125WL	\$641.00
3	150	10kA	TQD32150WL	\$641.00
3	175	10kA	TQD32175WL	\$641.00
3	200	10kA	TQD32200WL	\$641.00
3	225	10kA	TQD32225WL	\$641.00



TJD432300WL

TQD 240 Vac, Internal Common Trip with Factory Installed 120 Vac Shunt Trip³

# of Poles	Ampere Rating	240 Vac Interrupting Rating	Product Number ^{1,2}	List Price GO-135F
3	125	10kA	TQD32125ST1	\$793.00
3	150	10kA	TQD32150ST1	\$793.00
3	175	10kA	TQD32175ST1	\$793.00
3	200	10kA	TQD32200ST1	\$793.00
3	225	10kA	TQD32225ST1	\$793.00

THQD 240 Vac, Internal Common Trip

# of Poles	Ampere Rating	240 Vac Interrupting Rating	Product Number ^{1,2}	List Price GO-135F
2	100	22kA	THQD22100WL	\$568.00
2	125	22kA	THQD22125WL	\$568.00
2	150	22kA	THQD22150WL	\$568.00
2	175	22kA	THQD22175WL	\$568.00
2	200	22kA	THQD22200WL	\$568.00
2	225	22kA	THQD22225WL	\$568.00
3	100	22kA	THQD32100WL	\$907.00
3	125	22kA	THQD32125WL	\$907.00
3	150	22kA	THQD32150WL	\$907.00
3	175	22kA	THQD32175WL	\$907.00
3	200	22kA	THQD32200WL	\$907.00
3	225	22kA	THQD32225WL	\$907.00

TJD 240 Vac, Internal Common Trip

# of Poles	Ampere Rating	240 Vac Interrupting Rating	Product Number ^{1,2}	List Price GO-135LGJ
2	250	22kA	TJD422250WL	\$1494.00
2	300	22kA	TJD422300WL	\$1494.00
2	350	22kA	TJD422350WL	\$1494.00
2	400	22kA	TJD422400WL	\$1494.00
2	400 Molded Case Switch	22kA	TJD422Y400	\$1169.00
3	250	22kA	TJD432250WL ⁴	\$1802.00
3	300	22kA	TJD432300WL ⁴	\$1802.00
3	350	22kA	TJD432350WL ⁴	\$1802.00
3	400	22kA	TJD432400WL ⁴	\$1802.00
3	400 Molded Case Switch	22kA	TJD432Y400 ⁴	\$1509.00

¹Refer to table on page 3-101 for lug and wire range data.

²Includes line and load lugs. For optional configurations see page 3-3.

³For additional shunt trip options see page 3-42.

⁴TJD uses same accessories as J600 line. TJD not listed HACR.

UL listed HACR (heating, air conditioning and refrigeration).



Molded Case Circuit Breakers

Q-Line Circuit Breakers

Molded Case Switches 240V Class

Note: Molded case switches may be used as main devices in panelboards and switchboards but cannot be used as subfeeds or branch breakers because they do not provide wire protection. Q-Line and TEB molded case switches have a 10,000 ampere symmetrical short circuit withstand rating when protected by a fuse or circuit breaker rated 10,000 amperes IC or greater and whose ampere rating does not exceed the ampere rating of the switch.

Plug-in TQL 120/240, Vac Internal Common Trip

# of Poles	Ampere Rating	Wire Range ¹	120/240 Vac Short Circuit Withstand Rating	Product Number	List Price GO-138
2	60	8-3 Cu/8-3 Al	10kA	TQL21Y60	\$51.00
2	100	6-1/0 Cu/4-1/0 Al	10kA	TQL21Y100	\$147.00

Plug-in TQL 240, Vac Internal Common Trip

# of Poles	Ampere Rating	Wire Range ¹	240 Vac Short Circuit Withstand Rating	Product Number	List Price GO-138
2	60	8-3 Cu/8-3 Al	10kA	TQL22Y60	\$139.00
2	100	6-1/0 Cu/4-1/0 Al	10kA	TQL22Y100	\$235.00
3	60	8-3 Cu/8-3 Al	10kA	TQL32Y60	\$177.00
3	100	6-1/0 Cu/4-1/0 Al	10kA	TQL32Y100	\$266.00

Bolt-on TQB 120/240, Vac Internal Common Trip

# of Poles	Ampere Rating	Wire Range ¹	120/240 Vac Short Circuit Withstand Rating	Product Number	List Price GO-138
2	60	8-3 Cu/8-3 Al	10kA	TQB21Y60	\$43.50
2	100	6-1/0 Cu/4-1/0 Al	10kA	TQB21Y100	\$113.00

Bolt-on TQB 240 Vac, Internal Common Trip

# of Poles	Ampere Rating	Wire Range ¹	240 Vac Short Circuit Withstand Rating	Product Number	List Price GO-138
2	60	8-3 Cu/8-3 Al	10kA	TQB22Y60	\$113.00
2	100	6-1/0 Cu/4-1/0 Al	10kA	TQB22Y100	\$170.00
3	60	8-3 Cu/8-3 Al	10kA	TQB32Y60	\$139.00
3	100	6-1/0 Cu/4-1/0 Al	10kA	TQB32Y100	\$199.00

Cable In-Cable Out (Lug-Lug) TQC 120/240 Vac, Internal Common Trip

# of Poles	Ampere Rating	Wire Range ¹	120/240 Vac Short Circuit Withstand Rating	Product Number	List Price GO-135B
2	60	8-3 Cu/8-3 Al	10kA	TQC21Y60	\$43.50
2	100	6-1/0 Cu/4-1/0 Al	10kA	TQC21Y100	\$116.00

Cable In-Cable Out (Lug-Lug) TQC 240 Vac, Internal Common Trip

# of Poles	Ampere Rating	Wire Range ¹	240 Vac Short Circuit Withstand Rating	Product Number	List Price GO-135B
2	60	8-3 Cu/8-3 Al	10kA	TQC22Y60	\$116.00
2	100	6-1/0 Cu/4-1/0 Al	10kA	TQC22Y100	\$173.00
3	60	8-3 Cu/8-3 Al	10kA	TQB32Y60	\$139.00
3	100	6-1/0 Cu/4-1/0 Al	10kA	TQB32Y100	\$199.00

Cable In-Cable Out (Lug-Lug) TQD, TJD 240 Vac, Internal Common Trip

# of Poles	Ampere Rating	240 Vac Short Circuit Withstand Rating	Product Number ⁴	List Price GO-135F
2	225	14kA	TQD22Y225	\$198.00
3	225	14kA	TQD32Y225 ²	\$559.00
2	400	22kA	TJD422Y400	\$1169.00 ⁵
3	400	22kA	TJD432Y400 ³	\$1509.00 ⁵

¹Solid or stranded for 14-10 AWG.

²TQD32Y225 with dummy trip used for accessorized applications.

³TJD uses same accessories as J600 line.

⁴Refer to table on page 3-101 for lug and wire range data. Line and load lugs included in basic switch product number.

⁵GO-135LGJ.



Publications and Reference: See Section 22 for a complete list of additional product-related publications

Molded Case Circuit Breakers

Q-Line Circuit Breakers

Section 3

Accessories
240V Class

Terminals (Lugs) for Q-Line Circuit Breakers

Ampere Rating	Termination Type	Wire Range (Cu/Al)	Product Number	List Price GO-135B
15-60	Lug (line only)	14-6/12-2	TQAL3A	\$1.50
15-60	Lug (load only)	14-2/12-2	THQEL3	\$1.50
15-60	Quick connector (load only)	(4) 14/14 12	THQECC	\$2.50



Quick Connector THQECC

Mounting Accessories for THQB, THQC

Product Type	Ampere Rating	# of Poles	Used With Frame	Product Number	List Price GO-135B
Bolt-on Mounting Base		3	THQB/TEY	TEY3B	\$31.50
Back Mounting Plates		1	THQC	TQCBMPA1	\$8.30
Screw Type					
Back Mounting Plates		2	THQC	TQCBMPA2	\$9.80
Screw Type					
Back Mounting Plates		3	THQC	TQCBMPA3	\$12.00
Screw Type					
Back Mounting Plates		10	THQC	TQCBMPA10	\$32.00
Screw Type					
Front-mounting Plates		1	THQC	TQCFMP1 ¹	\$8.30
Front-mounting Plates		2	THQC	TQCFMP2 ¹	\$9.80
Front-mounting Plates		3	THQC	TQCFMP3 ¹	\$12.00
Front-mounting Plates		4	THQC	TQCFMP4 ¹	\$14.00
Pack of 48 Front/Rear Mounting Clips		1 & 2-pole 15-60A	THQC	THQCFMK	\$48.00 ²
Pack of 24 DIN rail clips			THQC	THQCDIN	\$24.00 ²

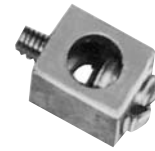

Load Lug THQEL3

¹Not UL listed.

²Price is per pack.

Mounting Accessories for THQC, THQC-GF, GFEP

Product Type	# of Poles	Used With Frame	Product Number	List Price GO-133
Snap In Back Mounting Plates	1	THQC, THQC-GF	TQCGFBMPA1	\$6.10
Snap In Back Mounting Plates	2	THQC, THQC-GF	TQCGFBMPA2	\$7.60
Snap In Back Mounting Plates	3	THQC, THQC-GF	TQCGFBMPA3	\$9.10
Snap In Back Mounting Plates	10	THQC, THQC-GF	TQCGFBMPA10	\$25.00

MOUNTING KIT
CATALOG NUMBER
THQCFMK

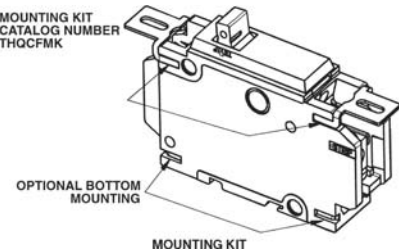

Mounting Kit THQCFMK

Mounting Accessories for TQL

Product Type	Ampere Rating	# of Poles	Used With Frame	Product Number	List Price GO-134A
Plug-in Mounting Base	70 amp	2	TQL	571B595DDG1	\$23.75
Plug-in Mounting Base	70 amp	3	TQL	571B595DDG2	\$32.00
Plug-in Mounting Base	100 amp	3	TQL	565B837G1	\$38.00
Plug-in Mounting Base	100 amp	2	TQL	565B837G2	\$23.75



Molded Case Circuit Breakers

Q-Line Circuit Breakers

Accessories

Section 3

Handle Locking Devices & Handle Ties

Product Type	Used With Frame	Product Number	List Price GO-137A
Handle Locks - Non Padlocking	TQC	THL103	\$6.50
	TQB		
	TQL		
Handle Locks - Non Padlocking	THQP	TQPL	\$5.50
Handle Locks - Padlocking	TQD	TQDPLD1 ³	\$20.75
Handle Locks - Padlocking	TQD	TQDPLD2 ²	\$32.00 ¹
Handle Locks - Padlocking	TQDL	TQDLPLD1 ³	\$17.75
Handle Locks - Padlocking	TQB	THP100	\$6.50
	TQL		
Handle Locks - Padlocking	THQP	TQPPL	\$5.75
Handle Locks - Padlocking	TQC	TQPLD1 ³	\$4.70 ¹
Snap-on Handle Tie - Trip Indicating	TQB	TQHT1	\$2.30
	TQC		
	TQL		
Snap-on Handle Tie - Solid	TQL	THT104	\$2.30

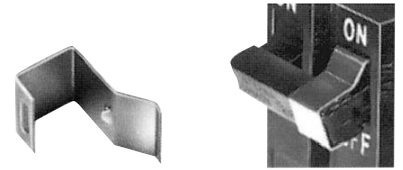

THL103

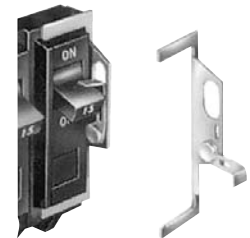

THP100

Breaker Mounting Screw Kit

Product Type	Used With Frame	Product Number	List Price GO-135B
Breaker Mounting Screw Kit	THQB	TQBS1 ⁴	\$6.00

¹GO-135B.

²EUSERC Approved-Factory Installed Only.

³Suitable for circuit breakers used in group mounted panelboard construction only.

⁴Price is per screw. Packaged in quantities of 24. Must be ordered in multiples of 24.

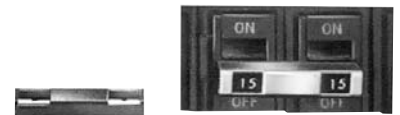

THT104



TQHT1



Publications and Reference: See Section 22 for a complete list of additional product-related publications

Molded Case Circuit Breakers Industrial Circuit Breakers

Section 3

15-100A

Thermal Magnetic Trip

Type TEY

Noninterchangeable Trip

Bolt-on

480Y/277V Class

The TEY is a one-inch wide per pole, compact, "bolt-on" circuit breaker for use on grounded 480Y/277 Vac systems. The bolt-on mounting base (TEY3B) shown on page 3-100, makes the TEY suitable for various applications as a lug-lug breaker.

TEY

65kA @120, 120/240, 240 Vac; 14kA @120/240, 240, 277, 480/277 Vac

# of Poles	Ampere Rating	Wire Range ¹	Product Number	List Price GO-135B
1	15	14-10 Cu/14-10 Al	TEY115 ^{2,3}	\$72.00
1	20	14-10 Cu/14-10 Al	TEY120 ^{2,3}	\$72.00
1	25	14-10 Cu/14-10 Al	TEY125 ³	\$72.00
1	30	14-10 Cu/14-10 Al	TEY130 ³	\$72.00
1	35	10-4 Cu/10-4 Al	TEY135 ³	\$72.00
1	40	10-4 Cu/10-4 Al	TEY140 ³	\$72.00
1	45	10-4 Cu/10-4 Al	TEY145 ³	\$72.00
1	50	10-4 Cu/10-4 Al	TEY150 ³	\$72.00
1	60	10-4 Cu/10-4 Al	TEY160	\$72.00
1	70	4-1/0 Cu/4-1/0 Al	TEY170	\$142.00
1	80	4-1/0 Cu/4-1/0 Al	TEY180	\$142.00
1	90	4-1/0 Cu/4-1/0 Al	TEY190	\$142.00
1	100	4-1/0 Cu/4-1/0 Al	TEY1100	\$142.00
2	15	14-10 Cu/14-10 Al	TEY215 ³	\$216.00
2	20	14-10 Cu/14-10 Al	TEY220 ³	\$216.00
2	25	14-10 Cu/14-10 Al	TEY225 ³	\$216.00
2	30	14-10 Cu/14-10 Al	TEY230 ³	\$216.00
2	35	10-4 Cu/10-4 Al	TEY235 ³	\$216.00
2	40	10-4 Cu/10-4 Al	TEY240 ³	\$216.00
2	45	10-4 Cu/10-4 Al	TEY245 ³	\$216.00
2	50	10-4 Cu/10-4 Al	TEY250 ³	\$216.00
2	60	10-4 Cu/10-4 Al	TEY260	\$216.00
2	70	4-1/0 Cu/4-1/0 Al	TEY270	\$352.00
2	80	4-1/0 Cu/4-1/0 Al	TEY280	\$352.00
2	90	4-1/0 Cu/4-1/0 Al	TEY290	\$352.00
2	100	4-1/0 Cu/4-1/0 Al	TEY2100	\$352.00
3	15	14-10 Cu/14-10 Al	TEY315 ³	\$316.00
3	20	14-10 Cu/14-10 Al	TEY320 ³	\$316.00
3	25	14-10 Cu/14-10 Al	TEY325 ³	\$316.00
3	30	14-10 Cu/14-10 Al	TEY330 ³	\$316.00
3	35	10-4 Cu/10-4 Al	TEY335 ³	\$316.00
3	40	10-4 Cu/10-4 Al	TEY340 ³	\$316.00
3	45	10-4 Cu/10-4 Al	TEY345 ³	\$316.00
3	50	10-4 Cu/10-4 Al	TEY350 ³	\$316.00
3	60	10-4 Cu/10-4 Al	TEY360	\$316.00
3	70	4-1/0 Cu/4-1/0 Al	TEY370	\$424.00
3	80	4-1/0 Cu/4-1/0 Al	TEY380	\$424.00
3	90	4-1/0 Cu/4-1/0 Al	TEY390	\$424.00
3	100	4-1/0 Cu/4-1/0 Al	TEY3100	\$424.00

¹Solid or stranded for 14-10 AWG.

²Single-pole, 15 and 20 ampere breakers are also UL listed as switching duty breakers, suitable for switching 120, 240, or 277 Vac.

³UL listed HACR (Heating, Air Conditioning, Refrigeration).

Internal Accessories for TEY (2- and 3-pole breaker only)

Factory Installed Only

Auxiliary Switch, Single-Pole (SA at 120, 240, 277 Vac, 1/4 hp at 120, 240 Vdc)	Add suffix to Breaker Product Number	List Price Adder GO-135B
"A" switch (normally open)	AS1A	\$148.00
"B" switch (normally closed)	AS1B	\$148.00
"AB" switch (both)	ASAB	\$288.00
Shunt Trip 120-277 Vac control voltage	ST12	\$358.00

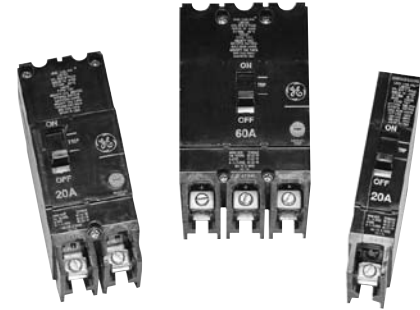

1- 2- and 3-pole TEY breakers



Molded Case Circuit Breakers Industrial Circuit Breakers

15-150A Circuit Breakers
Thermal-Magnetic Trip
E150 Line Circuit Breakers
Types TEB, TED, THED
Noninterchangeable Trip



Product Number Structure

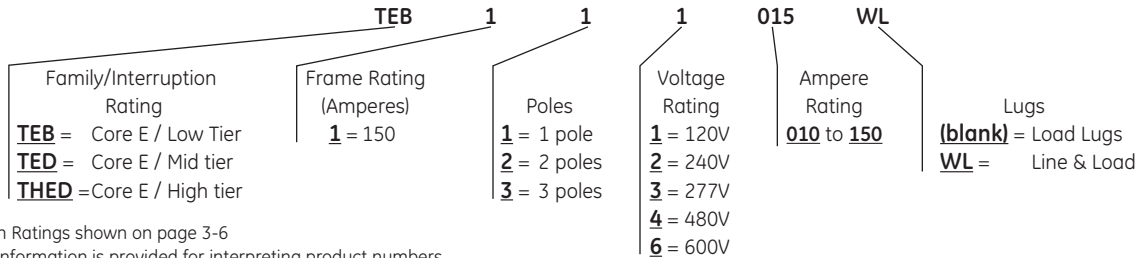

Interruption Ratings shown on page 3-6
Note: This information is provided for interpreting product numbers (it should not be used to build product numbers).

Single Pole — Includes Cu/Al load lugs only. If line lugs are required, add suffix "WL" to Product Number.

Ampere Rating	Type TEB		Type TED			Type THED				
	120 Vac 125 Vdc		277 Vac 125 Vdc		347 Vac ¹		277 Vac		347 Vac ¹	
	Product Number	List Price GO-135B	Product Number	List Price GO-135B	Product Number	List Price GO-135B	Product Number	List Price GO-135B	Product Number	List Price GO-135B
10	TEB111010 ²	\$78.50	TED113010 ²	\$82.50			THED113015	\$229.00	THED114015 ³	\$416.00
15	TEB111015 ³	\$78.50	TED113015 ³	\$82.50	TED114015 ³	\$152.00	THED113020	\$229.00	THED114020 ³	\$416.00
20	TEB111020 ³	\$78.50	TED113020 ³	\$82.50	TED114020 ³	\$152.00	THED113025	\$229.00	THED114025	\$416.00
25	TEB111025	\$78.50	TED113025	\$82.50	TED114025	\$152.00	THED113030	\$229.00	THED114030	\$416.00
30	TEB111030	\$78.50	TED113030	\$82.50	TED114030	\$152.00				
35	TEB111035	\$78.50	TED113035	\$82.50						
40	TEB111040	\$78.50	TED113040	\$82.50						
45	TEB111045	\$78.50	TED113045	\$82.50						
50	TEB111050	\$78.50	TED113050	\$82.50						
60	TEB111060	\$78.50	TED113060	\$82.50						
70	TEB111070	\$134.00	TED113070	\$159.00						
80	TEB111080	\$134.00	TED113080	\$159.00						
90	TEB111090	\$134.00	TED113090	\$159.00						
100	TEB111100	\$134.00	TED113100	\$159.00						

Two Pole — Includes Cu/Al line and load lugs. For optional lugs, see page 3-101 and 3-102.

Ampere Rating	Type TEB		Type TED		Type THED, Hi-Break ⁴	
	240 Vac, 250 Vdc		480 Vac, 250 Vdc		480 Vac, 250 Vdc	
	Product Number	List Price GO-135B	Product Number	List Price GO-135B	Product Number	List Price GO-135B
10	TEB122010WL ²	\$159.00	TED124010WL ²	\$290.00		
15	TEB122015WL	\$159.00	TED124015WL	\$290.00	THED124015WL	\$560.00
20	TEB122020WL	\$159.00	TED124020WL	\$290.00	THED124020WL	\$560.00
25	TEB122025WL	\$159.00	TED124025WL	\$290.00	THED124025WL	\$560.00
30	TEB122030WL	\$159.00	TED124030WL	\$290.00	THED124030WL	\$560.00
35	TEB122035WL	\$159.00	TED124035WL	\$290.00	THED124035WL	\$560.00
40	TEB122040WL	\$159.00	TED124040WL	\$290.00	THED124040WL	\$560.00
45	TEB122045WL	\$159.00	TED124045WL	\$290.00	THED124045WL	\$560.00
50	TEB122050WL	\$159.00	TED124050WL	\$290.00	THED124050WL	\$560.00
60	TEB122060WL	\$159.00	TED124060WL	\$290.00	THED124060WL	\$560.00
70	TEB122070WL	\$261.00	TED124070WL	\$377.00	THED124070WL	\$653.00
80	TEB122080WL	\$261.00	TED124080WL	\$377.00	THED124080WL	\$653.00
90	TEB122090WL	\$261.00	TED124090WL	\$377.00	THED124090WL	\$653.00
100	TEB122100WL	\$261.00	TED124100WL	\$377.00	THED124100WL	\$653.00
110			TED124110WL	\$1000.00		
125			TED124125WL	\$1000.00		
150			TED124150WL	\$1000.00		

¹Suitable for 10 kAIC at 480 Vac, but not labeled or UL listed.

²Not UL listed

³Single-pole, 15- and 20-ampere breakers are also UL listed as switching duty breakers, suitable for switching 120 Vac (TEB), 277, 347 Vac (TED, THED) fluorescent lighting loads.

⁴Two-pole breaker is furnished in three-pole case.

Notes: All TEB, TED, THED breakers UL listed as HACR type except 10 ampere.

All TEB, TED, THED breakers suitable for reverse feed.

60/75°C rating through 100 amperes, 75°C rating above 100 amperes.



Publications and Reference: See Section 22 for a complete list of additional product-related publications

Molded Case Circuit Breakers Industrial Circuit Breakers

Section 3

15-150A Circuit Breakers
Thermal-Magnetic Trip
E150 Line Circuit Breakers
Types TEB, TED, THED
Noninterchangeable Trip

Three Pole — Includes Cu/Al line and load lugs. For optional lugs, see page 3-101 and 3-102.

Ampere Rating	Type TEB		Type TED				Type THED, Hi-Break	
	240 Vac		480 Vac		600 Vac		600 Vac	
	Product Number	List Price GO-135B	Product Number	List Price GO-135B	Product Number	List Price GO-135B	Product Number	List Price GO-135B
10	TEB132010WL ¹	\$240.00	TED134010WL ¹	\$377.00	TED136010WL ¹	\$439.00	—	—
15	TEB132015WL	\$240.00	TED134015WL	\$377.00	TED136015WL	\$439.00	THED136015WL	\$655.00
20	TEB132020WL	\$240.00	TED134020WL	\$377.00	TED136020WL	\$439.00	THED136020WL	\$655.00
25	TEB132025WL	\$240.00	TED134025WL	\$377.00	TED136025WL	\$439.00	THED136025WL	\$655.00
30	TEB132030WL	\$240.00	TED134030WL	\$377.00	TED136030WL	\$439.00	THED136030WL	\$655.00
35	TEB132035WL	\$240.00	TED134035WL	\$377.00	TED136035WL	\$439.00	THED136035WL	\$655.00
40	TEB132040WL	\$240.00	TED134040WL	\$377.00	TED136040WL	\$439.00	THED136040WL	\$655.00
45	TEB132045WL	\$240.00	TED134045WL	\$377.00	TED136045WL	\$439.00	THED136045WL	\$655.00
50	TEB132050WL	\$240.00	TED134050WL	\$377.00	TED136050WL	\$439.00	THED136050WL	\$655.00
60	TEB132060WL	\$240.00	TED134060WL	\$377.00	TED136060WL	\$439.00	—	—
70	TEB132070WL	\$339.00	TED134070WL	\$445.00	TED136070WL	\$534.00	THED136070WL	\$742.00
80	TEB132080WL	\$339.00	TED134080WL	\$445.00	TED136080WL	\$534.00	—	—
90	TEB132090WL	\$339.00	TED134090WL	\$445.00	TED136090WL	\$534.00	THED136090WL	\$742.00
100	TEB132100WL	\$339.00	TED134100WL	\$445.00	TED136100WL	\$534.00	THED136100WL	\$742.00
110	—	—	TED134110WL	\$1198.00	TED136110WL	\$1198.00	THED136110WL	\$1683.00
125	—	—	TED134125WL	\$1198.00	TED136125WL	\$1198.00	THED136125WL	\$1683.00
150	—	—	TED134150WL	\$1198.00	TED136150WL	\$1198.00	THED136150WL	\$1683.00
100NA	—	—	TED134Y100 ²	\$377.00	TED136Y100 ²	\$445.00	—	—
150NA	—	—	TED134Y150 ²	\$967.00	TED136Y150 ²	\$967.00	—	—

¹Not UL listed.

²Includes factory-installed dummy trip.

Notes: All TEB, TED, THED breakers UL listed as HACR type except 10 ampere.
All TEB, TED, THED breakers suitable for reverse feed.
60/75°C rating through 100 amperes, 75°C rating above 100 amperes.

Accessories: See pages 3-39 to 3-45 and 3-92 to 3-104.

Add-on Current Limiter 100 kAIC³

Ampere Rating	Product Number	List Price GO-135B
15	TEDL36015	\$848.00
20	TEDL36020	\$848.00
30	TEDL36030	\$848.00
60	TEDL36060	\$848.00
100	TEDL36100	\$848.00

³For use with 3 Pole TED/THED only

E150 Reference Publications

TDR Operating Mechanism	GEH-2994
Shunt Trip	GEH-3416
Undervoltage Release	GEH-3417
Auxiliary Switch	GEH-3418
Three Coil Shunt Trip	GEH-3434
Mechanical Interlock	GEH-4310
TDM Operating Mechanism	GEH-4335
Bell Alarm	GEH-4576
Plug-in Mounting Base	GEH-4610
STDA Flange Handle	GEH-5314
STDA Operating Mechanism	GEH-5684
Cable Operator Mechanism	GEH-6290
Motor Operator	GEH-6500
Back Connected Studs	GEJ-3609
Padlocking Device - Standard	GEJ-5143
E150 Outline Drawing	139C3643SH1, 2, 4



Molded Case Circuit Breakers Industrial Circuit Breakers

Section 3

70-250A Circuit Breakers
Thermal-Magnetic Trip
F225 Line Circuit Breakers
Types TFJ, TFK, THFK



Product Number Structure

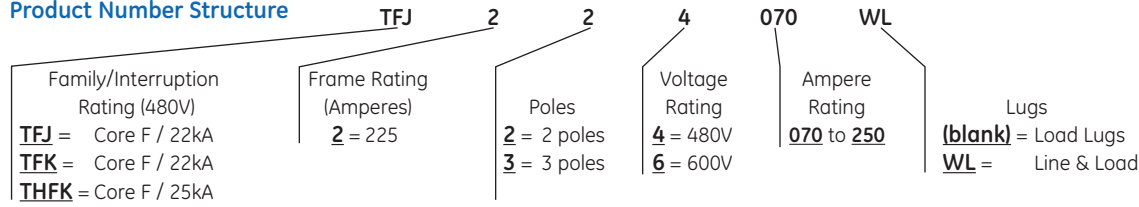

Note: This information is provided for interpreting product numbers (it should not be used to build product numbers).

Type TFJ – Noninterchangeable Trip, includes Cu/Al Line and Load lugs, suitable for reverse feed

Ampere Rating	Adjustable Instantaneous Trip Ampere Range		Complete Breaker 480 Vac Max		Complete Breaker 600 Vac Max		Copper/Aluminum Lugs	Wire Size
	Low	High	Two-Pole		Three-Pole			
70	600	900	TFJ224070WL	\$1122.00	TFJ236070WL	\$1407.00		
80	700	1000	TFJ224080WL	\$1122.00	TFJ236080WL	\$1407.00		
90	600	900	TFJ224090WL	\$1122.00	TFJ236090WL	\$1407.00		
100	600	1250	TFJ224100WL	\$1122.00	TFJ236100WL	\$1407.00		
110	660	1250	TFJ224110WL	\$1122.00	TFJ236110WL	\$1407.00		
125	600	1250	TFJ224125WL	\$1122.00	TFJ236125WL	\$1407.00	TCAL24	4-300 Cu/Al
150	700	1500	TFJ224150WL	\$1122.00	TFJ236150WL	\$1407.00		
175	800	1750	TFJ224175WL	\$1122.00	TFJ236175WL	\$1407.00		
200	900	2000	TFJ224200WL	\$1122.00	TFJ236200WL	\$1407.00		
225	1000	2250	TFJ224225WL	\$1122.00	TFJ236225WL	\$1407.00		
250	1000	2250	—	—	TFJ236250WL	\$2075.00	1	1

Types TFK, THFK – Interchangeable Trip, includes Cu/Al Line and Load lugs, not suitable for reverse feed

Ampere Rating	Adjustable Instantaneous Trip Ampere Range	Complete Circuit Breaker Includes Line and Load Lugs				Trip Unit Only		Frame Only		Terminal Lugs for Front Connection (Copper/Aluminum) ²			
		Standard		High-Break		Use with Standard and Hi-Break Frames	List Price GO-135LG	Product Number	List Price GO-135LG	Product Number			
		Product Number	List Price GO-135LG	Product Number	List Price GO-135LG					(Order 1 line and 1 load per pole)	List Price GO-135LG	Wire Size	
Two-Pole, 480 Vac Max., 250 Vdc Max.													
70	600	900	TFK224070WL	\$1122.00	THFK224070WL	\$2315.00	TFK226T070	\$337.00					
80	700	1000	TFK224080WL	\$1122.00	THFK224080WL	\$2315.00	TFK226T080	\$337.00	TFK224F000	\$753.00			
90	600	900	TFK224090WL	\$1122.00	THFK224090WL	\$2315.00	TFK226T090	\$337.00	Standard				
100	600	1250	TFK224100WL	\$1122.00	THFK224100WL	\$2315.00	TFK226T100	\$337.00	Frame				
110	660	1250	TFK224110WL	\$1122.00	THFK224110WL	\$2315.00	TFK226T110	\$337.00					
125	600	1250	TFK224125WL	\$1122.00	THFK224125WL	\$2315.00	TFK226T125	\$337.00			TCAL24	\$8.00	4-300 Cu/Al
150	700	1500	TFK224150WL	\$1122.00	THFK224150WL	\$2315.00	TFK226T150	\$337.00					
175	800	1750	TFK224175WL	\$1122.00	THFK224175WL	\$2315.00	TFK226T175	\$337.00	THFK224F000	\$1946.00			
200	900	2000	TFK224200WL	\$1122.00	THFK224200WL	\$2315.00	TFK226T200	\$337.00	Hi-Break				
225	1000	2250	TFK224225WL	\$1122.00	THFK224225WL	\$2315.00	TFK226T225	\$337.00	Frame				
Three-Pole, 600 Vac Max., 250 Vdc Max.													
70	600	900	TFK236070WL	\$1407.00	THFK236070WL	\$2787.00	TFK236T070	\$445.00					
80	700	1000	TFK236080WL	\$1407.00	THFK236080WL	\$2787.00	TFK236T080	\$445.00	TFK236F000	\$914.00			
90	600	900	TFK236090WL	\$1407.00	THFK236090WL	\$2787.00	TFK236T090	\$445.00	Standard				
100	600	1250	TFK236100WL	\$1407.00	THFK236100WL	\$2787.00	TFK236T100	\$445.00	Frame				
110	660	1250	TFK236110WL	\$1407.00	THFK236110WL	\$2787.00	TFK236T110	\$445.00					
125	600	1250	TFK236125WL	\$1407.00	THFK236125WL	\$2787.00	TFK236T125	\$445.00			TCAL24	\$8.00	4-300 Cu/Al
150	700	1500	TFK236150WL	\$1407.00	THFK236150WL	\$2787.00	TFK236T150	\$445.00					
175	800	1750	TFK236175WL	\$1407.00	THFK236175WL	\$2787.00	TFK236T175	\$445.00	THFK236F000	\$2294.00			
200	900	2000	TFK236200WL	\$1407.00	THFK236200WL	\$2787.00	TFK236T200	\$445.00	Hi-Break				
225	1000	2250	TFK236225WL	\$1407.00	THFK236225WL	\$2787.00	TFK236T225	\$445.00	Frame				
225	600	1400	—	—	—	—	TFK236TM1225 ³	\$555.00					
Mag Only	1000	2250	—	—	—	—	TFK236TM2225 ³	\$555.00					

¹TC024 load end. Wire range #4-300 copper only.

²For optional lug see page 3-101.

³Not UL listed.

Note: All TFJ, TFK and THFK breakers UL listed as HACR type.

Accessories: See pages 3-39 to 3-45 and 3-92 to 3-104.

F225 Reference Publications

Trip Unit	GEH-2996
TDR Operating Mechanism	GEH-3018
Mechanical Interlock	GEH-3022
TDM Operating Mechanism	GEH-3023
Motor Operator	GEH-4581
Plug-in Mounting Base	GEH-4610
Bell Alarm and Shunt Trip	GEH-4620
Three Coil Shunt Trip	GEH-4622
Undervoltage Release and Auxiliary Switch	GEH-4653
STDA Flange Handle	GEH-5314
STDA Operating Mechanism	GEH-5317
Back Connected Studs	GEJ-3635
F225 Outline Drawing	455C561SH6



Publications and Reference: See Section 22 for a complete list of additional product-related publications

Molded Case Circuit Breakers

Industrial Circuit Breakers

Section 3

125-600A Circuit Breakers
 Thermal-Magnetic Trip
 J600 Line Circuit Breakers
 Types TJJ, TJK, THJK

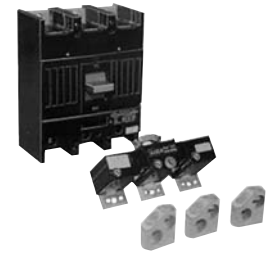

TYPE TJK

Product Number Structure

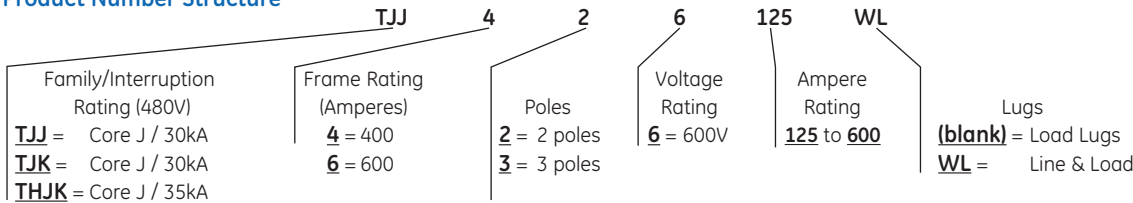

Note: This information is provided for interpreting product numbers (it should not be used to build product numbers).

Type TJJ Noninterchangeable Trip, includes Cu/Al Line and Load Lugs, suitable for reverse feed

Ampere Rating	Adjustable Instantaneous Trip Ampere Range		Frame				Terminal Lugs for Front Connection (Cu/Al)	
			2-Pole, 400 Ampere Frame 600 Vac, 250 Vdc		3-Pole, 400 Ampere Frame 600 Vac		Copper/ Aluminum Lugs	Wire Size
			Product Number	List Price GO-135LG	Product Number	List Price GO-135LG		
125	375	1250	TJJ426125WL	\$2118.00	TJJ436125WL	\$2573.00	TCAL43 ³ Included in price of breaker (1) 6-600 or (2) 2/0-250 Cu/Al	
150	450	1500	TJJ426150WL	\$2118.00	TJJ436150WL	\$2573.00		
175	525	1750	TJJ426175WL	\$2118.00	TJJ436175WL	\$2573.00		
200	600	2000	TJJ426200WL	\$2118.00	TJJ436200WL	\$2573.00		
225	675	2250	TJJ426225WL	\$2118.00	TJJ436225WL	\$2573.00		
250	750	2500	TJJ426250WL	\$2118.00	TJJ436250WL	\$2573.00		
300	900	3000	TJJ426300WL	\$2118.00	TJJ436300WL	\$2573.00		
350	1050	3500	TJJ426350WL	\$2118.00	TJJ436350WL	\$2573.00		
400	1200	4000	TJJ426400WL	\$2118.00	TJJ436400WL	\$2573.00		

Types TJK, THJK – Interchangeable Trip, includes Cu/Al Line and Load Lugs, not suitable for reverse feed

Adjustable Instantaneous Trip Ampere Range					Complete Circuit Breaker Includes Line and Load Lugs					Terminal Lugs for Front Connection (Cu/Al) ¹			
Ampere Rating	Range		Standard Product Number	List Price GO-135LG	Hi-Break Product Number	List Price GO-135LG	Frame Only Product		Trip Unit Only. Use with Standard and Hi-Break Frames	List Price GO-135LG	Product Number (Order 2 per pole)	List Price GO-135LG	Wire Size
	Low	High					Product Number	List Price GO-135LG					
400A Frame – Two-Pole													
125	375	1250	TJK426125WL	\$2118.00	THJK426125WL	\$3085.00			TJK426T125	\$464.00	TCAL43 ³	\$14.00	(1) 6-600 or (2) 2/0-250 Cu/Al
150	450	1500	TJK426150WL	\$2118.00	THJK426150WL	\$3085.00	TJK426F000	\$1598.00	TJK426T150	\$464.00			
175	525	1750	TJK426175WL	\$2118.00	THJK426175WL	\$3085.00	Standard		TJK426T175	\$464.00			
200	600	2000	TJK426200WL	\$2118.00	THJK426200WL	\$3085.00	Frame		TJK426T200	\$464.00			
225	675	2250	TJK426225WL	\$2118.00	THJK426225WL	\$3085.00			TJK426T225	\$464.00			
250	750	2500	TJK426250WL	\$2118.00	THJK426250WL	\$3085.00			TJK426T250	\$464.00			
300	900	3000	TJK426300WL	\$2118.00	THJK426300WL	\$3085.00			TJK426T300	\$464.00			
350	1050	3500	TJK426350WL	\$2118.00	THJK426350WL	\$3085.00	THJK426F000	\$2565.00	TJK426T350	\$464.00			
400	1200	4000	TJK426400WL	\$2118.00	THJK426400WL	\$3085.00	Hi-Break		TJK426T400	\$464.00			
400A Frame – Three-Pole													
125	375	1250	TJK436125WL	\$2573.00	THJK436125WL	\$3675.00			TJK436T125	\$464.00	TCAL43 ³	\$14.00	(1) 6-600 or (2) 2/0-250 Cu/Al
150	450	1500	TJK436150WL	\$2573.00	THJK436150WL	\$3675.00	TJK436F000	\$2025.00	TJK436T150	\$464.00			
175	525	1750	TJK436175WL	\$2573.00	THJK436175WL	\$3675.00	Standard		TJK436T175	\$464.00			
200	600	2000	TJK436200WL	\$2573.00	THJK436200WL	\$3675.00	Frame		TJK436T200	\$464.00			
225	675	2250	TJK436225WL	\$2573.00	THJK436225WL	\$3675.00			TJK436T225	\$464.00			
250	750	2500	TJK436250WL	\$2573.00	THJK436250WL	\$3675.00			TJK436T250	\$464.00			
300	900	3000	TJK436300WL	\$2573.00	THJK436300WL	\$3675.00			TJK436T300	\$464.00			
350	1050	3500	TJK436350WL	\$2573.00	THJK436350WL	\$3675.00	THJK436F000	\$3127.00	TJK436T350	\$464.00			
400	1200	4000	TJK436400WL	\$2573.00	THJK436400WL	\$3675.00	Hi-Break		TJK436T400	\$464.00			
400	600	2000	—	—	—	—			TJK436TM1400 ²	\$558.00			
Mag	1200	4000	—	—	—	—			TJK436TM2400 ²	\$558.00			
Only	350	1000	—	—	—	—			TJK436TM3400 ²	\$558.00			

¹For optional lugs, see page 3-101.

²Not UL listed.

³Alternate lug for 750 kcmil Cu/Al cable, Product Number TCAL47 List Price \$26.00, GO-135LG.

Accessories: See pages 3-39 to 3-45 and 3-92 to 3-104.



Molded Case Circuit Breakers Industrial Circuit Breakers

Section 3

125-600A Circuit Breakers
Thermal-Magnetic Trip
J600 Line Circuit Breakers
Types TJJ, TJK, THJK

Types TJK, THJK — Interchangeable Trip, includes Cu/Al Line and Load Lugs, not suitable for reverse feed

Complete Circuit Breaker Includes Line and Load Lugs							Terminal Lugs for Front Connection (Cu/Al) ¹						
Adjustable Instantaneous Trip Ampere Range			Standard Product Number	List Price GO-135LG	Hi-Break Product Number	List Price GO-135LG	Frame Only Product Number	List Price GO-135LG	Trip Unit Only. Use w/ Standard and Hi-Break Frames	List Price GO-135LG	Product Number (Order 2 per pole)	List Price GO-135LG	Wire Size
Ampere Rating	Low	High											
600A Frame—Two-Pole													
250	750	2500	TJK626250WL	\$2812.00	THJK626250WL	\$3704.00	TJK626F000 Standard Frame	TJK626T250	\$1221.00	TCAL43 ²	\$14.00	(1) 6-600 or (2) 2/0-250 Cu/Al	
300	900	3000	TJK626300WL	\$2812.00	THJK626300WL	\$3704.00		TJK626T300	\$1221.00				
350	1050	3500	TJK626350WL	\$2812.00	THJK626350WL	\$3704.00		TJK626T350	\$1221.00				
400	1200	4000	TJK626400WL	\$2812.00	THJK626400WL	\$3704.00		TJK626T400	\$1221.00				
450	1350	4500	TJK626450WL	\$2848.00	THJK626450WL	\$3740.00		THJK626F000	TJK626T450	\$1221.00	TCAL63	\$23.00	(2) 4/0-350 Cu or (2) 300-500 Al
500	1500	5000	TJK626500WL	\$2848.00	THJK626500WL	\$3740.00		Hi-Break Frame	TJK626T500	\$1221.00			
600	1800	6000	TJK626600WL	\$2848.00	THJK626600WL	\$3740.00		TJK626T600	\$1221.00				
600A Frame—Three-Pole													
250	750	2500	TJK636250WL	\$3539.00	THJK636250WL	\$4457.00	TJK636F000 Standard Frame	TJK636T250	\$1221.00	TCAL43 ²	\$14.00	(1) 6-600 or (2) 2/0-250 Cu/Al	
300	900	3000	TJK636300WL	\$3539.00	THJK636300WL	\$4457.00		TJK636T300	\$1221.00				
350	1050	3500	TJK636350WL	\$3539.00	THJK636350WL	\$4457.00		TJK636T350	\$1221.00				
400	1200	4000	TJK636400WL	\$3539.00	THJK636400WL	\$4457.00		TJK636T400	\$1221.00				
450	1350	4500	TJK636450WL	\$3593.00	THJK636450WL	\$4511.00		THJK636F000	TJK636T450	\$1221.00	TCAL63	\$23.00	(2) 4/0-350 Cu or (2) 300-500 Al
500	1500	5000	TJK636500WL	\$3593.00	THJK636500WL	\$4511.00		Hi-Break Frame	TJK636T500	\$1221.00			
600	1800	6000	TJK636600WL	\$3593.00	THJK636600WL	\$4511.00		TJK636T600	\$1221.00				
Mag Only	1800	6000	—	—	—	—		TJK636TM1600 ³	\$1465.00				
								TJK636TM2600 ³	\$1465.00				

¹For optional lugs, see page 3-101.

²Alternate lug for 750 kcmil Cu/Al cable, Product Number TCAL47 List Price \$26.00, GO-135LG.

³Not UL listed.

Accessories: See pages 3-39 to 3-45 and 3-92 to 3-104.

J600 Reference Publications

Mechanical Interlock	GEH-3033
Trip Unit	GEH-3035
Bell Alarm	GEH-3320
Auxiliary Switch	GEH-3321
Three Coil Shunt Trip	GEH-3346
Shunt Trip	GEH-3435
TDR Operating Mechanism	GEH-3450
Plug-in Mounting Base	GEH-4342
Motor Operator	GEH-4676
TDM Operating Mechanism	GEH-5023
STDA Flange Handle	GEH-5314
STDA Operating Mechanism	GEH-5318
Undervoltage Release	GEH-5407
J600 Outline Drawing	455C564SH1



Publications and Reference: See Section 22 for a complete list of additional product-related publications

Molded Case Circuit Breakers Industrial Circuit Breakers

Section 3

300-1200A Circuit Breakers
Thermal-Magnetic Trip
K1200 Line Circuit Breakers
Types TKM, THMK

Product Number Structure

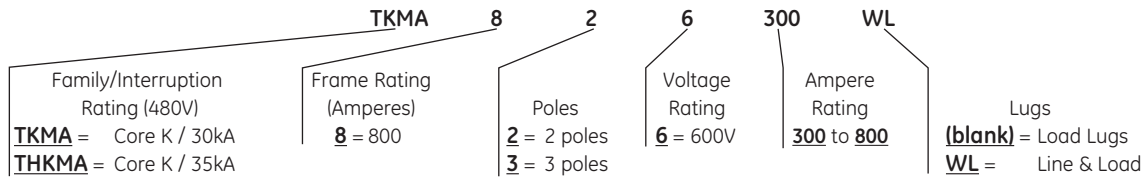

Note: This information is provided for interpreting product numbers (it should not be used to build product numbers).

Types TKM, THKM – Interchangeable Trip, includes Cu/Al Line and Load Lugs, not suitable for reverse feed

Complete Circuit Breaker Includes Line and Load Lugs						Terminal Lugs for Front Connection (Cu/Al) ¹							
Adjustable Instantaneous Trip Ampere Range	Standard Product Number	List Price GO-135LG	Hi-Break ¹ Product Number	List Price GO-135LG	Frame Only Product Number	List Price GO-135LG	Trip Unit Only. Use with Standard and Hi-Break Frames	List Price GO-135LG	Product Number (Order 2)				
									Ampere Rating	Low	High	List Price GO-135LG	Wire Size
800A Frame—Two-Pole													
300	900	3000	TKMA826300WL	\$3672.00	THKMA826300WL	\$4579.00							
350	1050	3500	TKMA826350WL	\$3672.00	THKMA826350WL	\$4579.00	TKM826F000 Standard Frame	\$1244.00			TKAL61	\$40.00	(2) 2/0-500 Cu/Al
400	1200	4000	TKMA826400WL	\$3672.00	THKMA826400WL	\$4579.00							
450	1350	4500	TKMA826450WL	\$3672.00	THKMA826450WL	\$4579.00							
500	1500	5000	TKMA826500WL	\$3672.00	THKMA826500WL	\$4579.00							
600	1800	6000	TKMA826600WL	\$3672.00	THKMA826600WL	\$4579.00							
700	2100	6400	TKMA826700WL	\$3700.00	THKMA826700WL	\$4611.00	THKM826F000 Hi-Break Frame	\$2167.00			TKAL81	\$47.00 ²	(3) 3/0-500 Cu/Al
800	2400	6400	TKMA826800WL	\$3700.00	THKMA826800WL	\$4611.00							
800A Frame—Three-Pole													
300	900	3000	TKMA836300WL	\$4713.00	THKMA836300WL	\$5624.00							
350	1050	3500	TKMA836350WL	\$4713.00	THKMA836350WL	\$5624.00	TKM836F000 Standard Frame	\$2205.00			TKAL61	\$40.00	(2) 2/0-500 Cu/Al
400	1200	4000	TKMA836400WL	\$4713.00	THKMA836400WL	\$5624.00							
450	1350	4500	TKMA836450WL	\$4713.00	THKMA836450WL	\$5624.00							
500	1500	5000	TKMA836500WL	\$4713.00	THKMA836500WL	\$5624.00							
600	1800	6000	TKMA836600WL	\$4713.00	THKMA836600WL	\$5624.00							
700	2100	6400	TKMA836700WL	\$4755.00	THKMA836700WL	\$5666.00							
800	2400	6400	TKMA836800WL	\$4755.00	THKMA836800WL	\$5666.00							
800	1200	4000	—	—	—	—	THKM836F000 Hi-Break Frame	\$3116.00			TKAL81	\$47.00 ⁴	(3) 3/0-500 Cu/Al
Mag Only	2400	8000	—	—	—	—							

¹For optional lugs, see page 3-101.

²Not UL listed.

³Internal accessory installation requires dummy trip unit. See page 3-45 for additional details. Nonautomatic trip unit and dummy trip unit not UL listed for field installation.

⁴GO-135S.



Molded Case Circuit Breakers Industrial Circuit Breakers

300-1200A Circuit Breakers
Thermal-Magnetic Trip
K1200 Line Circuit Breakers
Types TKM, THMK

Product Number Structure

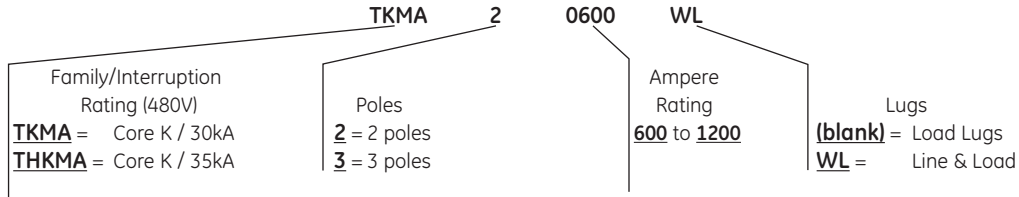

Note: This information is provided for interpreting product numbers (it should not be used to build product numbers).

Types TKM, THKM – Interchangeable Trip, includes Cu/Al Line and Load Lugs, not suitable for reverse feed

Adjustable Instantaneous Trip Ampere						Complete Circuit Breaker Includes Line and Load Lugs				Terminal Lugs for Front Connection (Cu/Al) ¹			
Ampere Rating	Range		Standard Product Number	List Price GO-135LG	Hi-Break ¹ Product Number	List Price GO-135LG	Frame Only Product Number	List Price GO-135LG	Trip Unit Only. Use with Standard and Hi-Break Frames	List Price GO-135LG	Product Number (Order 2 per pole)	List Price GO-135S	Wire Size
	Low	High											
1200A Frame—Two-Pole													
600	1800	6000	TKMA20600WL	\$5172.00	THKMA20600WL	\$6069.00	TKM2F Standard Frame	\$2690.00	TKMA3T0600	\$2294.00	TCAL81	\$47.00	(3) 3/0-500 Cu/Al
700	2100	6400	TKMA20700WL	\$5172.00	THKMA20700WL	\$6069.00			TKMA3T0700	\$2294.00			
800	2400	6400	TKMA20800WL	\$5172.00	THKMA20800WL	\$6069.00			TKMA3T0800	\$2294.00			
1000	3000	10000	TKMA21000WL ²	\$5472.00	THKMA21000WL ²	\$6353.00			TKMA3T1000 ³	\$2478.00			
1200	3600	10000	TKMA21200WL ²	\$7471.00	THKMA21200WL ²	\$8368.00			TKMA3T1200 ³	\$4477.00			
THKM2F Hi-Break Frame \$3587.00													
1200A Frame—Three-Pole													
600	1800	6000	TKMA30600WL	\$5885.00	THKMA30600WL	\$6795.00	TKM3F Standard Frame	\$3309.00	TKMA3T0600	\$2294.00	TCAL81	\$47.00	(3) 3/0-500 Cu/Al
700	2100	6400	TKMA30700WL	\$5885.00	THKMA30700WL	\$6795.00			TKMA3T0700	\$2294.00			
800	2400	6400	TKMA30800WL	\$5885.00	THKMA30800WL	\$6795.00			TKMA3T0800	\$2294.00			
1000	3000	10000	TKMA31000WL ³	\$6243.00	THKMA31000WL ³	\$7153.00			TKMA3T1000 ³	\$2478.00			
1200	3600	10000	TKMA31200WL ³	\$8242.00	THKMA31200WL ³	\$9152.00			TKMA3T1200 ³	\$4477.00			
THKM3F Hi-Break Frame \$4219.00													
Mag Only	1800	8000	—	—	—	—	THKM3F Hi-Break Frame	\$4219.00	TKMA3TM512 ²	\$4477.00	TCAL121	\$76.00	(4) 250-350 ⁴ Cu or (4) 300-500 Al
	2400	8000	—	—	—	—	THKM3F Hi-Break Frame	\$4219.00	TKMA3TM612 ²	\$4477.00			

¹For optional lugs, see page 3-101.

²Not UL listed.

³Not Suitable for use on dc systems.

⁴Suitable for 500 kcmil Cu for voltage drop considerations.

Accessories: See pages 3-39 to 3-45 and 3-92 to 3-104.

K1200 Reference Publications

Mechanical Interlock	GEH-2980
Trip Unit	GEH-2993
TDR Operating Mechanism	GEH-3000
Auxiliary Switch	GEH-3321
Shunt Trip	GEH-3344
Three Coil Shunt Trip	GEH-3346
Bell Alarm	GEH-4305
TDM Operating Mechanism	GEH-4314
Plug-in Mounting Base	GEH-4342
Motor Operator	GEH-4675
STDA Flange Handle	GEH-5314
STDA Operating Mechanism	GEH-5319
Undervoltage Release	GEH-5408
Back Connected Studs	GEJ-3616
Padlocking Device - Standard	GEJ-4636
K1200 Outline Drawing	455C840SH1



Publications and Reference: See Section 22 for a complete list of additional product-related publications

Molded Case Circuit Breakers Replacement Breakers

Tri-Break®
Internally Fused

Section 3



TB1



TB4



TB6

TB1, 150A Frame, Noninterchangeable Trip (Includes line and load lugs)

Ampere Rating	Adjustable Instantaneous Trip Amperes Range		Tri-Break®—Including Current Limiters ¹ Three-Pole		Lugs ²		Replacement Current Limiters ¹			
	Low	High	Product Number	List Price GO-135LG	Product No. and Wire Sizes (order 2 per pole)	List Price GO-135B	Standard Product Number	List Price GO-135LG	Optional ¹ Product Number	List Price GO-135LG
15	Fixed		TB13015BWE05	\$2680.00	TCAL14 #14-8 Cu-Al Lugs Furnished with Breaker		TB4E05	\$280.00	Not Available	
20	Fixed		TB13020BWE05	\$2680.00						
25	Fixed		TB13025BWE05	\$2680.00						
30	Fixed		TB13030BWE05	\$2680.00						
35	Fixed		TB13035BWE05	\$2680.00						
40	Fixed		TB13040BWE05	\$2680.00						
45	Fixed		TB13045BWE05	\$2680.00						
50	Fixed		TB13050BWE09	\$2680.00						
60	Fixed		TB13060BWE09	\$2680.00						
70	Fixed		TB13070BWE09	\$2680.00						
80	Fixed		TB13080BWE09	\$2680.00	TCAL 12 #14-2/0 Cu-Al Lugs Furnished with Breaker		TB7E09	\$360.00	TB4E05	\$280.00
90	Fixed		TB13090BWE09	\$2680.00						
100	Fixed		TB13100BWE09	\$2680.00						
100NA	-		TB13BYWE09 ^{4,5}	\$2680.00						

TB4 Replacement Limiters

Trip Units ³ Product Number	List Price GO-135LG	Current Limiters ¹			
		Standard Product Number	List Price GO-135LG	Optional ¹ Product Number	List Price GO-135LG
TB43T125	\$473.00	TB10F14	\$377.00	TB3F05 or TB6F09	\$401.00 \$377.00
TB43T150	\$473.00				
TB43T175	\$473.00				
TB43T200	\$473.00				
TB43T225	\$473.00				
TB43T250	\$1931.00				
TB43T300	\$1931.00				
TB43T350	\$1931.00				
TB43T400	\$1931.00				

¹Standard current limiters (bolt on: TB1, TB6, TB8 and plug-in: TB4) have been selected based upon recommended coordination with thermal magnetic trip characteristics of the breaker. Optional current limiters are not UL listed in combination with breaker except TB4 with TB3F05 or TB6F09, 250A maximum.

²For optional lugs, see page 3-101.

³Trip units fit 2 and 3 pole frames.

⁴Molded case switch. Includes dummy trip, line and load lugs.

⁵Not UL listed.



Molded Case Circuit Breakers Replacement Breakers

Tri-Break®
Internally Fused

TB6, 600A Frame, Interchangeable Trip (Without line or load lugs)

Ampere Rating	Adjustable Instantaneous Trip Amperes Range		Tri-Break®—Including Current Limiters ¹		Lugs ²		Replacement					
			Three-Pole		Product No. and Wire Sizes (order 2 per pole)	List Price GO-135LG	Trip Units ³		Current Limiters ¹		Optional ¹ Product Number	List Price GO-135LG
			Product Number	List Price GO-135LG			Product Number	List Price GO-135LG	Standard Product Number	List Price GO-135LG		
300	1200	3500	TB63300BJ14	\$7123.00	TCAL61 (2) 2/0-500 kcmil	\$40.00	TB63T300	\$2334.00	TB10BJ14	\$543.00	TB3BJ05 or TB6BJ09	\$579.00 \$543.00
350	1200	3500	TB63350BJ14	\$7123.00			TB63T350	\$2334.00				
400	1200	3500	TB63400BJ14	\$7123.00			TB63T400	\$2334.00				
500	1200	3500	TB63500BJ14	\$7123.00			TB63T500	\$2334.00				
600	1200	3500	TB63600BJ14	\$7123.00			TB63T600	\$2334.00				
600NA	-	-	TB63BYWJ14 ⁴	\$6894.00			-	-				

TB8, 800A Frame, Interchangeable Trip (Without line or load lugs)

Ampere Rating	Adjustable Instantaneous Trip Amperes Range		Tri-Break®—Including Current Limiters ¹		Lugs ²		Replacement					
			Three-Pole		Product No. and Wire Sizes (order 2 per pole)	List Price GO-135S	Trip Units ³		Current Limiters ¹		Optional ¹ Product Number	List Price GO-135LG
			Product Number	List Price GO-135LG			Product Number	List Price GO-135LG	Standard Product Number	List Price GO-135LG		
600	1800	3000	TB83600BK22	\$8204.00	TCAL81 (3) 250-500 kcmil	\$47.00	TB83T600	\$2334.00	TB15K22	543.00	TB6BJ09 ⁵ or TB10BJ14 ⁵	\$543.00
700	2100	4000	TB83700BK22	\$8204.00			TB83T700	\$2334.00				
800	2400	4000	TB83800BK22	\$8204.00			TB83T800	\$2334.00				
800NA	-	-	TB83AYWK22 ^{4,5}	\$8204.00			-	-				

Old Style (Plug-in) Replacement Limiters

Breaker Type	Ampere Range	Replacement Limiter ¹	
		Standard	Optional ¹
TB1	15-45	TB3E05	
TB1	50-100	TB6E09	TB3E05
TB1	110-150	TB7E10	TB7E09
TB6	300-600	TB10J14	TB3J05 TB6J09
TB8	600-800	TB15K18	-

¹Standard current limiters (bolt on: TB1, TB6, TB8 and plug-in: TB4) have been selected based upon recommended coordination with thermal magnetic trip characteristics of the breaker. Optional current limiters are not UL listed in combination with breaker except TB4 with TB3F05 or TB6F09, 250A maximum.

²For optional lugs, see page 3-101.

³Trip units fit 2 and 3 pole frames.

⁴Molded case switch. Includes dummy trip, line and load lugs.

⁵Not UL listed.

⁶GO-135S.



Publications and Reference: See Section 22 for a complete list of additional product-related publications

Molded Case Circuit Breakers

Internal Accessories

Internally Mounted Signaling and Controlling Functions

Section 3

How to Order

For factory installation, contact Customer Service Center and specify breaker product number, accessory base number, and appropriate suffix. (Example: Product Number TJK436125WL, TJUV1RS, TJKASA2AB2LS specifies a type TJK breaker with factory installed undervoltage release in the right-hand pole and an auxiliary switch in the left-hand pole.)

For field replacement, order the accessory by the base number only.

Where this number ends in "R" or "L" right-hand and left-hand devices are physically different. Specify only one suffix letter per accessory product number when option is available.

Nonautomatic circuit breakers require dummy trip units if internal accessories are to be mounted.



Undervoltage Release

Mine Duty Circuit Breaker Undervoltage Release

Circuit Breaker Frame	Control Voltage	Factory Installed ¹		Field Replacement Product Number ²	List Price GO-135A
		Product Number	Premium Duty		
E	24 Vac	TEMDVAS		TEMDVAS	\$485.00
	120 Vac	TEMDVBS		TEMDVBS	\$485.00
	240 Vac	TEMDVCS		TEMDVCS	\$485.00
	12 Vdc	TEMDVDS		TEMDVDS	\$485.00
	24 Vdc	TEMDVES		TEMDVES	\$485.00
	60 Vdc	TEMDVFS		TEMDVFS	\$485.00
J	24 Vac	TJMDVAS		TJRM DVA	\$509.00
	120 Vac	TJMDVBS		TJRM DVB	\$526.00
	230 Vac	TJMDVCS		TJRM DVC	\$526.00
	12 Vdc	TJMDVDS		TJRM DVD	\$526.00
	24 Vdc	TJMDVES		TJRM DVE	\$526.00
	60 Vdc	TJMDVFS		TJRM DVF	\$526.00
K	24 Vac	TKMDVAS		TKRM DVA	\$509.00
	120 Vac	TKMDVBS		TKRM DVB	\$526.00
	240 Vac	TKMDVCS		TKRM DVC	\$526.00
	12 Vdc	TKMDVDS		TKRM DVD	\$526.00
	24 Vdc	TKMDVES		TKRM DVE	\$526.00
	60 Vdc	TKMDVFS		TKRM DVF	\$526.00

¹Mounts in right pole only. "S" suffix-wires out the side of breaker. For factory installation, contact Customer Service Center.

²Replacement for standard and premium duty mine duty UVR, both old and new design.



Molded Case Circuit Breakers

Internal Accessories

Internally Mounted Signaling and Controlling Functions

Auxiliary Switches

Unless otherwise noted switch is SPDT rated 6 amperes at rated ac voltage, 1/2 amperes at 125 Vdc, 1/4 amperes at 250 Vdc.

Breaker Type	Number of SPDT Switch Elements	Control Voltage 240 Vac, 250 Vdc Maximum UL Listed When Factory Installed Suffix ¹			Control Voltage 600 Vac, 250 Vdc Maximum Not UL Listed Suffix ¹		
		Base Number	Add to Base Product Number for Factory Installation ¹²	List Price GO-135LG	Base Number	Add to Base Product Number for Factory Installation ¹²	List Price GO-135LG
TQB, THQB, THHQB, TXQB, TQL, THQL, THQL, TXQL	1 ³	TQAS2A1 ^{2,4}	5	\$64.50 ¹¹	-	-	-
TQC, THQC, THHQC, TXQC	1 ³	TQCAS2A1 ^{2,4}	5	\$77.50 ¹¹	-	-	-
TQD, THQD	1	TQDAS2AB1RS	N/A	\$148.00 ⁶	-	-	-
TEB, TEC, TB1	1	TEDAS2AB1R,L ^{7,8}	S	\$148.00 ¹¹	TEDAS6AB1R,L ^{7,8}	S	\$179.00 ¹¹
TED, THED, THLC1 ⁸	2	TEDAS2AB2R,L ^{7,8}	S	\$295.00 ¹¹	TEDAS6AB2R,L ^{7,8}	S	\$360.00 ¹¹
TFC, TFJ, TFK, THFK, ⁹	1	TFKASA2AB1 ¹⁰	RS or LS	\$148.00	TFKASA6AB1 ¹⁰	RS	\$167.00
THLC2, THLC4, TLB2, TLB4	2	TFKASA2AB2 ¹⁰	RS or LS	\$295.00	TFKASA6AB2 ¹⁰	RS	\$360.00
TJC, TJD, TJJ, TJK, THJK	1	TJKASA2AB1R,L	S	\$148.00	TJKASA6AB1R,L	S	\$179.00
	2	TJKASA2AB2R,L	S	\$295.00	TJKASA6AB2R,L	S	\$360.00
	3	TJKASA2AB3R,L	S	\$439.00	TJKASA6AB3R,L	S	\$530.00
	4	TJKASA2AB4R,L	S	\$598.00	TJKASA6AB4R,L	S	\$712.00
TB4, TBC4	1	TB4ASA2AB1R,L	S	\$148.00	TB4ASA6AB1R,L	S	\$179.00
	2	TB4ASA2AB2R,L	S	\$295.00	TB4ASA6AB2R,L	S	\$360.00
	3	TB4ASA2AB3R,L	S	\$439.00	TB4ASA6AB3R,L	S	\$530.00
	4	TB4ASA2AB4R,L	S	\$598.00	TB4ASA6AB4R,L	S	\$712.00
TKM, THKM, TKC, TB6, TB8, TBC6, TBC8	1	TKMAAS2AB1	RS or LS	\$148.00	TKMAAS6AB1	RS or LS	\$179.00
	2	TKMAAS2AB2	RS or LS	\$295.00	TKMAAS6AB2	RS or LS	\$360.00
	3	TKMAAS2AB3	RS or LS	\$439.00	TKMAAS6AB3	RS or LS	\$530.00
	4	TKMAAS2AB4	RS or LS	\$598.00	TKMAAS6AB4	RS or LS	\$712.00

¹"S" suffix for wires out the side of breaker. For lead exit from back of breaker, replace suffix "S" with "B" and multiply list price by 1.25. "B" suffix not UL listed. Not available with leads out the back for "Q-Line", or 2 element auxiliary switches used on TFG, TFJ, TFK, THFK, THLC2, THLC4, TLB2, and TLB4.

²Not available on GFCI (5 ma) or Equipment Ground Fault (30 ma) breakers.

³Switch is SPST. Operates like "A" side of an "AB" contact and is rated six amperes at 120 Vac and three amperes at 24 Vac.

⁴Accessories mounted in a one-inch frame and increase overall breaker size by one pole added to left side. May be applied to 1-, 2-, or 3-pole breakers. Must be factory installed. Maximum total breaker width is four poles.

⁵To order, specify both the accessory and breaker product number, e.g. THQL2130, TQASA1 identifies a 30 ampere, 2-pole plug-in breaker with a factory installed SPST auxiliary switch.

⁶GO-135F.

⁷Auxiliary switch mounts in right pole only on two-pole TEB, TED breakers. (Factory installed only.)

⁸Not available with "B" suffix-leads out back.

⁹Changes circuit breaker interrupting capacity to 10kAIC, 600 Vac; 22 kAIC, 240 and 480 Vac.

¹⁰UL listed for field installation.

¹¹GO-135B.

¹²For factory installation, contact Customer Service Center.



Molded Case Circuit Breakers

Internal Accessories

Internally Mounted Signaling and Controlling Functions

Section 3

How to Order

For field replacement, order base number only. For factory installation, contact Customer Service Center and order base number plus appropriate suffix. For a nonautomatic breaker (molded case switch) a dummy trip is required when installing either a shunt trip or UVR.

Shunt Trip

Remote Tripping – Trips breaker by remote control. Trip coil de-energized when breaker opens. Device meets UL requirements for service to ground fault system.

Undervoltage Release

Undervoltage release automatically trips breaker when applied coil voltage drops to 30 to 70 percent of rated value. Time-delay unit prevent nuisance tripping due to momentary loss of voltage. Separate externally mounted unit has 120 Vac input and 125 Vdc output. Used in conjunction with 125 Vdc undervoltage release which must be ordered separately. Product number SPUVTD for adjustable delay .1 to 1.0 seconds. List Price \$430.00 GO-245B.

Shunt Trip

Breaker Type	Accessory Voltage		Product Number ^{1,2} – UL Listed When Factory Installed		List Price GO-135B
	Vac	Vdc	Base Number for Field Replacement	Suffix Number ³	
				Add to Base Product Number for Factory Installation	
TQB, THQB, THHQB, TXQB, TQL, THQL, THHQL, TXQL	120-240	12	TQSTA ^{4,5,6,7}	10	\$95.50
			TQSTA ^{7,4,6,7}	10	\$95.50
			TQSTA ^{8,4,6,7}	10	\$95.50
TQD, THQD	120	24-48	TQDST ^{1,8,9}	10	\$178.00 ¹³
			TQDST ^{2,9}	10	\$178.00 ¹³
	240	12	TQDST ^{7,9}	10	\$178.00 ¹³
			TQDST ^{8,9}	10	\$178.00 ¹³
			TEDST ¹²	RS or LS ^{8,12}	\$363.00
TEB, TEC, TB1-B, ¹¹ TED, THED, THLC1	120	24	TEDST ¹²	RS or LS ^{8,12}	\$363.00
			TEDST ¹³	RS or LS ^{8,12}	\$363.00
	480	12	TEDST ¹³	RS or LS ^{8,12}	\$363.00
			TEDST ⁷	RS or LS ^{8,12}	\$363.00
			TEDST ⁸	RS or LS ^{8,12}	\$363.00
	600	48	TEDST ⁹	RS or LS ^{8,12}	\$363.00
			TEDST ¹²	RS or LS ^{8,12}	\$363.00
			TEDST ¹¹	RS or LS ^{8,12}	\$363.00
TFC, TFJ, TFK, THFK, THLC2, THLC4, TLB2, TLB4	120	24	TFKSTA ^{12,1}	RS or LS	\$363.00 ¹⁴
			TFKSTA ^{12,1}	RS or LS	\$363.00 ¹⁴
	480	12	TFKSTA ^{13,1}	RS or LS	\$363.00 ¹⁴
			TFKSTA ^{13,1}	RS or LS	\$363.00 ¹⁴
	600	48	TFKSTA ^{13,1}	RS or LS	\$363.00 ¹⁴
			TFKSTA ^{7,1}	RS or LS	\$363.00 ¹⁴
			TFKSTA ^{8,1}	RS or LS	\$363.00 ¹⁴
			TFKSTA ^{9,1}	RS or LS	\$363.00 ¹⁴
250	125	TFKSTA ^{12,1}	RS or LS	\$363.00 ¹⁴	
		TFKSTA ^{11,1}	RS or LS	\$363.00 ¹⁴	

¹UL listed for field installation on TFC, TFJ, TFK, and THFK model 4 frames and trips (mfg. Code date J101 or later) and on THLC2, THLC4, TLB4.

²For replacement voltage suppressor on 120 Vac UVRs for F225 line, order Product Number 286A8062G1. for 120 Vac UVRs on all other breaker lines, order Product Number 192A8300G1.

³"S" suffix for wires out the side of the breaker. For lead exit from back of breaker, replace suffix "S" with "B", and multiply "S" accessory List Price by 1.25. "B" suffix not UL listed. Not available with leads out the back on "Q-Line." For factory installation, contact Customer Service Center.

⁴Mounts on a one-inch frame and increases overall breaker size by one pole added to left side. May be applied to 1-, 2-, or 3-pole breakers. Maximum total breaker width is 4-pole. Must be factory installed.

⁵A selective listing of breaker product numbers that include 120 Volt ac shunt trip appears on page 3-19.

⁶Not available on GFCI (5 ma) or Equipment Ground Fault (30 ma) breakers.

⁷TQST shunt trips not available on breakers over 100 A.

⁸Not available with "B" suffix-leads out back.

⁹Must be factory installed, right pole only.

¹⁰To order, specify both the accessory and breaker product number =, e.g. THQL2130, TQST1 identifies a 30 A, 2-pole plug-in breaker with a factory installed 120 Vac shunt trip.

¹¹For TB1 with bolt-on limiters.

¹²Mounts in the right pole only on 2-pole TEB, TED breakers.

¹³GO-135F.

¹⁴GO-135LG.



Molded Case Circuit Breakers Internal Accessories

Internally Mounted Signaling and Controlling Functions

Section 3

Shunt Trip (continued)

Breaker Type	Product Number ^{1,2} — UL Listed When Factory Installed				List Price GO-135LG
	Accessory Voltage		Base Number for Field Replacement	Suffix Number ³ Add to Base Product Number for Factory Installation	
	Vac	Vdc			
TJC, TJD, TJJ, TJK, THJK	120		TJKSTA12R,L	S	\$363.00
	240		TJKSTA12R,L	S	\$363.00
	480		TJKSTA13R,L	S	\$363.00
	600		TJKSTA13R,L	S	\$363.00
		12	TJKSTA7R,L	S	\$363.00
		24	TJKSTA8R,L	S	\$363.00
		48	TJKSTA9R,L	S	\$363.00
		125	TJKSTA12R,L	S	\$363.00
		250	TJKSTA11R,L	S	\$363.00
	TB4, TBC4	120		TB4STA12R,L ⁵	
240			TB4STA12R,L ⁵		\$363.00
480			TB4STA13R,L ⁵		\$363.00
600			TB4STA13R,L ⁵		\$363.00
		12	TB4STA7R,L ⁵		\$363.00
		24	TB4STA8R,L ⁵		\$363.00
		48	TB4STA9R,L ⁵		\$363.00
		125	TB4STA12R,L ⁵		\$363.00
		250	TB4STA11R,L ⁵		\$363.00
TKC, TKM, THKM, TB6, TB8, TBC6, TBC8 ⁴		120		TKMASTA12R,L	S
	240		TKMASTA12R,L	S	\$363.00
	480		TKMASTA13R,L	S	\$363.00
	600		TKMASTA13R,L	S	\$363.00
		12	TKMASTA7R,L	S	\$363.00
		24	TKMASTA8R,L	S	\$363.00
		48	TKMASTA9R,L	S	\$363.00
		125	TKMASTA12R,L	S	\$363.00
		250	TKMASTA11R,L	S	\$363.00

¹UL listed for field installation on TFC, TFJ, TFK, and THFK model 4 frames and trips (mfg. Code date J101 or later) and on THLC2, THLC4, TLB4.

²For replacement voltage suppressor on 120 Vac UVRs for F225 line, order Product Number 286A8062G1. for 120 Vac UVRs on all other breaker lines, order Product Number 192A8300G1.

³"S" suffix for wires out the side of the breaker. For lead exit from back of breaker, replace suffix "S" with "B", and multiply "S" accessory List Price by 1.25. "B" suffix not UL listed. Not available with leads out the back on "Q-Line." For factory installation, contact Customer Service Center.

⁴Not UL listed.

⁵Not available for factory installation.



Publications and Reference: See Section 22 for a complete list of additional product-related publications

Molded Case Circuit Breakers

Internal Accessories

Internally Mounted Signaling and Controlling Functions

Section 3

Undervoltage Release

Breaker Type	Product Number ^{1,2} — UL Listed When Factory Installed					
	Accessory Voltage		Base Number for Field Replacement	Suffix Number ³ Add to Base Product Number for Factory Installation	List Price GO-135LG	
	Vac	Vdc				
TEB, TEC, TB1-B ⁵ TED, THED, THLC1	120		TEDUV1	RS ^B	\$363.00 ⁷	
	240		TEDUV2	RS ^B	\$363.00 ⁷	
	480		TEDUV4	RS ^B	\$363.00 ⁷	
	600		TEDUV6	RS ^B	\$363.00 ⁷	
		12	TEDUV7	RS ^B	\$363.00 ⁷	
		24	TEDUV8	RS ^B	\$363.00 ⁷	
		48	TEDUV9	RS ^B	\$363.00 ⁷	
		125	TEDUV10	RS ^B	\$363.00 ⁷	
		250	TEDUV11	RS ^B	\$363.00 ⁷	
	TFC, TFJ, TFK, THFK, THLC2, THLC4, TLB2, TLB4	120		TFKUA1 ¹	RS or LS	\$363.00
		240		TFKUA2	RS or LS	\$363.00
480			TFKUA4	RS or LS	\$363.00	
600			TFKUA6	RS or LS	\$363.00	
		12	TFKUA7	RS or LS	\$363.00	
		24	TFKUA8	RS or LS	\$363.00	
		48	TFKUA9	RS or LS	\$363.00	
		125	TFKUA10	RS or LS	\$363.00	
		250	TDKUA11	RS or LS	\$363.00	
TJC, TJD, TJJ, TJK, THJK		120		TJUV1R	S	\$363.00
		240		TJUV2R	S	\$363.00
	480		TJUV4R	S	\$363.00	
	600		TJUV6R	S	\$363.00	
		12	TJUV7R	S	\$363.00	
		24	TJUV8R	S	\$363.00	
		48	TJUV9R	S	\$363.00	
		125	TJUV10R	S	\$363.00	
		250	TJUV11R	S	\$363.00	
	TKC, TKM, THKM, TB6, TB8, TBC6, TBC8 ⁶	120		TKUV1R	S	\$363.00
		240		TKUV2R	S	\$363.00
480			TKUV4R	S	\$363.00	
600			TKUV6R	S	\$363.00	
		12	TKUV7R	S	\$363.00	
		24	TKUV8R	S	\$363.00	
		48	TKUV9R	S	\$363.00	
		125	TKUV10R	S	\$363.00	
		250	TKUV11R	S	\$363.00	

¹UL listed for field installation on TFC, TFJ, TFK, and THFK model 4 frames and trips (mfg. Code date J101 or later) and on THLC2, THLC4, TLB4.

²For replacement voltage suppressor on 120 Vac UVRs for F225 line, order Product Number 286A8062G1 for 120 Vac UVRs on all other breaker lines, order Product Number 192A8300G1.

³"S" suffix for wires out the side of the breaker. For lead exit from back of breaker, replace suffix "S" with "B", and multiply "S" accessory List Price by 1.25. "B" suffix not UL listed. Not available with leads out the back on "Q-Line." For factory installation, contact Customer Service Center.

⁴For TB1 with bolt-on limiters.

⁵Not available with "B" suffix – leads out back.

⁶Not UL listed.

⁷GO-135B.



Molded Case Circuit Breakers Internal Accessories

Internally Mounted Signaling and Controlling Functions

Heavy-Duty Undervoltage Release¹

Automatically trips breaker when an undervoltage or power outage condition occurs. Special PUSH-TO-TRIP/PUSH-TO-RESET button is used to manually trip the breaker (E-frame only). On J and K frames, the UVR is handle resettable with a cover-mounted button to provide local mechanical tripping.

The Heavy-Duty Undervoltage Release (UVR) is designed for applications where repeated UVR trips are anticipated. The manual reset feature prevents breaker reset or possible contact kiss until power is available and reset button is depressed.

Mounts in right pole of breaker only. Must be factory installed to incorporate special breaker frame modifications.² Motor-operated mechanism cannot be provided when heavy-duty UVR is installed.

How to Order

For field replacement, order mine duty UVR (field replacement product number) from page 3-40.

Breaker Type	Voltage		Product Number ³	List Price GO-135B
	ac	dc		
TEB, TED, THED, TEC, TB1 ^{4,5}	24	-	TEDXUVARS	\$543.00
	120	-	TEDXUVBRS	\$543.00
	240	-	TEDXUVCRS	\$543.00
	-	12	TEDXUVDRS	\$543.00
	-	24	TEDXUVERS	\$543.00
	-	60	TEDXUVFRS	\$543.00
TJJ, TJK, THJK, TJD, TJC, TB4, TBC4	-	125	TEDXUVGRS	\$543.00
	24	-	TJMDVAS	\$509.00 ⁷
	120	-	TJMDVBS	\$509.00 ⁷
	240	-	TJMDVCS	\$509.00 ⁷
	-	12	TJMDVDS	\$509.00 ⁷
	-	24	TJMDVES	\$509.00 ⁷
TKM, THKM, TKC, TB6, TB8, TBC6 ⁶ , TBC8 ⁶	-	60	TJMDVFS	\$509.00 ⁷
	24	-	TKMDVAS	\$509.00 ⁷
	120	-	TKMDVBS	\$509.00 ⁷
	240	-	TKMDVCS	\$509.00 ⁷
	-	12	TKMDVDS	\$509.00 ⁷
	-	24	TKMDVES	\$509.00 ⁷
-	60	TKMDVFS	\$509.00 ⁷	

¹Not UL listed when field installed.

²For Field Replacement, order Mine Duty UVR "Field Replacement Product Number" from page 3-40.

³Add "B" suffix for leads exit from back of breaker; for price, multiply List Price by 1.25. For factory installation, contact Customer Service Center.

⁴For TB1 with bolt-on limiters.

⁵Not available with "B" suffix - leads out back.

⁶Not UL listed.

⁷GO-135A.

⁸Not available for two-pole TEB, TED. Order TEDBAR.

⁹Changes circuit breaker interrupting capacity to: 10kA @ 600 Vac, 22kA @ 480 Vac, 22kA @ 240 Vac, for TFC, TFJ, TFK and THFK only.

¹⁰UL listed for field installation.

¹¹Mounts in center pole with leads out left side.

¹²GO-135B.

Bell Alarm Switches

Breaker Type	Product Number ³ UL Listed When Factory Installed		List Price GO-135LG
	Base No.	Suffix	
TEB, TEC, TB1	TEDBAR or	S	\$154.00 ¹²
TED, THED, THLC1	TEDBAL ^{5,8}		\$154.00 ¹²
TFC, TFJ, TFK, THFK, THLC2, THLC4, TLB4	TFKBAAR ^{9,10}	S	\$154.00
TJC, TJJ, TJK, THJK TB4, TBC4, TJD	TJKBAAL ¹¹	S	\$156.00
TKC, TKM, THKM, TB6, TBC6, TBC8, TB8	TKMABAAL ¹¹	S	\$141.00

Blown Fuse Detector-Three-Coil Shunt Trip

Breaker Type	Product Number ³ UL Listed When Factory Installed		List Price GO-135LG
	Base No.	Suffix	
TED, THED, TEC ⁵	TEDST316	RS	\$672.00 ¹²
TFJ, TJK, THFK, TFC	TFKBF316	LS or RS	\$672.00
TJJ, TJK, THJK, TJD, TJC	TJKST316	LS	\$672.00
TKM, THKM, TKC	TKMAST316	LS	\$672.00

Dummy Trip¹

Breaker Type	Product Number	List Price GO-135LG
E150	Internal accessories for these noninterchangeable breakers require factory-installed dummy trips.	No Charge
FJ225	Automatically supplied when accessories are ordered.	
JJ400		
FK225	TFKYT2 (two-pole)	\$148.00
FK225	TFKYT3 (three-pole)	\$208.00
JK400	TJKYT3 (two-pole, three-pole)	\$212.00
JK600	TJKYT36 (two-pole, three-pole)	\$212.00
KM800	TKMAYT3 (two-pole, three-pole)	\$261.00
KM1200	TKMA3YT12 (two-pole, three-pole)	\$424.00



Publications and Reference: See Section 22 for a complete list of additional product-related publications

Molded Case Circuit Breakers Industrial Circuit Breakers

Section 3

15-150A Circuit Breakers

Electronic Trip

Spectra® RMS

SE150 Line Circuit Breakers

Product Number Structure

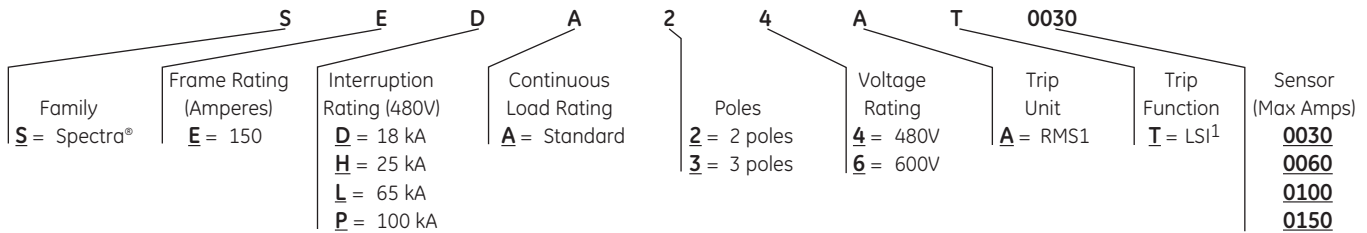

¹Adjustable Instantaneous with Tracking Short Time (Long Time established via Interchangeable Rating Plugs).

Note: This information is provided for interpreting product numbers (it should not be used to build product numbers).

SE150 Line, Suitable for Reverse Feed, UL File E-11592, CSA LR 40350

SED, SEH; 2-Pole, UL/CSA: 150A, 480 Vac Max., IEC 947-2: 160A, 415 Vac Max.

Rating Plug					Frame					Terminal Lugs for Front Connection (Cu/Al)		
Ampere Rating	Adj. Inst. Trip Range	Inst. Amps	Product Number	List Price GO-1355	UL 489 IC @480 Vac		UL 489 IC @480 Vac		Product Number	List Price GO-1355	Wire Range	
					Current Sensor	Product Number	List Price GO-1355	Product Number				List Price GO-1355
15	43	182	SRPE30A15	\$106.00	30	SEDA24AT0030	\$214.00	SEHA24AT0030	\$530.00	TCAL18	\$3.00	12-3/0 Cu 12-3/0 Al
20	58	254	SRPE30A20	\$106.00								
25	73	332	SRPE30A25	\$106.00								
30	87	415	SRPE30A30	\$106.00								
40	118	501	SRPE60A40	\$106.00								
50	148	637	SRPE60A50	\$106.00	60	SEDA24AT0060	\$214.00	SEHA24AT0060	\$530.00			
60	178	777	SRPE60A60	\$106.00								
70	206	863	SRPE100A70	\$106.00								
80	236	999	SRPE100A80	\$106.00	100	SEDA24AT0100	\$312.00	SEHA24AT0100	\$634.00			
90	267	1138	SRPE100A90	\$106.00								
100	297	1280	SRPE100A100	\$106.00								
110	328	1426	SRPE150A110	\$106.00	150	SEDA24AT0150	\$837.00	SEHA24AT0150	\$1427.00			
125	374	1640	SRPE150A125	\$106.00								
150	450	1991	SRPE150A150	\$106.00								

SE150 Line, Suitable for Reverse Feed, UL File E-11592, CSA LR 40350

SEL, SEP²; 2-Pole, UL/CSA: 150A, 480 Vac Max., IEC 947-2: 160A, 415 Vac Max.

Rating Plug					Frame					Terminal Lugs for Front Connection (Cu/Al)		
Ampere Rating	Adj. Inst. Trip Range	Inst. Amps	Product Number	List Price GO-1355	UL 489 IC @480 Vac		UL 489 IC @480 Vac		Product Number	List Price GO-1355	Wire Range	
					Current Sensor	Product Number	List Price GO-1355	Product Number				List Price GO-1355
15	43	182	SRPE30A15	\$106.00	30	SELA24AT0030	\$549.00	SEPA24AT0030	\$895.00	TCAL18	\$3.00	12-3/0 Cu 12-3/0 Al
20	58	254	SRPE30A20	\$106.00								
25	73	332	SRPE30A25	\$106.00								
30	87	415	SRPE30A30	\$106.00								
40	118	501	SRPE60A40	\$106.00								
50	148	637	SRPE60A50	\$106.00	60	SELA24AT0060	\$549.00	SEPA24AT0060	\$895.00			
60	178	777	SRPE60A60	\$106.00								
70	206	863	SRPE100A70	\$106.00								
80	236	999	SRPE100A80	\$106.00	100	SELA24AT0100	\$744.00	SEPA24AT0100	\$1179.00			
90	267	1138	SRPE100A90	\$106.00								
100	297	1280	SRPE100A100	\$106.00								
110	328	1426	SRPE150A110	\$106.00	150	SELA24AT0150	\$1808.00	SEPA24AT0150	\$2777.00			
125	374	1640	SRPE150A125	\$106.00								
150	450	1991	SRPE150A150	\$106.00								

²SEL, SEP UL current limiting.

Note: All Spectra® breakers UL listed as HACR type.



Molded Case Circuit Breakers Industrial Circuit Breakers

15-150A Circuit Breakers
Electronic Trip
Spectra® RMS
SE150 Line Circuit Breakers

SE150 Line, Suitable for Reverse Feed, UL File E-11592, CSA LR 40350

SED, SEH; 3-Pole, UL/CSA: 150A, 600 Vac Max., IEC 947-2: 160A, 690 Vac Max.

Rating Plug					Frame					Terminal Lugs for Front Connection (Cu/Al)		
					UL 489 IC @480 Vac			UL 489 IC @480 Vac				
					18kA			25kA				
Ampere Rating	Adj. Inst. Trip Range Amps		Product Number	List Price GO-135S	Current Sensor	Product Number	List Price GO-135S	Product Number	List Price GO-135S	Product Number	List Price GO-135S	Wire Range
	Low	High										
15	43	182	SRPE30A15	\$106.00	30	SEDA36AT0030	\$382.00	SEHA36AT0030	\$632.00	TCAL18	\$3.00	12-3/0 Cu 12-3/0 Al
20	58	254	SRPE30A20	\$106.00								
25	73	332	SRPE30A25	\$106.00								
30	87	415	SRPE30A30	\$106.00								
40	118	501	SRPE60A40	\$106.00								
50	148	637	SRPE60A50	\$106.00	60	SEDA36AT0060	\$382.00	SEHA36AT0060	\$632.00			
60	178	777	SRPE60A60	\$106.00								
70	206	863	SRPE100A70	\$106.00								
80	236	999	SRPE100A80	\$106.00	100	SEDA36AT0100	\$492.00	SEHA36AT0100	\$734.00			
90	267	1138	SRPE100A90	\$106.00								
100	297	1280	SRPE100A100	\$106.00								
110	328	1426	SRPE150A110	\$106.00	150	SEDA36AT0150	\$1253.00	SEHA36AT0150	\$1815.00			
125	374	1640	SRPE150A125	\$106.00								
150	450	1991	SRPE150A150	\$106.00								

SE150 Line, Suitable for Reverse Feed, UL File E-11592, CSA LR 40350

SEL, SEP¹; 3-Pole, UL/CSA: 150A, 600 Vac Max., IEC 947-2: 160A, 690 Vac Max.

Rating Plug					Frame					Terminal Lugs for Front Connection (Cu/Al)		
					UL 489 IC @480 Vac			UL 489 IC @480 Vac				
					65kA			100kA				
Ampere Rating	Adj. Inst. Trip Range Amps		Product Number	List Price GO-135S	Current Sensor	Product Number	List Price GO-135S	Product Number	List Price GO-135S	Product Number	List Price GO-135S	Wire Range
	Low	High										
15	43	182	SRPE30A15	\$106.00	30	SELA36AT0030	\$753.00	SEPA36AT0030	\$1189.00	TCAL18	\$3.00	12-3/0 Cu 12-3/0 Al
20	58	254	SRPE30A20	\$106.00								
25	73	332	SRPE30A25	\$106.00								
30	87	415	SRPE30A30	\$106.00								
40	118	501	SRPE60A40	\$106.00								
50	148	637	SRPE60A50	\$106.00	60	SELA36AT0060	\$753.00	SEPA36AT0060	\$1189.00			
60	178	777	SRPE60A60	\$106.00								
70	206	863	SRPE100A70	\$106.00								
80	236	999	SRPE100A80	\$106.00	100	SELA36AT0100	\$895.00	SEPA36AT0100	\$1482.00			
90	267	1138	SRPE100A90	\$106.00								
100	297	1280	SRPE100A100	\$106.00								
110	328	1426	SRPE150A110	\$106.00	150	SELA36AT0150	\$2165.00	SEPA36AT0150	\$3477.00			
125	374	1640	SRPE150A125	\$106.00								
150	450	1991	SRPE150A150	\$106.00								

¹SEL, SEP UL current limiting.

Note: All Spectra® breakers UL listed as HACR type.

SE 150 Reference Publications

Plug-in Mounting Base	GEH-4610
STDA Flange Handle	GEH-5314
Rating Plug	GEH-5549
Shunt Trip and Undervoltage Release	GEH-5551
Spectra® E-Frame Installation Instruction	GEH-5591
Auxiliary Switch and Bell Alarm	GEH-5593
TDR Operating Mechanism	GEH-5609
TDM Operating Mechanism	GEH-5611
Motor Operator	GEH-5613
Mechanical Interlock	GEH-5615
STDA Operating Mechanism	GEH-5684
Cable Operator Mechanism	GEH-6290
Lug	GEJ-3051
Padlocking Device - Standard	GEJ-3056
Back Connected Studs	GEJ-3609
SE150 Outline Drawing	168D1109SH1



Publications and Reference: See Section 22 for a complete list of additional product-related publications

Molded Case Circuit Breakers Industrial Circuit Breakers

Section 3

70-250A Circuit Breakers
Electronic Trip
Spectra® RMS
SF250 Line Circuit Breakers

Product Number Structure

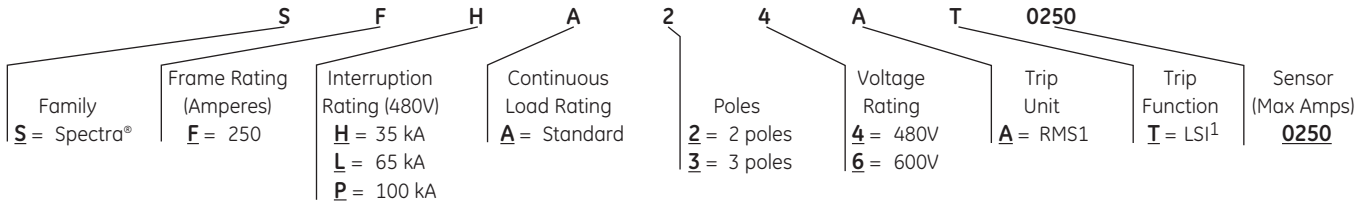

¹Adjustable Instantaneous with Tracking Short Time (Long Time established via Interchangeable Rating Plugs).
Note: This information is provided for interpreting product numbers (it should not be used to build product numbers).

SF250 Line, Suitable for Reverse Feed, UL File E-11592, CSA LR 40350

SFH; 2-Pole, UL/CSA: 250A, 480 Vac Max., IEC 947-2: 250A, 415 Vac Max.

Rating Plug				Frame			Terminal Lugs for Front Connection (Cu/Al)			
Adjustable Instantaneous				UL 489 IC @480 Vac			Product Number	List Price GO-135S	Wire Range	
Ampere Rating	Trip Ampere Range		Product Number	List Price GO-135S	Current Sensor	Product Number				List Price GO-135S
	Low	High								
70	205	700	SRPF250A70	\$106.00	250	SFHA24AT0250	\$1134.00	TCAL29	\$8.00	8-350 Cu 8-350 Al
90	265	900	SRPF250A90	\$106.00						
100	295	1000	SRPF250A100	\$106.00						
110	325	1100	SRPF250A110	\$106.00						
125	370	1250	SRPF250A125	\$106.00						
150	440	1500	SRPF250A150	\$106.00						
175	515	1750	SRPF250A175	\$106.00						
200	590	2000	SRPF250A200	\$106.00						
225	665	2250	SRPF250A225	\$106.00						
250	736	2500	SRPF250A250	\$106.00						

SF250 Line, Suitable for Reverse Feed, UL File E-11592, CSA LR 40350

SFL, SFP²; 2-Pole, UL/CSA: 250A, 480 Vac Max., IEC 947-2: 250A, 415 Vac Max.

Rating Plug				Frame					Terminal Lugs for Front Connection (Cu/Al)			
Adjustable Instantaneous				UL 489 IC @480 Vac			UL 489 IC @480 Vac		Product Number	List Price GO-135S	Wire Range	
Ampere Rating	Trip Ampere Range		Product Number	List Price GO-135S	Current Sensor	Product Number	List Price GO-135S	Product Number				List Price GO-135S
	Low	High										
70	205	700	SRPF250A70	\$106.00	250	SFLA24AT0250	\$2175.00	SFLA24AT0250	\$2790.00	TCAL29	\$8.00	8-350 Cu 8-350 Al
90	265	900	SRPF250A90	\$106.00								
100	295	1000	SRPF250A100	\$106.00								
110	325	1100	SRPF250A110	\$106.00								
125	370	1250	SRPF250A125	\$106.00								
150	440	1500	SRPF250A150	\$106.00								
175	515	1750	SRPF250A175	\$106.00								
200	590	2000	SRPF250A200	\$106.00								
225	665	2250	SRPF250A225	\$106.00								
250	736	2500	SRPF250A250	\$106.00								

²SFL, SFP UL current limiting.
Note: All Spectra® breakers UL listed as HACR type.



Molded Case Circuit Breakers Industrial Circuit Breakers

70-250A Circuit Breakers
Electronic Trip
Spectra® RMS
SF250 Line Circuit Breakers

SF250 Line, Suitable for Reverse Feed, UL File E-11592, CSA LR 40350
SFH; 3-Pole, UL/CSA: 250A, 600 Vac Max., IEC 947-2: 250A, 690 Vac Max.

Rating Plug					Frame			Terminal Lugs for Front Connection (Cu/Al)							
Ampere Rating	Adjustable Instantaneous Trip Ampere Range		Product Number	List Price GO-135S	UL 489 IC @480 Vac			Product Number	List Price GO-135S	Wire Range					
	Low	High			Current Sensor	35kA									
						Product Number	List Price GO-135S								
70	205	700	SRPF250A70	\$106.00	250	SFHA36AT0250	\$1441.00	TCAL29	\$8.00	8-350 Cu					
90	265	900	SRPF250A90	\$106.00											
100	295	1000	SRPF250A100	\$106.00											
110	325	1100	SRPF250A110	\$106.00											
125	370	1250	SRPF250A125	\$106.00											
150	440	1500	SRPF250A150	\$106.00											
175	515	1750	SRPF250A175	\$106.00											
200	590	2000	SRPF250A200	\$106.00											
225	665	2250	SRPF250A225	\$106.00											
250	736	2500	SRPF250A250	\$106.00											
															8-350 Al

SF250 Line, Suitable for Reverse Feed, UL File E-11592, CSA LR 40350
SFL, SFP¹; 3-Pole, UL/CSA: 250A, 600 Vac Max., IEC 947-2: 250A, 690 Vac Max.

Rating Plug					Frame					Terminal Lugs for Front Connection (Cu/Al)									
Ampere Rating	Adjustable Instantaneous Trip Ampere Range		Product Number	List Price GO-135S	UL 489 IC @480 Vac			UL 489 IC @480 Vac		Product Number	List Price GO-135S	Wire Range							
	Low	High			Current Sensor	65kA		100kA											
						Product Number	List Price GO-135S	Product Number	List Price GO-135S										
70	205	700	SRPF250A70	\$106.00	250	SFLA36AT0250	\$2631.00	SFPA36AT0250	\$3490.00	TCAL29	\$8.00	8-350 Cu							
90	265	900	SRPF250A90	\$106.00															
100	295	1000	SRPF250A100	\$106.00															
110	325	1100	SRPF250A110	\$106.00															
125	370	1250	SRPF250A125	\$106.00															
150	440	1500	SRPF250A150	\$106.00															
175	515	1750	SRPF250A175	\$106.00															
200	590	2000	SRPF250A200	\$106.00															
225	665	2250	SRPF250A225	\$106.00															
250	736	2500	SRPF250A250	\$106.00															
																			8-350 Al

¹SFL, SFP UL current limiting.
Note: All Spectra® breakers UL listed as HACR type.

SF250 Reference Publications

Plug-in Mounting Base	GEH-4610
STDA Flange Handle	GEH-5314
Rating Plug	GEH-5549
Shunt Trip and Undervoltage Release	GEH-5551
Spectra® F-Frame Installation Instruction	GEH-5591
Auxiliary Switch and Bell Alarm	GEH-5593
TDR Operating Mechanism	GEH-5609
TDM Operating Mechanism	GEH-5611
Motor Operator	GEH-5613
Mechanical Interlock	GEH-5615
STDA Operating Mechanism	GEH-5684
Cable Operator Mechanism	GEH-6290
Lug	GEJ-3045
Padlocking Device - Standard	GEJ-3056
Back Connected Studs	GEJ-3635
SF250 Outline Drawing	168D1103SH1



Publications and Reference: See Section 22 for a complete list of additional product-related publications

Molded Case Circuit Breakers

Industrial Circuit Breakers

Section 3

125-600A Circuit Breakers

Electronic Trip

Spectra® RMS

SG600

Digital, Solid-State Spectra® RMS Breakers

Product Number Structure

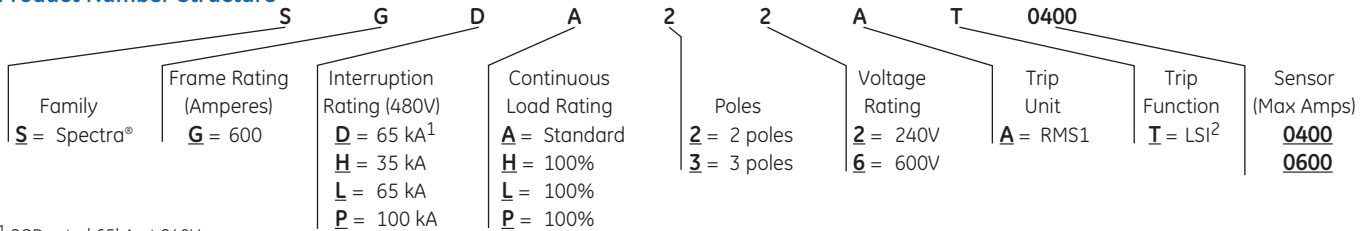

¹ SGD rated 65kA at 240V.

² Adjustable Instantaneous with Tracking Short Time (Long Time established via Interchangeable Rating Plugs).

Note: This information is provided for interpreting product numbers (it should not be used to build product numbers).

SG600 Line, Suitable for Reverse Feed, UL File E-11592, CSA LR 40350

SGD, SGH; UL/CSA: 400A, 600 Vac Max., IEC 947-2: 400A, 690 Vac Max.

Rating Plug					Frame						Terminal Lugs for Front Connection (Cu/Al)		
Ampere Rating	Adjustable Instantaneous Trip Ampere Range		Product Number	List Price GO-1355	Current Sensor	Poles	UL 489 IC @480 Vac		UL 489 IC @480 Vac		Product Number	List Price GO-1355	Wire Range
	Low	High					65kA (240 Vac)		35kA				
125	380	1275	SRPG400A125	\$106.00	400	2	SGDA22AT0400 ³	\$1540.00	SGHA26AT0400	\$1959.00	TCLK265 ⁴	\$28.00	(2) 2/0-500 Cu or (1) 8-600 Cu
150	455	1530	SRPG400A150	\$106.00									
175	530	1785	SRPG400A175	\$106.00									
200	605	2040	SRPG400A200	\$106.00									
225	680	2295	SRPG400A225	\$106.00		3	SGDA32AT0400 ³	\$1860.00	SGHA36AT0400	\$2383.00	TCLK365 ⁴	\$42.00	(2) 2/0-500 Al or (1) 6-600 Al
250	755	2550	SRPG400A250	\$106.00									
300	905	3060	SRPG400A300	\$106.00									
350	1060	3570	SRPG400A350	\$106.00									
400	1210	4080	SRPG400A400	\$106.00									

SG600 Line, Suitable for Reverse Feed, UL File E-11592, CSA LR 40350

SGL, SGP⁵; UL/CSA: 400A, 600 Vac Max., IEC 947-2: 400A, 690 Vac Max.

Rating Plug					Frame						Terminal Lugs for Front Connection (Cu/Al)		
Ampere Rating	Adjustable Instantaneous Trip Ampere Range		Product Number	List Price GO-1355	Current Sensor	Poles	UL 489 IC @480 Vac		UL 489 IC @480 Vac		Product Number	List Price GO-1355	Wire Range
	Low	High					65kA		100kA				
125	380	1275	SRPG400A125	\$106.00	400	2	SGLA26AT0400	\$2926.00	SGPA26AT0400	\$3856.00	TCLK265 ⁴	\$28.00	(2) 2/0-500 Cu or (1) 8-600 Cu
150	455	1530	SRPG400A150	\$106.00									
175	530	1785	SRPG400A175	\$106.00									
200	605	2040	SRPG400A200	\$106.00									
225	680	2295	SRPG400A225	\$106.00		3	SGLA36AT0400	\$3487.00	SGPA36AT0400	\$4653.00	TCLK365 ⁴	\$42.00	(2) 2/0-500 Al or (1) 6-600 Al
250	755	2550	SRPG400A250	\$106.00									
300	905	3060	SRPG400A300	\$106.00									
350	1060	3570	SRPG400A350	\$106.00									
400	1210	4080	SRPG400A400	\$106.00									

SG600 Line, Suitable for Reverse Feed, UL File E-11592, CSA LR 40350

SGH, SGL⁵; UL/CSA: 600A, 600 Vac Max., IEC 947-2: 630A, 690 Vac Max.

Rating Plug					Frame						Terminal Lugs for Front Connection (Cu/Al)		
Ampere Rating	Adjustable Instantaneous Trip Ampere Range		Product Number	List Price GO-1355	Current Sensor	Poles	UL 489 IC @480 Vac		UL 489 IC @480 Vac		Product Number	List Price GO-1355	Wire Range
	Low	High					35kA		65kA				
250	765	2530	SRPG600A250	\$106.00	600	2	SGHA26AT0600	\$2663.00	SGLA26AT0600	\$3545.00	TCLK265 ⁴	\$28.00	(2) 2/0-500 Cu or (1) 8-600 Cu
300	915	3035	SRPG600A300	\$106.00									
350	1070	3545	SRPG600A350	\$106.00									
400	1220	4050	SRPG600A400	\$106.00									
450	1375	4555	SRPG600A450	\$106.00		3	SGHA36AT0600	\$3354.00	SGLA36AT0600	\$4270.00	TCLK365 ⁴	\$42.00	(2) 2/0-500 Al or (1) 6-600 Al
500	1525	5060	SRPG600A500	\$106.00									
600	1830	6075	SRPG600A600	\$106.00									

³Rated 240 Vac max.

⁴Order one kit for either line or load end; two kits required for both.

⁵SGL, SGP UL current limiting.

Note: All Spectra® breakers UL listed as HACR type.



Molded Case Circuit Breakers Industrial Circuit Breakers

Section 3

125-600A Circuit Breakers

Electronic Trip

Spectra® RMS

SG600

Digital, Solid-State Spectra® RMS Breakers

SG600 Line, Suitable for Reverse Feed, UL File E-11592, CSA LR 40350

SGP²; UL/CSA: 600A, 600 Vac Max., IEC 947-2: 630A, 690 Vac Max.

Rating Plug					Frame				Terminal Lugs for Front Connection (Cu/Al)		
Ampere Rating	Adjustable Instantaneous Trip Ampere Range		Product Number	List Price GO-1355	UL 489 IC @480 Vac				Product Number	List Price GO-1355	Wire Range
	Low	High			Current Sensor	Poles	100kA				
							Product Number	List Price GO-1355			
250	765	2530	SRPG600A250	\$106.00	600	2	SGPA26AT0600	\$4607.00	2-pole lug kit	(2) 2/0-500 Cu or (1) 8-600 Cu	
300	915	3035	SRPG600A300	\$106.00							
350	1070	3545	SRPG600A350	\$106.00							
400	1220	4050	SRPG600A400	\$106.00							
450	1375	4555	SRPG600A450	\$106.00							
500	1525	5060	SRPG600A500	\$106.00							
600	1830	6075	SRPG600A600	\$106.00	3	SGPA36AT0600	\$5548.00	3-pole lug kit	(2) 2/0-500 Al or (1) 6-600 Al		

SG600 Line, Suitable for Reverse Feed, UL File E-11592, CSA LR 40350

SGH, SGL²; 100% UL Rated, 3-Pole: 400A, 600 Vac Max.; IEC 947-2: 400A, 690 Vac Max.

Rating Plug					Frame				Terminal Lugs for Front Connection (Cu/Al)				
Ampere Rating	Adjustable Instantaneous Trip Ampere Range		Product Number	List Price GO-1355	UL 489 IC @480 Vac				Product Number	List Price GO-1355	Wire Range		
	Low	High			Current Sensor	Poles	35kAIC					65kAIC	
							Product Number	List Price GO-1355	Product Number	List Price GO-1355			
125	380	1275	SRPG400A125	\$106.00	400	3	SGHH36AT0400	\$4381.00	SGLL36AT0400	\$5501.00	TCLK365 ¹	\$42.00	(2) 2/0-500 Cu or (1) 8-600 Cu
150	455	1530	SRPG400A150	\$106.00									
175	530	1785	SRPG400A175	\$106.00									
200	605	2040	SRPG400A200	\$106.00									
225	680	2295	SRPG400A225	\$106.00									
250	755	2550	SRPG400A250	\$106.00									
300	905	3060	SRPG400A300	\$106.00									
350	1060	3570	SRPG400A350	\$106.00									
400	1210	4080	SRPG400A400	\$106.00									

SG600 Line, Suitable for Reverse Feed, UL File E-11592, CSA LR 40350

SGP²; 100% UL Rated, 3-Pole: 400A, 600 Vac Max.; IEC 947-2: 400A, 690 Vac Max.

Rating Plug					Frame				Terminal Lugs for Front Connection (Cu/Al)		
Ampere Rating	Adjustable Instantaneous Trip Ampere Range		Product Number	List Price GO-1355	UL 489 IC @480 Vac				Product Number	List Price GO-1355	Wire Range
	Low	High			Current Sensor	Poles	100kAIC				
							Product Number	List Price GO-1355			
125	380	1275	SRPG400A125	\$106.00	400	3	SGPP36AT0400	\$6049.00	TCLK365 ¹	\$42.00	(2) 2/0-500 Cu or (1) 8-600 Cu
150	455	1530	SRPG400A150	\$106.00							
175	530	1785	SRPG400A175	\$106.00							
200	605	2040	SRPG400A200	\$106.00							
225	680	2295	SRPG400A225	\$106.00							
250	755	2550	SRPG400A250	\$106.00							
300	905	3060	SRPG400A300	\$106.00							
350	1060	3570	SRPG400A350	\$106.00							
400	1210	4080	SRPG400A400	\$106.00							

¹Order one kit for either line or load end; two kits required for both.

²SGL, SGP UL current limiting.

Note: All Spectra® breakers UL listed as HACR type.



Publications and Reference: See Section 22 for a complete list of additional product-related publications

Molded Case Circuit Breakers Industrial Circuit Breakers

Section 3

125-600A Circuit Breakers

Electronic Trip

Spectra® RMS

SG600

Digital, Solid-State Spectra® RMS Breakers

SG600 Line, Suitable for Reverse Feed, UL File E-11592, CSA LR 40350

SGH, SGL¹; 100% UL Rated, 3-Pole: 600A, 600 Vac Max.; IEC 947-2: 630A, 690 Vac Max.

Rating Plug					Frame						Terminal Lugs for Front Connection (Cu/Al)		
Ampere Rating	Adjustable Trip Ampere Range		Product Number	List Price GO-135S	UL 489 IC @480 Vac			UL 489 IC @480 Vac			Product Number	List Price GO-135S	Wire Range
	Low	High			35kAIC		65kAIC						
					Current Sensor	Poles	Product Number	List Price GO-135S	Product Number	List Price GO-135S			
250	765	2530	SRPG600A250	\$106.00	600	3	SGHH36AT0600	\$5451.00	SGLL36AT0600	\$6783.00	TCLK365 ¹	\$42.00	(2) 2/0-500 Cu or (1) 8-600 Cu
300	915	3035	SRPG600A300	\$106.00									
350	1070	3545	SRPG600A350	\$106.00									
400	1220	4050	SRPG600A400	\$106.00									
450	1375	4555	SRPG600A450	\$106.00									
500	1525	5060	SRPG600A500	\$106.00									
600	1830	6075	SRPG600A600	\$106.00									(2) 2/0-500 Al (1) 6-600 Al

SG600 Line, Suitable for Reverse Feed, UL File E-11592, CSA LR 40350

SGP²; 100% UL Rated, 3-Pole: 600A, 600 Vac Max.; IEC 947-2: 630A, 690 Vac Max.

Rating Plug					Frame						Terminal Lugs for Front Connection (Cu/Al)		
Ampere Rating	Adjustable Trip Ampere Range		Product Number	List Price GO-135S	UL 489 IC @480 Vac			UL 489 IC @480 Vac			Product Number	List Price GO-135S	Wire Range
	Low	High			100kAIC								
					Current Sensor	Poles	Product Number	List Price GO-135S	Product Number	List Price GO-135S			
250	765	2530	SRPG600A250	\$106.00	600	3	SGPP36AT0600	\$7212.00			TCLK365 ¹	\$42.00	(2) 2/0-500 Cu or (1) 8-600 Cu
300	915	3035	SRPG600A300	\$106.00									
350	1070	3545	SRPG600A350	\$106.00									
400	1220	4050	SRPG600A400	\$106.00									
450	1375	4555	SRPG600A450	\$106.00									
500	1525	5060	SRPG600A500	\$106.00									
600	1830	6075	SRPG600A600	\$106.00									(2) 2/0-500 Al or (1) 6-600 Al

¹Order one kit for either line or load end; two kits required for both.

²SGL, SGP UL current limiting.

Note: All Spectra® breakers UL listed as HACR type.

SG600 Reference Publications

STDA Flange Handle	GEH-5314
Rating Plug	GEH-5549
Shunt Trip and Undervoltage Release	GEH-5551
Auxiliary Switch and Bell Alarm	GEH-5593
TDM Operating Mechanism	GEH-5653
TDR Operating Mechanism	GEH-5654
Plug-in Mounting Base	GEH-5655
Motor Operator	GEH-5657
Spectra® G-Frame Installation Instruction	GEH-5663
Back Connected Studs	GEH-5665
STDA Operating Mechanism	GEH-5684
Mechanical Interlock	GEH-5697
Cable Operator Mechanism	GEH-6290
SG600 Outline Drawing	208C1549SH1, 2, 3



Molded Case Circuit Breakers Industrial Circuit Breakers

300-1200A Circuit Breakers

Electronic Trip

Spectra® RMS

Product Number Structure

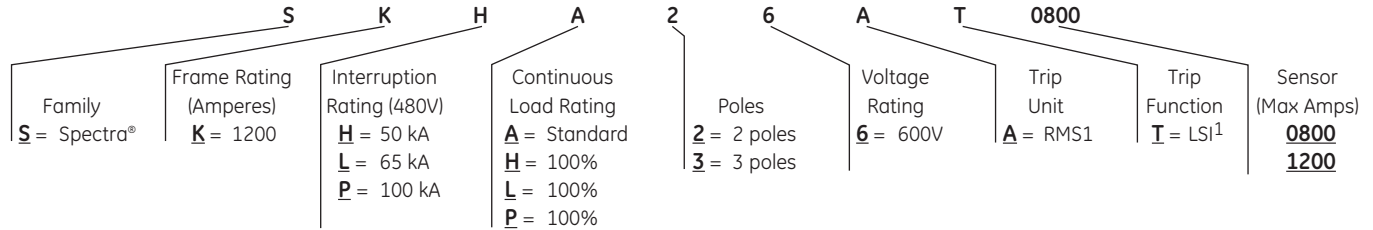

¹Adjustable Instantaneous with Tracking Short Time (Long Time established via Interchangeable Rating Plugs).

Note: This information is provided for interpreting product numbers (it should not be used to build product numbers).

SK1200 Line, Suitable for Reverse Feed, UL File E-11592, CSA LR 40350

UL/CSA: 800A, 600 Vac Max., IEC 947-2:800A 690 Vac Max.

Rating Plug					Frame					Terminal Lugs for Front Connection (Cu/Al)					
Ampere Rating	Adjustable Instantaneous Trip Ampere Range		Product Number	List Price GO-1355	Current Sensor	Poles	UL 489 IC @480 Vac		UL 489 IC @480 Vac		Product Number	List Price GO-1355	Wire Range		
	Low	High					50kA		65kA						
	Low	High					Product Number	List Price GO-1355	Product Number	List Price GO-1355					
300	940	3015	SRPK800A300	\$106.00	800	2	SKHA26AT0800	\$3377.00	SKLA26AT0800	\$4301.00	TCAL81	\$47.00	(3) 3/0-500 Cu		
400	1255	4015	SRPK800A400	\$106.00			SKHA36AT0800	\$4323.00	SKLA36AT0800	\$5234.00			(3) 3/0-500 Al		
500	1570	5020	SRPK800A500	\$106.00		3	2	SKHA26AT0800	\$3377.00	SKLA26AT0800	\$4301.00	TCAL81	\$47.00	(3) 3/0-500 Cu	
600	1875	6195	SRPK800A600	\$106.00				SKHA36AT0800	\$4323.00	SKLA36AT0800	\$5234.00				(3) 3/0-500 Al
700	2155	7420	SRPK800A700	\$106.00			3	2	SKHA26AT0800	\$3377.00	SKLA26AT0800	\$4301.00	TCAL81	\$47.00	(3) 3/0-500 Cu
800	2440	8705	SRPK800A800	\$106.00					SKHA36AT0800	\$4323.00	SKLA36AT0800	\$5234.00			

SK1200 Line, Suitable for Reverse Feed, UL File E-11592, CSA LR 40350

UL/CSA: 800A, 600 Vac Max., IEC 947-2:800A 690 Vac Max.

Rating Plug					Frame					Terminal Lugs for Front Connection (Cu/Al)					
Ampere Rating	Adjustable Instantaneous Trip Ampere Range		Product Number	List Price GO-1355	Current Sensor	Poles	UL 489 IC @480 Vac		UL 489 IC @480 Vac		Product Number	List Price GO-1355	Wire Range		
	Low	High					100kA		100kA						
	Low	High					Product Number	List Price GO-1355	Product Number	List Price GO-1355					
300	940	3015	SRPK800A300	\$106.00	800	2	SKPA26AT0800	\$6746.00	SKLA26AT0800	\$7958.00	TCAL81	\$47.00	(3) 3/0-500 Cu		
400	1255	4015	SRPK800A400	\$106.00			SKPA36AT0800	\$8240.00	SKLA36AT0800	\$9572.00			(3) 3/0-500 Al		
500	1570	5020	SRPK800A500	\$106.00		3	2	SKPA26AT0800	\$6746.00	SKLA26AT0800	\$7958.00	TCAL81	\$47.00	(3) 3/0-500 Cu	
600	1875	6195	SRPK800A600	\$106.00				SKPA36AT0800	\$8240.00	SKLA36AT0800	\$9572.00				(3) 3/0-500 Al
700	2155	7420	SRPK800A700	\$106.00			3	2	SKPA26AT0800	\$6746.00	SKLA26AT0800	\$7958.00	TCAL81	\$47.00	(3) 3/0-500 Cu
800	2440	8705	SRPK800A800	\$106.00					SKPA36AT0800	\$8240.00	SKLA36AT0800	\$9572.00			

SK1200 Line, Suitable for Reverse Feed, UL File E-11592, CSA LR 40350

UL/CSA: 1200A, 600 Vac Max., IEC 947-2: 1250A, 690 Vac Max.

Rating Plug					Frame					Terminal Lugs for Front Connection (Cu/Al)					
Ampere Rating	Adjustable Instantaneous Trip Ampere Range		Product Number	List Price GO-1355	Current Sensor	Poles	UL 489 IC @480 Vac		UL 489 IC @480 Vac		Product Number	List Price GO-1355	Wire Range		
	Low	High					50kA		65kA						
	Low	High					Product Number	List Price GO-1355	Product Number	List Price GO-1355					
600	1825	6110	SRPK1200A600	\$106.00	1200	2	SKHA26AT1200	\$7057.00	SKLA26AT1200	\$7958.00	TCAL125	\$76.00	(4) 250-500 Cu		
700	2125	7125	SRPK1200A700	\$106.00			SKHA36AT1200	\$7679.00	SKLA36AT1200	\$8586.00			(4) 250-500 Al		
800	2430	8145	SRPK1200A800	\$106.00		3	2	SKHA26AT1200	\$7057.00	SKLA26AT1200	\$7958.00	TCAL125	\$76.00	(4) 250-500 Cu	
1000	3040	10180	SRPK1200A1000	\$106.00				SKHA36AT1200	\$7679.00	SKLA36AT1200	\$8586.00				(4) 250-500 Al
1200	3650	12215	SRPK1200A1200	\$106.00			3	2	SKHA26AT1200	\$7057.00	SKLA26AT1200	\$7958.00	TCAL125	\$76.00	(4) 250-500 Cu
1200	3650	12215	SRPK1200A1200	\$106.00					SKHA36AT1200	\$7679.00	SKLA36AT1200	\$8586.00			

SK1200 Line, Suitable for Reverse Feed, UL File E-11592, CSA LR 40350

UL/CSA: 1200A, 600 Vac Max., IEC 947-2: 1250A, 690 Vac Max.

Rating Plug					Frame					Terminal Lugs for Front Connection (Cu/Al)					
Ampere Rating	Adjustable Instantaneous Trip Ampere Range		Product Number	List Price GO-1355	Current Sensor	Poles	UL 489 IC @480 Vac		UL 489 IC @480 Vac		Product Number	List Price GO-1355	Wire Range		
	Low	High					100kA		100kA						
	Low	High					Product Number	List Price GO-1355	Product Number	List Price GO-1355					
600	1825	6110	SRPK1200A600	\$106.00	1200	2	SKPA26AT1200	\$10136.00	SKLA26AT1200	\$11183.00	TCAL125	\$76.00	(4) 250-500 Cu		
700	2125	7125	SRPK1200A700	\$106.00			SKPA36AT1200	\$11183.00	SKLA36AT1200	\$12215.00			(4) 250-500 Al		
800	2430	8145	SRPK1200A800	\$106.00		3	2	SKPA26AT1200	\$10136.00	SKLA26AT1200	\$11183.00	TCAL125	\$76.00	(4) 250-500 Cu	
1000	3040	10180	SRPK1200A1000	\$106.00				SKPA36AT1200	\$11183.00	SKLA36AT1200	\$12215.00				(4) 250-500 Al
1200	3650	12215	SRPK1200A1200	\$106.00			3	2	SKPA26AT1200	\$10136.00	SKLA26AT1200	\$11183.00	TCAL125	\$76.00	(4) 250-500 Cu
1200	3650	12215	SRPK1200A1200	\$106.00					SKPA36AT1200	\$11183.00	SKLA36AT1200	\$12215.00			

Note: All Spectra® breakers UL listed as HACR type.



Publications and Reference: See Section 22 for a complete list of additional product-related publications

Molded Case Circuit Breakers Industrial Circuit Breakers

Section 3

300-1200A Circuit Breakers

Electronic Trip

Spectra® RMS

SK1200 Line, Suitable for Reverse Feed, UL File E-11592, CSA LR 40350

100% UL Rated, 3-Pole: 800A, 600 Vac Max.; IEC 947-2: 800A, 690 Vac Max.

Rating Plug					Frame													
Ampere Rating	Adjustable Instantaneous Trip Ampere Range		Product Number	List Price GO-1355	UL 489 IC @480 Vac		UL 489 IC @480 Vac				UL 489 IC @480 Vac							
	Low	High			50kA		65kA		100kA									
					Current Sensor	Poles	Product Number	List Price GO-1355	Product Number	List Price GO-1355	Product Number	List Price GO-1355	Product Number	List Price GO-1355				
300	940	3015	SRPK800A300	\$106.00														
400	1255	4015	SRPK800A400	\$106.00														
500	1570	5020	SRPK800A500	\$106.00	800	3	SKHH36AT0800	\$7514.00	SKLL36AT0800	\$9325.00	SKPP36AT0800	\$10712.00						
600	1875	6195	SRPK800A600	\$106.00														
700	2155	7420	SRPK800A700	\$106.00														
800	2440	8705	SRPK800A800	\$106.00														

Terminal Lugs for Front Connection (Cu/Al)

Product Number	Wire Range	List Price GO-1355
TCAL81	(3) 3/0-500 Cu	\$47.00
	(3) 3/0-500 Al	

SK1200 Line, Suitable for Reverse Feed, UL File E-11592, CSA LR 40350

100% UL Rated, 3-Pole: 1200A, 600 Vac Max.; IEC 947-2: 100A, 690 Vac Max.

Rating Plug					Frame													
Ampere Rating	Adjustable Instantaneous Trip Ampere Range		Product Number	List Price GO-1355	UL 489 IC @480 Vac		UL 489 IC @480 Vac				UL 489 IC @480 Vac							
	Low	High			50kA		65kA		100kA									
					Current Sensor	Poles	Product Number	List Price GO-1355	Product Number	List Price GO-1355	Product Number	List Price GO-1355	Product Number	List Price GO-1355				
600	1825	6110	SRPK1200A600	\$106.00														
700	2125	7125	SRPK1200A700	\$106.00														
800	2430	8145	SRPK1200A800	\$106.00	1200	3	SKHH36AT1000	\$11051.00	SKLL36AT1000	\$13678.00	SKPP36AT1000	\$14538.00						
1000	3040	10180	SRPK1200A1000	\$106.00														
1200	3650	12215	SRPK1200A1200	\$106.00														
							3	SKHH36AT1200 ¹	\$11450.00	SKLL36AT1200 ¹	\$14250.00	SKPP36AT1200 ¹	\$15235.00					

Terminal Lugs for Front Connection (Cu/Al)

Product Number	Wire Range	List Price GO-1355
TCAL125	(4) 250-500 Cu	\$76.00
	(4) 250-500 Al	

¹100% UL rated SK1200 supplied with back-connected assembly which increases breaker depth. Refer to outline drawings for details.
Lugs not required

Note: All Spectra® breakers UL listed as HACR type.

SK1200 Reference Publications

Plug-in Mounting Base	GEH-4342
STDA Flange Handle	GEH-5314
Rating Plug	GEH-5549
Shunt Trip and Undervoltage Release	GEH-5551
Spectra® K-Frame Installation Instruction	GEH-5592
Auxiliary Switch and Bell Alarm	GEH-5593
TDR Operating Mechanism	GEH-5610
TDM Operating Mechanism	GEH-5612
Motor Operator	GEH-5614
STDA Operating Mechanism	GEH-5684
Lug Cover	GEH-5699
Mechanical Interlock	GEH-5874
Padlocking Device - Standard	GEH-5877
Cable Operator Mechanism	GEH-6291
Back Connected Studs	GEJ-3619
SK1200 Outline Drawings	208C1757SH1
SK1200 Outline Drawings (1200A 100%)	168D1678SH2



Molded Case Circuit Breakers Spectra® RMS Circuit Breakers with MicroVersaTrip® Plus Trip Units

Features

MicroVersaTrip® Plus Trip Units Standard

- 3-phase Ammeter with $\pm 4\%$ accuracy.
- Adjustable Long Time (L) pickup, 0.5-1.0X, and delay (3-4 bands).
- Adjustable Instantaneous (I) pickup, 1.5-10X.
- Local Overload and Short Circuit Trip Indicators (T) with overload pickup warning.
- Interchangeable trip ratings plugs with test set jack for TVRMS test set.
- Digital LCD display with four-button keypad for function selection and set point adjustment and sealable, clear Lexan cover for tamper-resistant settings.
- True rms sensing for accurate response to high harmonic content waveforms.
- EMI immunity per ANSI C37.90.

Optional

- Adjustable Short-Time (S) pickup, 1.0-9.0C, and delay (4 bands) with I^2t IN/OUT selection.
- Adjustable Ground fault (G) pickup, 0.2-1.0S, and delay (4 bands) with I^2t IN/OUT selection and trip indicator. The 4 short-time and ground fault delay bands provide broader system selectivity.

World Standards—Frames rated to UL, CSA, IEC 947-2, and JIS.

Universal Internal Accessories—Uses the same front-mounted, field installable shunt trips, undervoltage releases, bell alarms, and auxiliary switches as standard Spectra® RMS breakers.

Accessory Lead Routing Left or Right—Side channels mean no extra space required for accessory leads.

Current Limiting—SE150, SF250 and SG600 frames rated 65kA and 100kA @ 480 Vac are UL listed as current limiting.

Reverse Feed—Front-mounted interchangeable rating plugs mean all frames are UL listed for reverse feed.



SG Frame with MicroVersaTrip®
Plus Trip Unit

Wide Current Setting Range—Interchangeable rating plugs combined with 5 current sensors and 0.5-1.0X long time pickup yield ampere ratings from 30 to 1200A.

100% Continuous Current Rated—Optionally available for 100% UL continuous current rating applications.

Control Power 24 Vdc—Optionally available, provides connection capability for +24 Vdc into the breaker via the distribution cable system.

MicroVersaTrip® Plus Trip Unit Characteristics¹

Current Setting (C) (Pick-Up) (Multiple of Rating Plug Amperes) (X)	Long-Time ²		Short-Time		Adjustable Instantaneous Pick-Up (Multiple of Rating Plug Amperes) (X)	Ground Fault	
	Delay (Seconds)	Pick-Up (Multiple of Current Setting) (C)	Delay (Seconds)	Pick-Up (Multiple of Sensor Ampere Rating) (X)		Delay (Seconds)	
0.5 to 1.0 in increments of 0.05	2.4, 4.9, 9.8, 20 ^{3,4}	1.5 to 9.0 in increments of 0.5	I^2t in: ⁴ .44	1.5 to 10.0 in increments of 0.5	.20 to 1.00 in increments of .05	I^2t in: ⁵ .41	
			I^2t out: ⁶ .10, .20, .30, .40			I^2t out: ⁶ .10, .20, .30, .40	

X = Rating Plug Amperes

S = Sensor Ampere Rating

C = Long-Time Current Settings (Pick-Up)

¹Contact local GE Sales Office for use on 400 Hz applications. Not UL listed for 400 Hz.

²Pick-up fixed at 1.1C.

³20 second delay (band) not available on SG frames.

⁴Time delay at 600% of current setting at lower limit of each band.

⁵Time delay at 200% of pick-up setting at lower limit of band.

⁶Time delay shown at lower limit of each band. Pick-up tolerances $\pm 10\%$. Ground fault pick-up not to exceed 1200 amperes.



Publications and Reference: See Section 22 for a complete list of additional product-related publications

Molded Case Circuit Breakers

Industrial Circuit Breakers

How To Order

Spectra® RMS Circuit Breakers with MicroVersa Trip Plus Trip Units

How to Order

- Determine the required breaker frame (i.e., 150, 400, 600, 800, or 1200 amperes), IC rating, and load requirements (UL Standard or 100%). Determine overcurrent protective functions (LI, LSI, LIG, LSIG). Select frame product number and list price from table on pages 3-60 to 3-65.
- Select and price the required rating plug from table below. The sensor rating of frame must match the sensor rating of the rating plug in table.
- Select and price lugs and lug covers as required from page 3-102 and 3-103.
- Select and price appropriate combination of Power Management System accessories from pages 3-66 to 3-69.
- Select and price any other accessories from pages 3-70 to 3-71 and 3-92 to 3-100.
- When ordering, specify separate product numbers as follows:
 - Frame
 - Rating Plug
 - Lugs
 - Power Management Accessories
 - Other Accessories

Trip Function Definitions

Long-Time (L)	Adjustable current setting Adjustable long-time delay
Short-Time (S)	Adjustable short-time pick-up Adjustable short-time delay with I ² t Adjustable short-time delay without I ² t
Instantaneous (I)	Adjustable pick-up
Ground Fault (G)	Adjustable ground fault pick-up Adjustable ground fault delay with I ² t Adjustable ground fault delay without I ² t
Control Power (CP)	+24 Vdc control power connection

Pricing Example

SG600 frame, 400 ampere sensor, 400 ampere rating plug, 100kAIC, 100% rated. Trip functions to include long-time (L), short-time (S), instantaneous (I) and ground fault. 3-phase/4 wire system with 400 ampere neutral sensor. Load lugs only. 120 Vac shunt trip and two stage auxiliary switch (2AB) with signal level contacts.

Description	Product Number	List Price GO-135S
Frame	SGPP36BD0400	\$8987.00
Rating Plug	SRPG400B400	\$106.00
Load Lugs (3 pole kit)	TCLK365	\$42.00
Terminal Block	SDCTBA11	\$110.00¹
400A neutral sensor	TSRG204	\$532.00
120 Vac Shunt Trip	SAST1	\$363.00
2AB Aux. Switch	SAUXGAB2	\$295.00

¹GO-135PM.

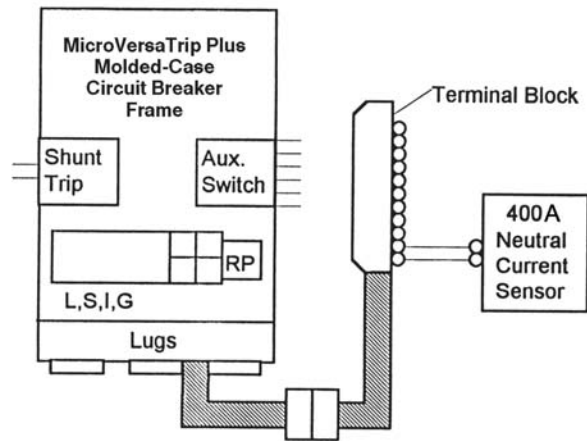

Note: All Spectra® RMS breakers with ground fault option will have a breaker cable. If the breaker is connected to a 3Ø4w or 1Ø3w service, a terminal block or junction box is required for connection to the neutral current sensor.



Molded Case Circuit Breakers Industrial Circuit Breakers

Spectra® RMS Circuit Breakers with
MicroVersaTrip® PM Trip Units

Section 3

MicroVersaTrip® PM Trip Unit

The MicroVersaTrip® PM trip unit adds power management system capability, advanced metering, and protective relays to the basic functions of MicroVersaTrip® Plus. MicroVersaTrip® PM trip units communicate directly on the GE POWER LEADER® communications bus. Suitable for use in applications from 45 Hz to 66 Hz. Not suitable for 400 Hz.

Standard Features

- Adjustable Long-Time (L) pickup, 0.5-1.0X, and delay (3-4 bands).
- Adjustable Instantaneous (I) pickup, 1.5-10X.
- Local Overload and Short-Circuit Trip Indicators (T) with overload pickup warning.
- Interchangeable trip rating plugs with test set jack for TVRMS test set.
- Digital LCD display with four-button keypad for function selection and set point adjustment and sealable, clear Lexan cover for tamper-resistant settings.
- True rms sensing for accurate response to high harmonic content waveforms.
- EMI immunity per ANSI C37.90.
- POWER LEADER® Communications System Link with user-selectable address assignment for COMNET communication.
- Metering
 - 3-Phase Ammeter with $\pm 4\%$ accuracy.
 - 3-Phase Voltmeter, $\pm 2\%$ @ 1X, configurable for Wye and Delta systems.
 - Frequency Meter, ± 1 Hz
 - kW Meter, $\pm 7\%$ (real power)
 - kVA Meter, $\pm 6\%$ (apparent power)
 - kWh Meter, $\pm 6\%$ (energy)

Control Power 24 Vdc provides connection capability for +24 Vdc control power into the breaker via the distribution cable system.

Optional Features

- Adjustable Short-Time (S) pickup, 1.0-9.0C, and delay (4 bands) with I^2t IN/OUT selection.
- Adjustable Ground fault (G) pickup, 0.2-1.0S, and delay (4 bands) with I^2t IN/OUT selection and trip indicator. The 4 short-time and ground fault delay bands provide broader system selectivity.
- Protective Relays—User selectable in any combination from 1 to 5 relays
 - Current Unbalance Relay
 - Undervoltage Relay
 - Overvoltage Relay
 - Voltage Unbalance Relay
 - Power Reversal Relay



Note: MicroVersaTrip® PM functions require 24 Vdc control power and voltage sensing signals.

Universal Internal Accessories—Uses the same front-mounted, field-installable shunt trips, undervoltage releases, bell alarms, and auxiliary switches as standard Spectra® RMS breakers.

Accessory Lead Routing Left or Right—Side channels mean no extra space required for accessory leads.

Current Limiting—SG600 frames rated 65kA and 100kA @ 480 Vac are UL listed as current limiting.

Reverse Feed—Front-mounted interchangeable rating plugs mean all frames are UL listed for reverse feed.

Wide Current Setting Range—Interchangeable rating plugs combined with 5 current sensors and 0.5-1.0X long time pickup yield ampere ratings from 30 to 1200A.

100% Continuous Current Rated—Optionally available for 100% UL continuous current rating applications.



Publications and Reference: See Section 22 for a complete list of additional product-related publications

Molded Case Circuit Breakers Industrial Circuit Breakers

Spectra® RMS Circuit Breakers with
MicroVersaTrip® PM Trip Units

Section 3

MicroVersaTrip® PM Trip Unit Characteristics

Current Setting (C) Pickup (Multiple of Rating Plus Amperes) (X)	Long-Time ¹	Short-Time		Adjustable Instantaneous Pickup (Multiple of Rating Plug Amperes) (X)	Ground Fault	
	Delay (Seconds)	Pick-Up (Multiple of Current Settings) (C)	Delay (Seconds)		Pick-Up (Multiple of Sensor Ampere Rating) (S)	Delay (Seconds)
0.50 to 1.0 in increments of 0.05 (11 Settings)	2,4,4.9,9,8,20 ^{2,3} (3-4 Bands)	1.5 to 9.0 in increments of 0.5 (16 Settings)	I ² t IN ³ 0.44 I ² t OUT ⁴ 0.1, 0.2, 0.3, 0.4 (8 Bands)	1.5 to 10.0 in increments of 0.5 (18 Settings)	0.2 to 1.0 in increments of 0.05 (17 Settings)	I ² t IN ⁵ 0.41 I ² t OUT ⁴ 0.1, 0.2, 0.3, 0.4 (8 Bands)

X = Rating Plug Amperes

S = Sensor Ampere Rating

C = Long-Time Current Settings (Pickup)

C = X Times Long-Time Pickup Setting

¹Pick-up fixed at 1.1C.

²20-second delay (band) not available on SG frames.

³Time delay at 600% of current setting at lower limit of each band.

⁴Time delay shown at lower limit of each band. Pickup tolerances ± 10%. Ground Fault Pick-up not to exceed 1200 amperes.

⁵Time delay at 200% of pickup setting at the lower limit of each band.

Functions	Accuracy and Description	PM Trip Unit	
		Metering (M)	Metering and Relaying (PM)
Amperes (A)	Current ±4% Selectable Phase	•	•
Voltage (V)	Volts ±2% Selectable Phase in L-L or L-N	•	•
Energy (kWh/MWh)	Watt hours ±7% Total energy flow through breaker	•	•
Real Power (kW/MW)	Watts ±6% L-L or L-N Power	•	•
Apparent Power (kVA/MVA)	Volt amps ±6% L-L or L-N Power	•	•
Frequency (45-66 Hz)	Hertz ±6%	•	•
Voltage Unbalance Relay	Adjustable pickup, 10 to 50% Adjustable delay, 1 to 15 seconds or OFF		•
Current Unbalance Relay	Adjustable pickup, 10 to 50% Adjustable delay, 1 to 15 seconds or OFF		•
Undervoltage Relay	Adjustable pickup, 50 to 90% Adjustable delay, 1 to 15 seconds or OFF		•
Overvoltage Relay	Adjustable pickup, 110 to 150% Adjustable delay, 1 to 15 seconds or OFF		•
Power Reversal Relay	Adjustable pickup, 0.01 MW to .90 MW Adjustable delay, 1 to 15 seconds or OFF		•
Communications	POWER LEADER™ Communications System Link (comment)	•	•



Molded Case Circuit Breakers Industrial Circuit Breakers

Spectra® RMS Circuit Breakers with
MicroVersaTrip® PM Trip Units

How to Order

- Determine the required breaker frame (i.e., 150, 400, 600, 800, or 1200 amperes), IC rating, and load requirements (UL Standard or 100%). Determine overcurrent protective functions (LI, LSI, LIG, LSIG) and whether protective relaying is required. Select frame product number and list price from table on pages 3-60 to 3-65.
- Select and price the required rating plug from table below.
The sensor rating of frame must match the sensor rating of the rating plug in table.
- Select and price lugs and lug covers as required from page 3-102 and 3-103.
- Select and price appropriate combination of Power Management System accessories from pages 3-66 to 3-69.
- Select and price an auxiliary switch as required from page 3-69.
- Select and price any other accessories from pages 3-70 to 3-71 and 3-92 to 3-100.
- When ordering, specify separate product numbers as follows:
 - Frame
 - Rating Plug
 - Lugs
 - Auxiliary Switch
 - Power Management System Accessories
 - Other Accessories

Trip Unit Function Definitions

Long-Time (L)	Adjustable current setting Adjustable long-time delay
Short-Time (S)	Adjustable short-time pick-up Adjustable short-time delay with I ² t Adjustable short-time delay without I ² t
Instantaneous (I)	Adjustable pick-up
Ground Fault (G)	Adjustable ground fault pick-up Adjustable ground fault delay with I ² t Adjustable ground fault delay without I ² t
Trip Indication Targets	Standard
Full Metering (Standard)	Amperes (A/kA) – Phase Selectable Voltage (V) – L-L or L-N and Phase Selectable Energy (kWh/MWh) Real Power (kW) – L-L or L-N Total Power (kVA) – L-L or L-N Frequency (45-66 Hz)
Protective Relay Functions	Adjustable Undervoltage pick-up Adjustable Undervoltage delay or OFF Adjustable Overvoltage pick-up Adjustable Overvoltage delay or OFF Adjustable Voltage Unbalance pick-up Adjustable Voltage Unbalance delay or OFF Adjustable Current Unbalance pick-up Adjustable Current Unbalance delay or OFF Adjustable Power Reversal pick-up Adjustable Power Reversal delay or OFF

Pricing Example

SG600 ampere frame breaker, 100% UL rated with 400 ampere sensors and 400 ampere rating plug with line and load lugs. Trip functions to include adjustable long-time (L), short-time (S), instantaneous (I) and equipment ground fault (G) and internal protective relay functions of current unbalance (CU), voltage unbalance (VU),

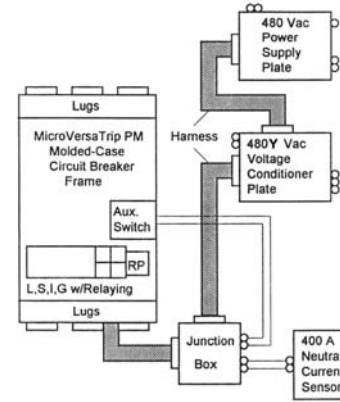

undervoltage (UV), overvoltage (OV) and power reversal (PR). Local metering values available at the breaker shall include Current (Amperes), Voltage (Volts), Energy (kWh), Real Power (kW), Apparent Power (kVA) and Frequency (Hz). The available system is 277/480 Vac, 3-phase/4-wire with 100 kAIC fault current available. The Distribution Cable Accessories are to be mounted on plates with all the necessary fuse protection, potential transformers, control power transformers, etc.

Description	Product Number	List Price	GO Schedule
Frame	SGPP36DD0400	\$11387.00	135PM
Rating Plug	SRPG400B400	\$106.00	135S
Line and Load Lugs (2-3 Pole Kits)	TCLK635	\$42.00	135S
Auxiliary Switch	SAUXPAB1	\$149.00	135S
Power Supply Plate	SPSA480	\$1215.00	135PM
Voltage Conditioner Plate	SVCA480Y	\$1000.00	135PM
Junction Box	SDCJBB	\$155.00	135PM
Harness (2)	SPCHA11	\$140.00	135PM
400A Neutral Current Sensor	TSRG204	\$532.00	135S

Spectra® MVT Plus/PM Reference Publications

Distribution Cable Junction Box	DEH-006
Sealable Trip Unit Cover MVT plus MVT PM	GEH-5664
Rating Plug	GEH-5887
MVT plus/pm Trip Unit User's Manual	GEH-5934
Spectra® K Circuit Breaker with MVT plus/pm Trip Unit	GEH-5960
Spectra® G Circuit Breaker with MVT plus/pm Trip Unit	GEH-5959
Voltage Module	GEH-6250
Power Supply Plate	GEH-6251
Voltage Conditioner Plate	GEH-6252
Power Supply Assembly	GEH-6253
Voltage Conditioner Assembly	GEH-6254
Distribution Cable Harness	GEH-6255
Distribution Cable Extension	GEH-6256
Distribution Cable Terminal Block	GEH-6257
Distribution Cable Junction Box	GEH-6258
SG600 MVT Outline Drawing	208C1549SH2, 4
SK1200 MVT Outling Drawing	208C1757SH2



Publications and Reference: See Section 22 for a complete list of additional product-related publications

Molded Case Circuit Breakers Industrial Circuit Breakers

Section 3

60-600A Circuit Breakers

Electronic Trip

Spectra® RMS

SG600 with MicroVersaTrip® Plus and PM

Product Number Structure

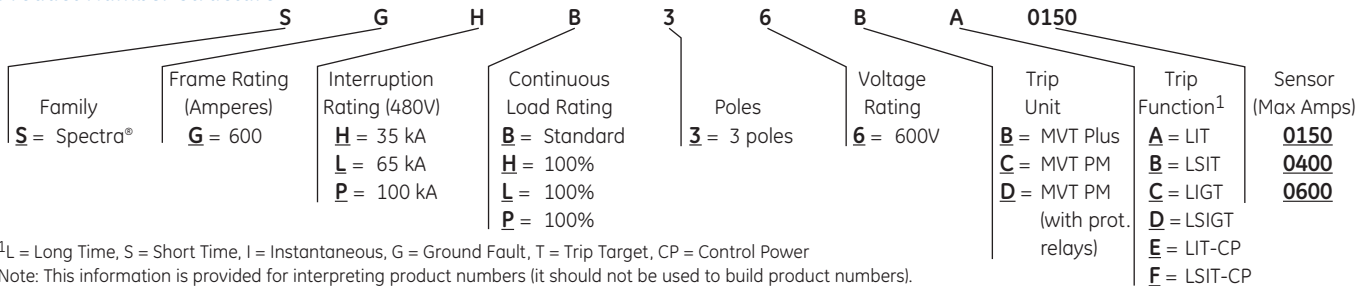

¹L = Long Time, S = Short Time, I = Instantaneous, G = Ground Fault, T = Trip Target, CP = Control Power

Note: This information is provided for interpreting product numbers (it should not be used to build product numbers).

MicroVersaTrip® Plus, Standard UL Rated

SG600 Line, Suitable for Reverse Feed, UL File E-11592, CSA LR 40350

SGL, SGP UL Current Limiting; 3-Pole, UL/CSA: 600 Vac Max., IEC 947-2: 630A, 690 Vac Max.

Frame								Terminal Lugs for Front connection (Cu/Al)		
		IC @480 Vac, UL 489		IC @480 Vac, UL 489		IC @480 Vac, UL 489				
Current Sensor	Trip Function	35kA Product Number	List Price GO-1355	65kA Product Number	List Price GO-1355	100kA Product Number	List Price GO-1355	Product Number	List Price GO-1355	Wire Range
150	LIT	SGHB36BA0150	\$2597.00	SGLB36BA0150	\$3752.00	SGPB36BA0150	\$4932.00	3-Pole lug kit TCLK365 ³	\$42.00	(2) 2/0-500 Cu or (1) 8-600 Cu
	LSIT	SGHB36BB0150	\$3962.00	SGLB36BB0150	\$5117.00	SGPB36BB0150	\$6297.00			
	LIGT ¹	SGHB36BC0150	\$3807.00	SGLB36BC0150	\$4962.00	SGPB36BC0150	\$6142.00			
	LSIGT ¹	SGHB36BD0150	\$5172.00	SGLB36BD0150	\$6327.00	SGPB36BD0150	\$7507.00			
	LIT-CP ²	SGHB36BE0150	\$2897.00	SGLB36BE0150	\$4052.00	SGPB36BE0150	\$5232.00			
	LSIT-CP ²	SGHB36BF0150	\$4262.00	SGLB36BF0150	\$5417.00	SGPB36BF0150	\$6597.00			
400	LIT	SGHB36BA0400	\$2597.00	SGLB36BA0400	\$3752.00	SGPB36BA0400	\$4932.00			(2) 2/0-500 Al or (1) 6-600 Al
	LSIT	SGHB36BB0400	\$3962.00	SGLB36BB0400	\$5117.00	SGPB36BB0400	\$6297.00			
	LIGT ¹	SGHB36BC0400	\$3807.00	SGLB36BC0400	\$4962.00	SGPB36BC0400	\$6142.00			
	LSIGT ¹	SGHB36BD0400	\$5172.00	SGLB36BD0400	\$6327.00	SGPB36BD0400	\$7507.00			
	LIT-CP ²	SGHB36BE0400	\$2897.00	SGLB36BE0400	\$4052.00	SGPB36BE0400	\$5232.00			
	LSIT-CP ²	SGHB36BF0400	\$4262.00	SGLB36BF0400	\$5417.00	SGPB36BF0400	\$6597.00			
600	LIT	SGHB36BA0600	\$3551.00	SGLB36BA0600	\$4505.00	SGPB36BA0600	\$5880.00			
	LSIT	SGHB36BB0600	\$4916.00	SGLB36BB0600	\$5870.00	SGPB36BB0600	\$7245.00			
	LIGT ¹	SGHB36BC0600	\$4761.00	SGLB36BC0600	\$5715.00	SGPB36BC0600	\$7090.00			
	LSIGT ¹	SGHB36BD0600	\$6126.00	SGLB36BD0600	\$7080.00	SGPB36BD0600	\$8455.00			
	LIT-CP ²	SGHB36BE0600	\$3851.00	SGLB36BE0600	\$4805.00	SGPB36BE0600	\$6180.00			
	LSIT-CP ²	SGHB36BF0600	\$5216.00	SGLB36BF0600	\$6170.00	SGPB36BF0600	\$7545.00			

MicroVersaTrip® Plus, 100% UL Rated

SG600 Line, Suitable for Reverse Feed, UL File E-11592, CSA LR 40350

SGL, SGP UL Current Limiting; 3-Pole, UL/CSA: 600 Vac Max., IEC 947-2: 630A, 690 Vac Max.

Frame								Terminal Lugs for Front connection (Cu/Al)		
		IC @480 Vac, UL 489		IC @480 Vac, UL 489		IC @480 Vac, UL 489				
Current Sensor	Trip Function	35kA Product Number	List Price GO-1355	65kA Product Number	List Price GO-1355	100kA Product Number	List Price GO-1355	Product Number	List Price GO-1355	Wire Range
150	LIT	SGHH36BA0150	\$4774.00	SGLL36BA0150	\$5919.00	SGPP36BA0150	\$6412.00	3-Pole lug kit TCLK365 ³	\$42.00	(2) 2/0-500 Cu or (1) 8-600 Cu
	LSIT	SGHH36BB0150	\$6139.00	SGLL36BB0150	\$7284.00	SGPP36BB0150	\$7777.00			
	LIGT ¹	SGHH36BC0150	\$5984.00	SGLL36BC0150	\$7129.00	SGPP36BC0150	\$7622.00			
	LSIGT ¹	SGHH36BD0150	\$7349.00	SGLL36BD0150	\$8494.00	SGPP36BD0150	\$8987.00			
	LIT-CP ²	SGHH36BE0150	\$5074.00	SGLL36BE0150	\$6219.00	SGPP36BE0150	\$6712.00			
	LSIT-CP ²	SGHH36BF0150	\$6439.00	SGLL36BF0150	\$7584.00	SGPP36BF0150	\$8077.00			
400	LIT	SGHH36BA0400	\$4774.00	SGLL36BA0400	\$5919.00	SGPP36BA0400	\$6412.00			(2) 2/0-500 Al or (1) 6-600 Al
	LSIT	SGHH36BB0400	\$6139.00	SGLL36BB0400	\$7284.00	SGPP36BB0400	\$7777.00			
	LIGT ¹	SGHH36BC0400	\$5984.00	SGLL36BC0400	\$7129.00	SGPP36BC0400	\$7622.00			
	LSIGT ¹	SGHH36BD0400	\$7349.00	SGLL36BD0400	\$8494.00	SGPP36BD0400	\$8987.00			
	LIT-CP ²	SGHH36BE0400	\$5074.00	SGLL36BE0400	\$6219.00	SGPP36BE0400	\$6712.00			
	LSIT-CP ²	SGHH36BF0400	\$6439.00	SGLL36BF0400	\$7584.00	SGPP36BF0400	\$8077.00			
600	LIT	SGHH36BA0600	\$5771.00	SGLL36BA0600	\$7155.00	SGPP36BA0600	\$7644.00			
	LSIT	SGHH36BB0600	\$7136.00	SGLL36BB0600	\$8520.00	SGPP36BB0600	\$9009.00			
	LIGT ³	SGHH36BC0600	\$6981.00	SGLL36BC0600	\$8365.00	SGPP36BC0600	\$8854.00			
	LSIGT ³	SGHH36BD0600	\$8346.00	SGLL36BD0600	\$9730.00	SGPP36BD0600	\$10219.00			
	LIT-CP ⁴	SGHH36BE0600	\$6071.00	SGLL36BE0600	\$7455.00	SGPP36BE0600	\$7944.00			
	LSIT-CP ⁴	SGHH36BF0600	\$7436.00	SGLL36BF0600	\$8820.00	SGPP36BF0600	\$9309.00			

¹For grounded neutral systems (1**/3w or 3**4w) a neutral current sensor is required. Refer to page 3-69.

²For +24 Vdc Control Power Accessories refer to pages 3-66 to 3-69.

³Order one kit for either line or load end; two kits required for both.

Note: All Spectra® breakers UL listed as HACR type.



Molded Case Circuit Breakers Industrial Circuit Breakers

Section 3

60-600A Circuit Breakers

Electronic Trip

Spectra® RMS

with MicroVersaTrip® PM Trip Units¹

MicroVersaTrip® PM, Standard UL Rated (No Protective Relays)

SG600 Line, Suitable for Reverse Feed, UL File E-11592, CSA LR 40350

SGL, SGP UL Current Limiting; 3-Pole, UL/CSA: 600 Vac Max., IEC 947-2: 630A, 690 Vac Max.

Frame								Terminal Lugs for Front connection (Cu/Al)			
		IC @480 Vac, UL 489		IC @480 Vac, UL 489		IC @480 Vac, UL 489					
Current Sensor	Trip Function	35kA Product Number	List Price GO-135PM	65kA Product Number	List Price GO-135PM	100kA Product Number	List Price GO-135PM	Product Number	List Price GO-135S	Wire Range	
150	LIT	SGHB36CA0150	\$3797.00	SGLB36CA0150	\$4952.00	SGPB36CA0150	\$6132.00	3-Pole lug kit TCLK365 ³	\$42.00	(2) 2/0-500 Cu or (1) 8-600 Cu	
	LSIT	SGHB36CB0150	\$5162.00	SGLB36CB0150	\$6317.00	SGPB36CB0150	\$7497.00				
	LIGT ²	SGHB36CC0150	\$5007.00	SGLB36CC0150	\$6162.00	SGPB36CC0150	\$7342.00				
	LSIGT ²	SGHB36CD0150	\$6372.00	SGLB36CD0150	\$7527.00	SGPB36CD0150	\$8707.00				
400	LIT	SGHB36CA0400	\$3797.00	SGLB36CA0400	\$4952.00	SGPB36CA0400	\$6132.00			(2) 2/0-500 Al or (1) 6-600 Al	
	LSIT	SGHB36CB0400	\$5162.00	SGLB36CB0400	\$6317.00	SGPB36CB0400	\$7497.00				
	LIGT ²	SGHB36CC0400	\$5007.00	SGLB36CC0400	\$6162.00	SGPB36CC0400	\$7342.00				
	LSIGT ²	SGHB36CD0400	\$6372.00	SGLB36CD0400	\$7527.00	SGPB36CD0400	\$8707.00				
600	LIT	SGHB36CA0600	\$4751.00	SGLB36CA0600	\$5705.00	SGPB36CA0600	\$7080.00				
	LSIT	SGHB36CB0600	\$6116.00	SGLB36CB0600	\$7070.00	SGPB36CB0600	\$8445.00				
	LIGT ²	SGHB36CC0600	\$5961.00	SGLB36CC0600	\$6915.00	SGPB36CC0600	\$8290.00				
	LSIGT ²	SGHB36CD0600	\$7326.00	SGLB36CD0600	\$8280.00	SGPB36CD0600	\$9655.00				

MicroVersaTrip® PM, 100% UL Rated (No Protective Relays)

SG600 Line, Suitable for Reverse Feed, UL File E-11592, CSA LR 40350

SGL, SGP UL Current Limiting; 3-Pole, UL/CSA: 600 Vac Max., IEC 947-2: 630A, 690 Vac Max.

Frame								Terminal Lugs for Front connection (Cu/Al)			
		IC @480 Vac, UL 489		IC @480 Vac, UL 489		IC @480 Vac, UL 489					
Current Sensor	Trip Function	35kA Product Number	List Price GO-135PM	65kA Product Number	List Price GO-135PM	100kA Product Number	List Price GO-135PM	Product Number	List Price GO-135S	Wire Range	
150	LIT	SGHH36CA0150	\$5974.00	SGLL36CA0150	\$7119.00	SGPP36CA0150	\$7612.00	3-Pole lug kit TCLK365 ³	\$42.00	(2) 2/0-500 Cu or (1) 8-600 Cu	
	LSIT	SGHH36CB0150	\$7339.00	SGLL36CB0150	\$8484.00	SGPP36CB0150	\$8977.00				
	LIGT ²	SGHH36CC0150	\$7184.00	SGLL36CC0150	\$8329.00	SGPP36CC0150	\$8822.00				
	LSIGT ²	SGHH36CD0150	\$8549.00	SGLL36CD0150	\$9694.00	SGPP36CD0150	\$10187.00				
400	LIT	SGHH36CA0400	\$5974.00	SGLL36CA0400	\$7119.00	SGPP36CA0400	\$7612.00			(2) 2/0-500 Al or (1) 6-600 Al	
	LSIT	SGHH36CB0400	\$7339.00	SGLL36CB0400	\$8484.00	SGPP36CB0400	\$8977.00				
	LIGT ²	SGHH36CC0400	\$7184.00	SGLL36CC0400	\$8329.00	SGPP36CC0400	\$8822.00				
	LSIGT ²	SGHH36CD0400	\$8549.00	SGLL36CD0400	\$9694.00	SGPP36CD0400	\$10187.00				
600	LIT	SGHH36CA0600	\$6971.00	SGLL36CA0600	\$8355.00	SGPP36CA0600	\$8844.00				
	LSIT	SGHH36CB0600	\$8336.00	SGLL36CB0600	\$9720.00	SGPP36CB0600	\$10209.00				
	LIGT ²	SGHH36CC0600	\$8181.00	SGLL36CC0600	\$9565.00	SGPP36CC0600	\$10054.00				
	LSIGT ²	SGHH36CD0600	\$9546.00	SGLL36CD0600	\$10930.00	SGPP36CD0600	\$11419.00				

MicroVersaTrip® Plus and PM Rating Plug Selection –

All Plugs List Price \$106.00, GO-135S

Circuit Breaker Frame	Sensor Rating	Rating Plug Rating (Amperes)	Rating Plug Product No.
SGHB, SGHH, SGLB, SGLL, SGPB, SGPP	150	60	SRPG150B60
		80	SRPG150B80
		100	SRPG150B100
		125	SRPG150B125
		150	SRPG150B150
	400	150	SRPG400B150
		200	SRPG400B200
		225	SRPG400B225
		250	SRPG400B250
		300	SRPG400B300
600	350	SRPG400B350	
	400	SRPG400B400	
	300	SRPG600B300	
	400	SRPG600B400	
	450	SRPG600B450	
	500	SRPG600B500	
		600	SRPG600B600

¹MicroVersaTrip® PM Trip Units require 24 Vdc control power and voltage sensing signals. Refer to pages 3-66 to 3-69.

²For grounded neutral systems (1**/3w or 3**/4w) a neutral current sensor is required. Refer to page 3-69.

³Order one kit for either line or load end; two kits required for both.

Note: All Spectra® breakers UL listed as HACR type.



Publications and Reference: See Section 22 for a complete list of additional product-related publications

Molded Case Circuit Breakers Industrial Circuit Breakers

Section 3

60-600A Circuit Breakers

Electronic Trip

Spectra® RMS

with MicroVersaTrip® PM Trip Units¹

MicroVersaTrip® PM, Standard UL Rated (With Protective Relaying)

SG600 Line, Suitable for Reverse Feed, UL File E-11592, CSA LR 40350

SGL, SGP UL Current Limiting; 3-Pole, UL/CSA: 600 Vac Max., IEC 947-2: 630A, 690 Vac Max.

Frame								Terminal Lugs for Front connection (Cu/Al)			
		IC @480 Vac, UL 489		IC @480 Vac, UL 489		IC @480 Vac, UL 489					
Current Sensor	Trip Function	35kA Product Number	List Price GO-135PM	65kA Product Number	List Price GO-135PM	100kA Product Number	List Price GO-135PM	Product Number	List Price GO-135S	Wire Range	
150	LIT	SGHB36DA0150	\$4997.00	SGLB36DA0150	\$6152.00	SGPB36DA0150	\$7332.00	3-Pole lug kit TCLK365 ³	\$42.00	(2) 2/0-500 Cu or (1) 8-600 Cu	
	LSIT	SGHB36DB0150	\$6362.00	SGLB36DB0150	\$7517.00	SGPB36DB0150	\$8697.00				
	LIGT ²	SGHB36DC0150	\$6207.00	SGLB36DC0150	\$7362.00	SGPB36DC0150	\$8542.00				
	LSIGT ²	SGHB36DD0150	\$7572.00	SGLB36DD0150	\$8727.00	SGPB36DD0150	\$9907.00				
400	LIT	SGHB36DA0400	\$4997.00	SGLB36DA0400	\$6152.00	SGPB36DA0400	\$7332.00			(2) 2/0-500 Al or (1) 6-600 Al	
	LSIT	SGHB36DB0400	\$6362.00	SGLB36DB0400	\$7517.00	SGPB36DB0400	\$8697.00				
	LIGT ²	SGHB36DC0400	\$6207.00	SGLB36DC0400	\$7362.00	SGPB36DC0400	\$8542.00				
	LSIGT ²	SGHB36DD0400	\$7572.00	SGLB36DD0400	\$8727.00	SGPB36DD0400	\$9907.00				
600	LIT	SGHB36DA0600	\$5951.00	SGLB36DA0600	\$6905.00	SGPB36DA0600	\$8280.00				
	LSIT	SGHB36DB0600	\$7316.00	SGLB36DB0600	\$8270.00	SGPB36DB0600	\$9645.00				
	LIGT ²	SGHB36DC0600	\$7161.00	SGLB36DC0600	\$8115.00	SGPB36DC0600	\$9490.00				
	LSIGT ²	SGHB36DD0600	\$8526.00	SGLB36DD0600	\$9480.00	SGPB36DD0600	\$10855.00				

MicroVersaTrip® PM, 100% UL Rated (With Protective Relays)

SG600 Line, Suitable for Reverse Feed, UL File E-11592, CSA LR 40350

SGL, SGP UL Current Limiting; 3-Pole, UL/CSA: 600 Vac Max., IEC 947-2: 630A, 690 Vac Max.

Frame								Terminal Lugs for Front connection (Cu/Al)			
		IC @480 Vac, UL 489		IC @480 Vac, UL 489		IC @480 Vac, UL 489					
Current Sensor	Trip Function	35kA Product Number	List Price GO-135PM	65kA Product Number	List Price GO-135PM	100kA Product Number	List Price GO-135PM	Product Number	List Price GO-135S	Wire Range	
150	LIT	SGHH36DA0150	\$7174.00	SGLL36DA0150	\$8319.00	SGPP36DA0150	\$8812.00	3-Pole lug kit TCLK365 ³	\$42.00	(2) 2/0-500 Cu or (1) 8-600 Cu	
	LSIT	SGHH36DB0150	\$8539.00	SGLL36DB0150	\$9684.00	SGPP36DB0150	\$10177.00				
	LIGT ²	SGHH36DC0150	\$8384.00	SGLL36DC0150	\$9529.00	SGPP36DC0150	\$10022.00				
	LSIGT ²	SGHH36DD0150	\$9749.00	SGLL36DD0150	\$10894.00	SGPP36DD0150	\$11387.00				
400	LIT	SGHH36DA0400	\$7174.00	SGLL36DA0400	\$8319.00	SGPP36DA0400	\$8812.00			(2) 2/0-500 Al or (1) 6-600 Al	
	LSIT	SGHH36DB0400	\$8539.00	SGLL36DB0400	\$9684.00	SGPP36DB0400	\$10177.00				
	LIGT ²	SGHH36DC0400	\$8384.00	SGLL36DC0400	\$9529.00	SGPP36DC0400	\$10022.00				
	LSIGT ²	SGHH36DD0400	\$9749.00	SGLL36DD0400	\$10894.00	SGPP36DD0400	\$11387.00				
600	LIT	SGHH36DA0600	\$8171.00	SGLL36DA0600	\$9555.00	SGPP36DA0600	\$10044.00				
	LSIT	SGHH36DB0600	\$9536.00	SGLL36DB0600	\$10920.00	SGPP36DB0600	\$11409.00				
	LIGT ²	SGHH36DC0600	\$9381.00	SGLL36DC0600	\$10765.00	SGPP36DC0600	\$11254.00				
	LSIGT ²	SGHH36DD0600	\$10746.00	SGLL36DD0600	\$12130.00	SGPP36DD0600	\$12619.00				

MicroVersaTrip® Plus and PM Rating Plug Selection –

All Plugs List Price \$106.00, GO-135S

Circuit Breaker Frame	Sensor Rating	Rating Plug Rating (Amperes)	Rating Plug Product No.
SGHB, SGHH, SGLB, SGLL, SGPB, SGPP	150	60	SRPG150B60
		80	SRPG150B80
		100	SRPG150B100
		125	SRPG150B125
		150	SRPG150B150
	400	150	SRPG400B150
		200	SRPG400B200
		225	SRPG400B225
		250	SRPG400B250
		300	SRPG400B300
	600	350	SRPG400B350
		400	SRPG400B400
		300	SRPG600B300
		400	SRPG600B400
		450	SRPG600B450
	500	SRPG600B500	
	600	SRPG600B600	

¹MicroVersaTrip® PM Trip Units require 24 Vdc control power and voltage sensing signals. Refer to pages 3-66 to 3-69.

²For grounded neutral systems (1**/3w or 3**4w) a neutral current sensor is required. Refer to page 3-69.

³Order one kit for either line or load end; two kits required for both.

Note: All Spectra® breakers UL listed as HACR type.



Molded Case Circuit Breakers Industrial Circuit Breakers

300-1200A Circuit Breakers

Electronic Trip

Spectra® RMS

SK1200 with Microversatrip® Plus and PM

Product Number Structure

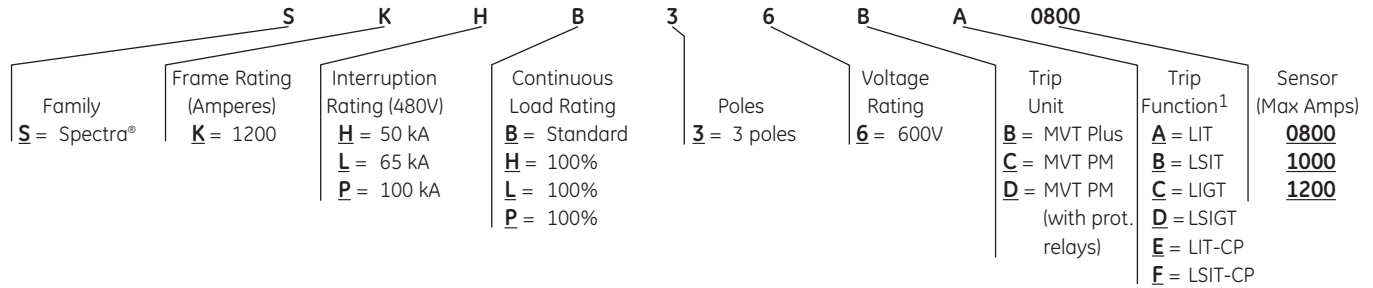

¹L = Long Time, S = Short Time, I = Instantaneous, G = Ground Fault, T = Trip Target, CP = Control Power

Note: This information is provided for interpreting product numbers (it should not be used to build product numbers).

MicroVersaTrip® Plus, Standard UL Rated

SK1200 Line, Suitable for Reverse Feed, UL File E-11592, CSA LR 40350

3-Pole, UL/CSA: 1200A, 600 Vac Max., IEC 947-2: 1250A, 690 Vac Max. (SKL, SKP only)

Frame								Terminal Lugs for Front connection (Cu/Al)		
		IC @480 Vac, UL 489		IC @480 Vac, UL 489		IC @480 Vac, UL 489				
Current Sensor	Trip Function	50kA Product Number	List Price GO-1355	65kA Product Number	List Price GO-1355	100kA Product Number	List Price GO-1355	Product Number	List Price GO-1355	Wire Range
800	LIT	SKHB36BA0800	\$4588.00	SKLB36BA0800	\$5552.00	SKPB36BA0800	\$8734.00	TCAL81	\$47.00	(3) 3/0-500 Cu (3) 3/0-500 Al
	LSIT	SKHB36BB0800	\$5953.00	SKLB36BB0800	\$6917.00	SKPB36BB0800	\$10099.00			
	LIGT ¹	SKHB36BC0800	\$5798.00	SKLB36BC0800	\$6762.00	SKPB36BC0800	\$9944.00			
	LSIGT ¹	SKHB36BD0800	\$7163.00	SKLB36BD0800	\$8127.00	SKPB36BD0800	\$11309.00			
	LIT-CP ²	SKHB36BE0800	\$4888.00	SKLB36BE0800	\$5852.00	SKPB36BE0800	\$9034.00			
	LSIT-CP ²	SKHB36BF0800	\$6253.00	SKLB36BF0800	\$7217.00	SKPB36BF0800	\$10399.00			
1200	LIT	SKHB36BA1200	\$8077.00	SKLB36BA1200	\$9048.00	SKPB36BA1200	\$11854.00	TCAL125	\$76.00	(4) 250-500 Cu (4) 250-500 Al
	LSIT	SKHB36BB1200	\$9442.00	SKLB36BB1200	\$10413.00	SKPB36BB1200	\$13219.00			
	LIGT ¹	SKHB36BC1200	\$9287.00	SKLB36BC1200	\$10258.00	SKPB36BC1200	\$13064.00			
	LSIGT ¹	SKHB36BD1200	\$10652.00	SKLB36BD1200	\$11623.00	SKPB36BD1200	\$14429.00			
	LIT-CP ²	SKHB36BE1200	\$8377.00	SKLB36BE1200	\$9348.00	SKPB36BE1200	\$12154.00			
	LSIT-CP ²	SKHB36BF1200	\$9742.00	SKLB36BF1200	\$10713.00	SKPB36BF1200	\$13519.00			

MicroVersaTrip® Plus, 100% UL Rated

SK1200 Line, Suitable for Reverse Feed, UL File E-11592, CSA LR 40350

3-Pole, UL/CSA: 1200A, 600 Vac Max., IEC 947-2: 1250A, 690 Vac Max. (SKL, SKP only)

Frame								Terminal Lugs for Front connection (Cu/Al)		
		IC @480 Vac, UL 489		IC @480 Vac, UL 489		IC @480 Vac, UL 489				
Current Sensor	Trip Function	50kA Product Number	List Price GO-1355	65kA Product Number	List Price GO-1355	100kA Product Number	List Price GO-1355	Product Number	List Price GO-1355	Wire Range
800	LIT	SKHH36BA0800	\$7975.00	SKLL36BA0800	\$9892.00	SKPP36BA0800	\$11354.00	TCAL81	\$47.00	(3) 3/0-500 Cu (3) 3/0-500 Al
	LSIT	SKHH36BB0800	\$9340.00	SKLL36BB0800	\$11257.00	SKPP36BB0800	\$12719.00			
	LIGT ¹	SKHH36BC0800	\$9185.00	SKLL36BC0800	\$11102.00	SKPP36BC0800	\$12564.00			
	LSIGT ¹	SKHH36BD0800	\$10550.00	SKLL36BD0800	\$12467.00	SKPP36BD0800	\$13929.00			
	LIT-CP ²	SKHH36BE0800	\$8275.00	SKLL36BE0800	\$10192.00	SKPP36BE0800	\$11654.00			
	LSIT-CP ²	SKHH36BF0800	\$9640.00	SKLL36BF0800	\$11557.00	SKPP36BF0800	\$13019.00			
1200	LIT	SKHH36BA1000	\$11624.00	SKLL36BA1000	\$14414.00	SKPP36BA1000	\$15410.00	TCAL125	\$76.00	(4) 250-500 Cu (4) 250-500 Al
	LSIT	SKHH36BB1000	\$12989.00	SKLL36BB1000	\$15779.00	SKPP36BB1000	\$16775.00			
	LIGT ¹	SKHH36BC1000	\$12834.00	SKLL36BC1000	\$15624.00	SKPP36BC1000	\$16620.00			
	LSIGT ¹	SKHH36BD1000	\$14199.00	SKLL36BD1000	\$16989.00	SKPP36BD1000	\$17985.00			
	LIT-CP ²	SKHH36BE1000	\$11924.00	SKLL36BE1000	\$14714.00	SKPP36BE1000	\$15710.00			
	LSIT-CP ²	SKHH36BF1000	\$13289.00	SKLL36BF1000	\$16079.00	SKPP36BF1000	\$17075.00			
1200 ³	LIT	SKHH36BA1200	\$11624.00	SKLL36BA1200	\$14414.00	SKPP36BA1200	\$15410.00	Lugs not required ³		
	LSIT	SKHH36BB1200	\$12989.00	SKLL36BB1200	\$15779.00	SKPP36BB1200	\$16775.00			
	LIGT ¹	SKHH36BC1200	\$12834.00	SKLL36BC1200	\$15624.00	SKPP36BC1200	\$16620.00			
	LSIGT ¹	SKHH36BD1200	\$14199.00	SKLL36BD1200	\$16989.00	SKPP36BD1200	\$17985.00			
	LIT-CP ²	SKHH36BE1200	\$11924.00	SKLL36BE1200	\$14714.00	SKPP36BE1200	\$15710.00			
	LSIT-CP ²	SKHH36BF1200	\$13289.00	SKLL36BF1200	\$16079.00	SKPP36BF1200	\$17075.00			

¹For grounded neutral systems (1**/3w or 3**4w) a neutral current sensor is required. Refer to page 3-69.

²For +24 Vdc Control Power Accessories refer to pages 3-66 to 3-69.

³100% UL rated SK1200 supplied with back-connected assembly which increases breaker depth. Refer to outline drawing 168D1678 Sh2 for details.

Note: All Spectra® breakers UL listed as HACR type.



Publications and Reference: See Section 22 for a complete list of additional product-related publications

Molded Case Circuit Breakers Industrial Circuit Breakers

Section 3

300-1200A Circuit Breakers
Electronic Trip
Spectra® RMS
SK1200 with MicroVersaTrip® PM¹

MicroVersaTrip® PM, Standard UL Rated (No Protective Relays)

SK1200 Line, Suitable for Reverse Feed, UL File E-11592, CSA LR 40350
3-Pole, UL/CSA: 1200A, 600 Vac Max., IEC 947-2: 1250A, 690 Vac Max. (SKL, SKP only)

Frame								Terminal Lugs for Front connection (Cu/Al)		
		IC @480 Vac, UL 489		IC @480 Vac, UL 489		IC @480 Vac, UL 489				
Current Sensor	Trip Function	50kA Product Number	List Price GO-135PM	65kA Product Number	List Price GO-135PM	100kA Product Number	List Price GO-135PM	Product Number	List Price GO-135S	Wire Range
800	LIT	SKHB36CA0800	\$5788.00	SKLB36CA0800	\$6752.00	SKPB36CA0800	\$9934.00	TCAL81	\$47.00	(3) 3/0-500 Cu (3) 3/0-500 Al
	LSIT	SKHB36CB0800	\$7153.00	SKLB36CB0800	\$8117.00	SKPB36CB0800	\$11299.00			
	LIGT ²	SKHB36CC0800	\$6998.00	SKLB36CC0800	\$7962.00	SKPB36CC0800	\$11144.00			
	LSIGT ²	SKHB36CD0800	\$8363.00	SKLB36CD0800	\$9327.00	SKPB36CD0800	\$12509.00			
1200	LIT	SKHB36CA1200	\$9277.00	SKLB36CA1200	\$10248.00	SKPB36CA1200	\$13054.00	TCAL125	\$76.00	(4) 250-500 Cu (4) 250-500 Al
	LSIT	SKHB36CB1200	\$10642.00	SKLB36CB1200	\$11613.00	SKPB36CB1200	\$14419.00			
	LIGT ²	SKHB36CC1200	\$10487.00	SKLB36CC1200	\$11458.00	SKPB36CC1200	\$14264.00			
	LSIGT ²	SKHB36CD1200	\$11852.00	SKLB36CD1200	\$12823.00	SKPB36CD1200	\$15629.00			

MicroVersaTrip® PM, 100% UL Rated (No Protective Relays)

SK1200 Line, Suitable for Reverse Feed, UL File E-11592, CSA LR 40350
3-Pole, UL/CSA: 1200A, 600 Vac Max., IEC 947-2: 1250A, 690 Vac Max. (SKL, SKP only)

Frame								Terminal Lugs for Front connection (Cu/Al)		
		IC @480 Vac, UL 489		IC @480 Vac, UL 489		IC @480 Vac, UL 489				
Current Sensor	Trip Function	50kA Product Number	List Price GO-135PM	50kA Product Number	List Price GO-135PM	100kA Product Number	List Price GO-135PM	Product Number	List Price GO-135S	Wire Range
800	LIT	SKHH36CA0800	\$9175.00	SKLL36CA0800	\$11092.00	SKPP36CA0800	\$12554.00	TCAL81	\$47.00	(3) 3/0-500 Cu (3) 3/0-500 Al
	LSIT	SKHH36CB0800	\$10540.00	SKLL36CB0800	\$12457.00	SKPP36CB0800	\$13919.00			
	LIGT ²	SKHH36CC0800	\$10385.00	SKLL36CC0800	\$12302.00	SKPP36CC0800	\$13764.00			
	LSIGT ²	SKHH36CD0800	\$11750.00	SKLL36CD0800	\$13667.00	SKPP36CD0800	\$15129.00			
1200	LIT	SKHH36CA1000	\$12824.00	SKLL36CA1000	\$15614.00	SKPP36CA1000	\$16610.00	TCAL125	\$76.00	(4) 250-500 Cu (4) 250-500 Al
	LSIT	SKHH36CB1000	\$14189.00	SKLL36CB1000	\$16979.00	SKPP36CB1000	\$17975.00			
	LIGT ²	SKHH36CC1000	\$14034.00	SKLL36CC1000	\$16824.00	SKPP36CC1000	\$17820.00			
	LSIGT ²	SKHH36CD1000	\$15399.00	SKLL36CD1000	\$18189.00	SKPP36CD1000	\$19185.00			
1200 ³	LIT	SKHH36CA1200	\$12824.00	SKLL36CA1200	\$15614.00	SKPP36CA1200	\$16610.00			Lugs not required. ³
	LSIT	SKHH36CB1200	\$14189.00	SKLL36CB1200	\$16979.00	SKPP36CB1200	\$17975.00			
	LIGT ²	SKHH36CC1200	\$14034.00	SKLL36CC1200	\$16824.00	SKPP36CC1200	\$17820.00			
	LSIGT ²	SKHH36CD1200	\$15399.00	SKLL36CD1200	\$18189.00	SKPP36CD1200	\$19185.00			

MicroVersaTrip® Plus and PM Rating Plug Selection – All Plugs List Price \$106.00, GO-135S

Circuit Breaker Frame	Sensor Rating	Rating Plug Rating (Amperes)	Rating Plug Product No.
SKHB, SKHH, SKLB, SKLL, SKPB, SKPP	800	300	SRPK800B300
		400	SRPK800B400
		500	SRPK800B500
		600	SRPK800B600
		700	SRPK800B700
		800	SRPK800B800
	1200	600	SRPK1200B600
		700	SRPK1200B700
		800	SRPK1200B800
		1000	SRPK1200B1000
		1200	SRPK1200B1200 ⁴

¹MicroVersaTrip® PM Trip Units require 24 Vdc control power and voltage sensing signals. Refer to pages 3-66 to 3-69.

²For grounded neutral systems (1**/3w or 3**4w) a neutral current sensor is required. Refer to page 3-69.

³100% UL rated SK1200 supplied with back-connected assembly which increases breaker depth. Refer to outline drawing 168D1678 Sh2 for details.

⁴Not suitable for use with 100% rated, 1000A breaker frame.

Note: All Spectra® breakers UL listed as HACR type.



Molded Case Circuit Breakers Industrial Circuit Breakers

300-1200A Circuit Breakers

Electronic Trip

Spectra® RMS

SK1200 with MicroVersaTrip® Plus and PM¹

MicroVersaTrip® PM, Standard UL Rated (With Protective Relaying)

SK1200 Line, Suitable for Reverse Feed, UL File E-11592, CSA LR 40350

3-Pole, UL/CSA: 1200A, 600 Vac Max., IEC 947-2: 1250A, 690 Vac Max. (SKL, SKP only)

Frame								Terminal Lugs for Front connection (Cu/Al)		
		IC @480 Vac, UL 489		IC @480 Vac, UL 489		IC @480 Vac, UL 489				
Current Sensor	Trip Function	50kA Product Number	List Price GO-135PM	65kA Product Number	List Price GO-135PM	100kA Product Number	List Price GO-135PM	Product Number	List Price GO-135S	Wire Range
800	LIT	SKHB36DA0800	\$6988.00	SKLB36DA0800	\$7952.00	SKPB36DA0800	\$11134.00	TCAL81	\$47.00	(3) 3/0-500 Cu (3) 3/0-500 Al
	LSIT	SKHB36DB0800	\$8353.00	SKLB36DB0800	\$9317.00	SKPB36DB0800	\$12499.00			
	LIGT ²	SKHB36DC0800	\$8198.00	SKLB36DC0800	\$9162.00	SKPB36DC0800	\$12344.00			
	LSIGT ²	SKHB36DD0800	\$9563.00	SKLB36DD0800	\$10527.00	SKPB36DD0800	\$13709.00			
1200	LIT	SKHB36DA1200	\$10477.00	SKLB36DA1200	\$11448.00	SKPB36DA1200	\$14254.00	TCAL125	\$76.00	(4) 250-500 Cu (4) 250-500 Al
	LSIT	SKHB36DB1200	\$11842.00	SKLB36DB1200	\$12813.00	SKPB36DB1200	\$15619.00			
	LIGT ²	SKHB36DC1200	\$11687.00	SKLB36DC1200	\$12658.00	SKPB36DC1200	\$15464.00			
	LSIGT ²	SKHB36DD1200	\$13052.00	SKLB36DD1200	\$14023.00	SKPB36DD1200	\$16829.00			

Microversatrip® PM, 100% UL Rated (With Protective Relays)

SK1200 Line, Suitable for Reverse Feed, UL File E-11592, CSA LR 40350

3-Pole, UL/CSA: 1200A, 600 Vac Max., IEC 947-2: 1250A, 690 Vac Max. (SKL, SKP only)

Frame								Terminal Lugs for Front connection (Cu/Al)		
		IC @480 Vac, UL 489		IC @480 Vac, UL 489		IC @480 Vac, UL 489				
Current Sensor	Trip Function	50kA Product Number	List Price GO-135PM	65kA Product Number	List Price GO-135PM	100kA Product Number	List Price GO-135PM	Product Number	List Price GO-135S	Wire Range
800	LIT	SKHH36DA0800	\$10375.00	SKLL36DA0800	\$12292.00	SKPP36DA0800	\$13754.00	TCAL81	\$47.00	(3) 3/0-500 Cu (3) 3/0-500 Al
	LSIT	SKHH36DB0800	\$11740.00	SKLL36DB0800	\$13657.00	SKPP36DB0800	\$15119.00			
	LIGT ²	SKHH36DC0800	\$11585.00	SKLL36DC0800	\$13502.00	SKPP36DC0800	\$14964.00			
	LSIGT ²	SKHH36DD0800	\$12950.00	SKLL36DD0800	\$14867.00	SKPP36DD0800	\$16329.00			
1200	LIT	SKHH36DA1000	\$14024.00	SKLL36DA1000	\$16814.00	SKPP36DA1000	\$17810.00	TCAL125	\$76.00	(4) 250-500 Cu (4) 250-500 Al
	LSIT	SKHH36DB1000	\$15389.00	SKLL36DB1000	\$18179.00	SKPP36DB1000	\$19175.00			
	LIGT ²	SKHH36DC1000	\$15234.00	SKLL36DC1000	\$18024.00	SKPP36DC1000	\$19020.00			
	LSIGT ²	SKHH36DD1000	\$16599.00	SKLL36DD1000	\$19389.00	SKPP36DD1000	\$20385.00			
1200 ³	LIT	SKHH36DA1200	\$14024.00	SKLL36DA1200	\$16814.00	SKPP36DA1200	\$17810.00			Lugs not required. ³
	LSIT	SKHH36DB1200	\$15389.00	SKLL36DB1200	\$18179.00	SKPP36DB1200	\$19175.00			
	LIGT ²	SKHH36DC1200	\$15234.00	SKLL36DC1200	\$18024.00	SKPP36DC1200	\$19020.00			
	LSIGT ²	SKHH36DD1200	\$16599.00	SKLL36DD1200	\$19389.00	SKPP36DD1200	\$20385.00			

Microversatrip® Plus and PM Rating Plug Selection –

All Plugs List Price \$106.00, GO-135S

Circuit Breaker Frame	Sensor Rating	Rating Plug Rating (Amperes)	Rating Plug Product No.
SKHB, SKHH, SKLB, SKLL, SKPB, SKPP	800	300	SRPK800B300
		400	SRPK800B400
		500	SRPK800B500
		600	SRPK800B600
		700	SRPK800B700
		800	SRPK800B800
	1200	600	SRPK1200B600
		700	SRPK1200B700
		800	SRPK1200B800
		1000	SRPK1200B1000
		1200	SRPK1200B1200 ⁴

¹Microversatrip® PM Trip Units require 24 Vdc control power and voltage sensing signals. Refer to pages 3-66 to 3-69.

²For grounded neutral systems (1**/3w or 3**4w) a neutral current sensor is required. Refer to page 3-69.

³100% UL rated SK1200 supplied with back-connected assembly which increases breaker depth. Refer to outline drawing 168D1678 Sh2 for details.

⁴Not suitable for use with 100% rated, 1000A breaker frame.

Note: All Spectra® breakers UL listed as HACR type.



Publications and Reference: See Section 22 for a complete list of additional product-related publications

Molded Case Circuit Breakers Power Management System Accessories

Spectra® RMS Circuit Breakers with MicroVersaTrip® Plus and MicroVersaTrip® PM Trip Units
All Devices UL Listed for Factory or Field Installation (UL File No. E-57253)

Required Accessories

	Type	Accessories
MicroVersaTrip® Plus Trip Unit	Standard	-
	Ground Fault Option with 3-phase, 4-wire or 1-phase, 3-wire service	Neutral Current Sensor and Terminal Block or Neutral Current Sensor and Junction Box
	Control Power Option	Power Supply Plate or Voltage Module ¹ or Power Supply Assembly ²
MicroVersaTrip® PM Trip Unit	Standard or with Protective Relaying	Power Supply Plate and Voltage Conditioner Plate or Voltage Module ¹ or Power Supply Assembly ² and Voltage Conditioner Assembly ²
	Ground Fault Option with 3-phase, 4-wire or 1-phase, 3-wire service	Junction Box, Cable Harness and Auxiliary Switch
		Neutral Current Sensor

¹For installation into GE Spectra® Series Switchboards only.

²Requires fuse protection and other components; refer to accessory detail for additional information.

Power Supply Plate

The Power Supply Plate is used to provide +24 Vdc control power to Spectra® RMS Molded Case Circuit Breakers with MicroVersaTrip® PM or MicroVersaTrip® Plus trip systems via the Distribution Cable System. The Power Supply Plate includes the Power Supply Assembly (product number SPSAA) as an integral component and also includes fuse protection for AC source input. Supplemental +24 Vdc input terminals are provided for backup control power applications. Five versions are available. Not suitable for 400 Hz.

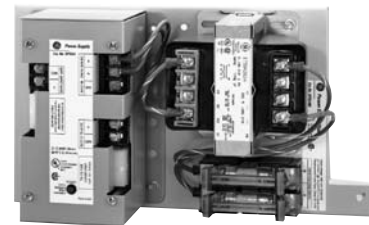

Power Supply Plate

Description	Voltage Rating	Product Number	List Price GO-135PM
The Power Supply Plate is rated 24 watts (+24 Vdc at 1.0 amperes) and has the maximum capacity to power a distribution Cable System consisting of 20 breakers and has a maximum system cable length of 40 feet.	120 Vac	SPSA120	\$1215.00
	208 Vac	SPSA208	\$1215.00
	240 Vac	SPSA240	\$1215.00
	480 Vac	SPSA480	\$1215.00
	600 Vac	SPSA600	\$1215.00

Voltage Conditioner Plate

The Voltage Conditioner Plate is used to provide voltage sensing signals to Spectra® RMS Molded Case Circuit Breakers with MicroVersaTrip® PM Trip Units via the Distribution Cable System. The Voltage Conditioner Plate includes the Voltage Conditioner Assembly (product number SVCAA) as an integral component and also includes fuse protection for the AC source input terminals and three 1-VA high accuracy potential transformers. The Voltage Conditioner Plate requires a control power source of +24 Vdc to operate properly (the Power Supply Assembly or Power Supply Plate can provide this required input). The unit also requires AC direct voltage inputs from the AC source. A GE POWER LEADER® network (commnet) connection is provided. Seven versions are available. Not suitable for 400 Hz.

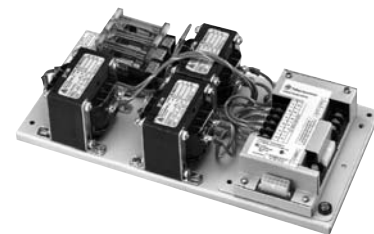

Voltage Conditioner Plate

Voltage Rating and Service Type	Comments	Product Number	List Price GO-135PM
120 Vac Wye system	Phase to Neutral potential	SVCA120Y	\$1000.00
208 Vac Wye system	Phase to Phase potential	SVCA208Y	\$1000.00
240 Vac Delta system	Phase to Phase potential	SVCA240D	\$1000.00
277 Vac Wye system	Phase to Neutral potential	SVCA277Y	\$1000.00
480 Vac Wye system	Phase to Phase potential	SVCA480Y	\$1000.00
480 Vac Delta system	Phase to Phase potential	SVCA480D	\$1000.00
600 Vac Delta system	Phase to Phase potential	SVCA600D	\$1000.00

Note: The Voltage Conditioner Plate has the maximum capacity to power a Distribution Cable System consisting of 20 breakers and has a maximum system cable length of 40 feet.

Distribution Cable Junction Box

The Distribution Cable Junction Box is a modular connector used to provide quick, easy and reliable attachment of Spectra® RMS Molded Case Circuit Breakers with MicroVersaTrip® Plus trip systems or MicroVersaTrip® PM trip systems to the Distribution Cable System. The Junction Box contains two Distribution Cable Harness plugs, one breaker plug and a terminal block for the connection of a neutral current sensor and an auxiliary switch. Product number SDCJBA is for general purpose OEM applications. Product number SDCJBB is designed for mounting in Spectra® Series Panelboards.

Description	Product Number	List Price GO-135PM
Distribution Cable Junction Box	SDCJBA ³	\$155.00
Distribution Cable Junction Box	SDCJBB	\$155.00

³Limited availability—obsolete when inventory depleted.



Molded Case Circuit Breakers Power Management System Accessories

Spectra® RMS Circuit Breakers with MicroVersaTrip® Plus and MicroVersaTrip® PM Trip Units
All Devices UL Listed for Factory or Field Installation (UL File No. E-57253)

Required Accessories

	Type	Accessories
MicroVersaTrip® Plus Trip Unit	Standard	-
	Ground Fault Option with 3-phase, 4-wire or 1-phase, 3-wire service	Neutral Current Sensor and Terminal Block or Neutral Current Sensor and Junction Box
	Control Power Option	Power Supply Plate or Voltage Module ¹ or Power Supply Assembly ²
MicroVersaTrip® PM Trip Unit	Standard or with Protective Relaying	Power Supply Plate and Voltage Conditioner Plate or Voltage Module ¹ or Power Supply Assembly ² and Voltage Conditioner Assembly ²
		Junction Box, Cable Harness and Auxiliary Switch
	Ground Fault Option with 3-phase, 4-wire or 1-phase, 3-wire service	Neutral Current Sensor

¹For installation into GE Spectra® Series Switchboards only.

²Requires fuse protection and other components; refer to accessory detail for additional information.

Distribution Cable Harness³

The Distribution Cable Harness is a modular connector used to carry electronic signals and/or control power between Spectra® RMS Molded Case Circuit Breakers with MicroVersaTrip® Plus or MicroVersaTrip® PM Trip Units and Distribution Cable accessories. The harnesses come in three lengths.

Description	Harness Length	Product Number	List Price GO-135PM
Distribution Cable Harness	11 inches	SDCHA11	\$70.00
Distribution Cable Harness	30 inches	SDCHA30	\$80.00
Distribution Cable Harness	60 inches	SDCHA60	\$100.00

³Cannot be connected together. Use 30 inch Distribution Cable Extension (SDCEA30) to extend.

Distribution Cable Extension

The Distribution Cable Extension is used to provide modular expansion of the Distribution Cable System.

Description	Harness Length	Product Number	List Price GO-135PM
Distribution Cable Extension	30 inches	SDCEA30	\$80.00

Distribution Cable Terminal Block

The Distribution Cable Terminal Block is a modular attachment primarily used to provide an alternate means of input to Spectra® RMS Molded Case Circuit Breakers with MicroVersaTrip® Plus or MicroVersaTrip® PM Trip Units. The Terminal Block plugs into the breaker distribution cable receptacle allowing the direct connection of breaker signals via screw terminals. This allows point-to-point wiring of breakers instead of using the Distribution Cable System.

Description	Product Number	List Price GO-135PM
Distribution Cable Terminal Block	SDCTBA11	\$110.00

Power Supply Assembly

The Power Supply Assembly is used to provide +24 Vdc Control Power to Spectra® RMS Molded Case Circuit Breakers with MicroVersaTrip® Plus or MicroVersaTrip® PM trip systems via the Distribution Cable System. The assembly requires a minimum input voltage of 85 Vac to operate properly (the maximum voltage rating is 240 Vac). Supplemental +24 Vdc input terminals are provided for backup control power applications. The input must be fused with 1/2 ampere class CC fuses (not included). Not suitable for 400 Hz.

Description	Voltage Rating	Product Number	List Price GO-135PM
The Power Supply Assembly is rated 24 watts (+24 Vdc @ 1.0 ampere) and has the maximum capacity to power a Distribution Cable System consisting of 20 breakers and has a maximum system cable length of 40 feet.	85 - 240 Vac	SPSAA	\$1000.00



Distribution Cable Harness



Distribution Cable Extension



Distribution Cable Terminal Block



Power Supply Assembly



Publications and Reference: See Section 22 for a complete list of additional product-related publications

Molded Case Circuit Breakers Power Management System Accessories

Section 3

Spectra® RMS Circuit Breakers with MicroVersaTrip® Plus and MicroVersaTrip® PM Trip Units
All Devices UL Listed for Factory or Field Installation (UL File No. E-57253)

Voltage Conditioner Assembly

The Voltage Conditioner Assembly is used to provide voltage sensing signals to Spectra® RMS Molded Case Circuit Breakers with MicroVersaTrip® PM Trip Units via the Distribution Cable System. The Voltage Conditioner Assembly requires a control power source of +24 Vdc to operate properly (the Power Supply Assembly or Power Supply Plate can provide this required input). The unit also requires 120 Vac voltage inputs from the secondary of three 1-VA high accuracy potential transformers (not included). The primary side of the potential transformers must be fused with three, 1/2 ampere class CC fuses (not included). A GE POWER LEADER® network (commnet) connection is provided. Not suitable for 400 Hz.

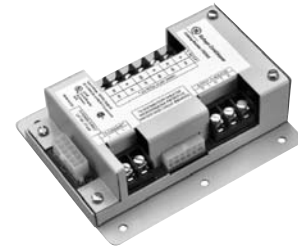

Voltage Conditioner Assembly

Description	Voltage Rating	Product Number	List Price GO-135PM
Requires 120 Vac voltage inputs from the secondary of three 1.0 VA high accuracy potential transformers	120 Vac	SVCAA	\$680.00

Note: the Voltage Conditioner Assembly has the maximum capacity to power a Distribution Cable System consisting of 20 breakers and has a maximum system cable length of 40 feet.

Voltage Modules

The Voltage Module is used primarily as a Spectra® Series Switchboard component to provide +24 Vdc Control Power to Spectra® RMS Molded Case Circuit Breakers with MicroVersaTrip® Plus or MicroVersaTrip® PM Trip Units via the Distribution Cable System. The Module also provides voltage sensing signals to Spectra® RMS Molded Case Circuit Breakers with MicroVersaTrip® PM Trip Units on the same Distribution Cable System. The Module contains both a Power Supply Plate and a Voltage Conditioner as integral components. It also includes fuse protection for the AC source input terminals (the modules pressure connectors which mate with the switchboard interior bus bars). A GE POWER LEADER® Network (commnet) connection is provided as well as supplemental 24 Vdc input terminals for backup control power applications. Seven versions are available. Not suitable for 400 Hz.

Voltage Rating and Service Type	Comments	Product Number	List Price GO-135PM
120 Vac Wye system	Phase to Neutral potential	ADSVMA120Y	\$2350.00
208 Vac Wye system	Phase to Phase potential	ADSVMA208Y	\$2350.00
240 Vac Delta system	Phase to Phase potential	ADSVMA240D	\$2350.00
277 Vac Wye system	Phase to Neutral potential	ADSVMA277Y	\$2350.00
480 Vac Wye system	Phase to Phase potential	ADSVMA480Y	\$2350.00
480 Vac Delta system	Phase to Phase potential	ADSVMA480D	\$2350.00
600 Vac Delta system	Phase to Phase potential	ADSVMA600D	\$2350.00

Note: The Voltage Module has the maximum capacity to power a Distribution Cable System consisting of 20 breakers and has a maximum system cable length of 40 feet.



Voltage Module Exterior View



Voltage Module Interior View



Molded Case Circuit Breakers

Accessories–Other

Spectra® RMS Circuit Breakers with MicroVersaTrip® Plus and MicroVersaTrip® PM Trip Units
All Devices UL Listed for Factory or Field Installation Except Where Noted

Neutral Current Sensor

The neutral current sensor is used in conjunction with breakers that have a MicroVersaTrip® Plus or MicroVersaTrip® PM Trip Unit with the optional ground fault function and the breaker is connected to a grounded neutral service (3-phase, 4-wire or 1-phase, 3-wire). The neutral current sensor provides an input signal to the breaker trip unit. Breakers connected to a service without a neutral (3-phase, 3-wire) require no external connection or shorting of the breaker cable connector for ground fault to function properly.

Breaker Type	Sensor Rating (S)	Product Number	List Price GO-135S
SG	150	TSRG201	\$532.00
SG	400	TSRG204	\$532.00
SG	600	TSRG206	\$532.00
SK	800	TSKG408	\$532.00
SK	1200	TSKG412	\$532.00

MicroVersaTrip® Rating Plug Removal Tool

Product Number	List Price GO-135S
TRTOOL	\$12.00

MicroVersaTrip® Portable Power Pack

The hand-held MicroVersaTrip® portable battery pack provides an independent power source for MicroVersaTrip® Plus and MicroVersaTrip® PM trip units as an alternative to the TVRMS test set. The power pack is used to power up the trip unit to set or adjust trip set points when the breaker is on the bench or otherwise not powered up. It connects to the trip unit through the rating plug test jack. It requires three standard 9 Vdc alkaline batteries (not included).

Description	Product Number	List Price GO-245A
Portable Power Pack	TVBPB	\$75.00

MicroVersaTrip® Portable Test Set

The portable, battery-powered test kit provides for RMS-9, Plus, or PM trip unit self-tests and functional trip/no trip tests. It also provides defeat of the ground fault function and can be used in conjunction with high current test equipment. Interface is via a plug on the front of the trip unit and tests can be conducted with breaker in service. Kit uses six rechargeable ni-cad or standard alkaline "D" cells supplied by customer. Kit can also be powered by 120 Vac source.

Description	Product Number	List Price GO-245A
Portable Test Set ¹	TVRMS2	\$3000.00

¹May also be used to temporarily defeat ground fault function when using primary injection (high current test set).
Note: This test kit is for use with MicroVersaTrip® RMS-9, Plus, or PM Trip Units only. Not for use with MicroVersaTrip® 4- or 9-Function Trip Units.



Publications and Reference: See Section 22 for a complete list of additional product-related publications

Molded Case Circuit Breakers

Internal Accessories

Spectra® RMS Circuit Breakers

Section 3

Universal Field-Installable Internal Accessories

All Spectra® RMS circuit breakers from the SE150 through the SK1200, including instantaneous-trip Mag Break motor circuit protectors and molded case switches, use the same UL listed, field-installable internal accessories that do not require cover removal to install.

Accessory Mounting

All accessories mount in pouches accessible from a front cover. All breakers have a left-side pouch and right-side pouch. The following combinations may be installed:

Left-Side Pouch—either shunt trip or undervoltage release plus bell alarm.

Right-Side Pouch—auxiliary switch (single or double pole).

Auxiliary Switch

Auxiliary switches provide remote indication of whether the circuit breaker main contacts are opened or closed via open or closed SPDT switch elements.

Switch Rating	Number of Switch Elements	Auxiliary Switch Product Number	List Price GO-135S
5A @240 Vac/	1 form C	SAUXPAB1	\$149.00
0.5A @ 125 Vdc	2 form C	SAUXPAB2	\$295.00
Gold-Plated Contacts	1 form C	SAUXGAB1	\$149.00
0.5A @ 30V	2 form C	SAUXGAB2	\$295.00
One each of above types	2 form C	SAUXGPAB2	\$295.00

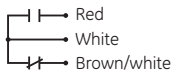

All accessory contacts shown with the circuit breaker in tripped position.

Shunt Trip

For remote tripping of breaker, use with momentary close contact. Not recommended for use with latching relay contact since electronics in shunt trip will pulse power to the coil if continuously energized, and breaker shunt tripping upon reclosure will be delayed 1-2 seconds at rated control voltage. (A short-circuit trip would be instantaneous.)

If maintained (latching relay) contact must be used and delayed shunt tripping is not acceptable, use small bell alarm in series with control power for SE150 and SF250 frames and auxiliary switch for SG600 and SK1200 breakers.

These devices are suitable for use with ground fault sensing and relaying equipment. Maximum VA is 75. AC devices are UL listed for 50-60 Hz.

Voltage		Current (mA)		Product Number	List Price GO-135S
ac	dc	Inrush	Cont		
120	125	500	6.0	SAST1	\$363.00
240	250	400	5.0	SAST2	\$363.00
—	12	1000	800	SAST5 ¹	\$363.00
24	24	300	10.0	SAST3	\$363.00
48	48	300	10.0	SAST4	\$363.00

¹Not suitable for use with ground fault sensing and relaying equipment.

Note: UL listed at 200,000 AIC without internal accessories, 100,000 AIC with internally mounted accessories.

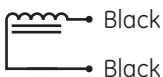

All accessory contacts shown with the circuit breaker in tripped position.

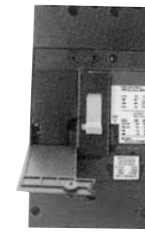

Left Side Pouch



Right Side Pouch



Auxiliary Switch



Shunt Trip



Molded Case Circuit Breakers

Internal Accessories

Spectra® RMS Circuit Breakers

Undervoltage Release

The undervoltage release provides automatic circuit breaker tripping when there is a power loss or major dip (to 35%-70% of rated voltage) in accessory control voltage. AC devices are UL listed for 50-60 Hz. Product number SAUV1 may be used with time delay unit SPUVTD (List Price \$430.00, GO-245B) (delay 0.1 to 1.0 seconds), 120 Vac input, 125 Vdc output.

Voltage		Peak Current (mA)	Product Number	List Price GO-135S
ac	dc			
120	125	200	SAUV1	\$363.00
240	250	200	SAUV2	\$363.00
24	24	100	SAUV3	\$363.00
48	48	100	SAUV4	\$363.00
120	125		SPUVTD	\$430.00 ¹

¹GO-245B.

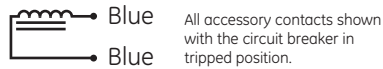

Bell Alarm Switch

The bell alarm switch provides remote indication of whether the circuit breaker has been tripped via open or closed SPDT switch elements, but remains unchanged during "On/Off" circuit breaker operation and during operation by the "Push-to-Trip" button.

Switch Rating	Number of Switch Elements	Product Number	List Price GO-135S
5A @ 240 Vac/ 0.5A @ 125 Vdc	1 form C	SABAP1	\$154.00
Gold-Plated Contacts 0.5A @30V	1 form C	SABAG1	\$154.00

Note: UL listed at 200,000 AIC without internal accessories, 100,000 AIC with internally mounted accessories.

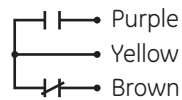

All accessory contacts shown with the circuit breaker in tripped position.

Actuator

All Spectra® circuit breakers are supplied with an actuator installed in the left-side pouch. The actuator is removed when installing either a shunt trip or undervoltage release.

Description	Product Number	List Price GO-148C
Replacement Actuator	SACTUATOR	\$250.00



Undervoltage Release



Bell Alarm Switch



Publications and Reference: See Section 22 for a complete list of additional product-related publications

Molded Case Circuit Breakers Molded Case Switches

100-1200A

Section 3

Molded Case Switches Spectra® RMS

UL File E-57546, CSA LR 91464

Includes fixed, high-set instantaneous trip suitable for reverse feed.

Frame Type	Switch ¹		Terminal Lugs for Front Connection (Cu/Al)			Maximum Short Circuit Withstand Rating ² (kA rms symmetrical)			
	Ampere Rating	Product Number	List Price GO-135S	Product Number	List Price GO-135S	Wire Range	240 Vac	480 Vac	600 Vac
SE150	100	SEDA36AN0100	\$650.00	TCAL18	\$3.00	Aluminum: #12-3/0 Copper: #14-3/0	200	100	25
	150	SEDA36AN0150	\$948.00						
SF250	250	SFDA36AN0250	\$1126.00	TCAL29	\$8.00	Aluminum: #8-350 kcmil Copper: #8-350 kcmil	200	100	25
SG600	400	SGDA36AN0400	\$1813.00	3-pole lug kit	\$42.00	Aluminum: (2) 2/0-500 kcmil or (1) #6-600 kcmil Copper: (2) 2/0-500 kcmil or (1) #8-600 kcmil	200	100	65
	600	SGDA36AN0600	\$2489.00	TCLK365 ³					
SK1200	800	SKDA36AN0800	\$2483.00	TCAL81	\$47.00	Aluminum: (3) 3/0-500 kcmil Copper: (3) 3/0-500 kcmil	100	65	42
	1000	SKDA36AN1000	\$3600.00	TCAL125	\$76.00	Aluminum: (4) 250-500 kcmil Copper: (4) 250-500 kcmil			
	1200	SKDA36AN1200	\$3600.00						

¹No rating plug required.

²The maximum withstand rating is limited by the application to the value set forth in this table or the short circuit rating of the upstream fuse or circuit breaker, whichever is less. The upstream protective device must have an instantaneous trip function or element and its rated ampacity may not exceed the ampere rating of the switch.

³Order one kit for either line or load end; two kits required for both.

Noninterchangeable Trip, Includes Cu/Al line and load lugs. For optional lugs, see page 3-101 and 3-102.

Type	Ampere Rating	Number of Poles	Voltage Rating	Product Number	List Price GO-135B
TEB	100	1	120 Vac, 125 Vdc	TEB111Y100 ⁴	\$65.50
TEB	100	2	240 Vac, 250 Vdc	TEB122Y100 ⁴	\$159.00
TEB	100	3	240 Vac	TEB132Y100 ⁴	\$240.00
TED	100	1	277 Vac, 125 Vdc	TED113Y100 ⁴	\$82.50
TED	100	2	480 Vac, 250 Vdc	TED124Y100 ⁴	\$263.00
TED	150	2	480 Vac, 250 Vdc	TED124Y150 ^{4,5}	\$708.00
TFJ	225	2	480 Vac	TFJ226Y225 ^{4,6}	\$803.00 ⁹
TFJ	225	3	600 Vac	TFJ236Y225	\$1174.00 ⁹
TJJ	400	2	600 Vac, 250 Vdc	TJJ426Y400 ⁷	\$1577.00 ⁹
TJJ	400	3	600 Vac	TJJ436Y400 ⁷	\$1904.00 ⁹

Interchangeable Trip, Includes Cu/Al line and load lugs. For optional lugs, see page 3-101 and 3-102.

Type	Ampere Rating	Number of Poles	Voltage Rating	Product Number	List Price GO-135LG
TFK	225	2	480 Vac, 250 Vdc	TFK226Y225 ^{6,7,8}	\$937.00
TFK	225	3	600 Vac, 250 Vdc	TFK236Y225 ^{7,8}	\$1174.00
TJK	400	2	600 Vac, 250 Vdc	TJK426Y400 ⁷	\$1874.00
TJK	400	3	600 Vac, 250 Vdc	TJK436Y400 ⁷	\$2330.00
TJK	600	2	600 Vac, 250 Vdc	TJK626Y600 ⁷	\$1844.00
TJK	600	3	600 Vac, 250 Vdc	TJK636Y600 ⁷	\$2595.00
TMK	800	2	600 Vac, 250 Vdc	TKMA826Y800 ⁷	\$1692.00
TMK	800	3	600 Vac, 250 Vdc	TKMA836Y800 ⁷	\$2769.00
TMK	1000	2	600 Vac, 250 Vdc	TKMA2Y1000 ⁷	\$3311.00
TMK	1000	3	600 Vac, 250 Vdc	TKMA3Y1000 ⁷	\$4030.00
TMK	1200	2	600 Vac, 250 Vdc	TKMA2Y1200 ⁷	\$3420.00
TMK	1200	3	600 Vac, 250 Vdc	TKMA3Y1200 ⁷	\$4191.00

⁴Internal accessory requires factory installed dummy trip. Specify on order. Accessories not available for one-pole TEB, TED.

⁵Not UL listed.

⁶600 Volts max.

⁷Internal accessory requires factory installed dummy trip unit. See page 3-45 for additional details. Nonautomatic trip unit and dummy trip not UL listed for field installation.

⁸UL listed only when ordered as a complete switch.

⁹GO-135LG.



Molded Case Circuit Breakers Motor Circuit Protectors

3-150A

Mag-Break Motor Circuit Protectors

Current Limiting, UL Component Recognized¹

Features

- Suitable for Reverse Feed
- UL Recognized File E-11592
- CSA Certified LR 40350
- IEC 947-2 690 Vac Max.
 - SE 150 160 Ampere Max.
 - SF250 250 Ampere Max.
 - SG600 630 Ampere Max.
 - SK1200 1250 Ampere Max.
- UL Current Limiting

High Interrupting Capacity Spectra® RMS Motor Circuit Protectors—SE150 Line 3-Pole

Rating Plug					Frame					Terminal Lugs for Front Connection (Cu/Al)		
Ampere Rating	Adjustable Instantaneous Trip Ampere Range		Product Number	List Price GO-135S	Current Sensor	65kAIC @480 Vac		100kAIC @480 Vac		Product Number	List Price GO-135S	Wire Range
	Low	High				Product Number	List Price GO-141S	Product Number	List Price GO-141S			
3	11	39	SRPE7A3	\$106.00	7	SELA36AI0007	\$530.00	SEPA36AI0007	\$663.00	TCAL18	\$3.00	14-3/0 Cu 12-3/0 Al
7	22	90	SRPE7A7	\$106.00								
15	43	182	SRPE30A15	\$106.00	30	SELA36AI0030	\$530.00	SEPA36AI0030	\$663.00	TCAL18	\$3.00	
20	58	254	SRPE30A20	\$106.00								
25	73	332	SRPE30A25	\$106.00								
30	87	415	SRPE30A30	\$106.00								
40	118	501	SRPE60A40	\$106.00								
50	148	637	SRPE60A50	\$106.00	60	SELA36AI0060	\$686.00	SEPA36AI0060	\$858.00	TCAL18	\$3.00	
60	178	777	SRPE60A60	\$106.00								
70	206	863	SRPE100A70	\$106.00								
80	236	999	SRPE100A80	\$106.00	100	SELA36AI0100	\$754.00	SEPA36AI0100	\$943.00	TCAL18	\$3.00	
90	267	1138	SRPE100A90	\$106.00								
100	297	1280	SRPE100A100	\$106.00								
110	328	1426	SRPE150A110	\$106.00								
125	374	1640	SRPE150A125	\$106.00								
150	450	1991	SRPE150A150	\$106.00	150	SELA36AI0150	\$848.00	SEPA36AI0150	\$1060.00	TCAL18	\$3.00	

Standard Capacity Mag-Break Motor Circuit Protectors—Adjustable Magnetic Trip, Noninterchangeable Types TEC, TECL

Complete Breaker (includes line and load lugs)								
Ampere Rating	Adjustable Trip Ampere Range ²		Two-Pole, 480 Vac ³		Three-Pole, 600 Vac		Add-on Limiter Three-Pole, 100 kAIC	
	Low	High	Product Number	List Price GO-141	Product Number	List Price GO-141	Product Number	List Price GO-141
3	8	38	TEC24003	\$318.00	TEC36003	\$388.00	TECL36003	\$231.00
7	18	90	TEC24007	\$318.00	TEC36007	\$388.00	TECL36007	\$231.00
15	42	198	TEC24015	\$318.00	TEC36015	\$388.00	TECL36015	\$231.00
30	90	390	TEC24030	\$318.00	TEC36030	\$388.00	TECL36030	\$231.00
50	180	660	TEC24050	\$377.00	TEC36050	\$464.00	TECL36050	\$231.00
100	300	1300	TEC24100	\$413.00	TEC36100	\$498.00	TECL36100	\$524.00
150	600	2700	TEC24150	\$477.00	TEC36150	\$545.00	TECL36150	\$1079.00

¹Per UL 489, interruption ratings are not printed on the product label (interruption ratings are established based on a tested combination of the motor circuit protector and a properly sized overload relay and contactor).

²AC only

³Two-pole furnished in three-pole case.



Publications and Reference: See Section 22 for a complete list of additional product-related publications

Molded Case Circuit Breakers Motor Circuit Protectors

Section 3

70-1200A

Mag-Break Motor Circuit Protectors

Current Limiting, UL Component Recognized¹

High Interrupting Capacity Motor Circuit Protectors—SF250 Line 3-Pole

Rating Plug					Frame				Terminal Lugs for Front Connection (Cu/Al)			
Ampere Rating	Adjustable Instantaneous Trip Ampere Range		Product Number	List Price GO-135S	Current Sensor	65kAIC @480 Vac		100kAIC @480 Vac		Product Number	List Price GO-135S	Wire Range
	Low	High				Product Number	List Price GO-141S	Product Number	List Price GO-141S			
70	205	700	SRPF250A70	\$106.00	250	SFLA36AI0250	\$1297.00	SFPA36AI0250	\$1622.00	TCAL29	\$8.00	8-350 Cu 8-350 Al
90	265	900	SRPF250A90	\$106.00								
100	295	1000	SRPF250A100	\$106.00								
110	325	1100	SRPF250A110	\$106.00								
125	370	1250	SRPF250A125	\$106.00								
150	440	1500	SRPF250A150	\$106.00								
175	515	1750	SRPF250A175	\$106.00								
200	590	2000	SRPF250A200	\$106.00								
225	665	2250	SRPF250A225	\$106.00								
250	736	2500	SRPF250A250	\$106.00								

Standard Capacity Mag Break Motor Circuit Protectors—Type TBC with Current Limiters³

Complete Breaker (includes line and load lugs)						
Ampere Rating	Adjustable Instantaneous Trip Ampere Range		Three-Pole		Standard Replacement Current Limiters	
	Low	High	Product Number	List Price GO-135LG	Product Number	List Price GO-135LG
600	3000	6000	TBC63600J14L	\$7443.00	TB10BJ14	\$543.00
800	2400	6000	TBC83800K22 ²	\$8622.00	TB15K22	\$543.00

Standard Capacity Mag Break Motor Circuit Protectors—Types TFC, TJC, TKC 3-Pole

Ampere Rating	Adjustable Instantaneous Trip Ampere Range		Complete Breaker (includes line and load lugs)	
	Low	High	Product Number	List Price GO-135LG
225	600	1400	TFC36225	\$1448.00
	100	2250	TFC36225A	\$1448.00
400	330	1100	TJC36400E	\$2589.00
	550	1670	TJC36400F	\$2589.00
	1000	3300	TJC36400G	\$2589.00
	1200	4000	TJC36400B	\$2589.00
600	1000	3300	TJC36600G	\$3676.00
	1800	6000	TJC36600H	\$3676.00
800	3000	6000	TKC36800L ²	\$4880.00
	5000	10000	TKC36800M ²	\$4880.00
1200	3000	6000	TKC361200L ²	\$8412.00
1200	5000	10000	TKC361200M ²	\$8412.00

¹Per UL 489, interruption ratings are not printed on the product label (interruption ratings are established based on a tested combination of the motor circuit protector and a properly sized overload relay and contactor).

²Balanced three-phase inrush current will trip the circuit breaker at lower than indicated currents.

³TBC4 motor circuit protectors no longer available.

For motors over 350 hp, use Spectra® RMS SK frame or circuit breakers with MicroVersaTrip® Plus Trip Units

Accessories: See pages 3-39 to 3-45, 3-70 to 3-71 and 3-92 to 3-104.



Molded Case Circuit Breakers Motor Circuit Protectors

Section 3

125-1200A

Spectra® RMS

Spectra® RMS Mag-Break Motor Circuit Protectors

Current Limiting, UL Component Recognized¹

SG 600 Line 3-Pole

Rating Plug					Frame				Terminal Lugs for Front Connection (Cu/Al)			
Ampere Rating	Adjustable Instantaneous Trip Ampere Range		Product Number	List Price GO-135S	Current Sensor	65kAIC @480 Vac		100kAIC @480 Vac		Product Number	List Price GO-135S	Wire Range
	Low	High				Product Number	List Price GO-141S	Product Number	List Price GO-141S			
400 Ampere Max.												
125	380	1275	SRPG400A125	\$106.00	400	SGLA36AI0400	\$2396.00	SGPA36AI0400	\$2995.00	TCLK365 ²	\$42.00	(2) 2/0-500 Cu or (1) 8-600 Cu
150	455	1530	SRPG400A150	\$106.00								
175	530	1785	SRPG400A175	\$106.00								
200	605	2040	SRPG400A200	\$106.00								
225	680	2295	SRPG400A225	\$106.00								
250	755	2550	SRPG400A250	\$106.00								
300	905	3060	SRPG400A300	\$106.00								
350	1060	3570	SRPG400A350	\$106.00								
400	1210	4080	SRPG400A400	\$106.00								
600 Ampere Max.												
250	765	2530	SRPG600A250	\$106.00	600	SGLA36AI0600	\$3481.00	SGPA36AI0600	\$4350.00	TCLK365 ²	\$42.00	(2) 2/0-500 Cu or (1) 8-600 Cu (2) 2/0-500 Al or (1) 6-600 Al
300	915	3035	SRPG600A300	\$106.00								
350	1070	3545	SRPG600A350	\$106.00								
400	1220	4050	SRPG600A400	\$106.00								
450	1375	4555	SRPG600A450	\$106.00								
500	1525	5060	SRPG600A500	\$106.00								
600	1830	6075	SRPG600A600	\$106.00								

SK1200 Line (Not Current Limiting) 3-Pole

Rating Plug					Frame			Terminal Lugs for Front Connection (Cu/Al)		
Ampere Rating	Adjustable Instantaneous Trip Ampere Range		Product Number	List Price GO-135S	Current Sensor	65kAIC @480 Vac		Product Number	List Price GO-135S	Wire Range
	Low	High				Product Number	List Price GO-141S			
800 Ampere Max.										
300	940	3015	SRPK800A300	\$106.00	800	SKLA36AI0800	\$4490.00	TCAL81	\$47.00	(3) 3/0-500 Cu (3) 3/0-500 Al
400	1250	4015	SRPK800A400	\$106.00						
500	1570	5020	SRPK800A500	\$106.00						
600	1875	6195	SRPK800A600	\$106.00						
700	2155	7420	SRPK800A700	\$106.00						
800	2440	8705	SRPK800A800	\$106.00						
1200 Ampere Max.										
600	1825	6110	SRPK1200A600	\$106.00	1200	SKLA36AI1200	\$7859.00	TCAL125	\$76.00	(4) 250-500 Cu (4) 250-500 Al
700	2125	7125	SRPK1200A700	\$106.00						
800	2430	8145	SRPK1200A800	\$106.00						
100	3040	10180	SRPK1200A1000	\$106.00						
1200	3650	12215	SRPK1200A1200	\$106.00						

¹Per UL 489, interruption ratings are not printed on the product label (interruption ratings are established based on a tested combination of the motor circuit protector and a properly sized overload relay and contactor).

²Order one kit for either the line or load end; two kits required for both.



Publications and Reference: See Section 22 for a complete list of additional product-related publications

Molded Case Circuit Breakers

Special Purpose

Section 3

Mine Duty Circuit Breakers
Standard Duty
50-1200 amperes
600 Vac
300 Vdc

Three-Pole 1000 Wye 577 Vac (Not UL Listed) – Without Line or Load Lugs¹

Complete Breaker							Frame Only		Trip Unit Only			
Ampere Rating	Magnetic Instantaneous Trip		Thermal Magnetic		Magnetic Only		Product Number	List Price GO-135A	Thermal Magnetic		Magnetic Only	
	Low	High	Product Number	List Price GO-135A	Product Number	List Price GO-135A			Product Number	List Price GO-135A	Product Number	List Price GO-135A
E Frame – 100 Amperes Maximum, Noninterchangeable Trip												
50	50 ²	180 ²	TE131050MD	\$1104.00	TE131M050MD	\$1104.00	–	–	–	–	–	–
100	100 ²	500 ²	TE131100MD	\$1104.00	TE131M100MD	\$1104.00	–	–	–	–	–	–
J Frame – 225 Amperes Maximum, Interchangeable Trip³												
225	300	1000	TJ132225MD1	–	TJ132M2MD1	–	TJ132FMD	\$3231.00	TJ32225TMD1	\$920.00	TJ32M2TMD1	\$920.00
225	500	1500	TJ132225MD2	–	TJ132M2MD2	–	–	–	TJ32225TMD2	\$920.00	TJ32M2TMD2	\$920.00
J Frame – 400 Amperes Maximum, Interchangeable Trip³												
400	500	1500	TJ134400MD2	–	TJ134M4MD2	–	TJ134FMD	\$4499.00	TJ34400TMD2	\$1007.00	TJ34M4TMD2	\$1007.00
400	900	3000	TJ134400MD3	–	TJ134M4MD3	–	–	–	TJ34400TMD3	\$1007.00	TJ34M4TMD3	\$1007.00
J Frame – 600 Amperes Maximum, Interchangeable Trip³												
600	900	3000	TJ136600MD3	–	TJ136M6MD3	–	TJ136FMD	\$4636.00	TJ36600TMD3	\$1071.00	TJ36M6TMD3	\$1671.00
K Frame – 800 Amperes Maximum, Interchangeable Trip³												
300	900	3000	TK138600MD3	–	–	–	–	–	TK38300TMD3	\$1815.00	–	–
400	1250	3000	TK138400MD4	–	–	–	–	–	TK38400TMD4	\$1815.00	–	–
600	1250	3000	TK138600MD4	–	–	–	TK138FMD	\$5296.00	TK38600TMD4	\$2813.00	–	–
600	2000	4000	TK138600MD5	–	–	–	–	–	TK38600TMD5	\$2813.00	–	–
800	1250	3000	TK138800MD4	–	TK13M8MD4	–	–	–	TK38800TMD4	\$2813.00	TK38M8TMD4	\$2813.00
800	2000	4000	TK138800MD5	–	TK13M8MD5	–	–	–	TK38800TMD5	\$2813.00	TK38M8TMD5	\$2813.00
K Frame – 1200 Amperes Maximum, Interchangeable Trip^{3,4}												
800	2000	4000	TK13A10MD5	–	–	–	TK13AFMD	\$7600.00	TK3A10TMD5	\$5923.00	–	–
800	2000	4000	TK13A12MD5	–	TK13M12MD5	–	–	–	TK3A12TMD5	\$5923.00	TK3M12TMD5	\$5923.00

¹The lugs recommended for use with all Mine Duty breakers are copper for use with copper cable. Select from page 3-101.

²Applies only to magnetic-only breakers.

³Order frame plus trip unit; not available as complete breaker.

⁴Not suitable for use on dc.

Accessories: See pages 3-40 to 3-45 and 3-92 to 3-104.



Molded Case Circuit Breakers Record Plus® FB 100

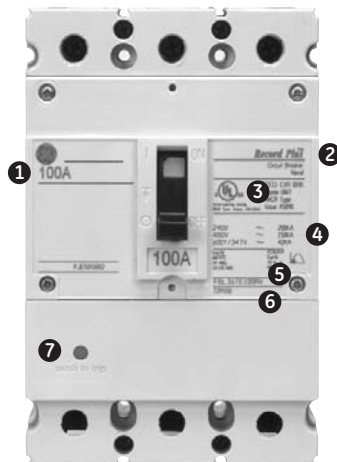

- 1 Breaker Frame Rating
- 2 Product Description
- 3 Standards & Ratings
- 4 Interrupting Ratings
- 5 Lug Data & Torque Info
- 6 Product Number
- 7 Push to Trip

FB Breaker Markings

cULus	UL File E-11592	
HACR	15 to 100A	1, 2, 3 Pole
HID	15 to 50A	1, 2, 3 Pole
NAVAL	15 to 100A	1, 2, 3 Pole
Cu/Al 60/75°C	15 to 100A	1, 2, 3 Pole
Current Limiting	15 to 100A	1, 2, 3 Pole

FB breakers are NOT marked LINE/LOAD and can be reverse fed.

Reference Publications

Available for download from www.geelectrical.com/publibrary

FB Breaker	
Installation Instructions	DEH-41073
Fact sheet	DET-406
FB Breaker Accessories	
Bell Alarm & Aux. Switch	DEH-40324
Shunt Trip & UVR	DEH-40363
Padlock Device	DEH-40521
Lug Kits	DEH-40532
Panelboards	
A-Series® AD Plus Catalog/Selection Guide	DEP-134
A-Series® AD Plus Fact Sheet	DET-397
Spectra® Power Panel - Plug-in Kits	DEH-41123
Spectra® Power Panel - Bolt-on Kits	DEH-41124
Spectra® Power Panel - Filler Plates	DEH-41125
Outline Drawings	
FB 1 pole	10091632SH1
FB 2 pole	10091636SH1
FB 3 pole	10091641SH1
Series Ratings	DET-008

Trip Curves

Trip Unit Rated Current (A)	Trip Curve
15	DES-013
20	DES-014
25	DES-015
30	DES-016
35	DES-017
40	DES-018
45	DES-019
50	DES-020
60	DES-021
70	DES-022
80	DES-023
90	DES-024
100	DES-025
Peak Current Curves	DES-030
Peak I ² t Curve	DES-031

Interrupting Ratings

Type	Ampere Rating	Max AC Voltage	No. Poles	UL Listed Interrupting Ratings - rms Symmetrical Amperes (in Thousands) AC Voltage				
				240	277	347	480	600/347
FBV	15-100	600/347VAC	1	35	35	22	-	-
			2	65	-	-	35	22
			3	65	-	-	35	22
FBN	15-100	600/347VAC	1	65	65	25	-	-
			2	150	-	-	65	25
			3	150	-	-	65	25
FBH	15-100	600/347VAC	1	100	100	35	-	-
			2	200	-	-	100	35
			3	200	-	-	100	35
FBL	15-100	600/347VAC	1	100	100	42	-	-
			2	200	-	-	150	42
			3	200	-	-	150	42

Product Number Structure

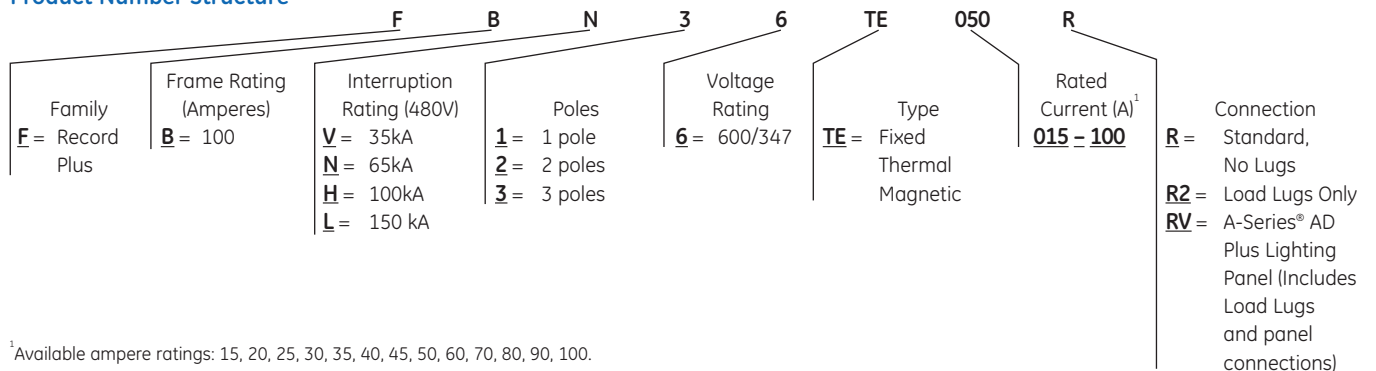

¹ Available ampere ratings: 15, 20, 25, 30, 35, 40, 45, 50, 60, 70, 80, 90, 100.



Publications and Reference: See Section 22 for a complete list of additional product-related publications

1-Pole Record Plus® FB 100 Breakers IC @ 600/347 Vac

Rated Current (A)	35kA Product No.	List Price GO-135H	65kA Product No.	List Price GO-135H	100kA Product No.	List Price GO-135H	150kA Product No.	List Price GO-135H	Connection
15	FBV16TE015R	\$253.00	FBN16TE015R	\$258.00	FBH16TE015R	\$397.00	FBL16TE015R	\$516.00	No Lugs
	FBV16TE015R2	\$256.00	FBN16TE015R2	\$261.00	FBH16TE015R2	\$400.00	FBL16TE015R2	\$519.00	Load Lugs Only
	FBV16TE015RV	\$259.00	FBN16TE015RV	\$264.00	FBH16TE015RV	\$403.00	FBL16TE015RV	\$522.00	Load Lugs and Panel Connections
20	FBV16TE020R	\$253.00	FBN16TE020R	\$258.00	FBH16TE020R	\$397.00	FBL16TE020R	\$516.00	No Lugs
	FBV16TE020R2	\$256.00	FBN16TE020R2	\$261.00	FBH16TE020R2	\$400.00	FBL16TE020R2	\$519.00	Load Lugs Only
	FBV16TE020RV	\$259.00	FBN16TE020RV	\$264.00	FBH16TE020RV	\$403.00	FBL16TE020RV	\$522.00	Load Lugs and Panel Connections
25	FBV16TE025R	\$253.00	FBN16TE025R	\$258.00	FBH16TE025R	\$397.00	FBL16TE025R	\$516.00	No Lugs
	FBV16TE025R2	\$256.00	FBN16TE025R2	\$261.00	FBH16TE025R2	\$400.00	FBL16TE025R2	\$519.00	Load Lugs Only
	FBV16TE025RV	\$259.00	FBN16TE025RV	\$264.00	FBH16TE025RV	\$403.00	FBL16TE025RV	\$522.00	Load Lugs and Panel Connections
30	FBV16TE030R	\$253.00	FBN16TE030R	\$258.00	FBH16TE030R	\$397.00	FBL16TE030R	\$516.00	No Lugs
	FBV16TE030R2	\$256.00	FBN16TE030R2	\$261.00	FBH16TE030R2	\$400.00	FBL16TE030R2	\$519.00	Load Lugs Only
	FBV16TE030RV	\$259.00	FBN16TE030RV	\$264.00	FBH16TE030RV	\$403.00	FBL16TE030RV	\$522.00	Load Lugs and Panel Connections
35	FBV16TE035R	\$253.00	FBN16TE035R	\$258.00	FBH16TE035R	\$397.00	FBL16TE035R	\$516.00	No Lugs
	FBV16TE035R2	\$256.00	FBN16TE035R2	\$261.00	FBH16TE035R2	\$400.00	FBL16TE035R2	\$519.00	Load Lugs Only
	FBV16TE035RV	\$259.00	FBN16TE035RV	\$264.00	FBH16TE035RV	\$403.00	FBL16TE035RV	\$522.00	Load Lugs and Panel Connections
40	FBV16TE040R	\$253.00	FBN16TE040R	\$258.00	FBH16TE040R	\$397.00	FBL16TE040R	\$516.00	No Lugs
	FBV16TE040R2	\$256.00	FBN16TE040R2	\$261.00	FBH16TE040R2	\$400.00	FBL16TE040R2	\$519.00	Load Lugs Only
	FBV16TE040RV	\$259.00	FBN16TE040RV	\$264.00	FBH16TE040RV	\$403.00	FBL16TE040RV	\$522.00	Load Lugs and Panel Connections
45	FBV16TE045R	\$253.00	FBN16TE045R	\$258.00	FBH16TE045R	\$397.00	FBL16TE045R	\$516.00	No Lugs
	FBV16TE045R2	\$256.00	FBN16TE045R2	\$261.00	FBH16TE045R2	\$400.00	FBL16TE045R2	\$519.00	Load Lugs Only
	FBV16TE045RV	\$259.00	FBN16TE045RV	\$264.00	FBH16TE045RV	\$403.00	FBL16TE045RV	\$522.00	Load Lugs and Panel Connections
50	FBV16TE050R	\$253.00	FBN16TE050R	\$258.00	FBH16TE050R	\$397.00	FBL16TE050R	\$516.00	No Lugs
	FBV16TE050R2	\$256.00	FBN16TE050R2	\$261.00	FBH16TE050R2	\$400.00	FBL16TE050R2	\$519.00	Load Lugs Only
	FBV16TE050RV	\$259.00	FBN16TE050RV	\$264.00	FBH16TE050RV	\$403.00	FBL16TE050RV	\$522.00	Load Lugs and Panel Connections
60	FBV16TE060R	\$253.00	FBN16TE060R	\$258.00	FBH16TE060R	\$397.00	FBL16TE060R	\$516.00	No Lugs
	FBV16TE060R2	\$256.00	FBN16TE060R2	\$261.00	FBH16TE060R2	\$400.00	FBL16TE060R2	\$519.00	Load Lugs Only
	FBV16TE060RV	\$259.00	FBN16TE060RV	\$264.00	FBH16TE060RV	\$403.00	FBL16TE060RV	\$522.00	Load Lugs and Panel Connections
70	FBV16TE070R	\$307.00	FBN16TE070R	\$336.00	FBH16TE070R	\$510.00	FBL16TE070R	\$691.00	No Lugs
	FBV16TE070R2	\$310.00	FBN16TE070R2	\$339.00	FBH16TE070R2	\$513.00	FBL16TE070R2	\$694.00	Load Lugs Only
	FBV16TE070RV	\$313.00	FBN16TE070RV	\$342.00	FBH16TE070RV	\$516.00	FBL16TE070RV	\$697.00	Load Lugs and Panel Connections
80	FBV16TE080R	\$307.00	FBN16TE080R	\$336.00	FBH16TE080R	\$510.00	FBL16TE080R	\$691.00	No Lugs
	FBV16TE080R2	\$310.00	FBN16TE080R2	\$339.00	FBH16TE080R2	\$513.00	FBL16TE080R2	\$694.00	Load Lugs Only
	FBV16TE080RV	\$313.00	FBN16TE080RV	\$342.00	FBH16TE080RV	\$516.00	FBL16TE080RV	\$697.00	Load Lugs and Panel Connections
90	FBV16TE090R	\$307.00	FBN16TE090R	\$336.00	FBH16TE090R	\$510.00	FBL16TE090R	\$691.00	No Lugs
	FBV16TE090R2	\$310.00	FBN16TE090R2	\$339.00	FBH16TE090R2	\$513.00	FBL16TE090R2	\$694.00	Load Lugs Only
	FBV16TE090RV	\$313.00	FBN16TE090RV	\$342.00	FBH16TE090RV	\$516.00	FBL16TE090RV	\$697.00	Load Lugs and Panel Connections
100	FBV16TE100R	\$307.00	FBN16TE100R	\$336.00	FBH16TE100R	\$510.00	FBL16TE100R	\$691.00	No Lugs
	FBV16TE100R2	\$310.00	FBN16TE100R2	\$339.00	FBH16TE100R2	\$513.00	FBL16TE100R2	\$694.00	Load Lugs Only
	FBV16TE100RV	\$313.00	FBN16TE100RV	\$342.00	FBH16TE100RV	\$516.00	FBL16TE100RV	\$697.00	Load Lugs and Panel Connections



Molded Case Circuit Breakers Record Plus® FB 100

Section 3

2-Pole Record Plus® FB 100 Breakers IC @ 600/347 Vac

Rated Current (A)	35kA Product No.	List Price GO-135H	65kA Product No.	List Price GO-135H	100kA Product No.	List Price GO-135H	150kA Product No.	List Price GO-135H	Connection
15	FBV26TE015R	\$636.00	FBN26TE015R	\$649.00	FBH26TE015R	\$995.00	FBL26TE015R	\$1293.00	No Lugs
	FBV26TE015R2	\$642.00	FBN26TE015R2	\$655.00	FBH26TE015R2	\$1001.00	FBL26TE015R2	\$1299.00	Load Lugs Only
	FBV26TE015RV	\$648.00	FBN26TE015RV	\$661.00	FBH26TE015RV	\$1007.00	FBL26TE015RV	\$1305.00	Load Lugs and Panel Connections
20	FBV26TE020R	\$636.00	FBN26TE020R	\$649.00	FBH26TE020R	\$995.00	FBL26TE020R	\$1293.00	No Lugs
	FBV26TE020R2	\$642.00	FBN26TE020R2	\$655.00	FBH26TE020R2	\$1001.00	FBL26TE020R2	\$1299.00	Load Lugs Only
	FBV26TE020RV	\$648.00	FBN26TE020RV	\$661.00	FBH26TE020RV	\$1007.00	FBL26TE020RV	\$1305.00	Load Lugs and Panel Connections
25	FBV26TE025R	\$636.00	FBN26TE025R	\$649.00	FBH26TE025R	\$995.00	FBL26TE025R	\$1293.00	No Lugs
	FBV26TE025R2	\$642.00	FBN26TE025R2	\$655.00	FBH26TE025R2	\$1001.00	FBL26TE025R2	\$1299.00	Load Lugs Only
	FBV26TE025RV	\$648.00	FBN26TE025RV	\$661.00	FBH26TE025RV	\$1007.00	FBL26TE025RV	\$1305.00	Load Lugs and Panel Connections
30	FBV26TE030R	\$636.00	FBN26TE030R	\$649.00	FBH26TE030R	\$995.00	FBL26TE030R	\$1293.00	No Lugs
	FBV26TE030R2	\$642.00	FBN26TE030R2	\$655.00	FBH26TE030R2	\$1001.00	FBL26TE030R2	\$1299.00	Load Lugs Only
	FBV26TE030RV	\$648.00	FBN26TE030RV	\$661.00	FBH26TE030RV	\$1007.00	FBL26TE030RV	\$1305.00	Load Lugs and Panel Connections
35	FBV26TE035R	\$636.00	FBN26TE035R	\$649.00	FBH26TE035R	\$995.00	FBL26TE035R	\$1293.00	No Lugs
	FBV26TE035R2	\$642.00	FBN26TE035R2	\$655.00	FBH26TE035R2	\$1001.00	FBL26TE035R2	\$1299.00	Load Lugs Only
	FBV26TE035RV	\$648.00	FBN26TE035RV	\$661.00	FBH26TE035RV	\$1007.00	FBL26TE035RV	\$1305.00	Load Lugs and Panel Connections
40	FBV26TE040R	\$636.00	FBN26TE040R	\$649.00	FBH26TE040R	\$995.00	FBL26TE040R	\$1293.00	No Lugs
	FBV26TE040R2	\$642.00	FBN26TE040R2	\$655.00	FBH26TE040R2	\$1001.00	FBL26TE040R2	\$1299.00	Load Lugs Only
	FBV26TE040RV	\$648.00	FBN26TE040RV	\$661.00	FBH26TE040RV	\$1007.00	FBL26TE040RV	\$1305.00	Load Lugs and Panel Connections
45	FBV26TE045R	\$636.00	FBN26TE045R	\$649.00	FBH26TE045R	\$995.00	FBL26TE045R	\$1293.00	No Lugs
	FBV26TE045R2	\$642.00	FBN26TE045R2	\$655.00	FBH26TE045R2	\$1001.00	FBL26TE045R2	\$1299.00	Load Lugs Only
	FBV26TE045RV	\$648.00	FBN26TE045RV	\$661.00	FBH26TE045RV	\$1007.00	FBL26TE045RV	\$1305.00	Load Lugs and Panel Connections
50	FBV26TE050R	\$636.00	FBN26TE050R	\$649.00	FBH26TE050R	\$995.00	FBL26TE050R	\$1293.00	No Lugs
	FBV26TE050R2	\$642.00	FBN26TE050R2	\$655.00	FBH26TE050R2	\$1001.00	FBL26TE050R2	\$1299.00	Load Lugs Only
	FBV26TE050RV	\$648.00	FBN26TE050RV	\$661.00	FBH26TE050RV	\$1007.00	FBL26TE050RV	\$1305.00	Load Lugs and Panel Connections
60	FBV26TE060R	\$636.00	FBN26TE060R	\$649.00	FBH26TE060R	\$995.00	FBL26TE060R	\$1293.00	No Lugs
	FBV26TE060R2	\$642.00	FBN26TE060R2	\$655.00	FBH26TE060R2	\$1001.00	FBL26TE060R2	\$1299.00	Load Lugs Only
	FBV26TE060RV	\$648.00	FBN26TE060RV	\$661.00	FBH26TE060RV	\$1007.00	FBL26TE060RV	\$1305.00	Load Lugs and Panel Connections
70	FBV26TE070R	\$770.00	FBN26TE070R	\$844.00	FBH26TE070R	\$1279.00	FBL26TE070R	\$1731.00	No Lugs
	FBV26TE070R2	\$776.00	FBN26TE070R2	\$850.00	FBH26TE070R2	\$1285.00	FBL26TE070R2	\$1737.00	Load Lugs Only
	FBV26TE070RV	\$782.00	FBN26TE070RV	\$856.00	FBH26TE070RV	\$1291.00	FBL26TE070RV	\$1743.00	Load Lugs and Panel Connections
80	FBV26TE080R	\$770.00	FBN26TE080R	\$844.00	FBH26TE080R	\$1279.00	FBL26TE080R	\$1731.00	No Lugs
	FBV26TE080R2	\$776.00	FBN26TE080R2	\$850.00	FBH26TE080R2	\$1285.00	FBL26TE080R2	\$1737.00	Load Lugs Only
	FBV26TE080RV	\$782.00	FBN26TE080RV	\$856.00	FBH26TE080RV	\$1291.00	FBL26TE080RV	\$1743.00	Load Lugs and Panel Connections
90	FBV26TE090R	\$770.00	FBN26TE090R	\$844.00	FBH26TE090R	\$1279.00	FBL26TE090R	\$1731.00	No Lugs
	FBV26TE090R2	\$776.00	FBN26TE090R2	\$850.00	FBH26TE090R2	\$1285.00	FBL26TE090R2	\$1737.00	Load Lugs Only
	FBV26TE090RV	\$782.00	FBN26TE090RV	\$856.00	FBH26TE090RV	\$1291.00	FBL26TE090RV	\$1743.00	Load Lugs and Panel Connections
100	FBV26TE100R	\$770.00	FBN26TE100R	\$844.00	FBH26TE100R	\$1279.00	FBL26TE100R	\$1731.00	No Lugs
	FBV26TE100R2	\$776.00	FBN26TE100R2	\$850.00	FBH26TE100R2	\$1285.00	FBL26TE100R2	\$1737.00	Load Lugs Only
	FBV26TE100RV	\$782.00	FBN26TE100RV	\$856.00	FBH26TE100RV	\$1291.00	FBL26TE100RV	\$1743.00	Load Lugs and Panel Connections



Publications and Reference: See Section 22 for a complete list of additional product-related publications

3-Pole Record Plus® FB 100 Breakers IC @ 600/347 Vac

Rated Current (A)	35kA Product No.	List Price GO-135H	65kA Product No.	List Price GO-135H	100kA Product No.	List Price GO-135H	150kA Product No.	List Price GO-135H	Connection
15	FBV36TE015R	\$769.00	FBN36TE015R	\$850.00	FBH36TE015R	\$1286.00	FBL36TE015R	\$1742.00	No Lugs
	FBV36TE015R2	\$778.00	FBN36TE015R2	\$859.00	FBH36TE015R2	\$1295.00	FBL36TE015R2	\$1751.00	Load Lugs Only
	FBV36TE015RV	\$787.00	FBN36TE015RV	\$868.00	FBH36TE015RV	\$1304.00	FBL36TE015RV	\$1760.00	Load Lugs and Panel Connections
20	FBV36TE020R	\$769.00	FBN36TE020R	\$850.00	FBH36TE020R	\$1286.00	FBL36TE020R	\$1742.00	No Lugs
	FBV36TE020R2	\$778.00	FBN36TE020R2	\$859.00	FBH36TE020R2	\$1295.00	FBL36TE020R2	\$1751.00	Load Lugs Only
	FBV36TE020RV	\$787.00	FBN36TE020RV	\$868.00	FBH36TE020RV	\$1304.00	FBL36TE020RV	\$1760.00	Load Lugs and Panel Connections
25	FBV36TE025R	\$769.00	FBN36TE025R	\$850.00	FBH36TE025R	\$1286.00	FBL36TE025R	\$1742.00	No Lugs
	FBV36TE025R2	\$778.00	FBN36TE025R2	\$859.00	FBH36TE025R2	\$1295.00	FBL36TE025R2	\$1751.00	Load Lugs Only
	FBV36TE025RV	\$787.00	FBN36TE025RV	\$868.00	FBH36TE025RV	\$1304.00	FBL36TE025RV	\$1760.00	Load Lugs and Panel Connections
30	FBV36TE030R	\$769.00	FBN36TE030R	\$850.00	FBH36TE030R	\$1286.00	FBL36TE030R	\$1742.00	No Lugs
	FBV36TE030R2	\$778.00	FBN36TE030R2	\$859.00	FBH36TE030R2	\$1295.00	FBL36TE030R2	\$1751.00	Load Lugs Only
	FBV36TE030RV	\$787.00	FBN36TE030RV	\$868.00	FBH36TE030RV	\$1304.00	FBL36TE030RV	\$1760.00	Load Lugs and Panel Connections
35	FBV36TE035R	\$769.00	FBN36TE035R	\$850.00	FBH36TE035R	\$1286.00	FBL36TE035R	\$1742.00	No Lugs
	FBV36TE035R2	\$778.00	FBN36TE035R2	\$859.00	FBH36TE035R2	\$1295.00	FBL36TE035R2	\$1751.00	Load Lugs Only
	FBV36TE035RV	\$787.00	FBN36TE035RV	\$868.00	FBH36TE035RV	\$1304.00	FBL36TE035RV	\$1760.00	Load Lugs and Panel Connections
40	FBV36TE040R	\$769.00	FBN36TE040R	\$850.00	FBH36TE040R	\$1286.00	FBL36TE040R	\$1742.00	No Lugs
	FBV36TE040R2	\$778.00	FBN36TE040R2	\$859.00	FBH36TE040R2	\$1295.00	FBL36TE040R2	\$1751.00	Load Lugs Only
	FBV36TE040RV	\$787.00	FBN36TE040RV	\$868.00	FBH36TE040RV	\$1304.00	FBL36TE040RV	\$1760.00	Load Lugs and Panel Connections
45	FBV36TE045R	\$769.00	FBN36TE045R	\$850.00	FBH36TE045R	\$1286.00	FBL36TE045R	\$1742.00	No Lugs
	FBV36TE045R2	\$778.00	FBN36TE045R2	\$859.00	FBH36TE045R2	\$1295.00	FBL36TE045R2	\$1751.00	Load Lugs Only
	FBV36TE045RV	\$787.00	FBN36TE045RV	\$868.00	FBH36TE045RV	\$1304.00	FBL36TE045RV	\$1760.00	Load Lugs and Panel Connections
50	FBV36TE050R	\$769.00	FBN36TE050R	\$850.00	FBH36TE050R	\$1286.00	FBL36TE050R	\$1742.00	No Lugs
	FBV36TE050R2	\$778.00	FBN36TE050R2	\$859.00	FBH36TE050R2	\$1295.00	FBL36TE050R2	\$1751.00	Load Lugs Only
	FBV36TE050RV	\$787.00	FBN36TE050RV	\$868.00	FBH36TE050RV	\$1304.00	FBL36TE050RV	\$1760.00	Load Lugs and Panel Connections
60	FBV36TE060R	\$769.00	FBN36TE060R	\$850.00	FBH36TE060R	\$1286.00	FBL36TE060R	\$1742.00	No Lugs
	FBV36TE060R2	\$778.00	FBN36TE060R2	\$859.00	FBH36TE060R2	\$1295.00	FBL36TE060R2	\$1751.00	Load Lugs Only
	FBV36TE060RV	\$787.00	FBN36TE060RV	\$868.00	FBH36TE060RV	\$1304.00	FBL36TE060RV	\$1760.00	Load Lugs and Panel Connections
70	FBV36TE070R	\$884.00	FBN36TE070R	\$992.00	FBH36TE070R	\$1579.00	FBL36TE070R	\$2129.00	No Lugs
	FBV36TE070R2	\$893.00	FBN36TE070R2	\$1001.00	FBH36TE070R2	\$1588.00	FBL36TE070R2	\$2138.00	Load Lugs Only
	FBV36TE070RV	\$902.00	FBN36TE070RV	\$1010.00	FBH36TE070RV	\$1597.00	FBL36TE070RV	\$2147.00	Load Lugs and Panel Connections
80	FBV36TE080R	\$884.00	FBN36TE080R	\$992.00	FBH36TE080R	\$1579.00	FBL36TE080R	\$2129.00	No Lugs
	FBV36TE080R2	\$893.00	FBN36TE080R2	\$1001.00	FBH36TE080R2	\$1588.00	FBL36TE080R2	\$2138.00	Load Lugs Only
	FBV36TE080RV	\$902.00	FBN36TE080RV	\$1010.00	FBH36TE080RV	\$1597.00	FBL36TE080RV	\$2147.00	Load Lugs and Panel Connections
90	FBV36TE090R	\$884.00	FBN36TE090R	\$992.00	FBH36TE090R	\$1579.00	FBL36TE090R	\$2129.00	No Lugs
	FBV36TE090R2	\$893.00	FBN36TE090R2	\$1001.00	FBH36TE090R2	\$1588.00	FBL36TE090R2	\$2138.00	Load Lugs Only
	FBV36TE090RV	\$902.00	FBN36TE090RV	\$1010.00	FBH36TE090RV	\$1597.00	FBL36TE090RV	\$2147.00	Load Lugs and Panel Connections
100	FBV36TE100R	\$884.00	FBN36TE100R	\$992.00	FBH36TE100R	\$1579.00	FBL36TE100R	\$2129.00	No Lugs
	FBV36TE100R2	\$893.00	FBN36TE100R2	\$1001.00	FBH36TE100R2	\$1588.00	FBL36TE100R2	\$2138.00	Load Lugs Only
	FBV36TE100RV	\$902.00	FBN36TE100RV	\$1010.00	FBH36TE100RV	\$1597.00	FBL36TE100RV	\$2147.00	Load Lugs and Panel Connections



Molded Case Circuit Breakers

Record Plus® FB 100

Internal Accessories

Releases – Shunt Trip and Undervoltage

Voltage	Shunt Trip		Undervoltage Release	
	Product No.	List Price GO-135H	Product No.	List Price GO-135H
12 VDC	FASHTBW	\$363.00	—	—
24 VAC/DC	FASHTDW	\$363.00	FAUVRDW	\$363.00
48 VAC/DC	FASHTFW	\$363.00	FAUVRFW	\$363.00
110-130 VAC/110-125 VDC	FASHTJW	\$363.00	FAUVRJW	\$363.00
120 VAC	FASHTKW	\$363.00	—	—
220/240 VAC, 250 VDC	FASHTNW	\$363.00	FAUVRNW	\$363.00
277 VAC	FASHT7W	\$363.00	FAUVR7W	\$363.00
400/480 VAC	FASHTUW	\$363.00	FAUVRUW	\$363.00

UL Listed for field installation. Accessories are prewired from the factory with 36 inch long leads (#18 AWG). Shunt trip wire leads are black and UVR wire leads are blue.

Bell Alarm

Contact Configuration	Contacts	Contact Rating	Wire leads	Product No.	List Price GO-135H
1 NO (Form A)	Standard	5A @ 277 VAC, 0.3A @ 125 VDC	#16 AWG	FABAM10W	\$154.00
1 NC (Form B)	Standard	5A @ 277 VAC, 0.3A @ 125 VDC	#16 AWG	FABAM01W	\$154.00

UL Listed for field installation. Accessories are prewired from the factory with 36 inch long leads. Reference instruction sheet DEH-40324 for wire lead colors.

Auxiliary Switches

Contact Configuration	Contacts	Contact Rating	Wire leads	Left Mount		Right Mount	
				Product No.	List Price GO-135H	Product No.	List Price GO-135H
1 NO (Form A)	Standard	5A @ 277 VAC, 0.3A @ 125 VDC	#16 AWG	FAS10LW	\$149.00	FAS10RW	\$149.00
1 NC (Form B)	Standard	5A @ 277 VAC, 0.3A @ 125 VDC	#16 AWG	FAS01LW	\$149.00	FAS01RW	\$149.00

UL Listed for field installation. Accessories are prewired from the factory with 36 inch long leads. Reference instruction sheet DEH-40324 for wire lead colors.

Mounting Locations and Limitations

Accessory	Mounting Pocket Location	Accessory Installation		
		1 Pole	2 Pole	3 Pole
Shunt Trip or Undervoltage Release	□	0	1	1
Aux. Switch - Left Mount	⌚	0	0	1
Aux. Switch - Right Mount	⌚	0	0	1
Bell Alarm	⌚	0	0	1
Maximum Number of Internal Accessories That Can Be Installed		0	1	4

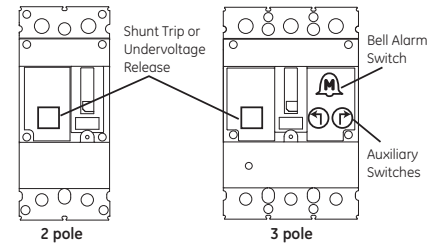

Mounting Locations



Publications and Reference: See Section 22 for a complete list of additional product-related publications

Molded Case Circuit Breakers

Record Plus® FB 100

External Accessories

Section 3

Padlocking Devices

Description	Product No.	List Price GO-135H
Padlock Fixed Toggle	FB1PF	\$8.70
Padlock EUSERC Toggle	FB1PE	\$32.00

Lugs and Lug Kits

Amp Range	Wire Range	Single Lug Product No.	List Price GO-135H	Lug Kit Product No. (Set of 3)	List Price GO-135H	Torque	Tool
15-20A	14-10 AWG Cu/Al	FCAL12	\$3.25	FCALK12	\$9.00	25-32 lb-in	Slot
25-60A	10-4 AWG Cu/Al	FCAL13	\$3.25	FCALK13	\$9.00	25-32 lb-in	5/32" Hex
70-100A	4-1/0 AWG Cu/Al	FCAL14	\$3.25	FCALK14	\$9.00	25-32 lb-in	5/32" Hex

Dimensions in. (mm)

FB 100 Dimensions

Poles	A	B	C	D	E	F	G1	G2	H
1	3.88 (98.6)	3.28 (83.3)	1.06 (26.9)	1.36 (34.5)	N/A	N/A	5.11 (129.8)	5.01 (127.3)	6.45 (163.8)
2	3.88 (98.6)	3.28 (83.3)	1.06 (26.9)	2.74 (69.6)	0.69 (17.5)	1.38 (35.1)	5.11 (129.8)	5.01 (127.3)	6.45 (163.8)
3	3.88 (98.6)	3.28 (83.3)	1.06 (26.9)	4.11 (104.4)	1.38 (35.1)	1.38 (35.1)	5.11 (129.8)	5.01 (127.3)	6.45 (163.8)

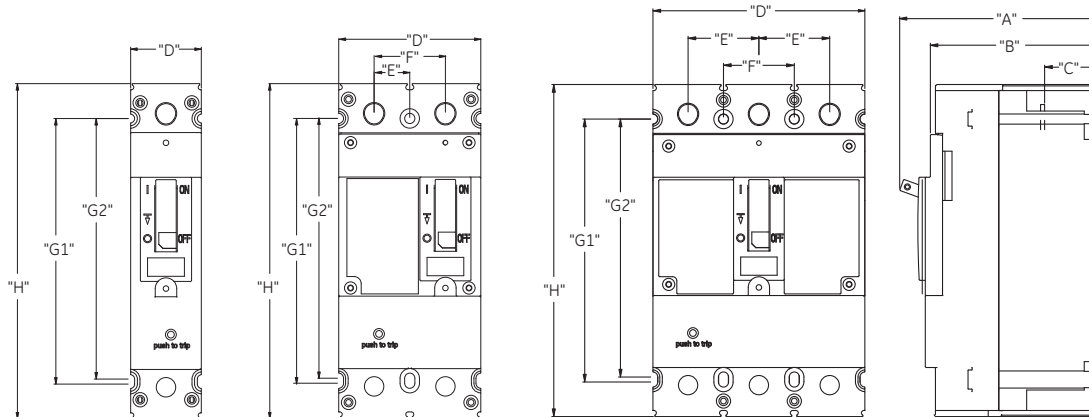

Molded Case Circuit Breakers Record Plus® FC 100

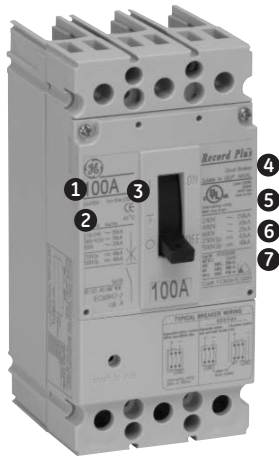

- 1 Breaker Frame Rating
- 2 Rated Voltage
- 3 Breaker Frame
- 4 Enclosed Rating
- 5 Product Description
- 6 Standards
- 7 Interruption Capacity Product Number

Reference Publications

Available for download from www.geelectrical.com/publibrary

FC Breaker	
Installation Instructions	DEH-40463
FC Breaker Accessories	
Bell Alarm & Aux. Switch	DEH-40324
Shunt Trip & Undervoltage Release	DEH-40363
Lug Kits	DEH-40532
Outline Drawings	
FC 2-3 pole	10085772SH1
Series Ratings	DET-008

Trip Curves

Trip Unit Rated Current (A)	Trip Curve
15	DES-013
20	DES-014
25	DES-015
30	DES-016
35	DES-017
40	DES-018
45	DES-019
50	DES-020
60	DES-021
70	DES-022
80	DES-023
90	DES-024
100	DES-025
Peak Current Curves	DES-030
Peak I ² t Curve	DES-031

Main Standards

- UL 489
- IEC 947 and associated EN Sections

FC Breaker Markings

cULus	UL File E-11592
HACR	15 to 100A
Cu/Al 60/75°C	15 to 100A
Current Limiting	15 to 100A

FC 100 Amp Frame Overview

Interrupting Ratings — Federal Spec C/B Class WC-375B

Type	Ampere Rating	No. Poles	Max AC/DC Voltage	UL Listed Interrupting Ratings - rms Symmetrical Amperes (in Thousands)					IEC Listed Interrupting Ratings, Icu, Amperes (in Thousands)				
				AC Voltage			DC Voltage		AC Voltage			DC Voltage	
				240	480	600/347	250 (2p)	500 (3p)	220-240	400-415	500	250 (2p)	500 (3p)
FCS	15-100	2,3	600VAC, 500VDC	42	25	18	22	30	36	22	14	22	30
FCV	15-100	2,3	600VAC, 500VDC	65	35	22	25	35	50	30	18	25	35
FCN	15-100	2,3	600VAC, 500VDC	150	65	25	30	42	85	50	22	30	42
FCH	15-100	2,3	600VAC, 500VDC	200	100	35	42	65	100	80	36	42	65
FCL	15-100	2,3	600VAC, 500VDC	200	150	42	65	80	200	150	50	65	80

Product Number Structure

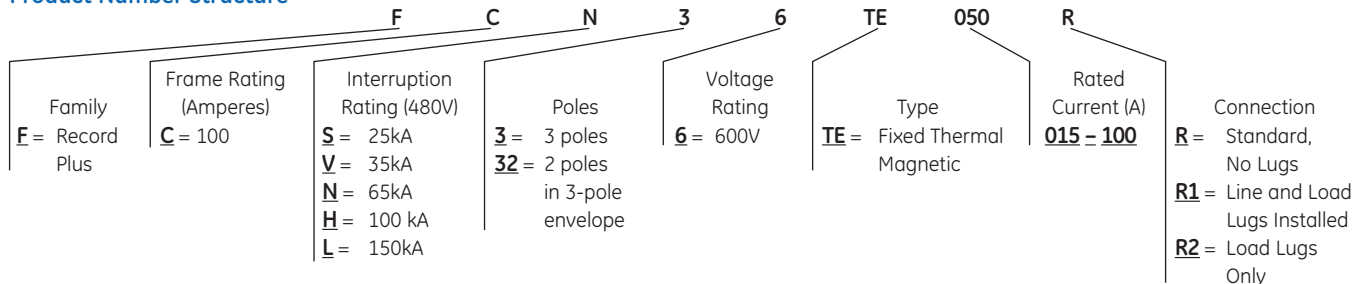

Selection

Record Plus®, Non-Automatic Circuit Breaker (Molded Case Switch), 600 VAC

Ampere Rating	2-Pole		3-Pole		Lug Kit (3 per kit)	
	Product No.	List Price GO-135H	Product No.	List Price GO-135H	Product No.	List Price GO-135H
60	FCY206F060R	\$345.00	FCY306F060R	\$445.00	FCALK13	\$9.00
100	FCY206F100R	\$345.00	FCY306F100R	\$445.00	FCALK14	\$9.00



Publications and Reference: See Section 22 for a complete list of additional product-related publications

Molded Case Circuit Breakers Record Plus® FC 100

Section 3

2-Pole Record Plus® FC 100 Breakers IC @ 600 Vac

Rated Current (A)	25kA Product No.	List Price GO-135H	35kA Product No.	List Price GO-135H	65kA Product No.	List Price GO-135H	100kA Product No.	List Price GO-135H	150kA Product No.	List Price GO-135H	Connection
15	FCS326TE015R2	\$636.00	FCV326TE015R2	\$642.00	FCN326TE015R2	\$655.00	FCH326TE015R2	\$1001.00	FCL326TE015R2	\$1299.00	Load Lugs Only
20	FCS326TE020R2	\$636.00	FCV326TE020R2	\$642.00	FCN326TE020R2	\$655.00	FCH326TE020R2	\$1001.00	FCL326TE020R2	\$1299.00	Load Lugs Only
25	FCS326TE025R	\$630.00	FCV326TE025R	\$636.00	FCN326TE025R	\$649.00	FCH326TE025R	\$995.00	FCL326TE025R	\$1293.00	No Lugs
	FCS326TE025R1	\$642.00	FCV326TE025R1	\$648.00	FCN326TE025R1	\$661.00	FCH326TE025R1	\$1007.00	FCL326TE025R1	\$1305.00	Line and Load Lugs Installed
30	FCS326TE025R2	\$636.00	FCV326TE025R2	\$642.00	FCN326TE025R2	\$655.00	FCH326TE025R2	\$1001.00	FCL326TE025R2	\$1299.00	Load Lugs Only
	FCS326TE030R	\$630.00	FCV326TE030R	\$636.00	FCN326TE030R	\$649.00	FCH326TE030R	\$995.00	FCL326TE030R	\$1293.00	No Lugs
	FCS326TE030R1	\$642.00	FCV326TE030R1	\$648.00	FCN326TE030R1	\$661.00	FCH326TE030R1	\$1007.00	FCL326TE030R1	\$1305.00	Line and Load Lugs Installed
35	FCS326TE030R2	\$636.00	FCV326TE030R2	\$642.00	FCN326TE030R2	\$655.00	FCH326TE030R2	\$1001.00	FCL326TE030R2	\$1299.00	Load Lugs Only
	FCS326TE035R	\$630.00	FCV326TE035R	\$636.00	FCN326TE035R	\$649.00	FCH326TE035R	\$995.00	FCL326TE035R	\$1293.00	No Lugs
40	FCS326TE035R1	\$642.00	FCV326TE035R1	\$648.00	FCN326TE035R1	\$661.00	FCH326TE035R1	\$1007.00	FCL326TE035R1	\$1305.00	Line and Load Lugs Installed
	FCS326TE035R2	\$636.00	FCV326TE035R2	\$642.00	FCN326TE035R2	\$655.00	FCH326TE035R2	\$1001.00	FCL326TE035R2	\$1299.00	Load Lugs Only
45	FCS326TE040R	\$630.00	FCV326TE040R	\$636.00	FCN326TE040R	\$649.00	FCH326TE040R	\$995.00	FCL326TE040R	\$1293.00	No Lugs
	FCS326TE040R1	\$642.00	FCV326TE040R1	\$648.00	FCN326TE040R1	\$661.00	FCH326TE040R1	\$1007.00	FCL326TE040R1	\$1305.00	Line and Load Lugs Installed
50	FCS326TE040R2	\$636.00	FCV326TE040R2	\$642.00	FCN326TE040R2	\$655.00	FCH326TE040R2	\$1001.00	FCL326TE040R2	\$1299.00	Load Lugs Only
	FCS326TE045R	\$630.00	FCV326TE045R	\$636.00	FCN326TE045R	\$649.00	FCH326TE045R	\$995.00	FCL326TE045R	\$1293.00	No Lugs
	FCS326TE045R1	\$642.00	FCV326TE045R1	\$648.00	FCN326TE045R1	\$661.00	FCH326TE045R1	\$1007.00	FCL326TE045R1	\$1305.00	Line and Load Lugs Installed
55	FCS326TE045R2	\$636.00	FCV326TE045R2	\$642.00	FCN326TE045R2	\$655.00	FCH326TE045R2	\$1001.00	FCL326TE045R2	\$1299.00	Load Lugs Only
	FCS326TE050R	\$630.00	FCV326TE050R	\$636.00	FCN326TE050R	\$649.00	FCH326TE050R	\$995.00	FCL326TE050R	\$1293.00	No Lugs
60	FCS326TE050R1	\$642.00	FCV326TE050R1	\$648.00	FCN326TE050R1	\$661.00	FCH326TE050R1	\$1007.00	FCL326TE050R1	\$1305.00	Line and Load Lugs Installed
	FCS326TE050R2	\$636.00	FCV326TE050R2	\$642.00	FCN326TE050R2	\$655.00	FCH326TE050R2	\$1001.00	FCL326TE050R2	\$1299.00	Load Lugs Only
65	FCS326TE060R	\$630.00	FCV326TE060R	\$636.00	FCN326TE060R	\$649.00	FCH326TE060R	\$995.00	FCL326TE060R	\$1293.00	No Lugs
	FCS326TE060R1	\$642.00	FCV326TE060R1	\$648.00	FCN326TE060R1	\$661.00	FCH326TE060R1	\$1007.00	FCL326TE060R1	\$1305.00	Line and Load Lugs Installed
70	FCS326TE060R2	\$636.00	FCV326TE060R2	\$642.00	FCN326TE060R2	\$655.00	FCH326TE060R2	\$1001.00	FCL326TE060R2	\$1299.00	Load Lugs Only
	FCS326TE070R	\$734.00	FCV326TE070R	\$770.00	FCN326TE070R	\$844.00	FCH326TE070R	\$1279.00	FCL326TE070R	\$1731.00	No Lugs
	FCS326TE070R1	\$746.00	FCV326TE070R1	\$782.00	FCN326TE070R1	\$856.00	FCH326TE070R1	\$1291.00	FCL326TE070R1	\$1743.00	Line and Load Lugs Installed
75	FCS326TE070R2	\$740.00	FCV326TE070R2	\$776.00	FCN326TE070R2	\$850.00	FCH326TE070R2	\$1285.00	FCL326TE070R2	\$1737.00	Load Lugs Only
	FCS326TE080R	\$734.00	FCV326TE080R	\$770.00	FCN326TE080R	\$844.00	FCH326TE080R	\$1279.00	FCL326TE080R	\$1731.00	No Lugs
80	FCS326TE080R1	\$746.00	FCV326TE080R1	\$782.00	FCN326TE080R1	\$856.00	FCH326TE080R1	\$1291.00	FCL326TE080R1	\$1743.00	Line and Load Lugs Installed
	FCS326TE080R2	\$740.00	FCV326TE080R2	\$776.00	FCN326TE080R2	\$850.00	FCH326TE080R2	\$1285.00	FCL326TE080R2	\$1737.00	Load Lugs Only
85	FCS326TE090R	\$734.00	FCV326TE090R	\$770.00	FCN326TE090R	\$844.00	FCH326TE090R	\$1279.00	FCL326TE090R	\$1731.00	No Lugs
	FCS326TE090R1	\$746.00	FCV326TE090R1	\$782.00	FCN326TE090R1	\$856.00	FCH326TE090R1	\$1291.00	FCL326TE090R1	\$1743.00	Line and Load Lugs Installed
90	FCS326TE090R2	\$740.00	FCV326TE090R2	\$776.00	FCN326TE090R2	\$850.00	FCH326TE090R2	\$1285.00	FCL326TE090R2	\$1737.00	Load Lugs Only
	FCS326TE100R	\$734.00	FCV326TE100R	\$770.00	FCN326TE100R	\$844.00	FCH326TE100R	\$1279.00	FCL326TE100R	\$1731.00	No Lugs
	FCS326TE100R1	\$746.00	FCV326TE100R1	\$782.00	FCN326TE100R1	\$856.00	FCH326TE100R1	\$1291.00	FCL326TE100R1	\$1743.00	Line and Load Lugs Installed
100	FCS326TE100R2	\$740.00			FCN326TE100R2	\$850.00	FCH326TE100R2	\$1285.00	FCL326TE100R2	\$1737.00	Load Lugs Only



Molded Case Circuit Breakers Record Plus® FC 100

Section 3

3-Pole Record Plus® FC 100 Breakers IC @ 600 Vac

Rated Current (A)	25kA Product No.	List Price GO-135H	35kA Product No.	List Price GO-135H	65kA Product No.	List Price GO-135H	100kA Product No.	List Price GO-135H	150kA Product No.	List Price GO-135H	Connection
15	FCS36TE015R1	\$747.00									Line and Load Lugs Installed
	FCS36TE015R2	\$738.00	FCV36TE015R2	\$778.00	FCN36TE015R2	\$859.00	FCH36TE015R2	\$1295.00	FCL36TE015R2	\$1751.00	Load Lugs Only
20	FCS36TE020R1	\$747.00									Line and Load Lugs Installed
	FCS36TE020R2	\$738.00	FCV36TE020R2	\$778.00	FCN36TE020R2	\$859.00	FCH36TE020R2	\$1295.00	FCL36TE020R2	\$1751.00	Load Lugs Only
25	FCS36TE025R	\$729.00	FCV36TE025R	\$769.00	FCN36TE025R	\$850.00	FCH36TE025R	\$1286.00	FCL36TE025R	\$1742.00	No Lugs
	FCS36TE025R1	\$747.00	FCV36TE025R1	\$787.00	FCN36TE025R1	\$868.00	FCH36TE025R1	\$1304.00	FCL36TE025R1	\$1760.00	Line and Load Lugs Installed
30	FCS36TE025R2	\$738.00	FCV36TE025R2	\$778.00	FCN36TE025R2	\$859.00	FCH36TE025R2	\$1295.00	FCL36TE025R2	\$1751.00	Load Lugs Only
	FCS36TE030R	\$729.00	FCV36TE030R	\$769.00	FCN36TE030R	\$850.00	FCH36TE030R	\$1286.00	FCL36TE030R	\$1742.00	No Lugs
35	FCS36TE030R1	\$747.00	FCV36TE030R1	\$787.00	FCN36TE030R1	\$868.00	FCH36TE030R1	\$1304.00	FCL36TE030R1	\$1760.00	Line and Load Lugs Installed
	FCS36TE030R2	\$738.00	FCV36TE030R2	\$778.00	FCN36TE030R2	\$859.00	FCH36TE030R2	\$1295.00	FCL36TE030R2	\$1751.00	Load Lugs Only
40	FCS36TE035R	\$729.00	FCV36TE035R	\$769.00	FCN36TE035R	\$850.00	FCH36TE035R	\$1286.00	FCL36TE035R	\$1742.00	No Lugs
	FCS36TE035R1	\$747.00	FCV36TE035R1	\$787.00	FCN36TE035R1	\$868.00	FCH36TE035R1	\$1304.00	FCL36TE035R1	\$1760.00	Line and Load Lugs Installed
45	FCS36TE035R2	\$738.00	FCV36TE035R2	\$778.00	FCN36TE035R2	\$859.00	FCH36TE035R2	\$1295.00	FCL36TE035R2	\$1751.00	Load Lugs Only
	FCS36TE040R	\$729.00	FCV36TE040R	\$769.00	FCN36TE040R	\$850.00	FCH36TE040R	\$1286.00	FCL36TE040R	\$1742.00	No Lugs
50	FCS36TE040R1	\$747.00	FCV36TE040R1	\$787.00	FCN36TE040R1	\$868.00	FCH36TE040R1	\$1304.00	FCL36TE040R1	\$1760.00	Line and Load Lugs Installed
	FCS36TE040R2	\$738.00	FCV36TE040R2	\$778.00	FCN36TE040R2	\$859.00	FCH36TE040R2	\$1295.00	FCL36TE040R2	\$1751.00	Load Lugs Only
55	FCS36TE045R	\$729.00	FCV36TE045R	\$769.00	FCN36TE045R	\$850.00	FCH36TE045R	\$1286.00	FCL36TE045R	\$1742.00	No Lugs
	FCS36TE045R1	\$747.00	FCV36TE045R1	\$787.00	FCN36TE045R1	\$868.00	FCH36TE045R1	\$1304.00	FCL36TE045R1	\$1760.00	Line and Load Lugs Installed
60	FCS36TE045R2	\$738.00	FCV36TE045R2	\$778.00	FCN36TE045R2	\$859.00	FCH36TE045R2	\$1295.00	FCL36TE045R2	\$1751.00	Load Lugs Only
	FCS36TE050R	\$729.00	FCV36TE050R	\$769.00	FCN36TE050R	\$850.00	FCH36TE050R	\$1286.00	FCL36TE050R	\$1742.00	No Lugs
65	FCS36TE050R1	\$747.00	FCV36TE050R1	\$787.00	FCN36TE050R1	\$868.00	FCH36TE050R1	\$1304.00	FCL36TE050R1	\$1760.00	Line and Load Lugs Installed
	FCS36TE050R2	\$738.00	FCV36TE050R2	\$778.00	FCN36TE050R2	\$859.00	FCH36TE050R2	\$1295.00	FCL36TE050R2	\$1751.00	Load Lugs Only
70	FCS36TE060R	\$729.00	FCV36TE060R	\$769.00	FCN36TE060R	\$850.00	FCH36TE060R	\$1286.00	FCL36TE060R	\$1742.00	No Lugs
	FCS36TE060R1	\$747.00	FCV36TE060R1	\$787.00	FCN36TE060R1	\$868.00	FCH36TE060R1	\$1304.00	FCL36TE060R1	\$1760.00	Line and Load Lugs Installed
75	FCS36TE060R2	\$738.00	FCV36TE060R2	\$778.00	FCN36TE060R2	\$859.00	FCH36TE060R2	\$1295.00	FCL36TE060R2	\$1751.00	Load Lugs Only
	FCS36TE070R	\$831.00	FCV36TE070R	\$884.00	FCN36TE070R	\$992.00	FCH36TE070R	\$1579.00	FCL36TE070R	\$2129.00	No Lugs
80	FCS36TE070R1	\$849.00	FCV36TE070R1	\$902.00	FCN36TE070R1	\$1010.00	FCH36TE070R1	\$1597.00	FCL36TE070R1	\$2147.00	Line and Load Lugs Installed
	FCS36TE070R2	\$840.00	FCV36TE070R2	\$893.00	FCN36TE070R2	\$1001.00	FCH36TE070R2	\$1588.00	FCL36TE070R2	\$2138.00	Load Lugs Only
85	FCS36TE080R	\$831.00	FCV36TE080R	\$884.00	FCN36TE080R	\$992.00	FCH36TE080R	\$1579.00	FCL36TE080R	\$2129.00	No Lugs
	FCS36TE080R1	\$849.00	FCV36TE080R1	\$902.00	FCN36TE080R1	\$1010.00	FCH36TE080R1	\$1597.00	FCL36TE080R1	\$2147.00	Line and Load Lugs Installed
90	FCS36TE080R2	\$840.00	FCV36TE080R2	\$893.00	FCN36TE080R2	\$1001.00	FCH36TE080R2	\$1588.00	FCL36TE080R2	\$2138.00	Load Lugs Only
	FCS36TE090R	\$831.00	FCV36TE090R	\$884.00	FCN36TE090R	\$992.00	FCH36TE090R	\$1579.00	FCL36TE090R	\$2129.00	No Lugs
95	FCS36TE090R1	\$849.00	FCV36TE090R1	\$902.00	FCN36TE090R1	\$1010.00	FCH36TE090R1	\$1597.00	FCL36TE090R1	\$2147.00	Line and Load Lugs Installed
	FCS36TE090R2	\$840.00	FCV36TE090R2	\$893.00	FCN36TE090R2	\$1001.00	FCH36TE090R2	\$1588.00	FCL36TE090R2	\$2138.00	Load Lugs Only
100	FCS36TE100R	\$831.00	FCV36TE100R	\$884.00	FCN36TE100R	\$992.00	FCH36TE100R	\$1579.00	FCL36TE100R	\$2129.00	No Lugs
	FCS36TE100R1	\$849.00	FCV36TE100R1	\$902.00	FCN36TE100R1	\$1010.00	FCH36TE100R1	\$1597.00	FCL36TE100R1	\$2147.00	Line and Load Lugs Installed
	FCS36TE100R2	\$840.00	FCV36TE100R2	\$893.00	FCN36TE100R2	\$1001.00	FCH36TE100R2	\$1588.00	FCL36TE100R2	\$2138.00	Load Lugs Only



Publications and Reference: See Section 22 for a complete list of additional product-related publications

Molded Case Circuit Breakers

Section 3

Record Plus® FC 100

Internal Accessories (supplied with leads attached)

Contacts – Auxiliary and Bell Alarm (Rated 5A @240VAC, 0.5A @125VDC)

Accessory	Normally Open		Normally Closed	
	Product No.	List Price GO-135H	Product No.	List Price GO-135H
Aux. Switch Right Mounted	FAS10RW	\$149.00	FAS01RW	\$149.00
Aux. Switch Left Mounted	FAS10LW	\$149.00	FAS01LW	\$149.00
Bell Alarm Mechanism	FABAM10W	\$154.00	FABAM01W	\$154.00

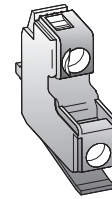

Auxiliary Switch/Bell Alarm Mechanism

Releases – Shunt Trip and Undervoltage

Voltage	Shunt Trip			Undervoltage Release		
	Rating (Inrush Power Consumption)	Product No.	List Price GO-135H	Rating (Inrush Power Consumption)	Product No.	List Price GO-135H
12 VDC	200 mA / 2.4W	FASHTBW	\$363.00	—	—	—
24 VAC/DC	100 mA / 3.6W	FASHTDW	\$363.00	50 mA / 1.2W	FAUVRDW	\$363.00
48 VAC/DC	60 mA / 2.88W	FASHTFW	\$363.00	20 mA / 0.96W	FAUVRFW	\$363.00
120 VAC	40 mA / 4.8W	FASHTKW	\$363.00	—	—	—
110/130 VAC/DC	40 mA / 4.8W	FASHTJW	\$363.00	15 mA / 1.8W	FAUVRJW	\$363.00
220/240 VAC, 250 VDC	20 mA / 4.6W	FASHTNW	\$363.00	15 mA / 3.45W	FAUVRNW	\$363.00
277 VAC	11 mA / 3.0W	FASHT7W	\$363.00	15 mA / 4.0W	FAUVR7W	\$363.00
400/480 VAC	20 mA / 8.4W	FASHTUW	\$363.00	15 mA / 6.3W	FAUVRUW	\$363.00

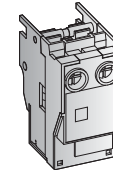

Shunt Trip/Undervoltage Release

Mounting Locations and Limitations

Accessory	Mounting Pocket Location	Accessory Installation	
		2 Pole	3 Pole
Shunt Trip or Undervoltage Release	□	1	1
Aux. Switch - Left Mount	⊖	1	1
Aux. Switch - Right Mount	⊕	1	1
Bell Alarm	Ⓜ	1	1
Maximum Number of Internal Accessories That Can Be Installed		4	4

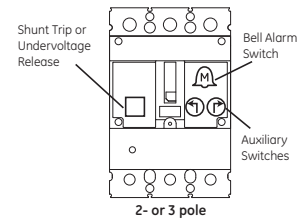

Mounting Locations

External Accessories

Electrical Operator Motor Drives, Front Mounted

Voltage	Product No.	List Price GO-135H
120 VAC/125 VDC	FCMF3	\$710.00
220/240 VAC, 50/60 Hz	FCMF6	\$710.00
48 VDC	FCMEFF	\$710.00

Padlocking Devices

Description	Product No.	List Price GO-135H
Padlock Fixed Toggle	FC1PF	\$8.70
Padlock EUSERC Toggle	FC1PE	\$32.00



Motor Drive

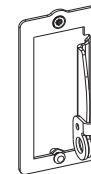

Padlock

Plug-In Types

Type	Description	Product No.	List Price GO-135H
Base Only	3 Pole - LSL - Horizontal Strap	FCDDF1	\$250.00
	3 Pole - SLS - Horizontal Strap	FCDDF2	\$250.00
	3 Pole - LSL - Vertical Strap	FCDDF3	\$75.00
Secondary Disconnect	3 Pole - SLS - Vertical Strap	FCDDF4	\$40.00
	Secondary Disconnect Kit	FCDSD	\$75.00
	Secondary Disconnect - Base Part	FCSDSP	\$40.00
	Secondary Disconnect - Breaker Part	FCSDSB	\$40.00
Mounting Plate	Mounting Plate	FCDMP	\$40.00

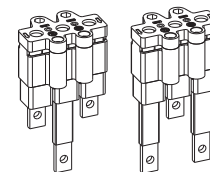

Plug-In Bases

Hardware Kits

Description	Product No.	List Price GO-135H
Mounting screws for mounting plates with tapped holes, quantity 4 (#8-32 x 2 7/8" screws with lockwashers)	FCMSK3	\$6.10
Mounting screws for mounting plates with clearance holes, quantity 4 (#8-32 x 3" screws with nuts lockwashers)	FCMSK4	\$6.10
Nut plates (quantity 3)	FCNP3	\$2.10
Nut plates (quantity 36)	FCNPB	\$25.20

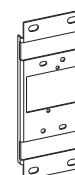

Plug-In Plate



Molded Case Circuit Breakers

Record Plus® FC 100

External Accessories

Section 3

Lugs and Lug Kits

Amp Range	Wire Range	Strip Length	Single Lug Product No.	List Price GO-135H	Lug Kit Product No. (Set of 3)	List Price GO-135H
15-20A	14-10 Cu/Al	.040-.045"	FCAL12	\$3.25	FCALK12	\$9.00
25-60A	10-4 Cu/Al	.040-.045"	FCAL13	\$3.25	FCALK13	\$9.00
70-100A	4-1/0 Cu/Al	.040-.045"	FCAL14	\$3.25	FCALK14	\$9.00

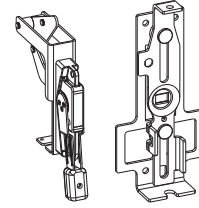

Lug Tightening Torque

Wire Size	Torque
#10 AWG	35 in-lb
#8 AWG	40 in-lb
#6-#4 AWG	45 in-lb
#3 AWG - 1/0	50 in-lb

Handles and Handle Accessories

Type	Description	Product No.	List Price	
STDA Flange	Breaker Mechanism	Breaker Mechanism	FCNBM \$96.00 ¹	
Handle	Flange Mounted Handle	6 inches for NEMA 1, 3R, 12,13	FCNHM1 \$188.00 ¹	
Operators	Mechanism for Cable Operator	10 inches for NEMA 1, 3R, 12,13	FCNHM2 \$280.00 ¹	
		6 inches for NEMA 4/4X	FCNHM3 \$258.00 ¹	
		10 inches for NEMA 4/4X	FCNHM4 \$373.00 ¹	
		Operating Cable	3 feet	SC3L \$91.00 ²
		4 feet	SC4L \$108.00 ²	
		5 feet	SC5L \$119.00 ²	
		6 feet	SC6L \$134.00 ²	
		7 feet	SC7L \$148.00 ²	
		8 feet	SC8L \$163.00 ²	
		9 feet	SC9L \$196.00 ²	
		10 feet	SC10L \$243.00 ²	
STDA Flange	Flange Handle for Variable	Same as Spectra®: 6-inch for NEMA 12/13	STDA1 \$83.00 ²	
Handles &	Depth Operating Mechanism	Same as Spectra®: 10-inch for NEMA 12/13	STDA2 \$95.00 ²	
Hardware Kits		Same as Spectra®: 6-inch for NEMA 4/4X	STDA1X \$148.00 ²	
		Same as Spectra®: 10-inch for NEMA 4/4X	STDA2X \$165.00 ²	
	Flange Operating Mechanism	Operating Mechanism Only	FCNFM \$67.00 ²	
	Flange Stiffener Kit	Use with FCNFM	TDSR \$30.00 ²	
	Extender Kit	Use with FCNFM	TDSR \$30.00 ²	
	Extended Drive Stud	Use with FCNFM	TDS1 \$30.00 ²	
	Door Hardware Kit NEMA12/13	Door Hinged on Left, NEMA 12/13, 2-point Kit	TDV1 \$134.00 ²	
	Door Hardware Kit NEMA 4/4X	Door Hinged on Left, NEMA 4/4X, 2-point Kit	TDV1X \$174.00 ²	
	Third Point Latch Kit	For Use With TDV1/TDV1X Above	TDV3 \$30.00 ²	
	Door Hardware Kit NEMA12/13	Door Hinged on Right, NEMA 12/13 2-point Kit	TDV1L \$134.00 ²	
	Door Hardware Kit NEMA 4/4X	Door Hinged on Right, NEMA 4/4X, 2-point Kit	TDV1LX \$174.00 ²	
	Third Point Latch Kit	For Use with TDV1L, TDC1LX Above	TDV3L \$30.00 ²	
Auxiliary	DPDT for STDA Handle on Right		TDAS1L2 \$134.00 ²	
Contact Kits	DPDT for STDA Handle on Left		TDAS1R2 \$144.00 ²	
TDR Style	Vertical Mount		FCNRC \$66.00 ¹	
Rotary Handles	Horizontal Mount		FCNRD \$66.00 ¹	
	Door Ring Gasket	Door Ring-Interlock	FCFRDRCK \$11.00 ¹	
	Door Gasket Kit		SEFRGSK \$4.00 ³	
TDM Style	Direct Mount	Complete Kit for NEMA 1, 3R, 12	FCNRM \$79.00 ¹	
Rotary Handles	Direct Through Door	Complete Kit for NEMA 1, 3R, 12	FCNRT \$79.00 ¹	
		Operating Mechanism Only	For NEMA 1, 3R, 12, 4 and 3/16	FCNRM1 \$52.00 ¹
			For NEMA 4/4X, 4 and 3/16	FCNRM2 \$52.00 ¹
			For NEMA 1, 3R, 12, 6 and 1/8 - 15	FCNRM3 \$52.00 ¹
		For NEMA 4/4X, 6 and 1/8 - 15	FCNRM4 \$52.00 ¹	
	Handle Only	For NEMA 1, 3R, 12	FNRH \$27.00 ¹	
	For NEMA 4/4X	THCH45 \$303.00 ³		

¹GO-144H

²GO-144A

³GO-144

Dimensions in. (mm)

FC 100 Dimensions

Frame	A	B	C	D	E	F	G	H
FC	3.7 (29.1)	3.2 (81.3)	.96 (24.4)	3.0 (76.2)	1.0 (25.4)	6.4 (162.6)	5.0 (127.0)	1.0 (25.4)

STDA Flange Handle Operators

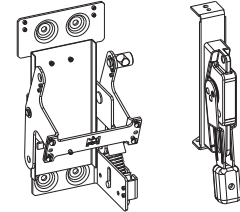

STDA Flange Handles and Hardware Kits

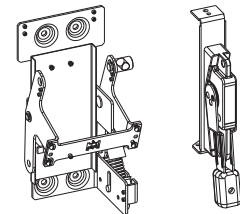

TDR Style Rotary Handle

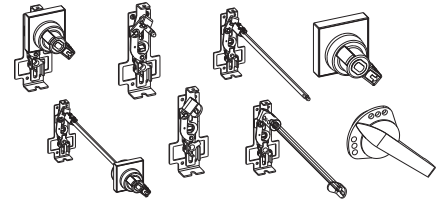

TDM Style Rotary Handles

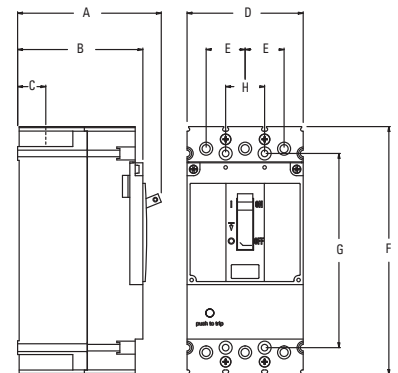

FC 100 Amp Dimensions



Publications and Reference: See Section 22 for a complete list of additional product-related publications

Molded Case Circuit Breakers Record Plus® FG 600

Section 3



- 1 Breaker Frame Rating
- 2 Product Description
- 3 Standards & Markings
- 4 Interrupting Ratings
- 5 Lug Data & Torque Info
- 6 Product Number
- 7 Push to Trip

Main Standards

- UL 489
- IEC 947 and associated EN Sections

Other Global Standards

BS, CE, CEI, JIS, UNE, VDE

FG Breaker Markings

cULus	UL File E-11592
HACR	250 to 600A
Cu/Al 60/75°C	250 to 600A
Current Limiting	250 to 600A

Not suitable for reverse feed.

Reference Publications

Available for download from www.geelectrical.com/publibrary

FG Breaker	Installation Instructions	DEH-41177
FG Breaker Accessories	Bell Alarm & Aux. Switch	DEH-40324
	Shunt Trip & UVR	DEH-40259
	Padlock Device	DEH-41031
	Lug Kits	DEH-40404
	Auxiliary Contacts	DEH-40261
Panelboards	Spectra® Power Panel - Plug-in Kits - Single	DEH-40420
	Spectra® Power Panel - Plug-in Kits - Double	DEH-40419
	Spectra® Power Panel - Bolt-on Kits - Single	DEH-40426
	Spectra® Power Panel - Bolt-on Kits - Double	DEH-41047
		DET-008

External
Accessories
3-87

See Table 3-87 for Rating Plug Trip Curves)

	DES-040
	DES-041
	10085108SHI

Interrupting Ratings

Type	Ampere Rating	Max Voltage	No. Poles	UL Listed Interrupting Ratings - rms Symmetrical Amperes (in Thousands) AC Voltage			EN 60947-2 Interrupting Ratings - rms Symmetrical Amperes (in Thousands)		
				240	480	600	240	400-415	690
FGN	250-600A	600VAC	2	150	65	25	-	-	-
			3	150	65	25	85	50	10
FGH	250-600A	600VAC	2	200	100	35	-	-	-
			3	200	100	35	100	80	22
FGL	250-600A	600VAC	2	200	150	42	-	-	-
			3	200	150	42	200	150	40
FGP	250-600A	600VAC	2	200	200	65	-	-	-
			3	200	200	65	-	-	-

Product Number Structure

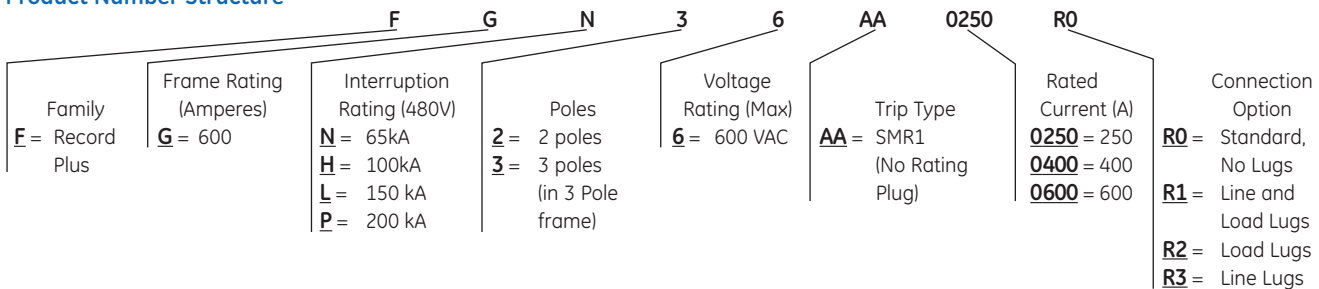

Molded Case Circuit Breakers Record Plus® FG 600

Section 3

2-Pole Record Plus® FG Breakers IC @ 480 Vac

Rated Current (A)	65kA Product No.	List Price GO-135H	100kA Product No.	List Price GO-135H	150kA Product No.	List Price GO-135H	200kA Product No.	List Price GO-135H	Connection
250	FGN26AA0250R0	\$4460.00	FGH26AA0250R0	\$4924.00	FGL26AA0250R0	\$5424.32	FGP26AA0250R0	\$6424.32	No Lugs
	FGN26AA0250R1	\$4516.00	FGH26AA0250R1	\$4980.00	FGL26AA0250R1	\$5480.32	FGP26AA0250R1	\$6480.32	Line and Load Lugs
	FGN26AA0250R2	\$4488.00	FGH26AA0250R2	\$4952.00	FGL26AA0250R2	\$5452.32	FGP26AA0250R2	\$6452.32	Load Lugs
	FGN26AA0250R3	\$4488.00	FGH26AA0250R3	\$4952.00	FGL26AA0250R3	\$5452.32	FGP26AA0250R3	\$6452.32	Line Lugs
400	FGN26AA0400R0	\$3973.00	FGH26AA0400R0	\$4236.00	FGL26AA0400R0	\$4736.00	FGP26AA0400R0	\$5736.00	No Lugs
	FGN26AA0400R1	\$4029.00	FGH26AA0400R1	\$4292.00	FGL26AA0400R1	\$4792.00	FGP26AA0400R1	\$5792.00	Line and Load Lugs
	FGN26AA0400R2	\$4001.00	FGH26AA0400R2	\$4264.00	FGL26AA0400R2	\$4764.00	FGP26AA0400R2	\$5764.00	Load Lugs
	FGN26AA0400R3	\$4001.00	FGH26AA0400R3	\$4264.00	FGL26AA0400R3	\$4764.00	FGP26AA0400R3	\$5764.00	Line Lugs
600	FGN26AA0600R0	\$3973.00	FGH26AA0600R0	\$6867.00	FGL26AA0600R0	\$7367.00	FGP26AA0600R0	\$8367.00	No Lugs
	FGN26AA0600R1	\$4029.00	FGH26AA0600R1	\$6923.00	FGL26AA0600R1	\$7423.00	FGP26AA0600R1	\$8423.00	Line and Load Lugs
	FGN26AA0600R2	\$4001.00	FGH26AA0600R2	\$6895.00	FGL26AA0600R2	\$7395.00	FGP26AA0600R2	\$8395.00	Load Lugs
	FGN26AA0600R3	\$4001.00	FGH26AA0600R3	\$6895.00	FGL26AA0600R3	\$7395.00	FGP26AA0600R3	\$8395.00	Line Lugs

3-Pole Record Plus® FG Breakers IC @ 480 Vac

Rated Current (A)	65kA Product No.	List Price GO-135H	100kA Product No.	List Price GO-135H	150kA Product No.	List Price GO-135H	200kA Product No.	List Price GO-135H	Connection
250	FGN36AA0250R0	\$3744.00	FGH36AA0250R0	\$6008.00	FGL36AA0250R0	\$6508.00	FGP36AA0250R0	\$7508.00	No Lugs
	FGN36AA0250R1	\$3828.00	FGH36AA0250R1	\$6092.00	FGL36AA0250R1	\$6592.00	FGP36AA0250R1	\$7592.00	Line and Load Lugs
	FGN36AA0250R2	\$3786.00	FGH36AA0250R2	\$6050.00	FGL36AA0250R2	\$6550.00	FGP36AA0250R2	\$7550.00	Load Lugs
	FGN36AA0250R3	\$3786.00	FGH36AA0250R3	\$6050.00	FGL36AA0250R3	\$6550.00	FGP36AA0250R3	\$7550.00	Line Lugs
400	FGN36AA0400R0	\$5040.00	FGH36AA0400R0	\$9433.00	FGL36AA0400R0	\$9933.00	FGP36AA0400R0	\$10933.00	No Lugs
	FGN36AA0400R1	\$5124.00	FGH36AA0400R1	\$9517.00	FGL36AA0400R1	\$10017.00	FGP36AA0400R1	\$11017.00	Line and Load Lugs
	FGN36AA0400R2	\$5082.00	FGH36AA0400R2	\$9475.00	FGL36AA0400R2	\$9975.00	FGP36AA0400R2	\$10975.00	Load Lugs
	FGN36AA0400R3	\$5082.00	FGH36AA0400R3	\$9475.00	FGL36AA0400R3	\$9975.00	FGP36AA0400R3	\$10975.00	Line Lugs
600	FGN36AA0600R0	\$5040.00	FGH36AA0600R0	\$14000.00	FGL36AA0600R0	\$14500.00	FGP36AA0600R0	\$15500.00	No Lugs
	FGN36AA0600R1	\$5124.00	FGH36AA0600R1	\$14084.00	FGL36AA0600R1	\$14584.00	FGP36AA0600R1	\$15584.00	Line and Load Lugs
	FGN36AA0600R2	\$5082.00	FGH36AA0600R2	\$14042.00	FGL36AA0600R2	\$14542.00	FGP36AA0600R2	\$15542.00	Load Lugs
	FGN36AA0600R3	\$5082.00	FGH36AA0600R3	\$14042.00	FGL36AA0600R3	\$14542.00	FGP36AA0600R3	\$15542.00	Line Lugs



Publications and Reference: See Section 22 for a complete list of additional product-related publications

Molded Case Circuit Breakers

Record Plus® FG 600

Internal Accessories

Section 3

FG Rating Plugs

CT Rating	Rated Current	Trip Curve	Product No.	List Price GO-135H
250A	125A	DES-042	FGRP3K0125	\$106.00
	150A	DES-043	FGRP3K0150	\$106.00
	175A	DES-044	FGRP3K0175	\$106.00
	200A	DES-045	FGRP3K0200	\$106.00
	225A	DES-046	FGRP3K0225	\$106.00
400A	250A	DES-047	FGRP3K0250	\$106.00
	175A	DES-048	FGRP3L0175	\$106.00
	200A	DES-049	FGRP3L0200	\$106.00
	225A	DES-050	FGRP3L0225	\$106.00
	250A	DES-051	FGRP3L0250	\$106.00
	300A	DES-052	FGRP3L0300	\$106.00
	350A	DES-053	FGRP3L0350	\$106.00
600A	400A	DES-054	FGRP3L0400	\$106.00
	300A	DES-055	FGRP3M0300	\$106.00
	350A	DES-056	FGRP3M0350	\$106.00
	400A	DES-057	FGRP3M0400	\$106.00
	450A	DES-058	FGRP3M0450	\$106.00
	500A	DES-059	FGRP3M0500	\$106.00
	600A	DES-060	FGRP3M0600	\$106.00

Releases – Shunt Trip and Undervoltage

Voltage	Shunt Trip		Undervoltage Release	
	Product No.	List Price GO-135H	Product No.	List Price GO-135H
12 VDC	FASHTBW	\$363.00	—	—
24 VAC/DC	FASHTDW	\$363.00	FAUVRDW	\$363.00
48 VAC/DC	FASHTFW	\$363.00	FAUVRFW	\$363.00
110-130 VAC/110-125 VDC	FASHTJW	\$363.00	FAUVRJW	\$363.00
120 VAC	FASHTKW	\$363.00	—	—
220/240 VAC, 250 VDC	FASHTNW	\$363.00	FAUVRNW	\$363.00
277 VAC	FASHT7W	\$363.00	FAUVR7W	\$363.00
400/480 VAC	FASHTUW	\$363.00	FAUVRUW	\$363.00

UL Listed for field installation. Accessories are prewired from the factory with 36 inch long leads (#18 AWG). Shunt trip wire leads are black and UVR wire leads are blue.

Bell Alarm

Contact Configuration	Contacts	Contact Rating	Wire leads	Mechanisms		Trip Units	
				Product No.	List Price GO-135H	Product No.	List Price GO-135H
1 NO (Form A)	Standard	5A @ 277 VAC, 0.3A @ 125 VDC	#16 AWG	FABAM10W	\$154.00	FABAT10W	\$154.00
1 NC (Form B)	Standard	5A @ 277 VAC, 0.3A @ 125 VDC	#16 AWG	FABAM01W	\$154.00	FABAT01W	\$154.00

UL Listed for field installation. Accessories are prewired from the factory with 36 inch long leads. Reference instruction sheet DEH-40324 for wire lead colors.

Auxiliary Switches

Contact Configuration	Contacts	Contact Rating	Wire leads	Left Mount		Right Mount	
				Product No.	List Price GO-135H	Product No.	List Price GO-135H
1 NO (Form A)	Standard	5A @ 277 VAC, 0.3A @ 125 VDC	#16 AWG	FAS10LW	\$149.00	FAS10RW	\$149.00
1 NC (Form B)	Standard	5A @ 277 VAC, 0.3A @ 125 VDC	#16 AWG	FAS01LW	\$149.00	FAS01RW	\$149.00

UL Listed for field installation. Accessories are prewired from the factory with 36 inch long leads. Reference instruction sheet DEH-40324 for wire lead colors.

Mounting Locations and Limitations

Accessory	Mounting Pocket Location	Maximum Quantity
Shunt Trip or Undervoltage Release	□	1
Aux. Switch - Left Mount	Ⓛ	3
Aux. Switch - Right Mount	Ⓡ	2
Bell Alarm Mechanism	Ⓜ	1
Bell Alarm Trip Unit	Ⓣ	1

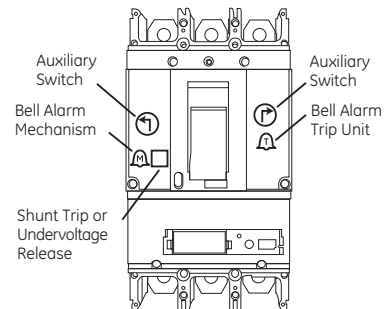

Mounting Locations



Molded Case Circuit Breakers

Record Plus® FG 600

External Accessories

Padlocking Device

Description	Product No.	List Price GO-135H
Padlocking EUSERC Toggle	FG1PE	\$8.70

Lug Kits

Pole/Lugs	Location	Wire Type	Torque		Strip Length		Product No.	List Price GO-135H
			Wire-Lug	Lug-Strap	Top	Bottom		
2	Top	#8-400kcmil Cu, #6-500kcmil Al	#8-#4 AWG Cu/Al	200 lb-in (23 N-m)	7/8"	1 5/8"	FCALK218H	\$28.00
	Bottom	#2/0-600kcmil Cu/Al	#3 AWG-600kcmil Cu/Al	200 lb-in (23 N-m)				
3	Top	#8-400kcmil Cu, #6-500kcmil Al	#8-#4 AWG Cu/Al	200 lb-in (23 N-m)	7/8"	1 5/8"	FCALK318H	\$42.00
	Bottom	#2/0-600kcmil Cu/Al	#3 AWG-600kcmil Cu/Al	200 lb-in (23 N-m)				

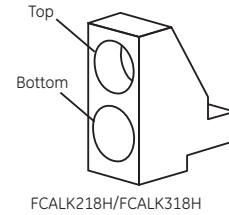

Other Accessories

	Product No.	List Price GO-135H
Rating Plug Removal Tool	FAR	\$12.00
Breaker External Test Kit	FAT	\$35.00
Lug Cover Kit	FG1BCK	\$25.00
Replacement Trip Unit Shield	FG1TUSHLD	\$15.00
Replacement Handle Extension	FGHDLEXT	\$35.00
Hardware Kit (Tapped Holes)	FGMSK1	\$6.00
Hardware Kit (Through Holes)	FGMSK2	\$6.00

Dimensions in. (mm)

FG 600 Dimensions

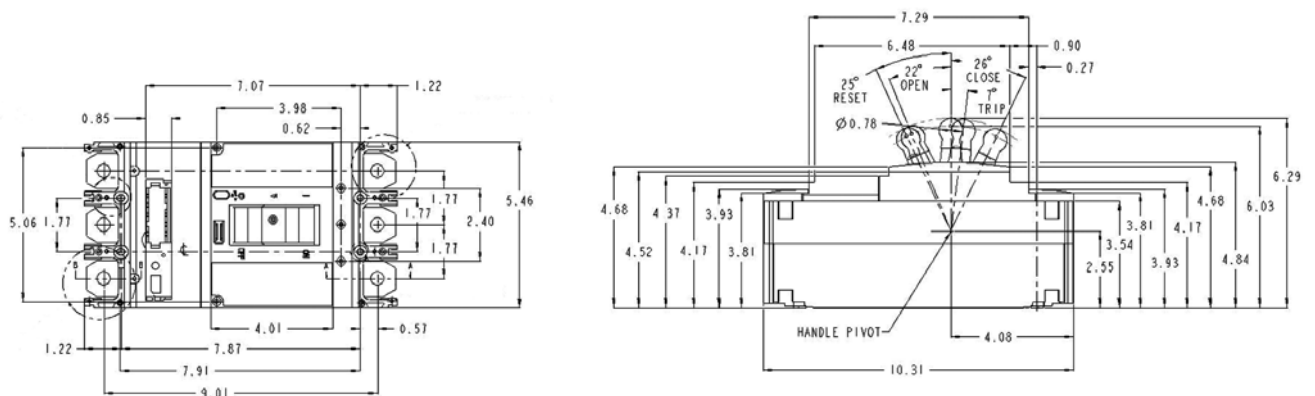

Publications and Reference: See Section 22 for a complete list of additional product-related publications

Molded Case Circuit Breakers

External Accessories

Cable Operators

Section 3

Spectra® Flex Cable Operators

- UL Listed—File E-57253
- Reduced installation costs:
 - Simpler, faster installation
 - No special alignment required
- Optimized panel layout:
 - Breaker mounting position is independent of flange-mounted handle location
- Covers a full spectrum of enclosure types and sizes:
 - Flange-mounted handle for NEMA Types 1, 3R, 12 and 13 enclosures
 - Flange-mounted handle for NEMA 4/4X enclosures—optional
 - Broad range of enclosure sizes and breaker mounting configurations
 - 8 different operating cable lengths available from 3 to 10 feet
 - For circuit breaker types E150, SE150, SF250, SG600 and SK1200
 - Force and motion transmitted independently of breaker mounting plane or position relative to handle location
 - Common breaker mounted operator for SE150 and SF250 frames

Spectra® Flex cable operating mechanisms are suitable for application with GE circuit breakers mounted in a wide variety of flanged enclosure types and sizes.

Flange-mounted handle mechanisms are available for NEMA Types 1, 12 or 13 enclosures in either 6 inch (Model SCH1) or 10 inch (Model SCH2) handle lengths. Corresponding mechanisms, SCH1X and SCH2X, are available for NEMA Type 4/4X enclosures. Handle mechanisms are suitable for either left or right flange operation.

The handle mechanism is combined with one of eight operating cables, with lengths from 3 to 10 feet, to cover a broad range of possible breaker mounting locations in the enclosure. The cable links the handle mechanism to the breaker-mounted operating mechanism and transmits the mechanical force and motion of the handle mechanism to the breaker mounted mechanism. The force and motion is transmitted independently of the breaker mounting plane or location relative to the location of the handle mechanism, provided only that the bending radius of the cable is not less than 3 inches. No mounting reinforcement of the breaker or enclosure flange is required.

The breaker-operating mechanism mounts directly to the face of the breaker and does not involve any mounting interface with the enclosure. A standard breaker mounting screw kit for tapped holes is furnished with each mechanism to mount the breaker in the enclosure.

See page 3-93 for ordering and pricing information.



Molded Case Circuit Breakers

External Accessories

Cable Operators

How to Order

Use the circuit breaker mounting zone dimension table to determine the correct cable length for the application and ensure that the 3-inch minimum bending radius is not violated. Select the breaker mounted mechanism, operating cable and handle mechanism below. Order as separate components.

Publication References

Breaker types E150, SE150, SF250, SG600	GEH-6290
Breaker type SK1200	GEH-6291

See Section 22 for publication ordering information.

Maximum Dimensions in Inches

To determine the maximum mounting dimensions for 60-through 120-inch-long operating cables, add the respective additional lengths to the 48-inch cable maximum dimensions. (Example: Add 12 inches to E, F and G dimensions for 60-inch cable length.) When cable is installed, the minimum cable bend radius should not be less than 3 inches. The minimum cable bending requirement must be met to ensure a safe operating environment.

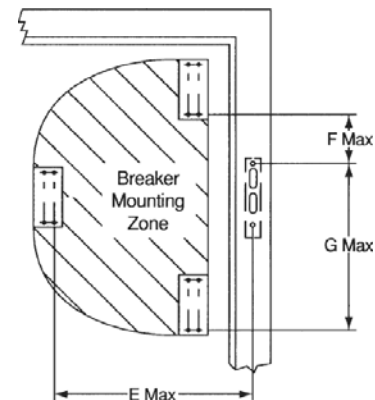

Circuit Breaker Mounting Zone Dimensions

Maximum Mounting Dimensions (in.)

Box Depth	36" Cable			48" Cable		
	E ¹	F	G	E ¹	F	G
8"	13.5	4.0	15.0	25.5	16.0	27.0
10"	13.0	5.0	14.8	25.0	17.0	26.8
12"	12.8	6.0	14.5	24.8	17.0	26.5
16"	10.5	4.5	14.2	22.5	16.5	26.2
18"	8.5	3.5	12.6	20.5	15.5	24.6
20"	-	0.5	10.0	22.0	15.0	24.0
24"	-	-	-	19.5	14.0	22.0

¹Maximum E Dimension only if F = 4.5"

Operating Cables

Cable Length	Circuit Breaker Type			
	E150, SE150, SF250, SG600		SK1200	
	Product Number	List Price GO-144A	Product Number	List Price GO-144A
3'	SC3L	\$91.00	SC3H	\$119.00
4'	SC4L	\$108.00	SC4H	\$141.00
5'	SC5L	\$119.00	SC5H	\$163.00
6'	SC6L	\$134.00	SC6H	\$185.00
7'	SC7L	\$148.00	SC7H	\$207.00
8'	SC8L	\$163.00	SC8H	\$229.00
9'	SC9L	\$196.00	SC9H	\$251.00
10'	SC10L	\$211.00	SC10H	\$273.00

Breaker and Handle Mechanisms

Circuit Breaker Type	Breaker Mounted Mechanism		Flange-Mounted Handle Mechanism							
			NEMA Enclosure Type 1, 3R, 12, 13				NEMA Enclosure Type 4, 4X			
			6"		10"		6"		10"	
Product Number	List Price GO-144A	Product Number	List Price GO-144A	Product Number	List Price GO-144A	Product Number	List Price GO-144A	Product Number	List Price GO-144A	
E150	SCOM1A	\$96.00								
SE150	SCOM1EF	\$133.00								
SF250	SCOM1EF	\$133.00	SCH1	\$188.00	SCH2	\$322.00	SCH1X	\$258.00	SCH2X	\$373.00
SG600	SCOM1G	\$148.00								
SK1200	SCOM1K	\$149.00	-	-	SCH2K	\$322.00	-	-	SCH2KX	\$373.00



Publications and Reference: See Section 22 for a complete list of additional product-related publications

Molded Case Circuit Breakers

External Accessories

Flange-Mounted Operators

Section 3

Type STDA Flange Handles and Variable Depth Operating Mechanisms

- Designed to meet automotive duty specifications
- NEMA 12/13 and 4/4X UL Component Recognized components, File E-572531 CSA LR 10263
- For right or left hand flange mounting – field convertible
- Mounting dimensions to fit standard flange enclosures 8 inches – 24 inches deep
- Detailed installation instructions
- Superior strength

Flange Handle Construction

- Rugged die cast housing with provisions for locking in OFF position with up to three 3/16-inch to 5/16-inch padlocks
- O-ring seals for dirt-tight/oil-tight duty
- Gusseted, 3/32-inch thick double-sided steel handle with large, red-black self-extinguishing grade plastic grip.

Flange Handle Selection

Product Number STDA1 (6 inch) and STDA2 (10 inch) flange series handles are interchangeable. While the SE150 through SG600 operating mechanisms can be easily operated with the 6-inch STDA1 handle, the 10-inch STDA2 may be used to obtain lower operating force and/or to provide a proportionally larger handle on large enclosures. STDA3 and STDA3X can be used only with SDOM6 (for SK1200) operating mechanism.

NEMA 12/13 Flange Handle Product Number	List Price GO-144A	NEMA 4/4X Flange Handle Product Number	List Price GO-144A	Nominal Length Inches	Installation Instruction Number	Drilling Template Number
STDA1	\$82.50	STDA1X	\$148.00	6		
STDA2	\$94.50	STDA2X	\$165.00	10	GEH-5314	GEH-5314
STDA3	\$94.50	STDA3X	\$165.00	10		

Operating Mechanism Selection

Circuit Breaker Type	Flange Handle Product Number	Operating Mechanism Product Number	List Price GO-144A
SE150	STDA1, 1X (6 inch) or	SDOM1A	\$67.00
SF250		SDOM3	\$76.50
SG600	STDA2, 2X (10-inch)	SDOM4	\$194.00
SK1200 ¹	STDA3, 3X	SDOM6 ¹	\$303.00
TEB, TED, THED, TEC		SDOM1A	\$67.00
TB1 (150A), TEC with TECL		SDOM1A	\$67.00
THLC1 (150A)		SDOM1AP	\$15.00
TFJ, TFK, TFC (225A)		TDOM1D	\$252.00
J-Frames, TJC (400, 600A) ³	STDA1, 1X (6 inch) or	TDOM3 ²	\$76.50
TB4 (400A) TJH/TJL ⁴ (600A Max)		TDOM4	\$194.00
K-Frames, TKC (800A, 1200A) ⁵ , THLC2 (225A), THLC4 TLB4 (400A)	STDA2, 2X (10-inch)	TDOM5	\$265.00
TB6 (600A), TB8 (800A) TKH/TKLD ⁶ (1200A Max)		TDOM6	\$303.00
		TDOM7	\$303.00

¹Requires STDA3 or STDA3X (10 inch, SK1200 only).

²Not suitable for left hand mounting.

³Includes TJ/TJH/TJL with MicroVersaTrip® R trip unit.

⁴Use TDOM5 for TJH/TJL with MicroVersaTrip® R RMS-9 trip unit.

⁵Includes TK/TKL with MicroVersaTrip® R trip unit.

⁶Use TDOM7 for TKH/TKL with MicroVersaTrip® R trip unit.

Flange Stiffener Kit or Extended Length Drive Rod, Product Number TDSR

Provides rigid 3/8-inch diameter rod between STDA handle mounting surface (flange or center mullion) and operating mechanism when STDA handle would otherwise not be rigidly supported.

Rod length is 22 inches and may be cut to appropriate length. Also used as extended-length drive rod for SDOM1A and SDOM3 when standard 16 inch rod is not long enough. (Operating mechanism Product Number SDOM6 for SK1200 includes two 22" unique 3/8-16x22 inch flange stiffener rods, Product Number TDSR and drive rod.)

Operating Mechanism Product Number	Flange Stiffener Kit Product Number	Extended Drive Rod Product Number	List Price GO-144A
SDOM1A, SDOM3, TDOM1A through TDOM3	TDSR	TDSR	\$29.50
SDOM4, TDOM4 through TDOM7	TDSR (16" supplied with operating mechanism)	TDSR1	\$28.00

Extended Drive Stud, Product Number TDS1, TDS2

This optional drive study permits locating the operating mechanism 1-5/16 inches farther to the left (When flange handle is on right side) or to the right (when handle is on the left side) to accommodate specific mounting restrictions. Not suitable for use with SDOM4, SDOM6, TDOM4 and TDOM5 operating mechanisms.

Operating Mechanism Product Number	Extended Drive Stud Product Number	List Price GO-144A
SDOM1A, SDOM3, TDOM1A through TDOM3	TDS1	\$29.50
TDOM6, TDOM7	TDS2	\$29.50

Door Hardware NEMA 12/13 and 4/4X

Type TDV door hardware provides sealing and interlocking of 3/4-inch nominal door depth hinged on left or right. Interlocking design requires use of screwdriver to release. When used with an STDA flange handle and operating mechanisms, disconnect or circuit breaker cannot be turned on unless door and door hardware have been closed. For noninterlocking type, one bracket in kit is not used. Use of third point latch recommended for doors 40 inches or longer.

Description	Door Hinged on Left Product Number	Door Hinged on Right Product Number	List Price GO-144A
NEMA 12/13 two point interlocking door hardware kit	TDV1	TDV1L	\$134.00
NEMA 4/4X two point interlocking door hardware kit	TDV1X	TDV1LX	\$174.00
Third point latch kit for above	TDV3	TDV3L	\$29.50



Molded Case Circuit Breakers

External Accessories

Flange-Mounted Operators

Auxiliary Contact Kits

Available SPDT and DPDT and actuated by operating mechanism yoke.

Used With Operating Mechanism Product Number	When STDA handle is on		Auxiliary Contact Kit			
	Right Flange	Left Flange	SPDT		DPDT	
			Product Number	List Price GO-144A	Product Number	List Price GO-144A
SDOM1A, SDOM3 SDOM4	•		TDAS1L1	\$71.00	TDAS1L2	\$134.00
TDOM1A, JA TDOM1B, JB						
TDOM1C TDOM1D TDOM3		•	TDAS1R1	\$71.00	TDAS1R2	\$134.00
SDOM6 TDOM4 TDOM5	•		TDAS2L1	\$71.00	TDAS2L2	\$134.00
TDOM6 TDOM7		•	TDAS1R1	\$71.00	TDAS1R2	\$134.00

Publication References

Instructions:

Door Hardware	GEH-5322
Auxiliary Contact Kit	GEH-5323
Flange Stiffener Kit or Extended Length Drive Rod	GEH-5324
Extended Drive Stud	GEH-5325

Operating Mechanism:

SDOM1A through SDOM4, SDOM6	GEH-5684
TDOM1A through TDOM1D	GEH-5315
TDOM3	GEH-5317
TDOM4 and TDOM5	GEH-5318
TDOM6 and TDOM7	GEH-5319

See Section 22 for publication ordering information.



Molded Case Circuit Breakers

External Accessories

Door-Mounted Operators

Section 3

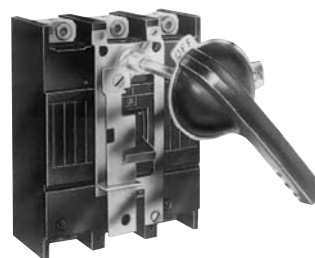

TDM Operating Handle, Fixed or Adjustable Shaft

TDM Handle Operating Mechanisms, Door Mounted

Complete mechanism with handle UL listed, E-57253

Operating mechanism only, UL Component Recognized, E-57253

Breaker Type	Box Depth in Inches	Complete Mechanism ¹ with NEMA 1, 3R, 12 Handle		Operating Mechanism Only		Handle Only			
		Product Number	List Price GO-144	Product Number	List Price GO-144	NEMA 1, 3R, 12		NEMA 4/4X	
						Product Number	List Price GO-144	Product Number	List Price GO-144
TQD, THQD	Shallow Mount 3 7/16	TQDHM1	\$69.00	TQDOM1	\$42.00				
	Extended Shaft 4 5/16 - 14 5/16	TQDHM2	\$82.00	TQDOM2 ²	\$55.00				
TEB, TEC, TB1, TED, THED	Shallow Mount 4 3/16	TEFHM1	\$69.00	TEFOM1	\$42.00				
	Extended Shaft 5-1/8 - 5 7/32 5 1/8 - 5 13/16 5 1/8 - 15	TEFHM3	\$82.00	TEFOM3	\$55.00	TH1	\$27.00		
		TEFHM4	\$82.00	TEFOM4	\$55.00				
		TEFHM2	\$82.00	TEFOM2	\$55.00				
TFC, TFJ, TFK, THFK	Shallow Mount 5 7/8	TFKHM1	\$103.50	TFKOM1	\$76.50			THCH45 ^{3,4}	\$303.00
	Extended Shaft 6 7/8 - 15 1/2	TFKHM2	\$107.50	TFKOM2 ²	\$80.50				
TJC, TJD, TJJ, TJK, THJK, TB4, TBC4	Shallow Mount 5 7/8	TJKHM1	\$143.00	TJKOM1	\$102.00				
	Extended Shaft 5 5/8 - 15 5/8	TJKHM2	\$147.00	TJKOM2 ⁴	\$106.00	TH2	\$41.00		
TKC, TKM, THKM, TB6, TBC6, TB8, TBC8	Shallow Mount 7 7/16	TKMHM1	\$143.00	TKMOM1	\$102.00				
	Extended Shaft 7 1/32 - 17 5/16	TKMHM2	\$147.00	TKMOM2 ⁴	\$106.00				
SE150 (GEH-5611) ⁵	4 3/16	SEFHM1	\$79.00	SEFOM1	\$52.00	TH1	\$7.00		
	6 1/8 - 15	SEFHM2	\$81.50	SEFOM2 ²	\$55.00				
SF250 (GEH-5611) ⁵	5 7/8	SEFHM1	\$79.00	SEFOM1	\$52.00			THCH45 ^{3,4}	\$303.00
	7 3/4 - 15 1/2	SEFHM2	\$81.50	SEFOM2 ²	\$55.00				
SG600 (GEH-5653) ⁵	5 7/8	SGHM1	\$143.00	SGOM1	\$102.00	TH2	\$41.00		
	5 5/8 - 15 5/8	SGHM2	\$147.00	SGOM2 ⁴	\$106.00				
SK1200 (GEH-5612) ⁵	6	SKHM1	\$143.00	SKOM1	\$102.00				
	7	SKHM2	\$147.00	SKOM2 ⁴	\$106.00				

¹Handle assembly and operating mechanism separately packaged.

²For 15-inch long shaft order Product Number 788A831G10, List Price \$40.00, GO-135B. For 20-inch long shaft order Product Number 788A831G21 List Price \$40.00, GO-135B.

³Provides interlocking for J600, SG600 SK1200, and K1200 breakers when used with the extended shaft operating mechanism. For interlocking with E150/SE150, F225 and SF250 order special shaft Product Number 788A832G1, List Price \$40.00, GO-135B.

⁴For 15-inch long shaft order Product Number 788A832G2, List Price \$40.00, GO-135B. For 20-inch long shaft order Product Number 788A832G5, List Price \$40.00, GO-135B.

⁵Installation instructions publication number.

⁶MOD 1 is 7 7/16; MOD 2 is 8 3/32.

⁷MOD 1 is 7 3/16 - 17 3/16; MOD 2 is 7 15/16 - 17 15/16.

Handle Accessories for TDM Operating Mechanisms

Device	Product Number	List Price GO-139
Replacement neoprene gaskets for NEMA 1, 3R and 12 enclosures		
Use with TH1	788A742P3	\$2.80
Use with TH2	788A742P4	\$6.10



Molded Case Circuit Breakers

External Accessories

Door-Mounted Operators

Section 3



TDR Handle on TEC Mag-Break

TDR Integral Handle Mechanism¹ Suitable for NEMA 12 Applications²

Breaker Type	Handle		List Price GO-144	Ship Weight	Door Ring - Interlock Catch Kit		NEMA 12 Gasket Kit	
	Vertical Mounting Product Number	Horizontal Mounting Product Number			Product Number	List Price GO-144	Product Number	List Price GO-144
TEB, TEC, TB1-B, TED, THED	TEFR1B	TEFR1HB	\$65.50	17 ³	SEFRDRCK	\$11.25		
THLC1	TLC1RB	TLC1RHB	\$65.50	17 ³	-	-	SEFRGSK	\$4.00
TFC, TFJ, TFK, THFK	TFKR1B	TFKR1HB	\$78.50	22 ³	343L483G5	\$11.25		
THLC2, 4; TLB4	TLC4RB	TLC4RHB	\$78.50	3	343L483G9	\$11.25		
TJD, TJC, TJJ, TJK, THJK, TB4, TBC4	TJR1B	TJR1HB	\$78.50	5	343L483G2	\$20.25	SGRGSK	\$11.00
TKC, TKM, THKM, TB6, TB8, TBC6, TBC8	TKMR1B	TKMR1HB	\$128.00	5	SKRDRCK	\$21.75	SKRGSK	\$11.00
SE150, SF250 (GEH-5609) ⁵	SEFR1 ⁴	SEFR1H ⁴	\$65.50	17 ³	SEFRDRCK	\$11.25	SEFRGSK	\$4.00
SG600 (GEH-5654) ⁵	SGR1	SGR1H	\$78.50	5	SGRDRCK	\$20.25	SGRGSK	\$11.00
SK1200 (GEH-5610) ⁵	SKR1	SKR1H	\$128.00	5	SKRDRCK	\$21.75	SKRGSK	\$11.00

¹Not suitable for use with mine duty or heavy duty UVR breakers.

²Requires Gasket kit.

³Shipped 12 per pack.

⁴For F250 Frame also order adapter bracket, Product Number SFRAK, no charge when ordered with handle.

⁵Installation instructions publication number. See Section 22 for publication ordering information.



Publications and Reference: See Section 22 for a complete list of additional product-related publications

Molded Case Circuit Breakers

External Accessories

Motor Operators and Plug-in Hardware

Section 3

Motor Mounted Mechanism

UL Listed

Breaker Type	Voltage		Product Number	List Price GO-1355	Installation Instructions
	Vac 50/60 Hz	Vdc			
TEB, ¹ TEC, TED, ¹ THED, TB1, THLC1 ²	-	24	TEDMOMA8	\$1572.00 ⁶	-
	120 ³	-	TEDMOMA1	\$710.00 ⁶	
	240 ^{4,5}	-	TEDMOMA2	\$710.00 ⁶	
TFC, TFJ, TFK, THFK	-	24	TFKMOMA8	\$1692.00 ⁹	-
	-	48	TFKMOMA9	\$1692.00 ⁹	
	120	125	TFKMOMA1	\$1692.00 ⁹	
	240 ^{4,5}	250	TFKMOMA2	\$1692.00 ⁹	
TJC, TJJ, TJD, TJK, THJK, TB4, TBC4	-	24	TJKMOMA8	\$2160.00 ⁹	-
	-	48	TJKMOMA9	\$2160.00 ⁹	
	120	125	TJKMOMA1	\$2160.00 ⁹	
	240 ^{4,5}	250	TJKMOMA2	\$2160.00 ⁹	
TKC, TKM, THKM, TB6, TB8, TBC6, TBC8	-	24	TKMMOMA8	\$2340.00 ⁹	-
	-	48	TKMMOMA9	\$2340.00 ⁹	
	120	125	TKMMOMA1	\$2340.00 ⁹	
	240 ^{4,5}	250	TKMMOMA2	\$2340.00 ⁹	
SE150	120	125	SEMOM1	\$710.00	GEH-5613
	240 ⁴	-	SEMOM2	\$710.00	
	-	24	SEMOM8	\$710.00	
	-	48	SEMOM9	\$710.00	
SF250	120	125	SFMOM1	\$1692.00	GEH-5613
	240 ⁴	-	SFMOM2	\$1692.00	
	-	24	SFMOM8	\$1692.00	
	-	48	SFMOM9	\$1692.00	
SG600	120	125	SGMOM1	\$2160.00	GEH-5657
	240 ⁴	250	SGMOM2	\$2160.00	
	-	24	SGMOM8	\$2160.00	
	-	48	SGMOM9	\$2160.00	
SK1200	120	125	SKMOM1	\$2340.00	GEH-5614
	240 ⁴	250	SKMOM2	\$2340.00	
	-	24	SKMOM8	\$2340.00	
	-	48	SKMOM9	\$2340.00	



Motor Operated Mechanism on SF-Frame breaker

Mounting Screw Kit for Motor-Operated Mechanism⁷

Breaker Type	Mounting Screw Kit Product Number	List Price GO-148B
TED, TB1	343L564G7	\$33.50 ⁶
TFJ, TFK	343L564G1	\$8.70 ⁶
TJJ, TJK, TB4	343L564G2	\$87.00
SG600	SGMSKMOM	\$87.00 ⁸
TKM, TB6, TB8, SK	343L564G3	\$121.00

Mounting Screw Kit for TDR Integral Handle

Breaker Type	Mounting Screw Kit Product Number	List Price GO-135B
TFC, TFJ, TFK	343L564G4	\$8.60
TEC, TED, TB1-B, TJC, TJJ, TJK, TB4, TBC, TKC, TKM, TB6, TB8, TBC6, TBC8	No Special Mounting Screw Required	

¹For use on 3-pole breaker only.

²Motor-operated mechanisms must have Code Date 506 + or later for use with THLC1.

³TEDMOMA1 not rated at 50 hertz.

⁴Suitable for use at 208 Vac.

⁵Not UL listed.

⁶GO-135B.

⁷Required with plug-in mounting base assembly when used with motor-operating mechanisms or TDR integral-handle kits. Furnished no charge when ordered with mounting base.

⁸GO-135S.

⁹GO-135LG.



Molded Case Circuit Breakers External Accessories

Mechanical Interlocks and Locking Devices

Mechanical Interlocks

Walking Beam Type Externally Mounted—UL Component Recognized

Breaker Type	Panel Thickness in Inches	Requires Breaker with Special Factory Drilling. Order 2 Breakers per Interlock, Specifying "Drilled for Mech. Interlock" Product Number		List Price GO-135B
E-150, TB1	.25-1.0	TEDMI		\$341.00
F225	.25-1.0	TFKMI ⁷		\$341.00
TJJ, TJK, TJ4V, THJ4V, TB4	0.38 1.0	TJKMIB ⁷ TJKMIE ⁷		\$341.00
TKM, TK4V, TB6, TB8	.75-1.0	TKMMI		\$341.00¹

These face-mounted interlocks prevent two adjacent breakers from being in the ON position at the same time.

Spectra® RMS Breaker Type	Face-mounted Interlock Product Number	List Price GO-135S	Adapter Kit Required when using handle operator (TDM) or motor operator. Order separately.	
			Product Number	List Price GO-135S
SE150, SF250	SEFFMI	\$341.00	SEFFMIAK ²	\$33.50
SG600	SGFMI	\$683.00	SGFMIAK ³	\$42.00
SK1200	SKFMI	\$683.00	SKFMIAK	\$59.50

Handle-Locking, Handle-Extension Devices

Breaker Type	Device	Product Number	List Price GO-135B
TEY	Handle locking	TEYLD1	\$5.00
E150 Line	Handle locking	TLD3	\$5.00
F225 Line, THLC2, 4	Handle locking	TFKLD1 ⁷	\$6.00
SE150, SF250	Handle locking	SBD1	\$4.70⁴
SK1200	Handle extension - replacement	SKHDLEXT	\$96.50⁴

Standard Padlocking Devices⁵

Breaker Type	Device Product Number	List Price GO-135B
TEY	TEYPLD1	\$9.00
E150, TB1	TEFPLD1	\$8.00
THLC1	TLC1PLD1	\$17.00⁸
F225	TFKPLD1	\$4.00⁷
THLC2, THLC4, TLB4	TLC4PLD1	\$22.00⁸
J600 Line	TJKPLD1	\$8.00⁷
K1200 Line	TKMPLD1	\$28.50⁷
SE150, SF250	SEPLD	\$8.70⁴
SG600	SGPLD	\$15.00⁴
SK1200	SKPLD	\$28.50⁴

EUSERC Approved—Factory Installed Only

Breaker Type	Product Number	List Price GO-135B
E150	TEDPLD2	\$32.00
SE150, SF250 ⁶	SEFPLD2	\$32.00⁴
SG600	SGPLD2	\$48.00⁴
J600	TJKPLD2	\$48.00⁷
SK1200	SKPLD2	\$60.00⁴
THLC1	TLC1PLD2	\$48.00⁸
THLC2/4	TLC4PLD2	\$48.00⁸

¹GO-144.

²Not suitable with THCH45 handle.

³Compatible with motor operator only. Product Number SGFMI cannot be used with the handle operator.

⁴GO-135S.

⁵Suitable for circuit breakers used in group mounted panelboard construction only except for J600, K1200, SE150/SF250, SG600 and SK1200 which screw down to face of breaker.

⁶Field installable.

⁷GO-135LG.

⁸GO-148D.



Breaker Mounting Screw Kits

Application	Spectra® RMS Breaker Type	Kit Product Number	Screw Size (inches)	List Price GO-135S
For use on mounting plates with tapped holes (4 screws and lockwashers)	SE150	SEMSK1	10-32x2 7/8 (std.)	\$2.10
		SEMSK3	8-32x2 7/8 (opt.)	\$2.10
	SF250	SFGMSK1	12-24x3 3/4 (std.)	\$6.10
		SFMSK1	10-32x3 3/4 (opt.)	\$6.10
		SG600	SFGMSK1	12-24x3 3/4
SK1200	SKMSK1	5/16-18x1 1/4	\$8.70	
For use on mounting plates with clearance holes (4 screws, lockwashers and nuts)	SE150	SEMSK2	10-32x3 (std.)	\$2.10
		SEMSK4	8-32x3 (opt.)	\$2.10
	SF250	SFGMSK2	12-24x4 (std.)	\$6.10
		SFMSK2	10-32x4 (opt.)	\$6.10
	SG600	SFGMSK2	12-24x4	\$6.10
		SK1200	SKMSK2	5/16-18x1 3/4

Breaker Mounting Screw Kits and Accessories

Application	Breaker Type	Product Number	List Price GO-135B	
Bolt-on Mounting Base	TEY	TEY3B1	\$31.50	
		THQB	\$6.00	
Mounting Screws	1-pole E150	343L162G1	\$0.85	
		2- and 3-pole E150	SEMSK4	\$2.10²
For use on mounting plates with clearance holes	THLC1	343L162G22	\$2.10⁶	
		F225	SFGMSK2	\$6.10²
		THLC2, 4, TLB4	343L162G24	\$5.70⁶
		J600	343L162G20	\$4.50⁵
		K1200	SKMSK2	\$8.70²
For use on mounting plates with tapped holes	1-pole TE, E150	343L162G7	\$0.85	
		2- and 3-pole E150	SEMSK3	\$2.10²
	THLC1	343L162G23	\$2.10⁶	
		2- and 3-pole TQD/THQD	343L184G18	\$4.40³
		F225	SFGMSK1	\$6.10²
Cup washer (for mounting 1-pole breakers)	E150	THLC2, 4, TLB4	343L162G25	\$5.70⁶
		J600	343L162G11	\$4.50⁵
		K1200	SKMSK1	\$8.70²
		254V644P1 (2 req'd per breaker)	\$0.10	

Back-Connected Line and Load Studs

Breaker Type	Amperes	Length, Back of Breaker in Inches	Std Pkg	Product Number	List Price GO-135B
E150 ⁴ , TB1 ⁴ , THLC1 ⁴	50	2 25/32 (short)	1	TEF1	\$27.00
		4 13/32 (long)	1	TEF2	\$27.00
	150	3 13/32 (short)	1	TEF3	\$28.00
		5 25/32 (long)	1	TEF4	\$31.50
TFJ ⁴ , TFK ⁴ , THFK ⁴	225	2 23/32 (short)	1	TFK1	\$38.50⁵
		5 31/32 (long)	1	TFK2	\$59.50⁵
J600, TJ4V, TB4, TJL	400	5 17/32	1	TJK1	\$83.50⁵
K1200, TB6, TB8	600	5 17/32	1	TJK2	\$119.00⁵
		1200	5 1/2	1	TKM11
SE150	50	8	1	TKM12	\$242.00⁵
		2 25/32 (short)	1	TEF1	\$27.00
	150	4 13/32 (long)	1	TEF2	\$27.00
		3 13/32 (short)	1	TEF3	\$28.00
SF250	250	5 25/32 (long)	1	TEF4	\$31.50
		2 23/32 (short)	1	TFK1	\$38.50
SG600	600	5 31/32 (long)	1	TFK2	\$59.50
		2 13/16 (short)	2	SGBCS1	\$119.00²
SK1200	1200	6 1/16 (long)	2	SGBCS2	\$119.00²
		5 1/2	1	TKM11	\$220.00
		8	1	TKM12	\$242.00

¹Accepts up to 3 poles (any combination).

²GO-135S.

³GO-148C.

⁴For proper clearance between poles, a short and long stud must be assembled adjacent to each other.

⁵GO-135LG.

⁶GO-148D.

⁷Contains 24 mounting screws.



Molded Case Circuit Breakers

External Accessories

Lugs and Associated Hardware

Section 3

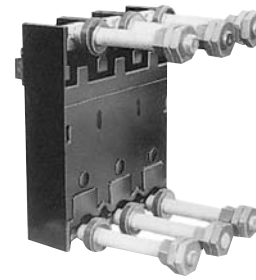

Breaker with Line and Load Studs

Lugs, Line Shields, Covers and Bus Connectors

Accessory	Wire Range	For Use With	Product Number	List Price GO-1358
Copper-Aluminum Lugs	(1) #14-6 Cu, #12-2 Al	TQC (15-60A) (Non DIN Rail)	TQAL3	\$1.50
	(1) #4-1/0 Cu-Al	TQC (70-100A)	TQAL4	\$1.50
	(1) #4-300 kcmil Cu-Al	TQD	TCAL25	\$8.00 ¹
	(1) #14-8	E150, THLC1, TB1, (15-30A)	TCAL14	\$3.00
	(1) #14-3 Cu, #12-1 Al	E150, THLC1, TB1, (15-60A)	TCAL12	\$3.00
	(1) #6-2/0 Cu, #4-2/0 Al	E150, THLC1, TB1, (70-90A)	TCAL12A	\$3.00
	(1) #3-3/0 Cu, #1-3/0 Al	E150, THLC1, TB1, (100-150A)	TCAL15	\$3.00
	(1) #4-300 kcmil Cu-Al	F225	TCAL24	\$8.00 ⁸
	(1) #4-300 kcmil Cu-Al	THLC2	TCAL27	\$10.00 ⁸
	(1) 6-600 kcmil or (2) 2/0-250 kcmil Cu-Al	J400, TB4, J600 (Thru 400A), TJD	TCAL43	\$14.00 ⁸
	(2) 4/0-350 kcmil Cu or (2) 300-500 kcmil Al	J600 (450-600A)	TCAL63	\$23.00 ⁸
	(1) 750 kcmil Cu-Al	J400, TJD	TCAL47	\$26.00 ⁸
	(1) 3/0-500 kcmil or (2) 3/0-250 kcmil Cu-Al	TLB4, THLC4	TCLK43	\$49.00
	(2) 1/0-250 kcmil or (1) #4-600 kcmil Cu-Al	K1200, TB6 (300-400A)	TCAL41	\$38.00 ⁸
	(2) 2/0-500 kcmil Cu-Al	K1200, TB6, (500-600A)	TCAL61	\$40.00 ⁸
	(3) 3/0-500 kcmil Cu-Al	K1200 (700-1000A), TB8	TCAL81 ²	\$47.00 ³
	(3) 3/0-500 kcmil Cu-Al	TK4V - Load end	TCAL91 ²	\$47.00 ³
	(4) 250-350 kcmil Cu or (4) 250-500 kcmil Al	K1200 (1200A)	TCAL121 ⁴	\$76.00 ³
	(4) 250-350 kcmil Cu or (4) 250-500 kcmil Al	TK4V - Load end	TCAL122	\$103.00 ⁸
	(4) 250-350 kcmil Cu or (4) 250-500 kcmil Al	TK4V - Load end	TCAL131 ⁴	\$76.00 ³
Copper Only Lugs With Follower and Extra Plating	#14-2/0	E150, TB1 (thru 150A)	TCO12	\$6.00
	(1) 6-600 kcmil or (2) 1/0-250 kcmil Cu	J400, TB4	TCO43	\$21.00 ⁸
	(2) 250-350 kcmil Cu	J600	TCO63	\$34.00 ⁸
	(1) 1/0-600 kcmil or (2) 1/0-250 kcmil Cu	K1200, TB6 (300-400A)	TCO41 ⁵	\$38.00 ⁸
	(2) 2/0-500 kcmil Cu	K1200, TB6, (500-600A)	TCO61	\$40.00 ⁸
	(3) 3/0-500 kcmil Cu	K1200 (700-1000A), TB8	TCO81A	\$53.00 ³
	(3) 3/0-500 kcmil Cu	TK4V - Load end	TCO91	\$53.00 ³
	(4) 250-400 kcmil Cu	K1200 (1200A)	TCO121	\$80.00 ³
	(4) 250-400 kcmil Cu	TK4V - Load end	TCO131	\$80.00 ³
	Line Shield		TEB, TEC, TED, THED	TEDLS
		TFJ, TFK, TFC	TFKLS	\$16.25
		TJJ, TJK, TJC	TJKLS	\$14.25
Lug Cover, TKM Breaker (two per breaker)		TCO41, TCAL41 Lugs	789A448G3 ⁶	\$35.00 ⁸
		TCO61, TCAL61, TCAL81 Lugs, TC081A	789A448G1	\$35.00 ⁸
		TCO121, TCAL121 Lugs	789A448G2	\$35.00 ⁸
Connector (back strap)		TH4V, THK9V	286A8066G1	\$33.50 ⁹
Line voltage control wire kit for terminating control wire at breaker lugs		TKM	TKMC1	\$38.00 ⁸
		J600	TJLVK7	\$9.00 ⁸
		K1200	SKLVK7	\$12.00 ³

¹GO-135F.

²Not suitable for 100 A aluminum conductor.

³GO-135S.

⁴Suitable for 500 kcmil copper for voltage drop considerations.

⁵Not UL listed.

⁶End cover supplied with 800A frame is used as lug cover.

⁷3-pole kit.

⁸GO-135LG.

⁹GO-148D.



Molded Case Circuit Breakers

External Accessories

Section 3

Lugs and Associated Hardware

Spectra® RMS Lugs, Lug Covers, and Bus Lugs

Accessory	For Use With	Wire Range (Qty.)		Product Number	Description	Ampacity Range ¹	List Price GO-135S
		Copper	Aluminum				
Plated extruded aluminum lugs for terminating copper or aluminum cables	SE150	(1) #12-3/0	(1) #12-3/0	TCAL18	Single lug	15-150	\$3.00
	SF250	(1) #8-350 kcmil	(1) #8-350 kcmil	TCAL29	Single lug	70-250	\$8.00
	SG600	(2) 2/0-500 kcmil or	(2) 2/0-500 kcmil or	TCLK265 ²	2-pole lug kit ²	125-600	\$28.00
		(1) #8-600 kcmil	(1) #6-600 kcmil	TCLK365 ²	3-pole lug kit ²	125-600	\$42.00
	SK1200	(3) 350-750 kcmil	(3) 350-750 kcmil	TCAL124	Single lug	Cu 275-1200 Al 225-1100	\$103.00
		(3) 3/0-500 kcmil	(3) 3/0-500 kcmil	TCAL81	Single lug	300-800	\$47.00
		(4) 250-500 kcmil	(4) 250-500 kcmil	TCAL125	Single lug	600-1200	\$76.00
	Replacement Lug Covers and End Covers	SE150	-	-	SE3LCK	Three lug covers for upper (line) end	-
SF250		-	-	SF3LCK	Three lug covers for upper (line) end	-	\$9.80
SG600		-	-	SG1LCK	3-pole lug cover for upper (line) or lower (load) end	-	\$21.25
		-	-	SG1BCK ⁴	3-pole lug cover for upper (line) or lower (load) end ⁴	-	\$37.00
SK1200		-	-	SK1LCK ³	Lug cover for upper (line) or lower (load) end ³	-	\$33.50
Plated Copper Lugs	SE150	(1) #12-3/0	-	TCO18	Single lug	15-150	\$6.00
	SF250	(1) #8-350 kcmil	-	TCO19	Single lug	70-250	\$21.25
	SG600	(2) 2/0-500 kcmil or	-	TCOK265	2-pole lug kit	125-600	\$42.00
		(1) #8-600 kcmil	-	TCOK365	3-pole lug kit	125-600	\$63.00
	SK1200	(3) 250-500 kcmil	-	TCO81A	Single lug	300-800	\$53.00
		(4) 250-400 kcmil	-	TCO121	Single lug	600-1200	\$80.00
		(3) 350-750 kcmil	-	TCO124	Single lug	600-1200	\$155.00
	(4) 250-500 kcmil	-	TCO125	Single lug	600-1200	\$155.00	
Line voltage control wire kit for terminating control wire at breaker lugs	SE150	(1) #12-3/0	(1) #12-3/0	TCAL18LV	Single lug with .25 Quick Connect for Control Voltage	15-150	\$6.60
	SF250	(1) #8-350 kcmil	(1) #8-350 kcmil	TCAL29LV		70-250	\$17.75
	SG600	-	-	SGLVK	3-pole kit	-	\$9.00
	SK1200	-	-	SKLVK	3-pole kit	-	\$12.00
Clear rating plug cover with provision for wire seal	SG600 / SK1200	-	-	SPCOV1	Replacement cover for MicroVersaTrip® Plus and MicroVersaTrip® PM	-	\$13.25
				SPCOV2	Cover with access to instantaneous set point	-	\$13.25
				SPCOV3	Cover with no access to instantaneous set point	-	\$13.25

¹Both copper and aluminum cables may not cover full ampacity range.

²With lug cover for line or load end.

³100kA, 480 Vac (SKPA) uses longer lug cover/arc shield on upper end. Use Product Number SKPSHLD for replacement. May be used on other SK1200 devices.

⁴Required for line end bus connection.



Molded Case Circuit Breakers

External Accessories

Neutral Grounds and Sensors

Power Distribution Lugs

Breaker Type	Max Amperes	Wire Range	Product Number	List Price GO-135
SE, TED	125	(2) 4-14 or (1) 2/0-4 Cu only	TCAL19PD3	\$50.00
SF	250	(6) 4-14 Cu only	TCAL28PD3	\$75.00
SG	400	(12) 4-14 Cu only	TCAL40PD3	\$88.00



Power Distribution Lugs

Neutral Current Sensors

For grounded neutral system ground fault applications

Breaker Type	Ampere Rating	Product Number	List Price GO-135S
J	150	TSRG201	\$532.00
	200	TSRG202	\$532.00
	300	TSRG203	\$532.00
	400	TSRG204	\$532.00
	500	TSRG205	\$532.00
	600	TSRG206	\$532.00
K	800	TSKG408	\$532.00
	1000	TSKG410	\$532.00
	1200	TSKG412	\$532.00



Neutral Current Sensor

Fungus and Moisture Proofing

Poles	Q-Line	E150	F225	J600	K1200	TB-1	TB-4	TB-6, 8
	List Price GO-135B	List Price GO-135B	List Price GO-135B	List Price GO-135B	List Price GO-135B	List Price GO-135B	List Price GO-135B	List Price GO-135B
1, 2 and 3	\$8.90 \$22.25	\$28.50 \$62.50	\$84.00	\$84.00	\$216.00	\$62.50		

Flange-Mounted
Operators 3-94

Test Set for MicroVersaTrip® Plus, MicroVersaTrip® and MicroVersaTrip® RMS-9 Trip Units

Description	Product Number
Portable Test Set	TVRMS2

Rating Plug Removal Tool

Product Number	List Price GO-135S
TRTOOL	\$12.00

"Naval Use" Molded Case Circuit Breakers

The following molded case circuit breaker types are optionally available as UL listed per Standard 489, Supplement SB for naval use:

- THQB
- THQC
- SE150
- SF250
- SG600
- SK1200

Contact GE sales office for price and delivery.

Special Calibration

Contact GE sales office for availability. May void UL listing status.



Publications and Reference: See Section 22 for a complete list of additional product-related publications

Molded Case Circuit Breakers

External Accessories

Section 3

Plug-in Hardware

Each plug-in mounting base assembly includes all mounting hardware, studs, and male or female connectors for attachment to one end of breaker. Studs are of different length so by using proper combinations of PD1 and PD2 units, adequate electrical spacing will be assured between adjacent breakers, i.e., a short-long-short (SLS) unit must be used adjacent to a long-short-long (LSL) unit. Two-pole breakers of the E150 line require an open-long-short (OLS) unit on one end of the breaker and a short-long-open (SLO) on the other since these breakers are built with the normal left pole missing while the mounting bases are built from standard three-pole molded supports.

Spectra® RMS and all other two-pole breakers are basically three-pole devices with the center pole omitted. When these breakers are to be mounted side by side, a short-open-short (SOS) unit must be used on one end and a long-open-long (LOL) on the other. Horizontal studs are normally supplied with the flat surface of studs at right angles to the long axis of the breaker. If vertical studs are desired, substitute "C" for "D" in the product number, e.g., TE13PC1 (vertical) or TE13PD1 (horizontal).

The optional mounting plate (TMP1, etc.) accurately locates and supports the pair of line and load plug-in mounting-base assemblies and provides a convenient means to attach the entire unit to a metal structure, and serves as a dead front barrier. New drawings are available for customers who prefer to fabricate their own mounting plates.

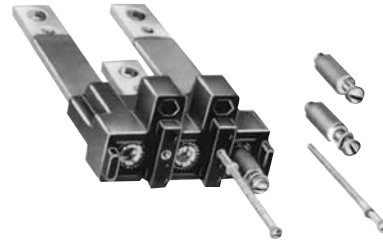

Plug-in Mounting Base with Hardware
Product Number TF23PD2 shown

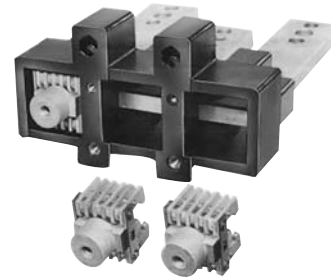

Plug-in Mounting Base
Product Number TK123PD2A shown

Plug-In Mounting Base Assembly

Ampere Rating	Breaker Type	No. Poles	Stud Configuration		Product Number	List Price GO-135LG	Optional Mounting Base	
			PD1	PD2			Product Number	List Price GO-135LG
150	E150 ¹	2	OLS	SLO	TE12PD1,2	\$250.00 ⁴	TMP1	\$40.00 ⁴
	TB1	3	SLS	LSL	TE13PD1,2	\$375.00 ⁴	TMP5	\$40.00 ⁴
	SE150	3	SLS	LSL	TE13PD1,2	\$375.00 ⁴	TMP1	\$40.00 ⁴
225	F225	2	SOS	LOL	TF22PD1,2	\$300.00	TMP2	\$40.00
		3	SLS	LSL	TF23PD1,2	\$450.00	TMP2	\$40.00
250	SF250	2	SOS	LOL	TF22PD1,2	\$300.00	TMP2	\$40.00
		3	SLS	LSL	TF23PD1,2	\$450.00	TMP2	\$40.00
400	J400	2	SOS	LOL	TJ42PD1A,2A	\$400.00	TMP3	\$40.00
		3	SLS	LSL	TJ43PD1A,2A	\$600.00	TMP3	\$40.00
	TB4	2	SOS	LOL	TJ42PD1A,2A	\$400.00	TMP6	\$50.00
		3	SLS	LSL	TJ43PD1A,2A	\$600.00	TMP6	\$50.00
600	SG400	3	SLS ²	LSL ²	SGPC1, SGPC2	\$600.00 ³	SMP3	\$40.00 ³
	J600	2	SOS	LOL	TJ62PD1A,2A	\$500.00	TMP3	\$40.00
		3	SLS	LSL	TJ63PD1A,2A	\$750.00	TMP3	\$40.00
	K1200	2	SOS	LOL	TK62PD1A,2A	\$500.00	TMP4	\$50.00
		3	SLS	LSL	TK63PD1A,2A	\$750.00	TMP4	\$50.00
		2	SOS	LOL	TK62PD1A,2A	\$500.00	TMP7	\$50.00
800	TB6	3	SLS	LSL	TK63PD1A,2A	\$750.00	TMP7	\$50.00
		3	SLS ²	LSL ²	SGPC7	\$600.00 ³	SMP3	\$40.00 ³
	K1200	2	SOS	LOL	TK82PD1A,2A	\$600.00	TMP4	\$50.00
		3	SLS	LSL	TK83PD1A,2A	\$900.00	TMP4	\$50.00
		2	SOS	LOL	TK82PD1A,2A	\$600.00	TMP7	\$50.00
1000	SK800	3	SLS	LSL	TK83PD1A,2A	\$900.00	TMP7	\$50.00
		3	SLS	LSL	TK83PD1A,2A	\$900.00	TMP4	\$50.00
		3	SLS	LSL	TK103PD1A,2A	\$1050.00	TMP4	\$50.00
	K1200	2	SOS	LOL	TK102PD1A,2A	\$700.00	TMP4	\$50.00
1200	K1200	3	SLS	LSL	TK103PD1A,2A	\$1050.00	TMP4	\$50.00
		2	SOS	LOL	TK122PD1A,2A	\$800.00	TMP4	\$50.00
	SK1200	3	SLS	LSL	TK123PD1A,2A	\$1200.00	TMP4	\$50.00

¹Order 3-pole base for use with 2-pole Hi Break and 600 Vac breakers.

²Vertical studs only for SG600 frame.

³GO-135S.

⁴GO-135B.

